

PR127 NEUTRON ACER TENDL-2021 LIBRARY; T=293.6K  
Principal cross sections

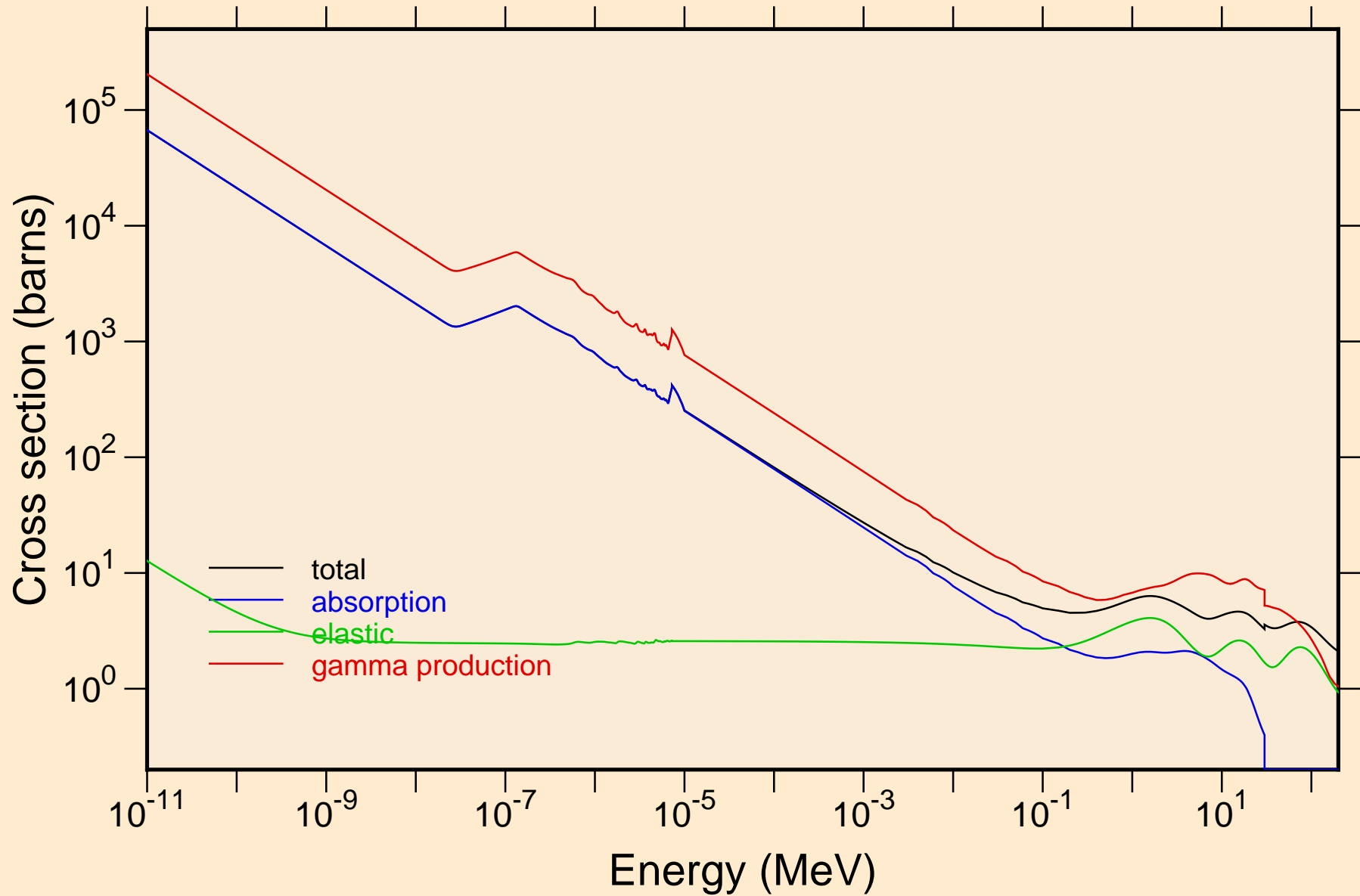

PR127 NEUTRON ACER TENDL-2021 LIBRARY; T=293.6K  
Heating

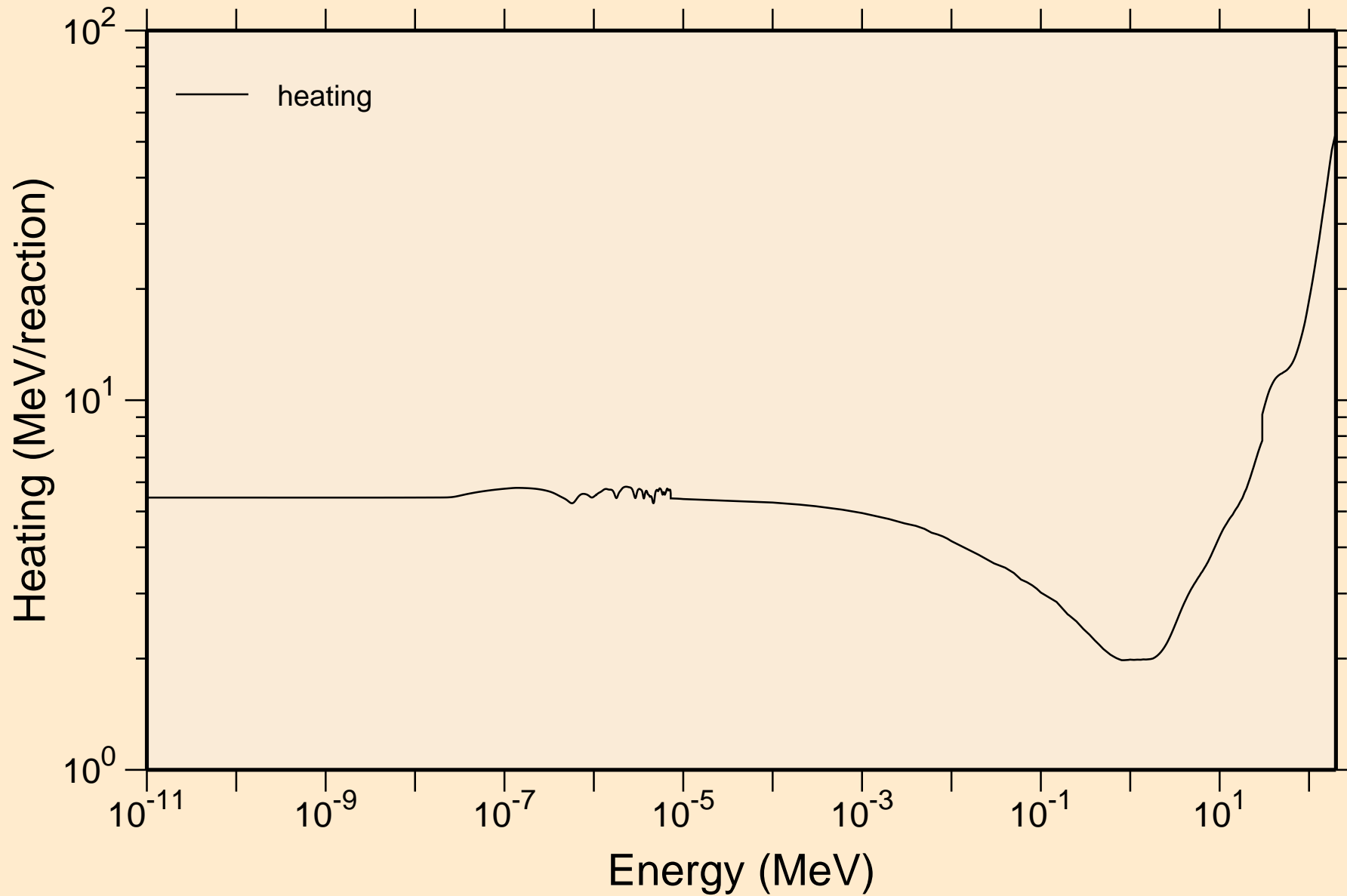

PR127 NEUTRON ACER TENDL-2021 LIBRARY; T=293.6K  
Damage

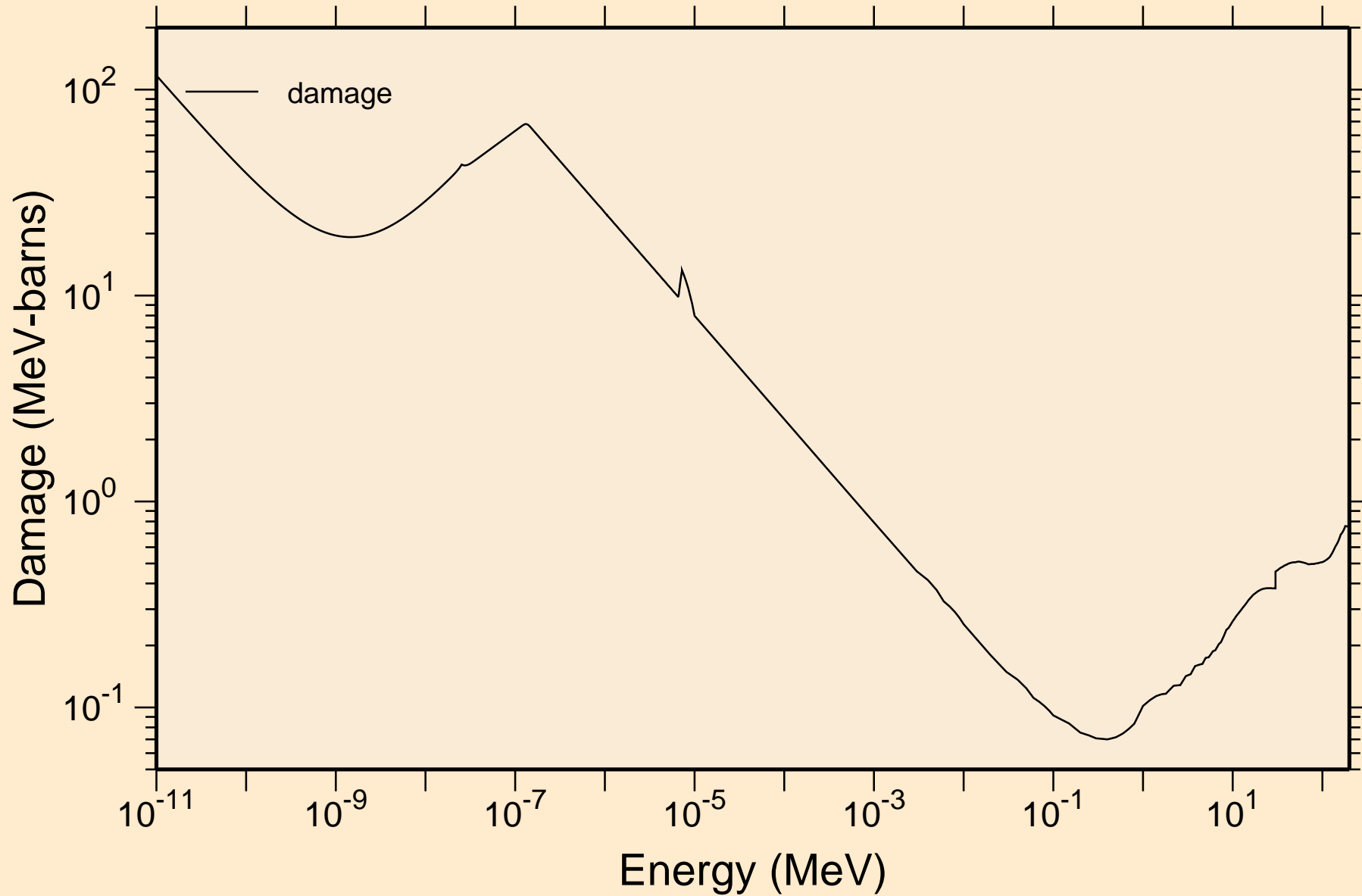

PR127 NEUTRON ACER TENDL-2021 LIBRARY; T=293.6K  
Non-threshold reactions

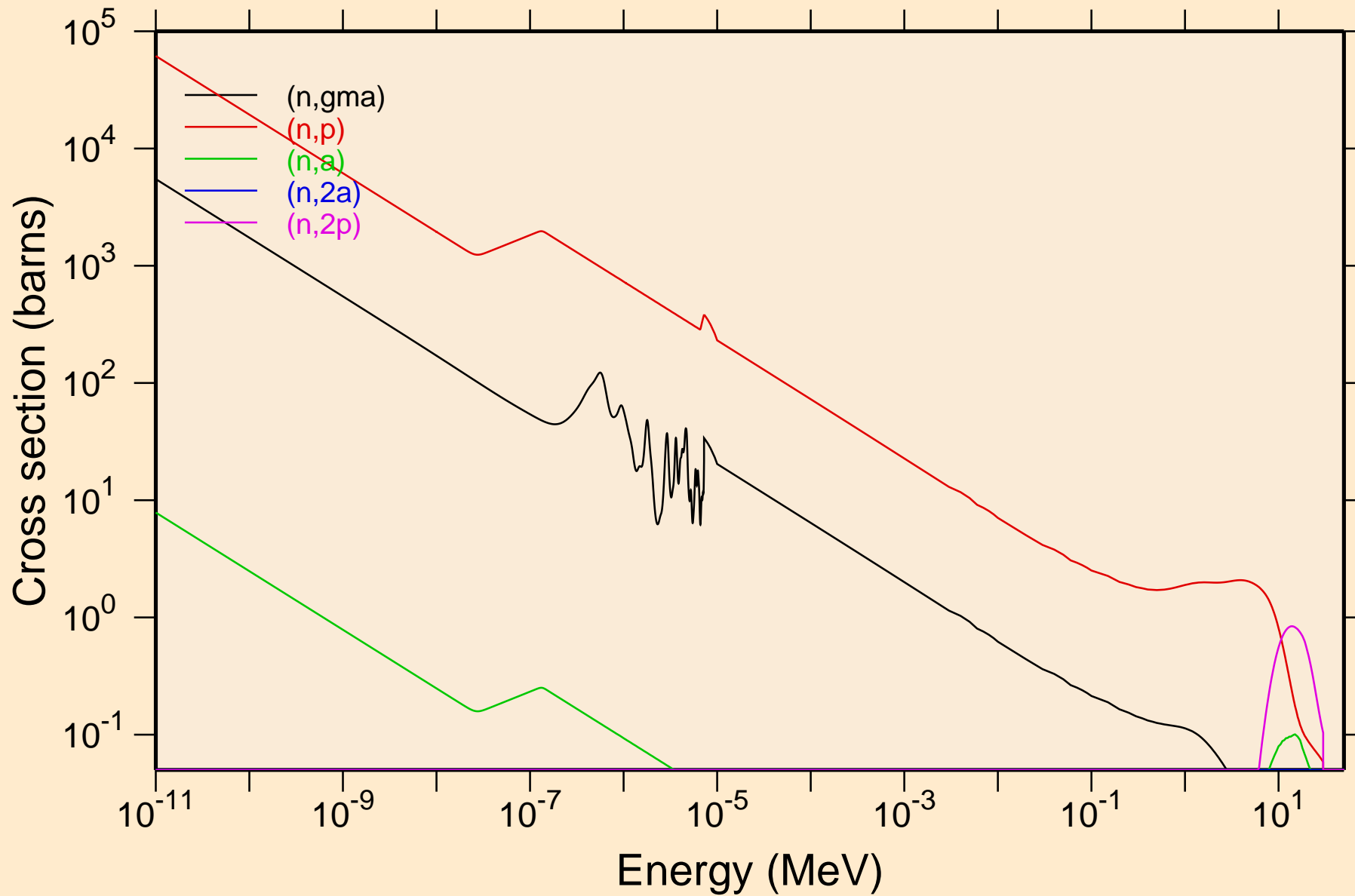

PR127 NEUTRON ACER TENDL-2021 LIBRARY; T=293.6K  
Non-threshold reactions

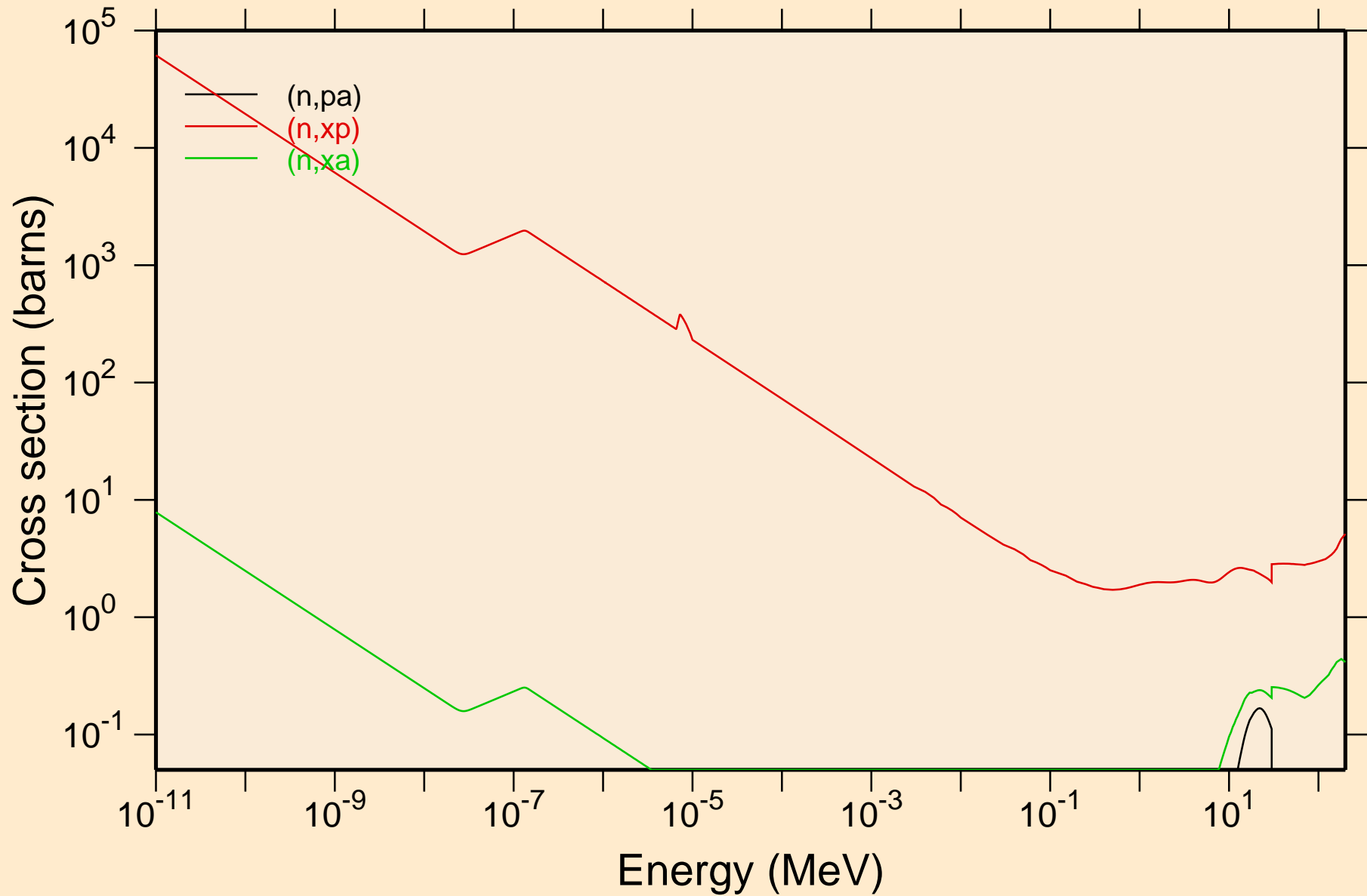

PR127 NEUTRON ACER TENDL-2021 LIBRARY; T=293.6K  
Principal cross sections

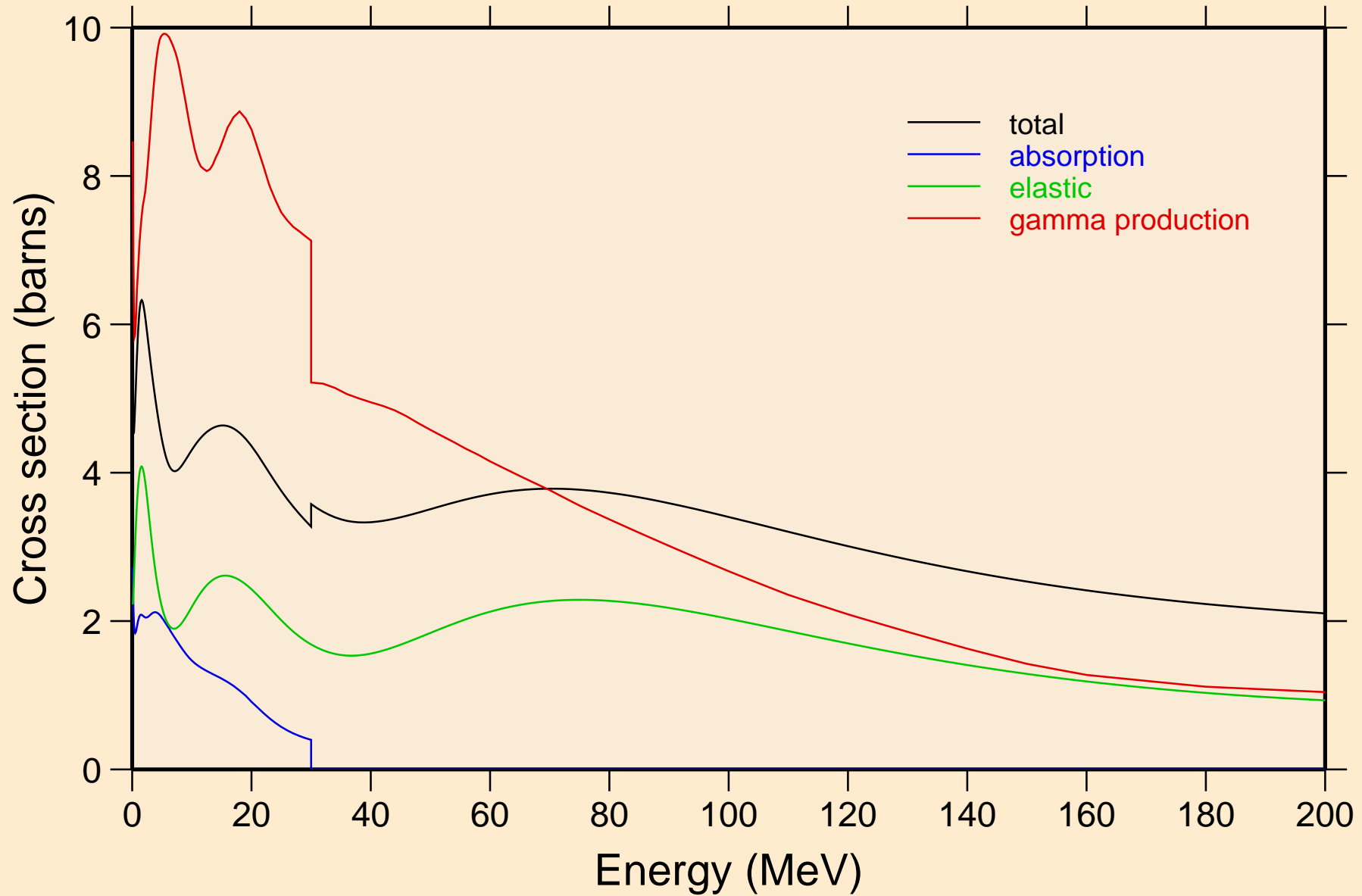

PR127 NEUTRON ACER TENDL-2021 LIBRARY; T=293.6K

Heating

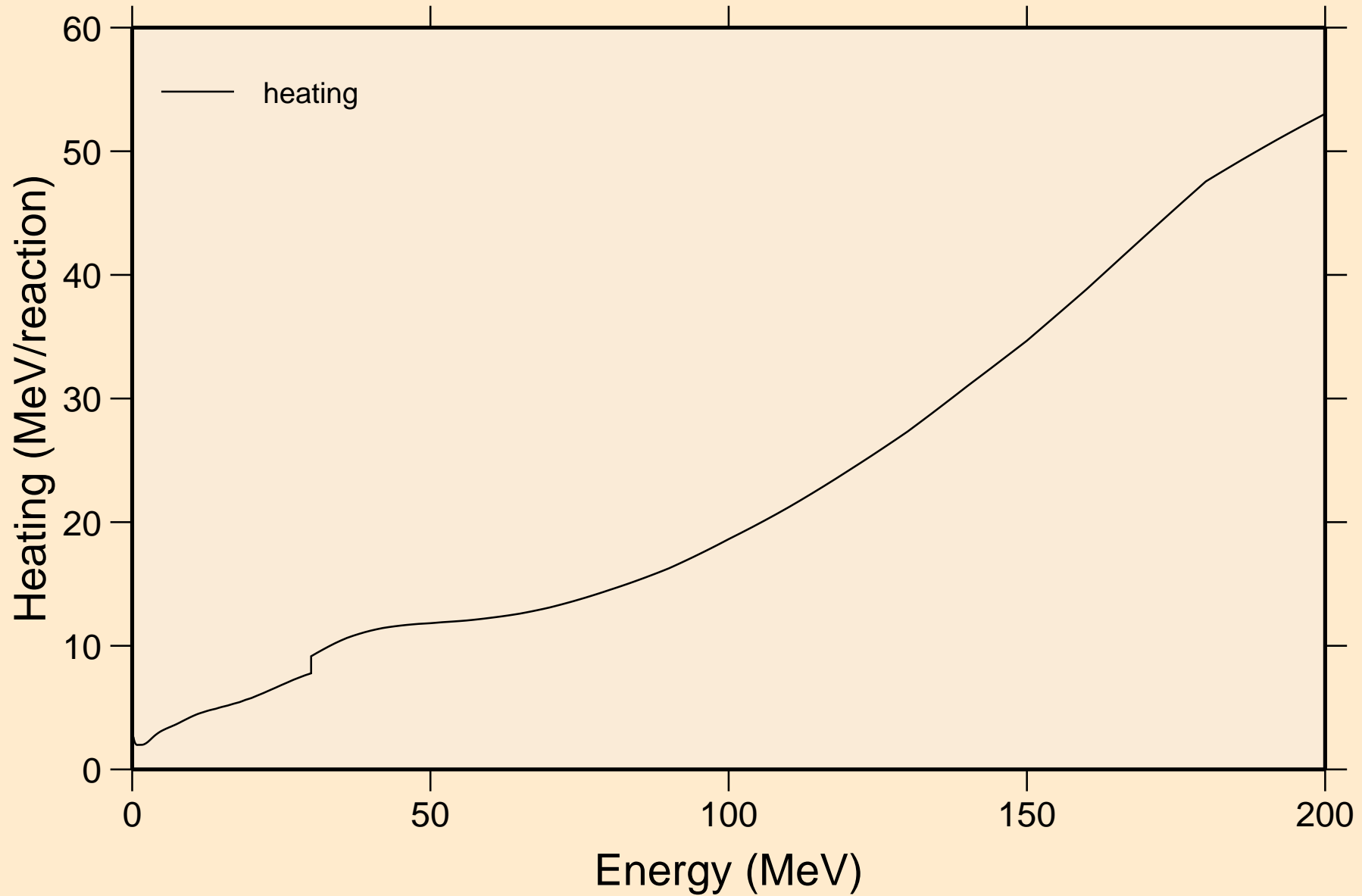

PR127 NEUTRON ACER TENDL-2021 LIBRARY; T=293.6K  
Damage

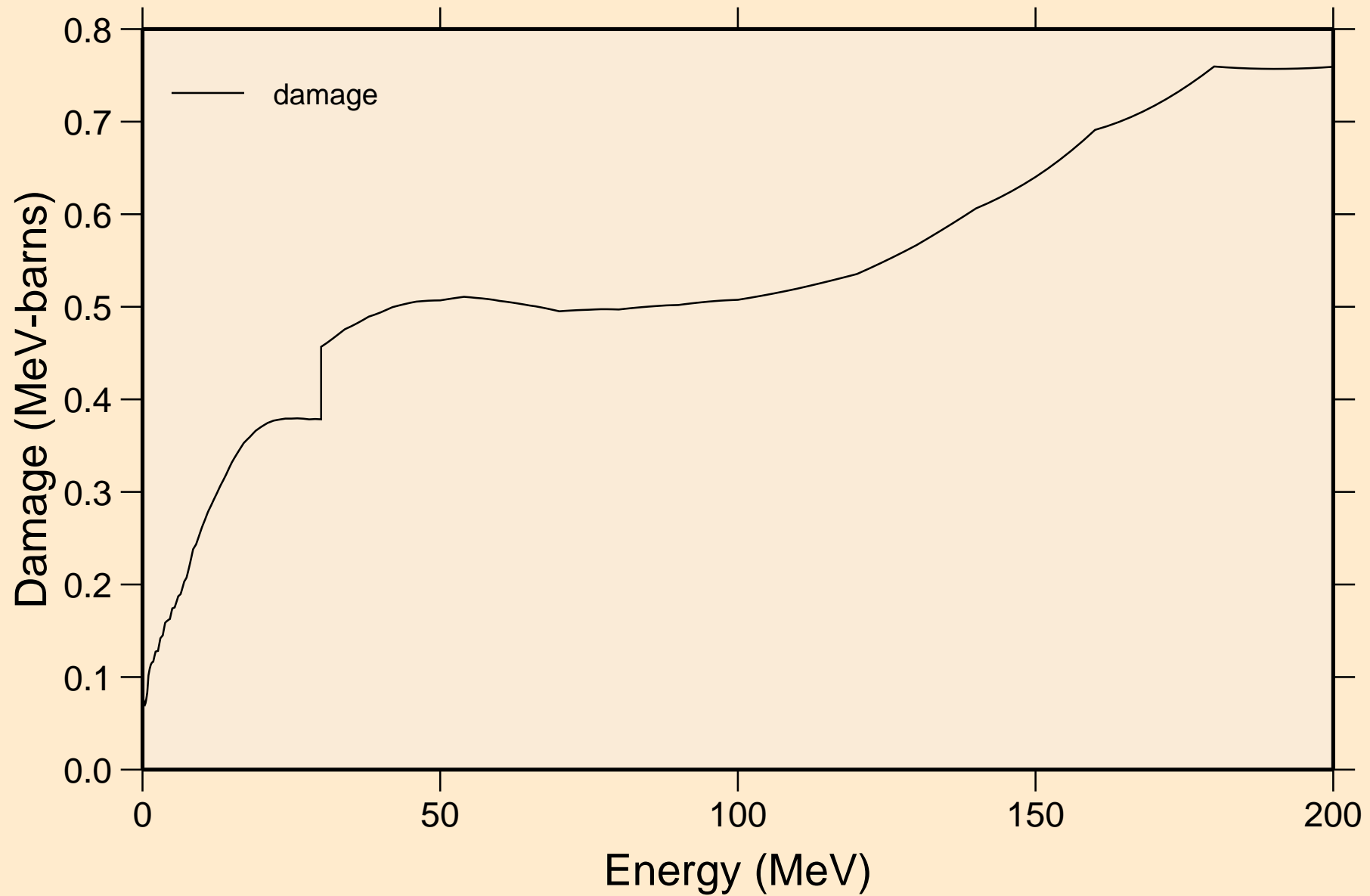

PR127 NEUTRON ACER TENDL-2021 LIBRARY; T=293.6K  
Non-threshold reactions

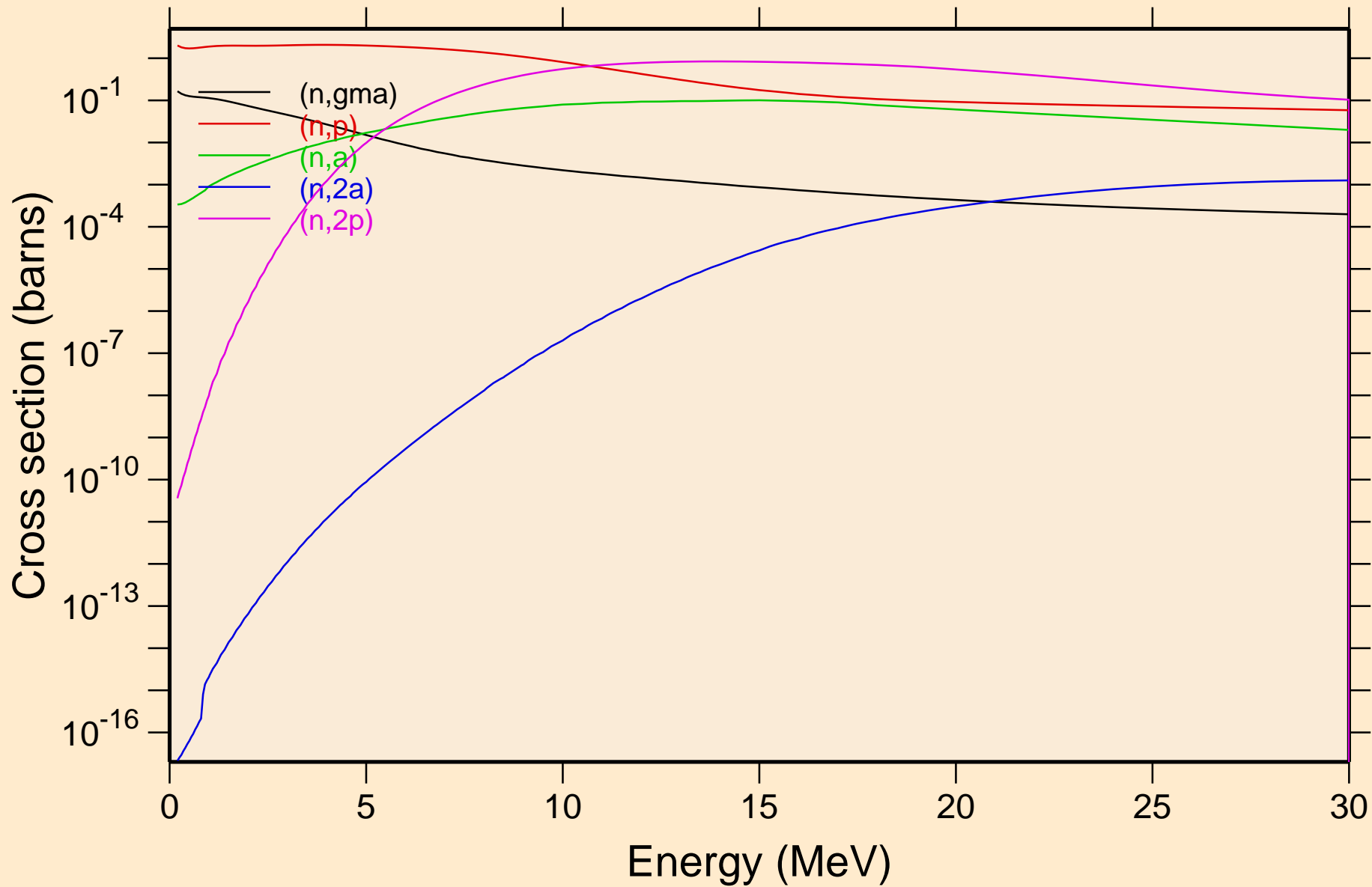

PR127 NEUTRON ACER TENDL-2021 LIBRARY; T=293.6K  
Non-threshold reactions

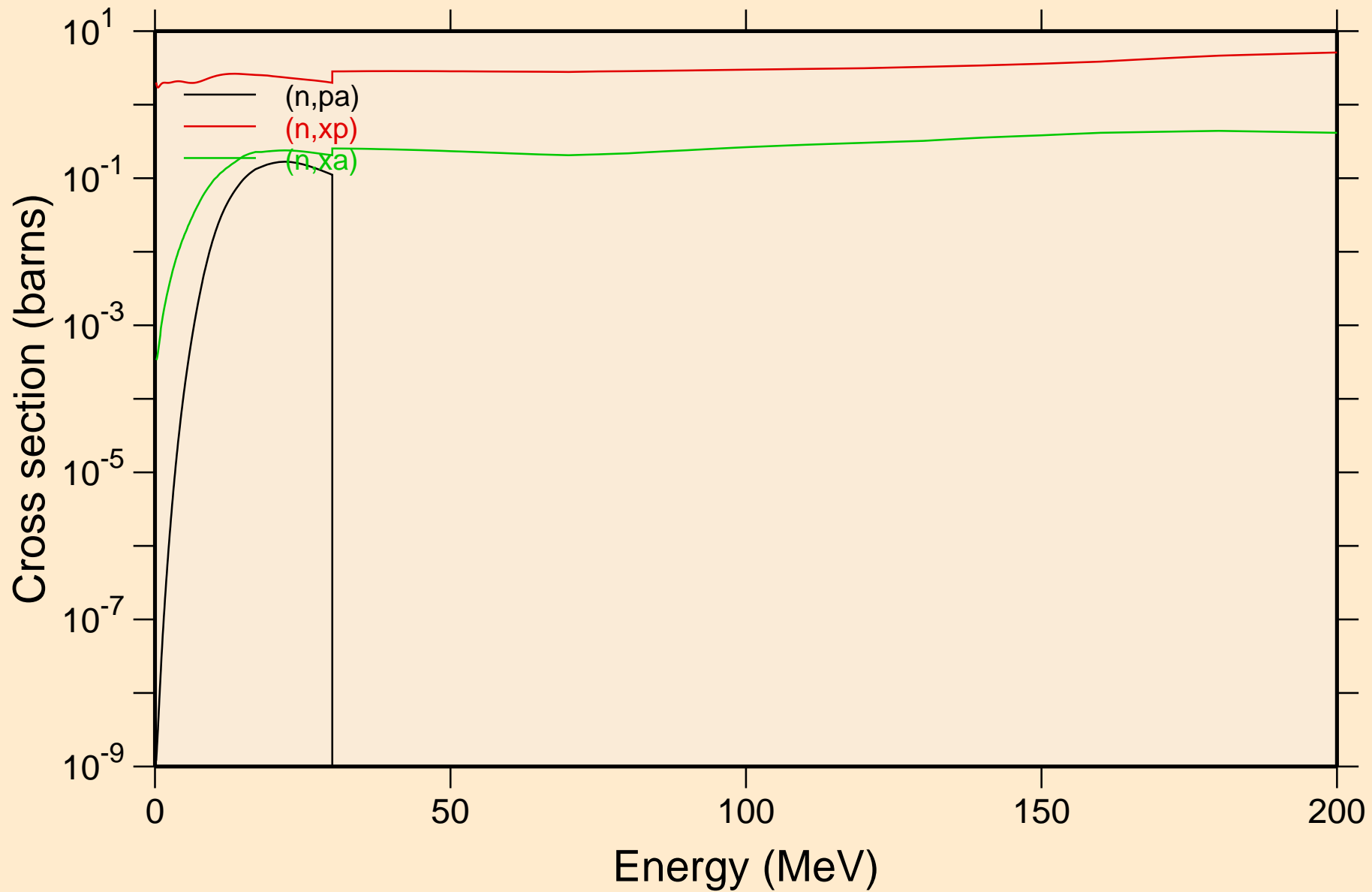

PR127 NEUTRON ACER TENDL-2021 LIBRARY; T=293.6K  
Inelastic levels

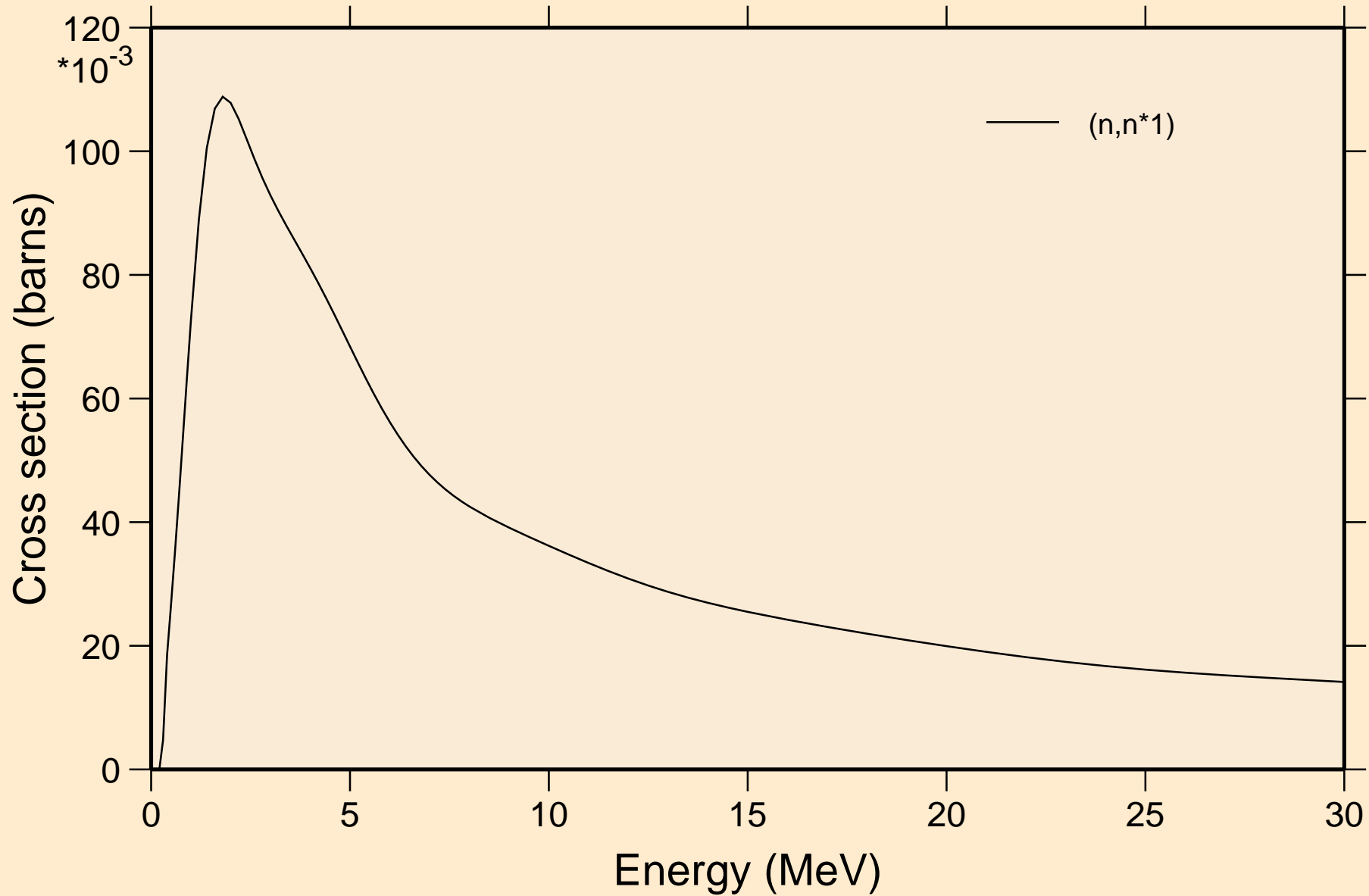

PR127 NEUTRON ACER TENDL-2021 LIBRARY; T=293.6K  
Threshold reactions

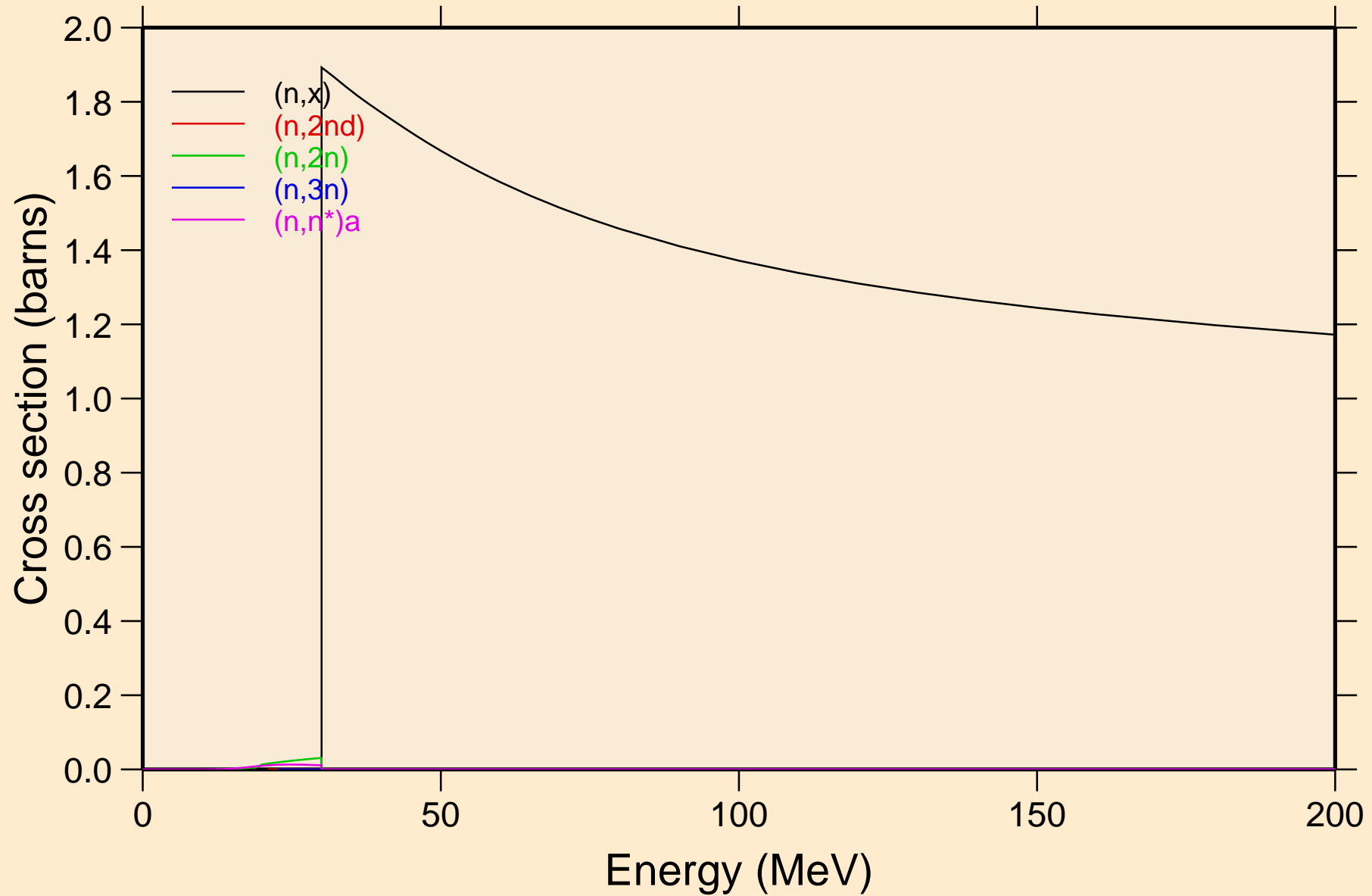

PR127 NEUTRON ACER TENDL-2021 LIBRARY; T=293.6K  
Threshold reactions

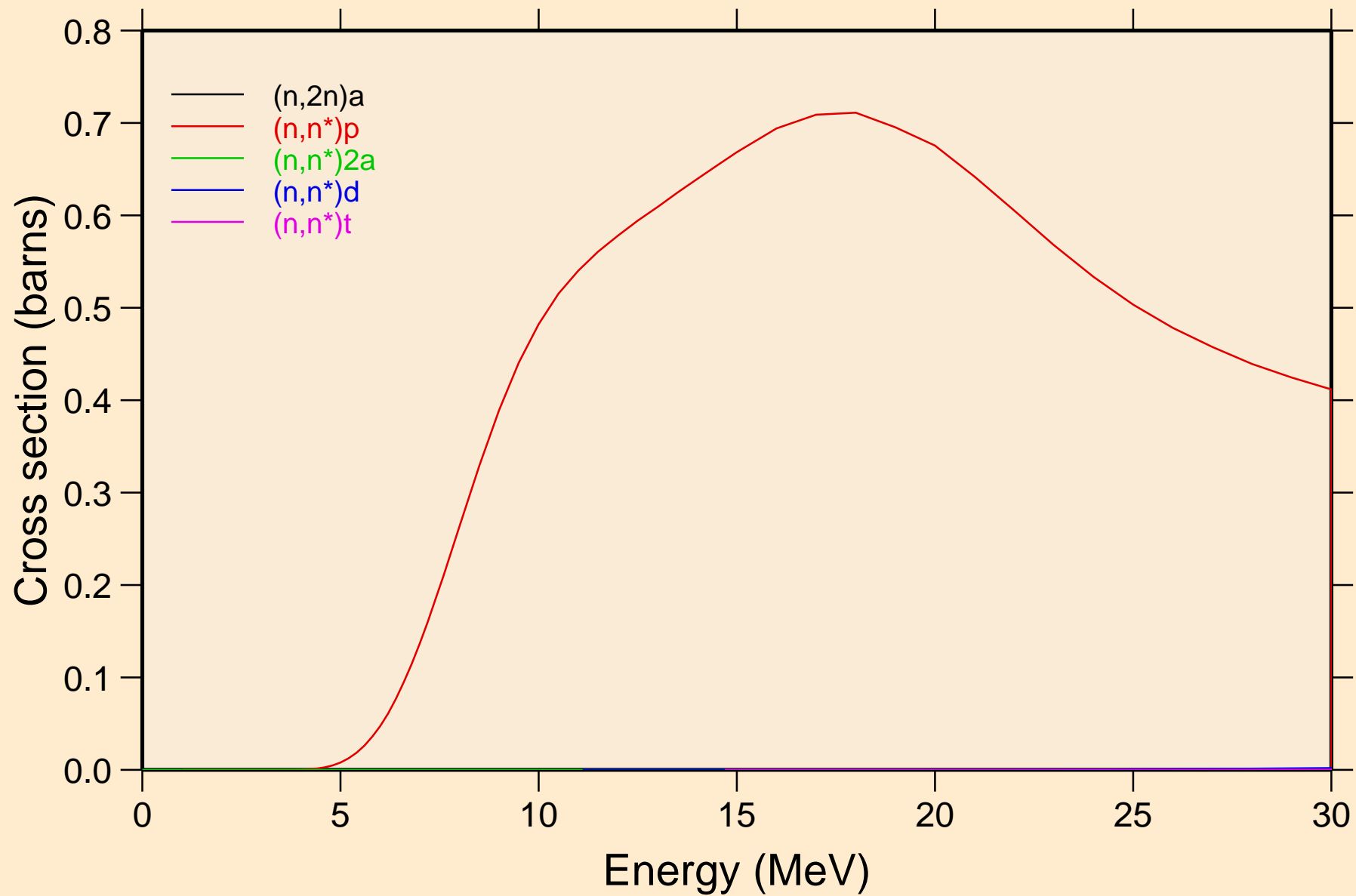

PR127 NEUTRON ACER TENDL-2021 LIBRARY; T=293.6K  
Threshold reactions

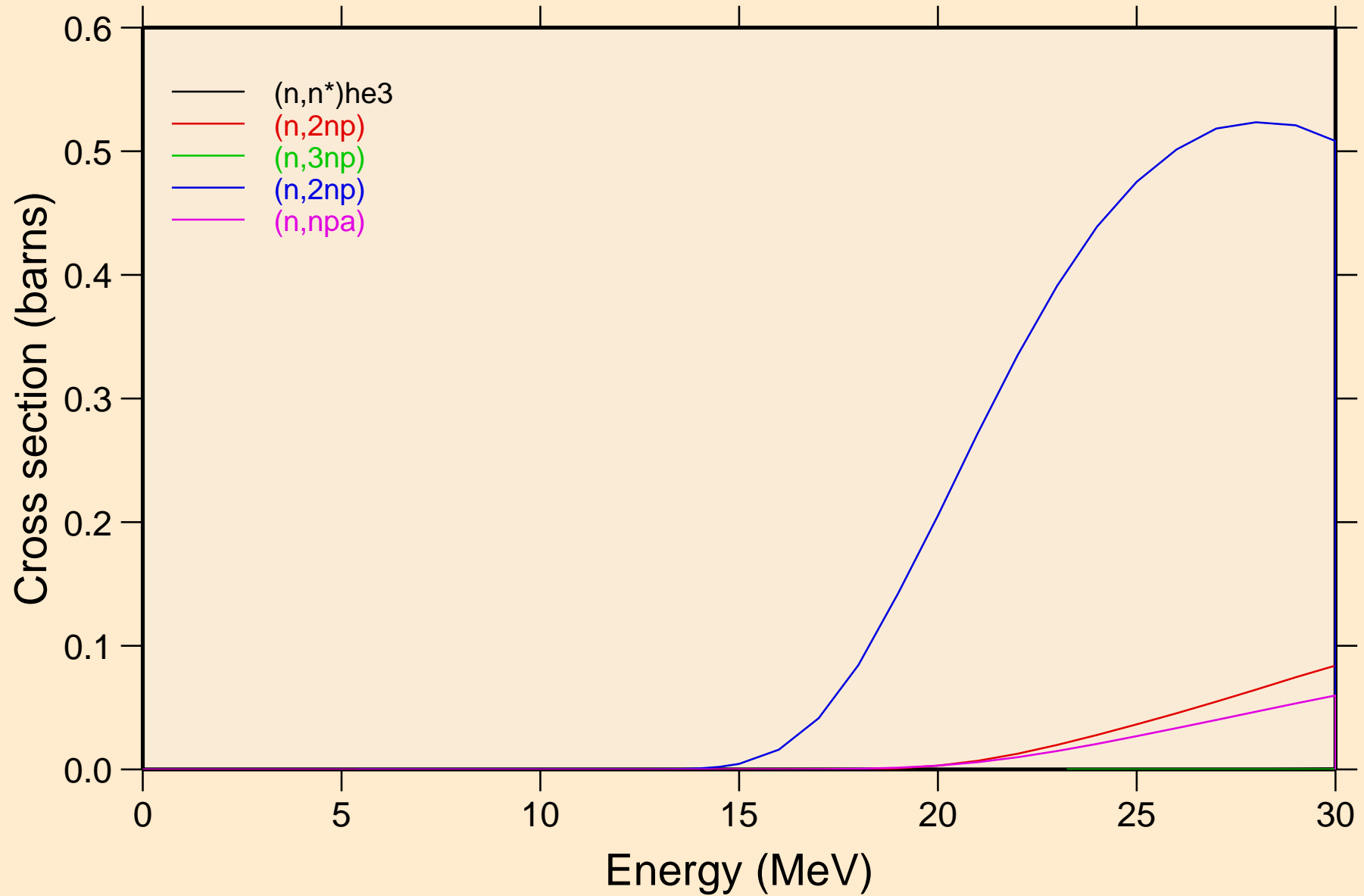

PR127 NEUTRON ACER TENDL-2021 LIBRARY; T=293.6K  
Threshold reactions

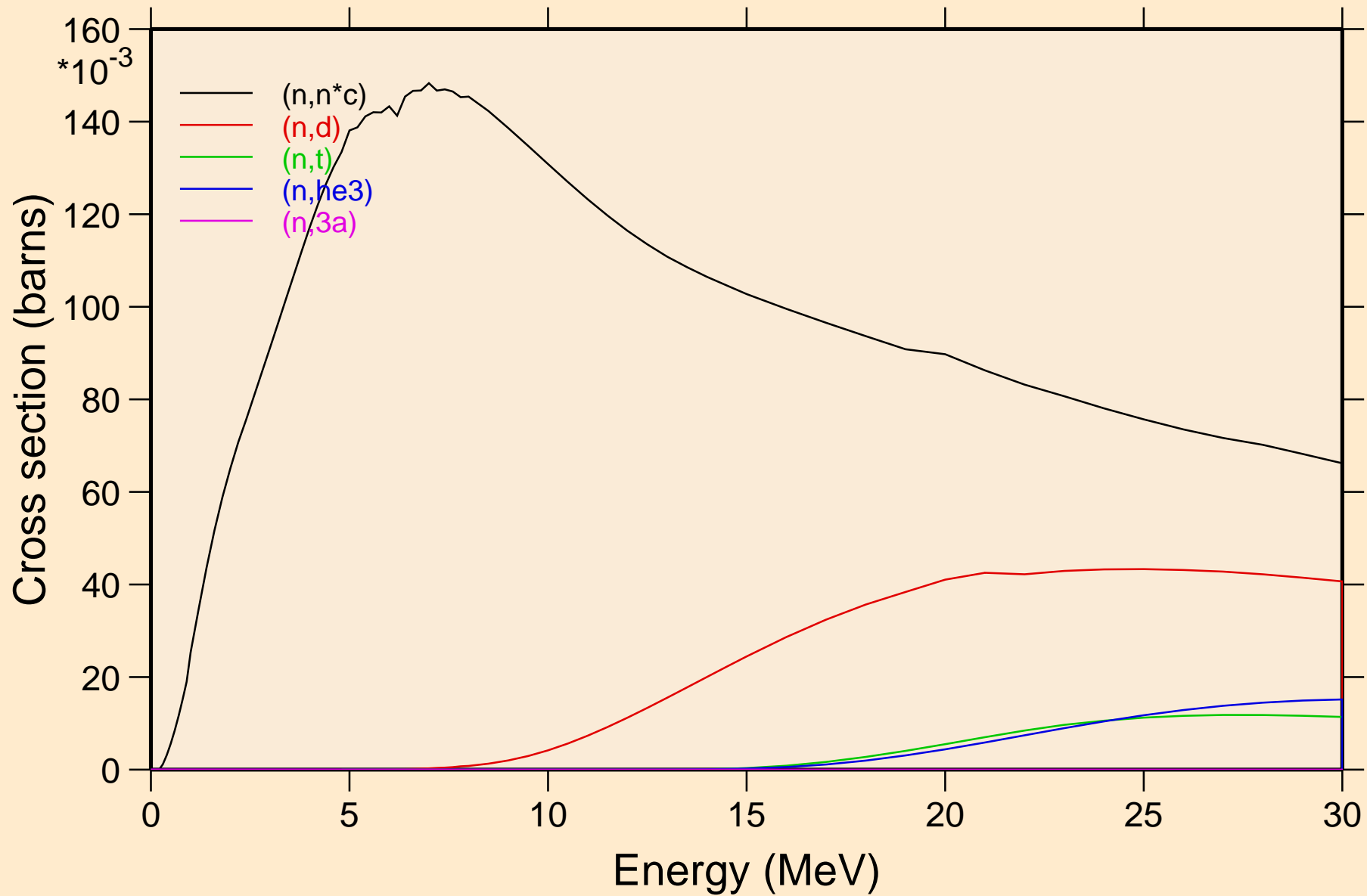

PR127 NEUTRON ACER TENDL-2021 LIBRARY; T=293.6K  
Threshold reactions

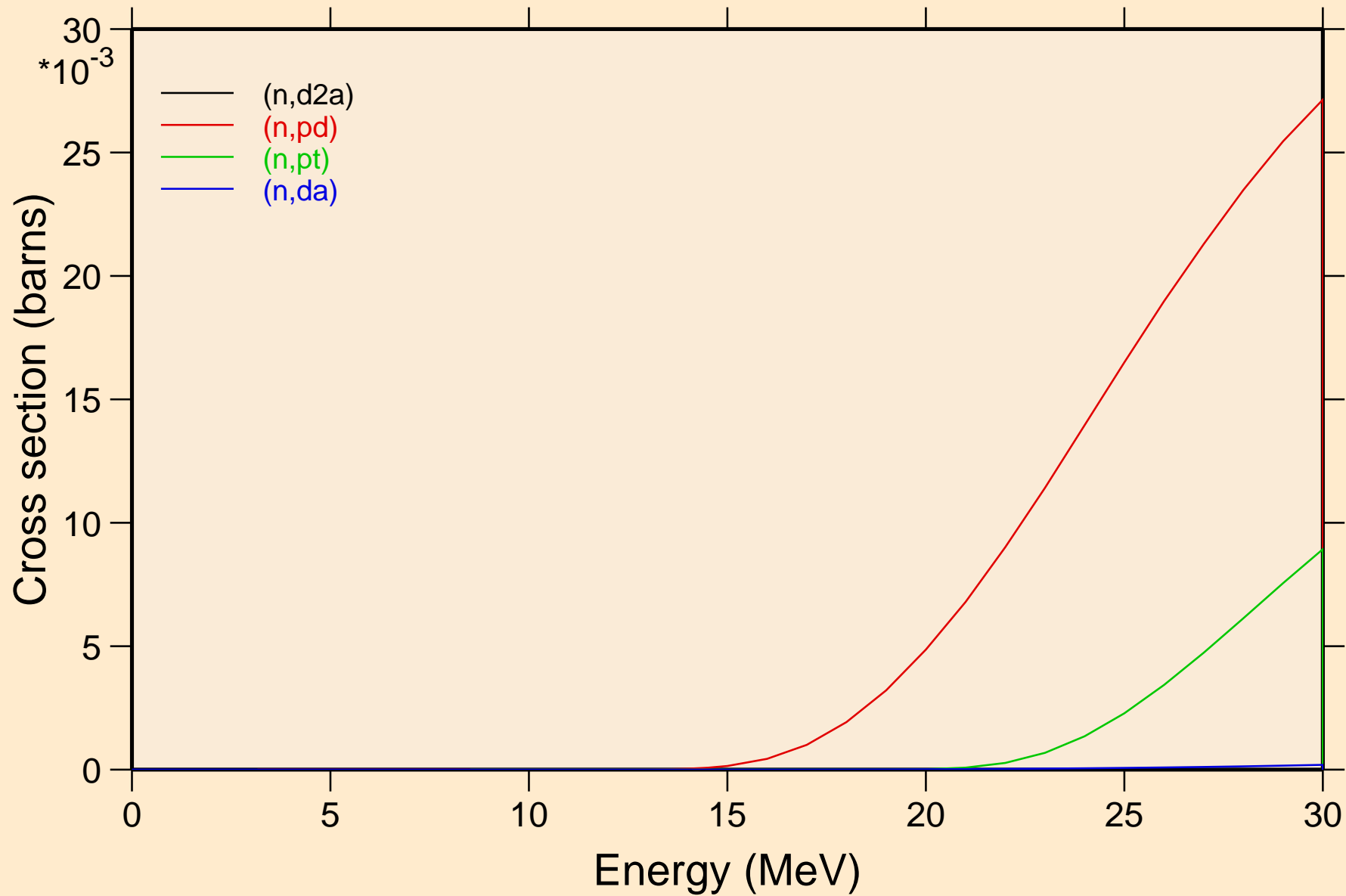

PR127 NEUTRON ACER TENDL-2021 LIBRARY; T=293.6K  
Threshold reactions

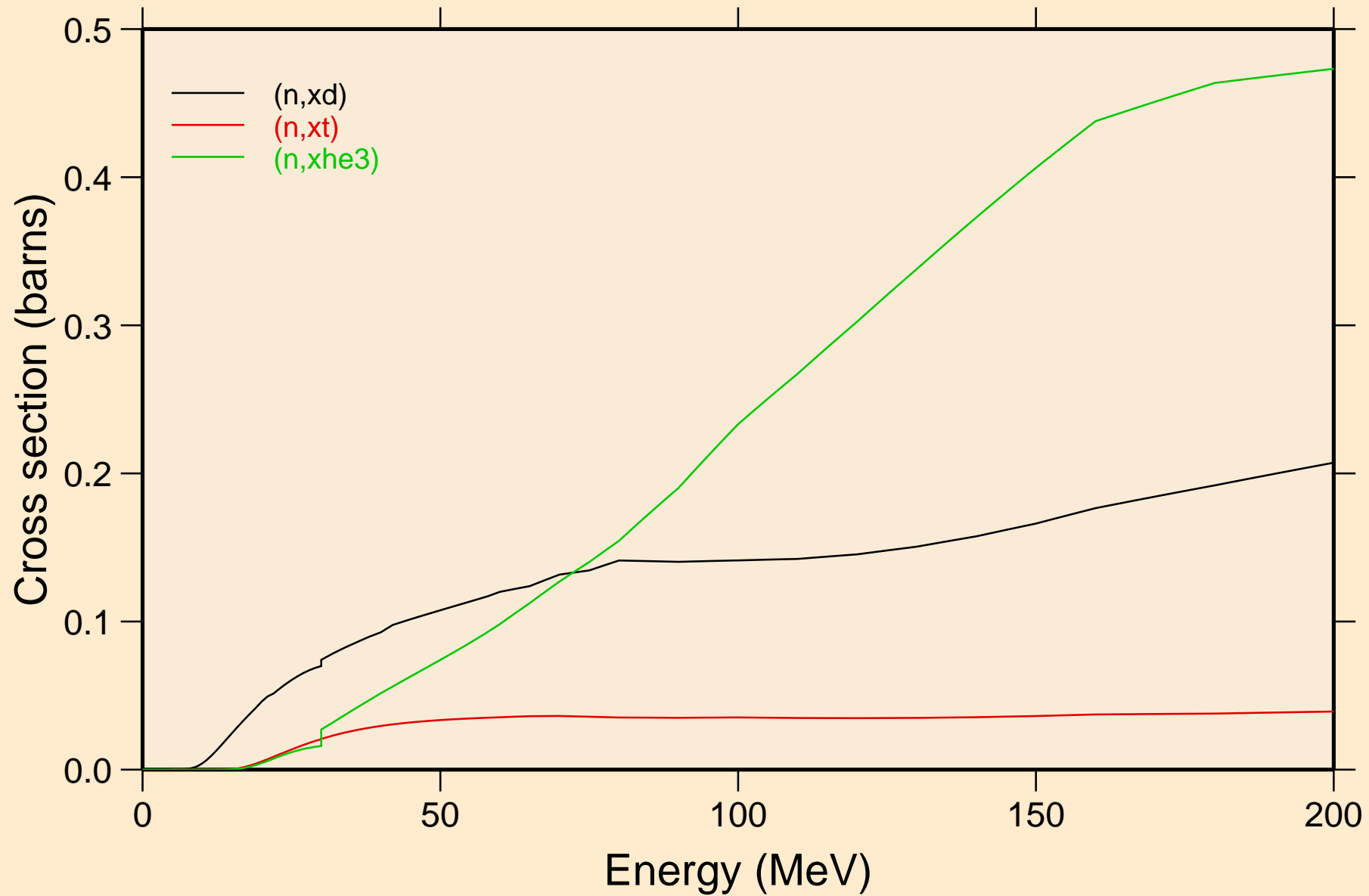

PR127 NEUTRON ACER TENDL-2021 LIBRARY; T=293.6K  
angular distribution for elastic

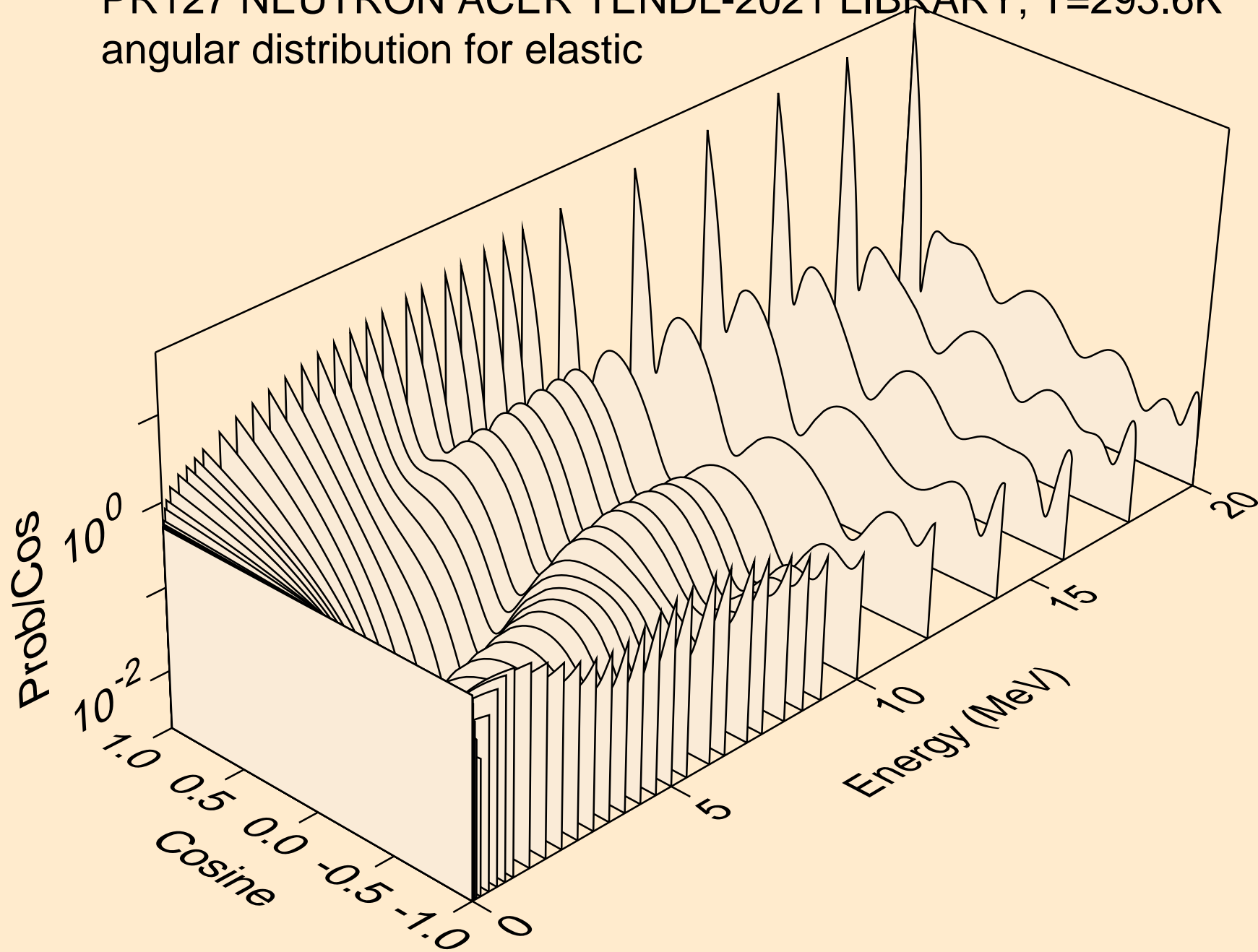

PR127 NEUTRON ACER TENDL-2021 LIBRARY; T=293.6K  
angular distribution for elastic

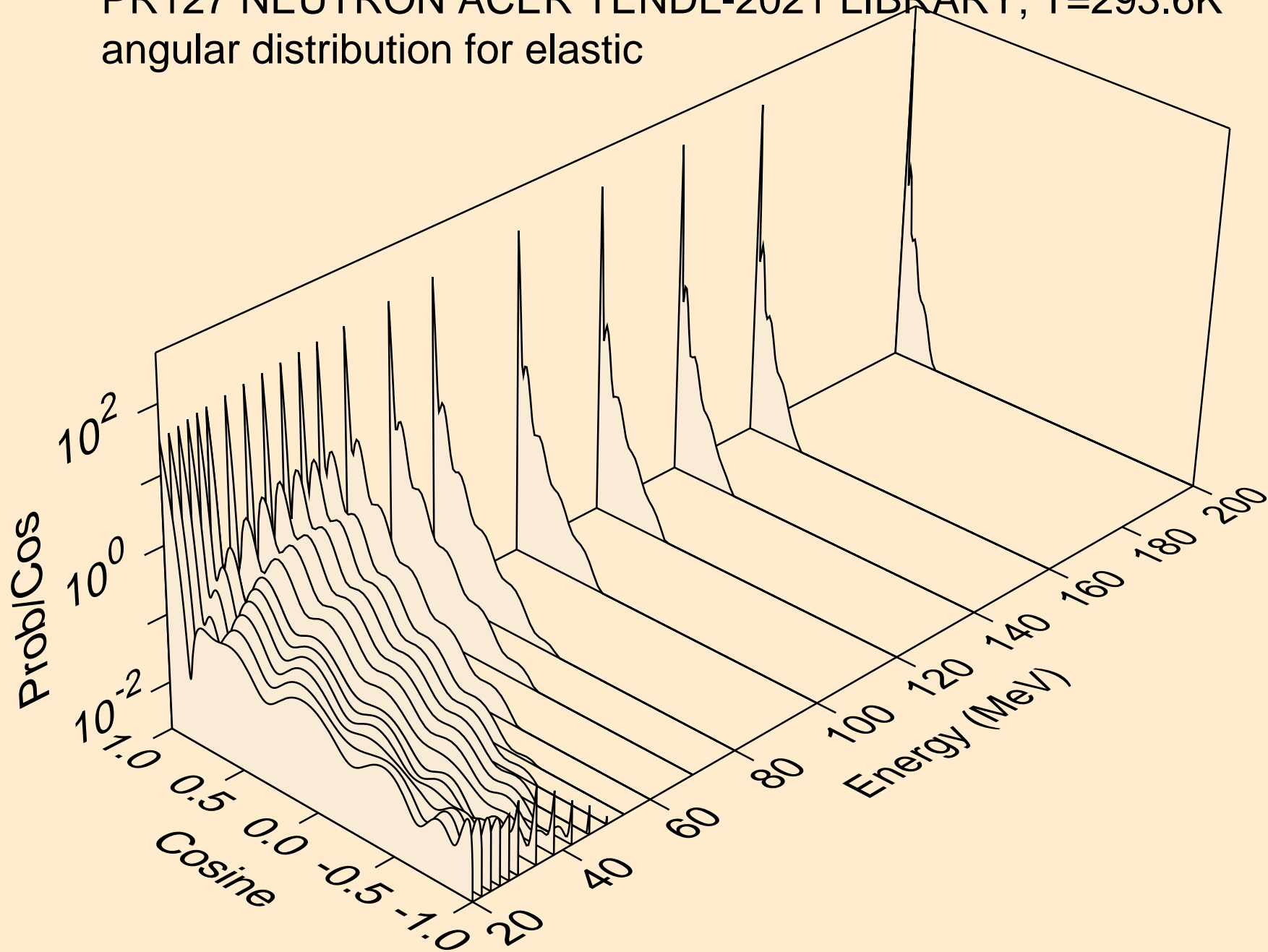

PR127 NEUTRON ACER TENDL-2021 LIBRARY; T=293.6K  
angular distribution for (n,n\*1)

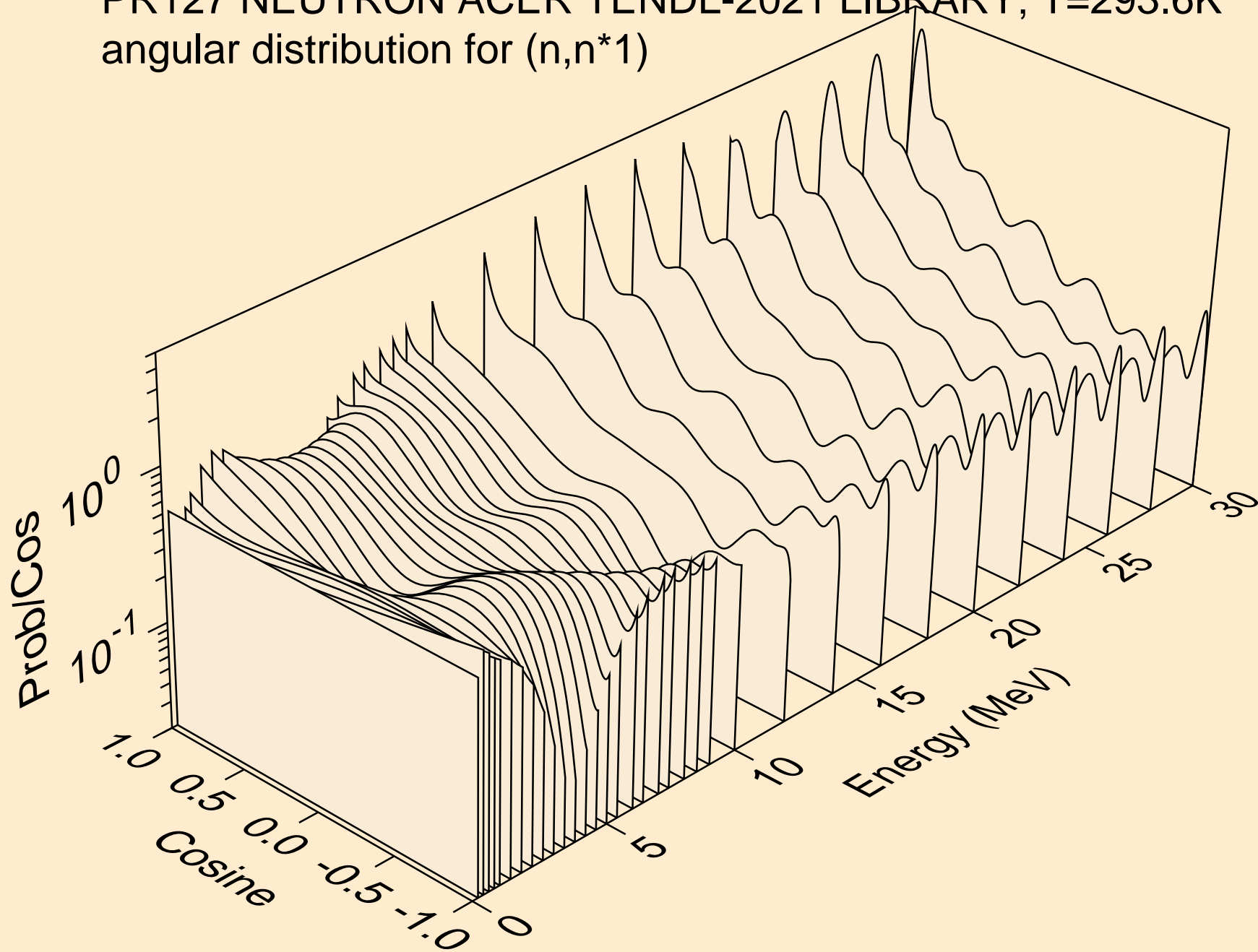

PR127 NEUTRON ACER TENDL-2021 LIBRARY; T=293.6K  
Neutron emission for (n,x)

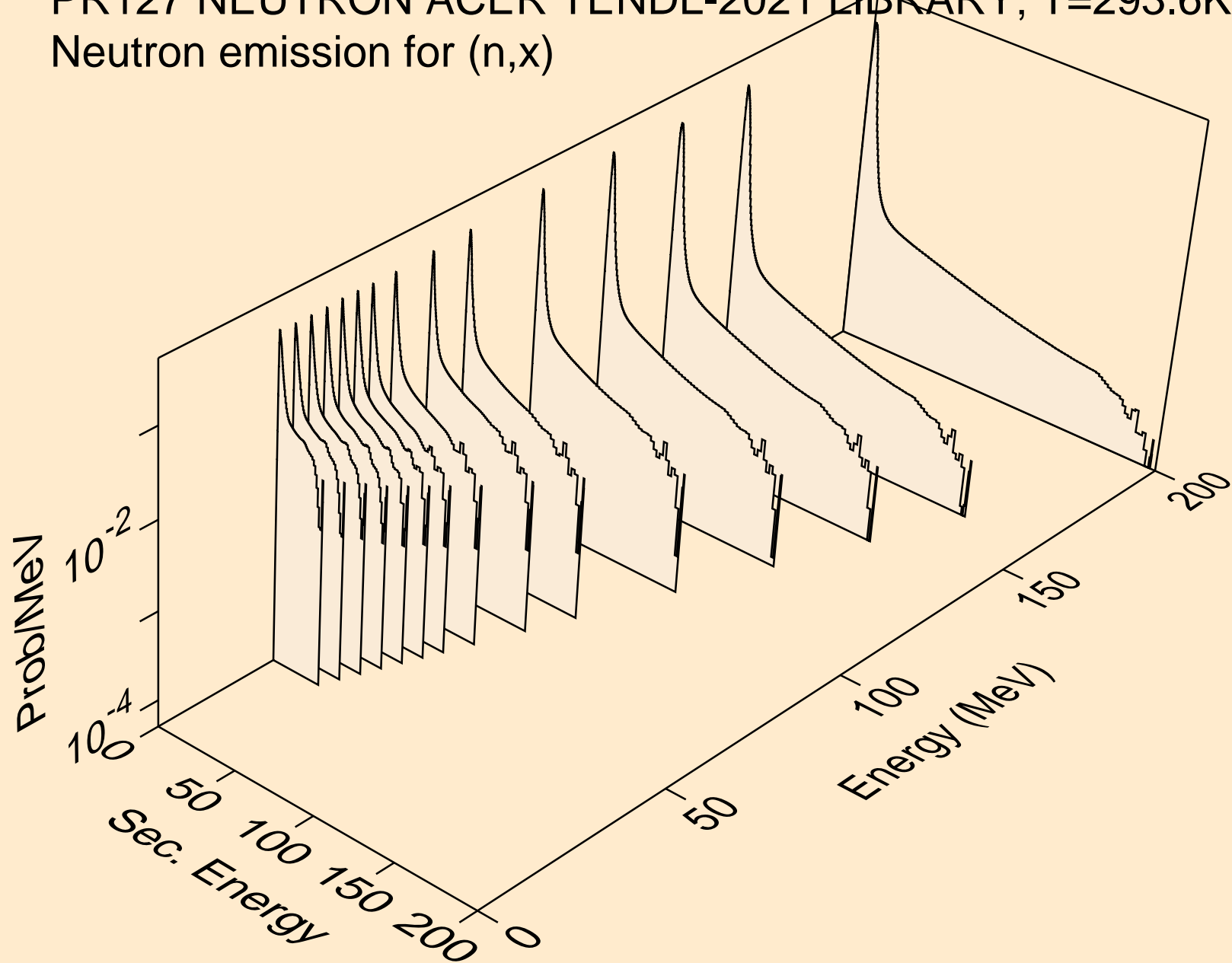

PR127 NEUTRON ACER TENDL-2021 LIBRARY; T=293.6K  
Neutron emission for (n,2nd)

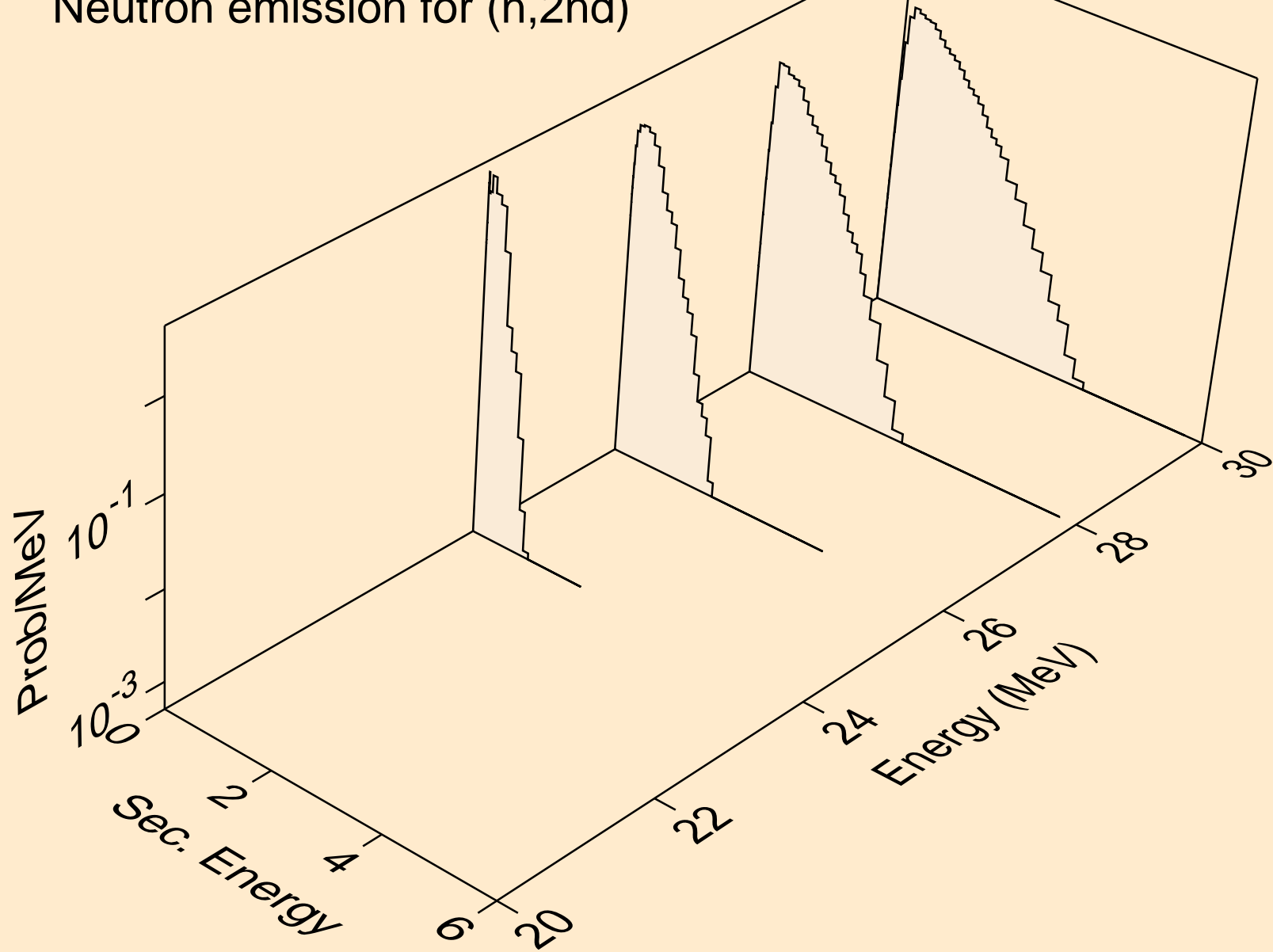

PR127 NEUTRON ACER TENDL-2021 LIBRARY; T=293.6K  
Neutron emission for (n,2n)

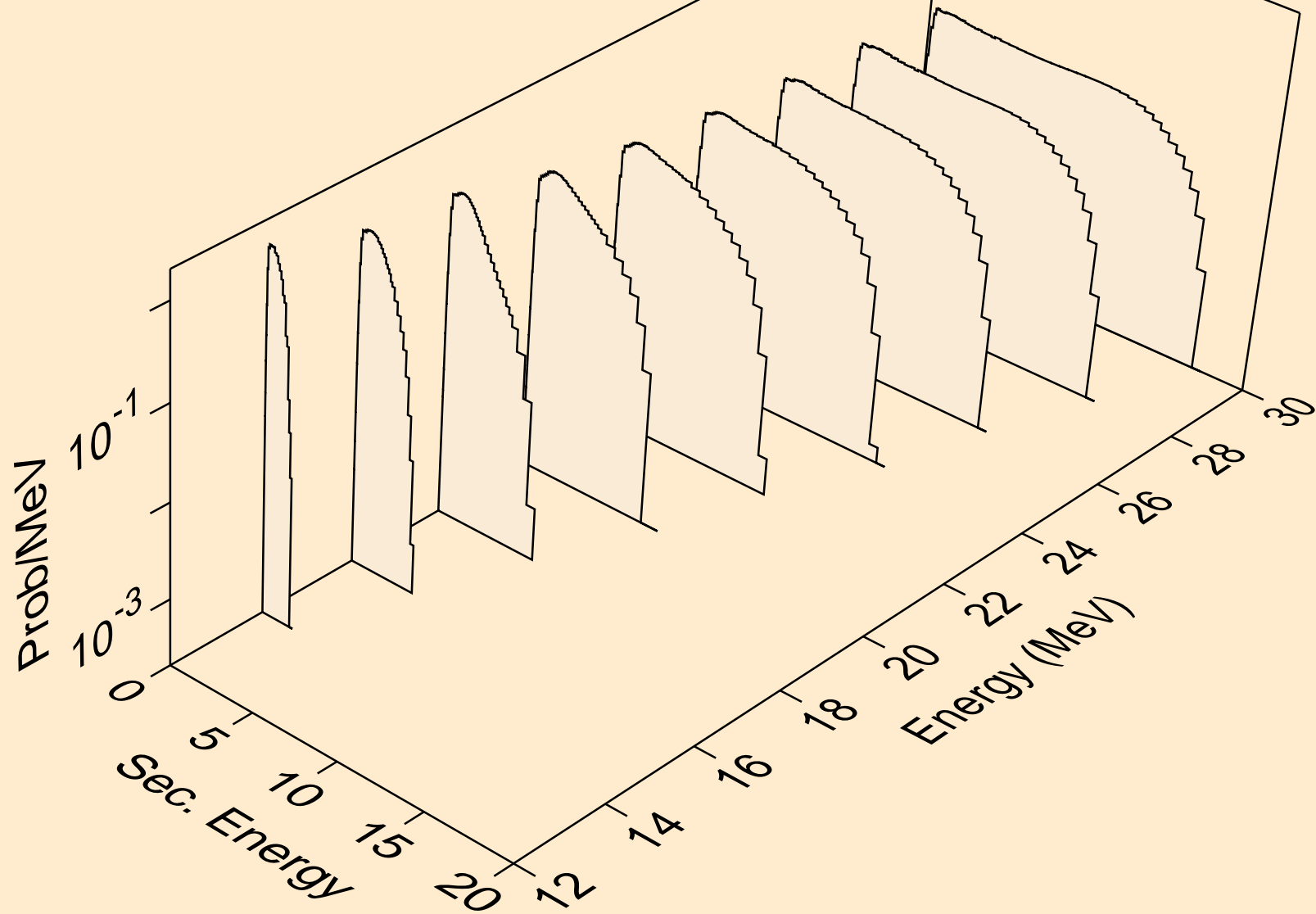

PR127 NEUTRON ACER TENDL-2021 LIBRARY; T=293.6K  
Neutron emission for (n,3n)

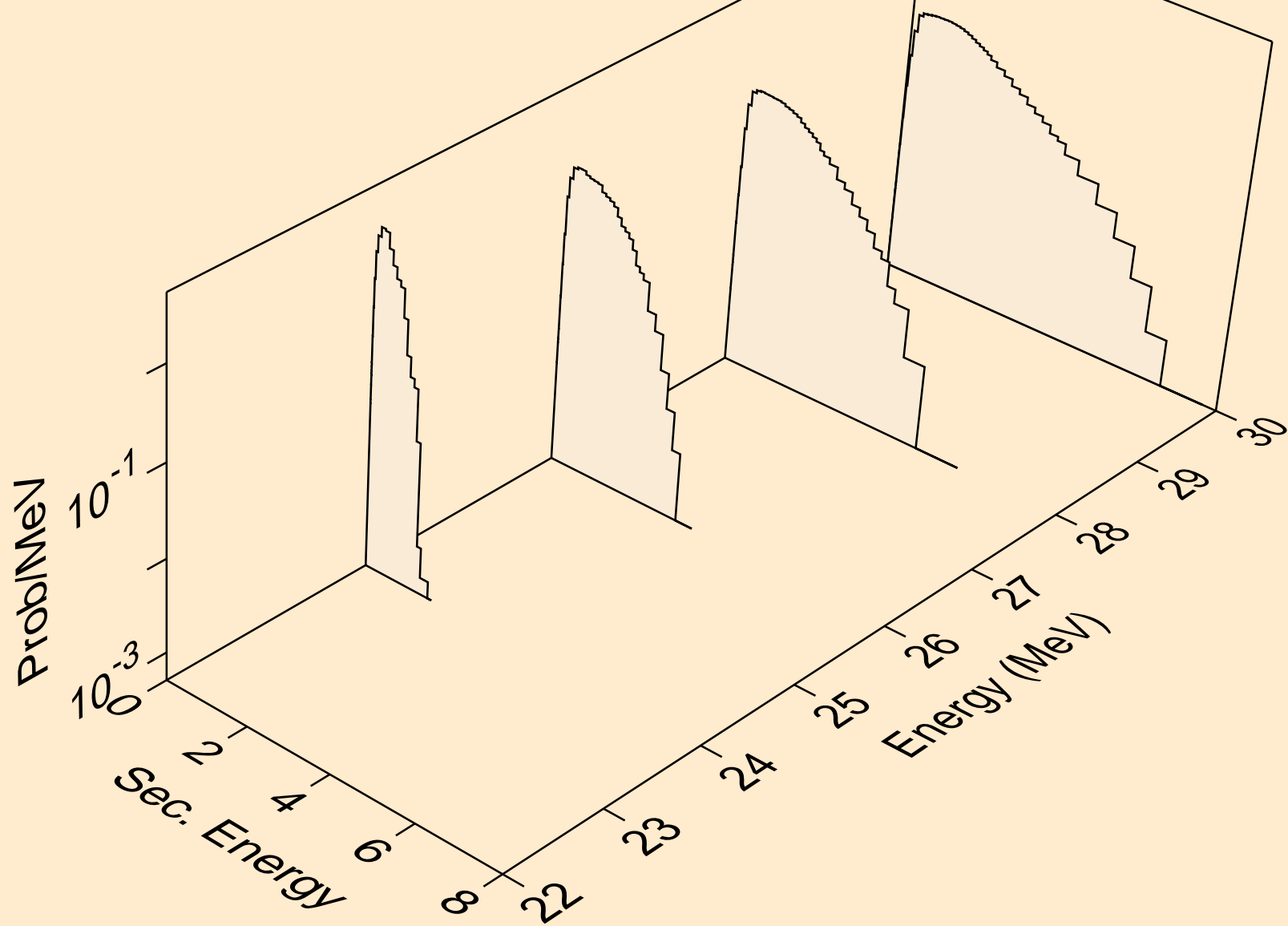

PR127 NEUTRON ACER TENDL-2021 LIBRARY; T=293.6K  
Neutron emission for (n,n\*)a

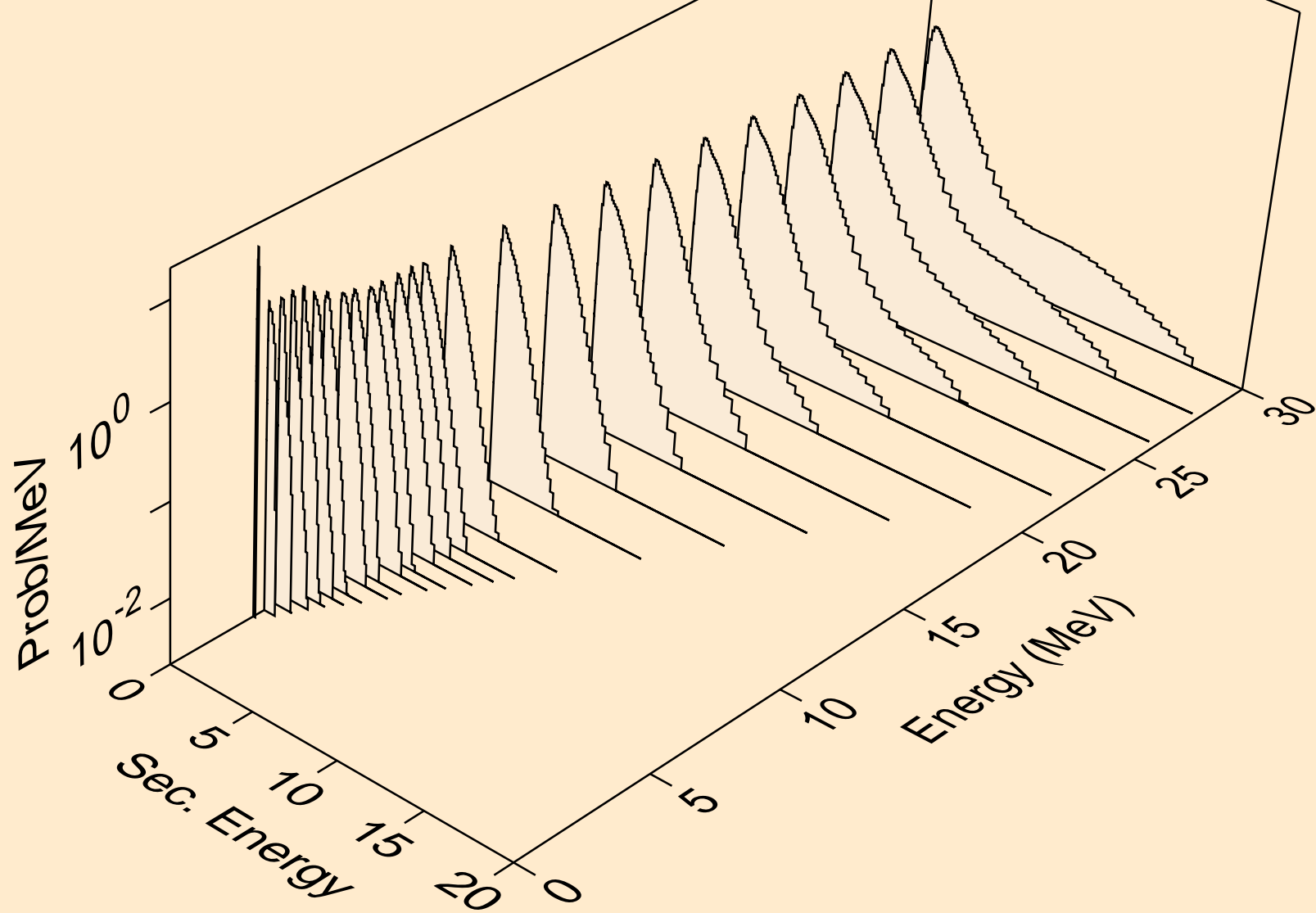

PR127 NEUTRON ACER TENDL-2021 LIBRARY; T=293.6K  
Neutron emission for (n,2n)<sub>a</sub>

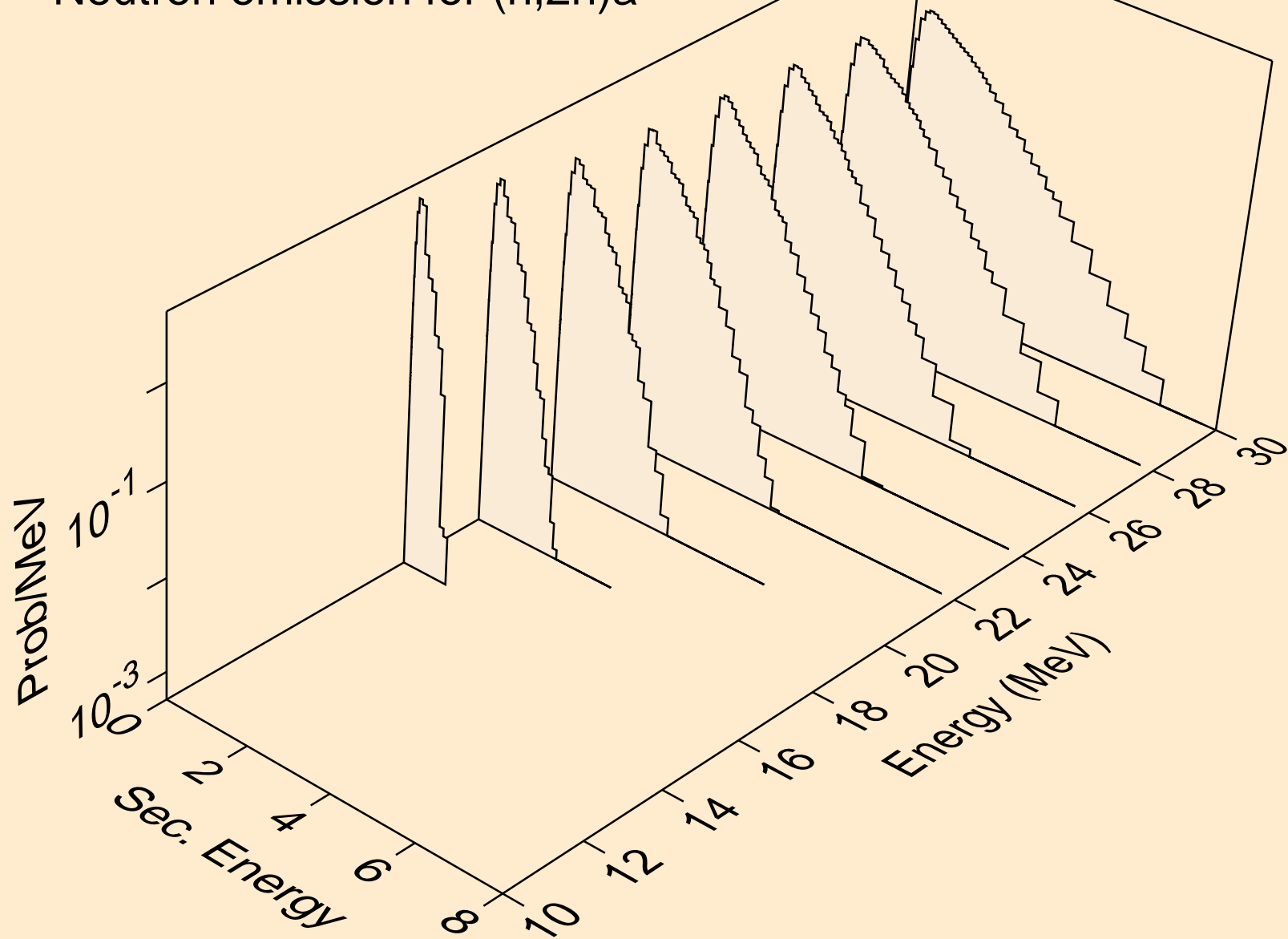

PR127 NEUTRON ACER TENDL-2021 LIBRARY; T=293.6K  
Neutron emission for (n,n\*)p

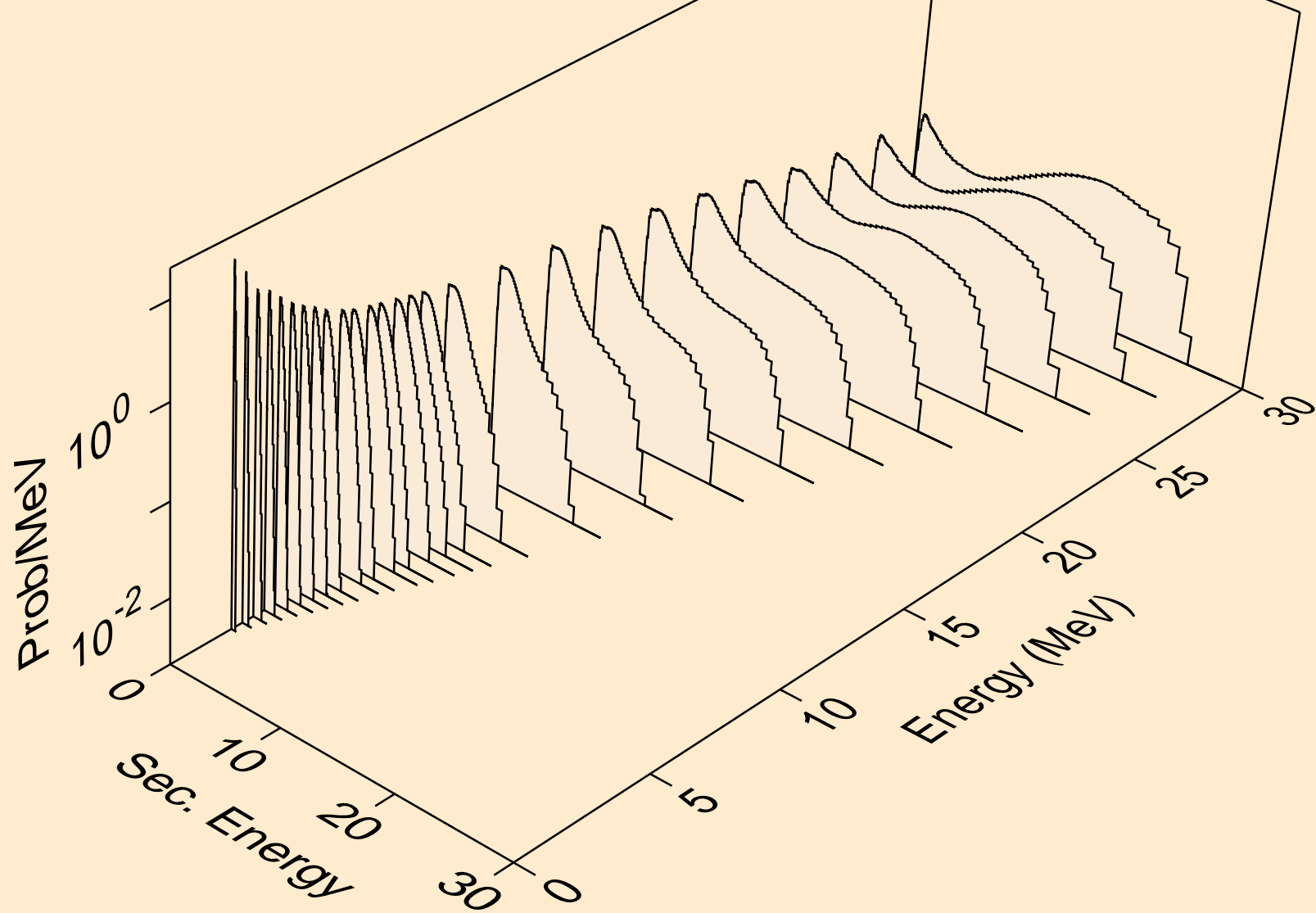

PR127 NEUTRON ACER TENDL-2021 LIBRARY; T=293.6K  
Neutron emission for (n,n\*)2a

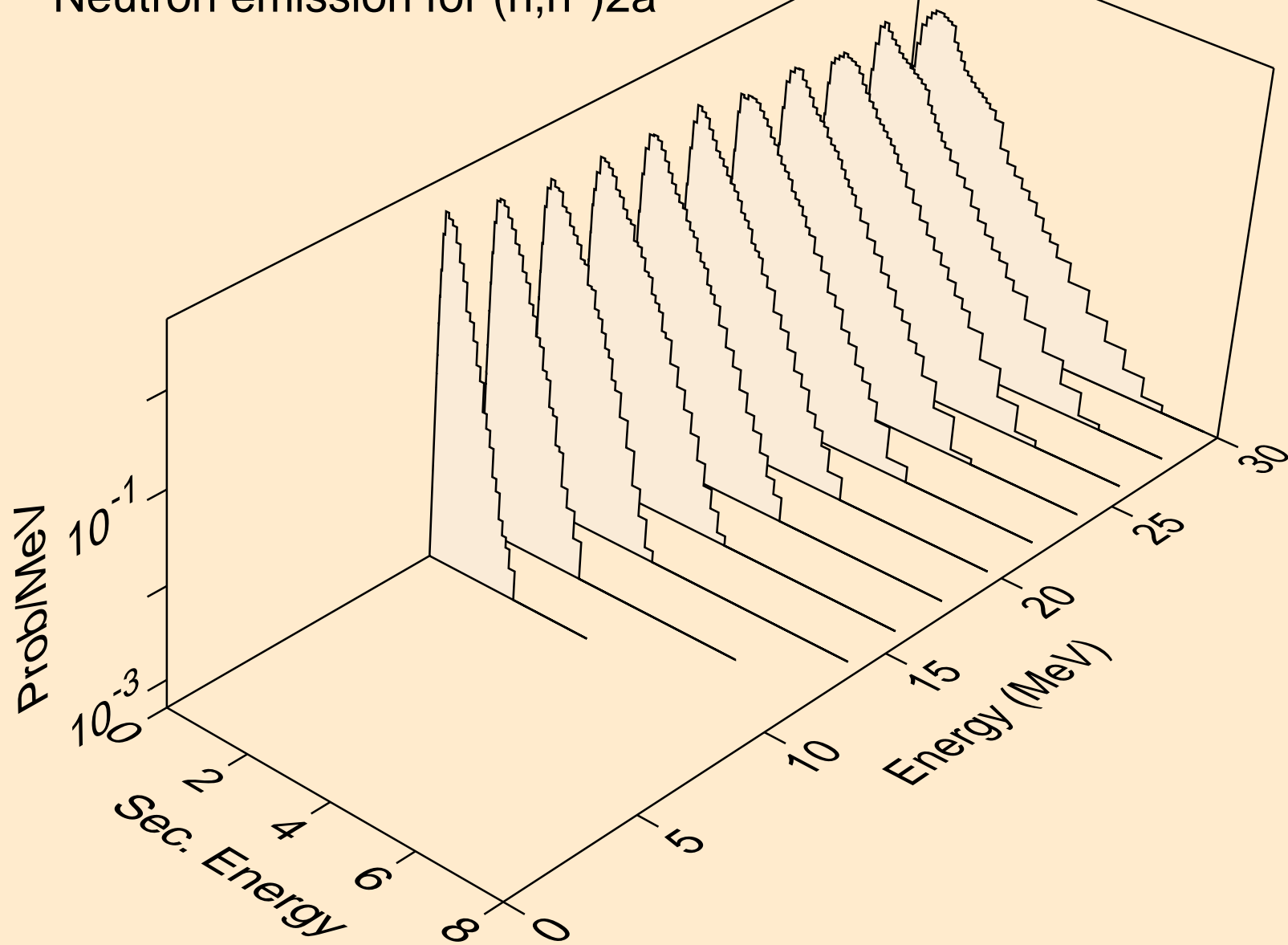

PR127 NEUTRON ACER TENDL-2021 LIBRARY; T=293.6K  
Neutron emission for (n,n\*)d

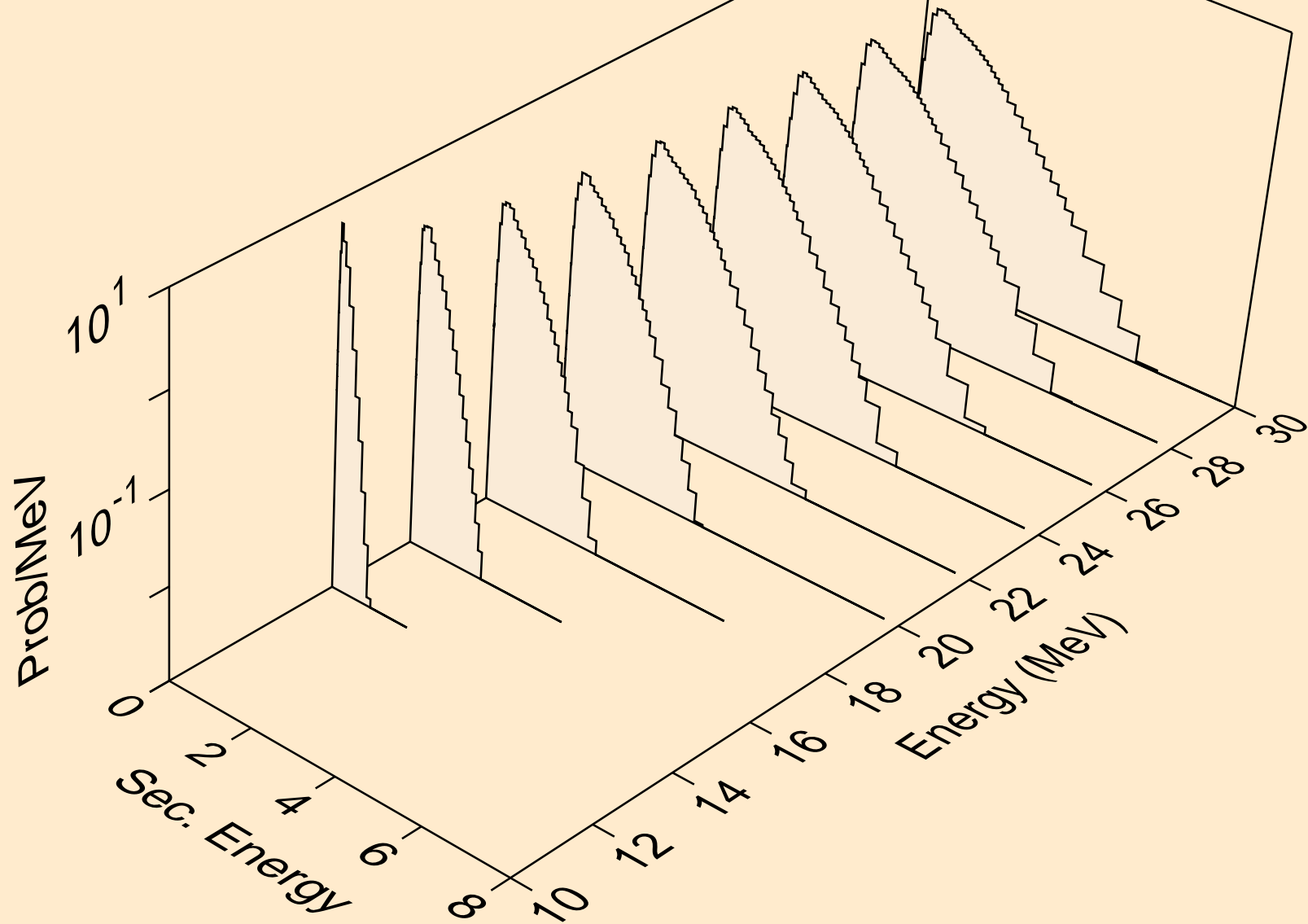

PR127 NEUTRON ACER TENDL-2021 LIBRARY; T=293.6K  
Neutron emission for (n,n\*)t

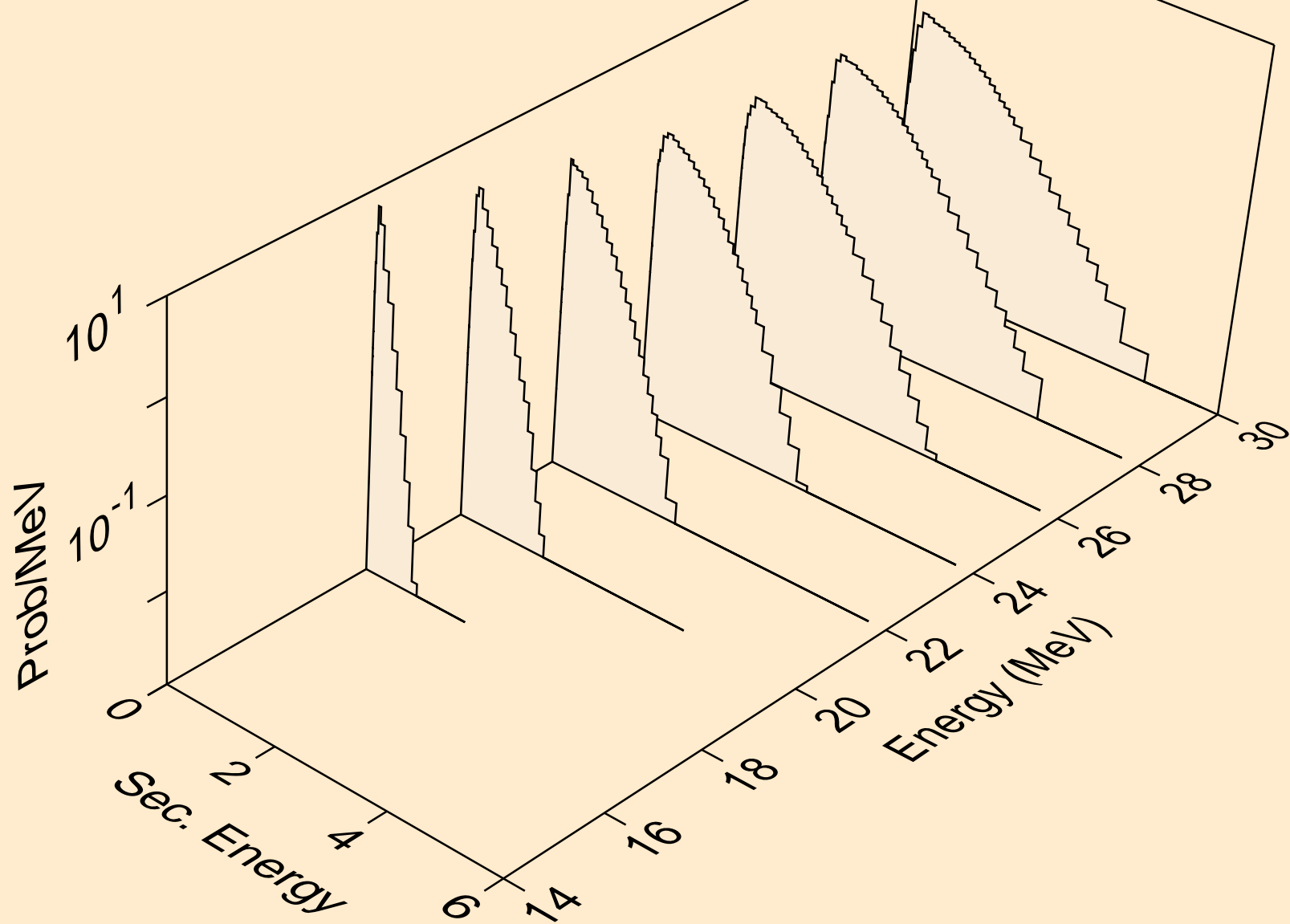

PR127 NEUTRON ACER TENDL-2021 LIBRARY; T=293.6K  
Neutron emission for (n,n\*)he3

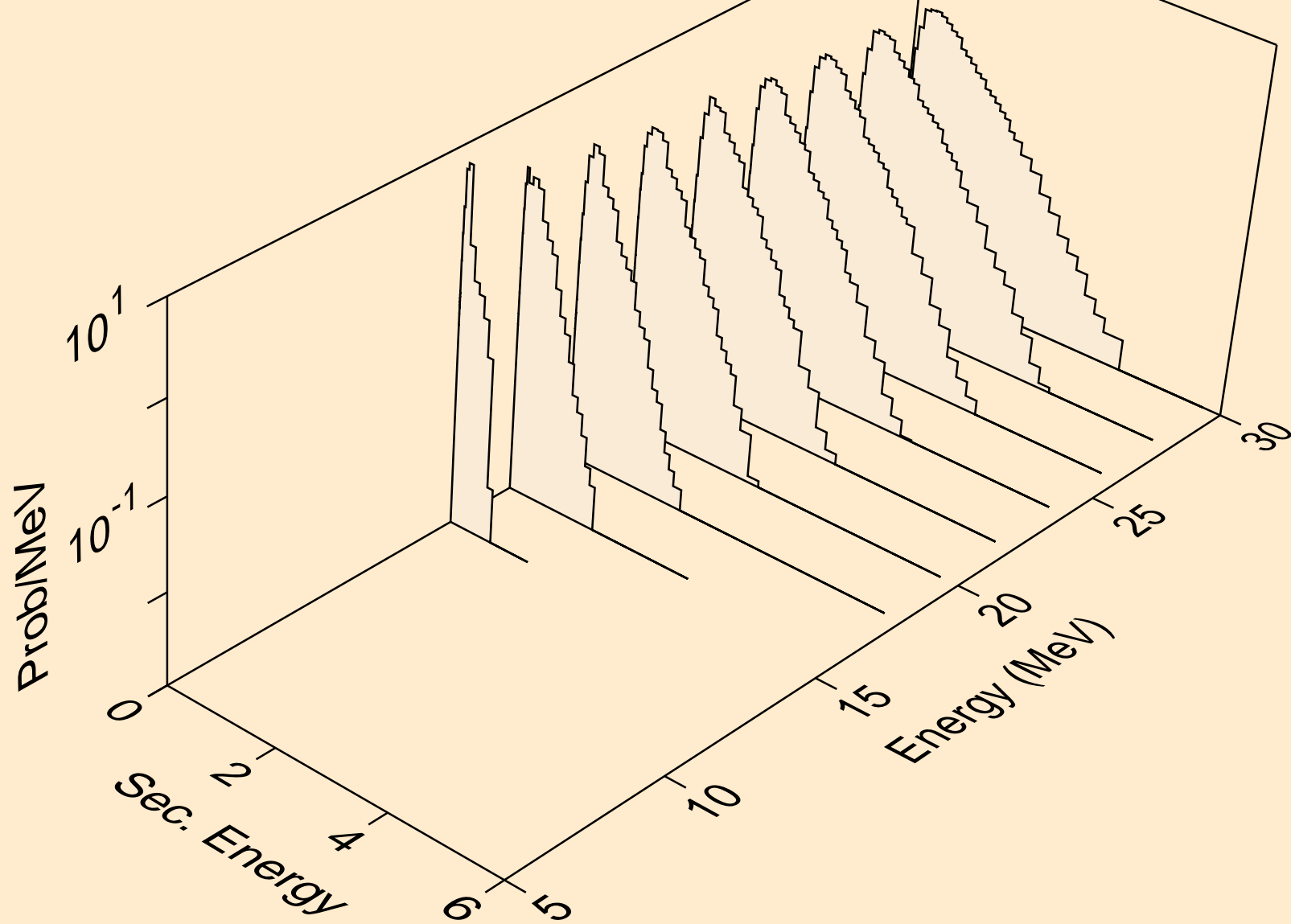

PR127 NEUTRON ACER TENDL-2021 LIBRARY; T=293.6K  
Neutron emission for (n,2np)

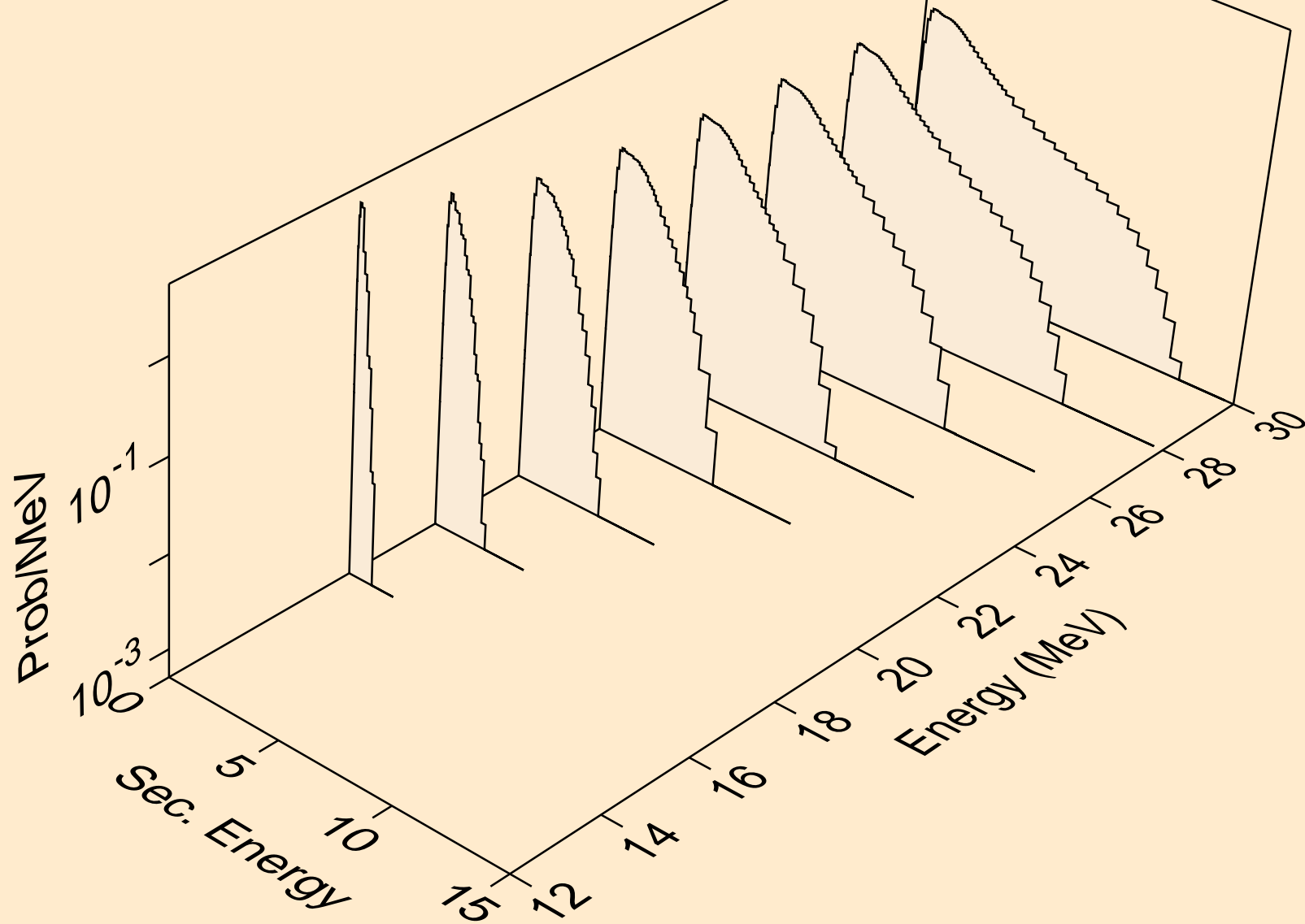

PR127 NEUTRON ACER TENDL-2021 LIBRARY; T=293.6K  
Neutron emission for (n,3np)

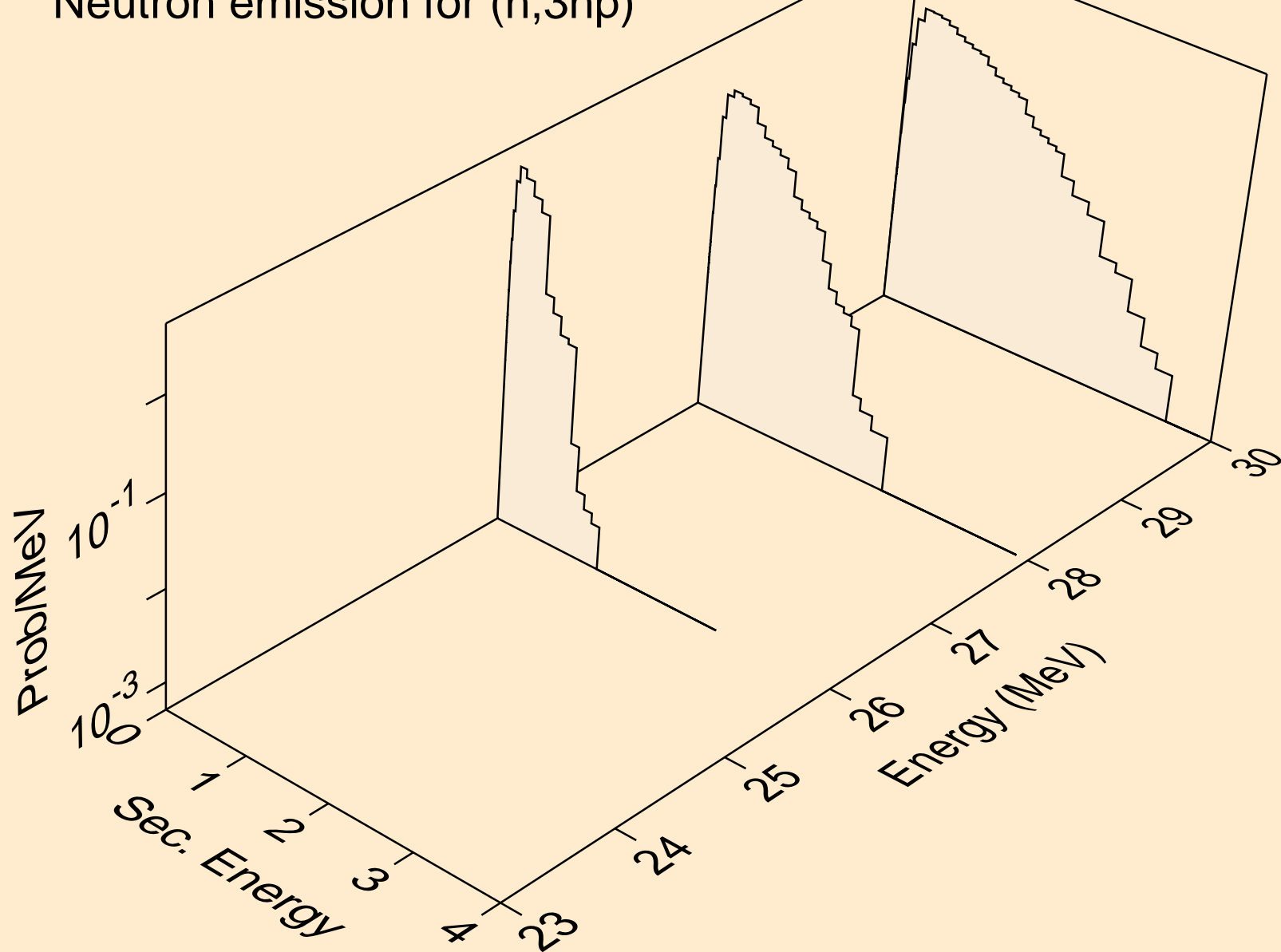

PR127 NEUTRON ACER TENDL-2021 LIBRARY; T=293.6K  
Neutron emission for (n,2np)

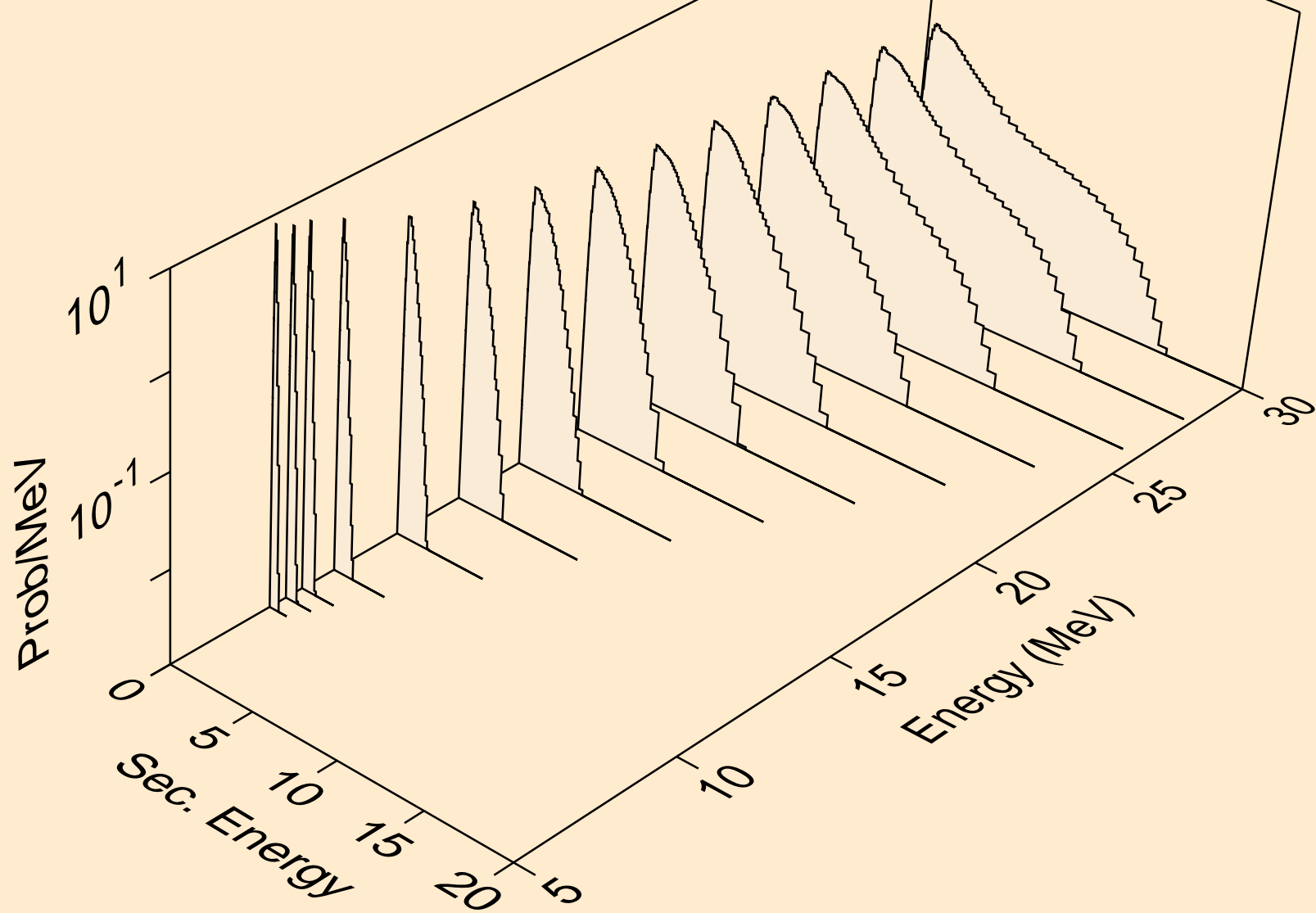

PR127 NEUTRON ACER TENDL-2021 LIBRARY; T=293.6K  
Neutron emission for (n,npa)

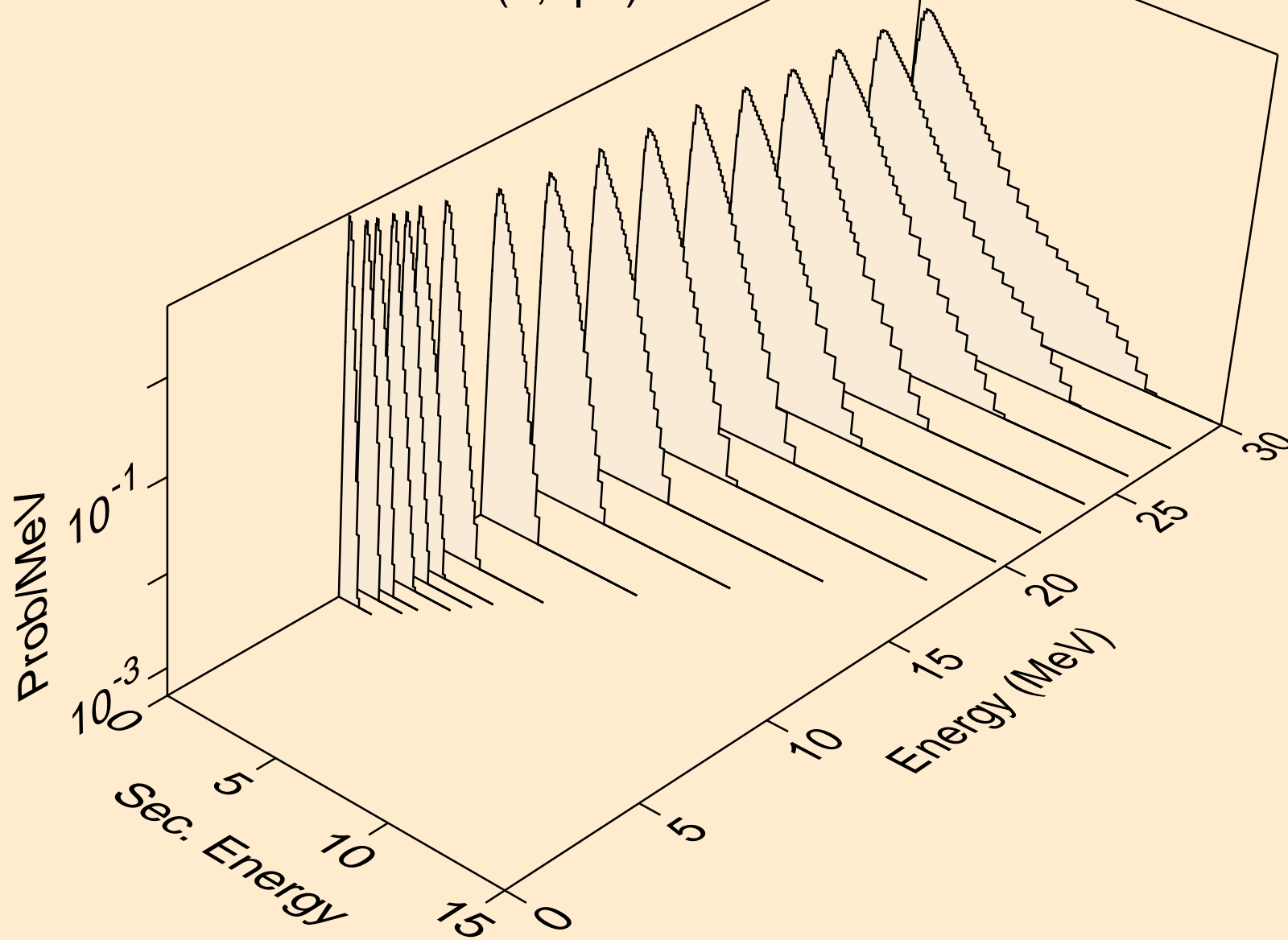

PR127 NEUTRON ACER TENDL-2021 LIBRARY; T=293.6K  
Neutron emission for (n,n\*c)

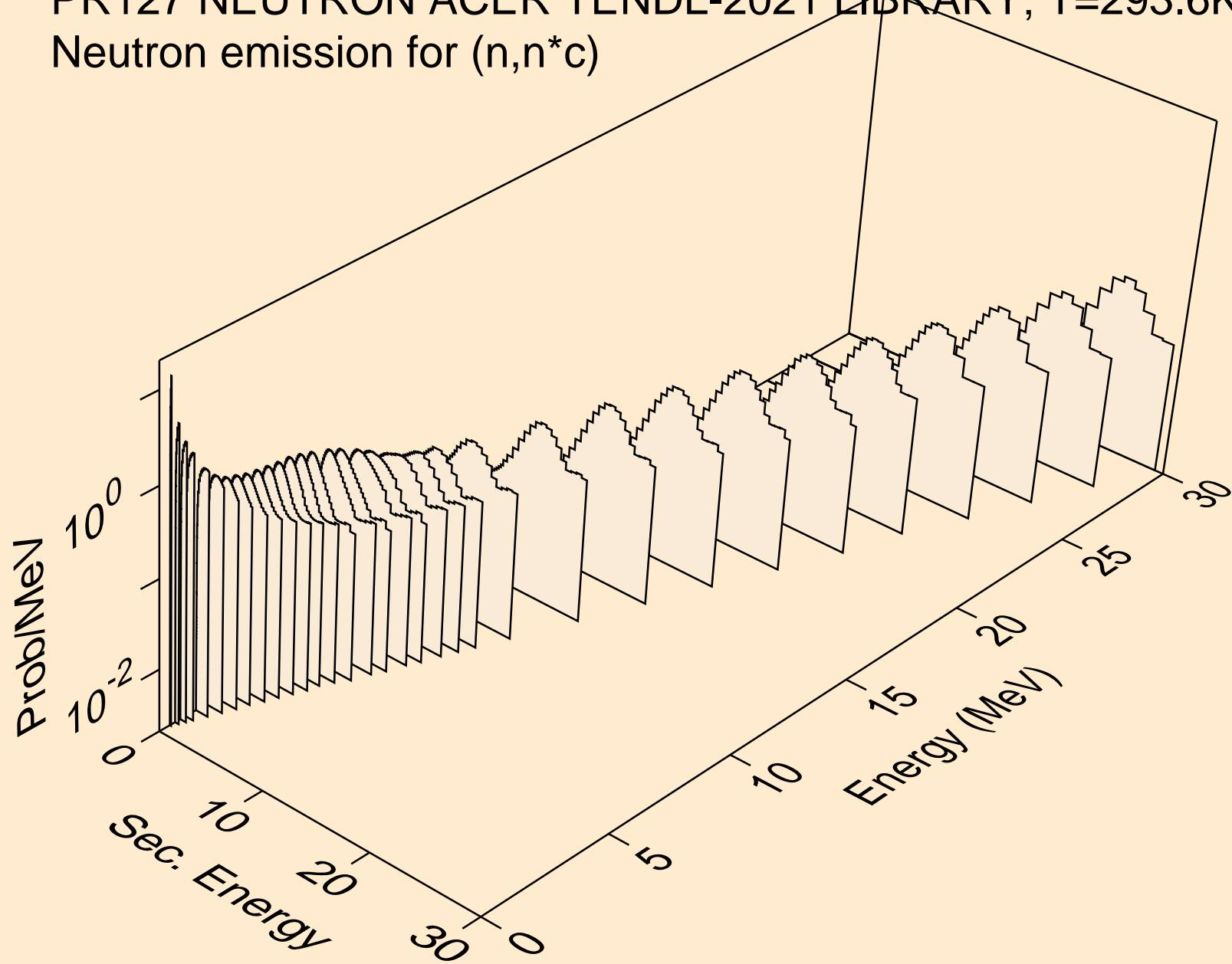

PR127 NEUTRON ACER TENDL-2021 LIBRARY; T=293.6K  
Photon emission for (n,x)

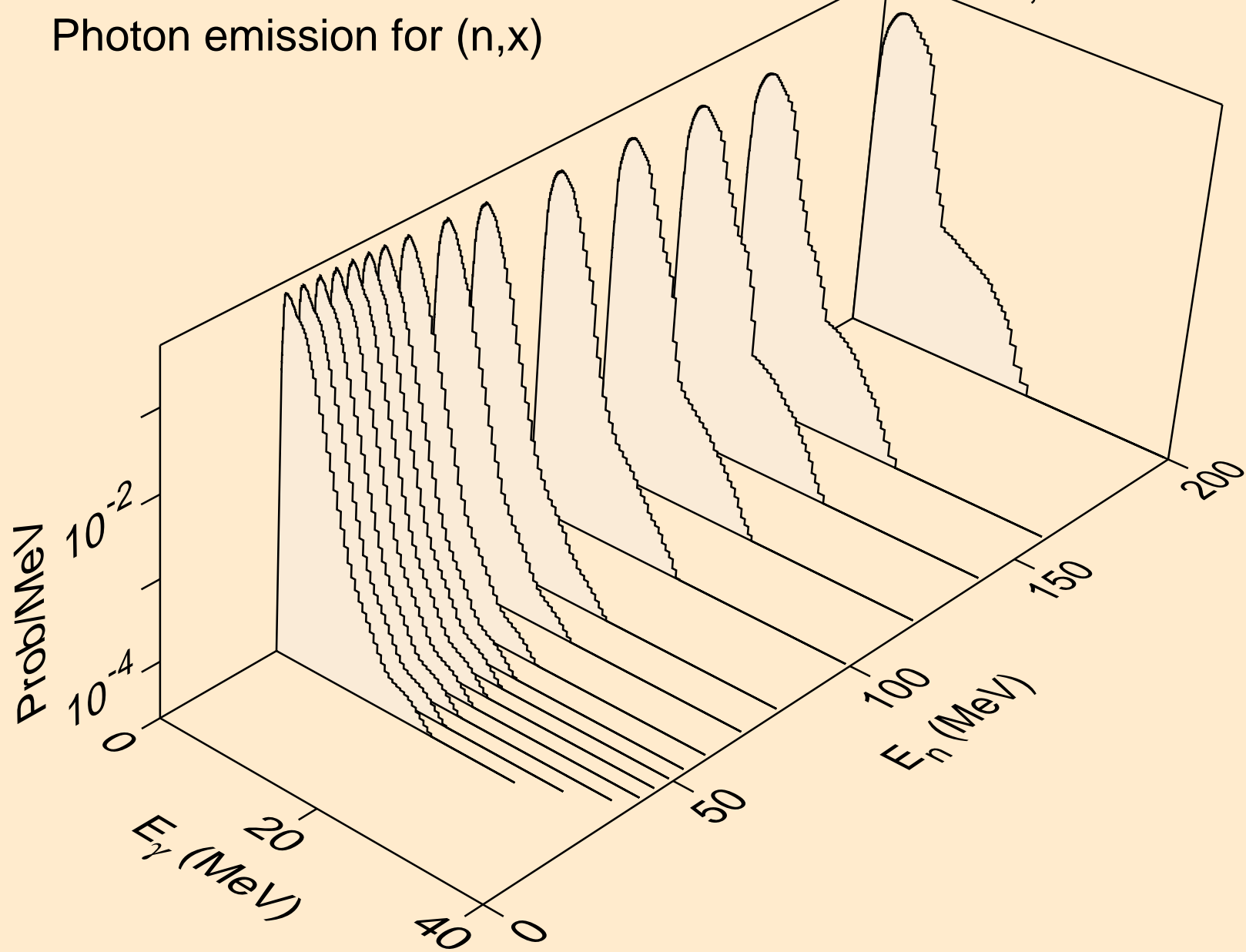

PR127 NEUTRON ACER TENDL-2021 LIBRARY; T=293.6K  
Photon emission for (n,2nd)

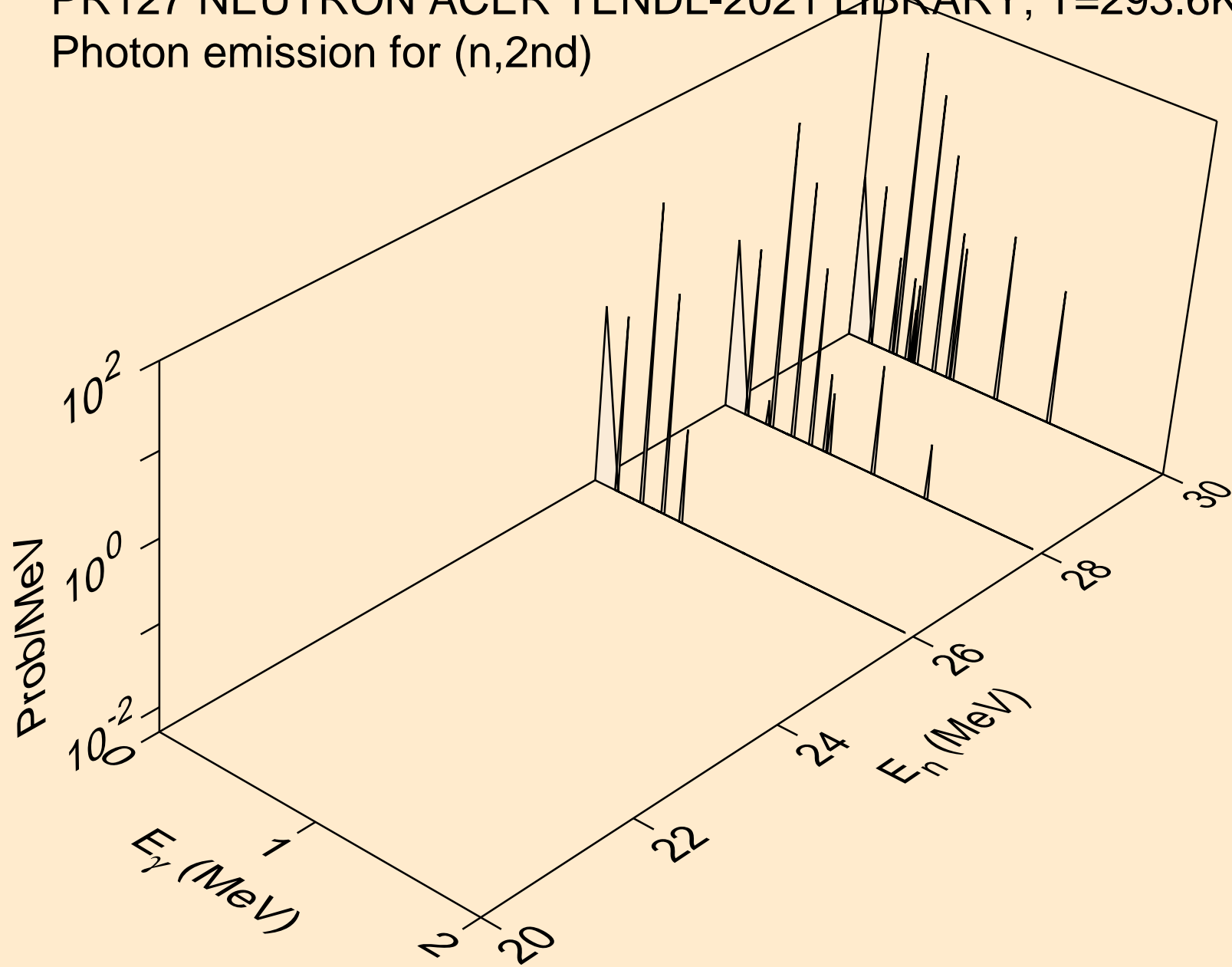

PR127 NEUTRON ACER TENDL-2021 LIBRARY; T=293.6K  
Photon emission for (n,2n)

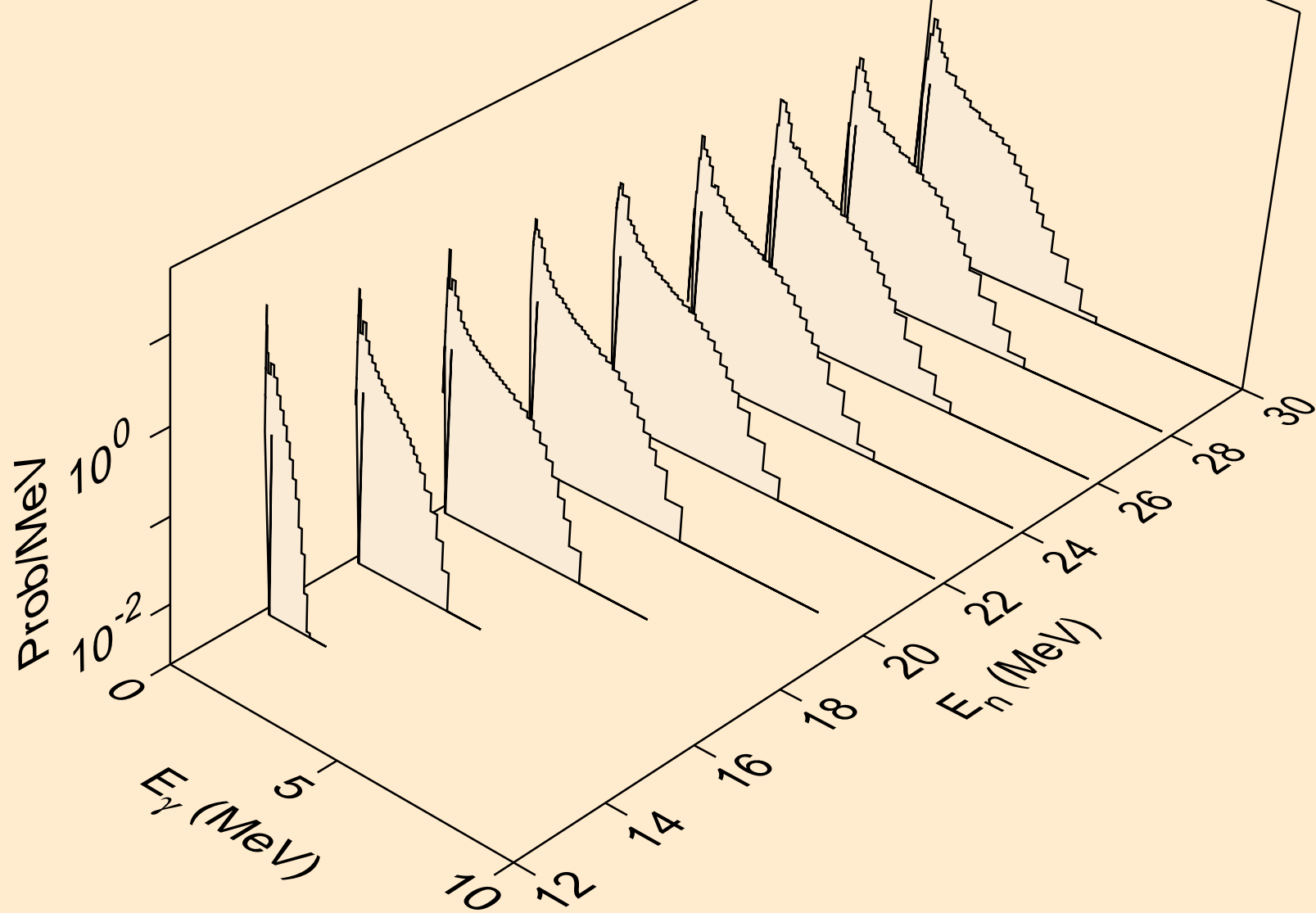

PR127 NEUTRON ACER TENDL-2021 LIBRARY; T=293.6K  
Photon emission for (n,3n)

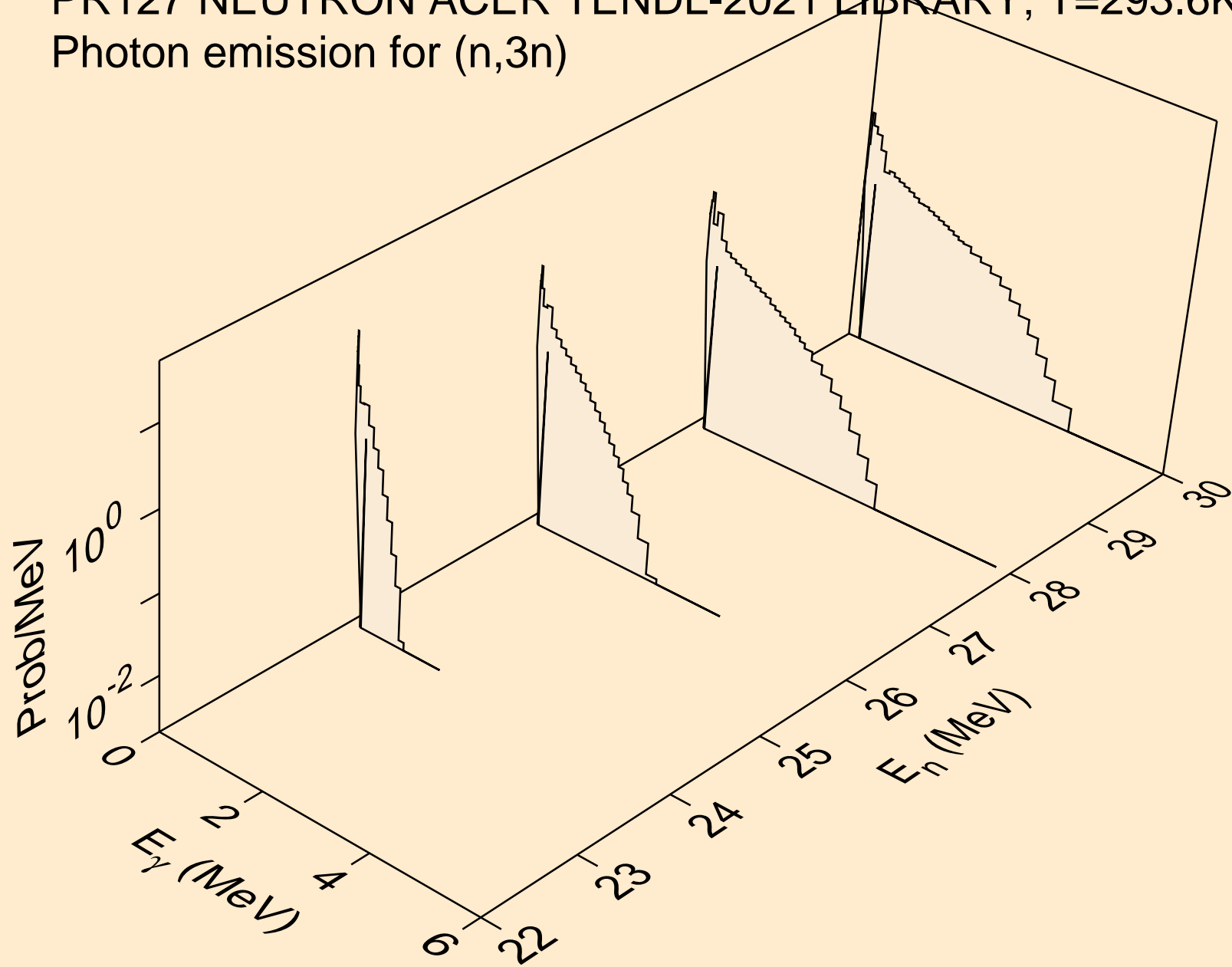

PR127 NEUTRON ACER TENDL-2021 LIBRARY; T=293.6K  
Photon emission for (n,n\*)a

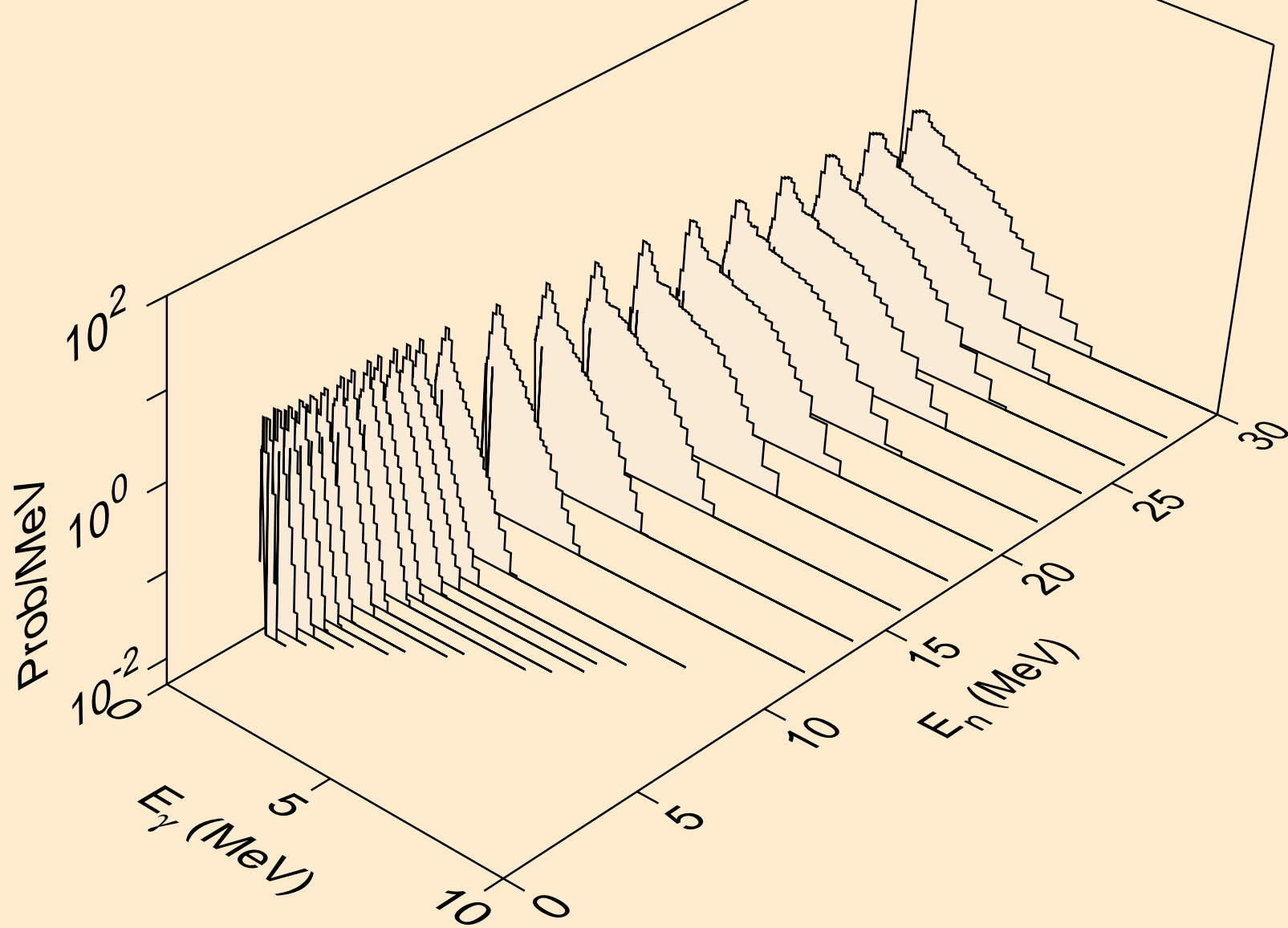

PR127 NEUTRON ACER TENDL-2021 LIBRARY; T=293.6K  
Photon emission for (n,2n)a

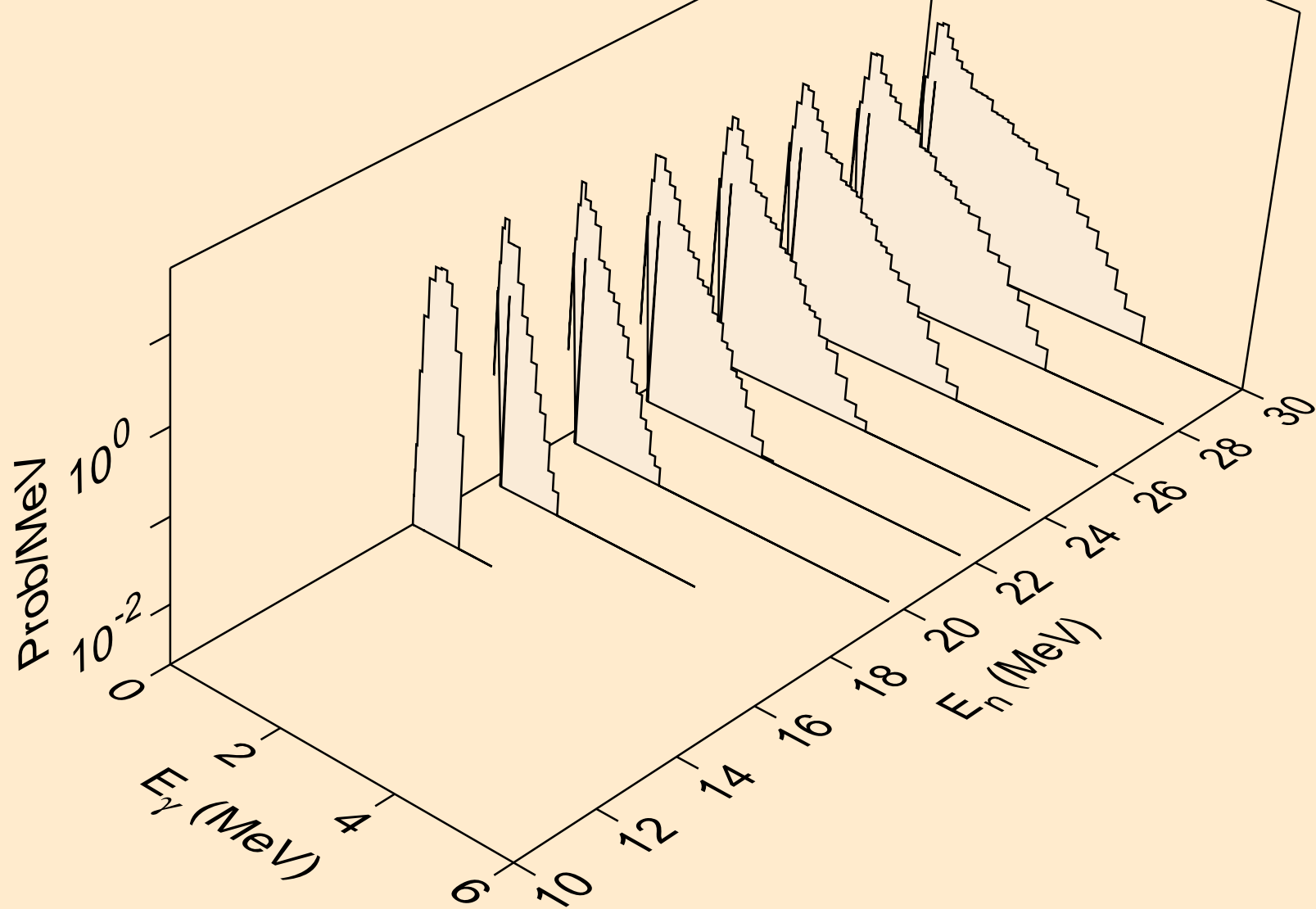

PR127 NEUTRON ACER TENDL-2021 LIBRARY; T=293.6K  
Photon emission for (n,n\*)p

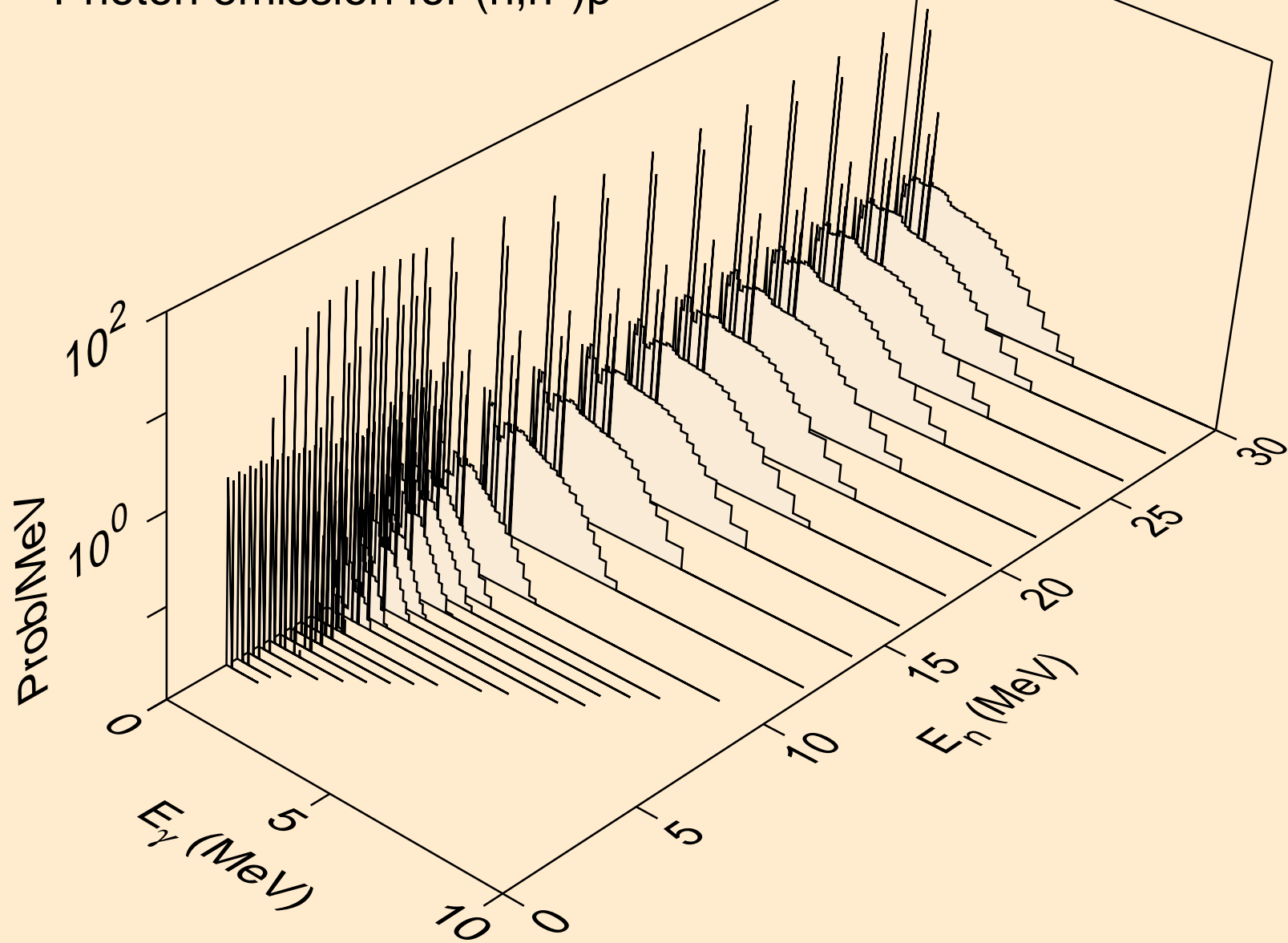

PR127 NEUTRON ACER TENDL-2021 LIBRARY; T=293.6K  
Photon emission for (n,n\*)2a

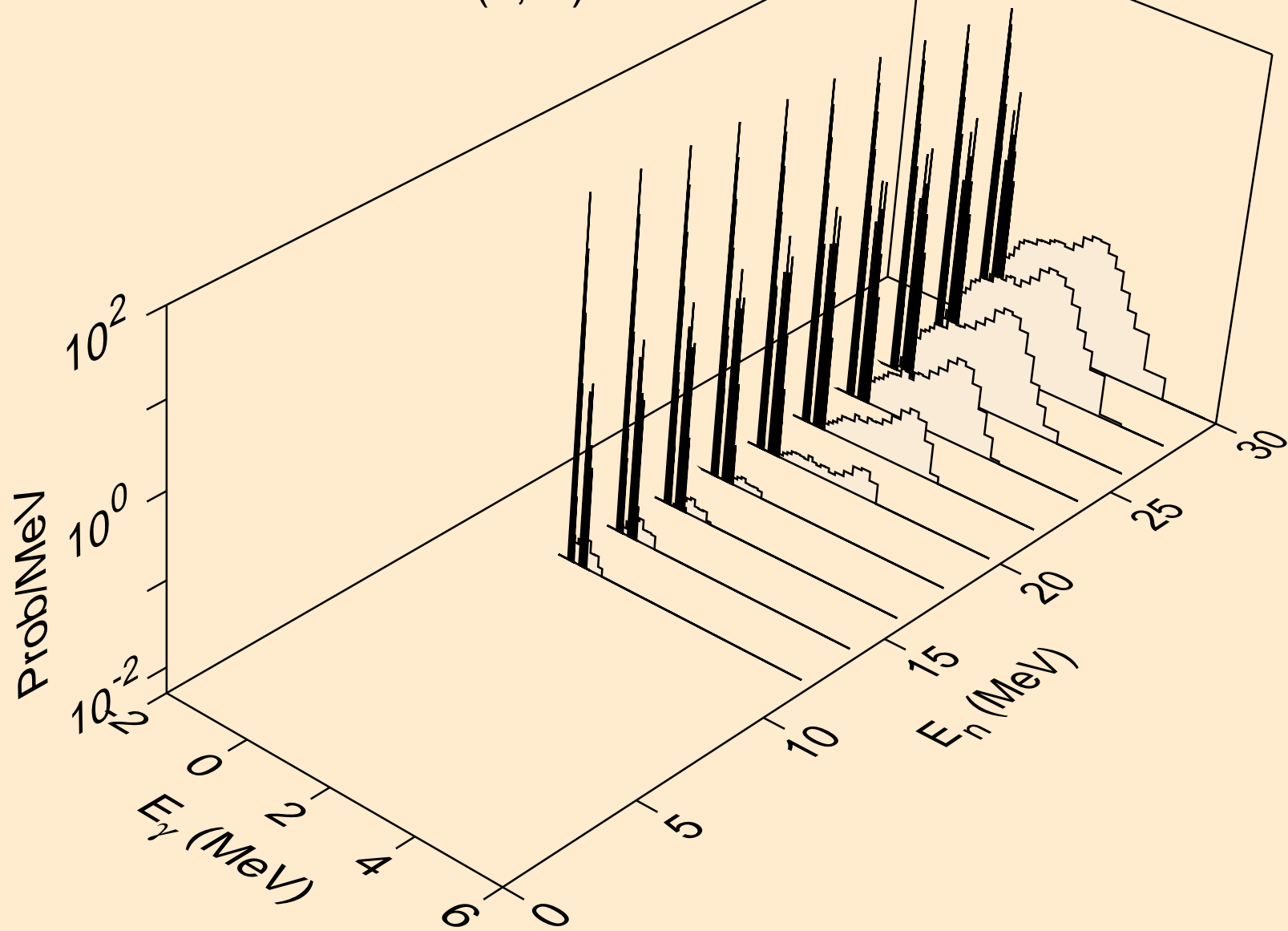

PR127 NEUTRON ACER TENDL-2021 LIBRARY; T=293.6K  
Photon emission for (n,n\*)d

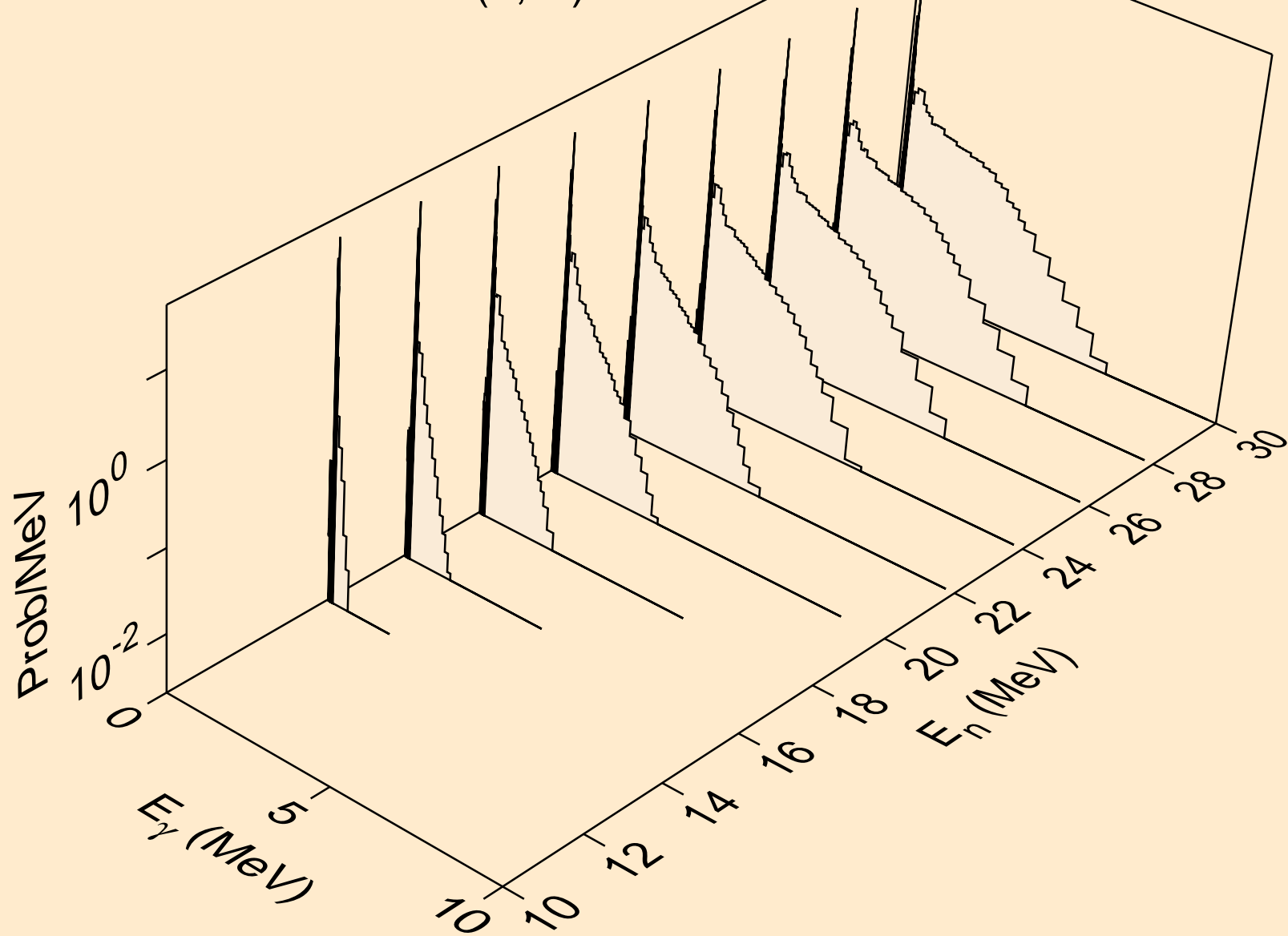

PR127 NEUTRON ACER TENDL-2021 LIBRARY; T=293.6K  
Photon emission for (n,n\*)t

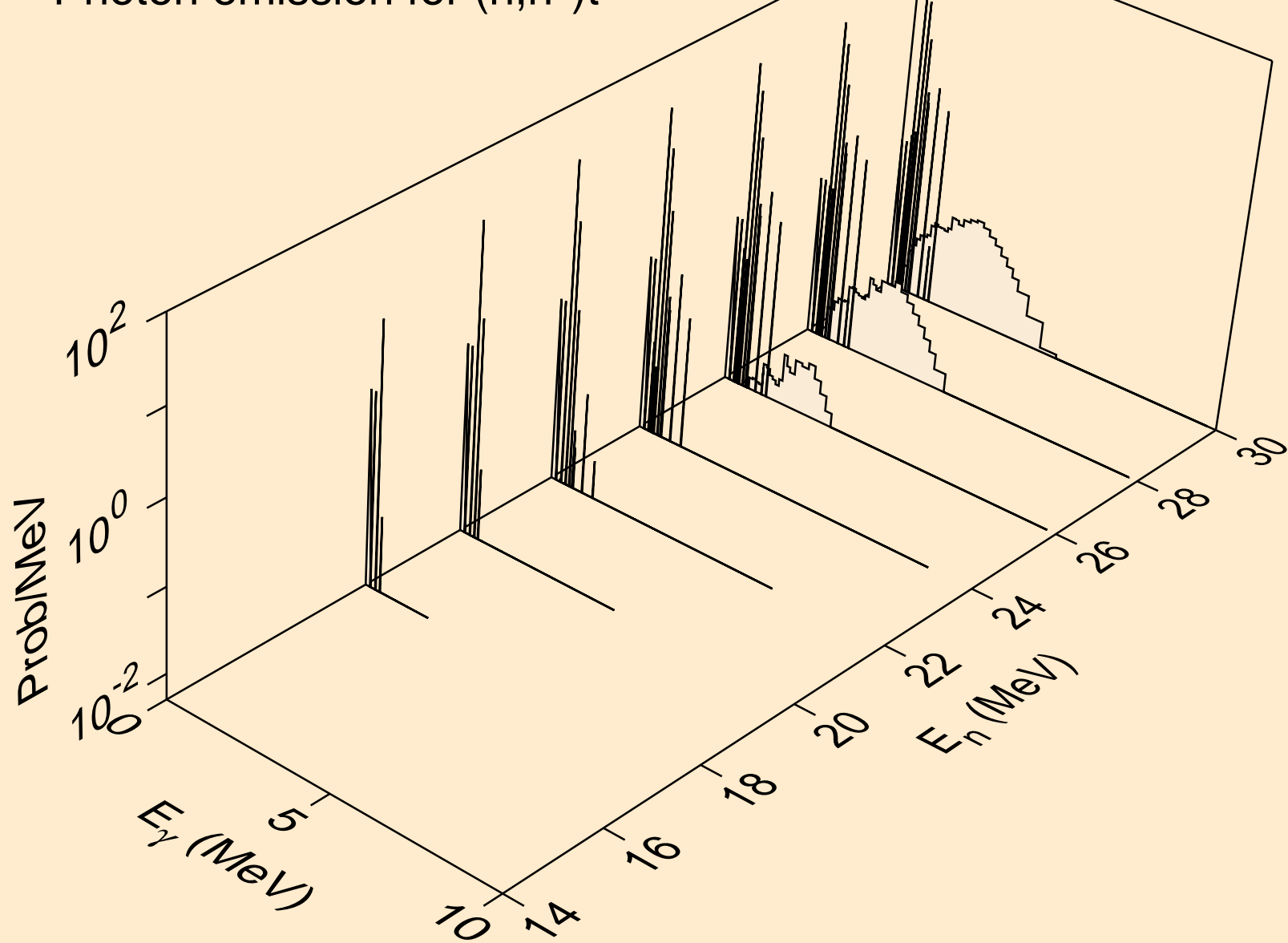

PR127 NEUTRON ACER TENDL-2021 LIBRARY; T=293.6K  
Photon emission for (n,n\*)he3

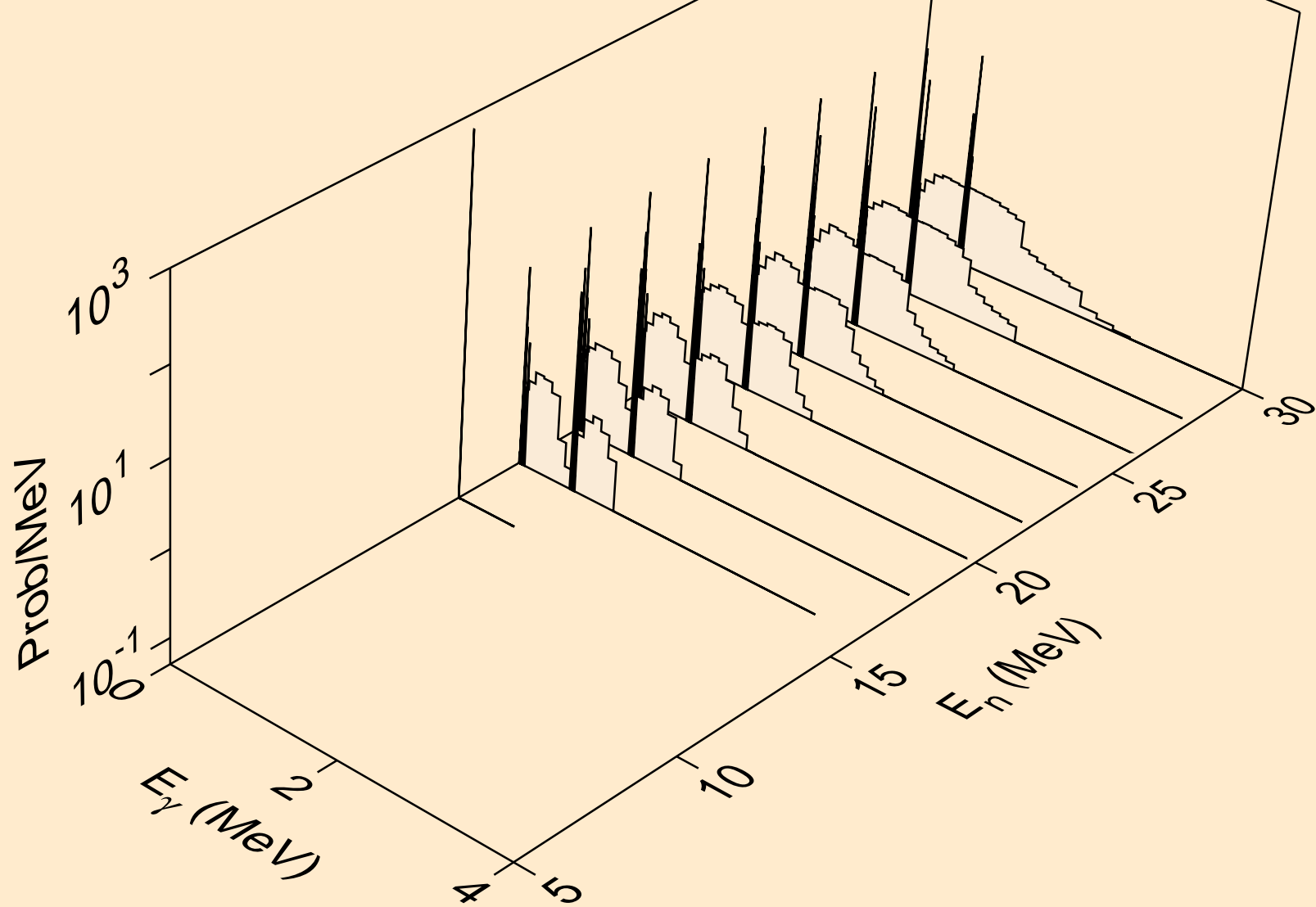

PR127 NEUTRON ACER TENDL-2021 LIBRARY; T=293.6K  
Photon emission for (n,2np)

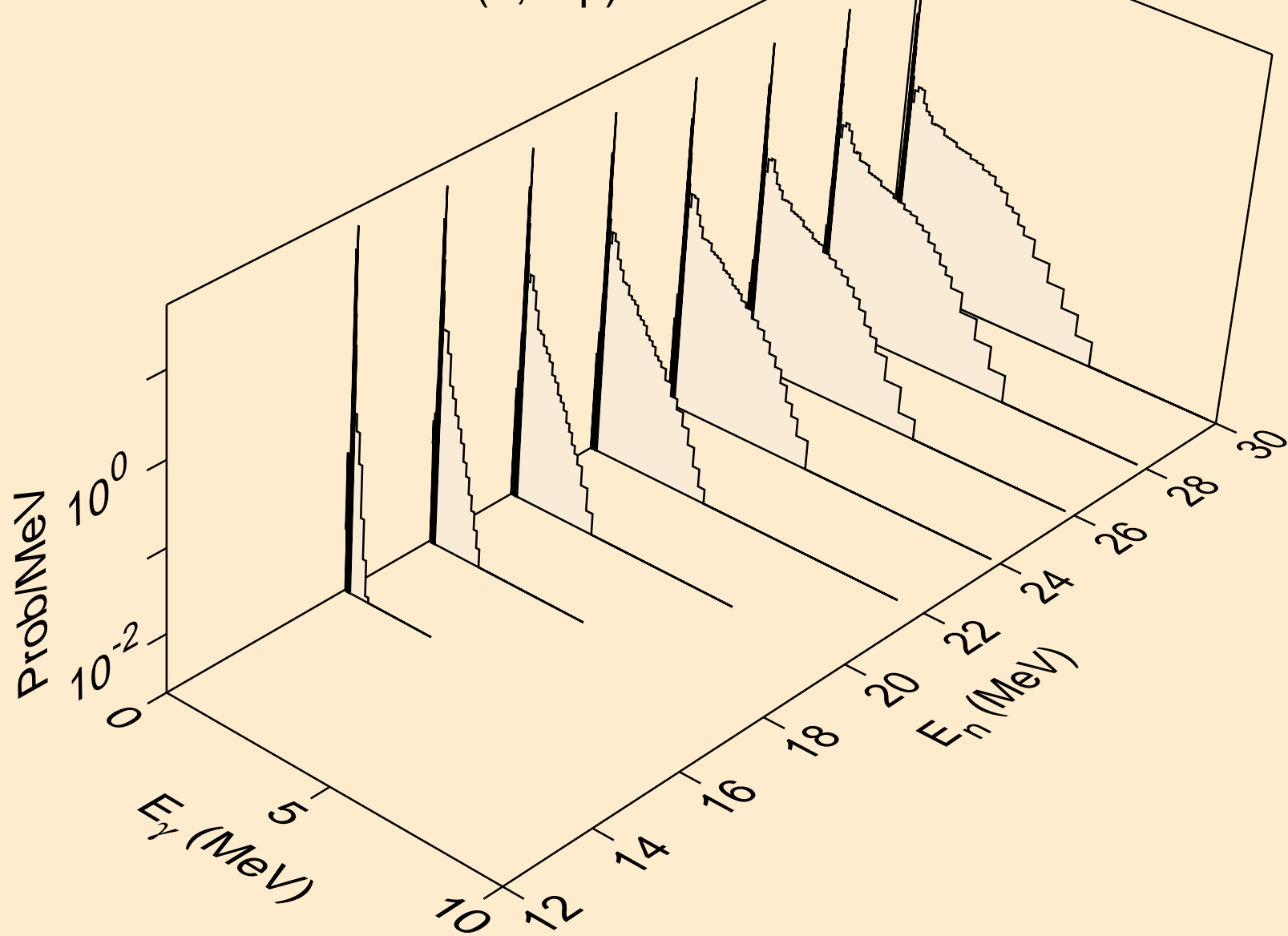

PR127 NEUTRON ACER TENDL-2021 LIBRARY; T=293.6K  
Photon emission for (n,3np)

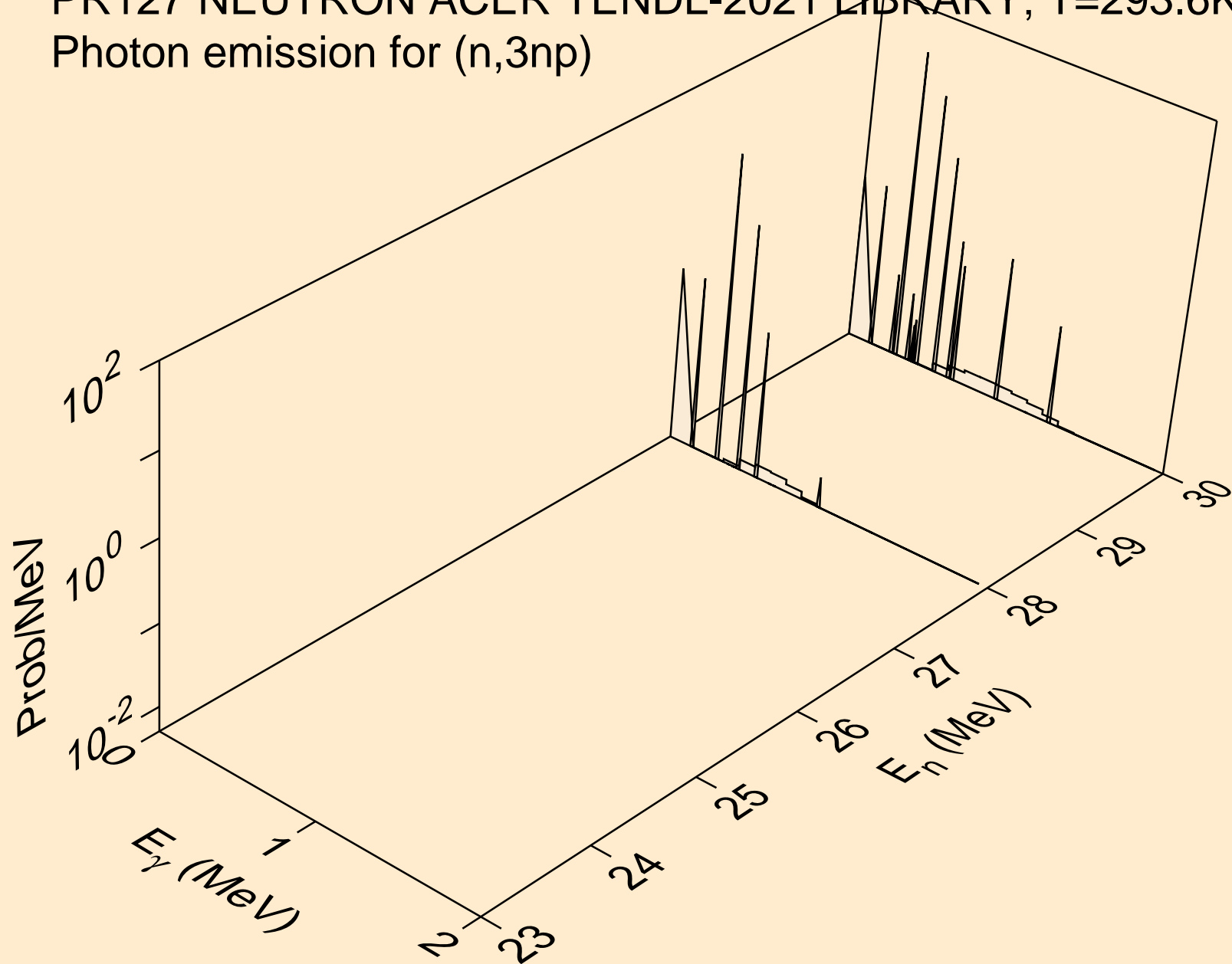

PR127 NEUTRON ACER TENDL-2021 LIBRARY; T=293.6K  
Photon emission for (n,2np)

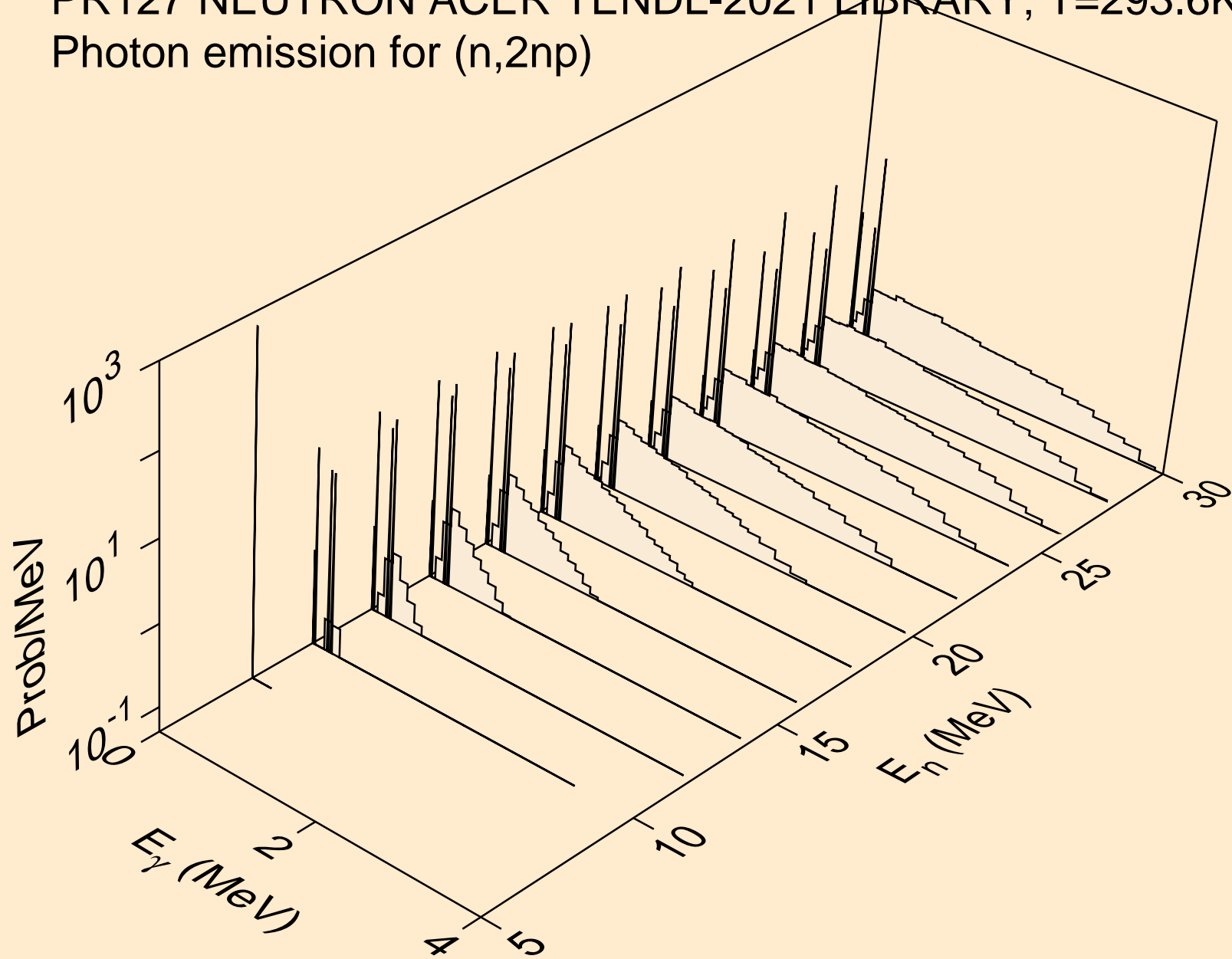

PR127 NEUTRON ACER TENDL-2021 LIBRARY; T=293.6K  
Photon emission for (n,npa)

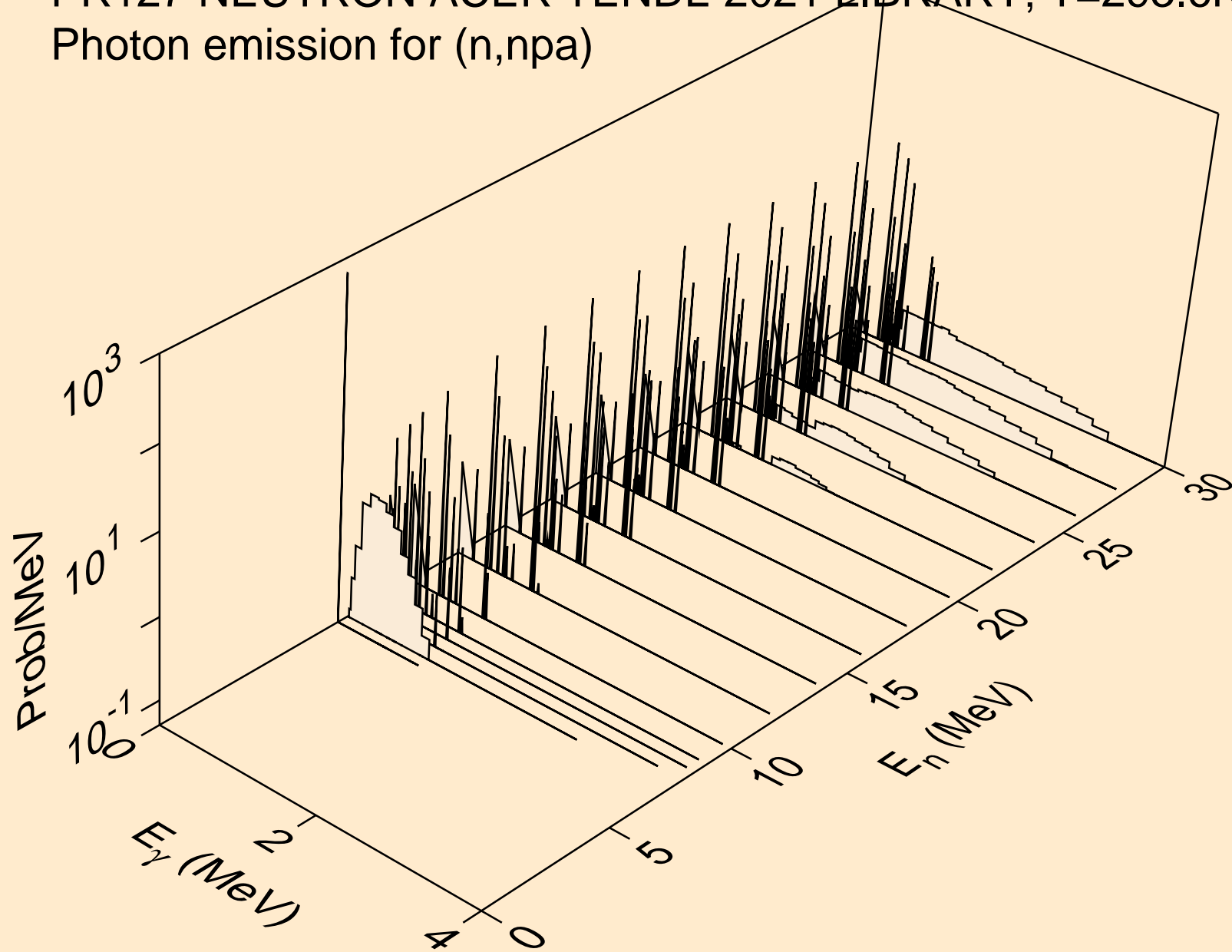

PR127 NEUTRON ACER TENDL-2021 LIBRARY; T=293.6K  
Photon emission for (n,n\*c)

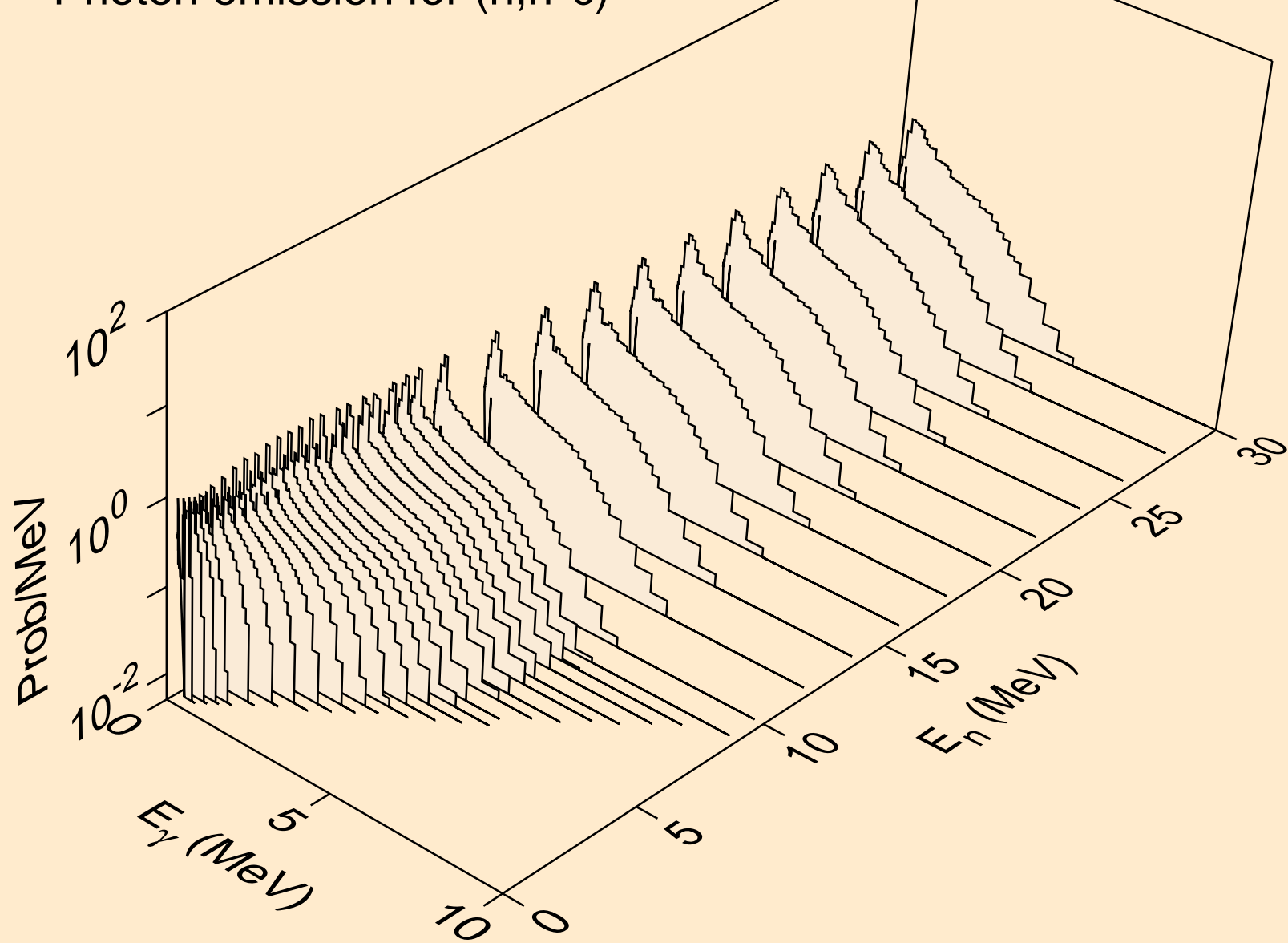

PR127 NEUTRON ACER TENDL-2021 LIBRARY; T=293.6K  
Photon emission for (n,gma)

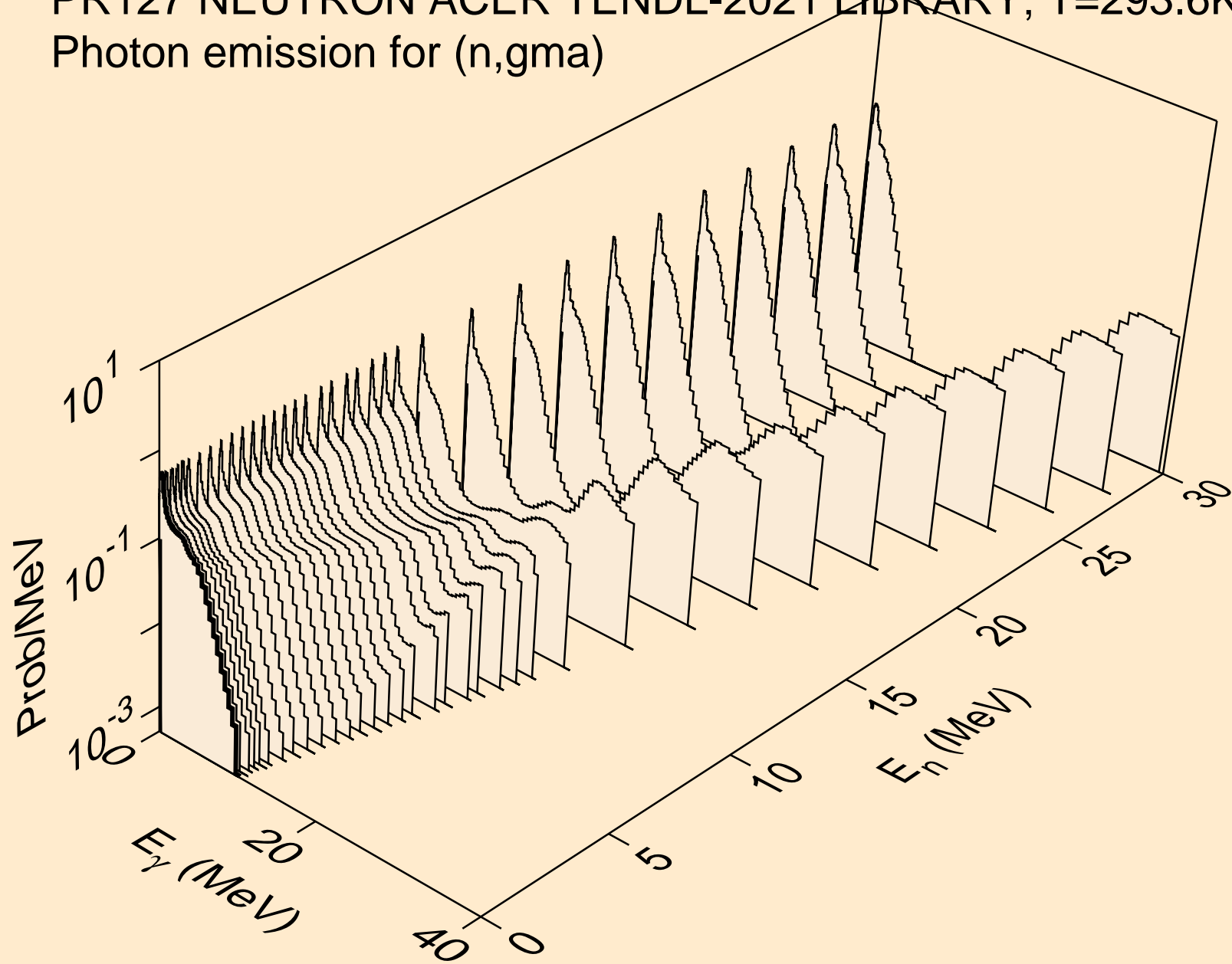

PR127 NEUTRON ACER TENDL-2021 LIBRARY; T=293.6K  
Photon emission for (n,p)

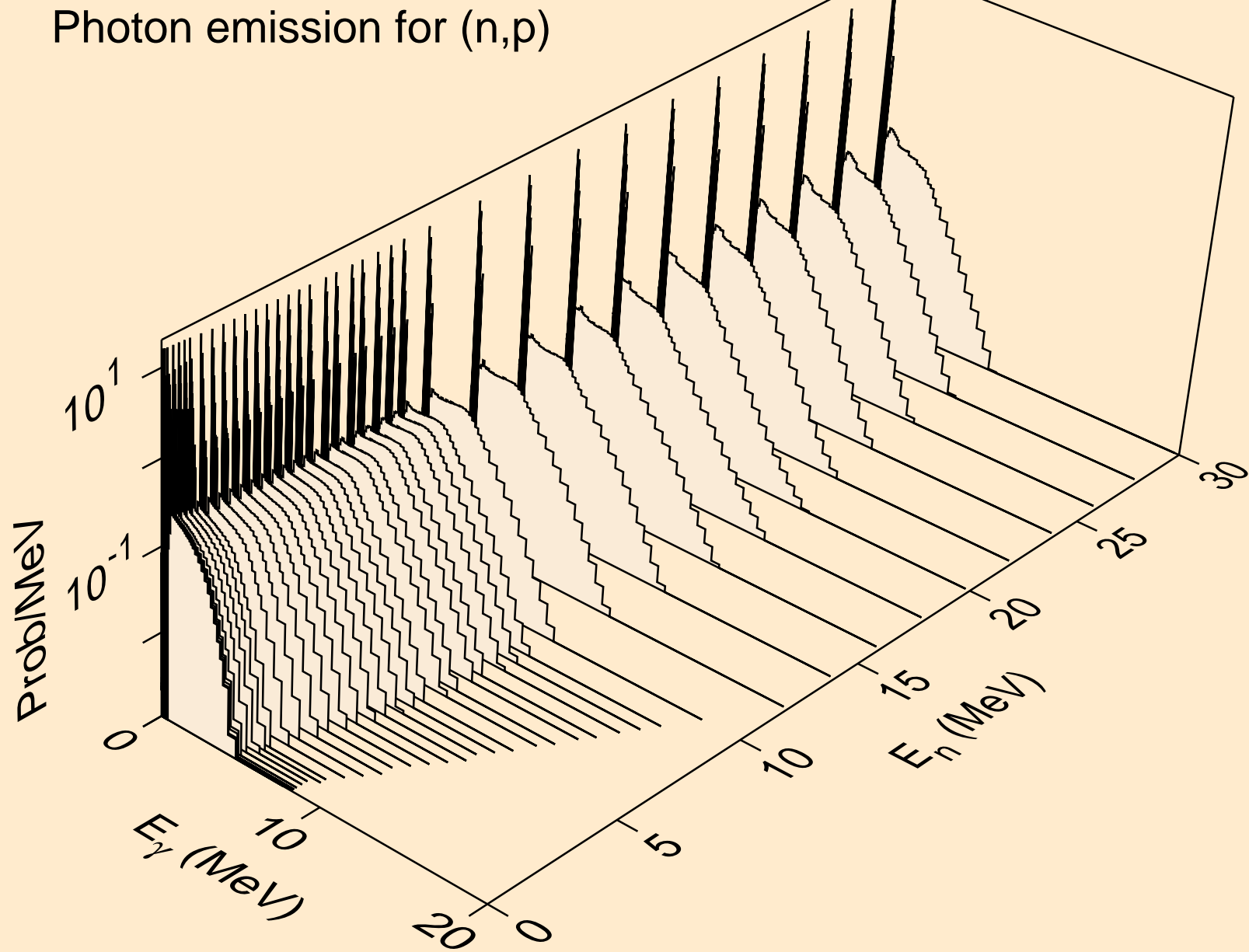

PR127 NEUTRON ACER TENDL-2021 LIBRARY; T=293.6K  
Photon emission for (n,d)

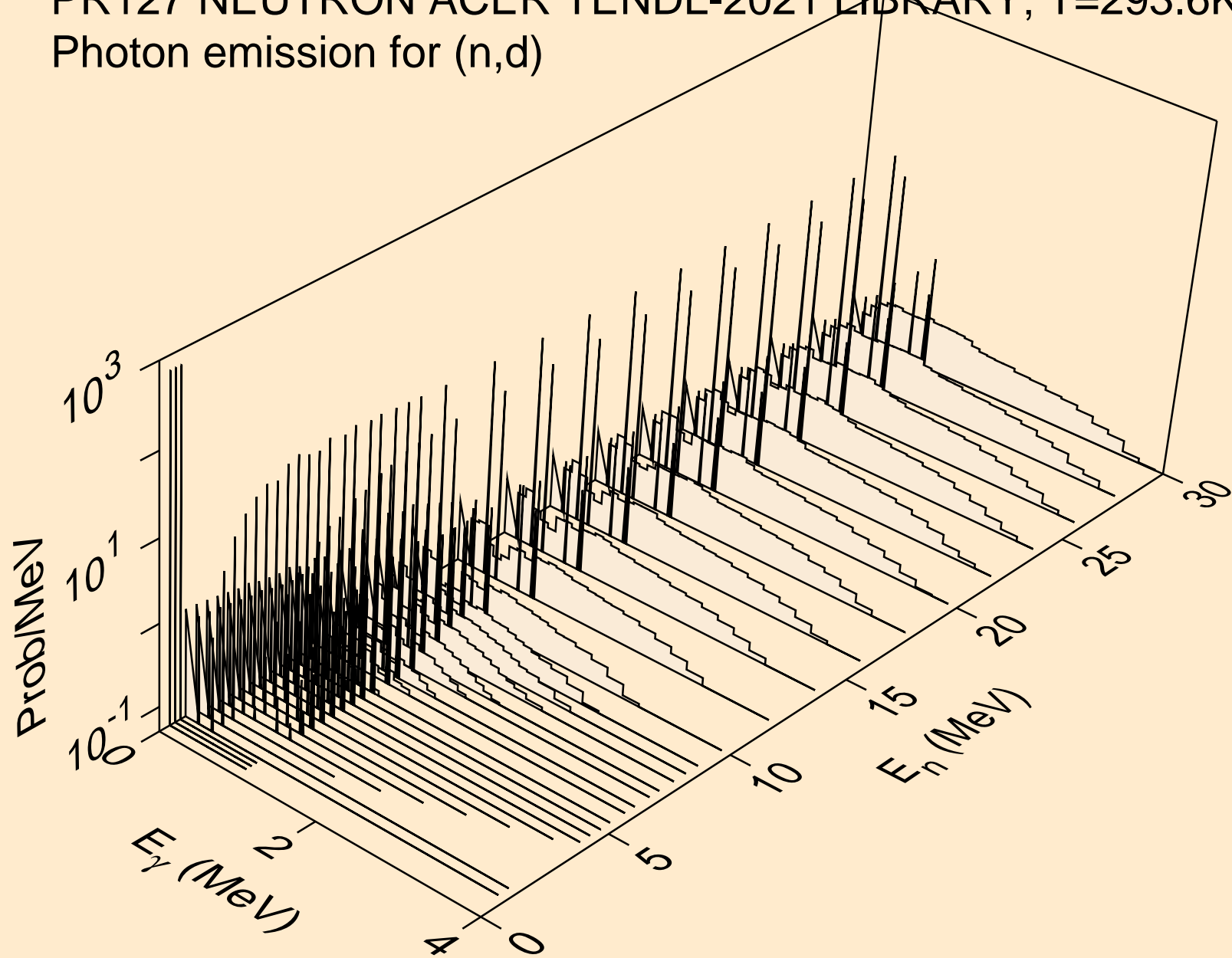

PR127 NEUTRON ACER TENDL-2021 LIBRARY; T=293.6K  
Photon emission for (n,t)

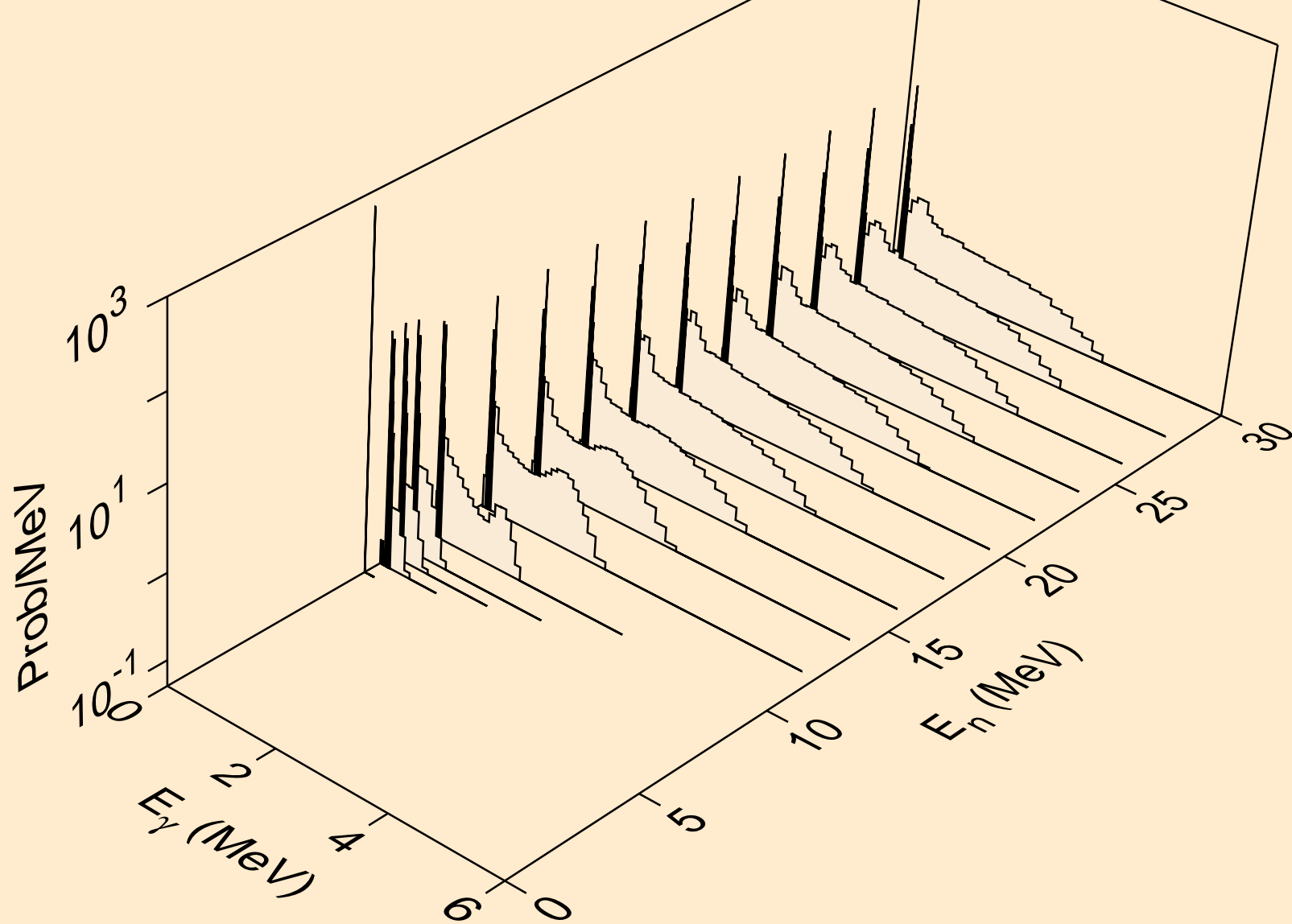

PR127 NEUTRON ACER TENDL-2021 LIBRARY; T=293.6K  
Photon emission for (n,he3)

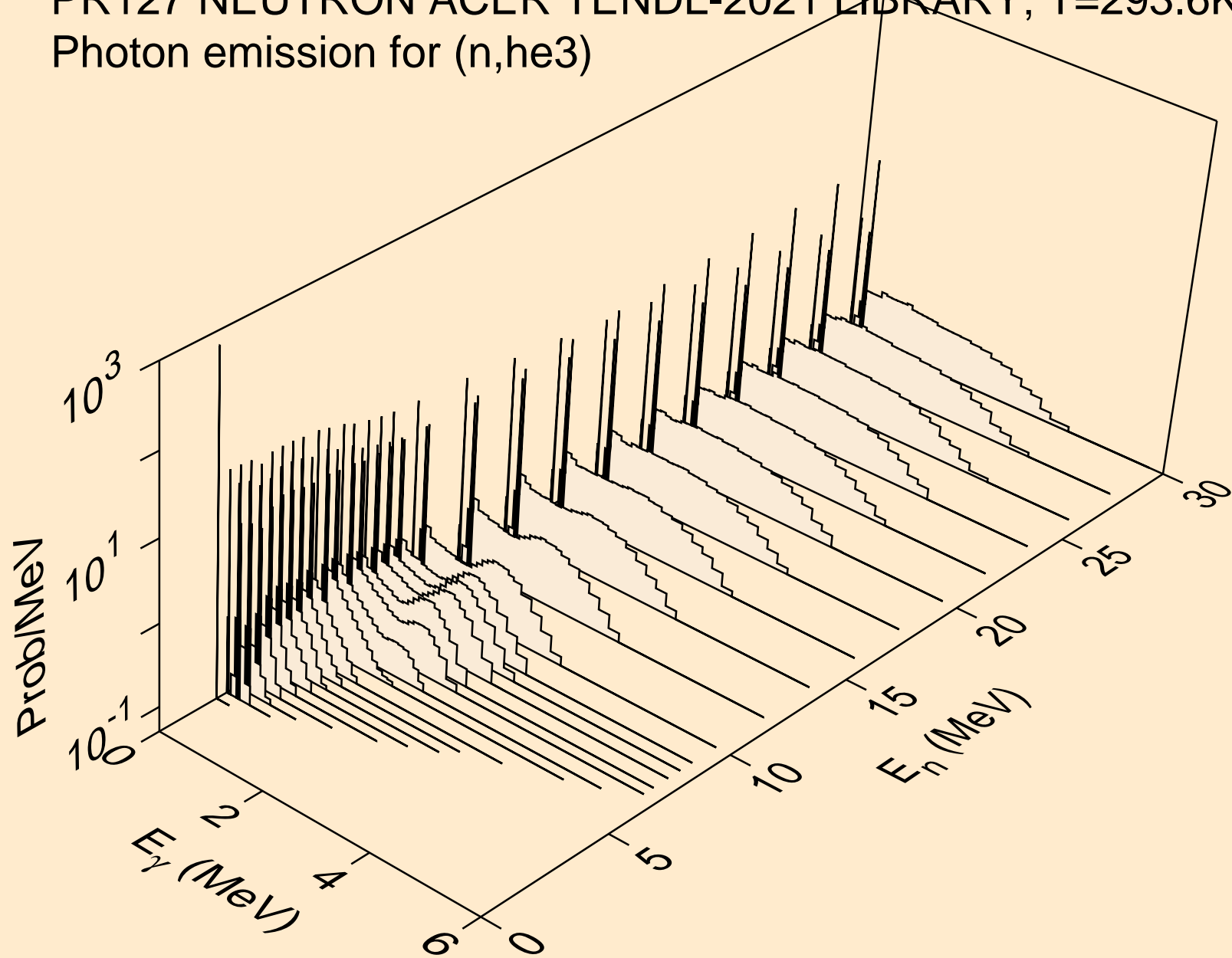

PR127 NEUTRON ACER TENDL-2021 LIBRARY; T=293.6K  
Photon emission for (n,a)

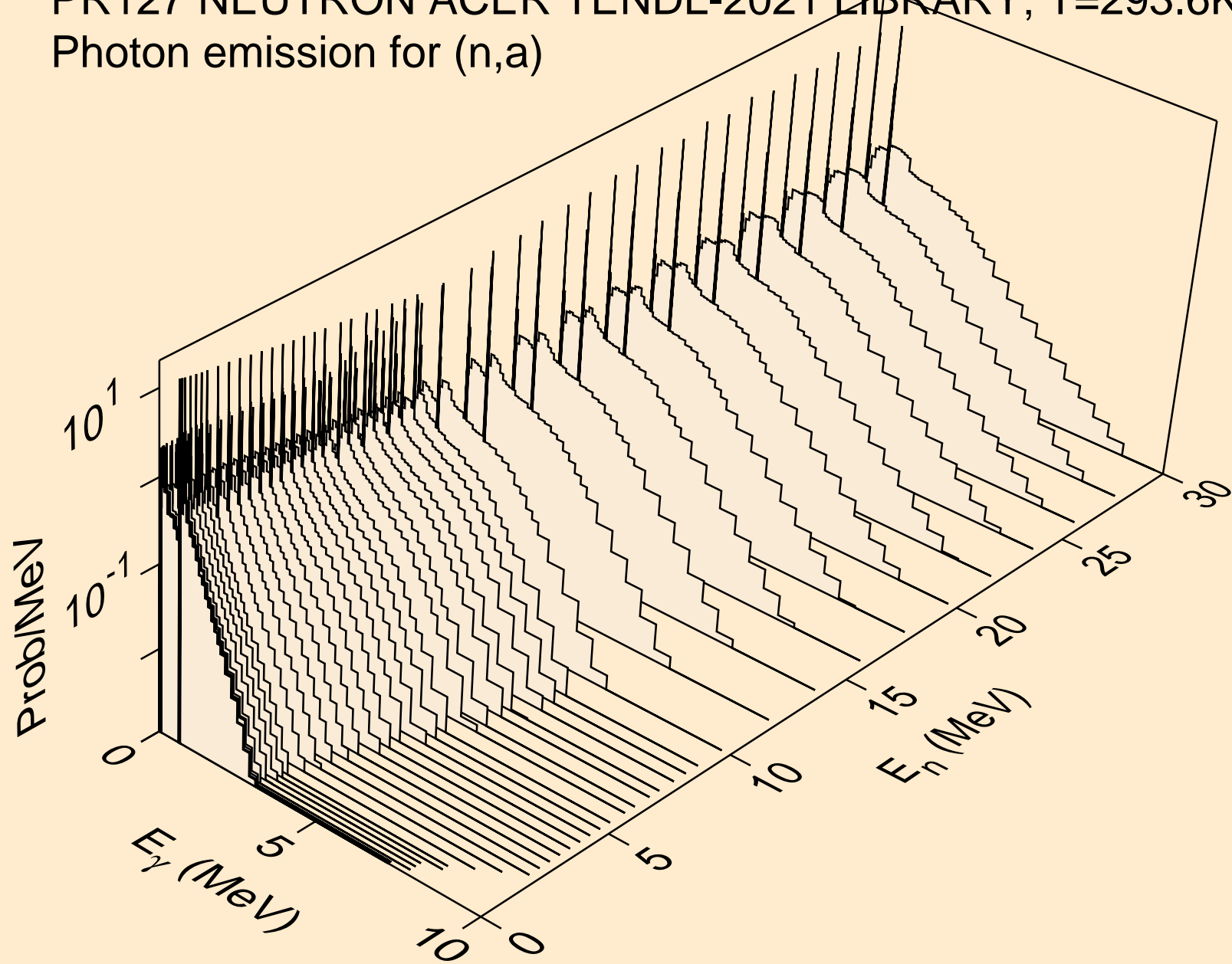

PR127 NEUTRON ACER TENDL-2021 LIBRARY; T=293.6K  
Photon emission for (n,2a)

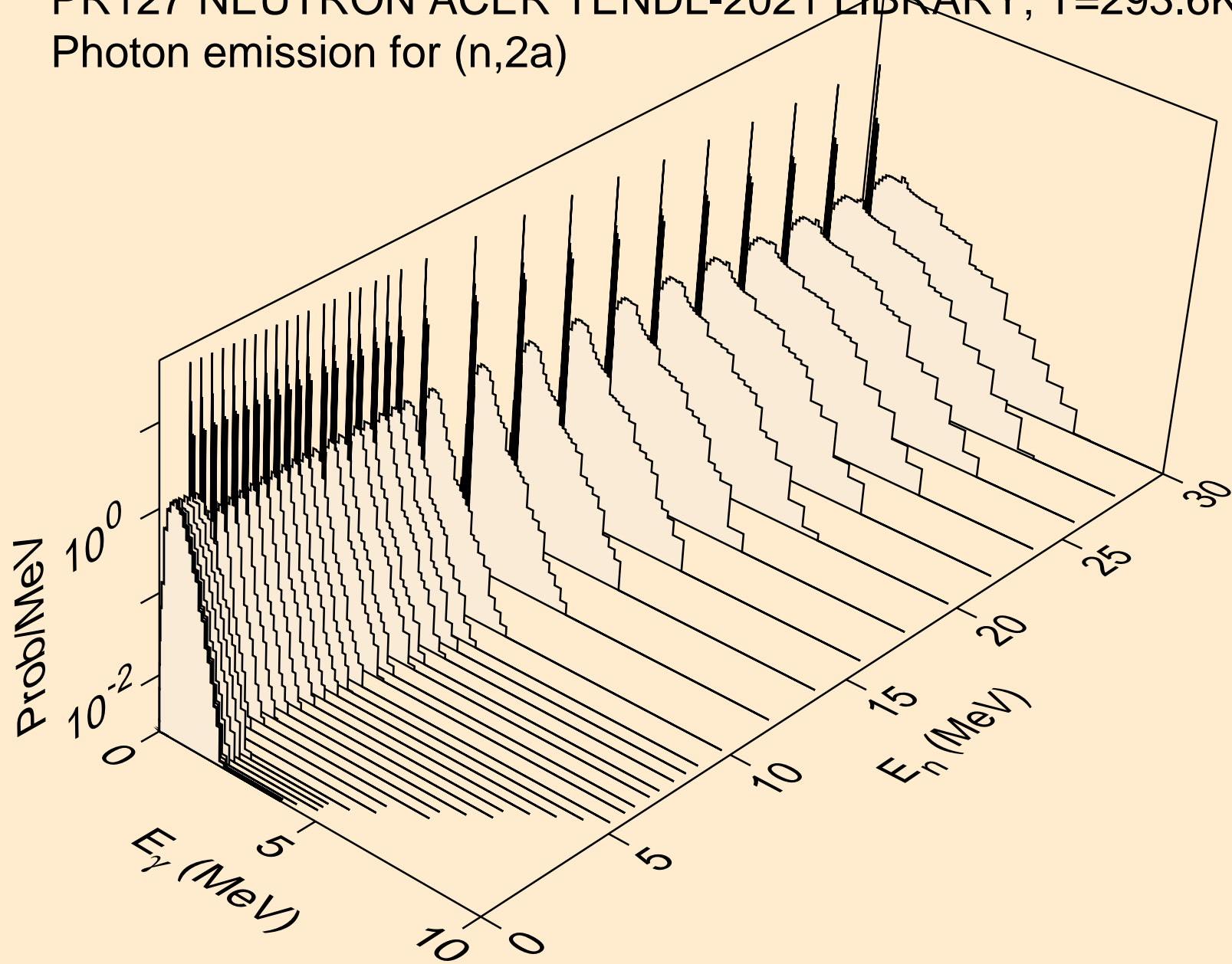

PR127 NEUTRON ACER TENDL-2021 LIBRARY; T=293.6K  
Photon emission for (n,3a)

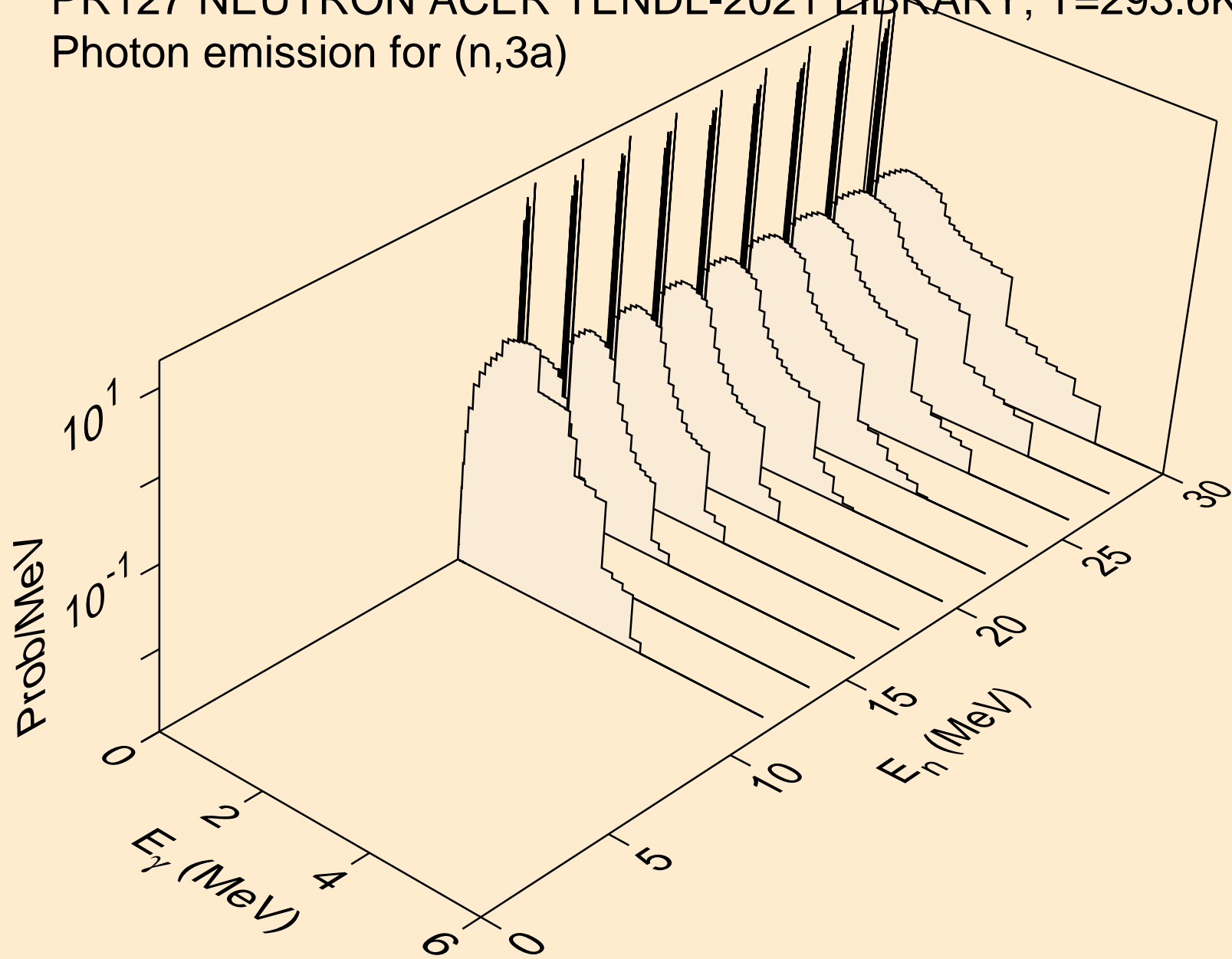

PR127 NEUTRON ACER TENDL-2021 LIBRARY; T=293.6K  
Photon emission for (n,2p)

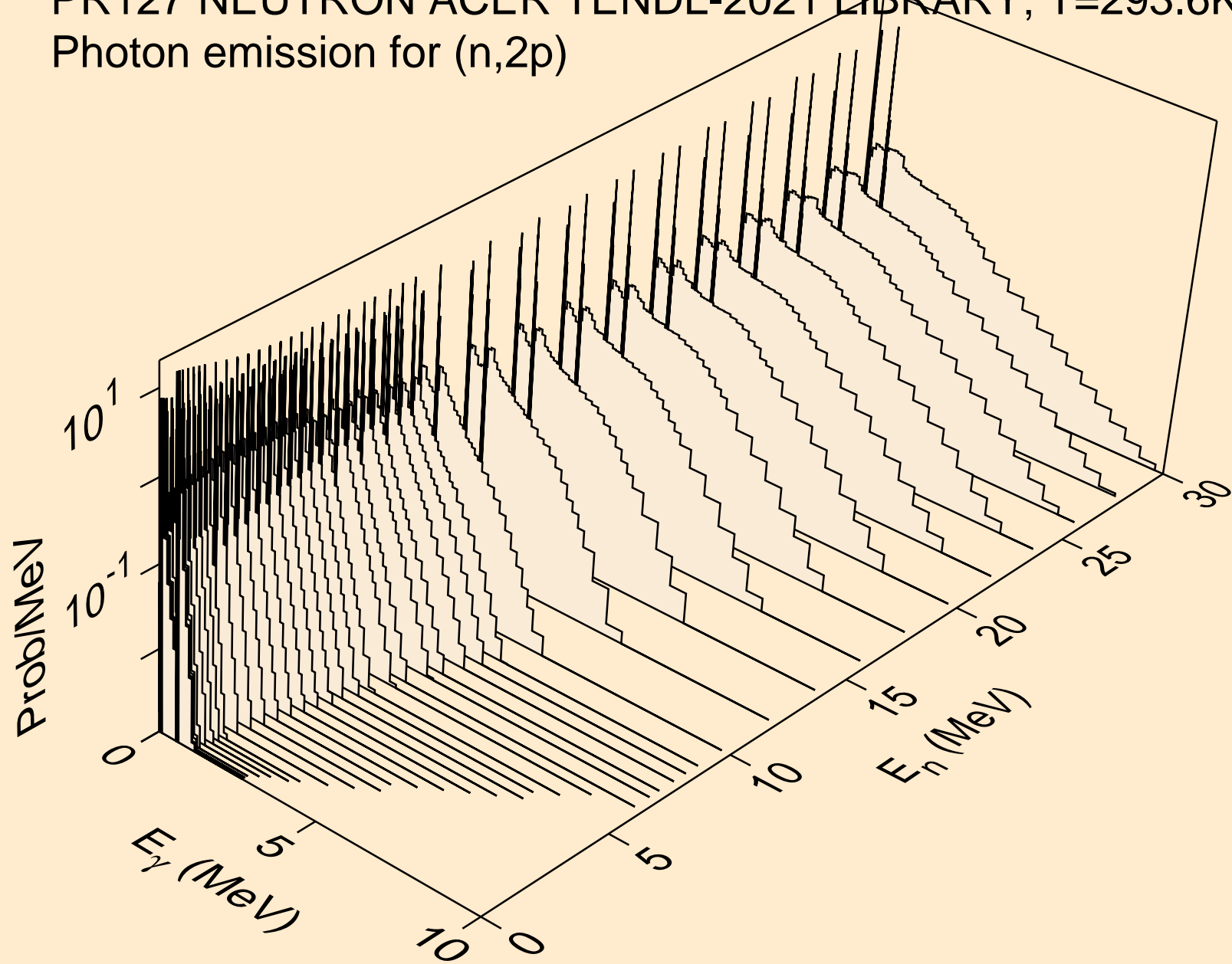

PR127 NEUTRON ACER TENDL-2021 LIBRARY; T=293.6K  
Photon emission for (n,p)

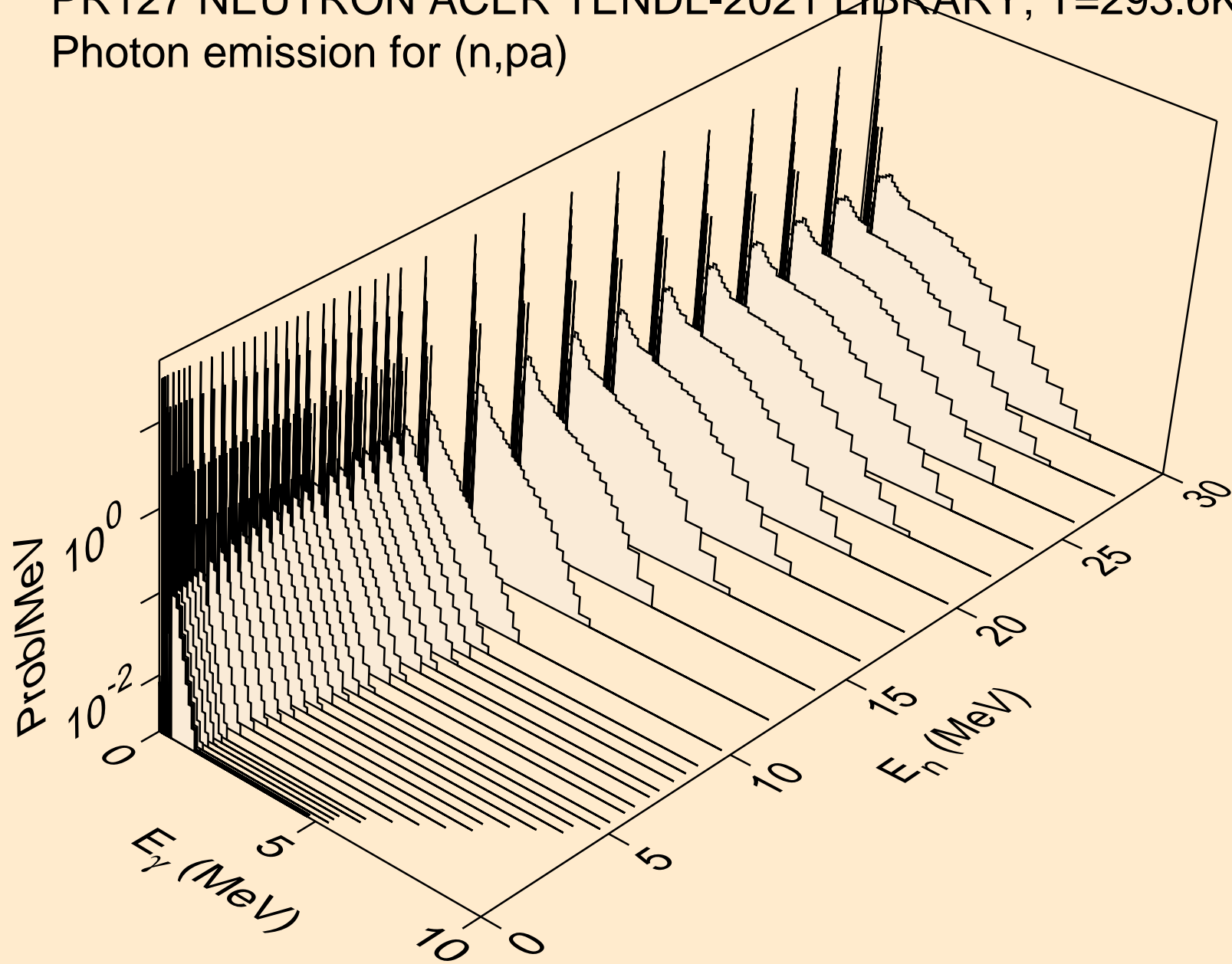

PR127 NEUTRON ACER TENDL-2021 LIBRARY; T=293.6K  
Photon emission for (n,d2a)

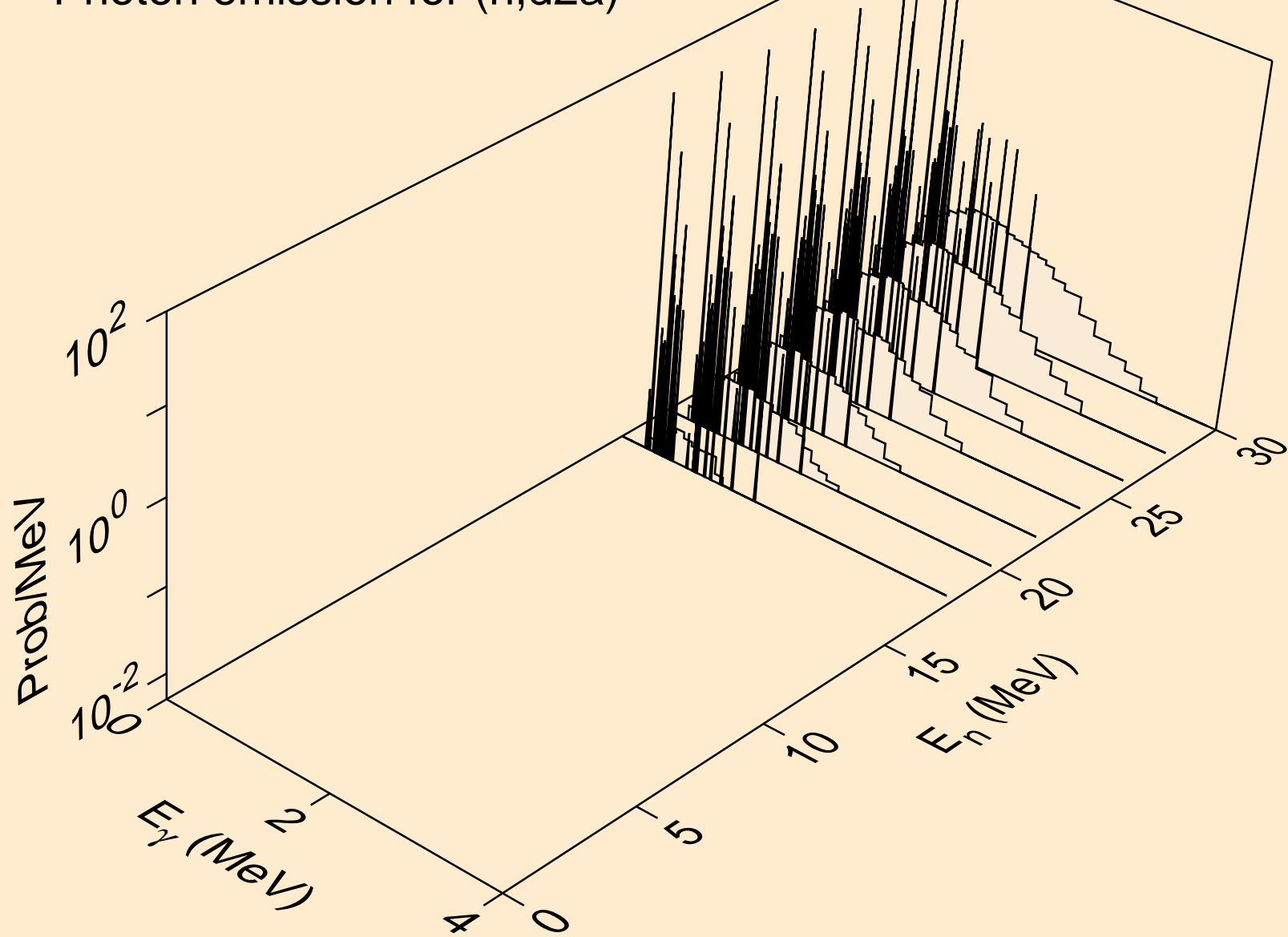

PR127 NEUTRON ACER TENDL-2021 LIBRARY; T=293.6K  
Photon emission for (n,pd)

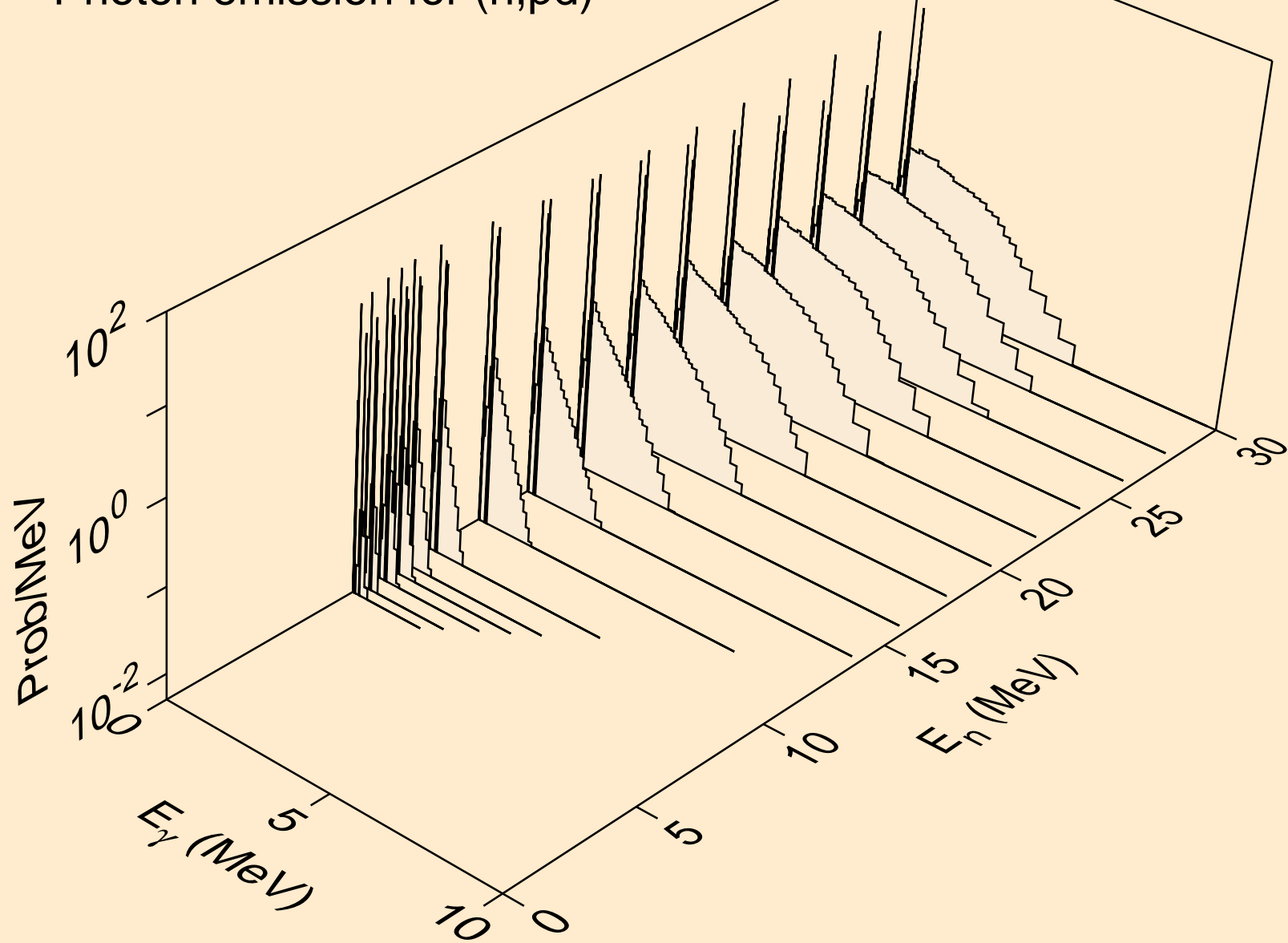

PR127 NEUTRON ACER TENDL-2021 LIBRARY; T=293.6K  
Photon emission for (n,pt)

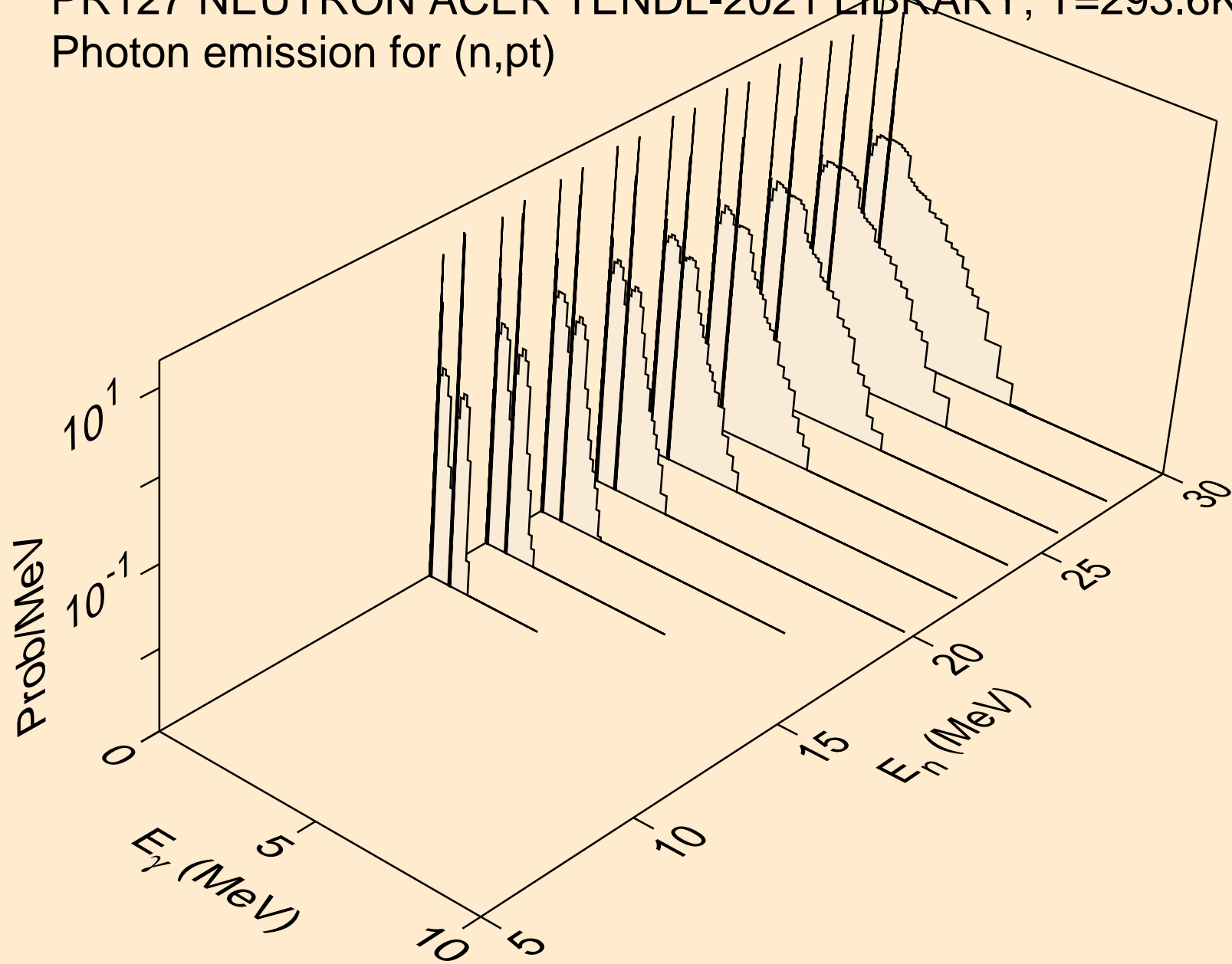

PR127 NEUTRON ACER TENDL-2021 LIBRARY; T=293.6K  
Photon emission for (n,da)

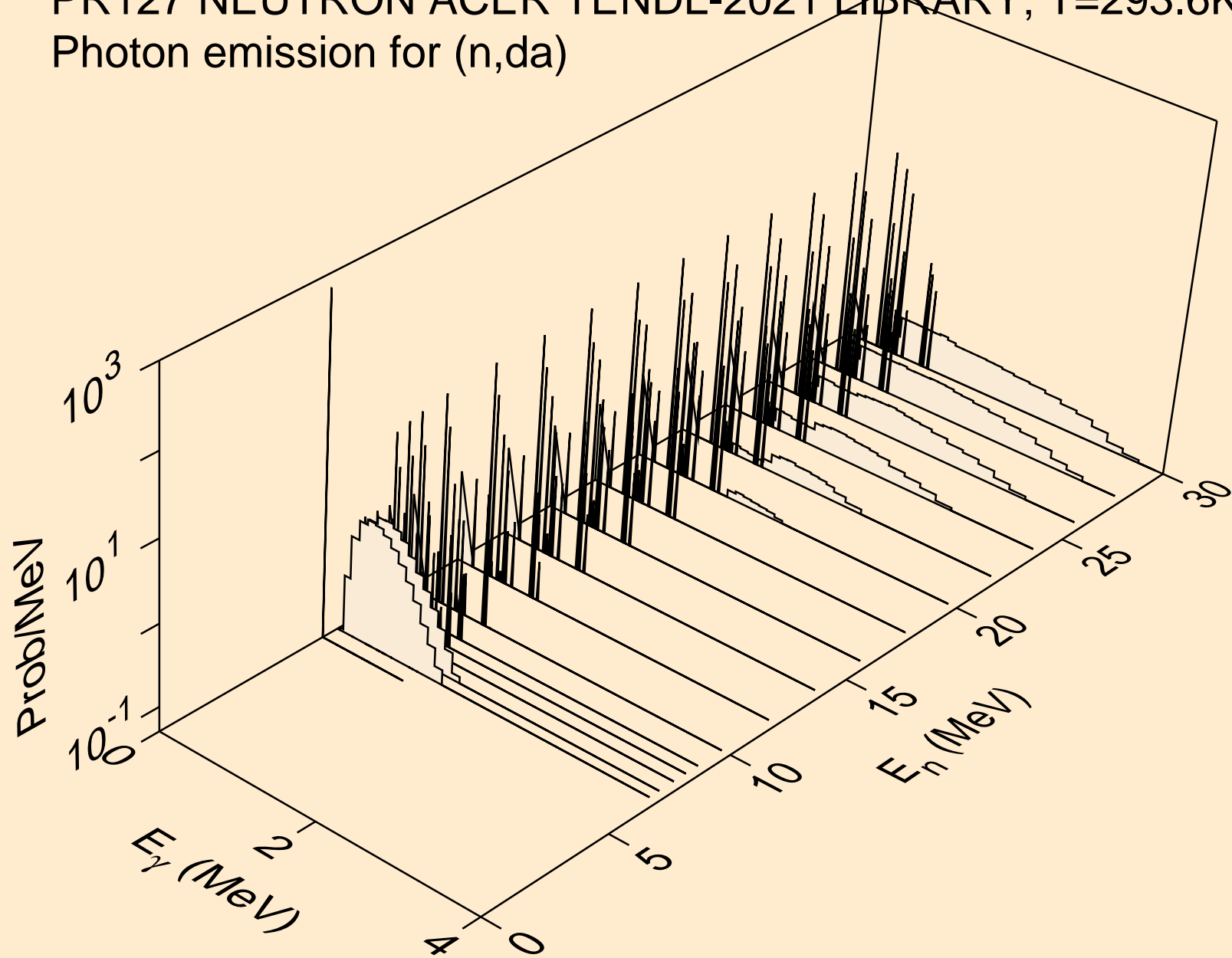

PR127 NEUTRON ACER TENDL-2021 LIBRARY; T=293.6K  
thermal capture photon spectrum

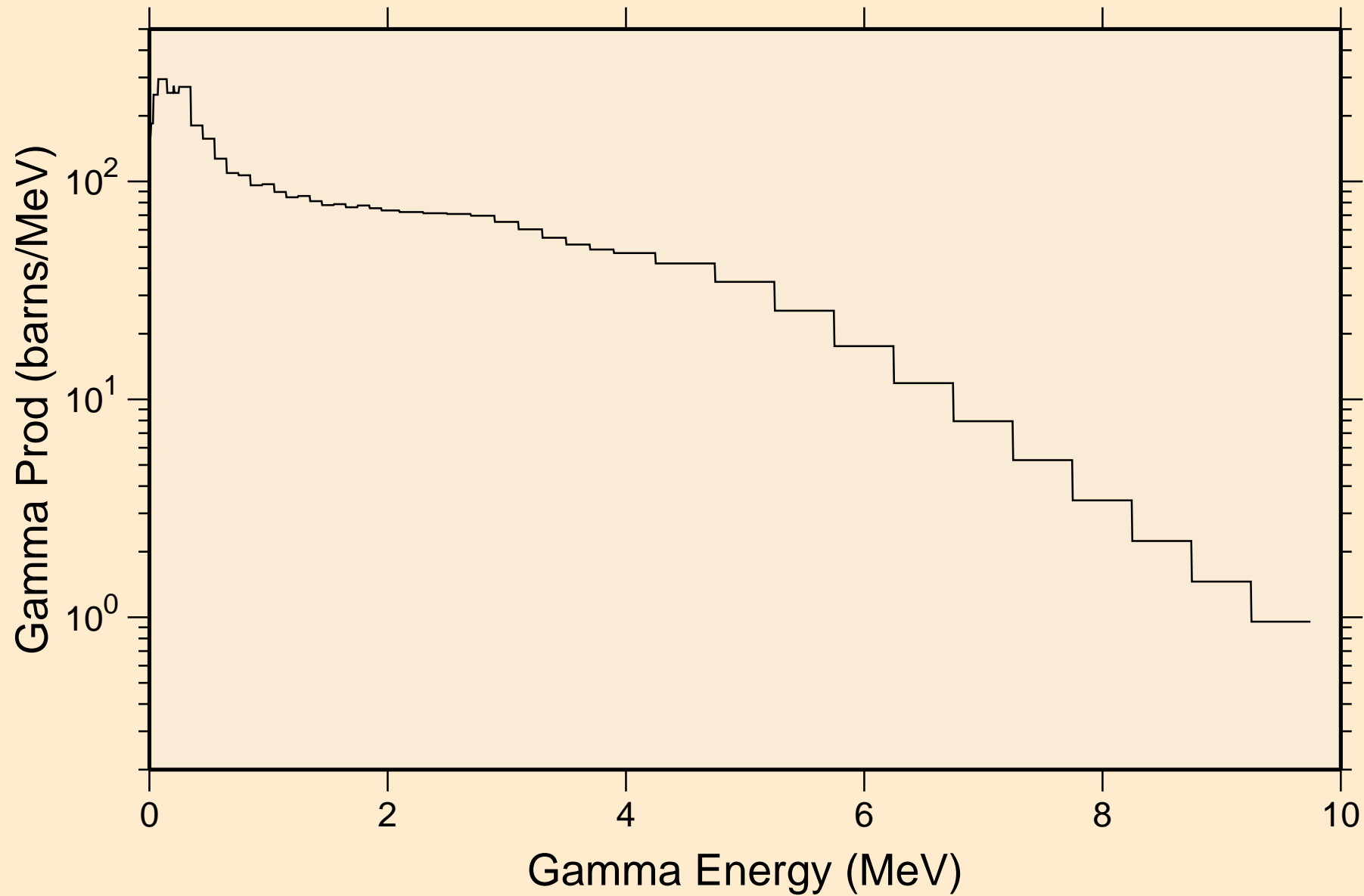

PR127 NEUTRON ACER TENDL-2021 LIBRARY; T=293.6K  
14 MeV photon spectrum

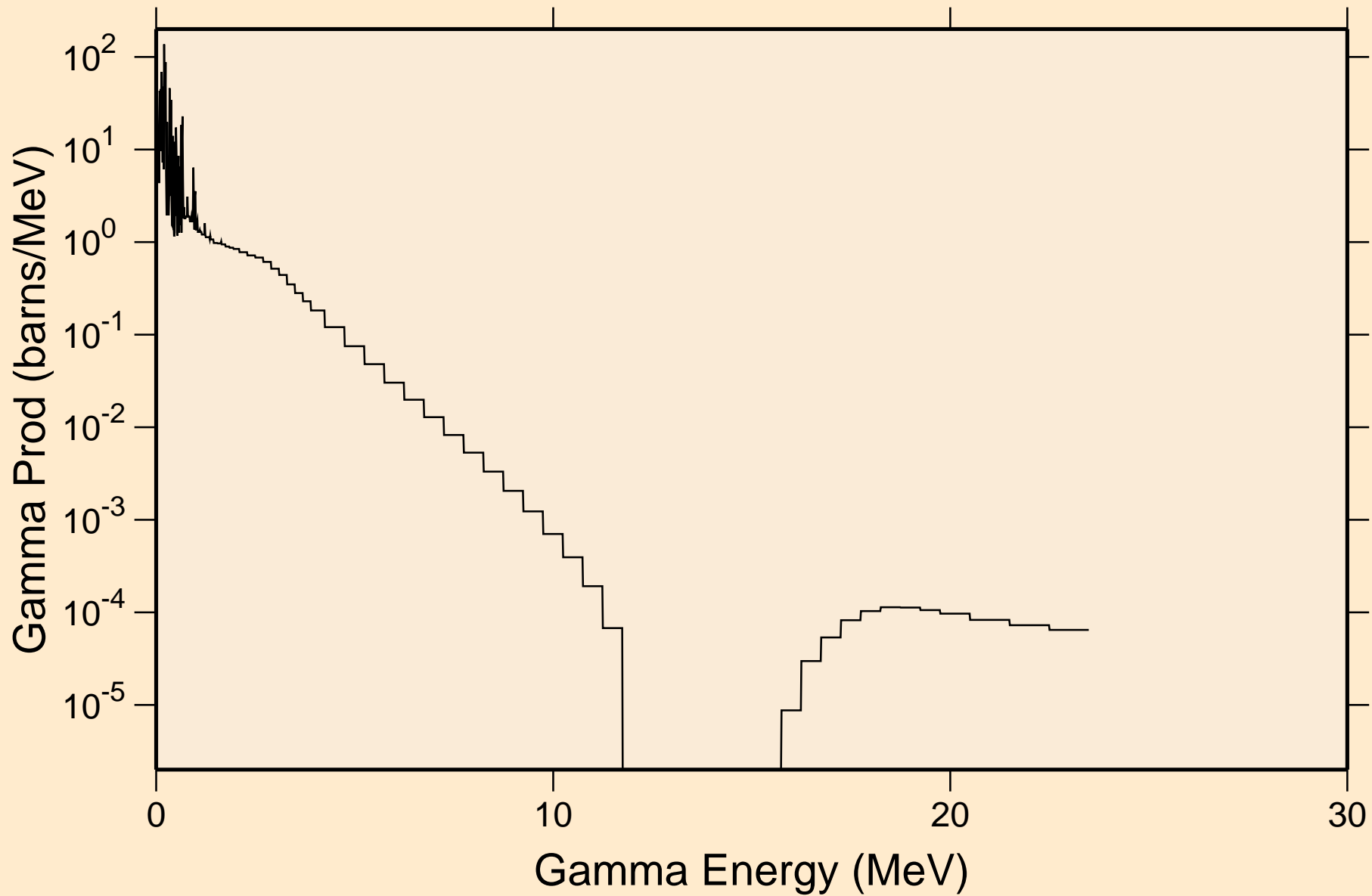

PR127 NEUTRON ACER TENDL-2021 LIBRARY; T=293.6K  
Particle heating contributions

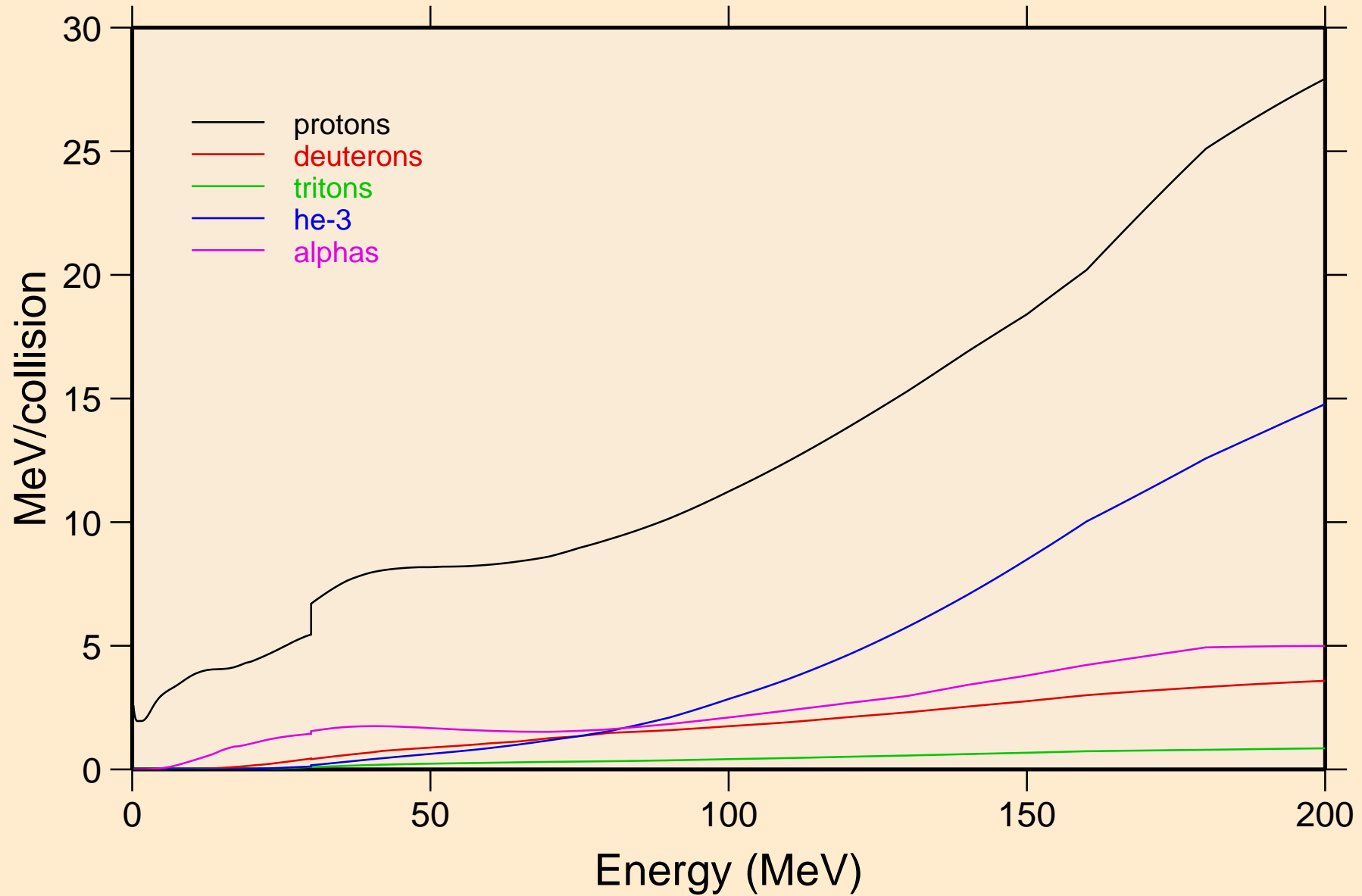

PR127 NEUTRON ACER TENDL-2021 LIBRARY; T=293.6K  
Recoil Heating

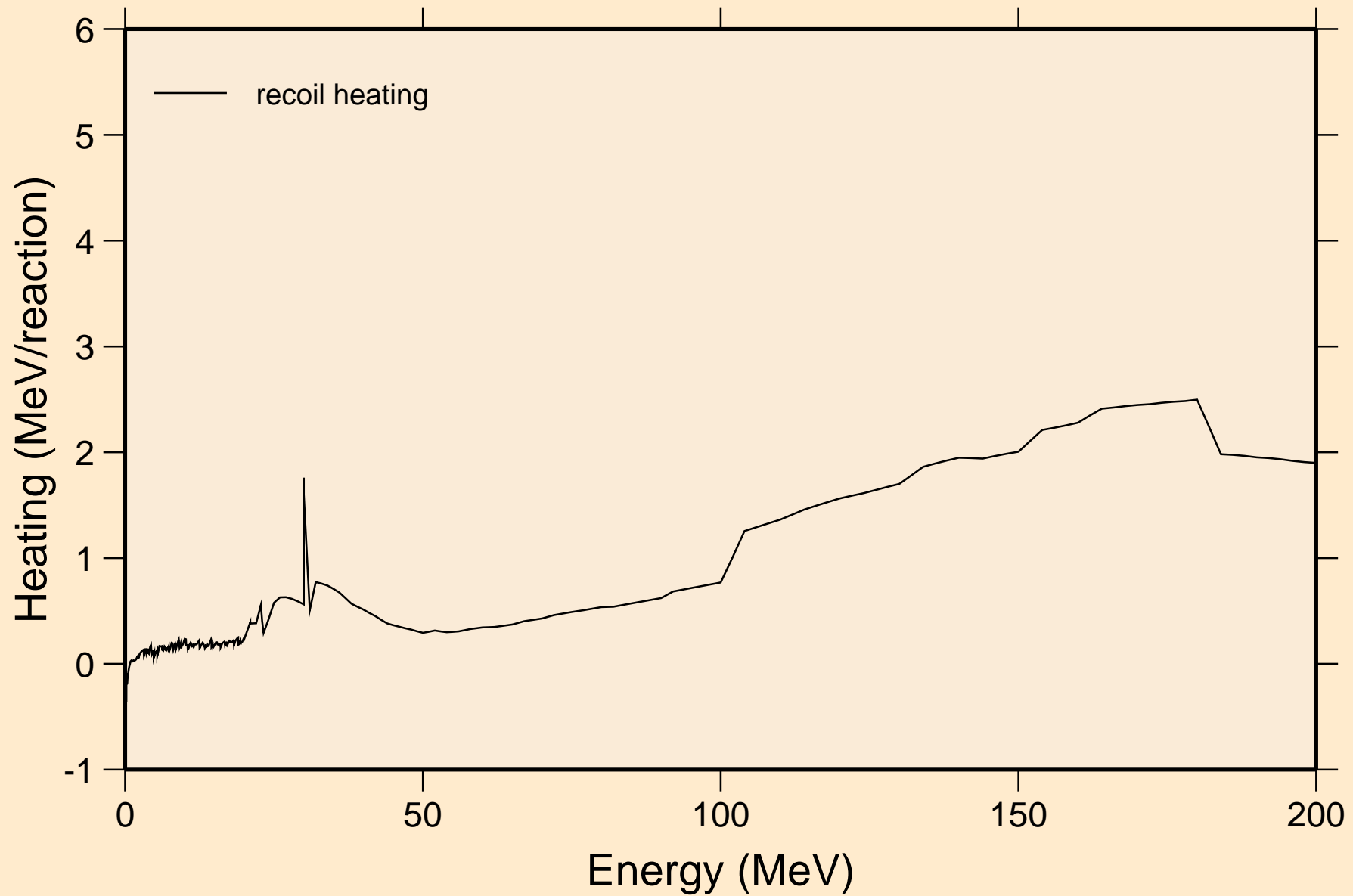

PR127 NEUTRON ACER TENDL-2021 LIBRARY; T=293.6K  
Particle production cross sections

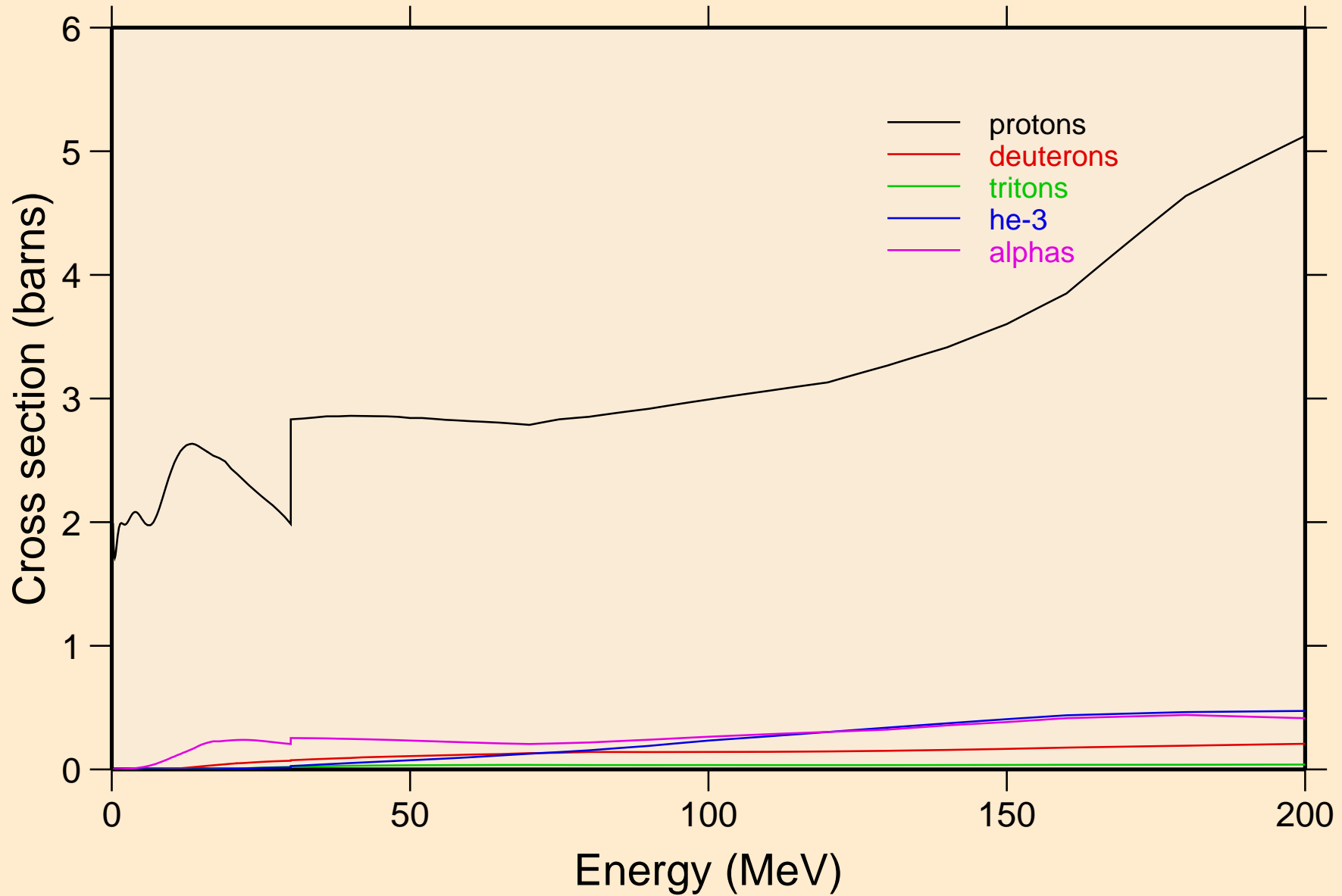

PR127 NEUTRON ACER TENDL-2021 LIBRARY; T=293.6K  
protons from (n,x)

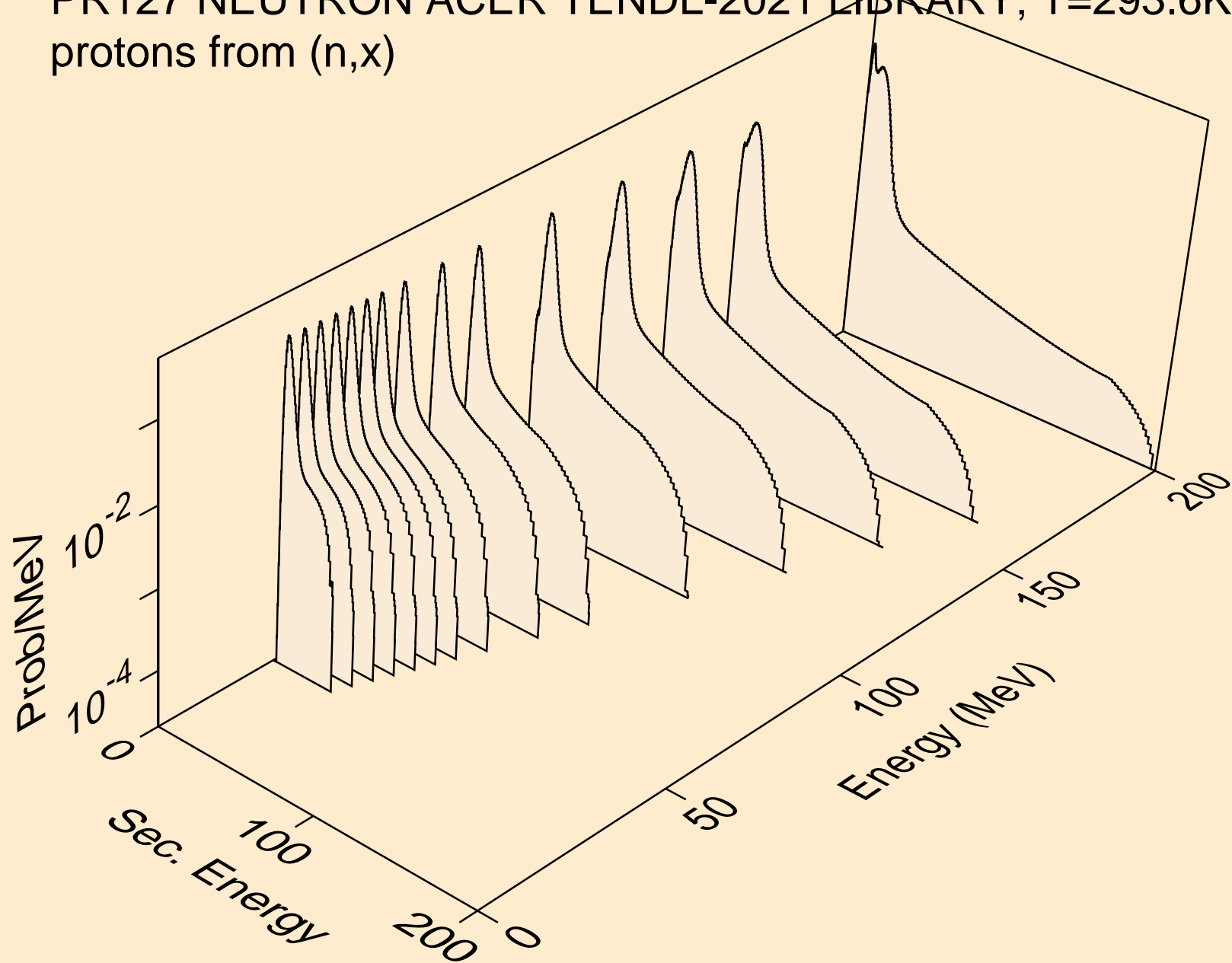

PR127 NEUTRON ACER TENDL-2021 LIBRARY; T=293.6K  
protons from (n,n\*)p

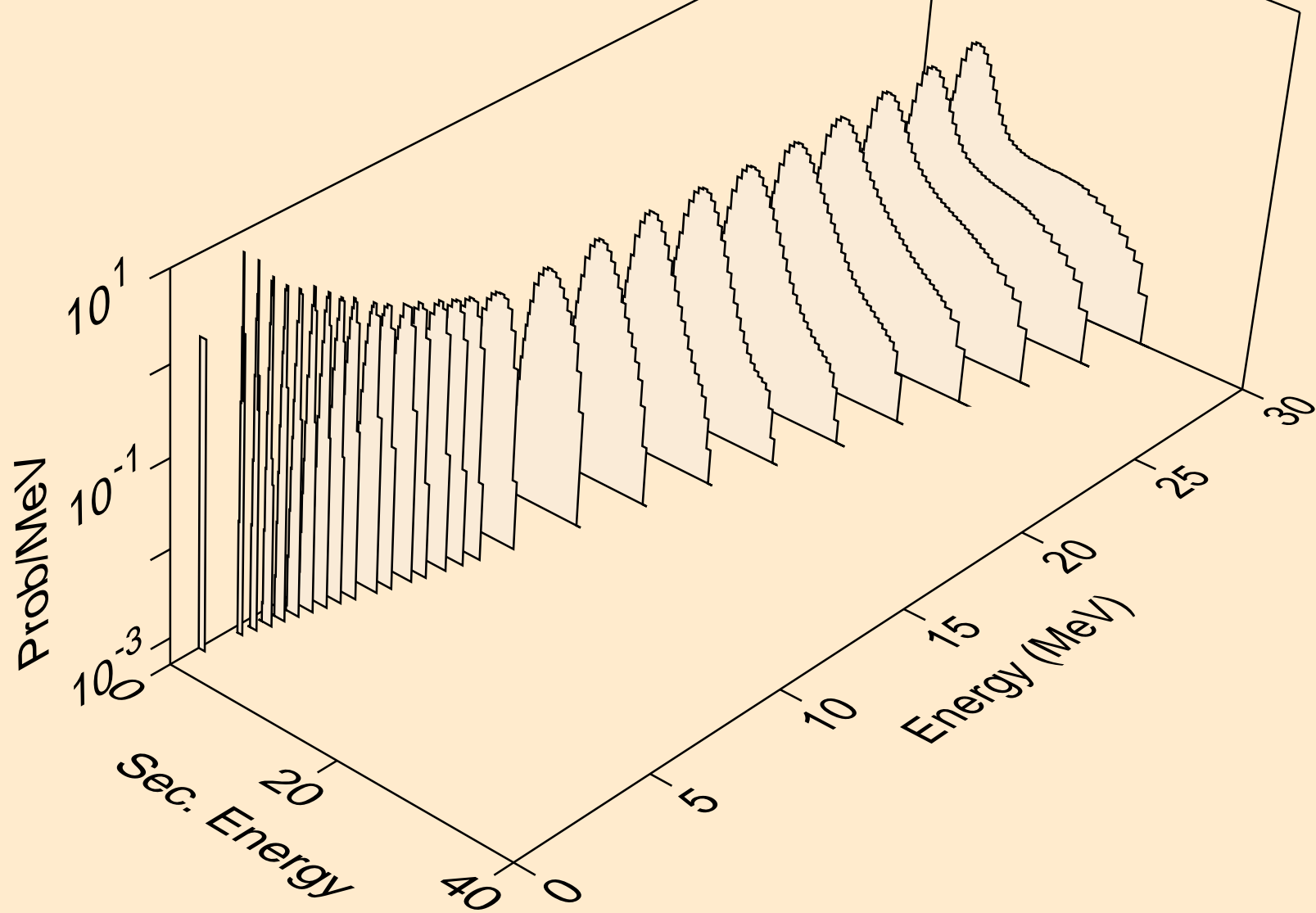

PR127 NEUTRON ACER TENDL-2021 LIBRARY; T=293.6K  
protons from (n,2np)

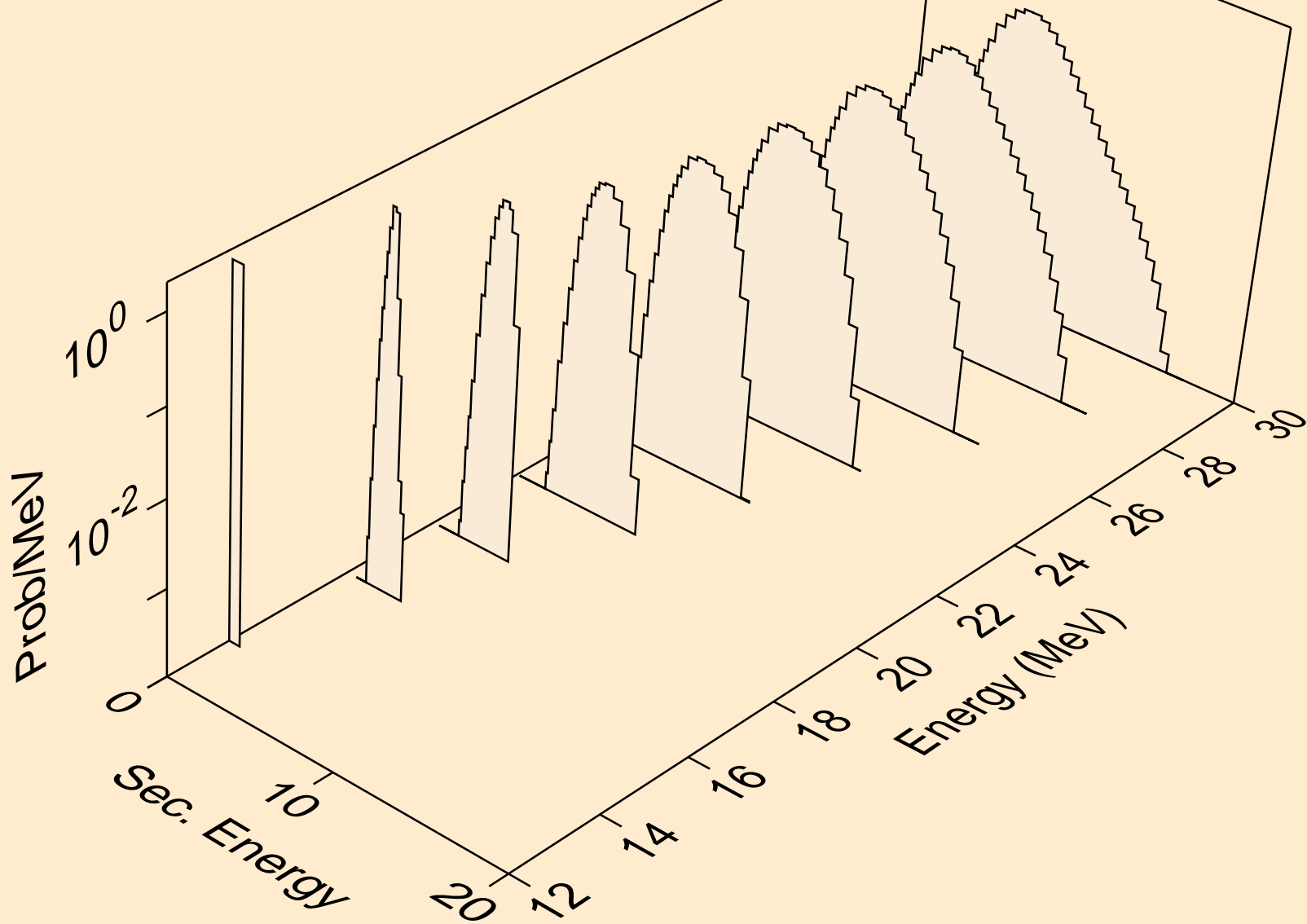

PR127 NEUTRON ACER TENDL-2021 LIBRARY; T=293.6K  
protons from (n,3np)

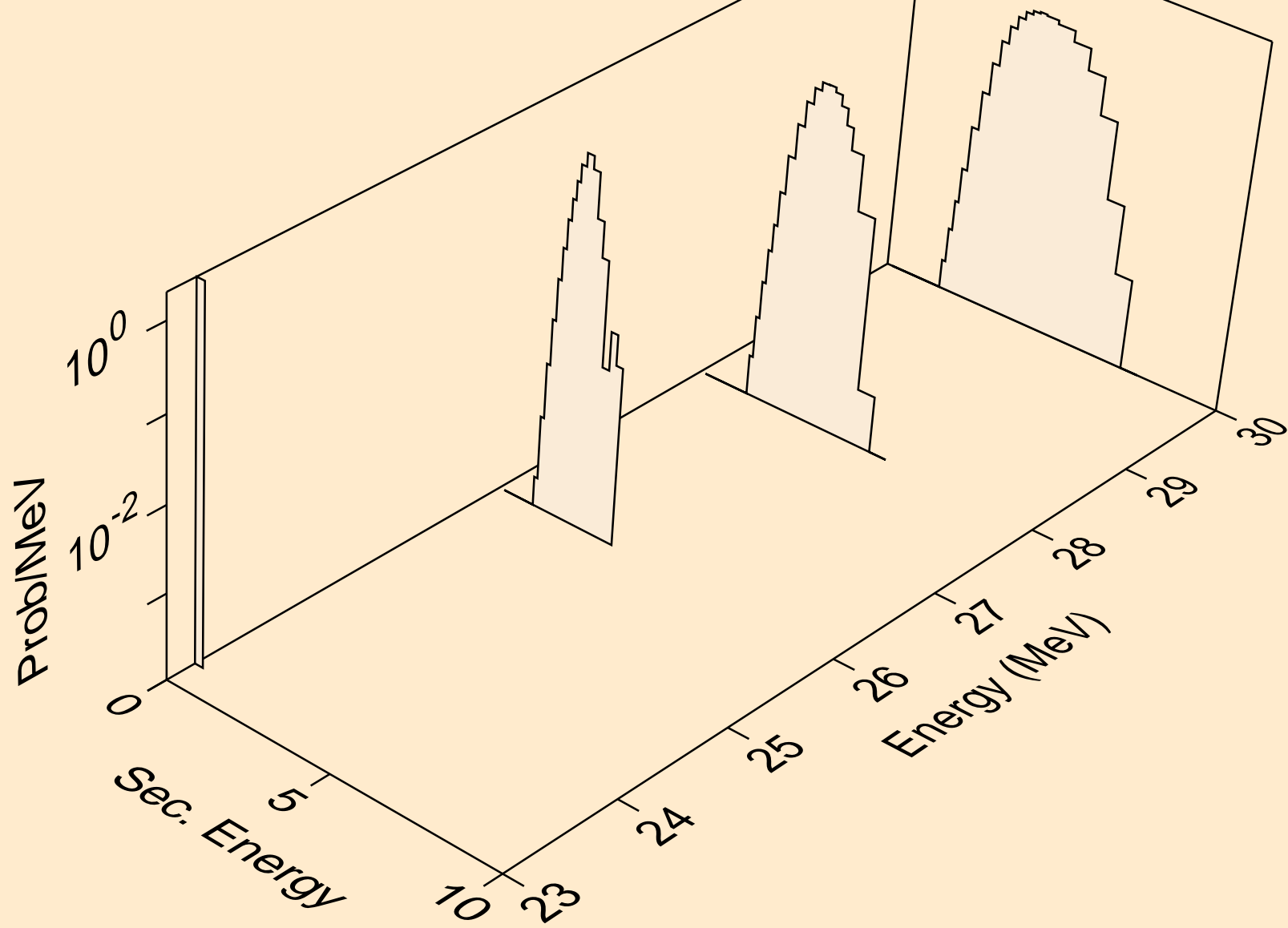

PR127 NEUTRON ACER TENDL-2021 LIBRARY; T=293.6K  
protons from (n,2np)

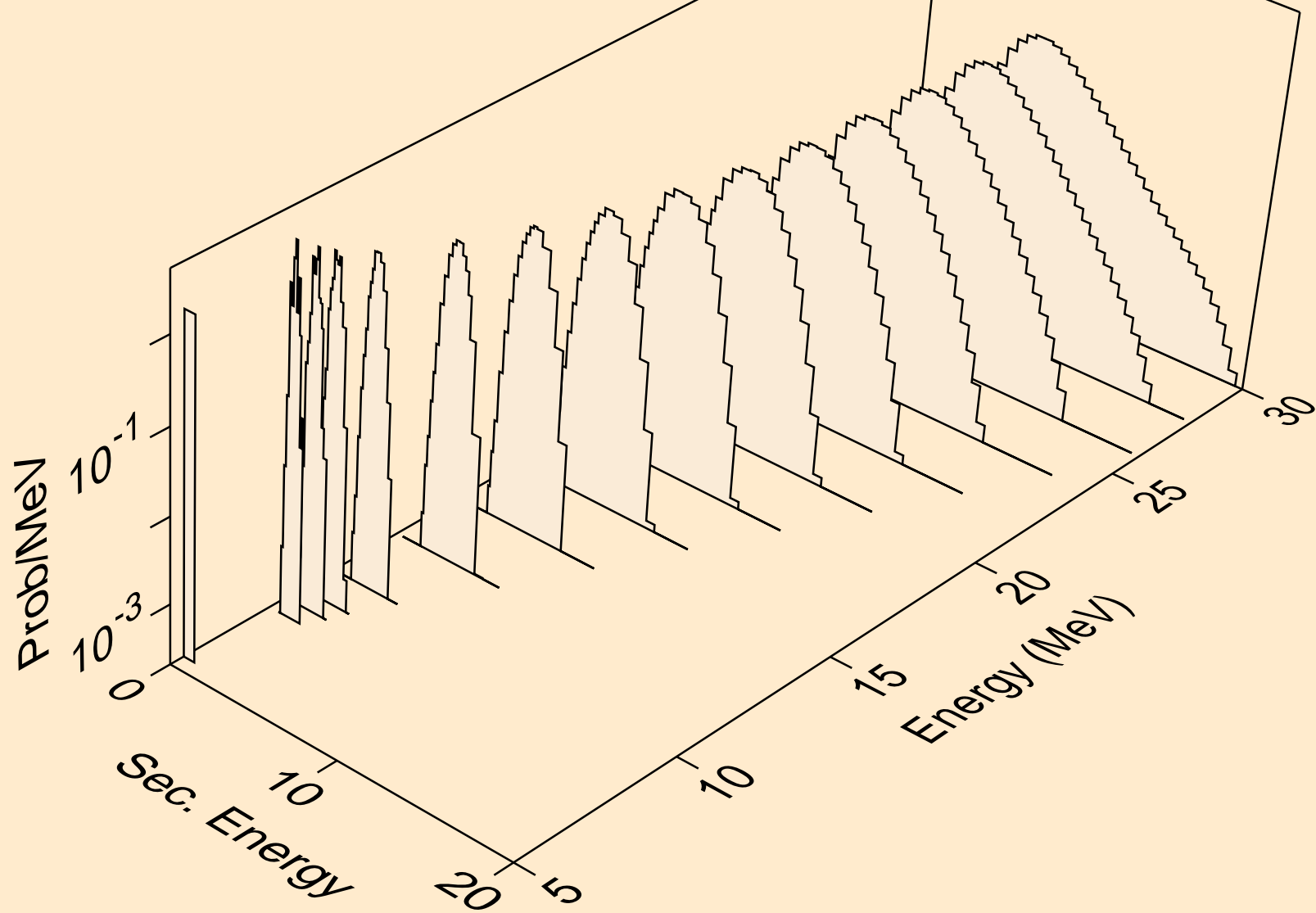

PR127 NEUTRON ACER TENDL-2021 LIBRARY; T=293.6K  
protons from (n,npa)

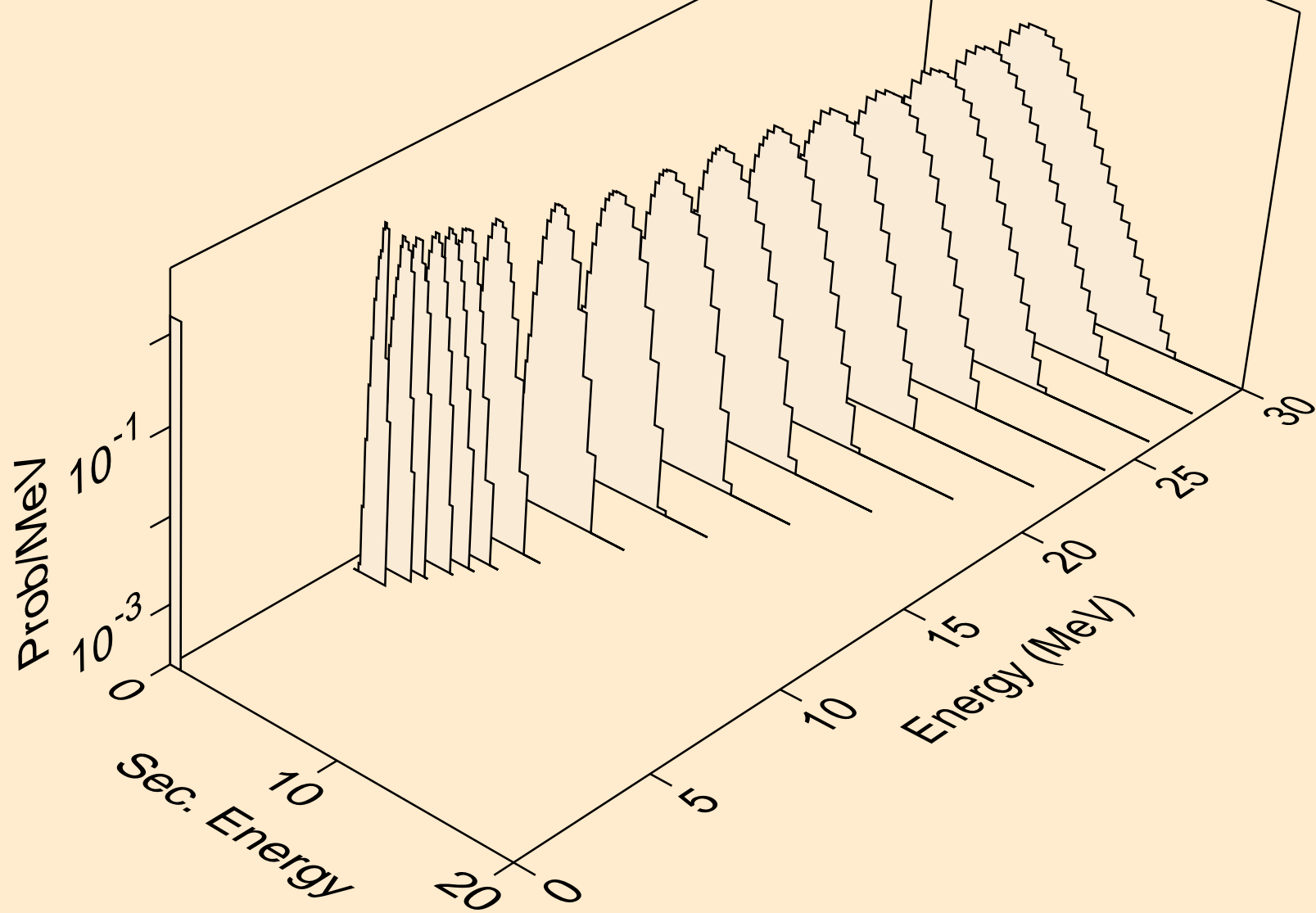

PR127 NEUTRON ACER TENDL-2021 LIBRARY; T=293.6K  
protons from (n,p)

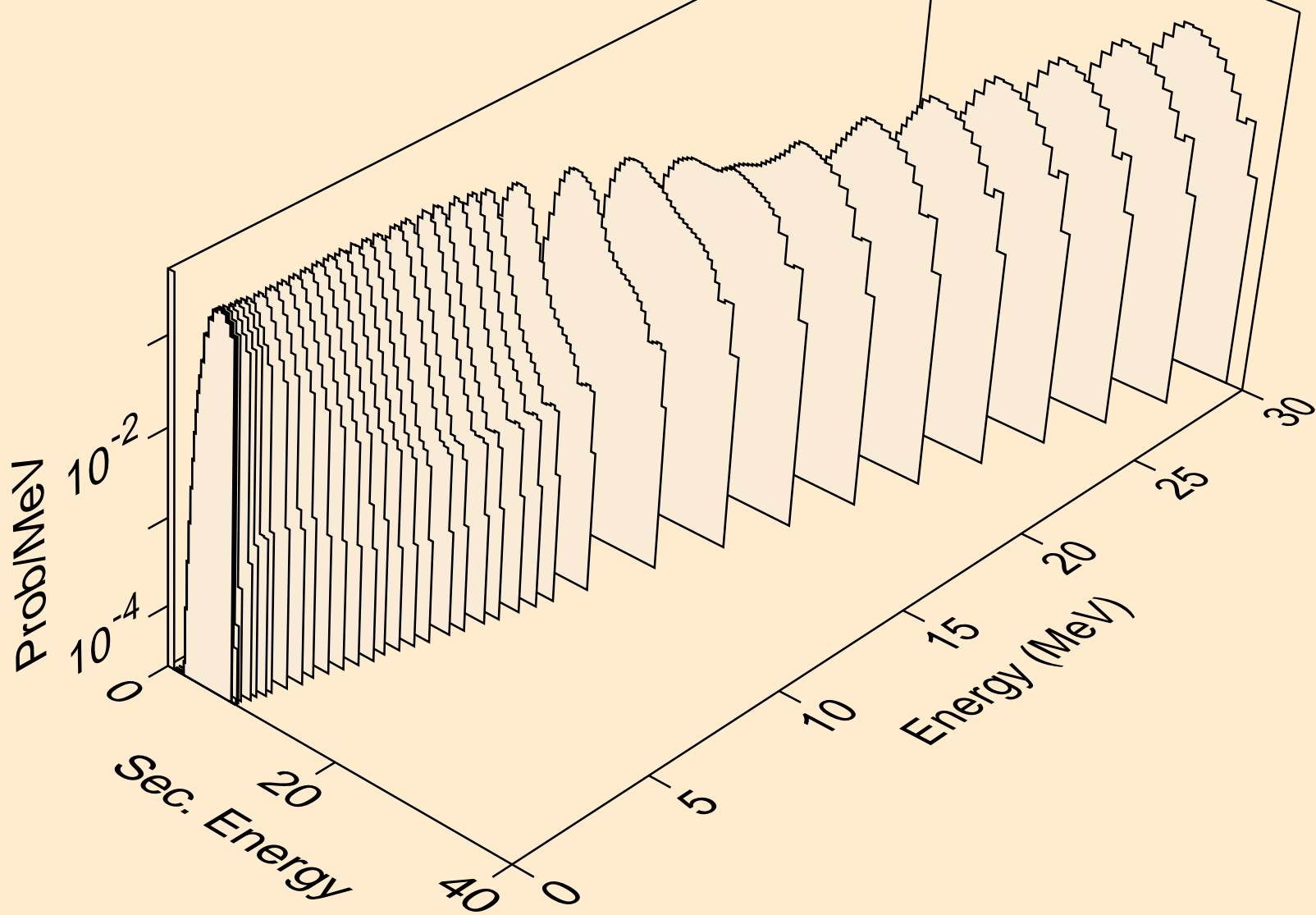

PR127 NEUTRON ACER TENDL-2021 LIBRARY; T=293.6K  
protons from (n,2p)

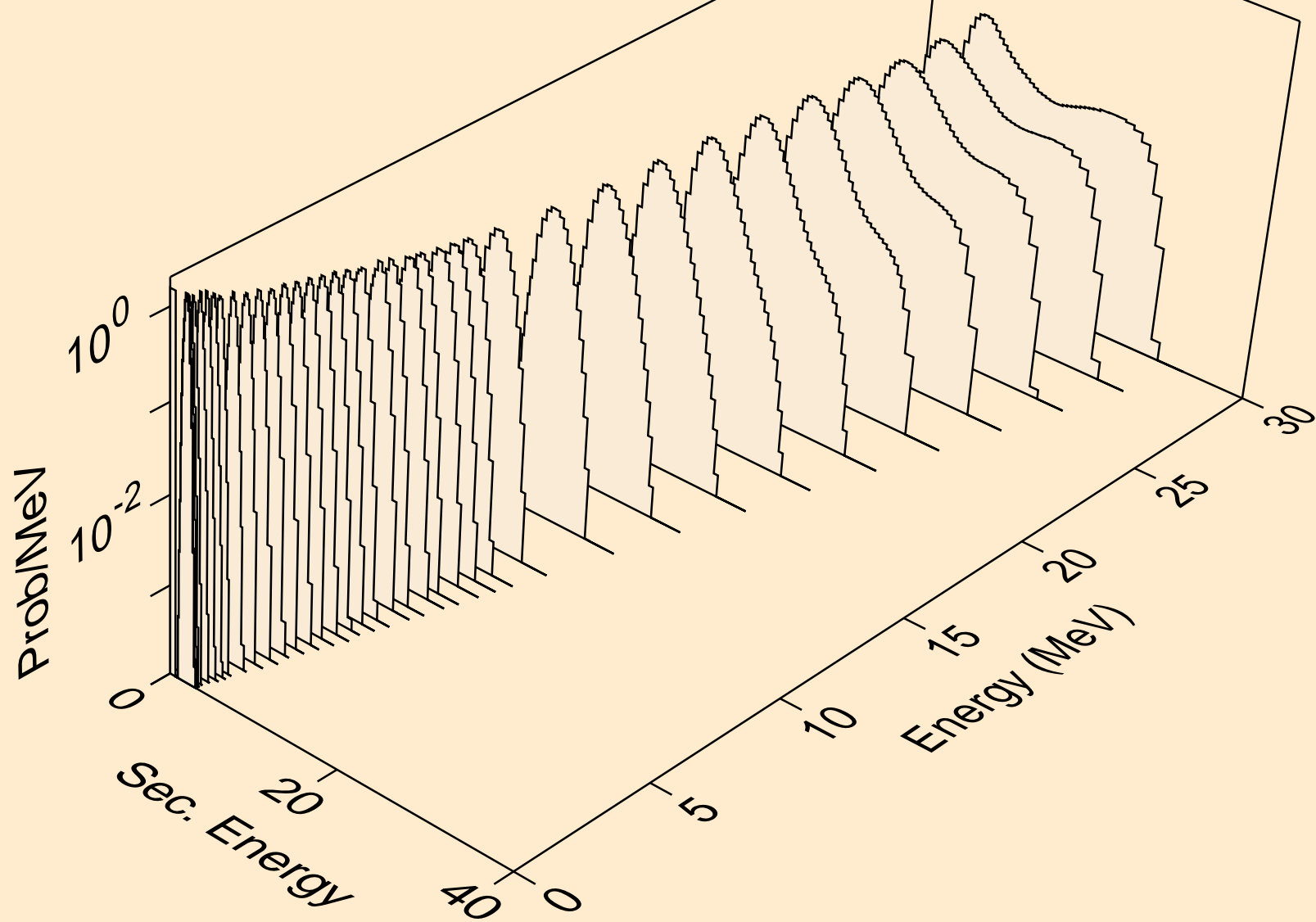

PR127 NEUTRON ACER TENDL-2021 LIBRARY; T=293.6K  
protons from (n,p)

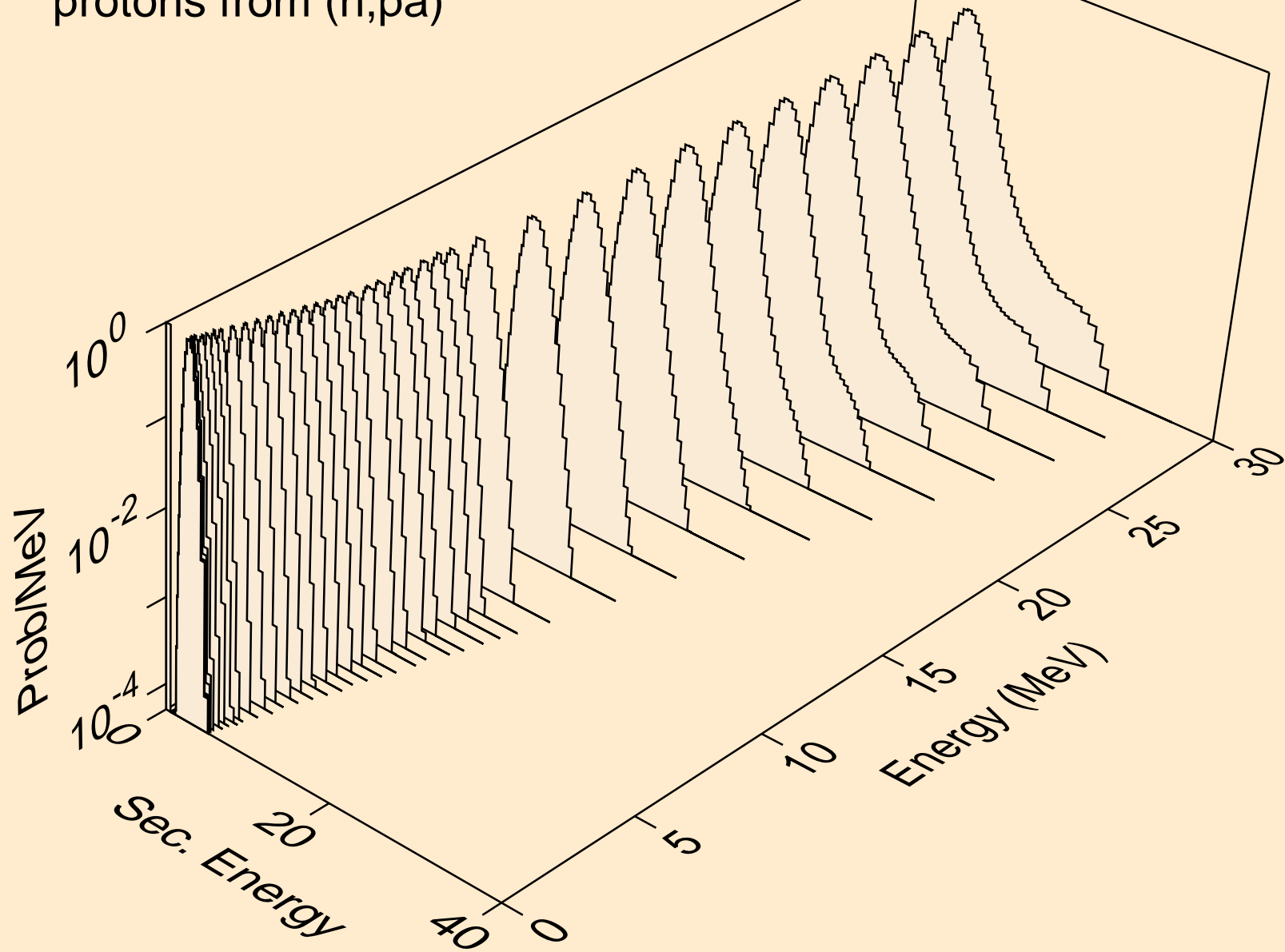

PR127 NEUTRON ACER TENDL-2021 LIBRARY; T=293.6K  
protons from (n,pd)

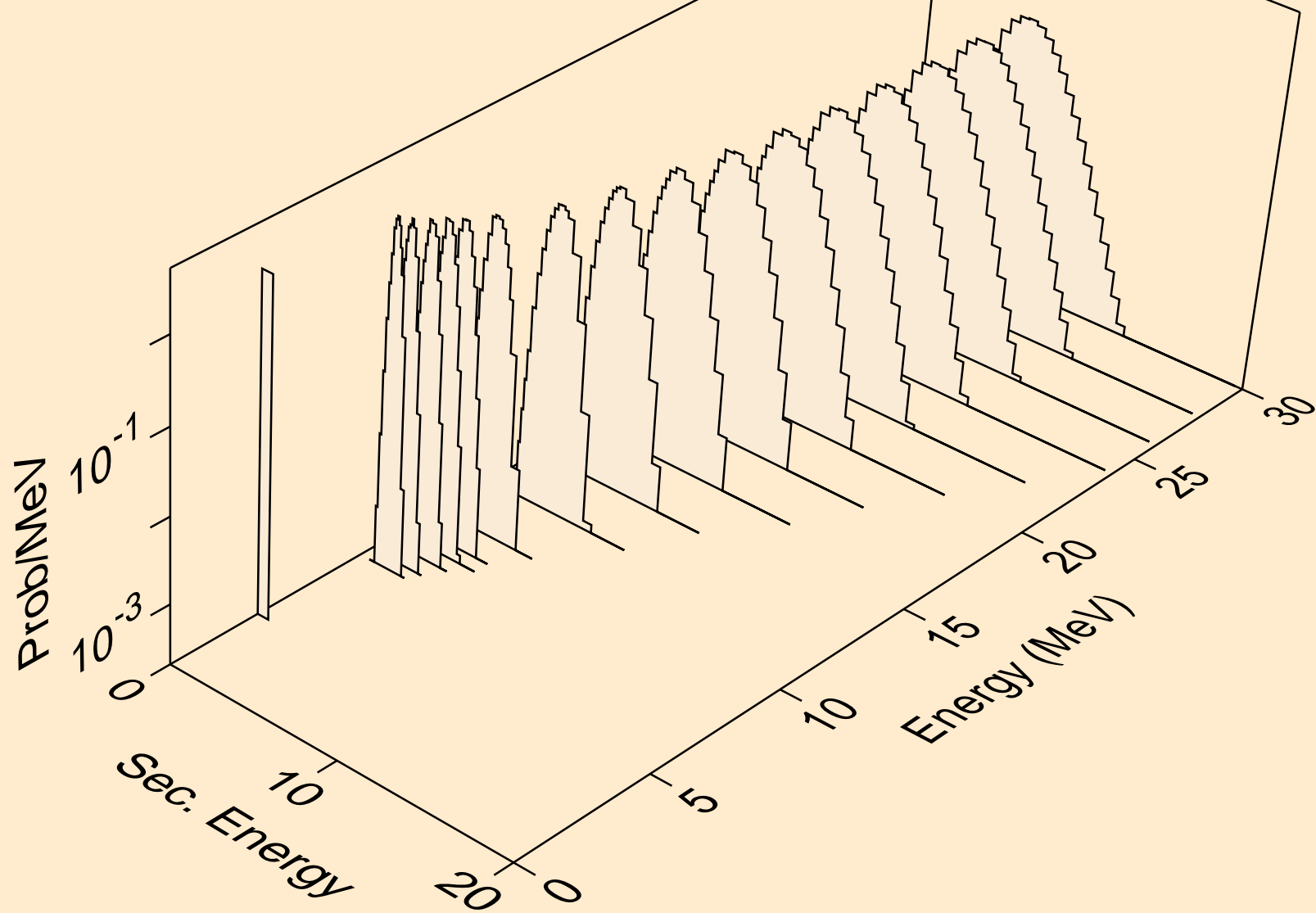

PR127 NEUTRON ACER TENDL-2021 LIBRARY; T=293.6K  
protons from (n,pt)

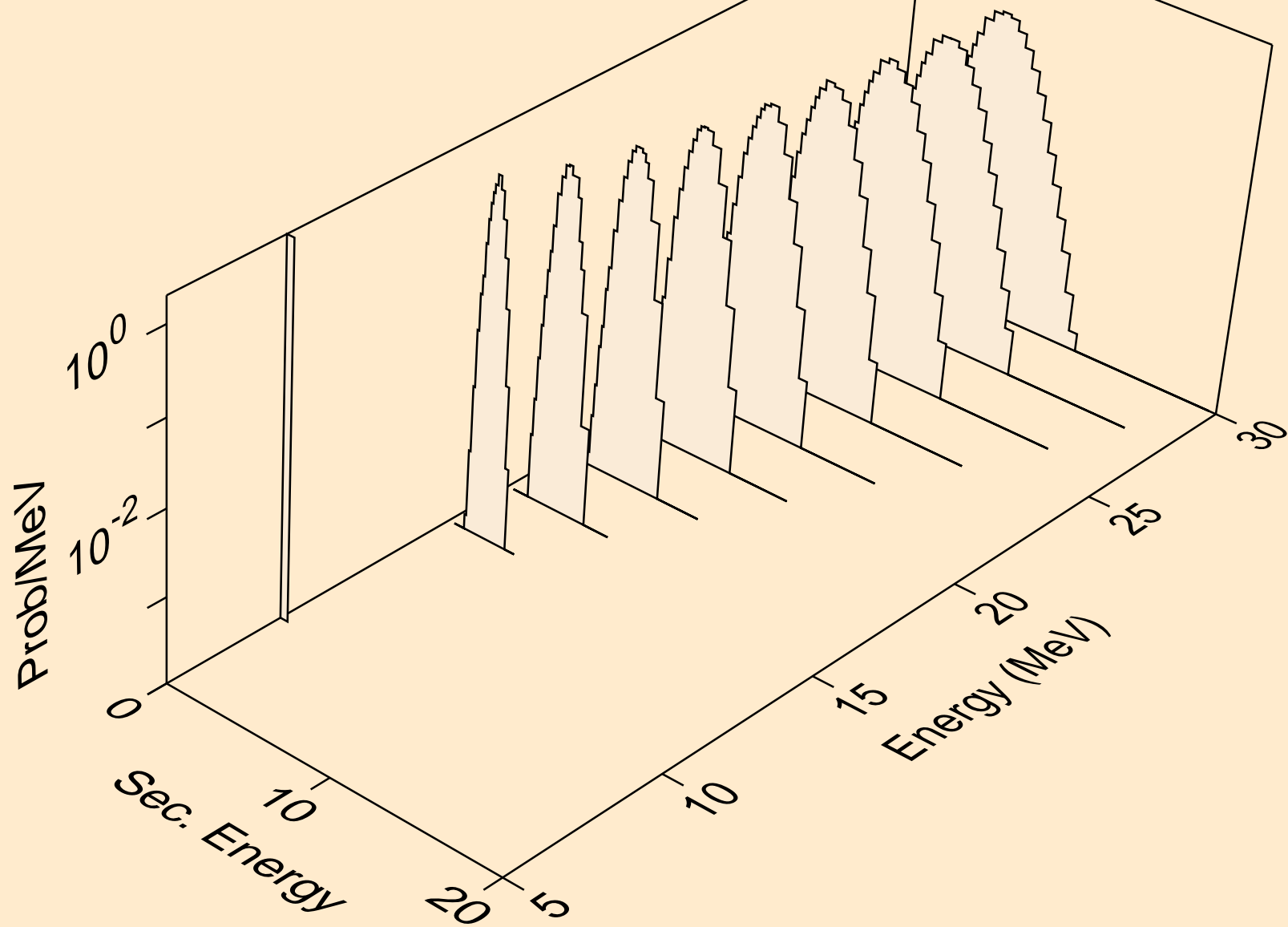

PR127 NEUTRON ACER TENDL-2021 LIBRARY; T=293.6K  
deuterons from (n,x)

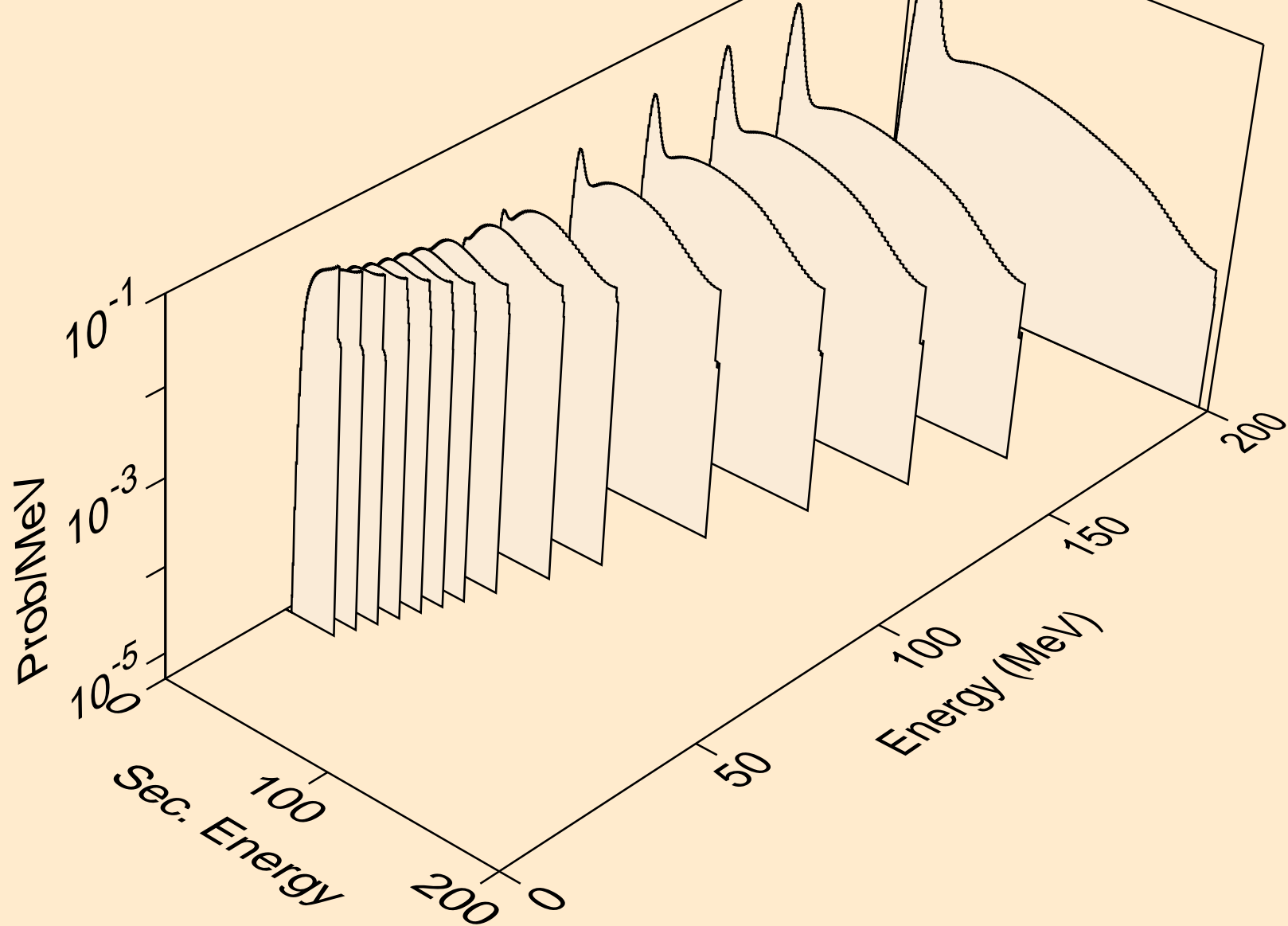

PR127 NEUTRON ACER TENDL-2021 LIBRARY; T=293.6K  
deuterons from (n,2nd)

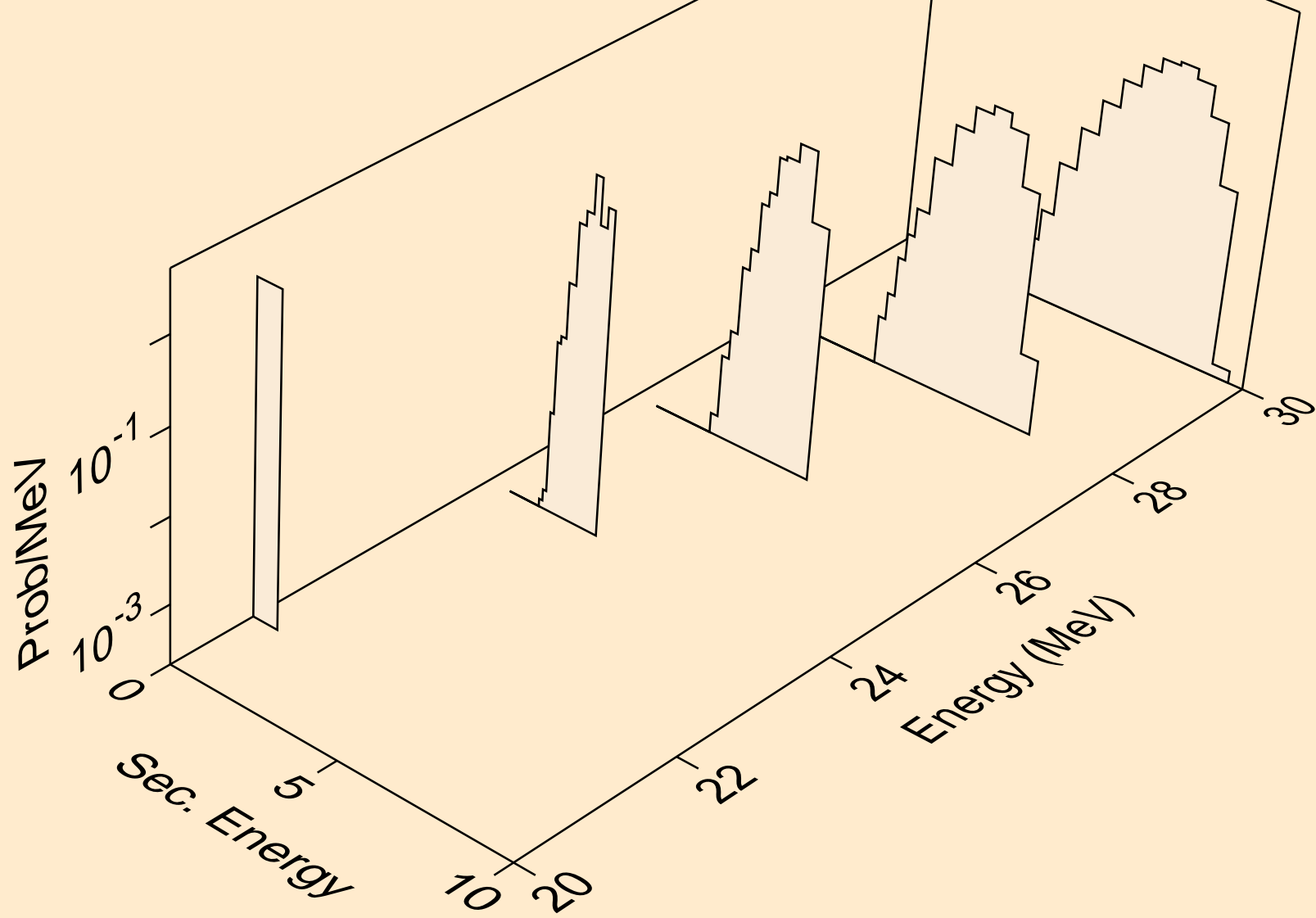

PR127 NEUTRON ACER TENDL-2021 LIBRARY; T=293.6K  
deuterons from (n,n\*)d

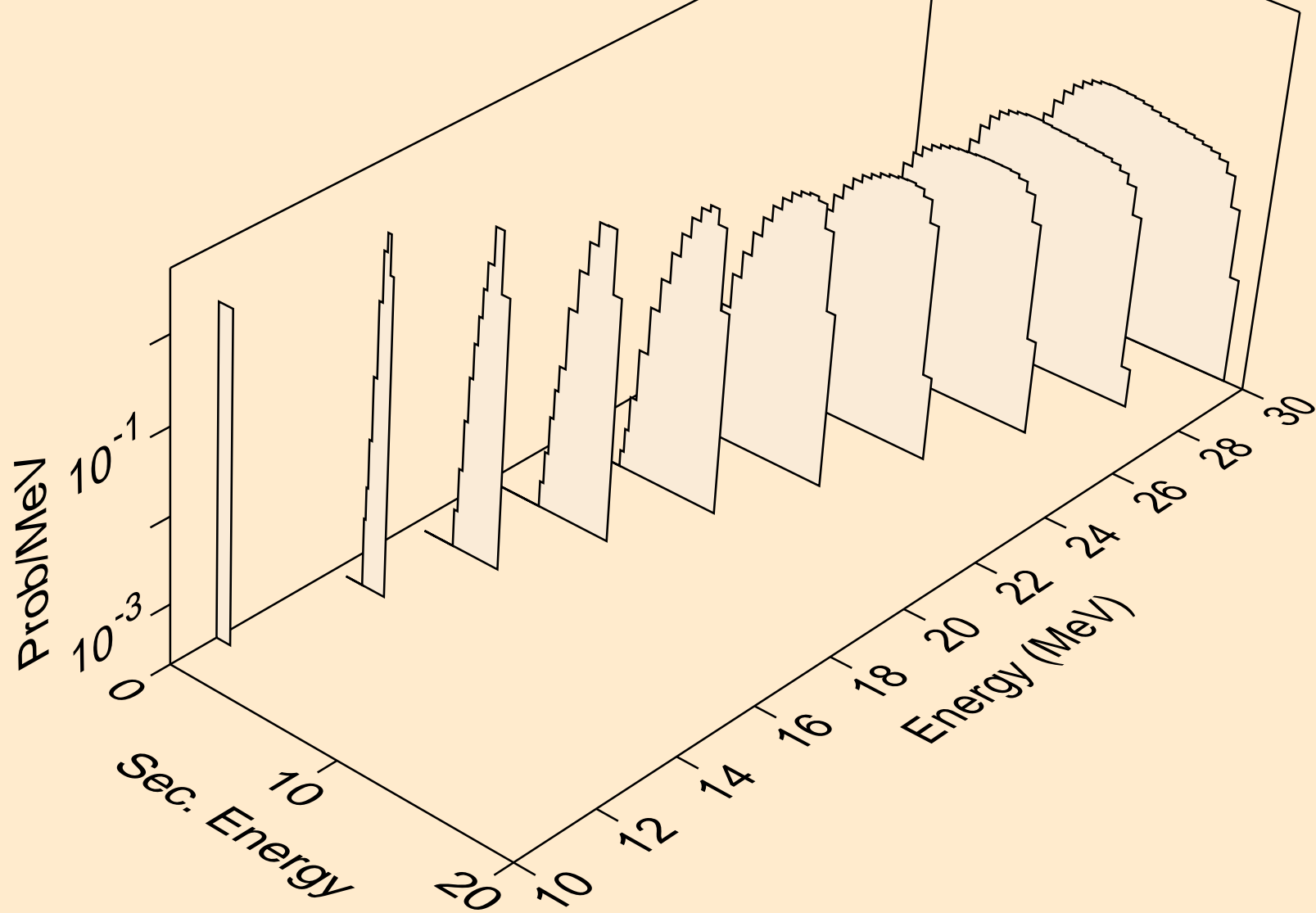

PR127 NEUTRON ACER TENDL-2021 LIBRARY; T=293.6K  
deuterons from (n,d)

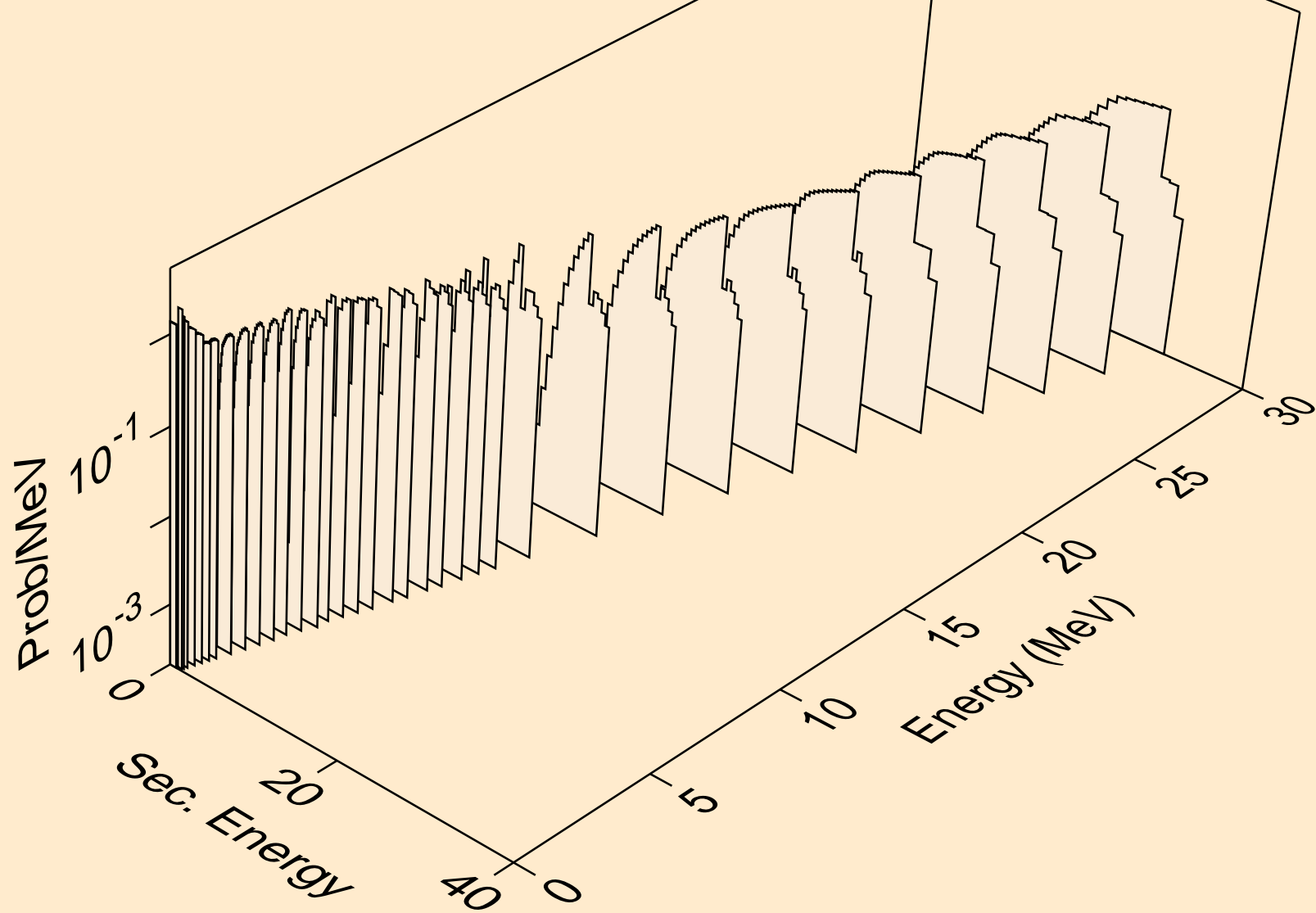

PR127 NEUTRON ACER TENDL-2021 LIBRARY; T=293.6K  
deuterons from (n,d2a)

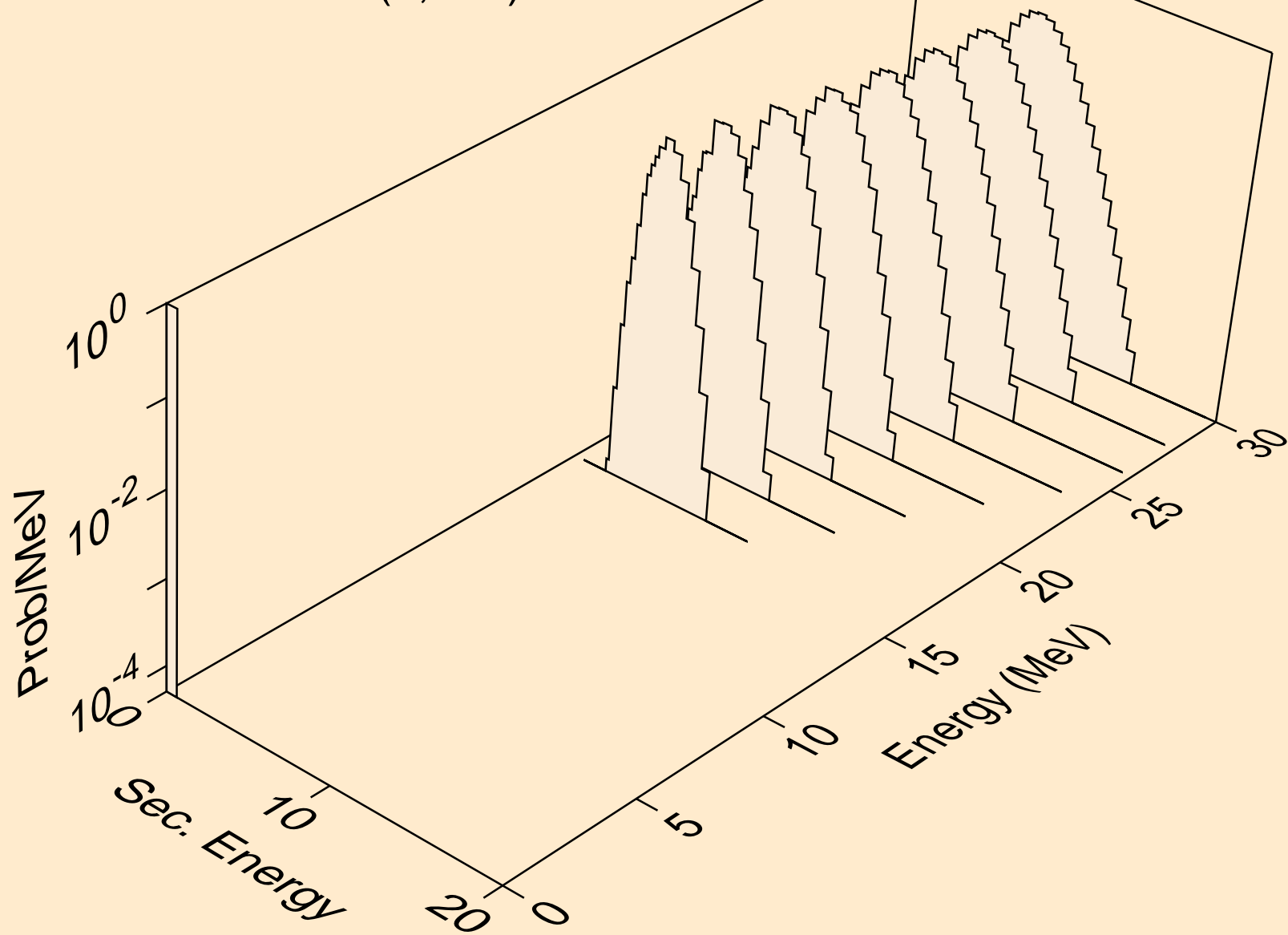

PR127 NEUTRON ACER TENDL-2021 LIBRARY; T=293.6K  
deuterons from (n,pd)

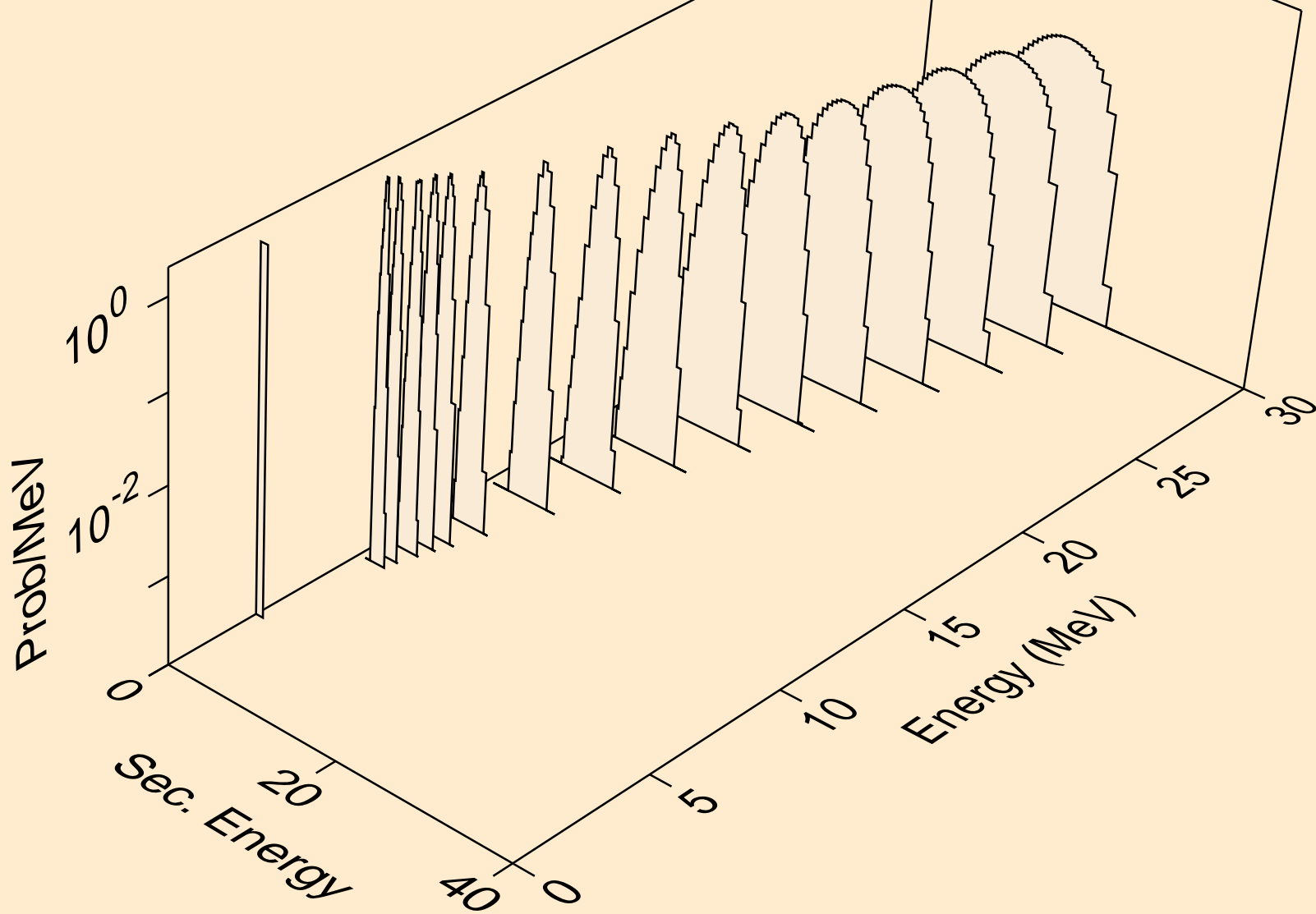

PR127 NEUTRON ACER TENDL-2021 LIBRARY; T=293.6K  
deuterons from (n,da)

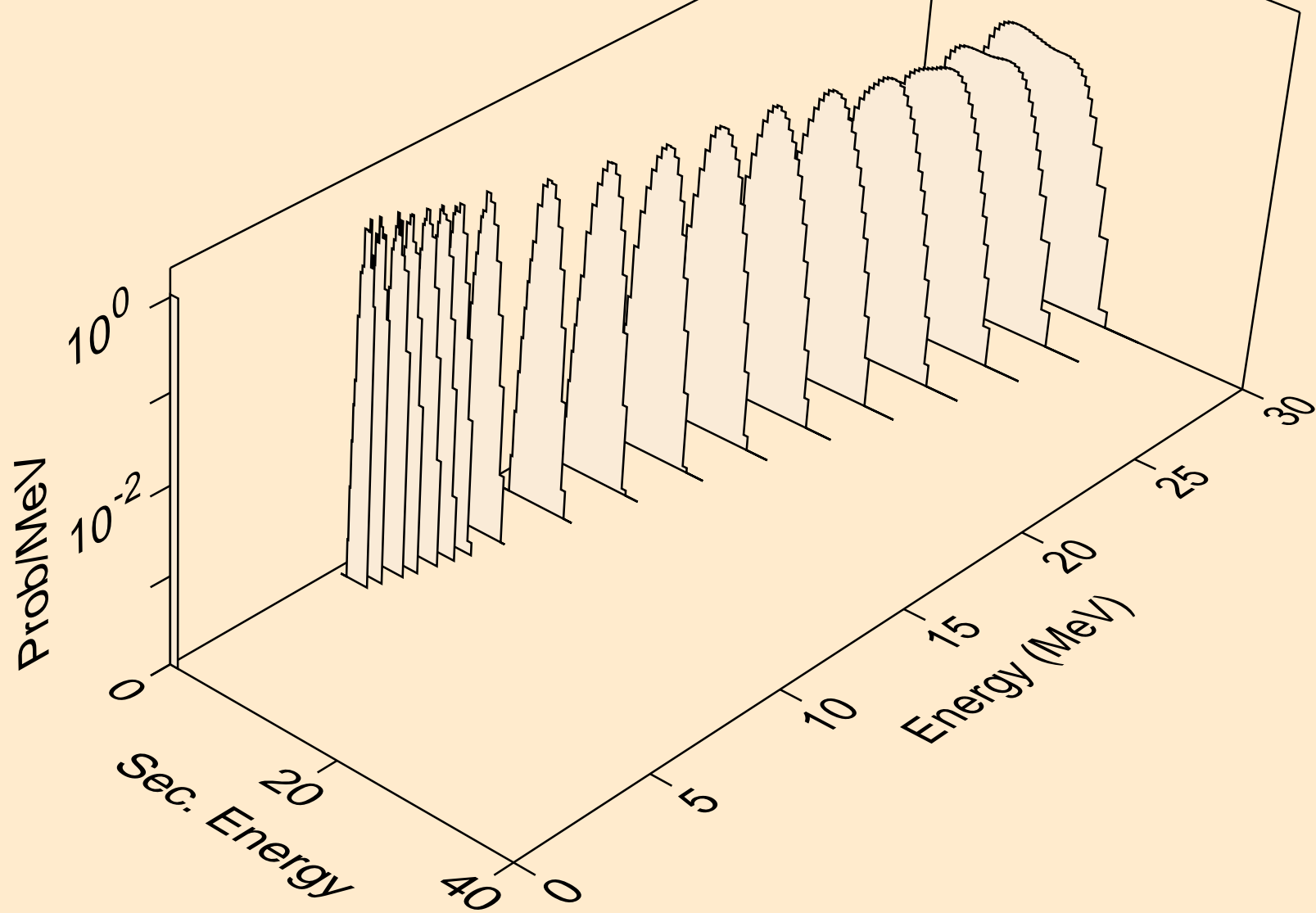

PR127 NEUTRON ACER TENDL-2021 LIBRARY; T=293.6K  
tritons from (n,x)

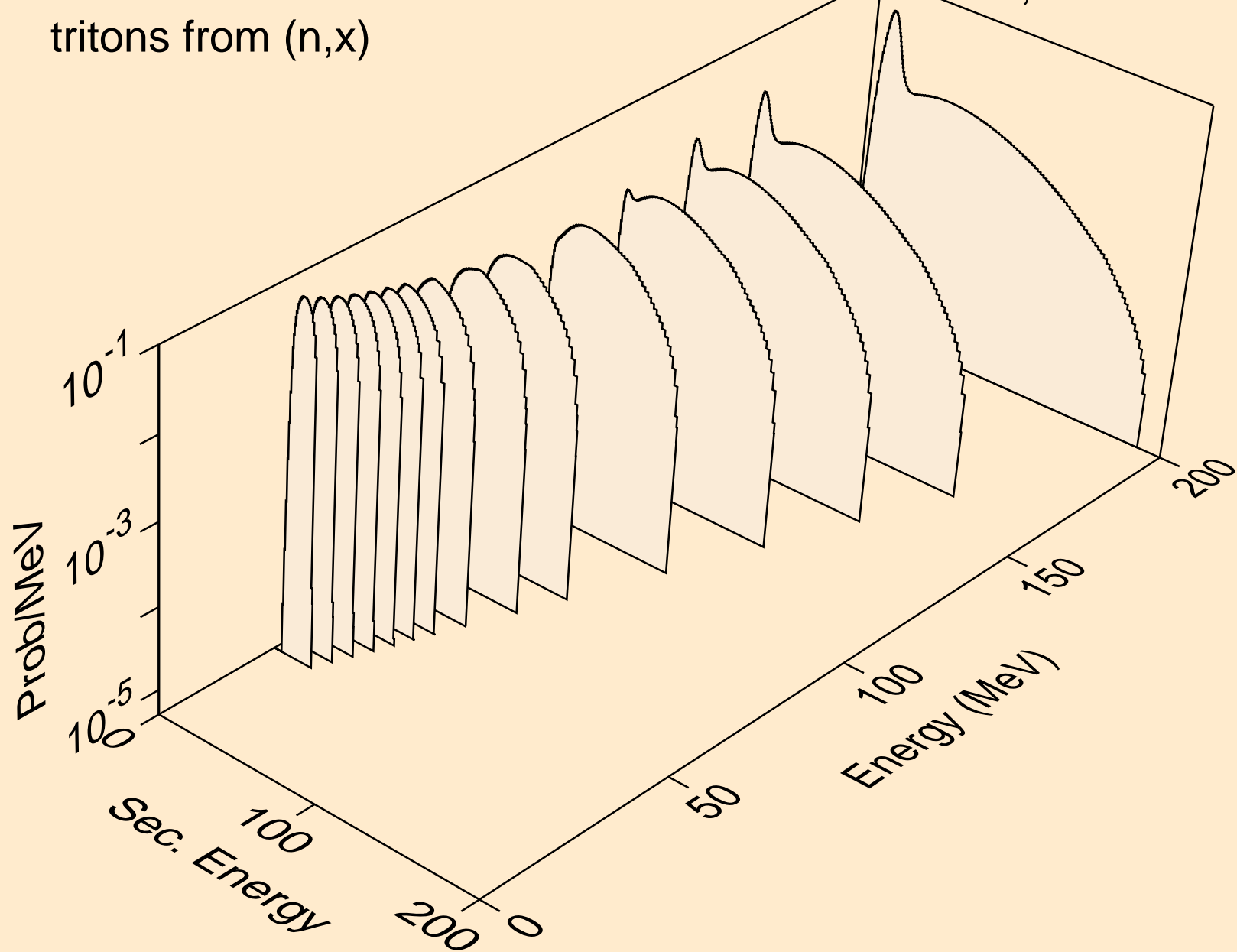

PR127 NEUTRON ACER TENDL-2021 LIBRARY; T=293.6K  
tritons from (n,n\*)t

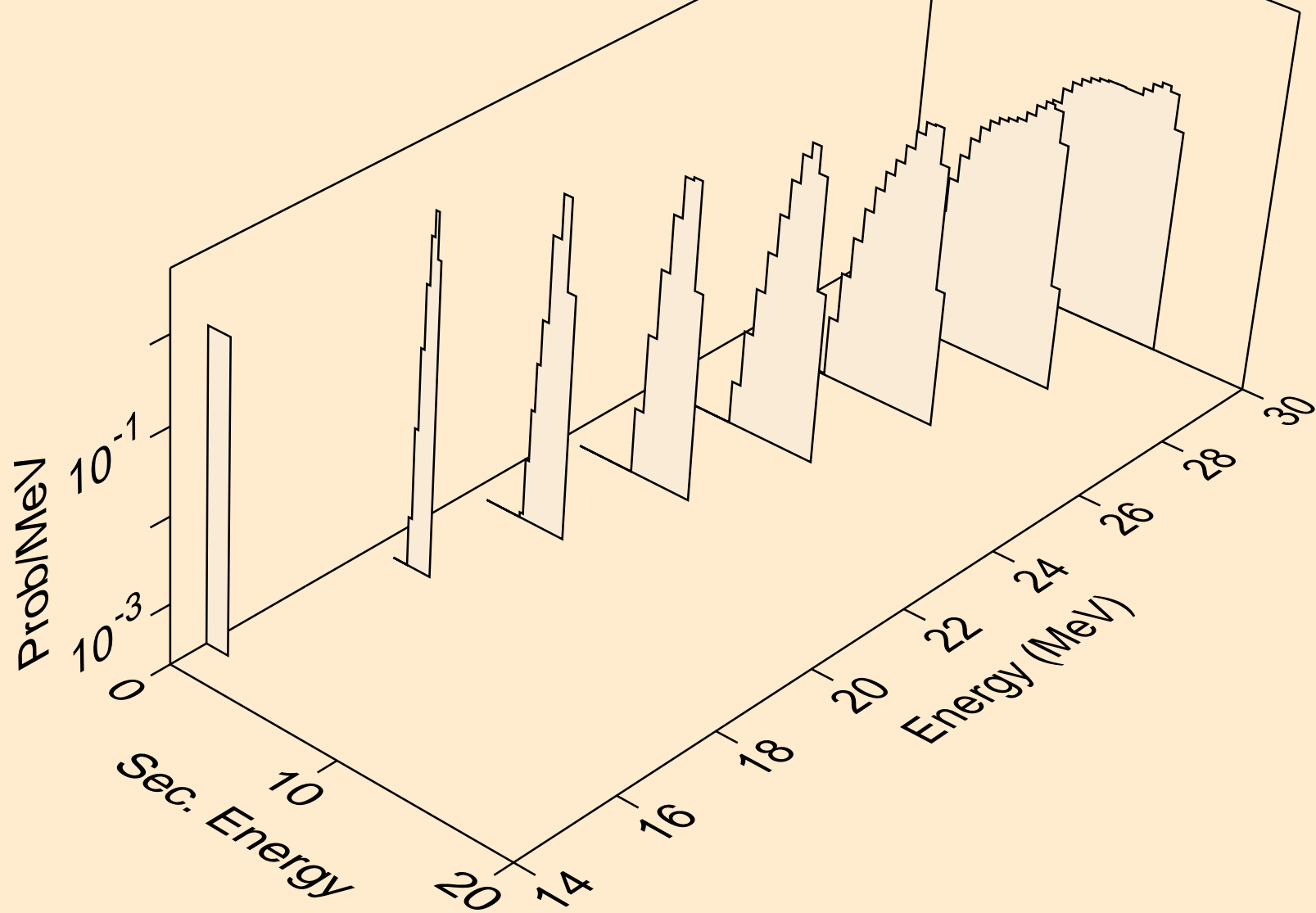

PR127 NEUTRON ACER TENDL-2021 LIBRARY; T=293.6K  
tritons from (n,t)

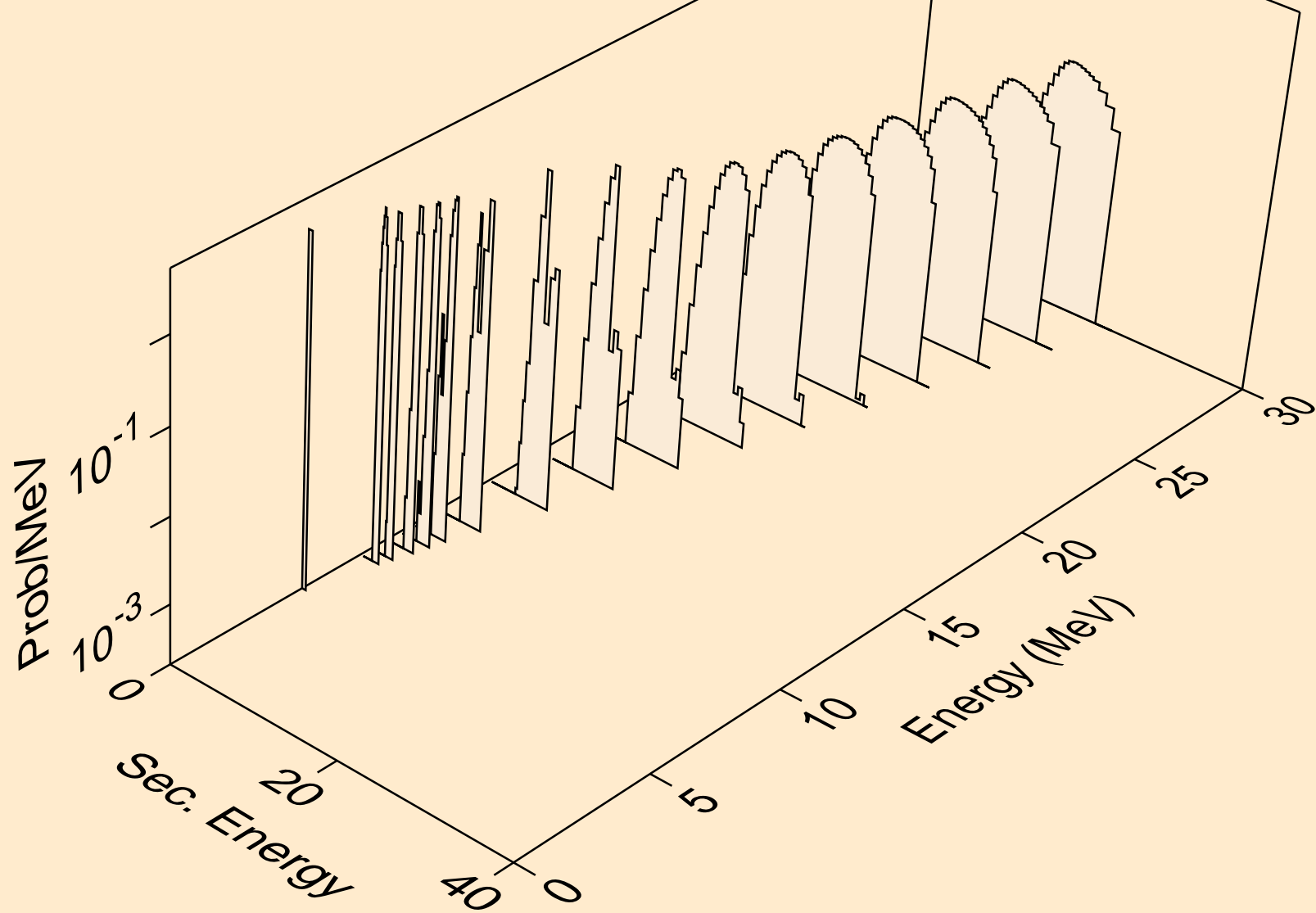

PR127 NEUTRON ACER TENDL-2021 LIBRARY; T=293.6K  
tritons from (n,pt)

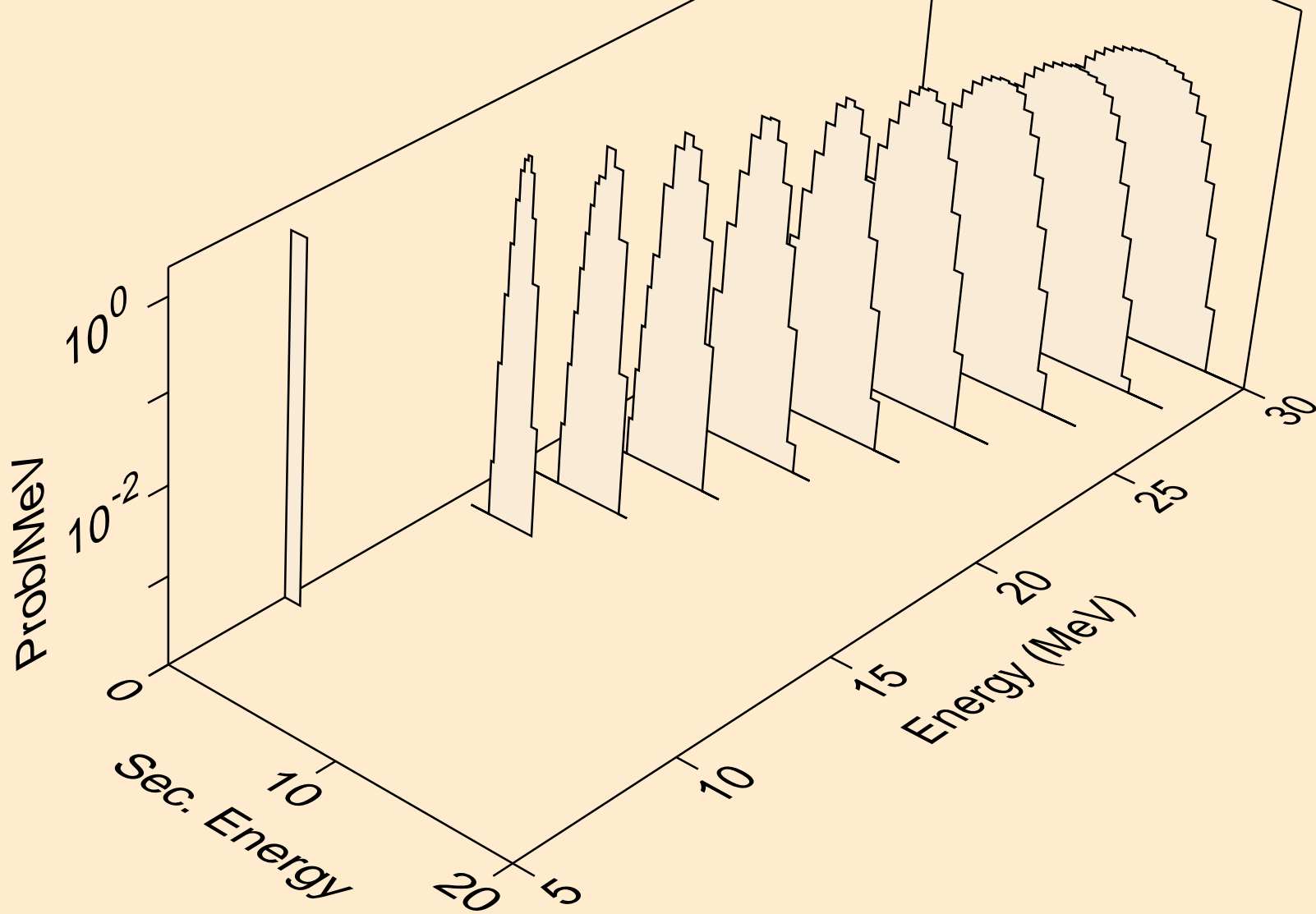

PR127 NEUTRON ACER TENDL-2021 LIBRARY; T=293.6K  
he3s from (n,x)

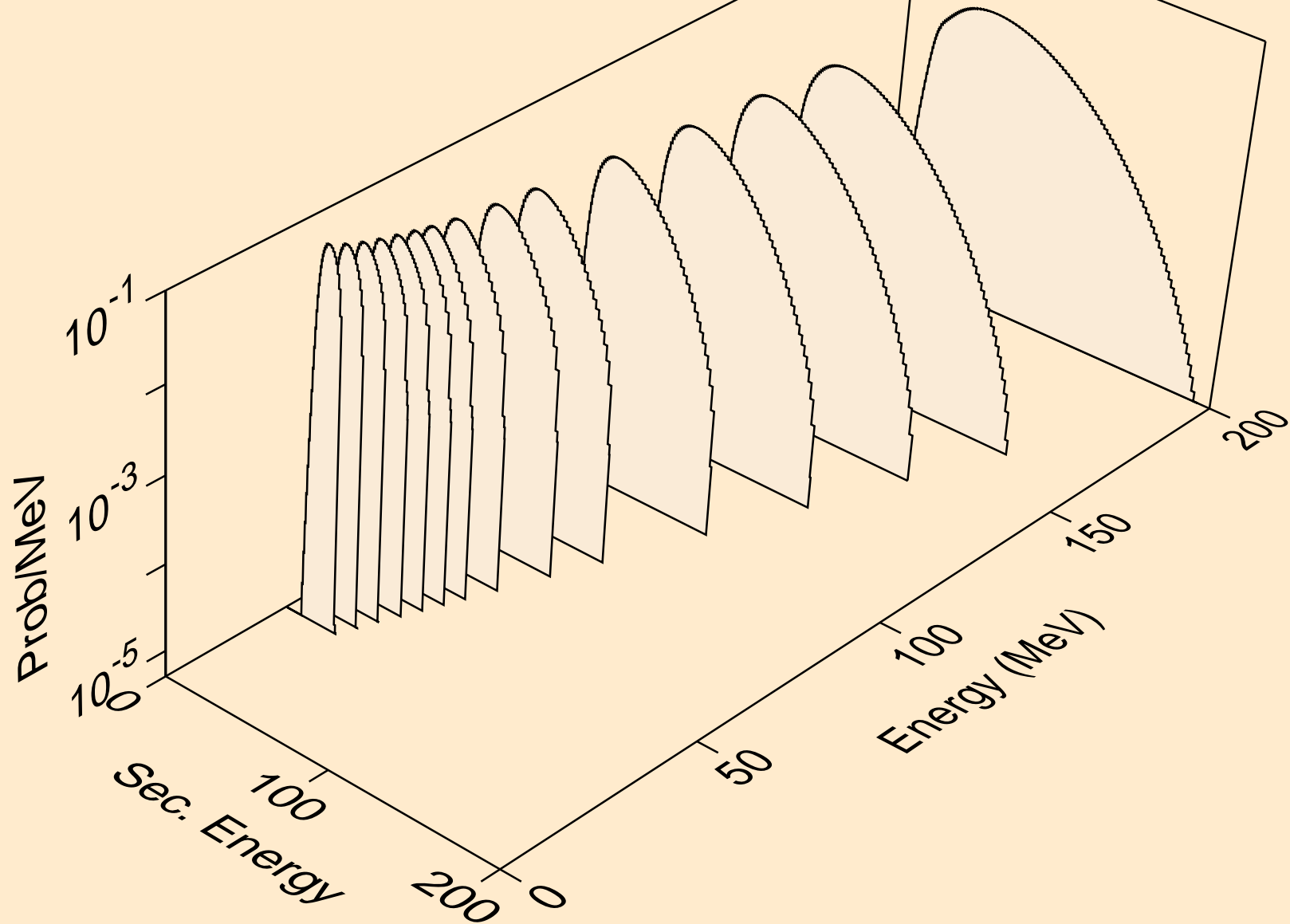

PR127 NEUTRON ACER TENDL-2021 LIBRARY; T=293.6K  
he3s from (n,n\*)he3

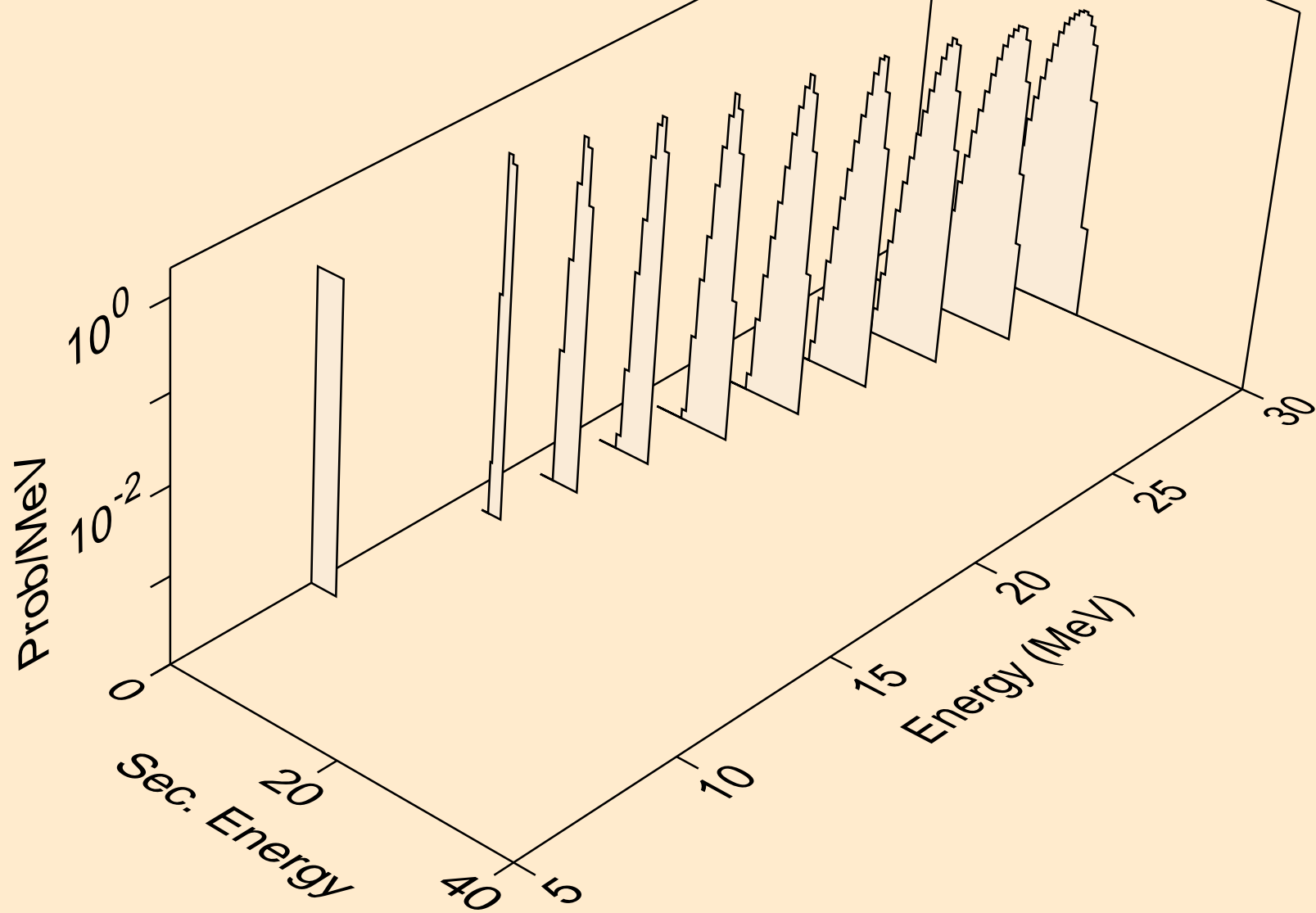

PR127 NEUTRON ACER TENDL-2021 LIBRARY; T=293.6K  
he3s from (n,he3)

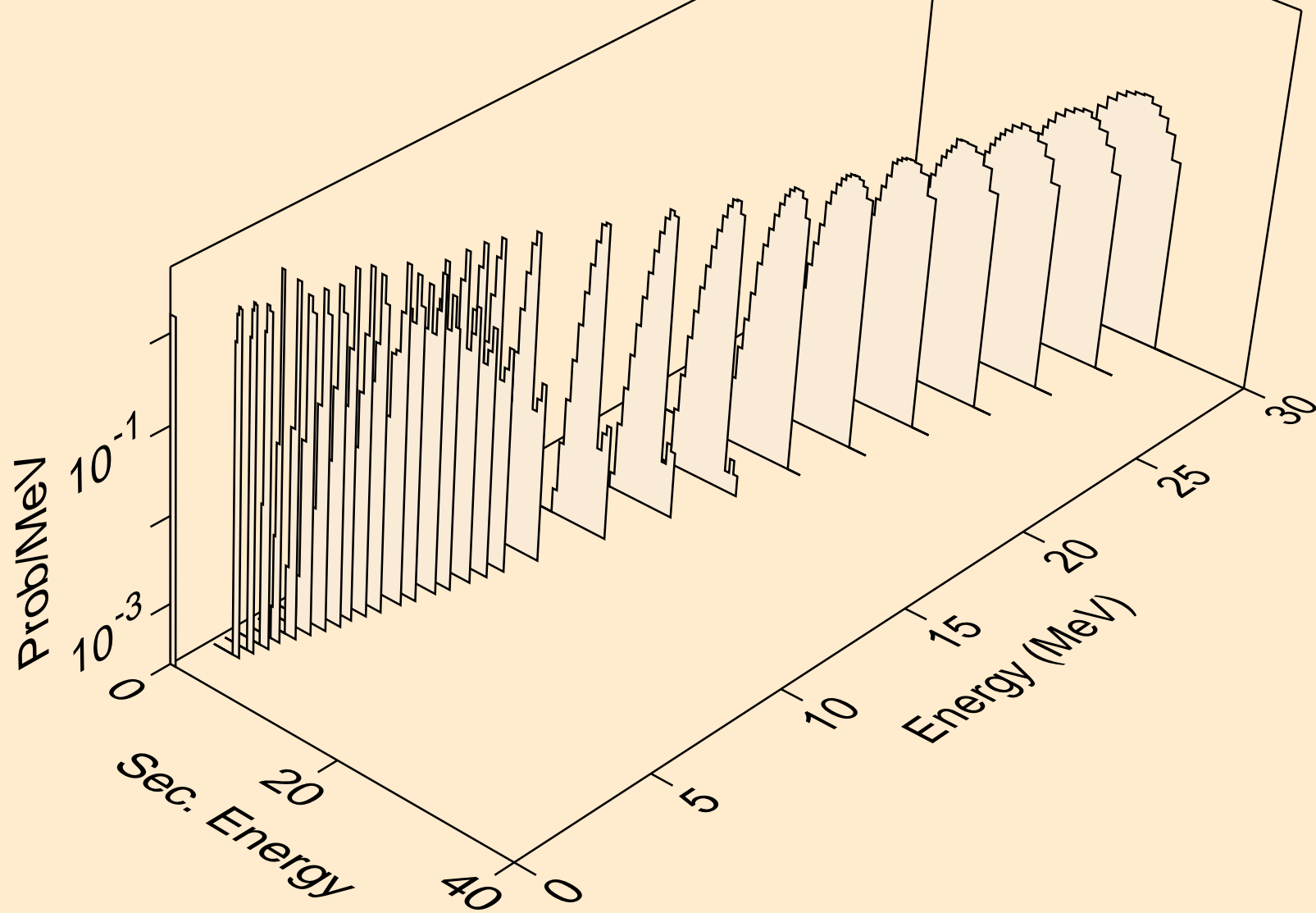

PR127 NEUTRON ACER TENDL-2021 LIBRARY; T=293.6K  
alphas from (n,x)

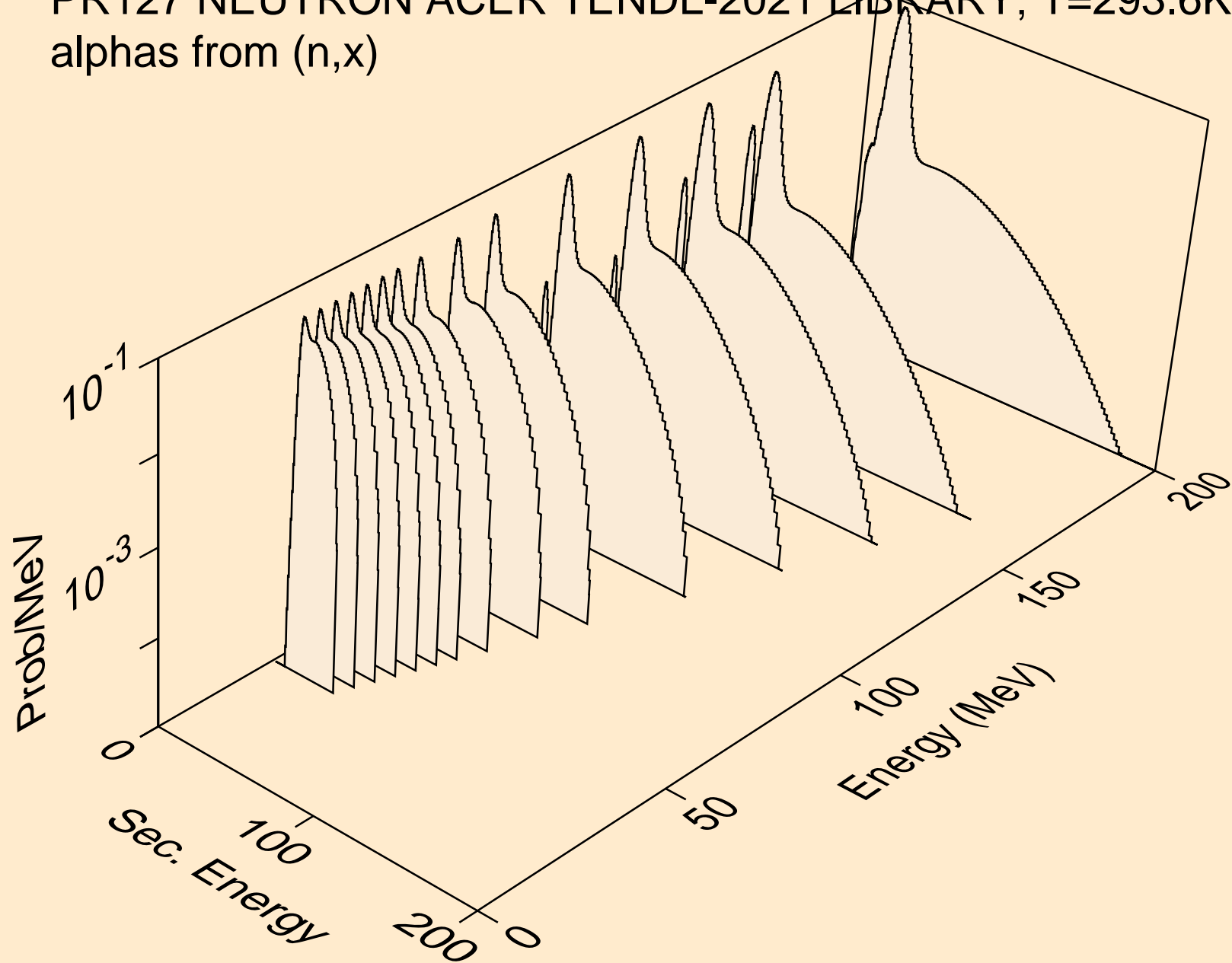

PR127 NEUTRON ACER TENDL-2021 LIBRARY; T=293.6K  
alphas from (n,n\*)a

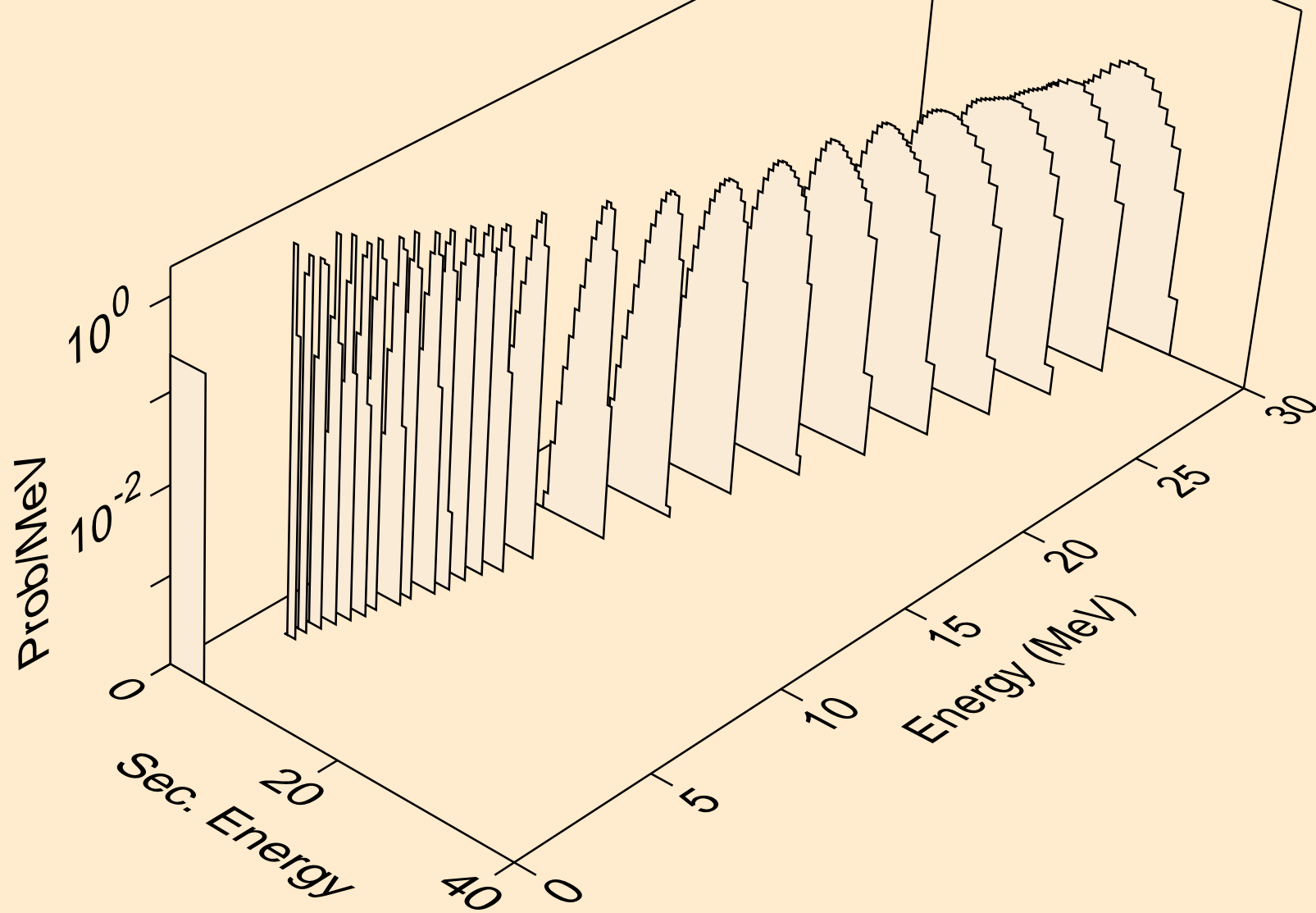

PR127 NEUTRON ACER TENDL-2021 LIBRARY; T=293.6K  
alphas from (n,2n)a

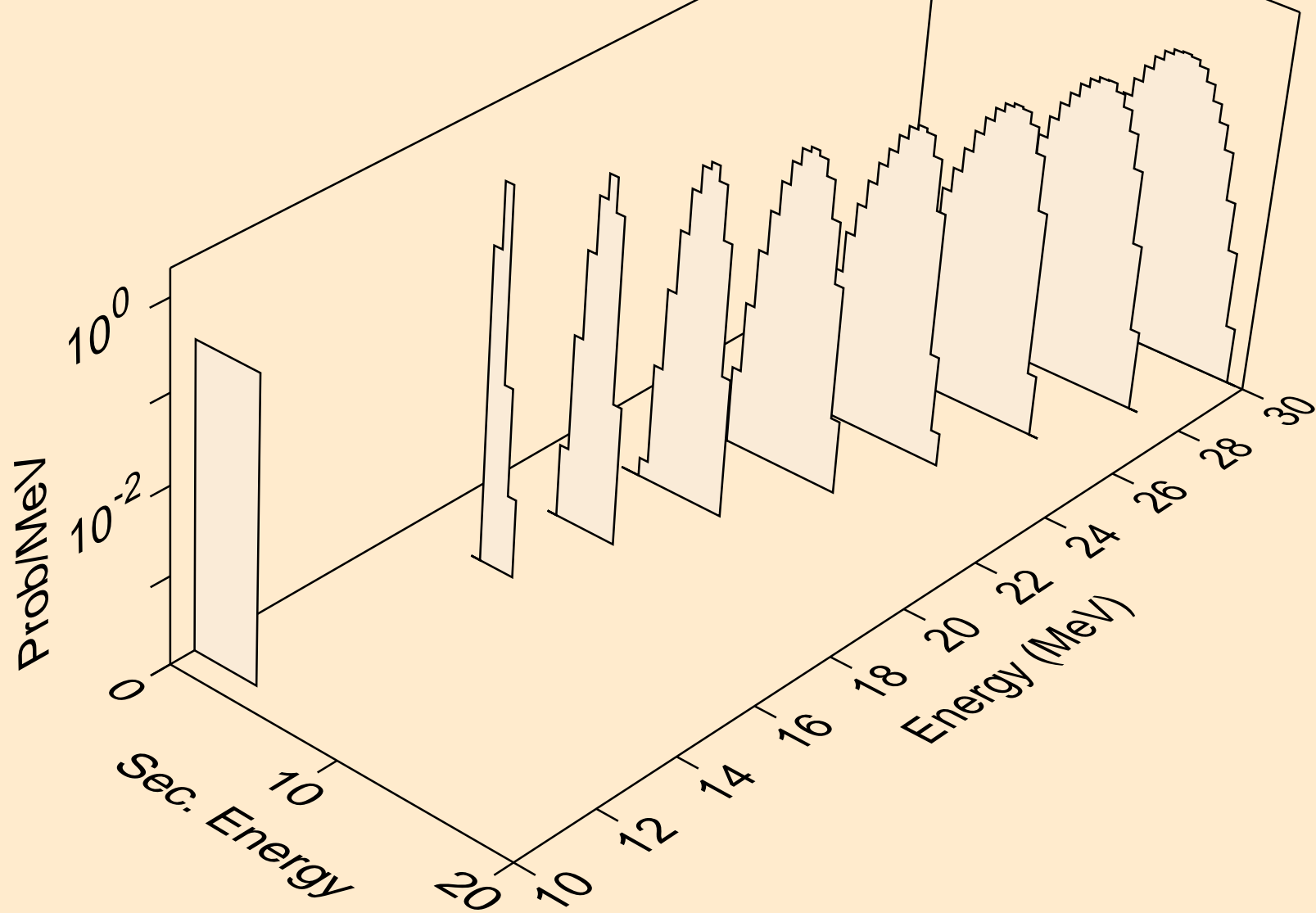

PR127 NEUTRON ACER TENDL-2021 LIBRARY; T=293.6K  
alphas from (n,n\*)2a

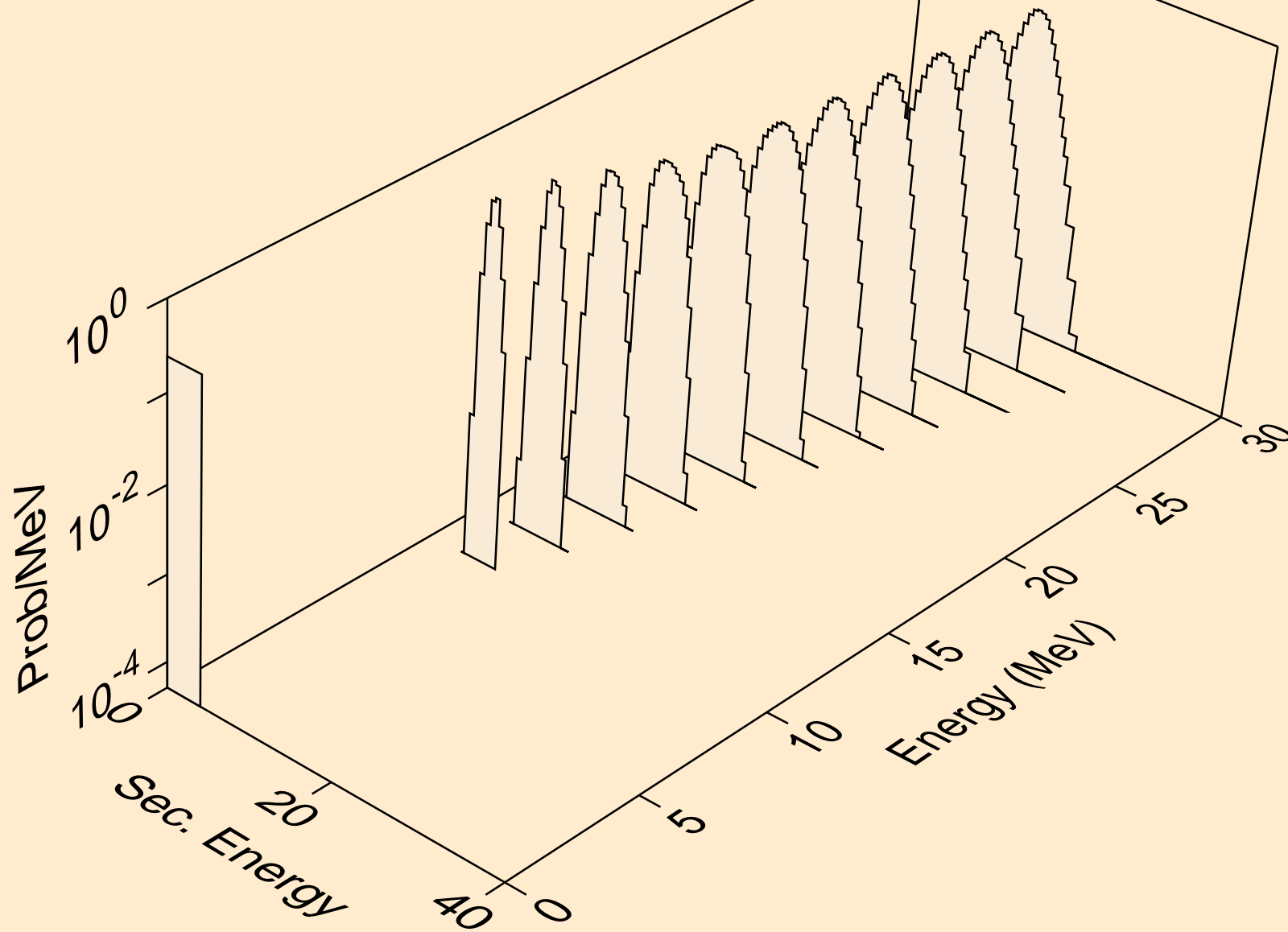

PR127 NEUTRON ACER TENDL-2021 LIBRARY; T=293.6K  
alphas from (n,npa)

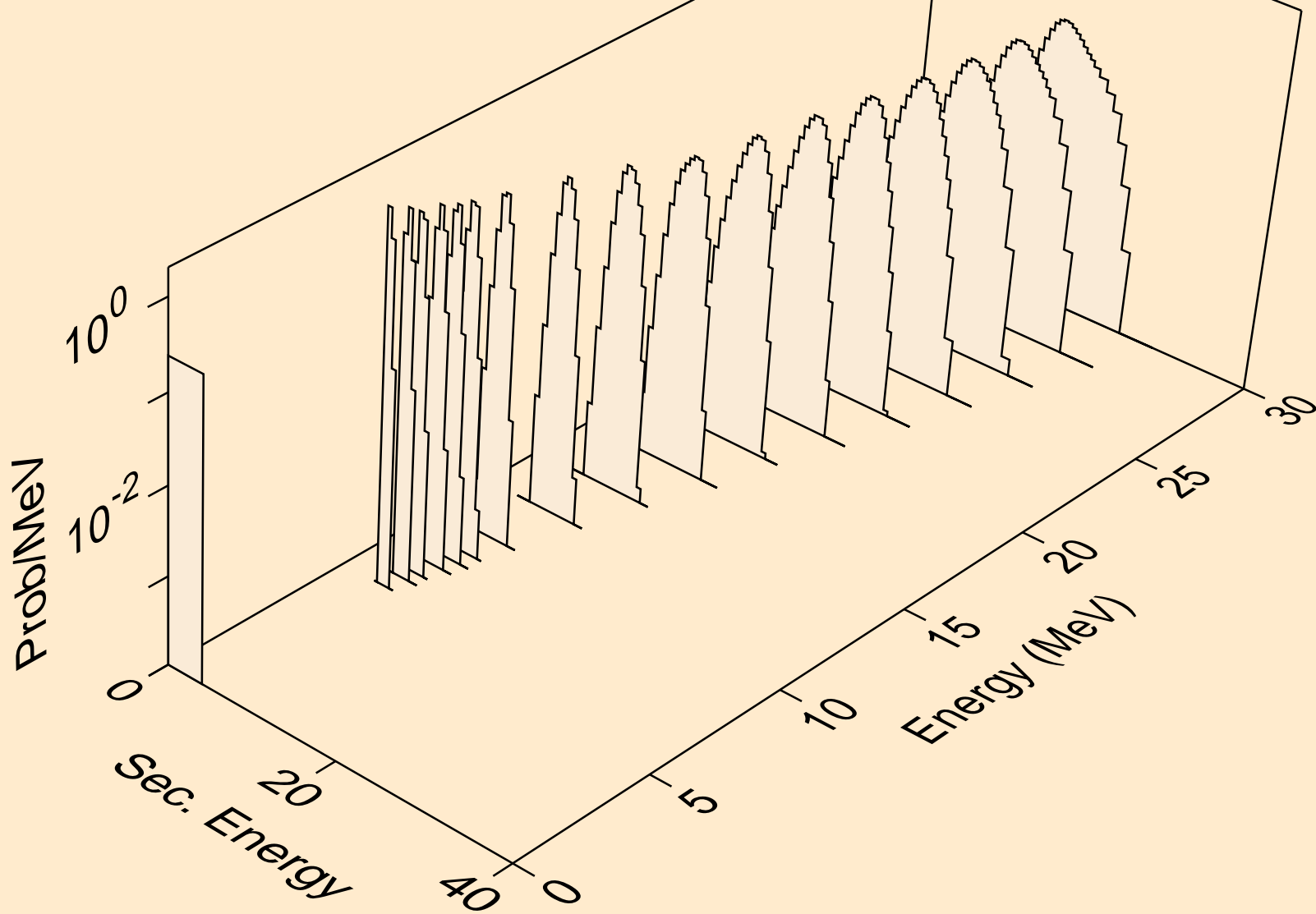

PR127 NEUTRON ACER TENDL-2021 LIBRARY; T=293.6K  
alphas from (n,a)

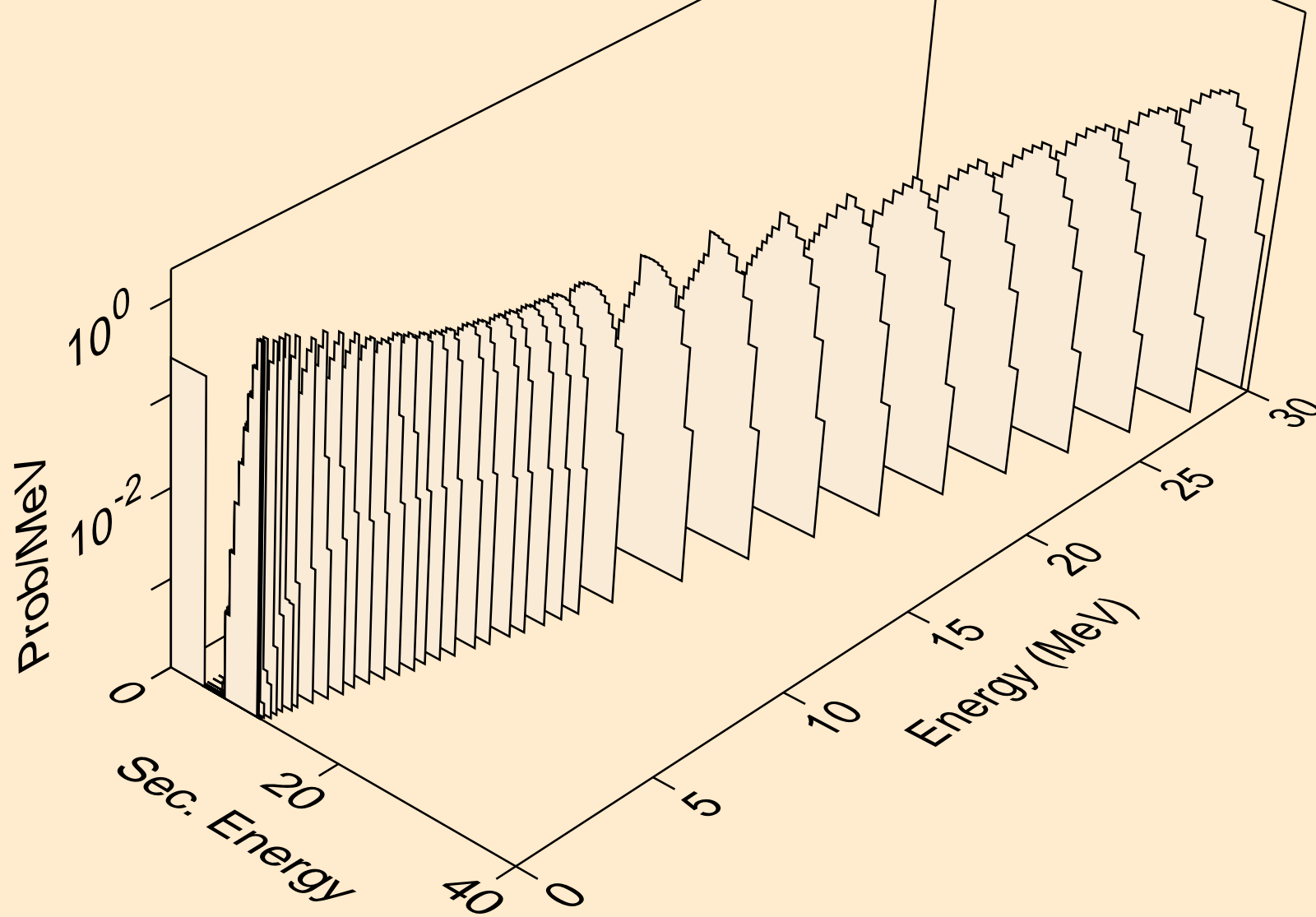

PR127 NEUTRON ACER TENDL-2021 LIBRARY; T=293.6K  
alphas from (n,2a)

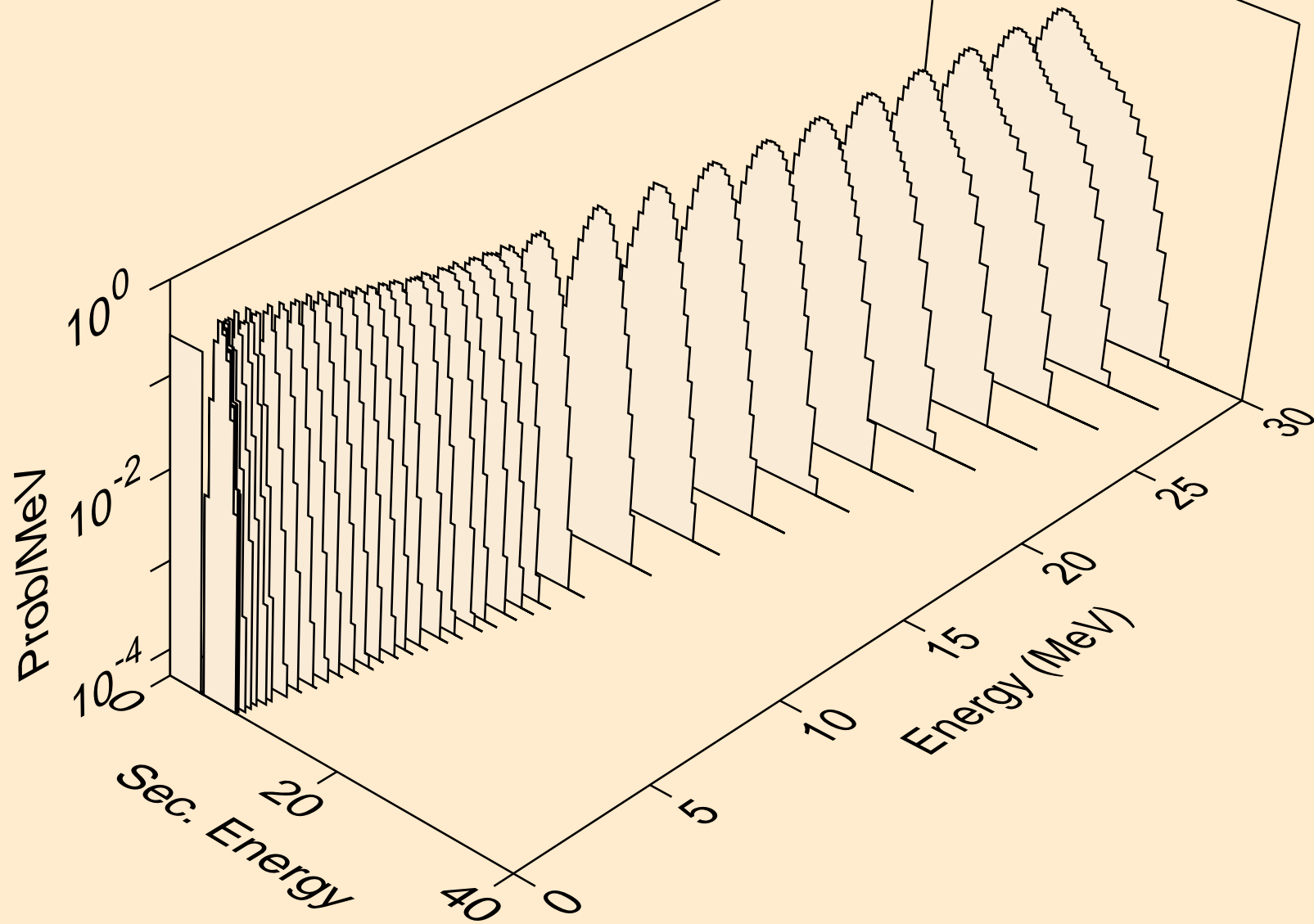

PR127 NEUTRON ACER TENDL-2021 LIBRARY; T=293.6K  
alphas from (n,3a)

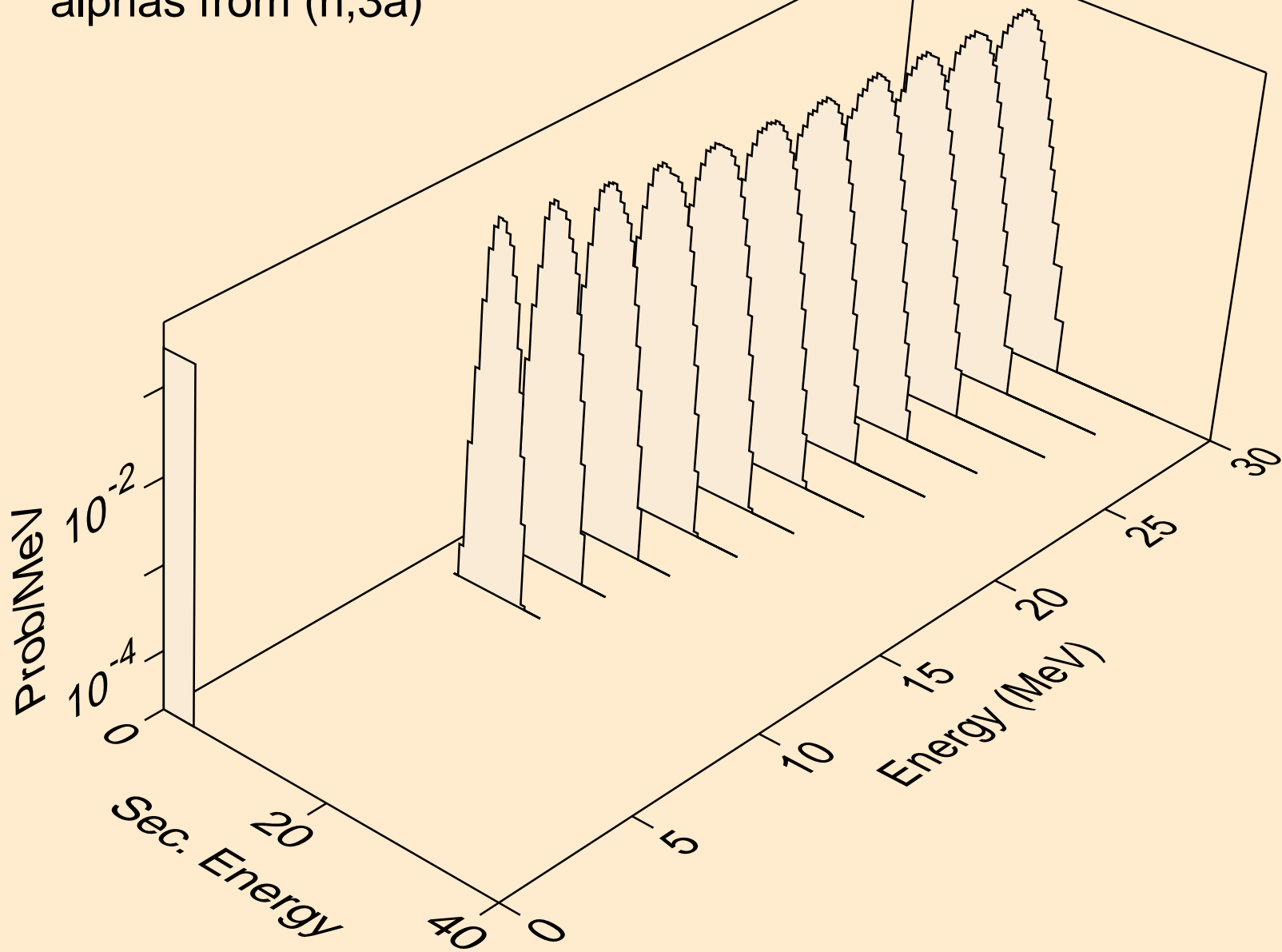

PR127 NEUTRON ACER TENDL-2021 LIBRARY; T=293.6K  
alphas from (n,p)

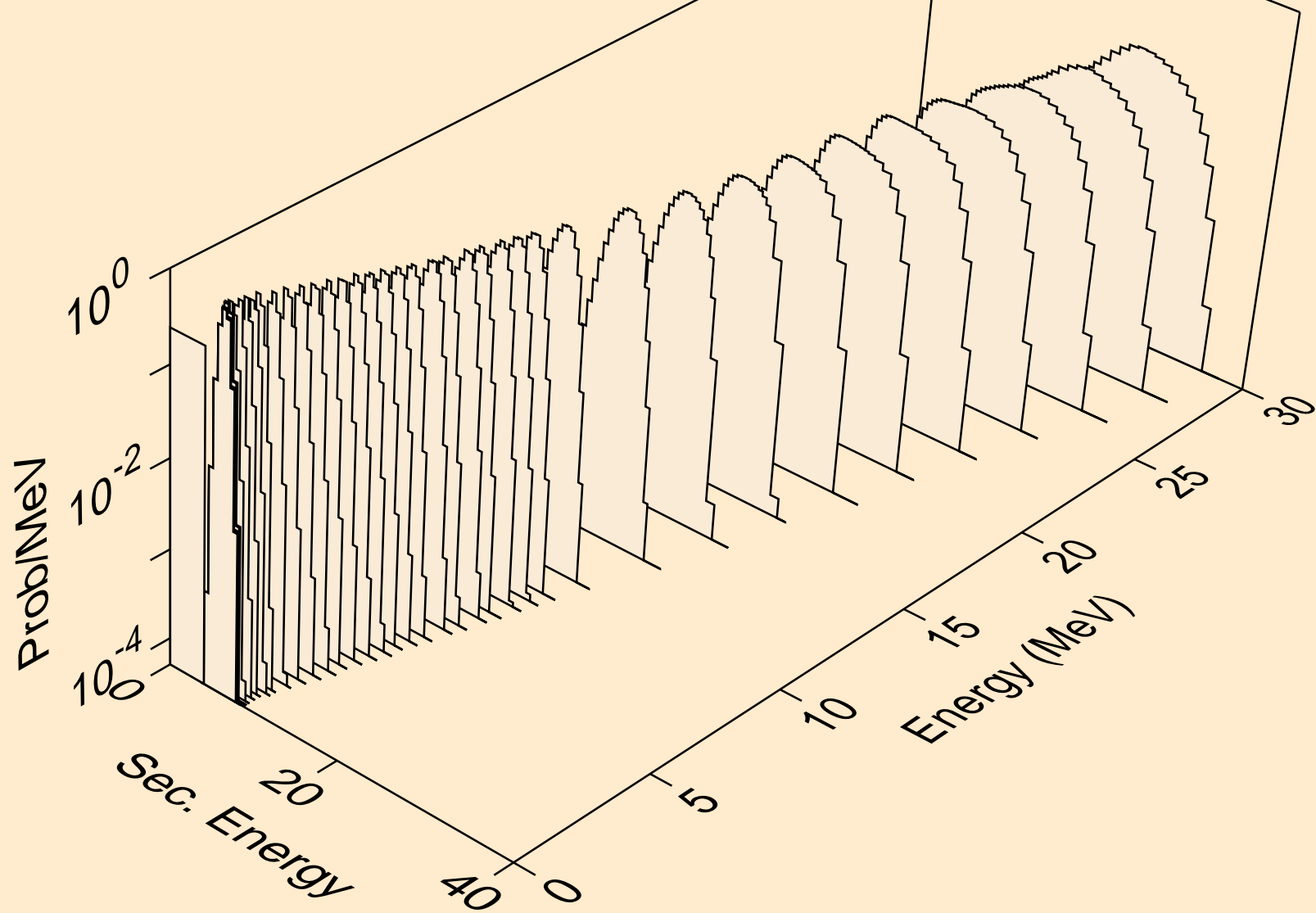

PR127 NEUTRON ACER TENDL-2021 LIBRARY; T=293.6K  
alphas from (n,d2a)

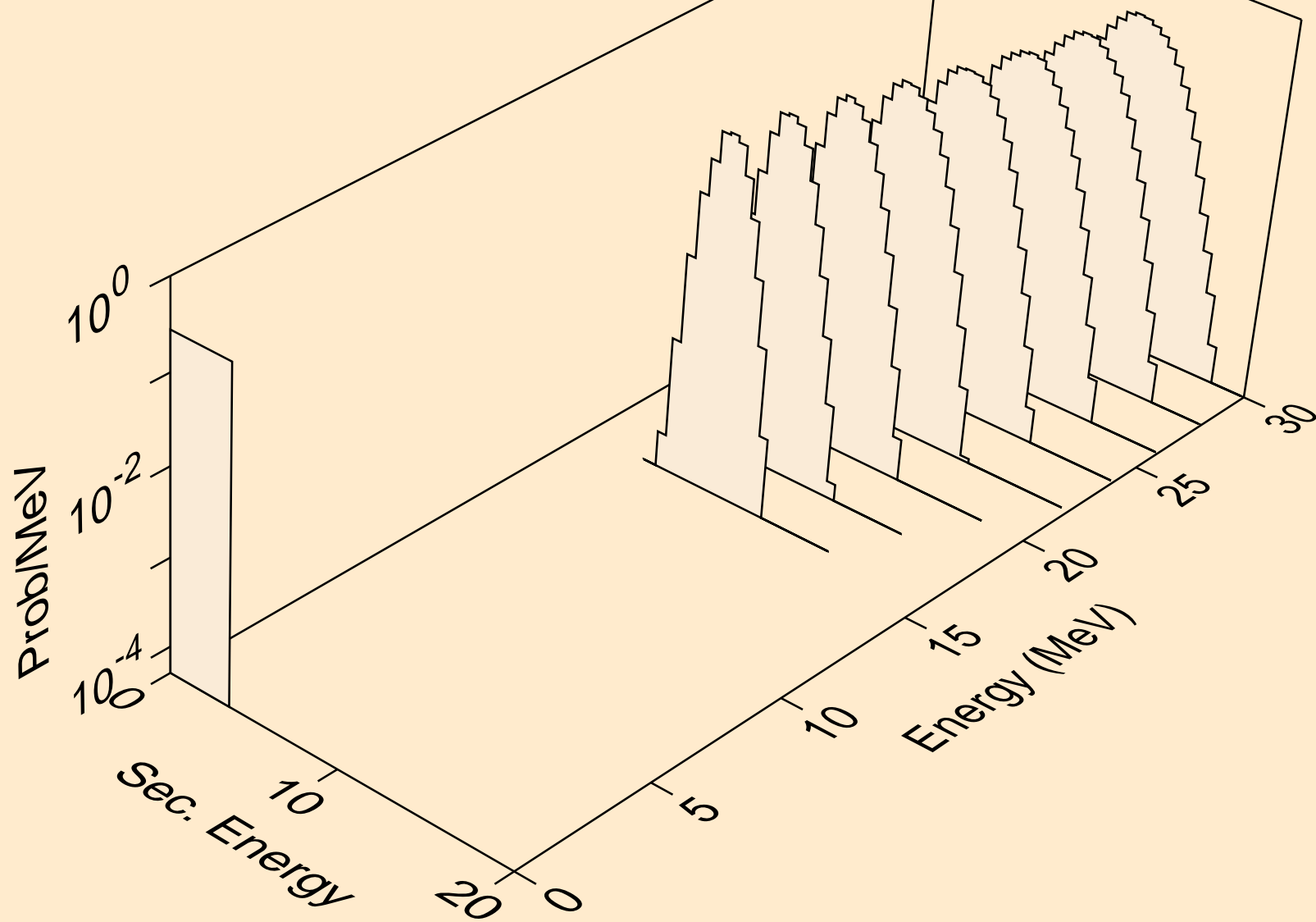

PR127 NEUTRON ACER TENDL-2021 LIBRARY; T=293.6K  
alphas from (n,da)

