

PU232 NEUTRON ACER TENDL-2021 LIBRARY; T=293.6K  
Principal cross sections

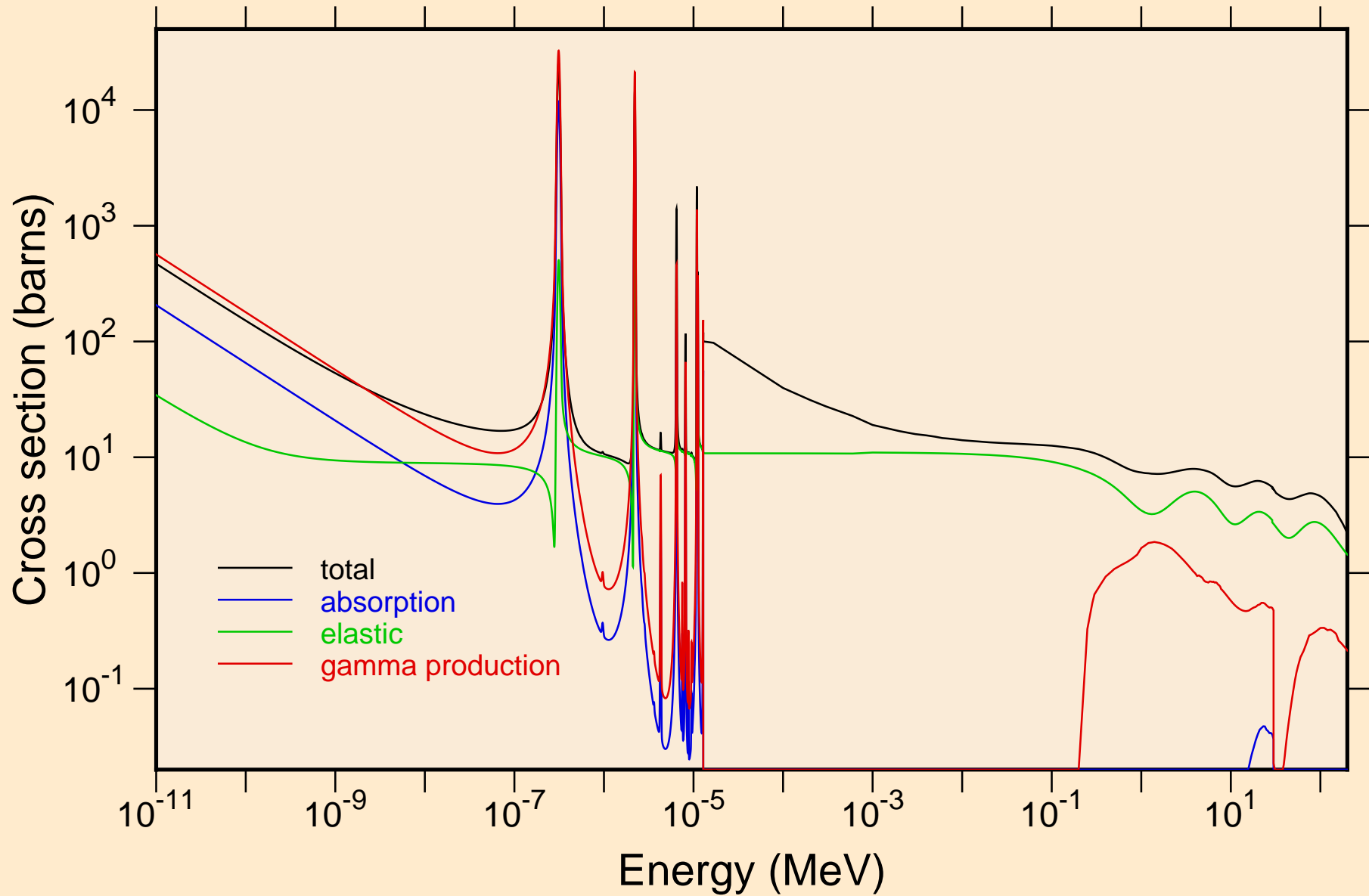

PU232 NEUTRON ACER TENDL-2021 LIBRARY; T=293.6K  
resonance total cross section

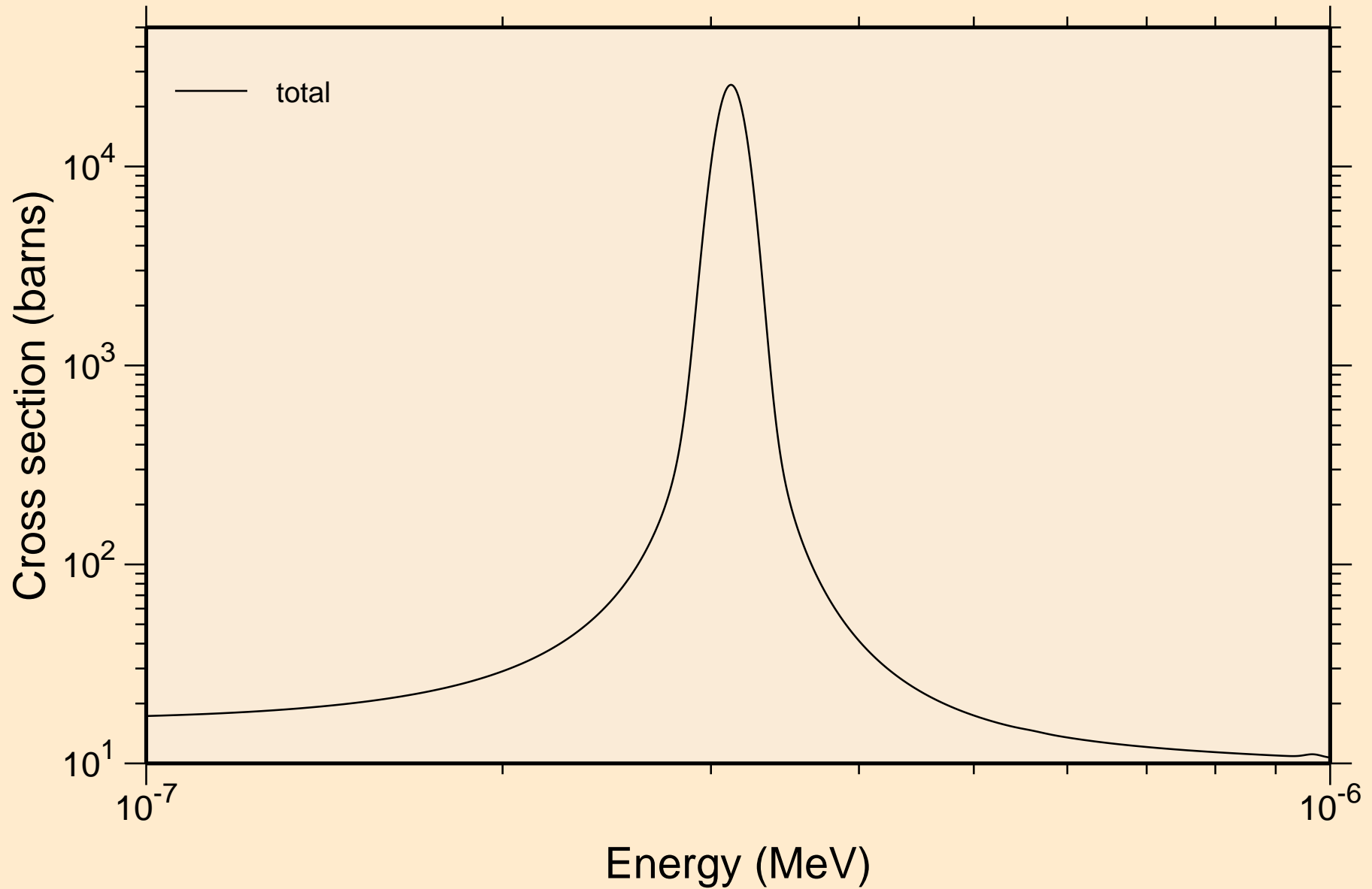

PU232 NEUTRON ACER TENDL-2021 LIBRARY; T=293.6K  
resonance total cross section

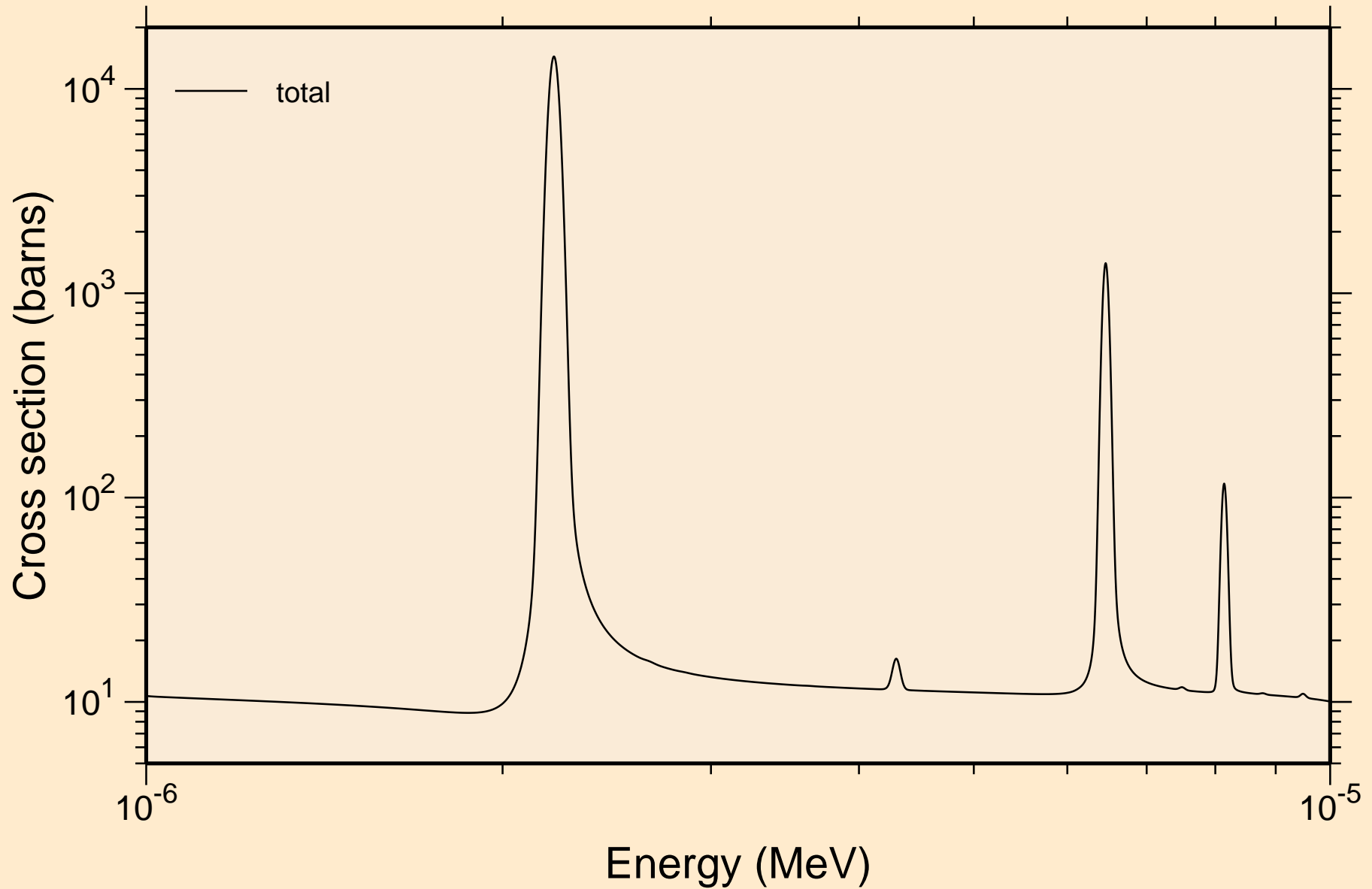

PU232 NEUTRON ACER TENDL-2021 LIBRARY; T=293.6K  
resonance total cross section

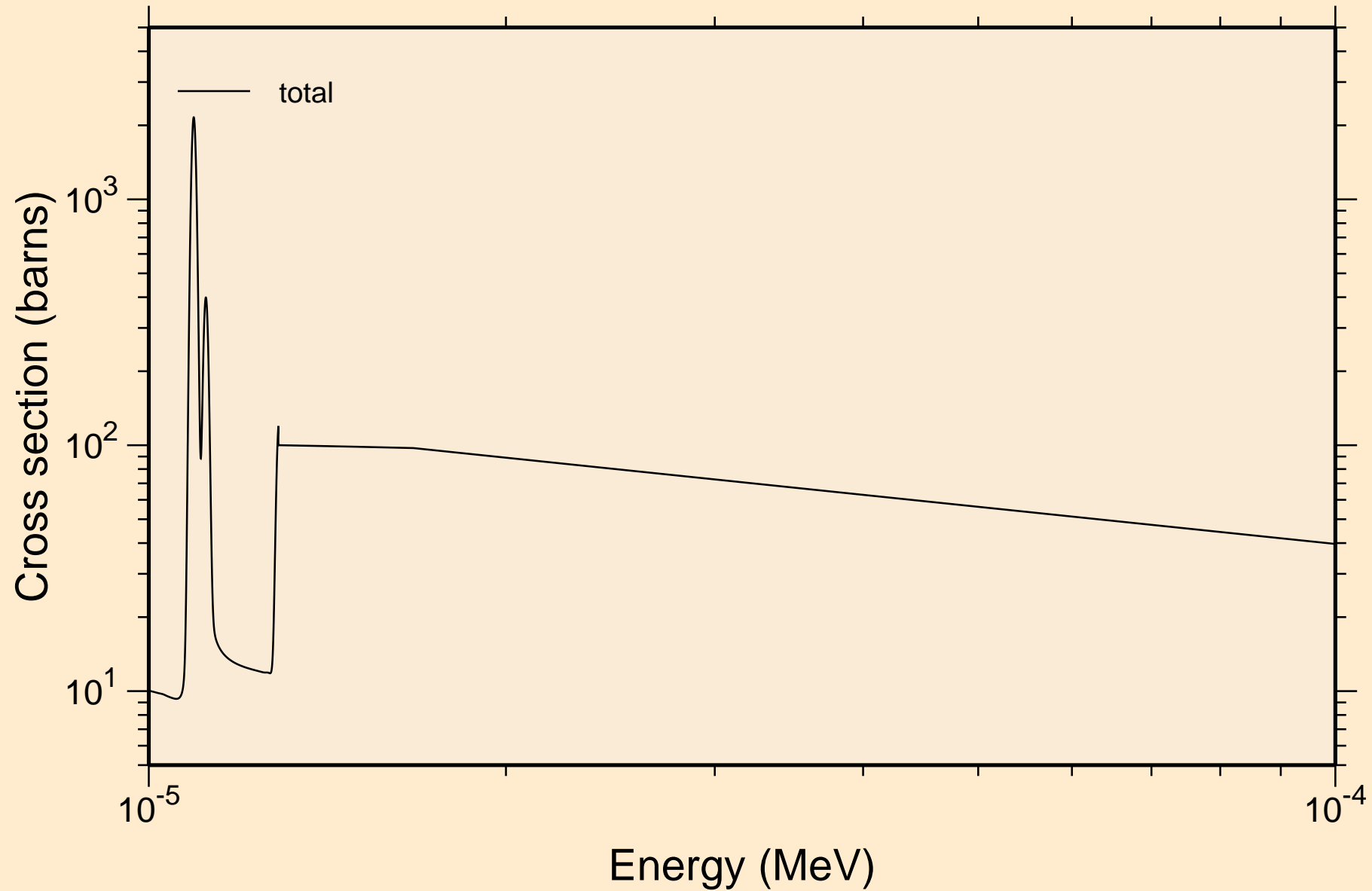

PU232 NEUTRON ACER TENDL-2021 LIBRARY; T=293.6K  
resonance total cross section

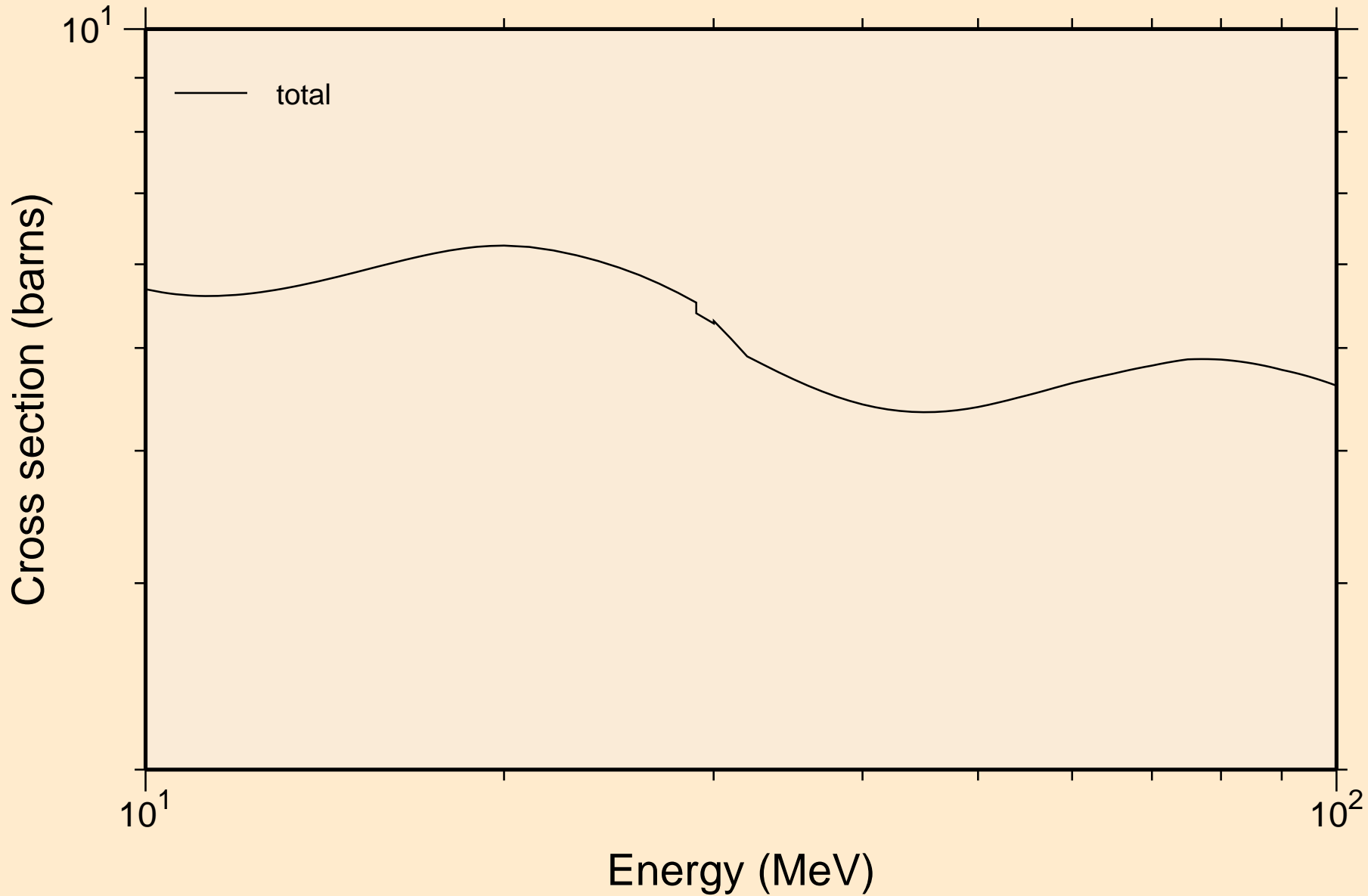

PU232 NEUTRON ACER TENDL-2021 LIBRARY; T=293.6K  
resonance absorption cross sections

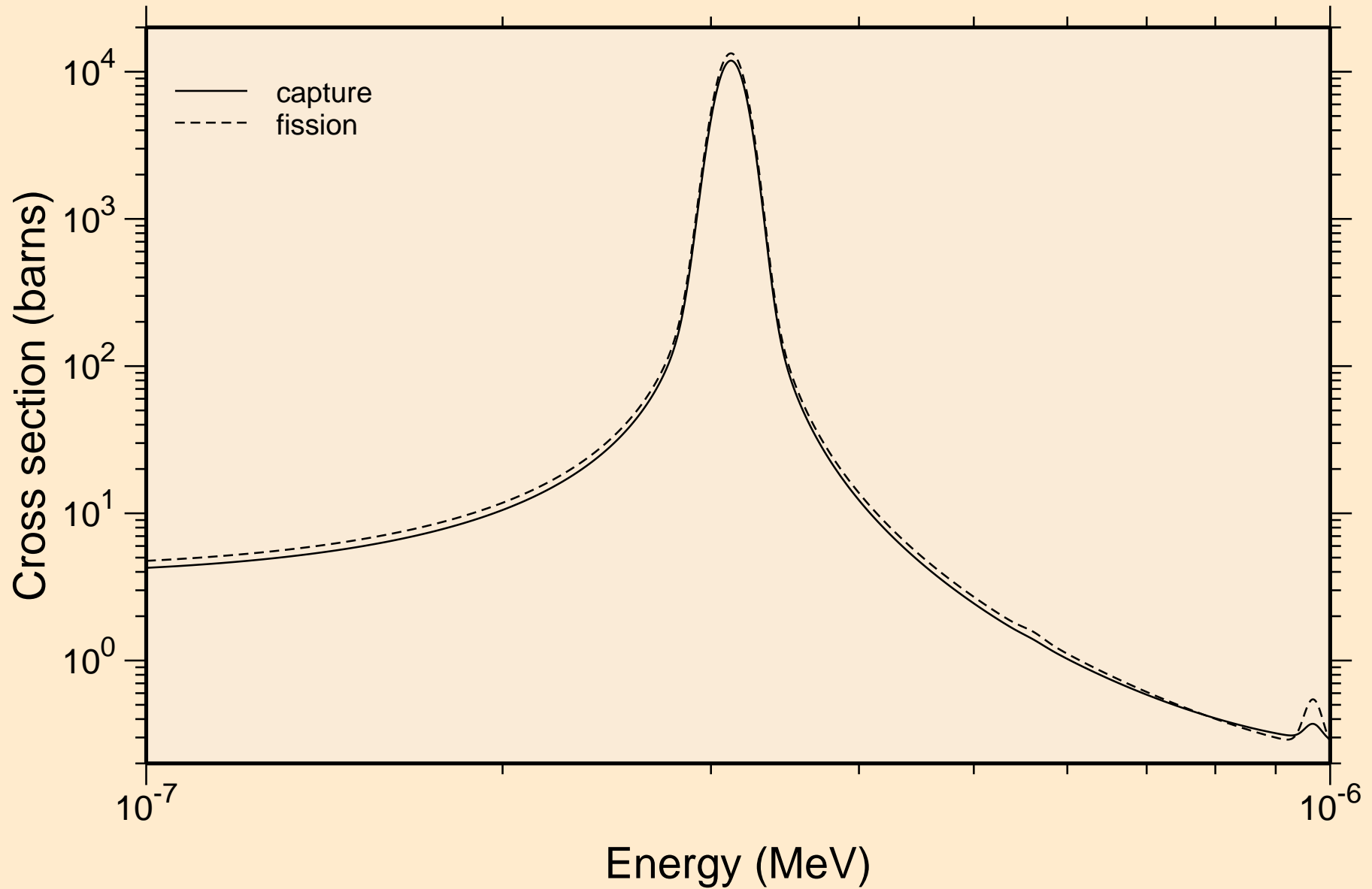

PU232 NEUTRON ACER TENDL-2021 LIBRARY; T=293.6K  
resonance absorption cross sections

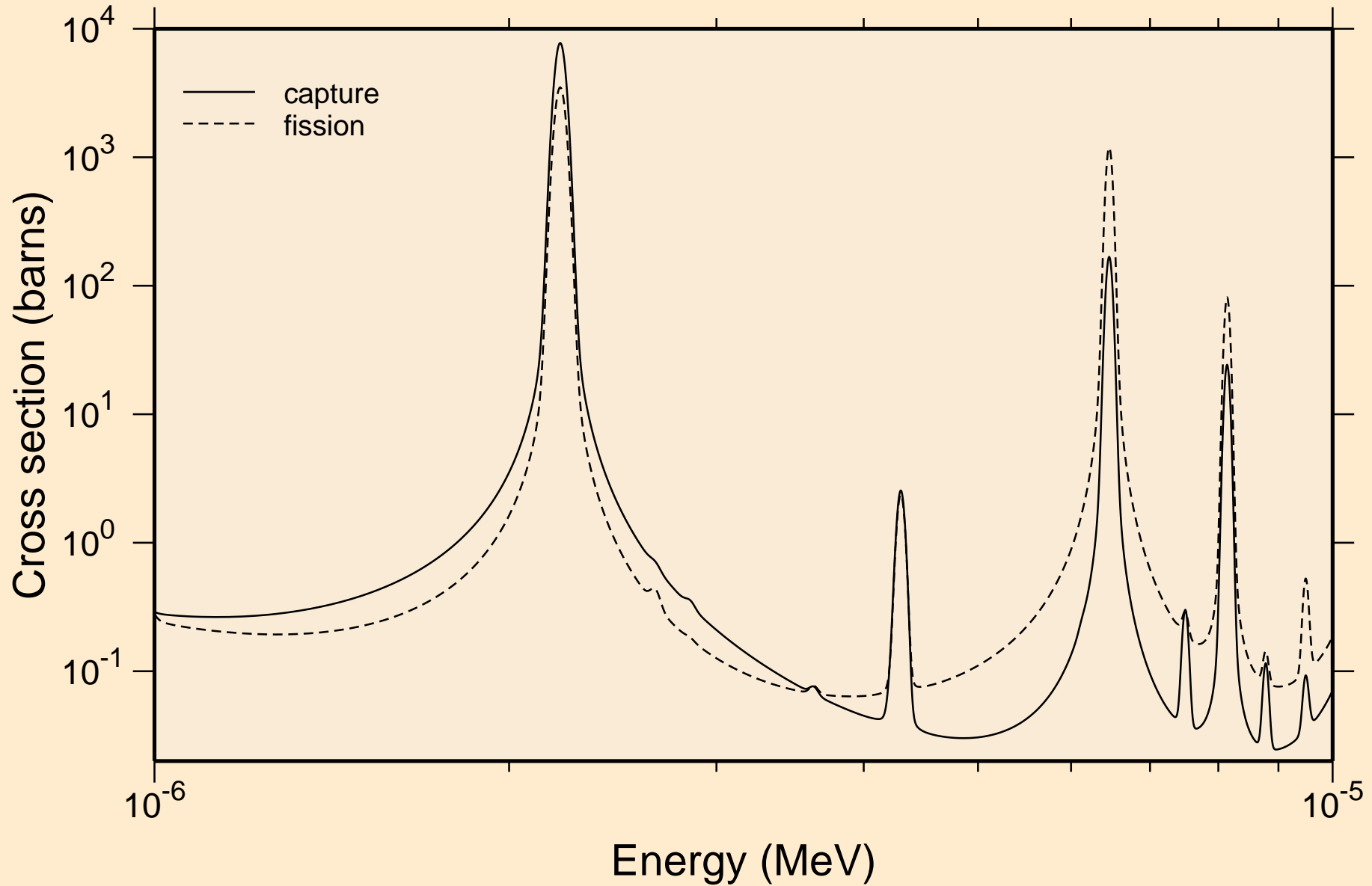

PU232 NEUTRON ACER TENDL-2021 LIBRARY; T=293.6K  
resonance absorption cross sections

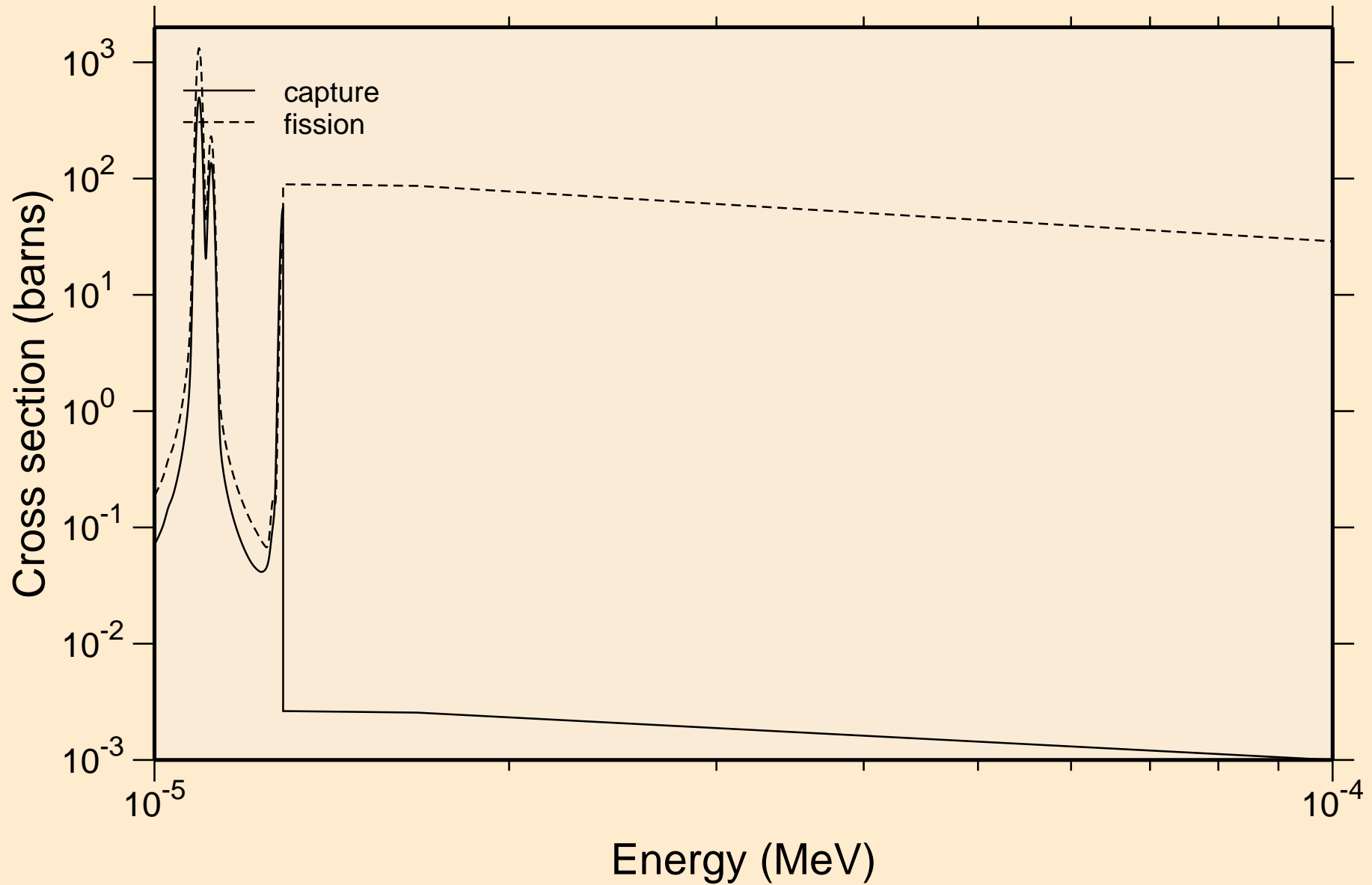

PU232 NEUTRON ACER TENDL-2021 LIBRARY; T=293.6K  
resonance absorption cross sections

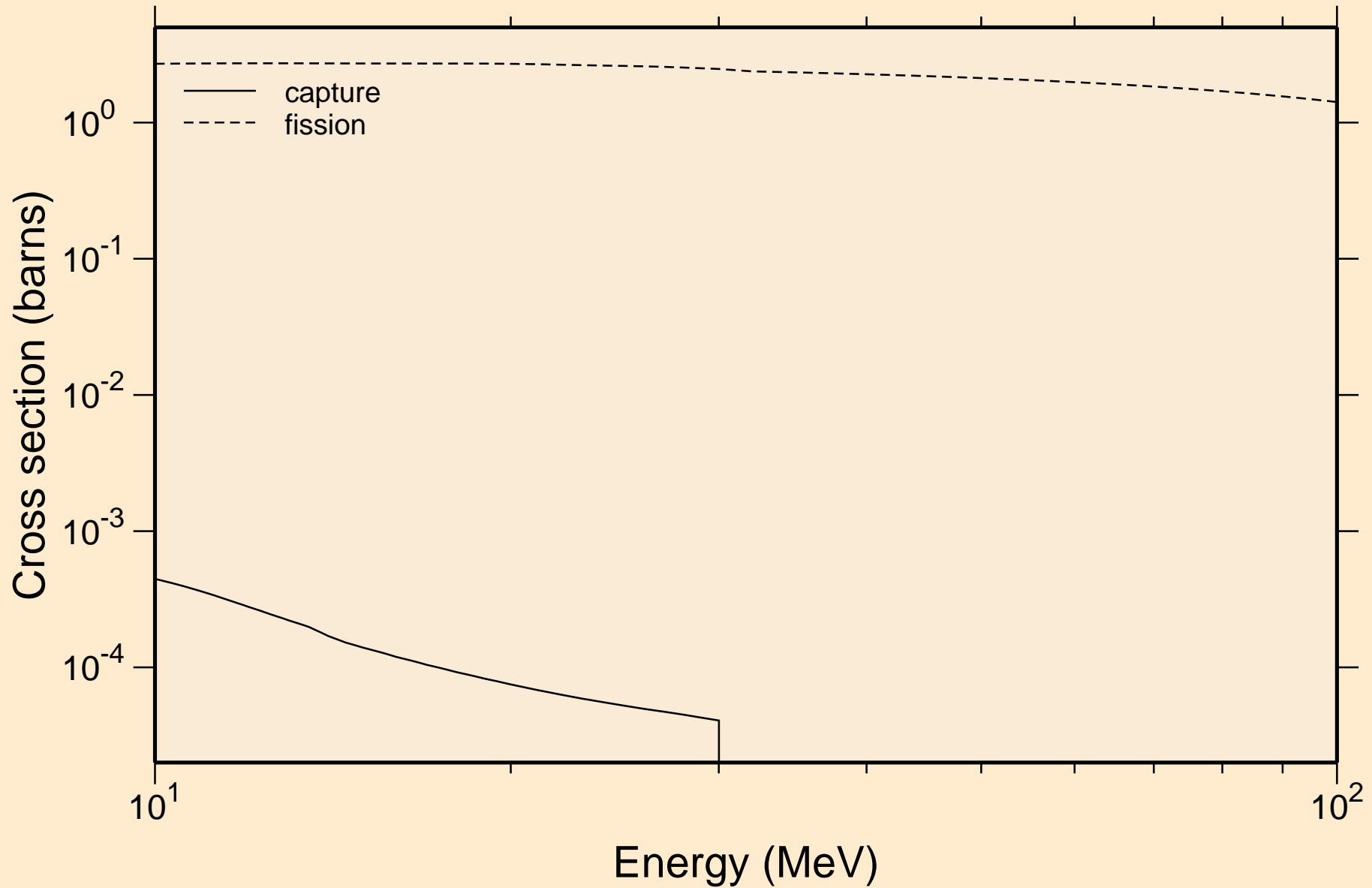

PU232 NEUTRON ACER TENDL-2021 LIBRARY; T=293.6K  
Heating

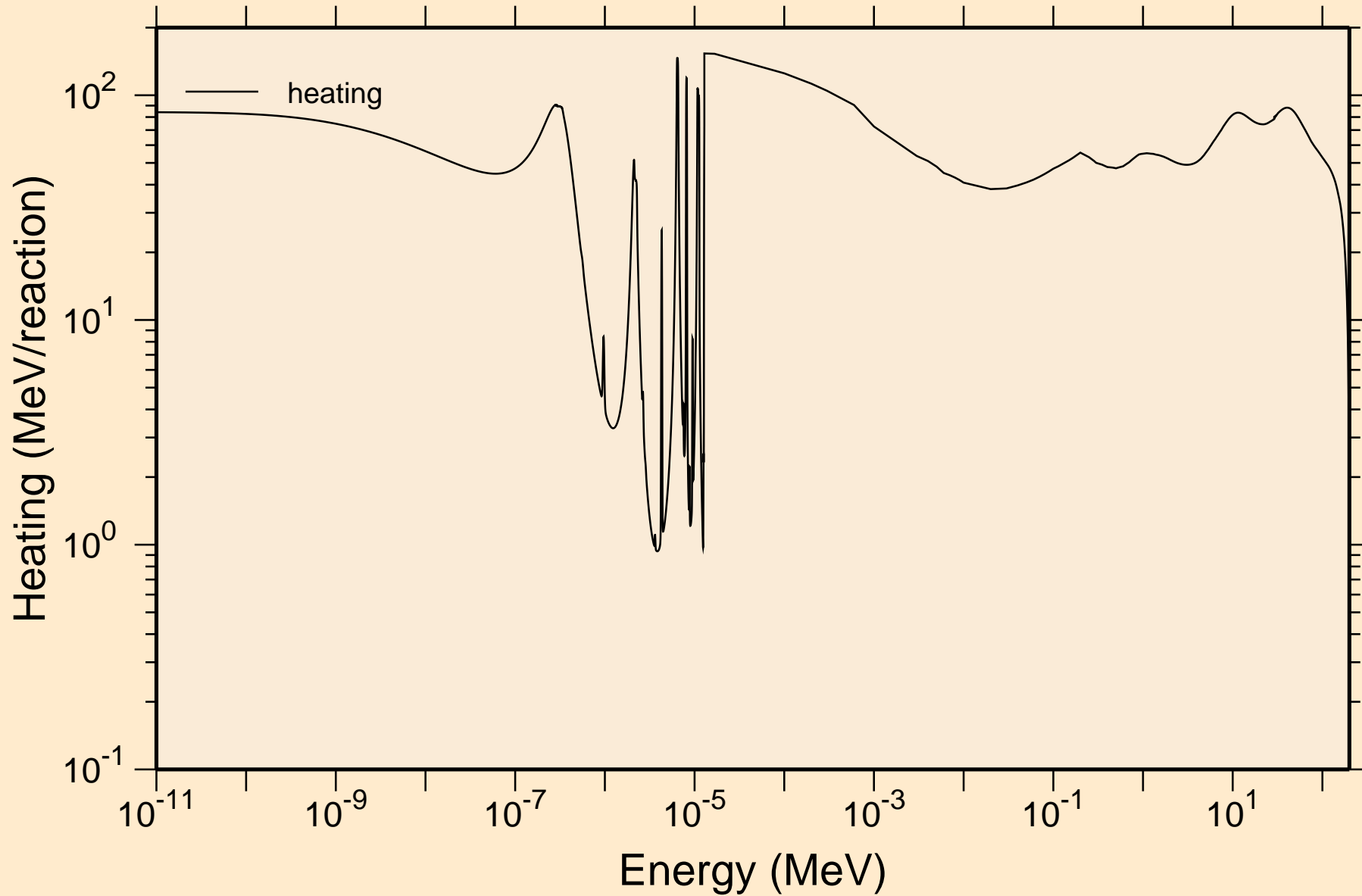

PU232 NEUTRON ACER TENDL-2021 LIBRARY; T=293.6K  
Damage

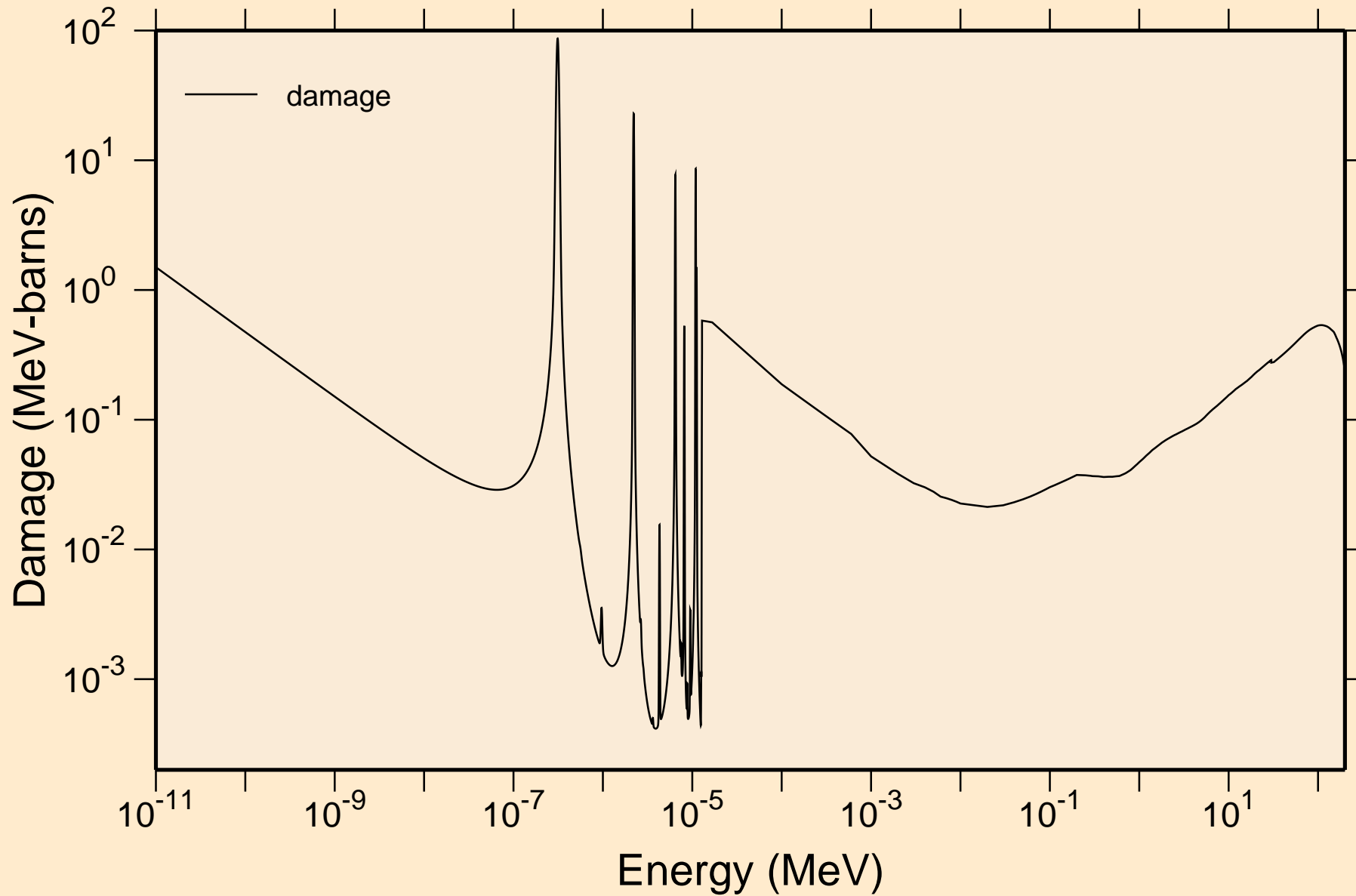

PU232 NEUTRON ACER TENDL-2021 LIBRARY; T=293.6K  
Non-threshold reactions

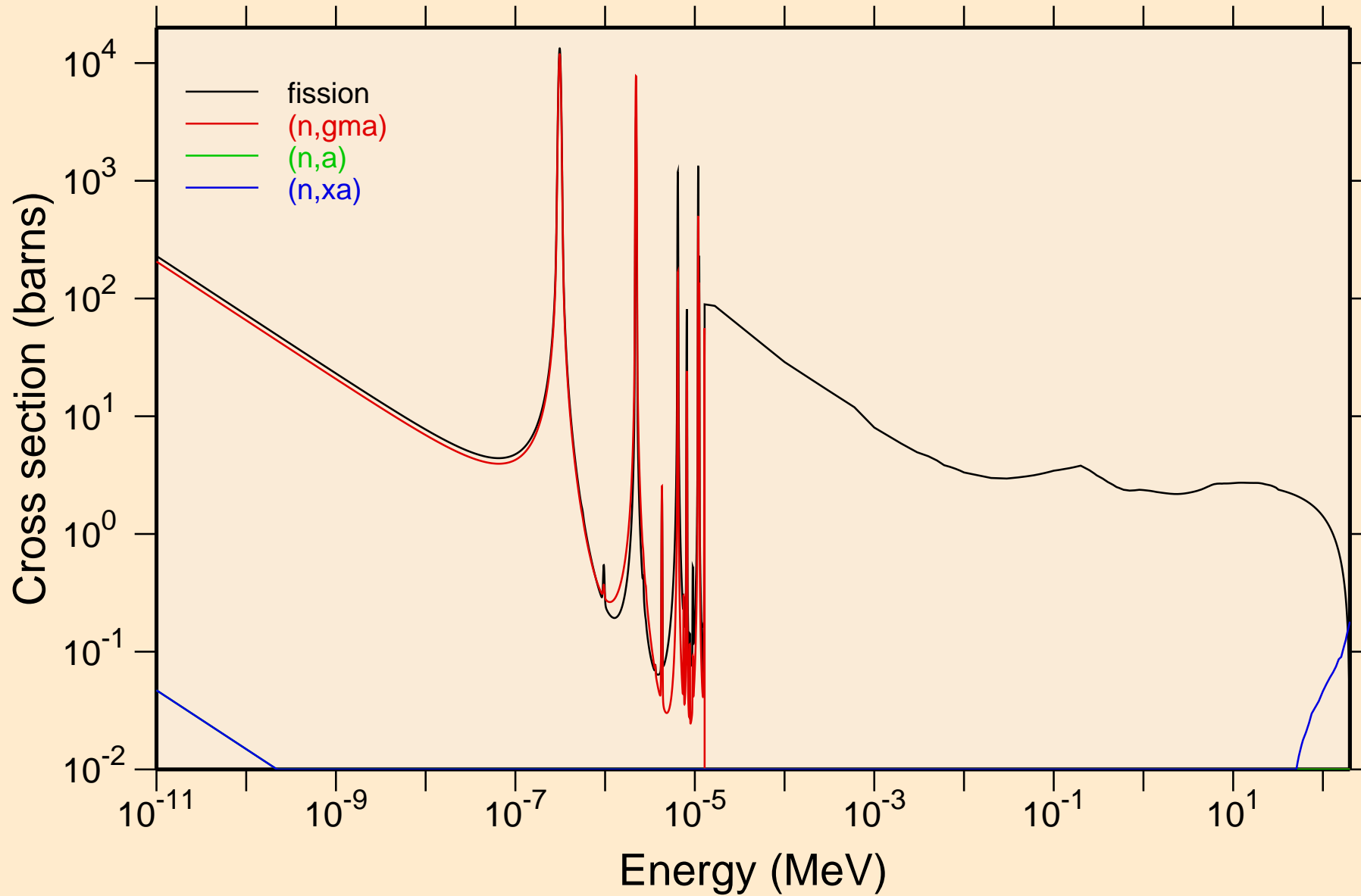

PU232 NEUTRON ACER TENDL-2021 LIBRARY; T=293.6K  
Principal cross sections

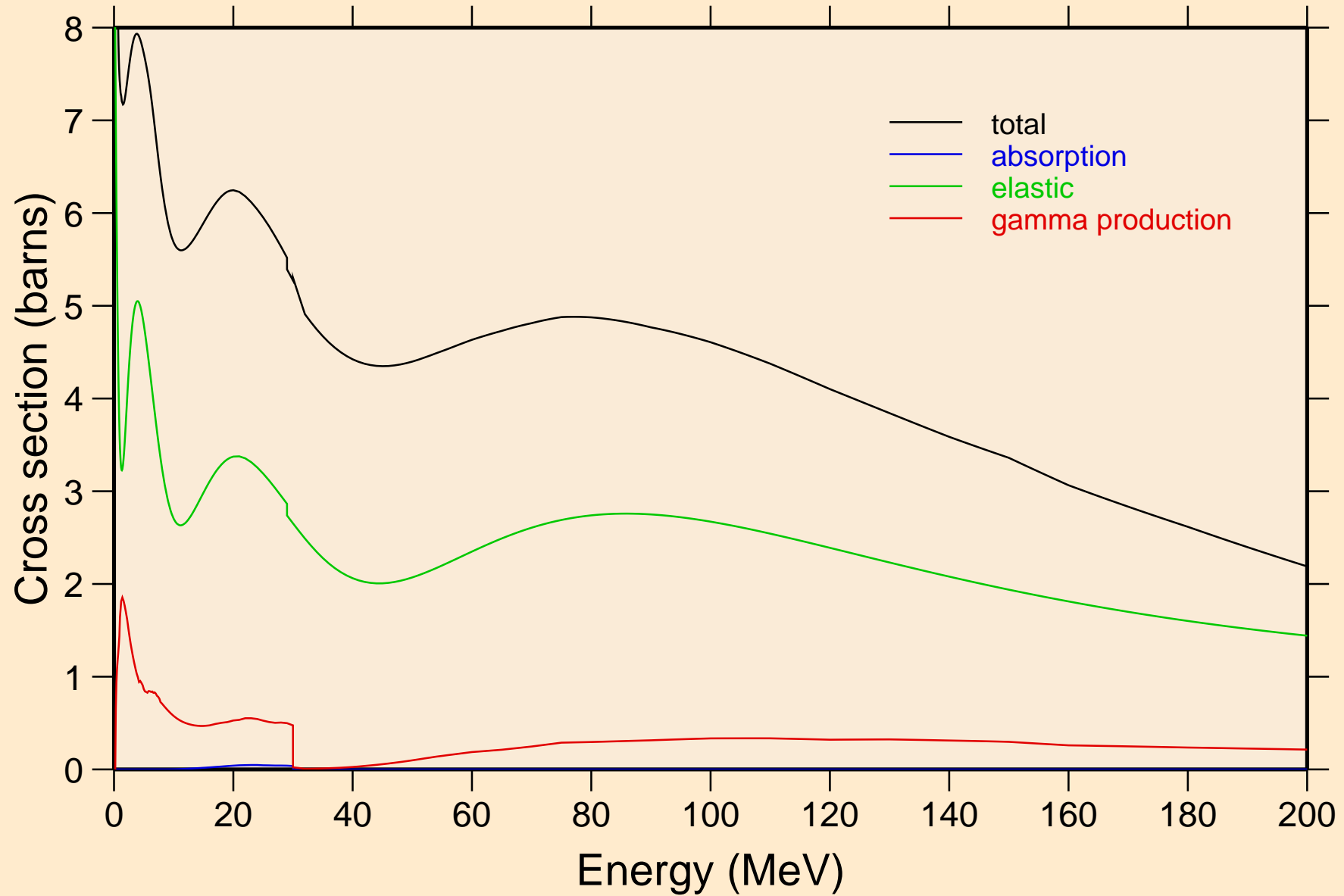

PU232 NEUTRON ACER TENDL-2021 LIBRARY; T=293.6K  
Heating

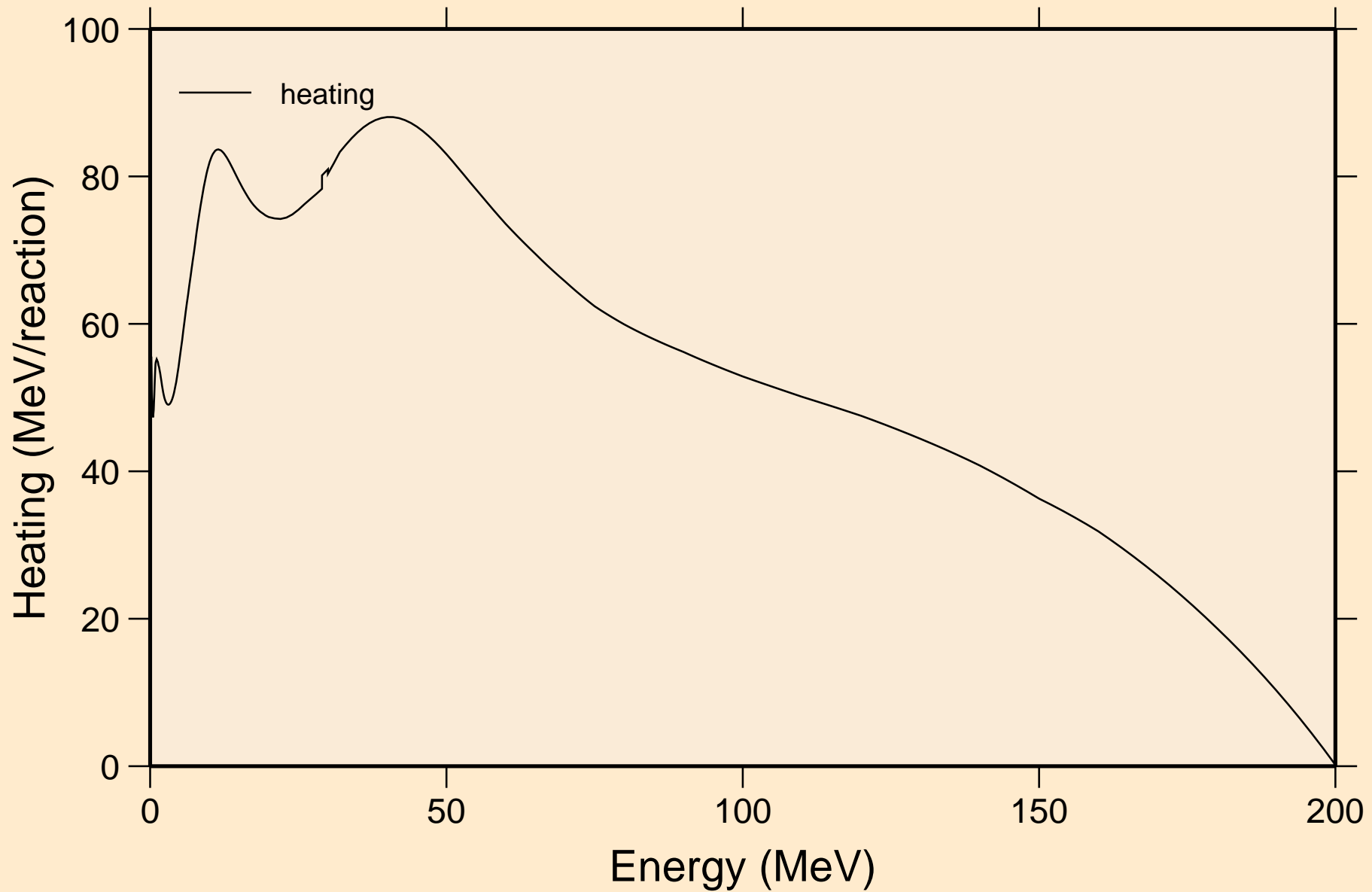

PU232 NEUTRON ACER TENDL-2021 LIBRARY; T=293.6K  
Damage

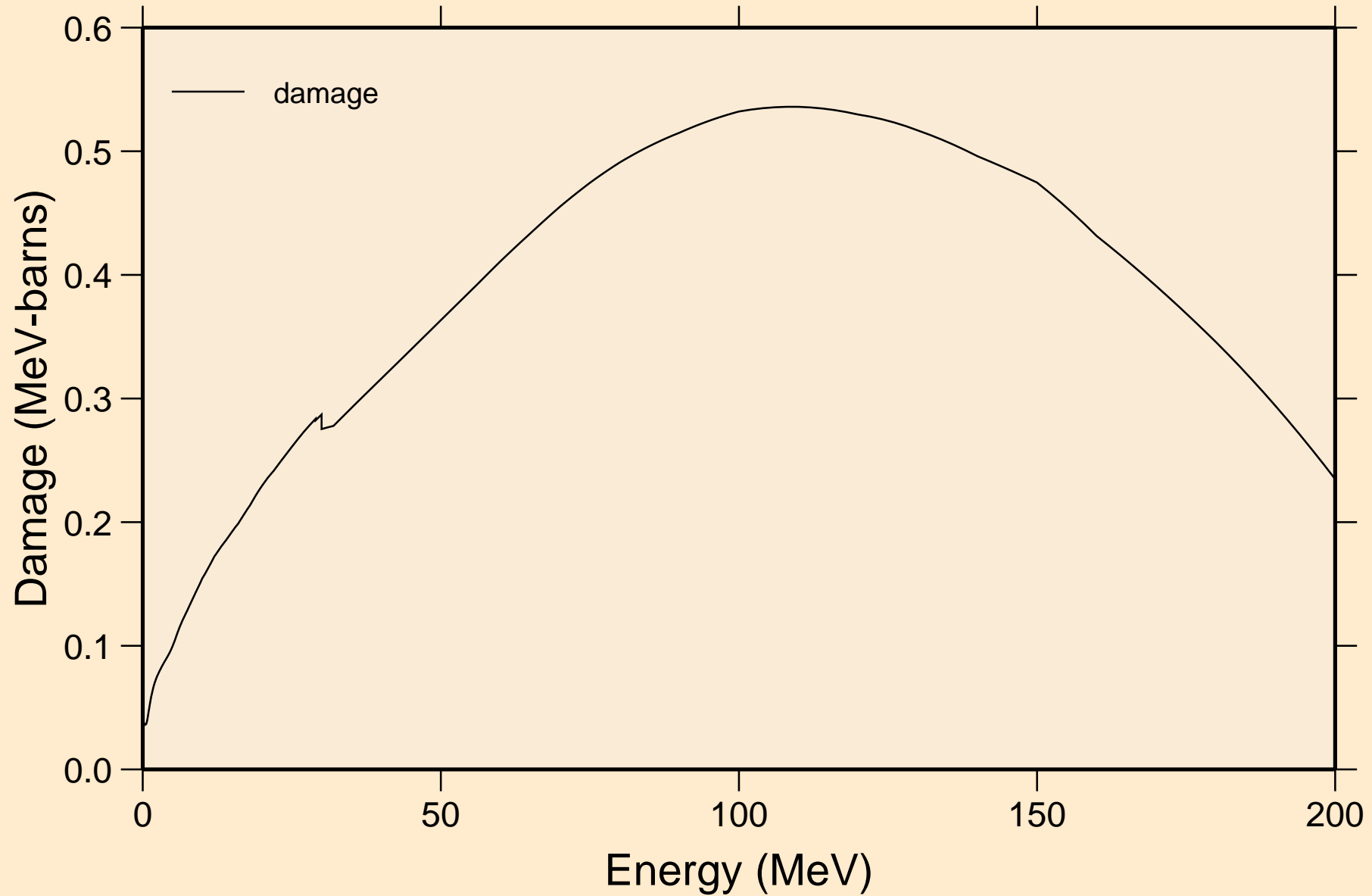

PU232 NEUTRON ACER TENDL-2021 LIBRARY; T=293.6K  
Non-threshold reactions

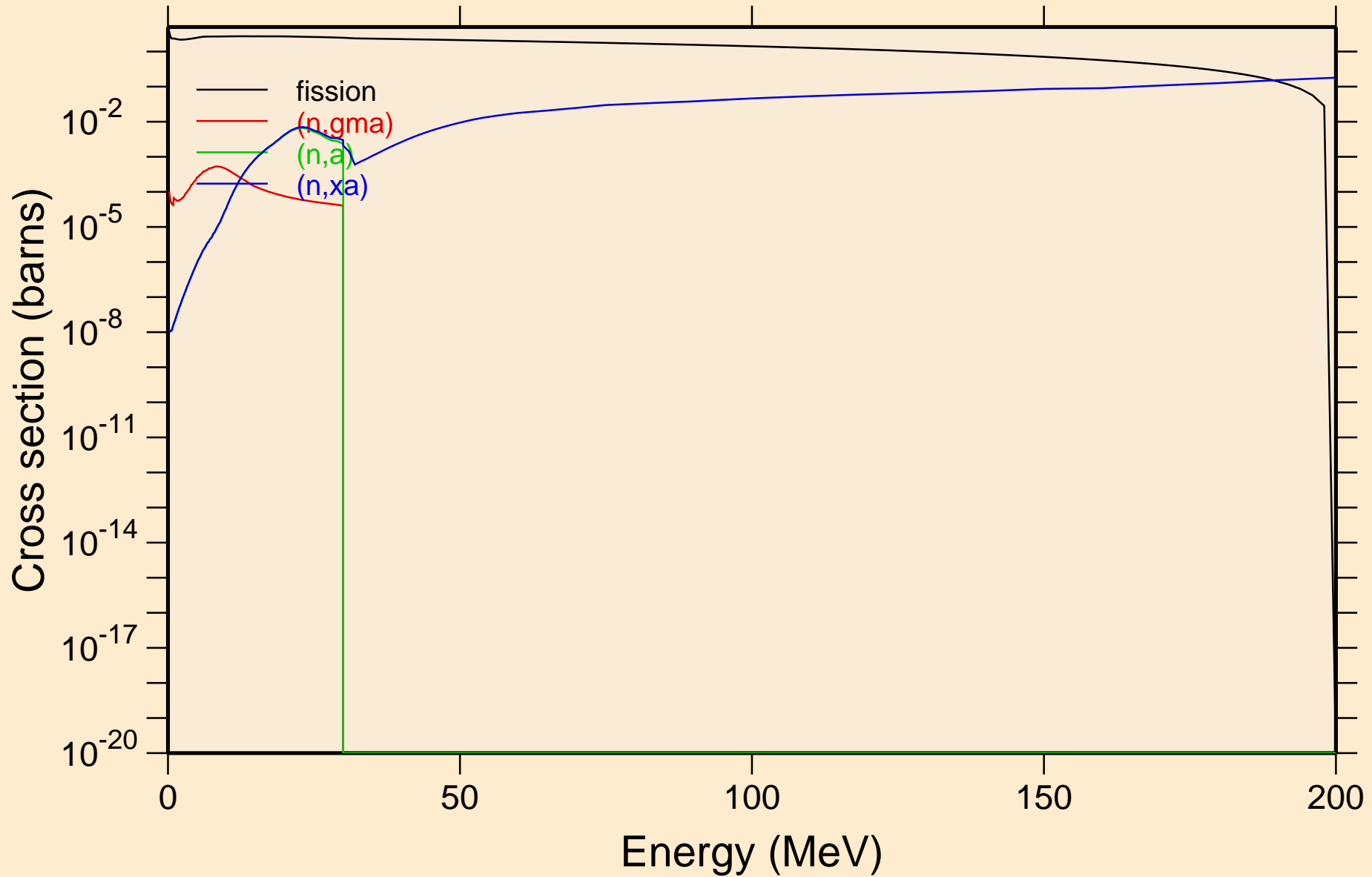

PU232 NEUTRON ACER TENDL-2021 LIBRARY; T=293.6K  
Inelastic levels

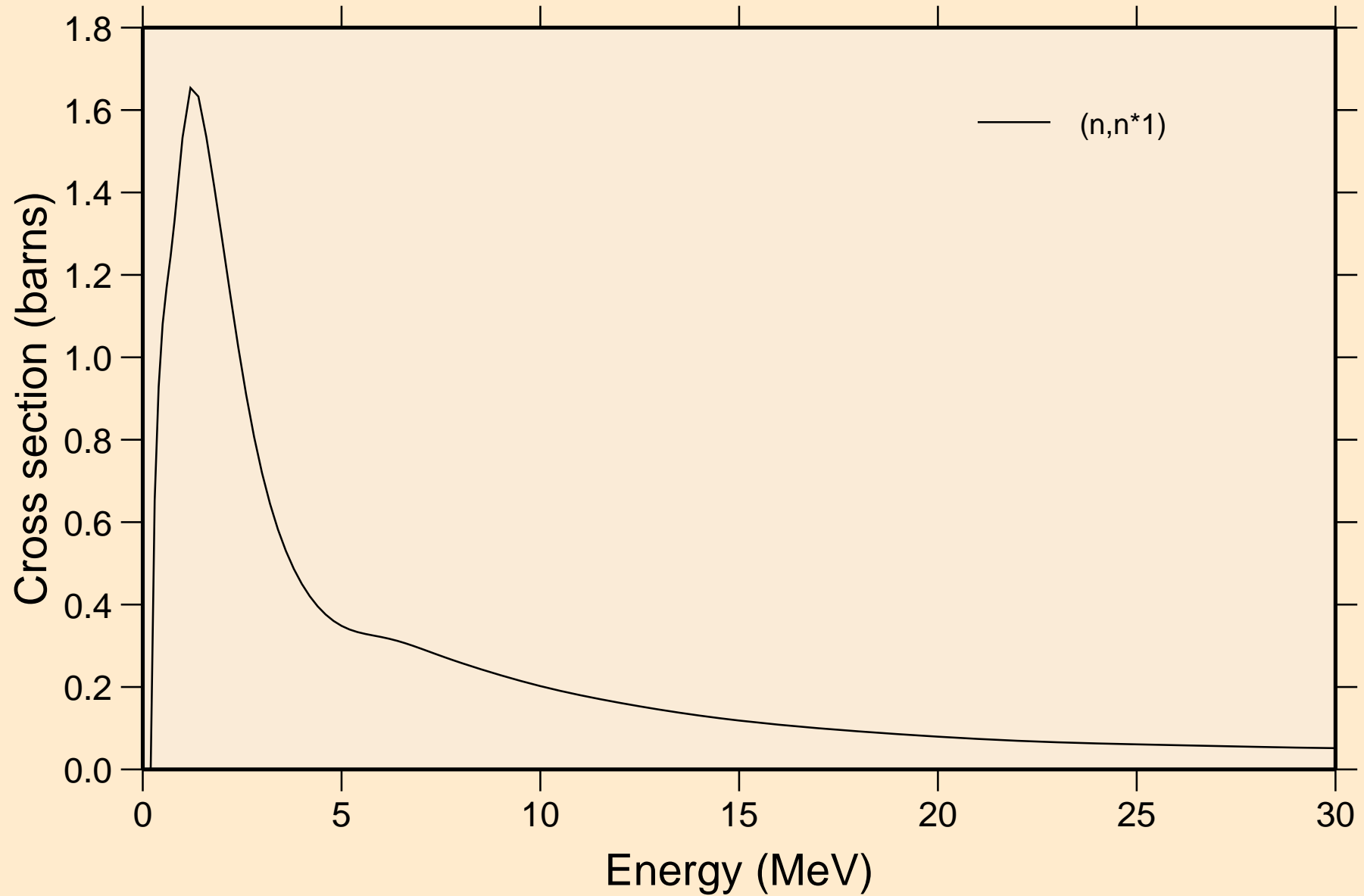

PU232 NEUTRON ACER TENDL-2021 LIBRARY; T=293.6K  
Threshold reactions

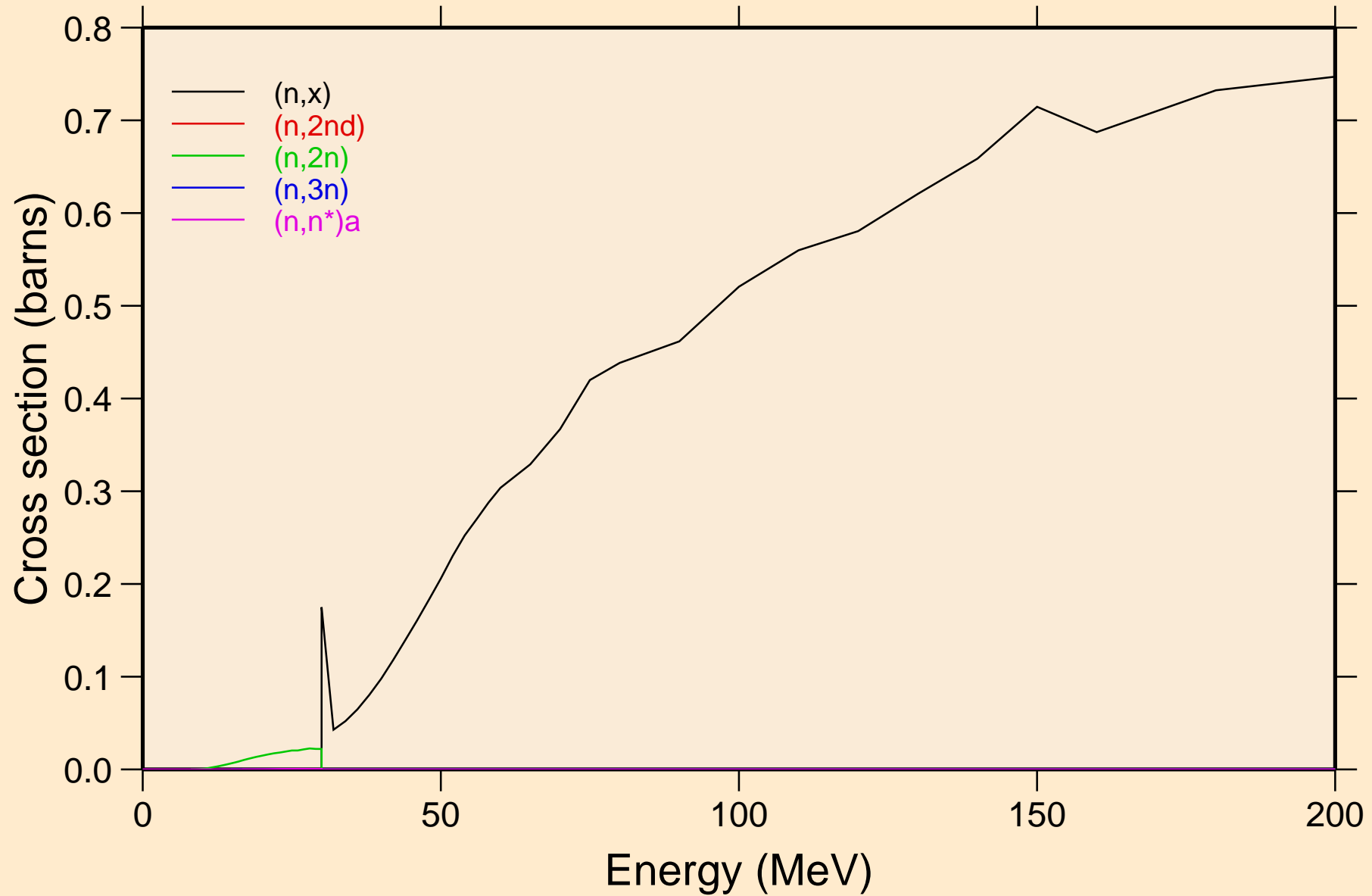

PU232 NEUTRON ACER TENDL-2021 LIBRARY; T=293.6K  
Threshold reactions

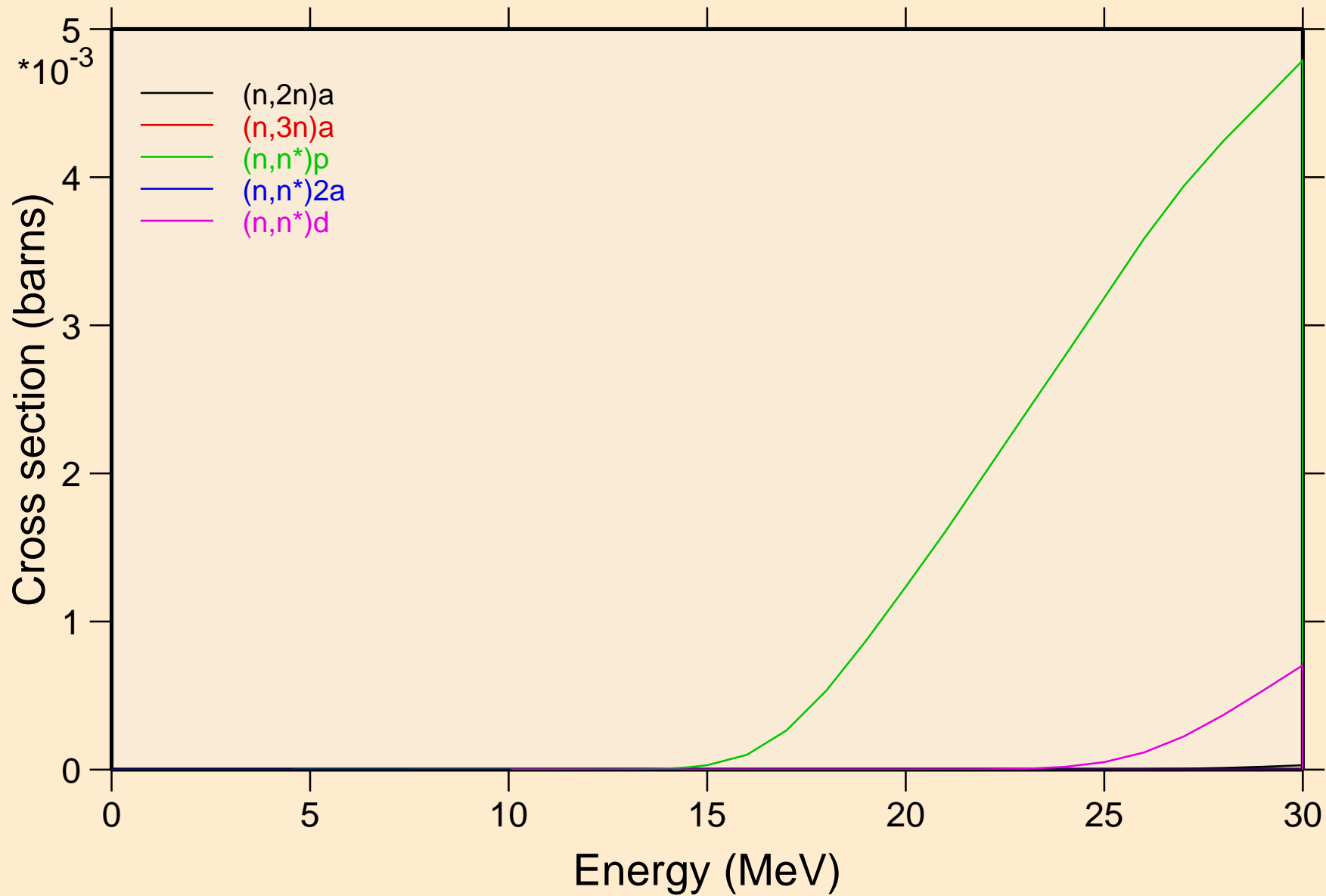

PU232 NEUTRON ACER TENDL-2021 LIBRARY; T=293.6K  
Threshold reactions

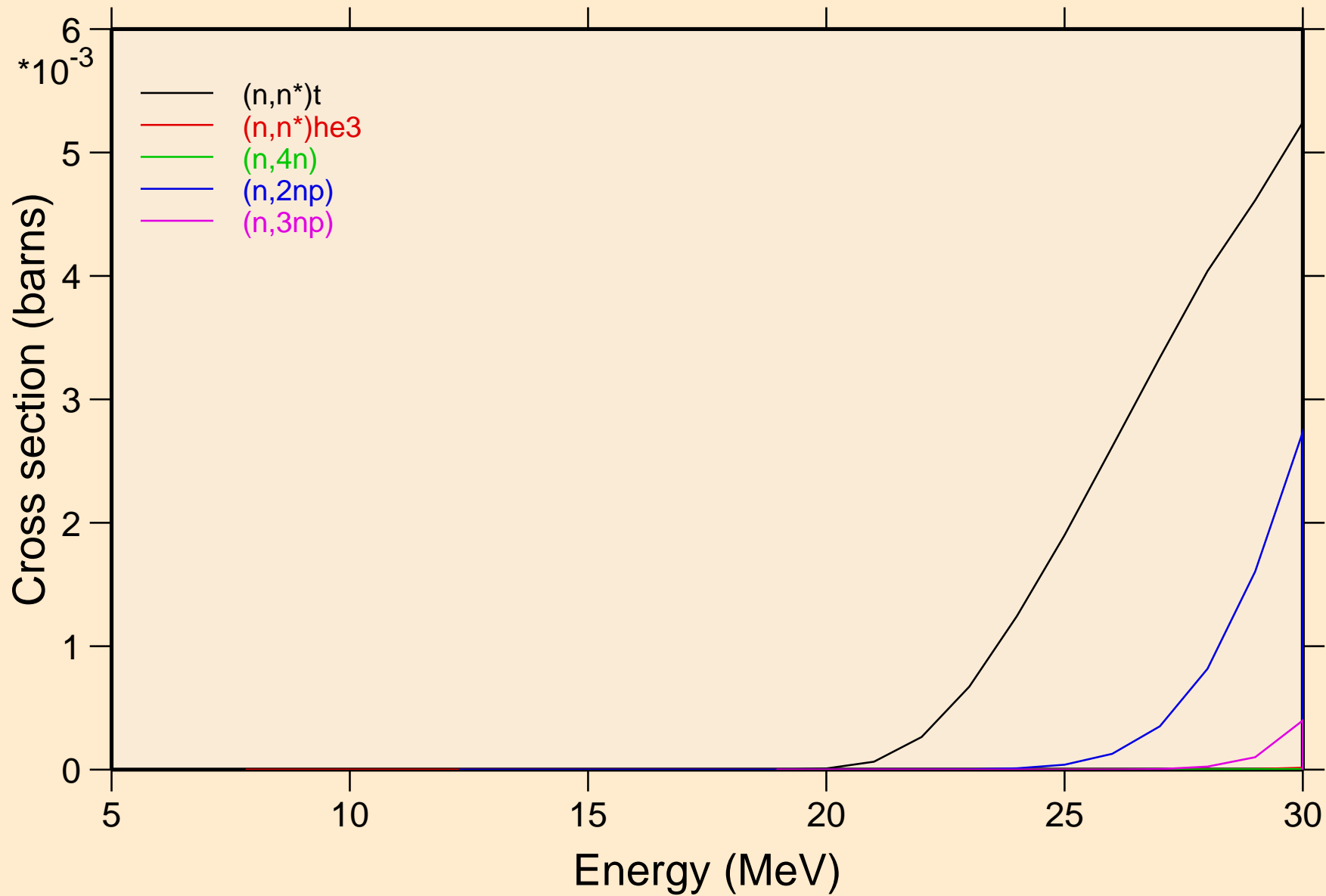

PU232 NEUTRON ACER TENDL-2021 LIBRARY; T=293.6K  
Threshold reactions

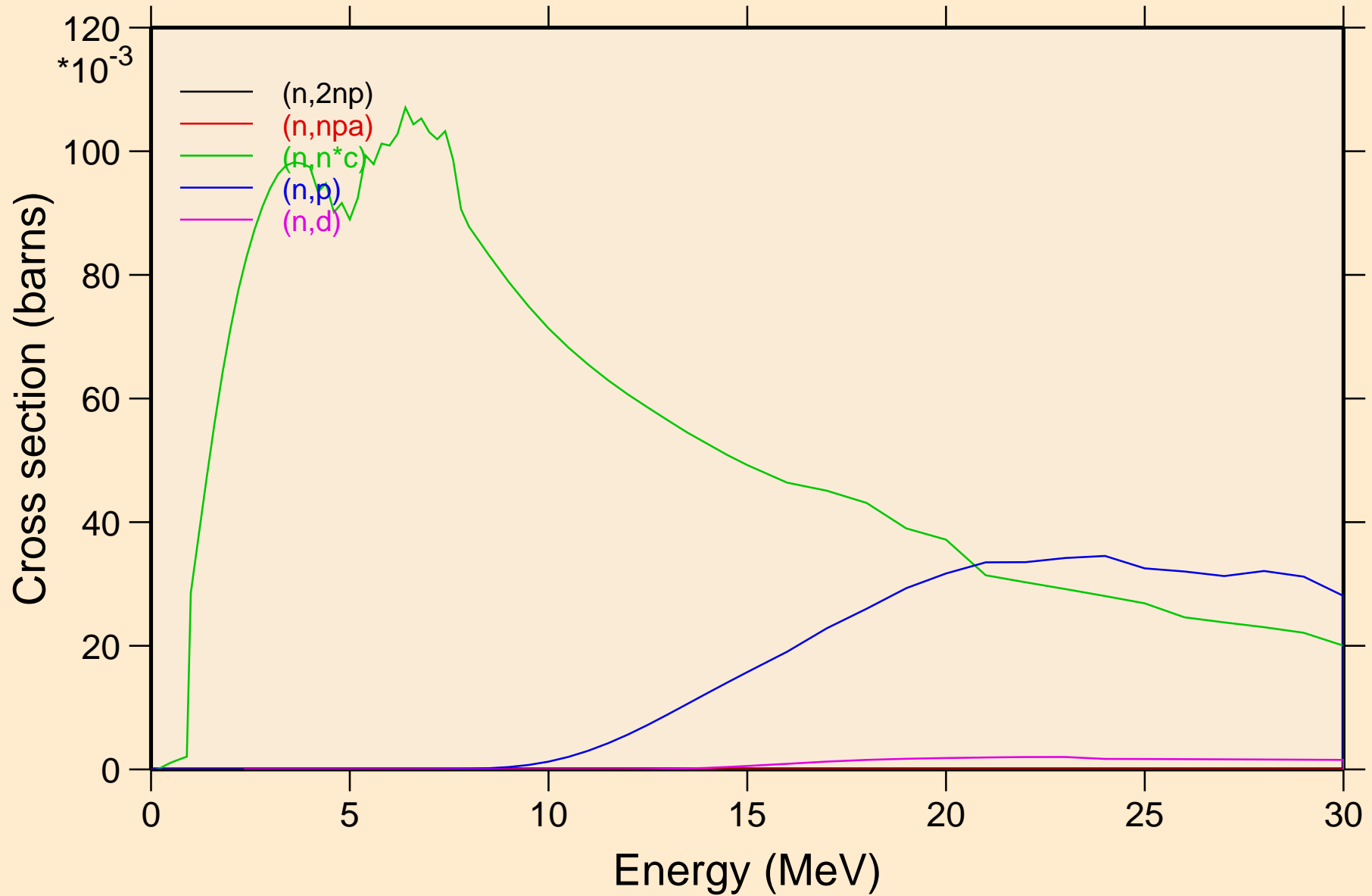

PU232 NEUTRON ACER TENDL-2021 LIBRARY; T=293.6K  
Threshold reactions

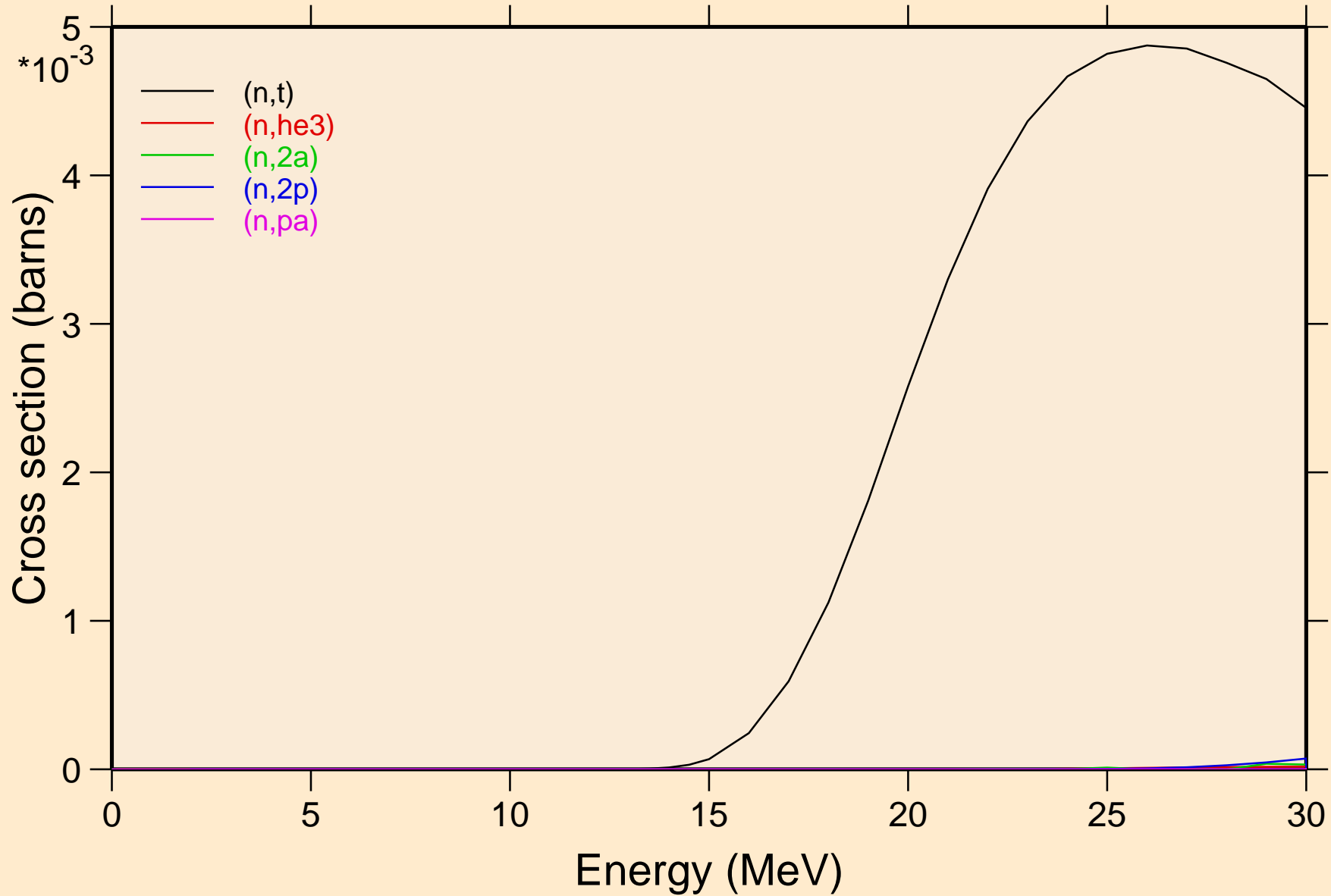

PU232 NEUTRON ACER TENDL-2021 LIBRARY; T=293.6K  
Threshold reactions

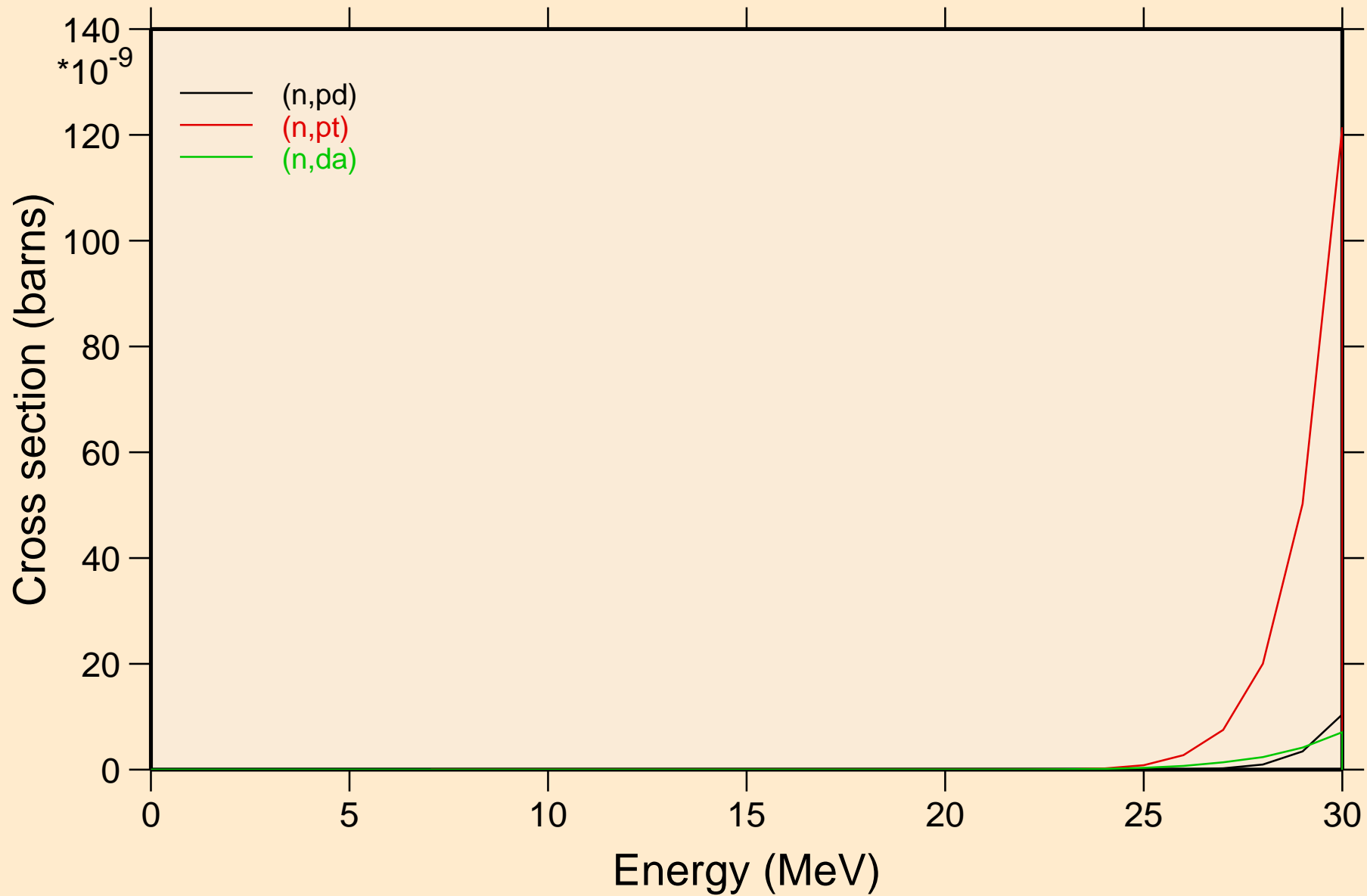

PU232 NEUTRON ACER TENDL-2021 LIBRARY; T=293.6K  
Threshold reactions

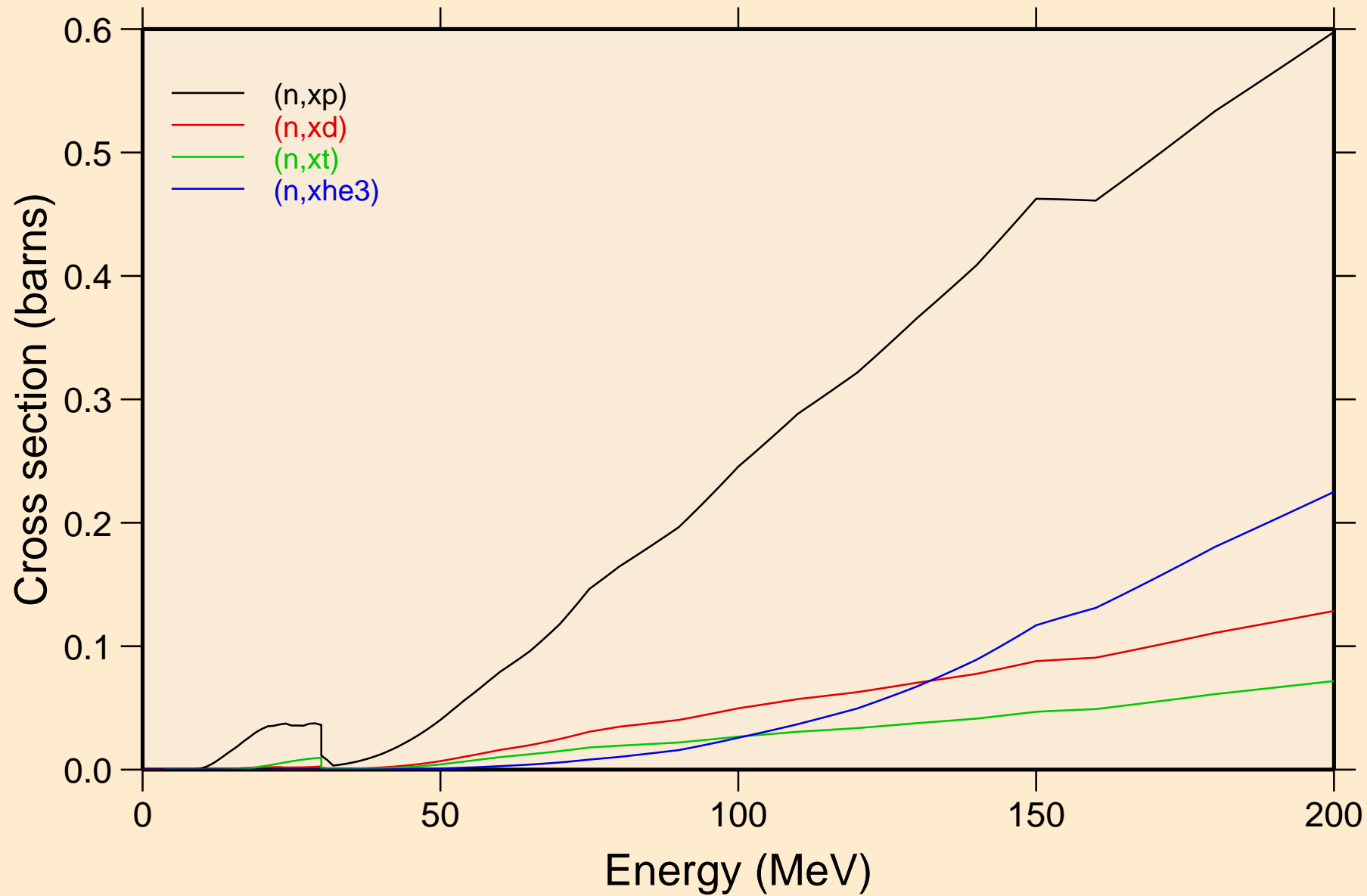

PU232 NEUTRON ACER TENDL-2021 LIBRARY; T=293.6K  
angular distribution for elastic

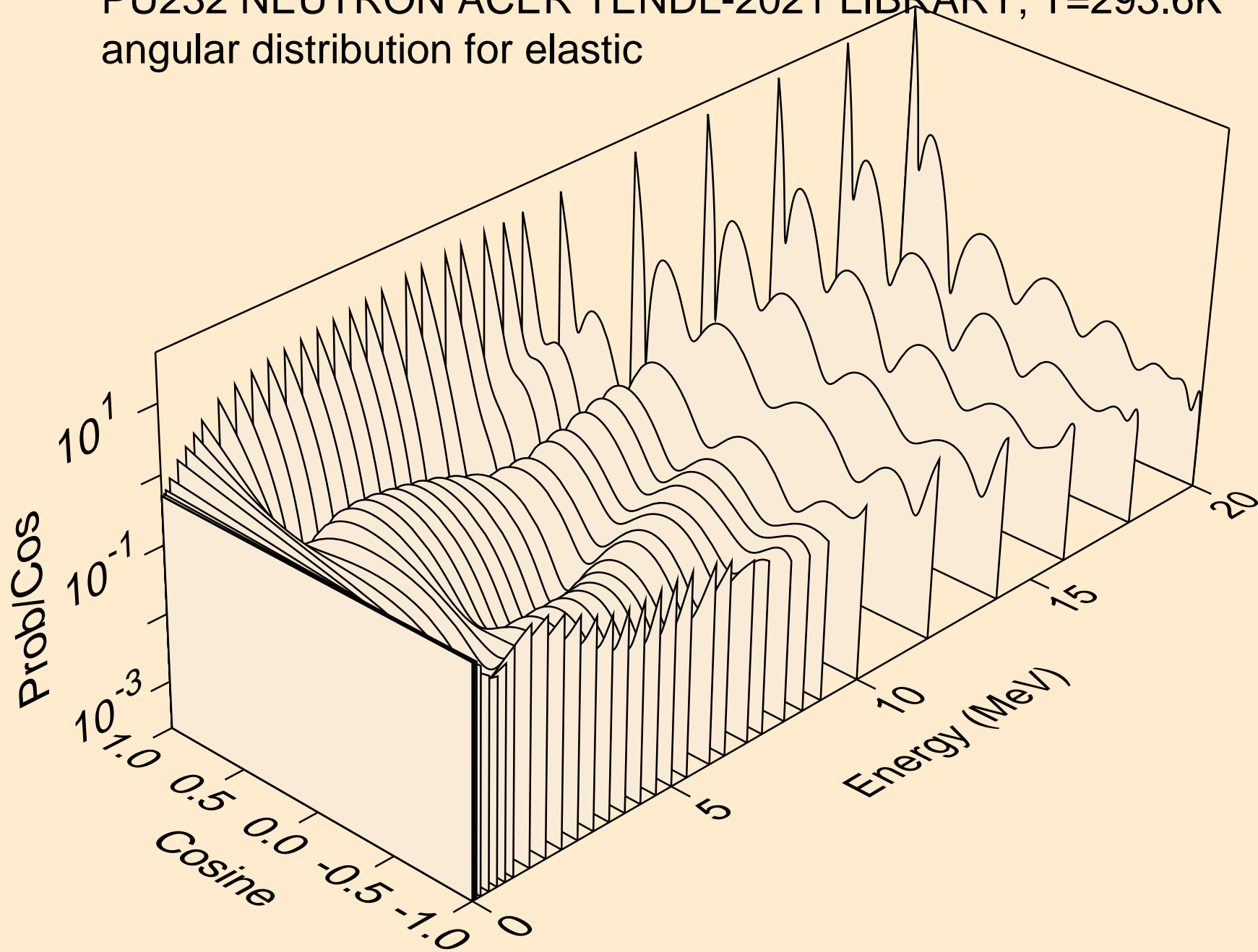

PU232 NEUTRON ACER TENDL-2021 LIBRARY; T=293.6K  
angular distribution for elastic

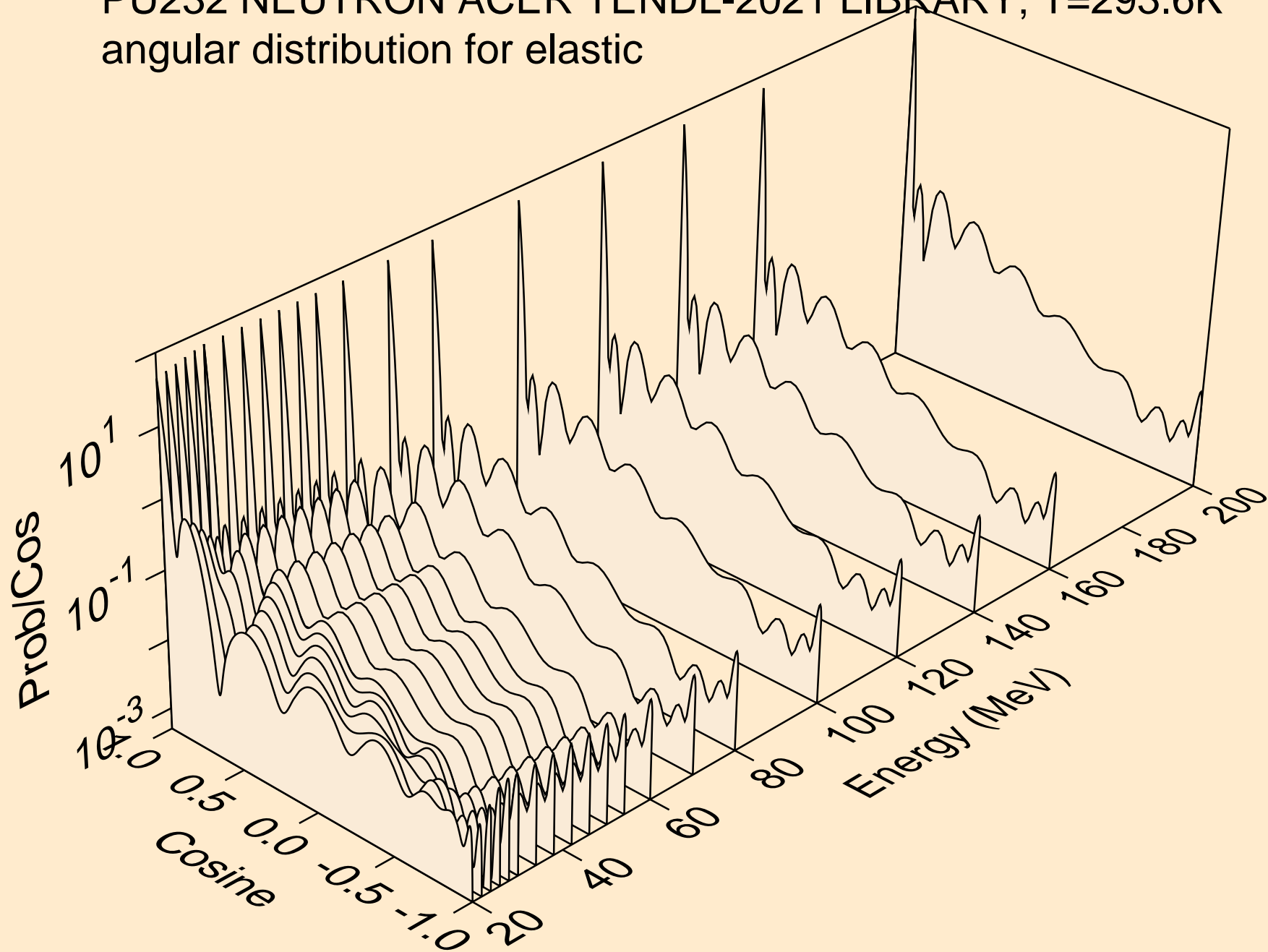

PU232 NEUTRON ACER TENDL-2021 LIBRARY; T=293.6K  
angular distribution for (n,n\*1)

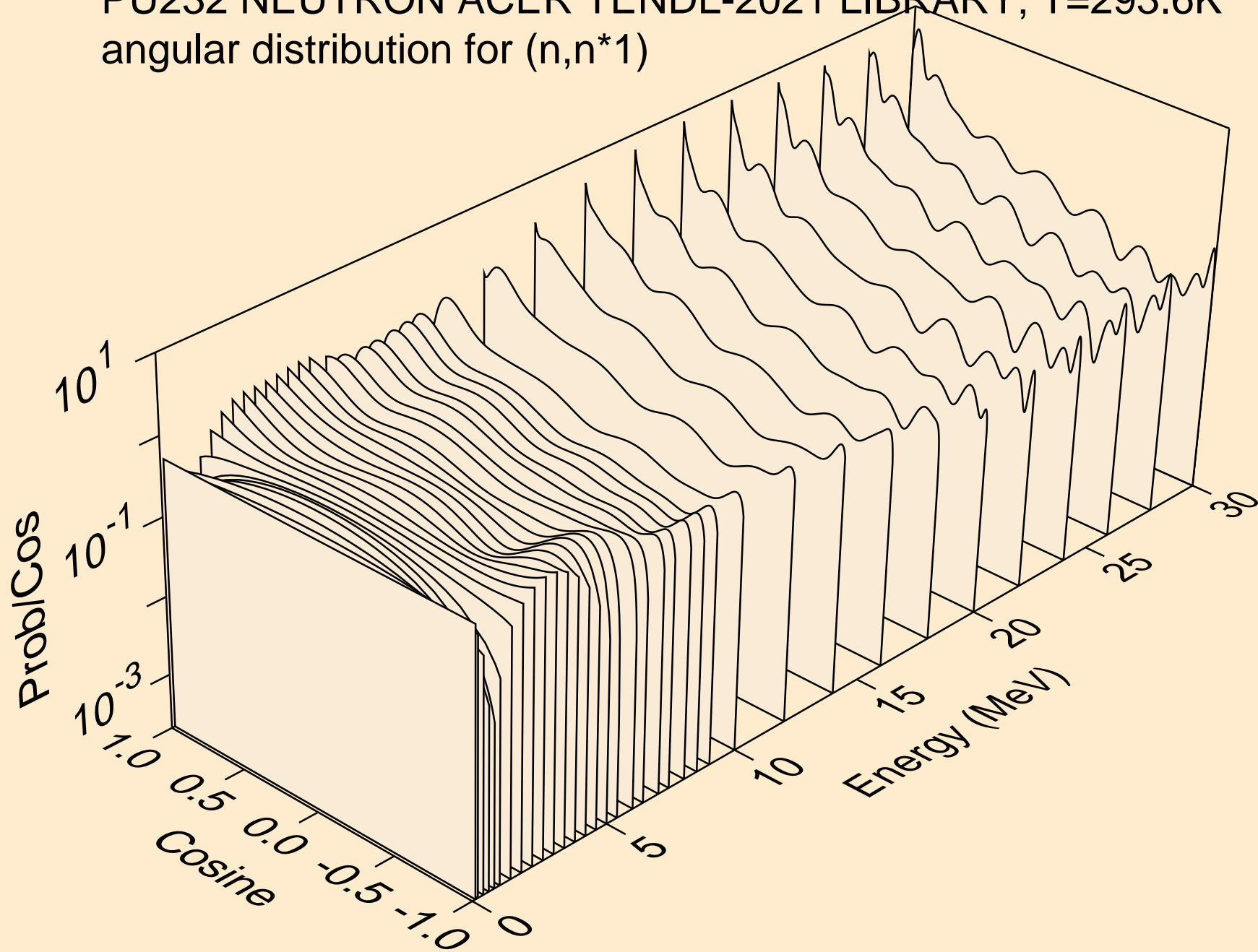

PU232 NEUTRON ACER TENDL-2021 LIBRARY; T=293.6K  
Total fission nubar

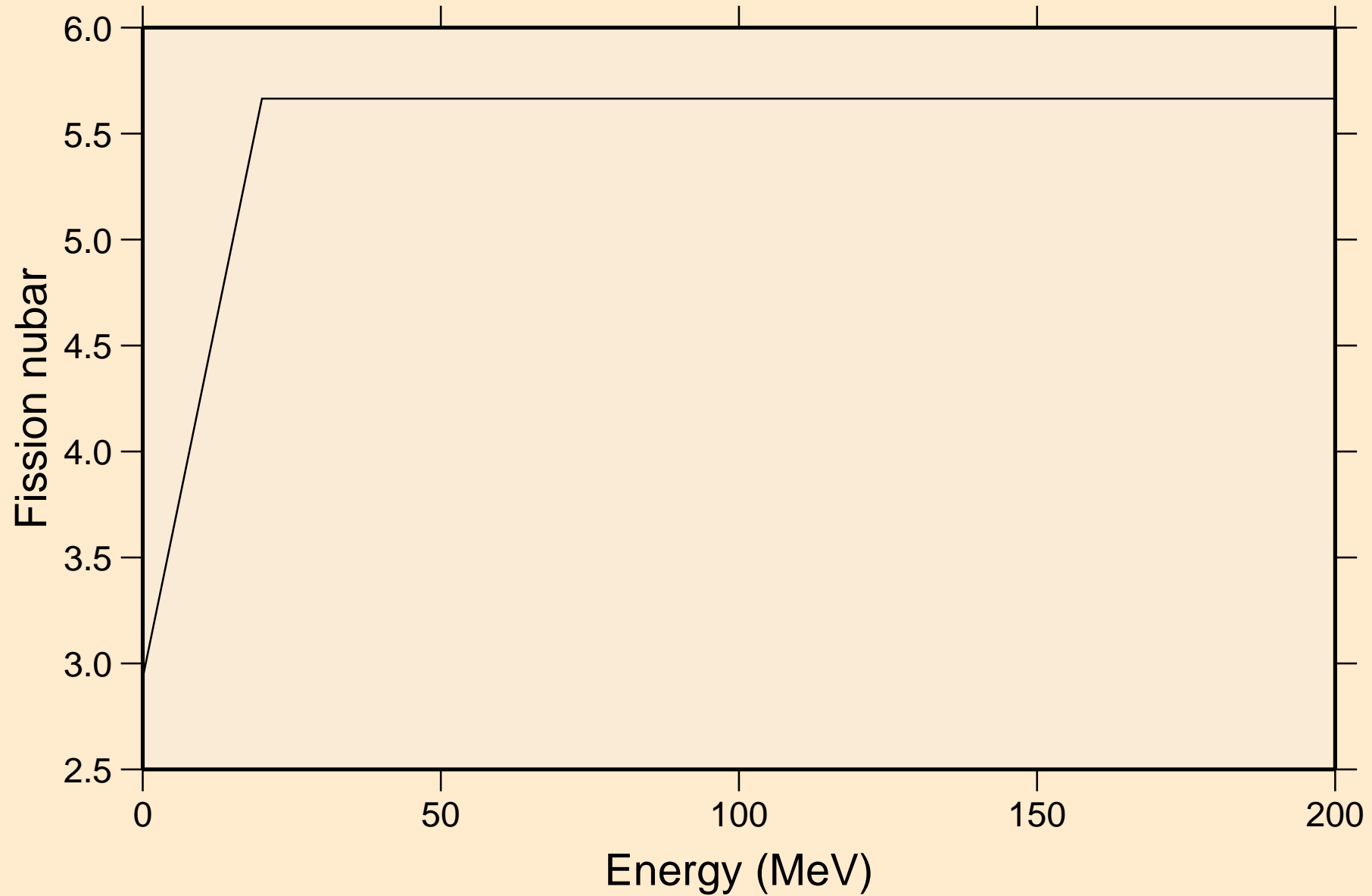

PU232 NEUTRON ACER TENDL-2021 LIBRARY; T=293.6K  
Neutron emission for (n,x)

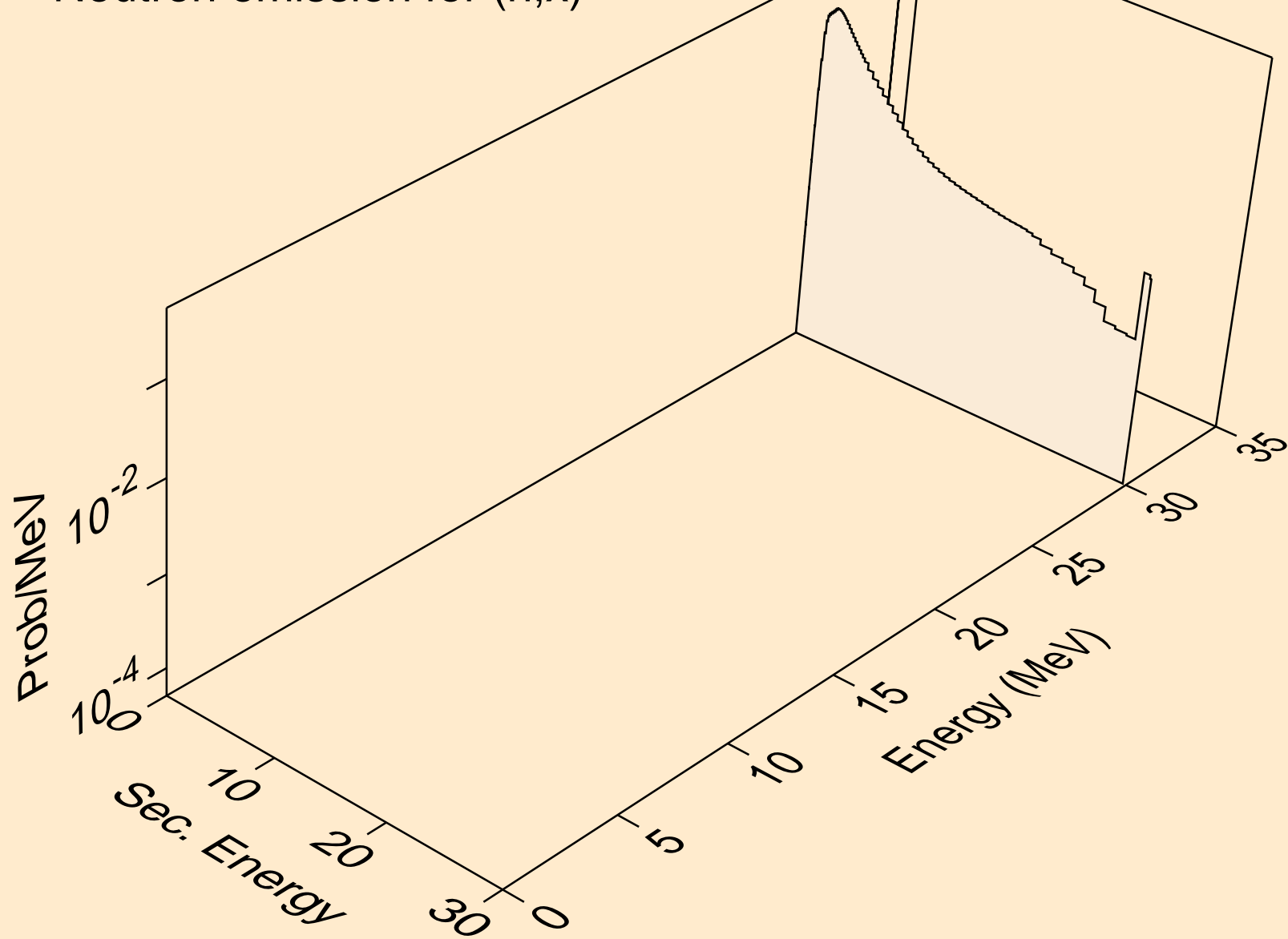

PU232 NEUTRON ACER TENDL-2021 LIBRARY; T=293.6K  
Neutron emission for (n,2nd)

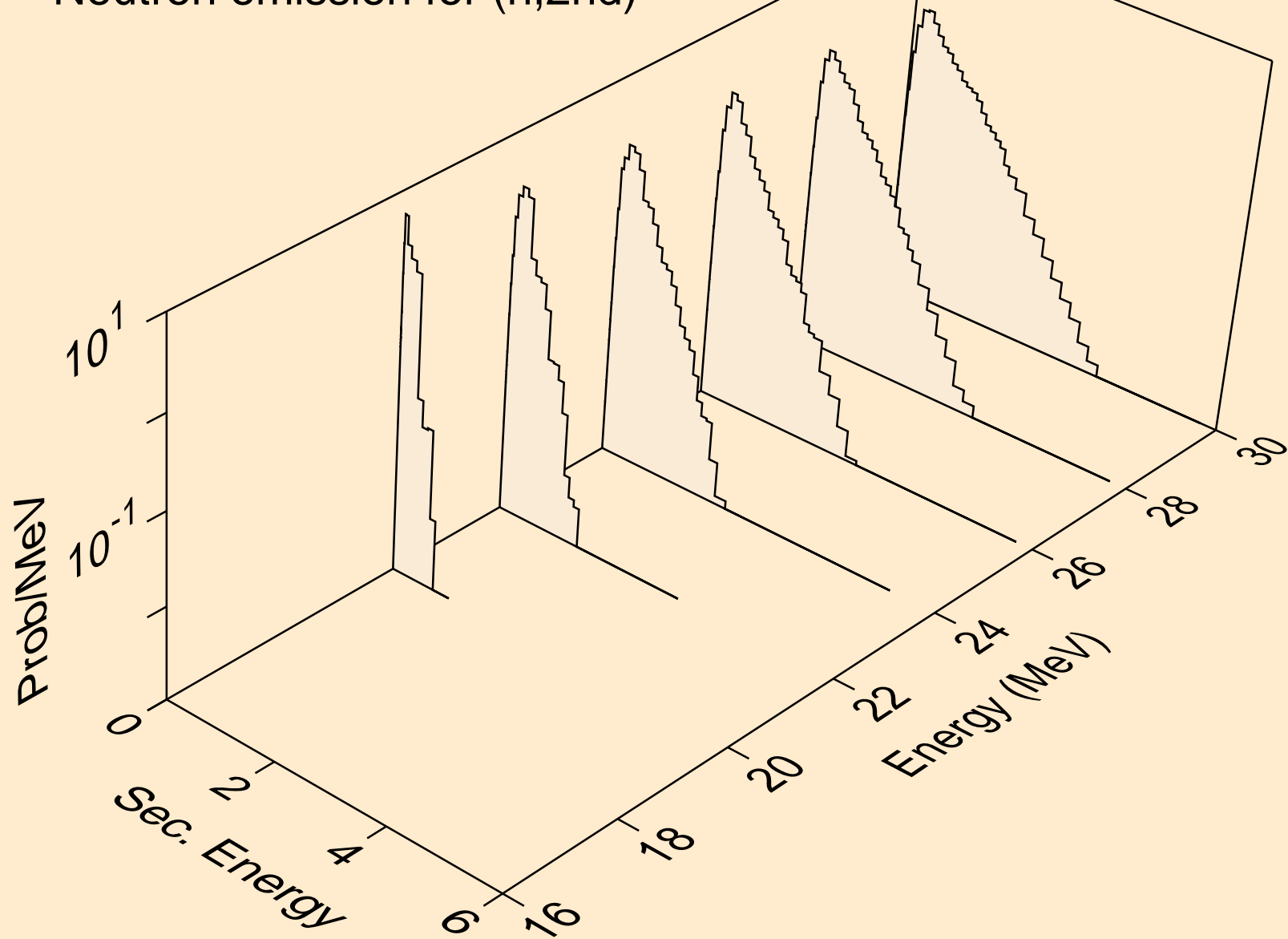

PU232 NEUTRON ACER TENDL-2021 LIBRARY; T=293.6K  
Neutron emission for (n,2n)

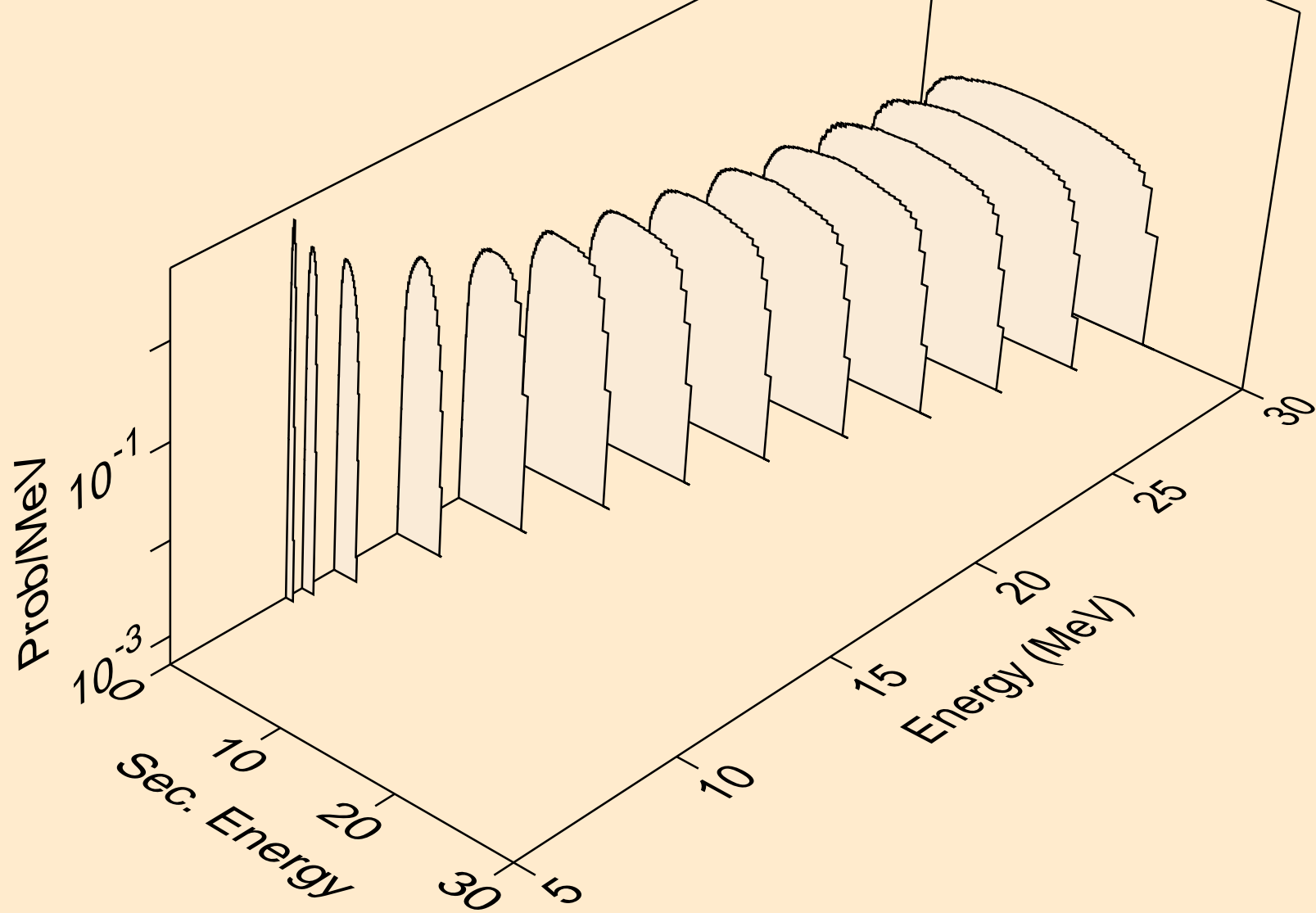

PU232 NEUTRON ACER TENDL-2021 LIBRARY; T=293.6K  
Neutron emission for (n,3n)

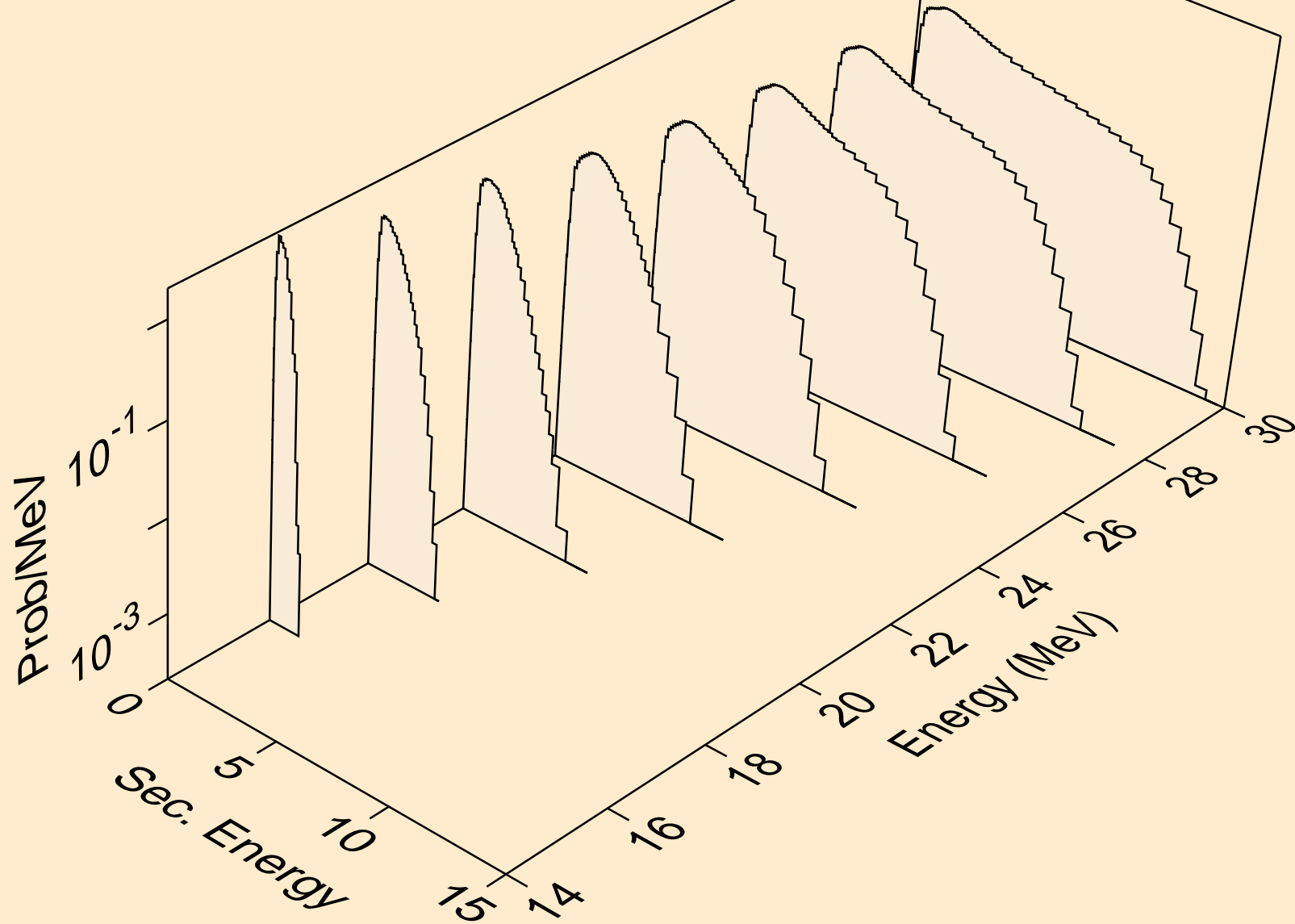

PU232 NEUTRON ACER TENDL-2021 LIBRARY; T=293.6K  
Neutron emission for fission

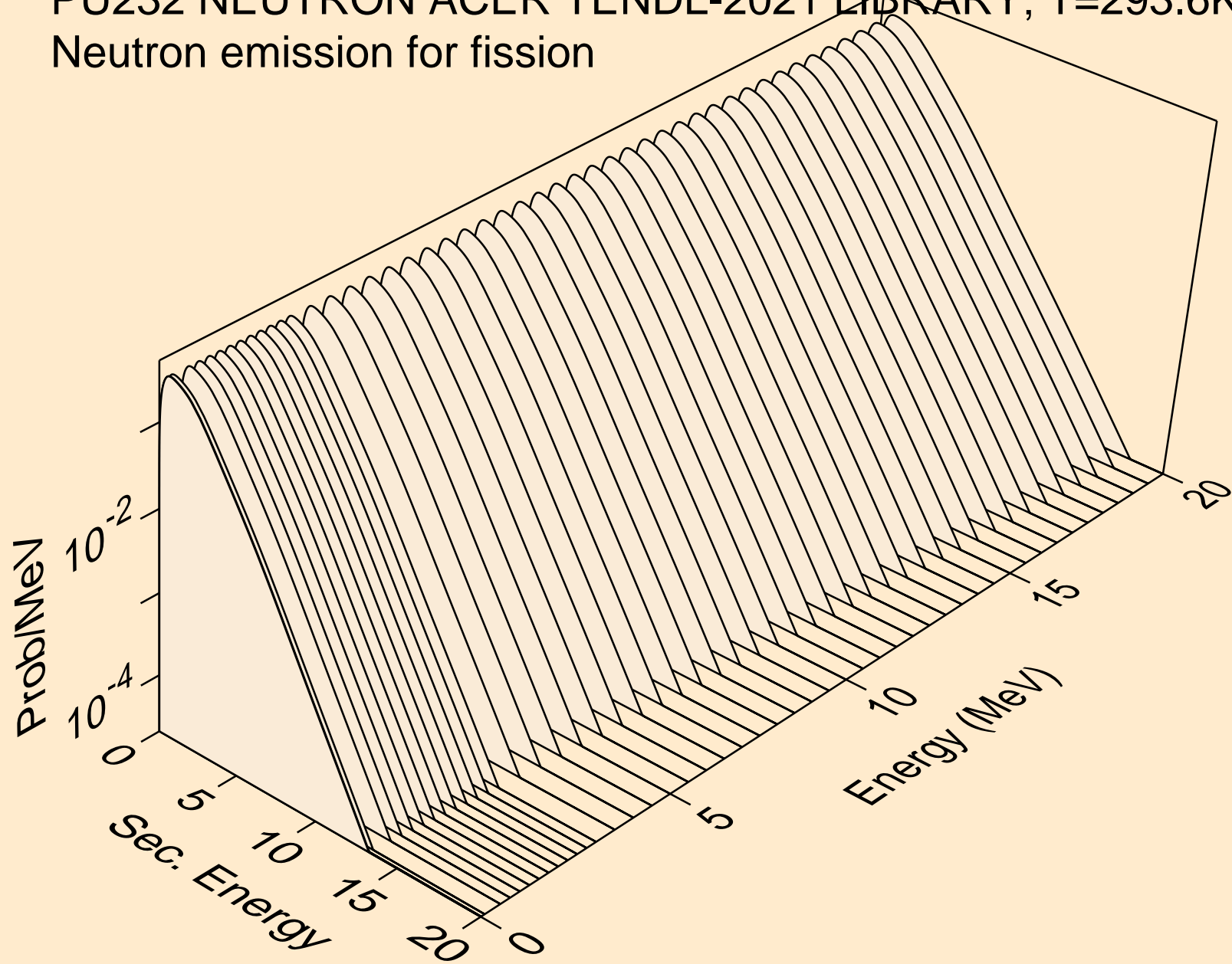

PU232 NEUTRON ACER TENDL-2021 LIBRARY; T=293.6K  
Neutron emission for (n,n\*)a

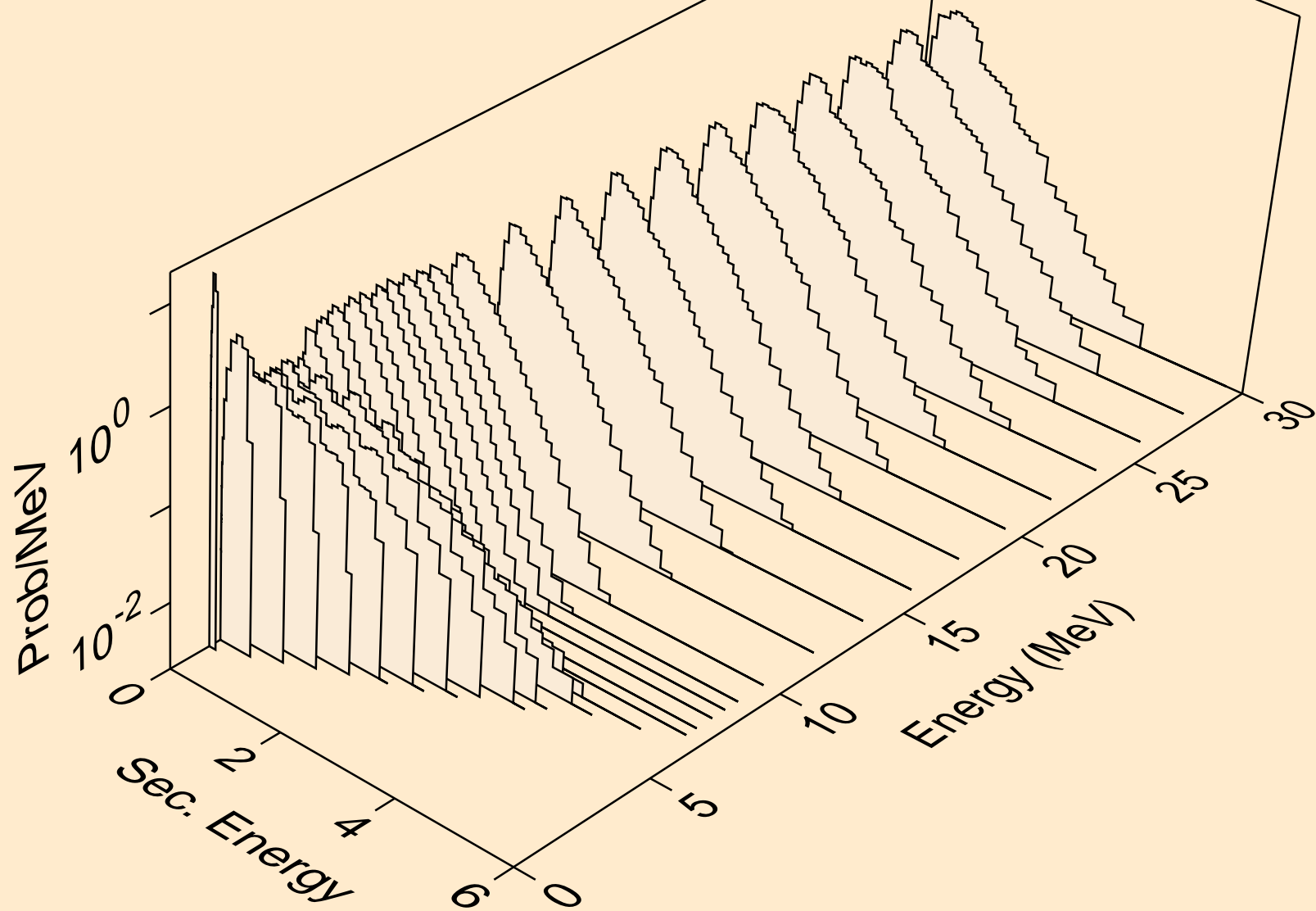

PU232 NEUTRON ACER TENDL-2021 LIBRARY; T=293.6K  
Neutron emission for (n,2n)a

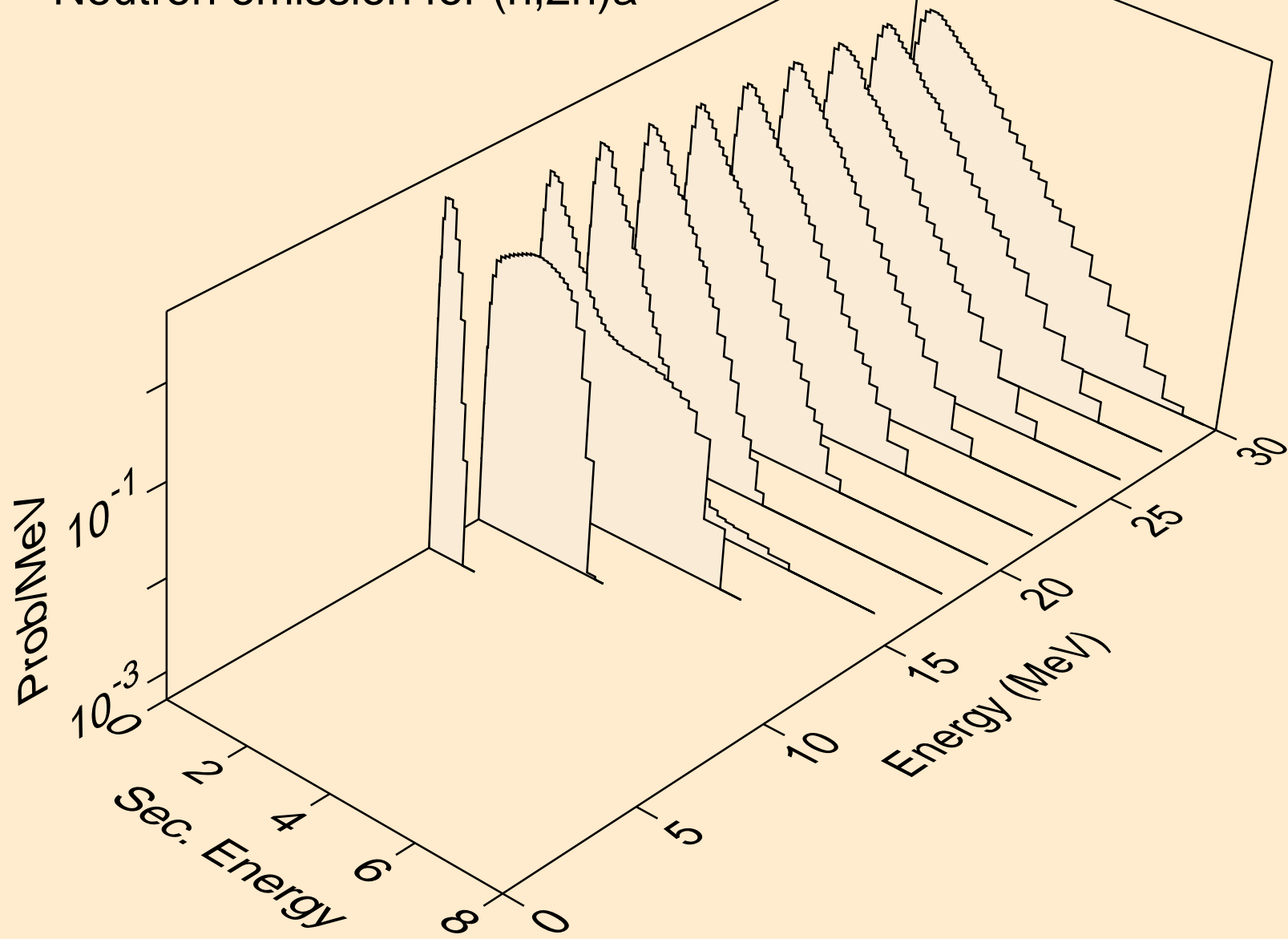

PU232 NEUTRON ACER TENDL-2021 LIBRARY; T=293.6K  
Neutron emission for (n,3n)a

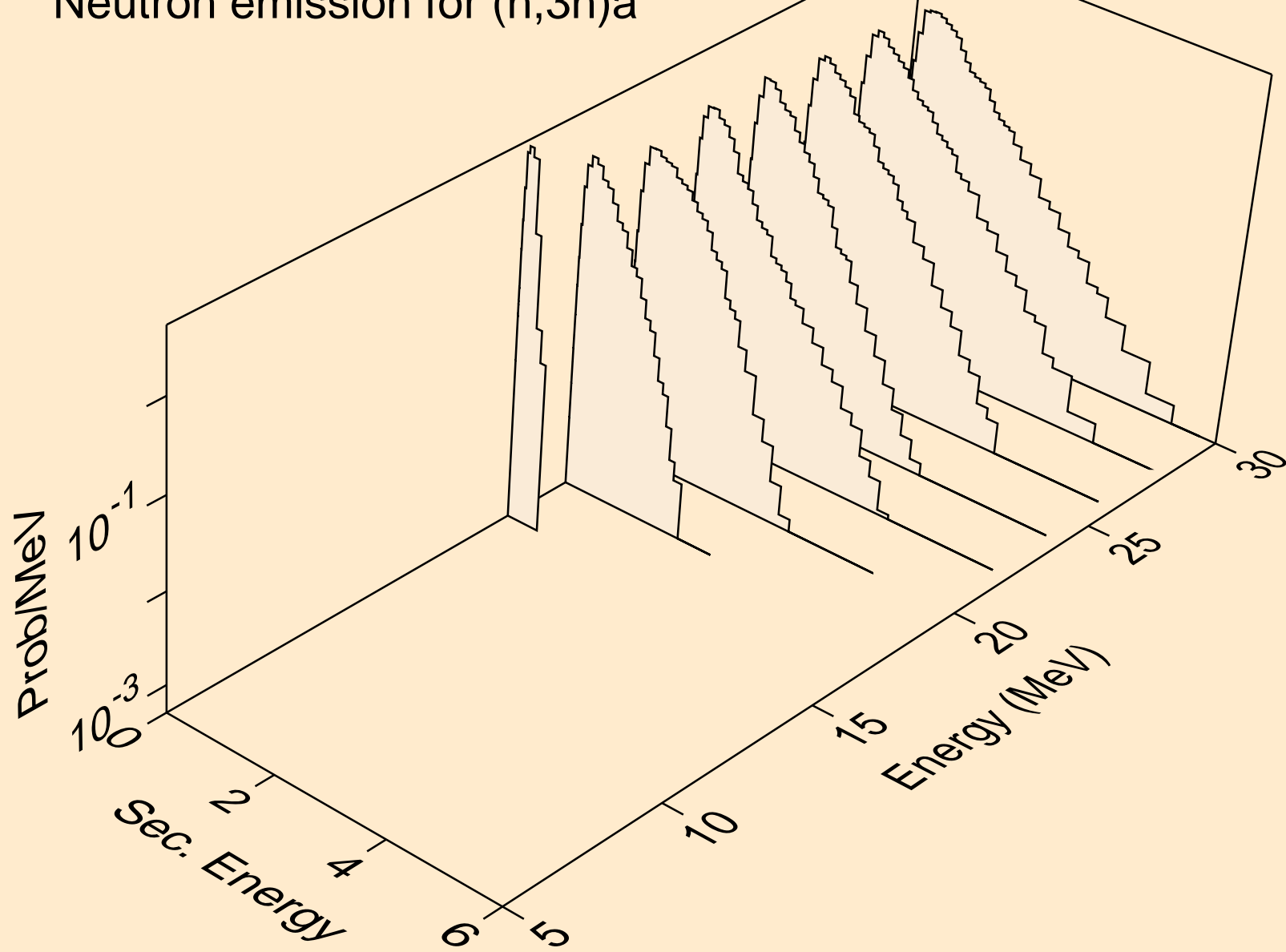

PU232 NEUTRON ACER TENDL-2021 LIBRARY; T=293.6K  
Neutron emission for (n,n\*)p

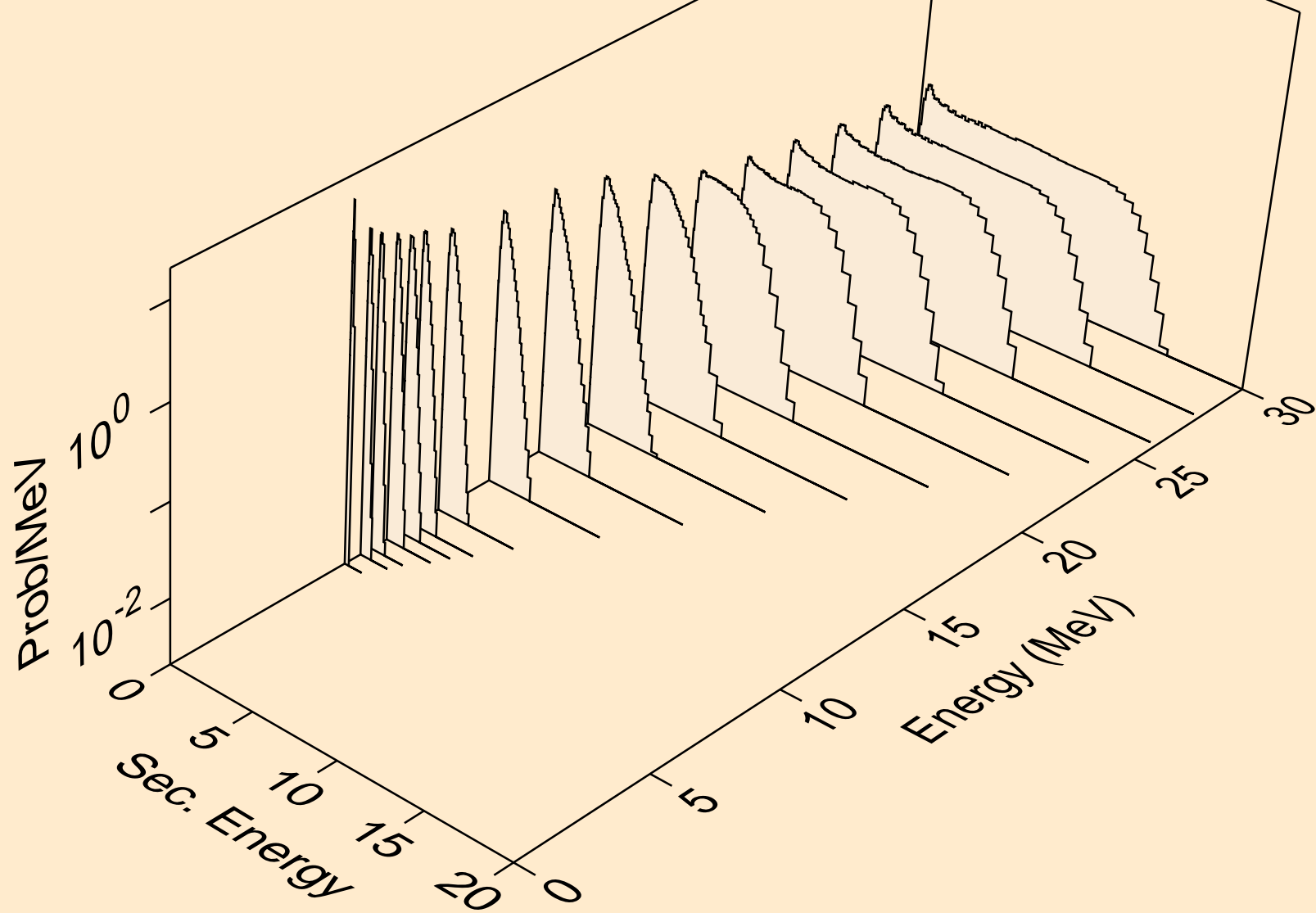

PU232 NEUTRON ACER TENDL-2021 LIBRARY; T=293.6K  
Neutron emission for (n,n\*)2a

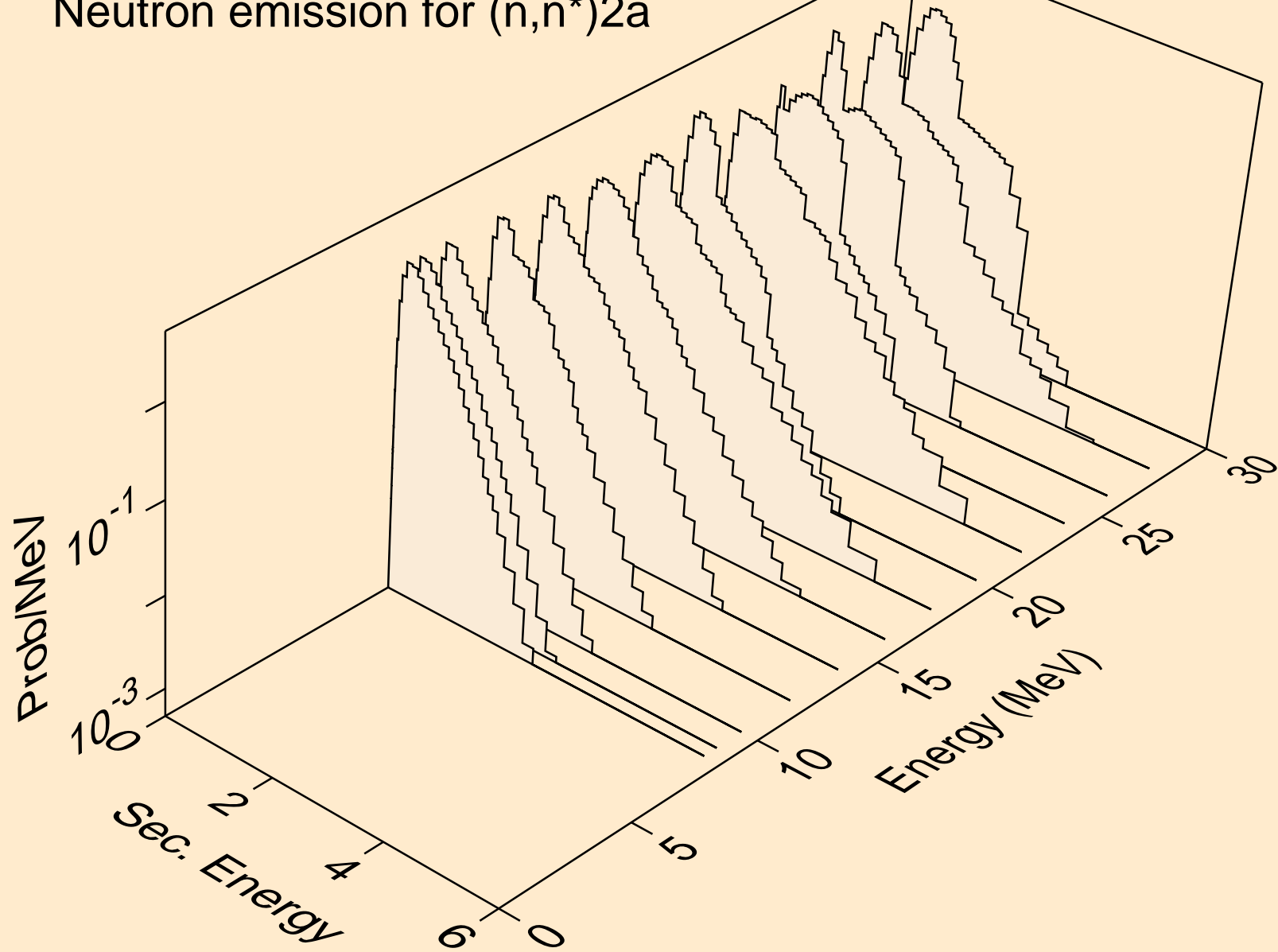

PU232 NEUTRON ACER TENDL-2021 LIBRARY; T=293.6K  
Neutron emission for (n,n\*)d

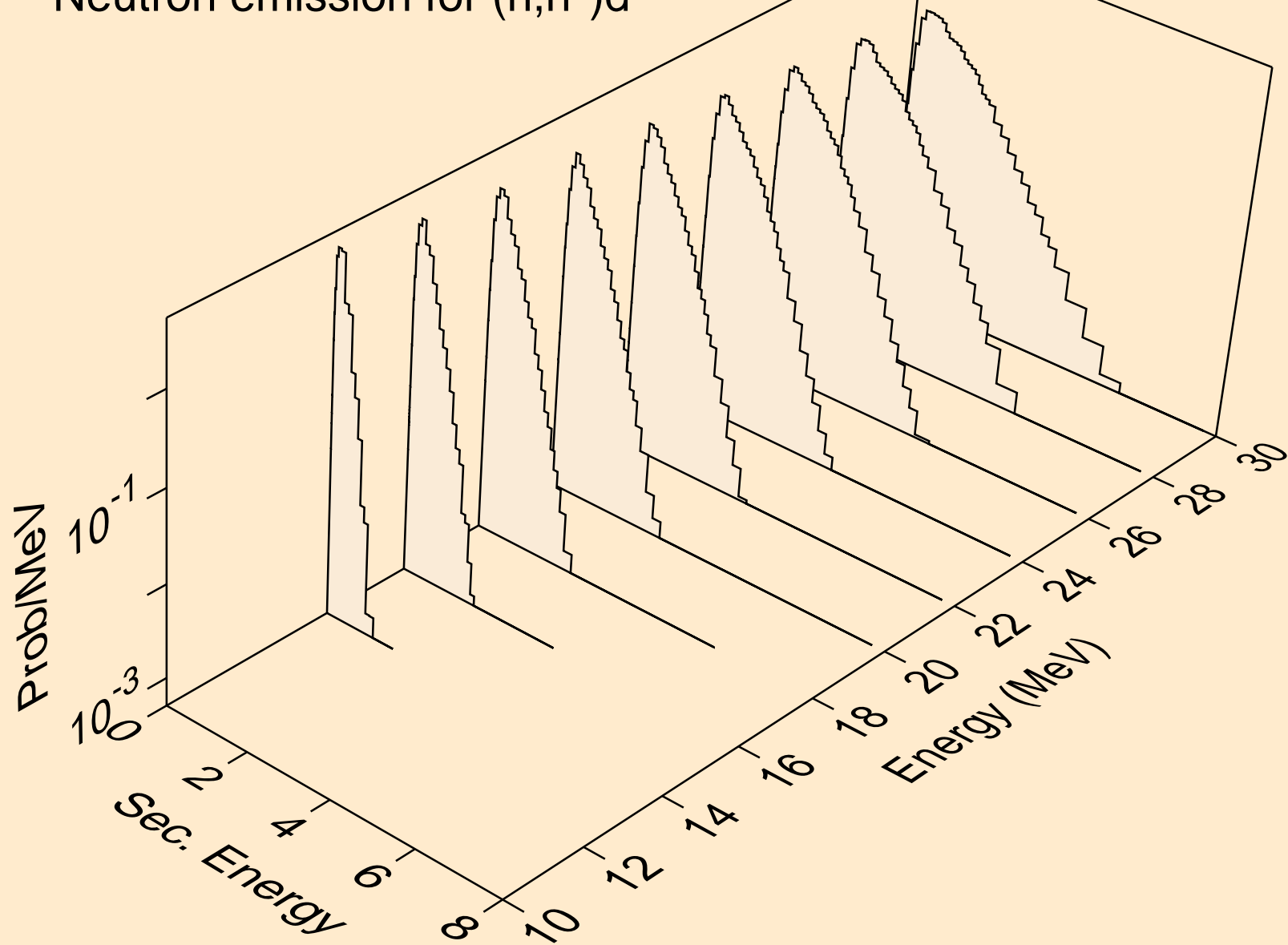

PU232 NEUTRON ACER TENDL-2021 LIBRARY; T=293.6K  
Neutron emission for (n,n\*)t

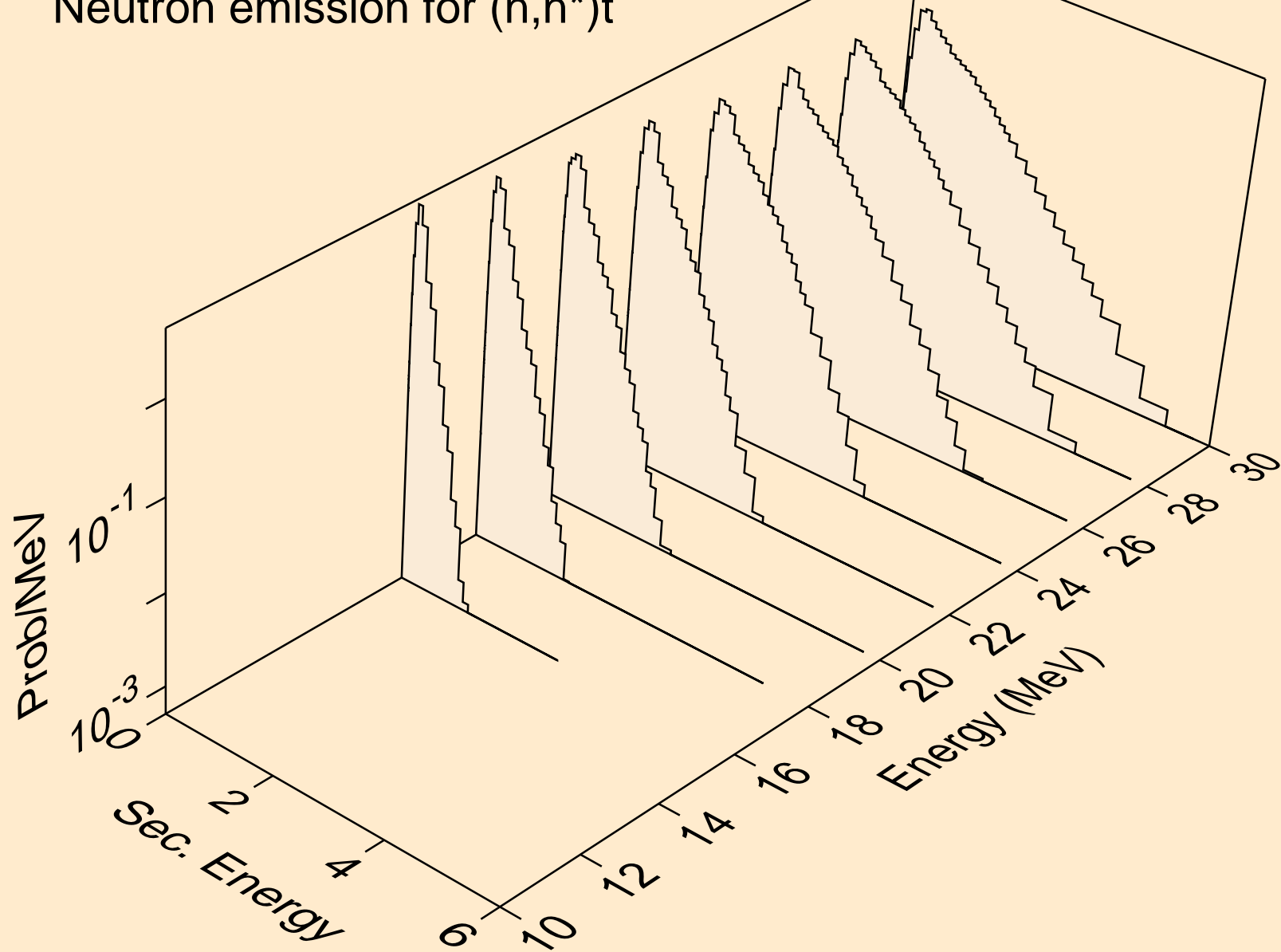

PU232 NEUTRON ACER TENDL-2021 LIBRARY; T=293.6K  
Neutron emission for (n,n\*)he3

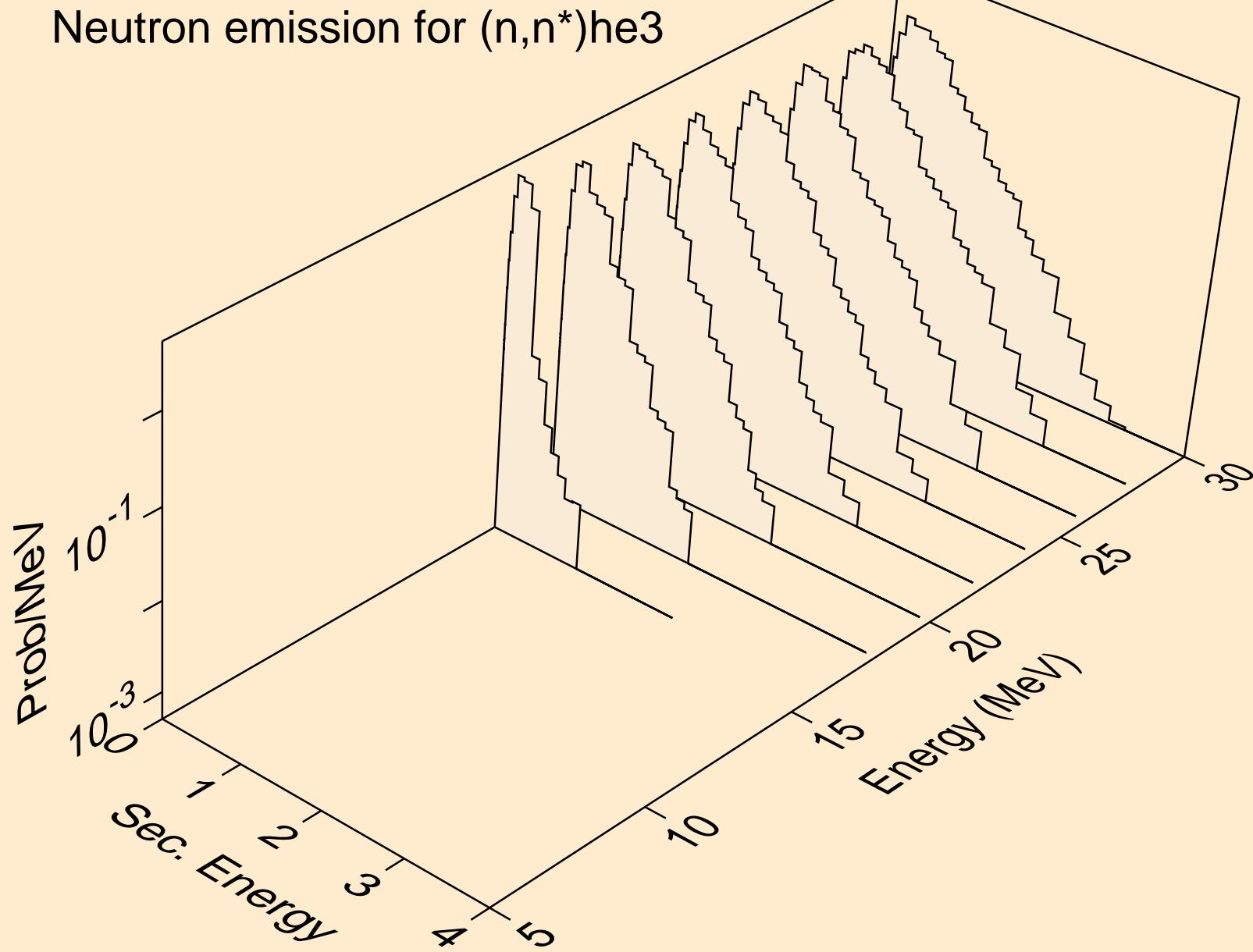

PU232 NEUTRON ACER TENDL-2021 LIBRARY; T=293.6K  
Neutron emission for (n,4n)

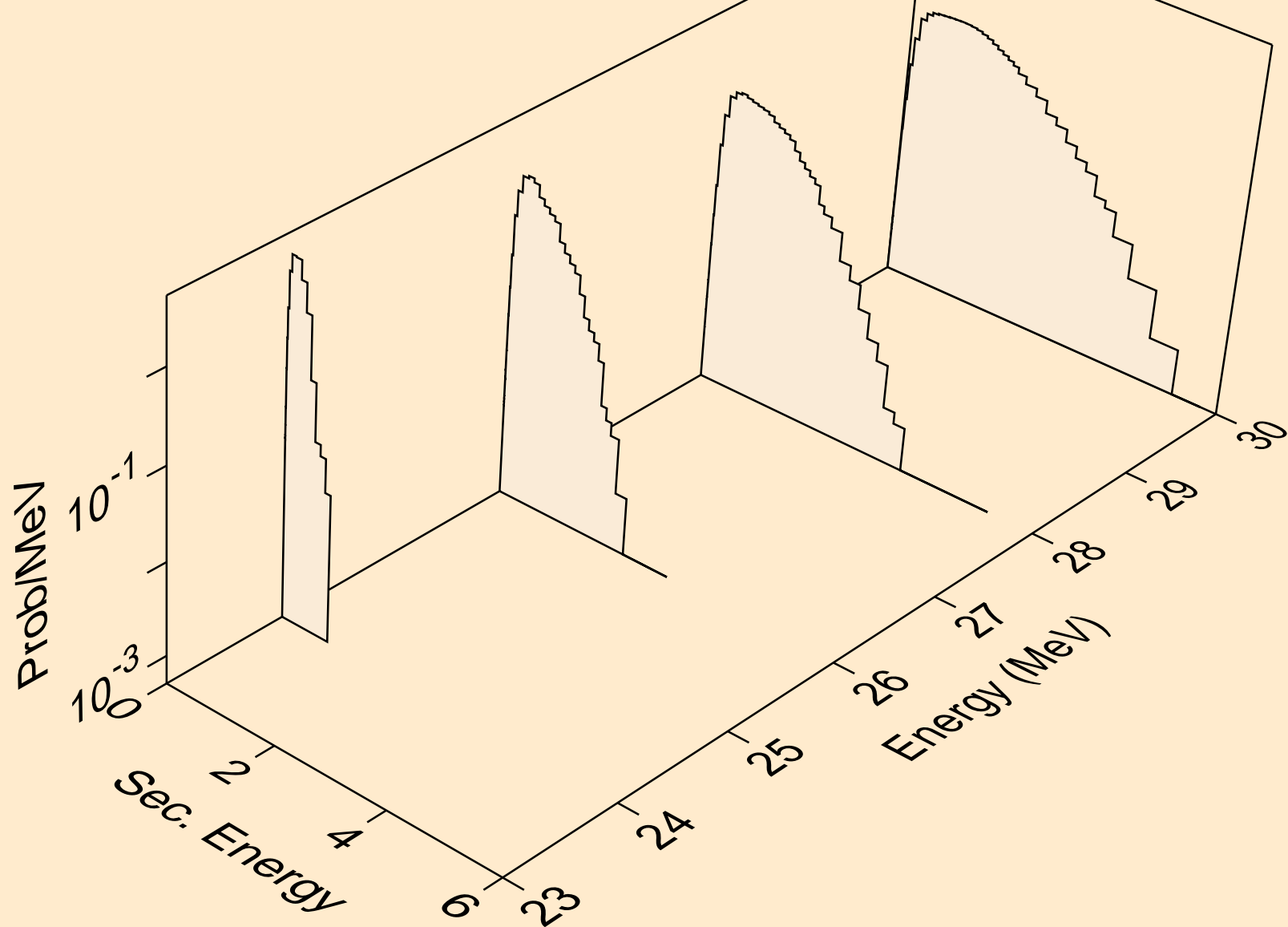

PU232 NEUTRON ACER TENDL-2021 LIBRARY; T=293.6K  
Neutron emission for (n,2np)

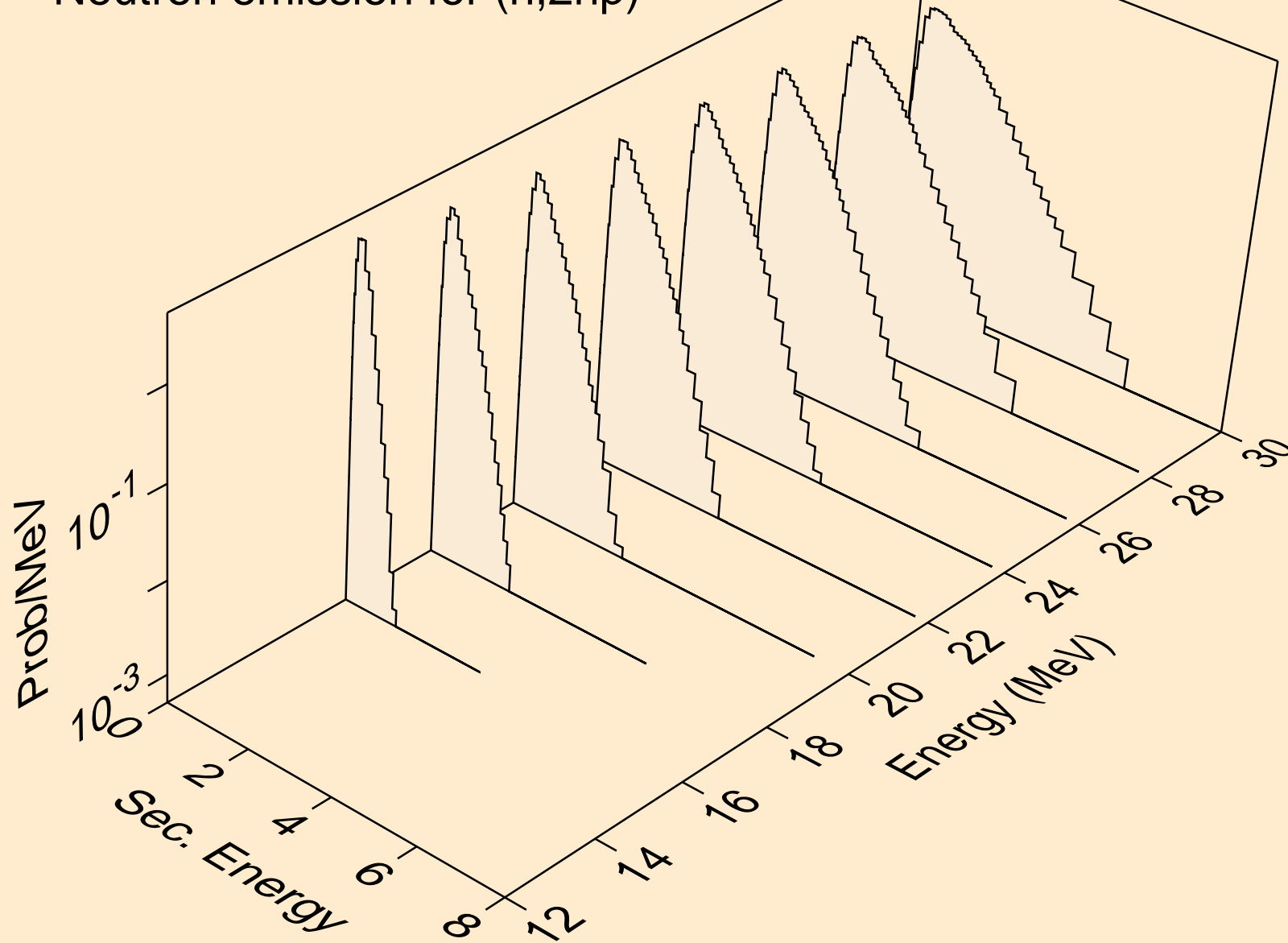

PU232 NEUTRON ACER TENDL-2021 LIBRARY; T=293.6K  
Neutron emission for (n,3np)

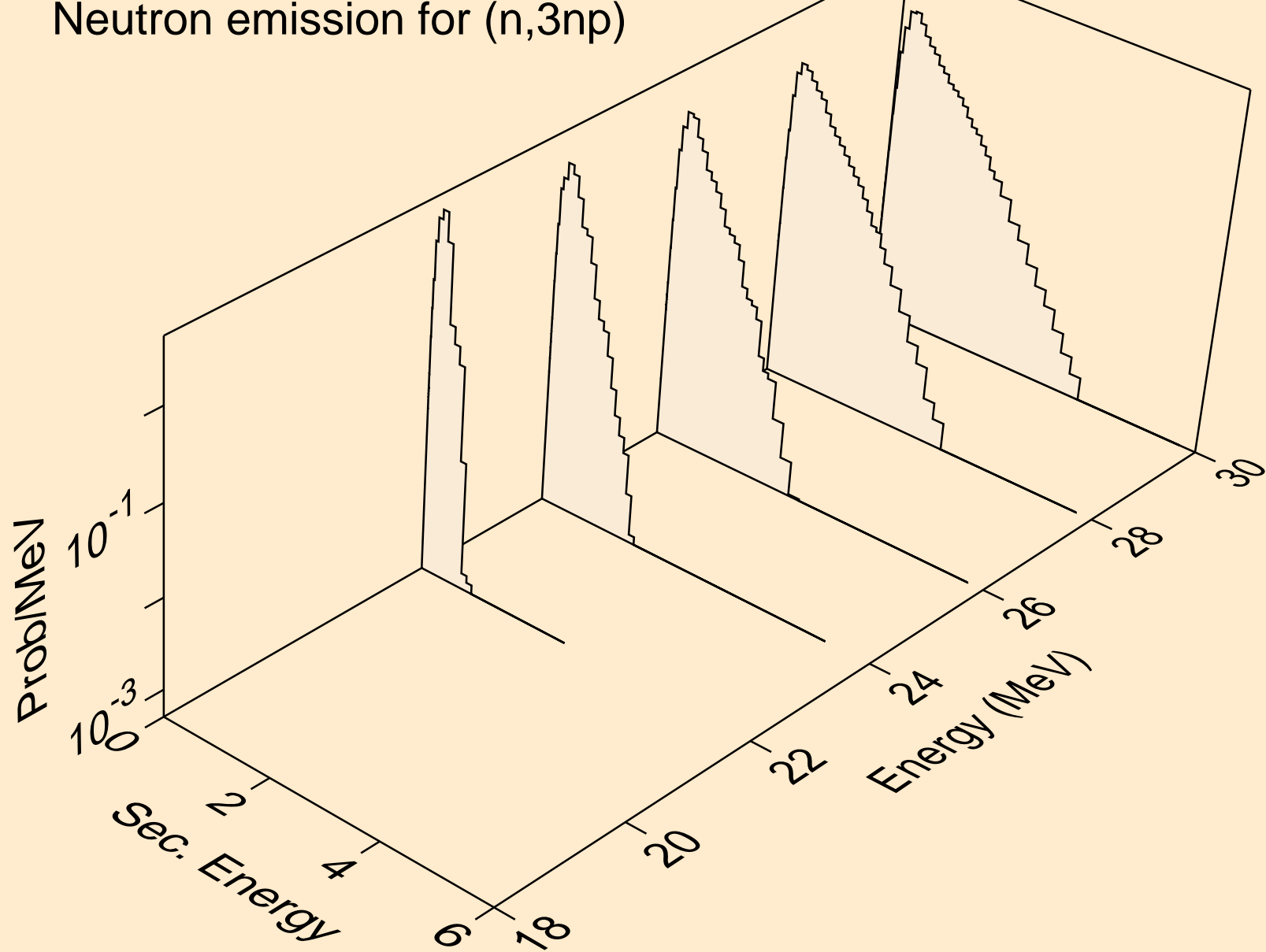

PU232 NEUTRON ACER TENDL-2021 LIBRARY; T=293.6K  
Neutron emission for (n,2np)

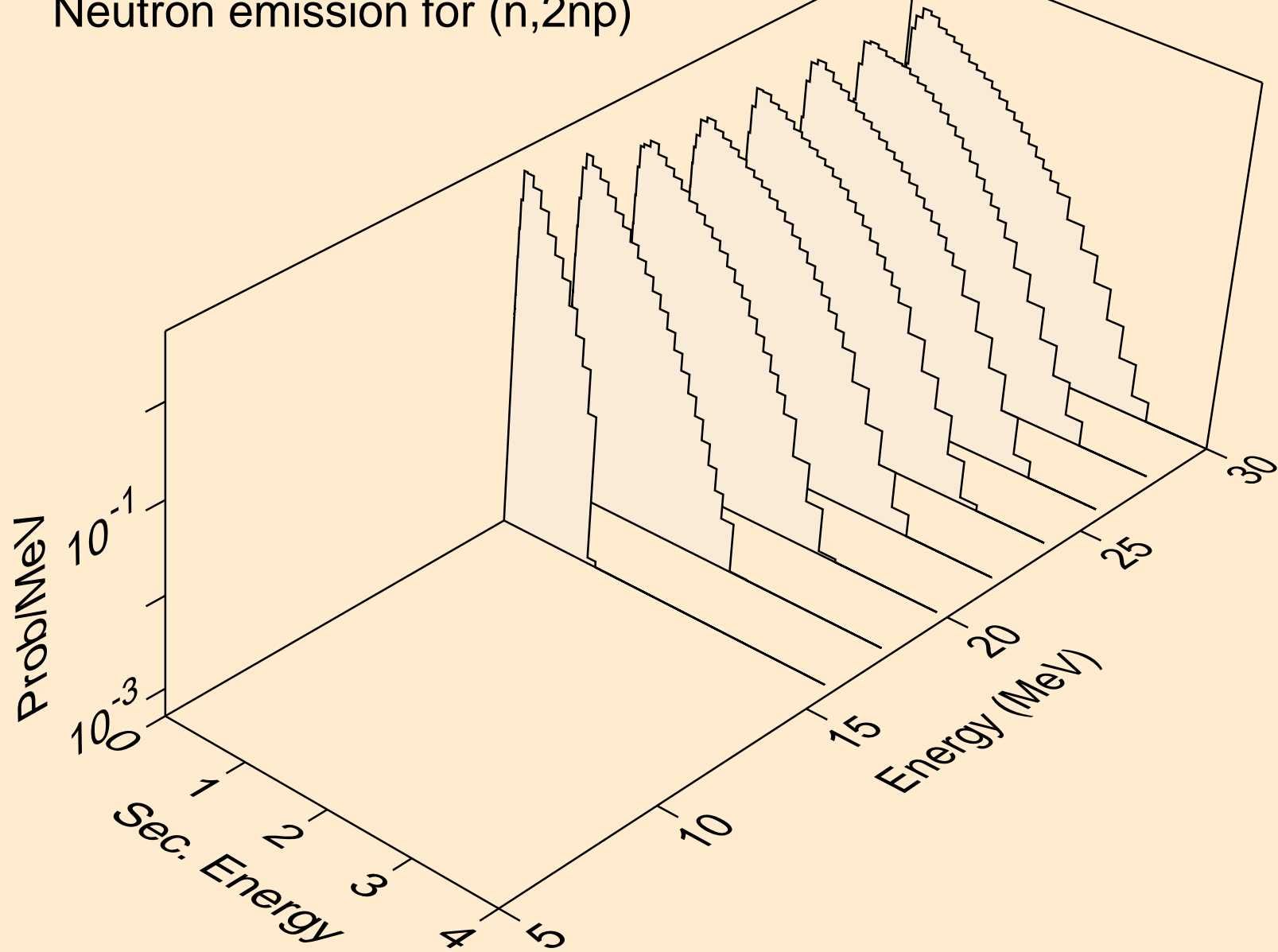

PU232 NEUTRON ACER TENDL-2021 LIBRARY; T=293.6K  
Neutron emission for (n,npa)

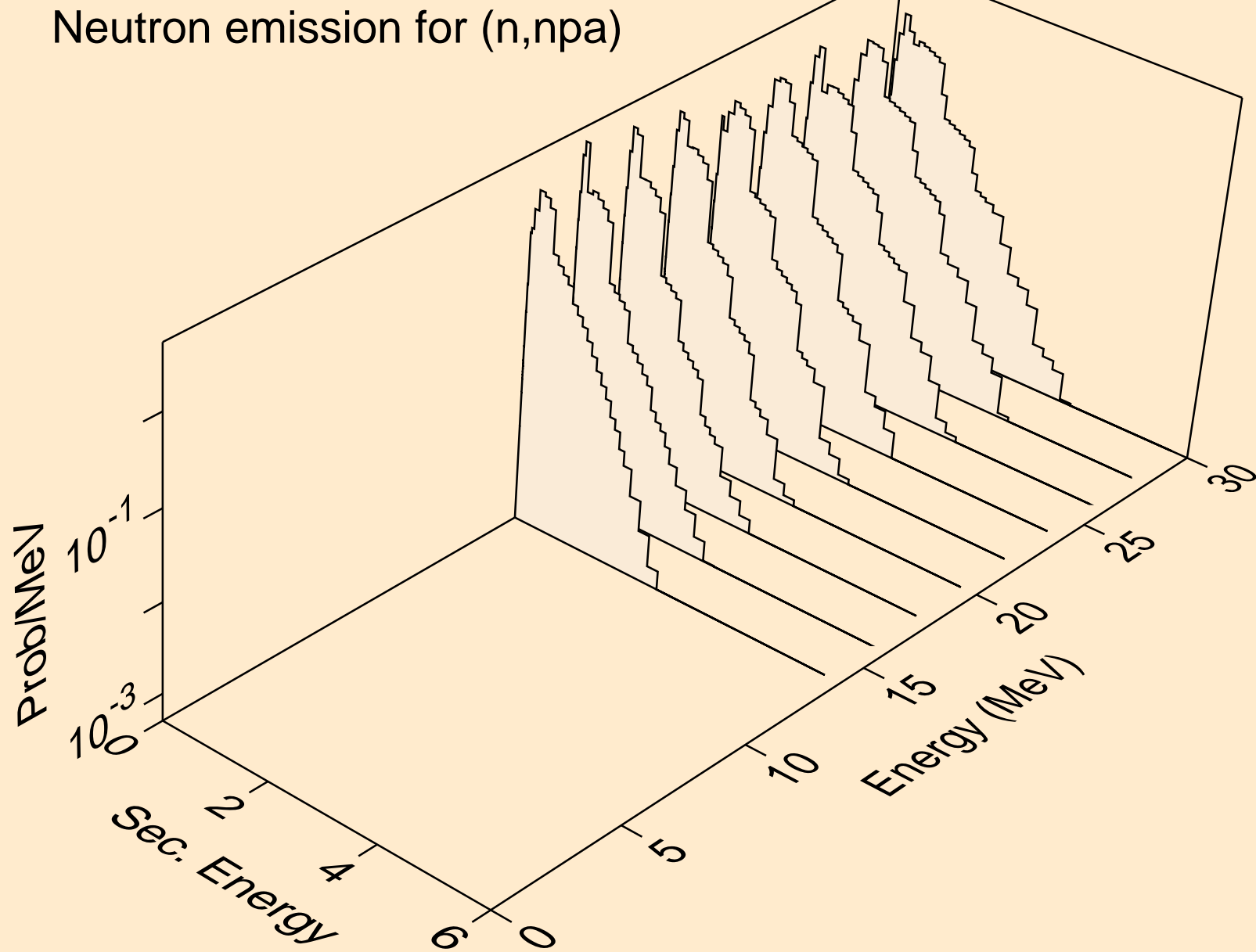

PU232 NEUTRON ACER TENDL-2021 LIBRARY; T=293.6K  
Neutron emission for (n,n\*c)

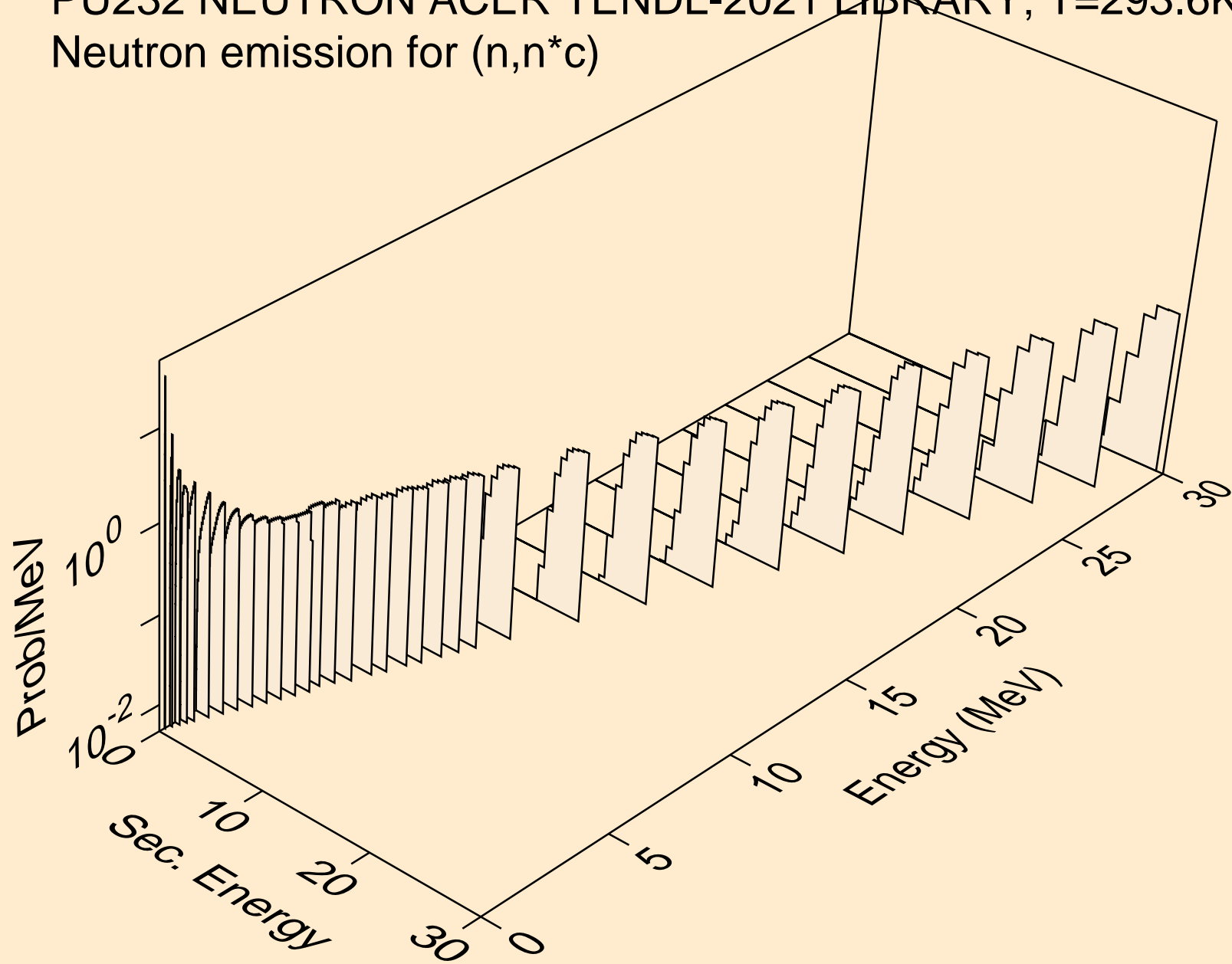

PU232 NEUTRON ACER TENDL-2021 LIBRARY; T=293.6K  
Delayed nubar

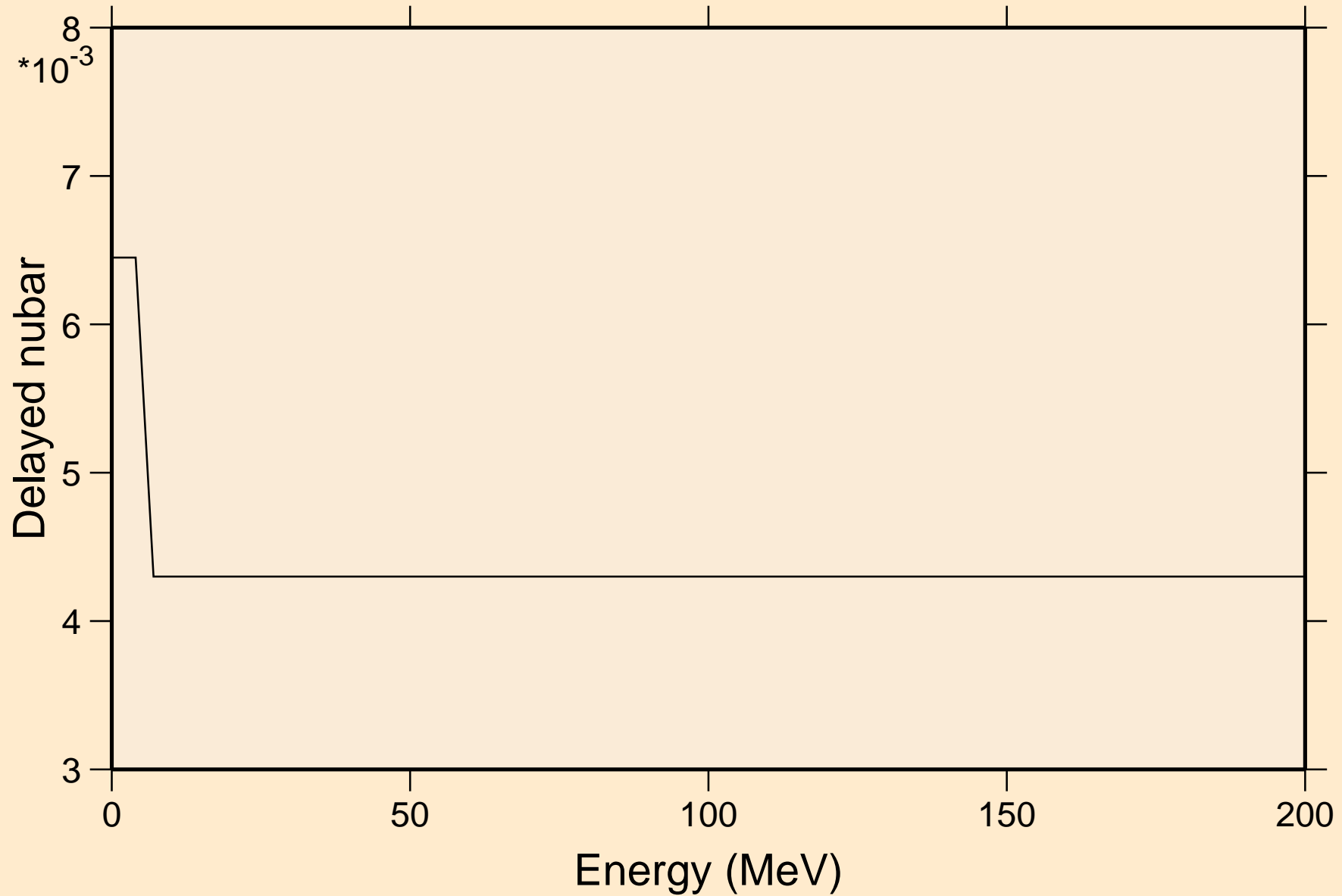

PU232 NEUTRON ACER TENDL-2021 LIBRARY; T=293.6K  
Delayed neutron spectra

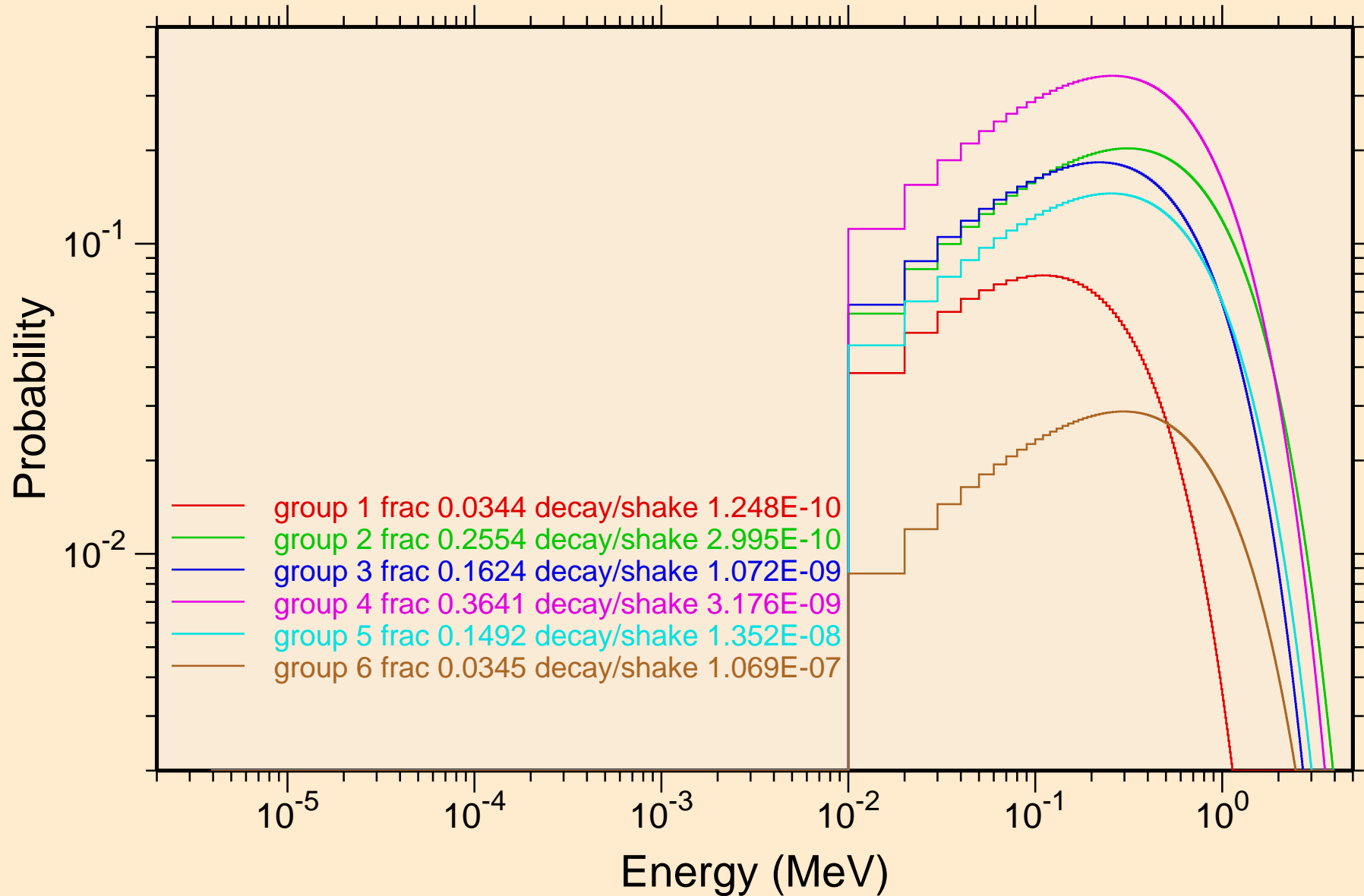

PU232 NEUTRON ACER TENDL-2021 LIBRARY; T=293.6K  
Photon emission for (n,x)

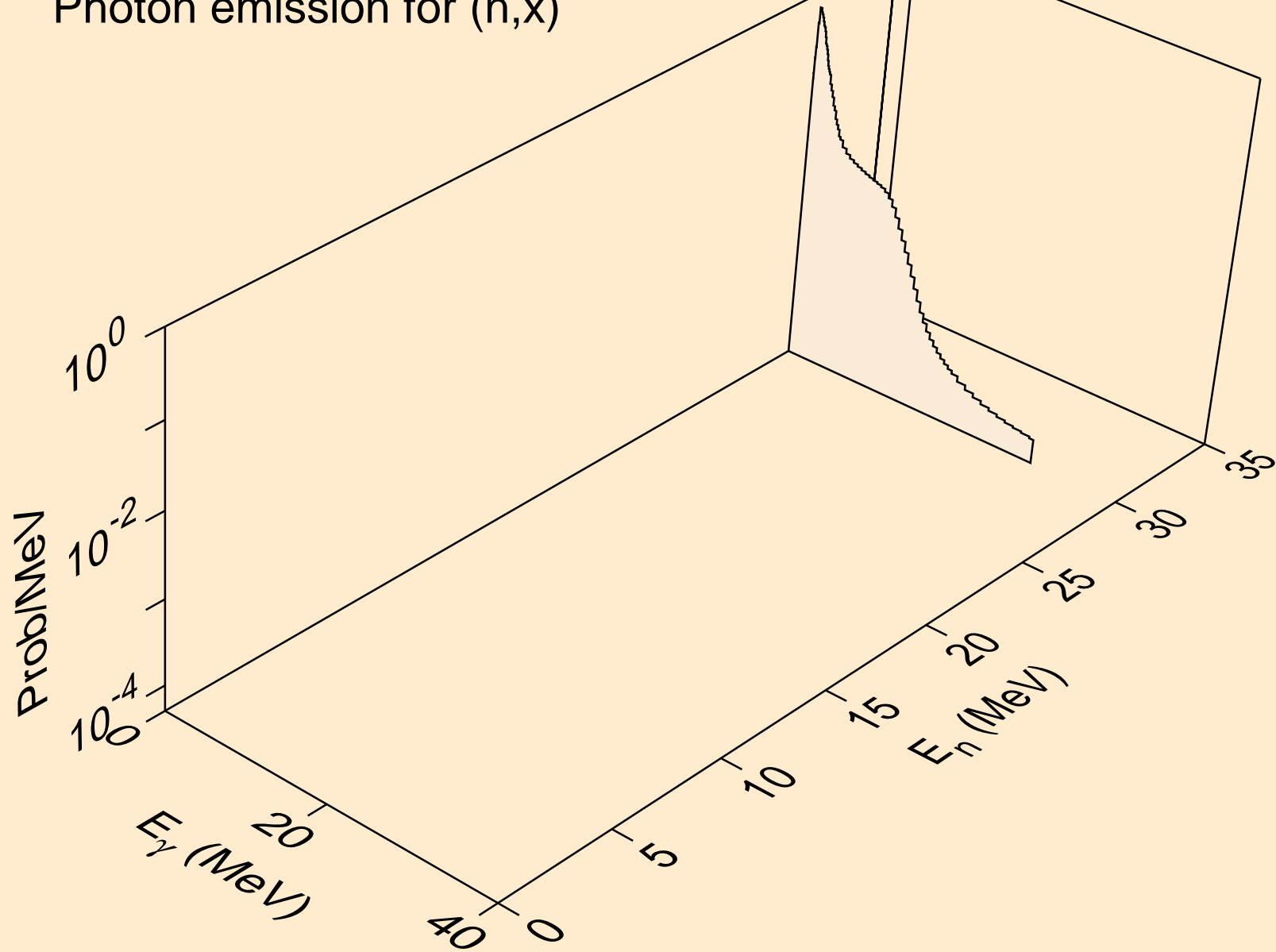

PU232 NEUTRON ACER TENDL-2021 LIBRARY; T=293.6K  
Photon emission for (n,2nd)

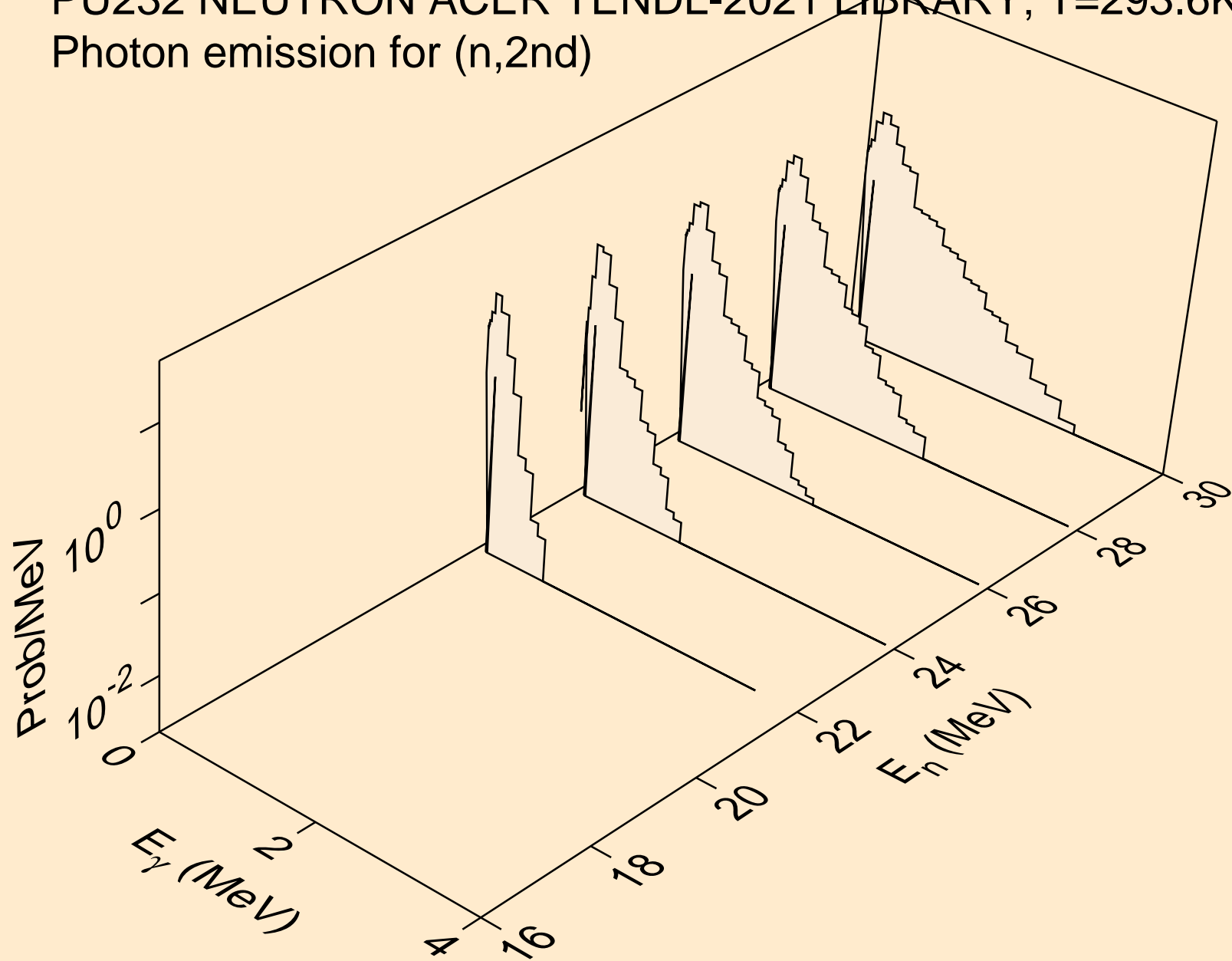

PU232 NEUTRON ACER TENDL-2021 LIBRARY; T=293.6K  
Photon emission for (n,2n)

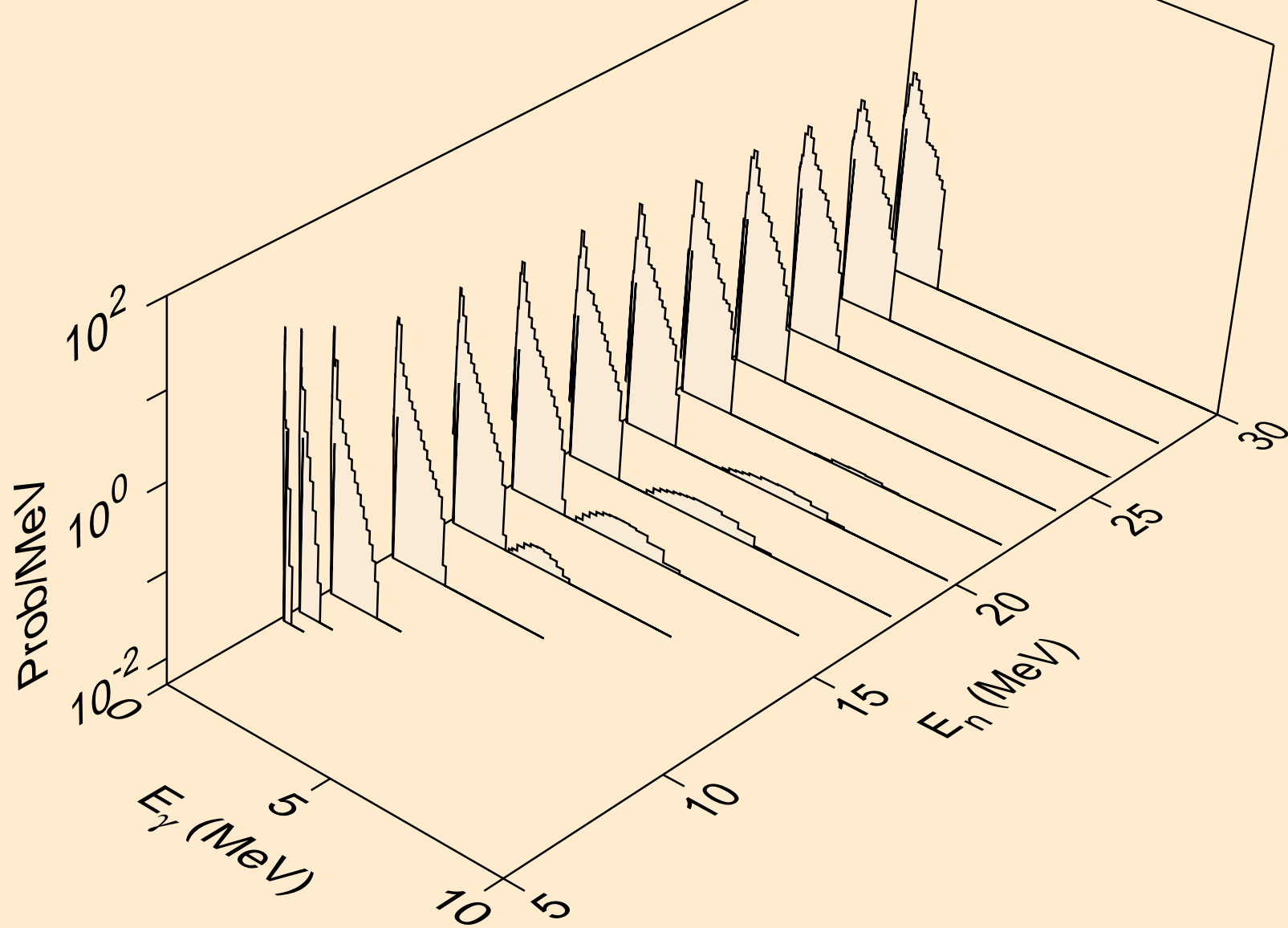

PU232 NEUTRON ACER TENDL-2021 LIBRARY; T=293.6K  
Photon emission for (n,3n)

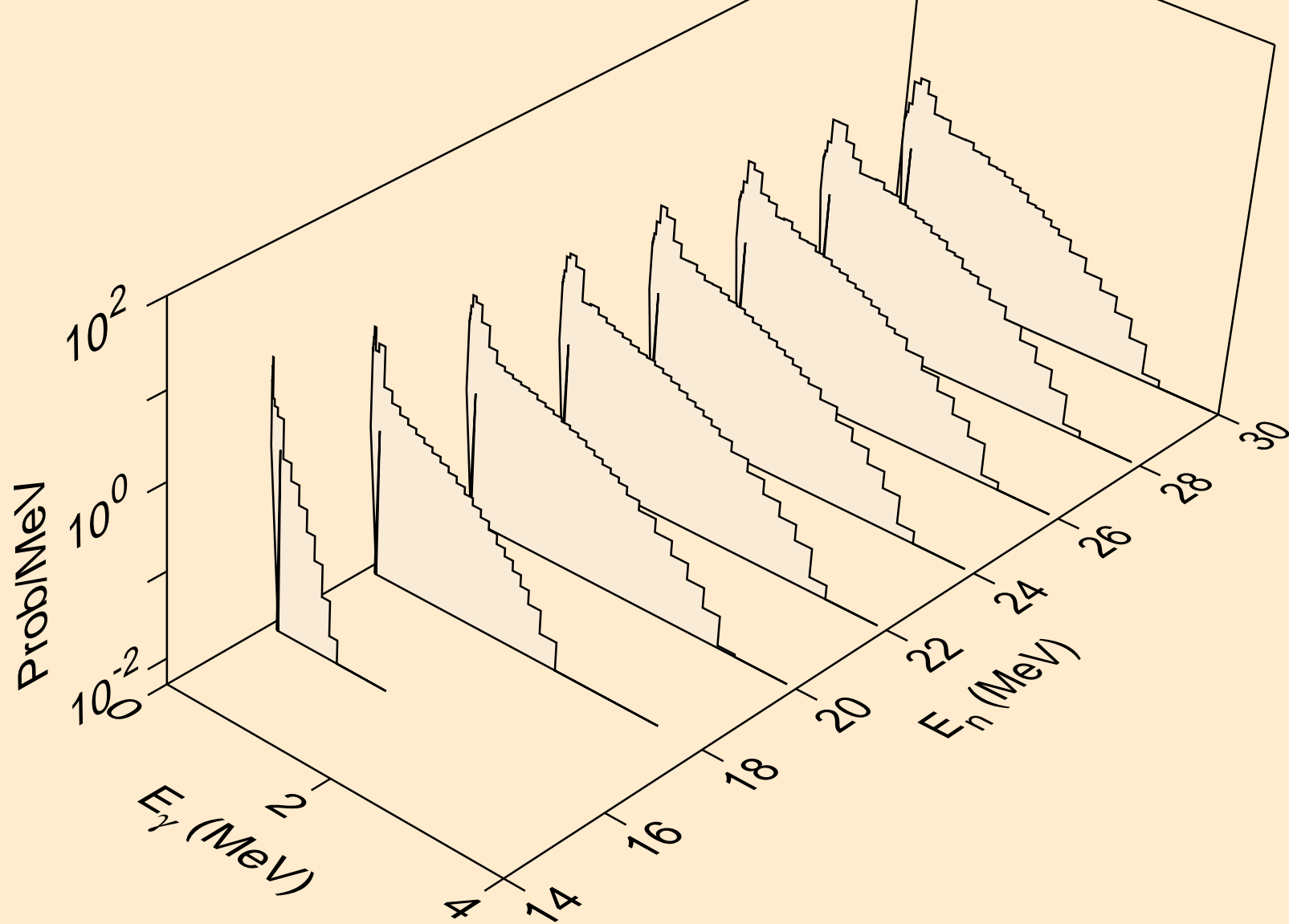

PU232 NEUTRON ACER TENDL-2021 LIBRARY; T=293.6K  
Photon emission for (n,n\*)a

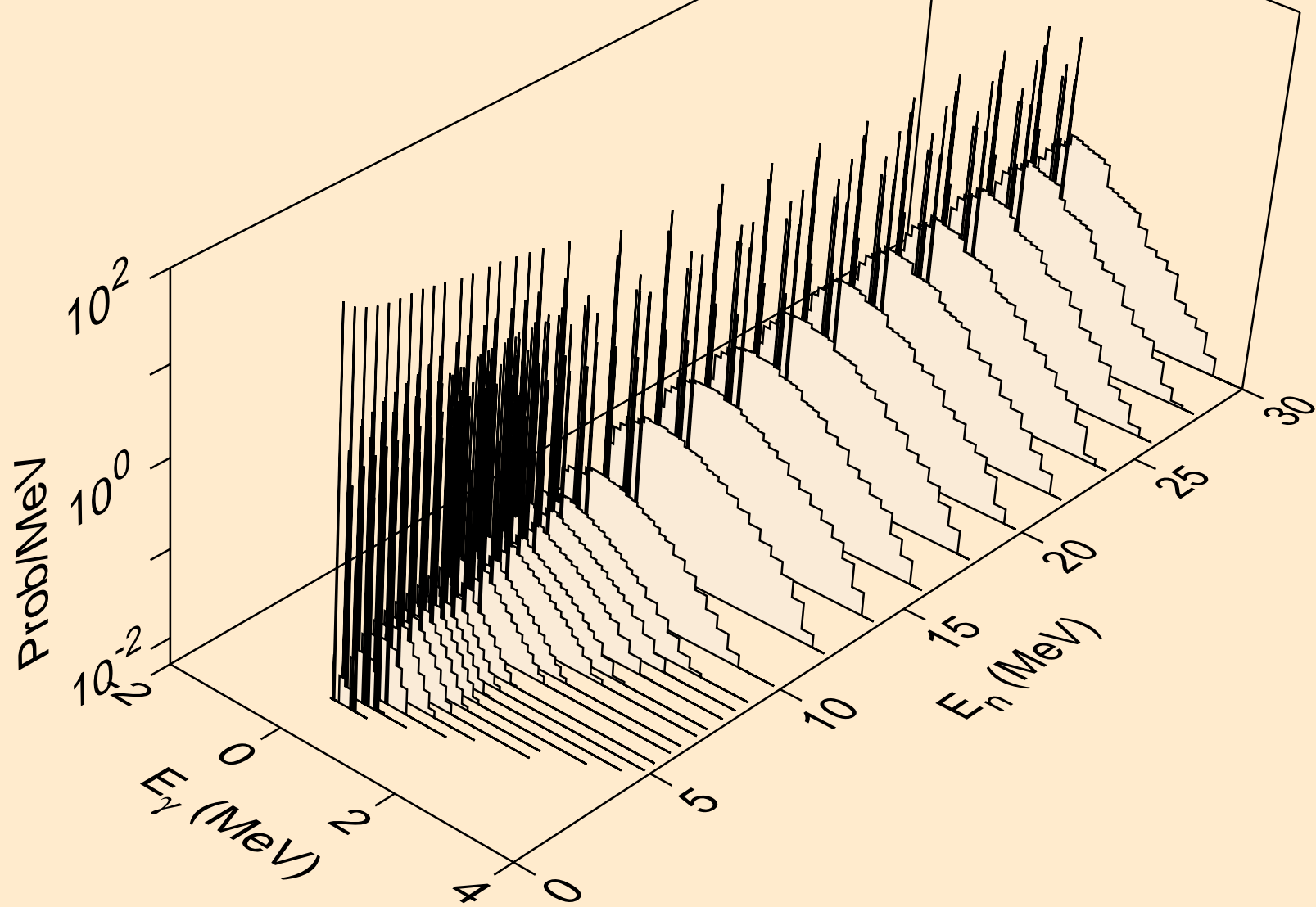

PU232 NEUTRON ACER TENDL-2021 LIBRARY; T=293.6K  
Photon emission for (n,2n)a

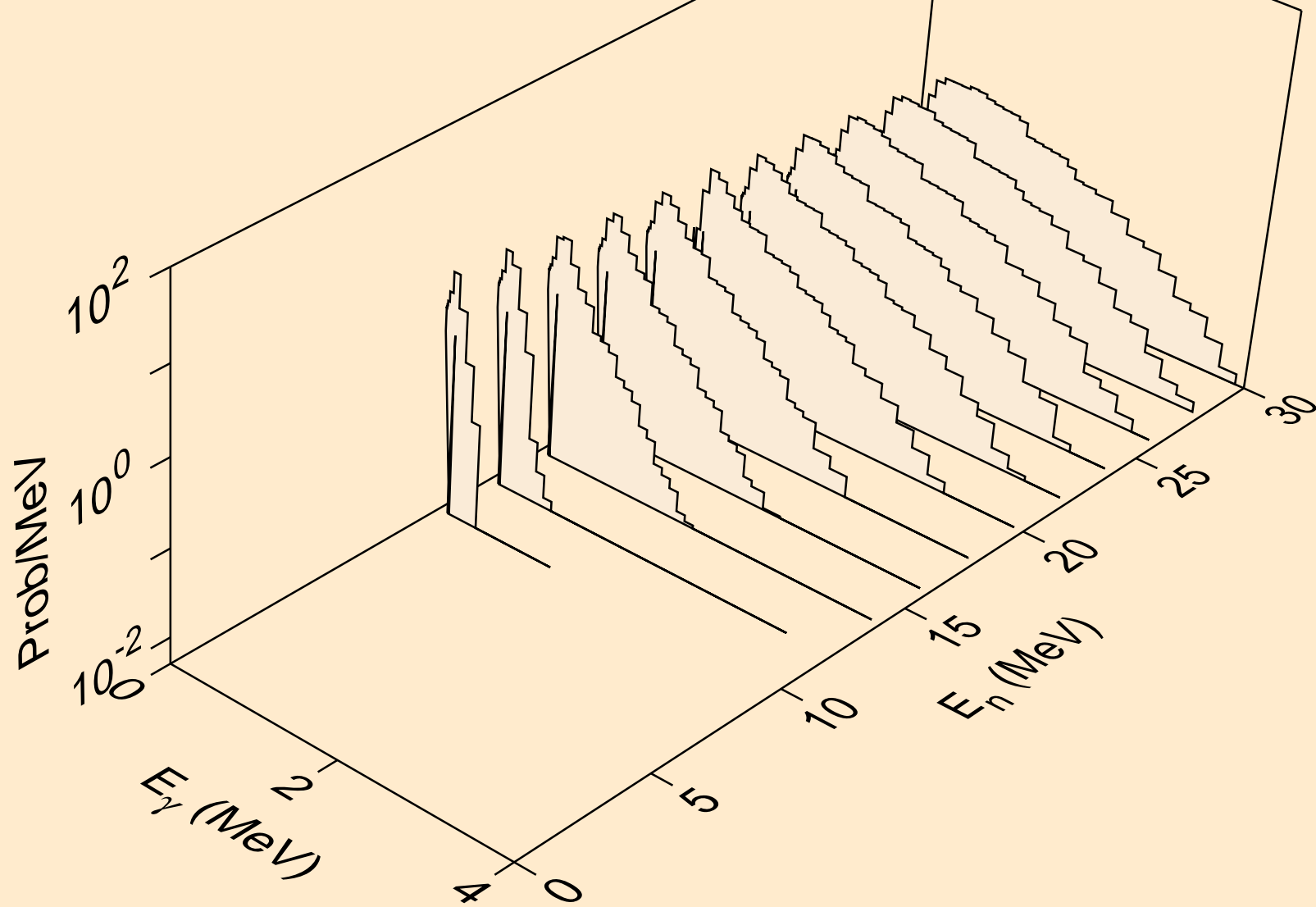

PU232 NEUTRON ACER TENDL-2021 LIBRARY; T=293.6K  
Photon emission for (n,3n)a

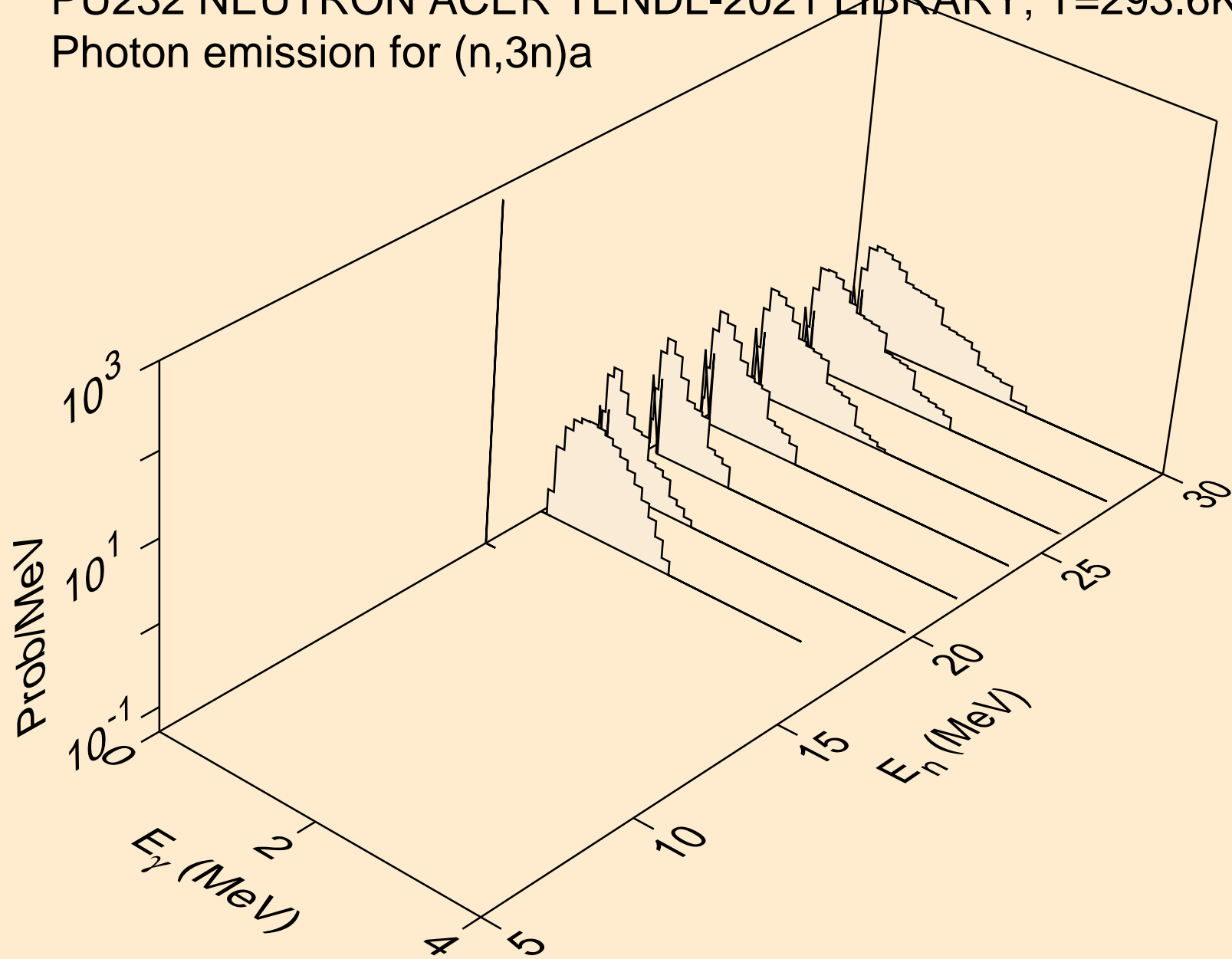

PU232 NEUTRON ACER TENDL-2021 LIBRARY; T=293.6K  
Photon emission for (n,n\*)p

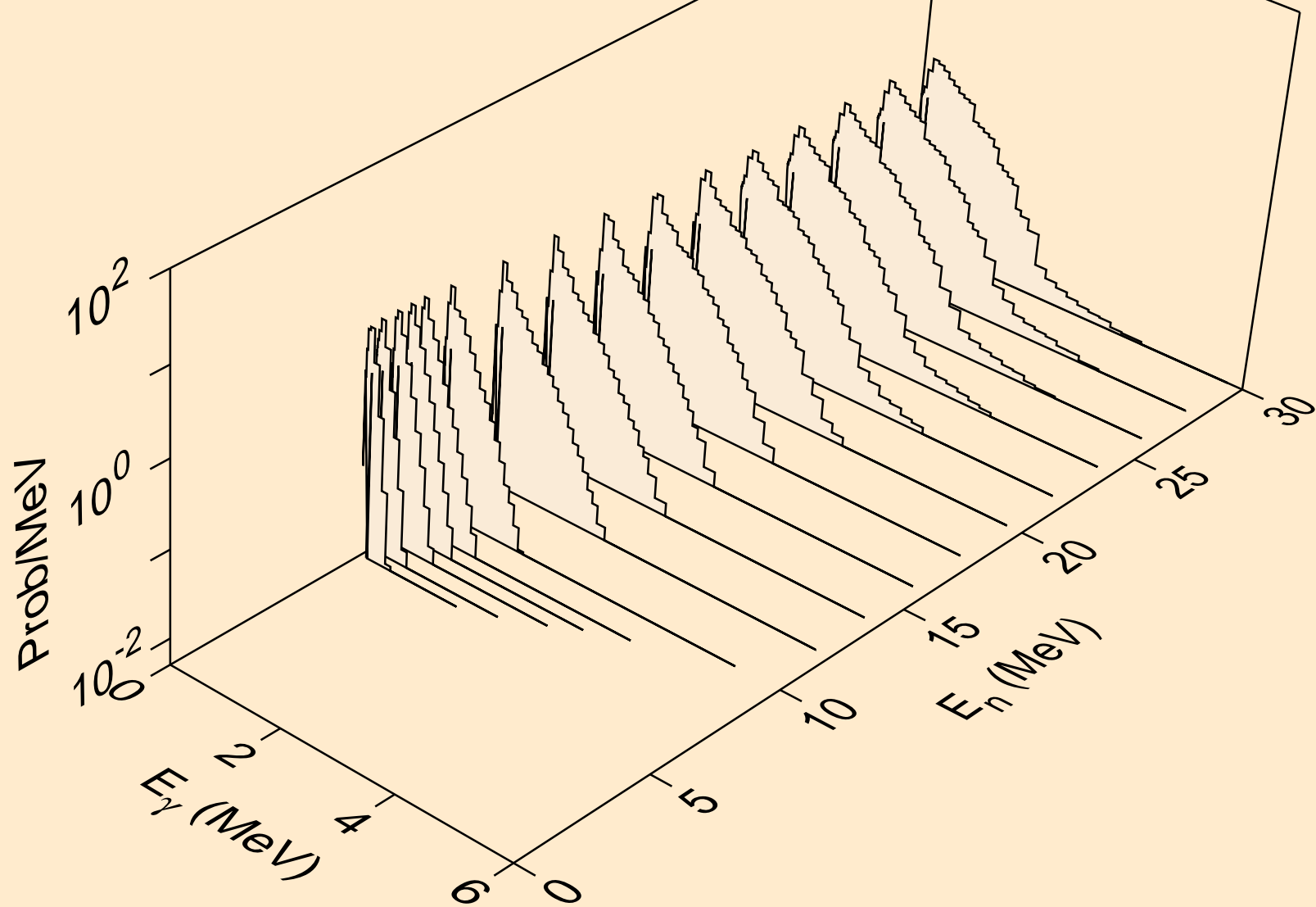

PU232 NEUTRON ACER TENDL-2021 LIBRARY; T=293.6K  
Photon emission for (n,n\*)2a

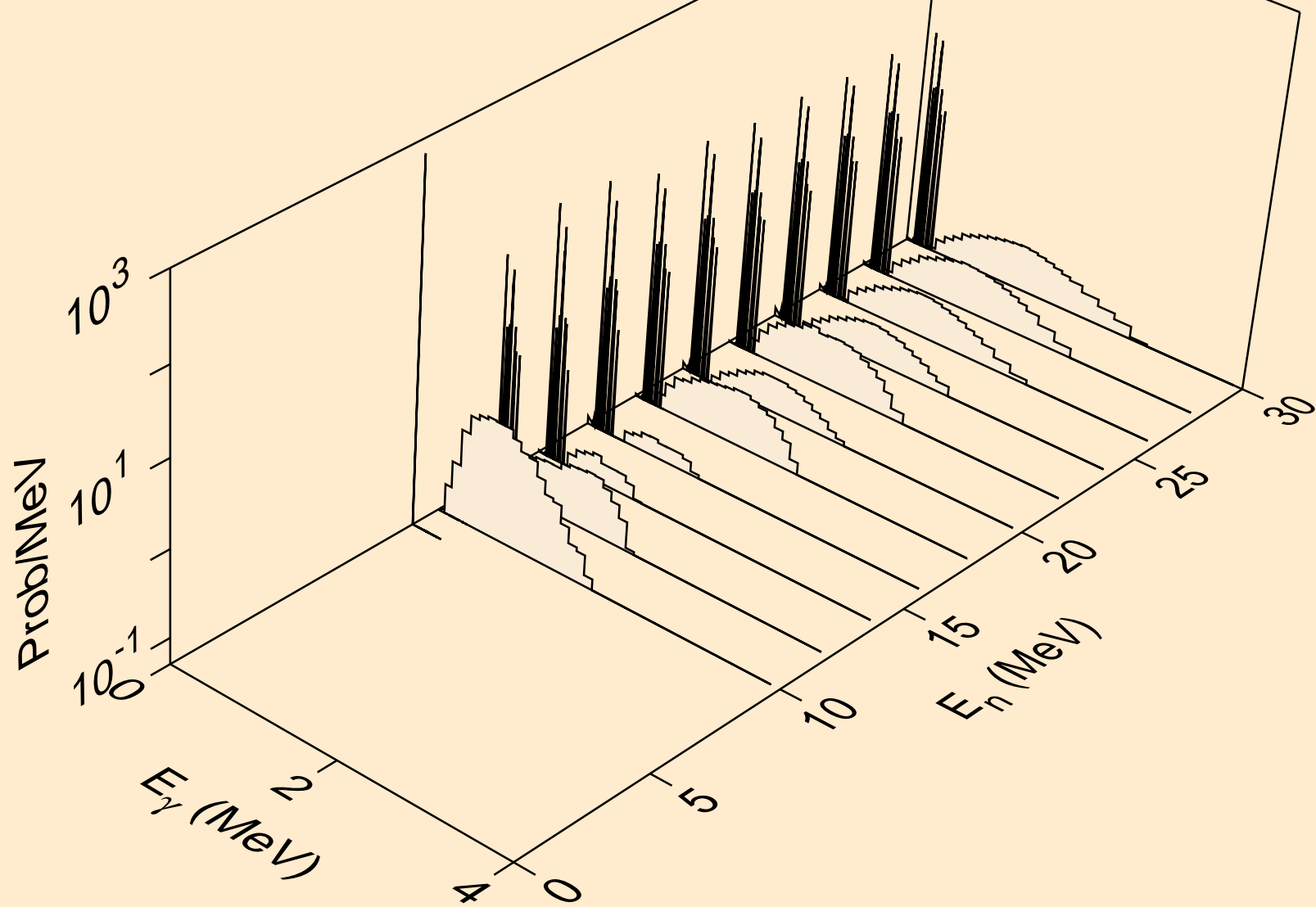

PU232 NEUTRON ACER TENDL-2021 LIBRARY; T=293.6K  
Photon emission for (n,n\*)d

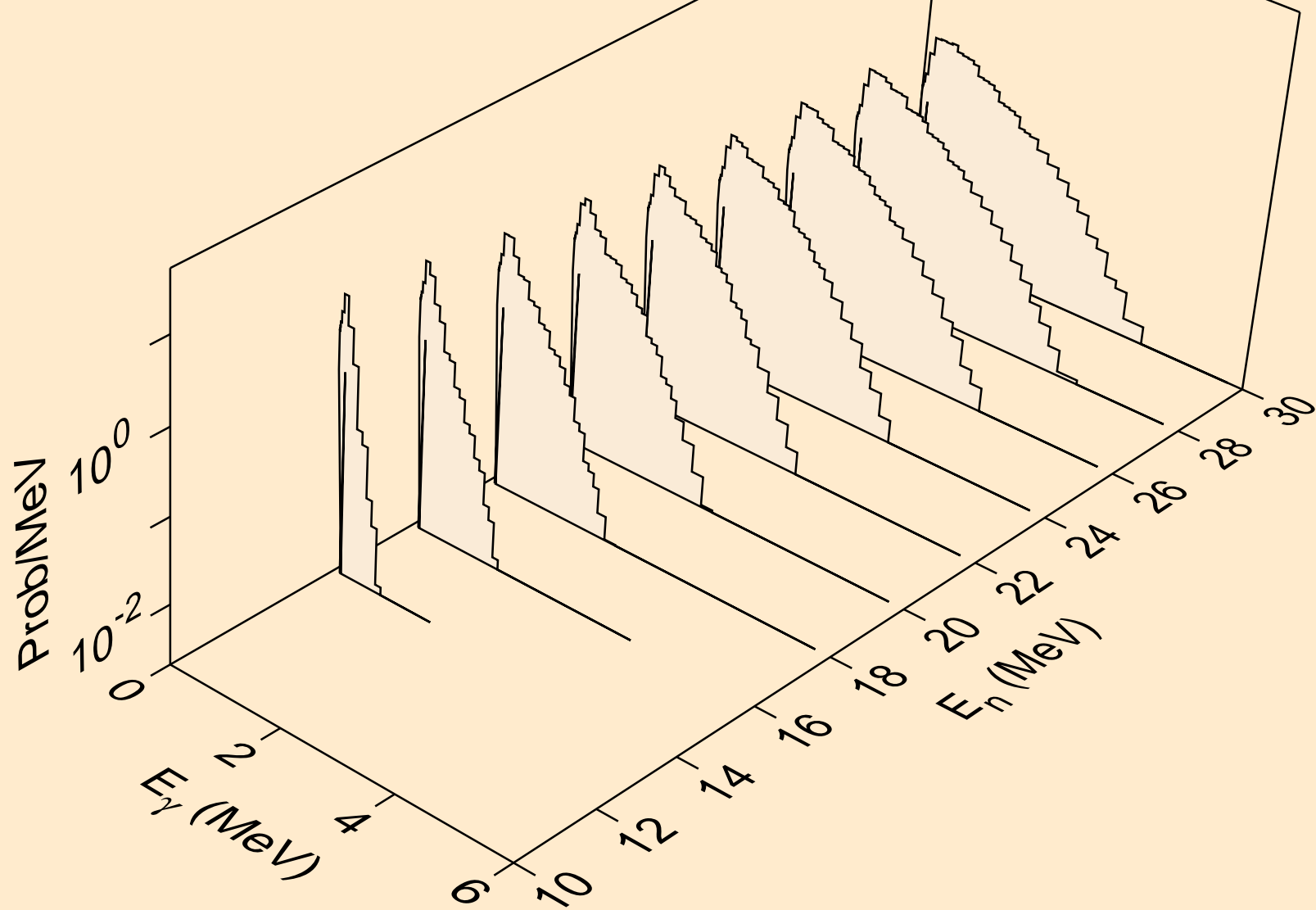

PU232 NEUTRON ACER TENDL-2021 LIBRARY; T=293.6K  
Photon emission for (n,n\*)t

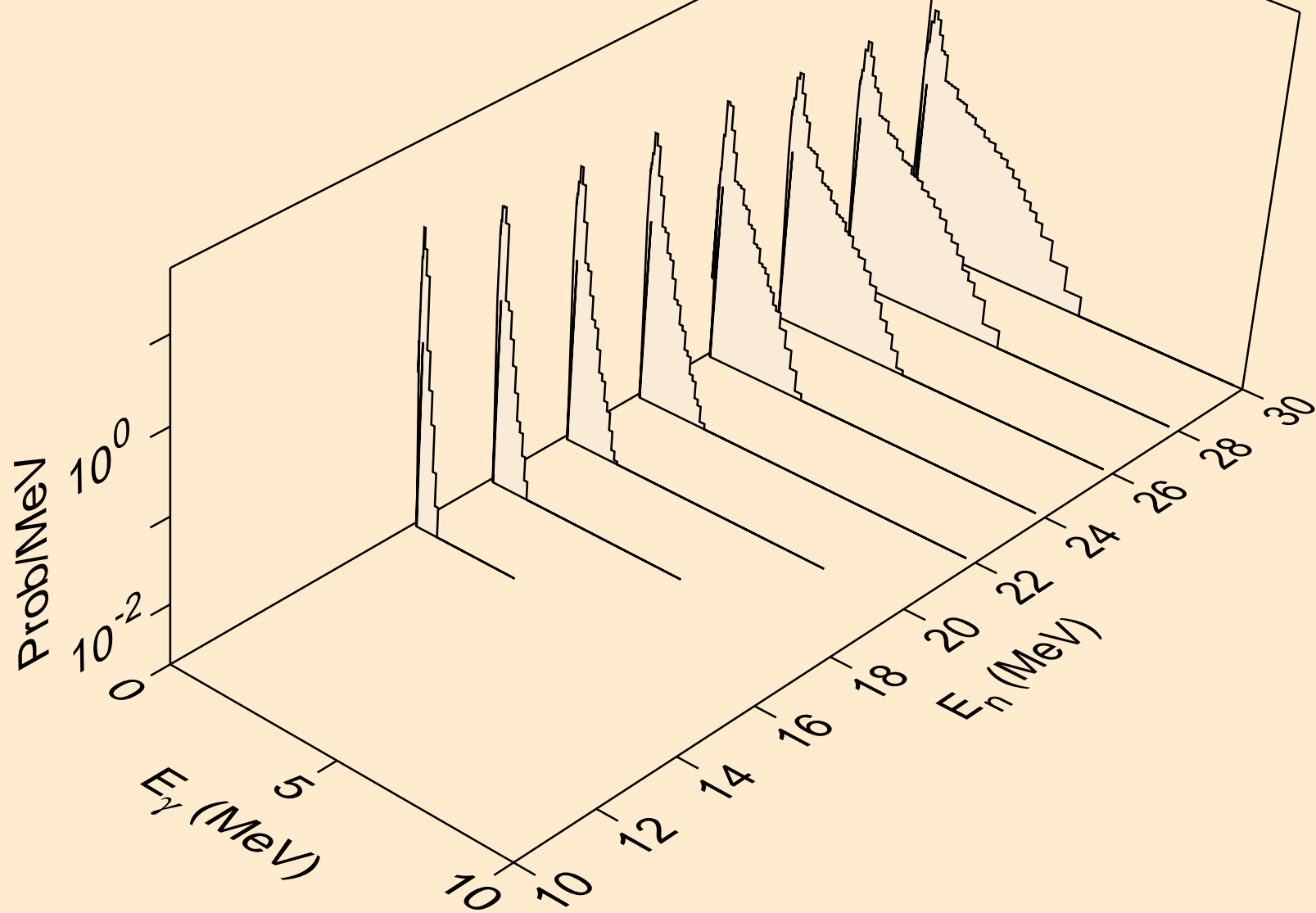

PU232 NEUTRON ACER TENDL-2021 LIBRARY; T=293.6K  
Photon emission for (n,n\*)he3

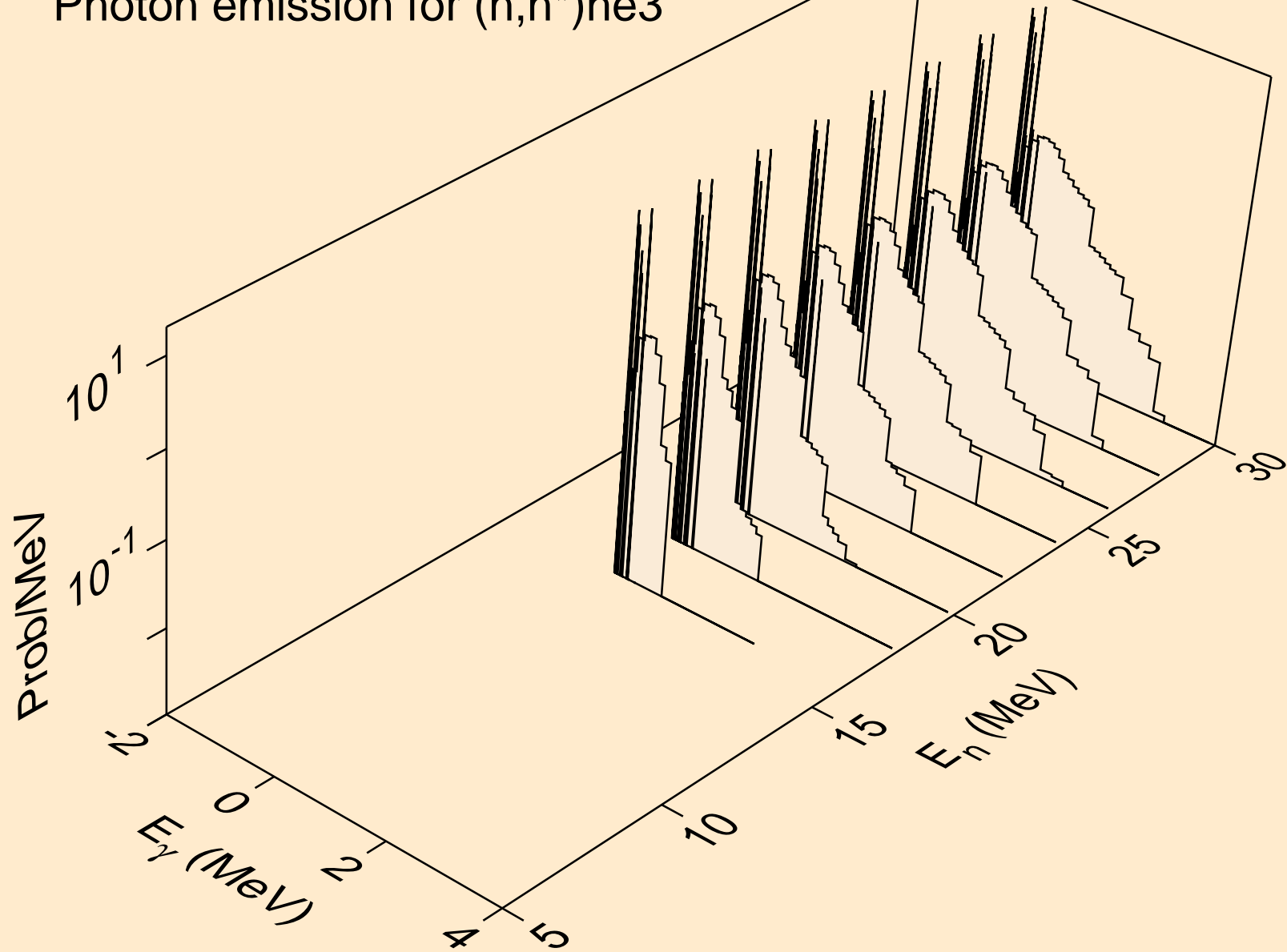

PU232 NEUTRON ACER TENDL-2021 LIBRARY; T=293.6K  
Photon emission for (n,4n)

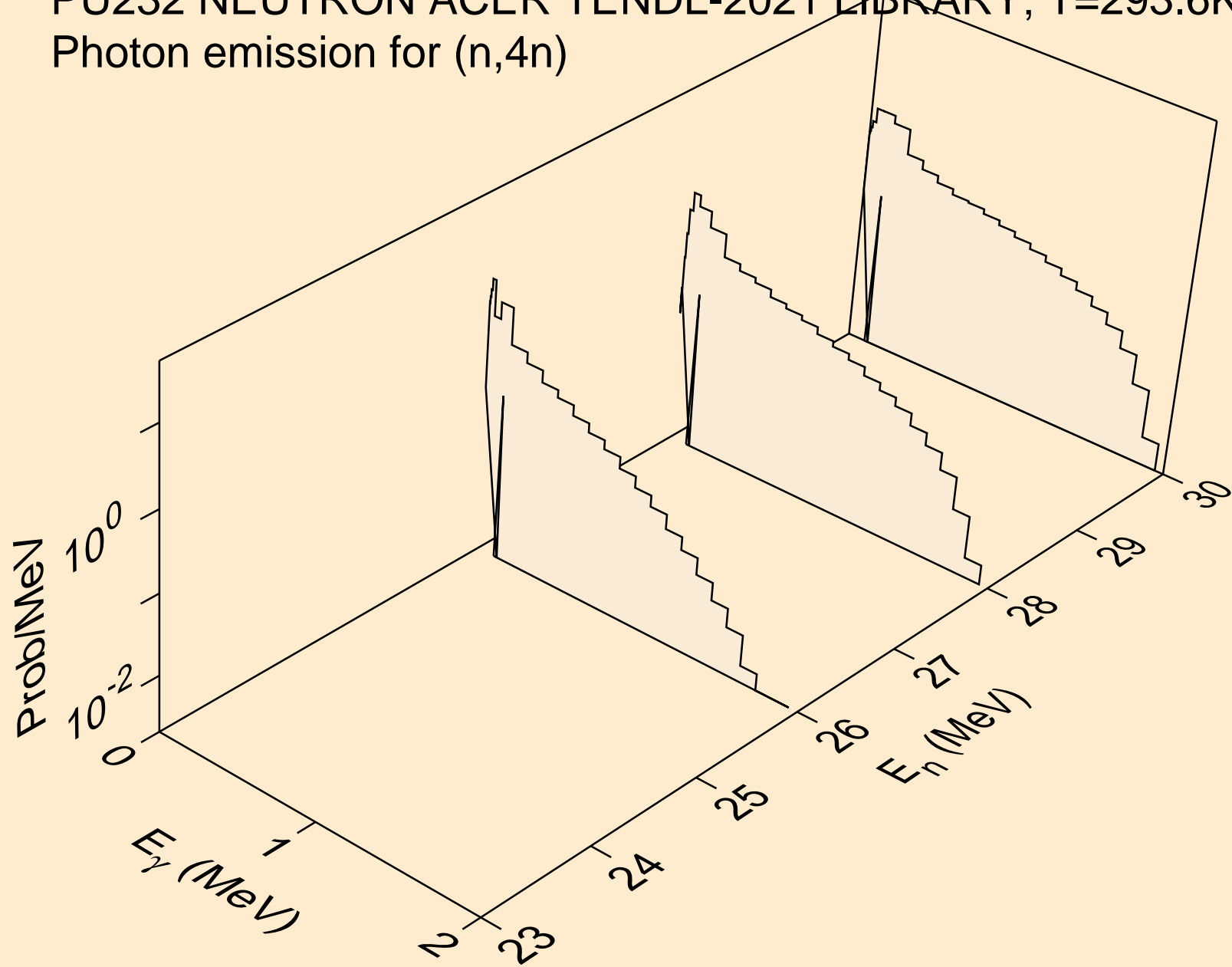

PU232 NEUTRON ACER TENDL-2021 LIBRARY; T=293.6K  
Photon emission for (n,2np)

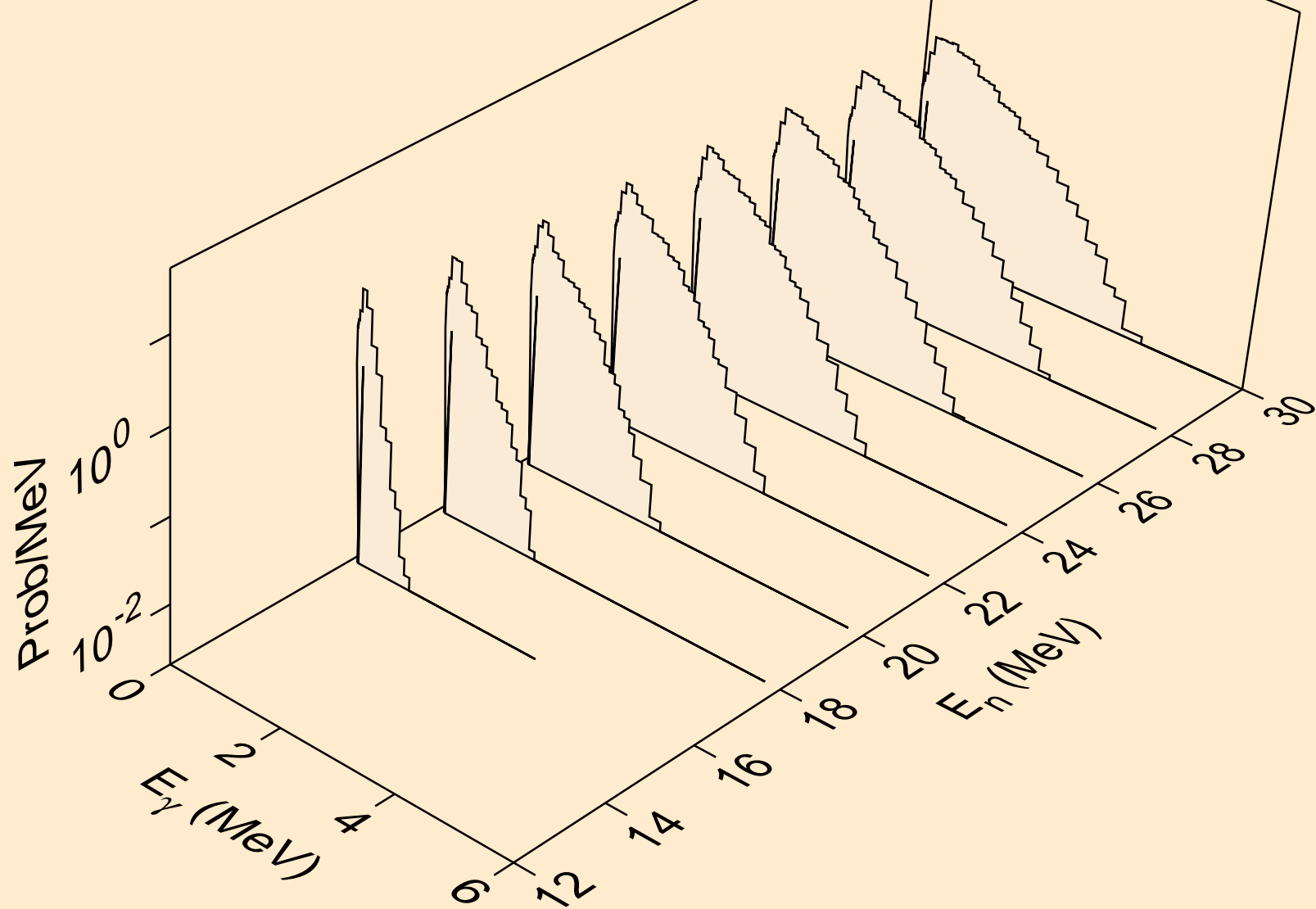

PU232 NEUTRON ACER TENDL-2021 LIBRARY; T=293.6K  
Photon emission for (n,3np)

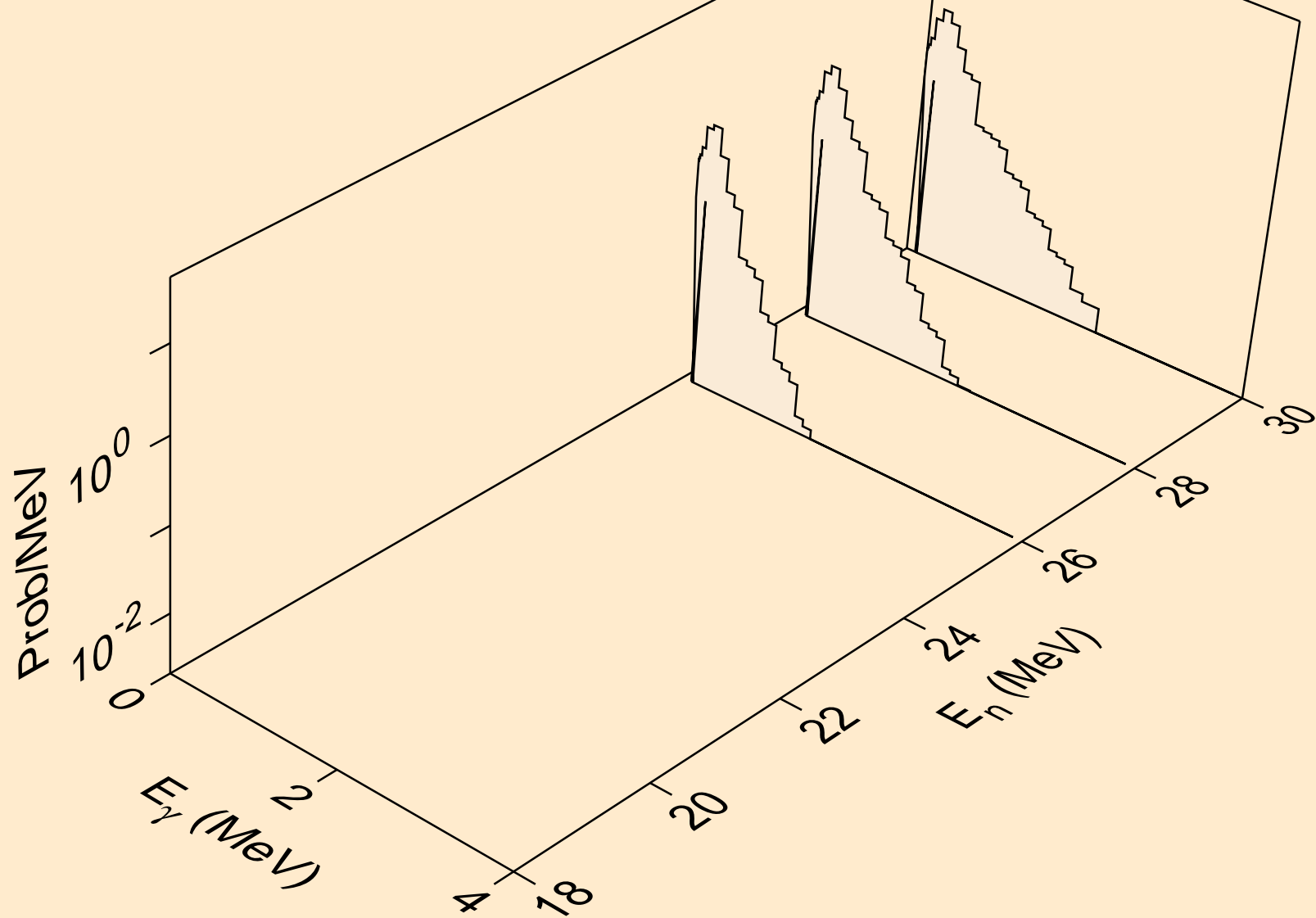

PU232 NEUTRON ACER TENDL-2021 LIBRARY; T=293.6K  
Photon emission for (n,2np)

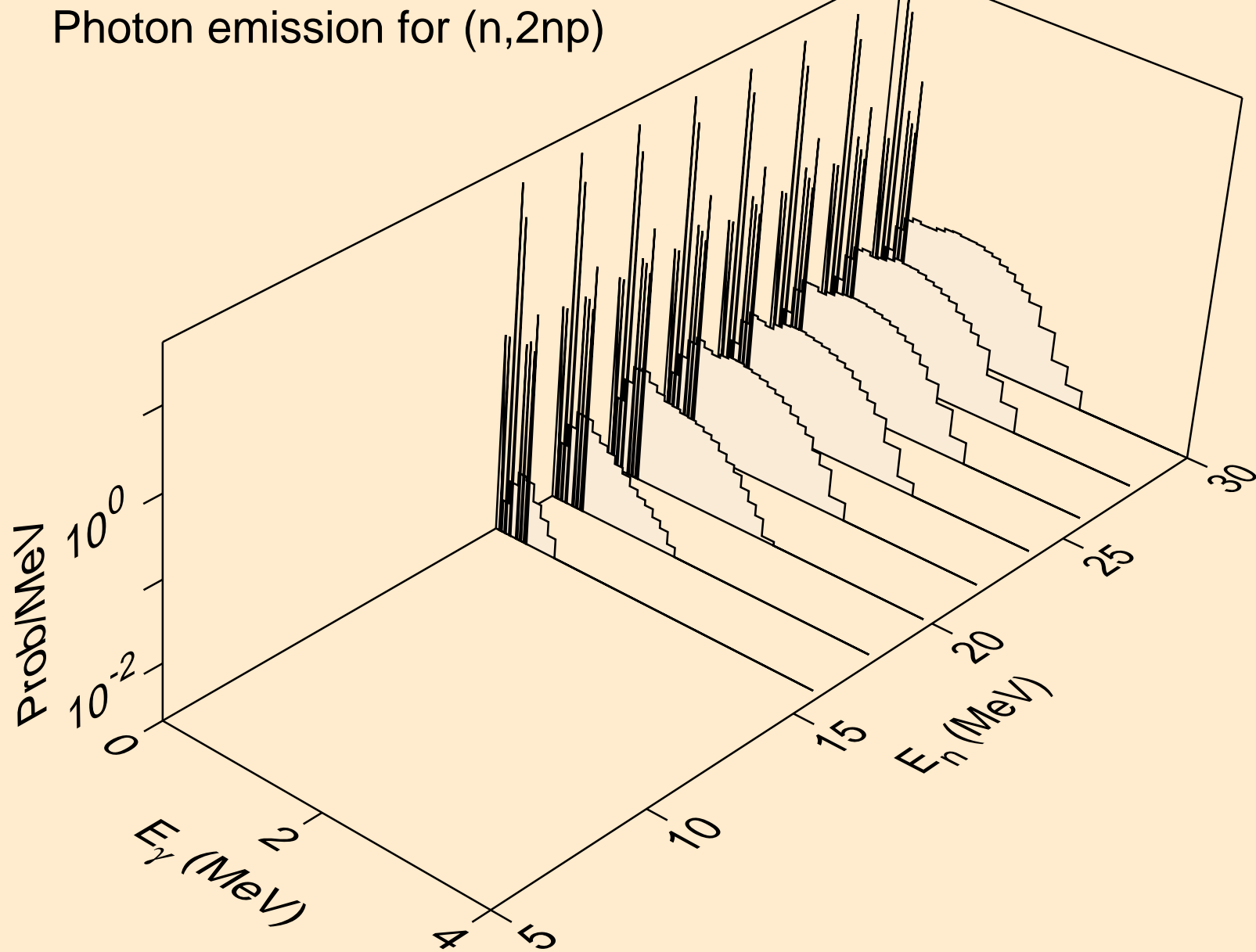

PU232 NEUTRON ACER TENDL-2021 LIBRARY; T=293.6K  
Photon emission for (n,npa)

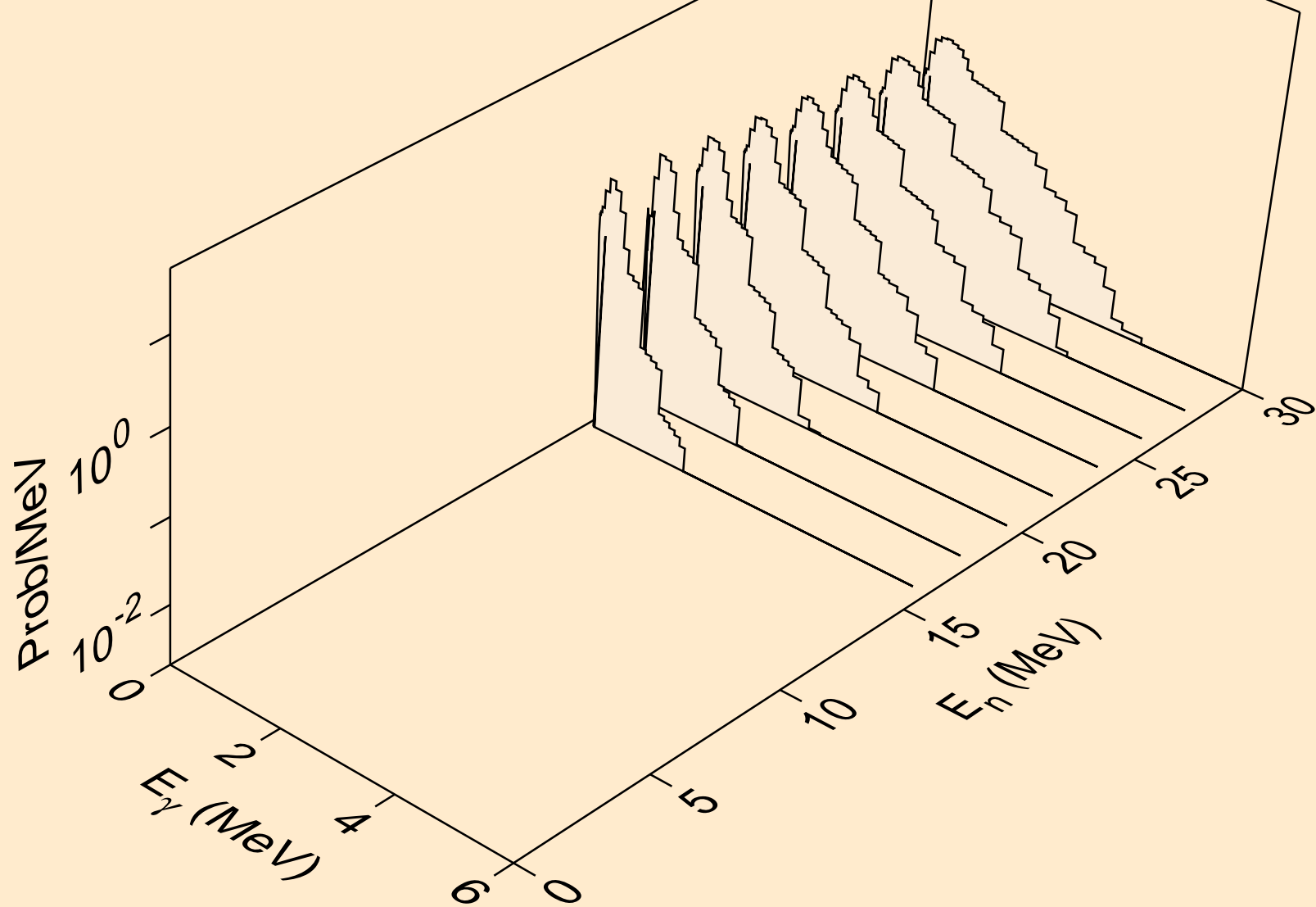

PU232 NEUTRON ACER TENDL-2021 LIBRARY; T=293.6K  
Photon emission for (n,n\*c)

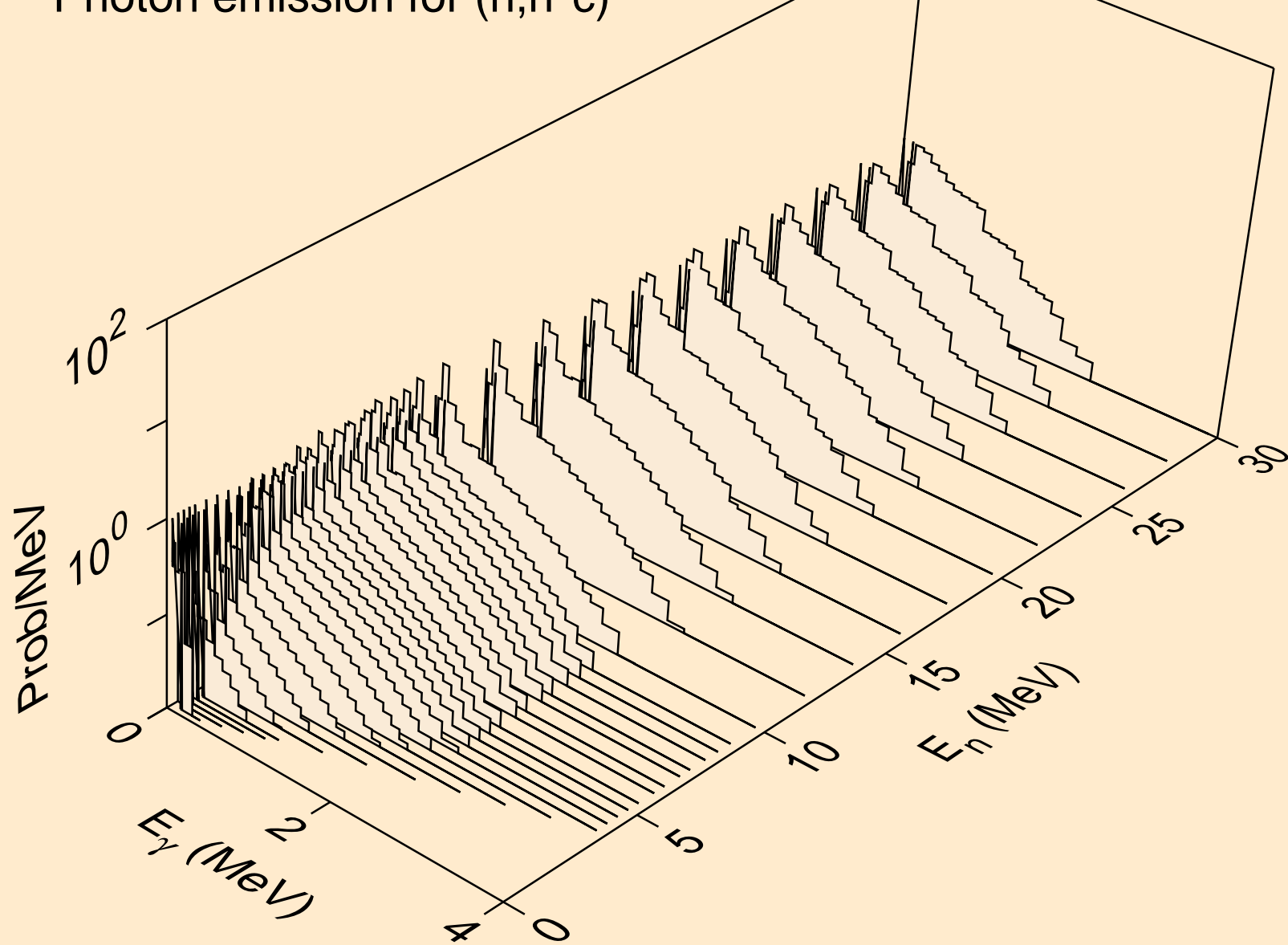

PU232 NEUTRON ACER TENDL-2021 LIBRARY; T=293.6K  
Photon emission for (n,gma)

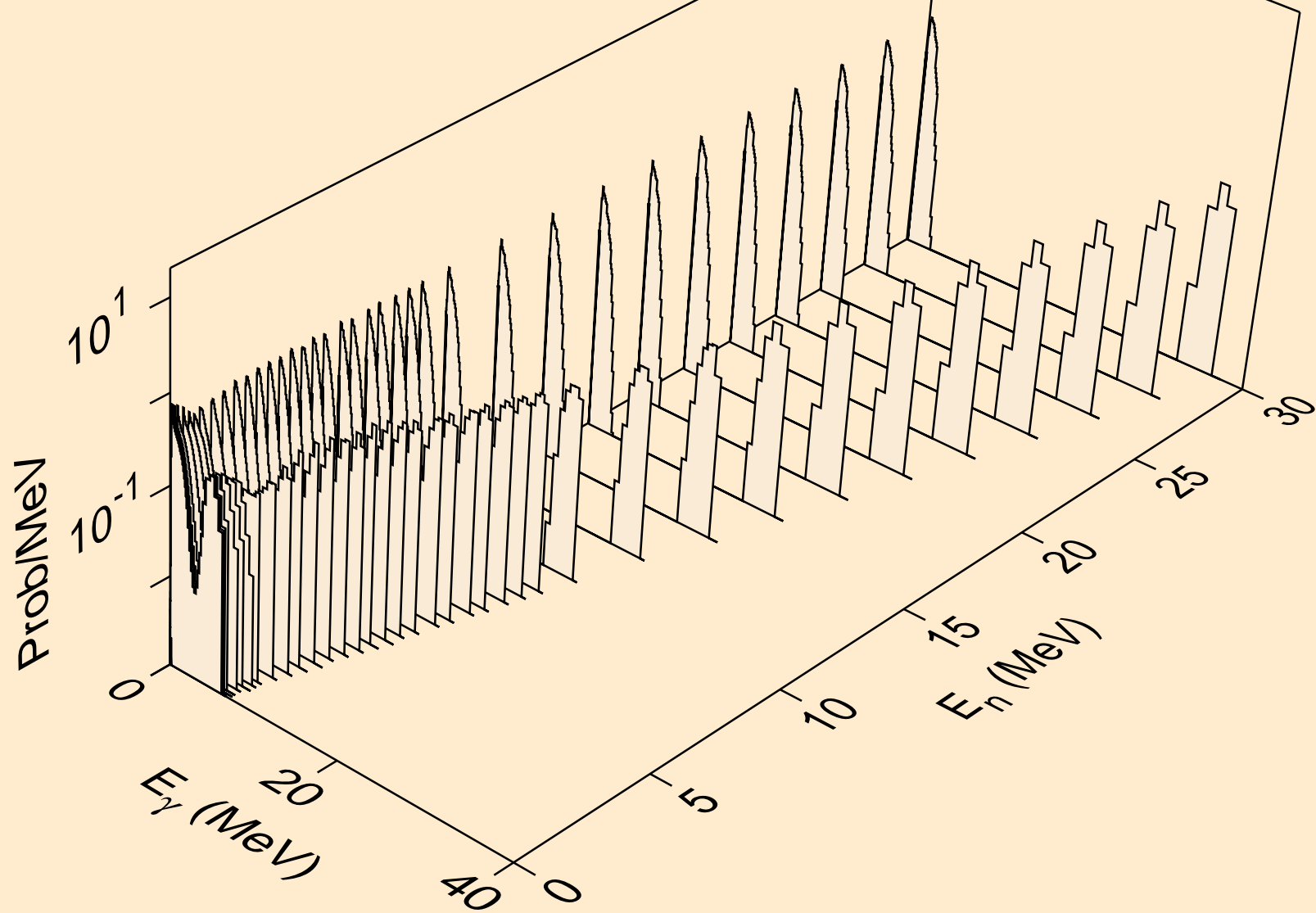

PU232 NEUTRON ACER TENDL-2021 LIBRARY; T=293.6K  
Photon emission for (n,p)

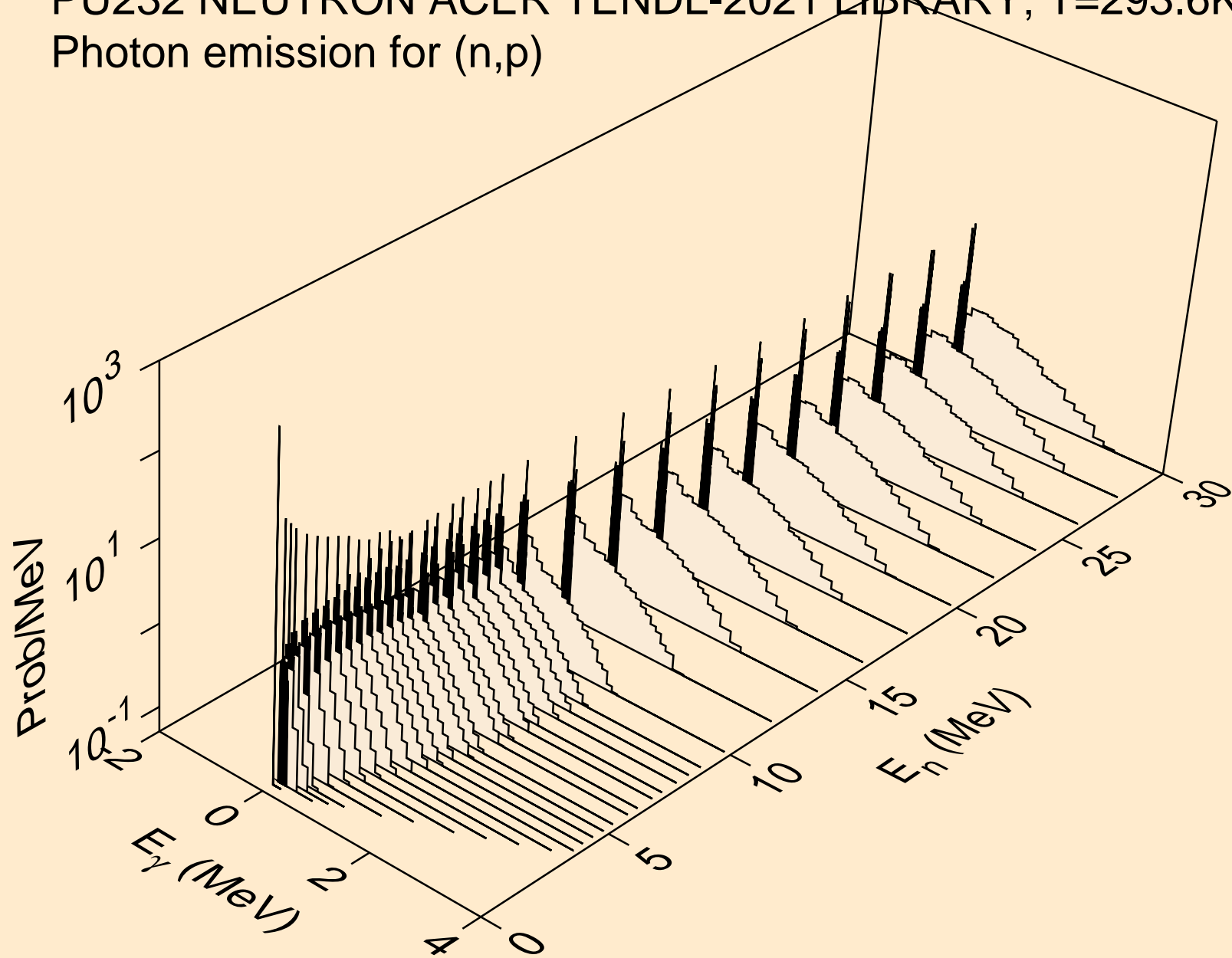

PU232 NEUTRON ACER TENDL-2021 LIBRARY; T=293.6K  
Photon emission for (n,d)

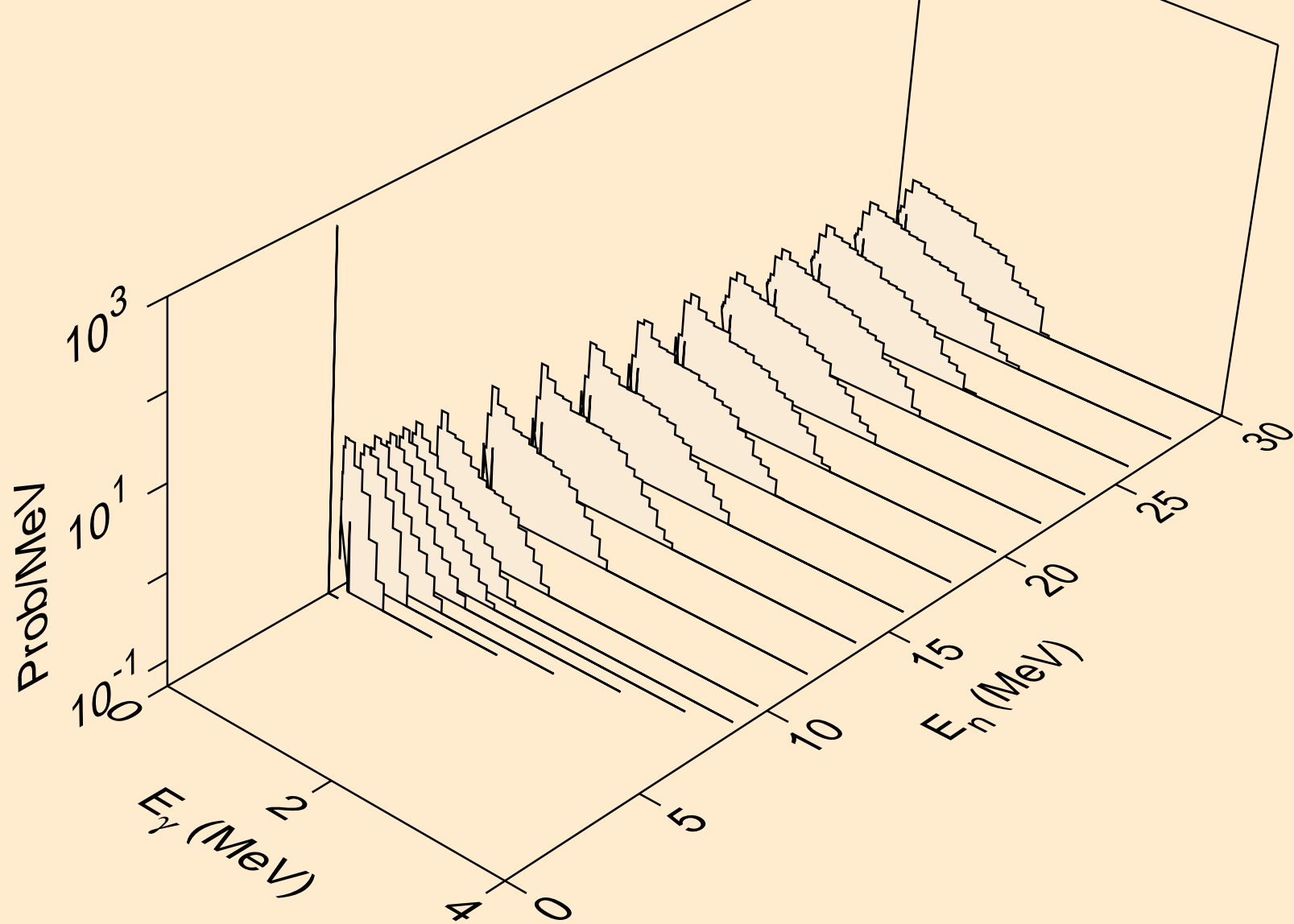

PU232 NEUTRON ACER TENDL-2021 LIBRARY; T=293.6K  
Photon emission for (n,t)

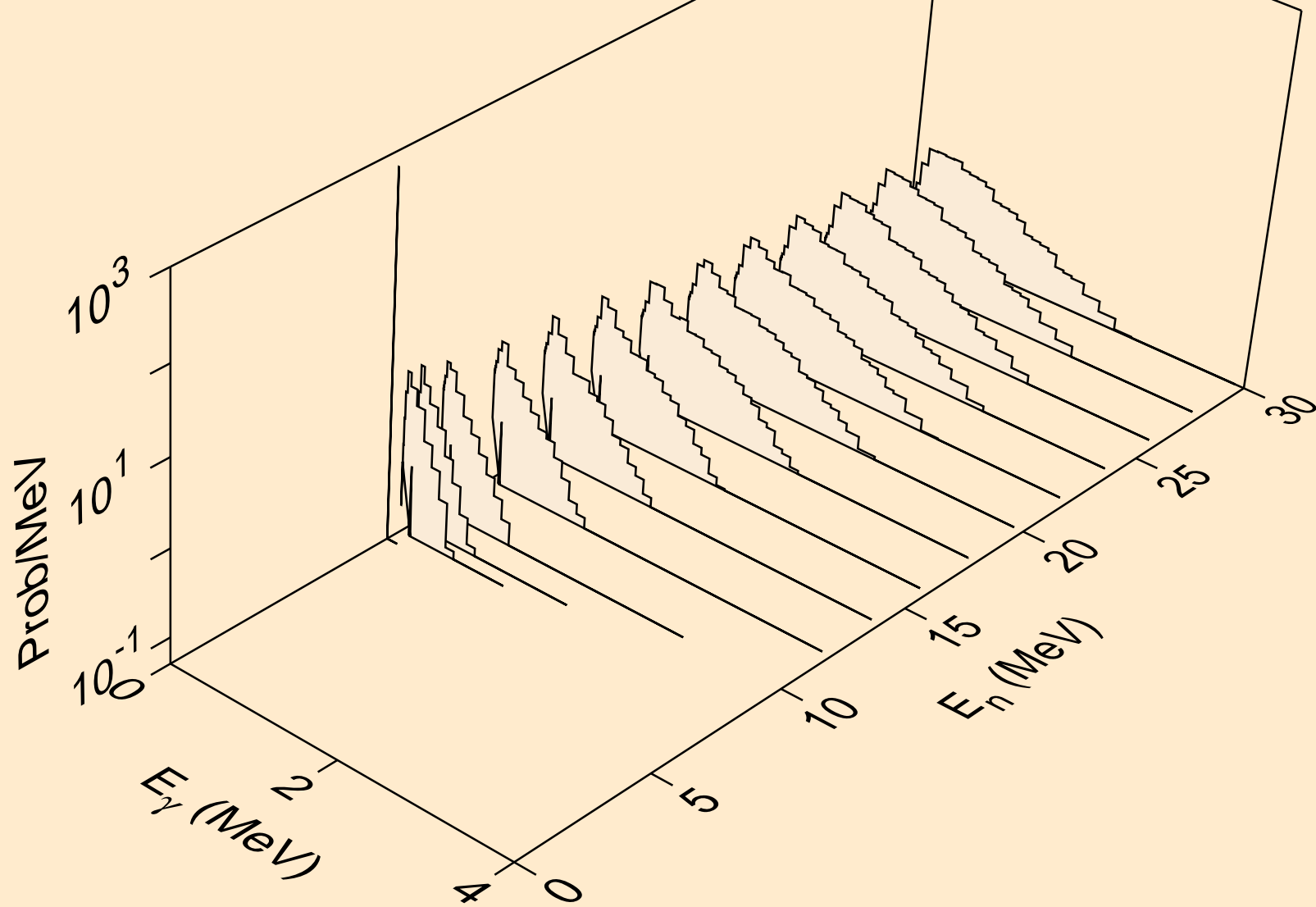

PU232 NEUTRON ACER TENDL-2021 LIBRARY; T=293.6K  
Photon emission for (n,he3)

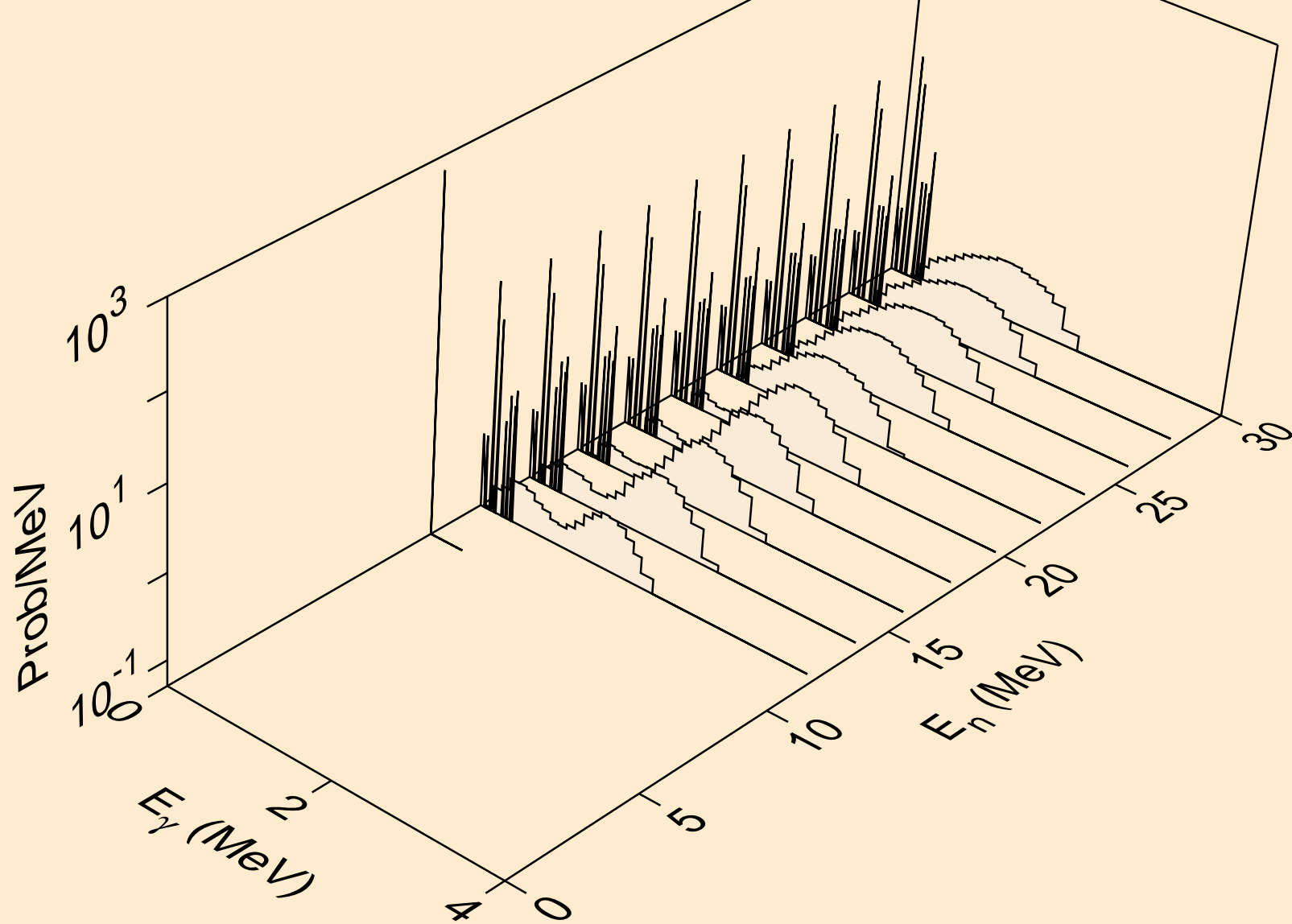

PU232 NEUTRON ACER TENDL-2021 LIBRARY; T=293.6K  
Photon emission for (n,a)

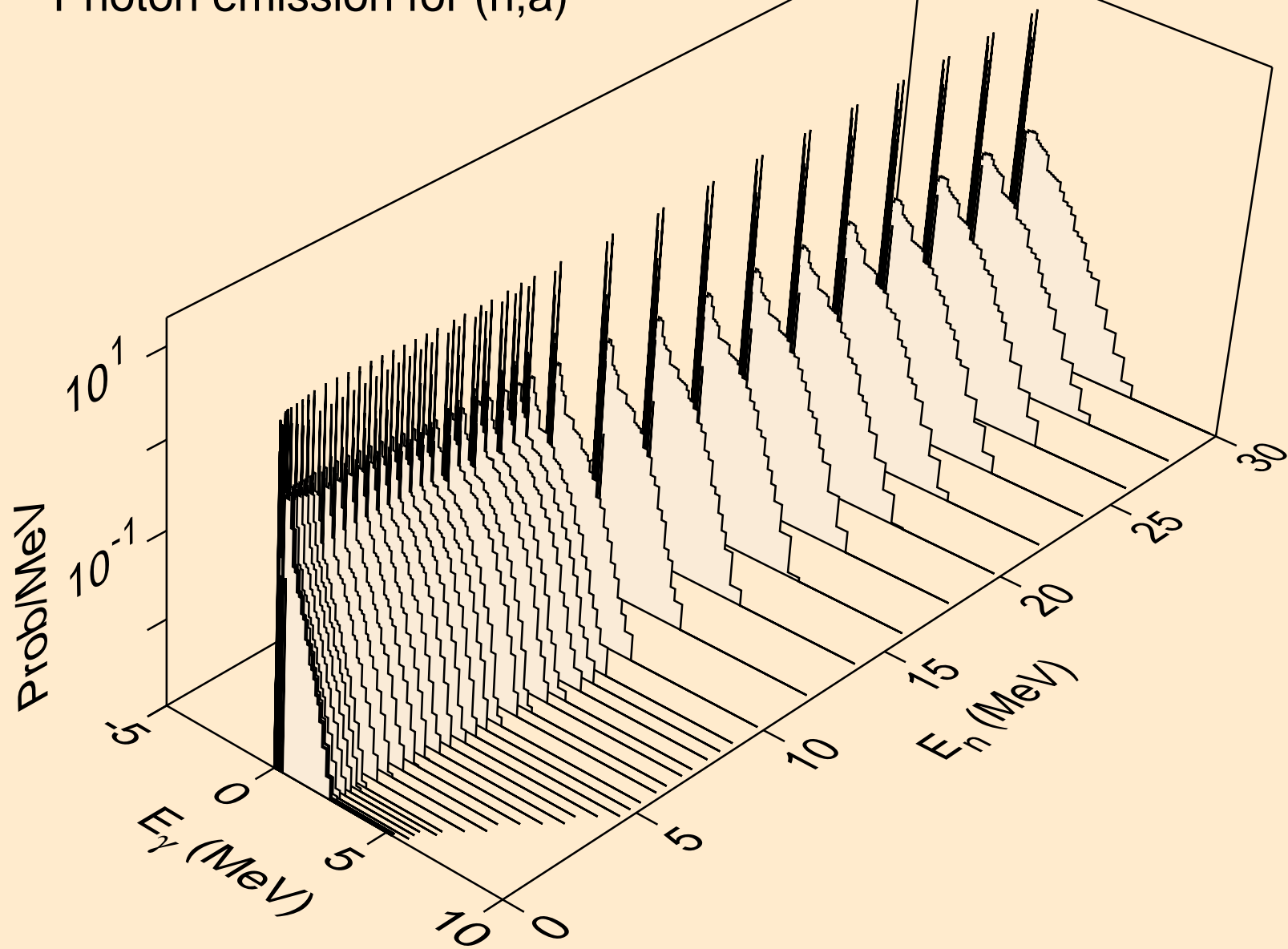

PU232 NEUTRON ACER TENDL-2021 LIBRARY; T=293.6K  
Photon emission for (n,2a)

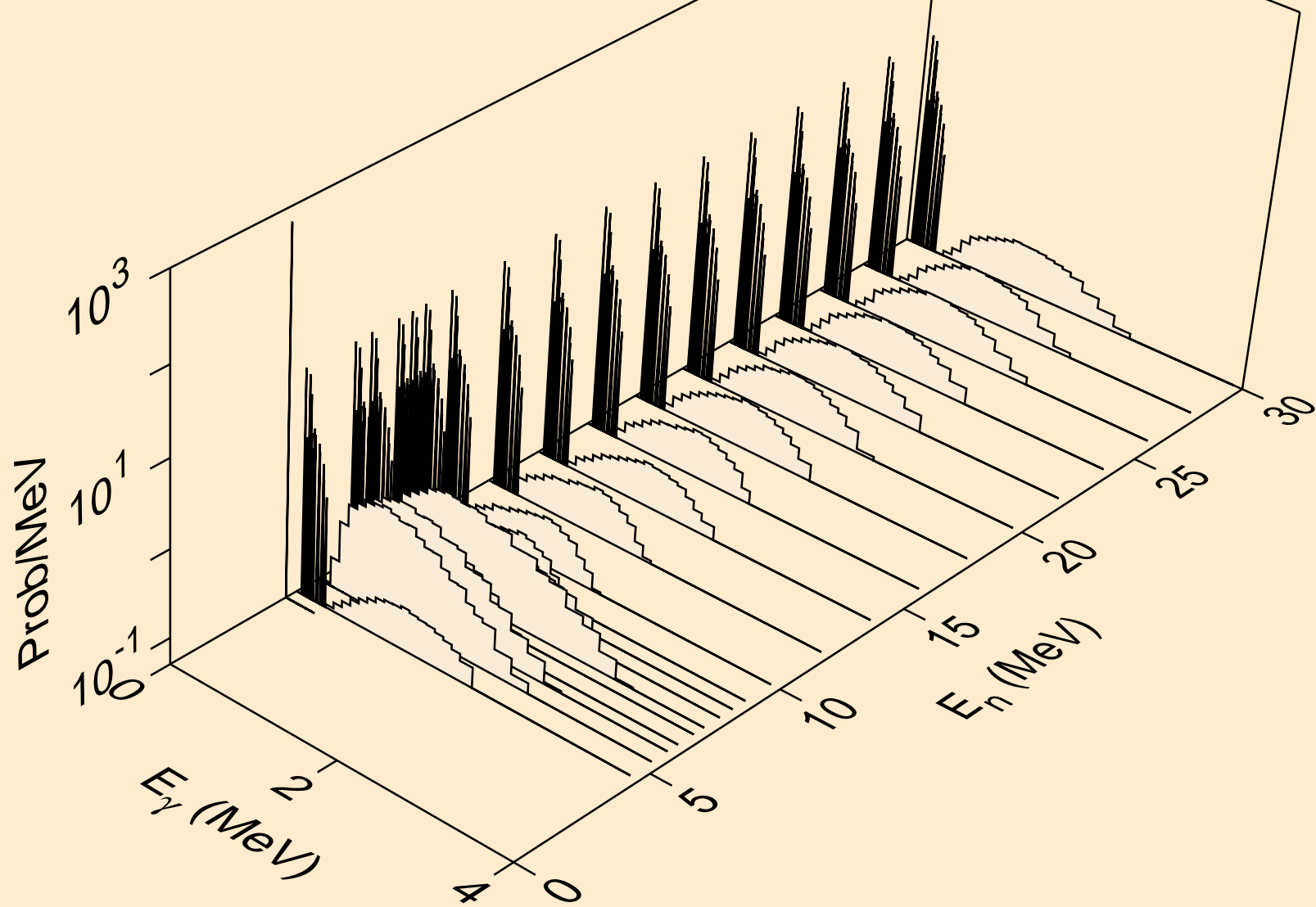

PU232 NEUTRON ACER TENDL-2021 LIBRARY; T=293.6K  
Photon emission for (n,2p)

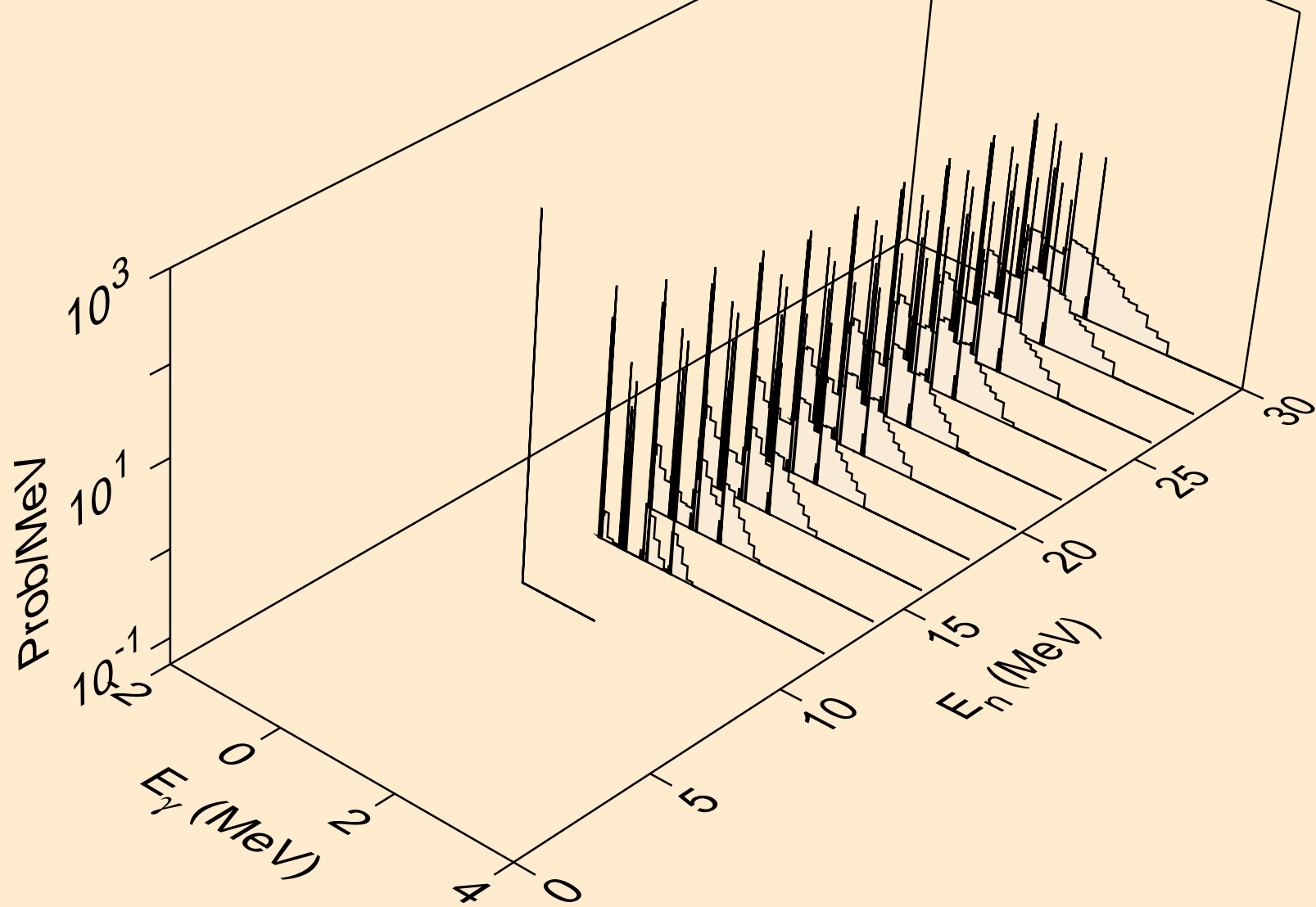

PU232 NEUTRON ACER TENDL-2021 LIBRARY; T=293.6K  
Photon emission for (n,p $\alpha$ )

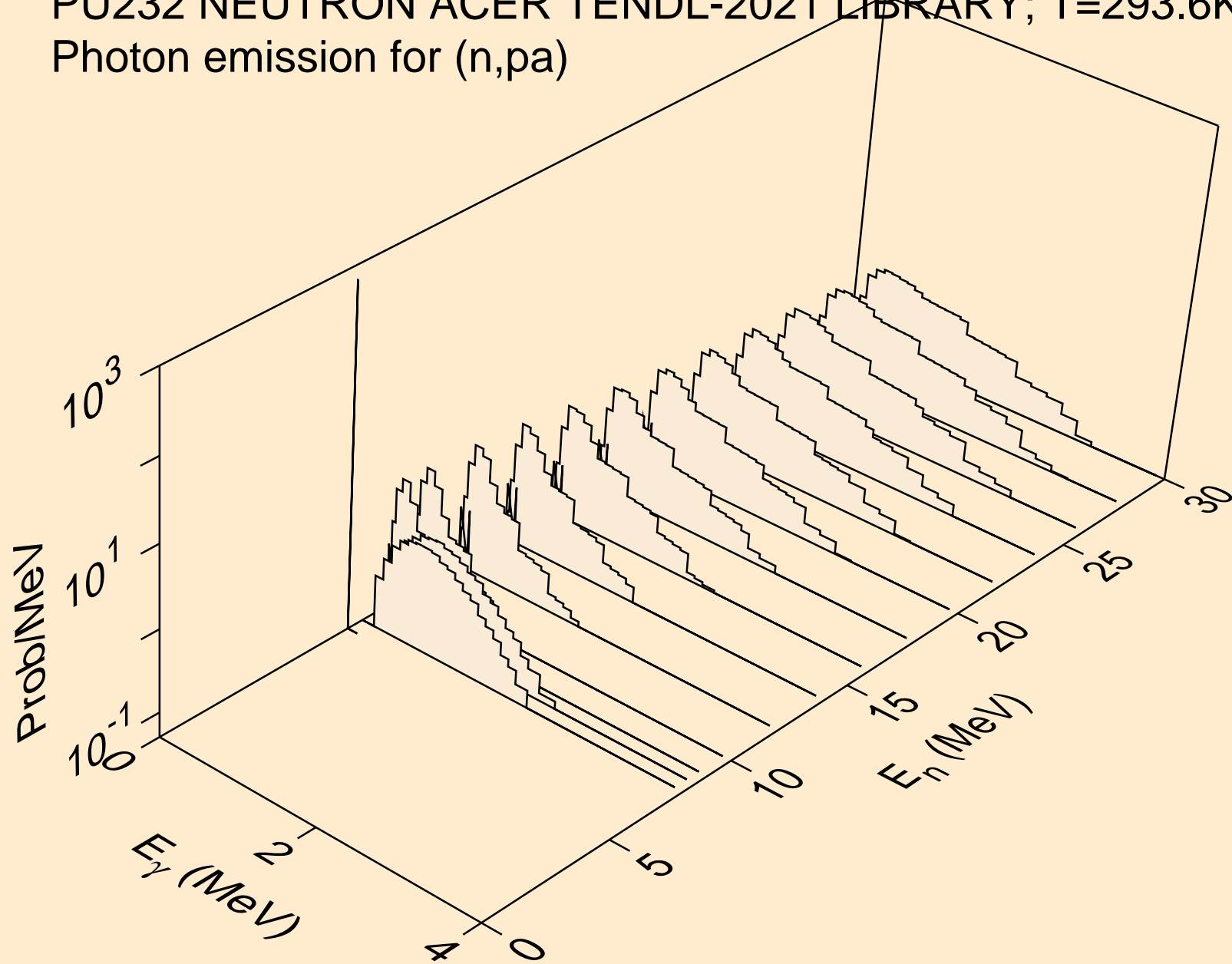

PU232 NEUTRON ACER TENDL-2021 LIBRARY; T=293.6K  
Photon emission for (n,pd)

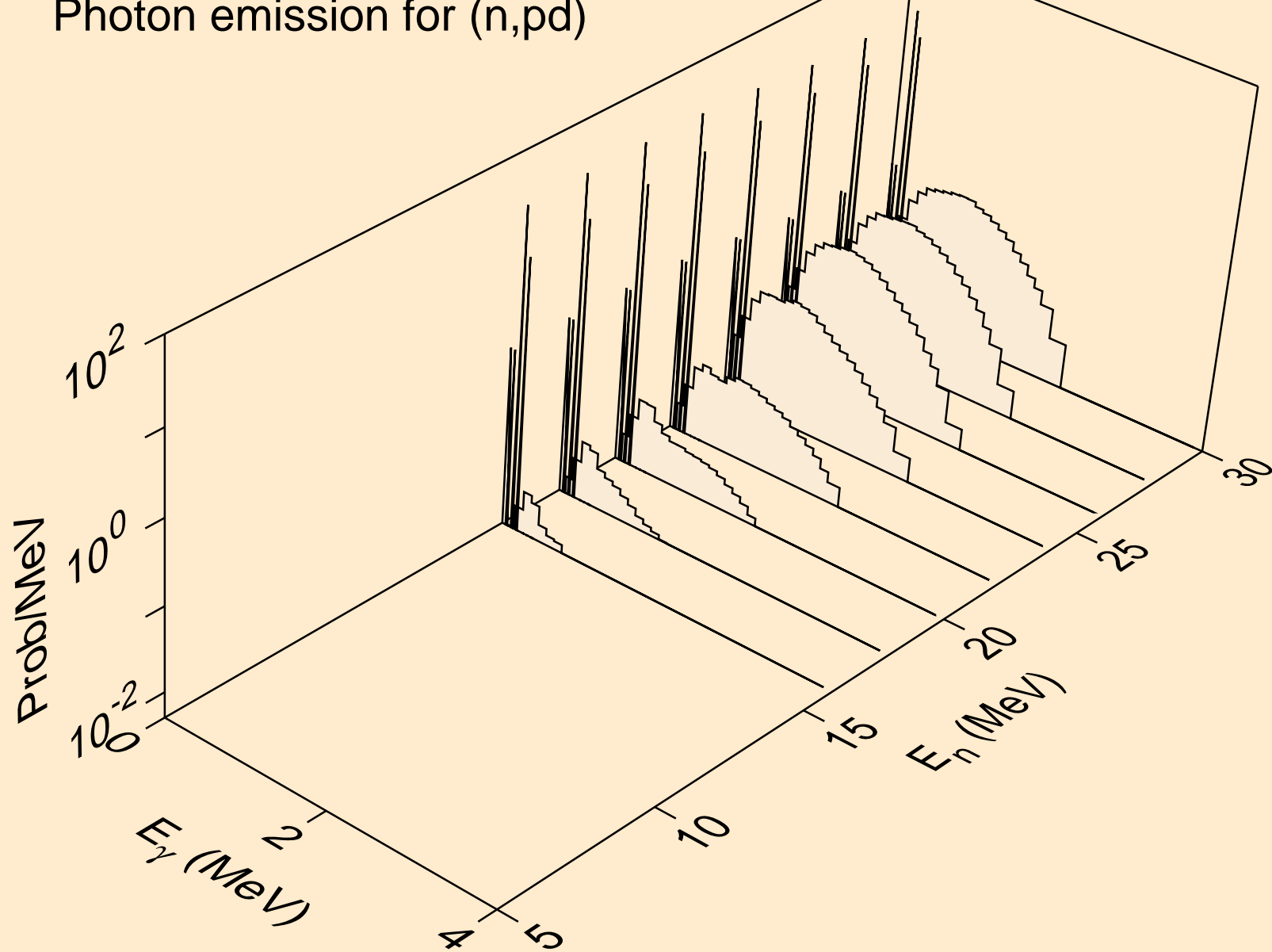

PU232 NEUTRON ACER TENDL-2021 LIBRARY; T=293.6K  
Photon emission for (n,pt)

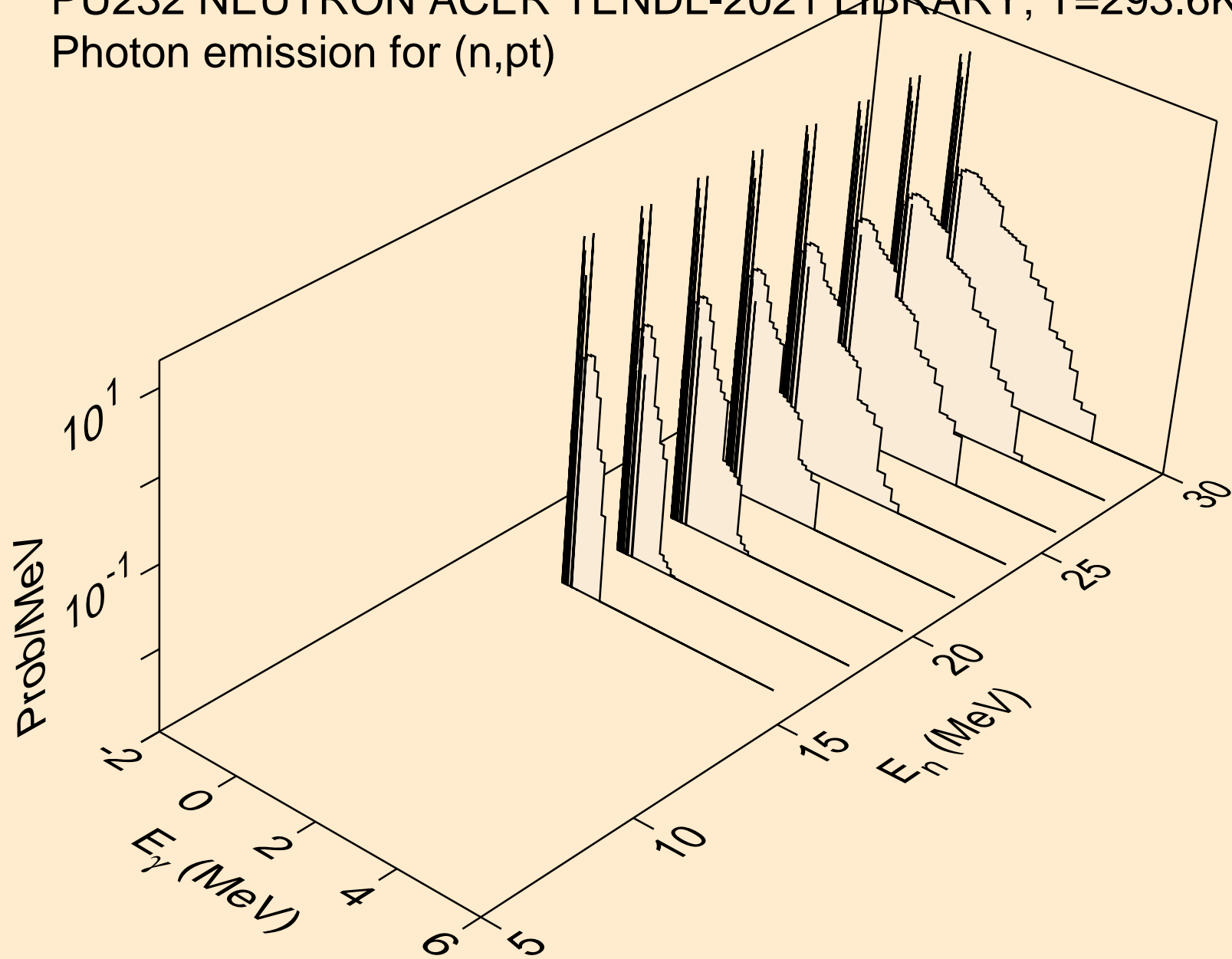

PU232 NEUTRON ACER TENDL-2021 LIBRARY; T=293.6K  
Photon emission for (n,da)

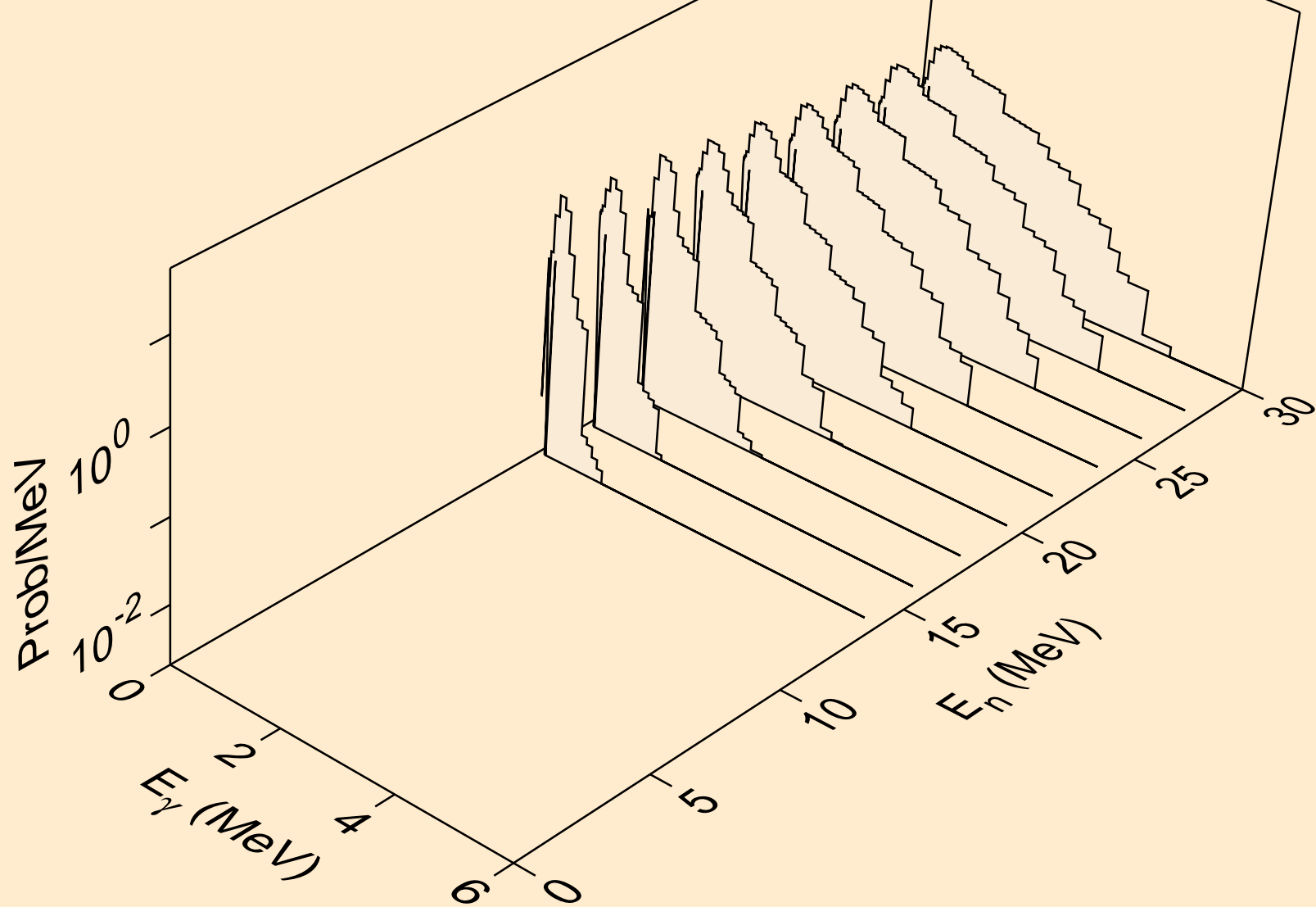

PU232 NEUTRON ACER TENDL-2021 LIBRARY; T=293.6K  
thermal capture photon spectrum

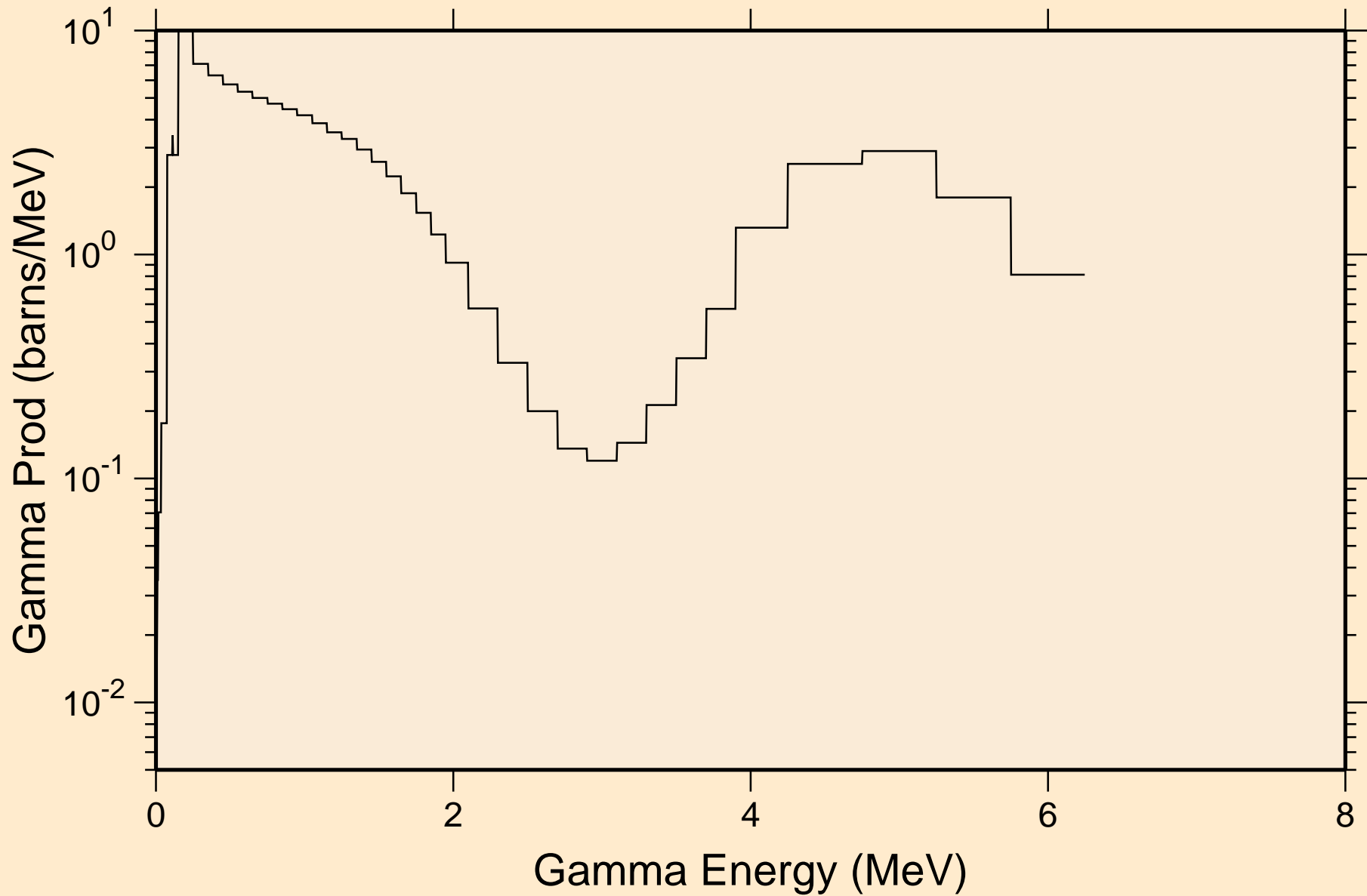

PU232 NEUTRON ACER TENDL-2021 LIBRARY; T=293.6K  
14 MeV photon spectrum

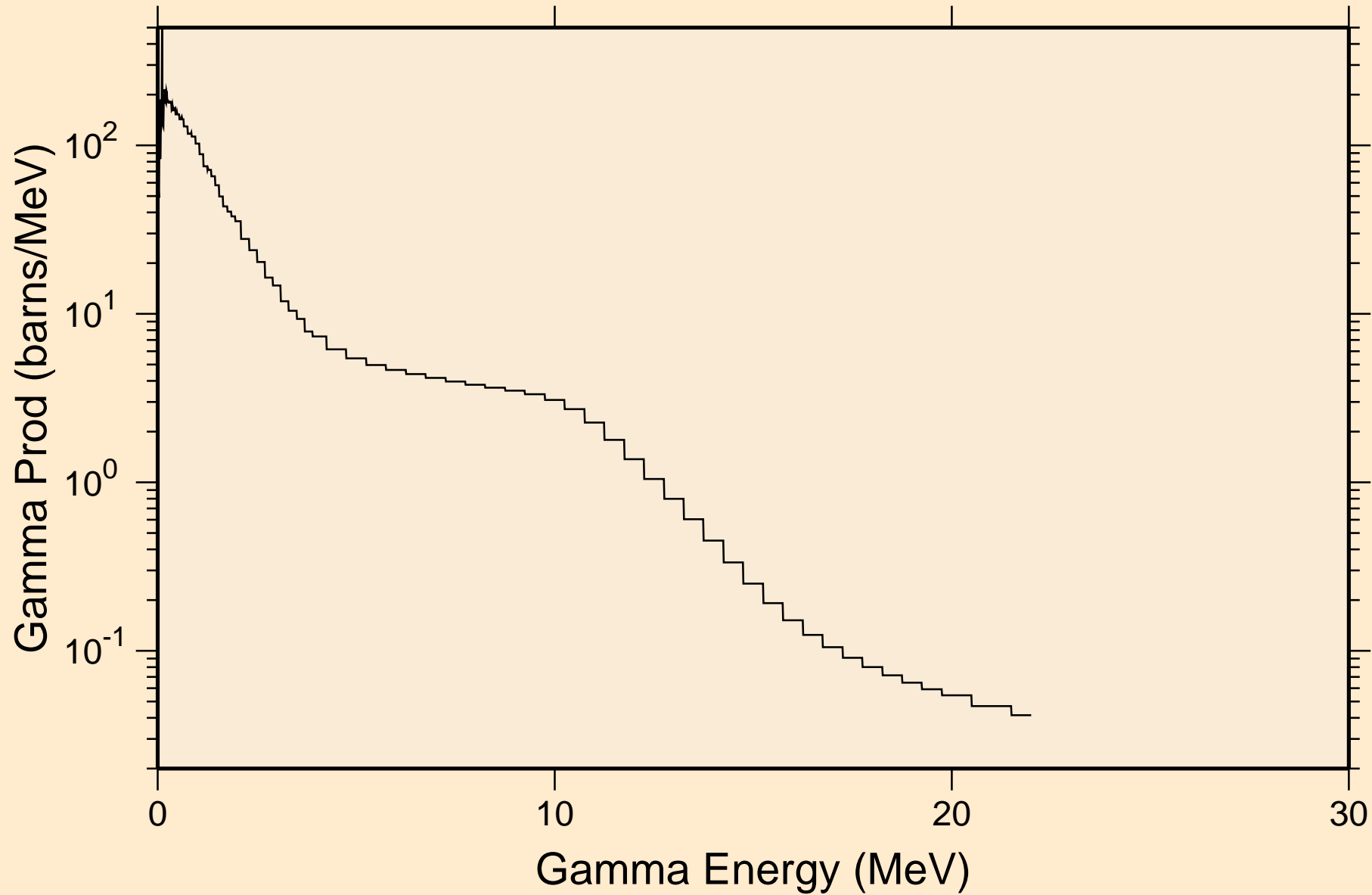

PU232 NEUTRON ACER TENDL-2021 LIBRARY; T=293.6K  
Particle heating contributions

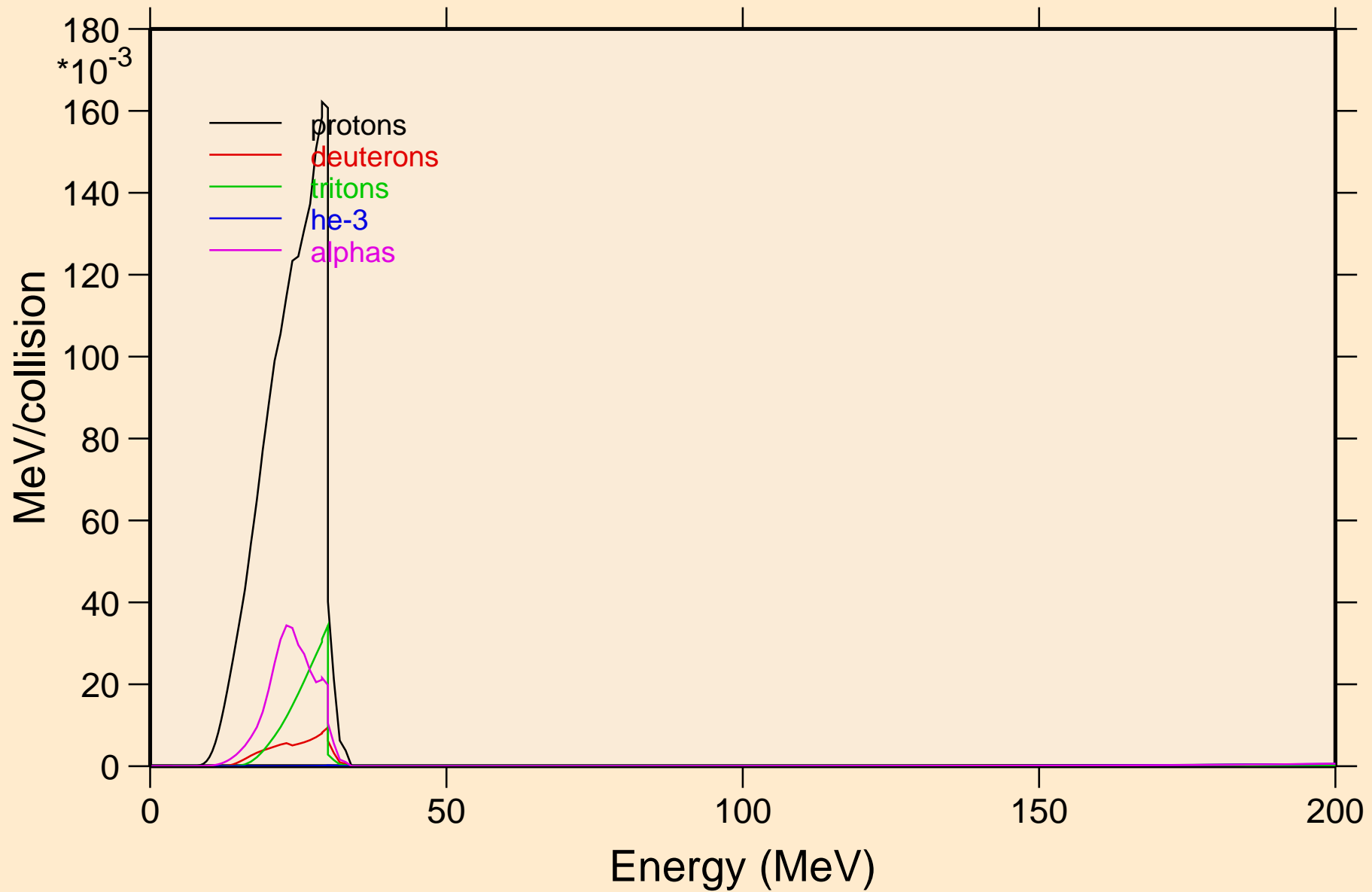

PU232 NEUTRON ACER TENDL-2021 LIBRARY; T=293.6K  
Recoil Heating

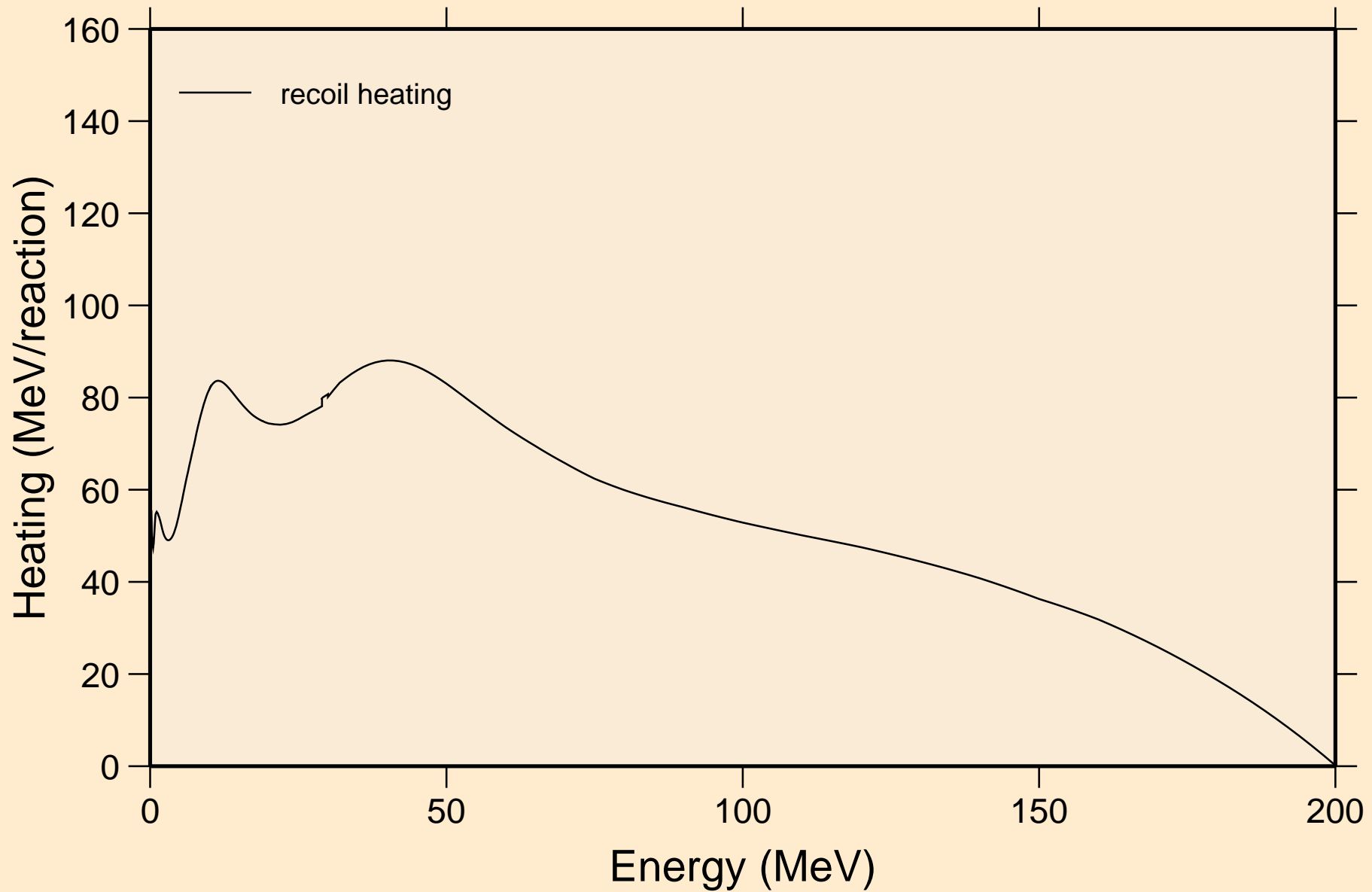

PU232 NEUTRON ACER TENDL-2021 LIBRARY; T=293.6K  
Particle production cross sections

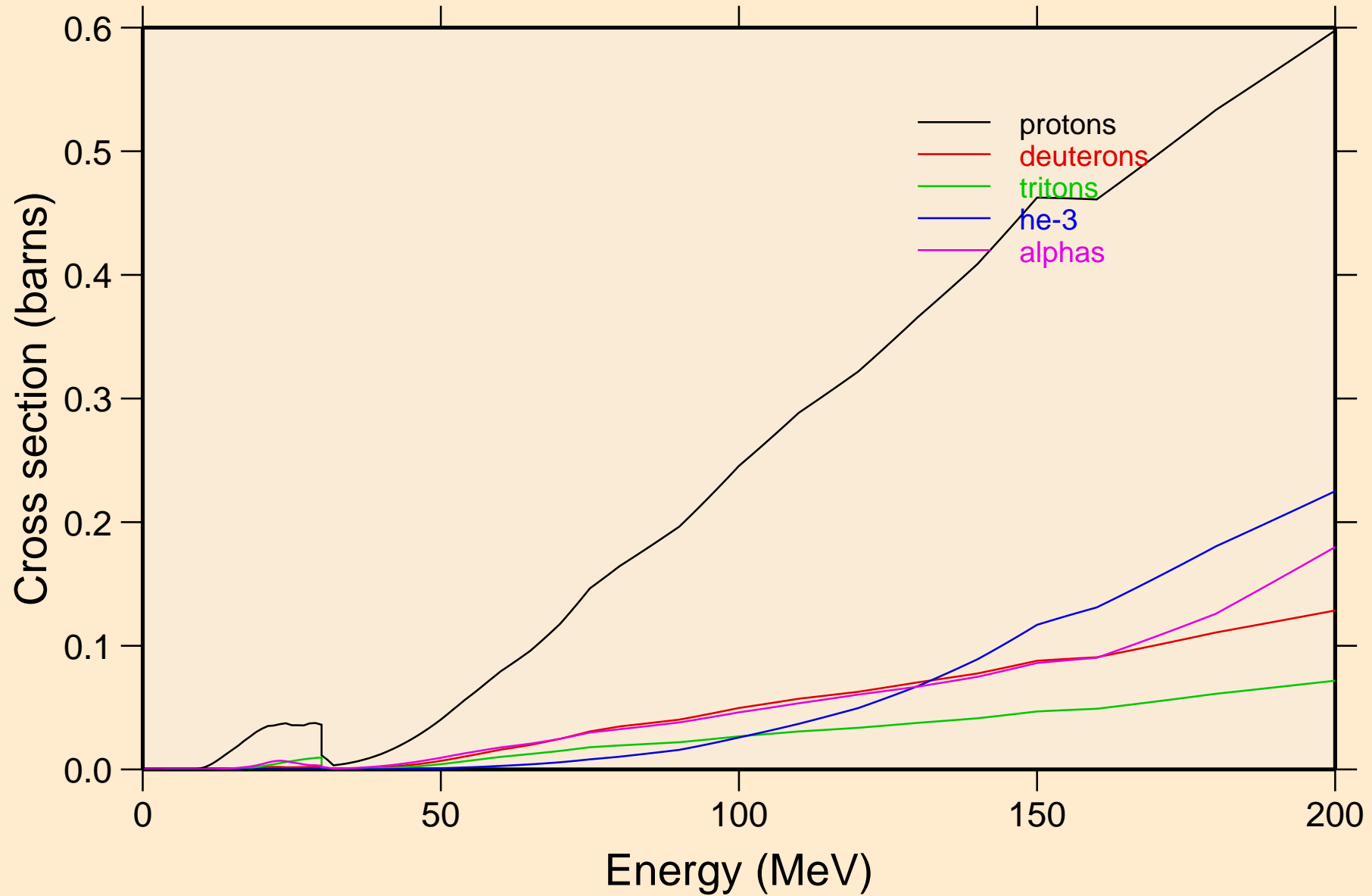

PU232 NEUTRON ACER TENDL-2021 LIBRARY; T=293.6K  
protons from (n,x)

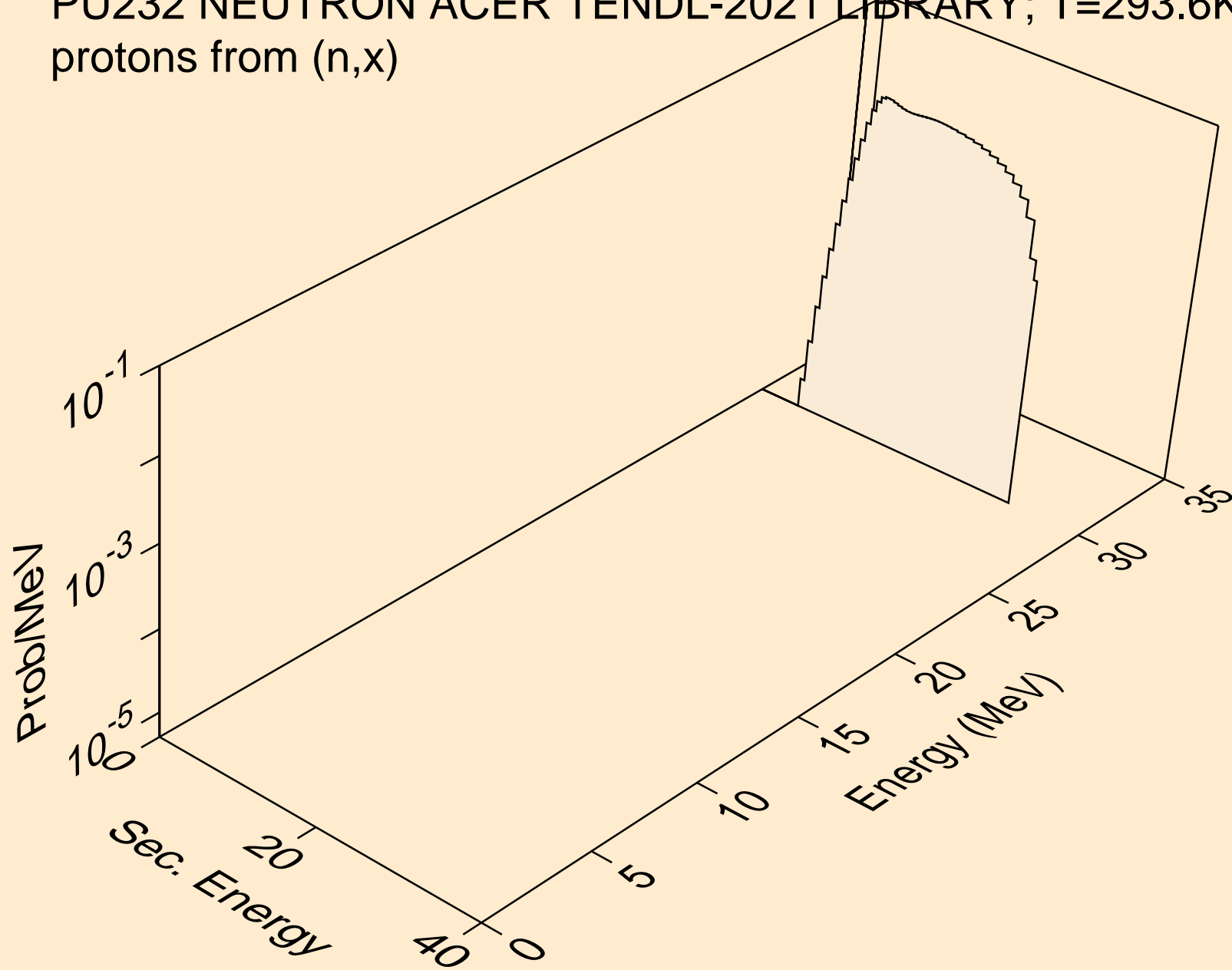

PU232 NEUTRON ACER TENDL-2021 LIBRARY; T=293.6K  
protons from (n,n\*)p

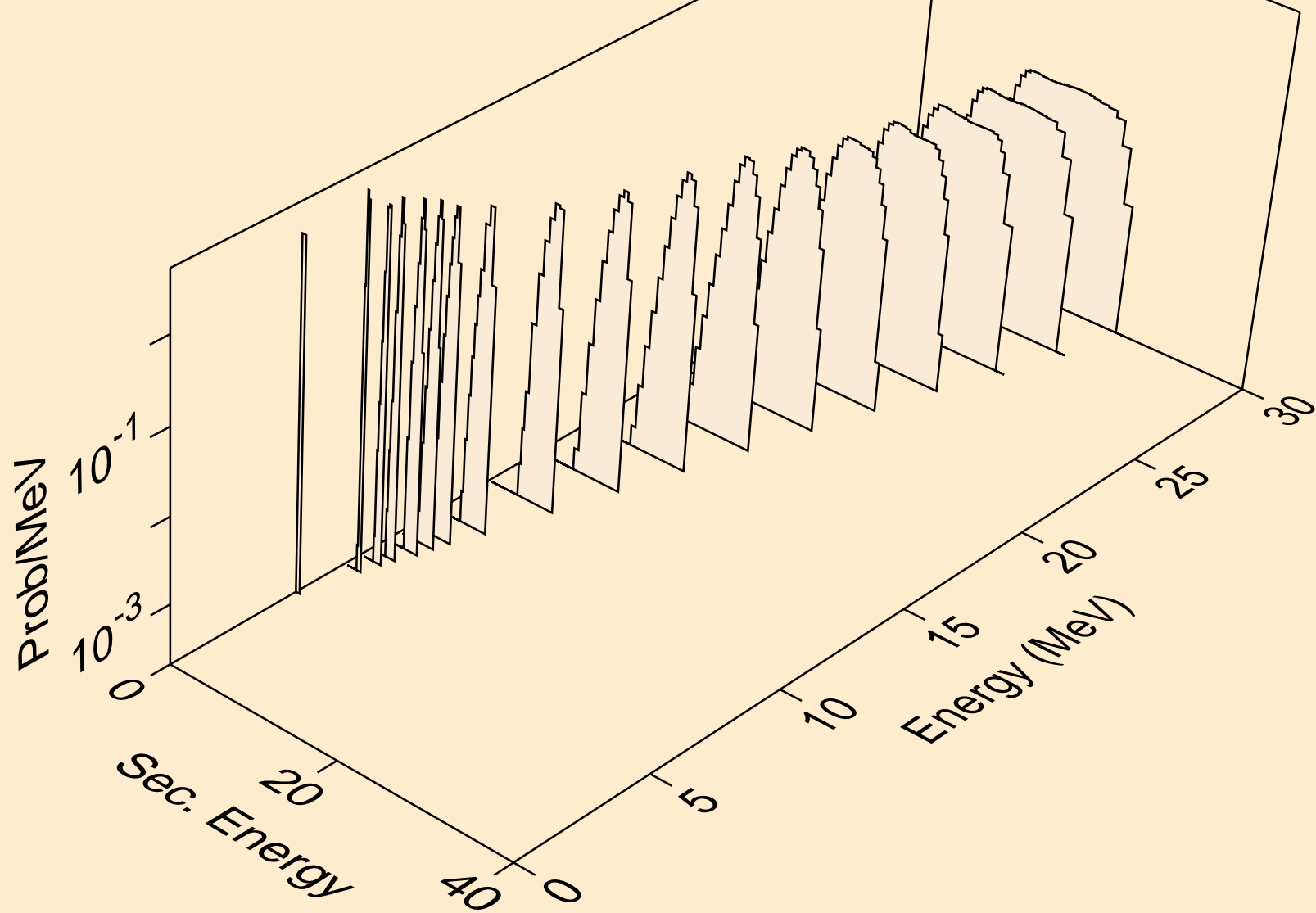

PU232 NEUTRON ACER TENDL-2021 LIBRARY; T=293.6K  
protons from (n,2np)

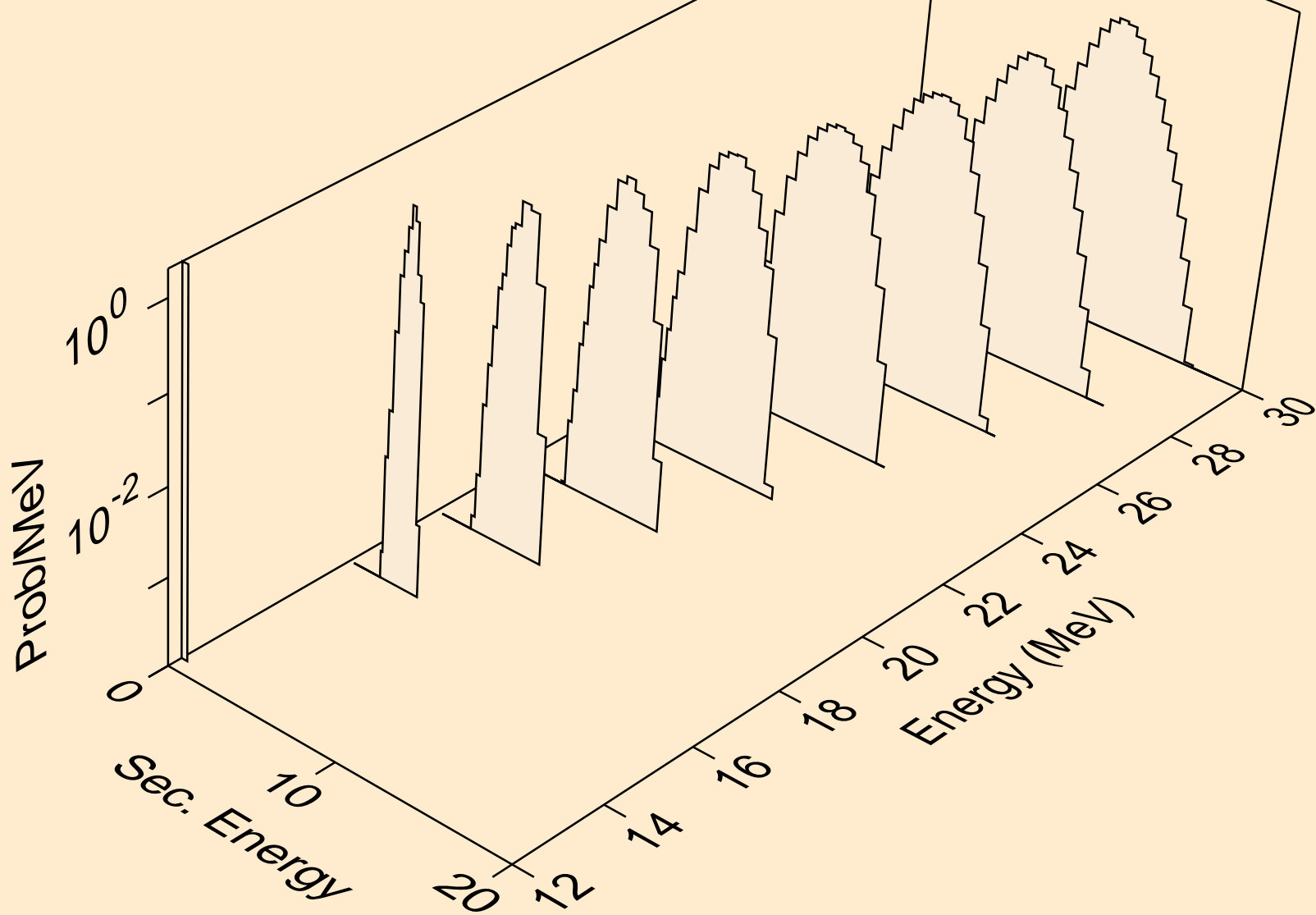

PU232 NEUTRON ACER TENDL-2021 LIBRARY; T=293.6K  
protons from (n,3np)

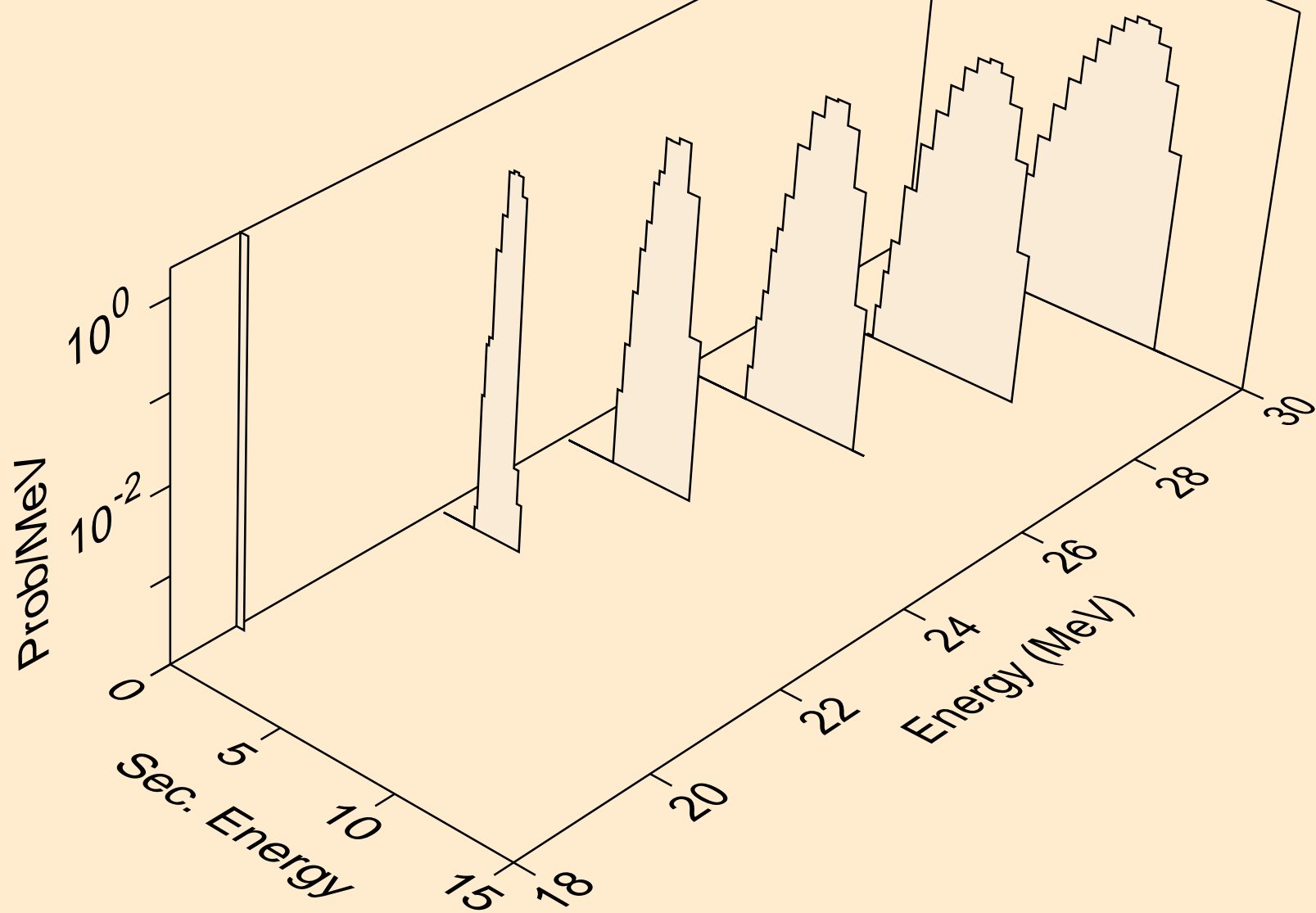

PU232 NEUTRON ACER TENDL-2021 LIBRARY; T=293.6K  
protons from (n,2np)

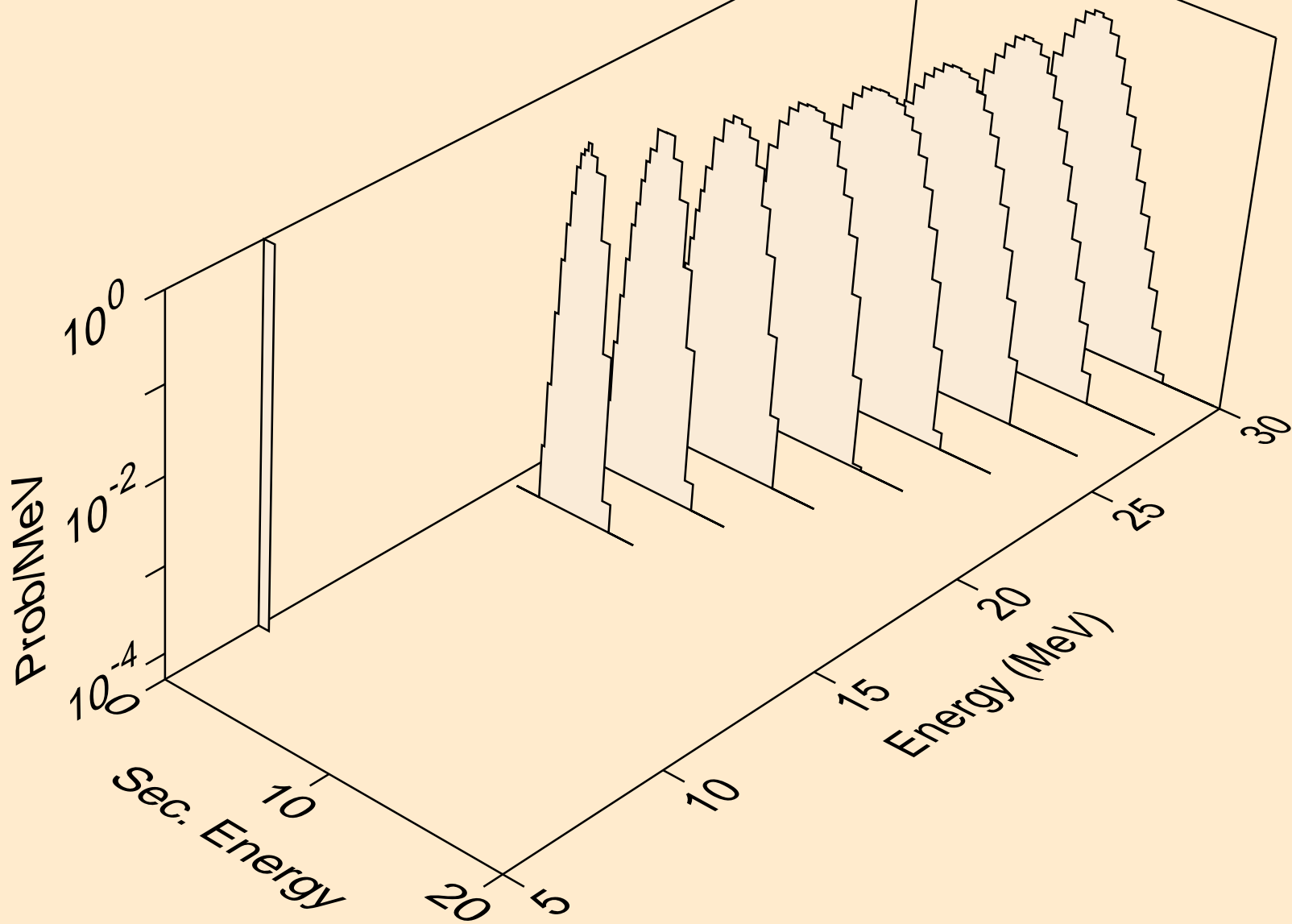

PU232 NEUTRON ACER TENDL-2021 LIBRARY; T=293.6K  
protons from (n,npa)

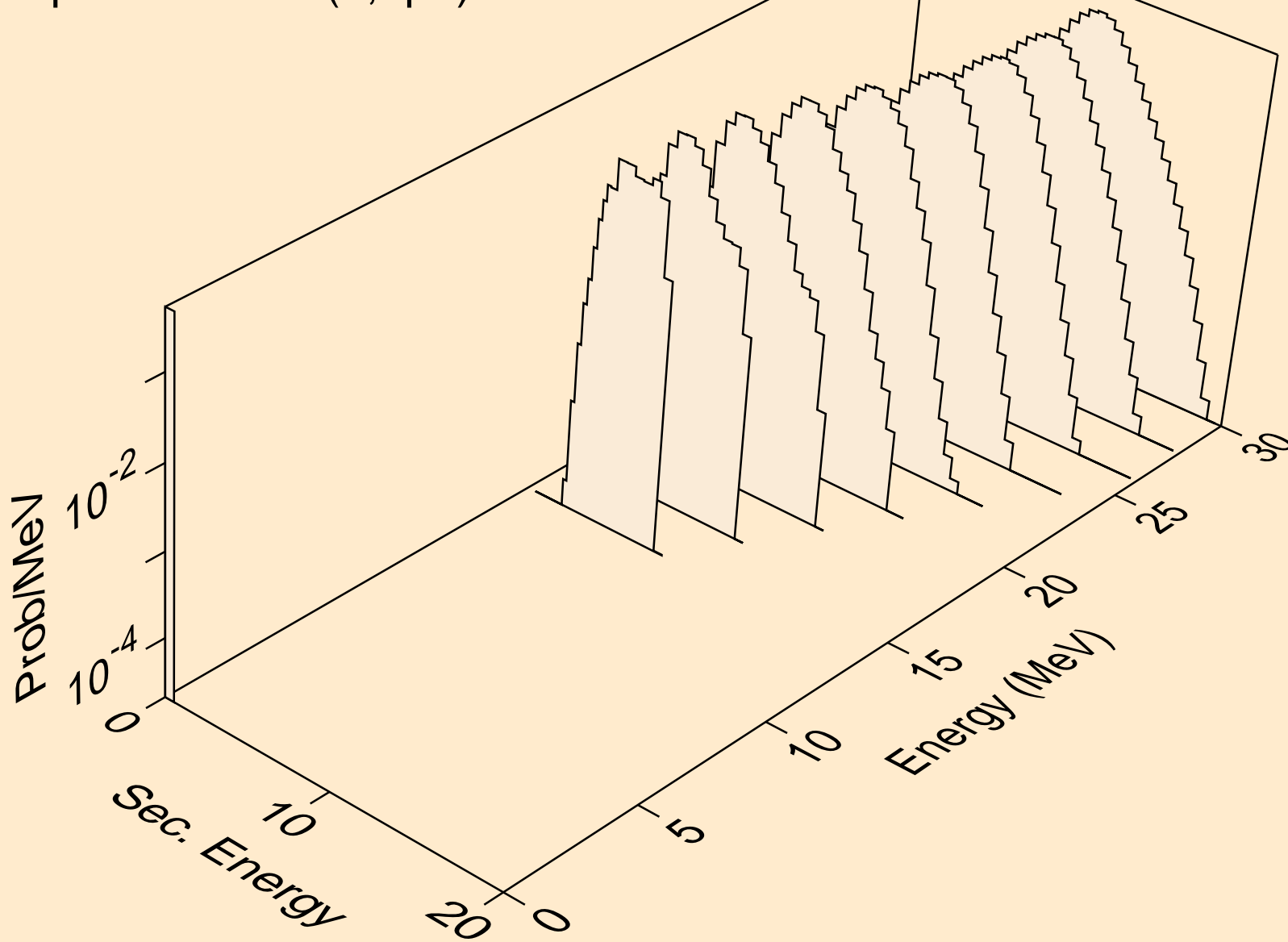

PU232 NEUTRON ACER TENDL-2021 LIBRARY; T=293.6K  
protons from (n,p)

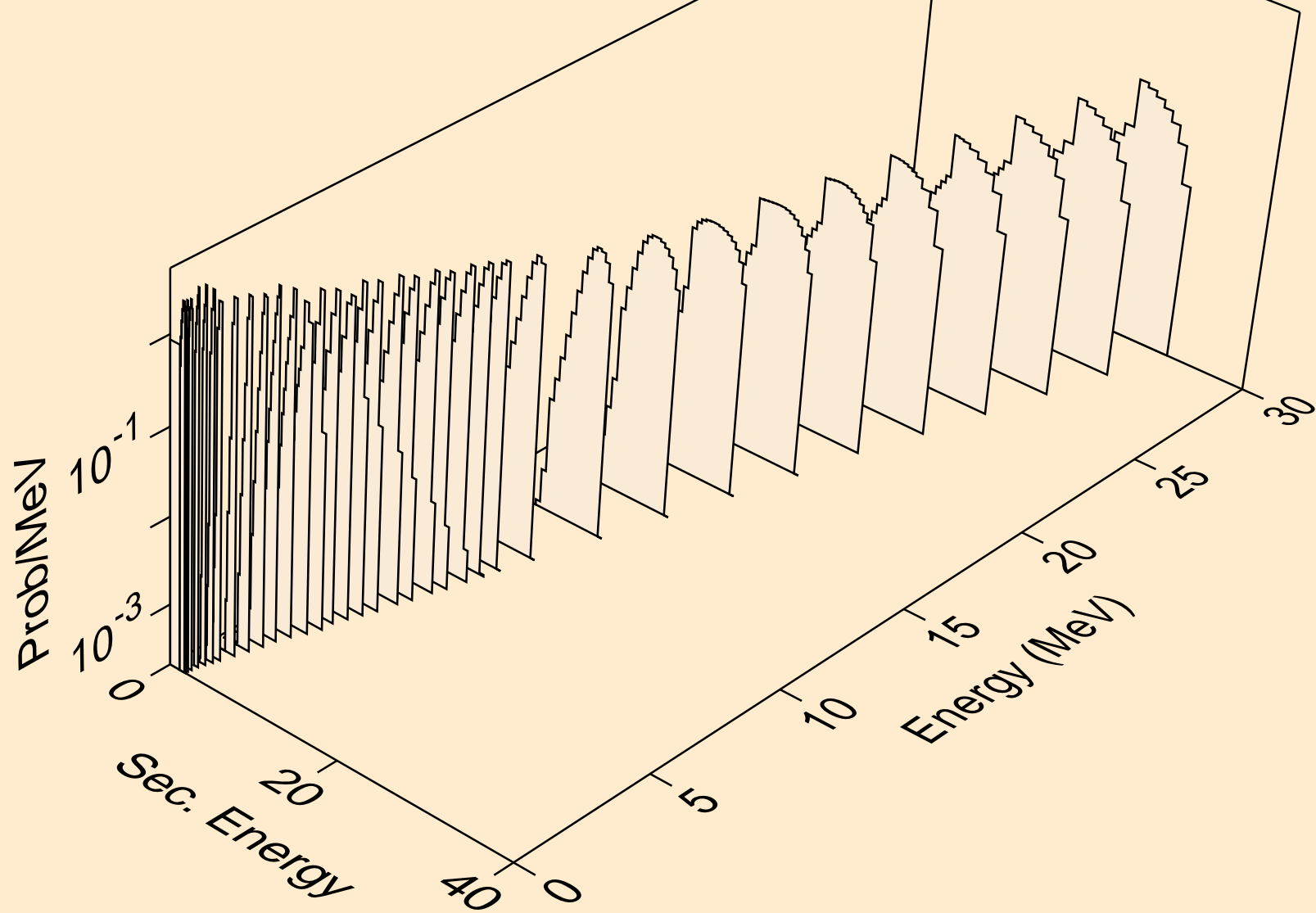

PU232 NEUTRON ACER TENDL-2021 LIBRARY; T=293.6K  
protons from (n,2p)

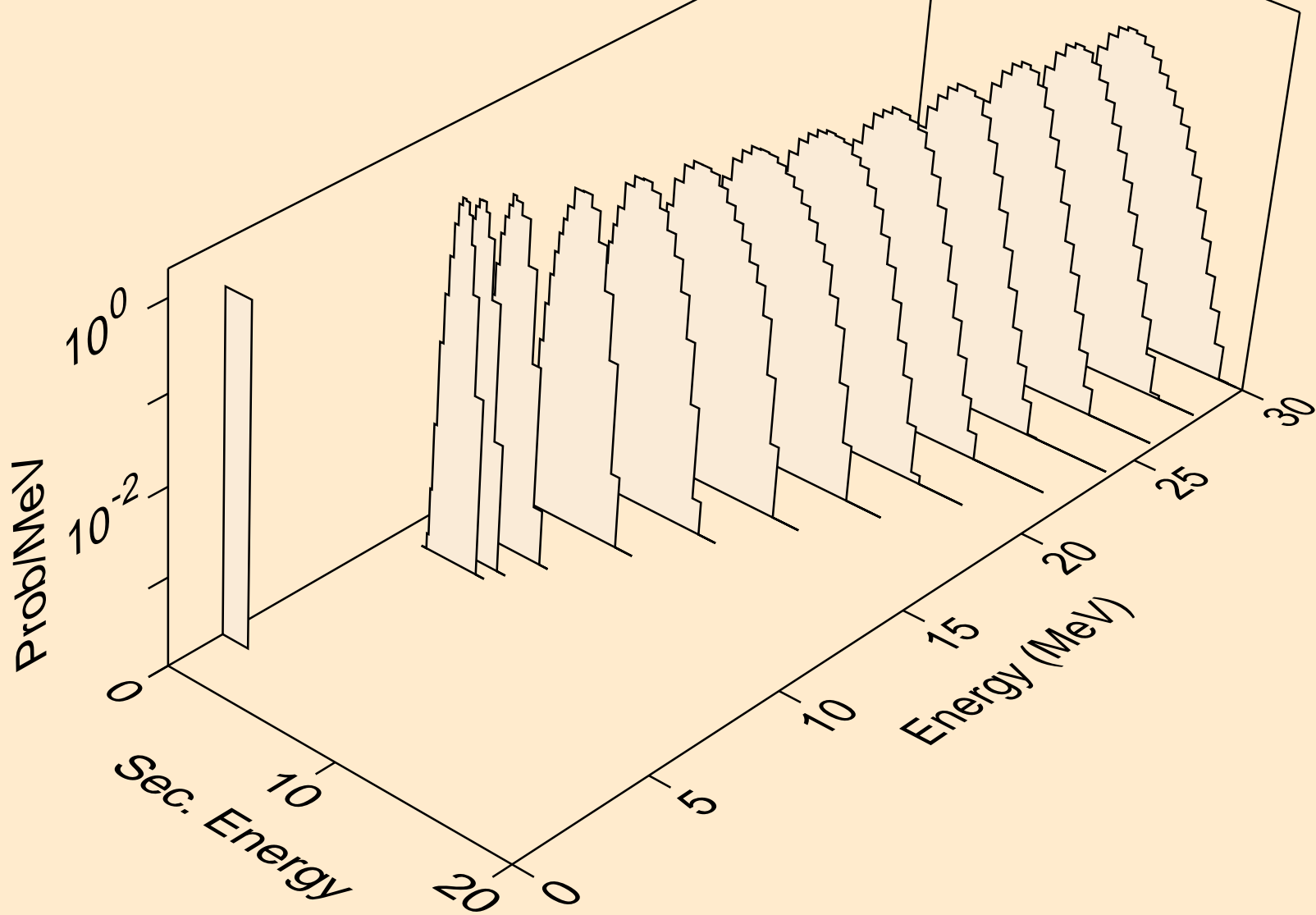

PU232 NEUTRON ACER TENDL-2021 LIBRARY; T=293.6K  
protons from (n,p)

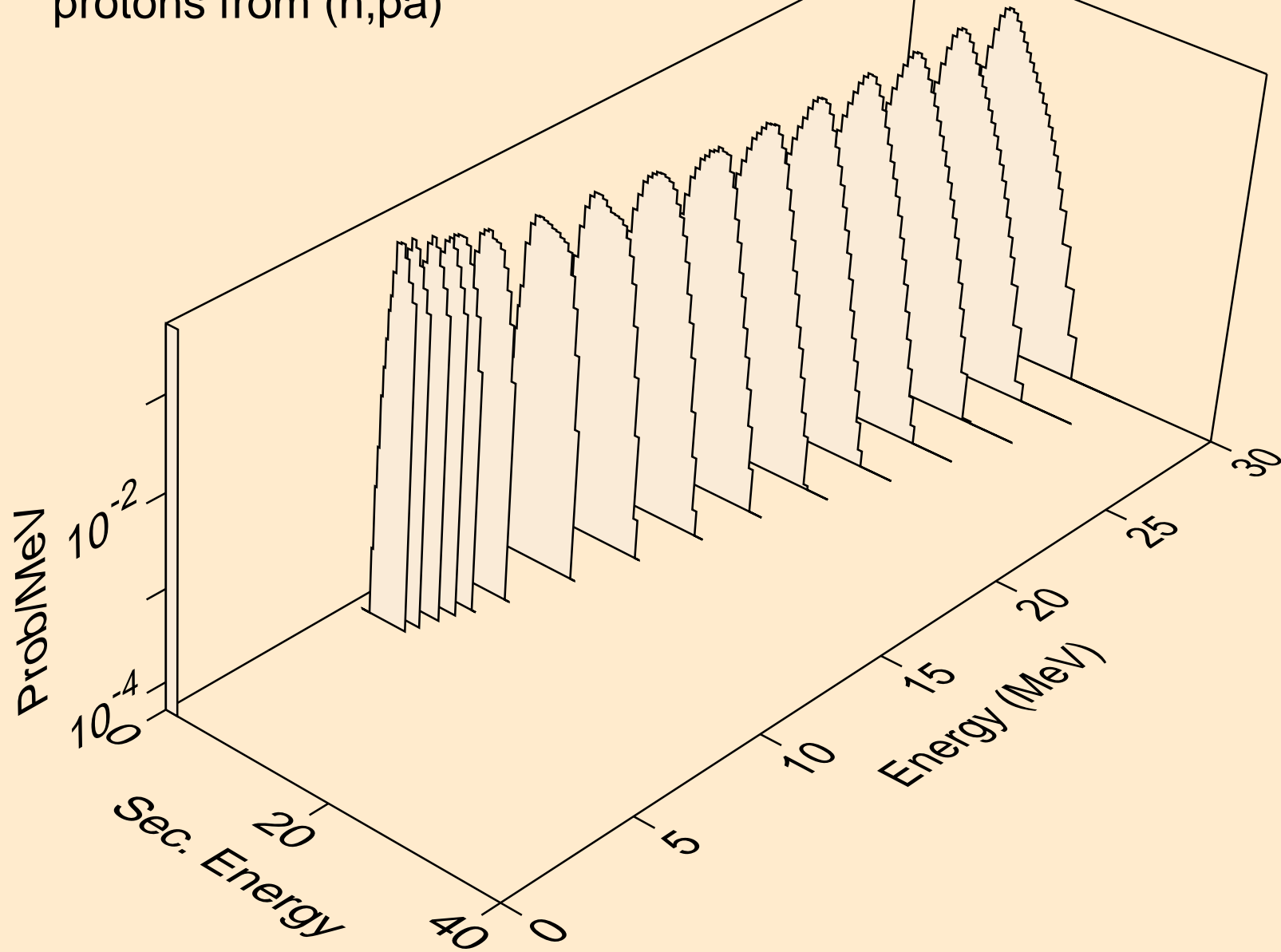

PU232 NEUTRON ACER TENDL-2021 LIBRARY; T=293.6K  
protons from (n,pd)

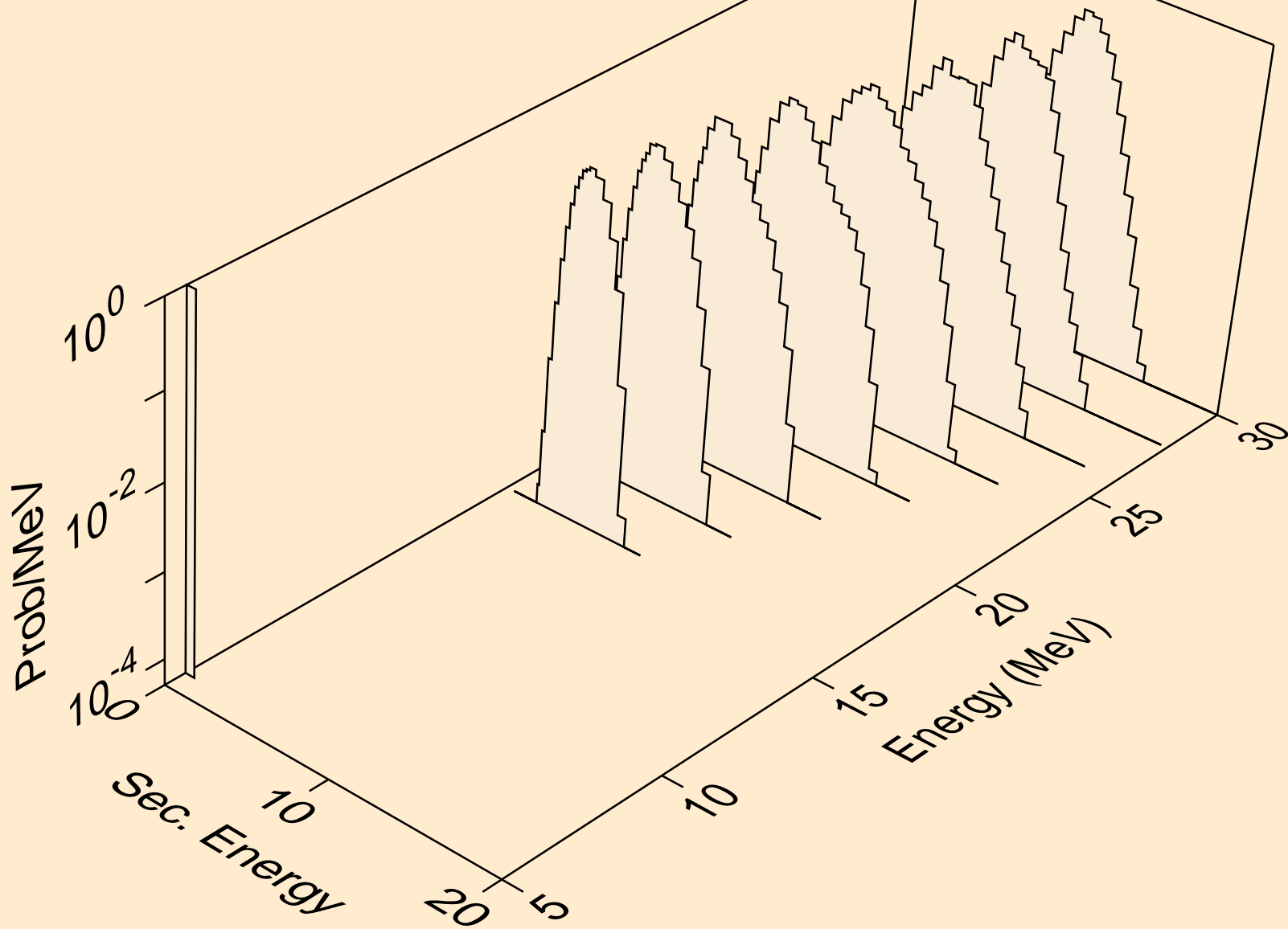

PU232 NEUTRON ACER TENDL-2021 LIBRARY; T=293.6K  
protons from (n,pt)

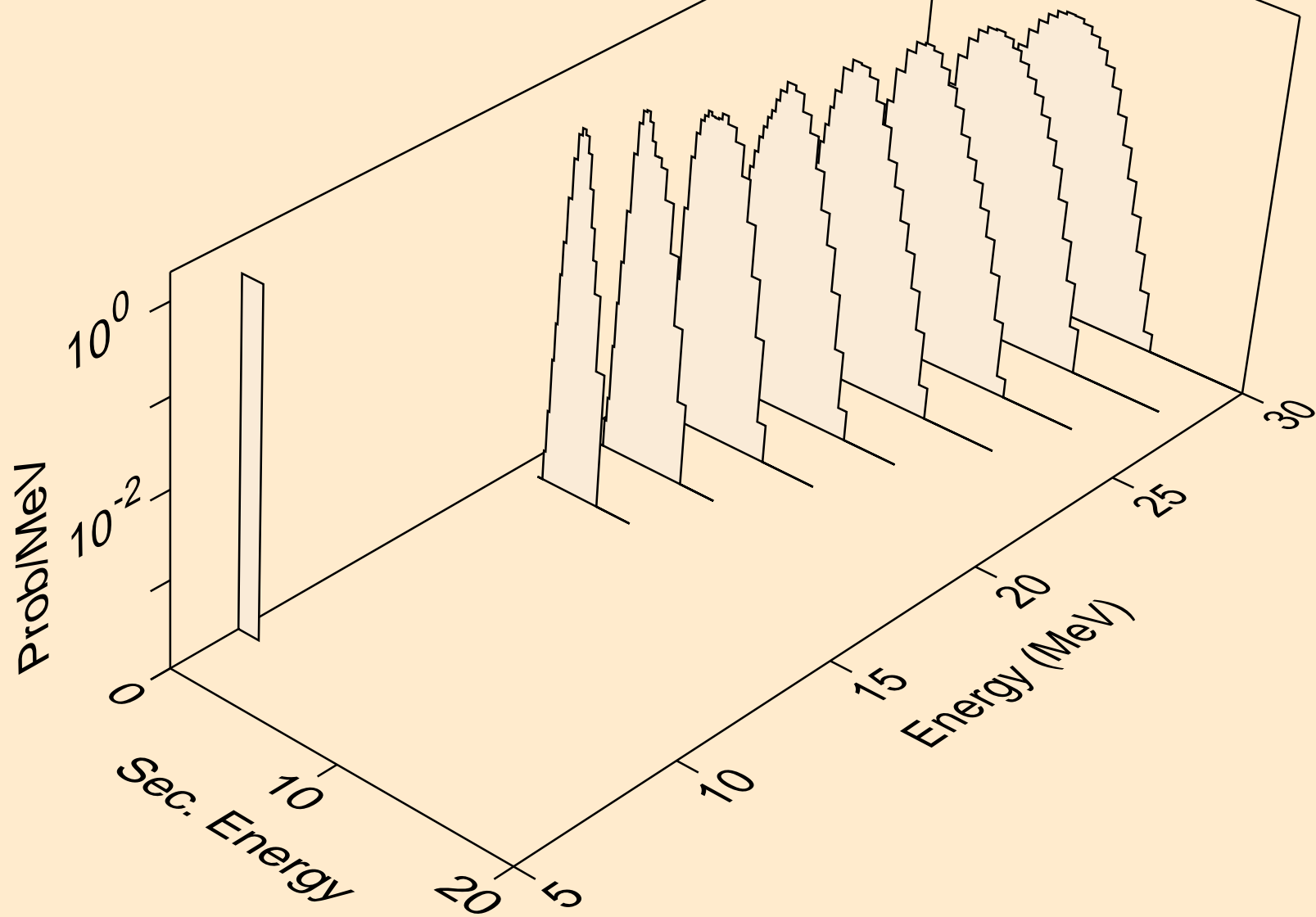

PU232 NEUTRON ACER TENDL-2021 LIBRARY; T=293.6K  
deuterons from (n,x)

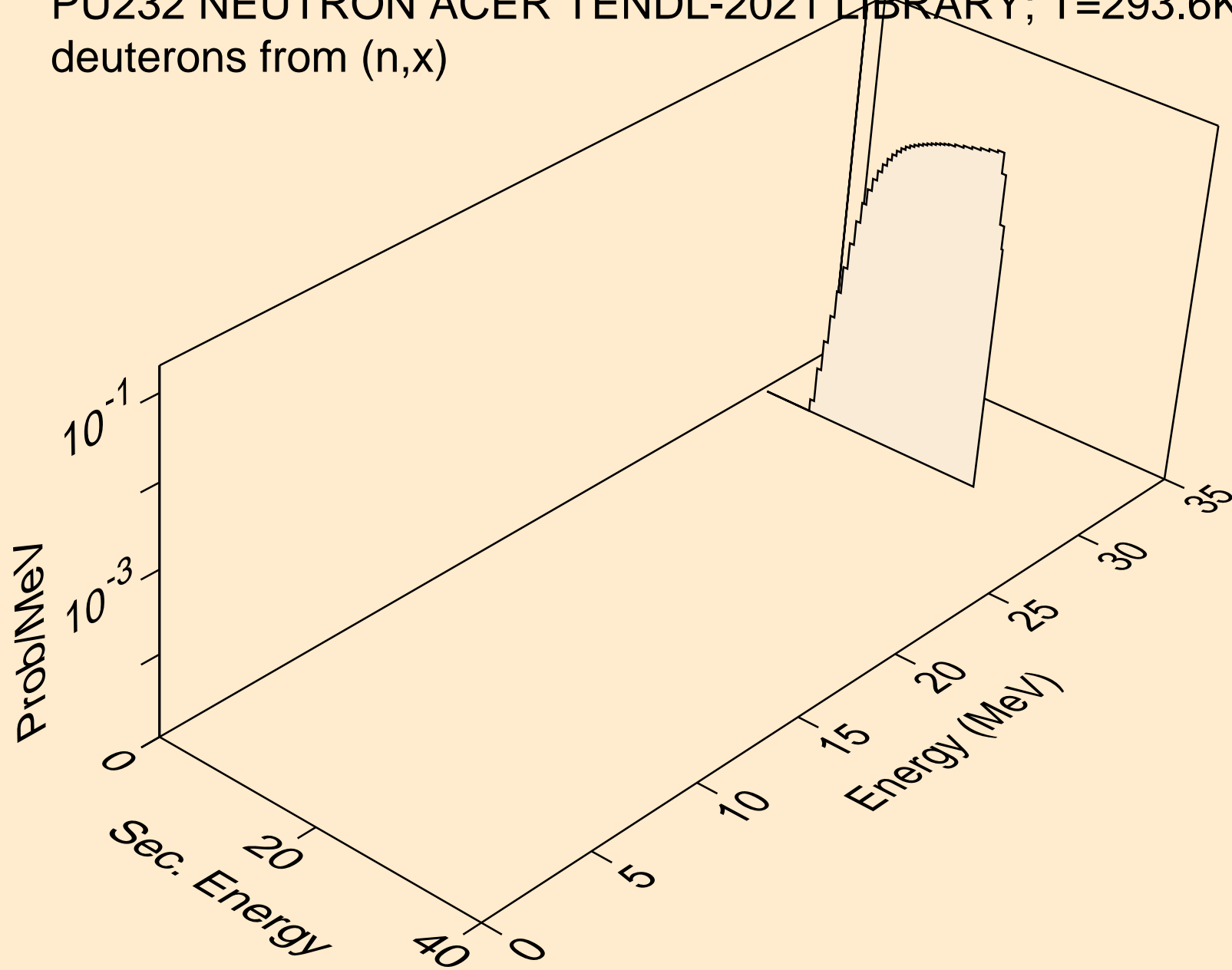

PU232 NEUTRON ACER TENDL-2021 LIBRARY; T=293.6K  
deuterons from (n,2nd)

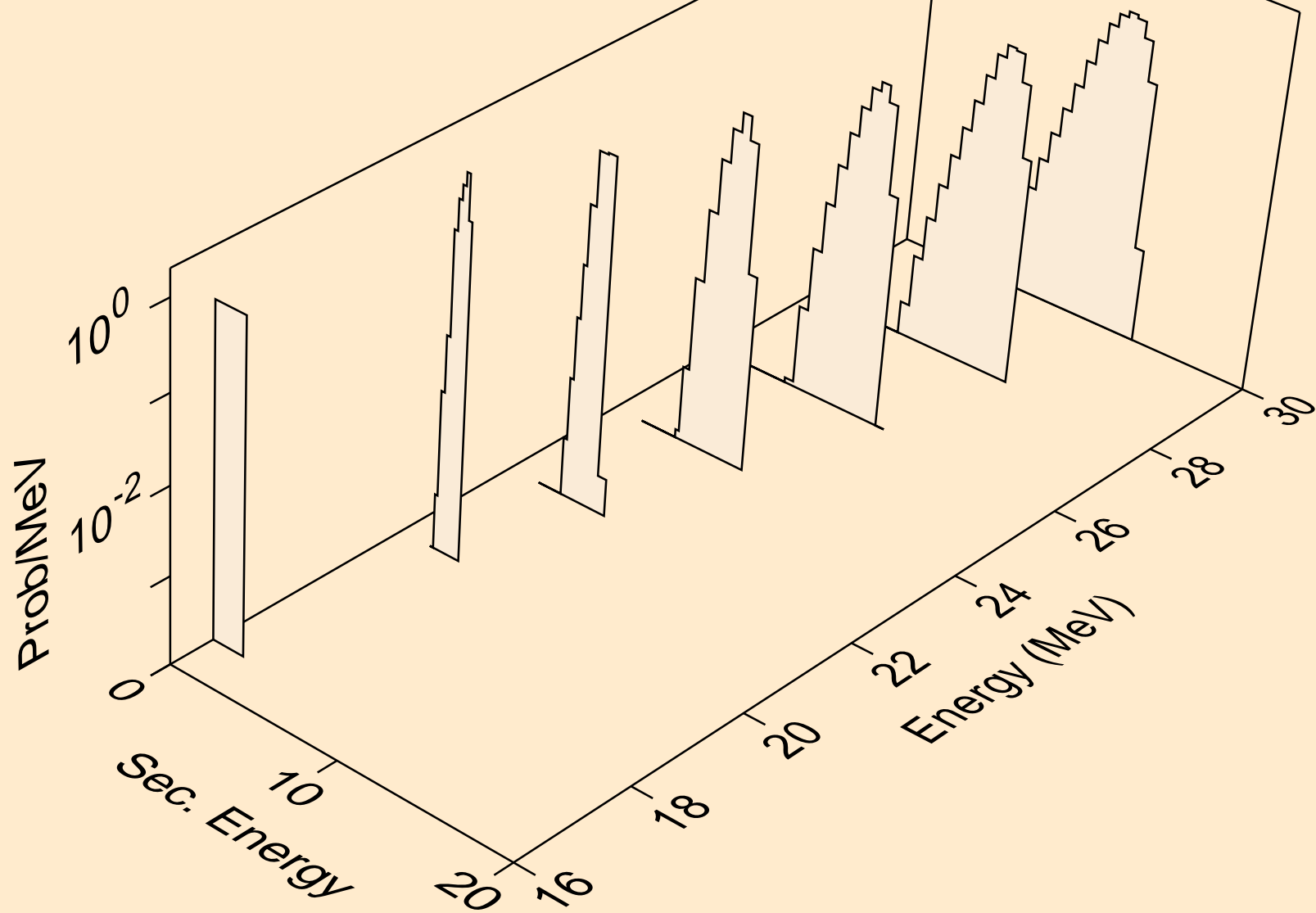

PU232 NEUTRON ACER TENDL-2021 LIBRARY; T=293.6K  
deuterons from (n,n\*)d

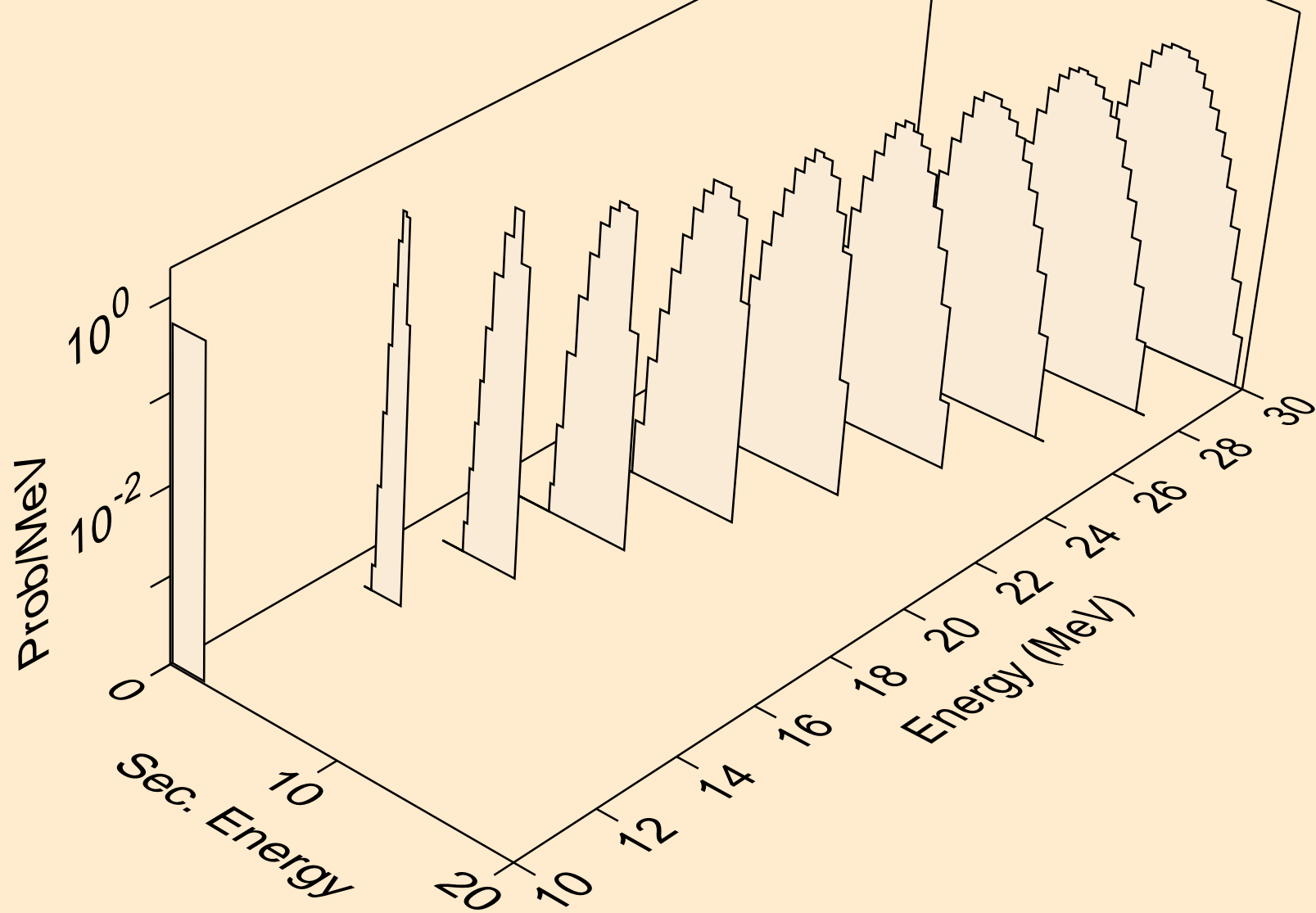

PU232 NEUTRON ACER TENDL-2021 LIBRARY; T=293.6K  
deuterons from (n,d)

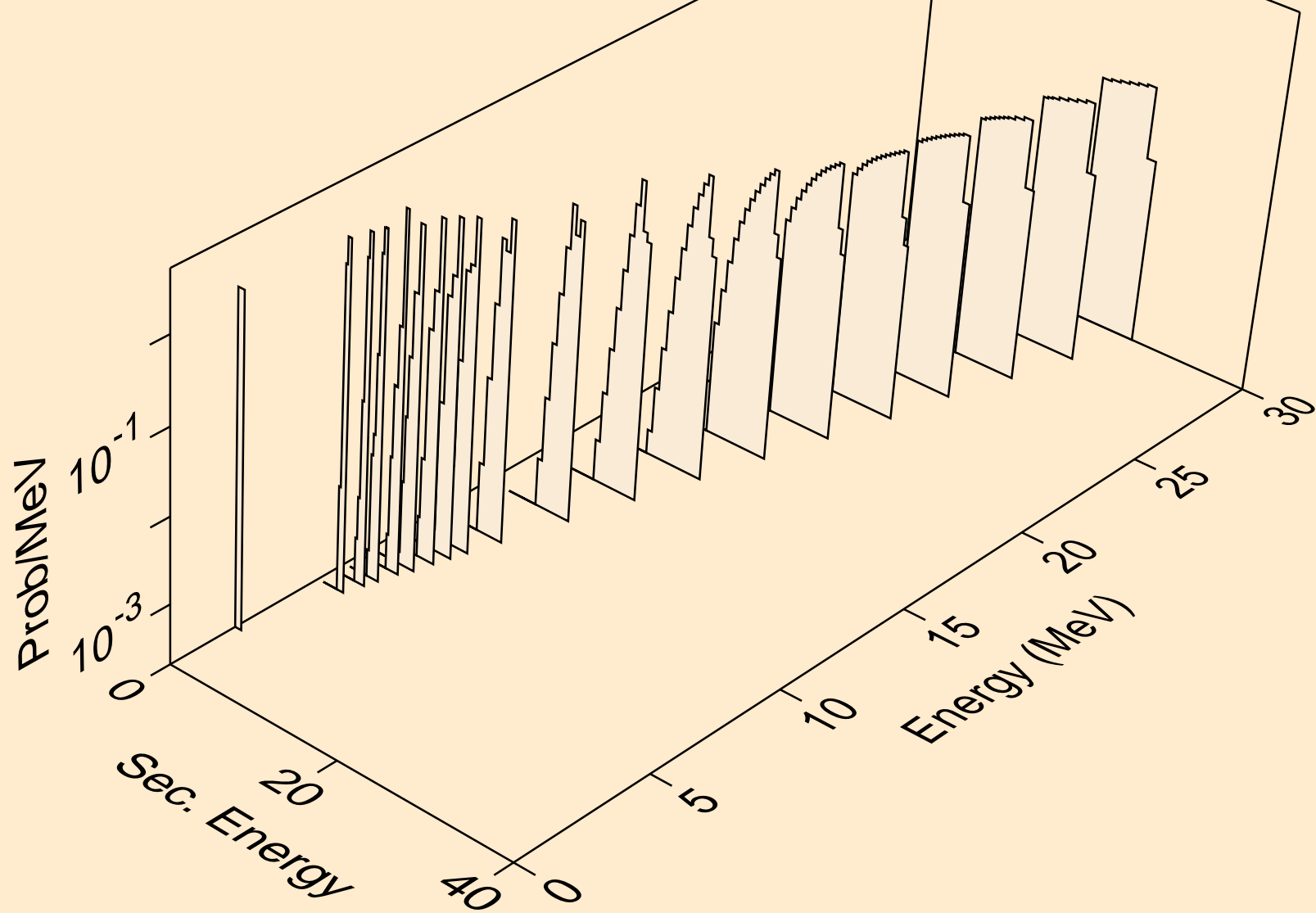

PU232 NEUTRON ACER TENDL-2021 LIBRARY; T=293.6K  
deuterons from (n,pd)

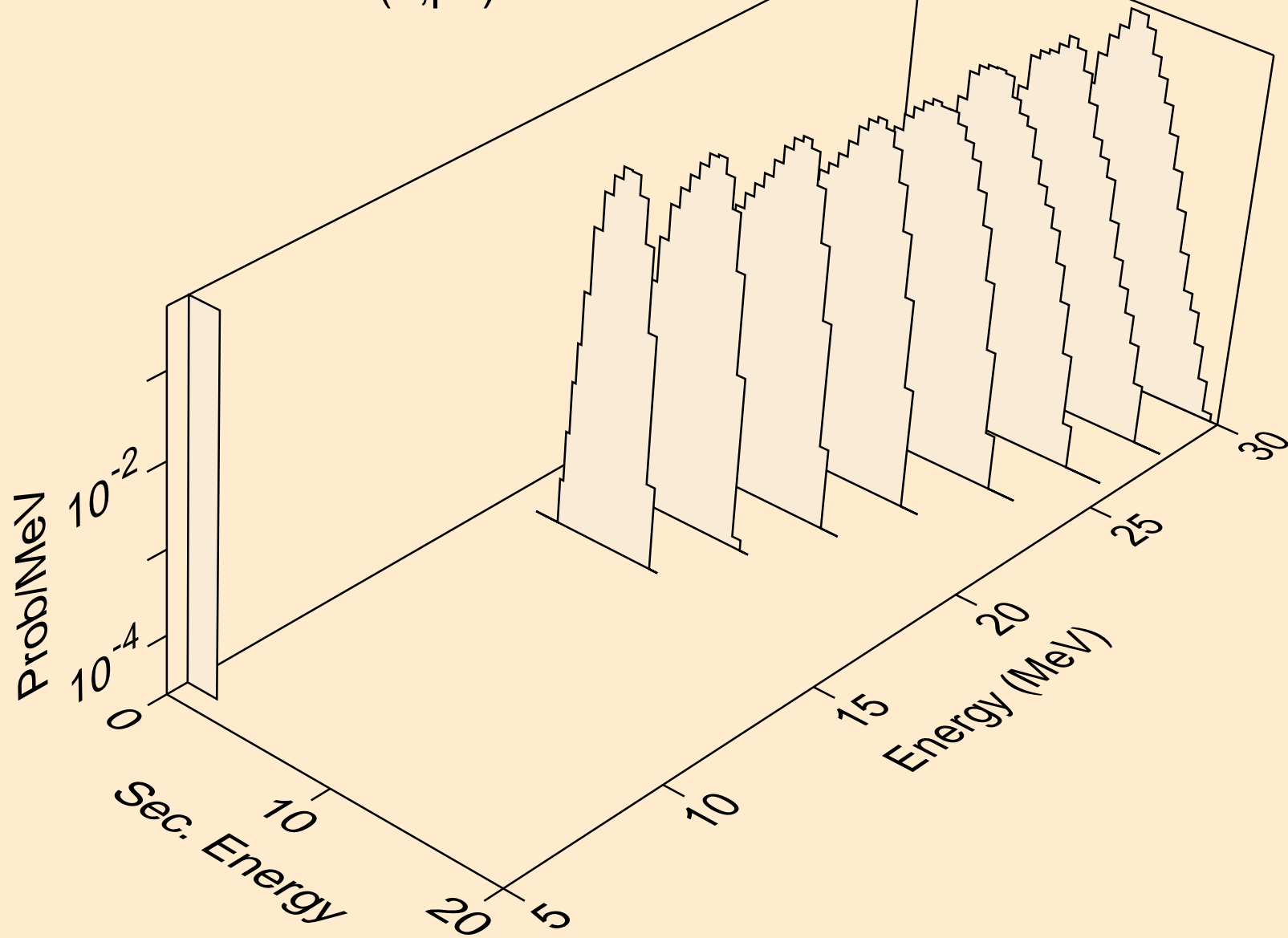

PU232 NEUTRON ACER TENDL-2021 LIBRARY; T=293.6K  
deuterons from (n,da)

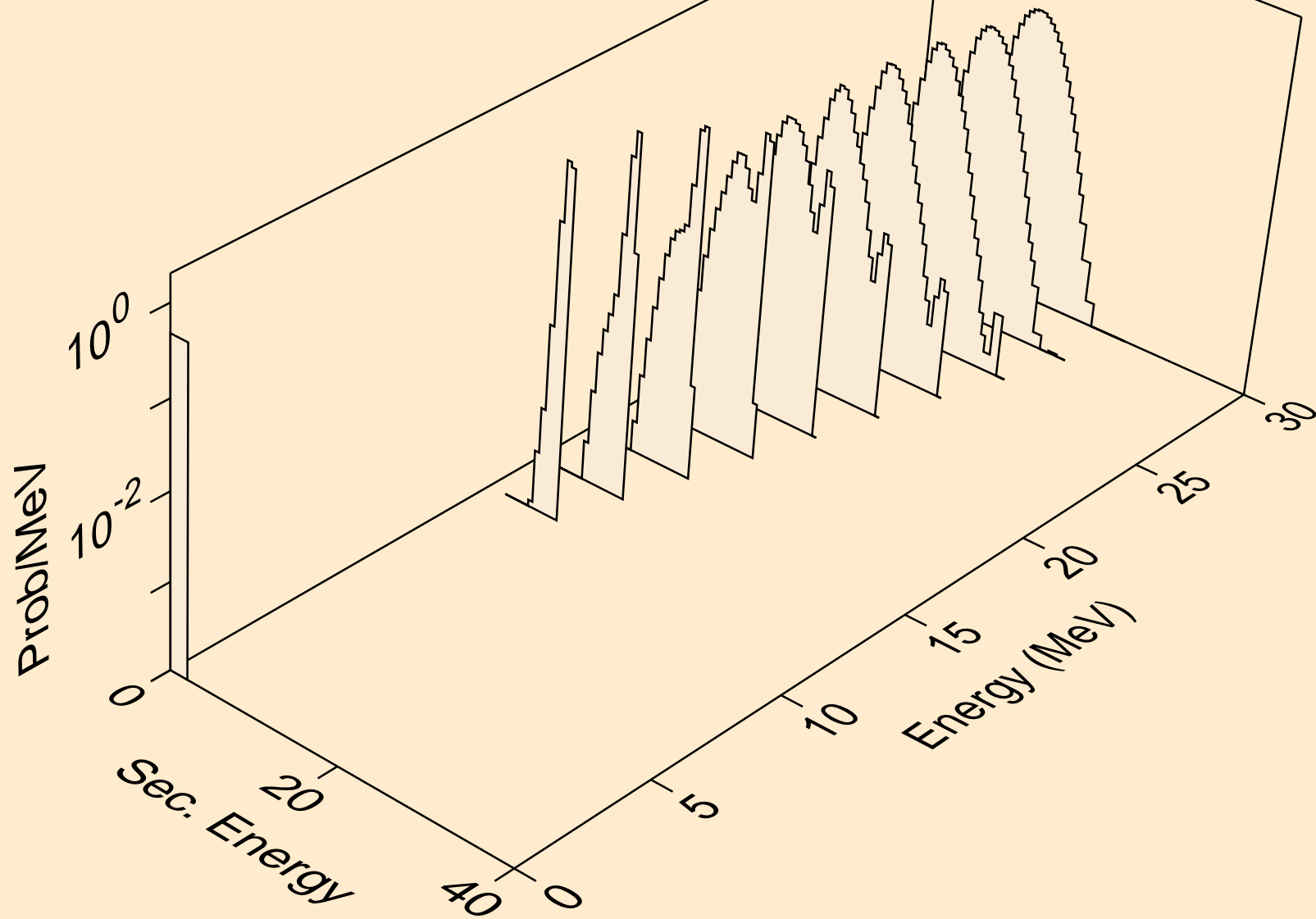

PU232 NEUTRON ACER TENDL-2021 LIBRARY; T=293.6K  
tritons from (n,x)

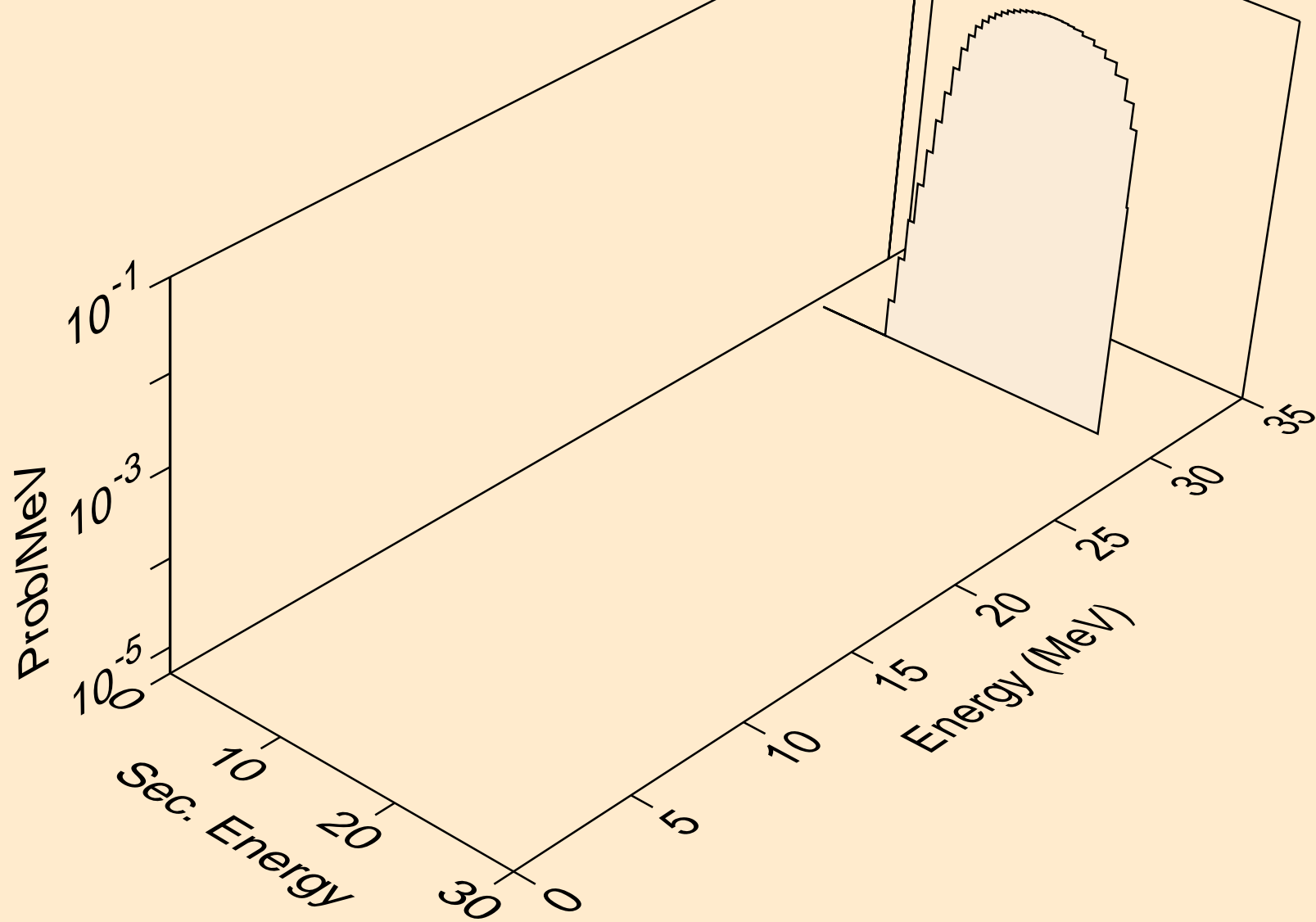

PU232 NEUTRON ACER TENDL-2021 LIBRARY; T=293.6K  
tritons from (n,n\*)t

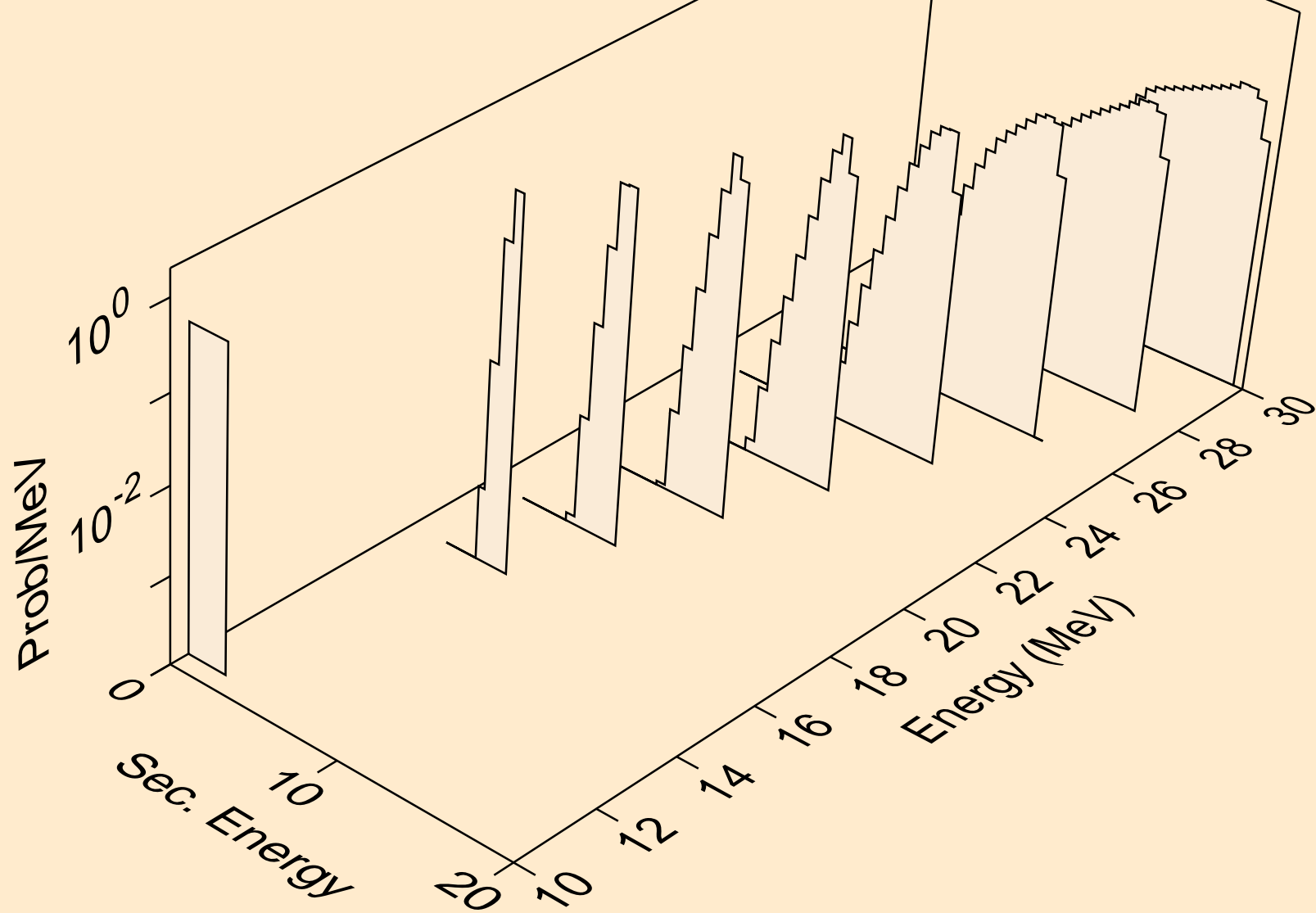

PU232 NEUTRON ACER TENDL-2021 LIBRARY; T=293.6K  
tritons from (n,t)

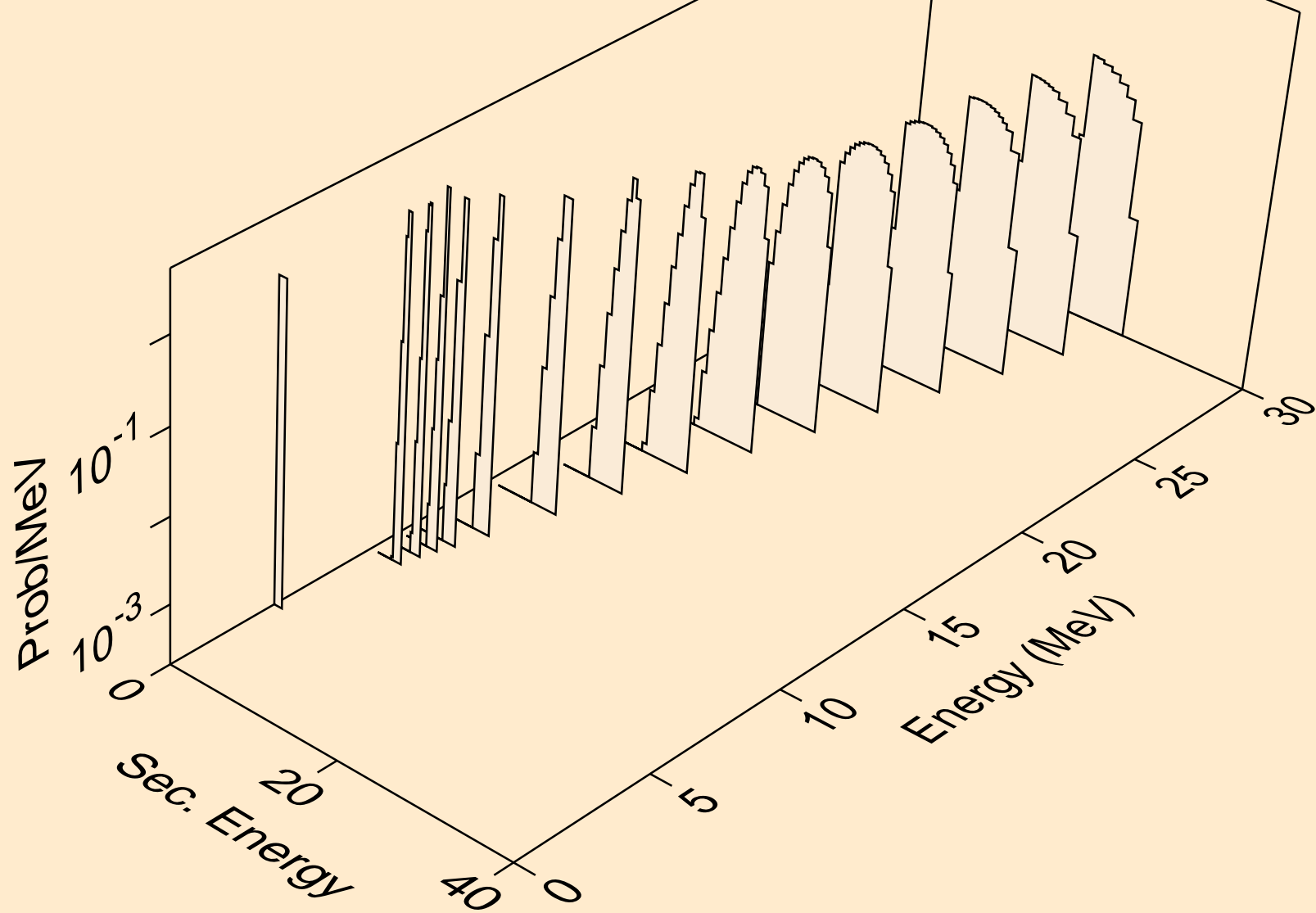

PU232 NEUTRON ACER TENDL-2021 LIBRARY; T=293.6K  
tritons from (n,pt)

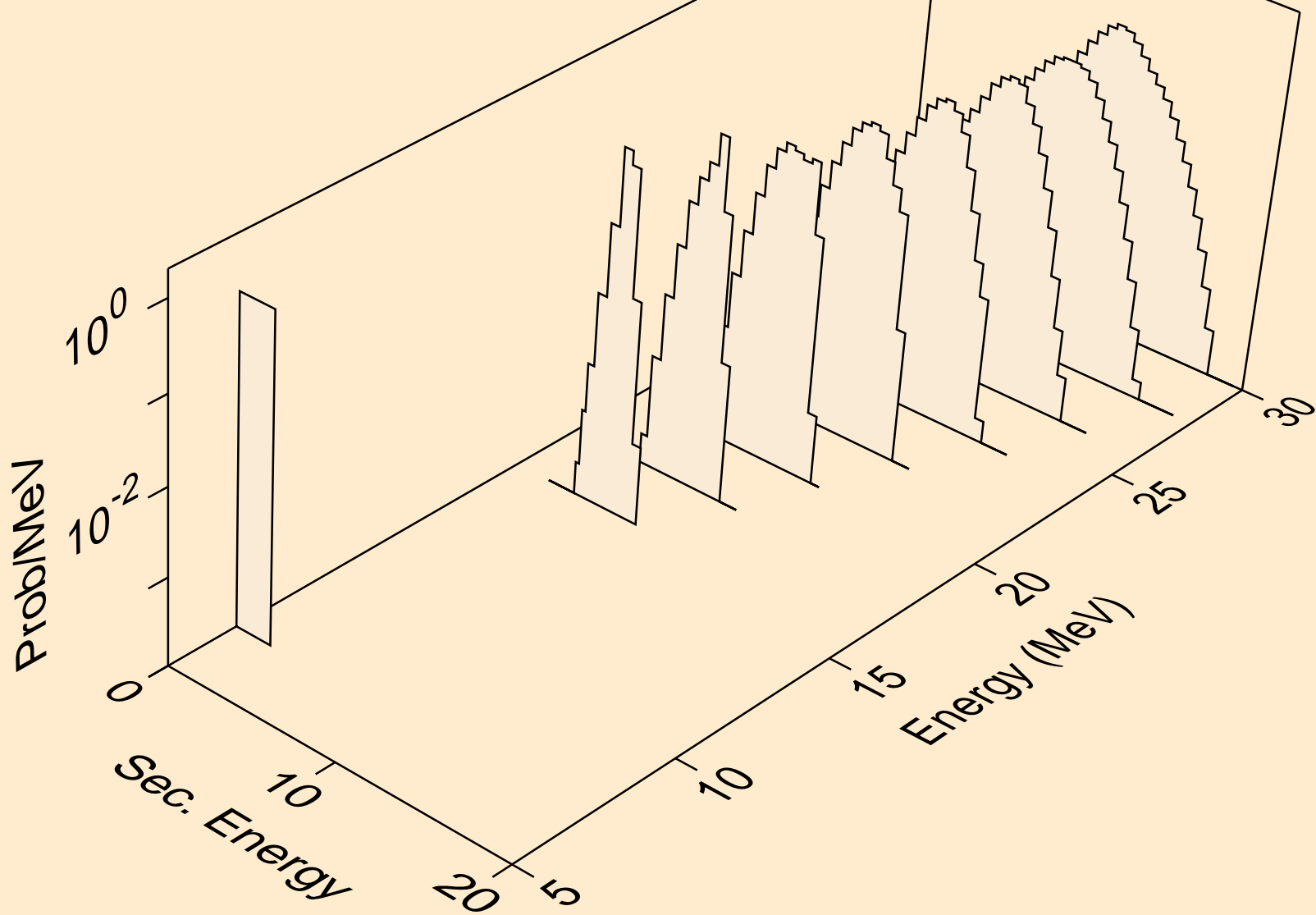

PU232 NEUTRON ACER TENDL-2021 LIBRARY; T=293.6K  
he3s from (n,x)

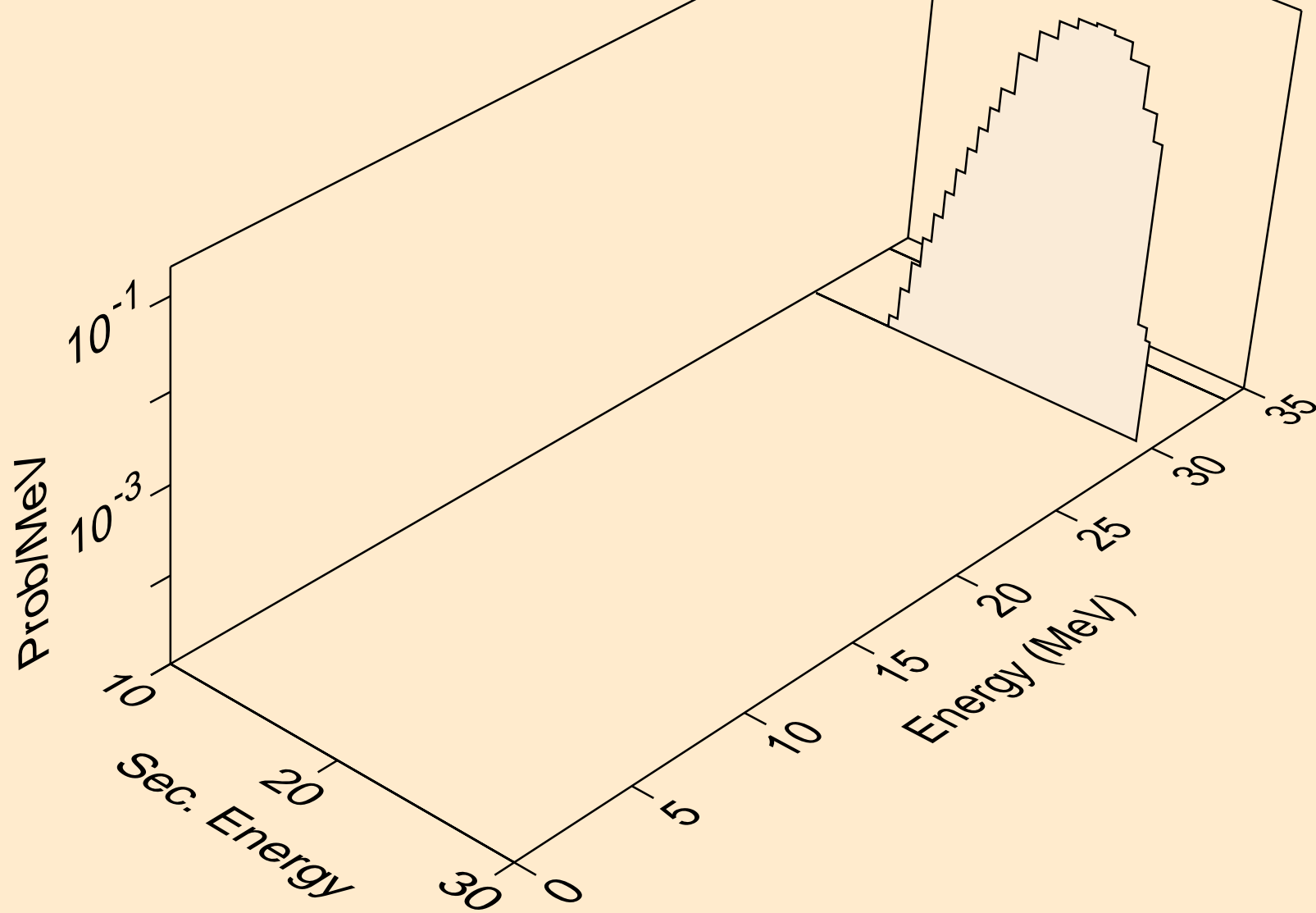

PU232 NEUTRON ACER TENDL-2021 LIBRARY; T=293.6K  
he3s from (n,n\*)he3

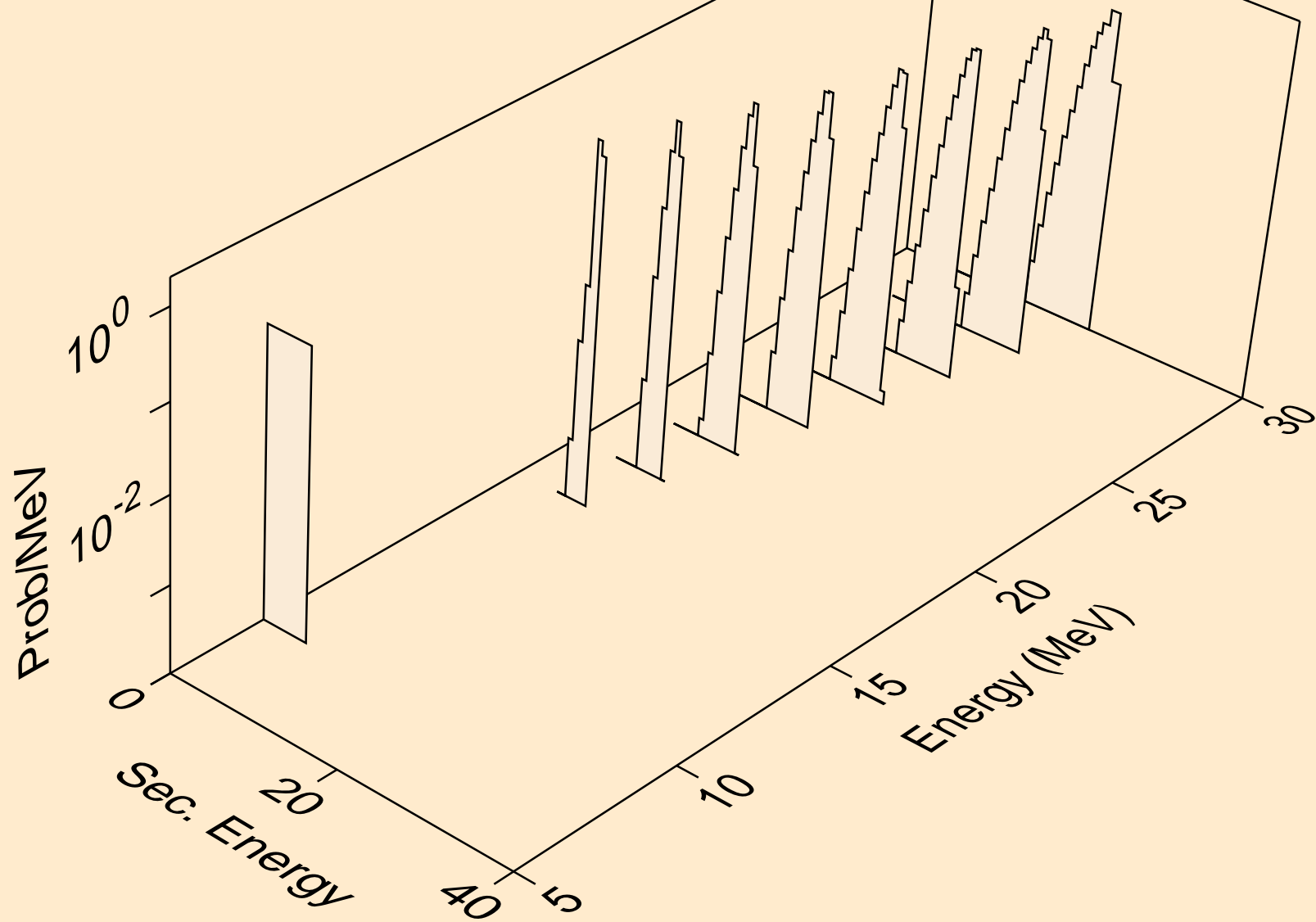

PU232 NEUTRON ACER TENDL-2021 LIBRARY; T=293.6K  
he3s from (n,he3)

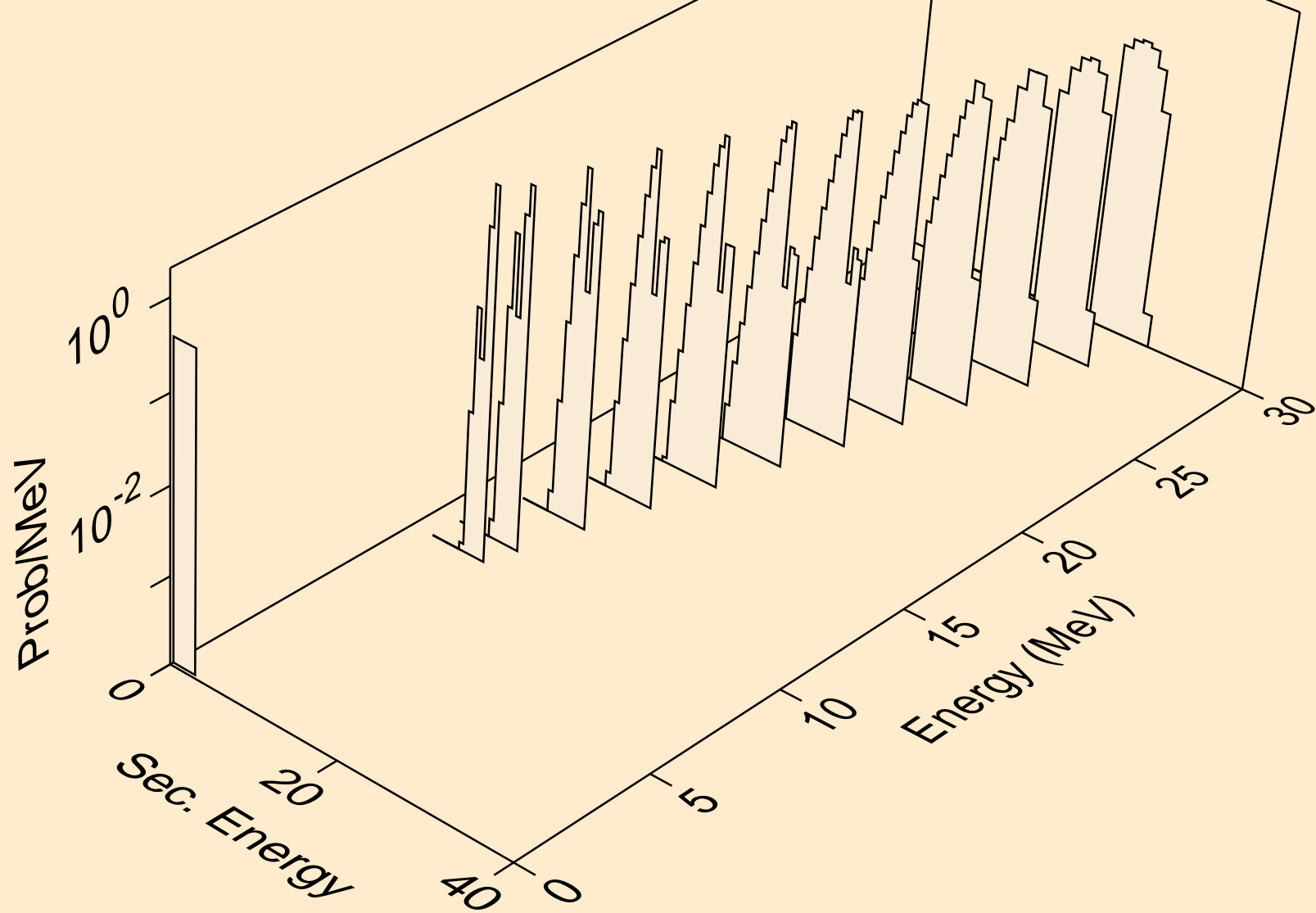

PU232 NEUTRON ACER TENDL-2021 LIBRARY; T=293.6K  
alphas from (n,x)

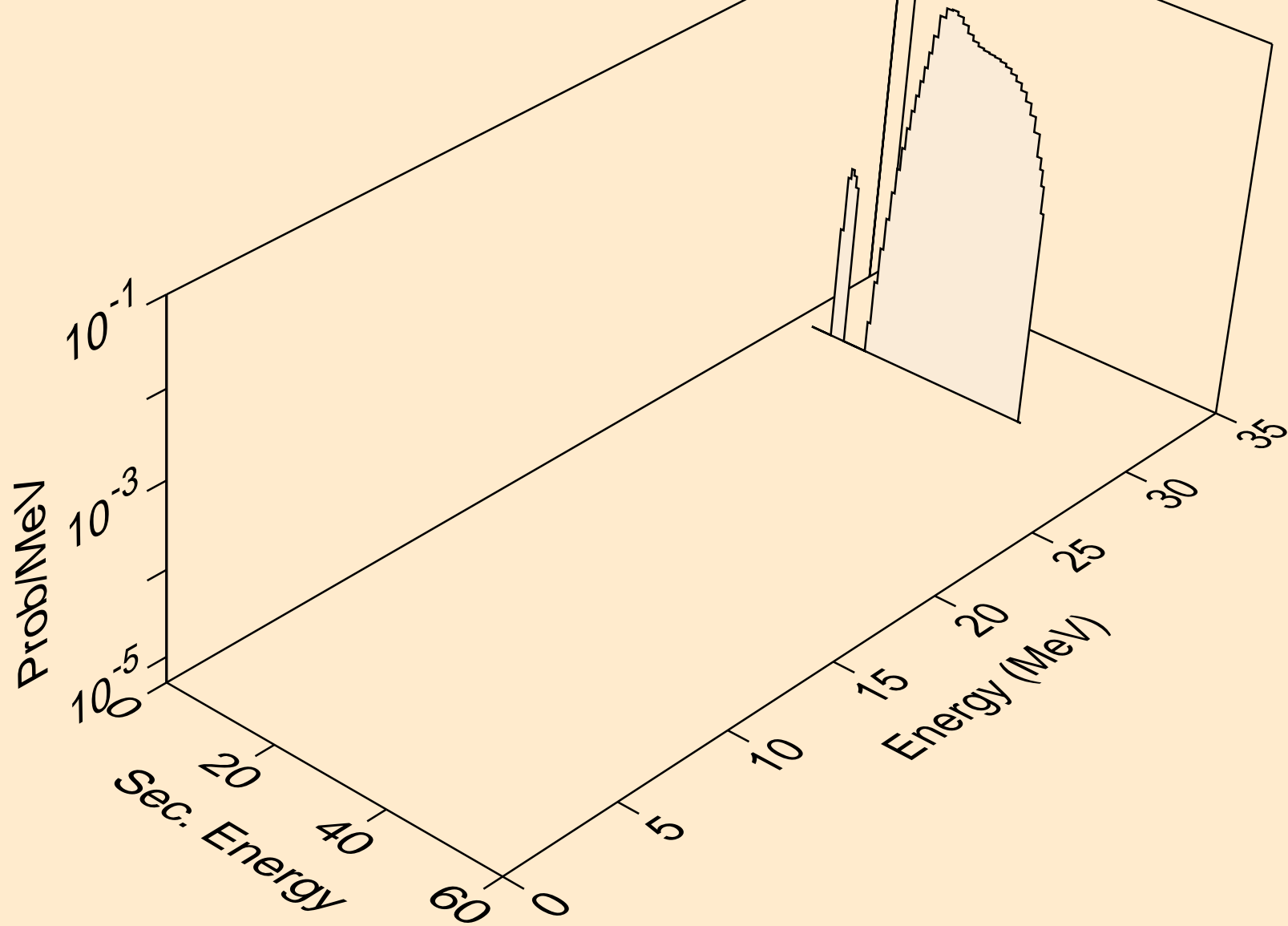

PU232 NEUTRON ACER TENDL-2021 LIBRARY; T=293.6K  
alphas from (n,n\*)a

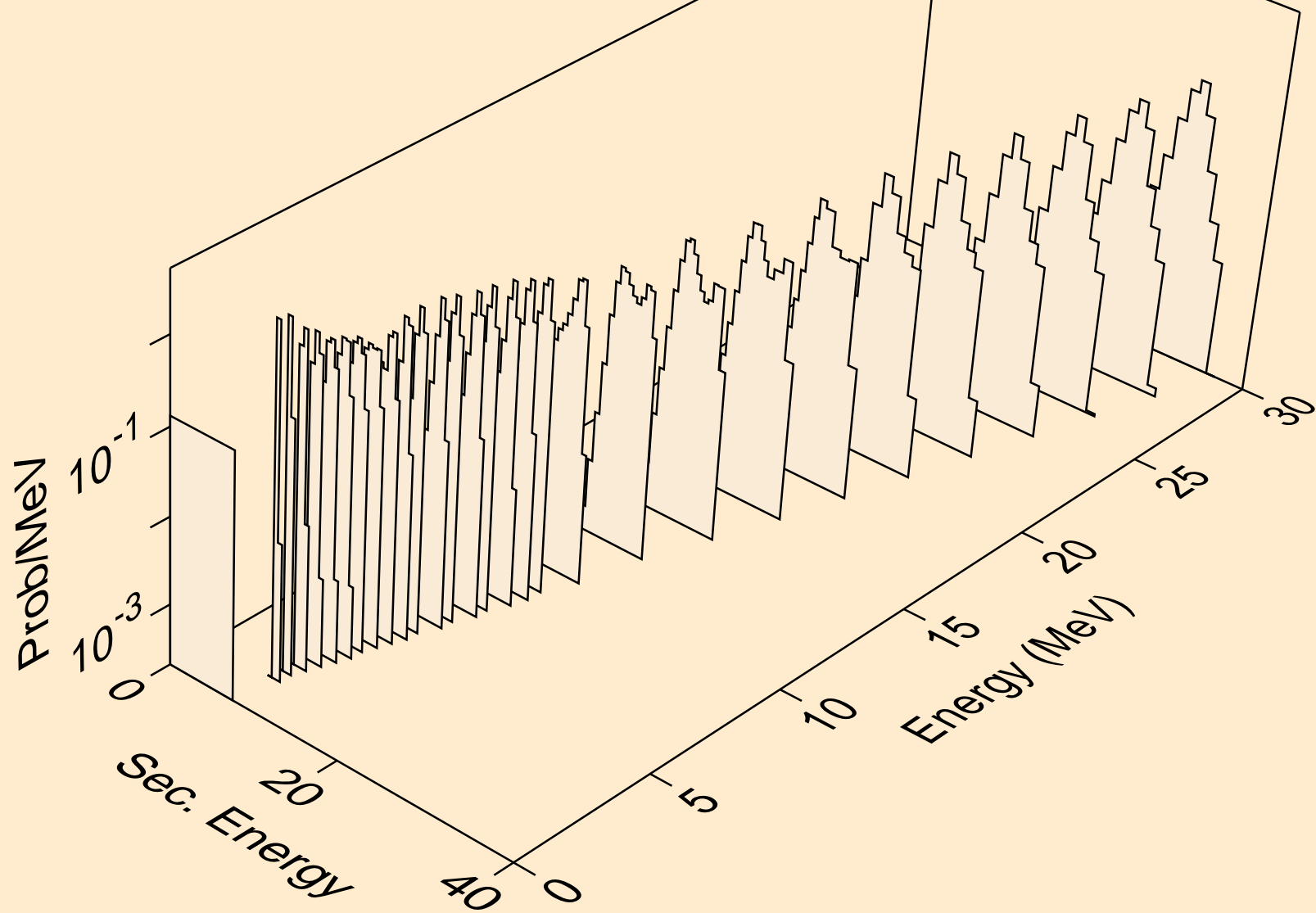

PU232 NEUTRON ACER TENDL-2021 LIBRARY; T=293.6K  
alphas from (n,2n)a

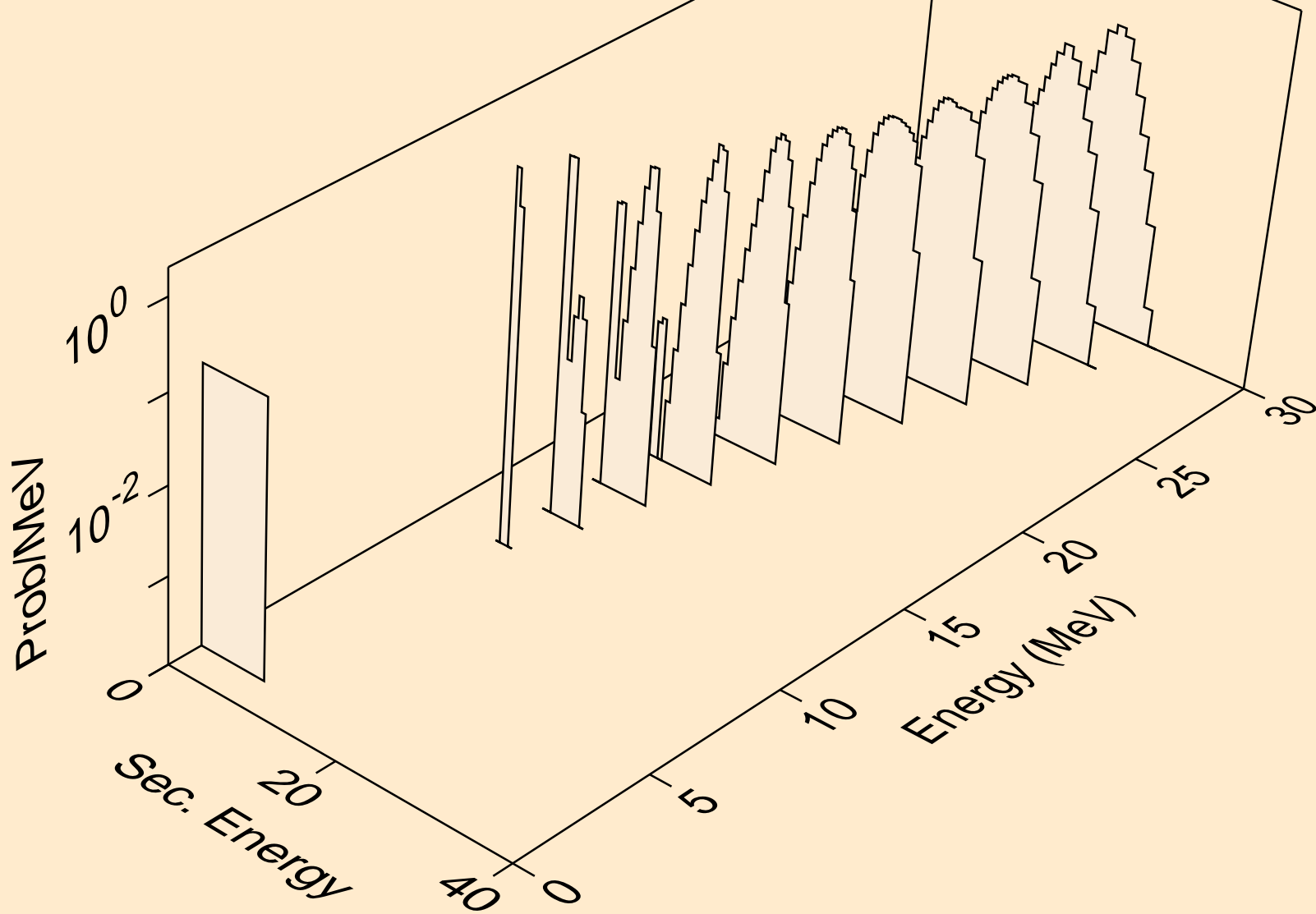

PU232 NEUTRON ACER TENDL-2021 LIBRARY; T=293.6K  
alphas from (n,3n)a

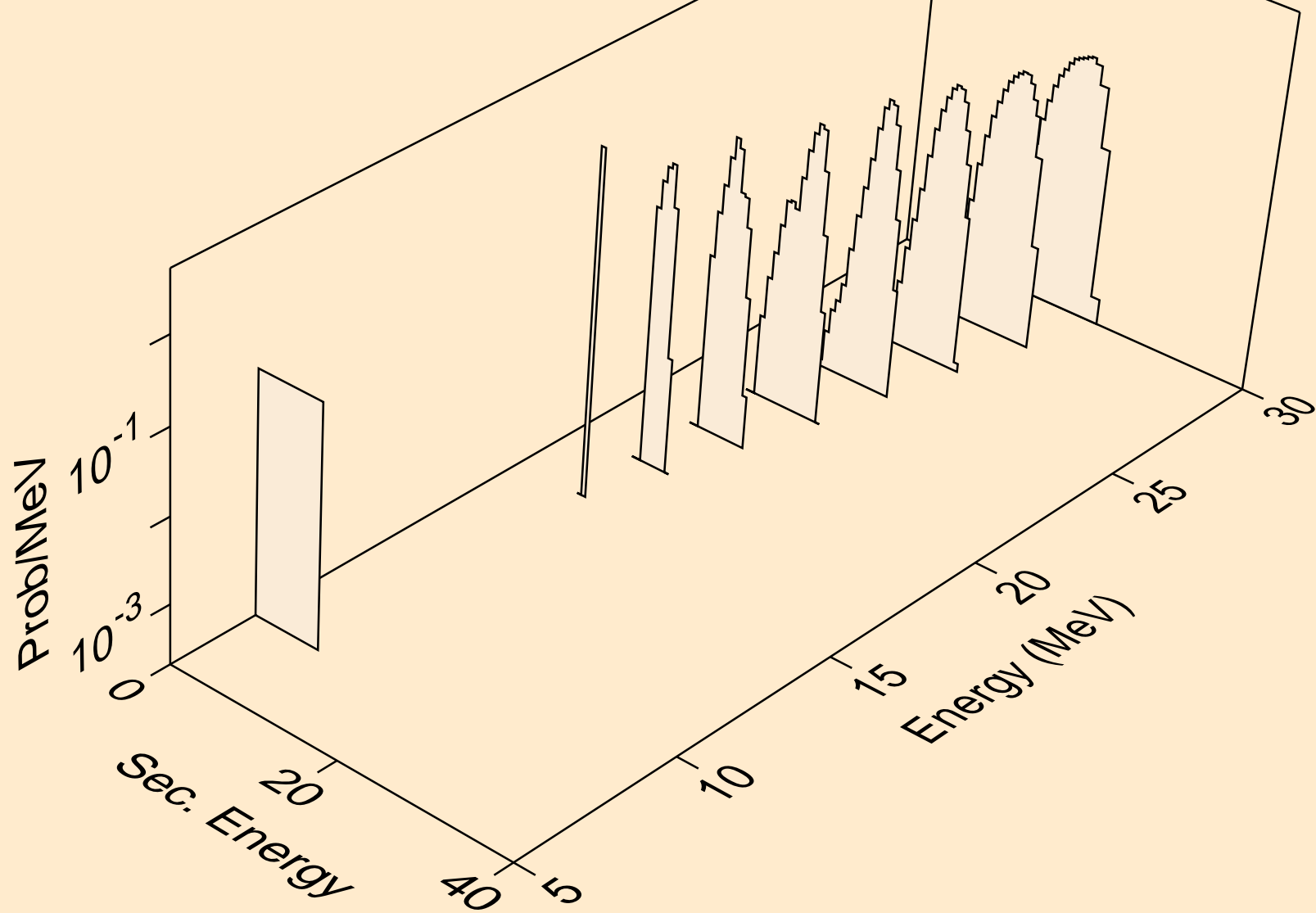

PU232 NEUTRON ACER TENDL-2021 LIBRARY; T=293.6K  
alphas from (n,n\*)2a

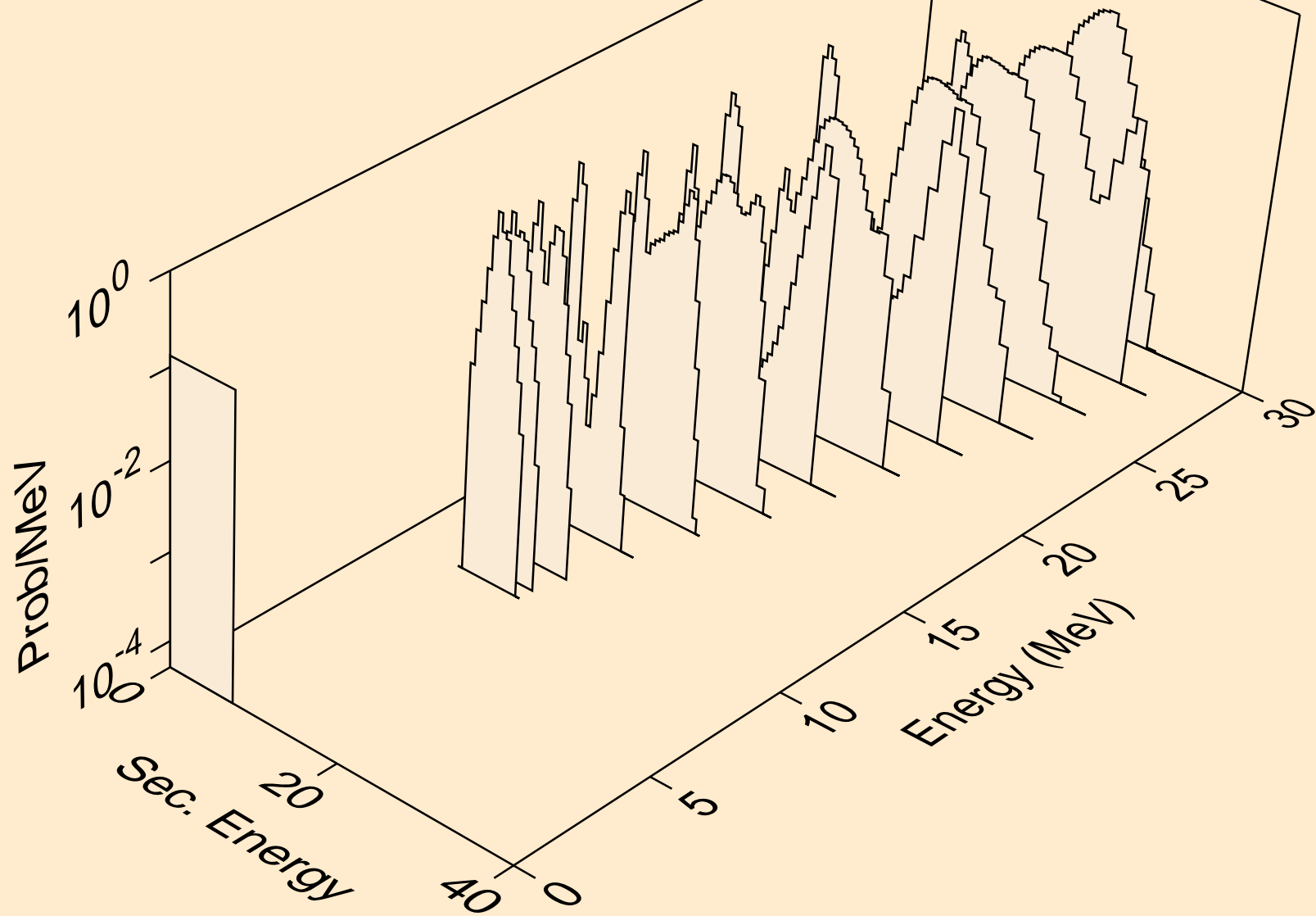

PU232 NEUTRON ACER TENDL-2021 LIBRARY; T=293.6K  
alphas from (n,npa)

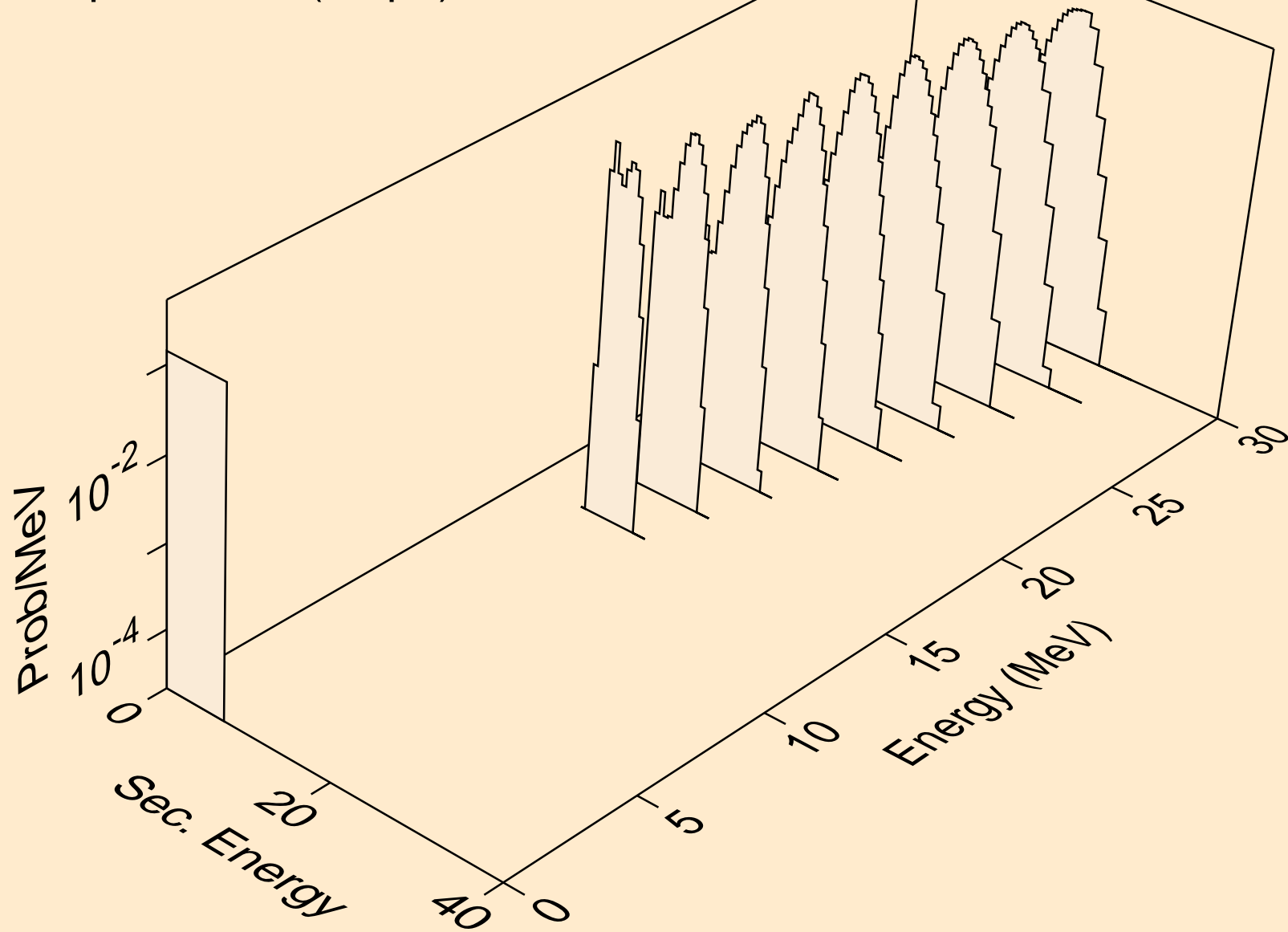

PU232 NEUTRON ACER TENDL-2021 LIBRARY; T=293.6K  
alphas from (n,a)

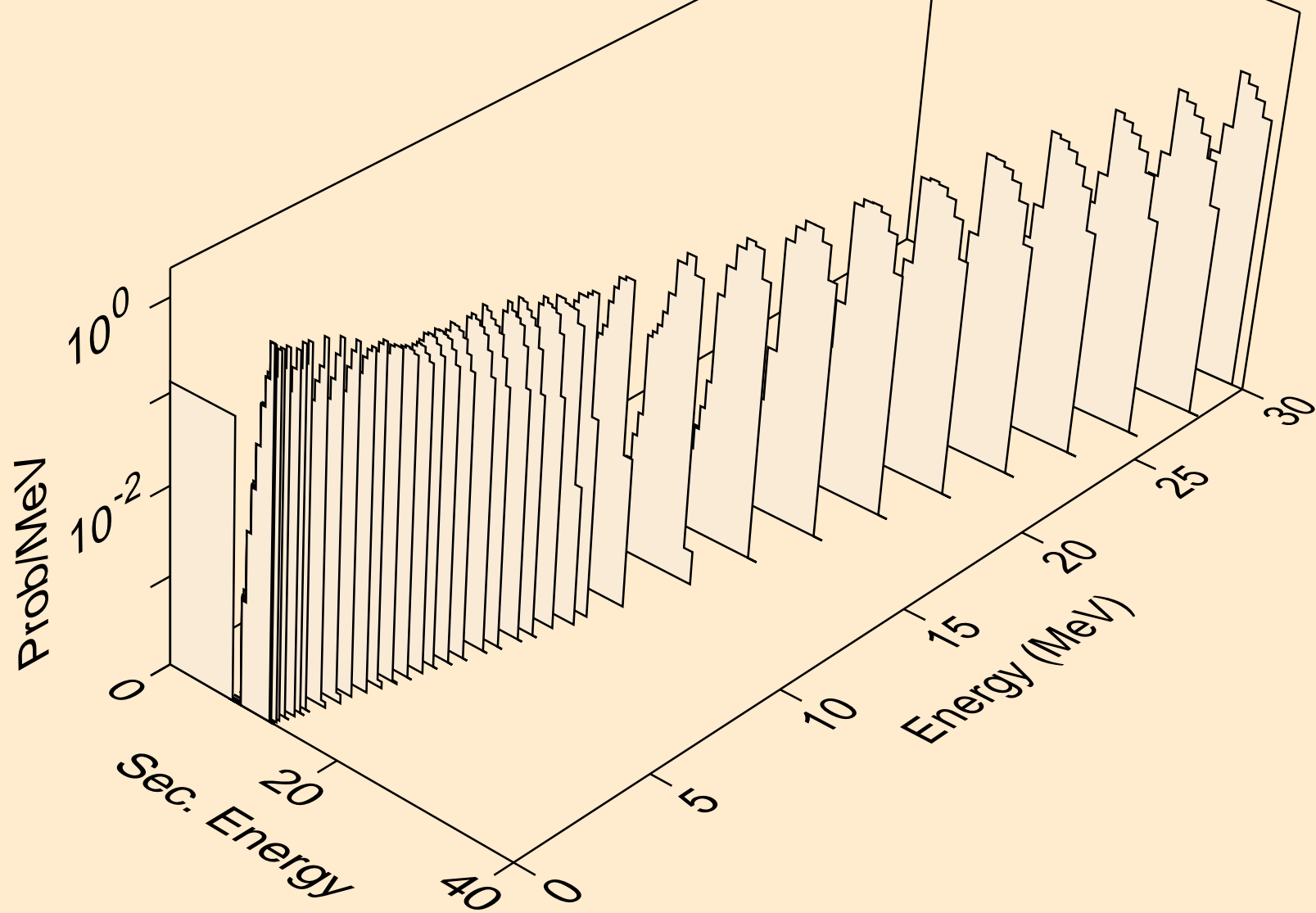

PU232 NEUTRON ACER TENDL-2021 LIBRARY; T=293.6K  
alphas from (n,2a)

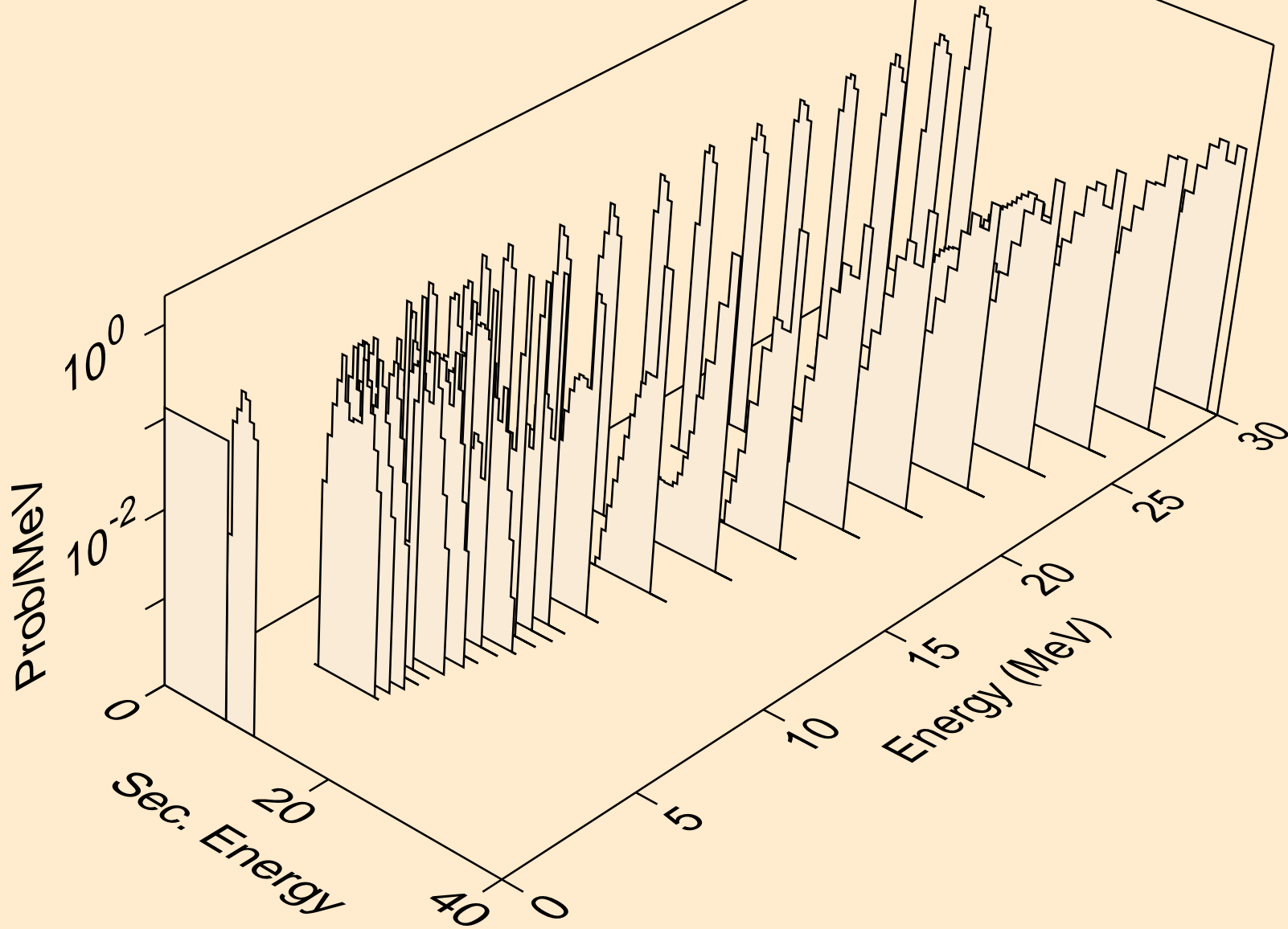

PU232 NEUTRON ACER TENDL-2021 LIBRARY; T=293.6K  
alphas from (n,pa)

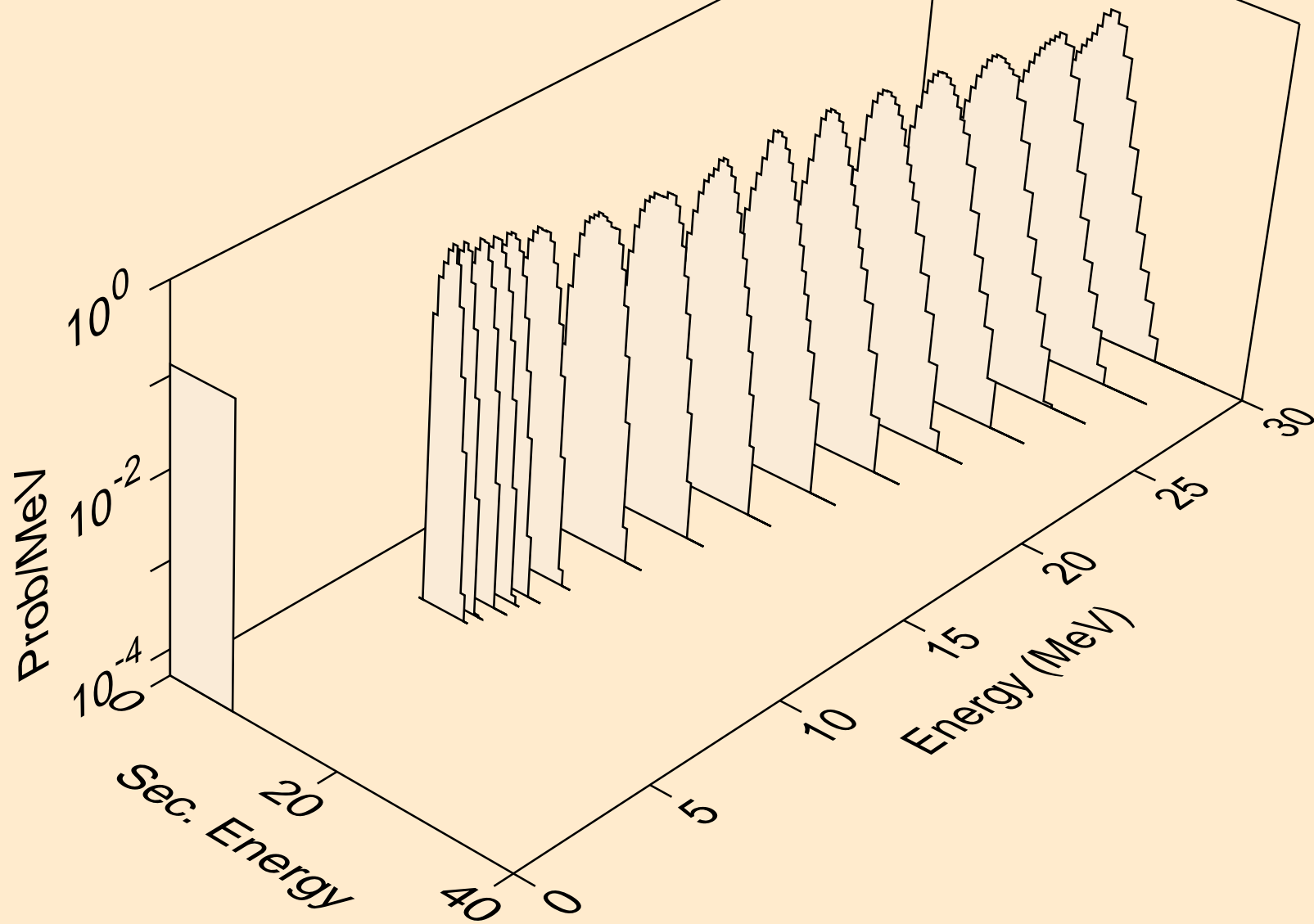

PU232 NEUTRON ACER TENDL-2021 LIBRARY; T=293.6K  
alphas from (n,da)

