

RH110M NEUTRON ACER TENDL-2021 LIBRARY; T=293.6K

Principal cross sections

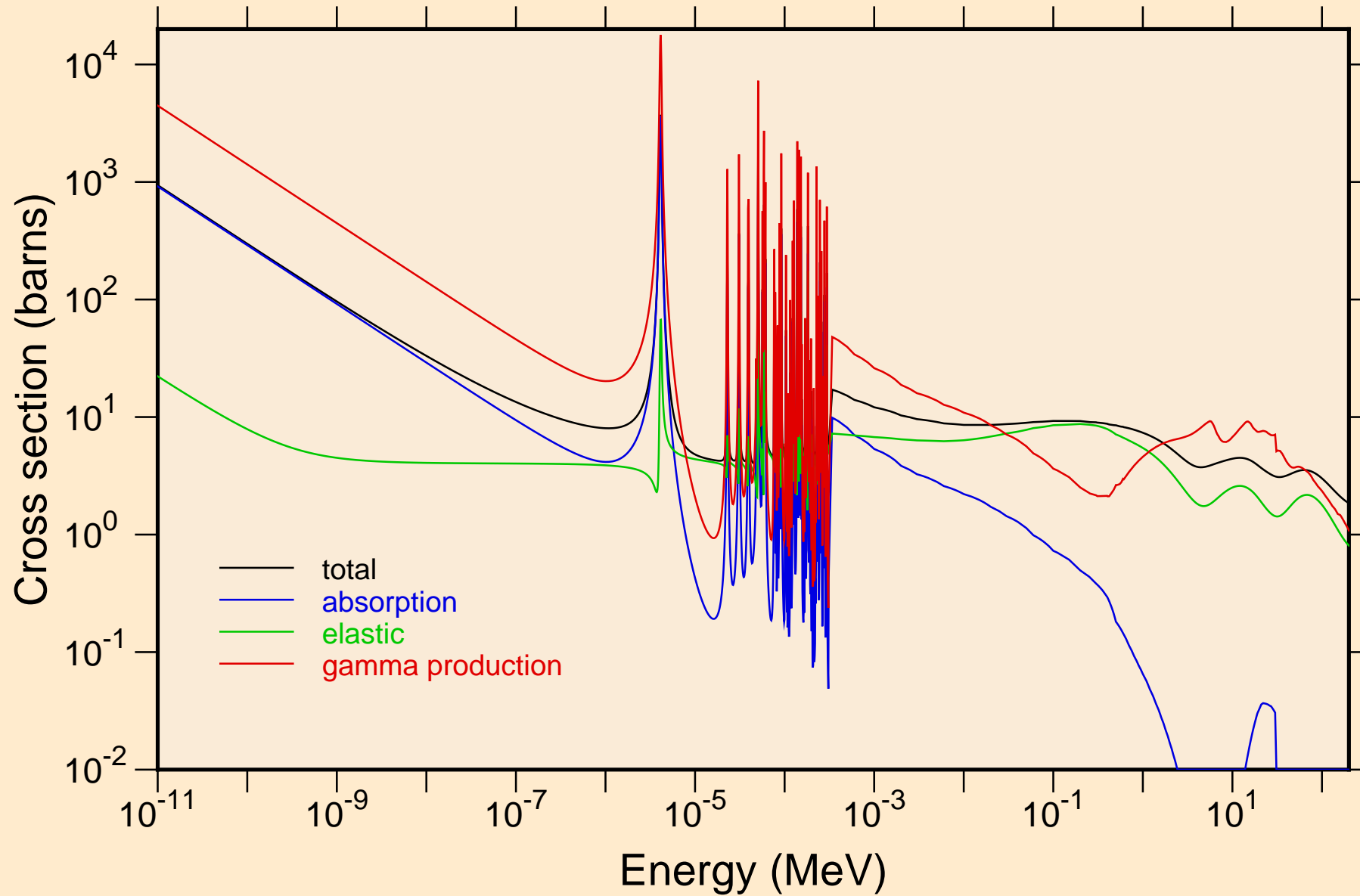

RH110M NEUTRON ACER TENDL-2021 LIBRARY; T=293.6K
resonance total cross section

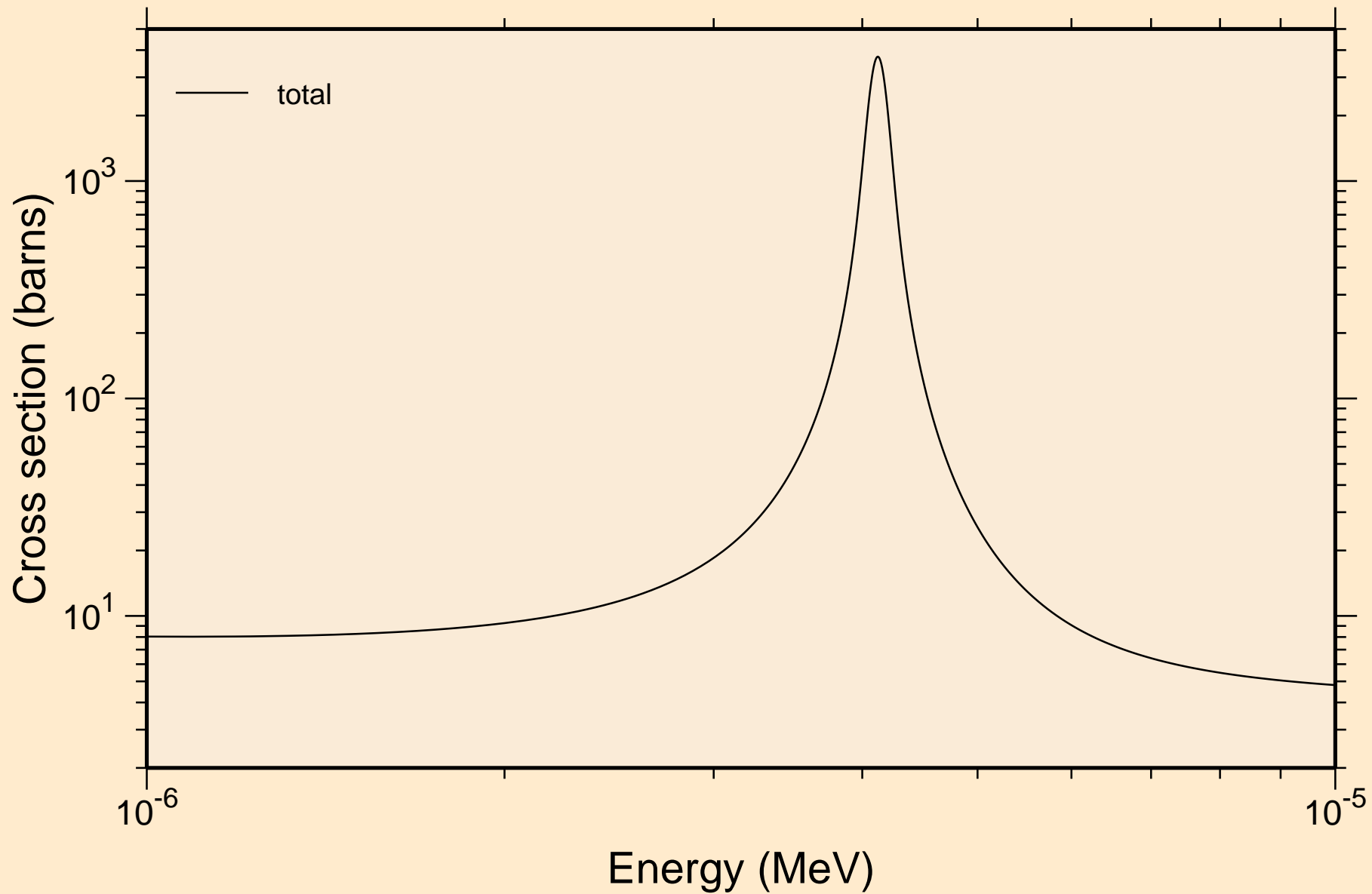

RH110M NEUTRON ACER TENDL-2021 LIBRARY; T=293.6K
resonance total cross section

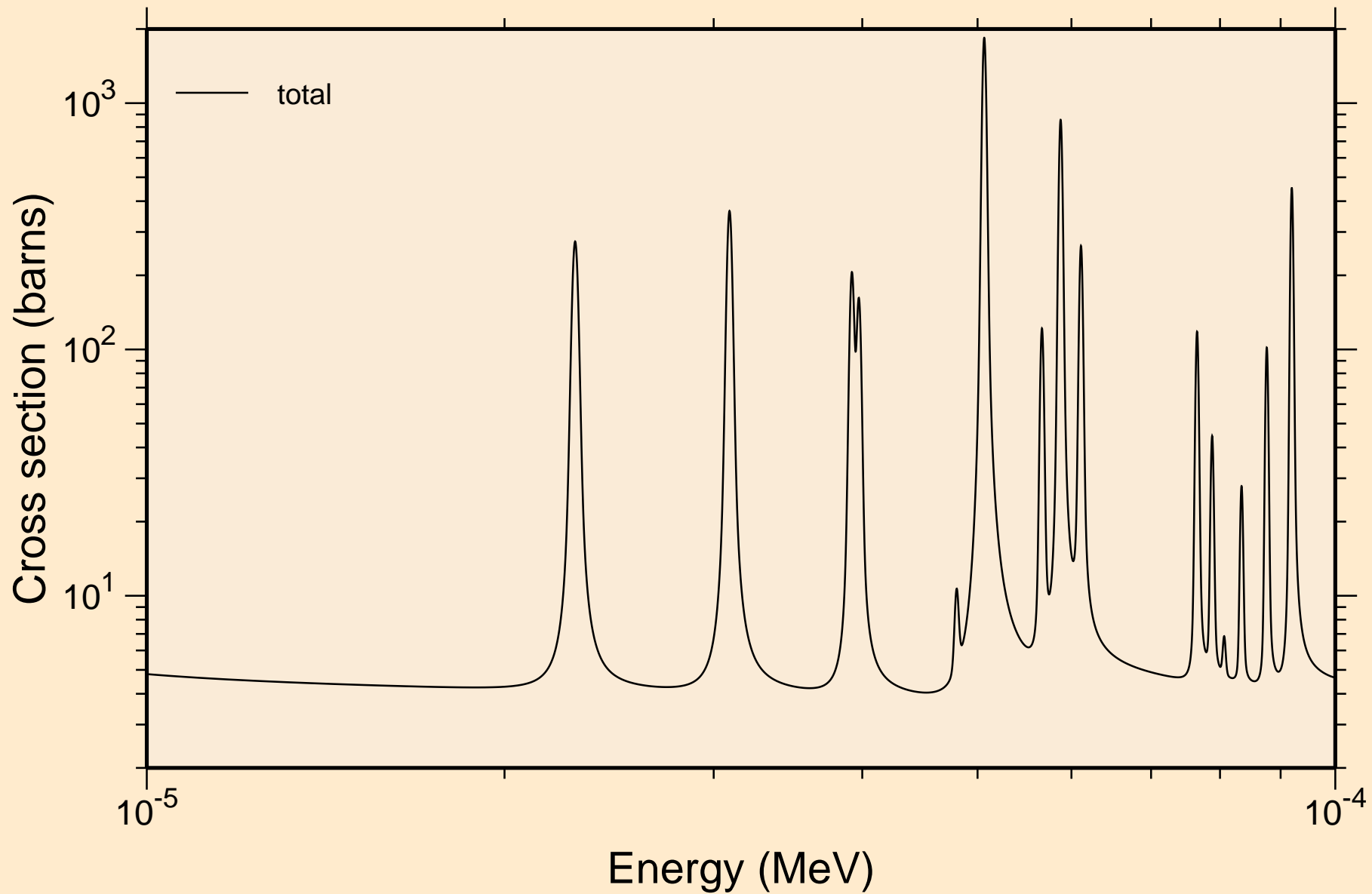

RH110M NEUTRON ACER TENDL-2021 LIBRARY; T=293.6K
resonance total cross section

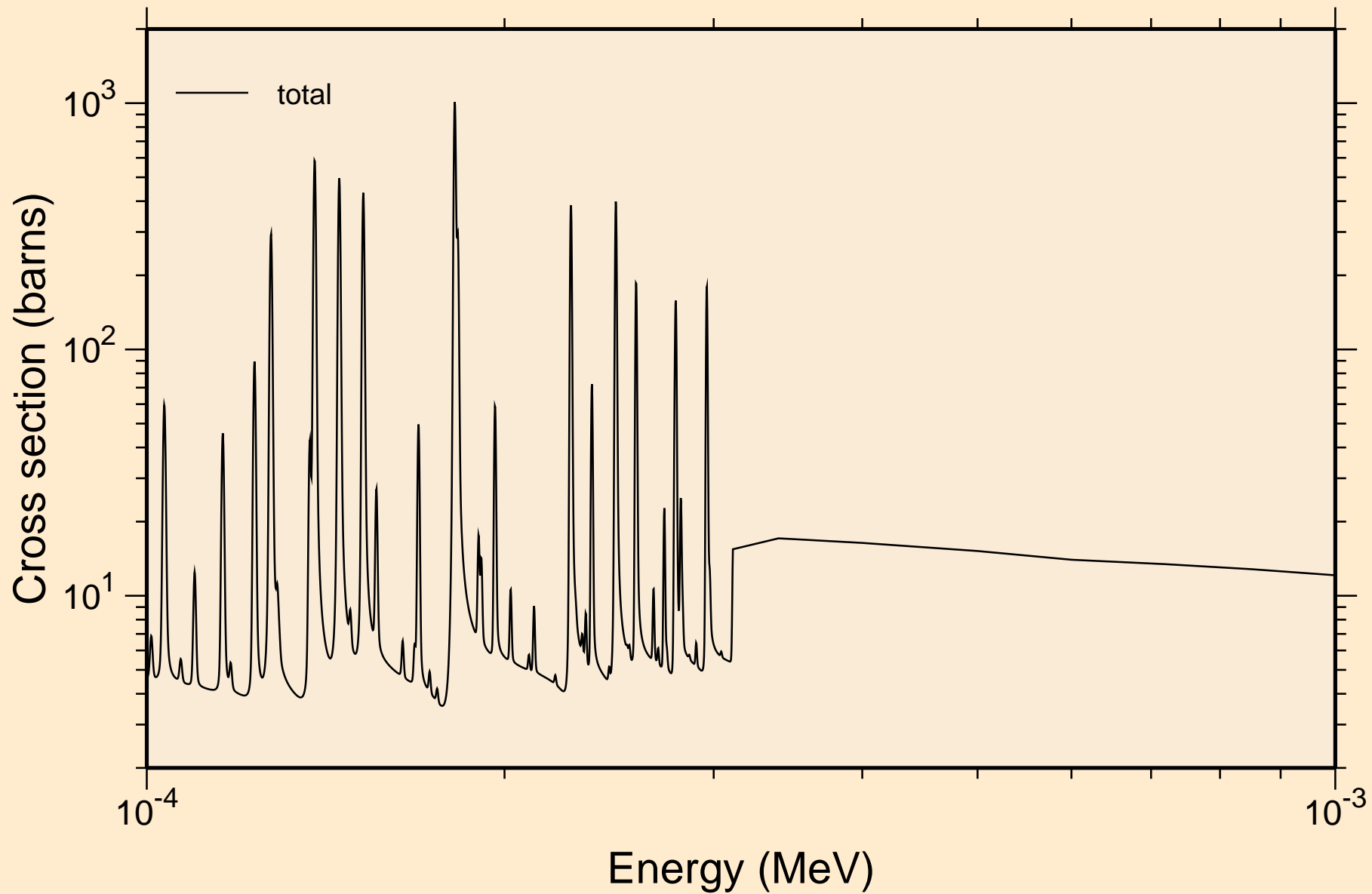

RH110M NEUTRON ACER TENDL-2021 LIBRARY; T=293.6K
resonance total cross section

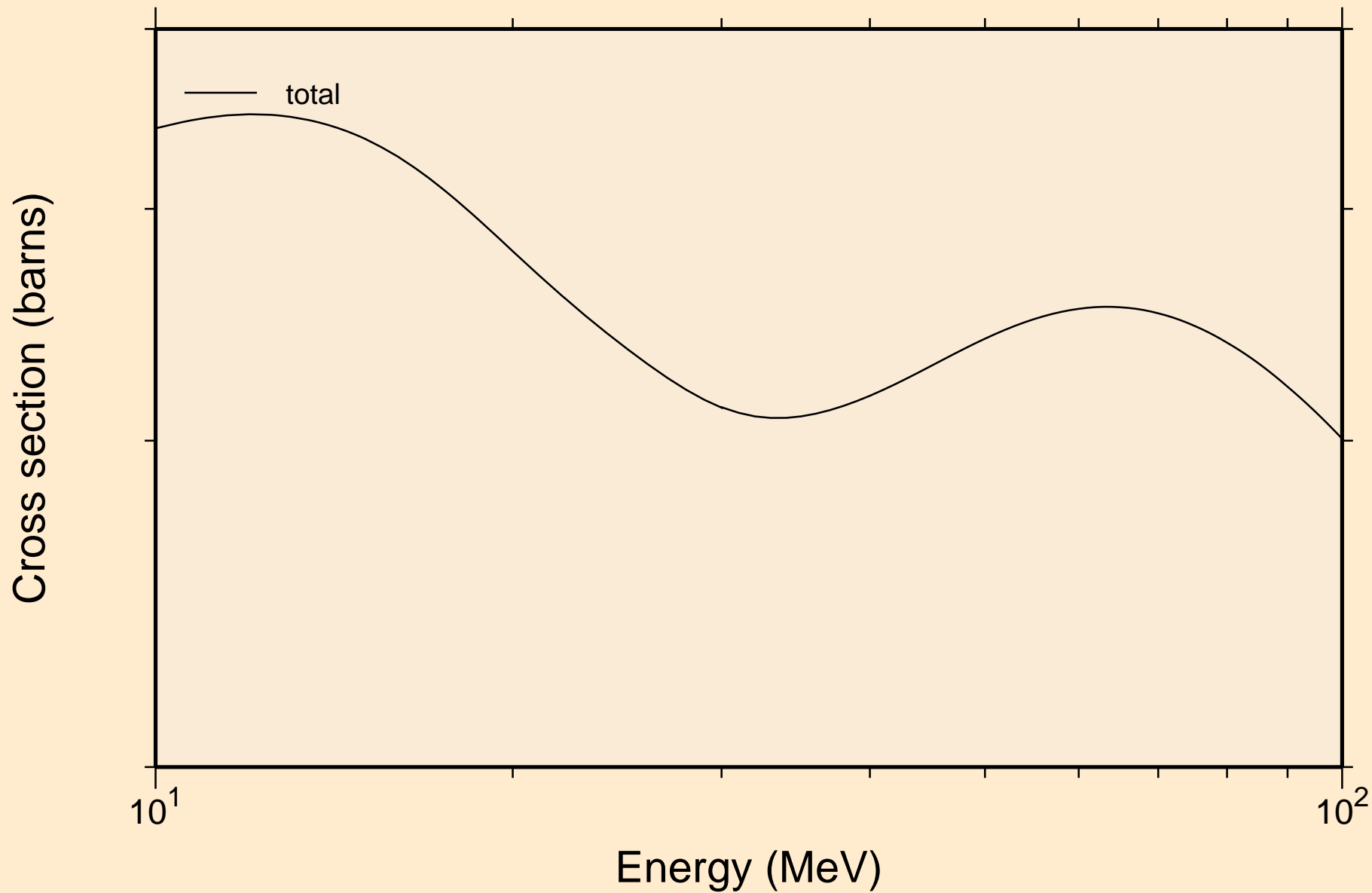

RH110M NEUTRON ACER TENDL-2021 LIBRARY; T=293.6K
resonance absorption cross sections

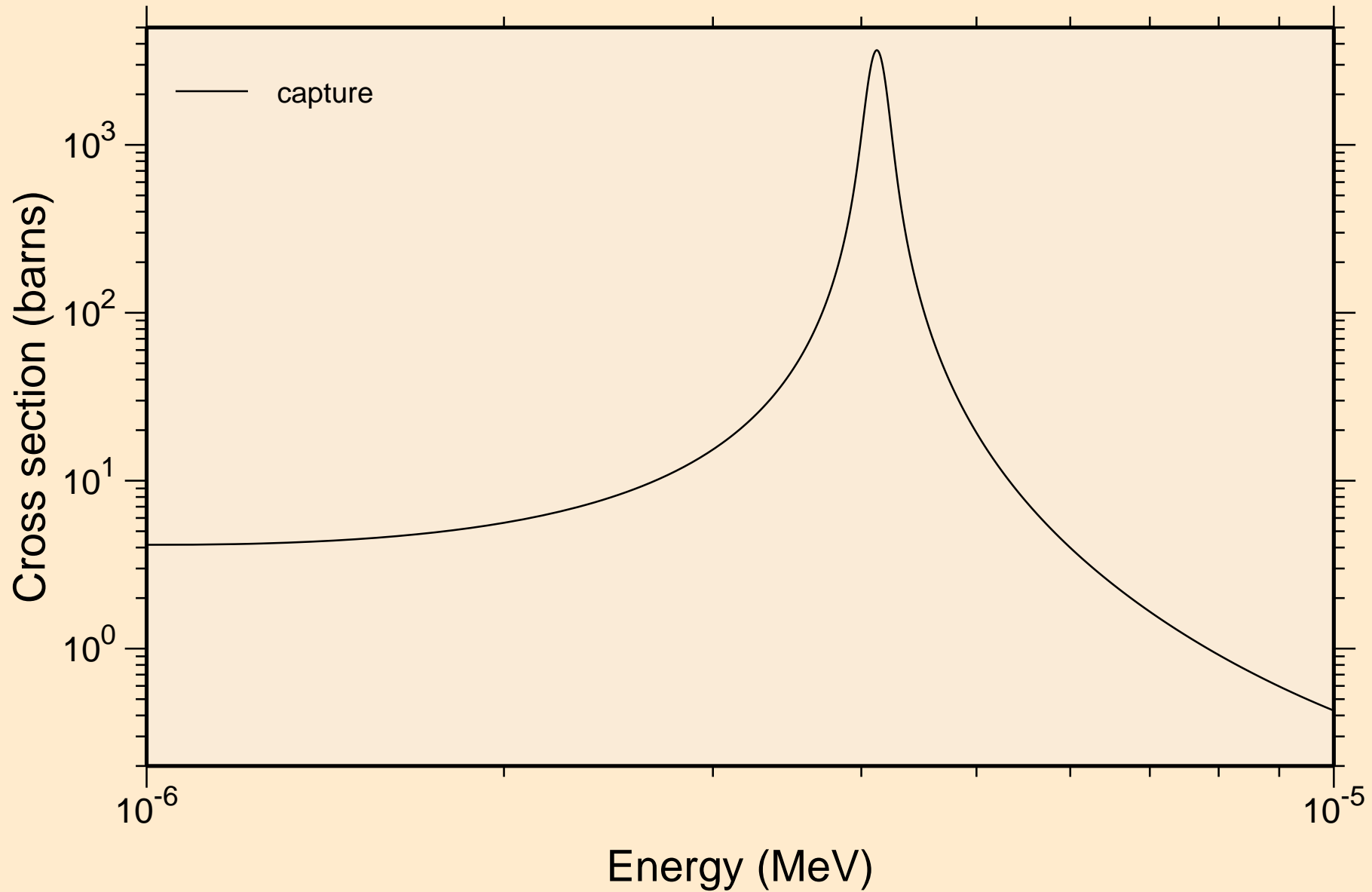

RH110M NEUTRON ACER TENDL-2021 LIBRARY; T=293.6K
resonance absorption cross sections

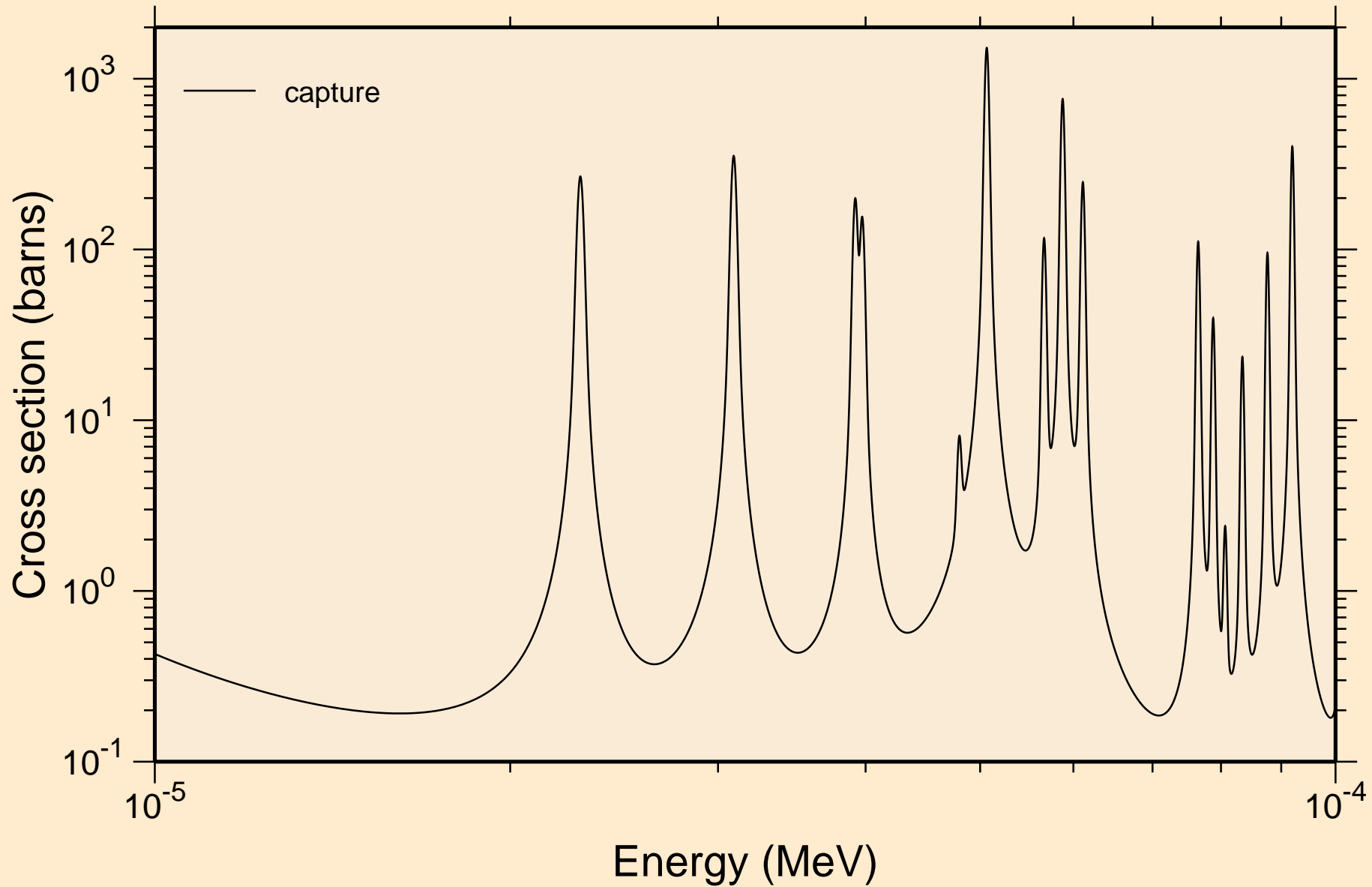

RH110M NEUTRON ACER TENDL-2021 LIBRARY; T=293.6K
resonance absorption cross sections

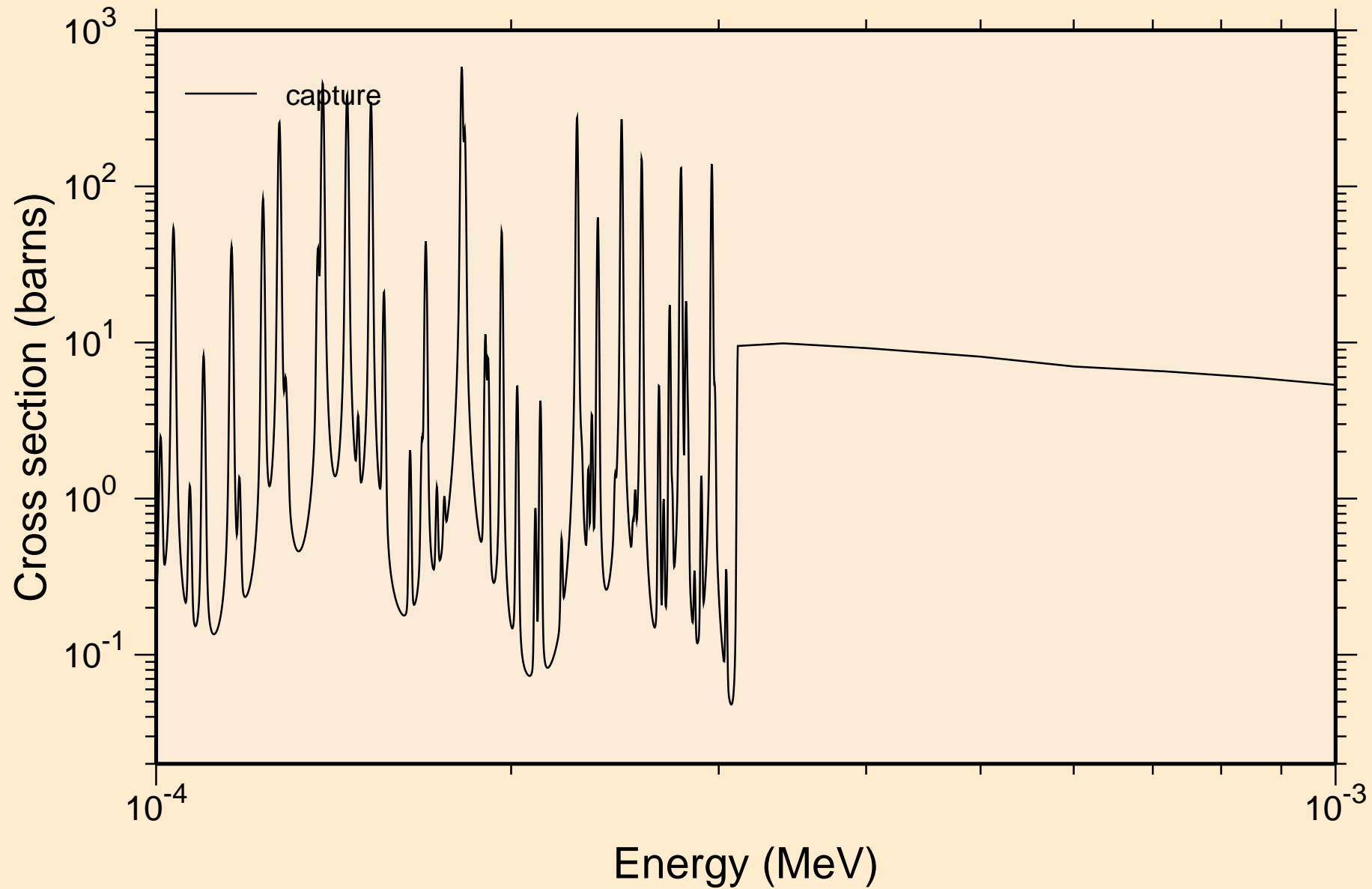

RH110M NEUTRON ACER TENDL-2021 LIBRARY; T=293.6K
resonance absorption cross sections

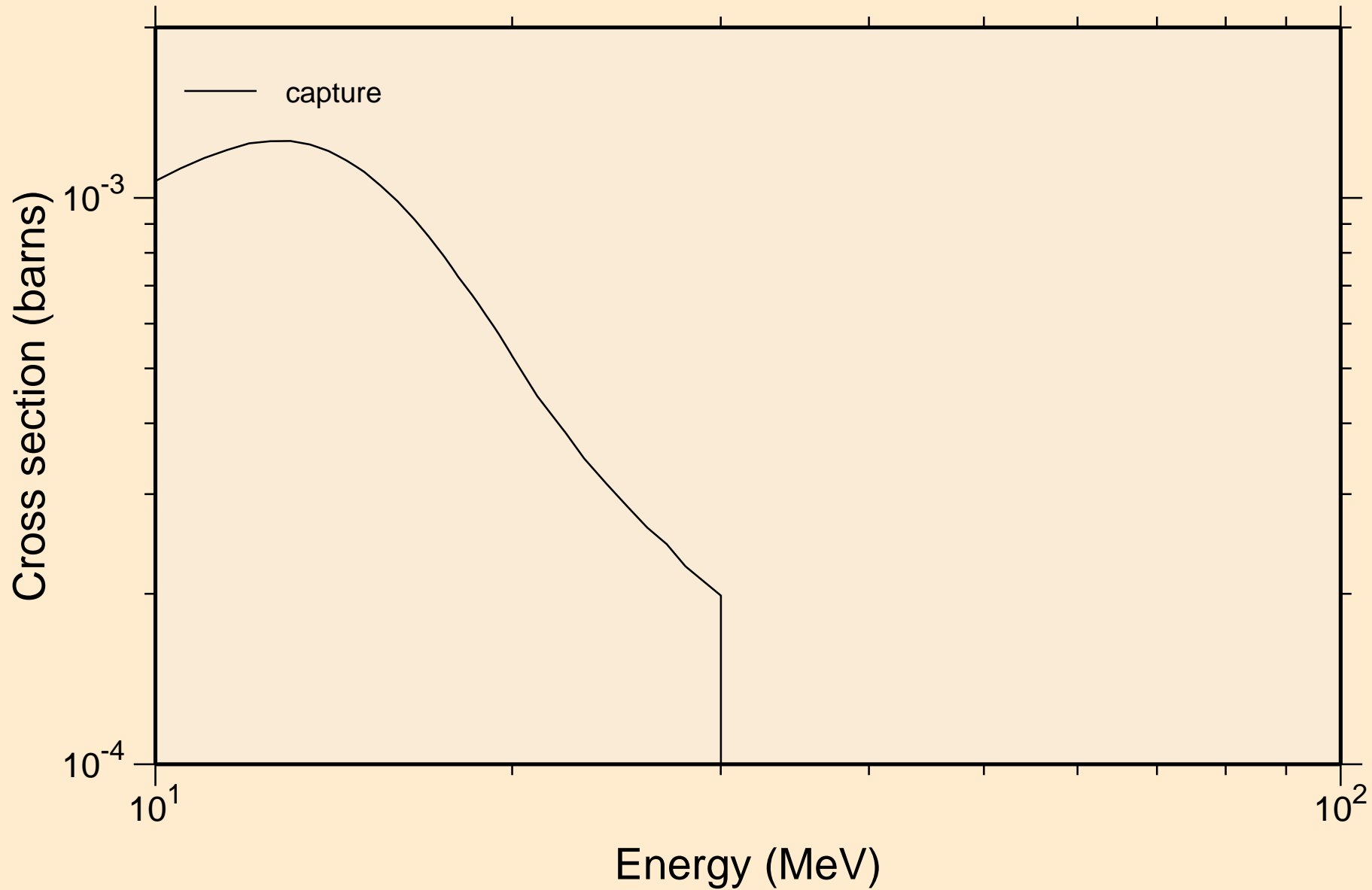

RH110M NEUTRON ACER TENDL-2021 LIBRARY; T=293.6K
Heating

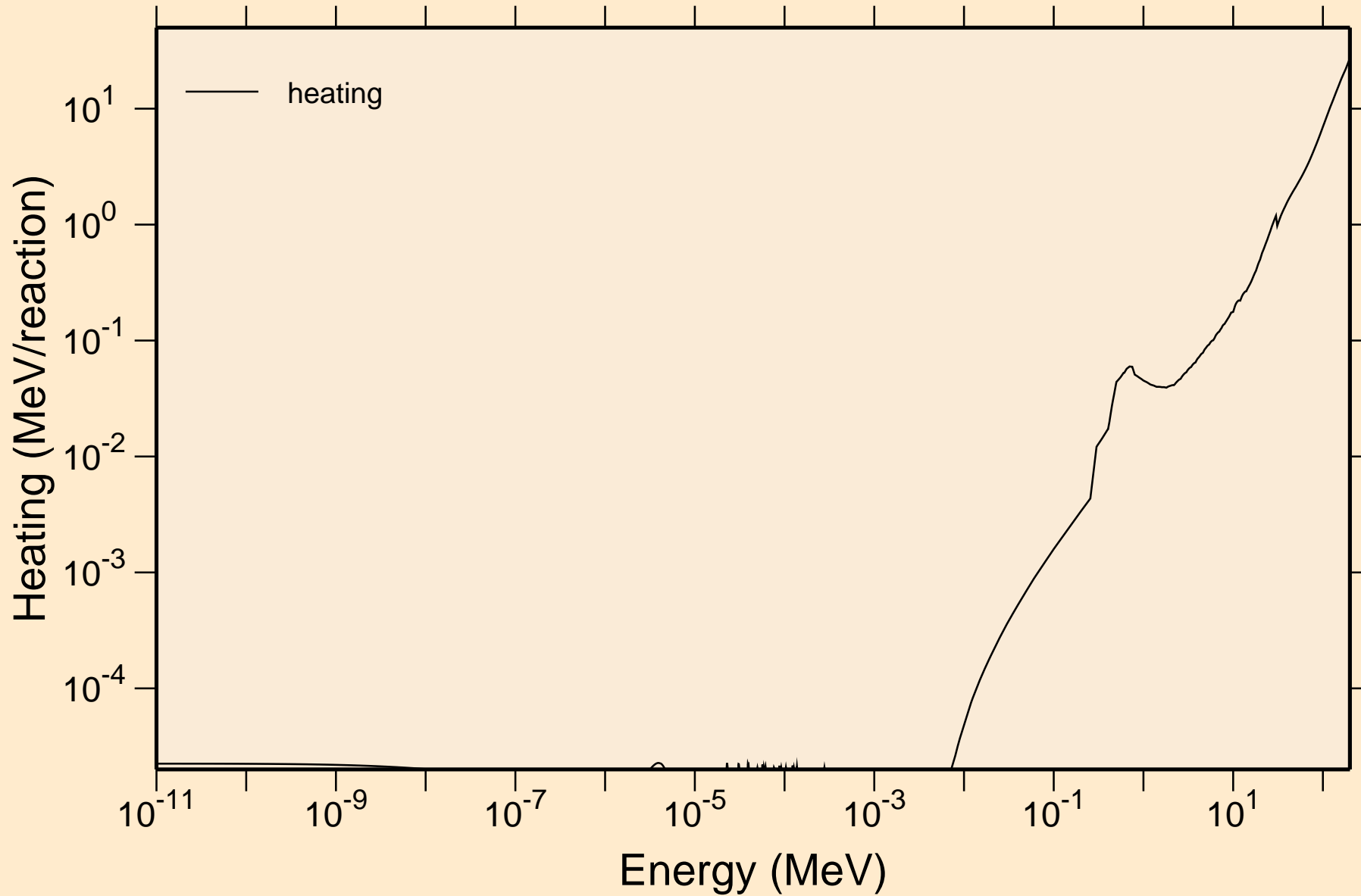

RH110M NEUTRON ACER TENDL-2021 LIBRARY; T=293.6K
Damage

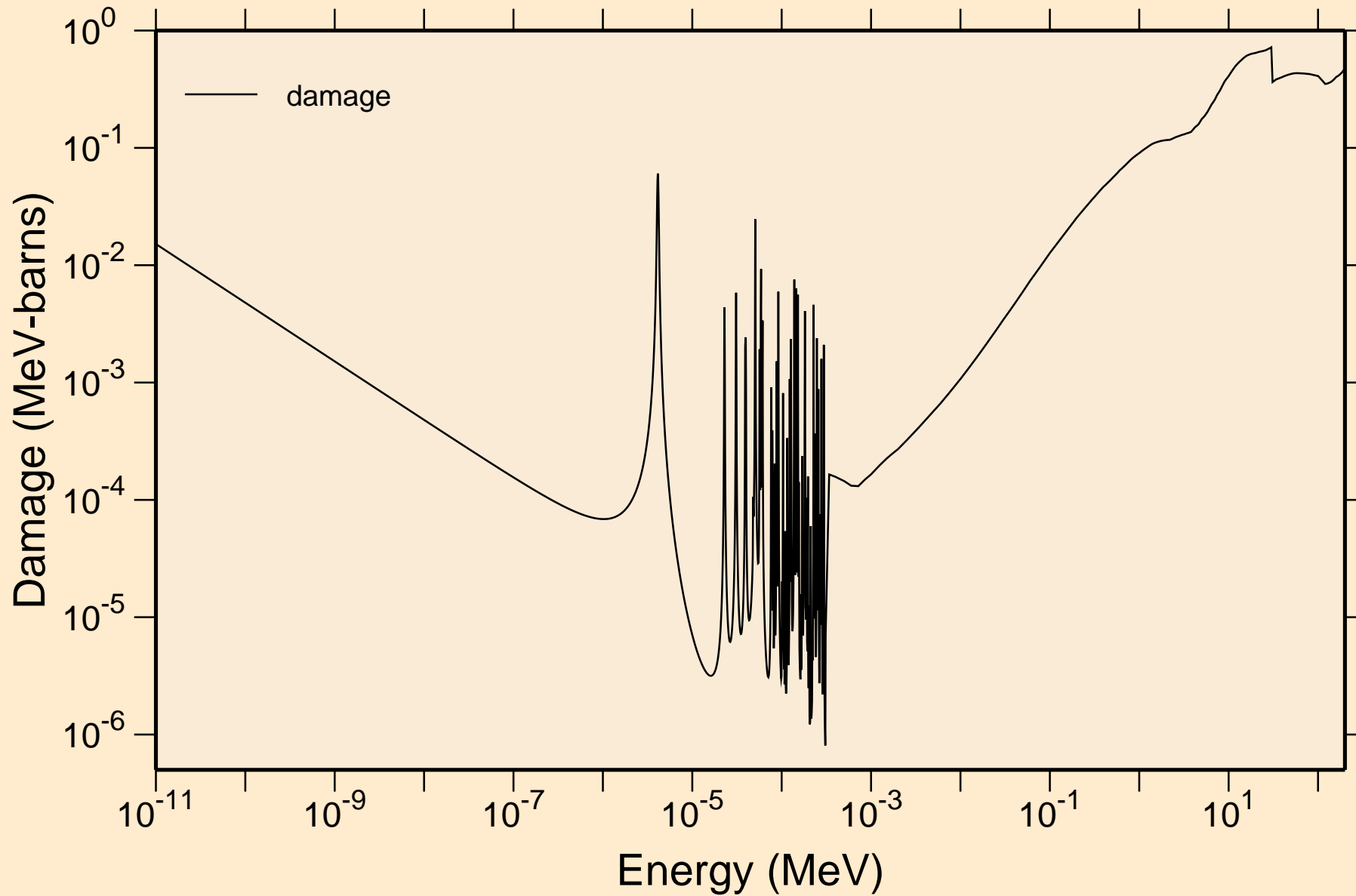

RH110M NEUTRON ACER TENDL-2021 LIBRARY; T=293.6K
Non-threshold reactions

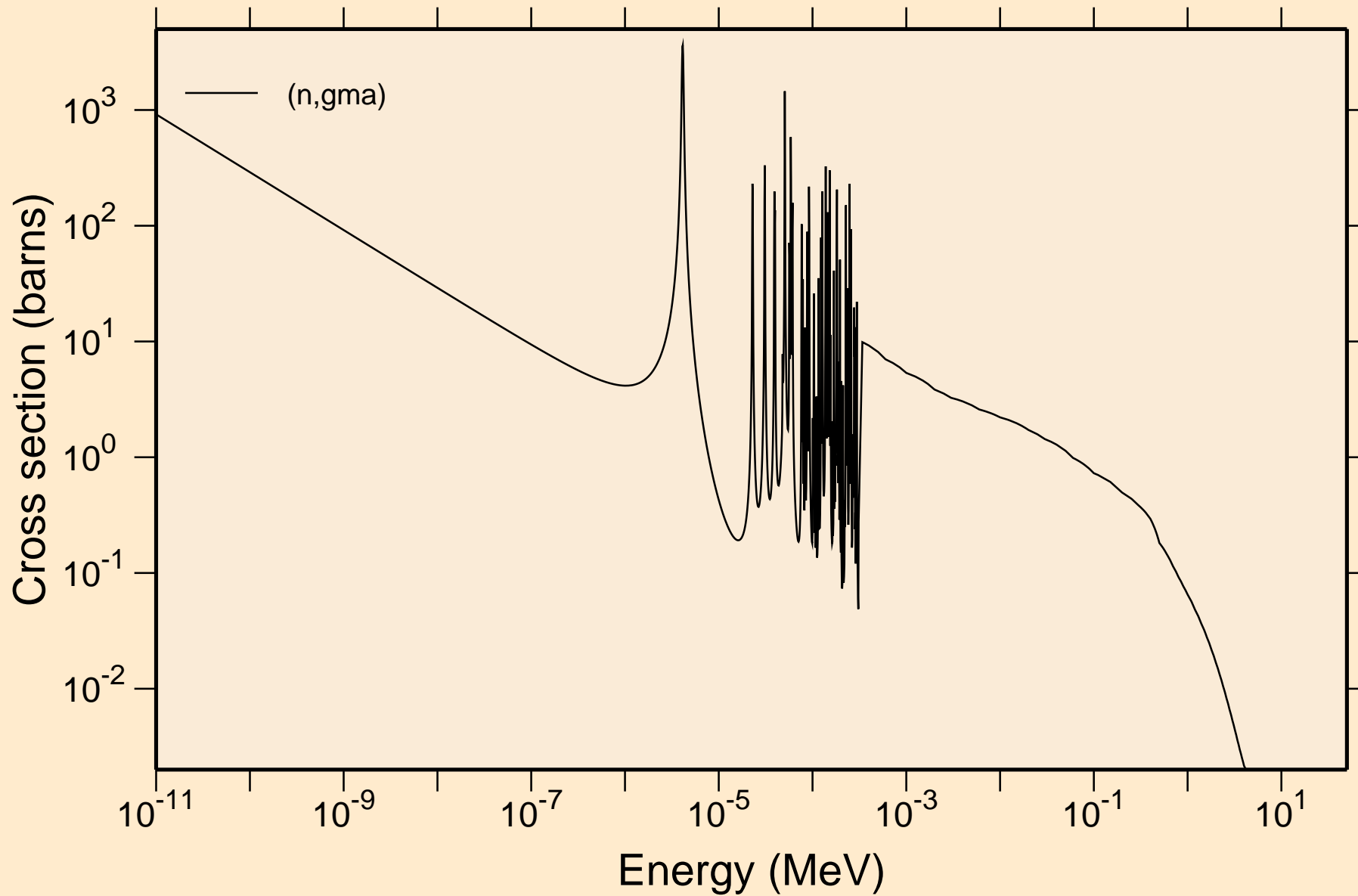

RH110M NEUTRON ACER TENDL-2021 LIBRARY; T=293.6K
Principal cross sections

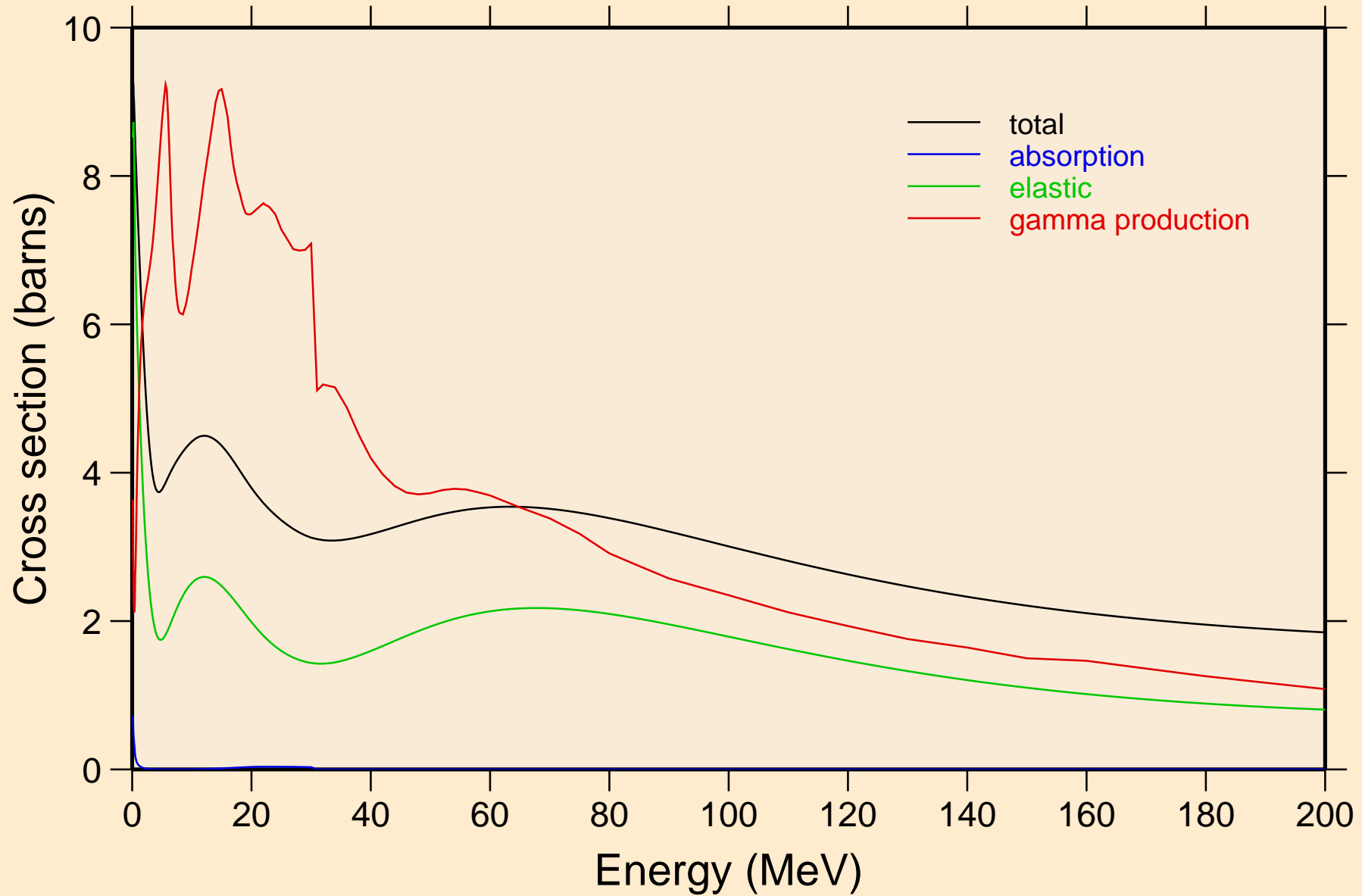

RH110M NEUTRON ACER TENDL-2021 LIBRARY; T=293.6K
Heating

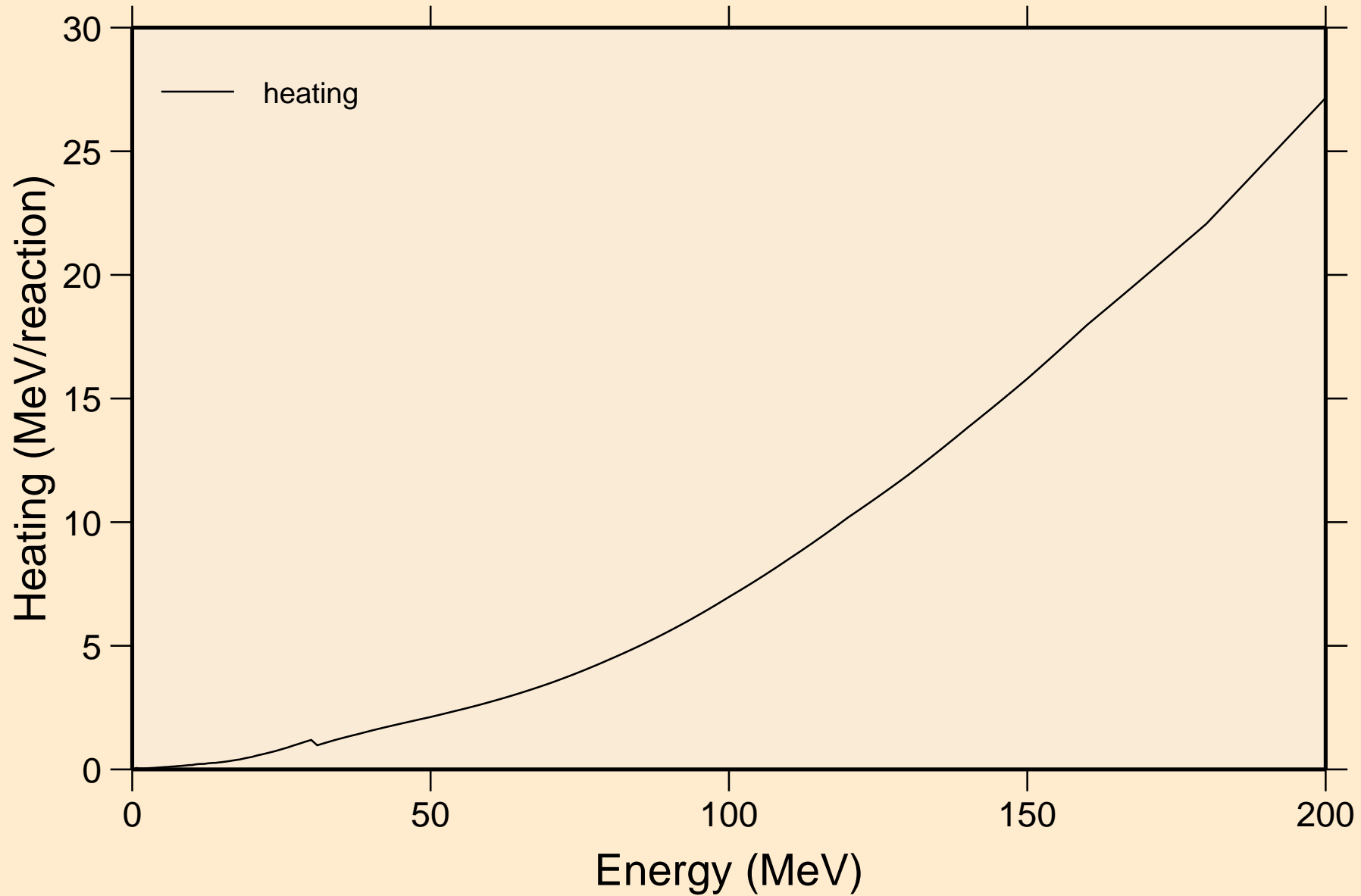

RH110M NEUTRON ACER TENDL-2021 LIBRARY; T=293.6K
Damage

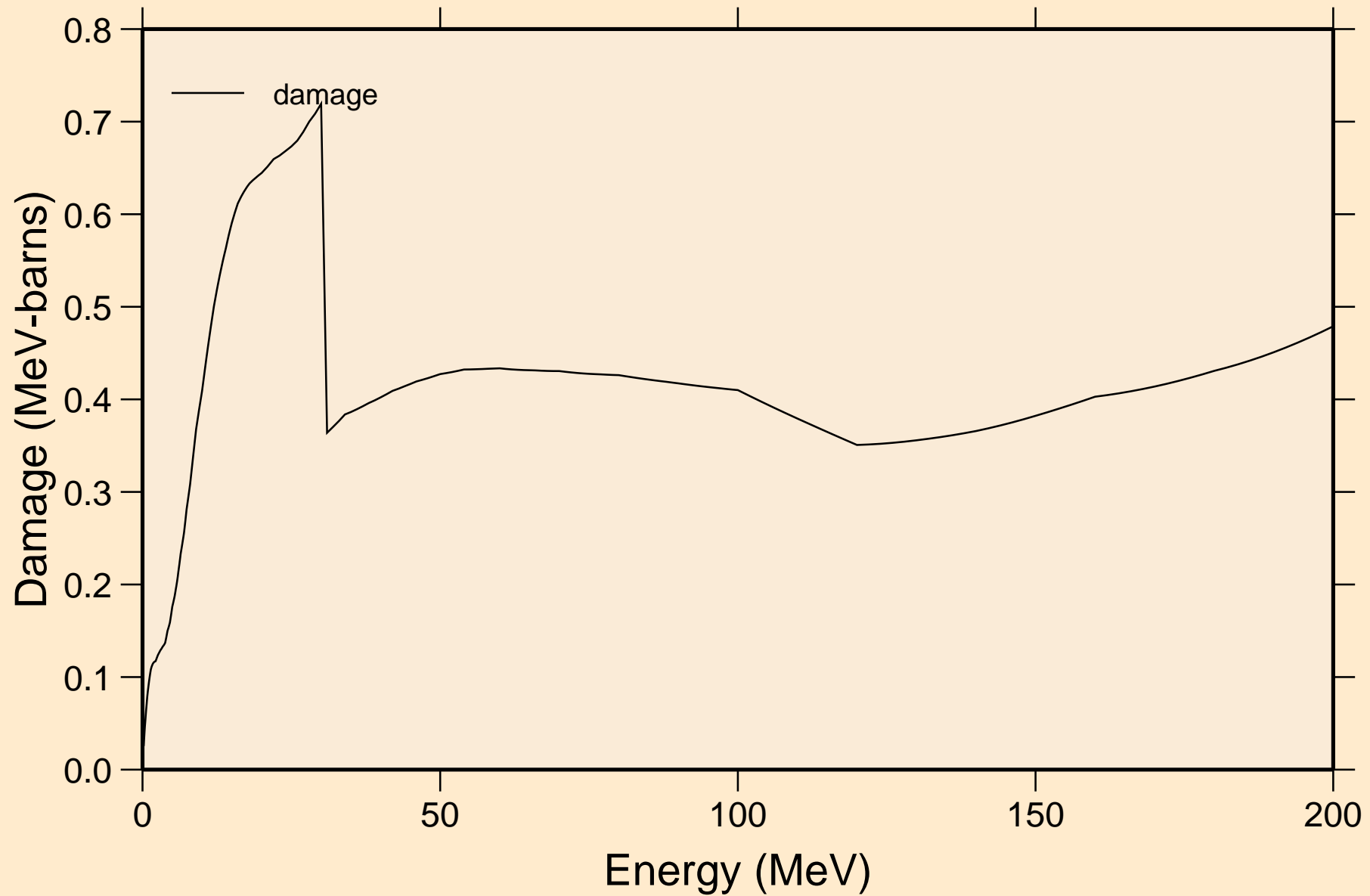

RH110M NEUTRON ACER TENDL-2021 LIBRARY; T=293.6K
Non-threshold reactions

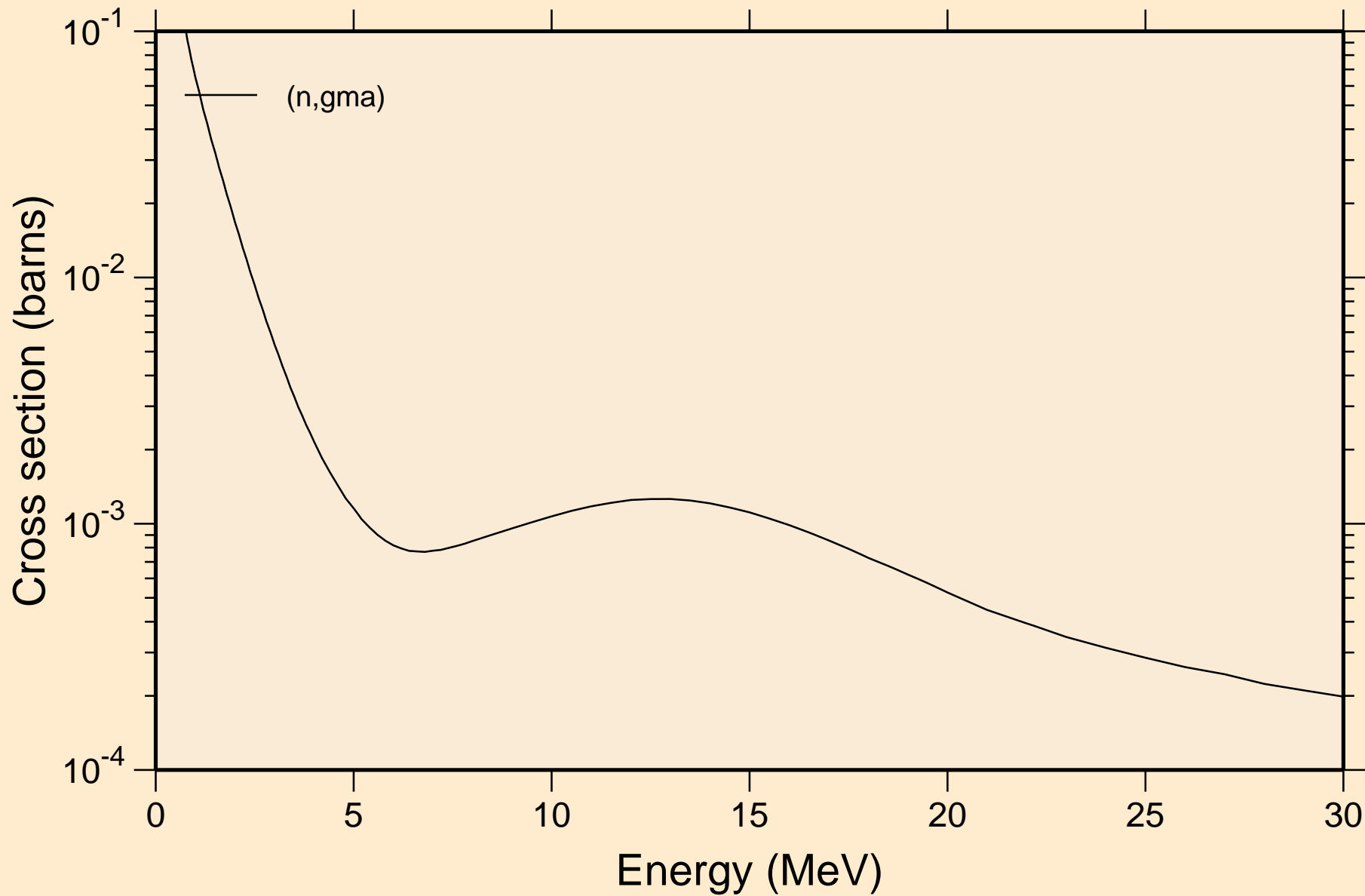

RH110M NEUTRON ACER TENDL-2021 LIBRARY; T=293.6K
Inelastic levels

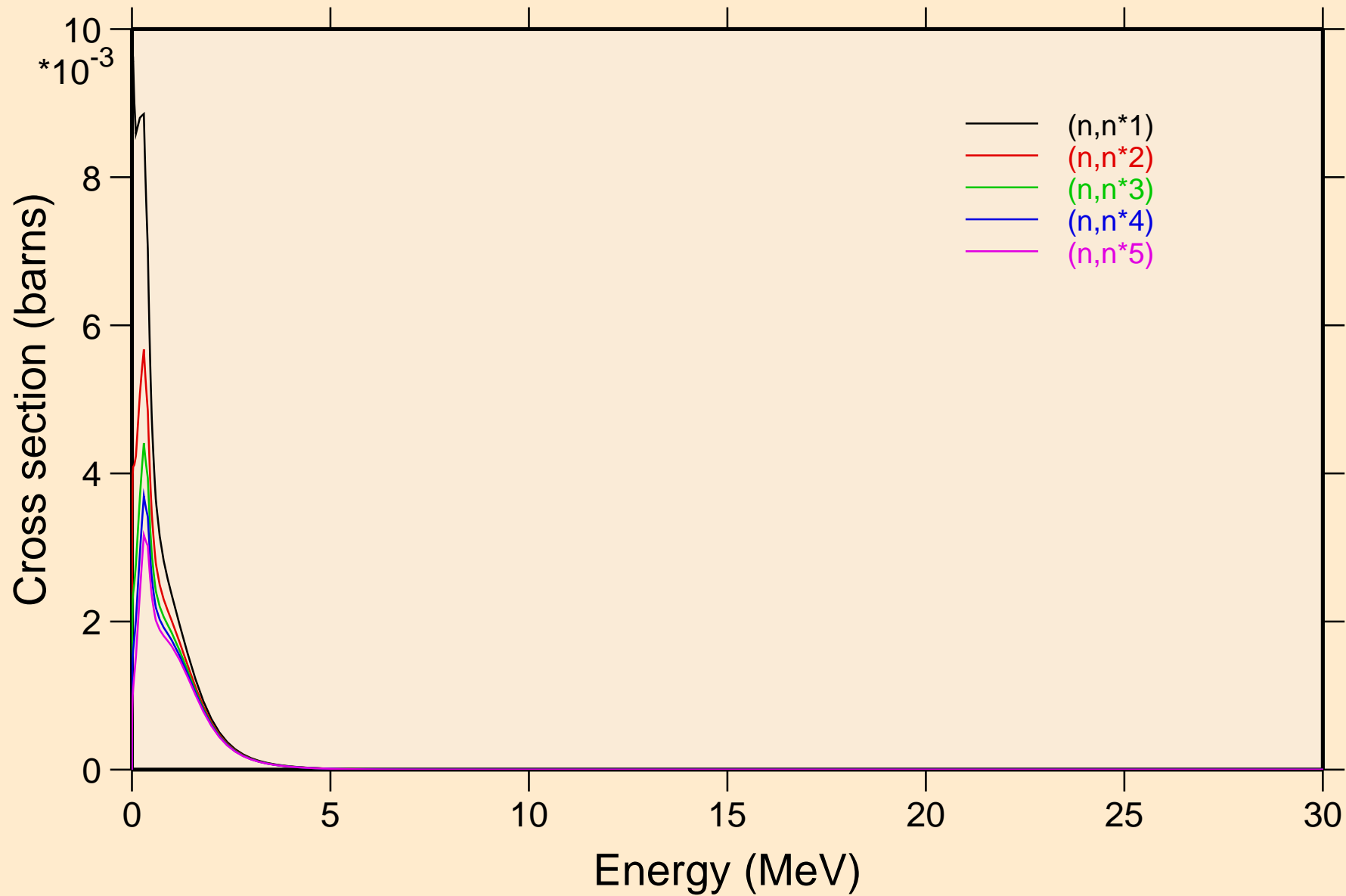

RH110M NEUTRON ACER TENDL-2021 LIBRARY; T=293.6K
Inelastic levels

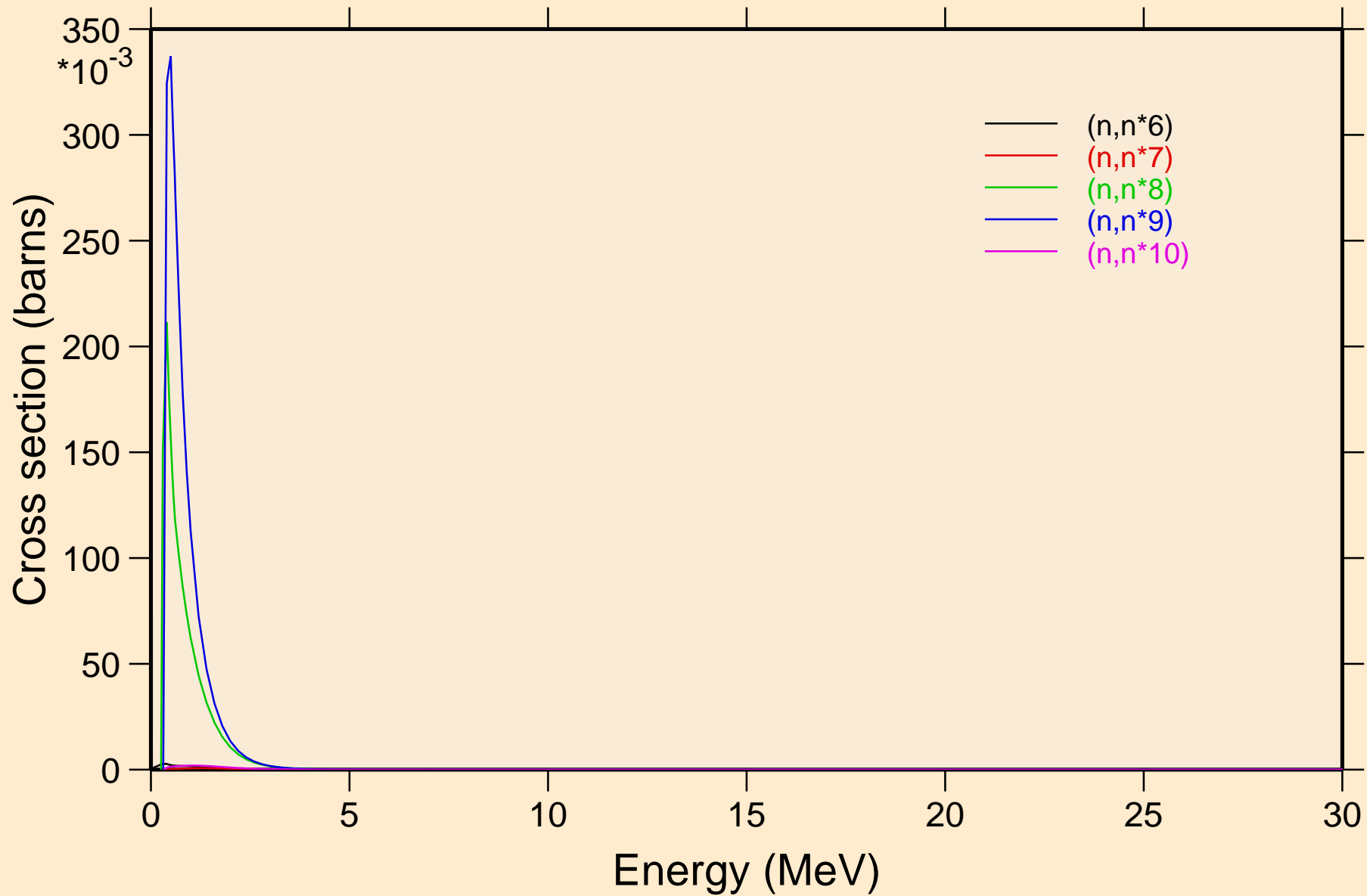

RH110M NEUTRON ACER TENDL-2021 LIBRARY; T=293.6K
Inelastic levels

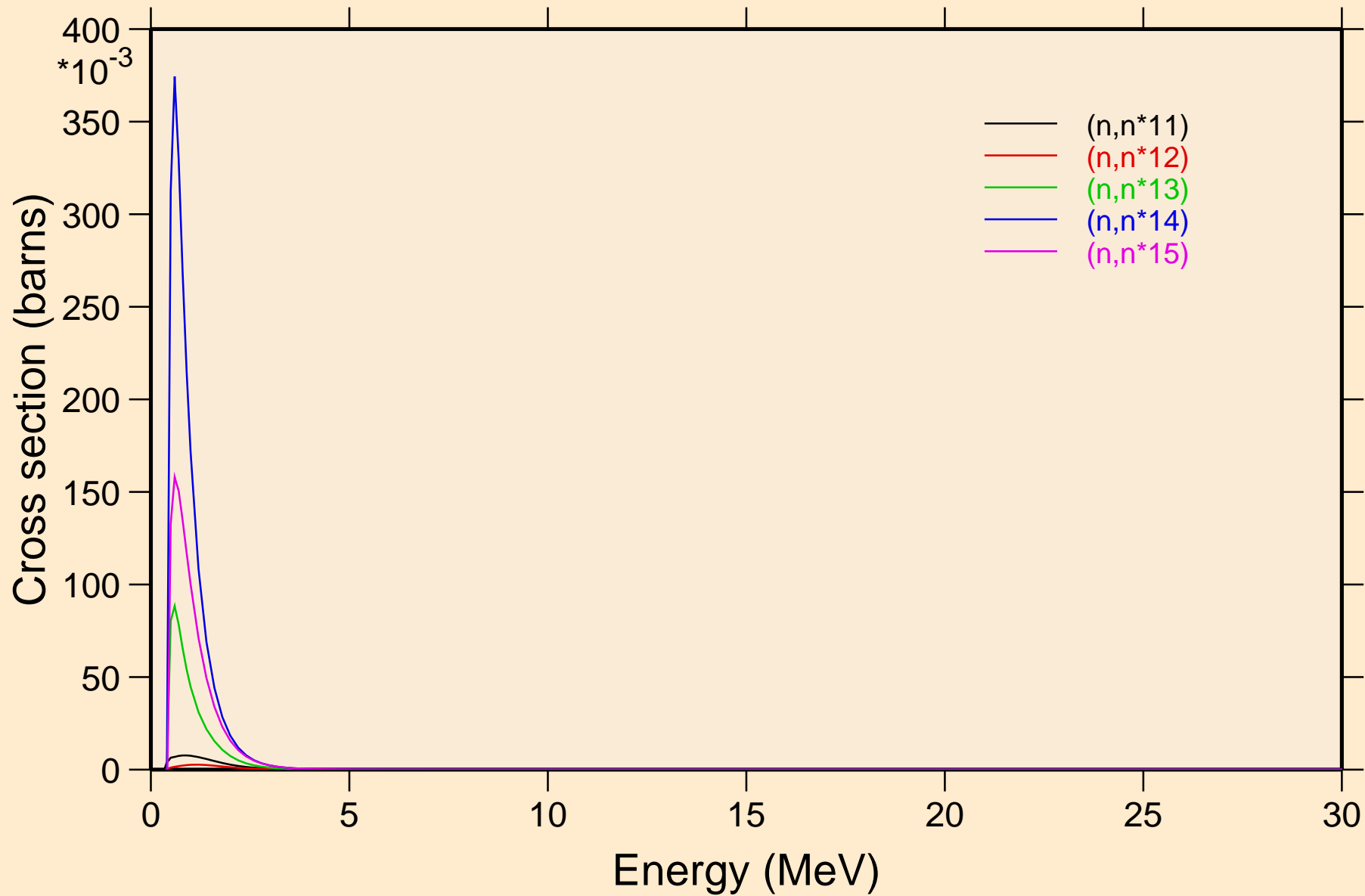

RH110M NEUTRON ACER TENDL-2021 LIBRARY; T=293.6K
Inelastic levels

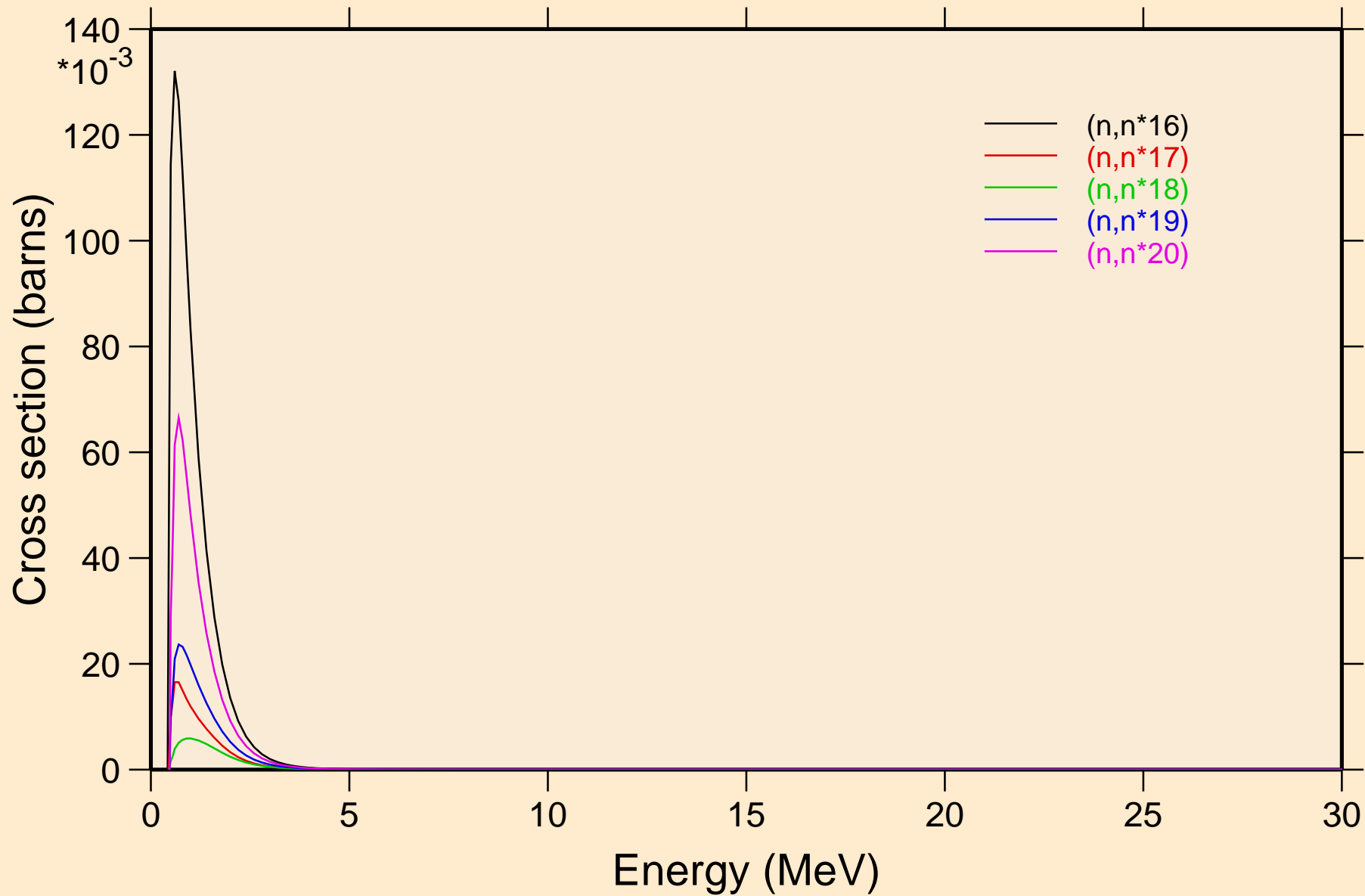

RH110M NEUTRON ACER TENDL-2021 LIBRARY; T=293.6K
Inelastic levels

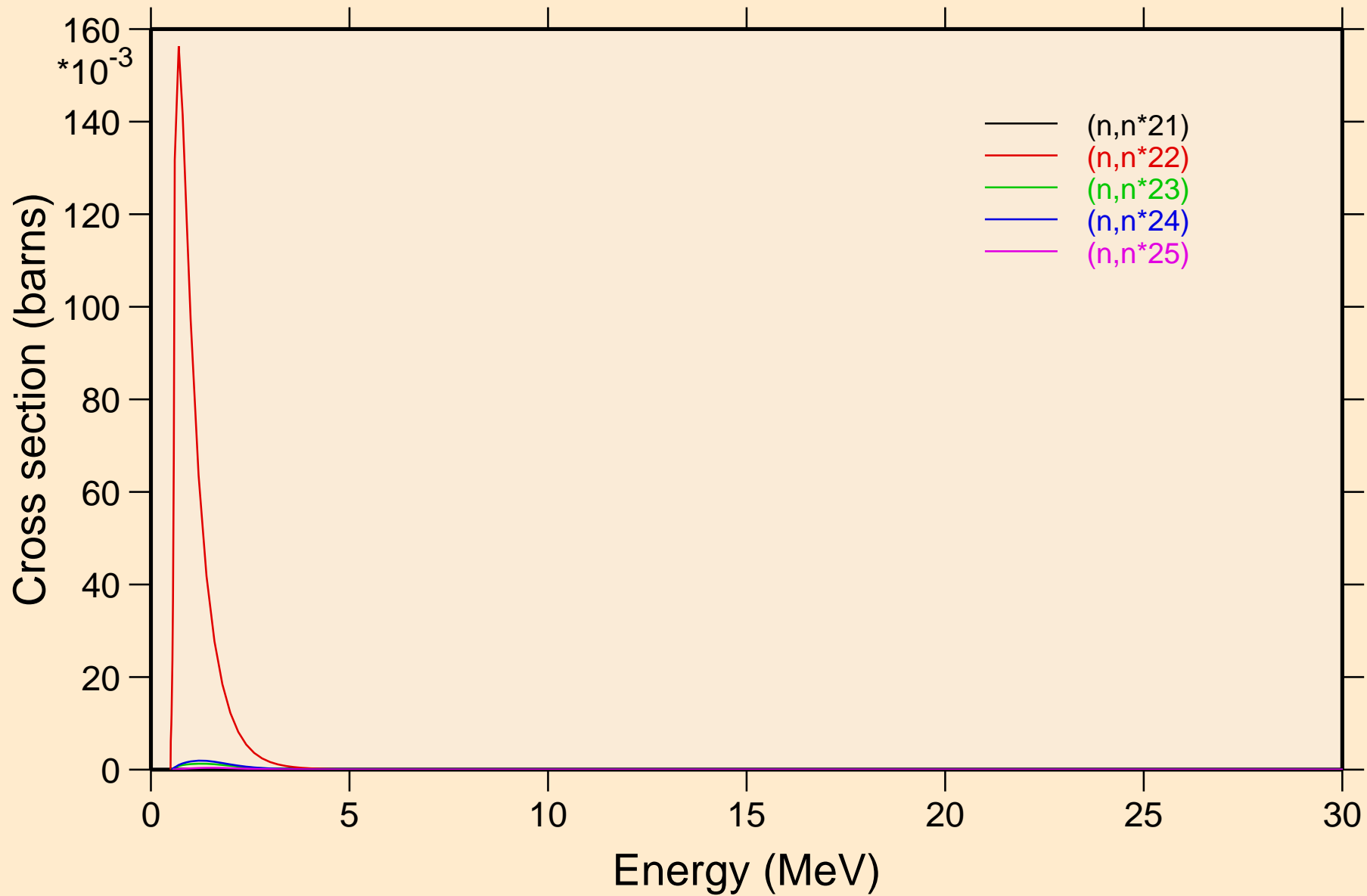

RH110M NEUTRON ACER TENDL-2021 LIBRARY; T=293.6K
Inelastic levels

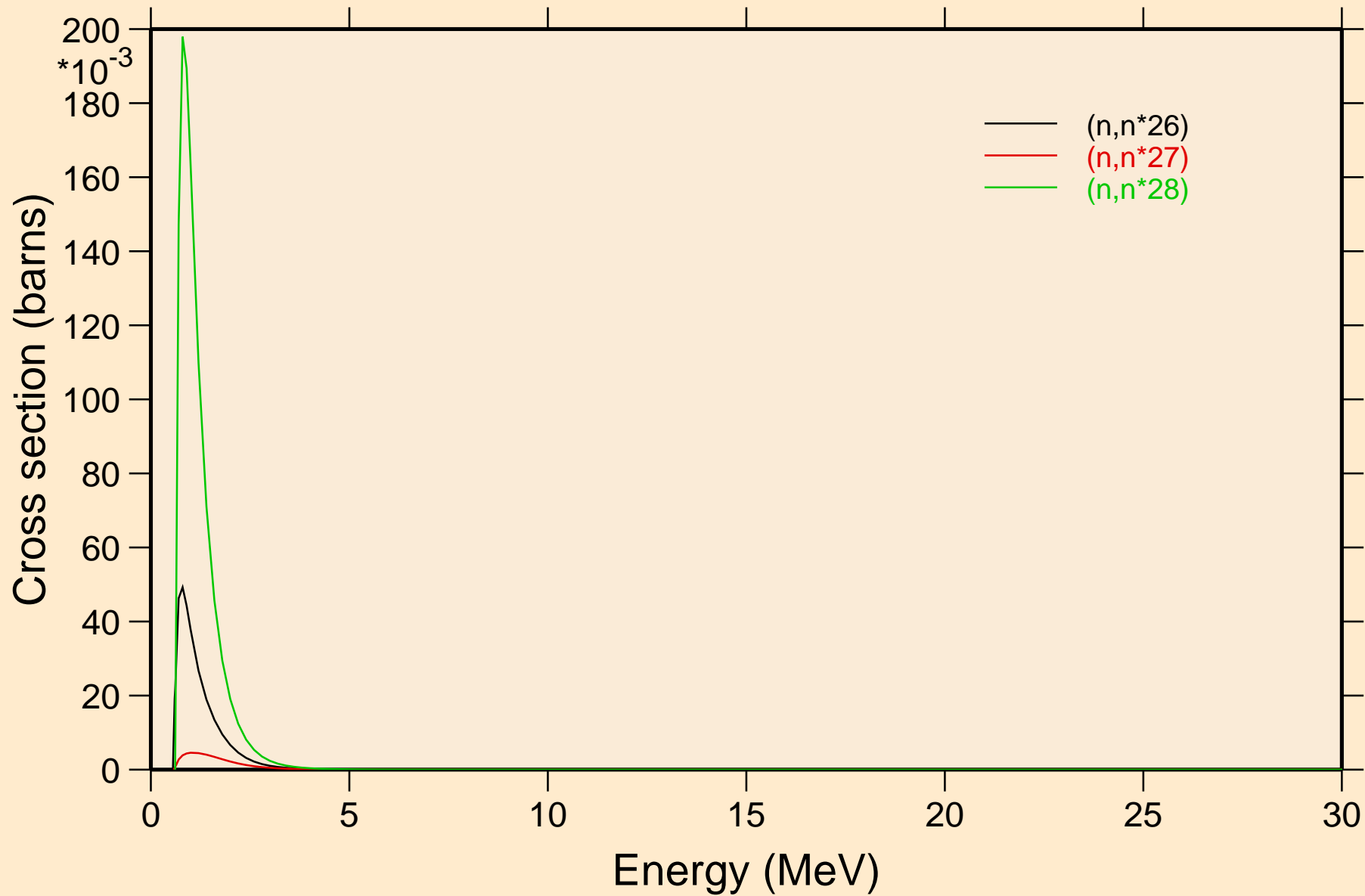

RH110M NEUTRON ACER TENDL-2021 LIBRARY; T=293.6K
Threshold reactions

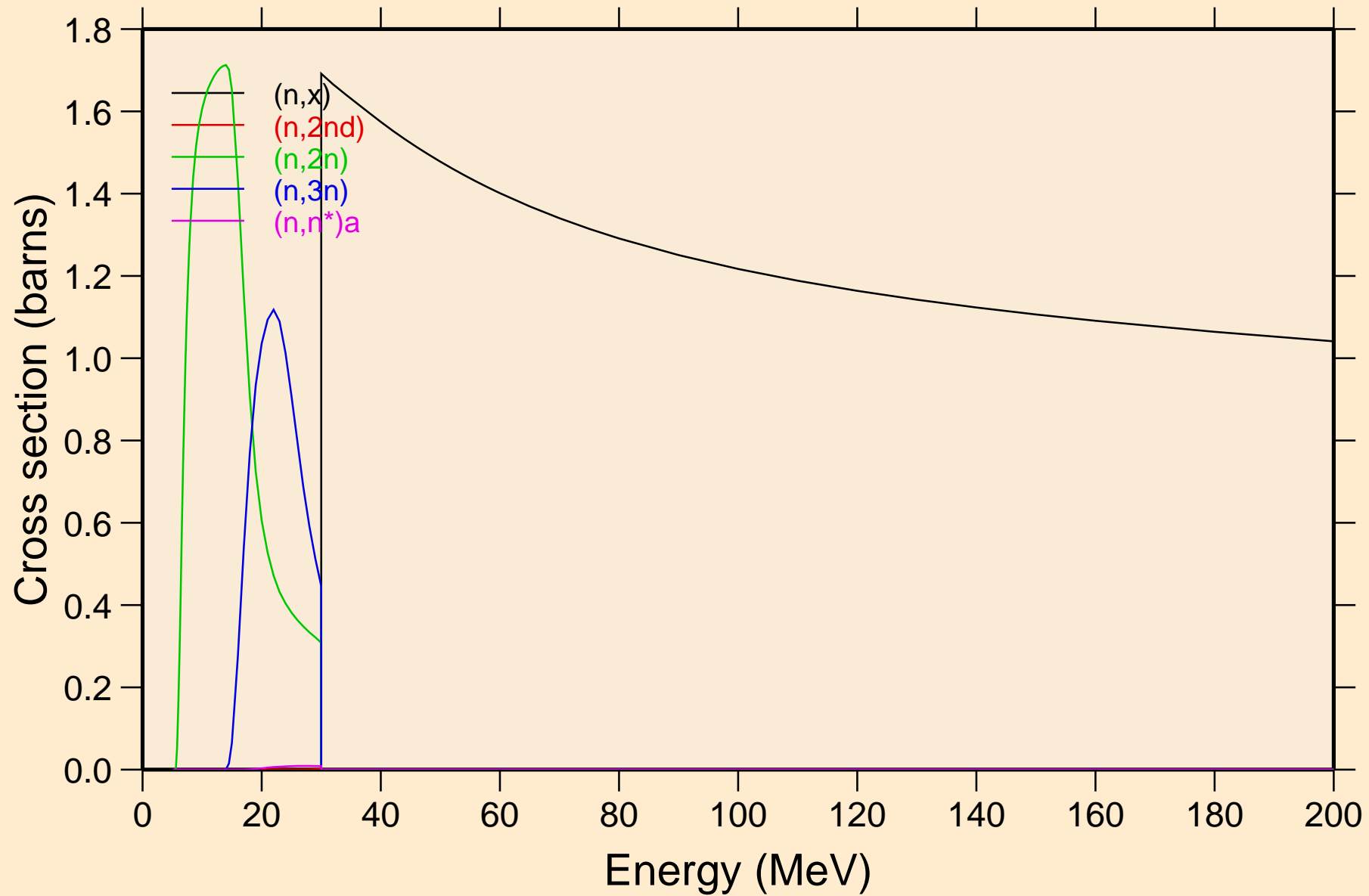

RH110M NEUTRON ACER TENDL-2021 LIBRARY; T=293.6K

Threshold reactions

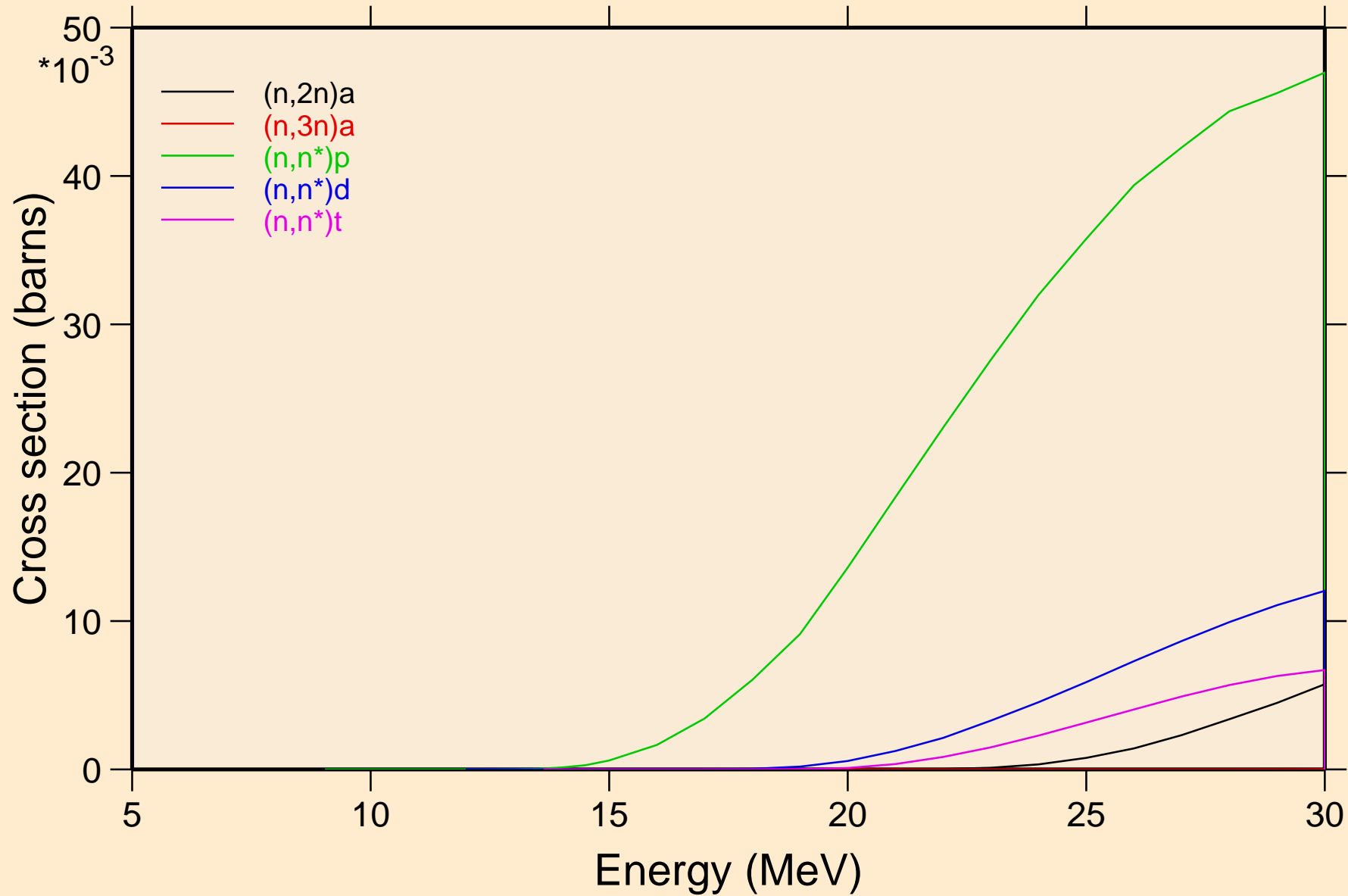

RH110M NEUTRON ACER TENDL-2021 LIBRARY; T=293.6K
Threshold reactions

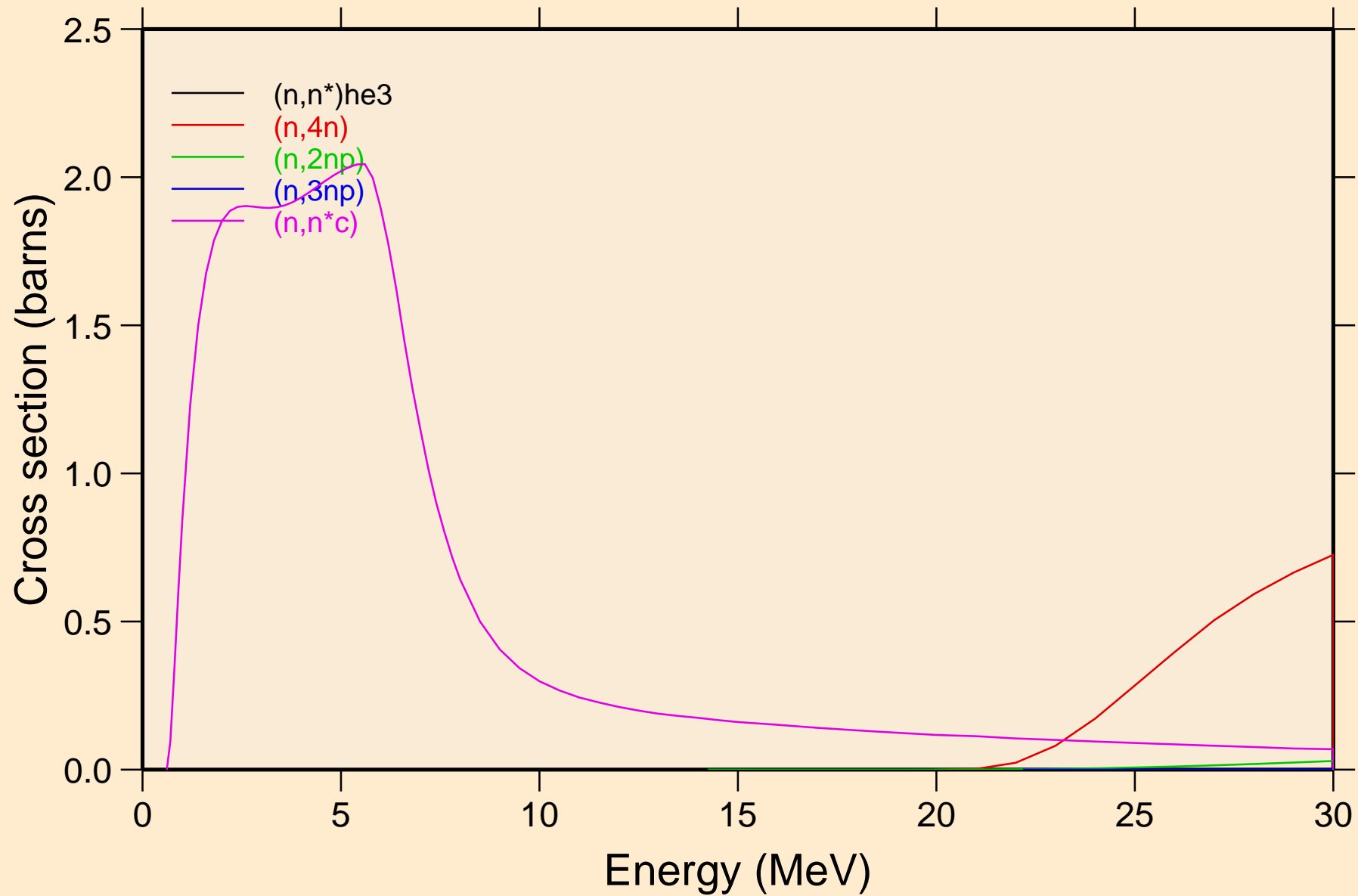

RH110M NEUTRON ACER TENDL-2021 LIBRARY; T=293.6K
Threshold reactions

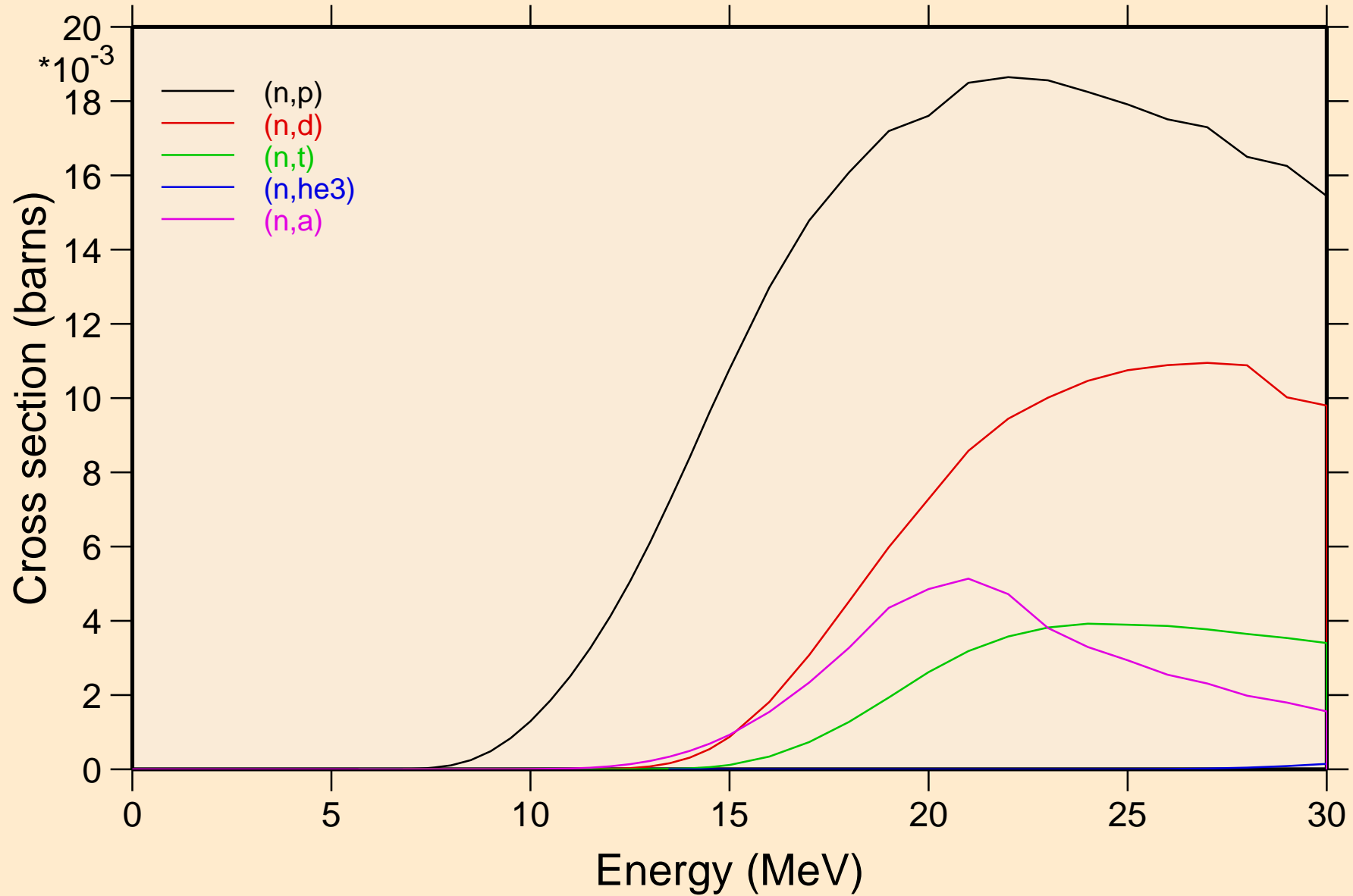

RH110M NEUTRON ACER TENDL-2021 LIBRARY; T=293.6K
Threshold reactions

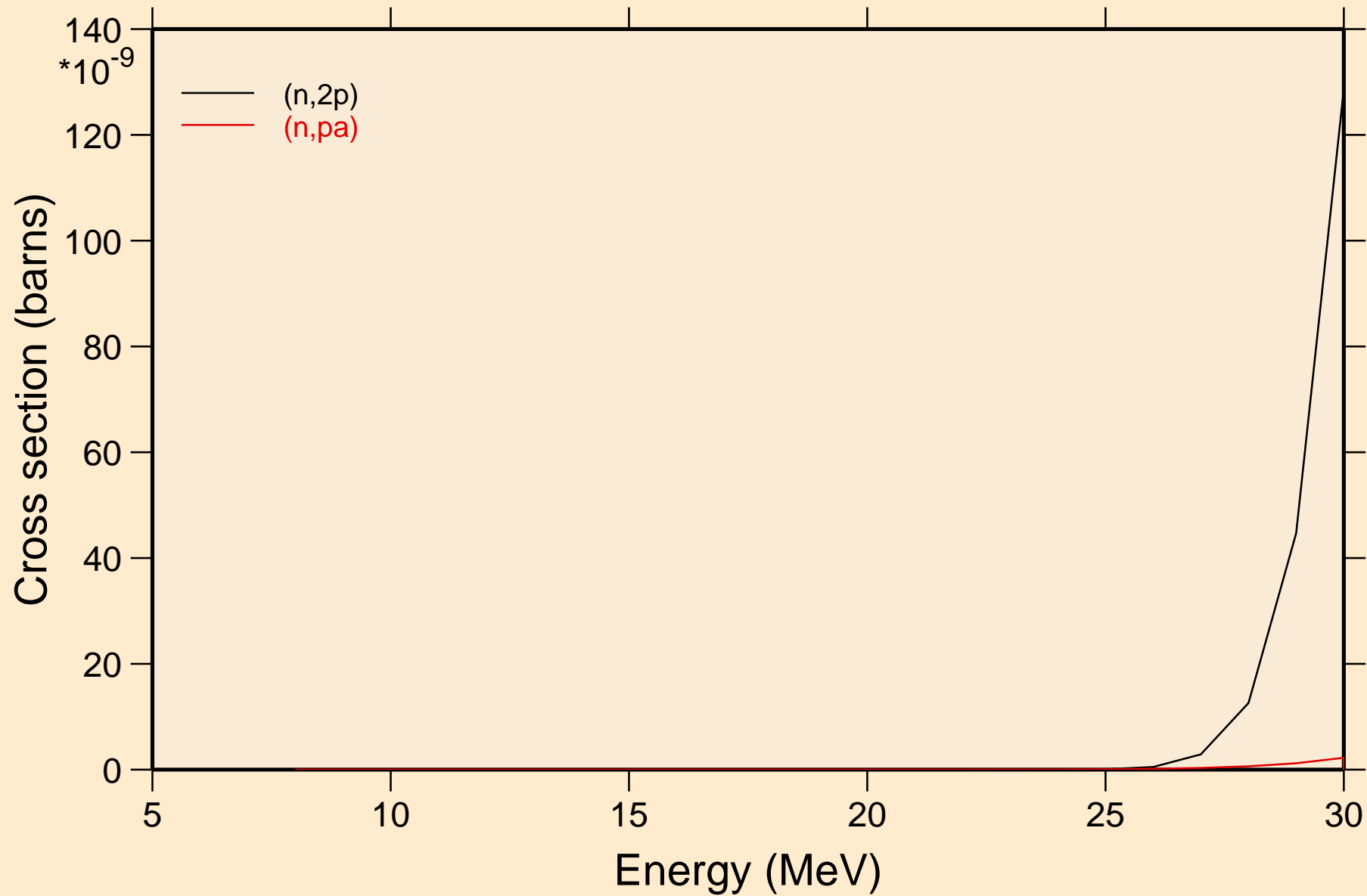

RH110M NEUTRON ACER TENDL-2021 LIBRARY; T=293.6K
Threshold reactions

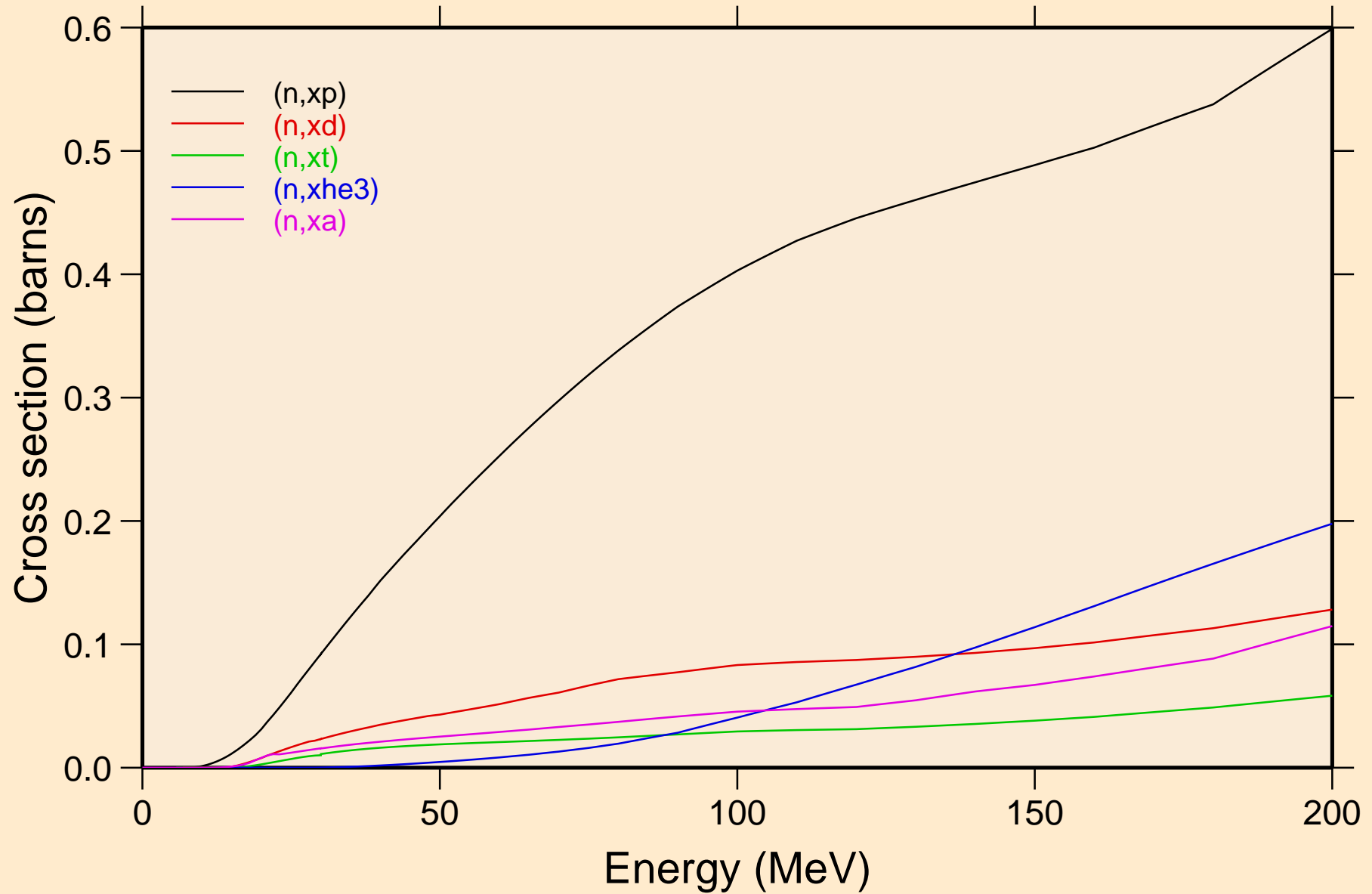

RH110M NEUTRON ACER TENDL-2021 LIBRARY; T=293.6K
angular distribution for elastic

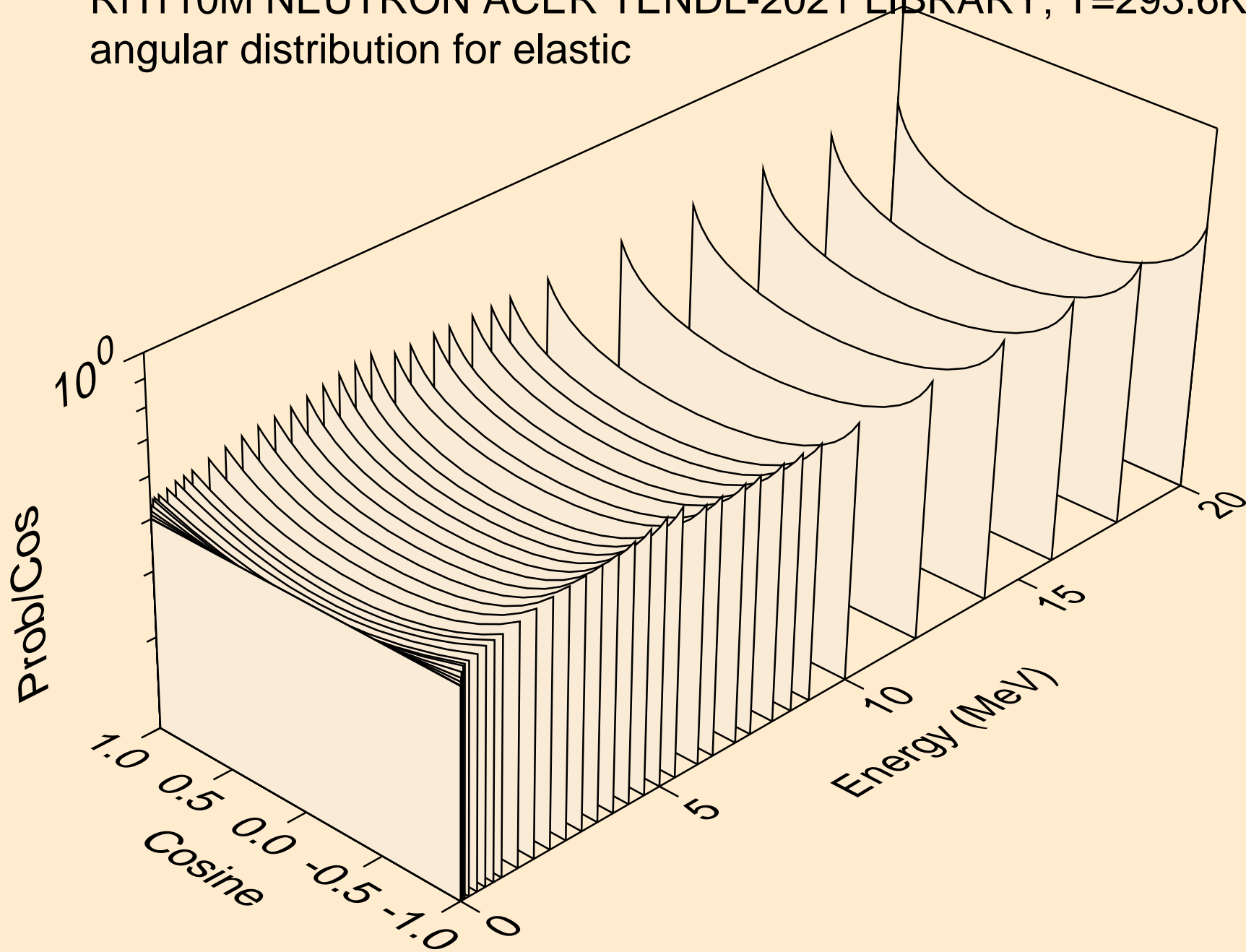

RH110M NEUTRON ACER TENDL-2021 LIBRARY; T=293.6K
angular distribution for elastic

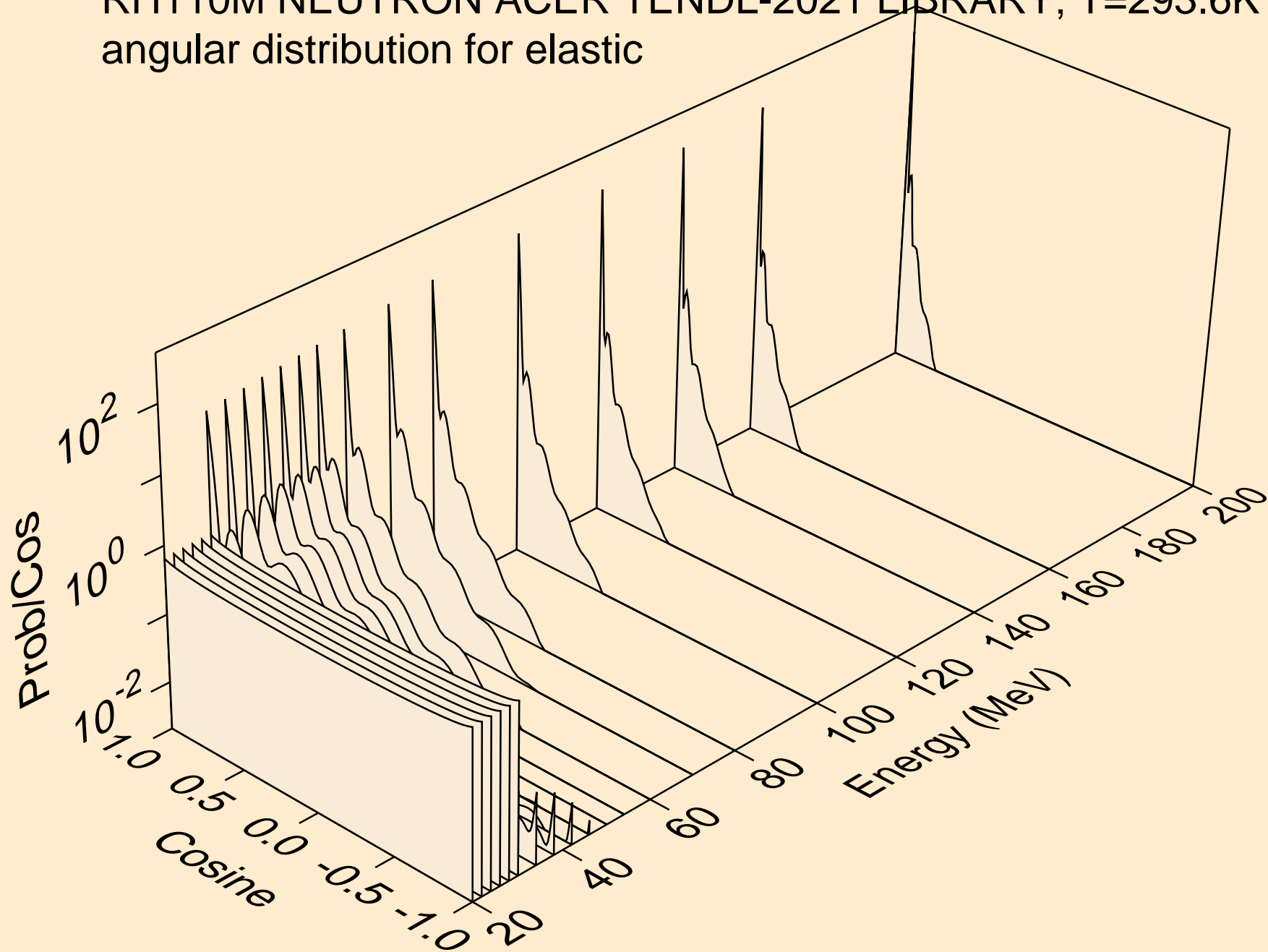

RH110M NEUTRON ACER TENDL-2021 LIBRARY; T=293.6K
angular distribution for (n,n*1)

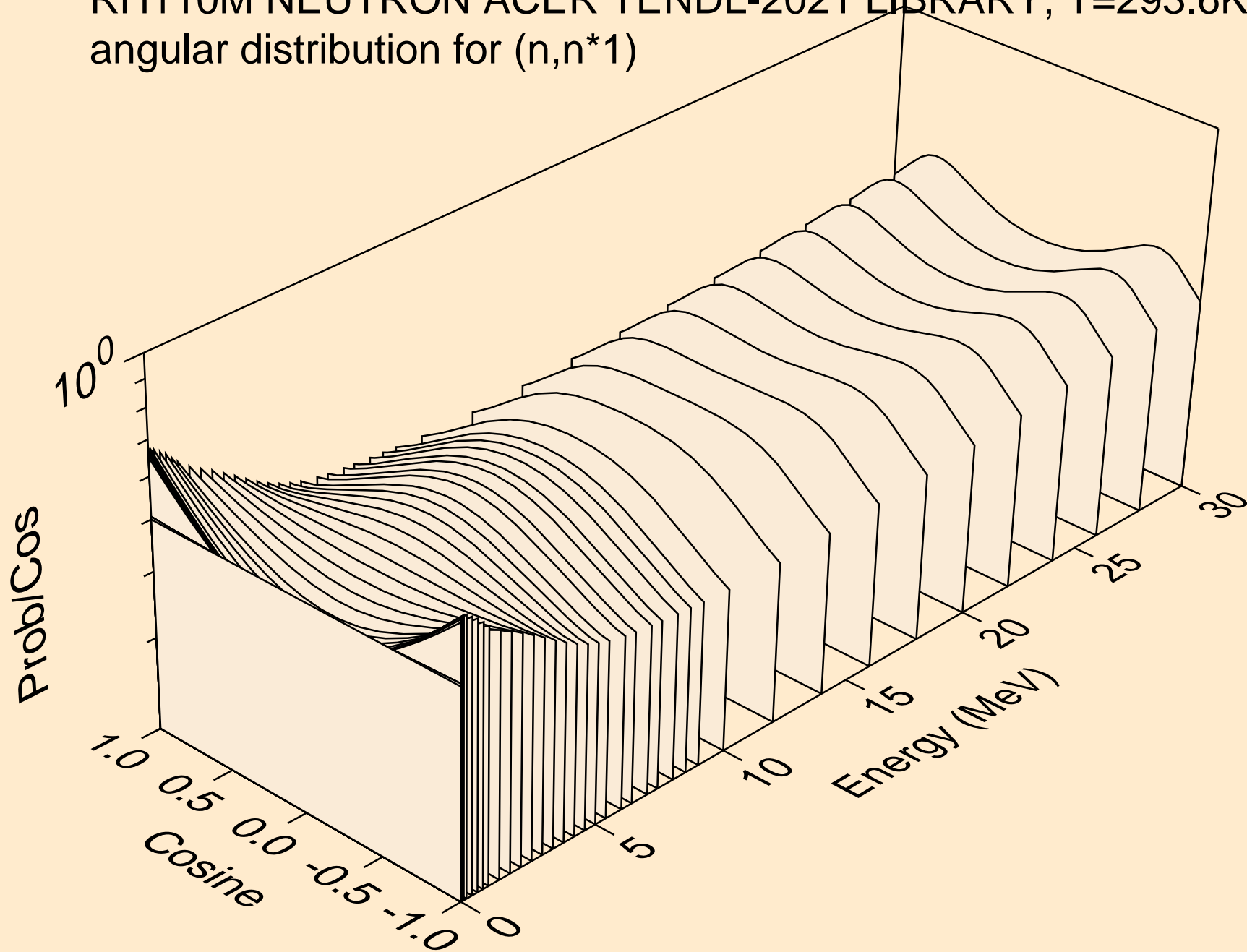

RH110M NEUTRON ACER TENDL-2021 LIBRARY; T=293.6K
angular distribution for (n,n*2)

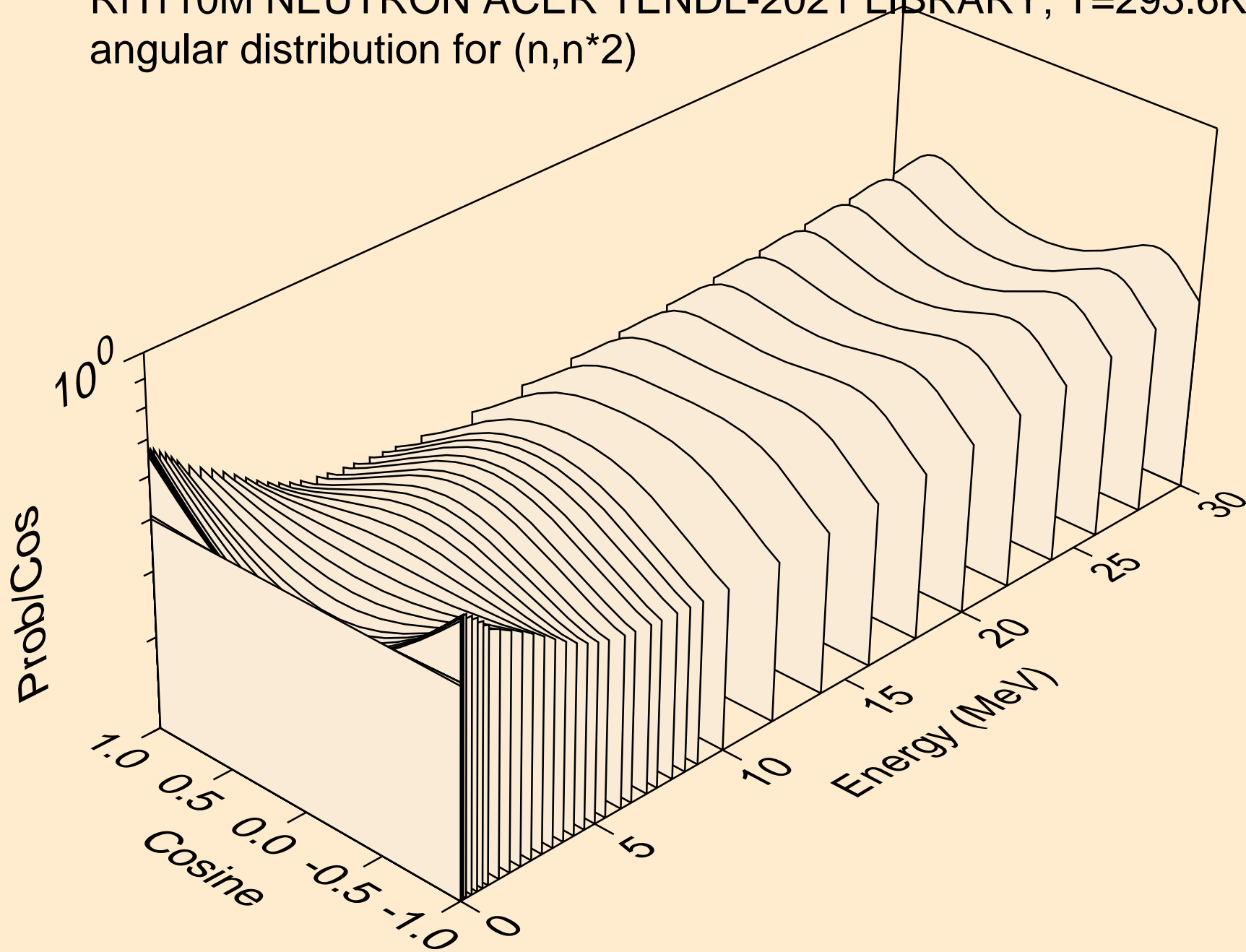

RH110M NEUTRON ACER TENDL-2021 LIBRARY; T=293.6K
angular distribution for (n,n*3)

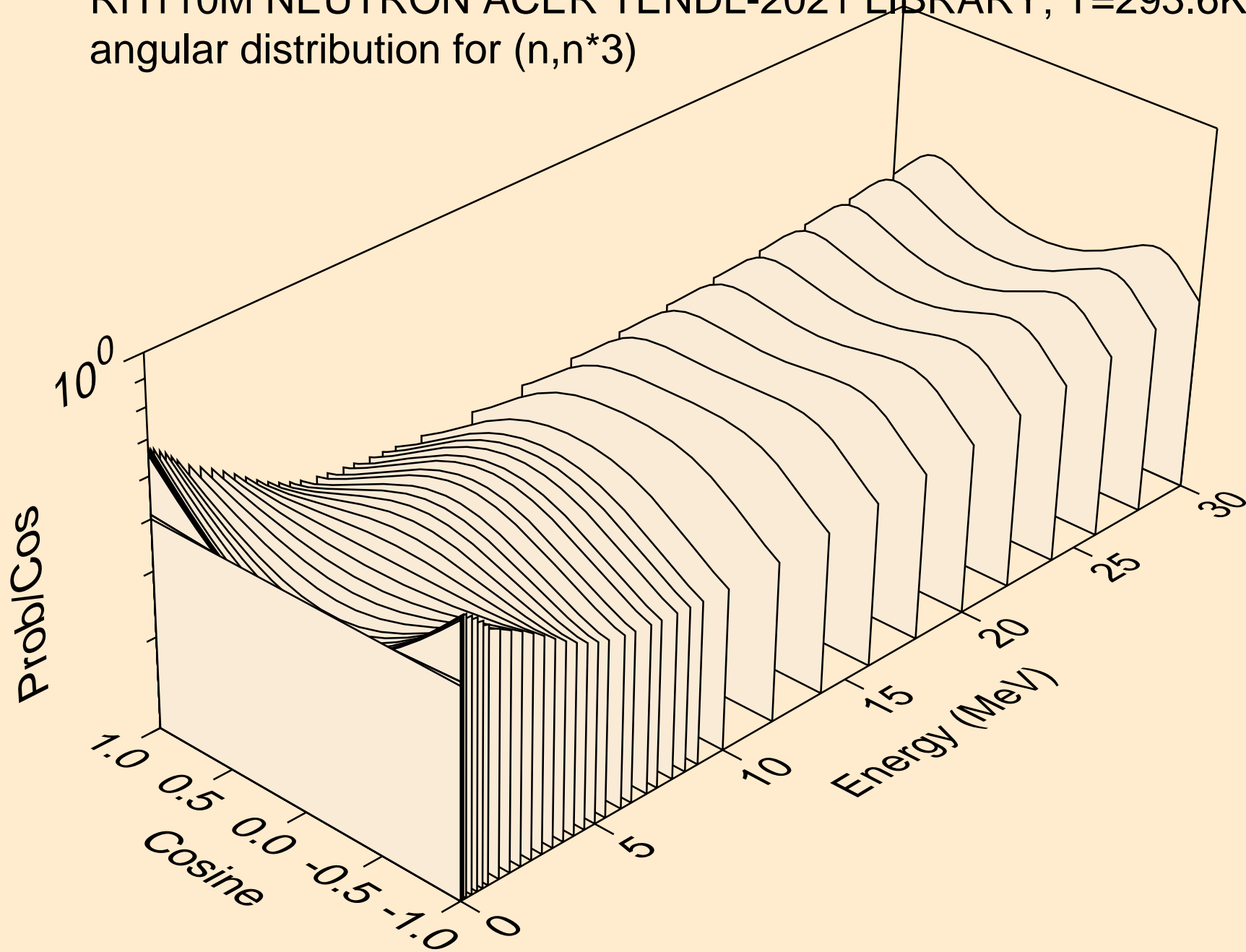

RH110M NEUTRON ACER TENDL-2021 LIBRARY; T=293.6K
angular distribution for (n,n*4)

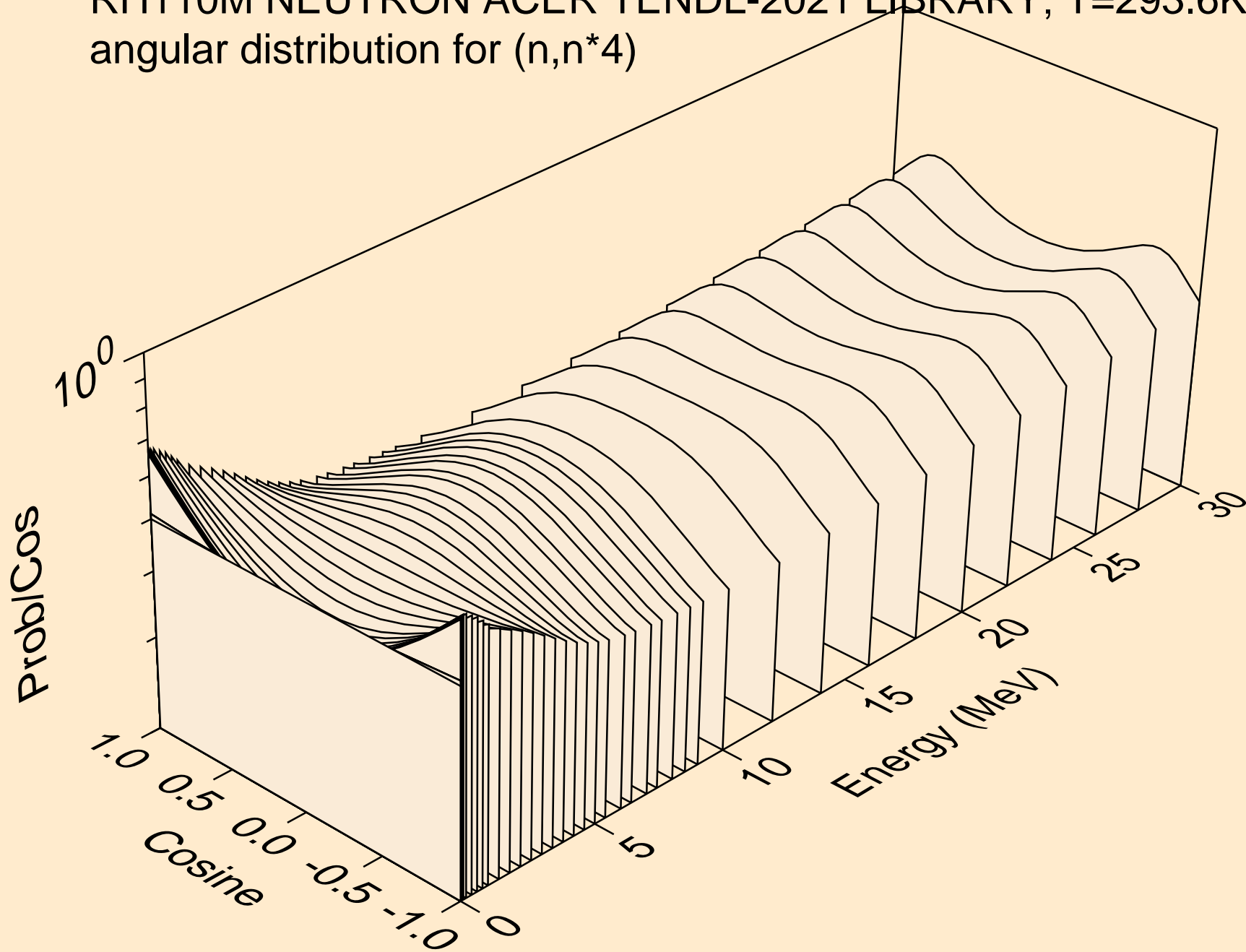

RH110M NEUTRON ACER TENDL-2021 LIBRARY; T=293.6K
angular distribution for (n,n*5)

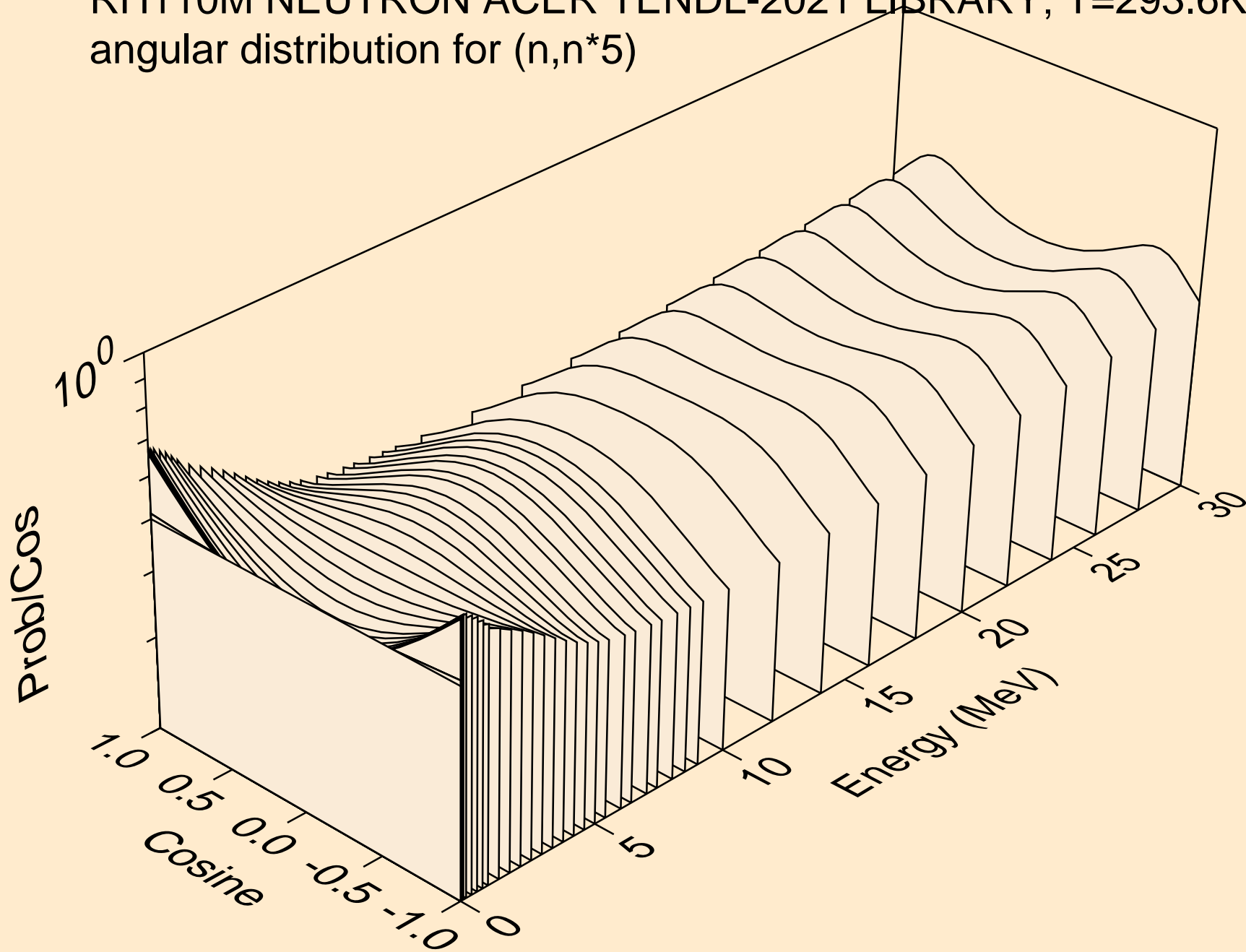

RH110M NEUTRON ACER TENDL-2021 LIBRARY; T=293.6K
angular distribution for (n,n*6)

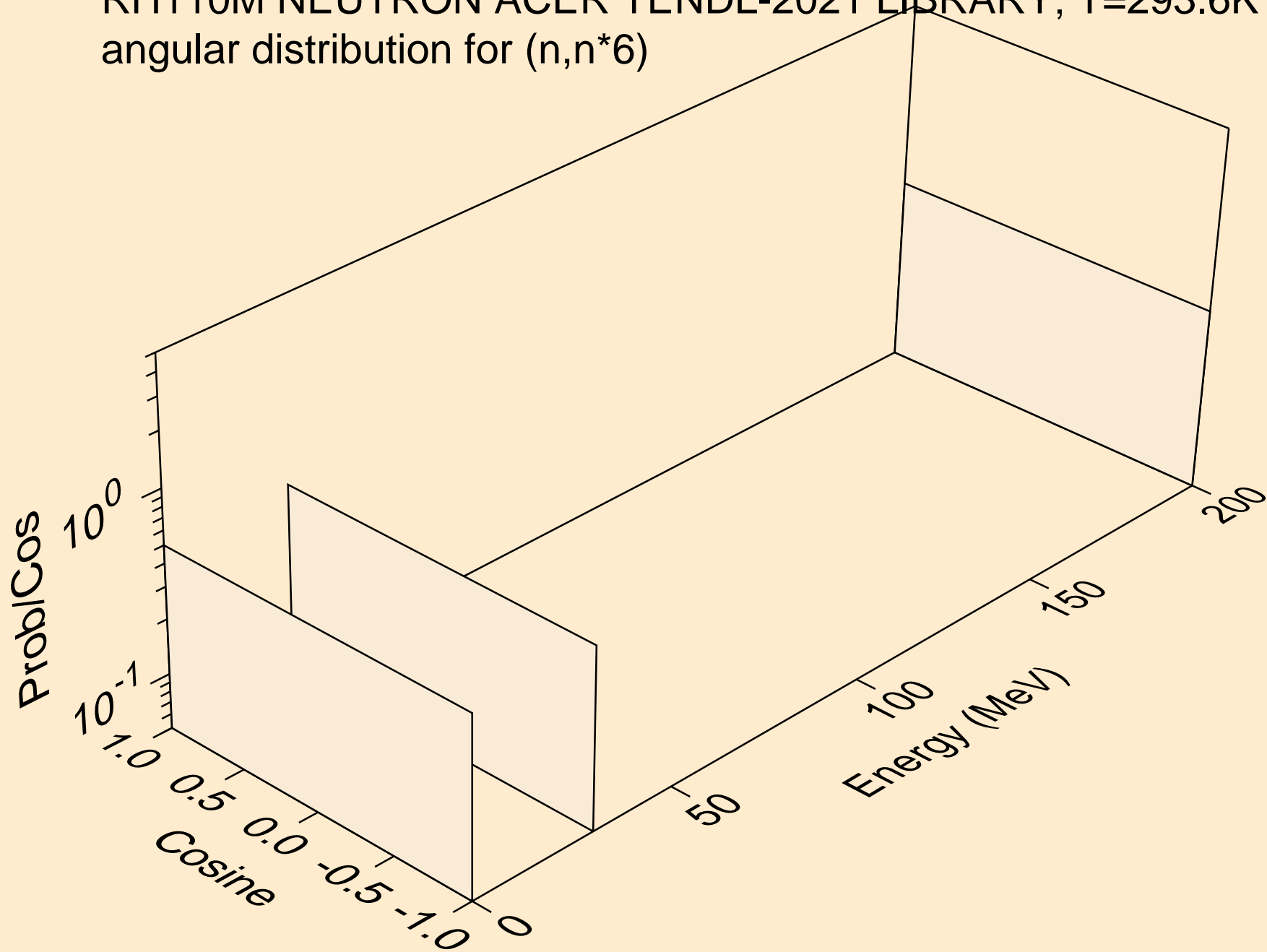

RH110M NEUTRON ACER TENDL-2021 LIBRARY; T=293.6K
angular distribution for (n,n*7)

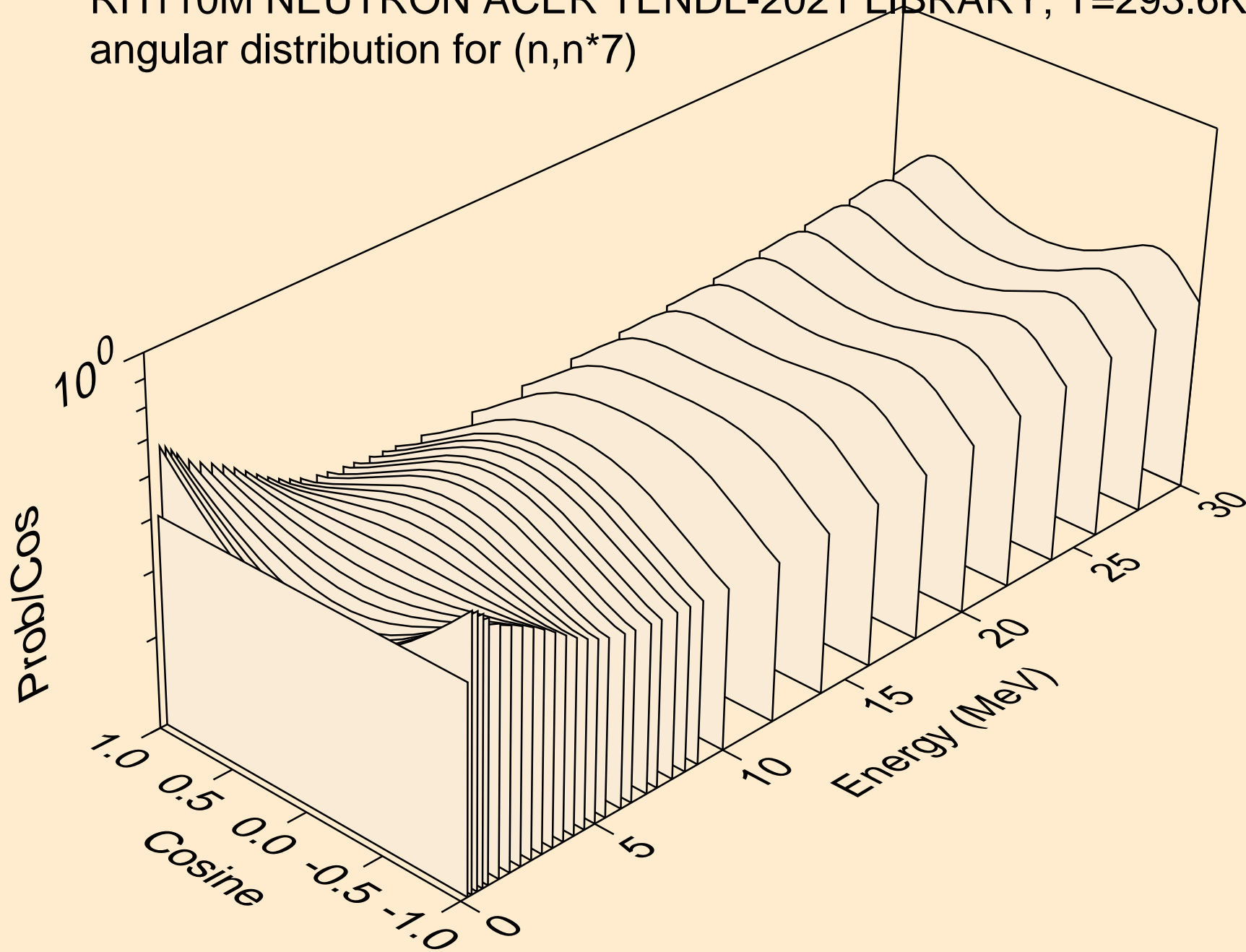

RH110M NEUTRON ACER TENDL-2021 LIBRARY; T=293.6K
angular distribution for (n,n*8)

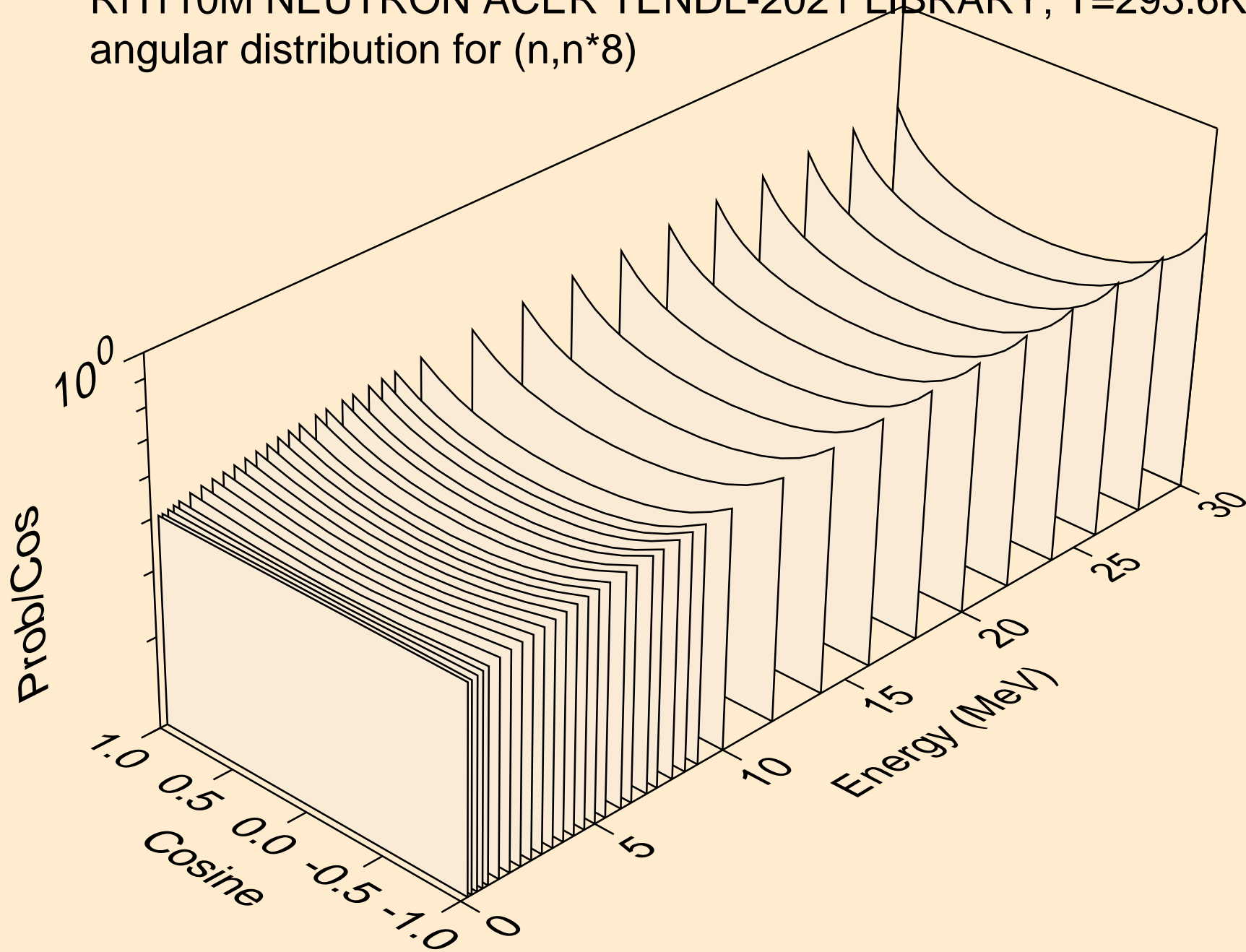

RH110M NEUTRON ACER TENDL-2021 LIBRARY; T=293.6K
angular distribution for (n,n*9)

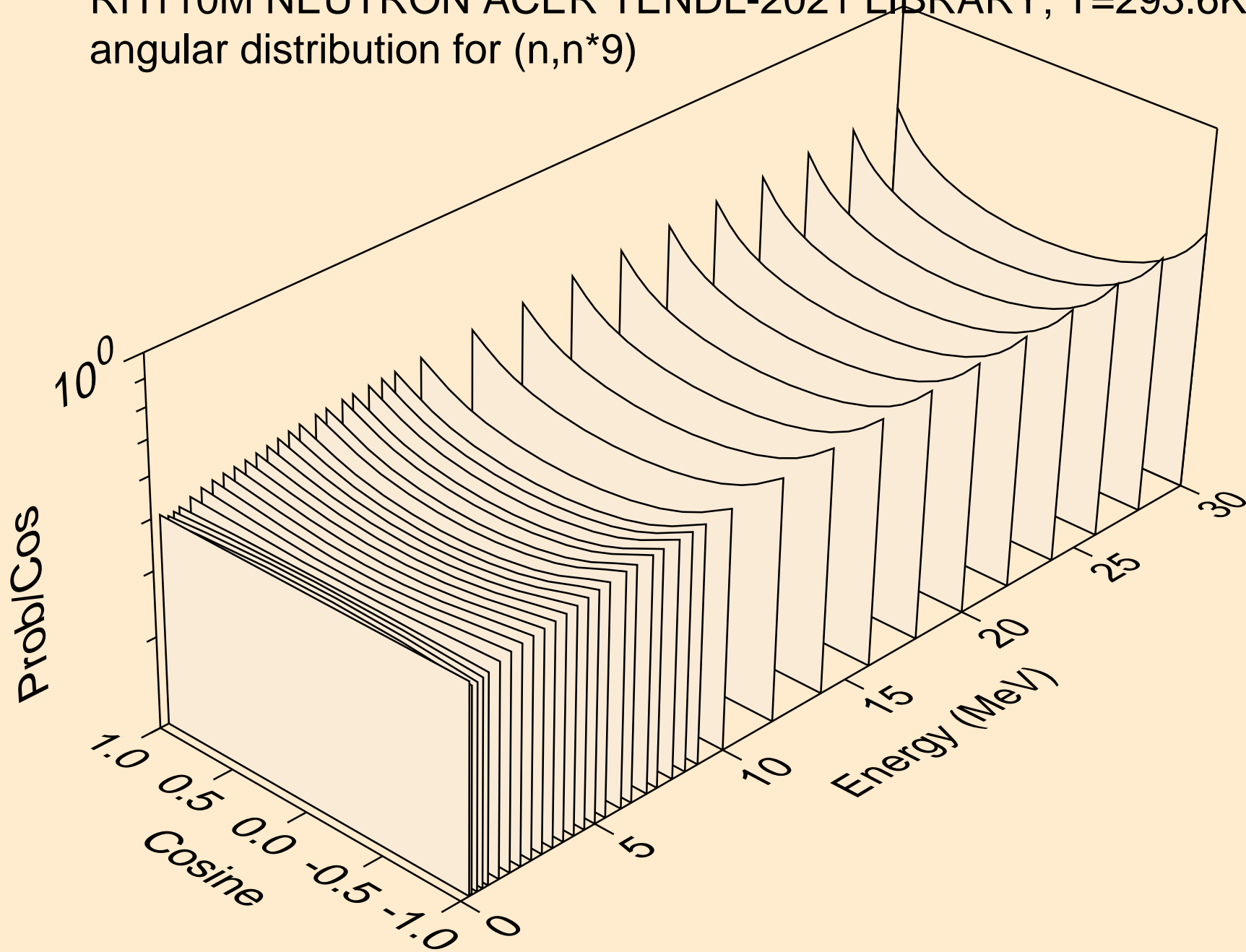

RH110M NEUTRON ACER TENDL-2021 LIBRARY; T=293.6K
angular distribution for (n,n*10)

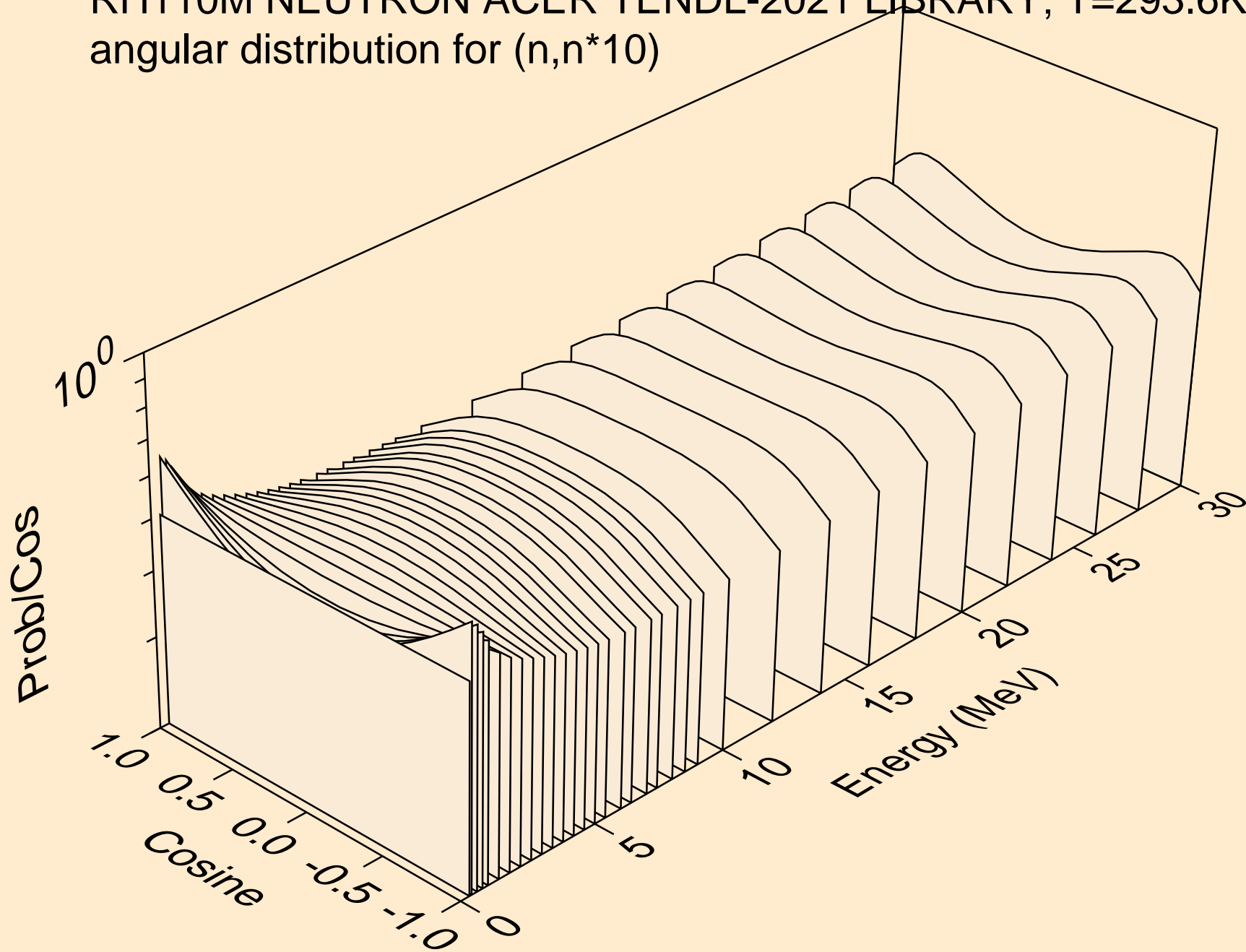

RH110M NEUTRON ACER TENDL-2021 LIBRARY; T=293.6K
angular distribution for (n,n*11)

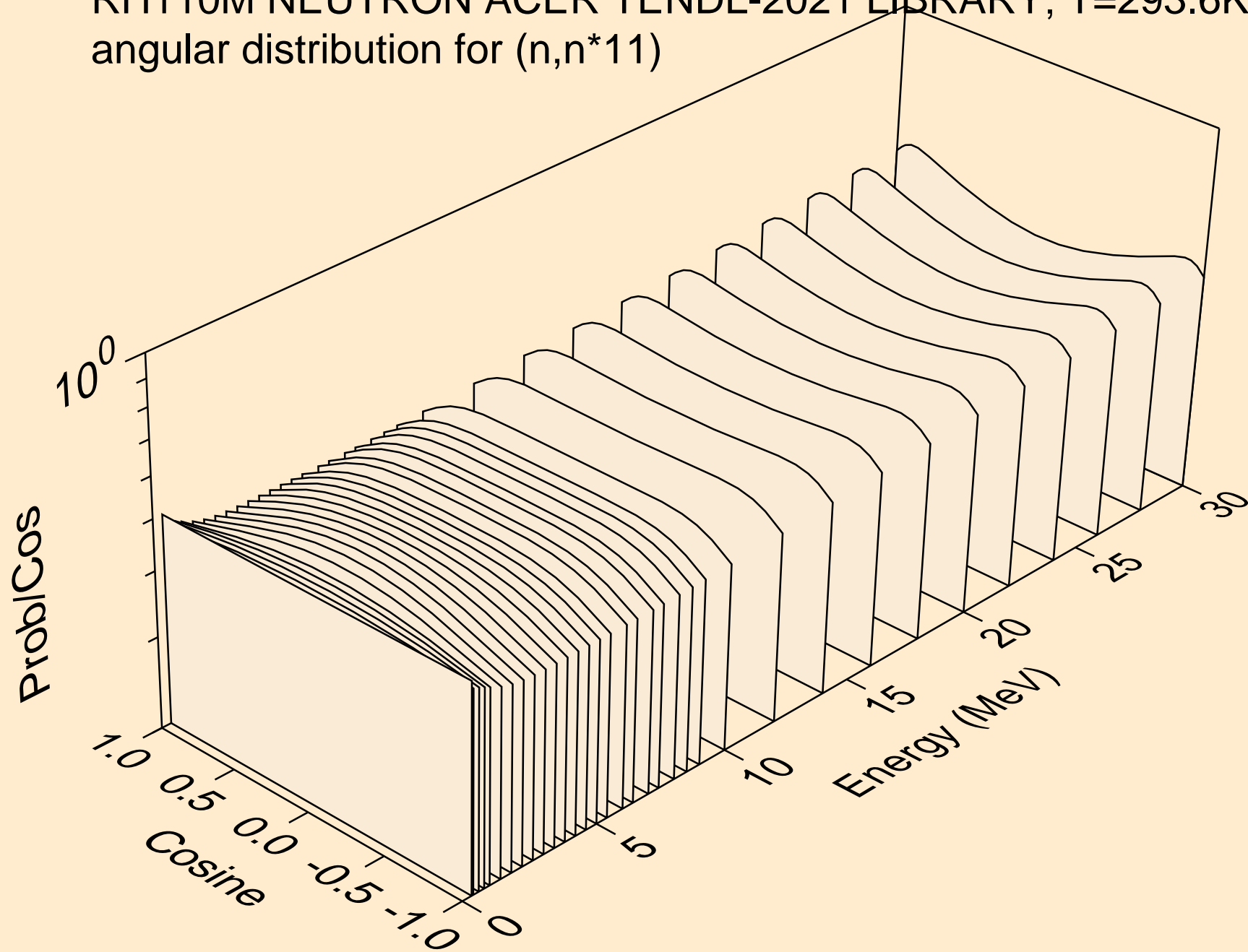

RH110M NEUTRON ACER TENDL-2021 LIBRARY; T=293.6K
angular distribution for (n,n*12)

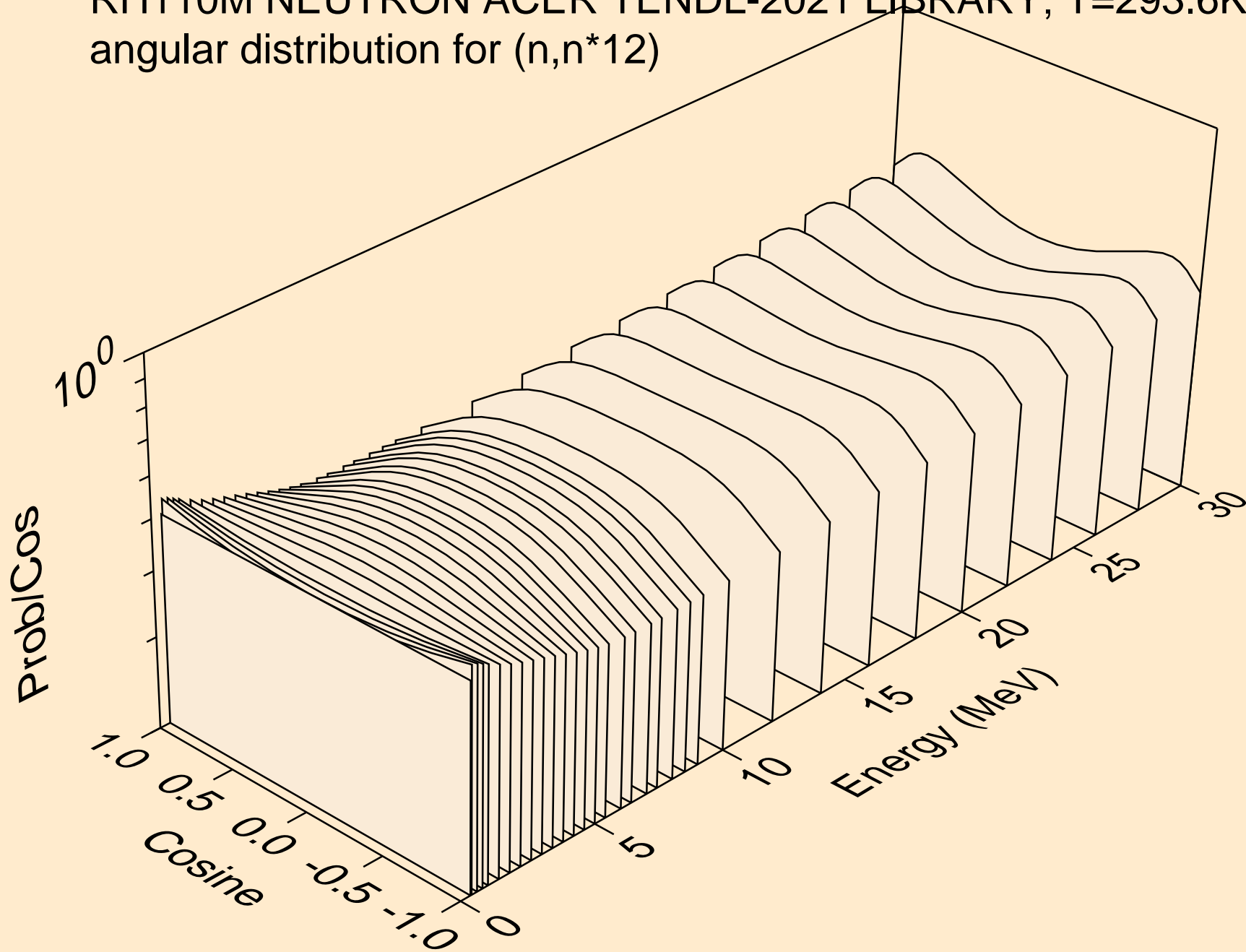

RH110M NEUTRON ACER TENDL-2021 LIBRARY; T=293.6K
angular distribution for (n,n*13)

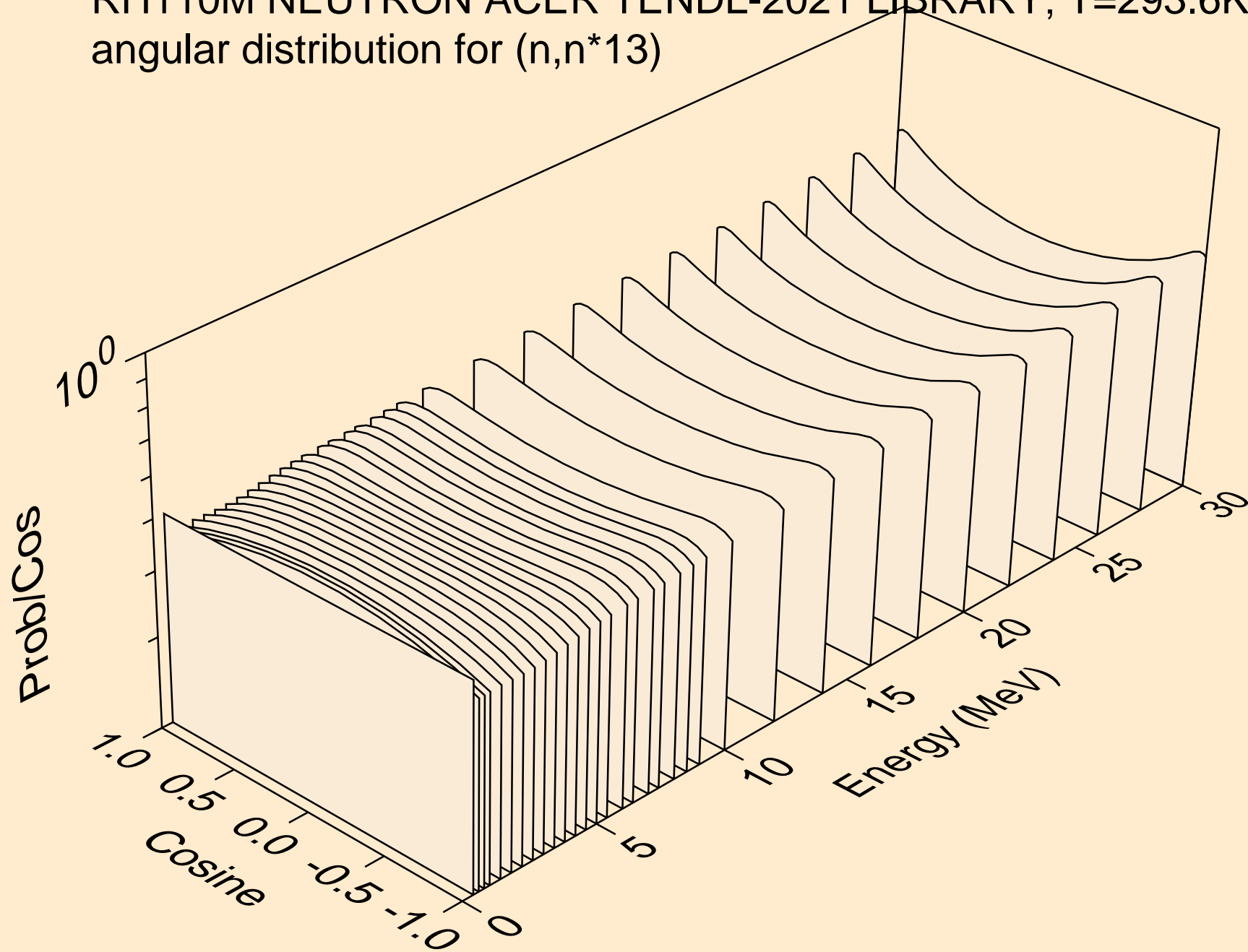

RH110M NEUTRON ACER TENDL-2021 LIBRARY; T=293.6K
angular distribution for (n,n*14)

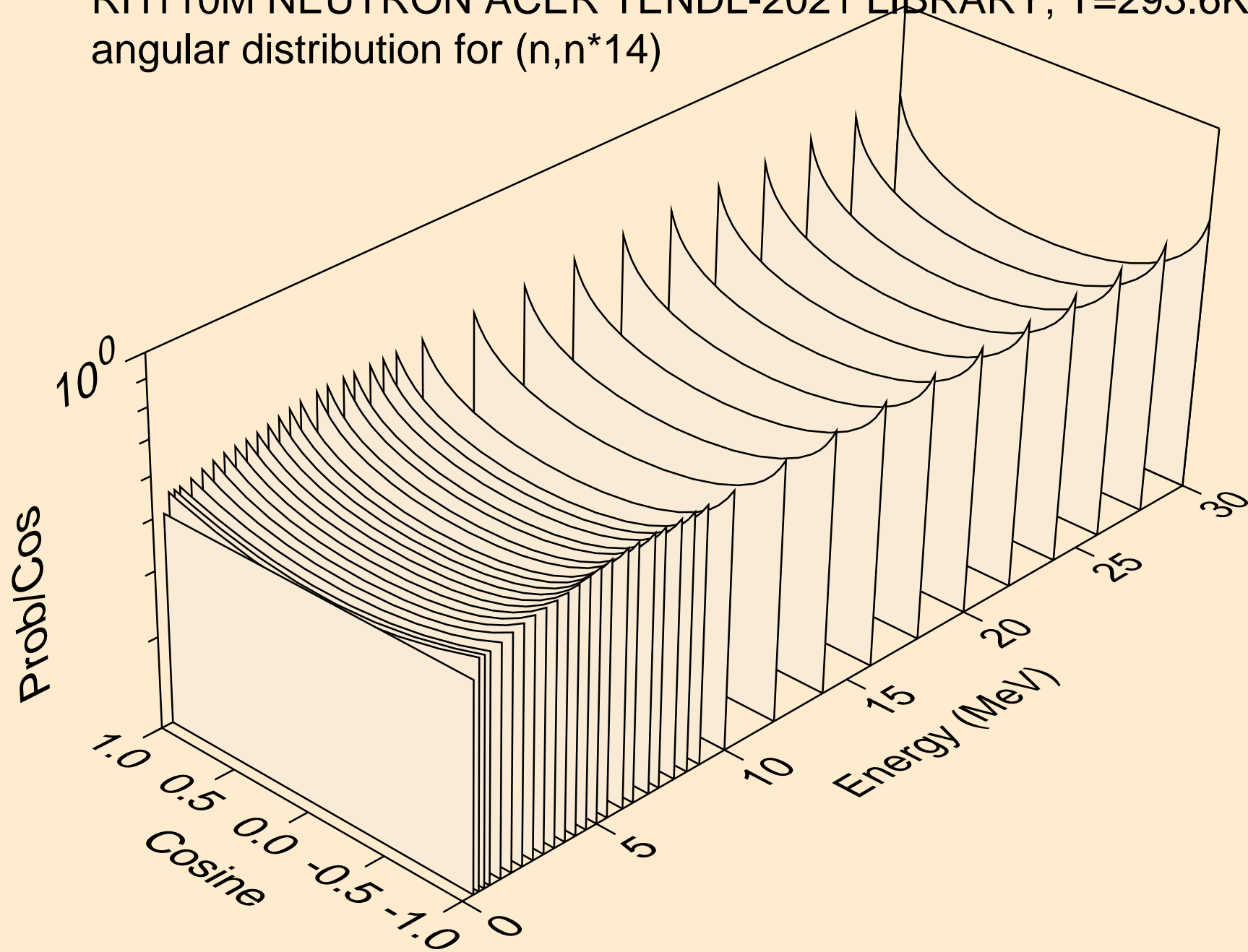

RH110M NEUTRON ACER TENDL-2021 LIBRARY; T=293.6K
angular distribution for (n,n*15)

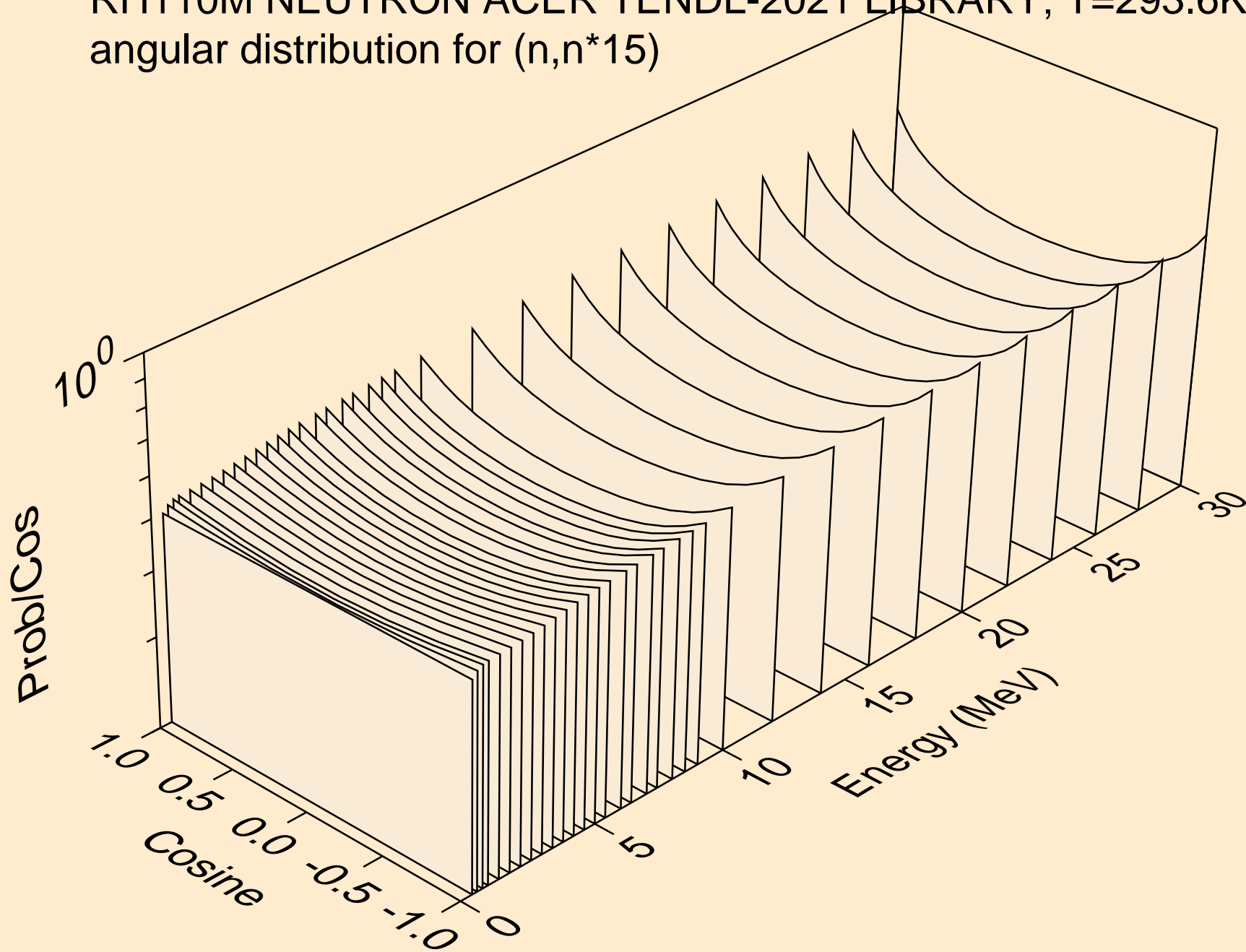

RH110M NEUTRON ACER TENDL-2021 LIBRARY; T=293.6K
angular distribution for (n,n*16)

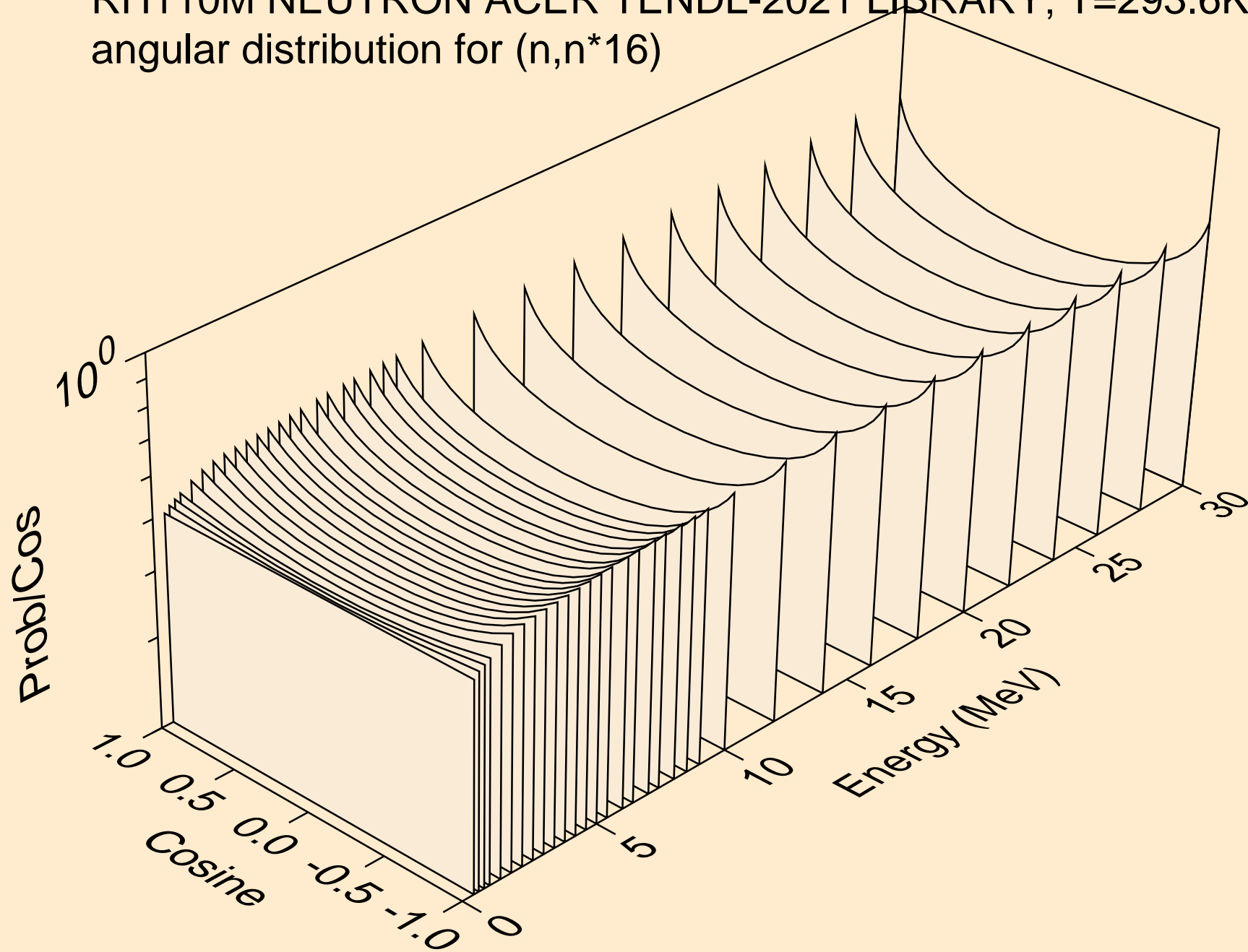

RH110M NEUTRON ACER TENDL-2021 LIBRARY; T=293.6K
angular distribution for (n,n*17)

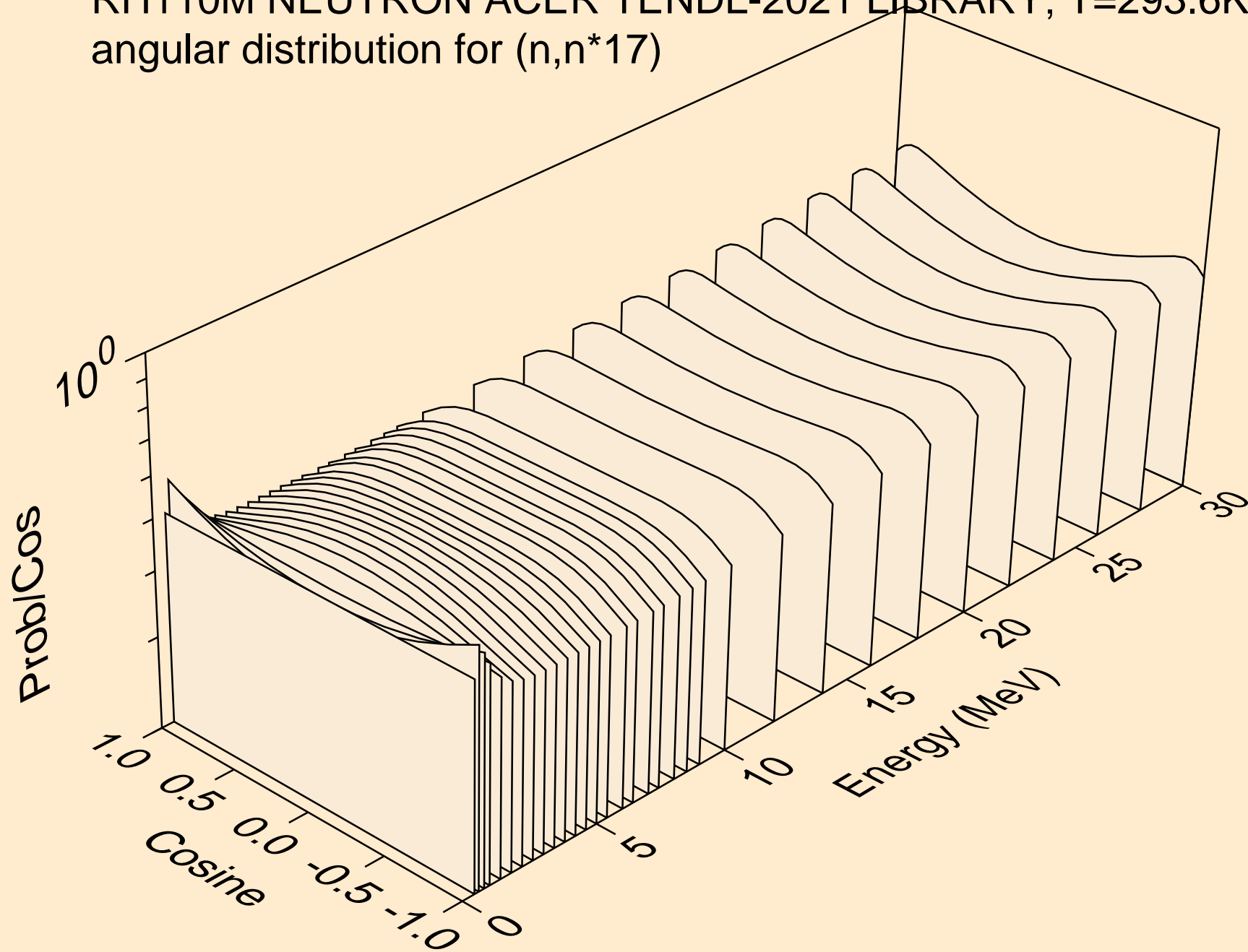

RH110M NEUTRON ACER TENDL-2021 LIBRARY; T=293.6K
angular distribution for (n,n*18)

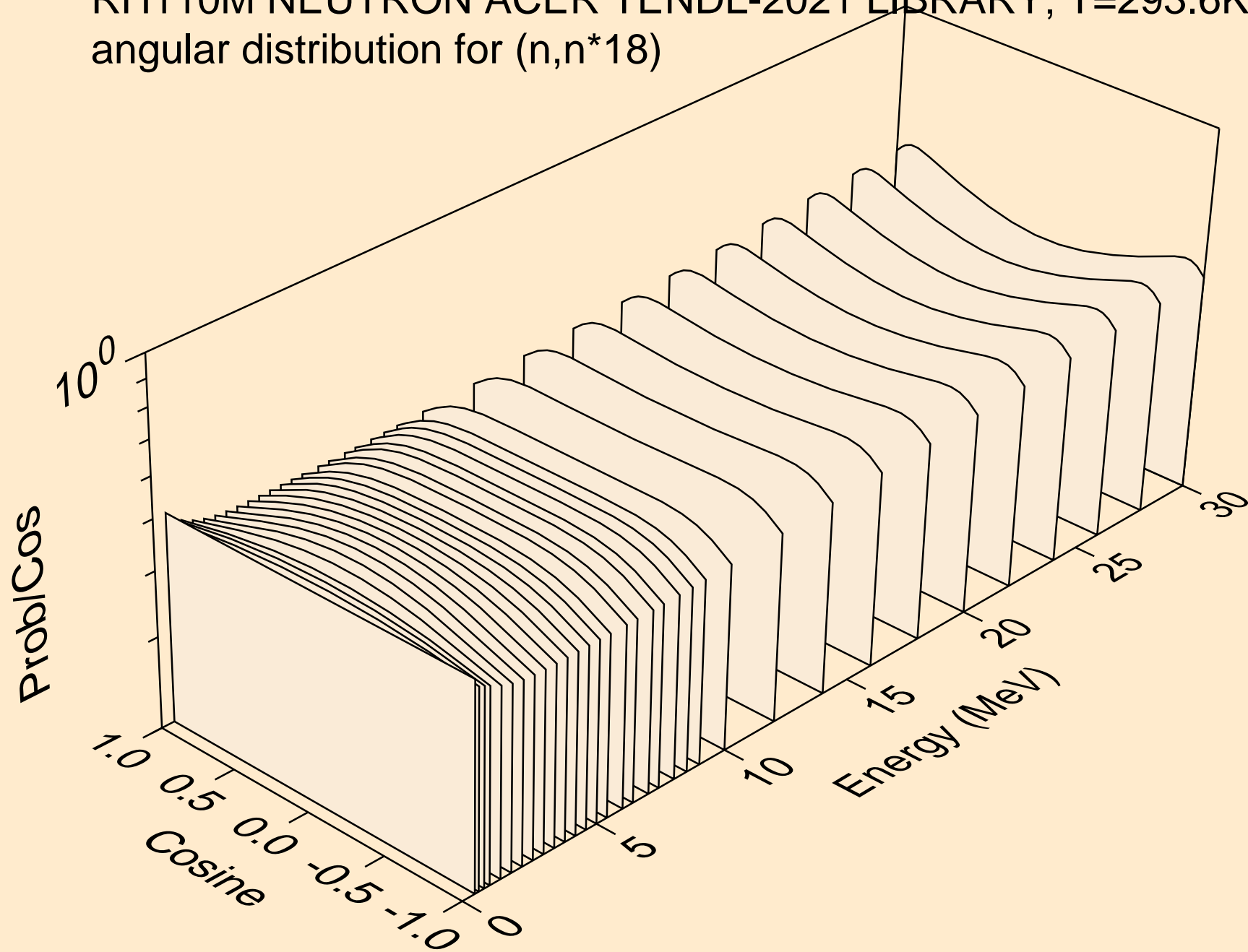

RH110M NEUTRON ACER TENDL-2021 LIBRARY; T=293.6K
angular distribution for (n,n*19)

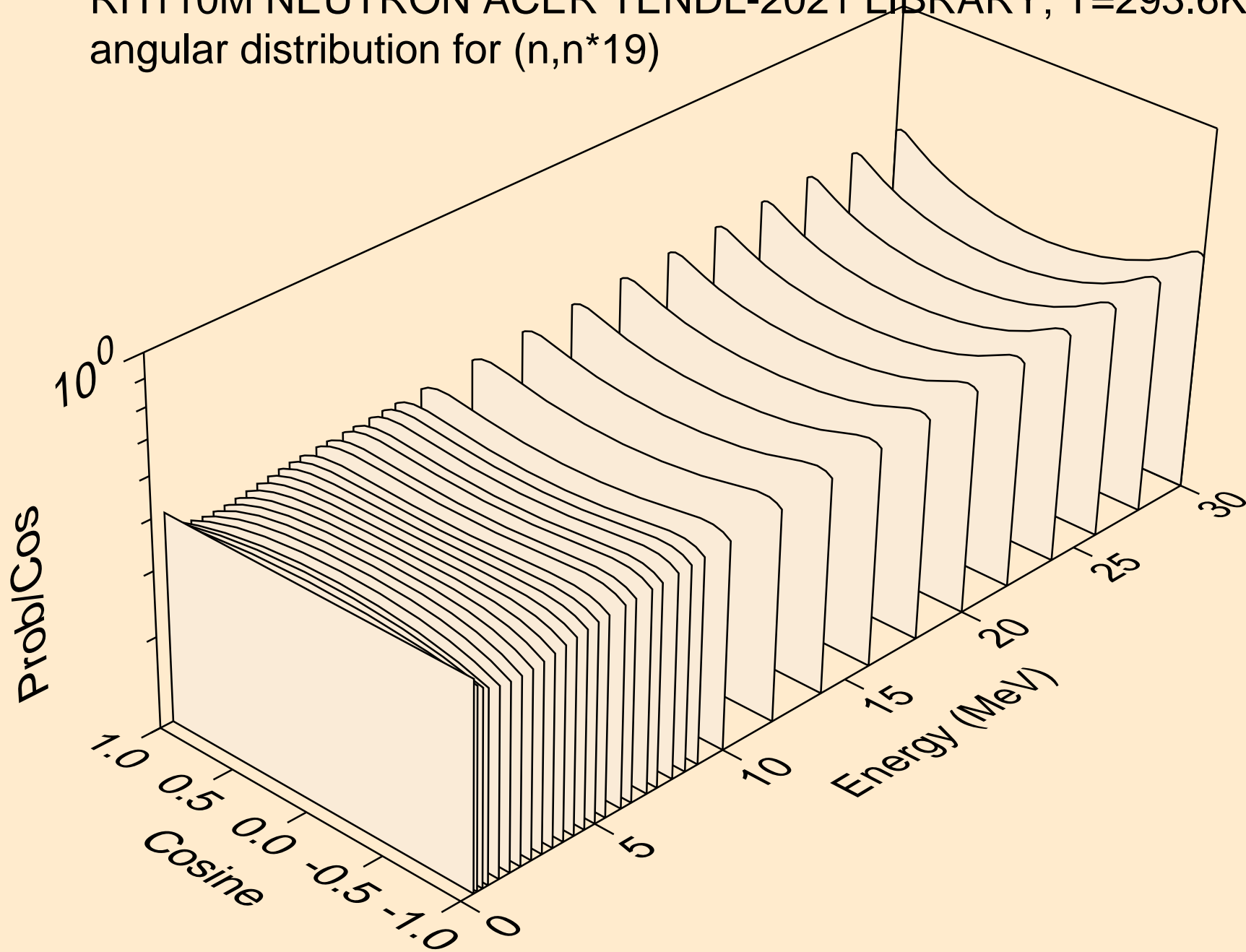

RH110M NEUTRON ACER TENDL-2021 LIBRARY; T=293.6K
angular distribution for (n,n*20)

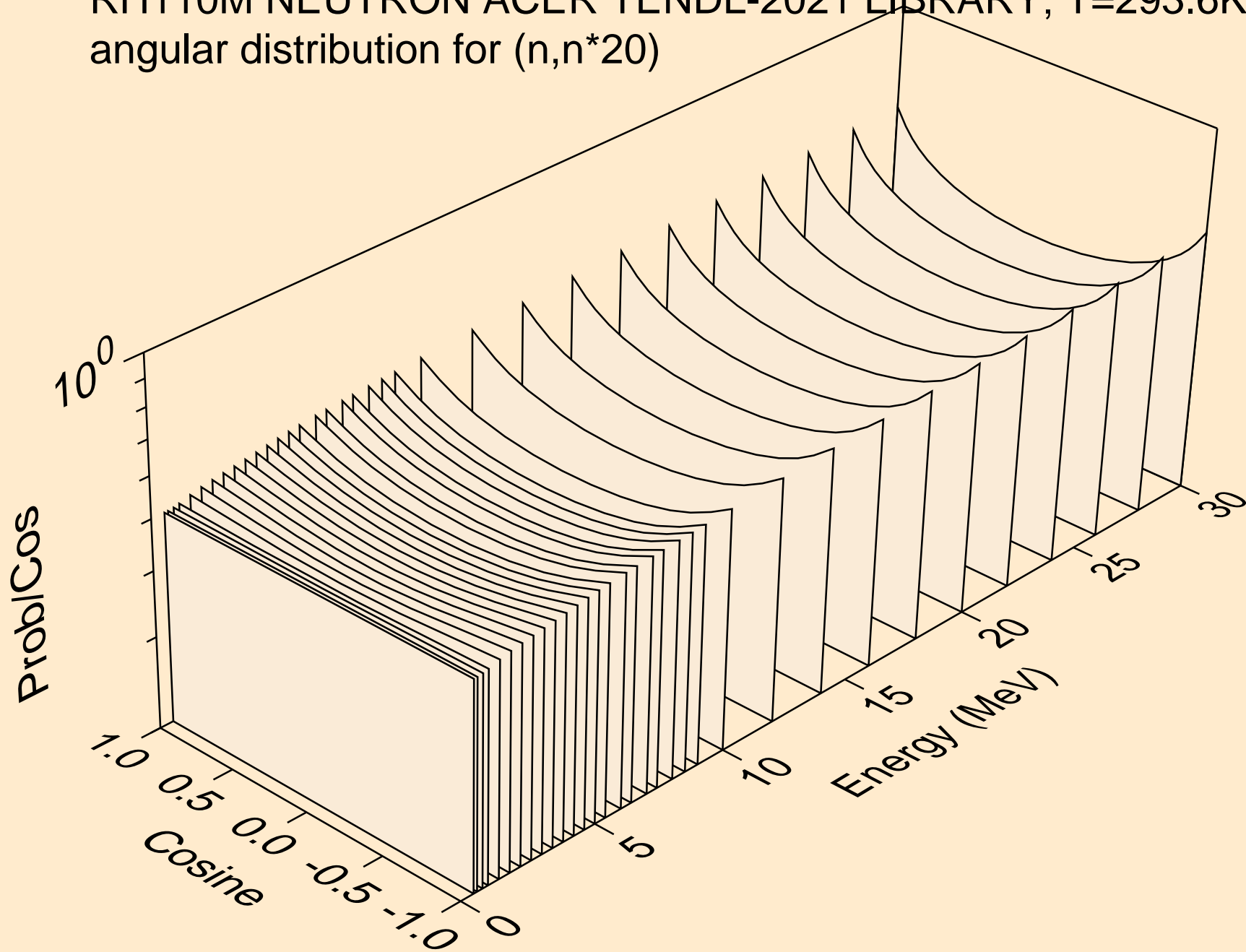

RH110M NEUTRON ACER TENDL-2021 LIBRARY; T=293.6K
angular distribution for (n,n*21)

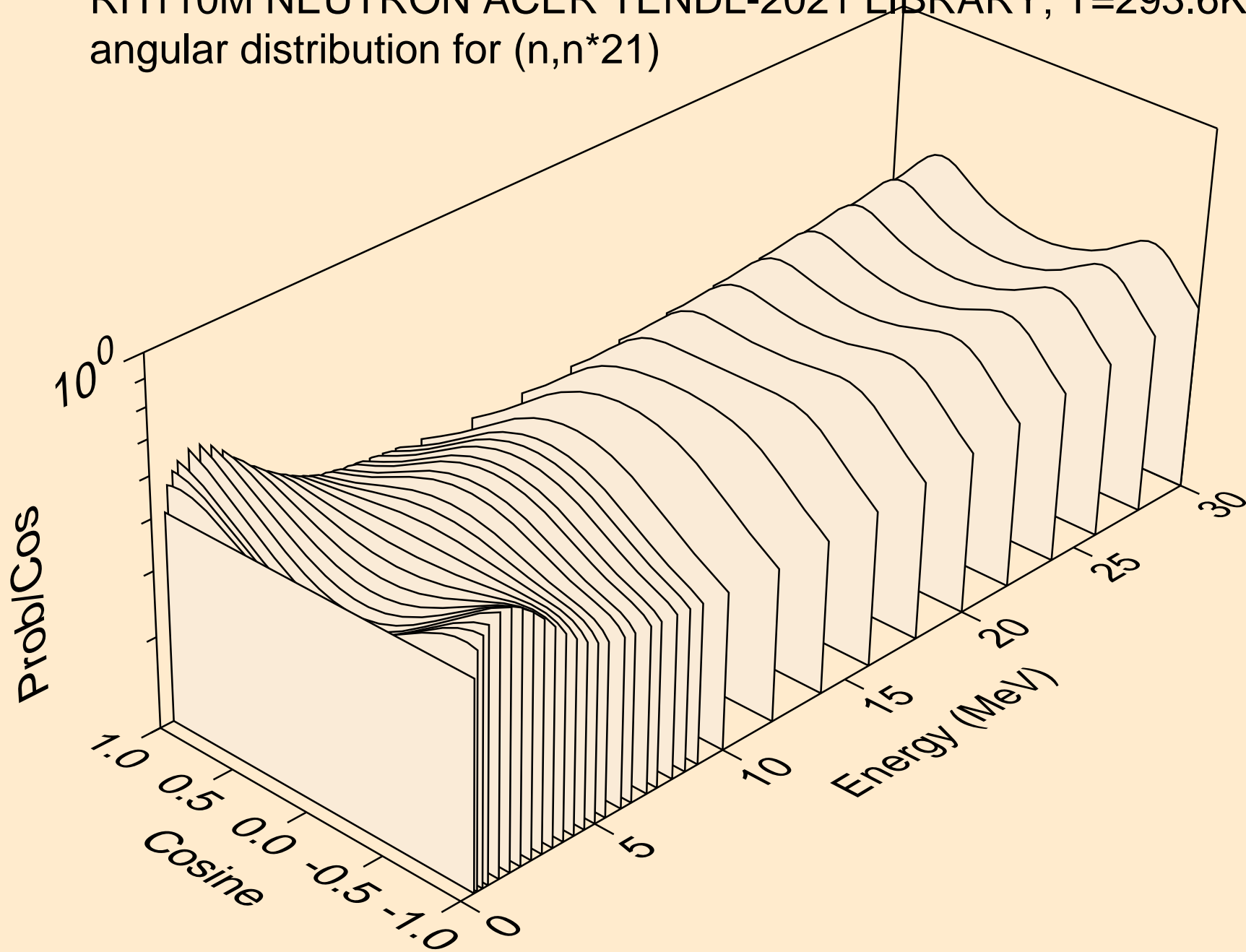

RH110M NEUTRON ACER TENDL-2021 LIBRARY; T=293.6K
angular distribution for (n,n*22)

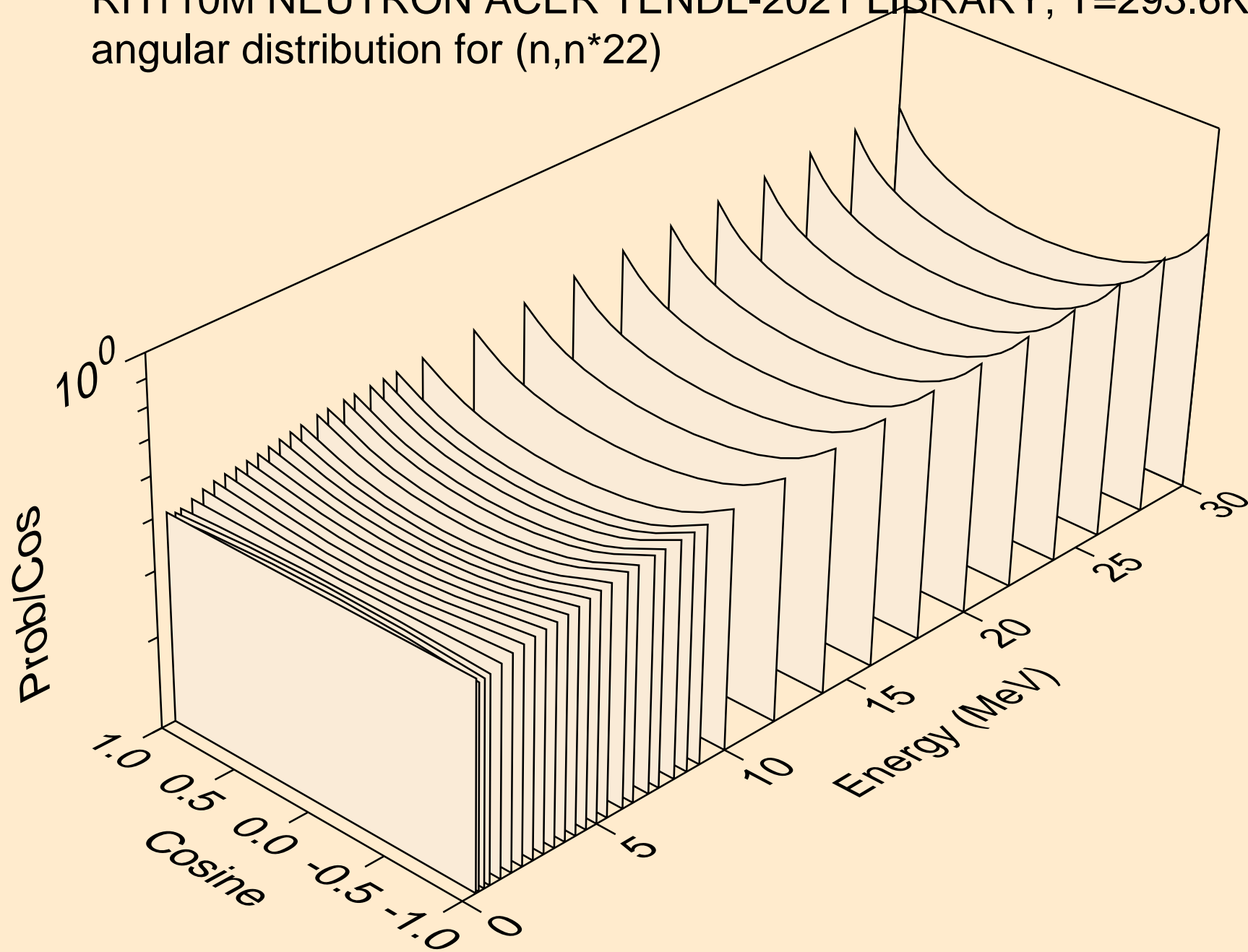

RH110M NEUTRON ACER TENDL-2021 LIBRARY; T=293.6K
angular distribution for (n,n*23)

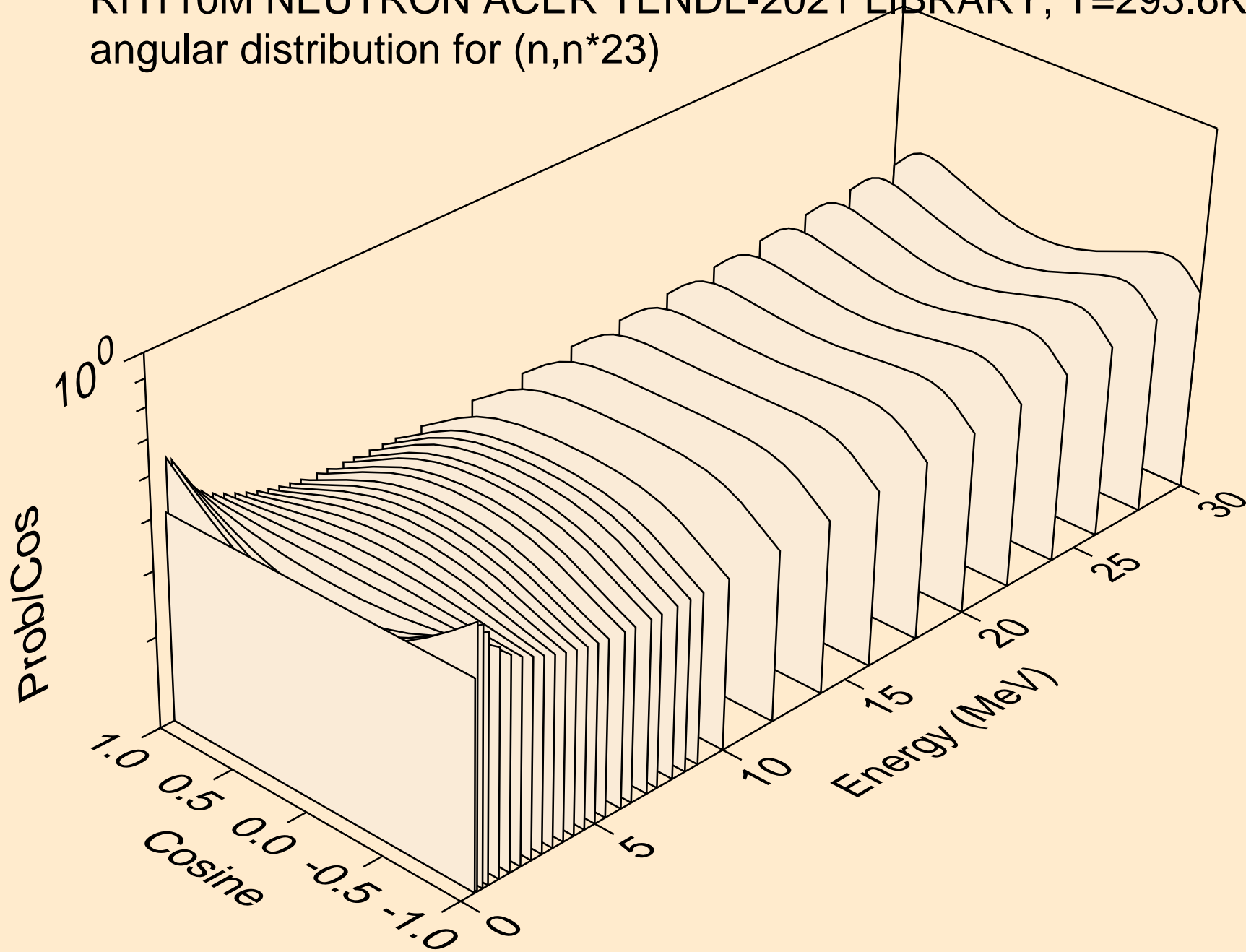

RH110M NEUTRON ACER TENDL-2021 LIBRARY; T=293.6K
angular distribution for (n,n*24)

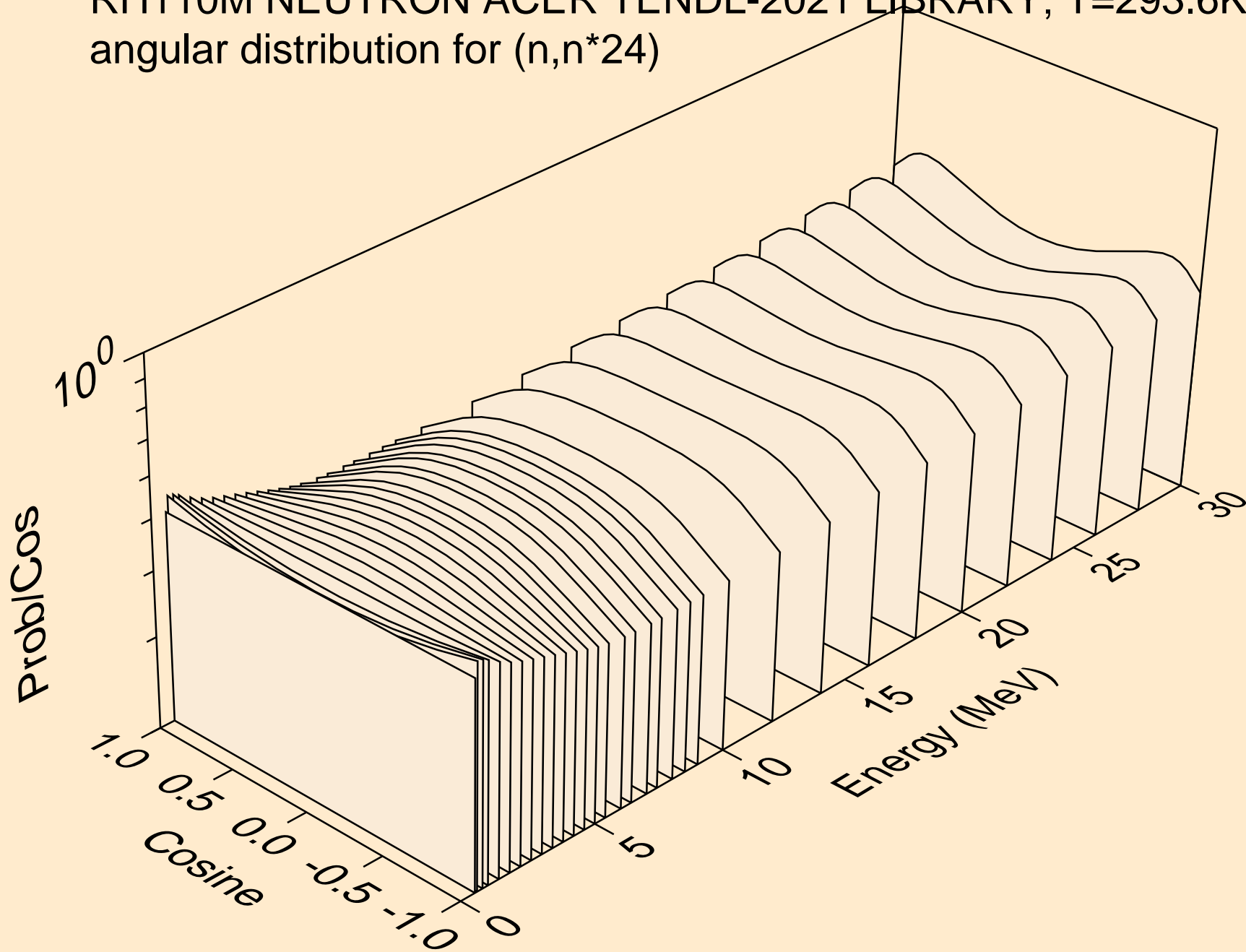

RH110M NEUTRON ACER TENDL-2021 LIBRARY; T=293.6K
angular distribution for (n,n*25)

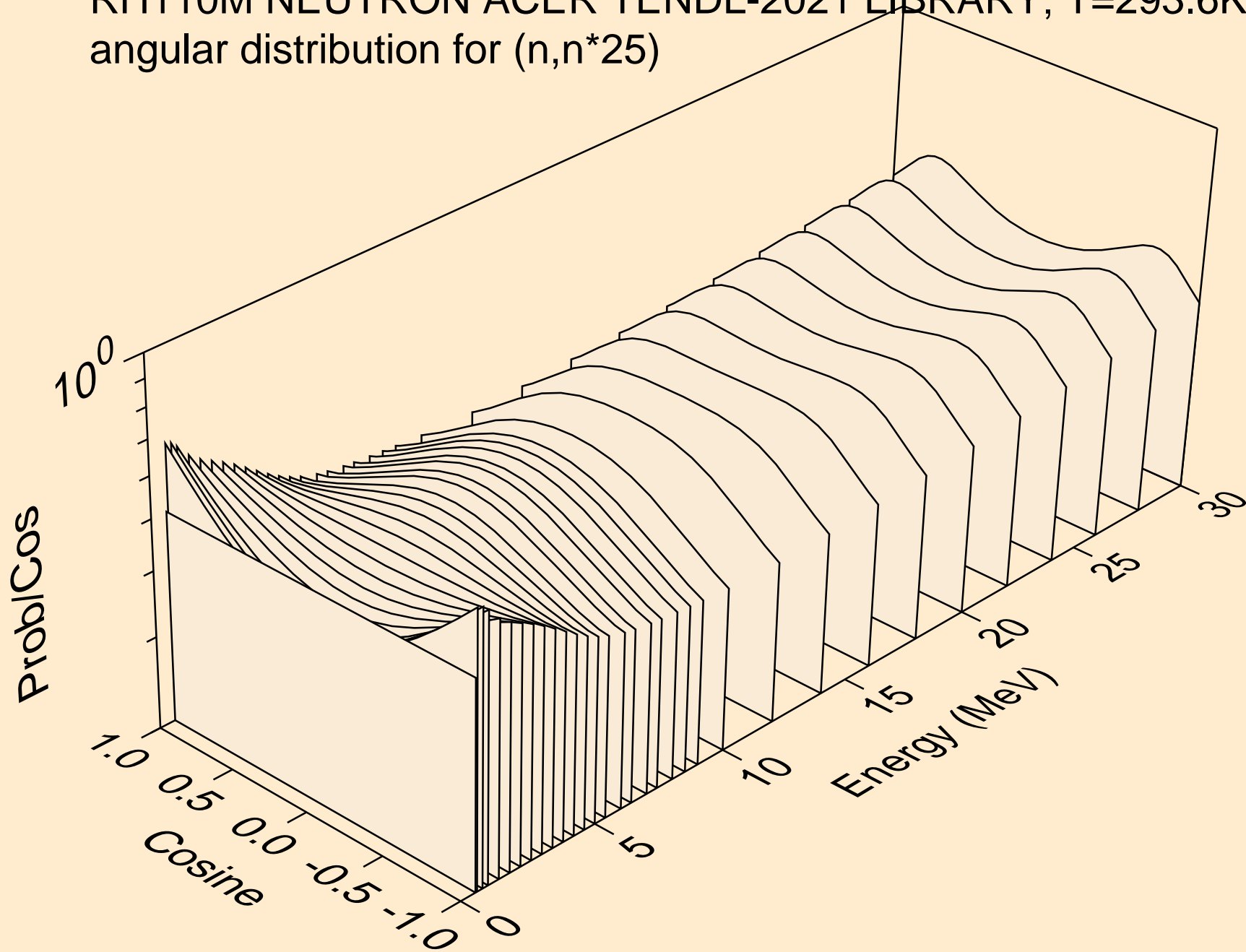

RH110M NEUTRON ACER TENDL-2021 LIBRARY; T=293.6K
angular distribution for (n,n*26)

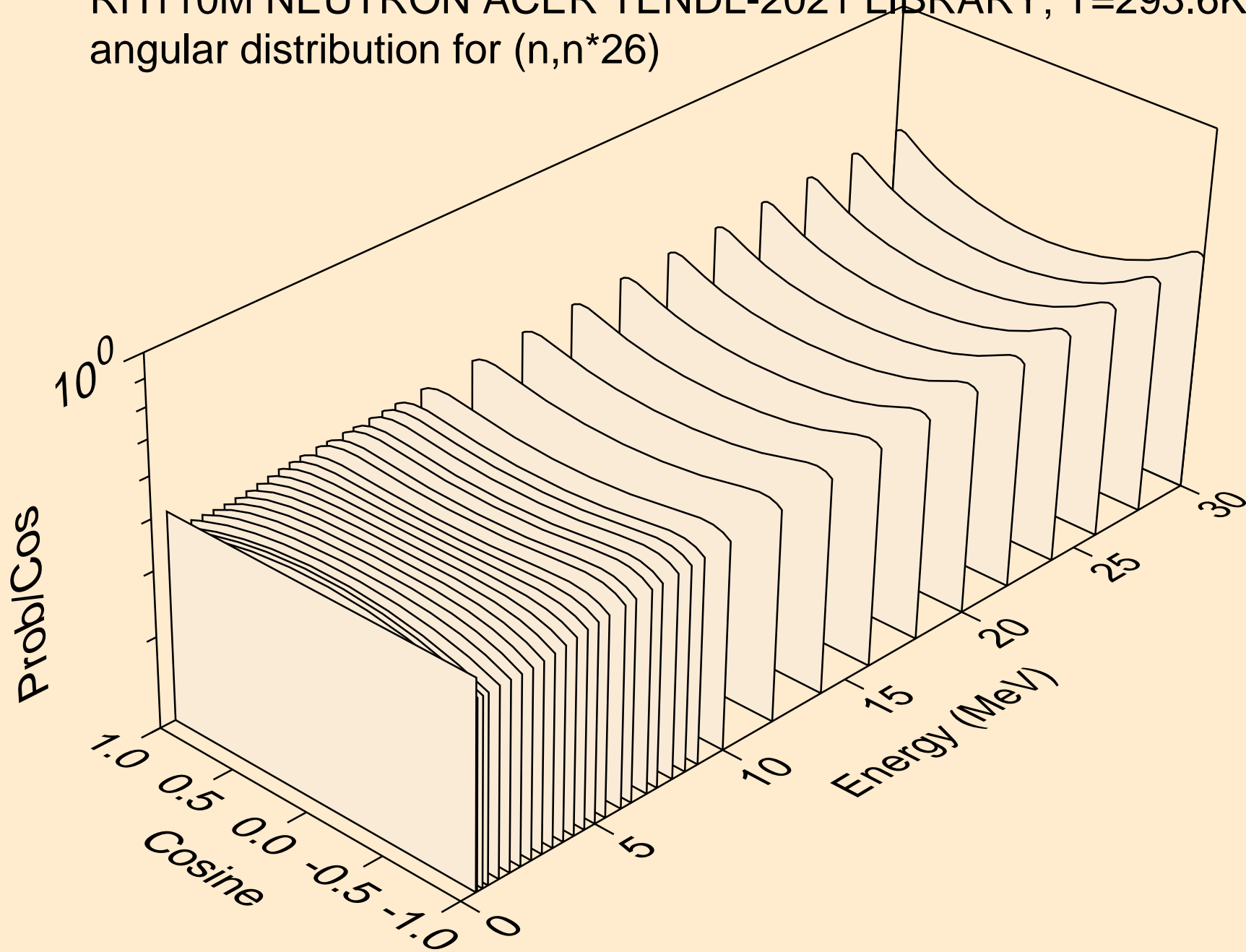

RH110M NEUTRON ACER TENDL-2021 LIBRARY; T=293.6K
angular distribution for (n,n*27)

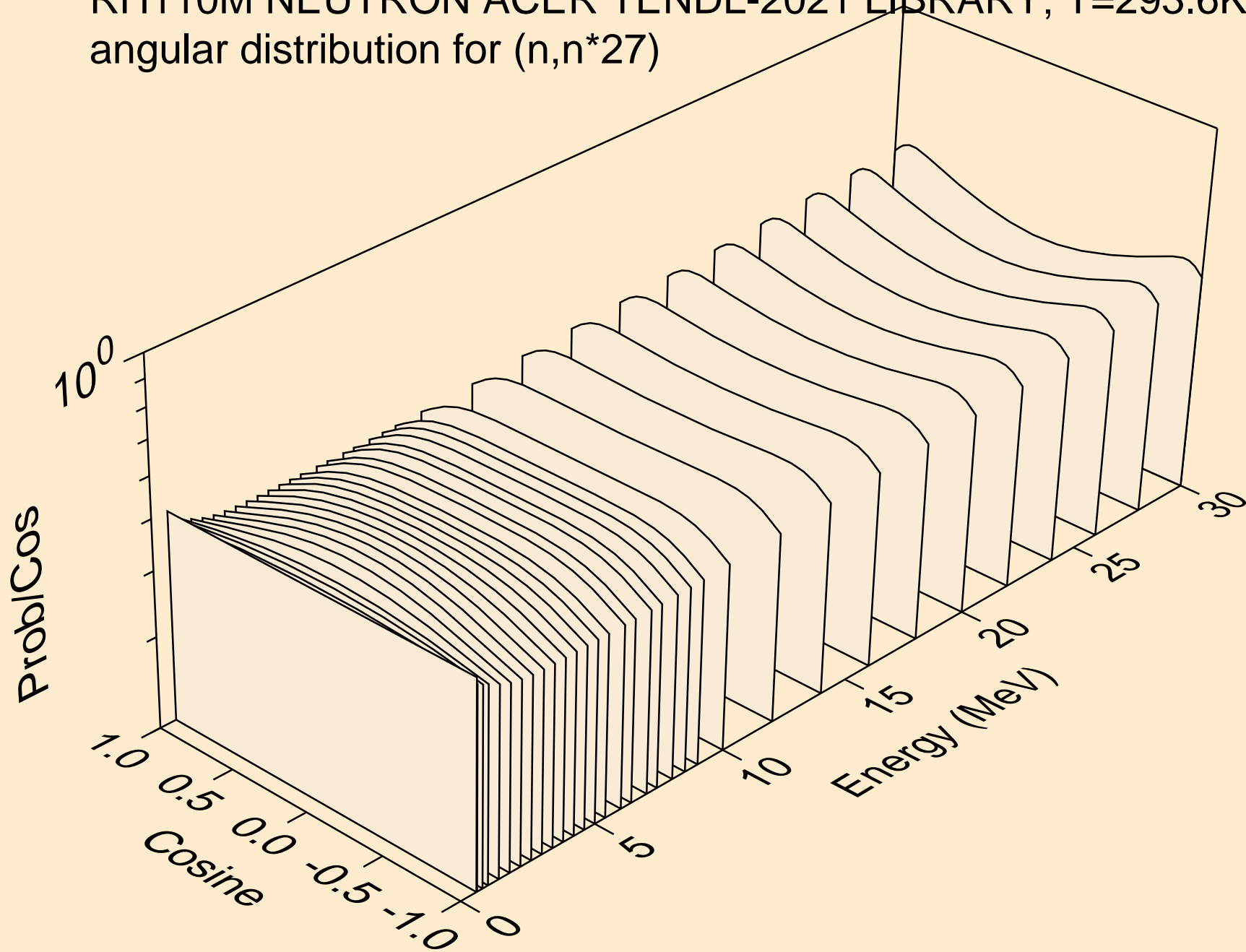

RH110M NEUTRON ACER TENDL-2021 LIBRARY; T=293.6K
angular distribution for (n,n*28)

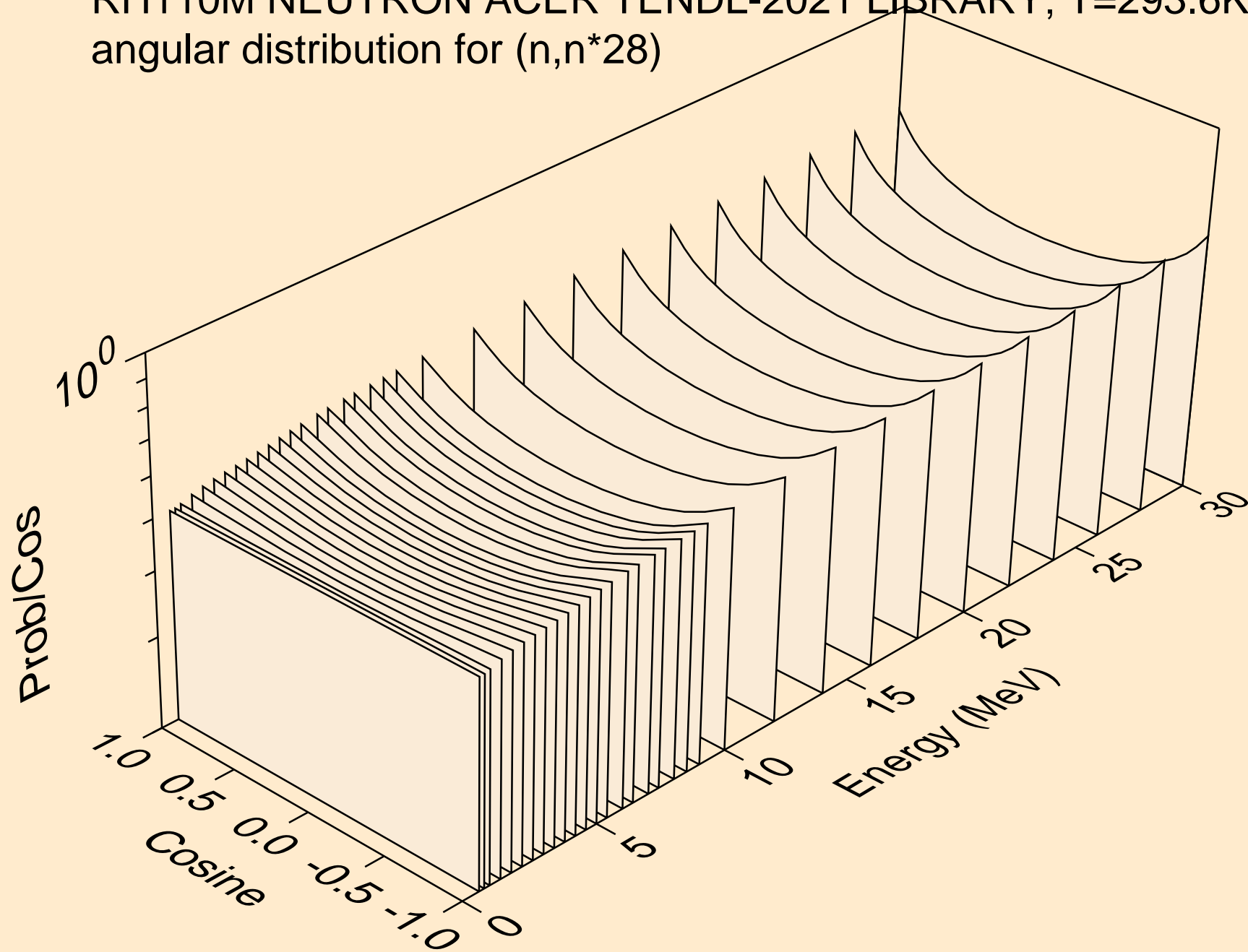

RH110M NEUTRON ACER TENDL-2021 LIBRARY; T=293.6K
Neutron emission for (n,x)

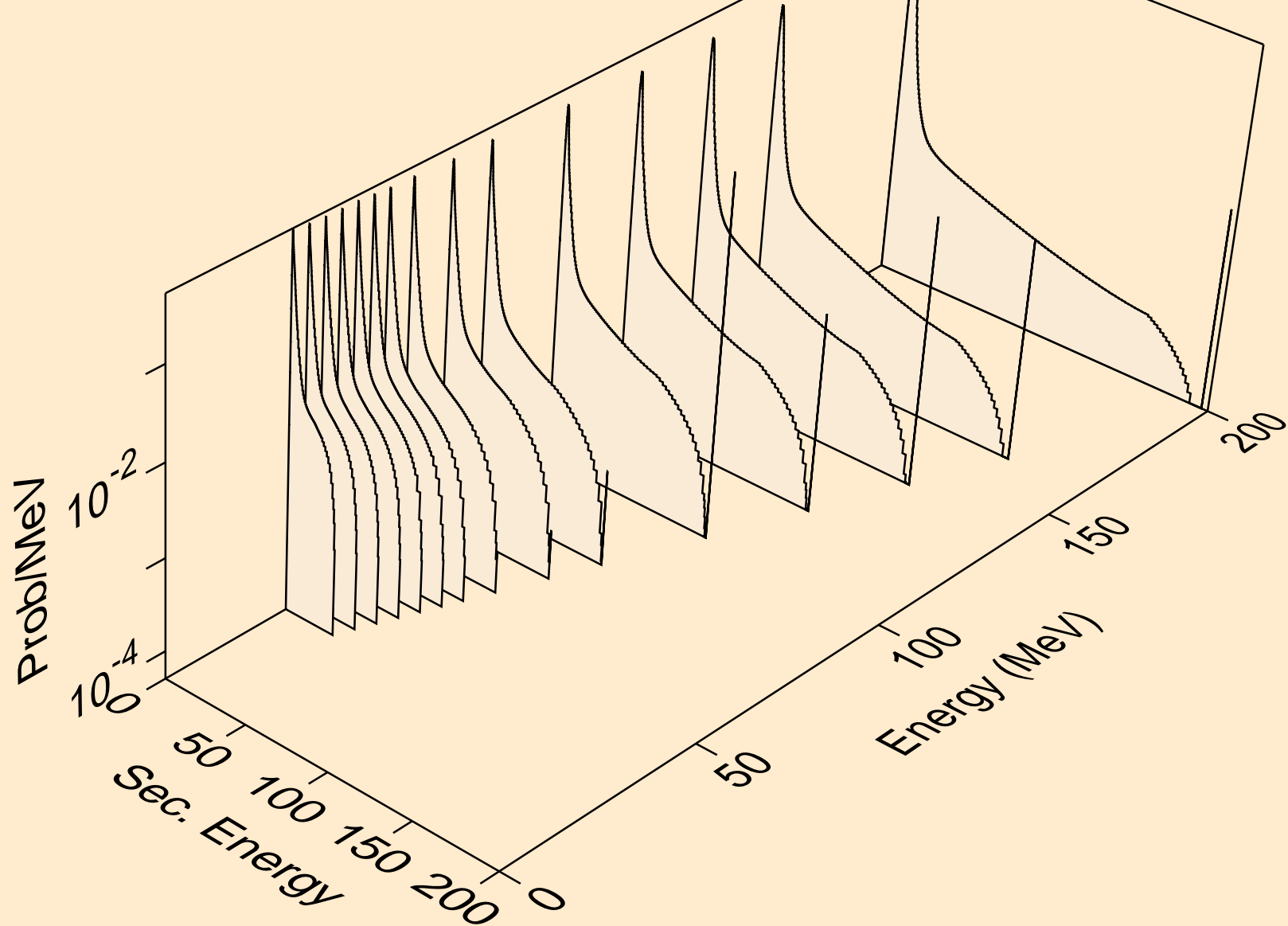

RH110M NEUTRON ACER TENDL-2021 LIBRARY; T=293.6K
Neutron emission for (n,2nd)

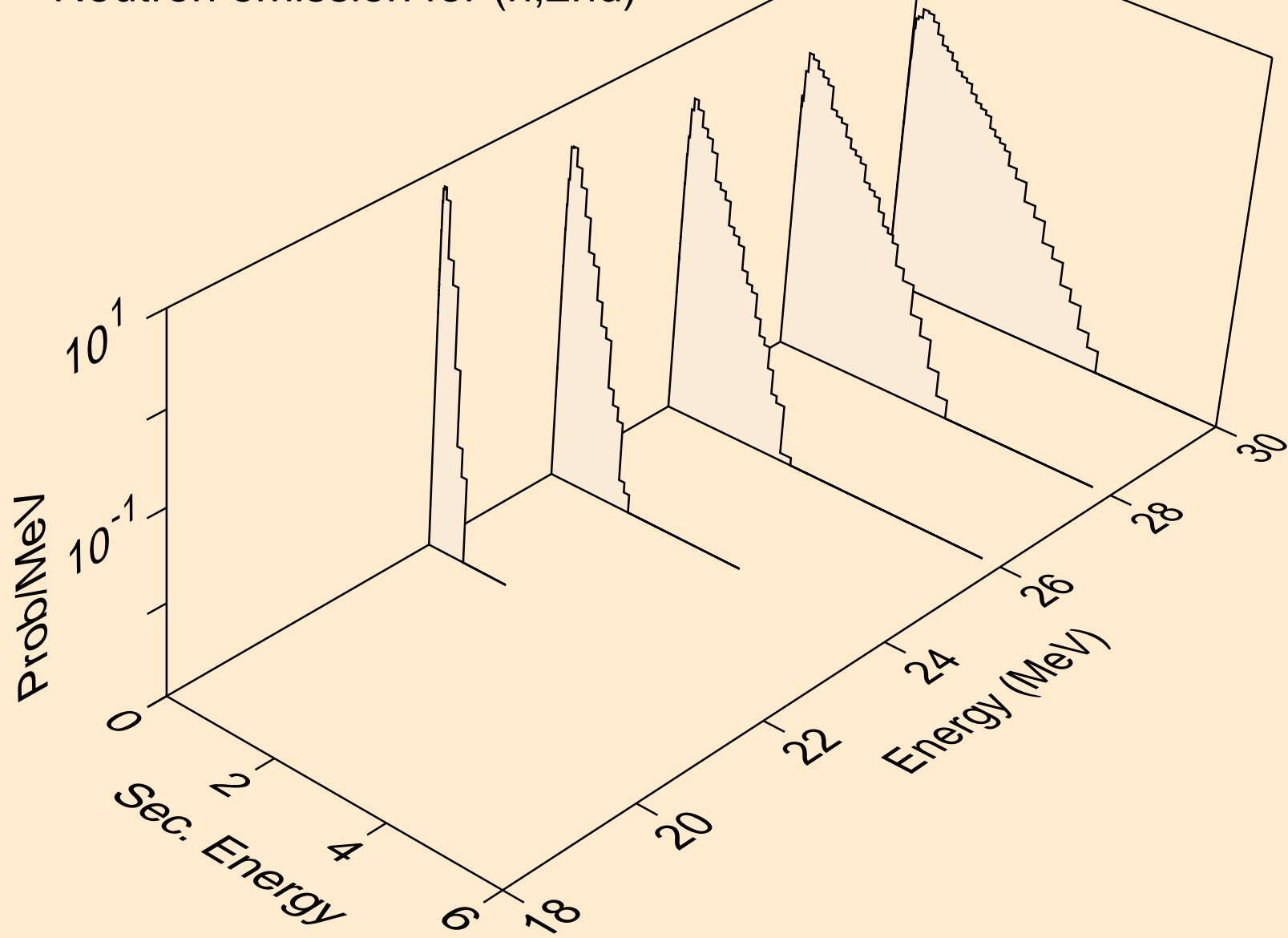

RH110M NEUTRON ACER TENDL-2021 LIBRARY; T=293.6K
Neutron emission for (n,2n)

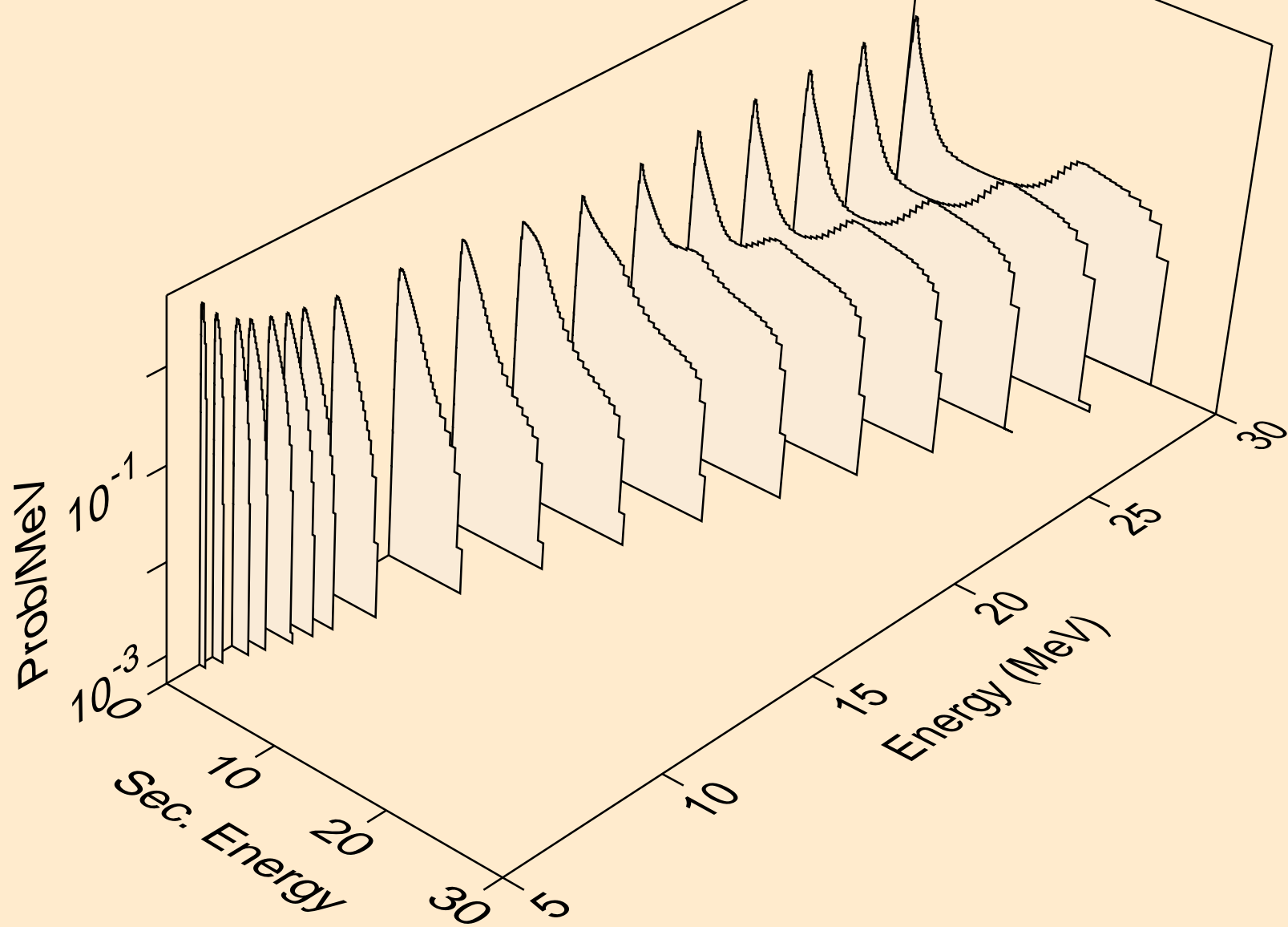

RH110M NEUTRON ACER TENDL-2021 LIBRARY; T=293.6K
Neutron emission for (n,3n)

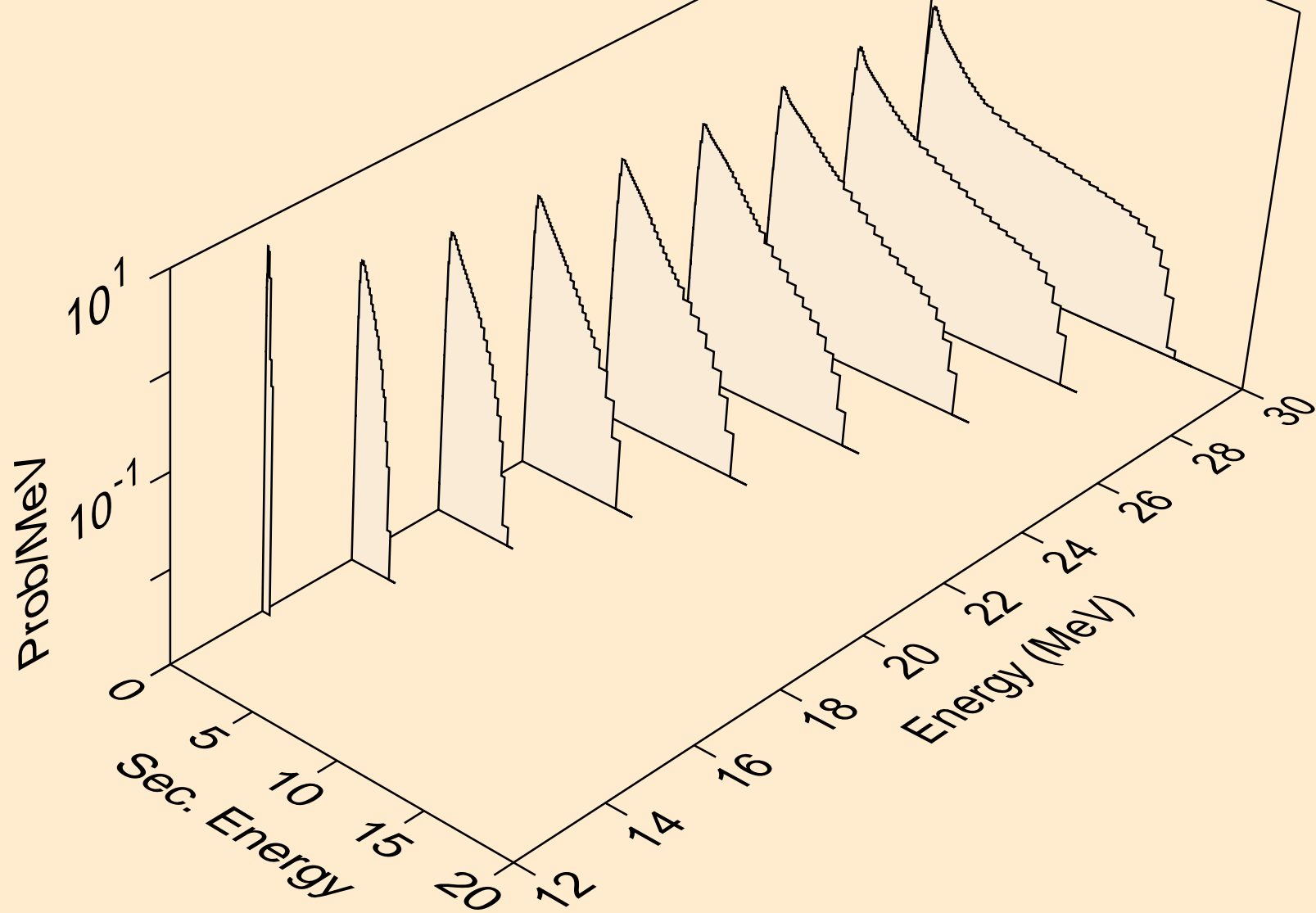

RH110M NEUTRON ACER TENDL-2021 LIBRARY; T=293.6K
Neutron emission for (n,n*)a

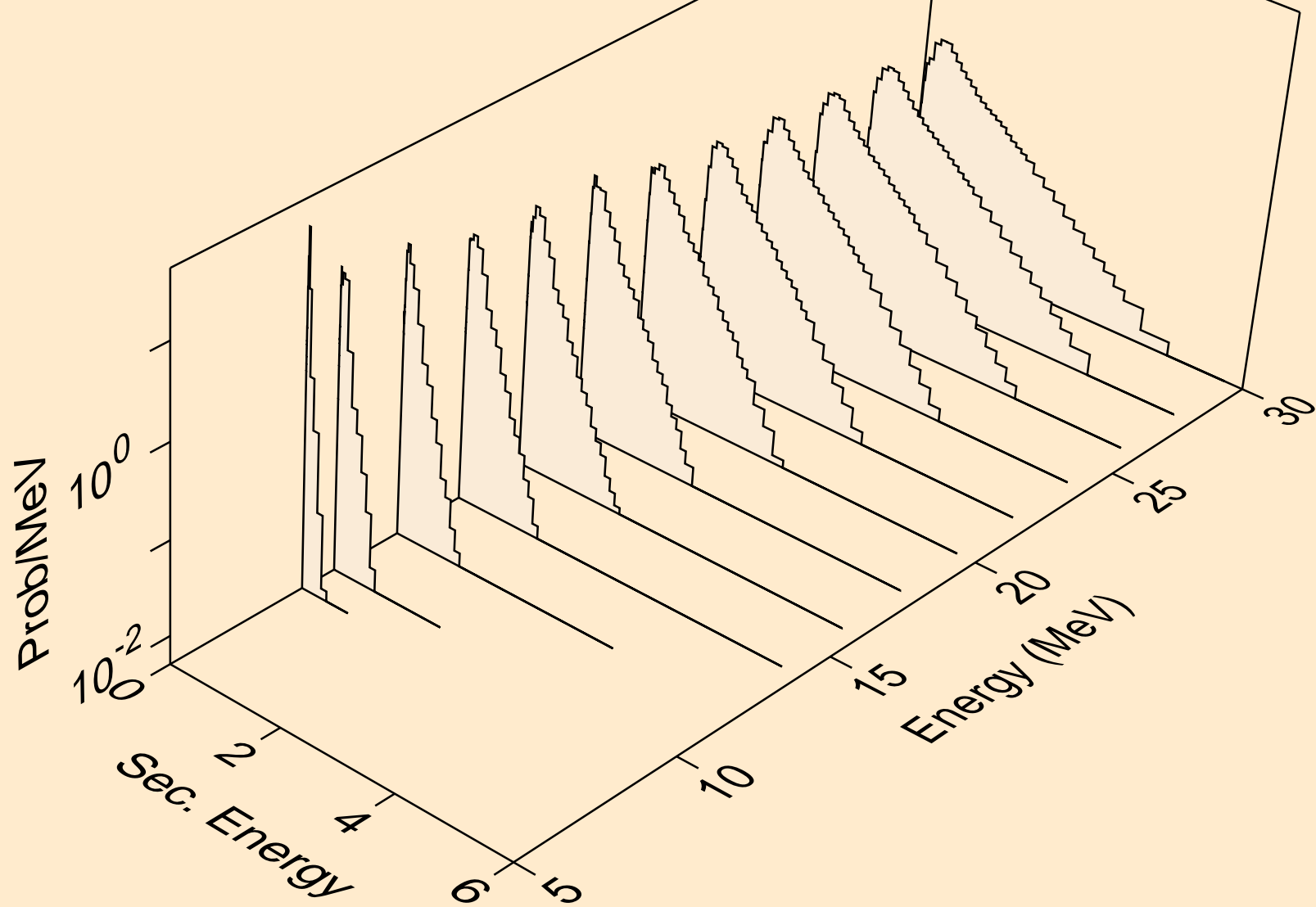

RH110M NEUTRON ACER TENDL-2021 LIBRARY; T=293.6K
Neutron emission for (n,2n)_a

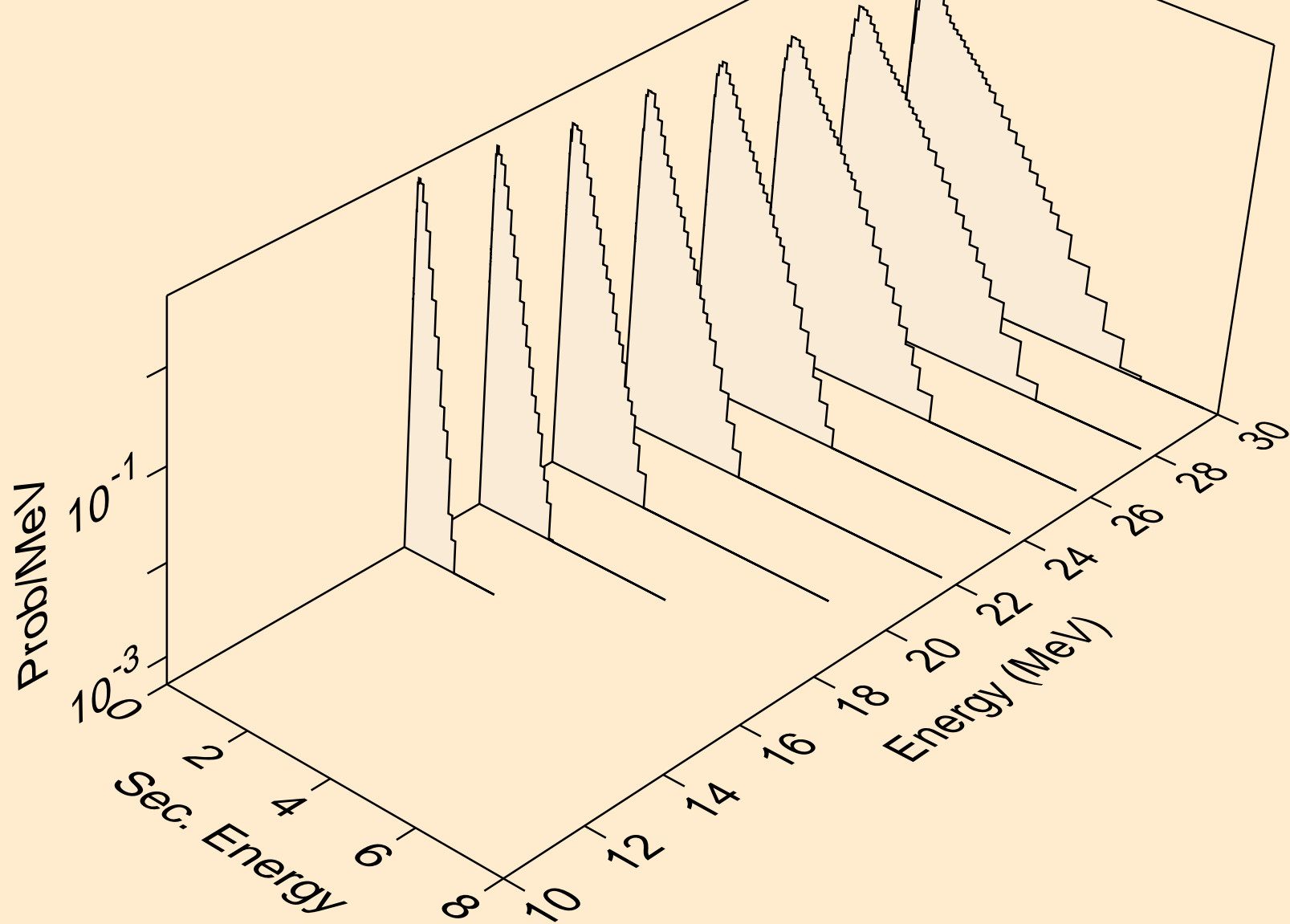

RH110M NEUTRON ACER TENDL-2021 LIBRARY; T=293.6K
Neutron emission for (n,3n)a

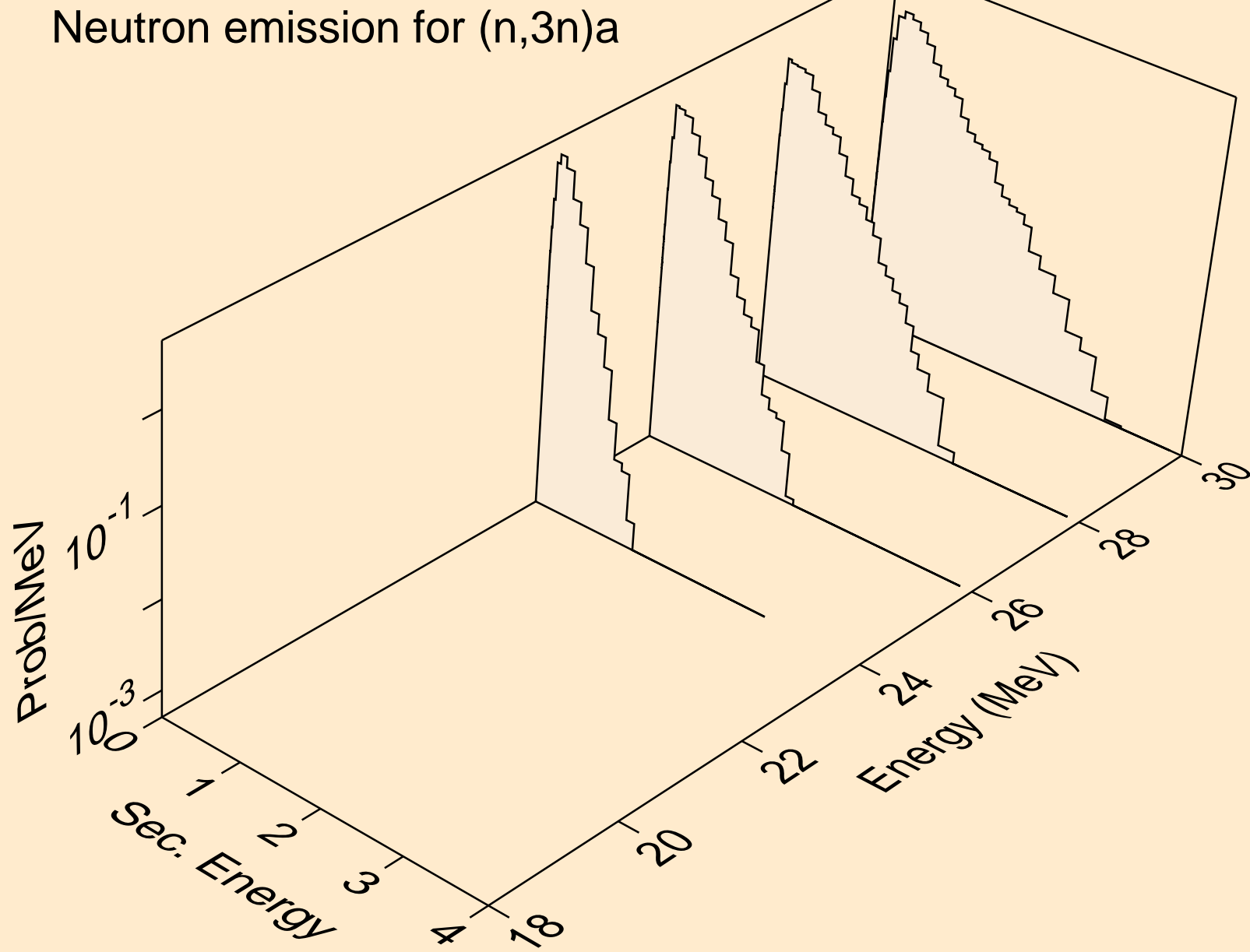

RH110M NEUTRON ACER TENDL-2021 LIBRARY; T=293.6K
Neutron emission for (n,n*)p

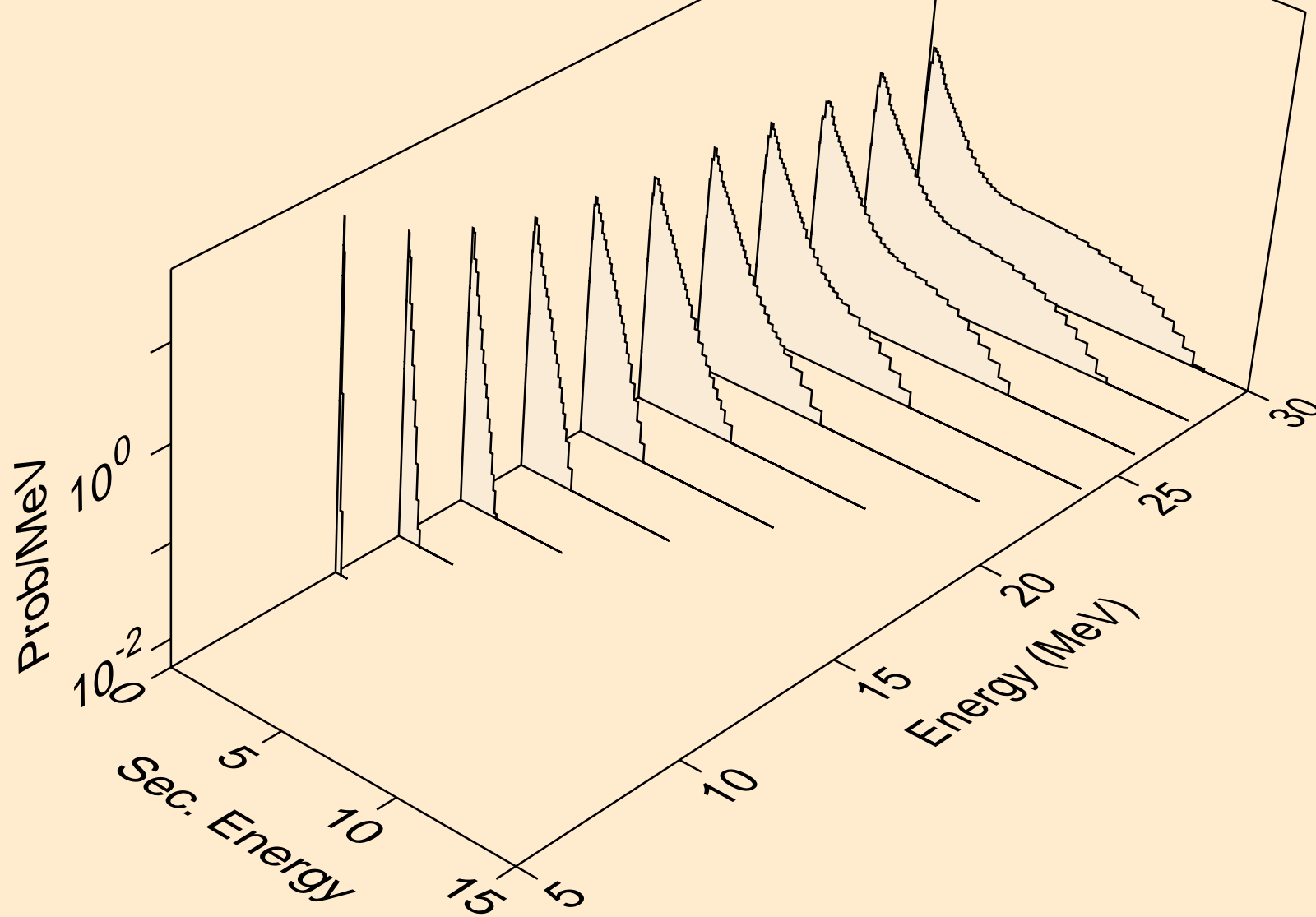

RH110M NEUTRON ACER TENDL-2021 LIBRARY; T=293.6K
Neutron emission for (n,n*)d

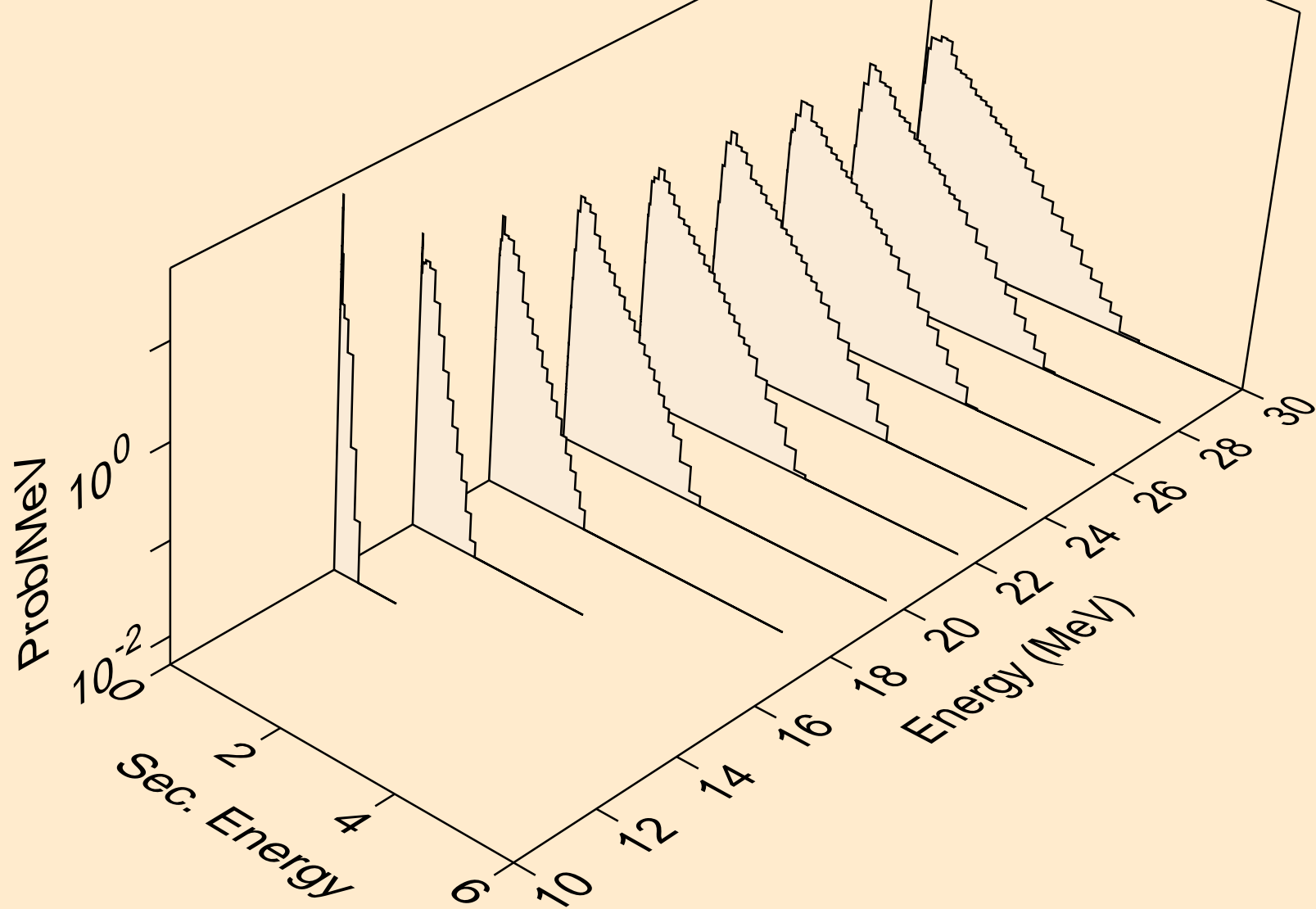

RH110M NEUTRON ACER TENDL-2021 LIBRARY; T=293.6K
Neutron emission for (n,n*)t

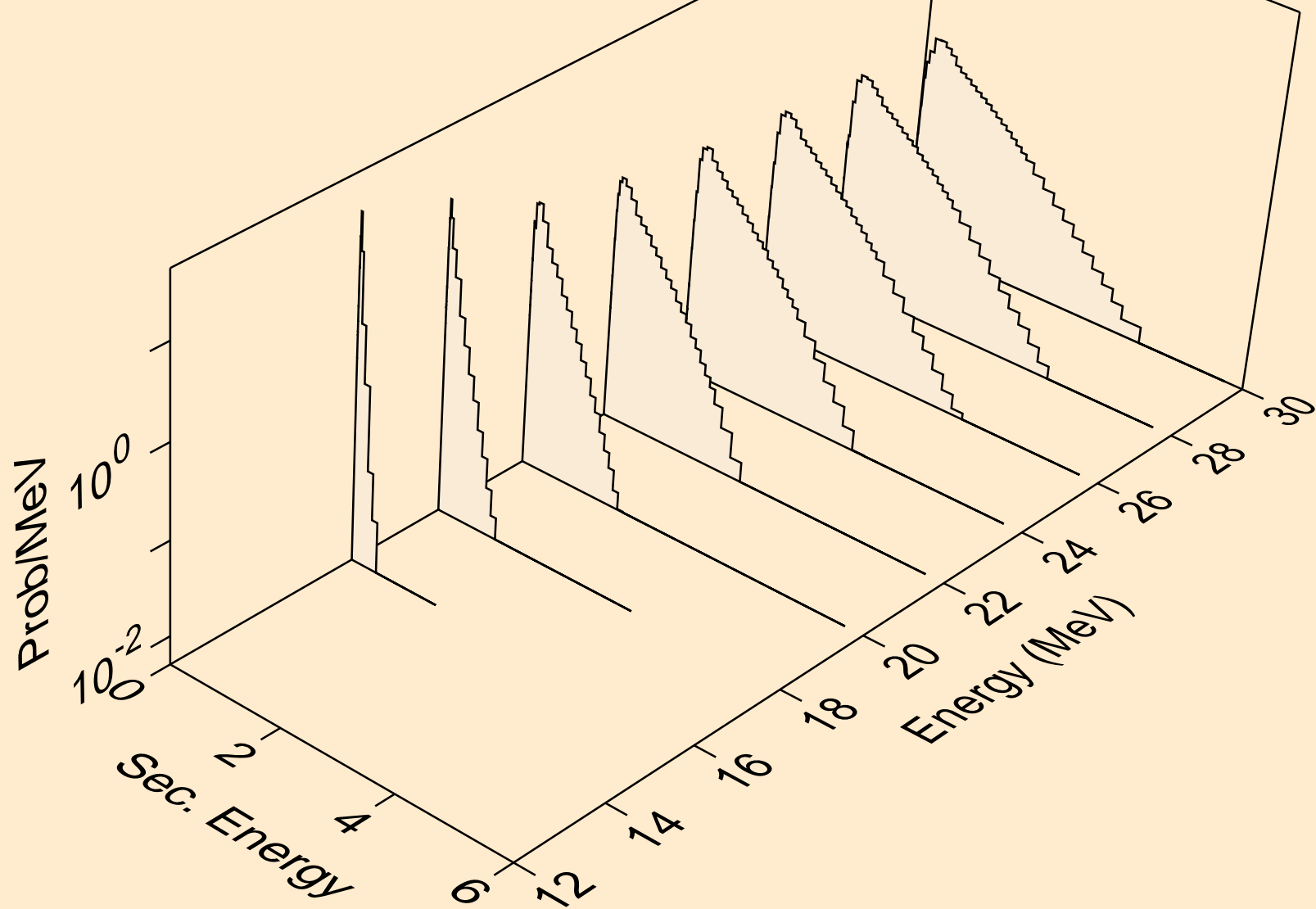

RH110M NEUTRON ACER TENDL-2021 LIBRARY; T=293.6K
Neutron emission for (n,n*)he3

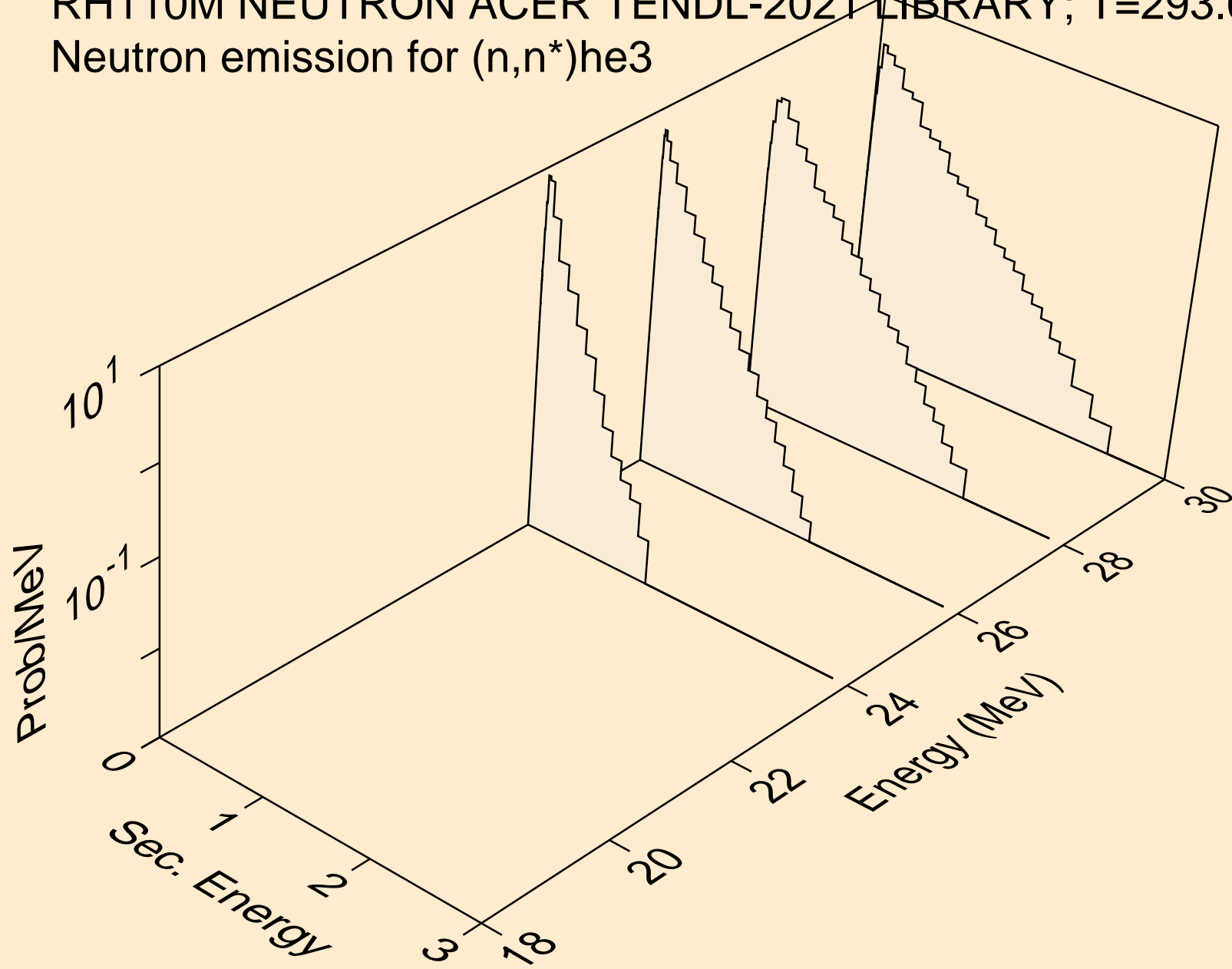

RH110M NEUTRON ACER TENDL-2021 LIBRARY; T=293.6K
Neutron emission for (n,4n)

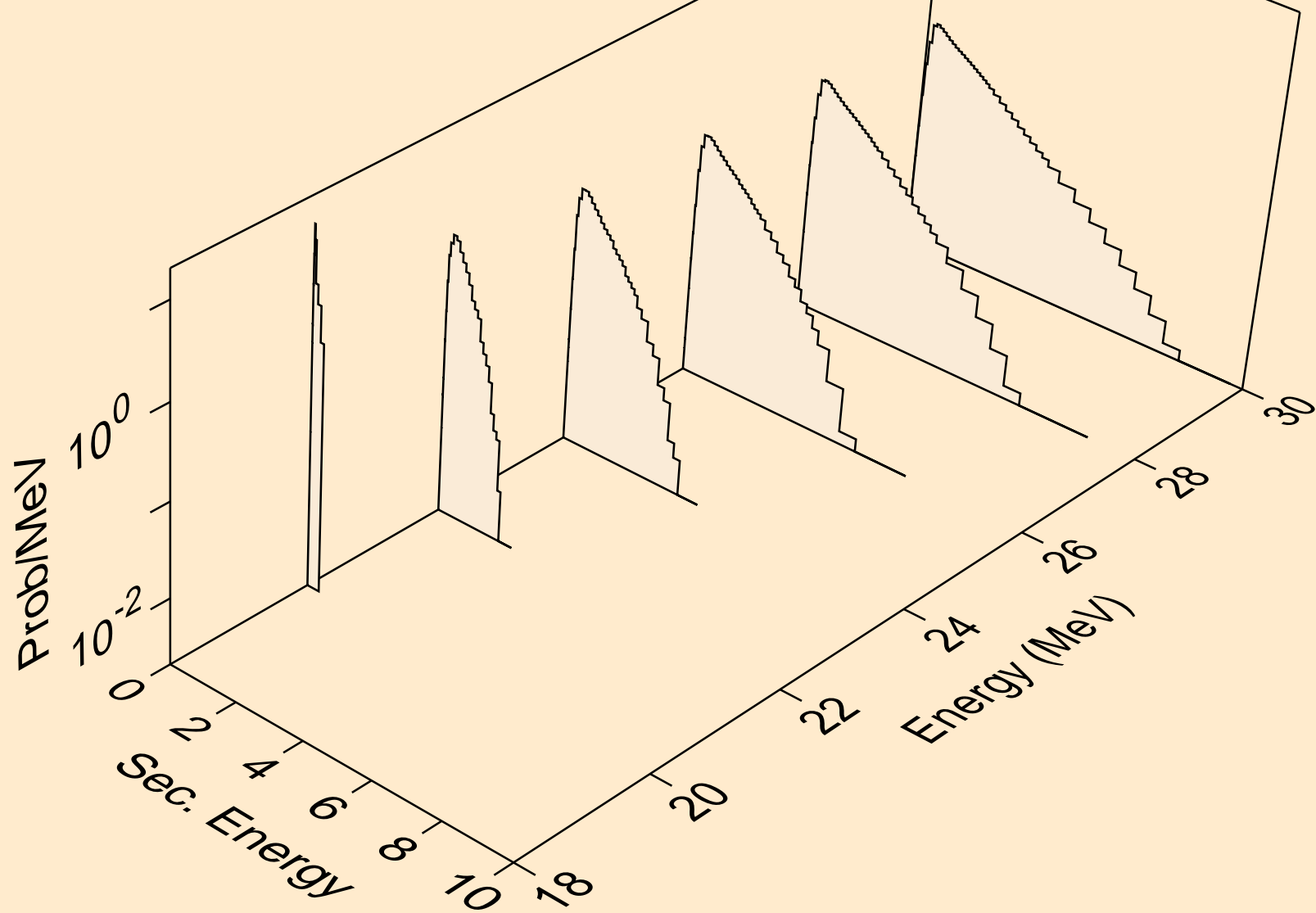

RH110M NEUTRON ACER TENDL-2021 LIBRARY; T=293.6K
Neutron emission for (n,2np)

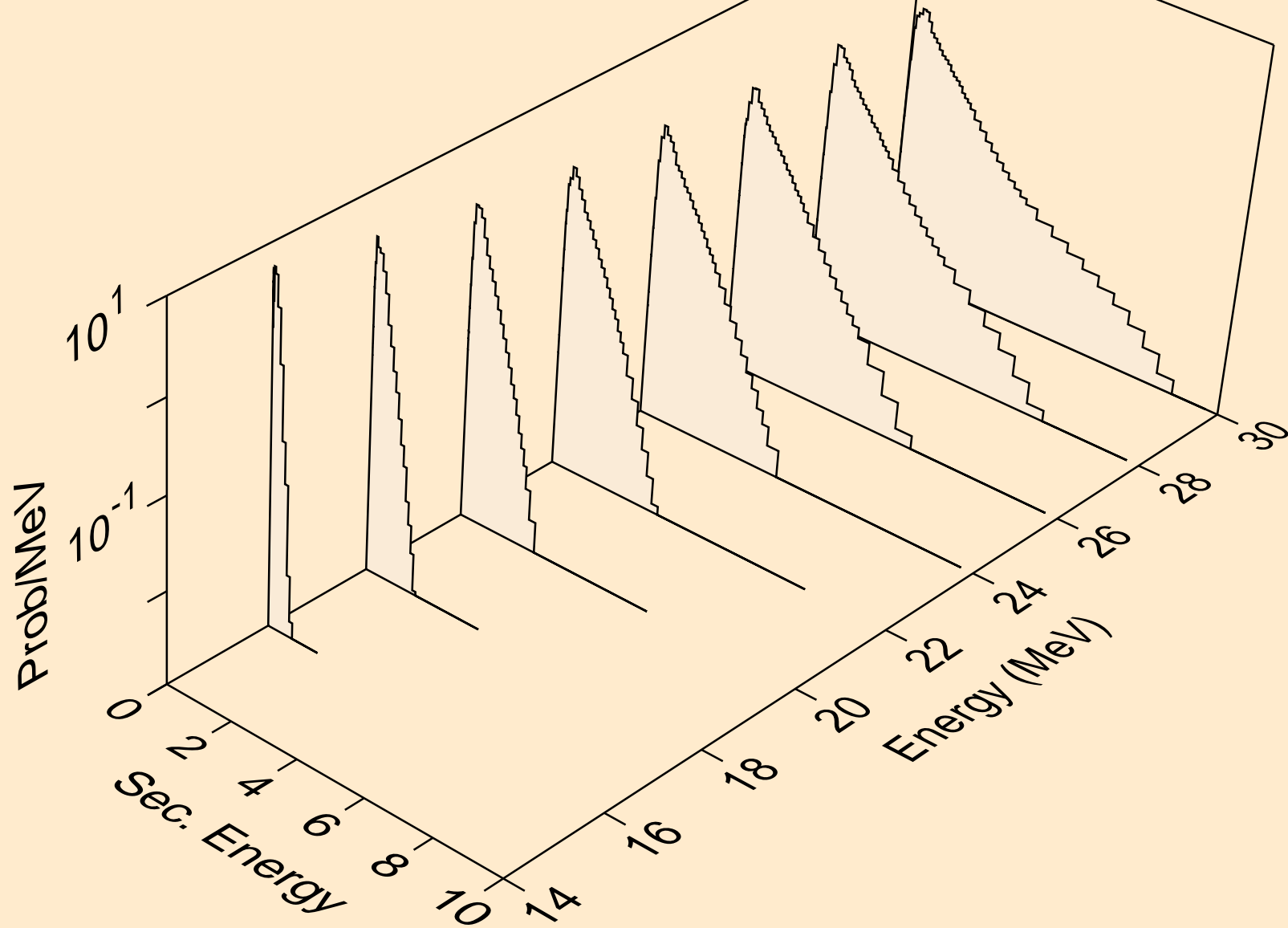

RH110M NEUTRON ACER TENDL-2021 LIBRARY; T=293.6K
Neutron emission for (n,3np)

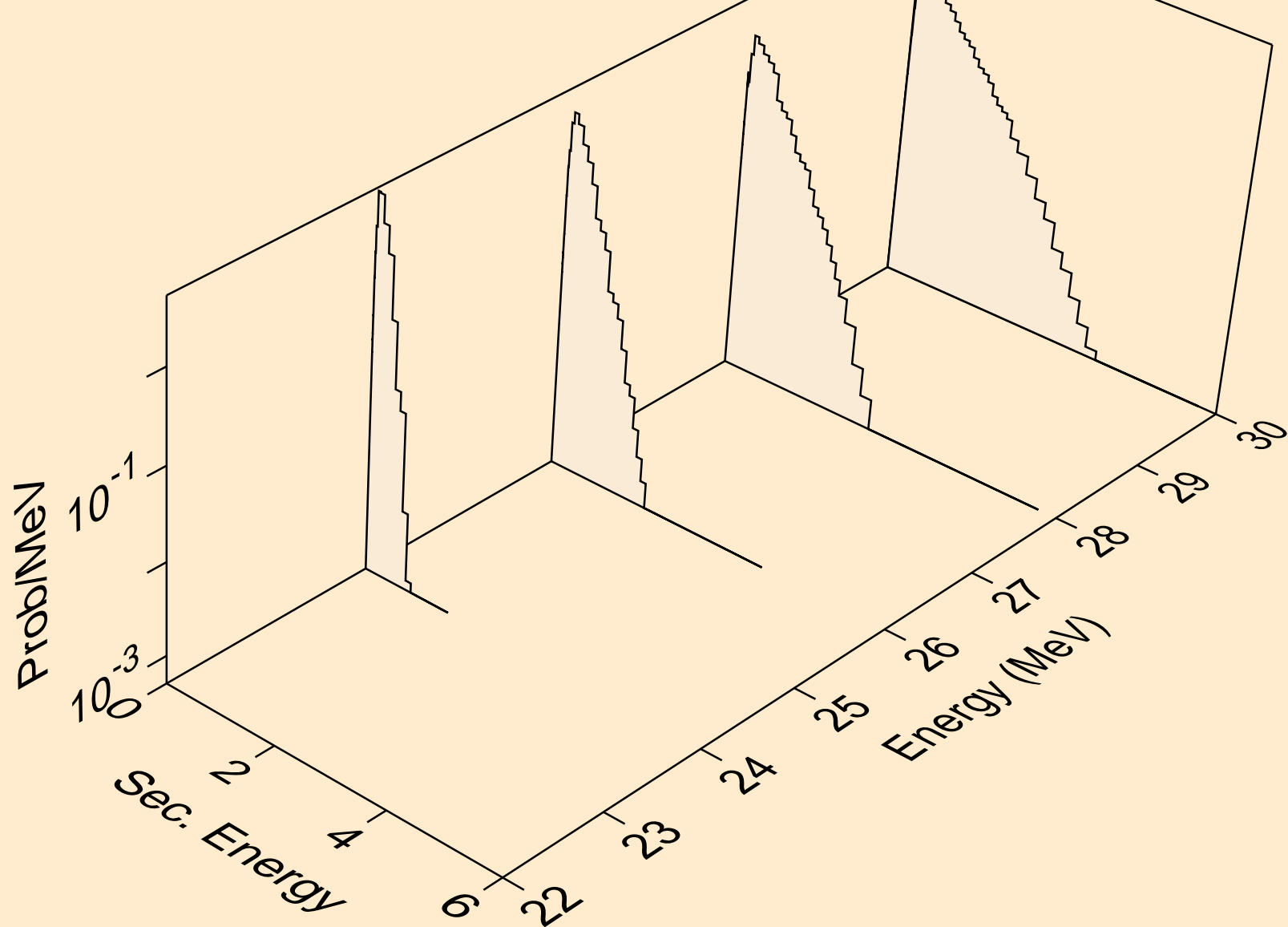

RH110M NEUTRON ACER TENDL-2021 LIBRARY; T=293.6K
Neutron emission for (n,n*c)

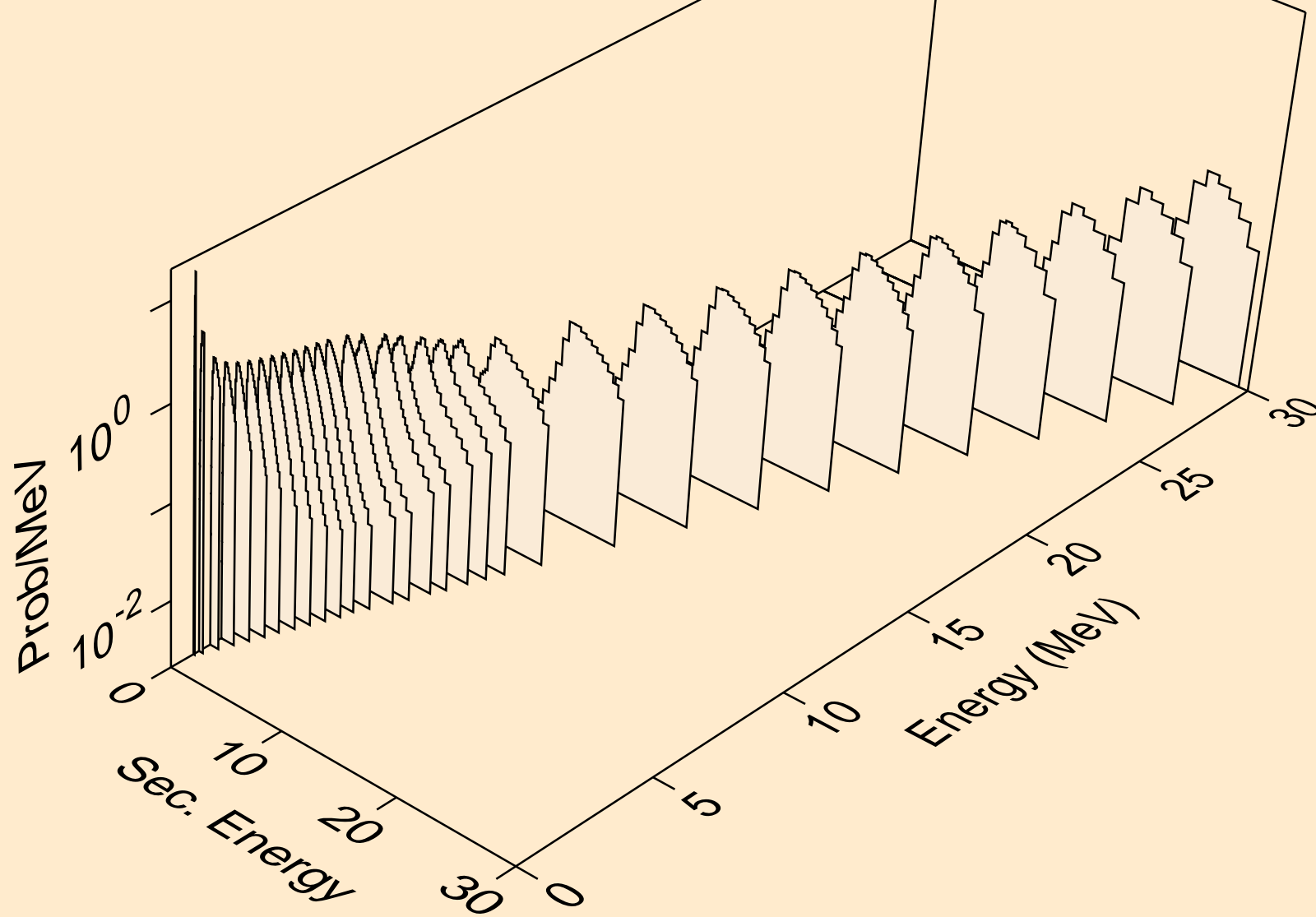

RH110M NEUTRON ACER TENDL-2021 LIBRARY; T=293.6K
Photon emission for (n,x)

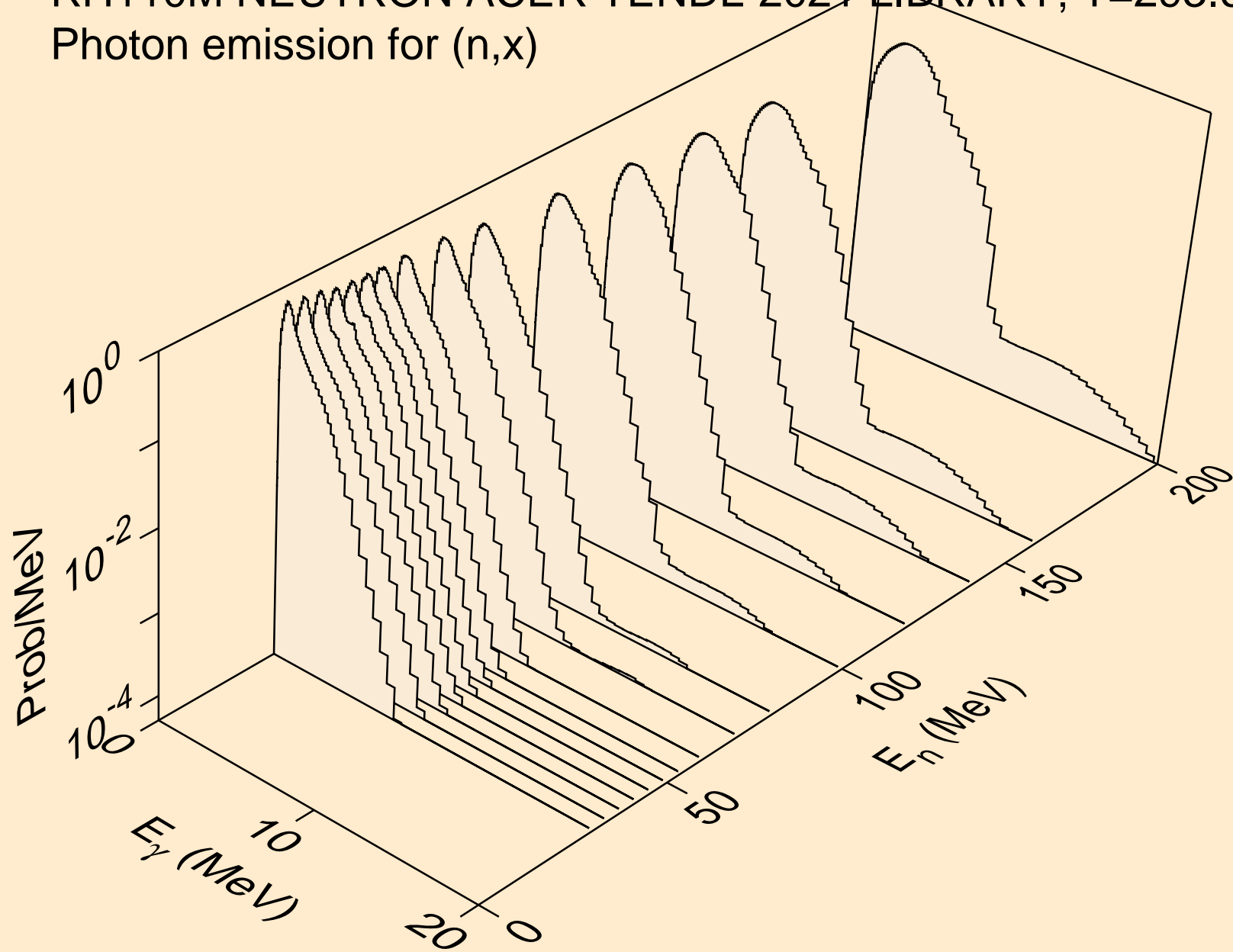

RH110M NEUTRON ACER TENDL-2021 LIBRARY; T=293.6K
Photon emission for (n,2nd)

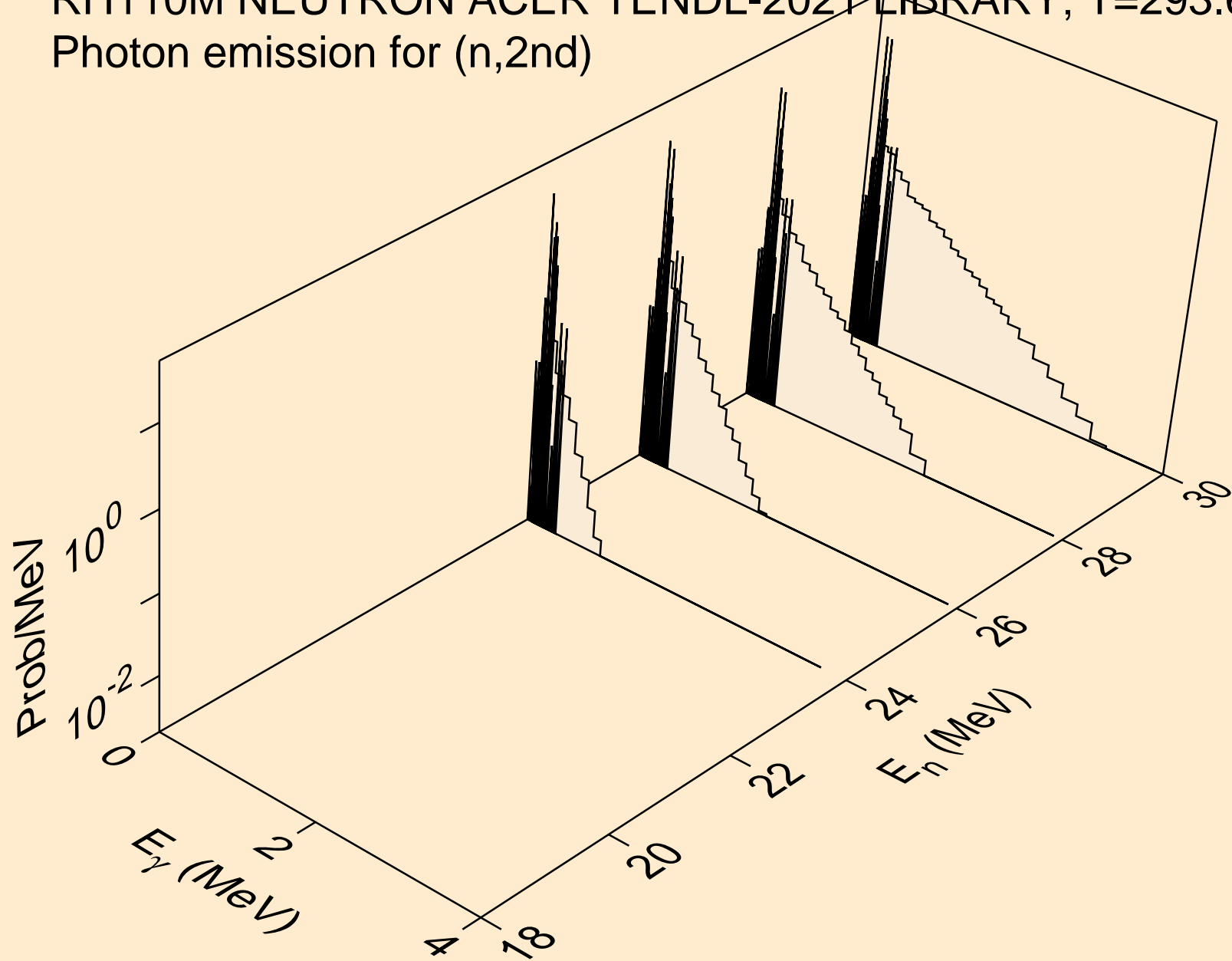

RH110M NEUTRON ACER TENDL-2021 LIBRARY; T=293.6K
Photon emission for (n,2n)

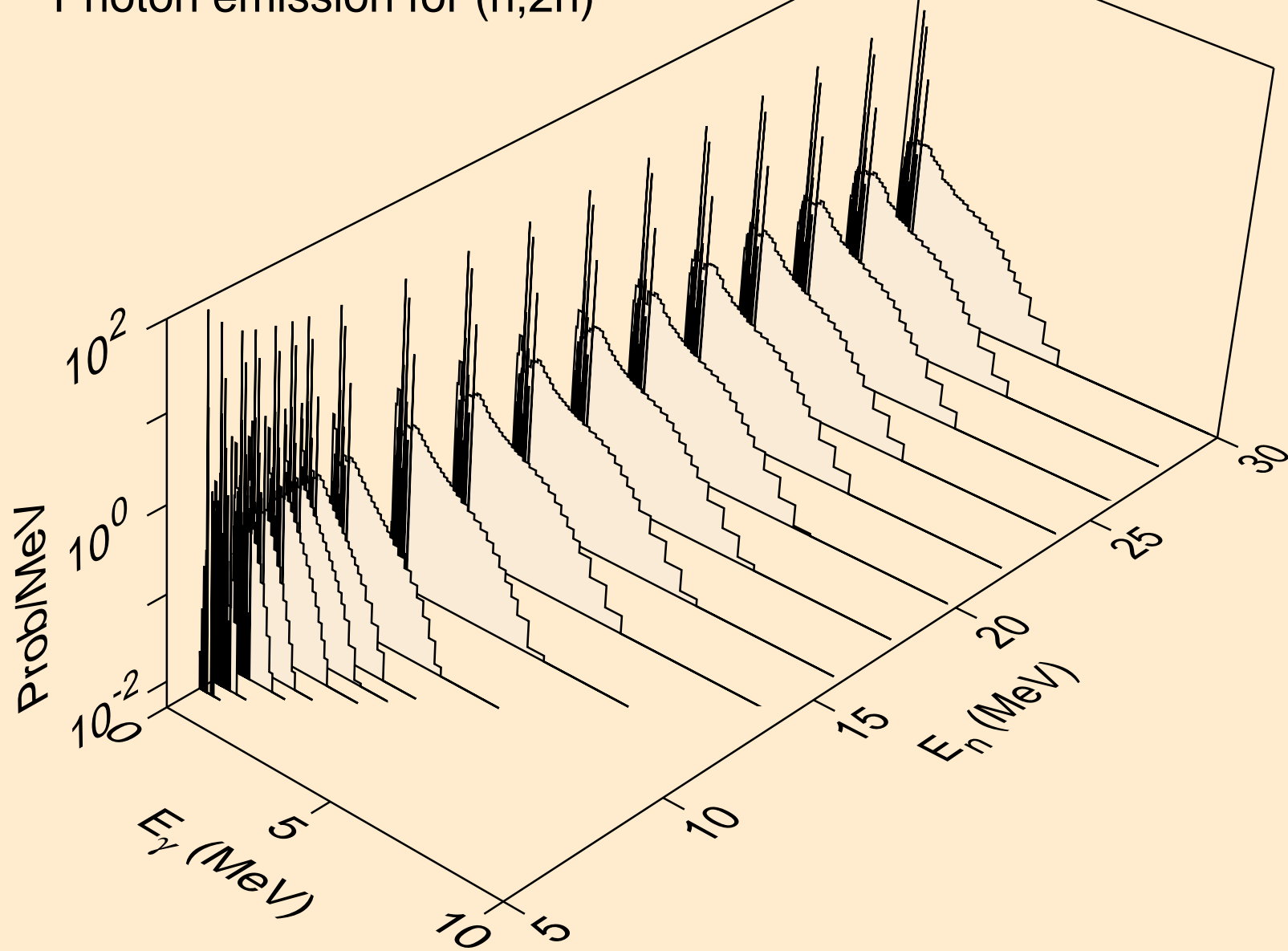

RH110M NEUTRON ACER TENDL-2021 LIBRARY; T=293.6K
Photon emission for (n,3n)

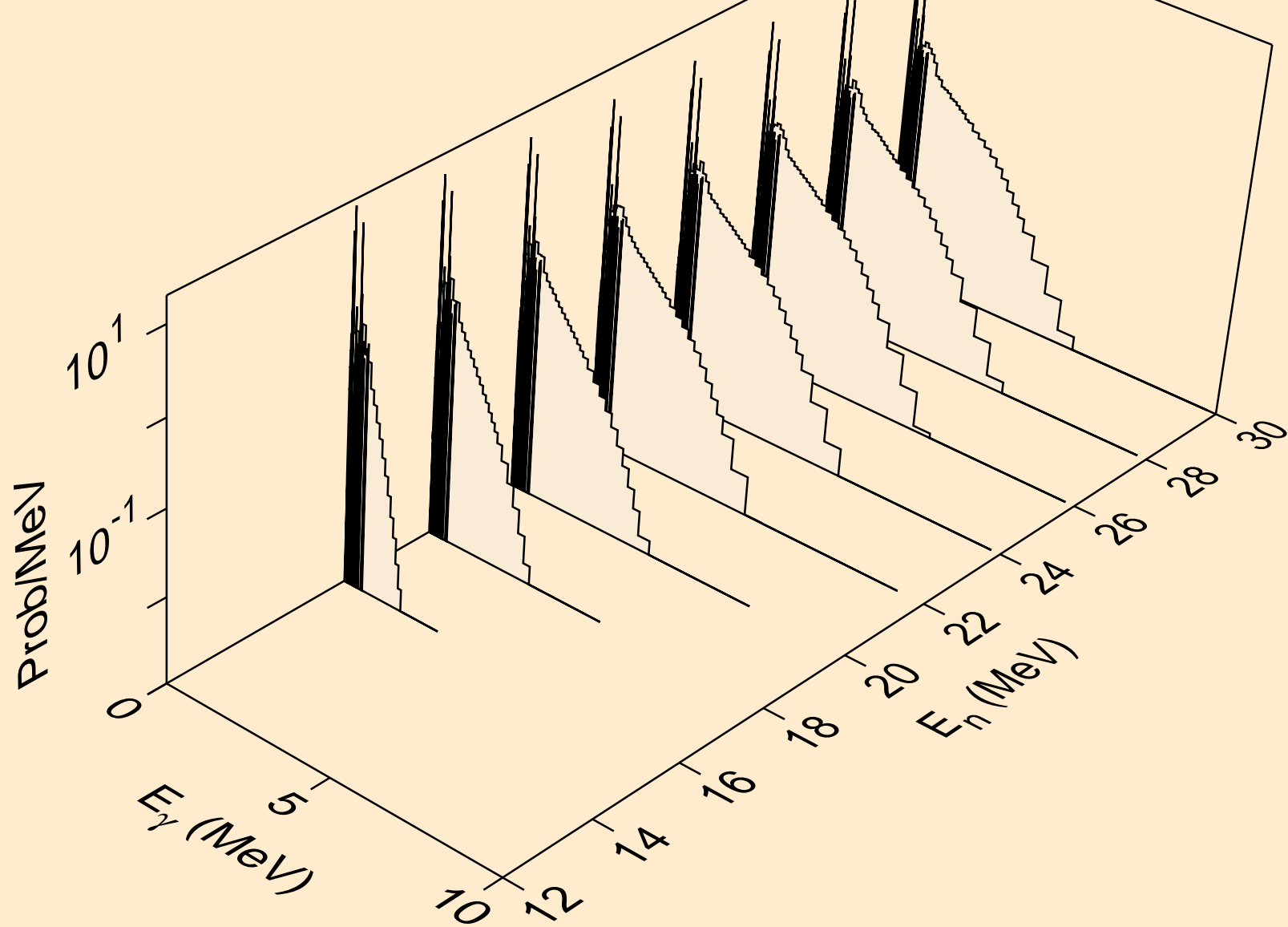

RH110M NEUTRON ACER TENDL-2021 LIBRARY; T=293.6K
Photon emission for (n,n*)a

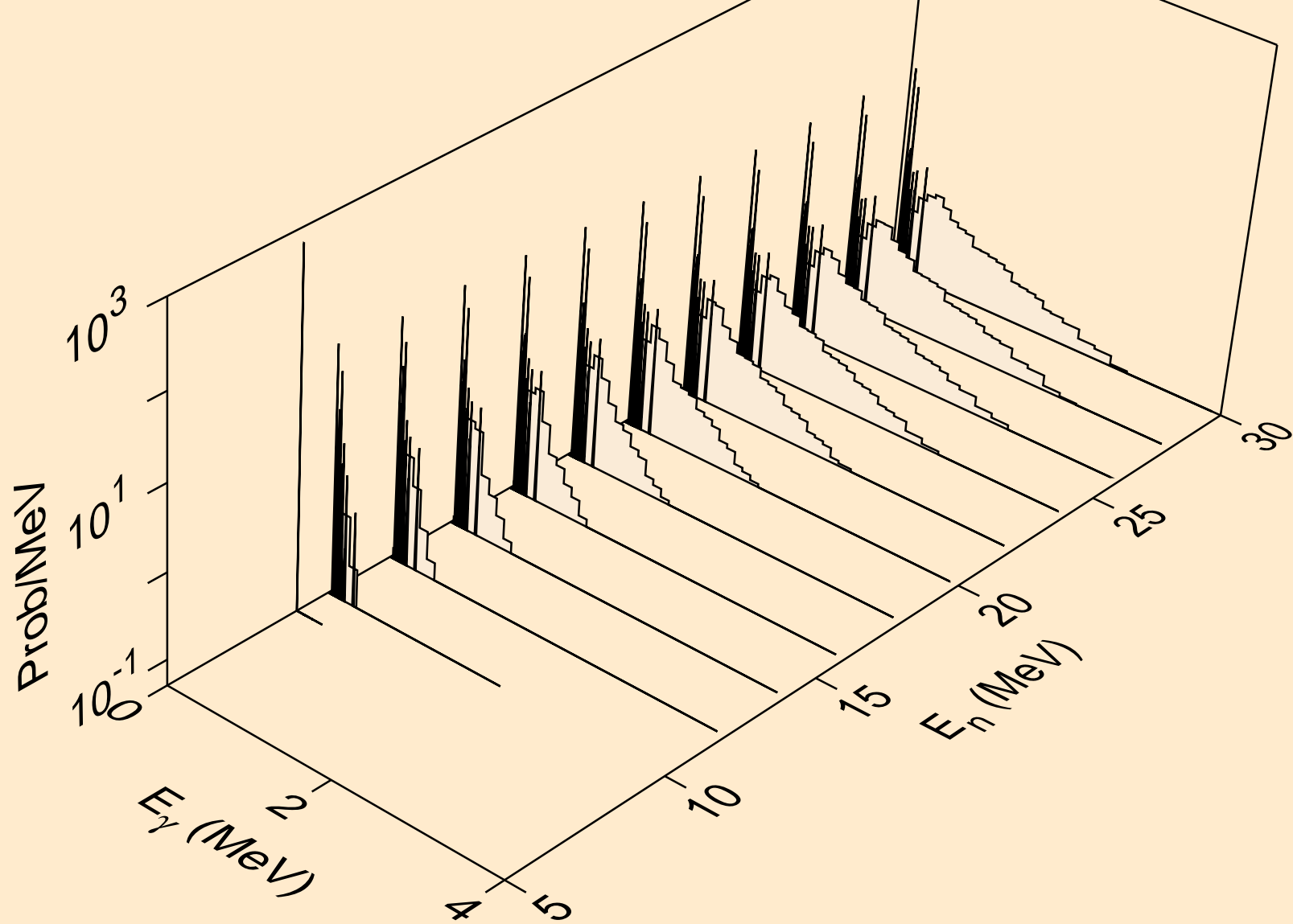

RH110M NEUTRON ACER TENDL-2021 LIBRARY; T=293.6K
Photon emission for (n,2n)a

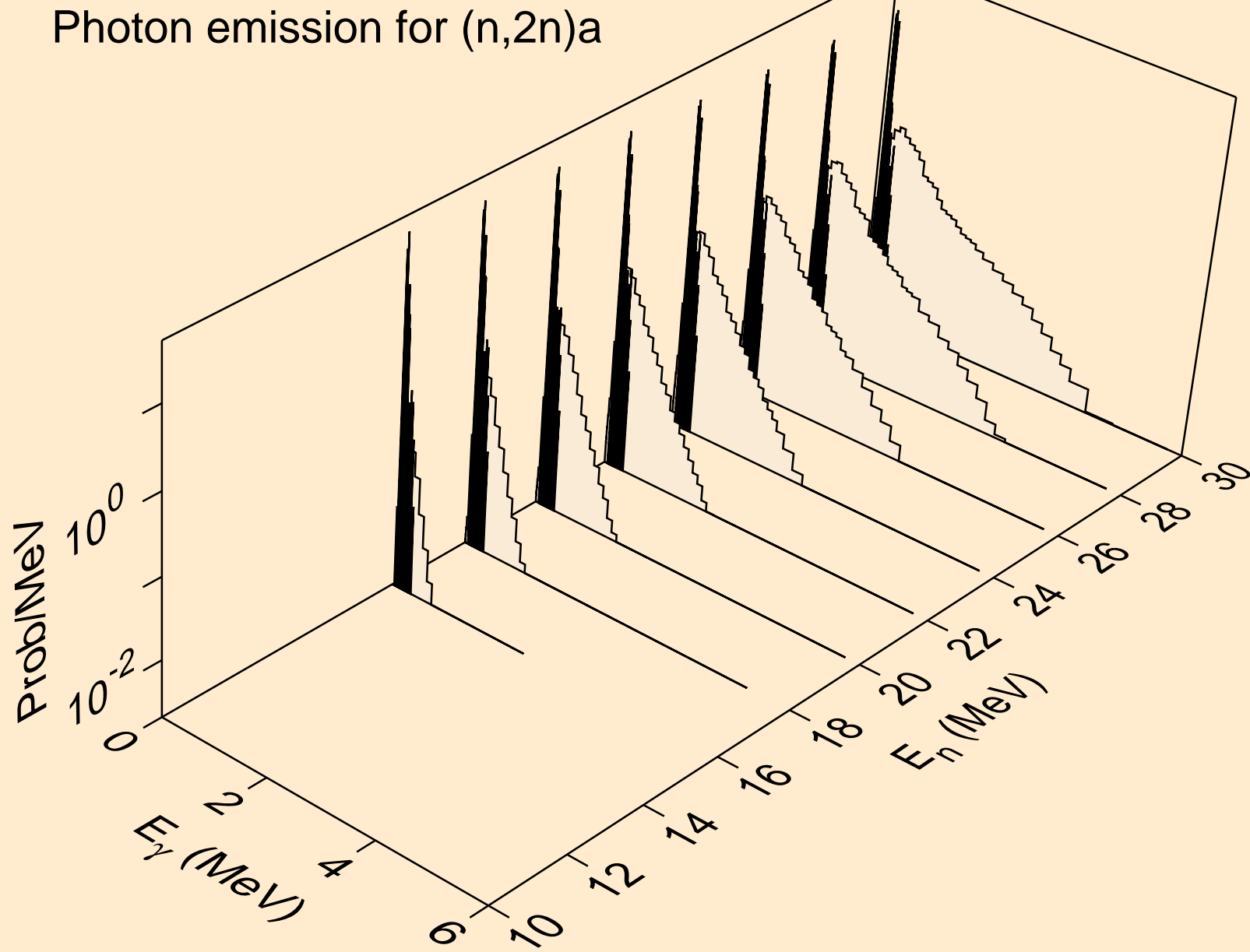

RH110M NEUTRON ACER TENDL-2021 LIBRARY; T=293.6K
Photon emission for (n,3n)a

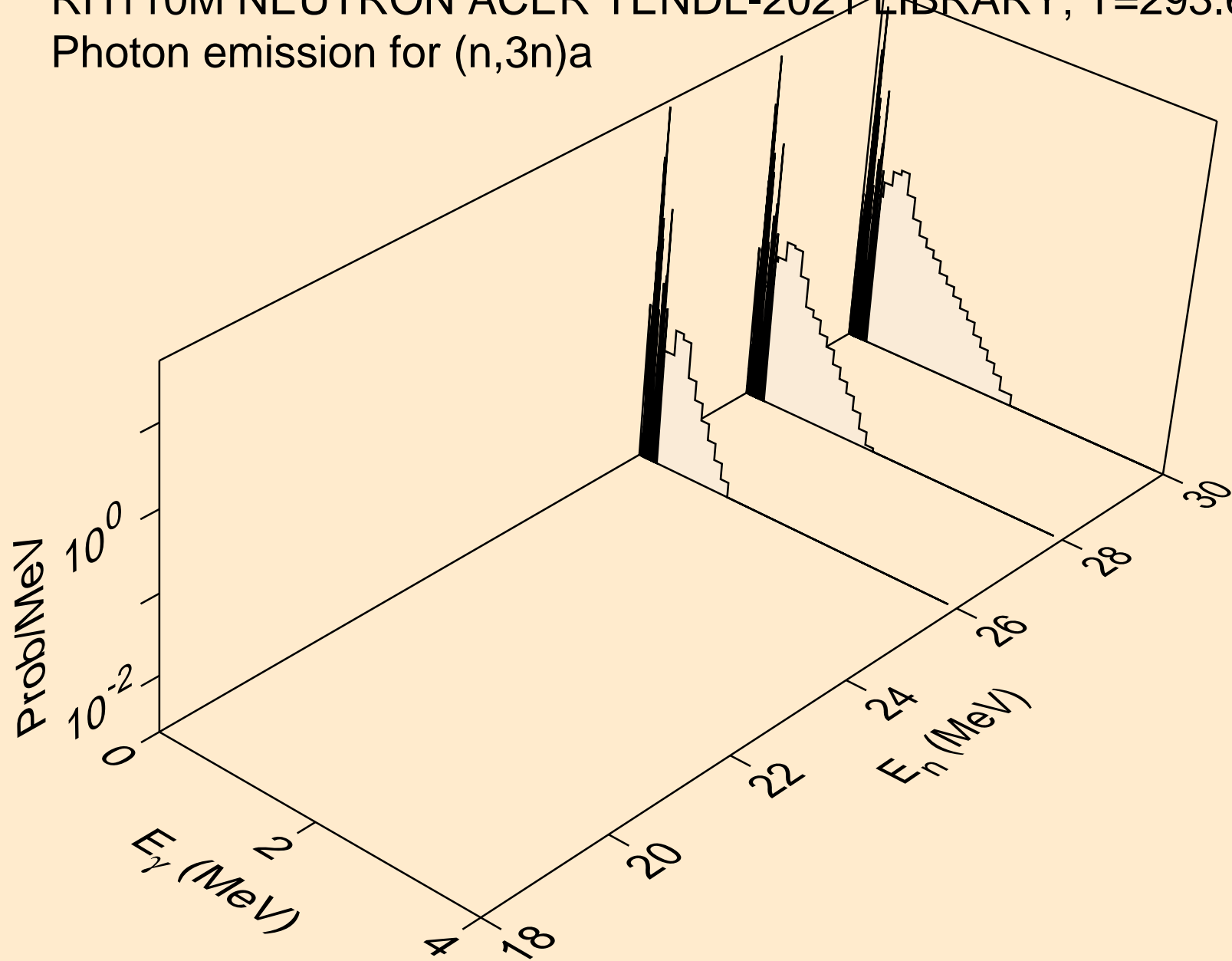

RH110M NEUTRON ACER TENDL-2021 LIBRARY; T=293.6K
Photon emission for (n,n*)p

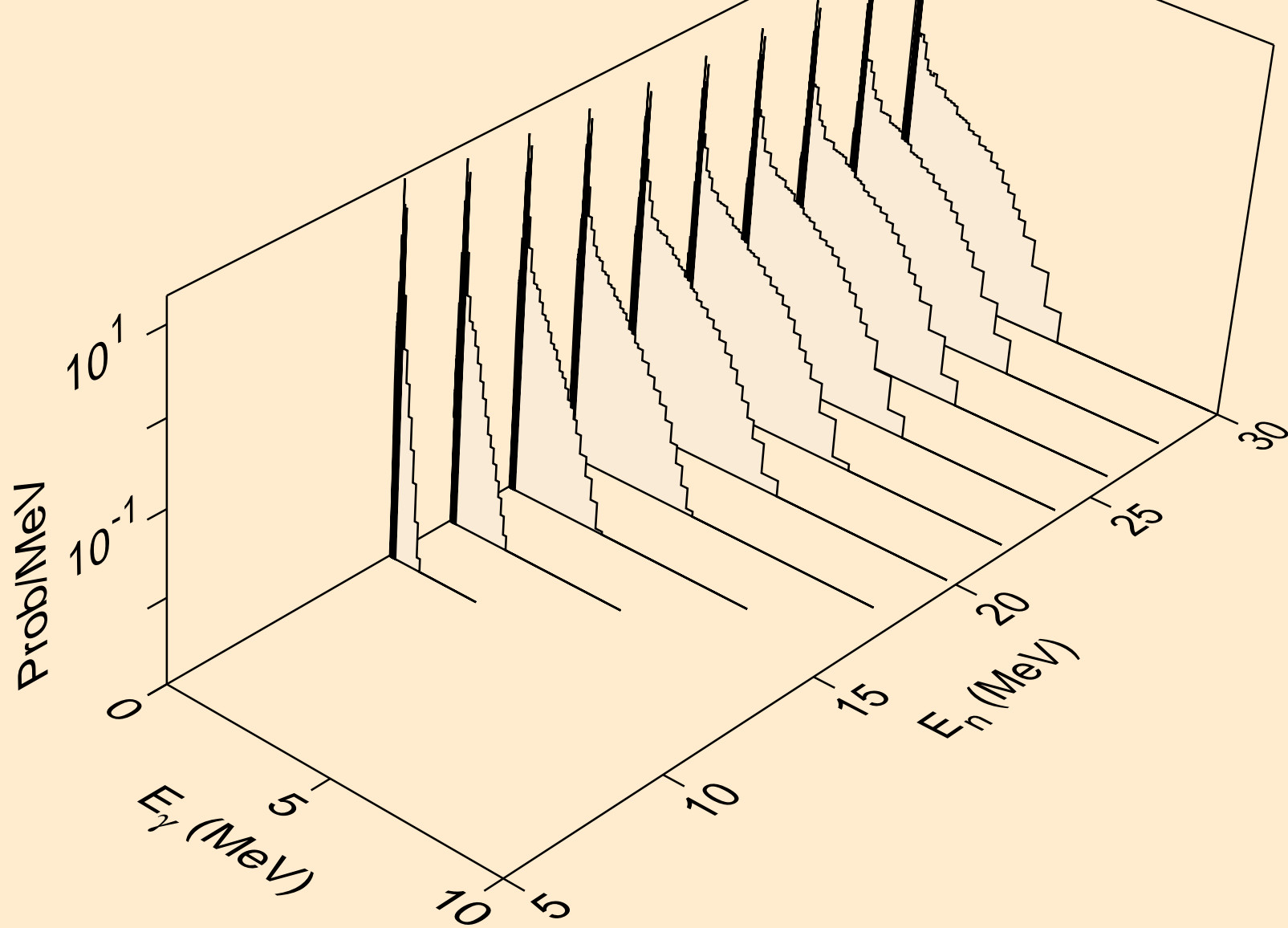

RH110M NEUTRON ACER TENDL-2021 LIBRARY; T=293.6K
Photon emission for (n,n*)d

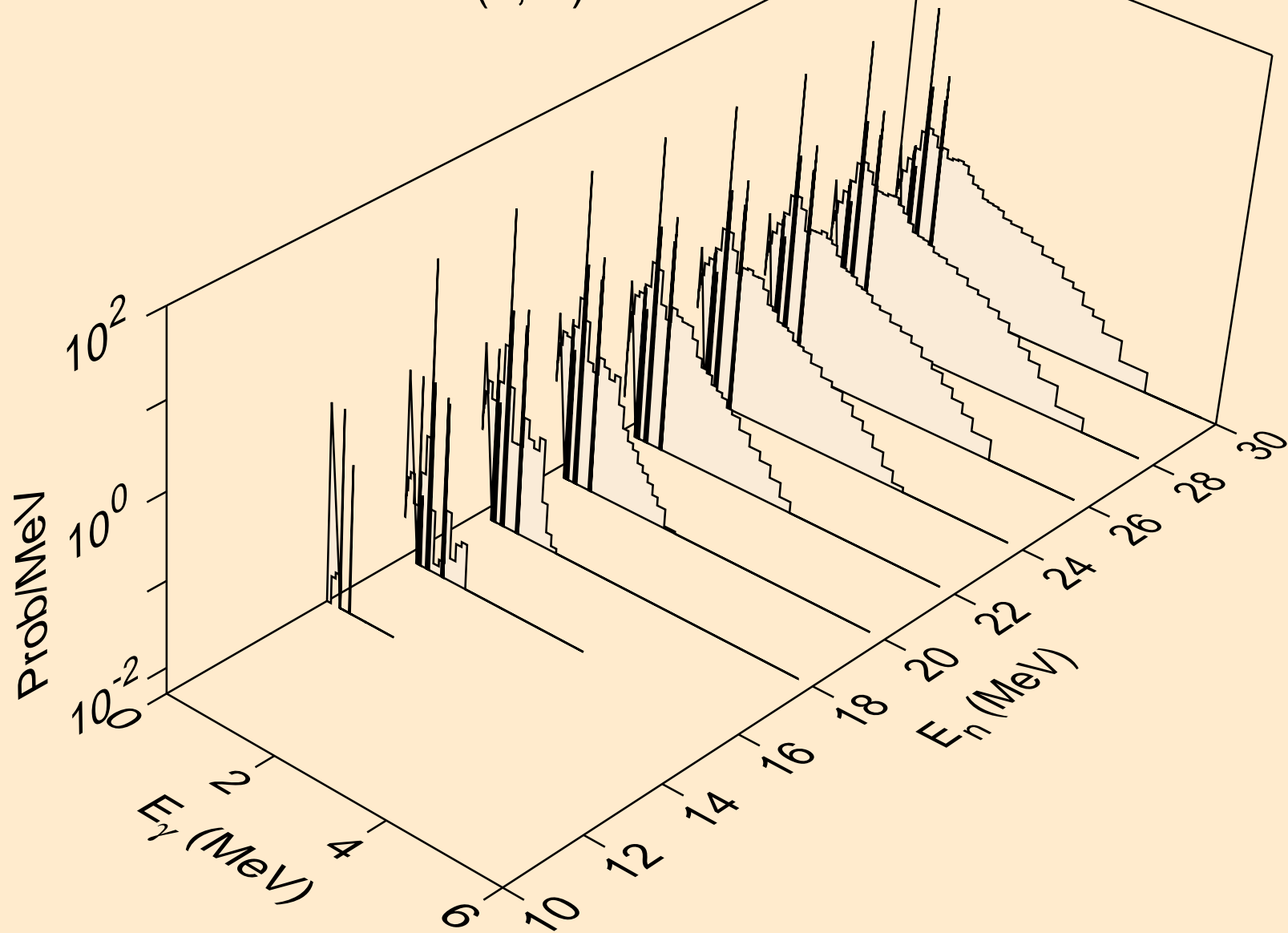

RH110M NEUTRON ACER TENDL-2021 LIBRARY; T=293.6K
Photon emission for (n,n*)t

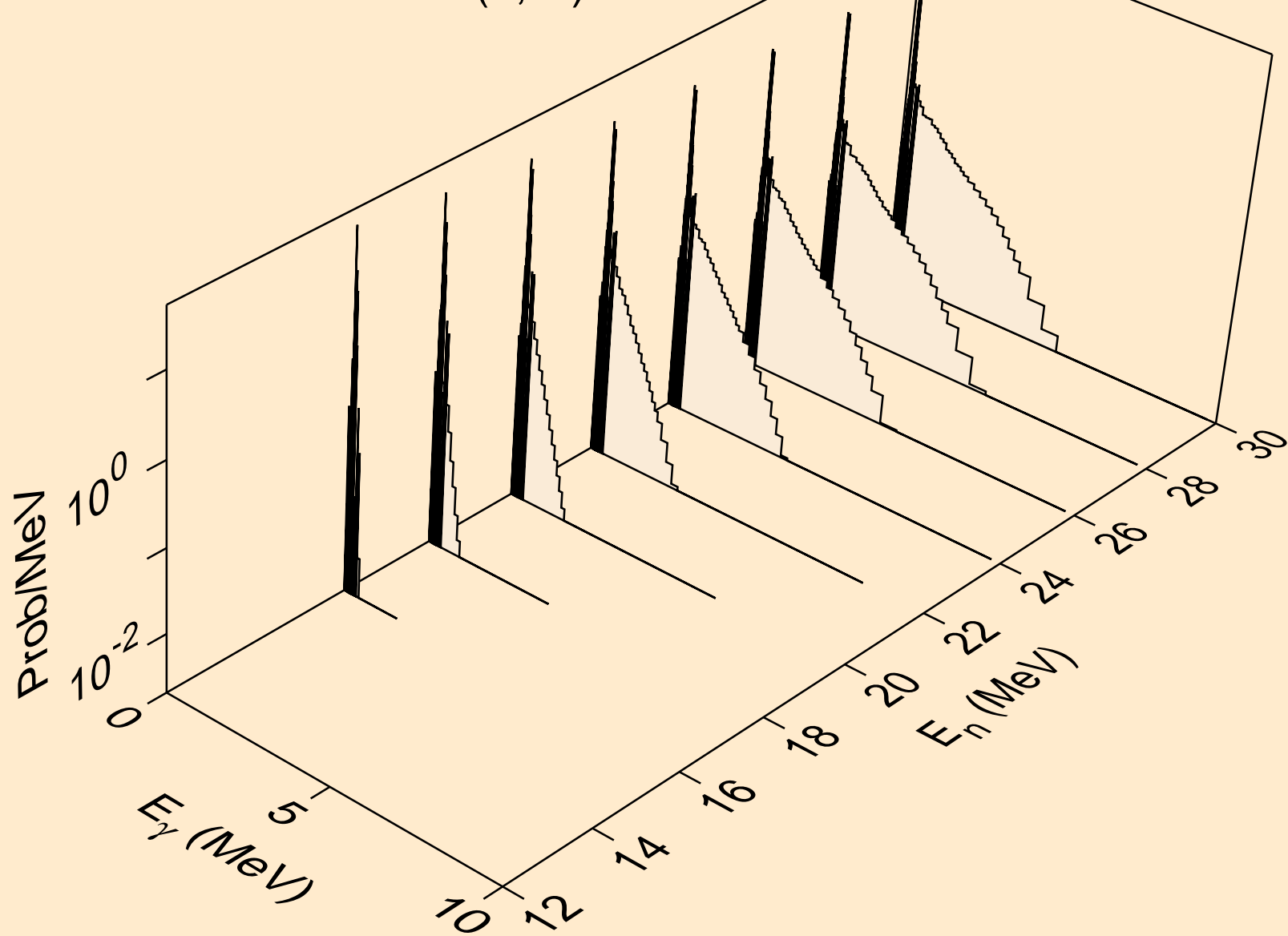

RH110M NEUTRON ACER TENDL-2021 LIBRARY; T=293.6K
Photon emission for (n,n*)he3

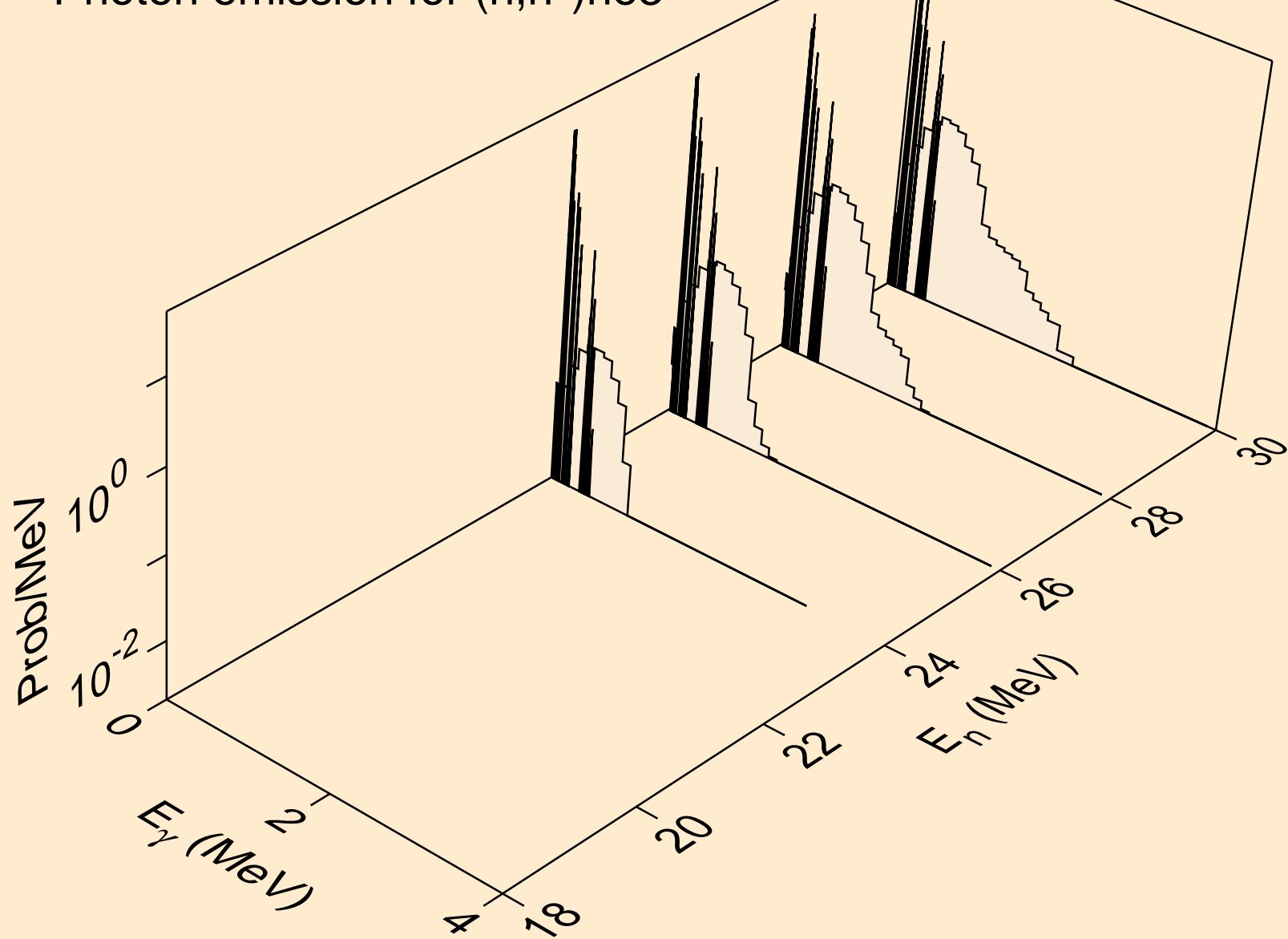

RH110M NEUTRON ACER TENDL-2021 LIBRARY; T=293.6K
Photon emission for (n,4n)

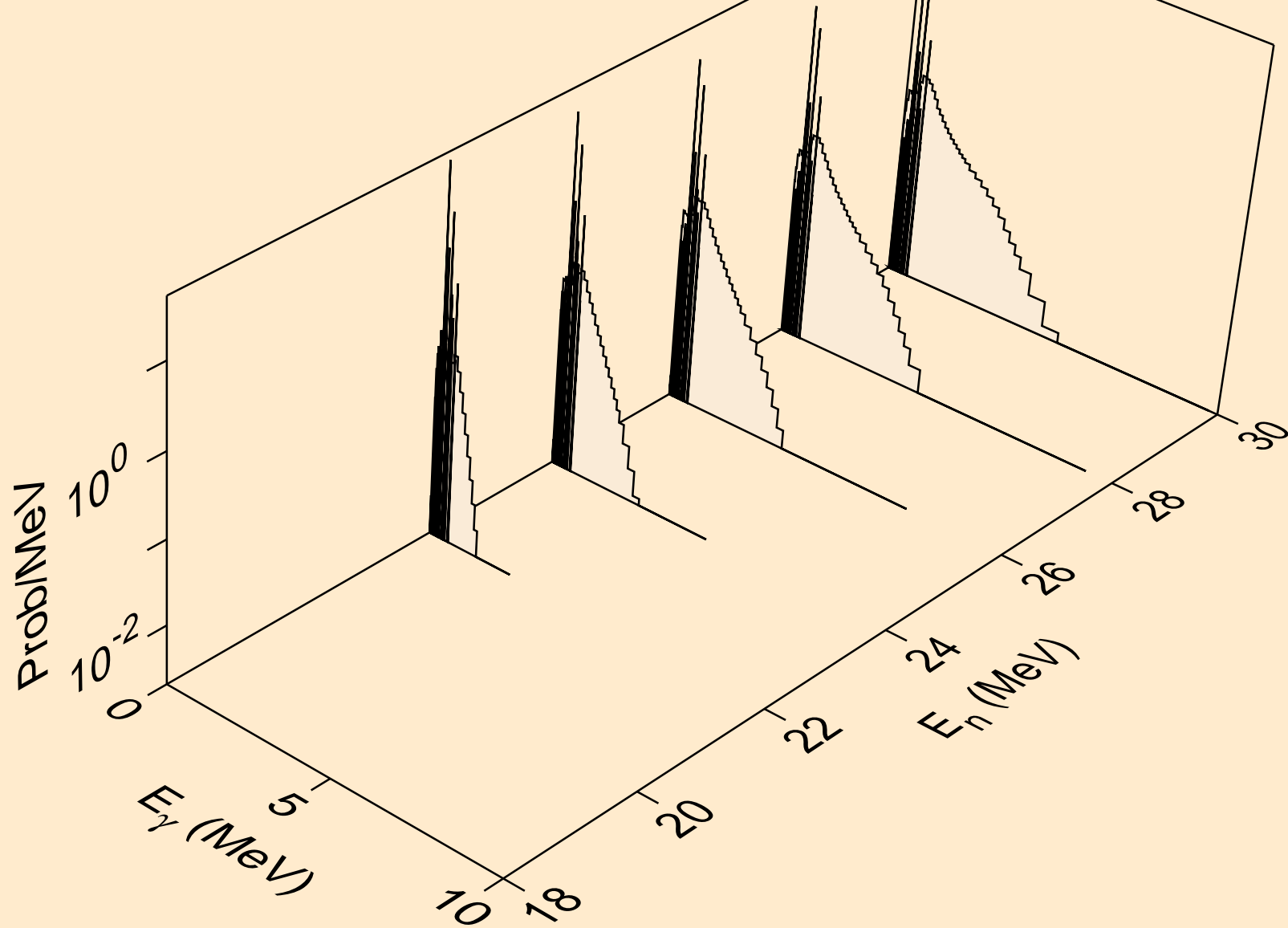

RH110M NEUTRON ACER TENDL-2021 LIBRARY; T=293.6K
Photon emission for (n,2np)

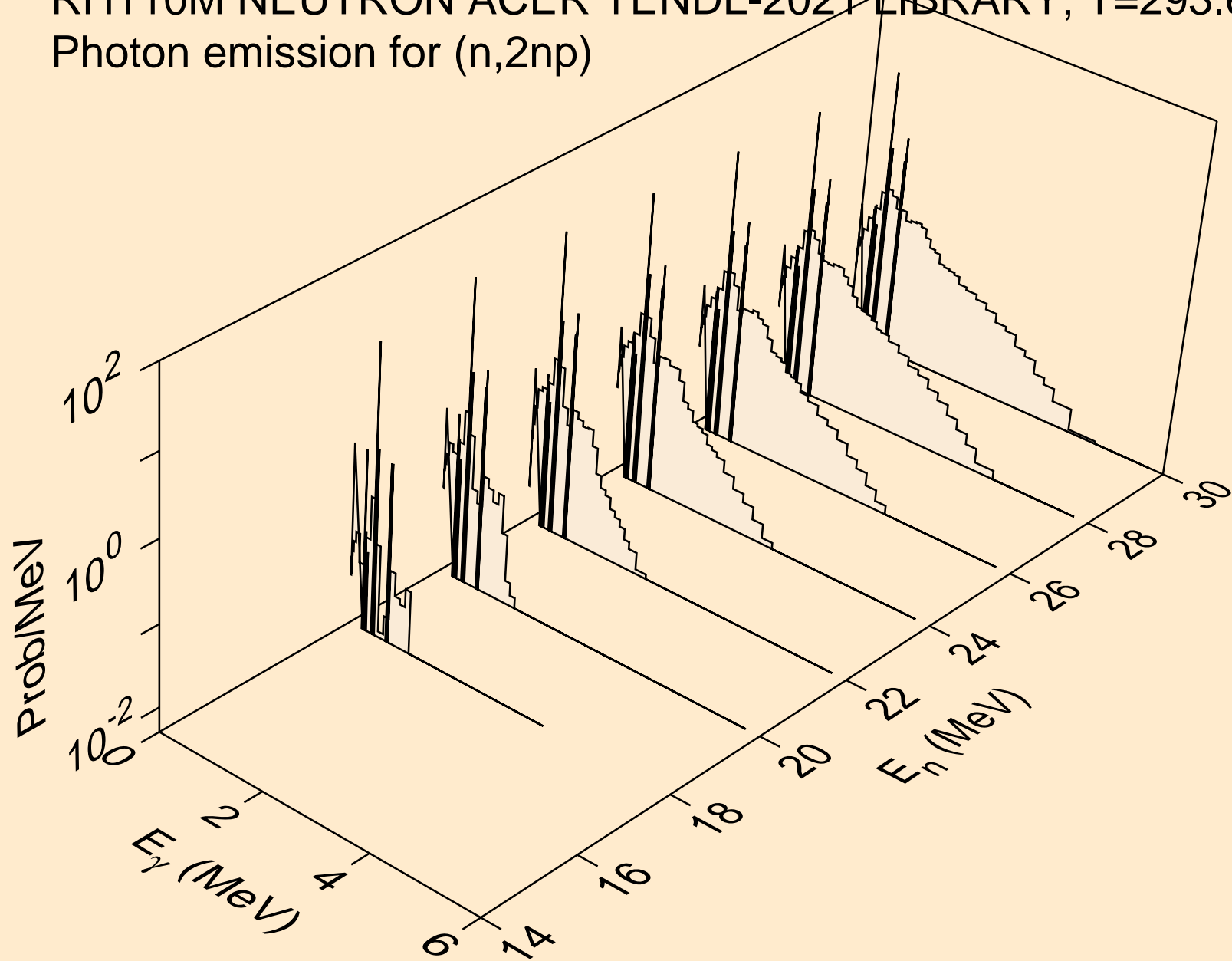

RH110M NEUTRON ACER TENDL-2021 LIBRARY; T=293.6K
Photon emission for (n,3np)

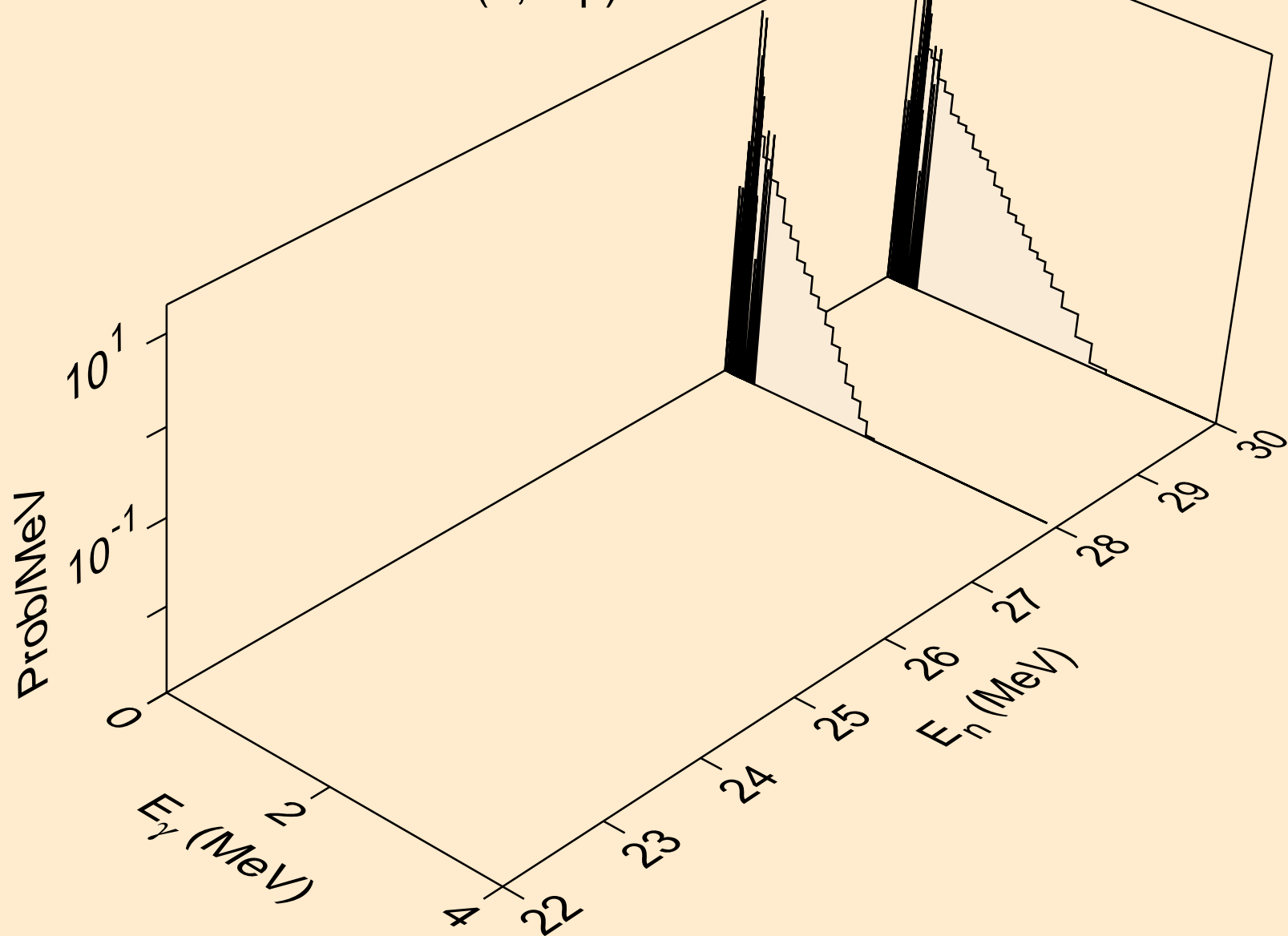

RH110M NEUTRON ACER TENDL-2021 LIBRARY; T=293.6K
Photon emission for (n,n*1)

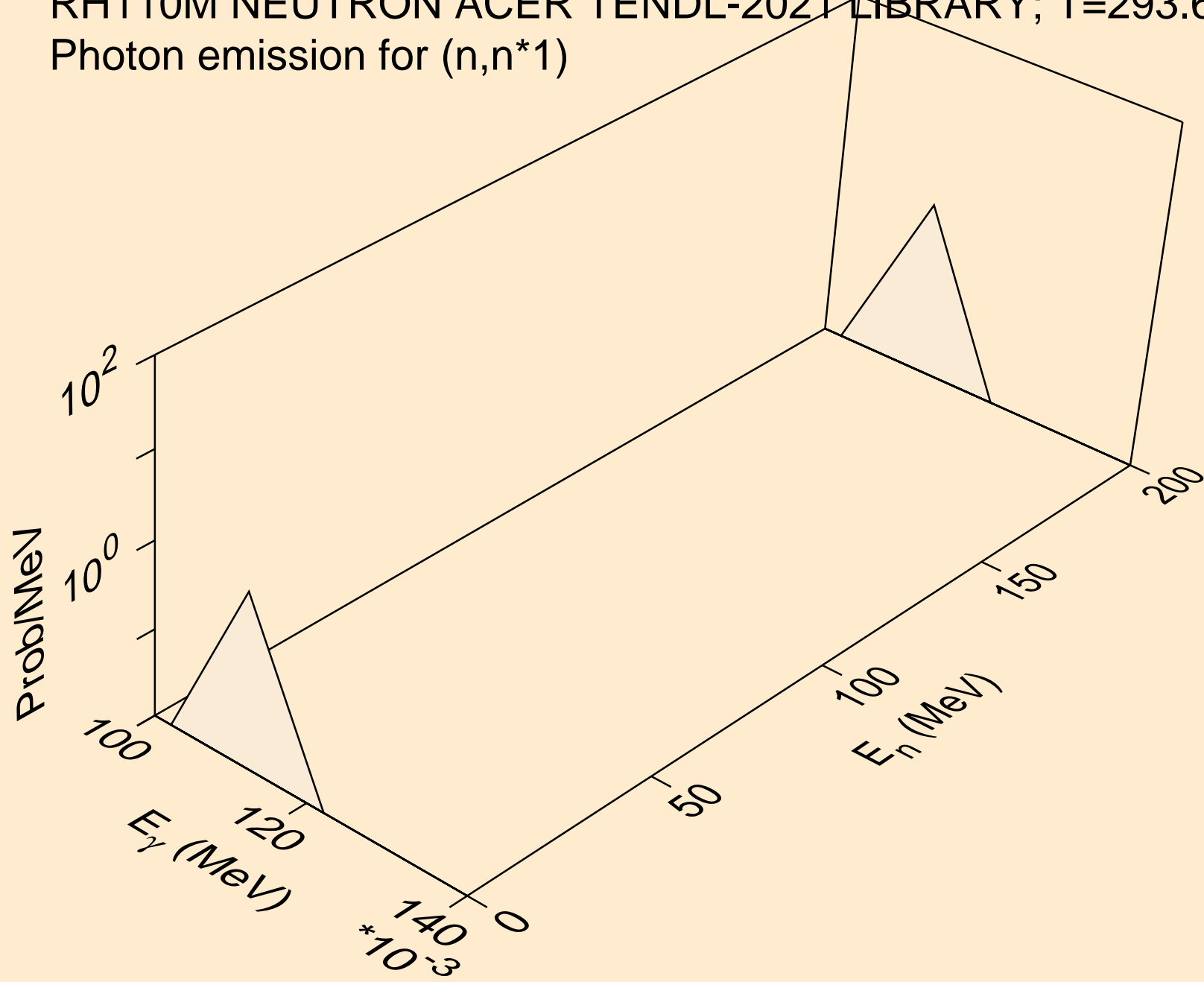

RH110M NEUTRON ACER TENDL-2021 LIBRARY; T=293.6K
Photon emission for (n,n*2)

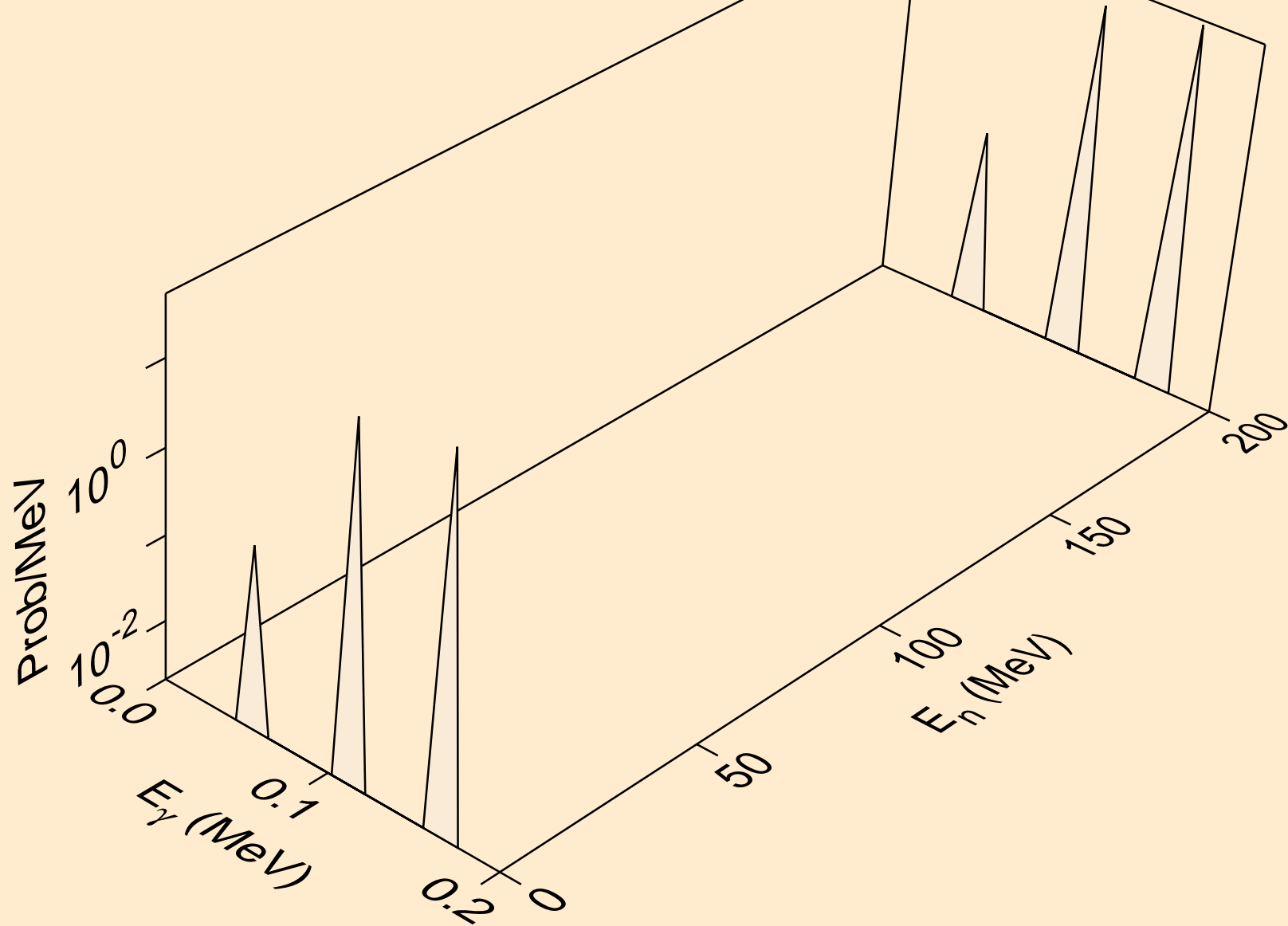

RH110M NEUTRON ACER TENDL-2021 LIBRARY; T=293.6K
Photon emission for (n,n*3)

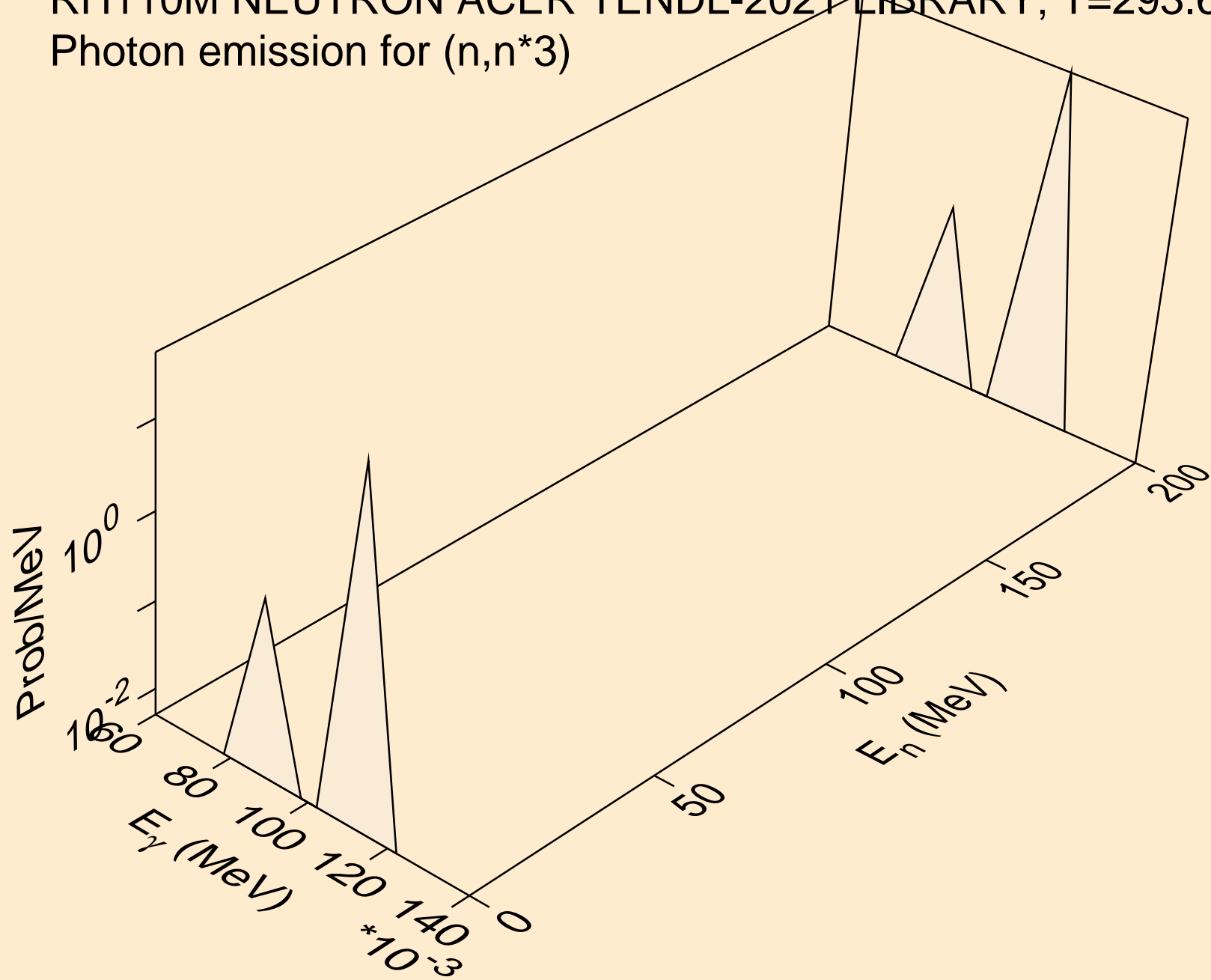

RH110M NEUTRON ACER TENDL-2021 LIBRARY; T=293.6K
Photon emission for (n,n*4)

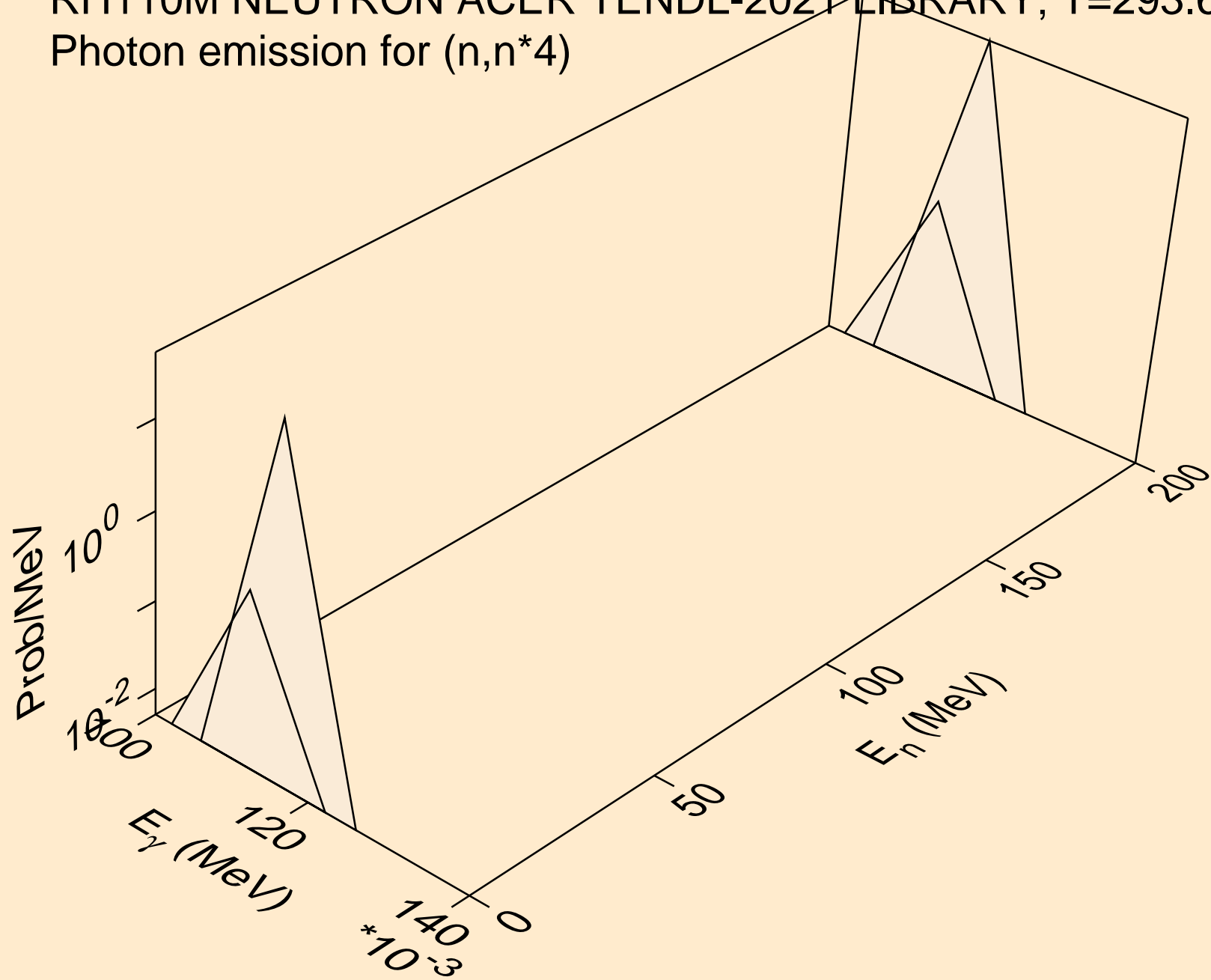

RH110M NEUTRON ACER TENDL-2021 LIBRARY; T=293.6K
Photon emission for (n,n*5)

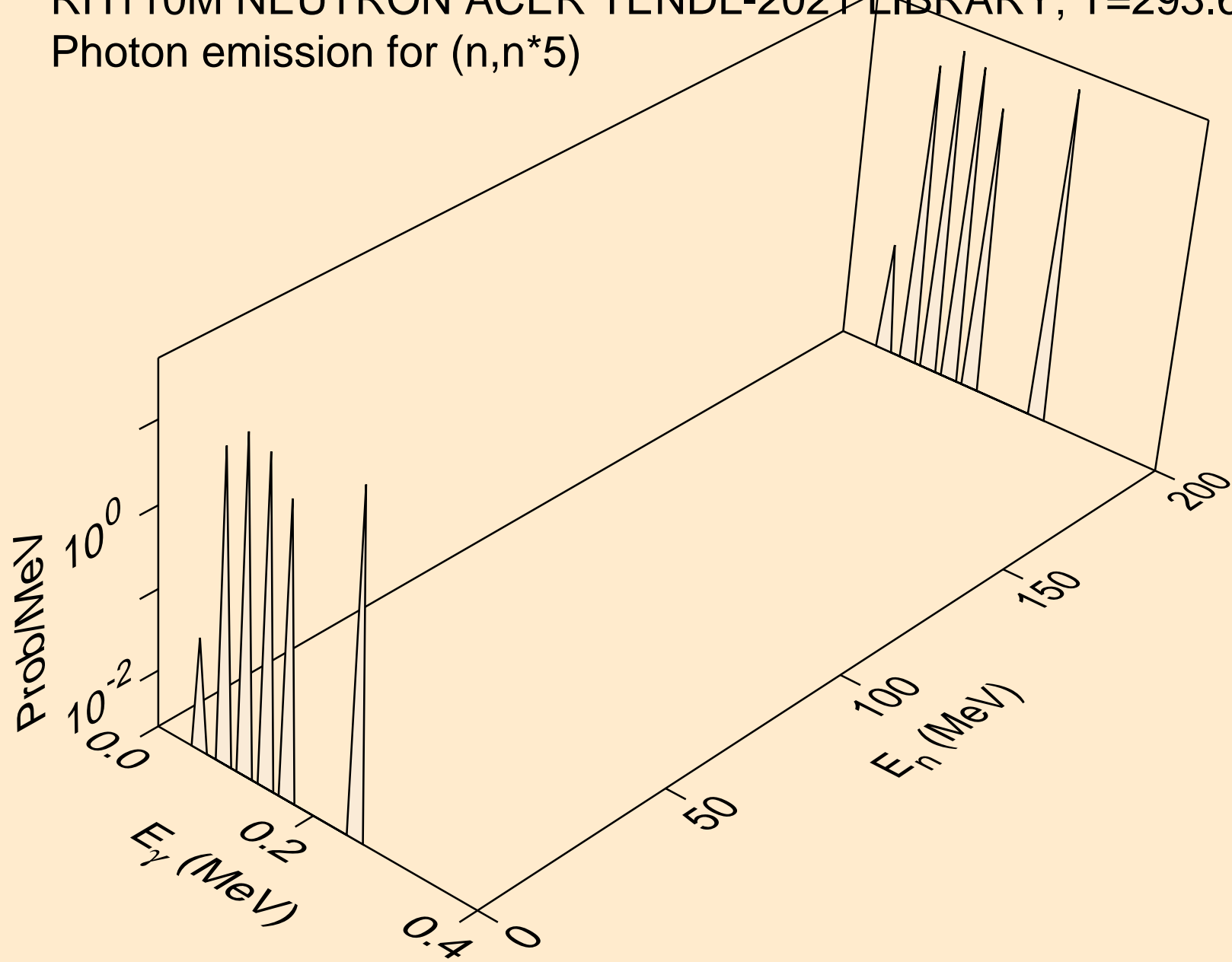

RH110M NEUTRON ACER TENDL-2021 LIBRARY; T=293.6K
Photon emission for (n,n*7)

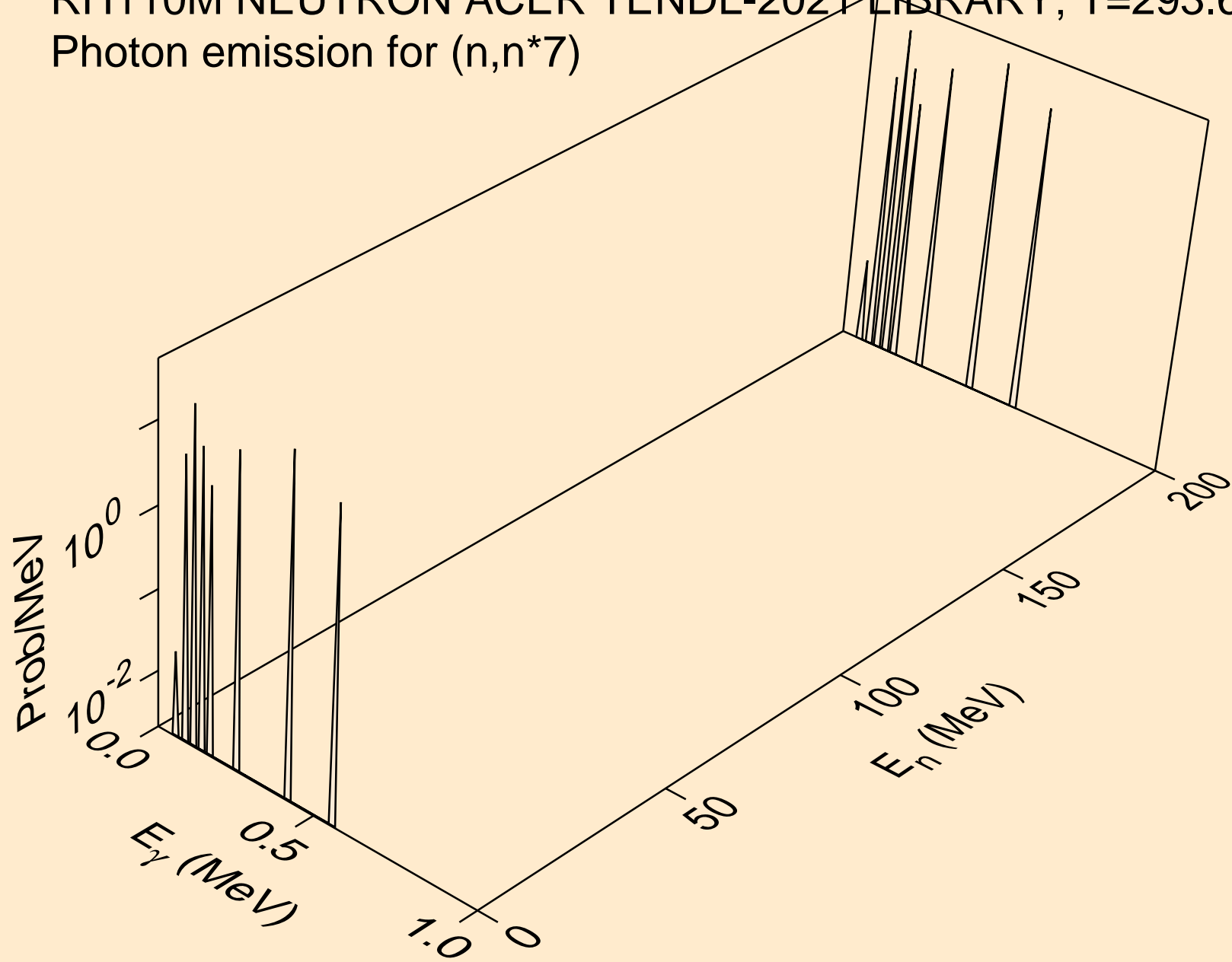

RH110M NEUTRON ACER TENDL-2021 LIBRARY; T=293.6K
Photon emission for (n,n*8)

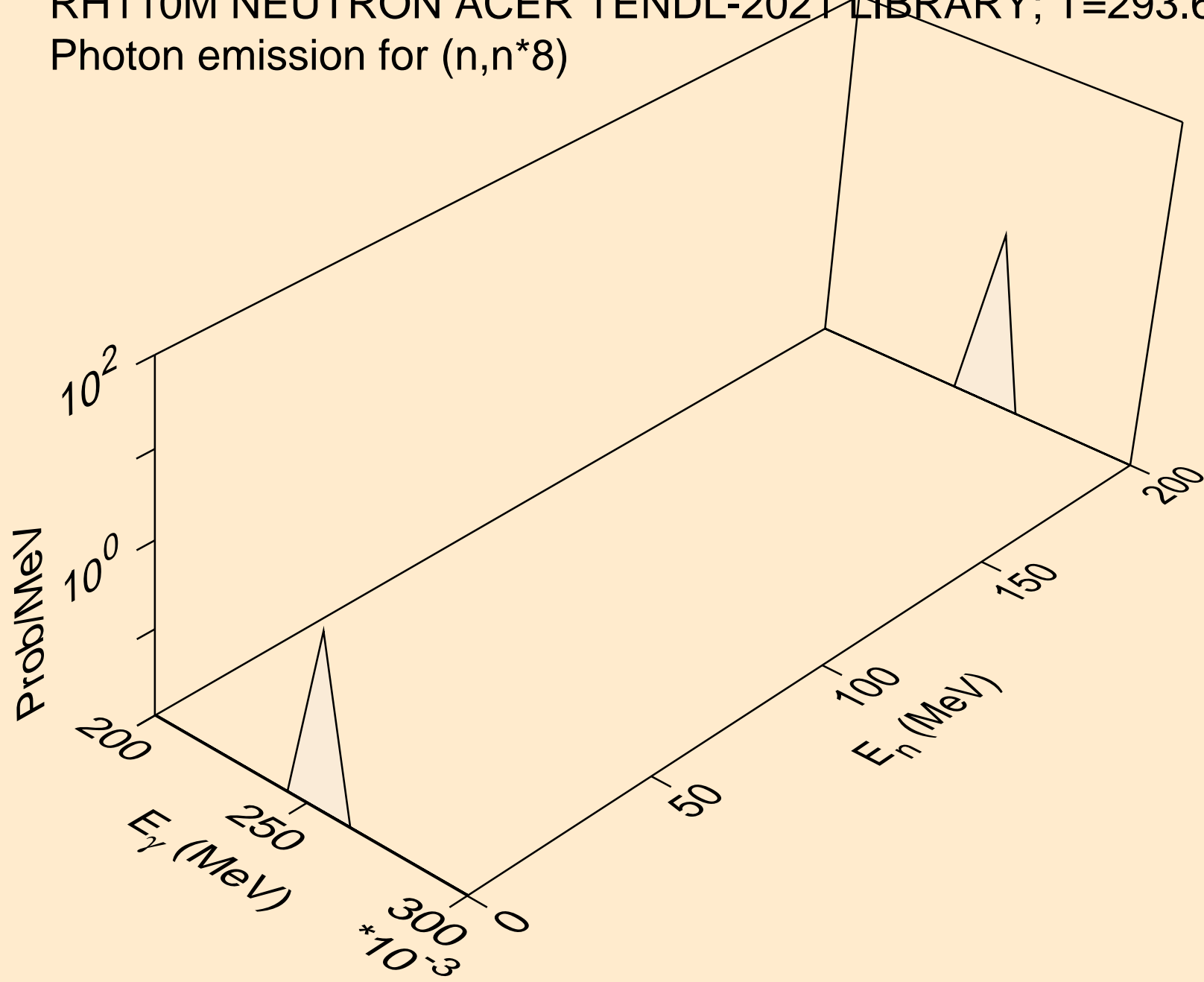

RH110M NEUTRON ACER TENDL-2021 LIBRARY; T=293.6K
Photon emission for (n,n*9)

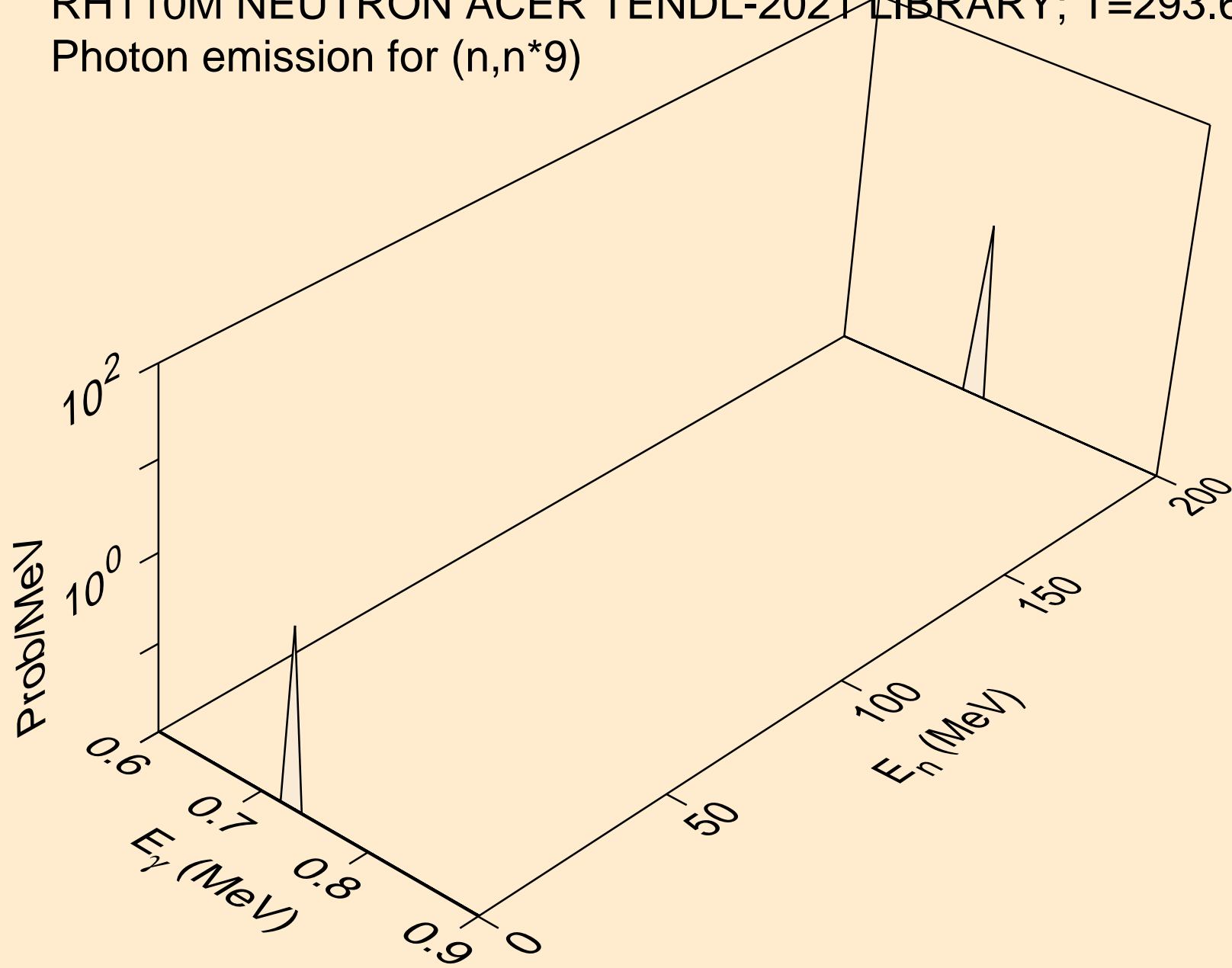

RH110M NEUTRON ACER TENDL-2021 LIBRARY; T=293.6K
Photon emission for (n,n*10)

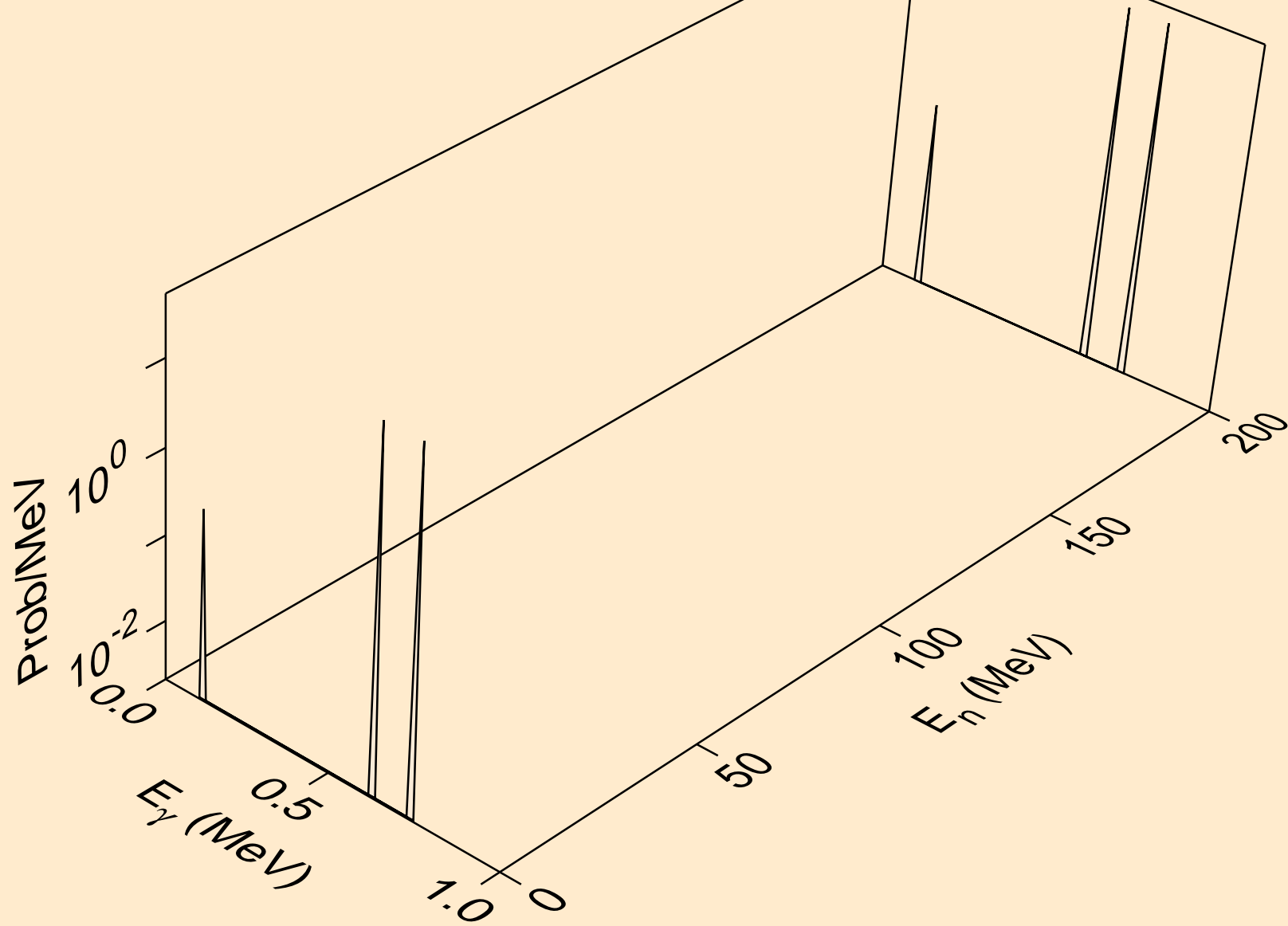

RH110M NEUTRON ACER TENDL-2021 LIBRARY; T=293.6K
Photon emission for (n,n*11)

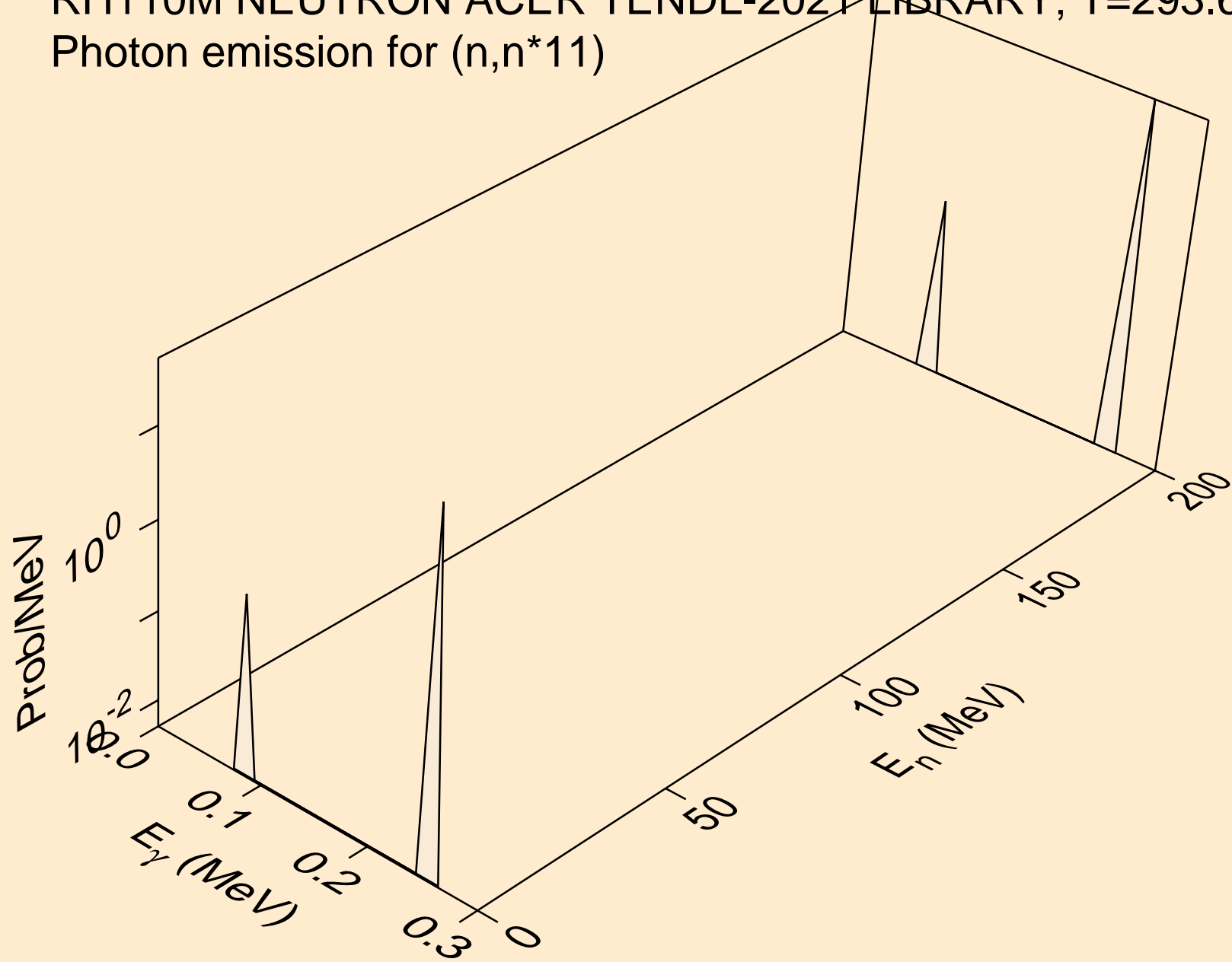

RH110M NEUTRON ACER TENDL-2021 LIBRARY; T=293.6K
Photon emission for (n,n*12)

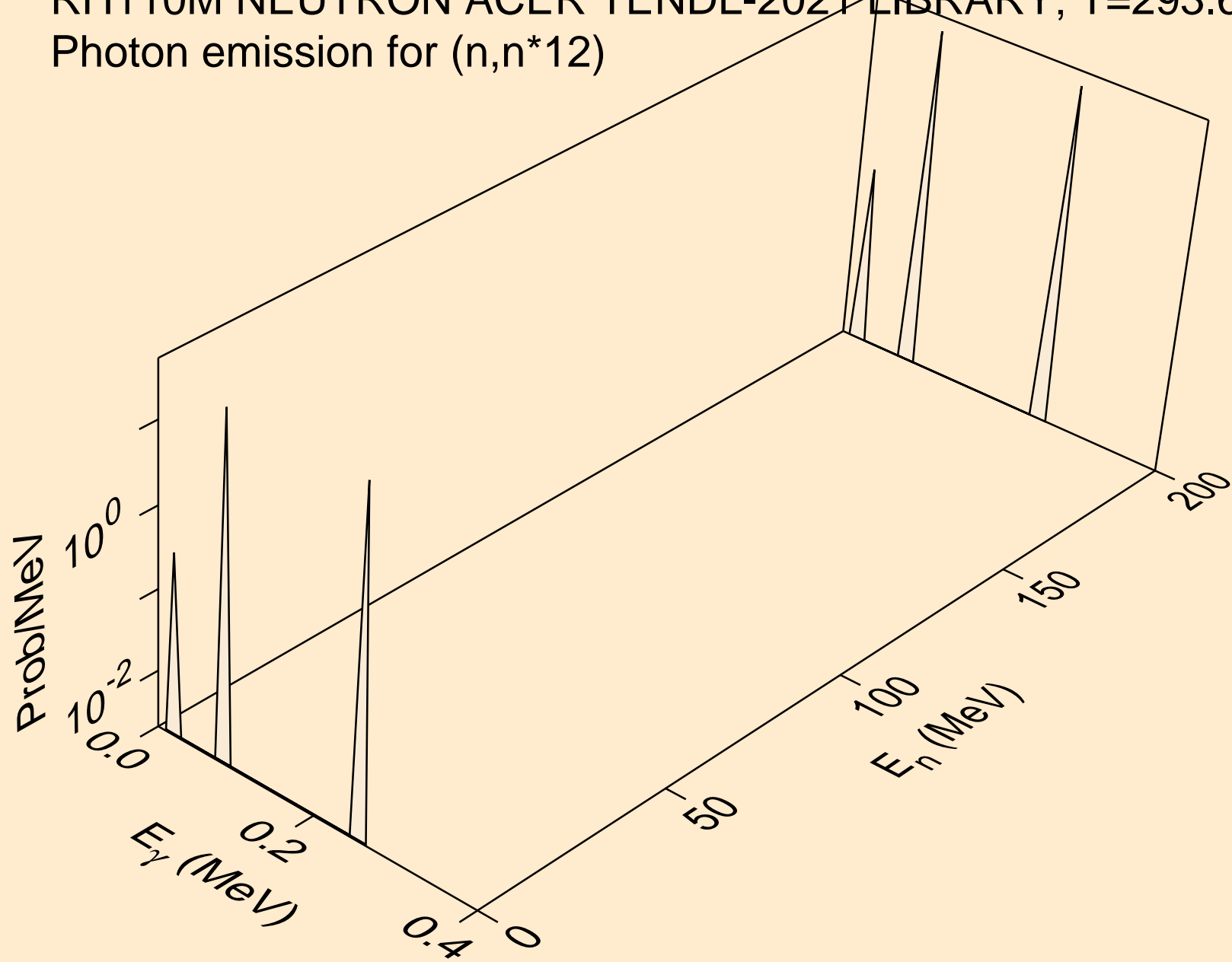

RH110M NEUTRON ACER TENDL-2021 LIBRARY; T=293.6K
Photon emission for (n,n*13)

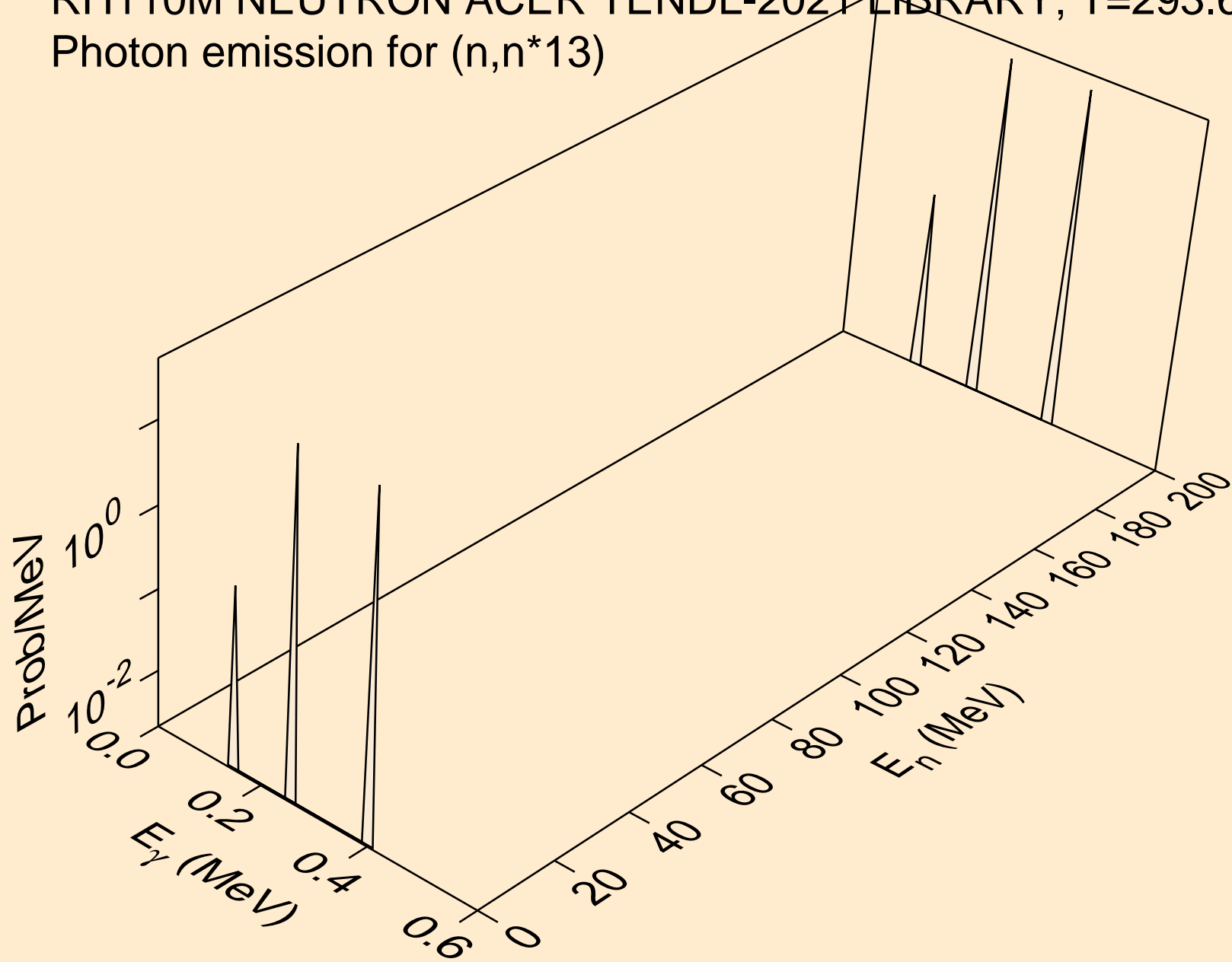

RH110M NEUTRON ACER TENDL-2021 LIBRARY; T=293.6K
Photon emission for (n,n*14)

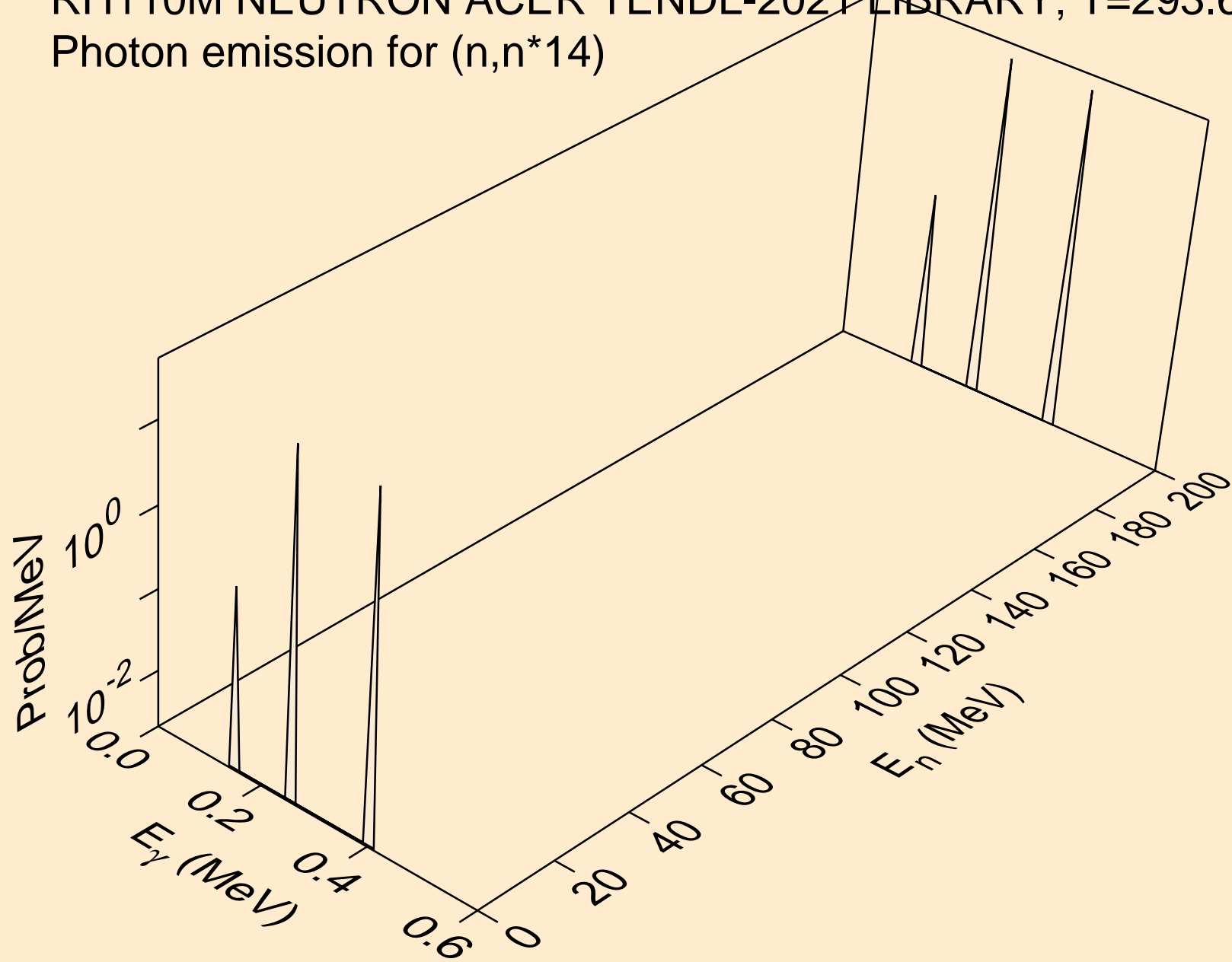

RH110M NEUTRON ACER TENDL-2021 LIBRARY; T=293.6K
Photon emission for (n,n*15)

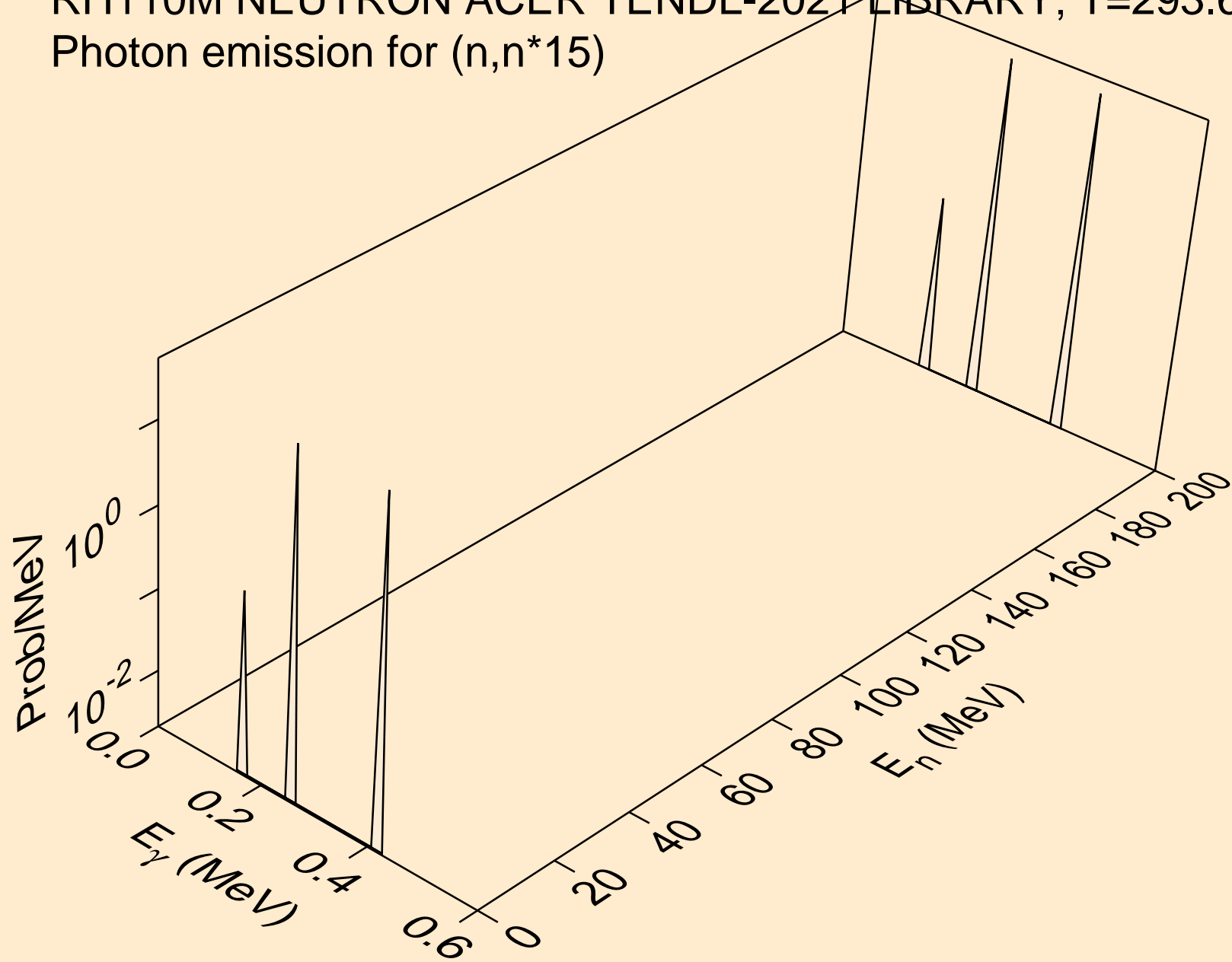

RH110M NEUTRON ACER TENDL-2021 LIBRARY; T=293.6K
Photon emission for (n,n*16)

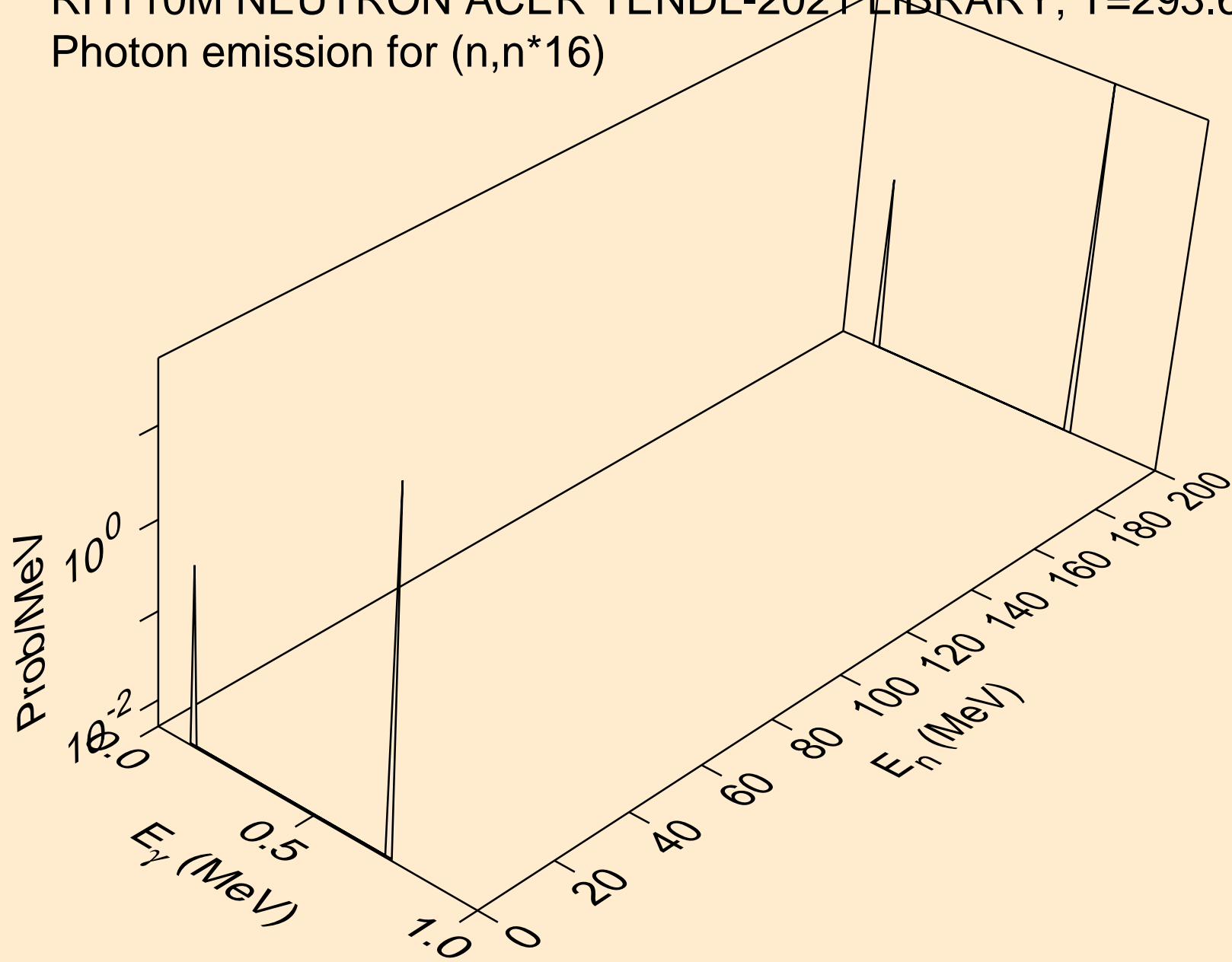

RH110M NEUTRON ACER TENDL-2021 LIBRARY; T=293.6K
Photon emission for (n,n*17)

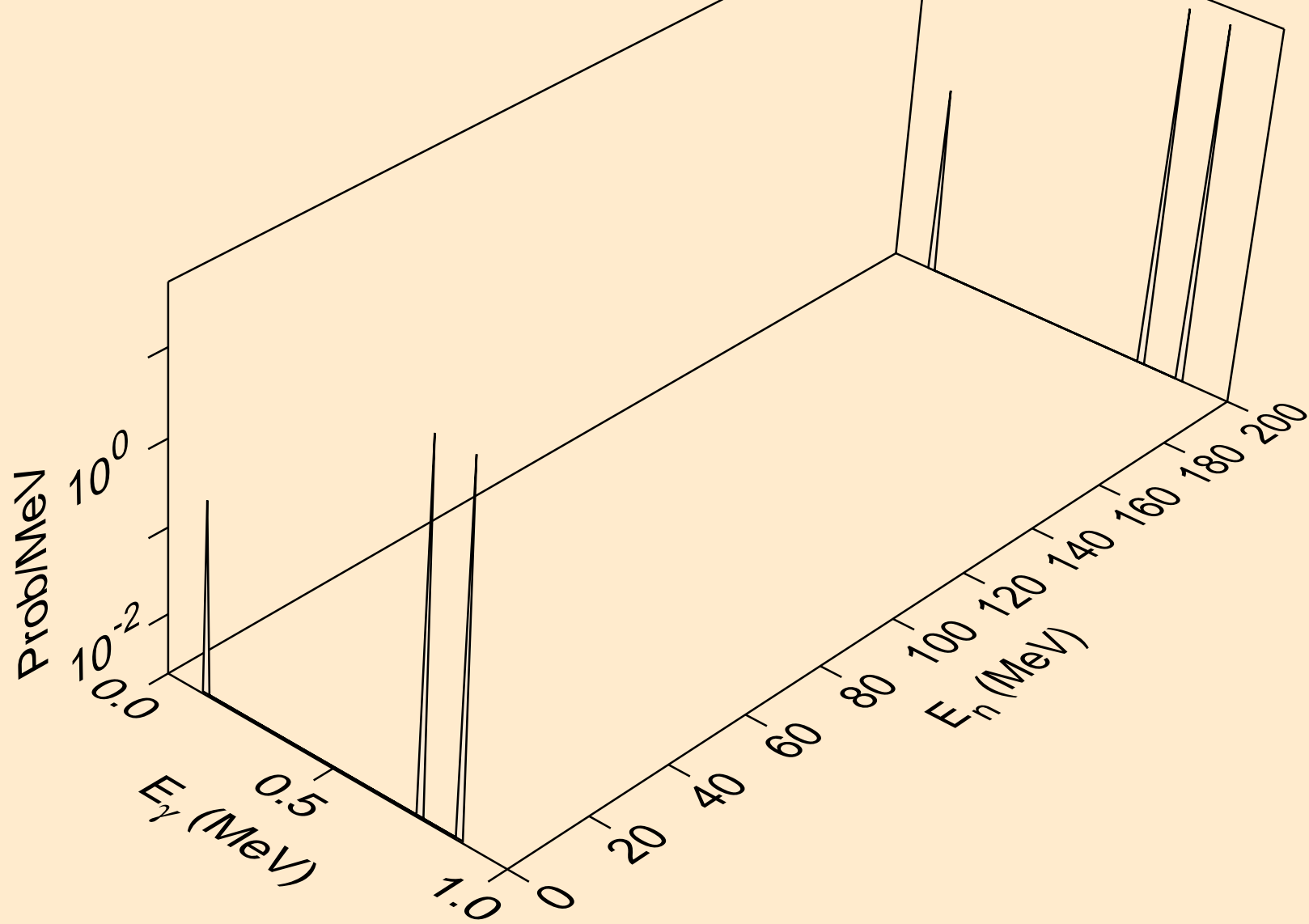

RH110M NEUTRON ACER TENDL-2021 LIBRARY; T=293.6K
Photon emission for (n,n*18)

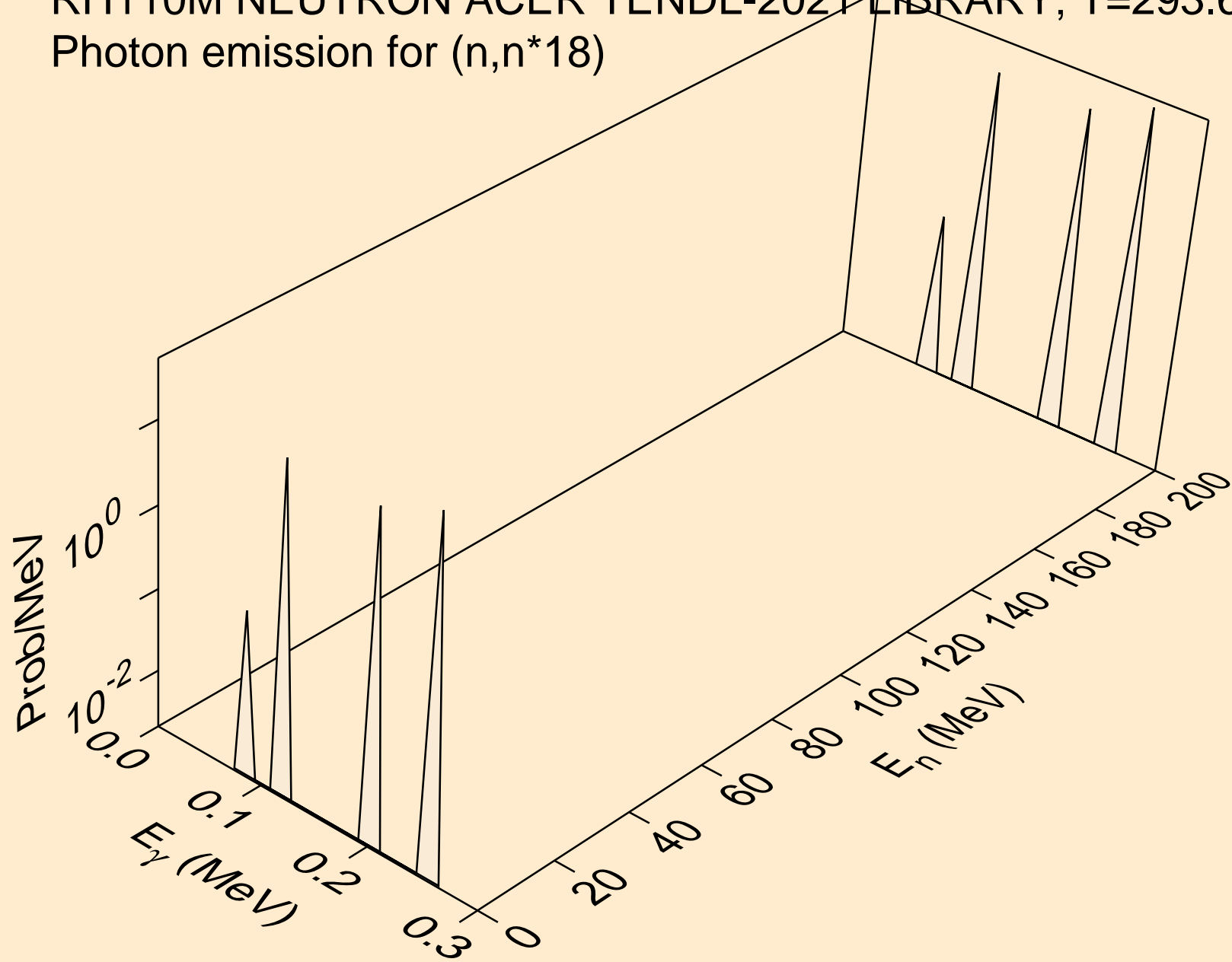

RH110M NEUTRON ACER TENDL-2021 LIBRARY; T=293.6K
Photon emission for (n,n*19)

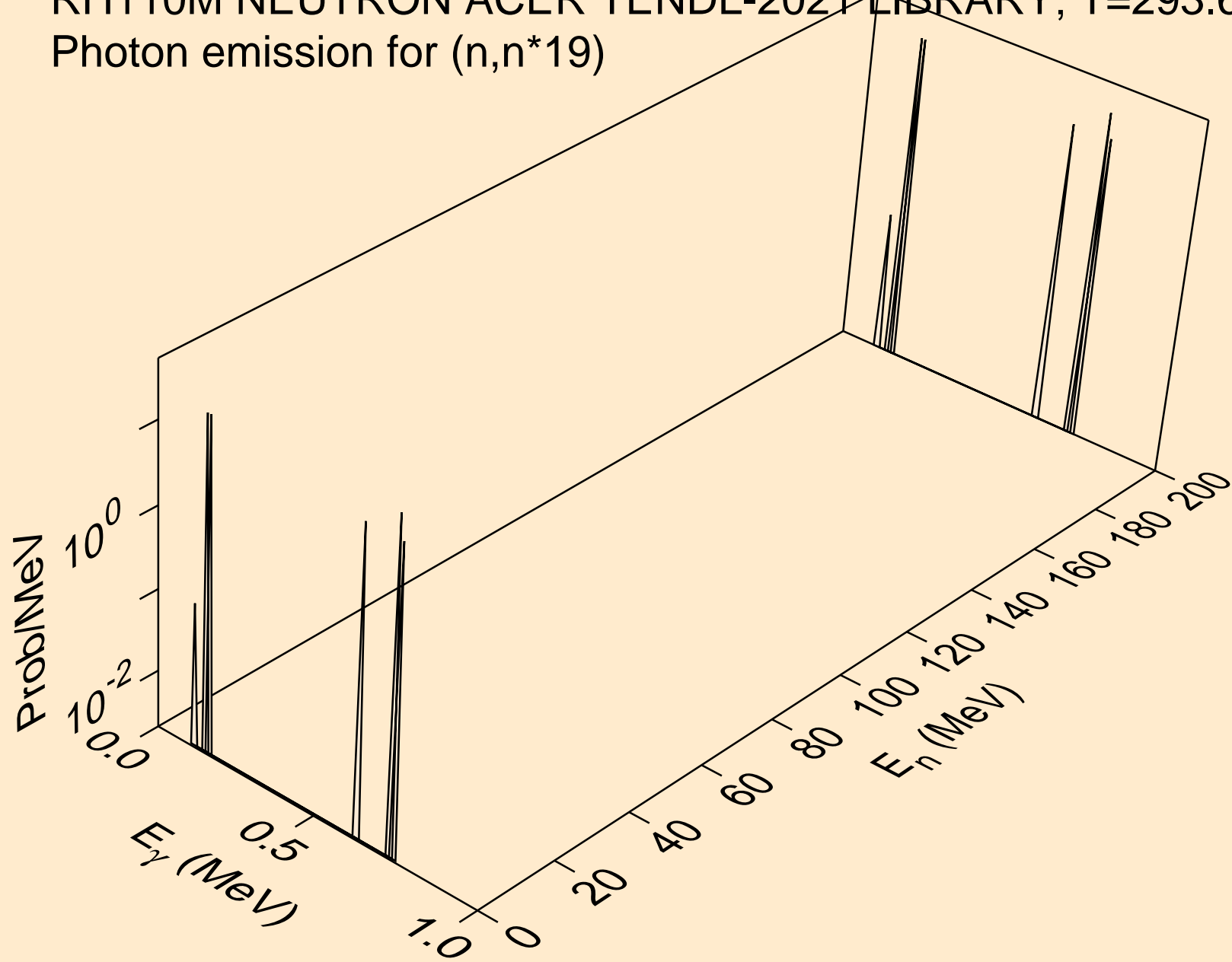

RH110M NEUTRON ACER TENDL-2021 LIBRARY; T=293.6K
Photon emission for (n,n*20)

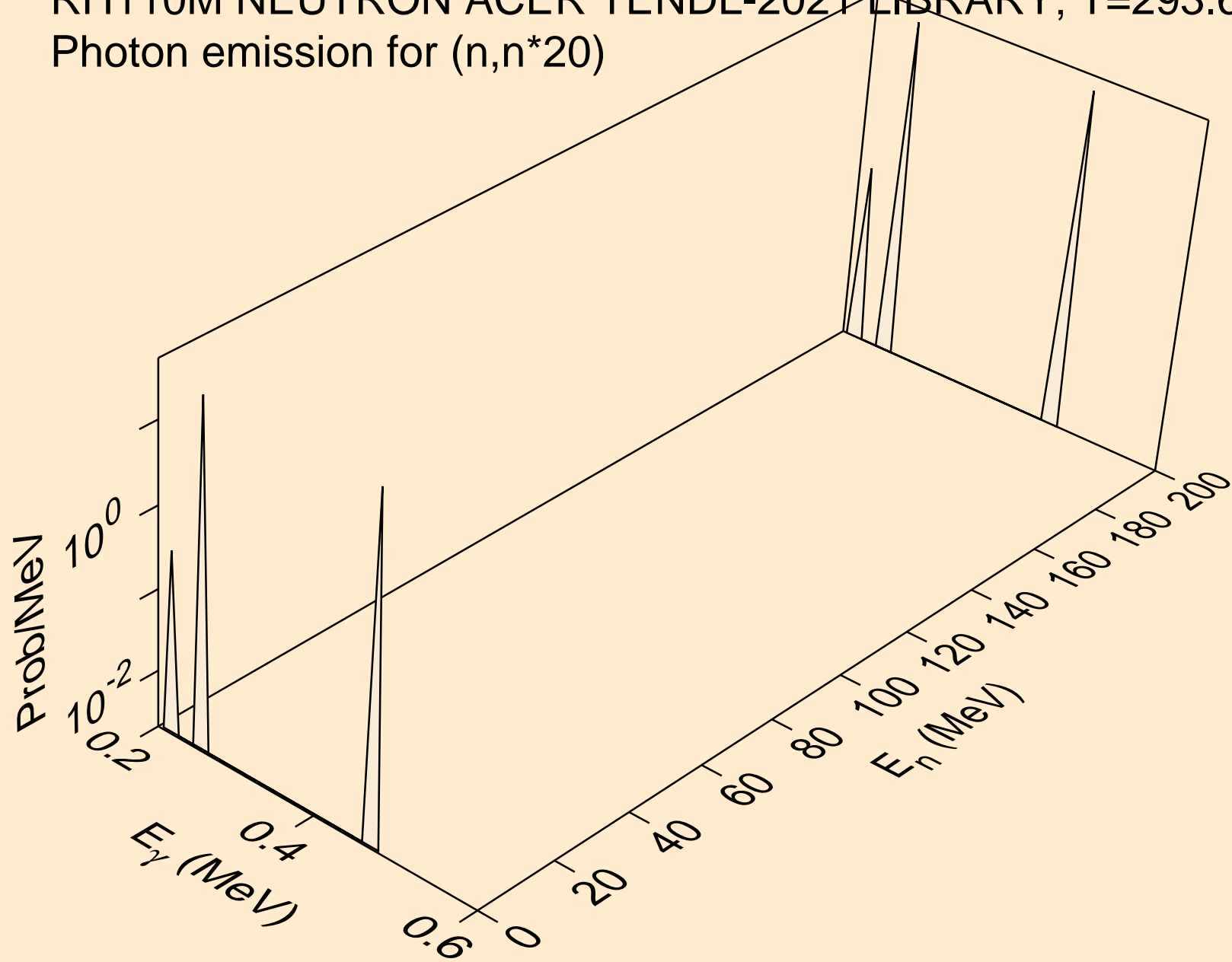

RH110M NEUTRON ACER TENDL-2021 LIBRARY; T=293.6K
Photon emission for (n,n*21)

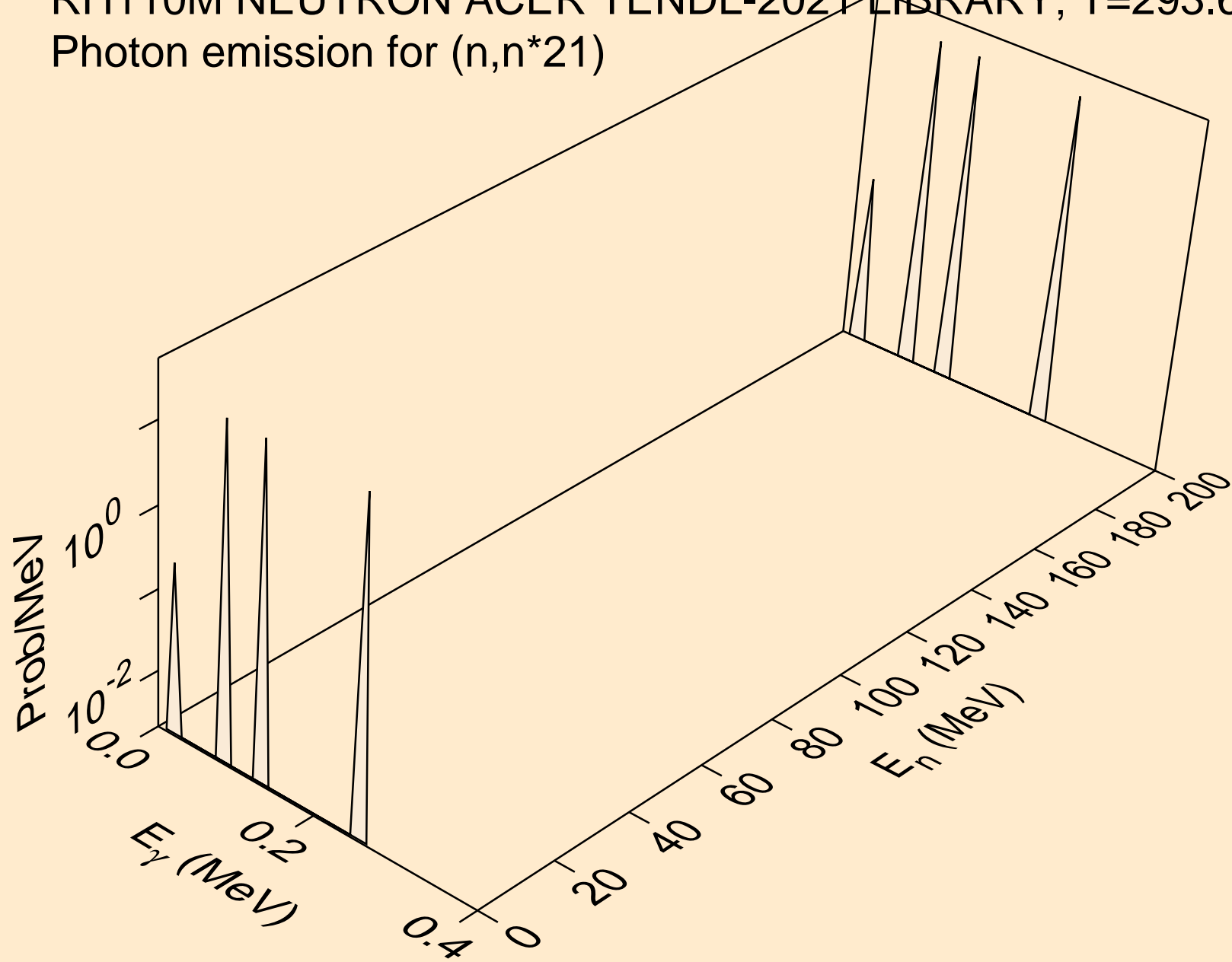

RH110M NEUTRON ACER TENDL-2021 LIBRARY; T=293.6K
Photon emission for (n,n*22)

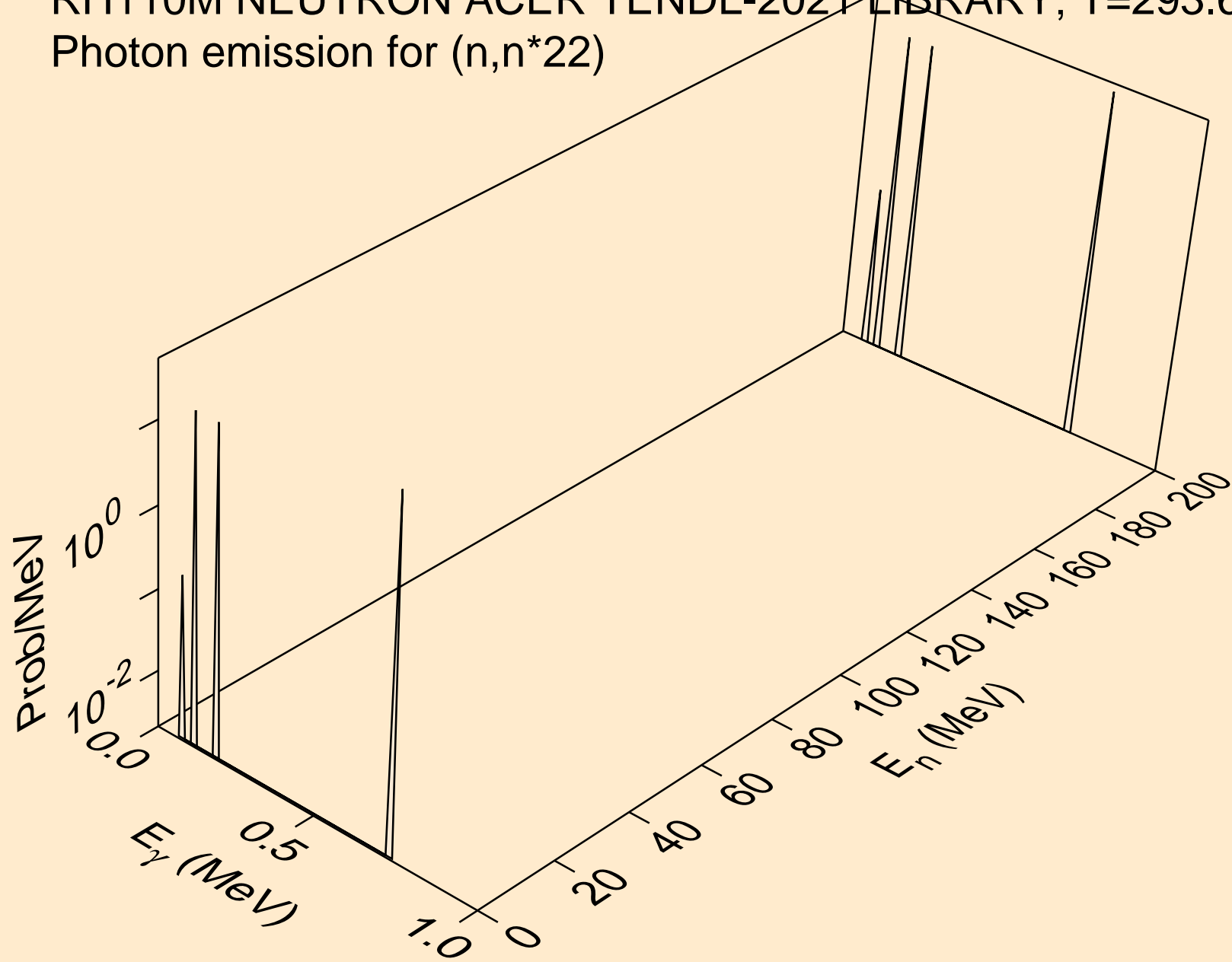

RH110M NEUTRON ACER TENDL-2021 LIBRARY; T=293.6K
Photon emission for (n,n*23)

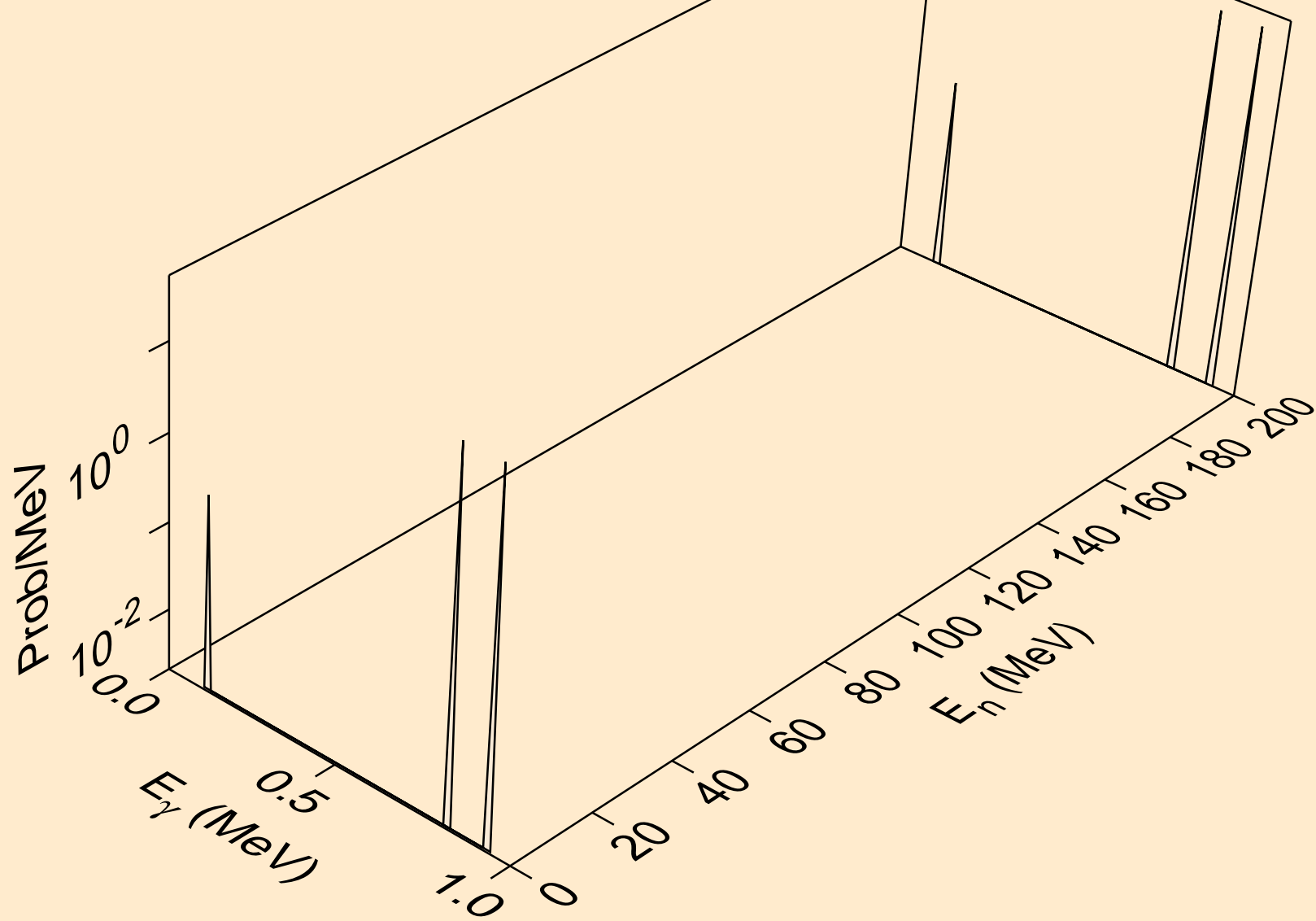

RH110M NEUTRON ACER TENDL-2021 LIBRARY; T=293.6K
Photon emission for (n,n*24)

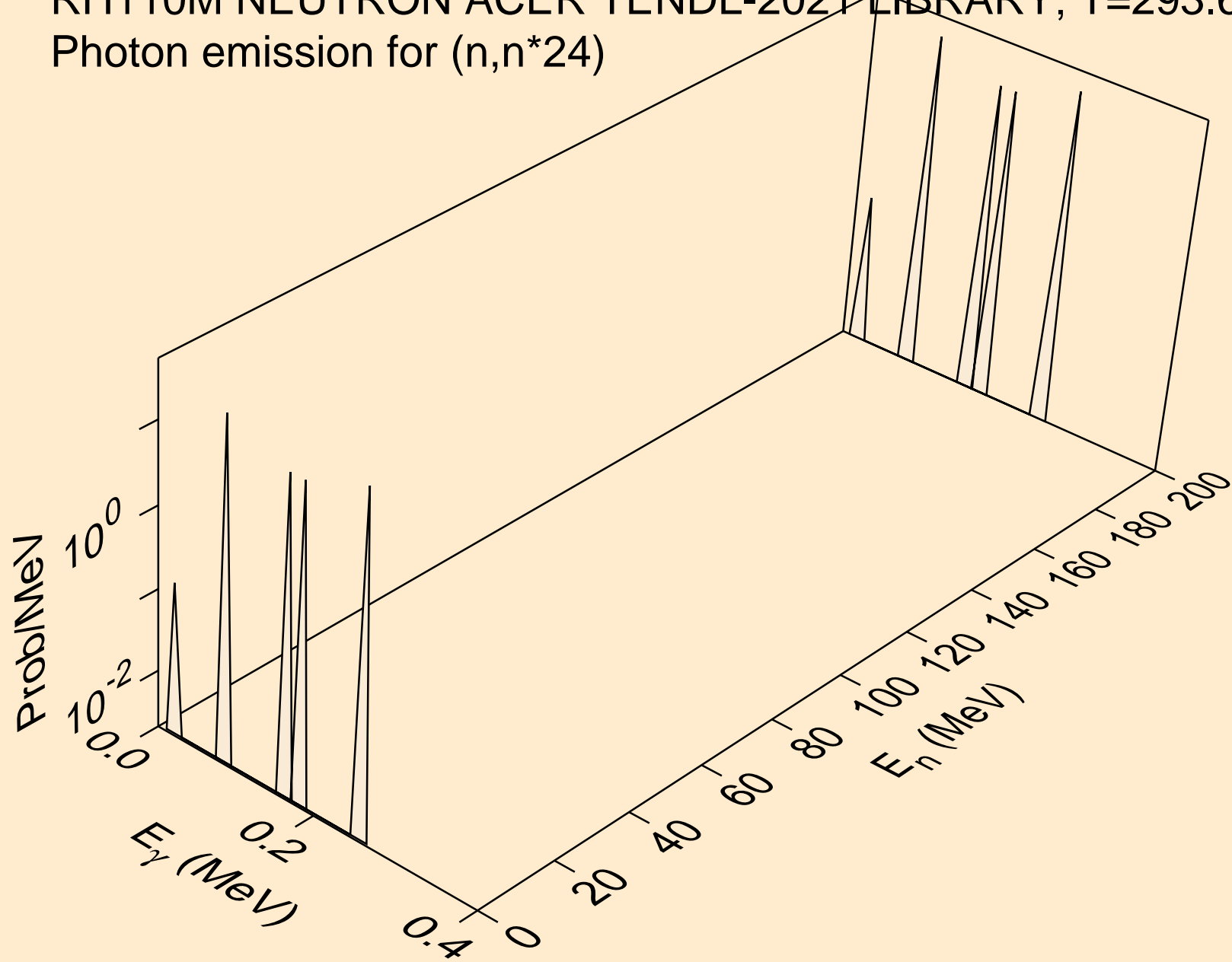

RH110M NEUTRON ACER TENDL-2021 LIBRARY; T=293.6K
Photon emission for (n,n*25)

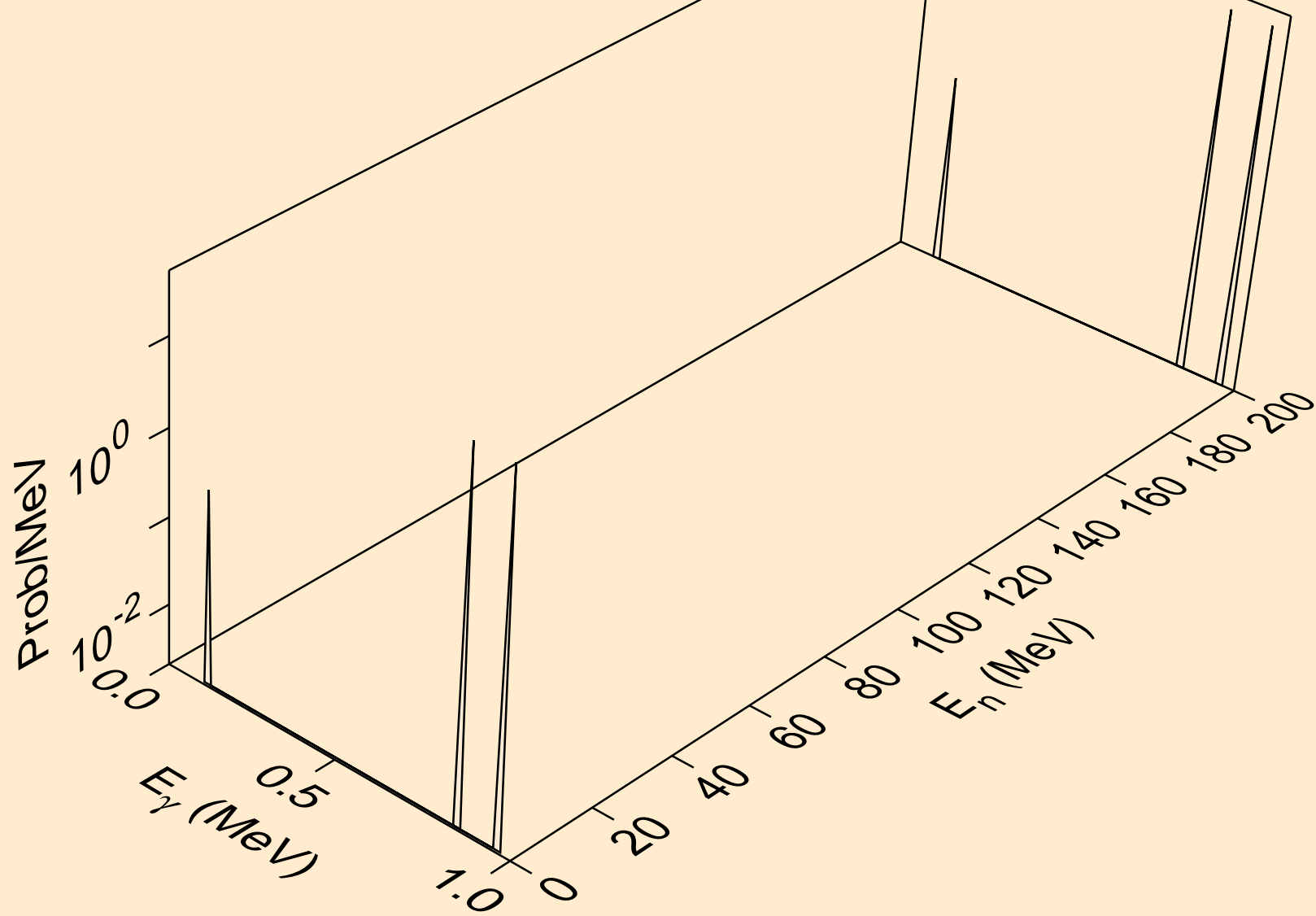

RH110M NEUTRON ACER TENDL-2021 LIBRARY; T=293.6K
Photon emission for (n,n*26)

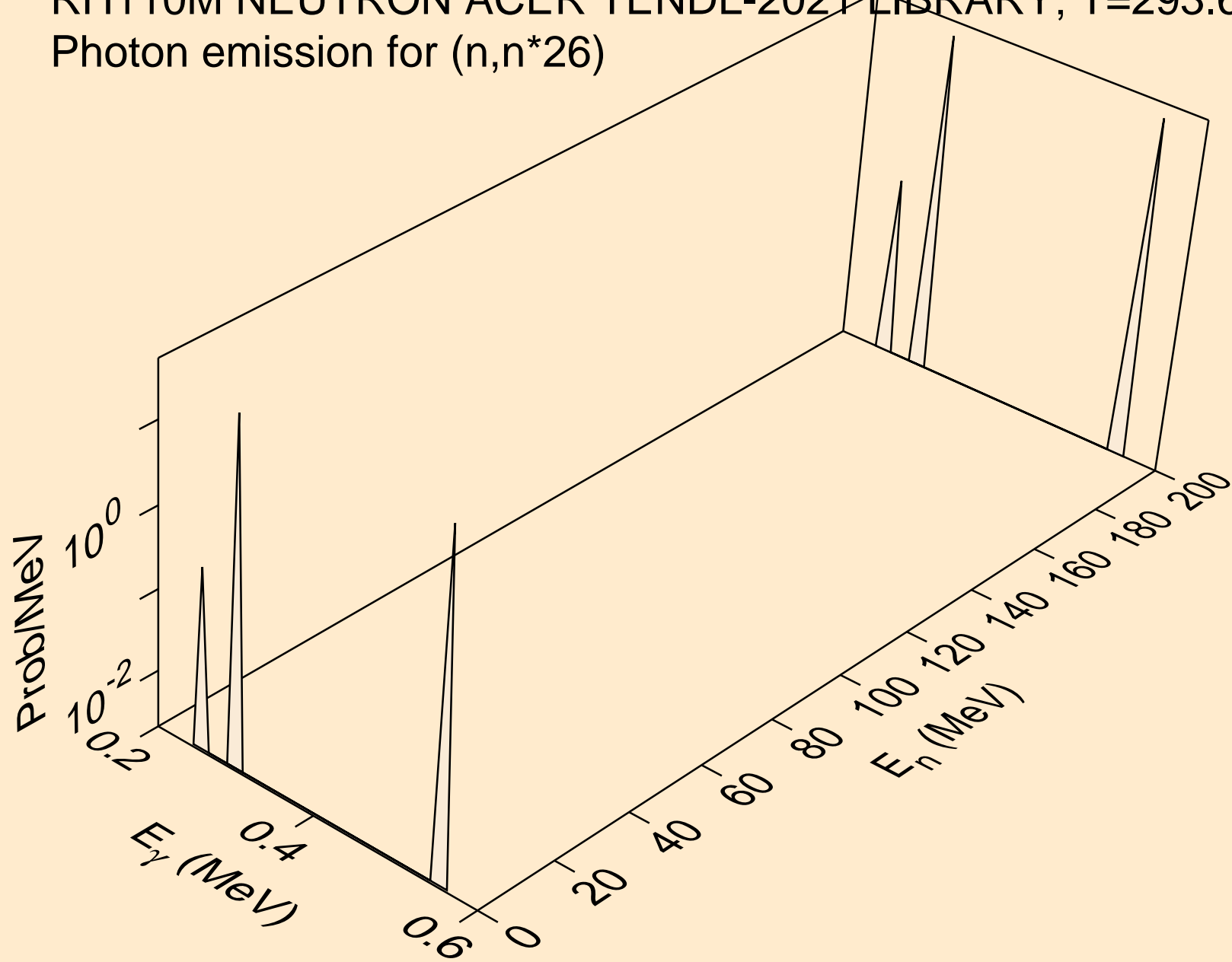

RH110M NEUTRON ACER TENDL-2021 LIBRARY; T=293.6K
Photon emission for (n,n*27)

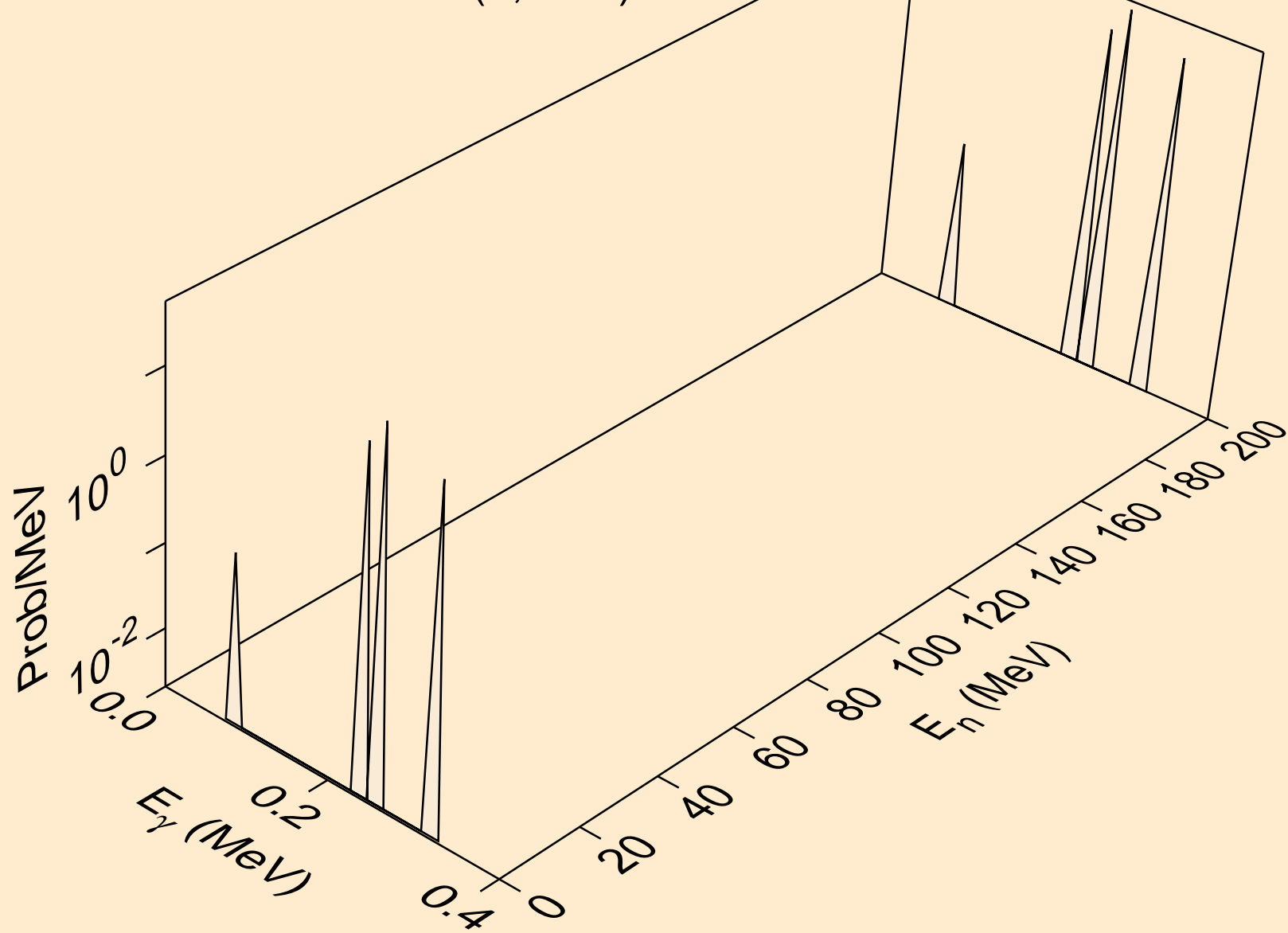

RH110M NEUTRON ACER TENDL-2021 LIBRARY; T=293.6K
Photon emission for (n,n*28)

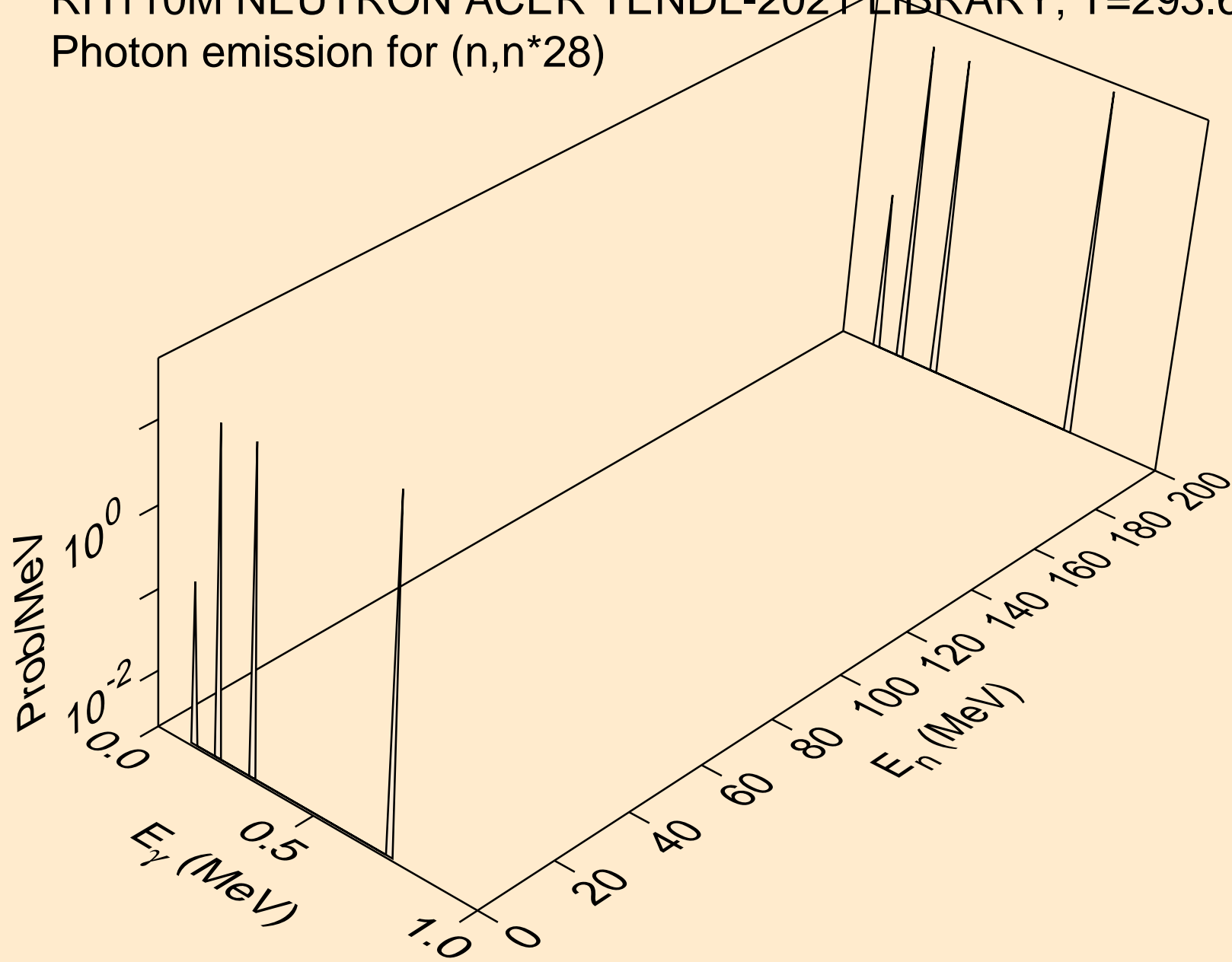

RH110M NEUTRON ACER TENDL-2021 LIBRARY; T=293.6K
Photon emission for (n,n*c)

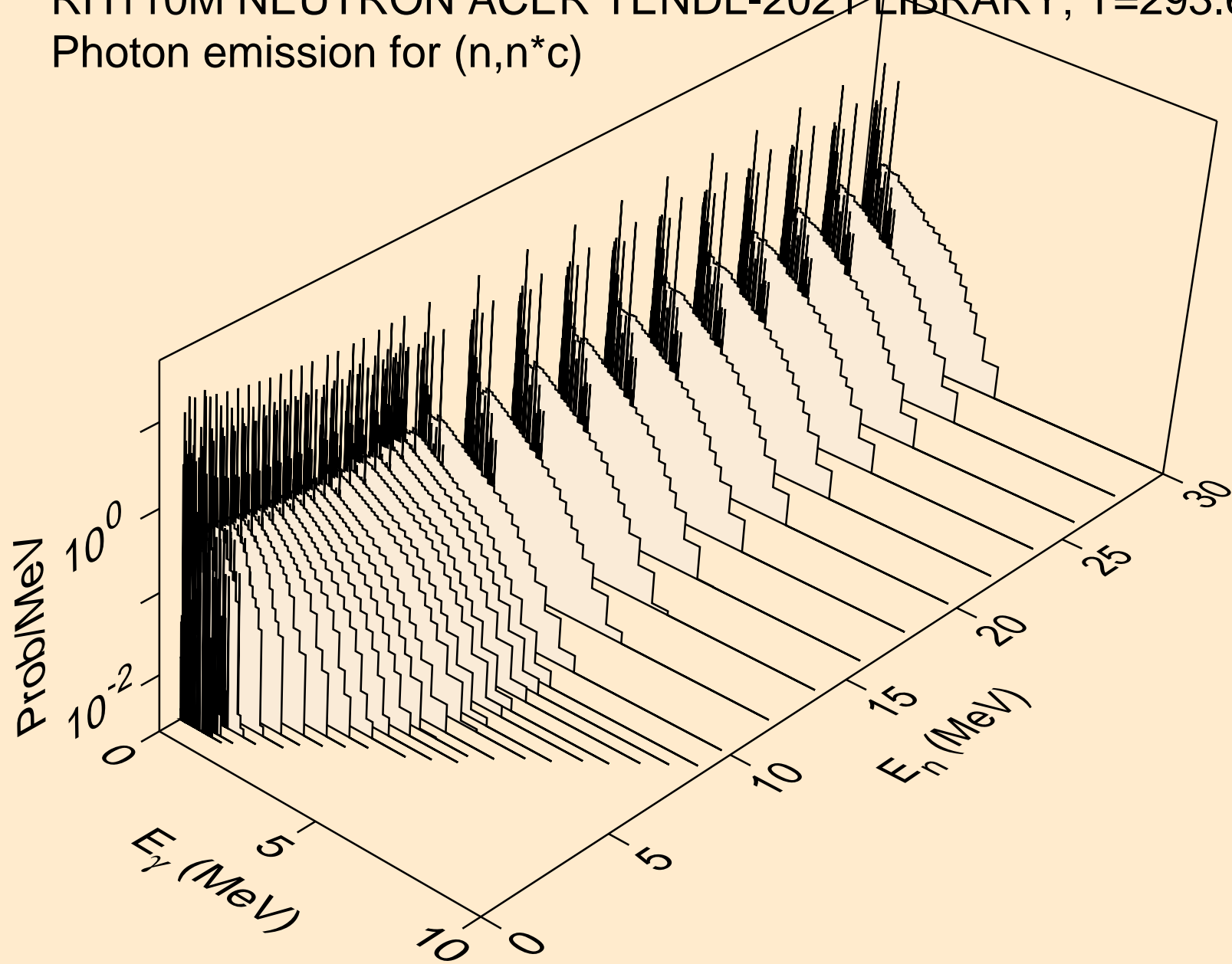

RH110M NEUTRON ACER TENDL-2021 LIBRARY; T=293.6K
Photon emission for (n,gma)

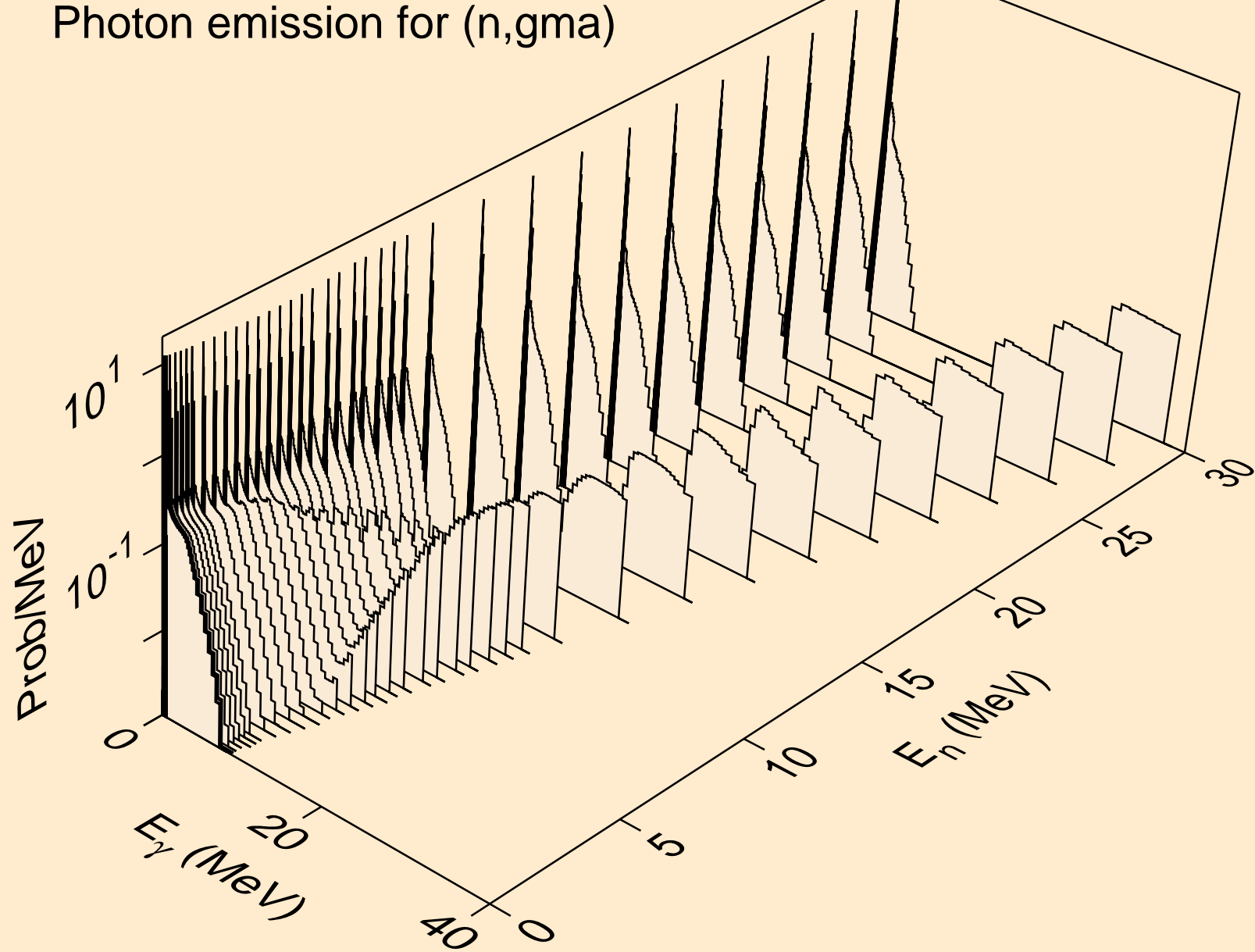

RH110M NEUTRON ACER TENDL-2021 LIBRARY; T=293.6K
Photon emission for (n,p)

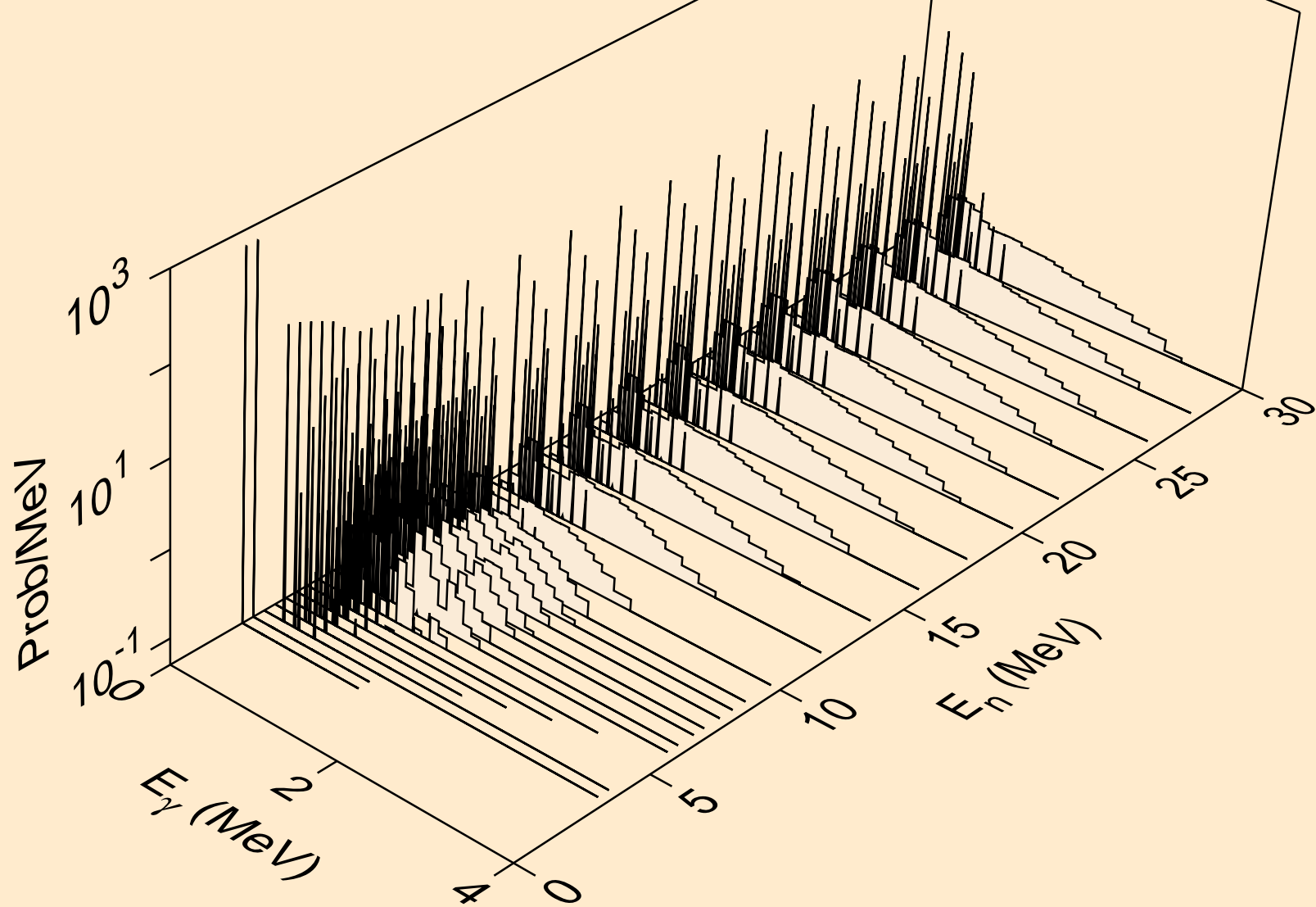

RH110M NEUTRON ACER TENDL-2021 LIBRARY; T=293.6K
Photon emission for (n,d)

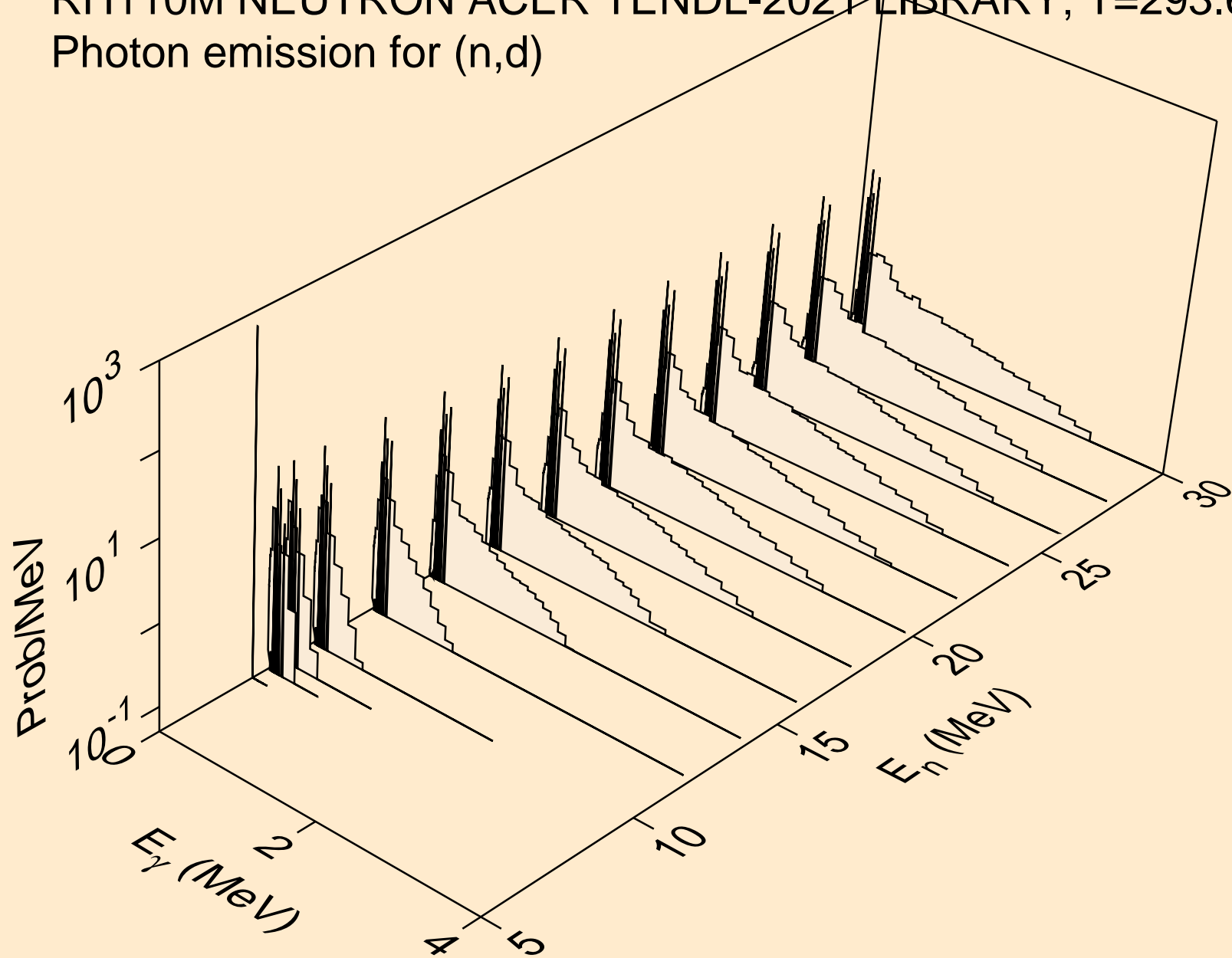

RH110M NEUTRON ACER TENDL-2021 LIBRARY; T=293.6K
Photon emission for (n,t)

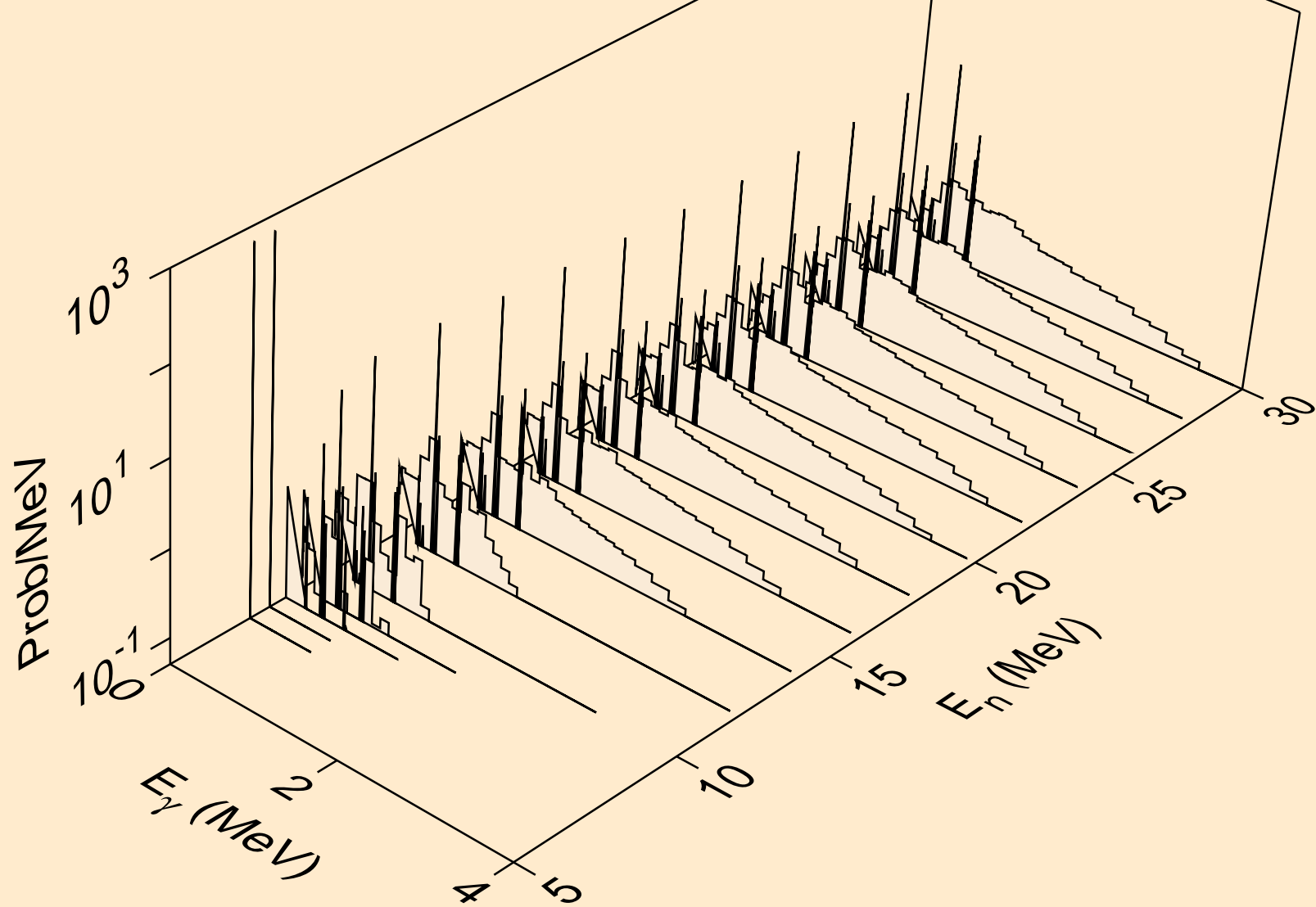

RH110M NEUTRON ACER TENDL-2021 LIBRARY; T=293.6K
Photon emission for (n,he3)

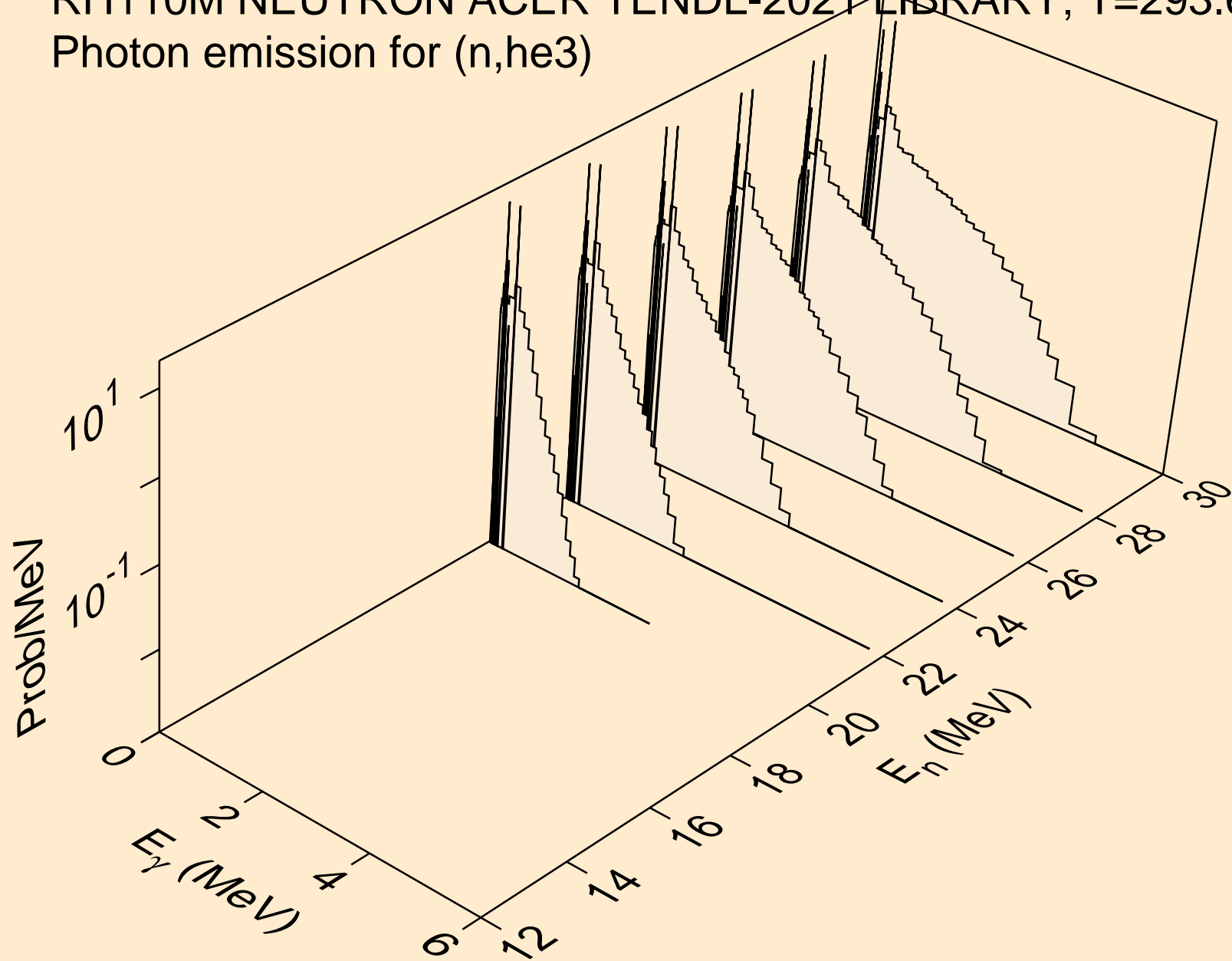

RH110M NEUTRON ACER TENDL-2021 LIBRARY; T=293.6K
Photon emission for (n,a)

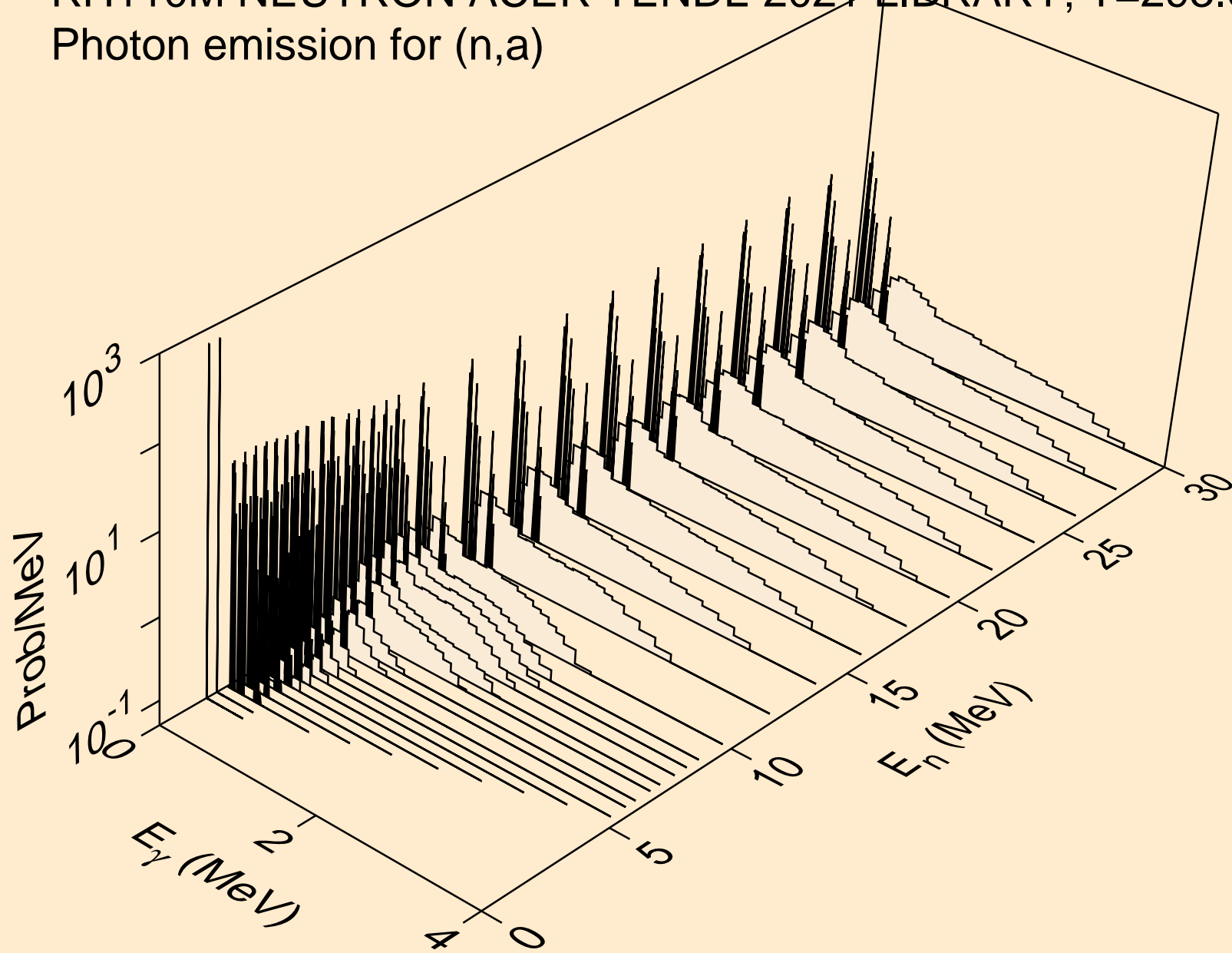

RH110M NEUTRON ACER TENDL-2021 LIBRARY; T=293.6K
Photon emission for (n,2p)

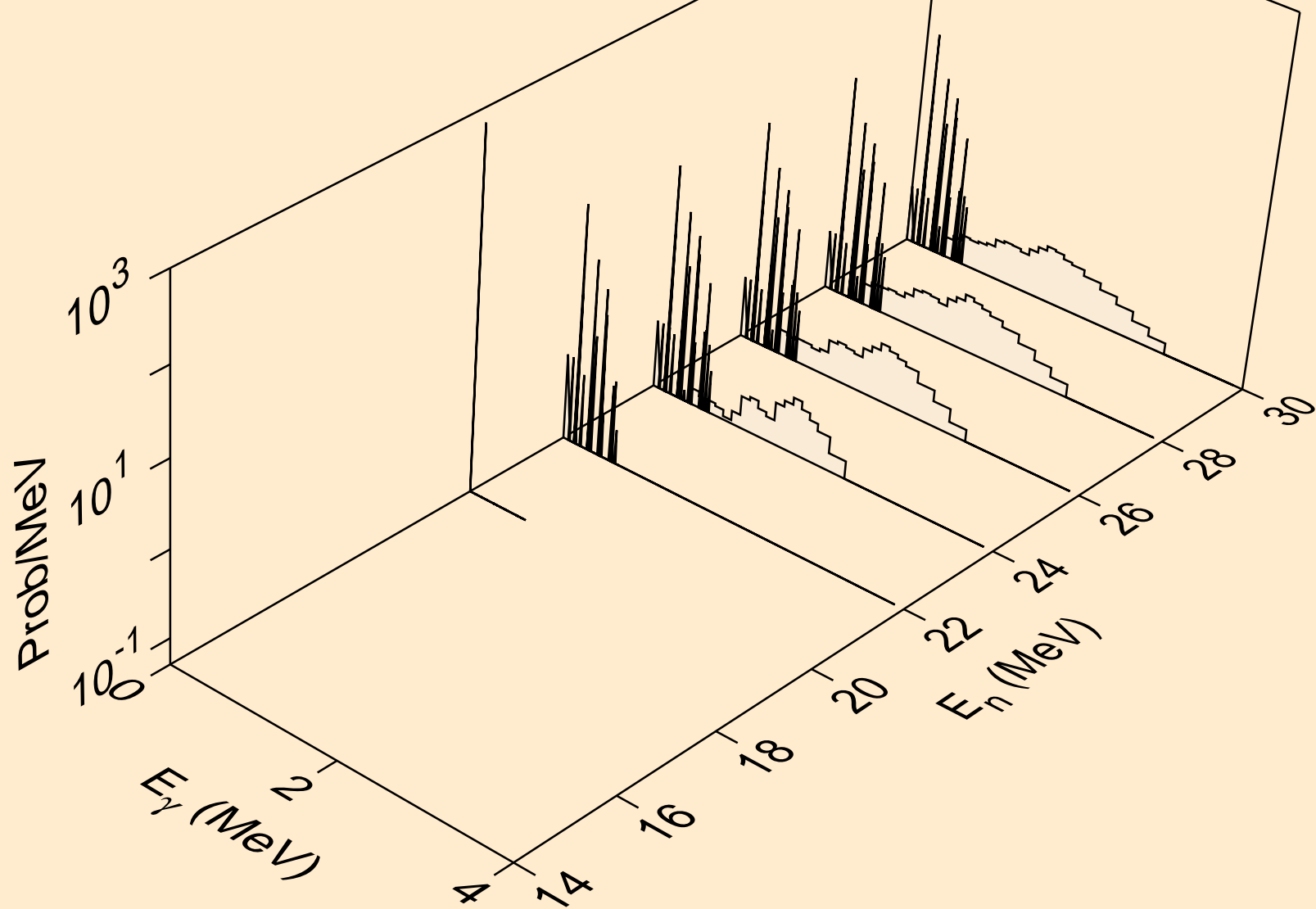

RH110M NEUTRON ACER TENDL-2021 LIBRARY; T=293.6K
Photon emission for (n,p)

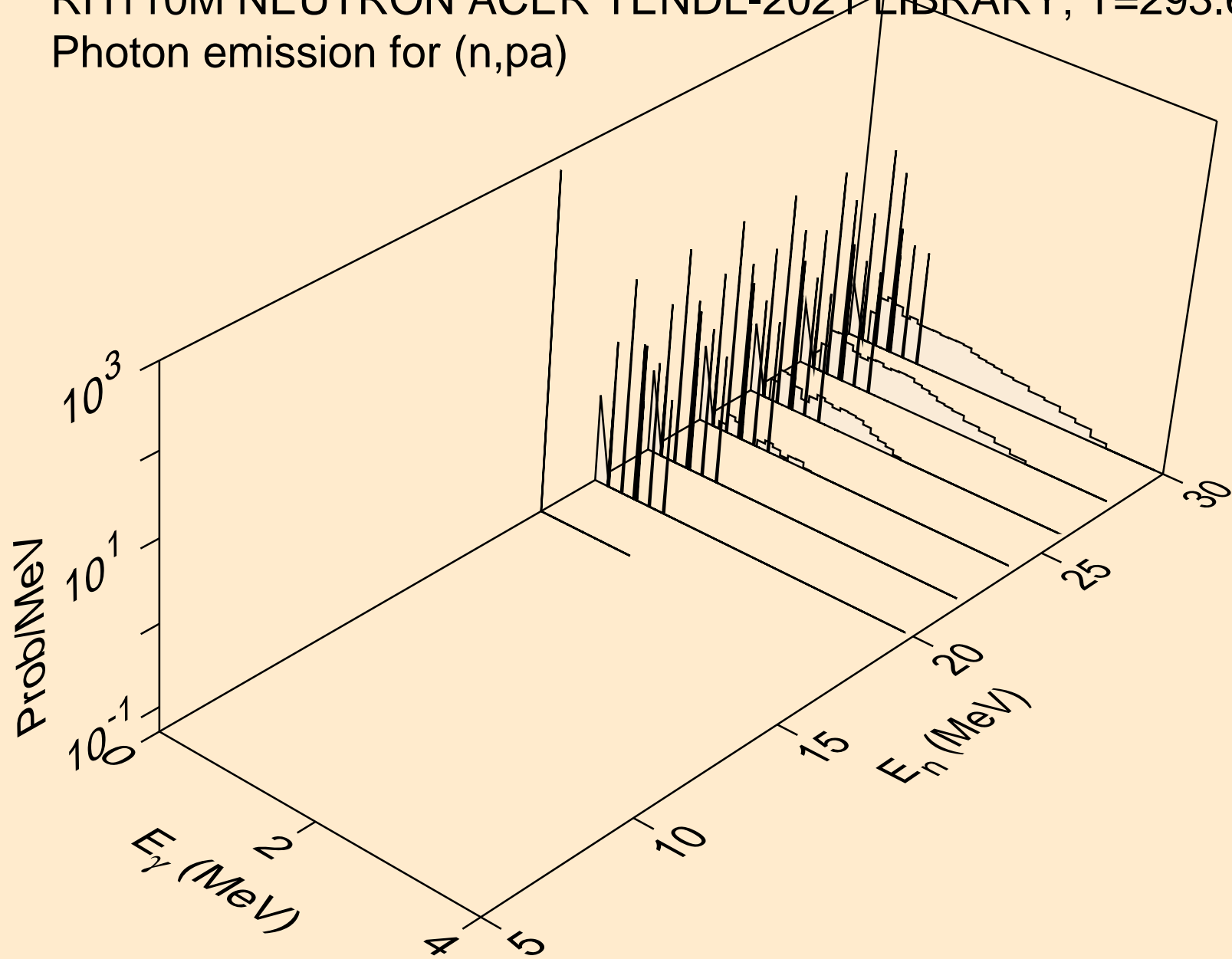

RH110M NEUTRON ACER TENDL-2021 LIBRARY; T=293.6K
thermal capture photon spectrum

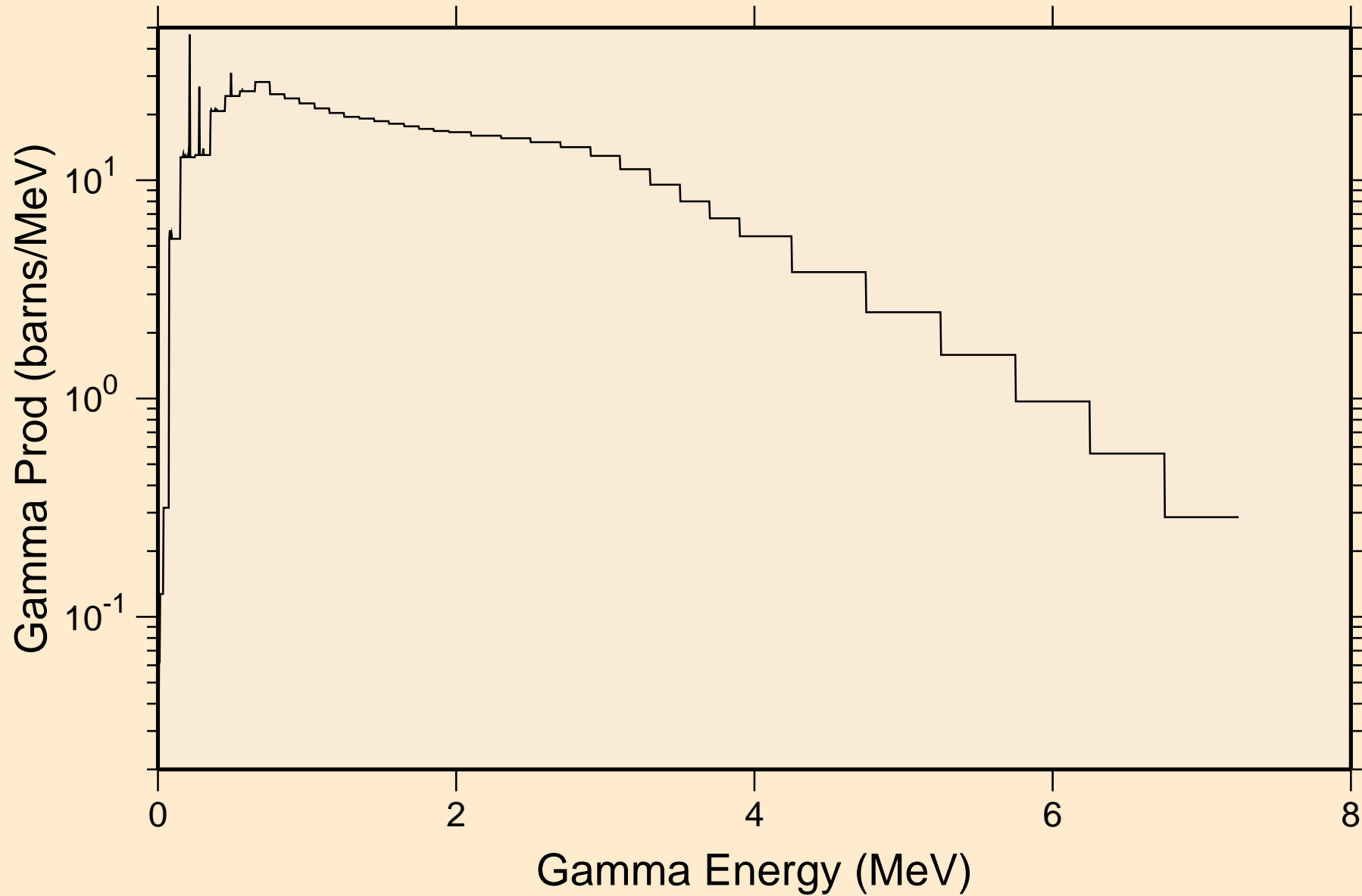

RH110M NEUTRON ACER TENDL-2021 LIBRARY; T=293.6K
14 MeV photon spectrum

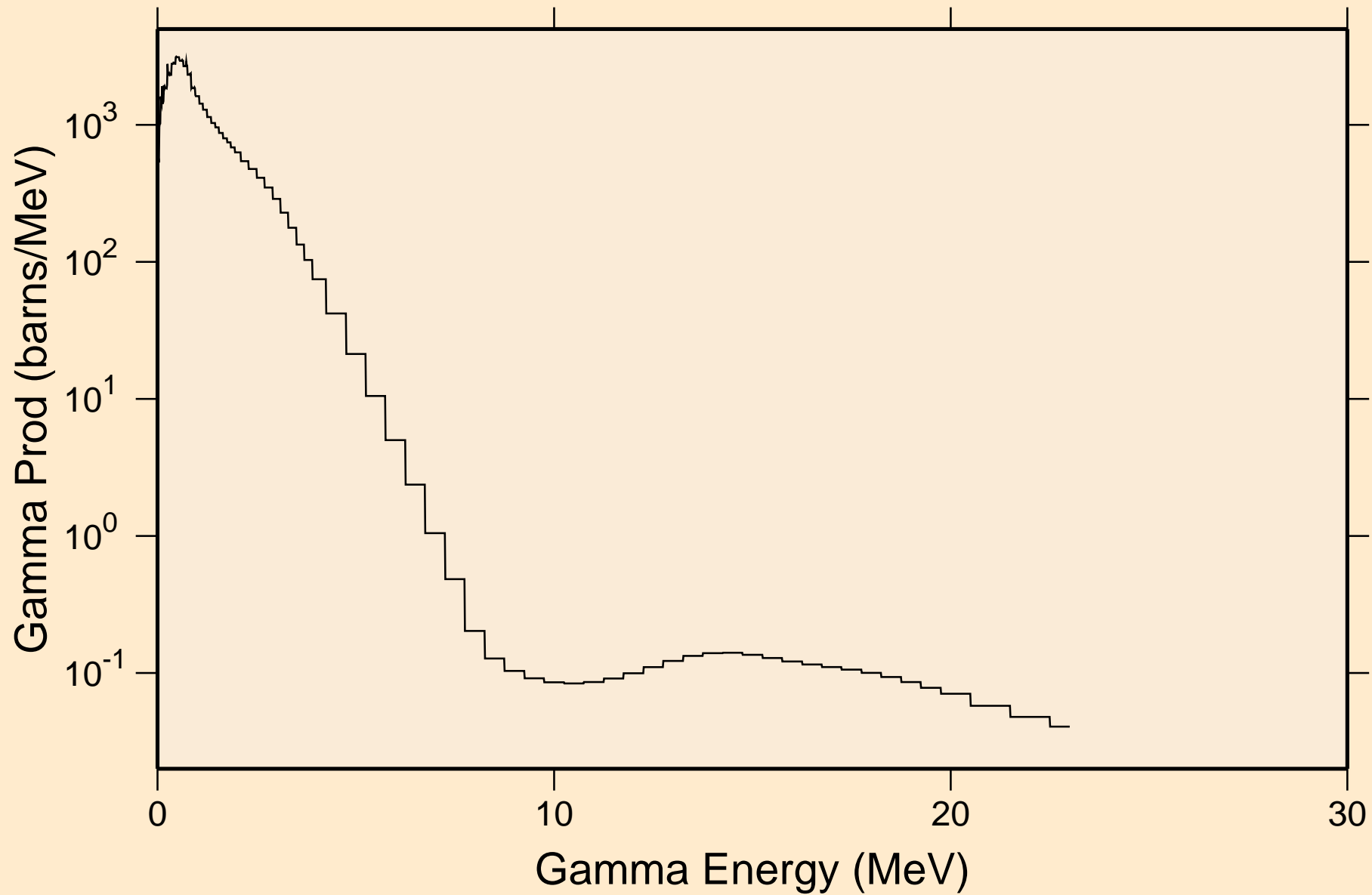

RH110M NEUTRON ACER TENDL-2021 LIBRARY; T=293.6K
Particle heating contributions

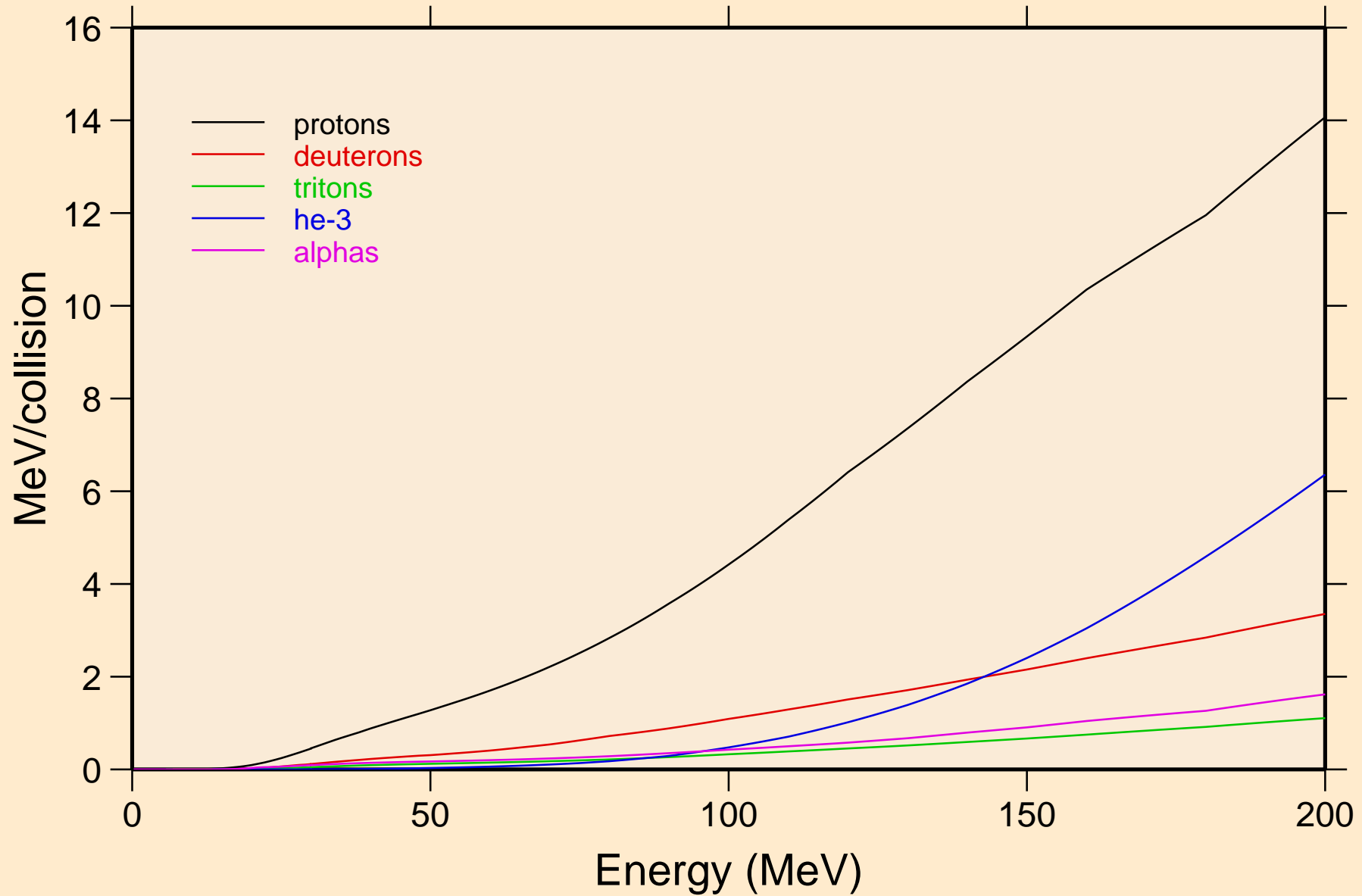

RH110M NEUTRON ACER TENDL-2021 LIBRARY; T=293.6K
Recoil Heating

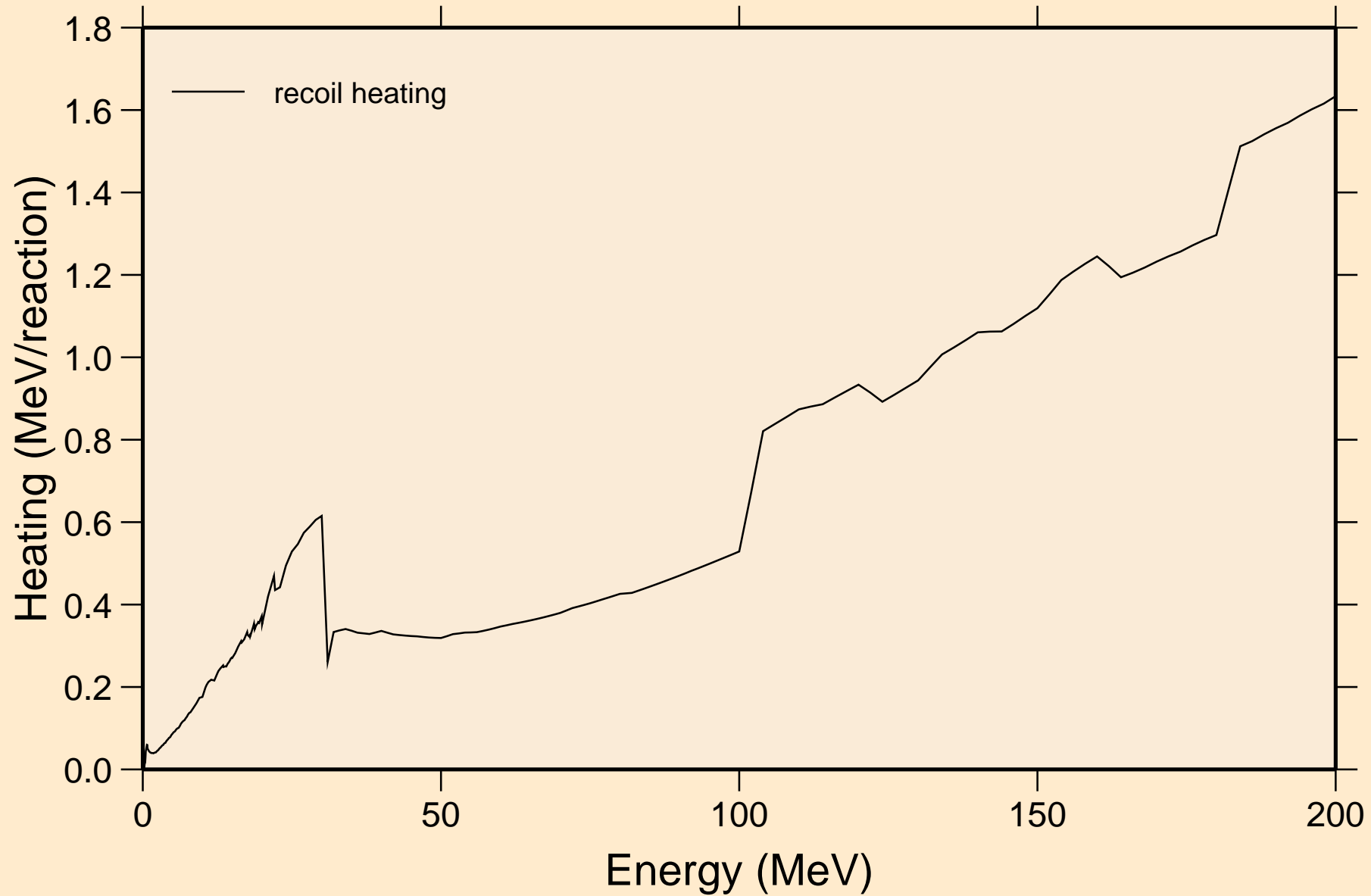

RH110M NEUTRON ACER TENDL-2021 LIBRARY; T=293.6K
Particle production cross sections

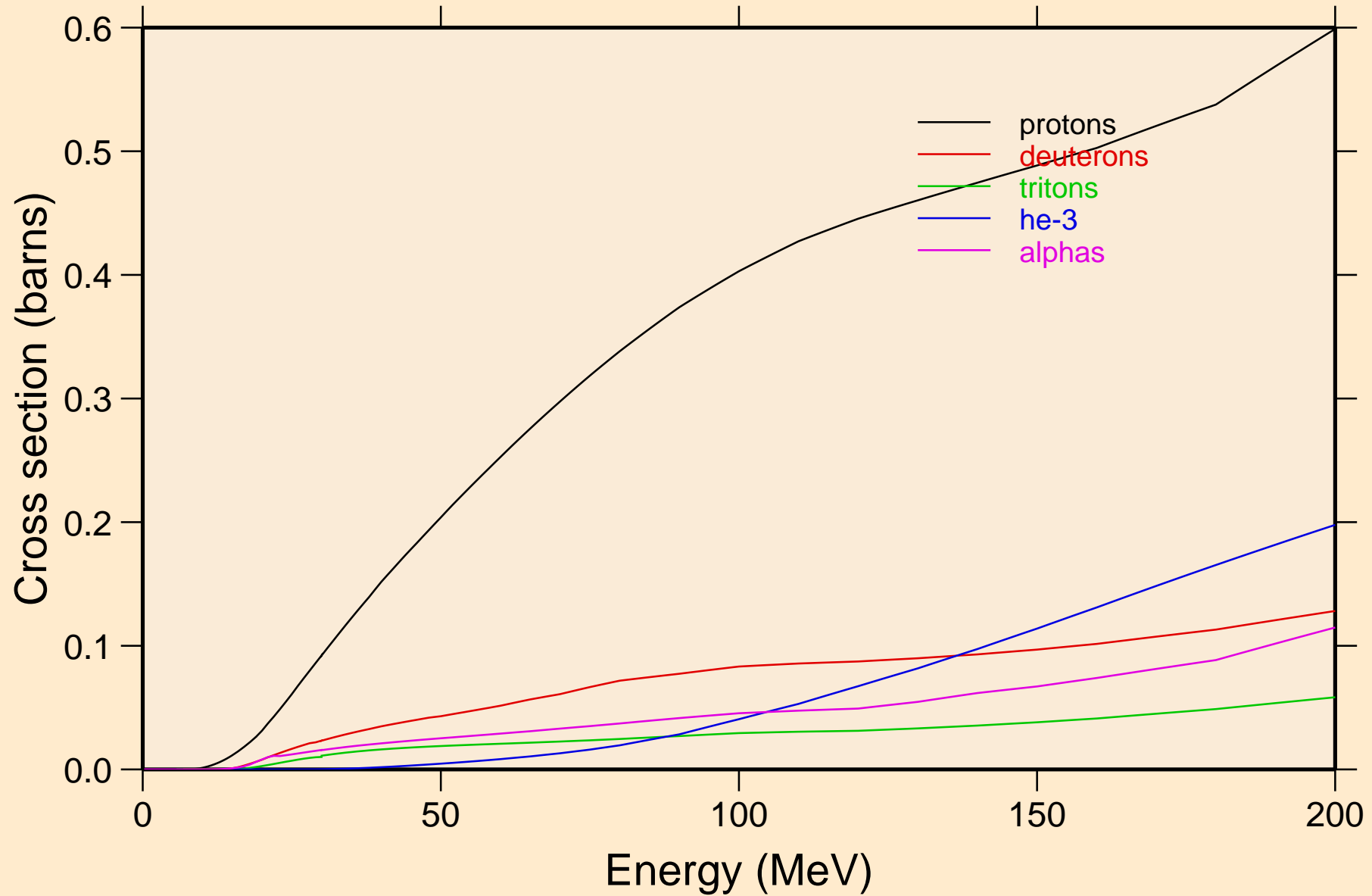

RH110M NEUTRON ACER TENDL-2021 LIBRARY; T=293.6K
protons from (n,x)

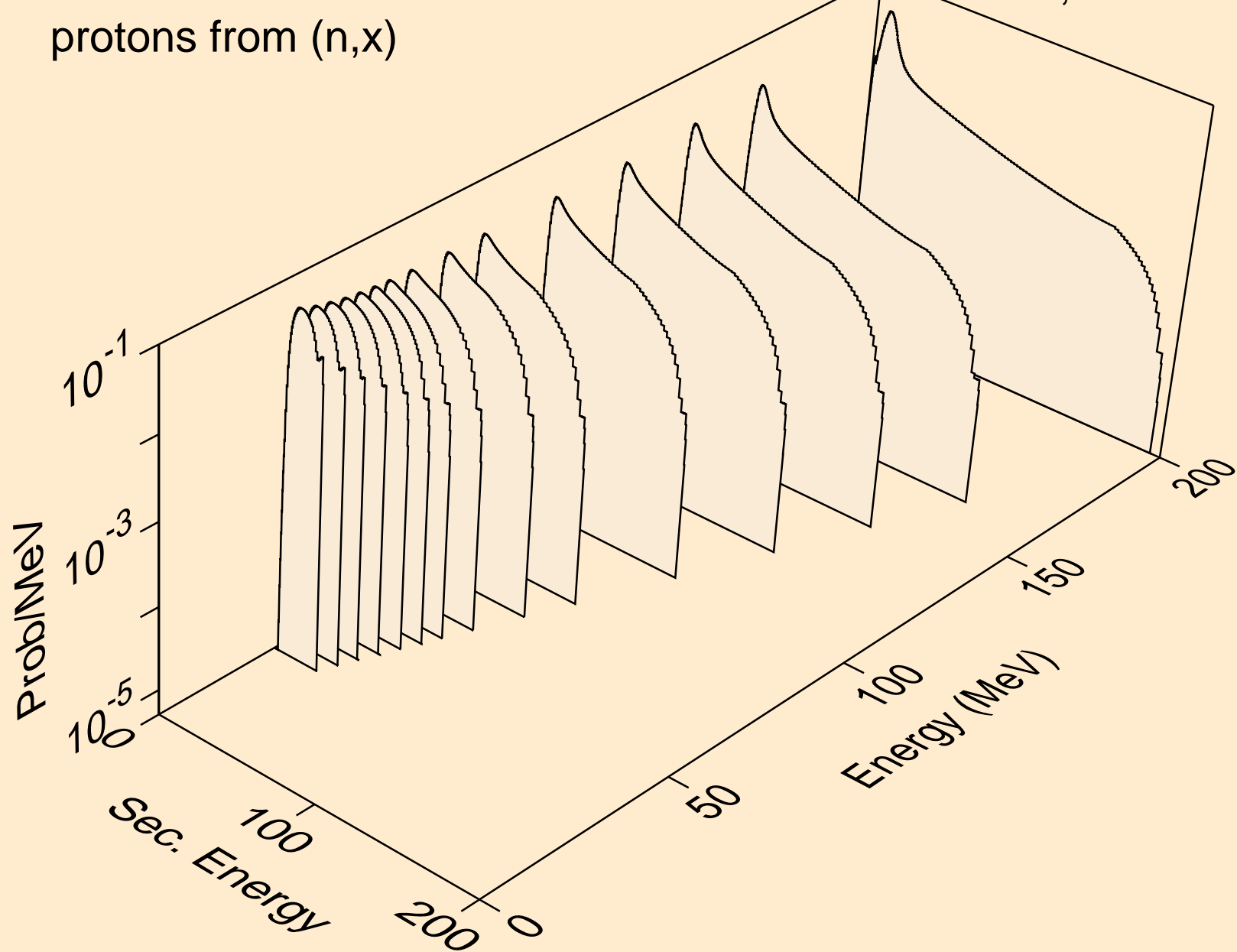

RH110M NEUTRON ACER TENDL-2021 LIBRARY; T=293.6K
protons from (n,n*)p

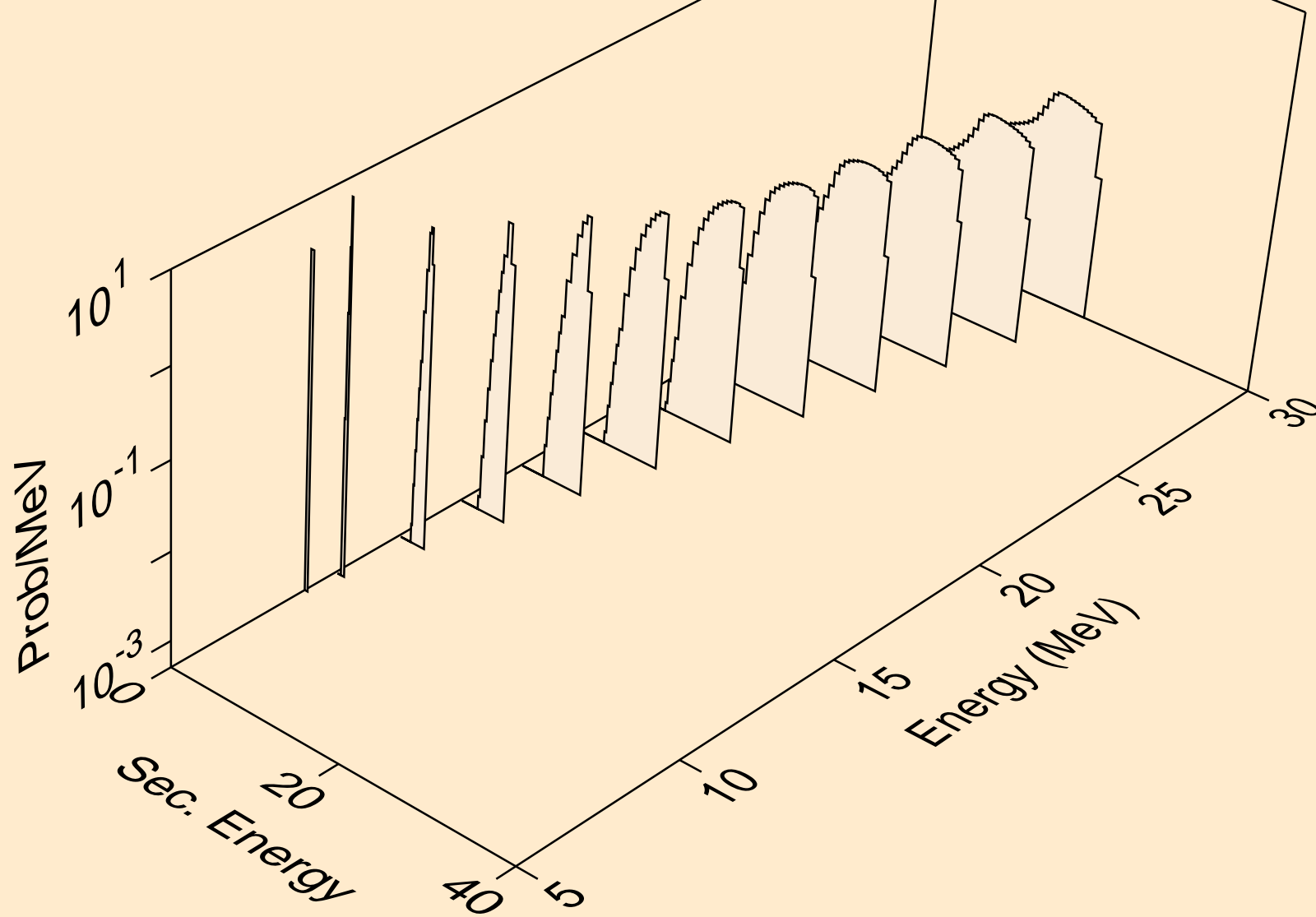

RH110M NEUTRON ACER TENDL-2021 LIBRARY; T=293.6K
protons from (n,2np)

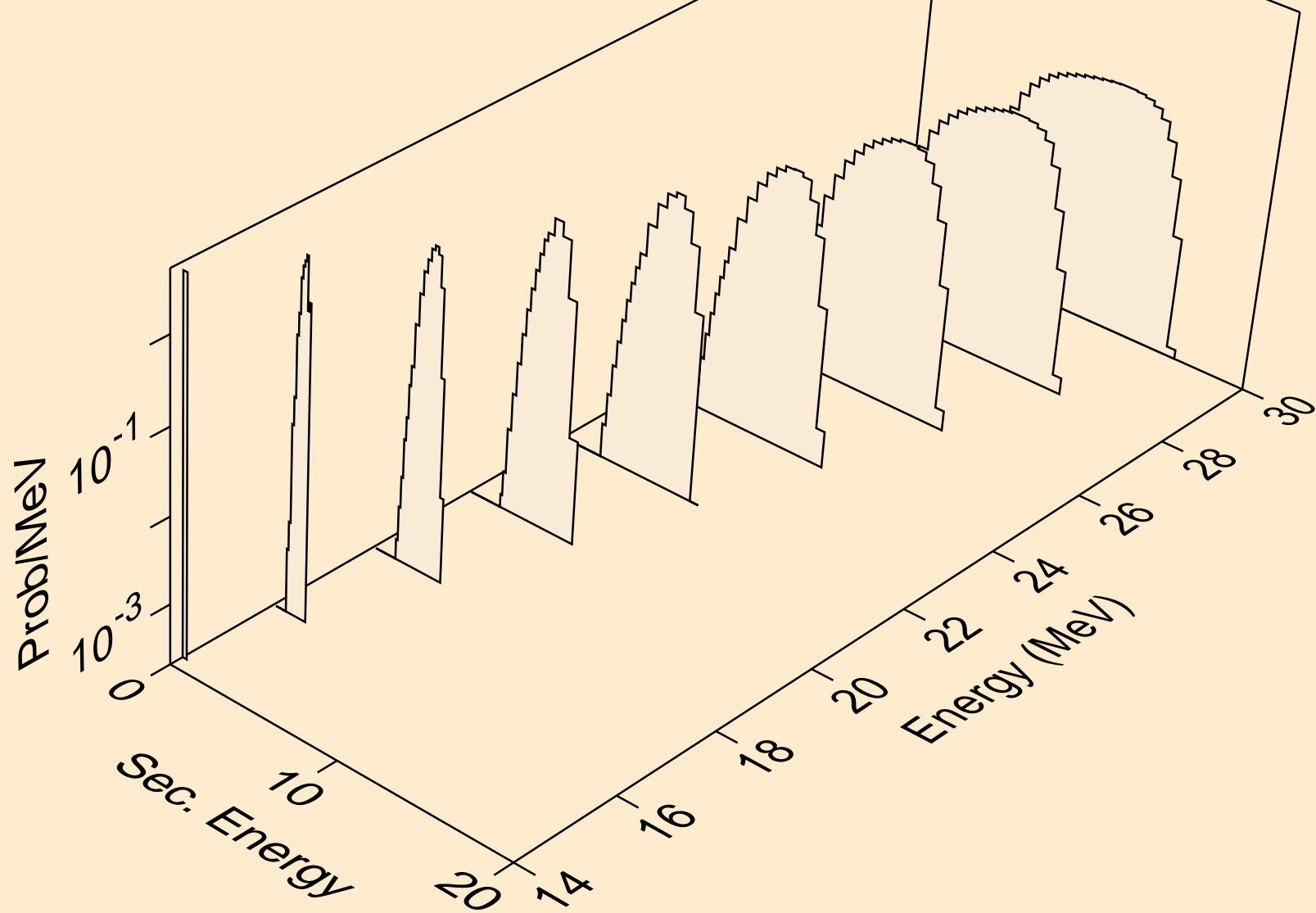

RH110M NEUTRON ACER TENDL-2021 LIBRARY; T=293.6K
protons from (n,3np)

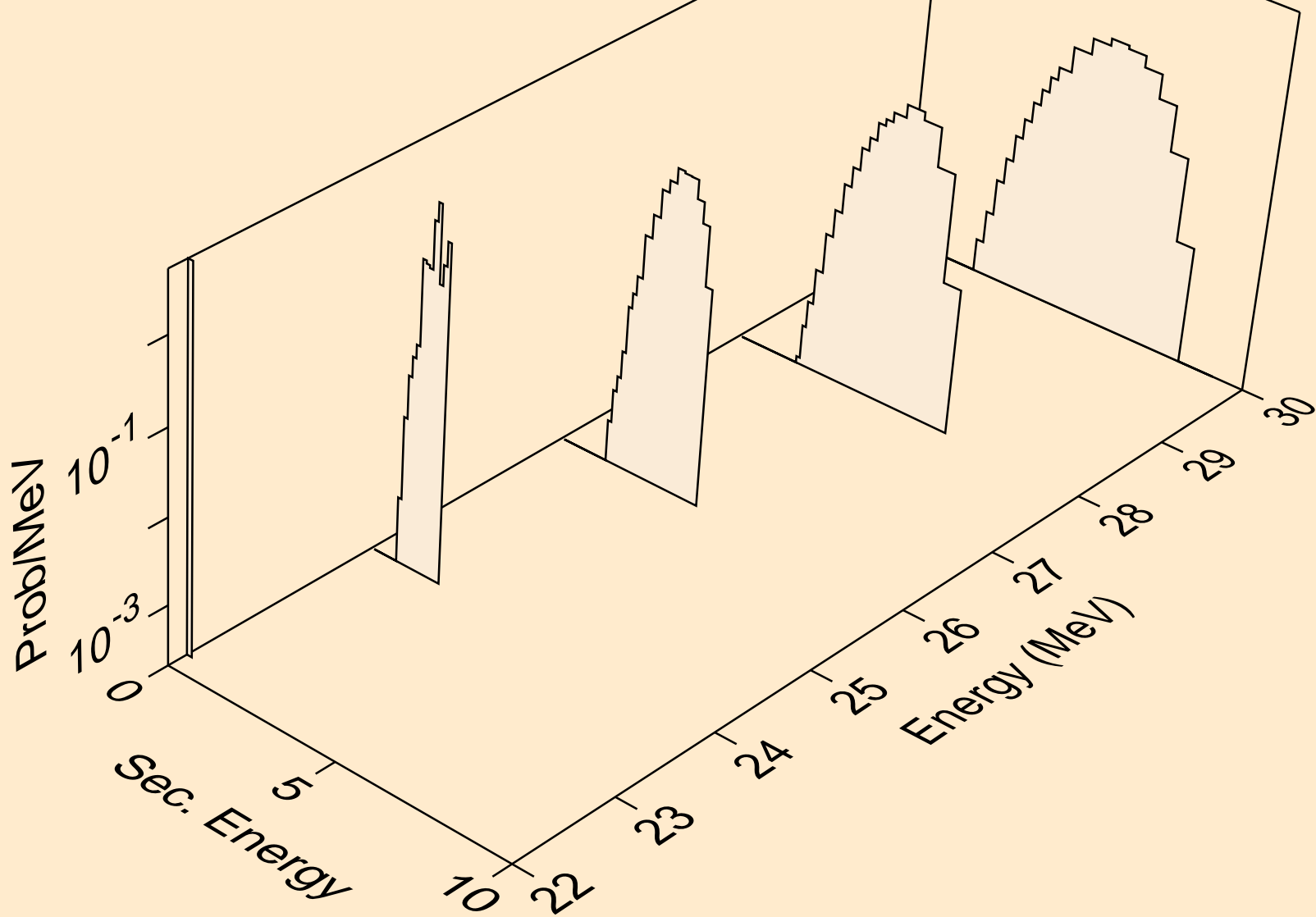

RH110M NEUTRON ACER TENDL-2021 LIBRARY; T=293.6K
protons from (n,p)

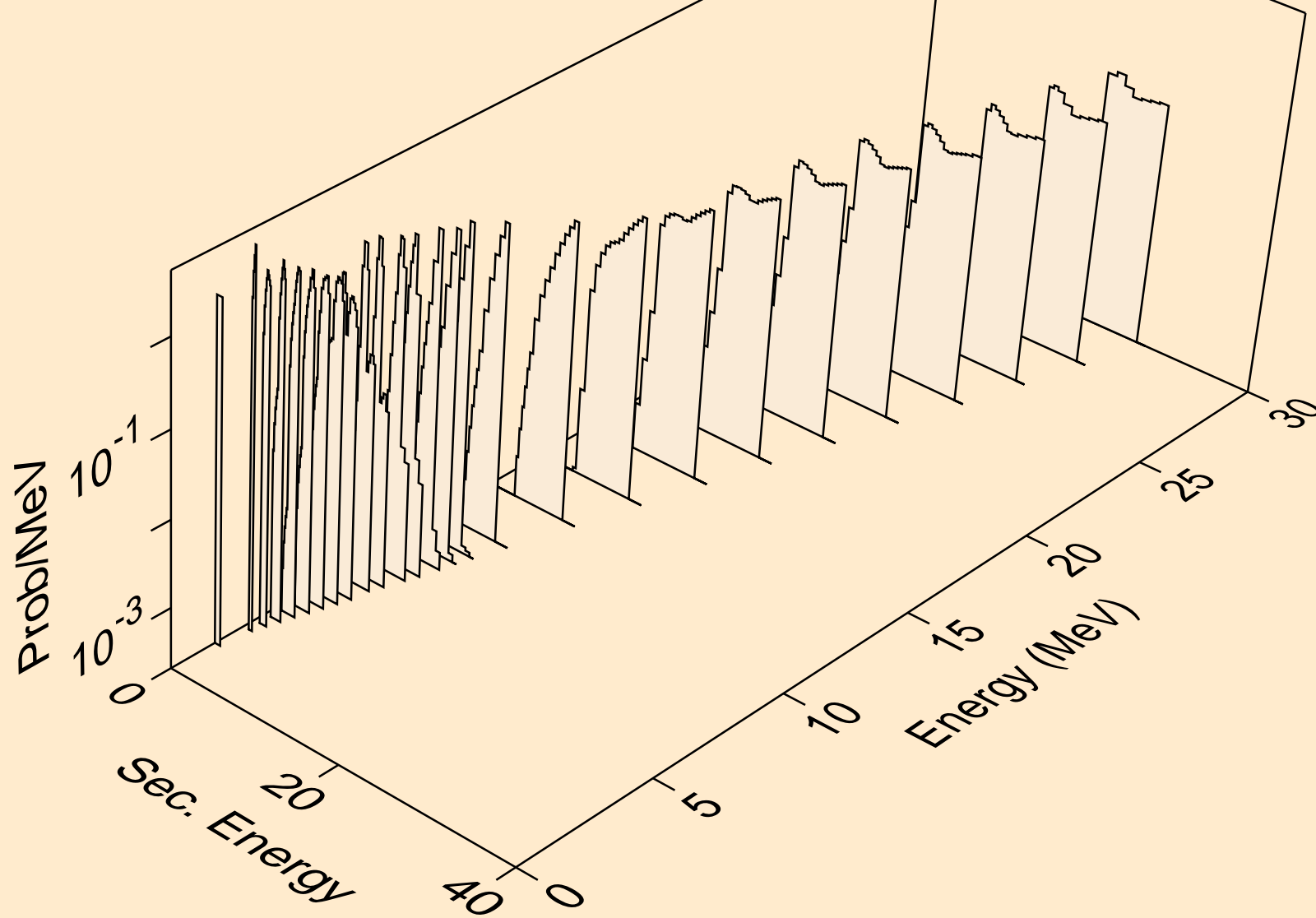

RH110M NEUTRON ACER TENDL-2021 LIBRARY; T=293.6K
protons from (n,2p)

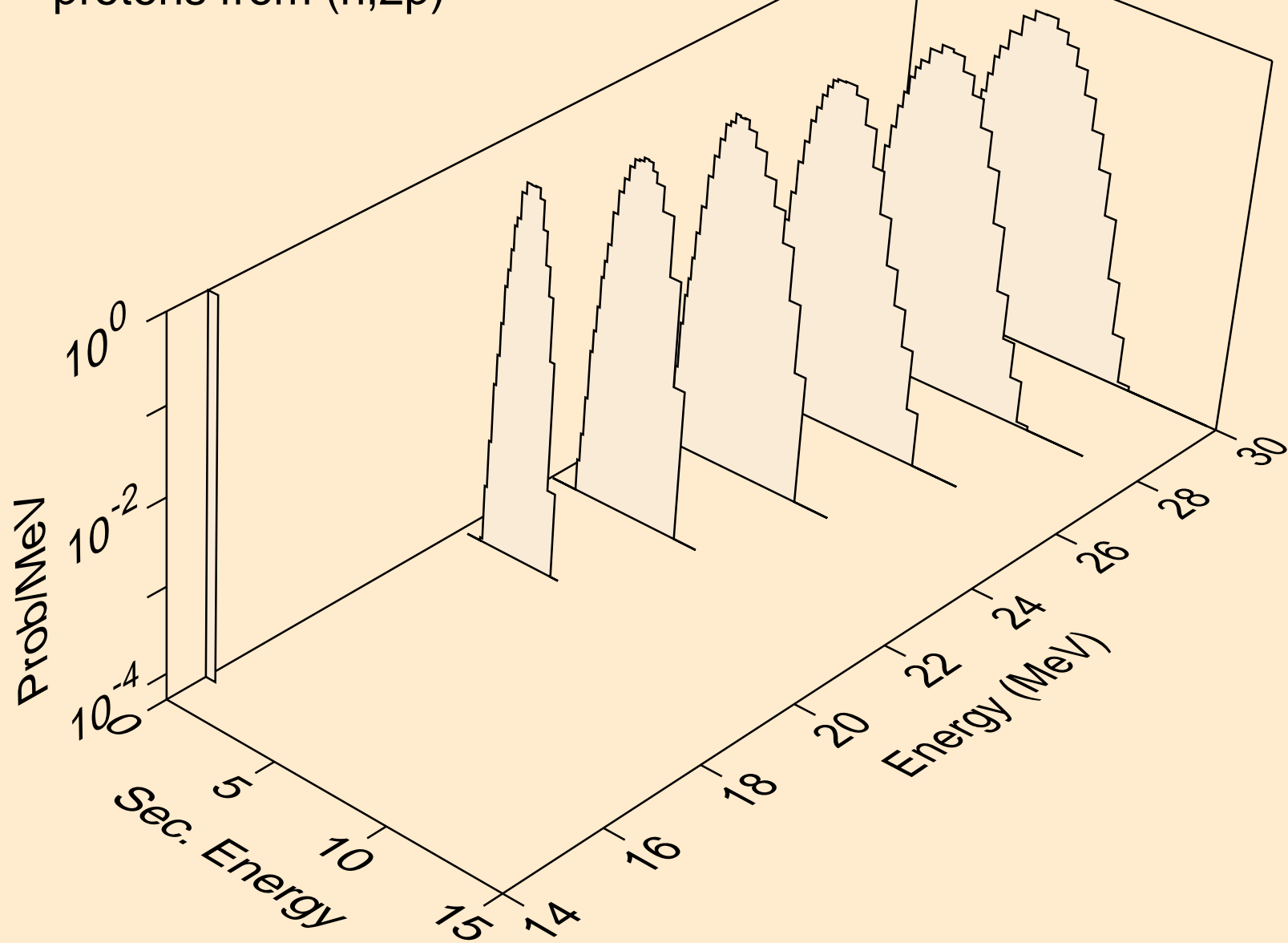

RH110M NEUTRON ACER TENDL-2021 LIBRARY; T=293.6K
protons from (n,p)

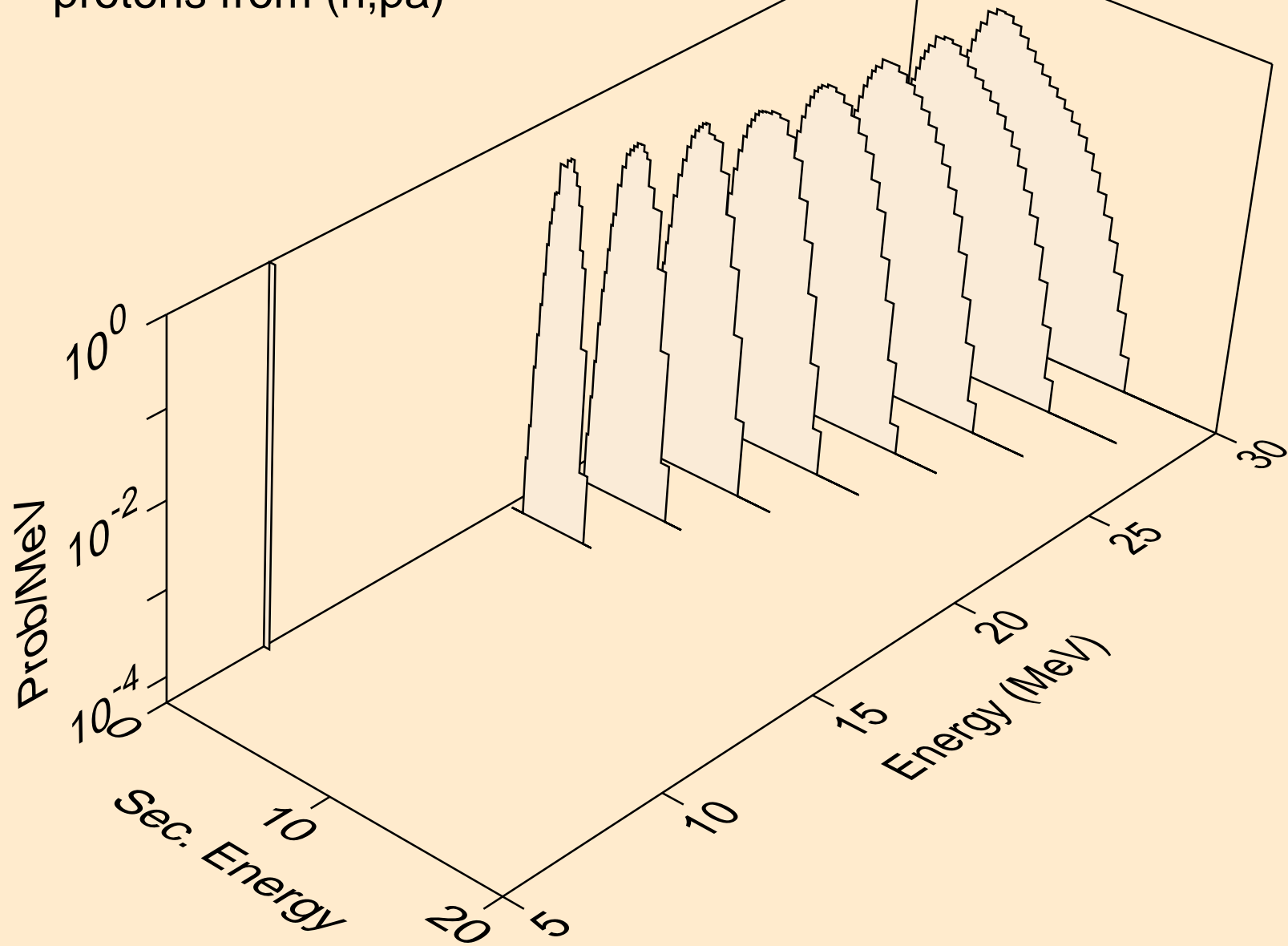

RH110M NEUTRON ACER TENDL-2021 LIBRARY; T=293.6K
deuterons from (n,x)

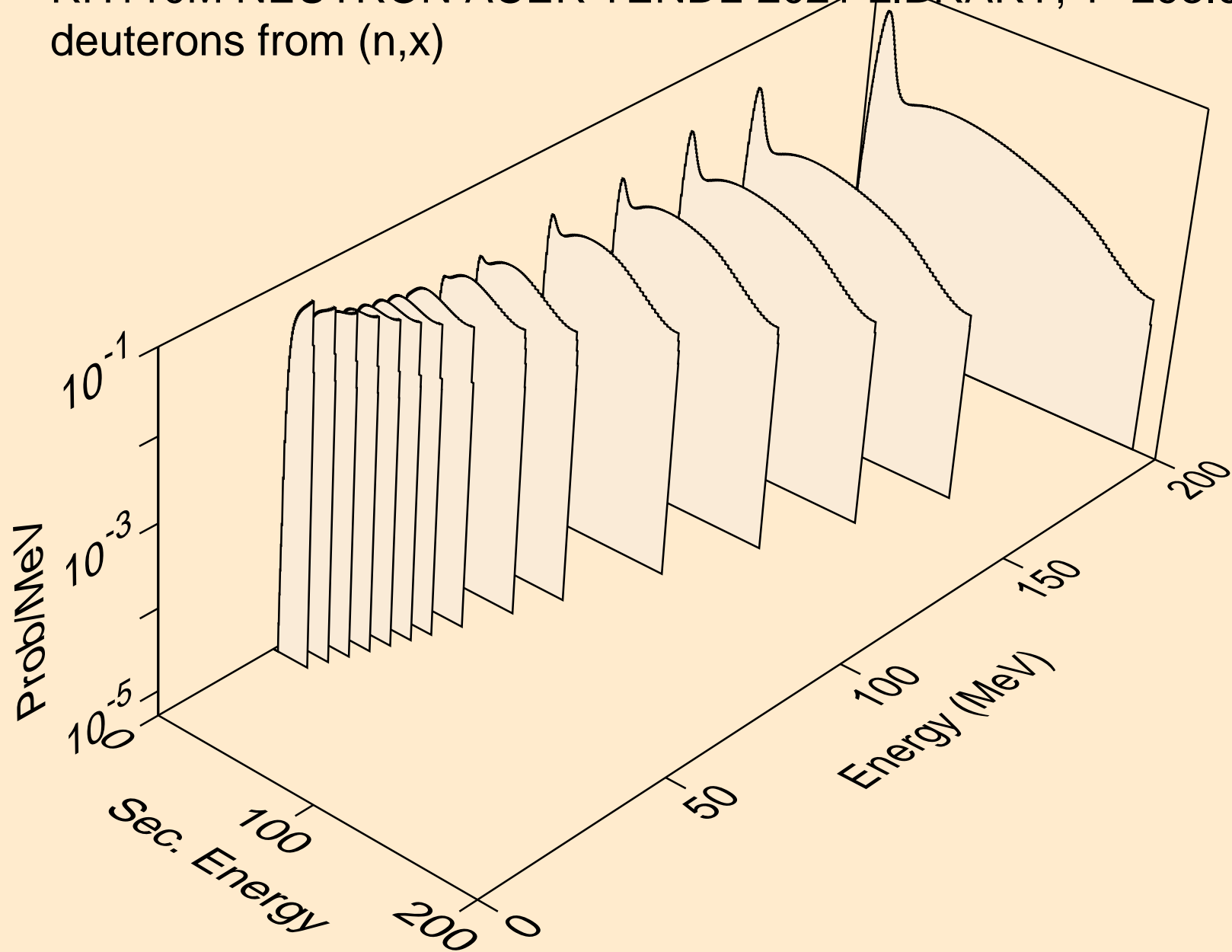

RH110M NEUTRON ACER TENDL-2021 LIBRARY; T=293.6K
deuterons from (n,2nd)

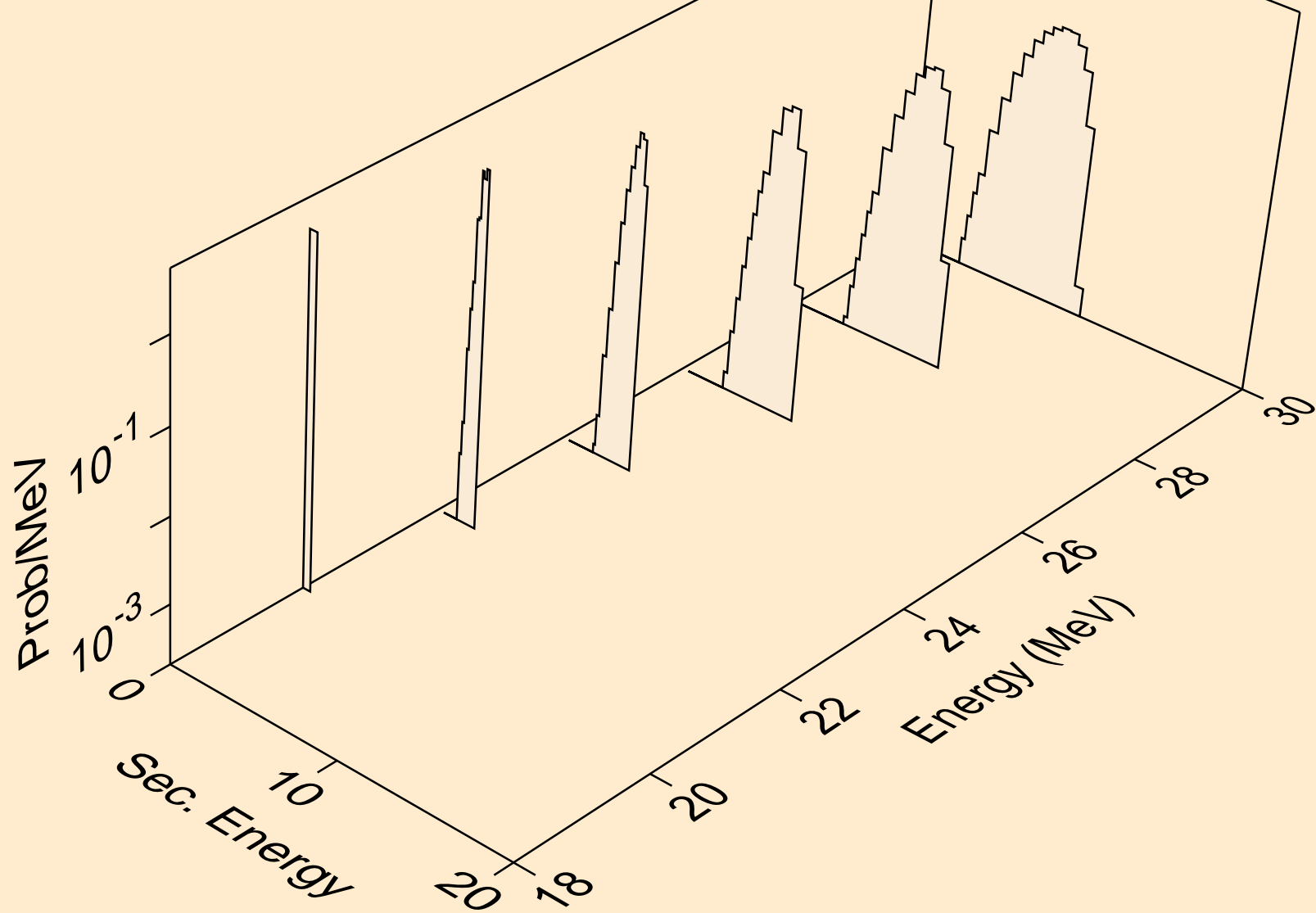

RH110M NEUTRON ACER TENDL-2021 LIBRARY; T=293.6K
deuterons from (n,n*)d

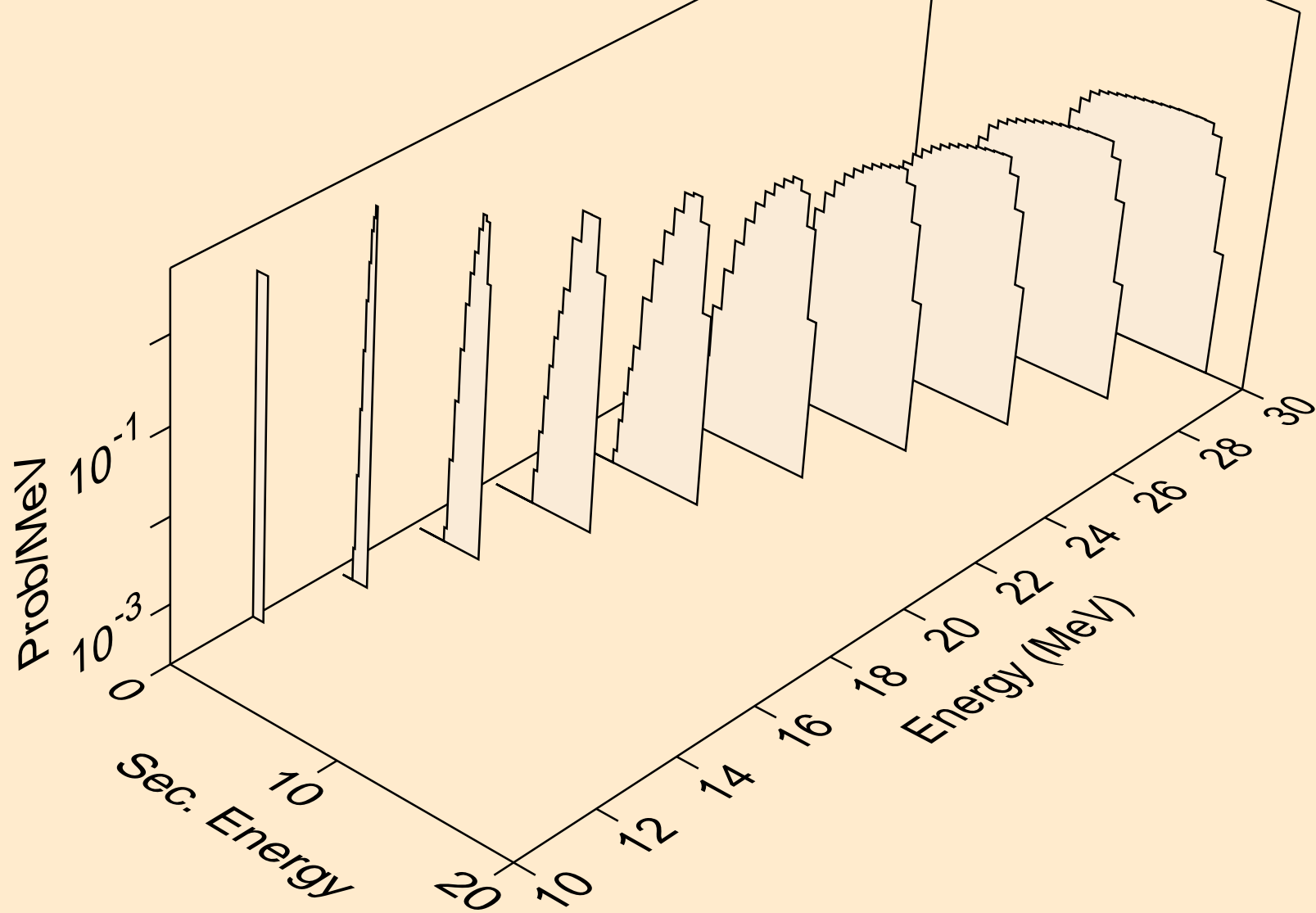

RH110M NEUTRON ACER TENDL-2021 LIBRARY; T=293.6K
deuterons from (n,d)

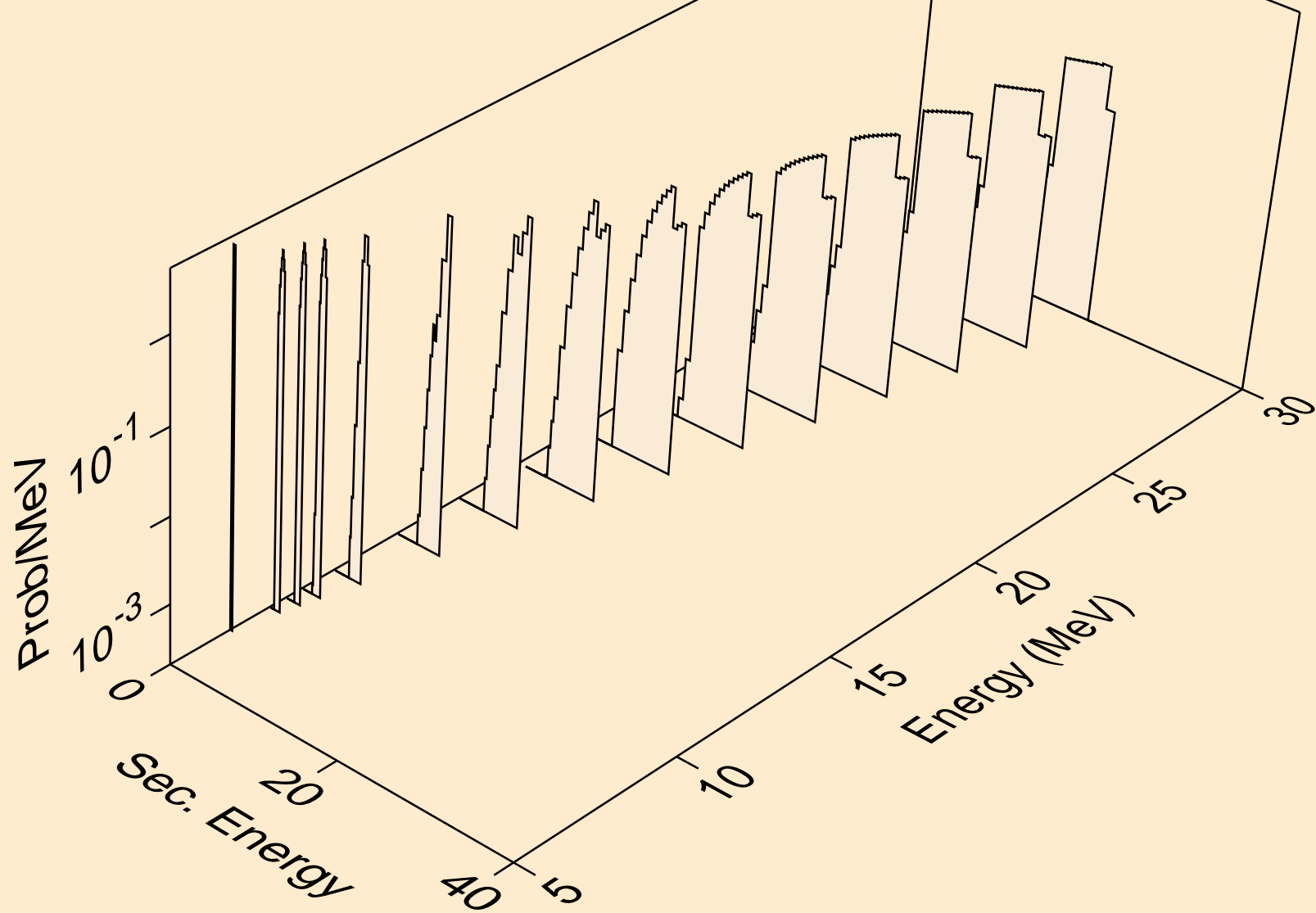

RH110M NEUTRON ACER TENDL-2021 LIBRARY; T=293.6K
tritons from (n,x)

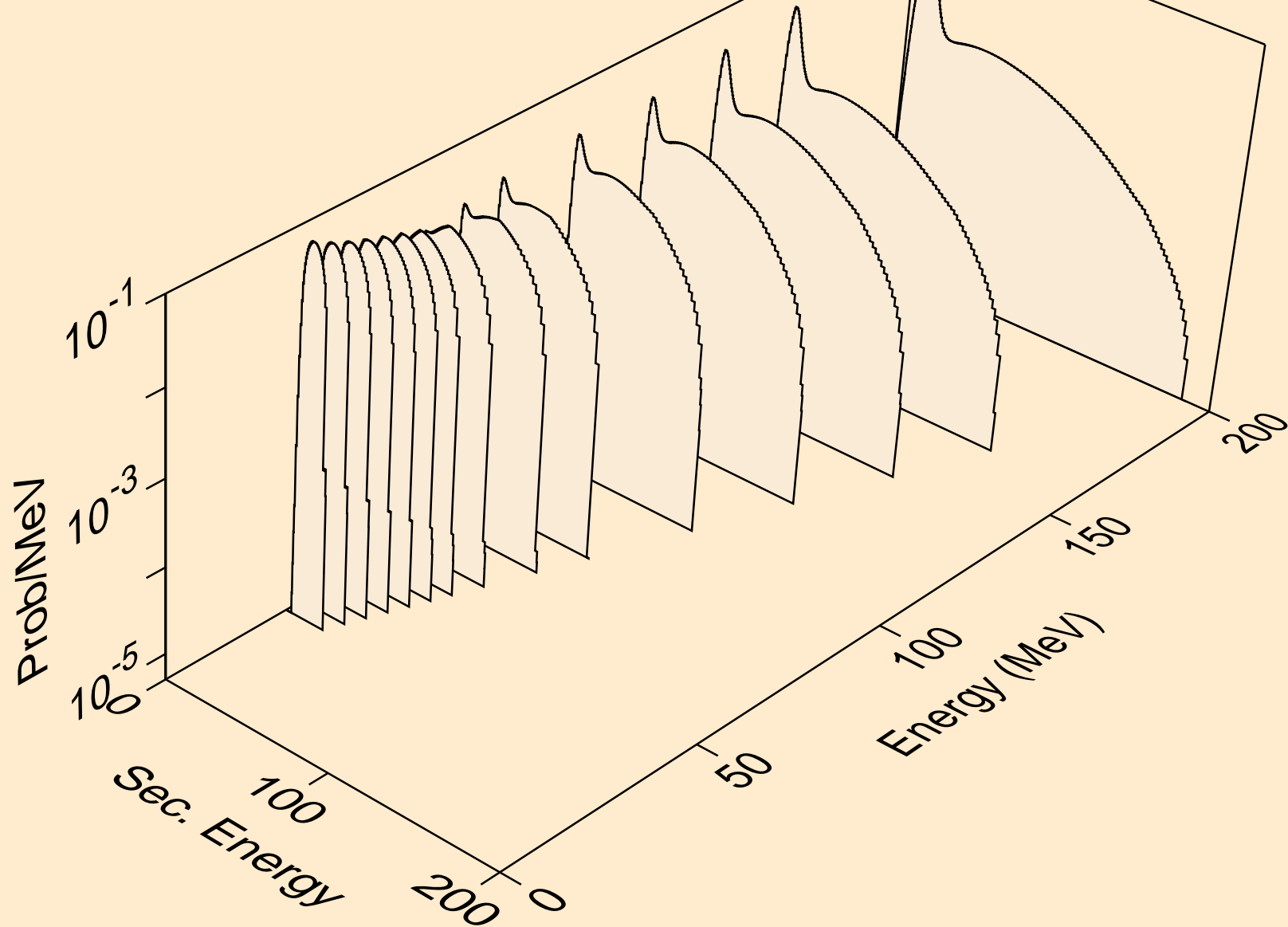

RH110M NEUTRON ACER TENDL-2021 LIBRARY; T=293.6K
tritons from (n,n*)t

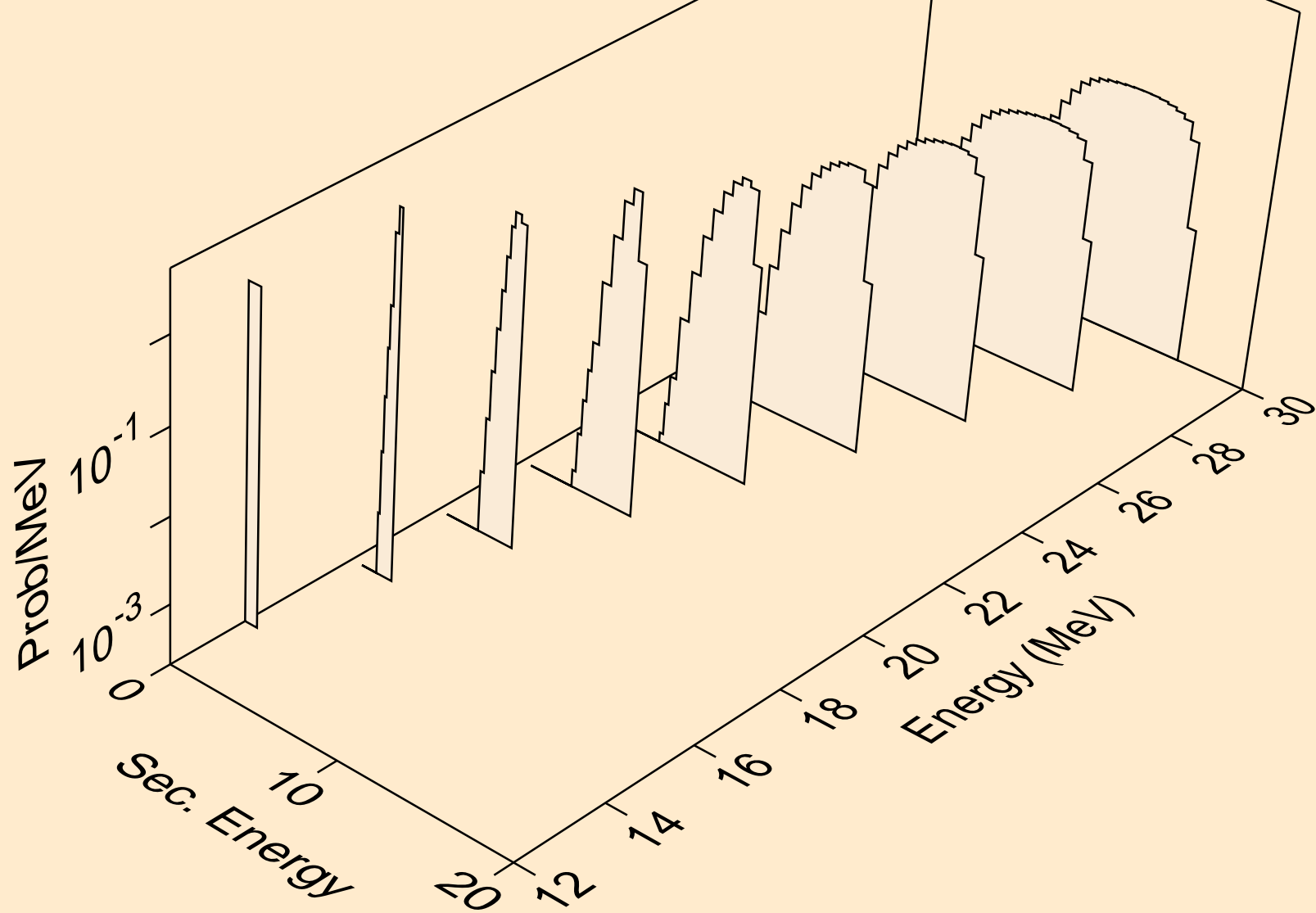

RH110M NEUTRON ACER TENDL-2021 LIBRARY; T=293.6K
tritons from (n,t)

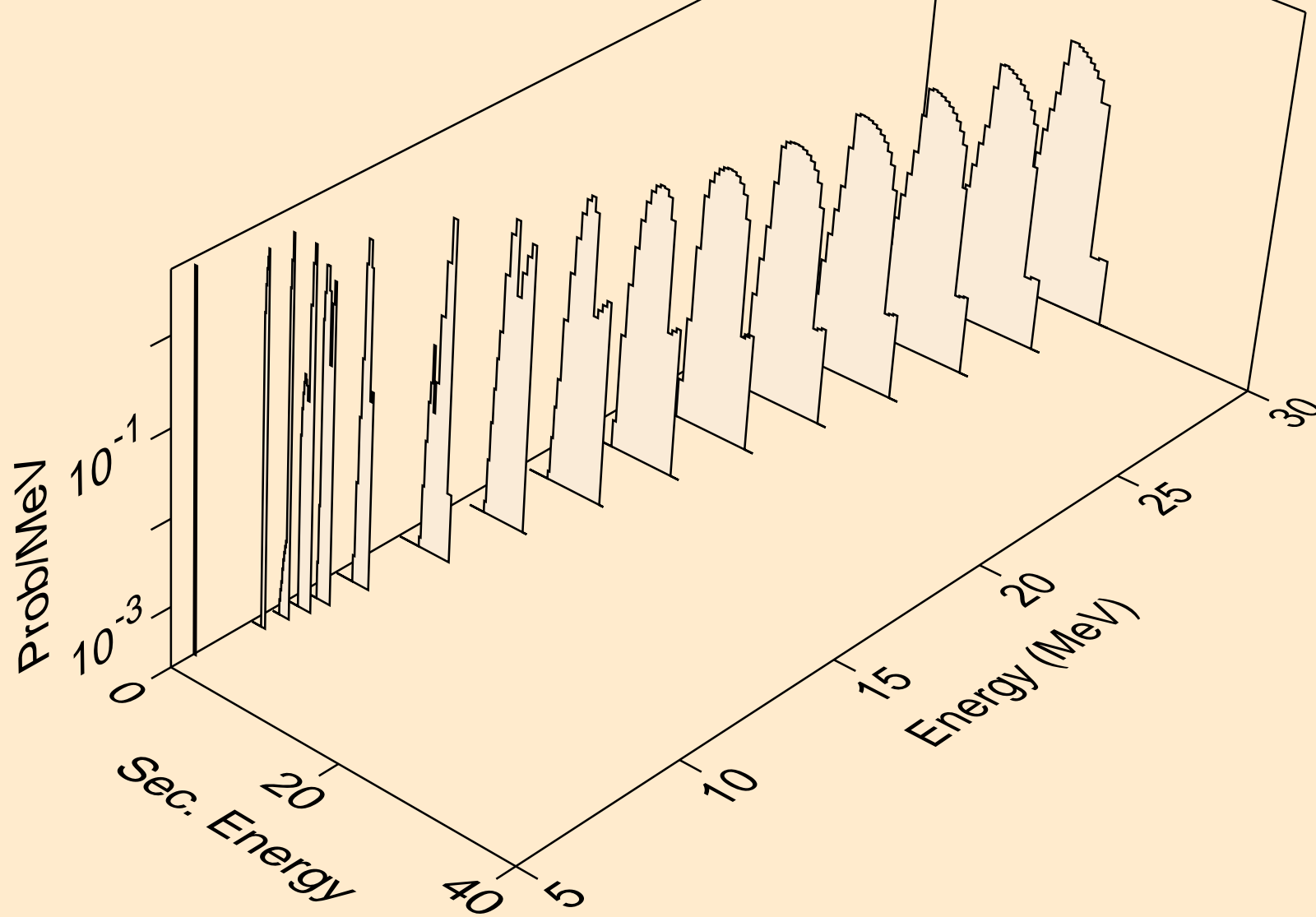

RH110M NEUTRON ACER TENDL-2021 LIBRARY; T=293.6K
he3s from (n,x)

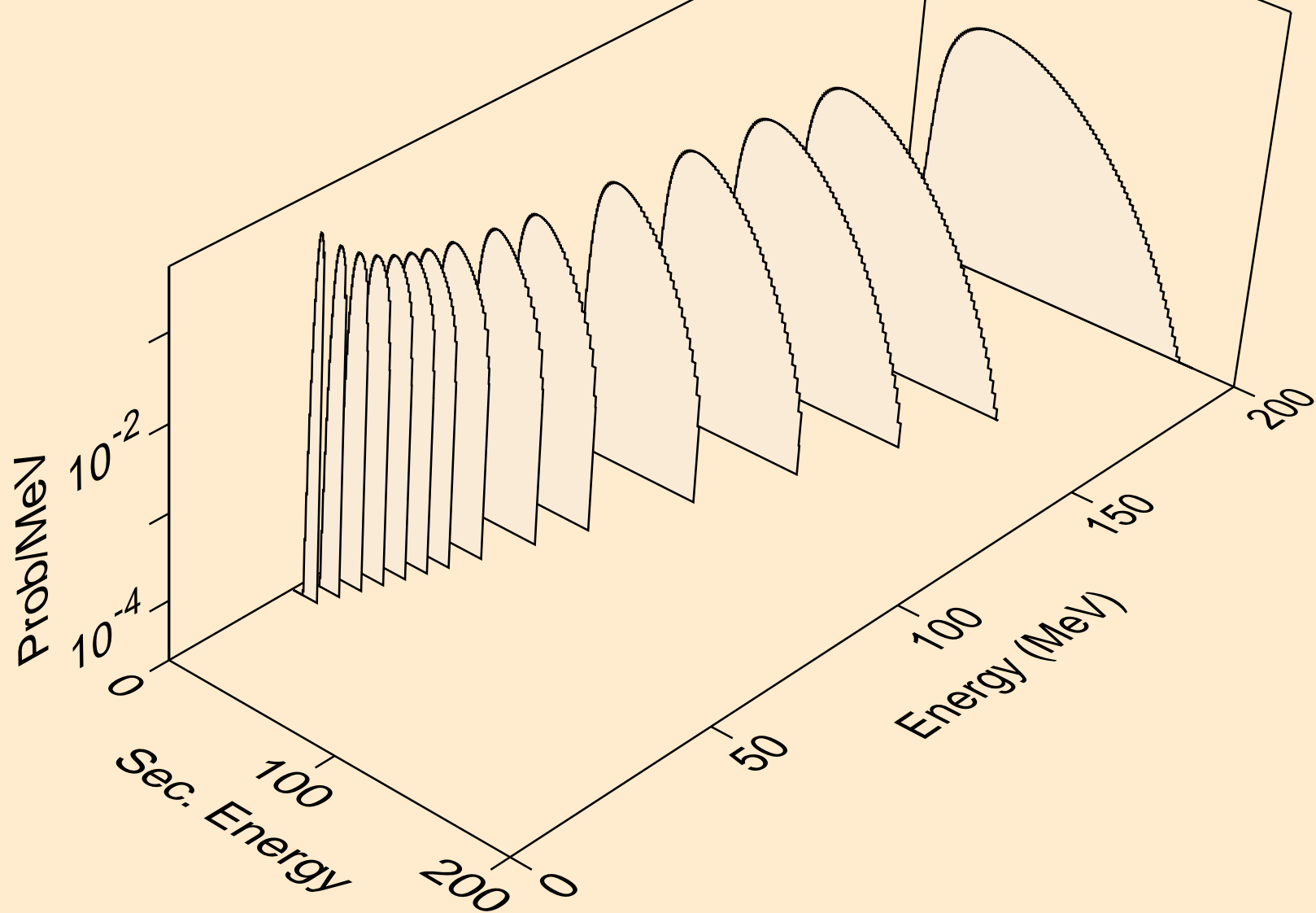

RH110M NEUTRON ACER TENDL-2021 LIBRARY; T=293.6K
he3s from (n,n*)he3

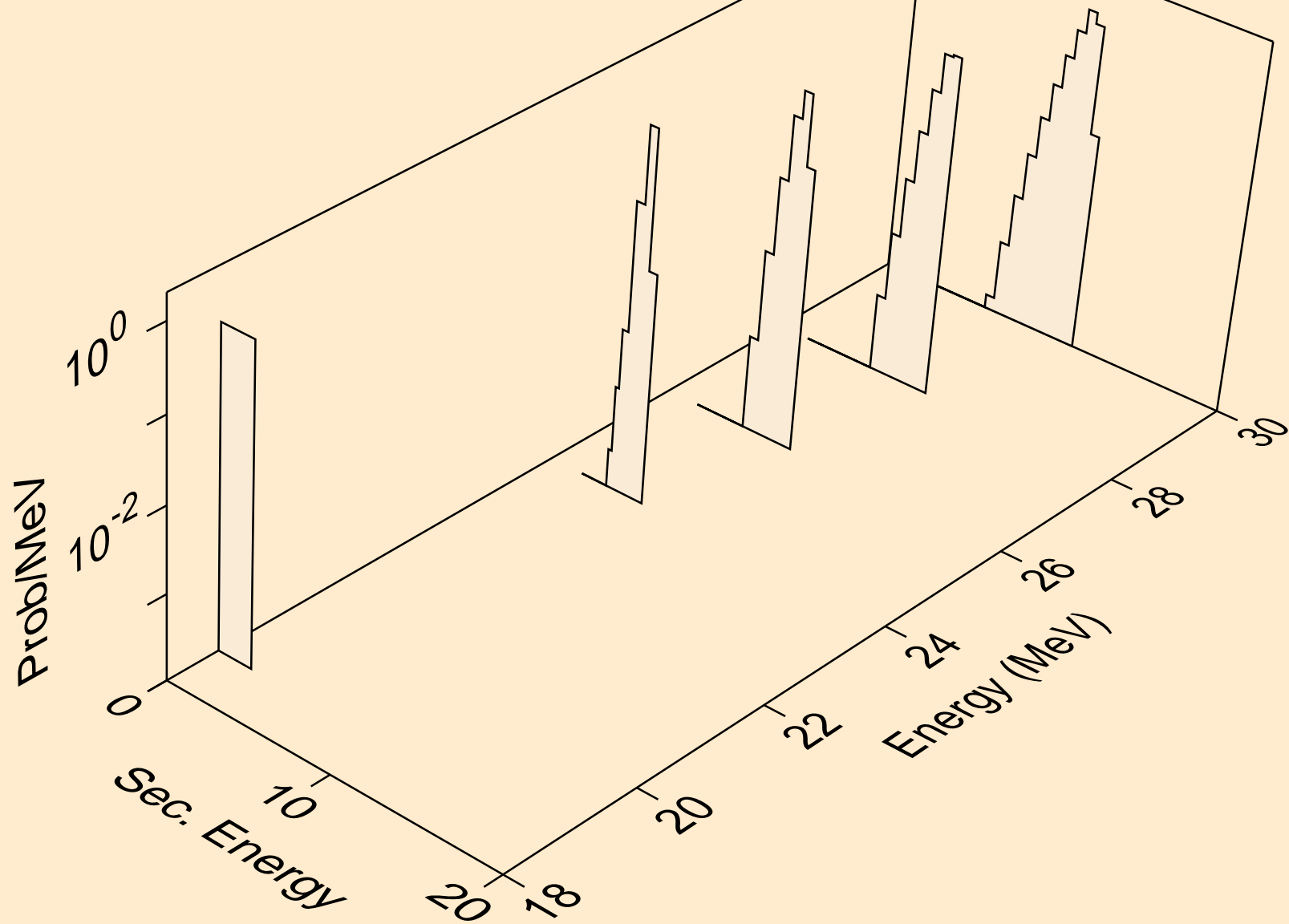

RH110M NEUTRON ACER TENDL-2021 LIBRARY; T=293.6K
he3s from (n,he3)

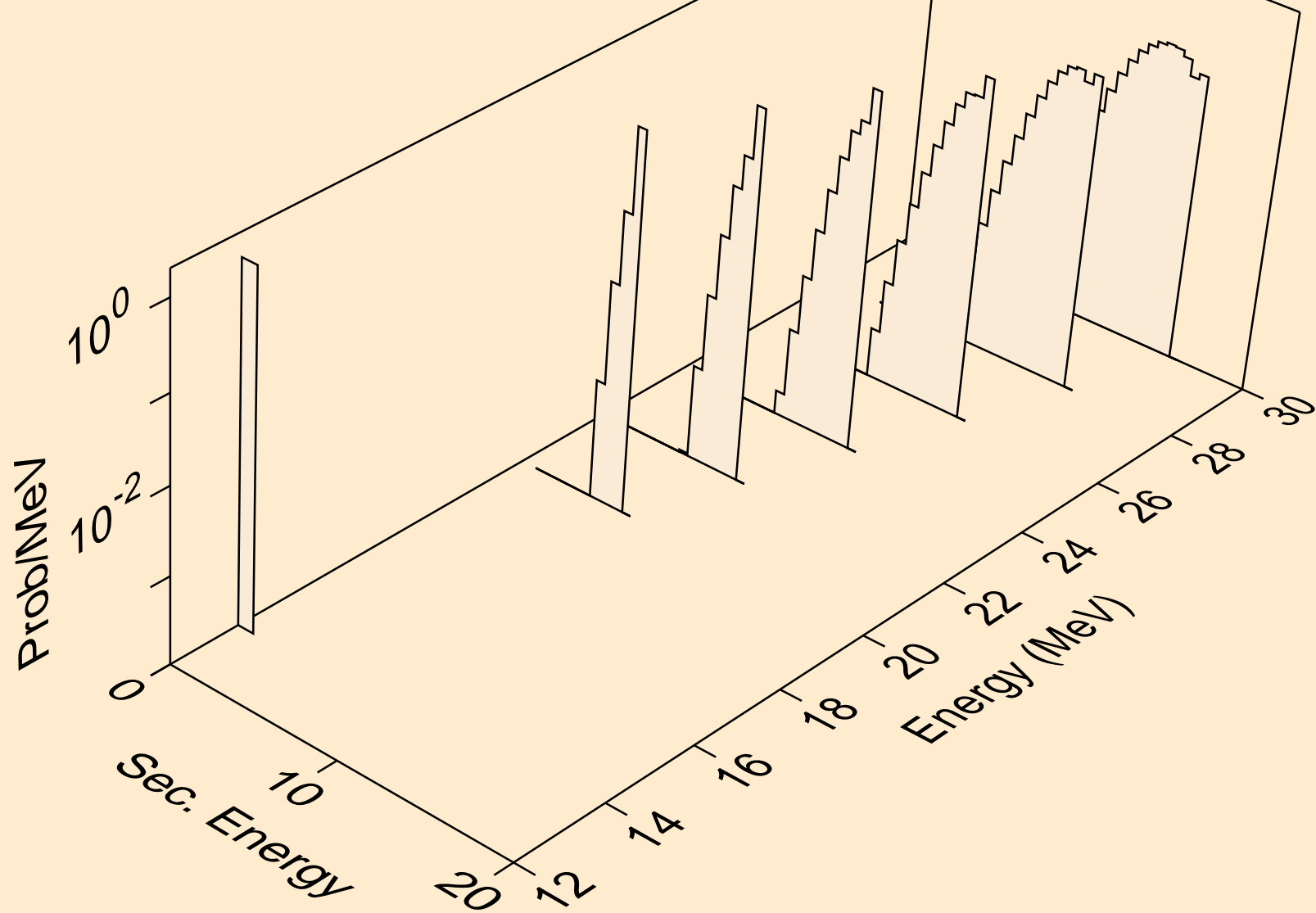

RH110M NEUTRON ACER TENDL-2021 LIBRARY; T=293.6K
alphas from (n,x)

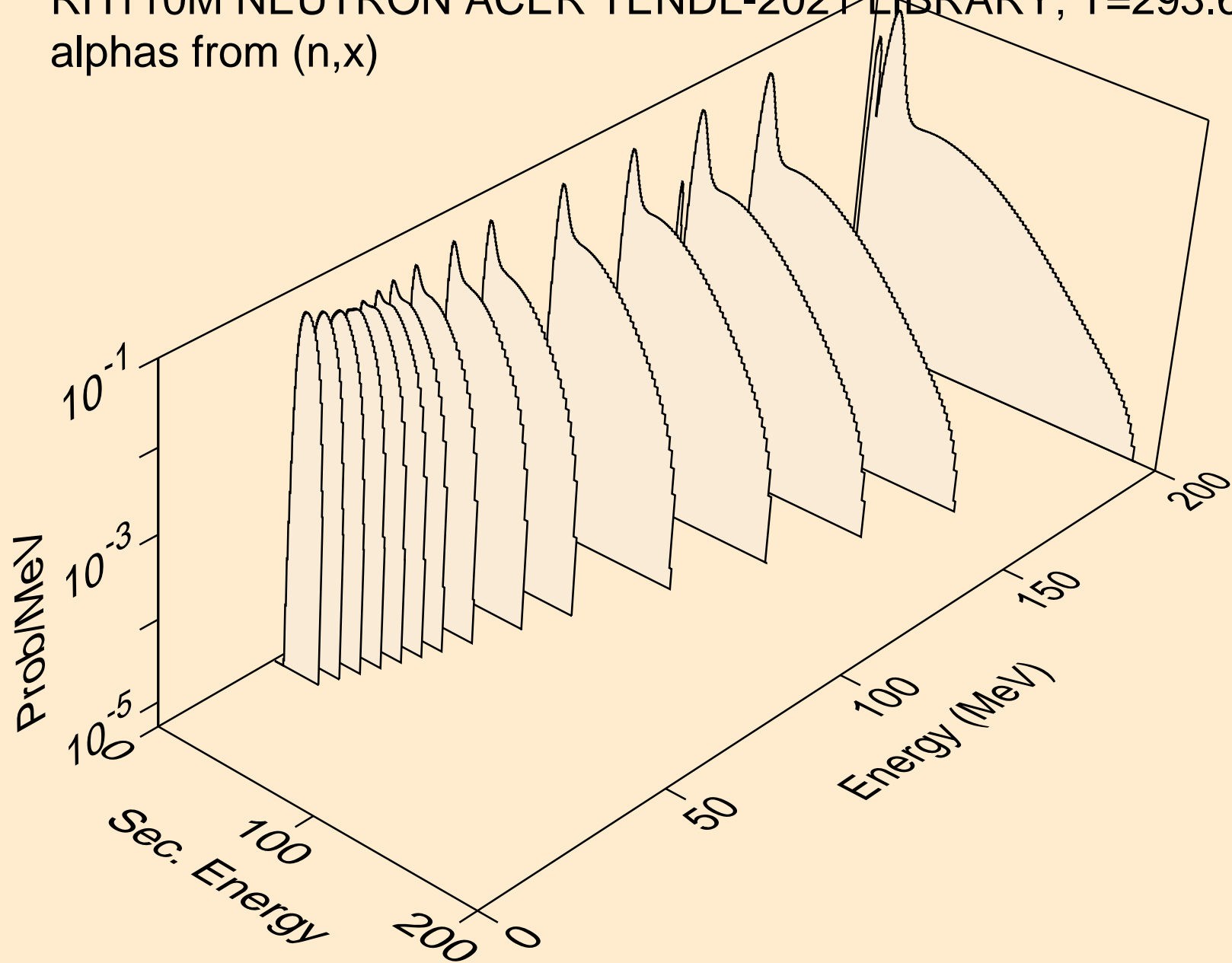

RH110M NEUTRON ACER TENDL-2021 LIBRARY; T=293.6K
alphas from (n,n*)a

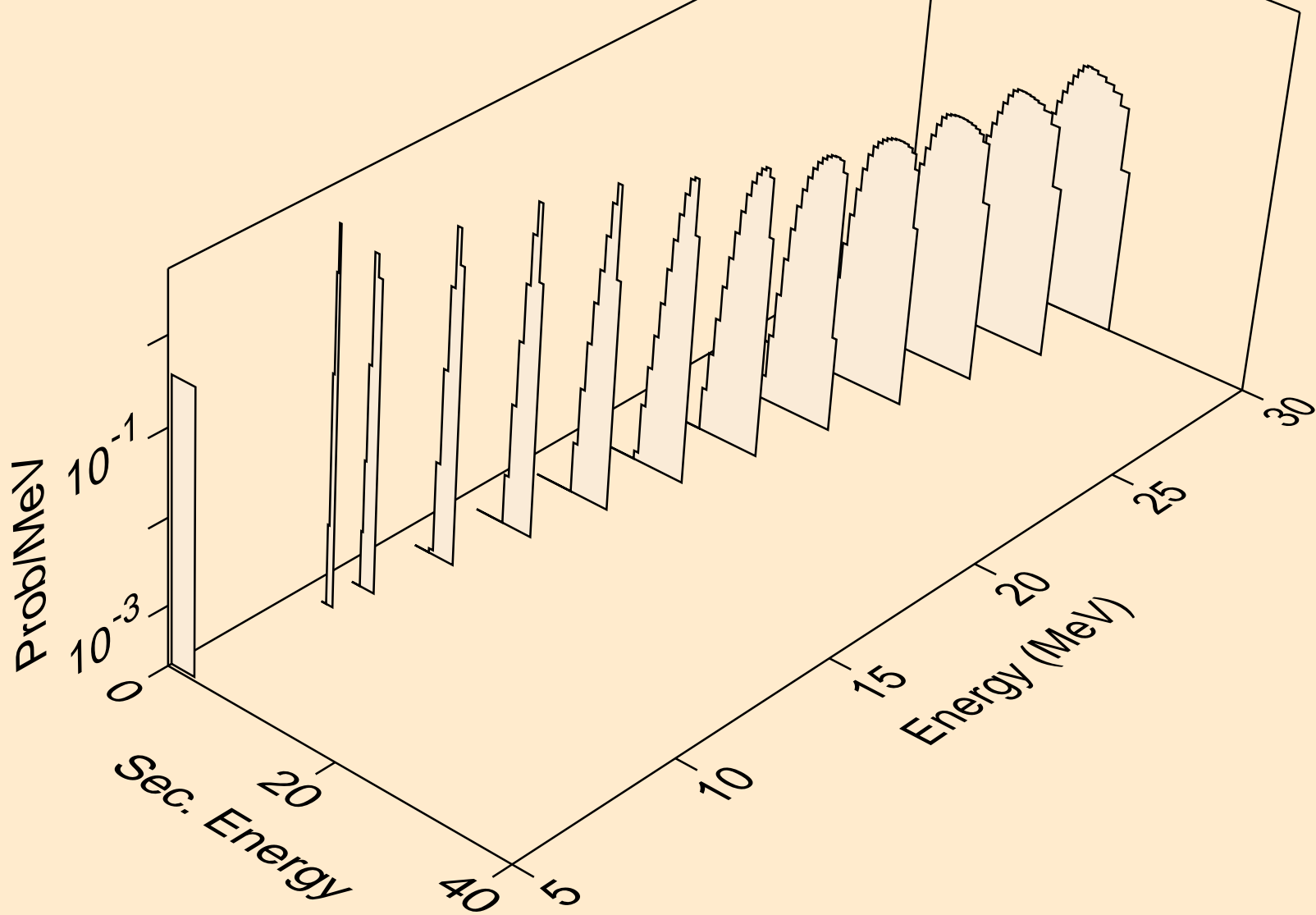

RH110M NEUTRON ACER TENDL-2021 LIBRARY; T=293.6K
alphas from (n,2n)a

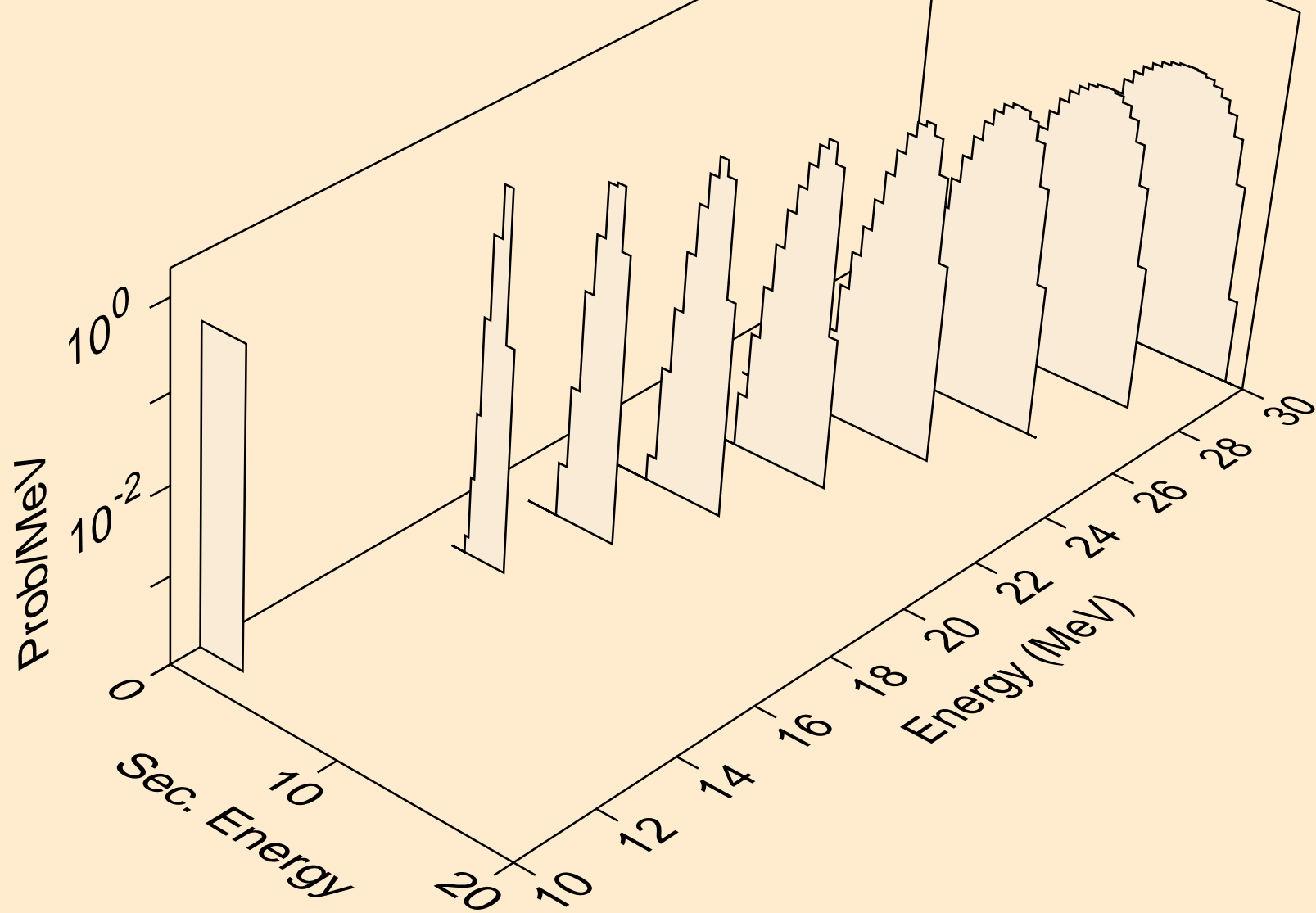

RH110M NEUTRON ACER TENDL-2021 LIBRARY; T=293.6K
alphas from (n,3n)a

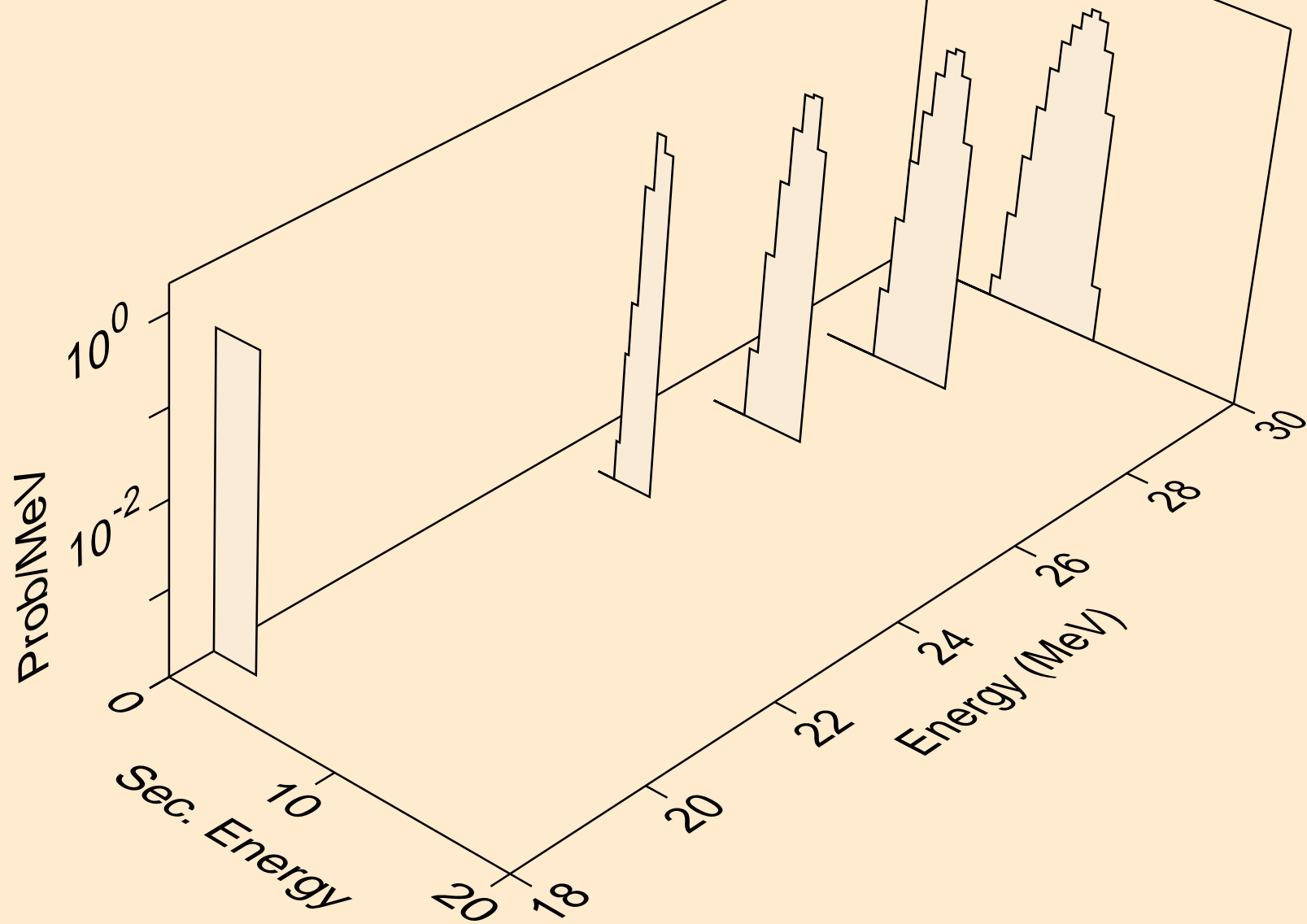

RH110M NEUTRON ACER TENDL-2021 LIBRARY; T=293.6K
alphas from (n,a)

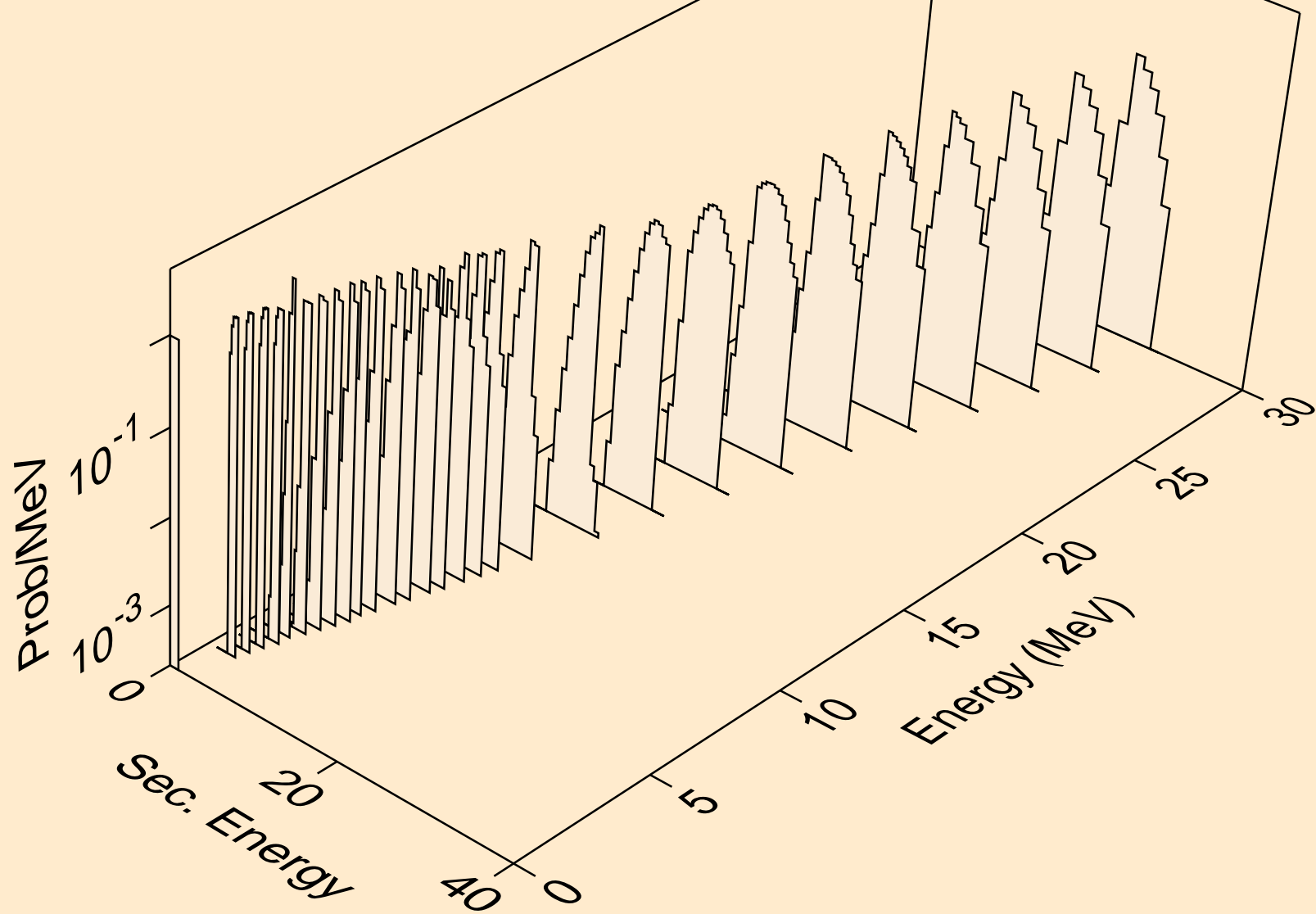

RH110M NEUTRON ACER TENDL-2021 LIBRARY; T=293.6K
alphas from (n,pa)

