

SB105 NEUTRON ACER TENDL-2021 LIBRARY; T=293.6K

Principal cross sections

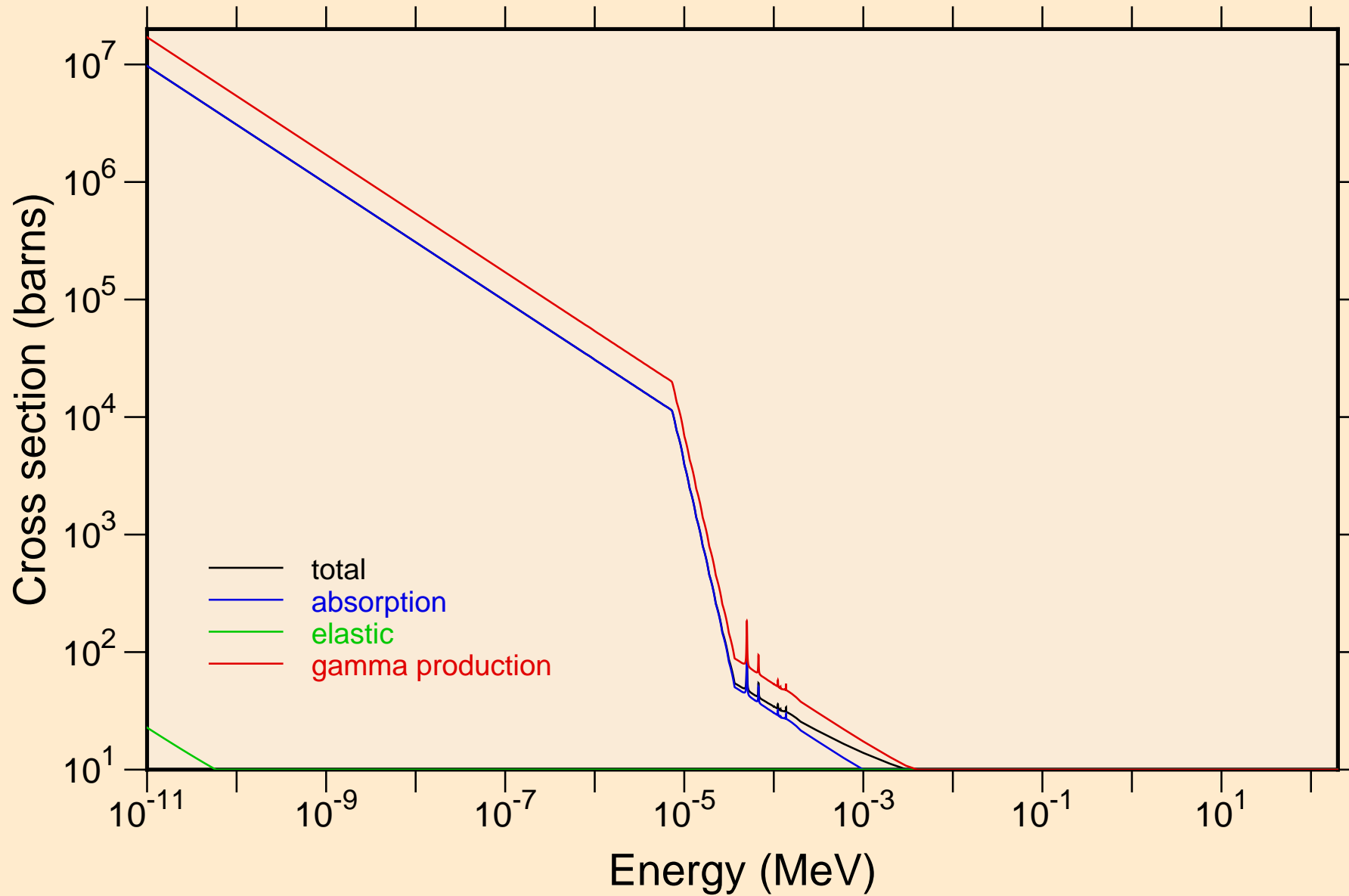

SB105 NEUTRON ACER TENDL-2021 LIBRARY; T=293.6K
resonance total cross section

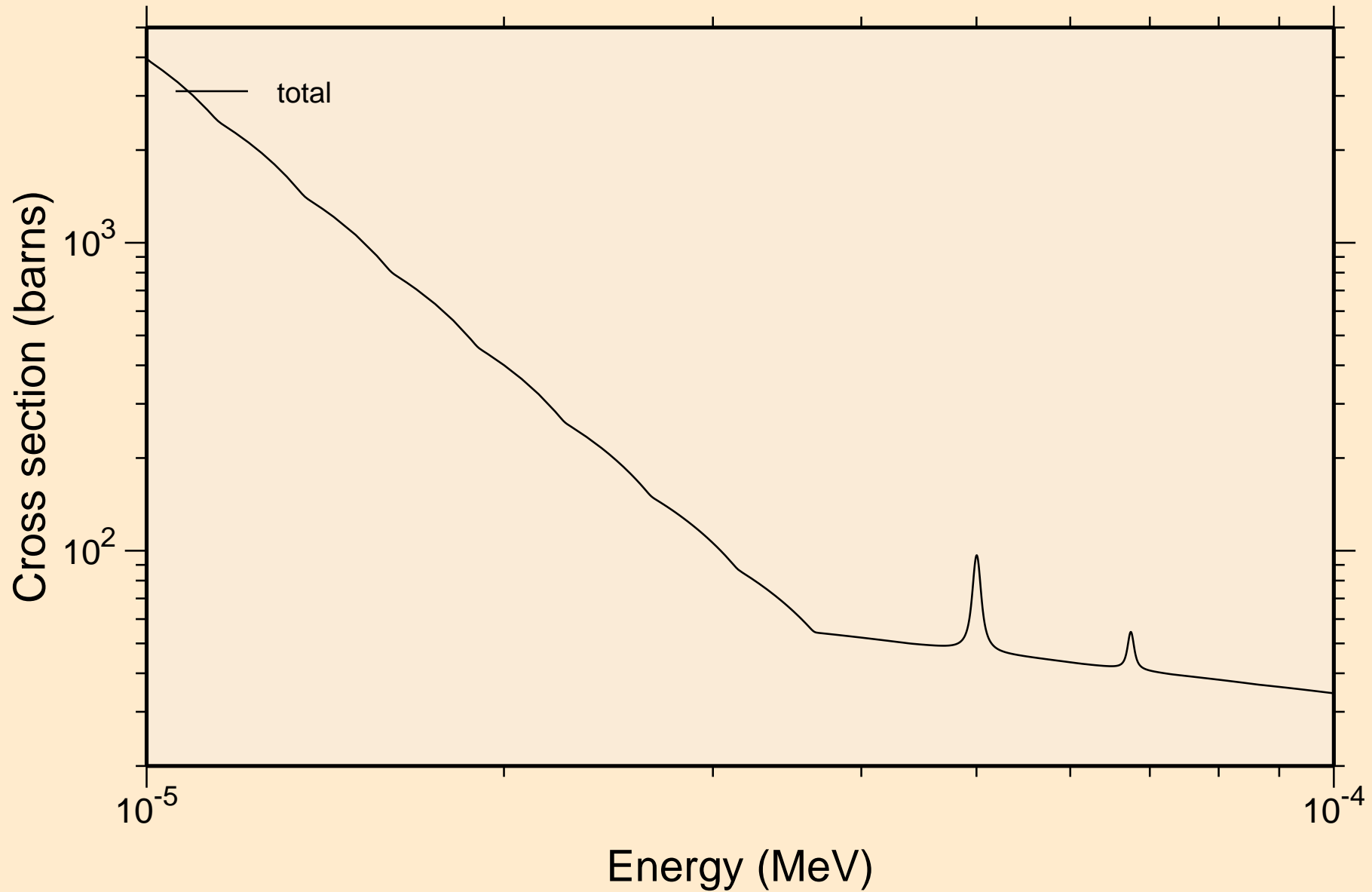

SB105 NEUTRON ACER TENDL-2021 LIBRARY; T=293.6K
resonance total cross section

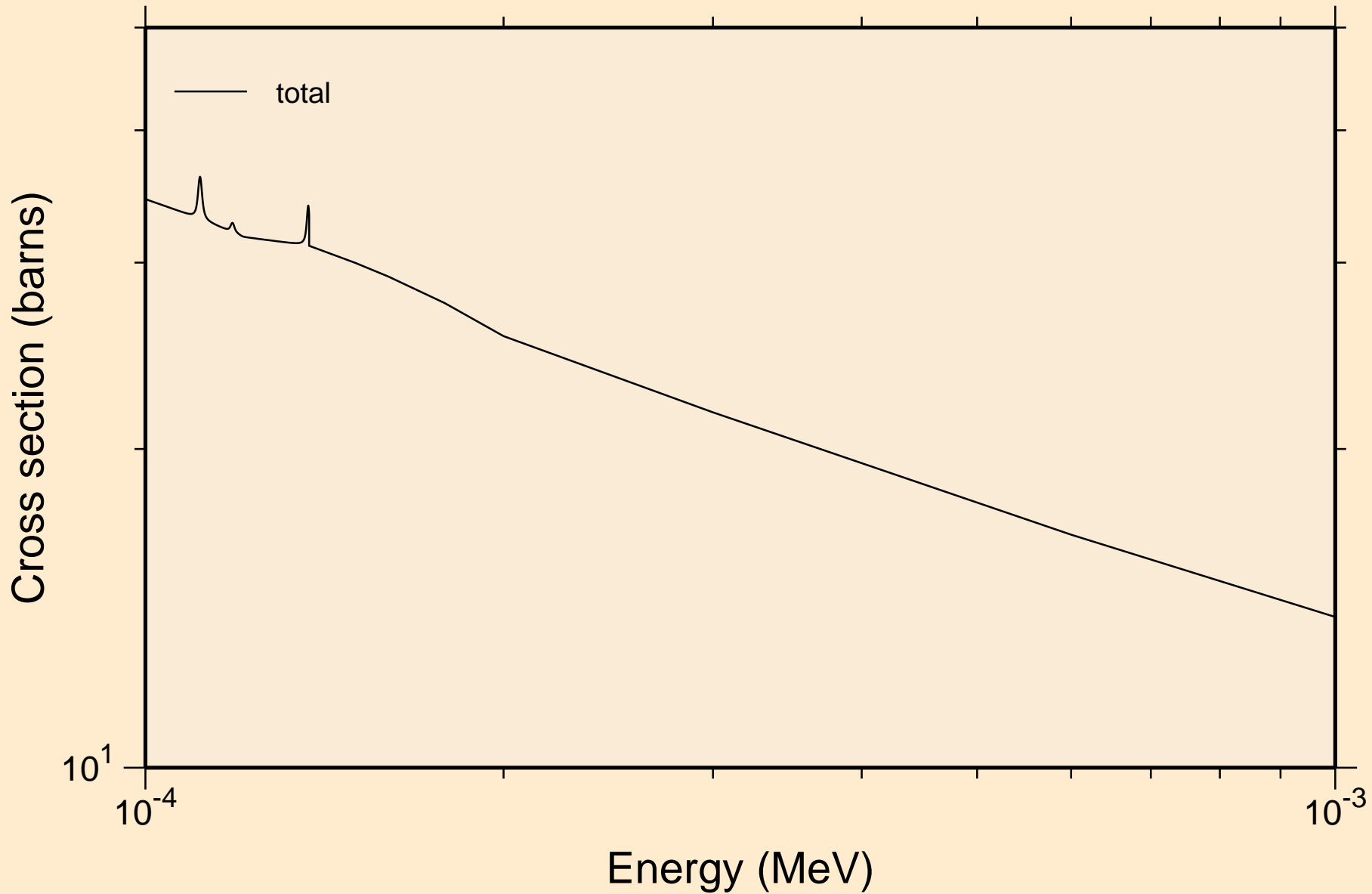

SB105 NEUTRON ACER TENDL-2021 LIBRARY; T=293.6K
resonance total cross section

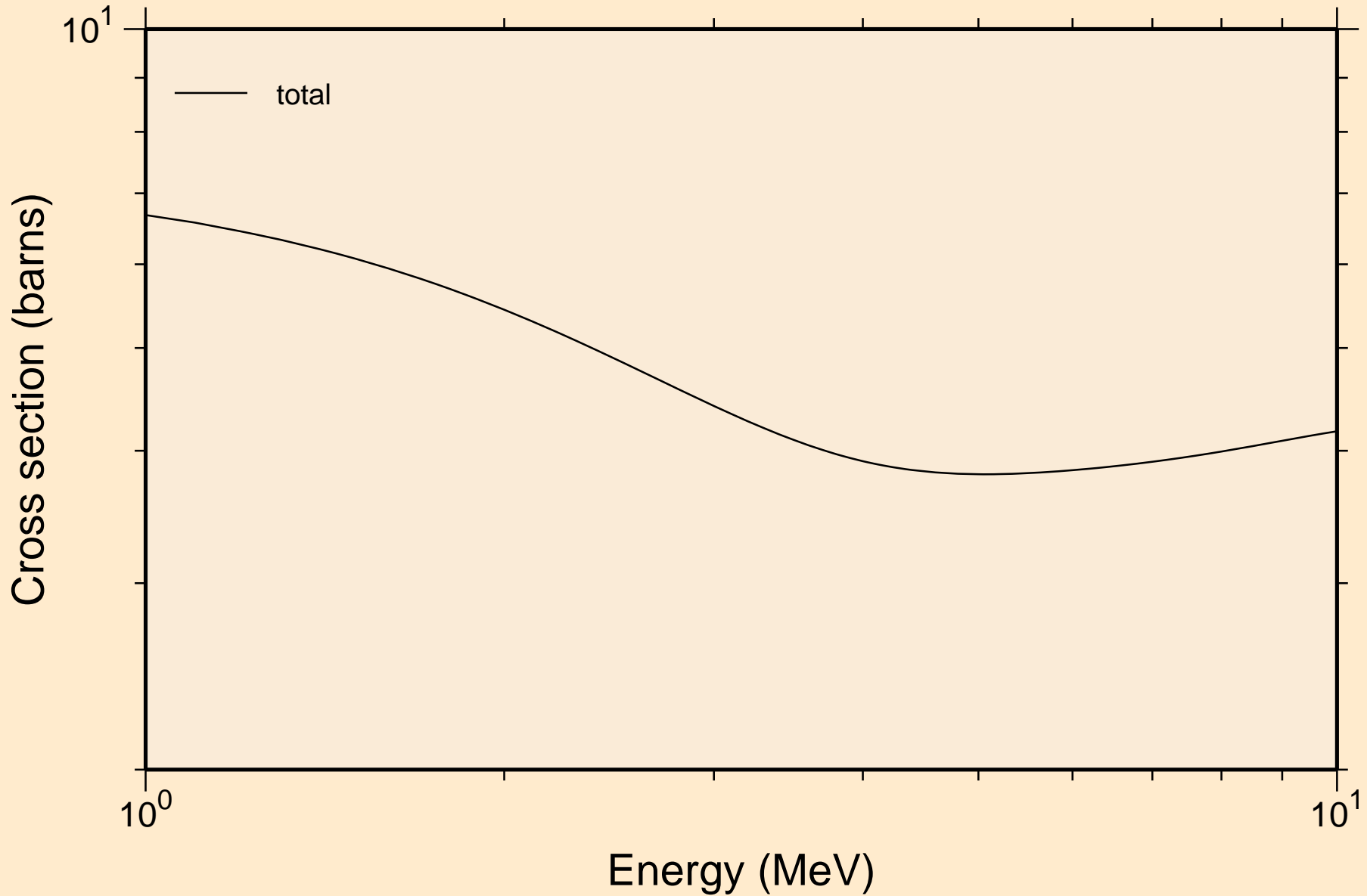

SB105 NEUTRON ACER TENDL-2021 LIBRARY; T=293.6K
resonance absorption cross sections

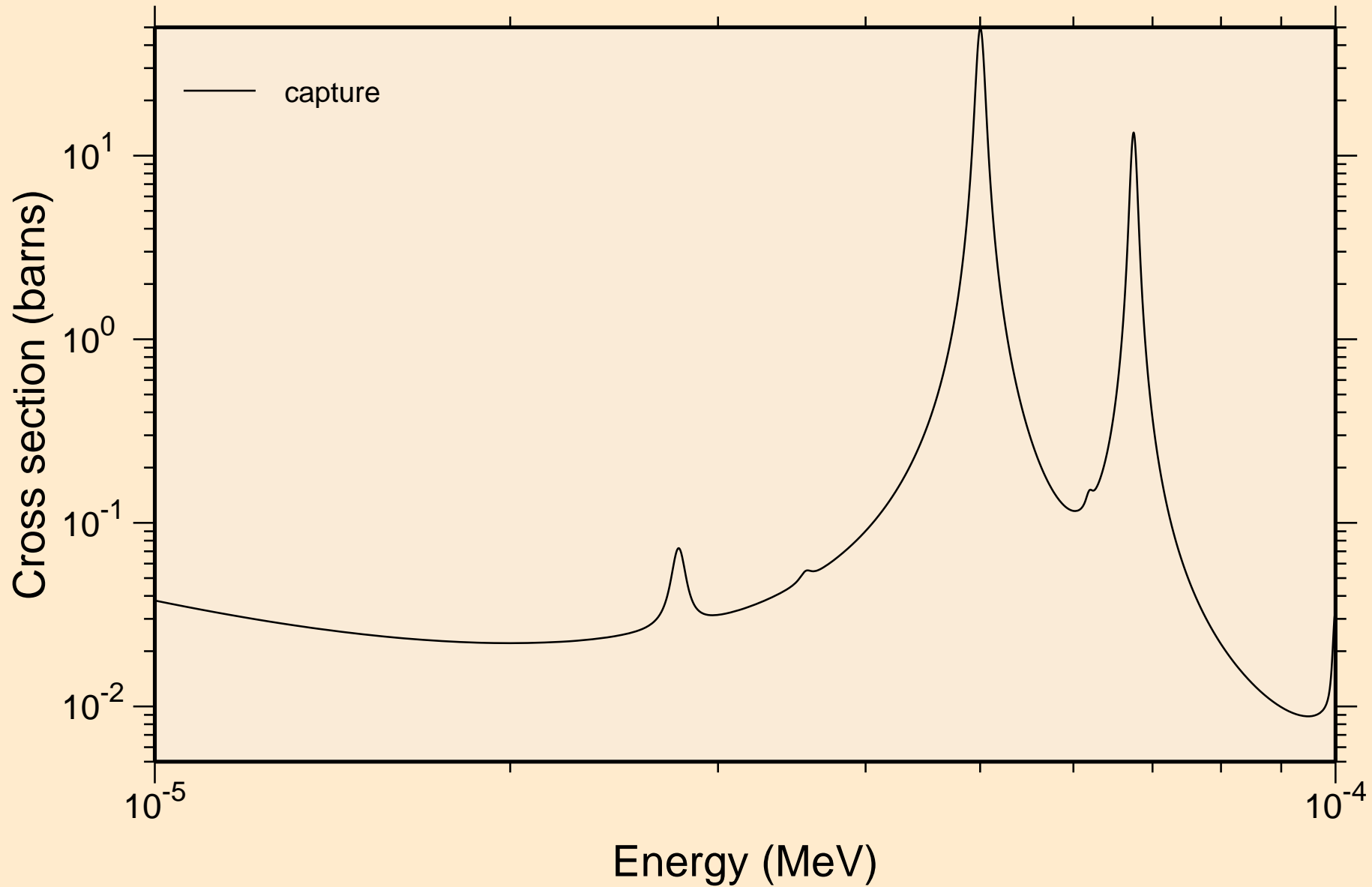

SB105 NEUTRON ACER TENDL-2021 LIBRARY; T=293.6K
resonance absorption cross sections

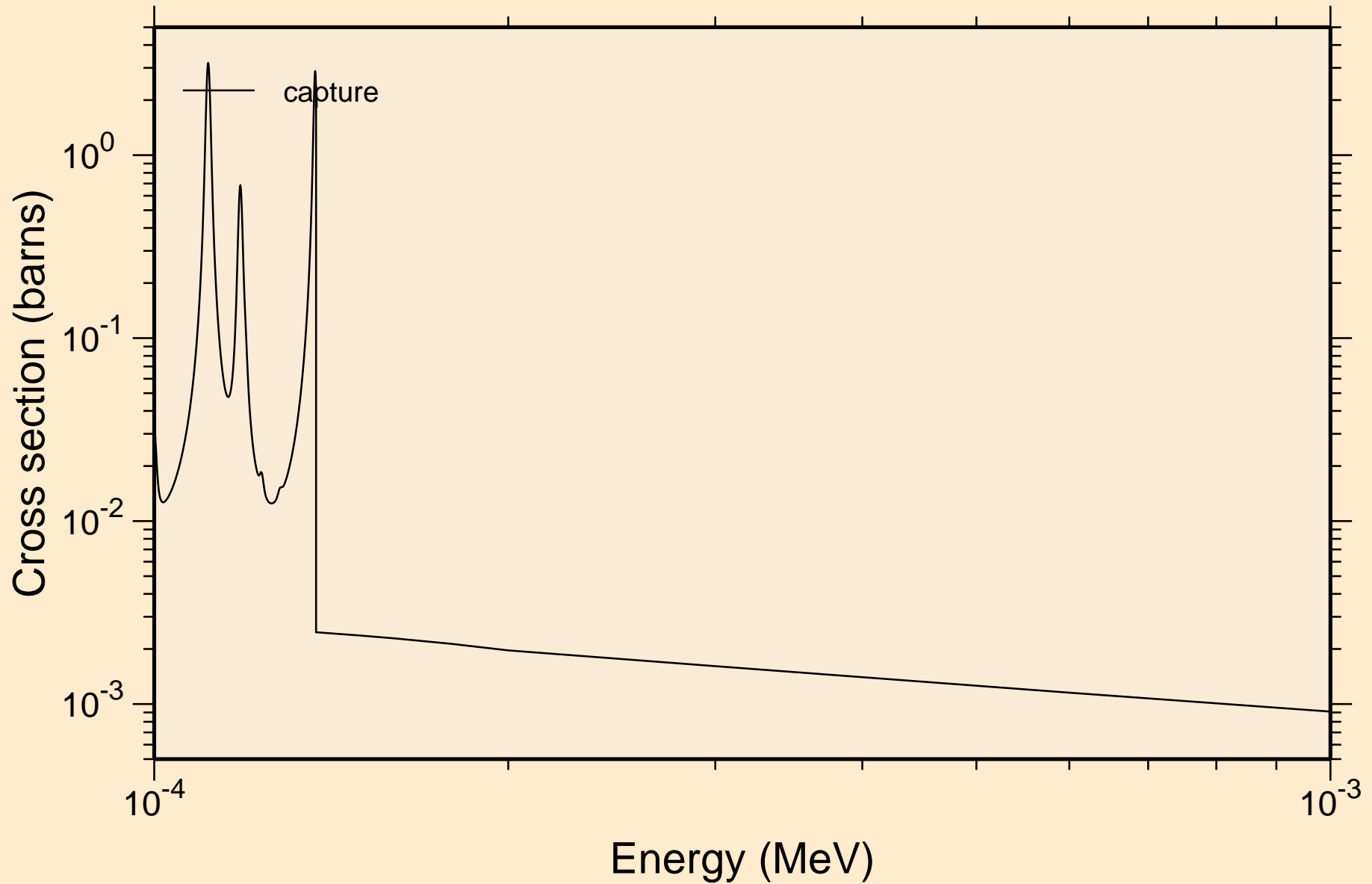

SB105 NEUTRON ACER TENDL-2021 LIBRARY; T=293.6K
resonance absorption cross sections

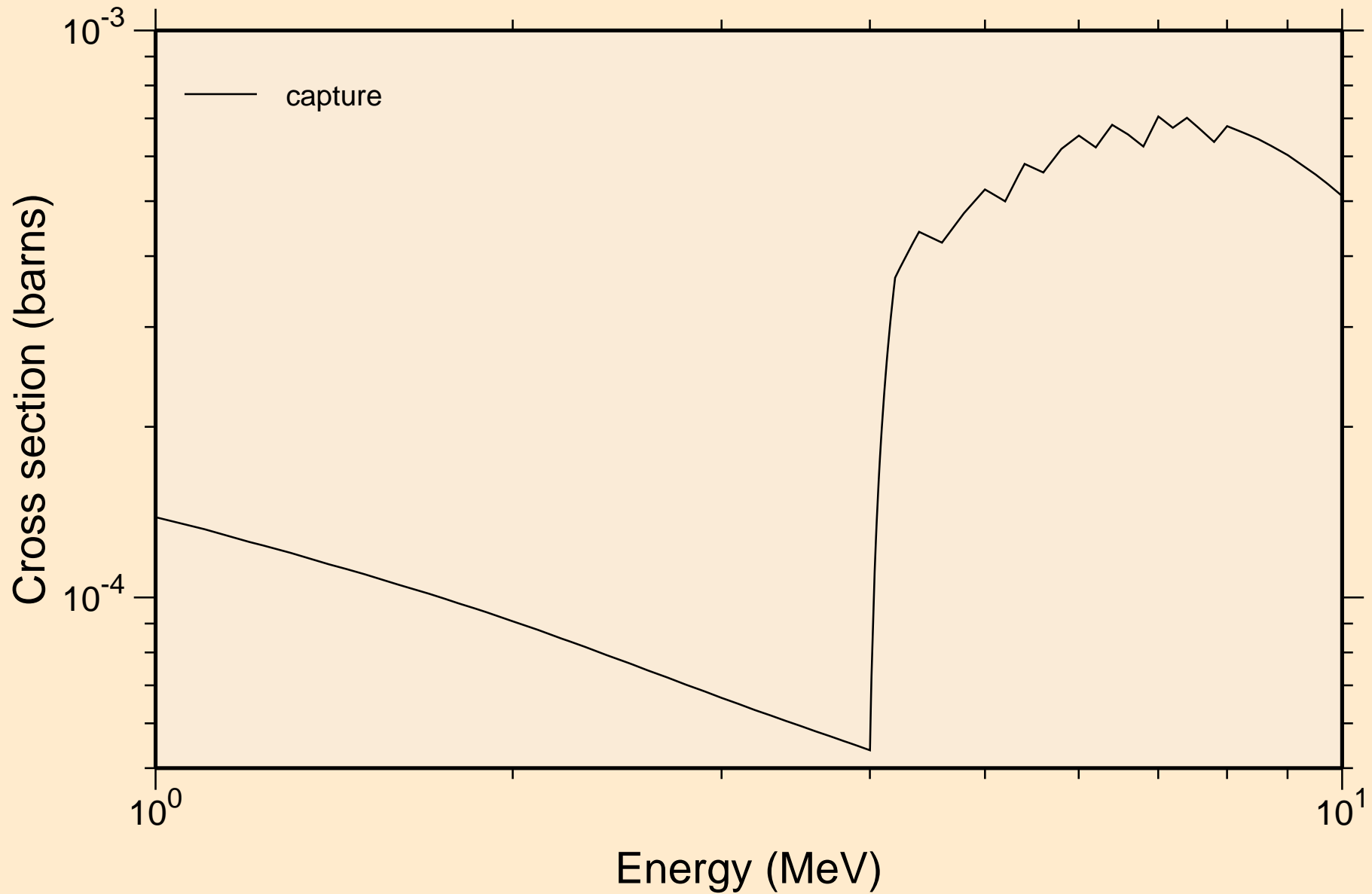

SB105 NEUTRON ACER TENDL-2021 LIBRARY; T=293.6K

Heating

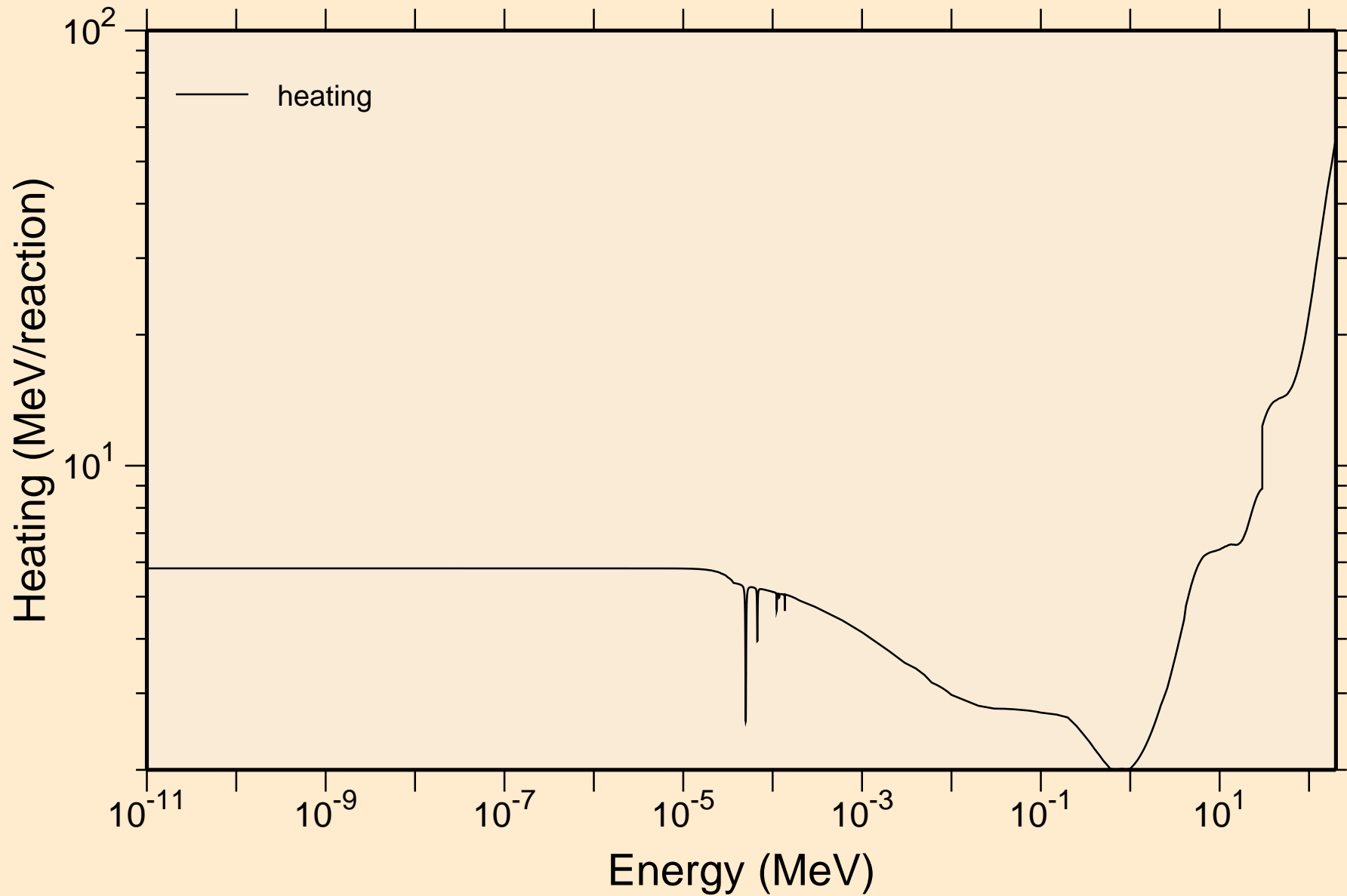

SB105 NEUTRON ACER TENDL-2021 LIBRARY; T=293.6K
Damage

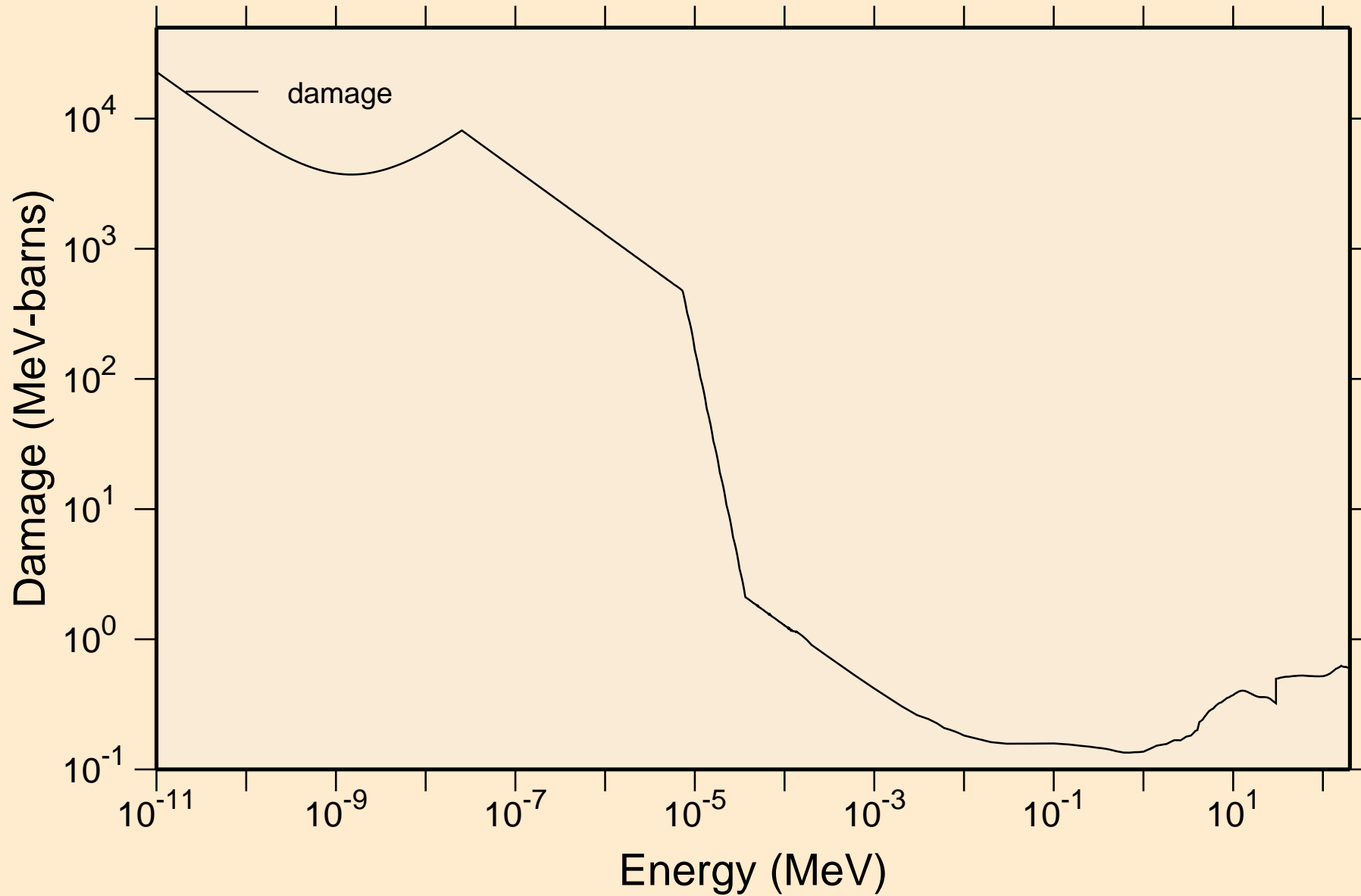

SB105 NEUTRON ACER TENDL-2021 LIBRARY; T=293.6K
Non-threshold reactions

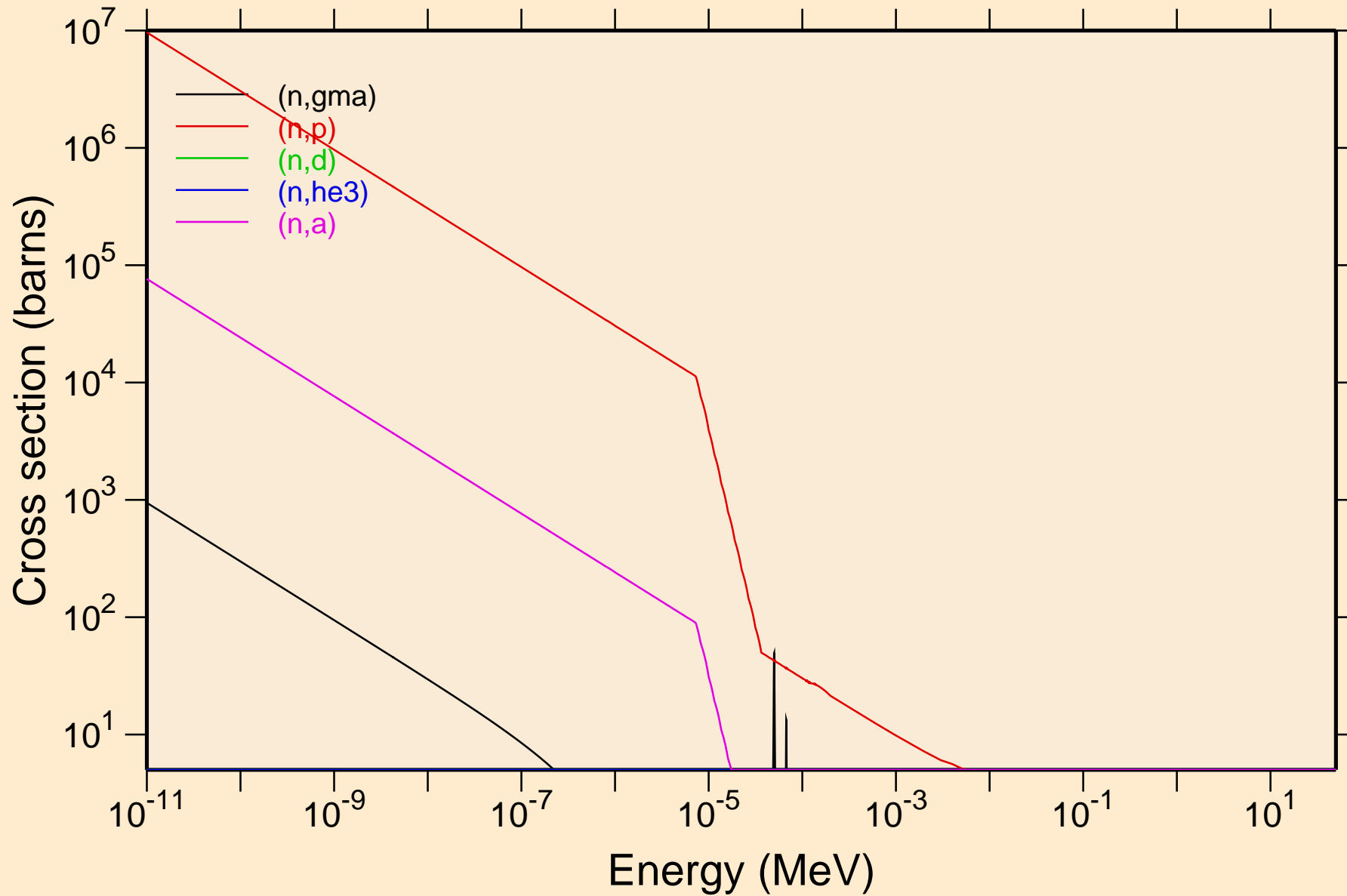

SB105 NEUTRON ACER TENDL-2021 LIBRARY; T=293.6K
Non-threshold reactions

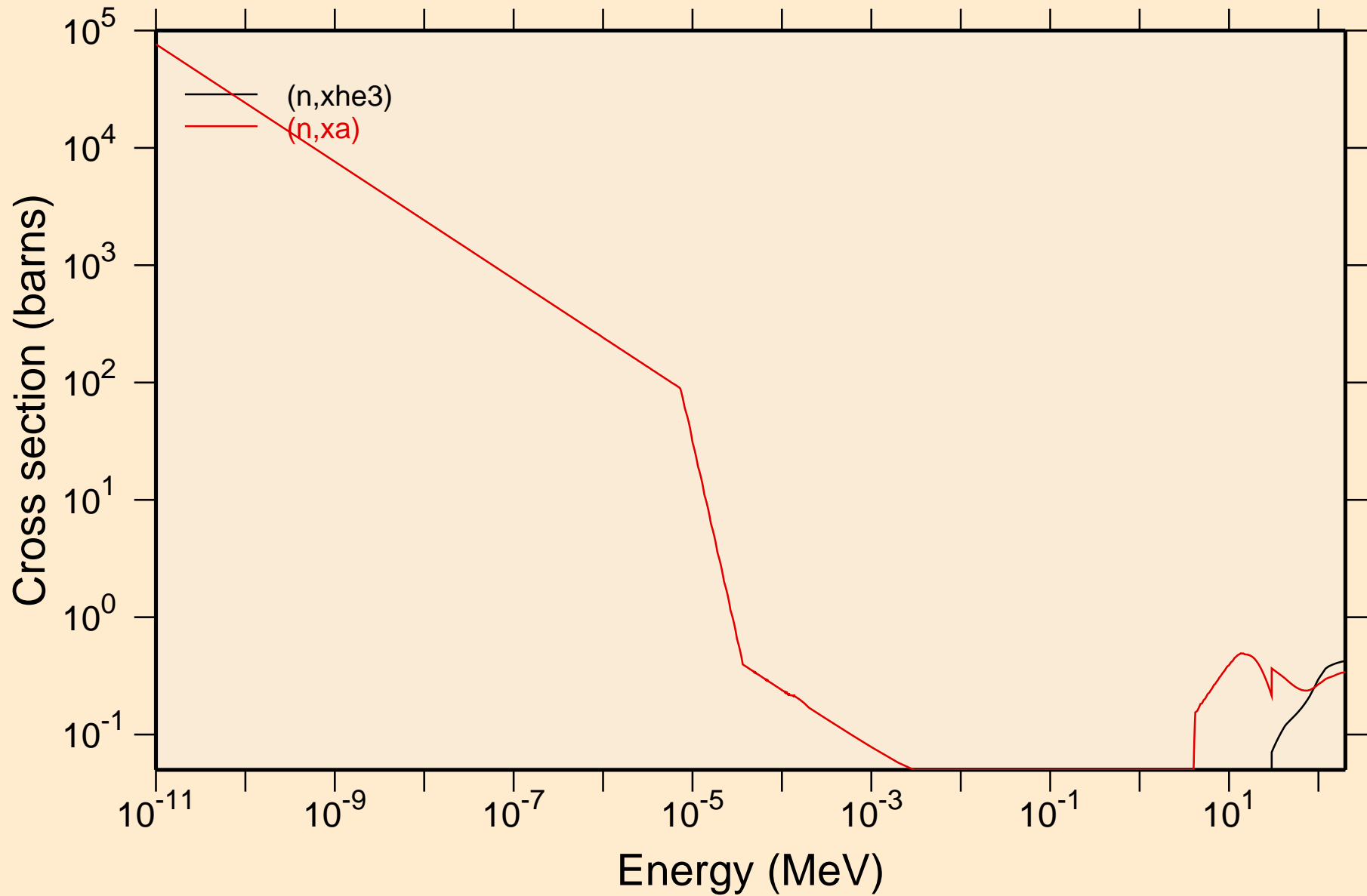

SB105 NEUTRON ACER TENDL-2021 LIBRARY; T=293.6K

Principal cross sections

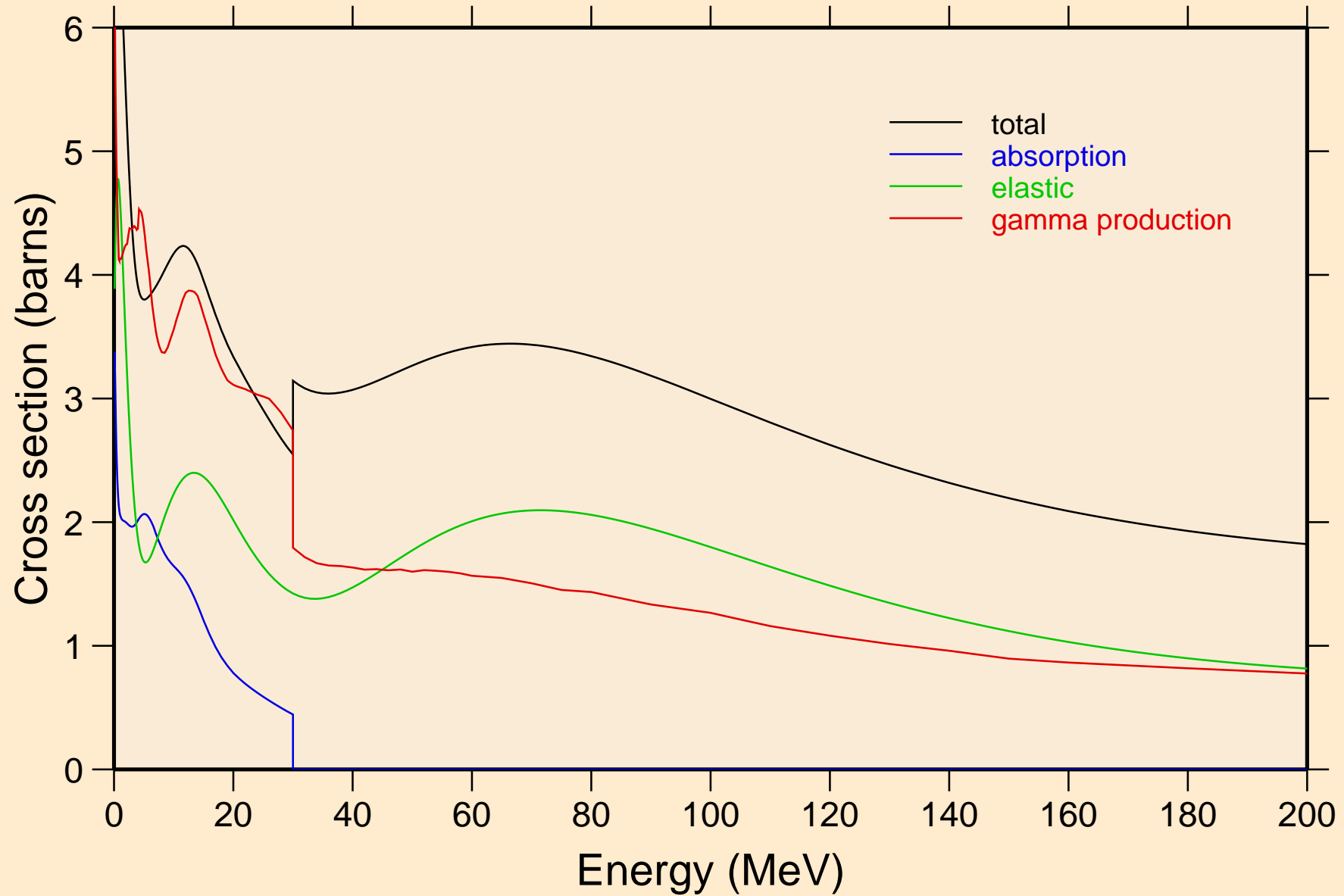

SB105 NEUTRON ACER TENDL-2021 LIBRARY; T=293.6K

Heating

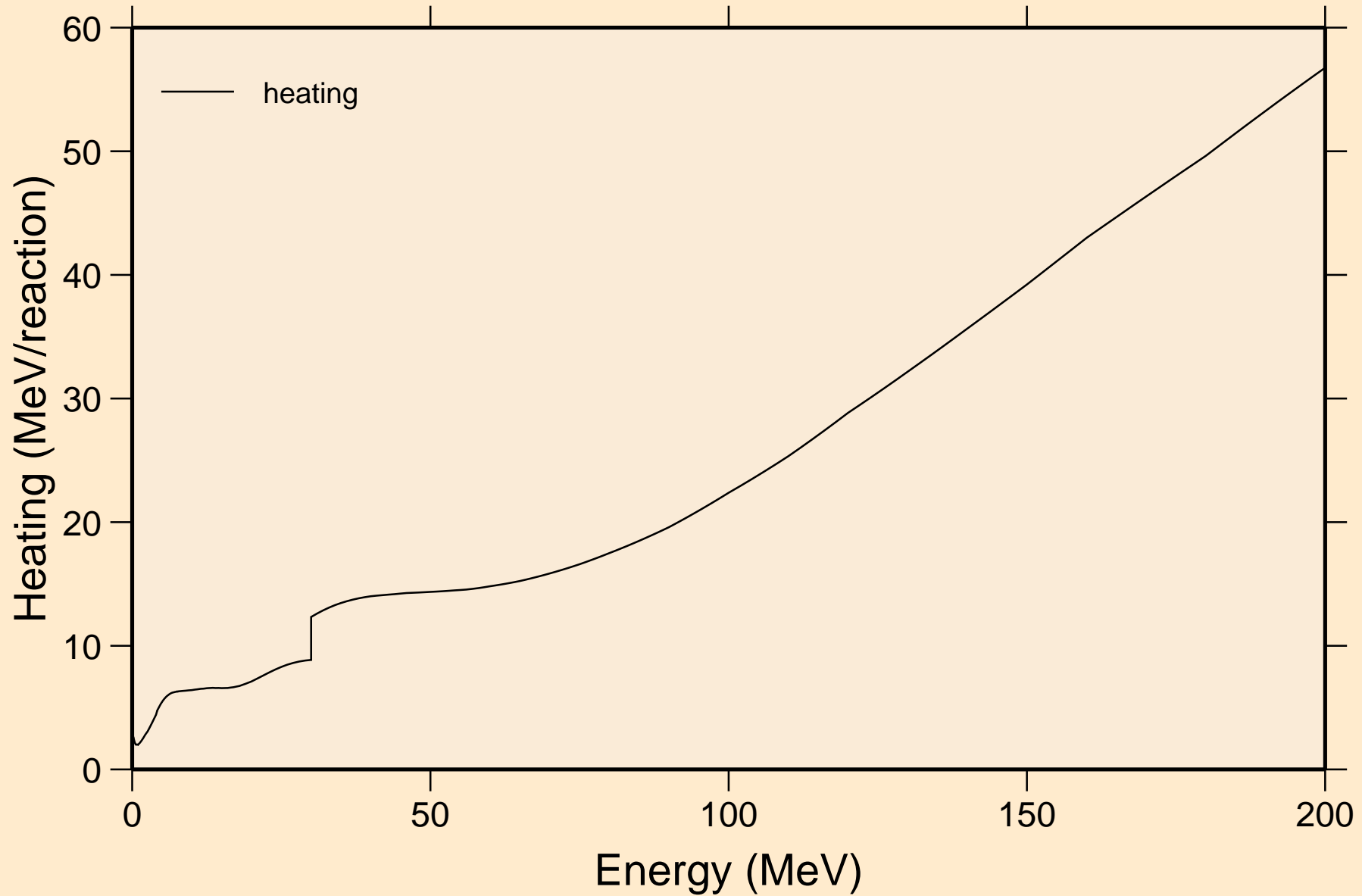

SB105 NEUTRON ACER TENDL-2021 LIBRARY; T=293.6K
Damage

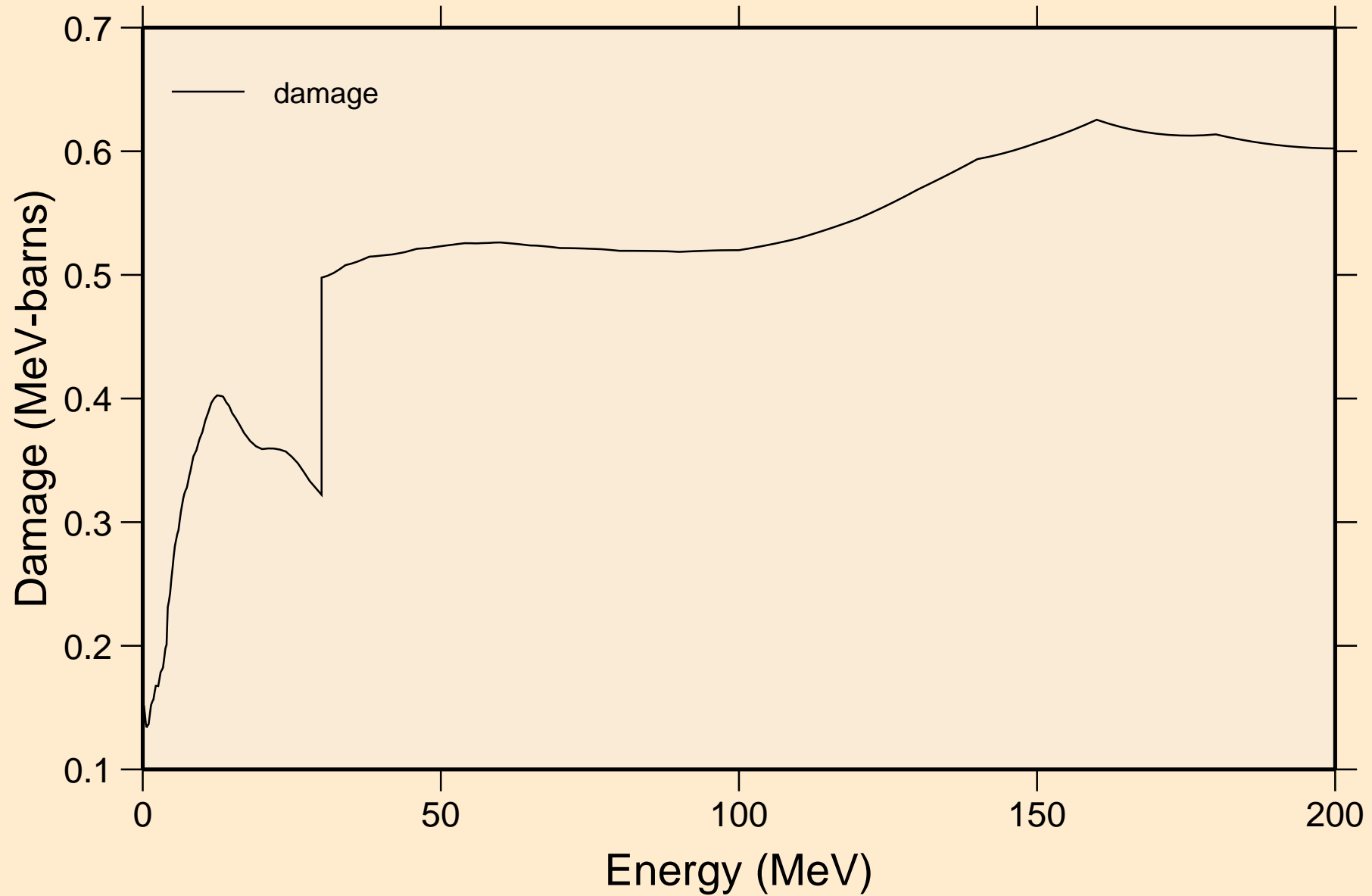

SB105 NEUTRON ACER TENDL-2021 LIBRARY; T=293.6K

Non-threshold reactions

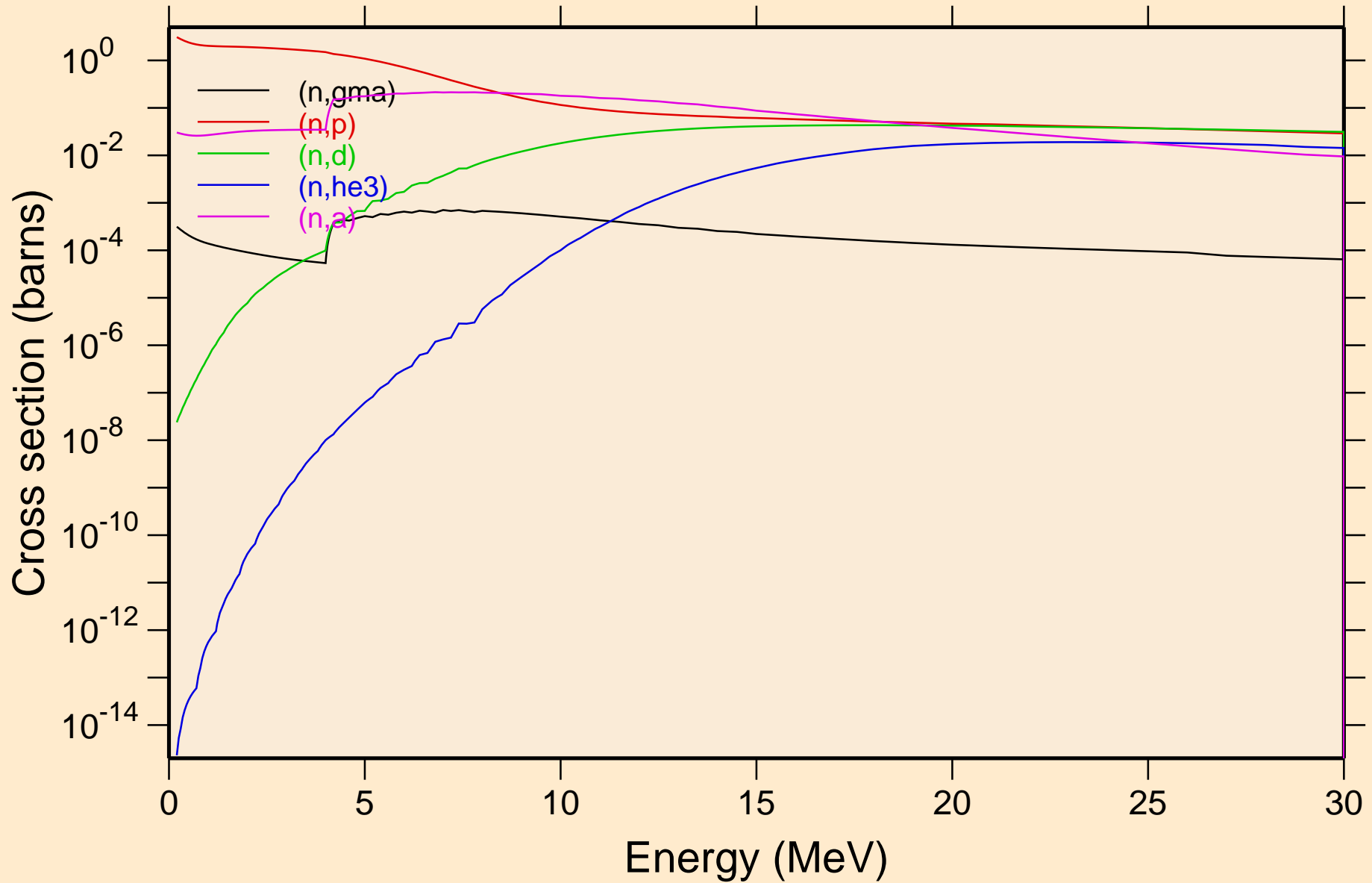

SB105 NEUTRON ACER TENDL-2021 LIBRARY; T=293.6K
Non-threshold reactions

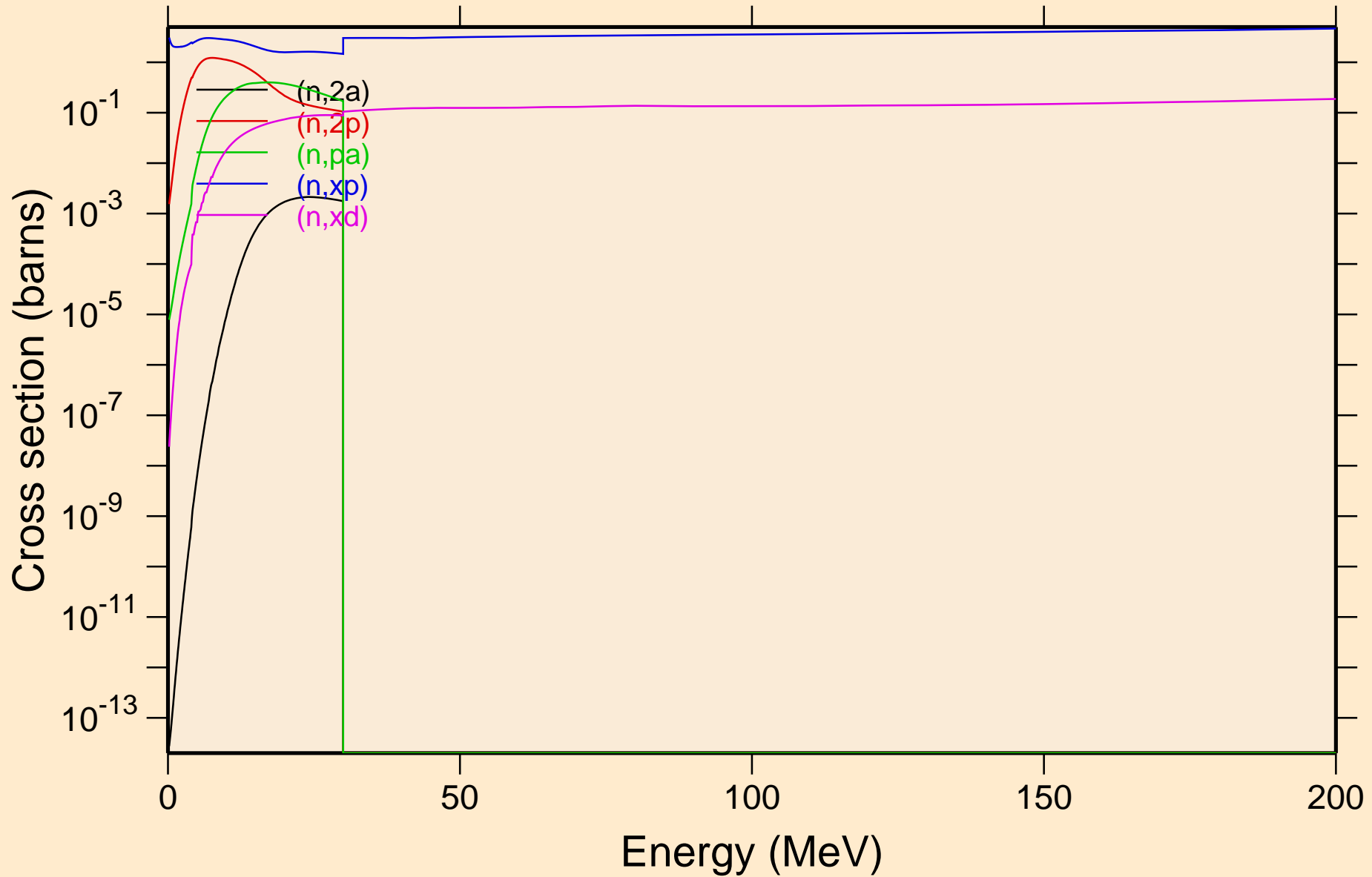

SB105 NEUTRON ACER TENDL-2021 LIBRARY; T=293.6K
Non-threshold reactions

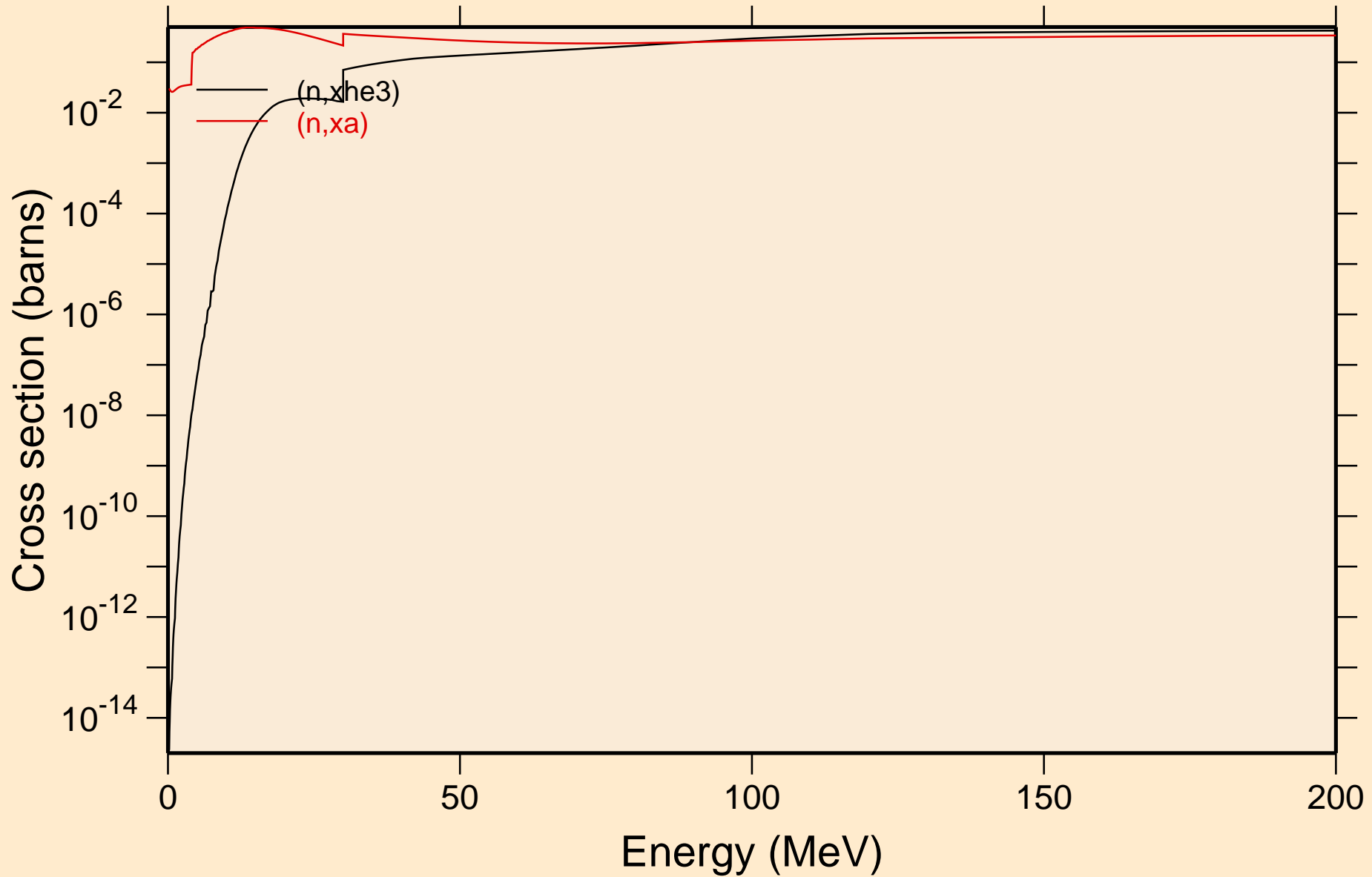

SB105 NEUTRON ACER TENDL-2021 LIBRARY; T=293.6K
Inelastic levels

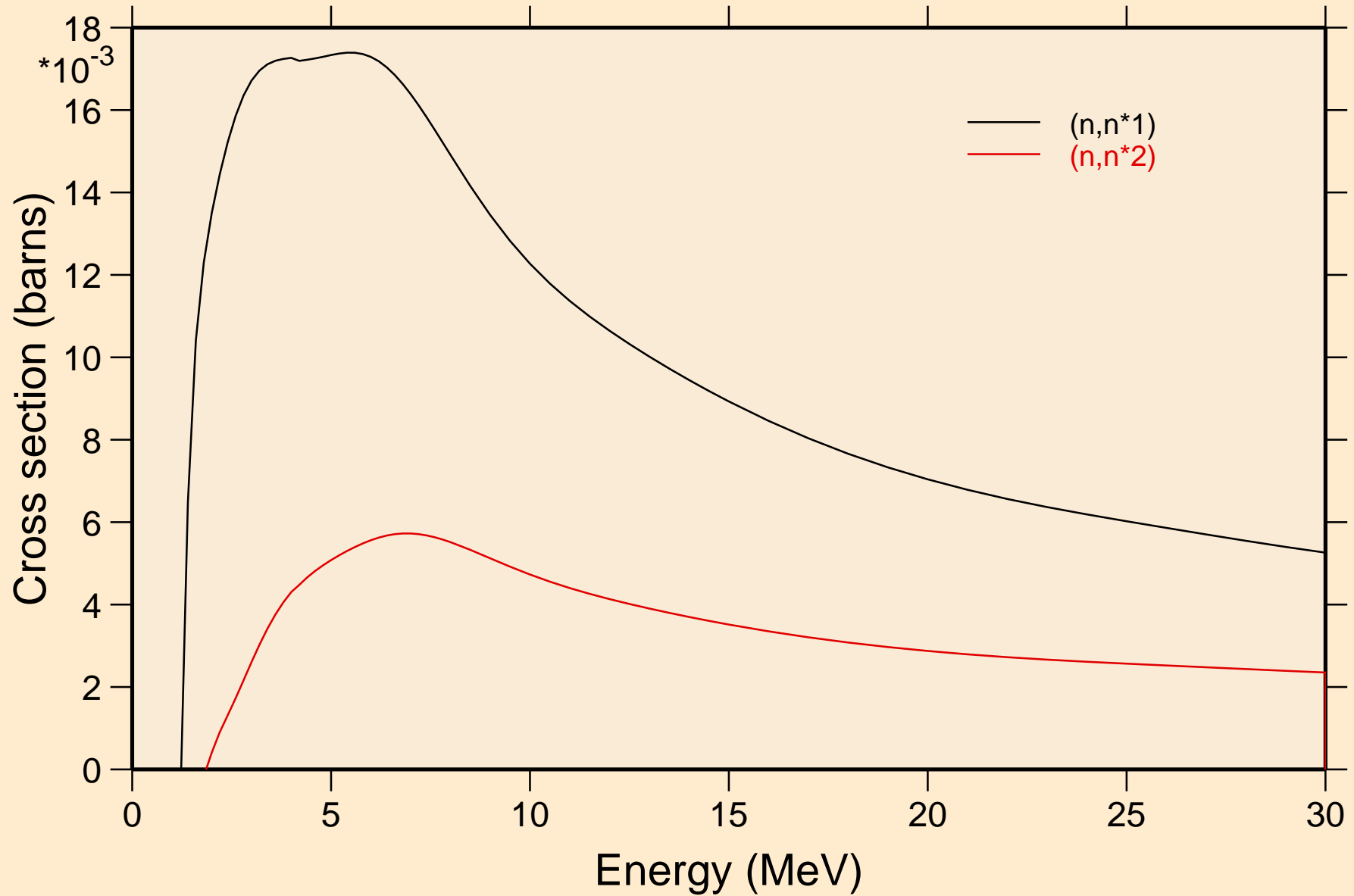

SB105 NEUTRON ACER TENDL-2021 LIBRARY; T=293.6K
Threshold reactions

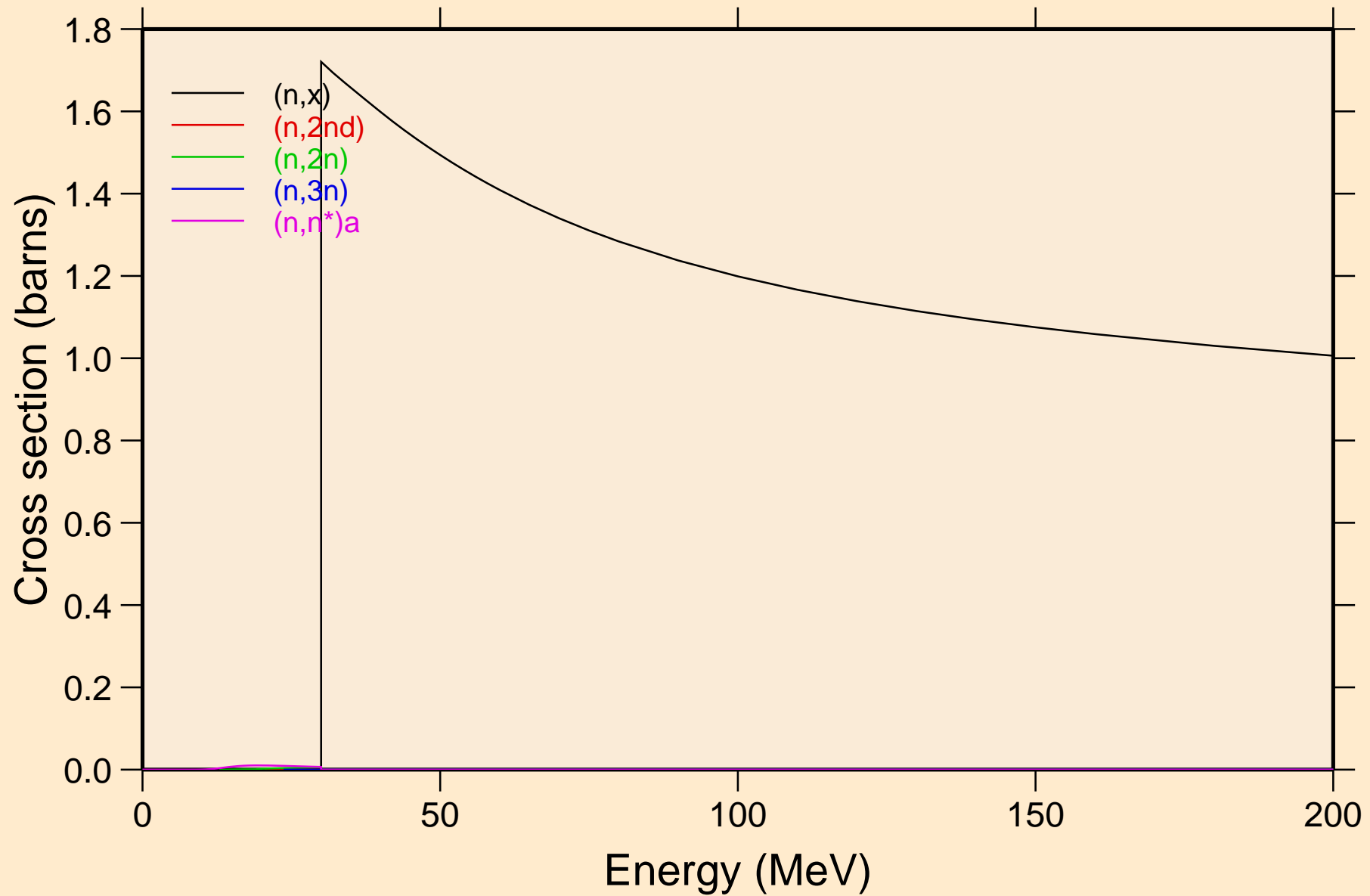

SB105 NEUTRON ACER TENDL-2021 LIBRARY; T=293.6K
Threshold reactions

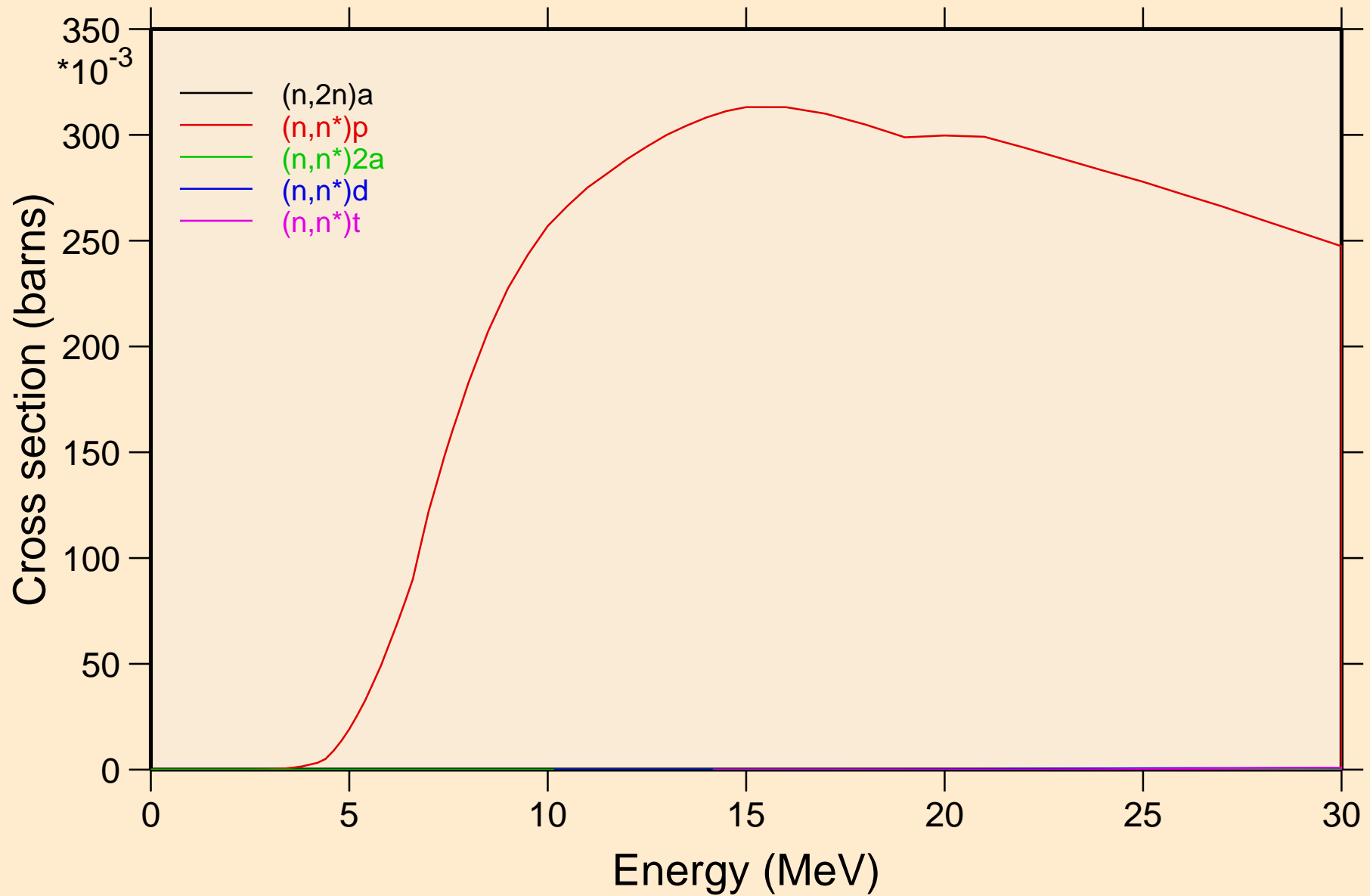

SB105 NEUTRON ACER TENDL-2021 LIBRARY; T=293.6K
Threshold reactions

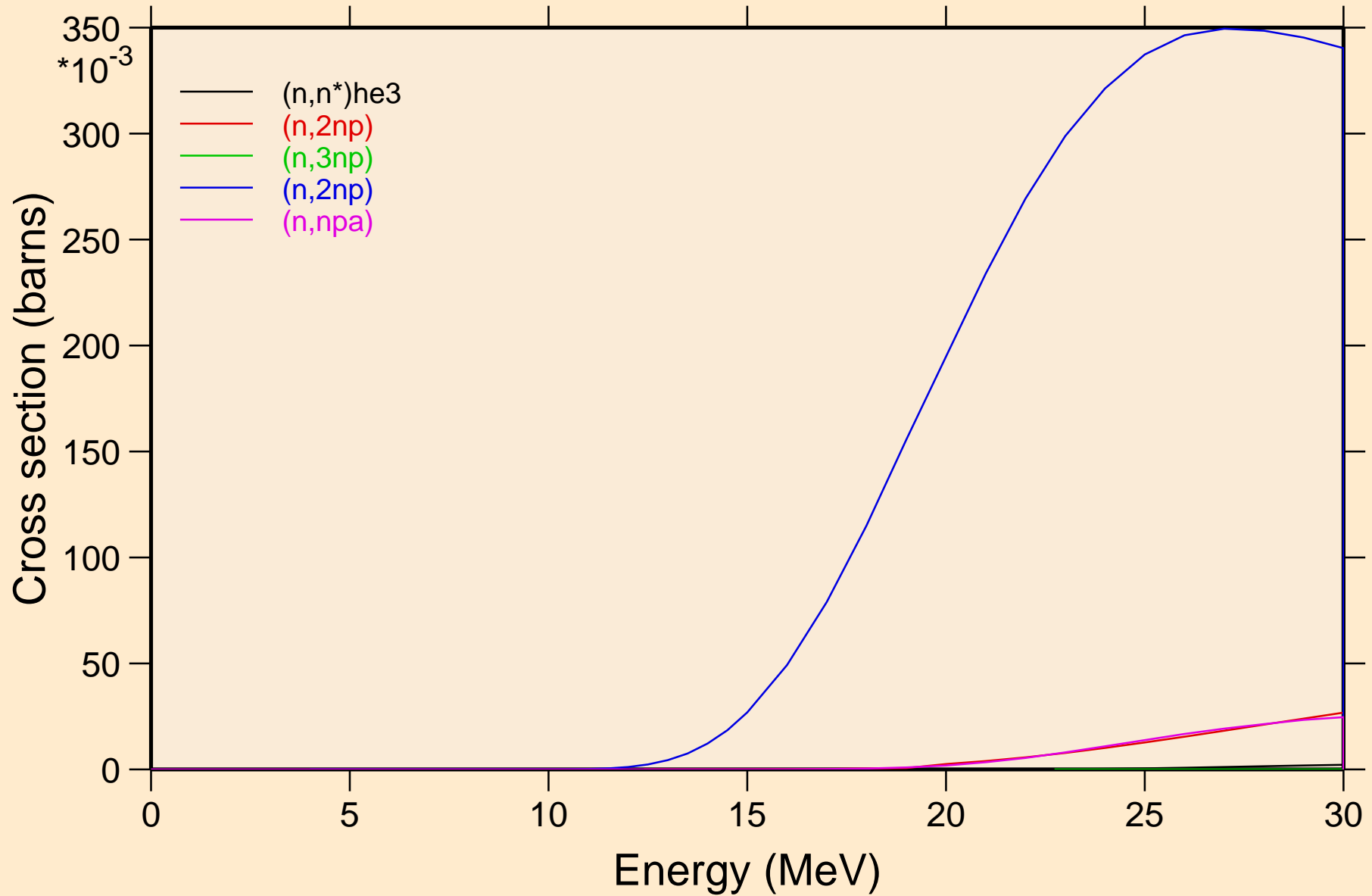

SB105 NEUTRON ACER TENDL-2021 LIBRARY; T=293.6K
Threshold reactions

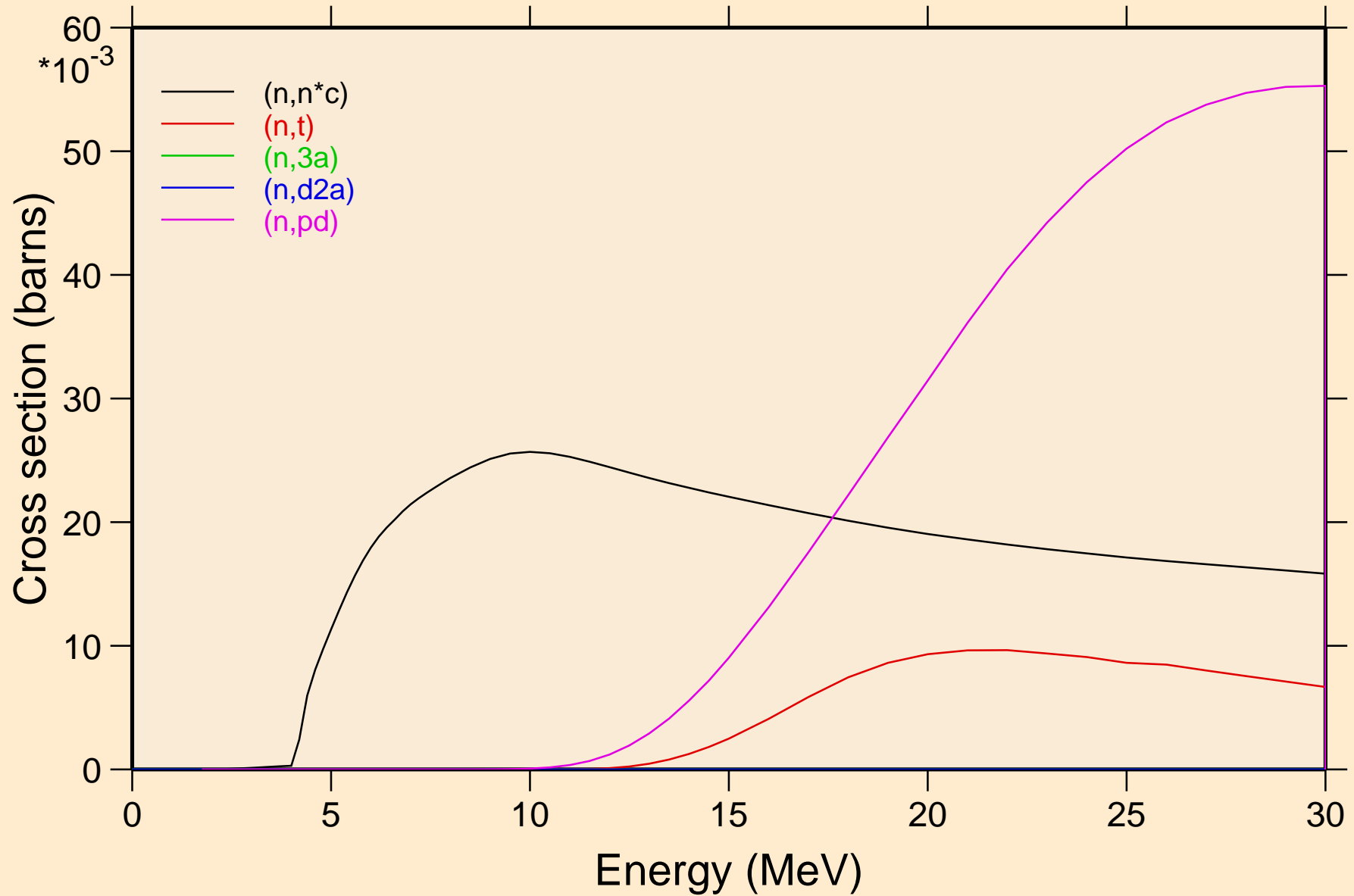

SB105 NEUTRON ACER TENDL-2021 LIBRARY; T=293.6K
Threshold reactions

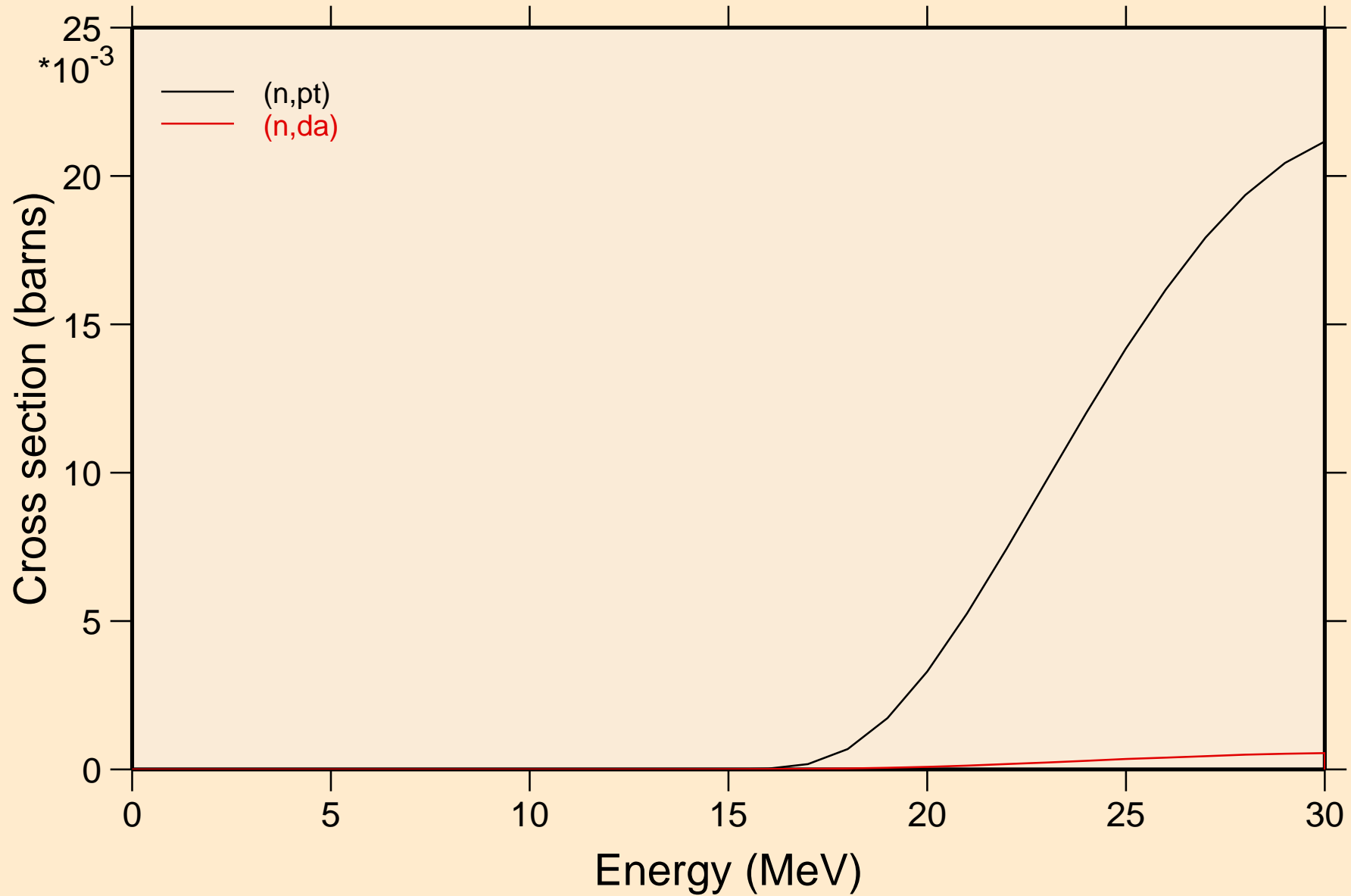

SB105 NEUTRON ACER TENDL-2021 LIBRARY; T=293.6K
Threshold reactions

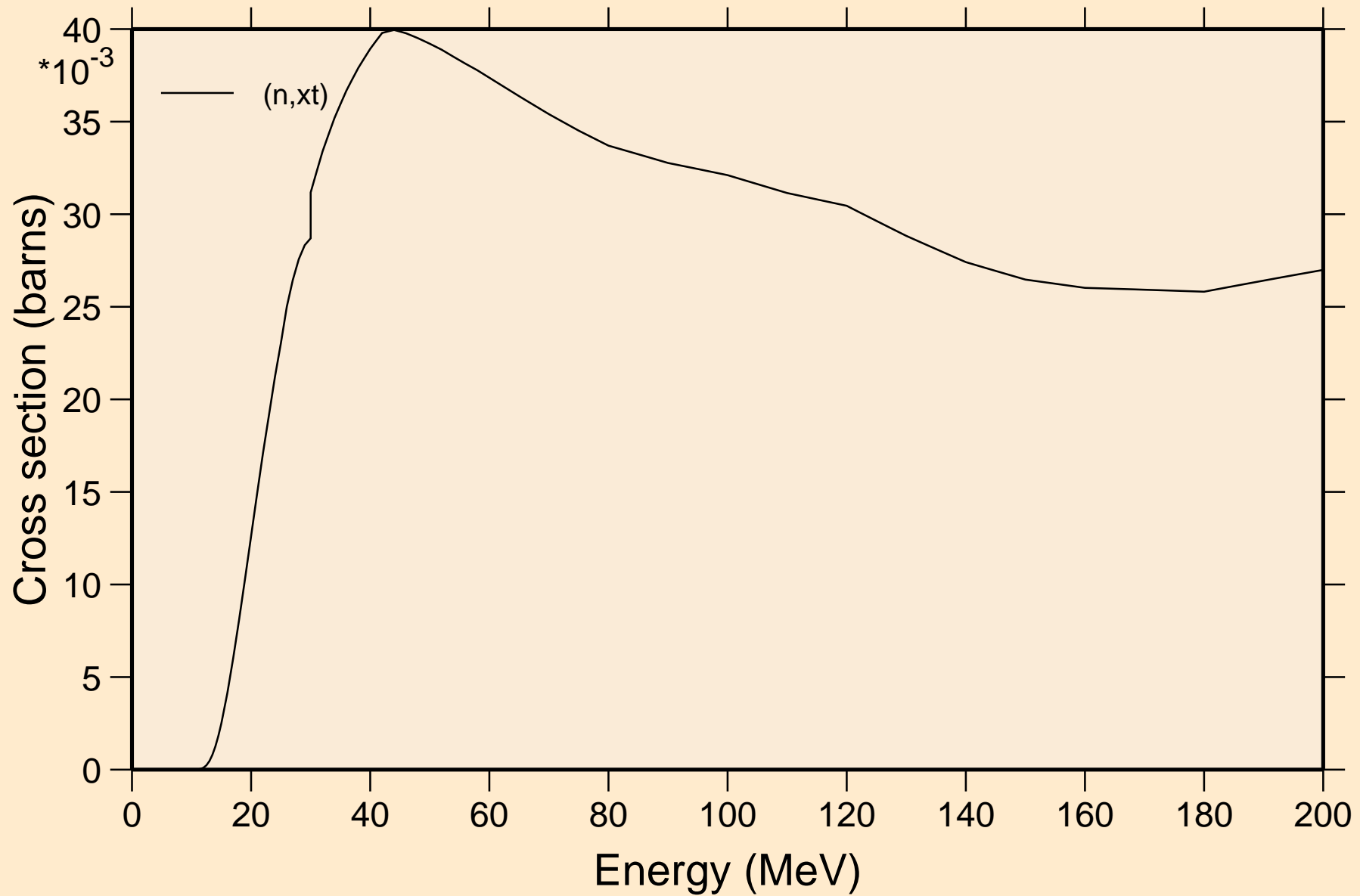

SB105 NEUTRON ACER TENDL-2021 LIBRARY; T=293.6K
angular distribution for elastic

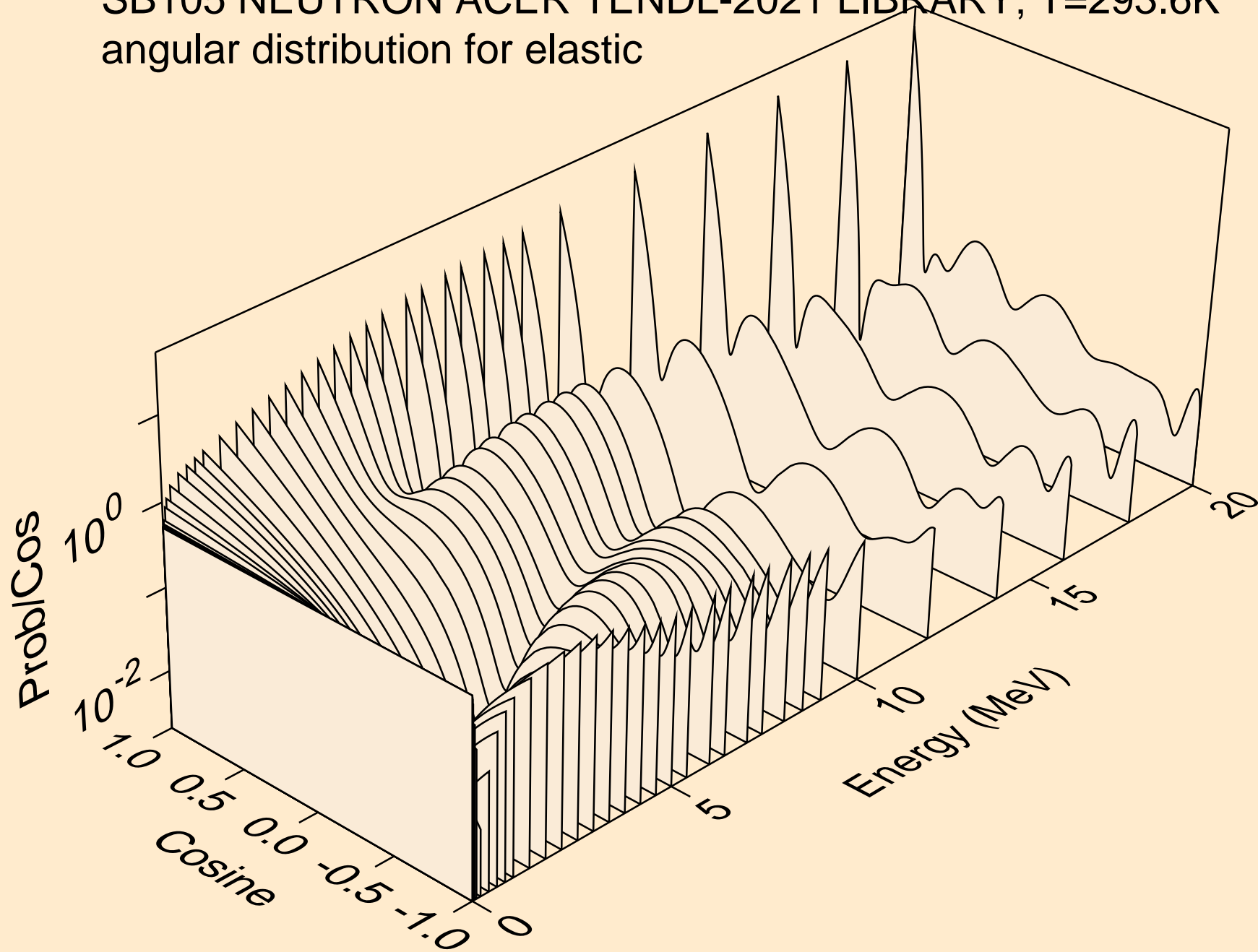

SB105 NEUTRON ACER TENDL-2021 LIBRARY; T=293.6K
angular distribution for elastic

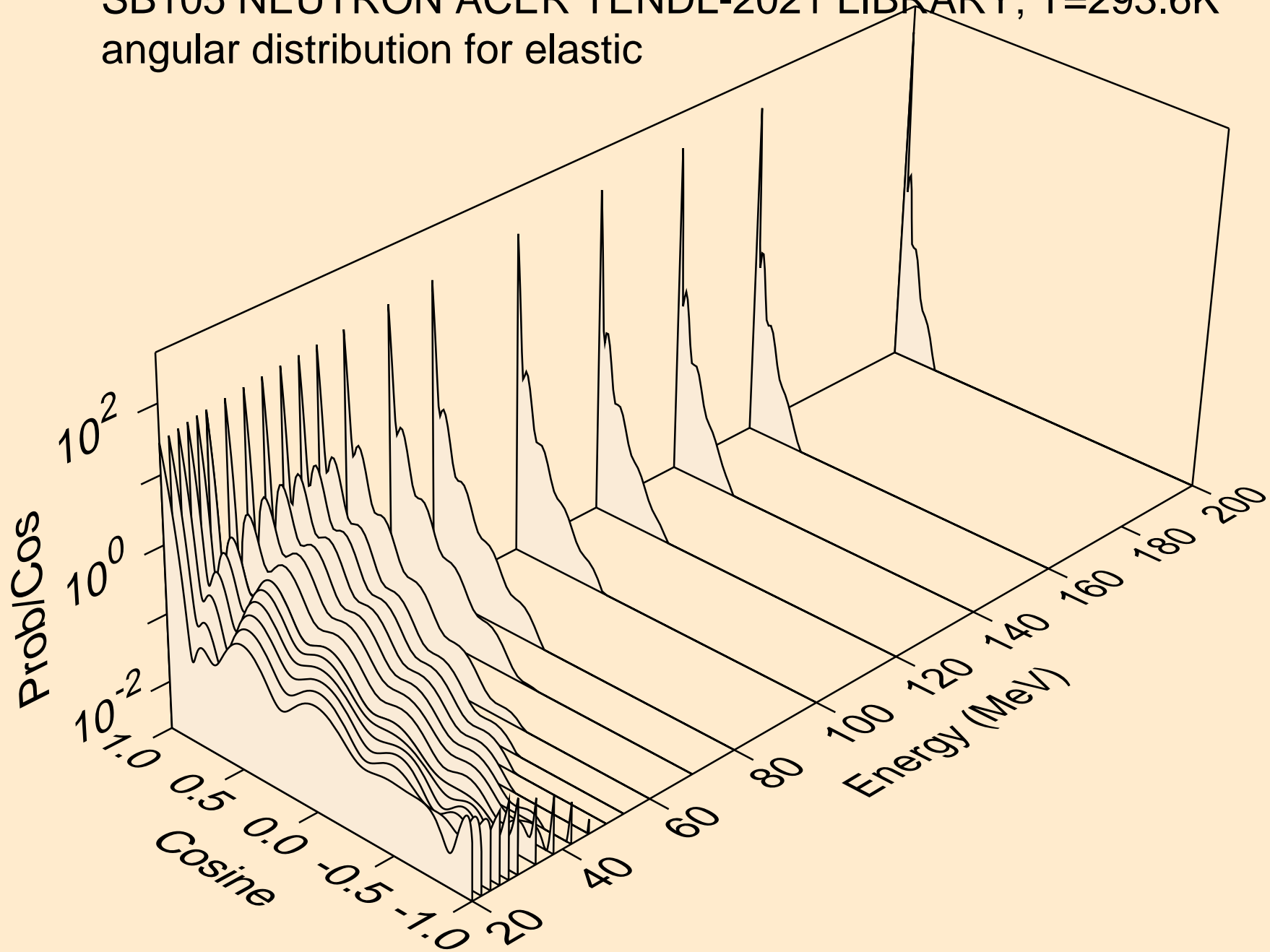

SB105 NEUTRON ACER TENDL-2021 LIBRARY; T=293.6K
angular distribution for (n,n*1)

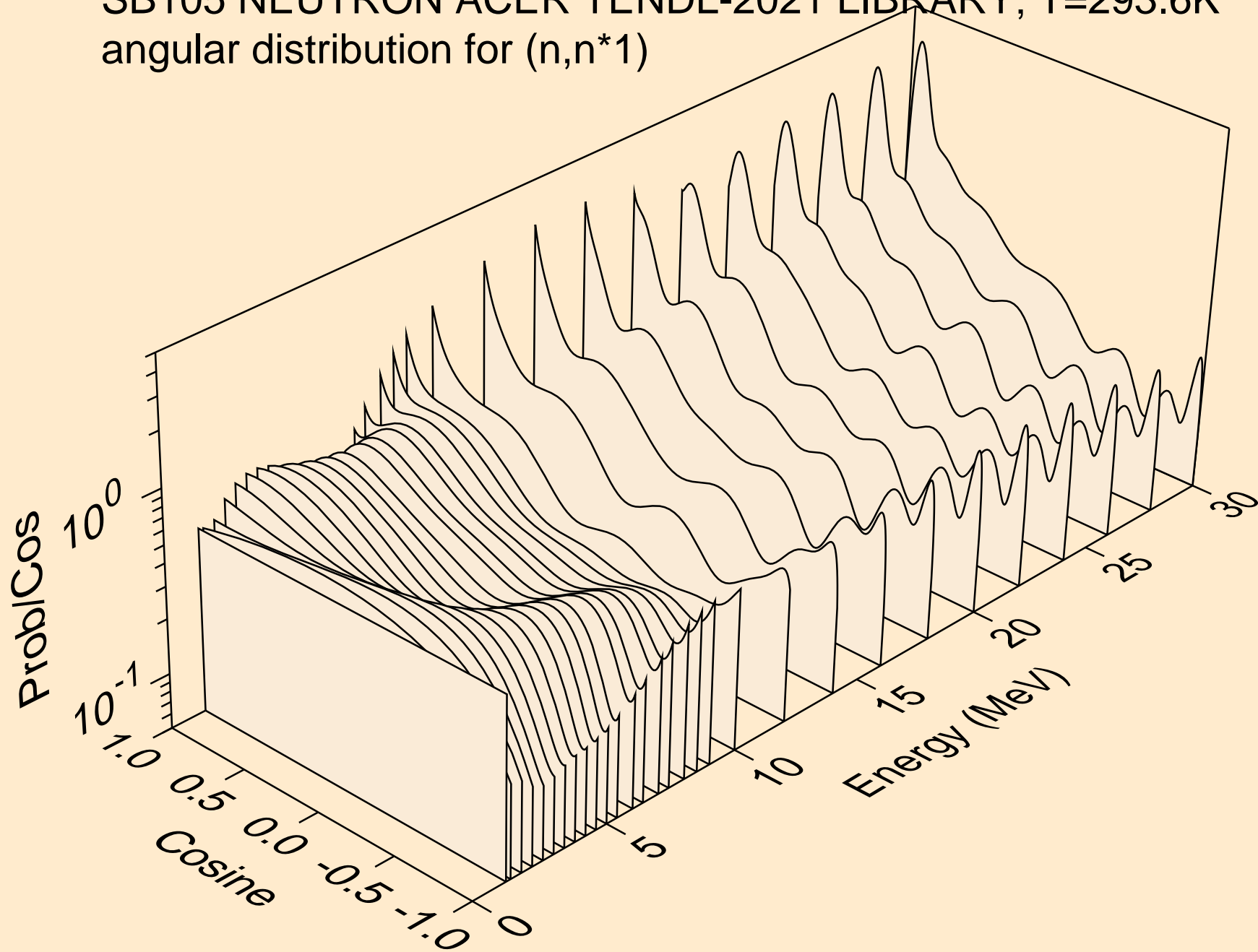

SB105 NEUTRON ACER TENDL-2021 LIBRARY; T=293.6K
angular distribution for (n,n*2)

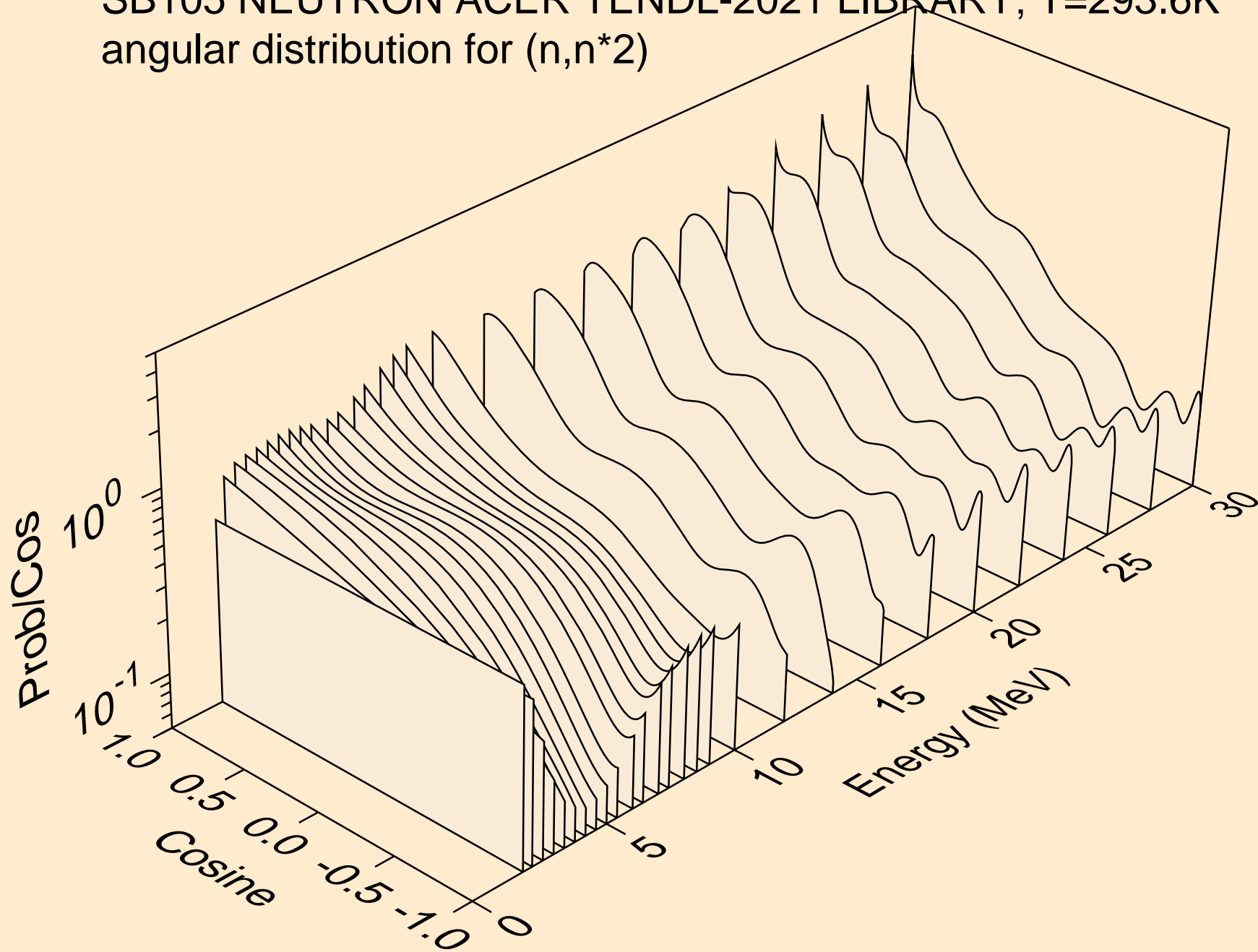

SB105 NEUTRON ACER TENDL-2021 LIBRARY; T=293.6K
Neutron emission for (n,x)

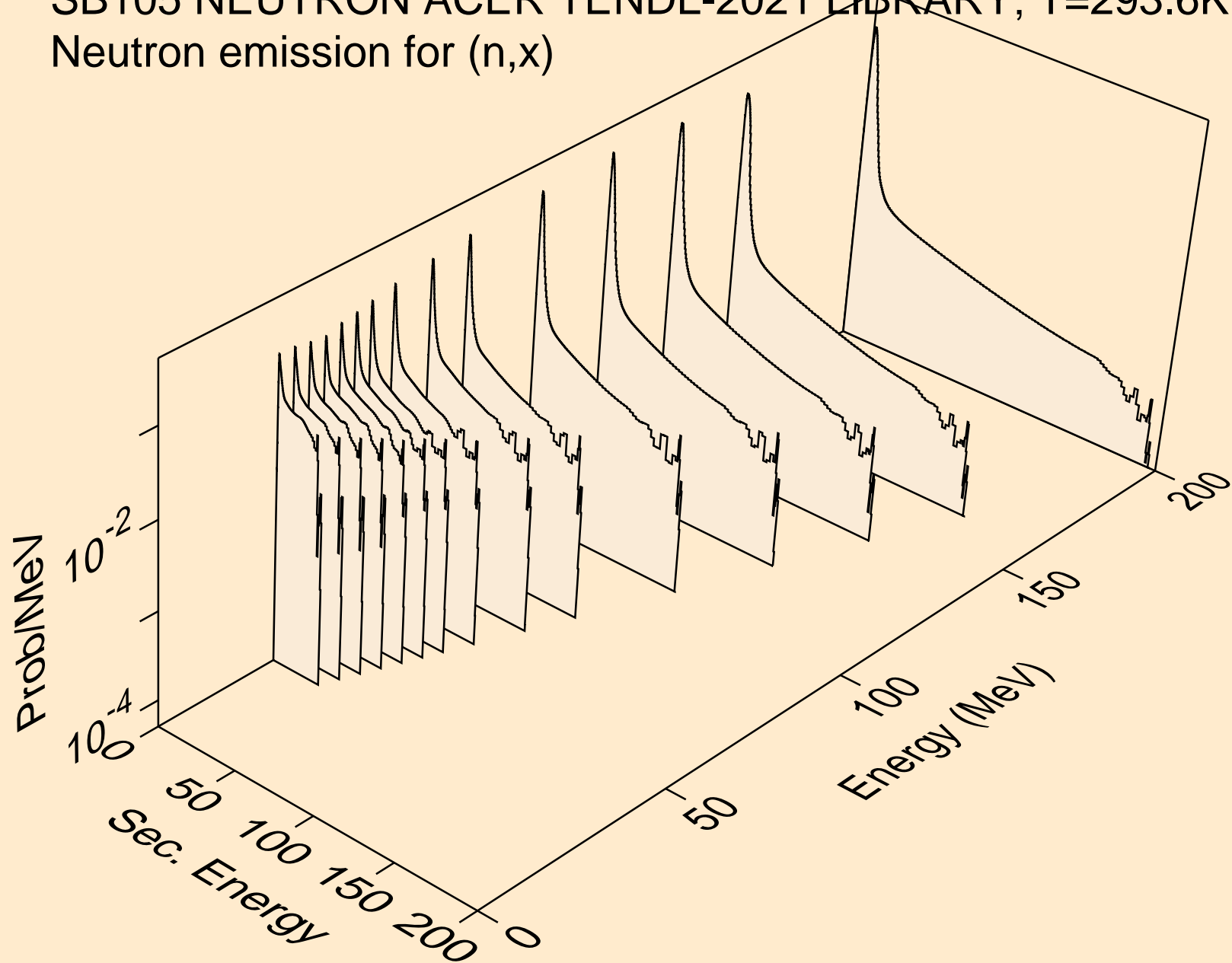

SB105 NEUTRON ACER TENDL-2021 LIBRARY; T=293.6K
Neutron emission for (n,2nd)

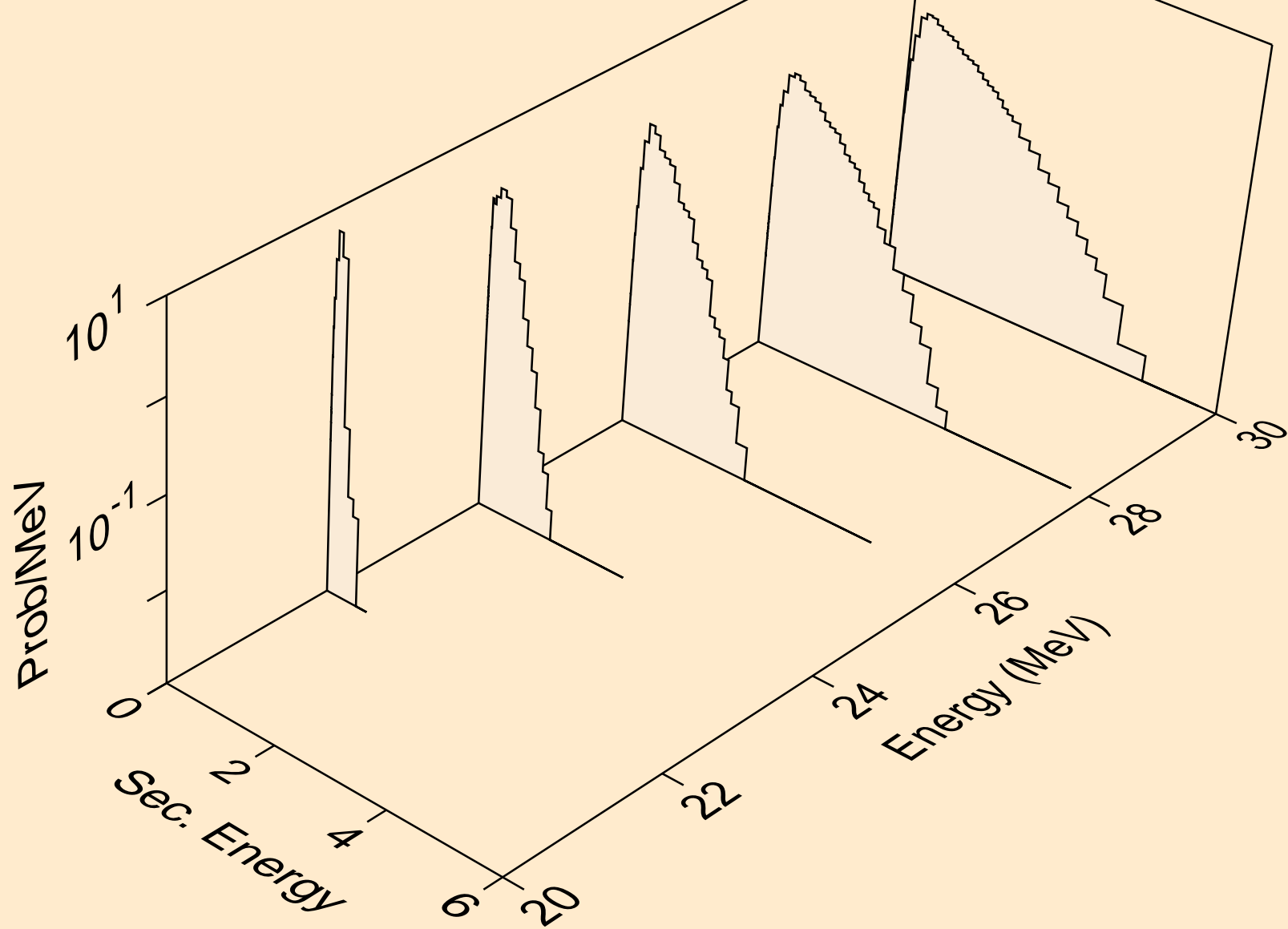

SB105 NEUTRON ACER TENDL-2021 LIBRARY; T=293.6K
Neutron emission for (n,2n)

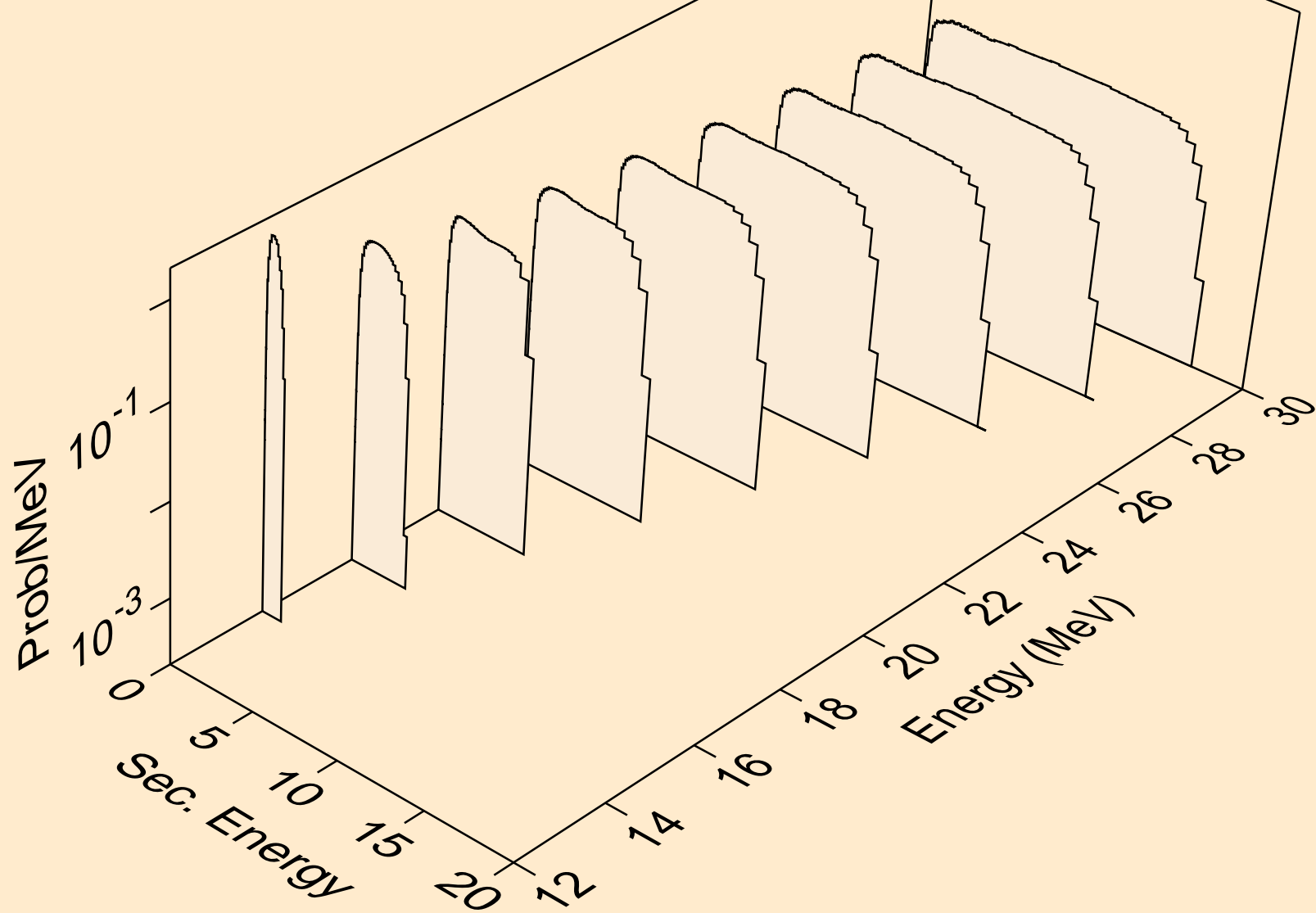

SB105 NEUTRON ACER TENDL-2021 LIBRARY; T=293.6K
Neutron emission for (n,3n)

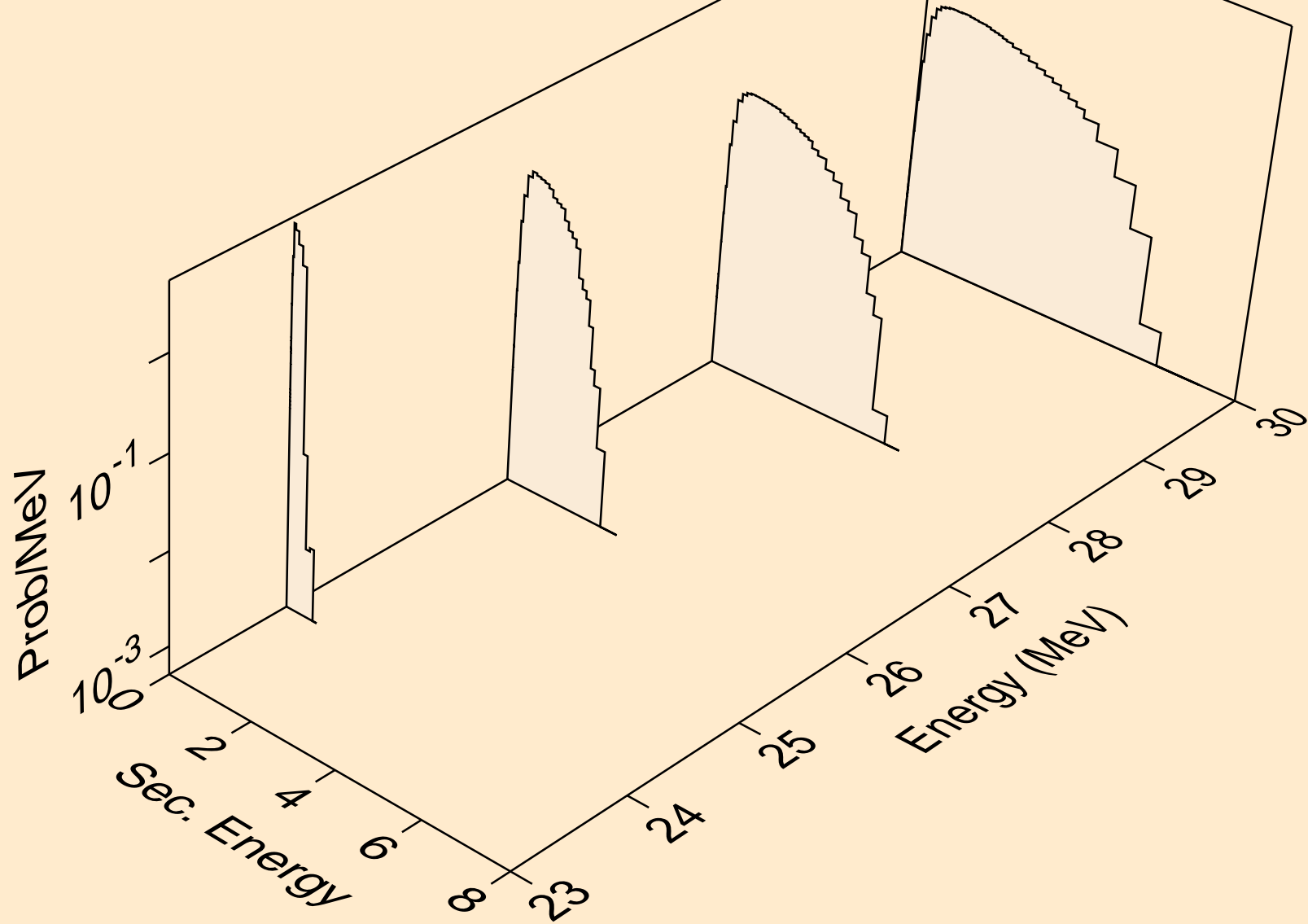

SB105 NEUTRON ACER TENDL-2021 LIBRARY; T=293.6K
Neutron emission for (n,n*)a

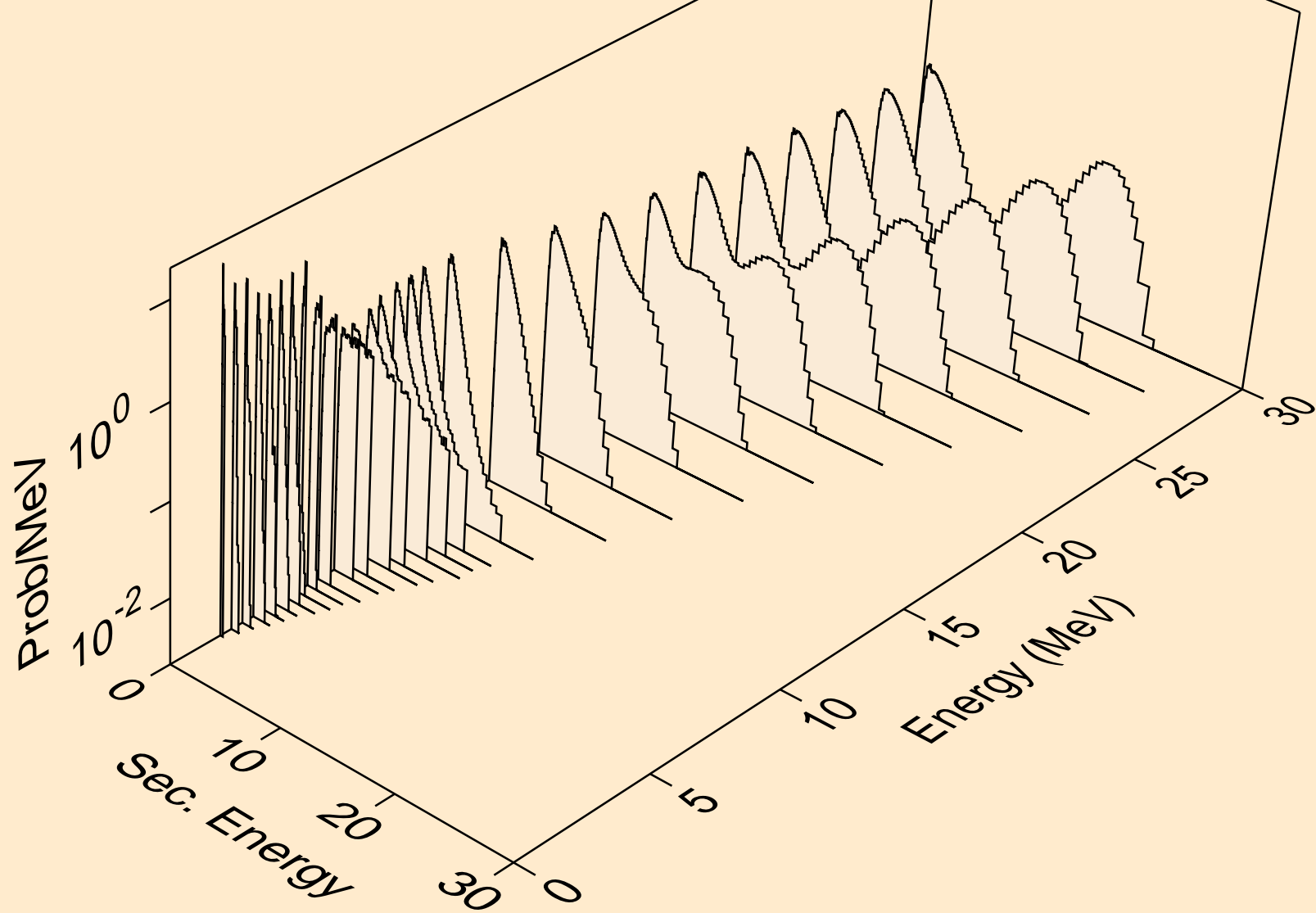

SB105 NEUTRON ACER TENDL-2021 LIBRARY; T=293.6K
Neutron emission for (n,2n)_a

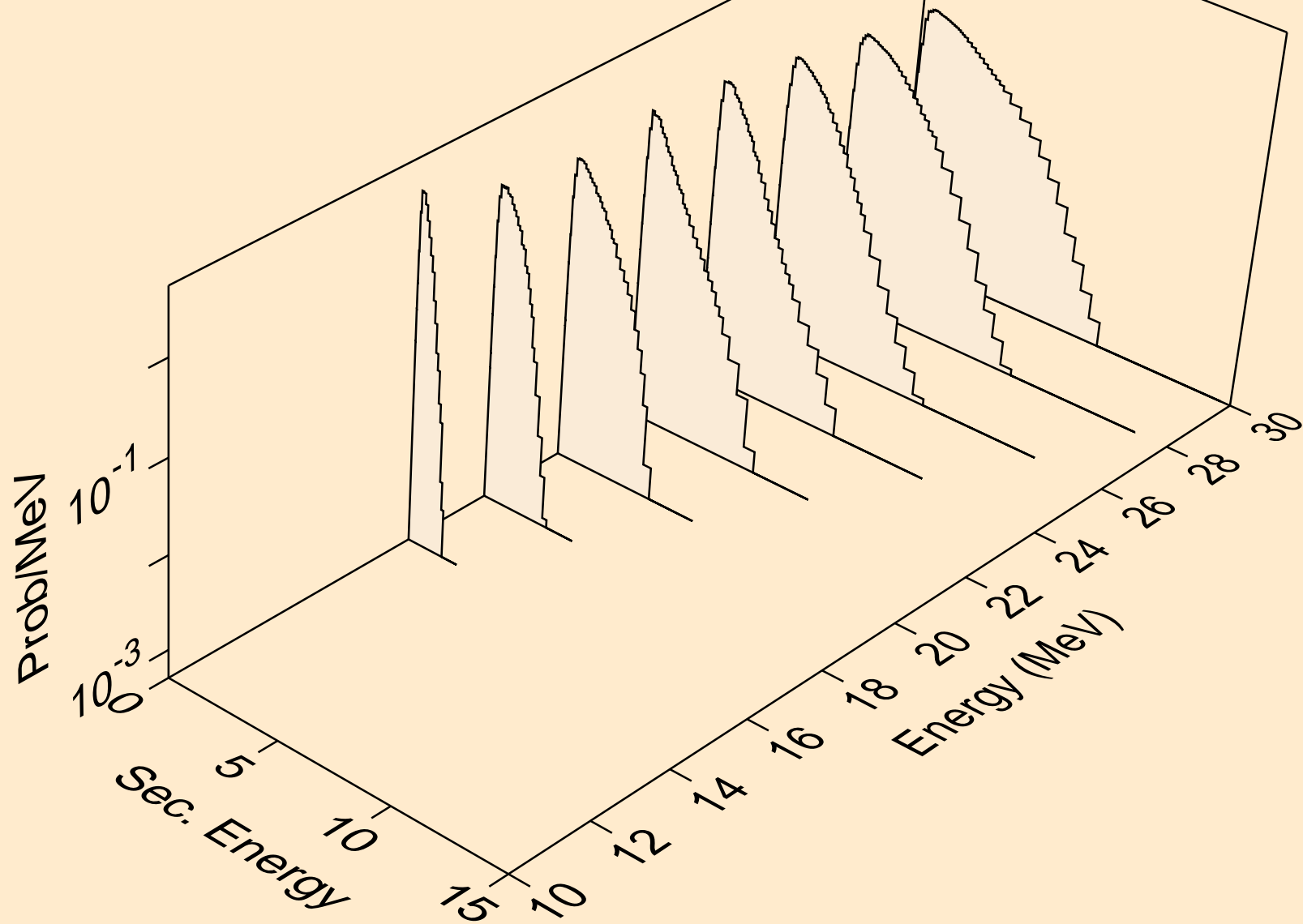

SB105 NEUTRON ACER TENDL-2021 LIBRARY; T=293.6K
Neutron emission for (n,n*)p

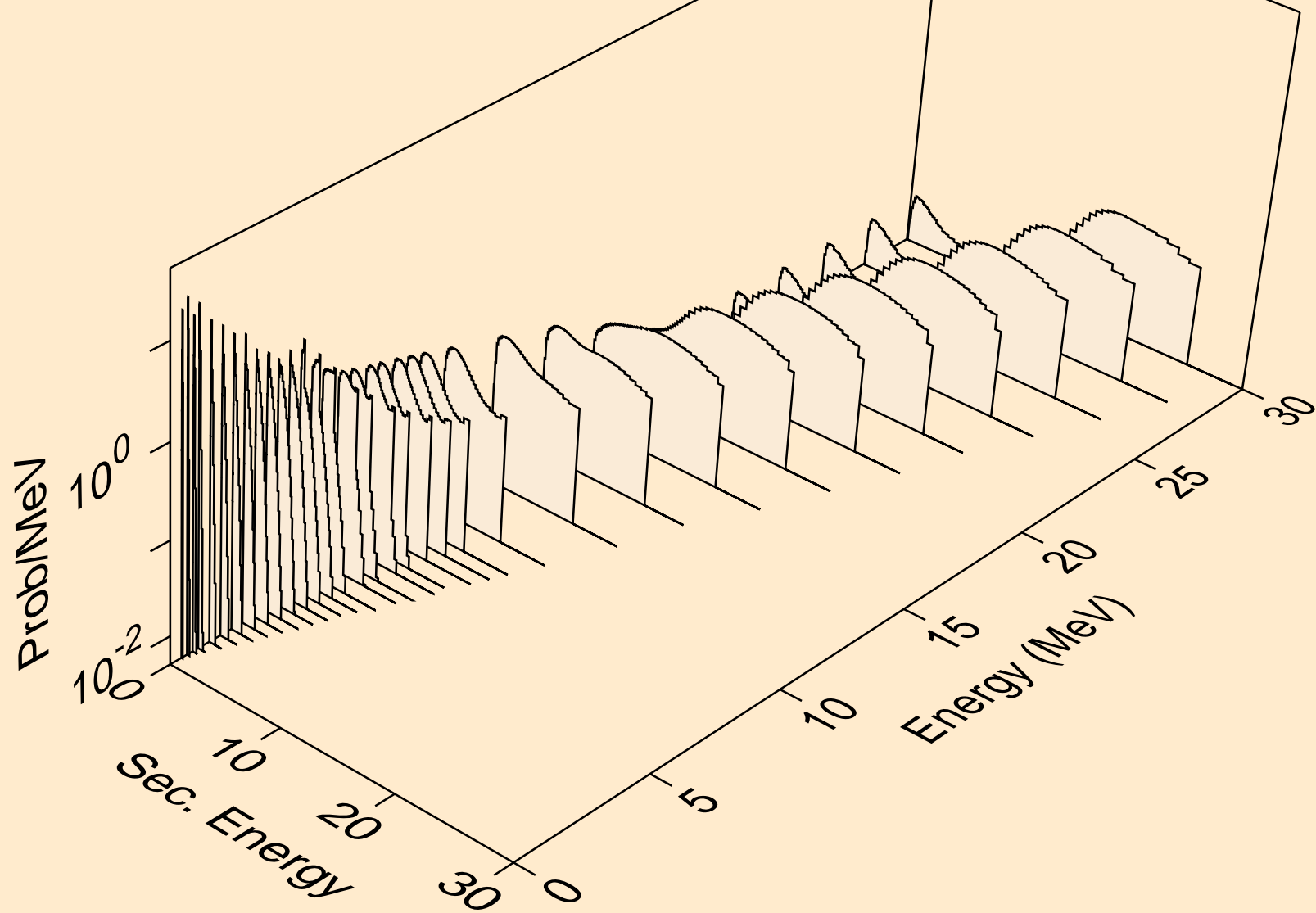

SB105 NEUTRON ACER TENDL-2021 LIBRARY; T=293.6K
Neutron emission for (n,n*)2a

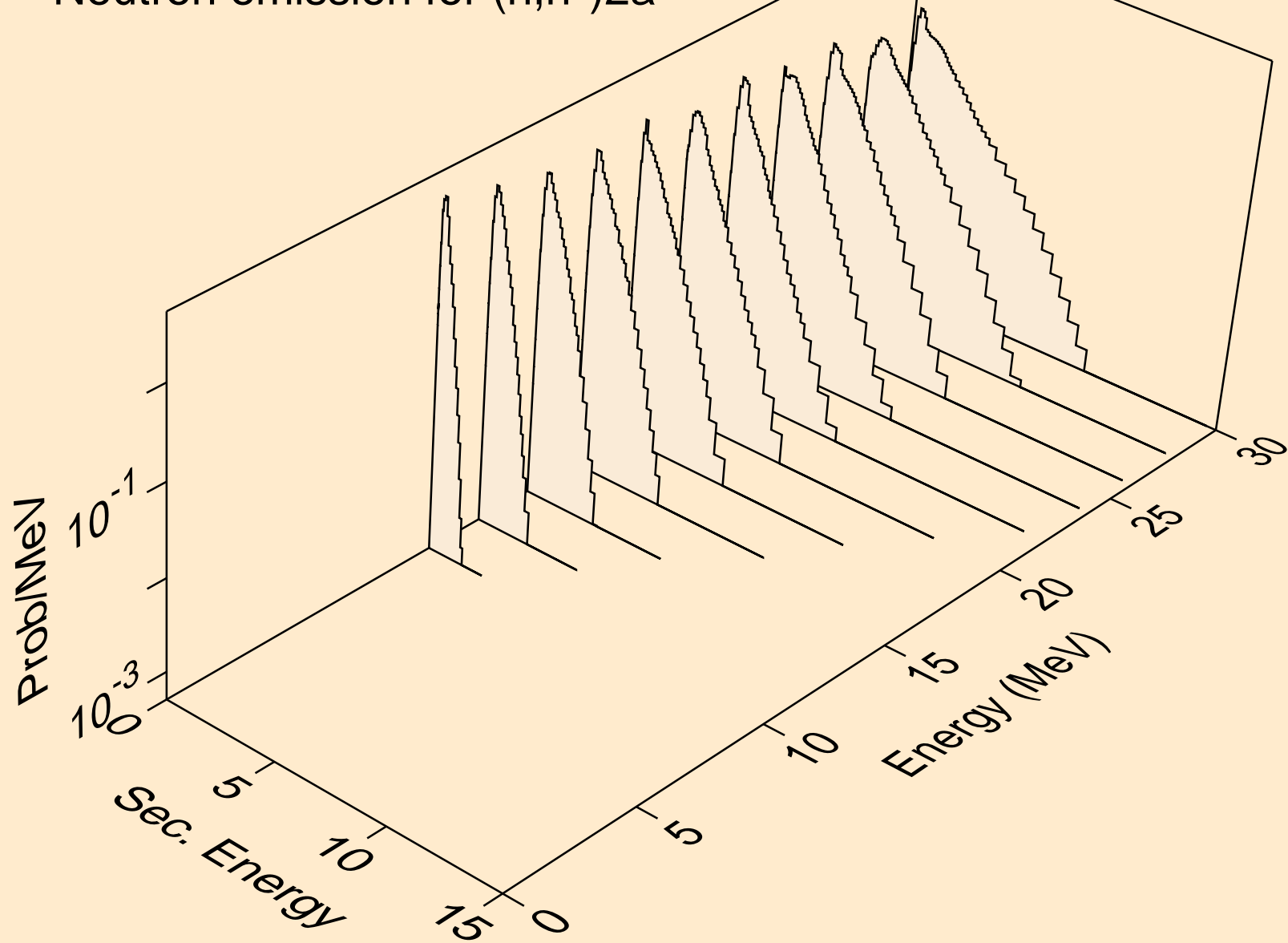

SB105 NEUTRON ACER TENDL-2021 LIBRARY; T=293.6K
Neutron emission for (n,n*)d

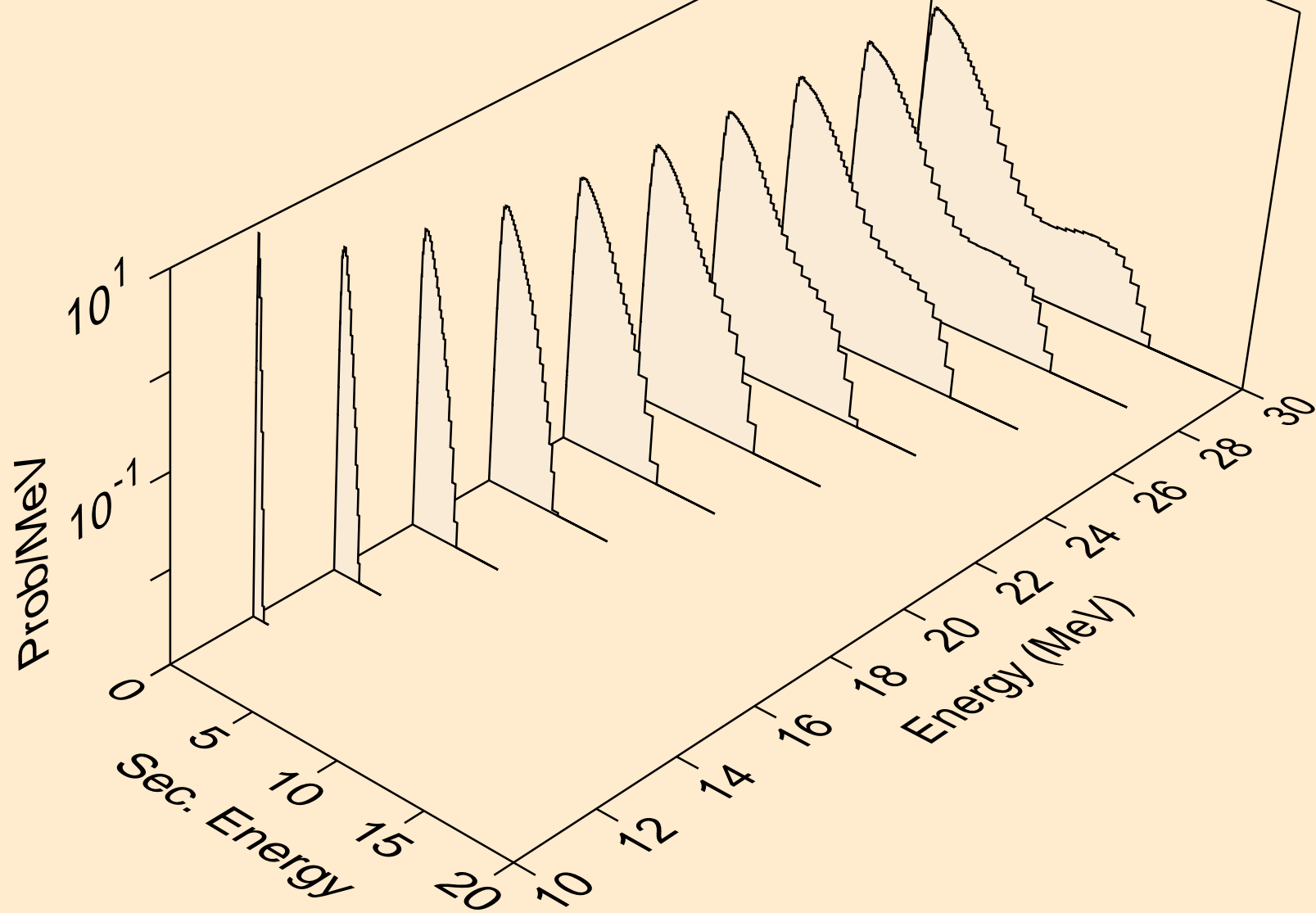

SB105 NEUTRON ACER TENDL-2021 LIBRARY; T=293.6K
Neutron emission for (n,n*)t

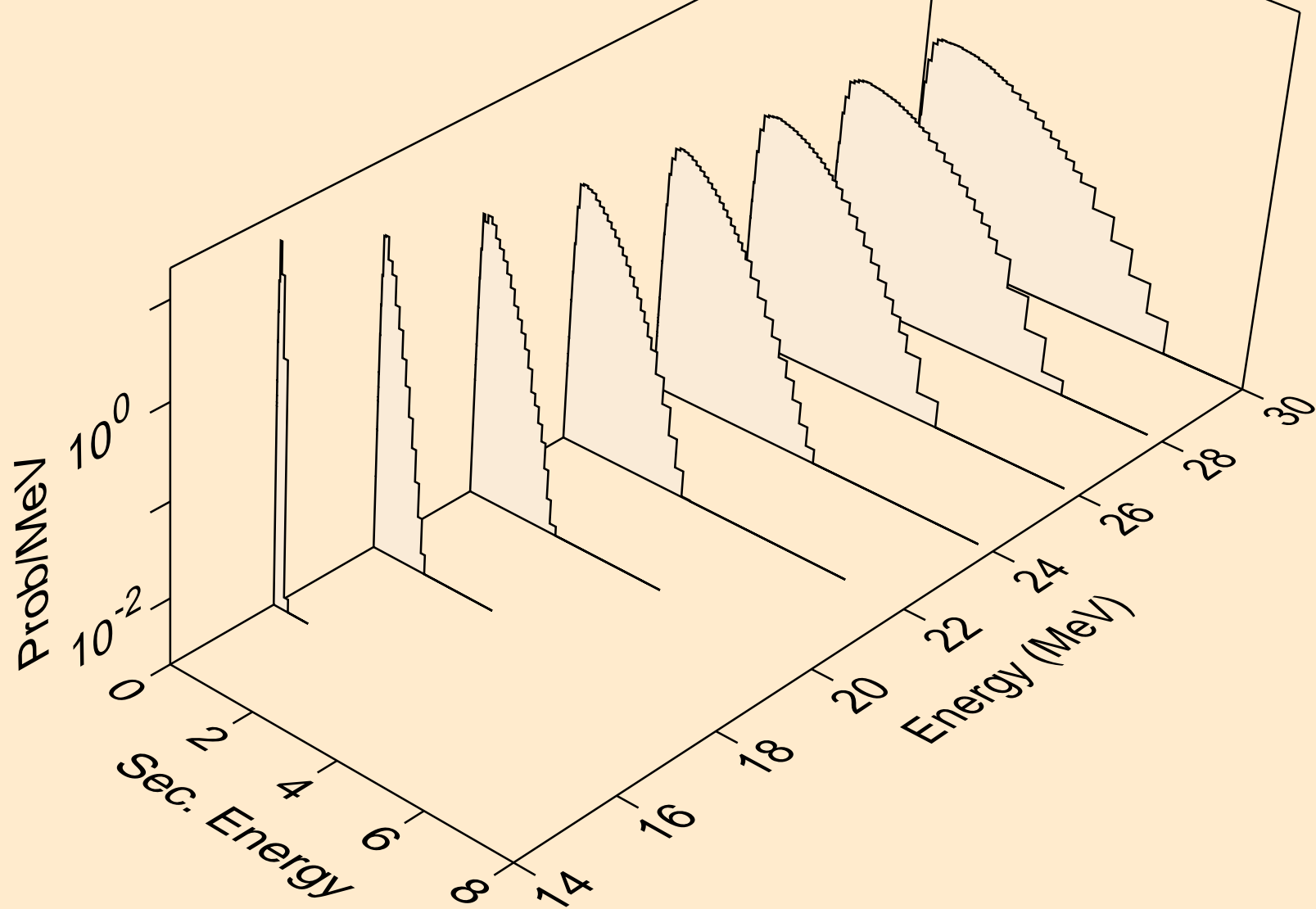

SB105 NEUTRON ACER TENDL-2021 LIBRARY; T=293.6K
Neutron emission for (n,n*)he3

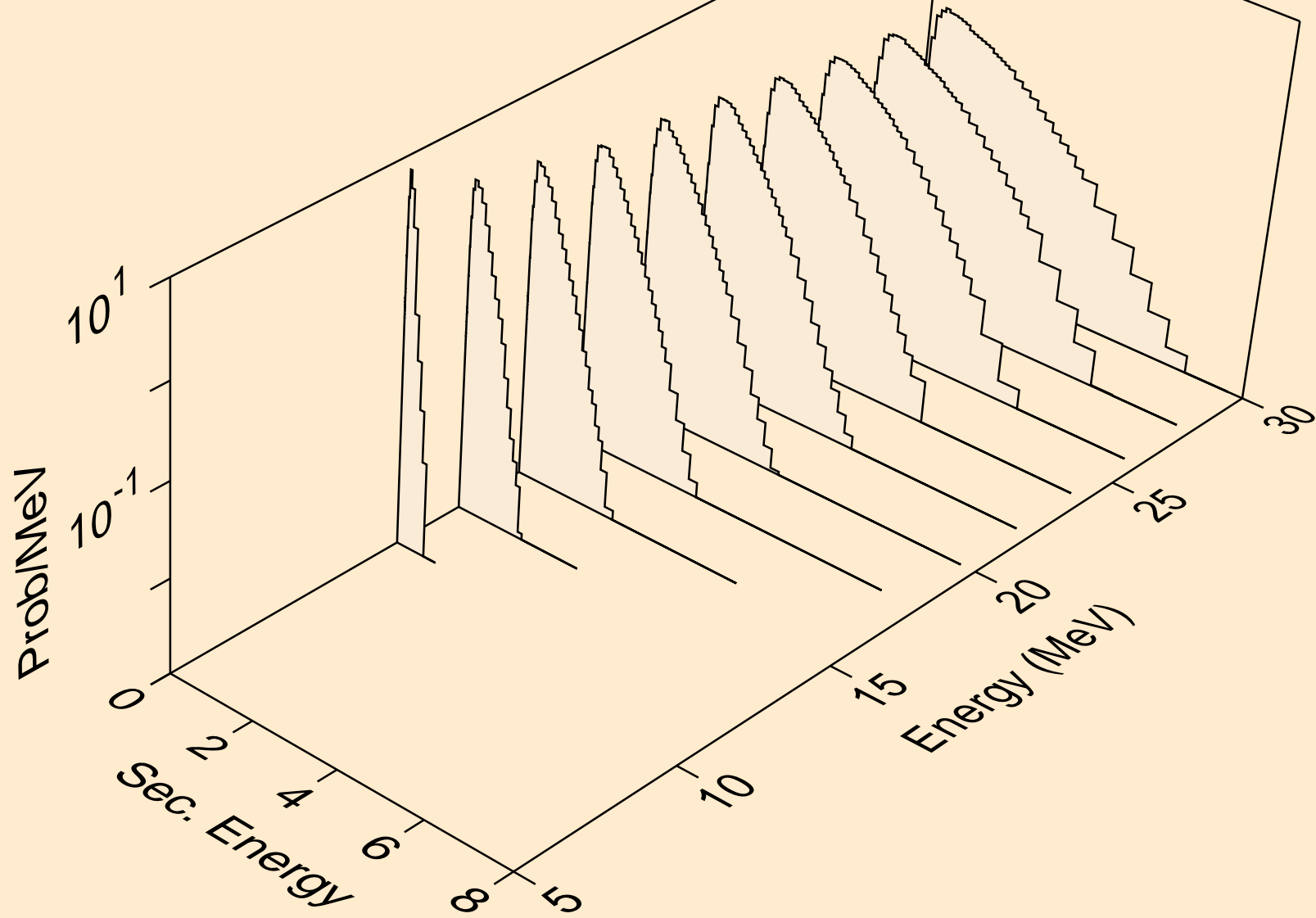

SB105 NEUTRON ACER TENDL-2021 LIBRARY; T=293.6K
Neutron emission for (n,2np)

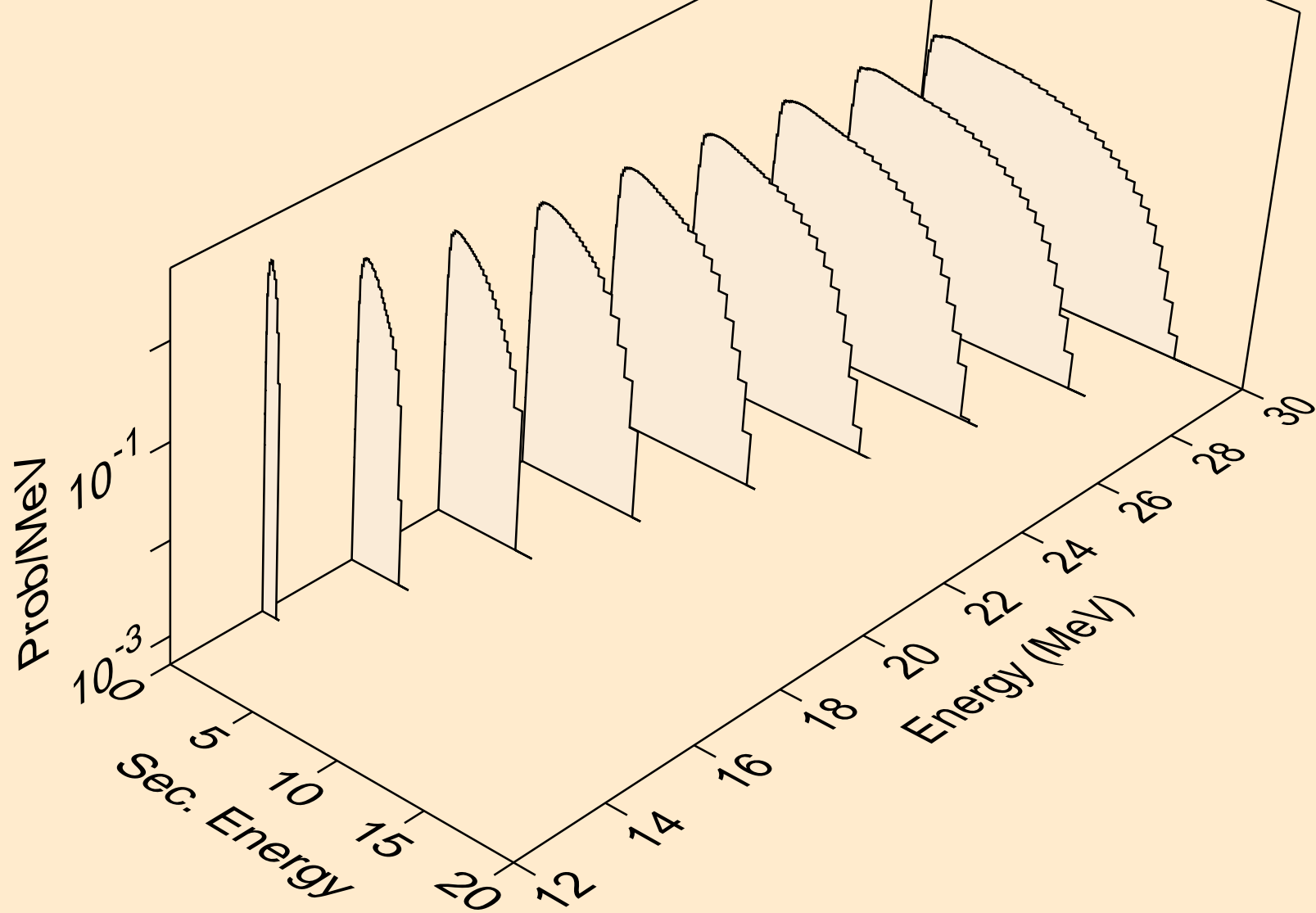

SB105 NEUTRON ACER TENDL-2021 LIBRARY; T=293.6K
Neutron emission for (n,3np)

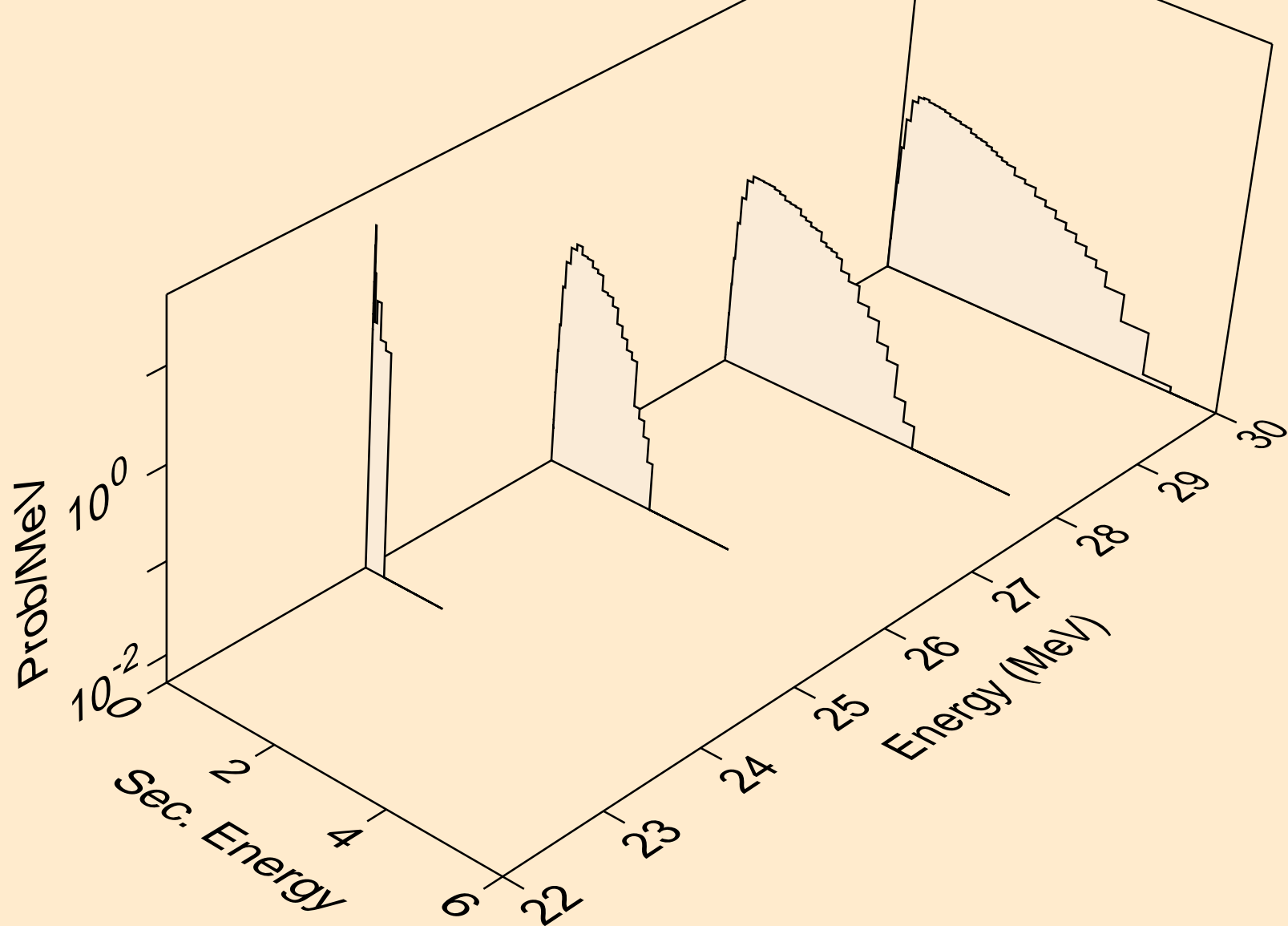

SB105 NEUTRON ACER TENDL-2021 LIBRARY; T=293.6K
Neutron emission for (n,2np)

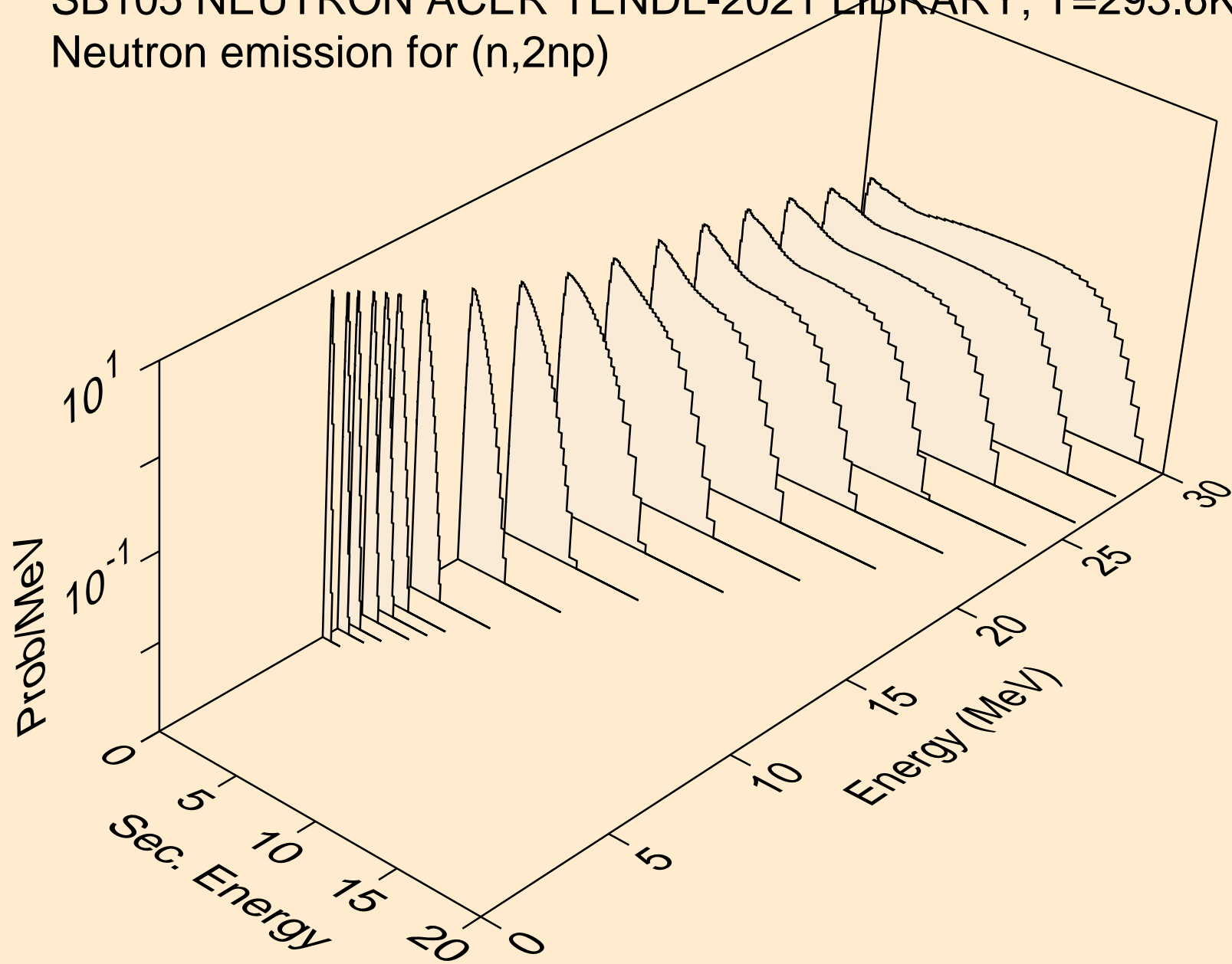

SB105 NEUTRON ACER TENDL-2021 LIBRARY; T=293.6K
Neutron emission for (n,npa)

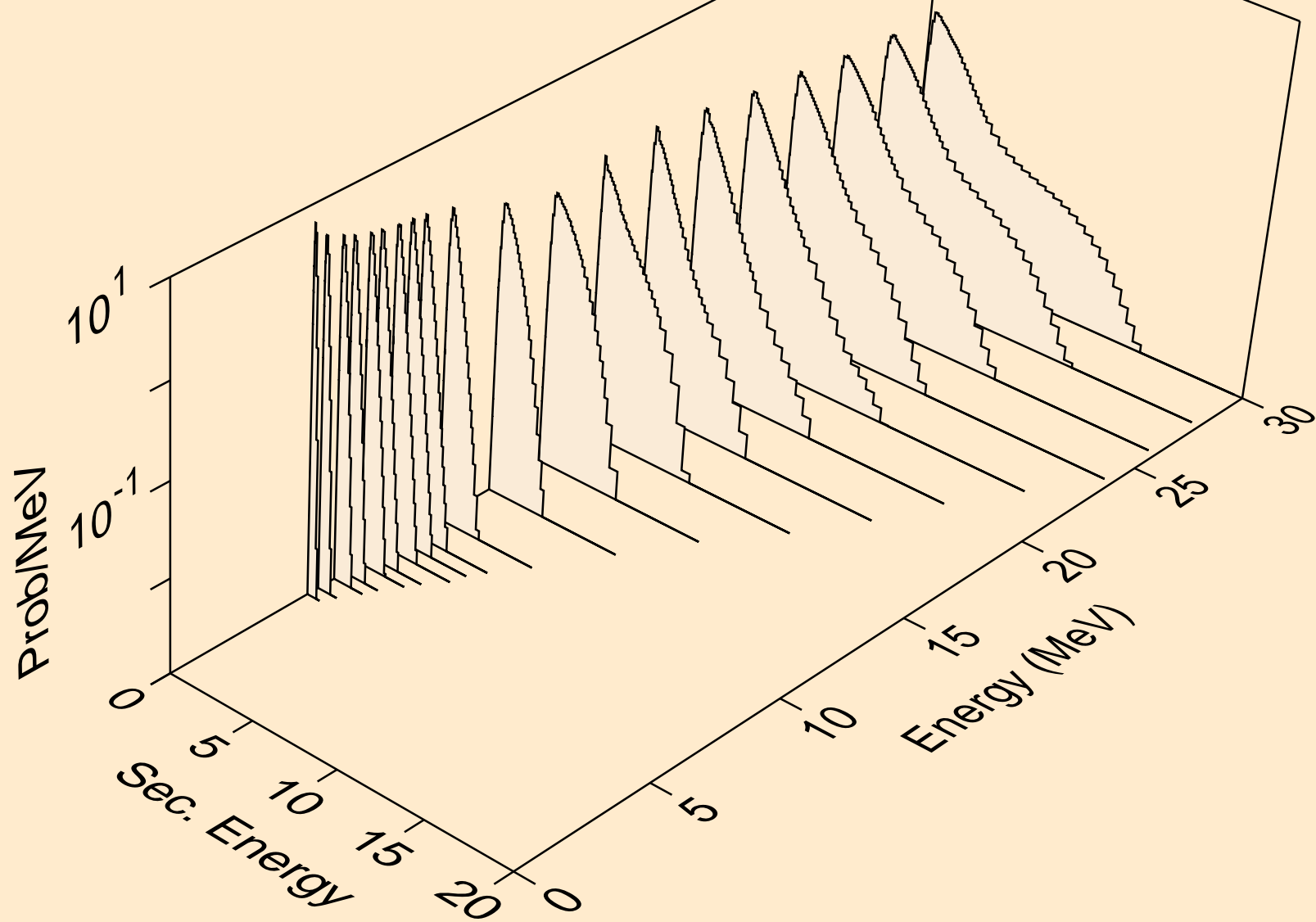

SB105 NEUTRON ACER TENDL-2021 LIBRARY; T=293.6K
Neutron emission for (n,n*c)

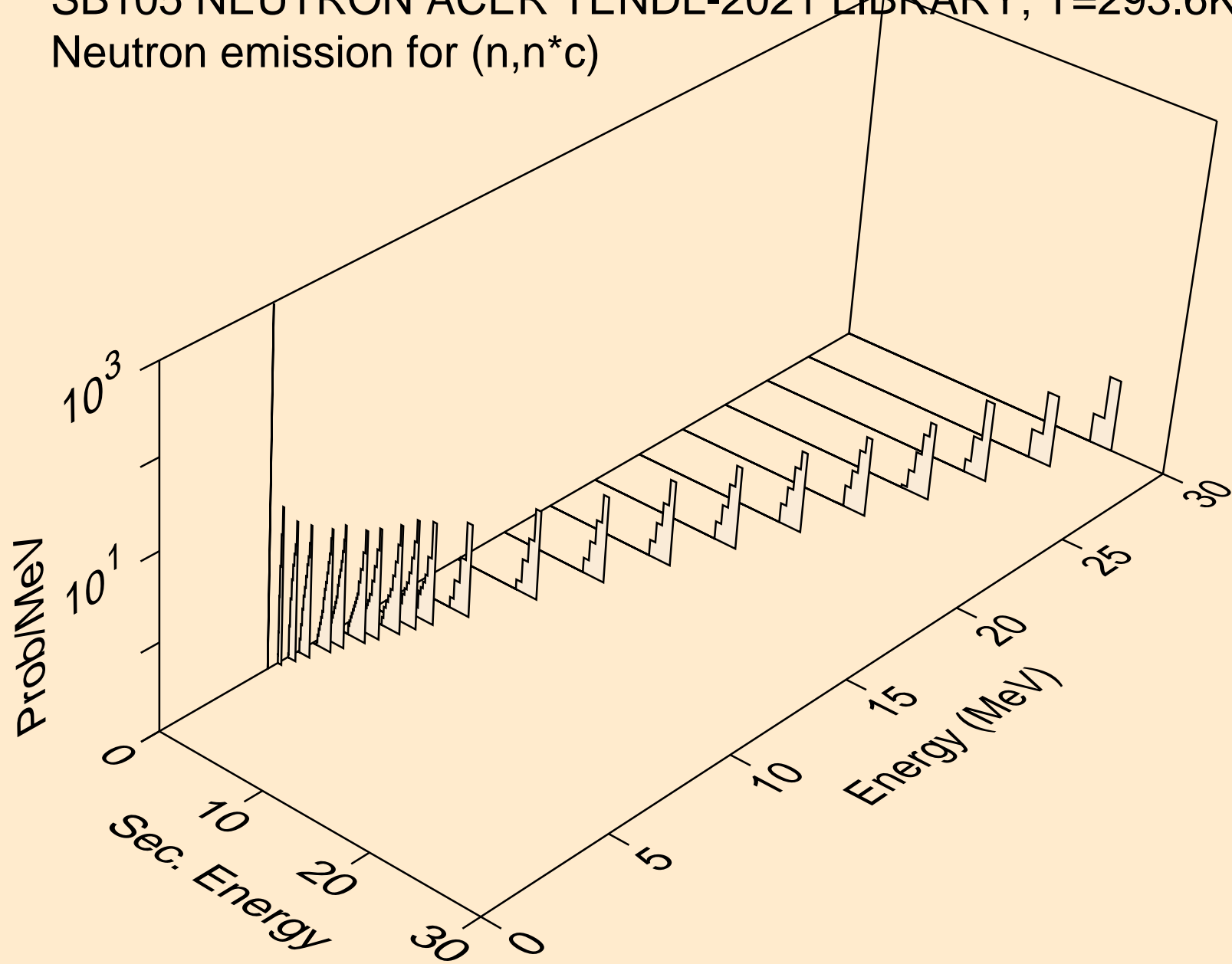

SB105 NEUTRON ACER TENDL-2021 LIBRARY; T=293.6K
Photon emission for (n,x)

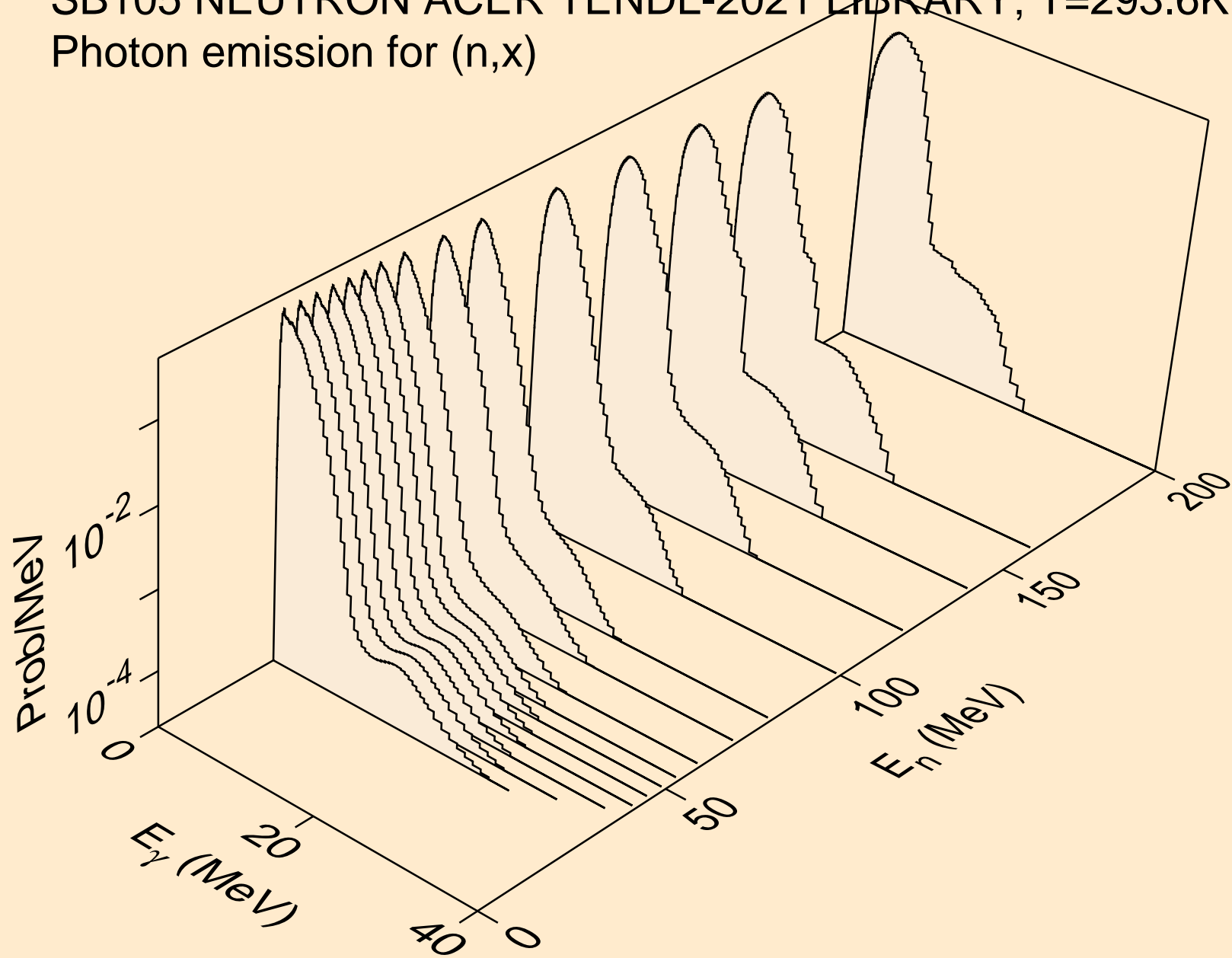

SB105 NEUTRON ACER TENDL-2021 LIBRARY; T=293.6K
Photon emission for (n,2nd)

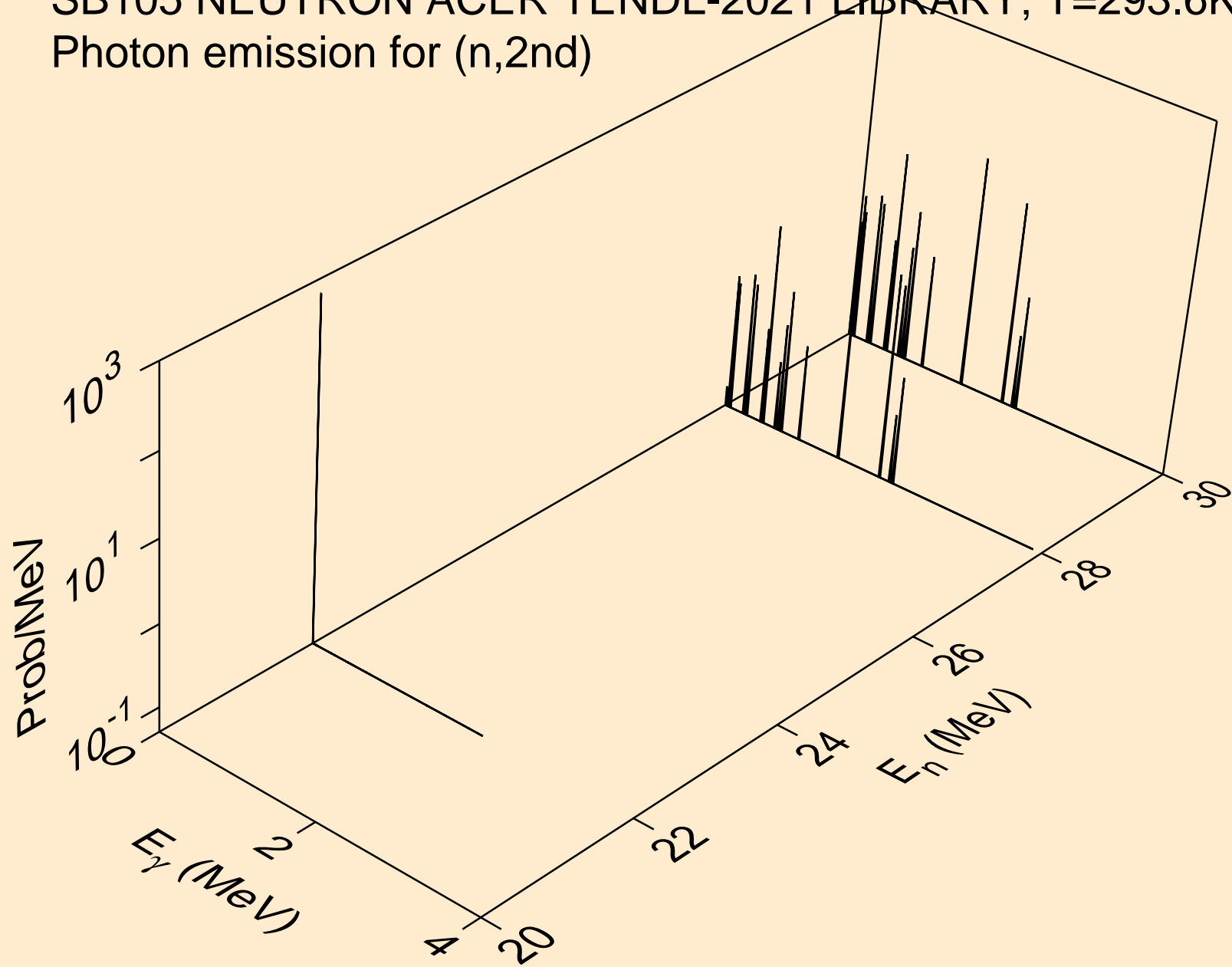

SB105 NEUTRON ACER TENDL-2021 LIBRARY; T=293.6K
Photon emission for (n,2n)

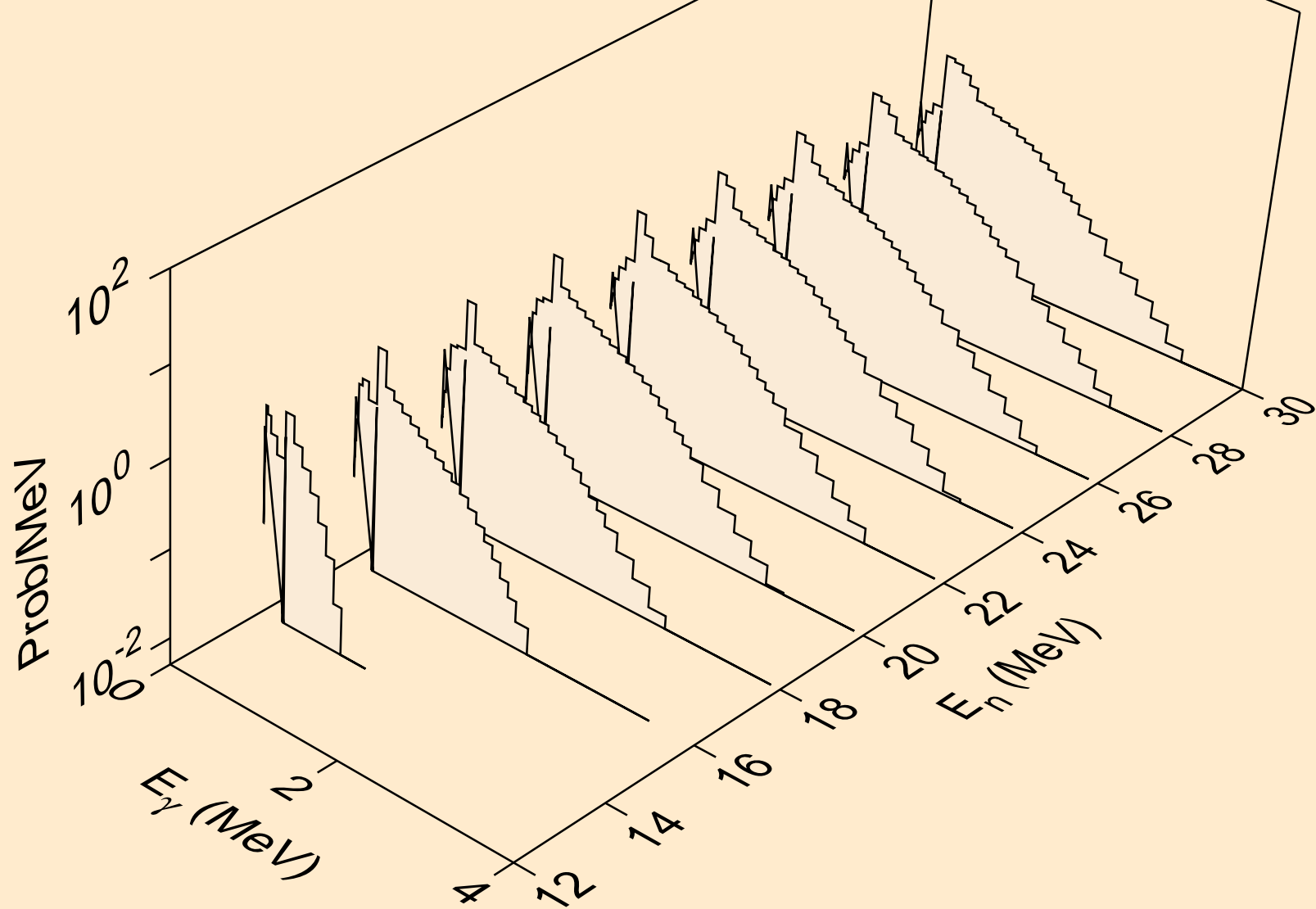

SB105 NEUTRON ACER TENDL-2021 LIBRARY; T=293.6K
Photon emission for (n,3n)

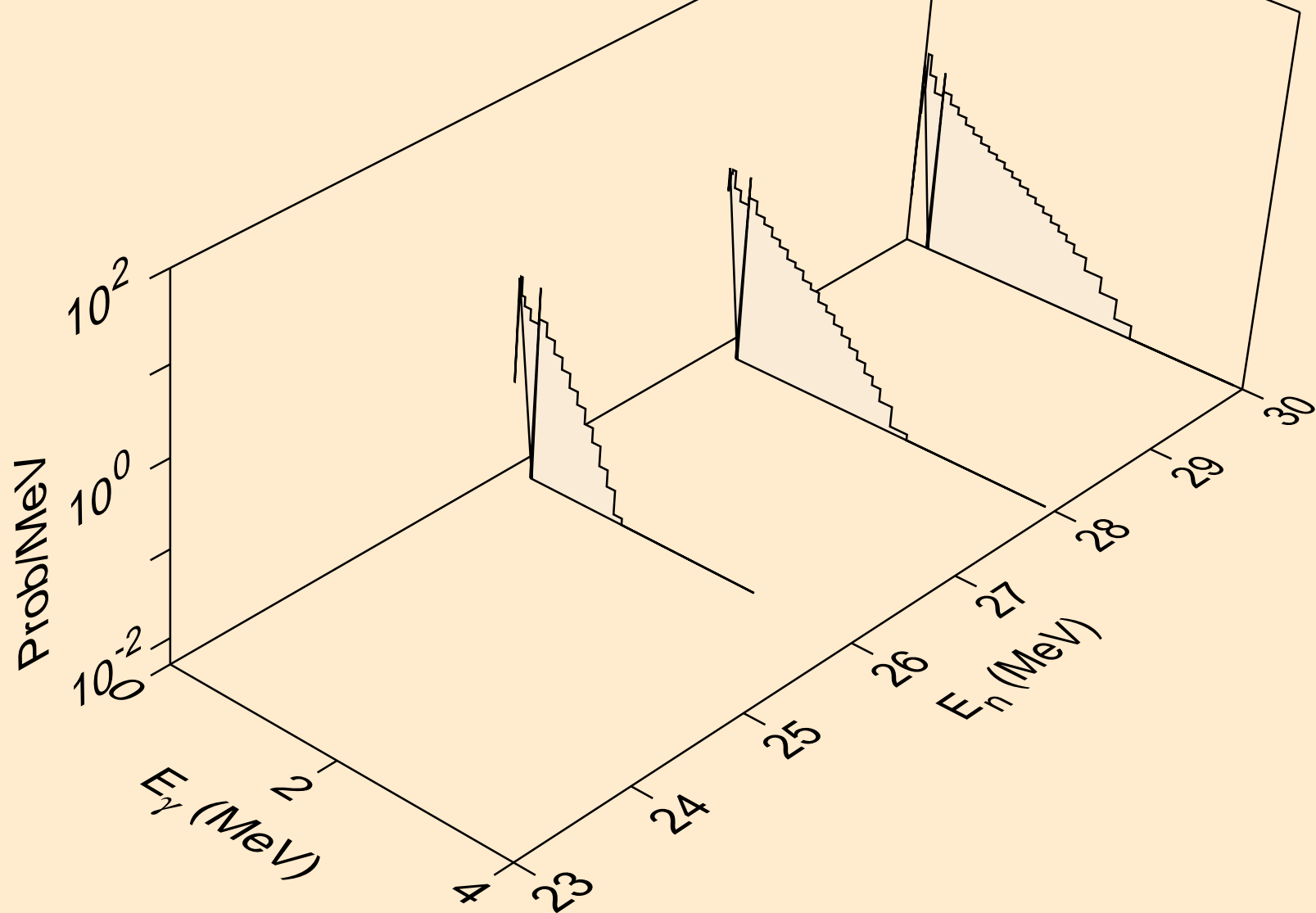

SB105 NEUTRON ACER TENDL-2021 LIBRARY; T=293.6K
Photon emission for (n,n*)a

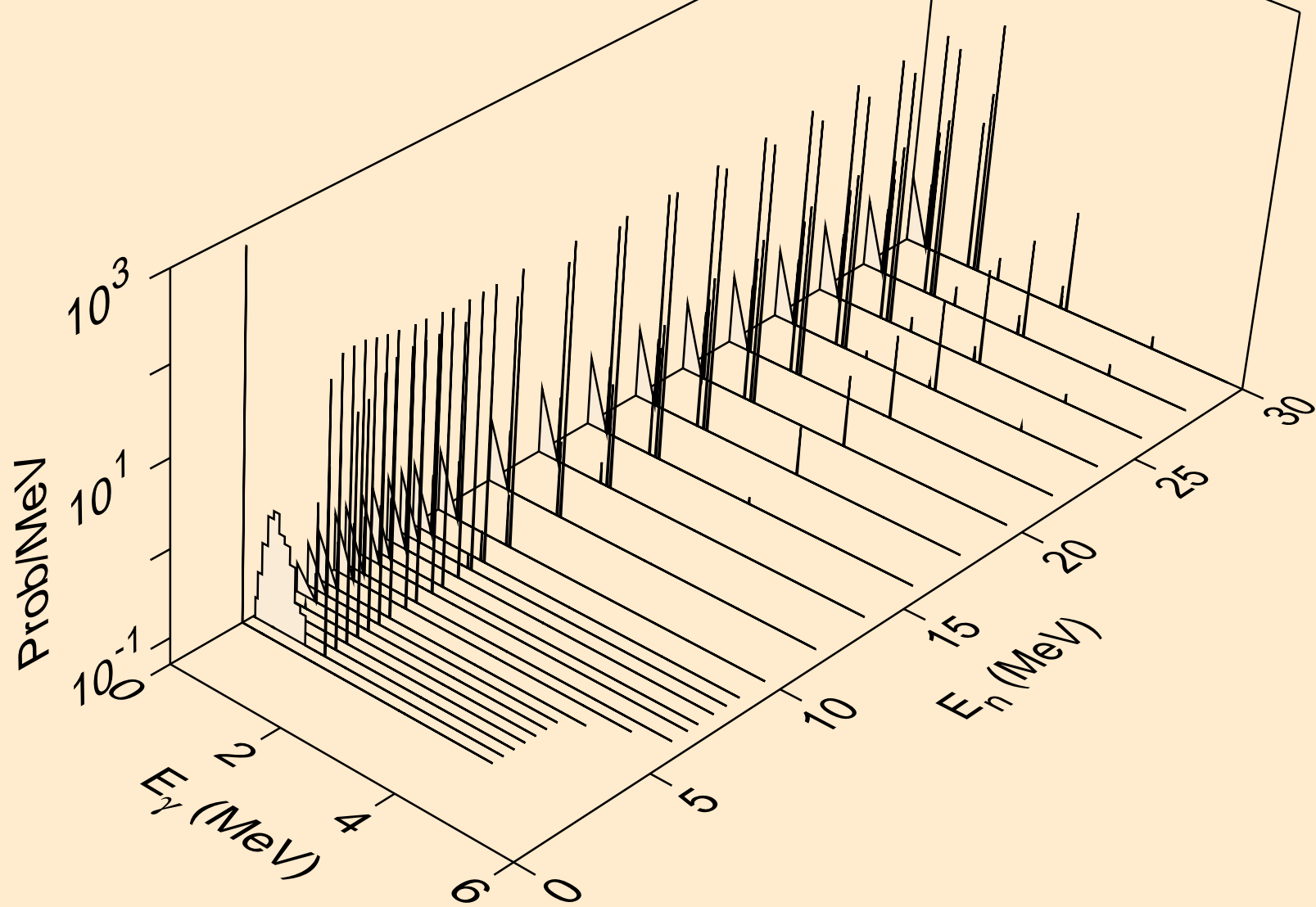

SB105 NEUTRON ACER TENDL-2021 LIBRARY; T=293.6K
Photon emission for (n,2n)a

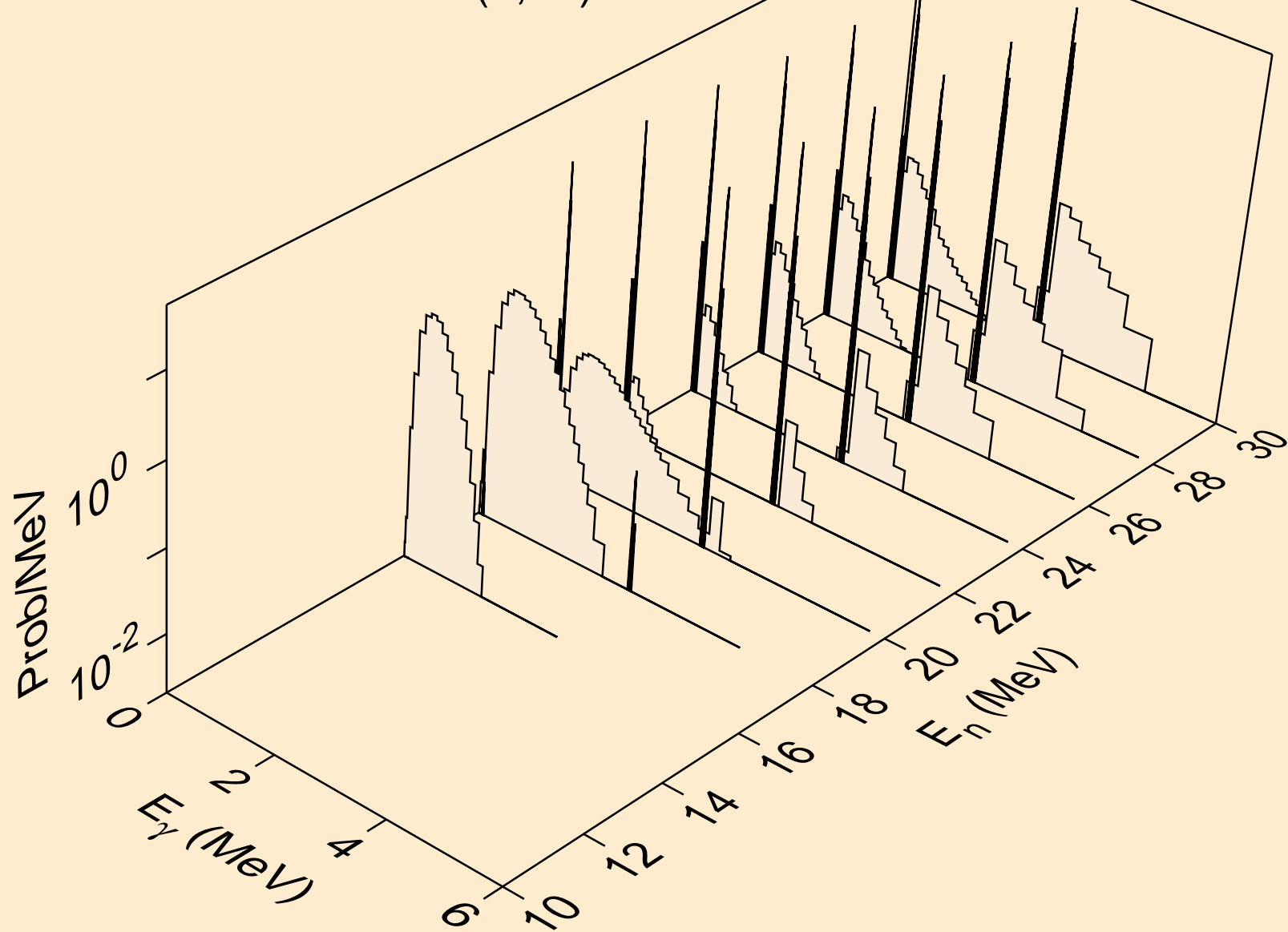

SB105 NEUTRON ACER TENDL-2021 LIBRARY; T=293.6K
Photon emission for (n,n*)p

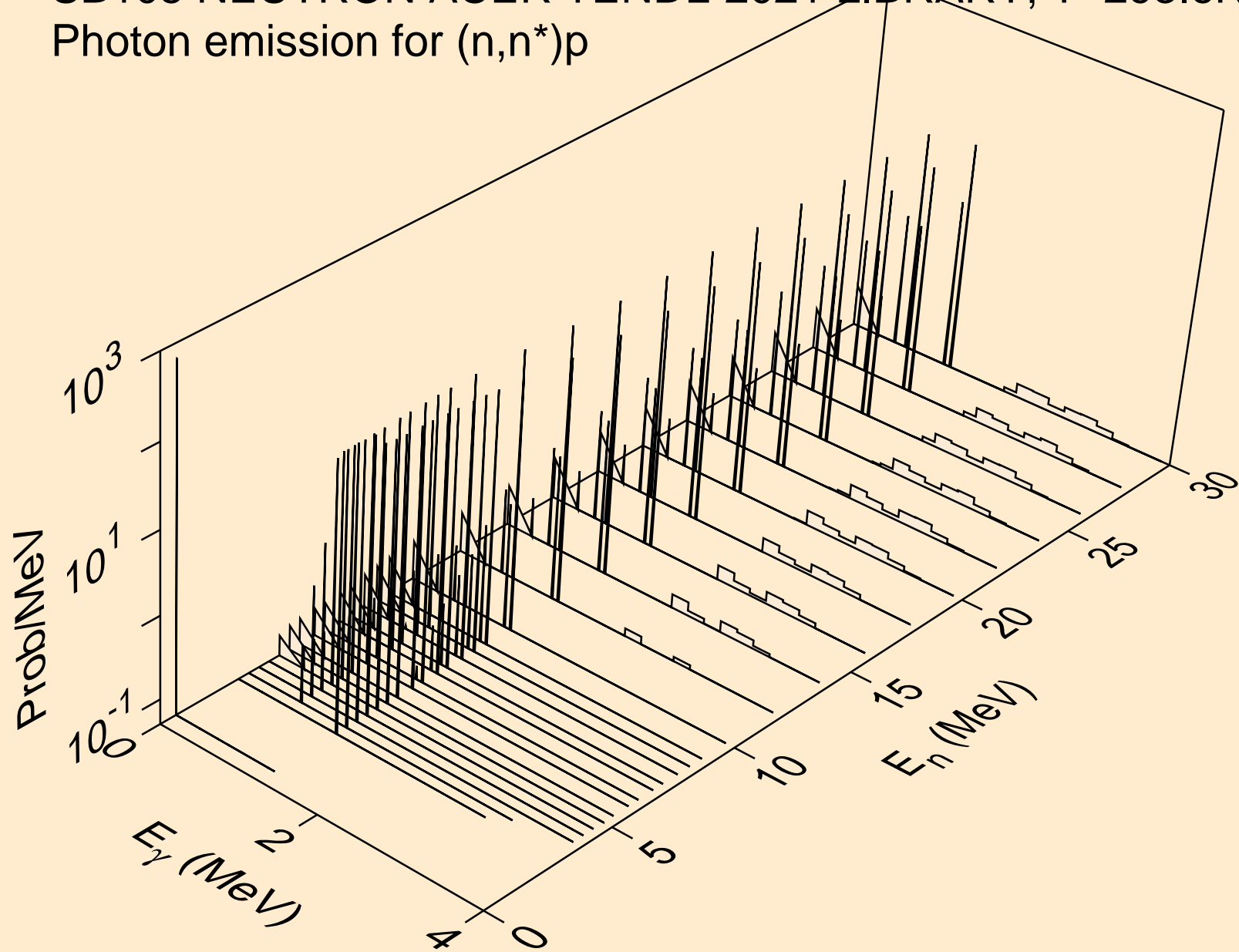

SB105 NEUTRON ACER TENDL-2021 LIBRARY; T=293.6K
Photon emission for (n,n*)2a

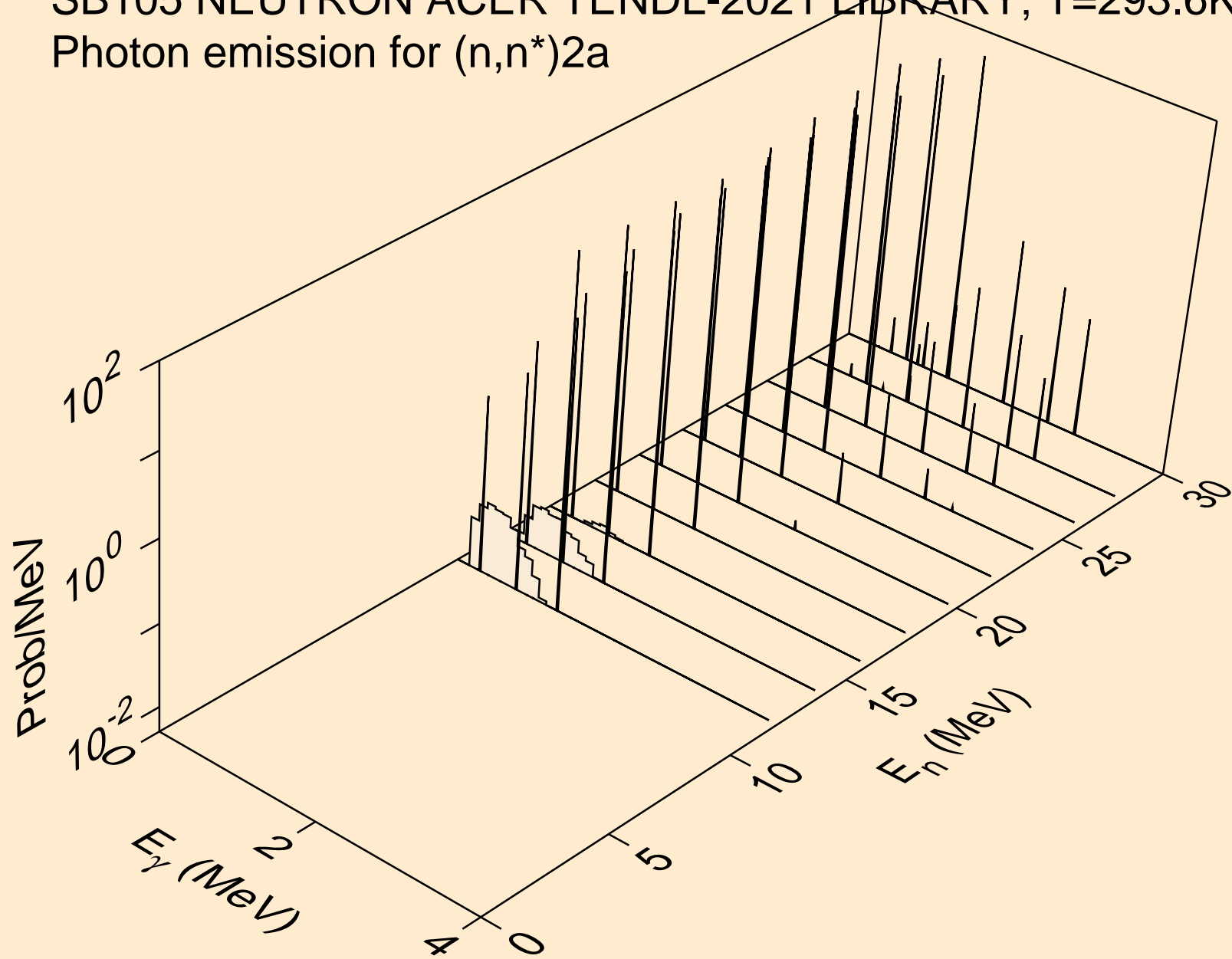

SB105 NEUTRON ACER TENDL-2021 LIBRARY; T=293.6K
Photon emission for (n,n*)d

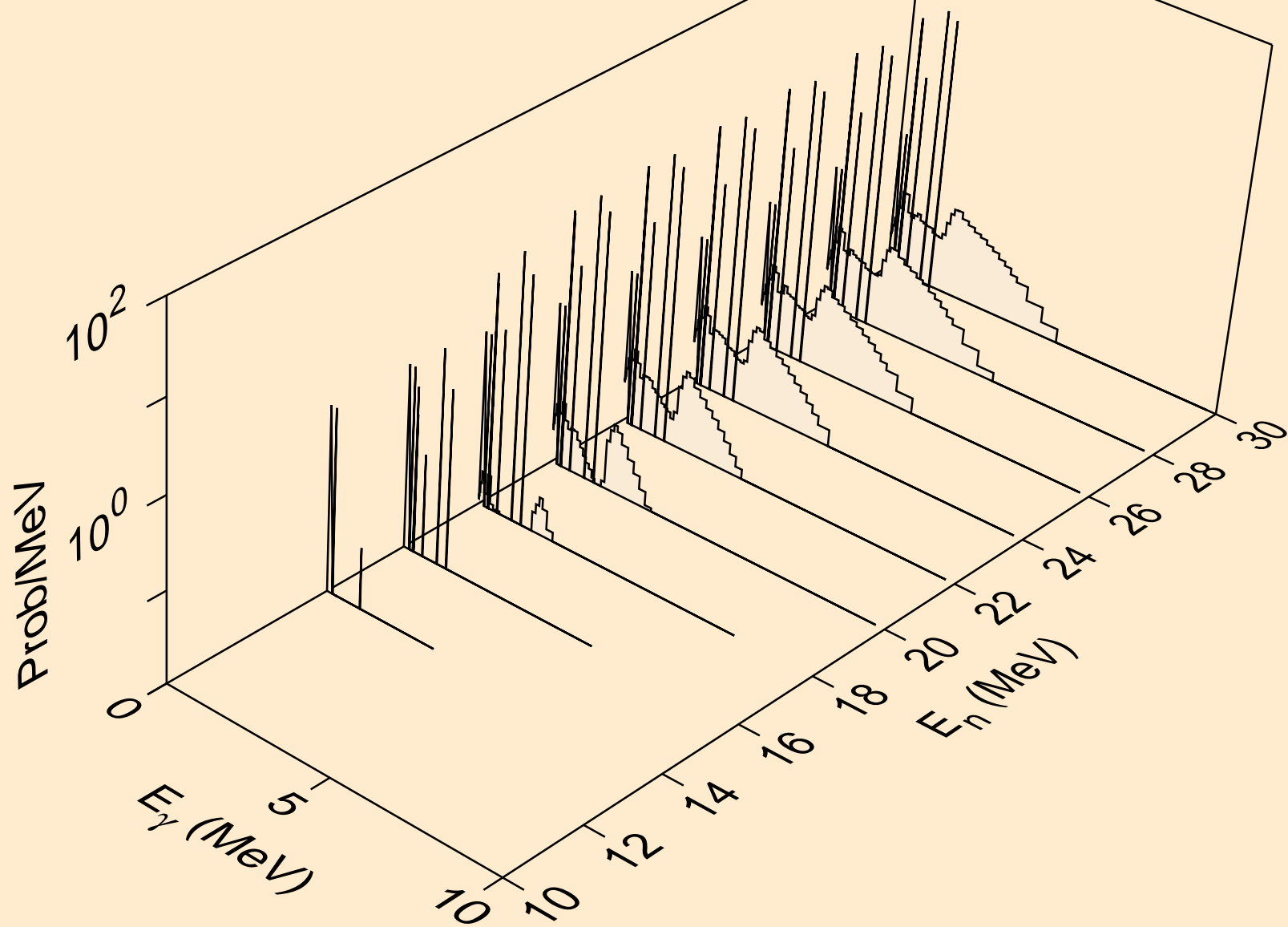

SB105 NEUTRON ACER TENDL-2021 LIBRARY; T=293.6K
Photon emission for (n,n*)t

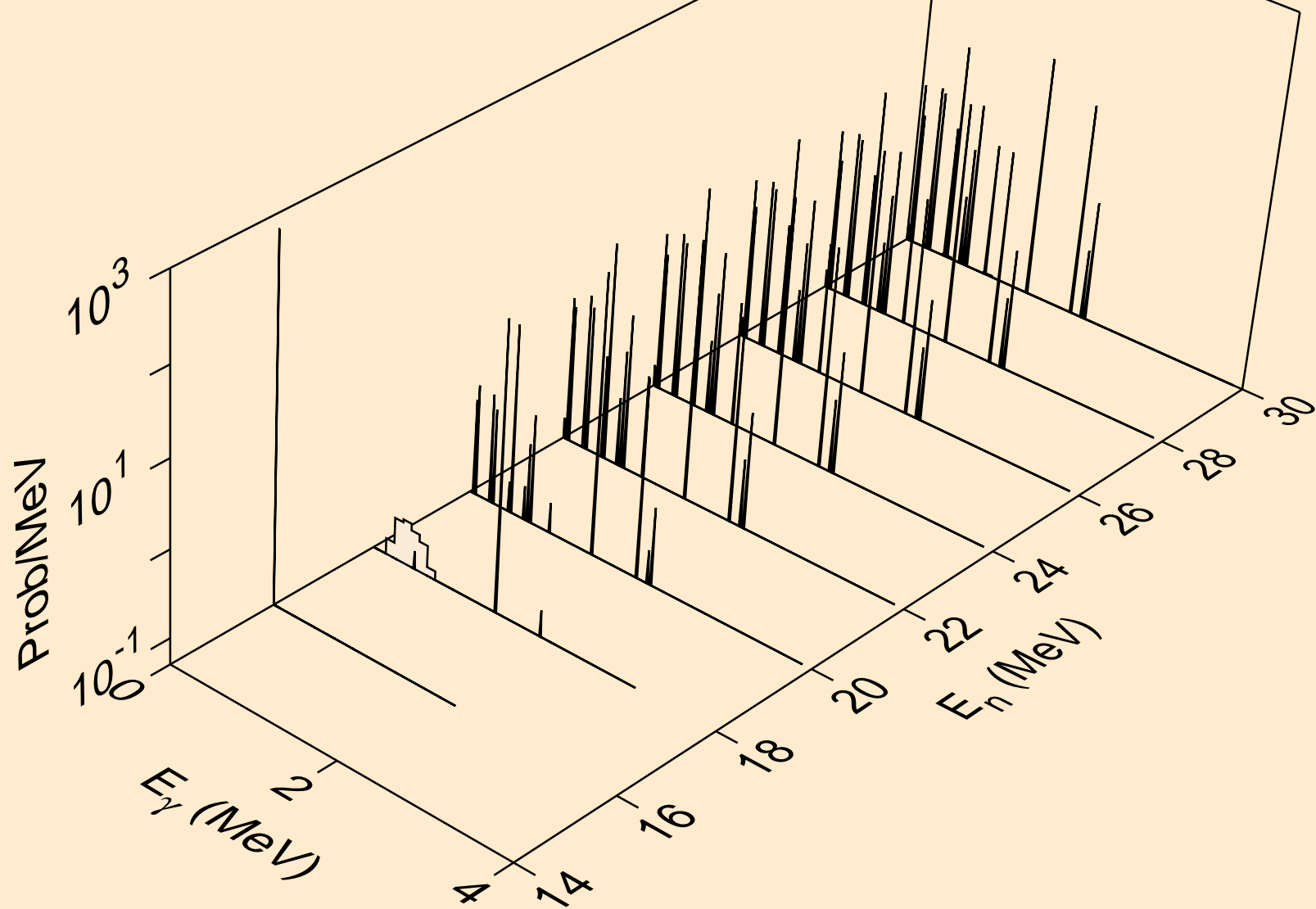

SB105 NEUTRON ACER TENDL-2021 LIBRARY; T=293.6K
Photon emission for (n,n*)he3

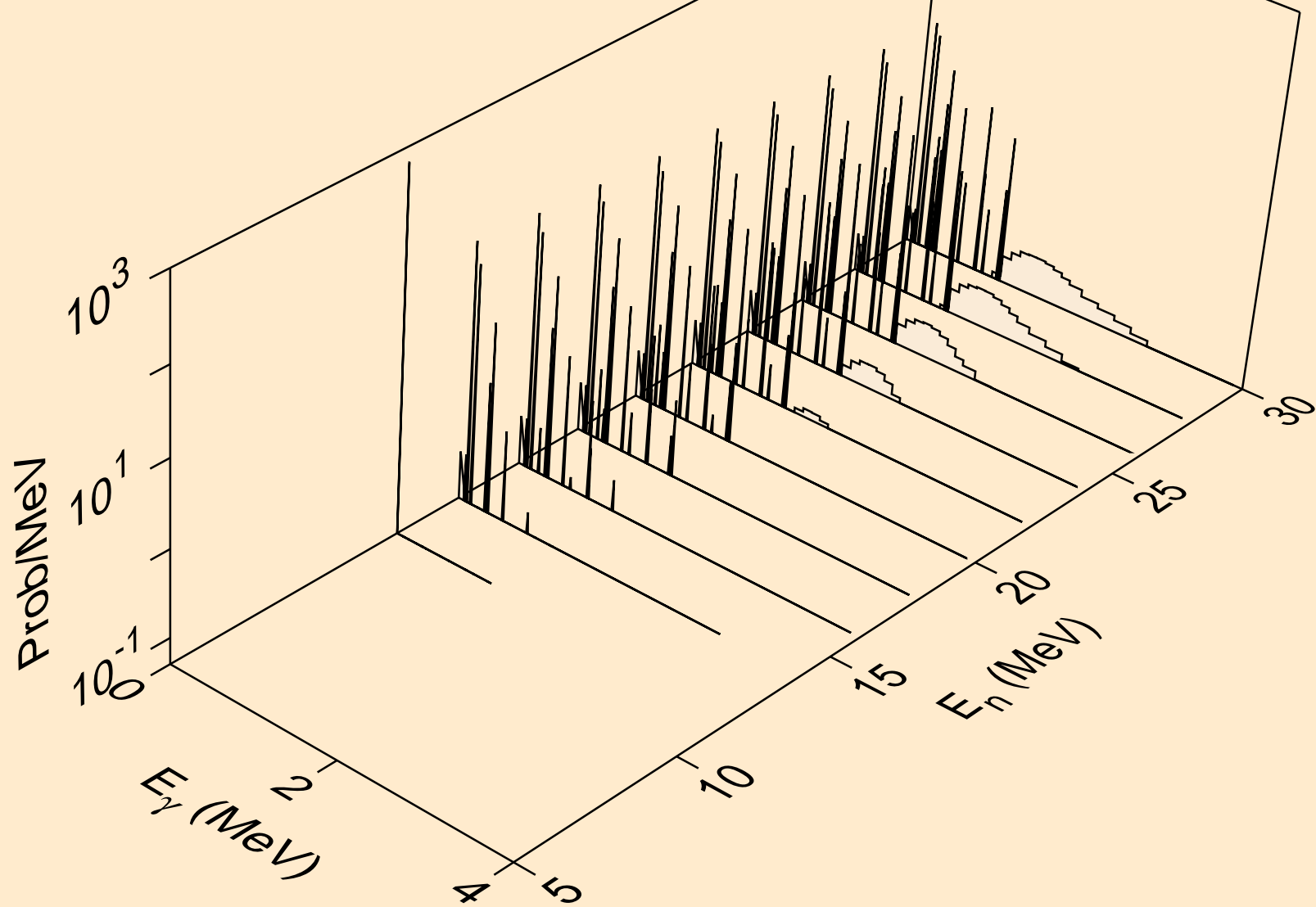

SB105 NEUTRON ACER TENDL-2021 LIBRARY; T=293.6K
Photon emission for (n,2np)

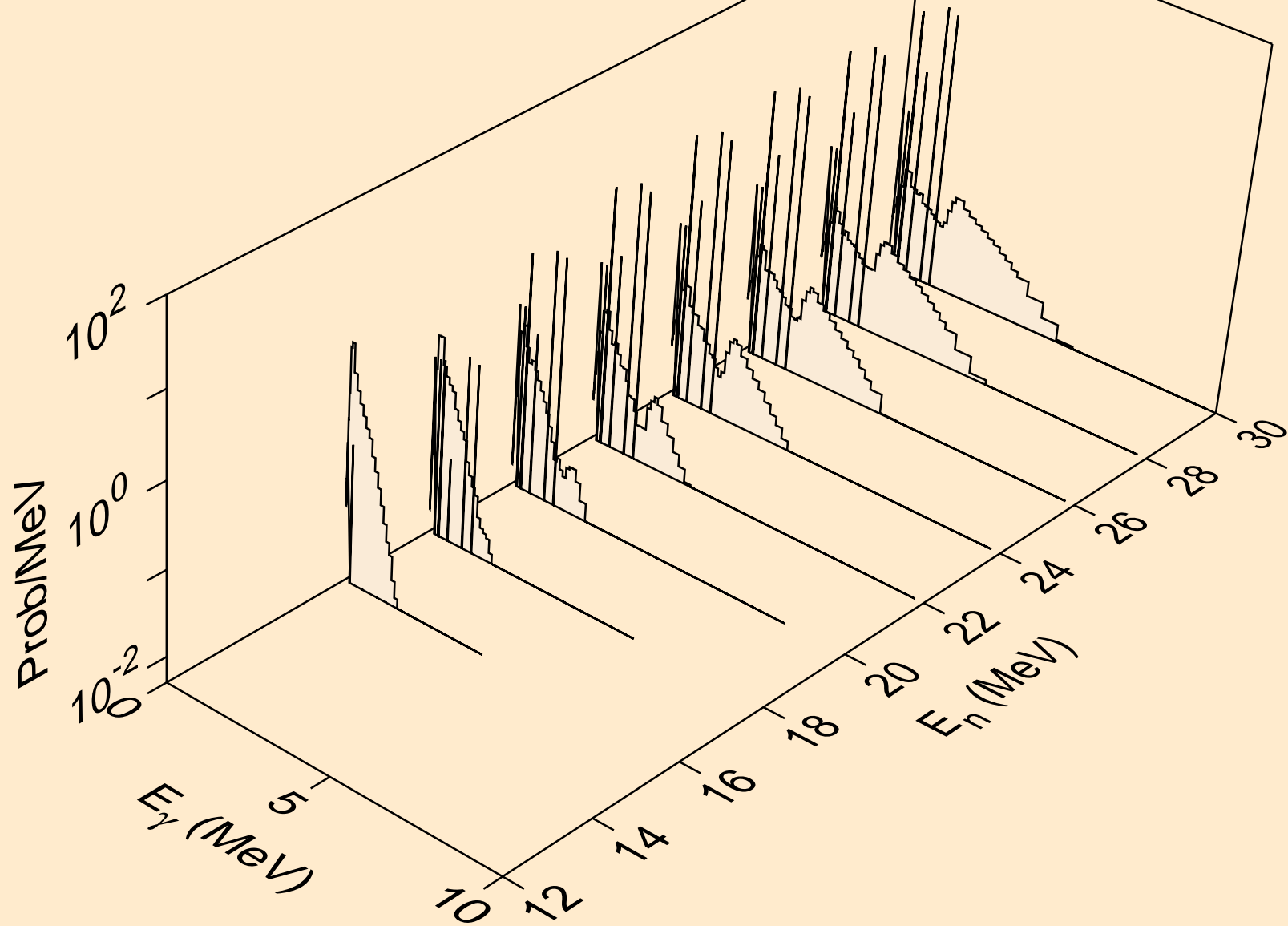

SB105 NEUTRON ACER TENDL-2021 LIBRARY; T=293.6K
Photon emission for (n,3np)

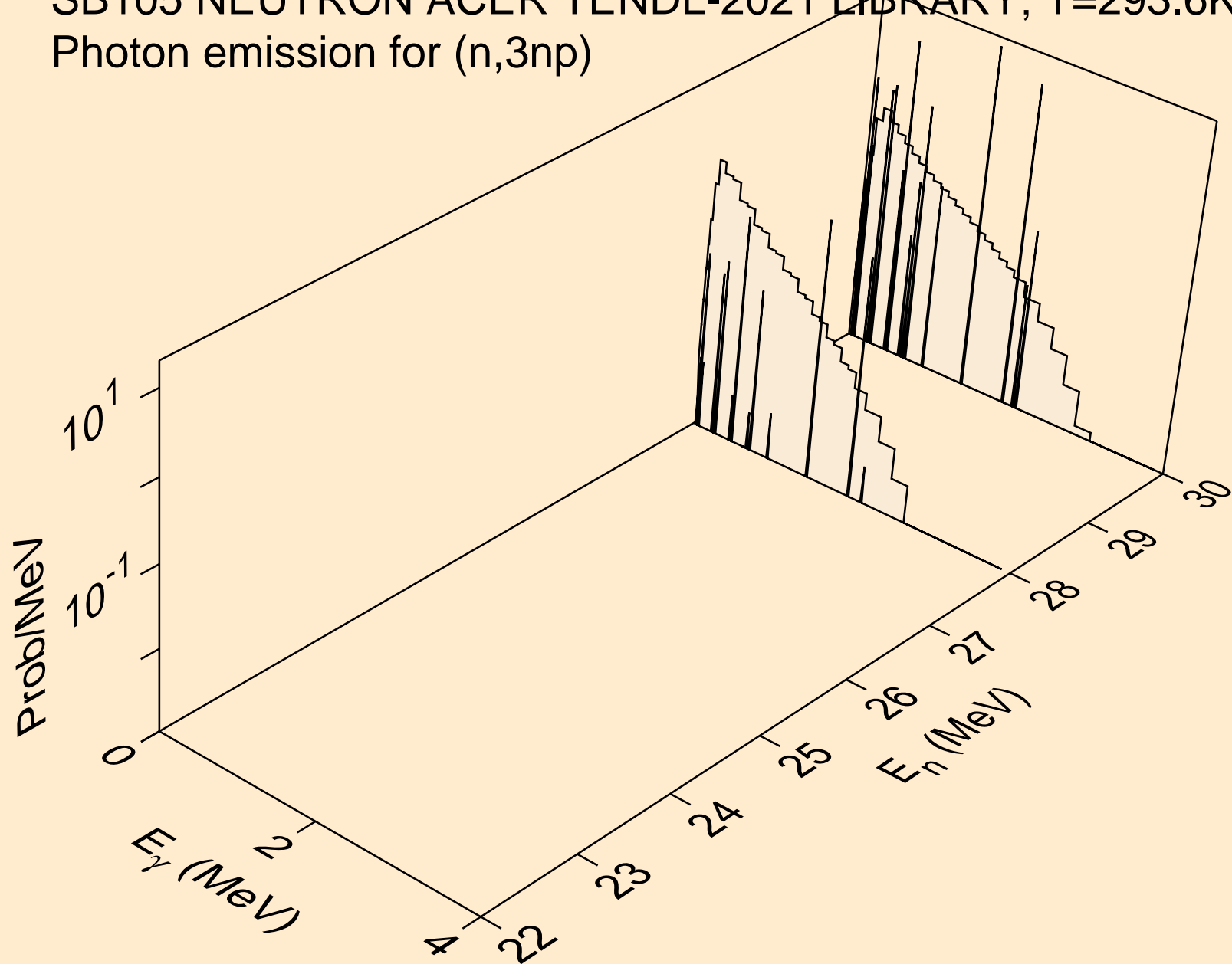

SB105 NEUTRON ACER TENDL-2021 LIBRARY; T=293.6K
Photon emission for (n,2np)

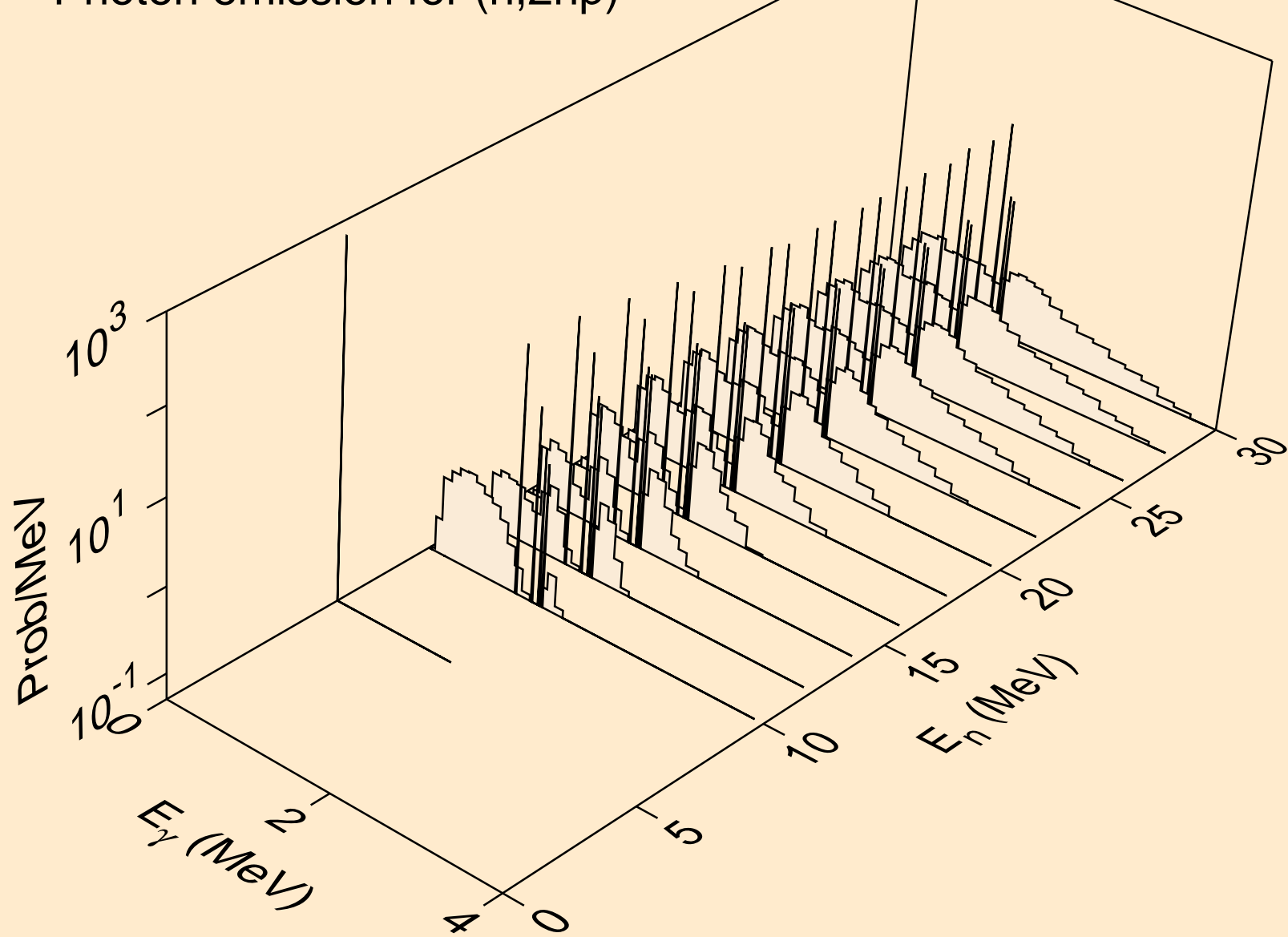

SB105 NEUTRON ACER TENDL-2021 LIBRARY; T=293.6K
Photon emission for (n,npa)

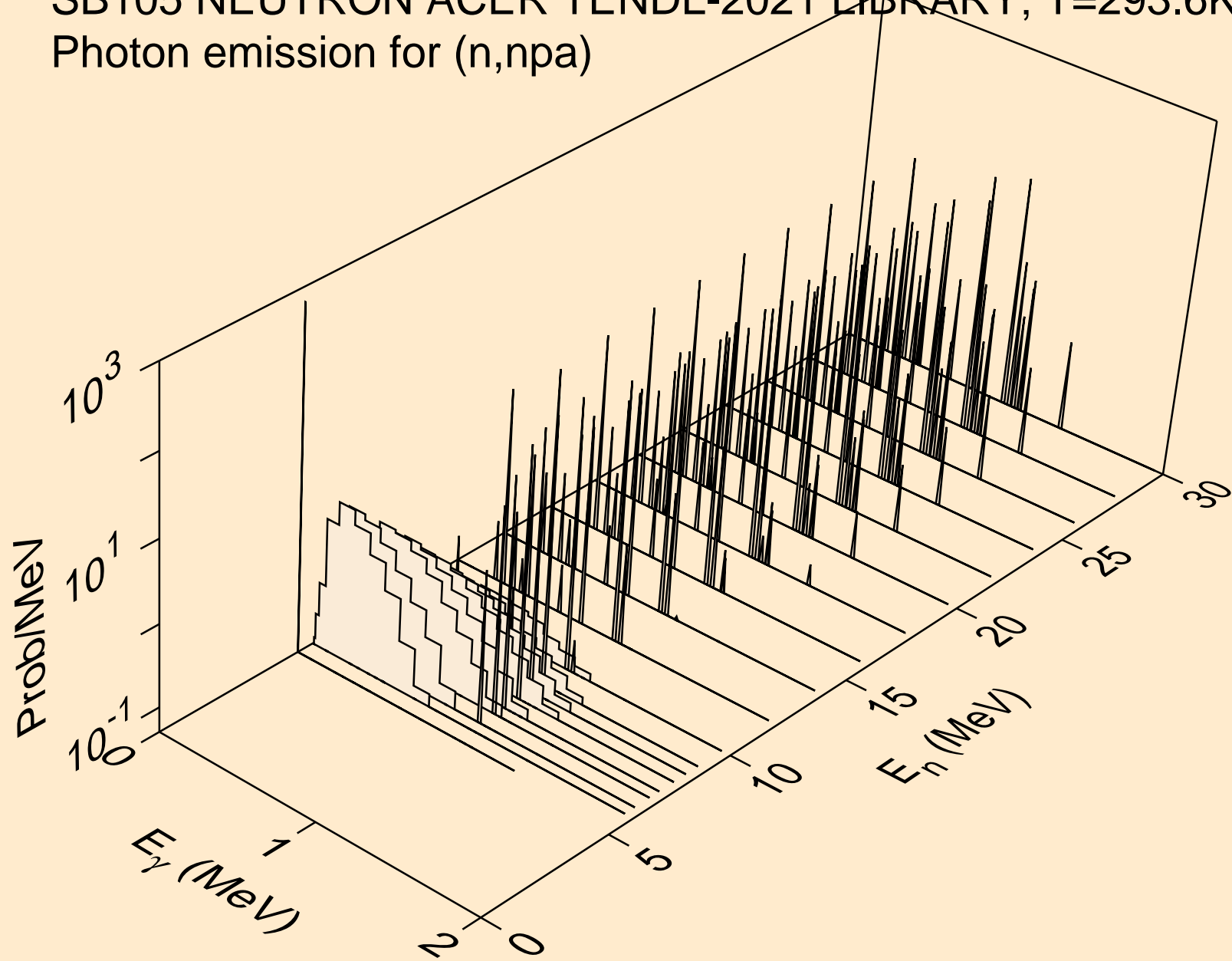

SB105 NEUTRON ACER TENDL-2021 LIBRARY; T=293.6K
Photon emission for (n,n*c)

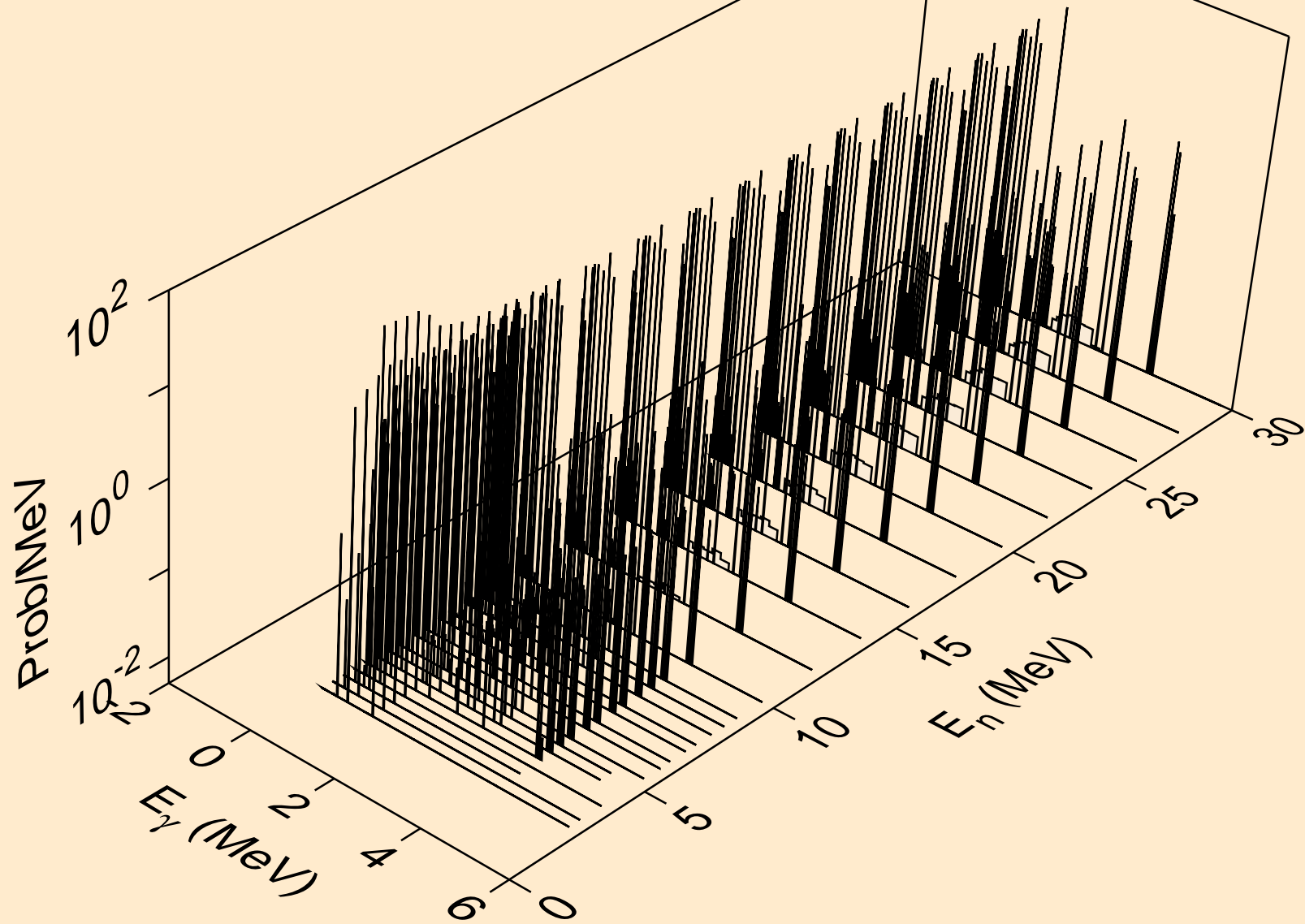

SB105 NEUTRON ACER TENDL-2021 LIBRARY; T=293.6K
Photon emission for (n,gma)

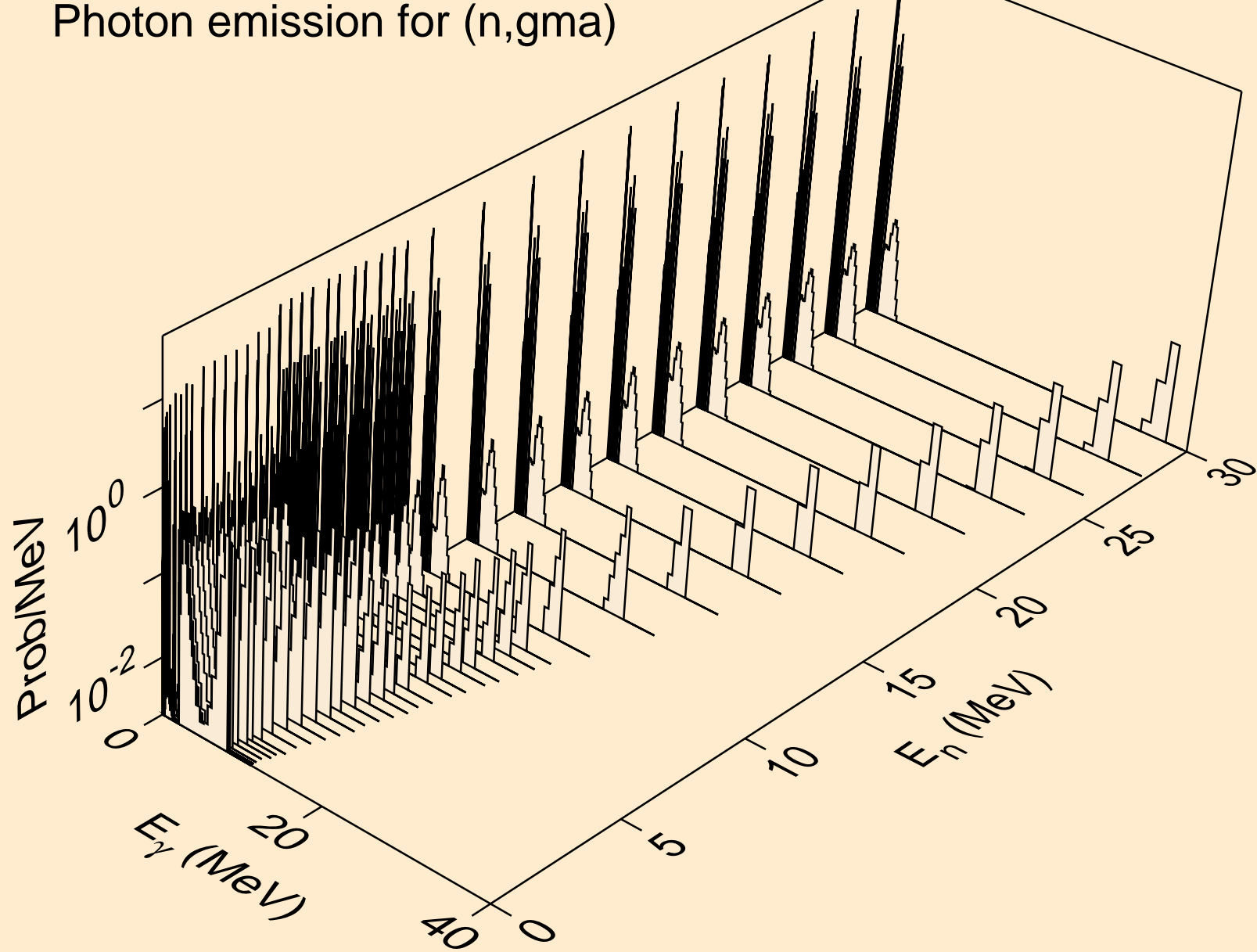

SB105 NEUTRON ACER TENDL-2021 LIBRARY; T=293.6K
Photon emission for (n,p)

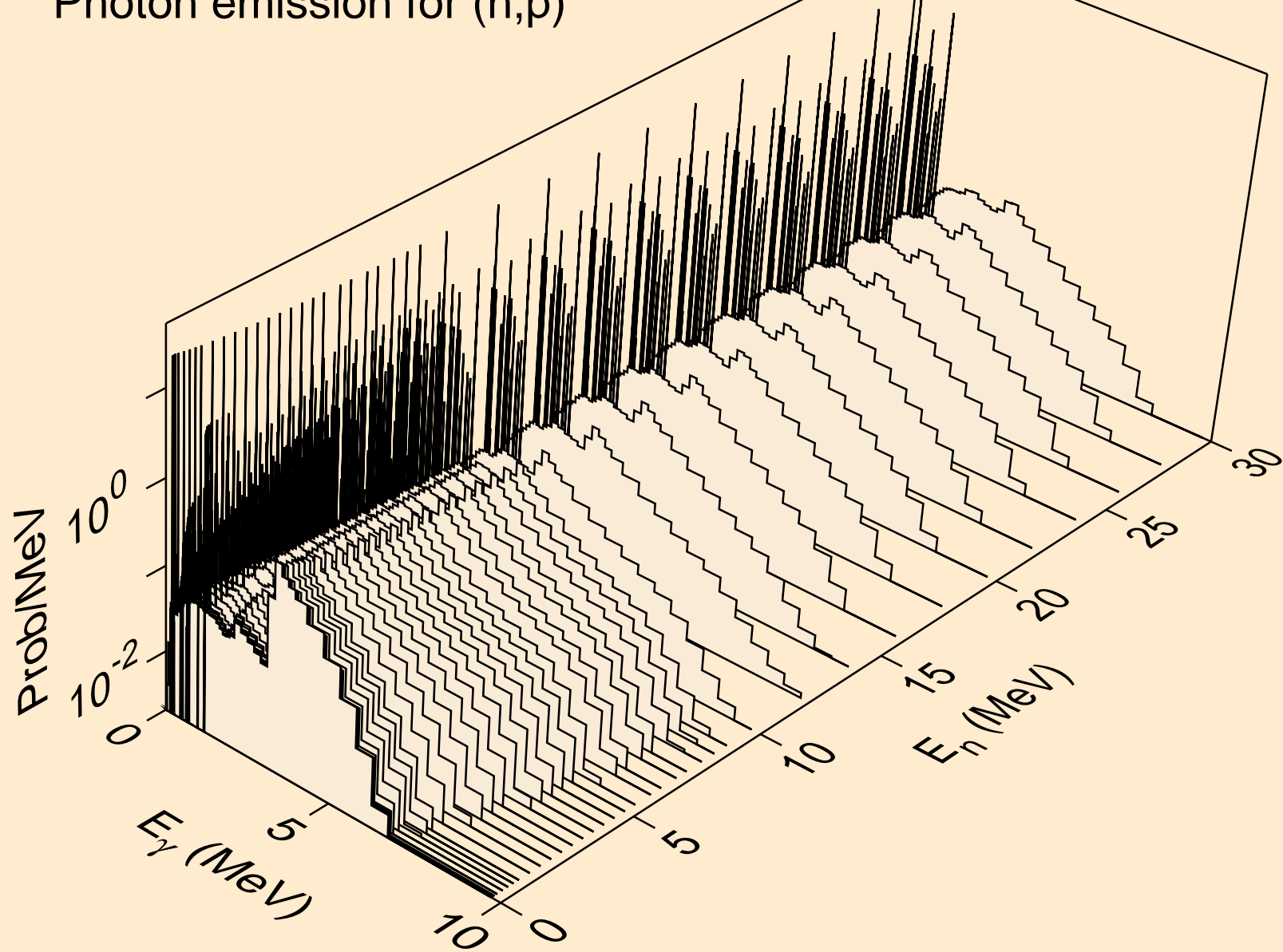

SB105 NEUTRON ACER TENDL-2021 LIBRARY; T=293.6K
Photon emission for (n,d)

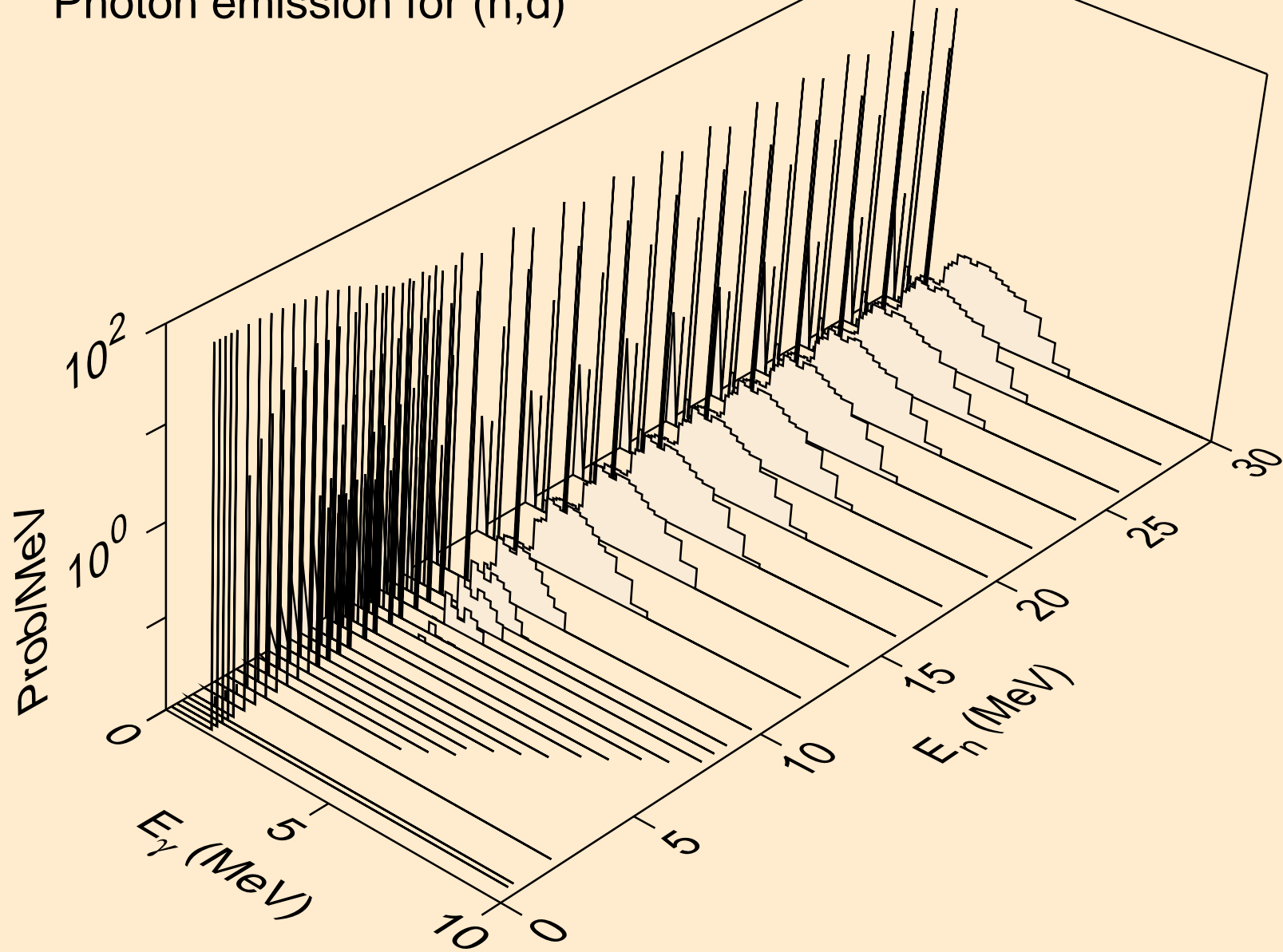

SB105 NEUTRON ACER TENDL-2021 LIBRARY; T=293.6K
Photon emission for (n,t)

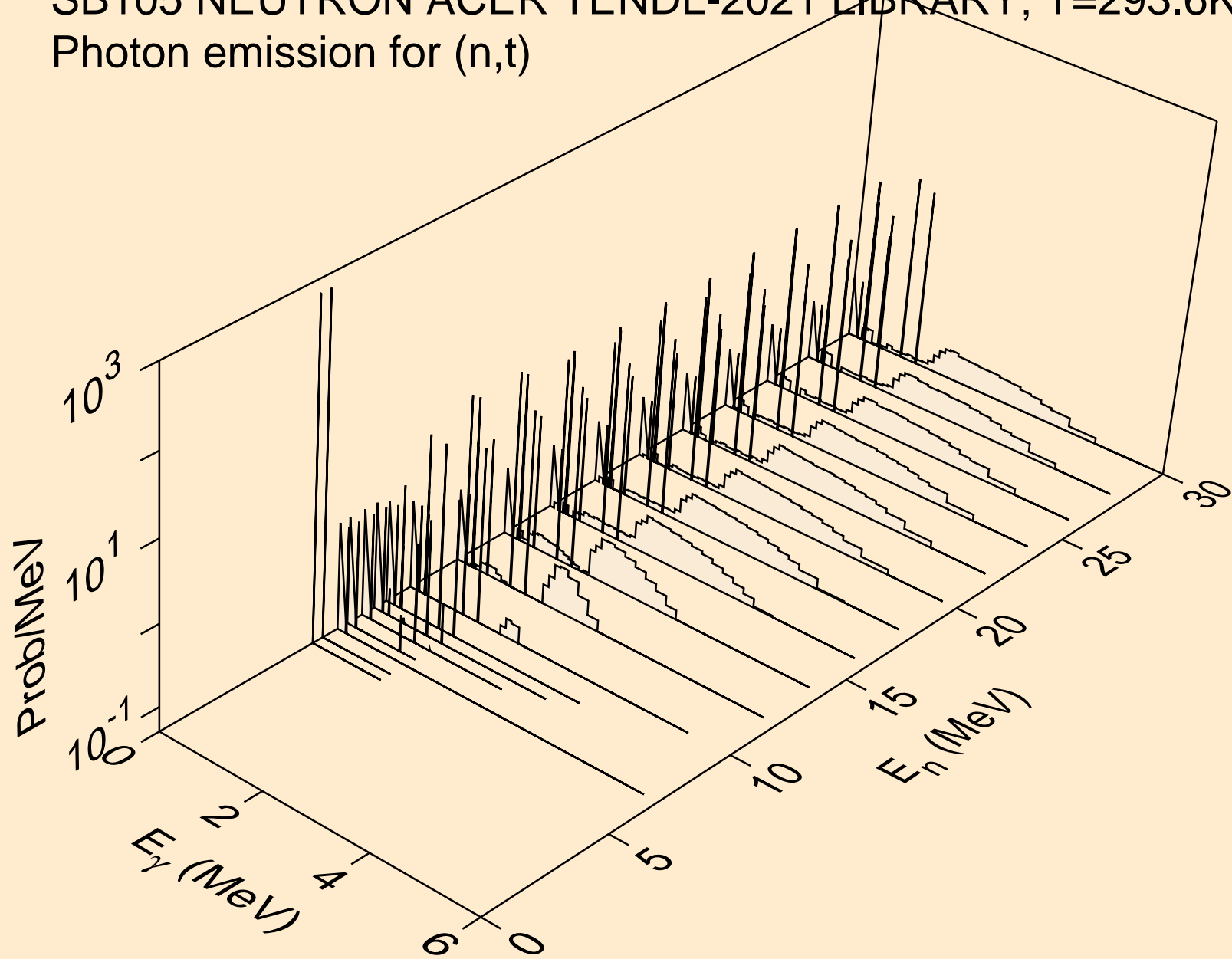

SB105 NEUTRON ACER TENDL-2021 LIBRARY; T=293.6K
Photon emission for (n,he3)

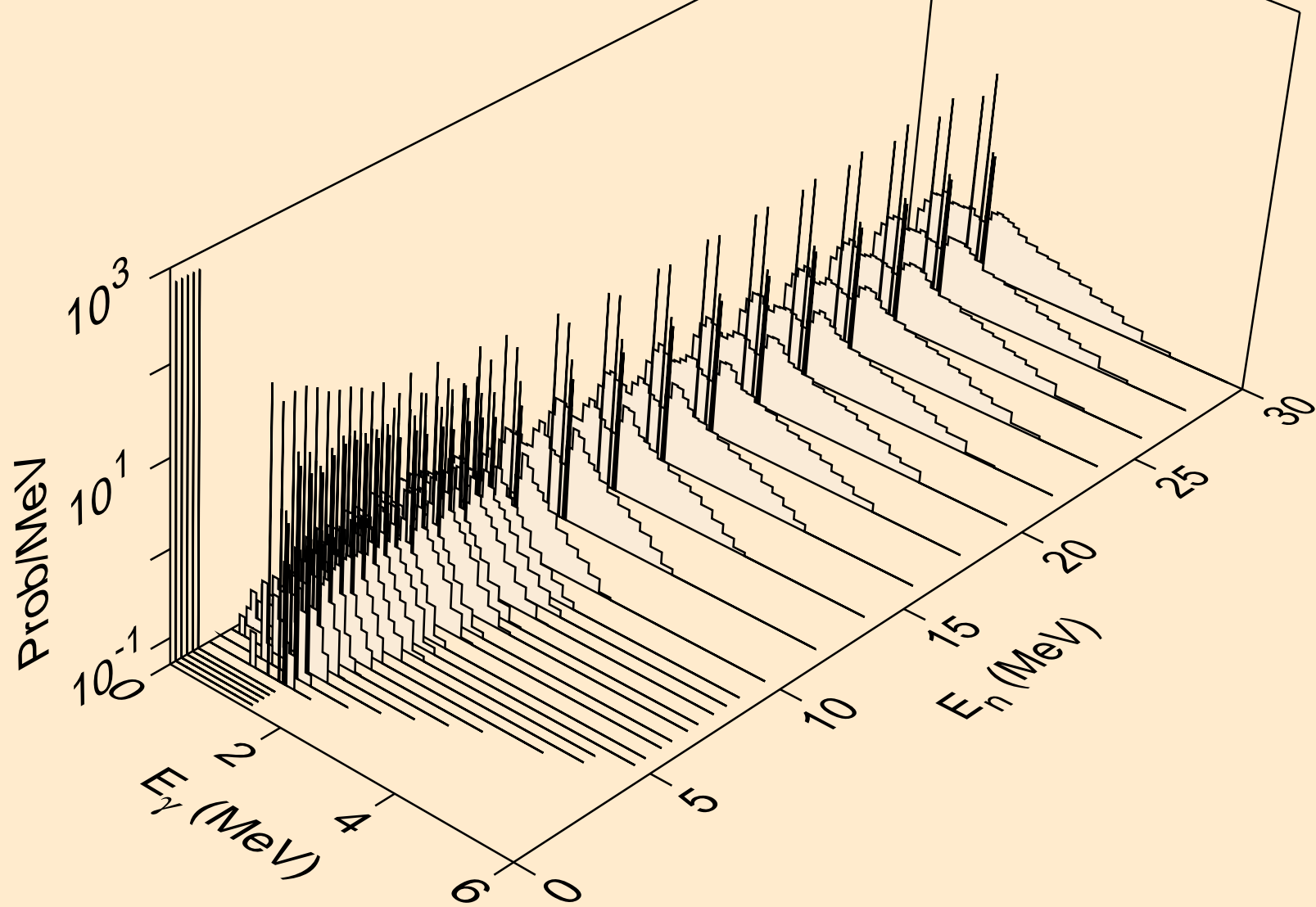

SB105 NEUTRON ACER TENDL-2021 LIBRARY; T=293.6K
Photon emission for (n,a)

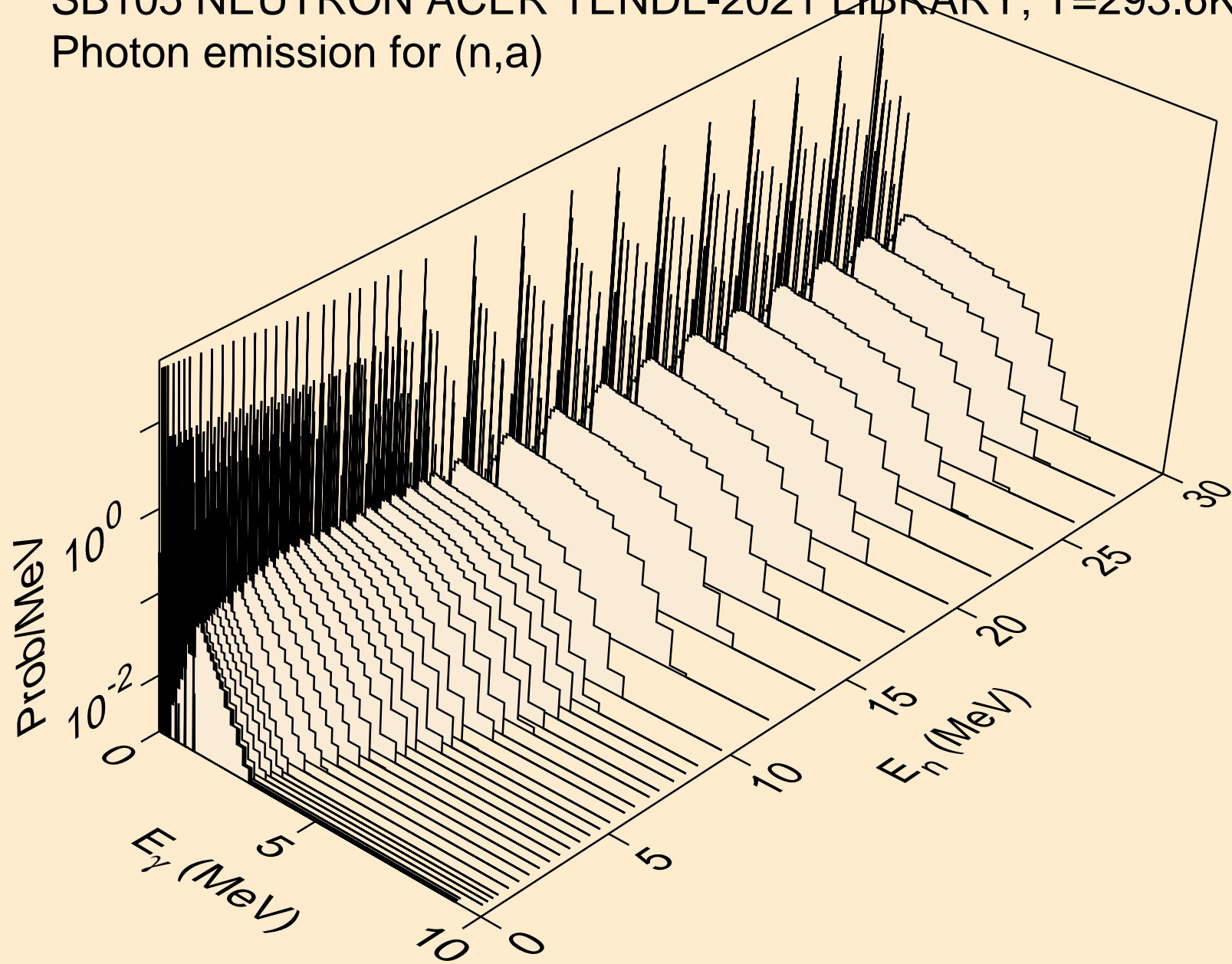

SB105 NEUTRON ACER TENDL-2021 LIBRARY; T=293.6K
Photon emission for (n,2a)

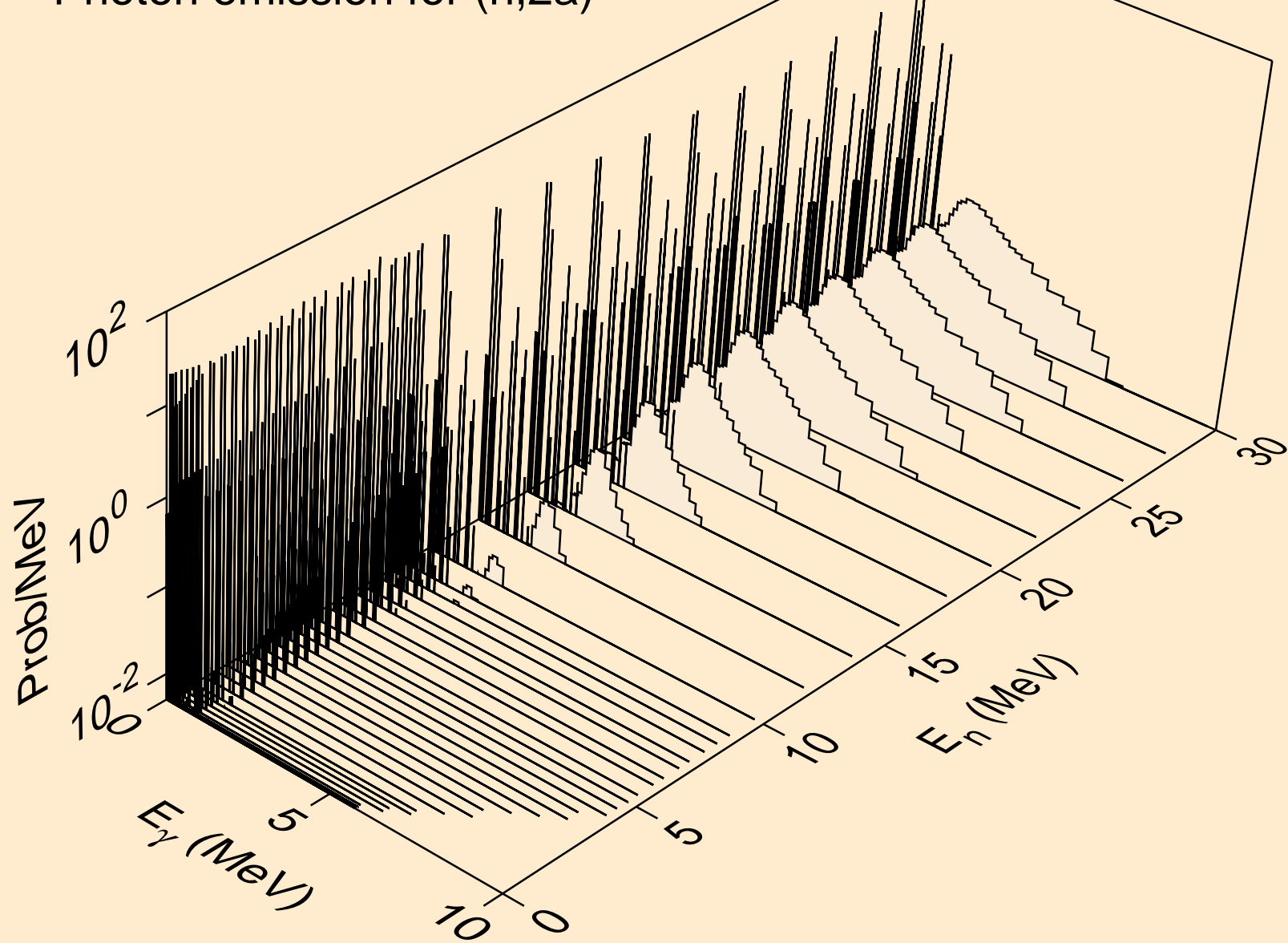

SB105 NEUTRON ACER TENDL-2021 LIBRARY; T=293.6K
Photon emission for (n,3a)

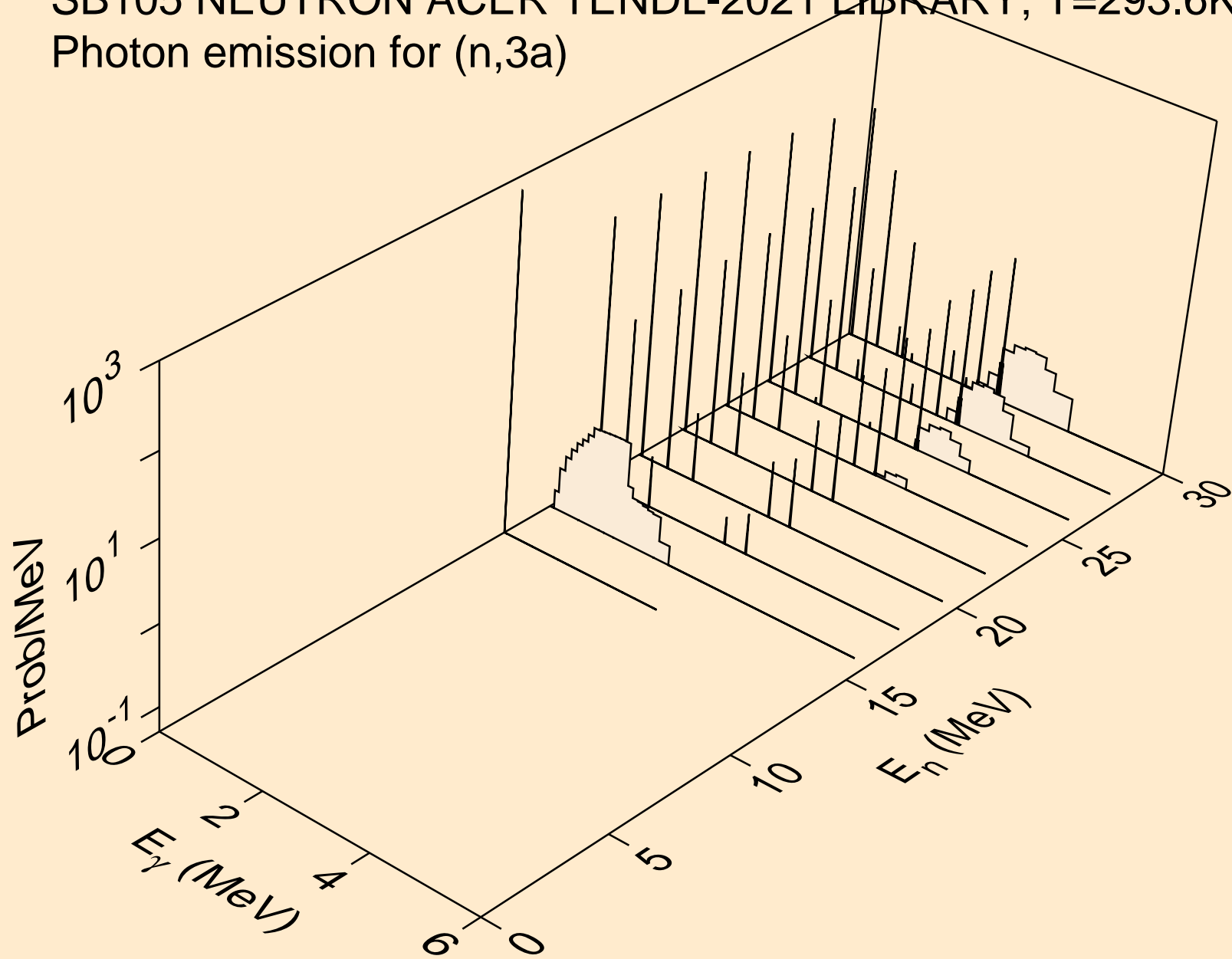

SB105 NEUTRON ACER TENDL-2021 LIBRARY; T=293.6K
Photon emission for (n,2p)

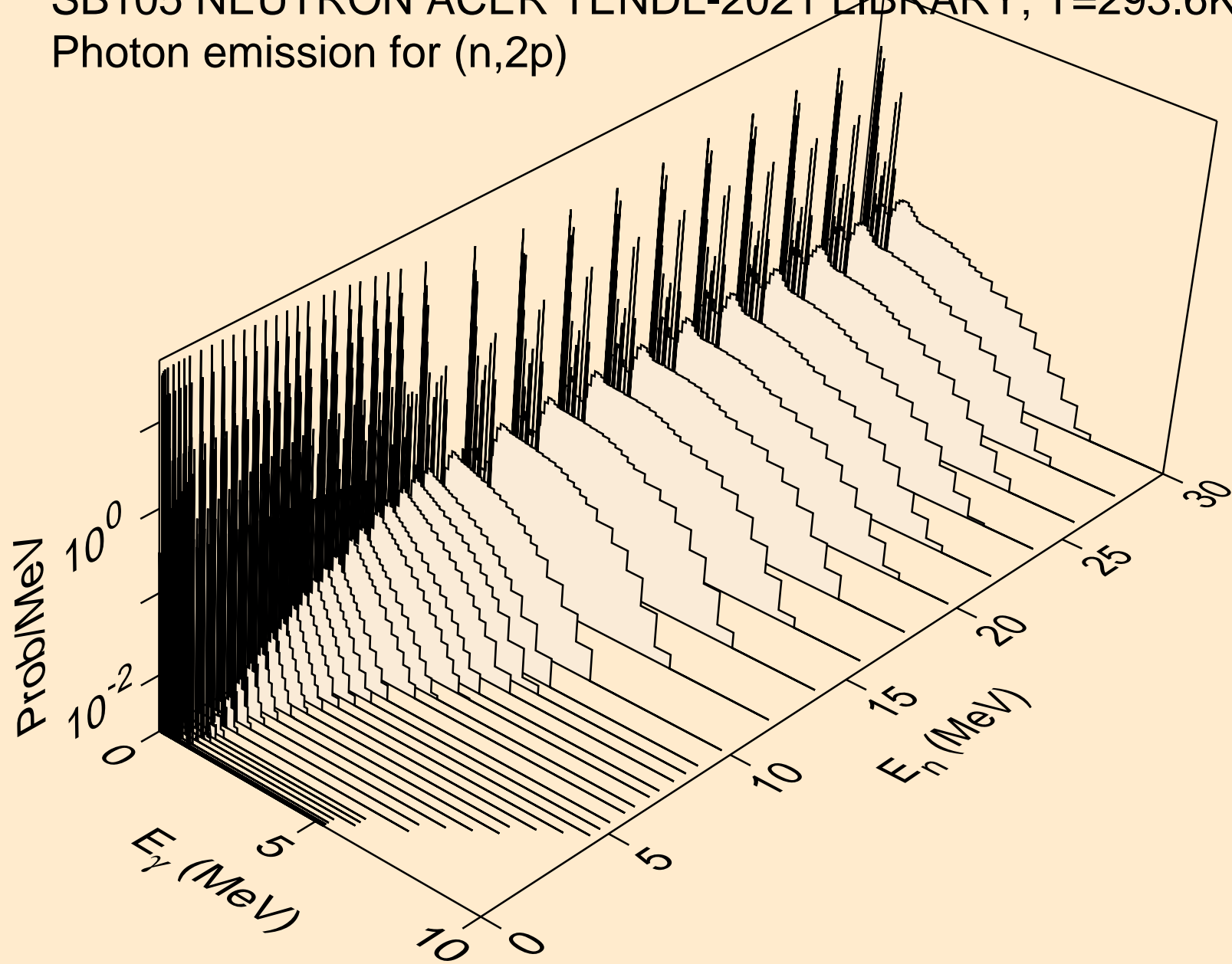

SB105 NEUTRON ACER TENDL-2021 LIBRARY; T=293.6K
Photon emission for (n,p α)

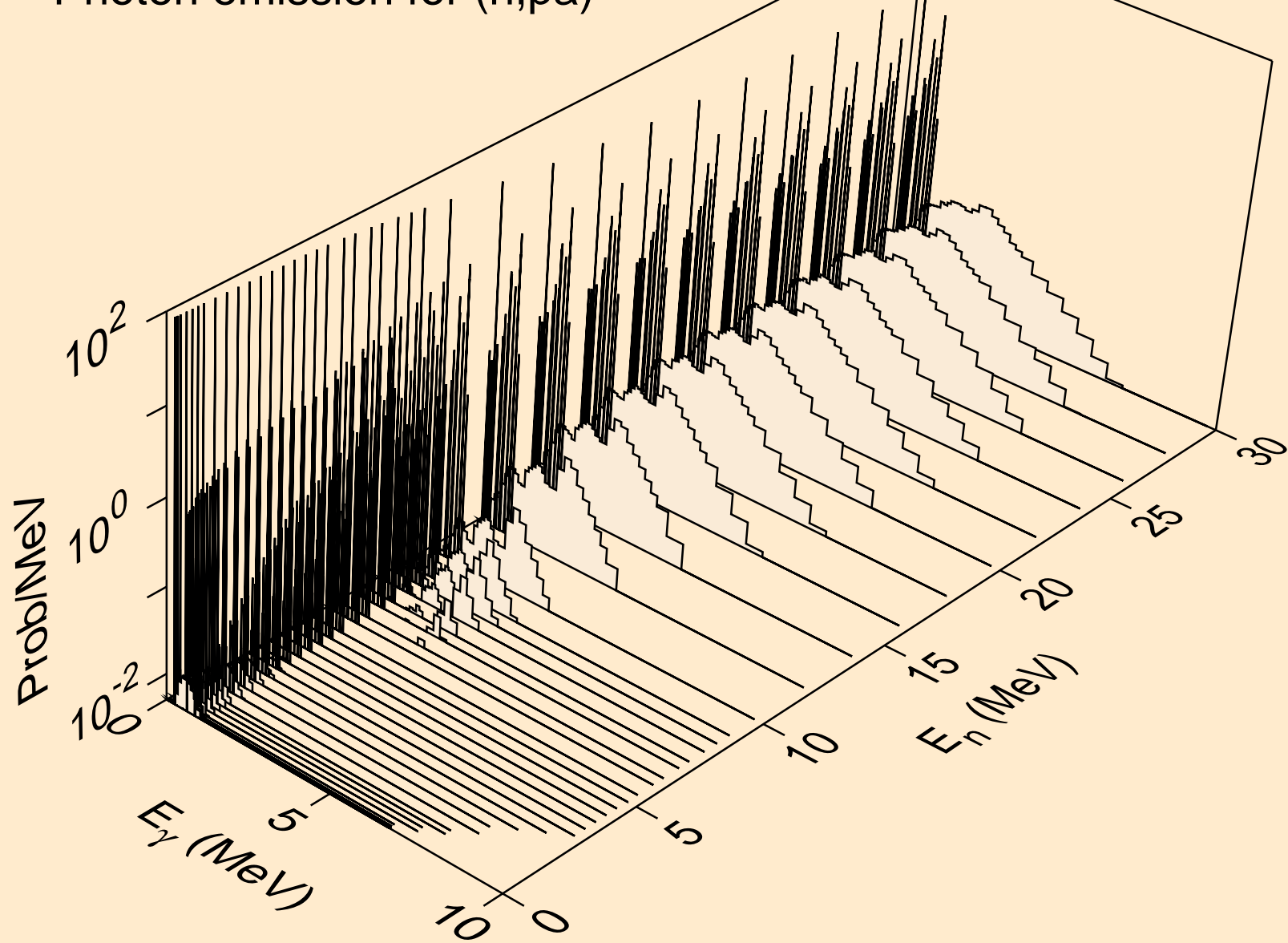

SB105 NEUTRON ACER TENDL-2021 LIBRARY; T=293.6K
Photon emission for (n,d2a)

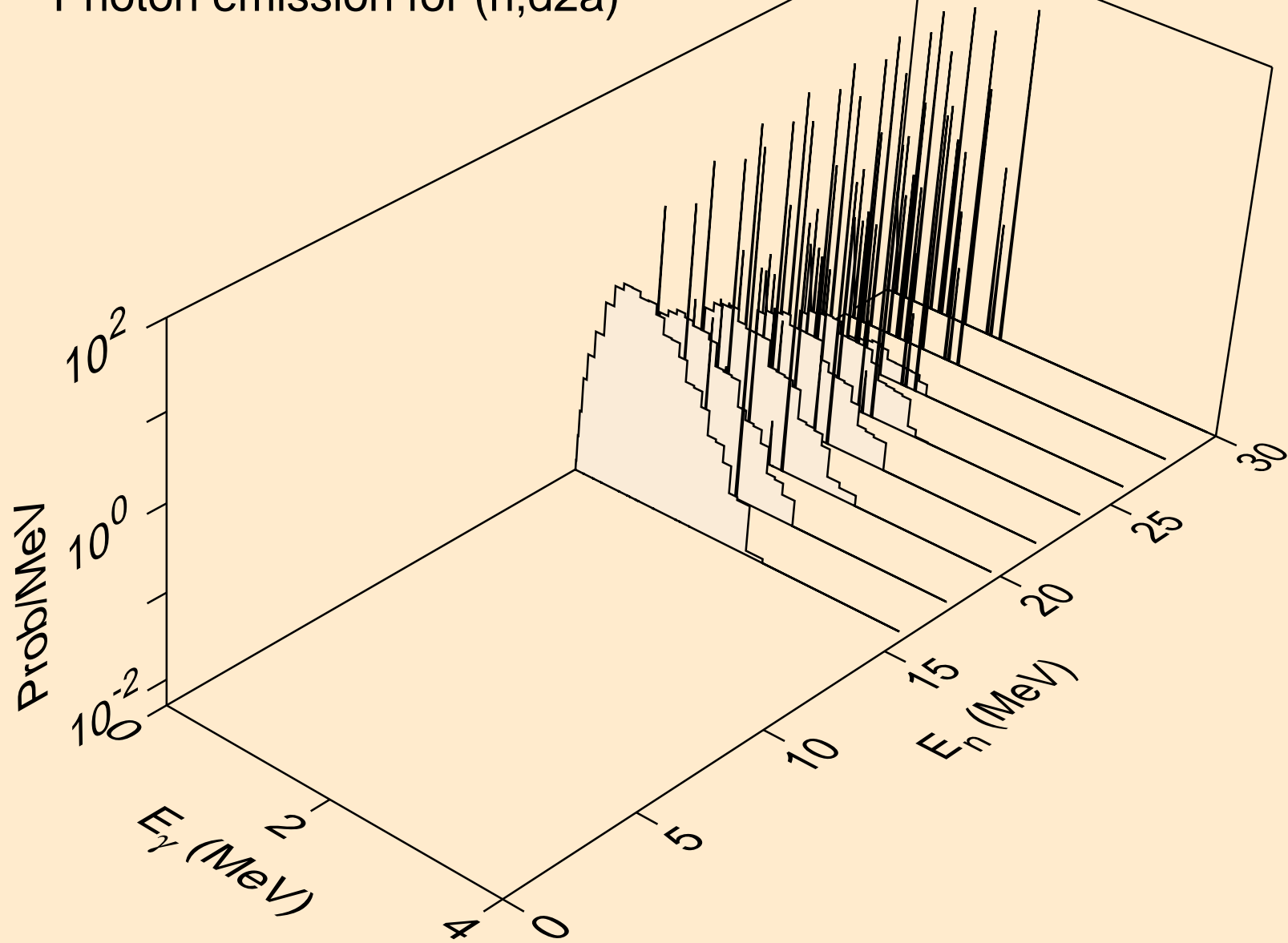

SB105 NEUTRON ACER TENDL-2021 LIBRARY; T=293.6K
Photon emission for (n,pd)

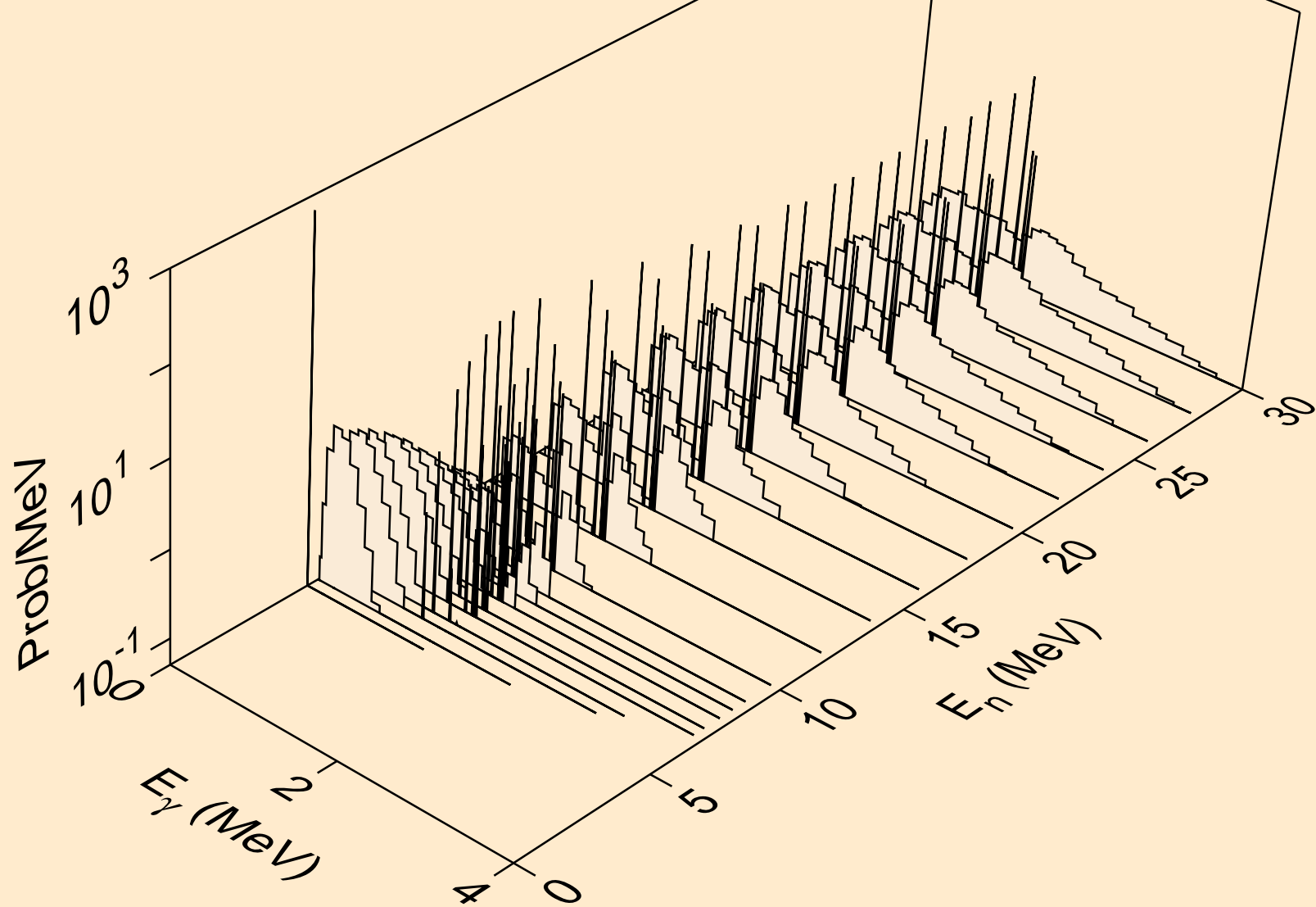

SB105 NEUTRON ACER TENDL-2021 LIBRARY; T=293.6K
Photon emission for (n,pt)

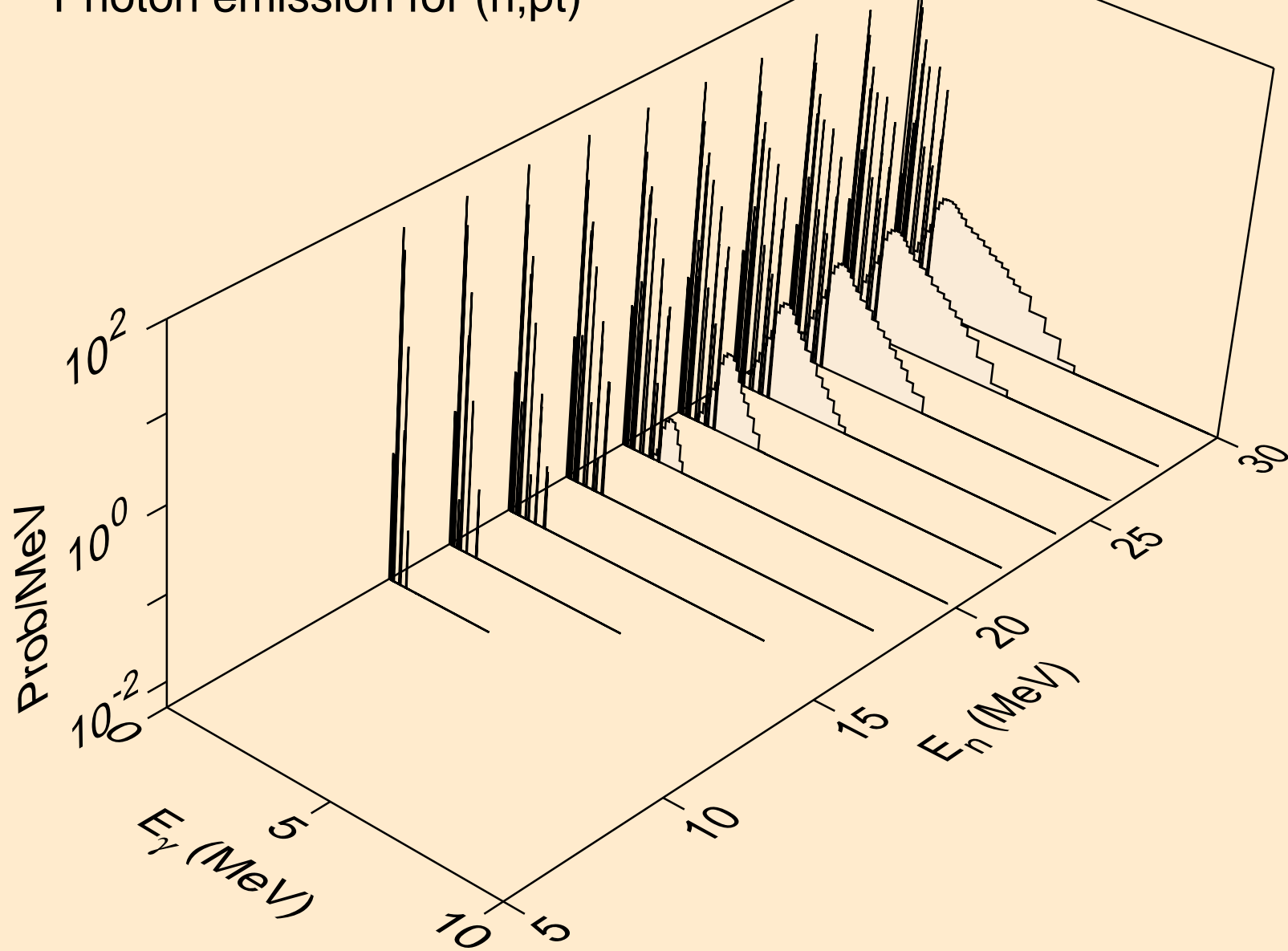

SB105 NEUTRON ACER TENDL-2021 LIBRARY; T=293.6K
Photon emission for (n,da)

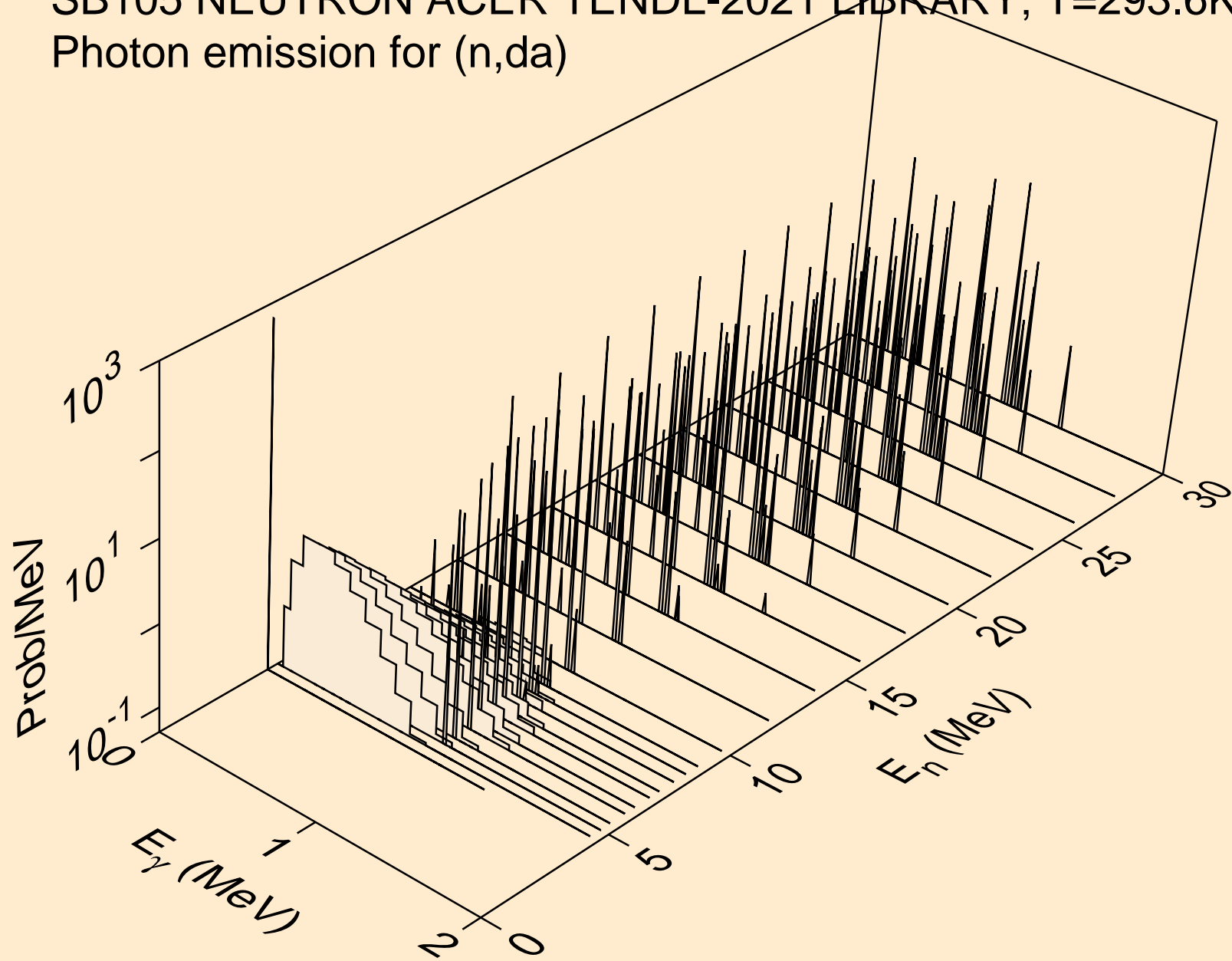

SB105 NEUTRON ACER TENDL-2021 LIBRARY; T=293.6K
thermal capture photon spectrum

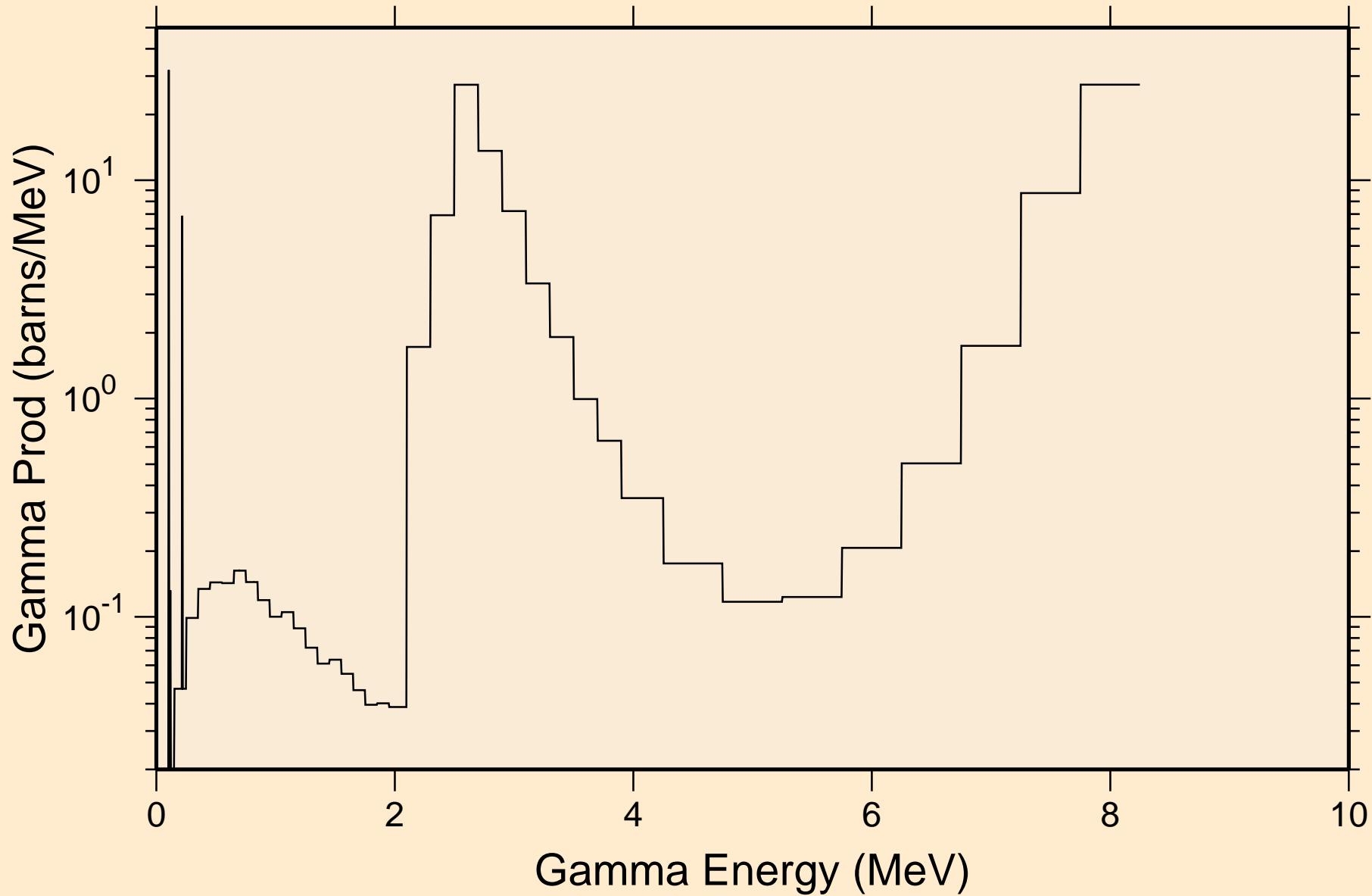

SB105 NEUTRON ACER TENDL-2021 LIBRARY; T=293.6K
14 MeV photon spectrum

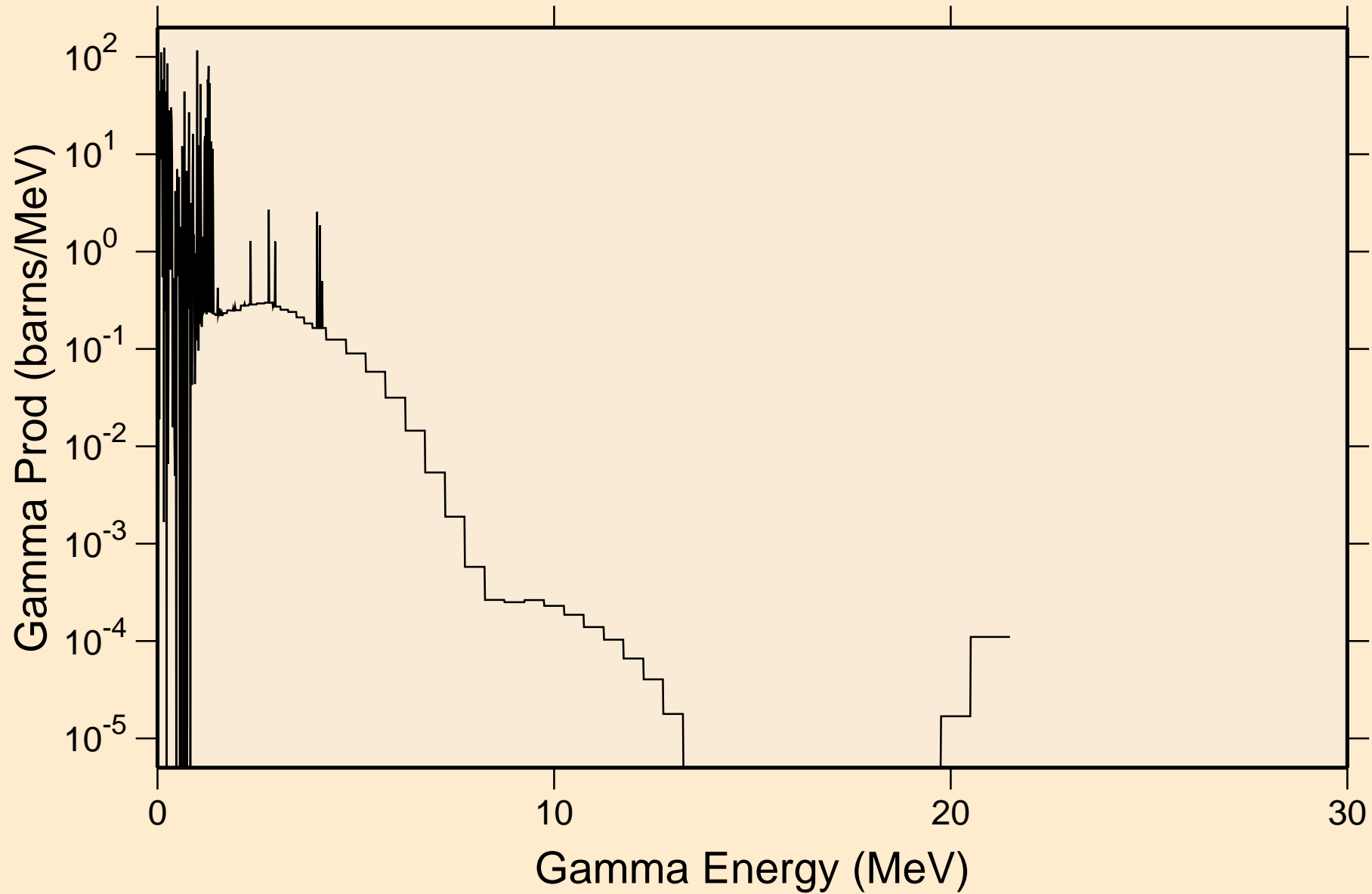

SB105 NEUTRON ACER TENDL-2021 LIBRARY; T=293.6K

Particle heating contributions

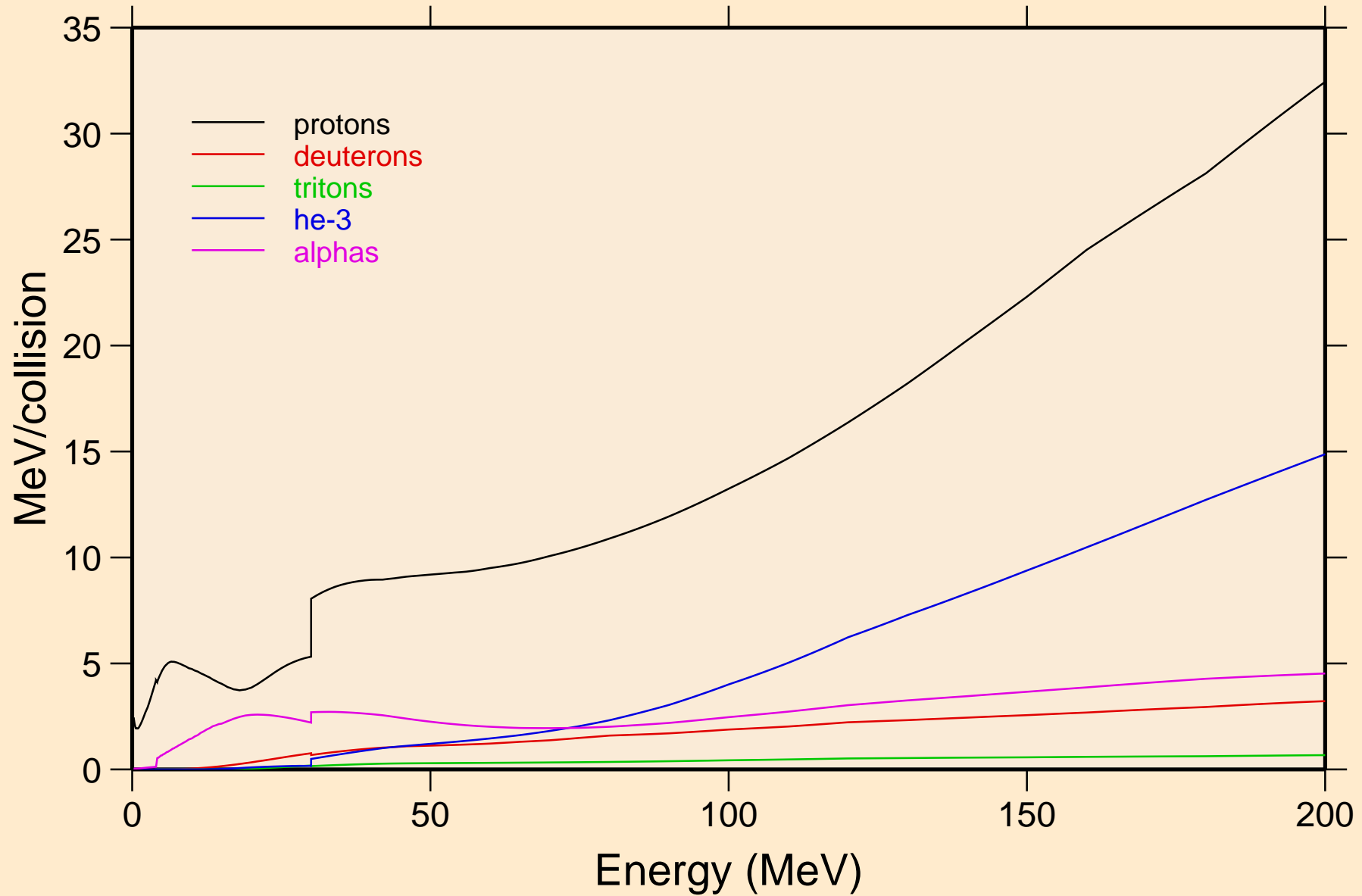

SB105 NEUTRON ACER TENDL-2021 LIBRARY; T=293.6K
Recoil Heating

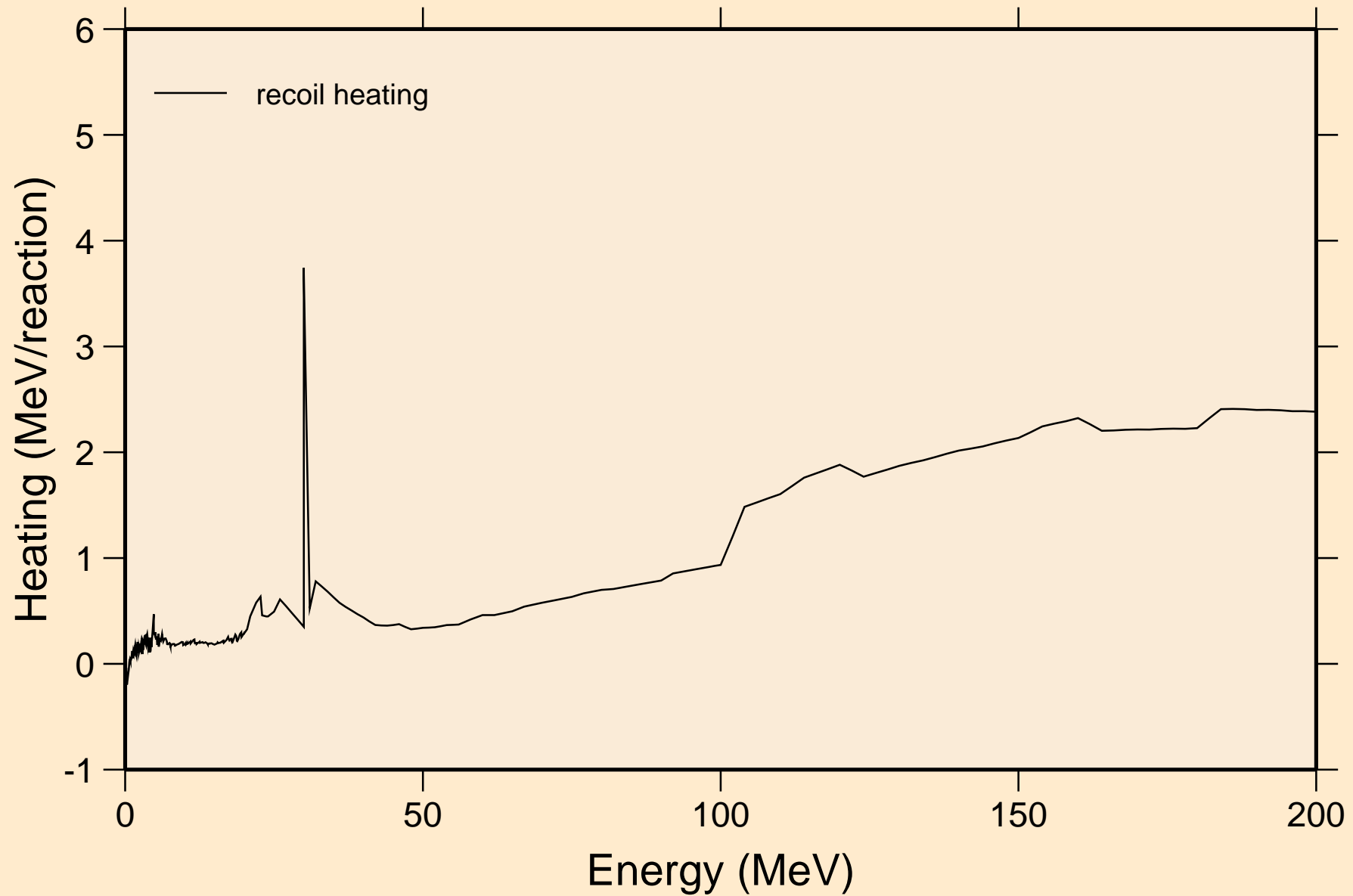

SB105 NEUTRON ACER TENDL-2021 LIBRARY; T=293.6K

Particle production cross sections

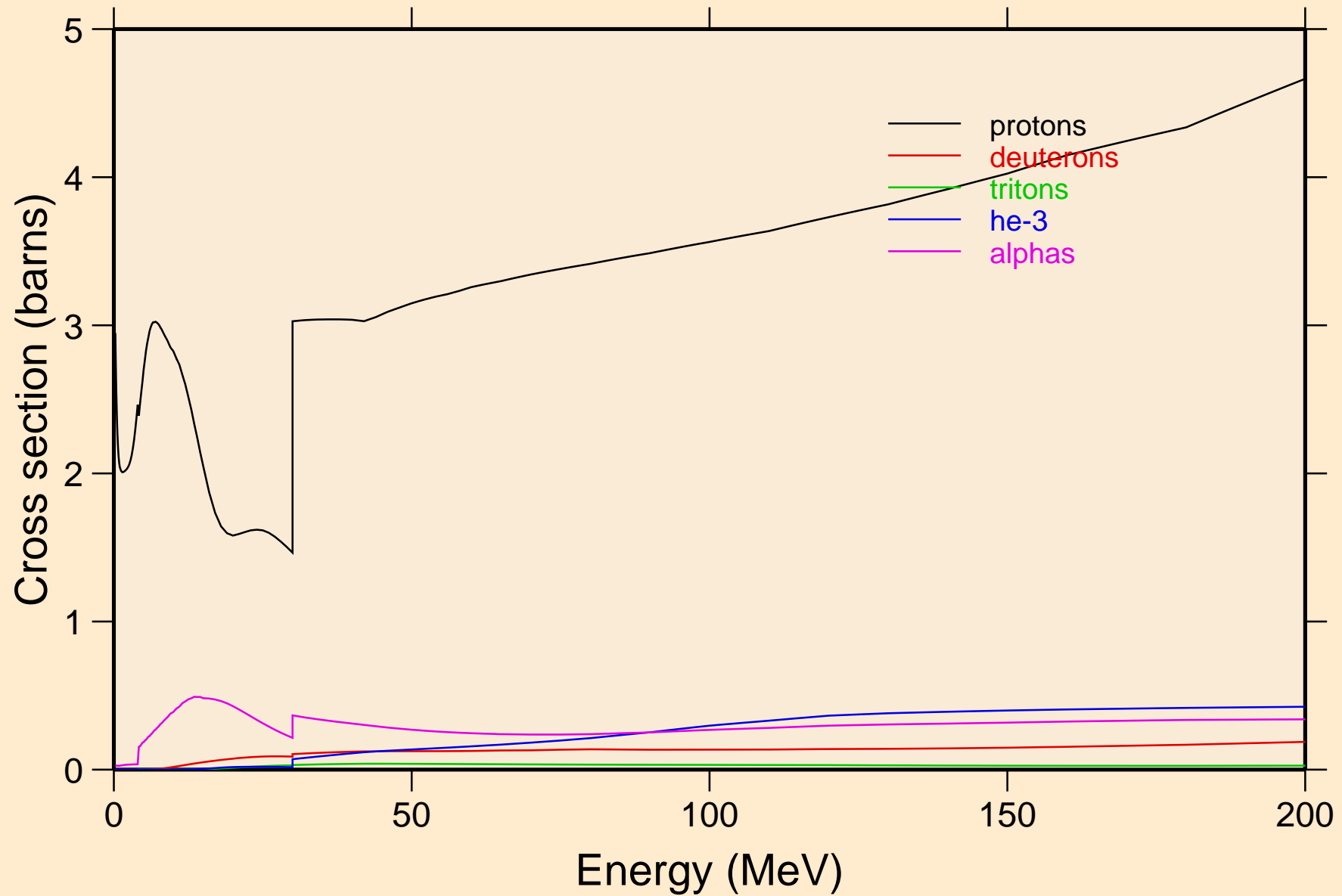

SB105 NEUTRON ACER TENDL-2021 LIBRARY; T=293.6K
protons from (n,x)

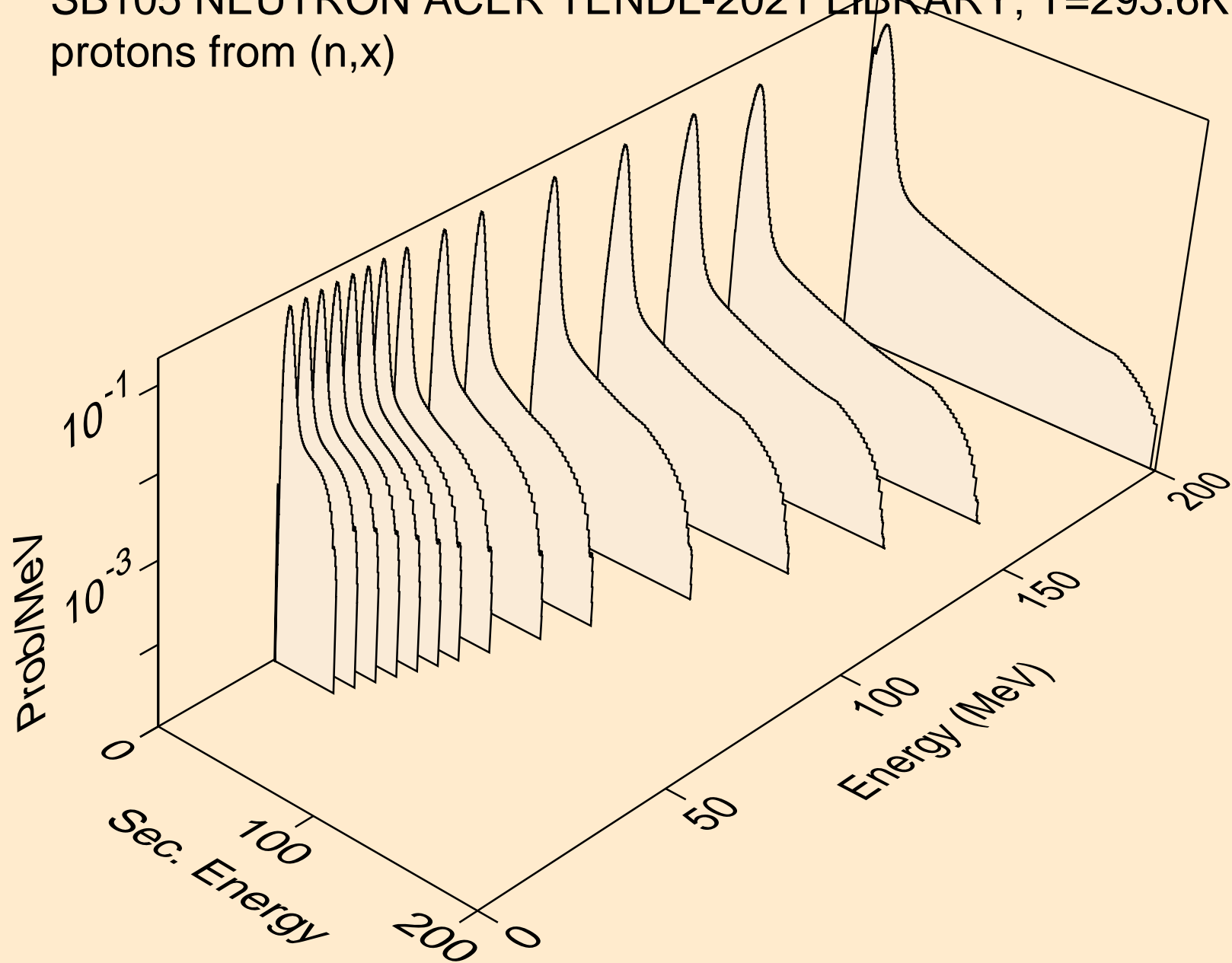

SB105 NEUTRON ACER TENDL-2021 LIBRARY; T=293.6K
protons from (n,n*)p

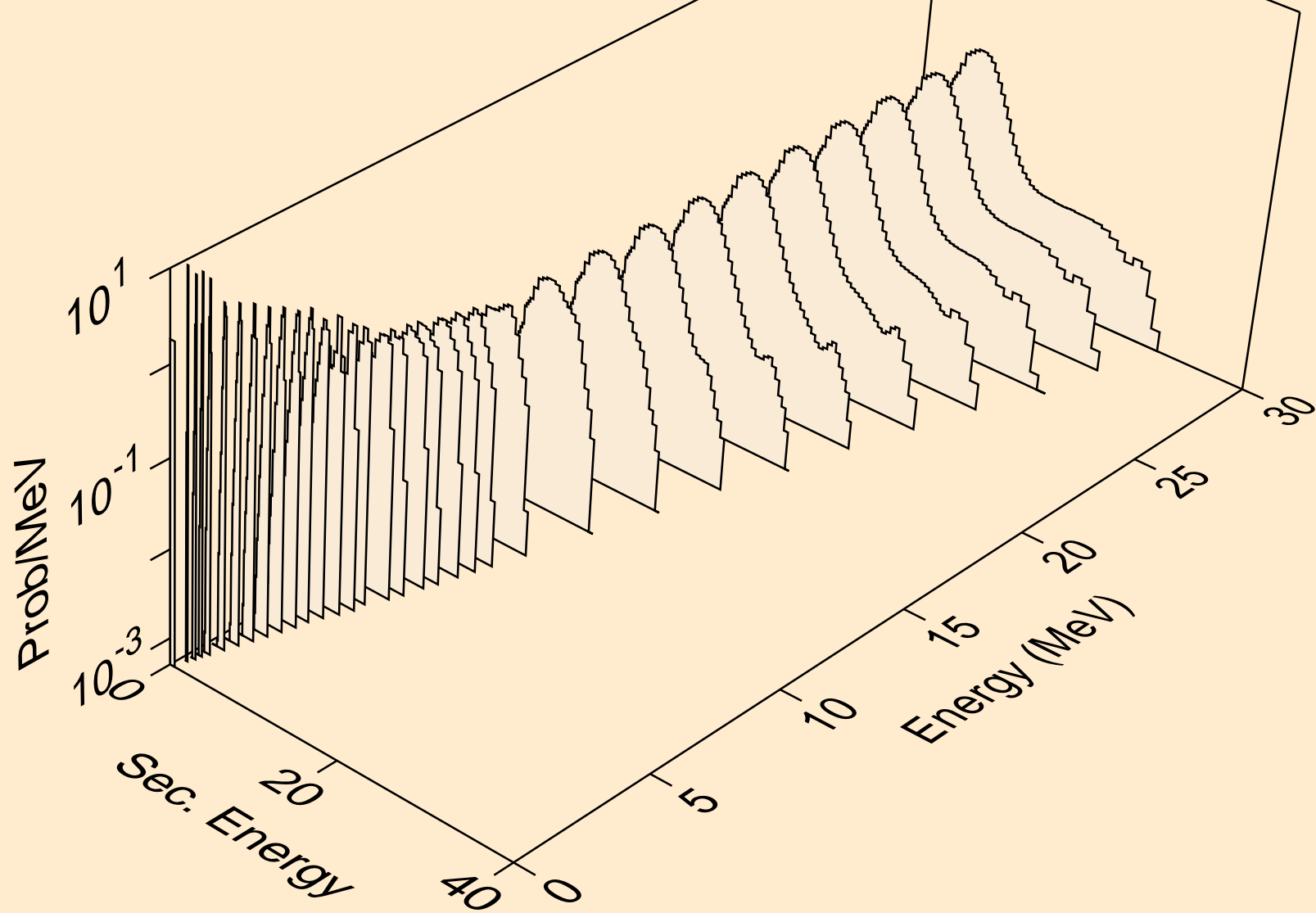

SB105 NEUTRON ACER TENDL-2021 LIBRARY; T=293.6K
protons from (n,2np)

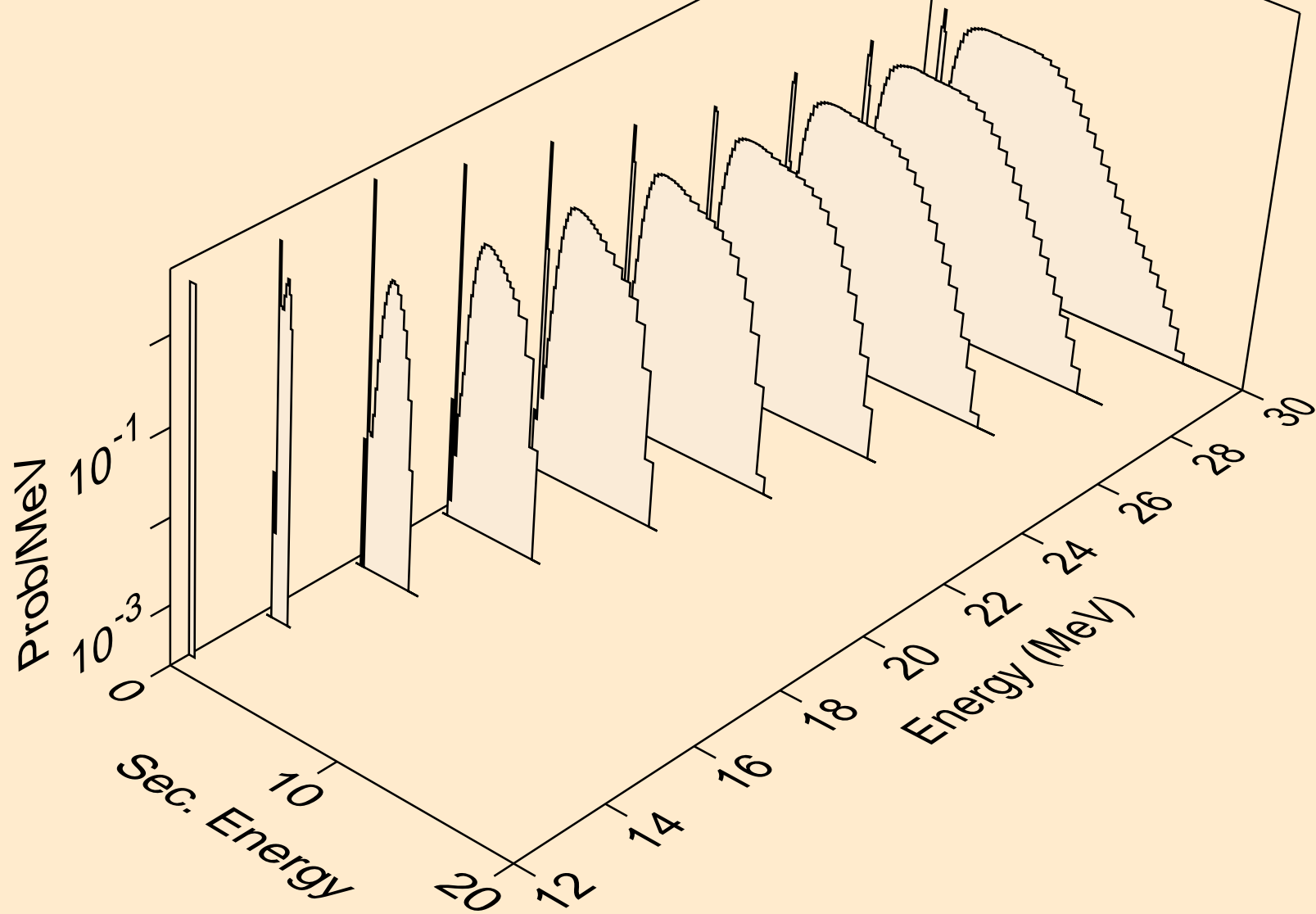

SB105 NEUTRON ACER TENDL-2021 LIBRARY; T=293.6K
protons from (n,3np)

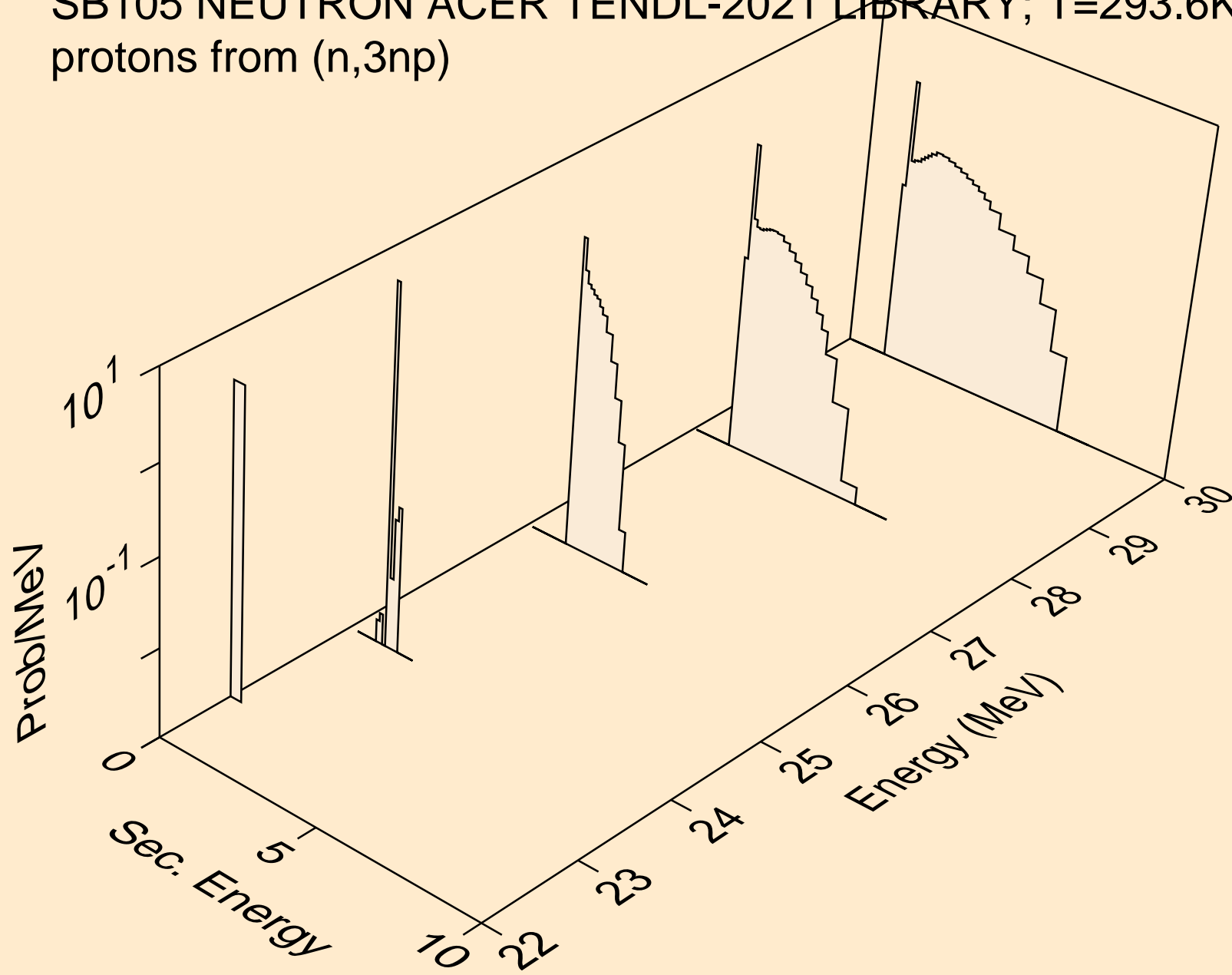

SB105 NEUTRON ACER TENDL-2021 LIBRARY; T=293.6K
protons from (n,2np)

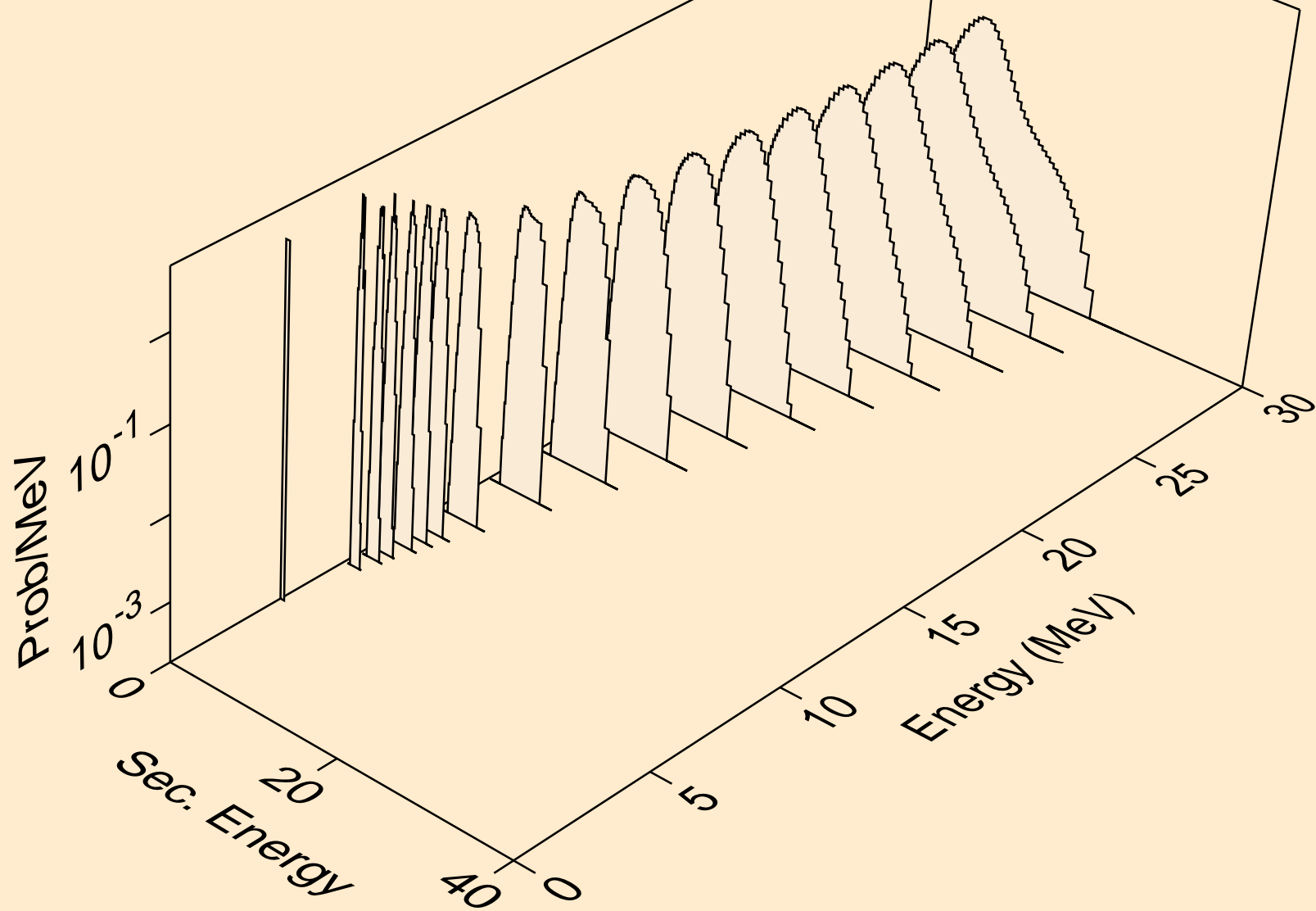

SB105 NEUTRON ACER TENDL-2021 LIBRARY; T=293.6K
protons from (n,npa)

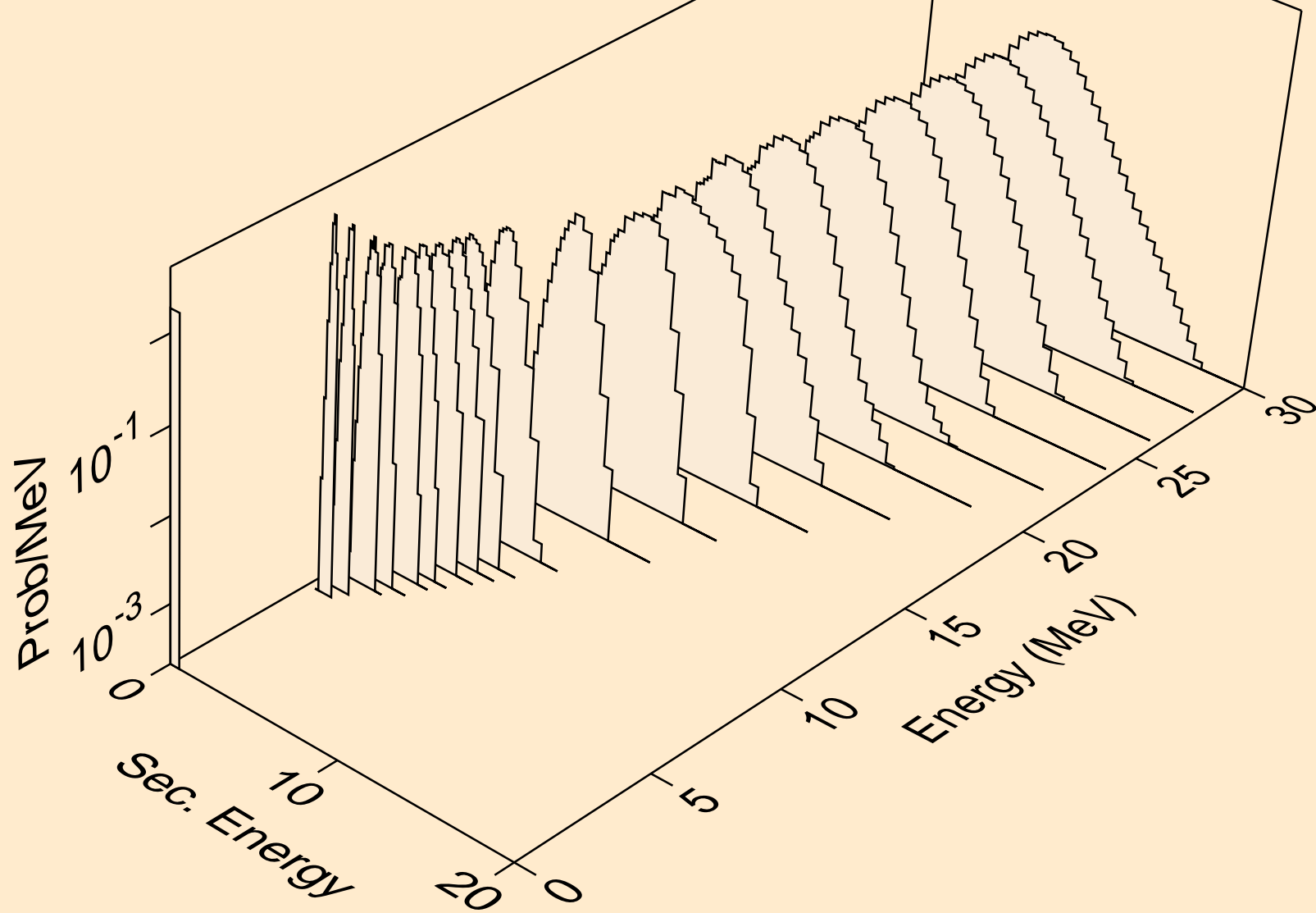

SB105 NEUTRON ACER TENDL-2021 LIBRARY; T=293.6K
protons from (n,p)

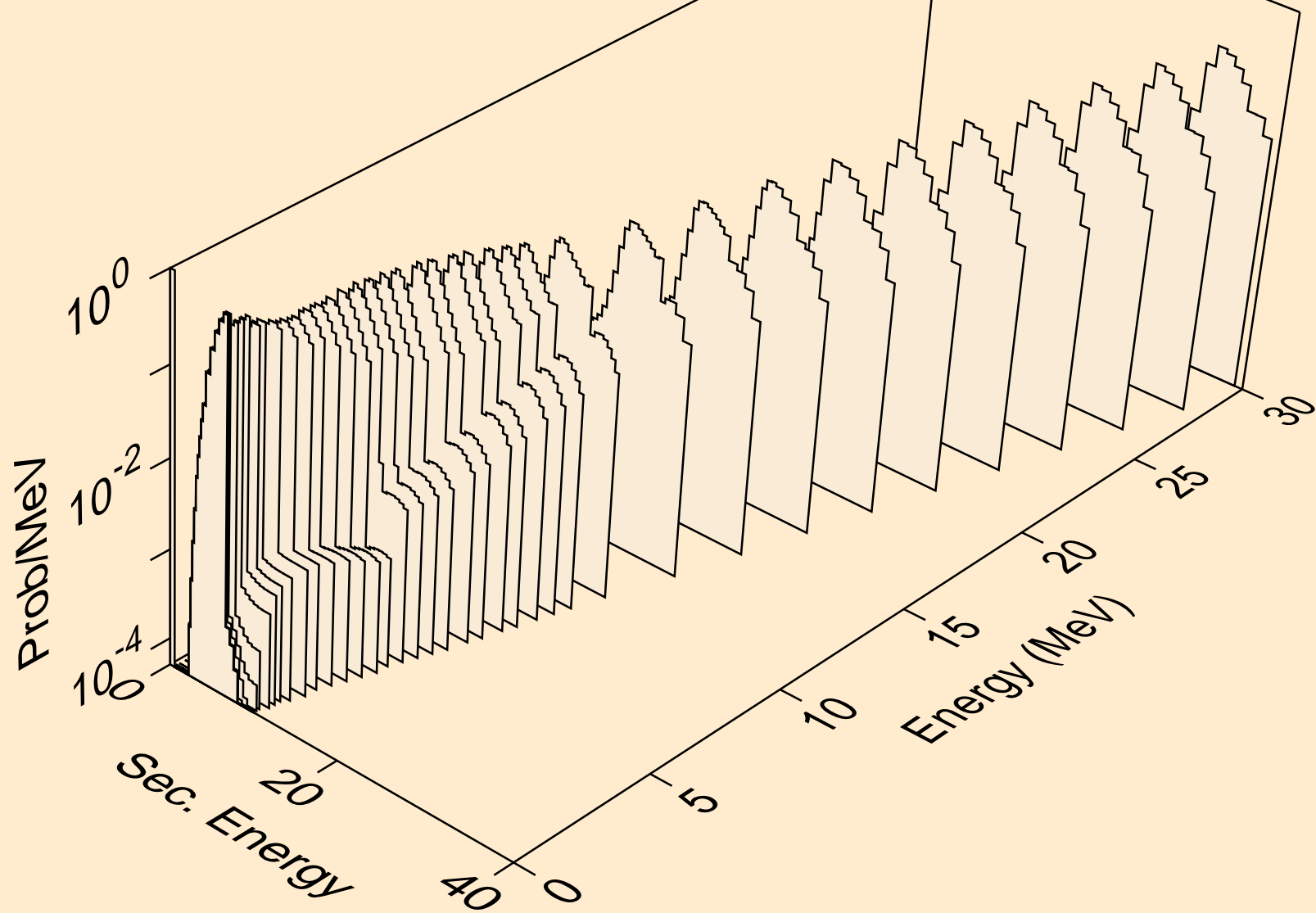

SB105 NEUTRON ACER TENDL-2021 LIBRARY; T=293.6K
protons from (n,2p)

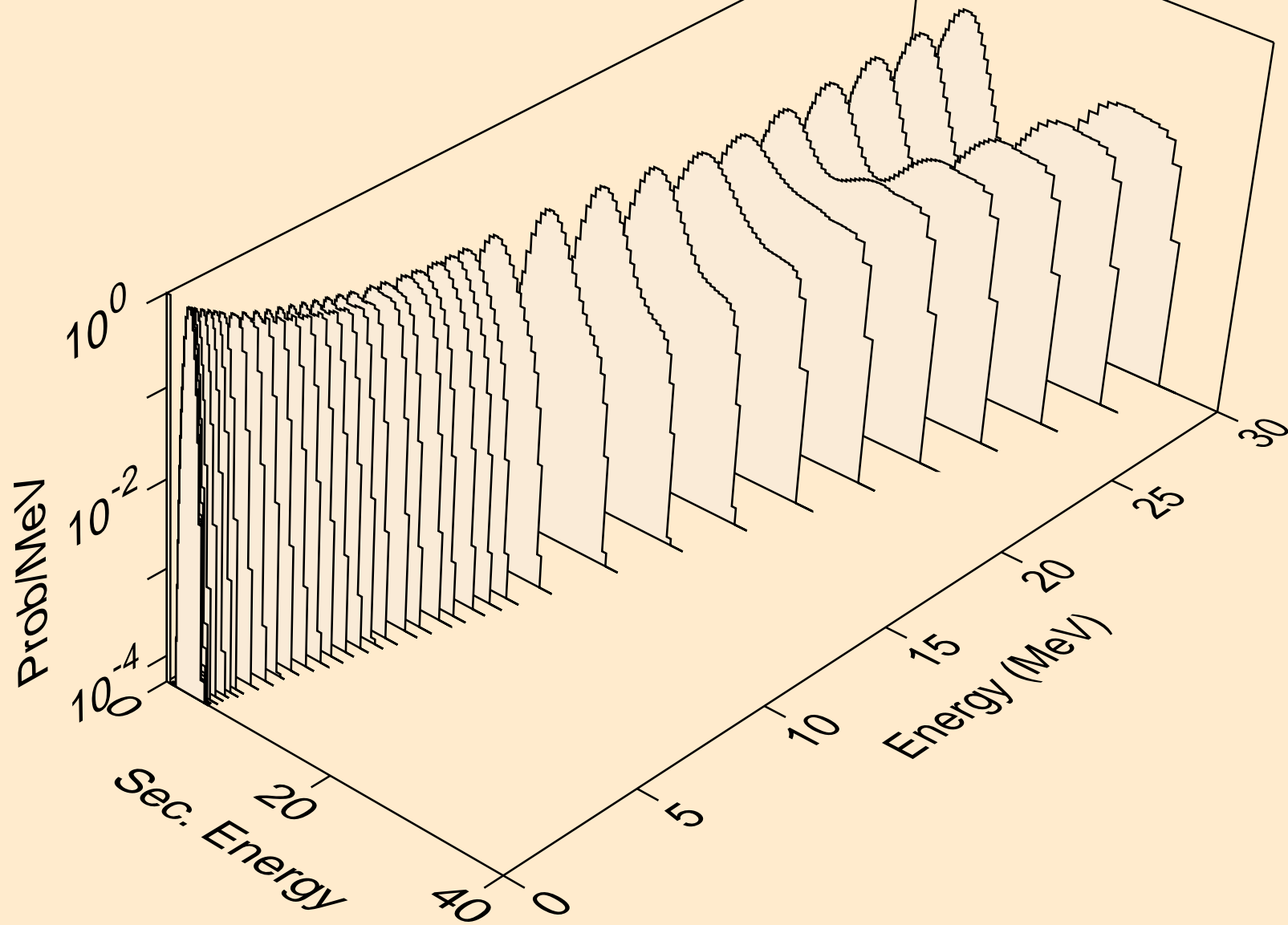

SB105 NEUTRON ACER TENDL-2021 LIBRARY; T=293.6K
protons from (n,p)

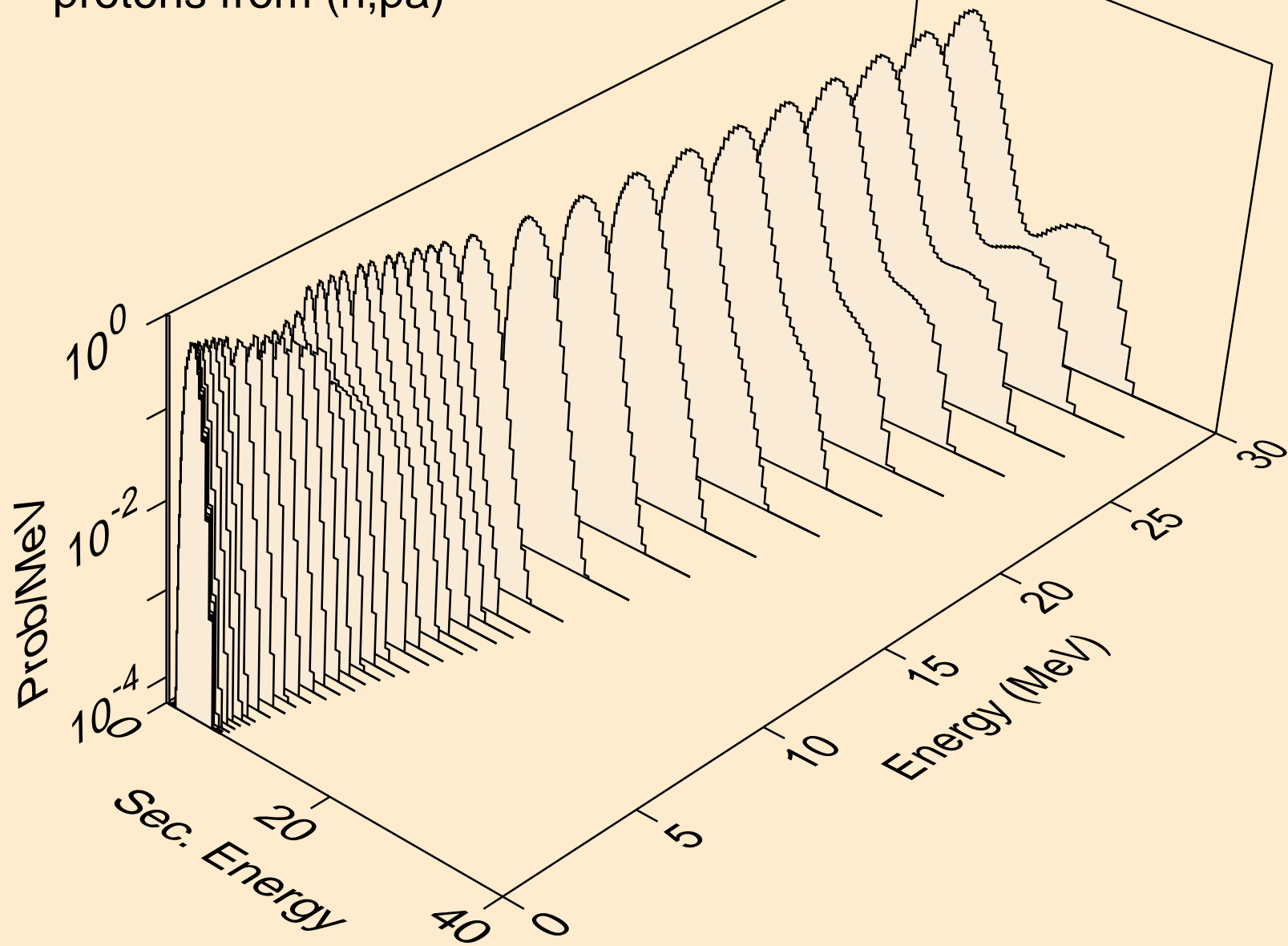

SB105 NEUTRON ACER TENDL-2021 LIBRARY; T=293.6K
protons from (n,pd)

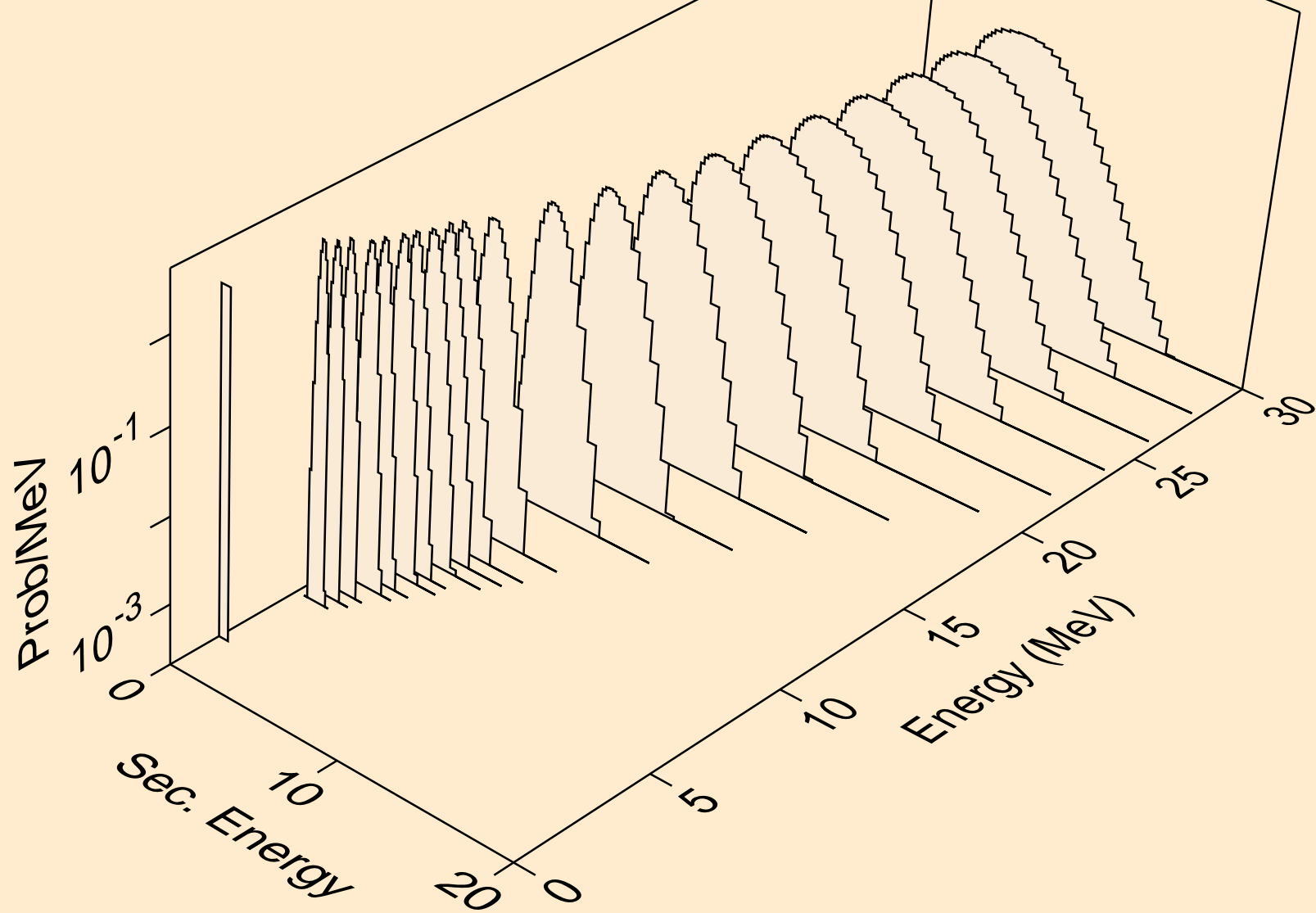

SB105 NEUTRON ACER TENDL-2021 LIBRARY; T=293.6K
protons from (n,pt)

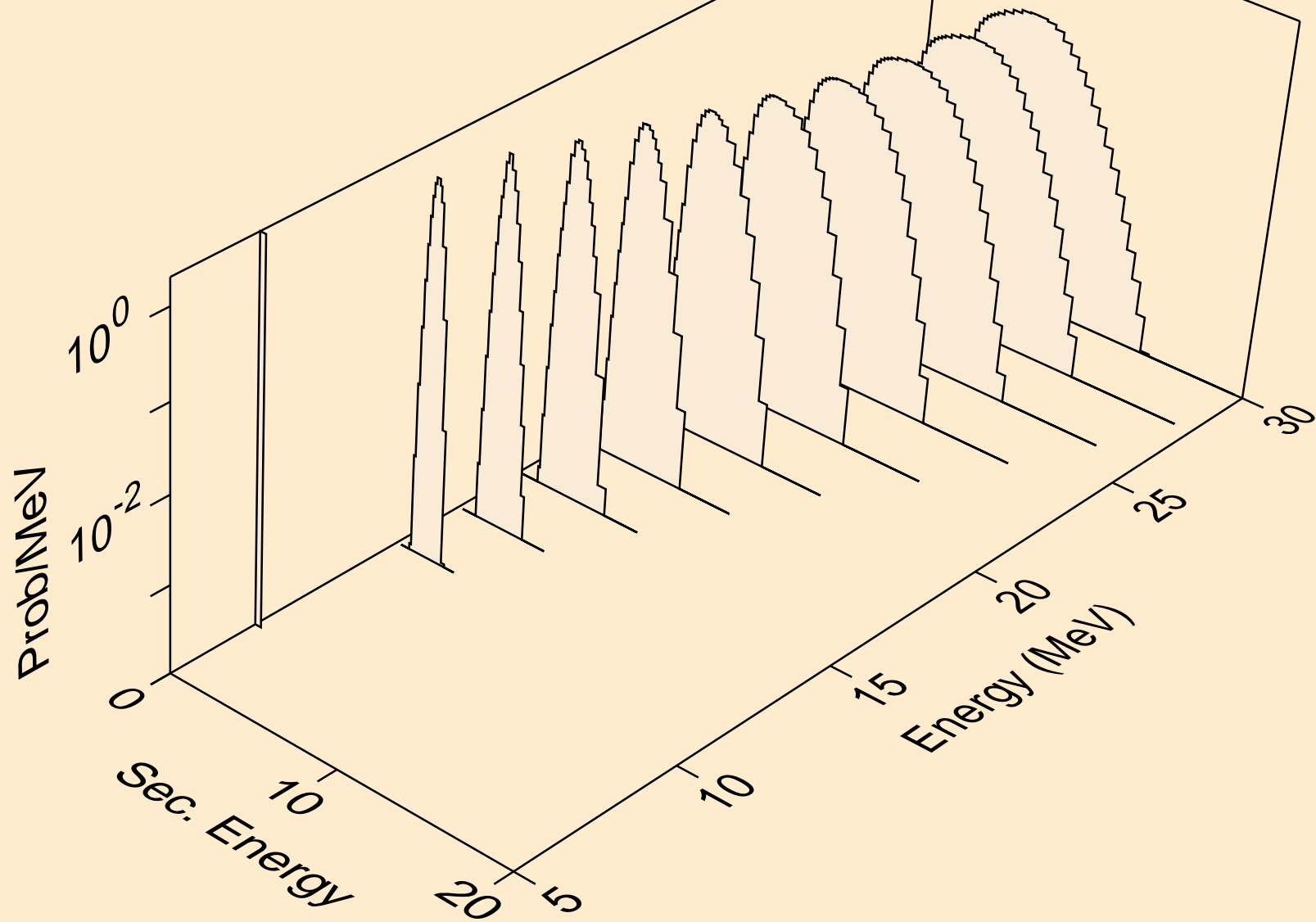

SB105 NEUTRON ACER TENDL-2021 LIBRARY; T=293.6K
deuterons from (n,x)

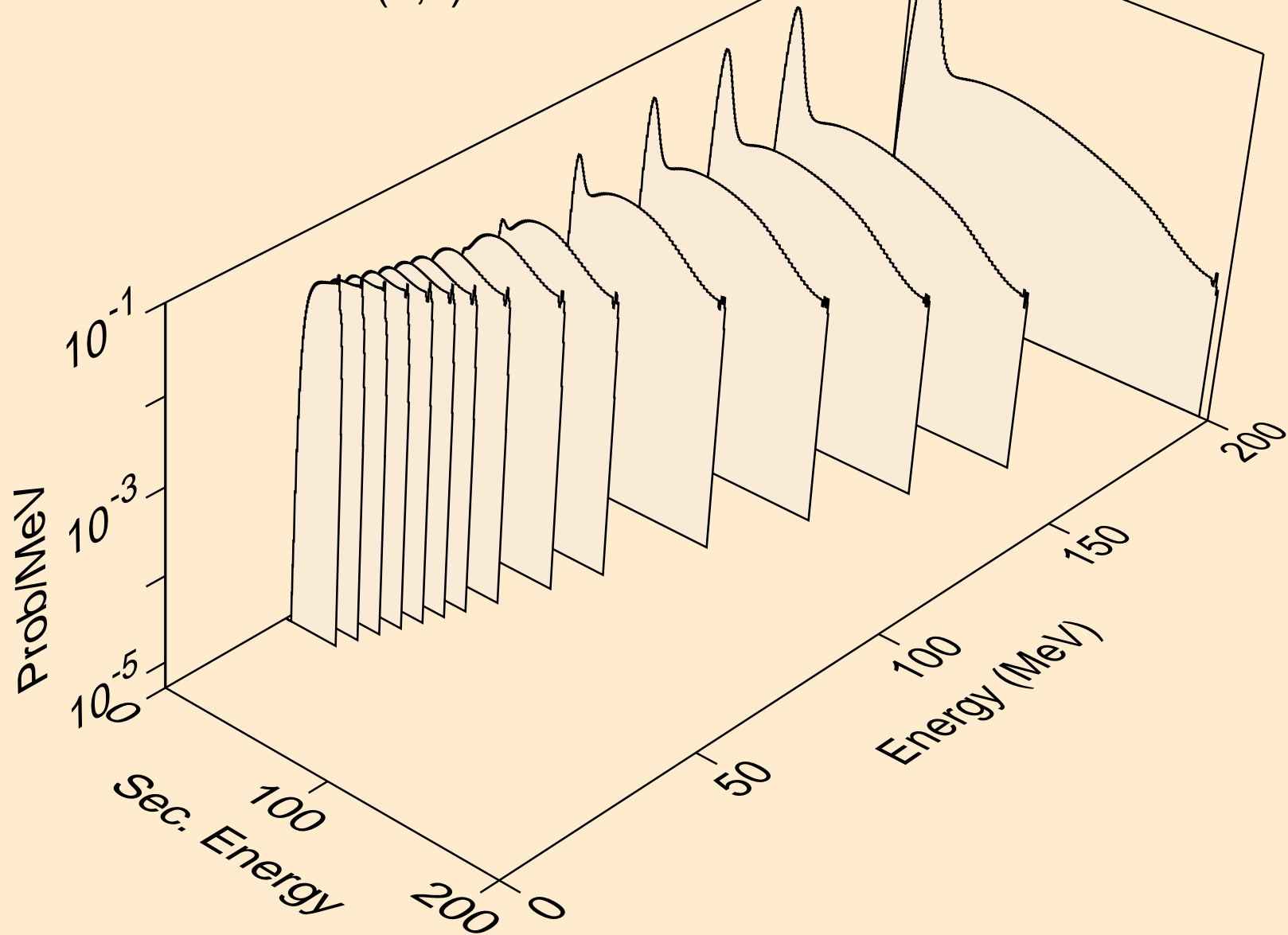

SB105 NEUTRON ACER TENDL-2021 LIBRARY; T=293.6K
deuterons from (n,2nd)

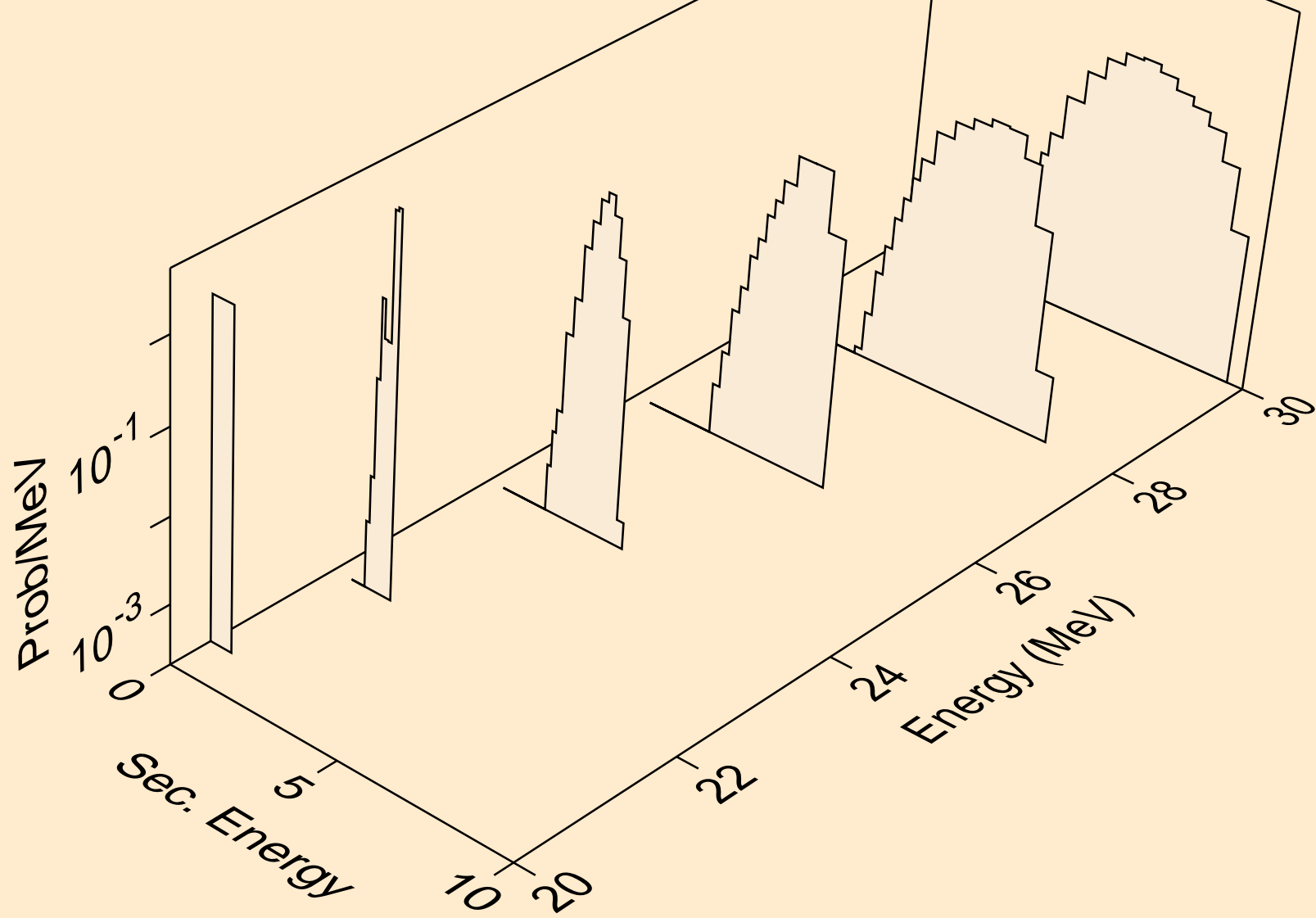

SB105 NEUTRON ACER TENDL-2021 LIBRARY; T=293.6K
deuterons from (n,n*)d

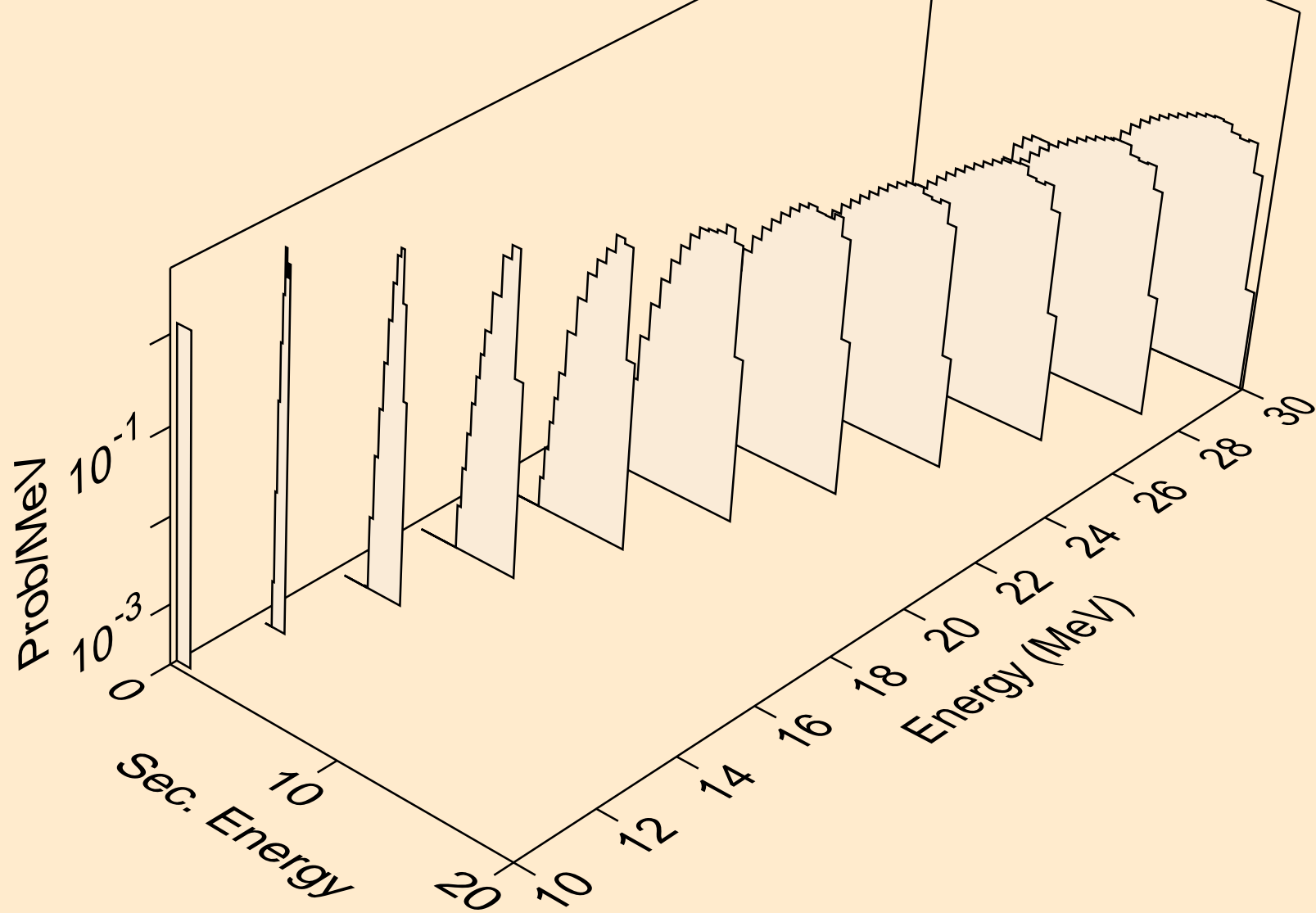

SB105 NEUTRON ACER TENDL-2021 LIBRARY; T=293.6K
deuterons from (n,d)

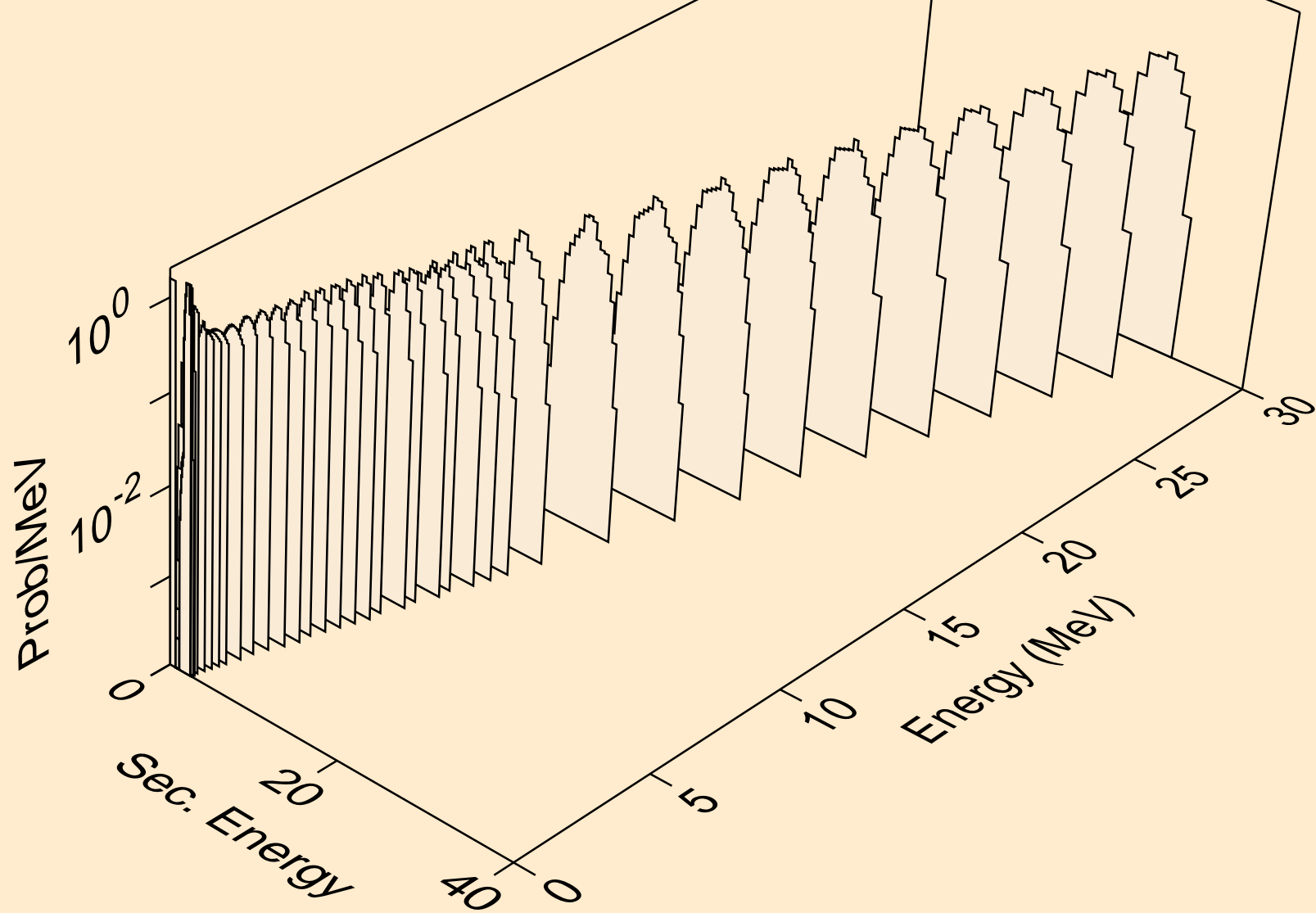

SB105 NEUTRON ACER TENDL-2021 LIBRARY; T=293.6K
deuterons from (n,d2a)

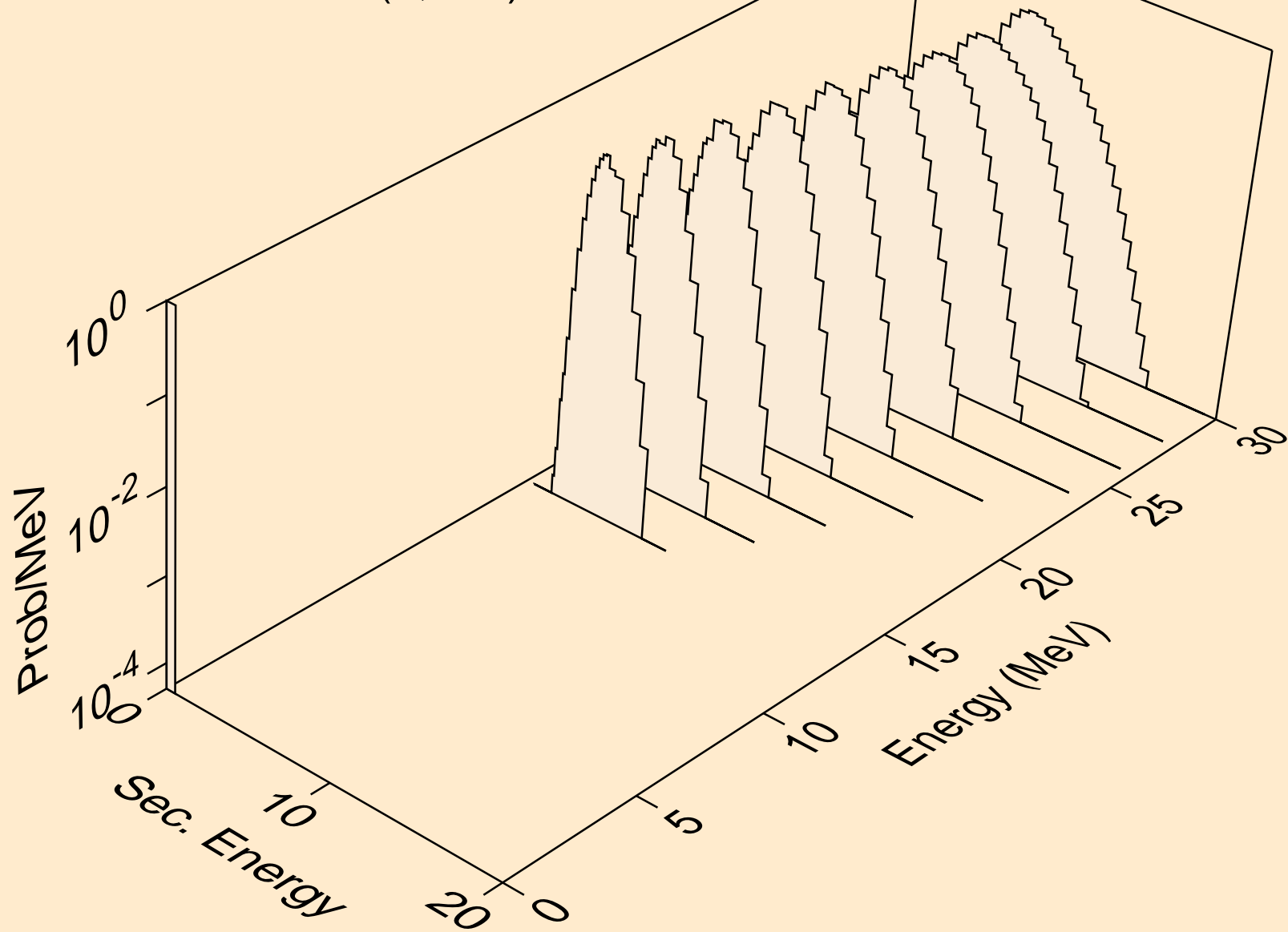

SB105 NEUTRON ACER TENDL-2021 LIBRARY; T=293.6K
deuterons from (n,pd)

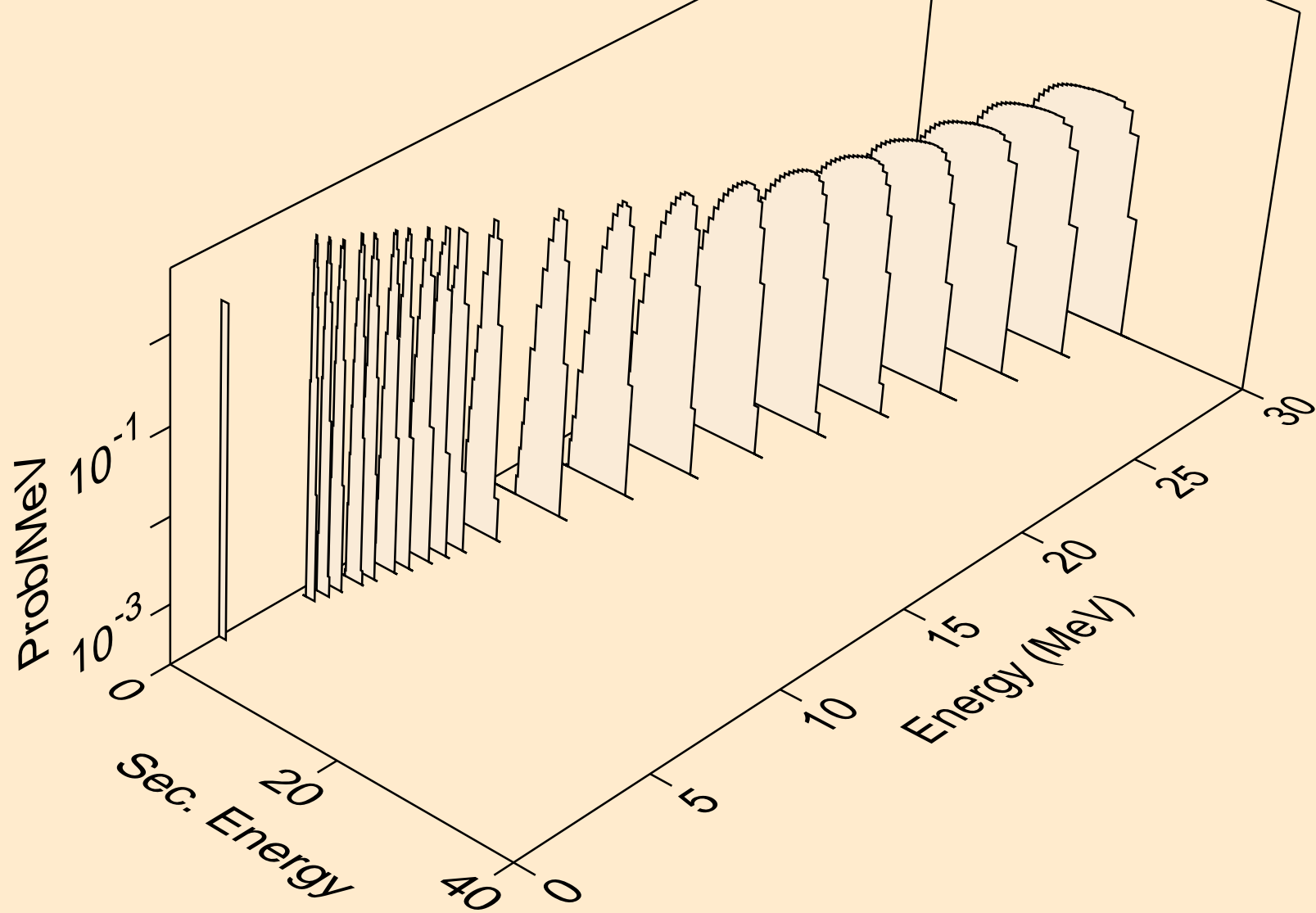

SB105 NEUTRON ACER TENDL-2021 LIBRARY; T=293.6K
deuterons from (n,da)

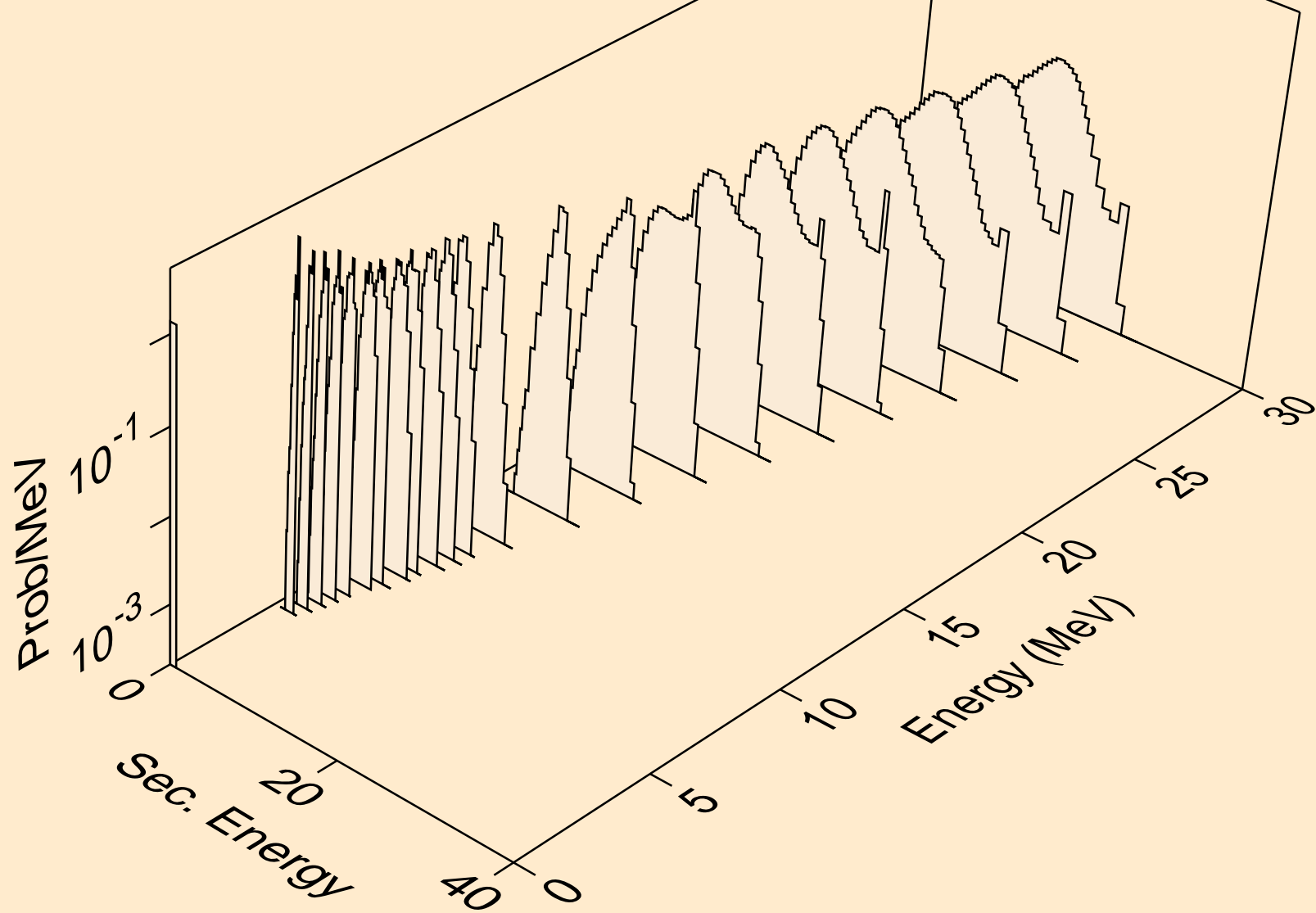

SB105 NEUTRON ACER TENDL-2021 LIBRARY; T=293.6K
tritons from (n,x)

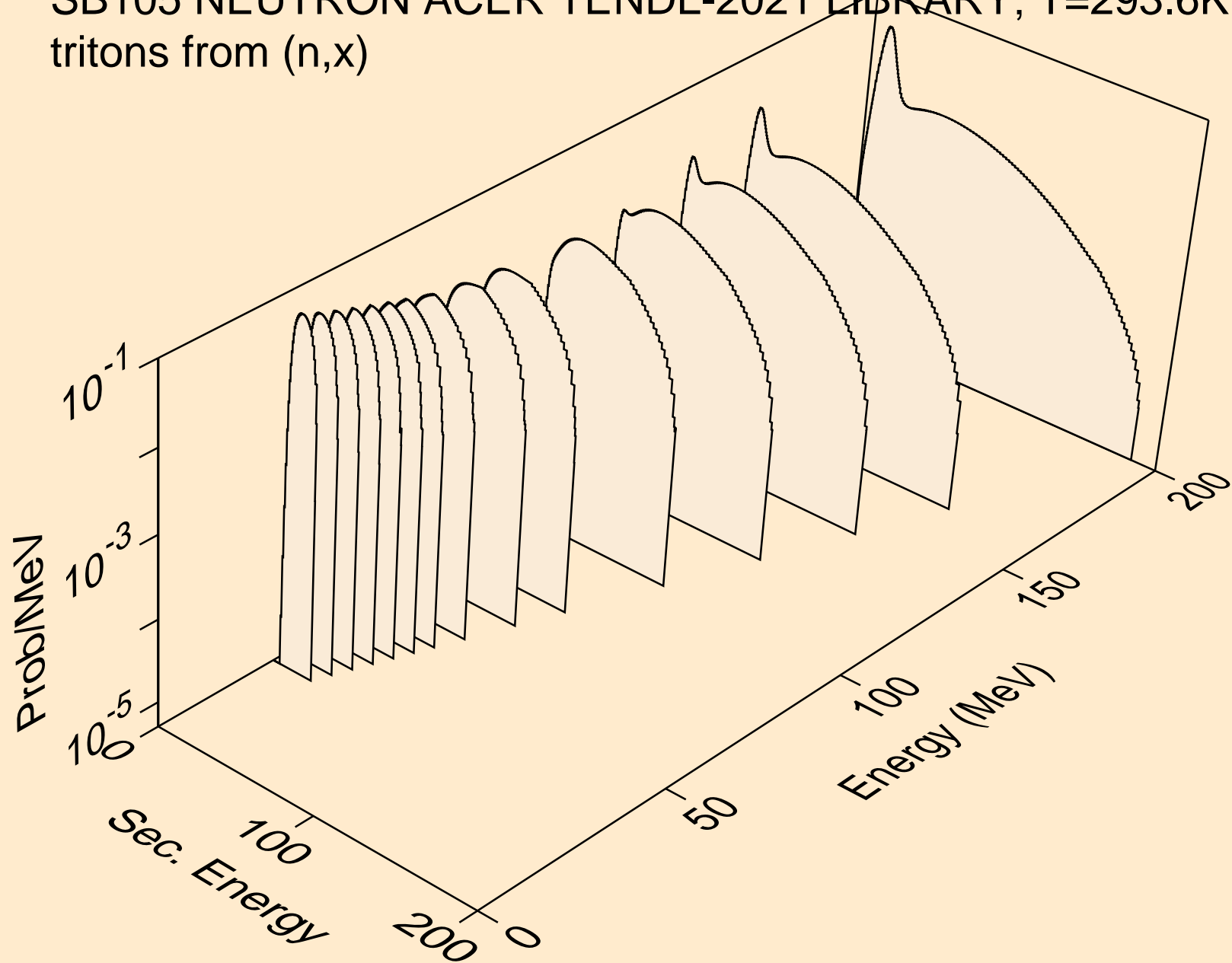

SB105 NEUTRON ACER TENDL-2021 LIBRARY; T=293.6K
tritons from (n,n*)t

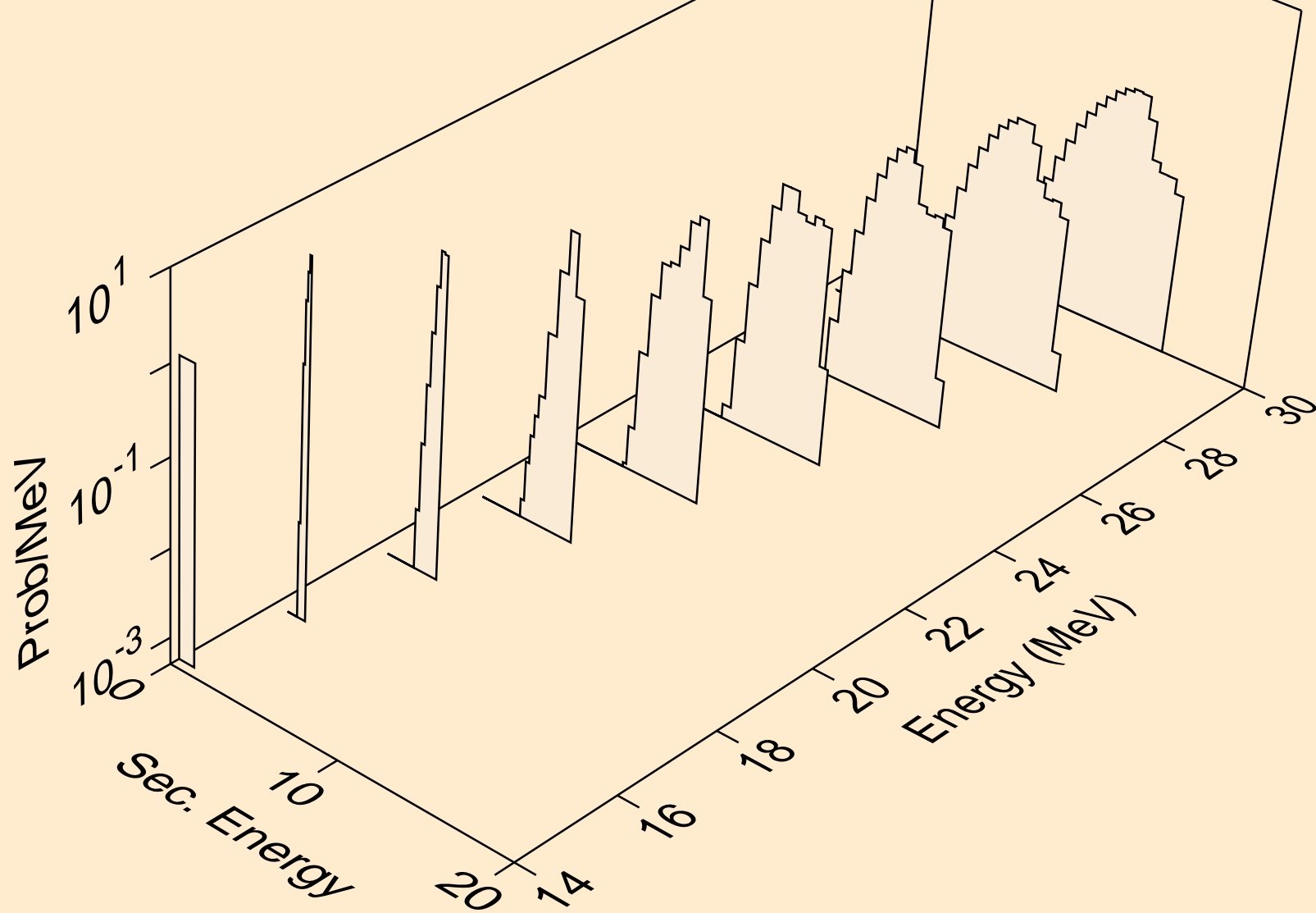

SB105 NEUTRON ACER TENDL-2021 LIBRARY; T=293.6K
tritons from (n,t)

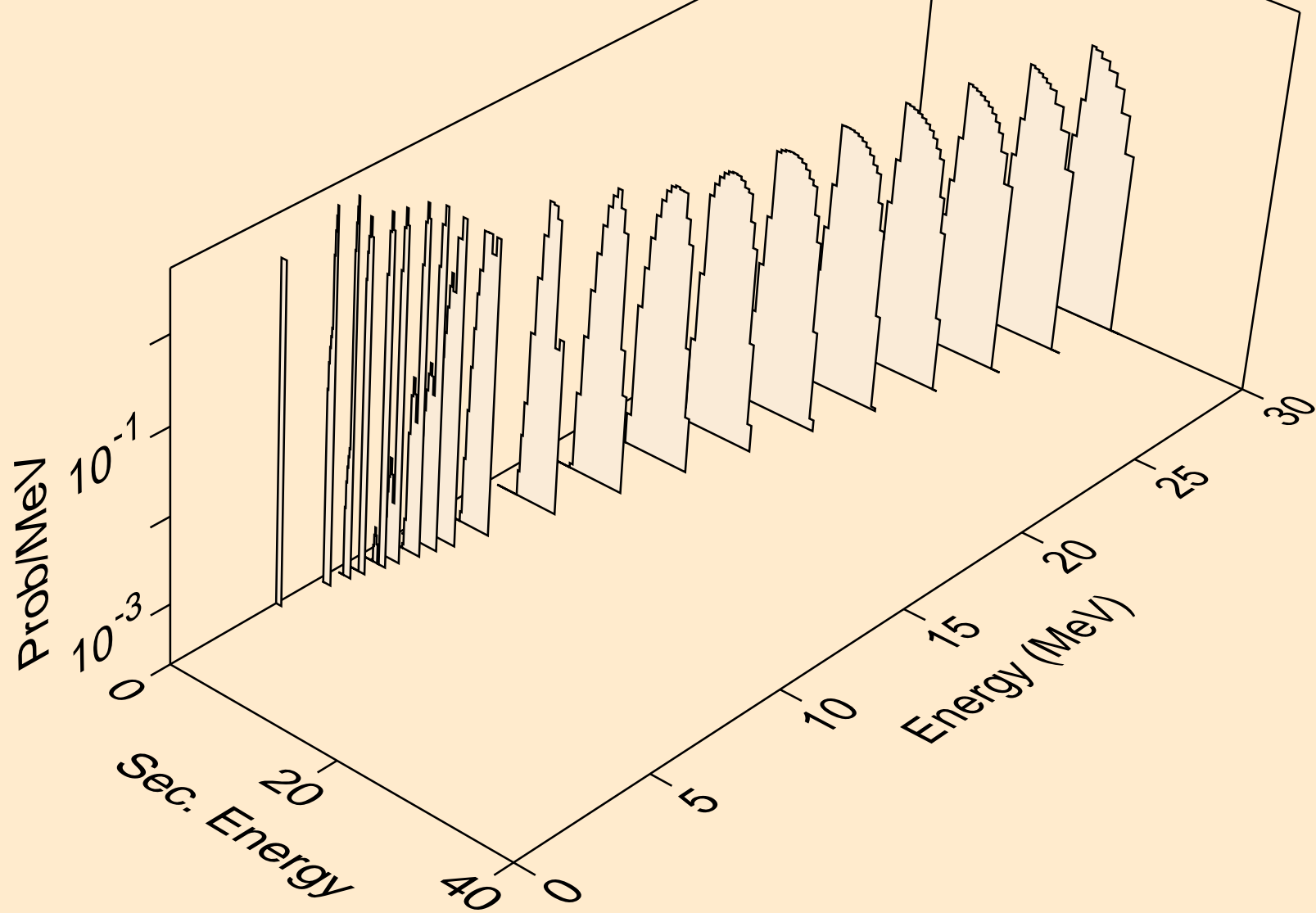

SB105 NEUTRON ACER TENDL-2021 LIBRARY; T=293.6K
tritons from (n,pt)

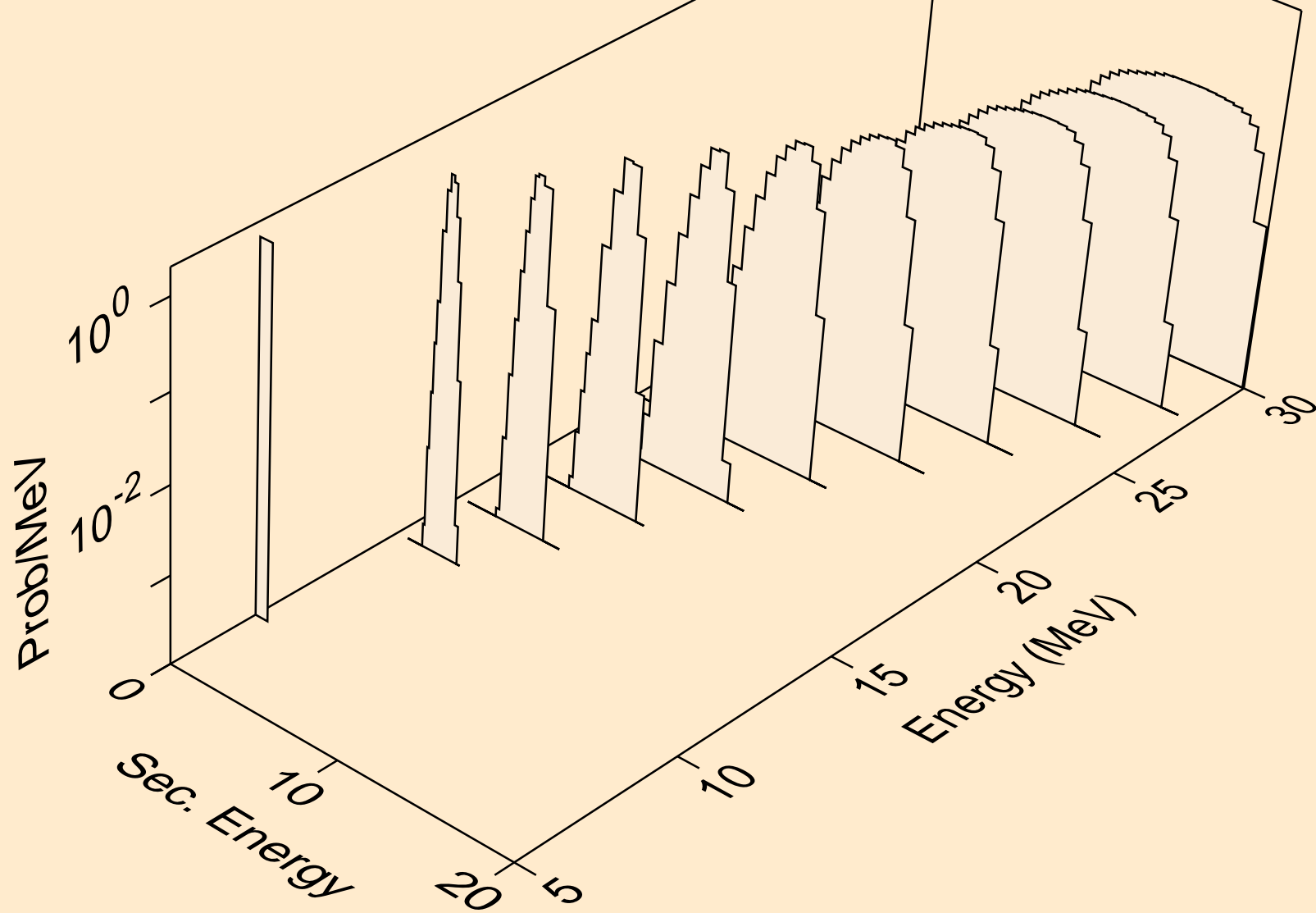

SB105 NEUTRON ACER TENDL-2021 LIBRARY; T=293.6K
he3s from (n,x)

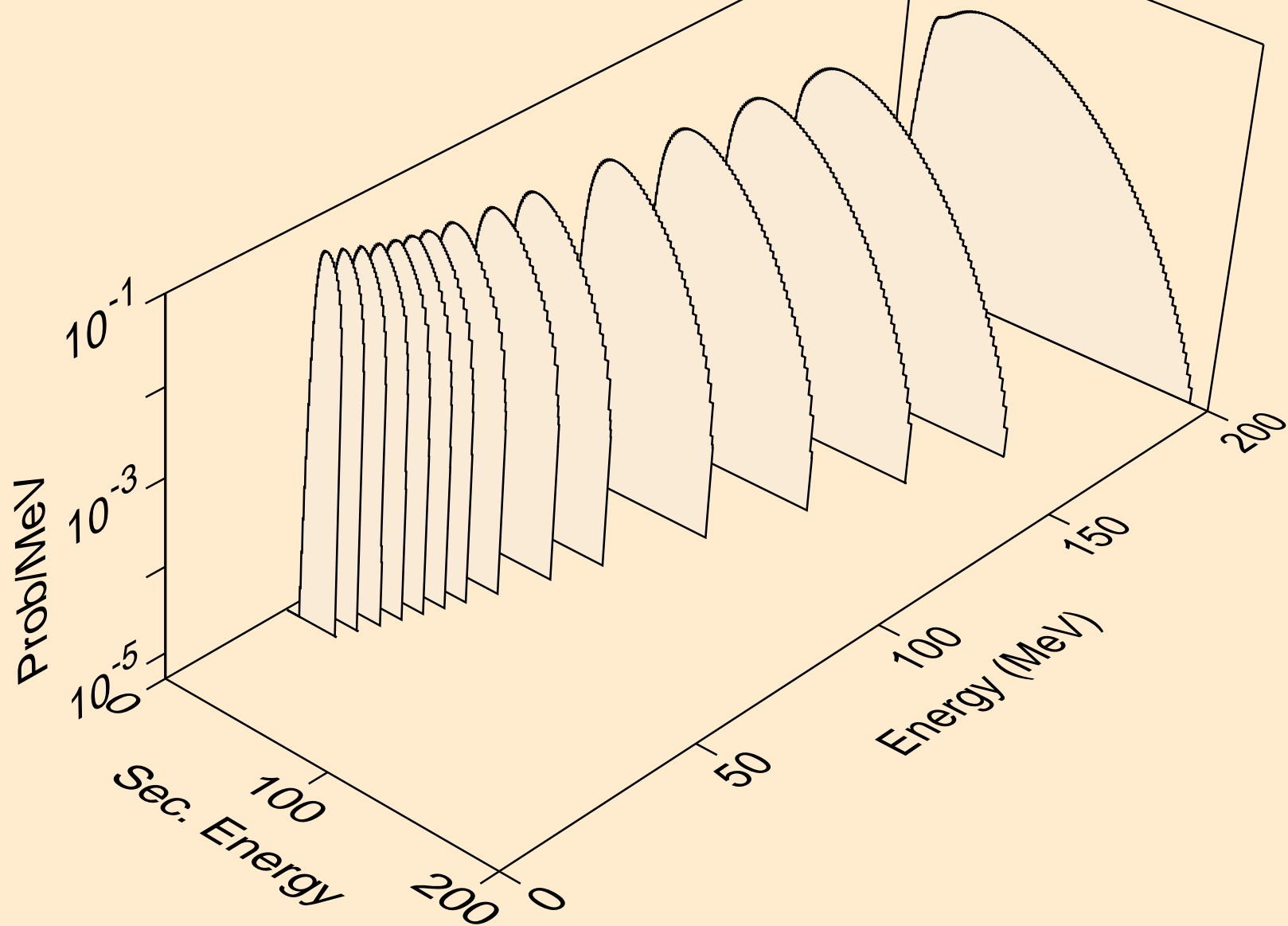

SB105 NEUTRON ACER TENDL-2021 LIBRARY; T=293.6K
he3s from (n,n*)he3

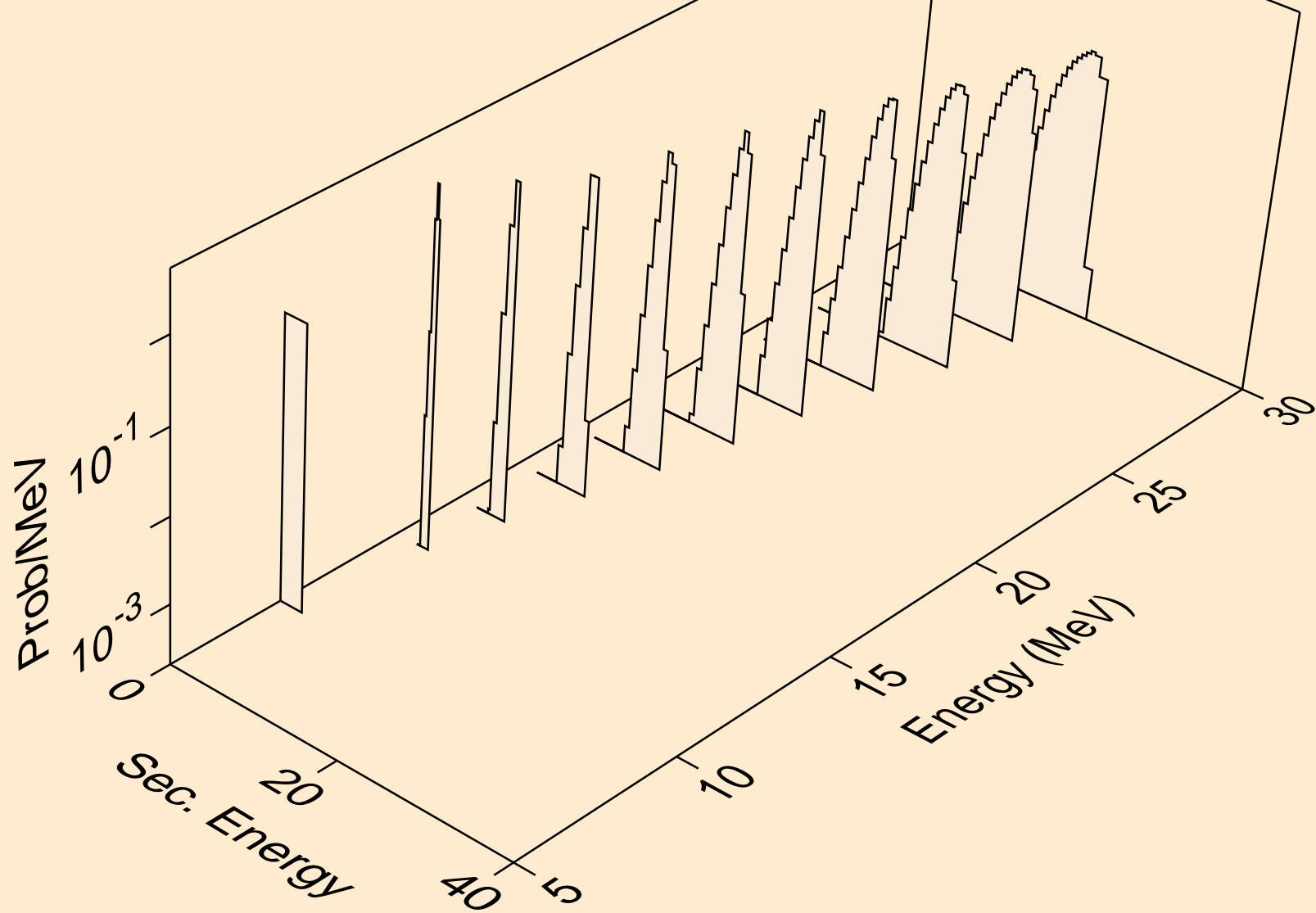

SB105 NEUTRON ACER TENDL-2021 LIBRARY; T=293.6K
he3s from (n,he3)

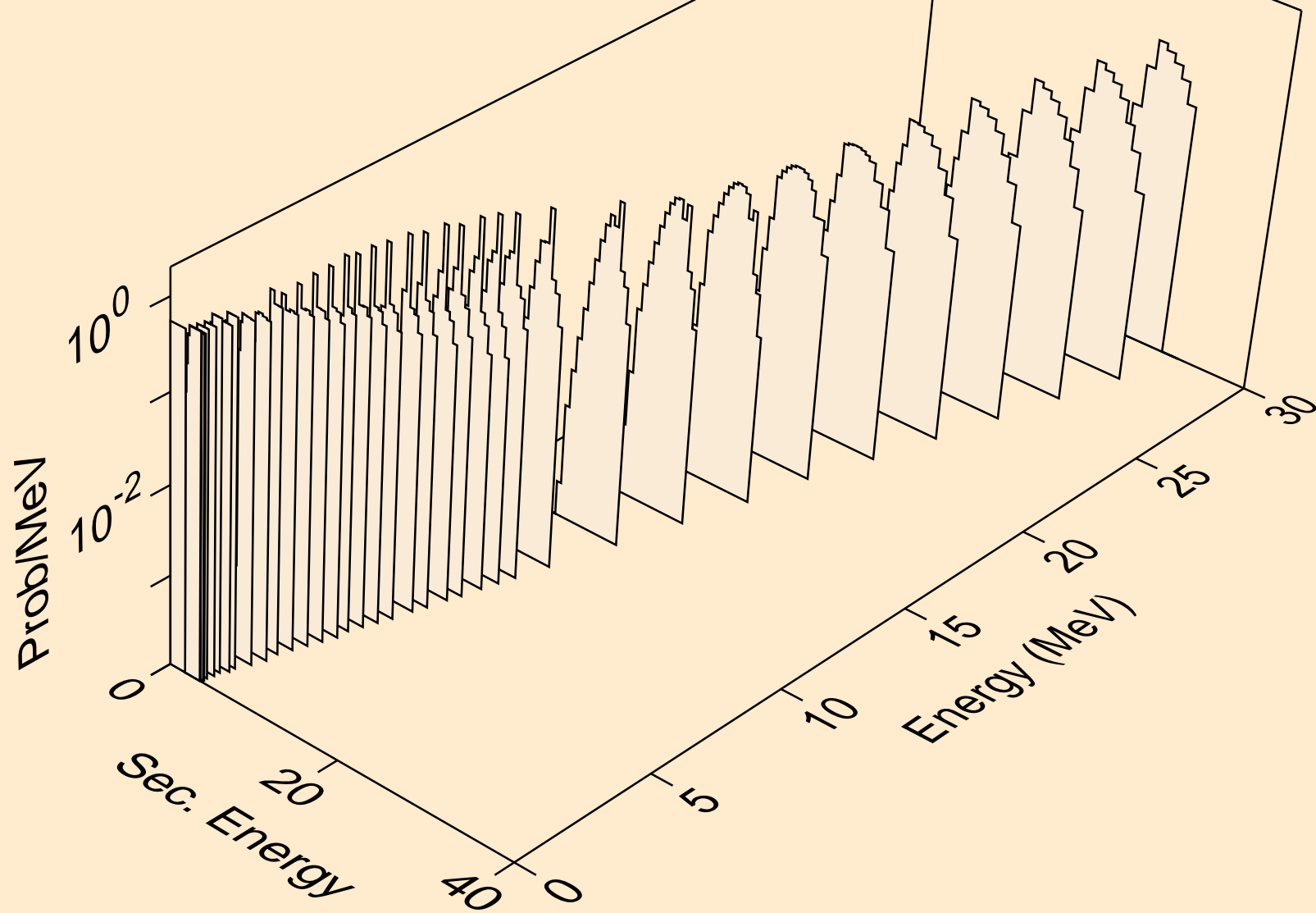

SB105 NEUTRON ACER TENDL-2021 LIBRARY; T=293.6K
alphas from (n,x)

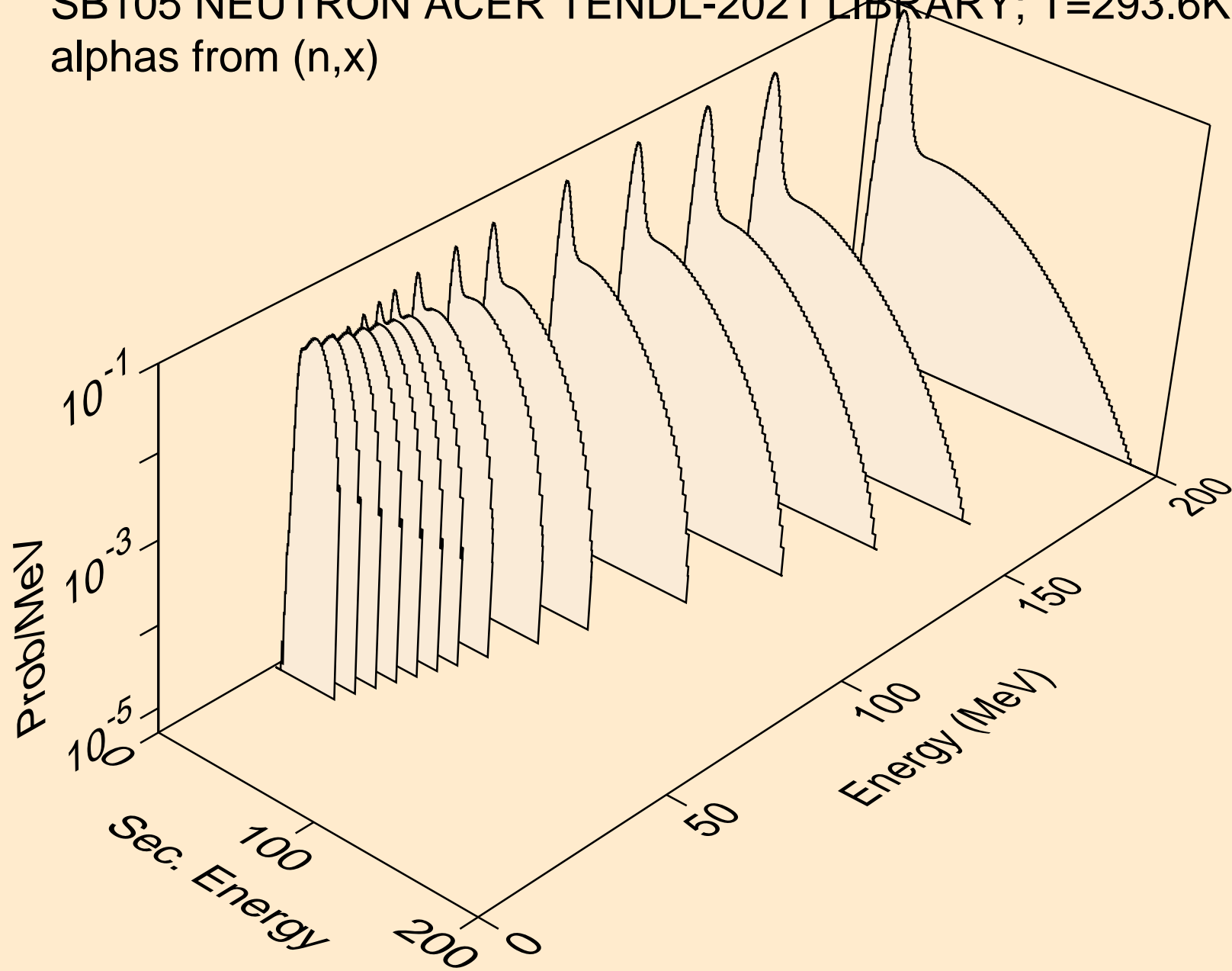

SB105 NEUTRON ACER TENDL-2021 LIBRARY; T=293.6K
alphas from (n,n*)a

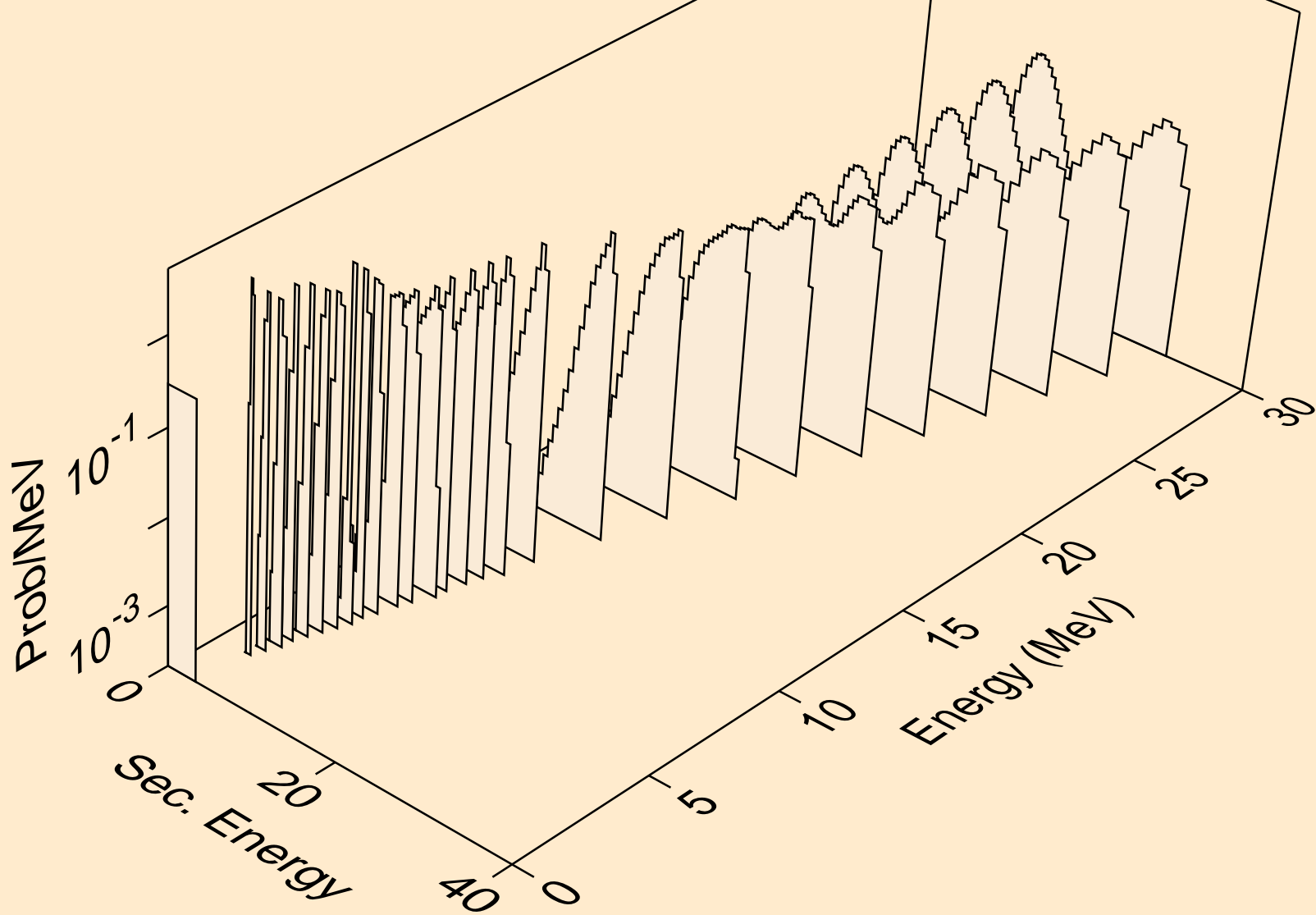

SB105 NEUTRON ACER TENDL-2021 LIBRARY; T=293.6K
alphas from (n,2n)a

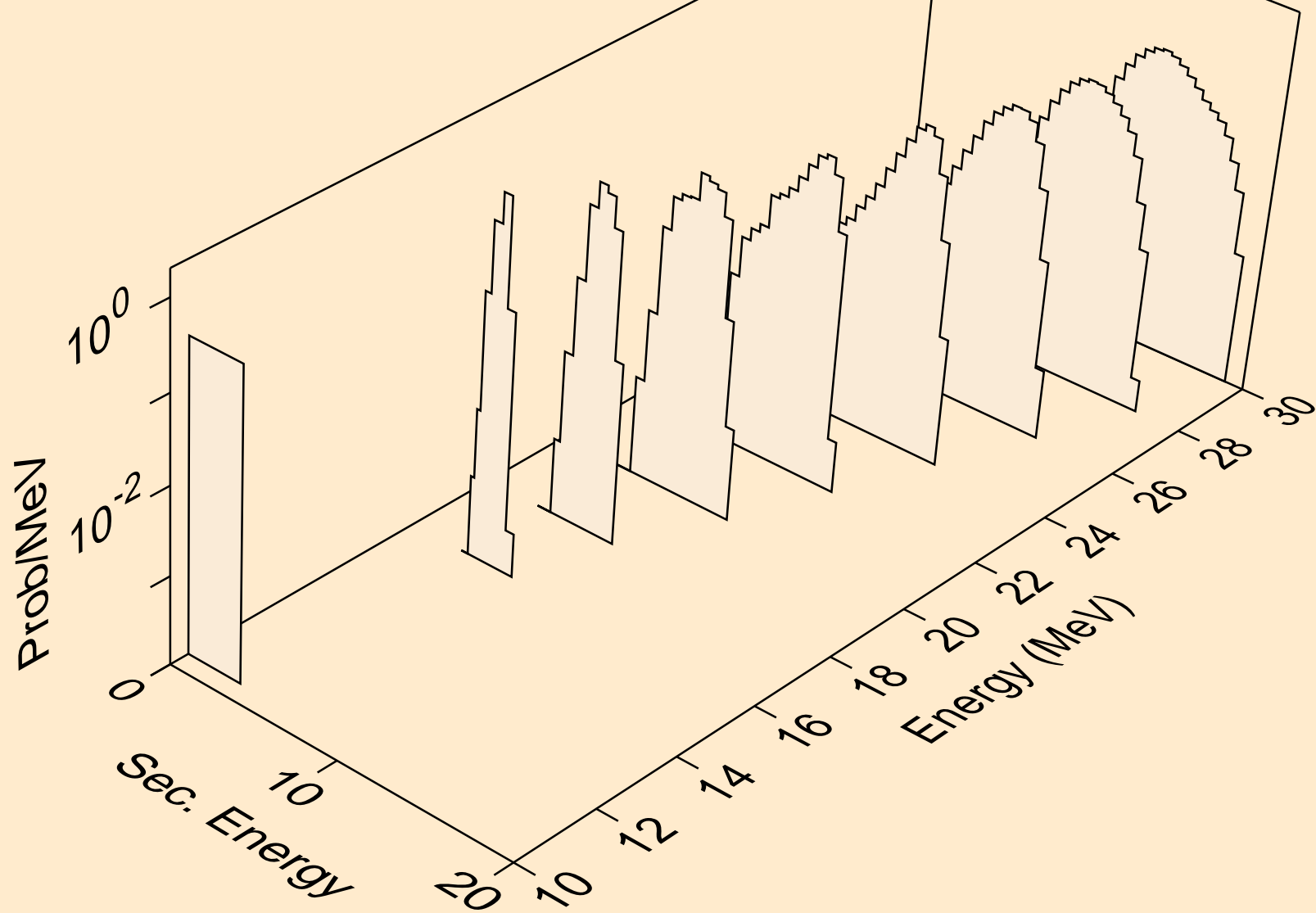

SB105 NEUTRON ACER TENDL-2021 LIBRARY; T=293.6K
alphas from (n,n*)2a

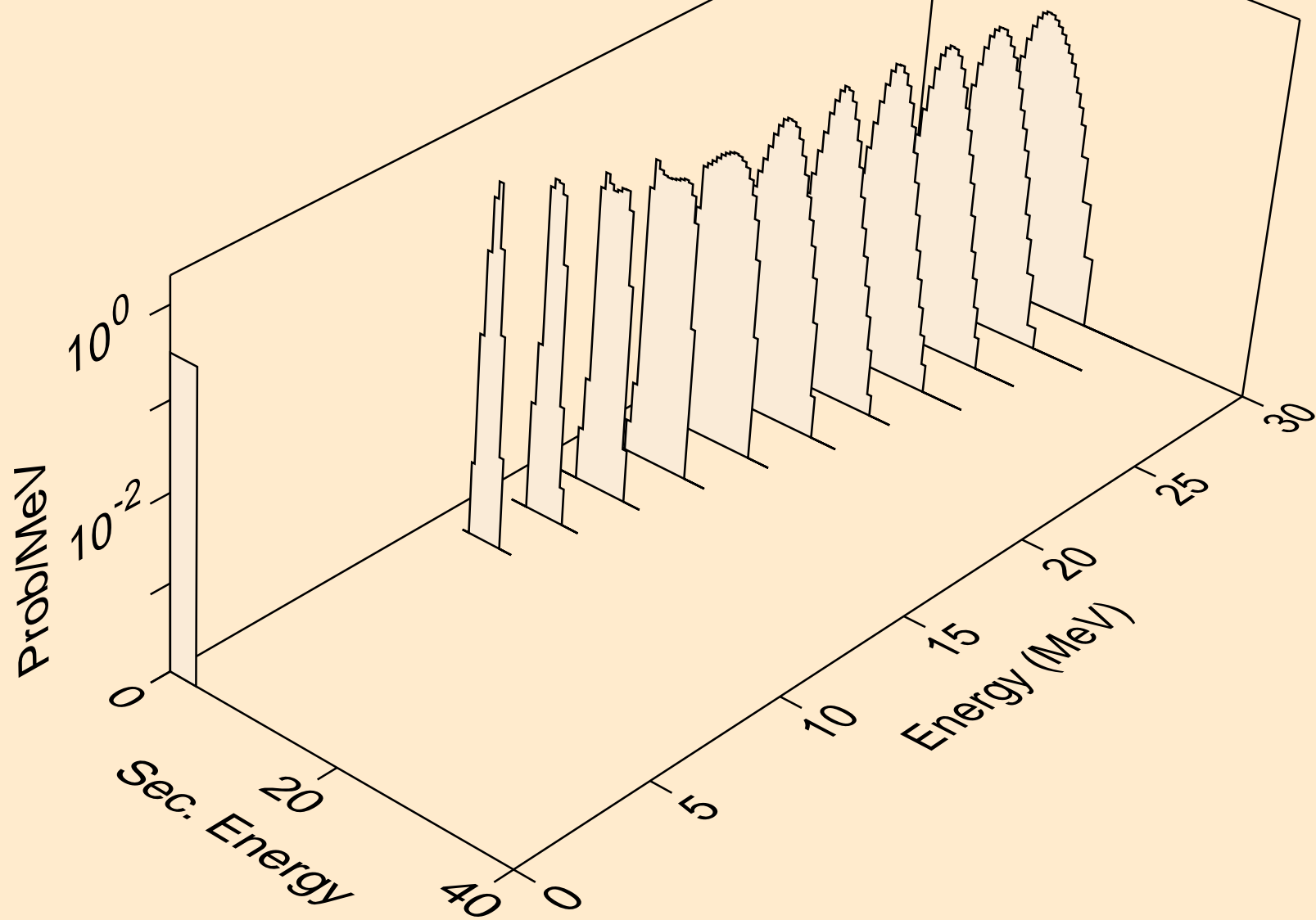

SB105 NEUTRON ACER TENDL-2021 LIBRARY; T=293.6K
alphas from (n,npa)

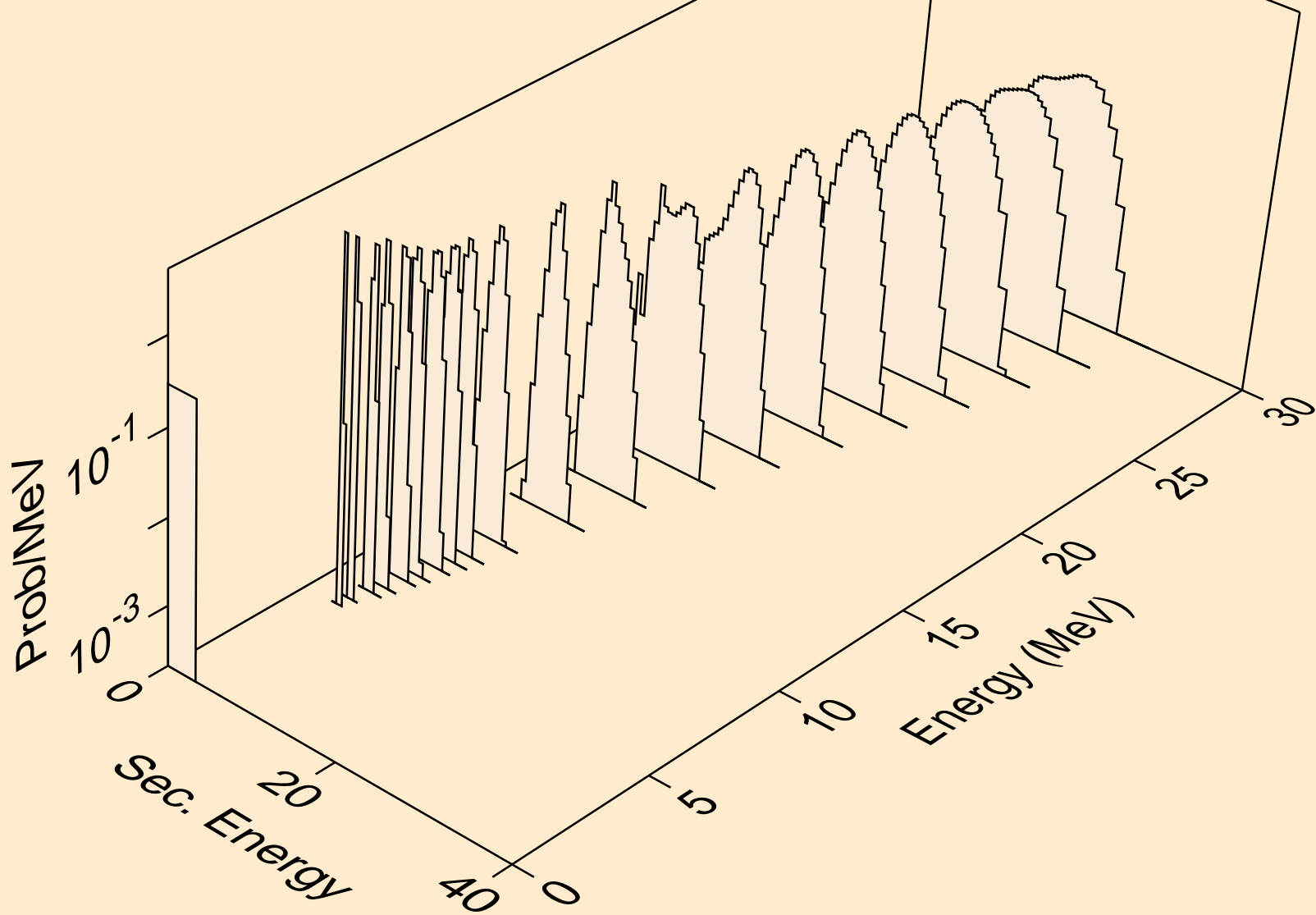

SB105 NEUTRON ACER TENDL-2021 LIBRARY; T=293.6K
alphas from (n,a)

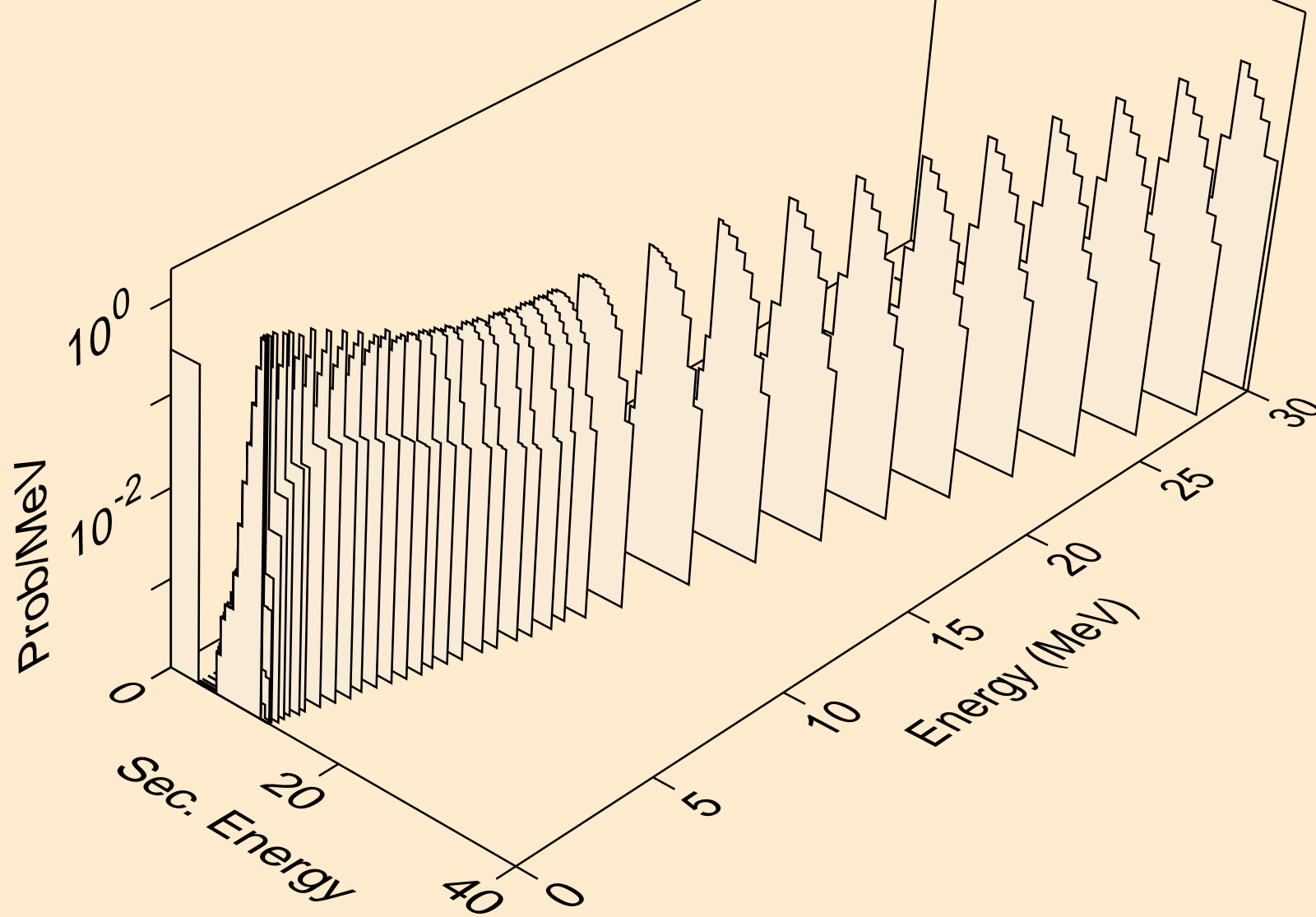

SB105 NEUTRON ACER TENDL-2021 LIBRARY; T=293.6K
alphas from (n,2a)

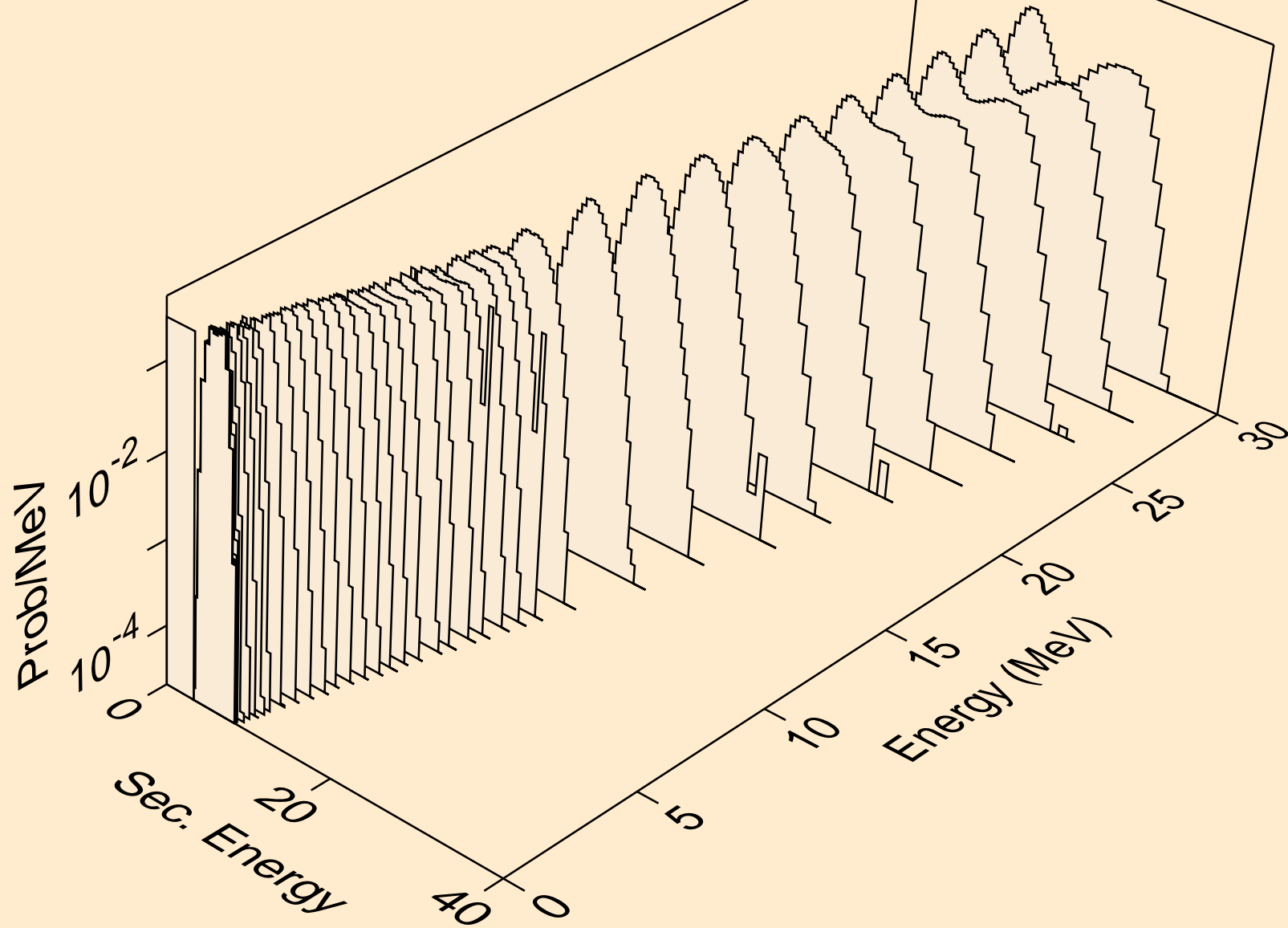

SB105 NEUTRON ACER TENDL-2021 LIBRARY; T=293.6K
alphas from (n,3a)

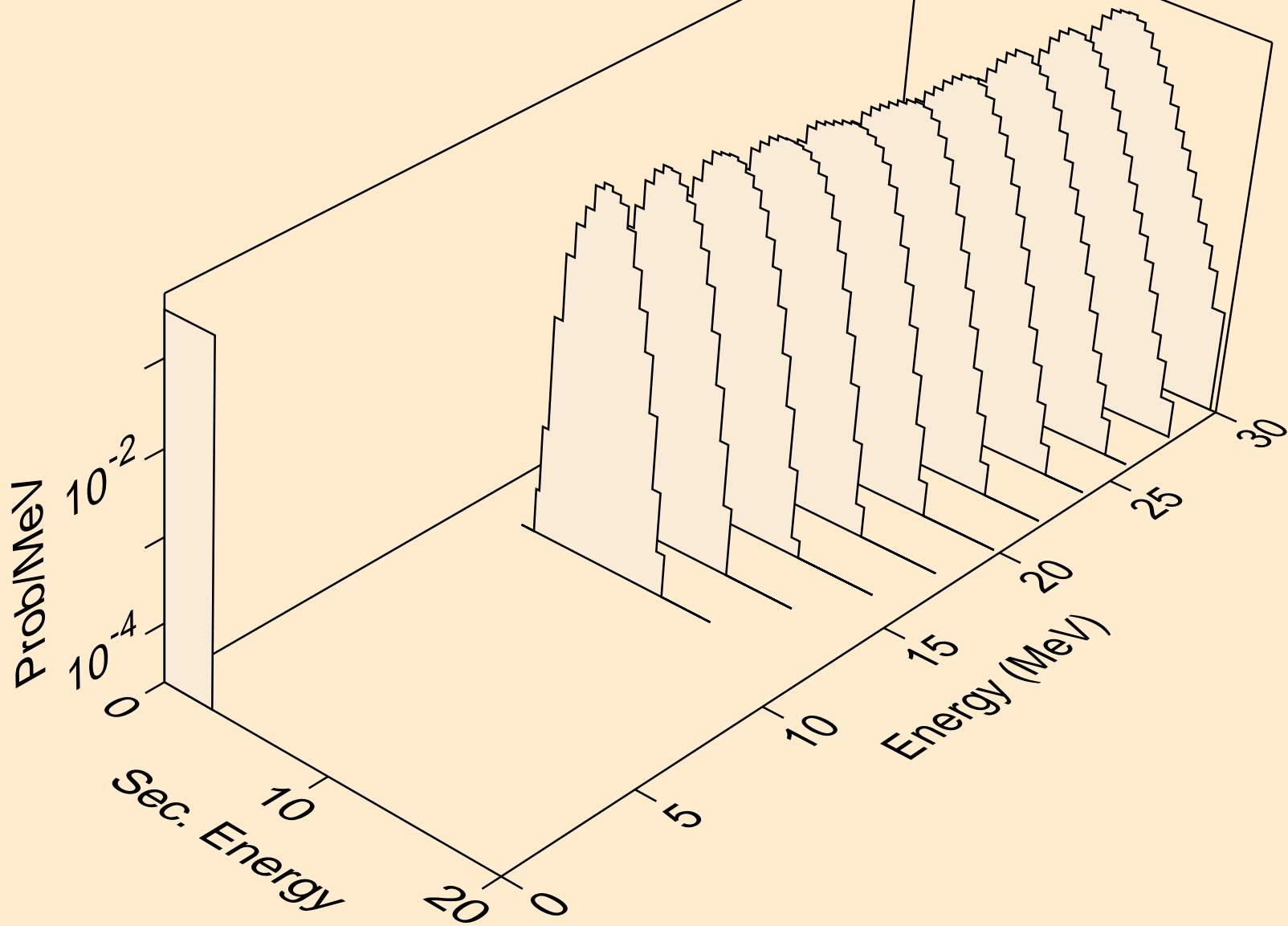

SB105 NEUTRON ACER TENDL-2021 LIBRARY; T=293.6K
alphas from (n,pa)

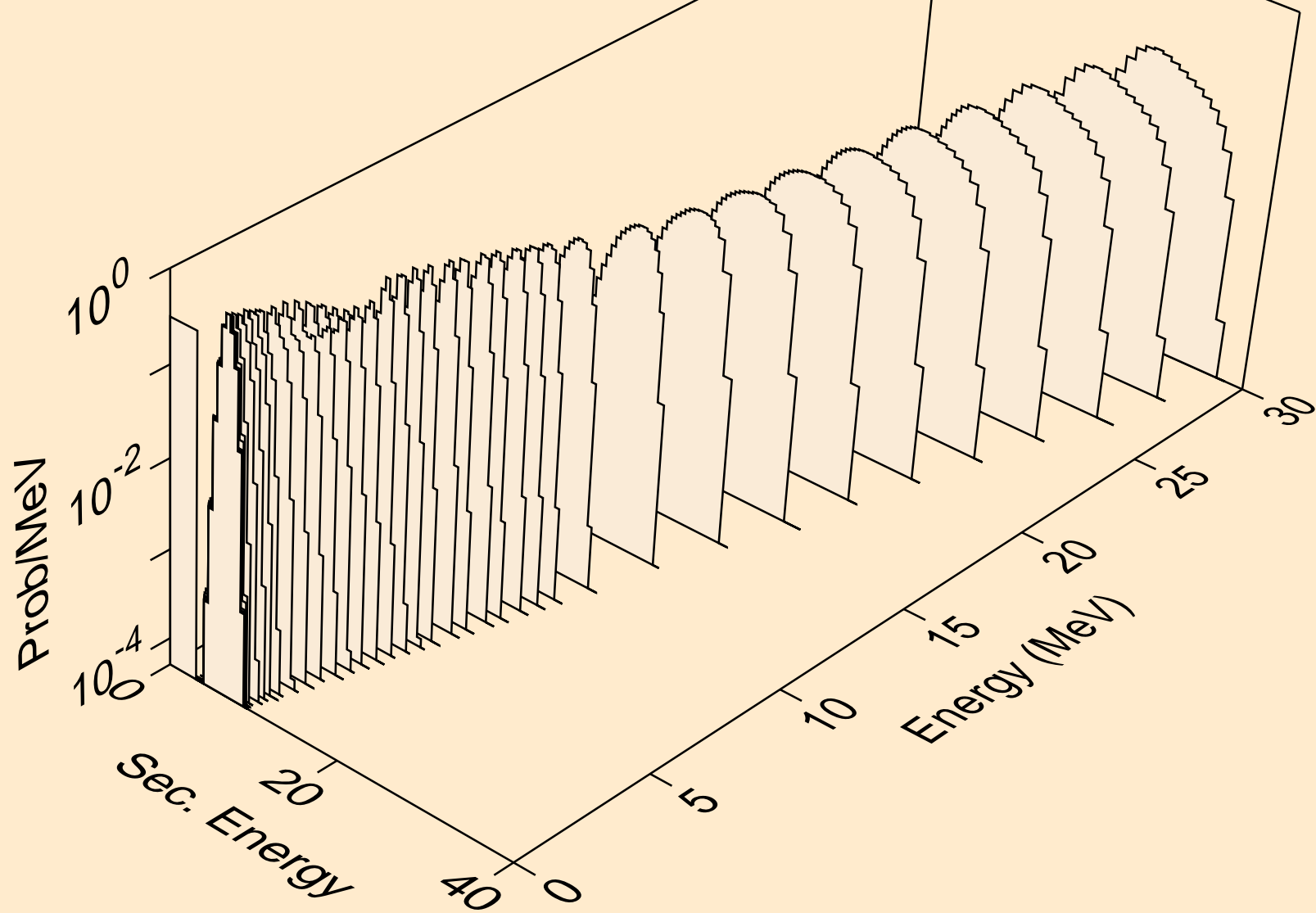

SB105 NEUTRON ACER TENDL-2021 LIBRARY; T=293.6K
alphas from (n,d2a)

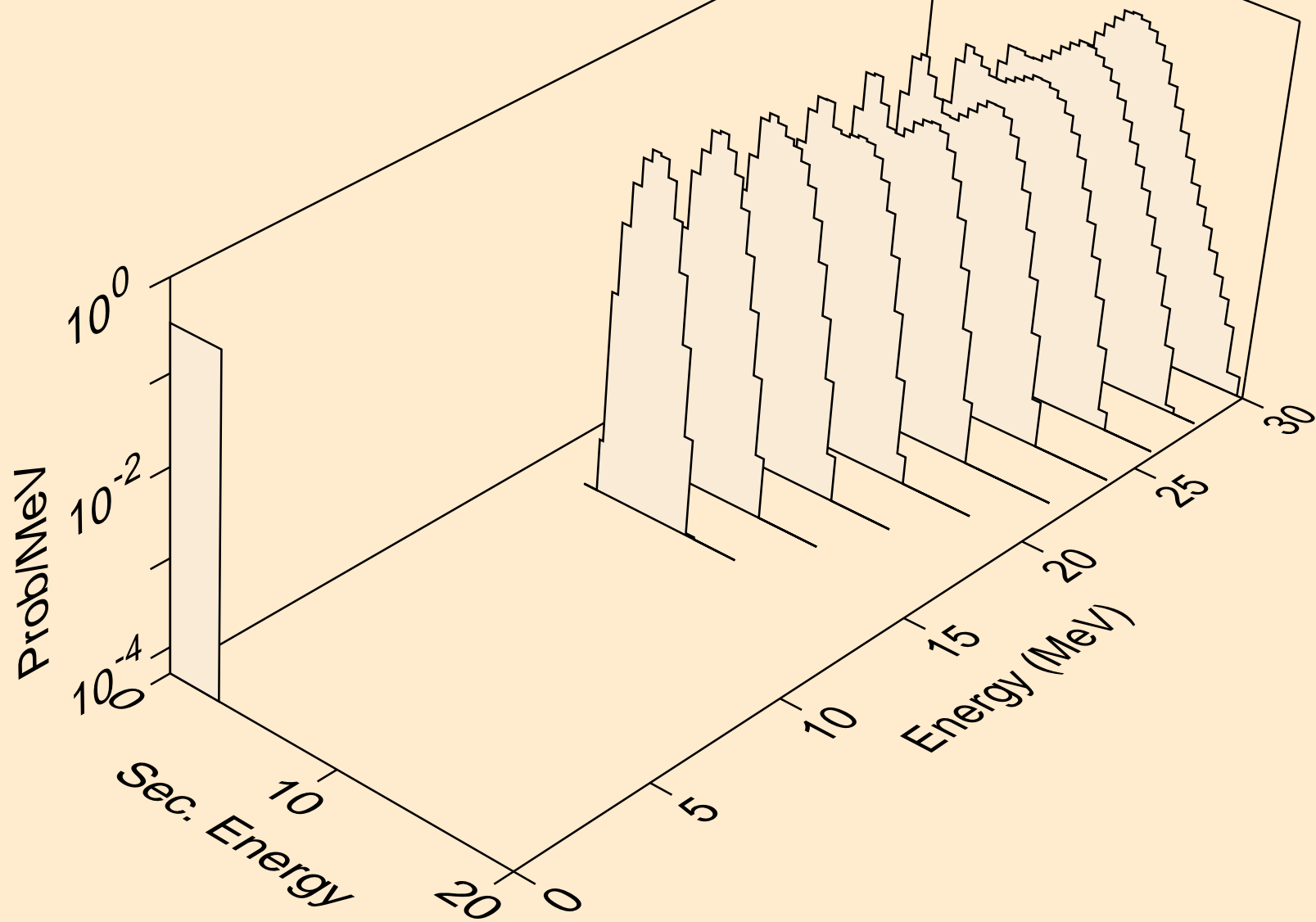

SB105 NEUTRON ACER TENDL-2021 LIBRARY; T=293.6K
alphas from (n,da)

