

TI046 NEUTRON ACER TENDL-2021 LIBRARY; T=293.6K
Principal cross sections

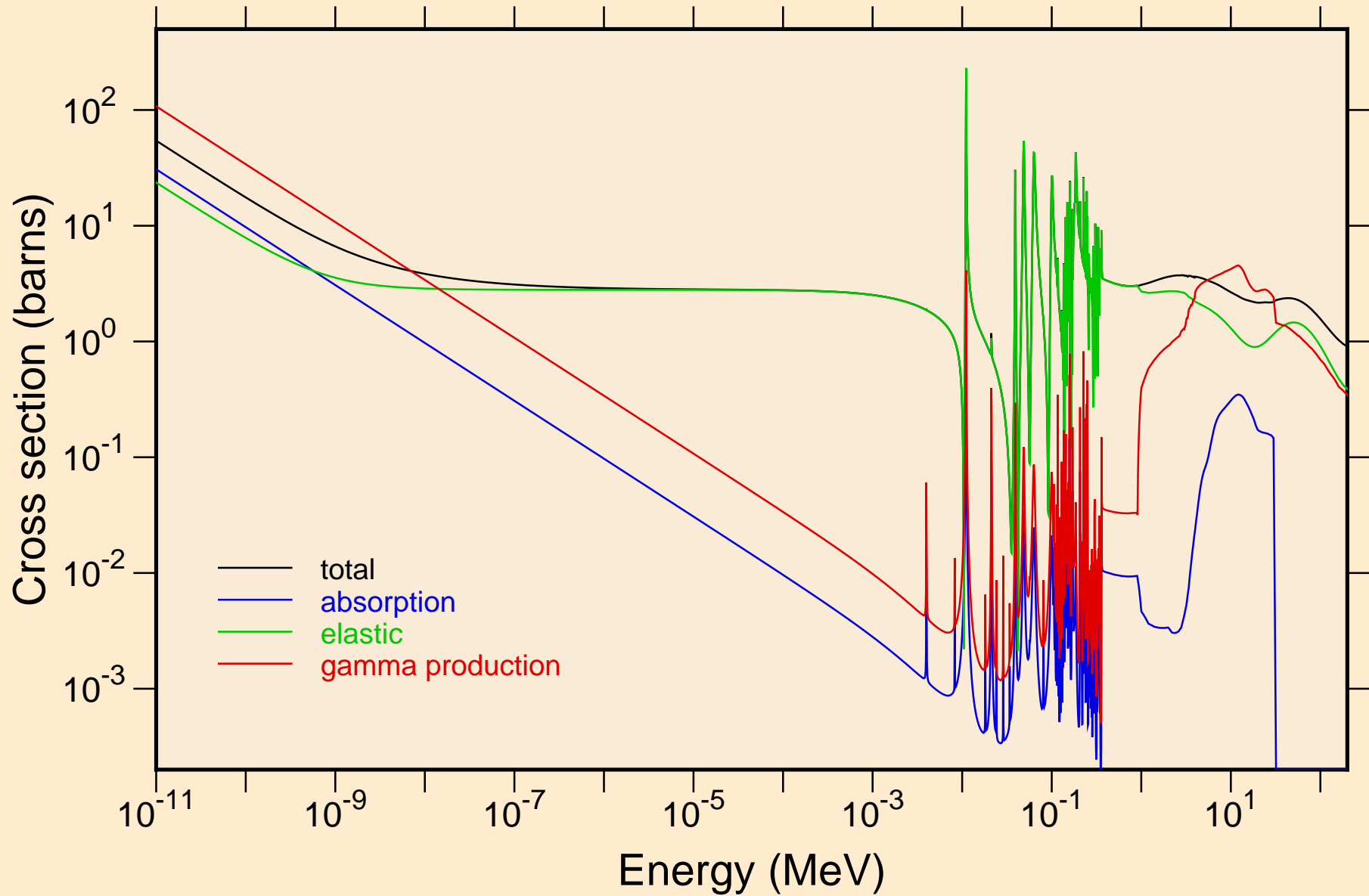

TI046 NEUTRON ACER TENDL-2021 LIBRARY; T=293.6K
resonance total cross section

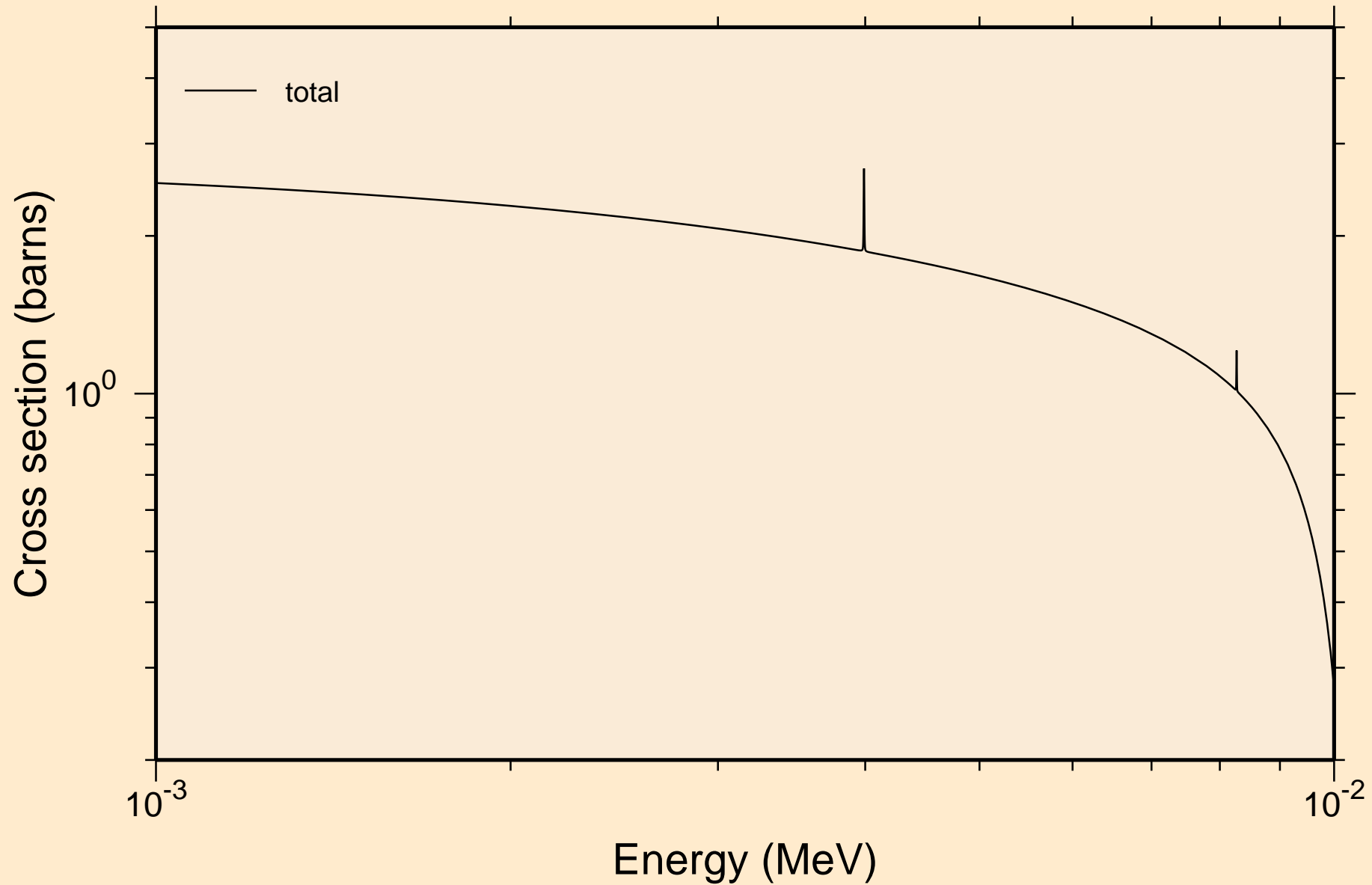

TI046 NEUTRON ACER TENDL-2021 LIBRARY; T=293.6K
resonance total cross section

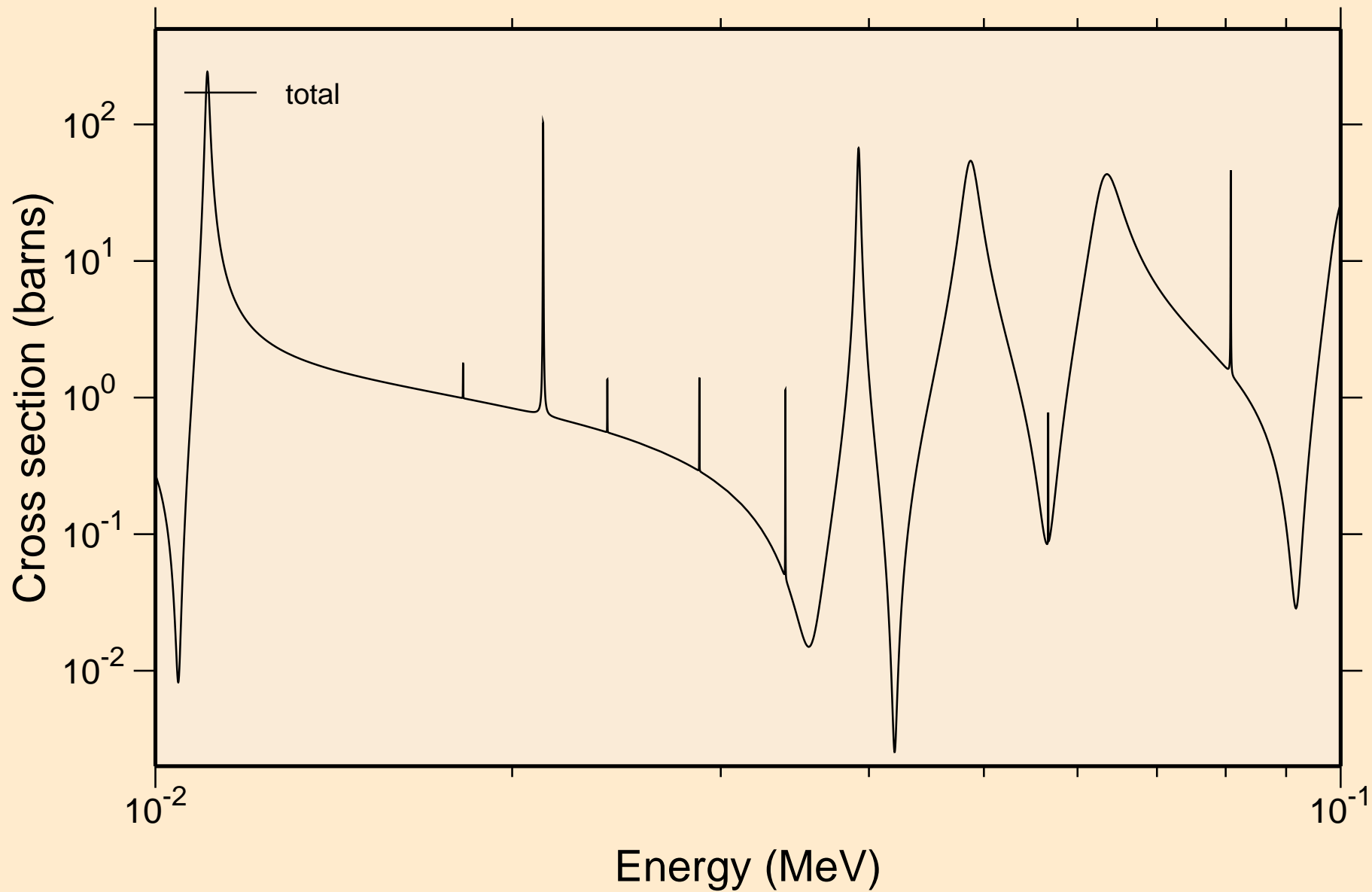

TI046 NEUTRON ACER TENDL-2021 LIBRARY; T=293.6K
resonance total cross section

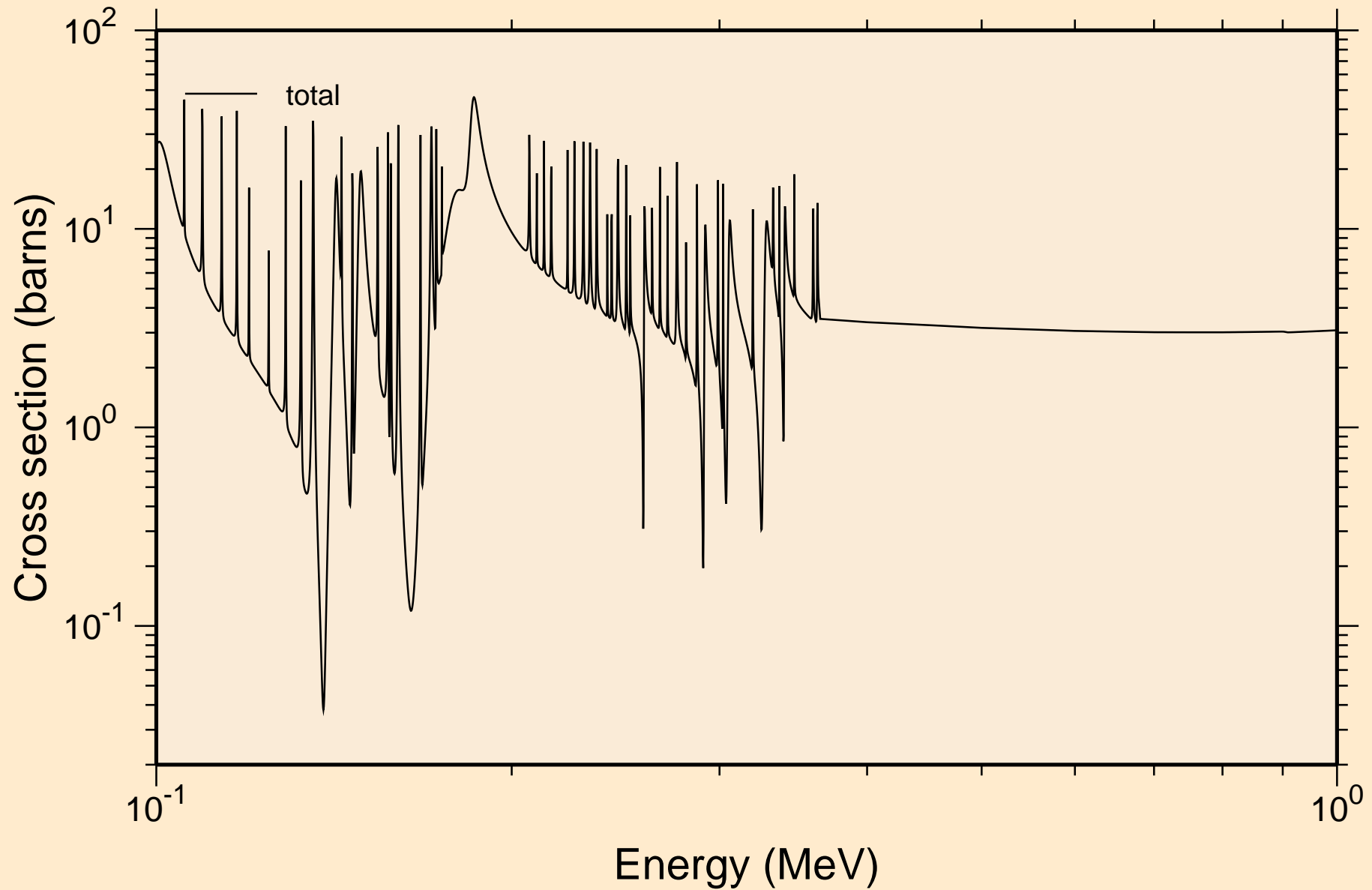

Ti046 NEUTRON ACER TENDL-2021 LIBRARY; T=293.6K
resonance total cross section

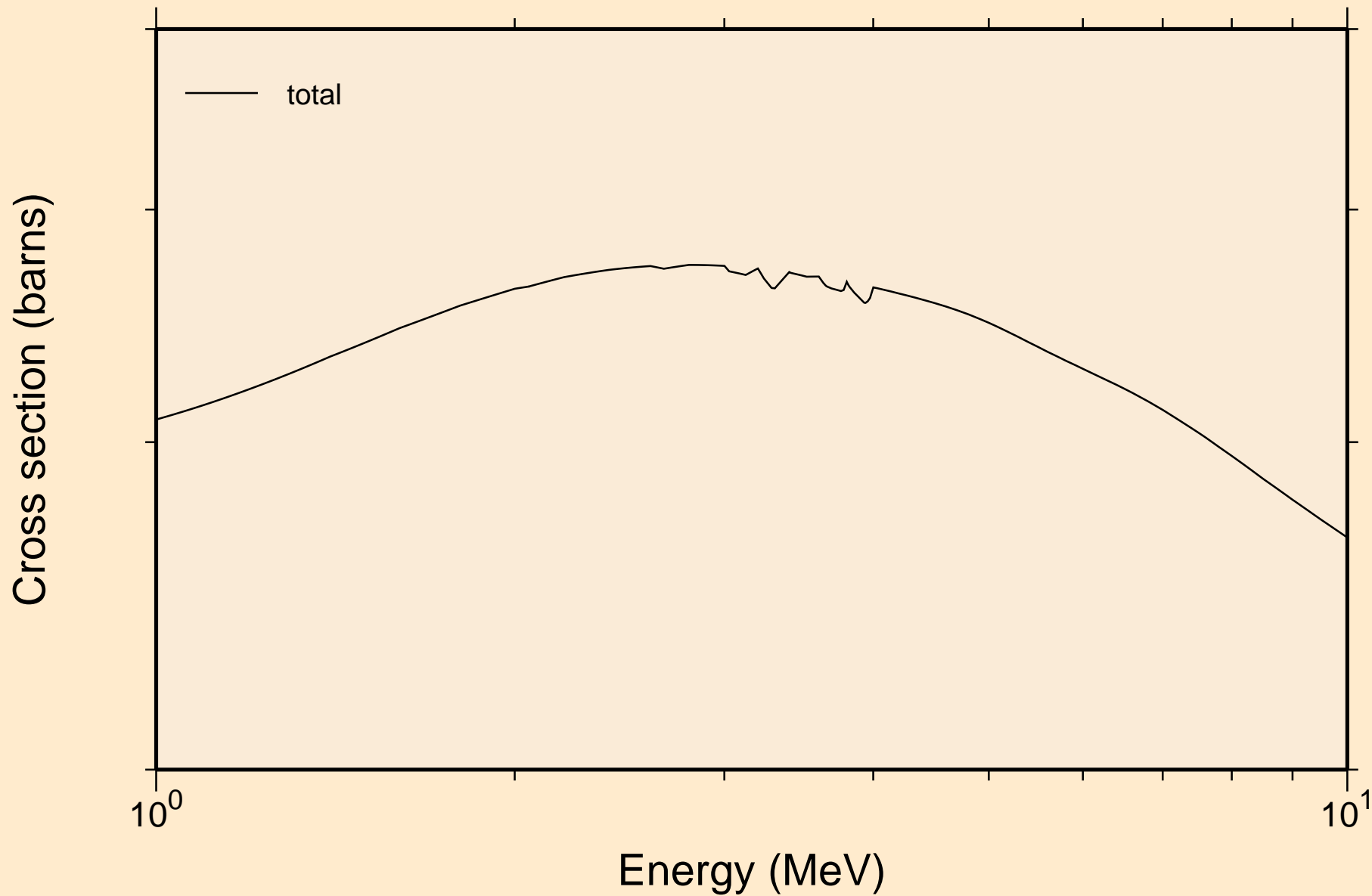

TI046 NEUTRON ACER TENDL-2021 LIBRARY; T=293.6K
resonance absorption cross sections

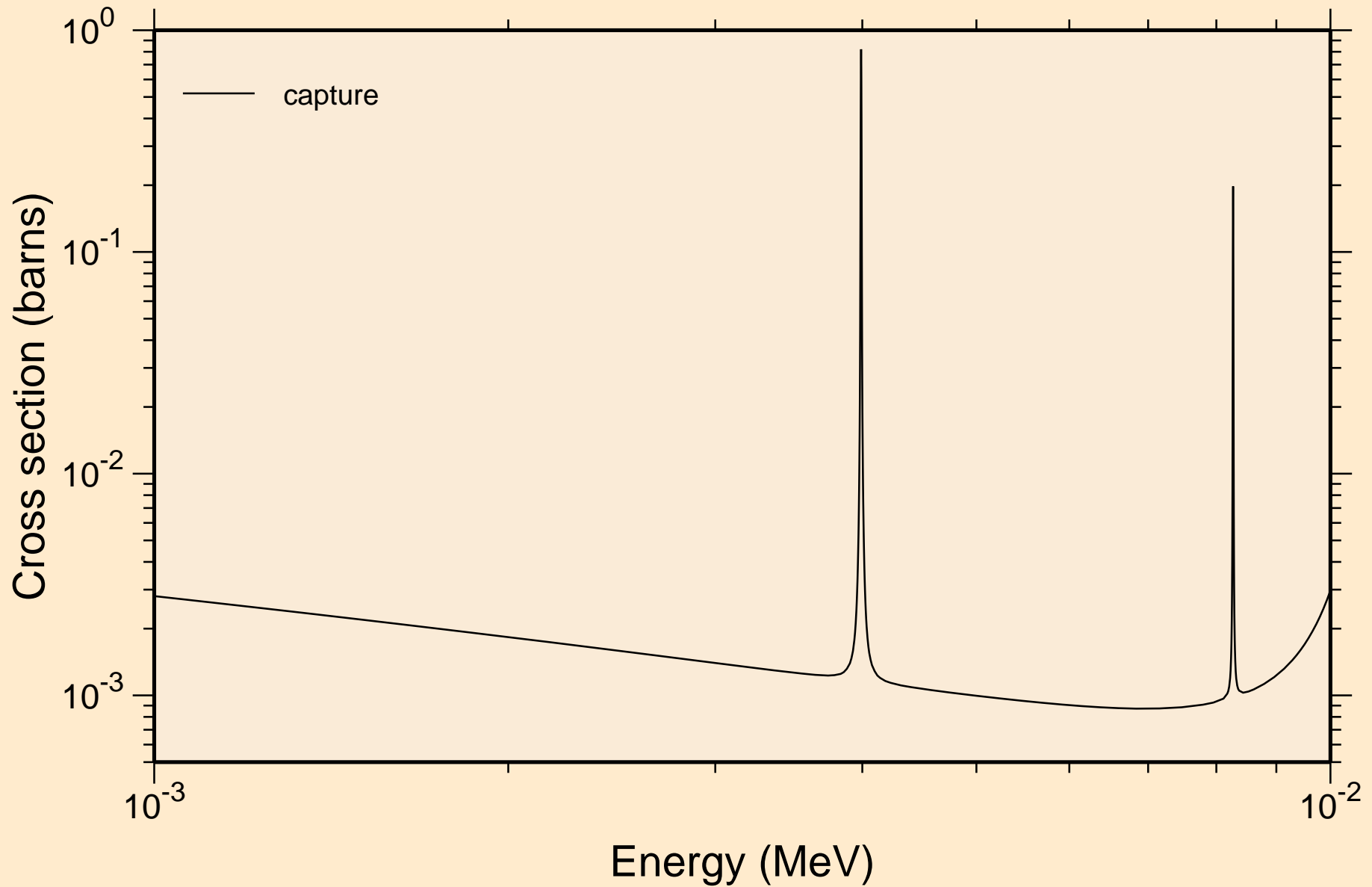

TI046 NEUTRON ACER TENDL-2021 LIBRARY; T=293.6K
resonance absorption cross sections

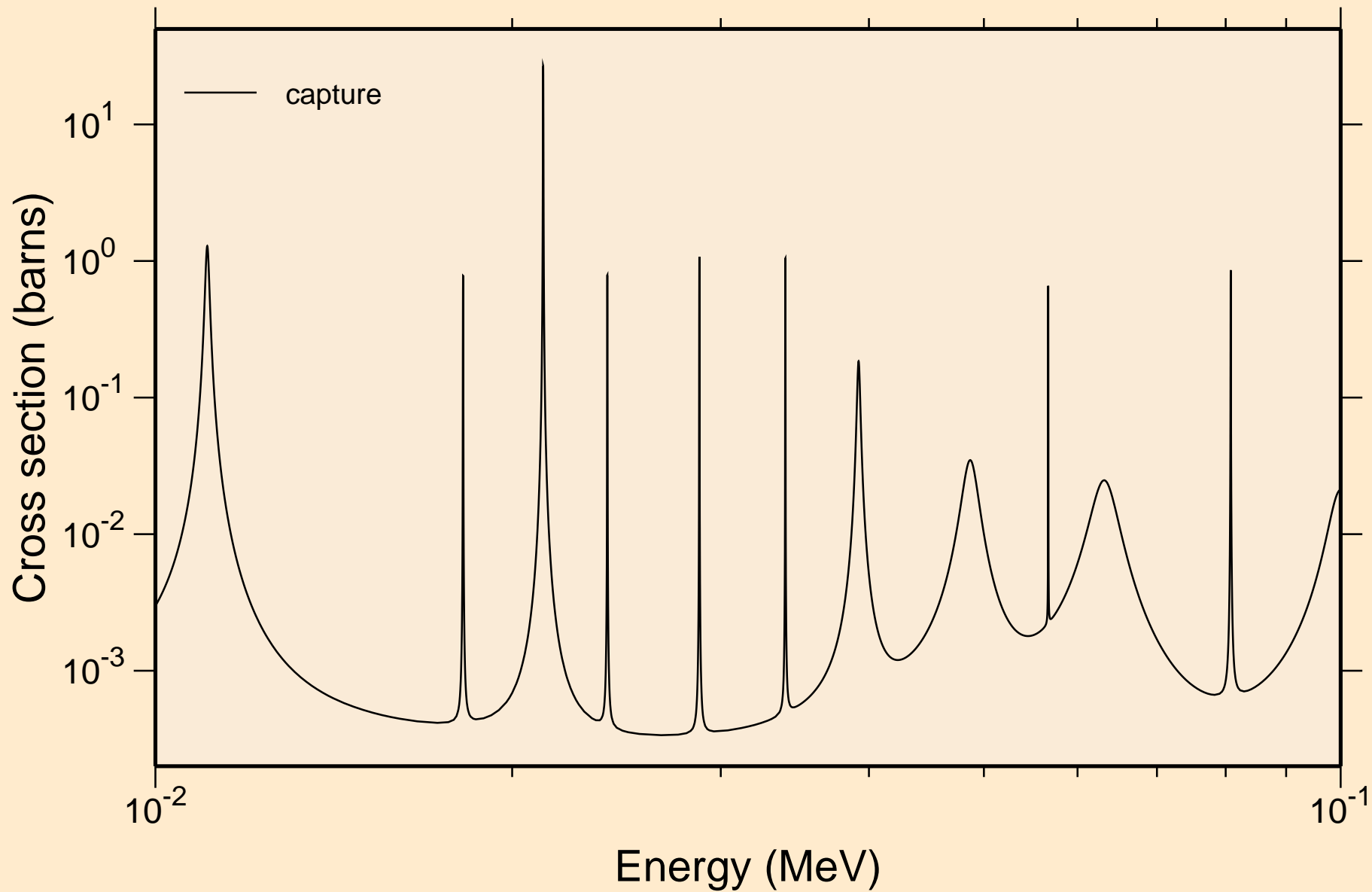

TI046 NEUTRON ACER TENDL-2021 LIBRARY; T=293.6K
resonance absorption cross sections

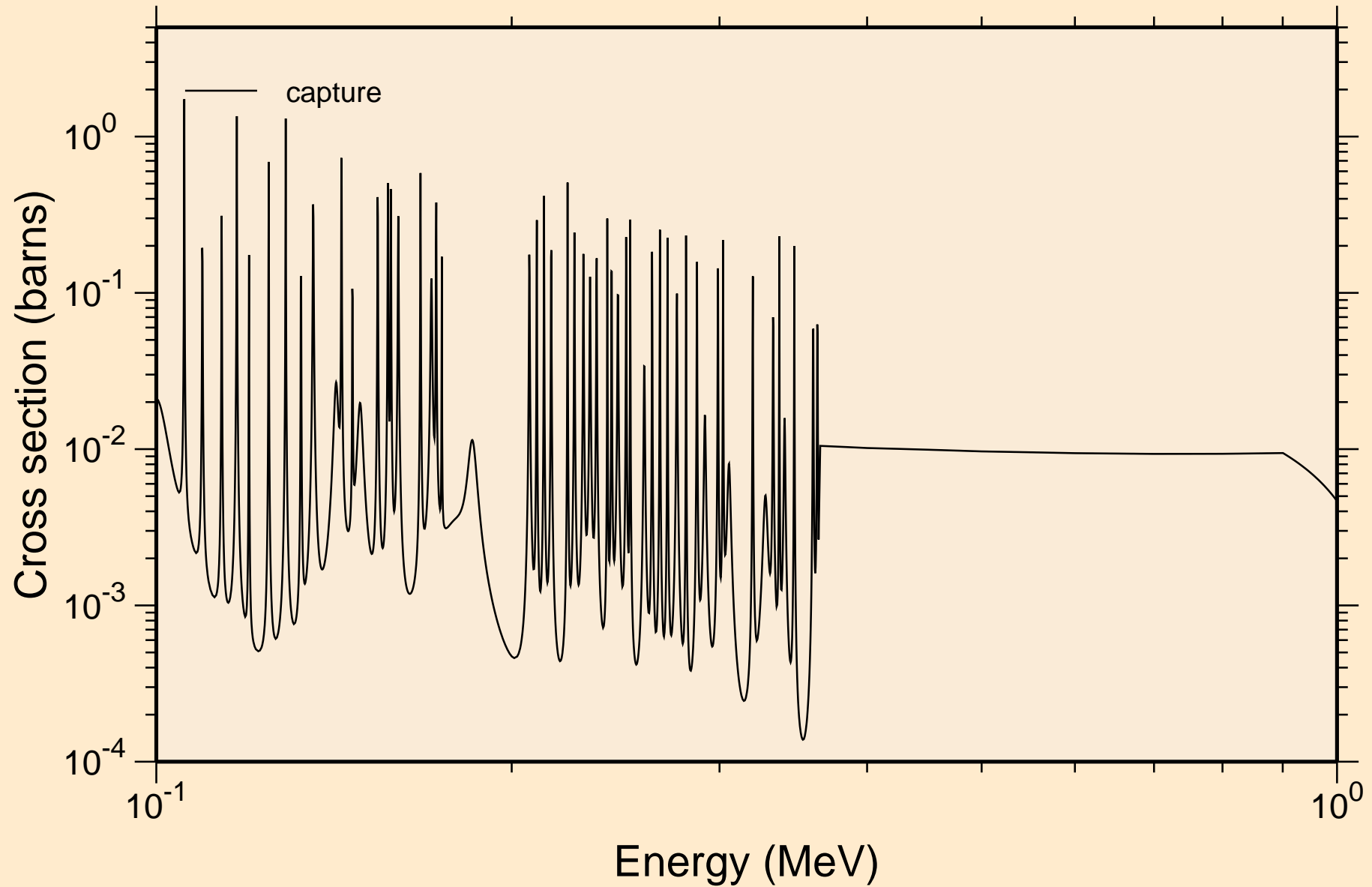

TI046 NEUTRON ACER TENDL-2021 LIBRARY; T=293.6K
resonance absorption cross sections

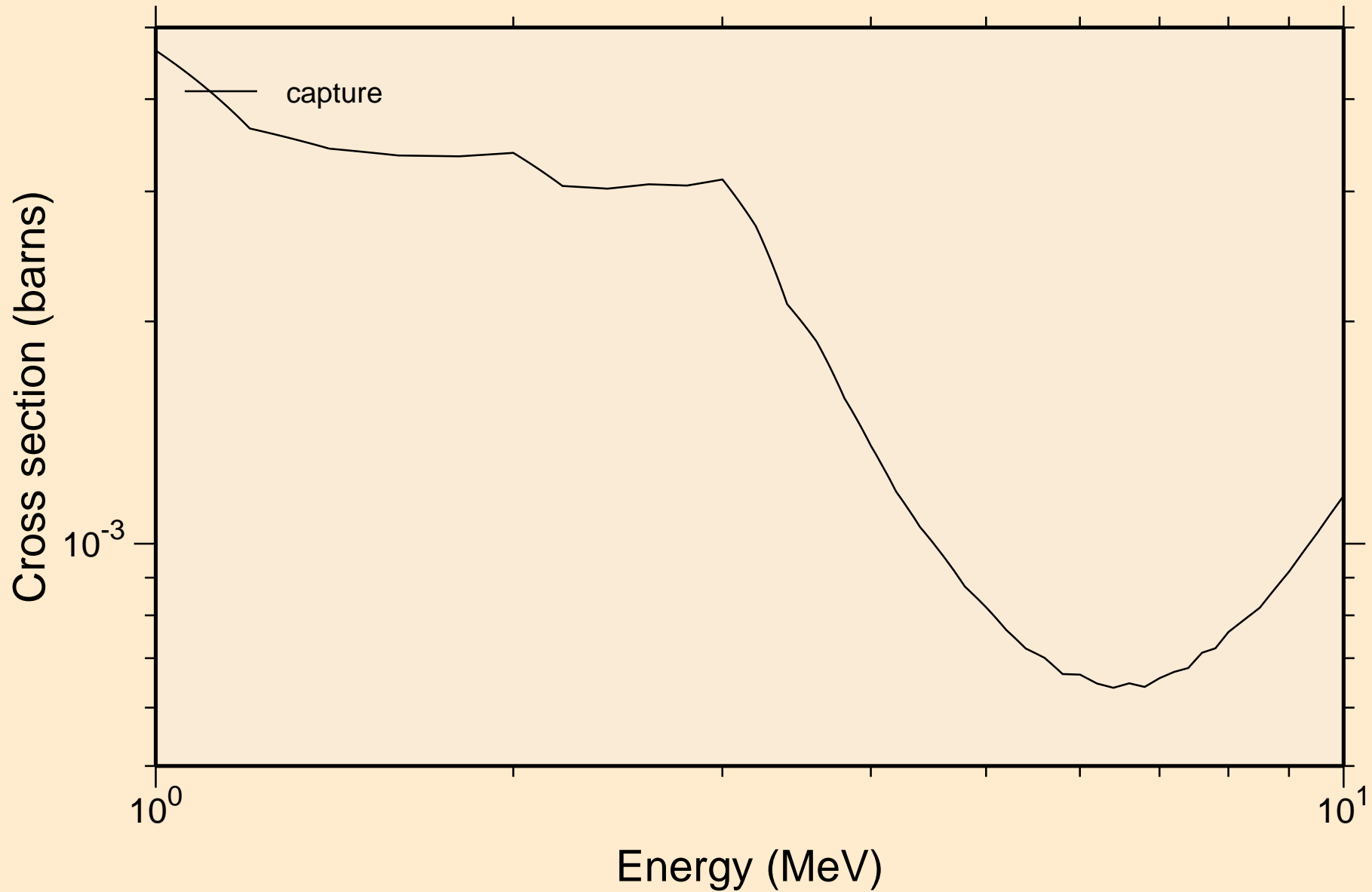

TI046 NEUTRON ACER TENDL-2021 LIBRARY; T=293.6K
Heating

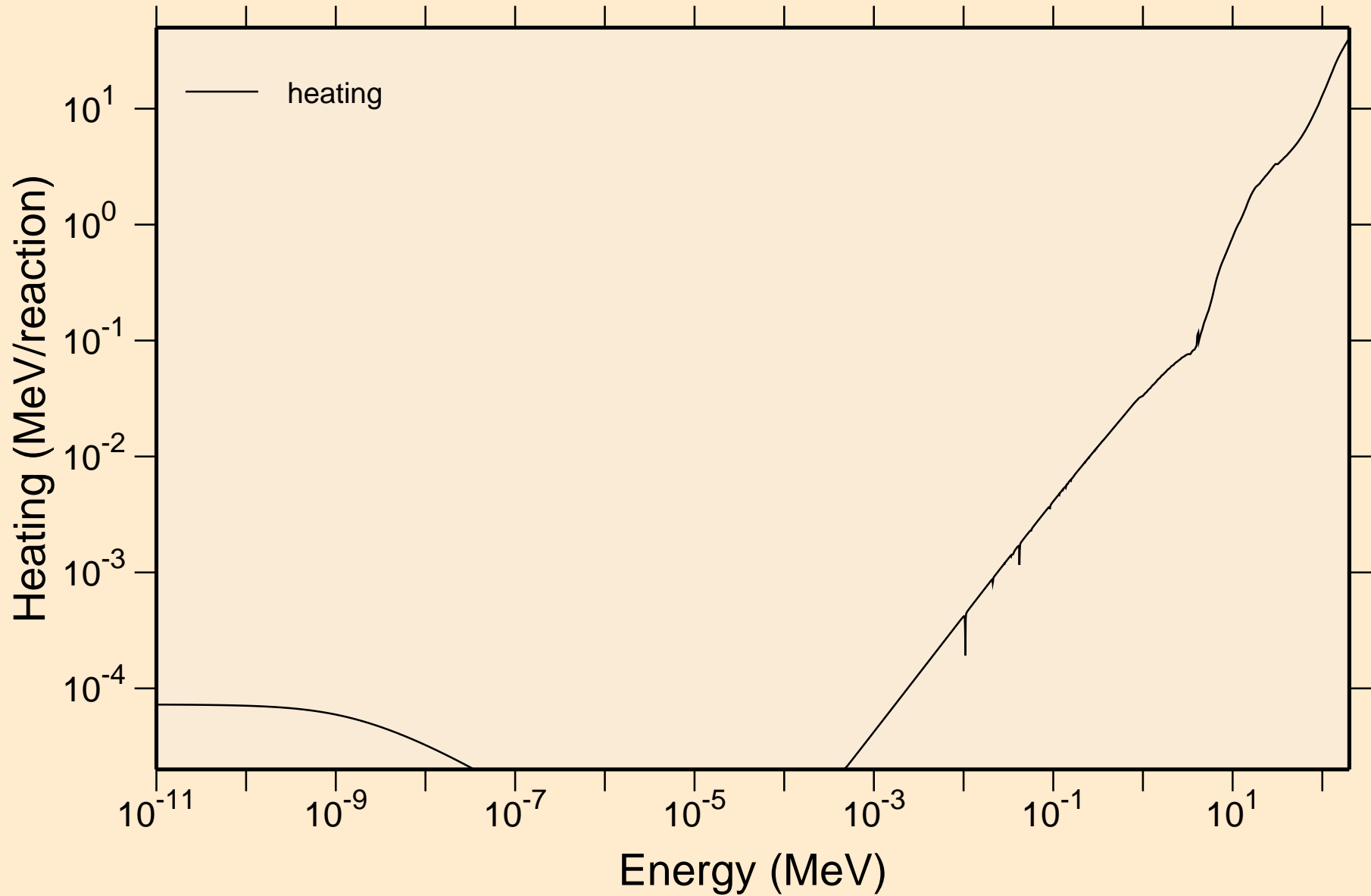

TI046 NEUTRON ACER TENDL-2021 LIBRARY; T=293.6K
Damage

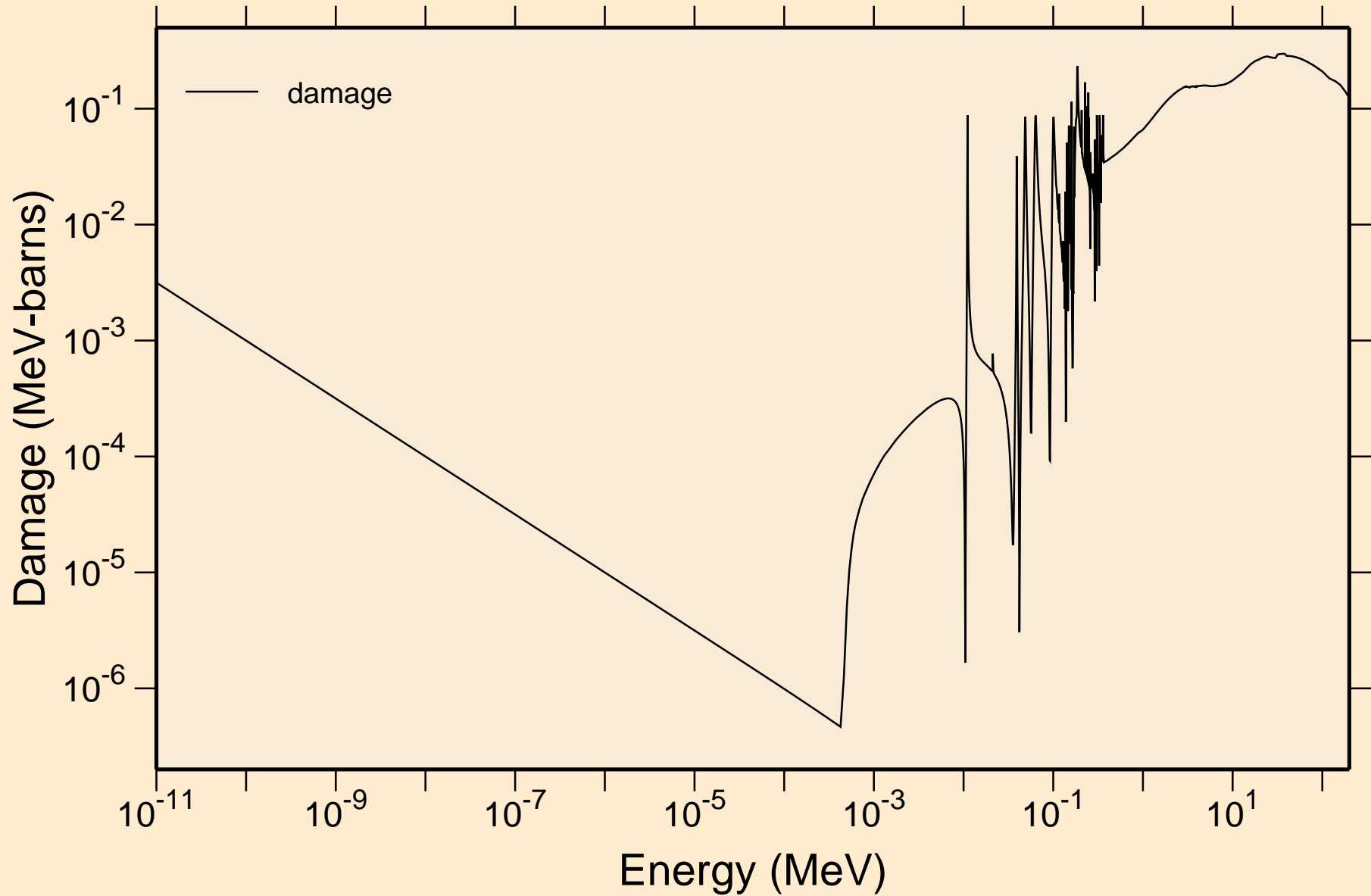

TI046 NEUTRON ACER TENDL-2021 LIBRARY; T=293.6K
Non-threshold reactions

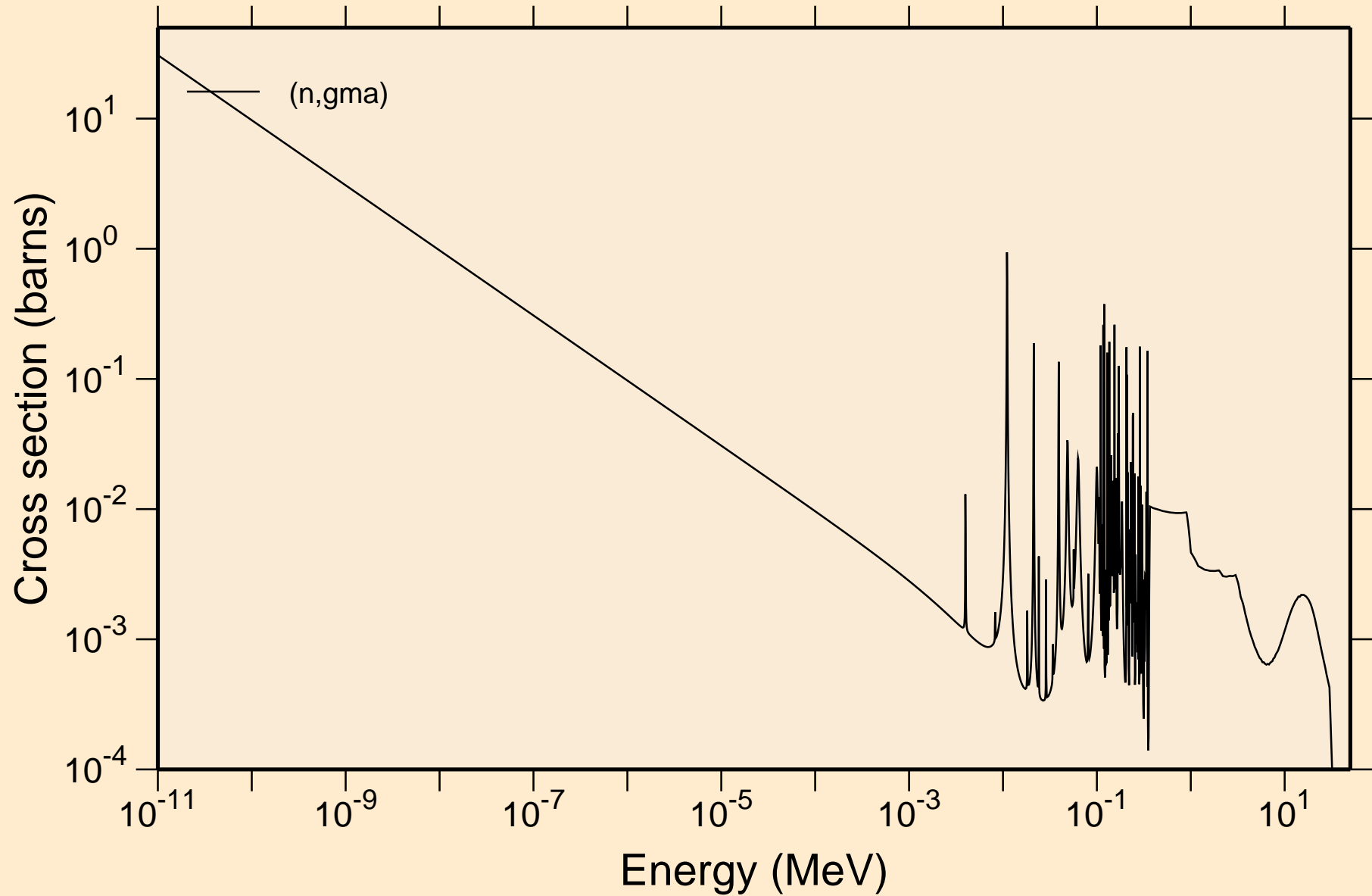

TI046 NEUTRON ACER TENDL-2021 LIBRARY; T=293.6K
Principal cross sections

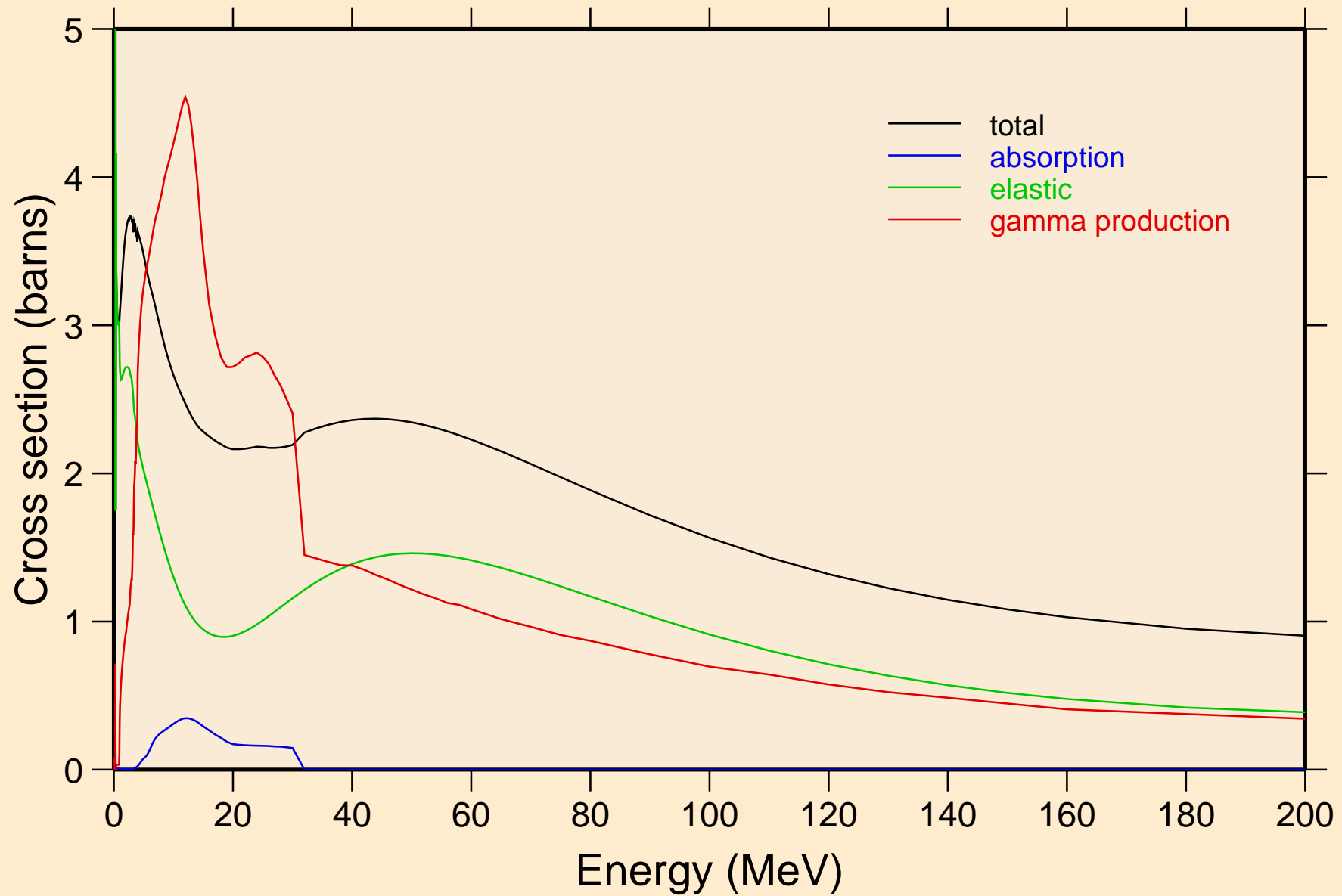

TI046 NEUTRON ACER TENDL-2021 LIBRARY; T=293.6K

Heating

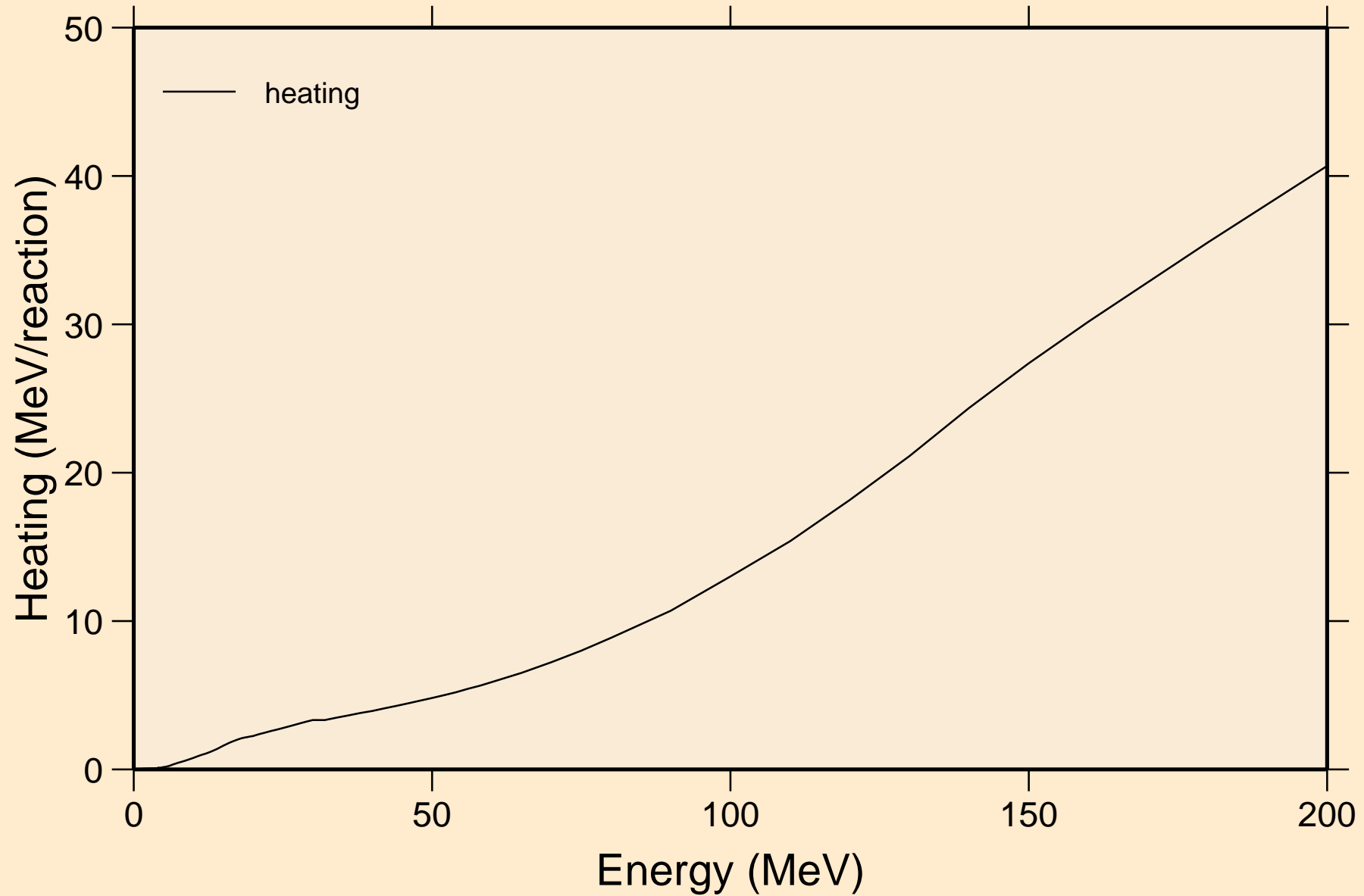

TI046 NEUTRON ACER TENDL-2021 LIBRARY; T=293.6K
Damage

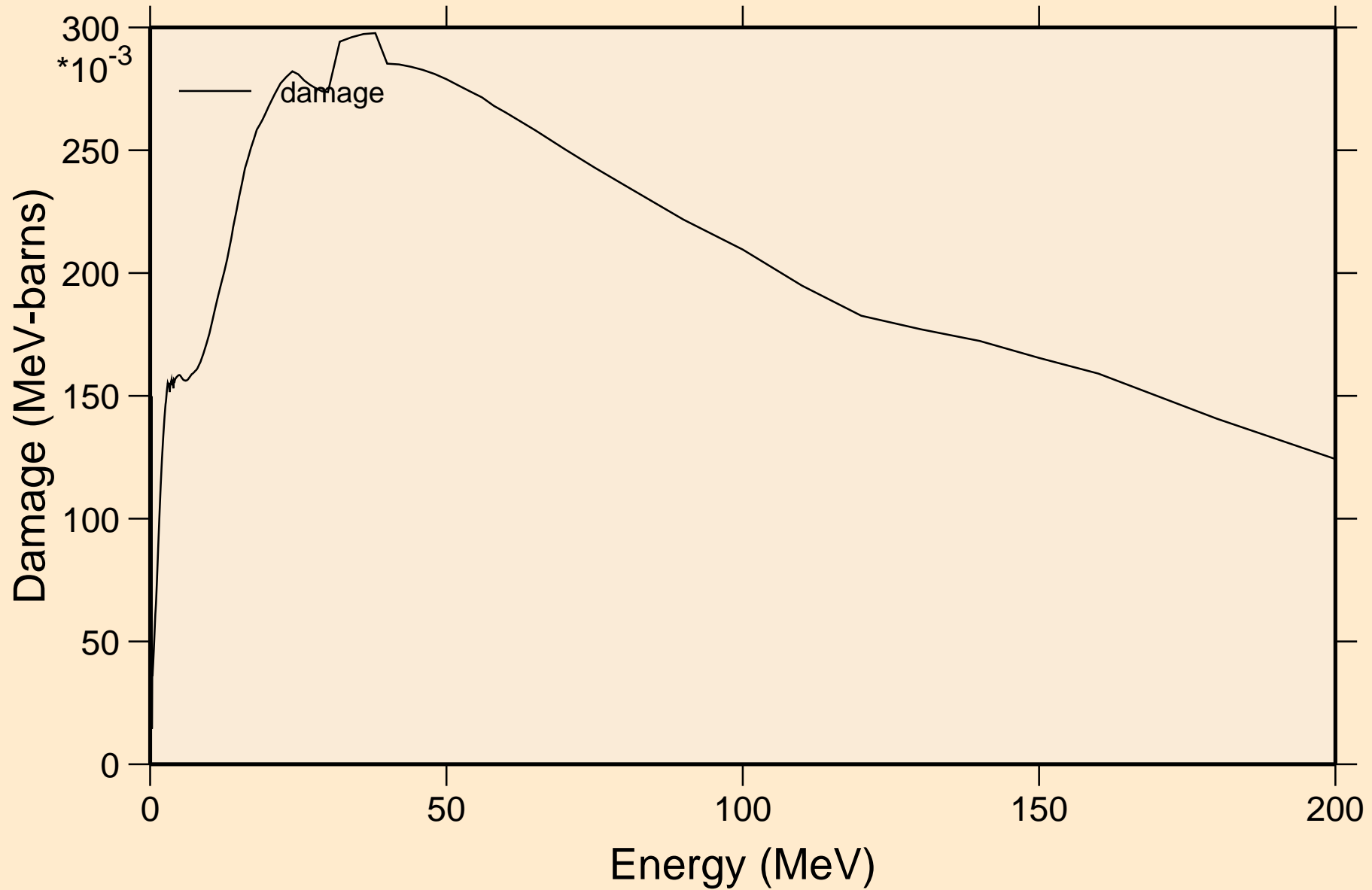

TI046 NEUTRON ACER TENDL-2021 LIBRARY; T=293.6K
Non-threshold reactions

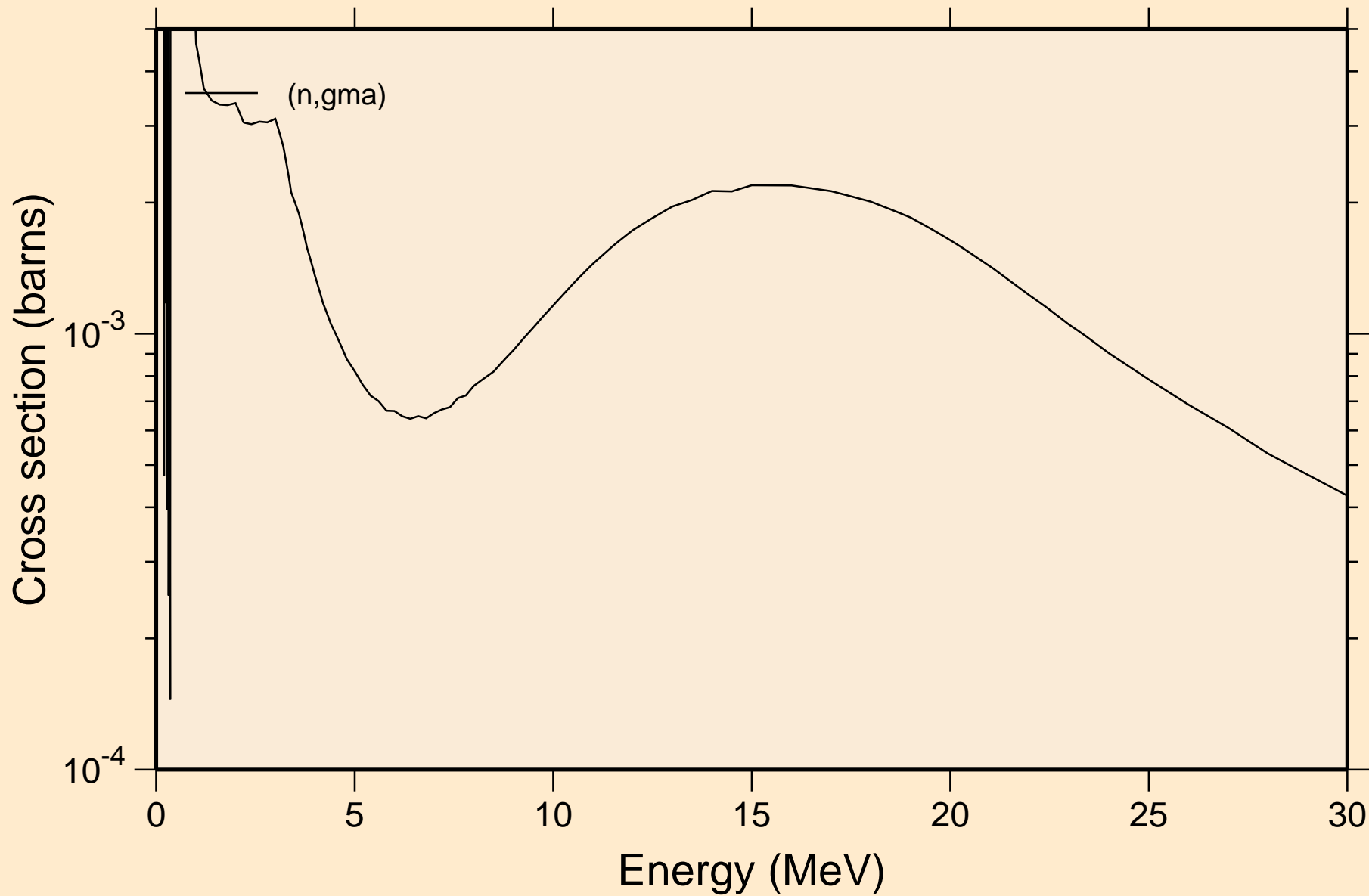

TI046 NEUTRON ACER TENDL-2021 LIBRARY; T=293.6K
Inelastic levels

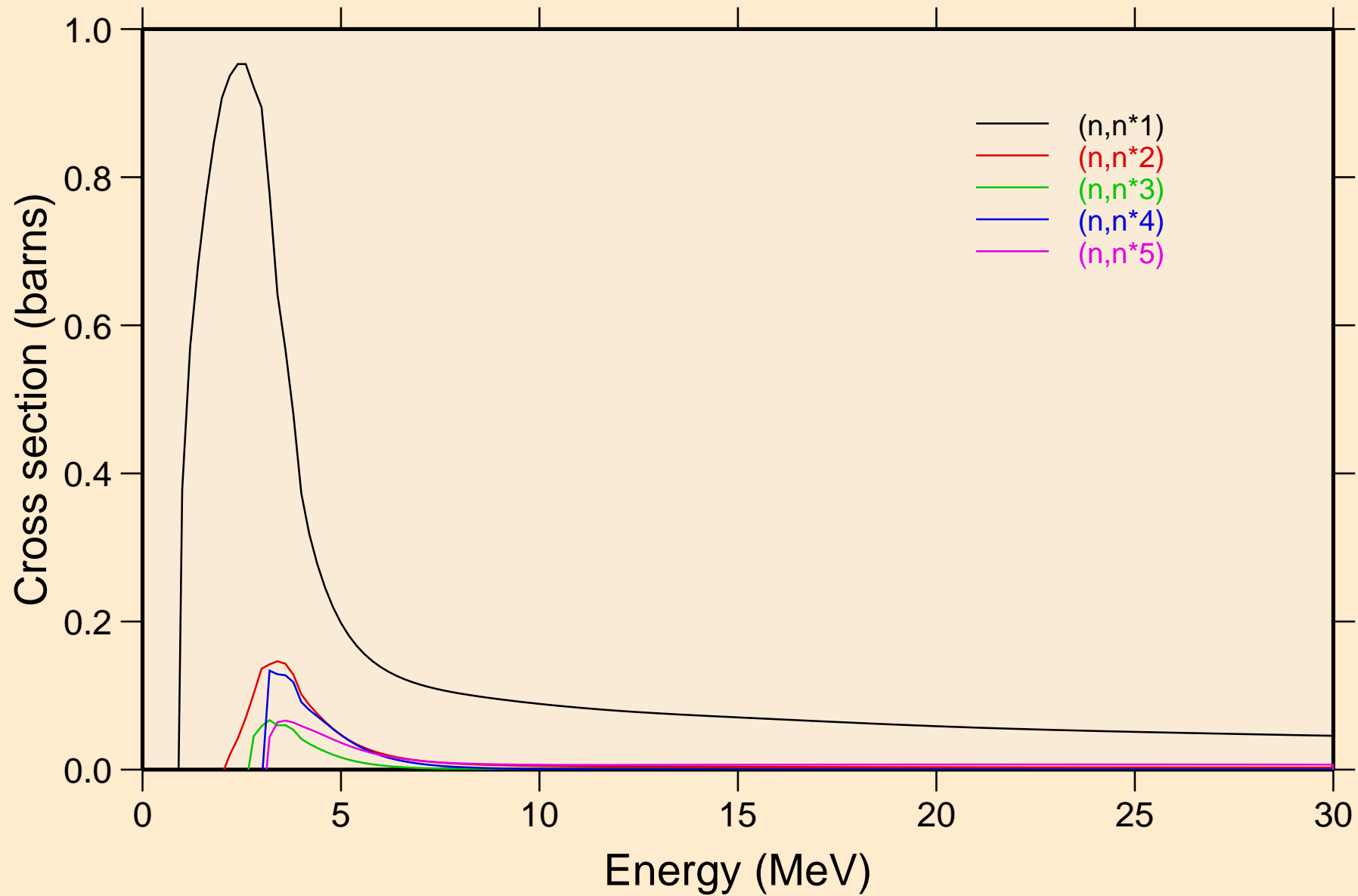

TI046 NEUTRON ACER TENDL-2021 LIBRARY; T=293.6K
Inelastic levels

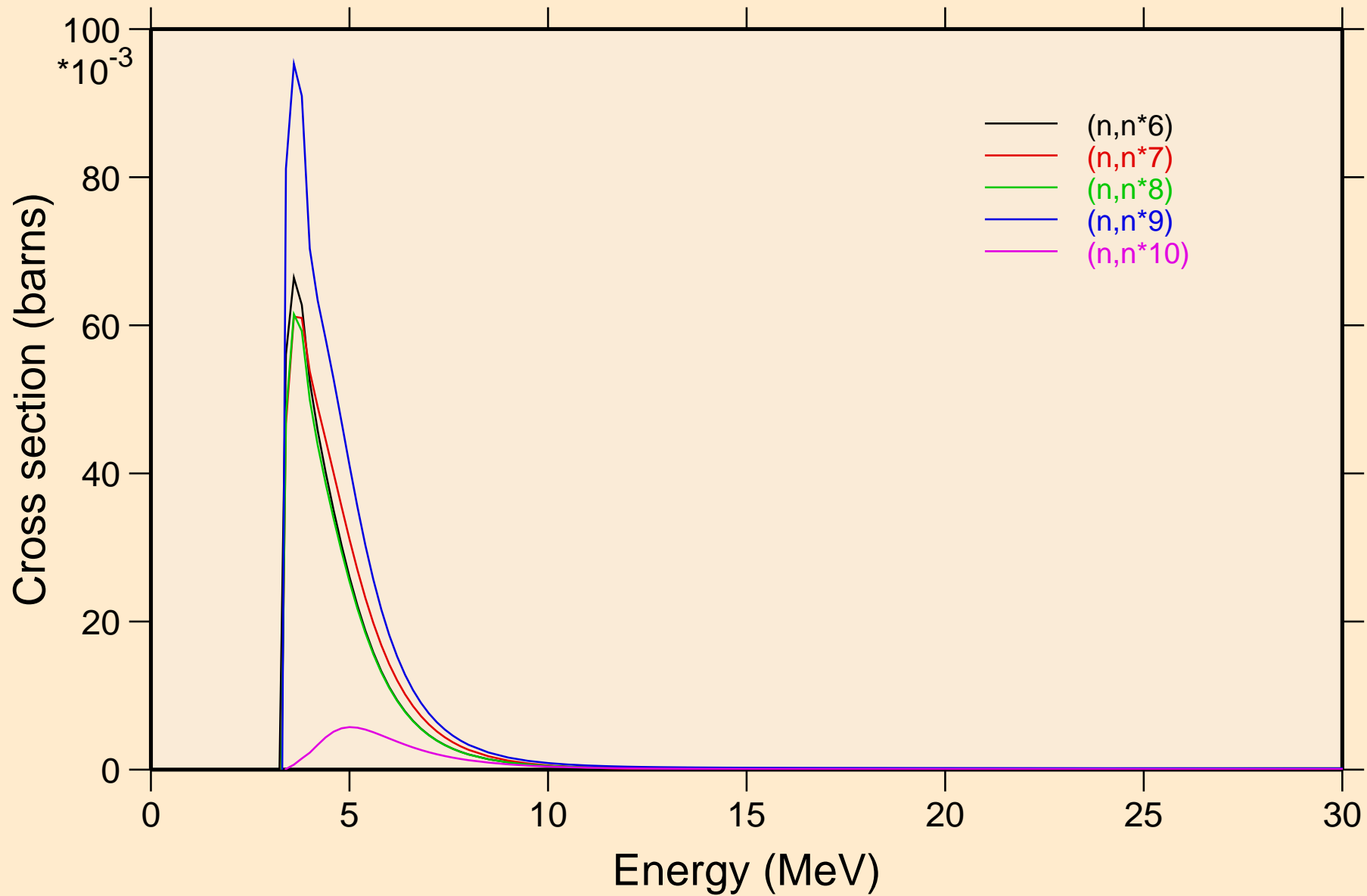

TI046 NEUTRON ACER TENDL-2021 LIBRARY; T=293.6K
Inelastic levels

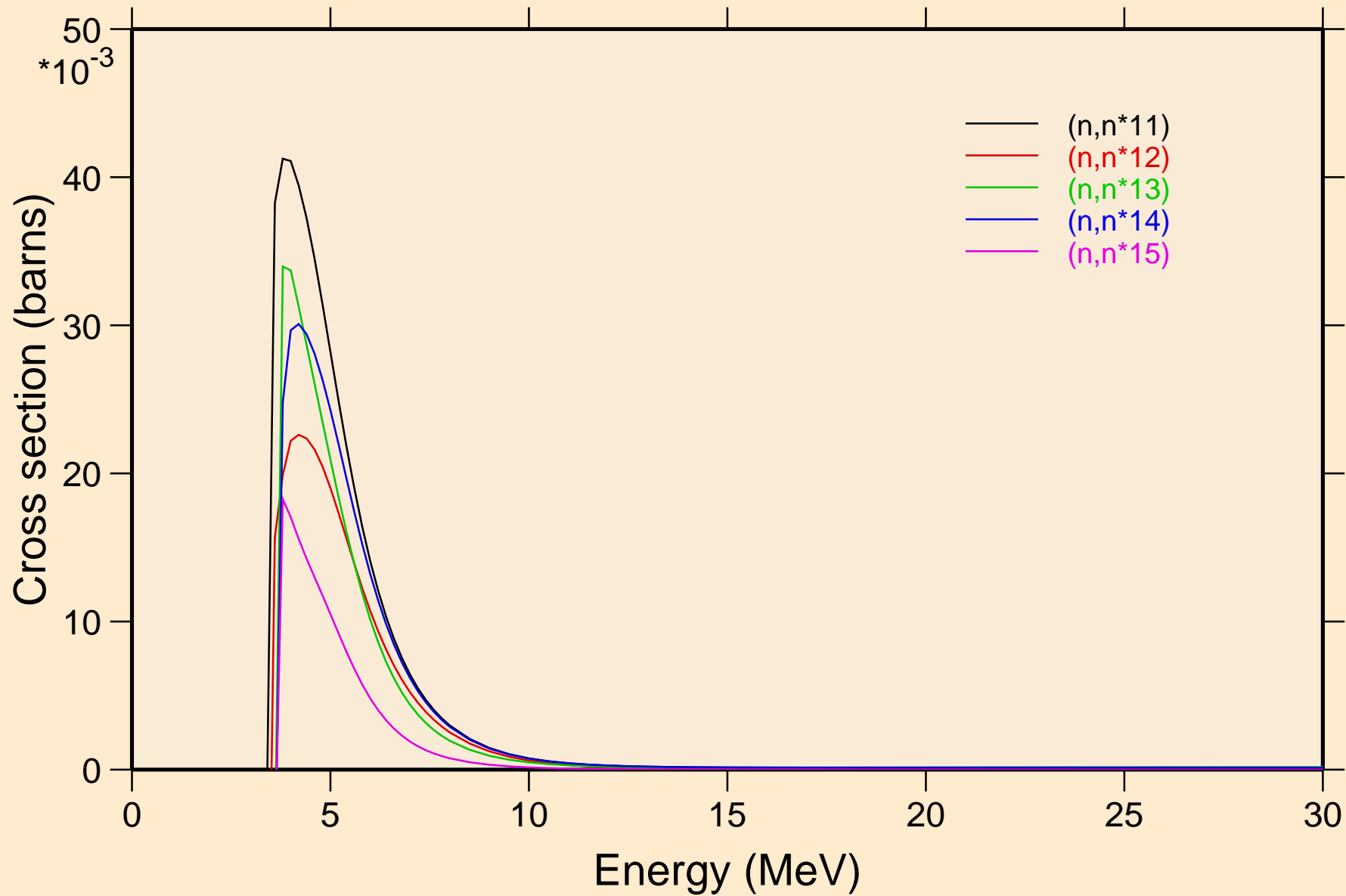

TI046 NEUTRON ACER TENDL-2021 LIBRARY; T=293.6K
Inelastic levels

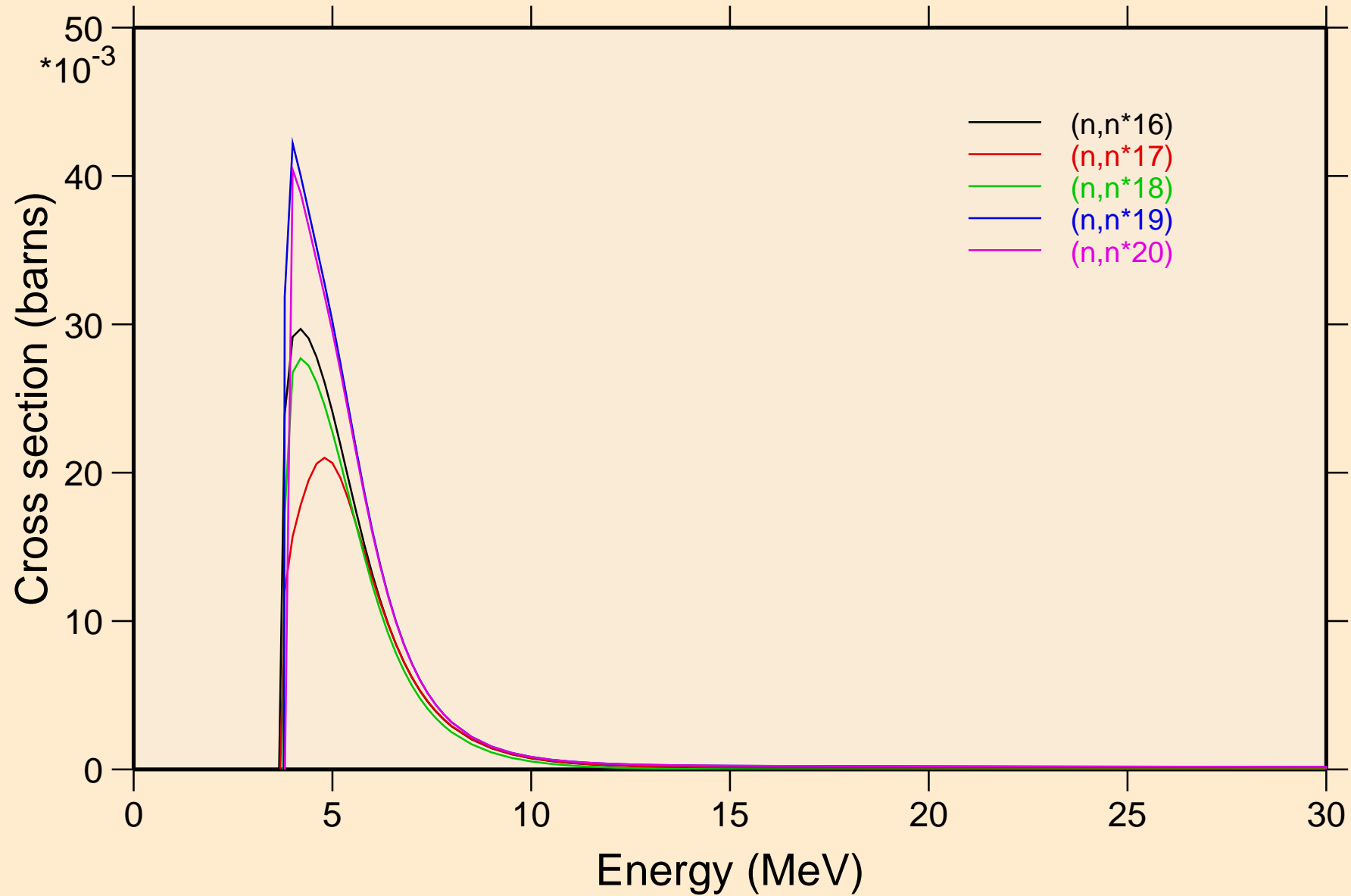

TI046 NEUTRON ACER TENDL-2021 LIBRARY; T=293.6K
Inelastic levels

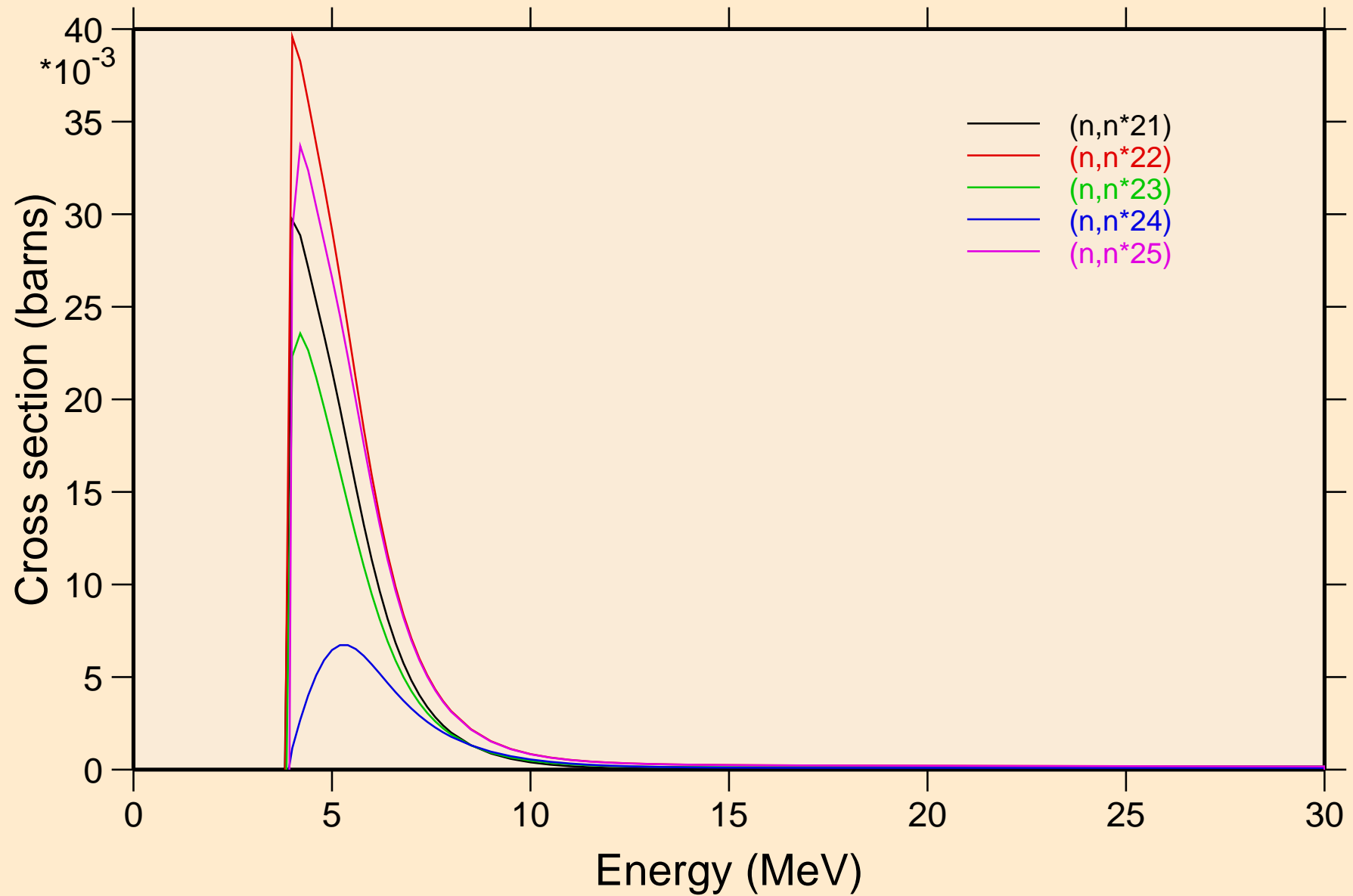

TI046 NEUTRON ACER TENDL-2021 LIBRARY; T=293.6K
Inelastic levels

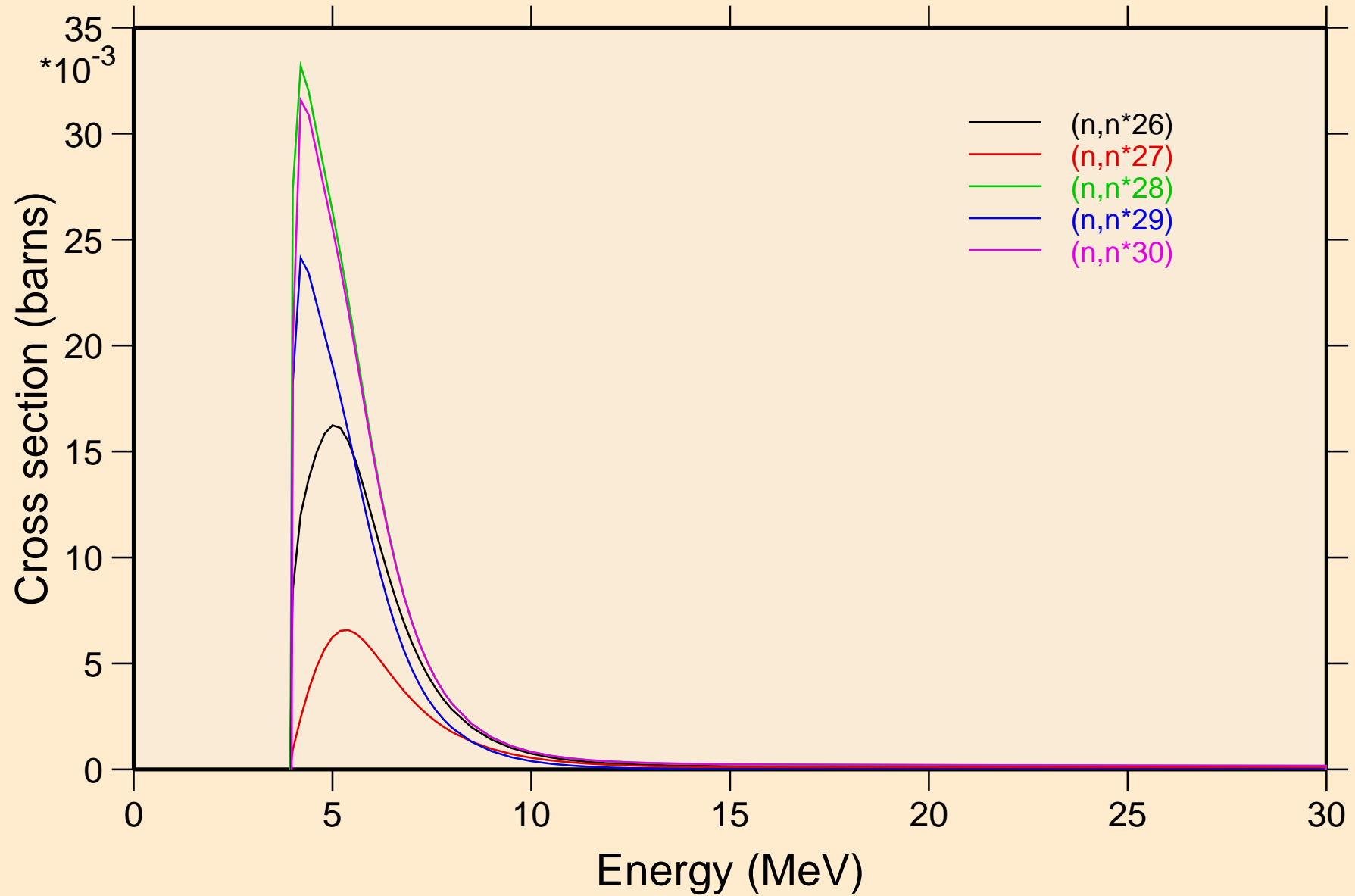

TI046 NEUTRON ACER TENDL-2021 LIBRARY; T=293.6K
Threshold reactions

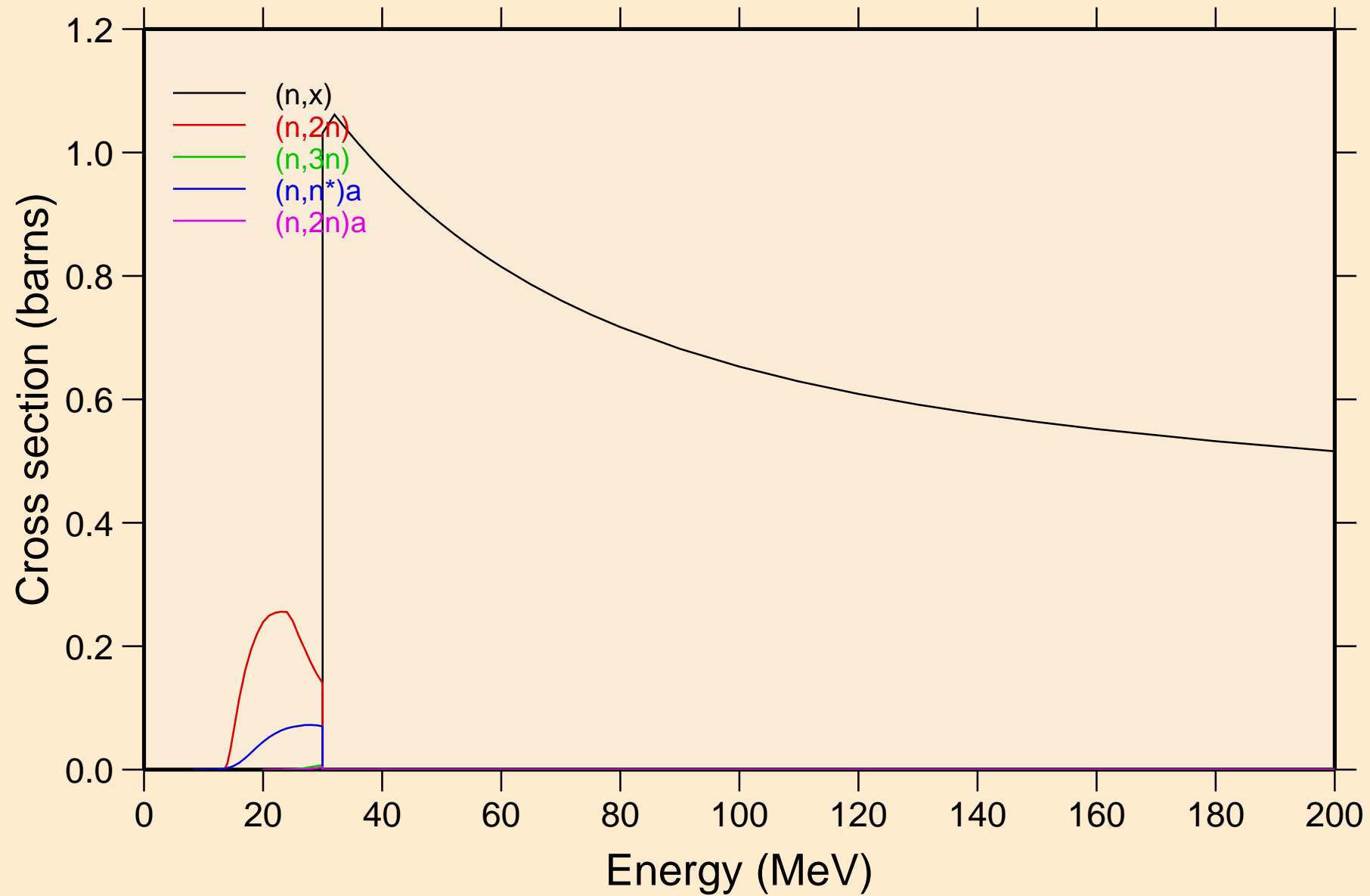

TI046 NEUTRON ACER TENDL-2021 LIBRARY; T=293.6K
Threshold reactions

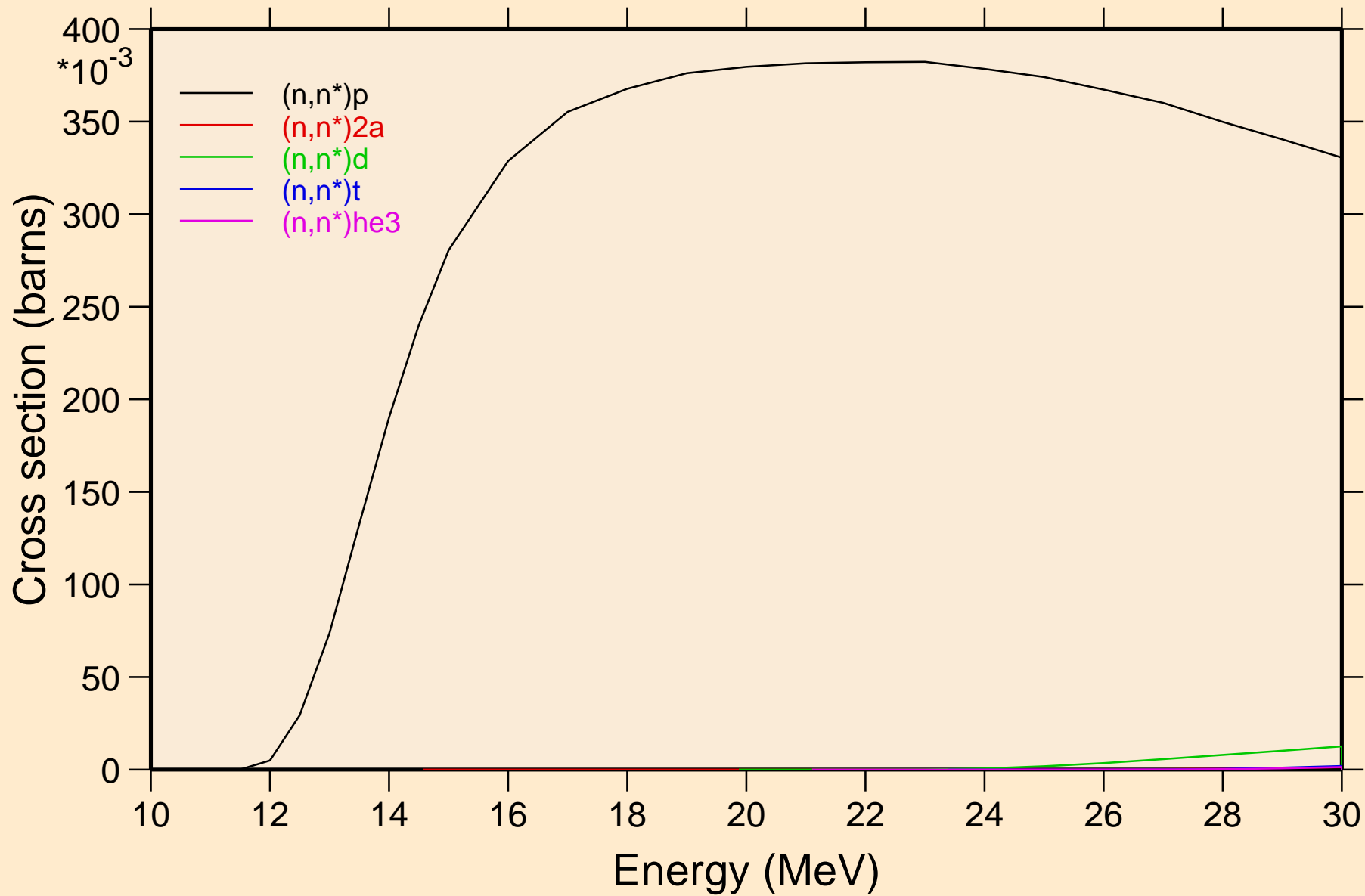

TI046 NEUTRON ACER TENDL-2021 LIBRARY; T=293.6K
Threshold reactions

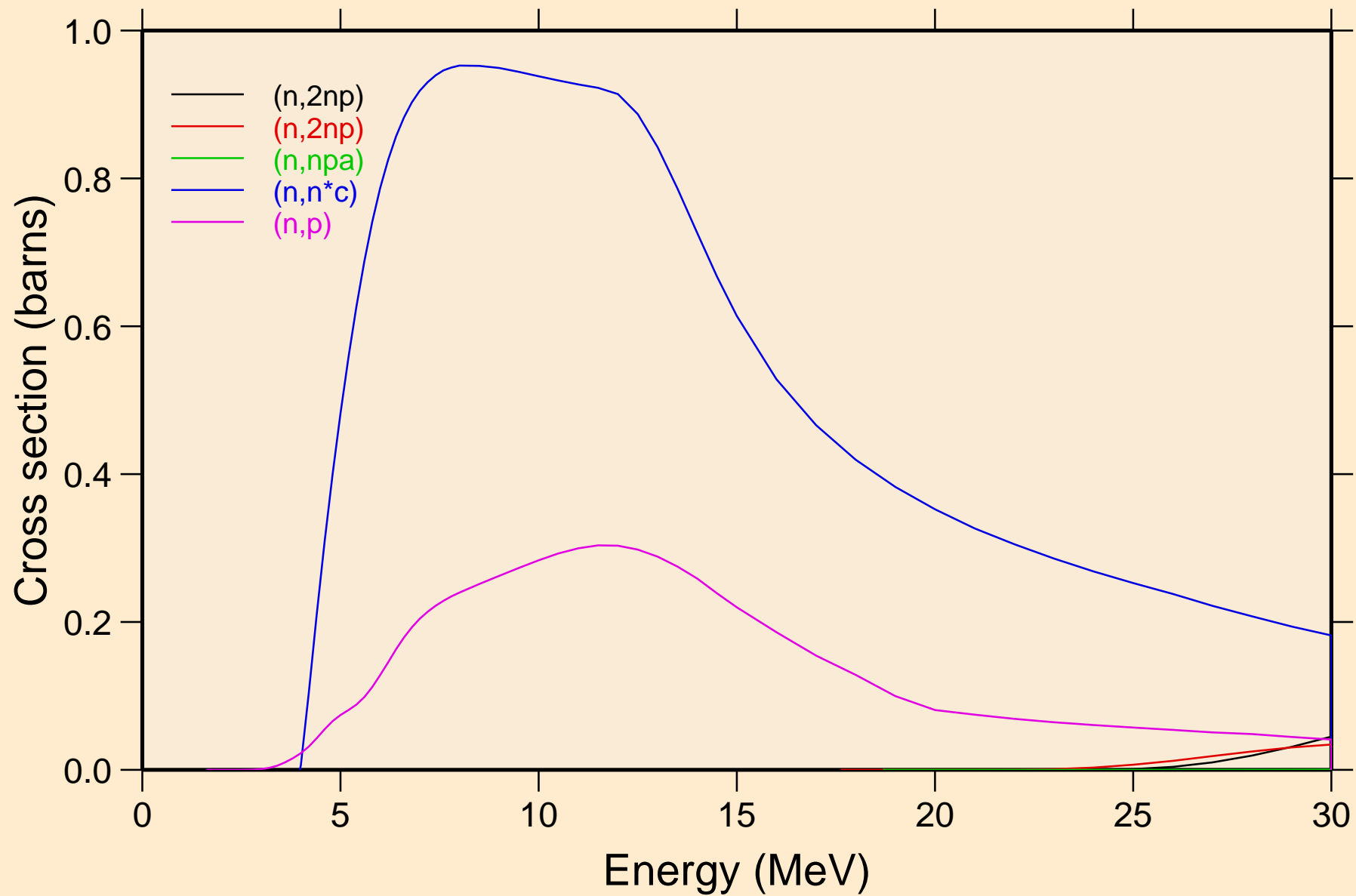

TI046 NEUTRON ACER TENDL-2021 LIBRARY; T=293.6K
Threshold reactions

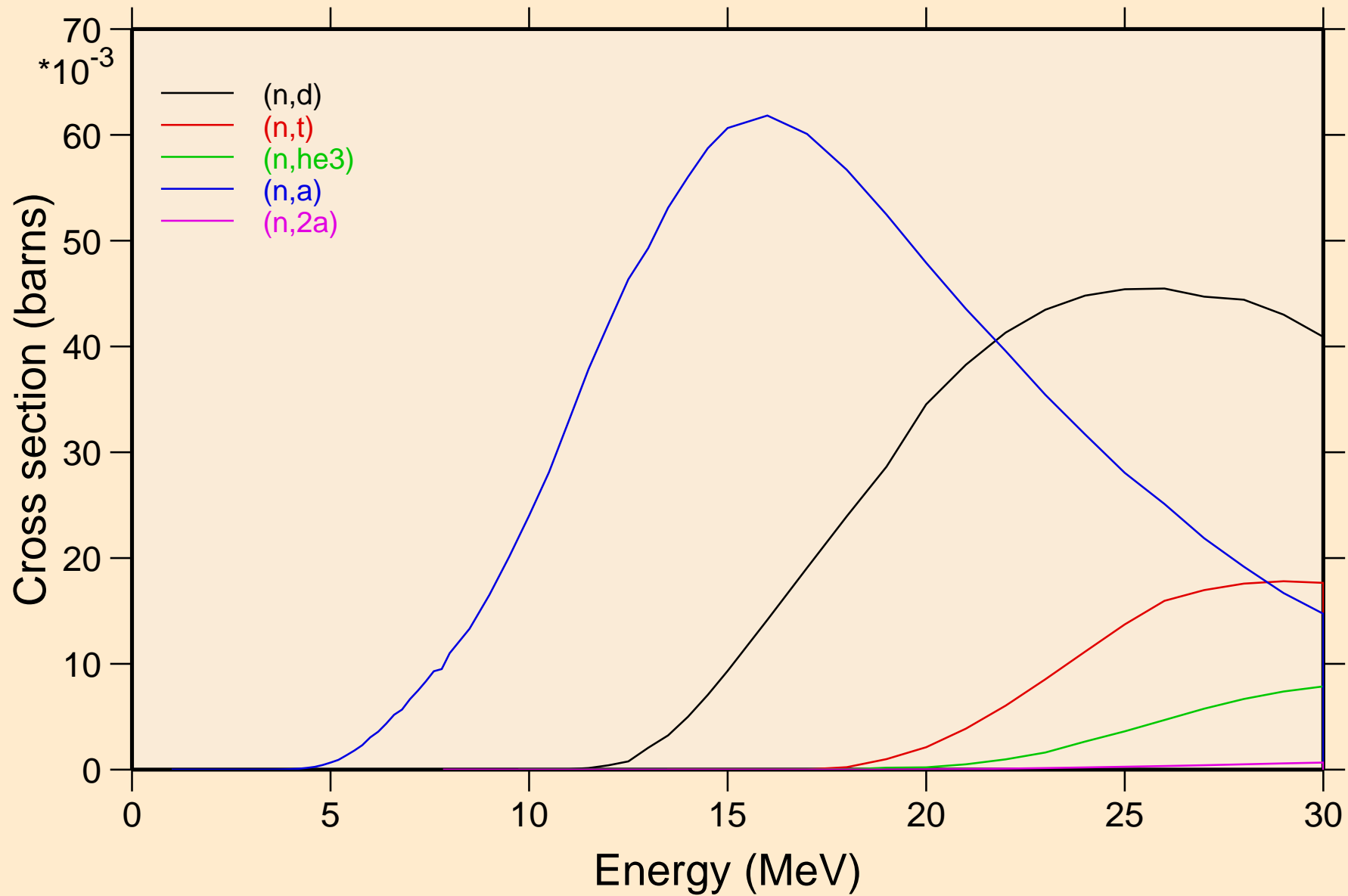

TI046 NEUTRON ACER TENDL-2021 LIBRARY; T=293.6K
Threshold reactions

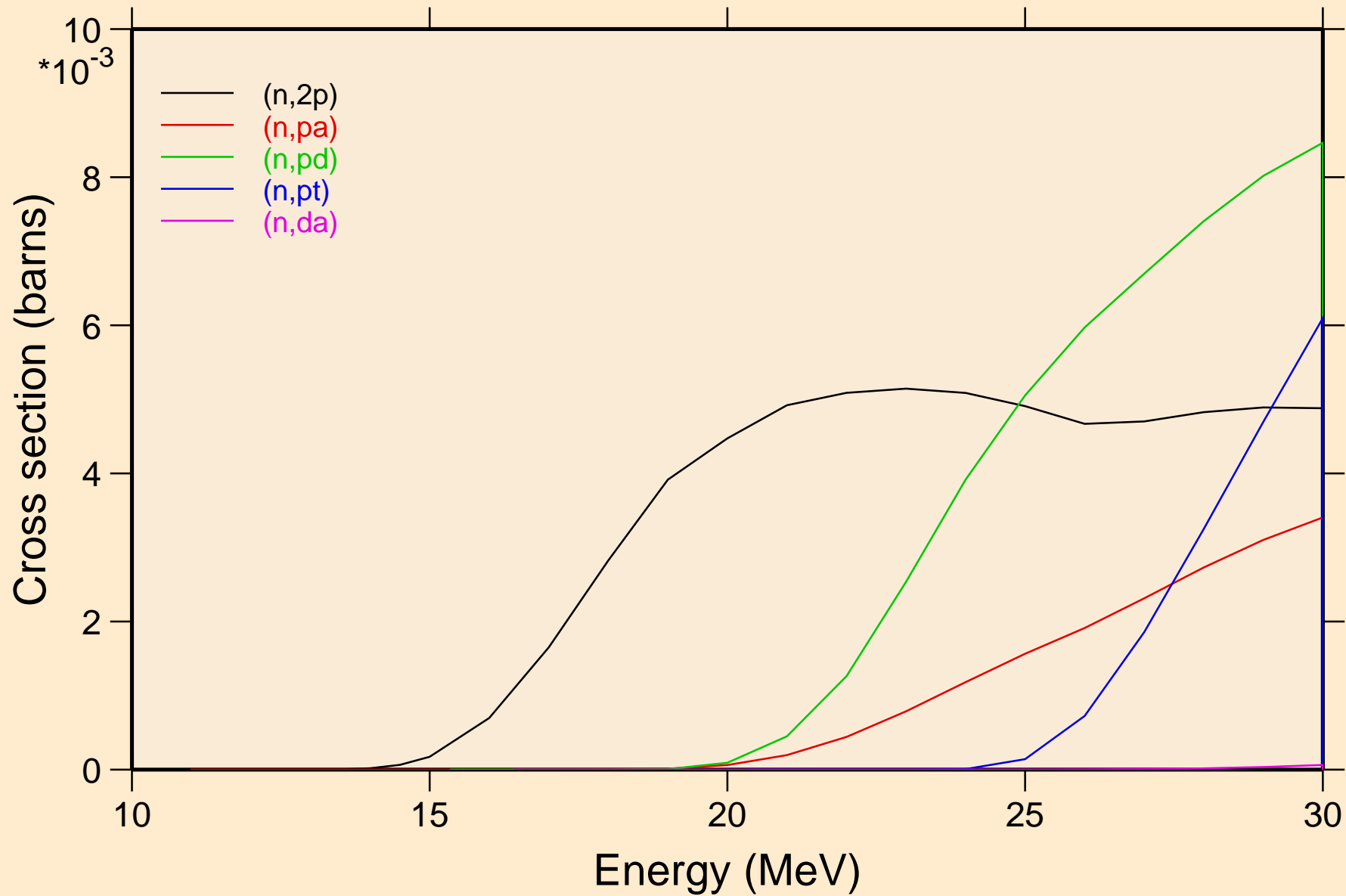

TI046 NEUTRON ACER TENDL-2021 LIBRARY; T=293.6K
Threshold reactions

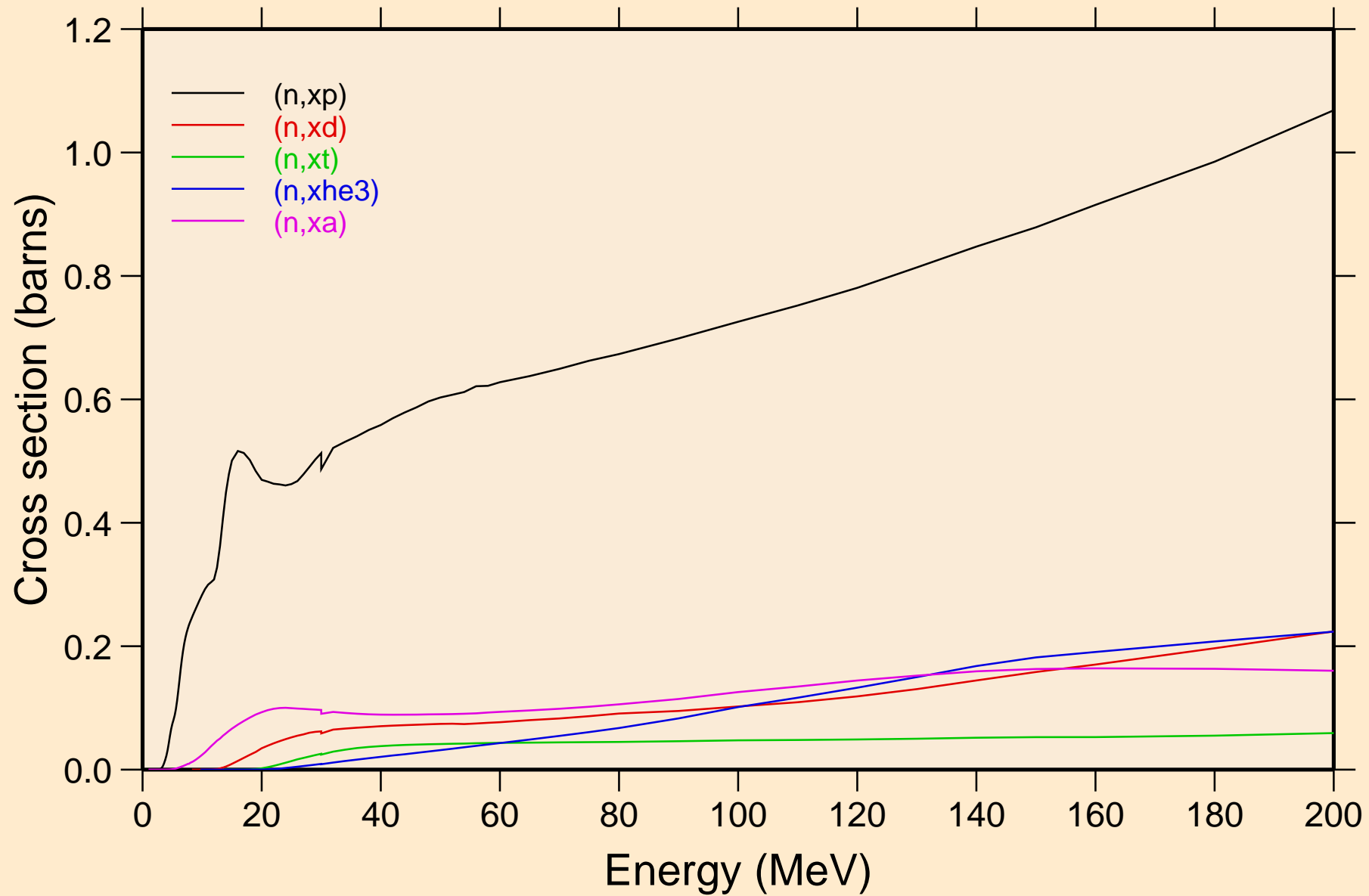

TI046 NEUTRON ACER TENDL-2021 LIBRARY; T=293.6K
angular distribution for elastic

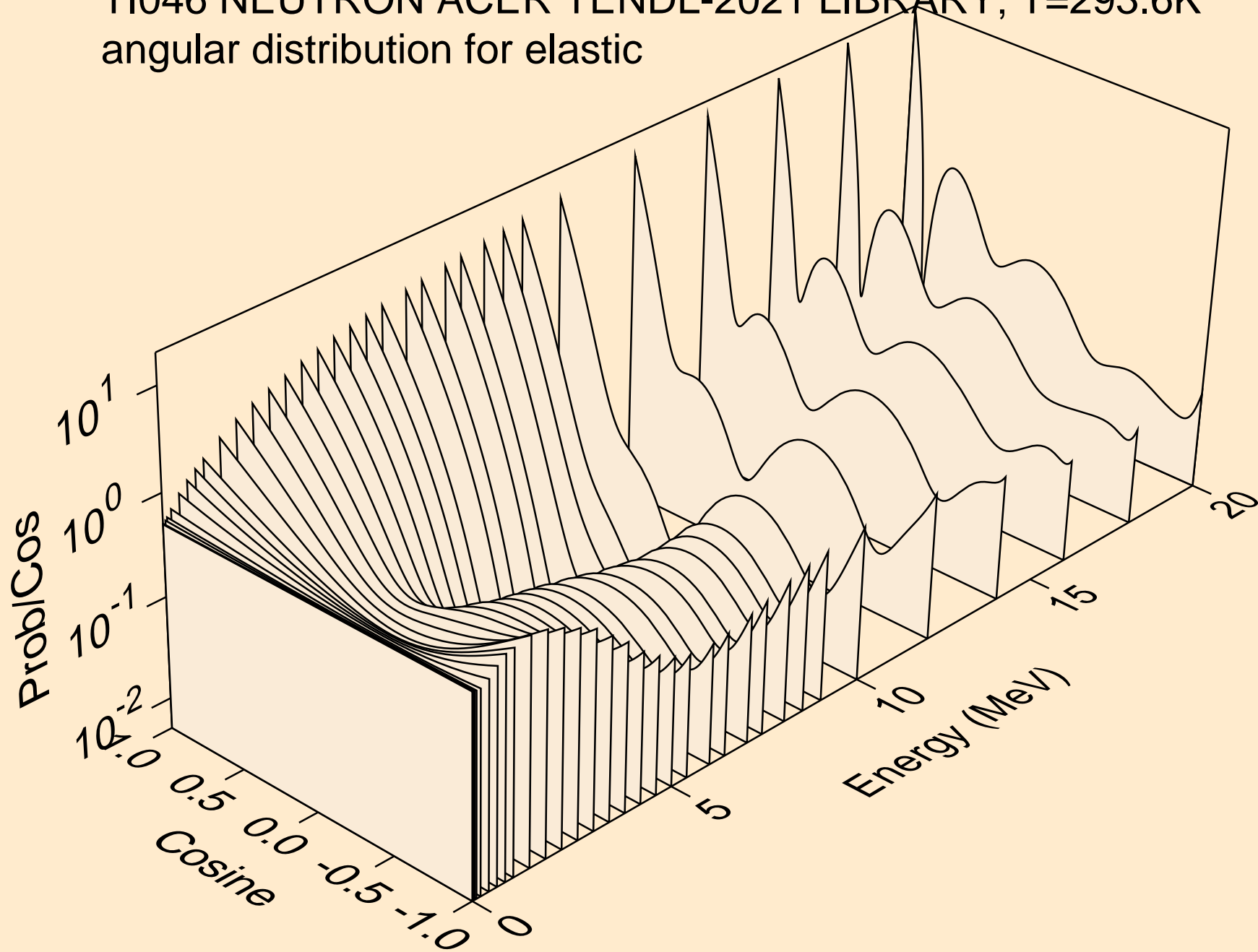

TI046 NEUTRON ACER TENDL-2021 LIBRARY; T=293.6K
angular distribution for elastic

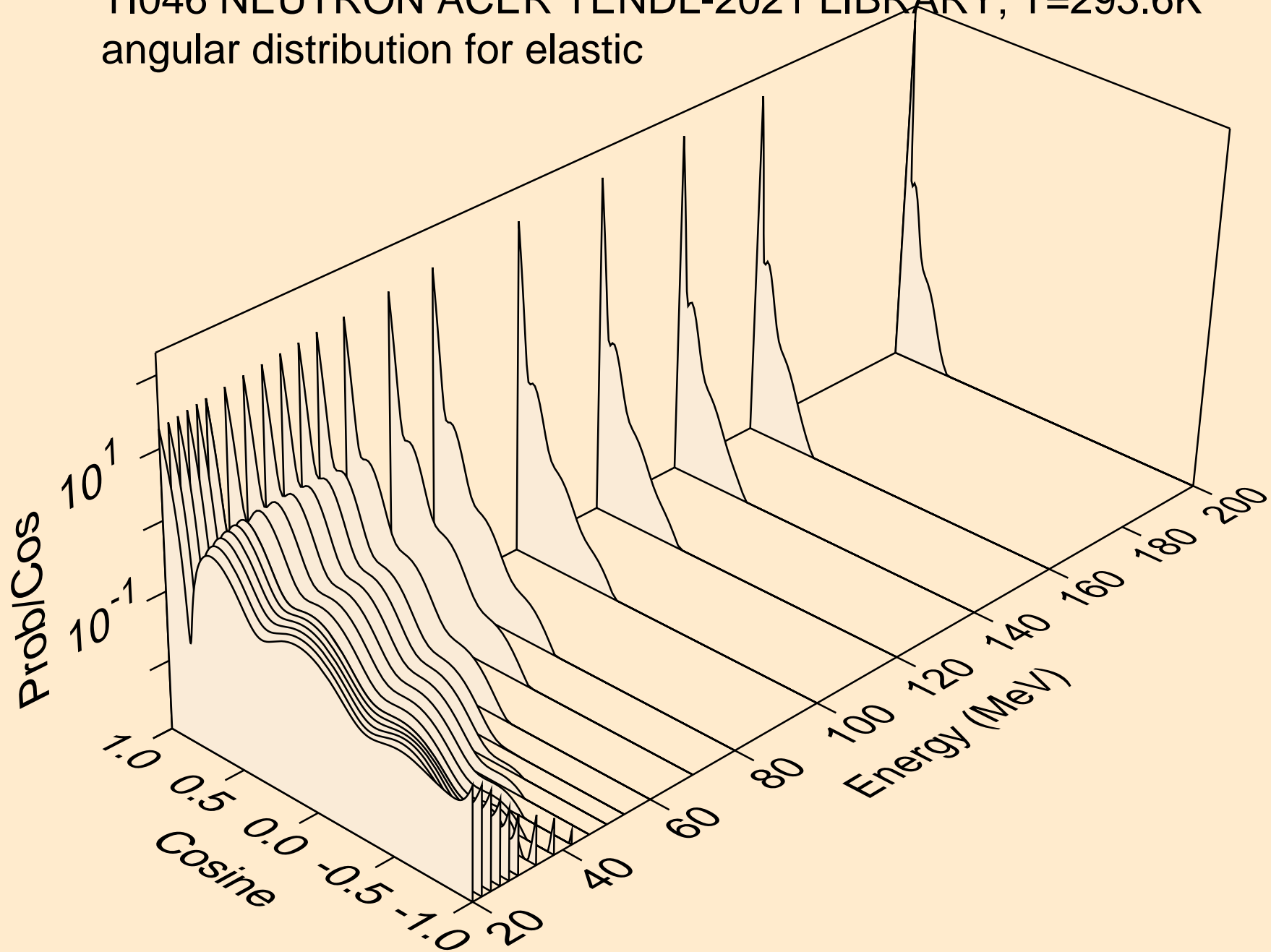

TI046 NEUTRON ACER TENDL-2021 LIBRARY; T=293.6K
angular distribution for (n,n*1)

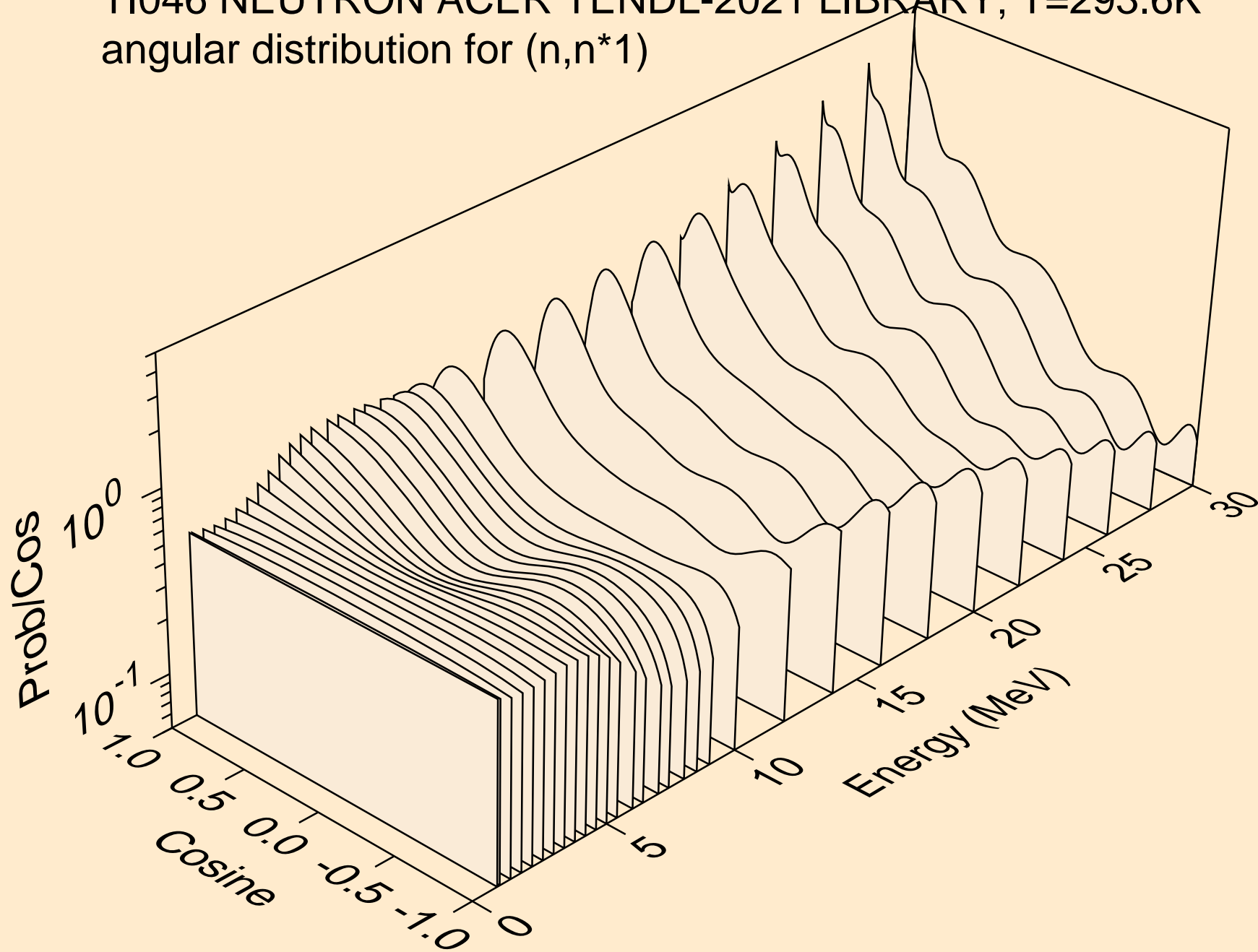

TI046 NEUTRON ACER TENDL-2021 LIBRARY; T=293.6K
angular distribution for (n,n*2)

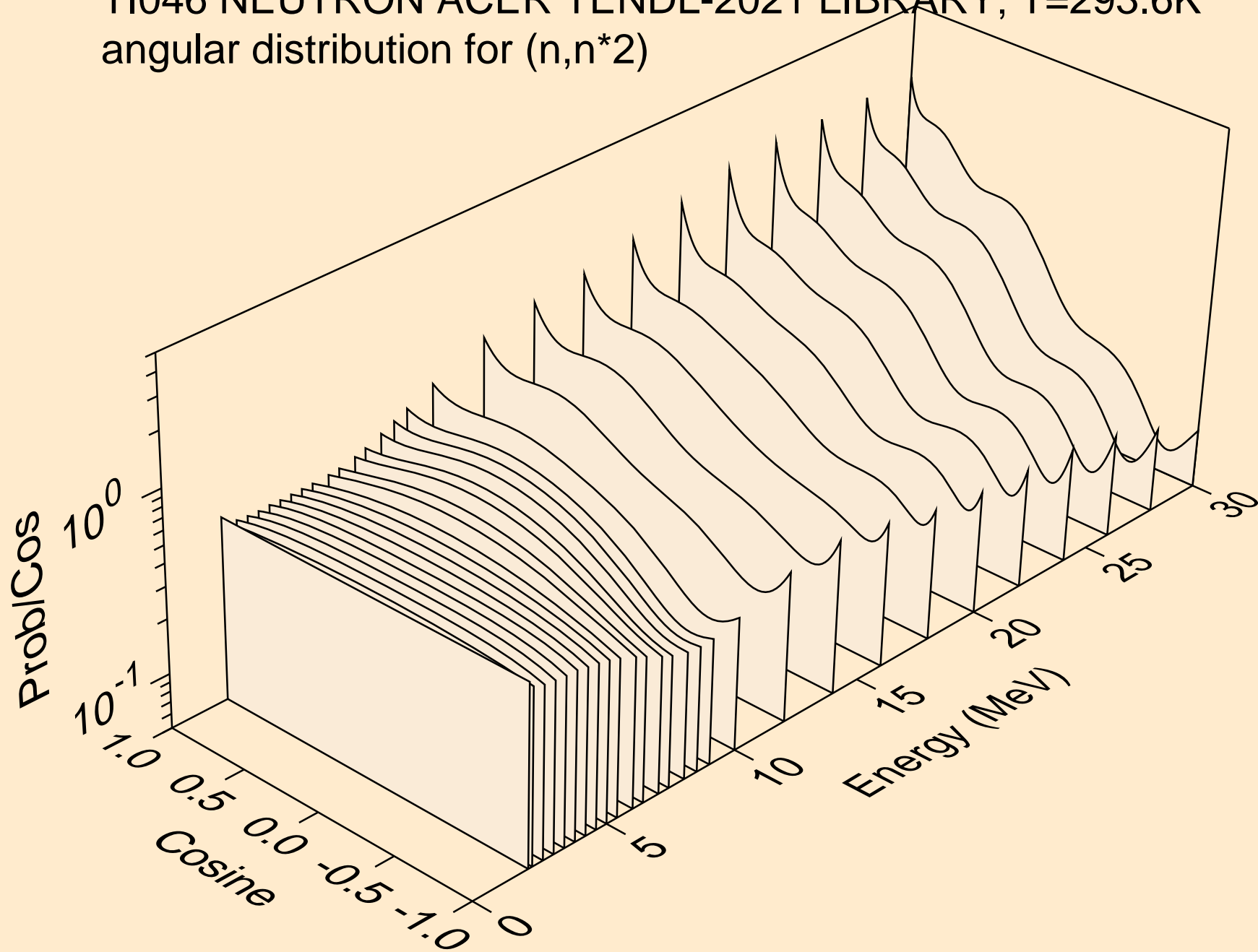

TI046 NEUTRON ACER TENDL-2021 LIBRARY; T=293.6K
angular distribution for (n,n*3)

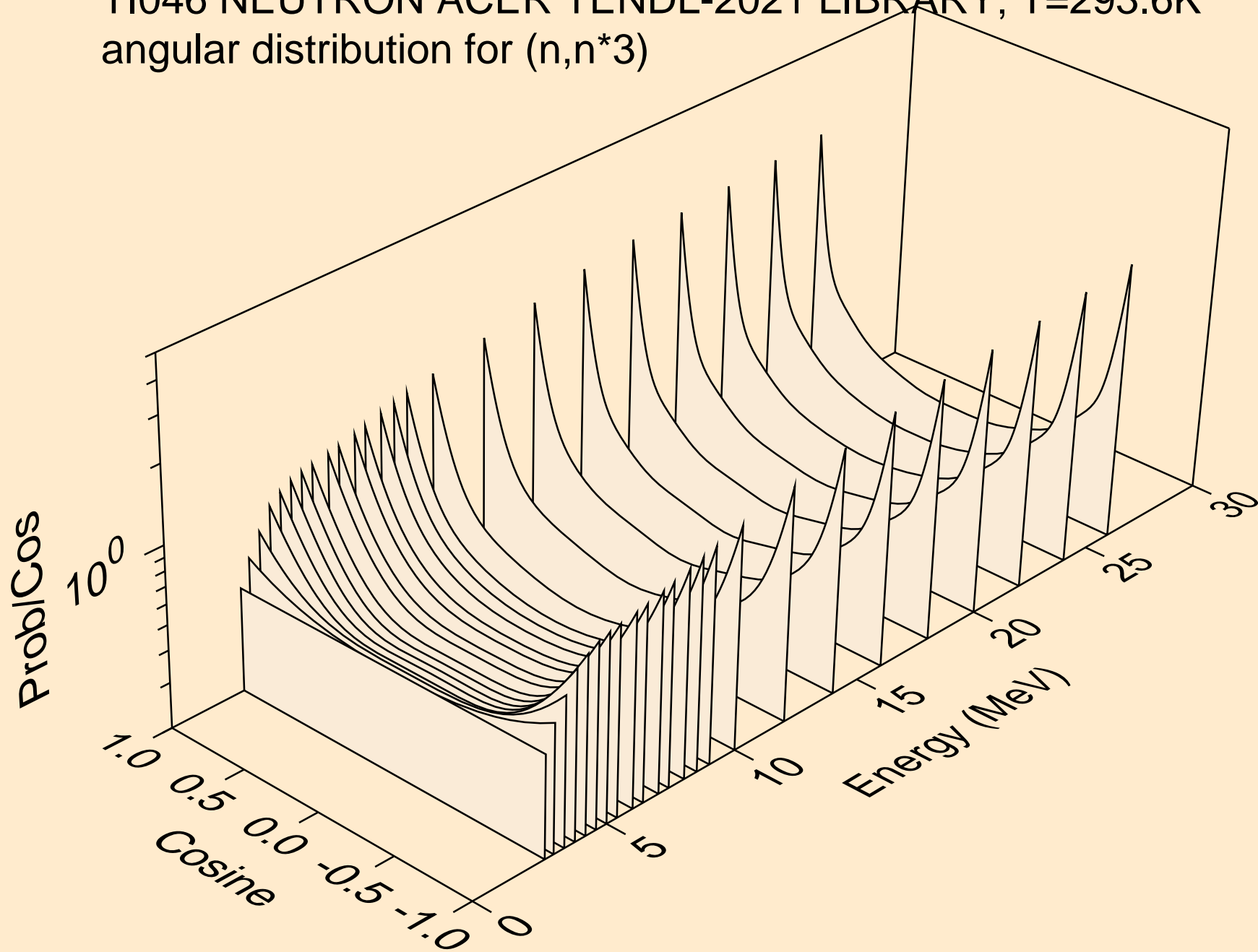

TI046 NEUTRON ACER TENDL-2021 LIBRARY; T=293.6K
angular distribution for (n,n*4)

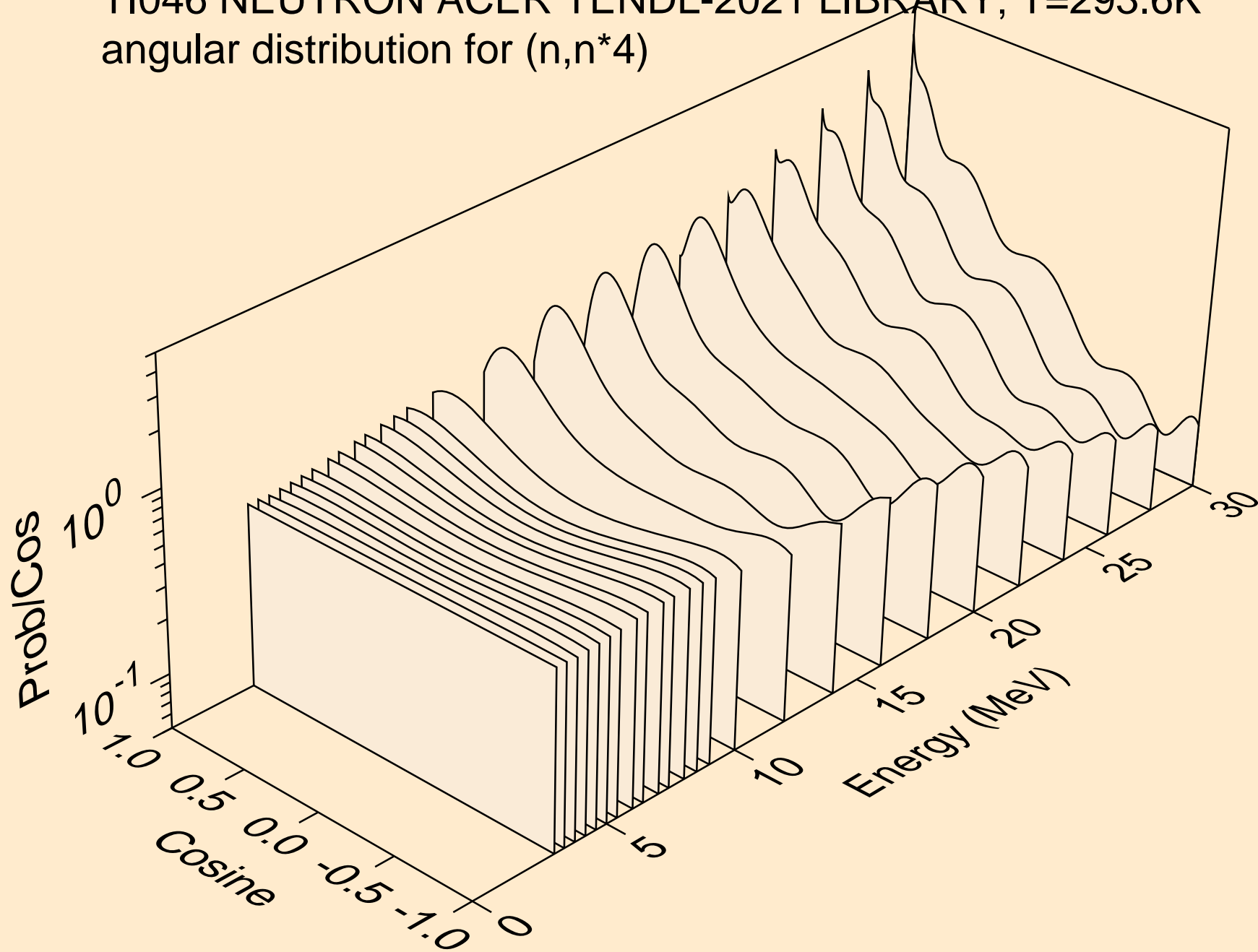

TI046 NEUTRON ACER TENDL-2021 LIBRARY; T=293.6K
angular distribution for (n,n*5)

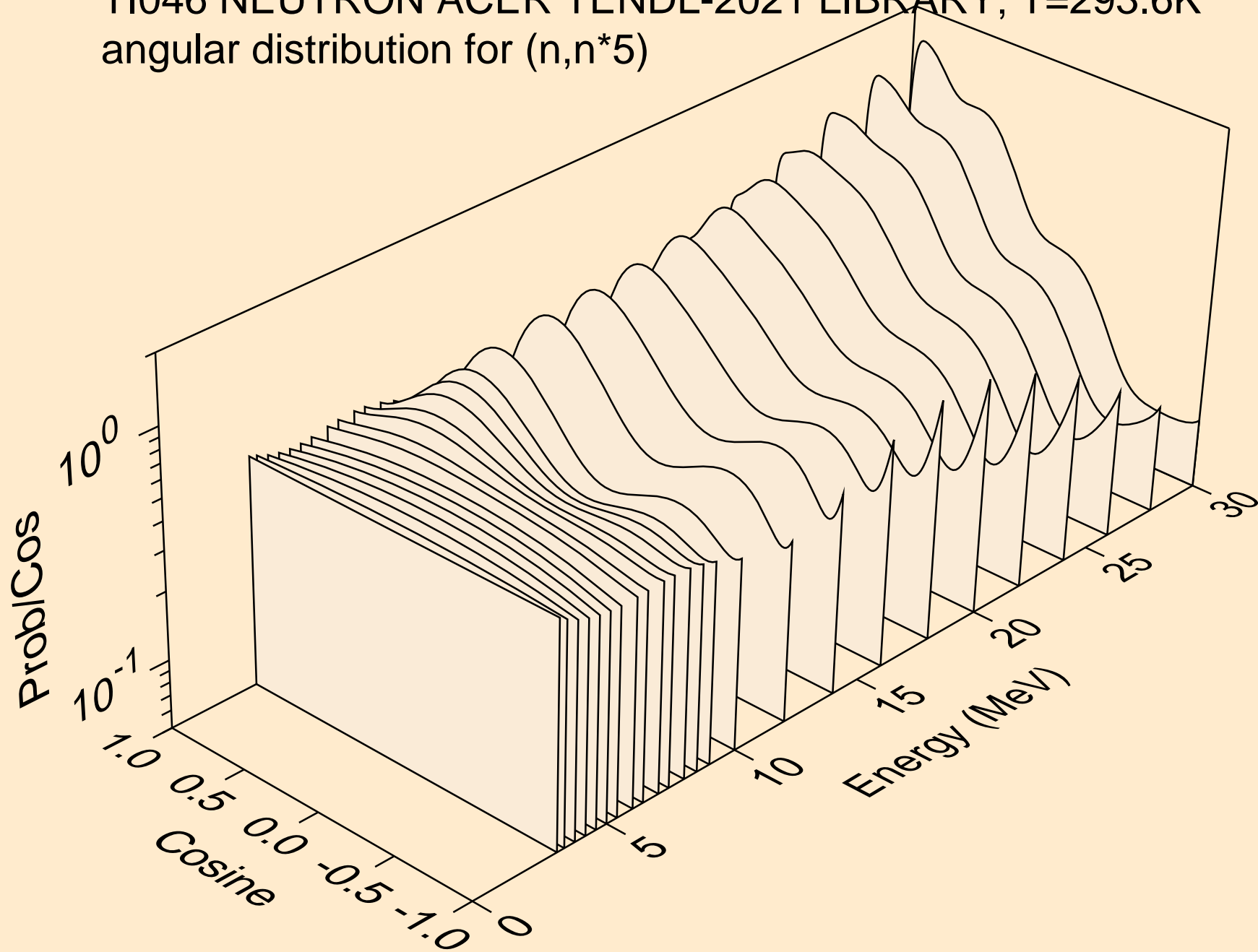

TI046 NEUTRON ACER TENDL-2021 LIBRARY; T=293.6K
angular distribution for (n,n*6)

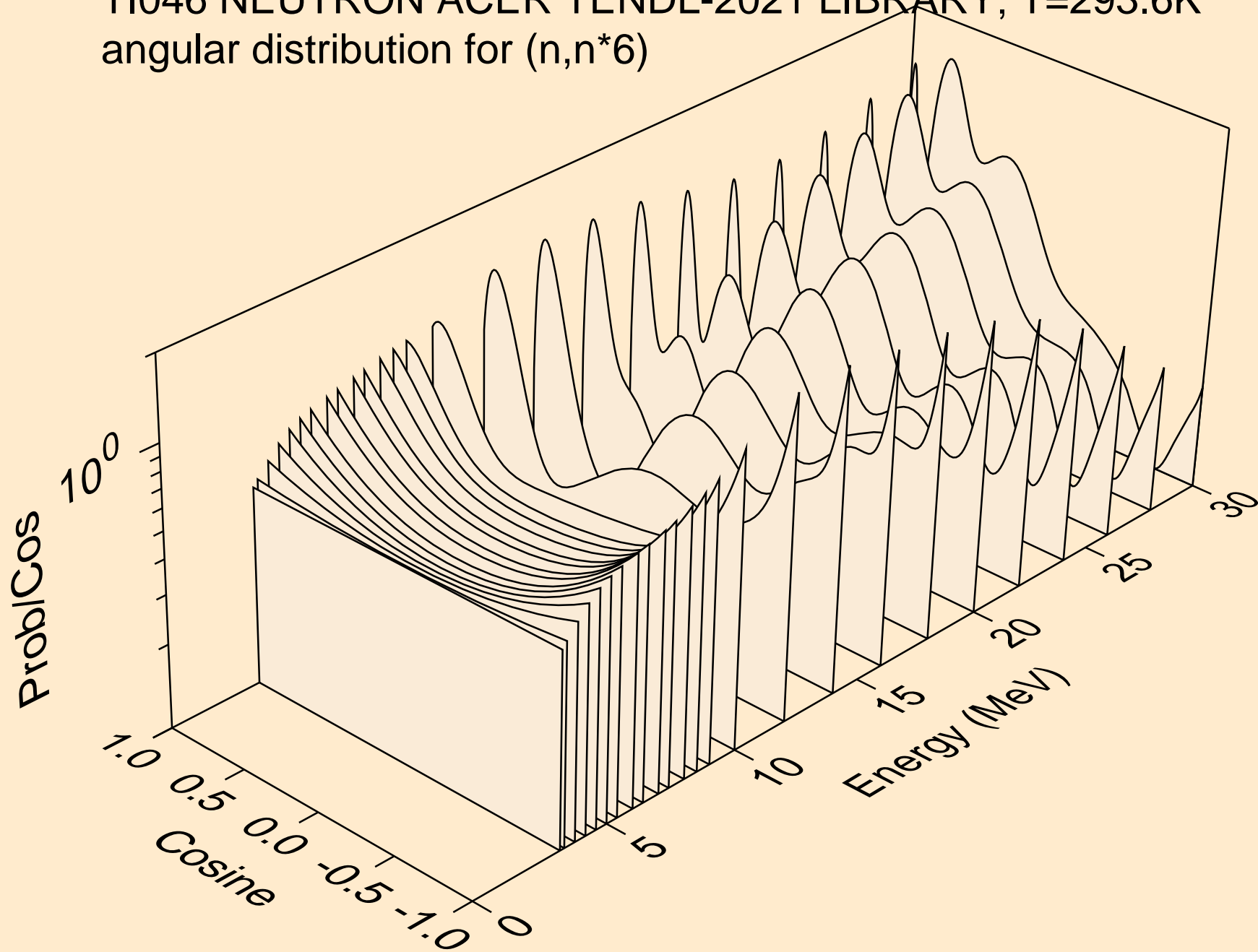

TI046 NEUTRON ACER TENDL-2021 LIBRARY; T=293.6K
angular distribution for (n,n*7)

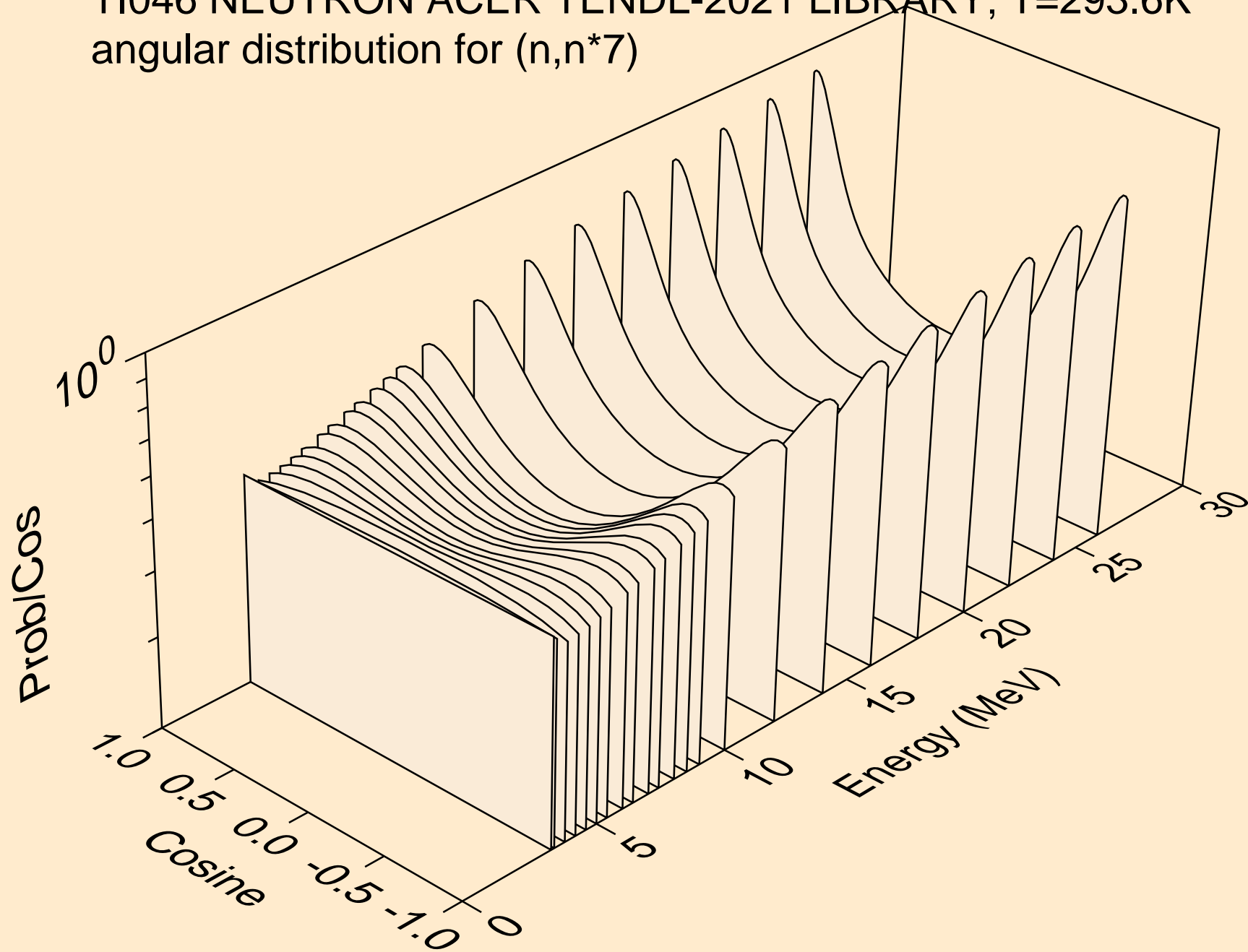

TI046 NEUTRON ACER TENDL-2021 LIBRARY; T=293.6K
angular distribution for (n,n*8)

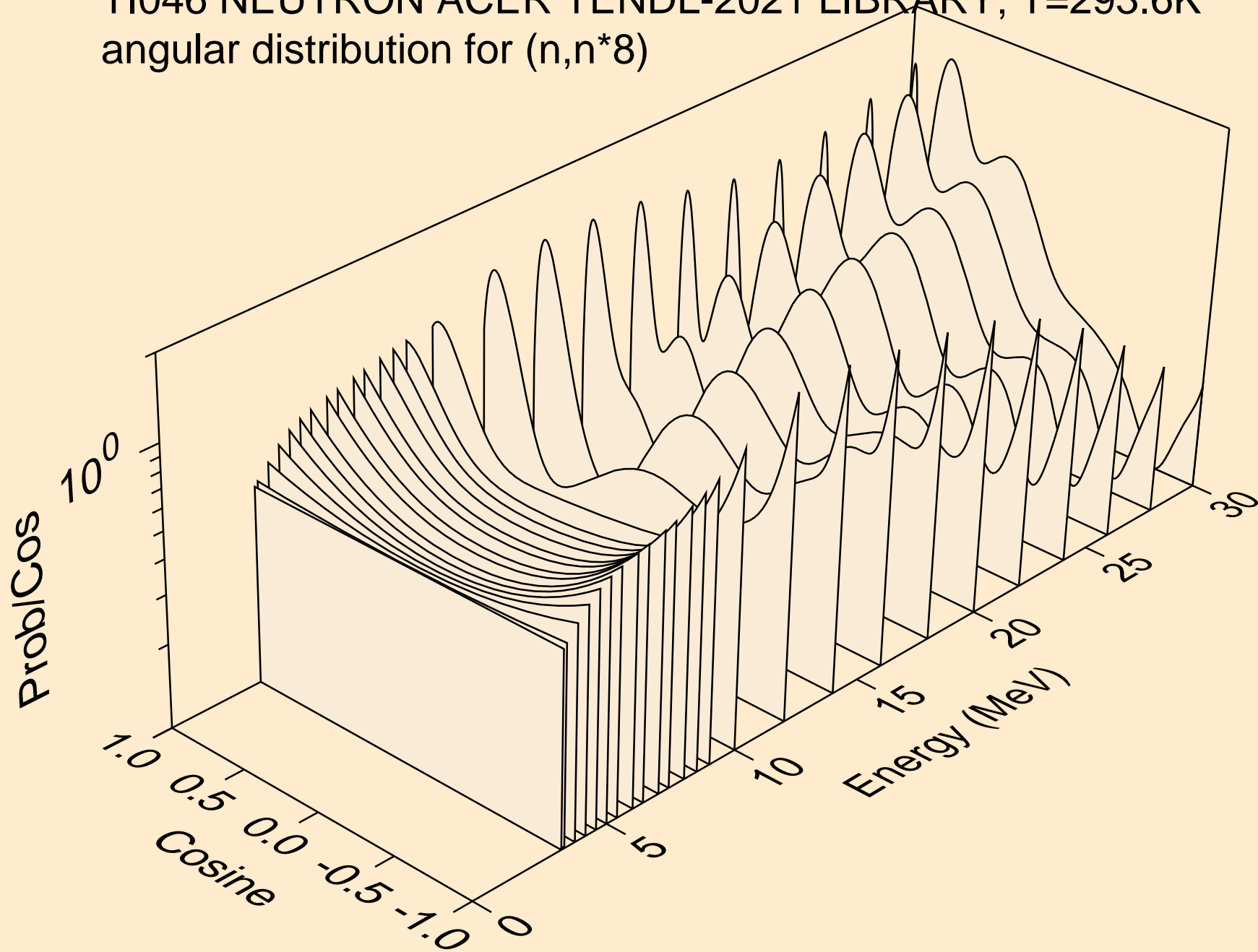

TI046 NEUTRON ACER TENDL-2021 LIBRARY; T=293.6K
angular distribution for (n,n*9)

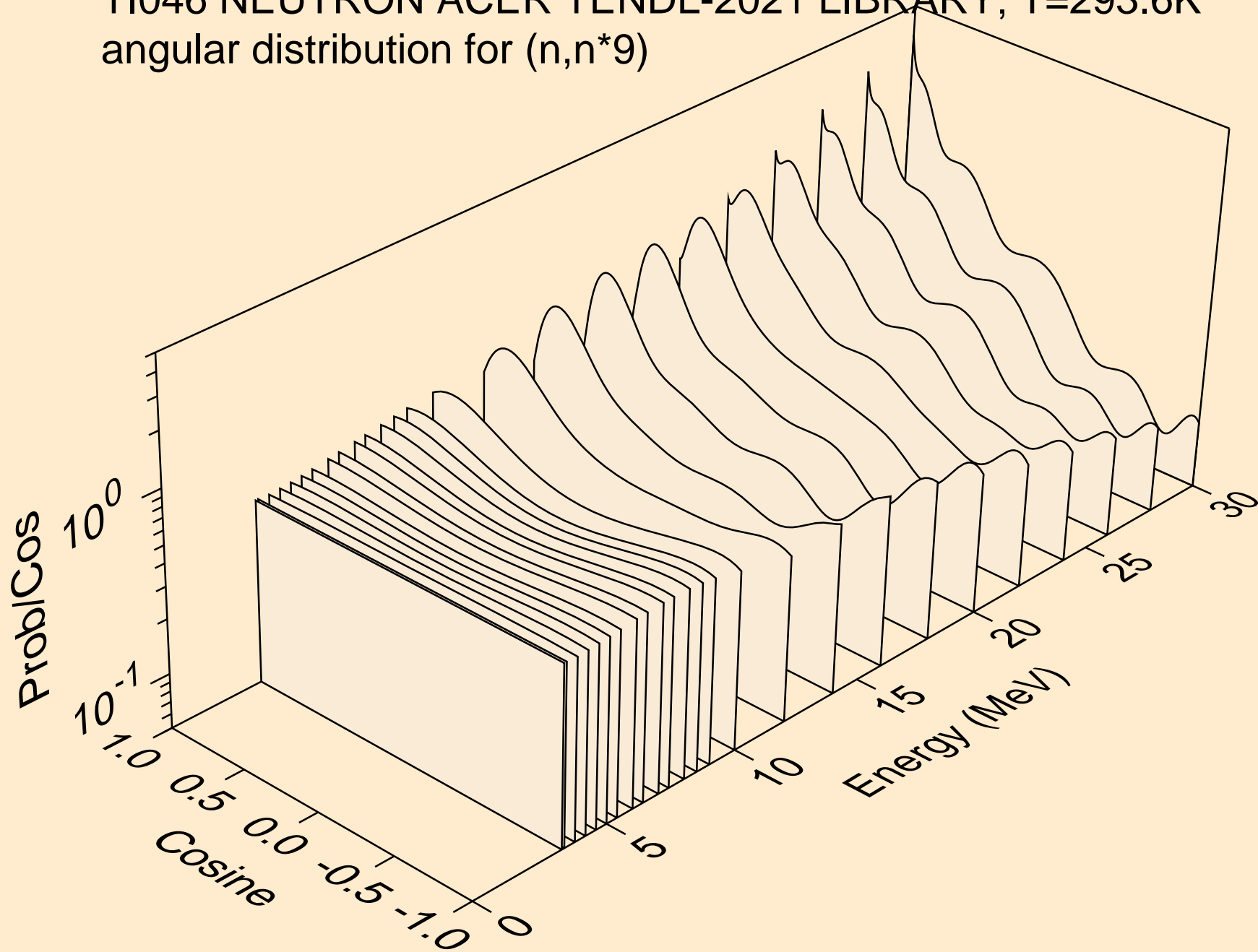

TI046 NEUTRON ACER TENDL-2021 LIBRARY; T=293.6K
angular distribution for (n,n*10)

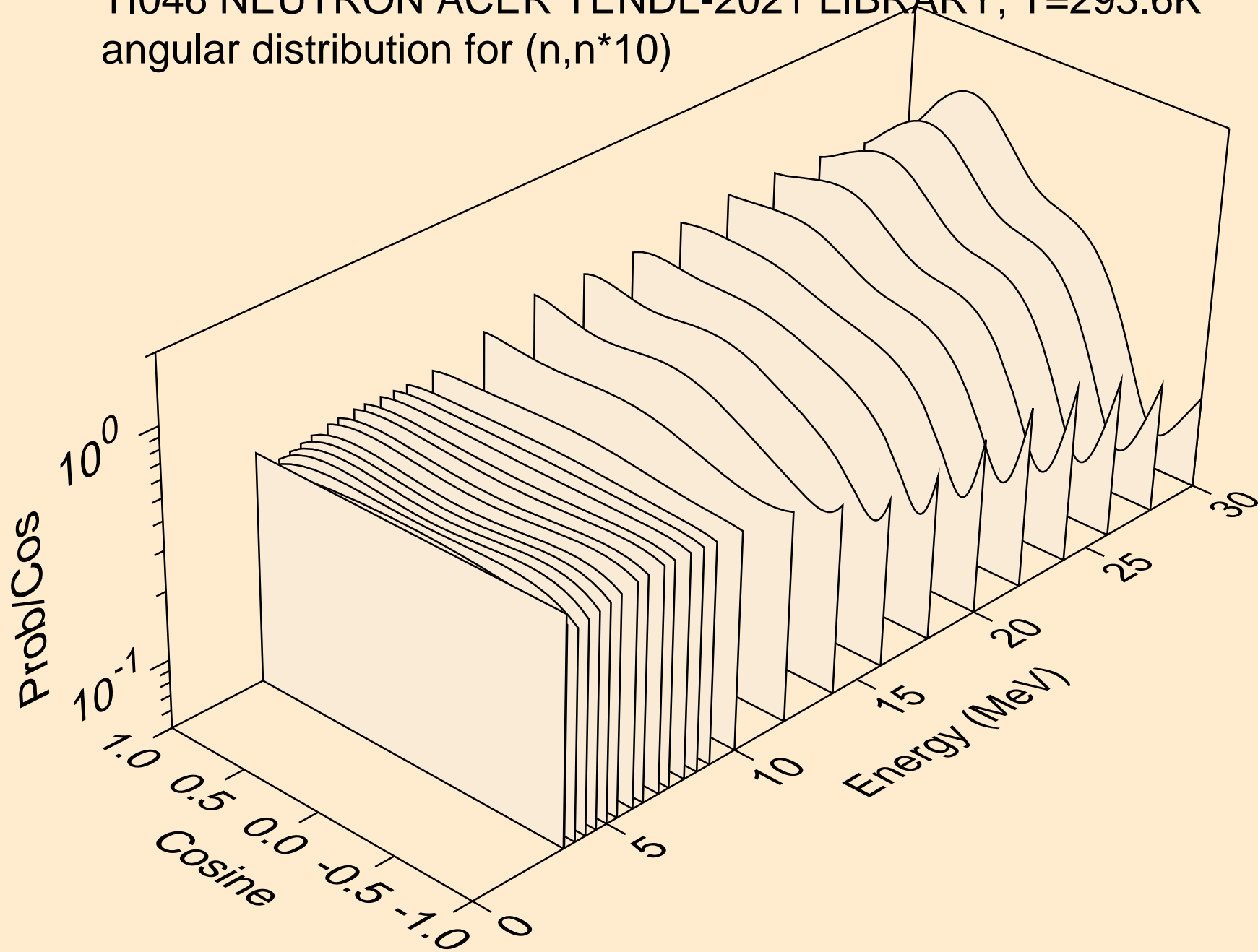

TI046 NEUTRON ACER TENDL-2021 LIBRARY; T=293.6K
angular distribution for (n,n*11)

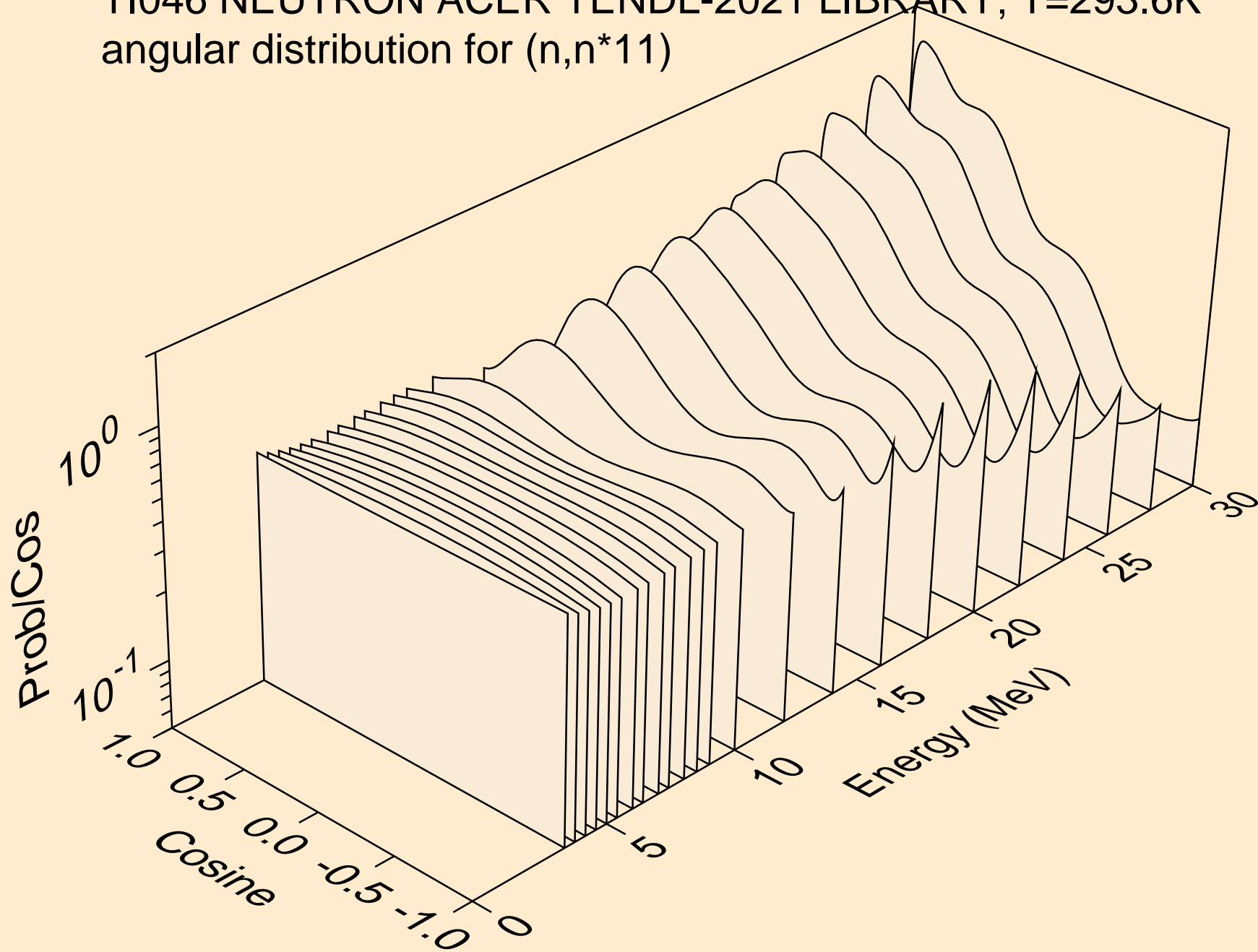

TI046 NEUTRON ACER TENDL-2021 LIBRARY; T=293.6K
angular distribution for (n,n*12)

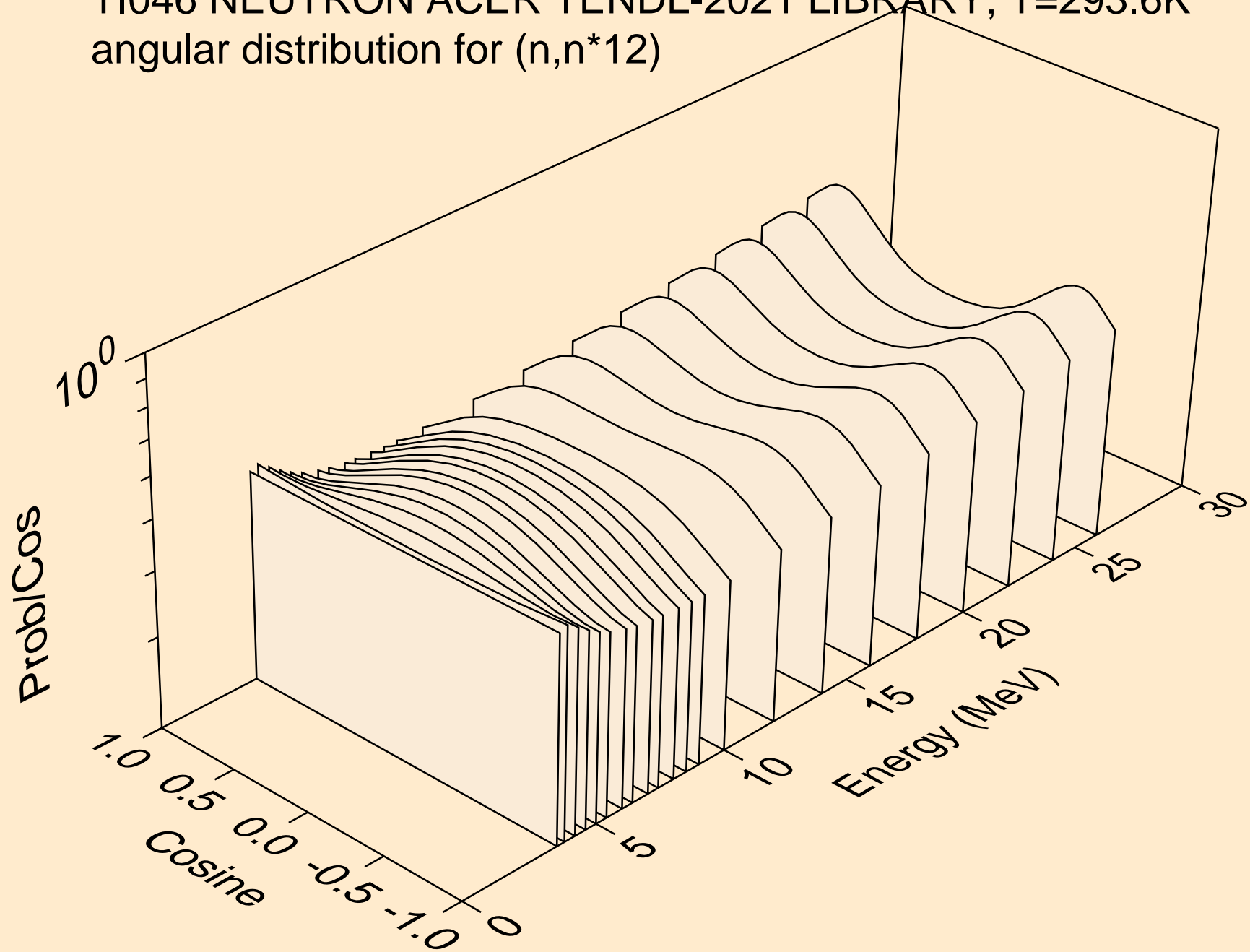

TI046 NEUTRON ACER TENDL-2021 LIBRARY; T=293.6K
angular distribution for (n,n*13)

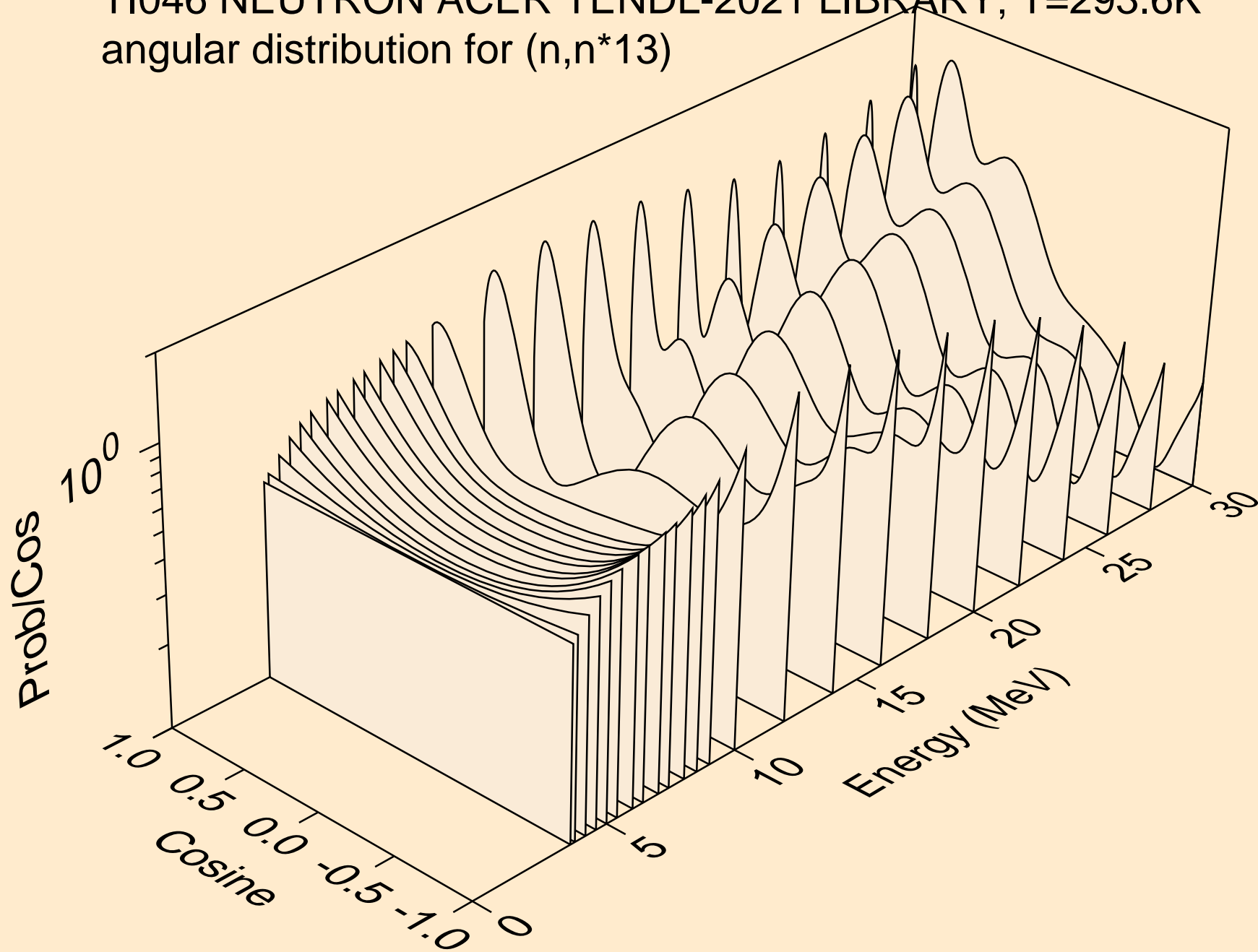

TI046 NEUTRON ACER TENDL-2021 LIBRARY; T=293.6K
angular distribution for (n,n*14)

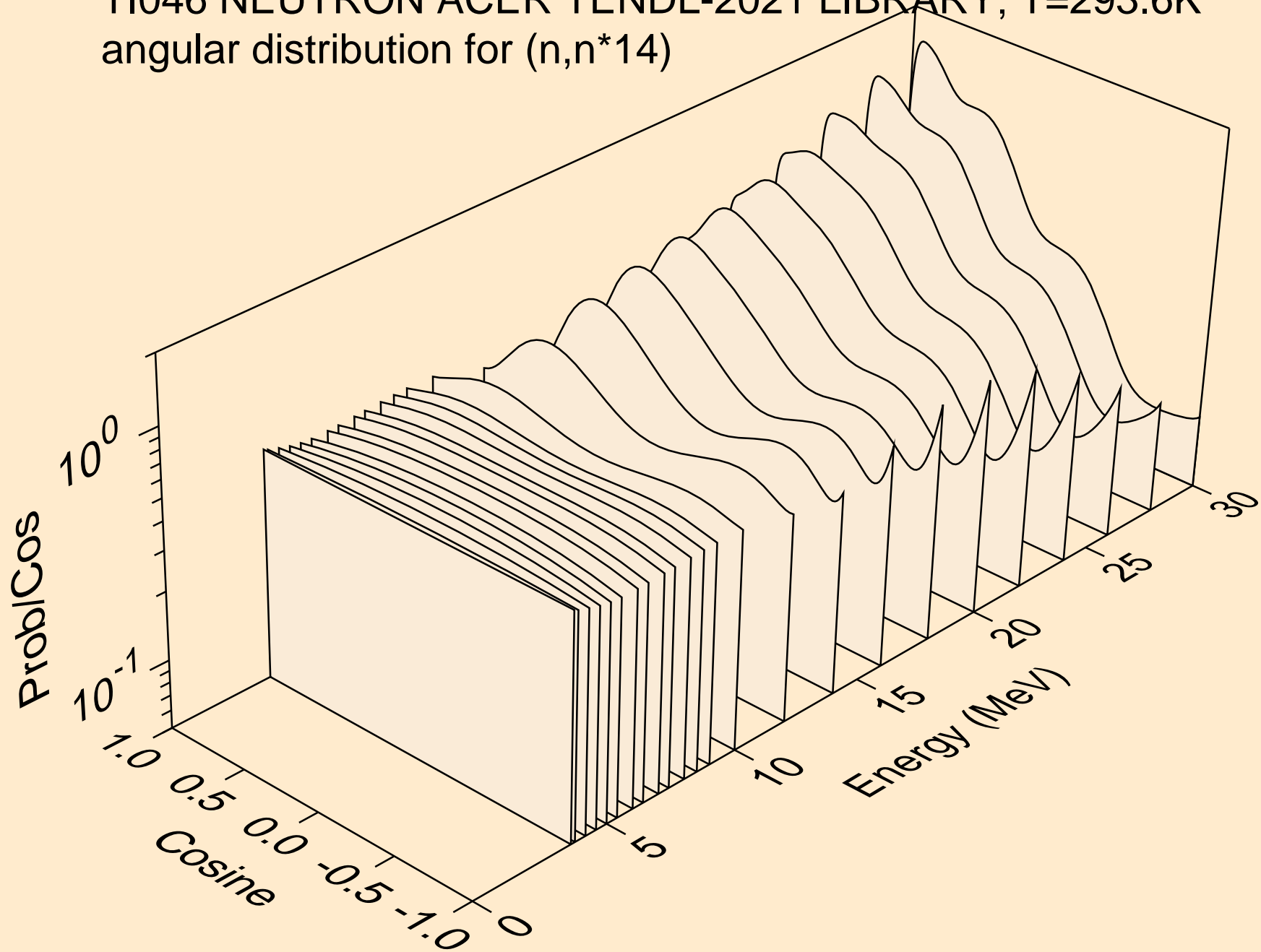

TI046 NEUTRON ACER TENDL-2021 LIBRARY; T=293.6K
angular distribution for (n,n*15)

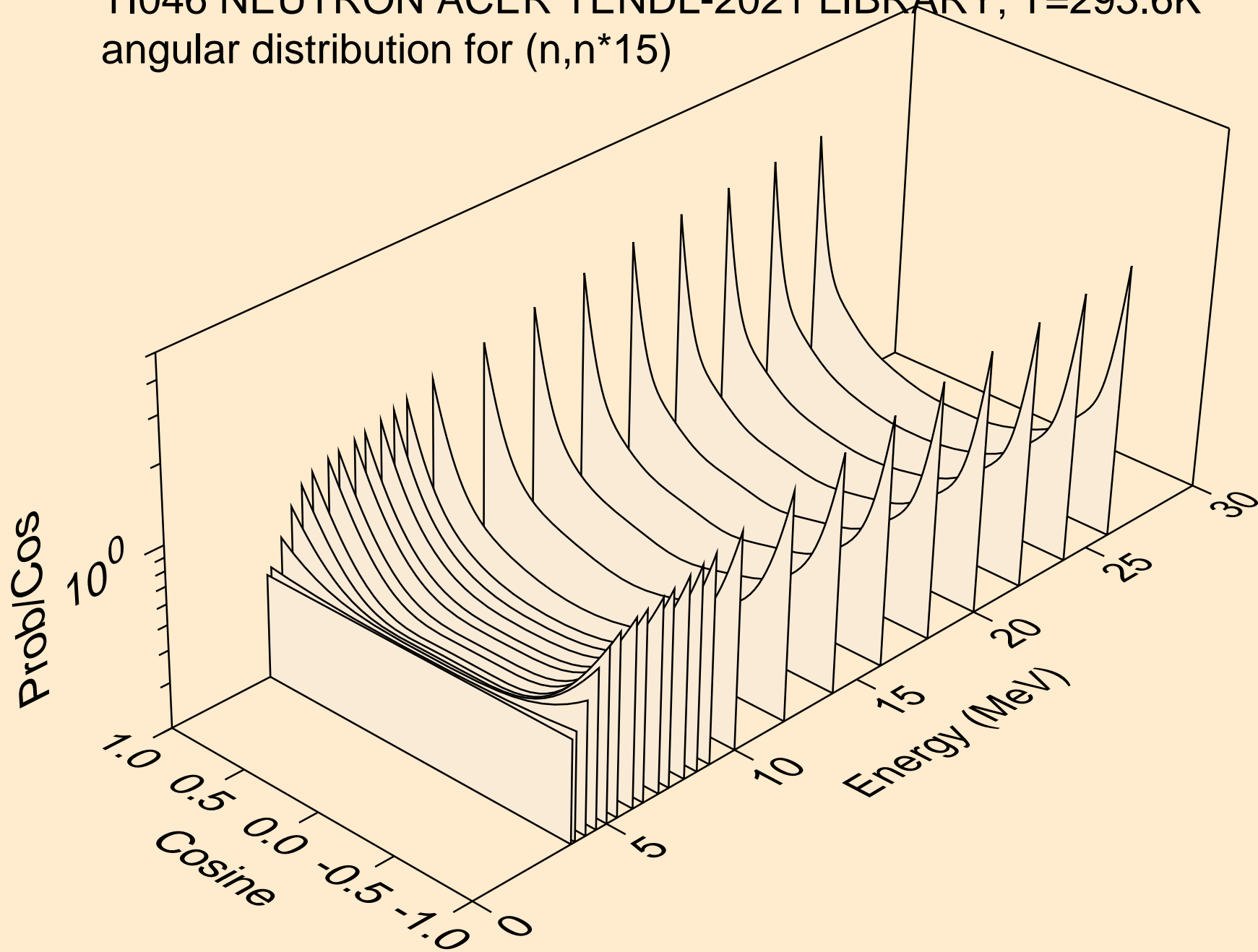

TI046 NEUTRON ACER TENDL-2021 LIBRARY; T=293.6K
angular distribution for (n,n*16)

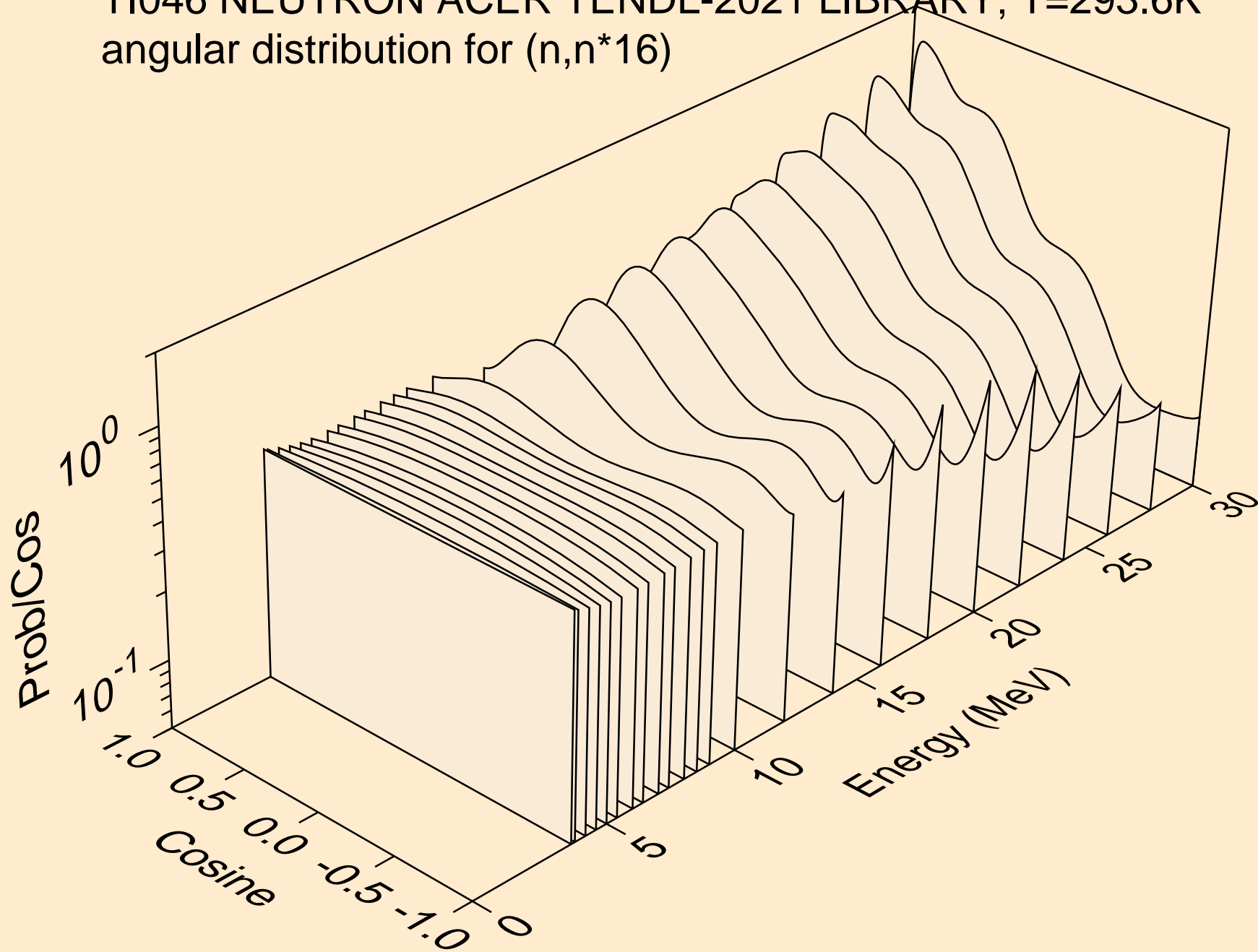

TI046 NEUTRON ACER TENDL-2021 LIBRARY; T=293.6K
angular distribution for (n,n*17)

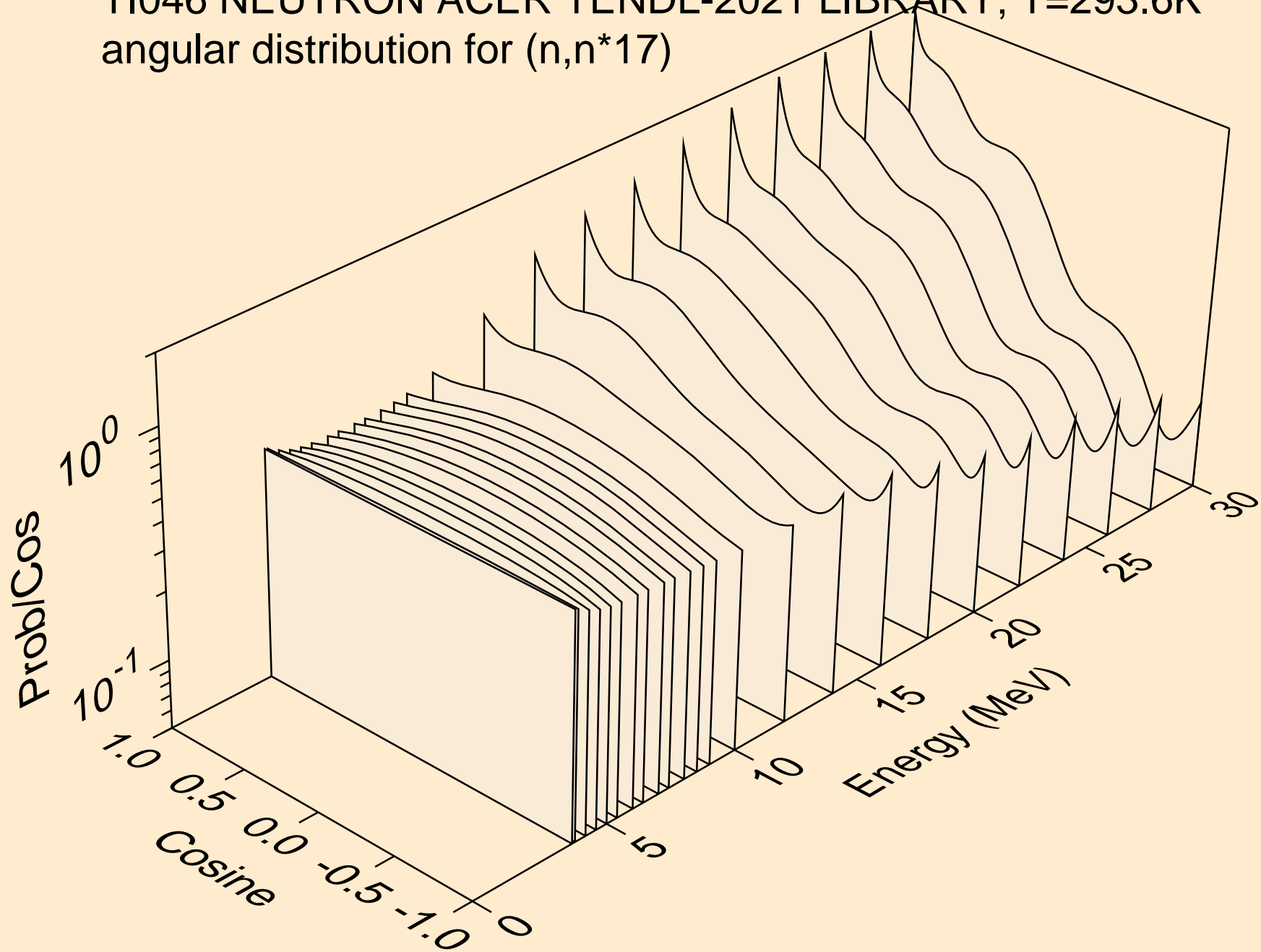

TI046 NEUTRON ACER TENDL-2021 LIBRARY; T=293.6K
angular distribution for (n,n*18)

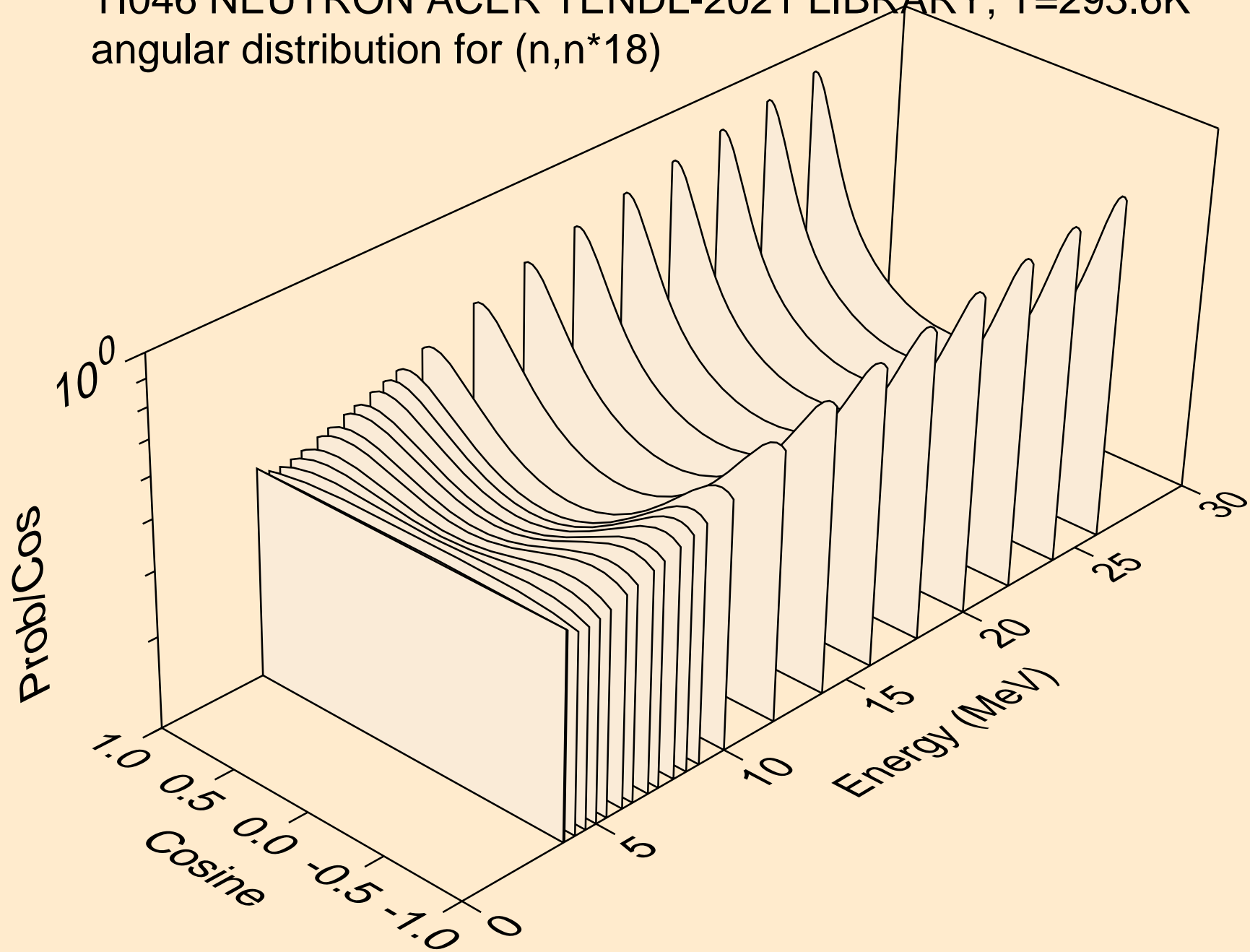

TI046 NEUTRON ACER TENDL-2021 LIBRARY; T=293.6K
angular distribution for (n,n*19)

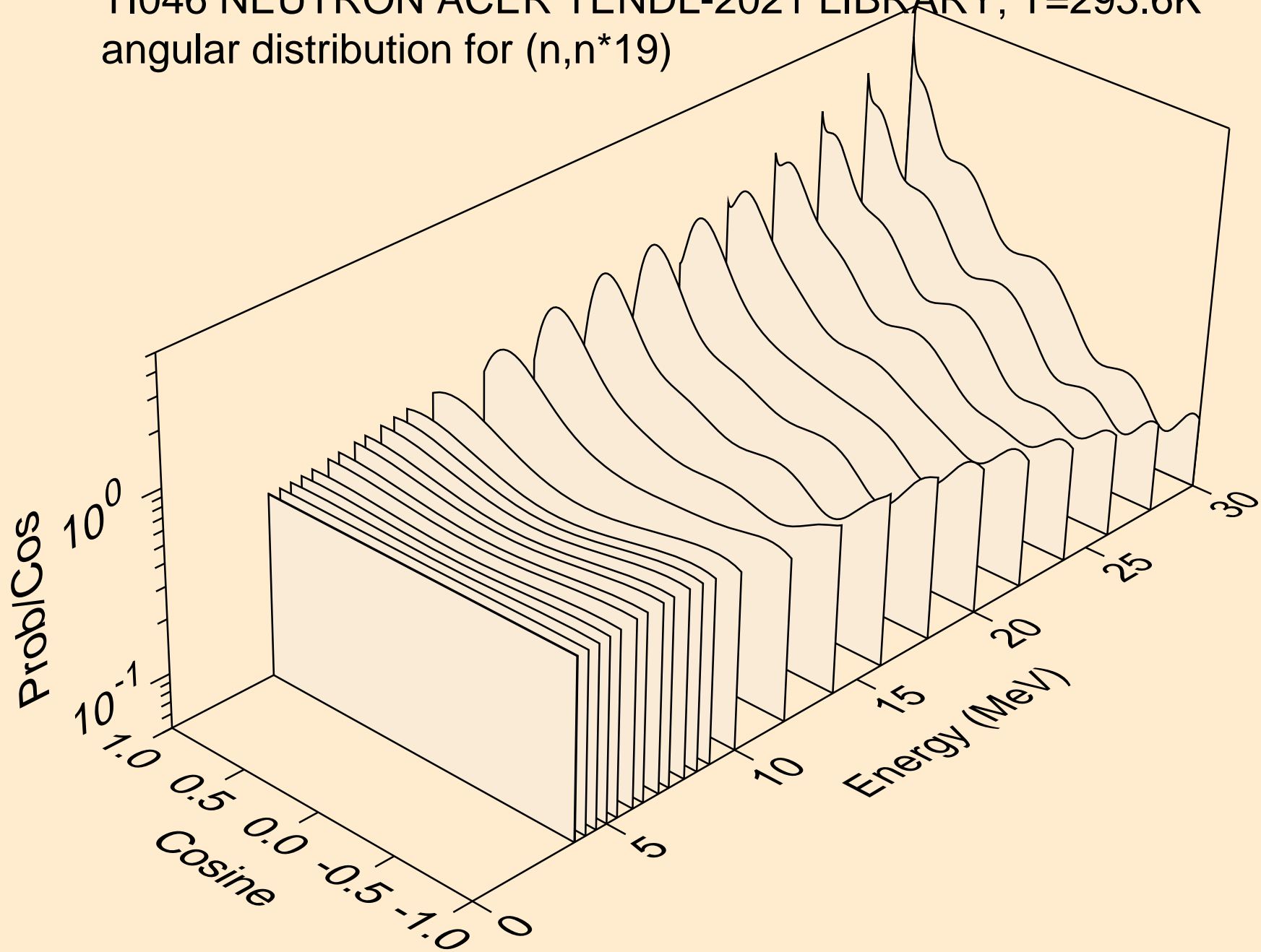

TI046 NEUTRON ACER TENDL-2021 LIBRARY; T=293.6K
angular distribution for (n,n*20)

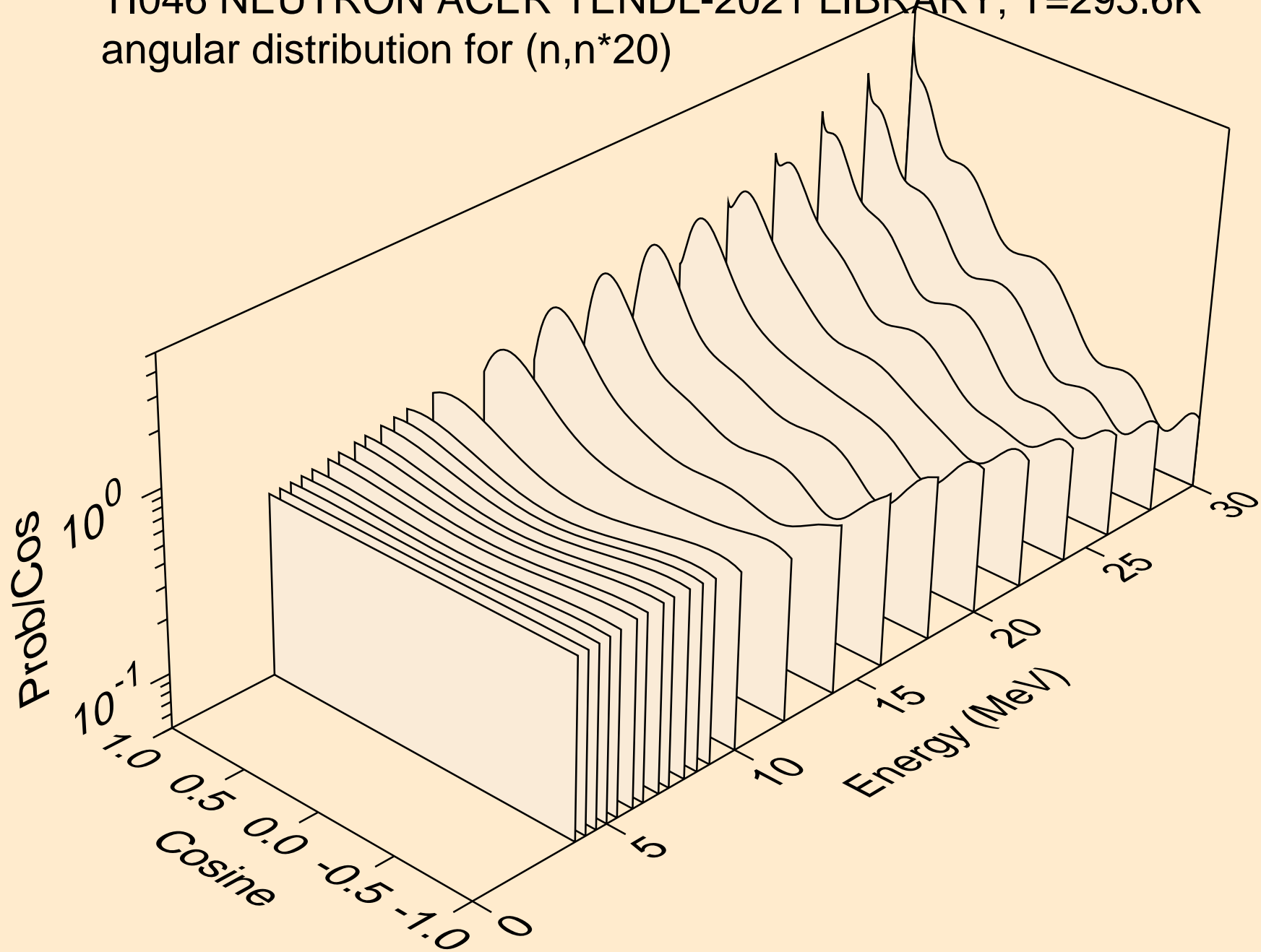

TI046 NEUTRON ACER TENDL-2021 LIBRARY; T=293.6K
angular distribution for (n,n*21)

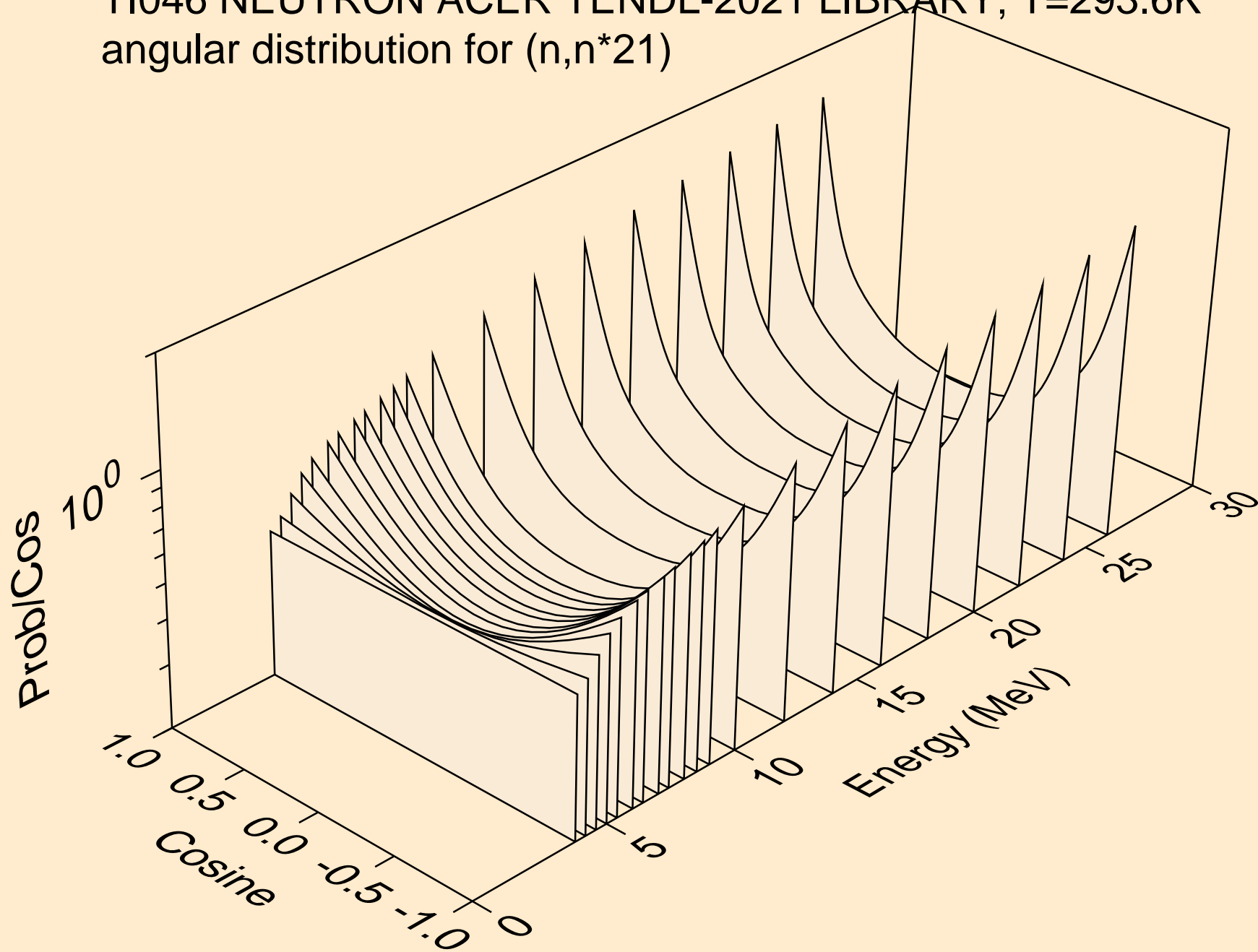

TI046 NEUTRON ACER TENDL-2021 LIBRARY; T=293.6K
angular distribution for (n,n*22)

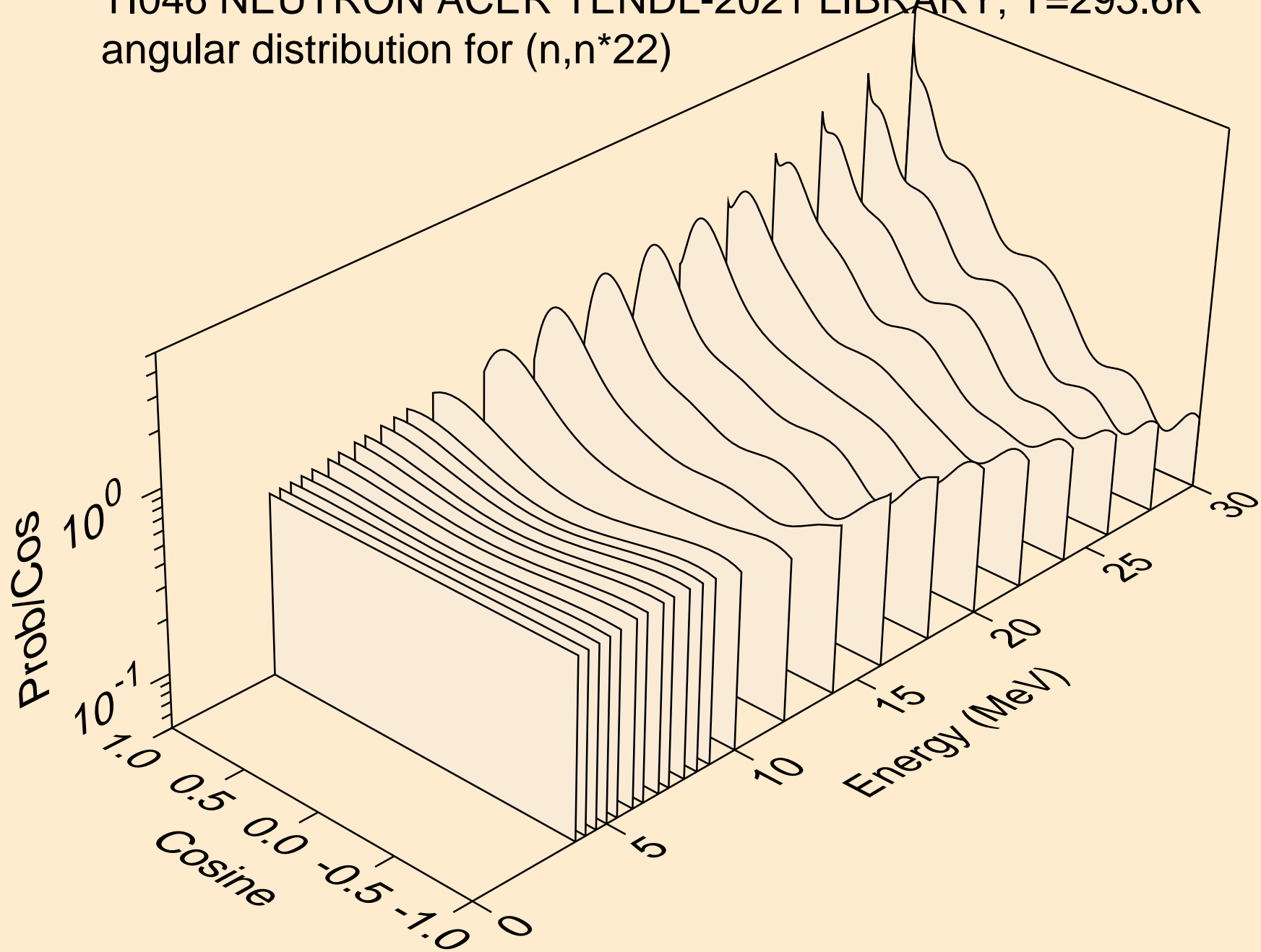

TI046 NEUTRON ACER TENDL-2021 LIBRARY; T=293.6K
angular distribution for (n,n*23)

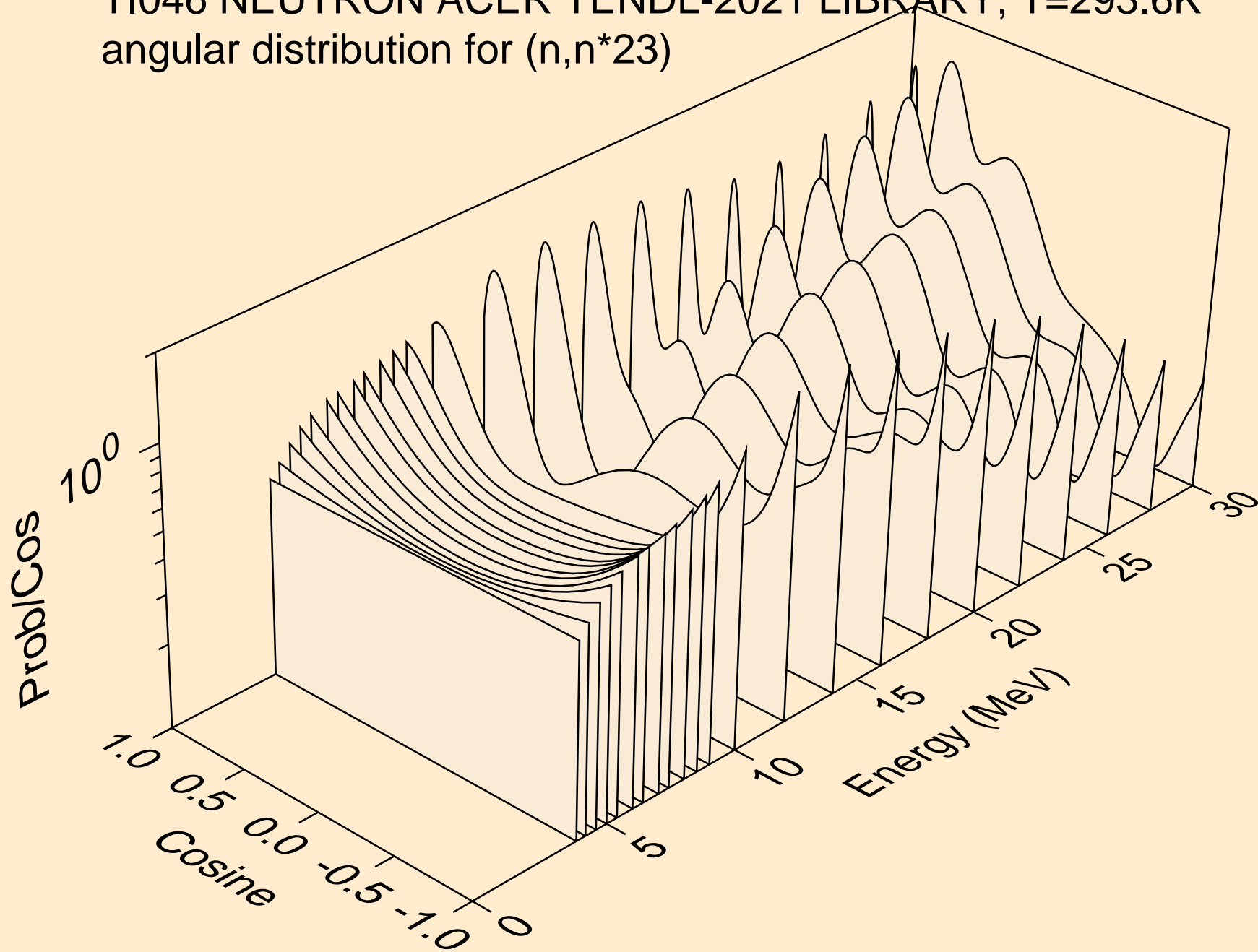

TI046 NEUTRON ACER TENDL-2021 LIBRARY; T=293.6K
angular distribution for (n,n*24)

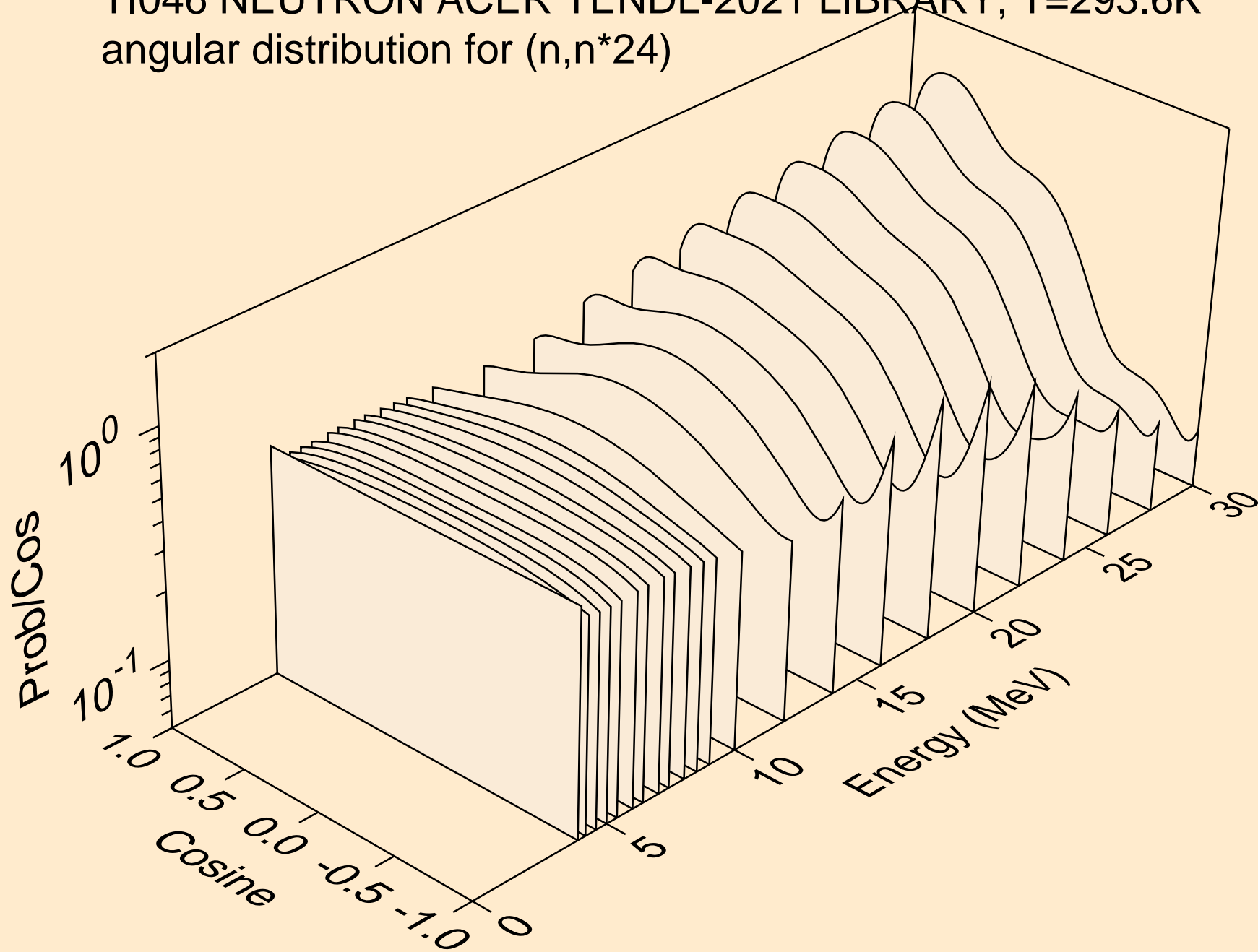

TI046 NEUTRON ACER TENDL-2021 LIBRARY; T=293.6K
angular distribution for (n,n*25)

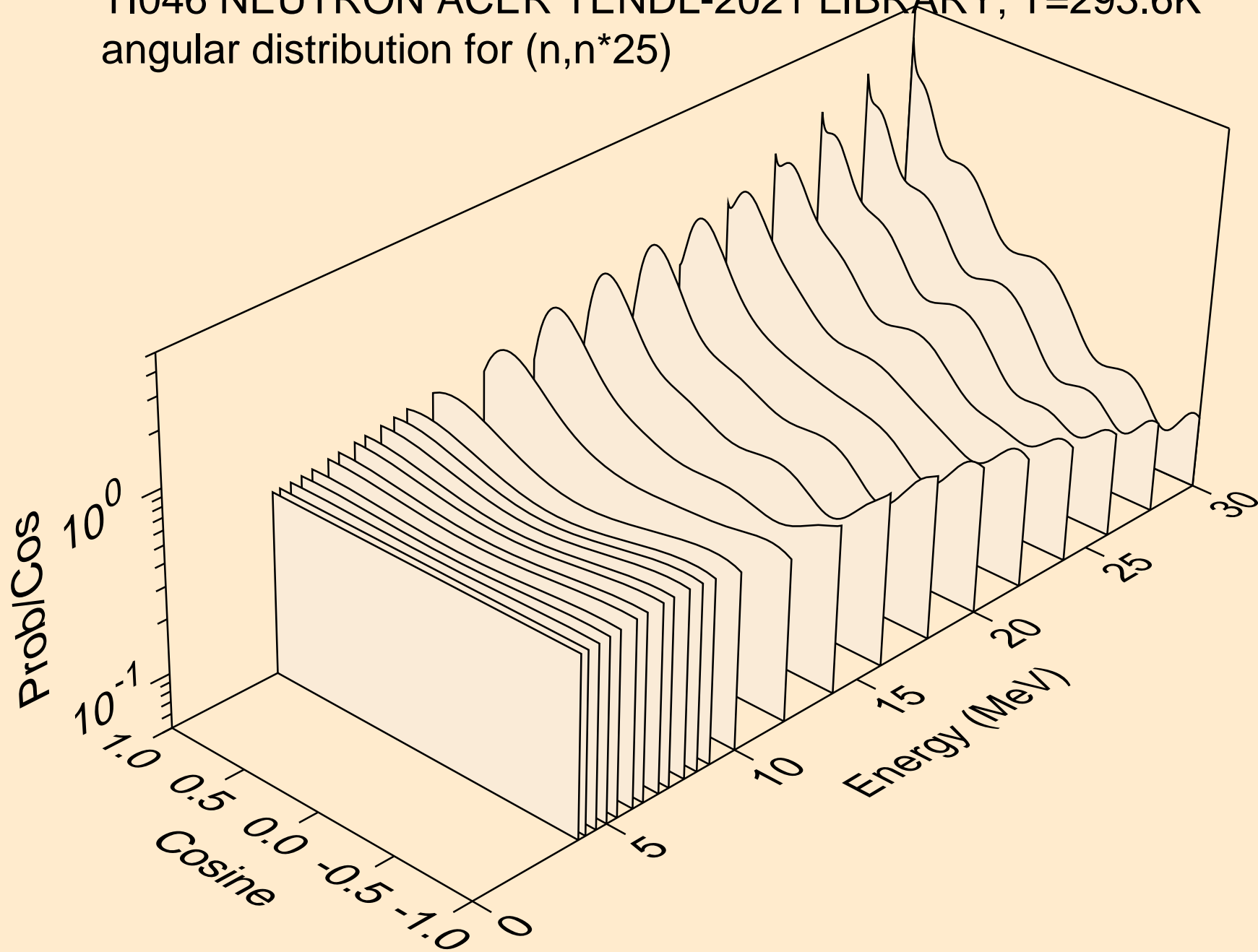

TI046 NEUTRON ACER TENDL-2021 LIBRARY; T=293.6K
angular distribution for (n,n*26)

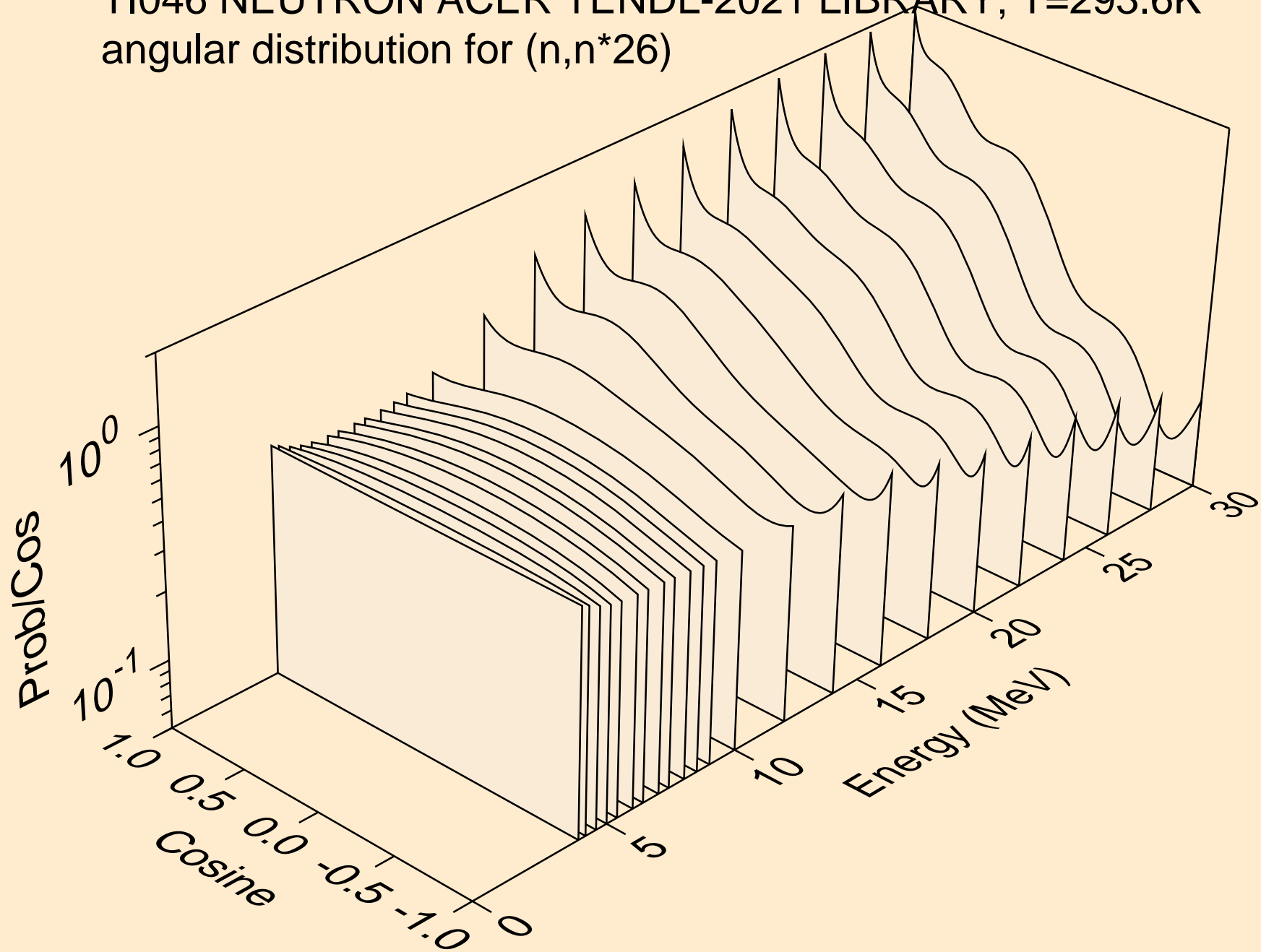

TI046 NEUTRON ACER TENDL-2021 LIBRARY; T=293.6K
angular distribution for (n,n*27)

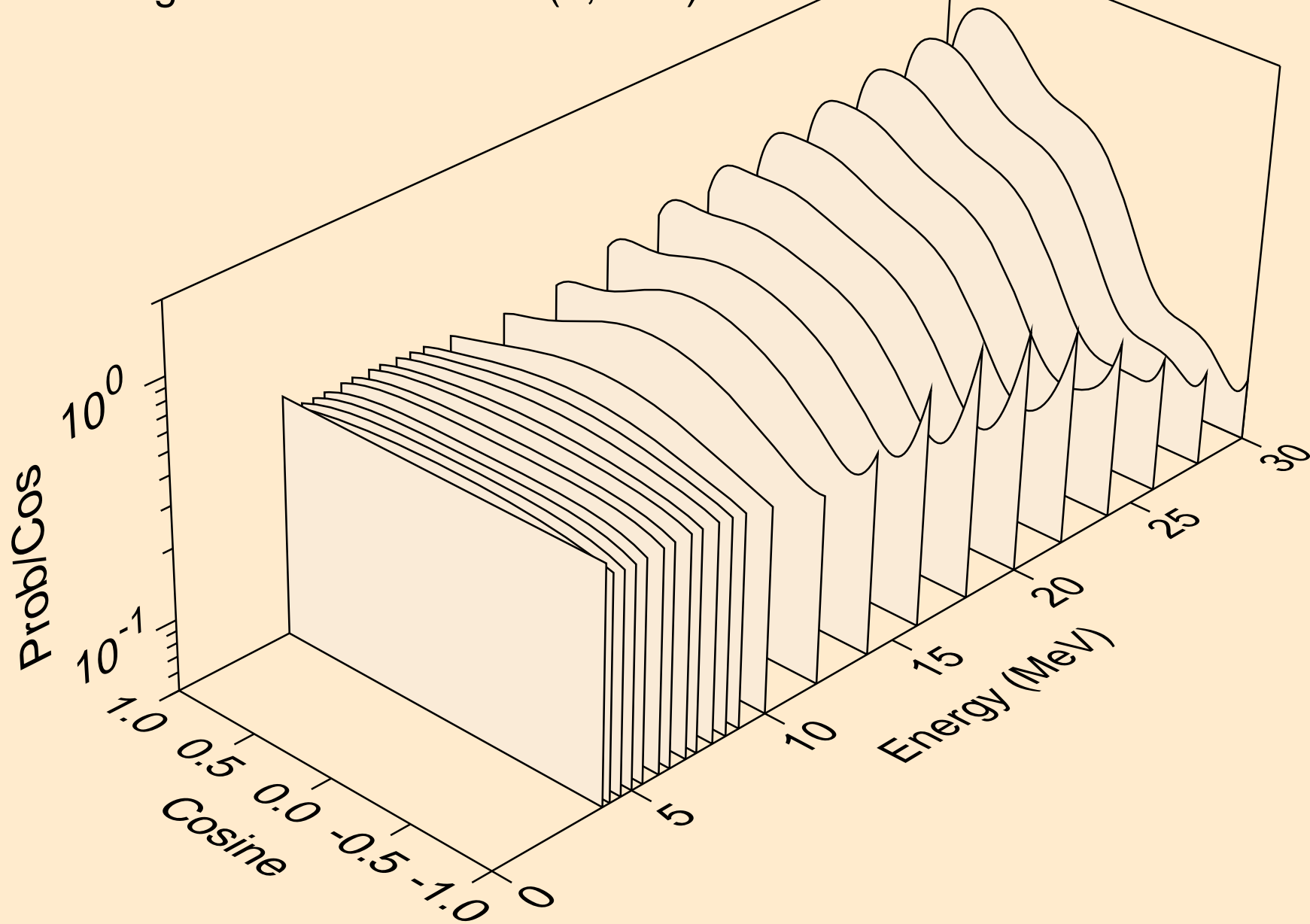

TI046 NEUTRON ACER TENDL-2021 LIBRARY; T=293.6K
angular distribution for (n,n*28)

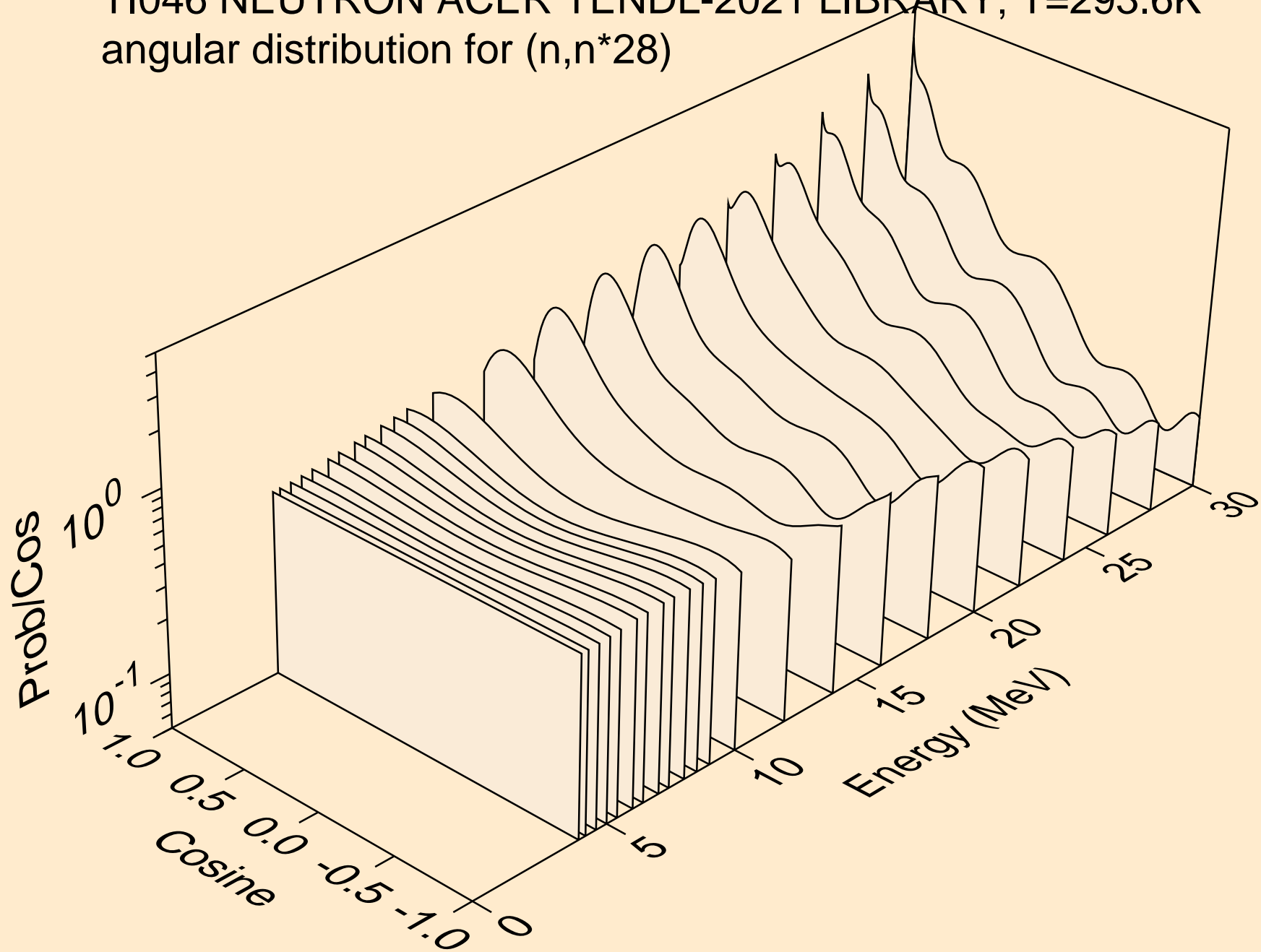

TI046 NEUTRON ACER TENDL-2021 LIBRARY; T=293.6K
angular distribution for (n,n*29)

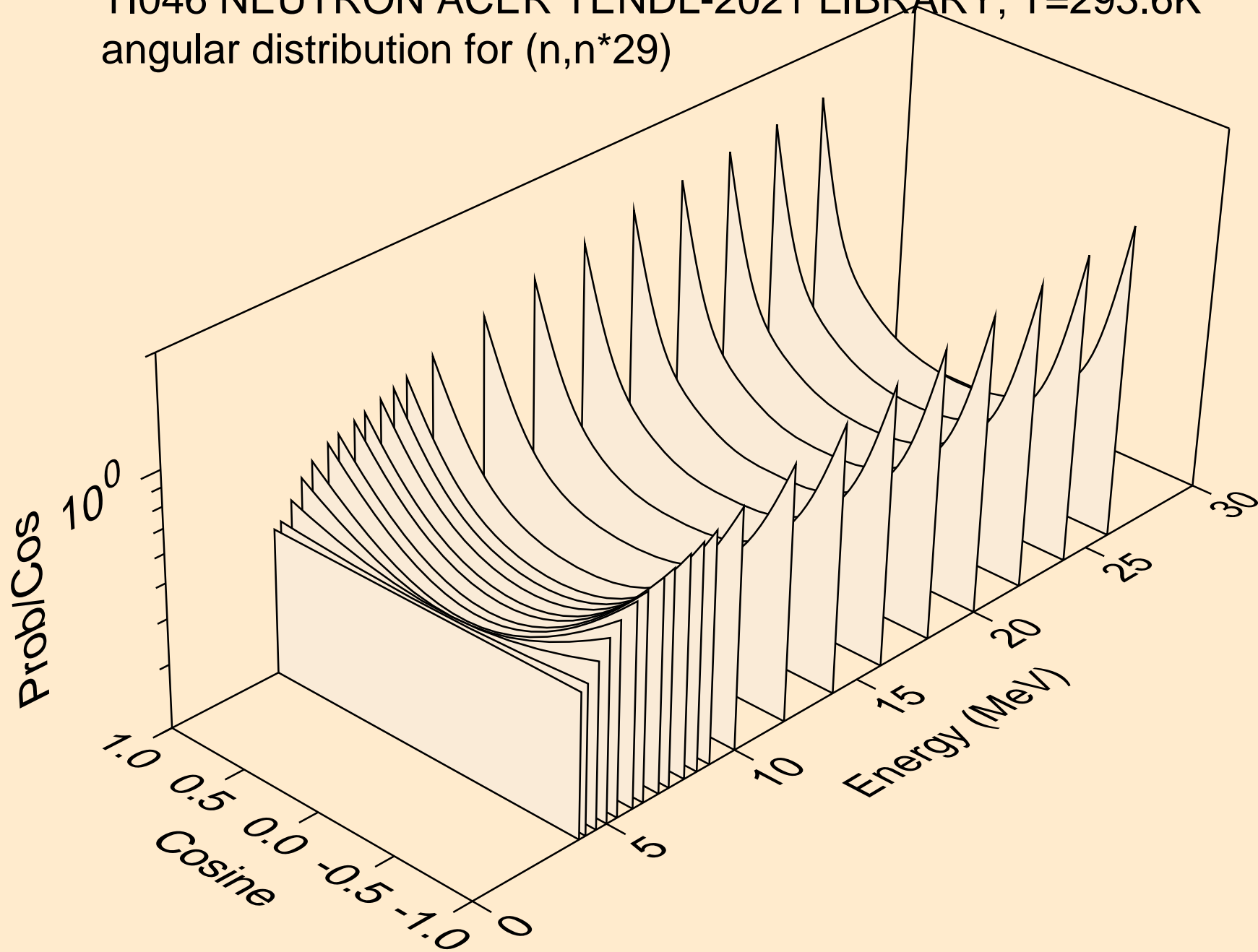

TI046 NEUTRON ACER TENDL-2021 LIBRARY; T=293.6K
angular distribution for (n,n*30)

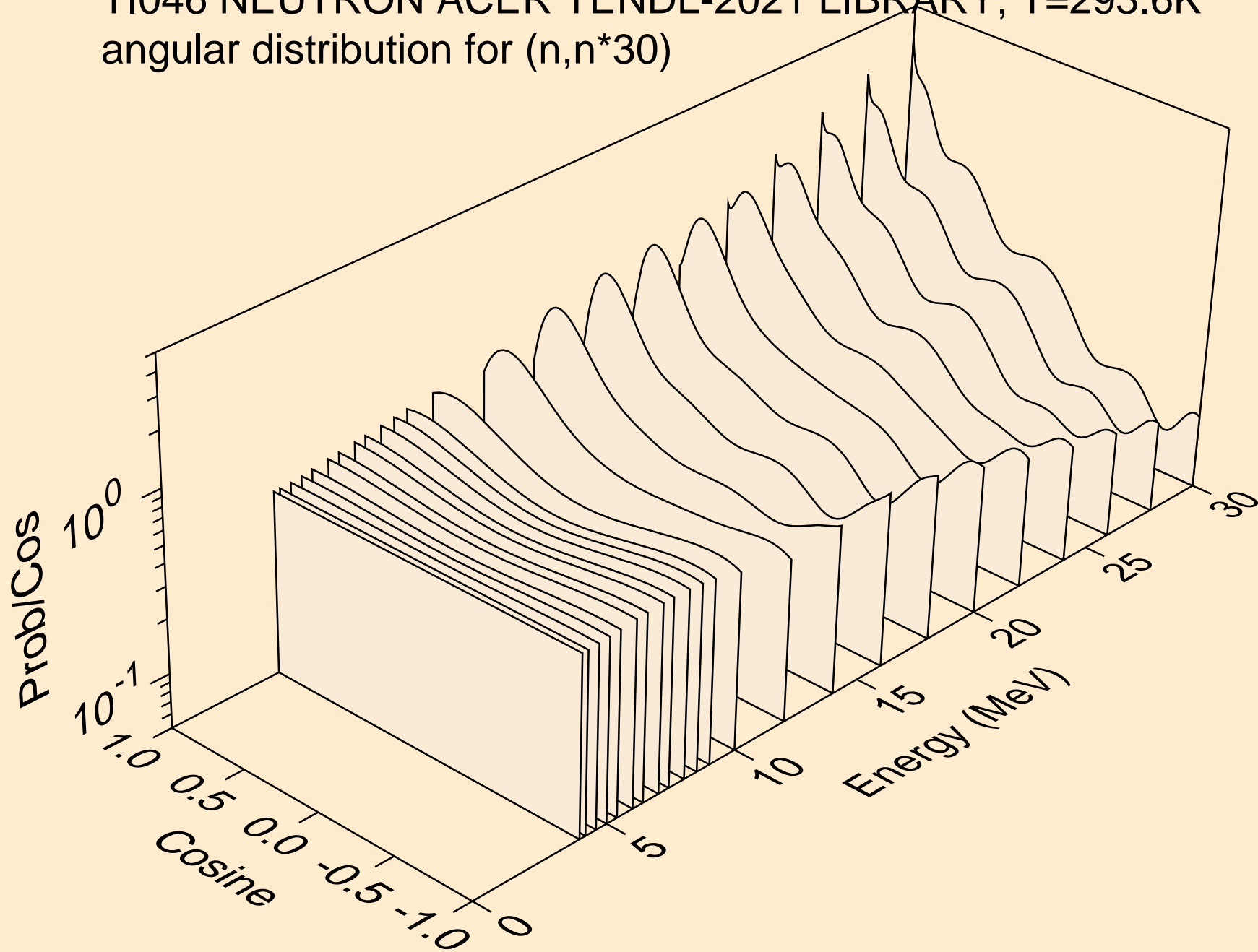

TI046 NEUTRON ACER TENDL-2021 LIBRARY; T=293.6K
Neutron emission for (n,x)

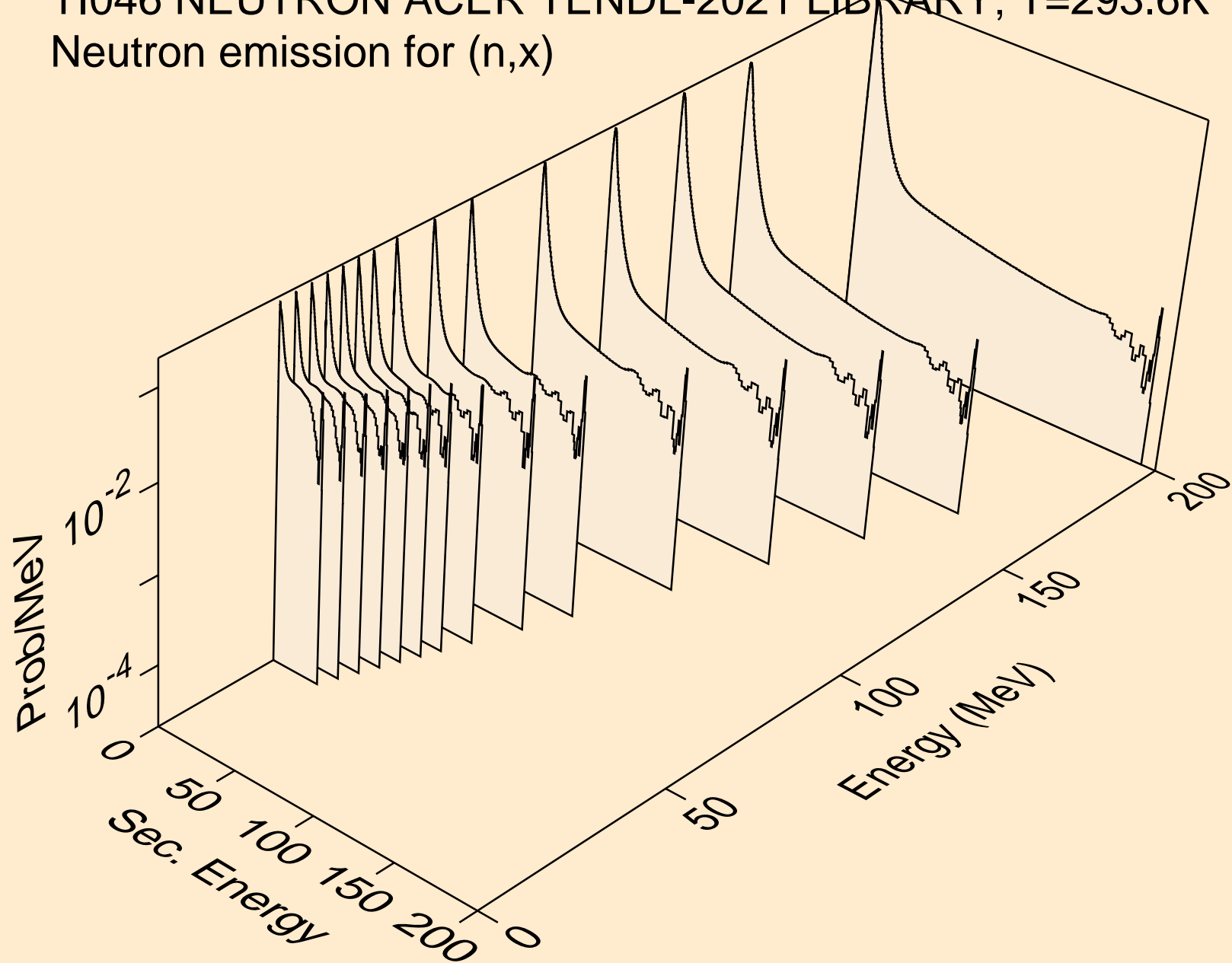

TI046 NEUTRON ACER TENDL-2021 LIBRARY; T=293.6K
Neutron emission for (n,2n)

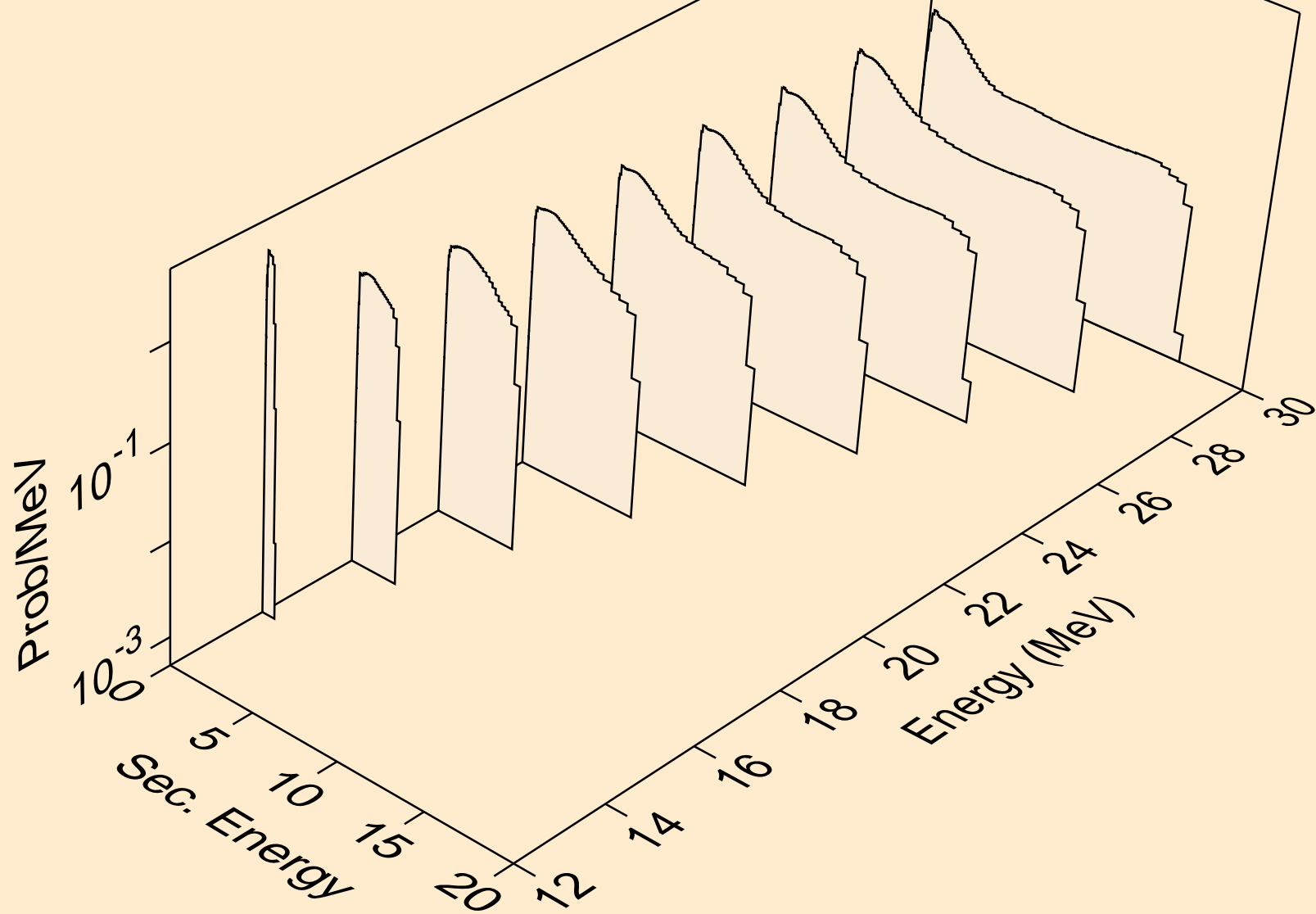

TI046 NEUTRON ACER TENDL-2021 LIBRARY; T=293.6K
Neutron emission for (n,3n)

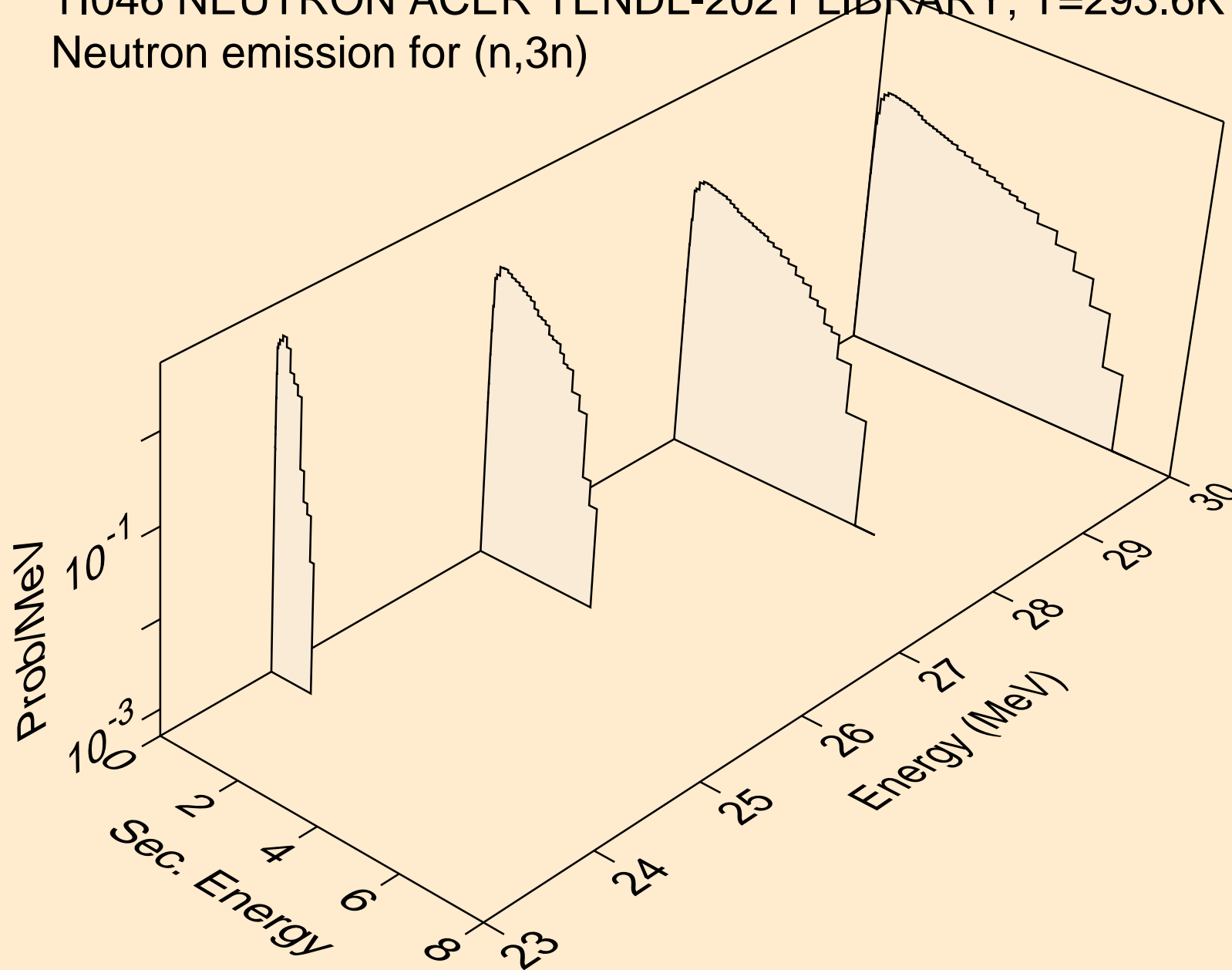

TI046 NEUTRON ACER TENDL-2021 LIBRARY; T=293.6K
Neutron emission for (n,n*)a

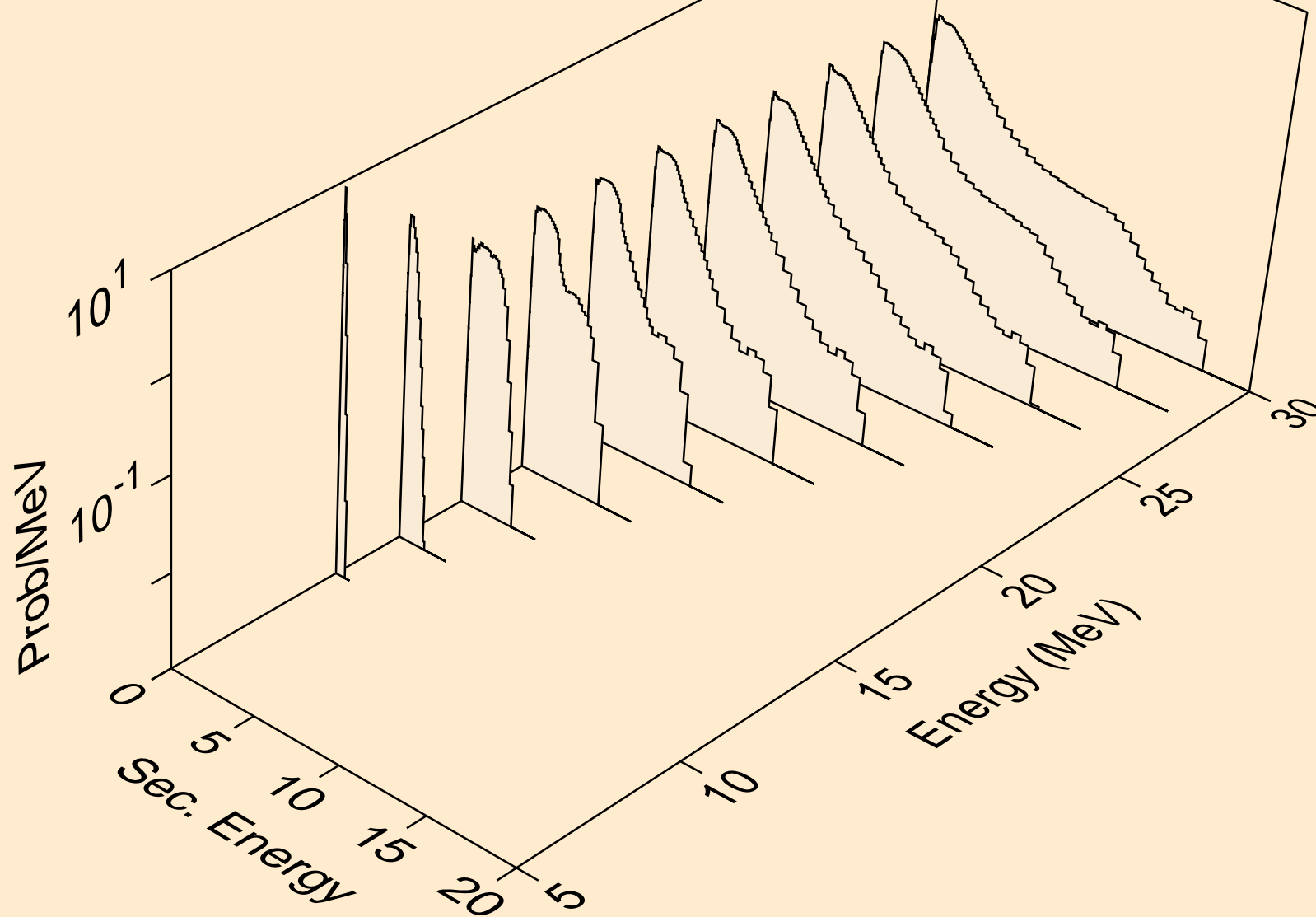

TI046 NEUTRON ACER TENDL-2021 LIBRARY; T=293.6K
Neutron emission for (n,2n)a

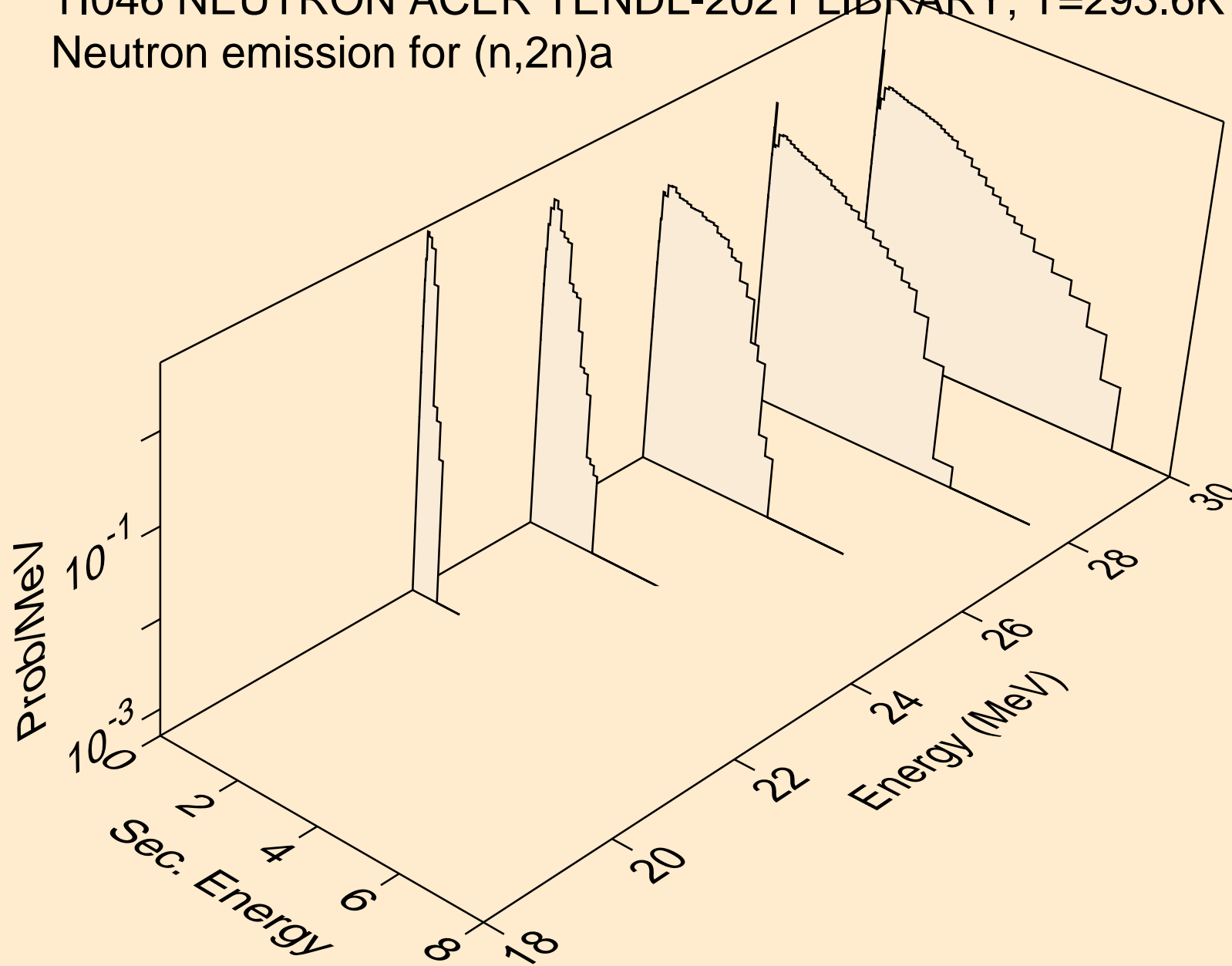

TI046 NEUTRON ACER TENDL-2021 LIBRARY; T=293.6K
Neutron emission for (n,n*)p

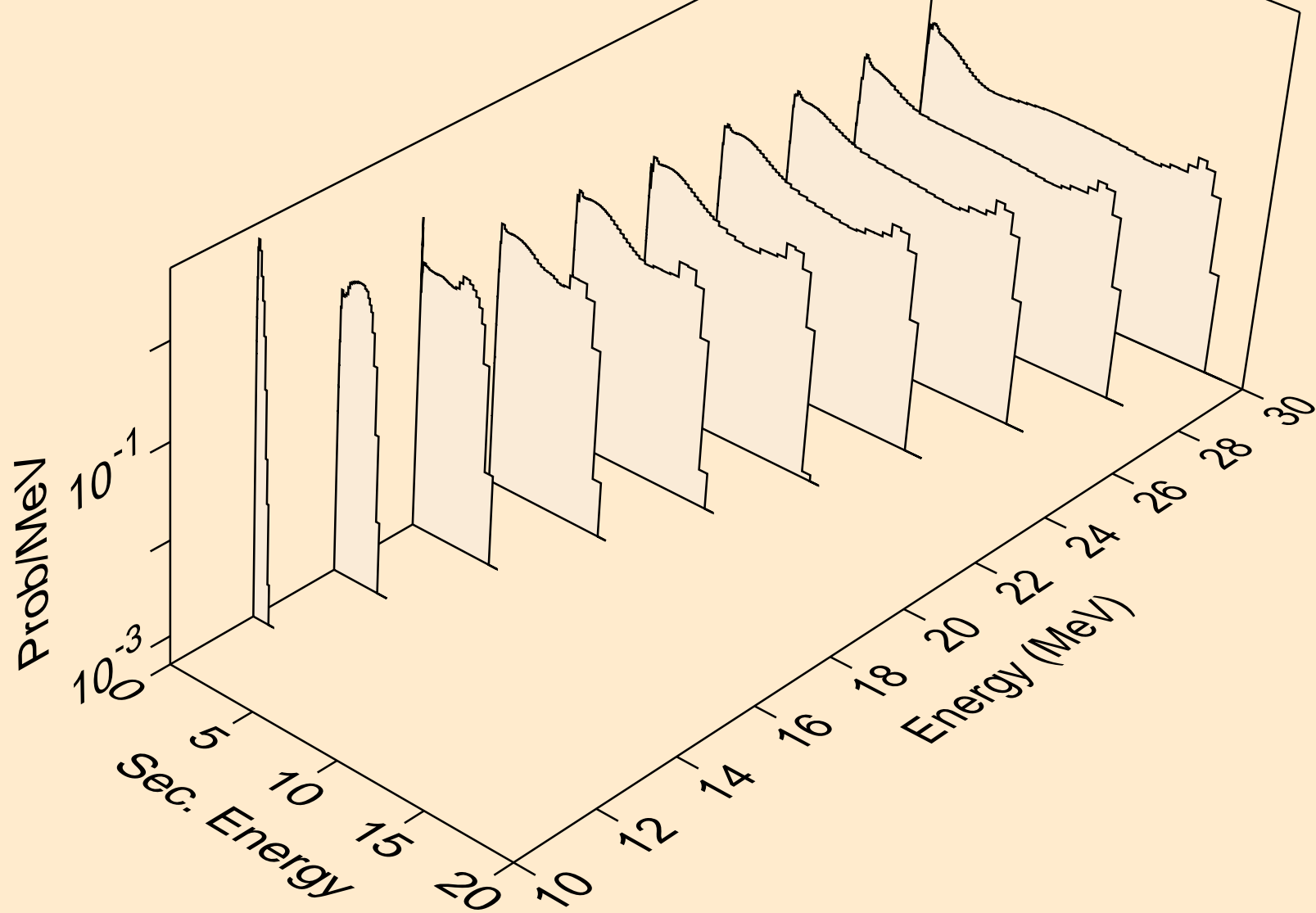

TI046 NEUTRON ACER TENDL-2021 LIBRARY; T=293.6K
Neutron emission for (n,n*)2a

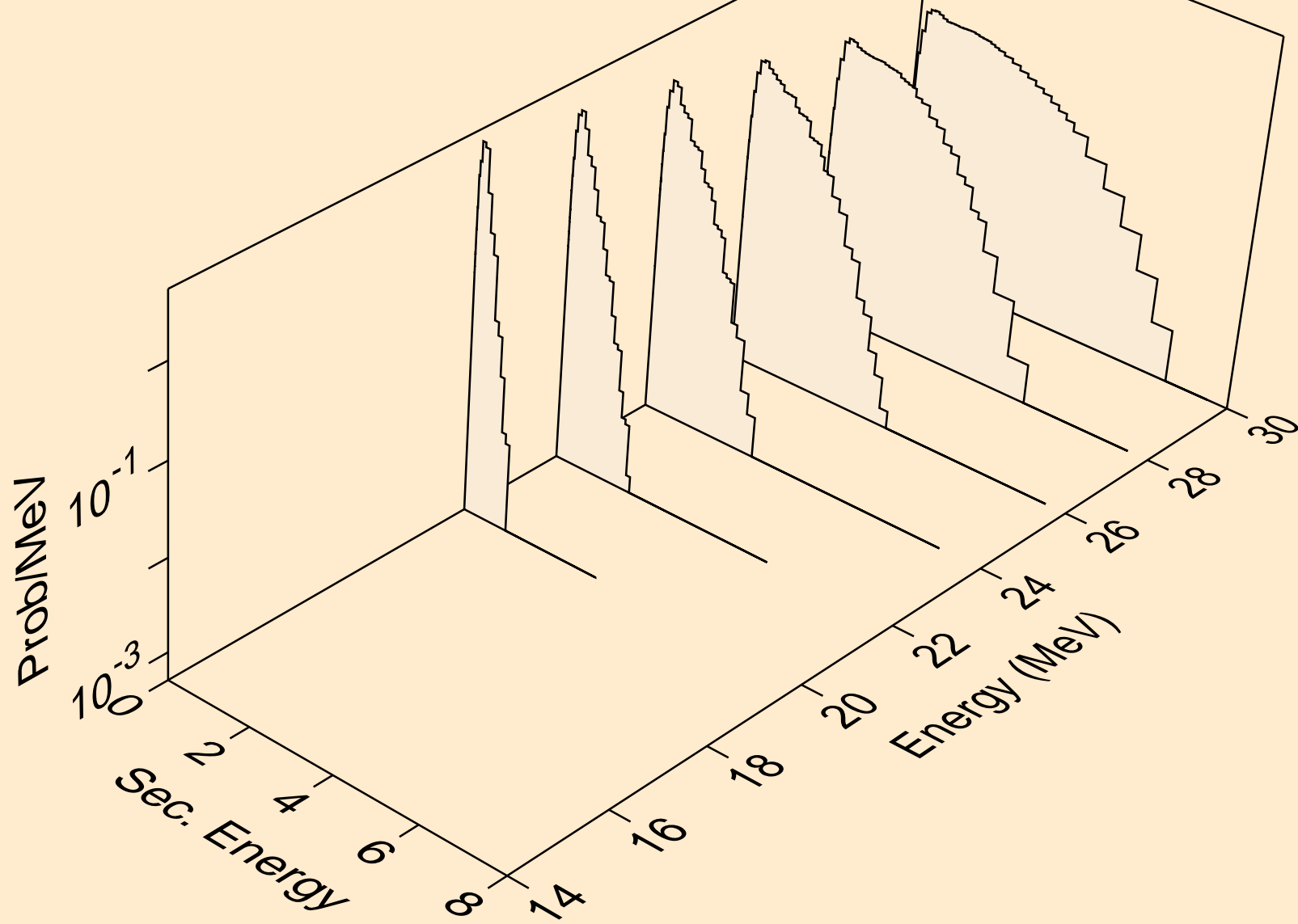

TI046 NEUTRON ACER TENDL-2021 LIBRARY; T=293.6K
Neutron emission for (n,n*)d

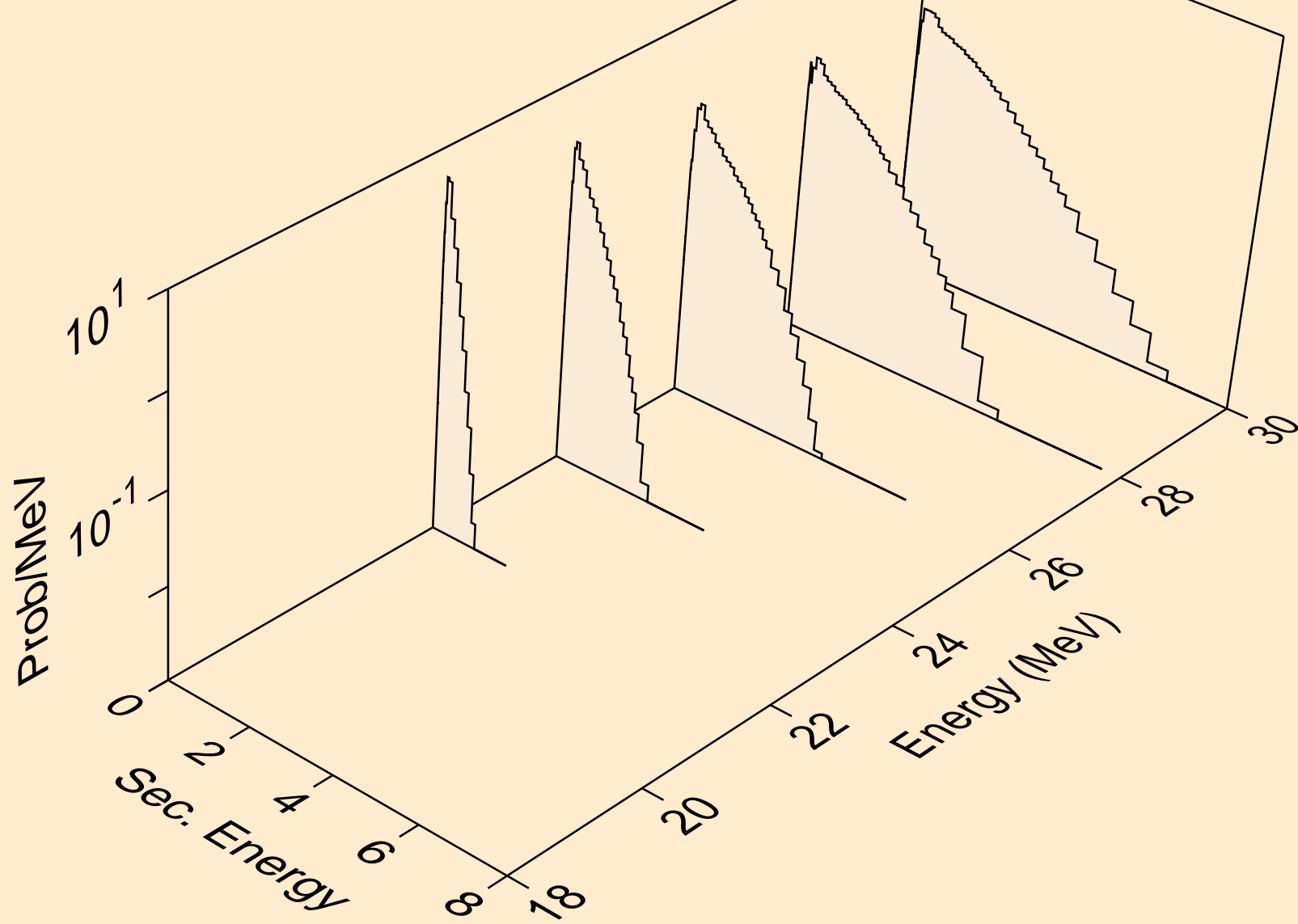

TI046 NEUTRON ACER TENDL-2021 LIBRARY; T=293.6K
Neutron emission for (n,n*)t

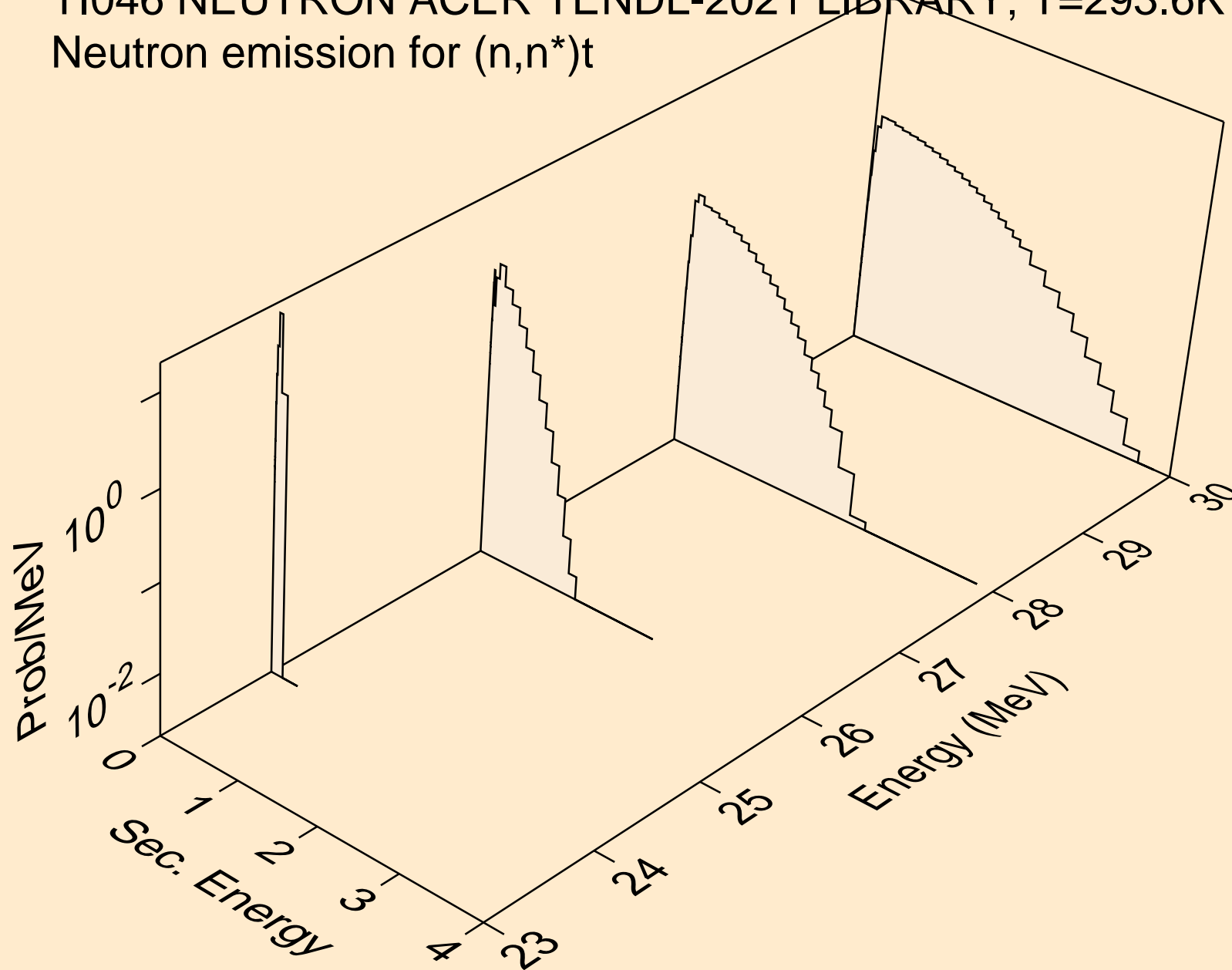

TI046 NEUTRON ACER TENDL-2021 LIBRARY; T=293.6K
Neutron emission for (n,n*)he3

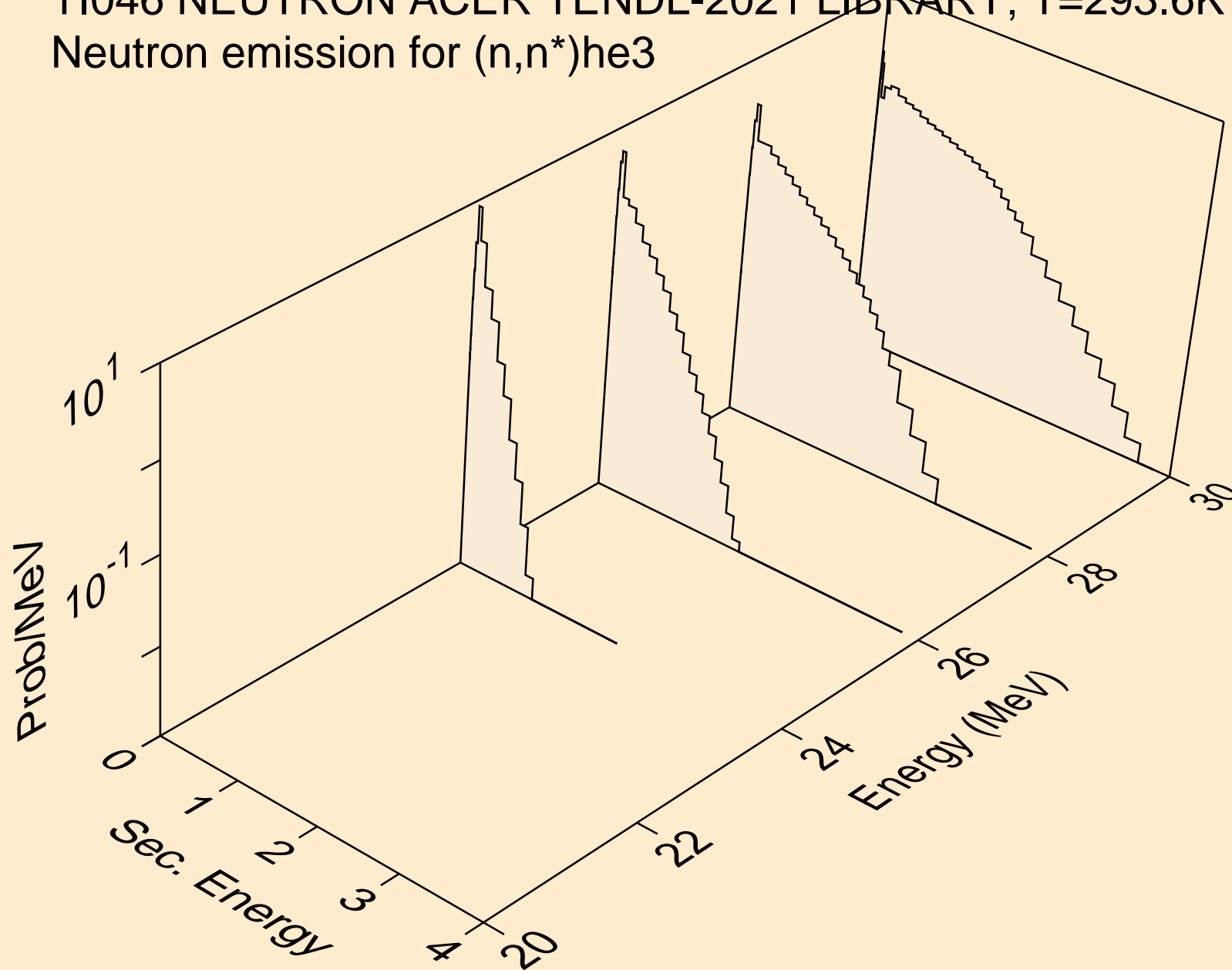

TI046 NEUTRON ACER TENDL-2021 LIBRARY; T=293.6K
Neutron emission for (n,2np)

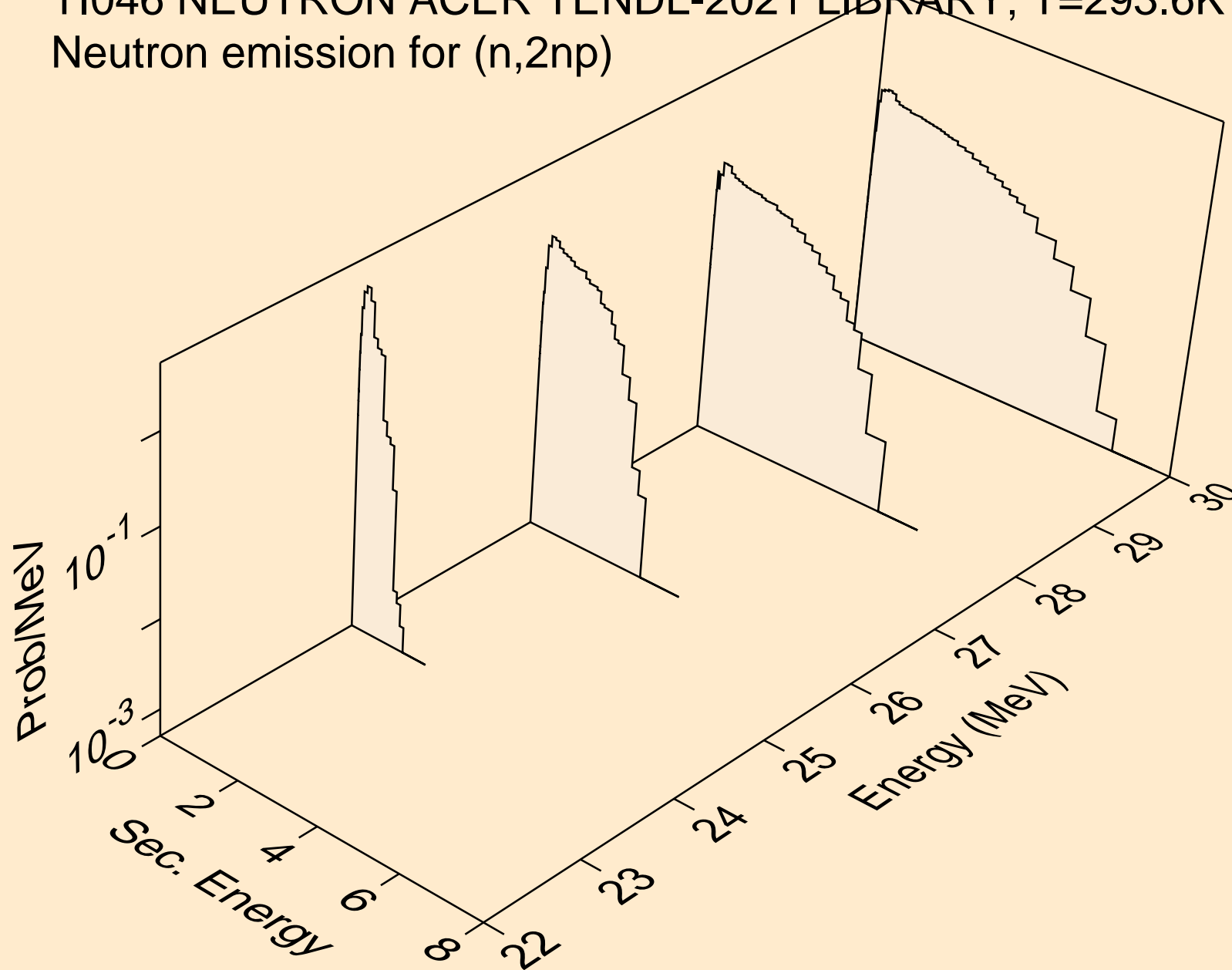

TI046 NEUTRON ACER TENDL-2021 LIBRARY; T=293.6K
Neutron emission for (n,2np)

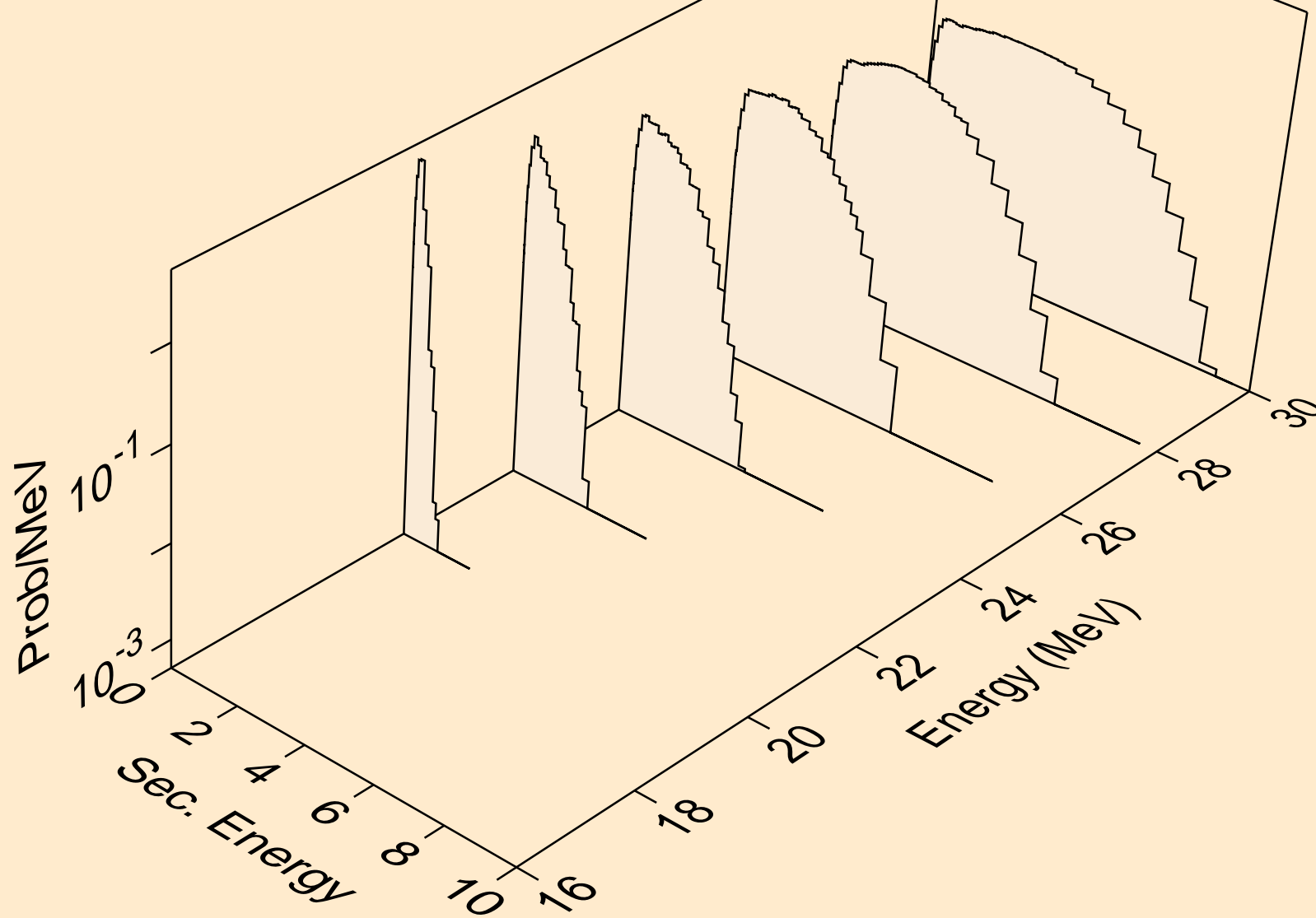

TI046 NEUTRON ACER TENDL-2021 LIBRARY; T=293.6K
Neutron emission for (n,npa)

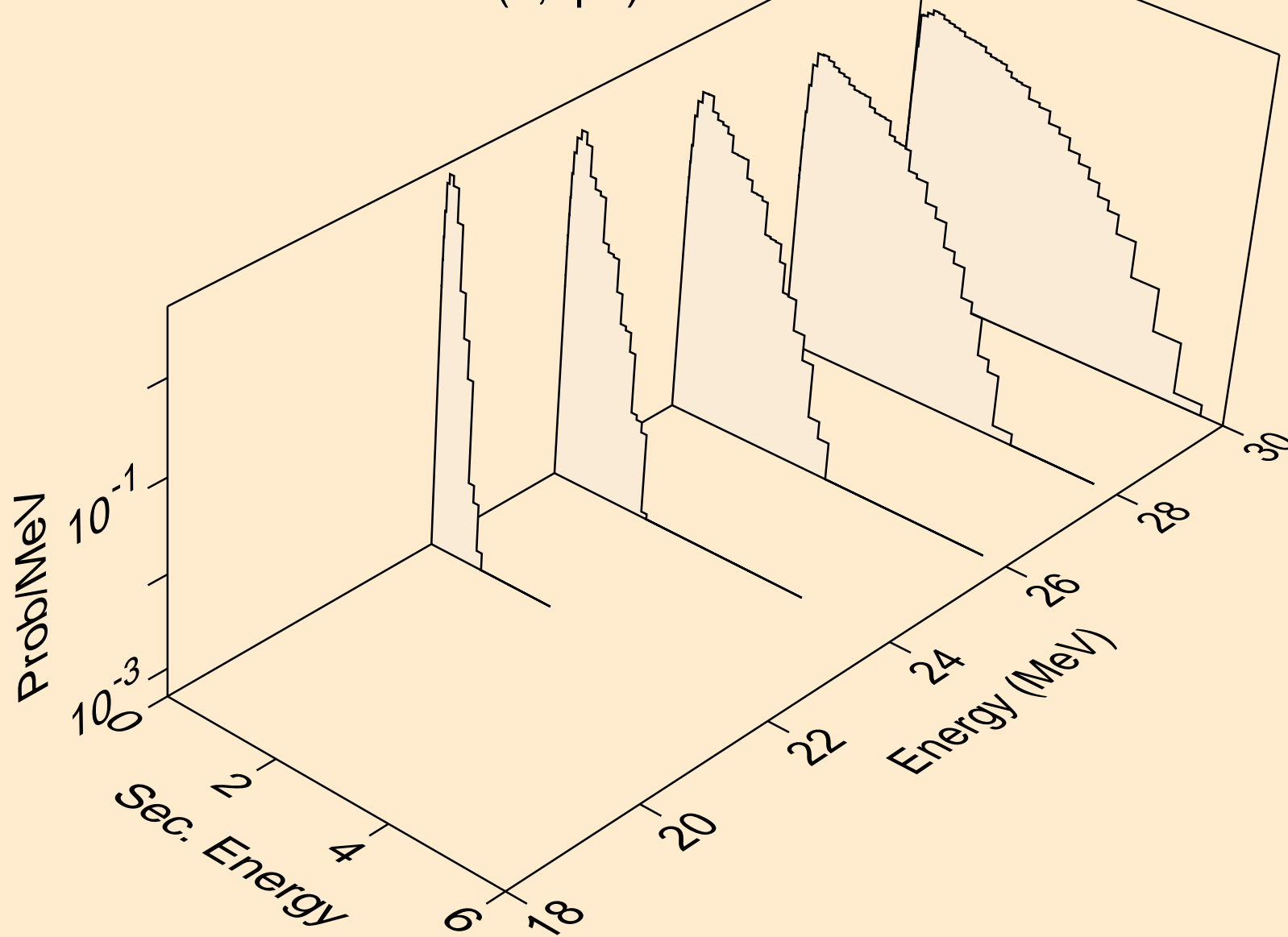

TI046 NEUTRON ACER TENDL-2021 LIBRARY; T=293.6K
Neutron emission for (n,n*c)

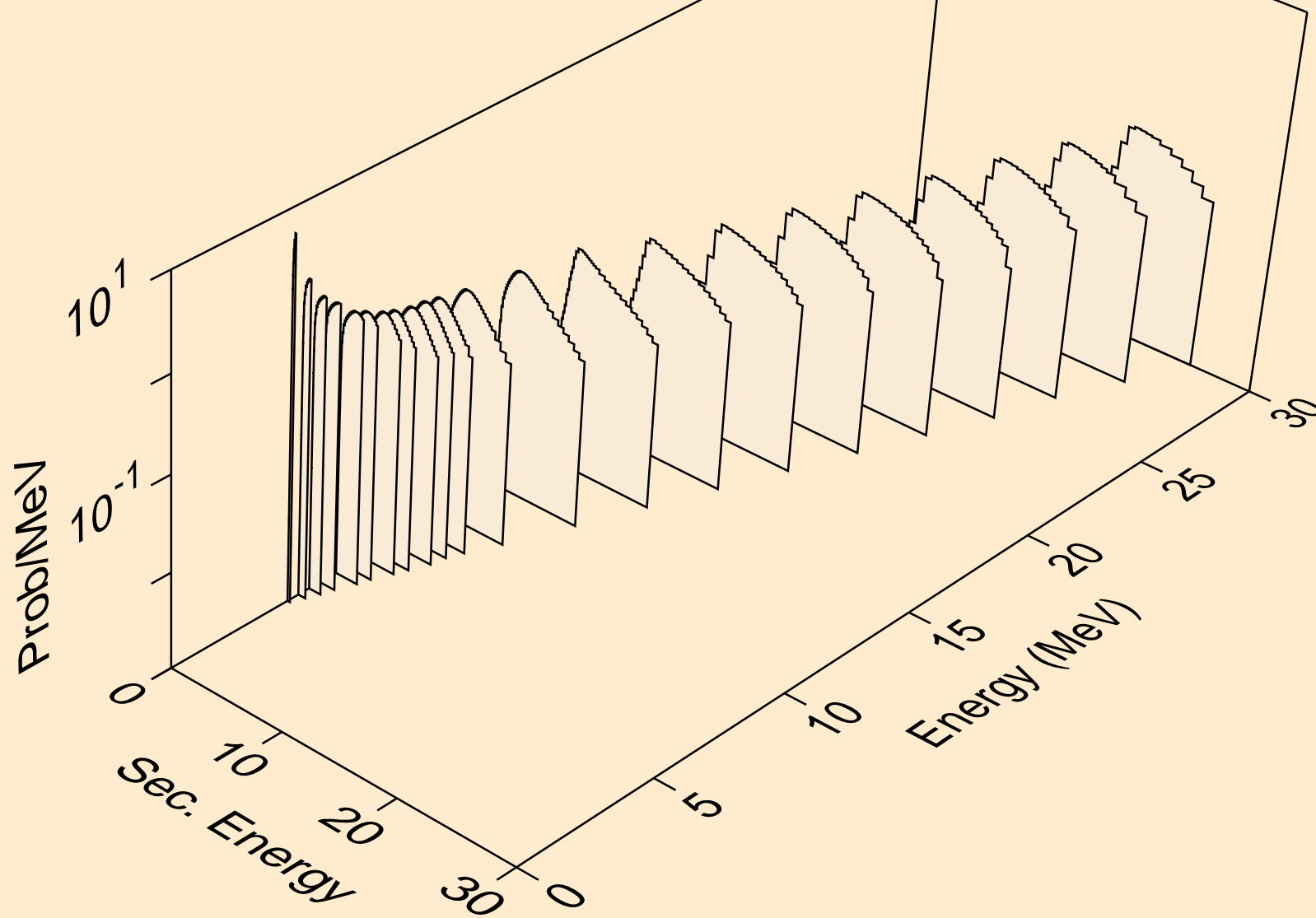

TI046 NEUTRON ACER TENDL-2021 LIBRARY; T=293.6K
Photon emission for (n,x)

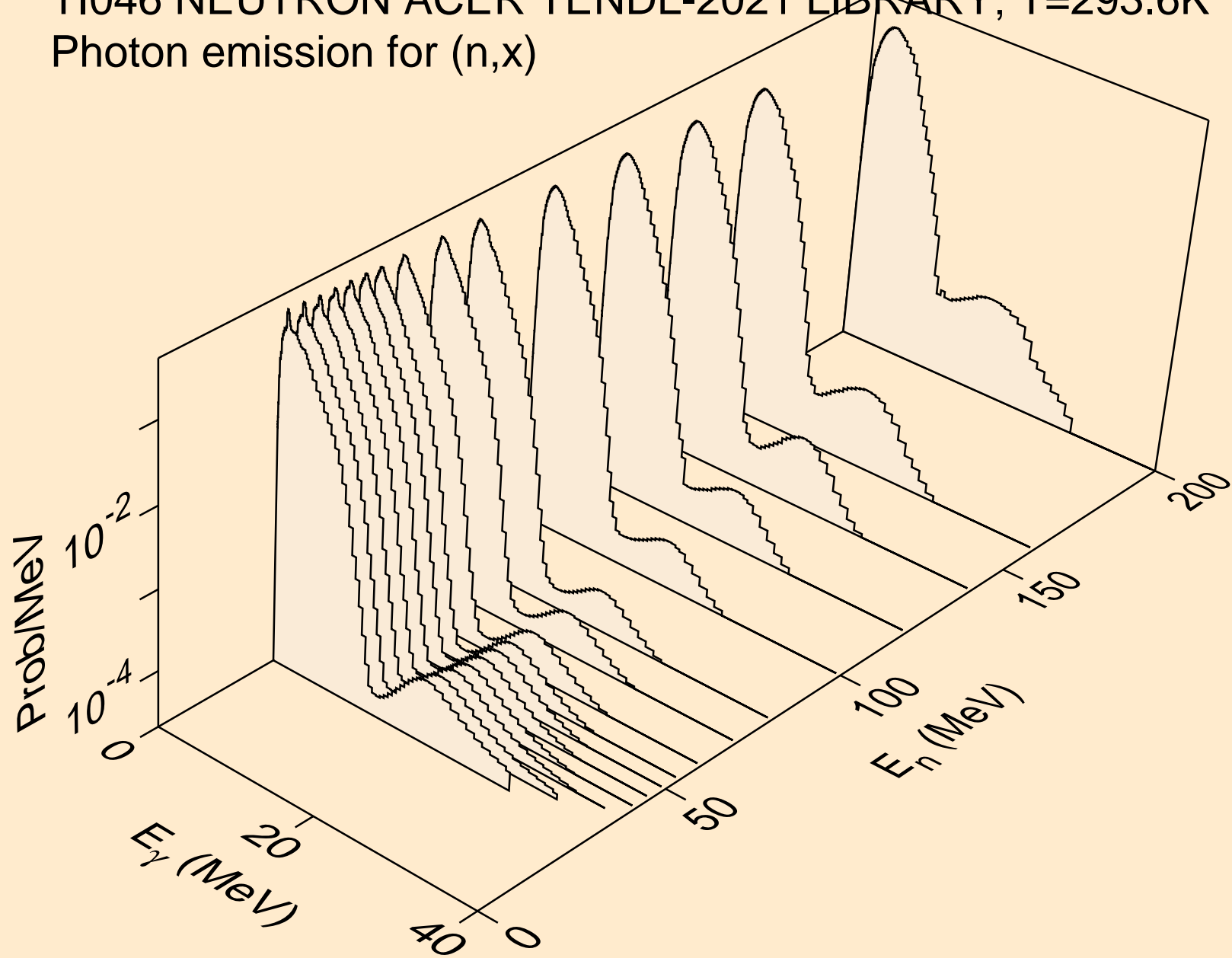

TI046 NEUTRON ACER TENDL-2021 LIBRARY; T=293.6K
Photon emission for (n,2n)

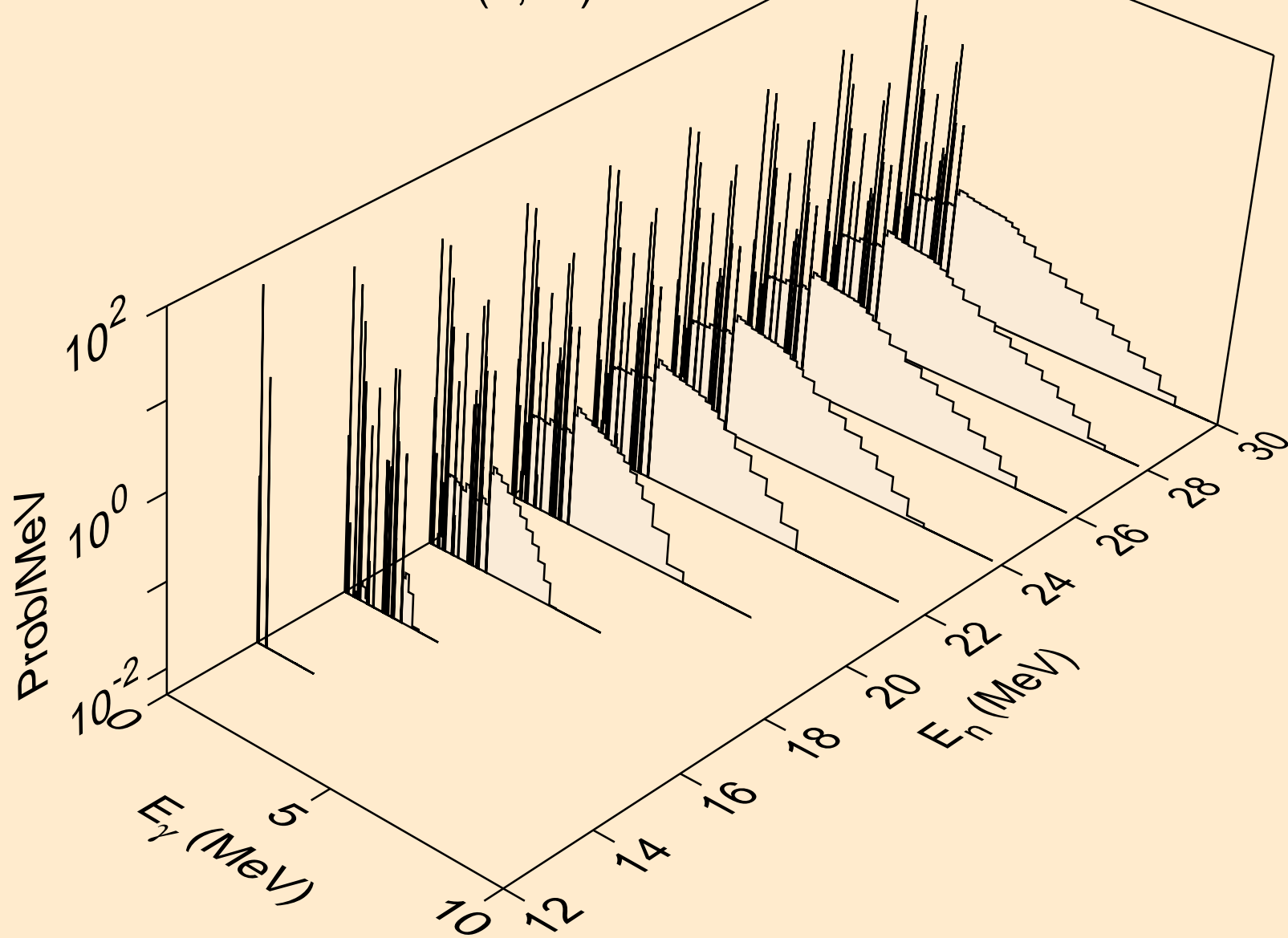

TI046 NEUTRON ACER TENDL-2021 LIBRARY; T=293.6K
Photon emission for (n,3n)

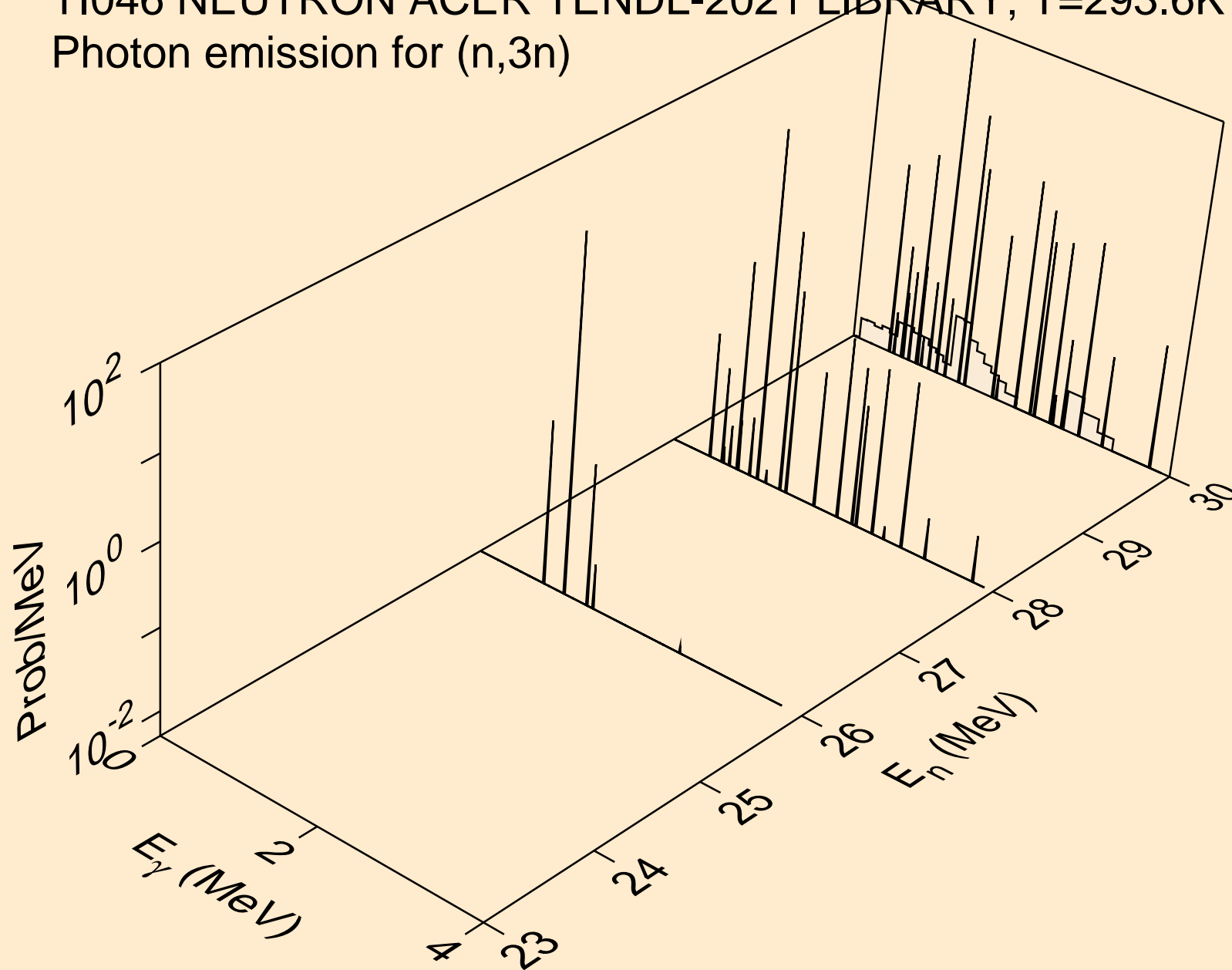

TI046 NEUTRON ACER TENDL-2021 LIBRARY; T=293.6K
Photon emission for (n,n*)a

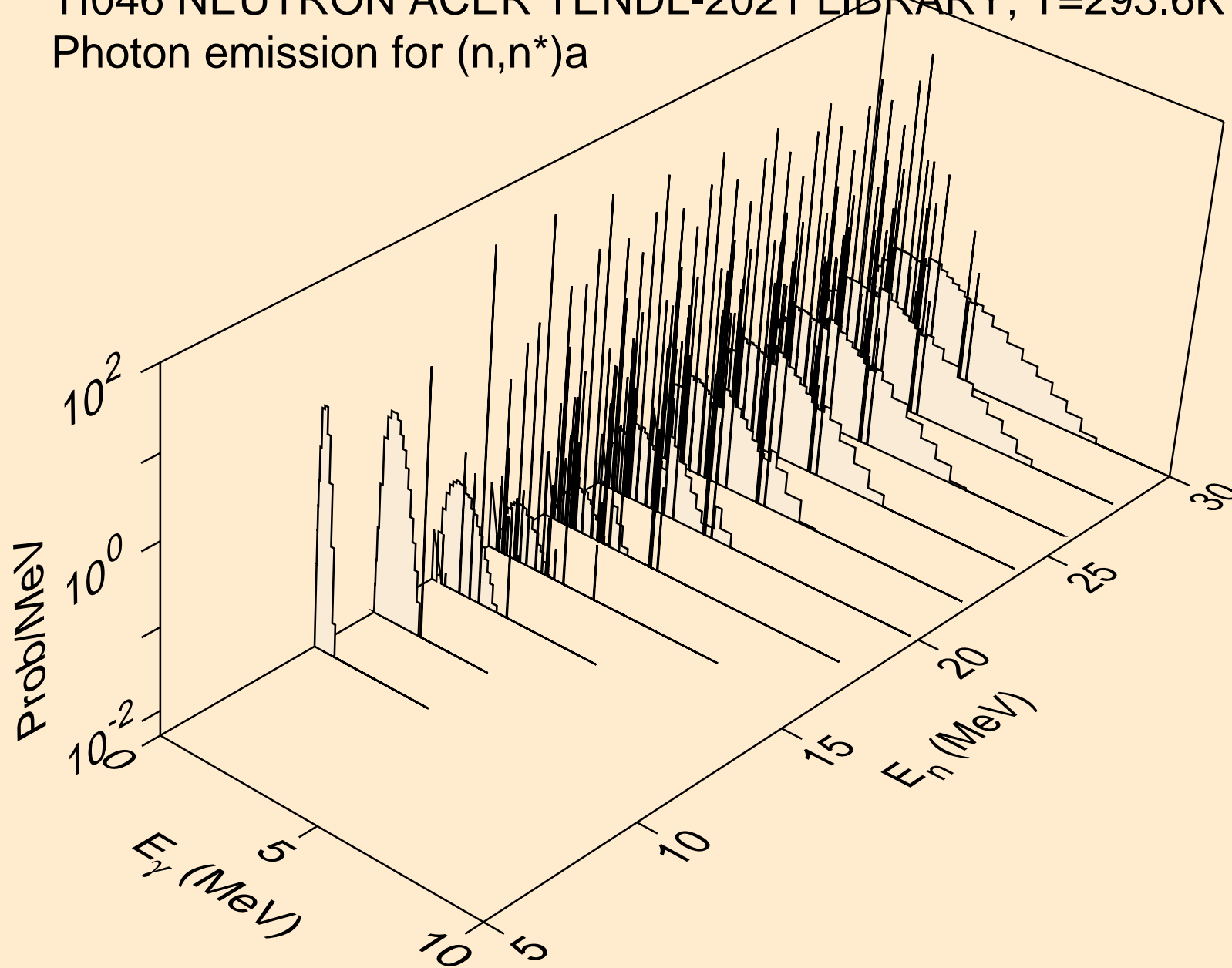

TI046 NEUTRON ACER TENDL-2021 LIBRARY; T=293.6K
Photon emission for (n,2n)a

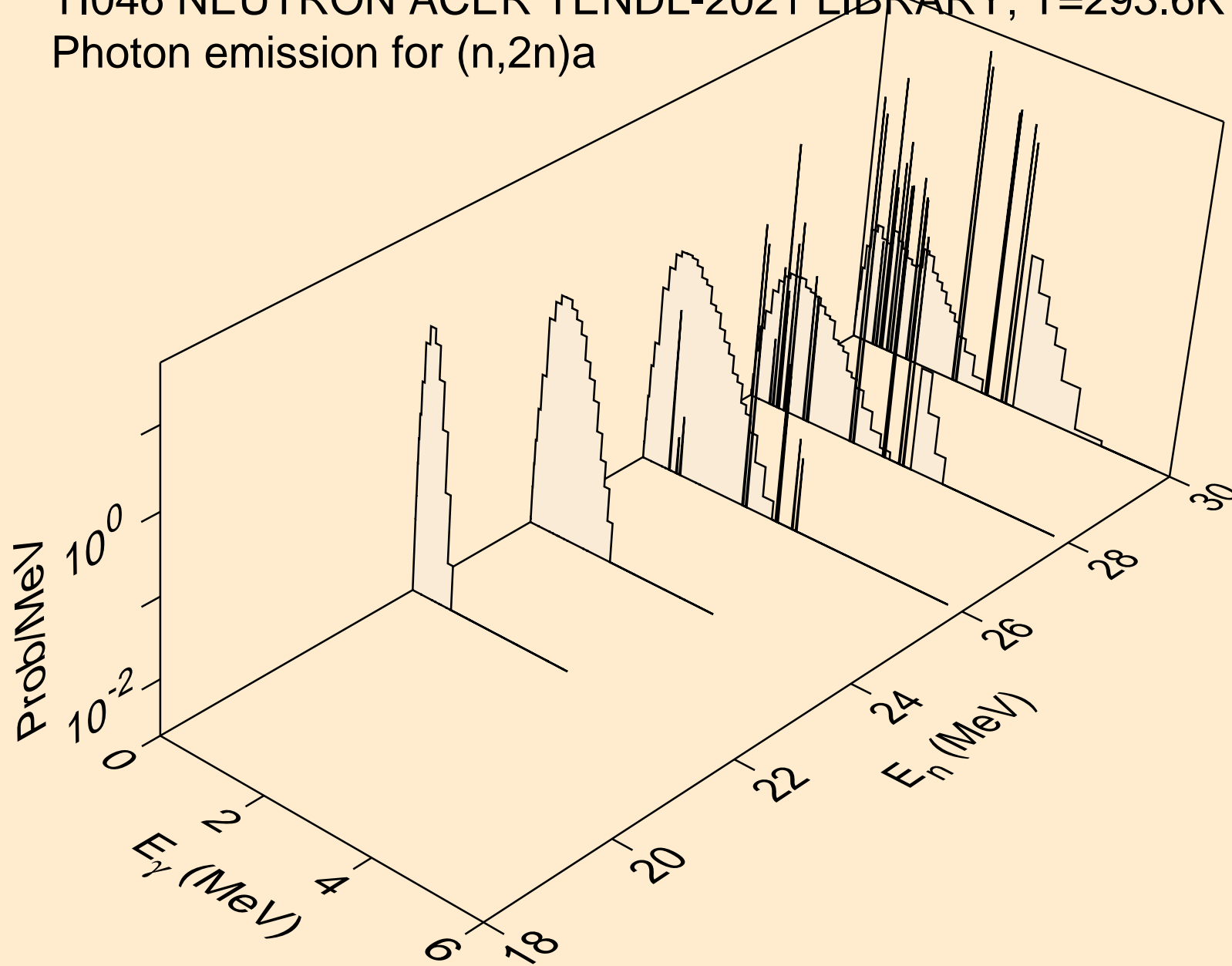

TI046 NEUTRON ACER TENDL-2021 LIBRARY; T=293.6K
Photon emission for (n,n*)p

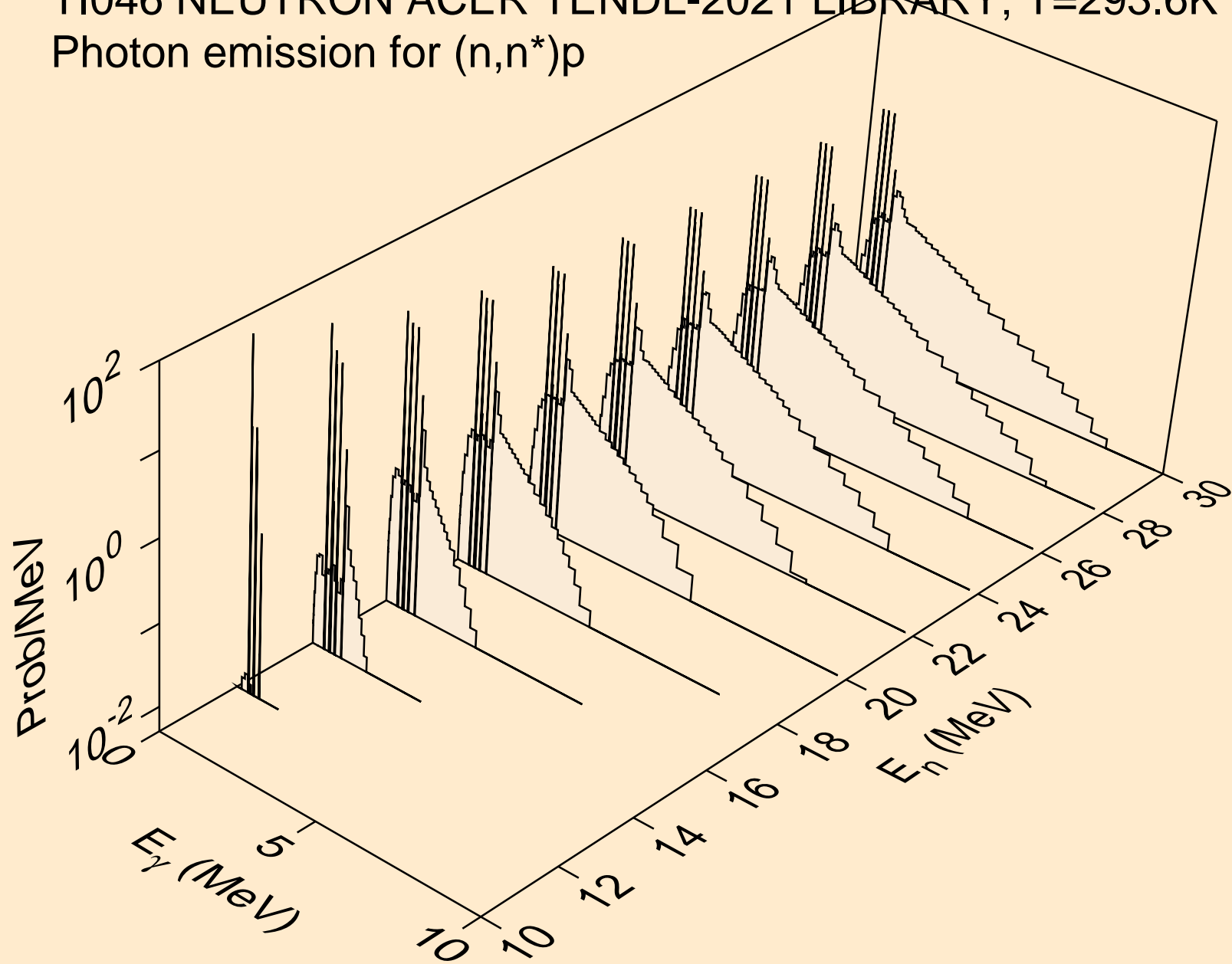

TI046 NEUTRON ACER TENDL-2021 LIBRARY; T=293.6K
Photon emission for (n,n*)2a

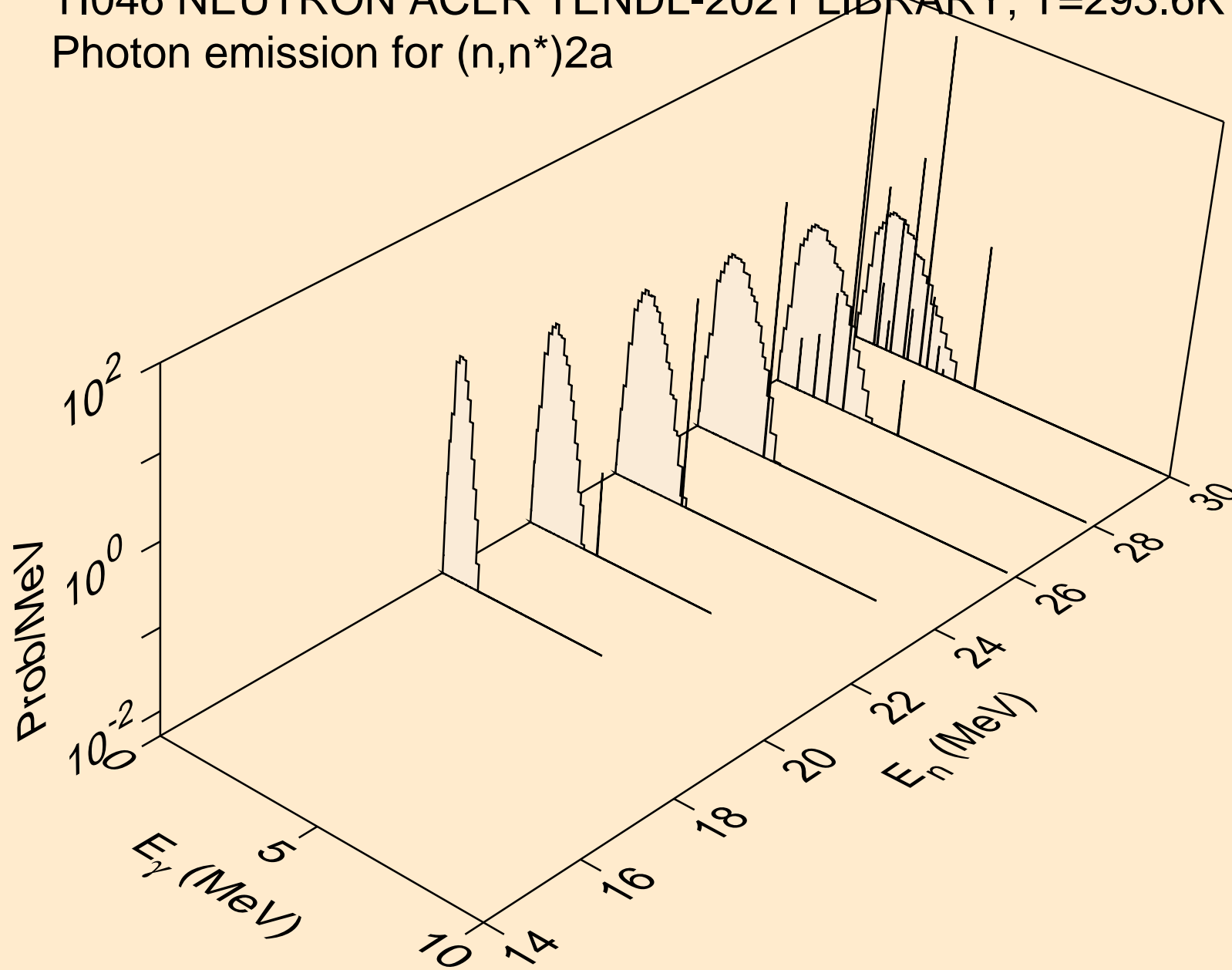

TI046 NEUTRON ACER TENDL-2021 LIBRARY; T=293.6K
Photon emission for (n,n*)d

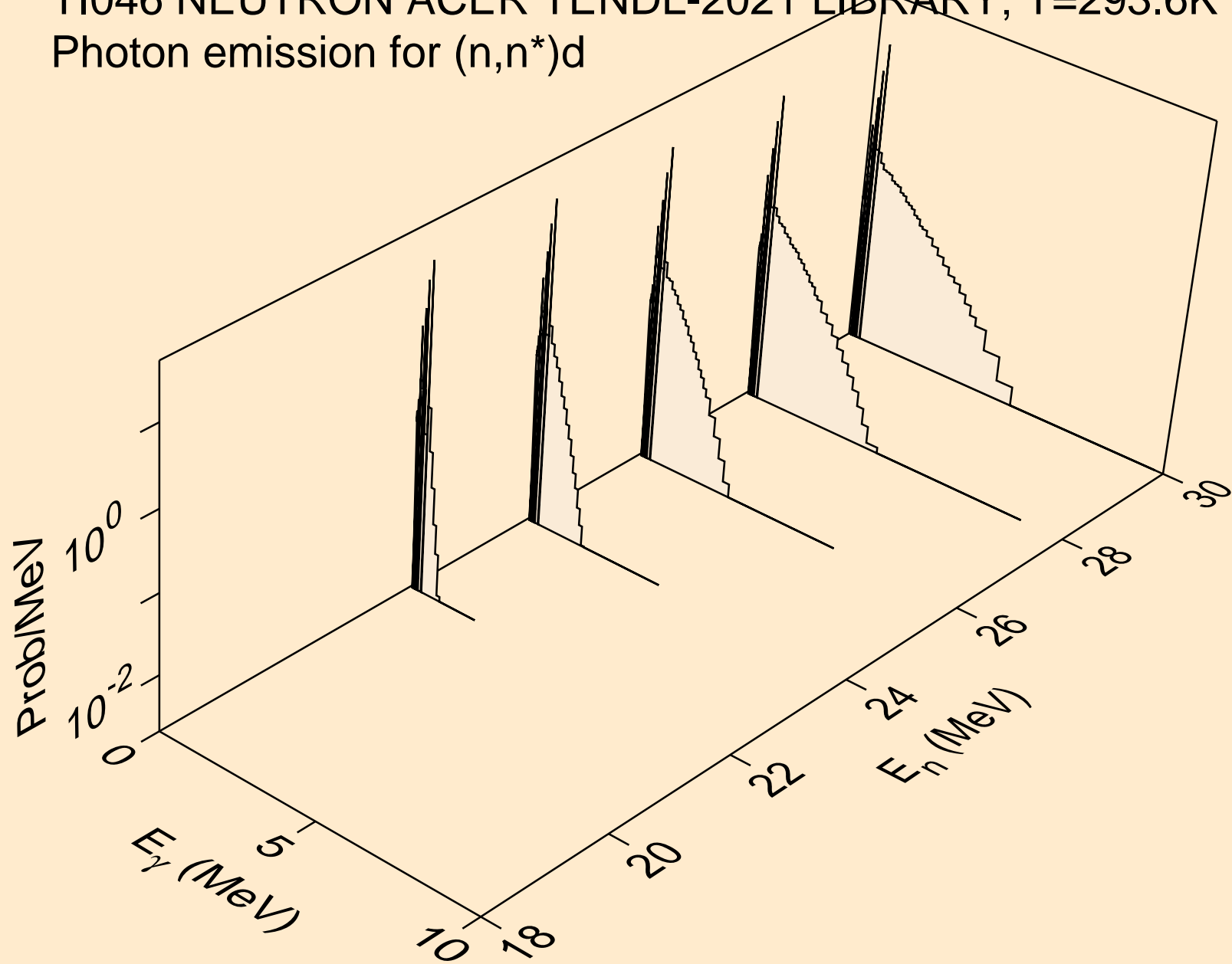

TI046 NEUTRON ACER TENDL-2021 LIBRARY; T=293.6K
Photon emission for (n,n*)t

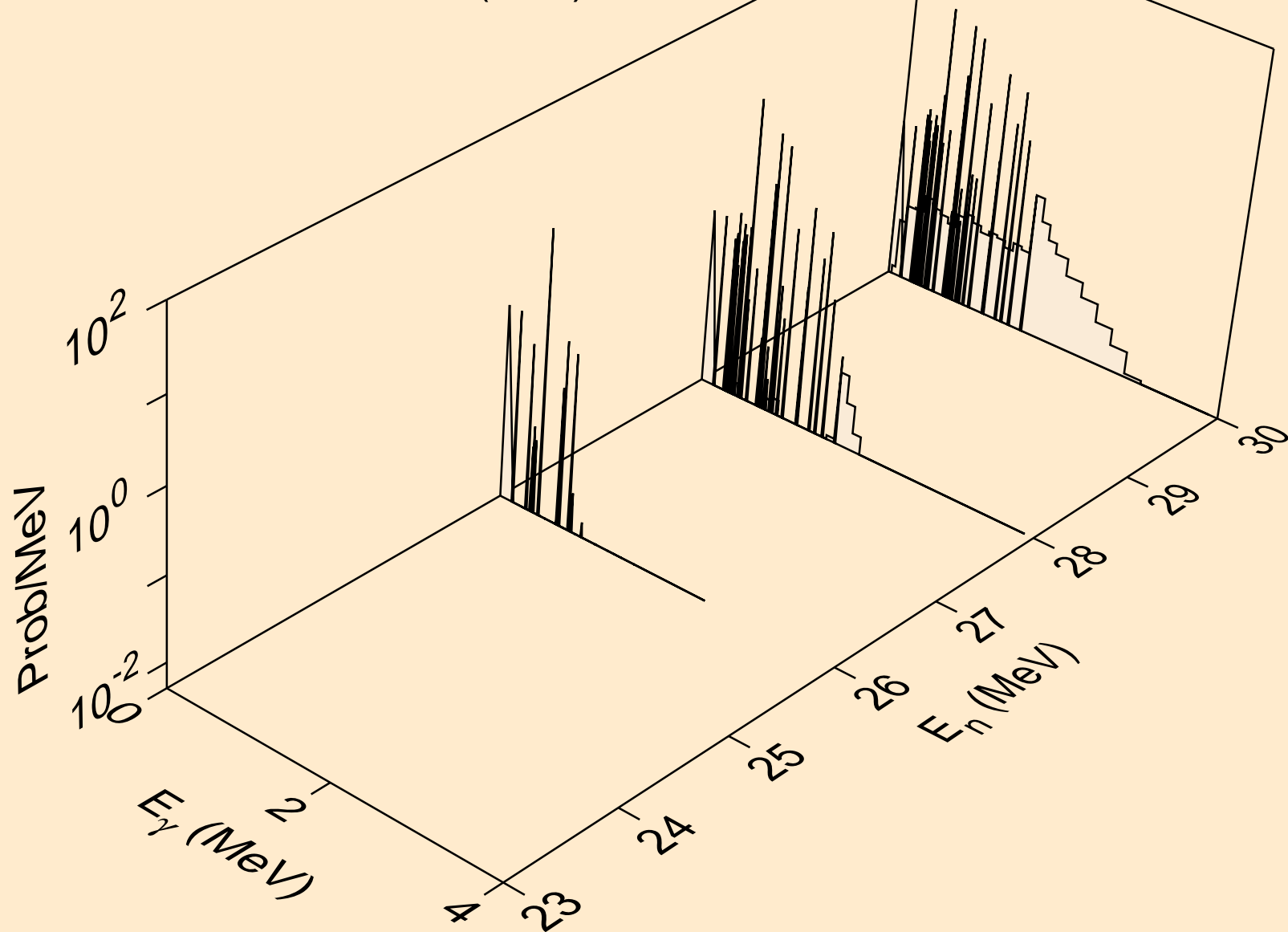

TI046 NEUTRON ACER TENDL-2021 LIBRARY; T=293.6K
Photon emission for (n,n*)he3

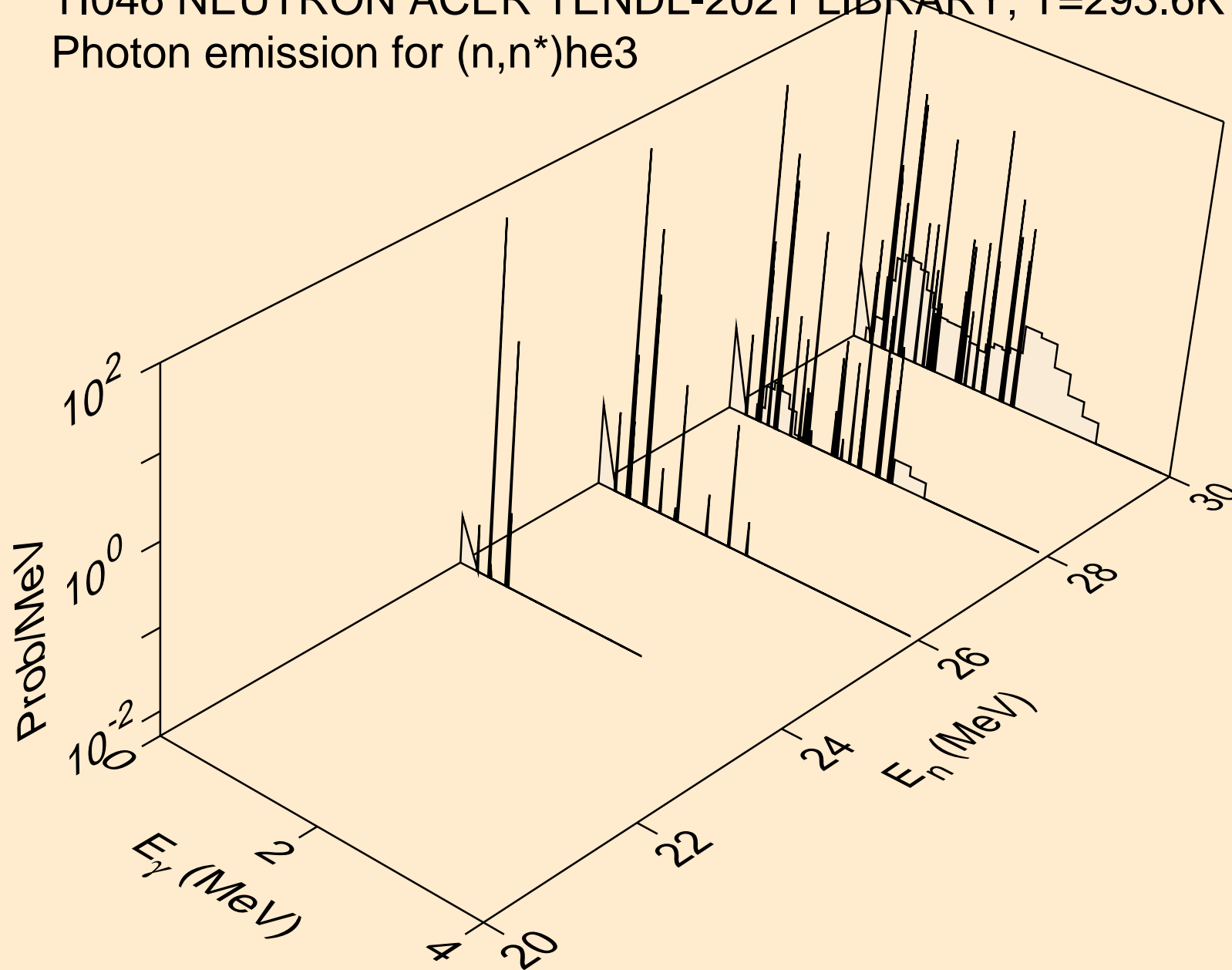

TI046 NEUTRON ACER TENDL-2021 LIBRARY; T=293.6K
Photon emission for (n,2np)

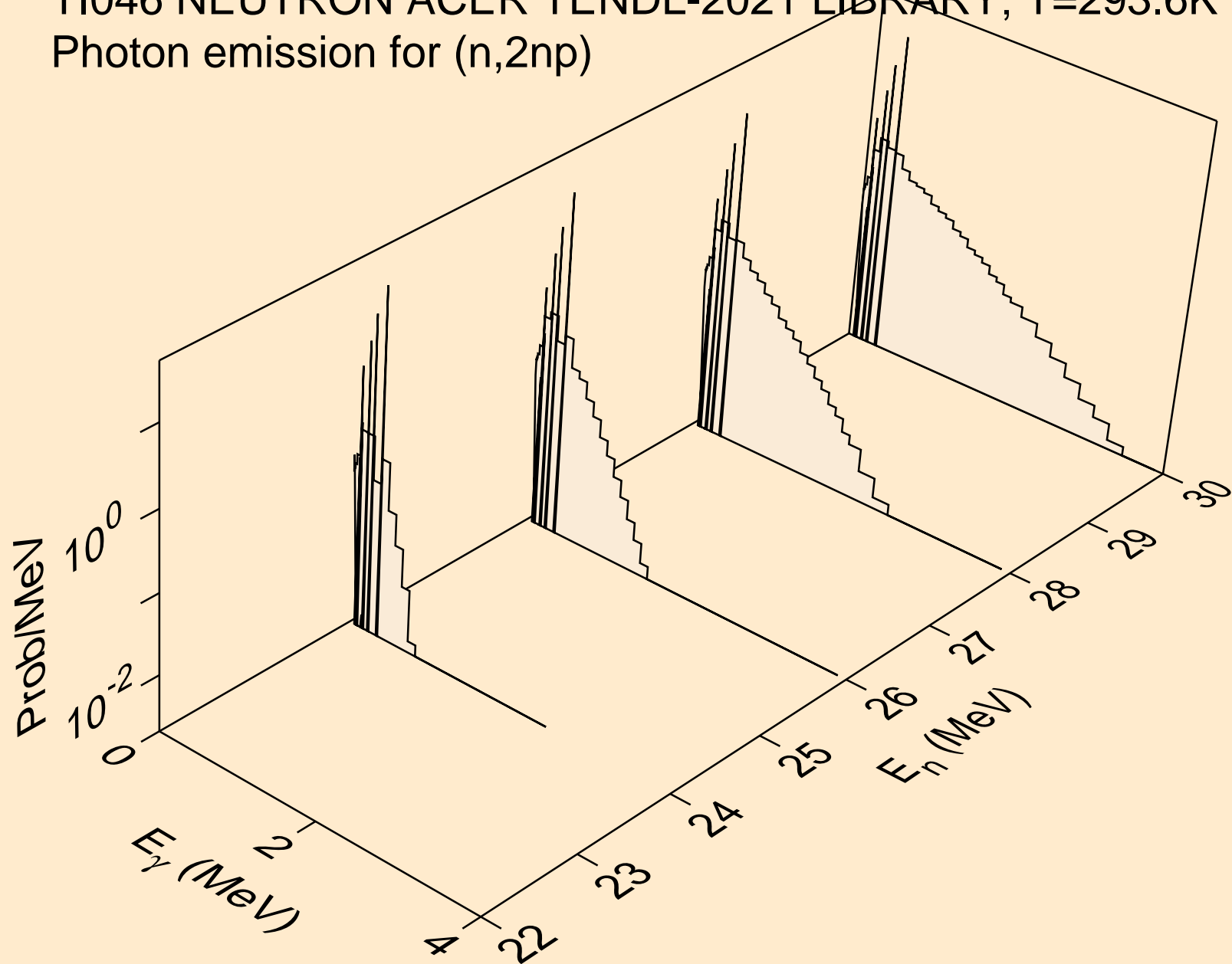

TI046 NEUTRON ACER TENDL-2021 LIBRARY; T=293.6K
Photon emission for (n,2np)

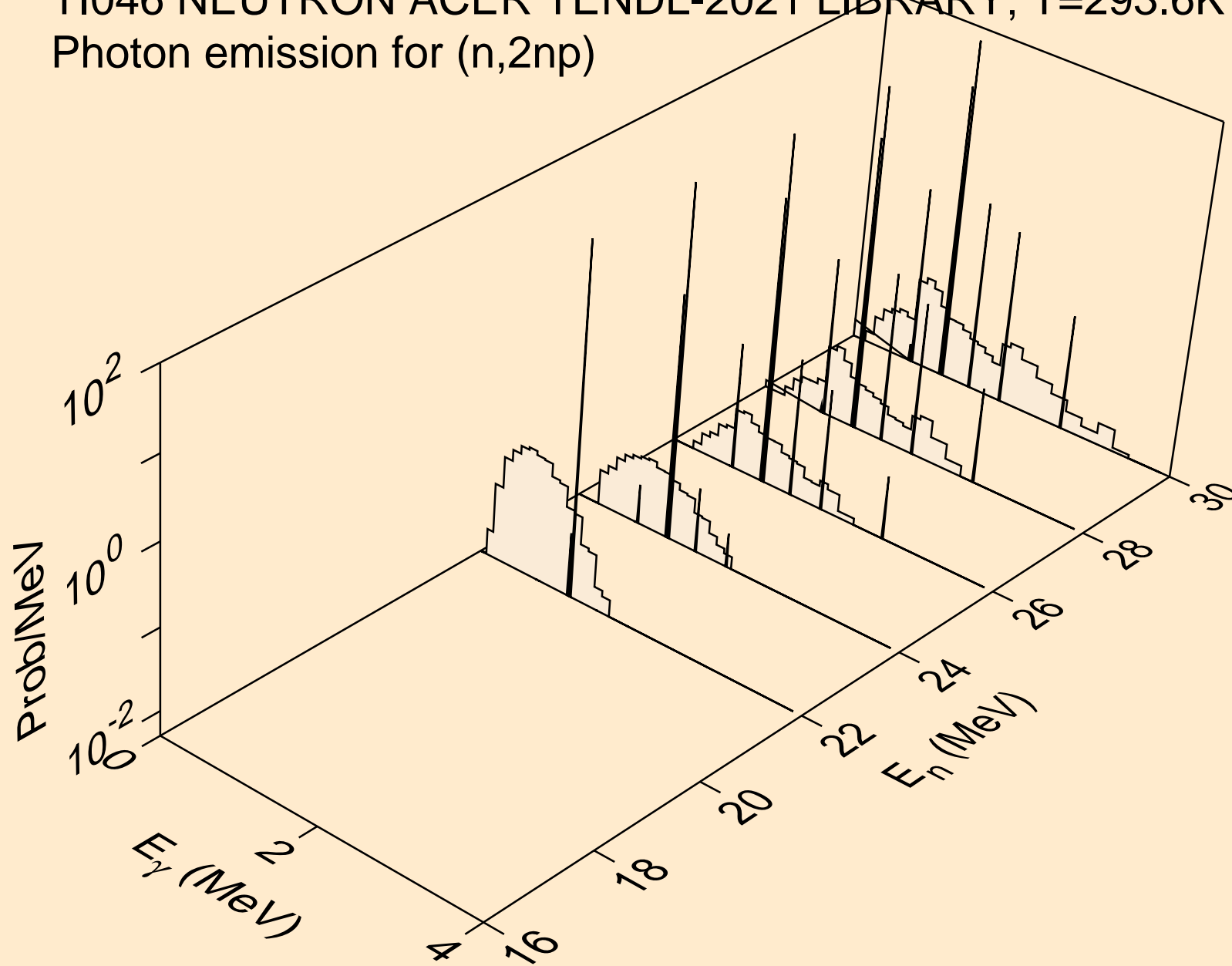

TI046 NEUTRON ACER TENDL-2021 LIBRARY; T=293.6K
Photon emission for (n,npa)

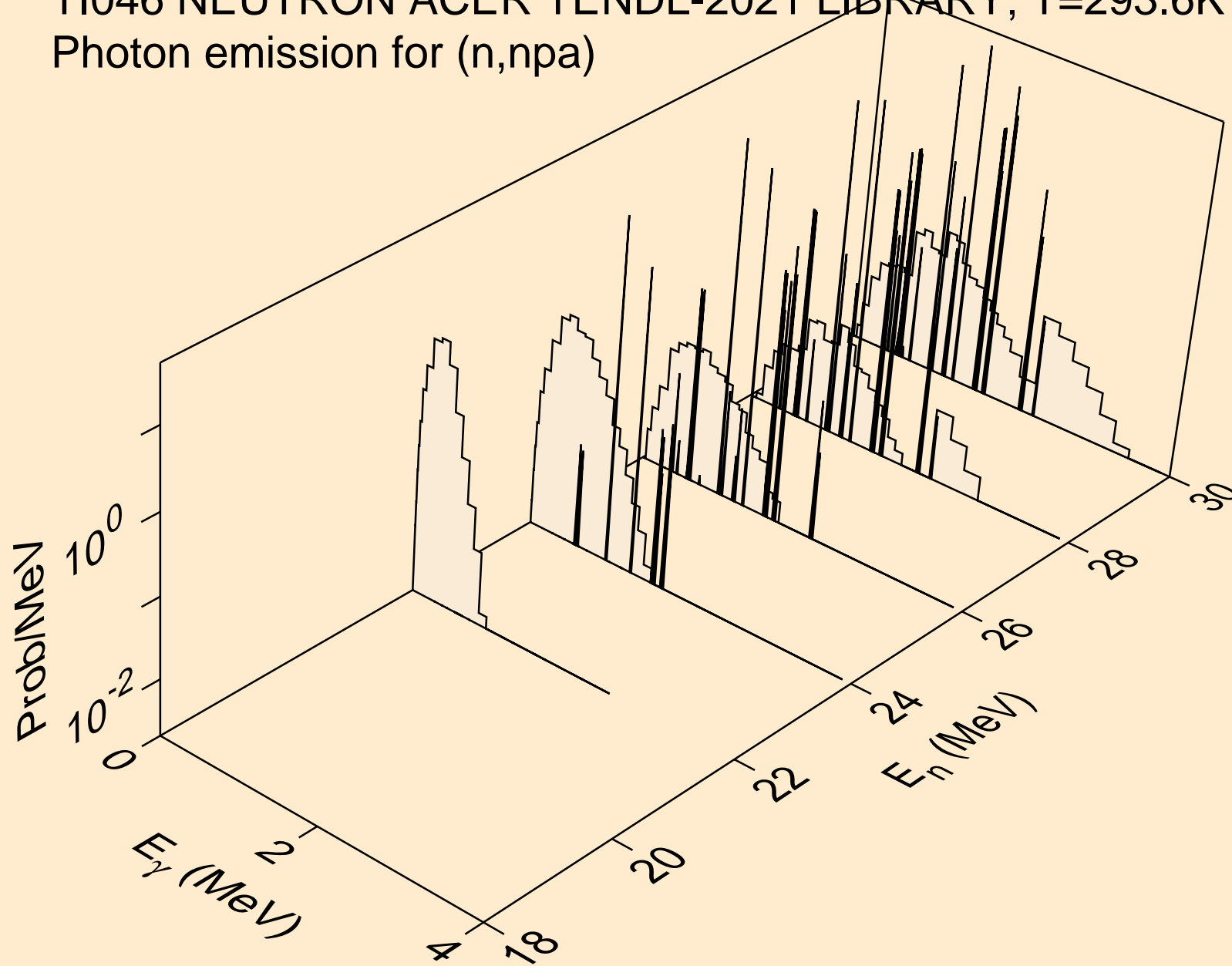

TI046 NEUTRON ACER TENDL-2021 LIBRARY; T=293.6K
Photon emission for (n,n*c)

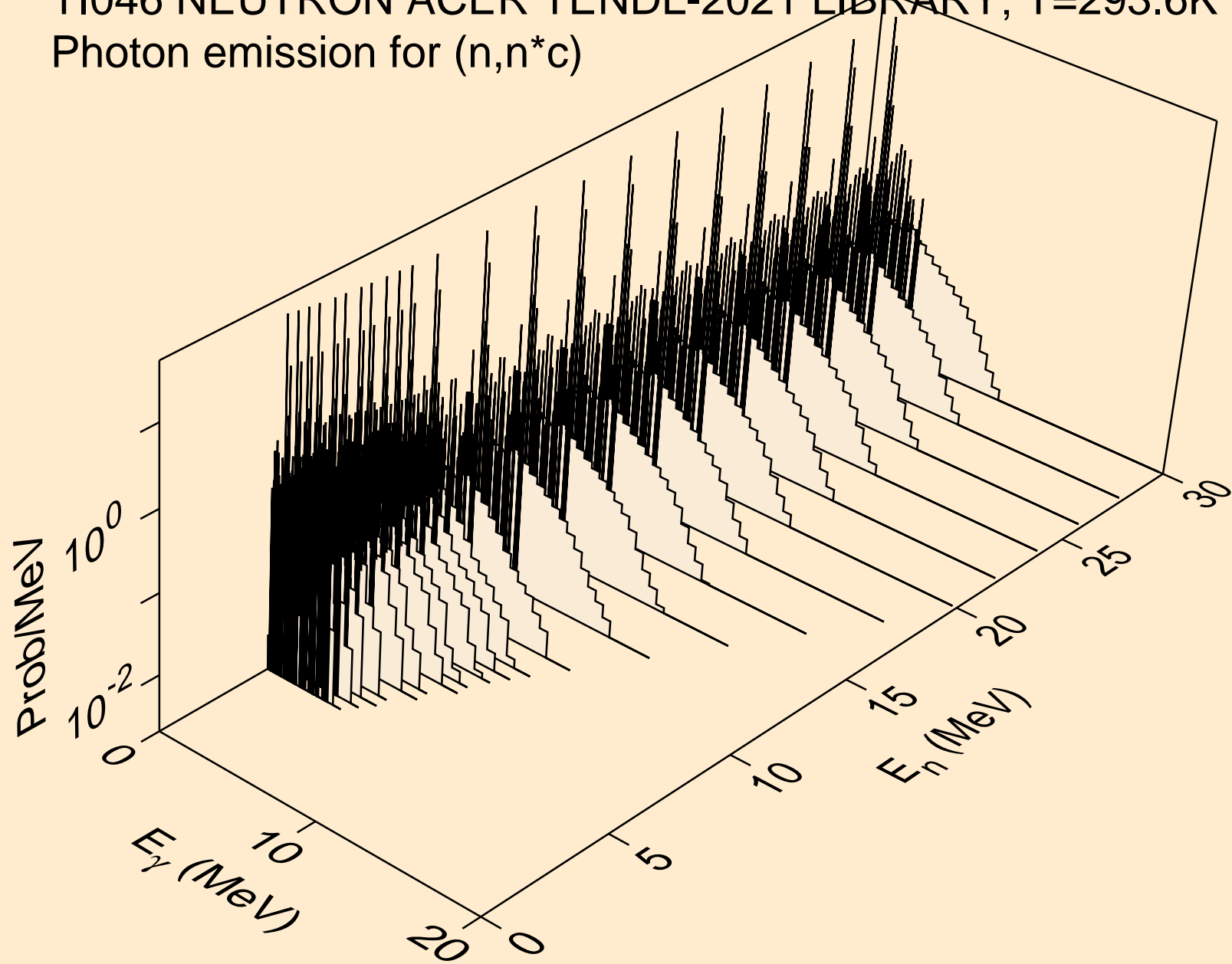

TI046 NEUTRON ACER TENDL-2021 LIBRARY; T=293.6K
Photon emission for (n,gma)

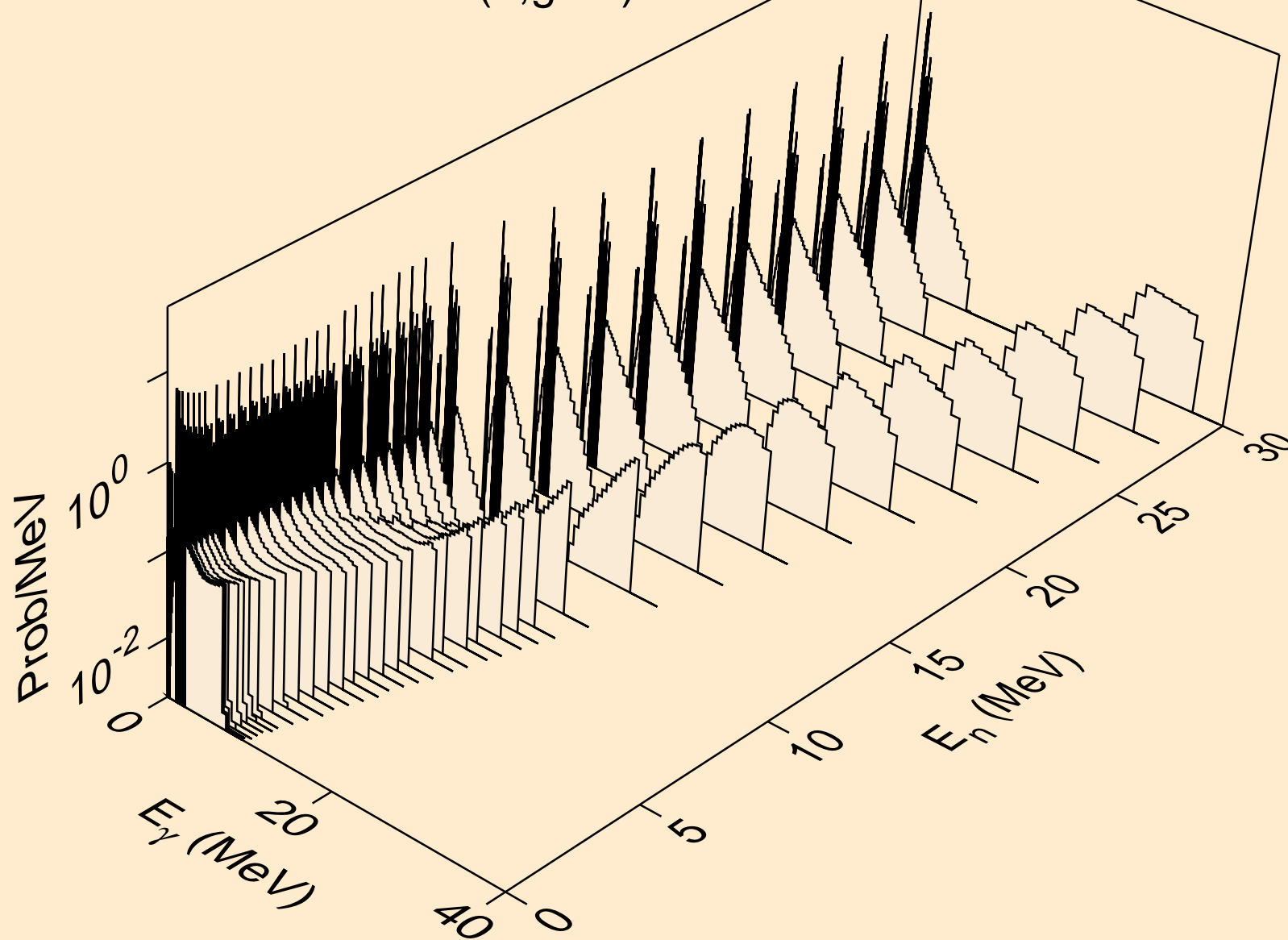

TI046 NEUTRON ACER TENDL-2021 LIBRARY; T=293.6K
Photon emission for (n,p)

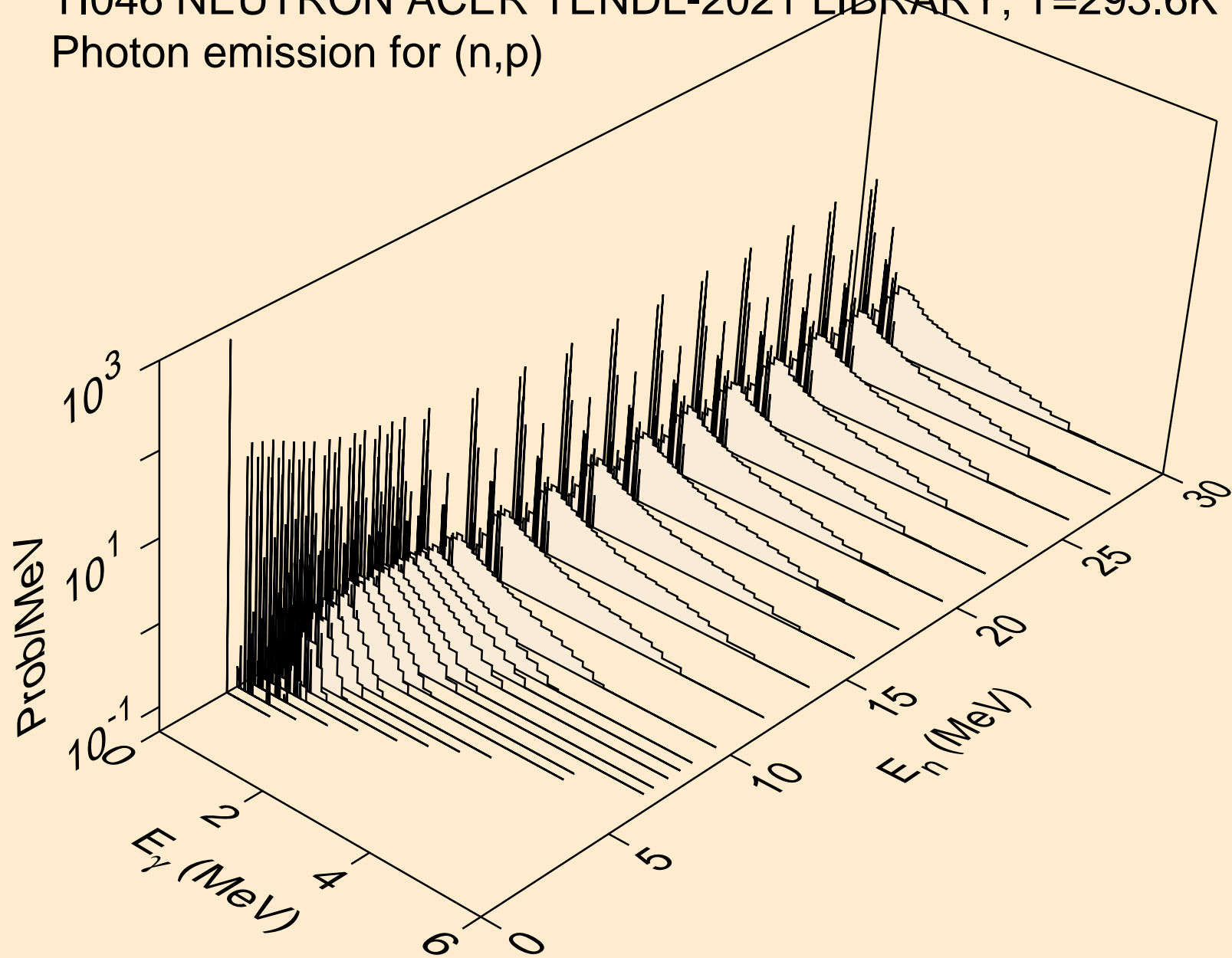

TI046 NEUTRON ACER TENDL-2021 LIBRARY; T=293.6K
Photon emission for (n,d)

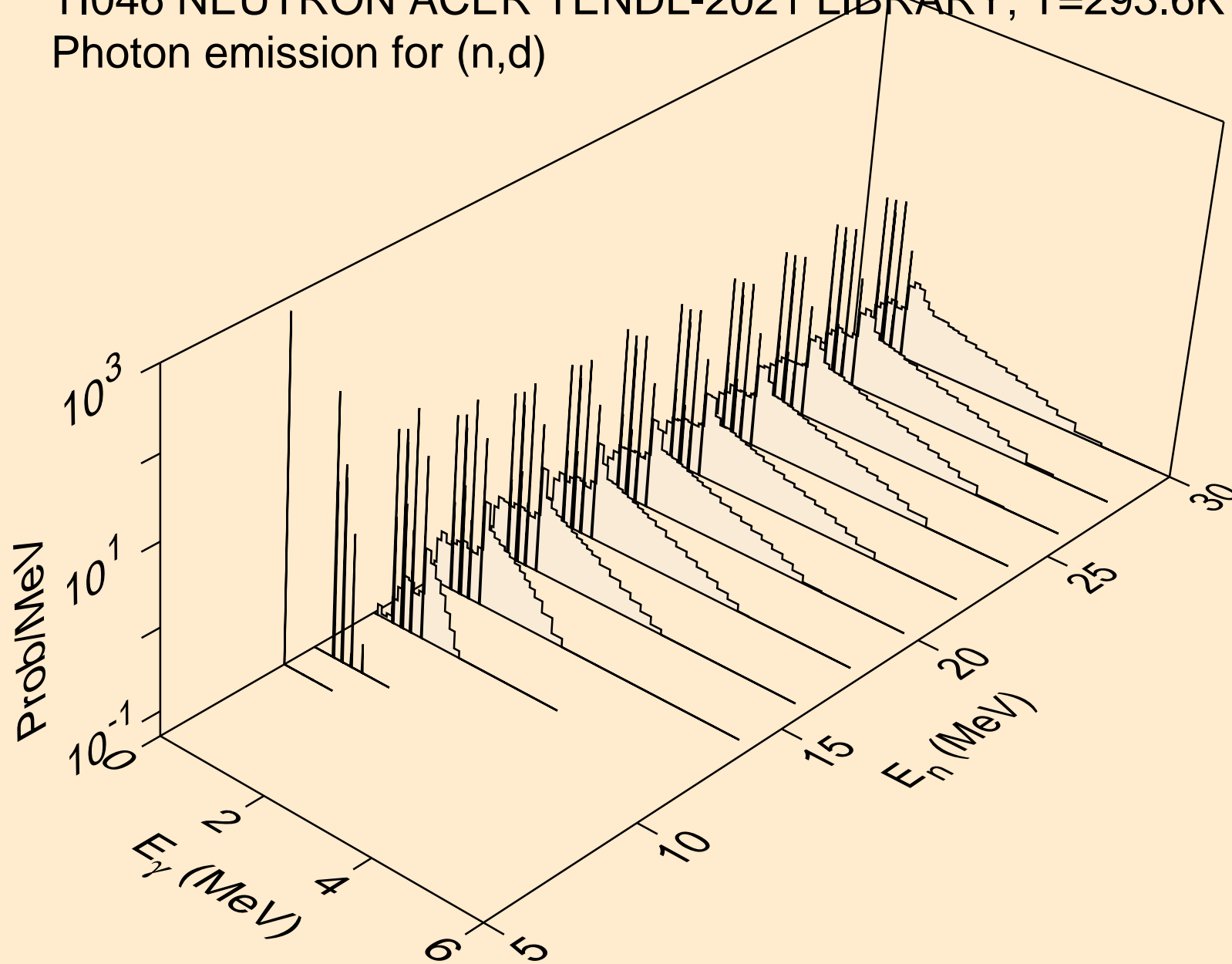

TI046 NEUTRON ACER TENDL-2021 LIBRARY; T=293.6K
Photon emission for (n,t)

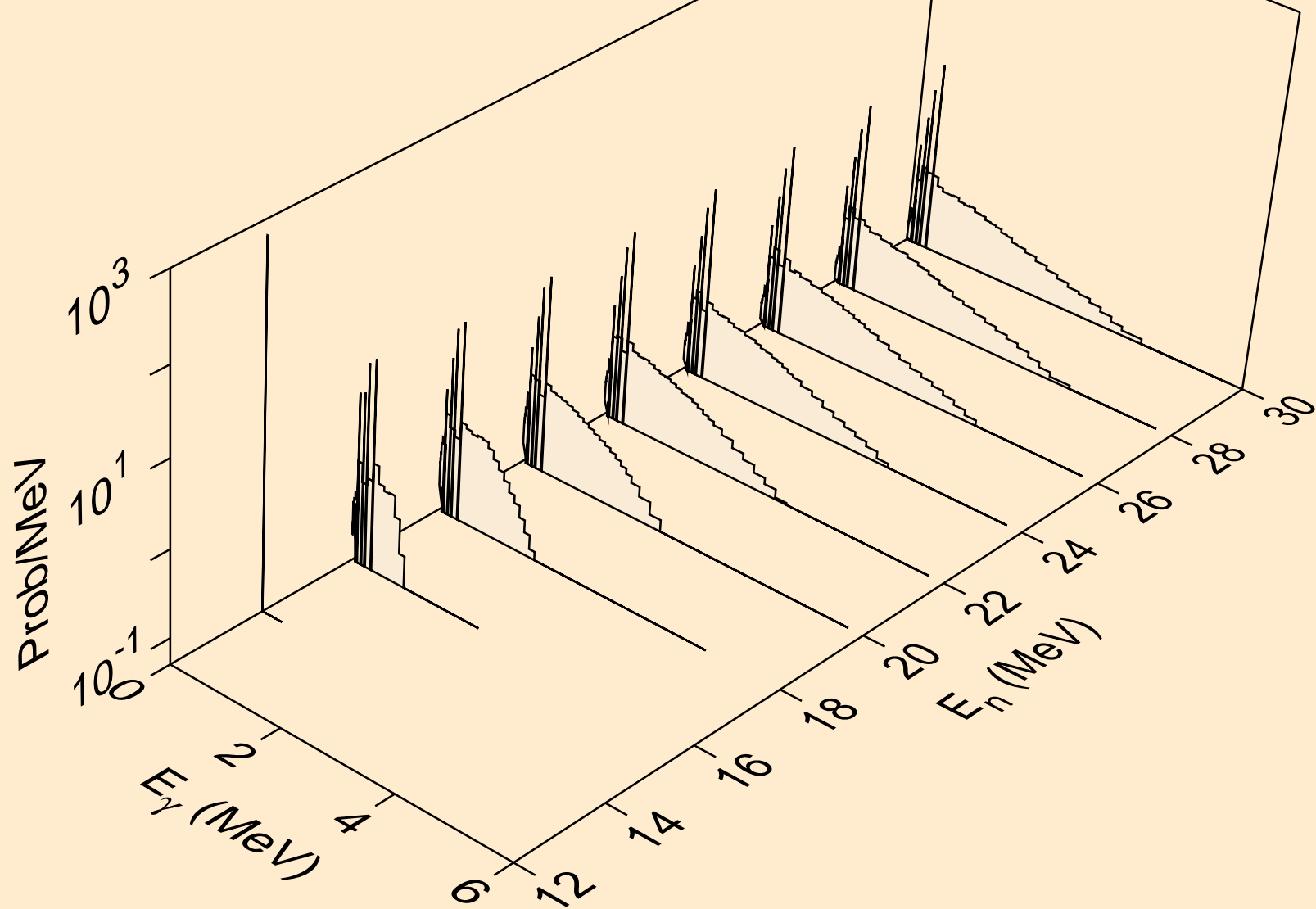

TI046 NEUTRON ACER TENDL-2021 LIBRARY; T=293.6K
Photon emission for (n,he3)

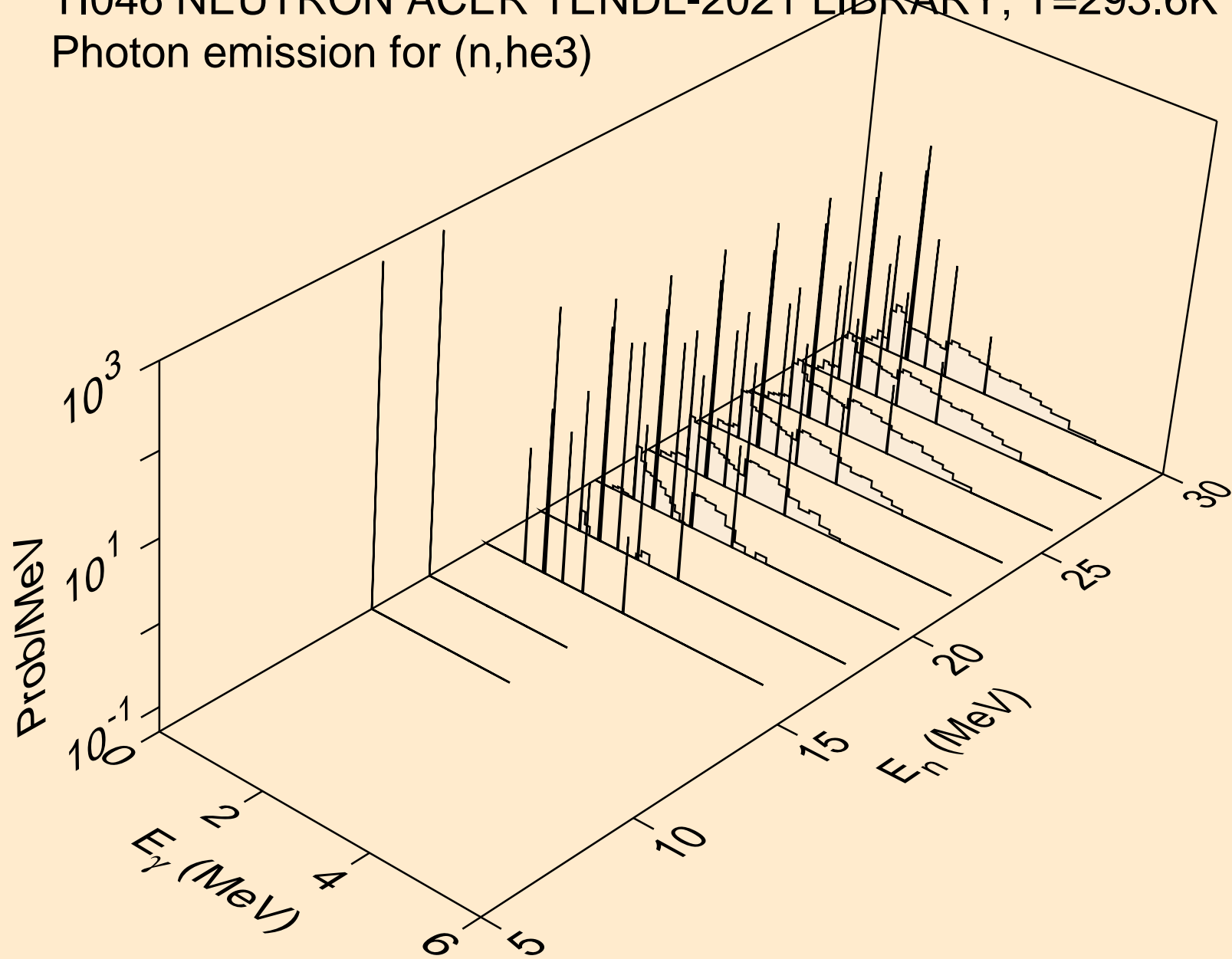

TI046 NEUTRON ACER TENDL-2021 LIBRARY; T=293.6K
Photon emission for (n,a)

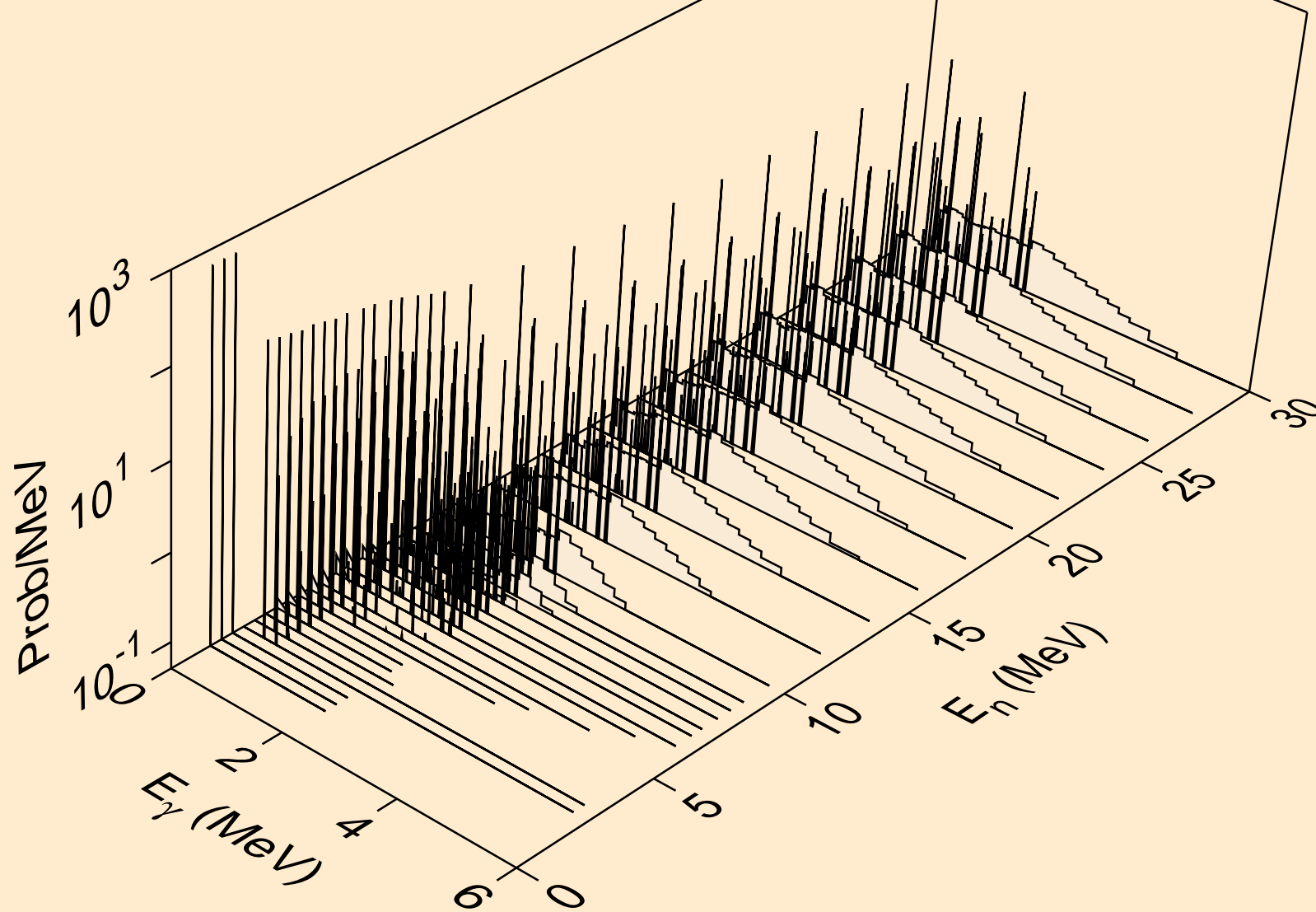

TI046 NEUTRON ACER TENDL-2021 LIBRARY; T=293.6K
Photon emission for (n,2a)

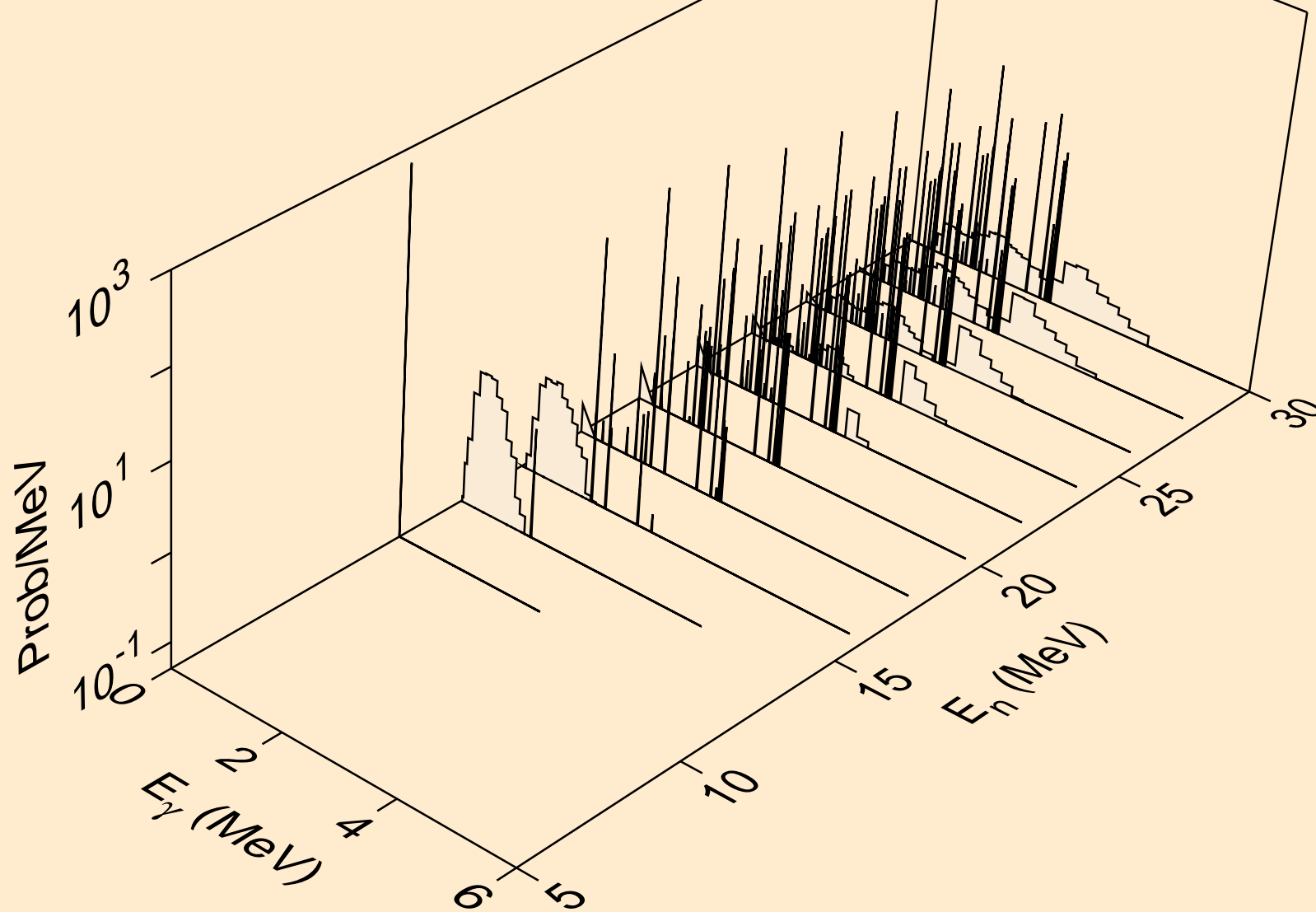

TI046 NEUTRON ACER TENDL-2021 LIBRARY; T=293.6K
Photon emission for (n,2p)

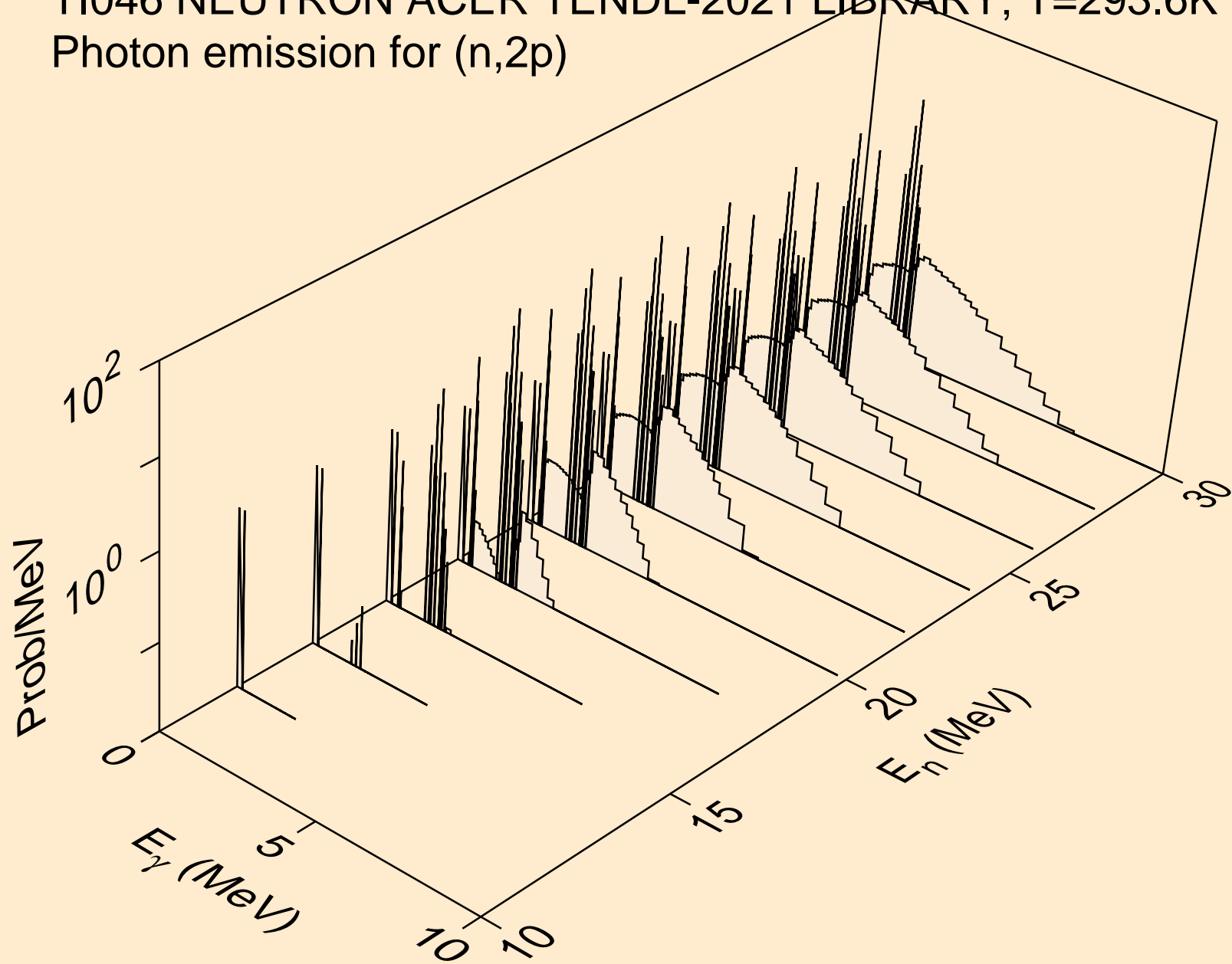

TI046 NEUTRON ACER TENDL-2021 LIBRARY; T=293.6K
Photon emission for (n,p)

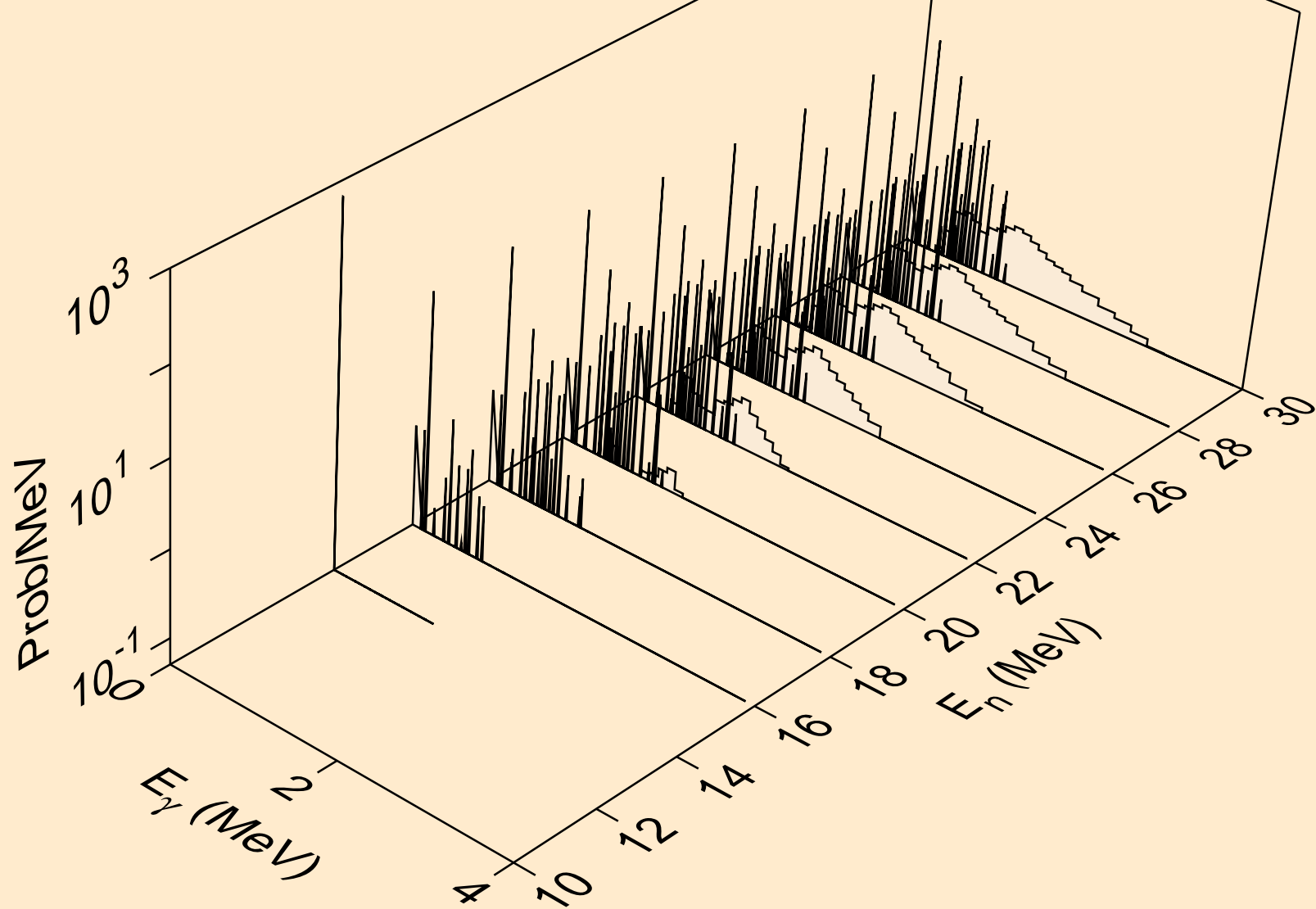

TI046 NEUTRON ACER TENDL-2021 LIBRARY; T=293.6K
Photon emission for (n,pd)

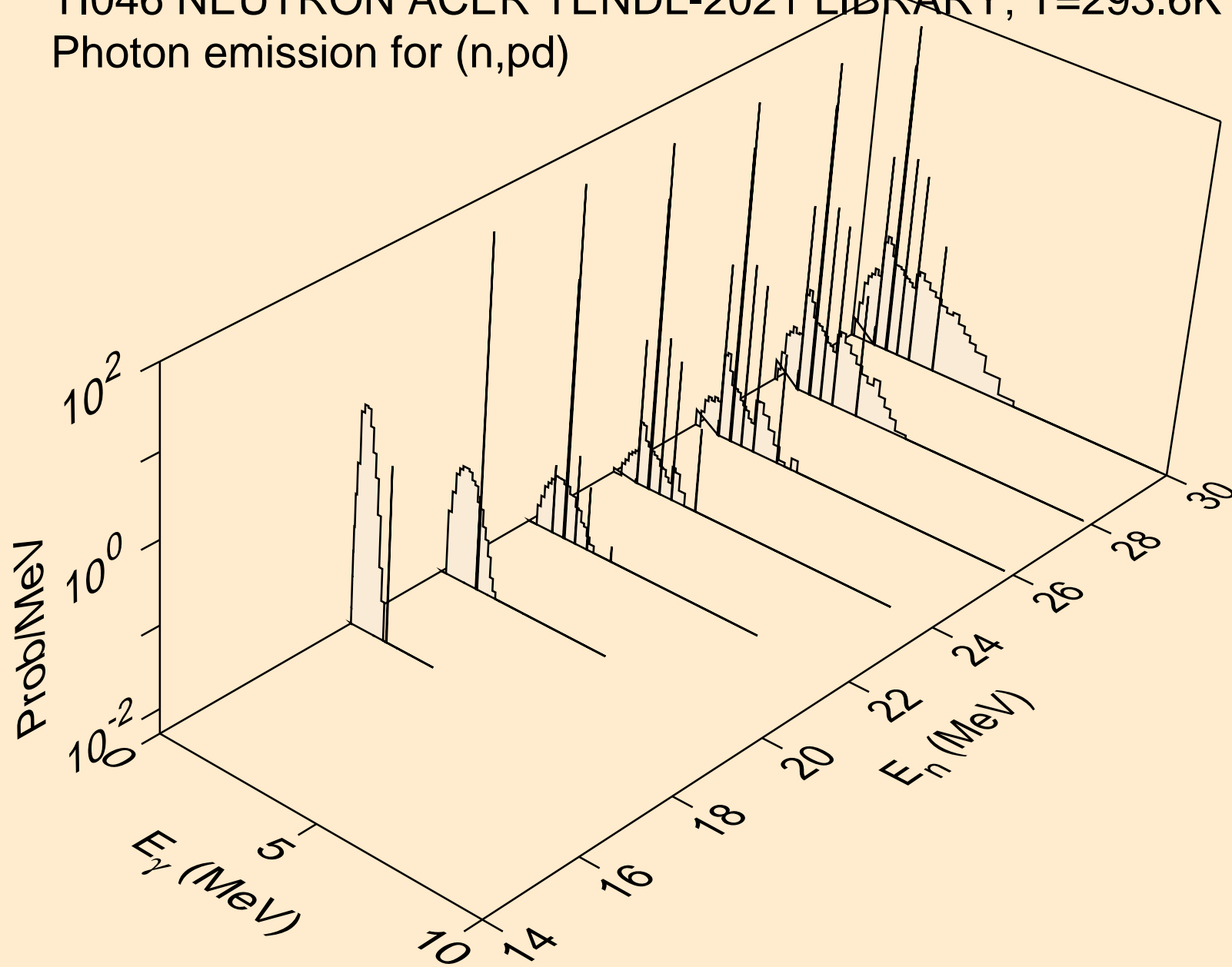

TI046 NEUTRON ACER TENDL-2021 LIBRARY; T=293.6K
Photon emission for (n,pt)

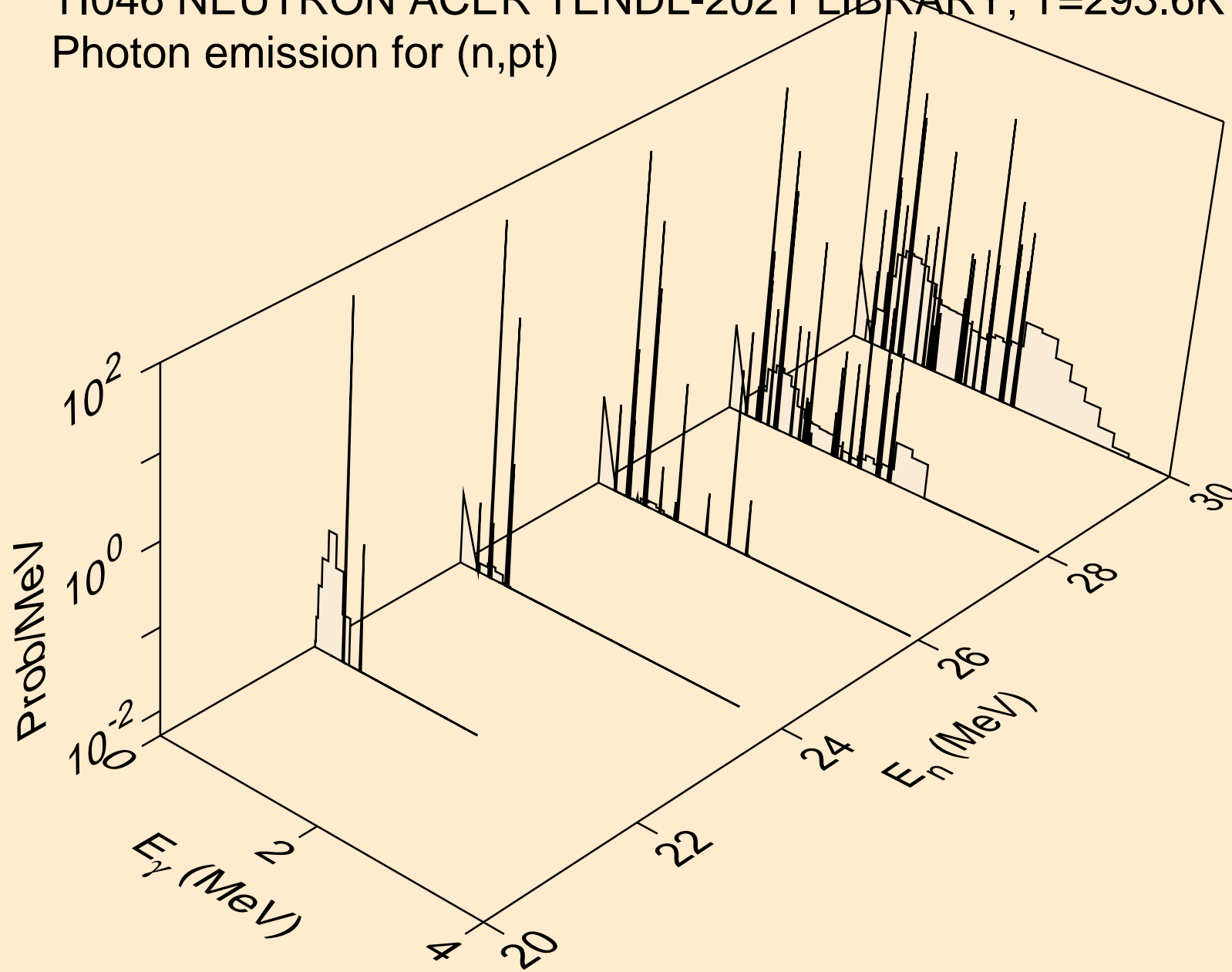

TI046 NEUTRON ACER TENDL-2021 LIBRARY; T=293.6K
Photon emission for (n,da)

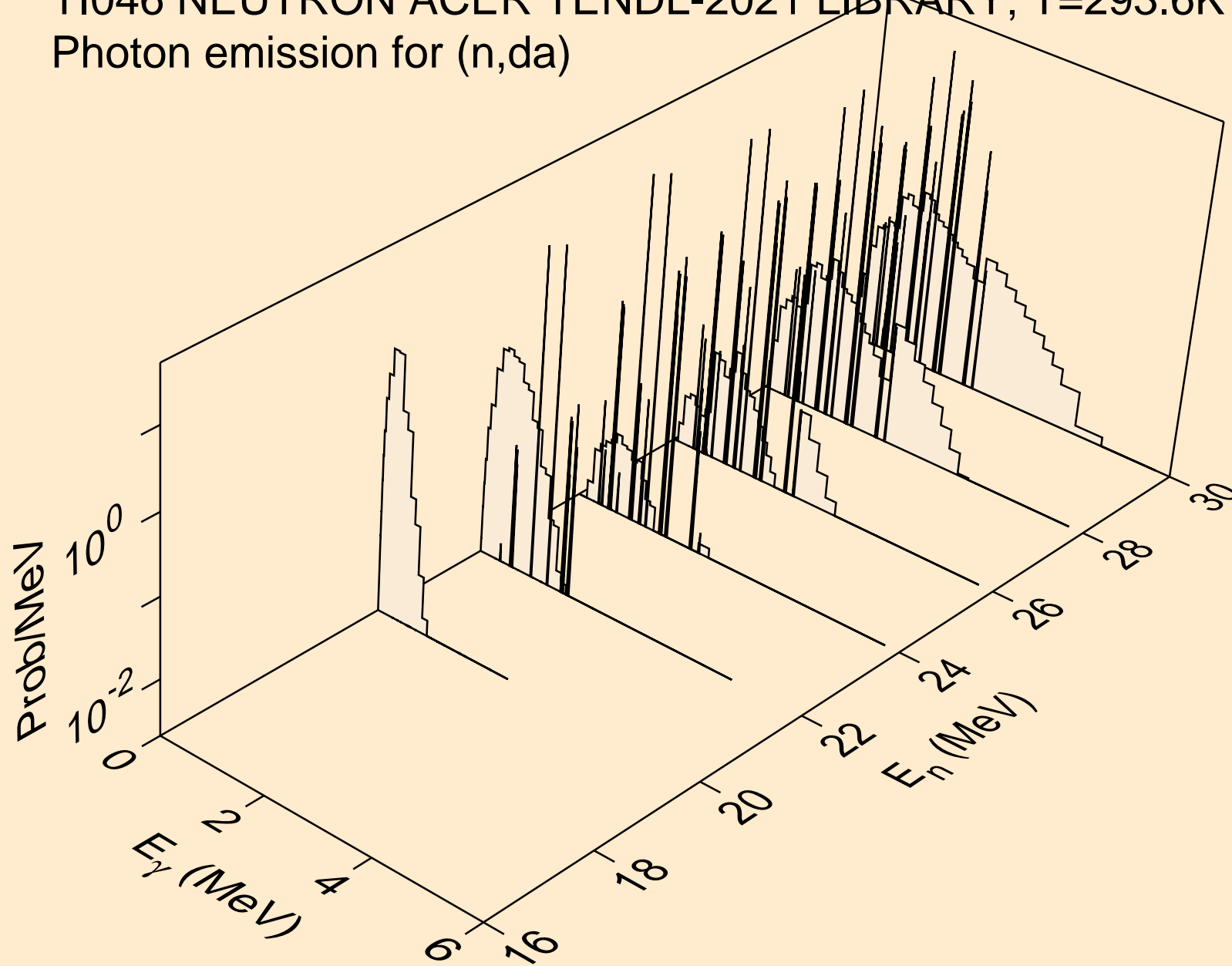

TI046 NEUTRON ACER TENDL-2021 LIBRARY; T=293.6K
thermal capture photon spectrum

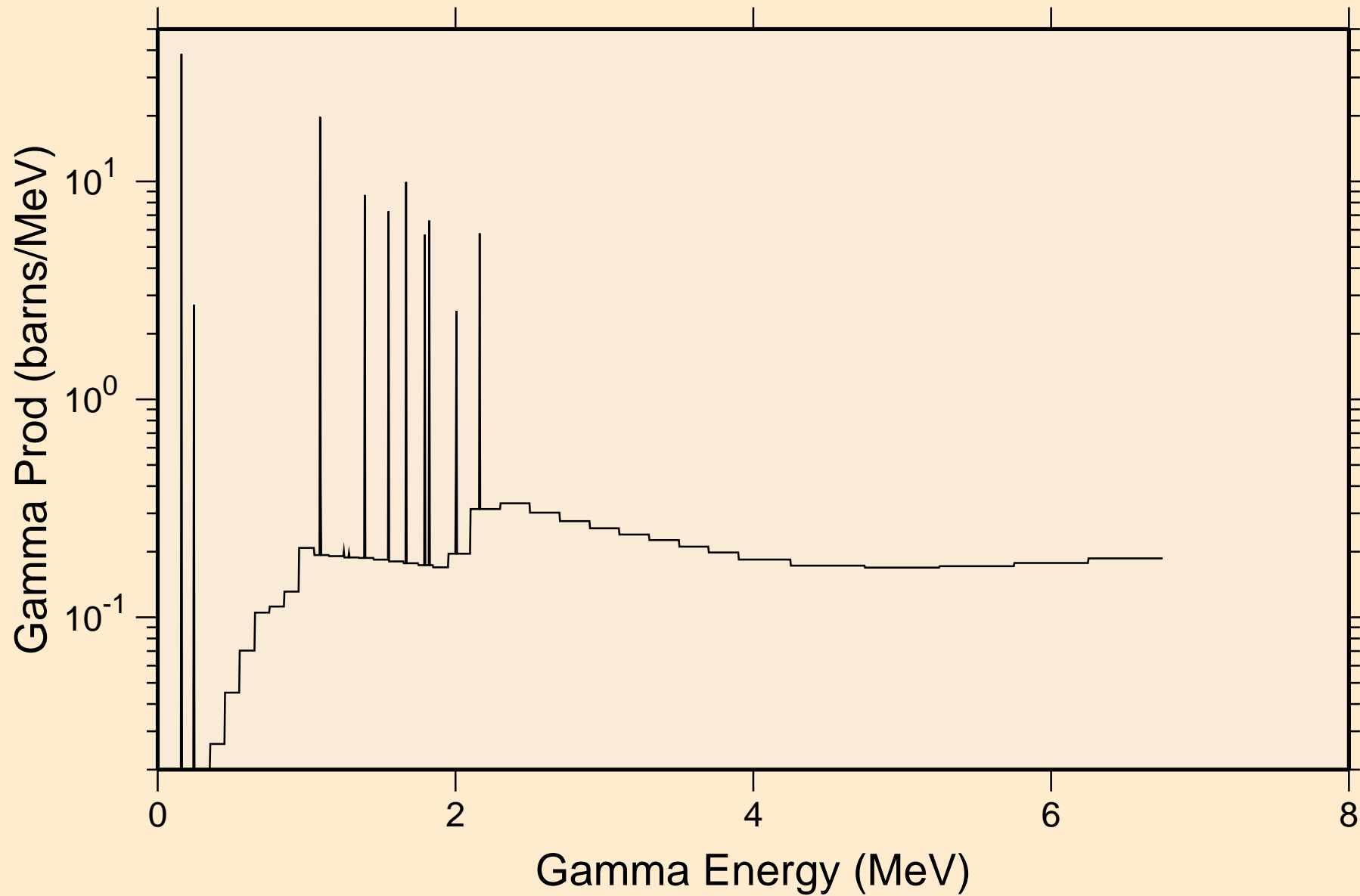

TI046 NEUTRON ACER TENDL-2021 LIBRARY; T=293.6K
14 MeV photon spectrum

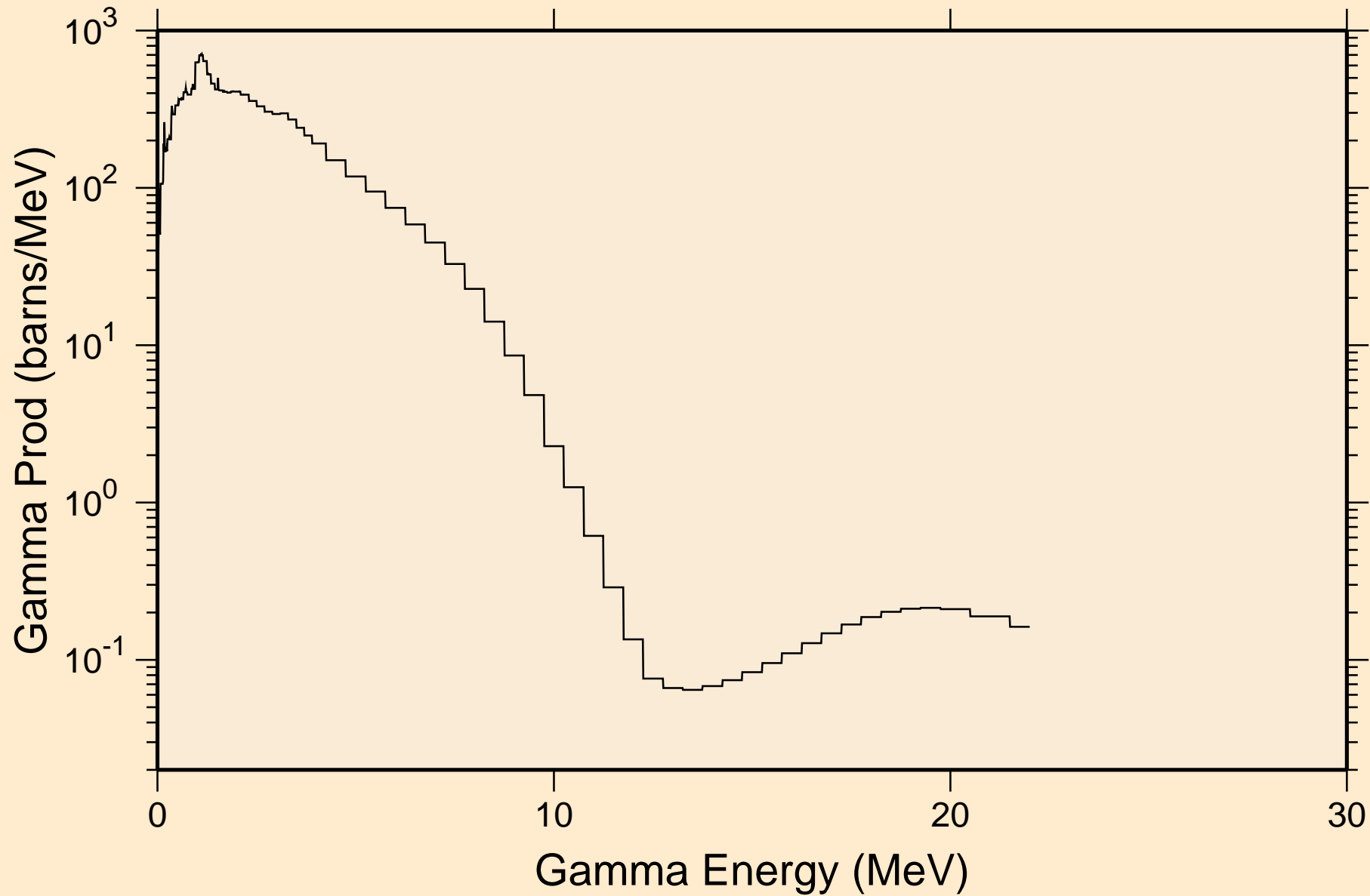

TI046 NEUTRON ACER TENDL-2021 LIBRARY; T=293.6K
Particle heating contributions

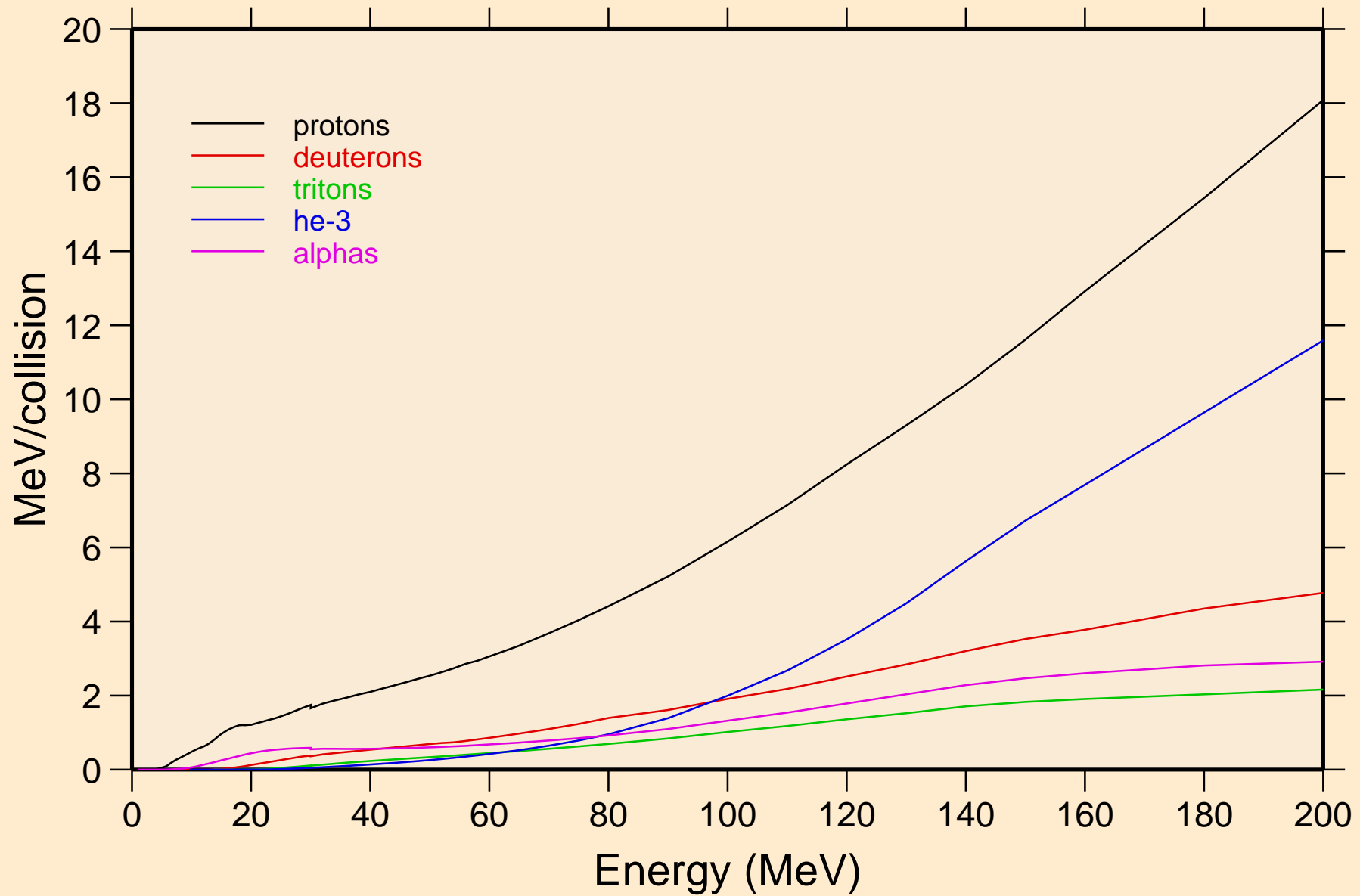

TI046 NEUTRON ACER TENDL-2021 LIBRARY; T=293.6K
Recoil Heating

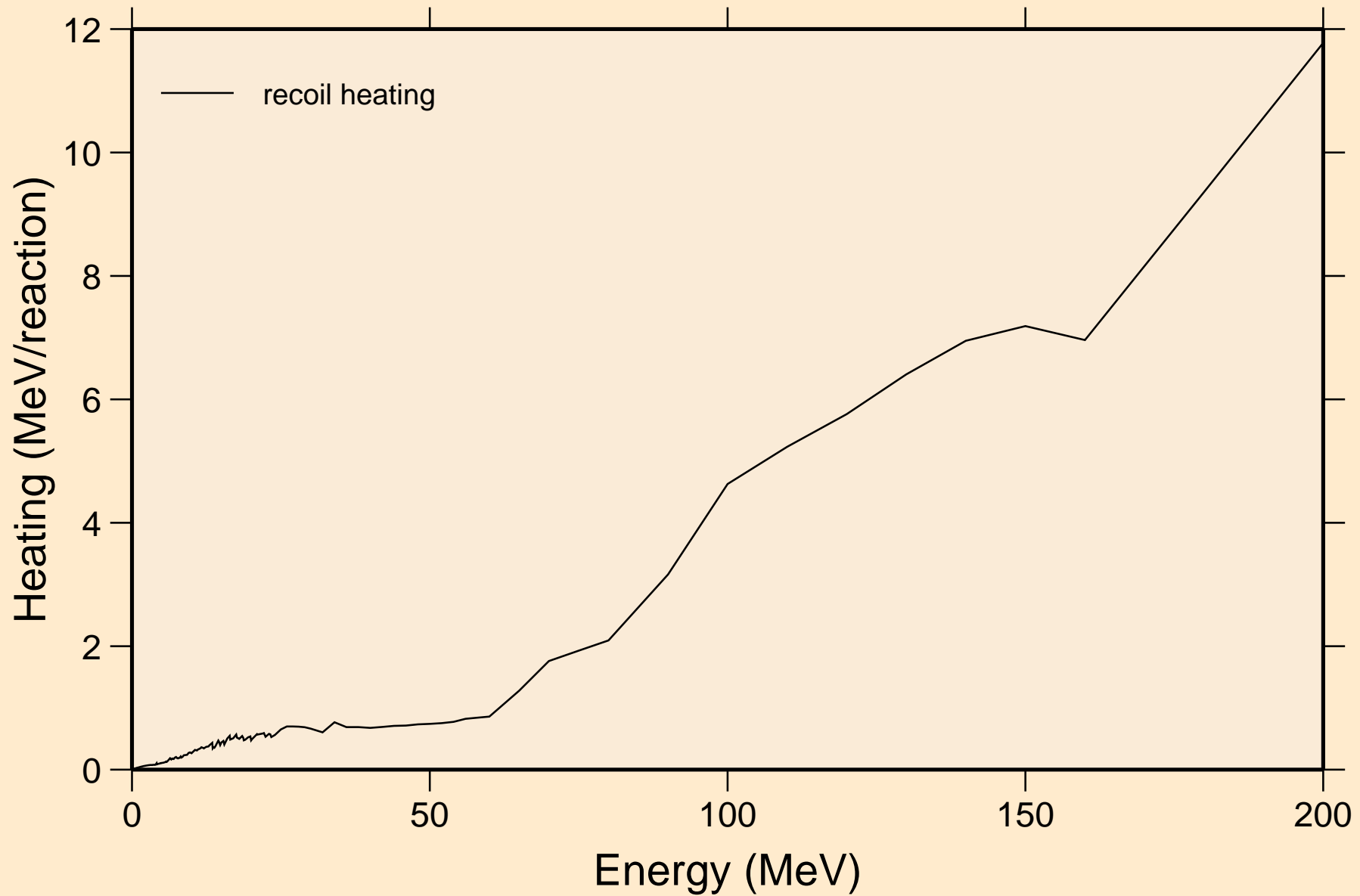

TI046 NEUTRON ACER TENDL-2021 LIBRARY; T=293.6K
Particle production cross sections

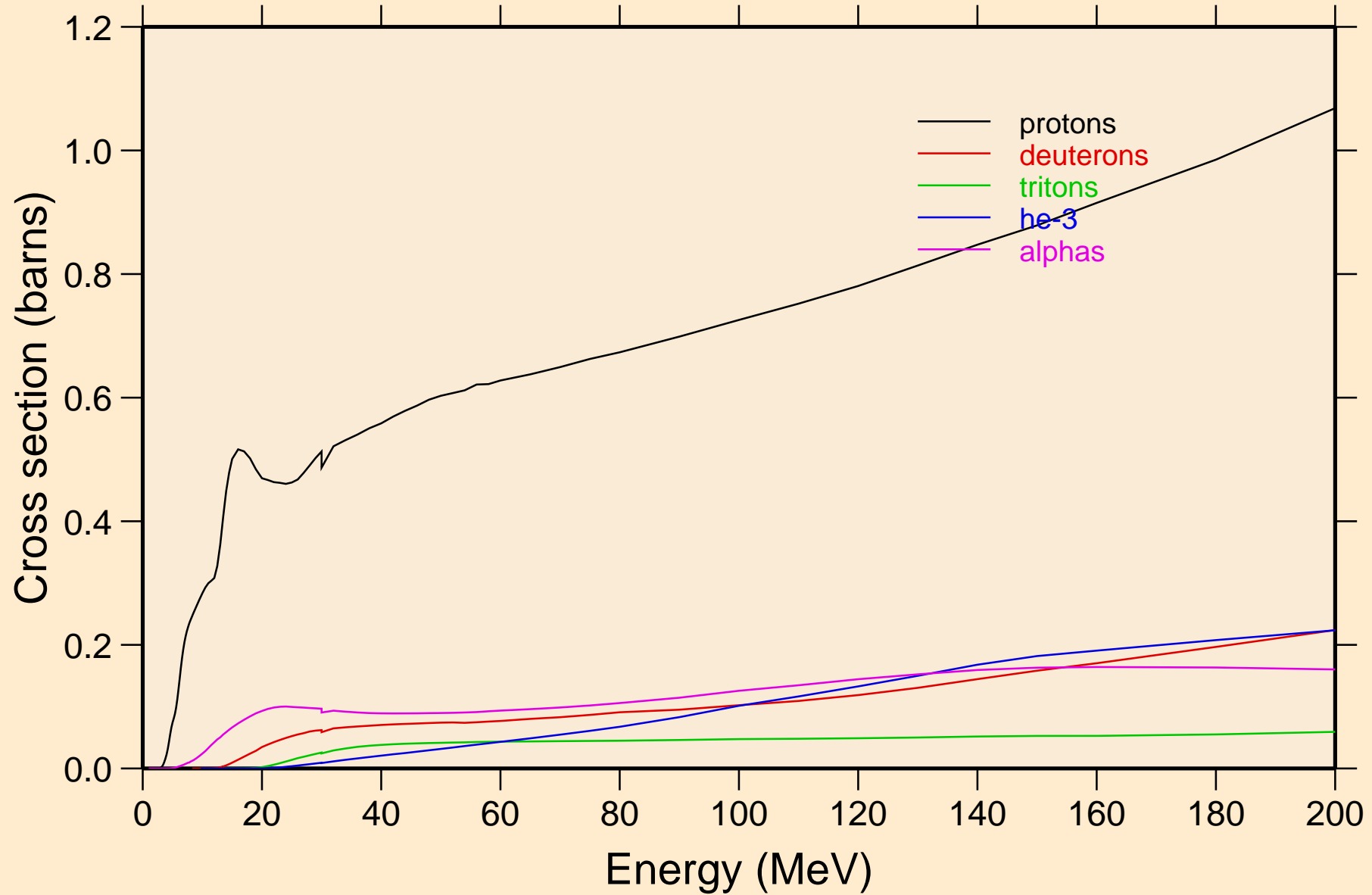

TI046 NEUTRON ACER TENDL-2021 LIBRARY; T=293.6K
protons from (n,x)

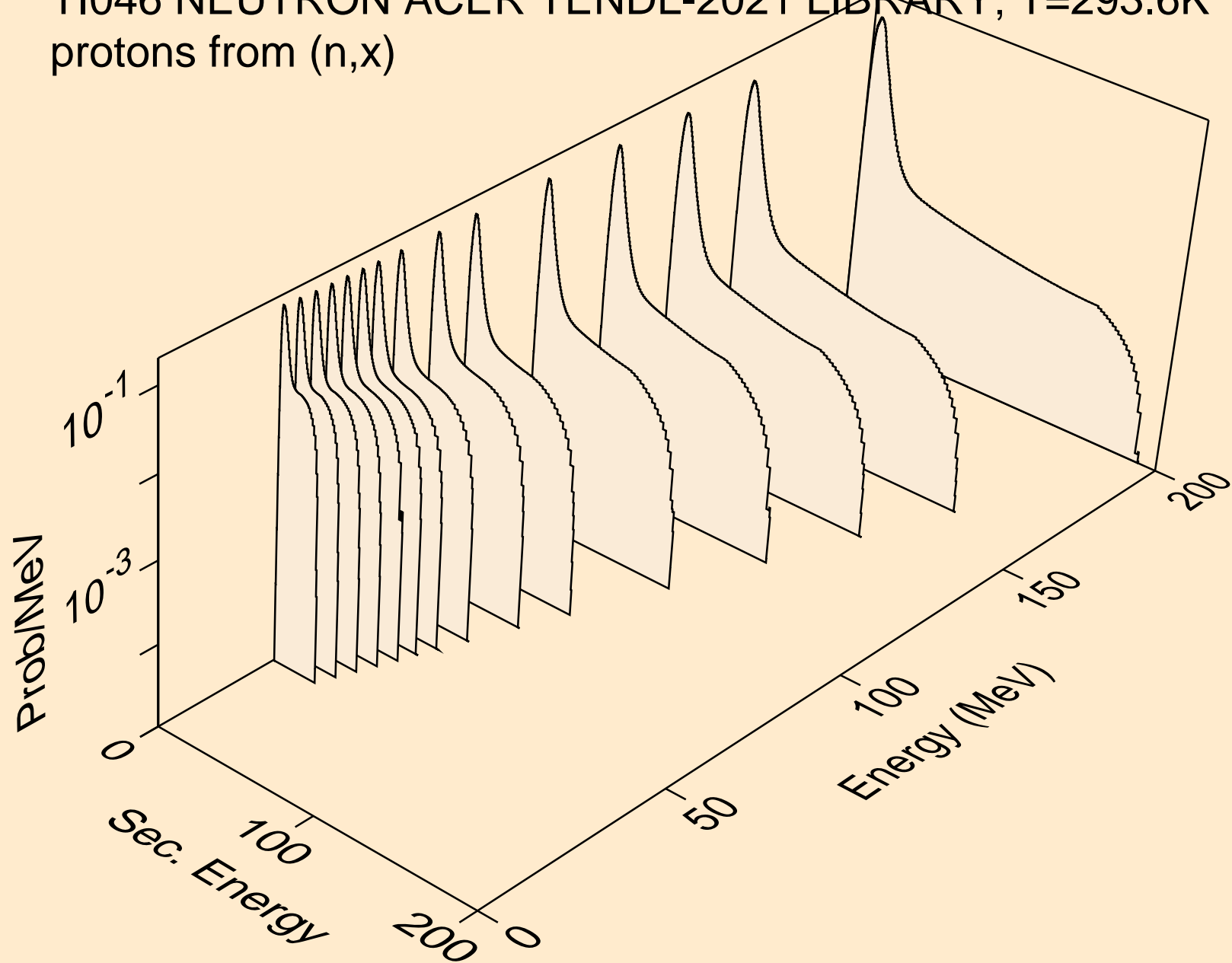

TI046 NEUTRON ACER TENDL-2021 LIBRARY; T=293.6K
protons from (n,n*)p

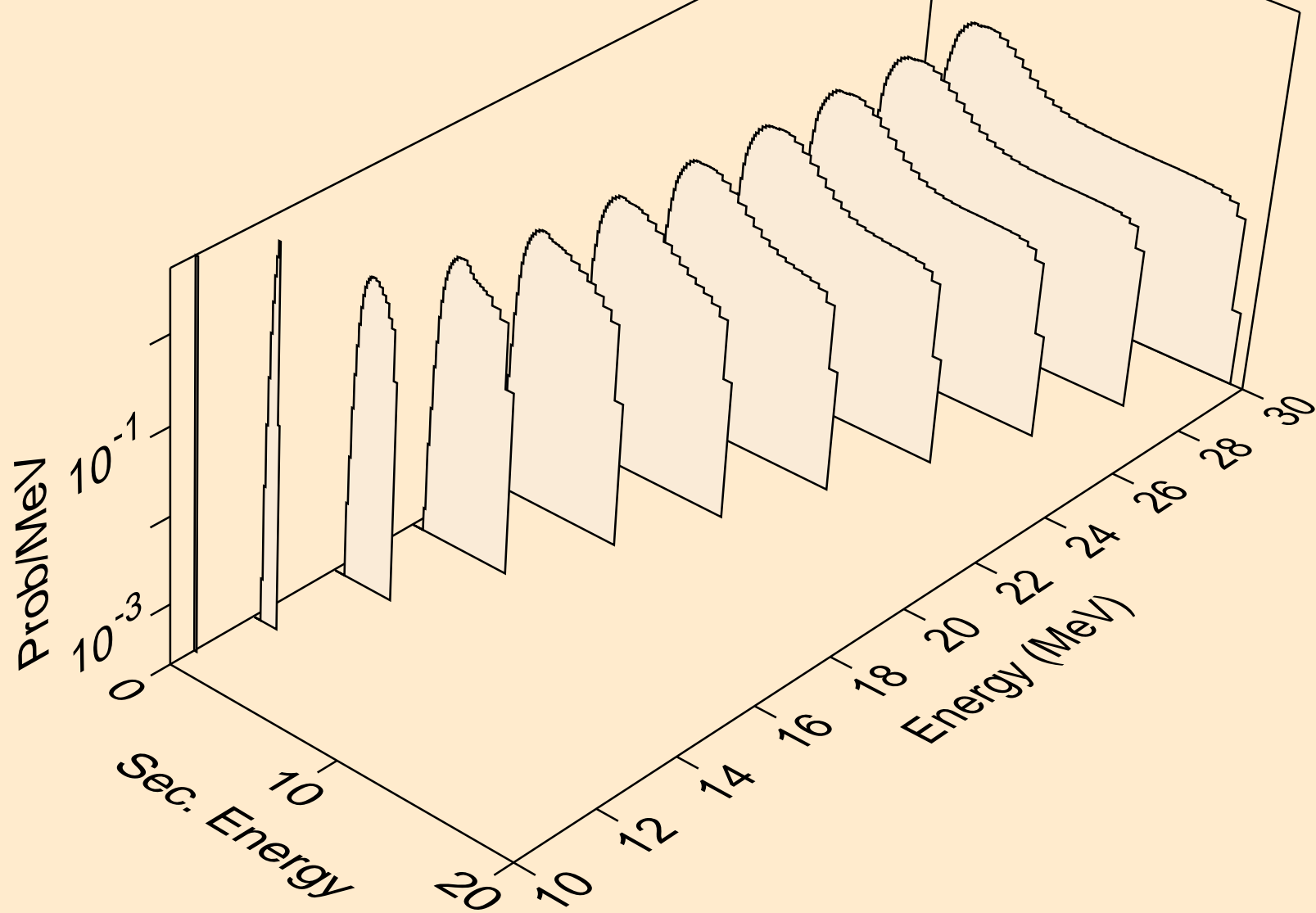

TI046 NEUTRON ACER TENDL-2021 LIBRARY; T=293.6K
protons from (n,2np)

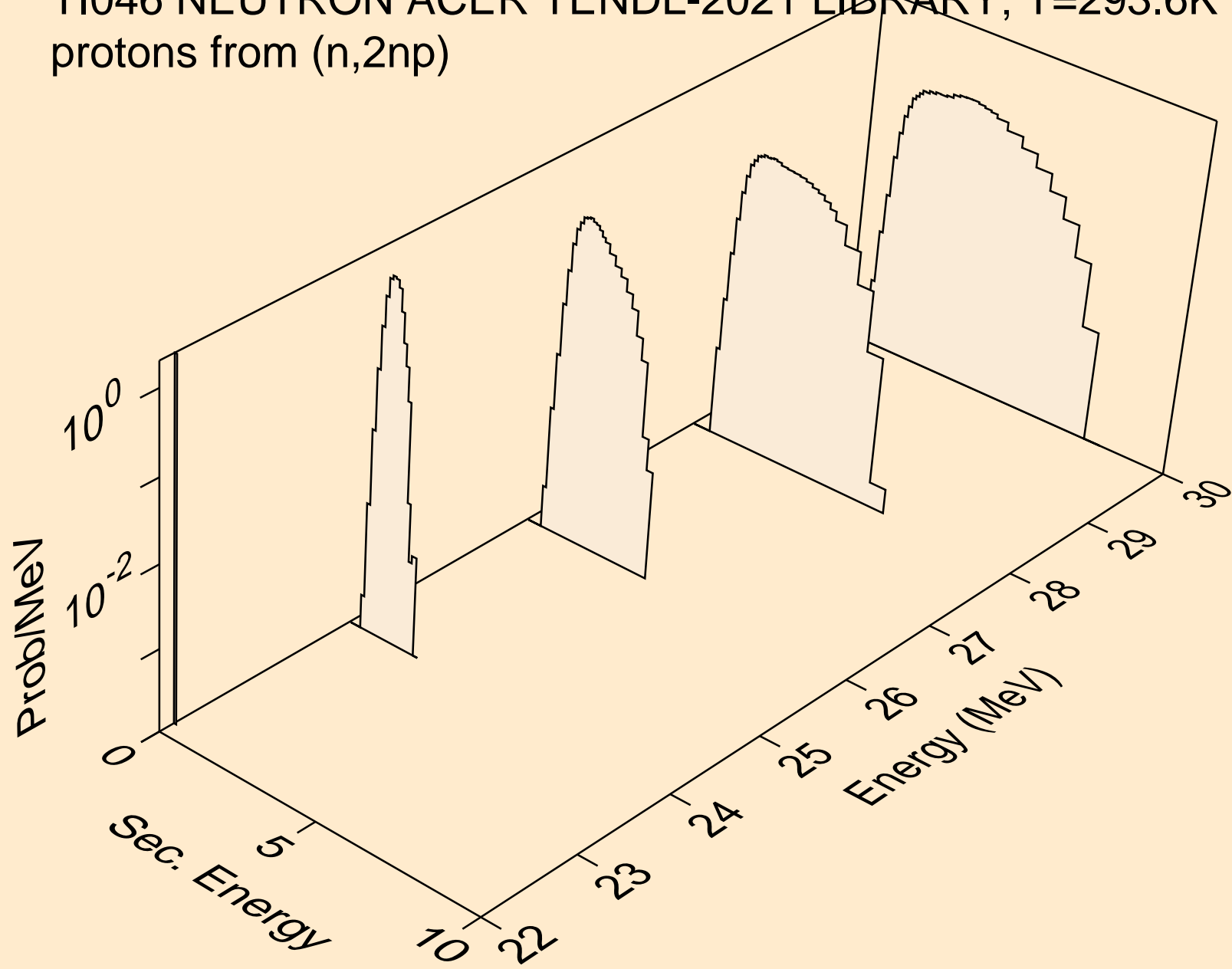

TI046 NEUTRON ACER TENDL-2021 LIBRARY; T=293.6K
protons from (n,2np)

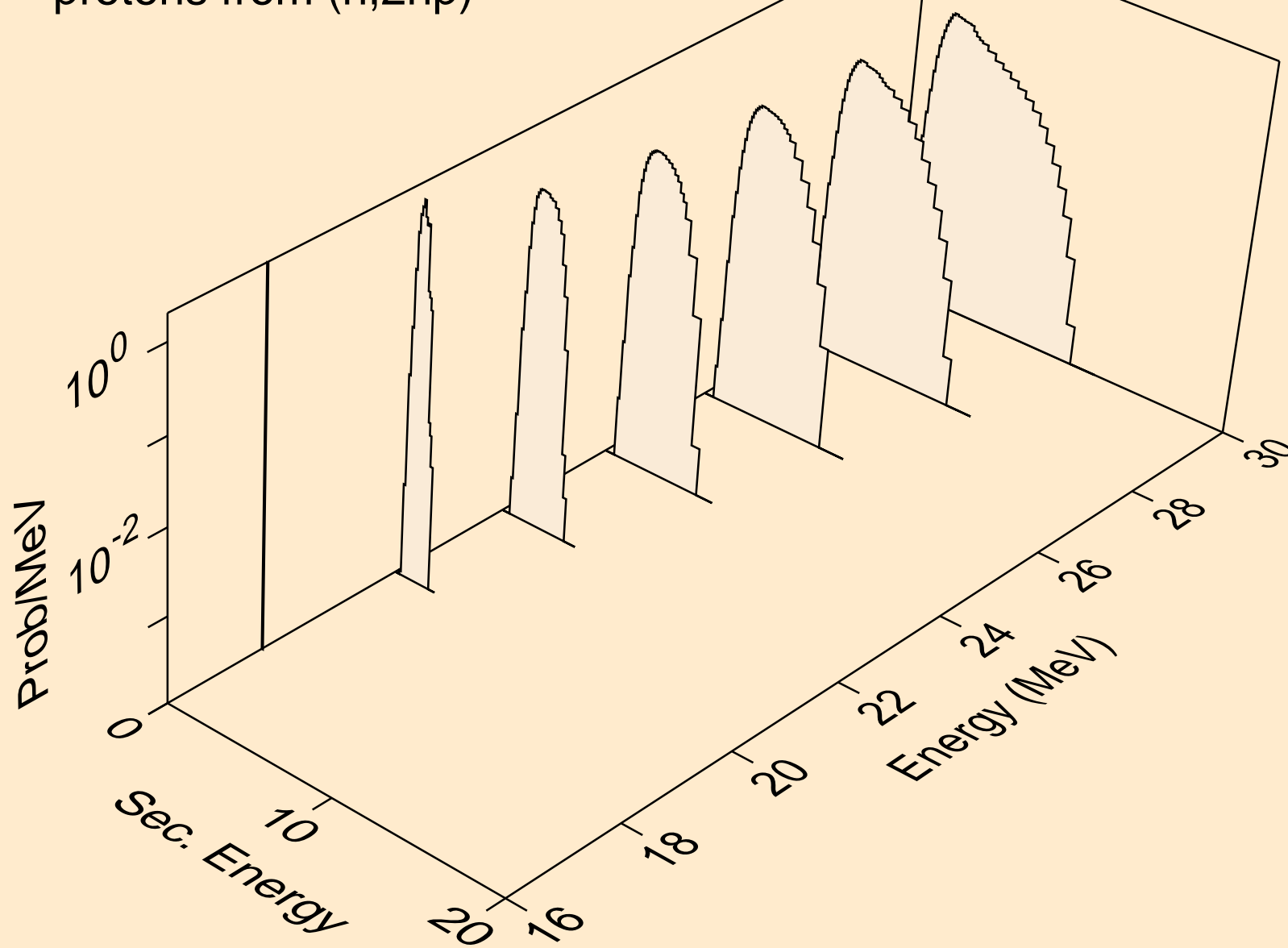

TI046 NEUTRON ACER TENDL-2021 LIBRARY; T=293.6K
protons from (n,npa)

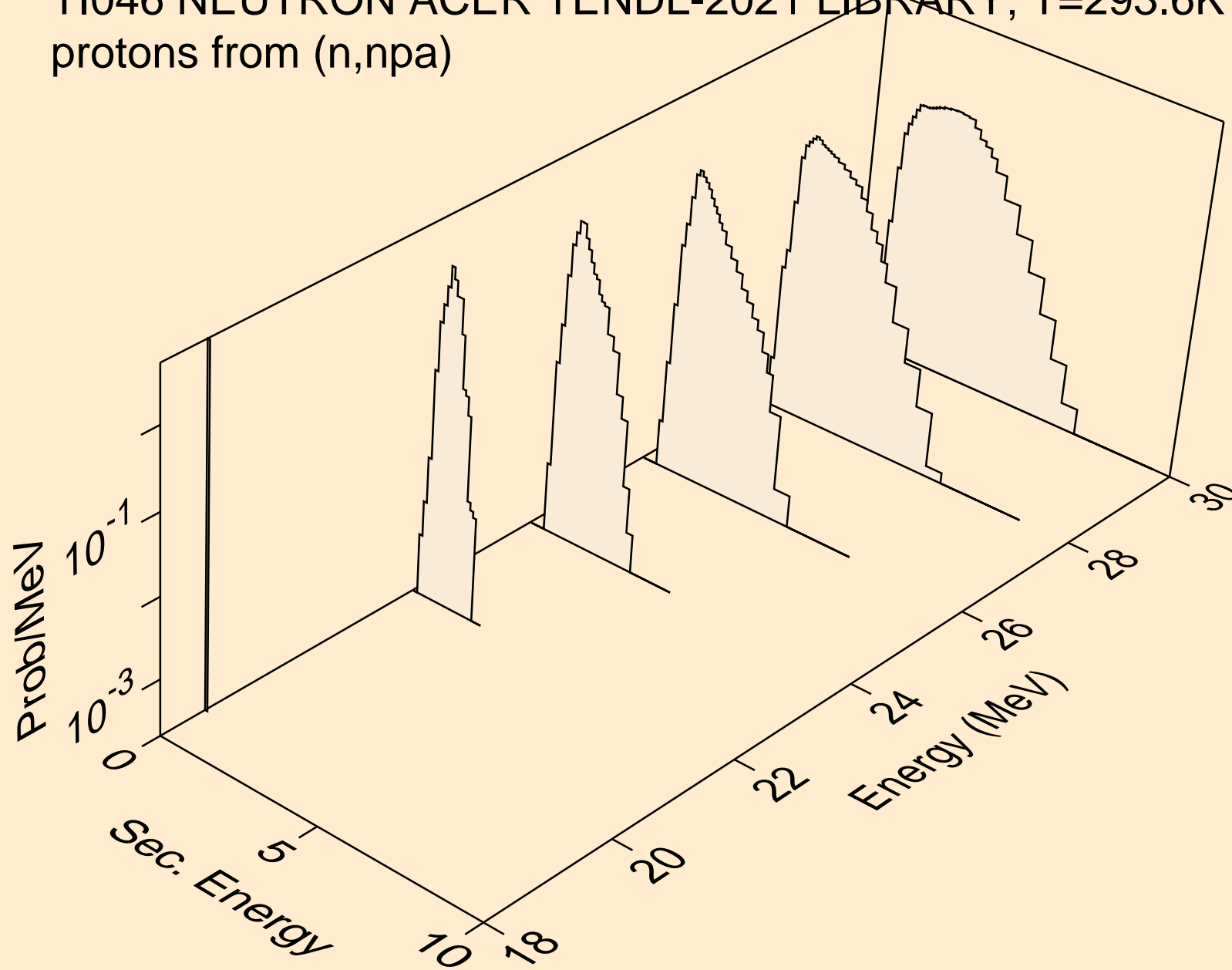

TI046 NEUTRON ACER TENDL-2021 LIBRARY; T=293.6K
protons from (n,p)

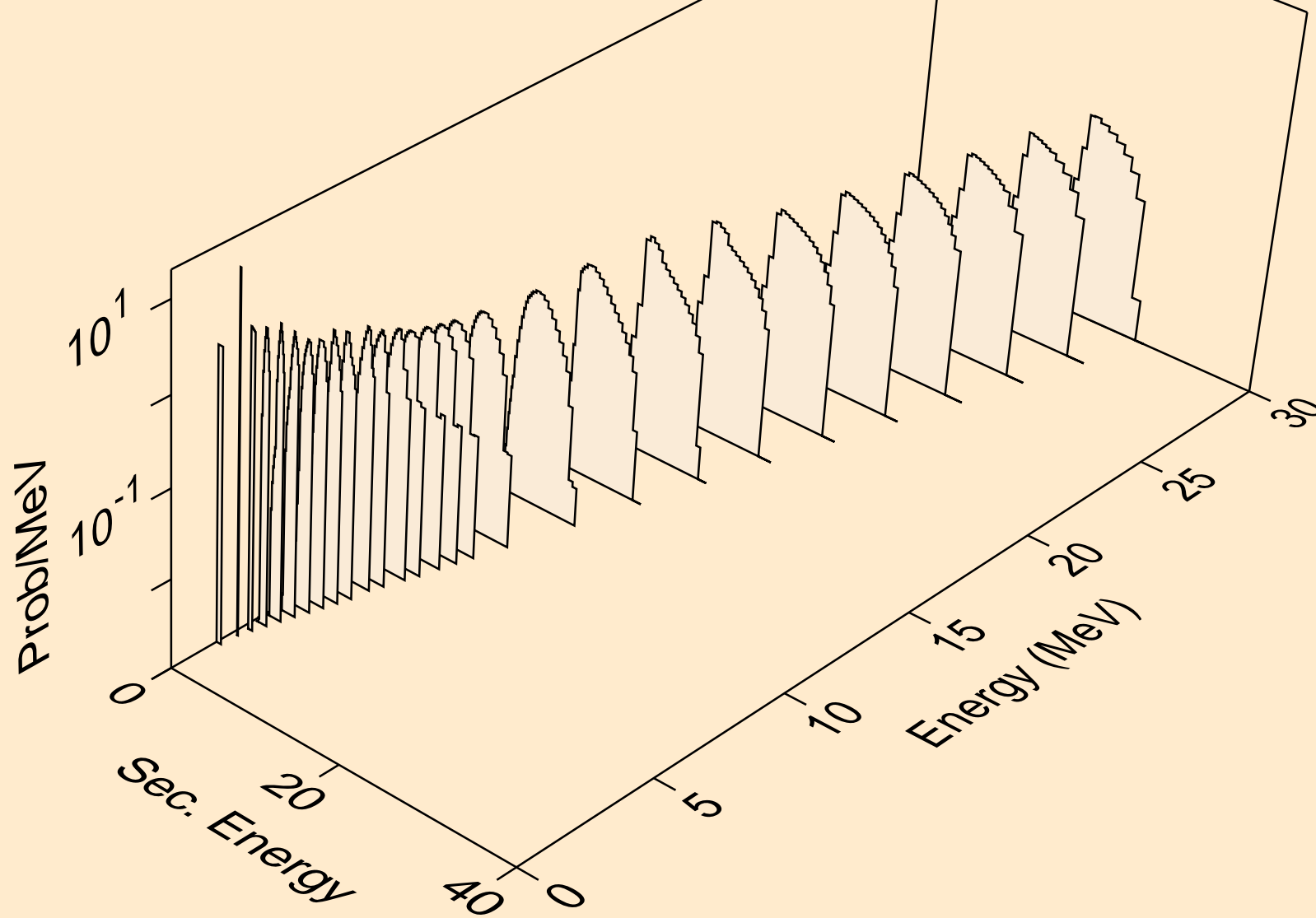

TI046 NEUTRON ACER TENDL-2021 LIBRARY; T=293.6K
protons from (n,2p)

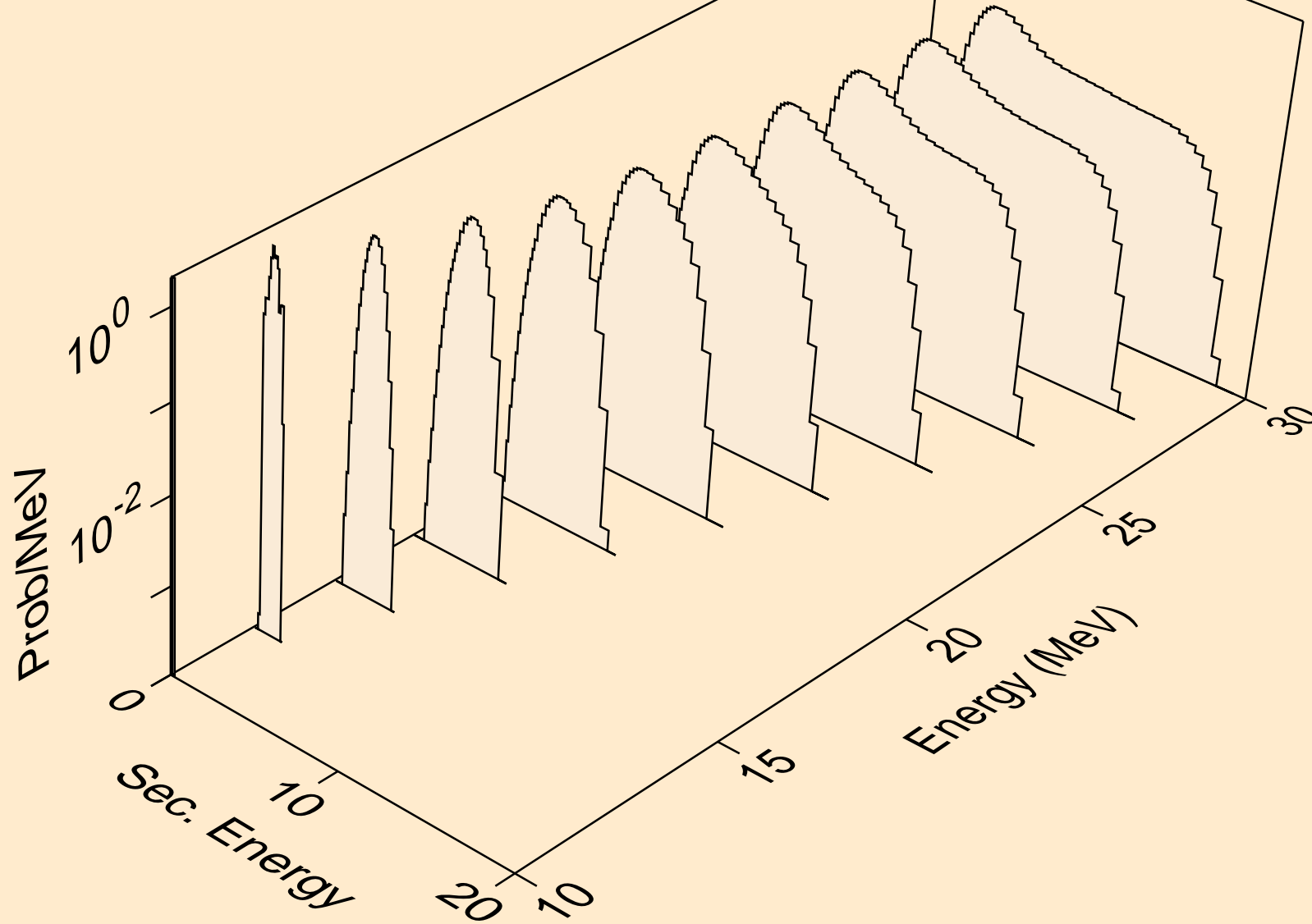

TI046 NEUTRON ACER TENDL-2021 LIBRARY; T=293.6K
protons from (n,p)

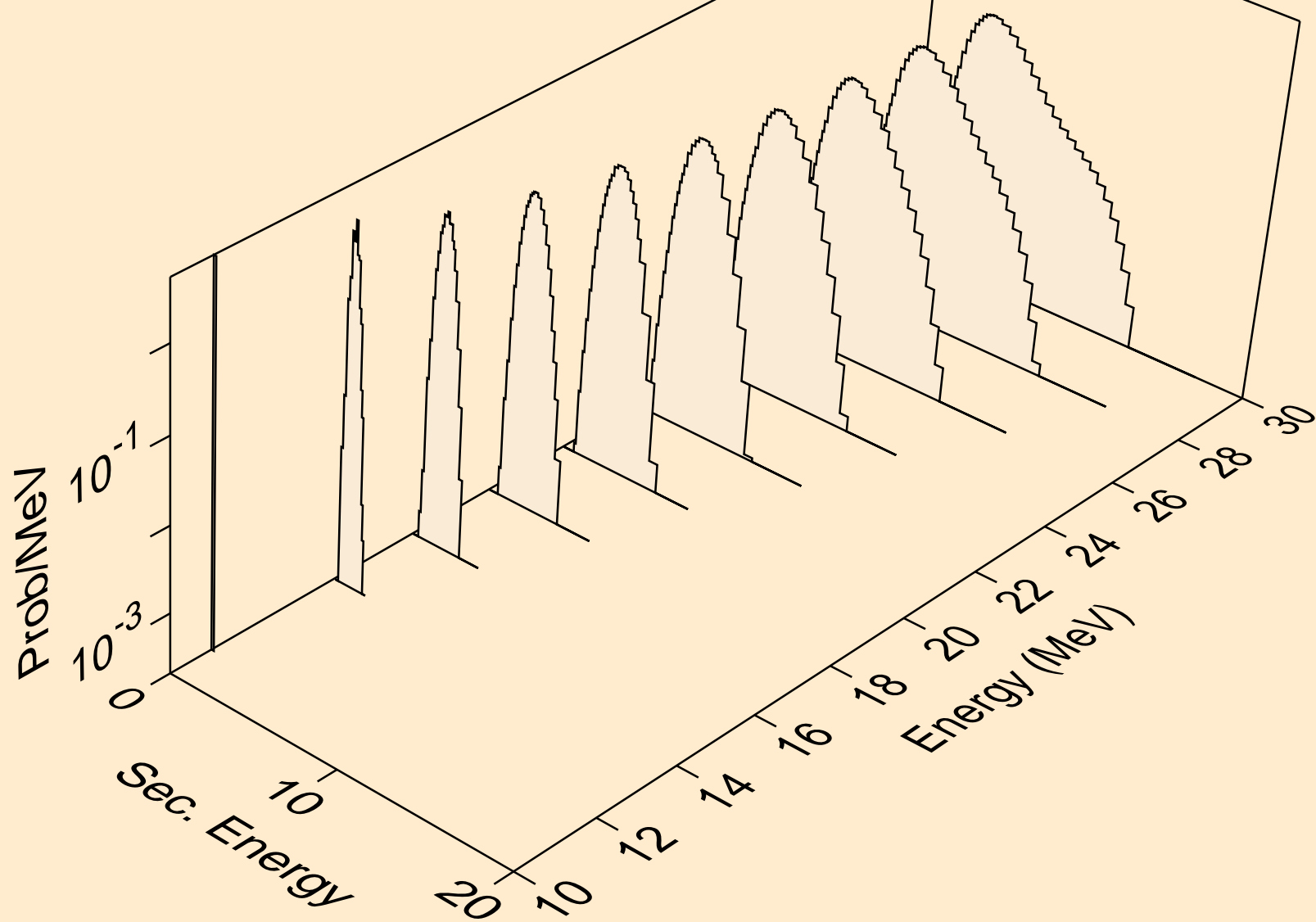

TI046 NEUTRON ACER TENDL-2021 LIBRARY; T=293.6K
protons from (n,pd)

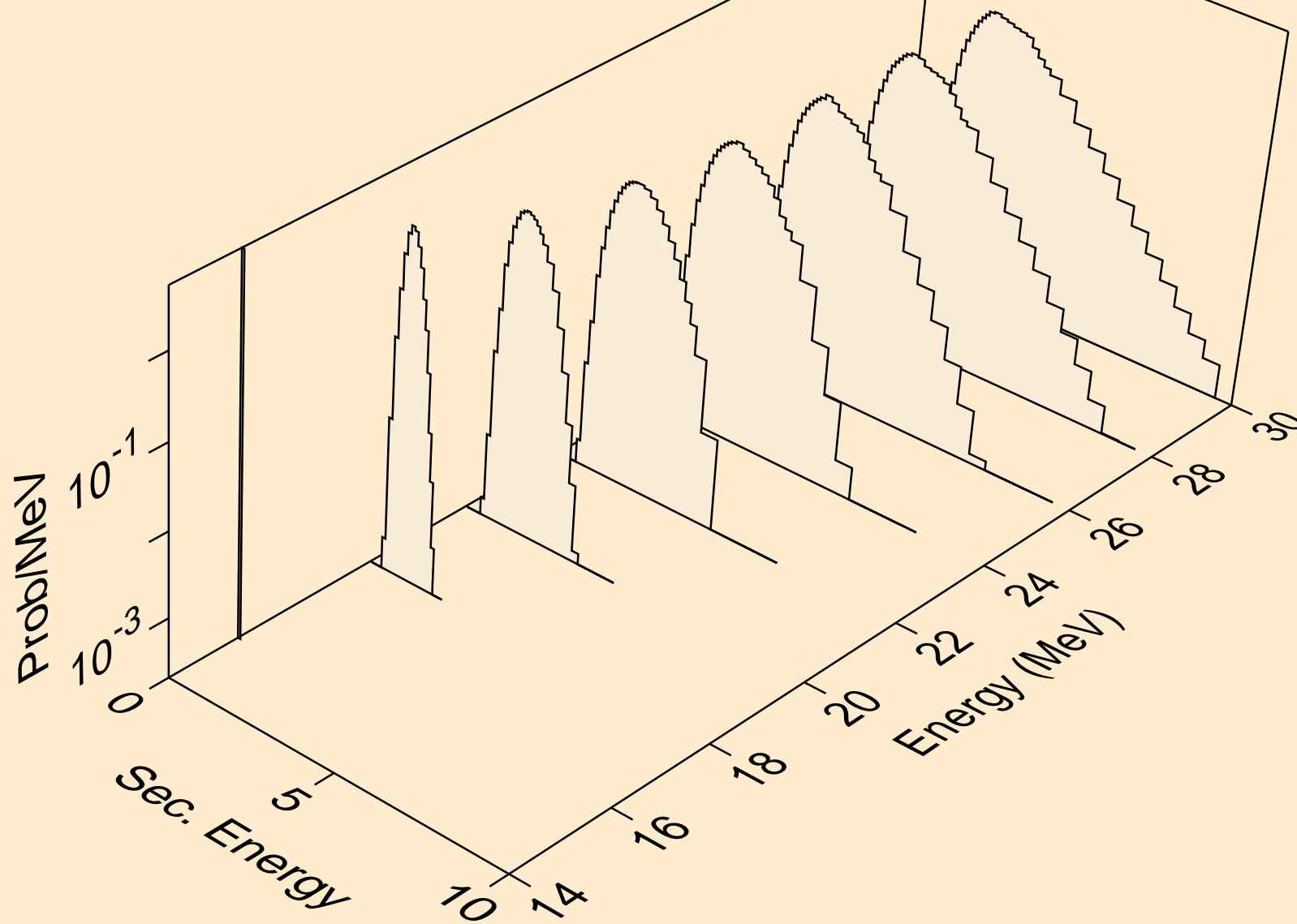

TI046 NEUTRON ACER TENDL-2021 LIBRARY; T=293.6K
protons from (n,pt)

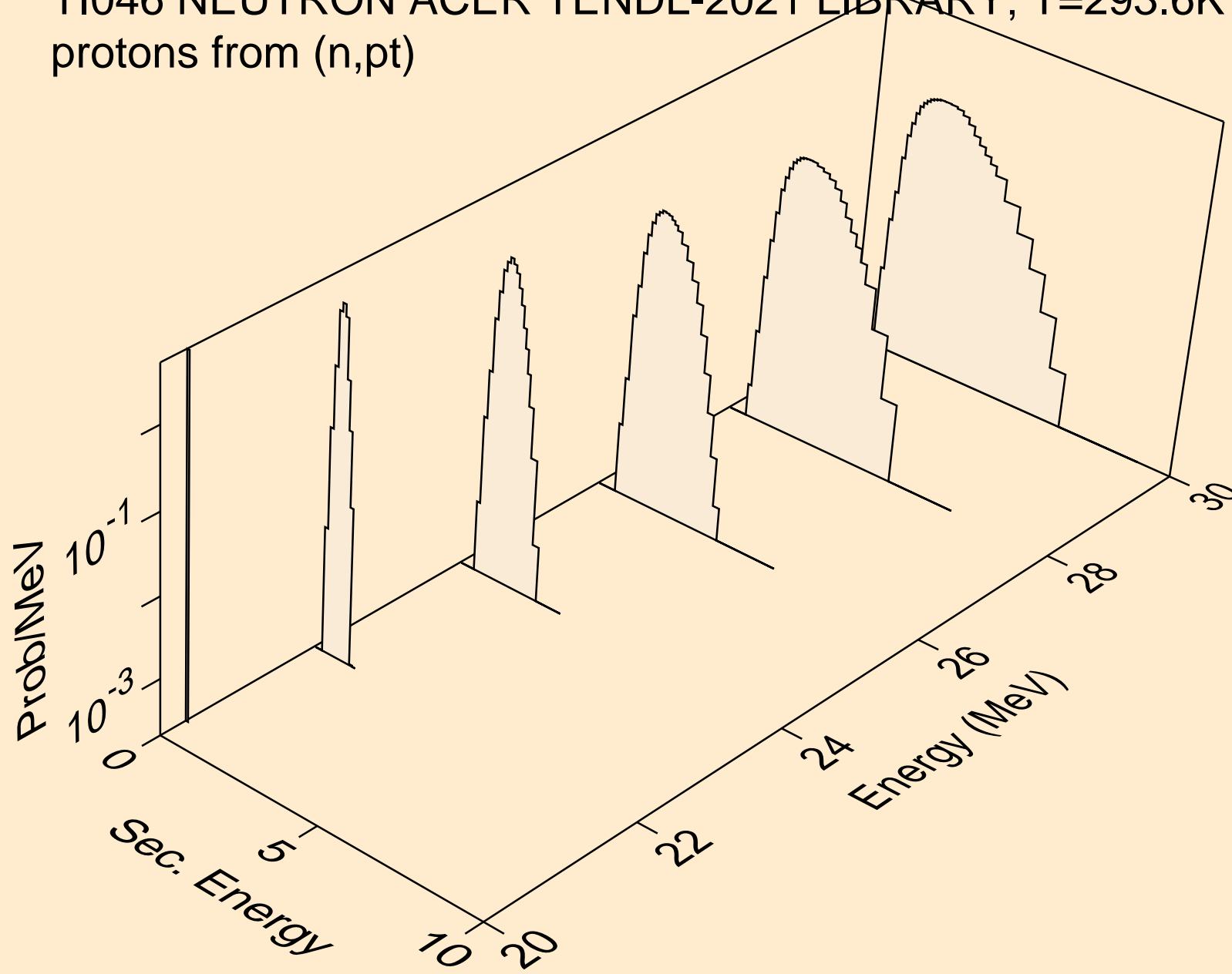

TI046 NEUTRON ACER TENDL-2021 LIBRARY; T=293.6K
deuterons from (n,x)

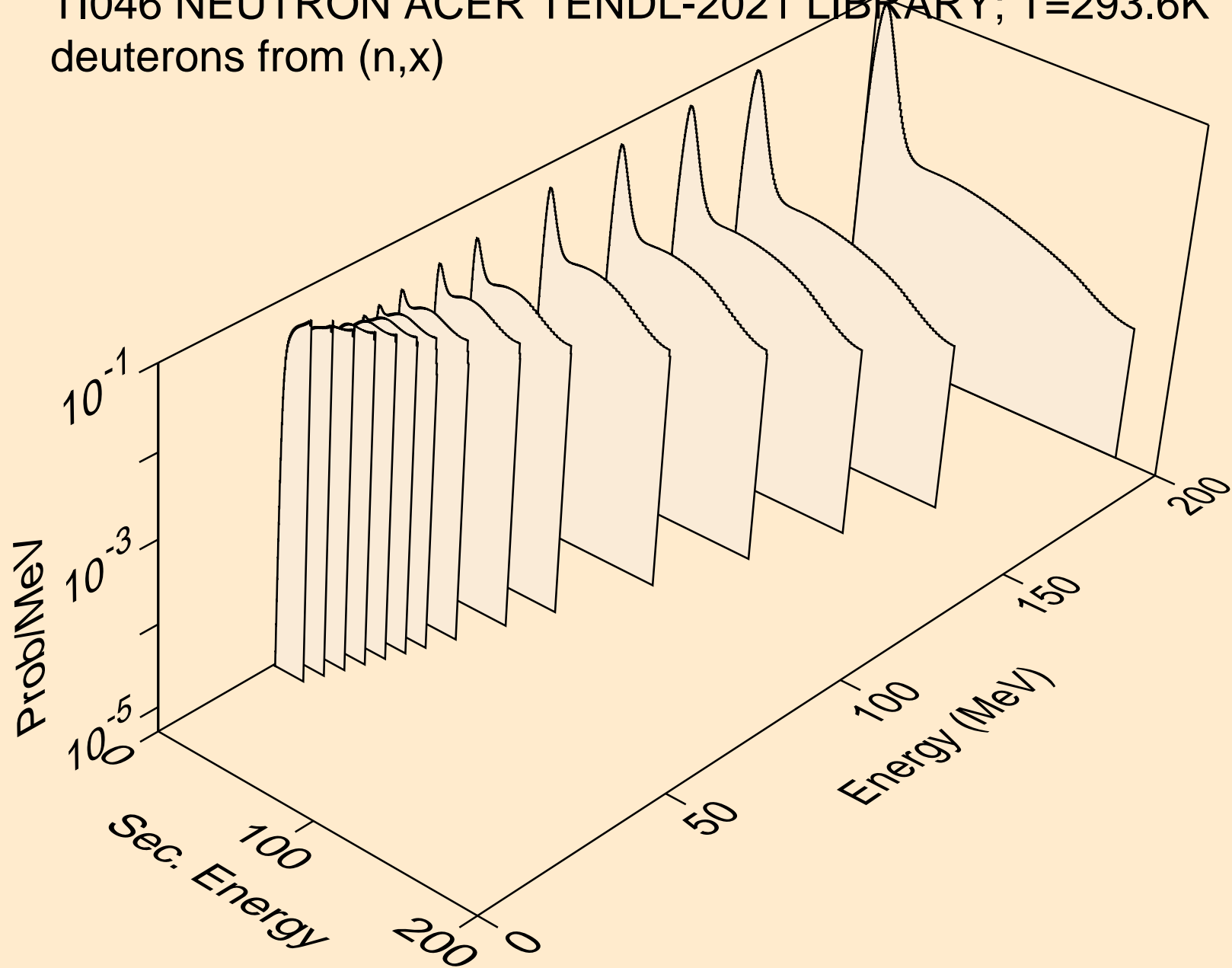

TI046 NEUTRON ACER TENDL-2021 LIBRARY; T=293.6K
deuterons from (n,n*)d

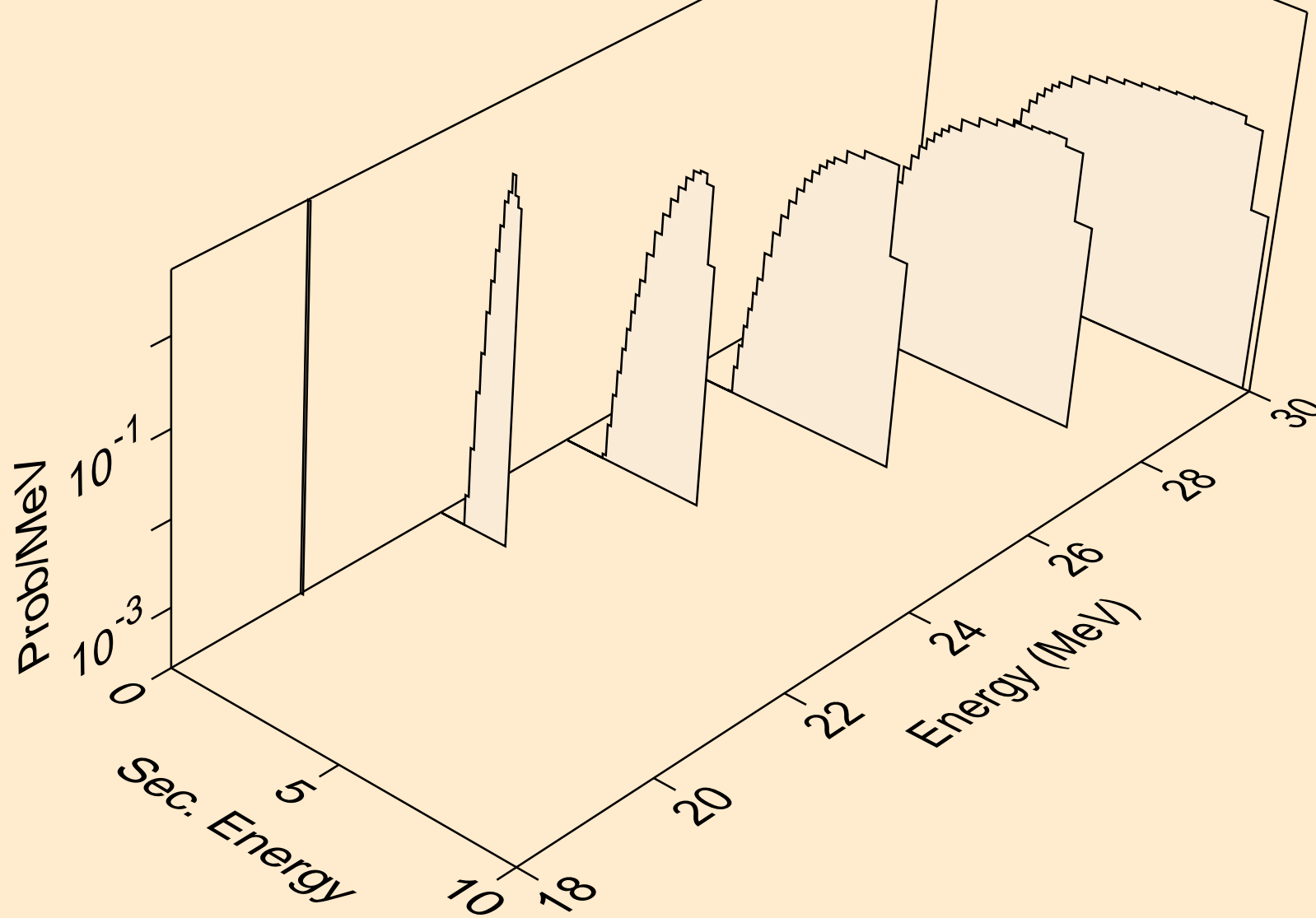

TI046 NEUTRON ACER TENDL-2021 LIBRARY; T=293.6K
deuterons from (n,d)

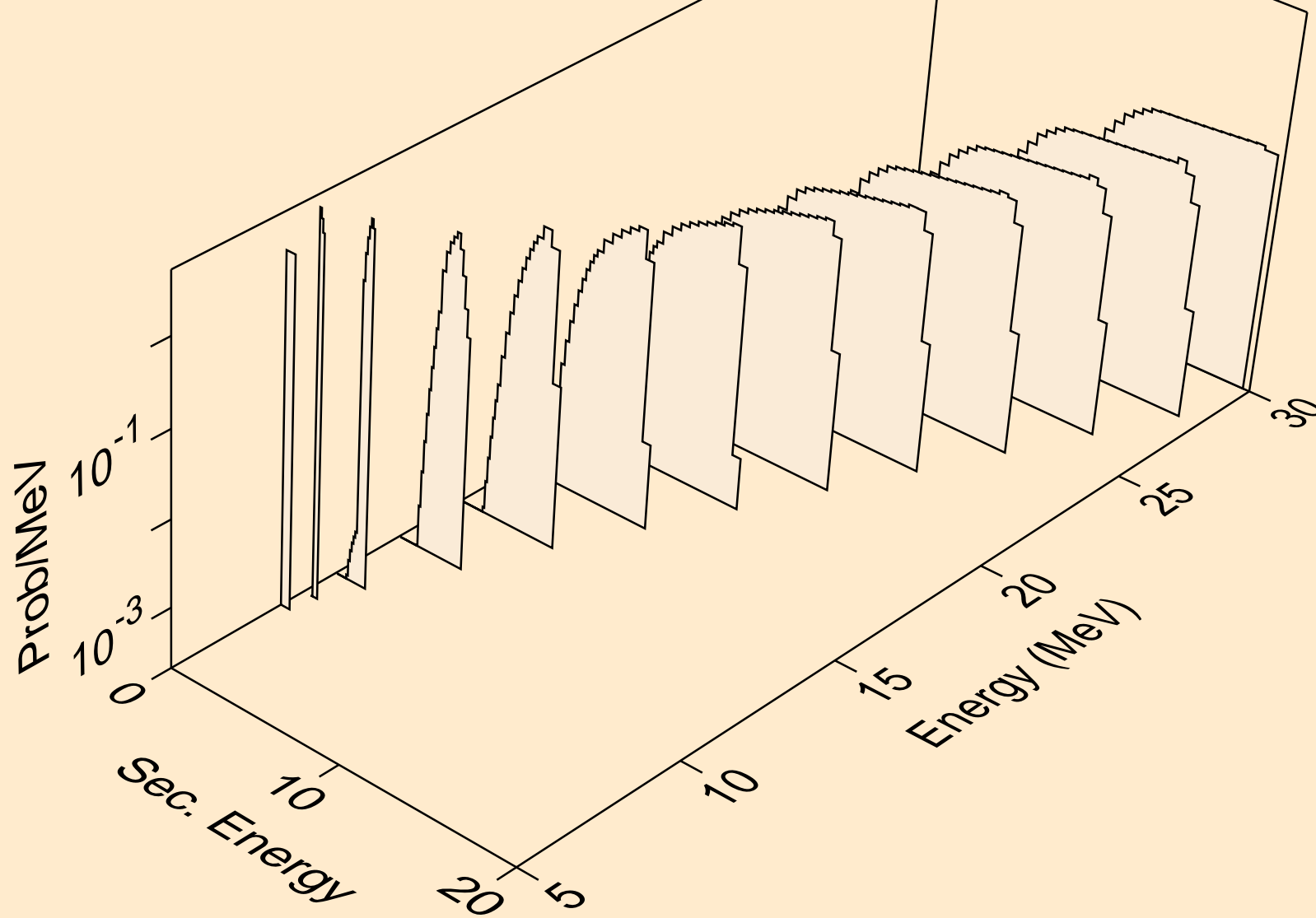

TI046 NEUTRON ACER TENDL-2021 LIBRARY; T=293.6K
deuterons from (n,pd)

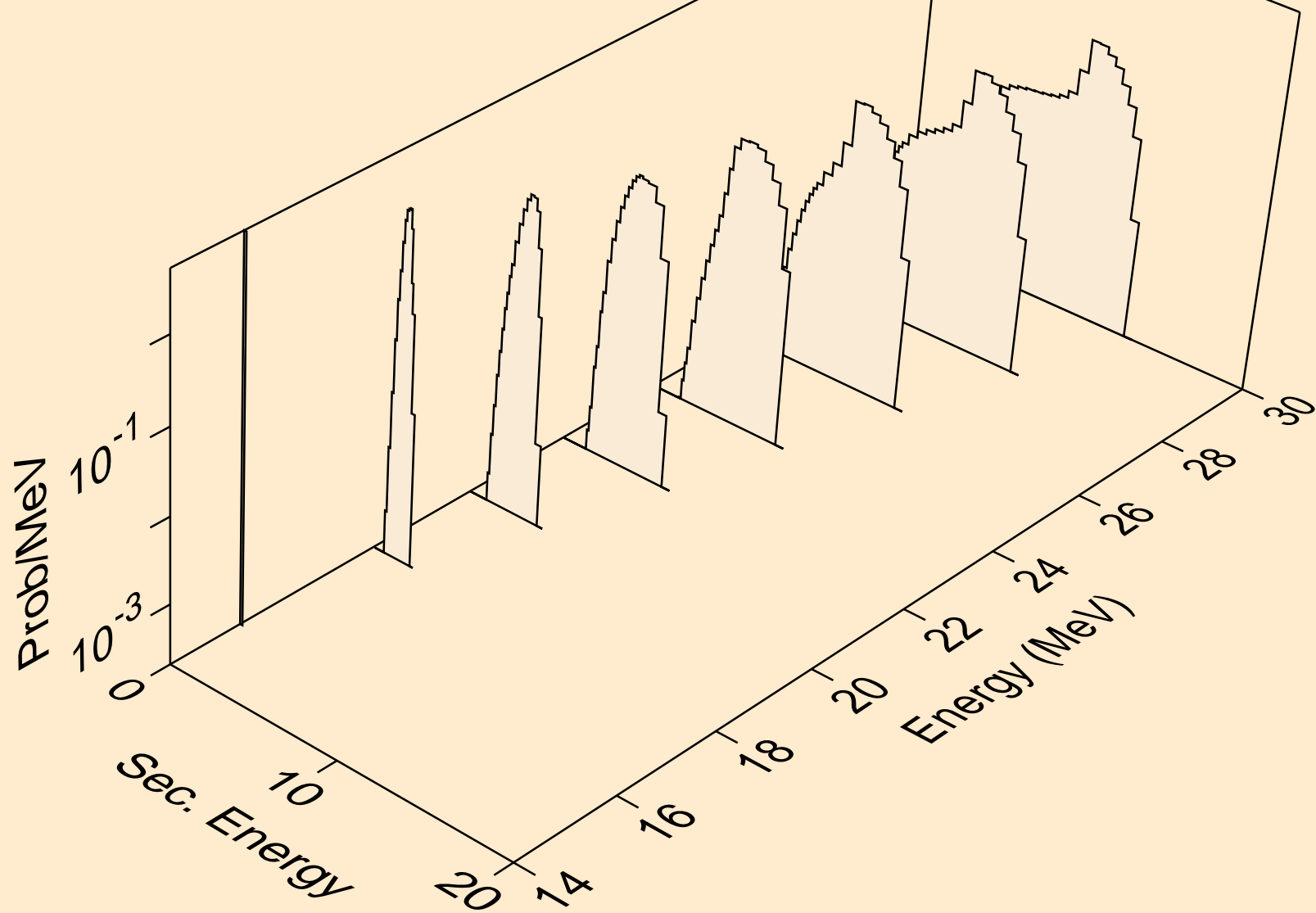

TI046 NEUTRON ACER TENDL-2021 LIBRARY; T=293.6K
deuterons from (n,da)

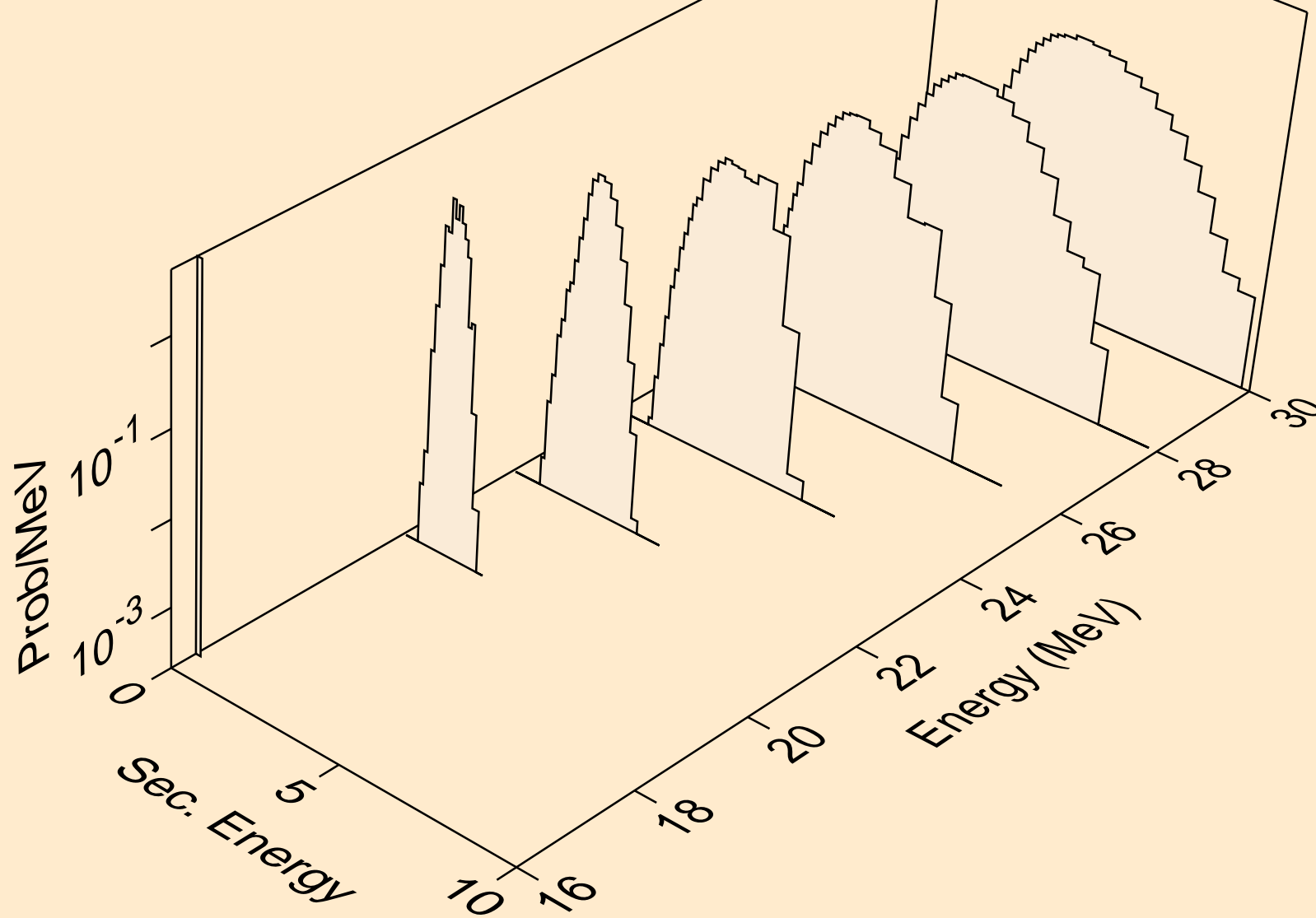

TI046 NEUTRON ACER TENDL-2021 LIBRARY; T=293.6K
tritons from (n,x)

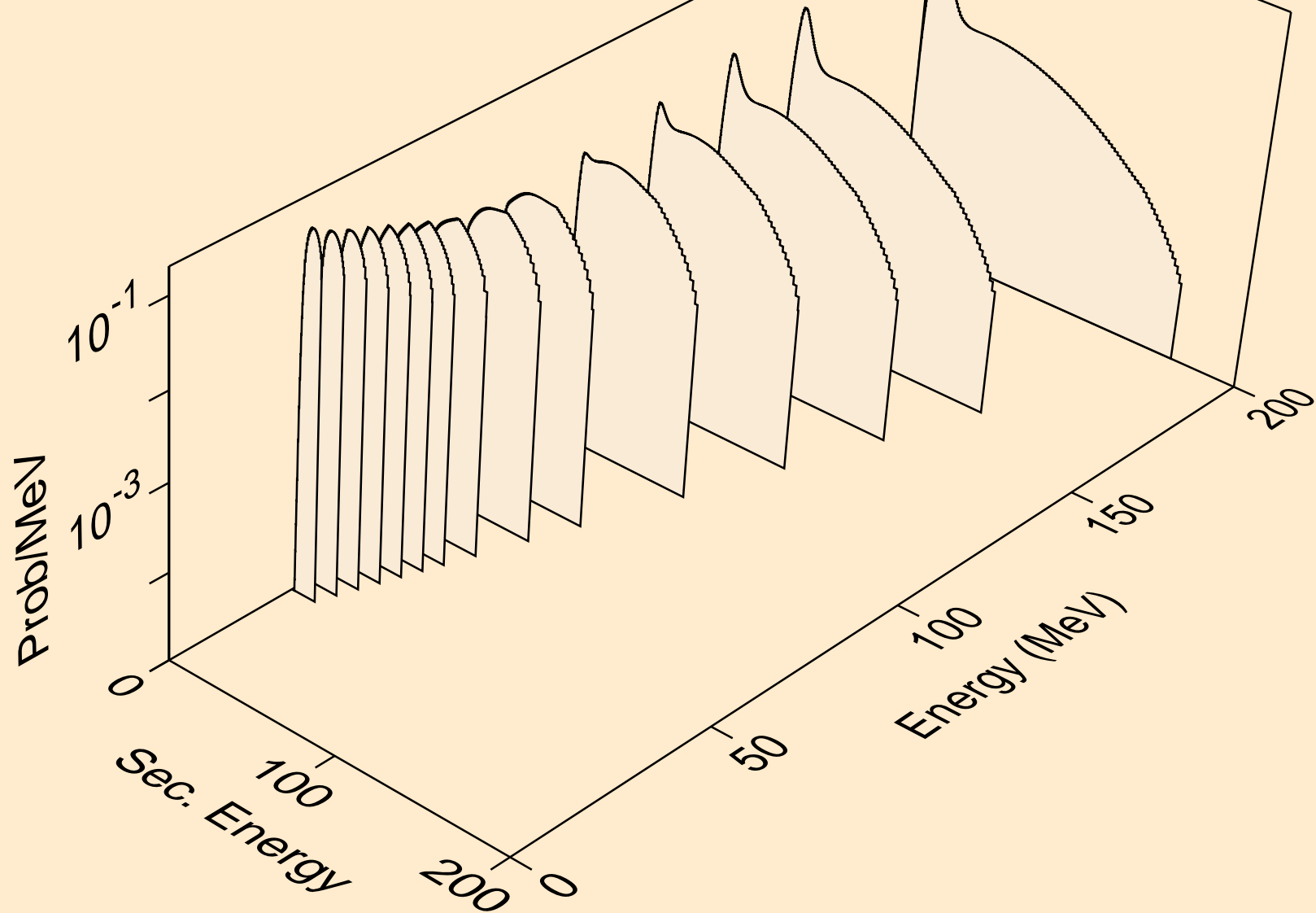

TI046 NEUTRON ACER TENDL-2021 LIBRARY; T=293.6K
tritons from (n,n*)t

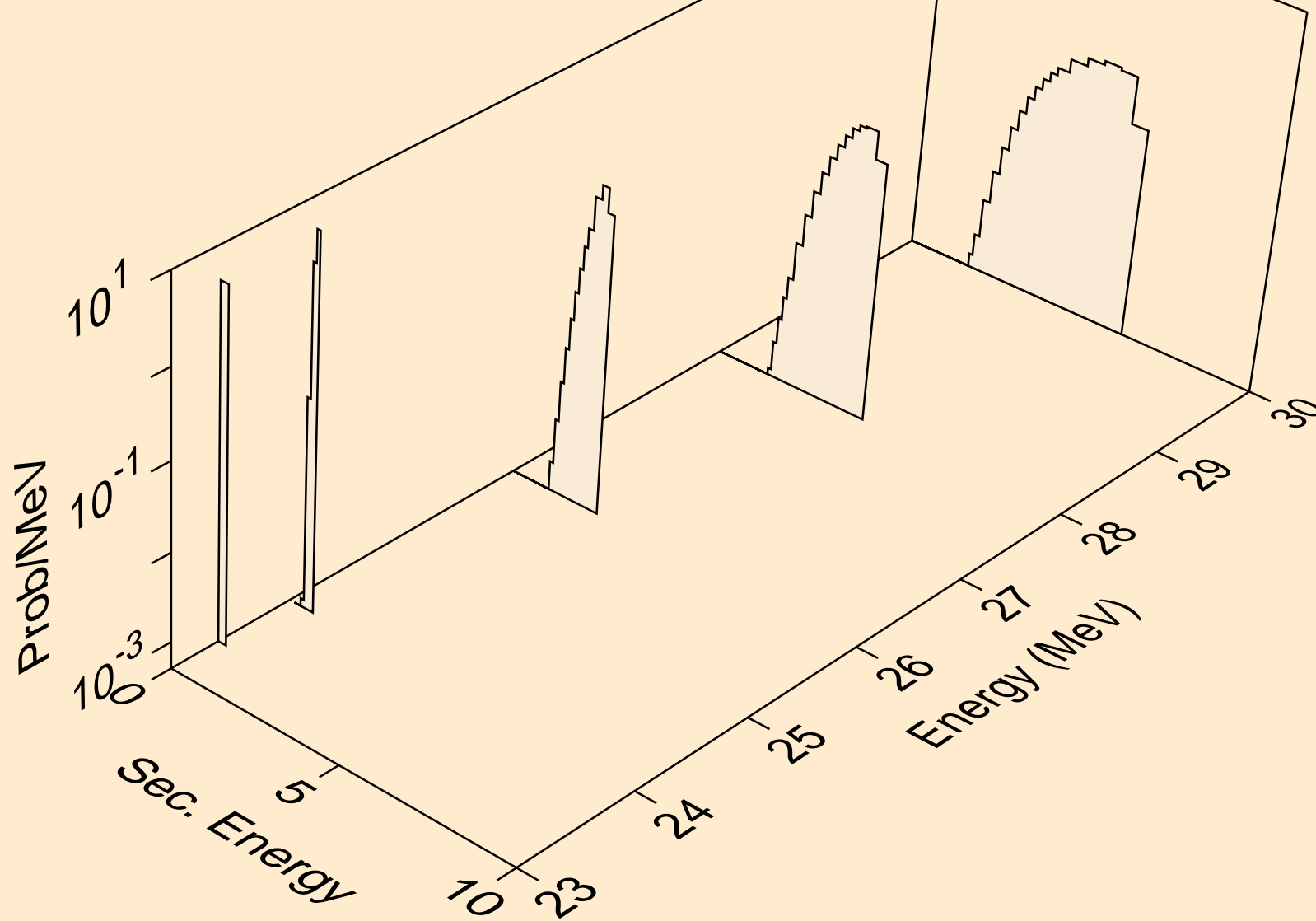

TI046 NEUTRON ACER TENDL-2021 LIBRARY; T=293.6K
tritons from (n,t)

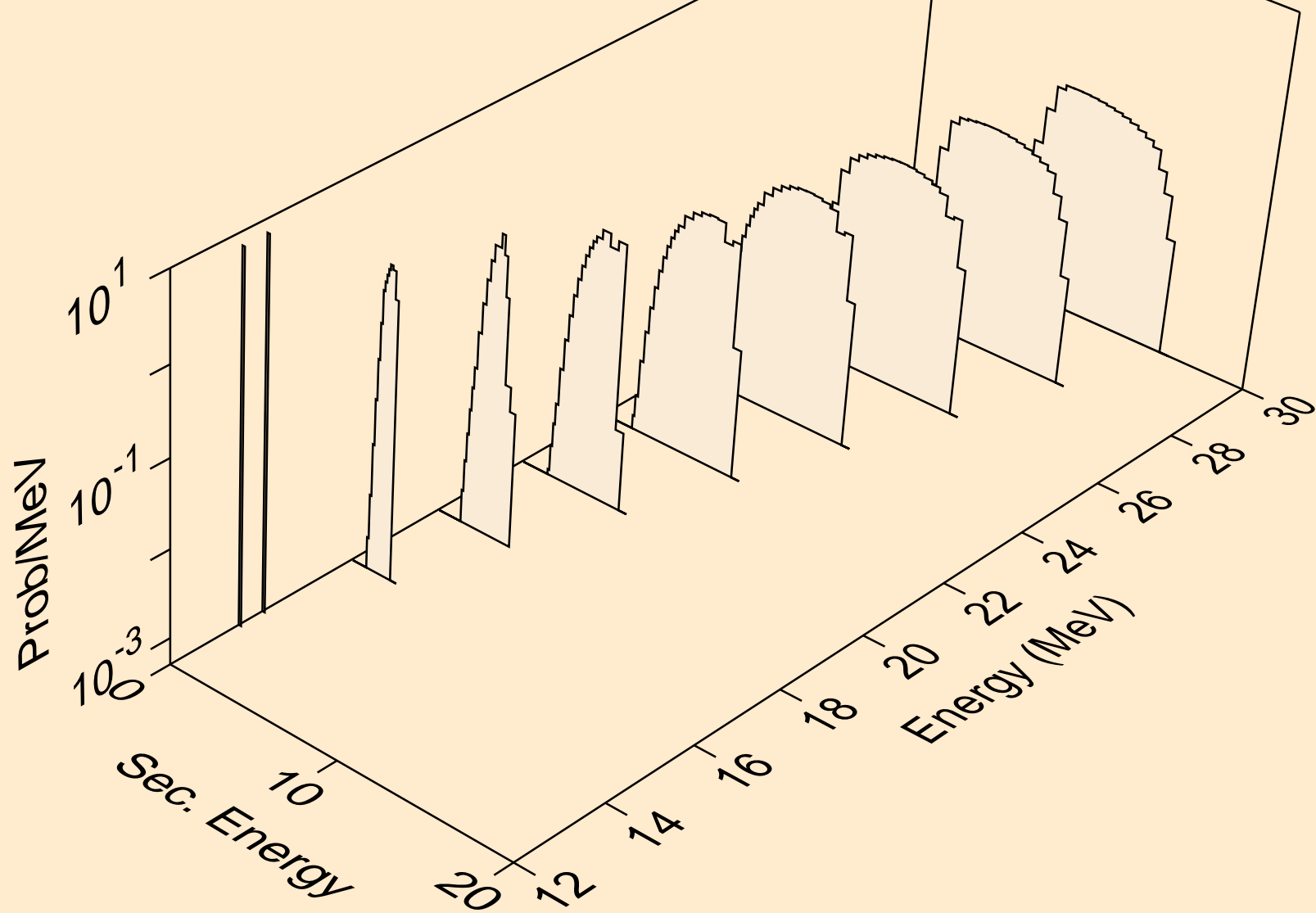

TI046 NEUTRON ACER TENDL-2021 LIBRARY; T=293.6K
tritons from (n,pt)

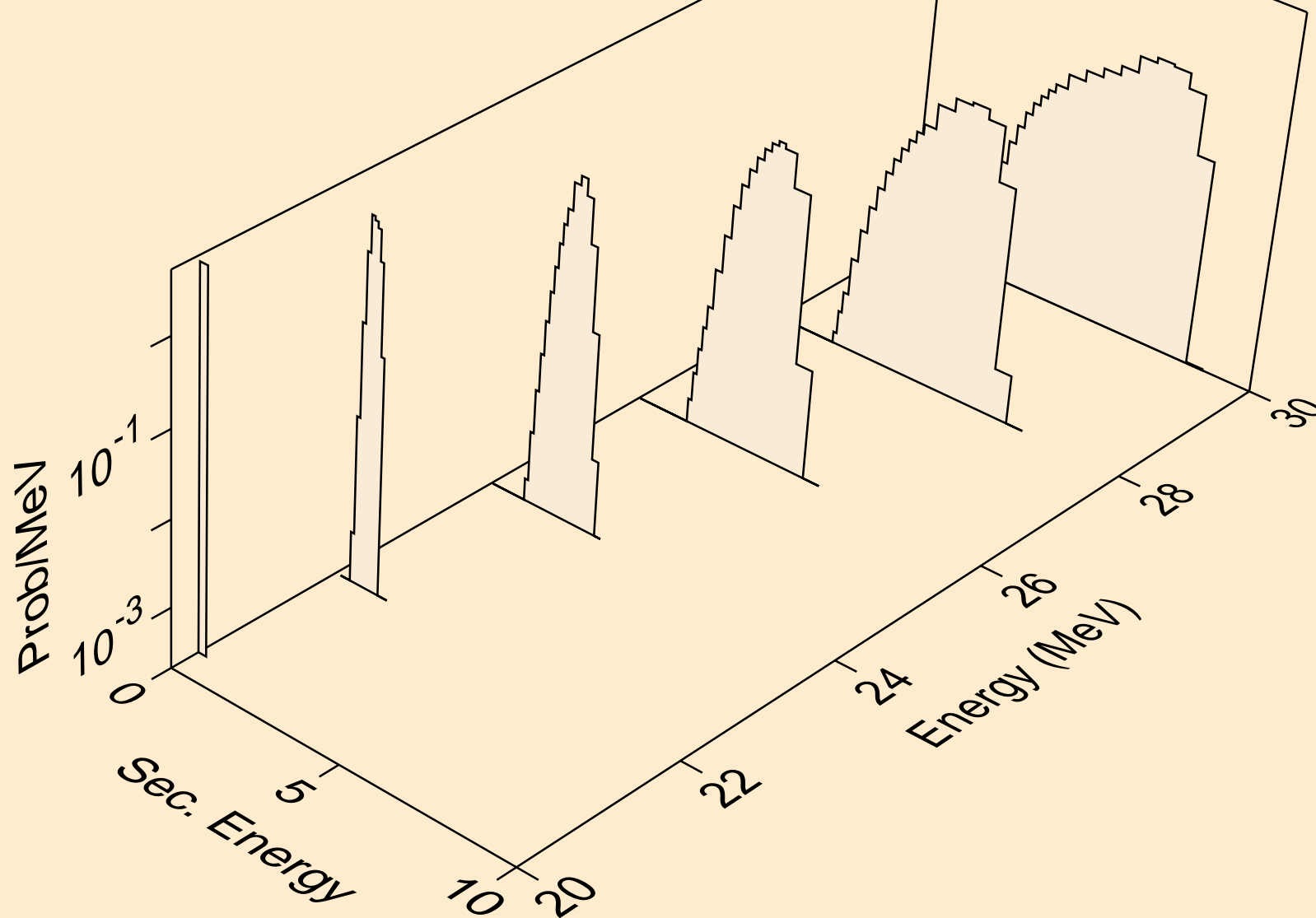

TI046 NEUTRON ACER TENDL-2021 LIBRARY; T=293.6K
he3s from (n,x)

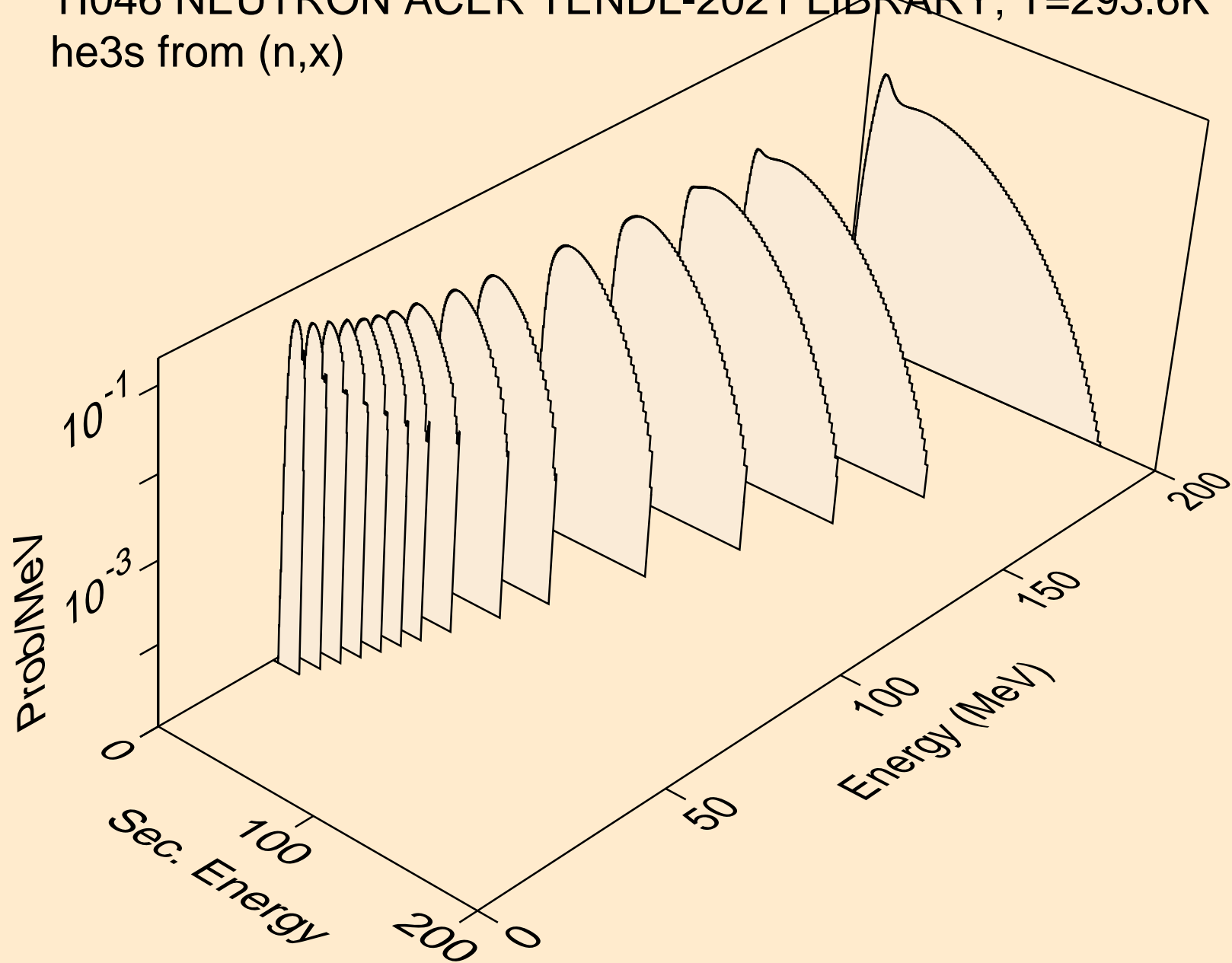

TI046 NEUTRON ACER TENDL-2021 LIBRARY; T=293.6K
he3s from (n,n*)he3

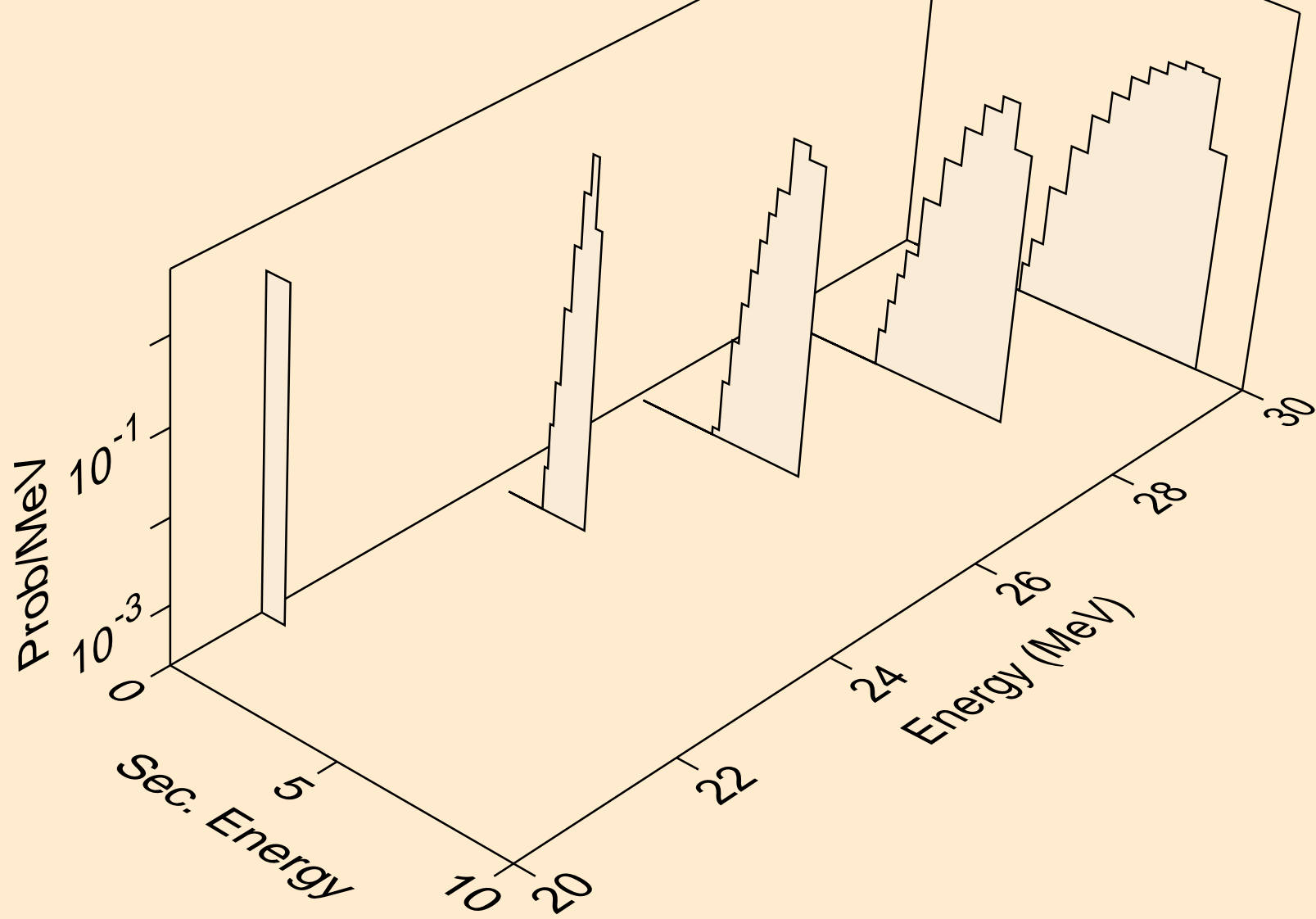

TI046 NEUTRON ACER TENDL-2021 LIBRARY; T=293.6K
he3s from (n,he3)

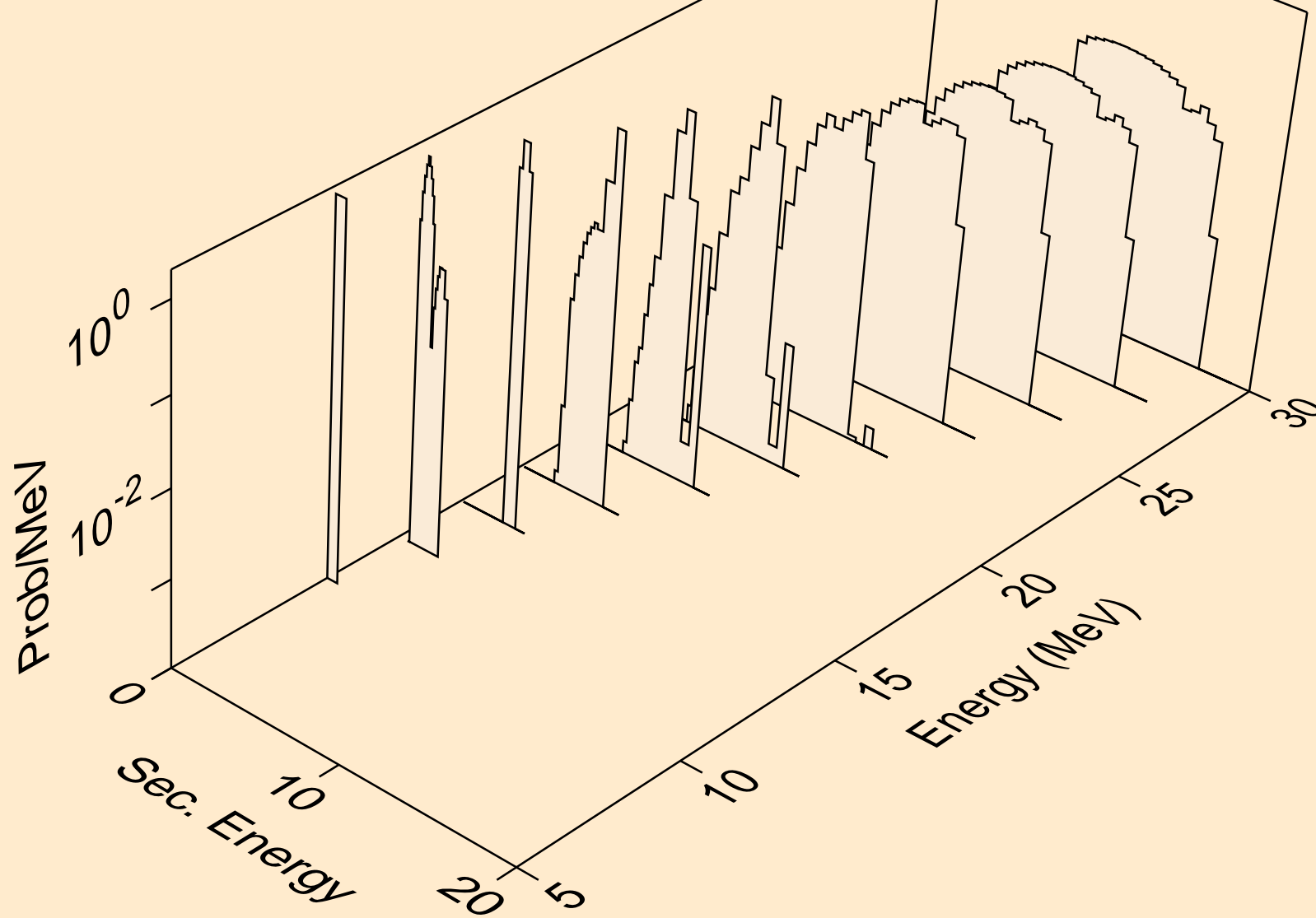

TI046 NEUTRON ACER TENDL-2021 LIBRARY; T=293.6K
alphas from (n,x)

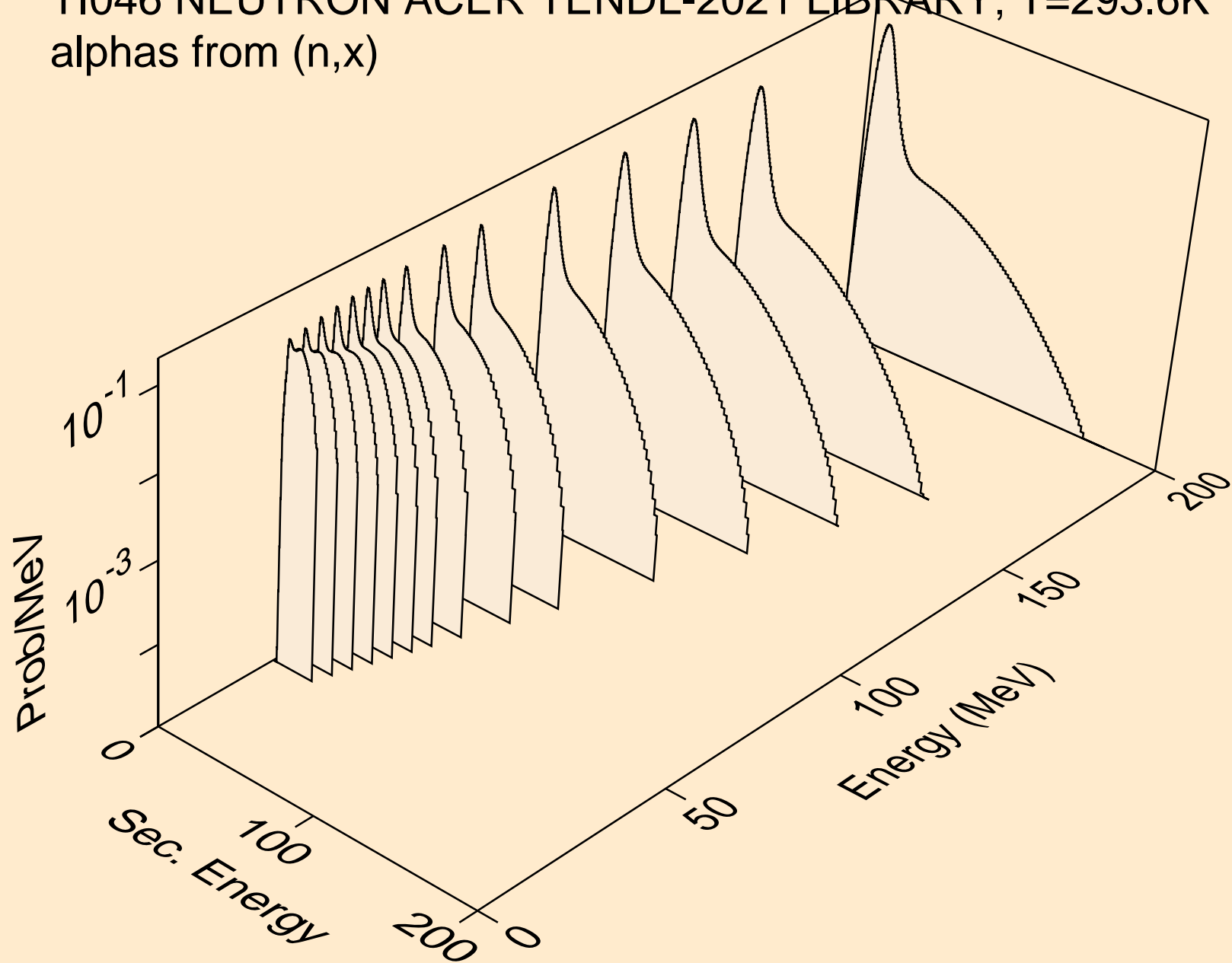

TI046 NEUTRON ACER TENDL-2021 LIBRARY; T=293.6K
alphas from (n,n*)a

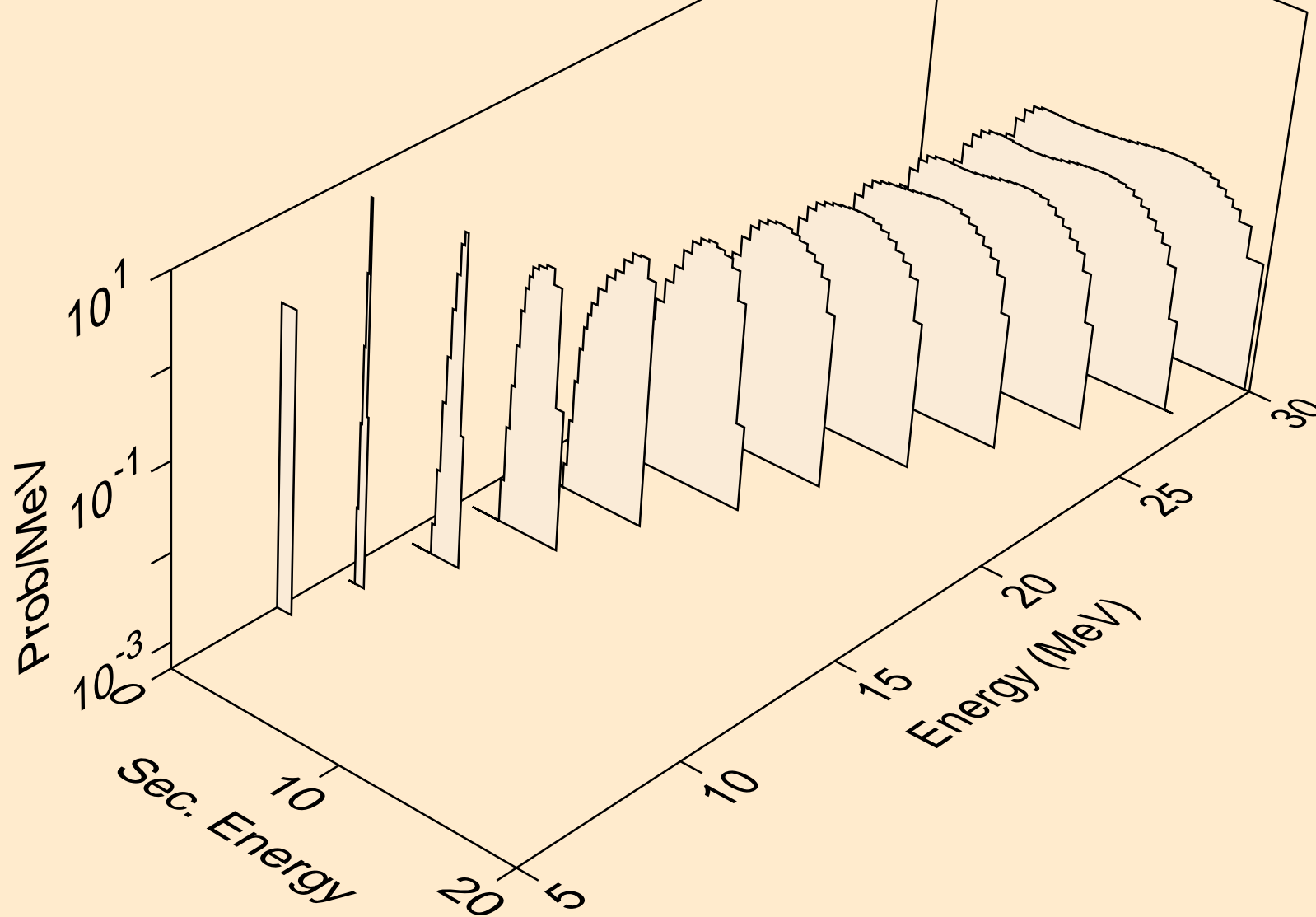

TI046 NEUTRON ACER TENDL-2021 LIBRARY; T=293.6K
alphas from (n,2n)a

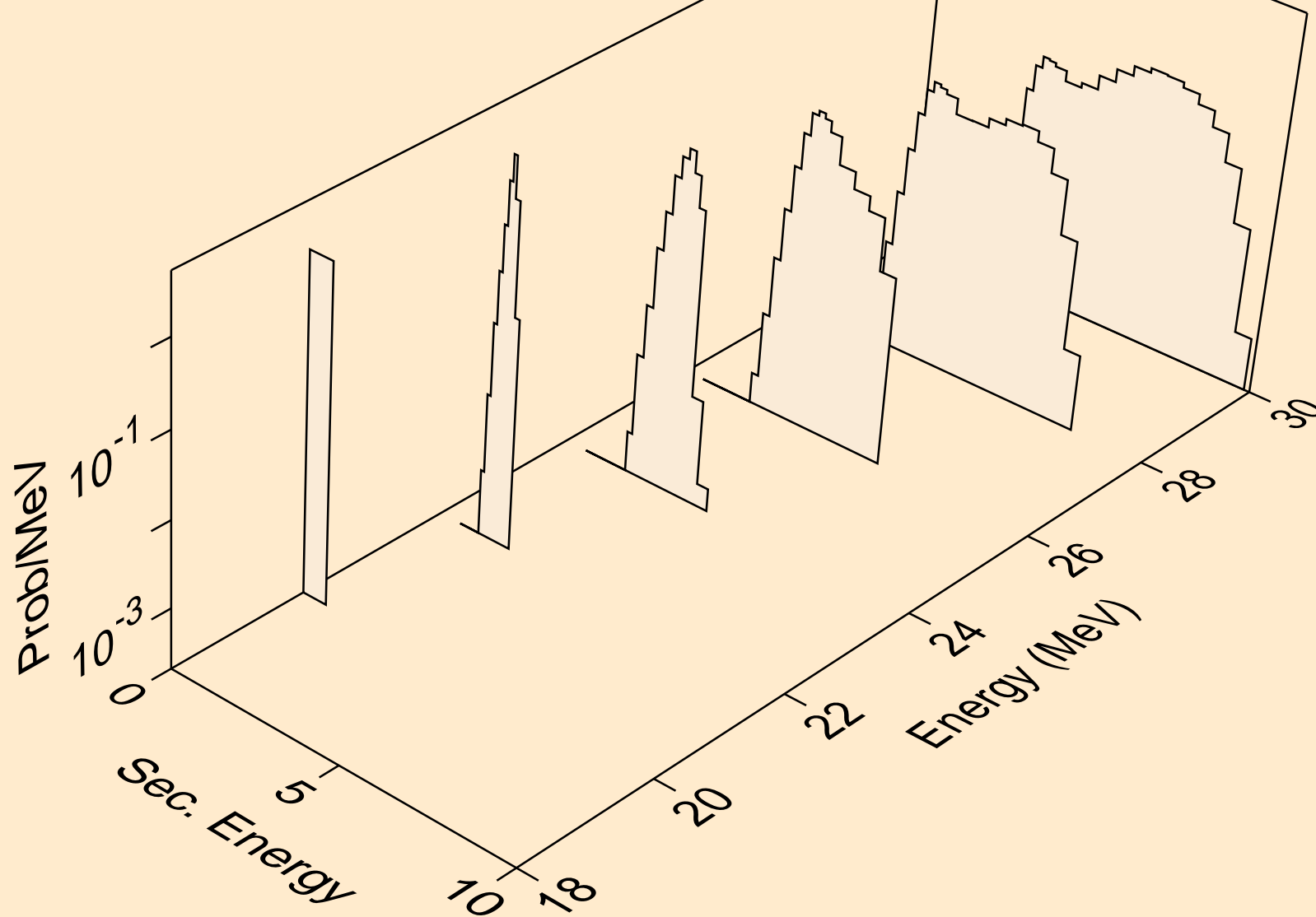

TI046 NEUTRON ACER TENDL-2021 LIBRARY; T=293.6K
alphas from (n,n*)2a

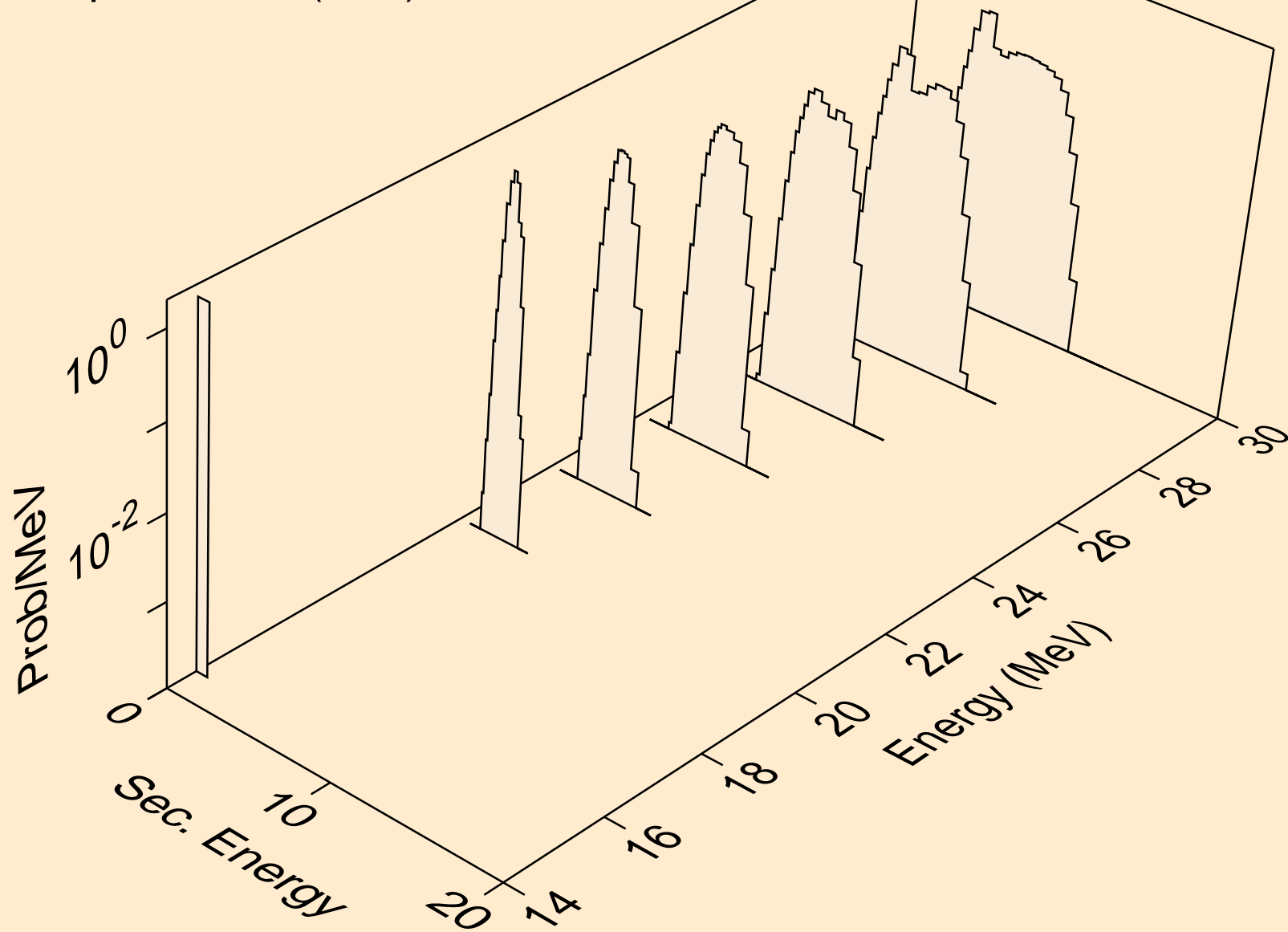

TI046 NEUTRON ACER TENDL-2021 LIBRARY; T=293.6K
alphas from (n,npa)

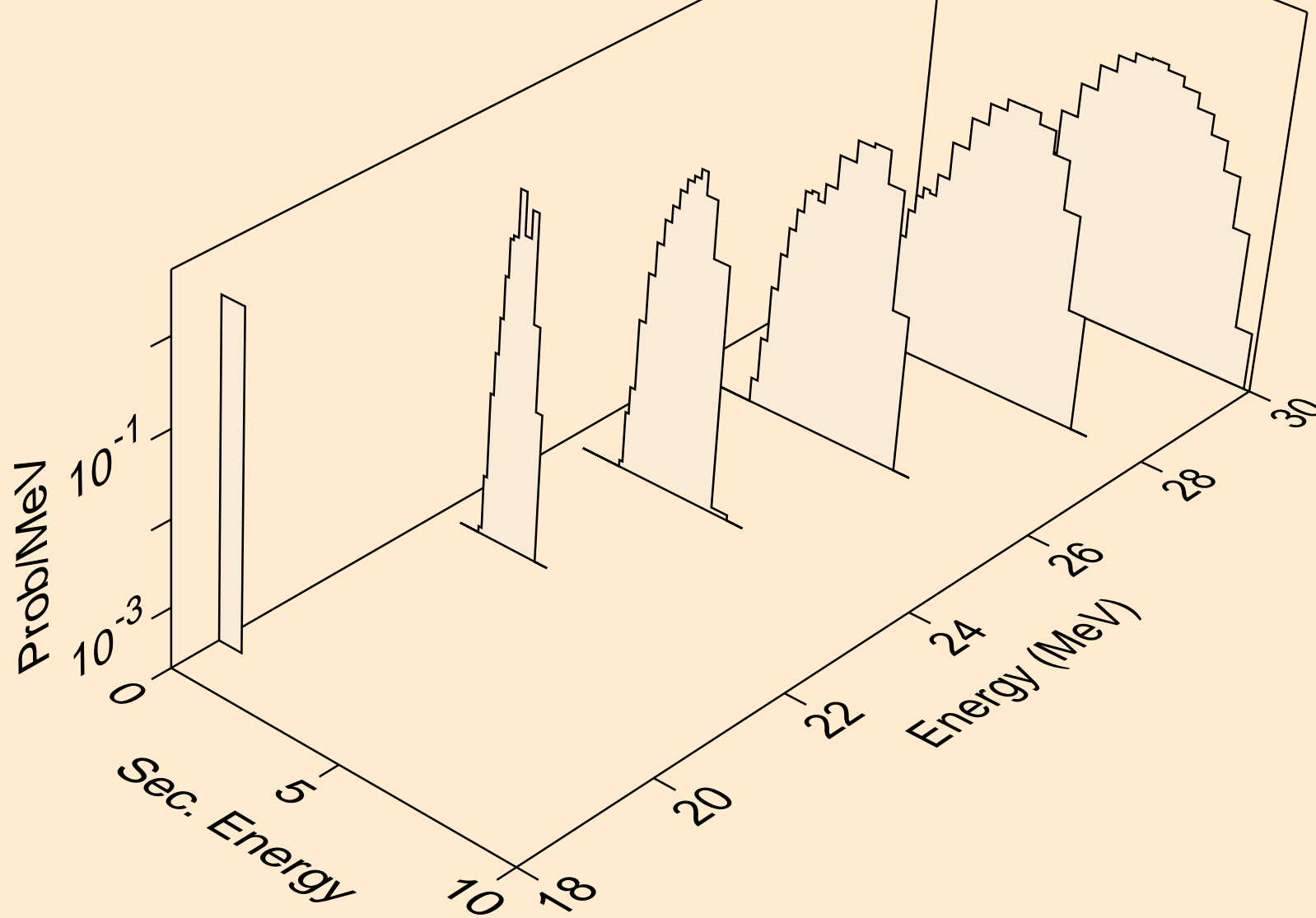

TI046 NEUTRON ACER TENDL-2021 LIBRARY; T=293.6K
alphas from (n,a)

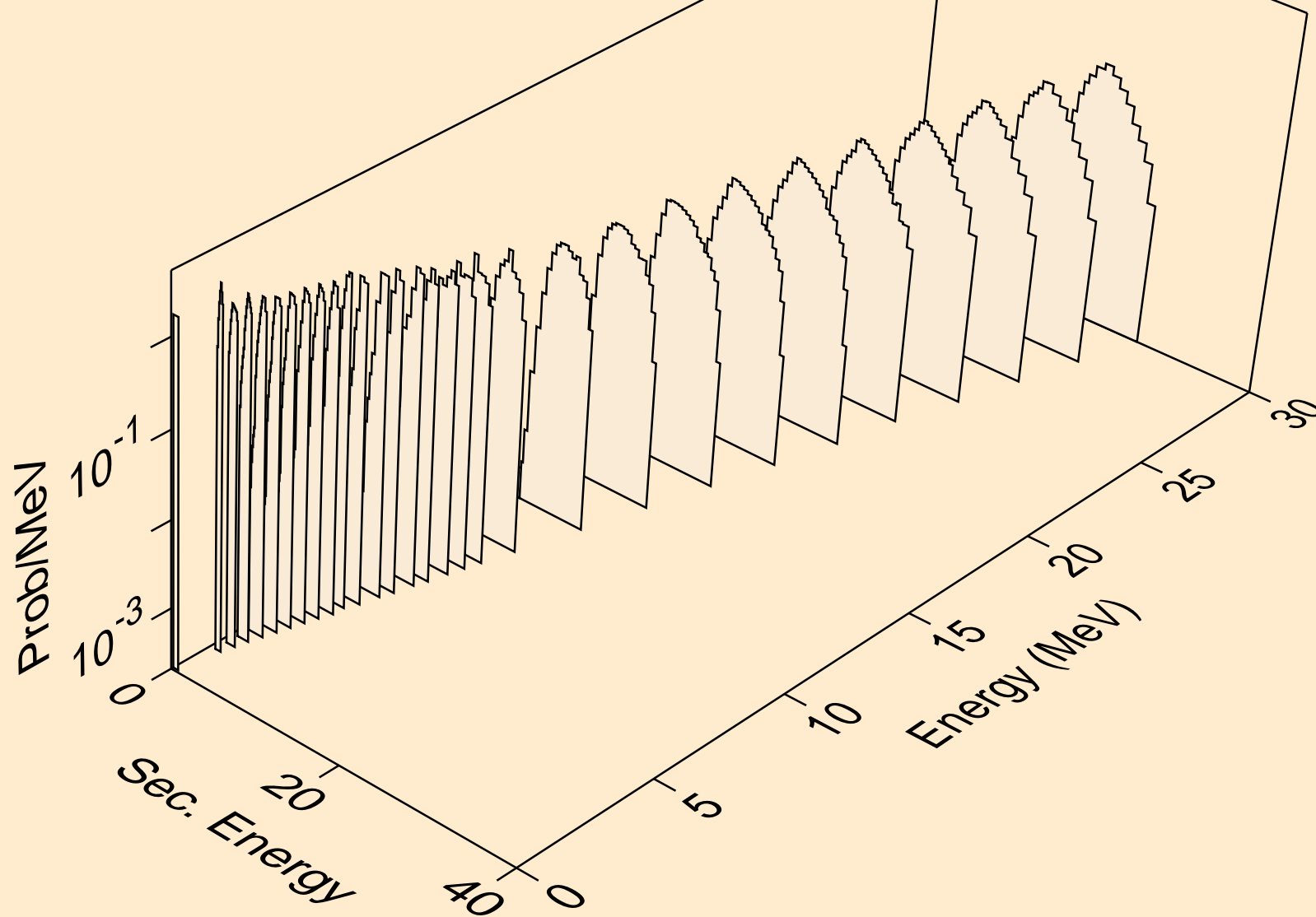

TI046 NEUTRON ACER TENDL-2021 LIBRARY; T=293.6K
alphas from (n,2a)

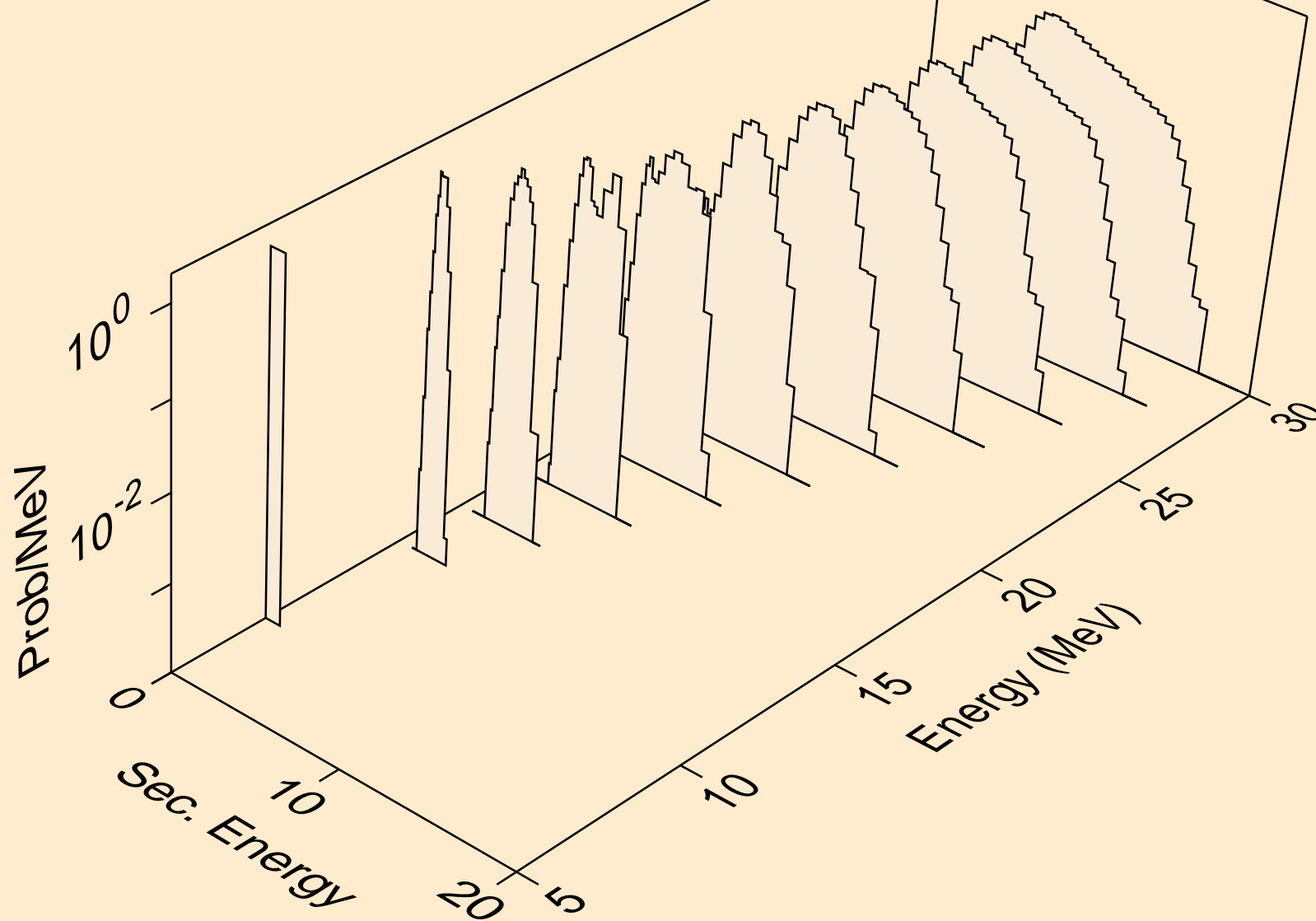

TI046 NEUTRON ACER TENDL-2021 LIBRARY; T=293.6K
alphas from (n,pa)

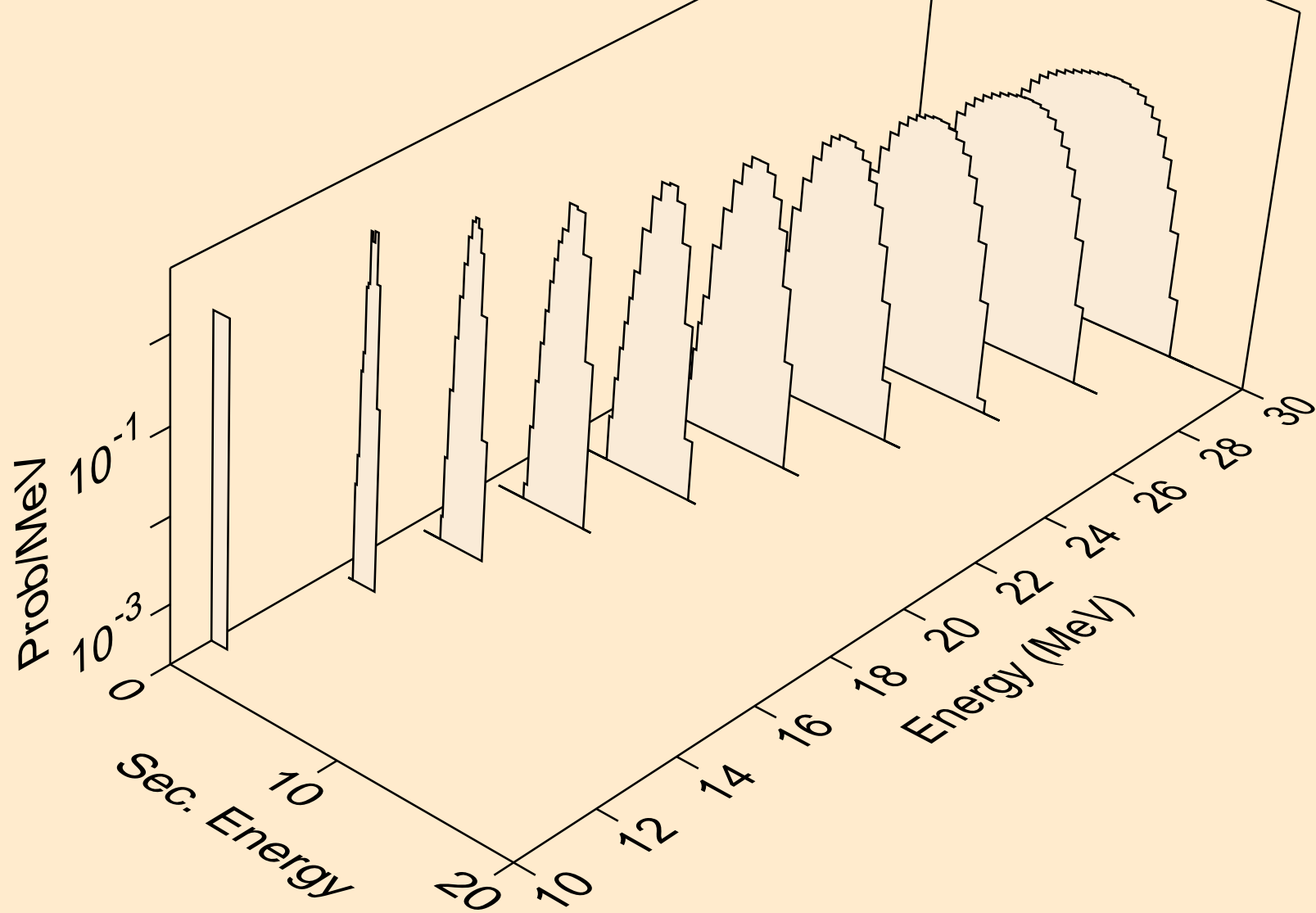

TI046 NEUTRON ACER TENDL-2021 LIBRARY; T=293.6K
alphas from (n,da)

