

Program EVALPLOT
(Version 2018-1)

by

Dermott E. Cullen
(Present Contact Information)

Dermott E. Cullen
1466 Hudson Way
Livermore, CA 94550
U.S.A.

Tele: 925-443-1911

E.Mail:redcullen1@comcast.net

Web:redcullen1.net/HOMEPAGE.NEW

Press Mouse Button to Start

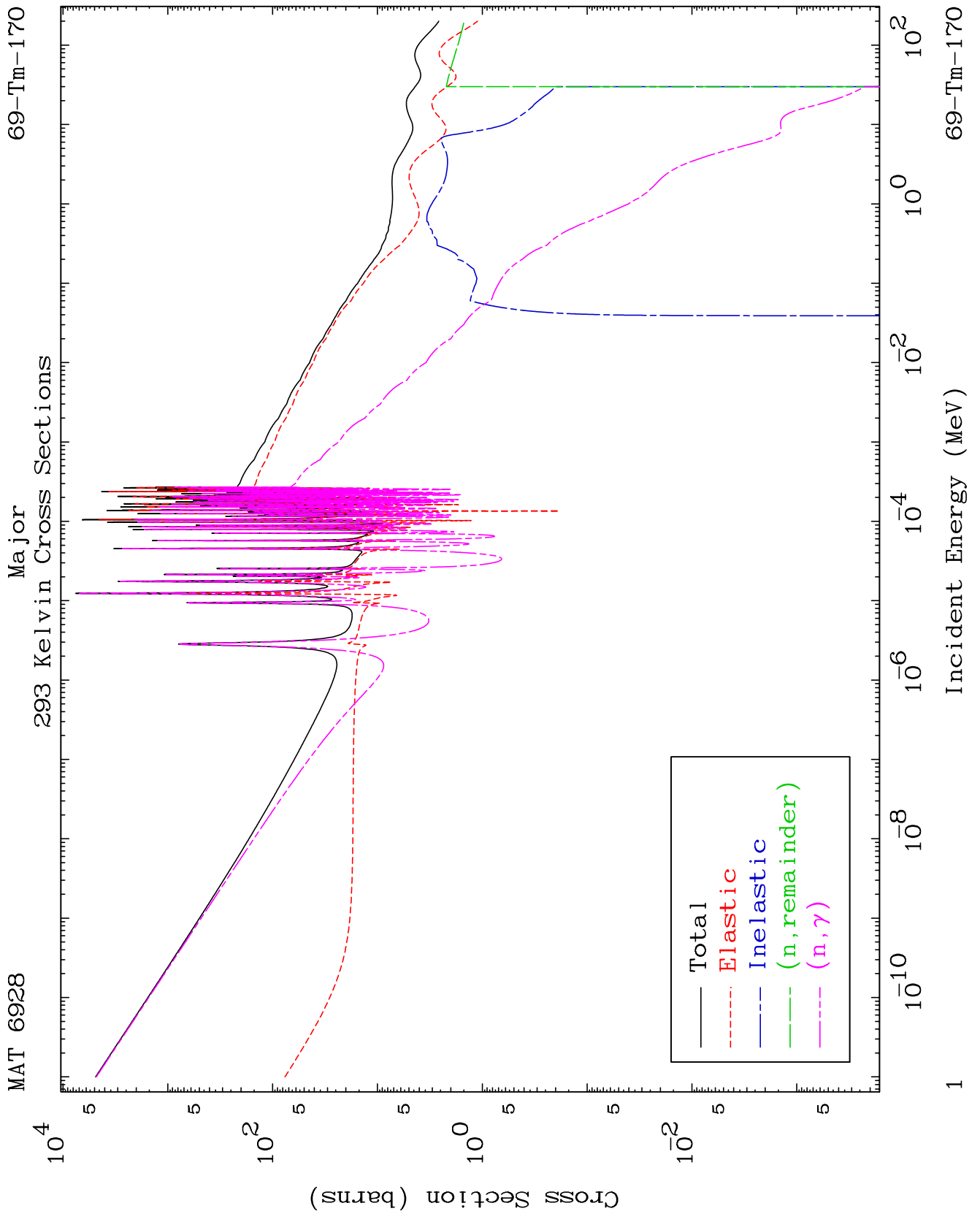

MAT 6928

Neutron Production
293 Kelvin Cross Sections

69-Tm-170

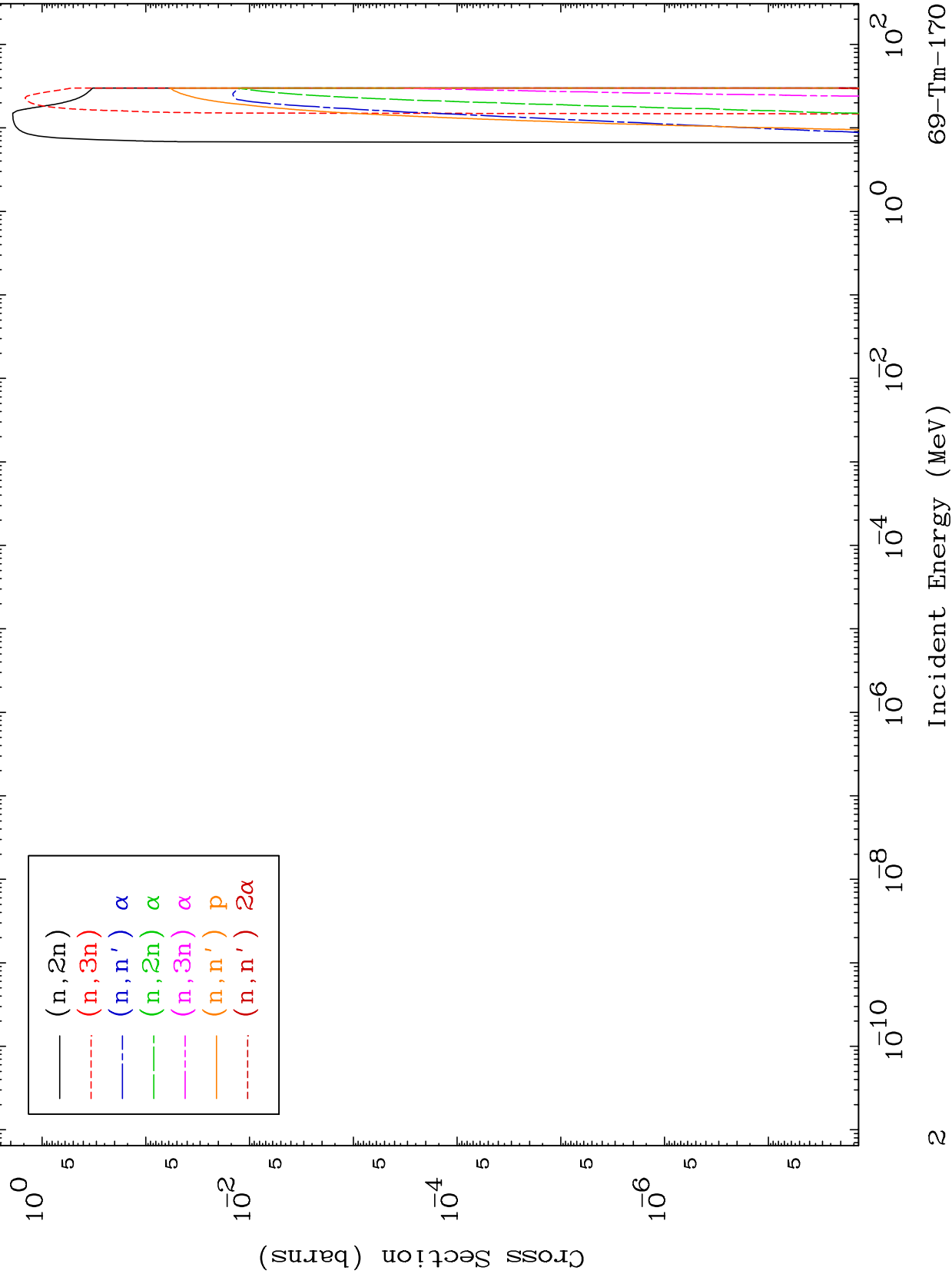

MAT 6928

Neutron Production
293 Kelvin Cross Sections

69-Tm-170

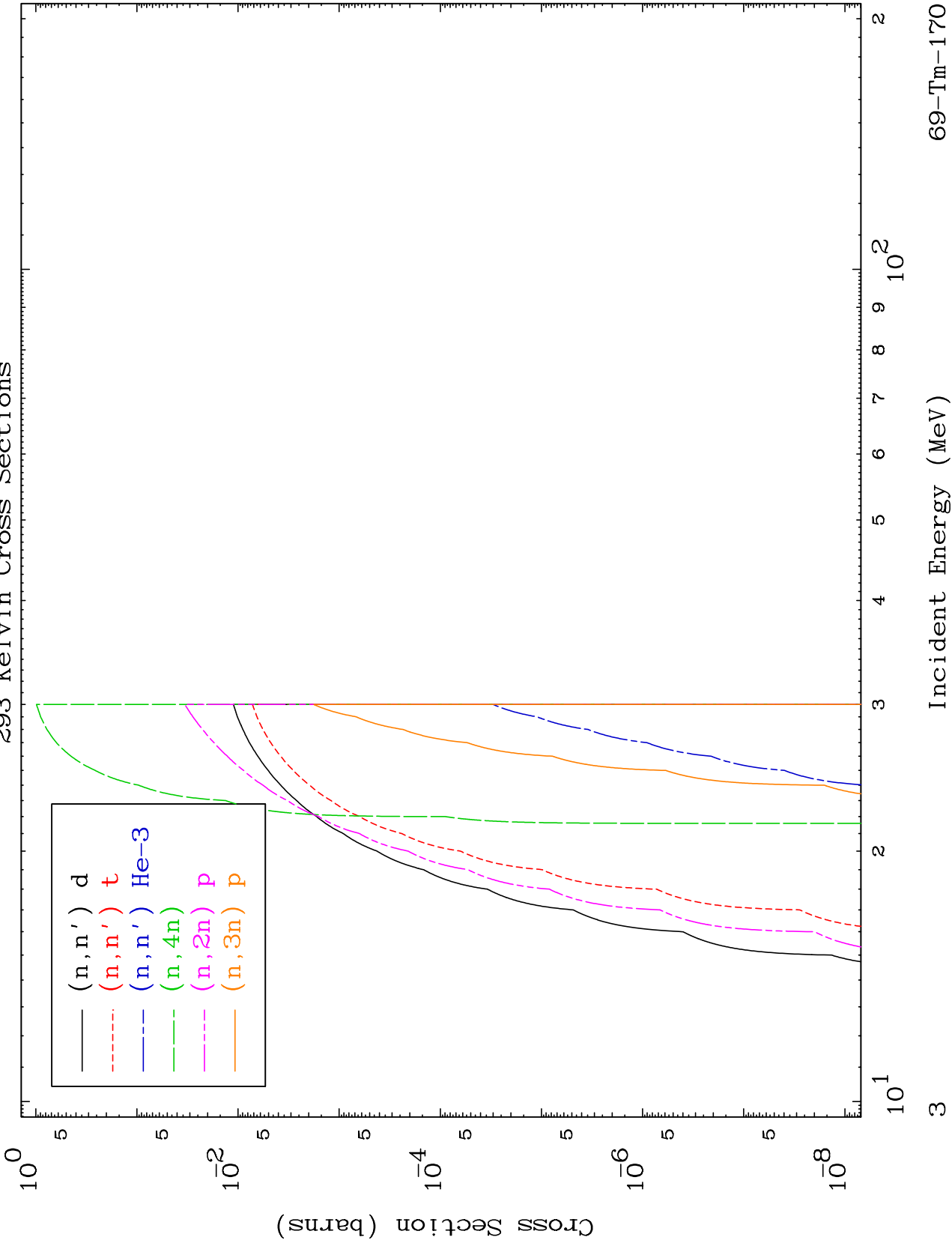

MAT 6928

Charged Particle
293 Kelvin Cross Sections

69-Tm-170

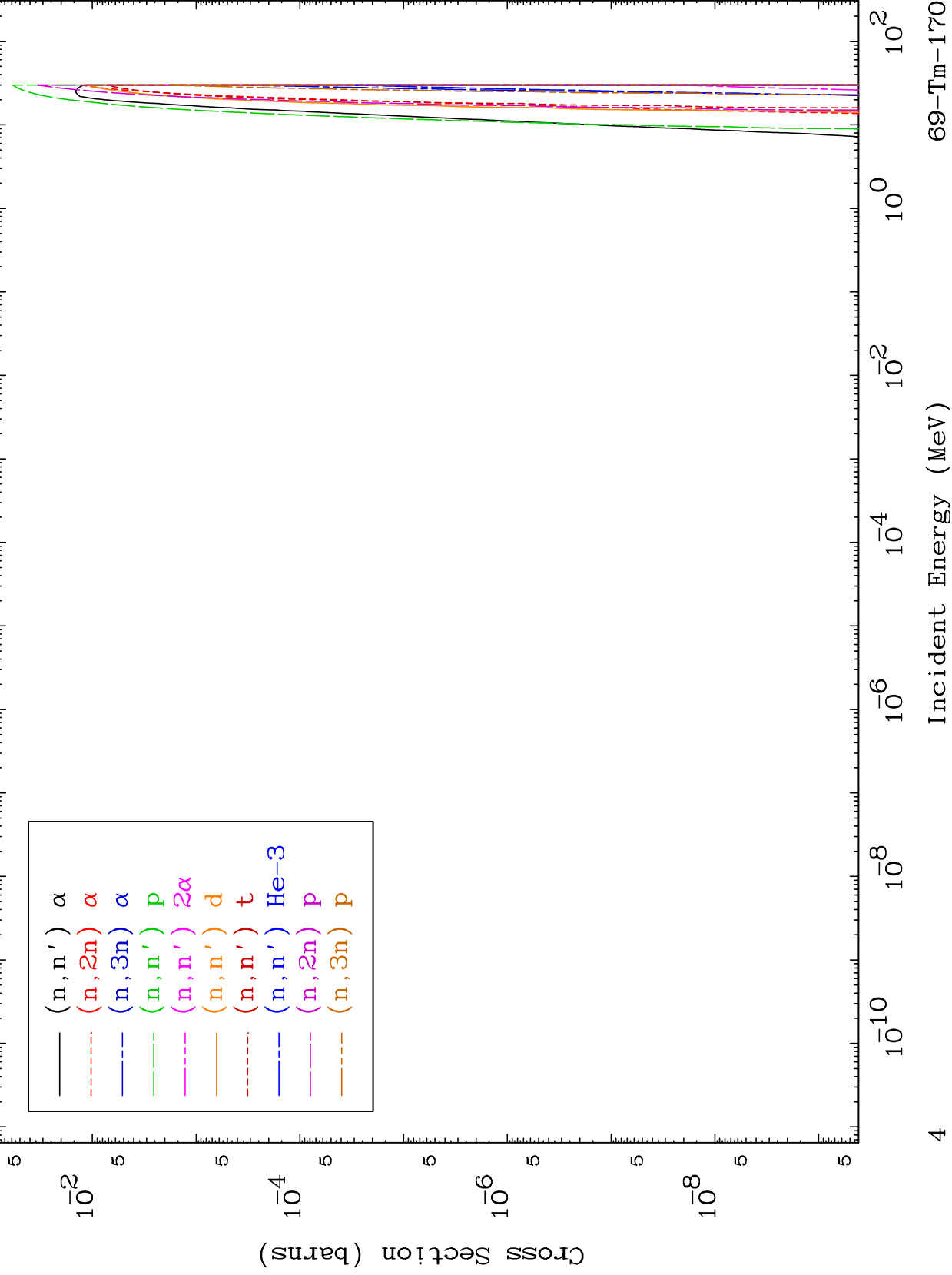

MAT 6928

Charged Particle
293 Kelvin Cross Sections

69-Tm-170

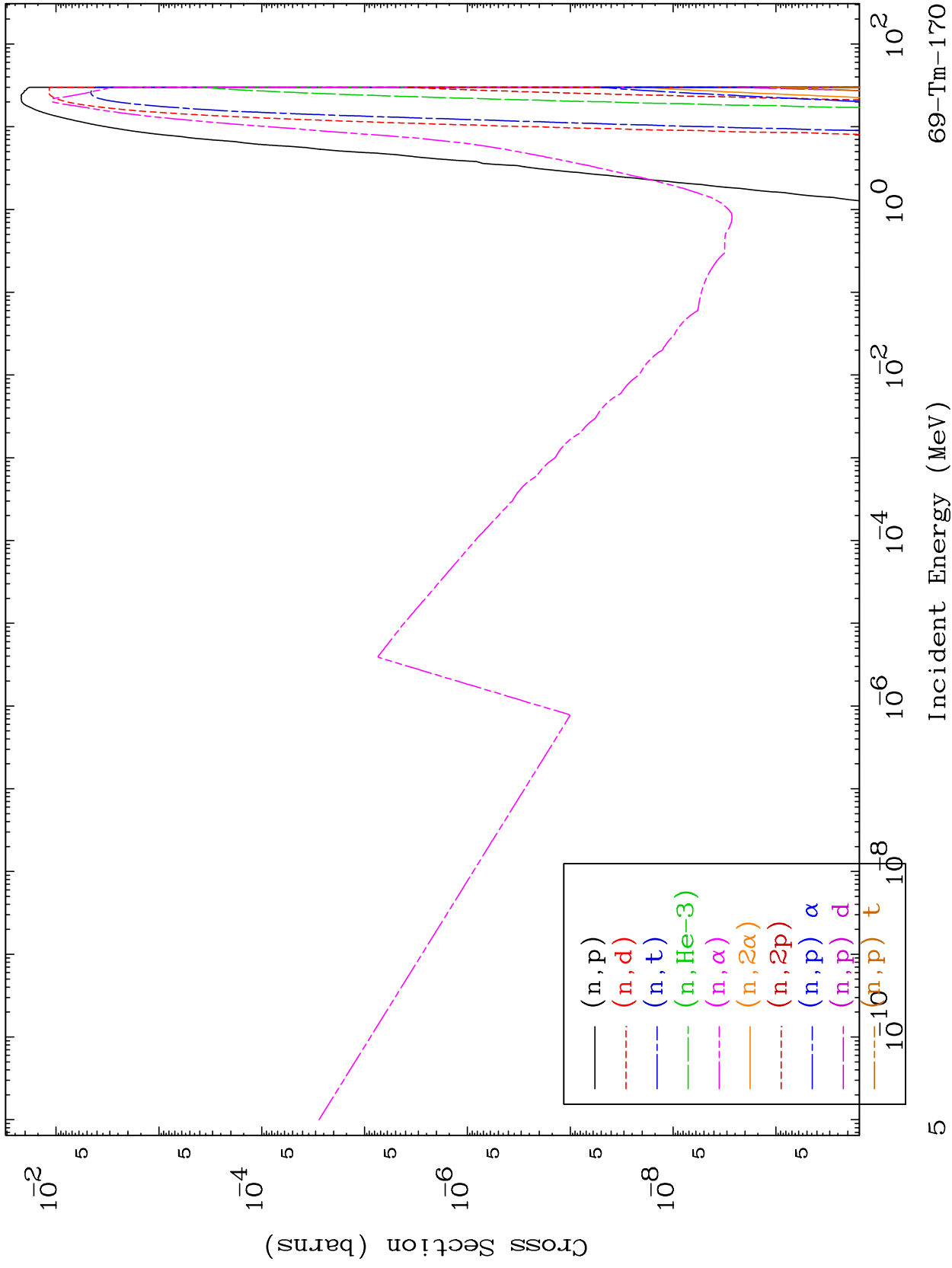

MAT 6928

Particle Production
293 Kelvin Cross Sections

69-Tm-170

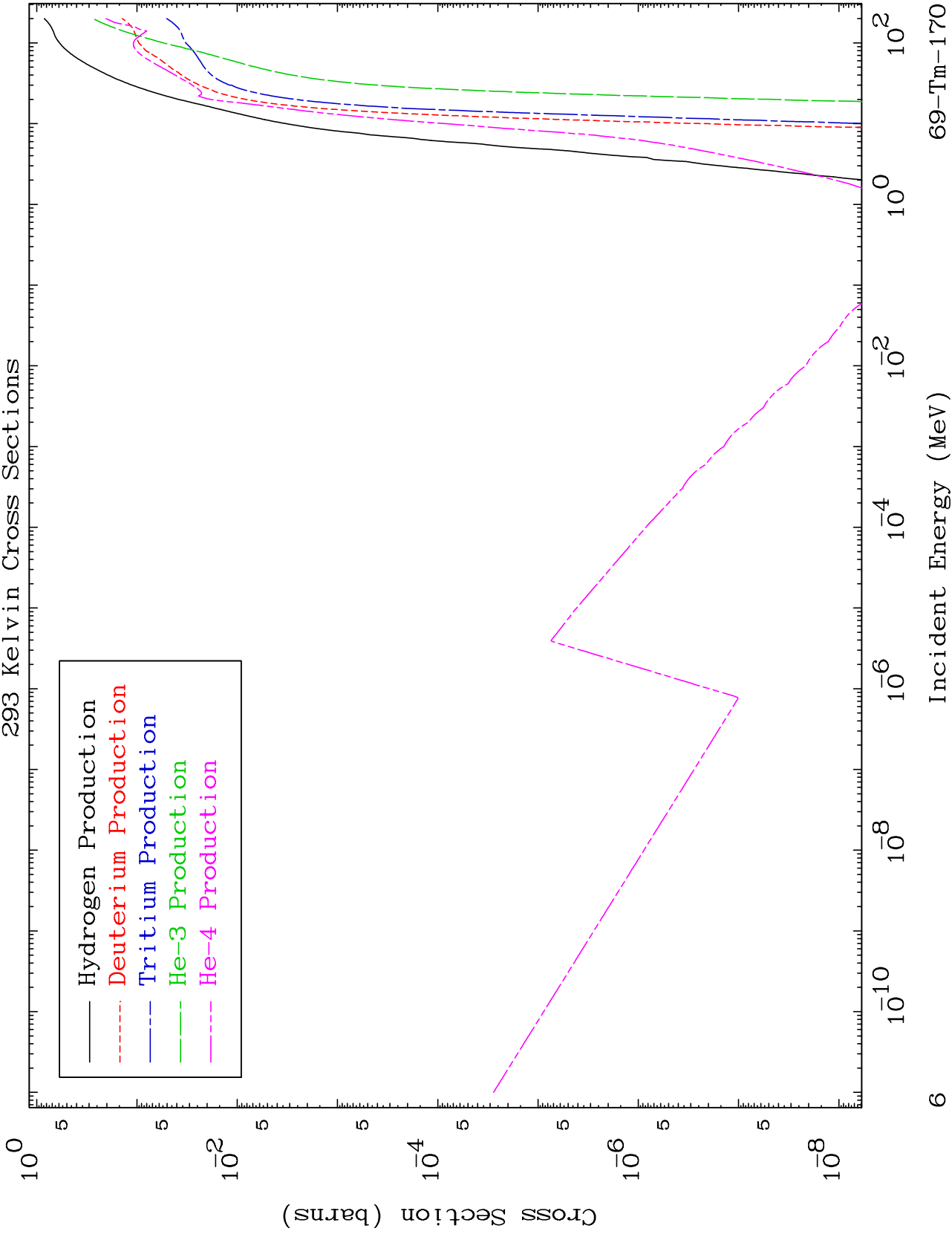

MAT 6928

(n,n') Level

69-Tm-170

293 Kelvin Cross Sections

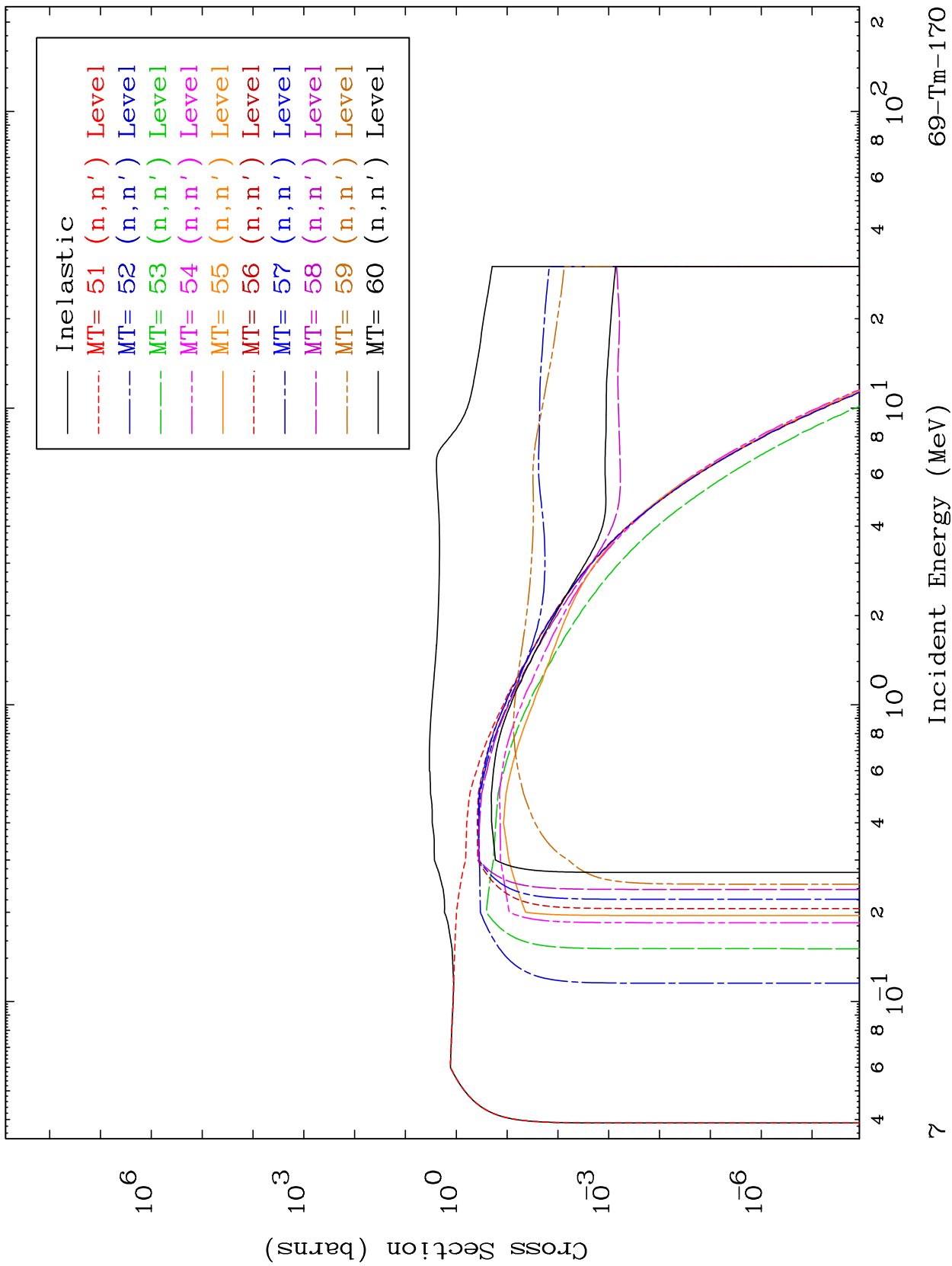

MAT 6928

(n,n') Level

69-Tm-170

293 Kelvin Cross Sections

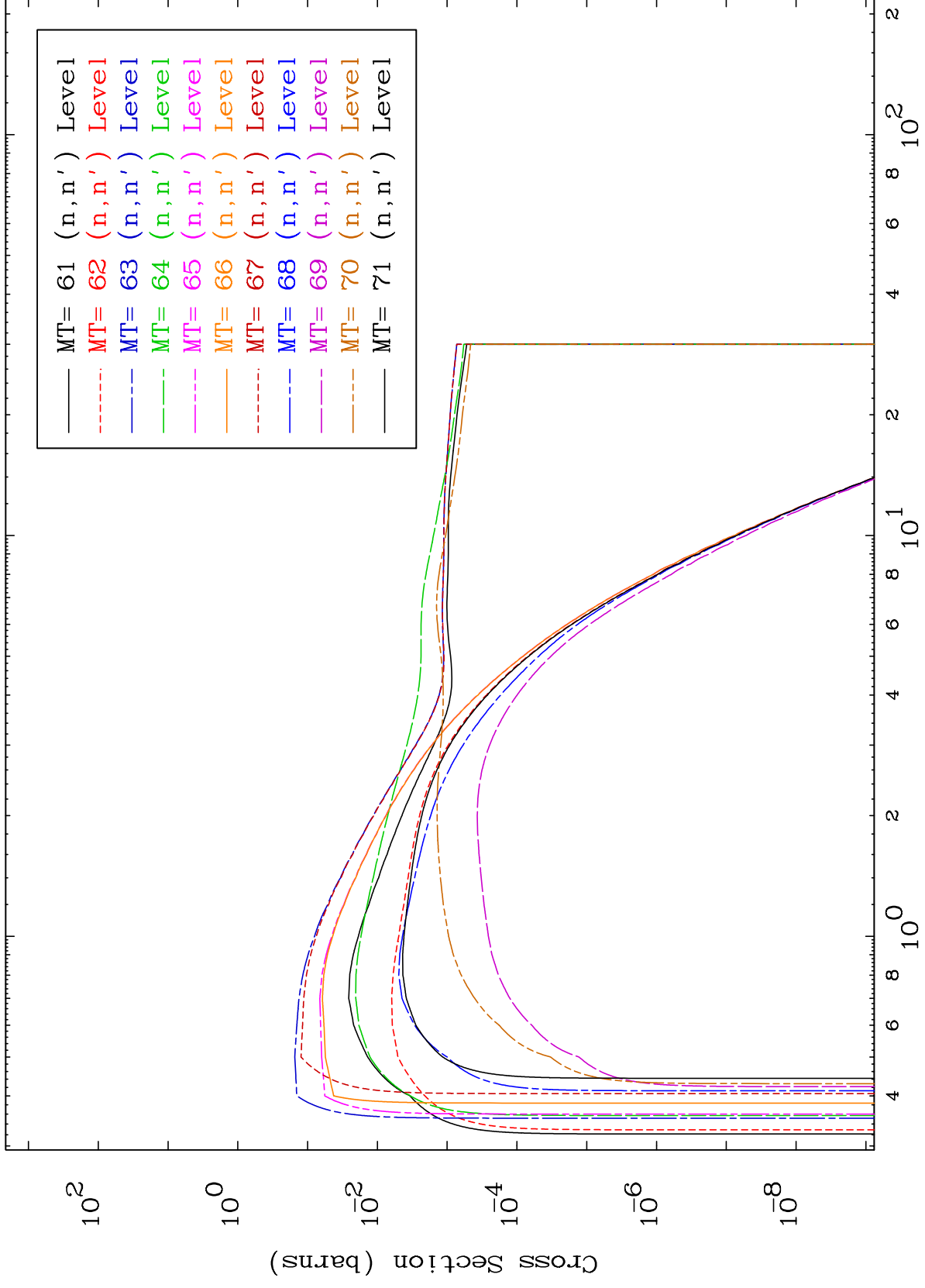

8

Incident Energy (MeV)

69-Tm-170

293 Kelvin Cross Sections

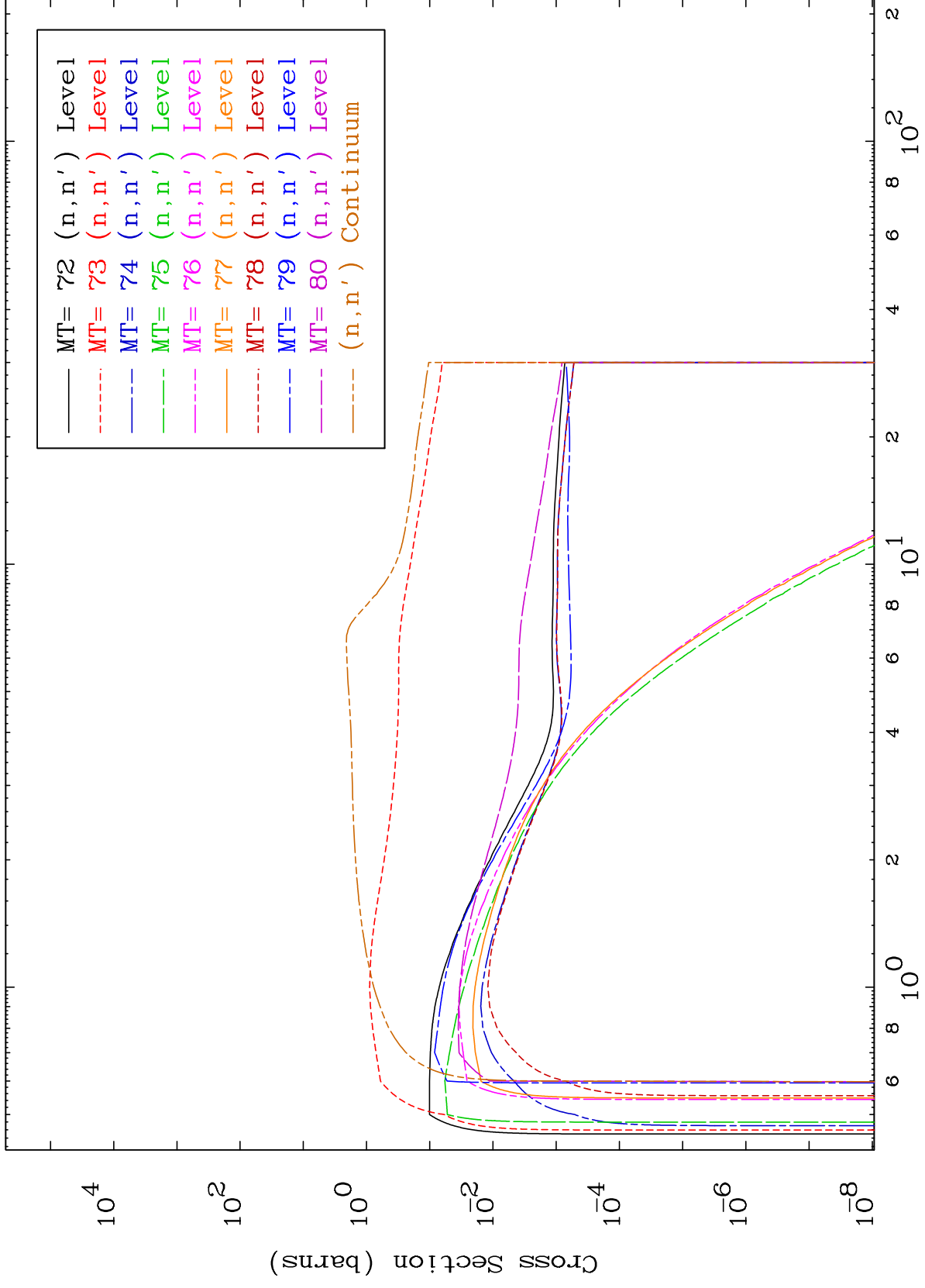

MAT 6928

(n,p) Levels
293 Kelvin Cross Sections

69-Tm-170

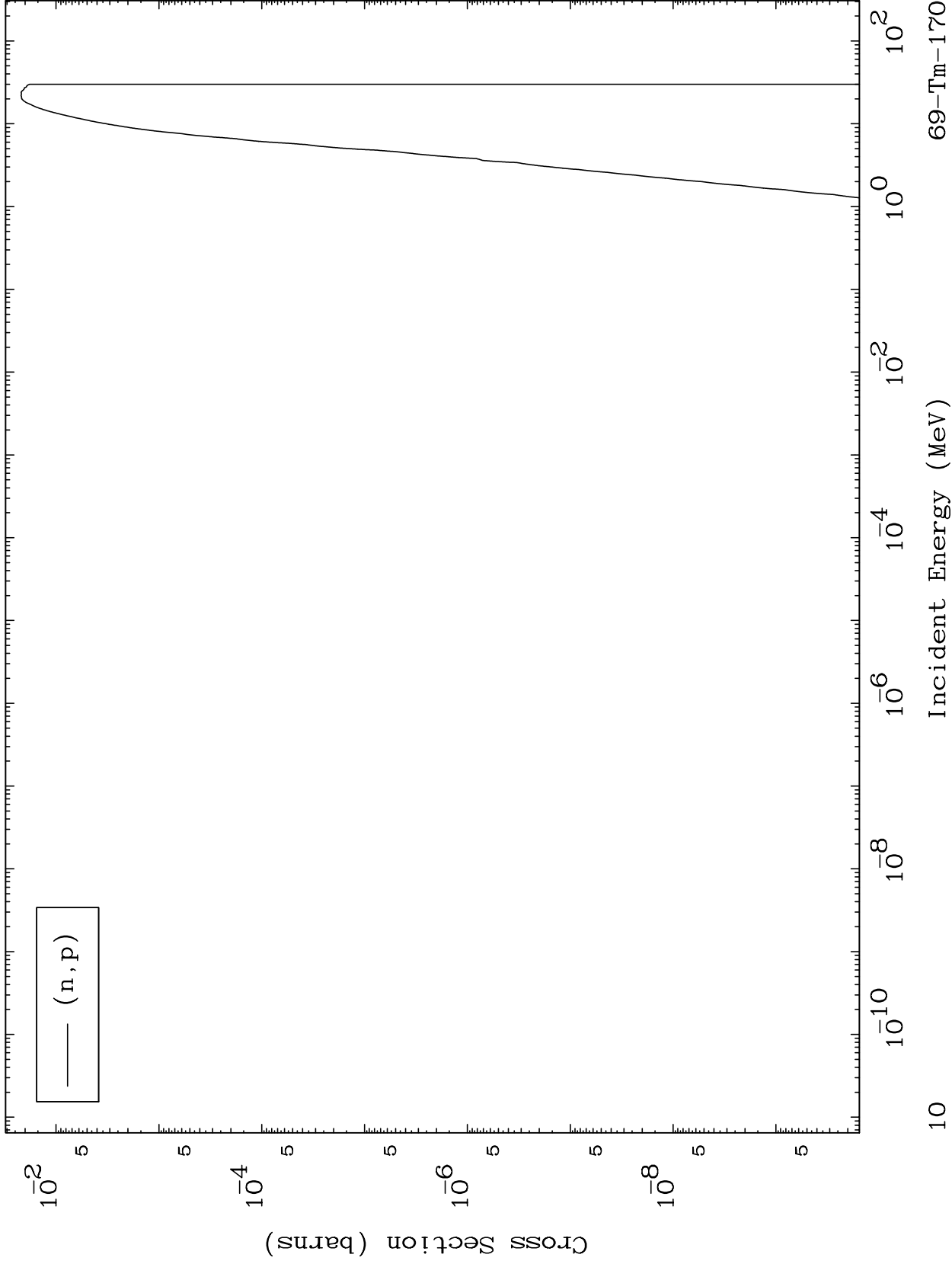

10

Incident Energy (MeV)

69-Tm-170

MAT 6928

(n,d) Levels
293 Kelvin Cross Sections

69-Tm-170

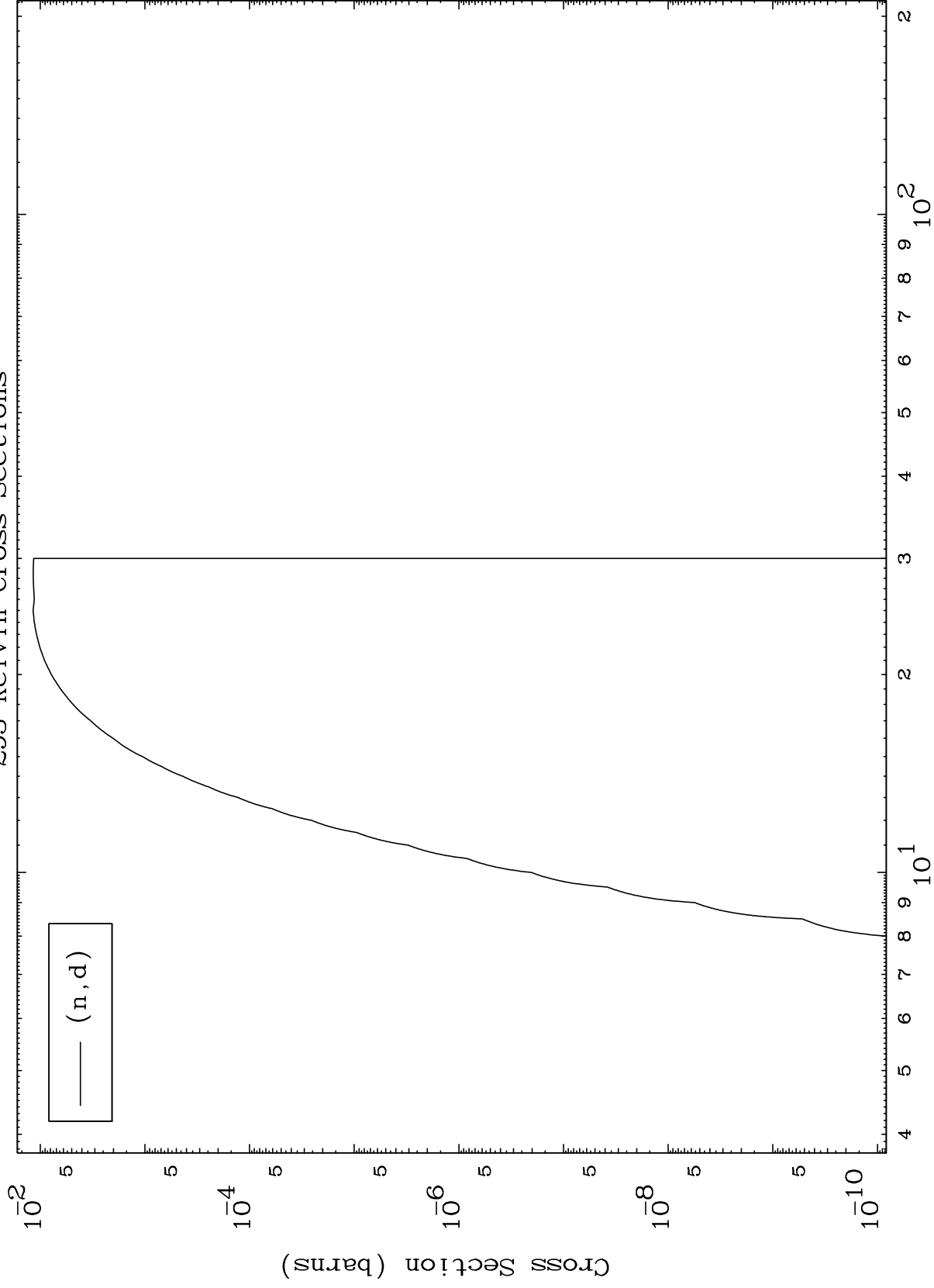

11

Incident Energy (MeV)

69-Tm-170

MAT 6928

(n,t) Levels
293 Kelvin Cross Sections

69-Tm-170

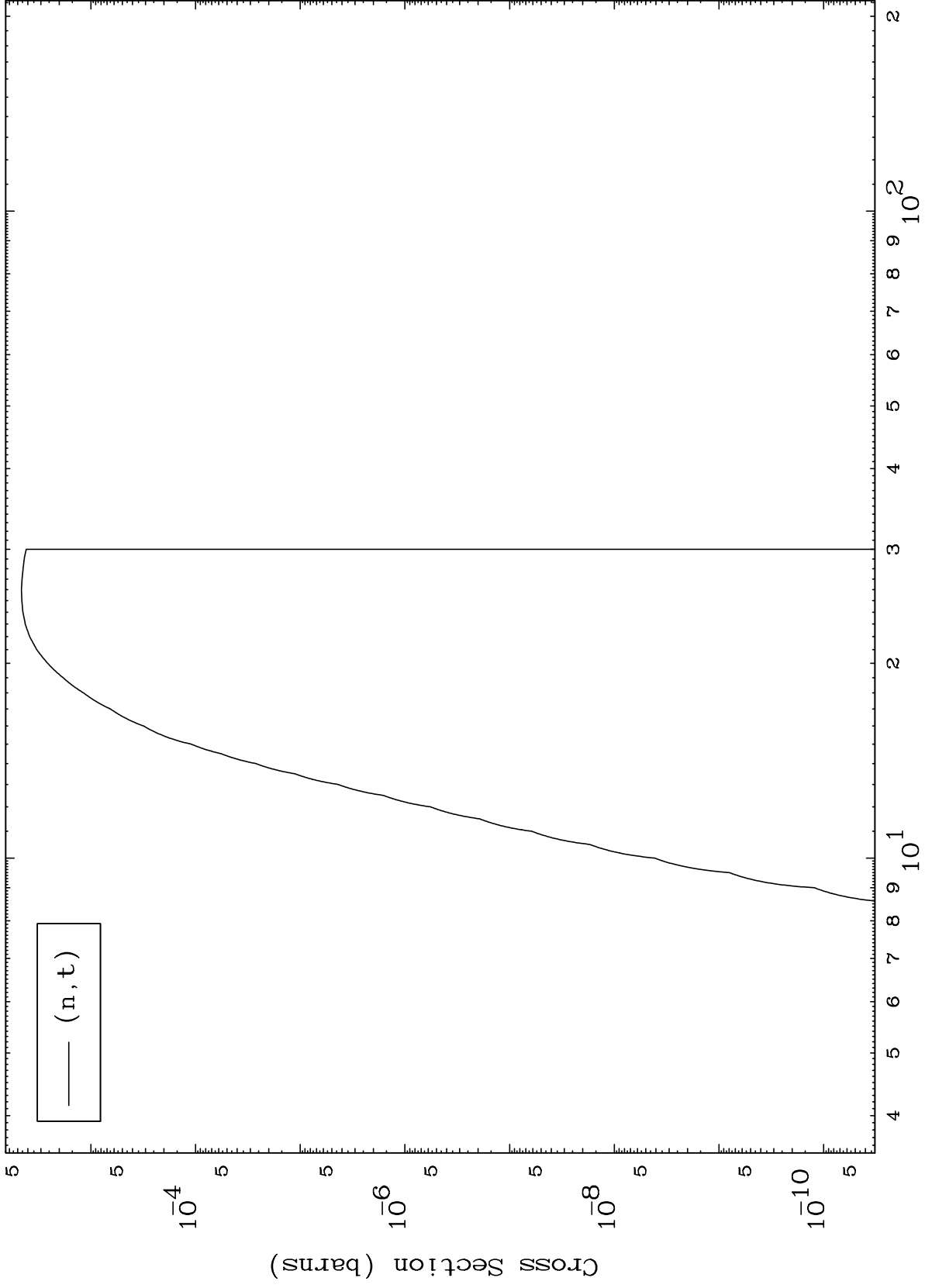

12

Incident Energy (MeV)

69-Tm-170

MAT 6928

(n,He3) Levels
293 Kelvin Cross Sections

69-Tm-170

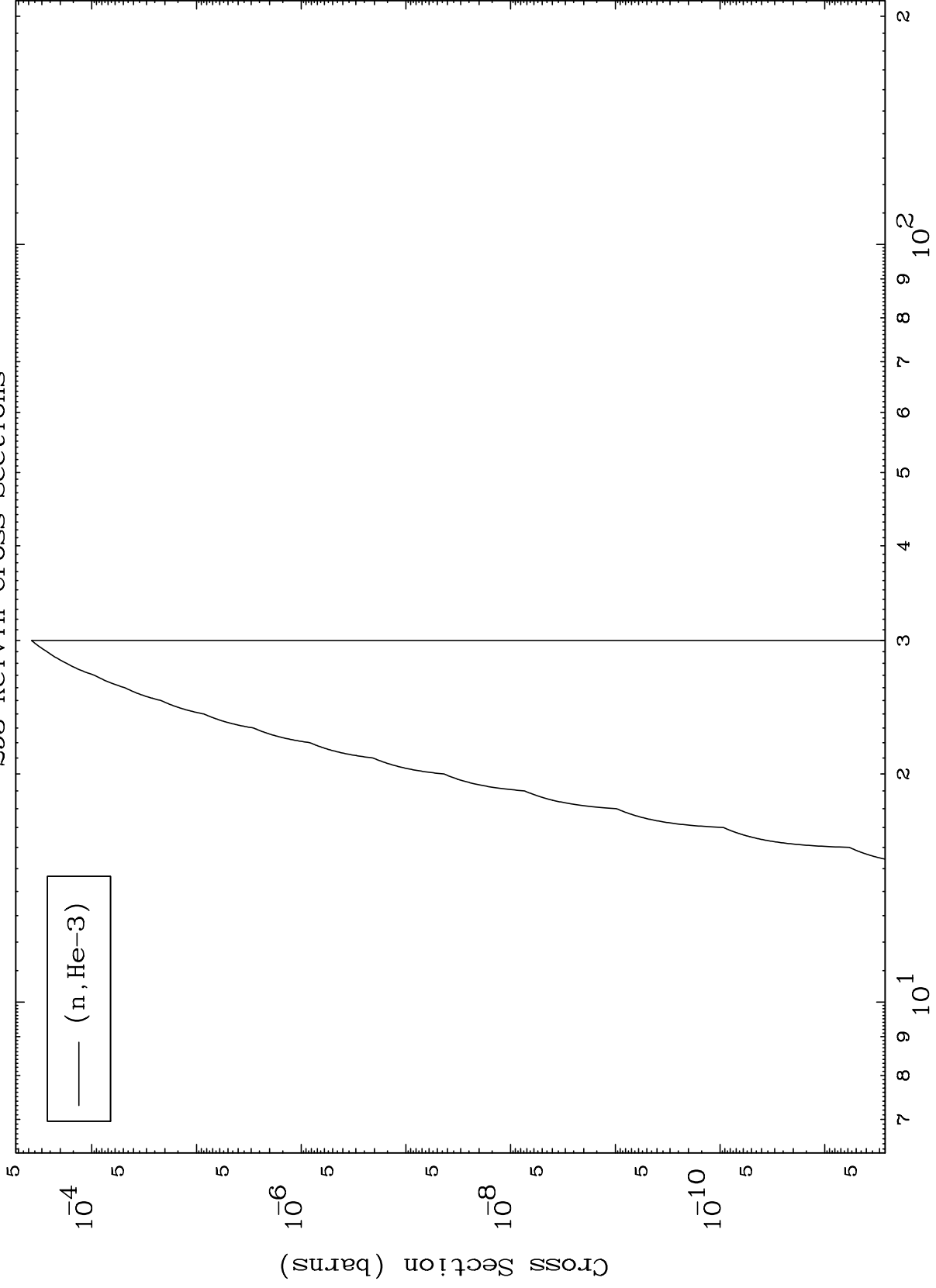

MAT 6928

(n,α) Levels
293 Kelvin Cross Sections

69-Tm-170

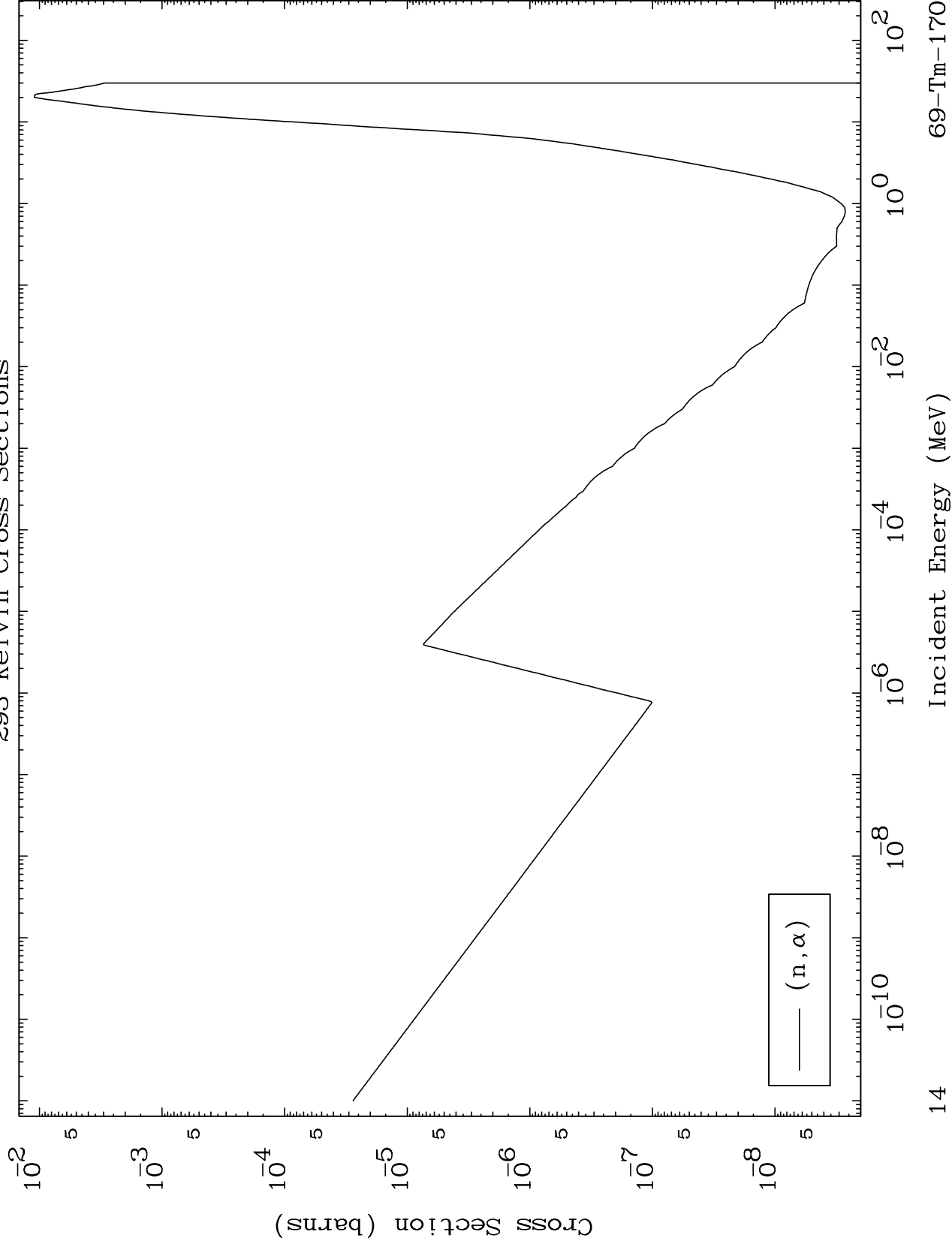

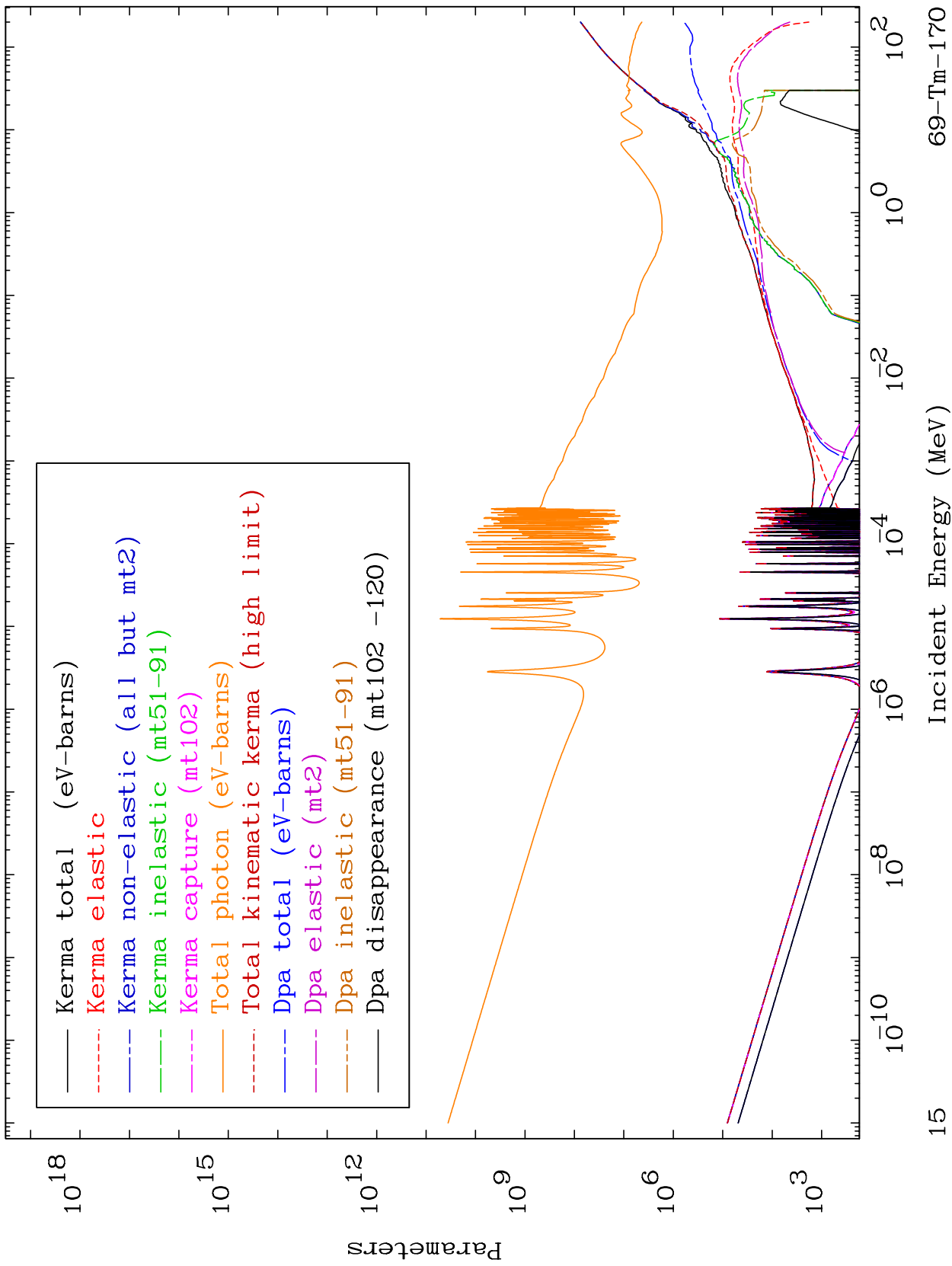

MAT 6928

Elastic Legendre Coefficients

69-Tm-170

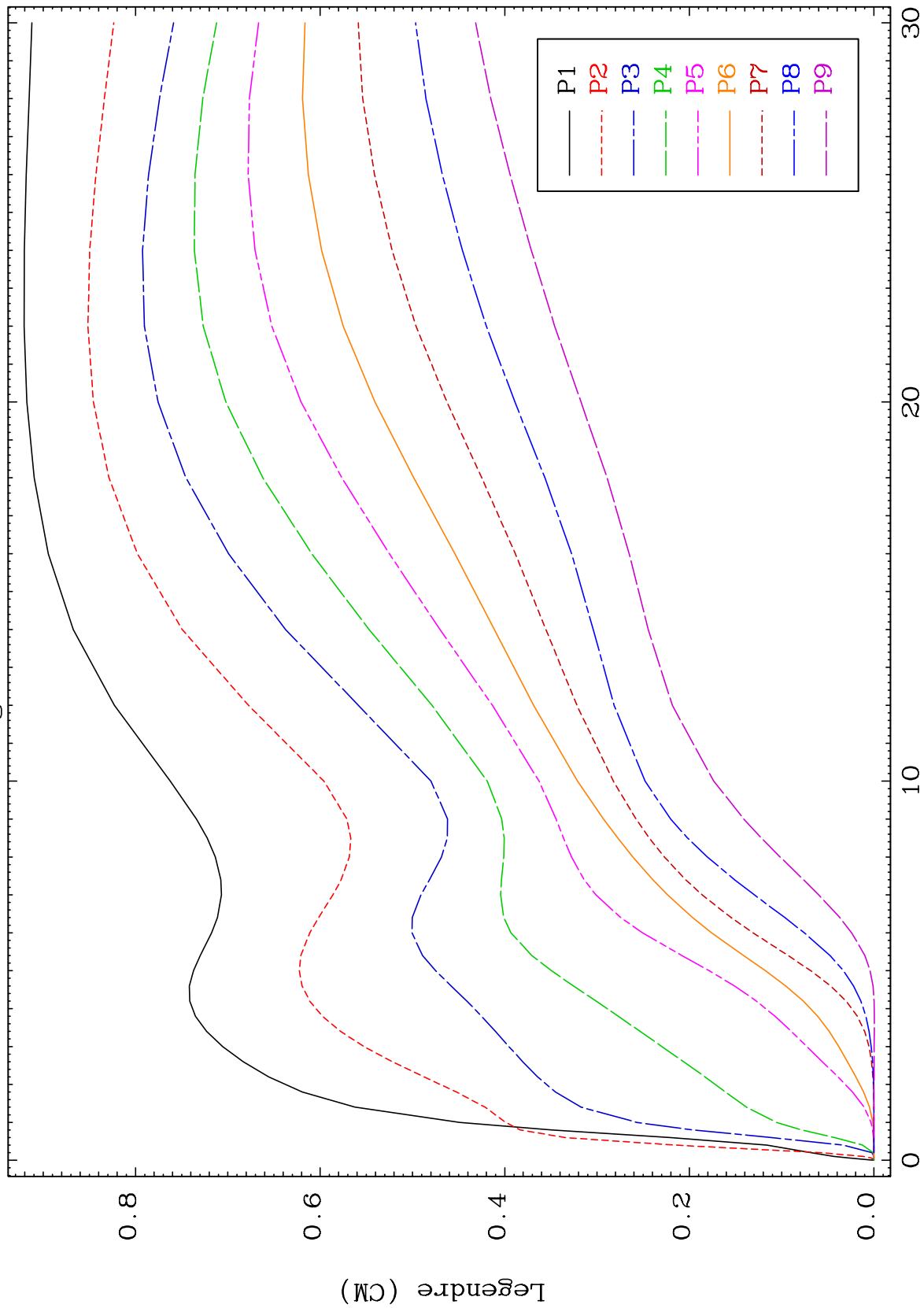

16

Incident Energy (MeV)

69-Tm-170

MAT 6928

Elastic Legendre Coefficients

69-Tm-170

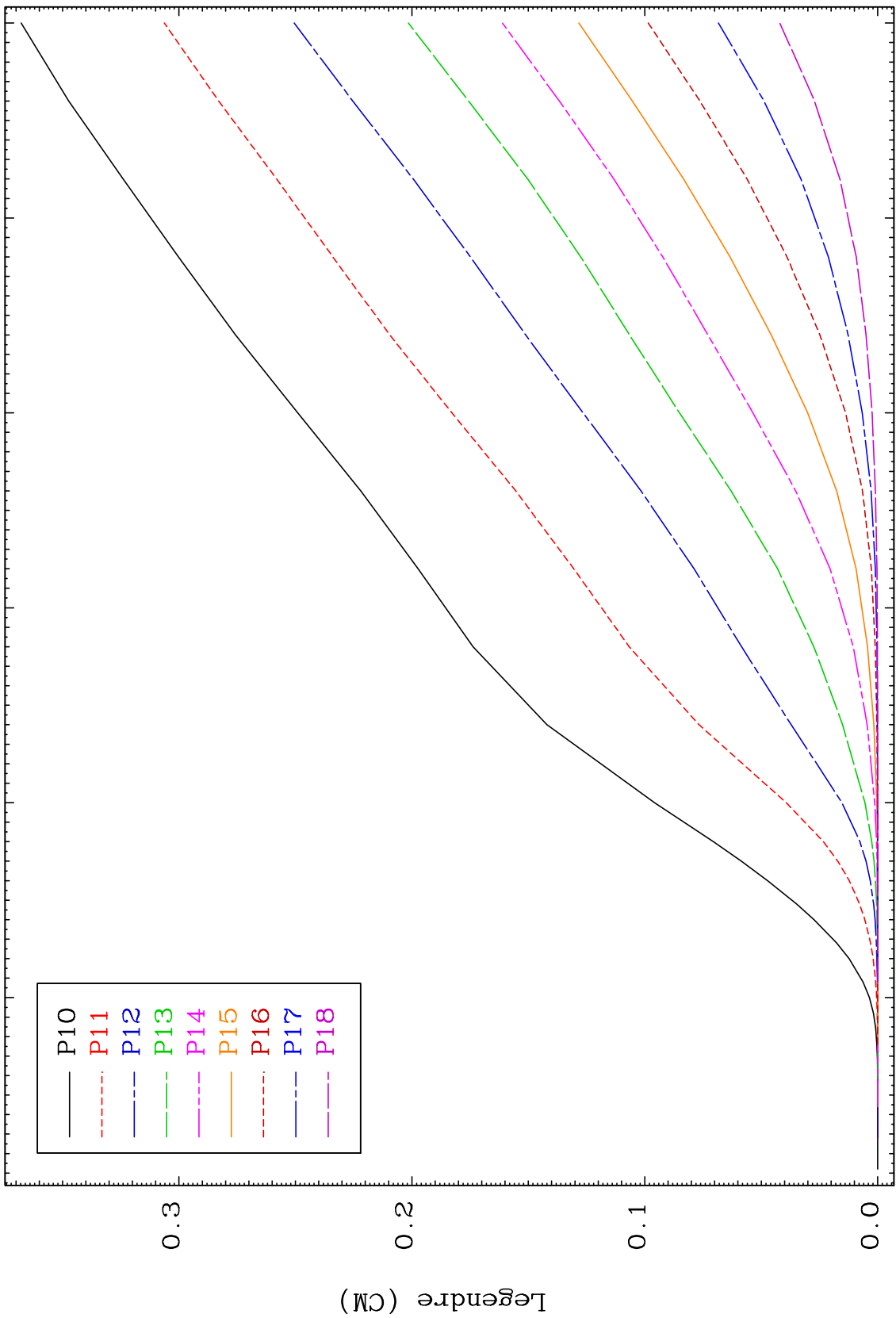

17

Incident Energy (MeV)

69-Tm-170

MAT 6928

Elastic Legendre Coefficients

69-Tm-170

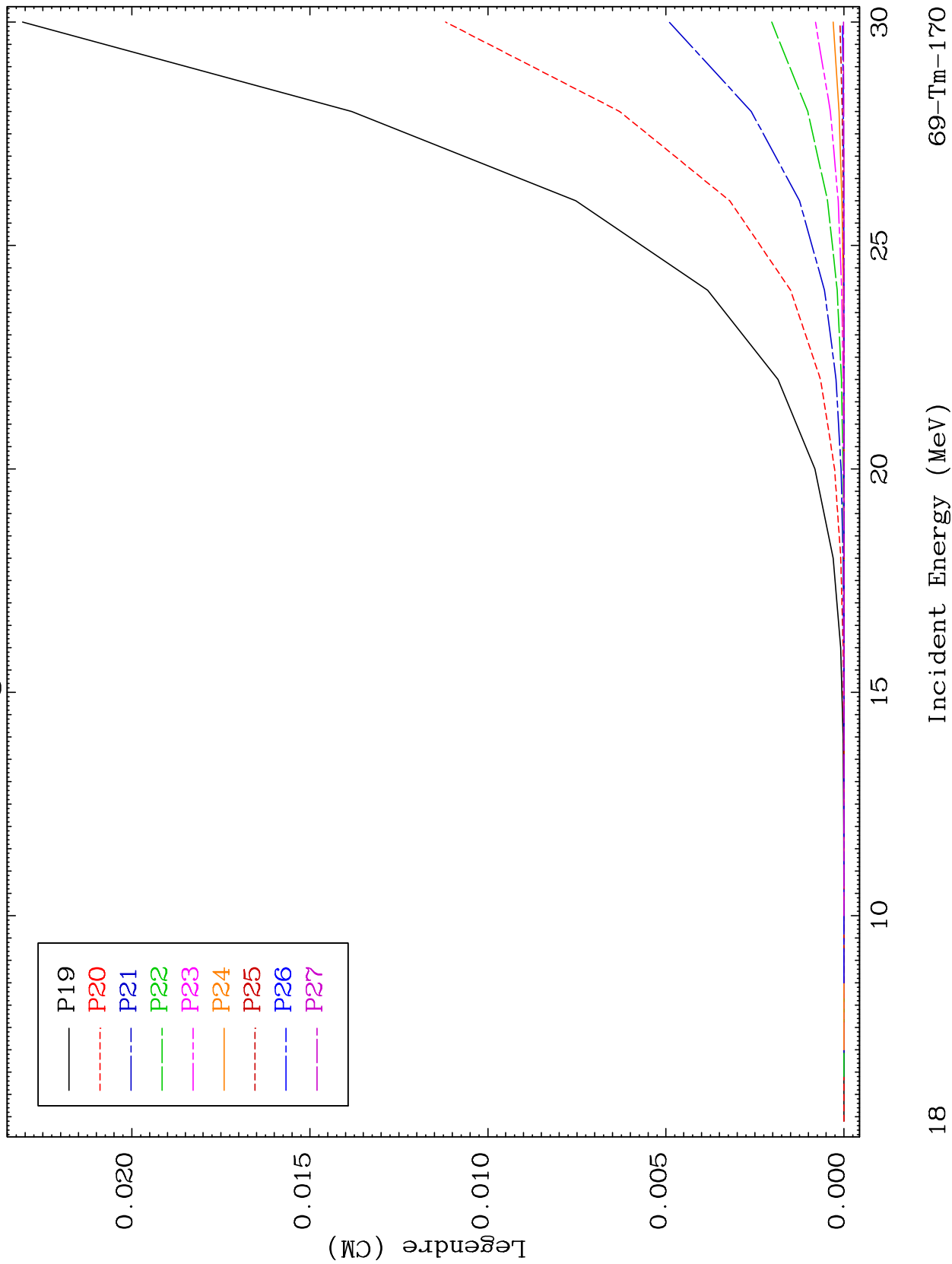

18

Incident Energy (MeV)

69-Tm-170

MAT 6928

Elastic Legendre Coefficients

69-Tm-170

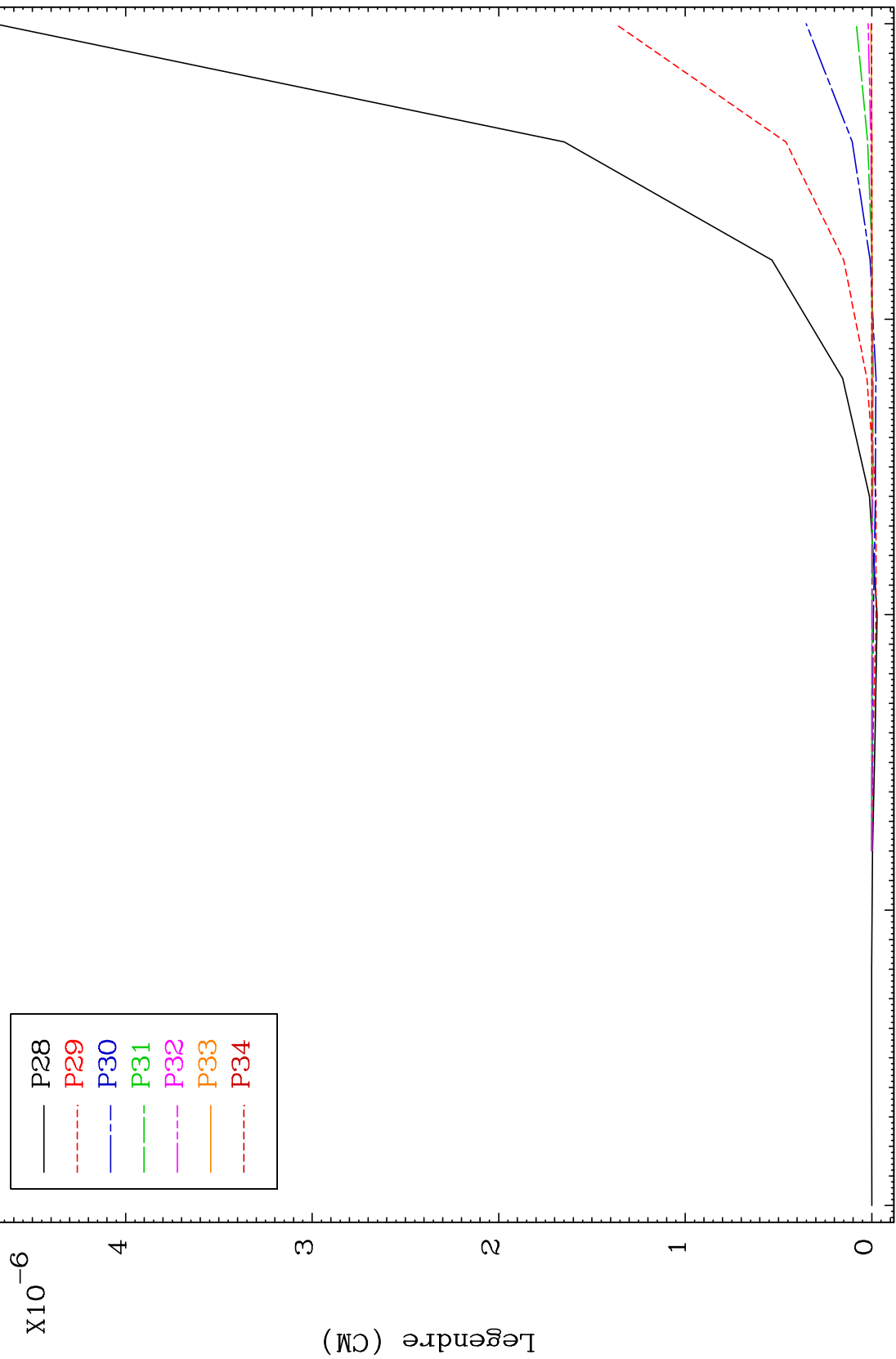
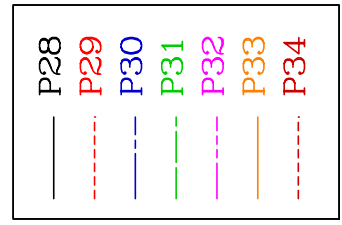

10

15

20

25

30

Incident Energy (MeV)

69-Tm-170

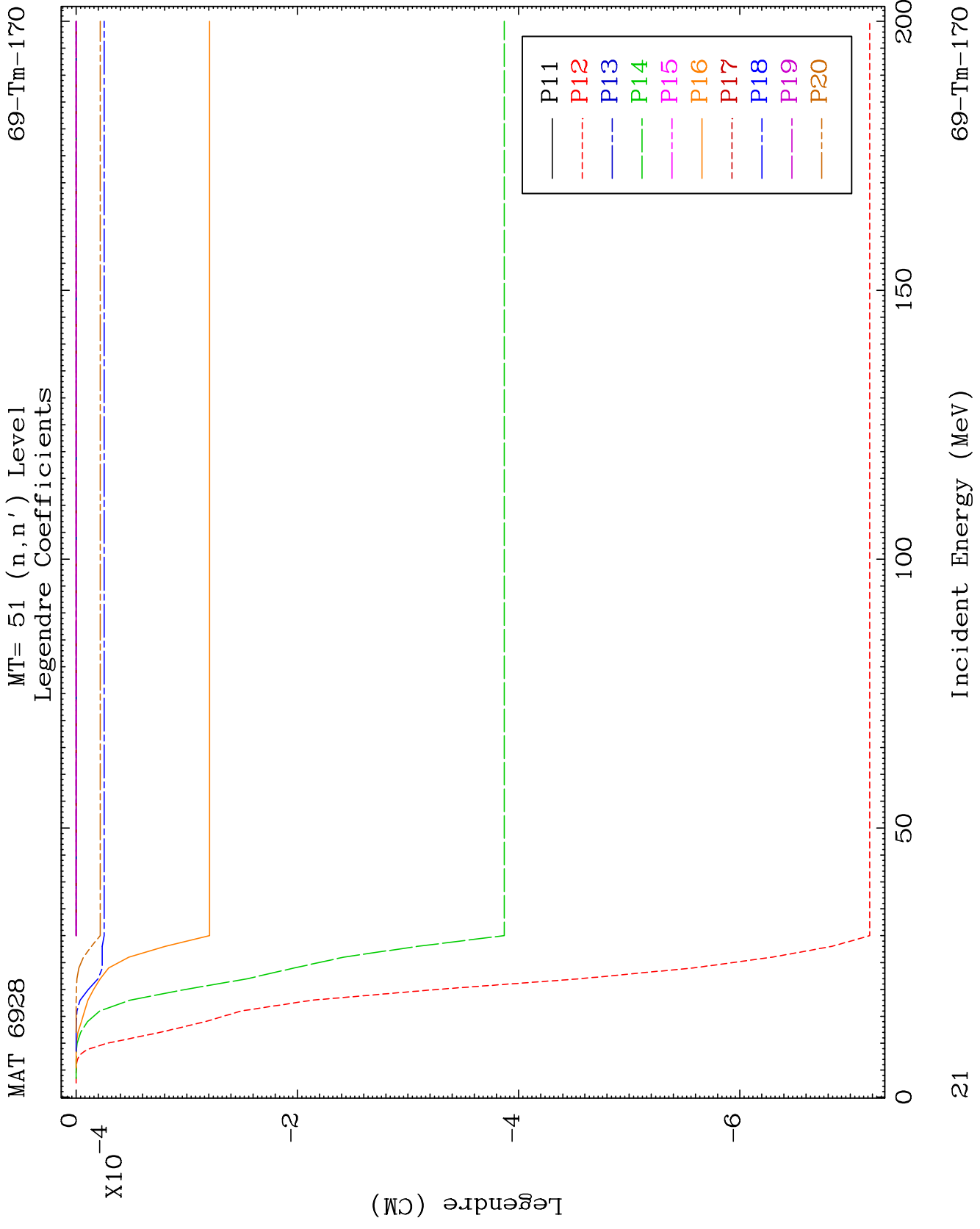

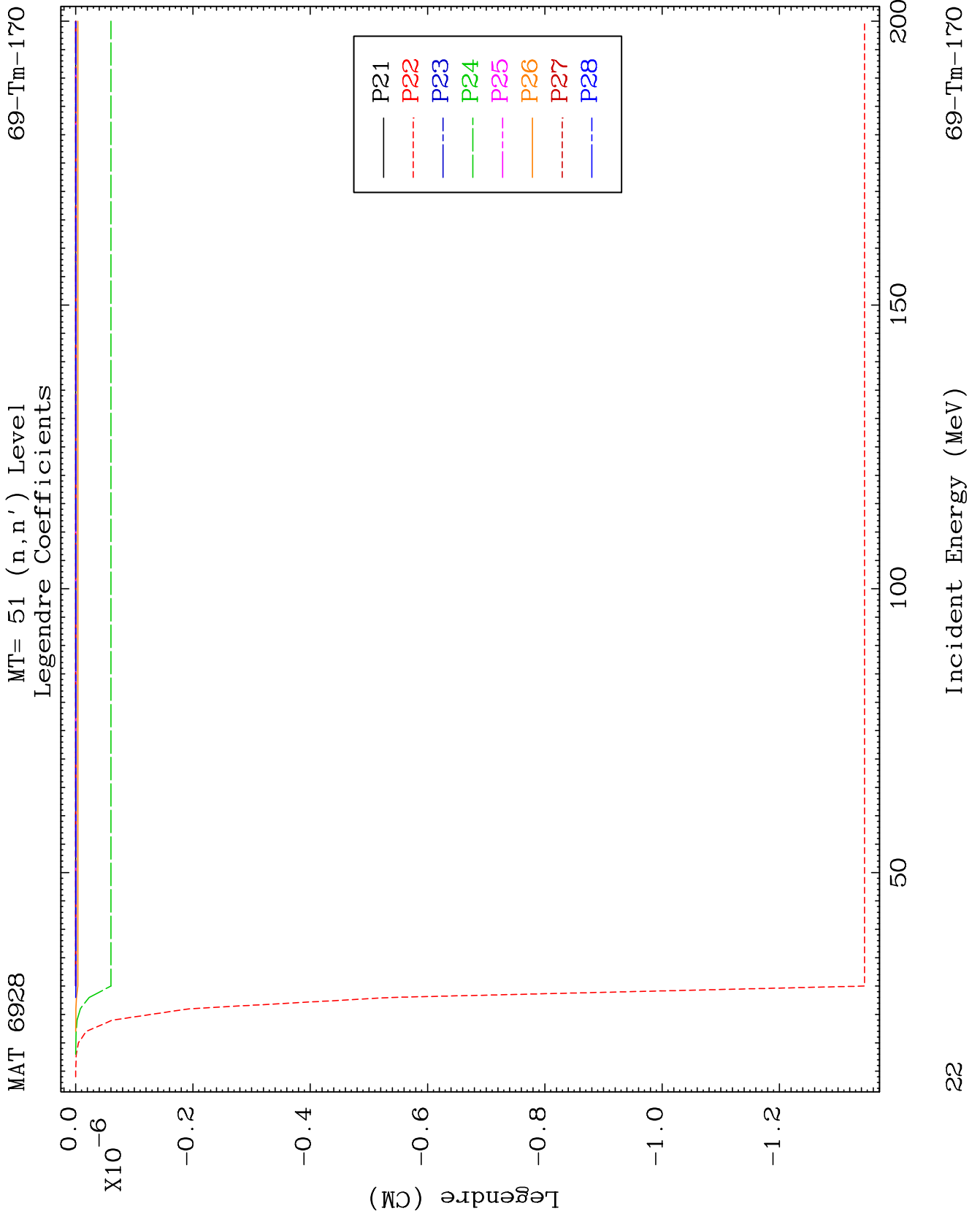

MAT 6928

MT= 52 (n,n') Level
Legendre Coefficients

69-Tm-170

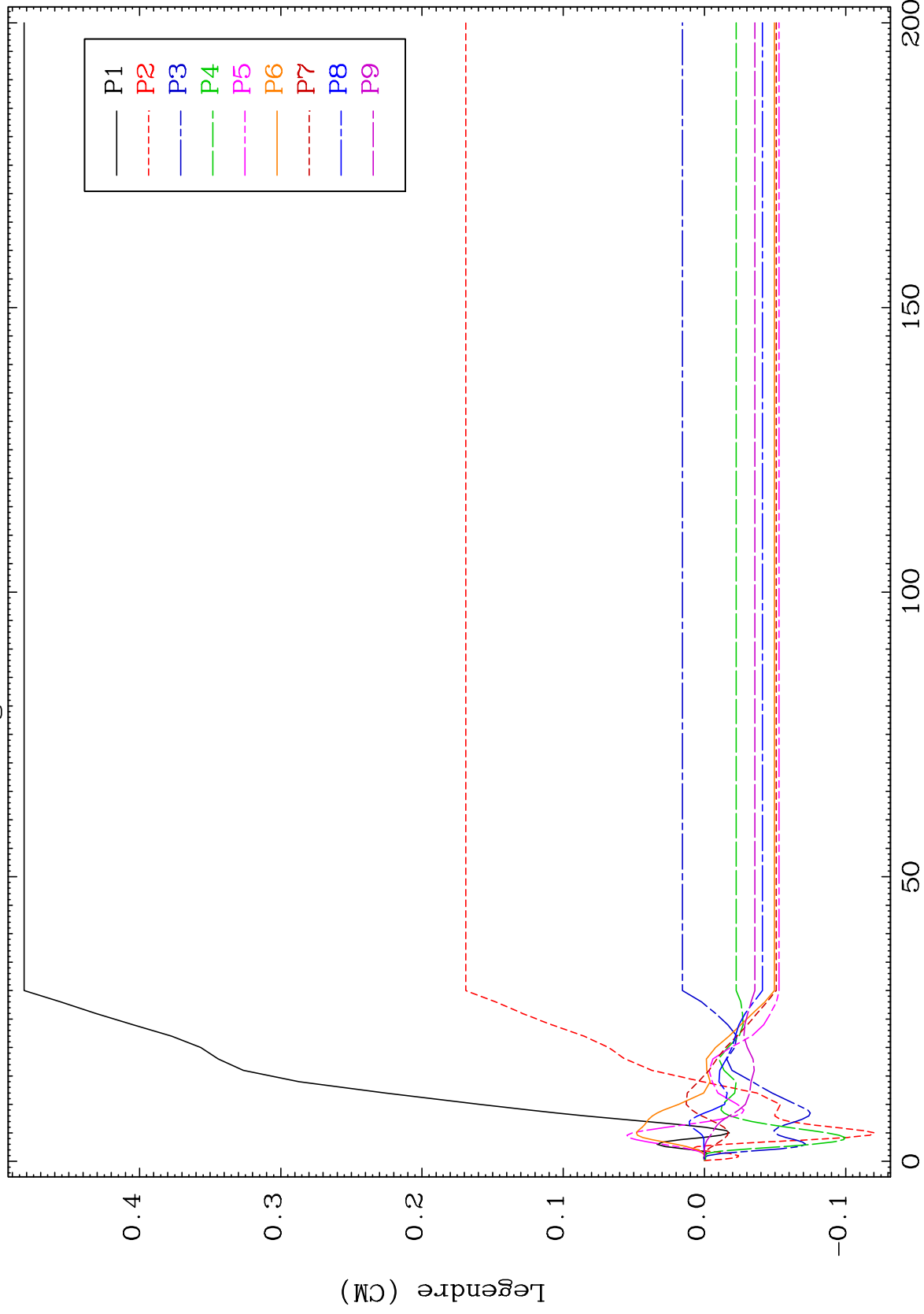

23

Incident Energy (MeV)

69-Tm-170

MAT 6928

MT= 52 (n,n') Level
Legendre Coefficients

69-Tm-170

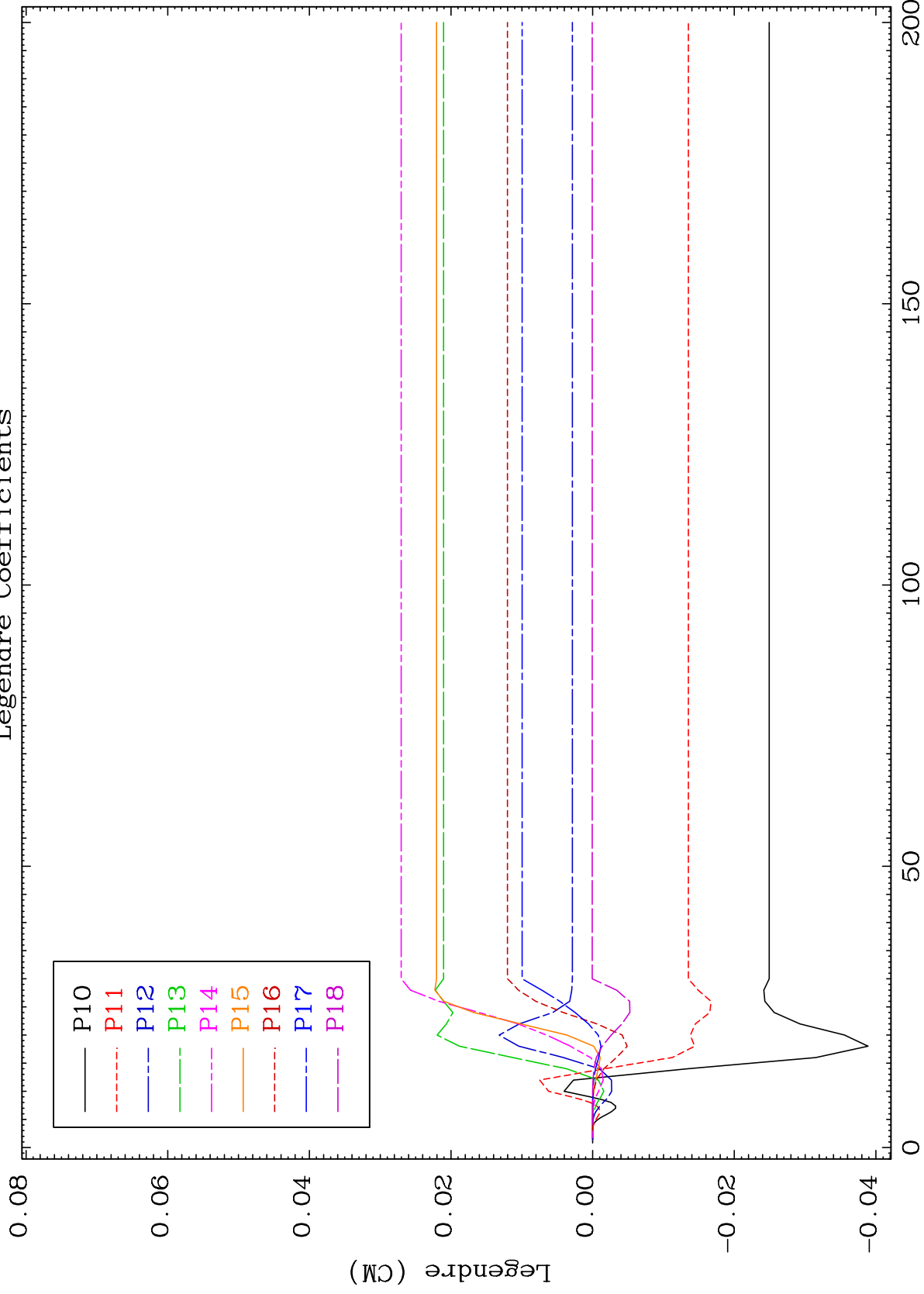

24

Incident Energy (MeV)

69-Tm-170

MAT 6928

MT= 52 (n,n') Level
Legendre Coefficients

69-Tm-170

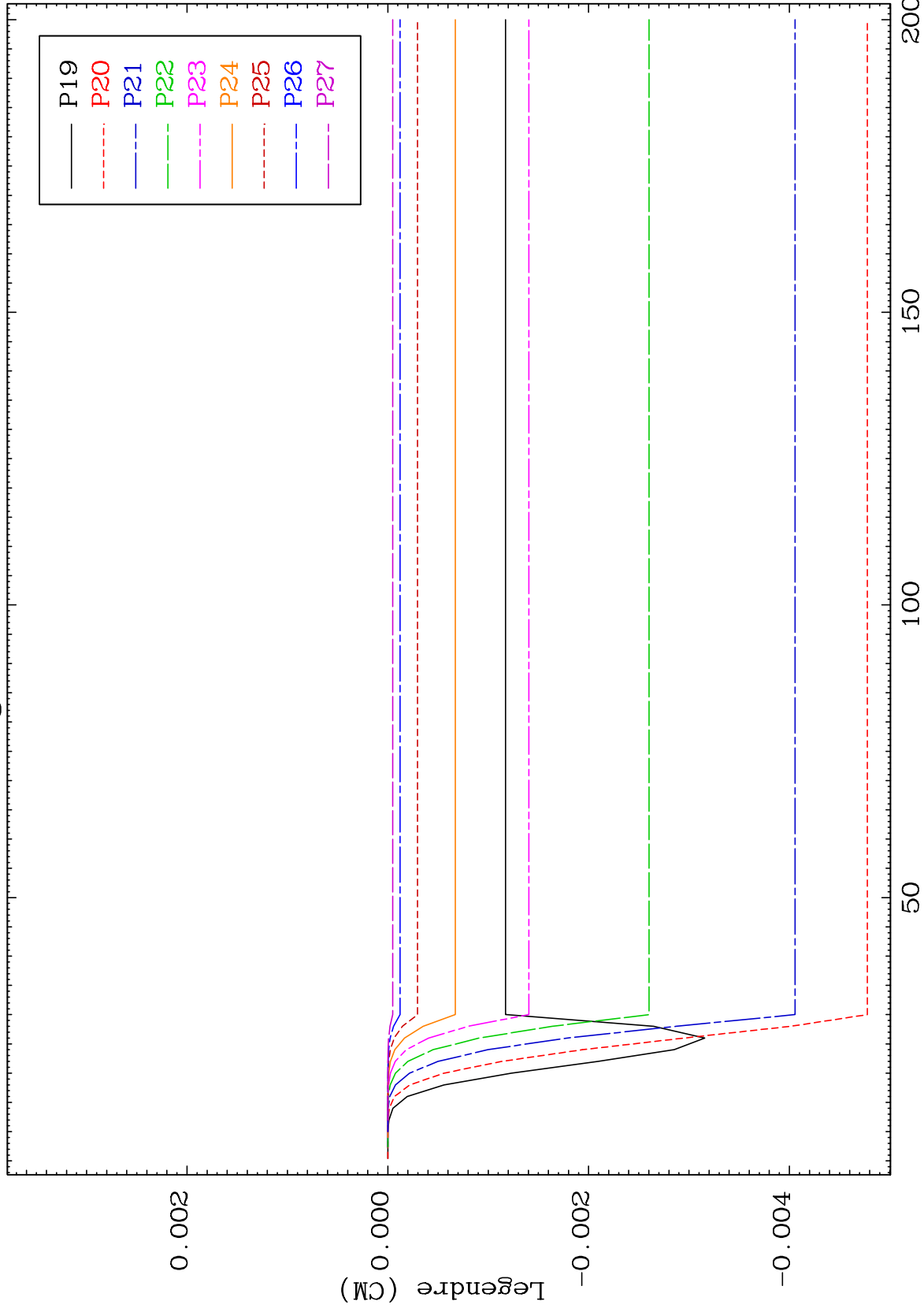

25

Incident Energy (MeV)

69-Tm-170

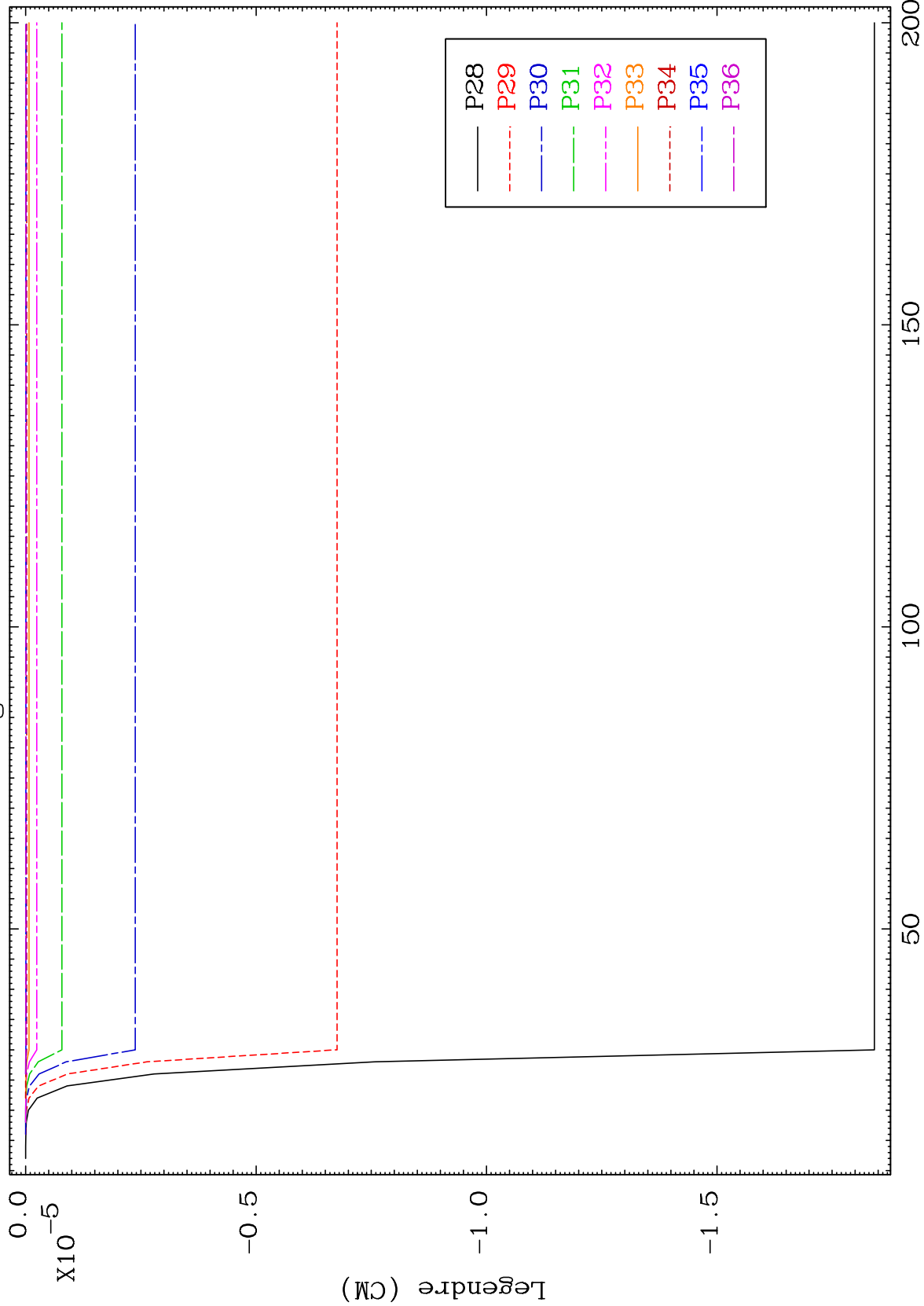

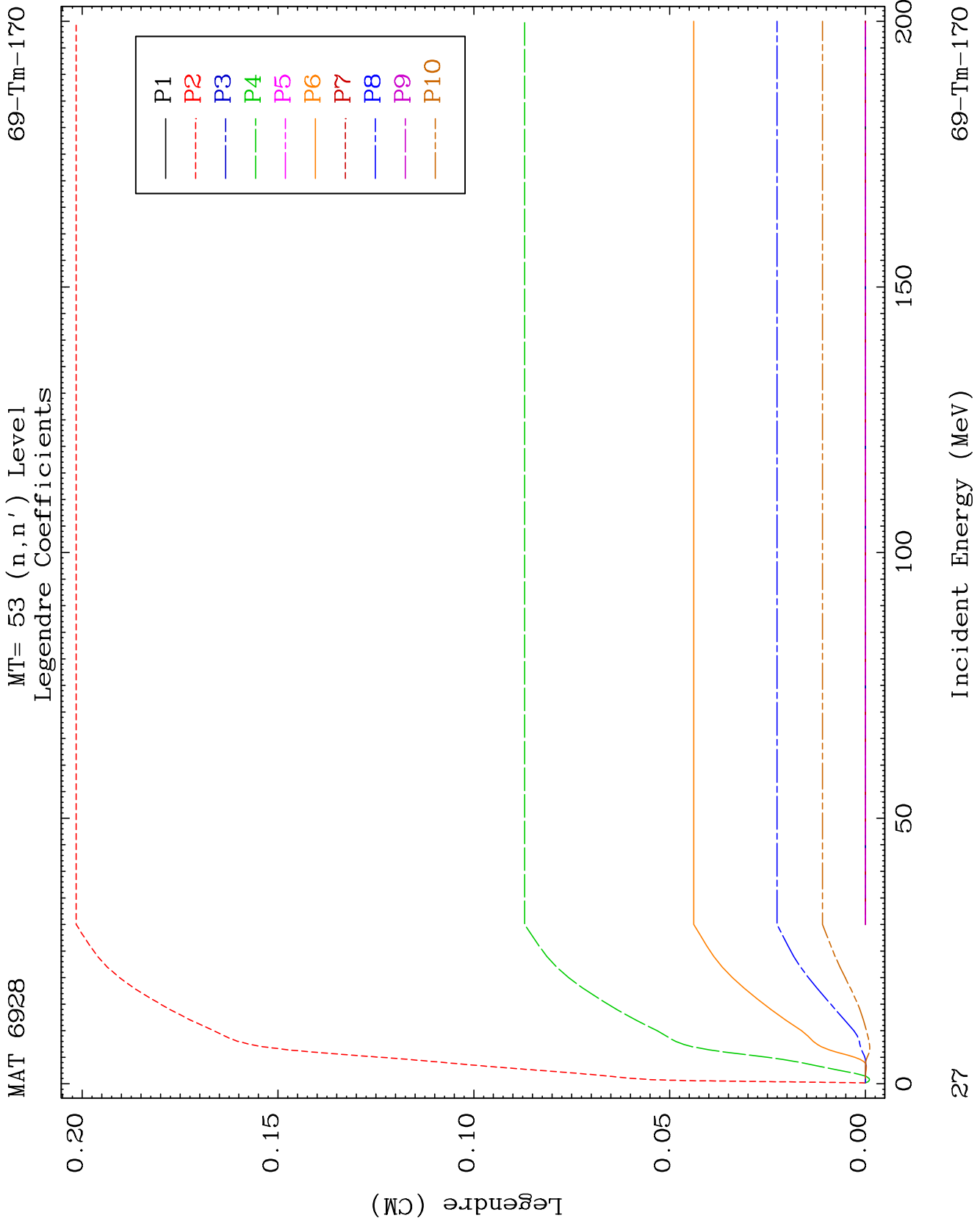

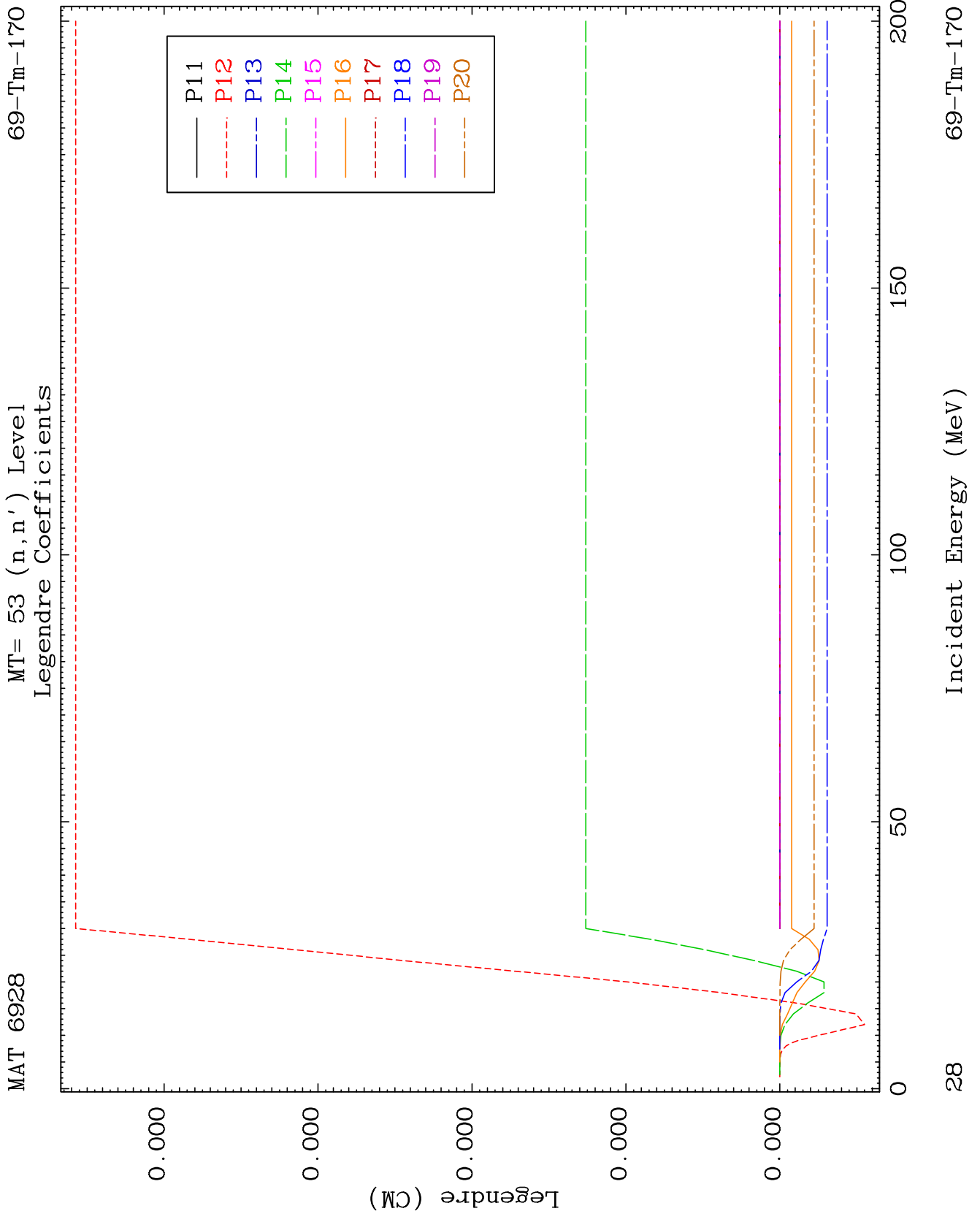

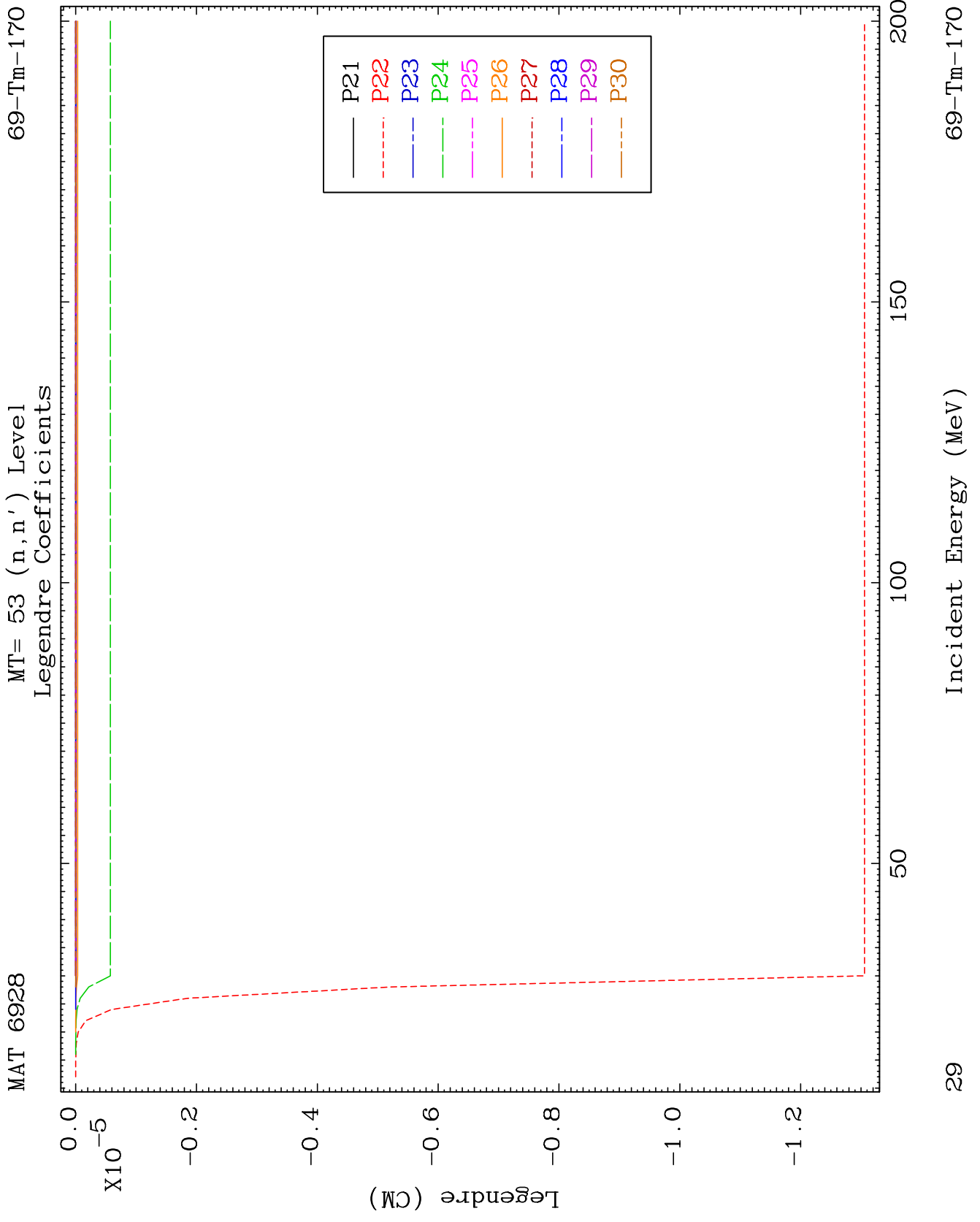

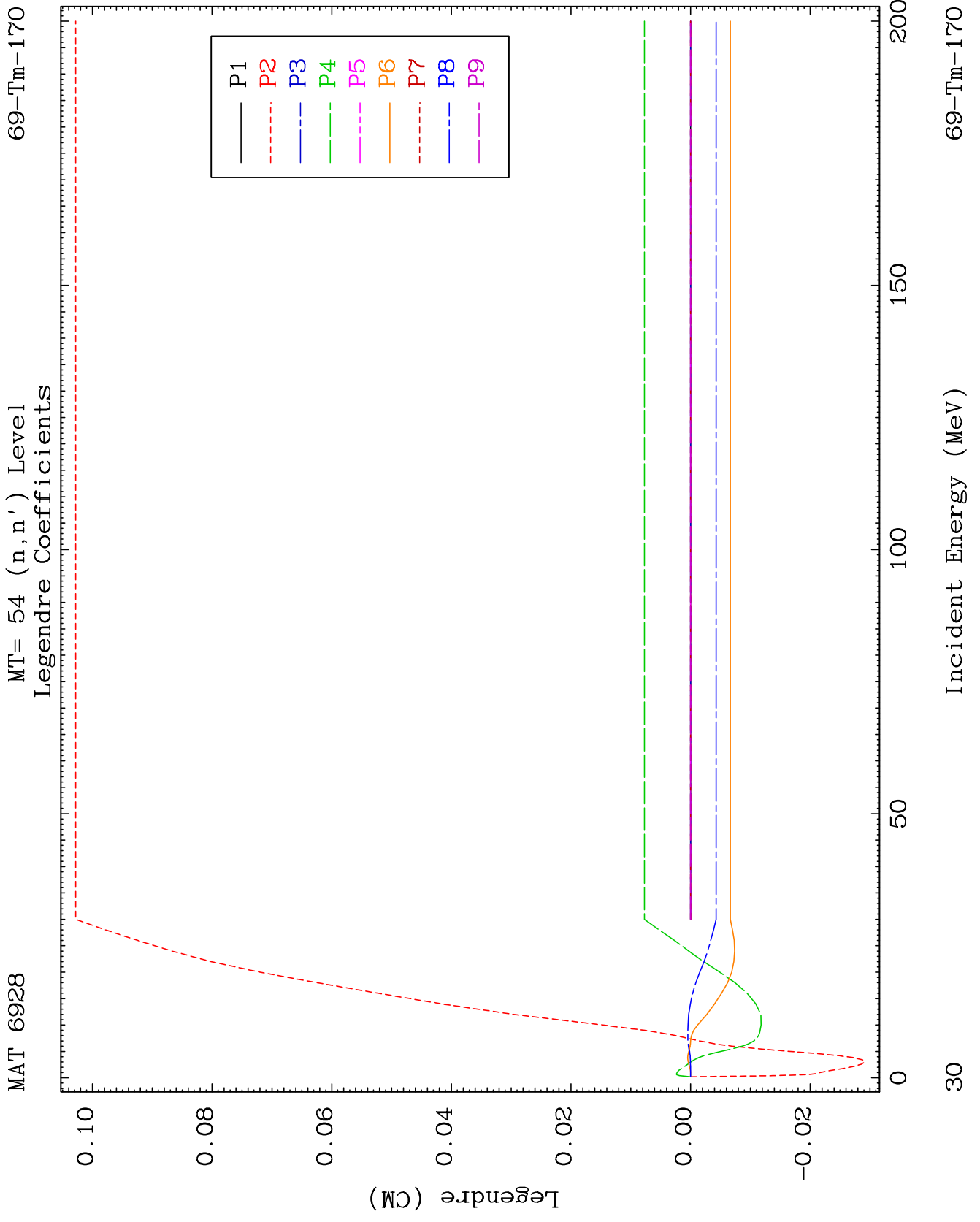

MAT 6928

MT= 54 (n,n') Level
Legendre Coefficients

69-Tm-170

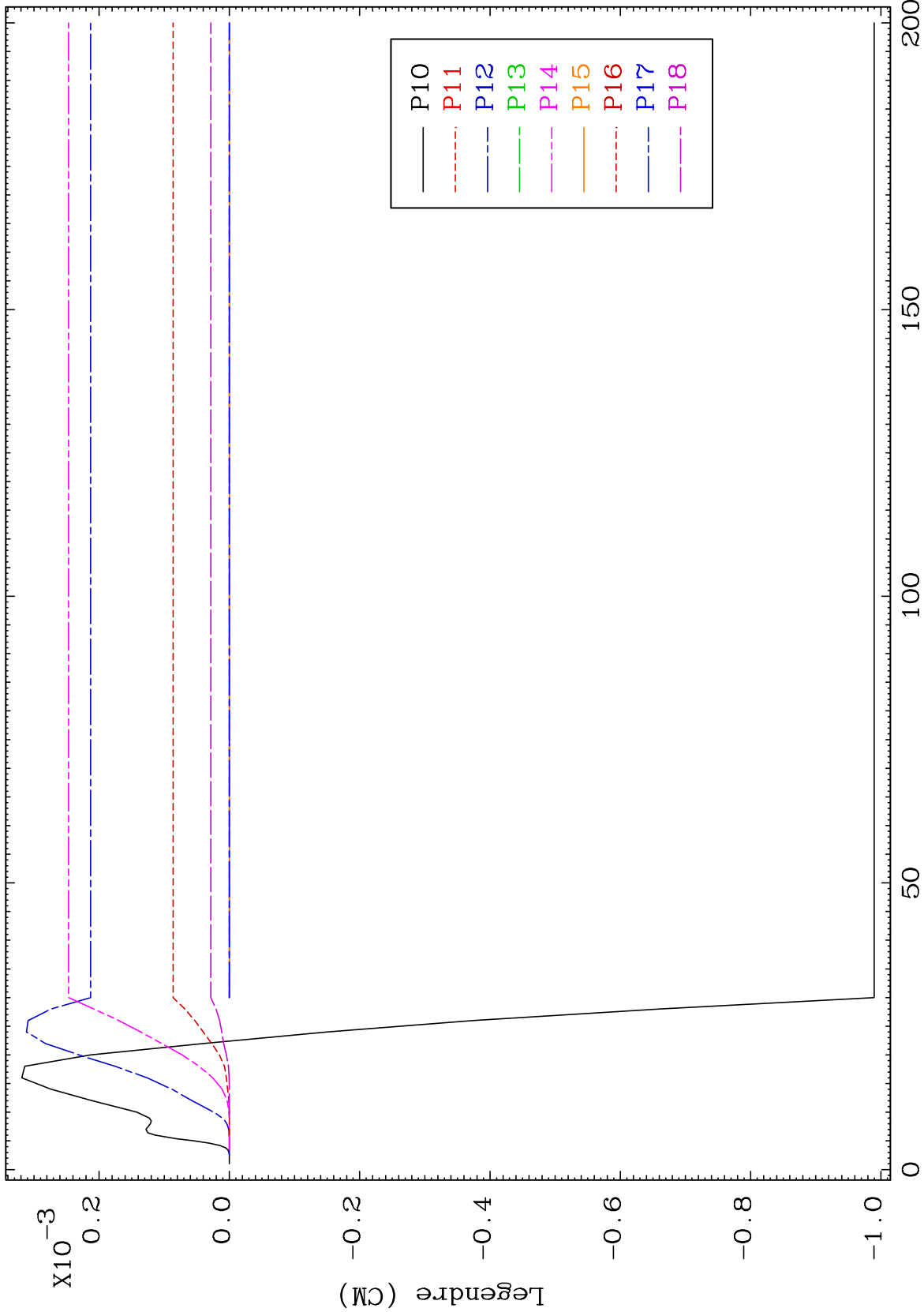

31

Incident Energy (MeV)

69-Tm-170

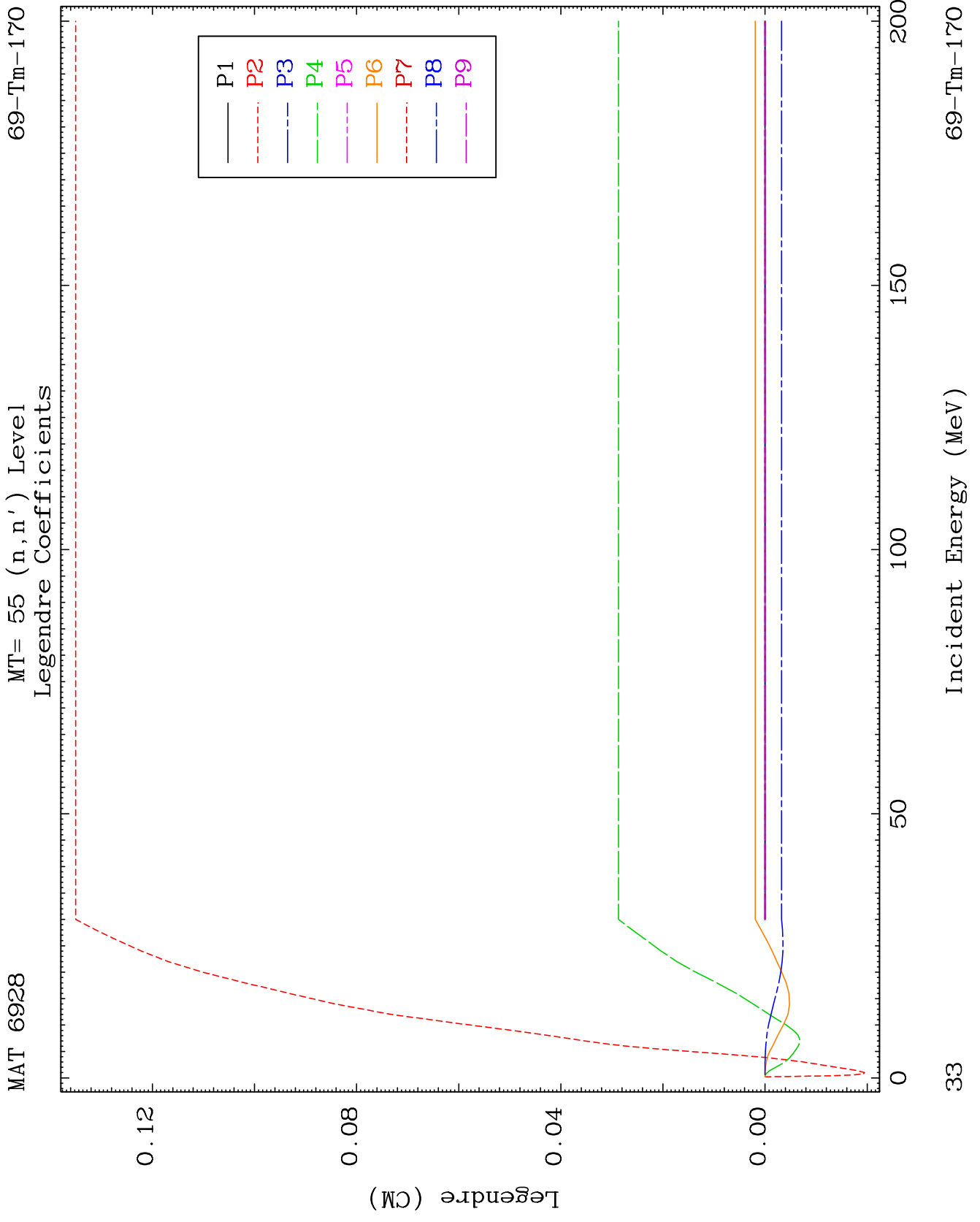

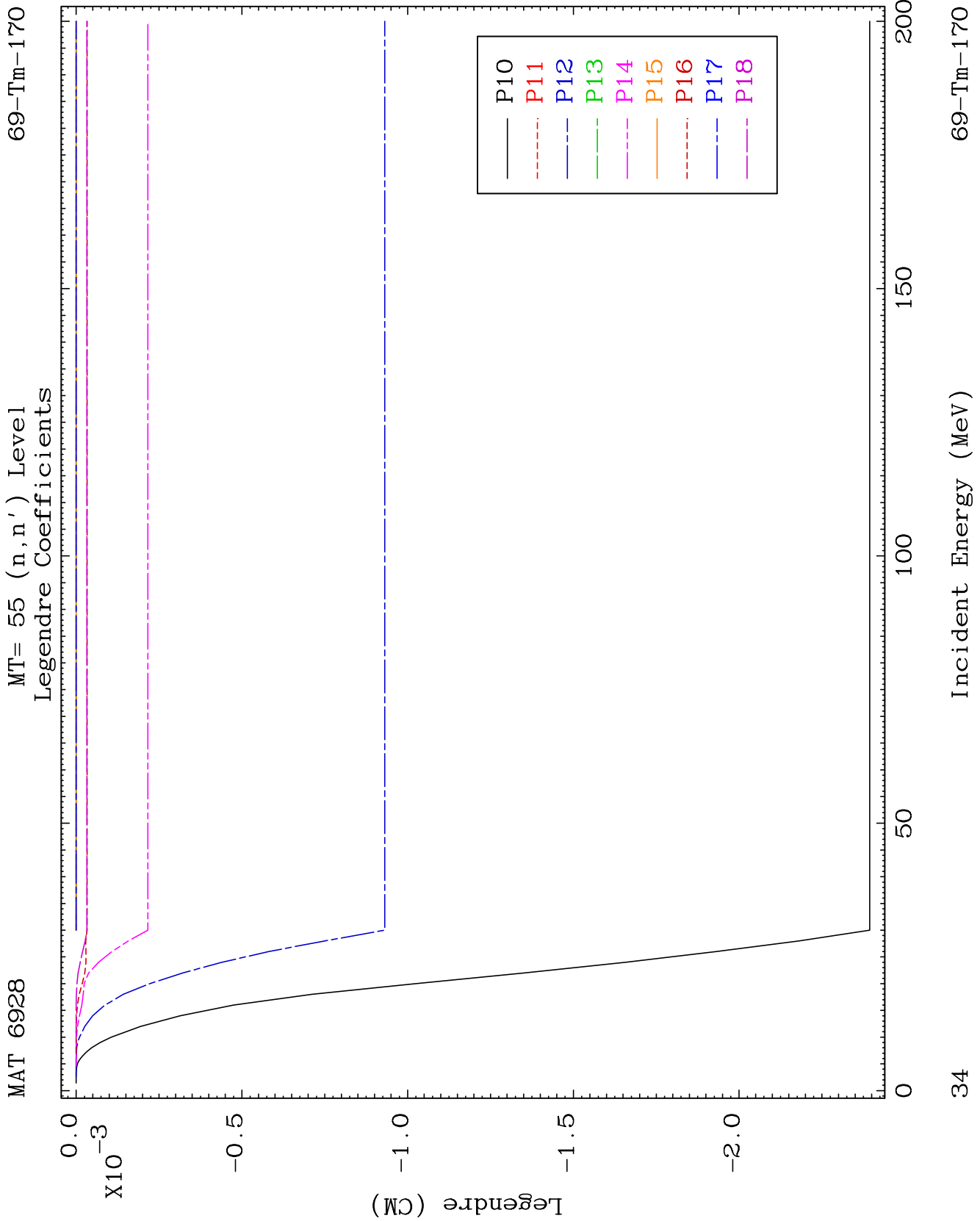

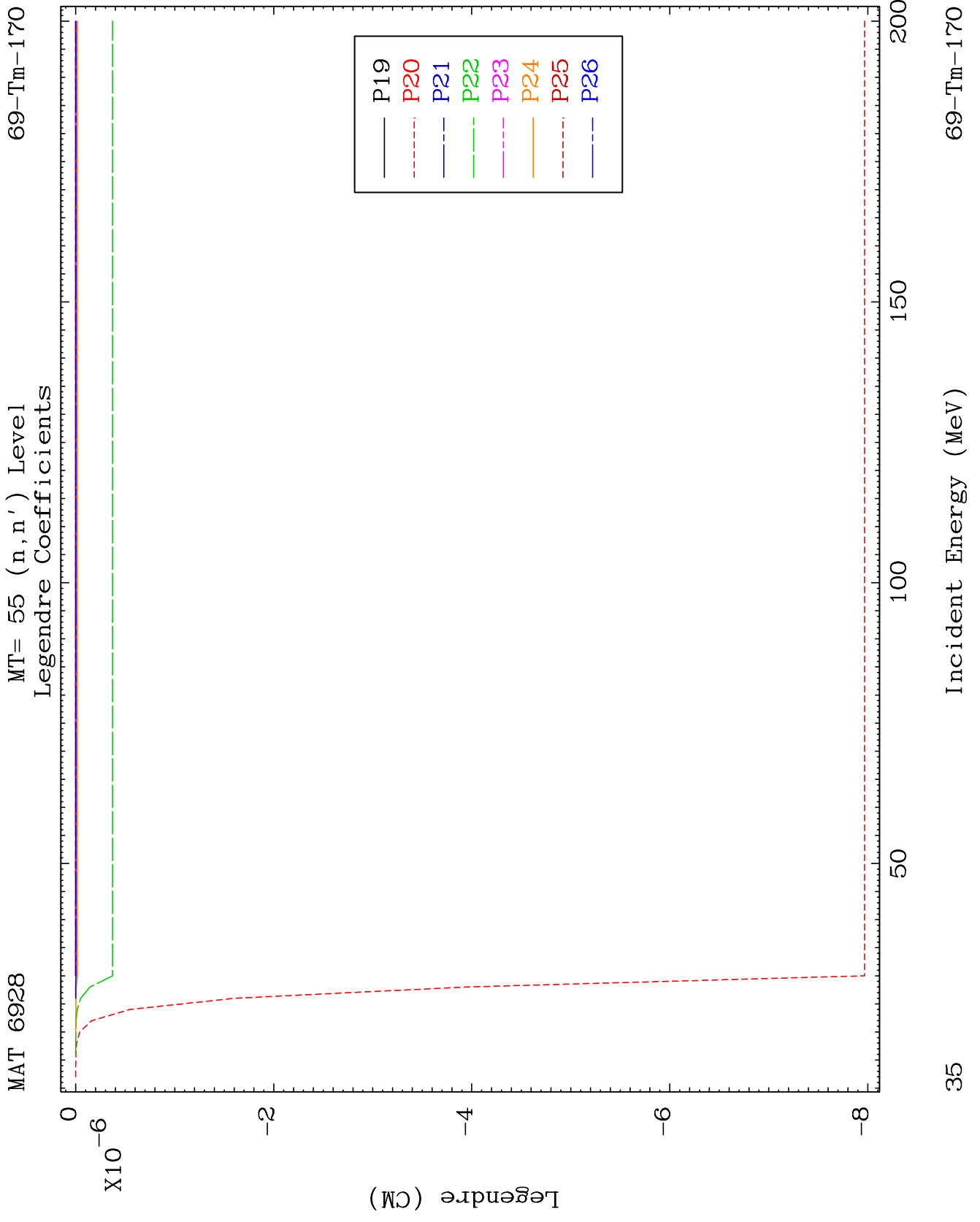

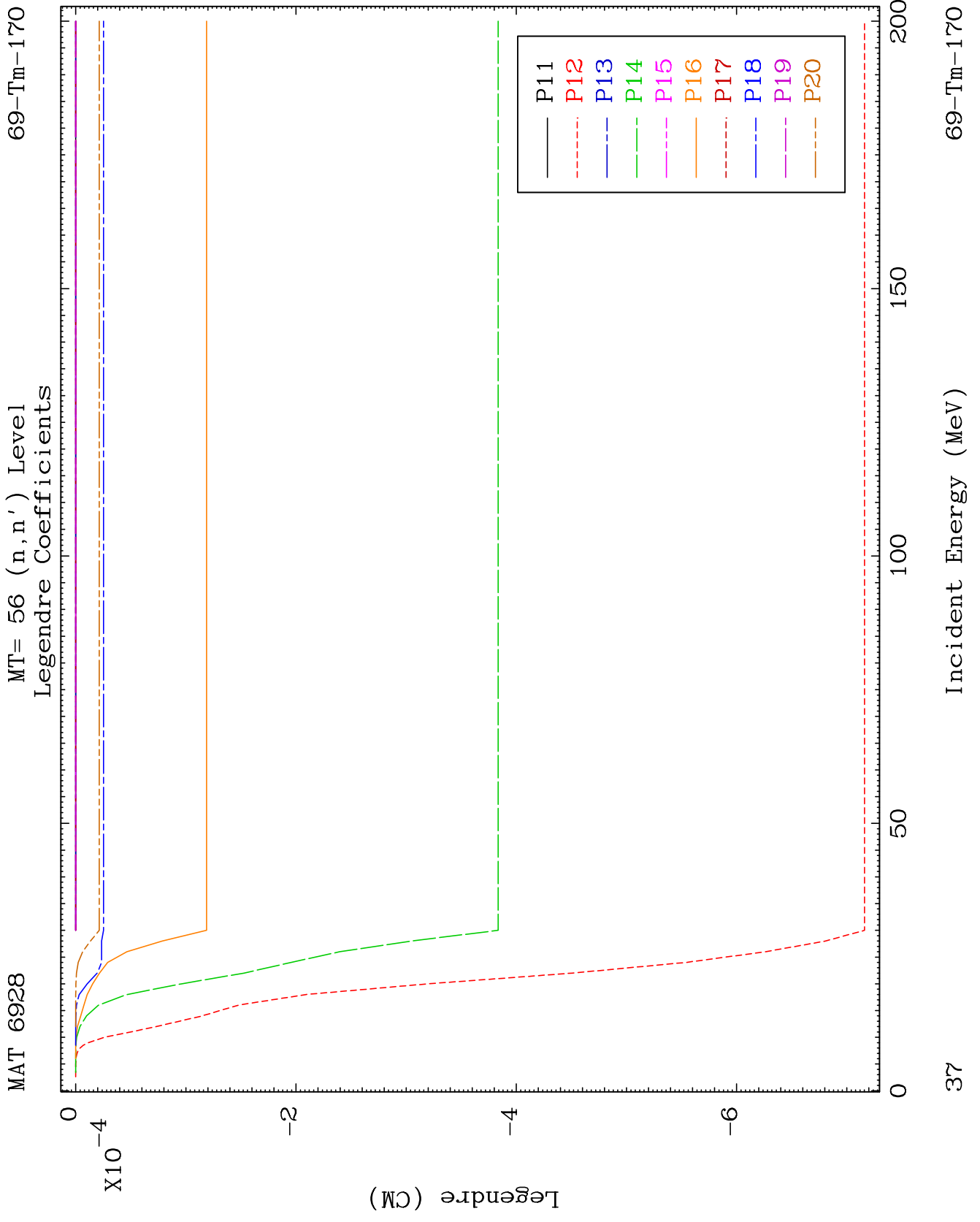

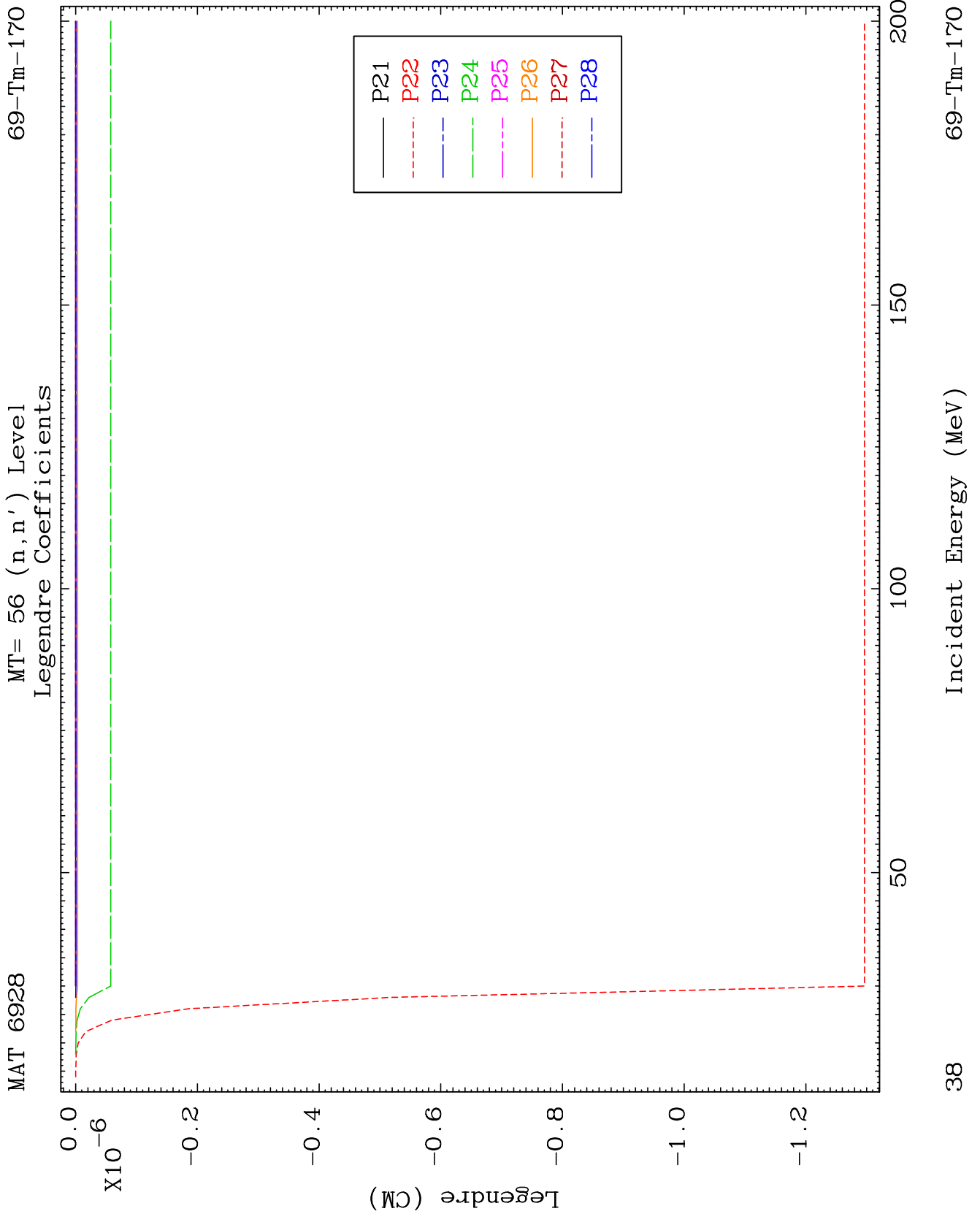

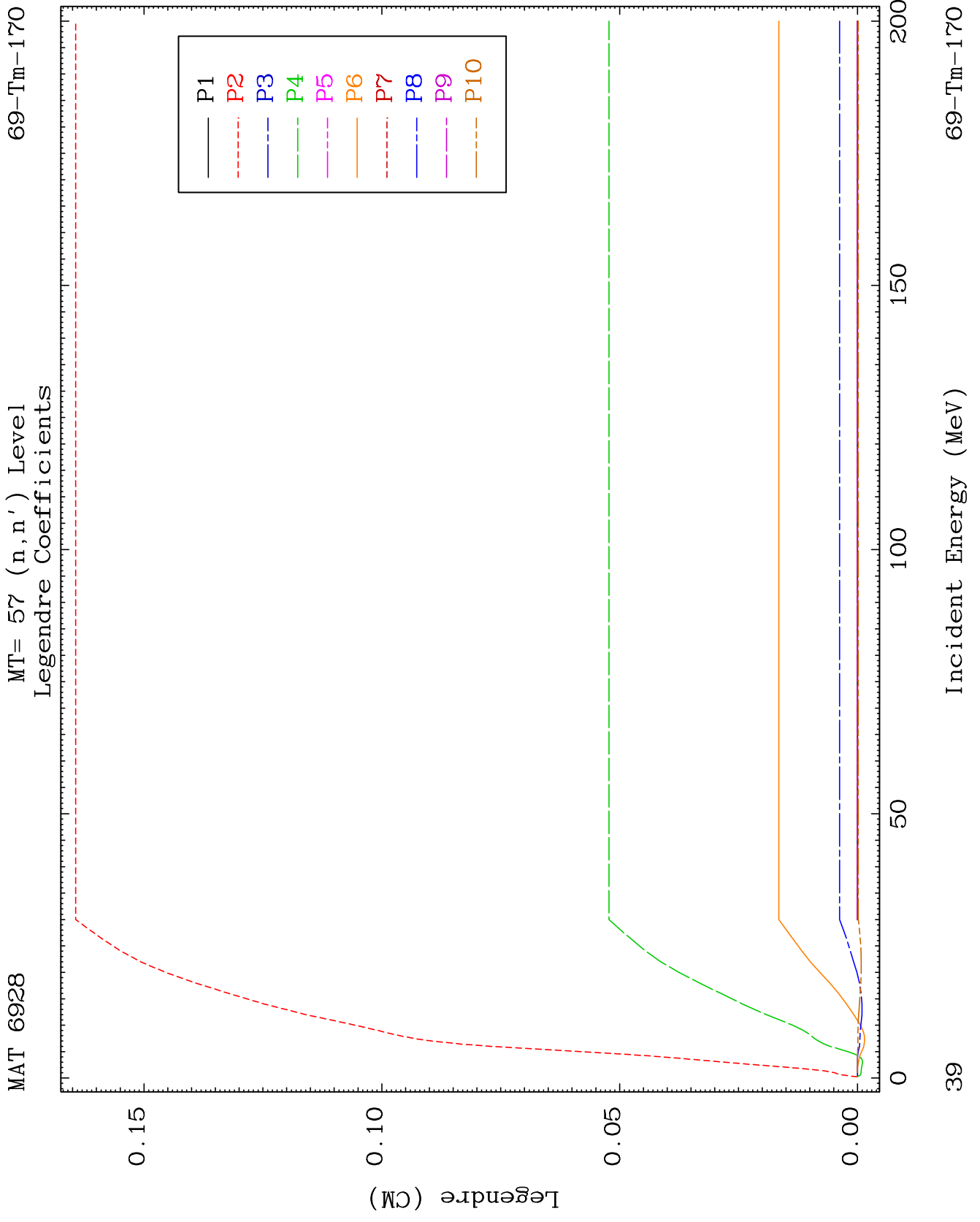

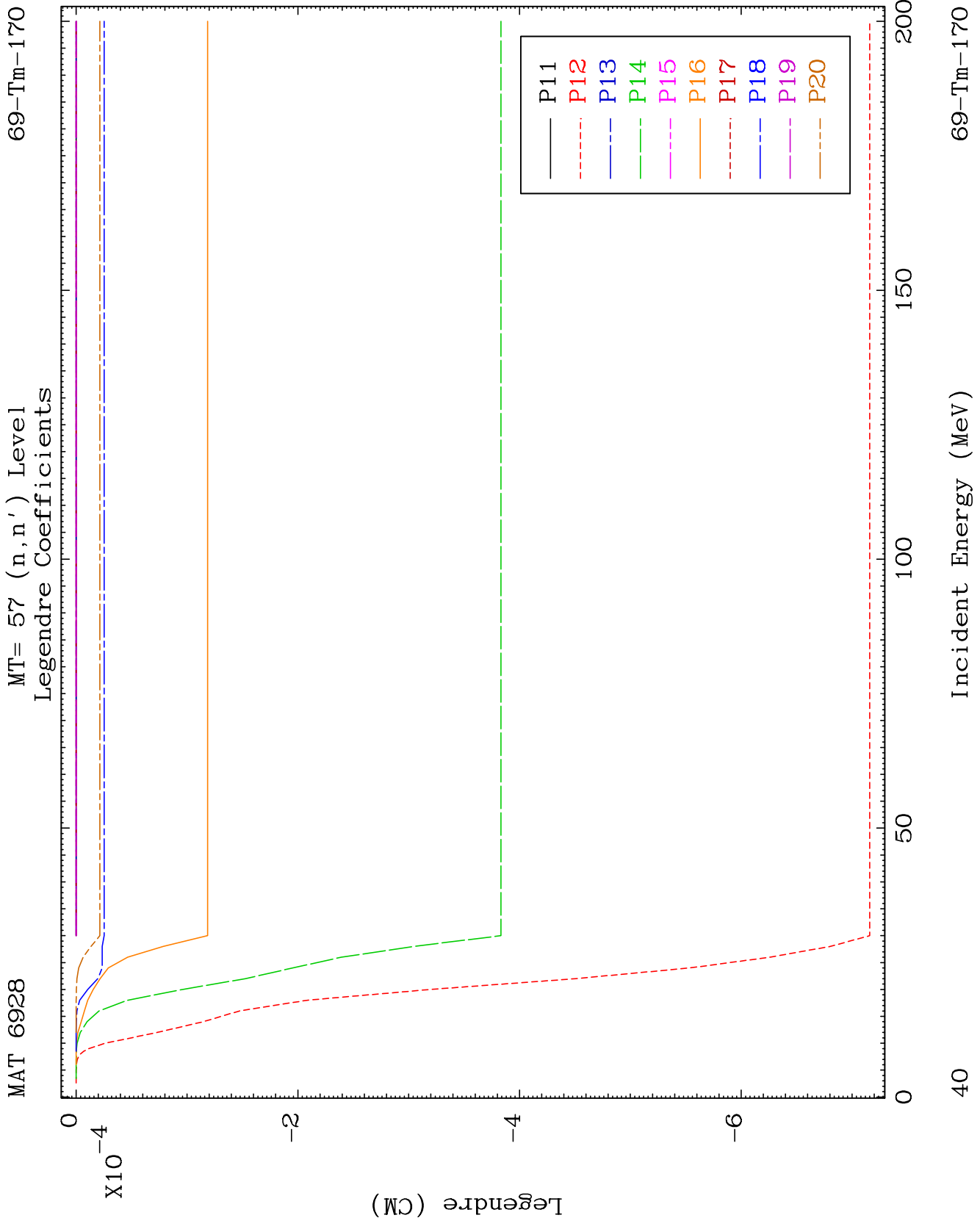

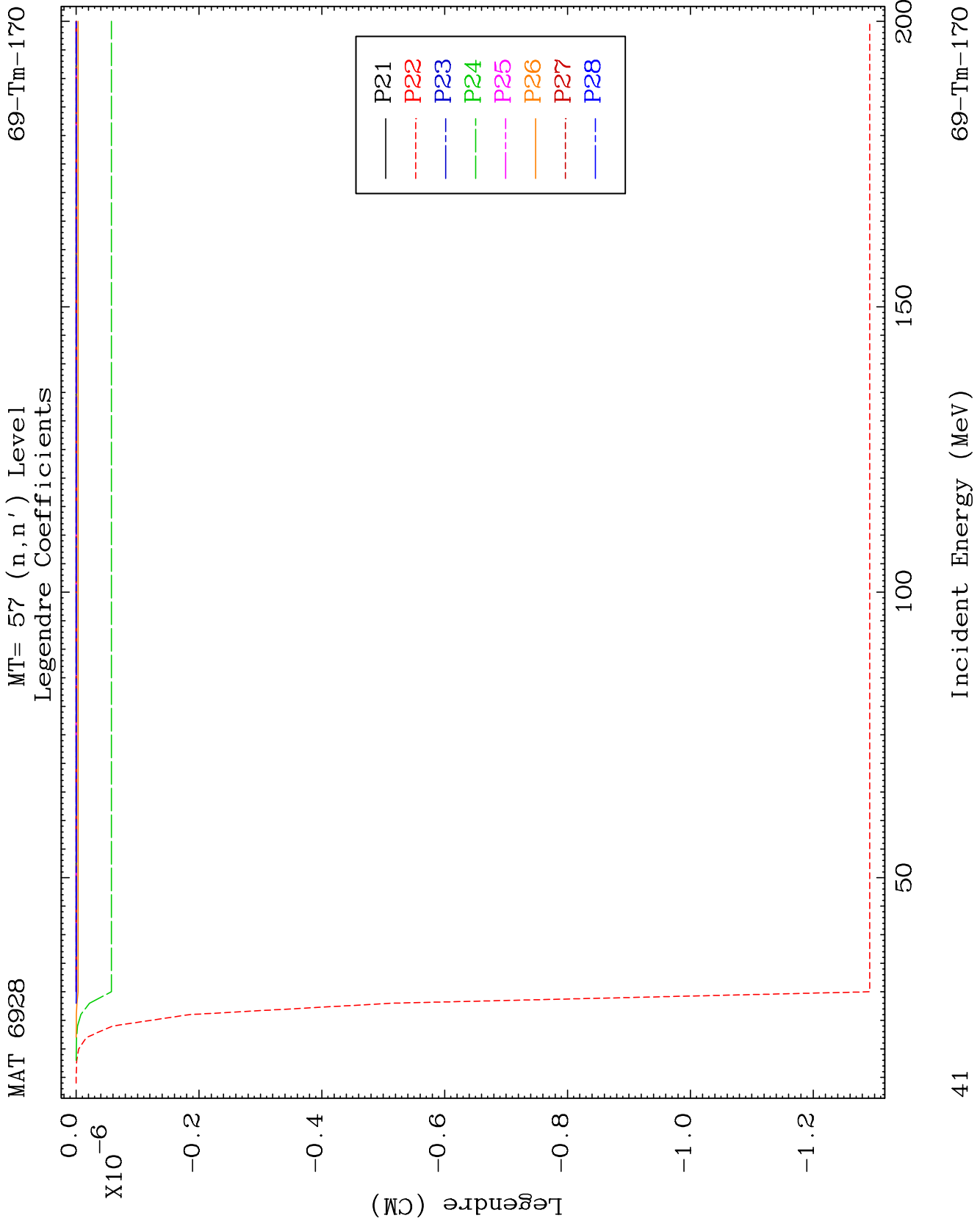

MAT 6928

MT= 58 (n,n') Level
Legendre Coefficients

69-Tm-170

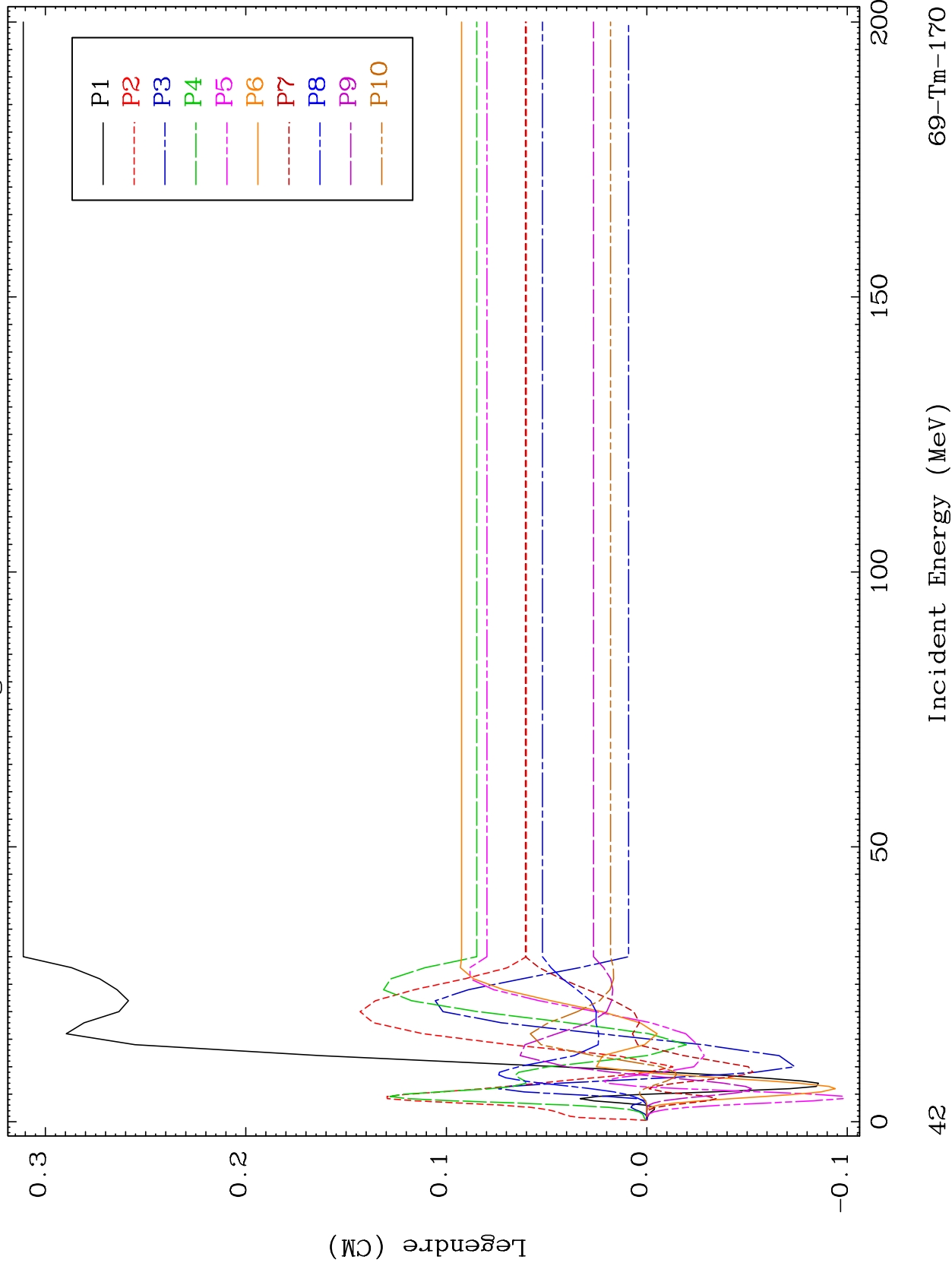

69-Tm-170

Incident Energy (MeV)

42

MAT 6928

MT= 58 (n,n') Level
Legendre Coefficients

69-Tm-170

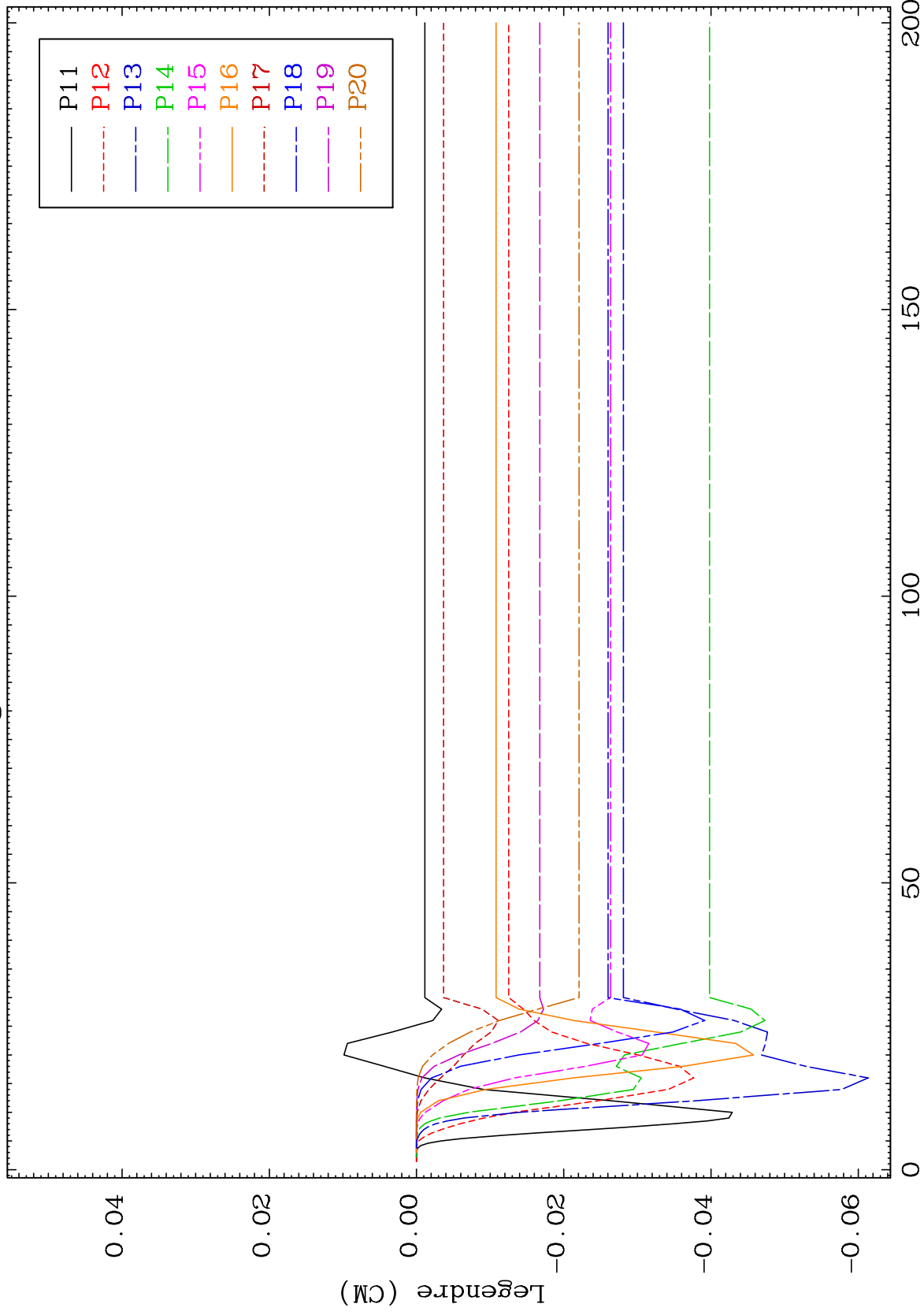

43

Incident Energy (MeV)

69-Tm-170

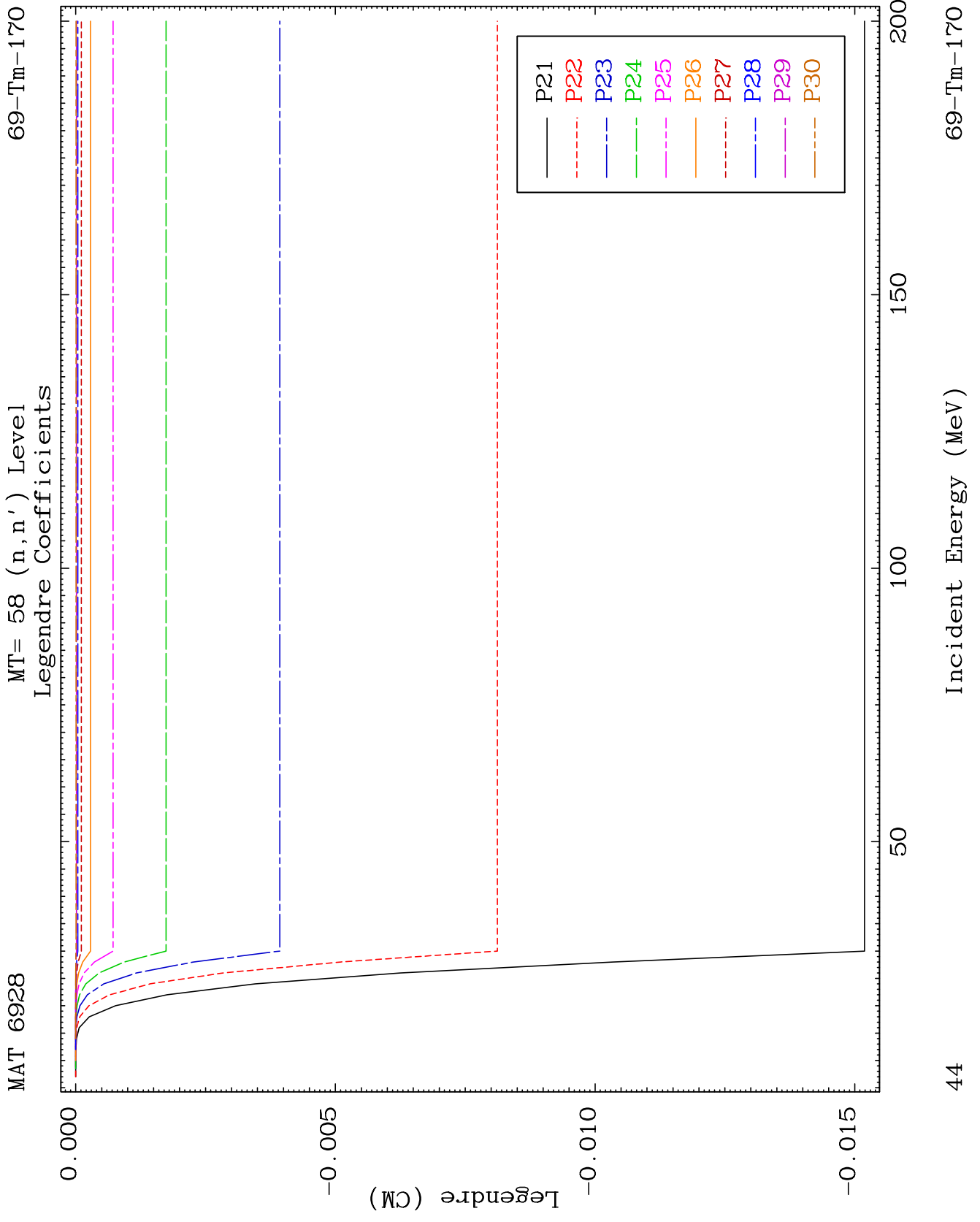

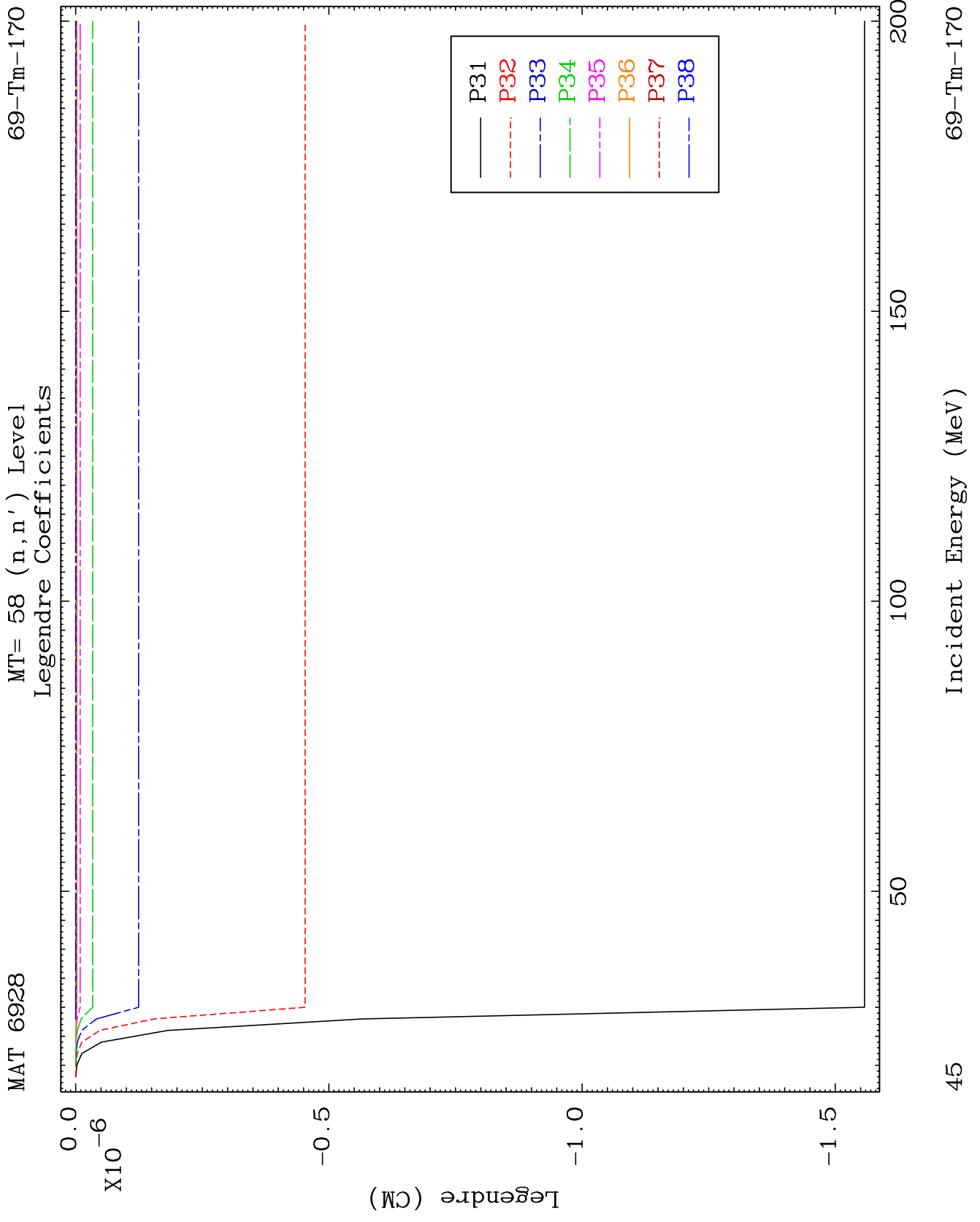

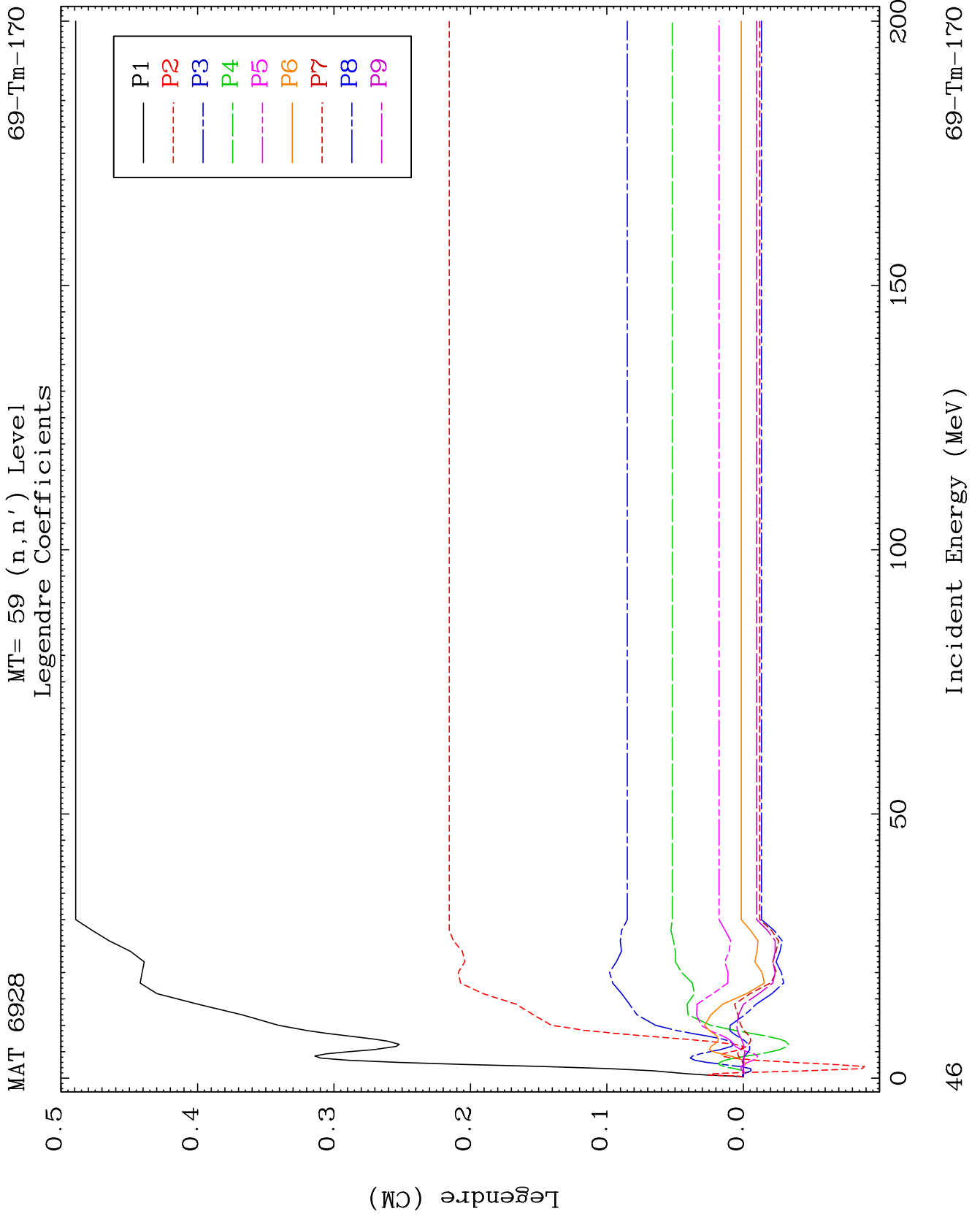

MAT 6928

MT= 59 (n,n') Level
Legendre Coefficients

69-Tm-170

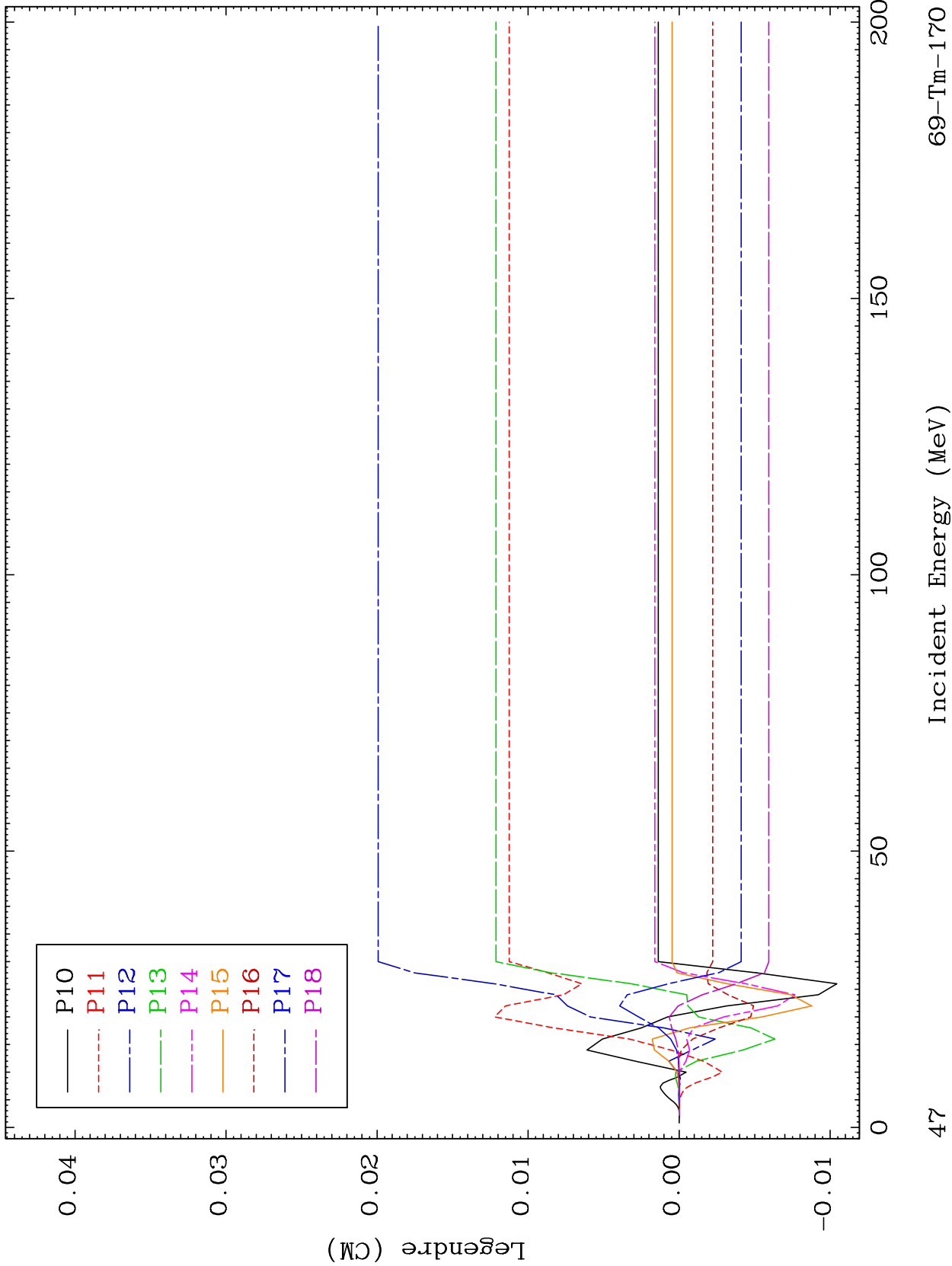

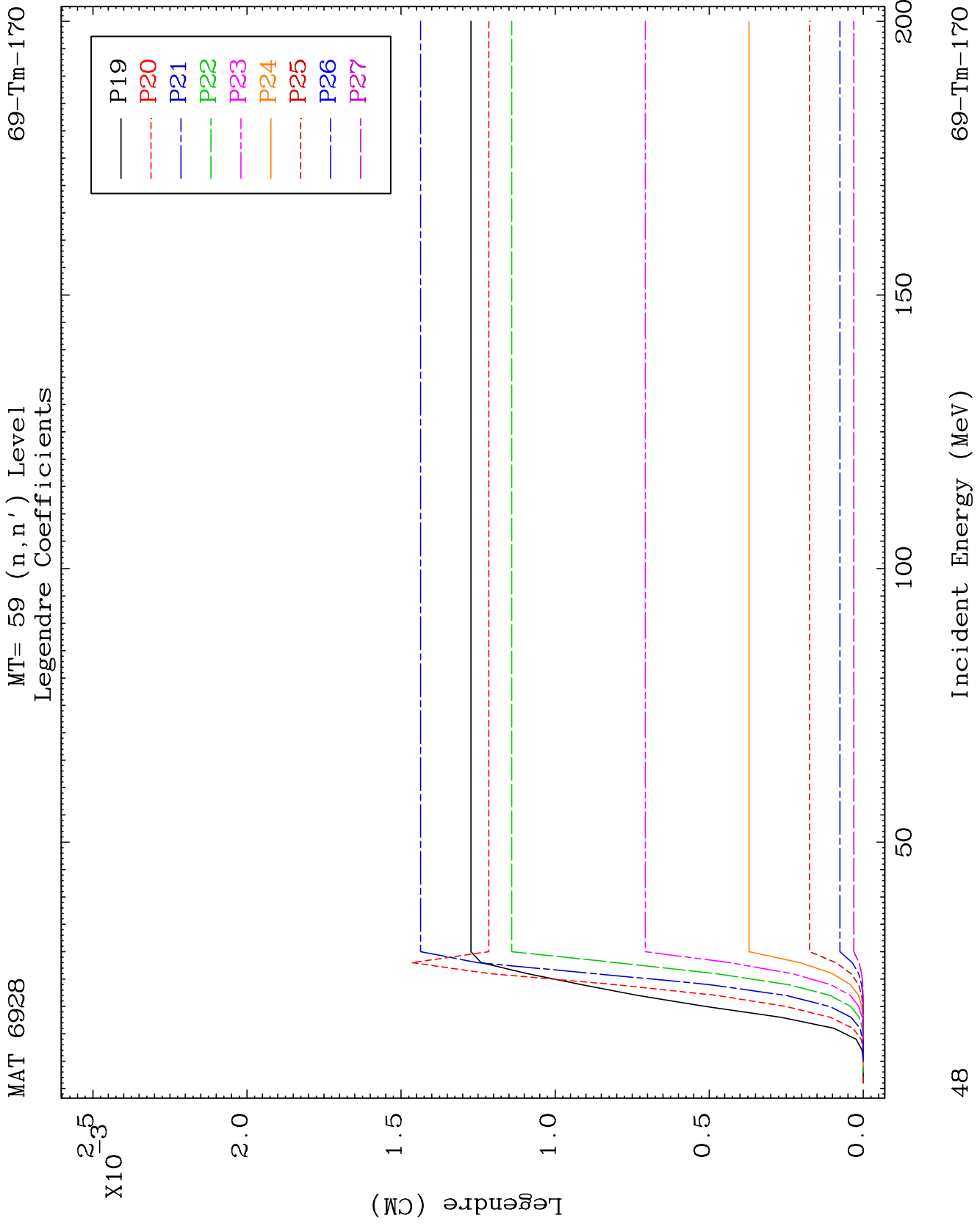

MAT 6928

MT= 59 (n,n') Level
Legendre Coefficients

69-Tm-170

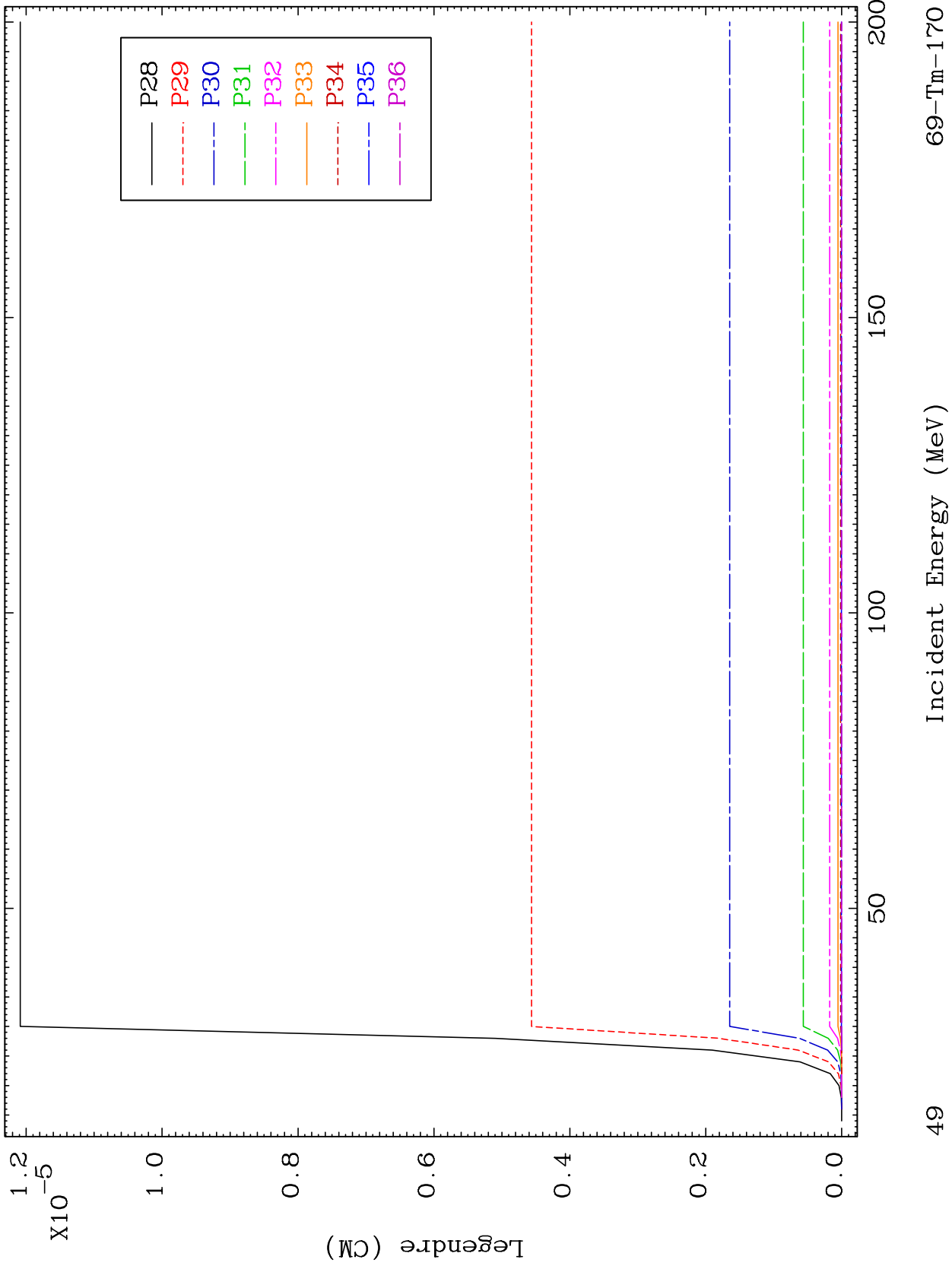

49

Incident Energy (MeV)

69-Tm-170

MAT 6928

MT= 60 (n,n') Level
Legendre Coefficients

69-Tm-170

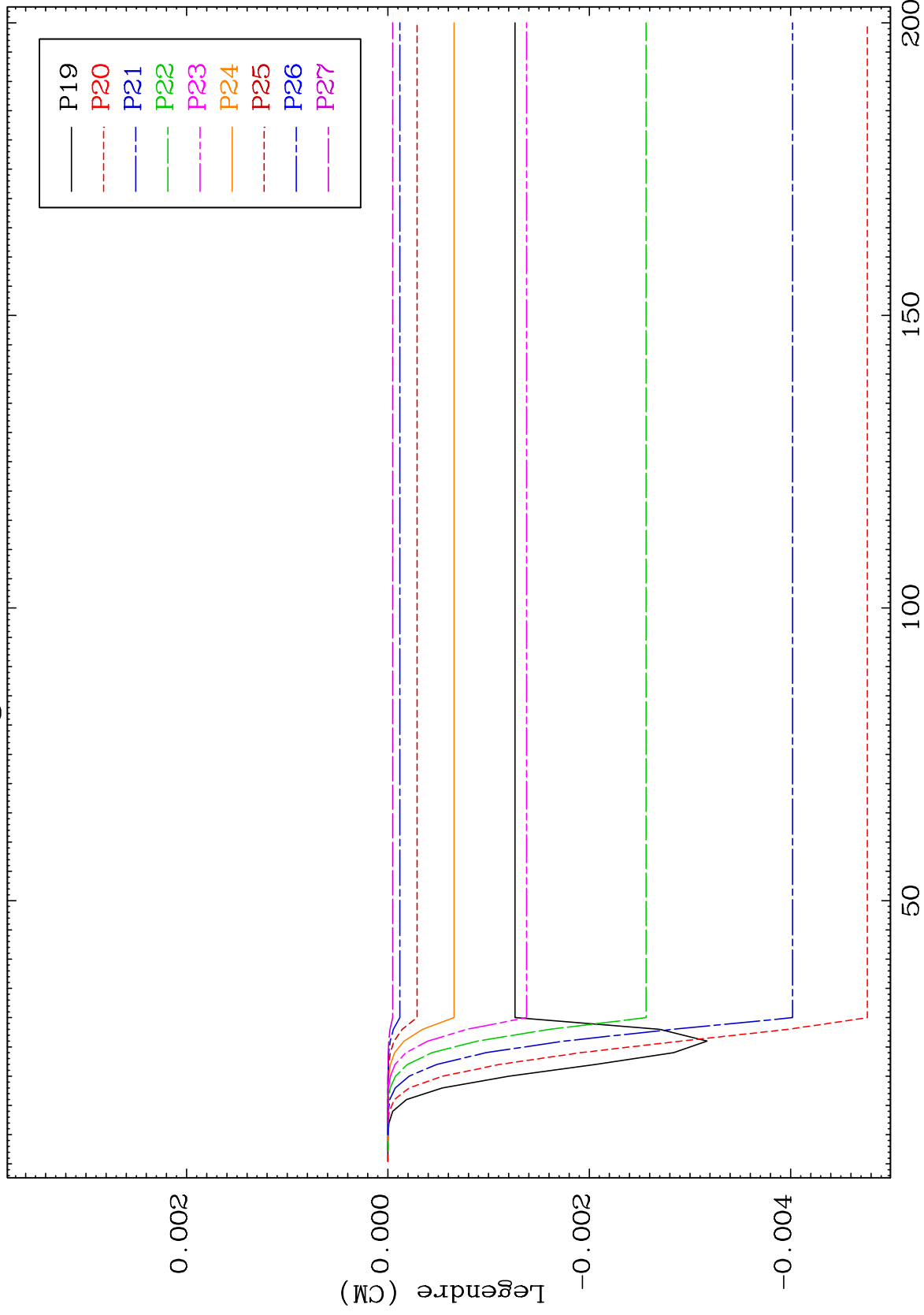

52

Incident Energy (MeV)

69-Tm-170

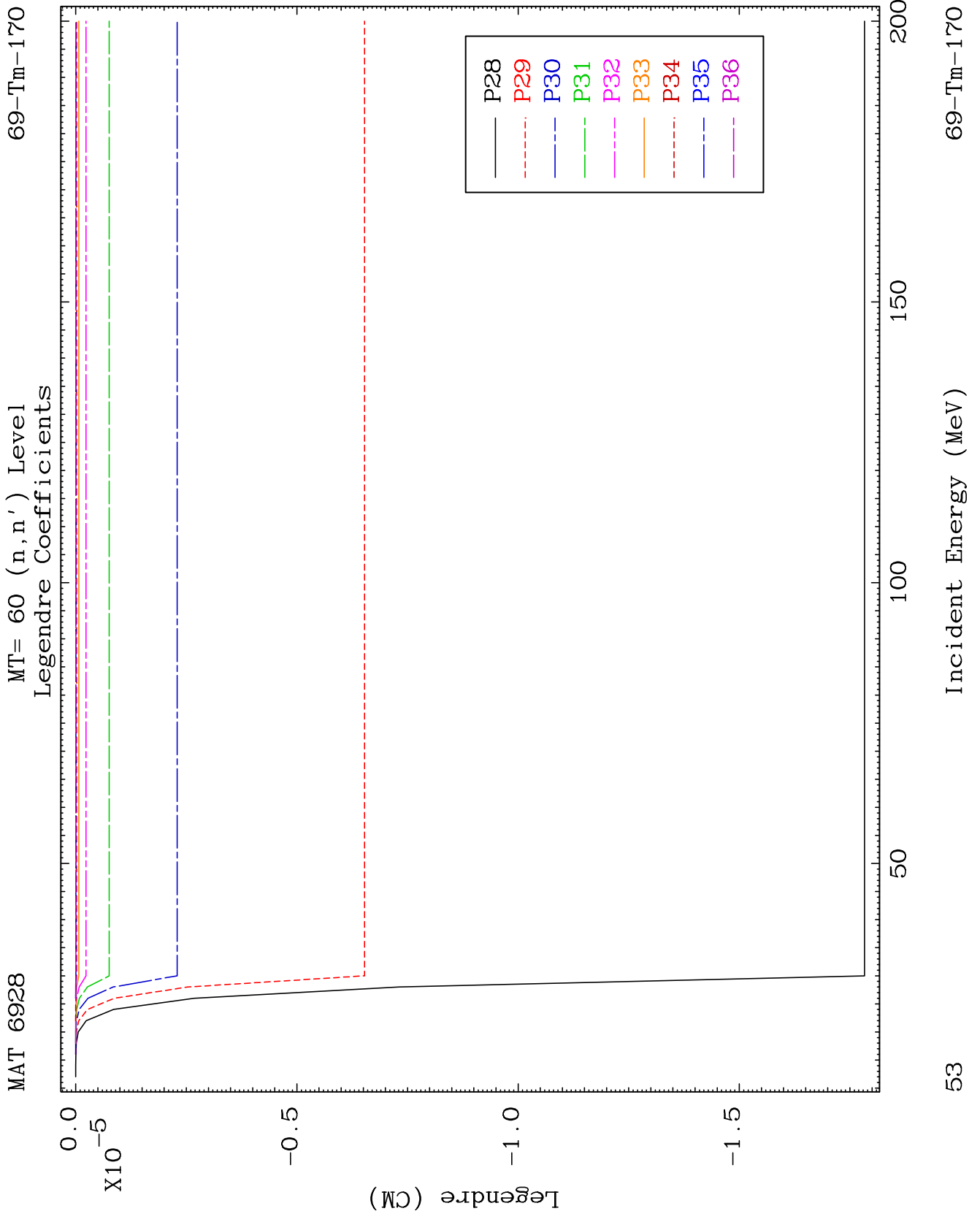

MAT 6928

MT= 61 (n,n') Level
Legendre Coefficients

69-Tm-170

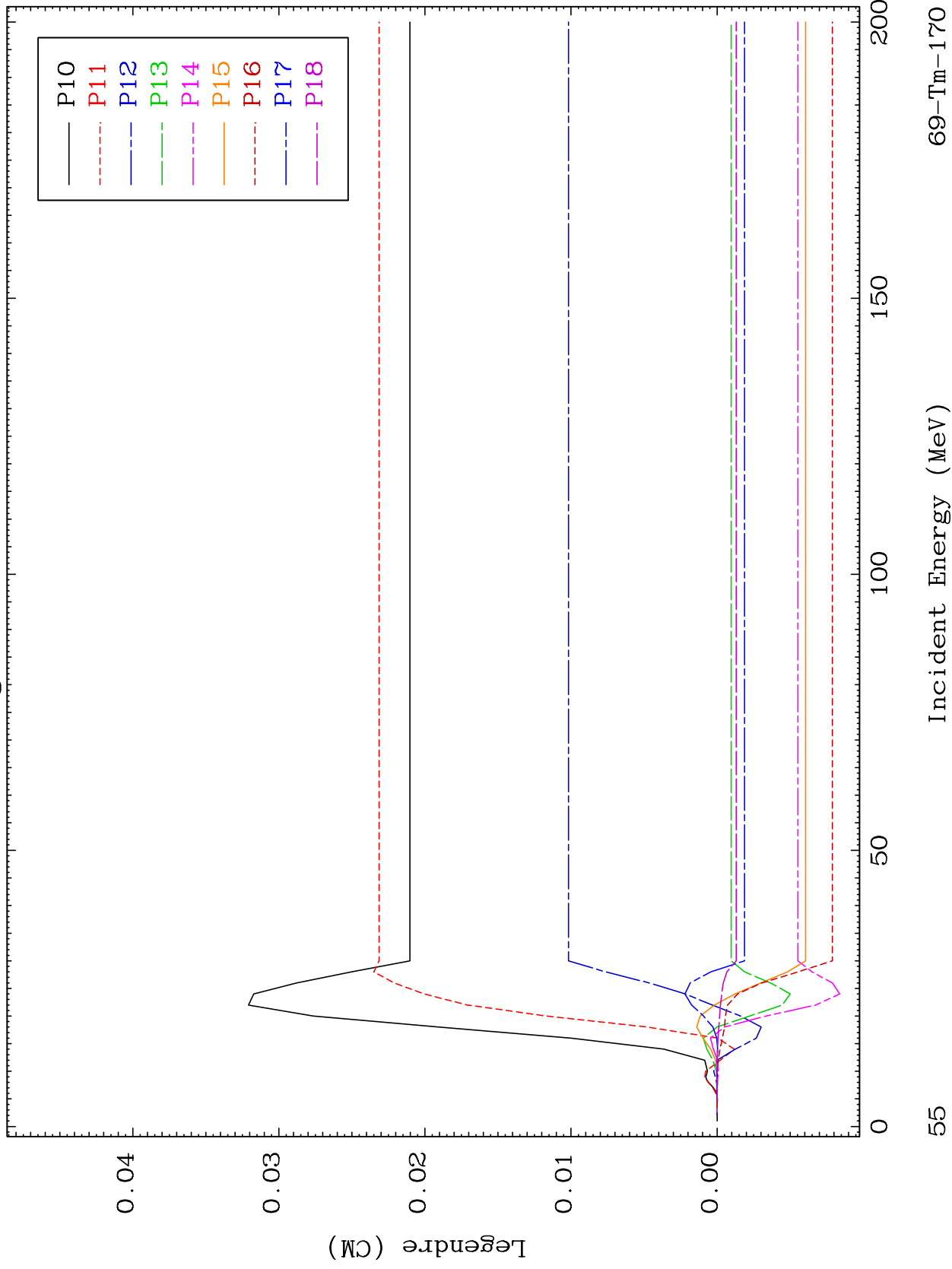

55

Incident Energy (MeV)

69-Tm-170

MAT 6928

MT= 61 (n,n') Level
Legendre Coefficients

69-Tm-170

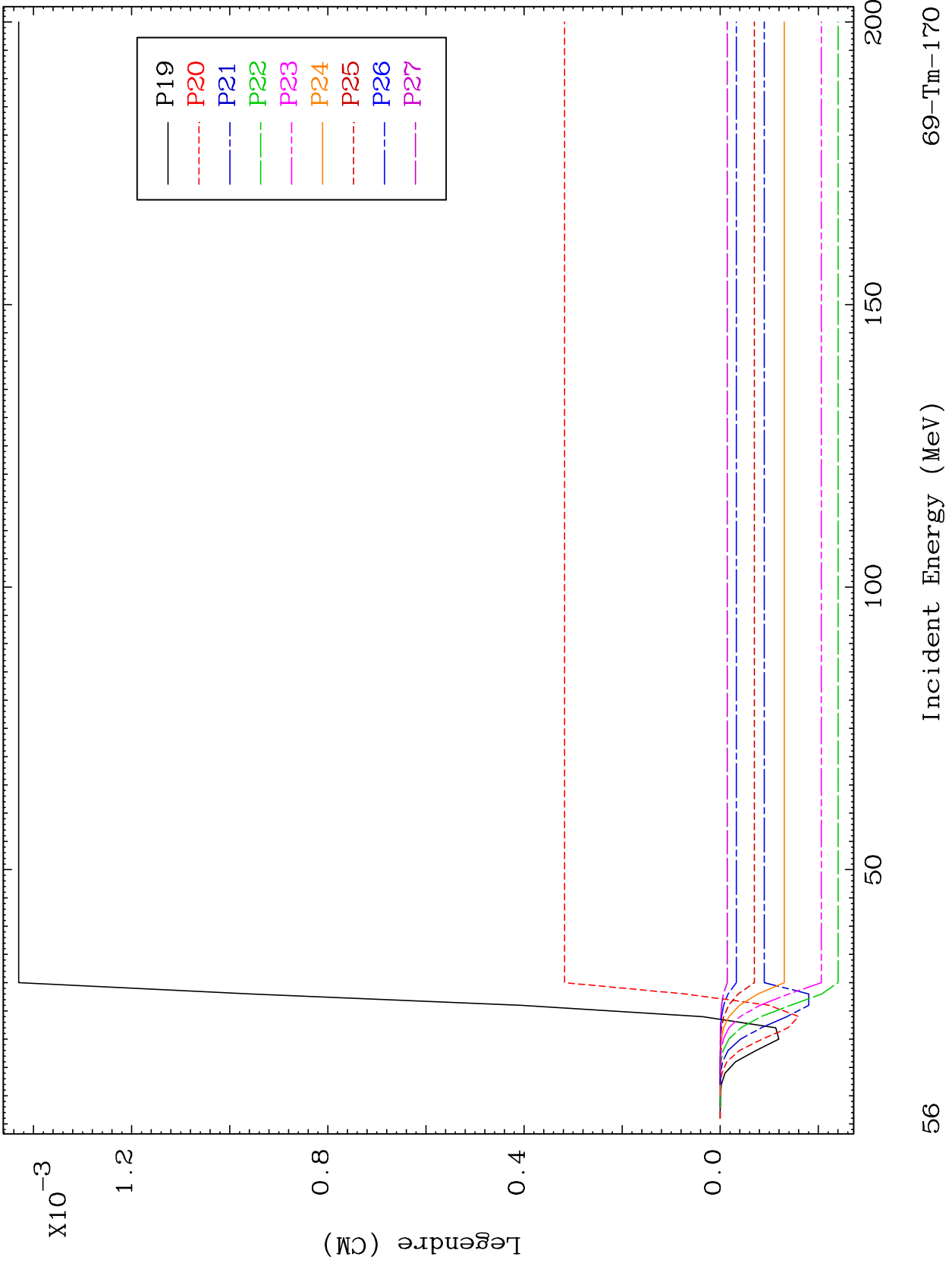

56

69-Tm-170

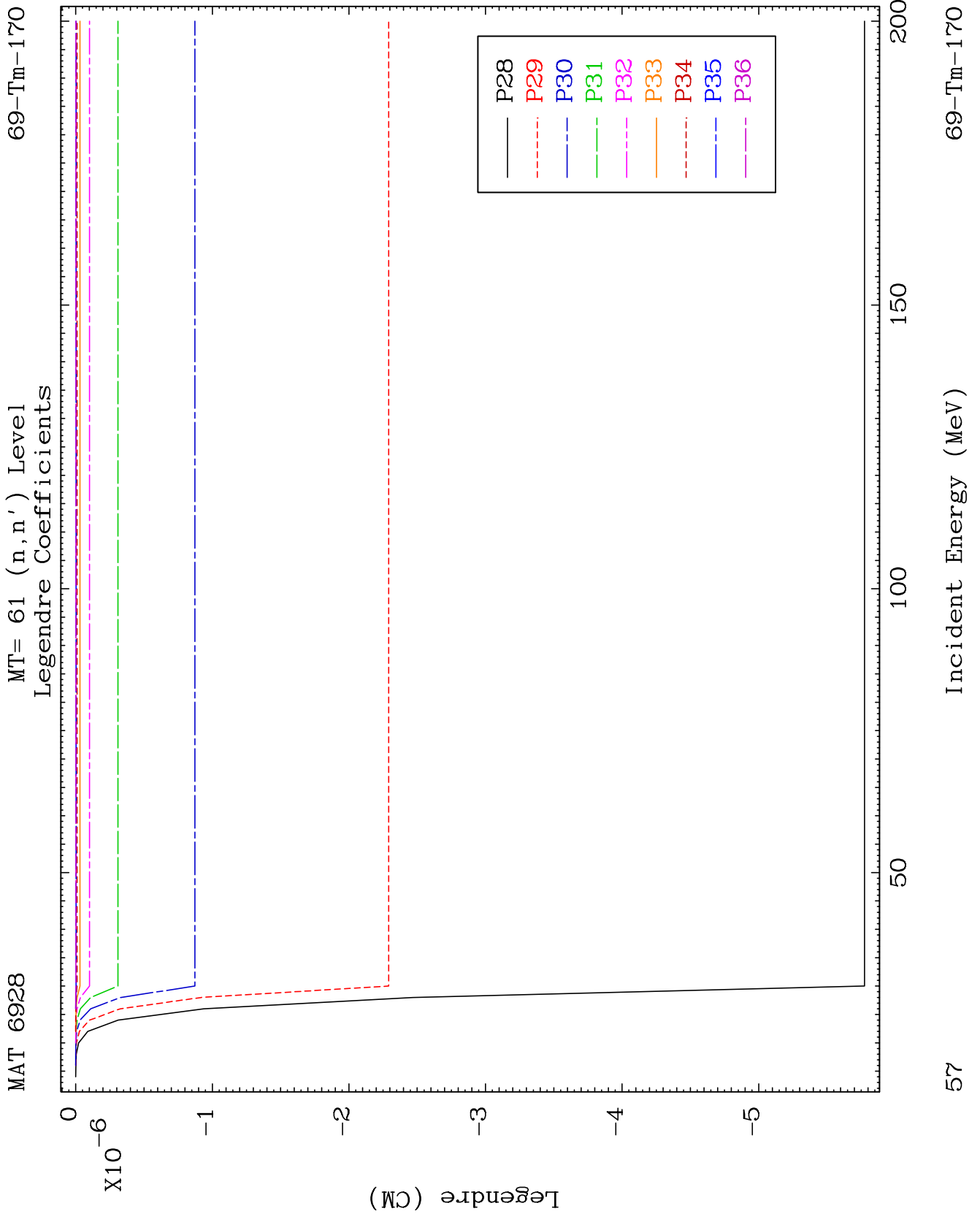

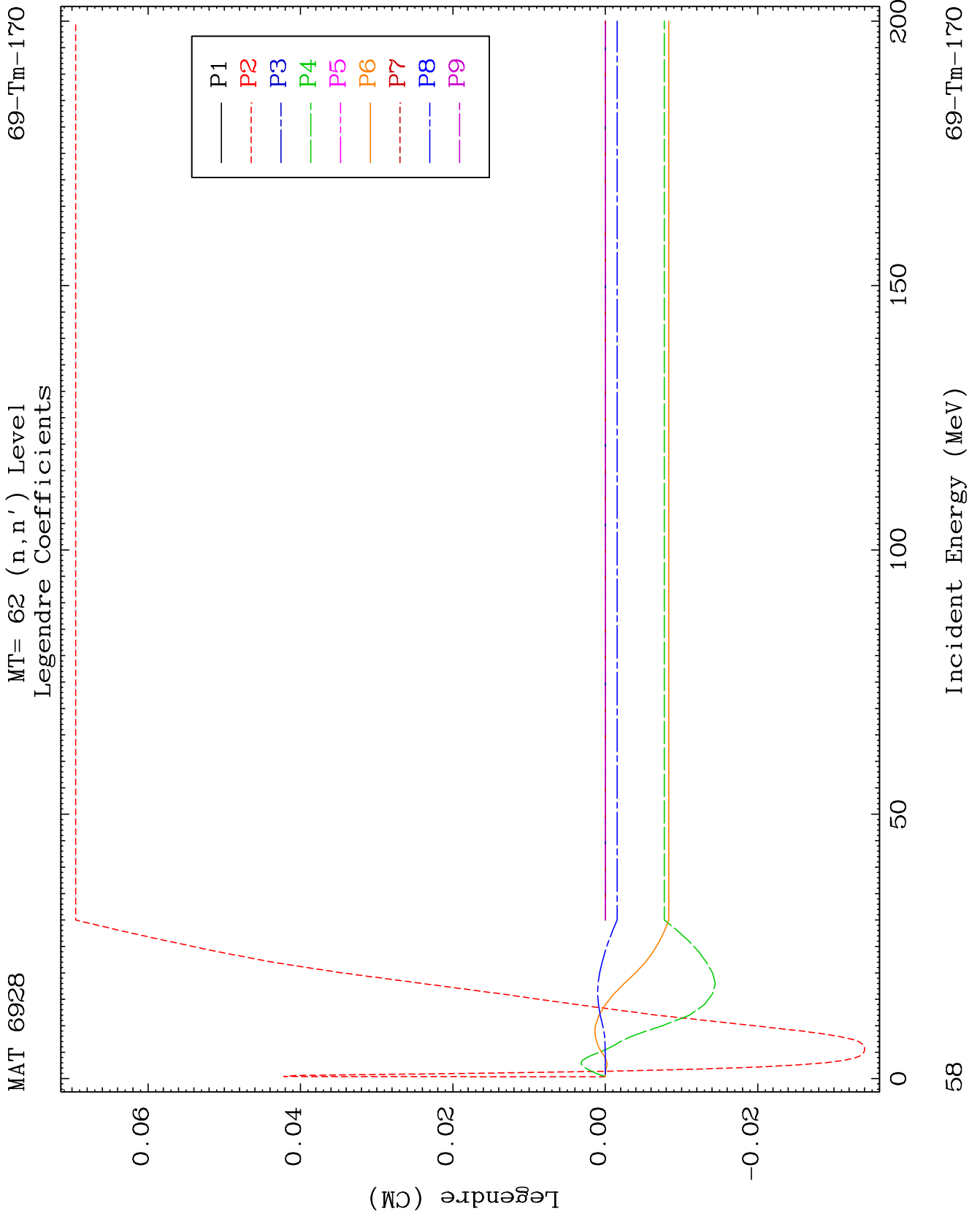

MAT 6928

MT= 62 (n,n') Level
Legendre Coefficients

69-Tm-170

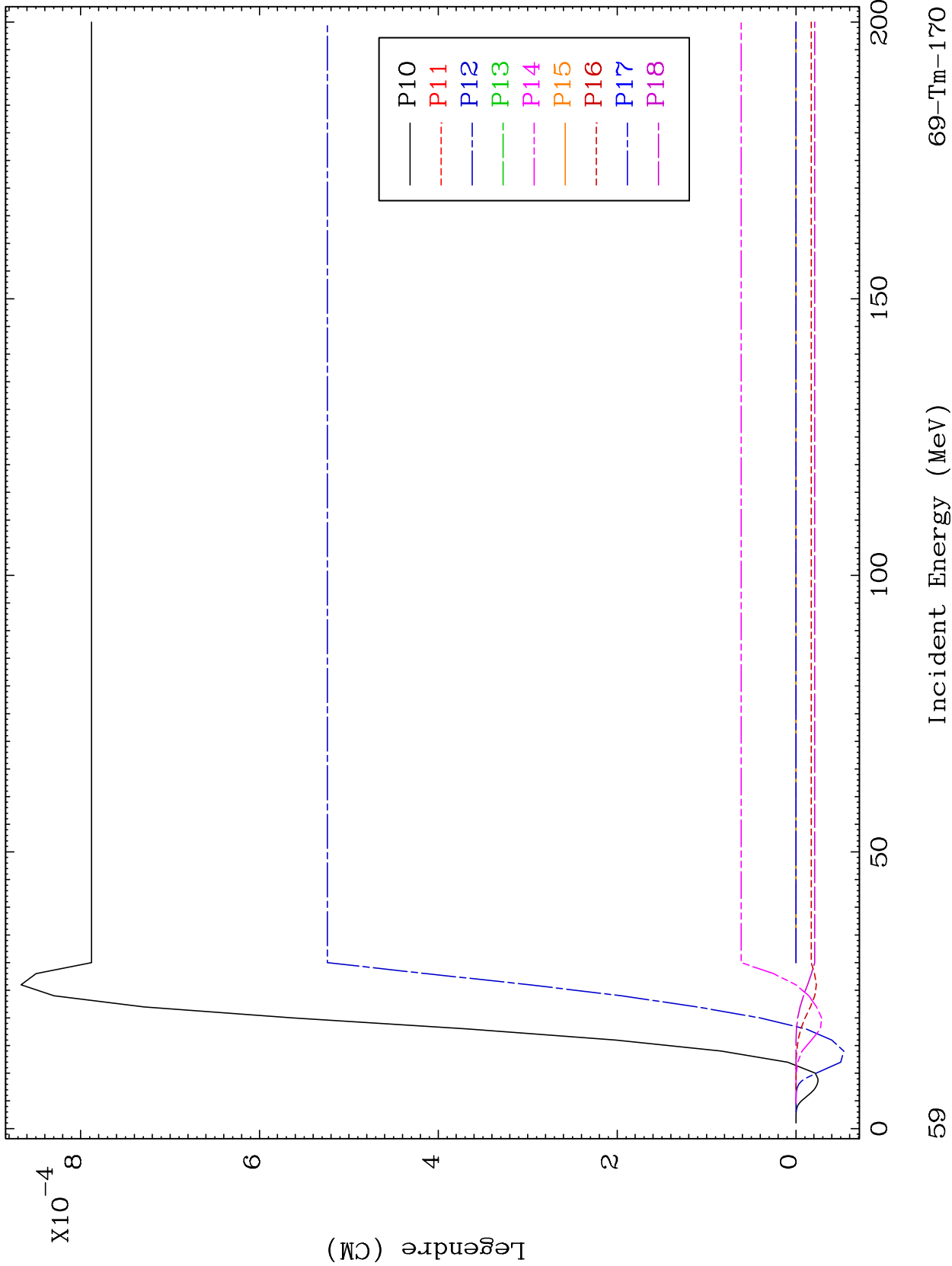

59

Incident Energy (MeV)

69-Tm-170

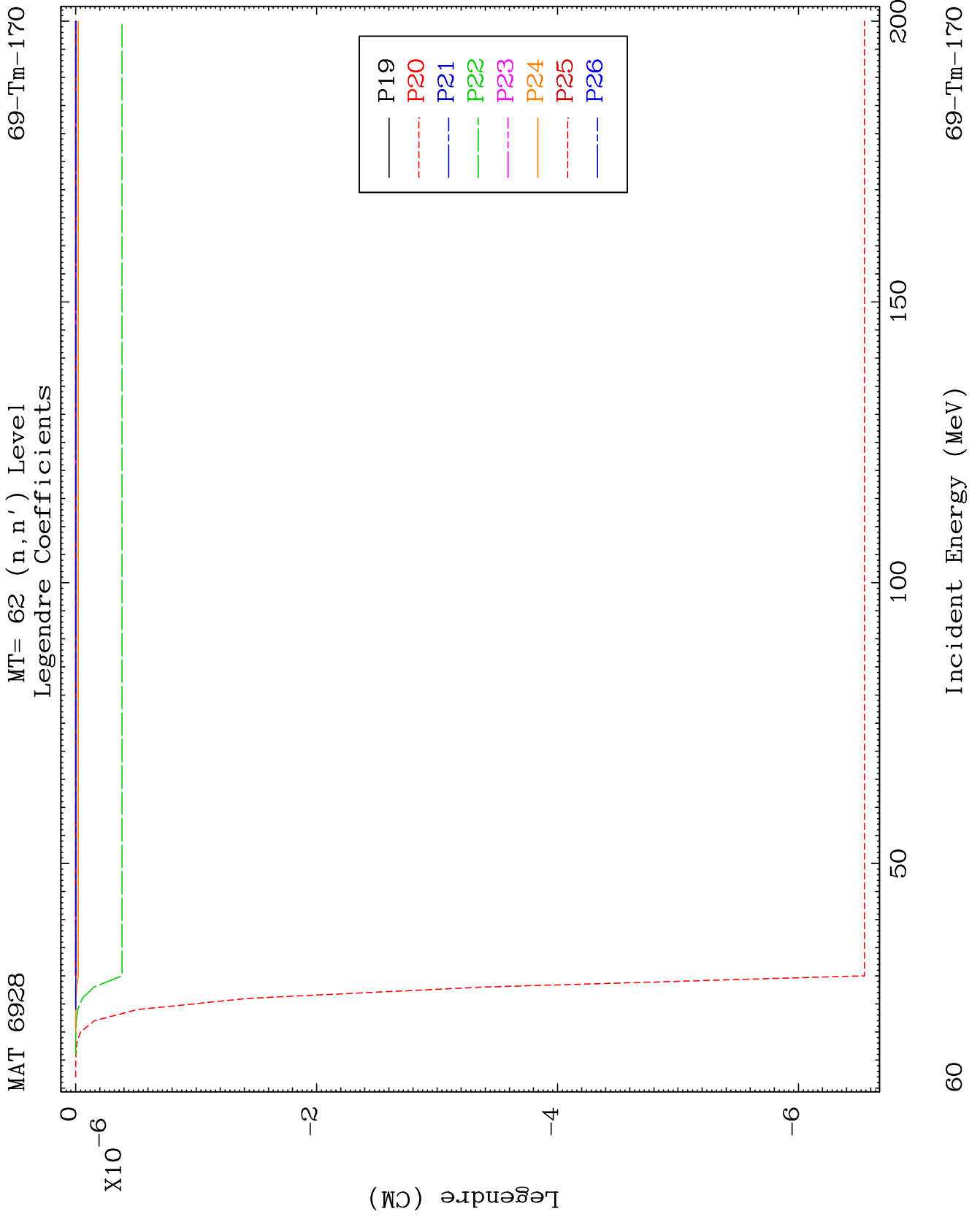

MAT 6928

MT= 63 (n,n') Level
Legendre Coefficients

69-Tm-170

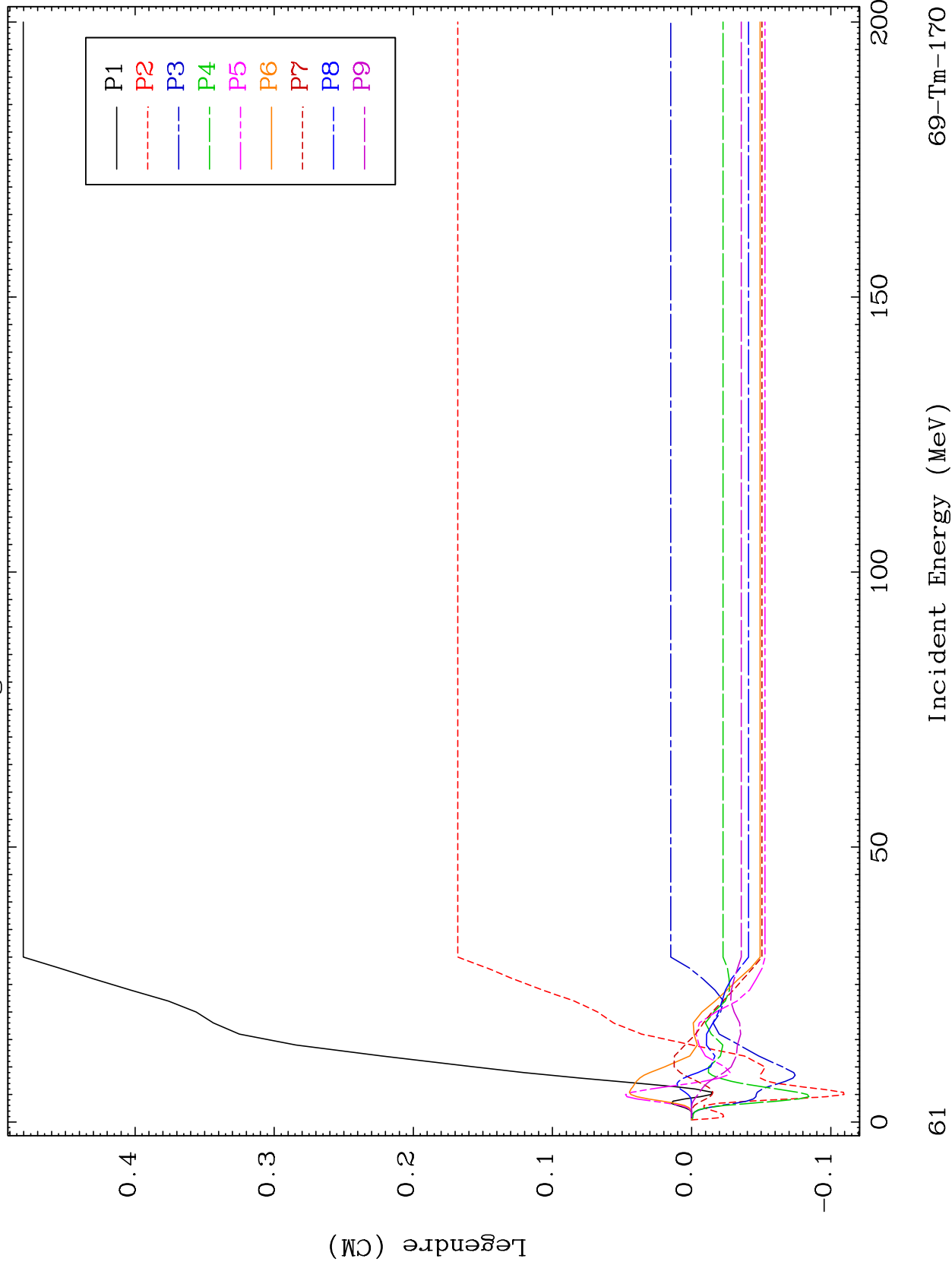

69-Tm-170

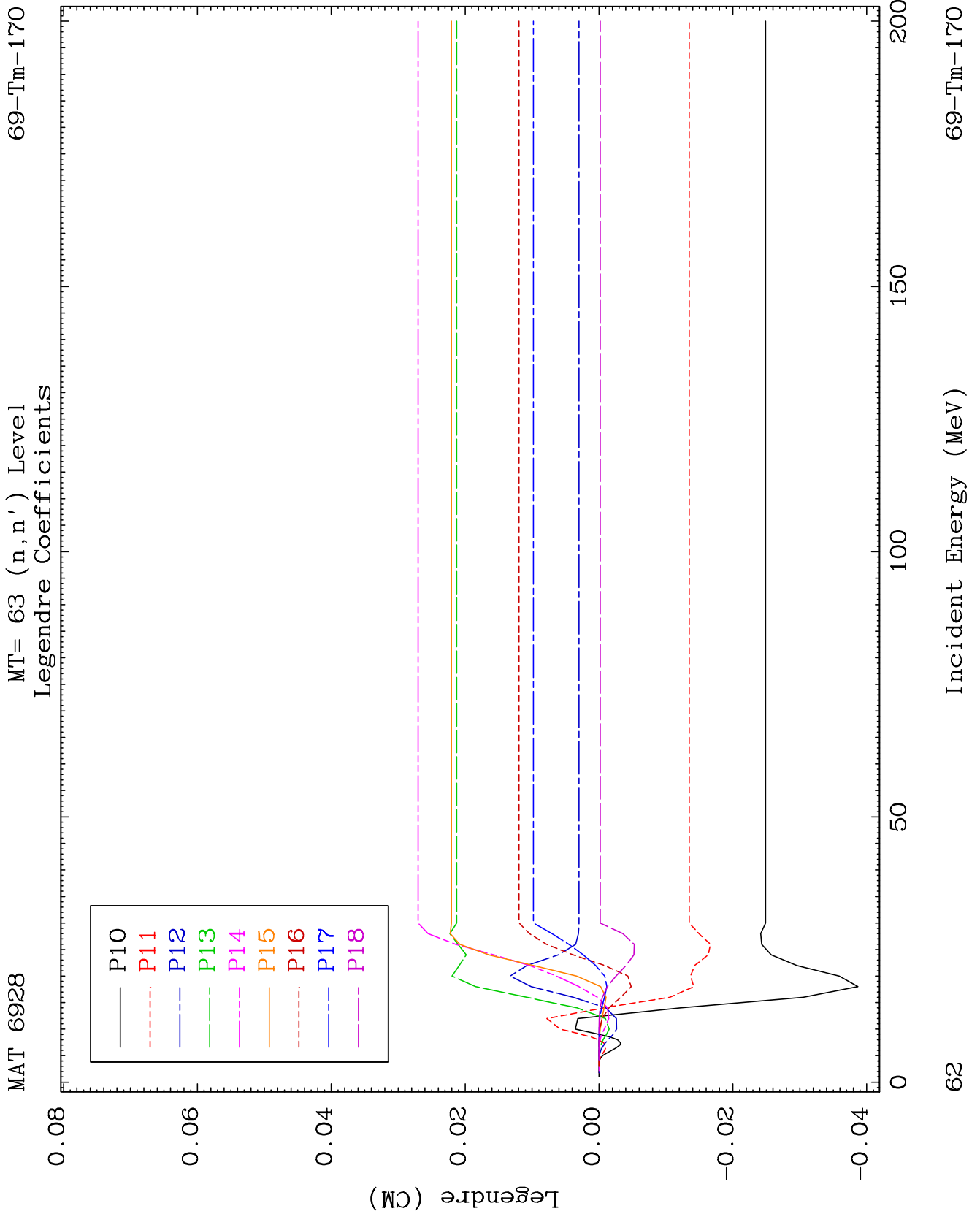

MAT 6928

MT= 63 (n,n') Level
Legendre Coefficients

69-Tm-170

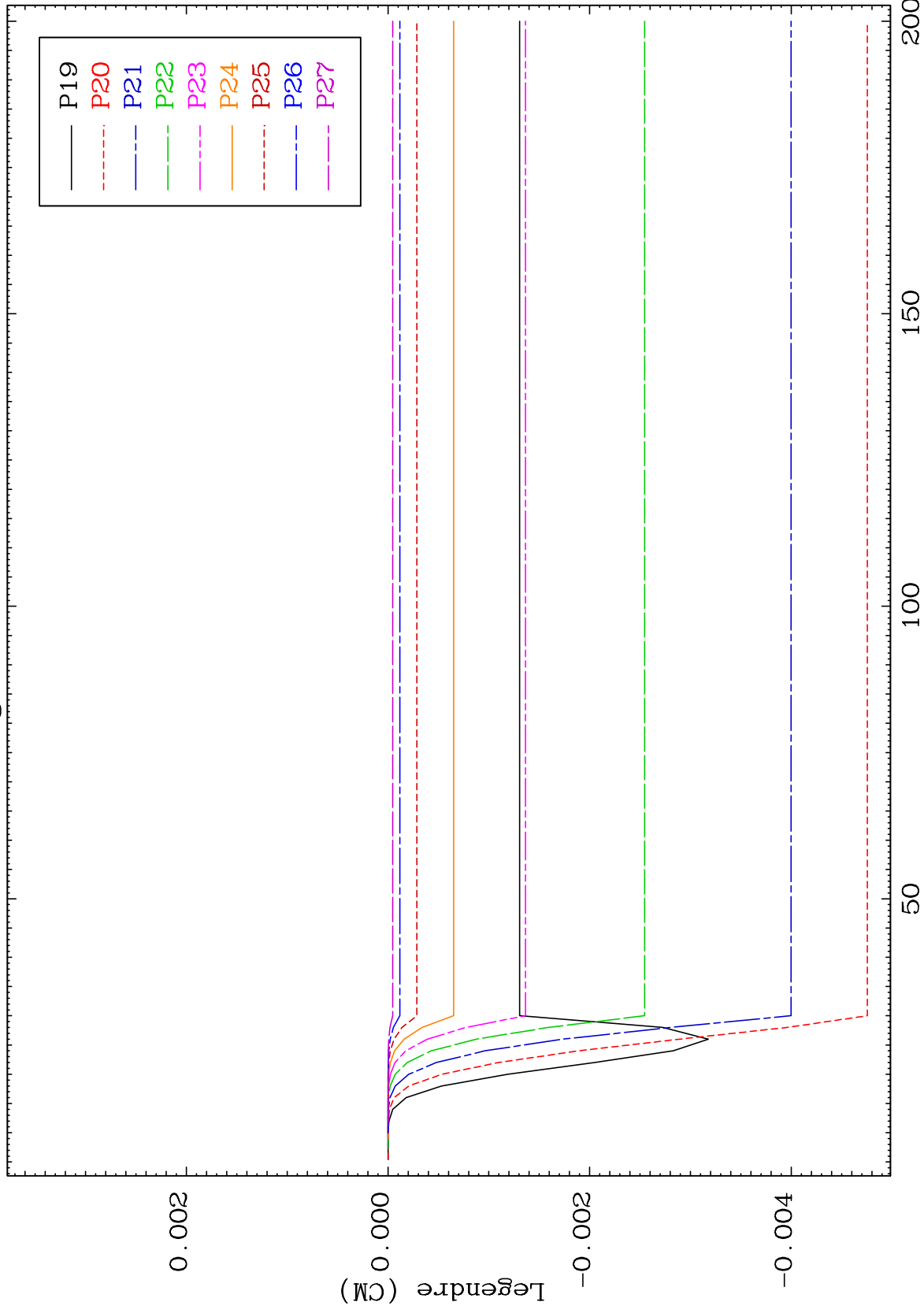

63

Incident Energy (MeV)

69-Tm-170

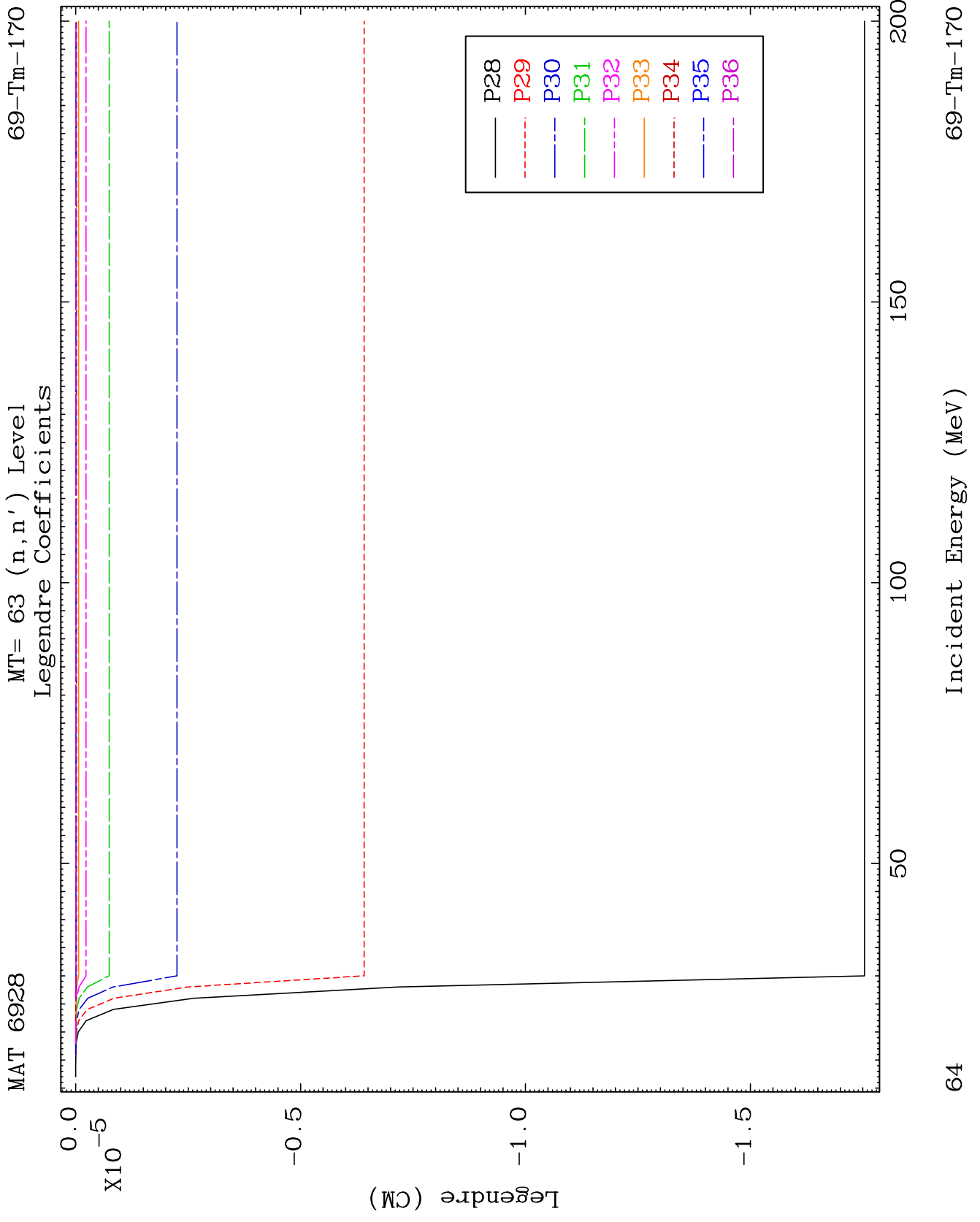

MAT 6928

MT= 64 (n,n') Level
Legendre Coefficients

69-Tm-170

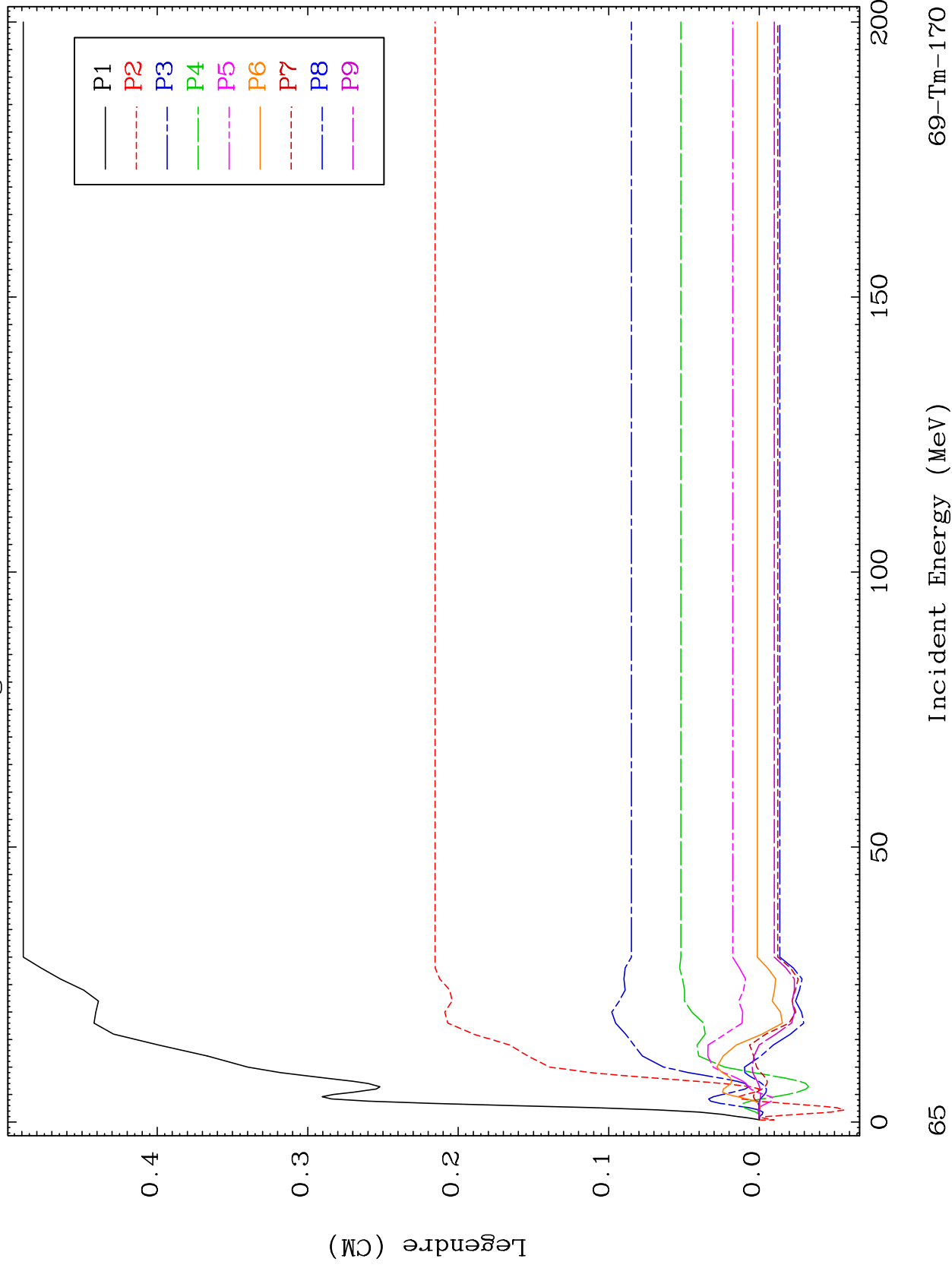

69-Tm-170

Incident Energy (MeV)

65

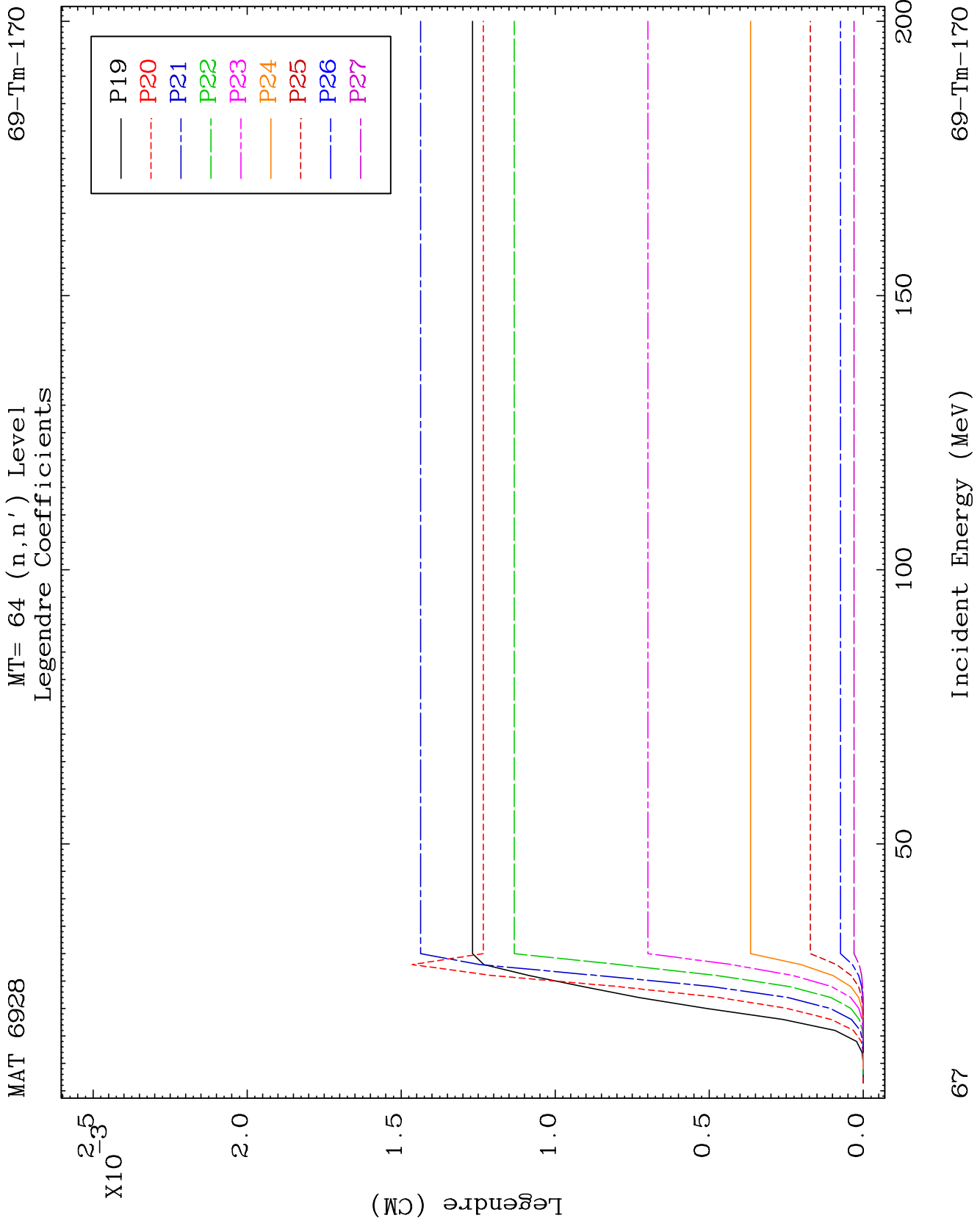

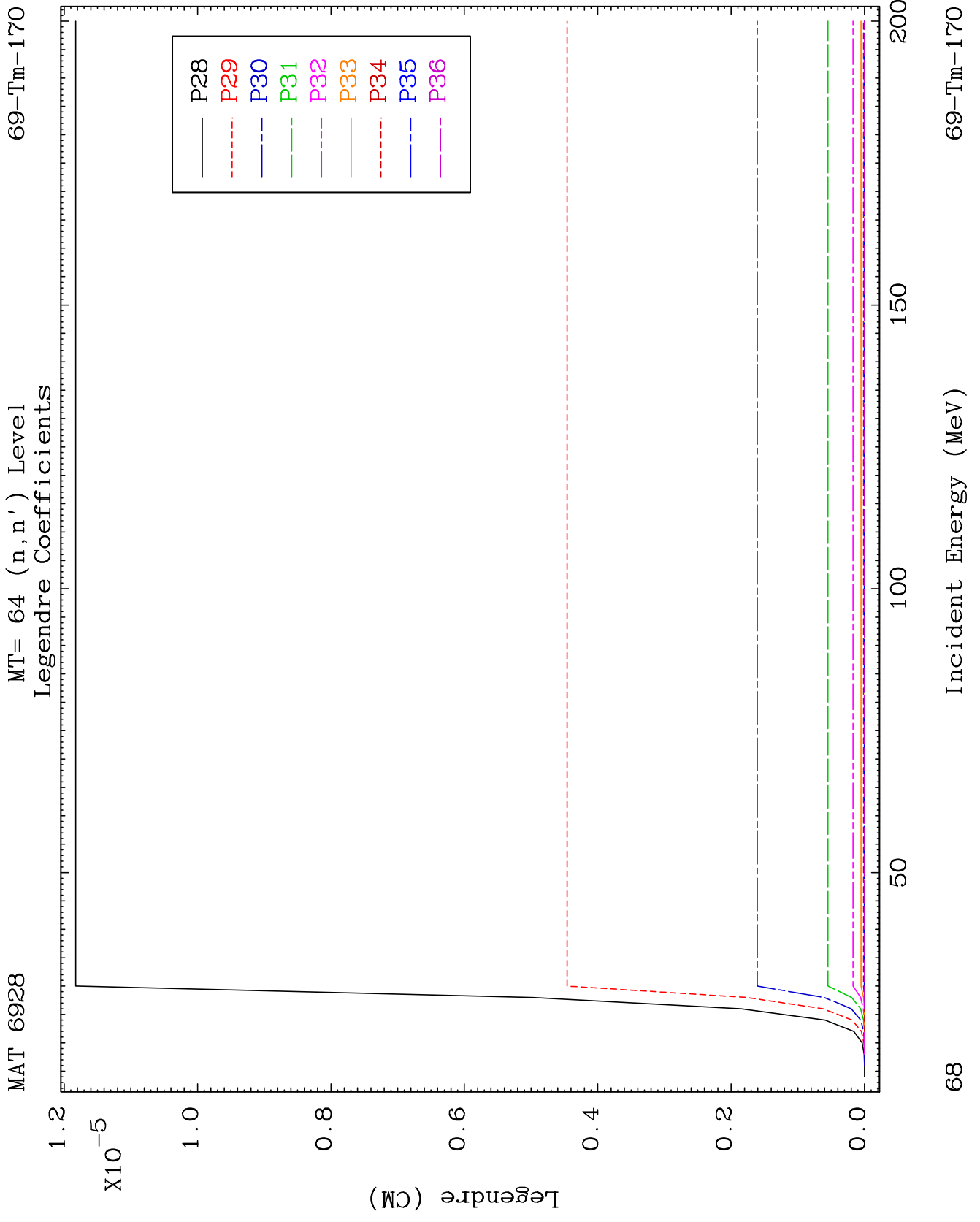

MAT 6928

MT= 65 (n,n') Level
Legendre Coefficients

69-Tm-170

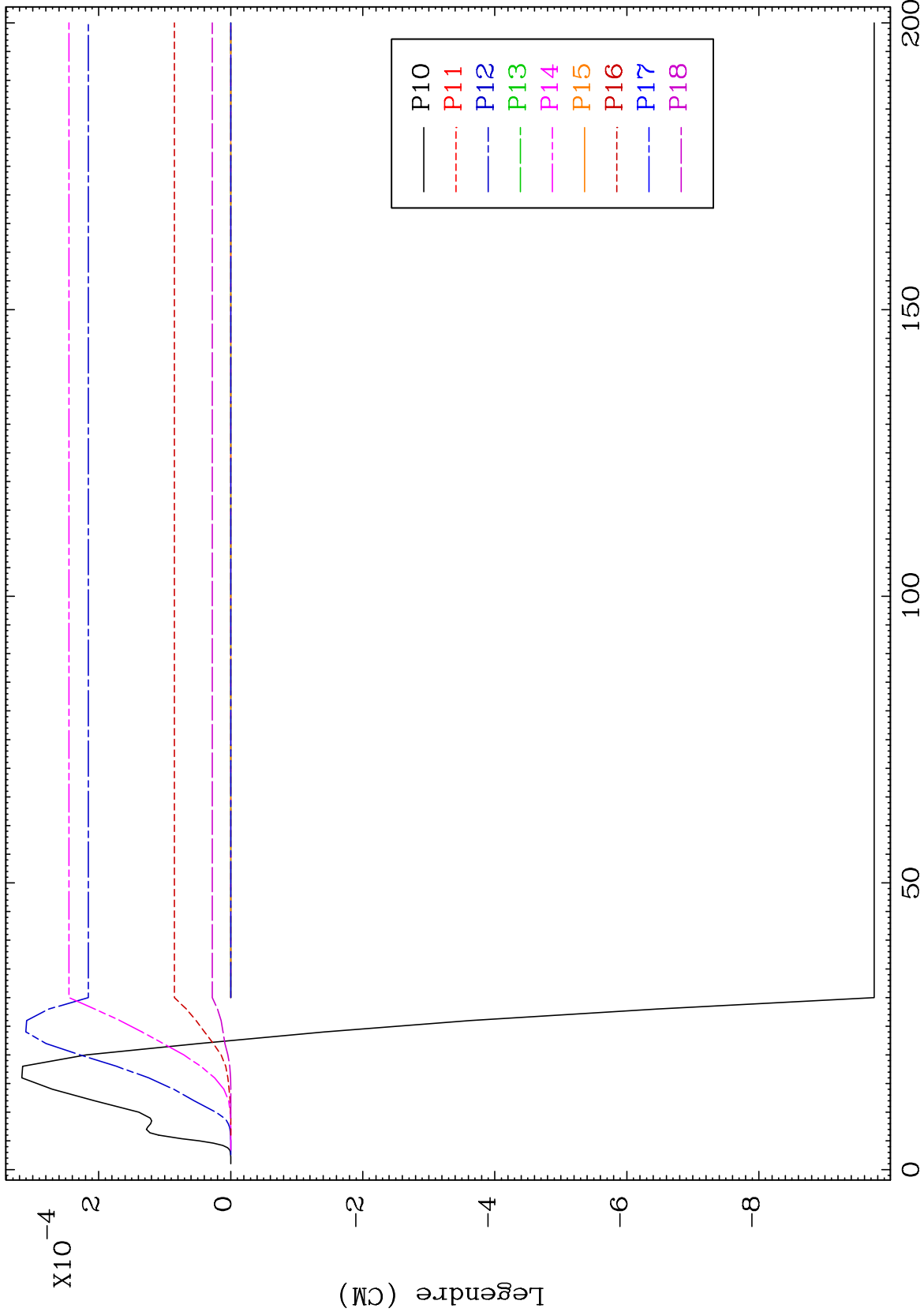

70

Incident Energy (MeV)

69-Tm-170

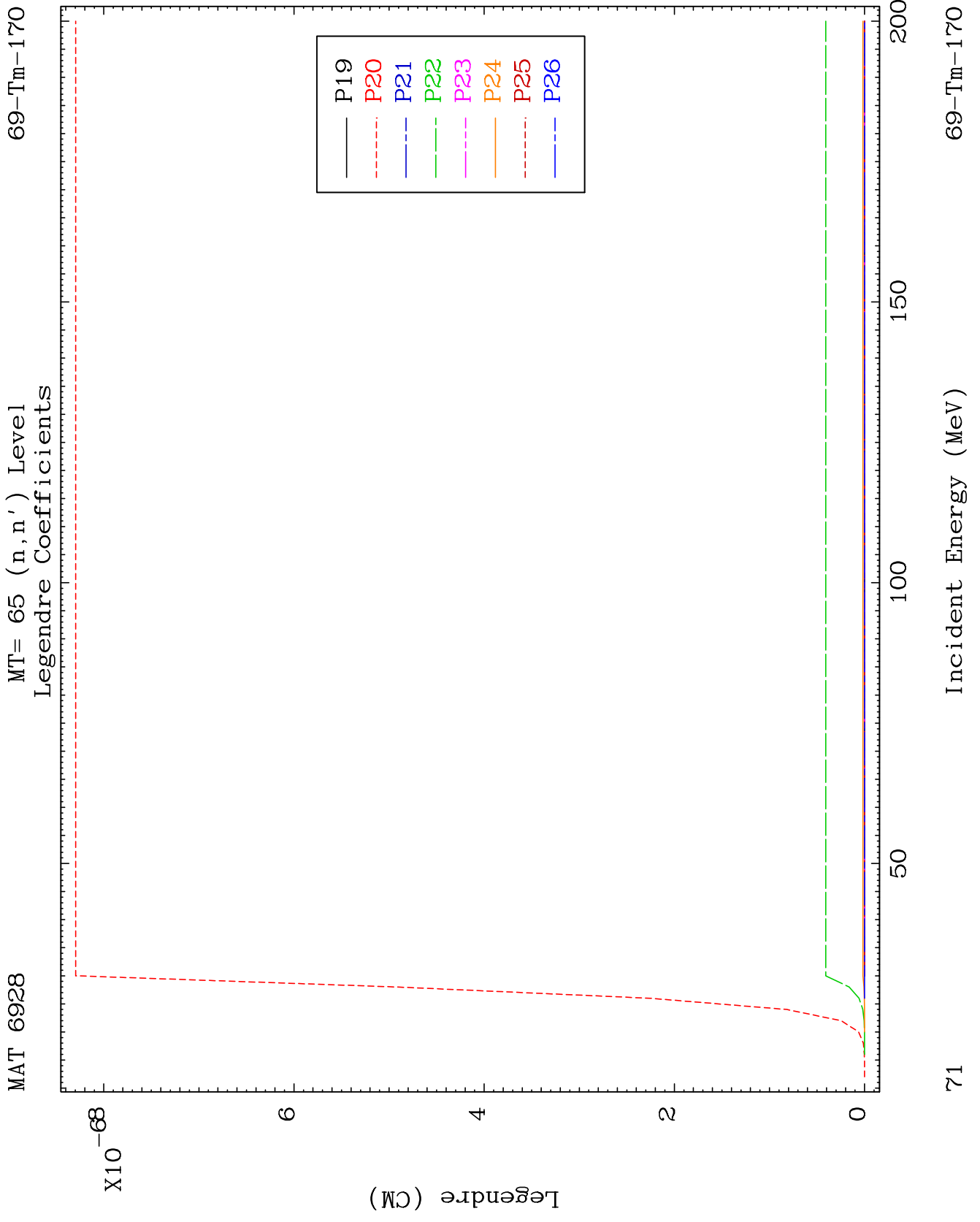

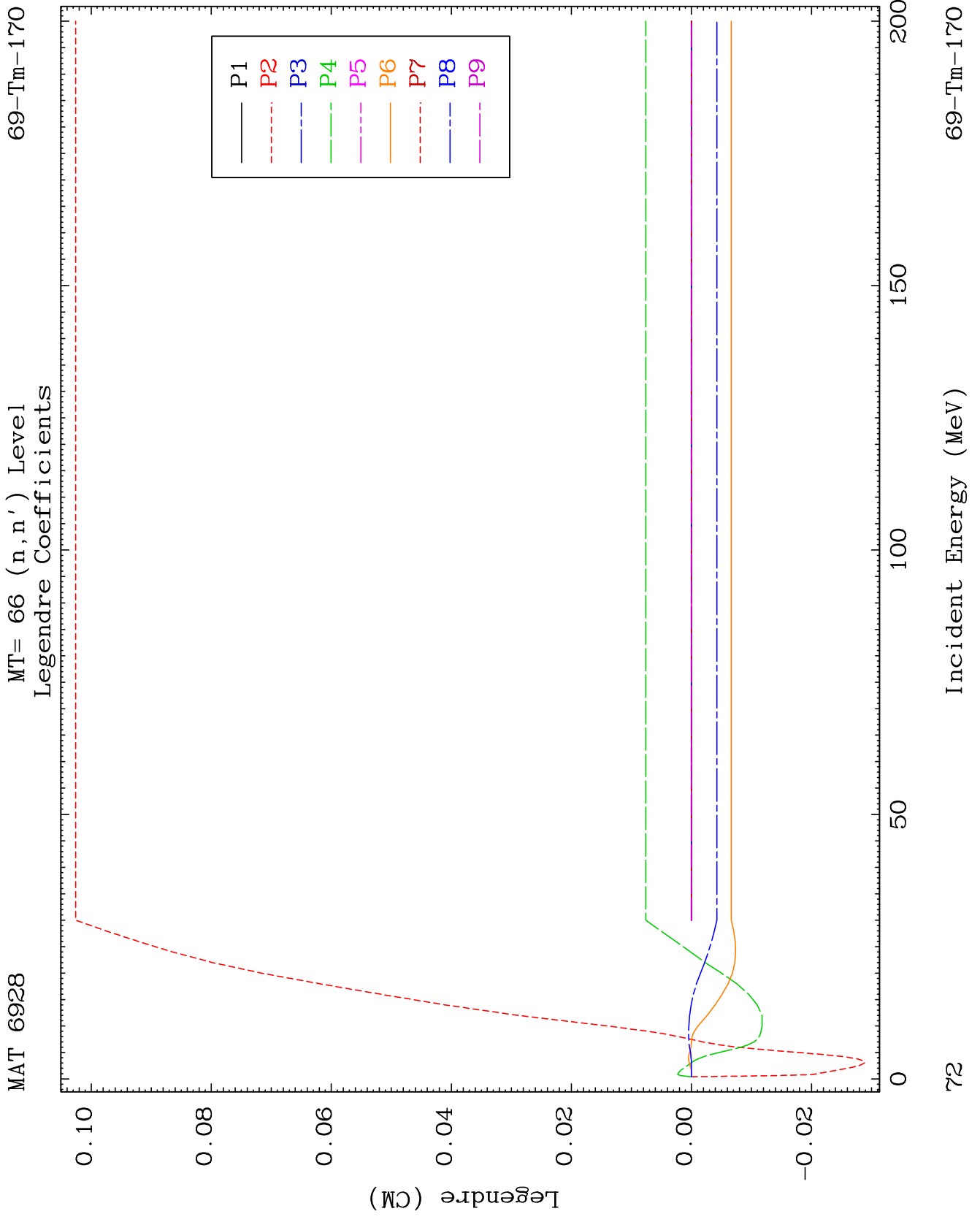

MAT 6928

MT= 66 (n,n') Level
Legendre Coefficients

69-Tm-170

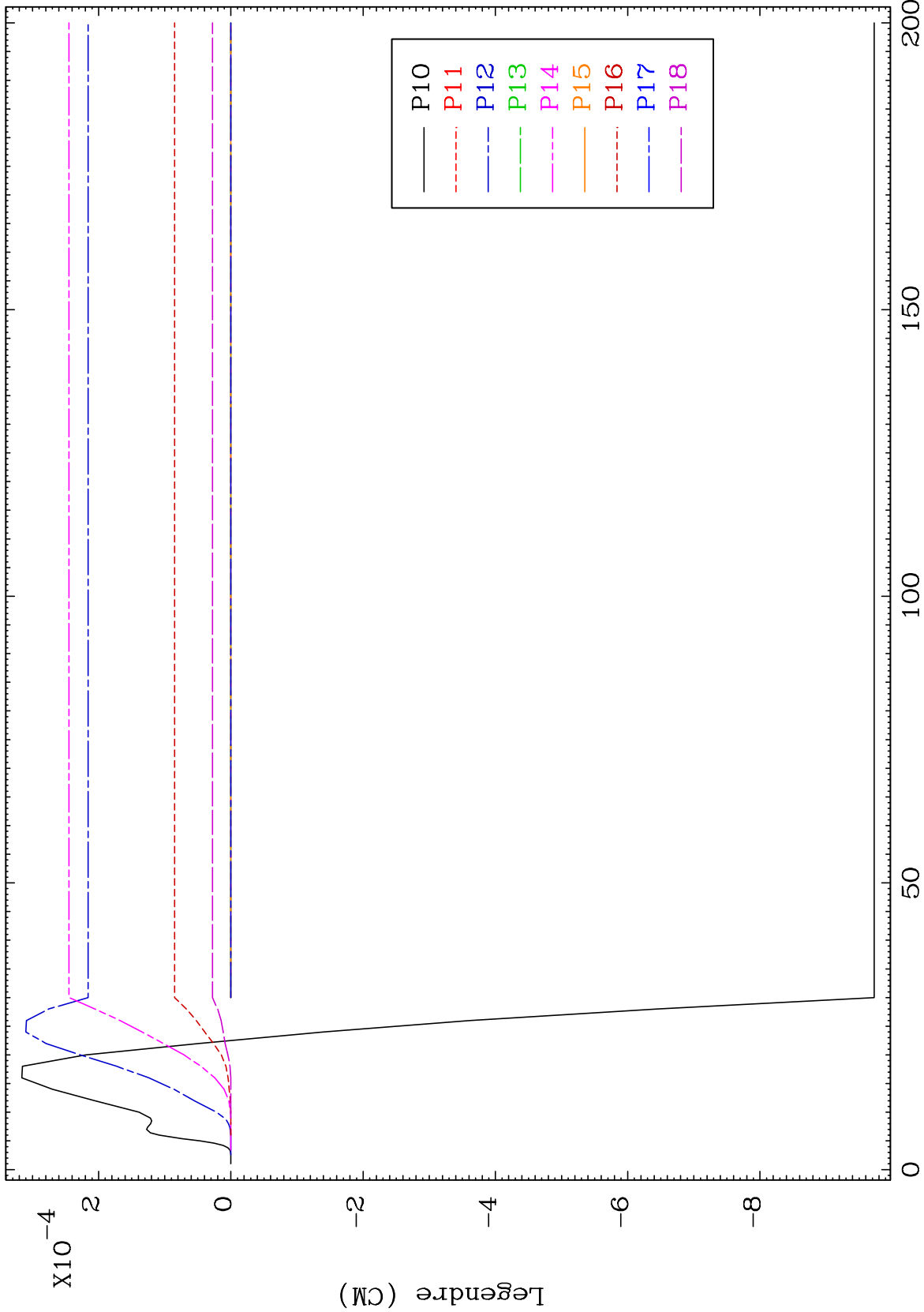

73

Incident Energy (MeV)

69-Tm-170

MAT 6928

MT= 67 (n,n') Level
Legendre Coefficients

69-Tm-170

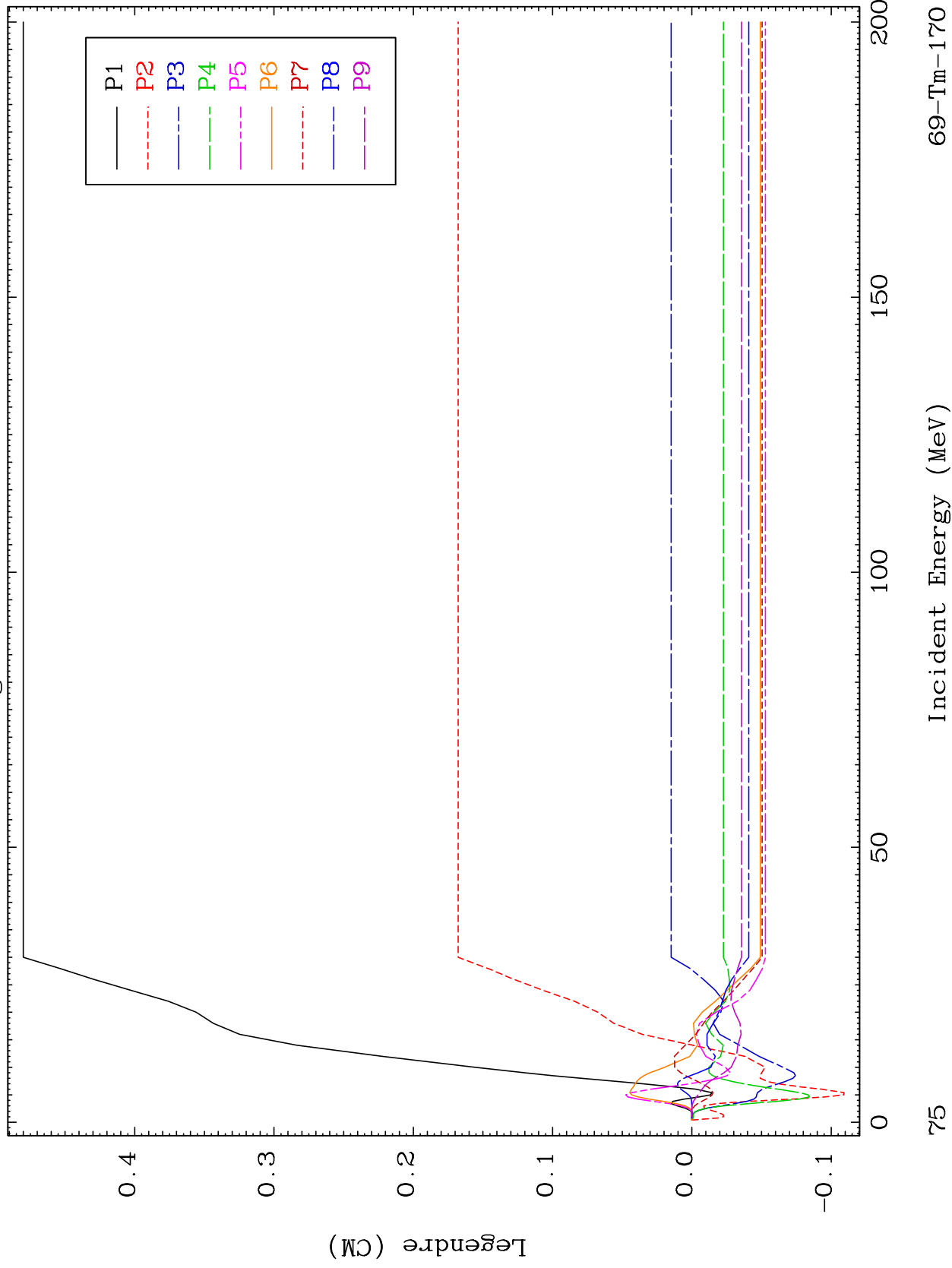

75

Incident Energy (MeV)

69-Tm-170

MAT 6928

MT= 67 (n,n') Level
Legendre Coefficients

69-Tm-170

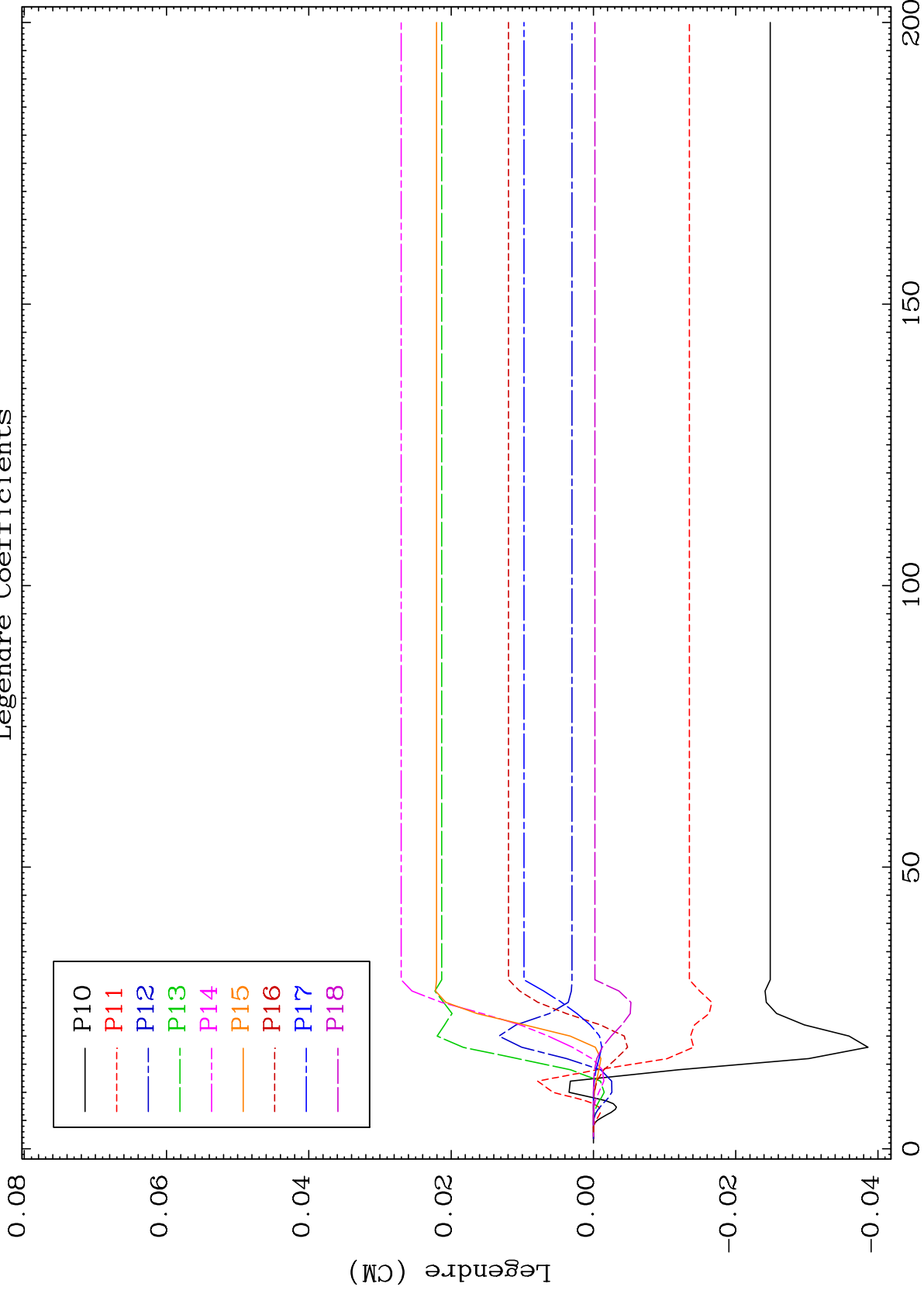

76

Incident Energy (MeV)

69-Tm-170

MAT 6928

MT= 67 (n,n') Level
Legendre Coefficients

69-Tm-170

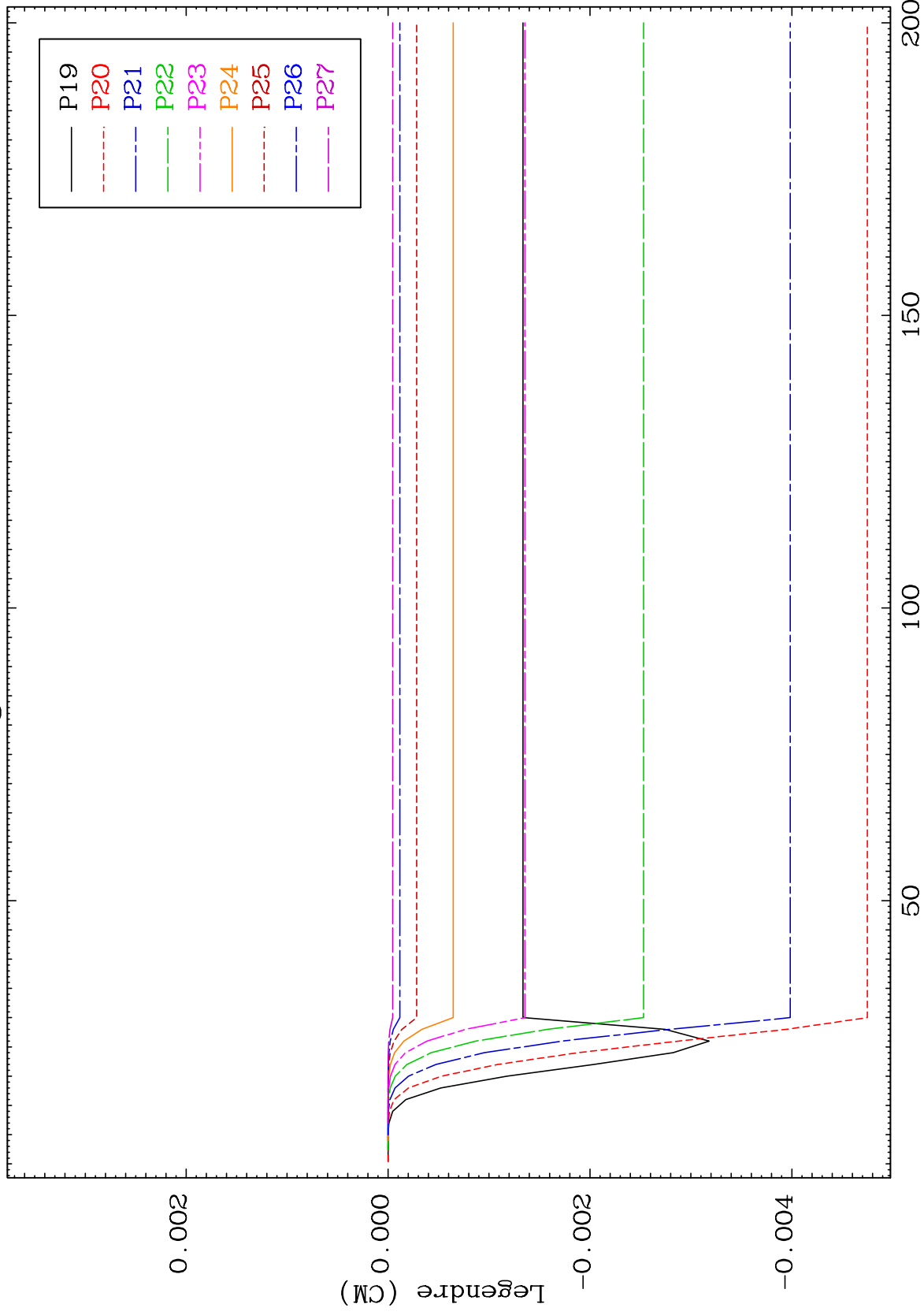

77

Incident Energy (MeV)

69-Tm-170

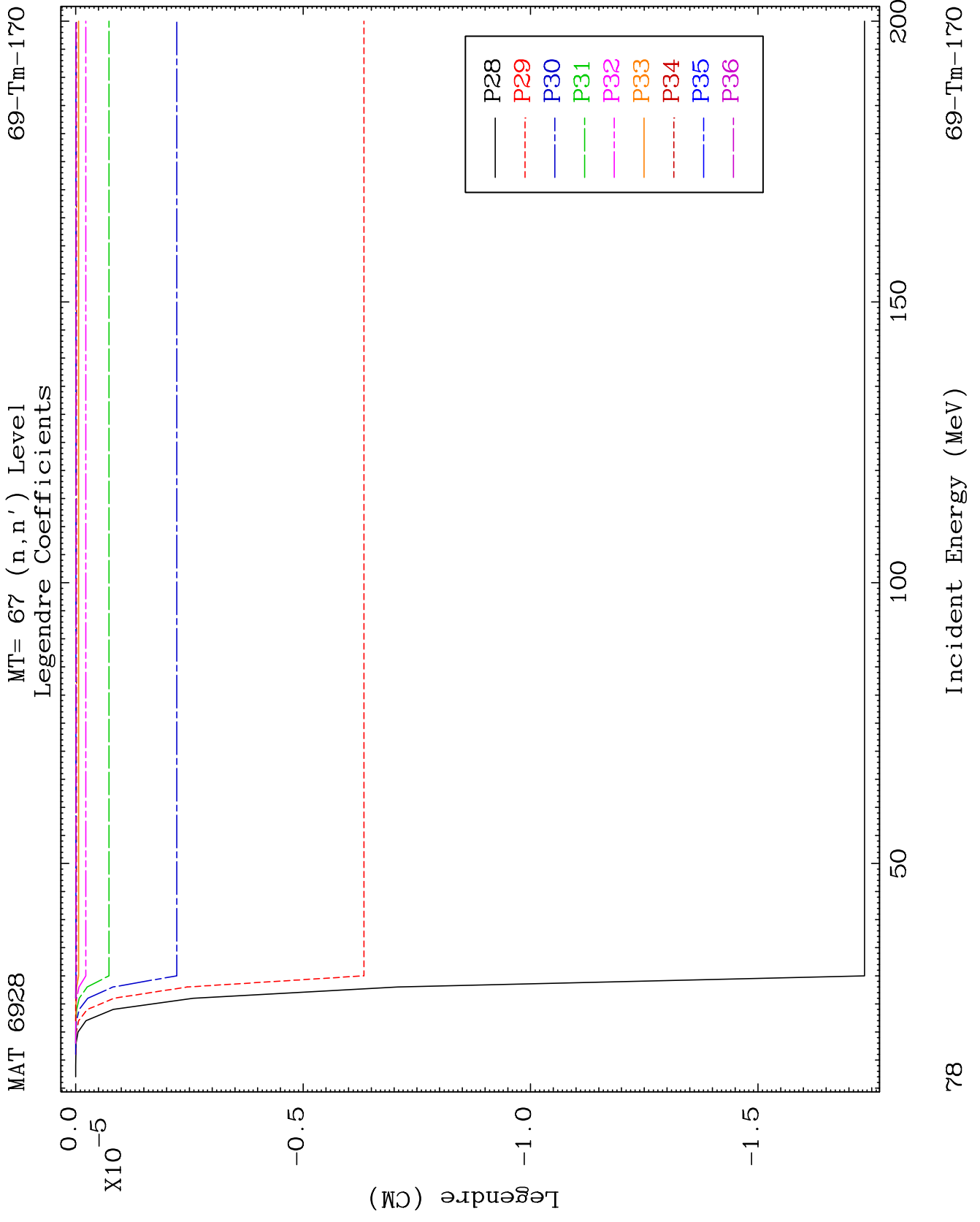

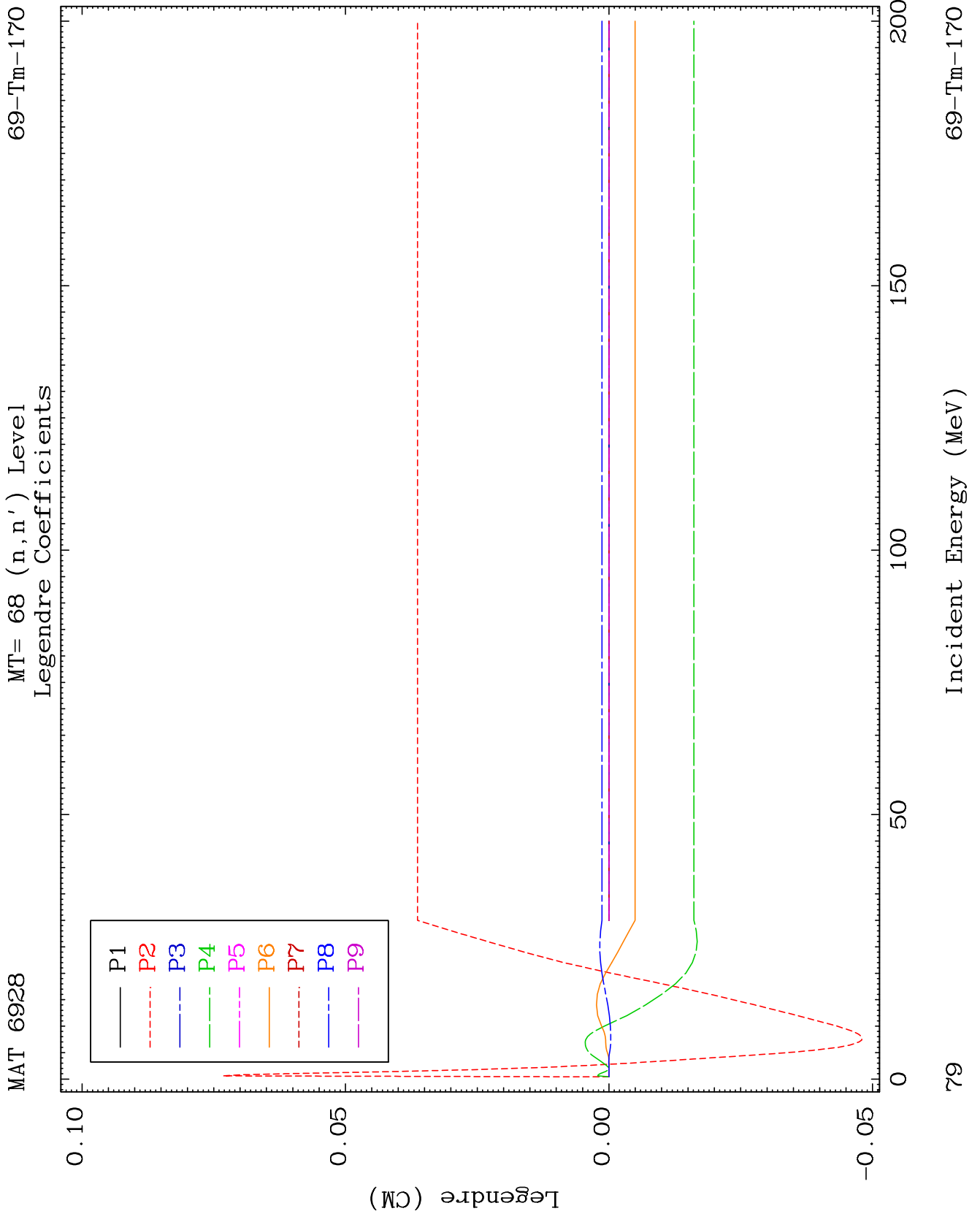

MAT 6928

MT= 68 (n,n') Level
Legendre Coefficients

69-Tm-170

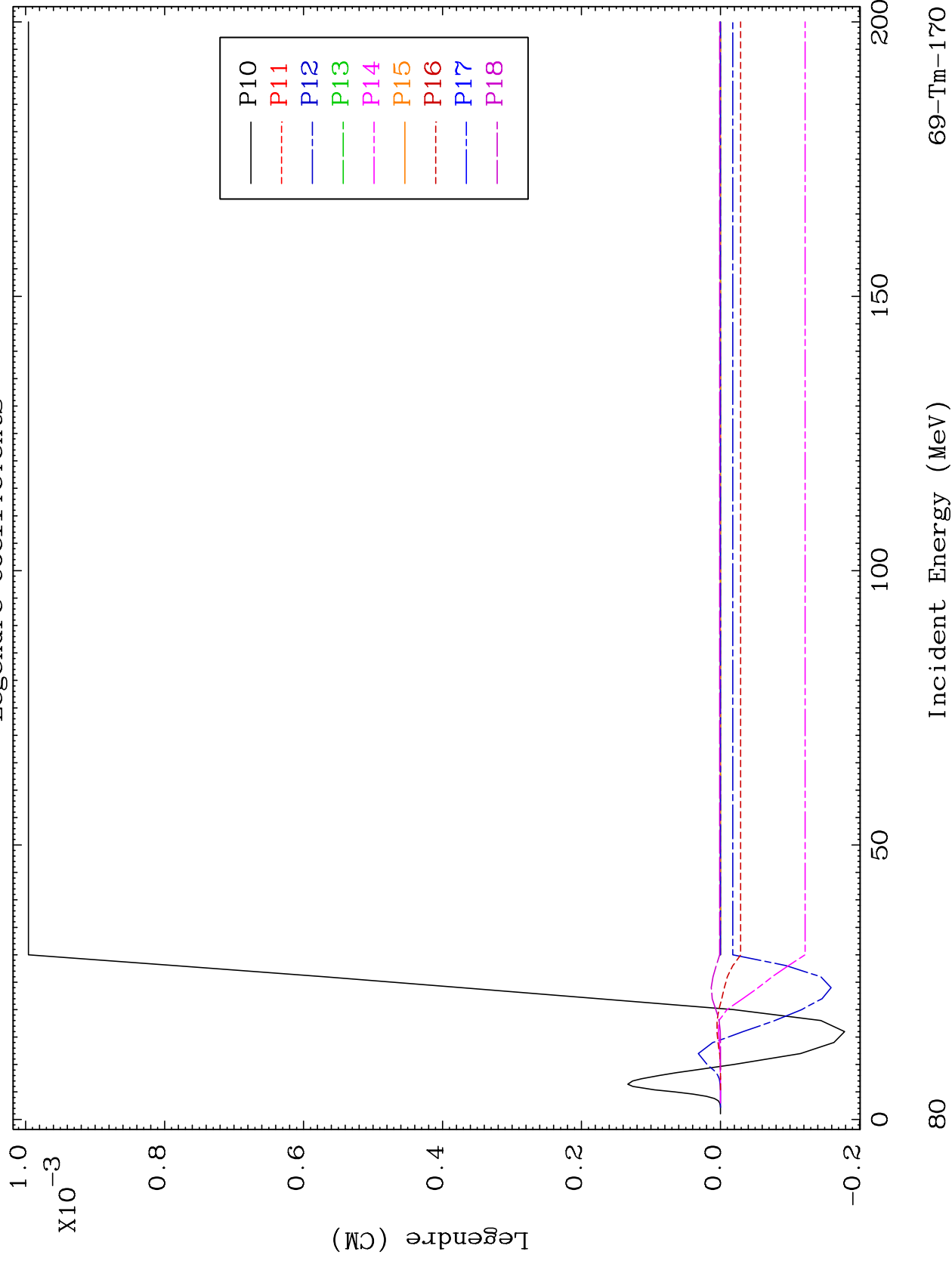

69-Tm-170

Incident Energy (MeV)

80

MAT 6928

MT= 69 (n,n') Level
Legendre Coefficients

69-Tm-170

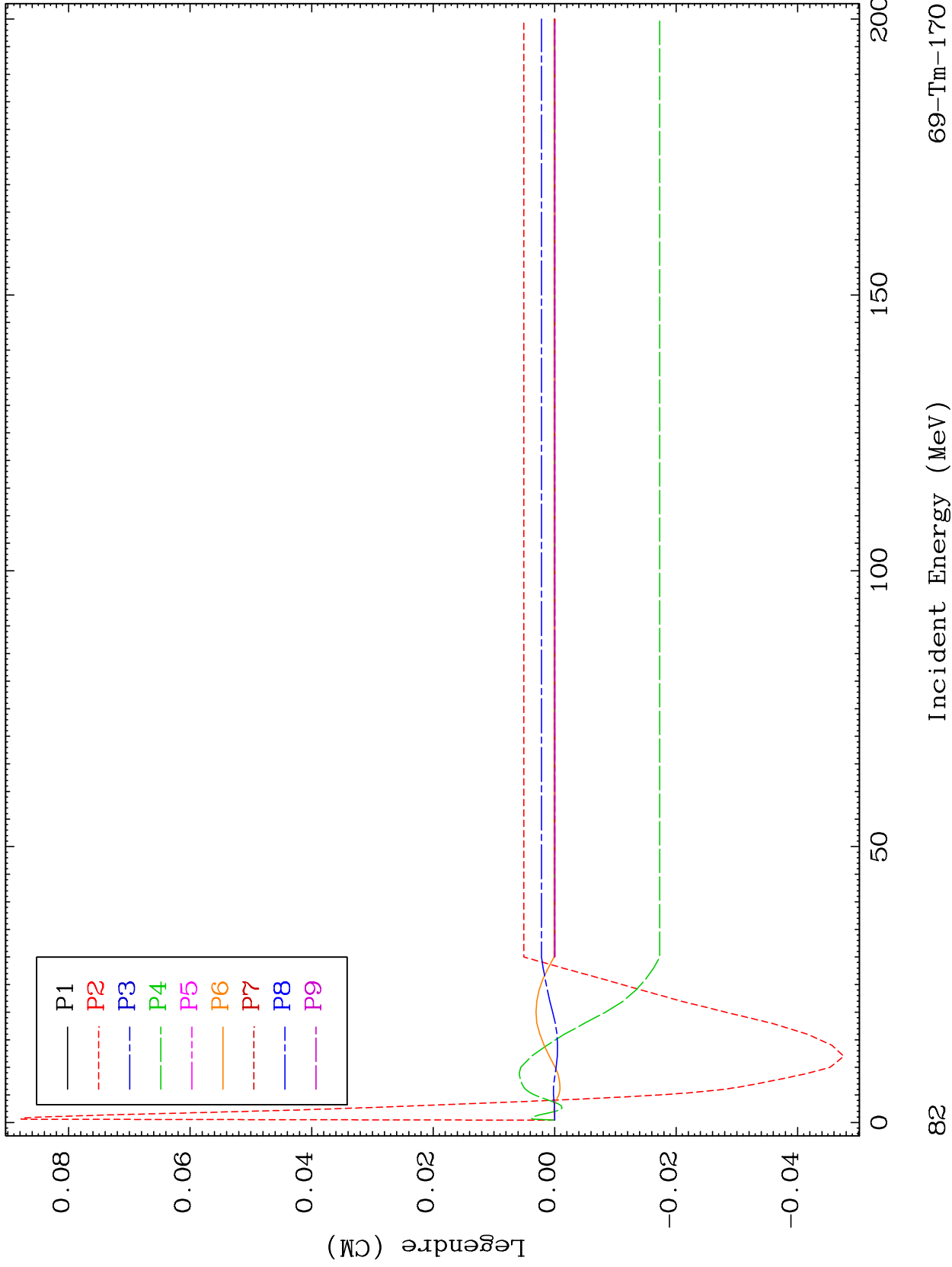

82

Incident Energy (MeV)

69-Tm-170

MAT 6928

MT= 69 (n,n') Level
Legendre Coefficients

69-Tm-170

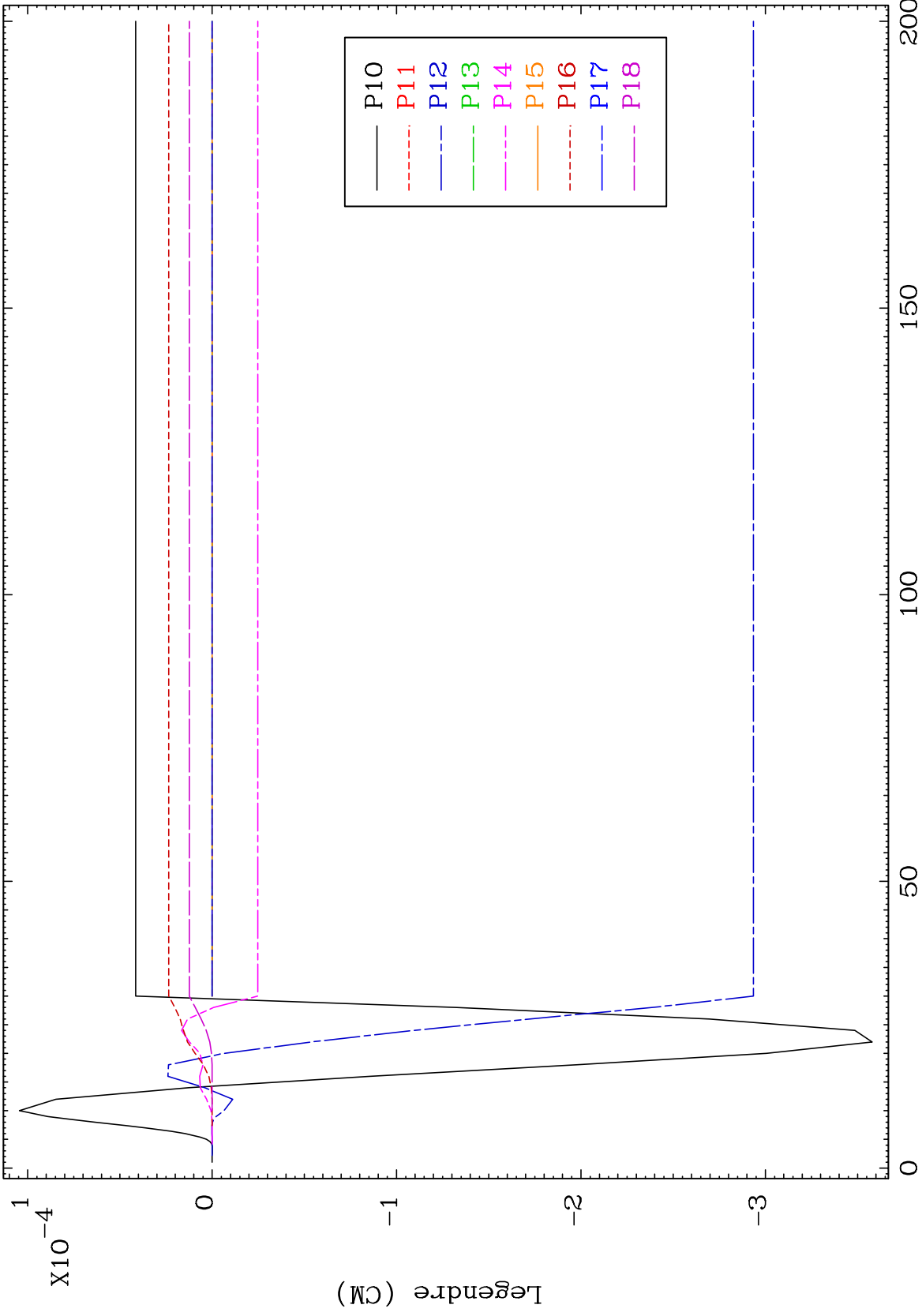

83

Incident Energy (MeV)

69-Tm-170

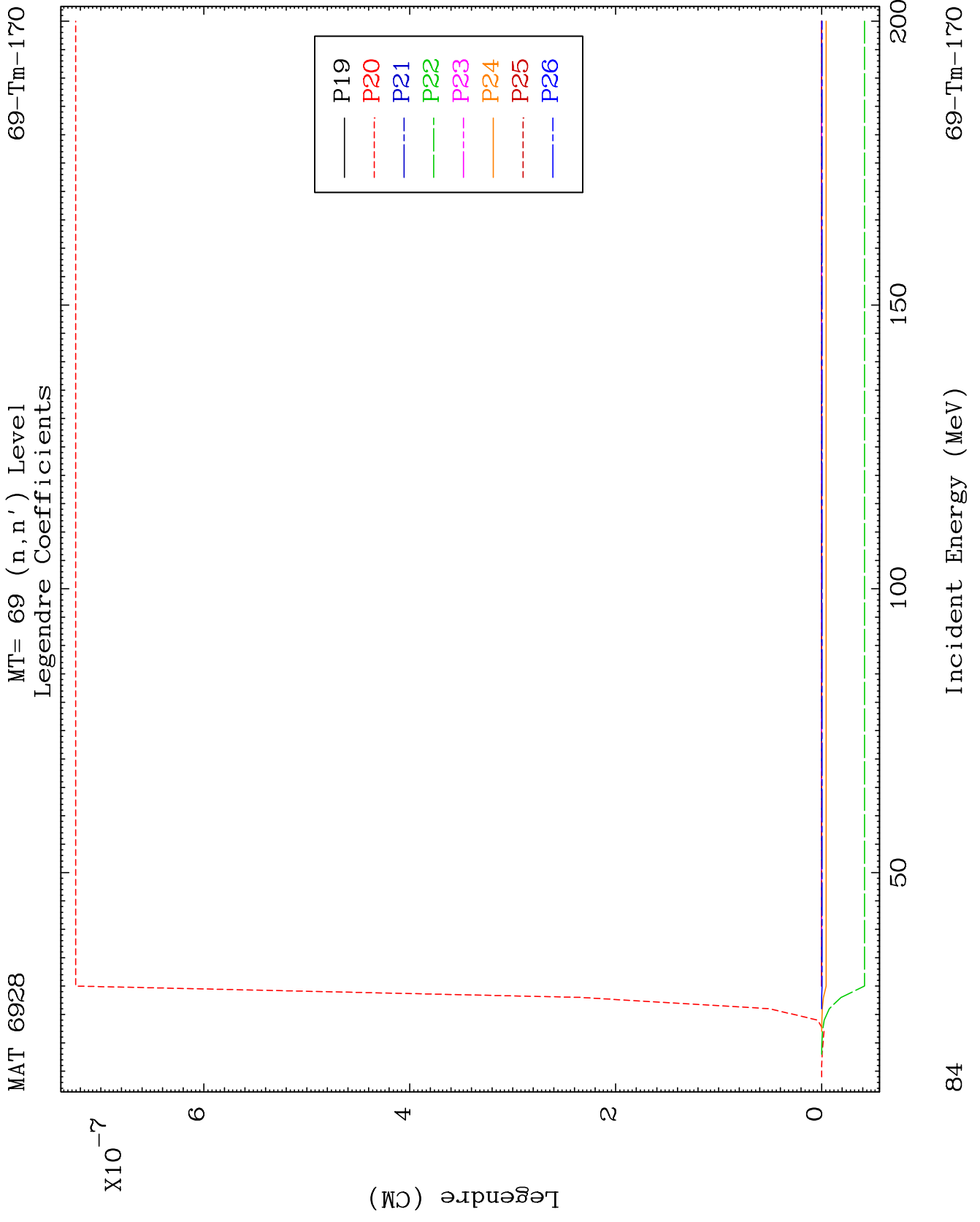

MAT 6928

MT= 70 (n,n') Level
Legendre Coefficients

69-Tm-170

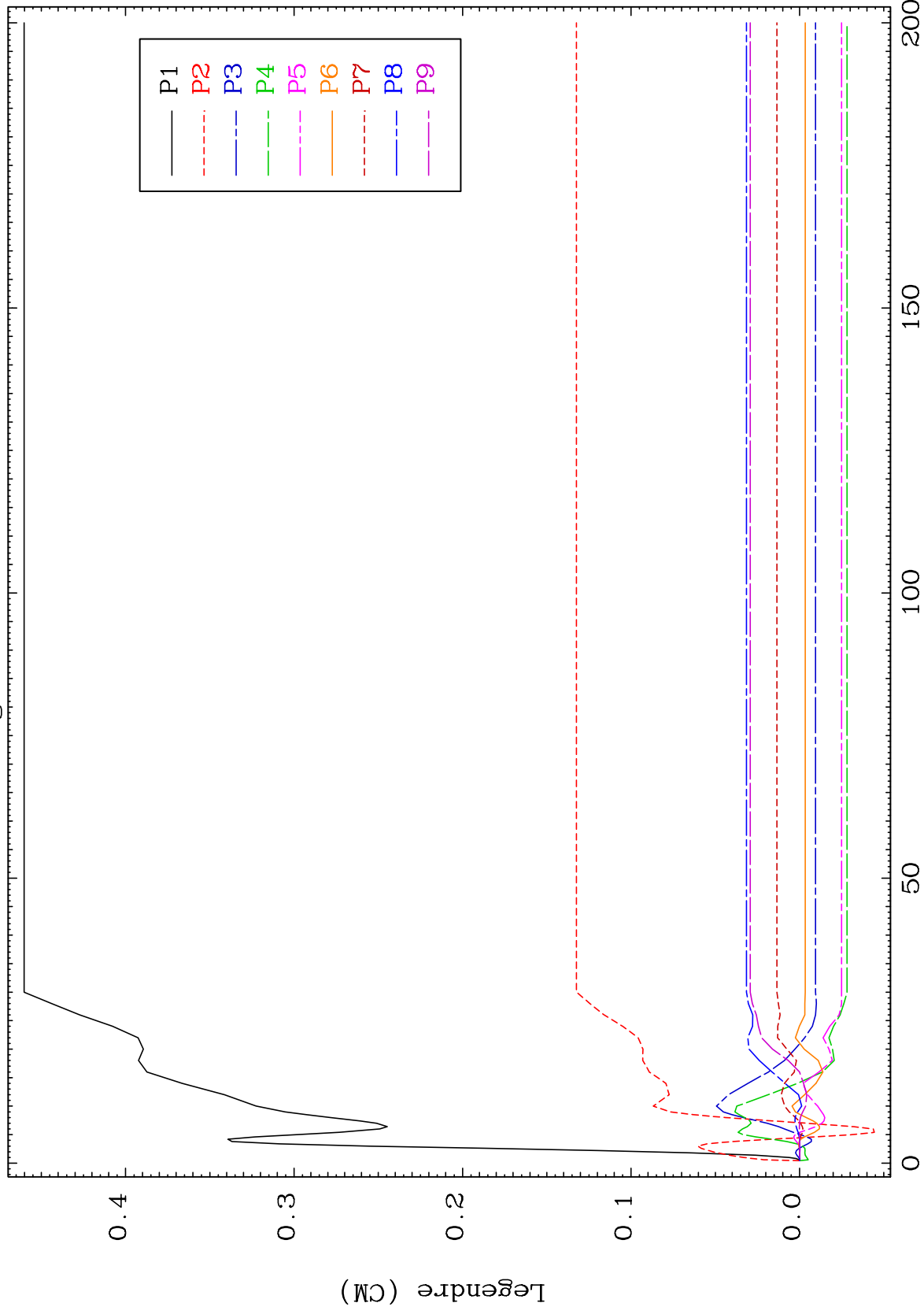

85

Incident Energy (MeV)

69-Tm-170

MAT 6928

MT= 70 (n,n') Level
Legendre Coefficients

69-Tm-170

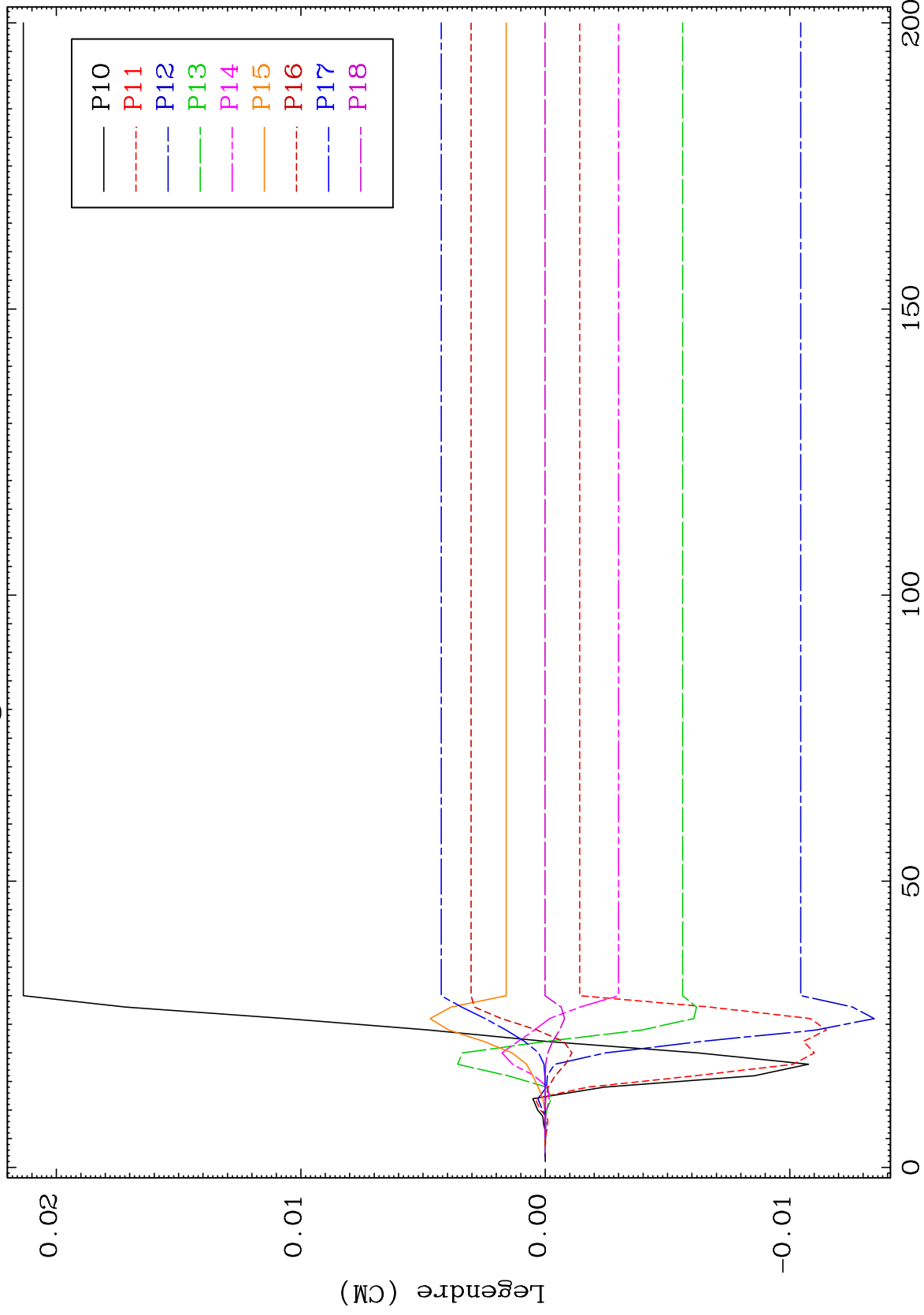

86

Incident Energy (MeV)

69-Tm-170

MAT 6928

MT= 70 (n,n') Level
Legendre Coefficients

69-Tm-170

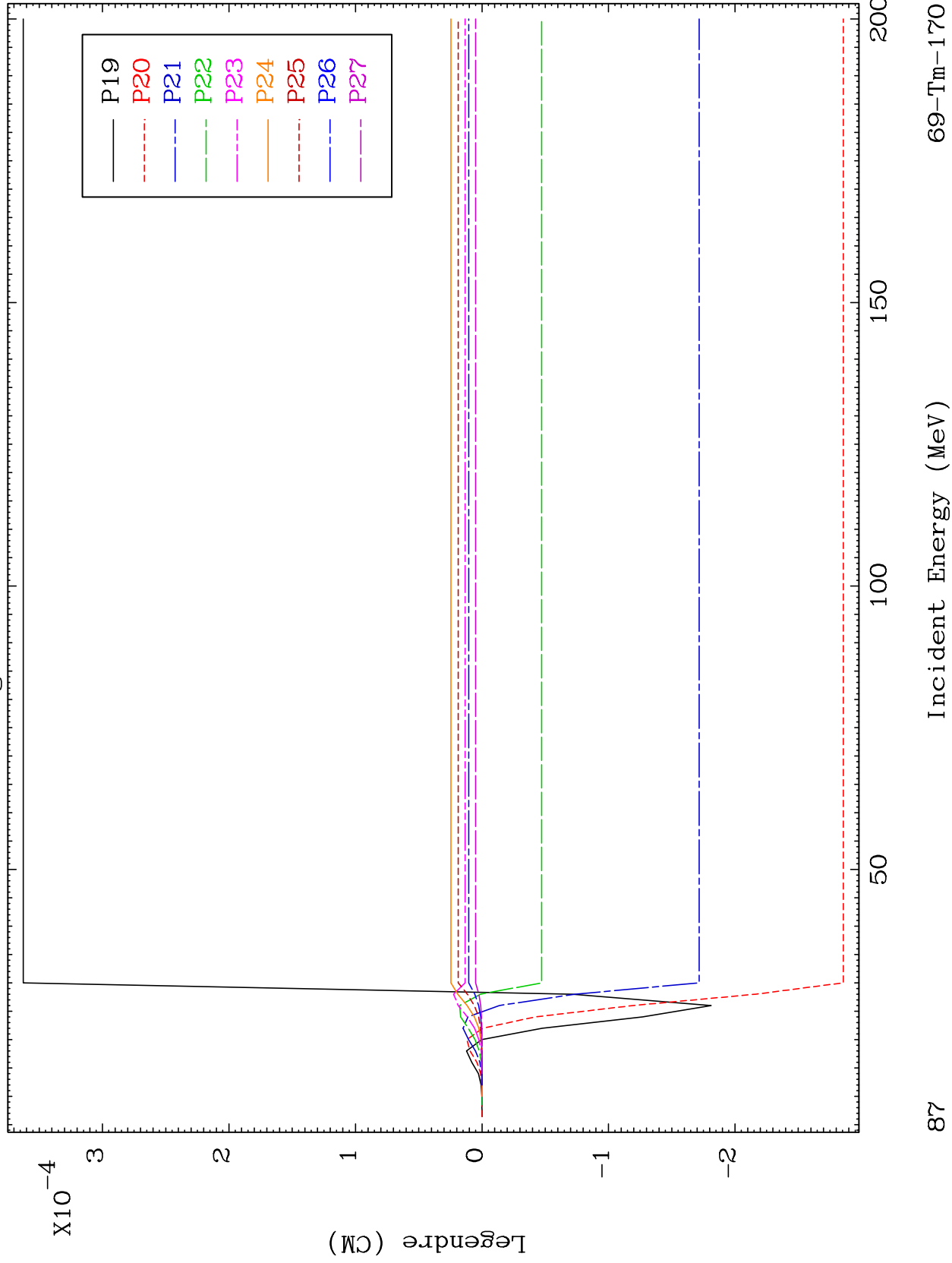

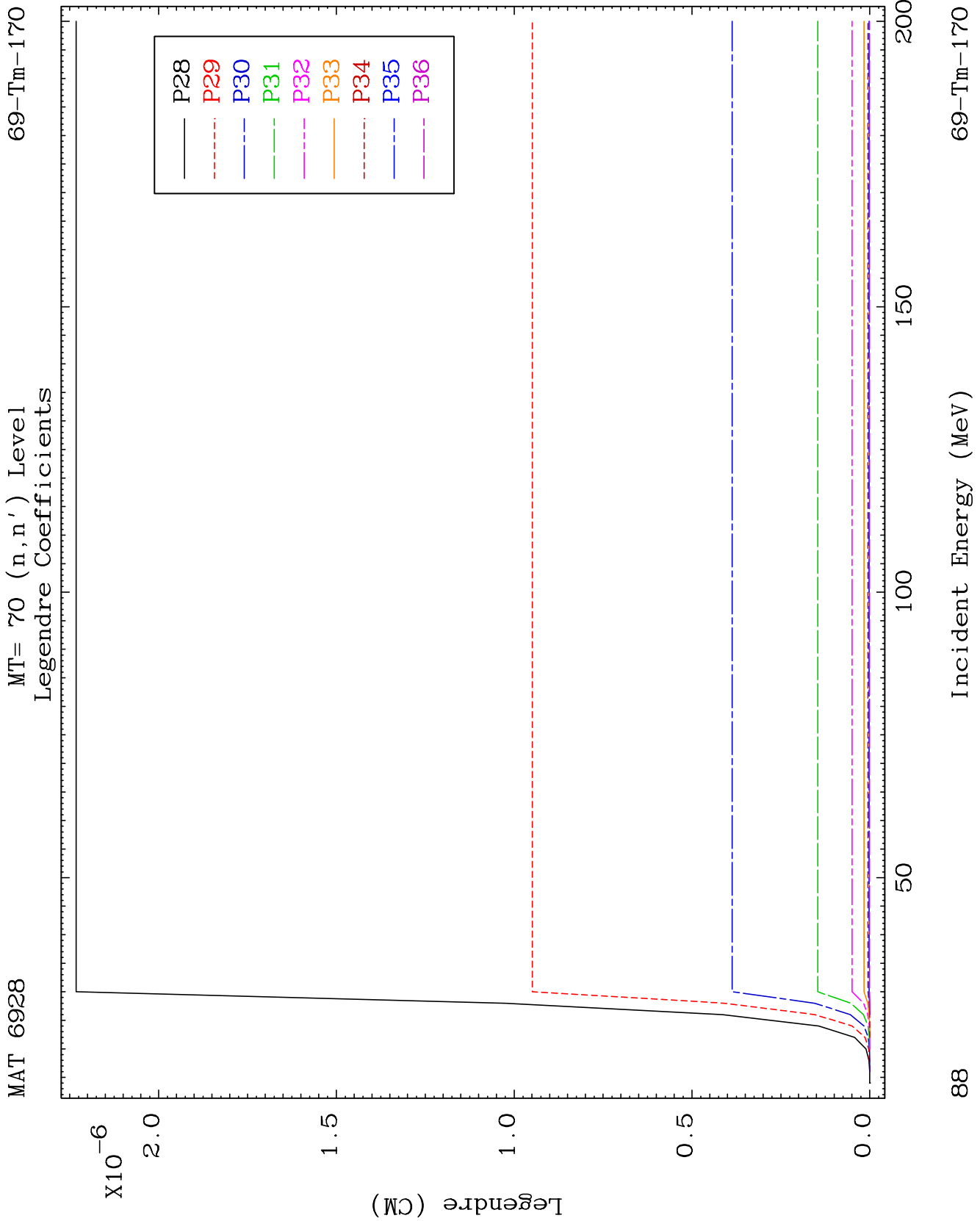

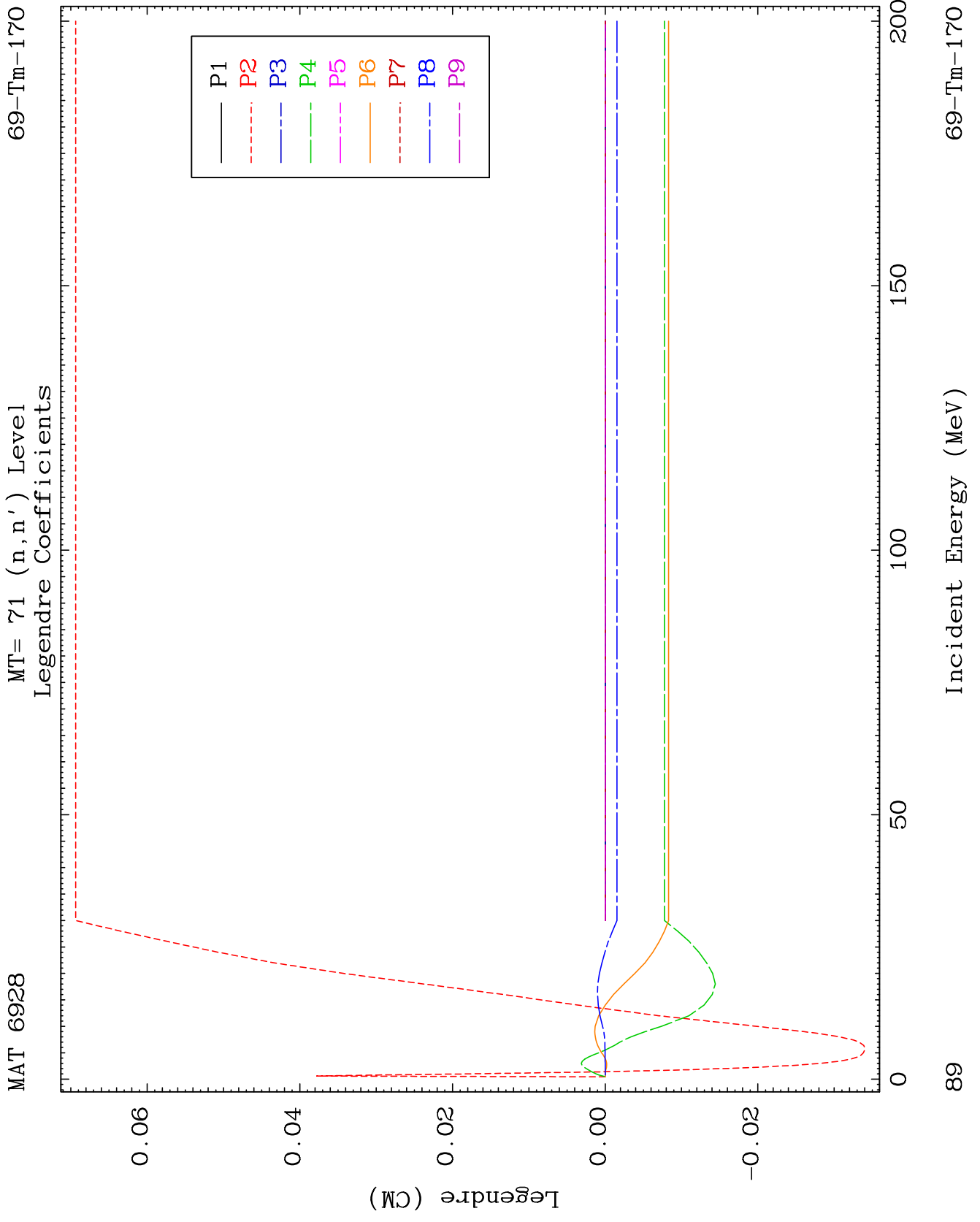

MAT 6928

MT= 71 (n,n') Level
Legendre Coefficients

69-Tm-170

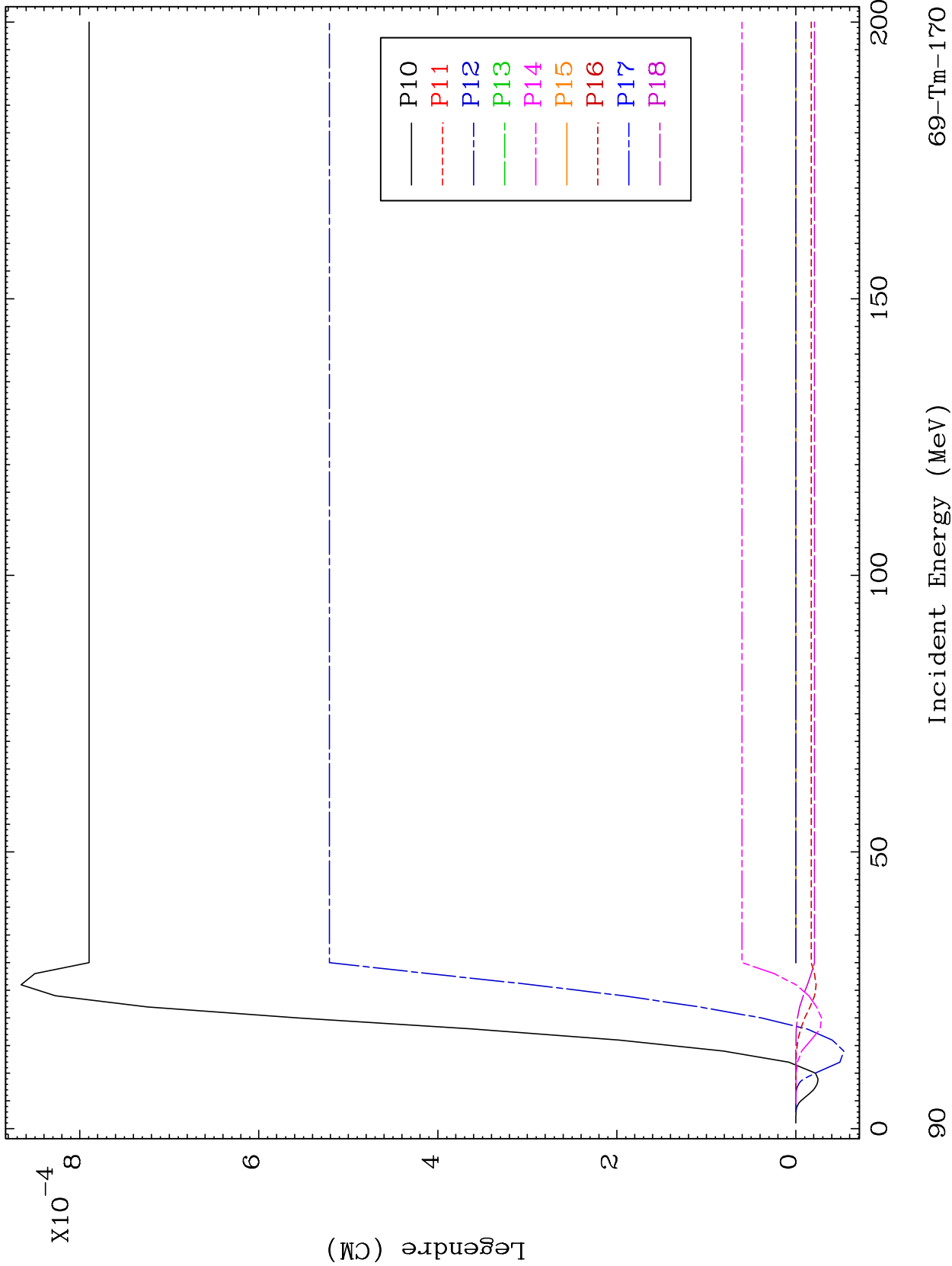

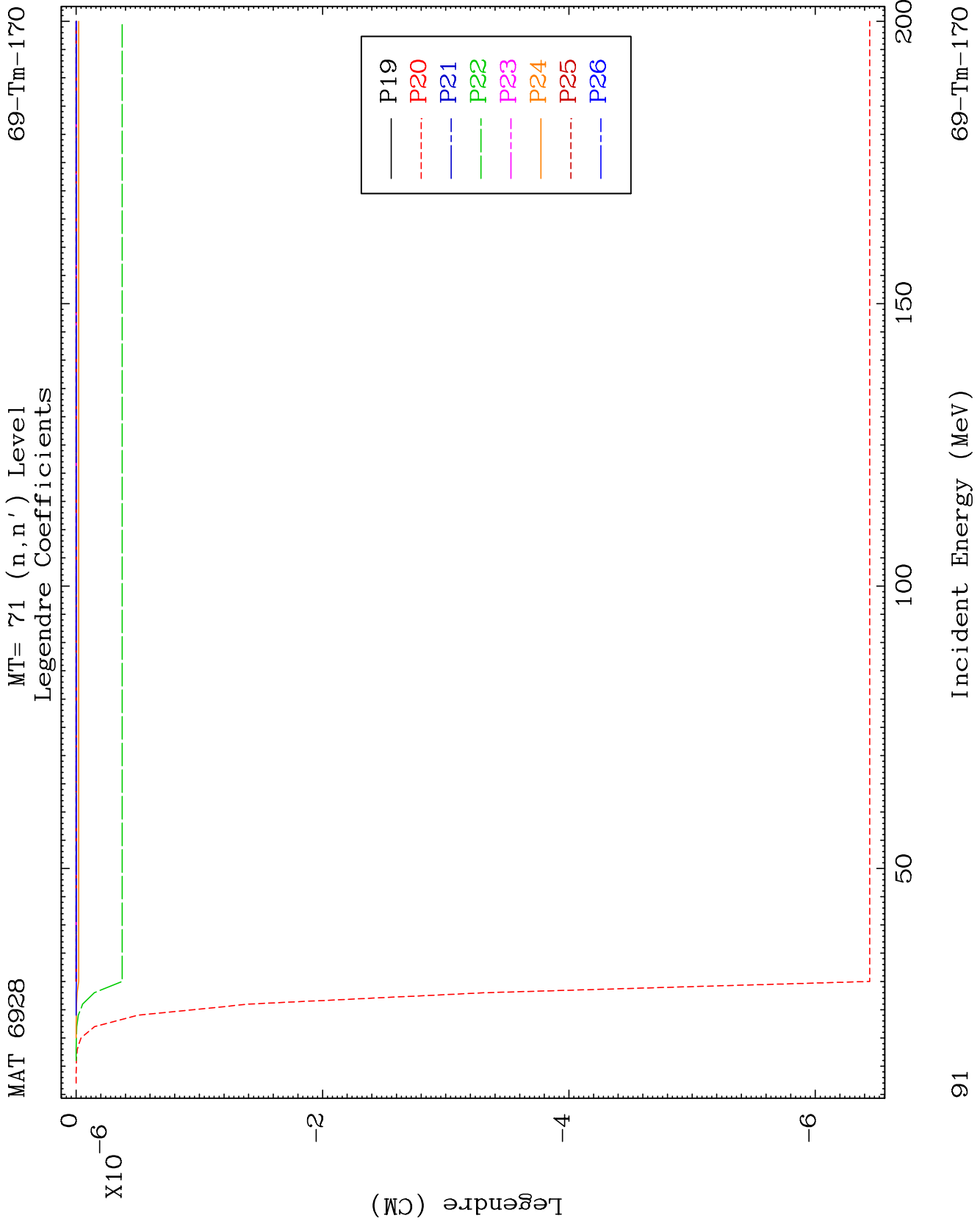

MAT 6928

MT= 72 (n,n') Level
Legendre Coefficients

69-Tm-170

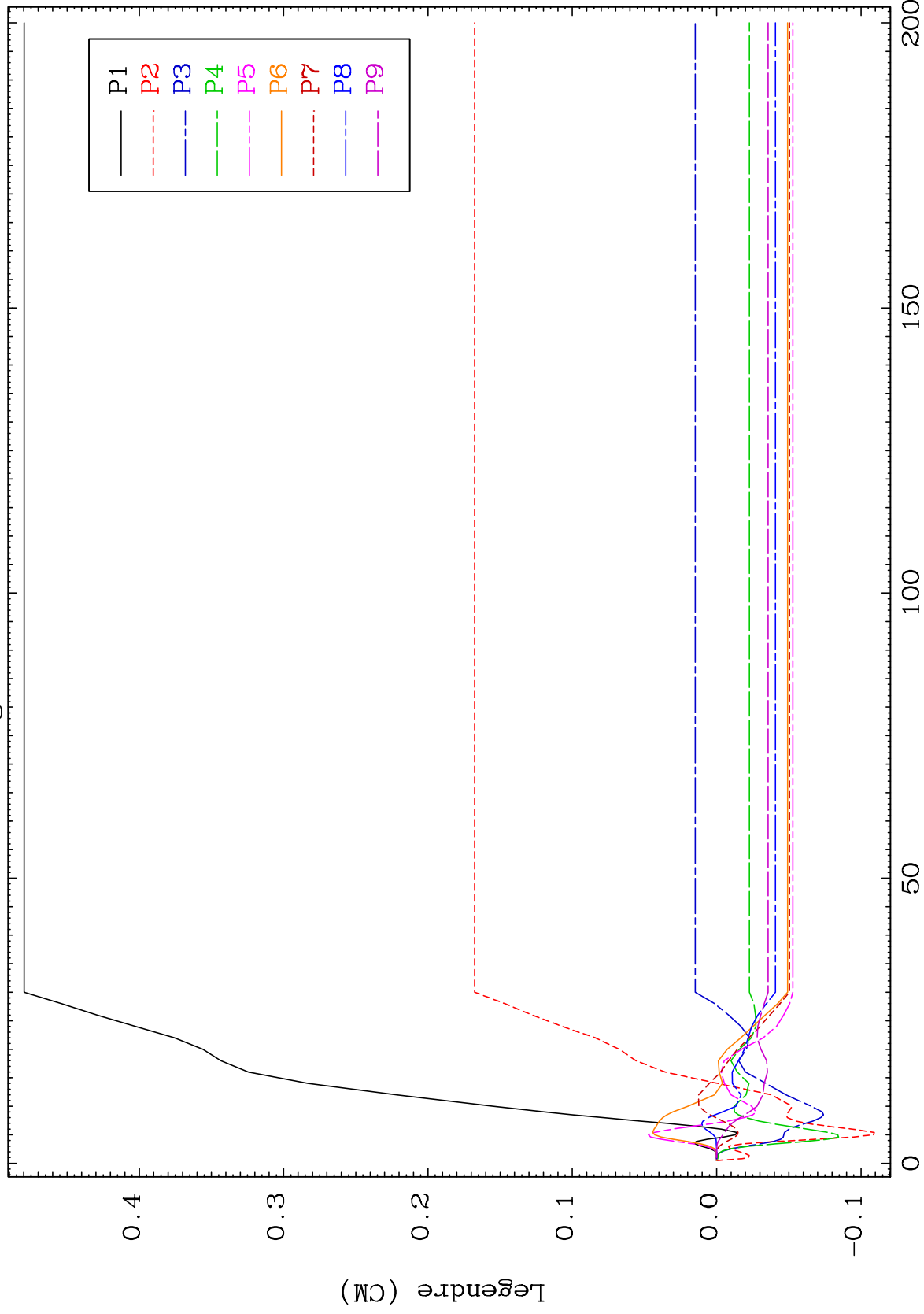

92

Incident Energy (MeV)

69-Tm-170

MAT 6928

MT= 72 (n,n') Level
Legendre Coefficients

69-Tm-170

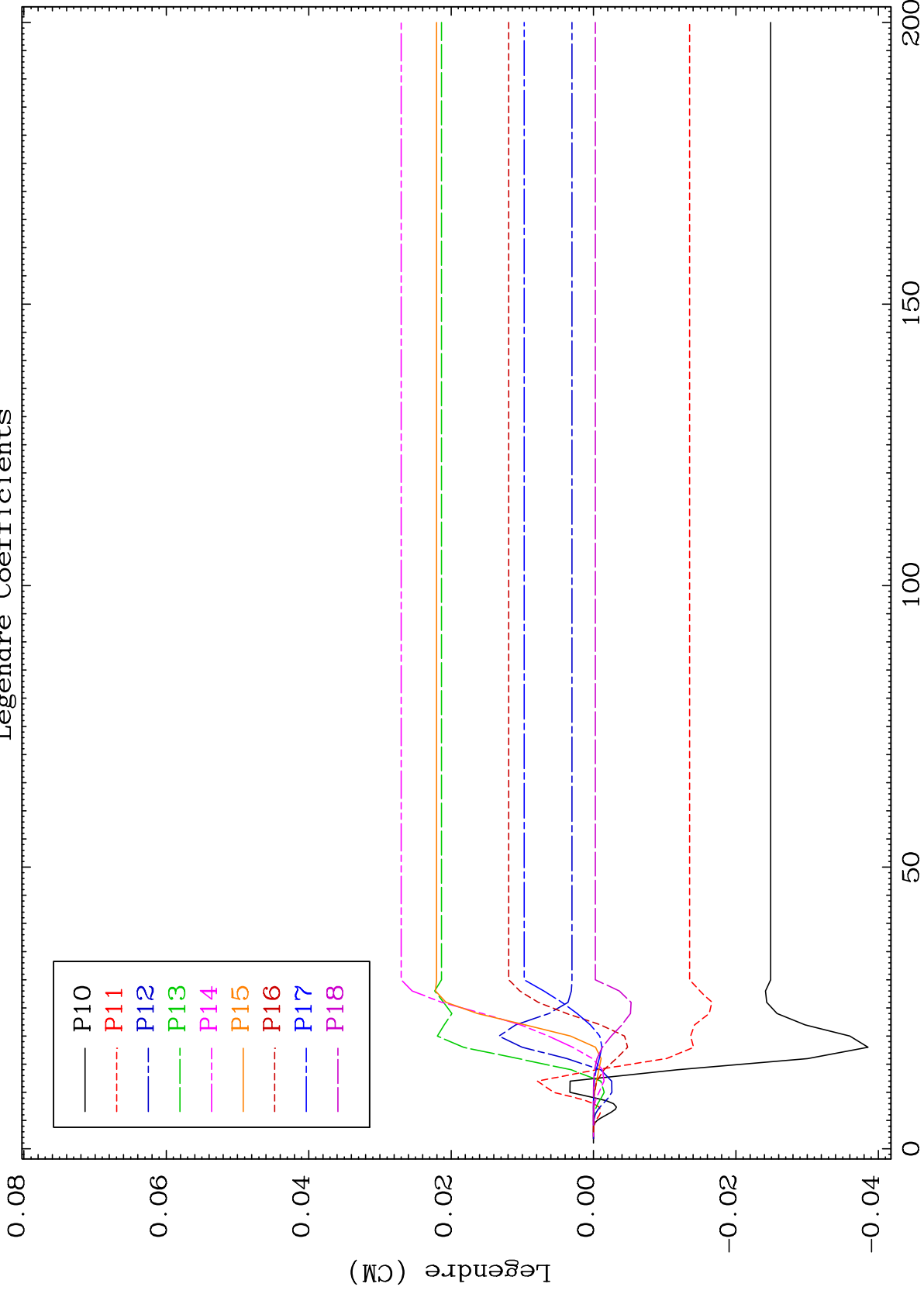

93

Incident Energy (MeV)

69-Tm-170

MAT 6928

MT= 72 (n,n') Level
Legendre Coefficients

69-Tm-170

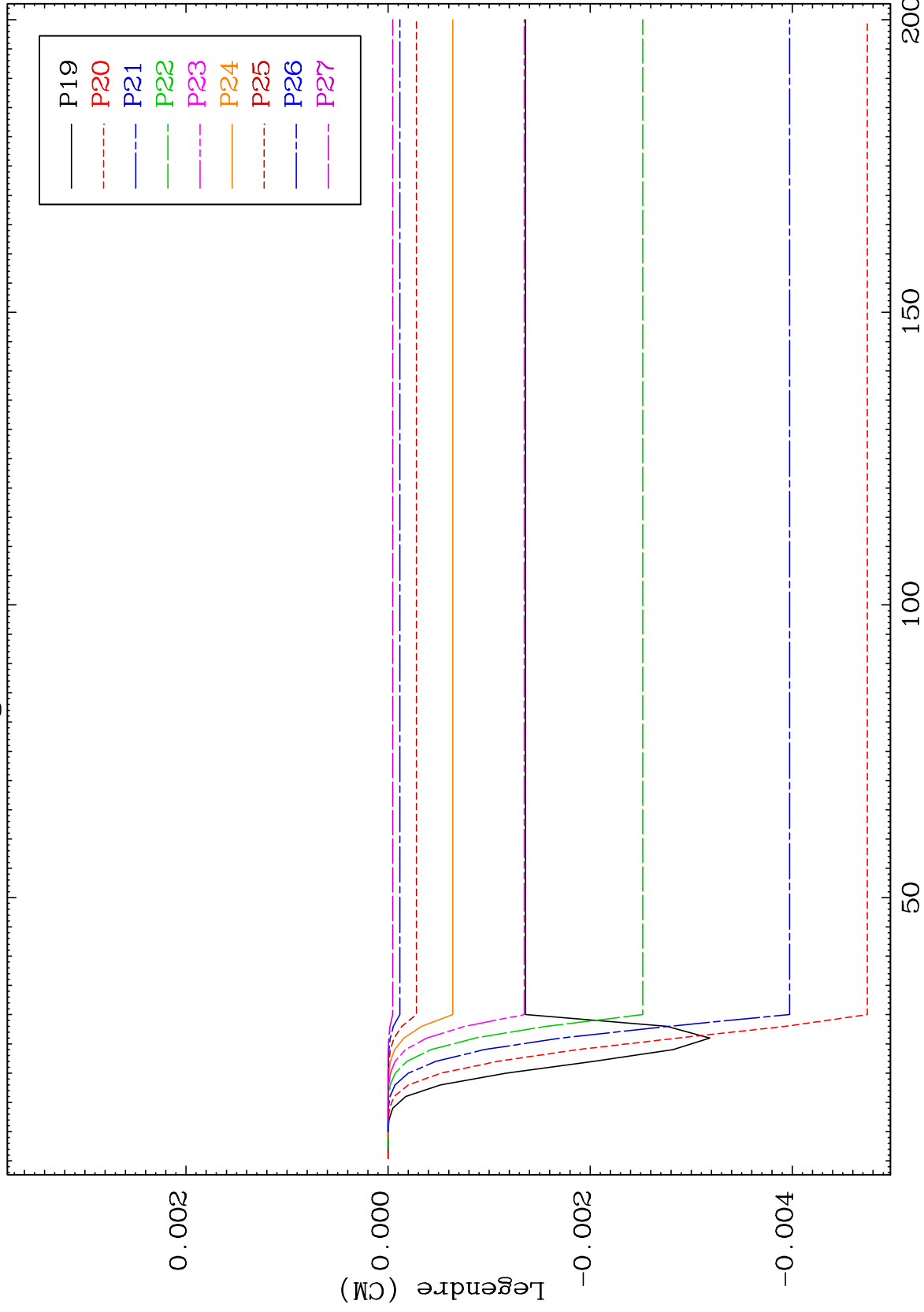

94

Incident Energy (MeV)

69-Tm-170

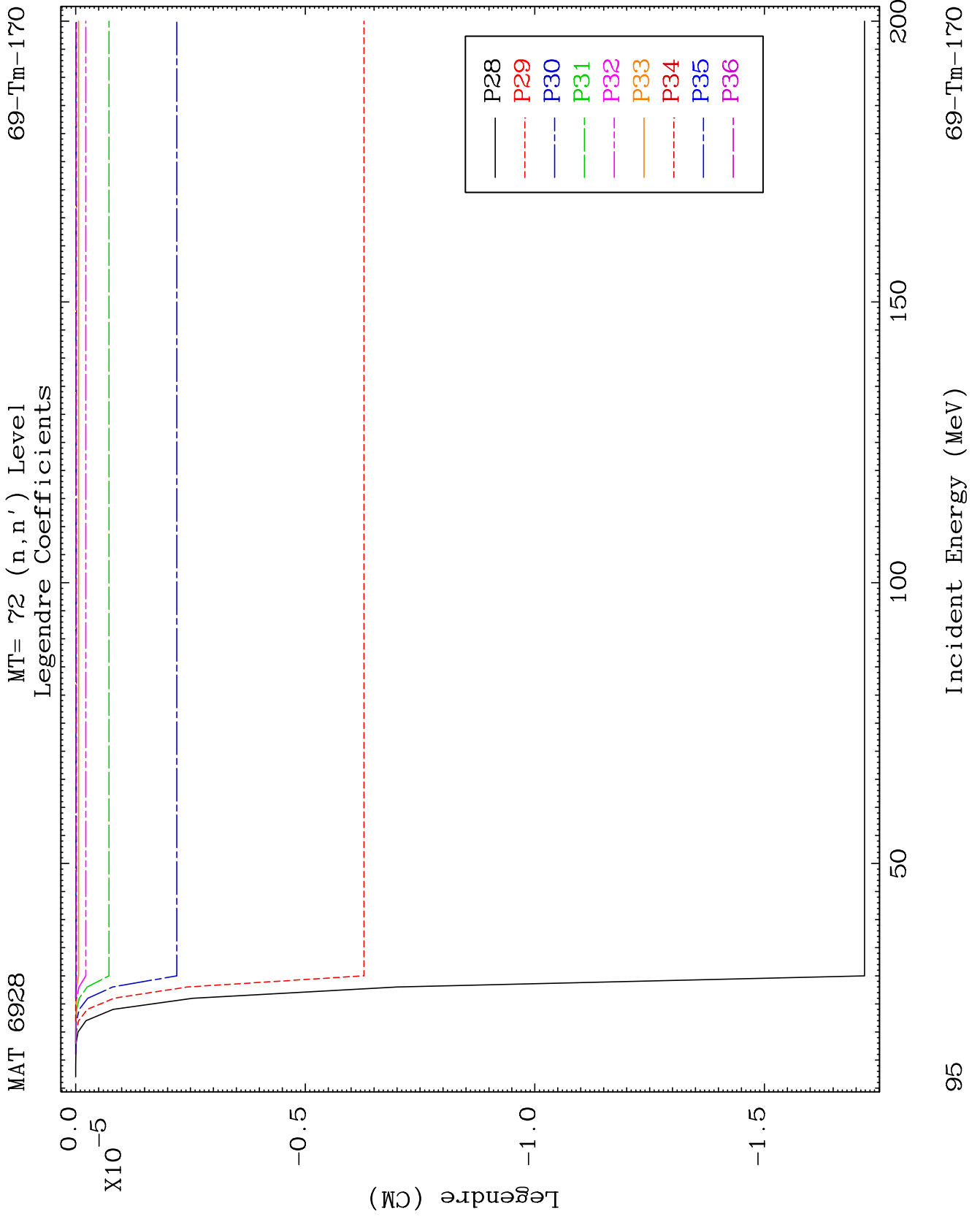

MAT 6928

MT= 73 (n,n') Level
Legendre Coefficients

69-Tm-170

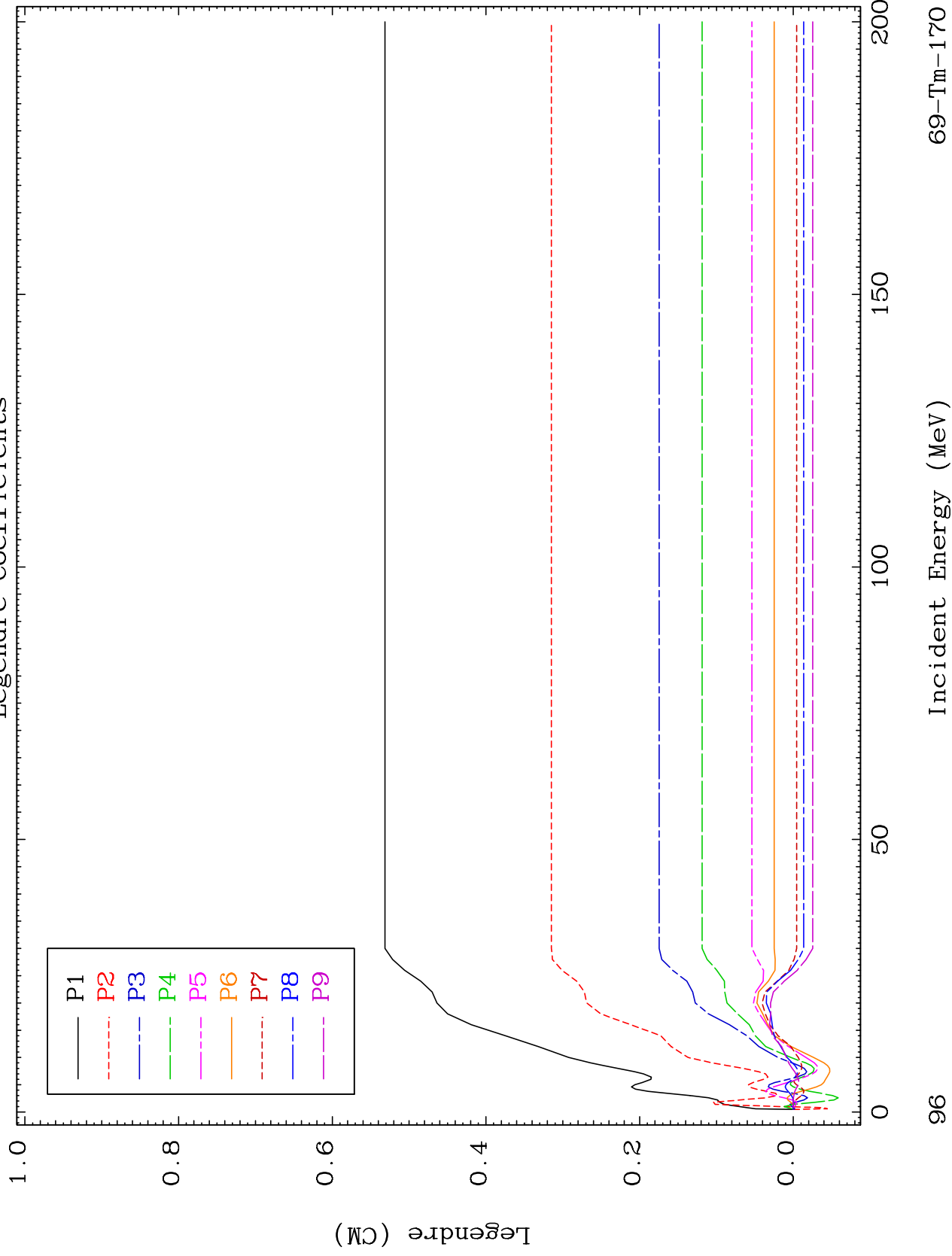

96

Incident Energy (MeV)

69-Tm-170

MAT 6928

MT= 73 (n,n') Level
Legendre Coefficients

69-Tm-170

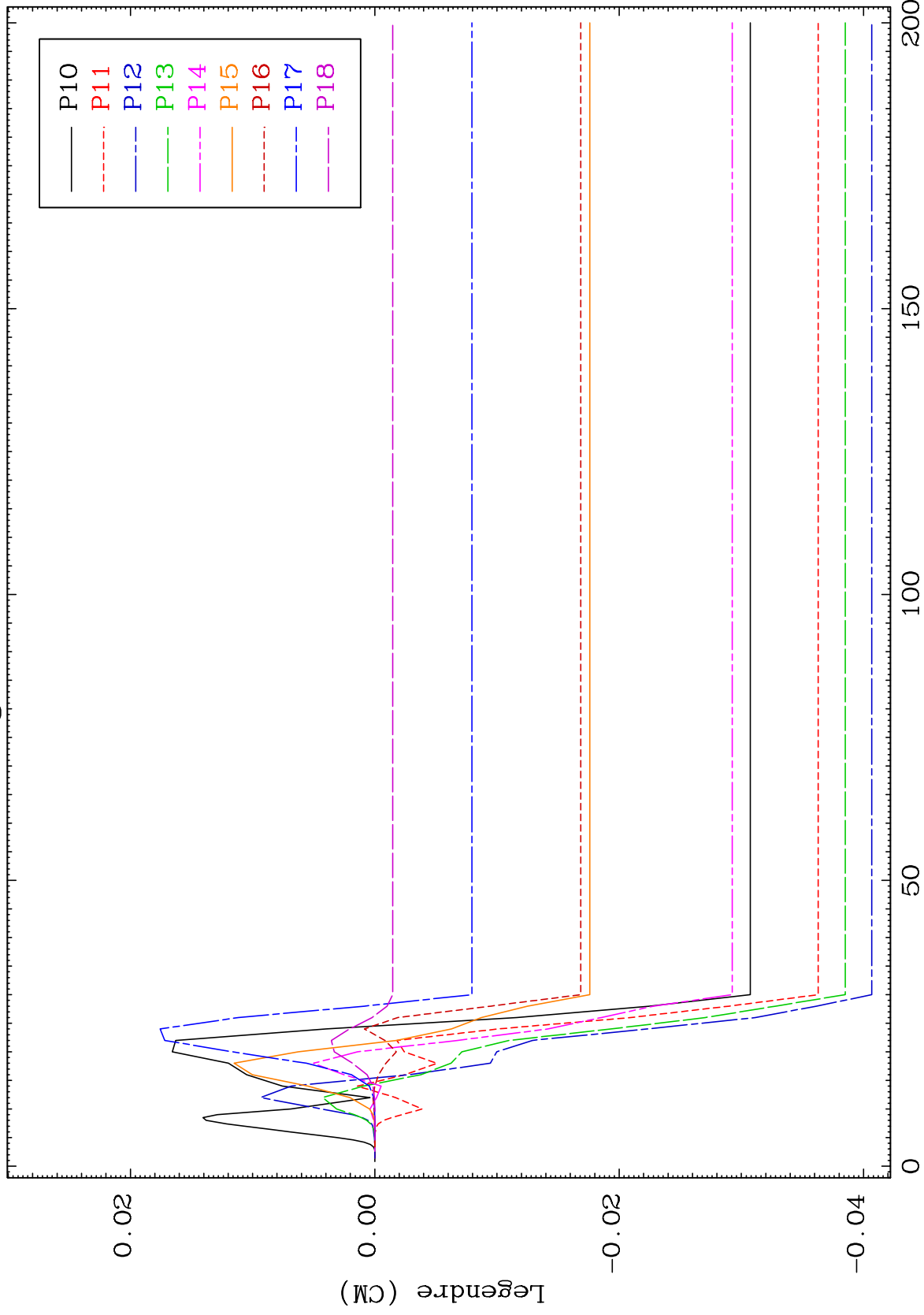

97

Incident Energy (MeV)

69-Tm-170

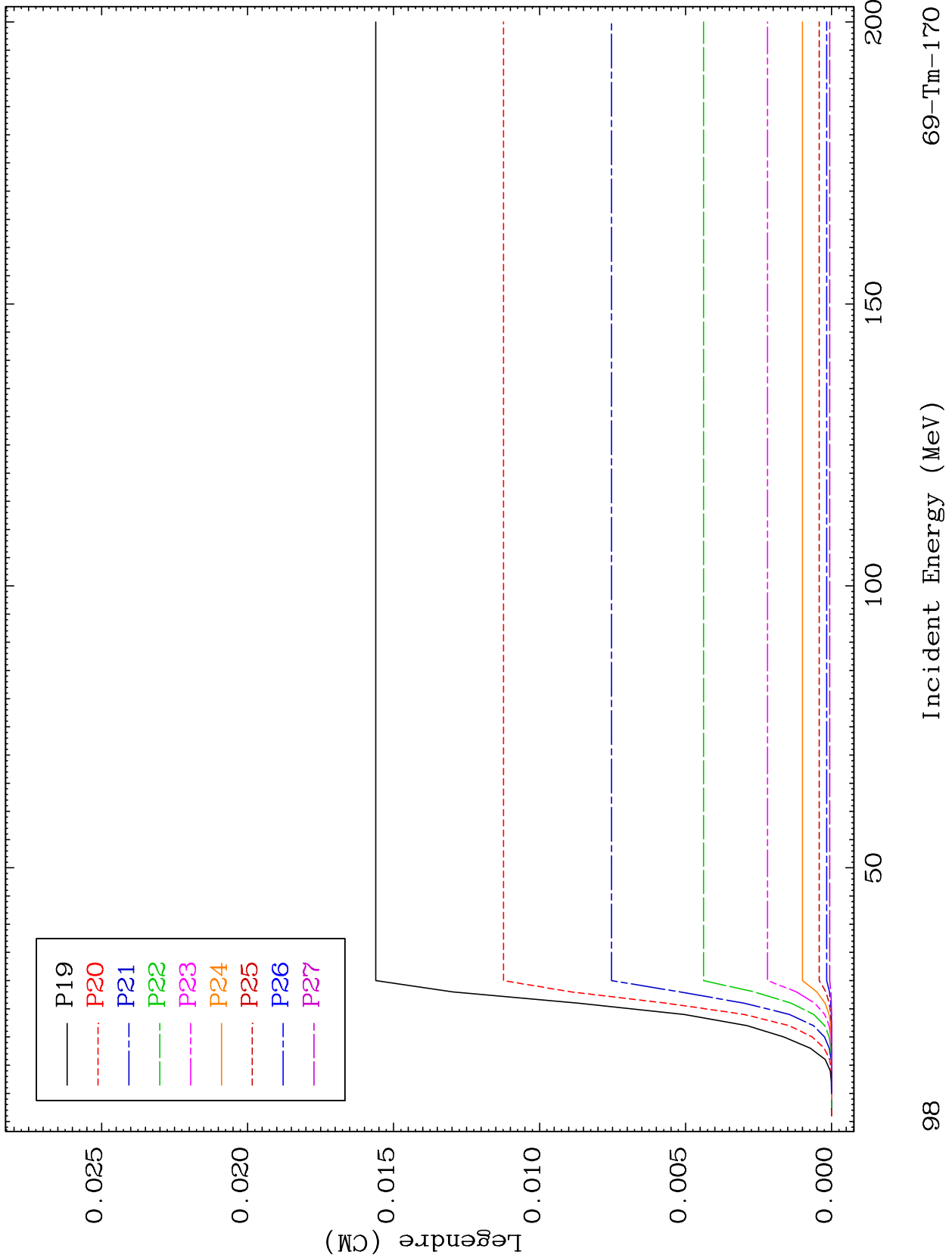

MAT 6928

MT= 73 (n,n') Level
Legendre Coefficients

69-Tm-170

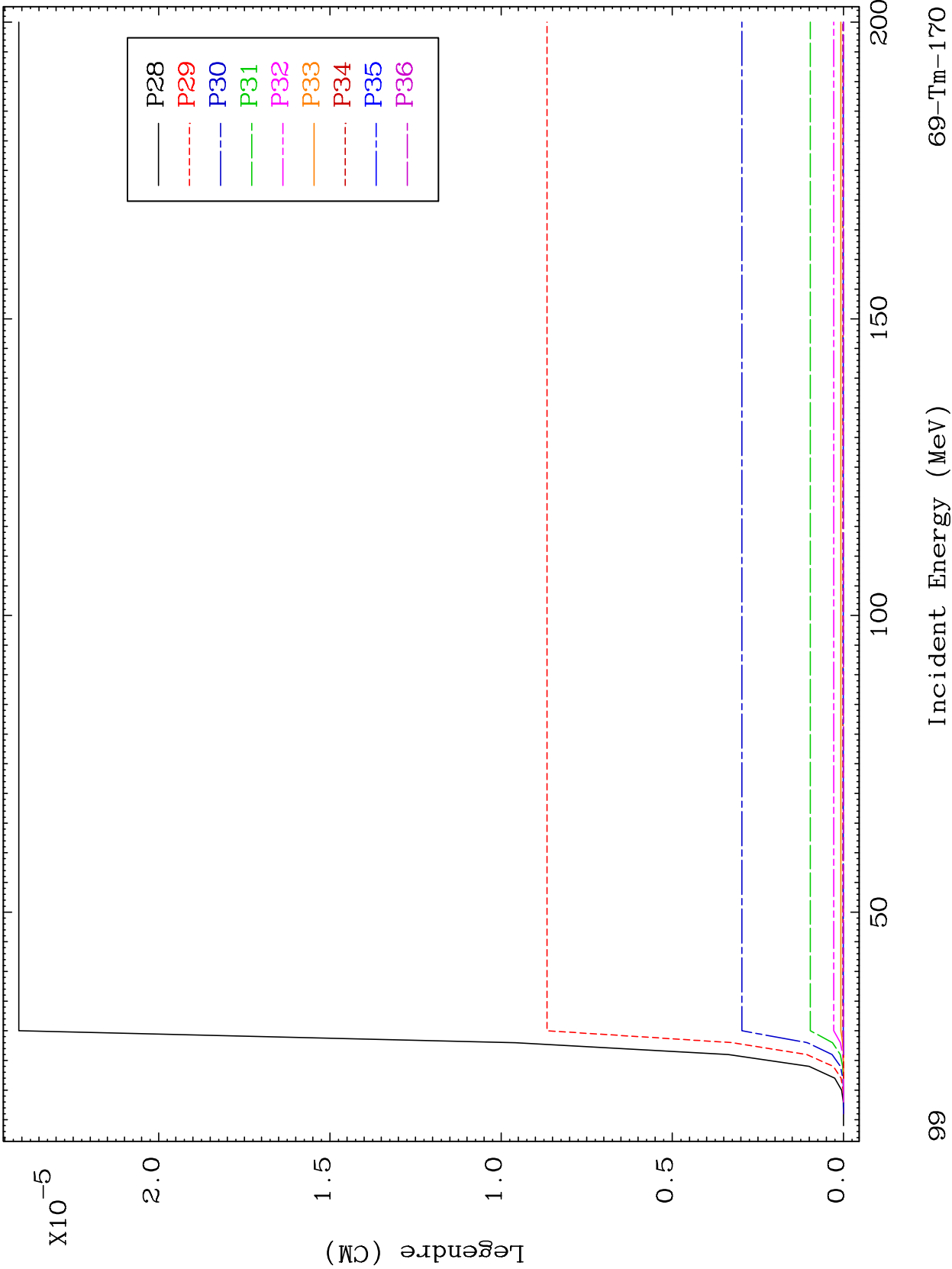

99

MAT 6928

MT= 74 (n,n') Level
Legendre Coefficients

69-Tm-170

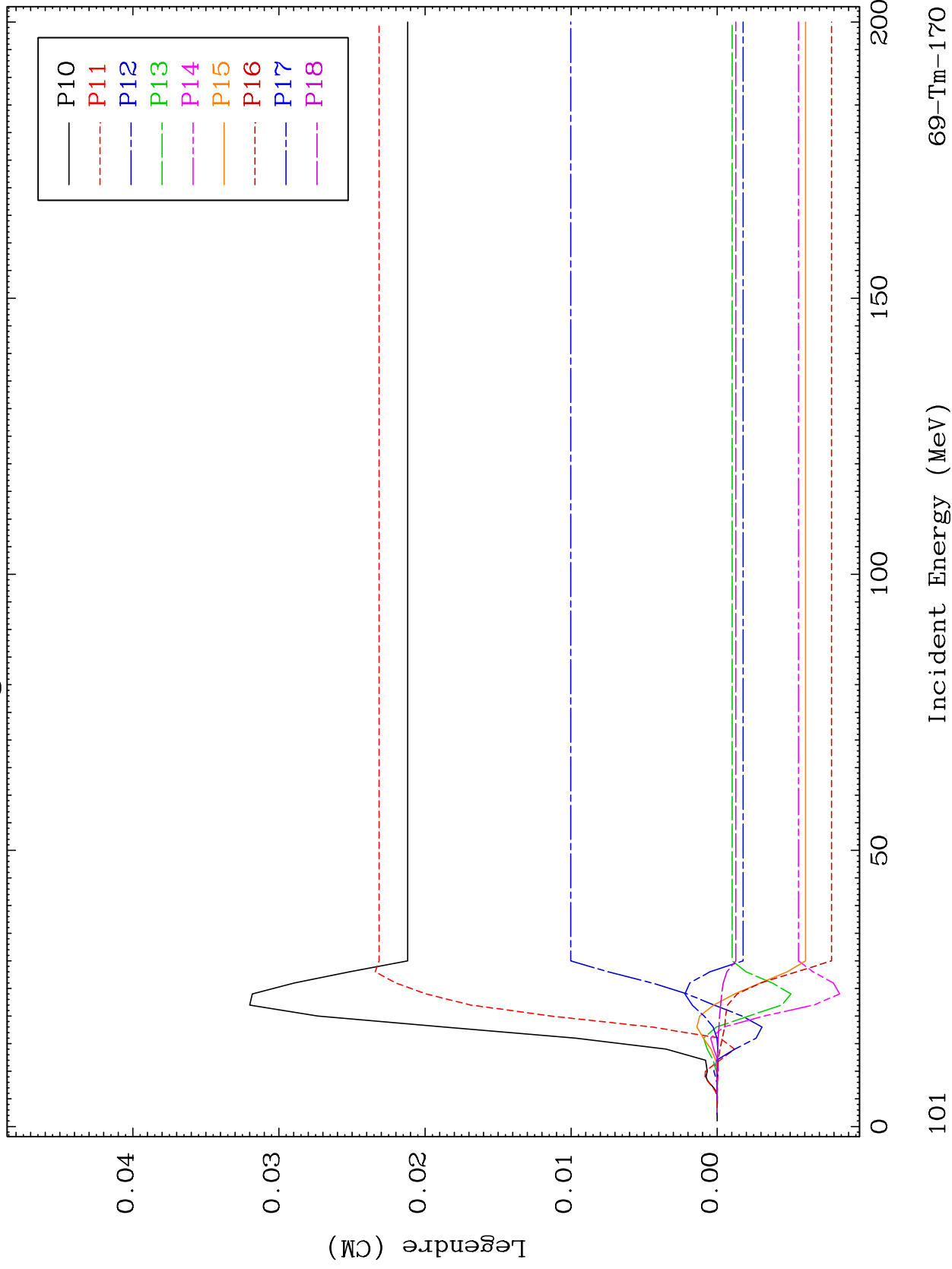

101

Incident Energy (MeV)

69-Tm-170

MAT 6928

MT= 74 (n,n') Level
Legendre Coefficients

69-Tm-170

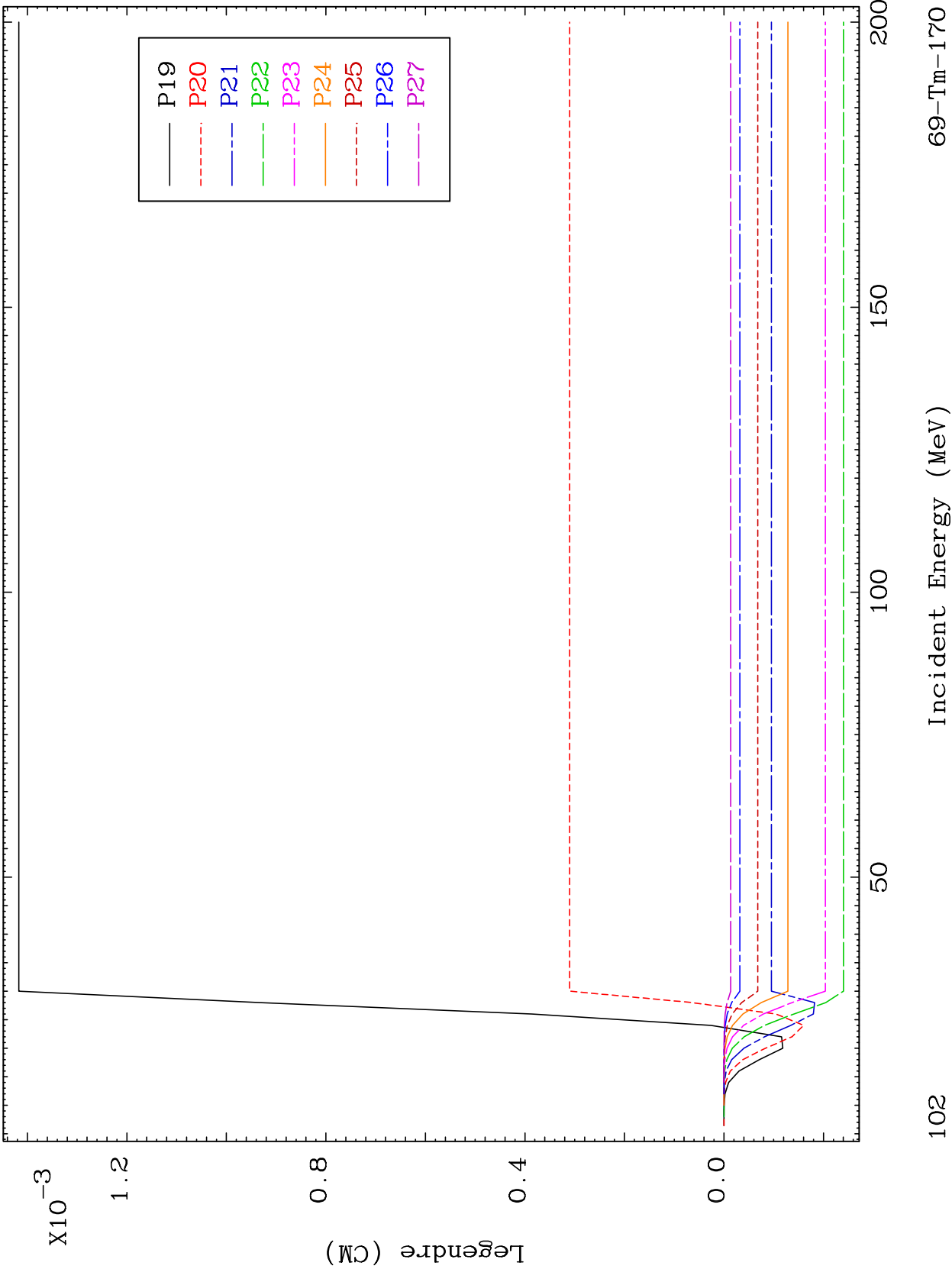

102

Incident Energy (MeV)

69-Tm-170

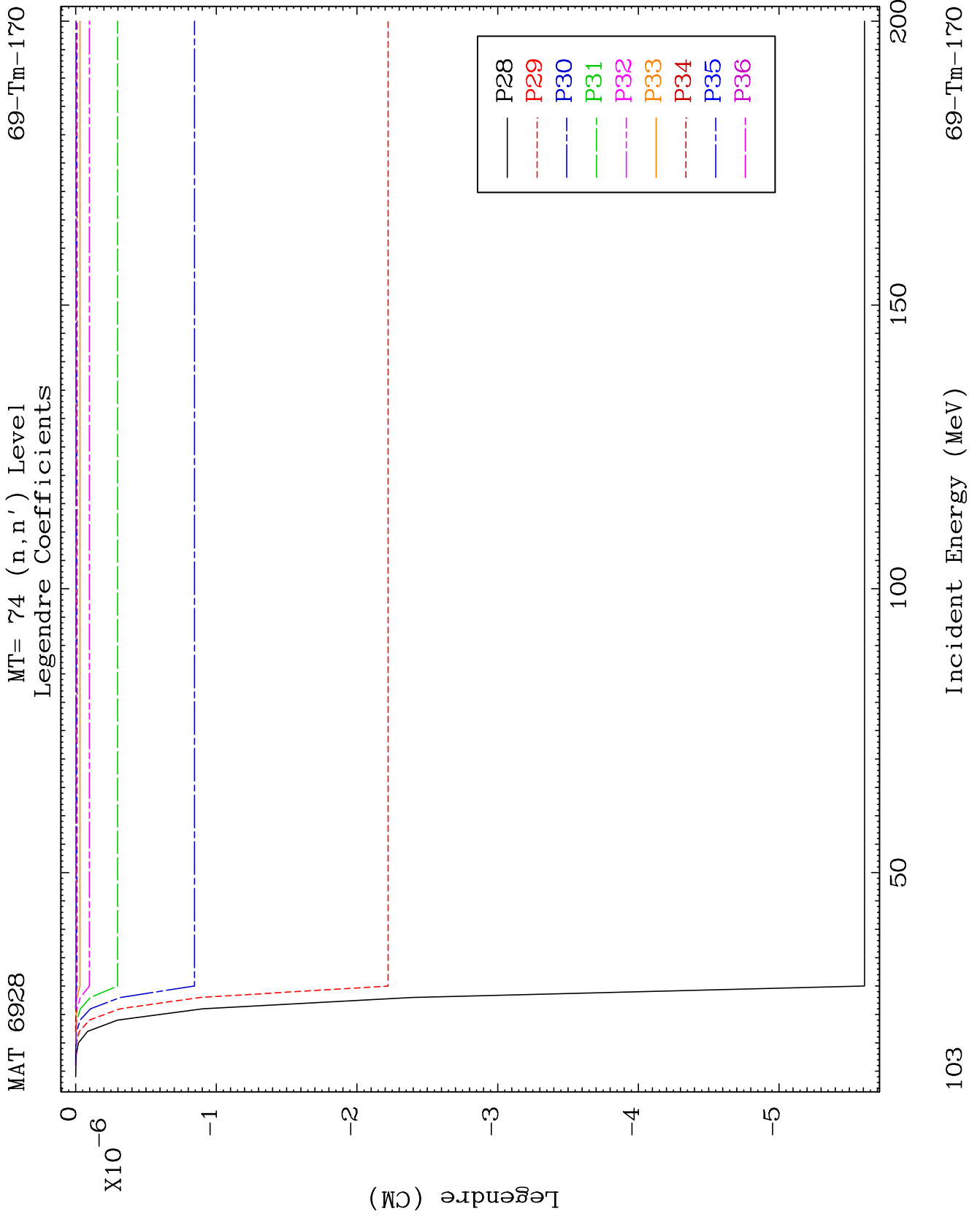

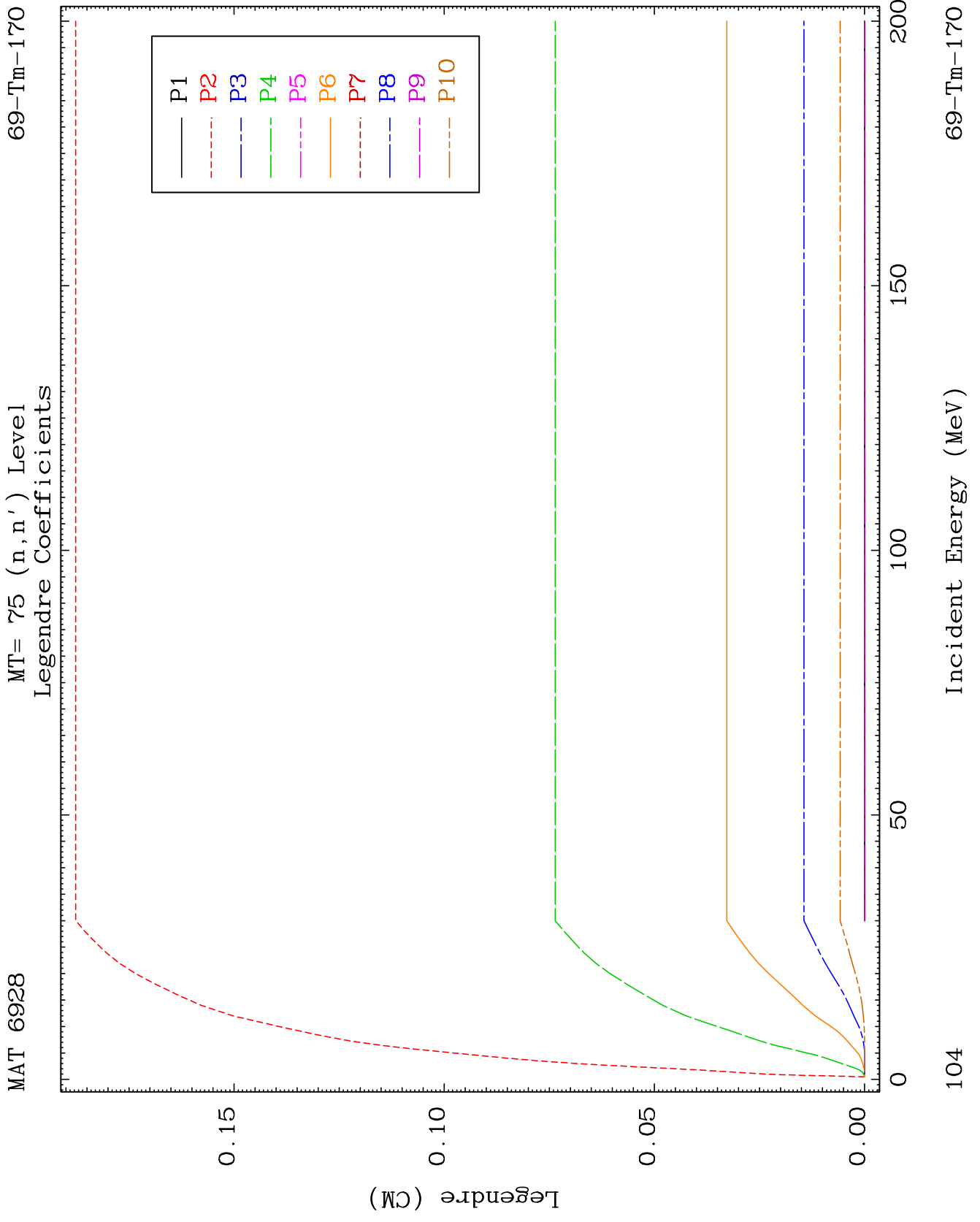

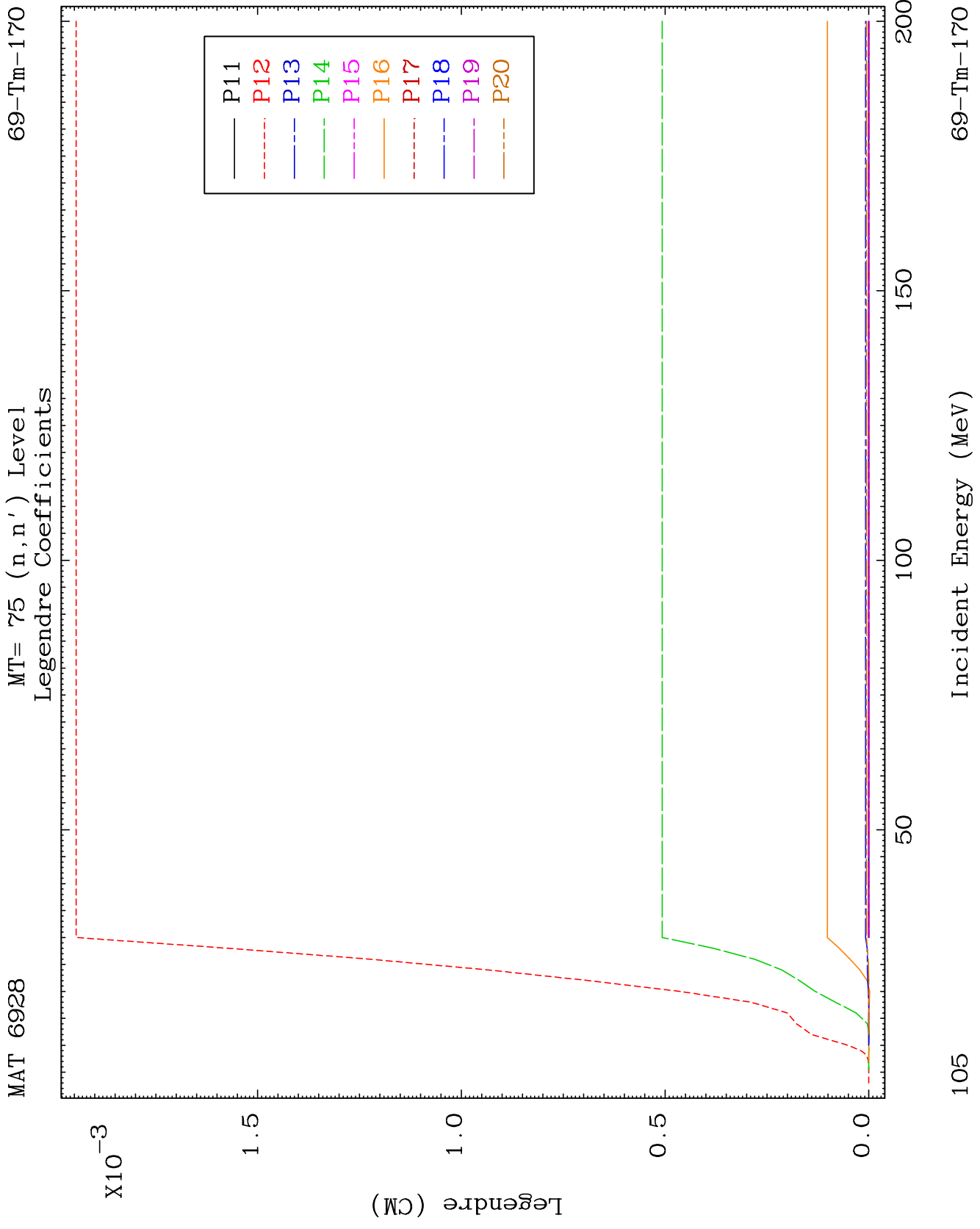

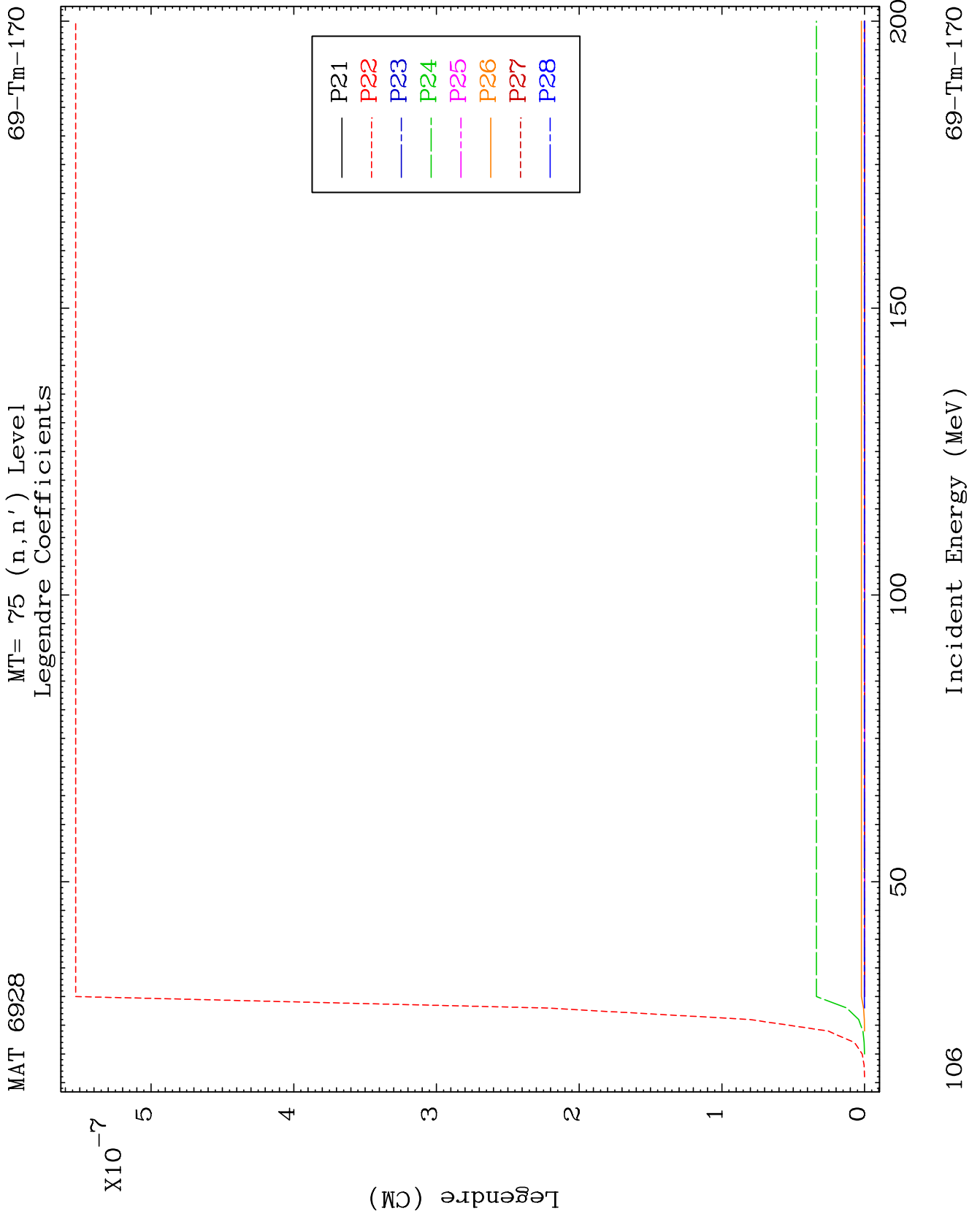

MAT 6928

MT= 76 (n,n') Level
Legendre Coefficients

69-Tm-170

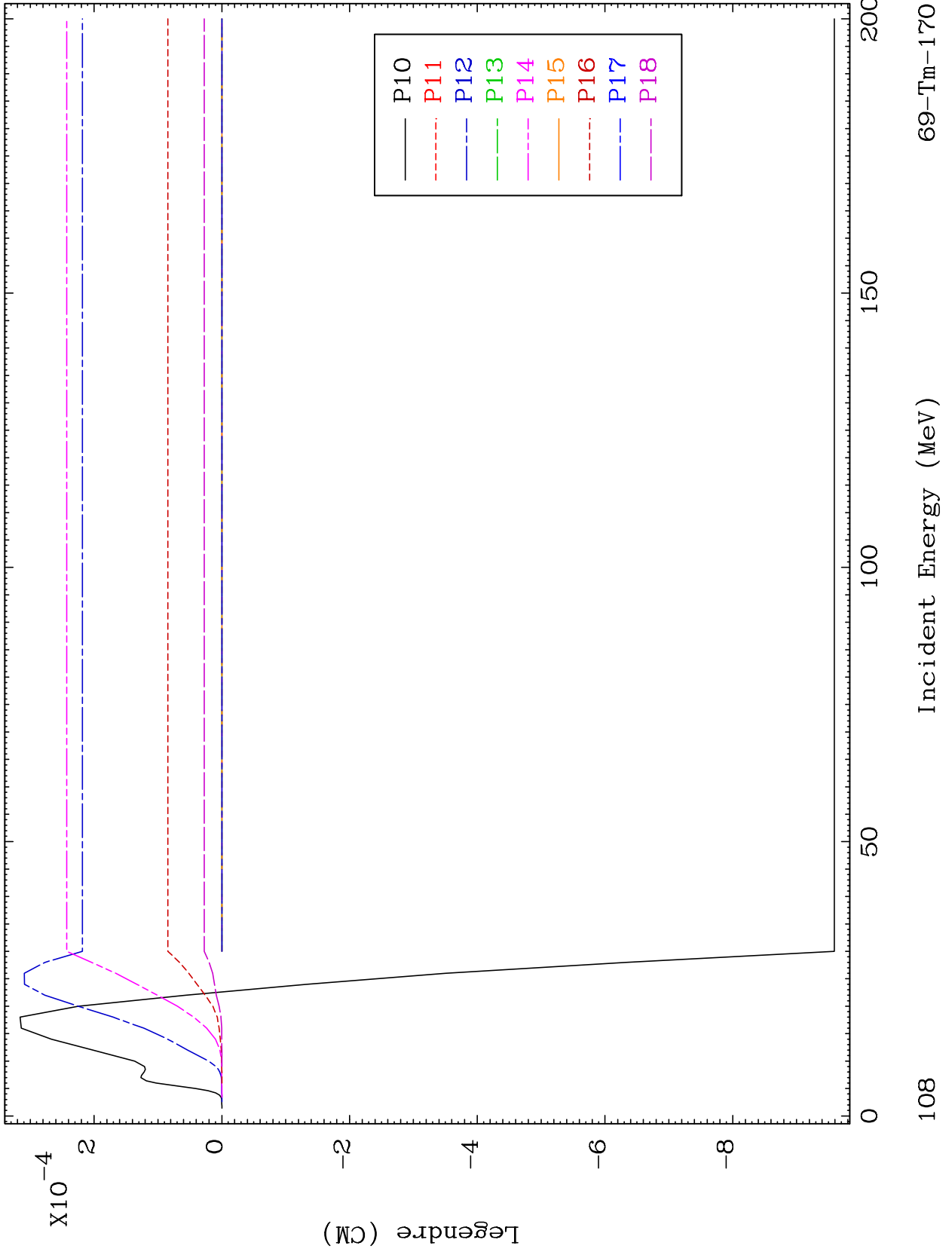

108

69-Tm-170

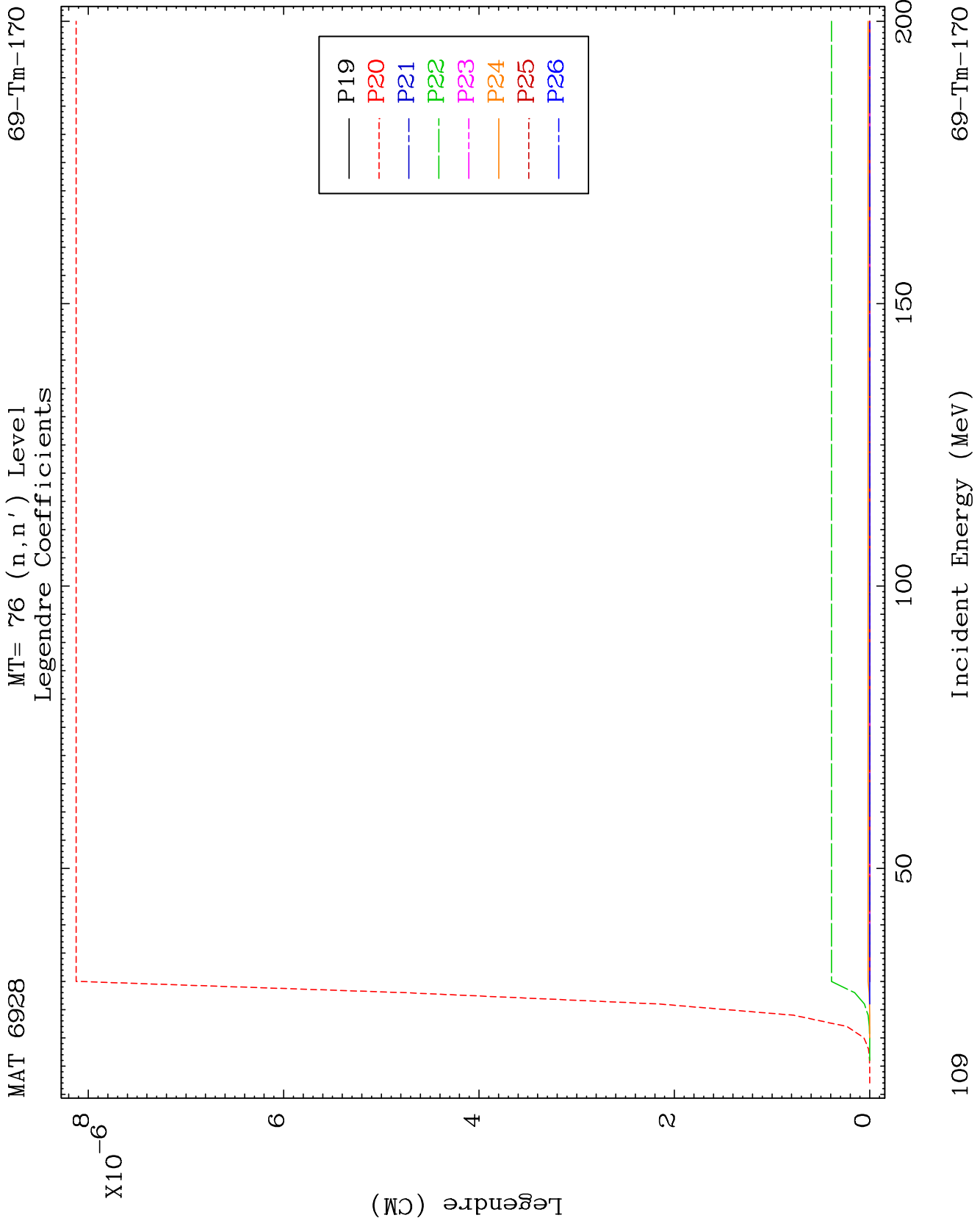

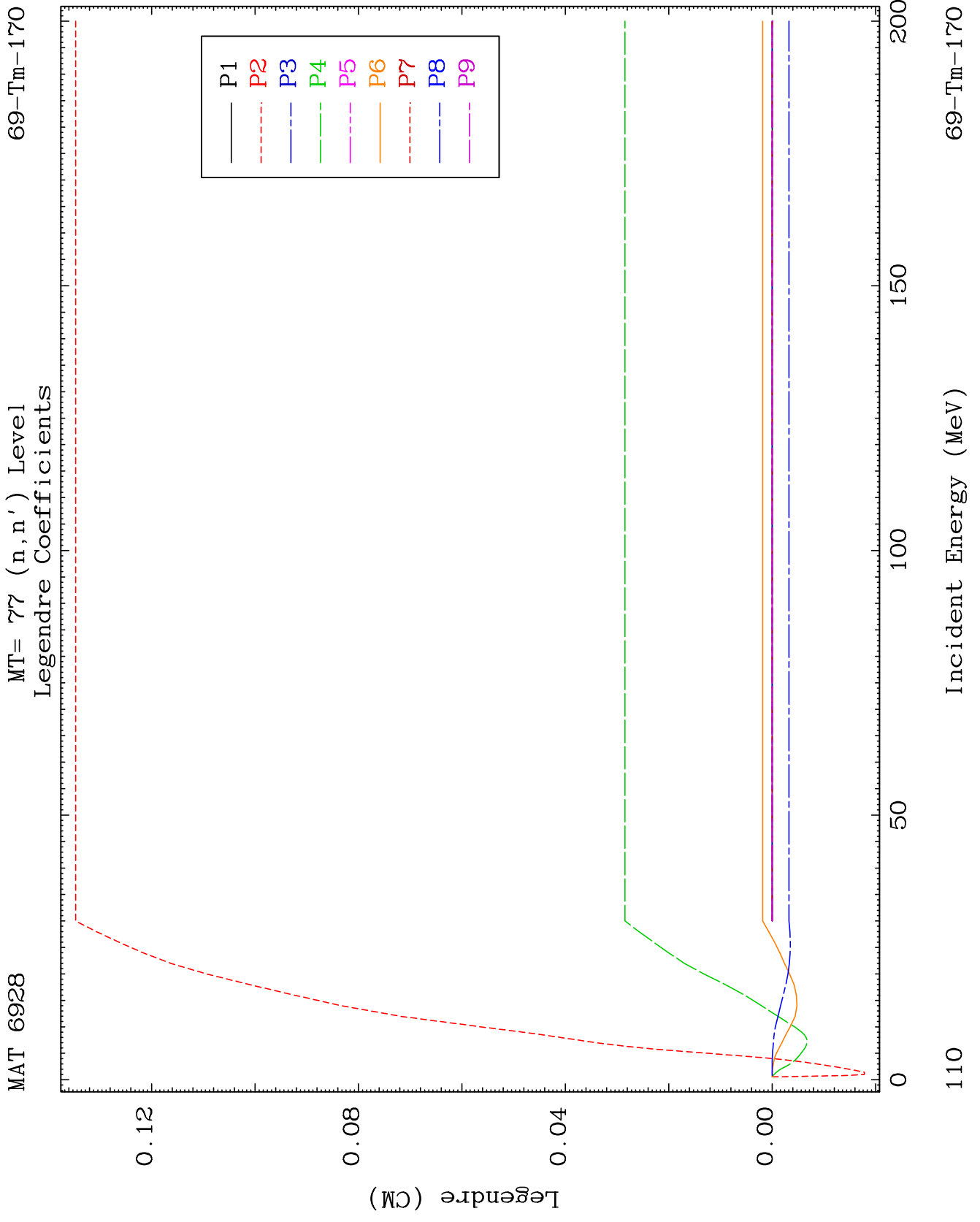

MAT 6928

MT= 77 (n,n') Level
Legendre Coefficients

69-Tm-170

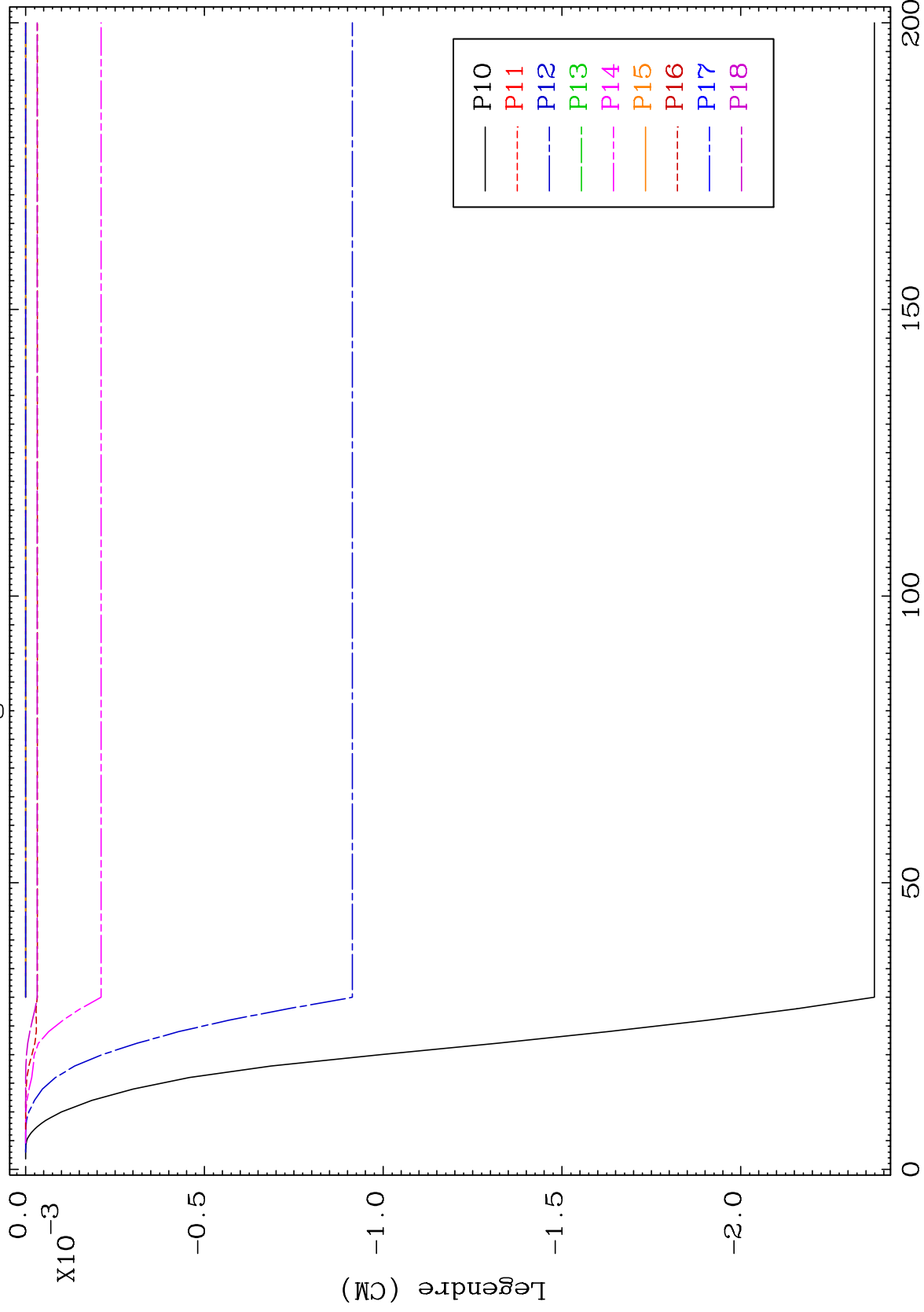

111

Incident Energy (MeV)

69-Tm-170

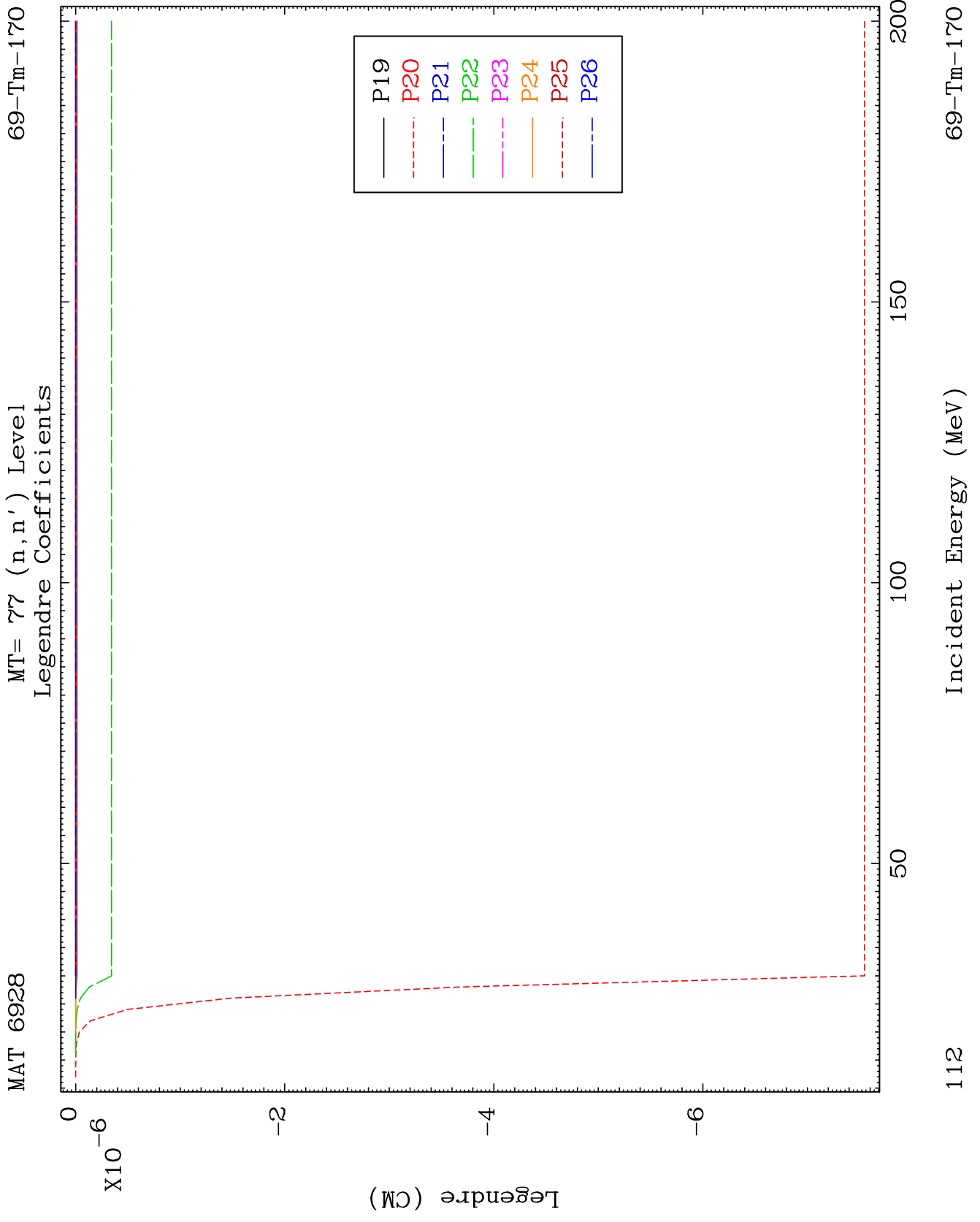

MAT 6928

MT= 78 (n,n') Level
Legendre Coefficients

69-Tm-170

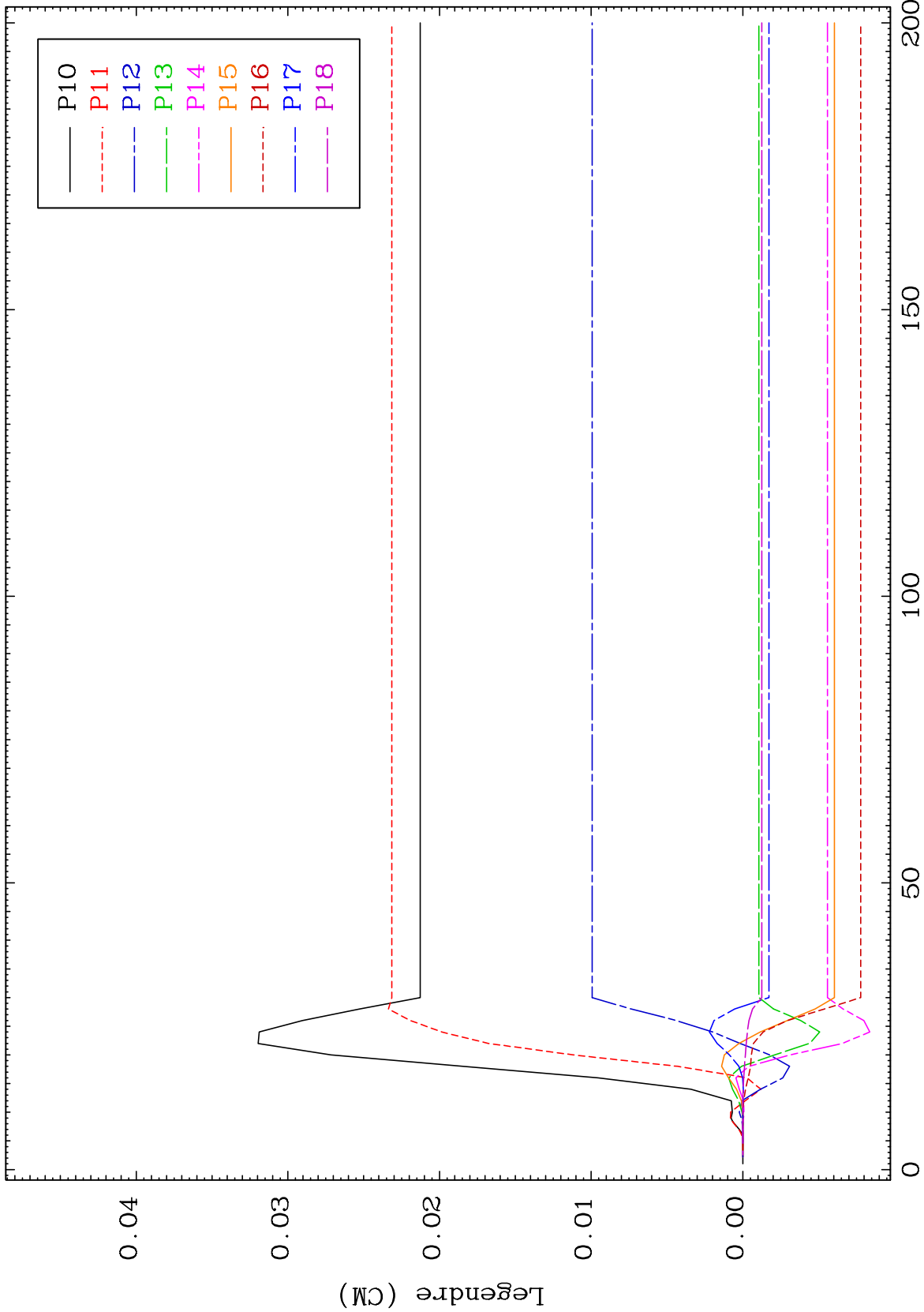

114

Incident Energy (MeV)

69-Tm-170

MAT 6928

MT= 78 (n,n') Level
Legendre Coefficients

69-Tm-170

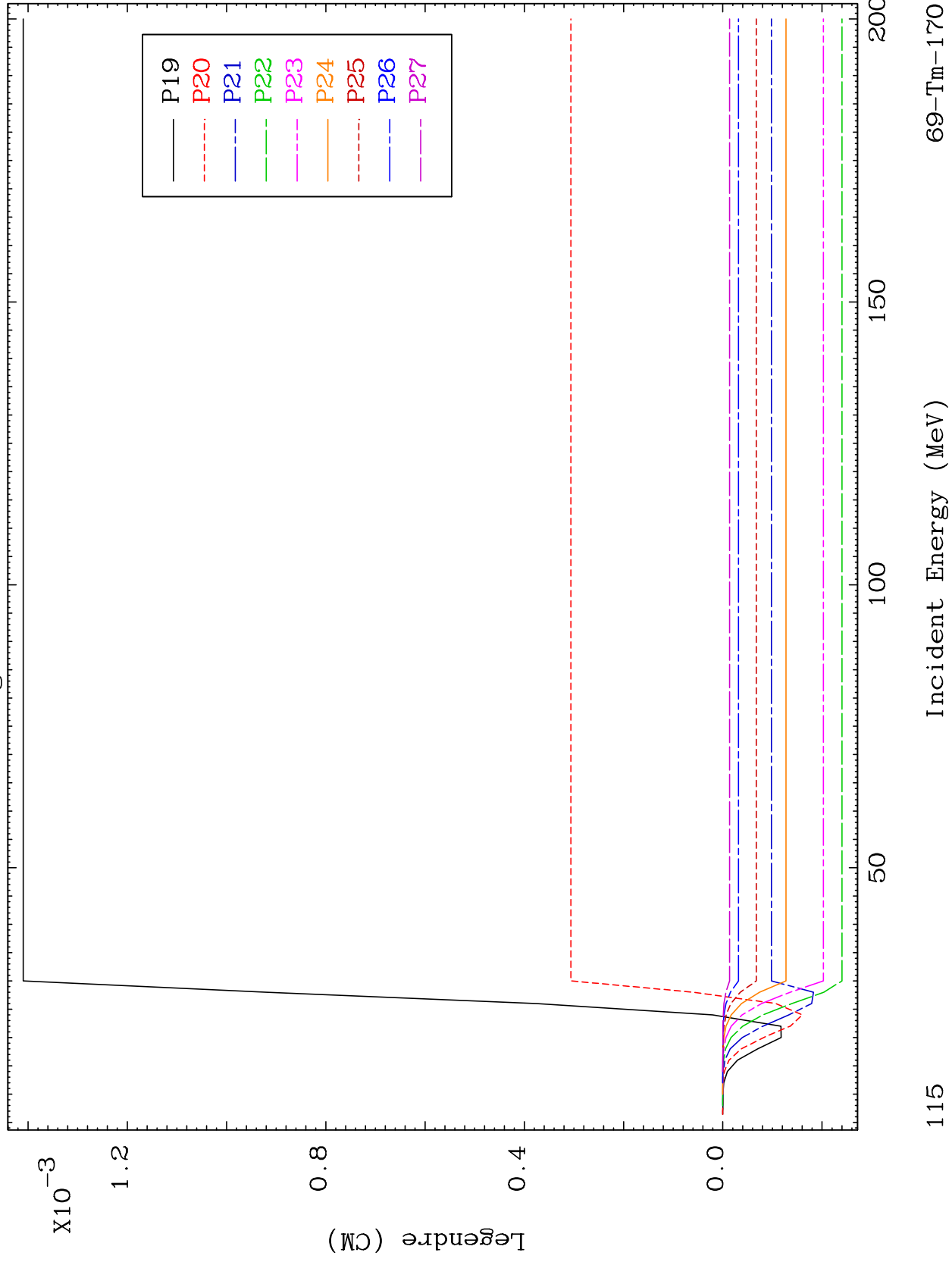

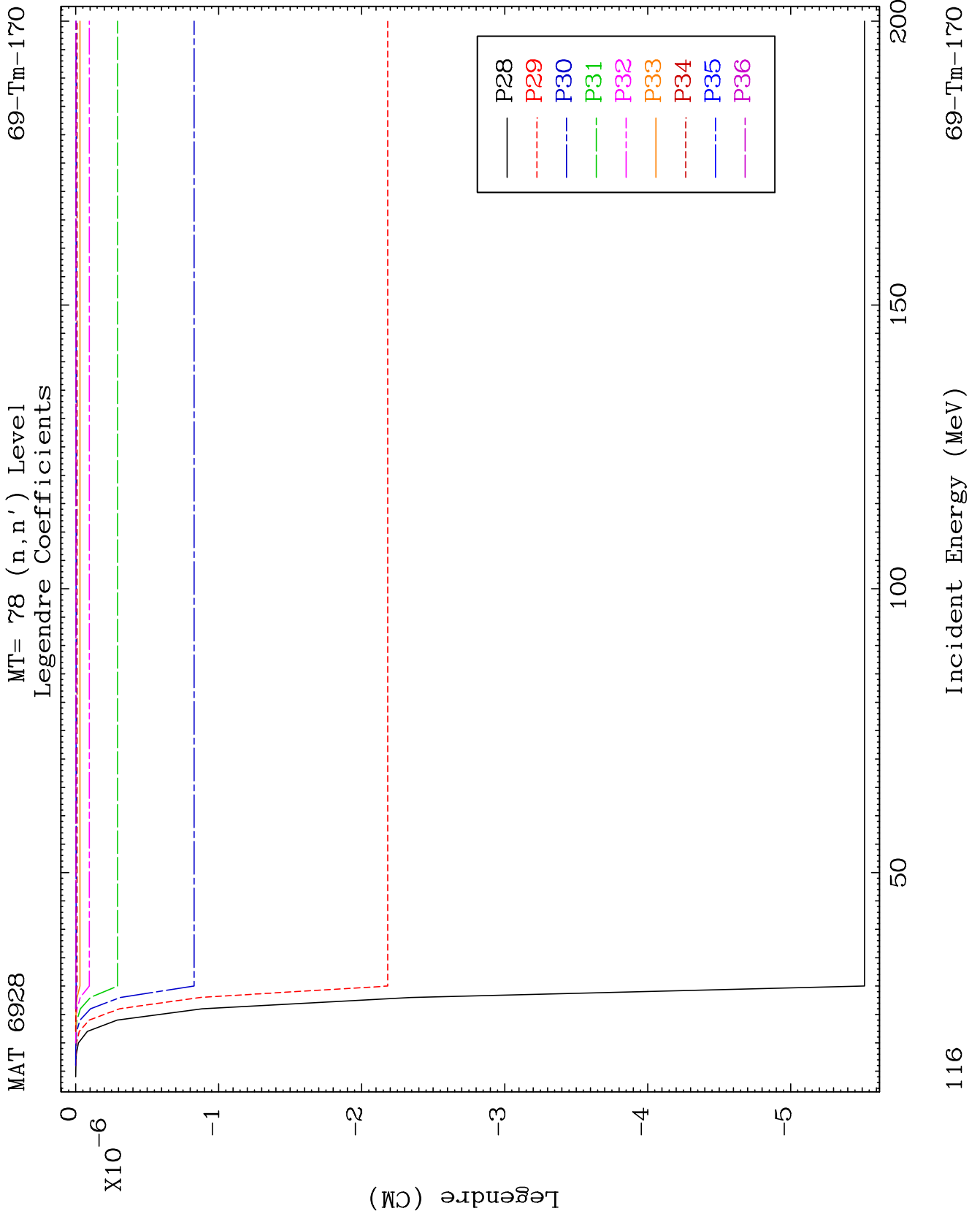

MAT 6928

MT= 79 (n,n') Level
Legendre Coefficients

69-Tm-170

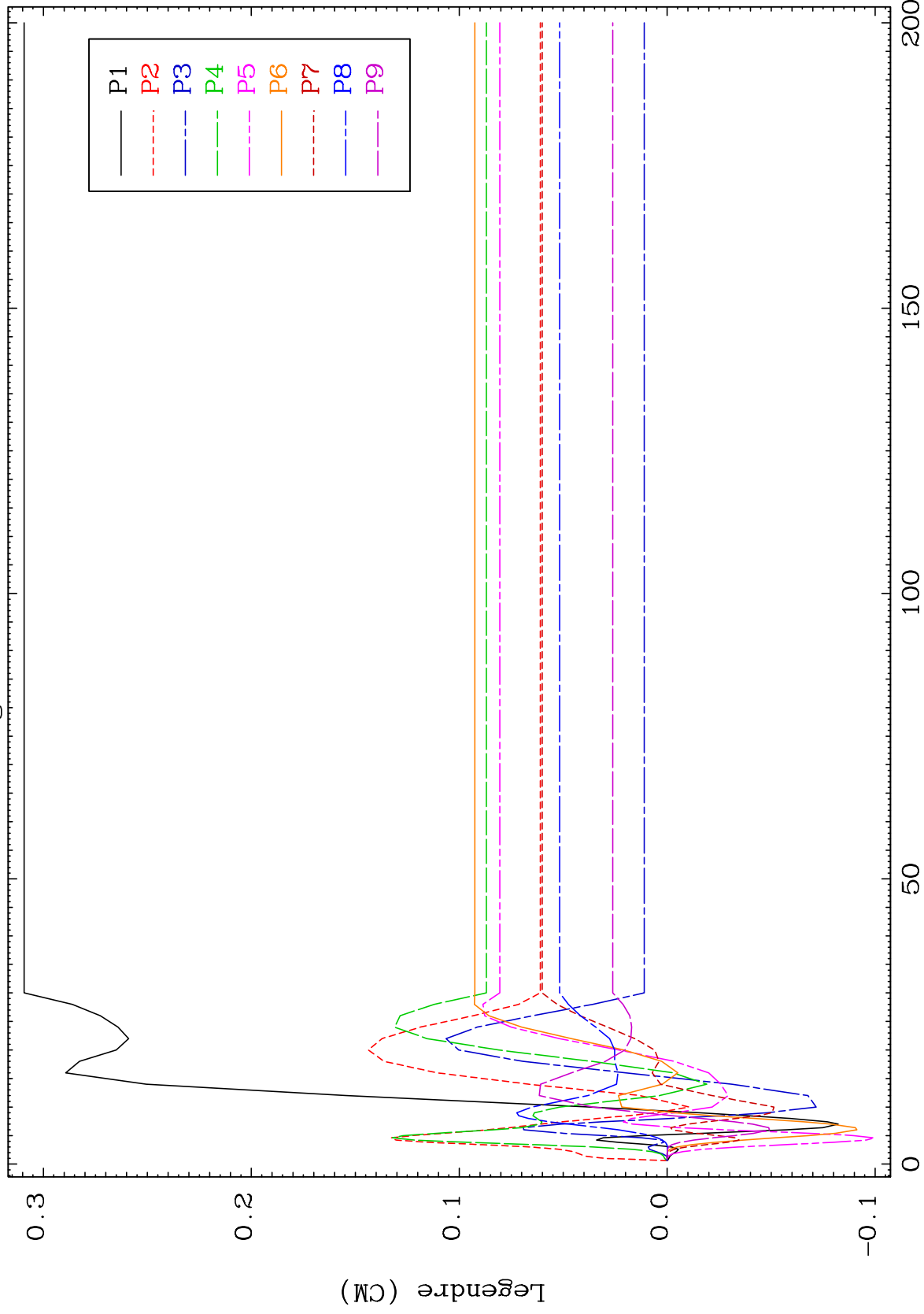

117

Incident Energy (MeV)

69-Tm-170

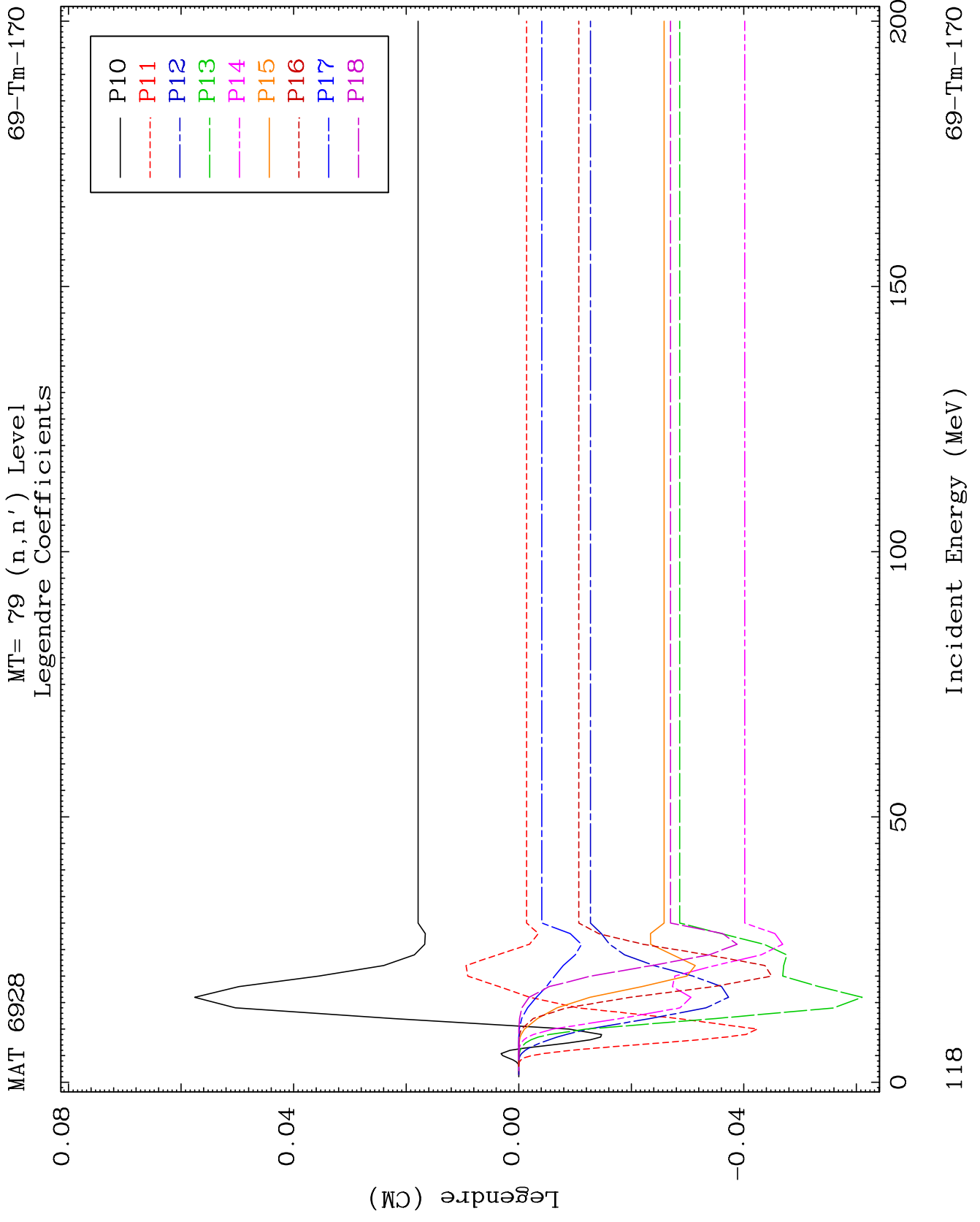

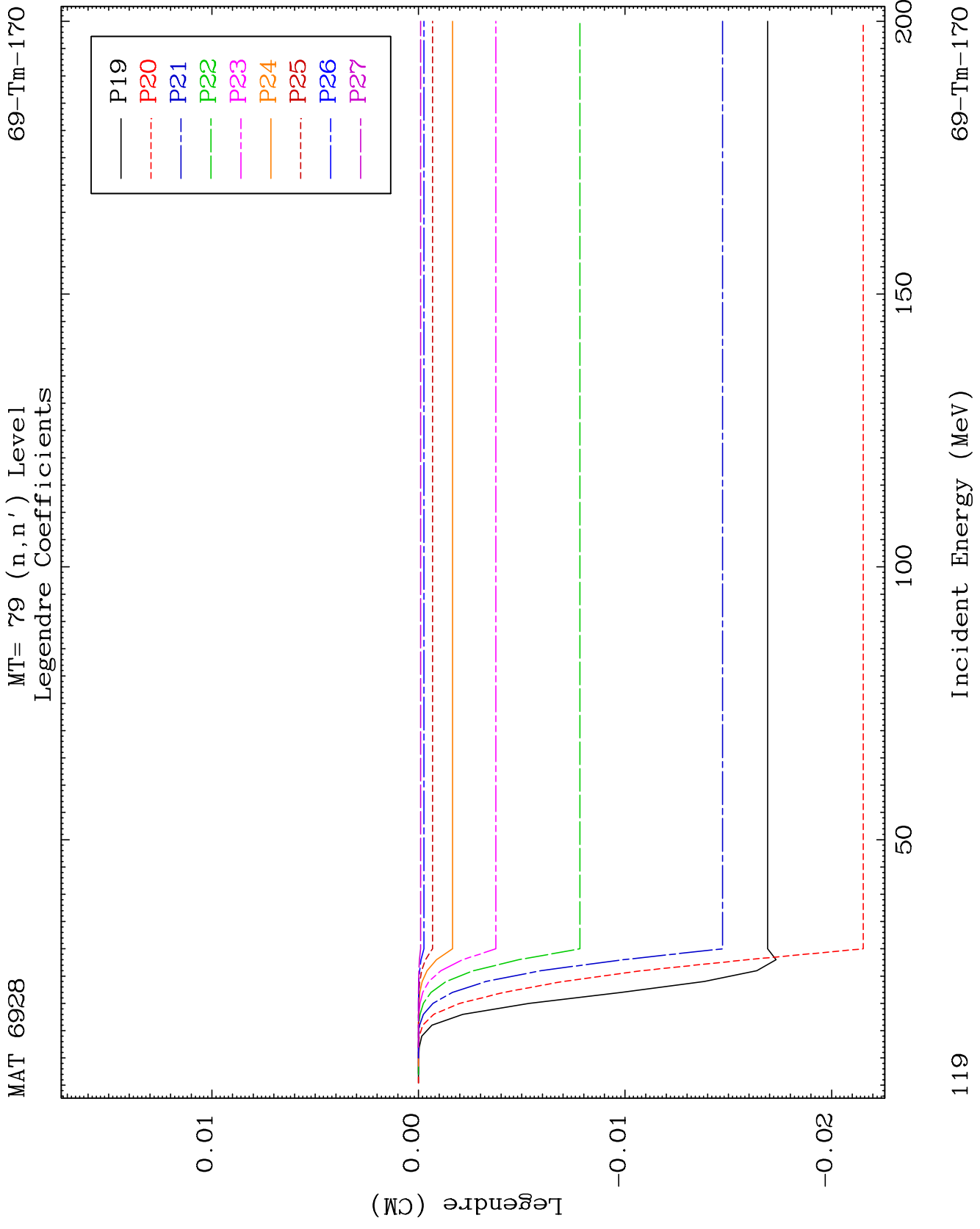

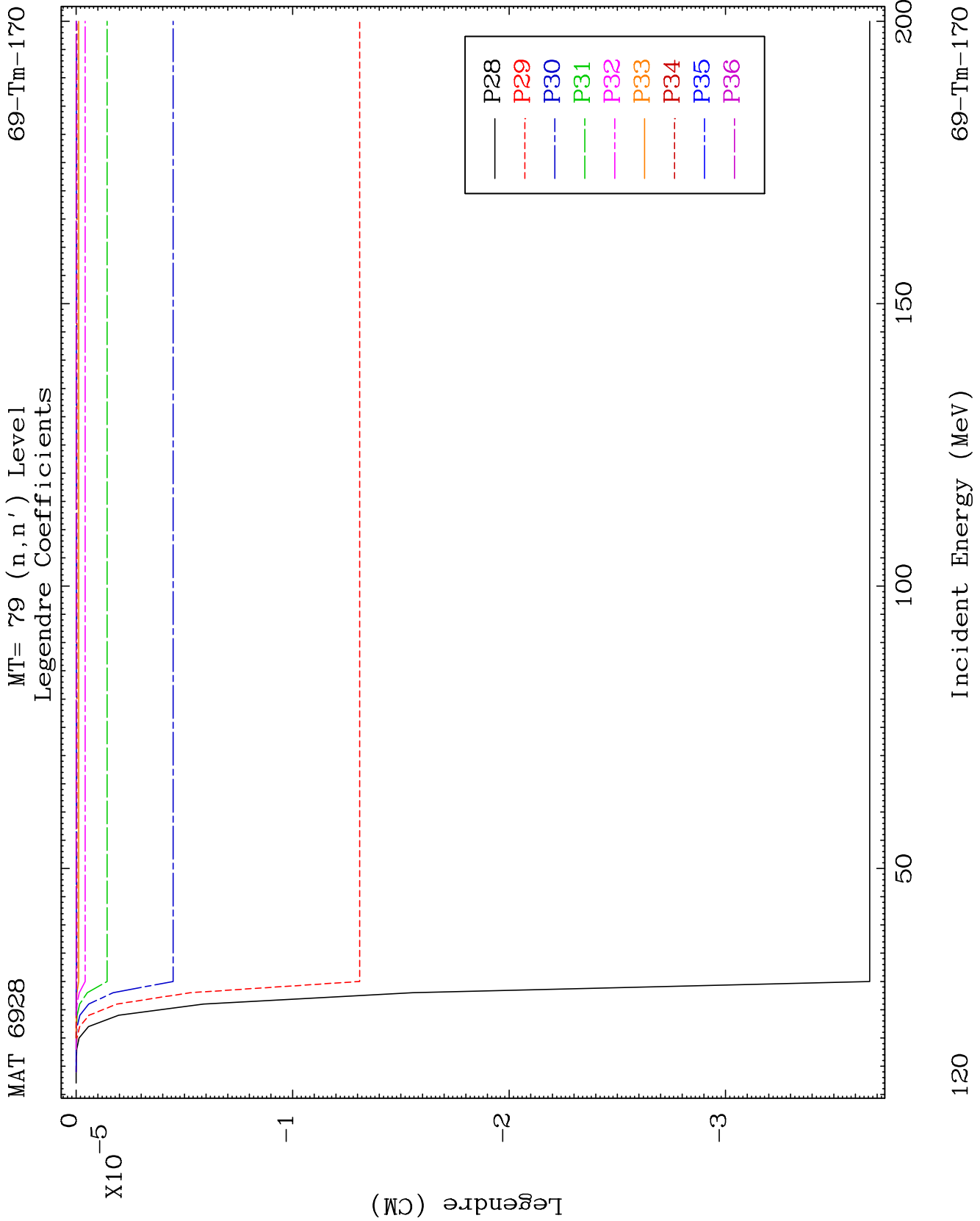

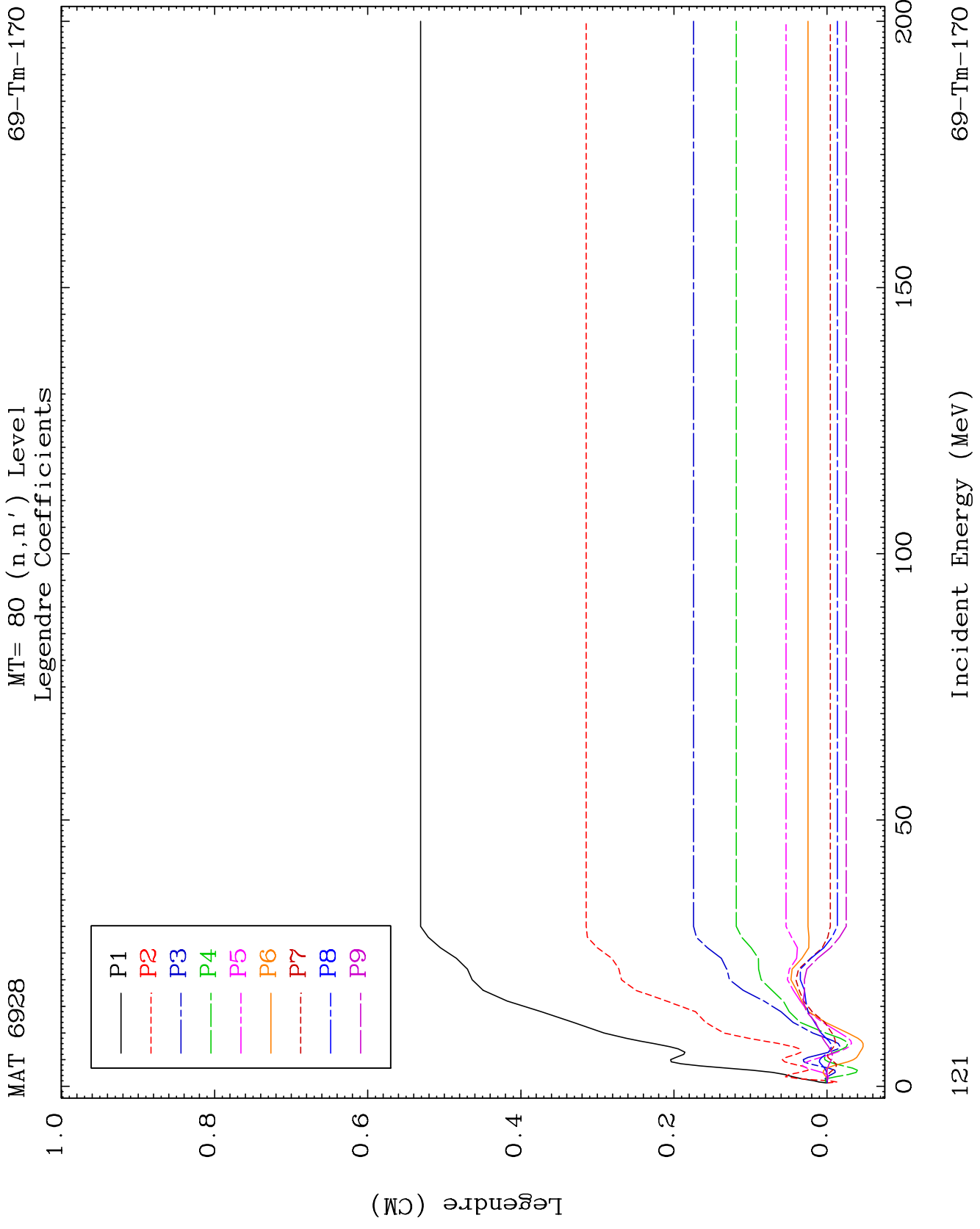

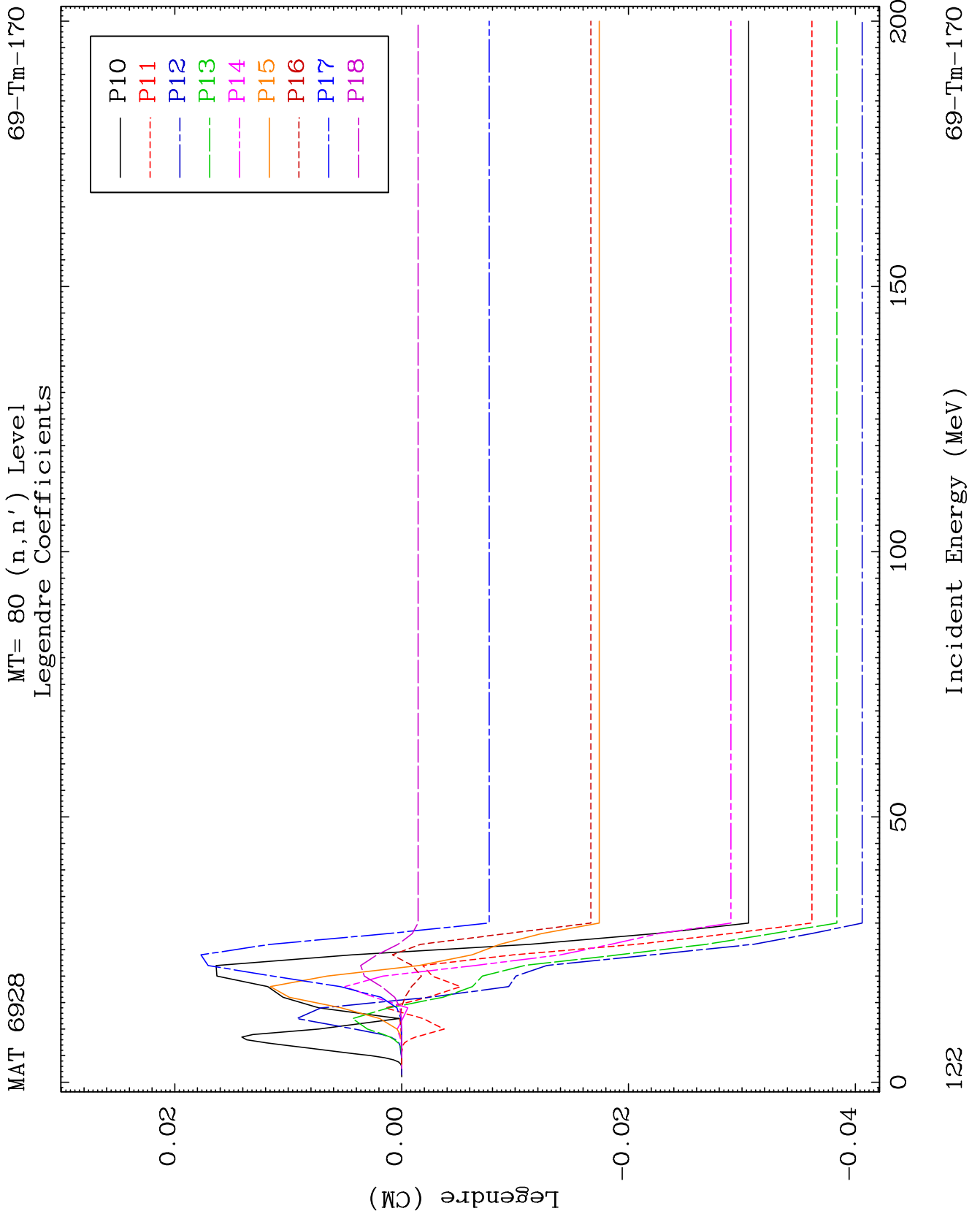

MAT 6928

MT= 80 (n,n') Level
Legendre Coefficients

69-Tm-170

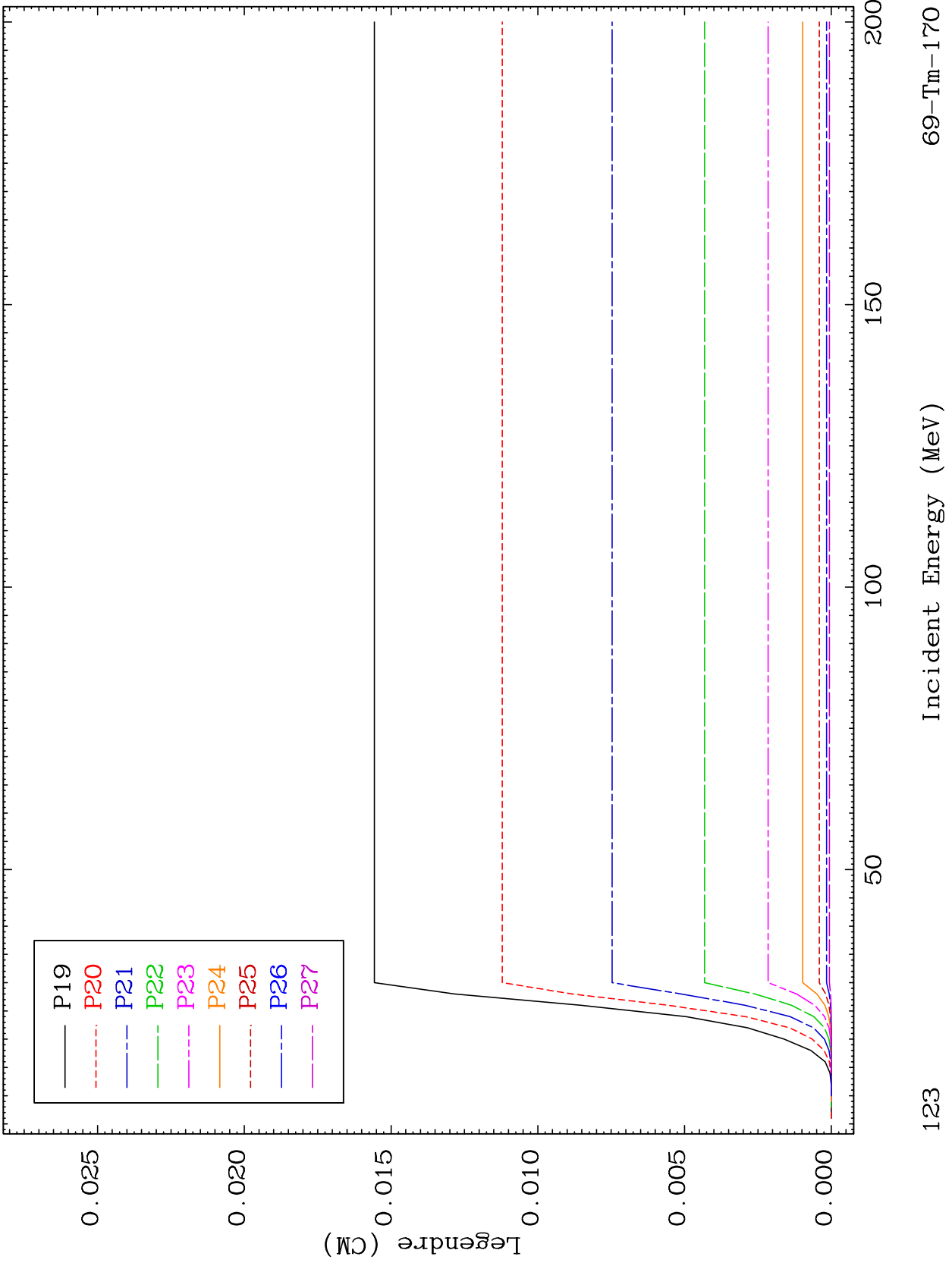

123

Incident Energy (MeV)

69-Tm-170

MAT 6928

MT= 80 (n,n') Level
Legendre Coefficients

69-Tm-170

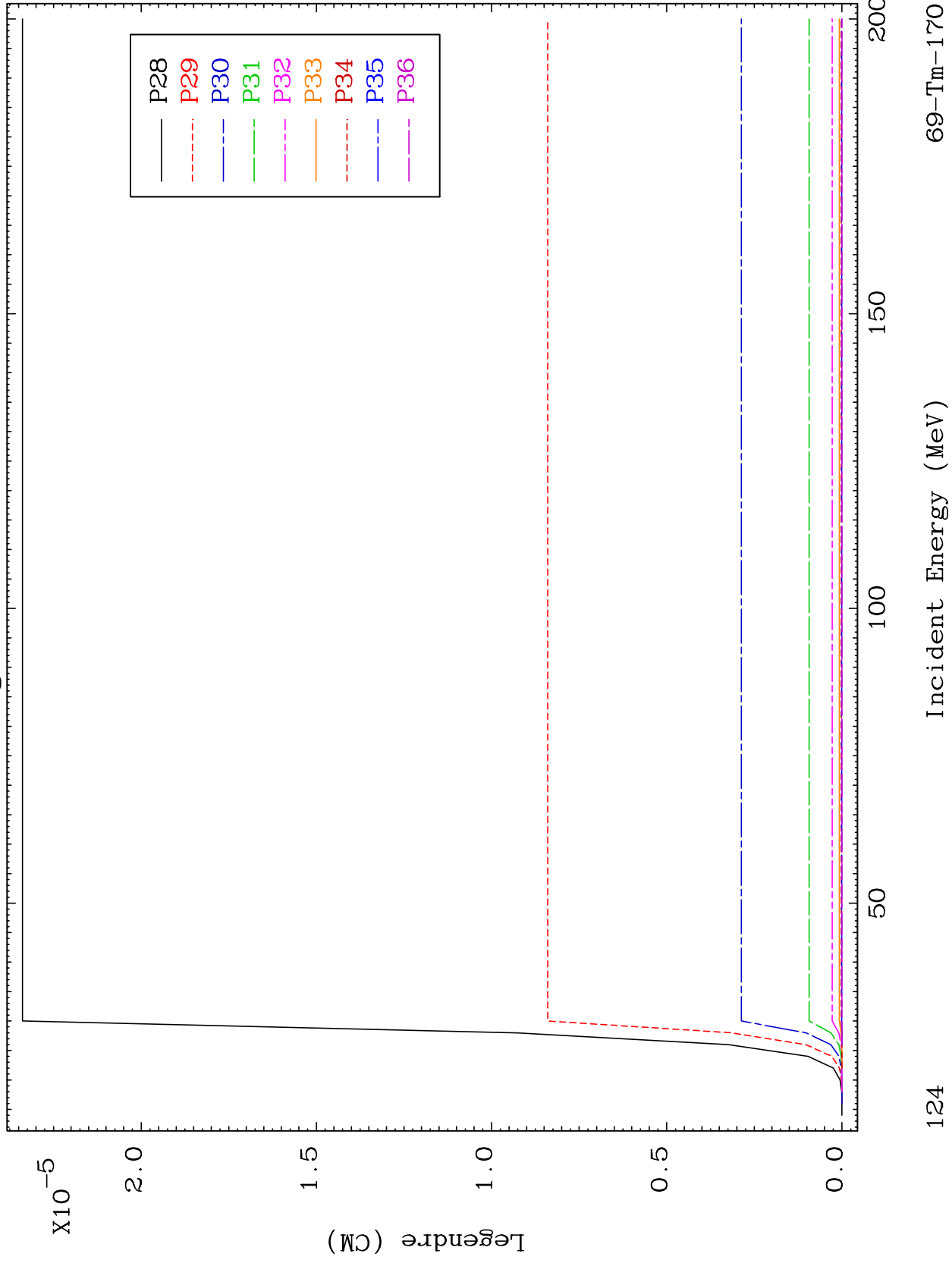

124

69-Tm-170

MAT 6928

(n,2n) d

69-Tm-170

Radionuclide Production Cross Section

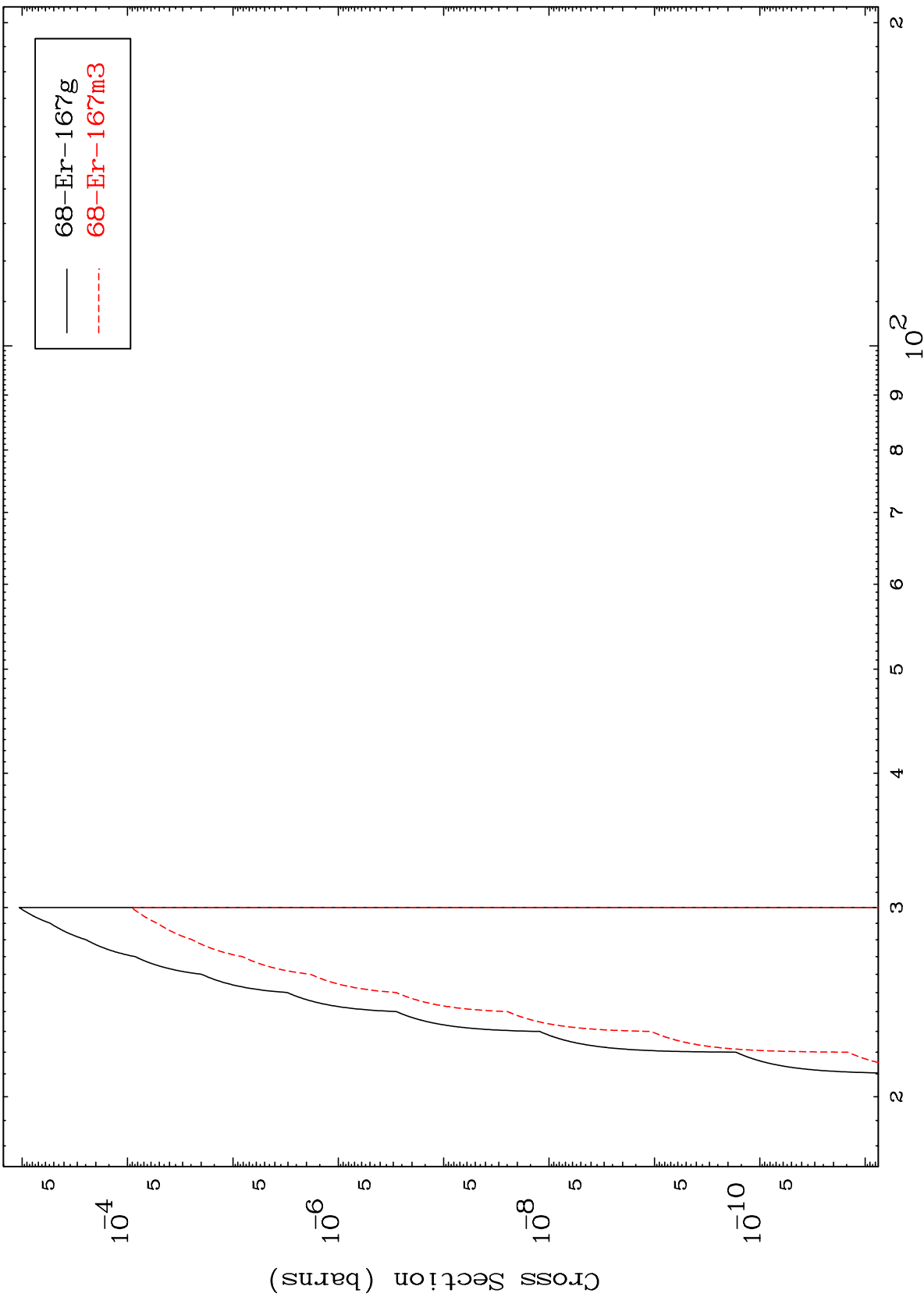

125

Incident Energy (MeV)

69-Tm-170

MAT 6928

$(n, n') \alpha$

69-Tm-170

Radionuclide Production Cross Section

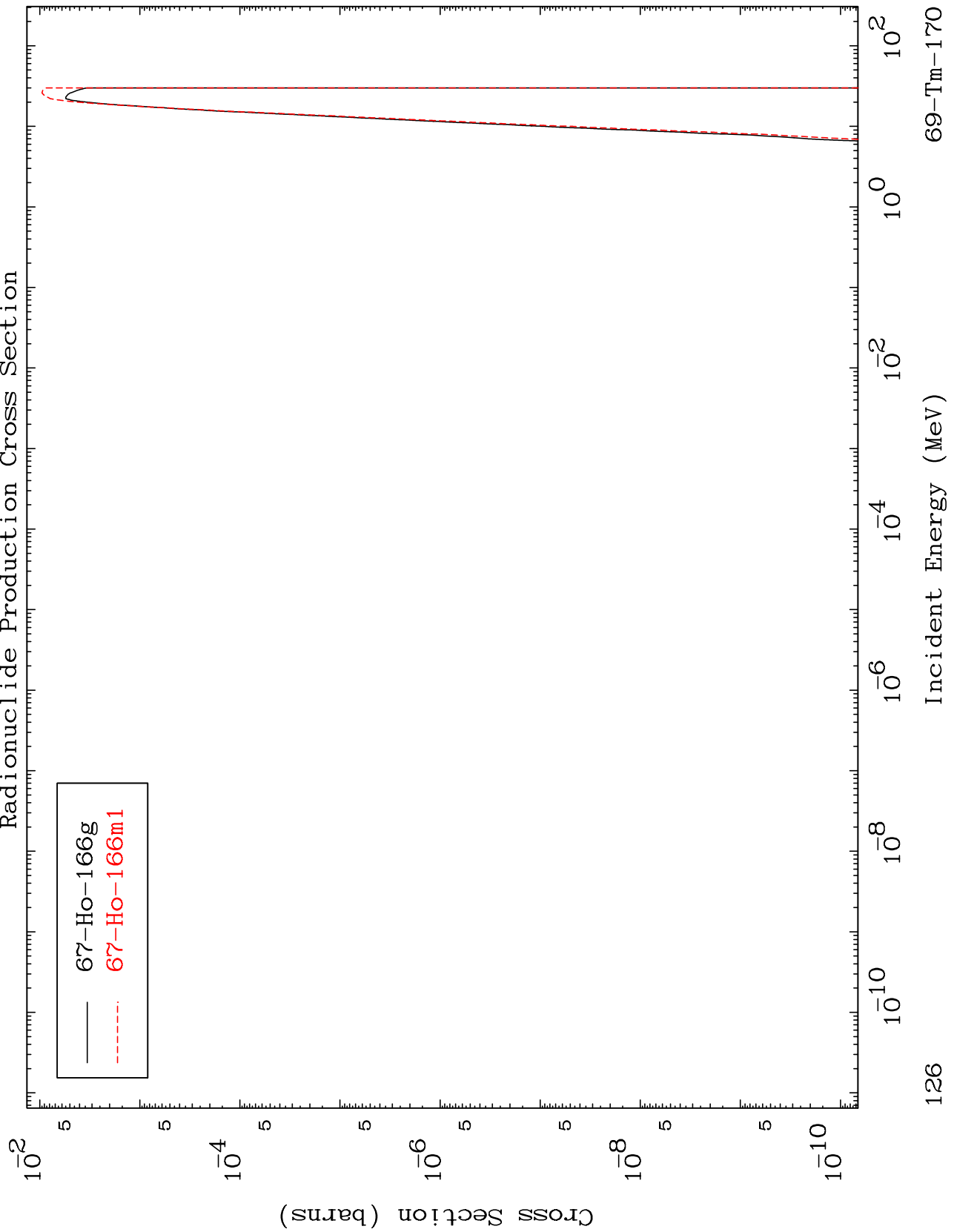

MAT 6928

$(n,3n) \alpha$

69-Tm-170

Radionuclide Production Cross Section

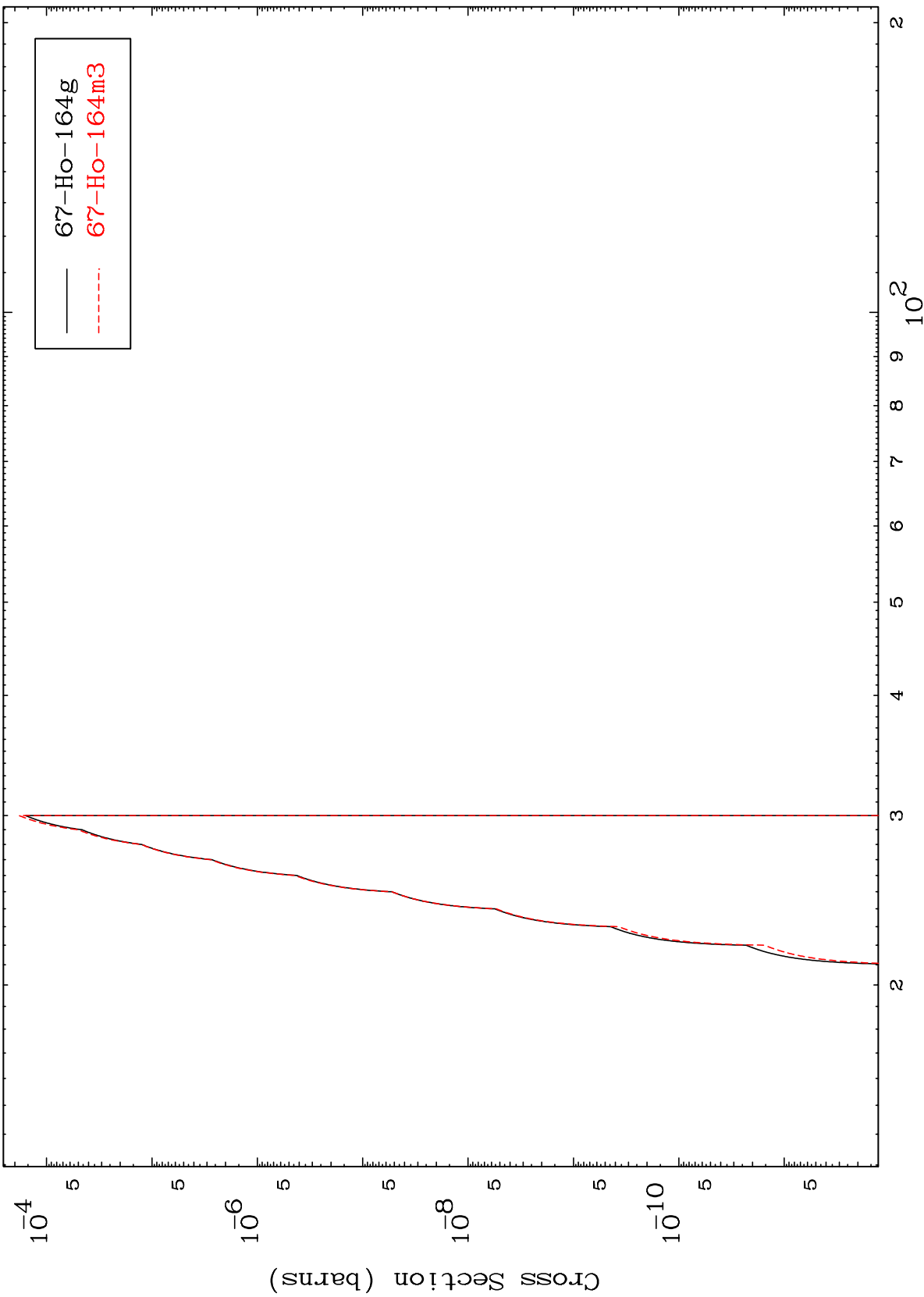

127

Incident Energy (MeV)

69-Tm-170

Radionuclide Production Cross Section

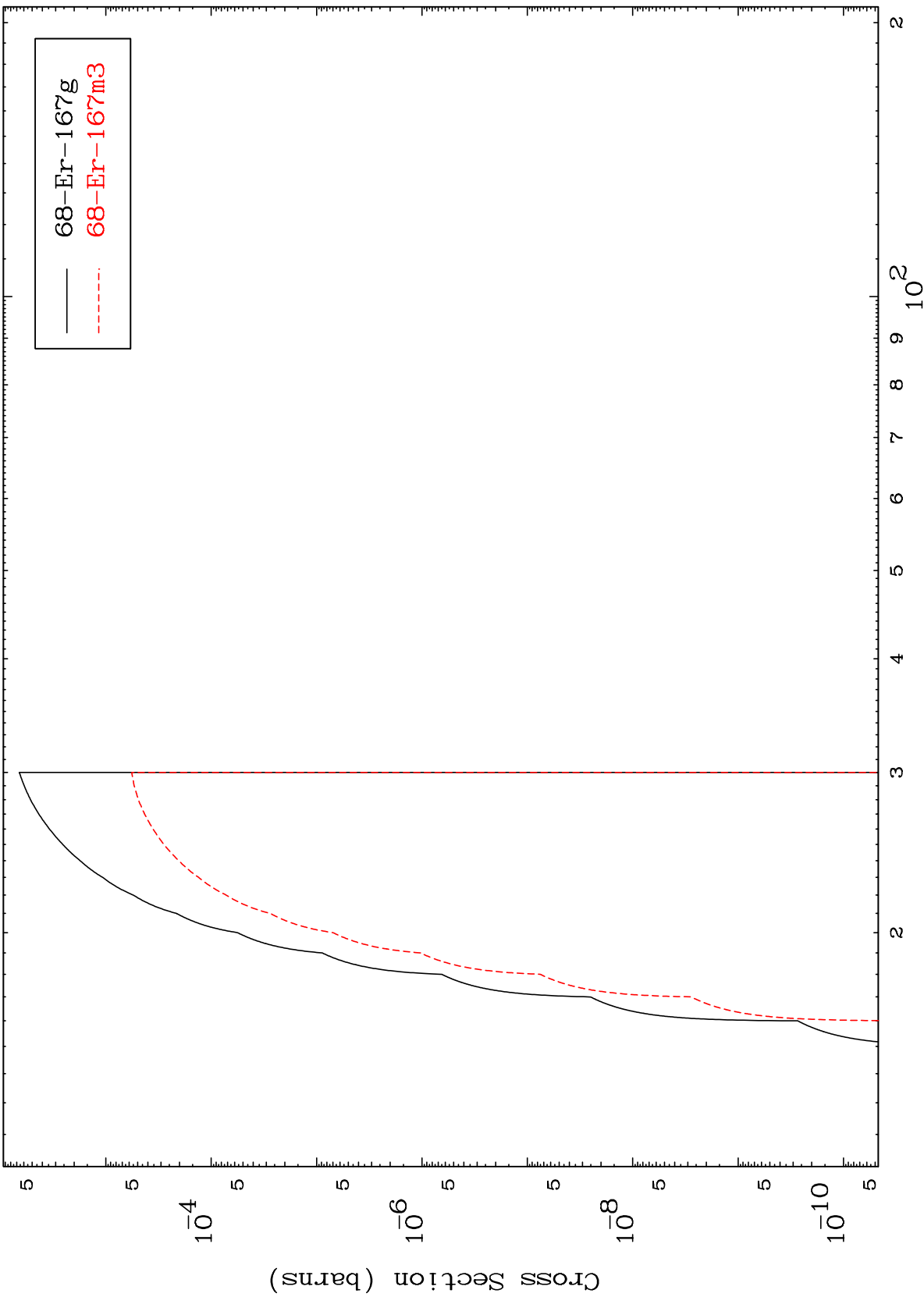

MAT 6928

(n,3n) p

69-Tm-170

Radionuclide Production Cross Section

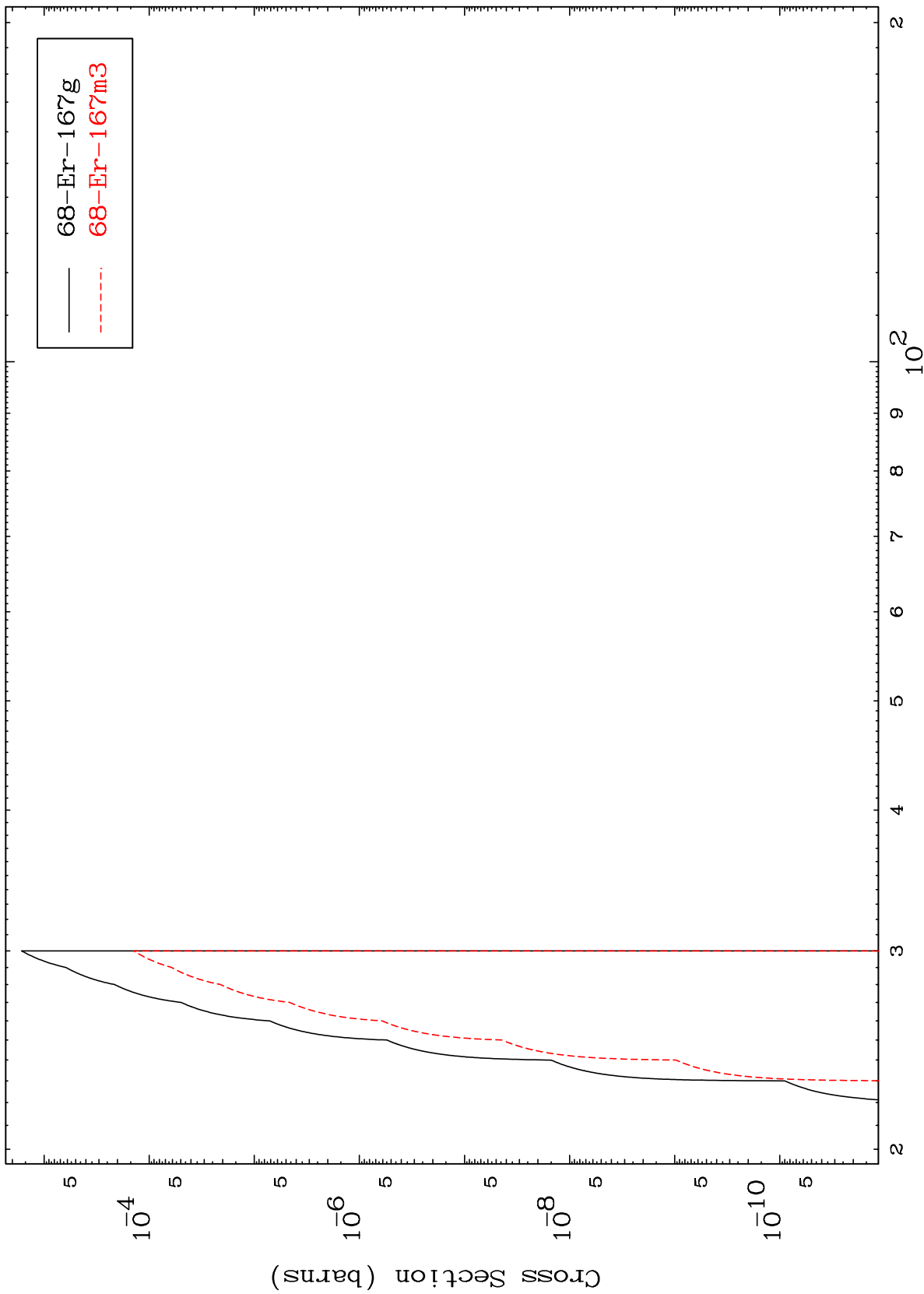

129

Incident Energy (MeV)

69-Tm-170

MAT 6928

(n,2n) p

69-Tm-170

Radionuclide Production Cross Section

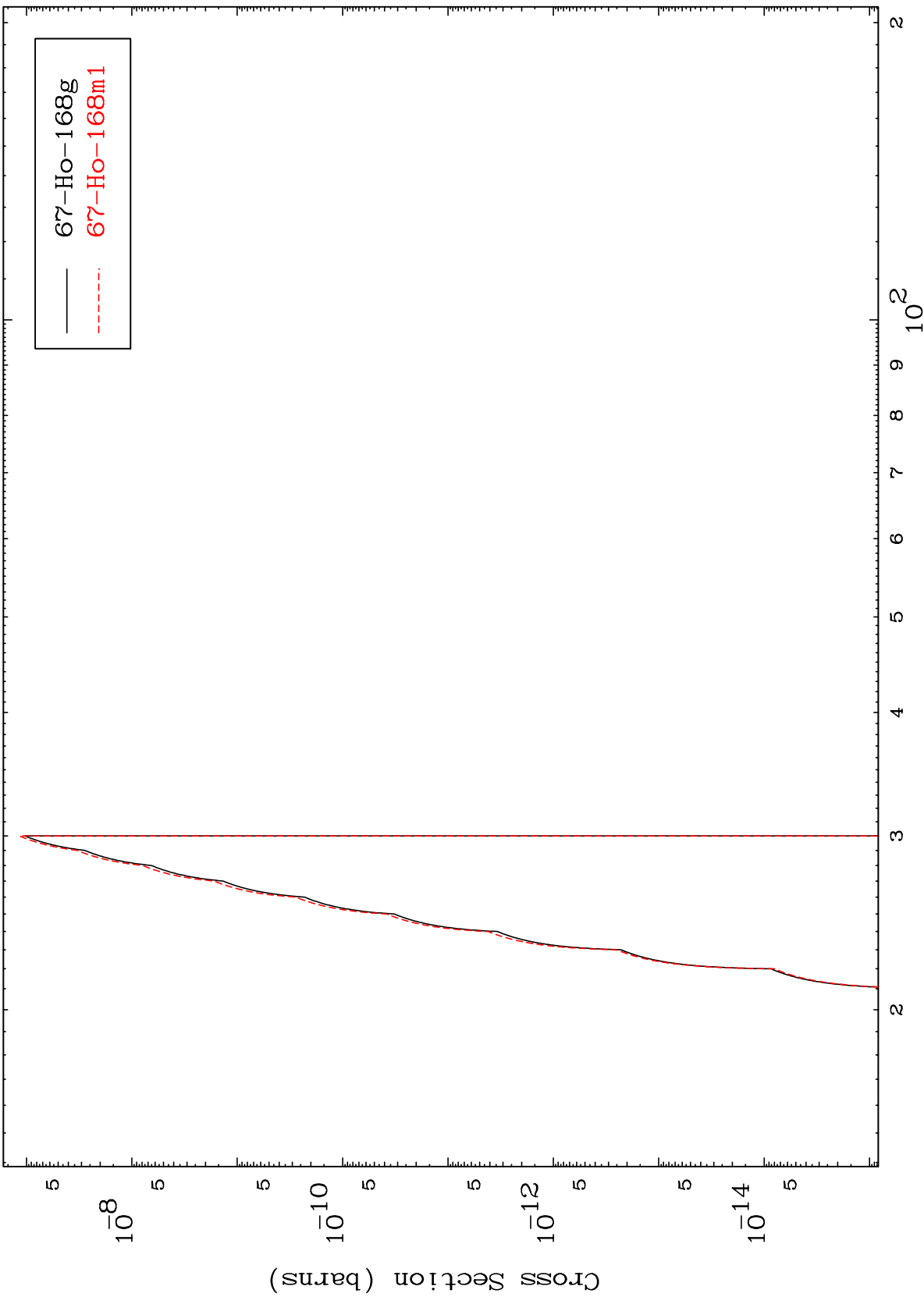

130

Incident Energy (MeV)

69-Tm-170

MAT 6928

(n,n') p α

69-Tm-170

Radionuclide Production Cross Section

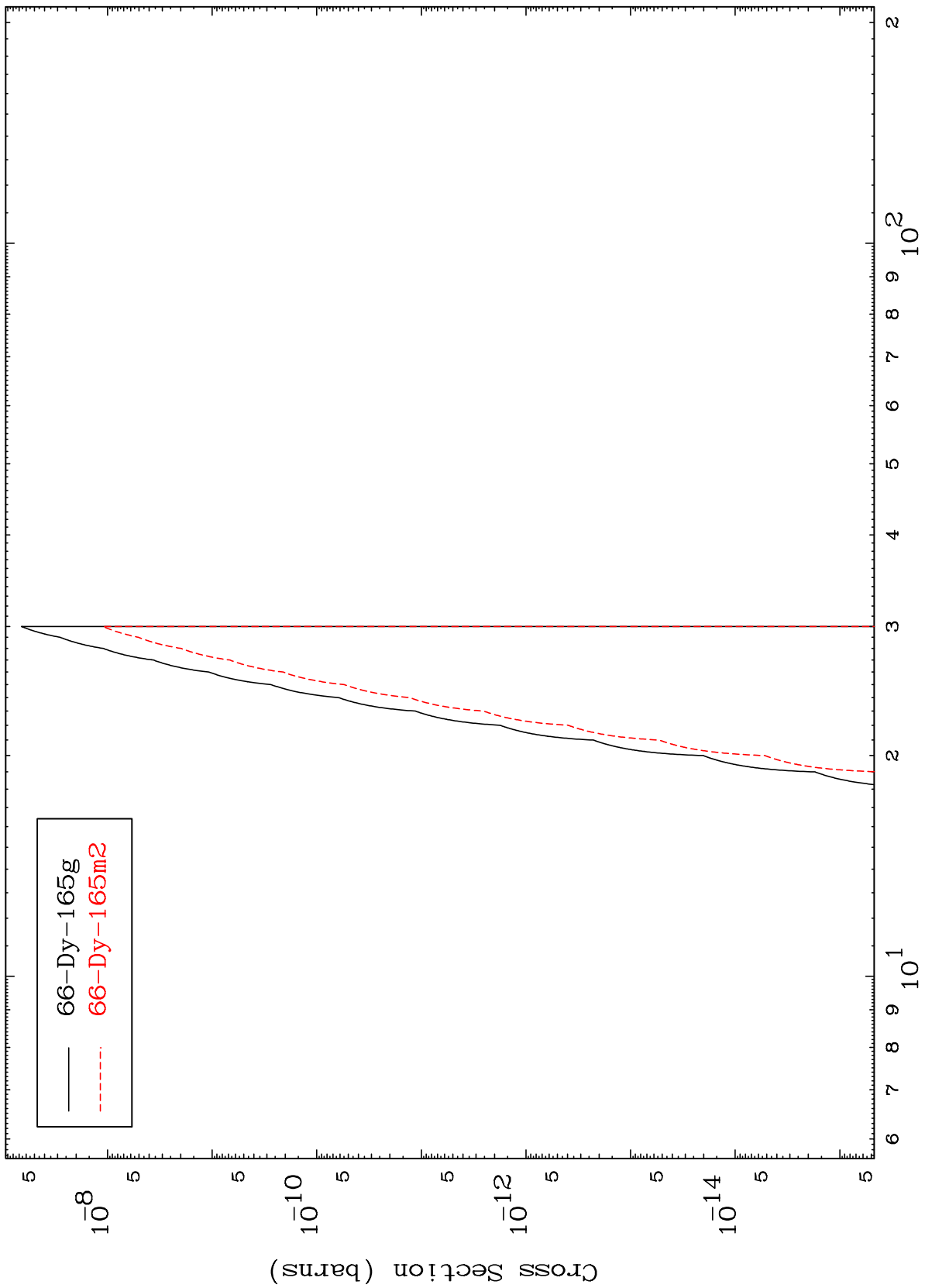

66-Dy-165g
66-Dy-165m2

131

Incident Energy (MeV)

69-Tm-170

MAT 6928

(n,He-3)

69-Tm-170

Radionuclide Production Cross Section

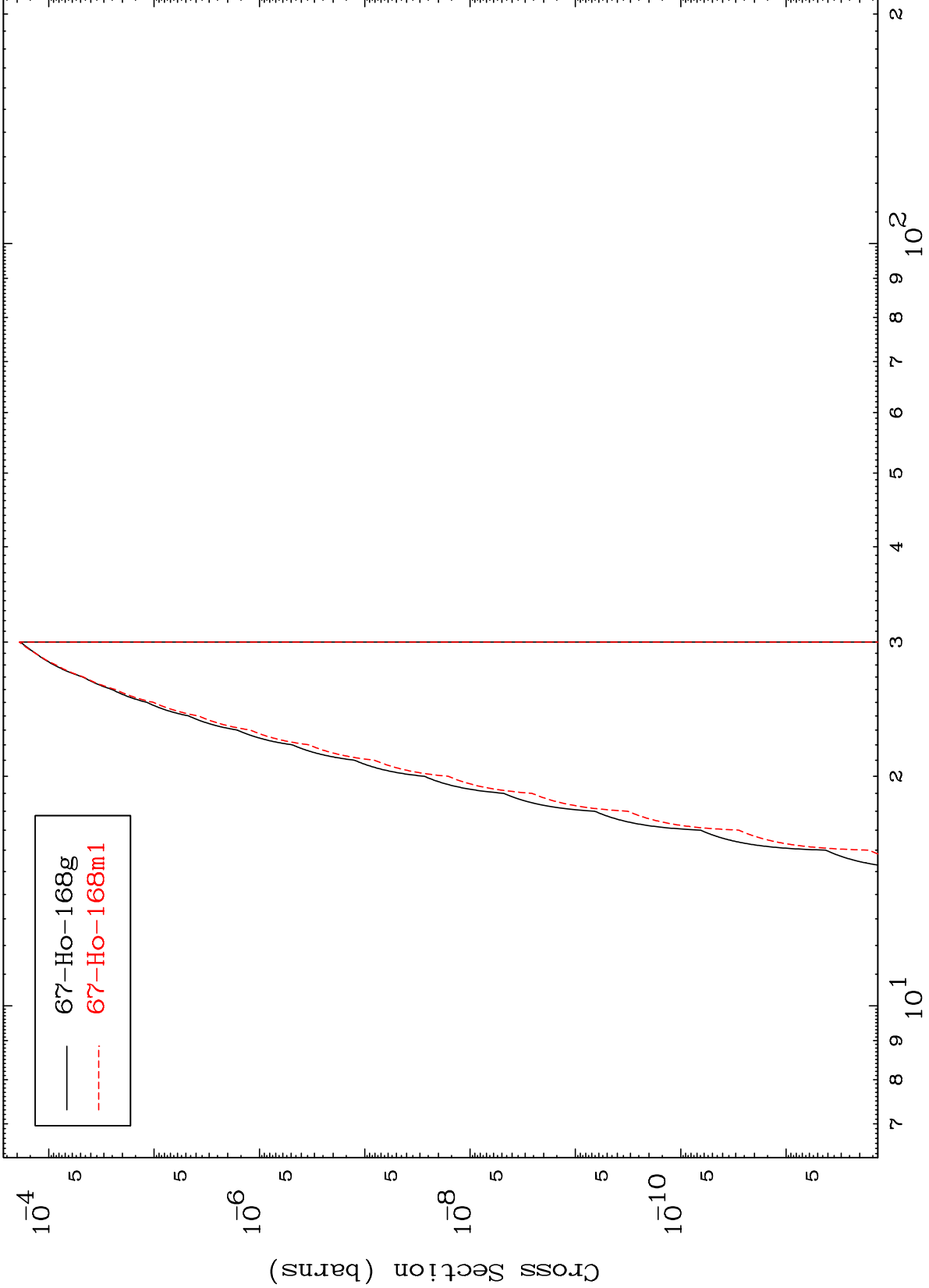

132

Incident Energy (MeV)

69-Tm-170

Radionuclide Production Cross Section

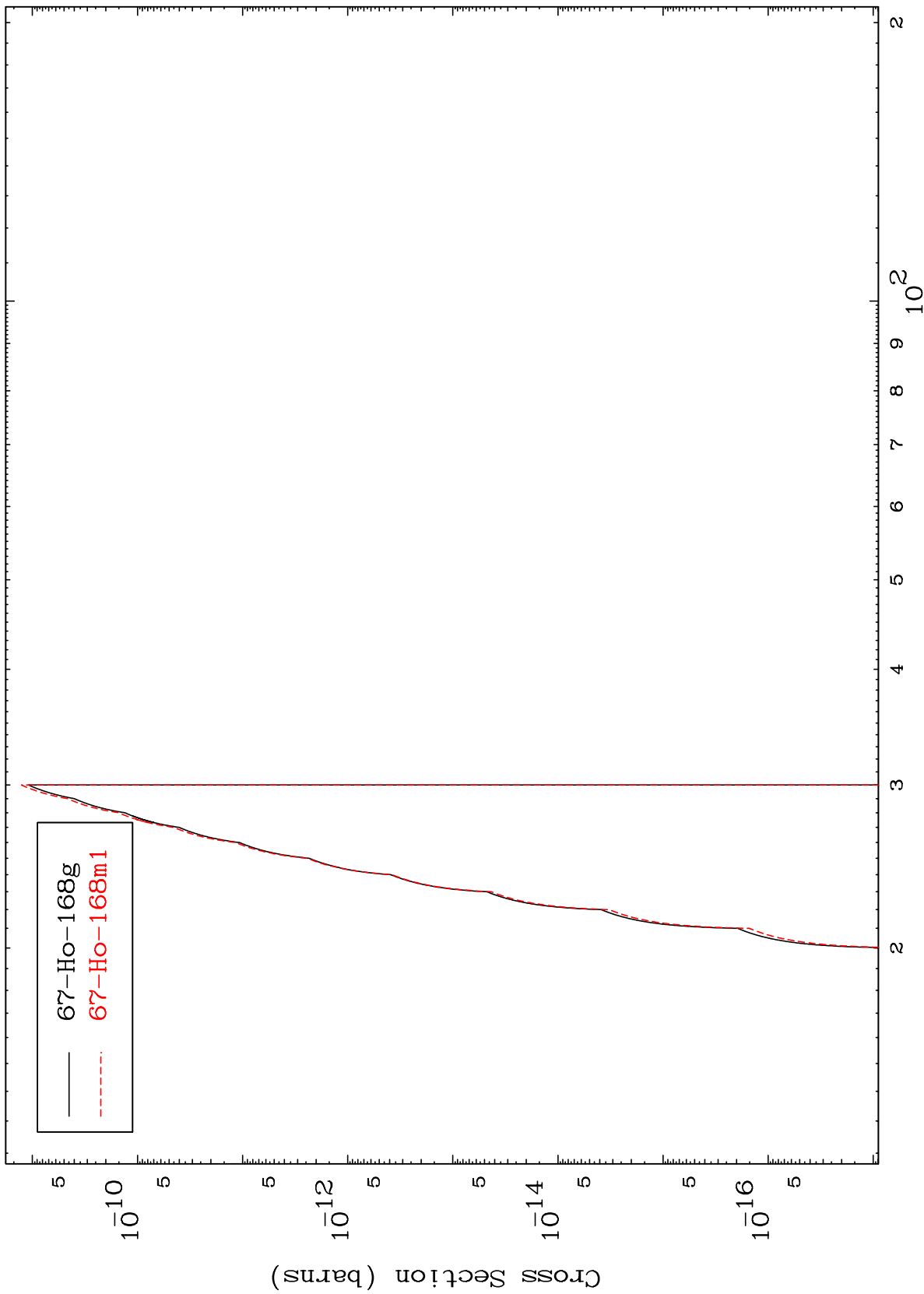

MAT 6928

(n,d) α

69-Tm-170

Radionuclide Production Cross Section

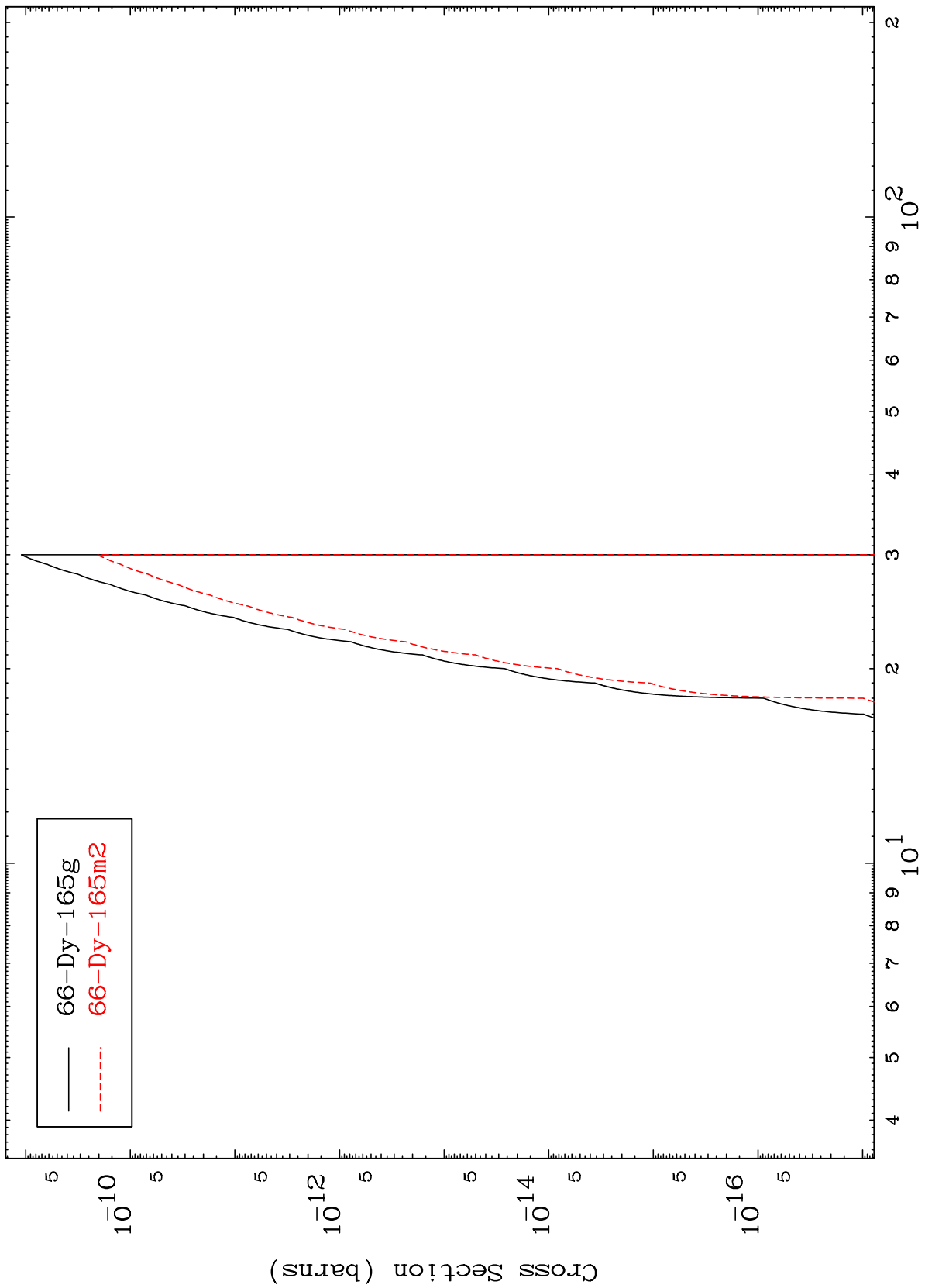

66-Dy-165g
66-Dy-165m2

134

Incident Energy (MeV)

69-Tm-170