

# AG111 PROTON ACER TENDL-2021 LIBRARY; T=0.K

## Principal cross sections

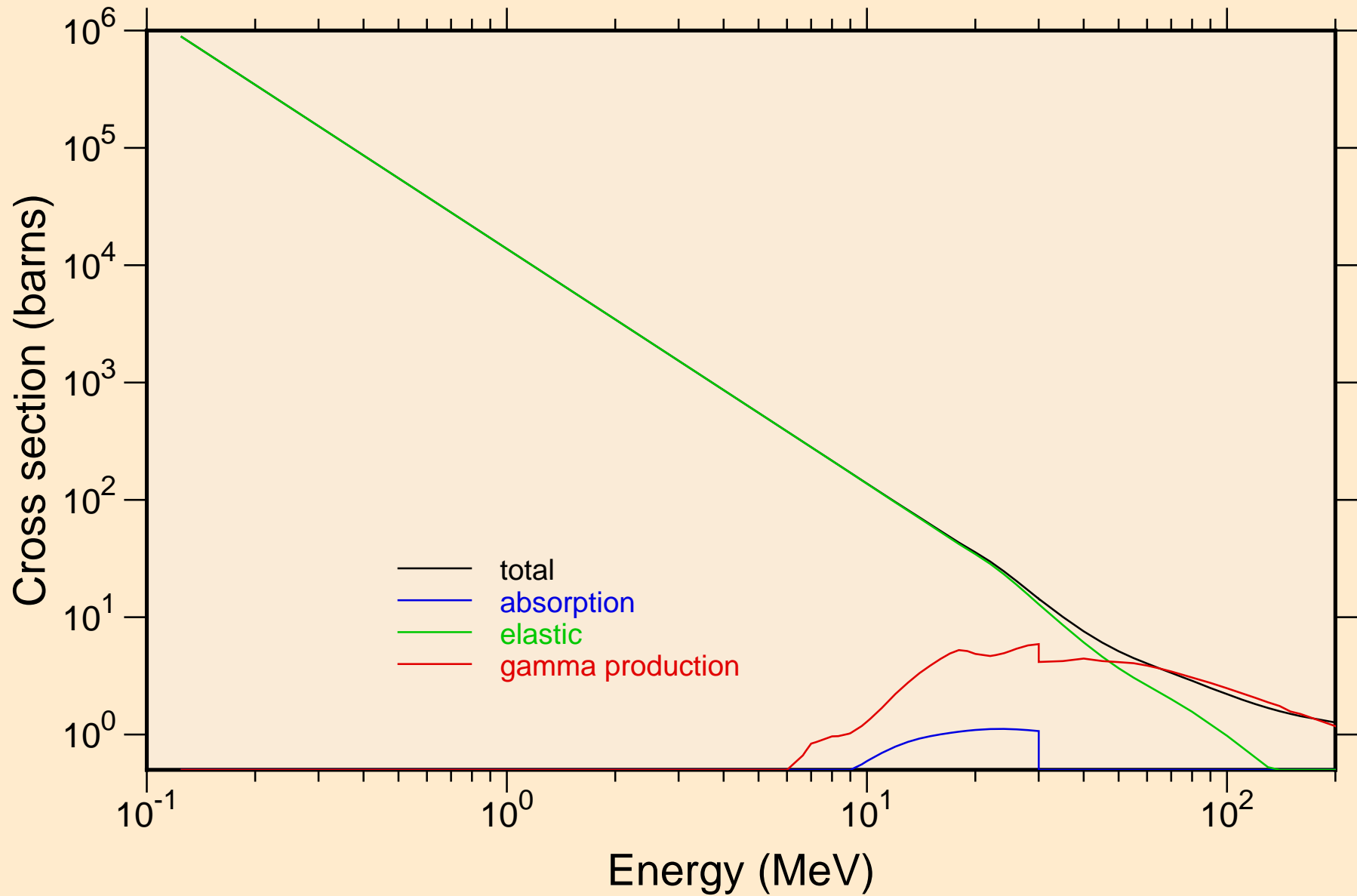

AG111 PROTON ACER TENDL-2021 LIBRARY; T=0.K  
Heating

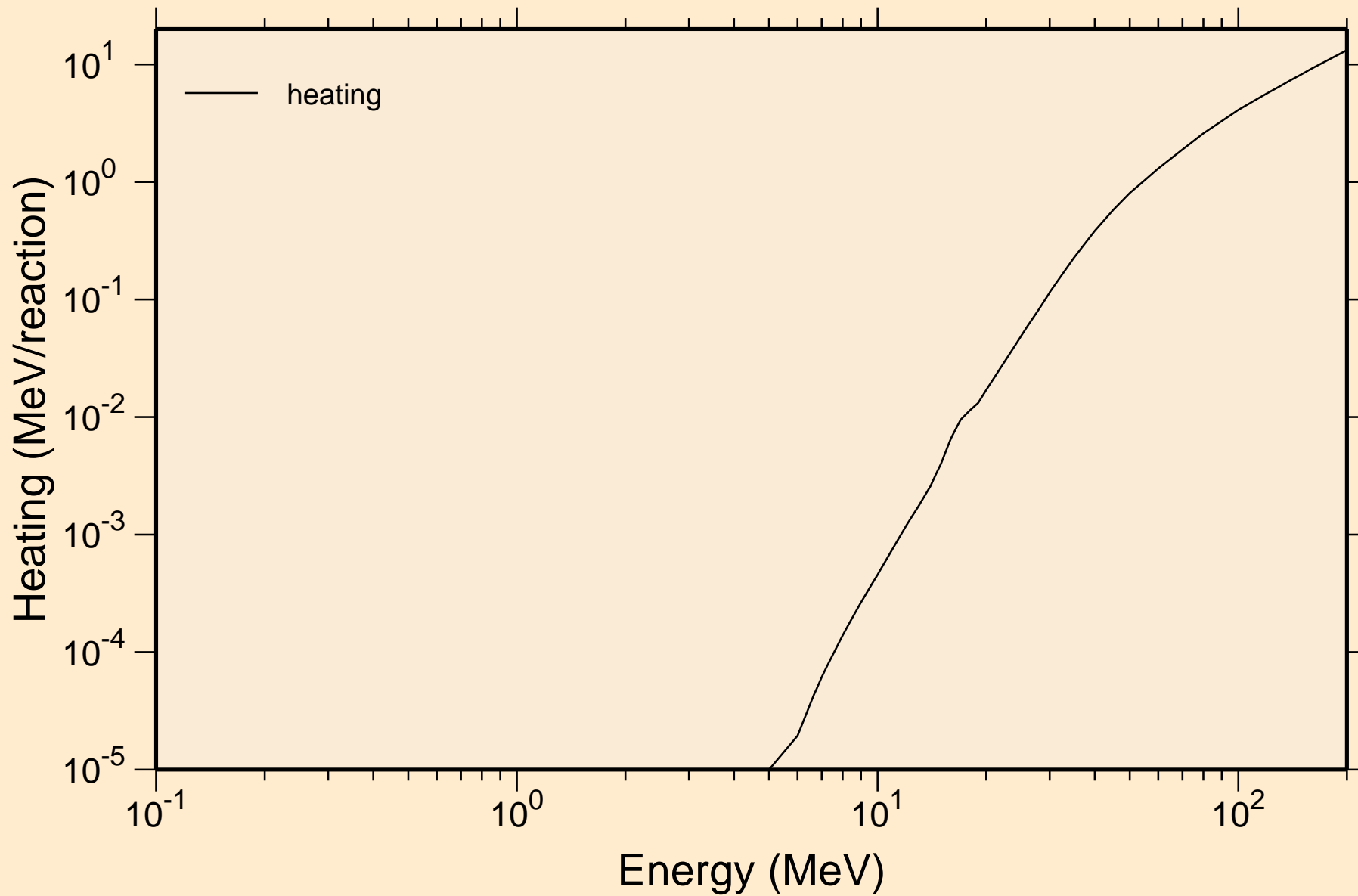

# AG111 PROTON ACER TENDL-2021 LIBRARY; T=0.K

## Principal cross sections

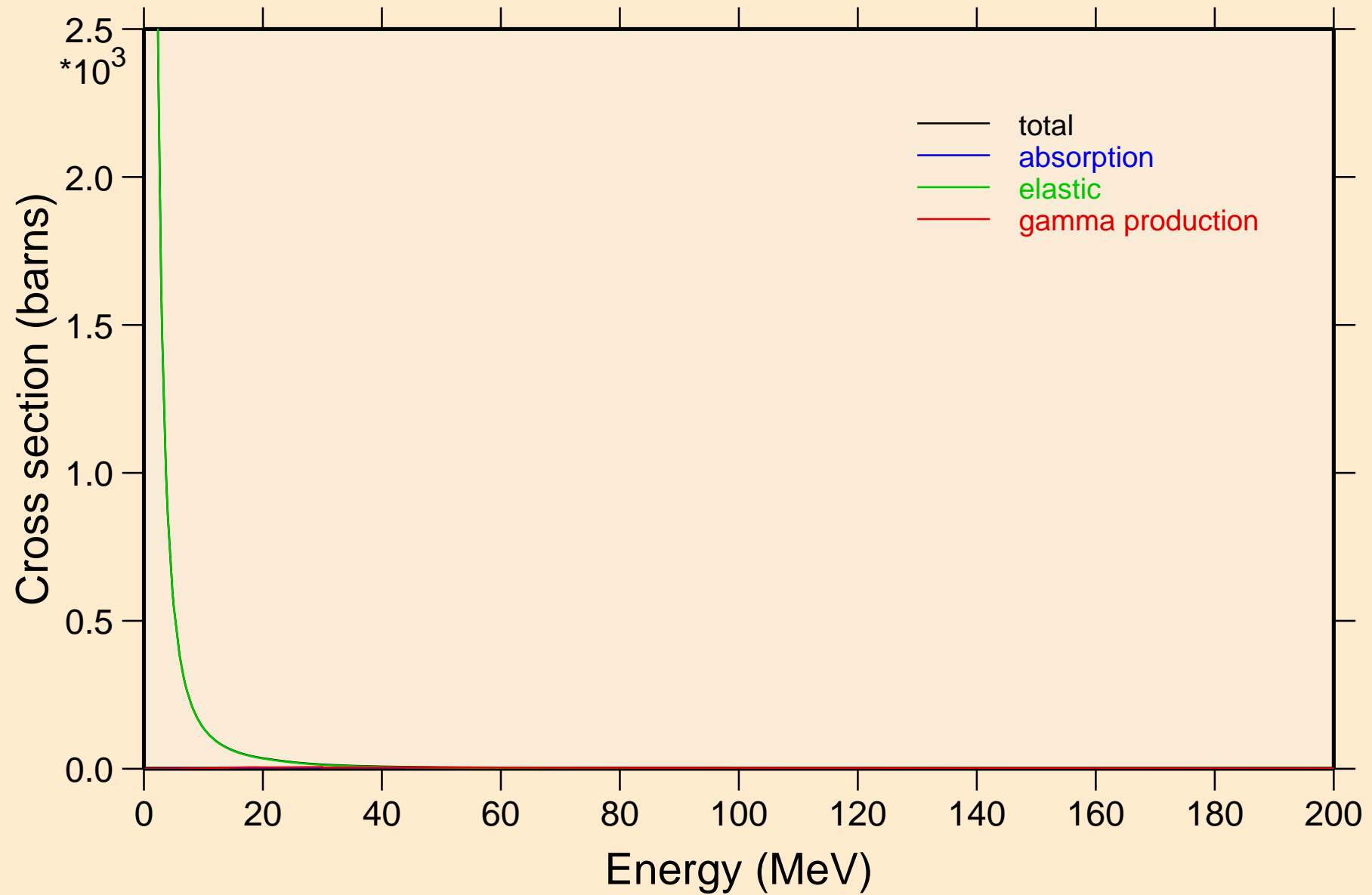

# AG111 PROTON ACER TENDL-2021 LIBRARY; T=0.K

## Heating

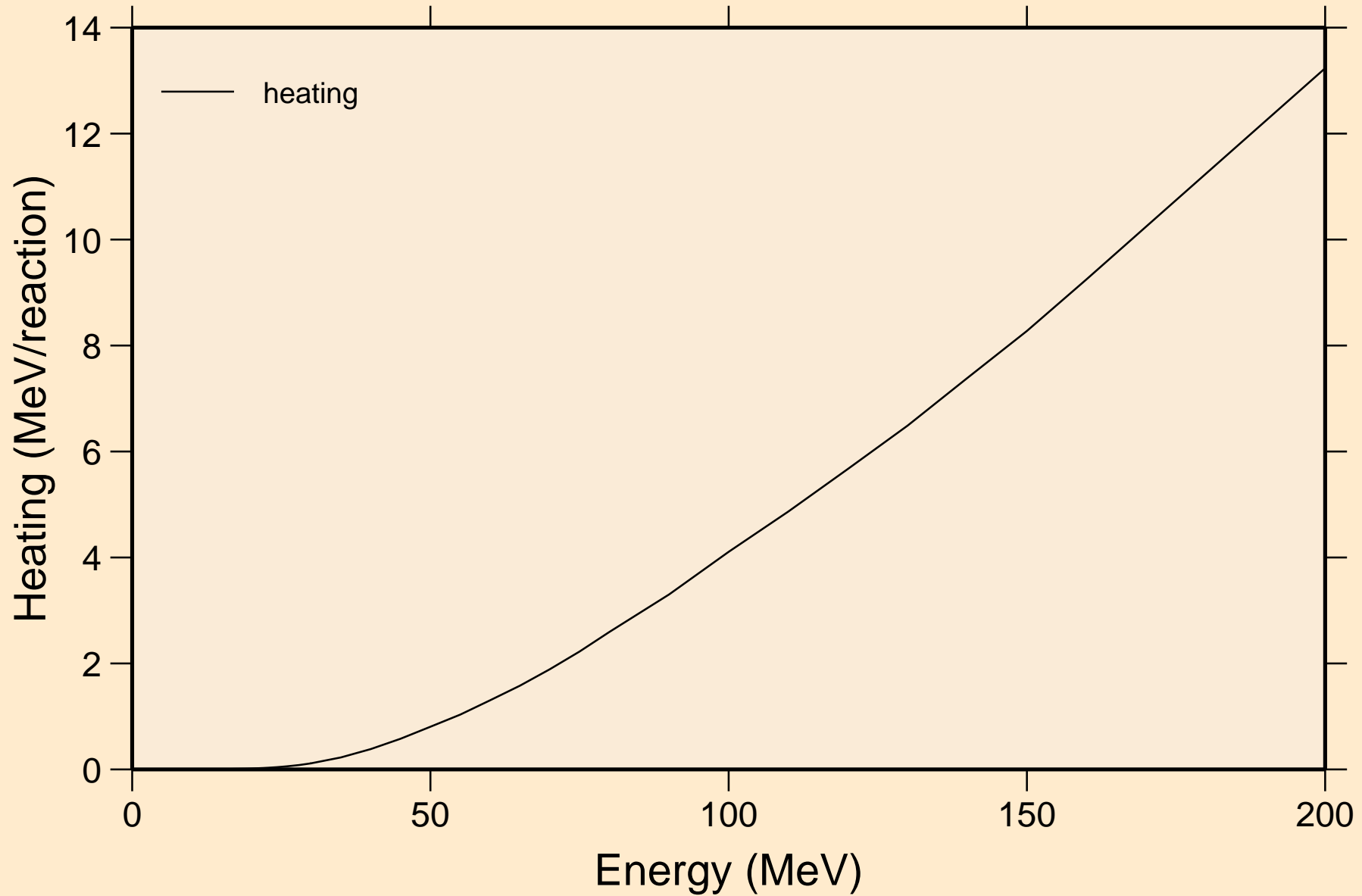

# AG111 PROTON ACER TENDL-2021 LIBRARY; T=0.K

## Threshold reactions

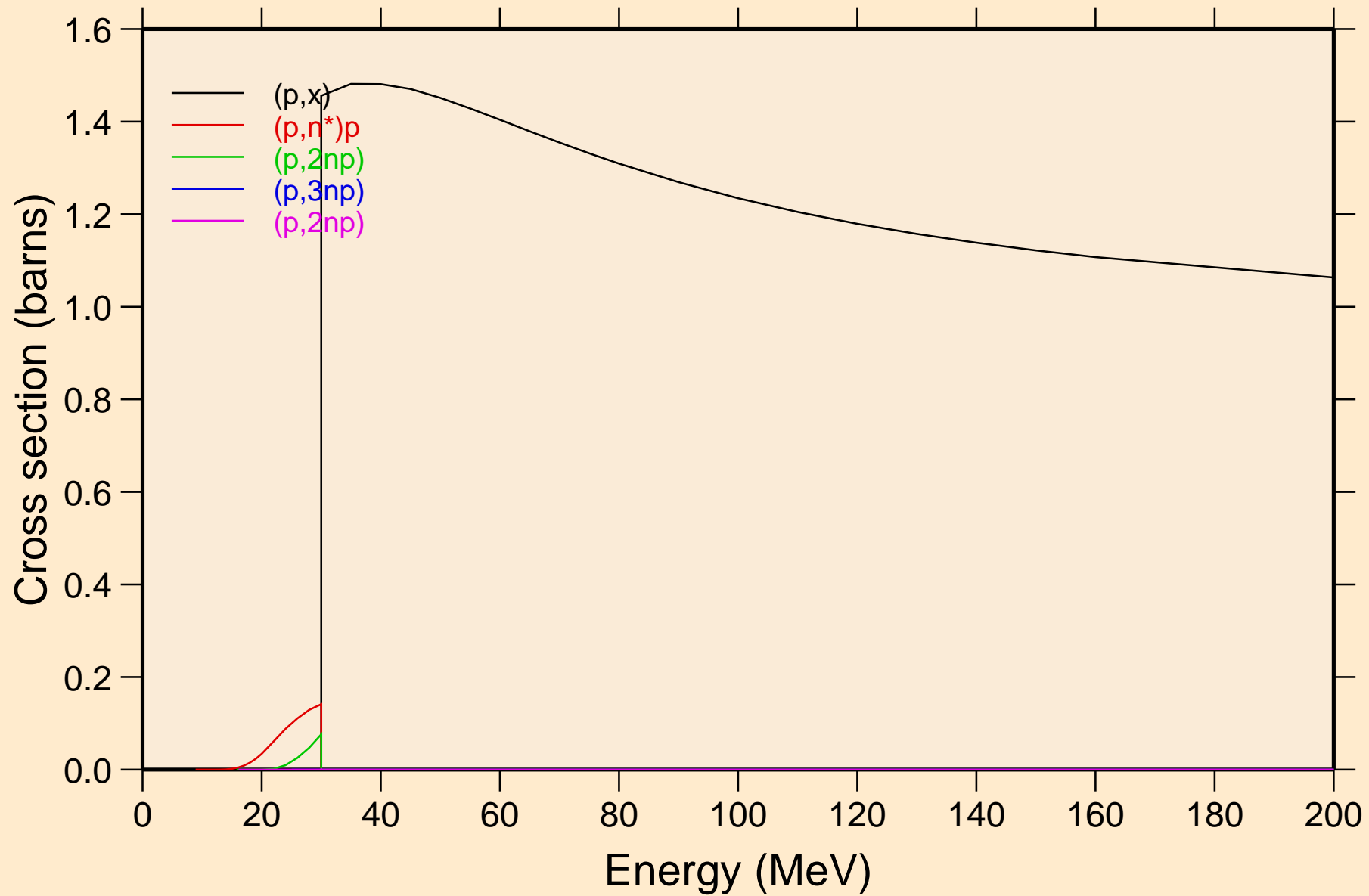

# AG111 PROTON ACER TENDL-2021 LIBRARY; T=0.K

## Threshold reactions

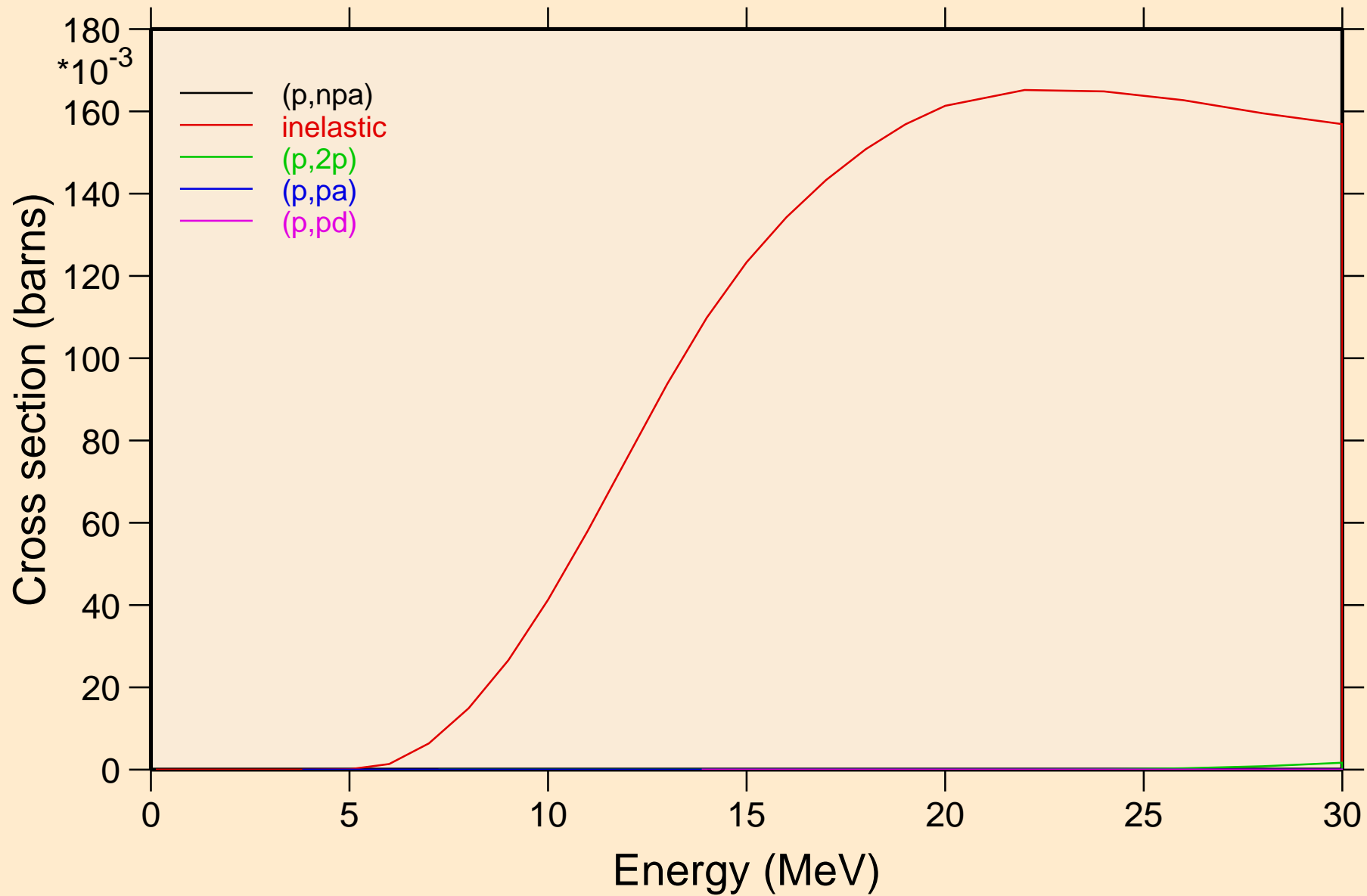

AG111 PROTON ACER TENDL-2021 LIBRARY; T=0.K  
Threshold reactions

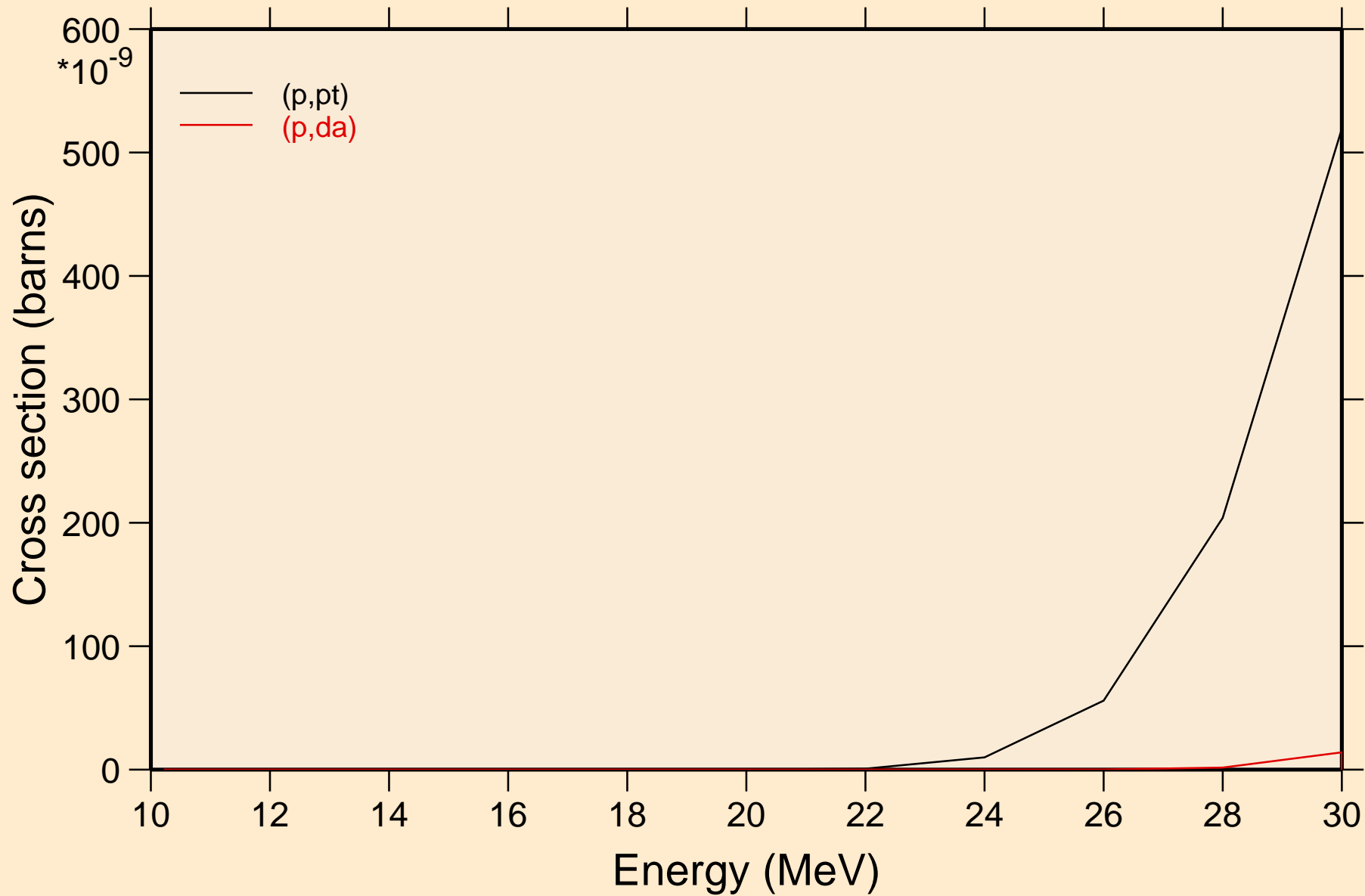

AG111 PROTON ACER TENDL-2021 LIBRARY; T=0.K  
angular distribution for elastic

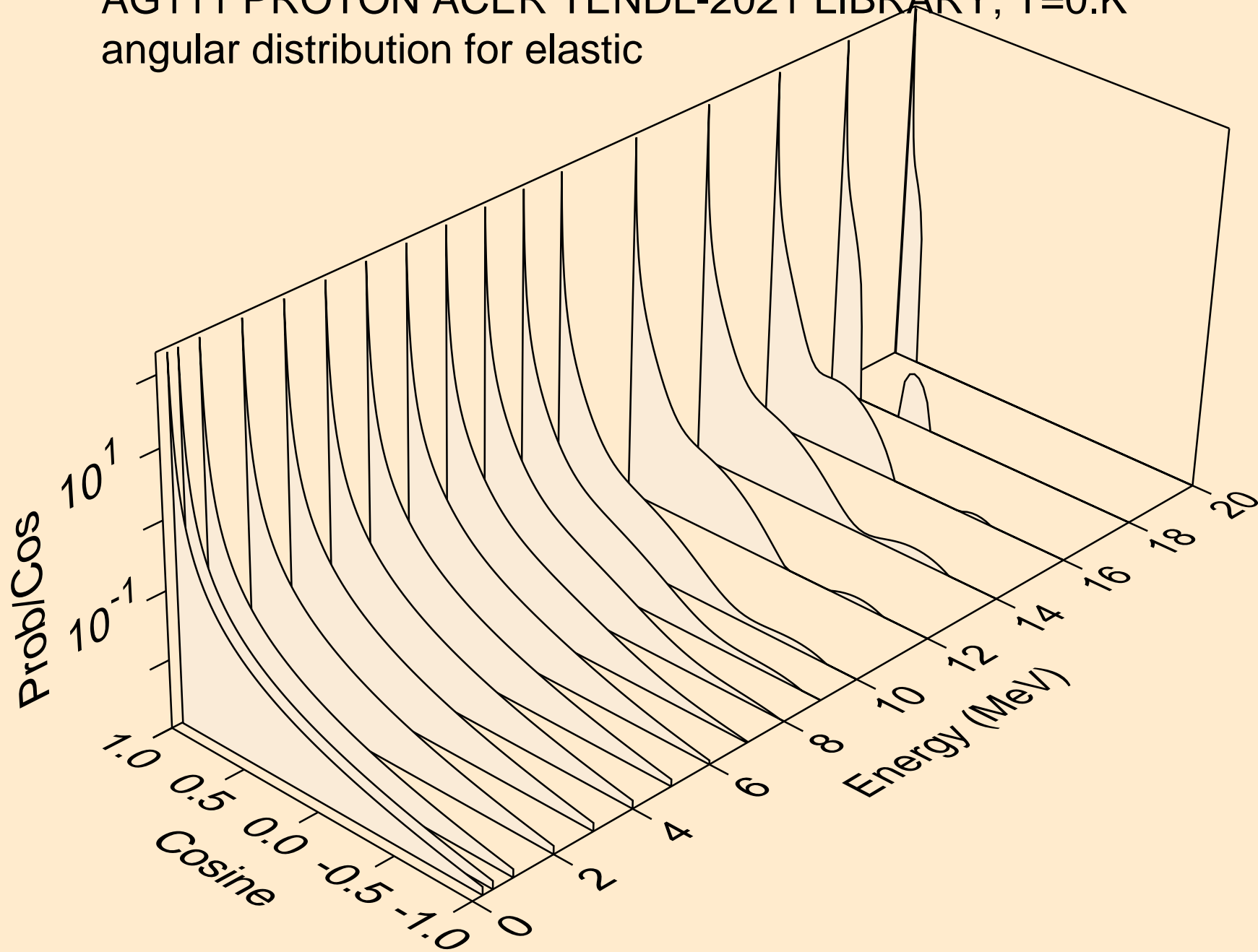

AG111 PROTON ACER TENDL-2021 LIBRARY; T=0.K  
angular distribution for elastic

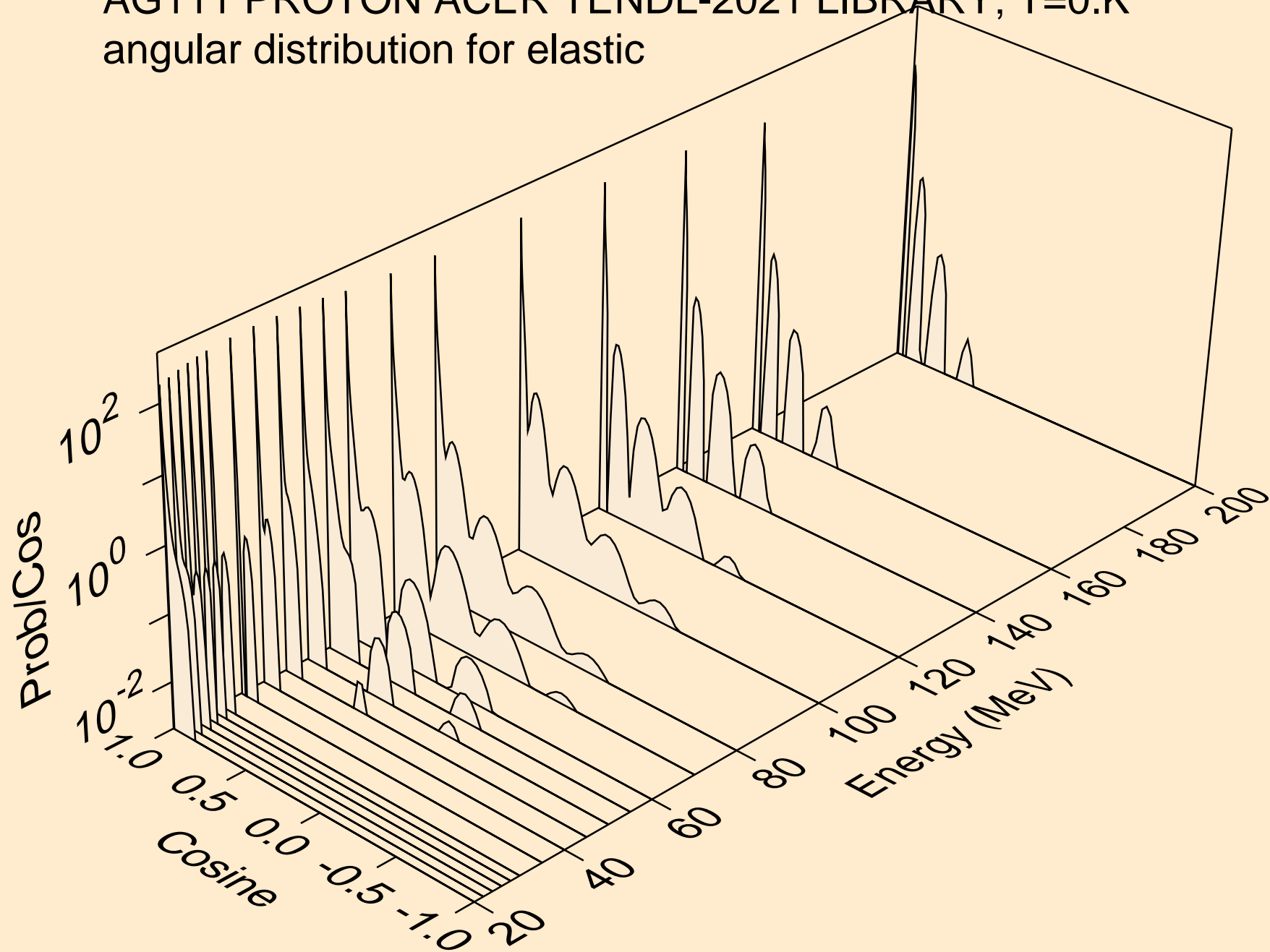

AG111 PROTON ACER TENDL-2021 LIBRARY; T=0.K  
Proton emission for (p,x)

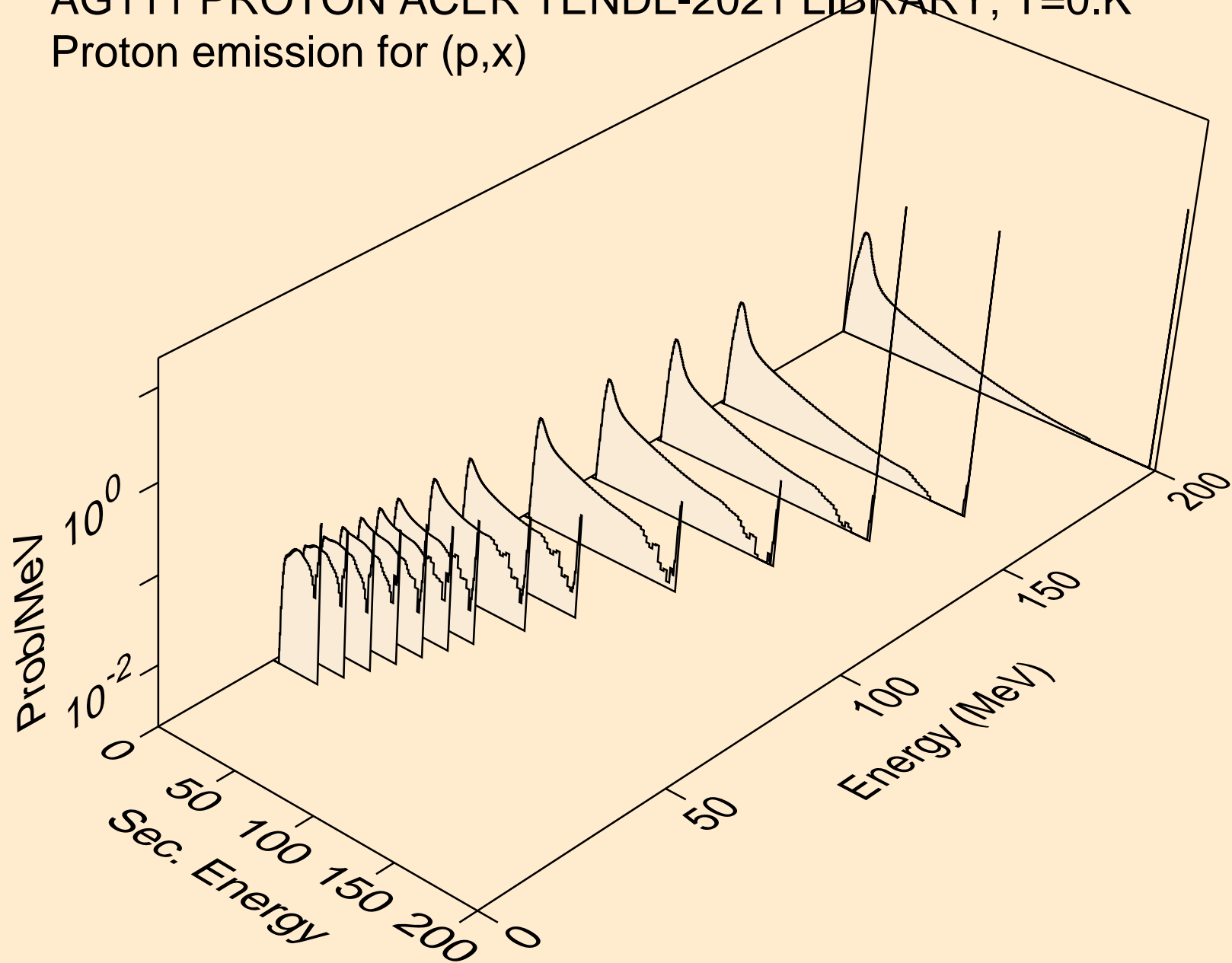

AG111 PROTON ACER TENDL-2021 LIBRARY; T=0.K  
Proton emission for (p,n\*)p

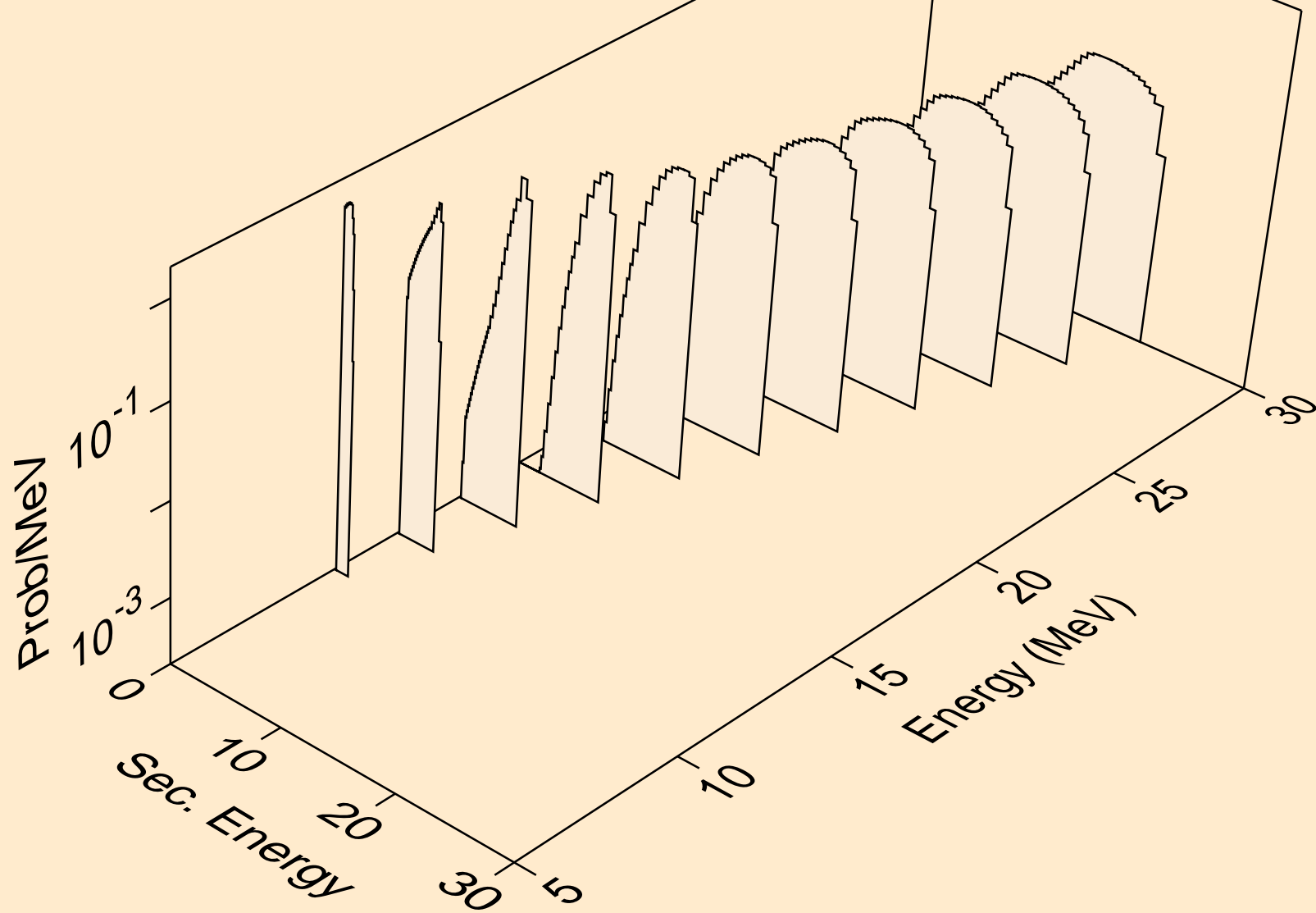

AG111 PROTON ACER TENDL-2021 LIBRARY; T=0.K  
Proton emission for (p,2np)

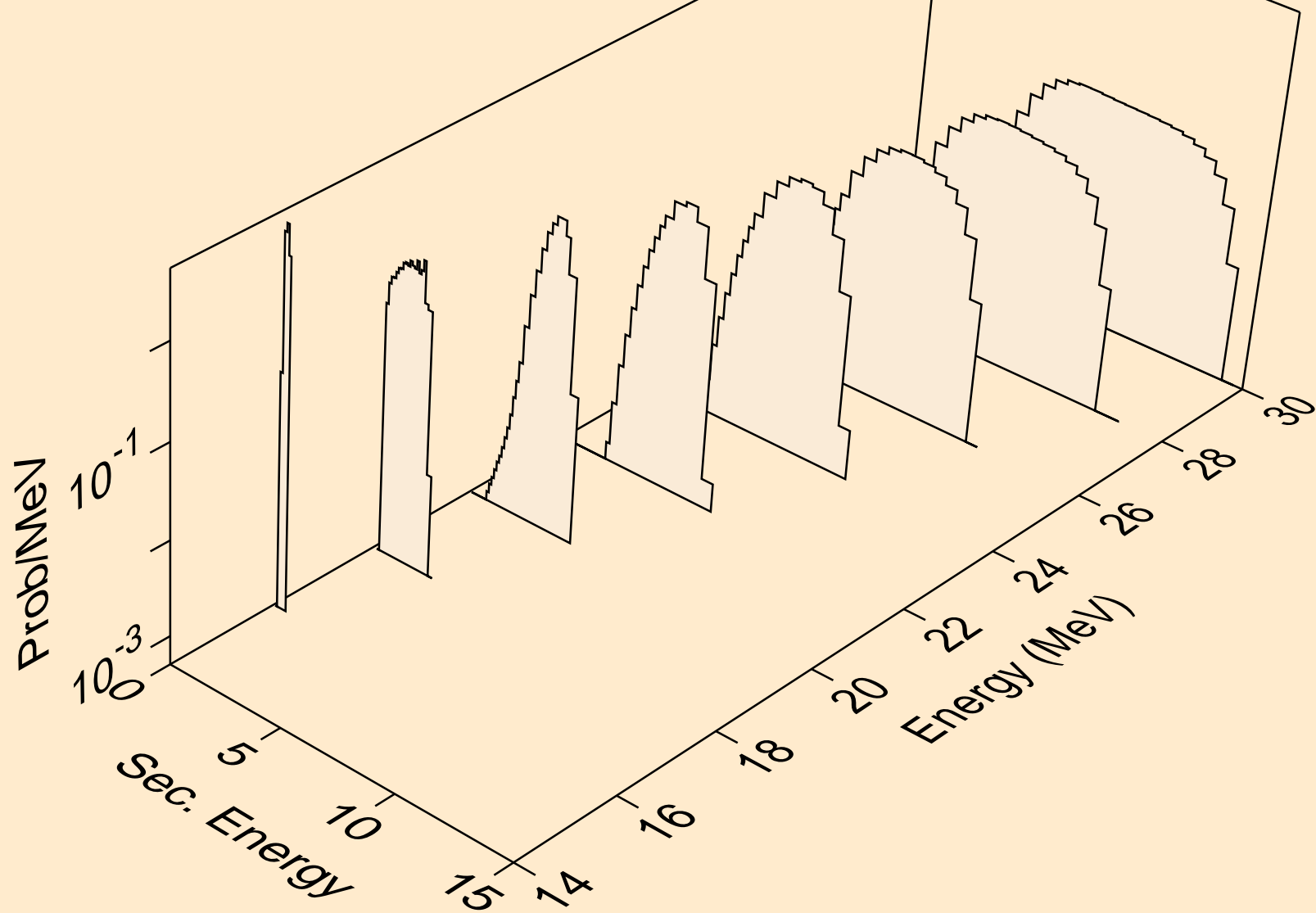

AG111 PROTON ACER TENDL-2021 LIBRARY; T=0.K  
Proton emission for (p,3np)

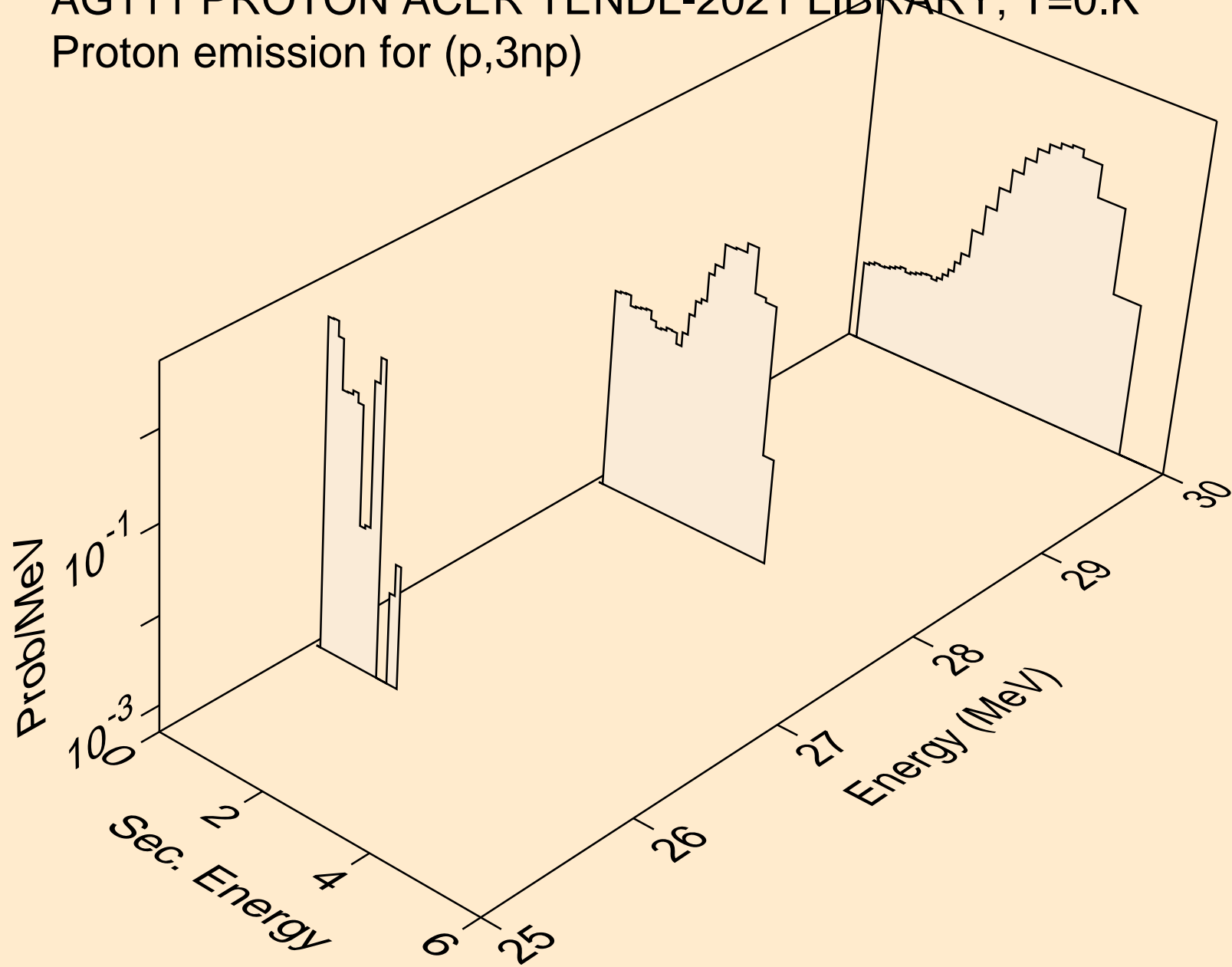

AG111 PROTON ACER TENDL-2021 LIBRARY; T=0.K  
Proton emission for (p,2np)

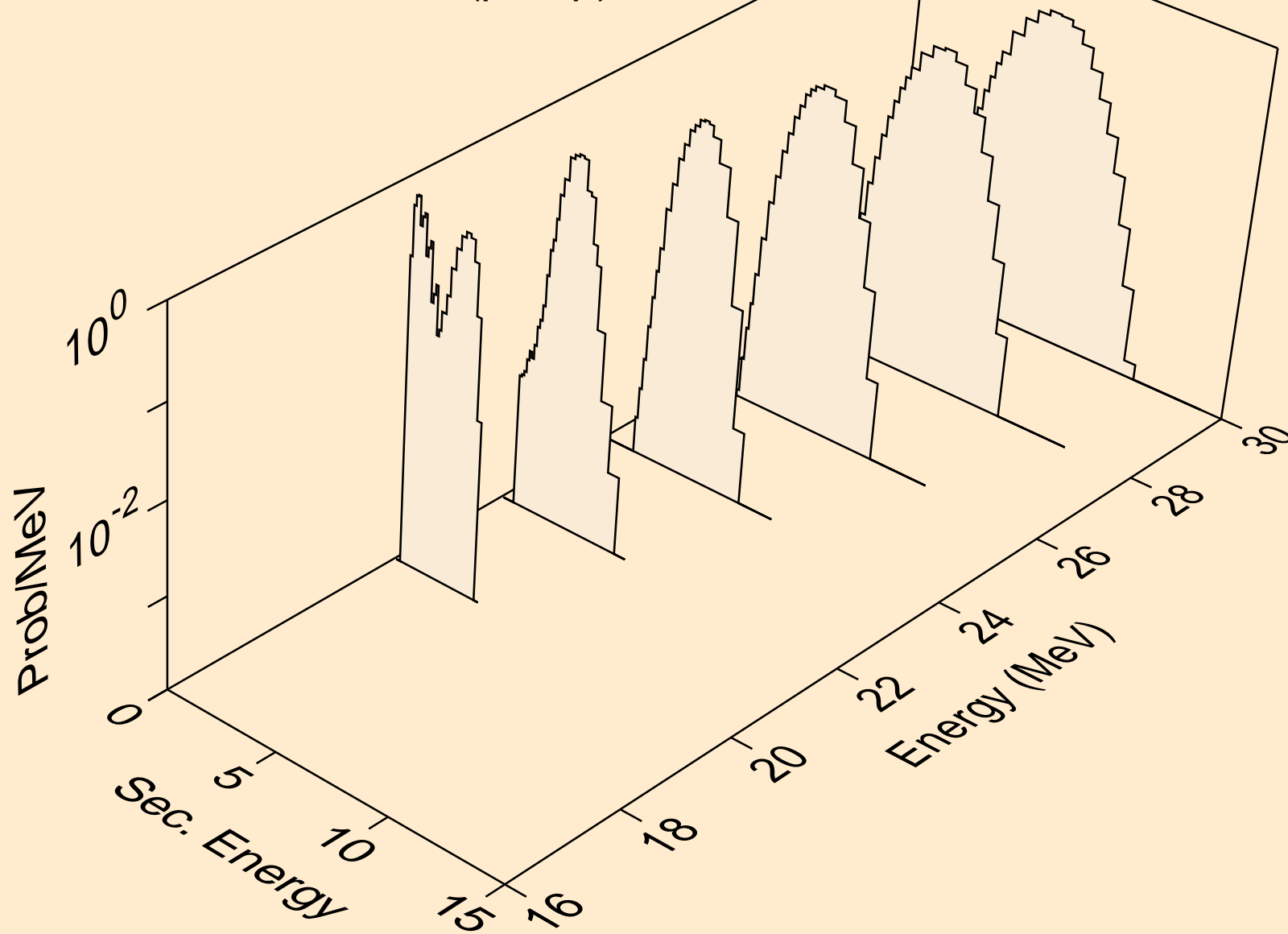

AG111 PROTON ACER TENDL-2021 LIBRARY; T=0.K  
Proton emission for (p,npa)

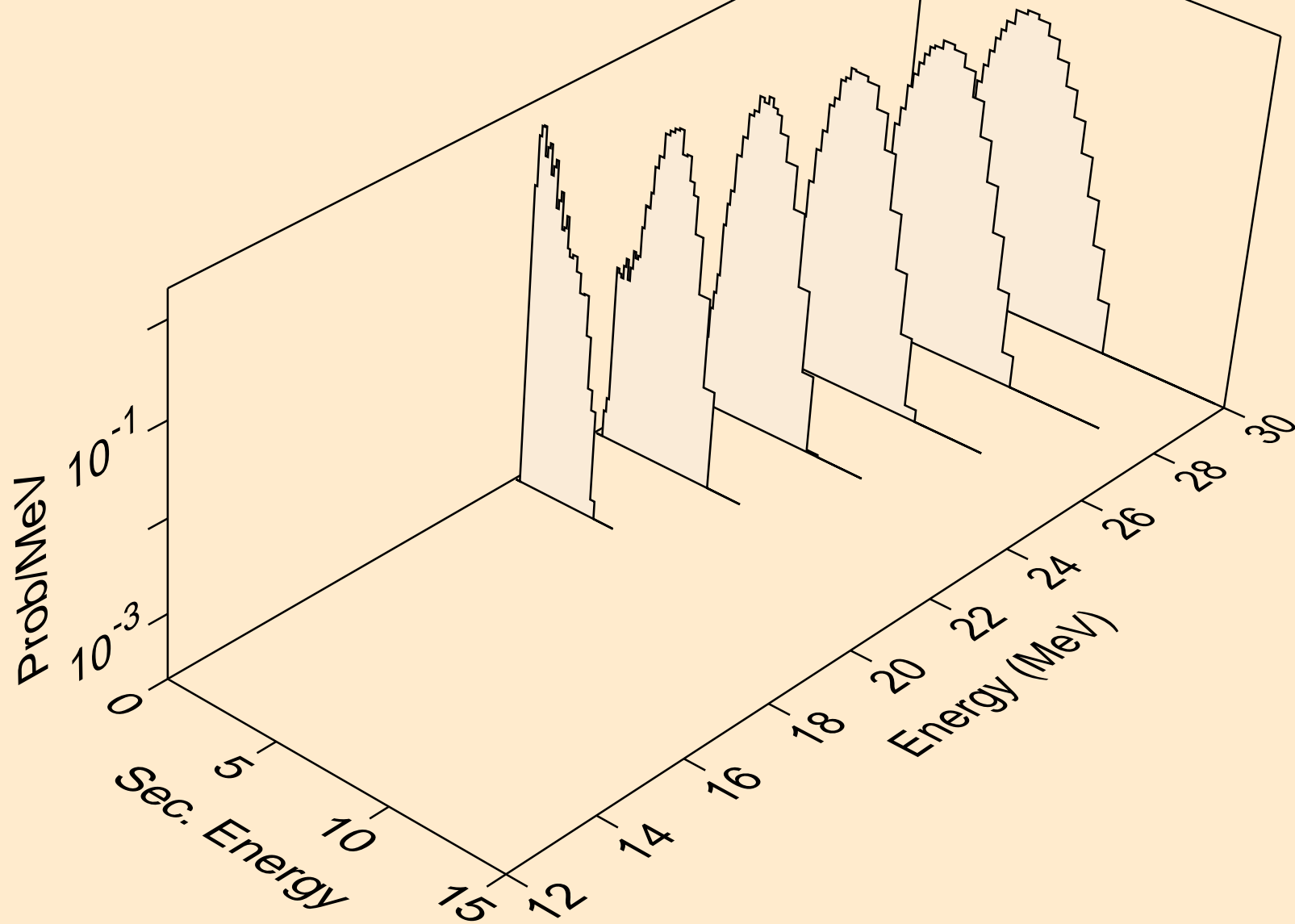

AG111 PROTON ACER TENDL-2021 LIBRARY; T=0.K  
Proton emission for inelastic

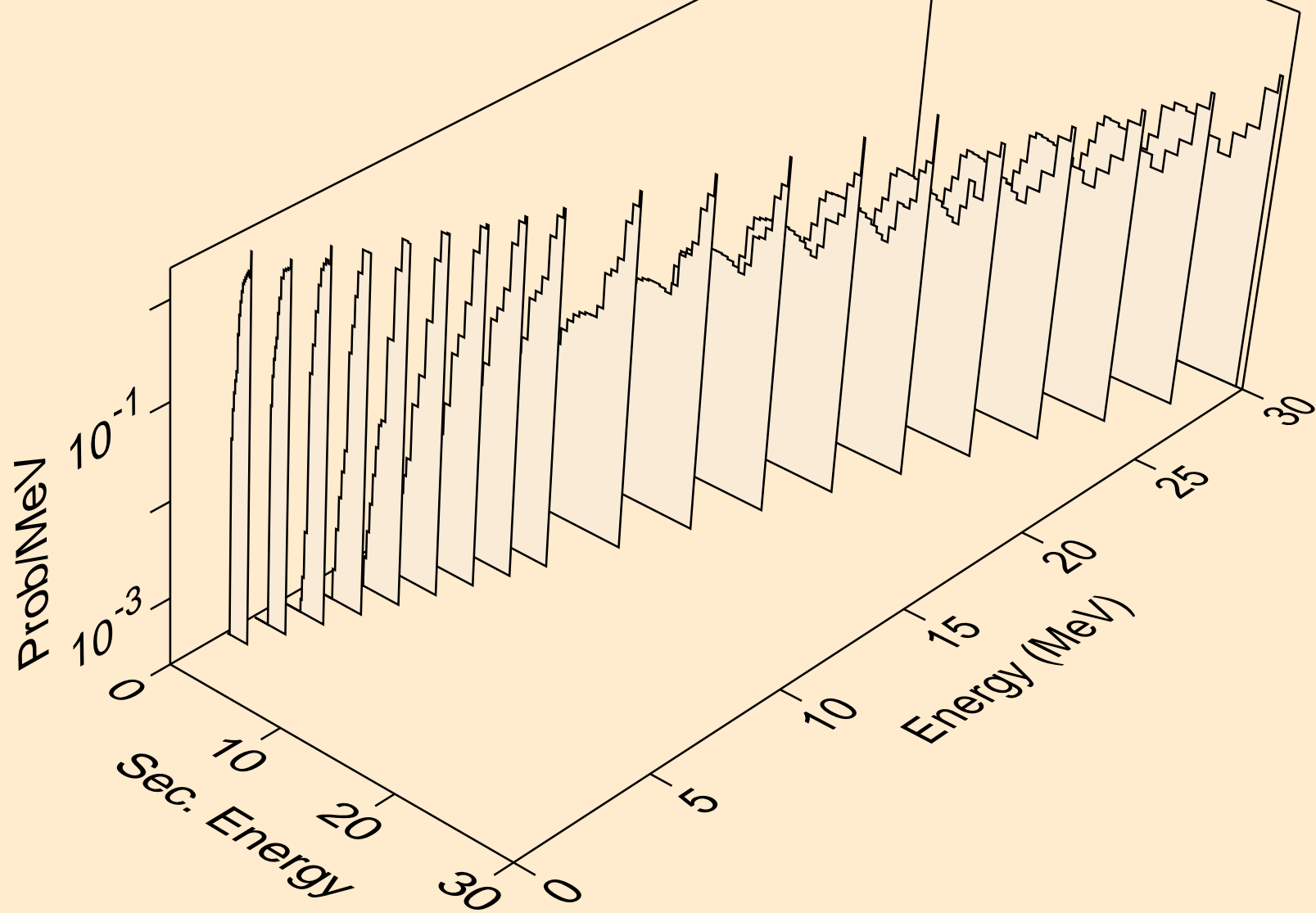

AG111 PROTON ACER TENDL-2021 LIBRARY; T=0.K  
Proton emission for (p,2p)

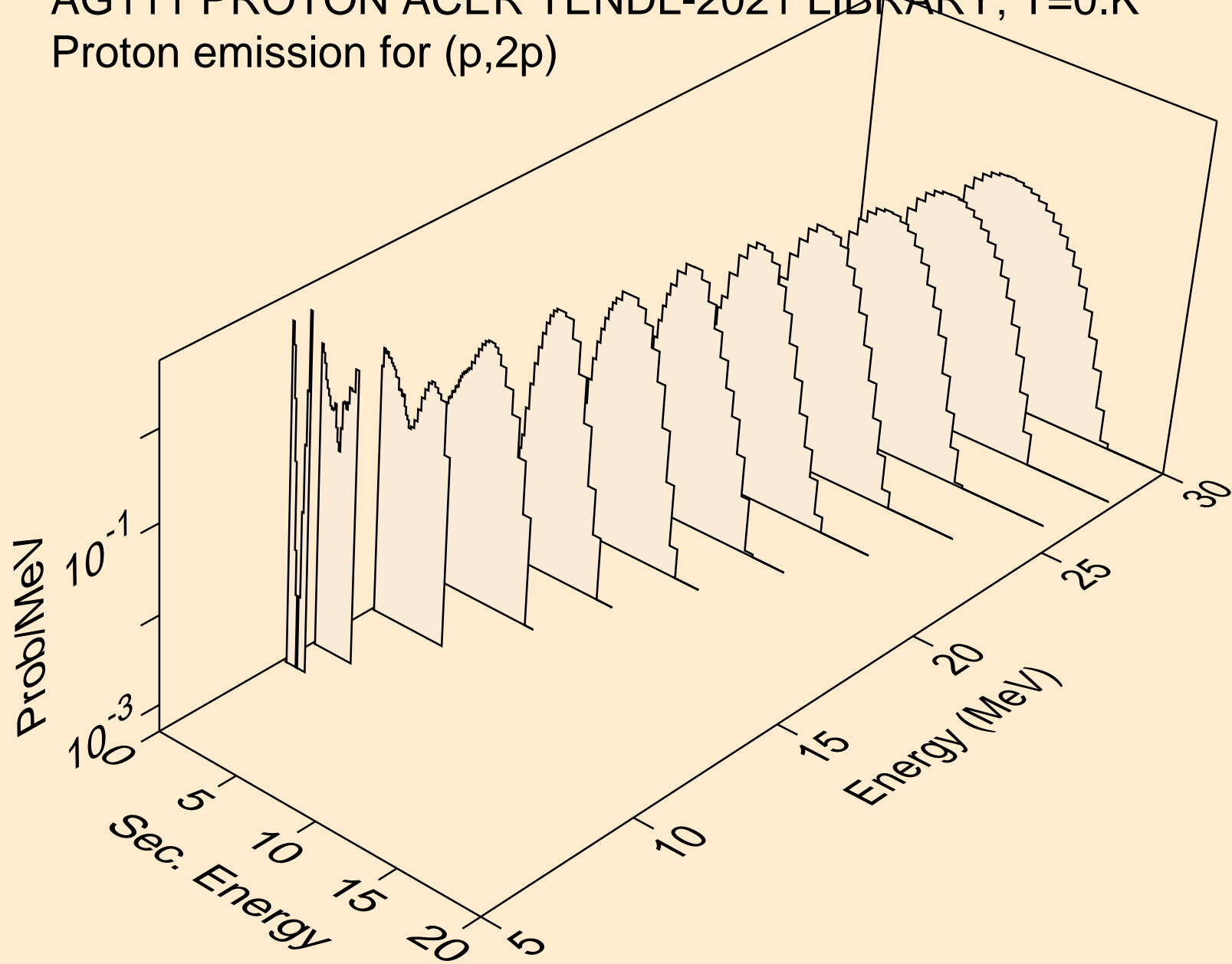

AG111 PROTON ACER TENDL-2021 LIBRARY; T=0.K  
Proton emission for (p,pa)

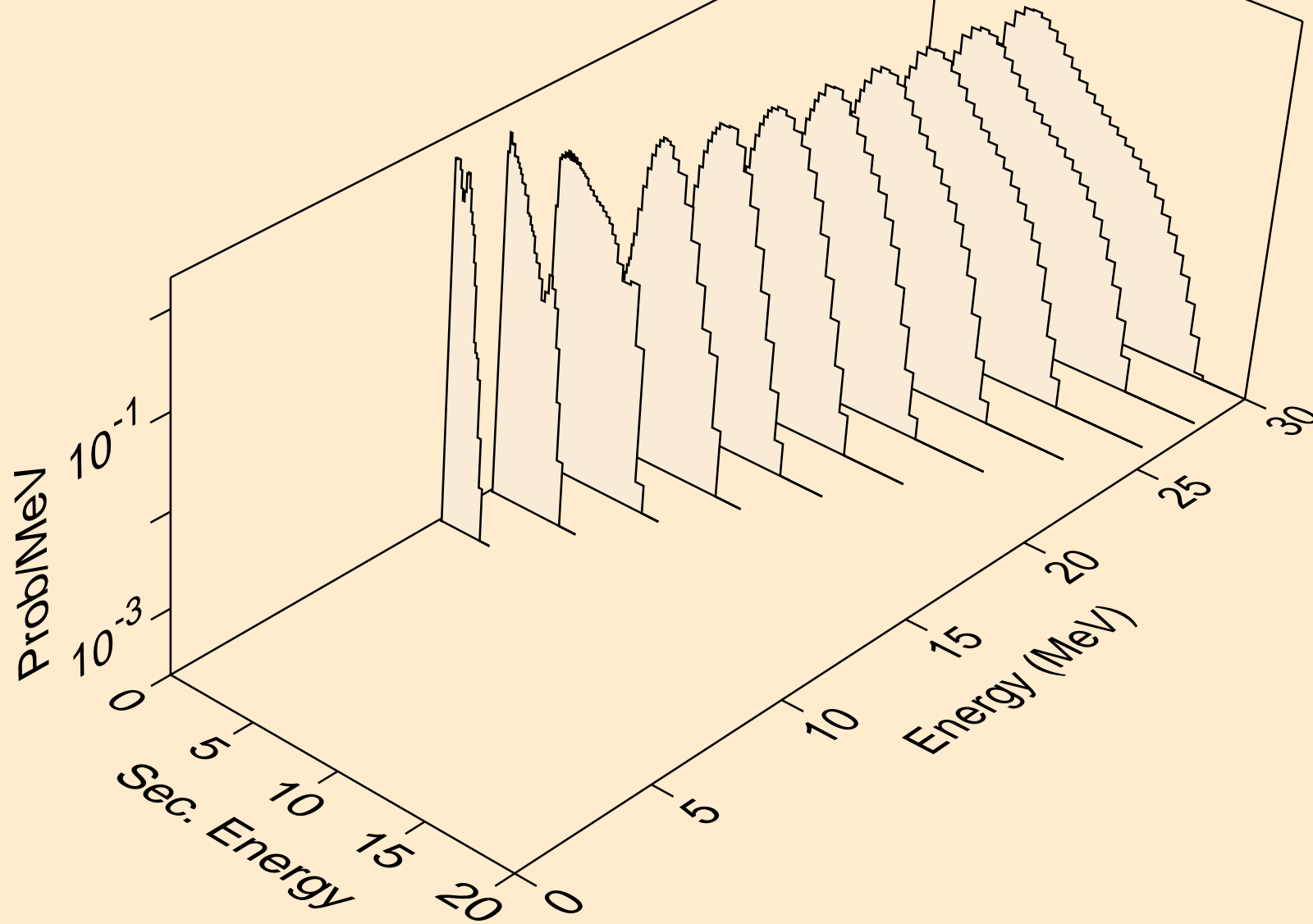

AG111 PROTON ACER TENDL-2021 LIBRARY; T=0.K  
Proton emission for (p,pd)

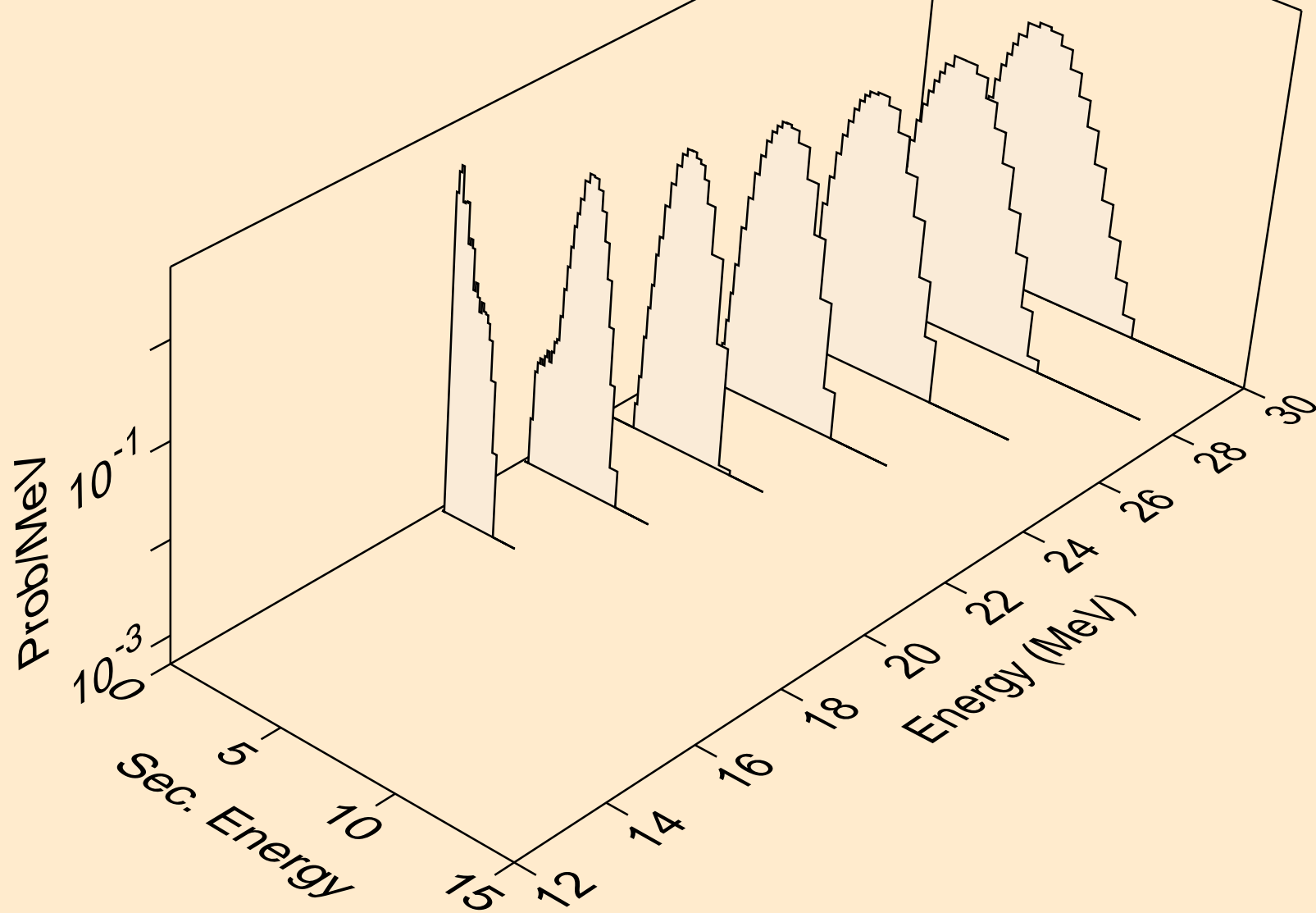

AG111 PROTON ACER TENDL-2021 LIBRARY; T=0.K  
Proton emission for (p,pt)

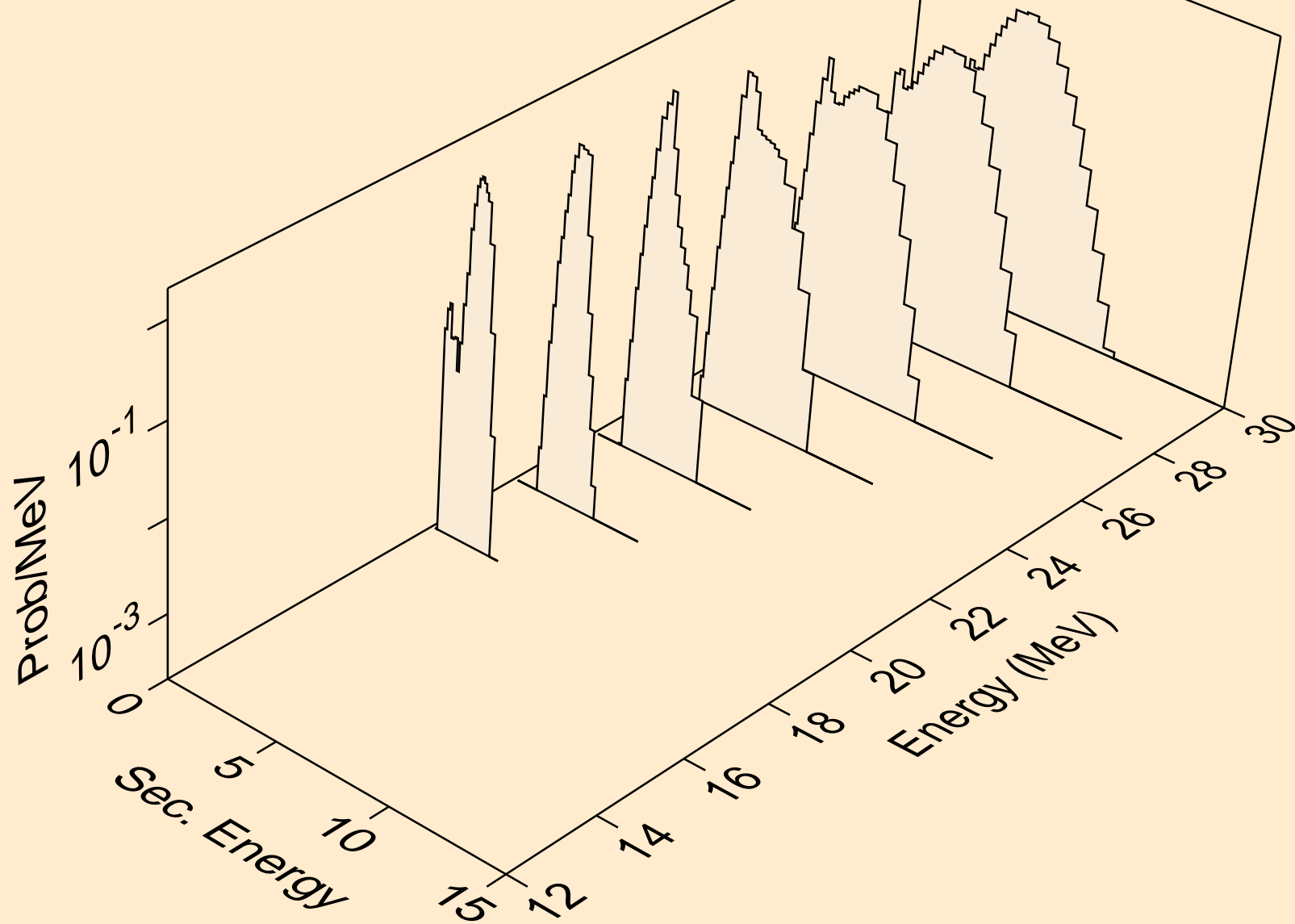

AG111 PROTON ACER TENDL-2021 LIBRARY; T=0.K  
Photon emission for (z,n)

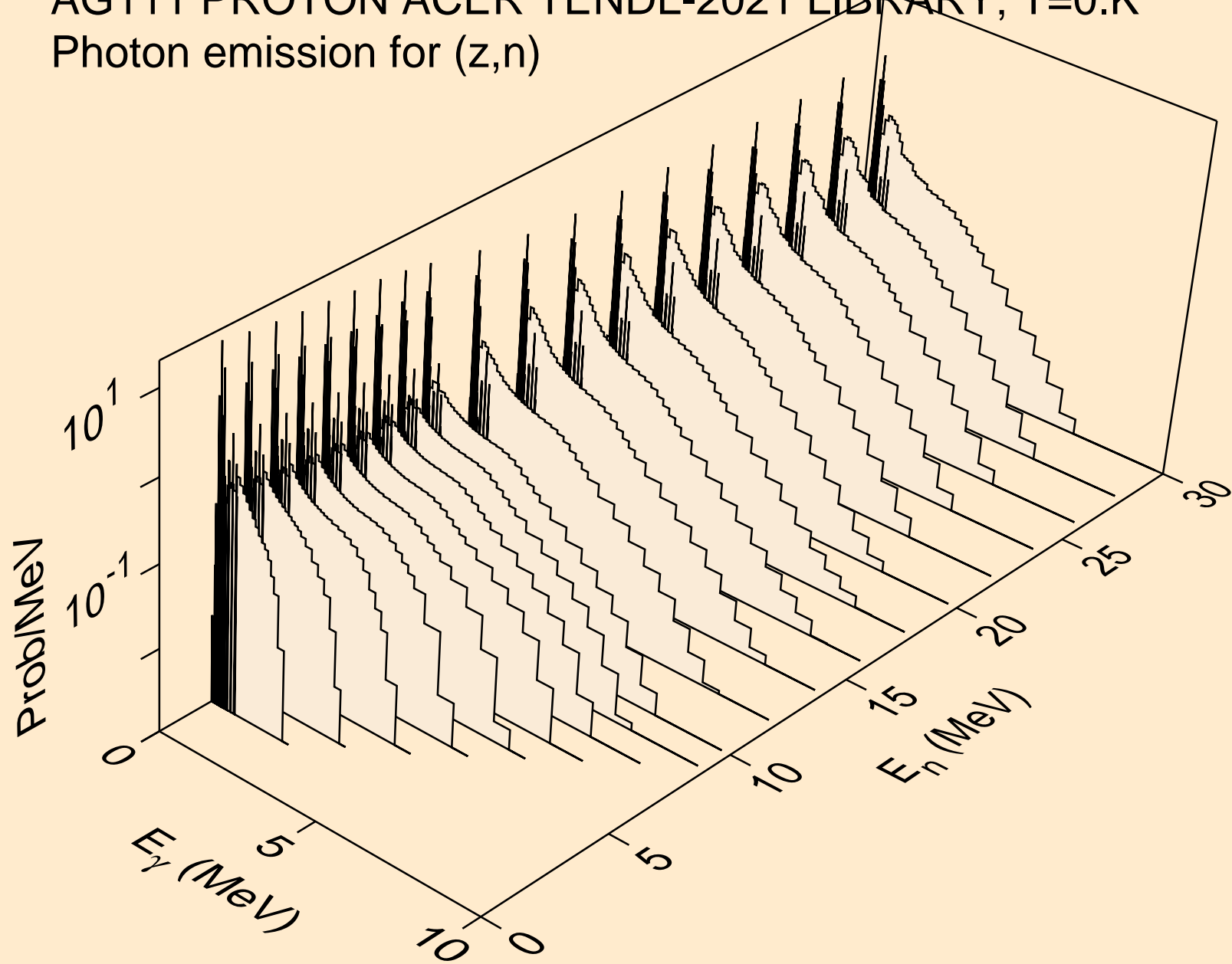

AG111 PROTON ACER TENDL-2021 LIBRARY; T=0.K  
Photon emission for (n,x)

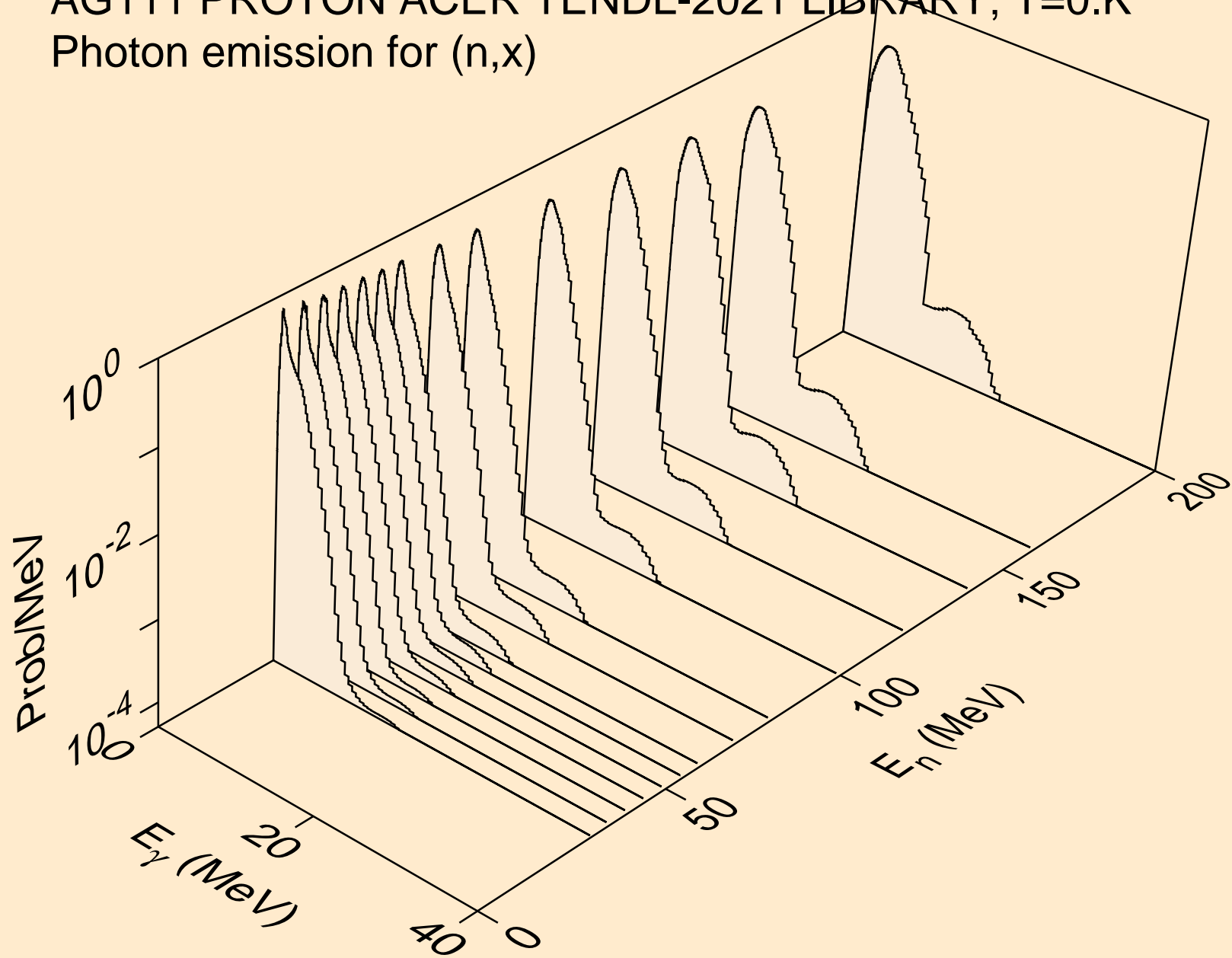

AG111 PROTON ACER TENDL-2021 LIBRARY; T=0.K  
Photon emission for (n,2nd)

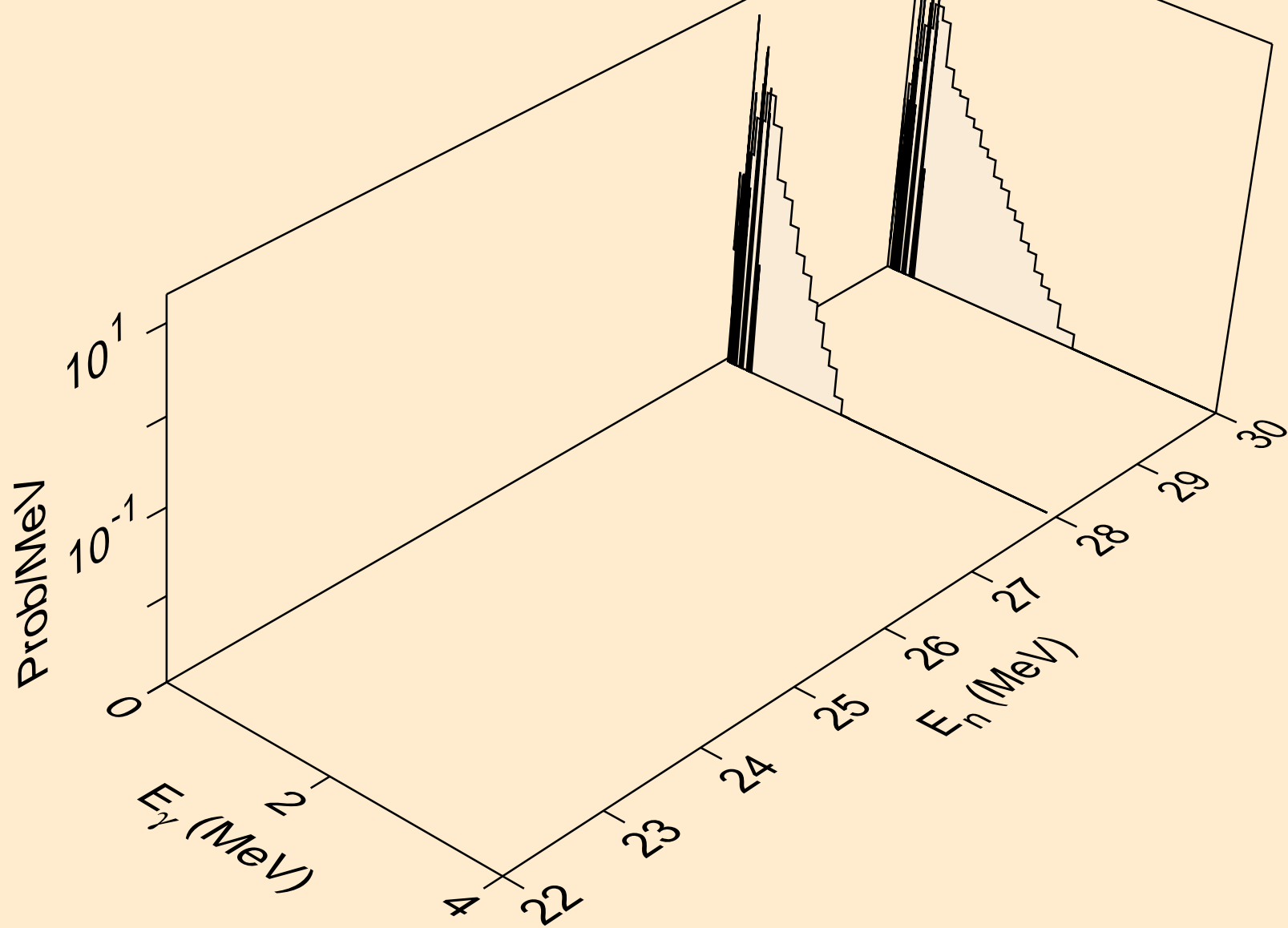

AG111 PROTON ACER TENDL-2021 LIBRARY; T=0.K  
Photon emission for (n,2n)

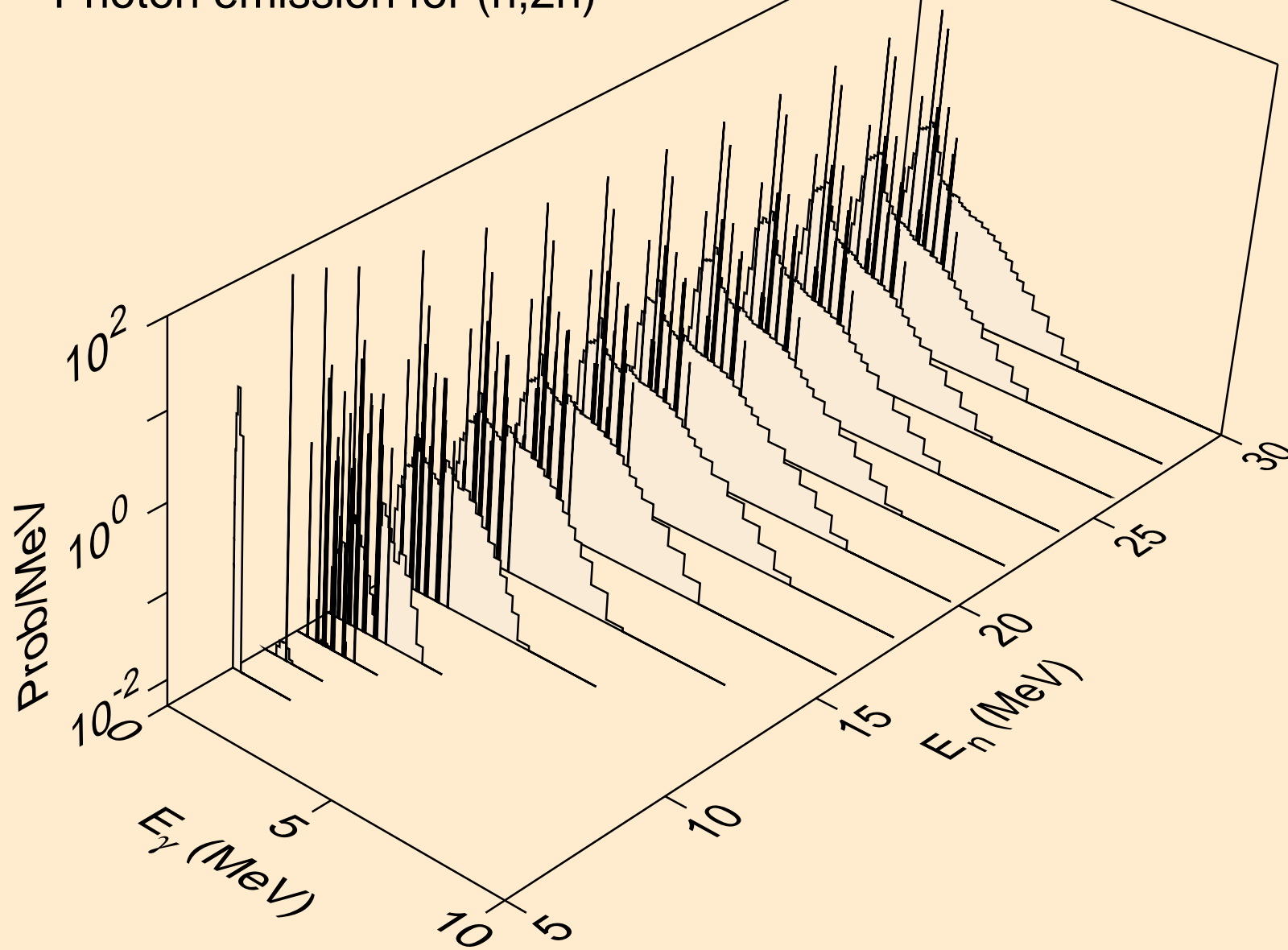

AG111 PROTON ACER TENDL-2021 LIBRARY; T=0.K  
Photon emission for (n,3n)

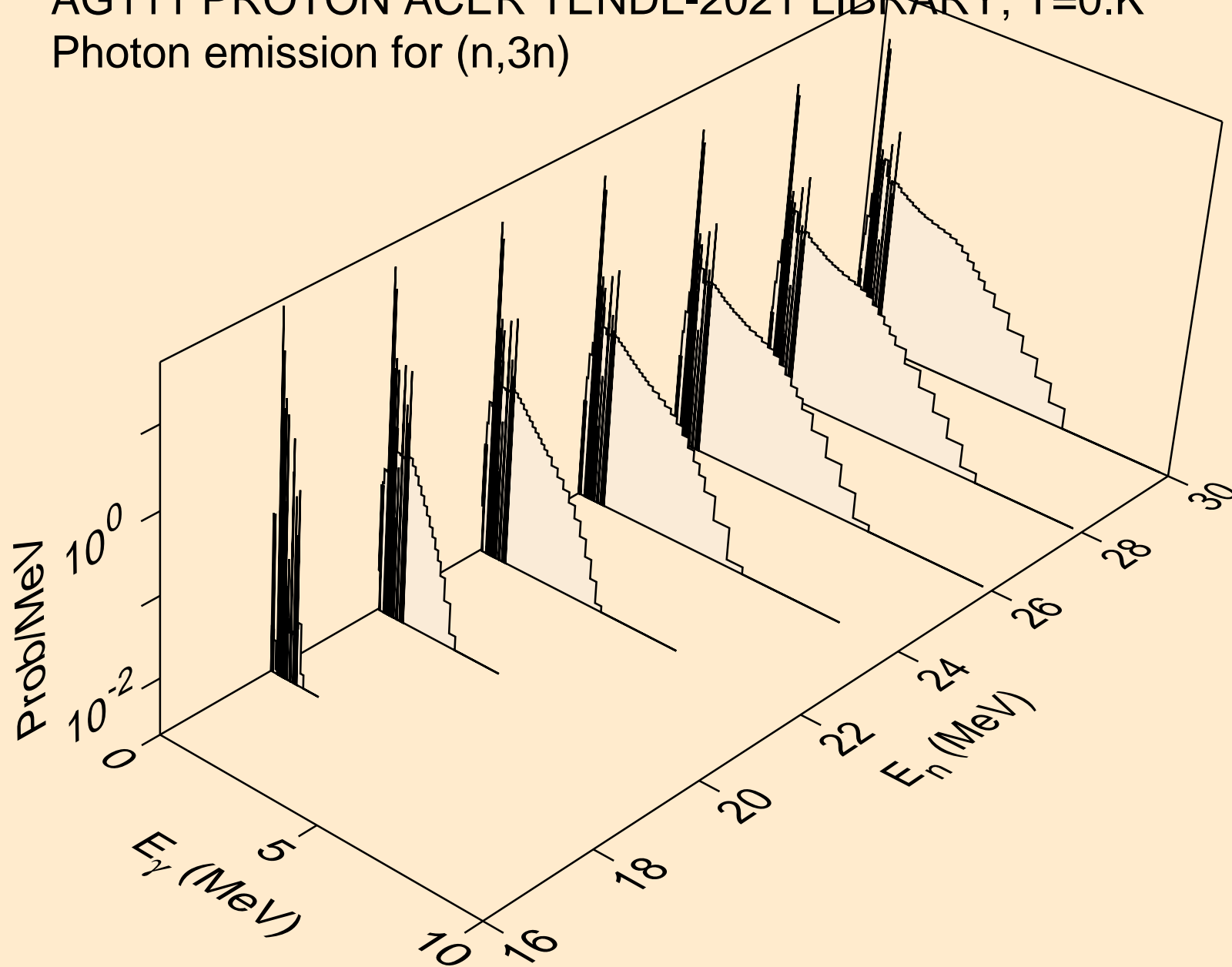

AG111 PROTON ACER TENDL-2021 LIBRARY; T=0.K  
Photon emission for (n,n\*)a

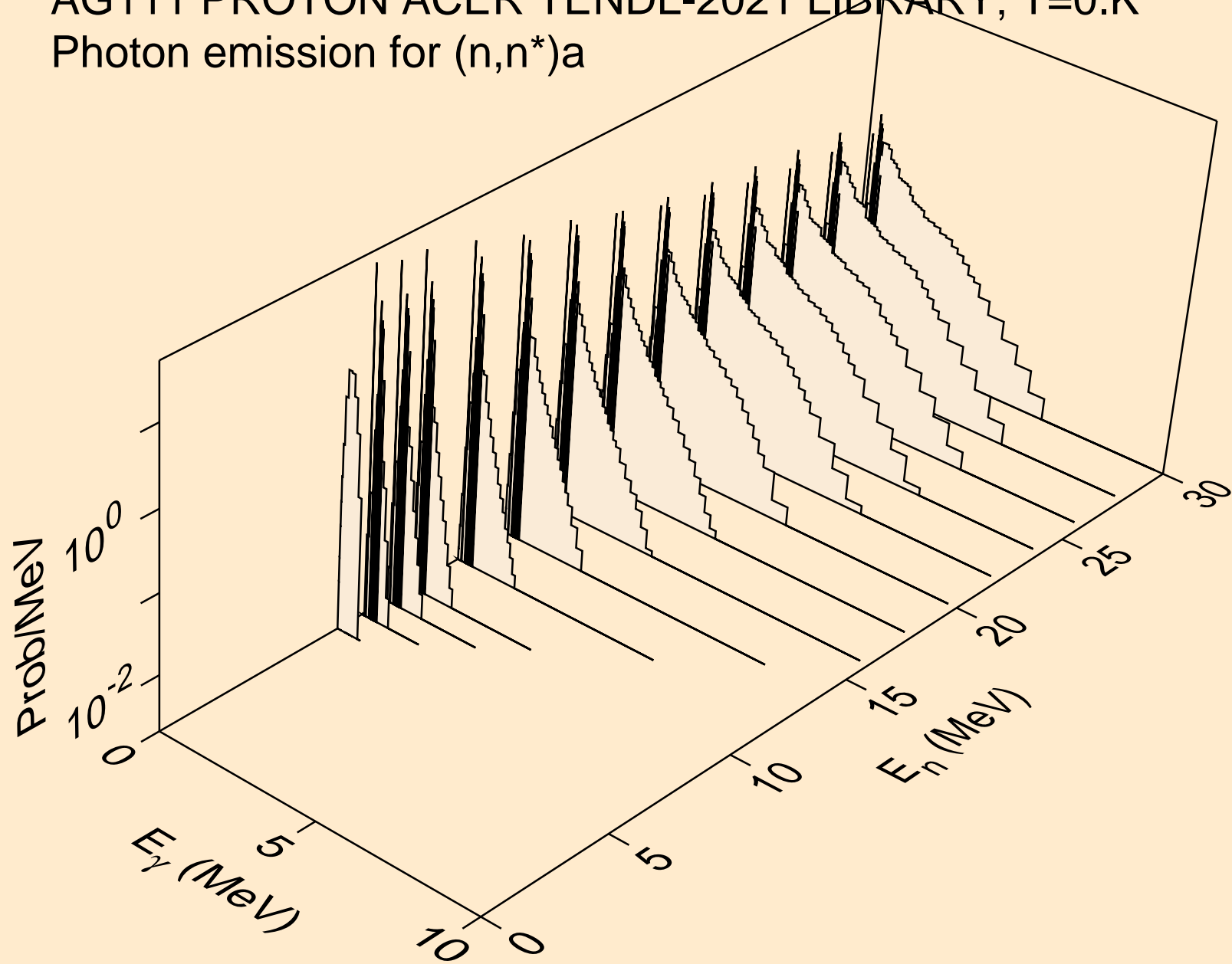

AG111 PROTON ACER TENDL-2021 LIBRARY; T=0.K  
Photon emission for (n,2n)a

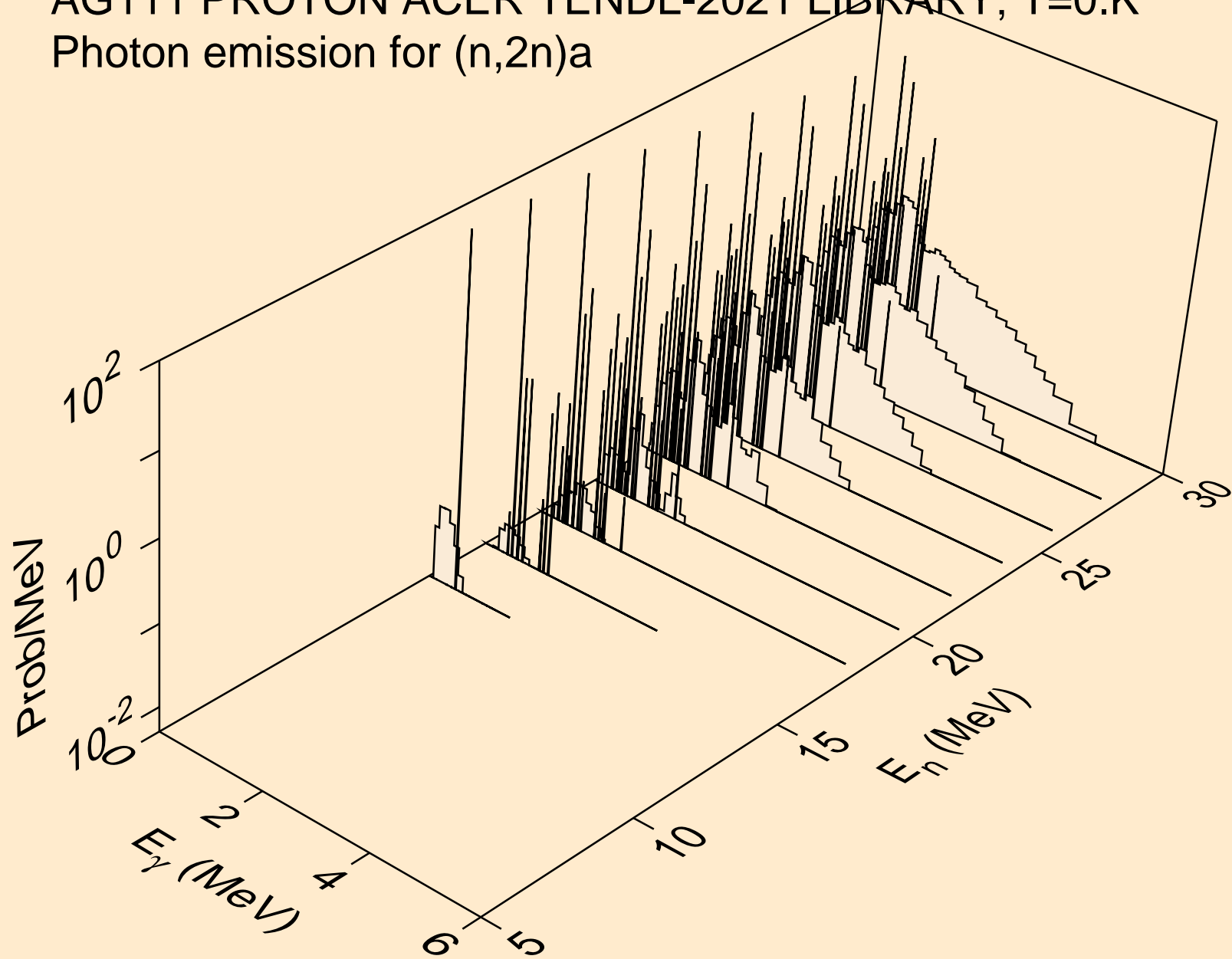

AG111 PROTON ACER TENDL-2021 LIBRARY; T=0.K  
Photon emission for (n,3n)a

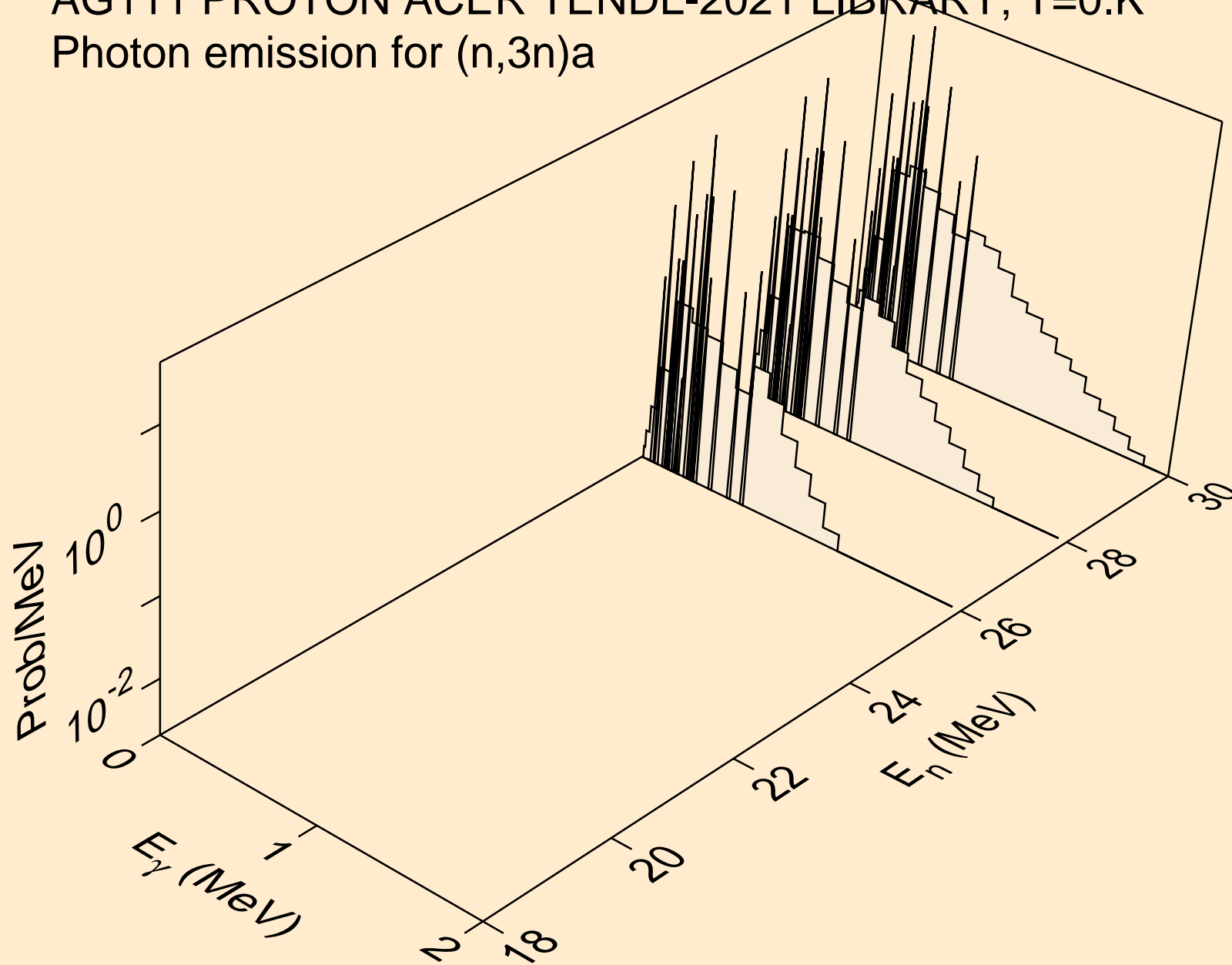

AG111 PROTON ACER TENDL-2021 LIBRARY; T=0.K  
Photon emission for (n,n\*)p

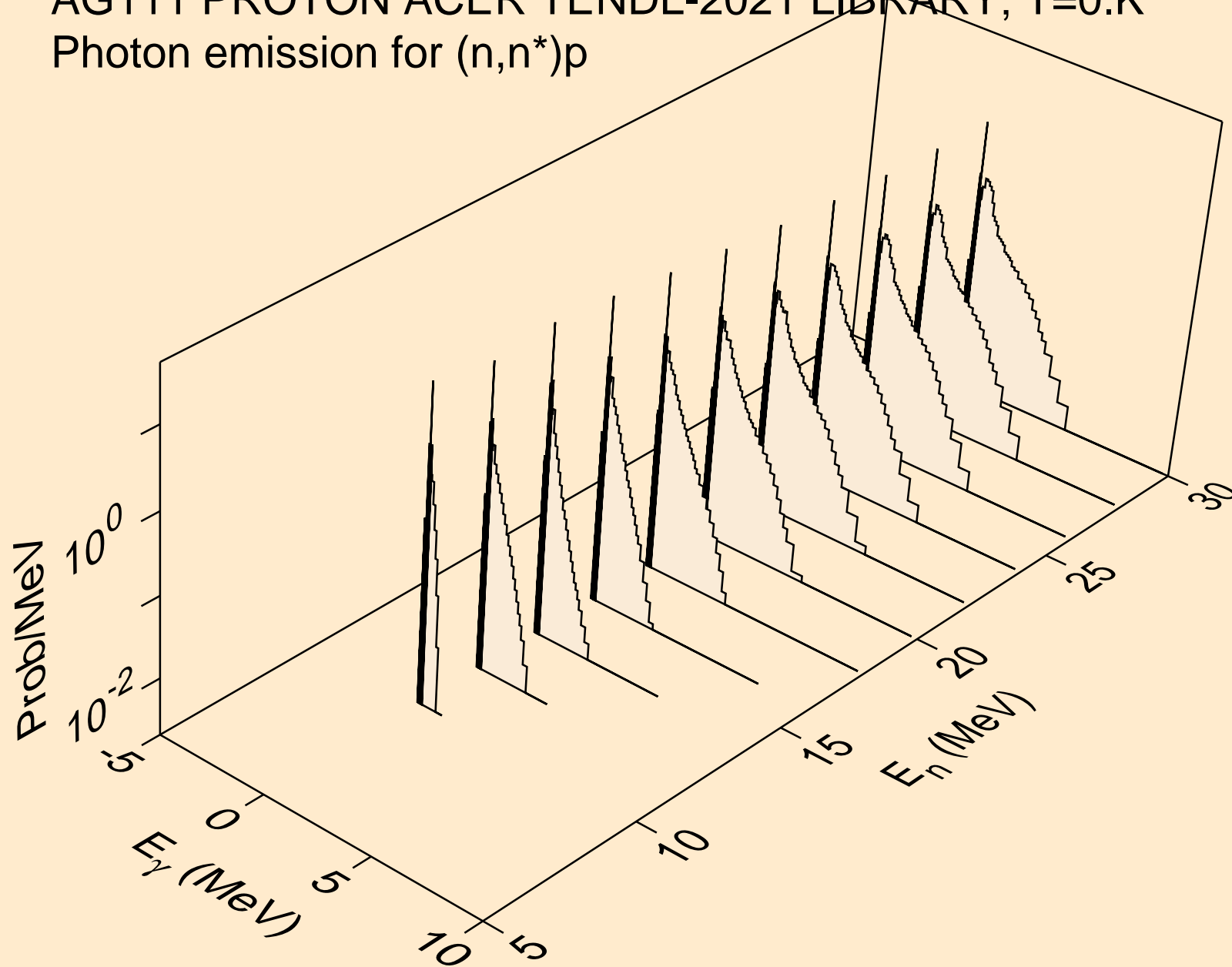

AG111 PROTON ACER TENDL-2021 LIBRARY; T=0.K  
Photon emission for (n,n\*)2a

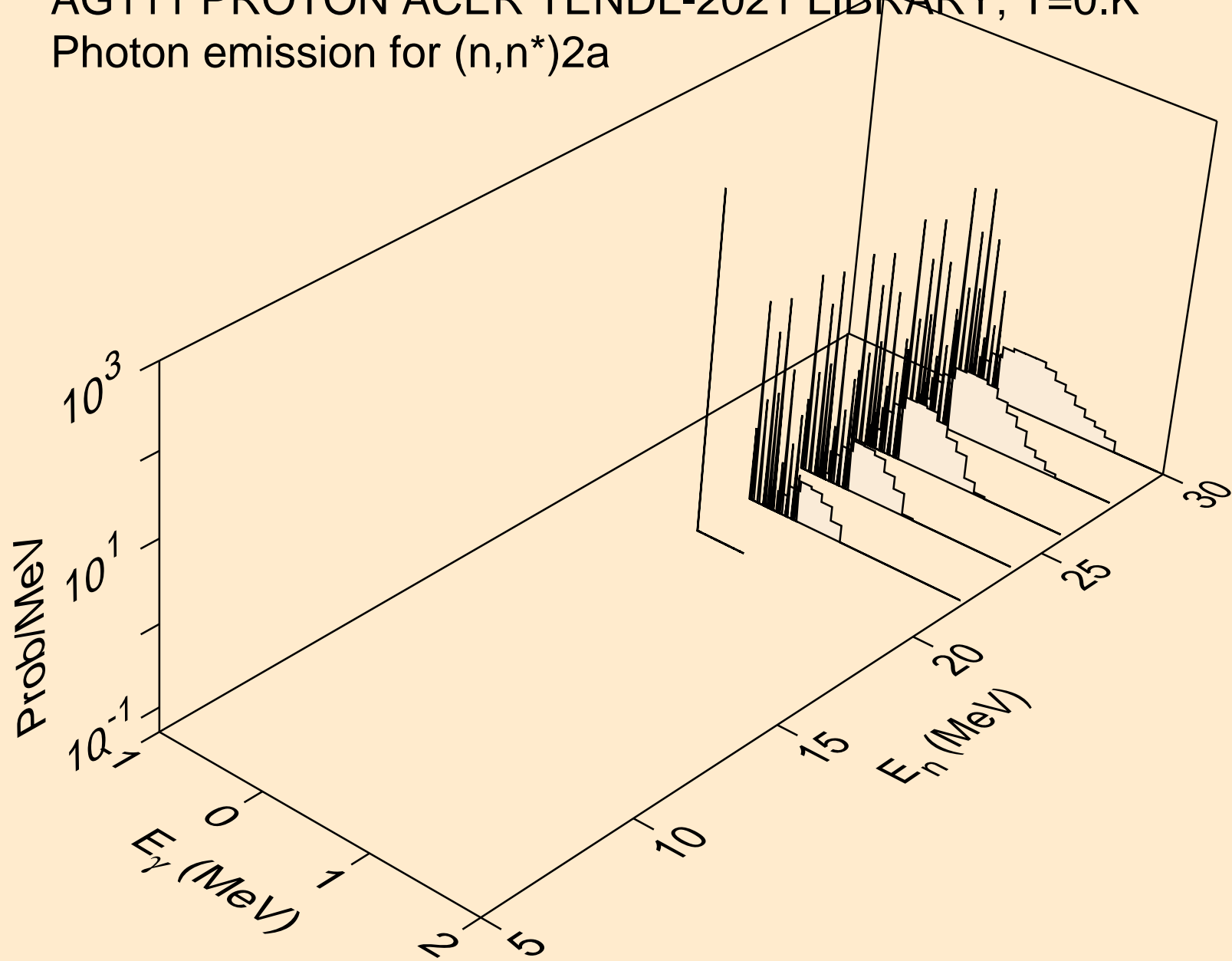

AG111 PROTON ACER TENDL-2021 LIBRARY; T=0.K  
Photon emission for (n,n\*)d

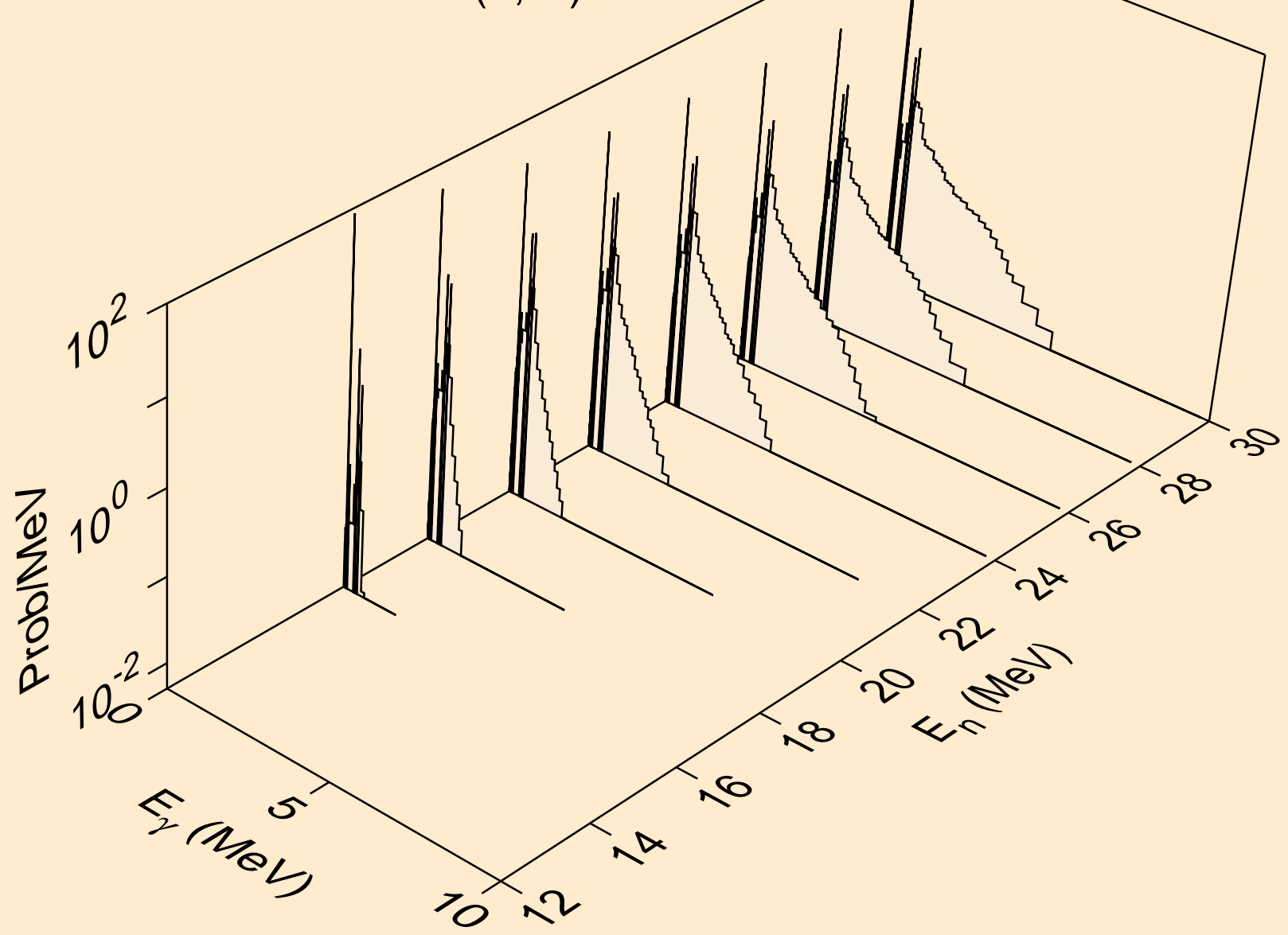

AG111 PROTON ACER TENDL-2021 LIBRARY; T=0.K  
Photon emission for (n,n\*)t

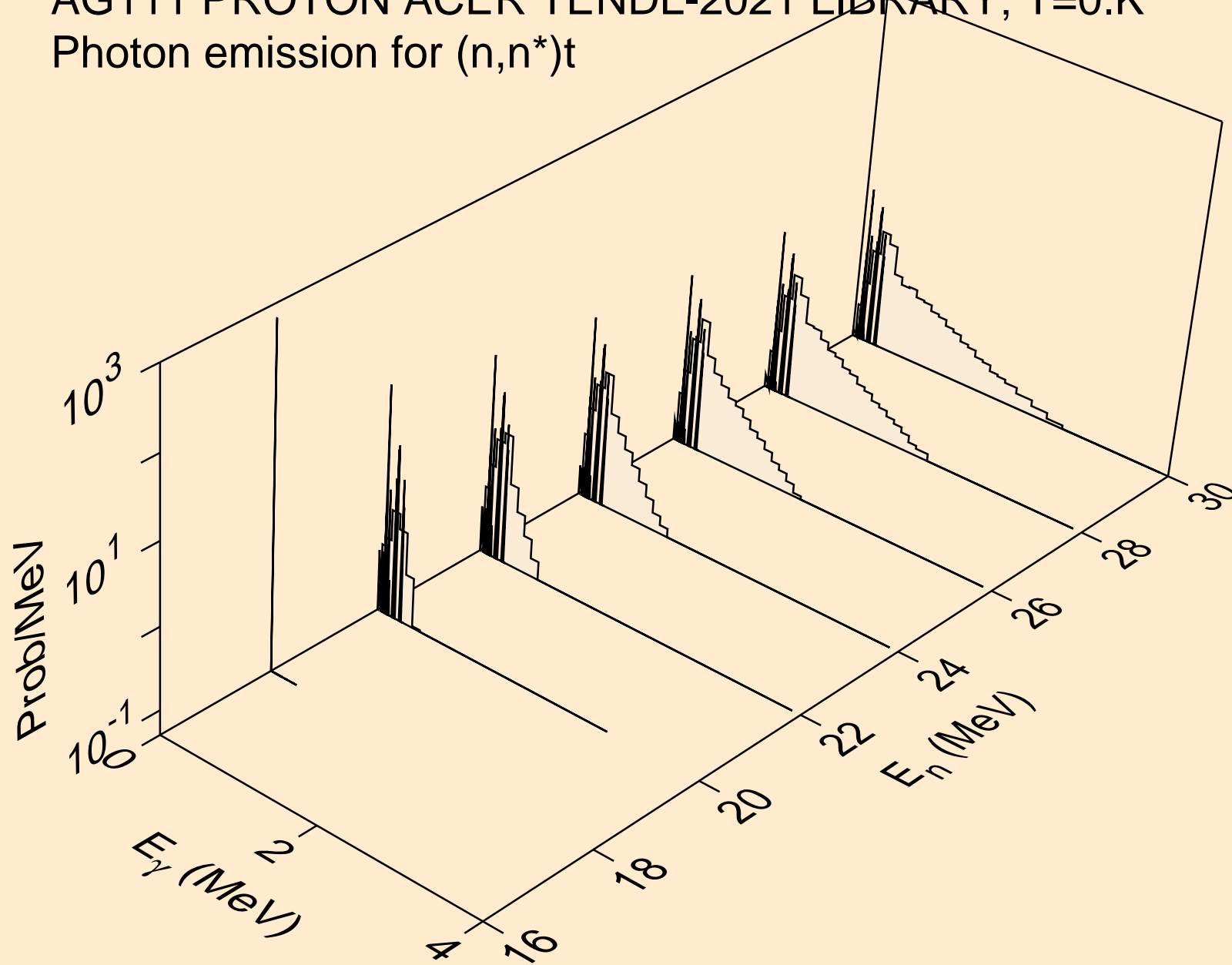

AG111 PROTON ACER TENDL-2021 LIBRARY; T=0.K  
Photon emission for (n,n\*)he3

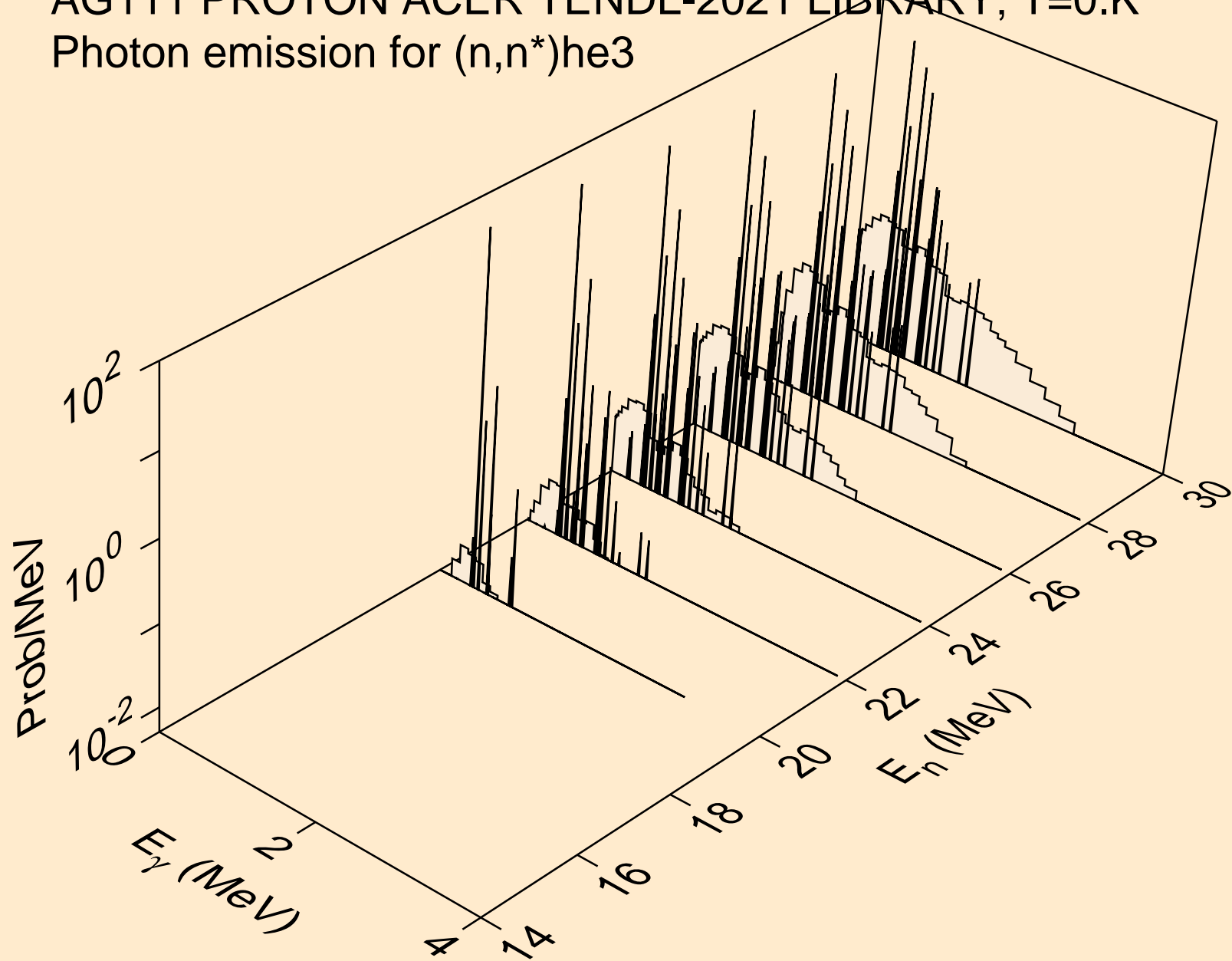

AG111 PROTON ACER TENDL-2021 LIBRARY; T=0.K  
Photon emission for (n,4n)

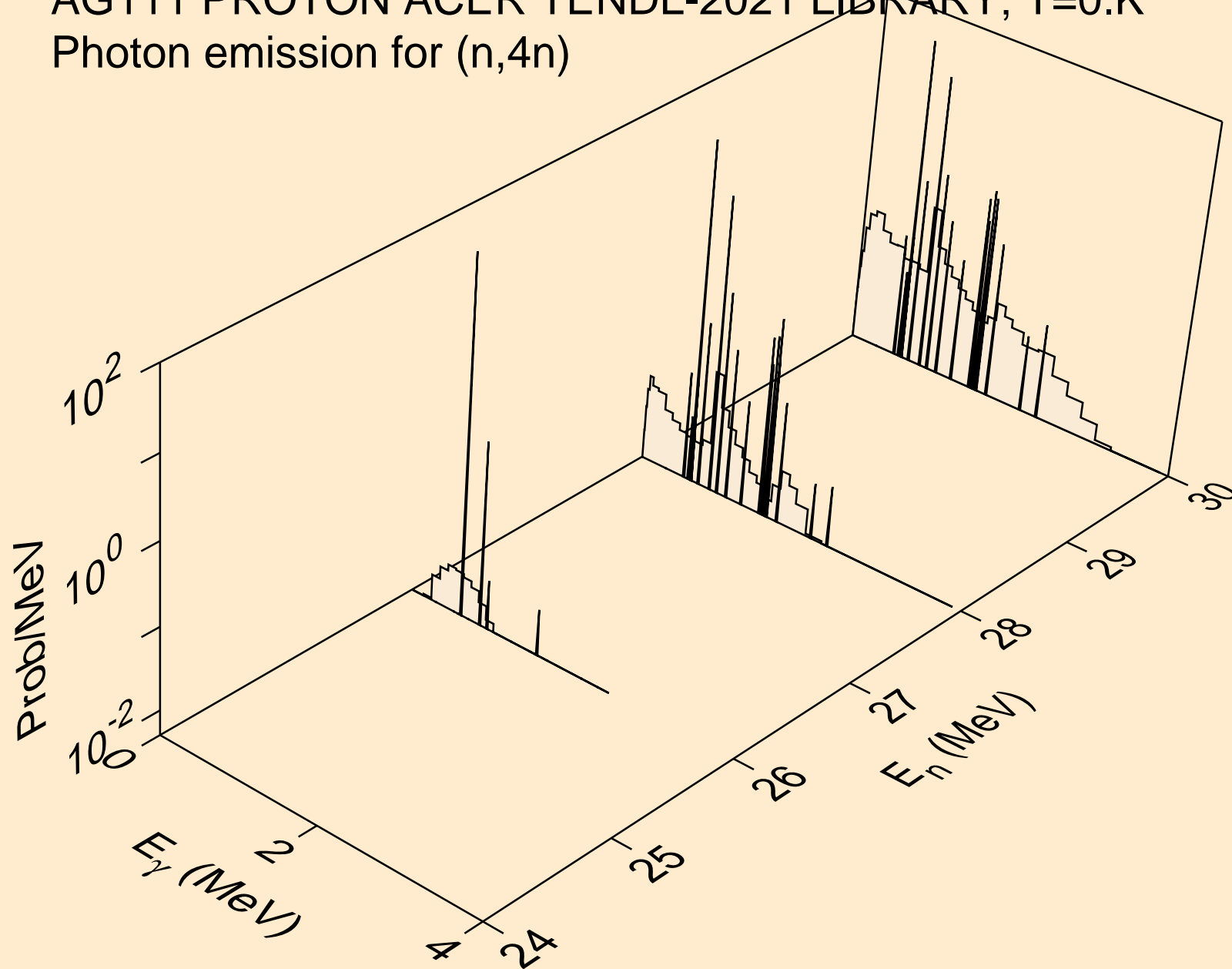

AG111 PROTON ACER TENDL-2021 LIBRARY; T=0.K  
Photon emission for (n,2np)

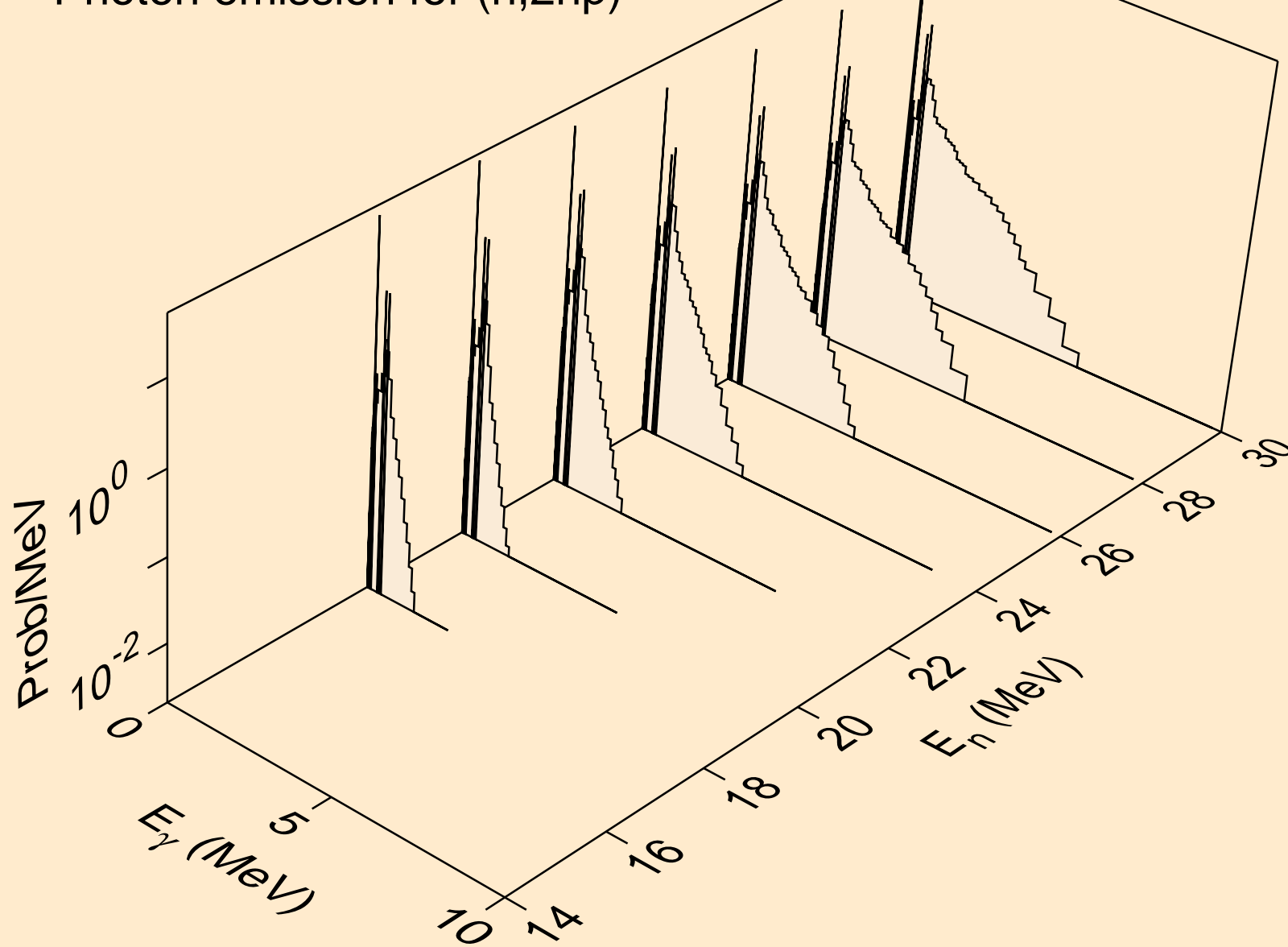

AG111 PROTON ACER TENDL-2021 LIBRARY; T=0.K  
Photon emission for (n,3np)

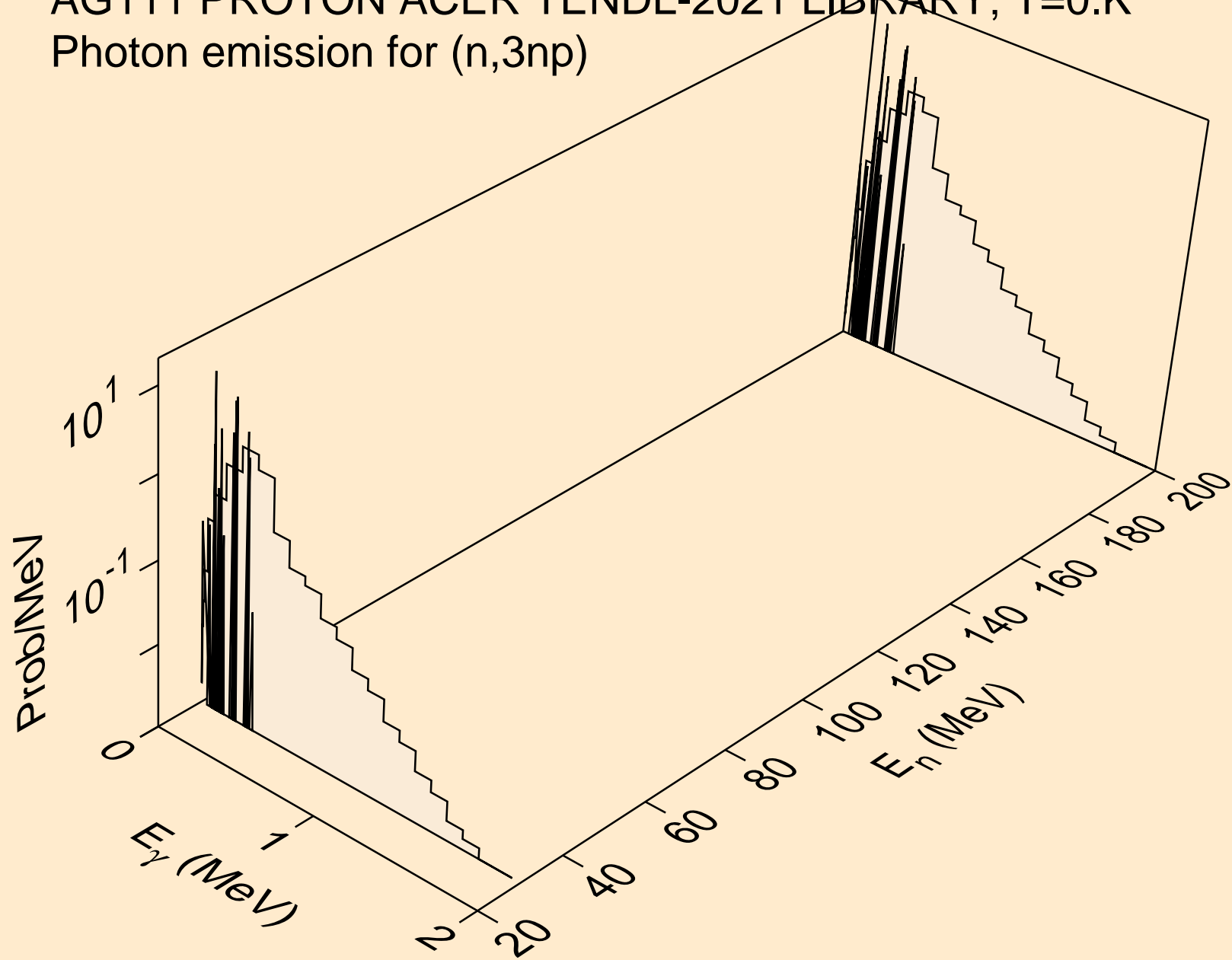

AG111 PROTON ACER TENDL-2021 LIBRARY; T=0.K  
Photon emission for (n,2np)

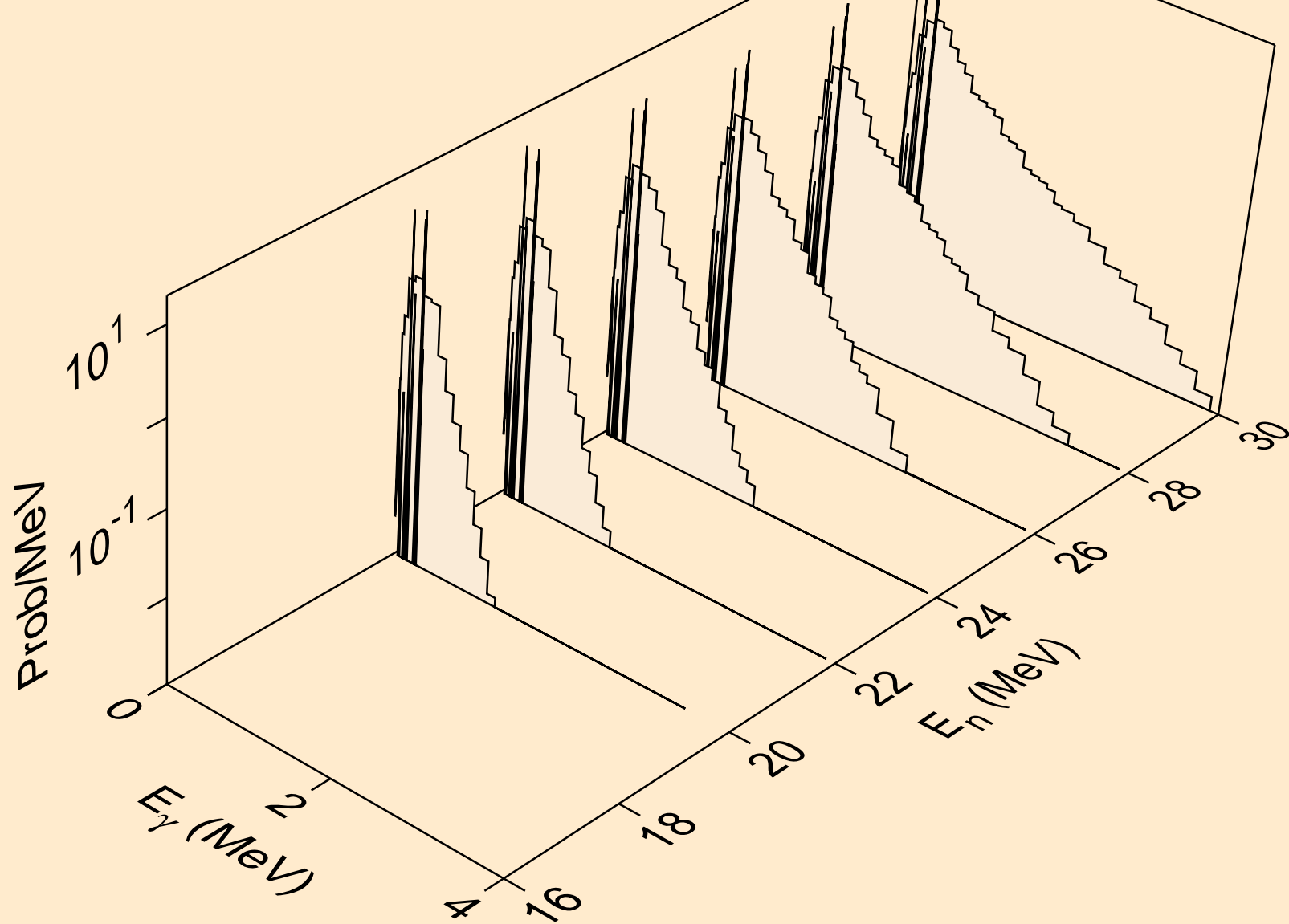

AG111 PROTON ACER TENDL-2021 LIBRARY; T=0.K  
Photon emission for (n,npa)

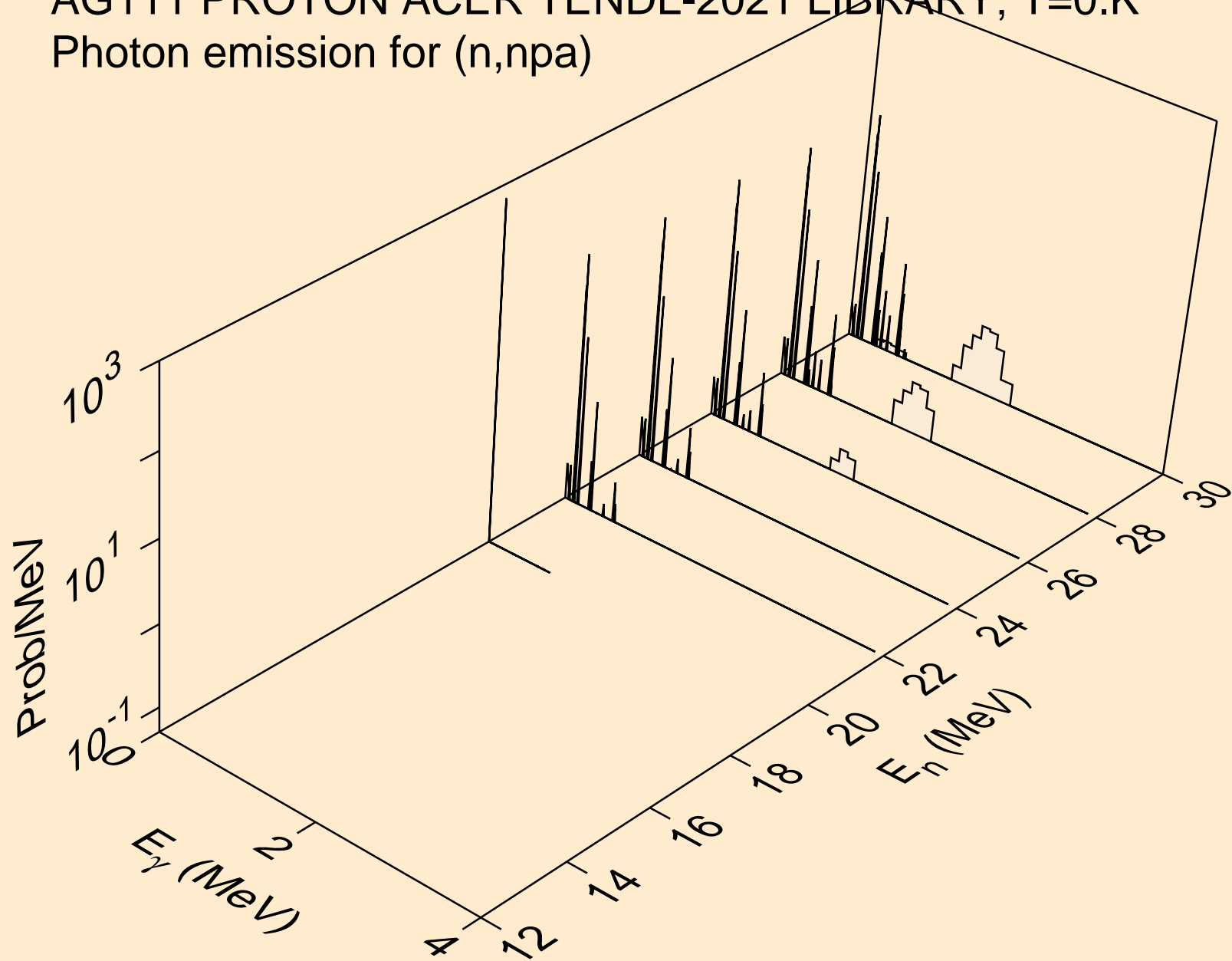

AG111 PROTON ACER TENDL-2021 LIBRARY; T=0.K  
Photon emission for (n,gma)

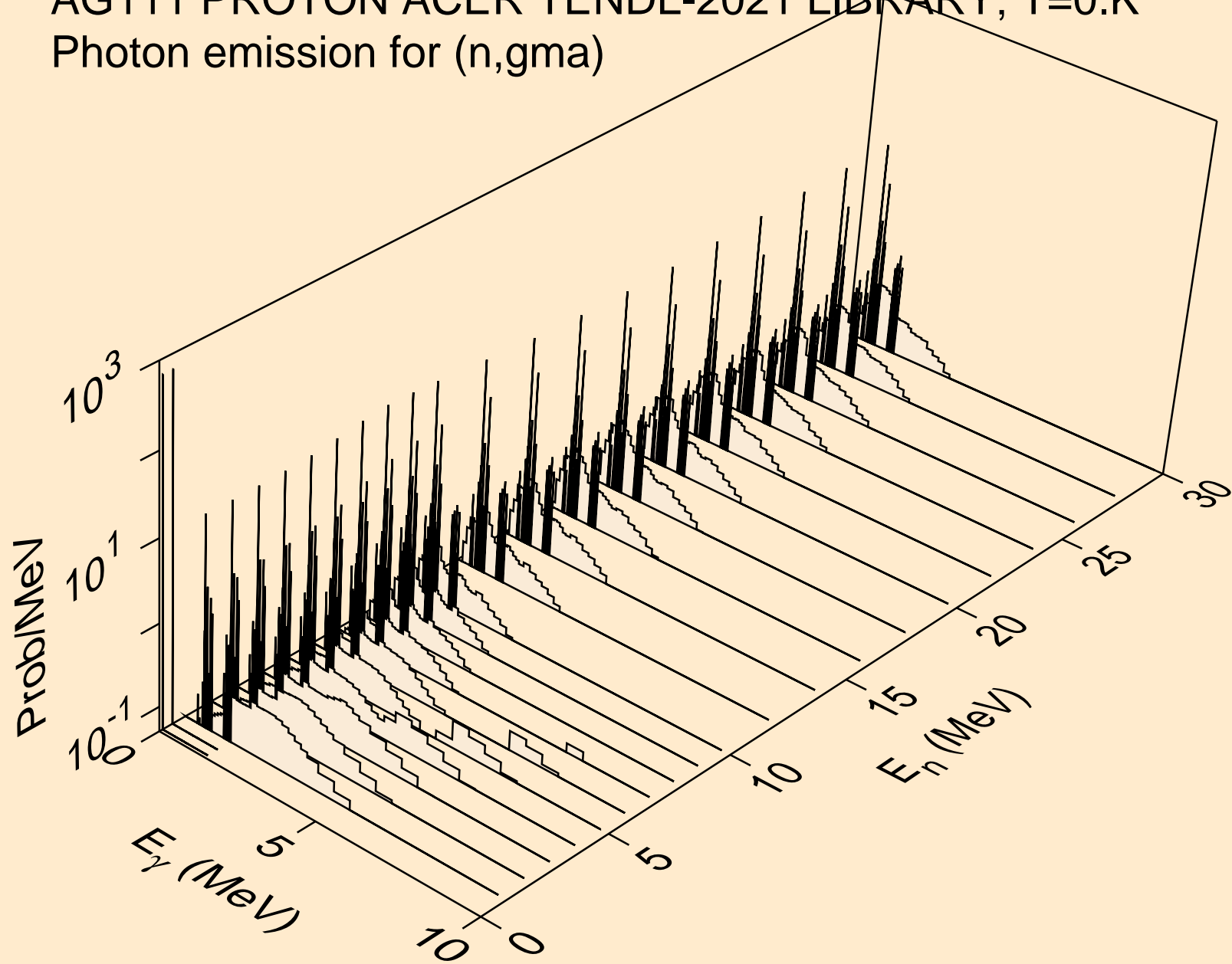

AG111 PROTON ACER TENDL-2021 LIBRARY; T=0.K  
Photon emission for inelastic

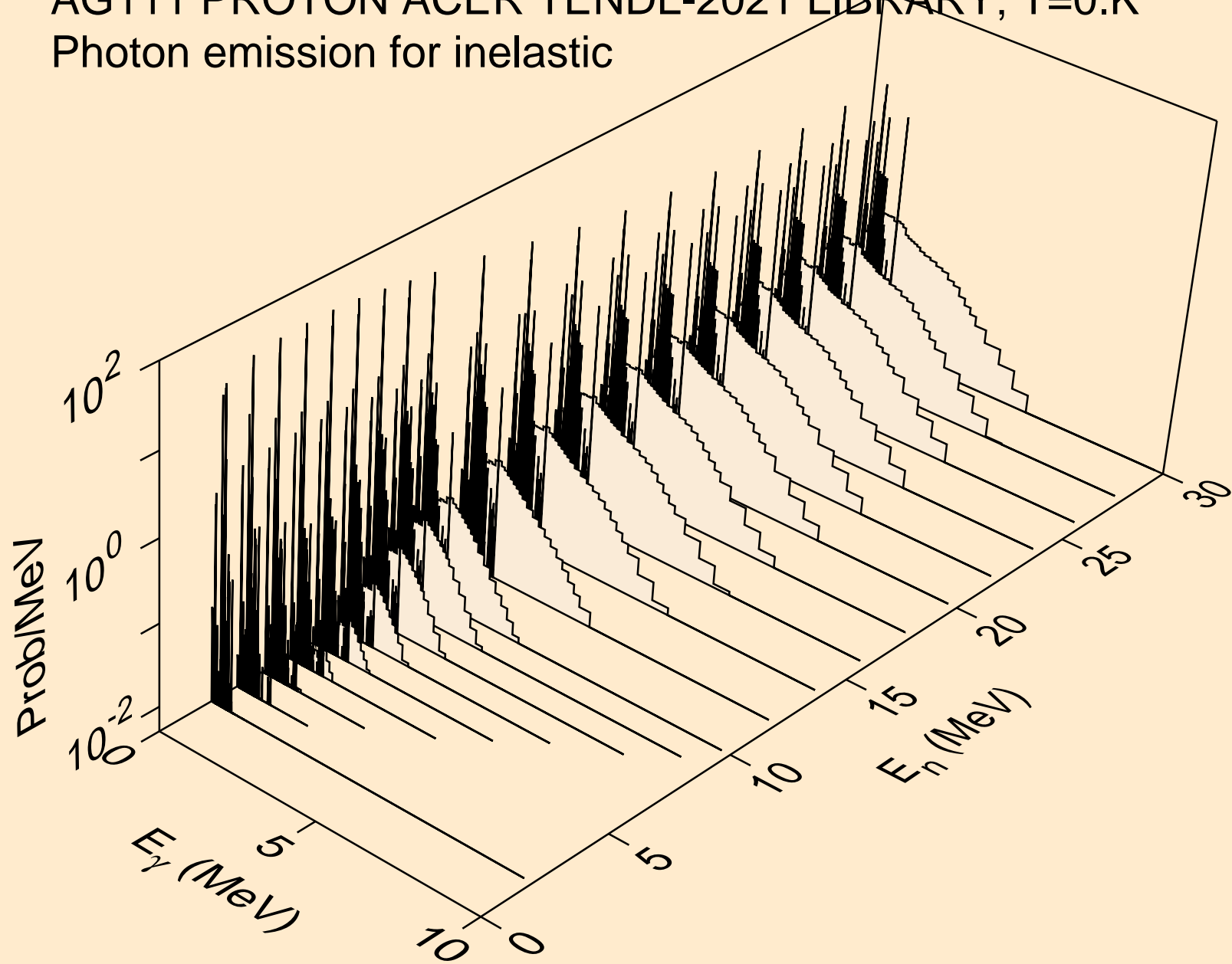

AG111 PROTON ACER TENDL-2021 LIBRARY; T=0.K  
Photon emission for (n,d)

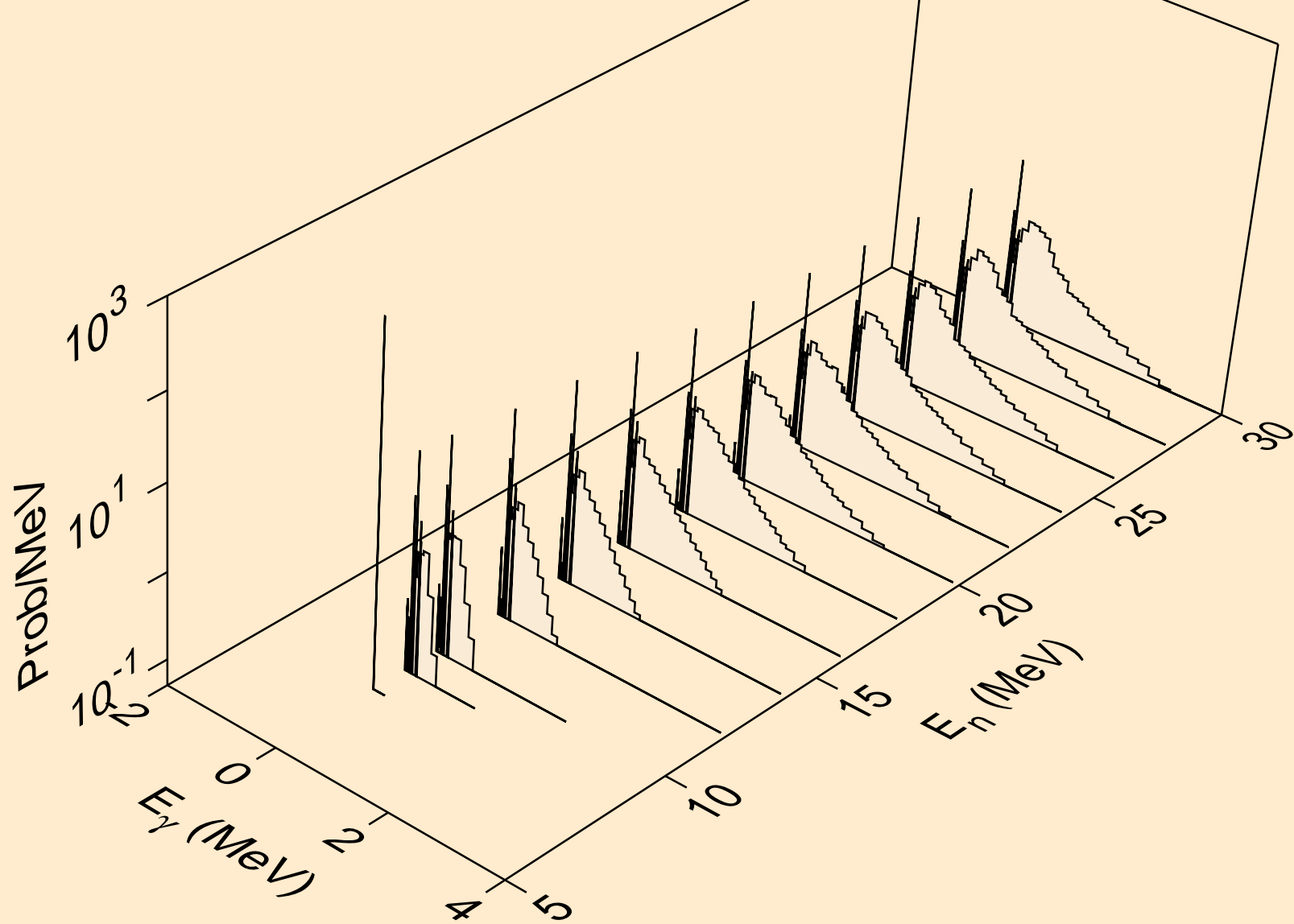

AG111 PROTON ACER TENDL-2021 LIBRARY; T=0.K  
Photon emission for (n,t)

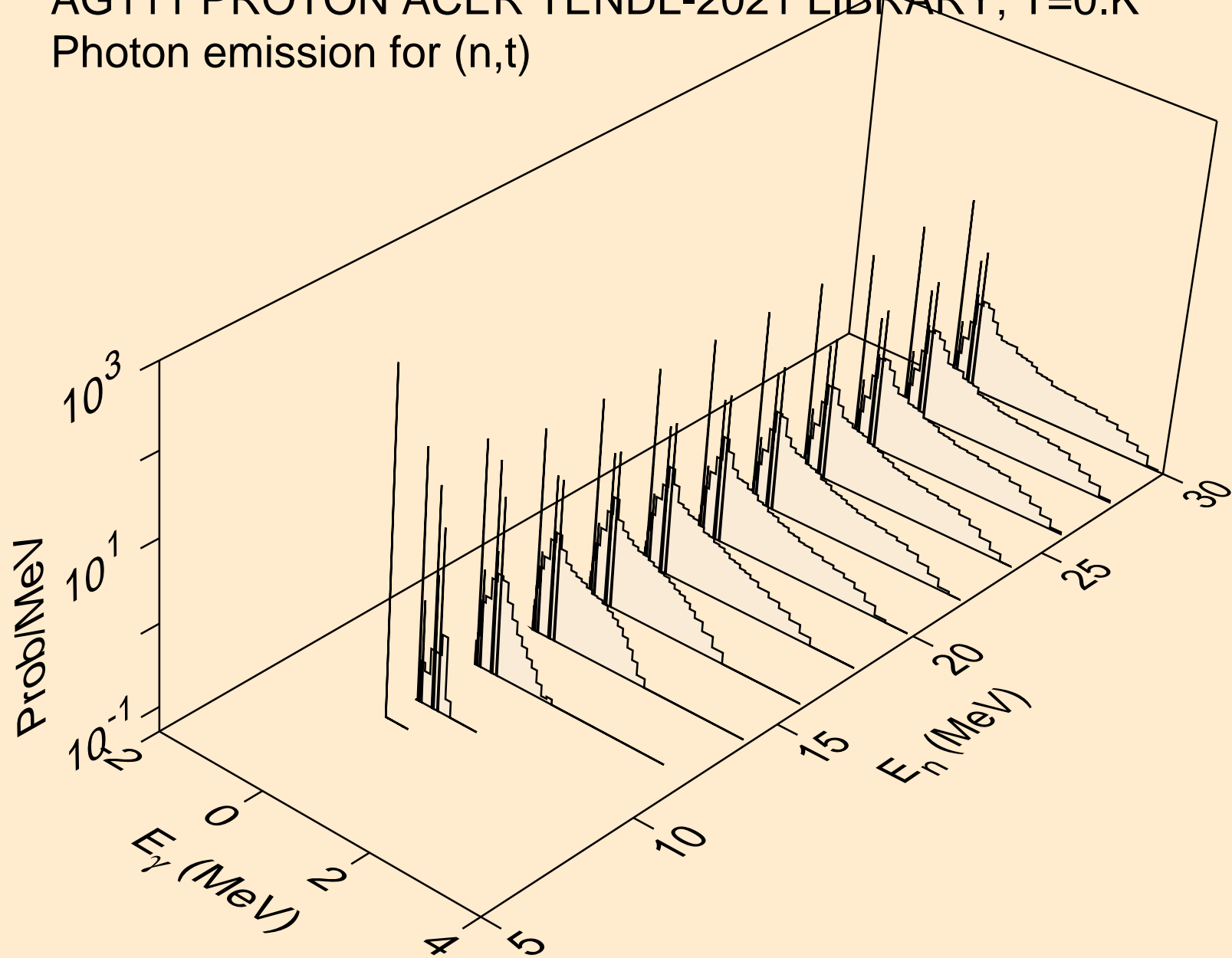

AG111 PROTON ACER TENDL-2021 LIBRARY; T=0.K  
Photon emission for (n,he3)

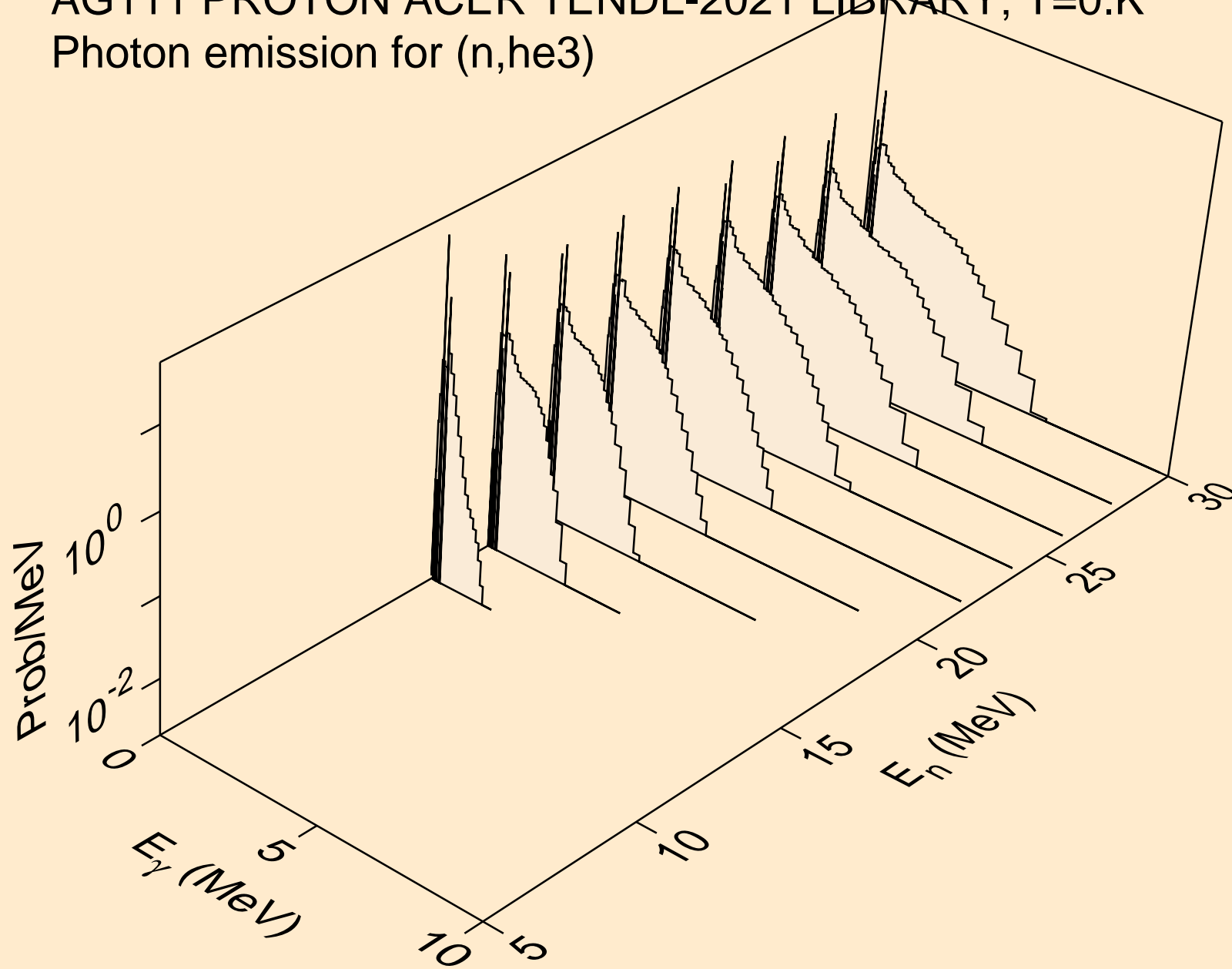

AG111 PROTON ACER TENDL-2021 LIBRARY; T=0.K  
Photon emission for (n,a)

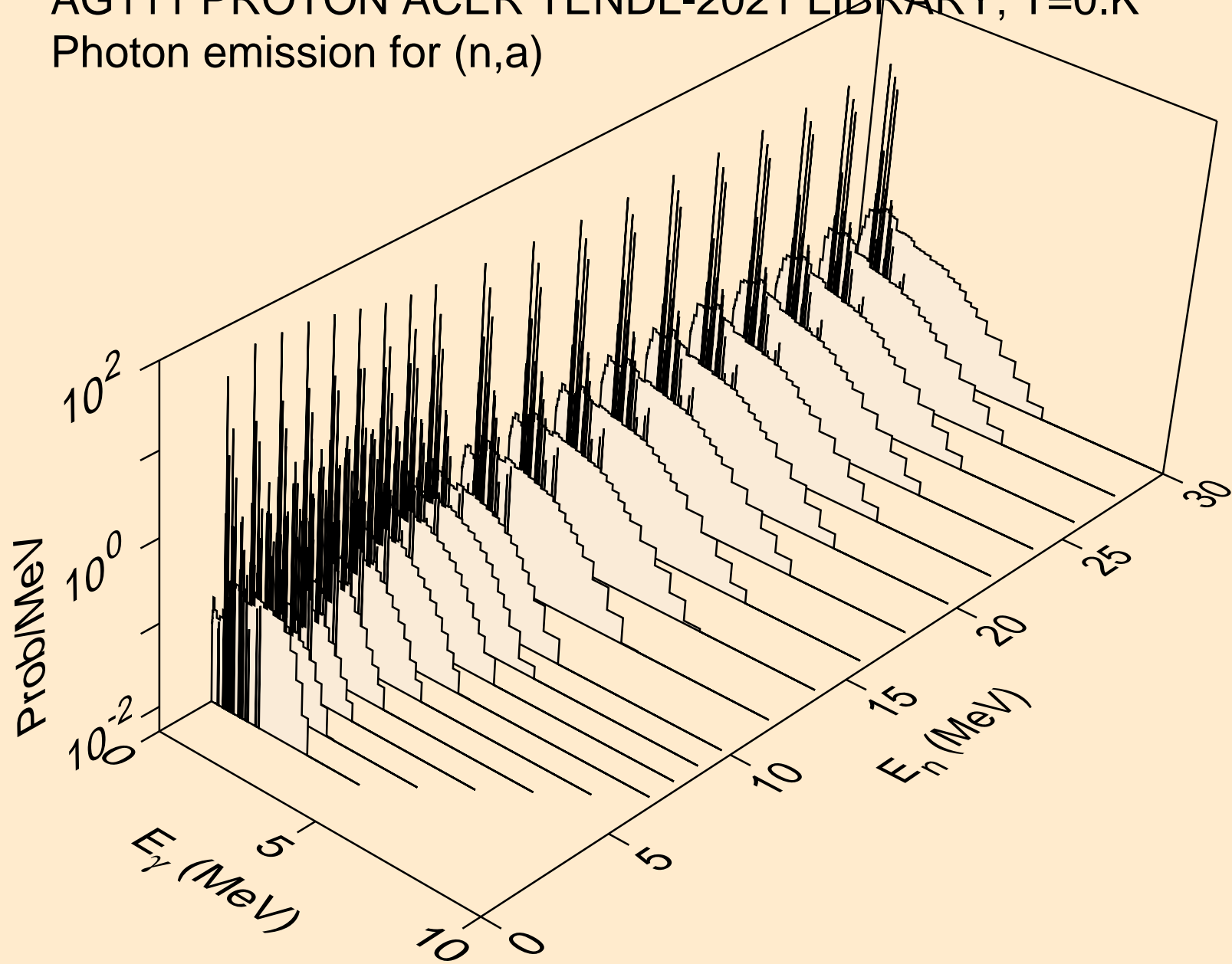

AG111 PROTON ACER TENDL-2021 LIBRARY; T=0.K  
Photon emission for (n,2a)

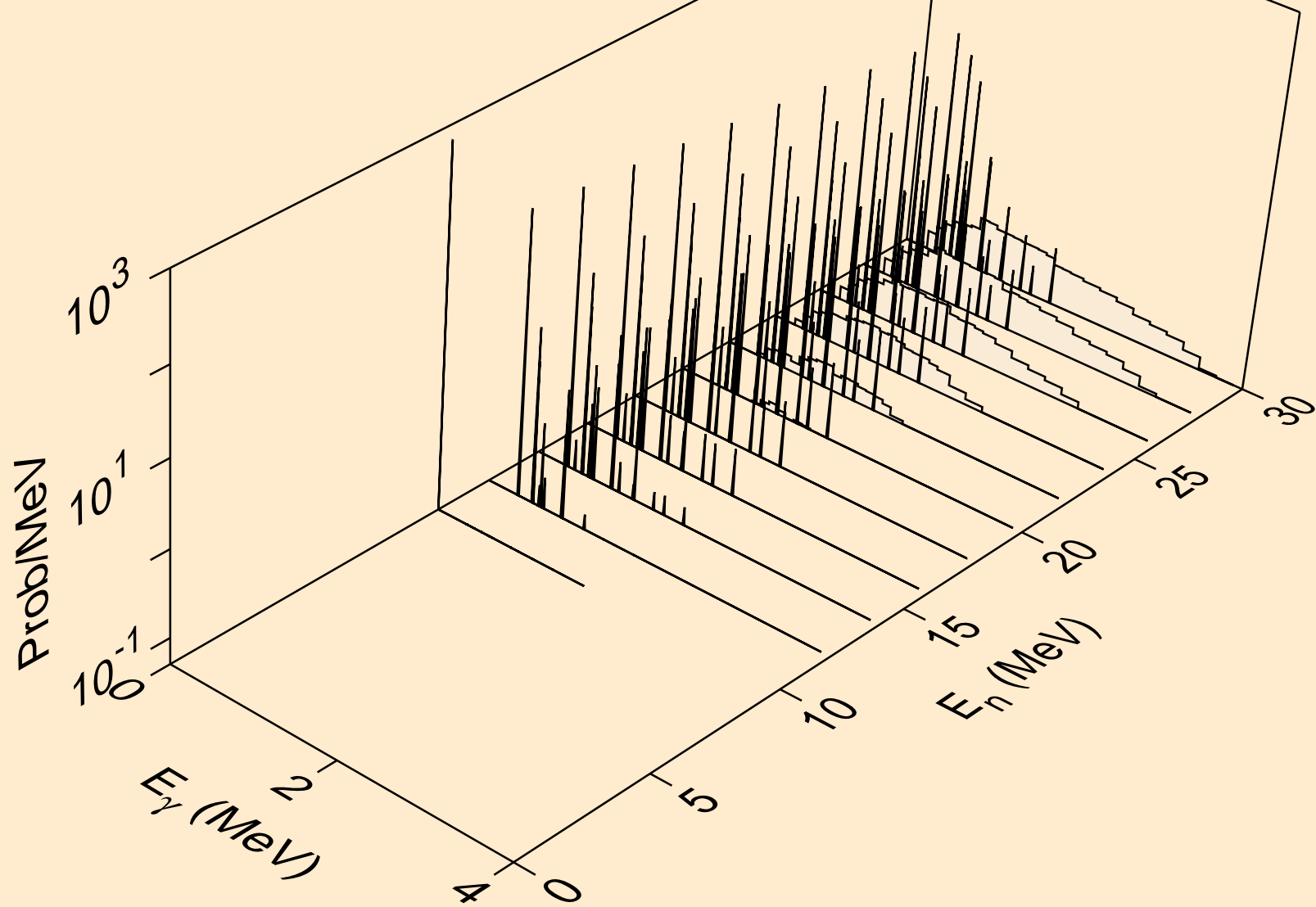

AG111 PROTON ACER TENDL-2021 LIBRARY; T=0.K  
Photon emission for (n,2p)

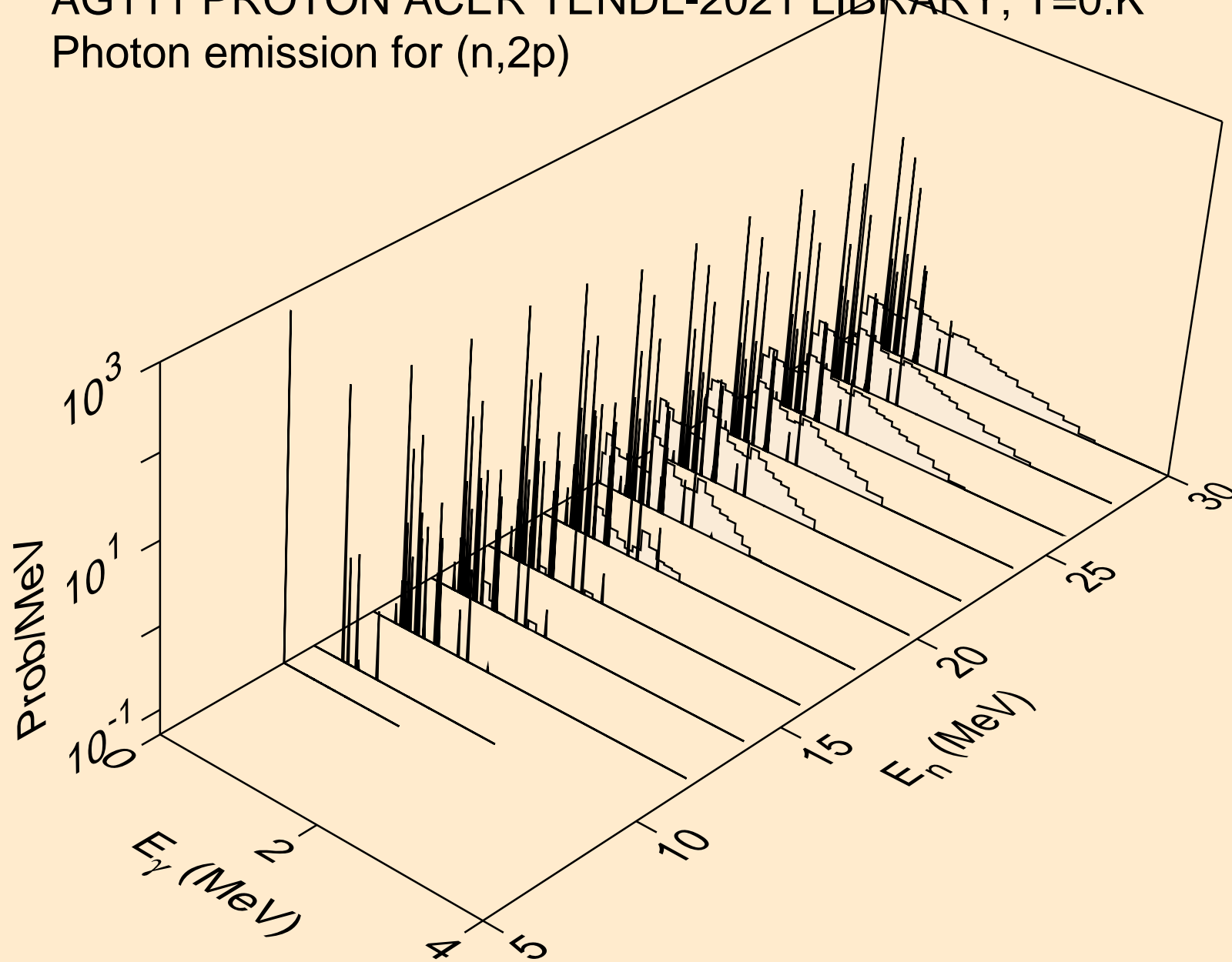

AG111 PROTON ACER TENDL-2021 LIBRARY; T=0.K  
Photon emission for (n,pa)

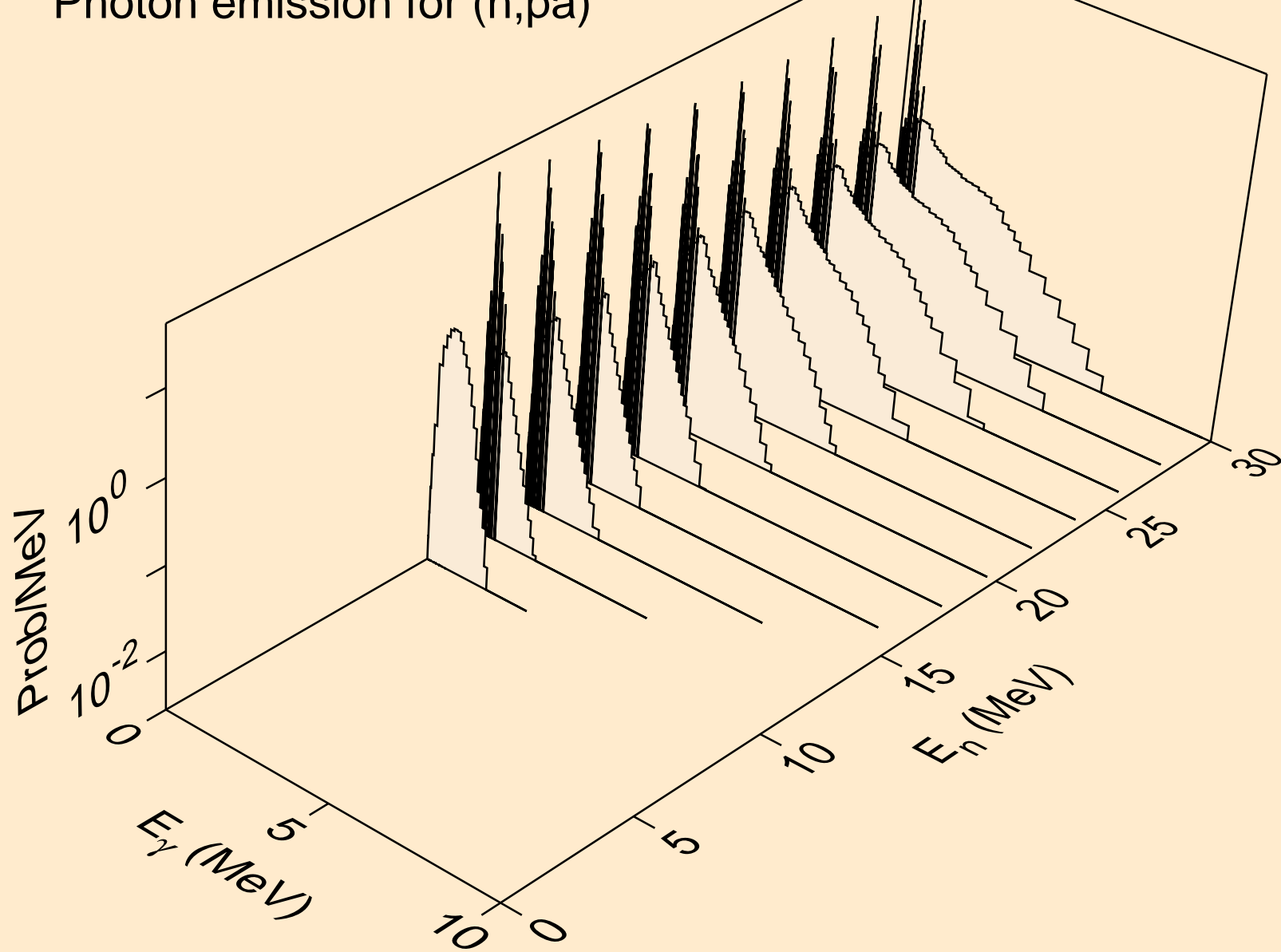

AG111 PROTON ACER TENDL-2021 LIBRARY; T=0.K  
Photon emission for (n,pd)

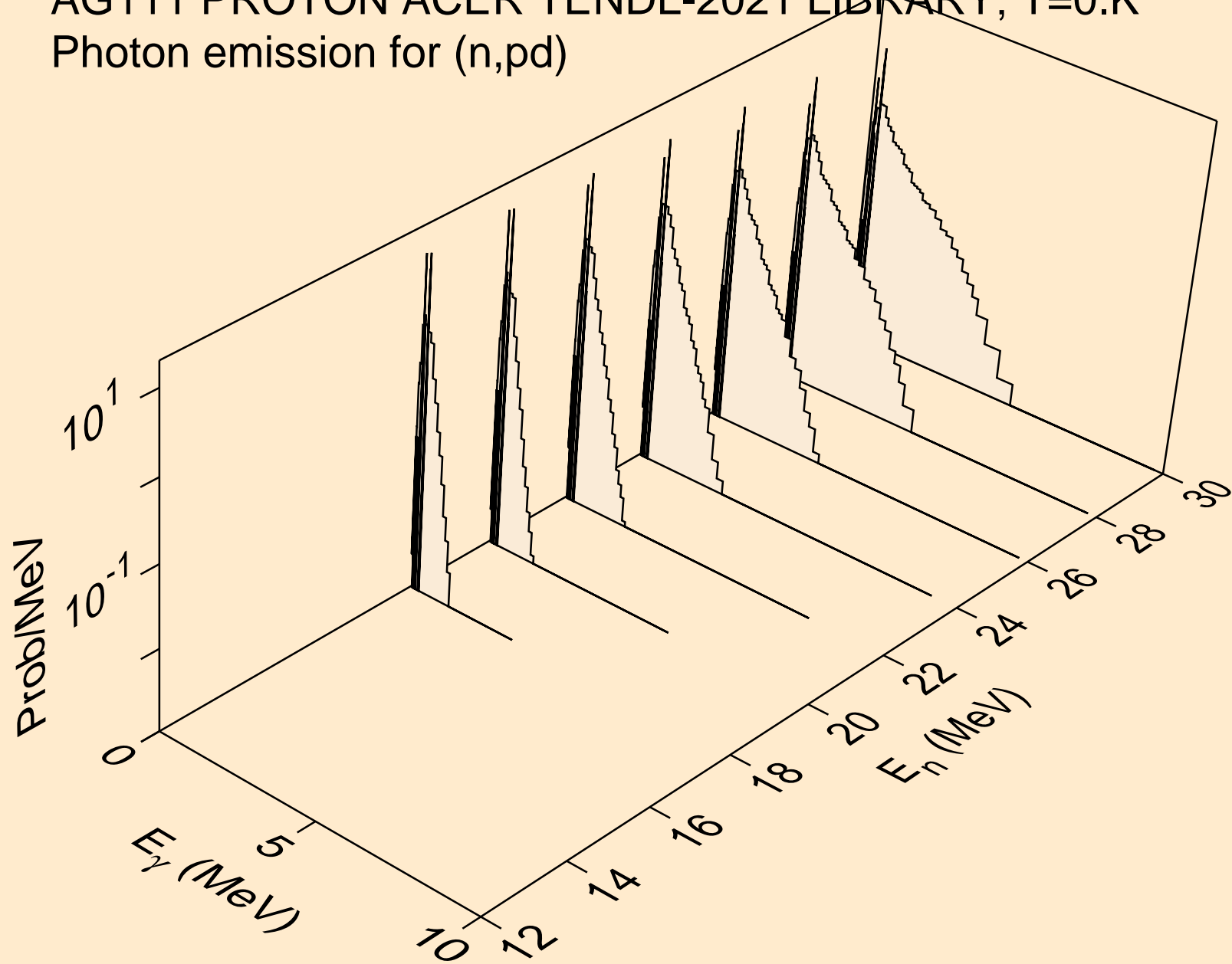

AG111 PROTON ACER TENDL-2021 LIBRARY; T=0.K  
Photon emission for (n,pt)

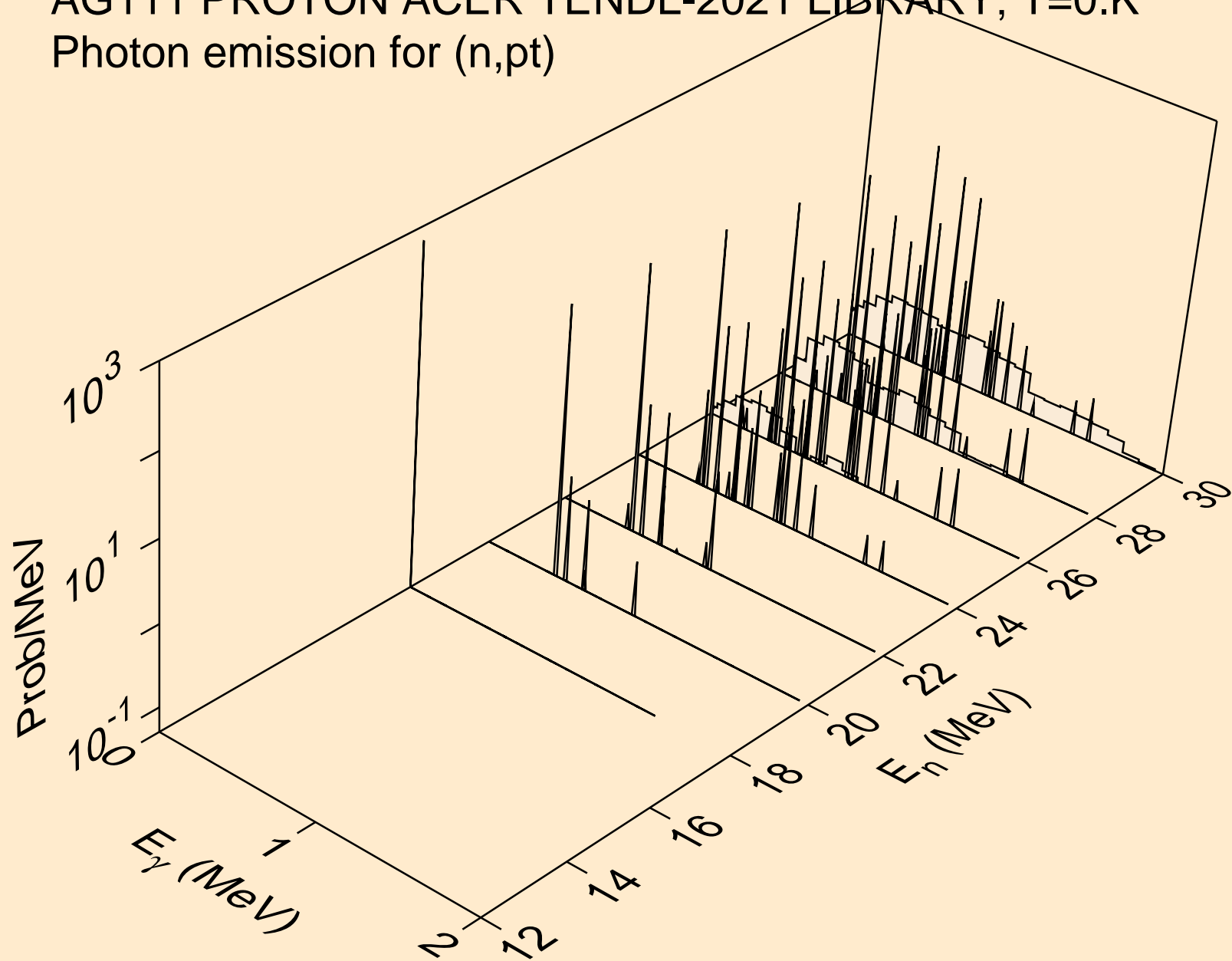

AG111 PROTON ACER TENDL-2021 LIBRARY; T=0.K  
Photon emission for (n,da)

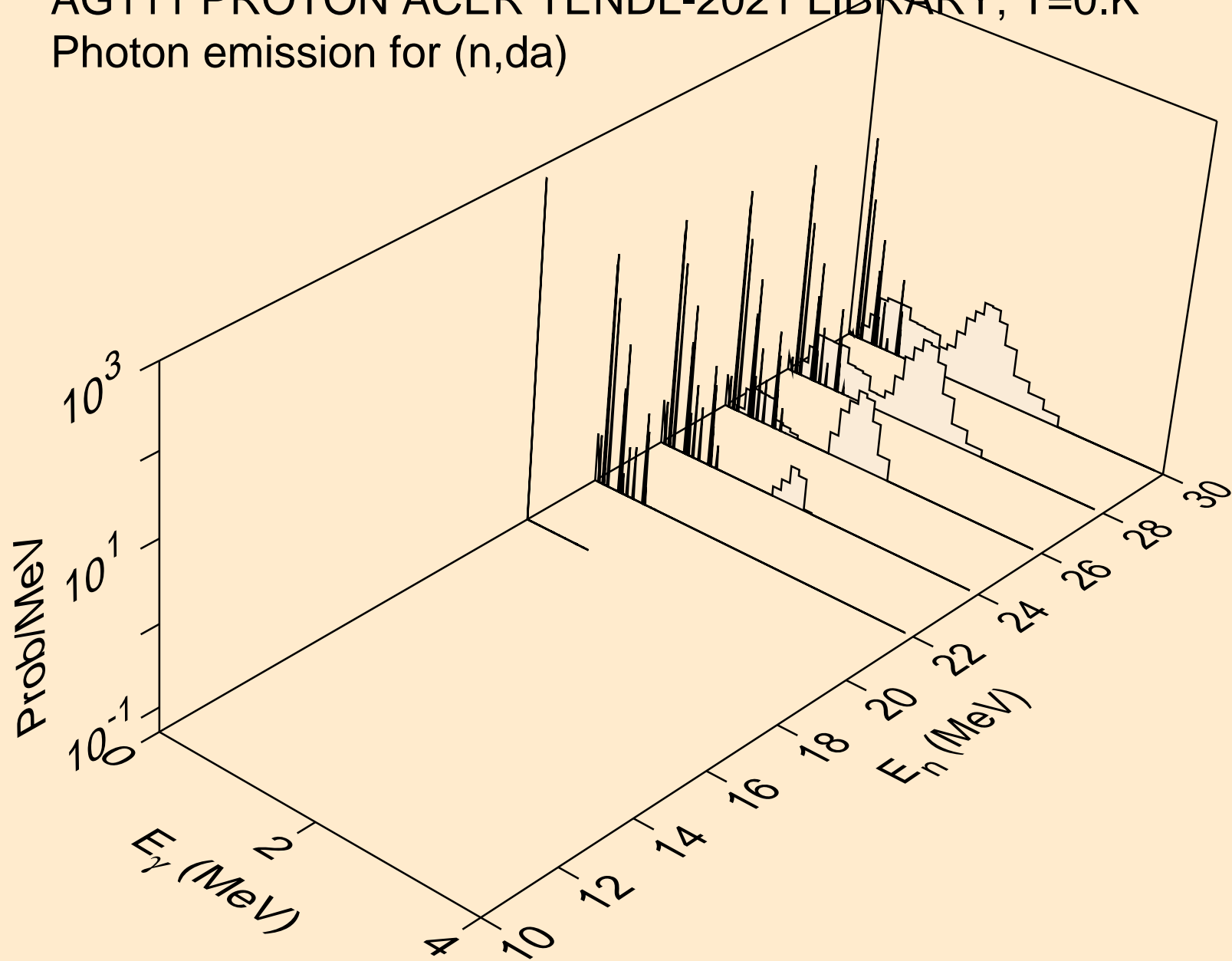

# AG111 PROTON ACER TENDL-2021 LIBRARY; T=0.K

## Particle heating contributions

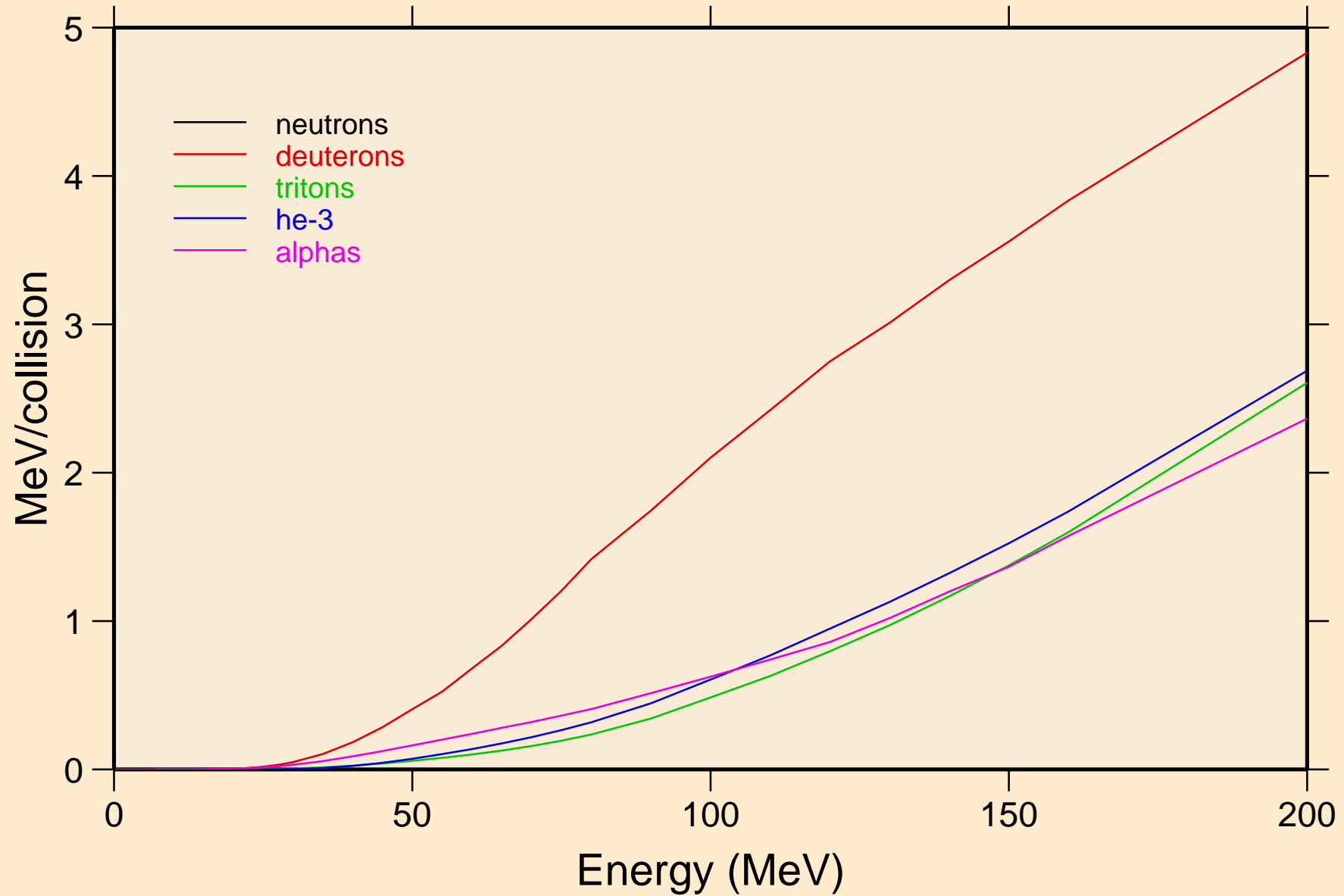

AG111 PROTON ACER TENDL-2021 LIBRARY; T=0.K  
Recoil Heating

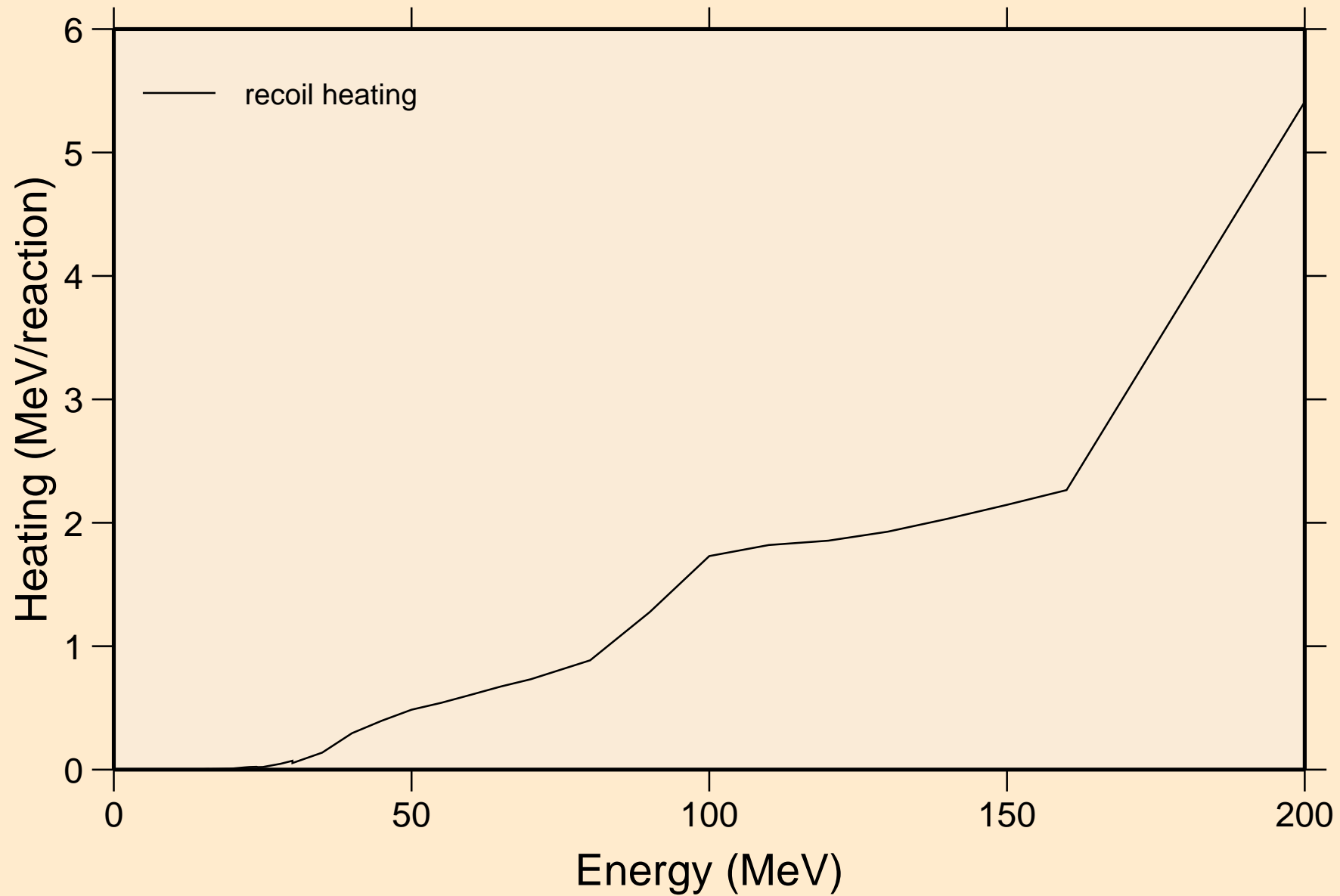

AG111 PROTON ACER TENDL-2021 LIBRARY; T=0.K  
Particle production cross sections

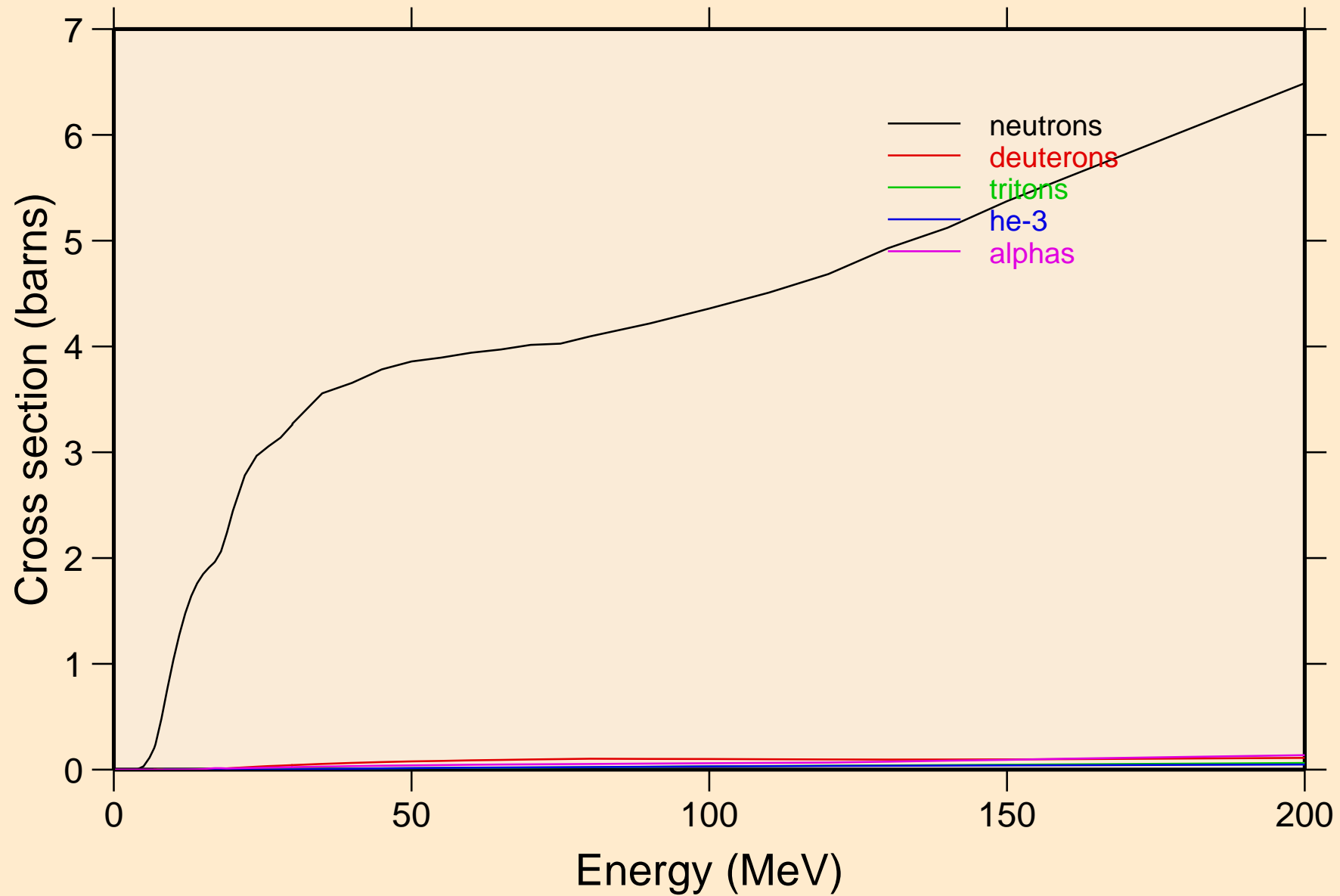

AG111 PROTON ACER TENDL-2021 LIBRARY; T=0.K  
neutrons from (p,n)

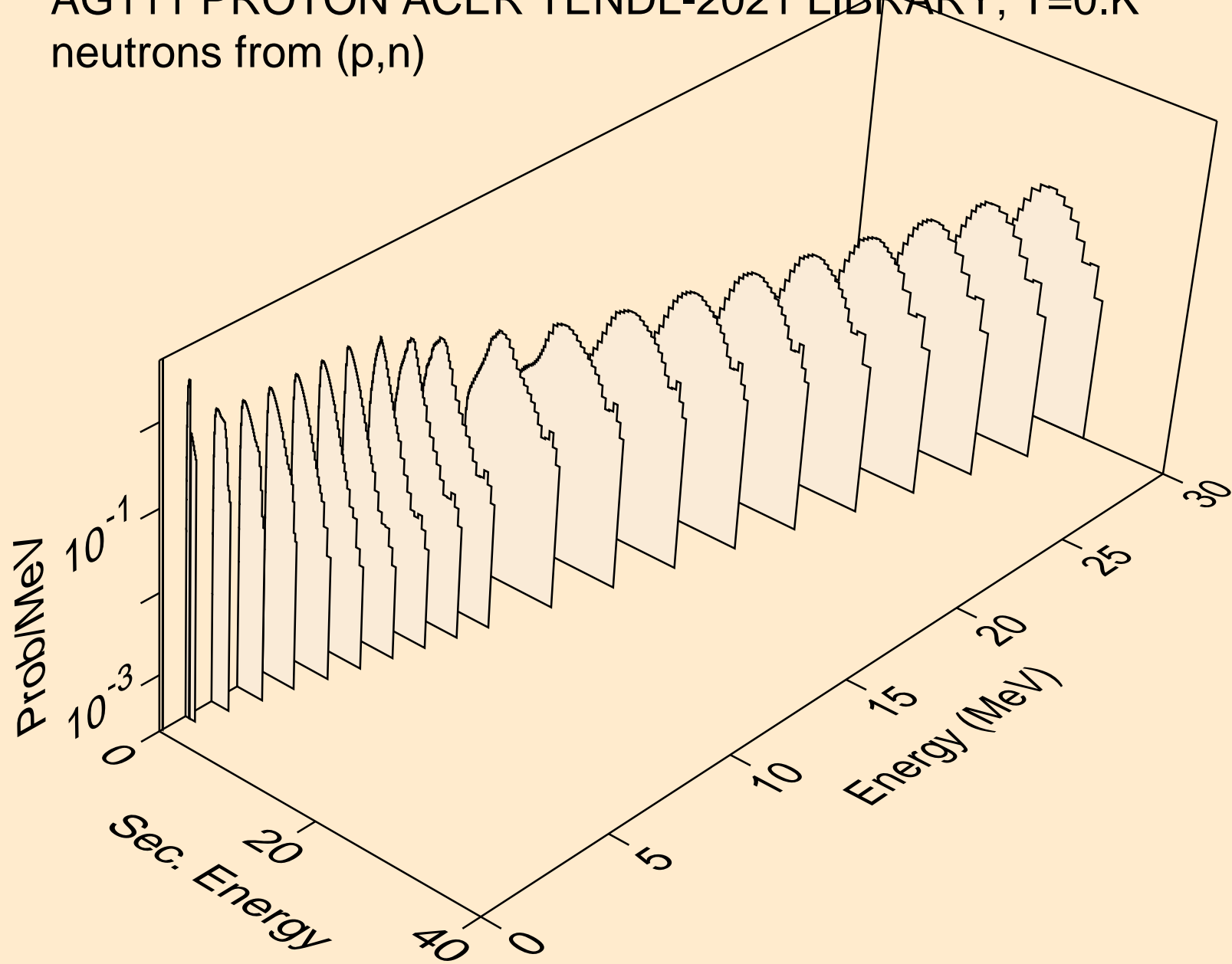

AG111 PROTON ACER TENDL-2021 LIBRARY; T=0.K  
neutrons from (p,x)

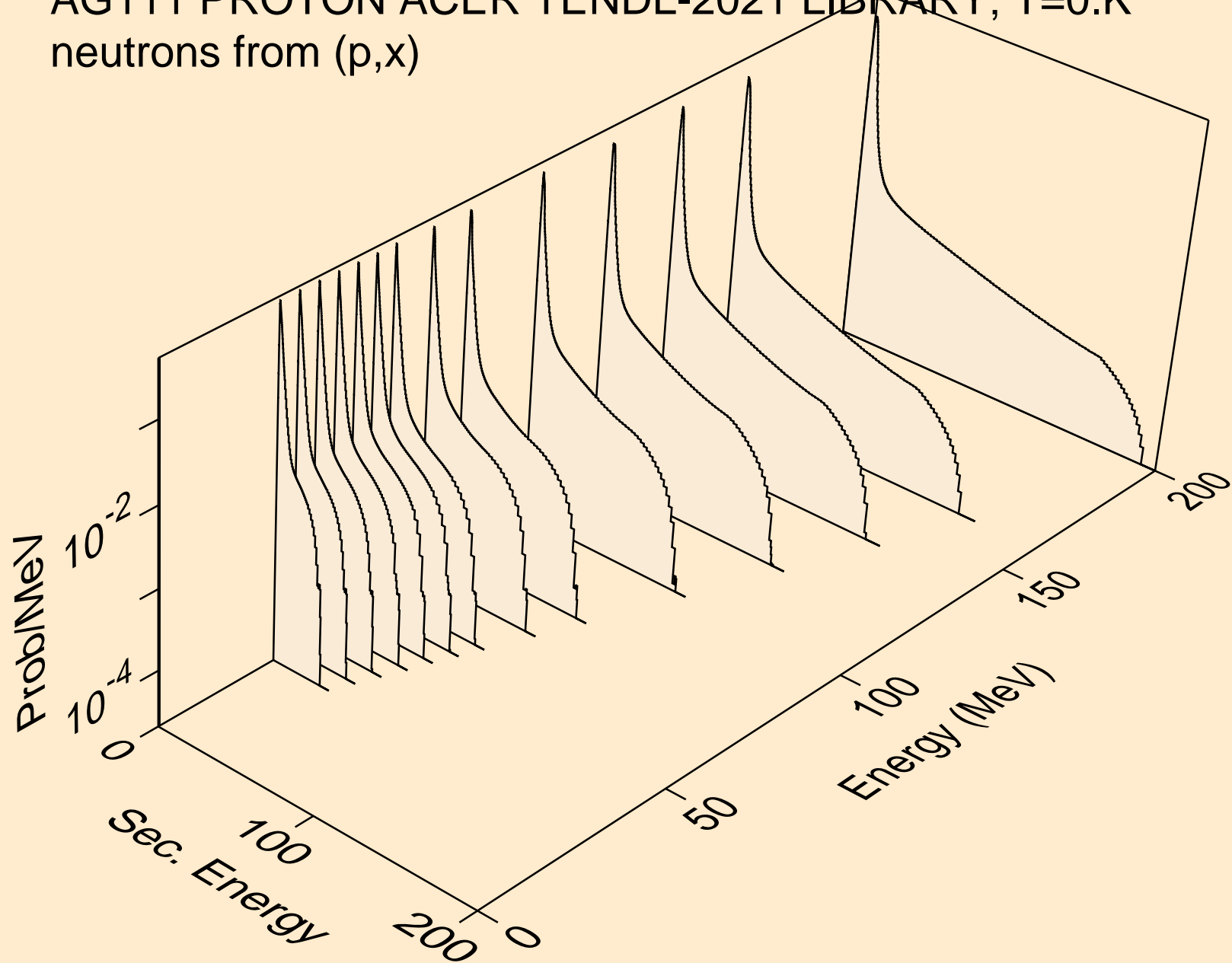

AG111 PROTON ACER TENDL-2021 LIBRARY; T=0.K  
neutrons from (p,2nd)

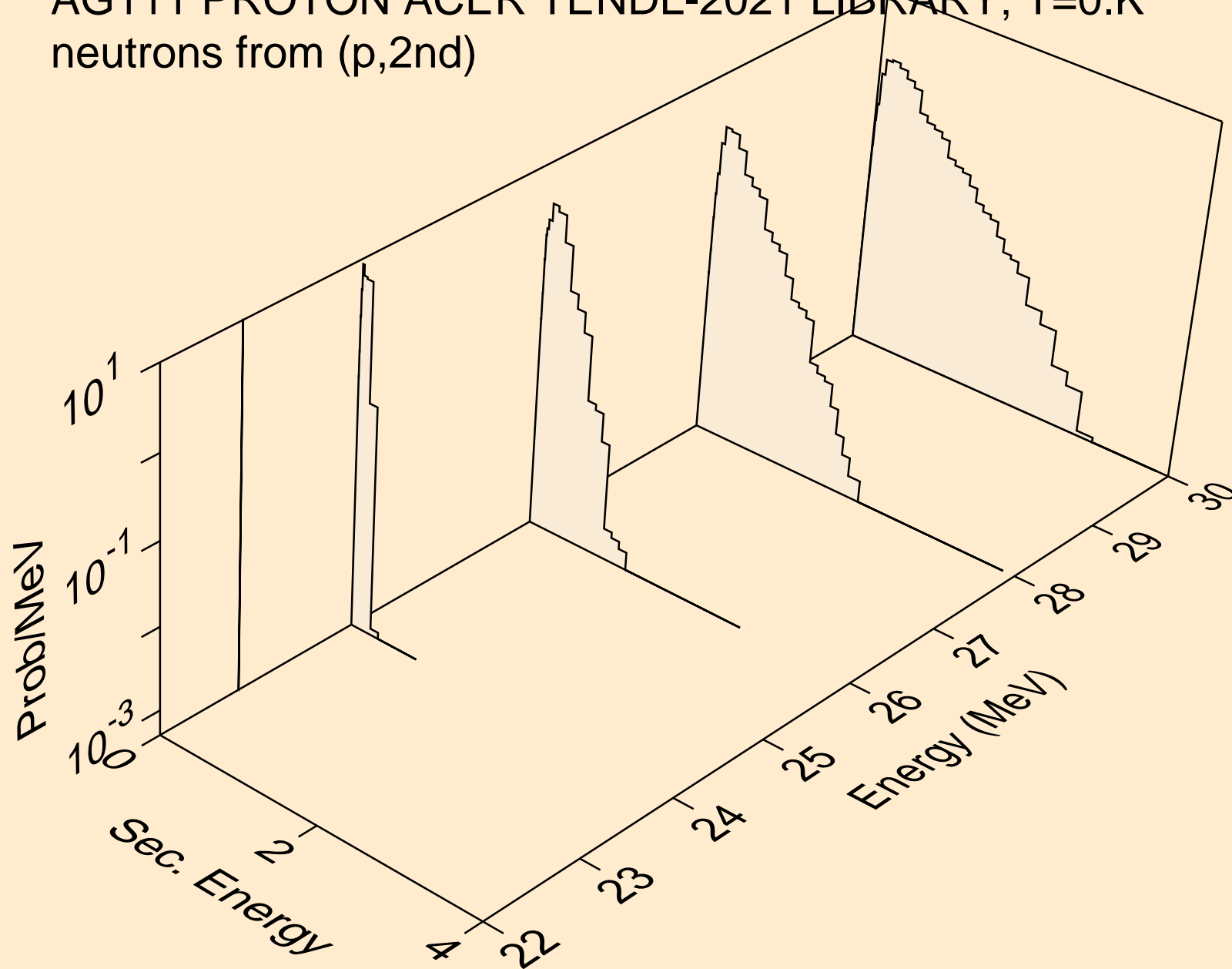

AG111 PROTON ACER TENDL-2021 LIBRARY; T=0.K  
neutrons from (p,2n)

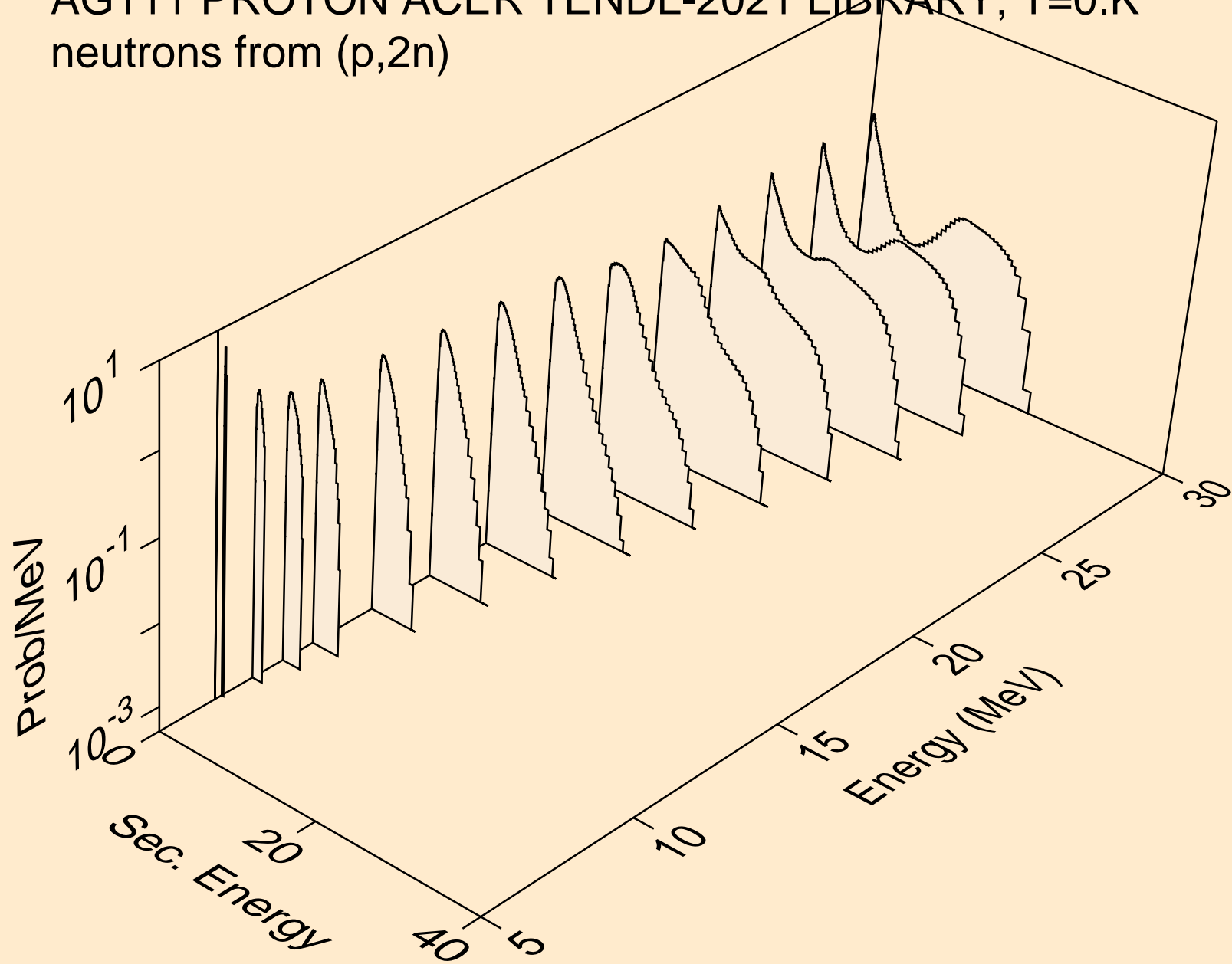

AG111 PROTON ACER TENDL-2021 LIBRARY; T=0.K  
neutrons from (p,3n)

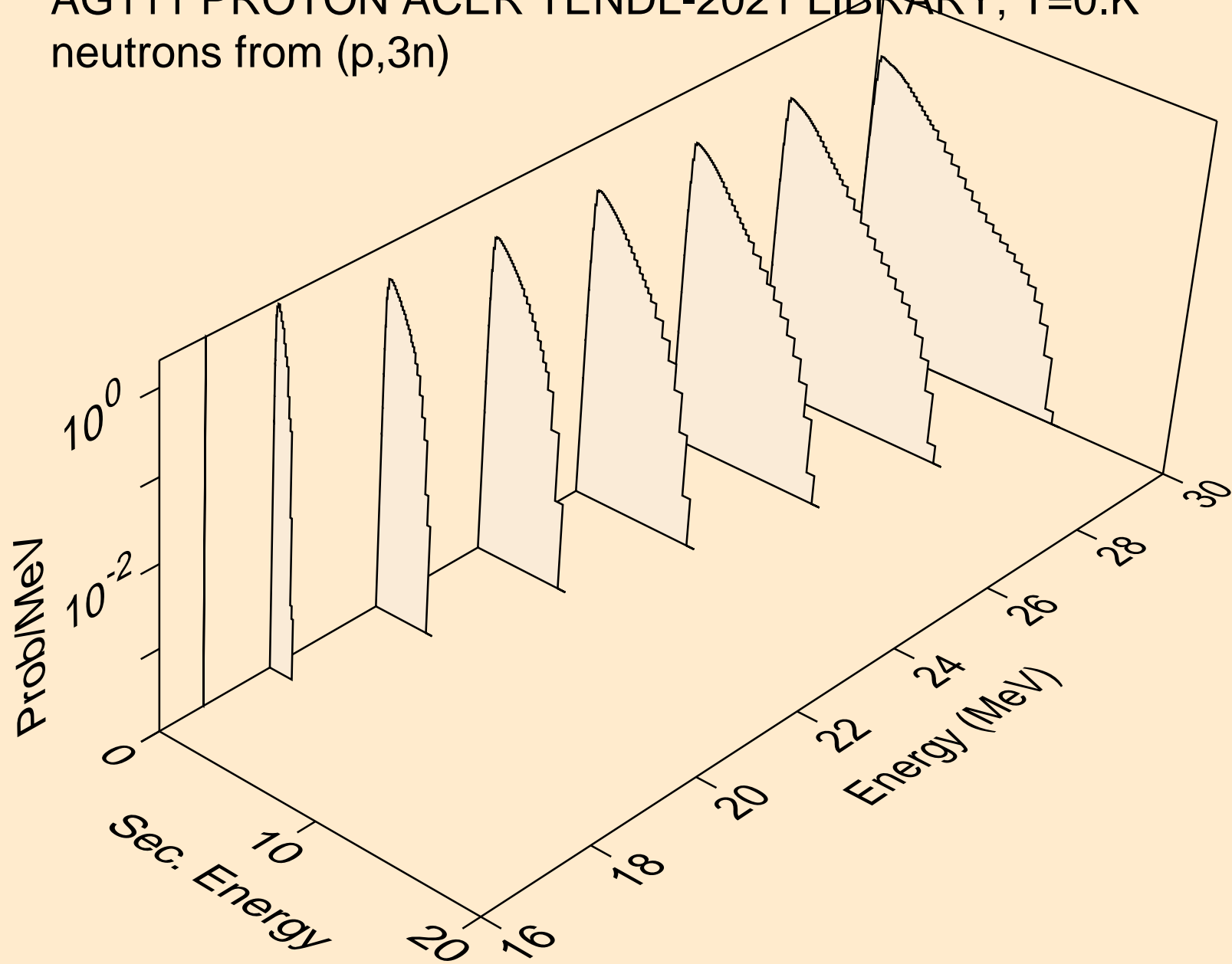

AG111 PROTON ACER TENDL-2021 LIBRARY; T=0.K  
neutrons from (p,n\*)a

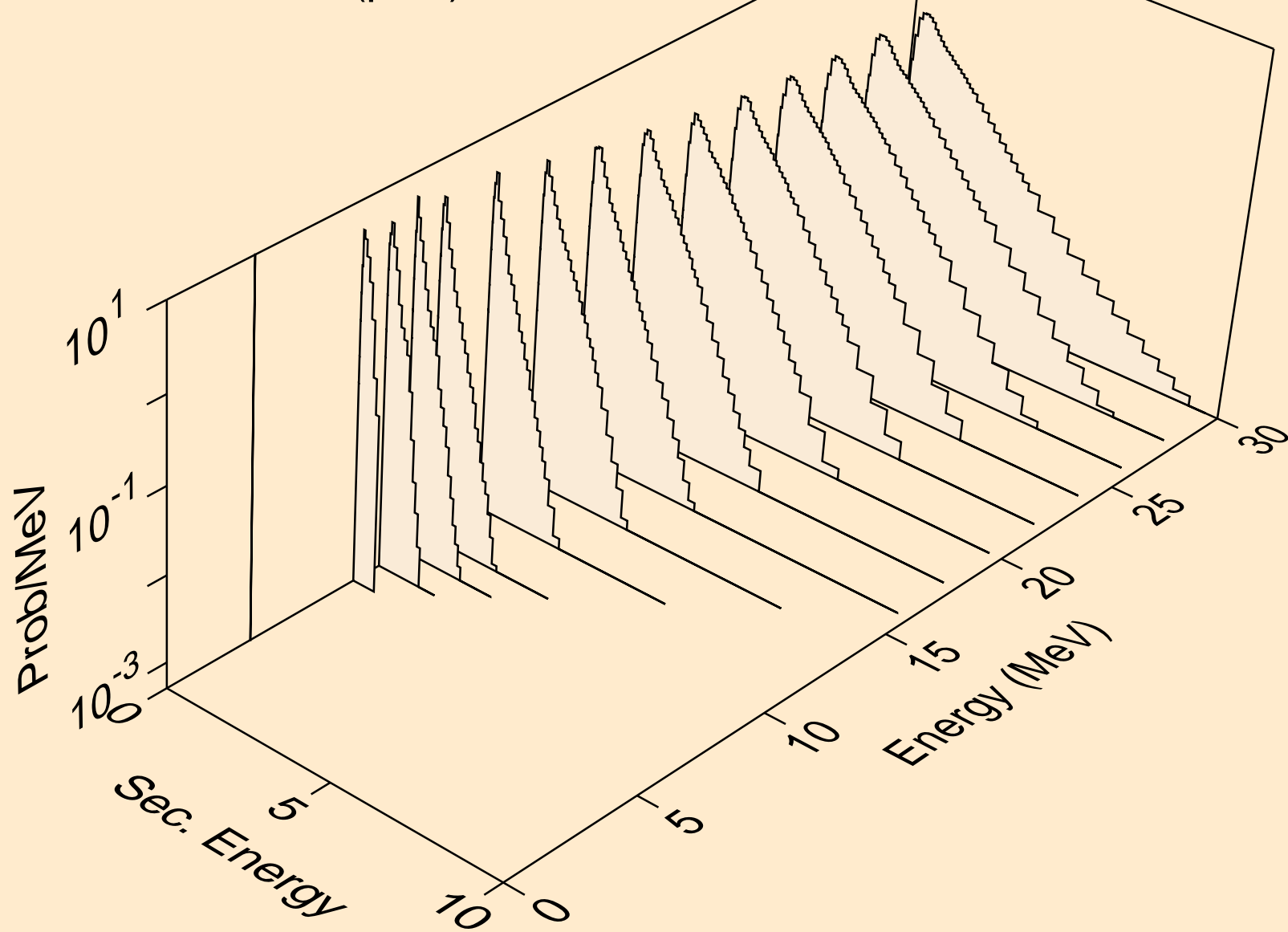

AG111 PROTON ACER TENDL-2021 LIBRARY; T=0.K  
neutrons from (p,2n)a

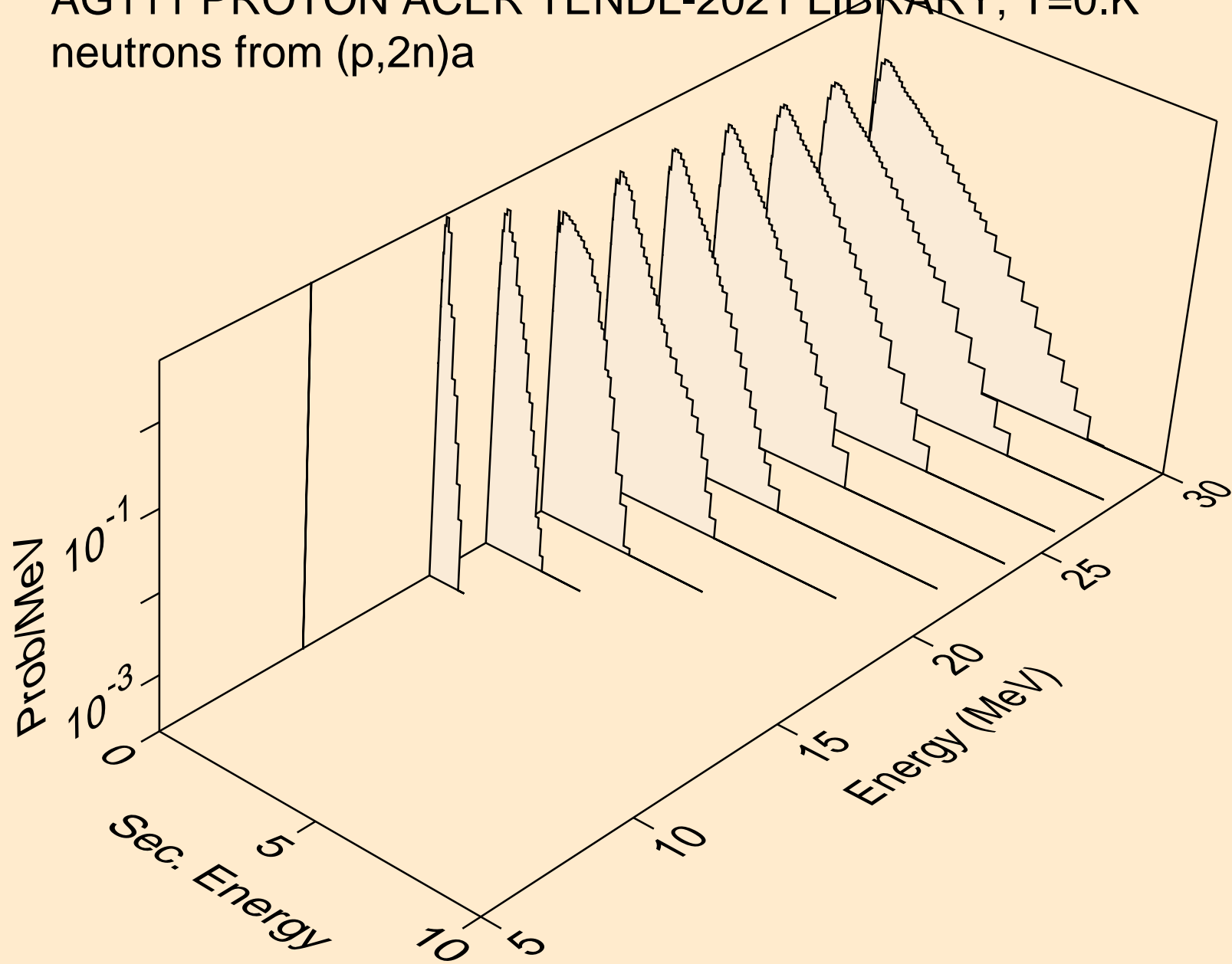

AG111 PROTON ACER TENDL-2021 LIBRARY; T=0.K  
neutrons from (p,3n)a

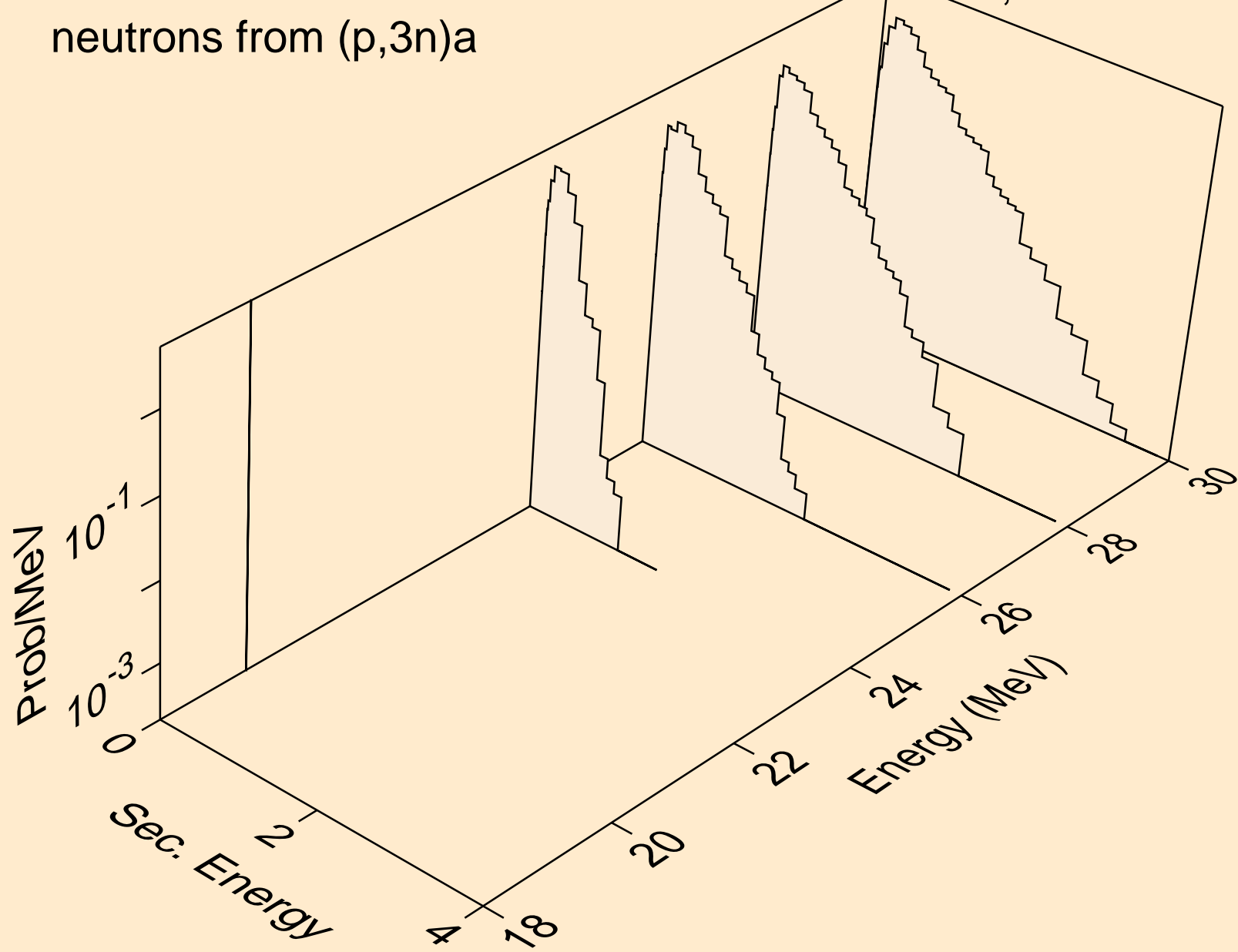

AG111 PROTON ACER TENDL-2021 LIBRARY; T=0.K  
neutrons from (p,n\*)p

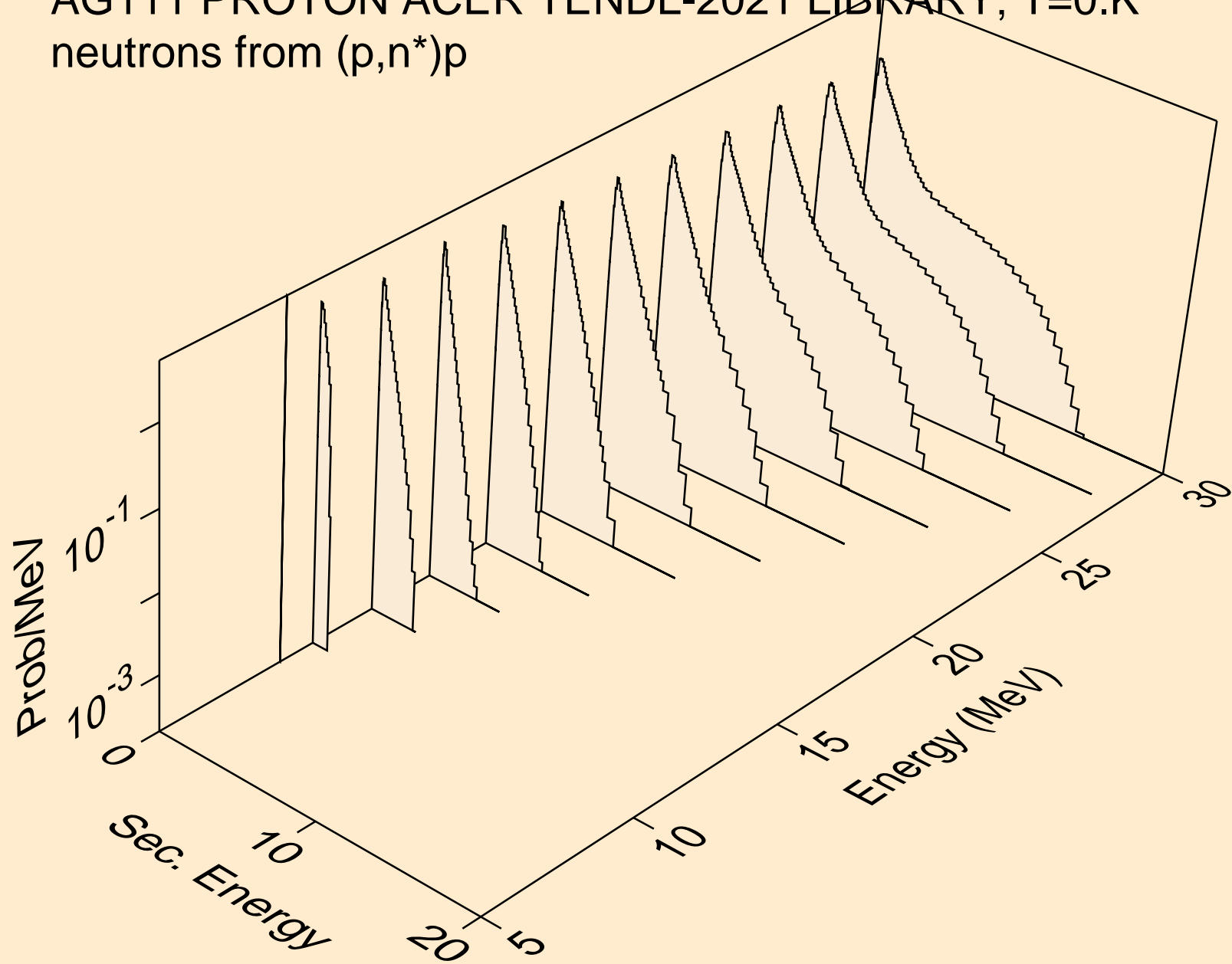

AG111 PROTON ACER TENDL-2021 LIBRARY; T=0.K  
neutrons from (p,n\*)2a

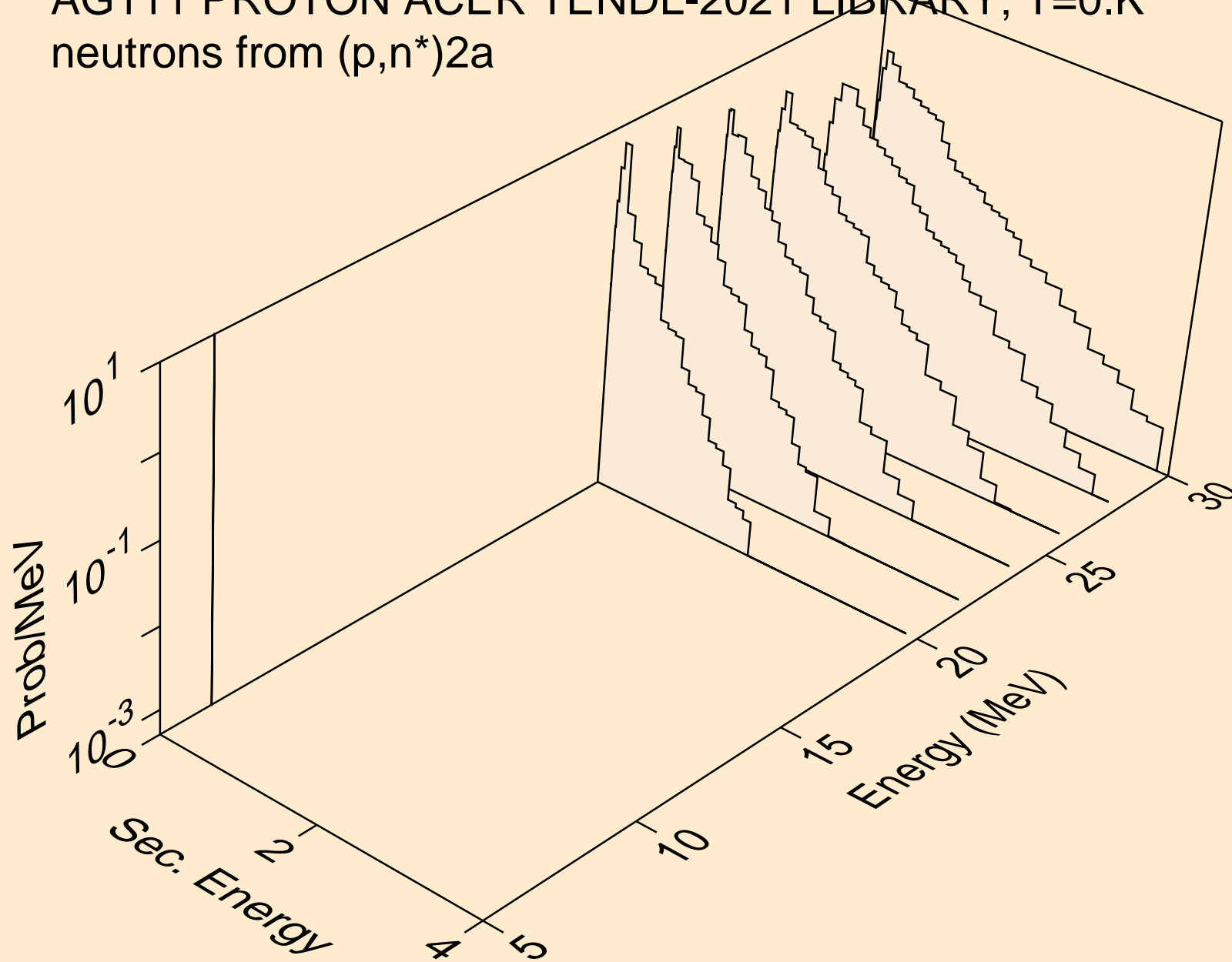

AG111 PROTON ACER TENDL-2021 LIBRARY; T=0.K  
neutrons from (p,n\*)d

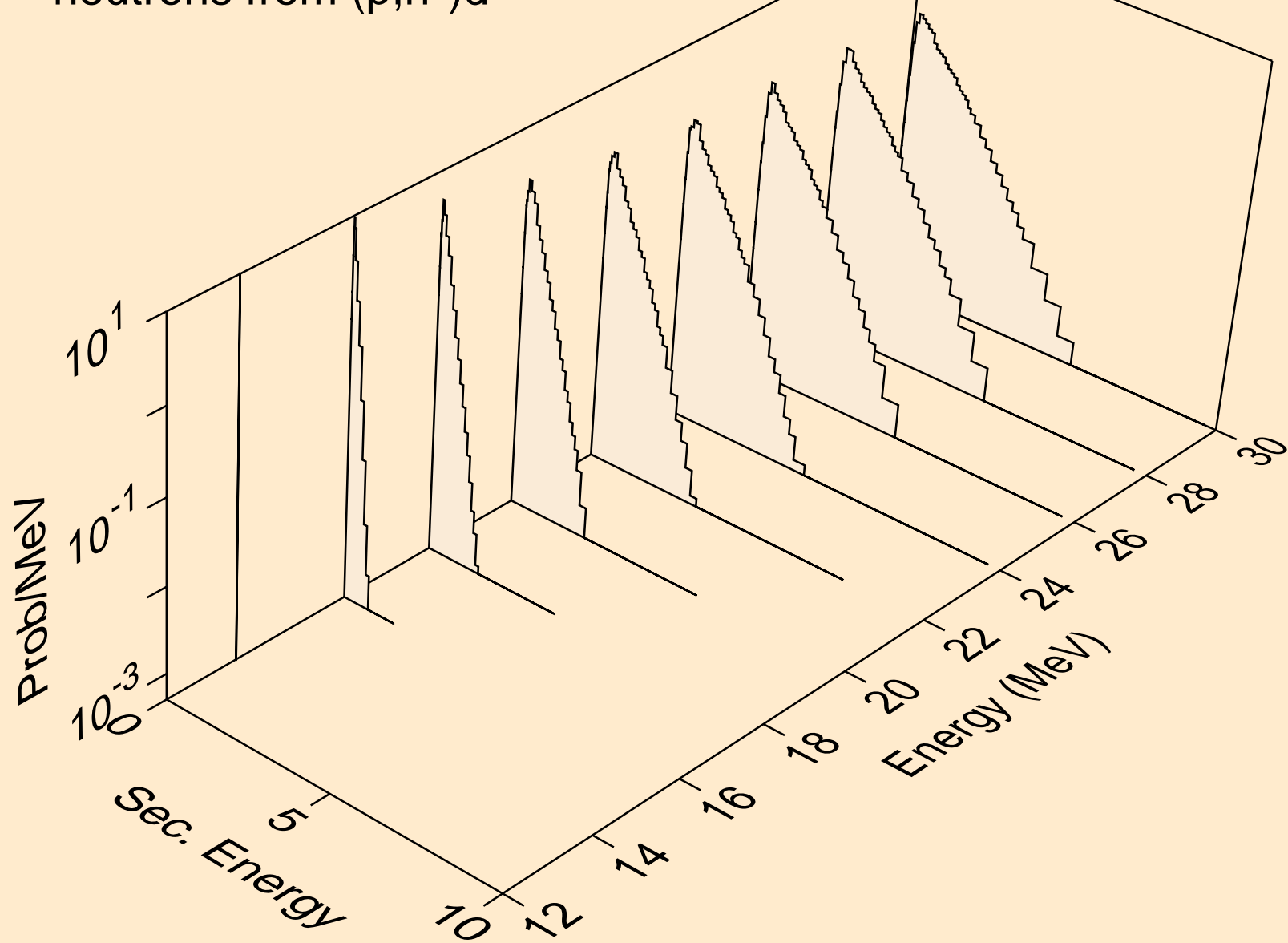

AG111 PROTON ACER TENDL-2021 LIBRARY; T=0.K  
neutrons from (p,n\*)t

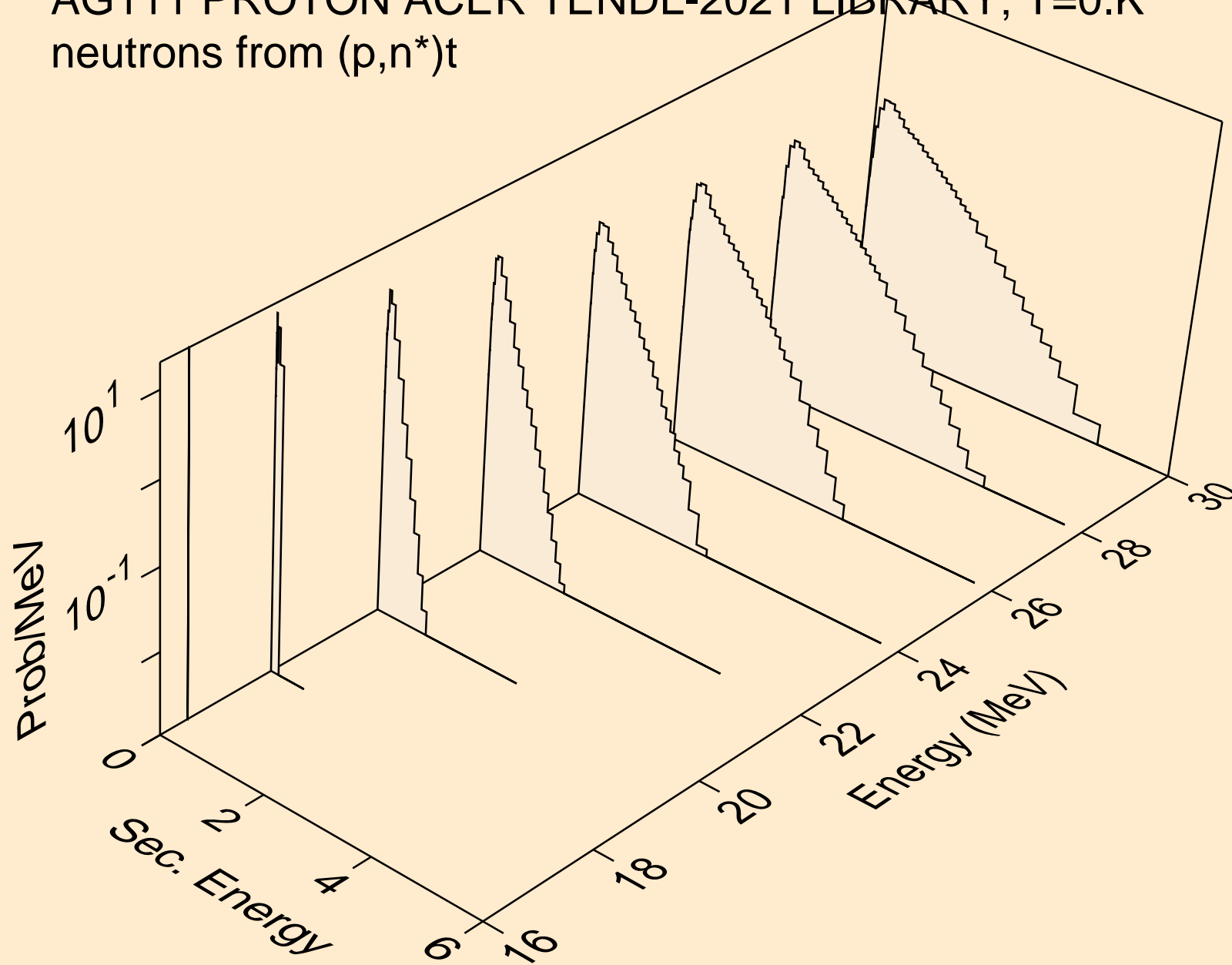

AG111 PROTON ACER TENDL-2021 LIBRARY; T=0.K  
neutrons from (p,n\*)he3

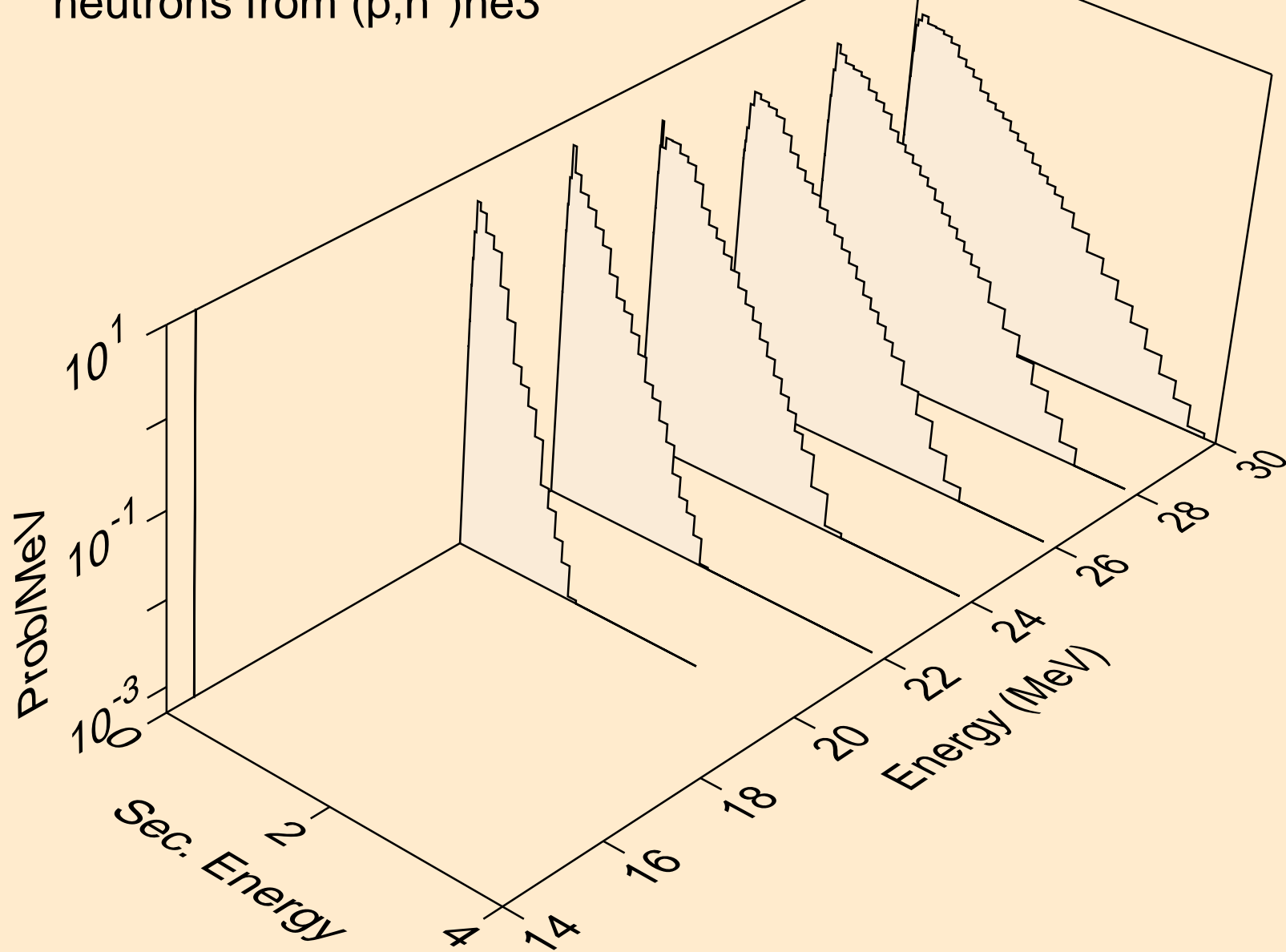

AG111 PROTON ACER TENDL-2021 LIBRARY; T=0.K  
neutrons from (p,4n)

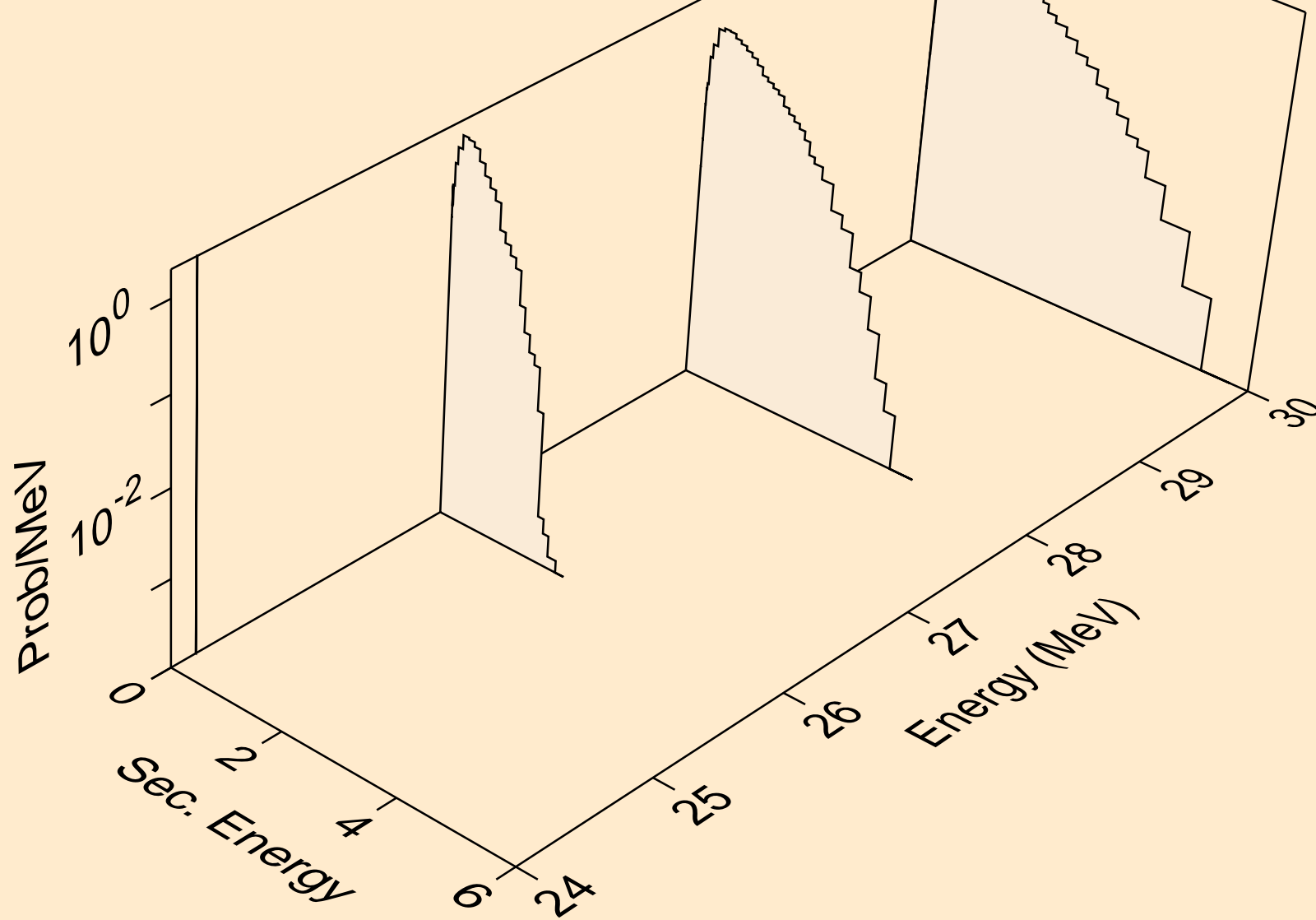

AG111 PROTON ACER TENDL-2021 LIBRARY; T=0.K  
neutrons from (p,2np)

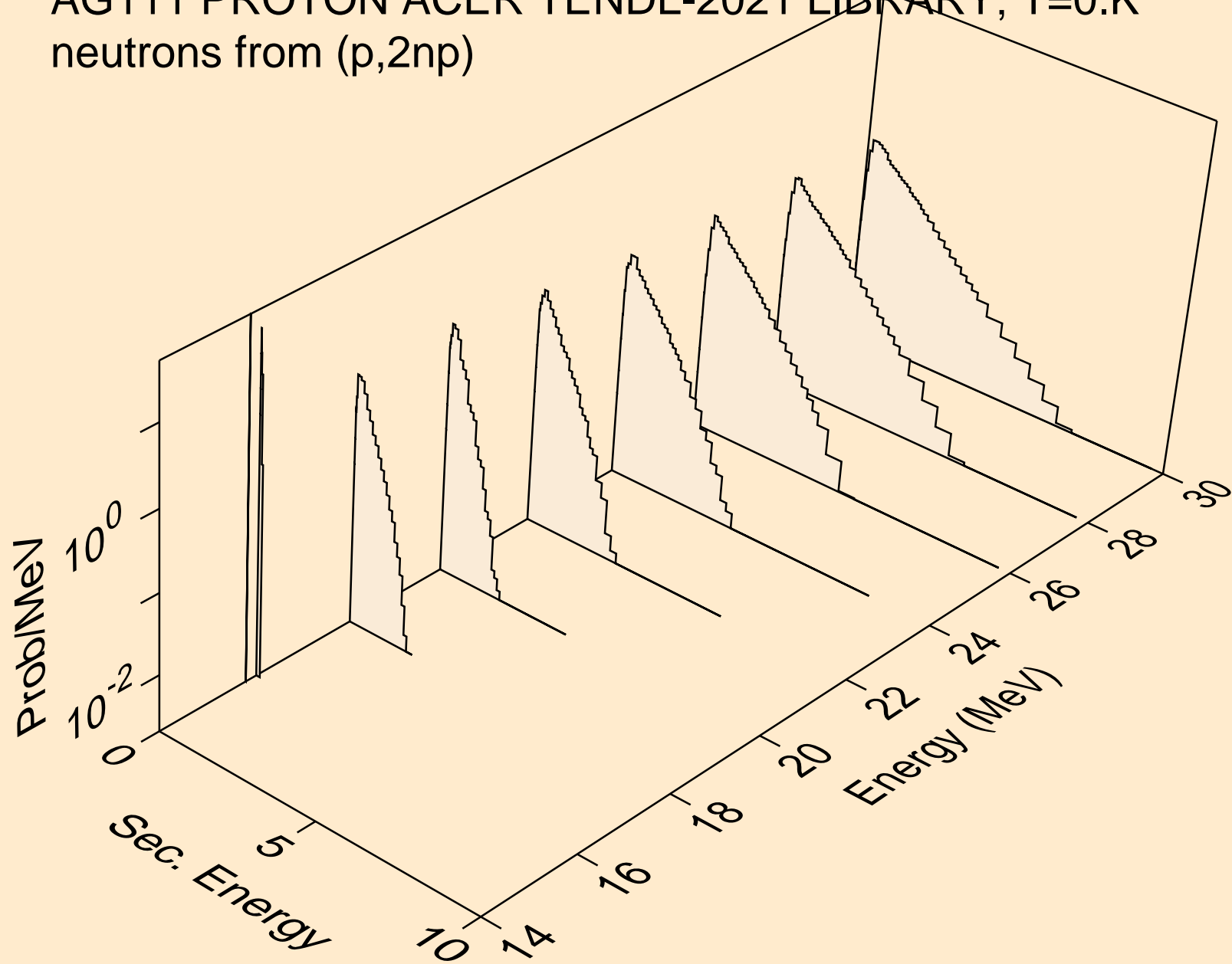

AG111 PROTON ACER TENDL-2021 LIBRARY; T=0.K  
neutrons from (p,3np)

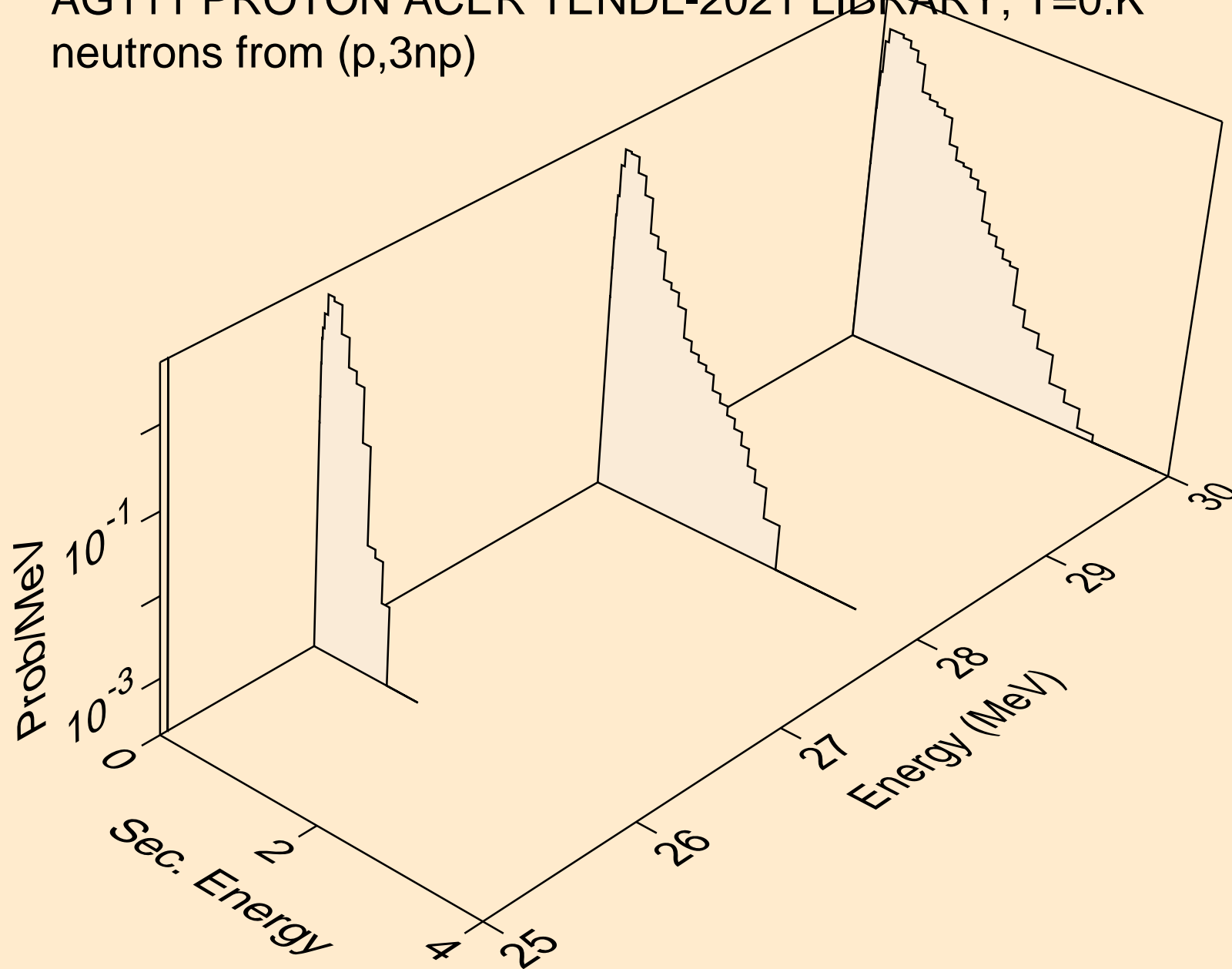

AG111 PROTON ACER TENDL-2021 LIBRARY; T=0.K  
neutrons from (p,2np)

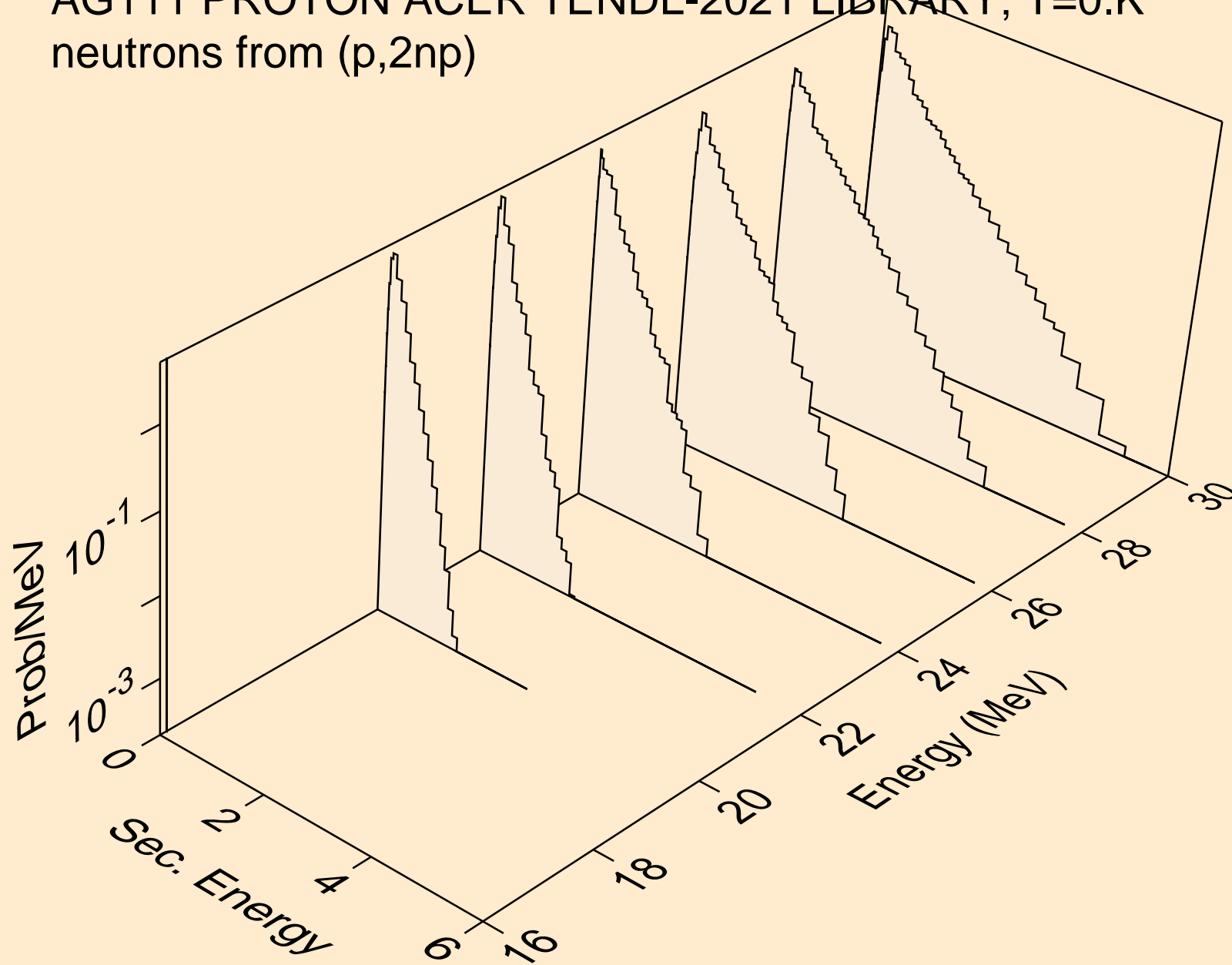

AG111 PROTON ACER TENDL-2021 LIBRARY; T=0.K  
neutrons from (p,npa)

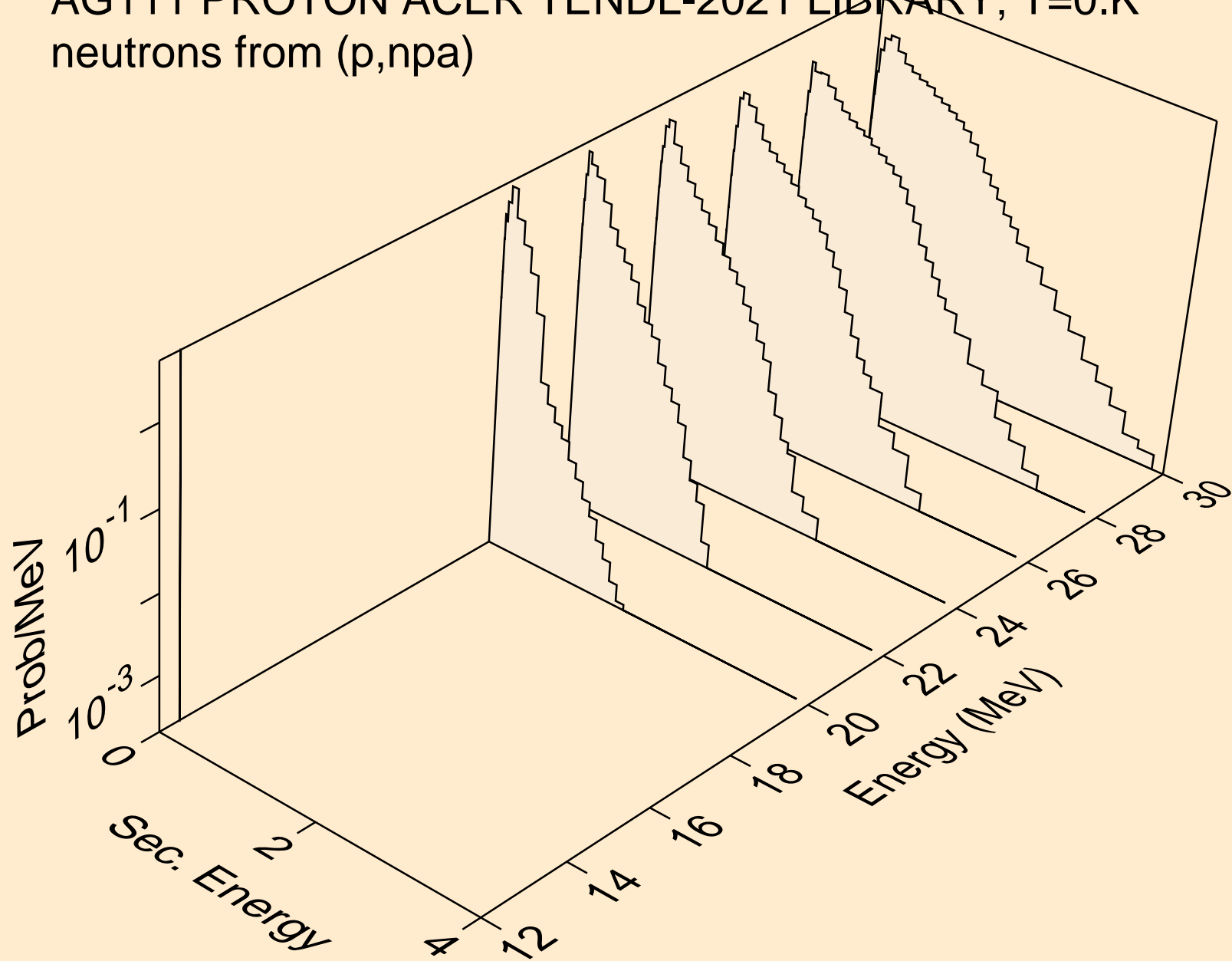

AG111 PROTON ACER TENDL-2021 LIBRARY; T=0.K  
deuterons from (p,x)

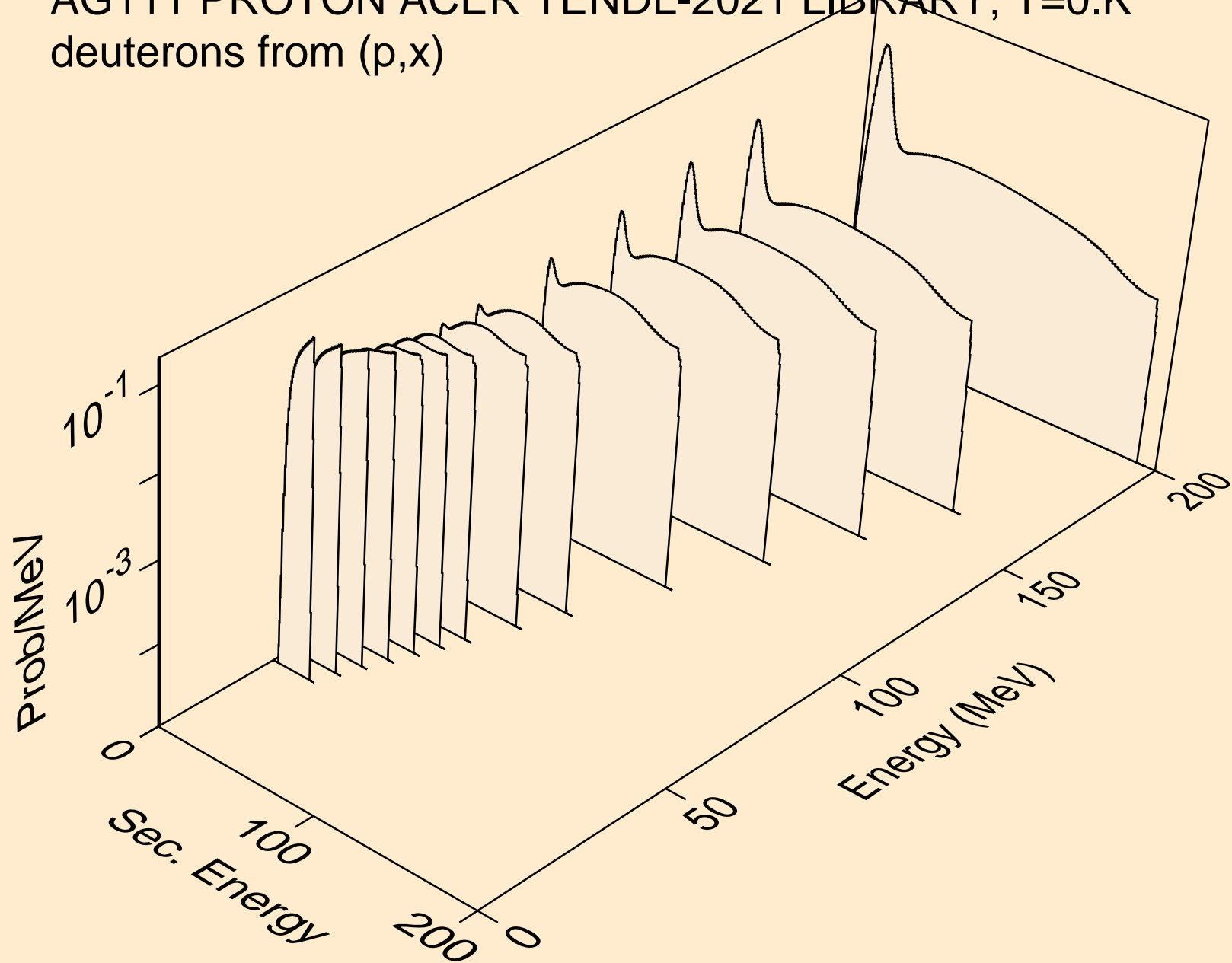

AG111 PROTON ACER TENDL-2021 LIBRARY; T=0.K  
deuterons from (p,2nd)

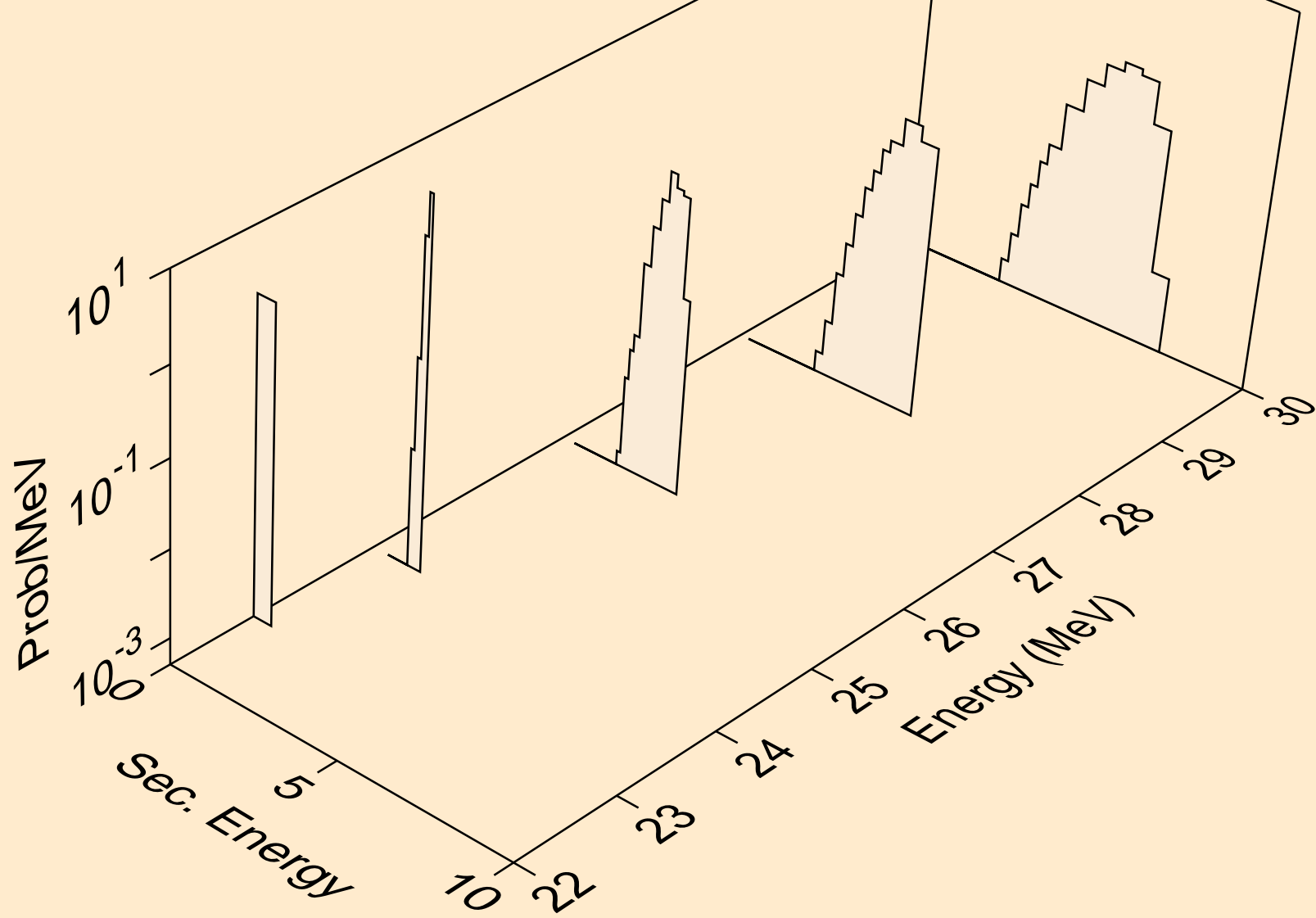

AG111 PROTON ACER TENDL-2021 LIBRARY; T=0.K  
deuterons from (p,n\*)d

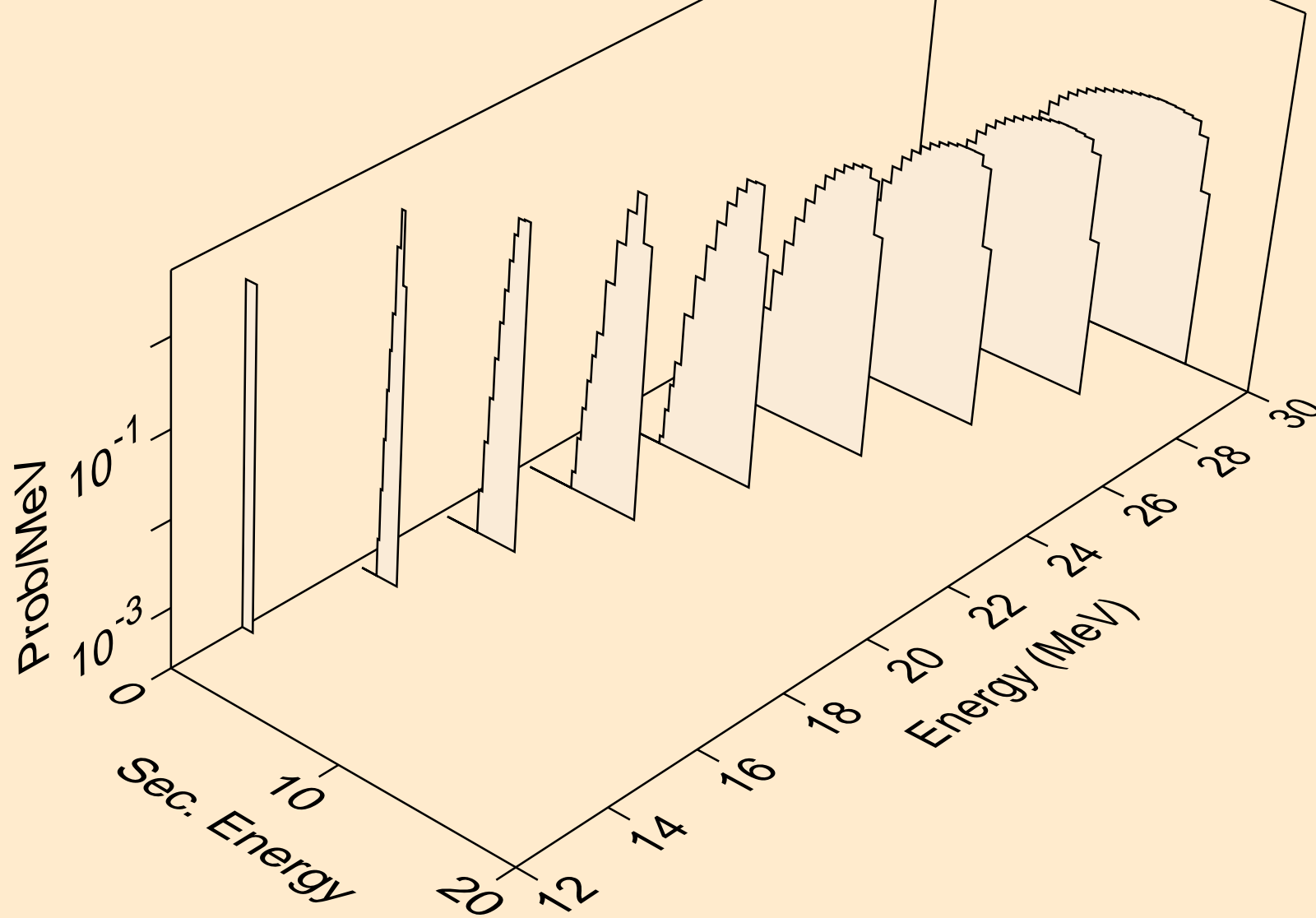

AG111 PROTON ACER TENDL-2021 LIBRARY; T=0.K  
deuterons from (p,d)

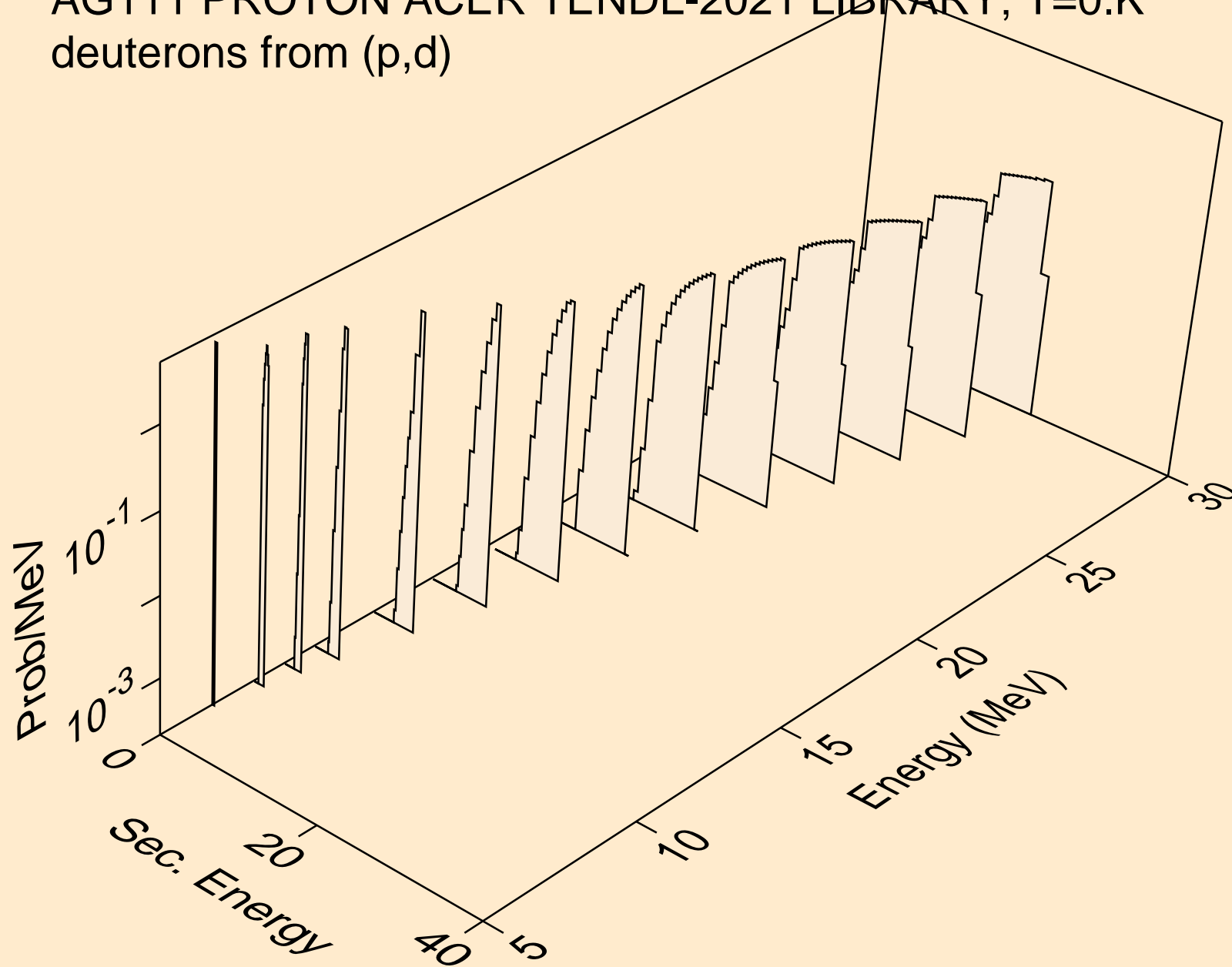

AG111 PROTON ACER TENDL-2021 LIBRARY; T=0.K  
deuterons from (p,pd)

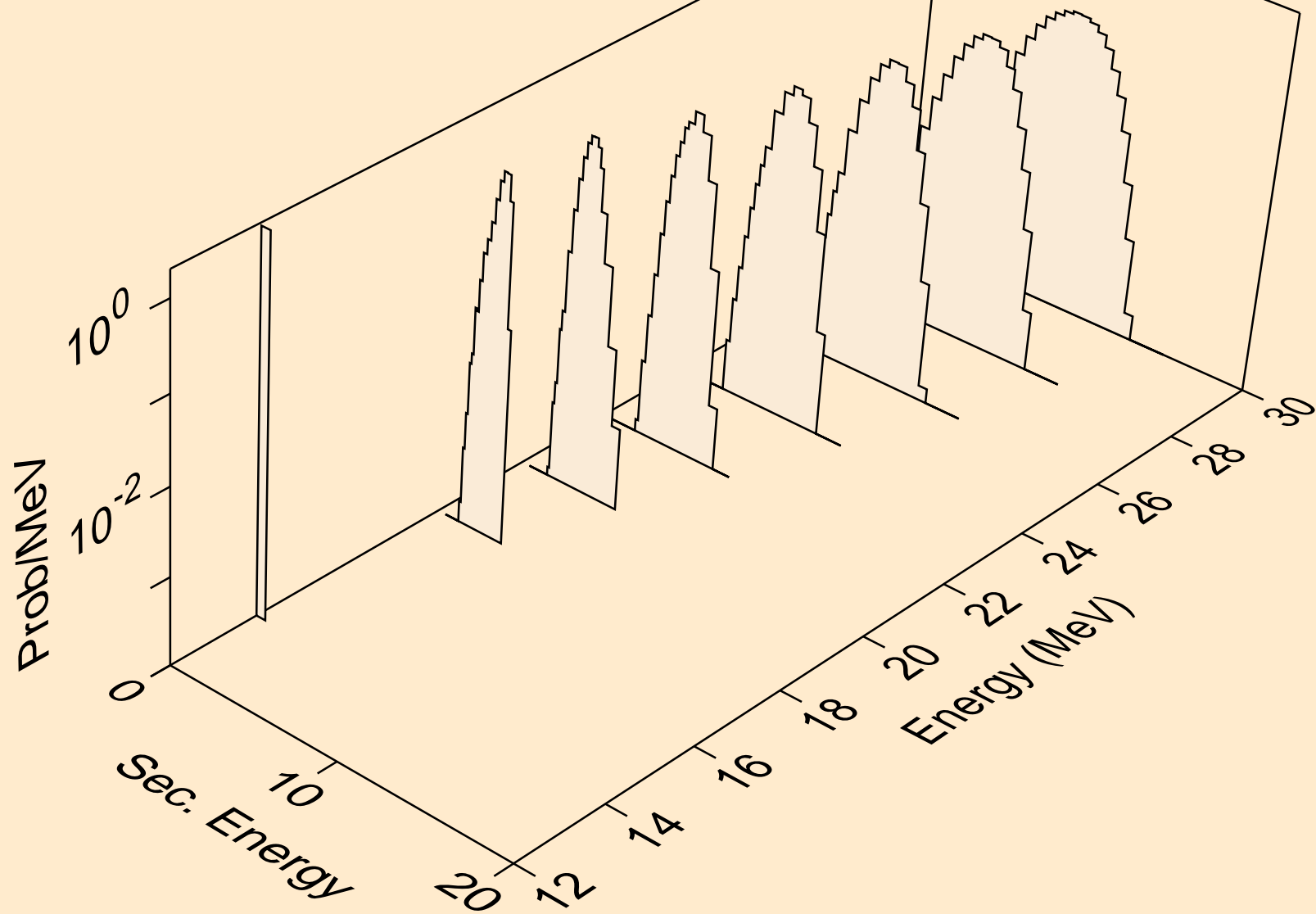

AG111 PROTON ACER TENDL-2021 LIBRARY; T=0.K  
deuterons from (p,da)

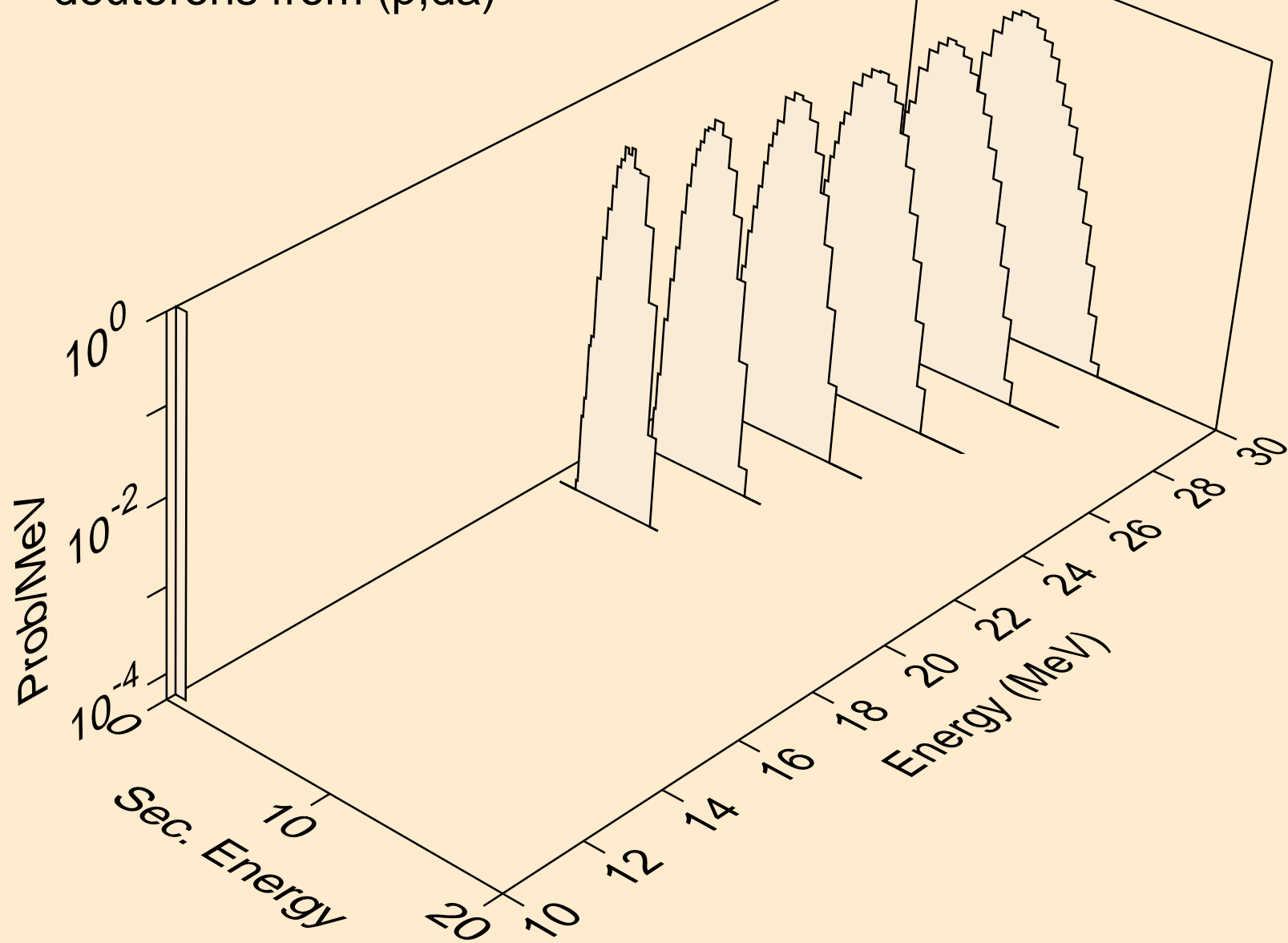

AG111 PROTON ACER TENDL-2021 LIBRARY; T=0.K  
tritons from (p,x)

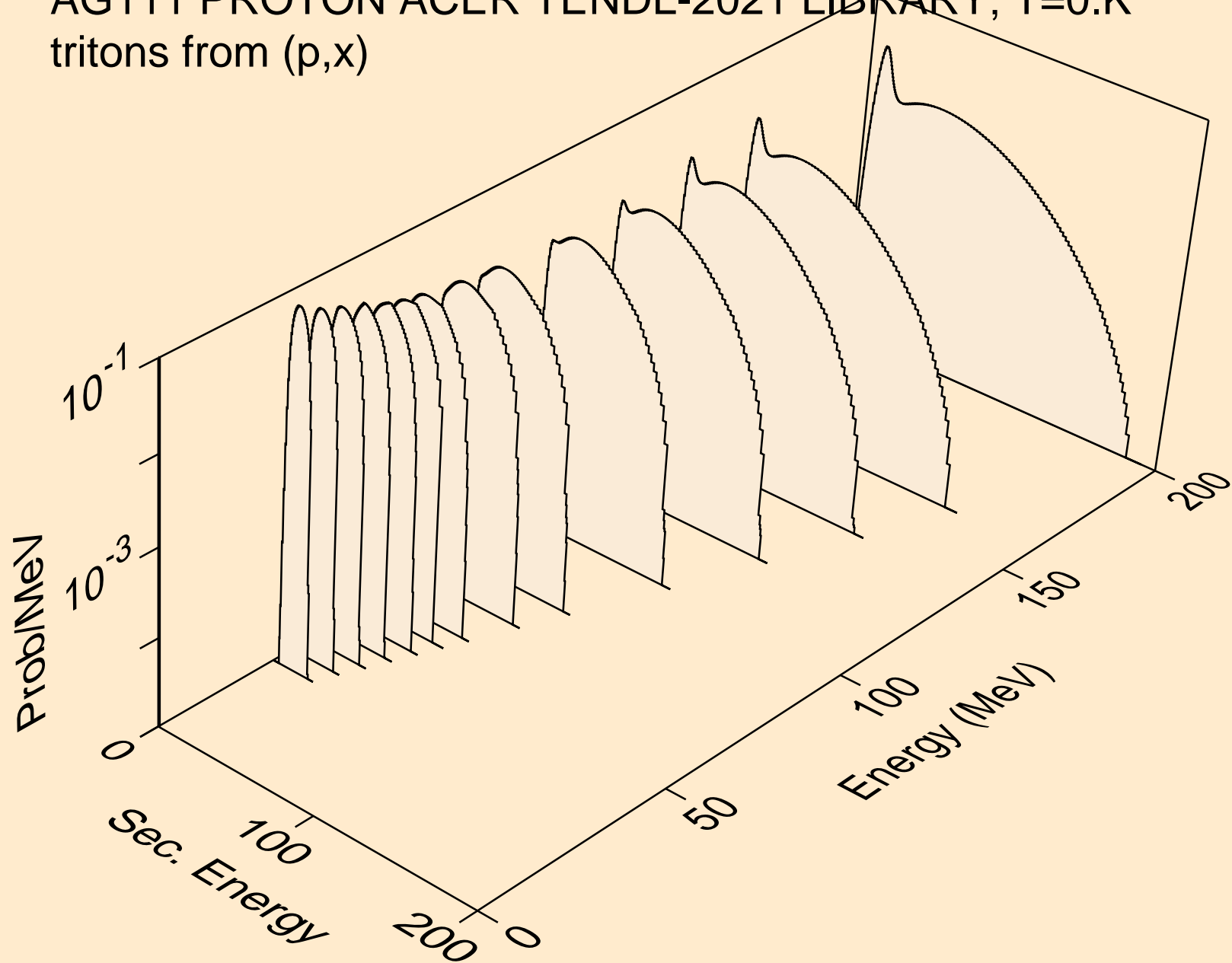

AG111 PROTON ACER TENDL-2021 LIBRARY; T=0.K  
tritons from (p,n\*)t

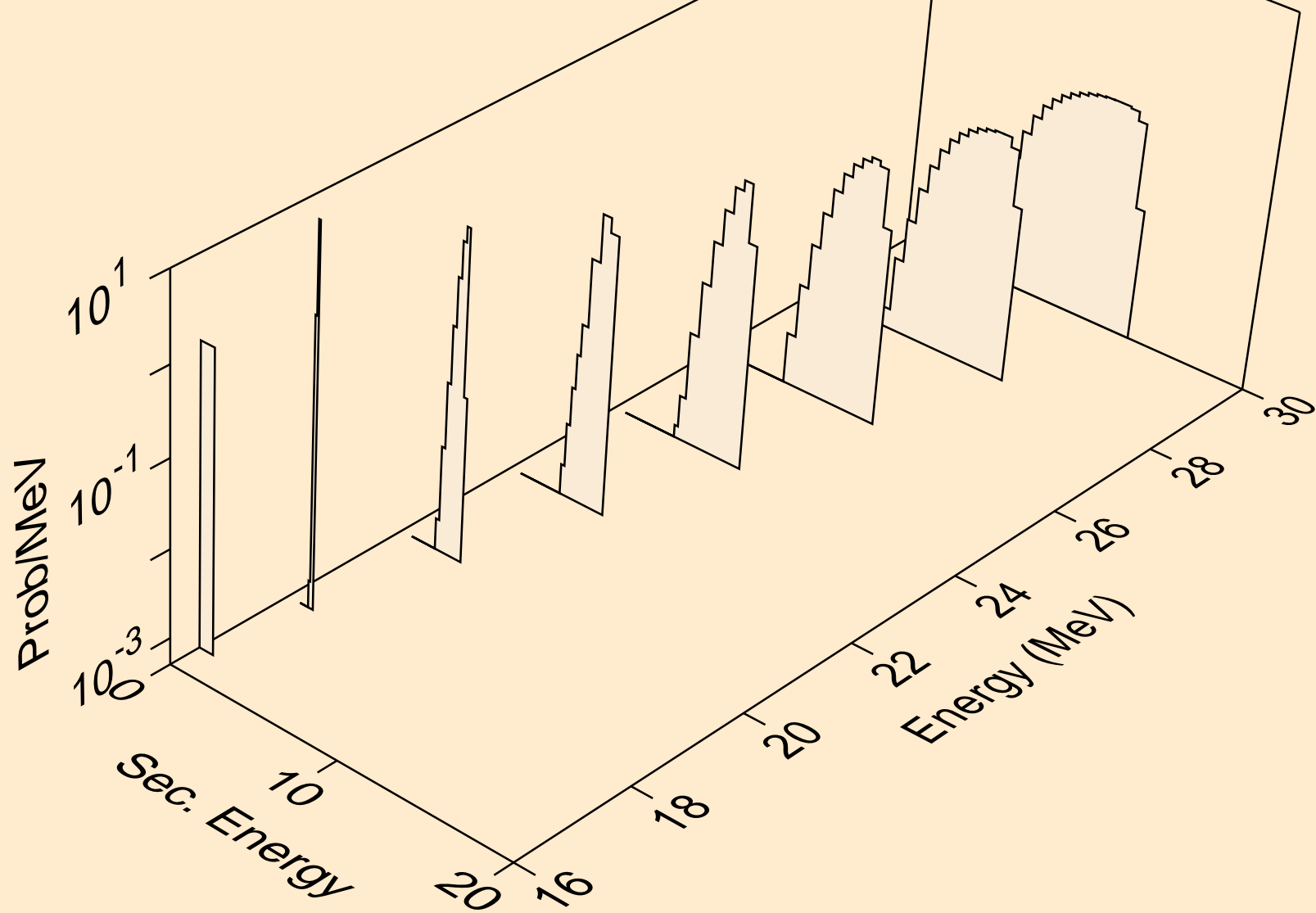

AG111 PROTON ACER TENDL-2021 LIBRARY; T=0.K  
tritons from (p,t)

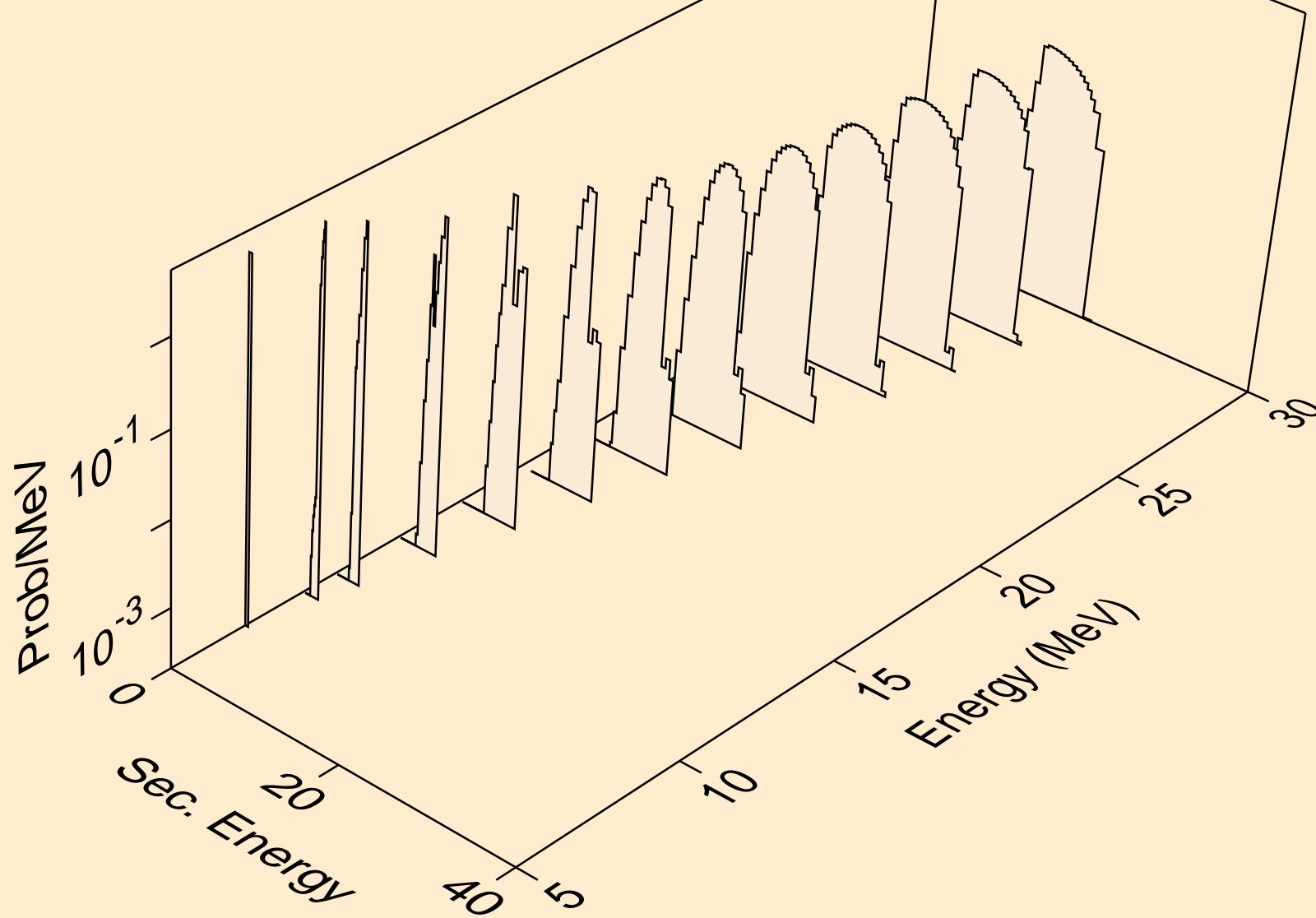

AG111 PROTON ACER TENDL-2021 LIBRARY; T=0.K  
tritons from (p,pt)

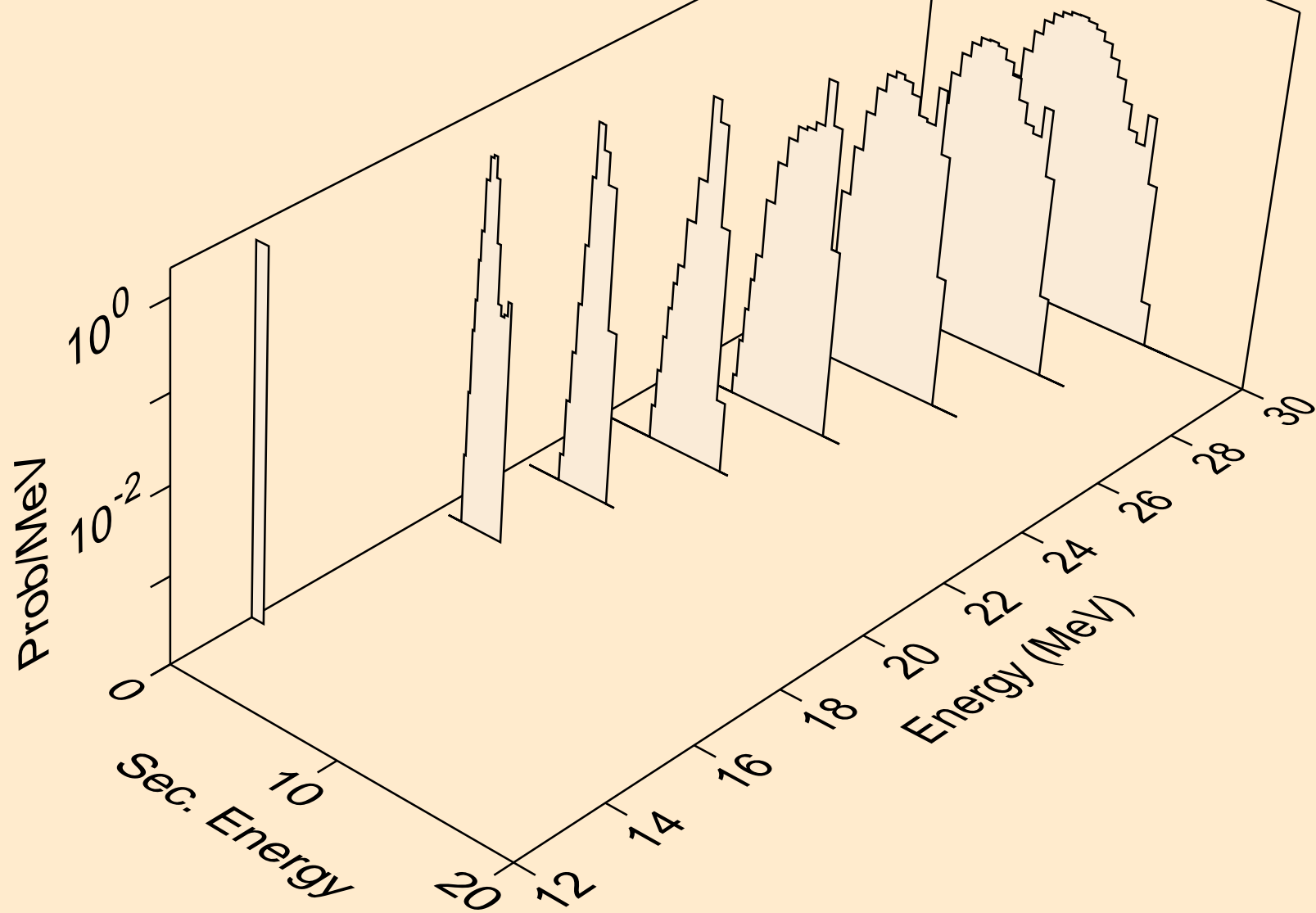

AG111 PROTON ACER TENDL-2021 LIBRARY; T=0.K  
he3s from (p,x)

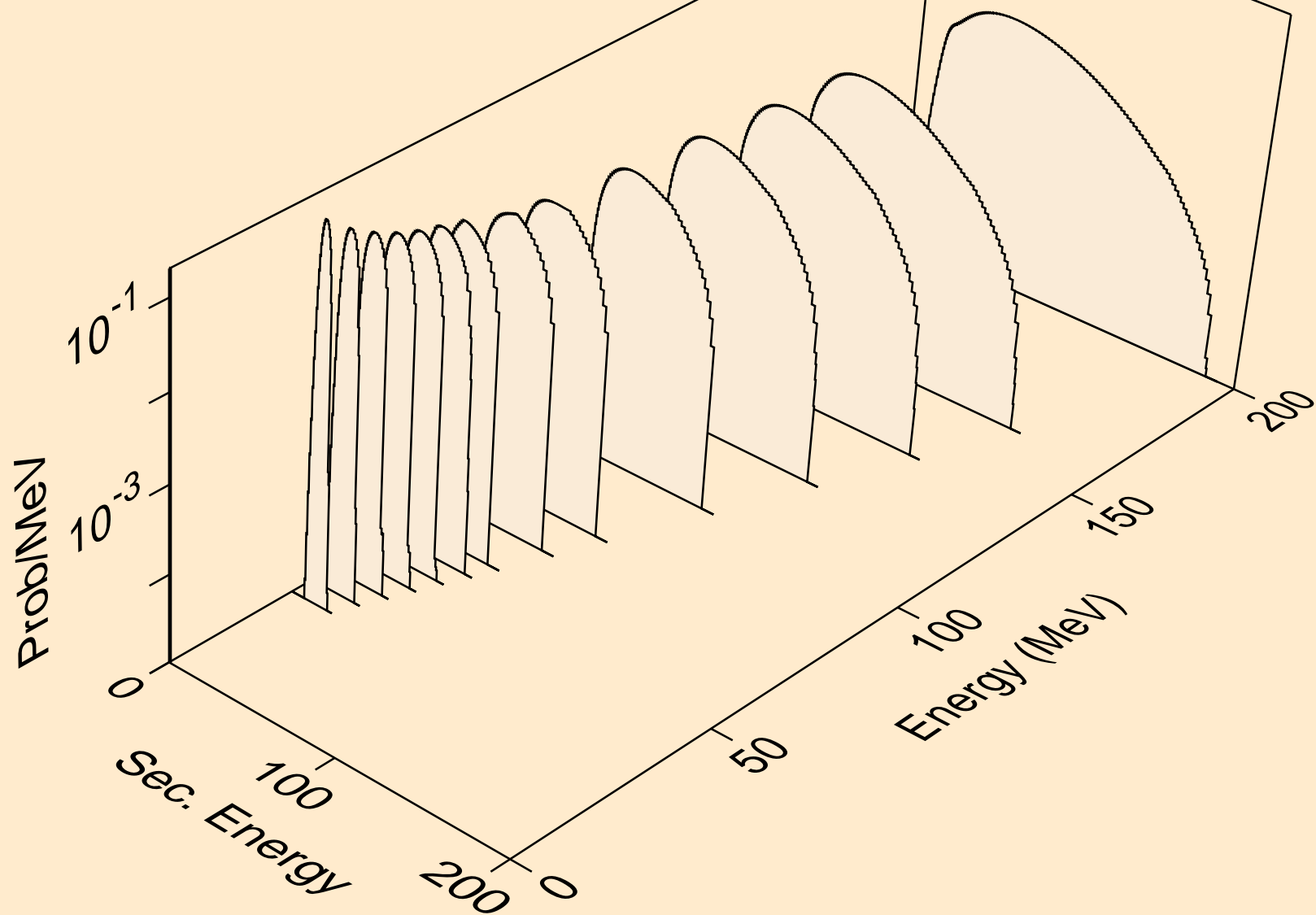

AG111 PROTON ACER TENDL-2021 LIBRARY; T=0.K  
he3s from (p,n\*)he3

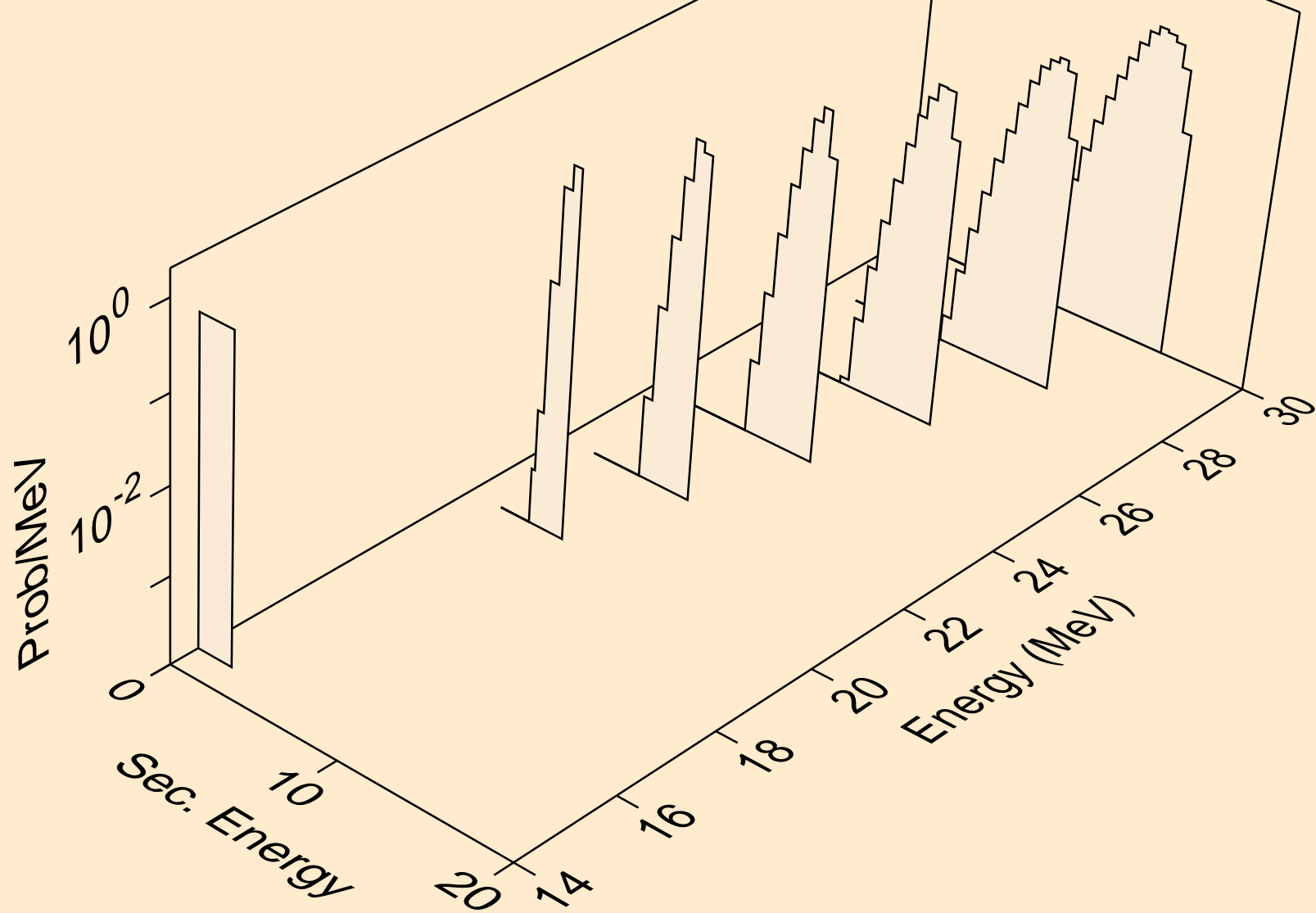

AG111 PROTON ACER TENDL-2021 LIBRARY; T=0.K  
he3s from (p,he3)

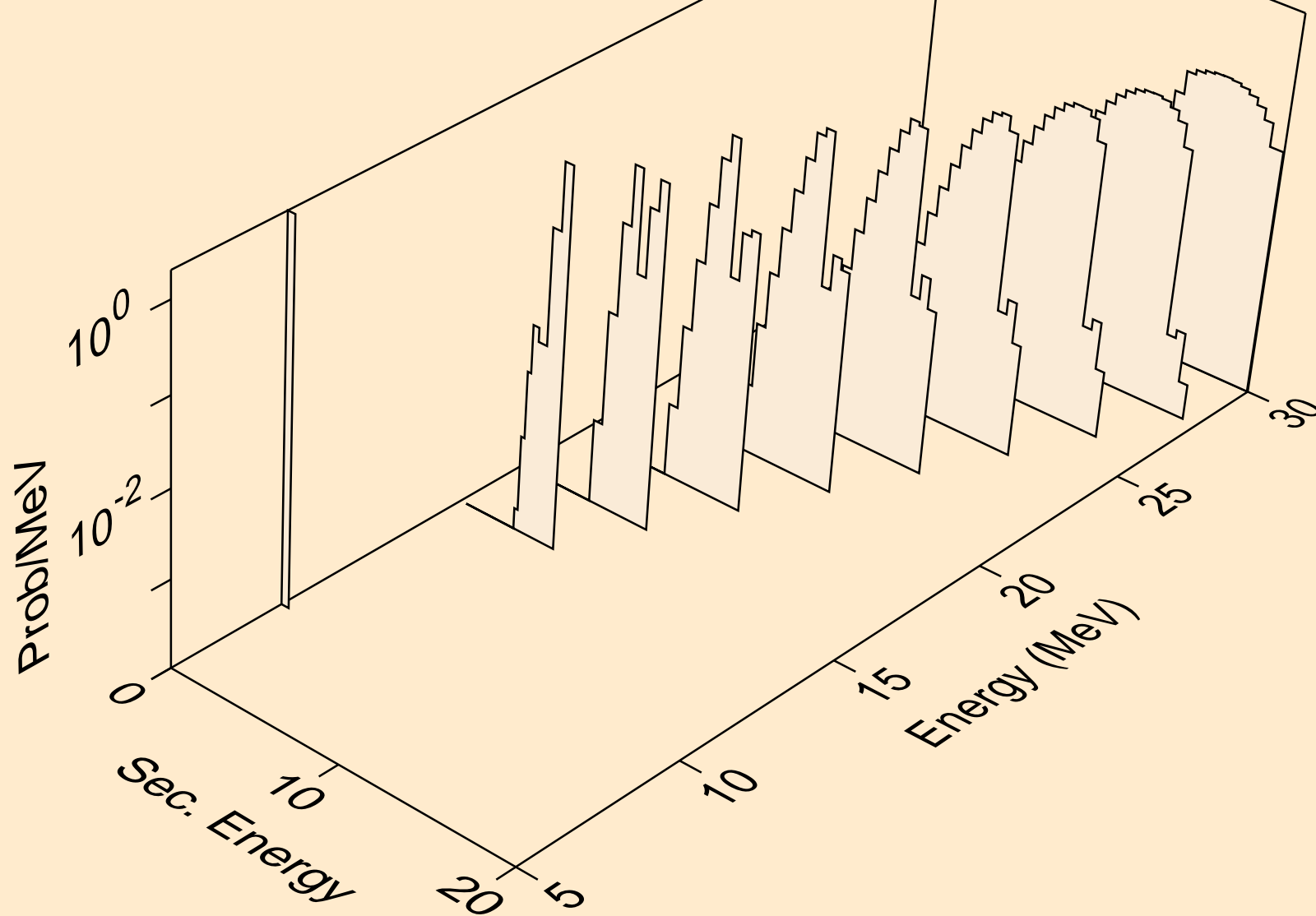

AG111 PROTON ACER TENDL-2021 LIBRARY; T=0.K  
alphas from (p,x)

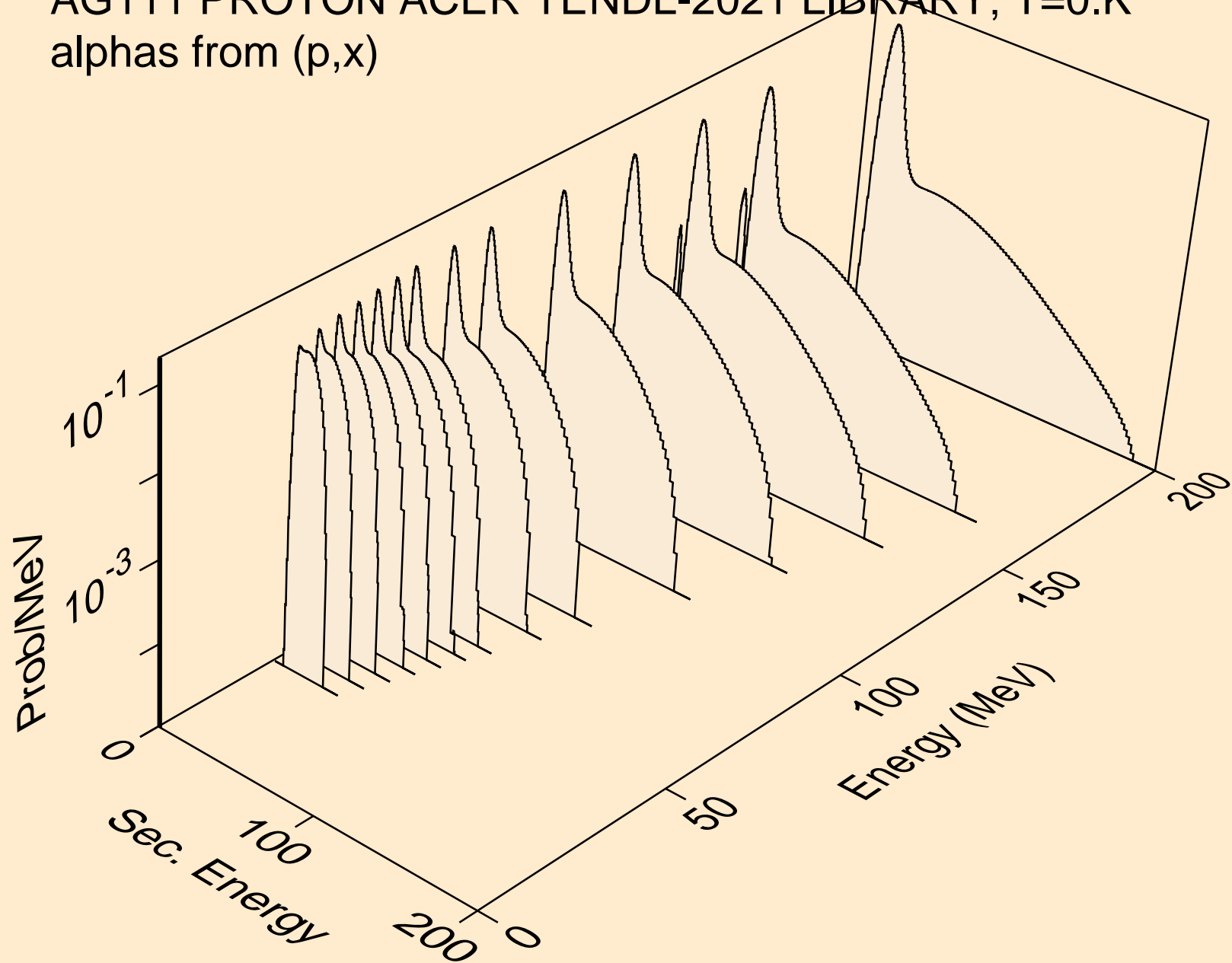

AG111 PROTON ACER TENDL-2021 LIBRARY; T=0.K  
alphas from (p,n\*)a

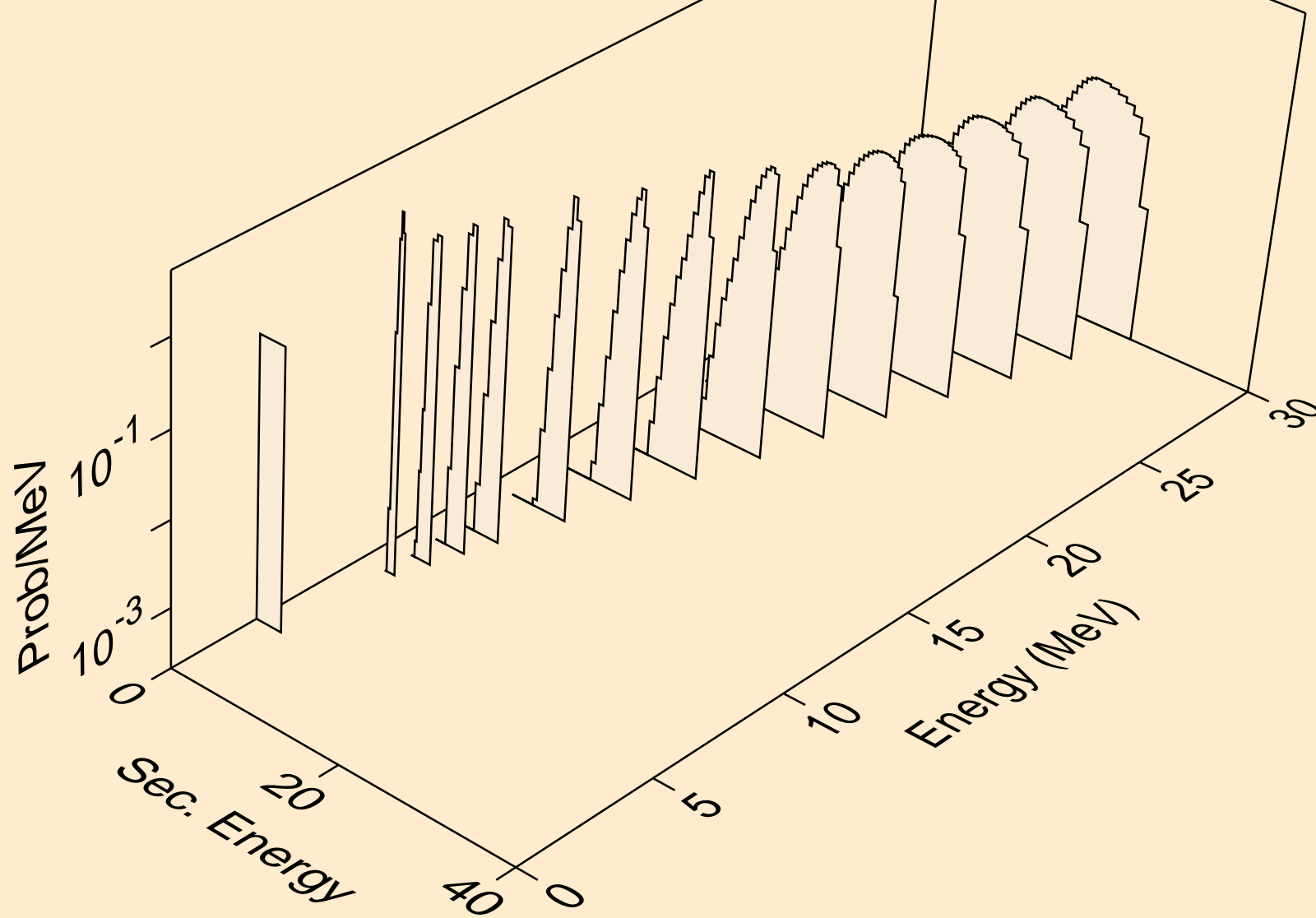

AG111 PROTON ACER TENDL-2021 LIBRARY; T=0.K  
alphas from (p,2n)a

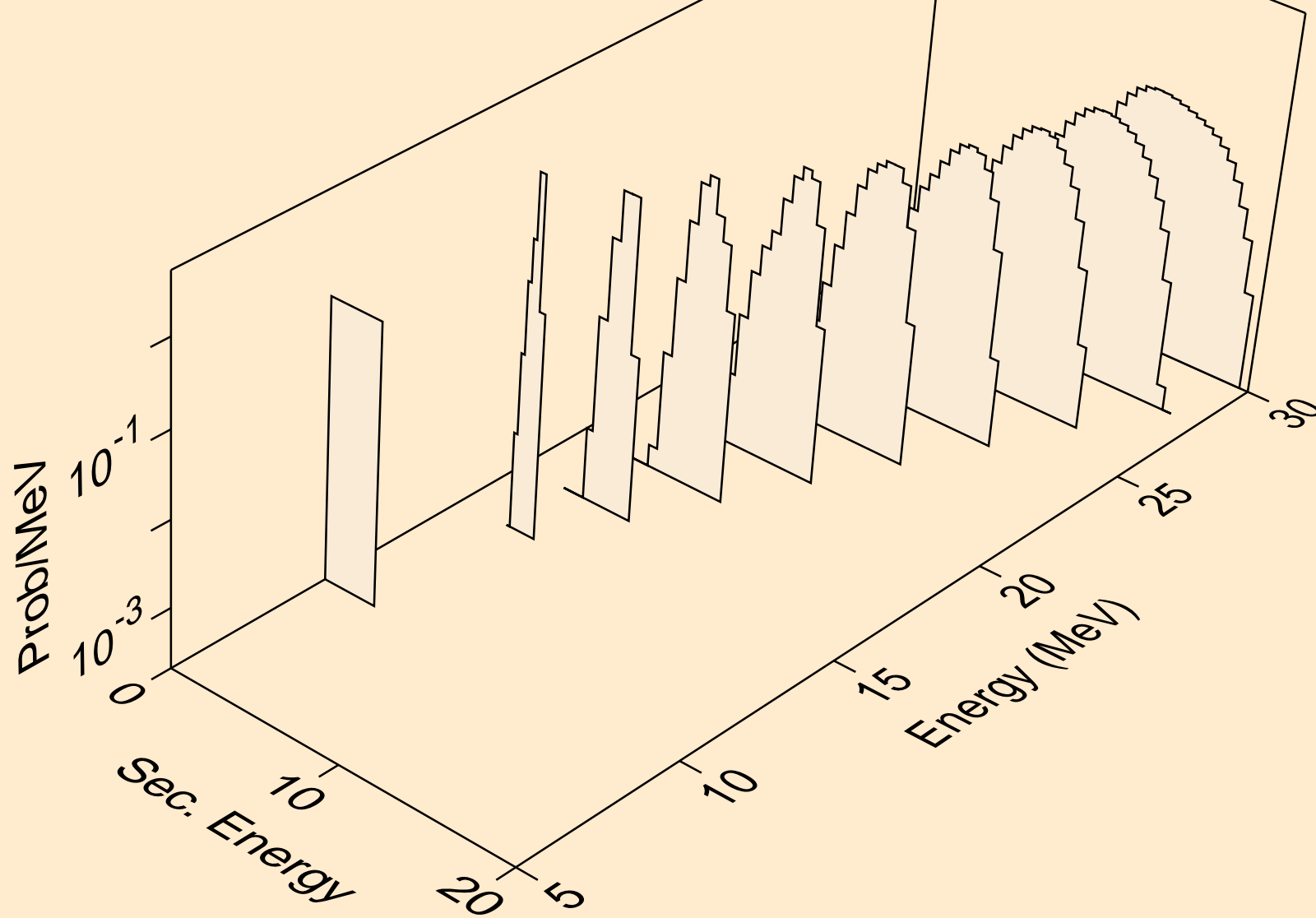

AG111 PROTON ACER TENDL-2021 LIBRARY; T=0.K  
alphas from (p,3n)a

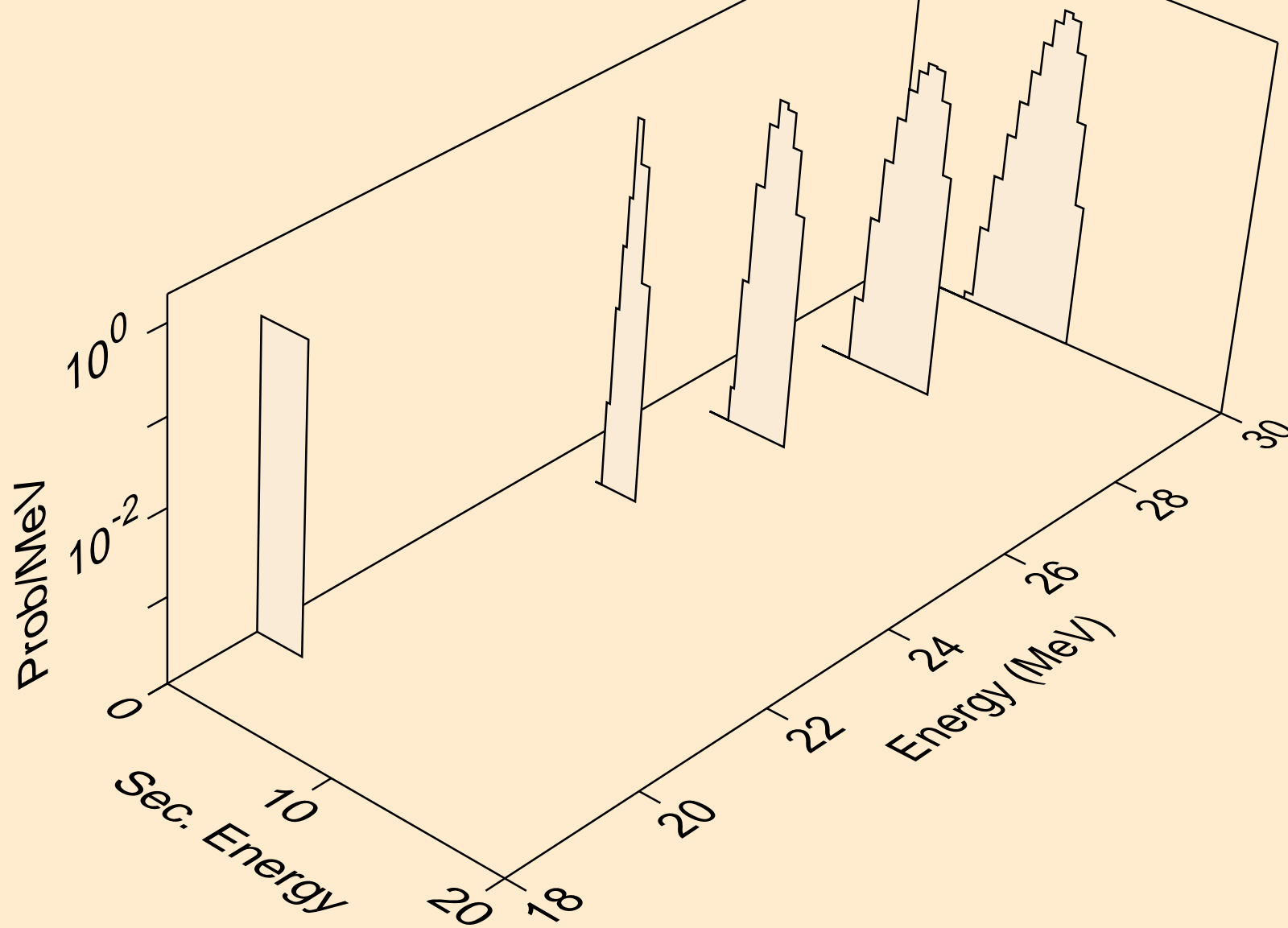

AG111 PROTON ACER TENDL-2021 LIBRARY; T=0.K  
alphas from (p,n\*)2a

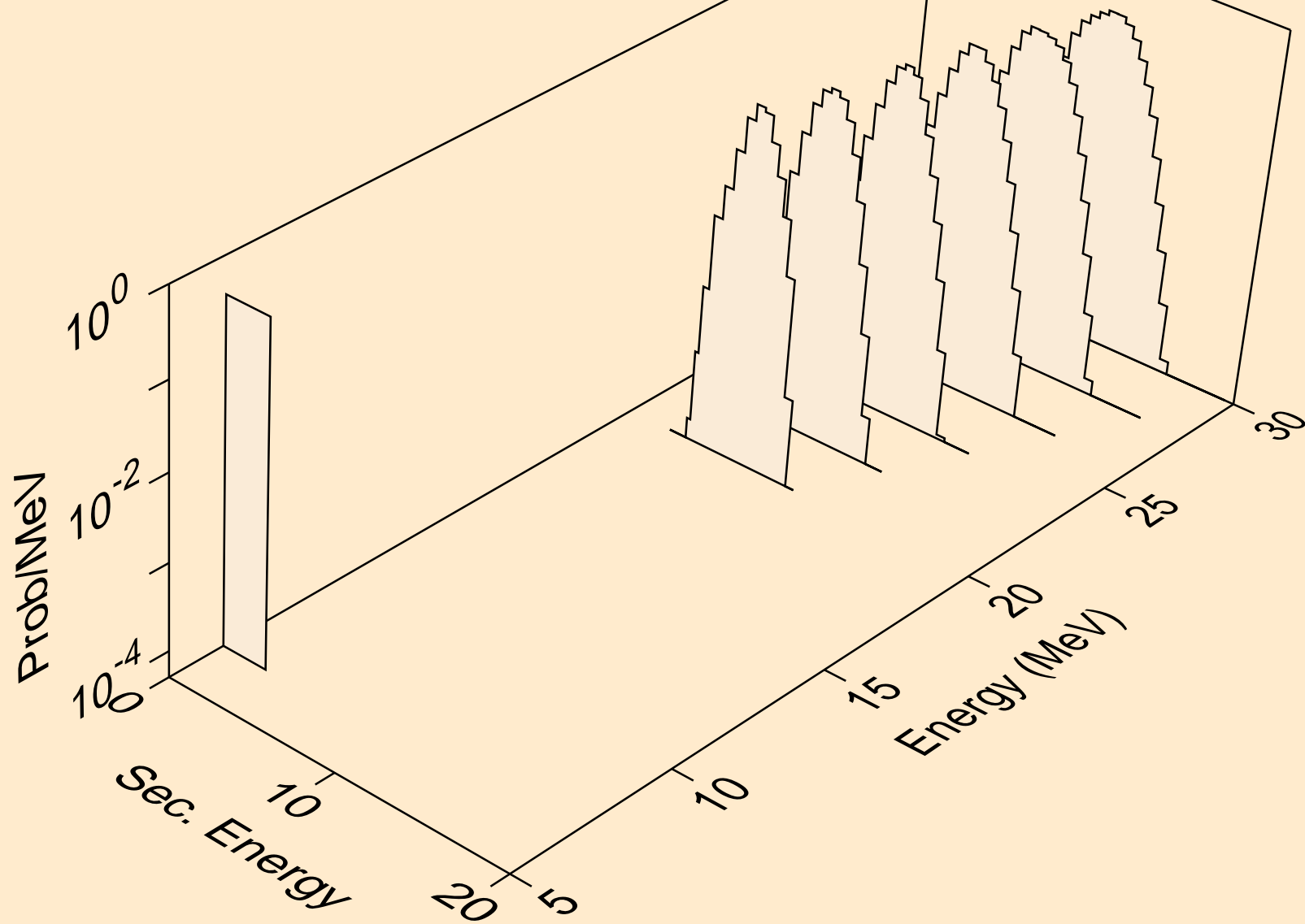

AG111 PROTON ACER TENDL-2021 LIBRARY; T=0.K  
alphas from (p,npa)

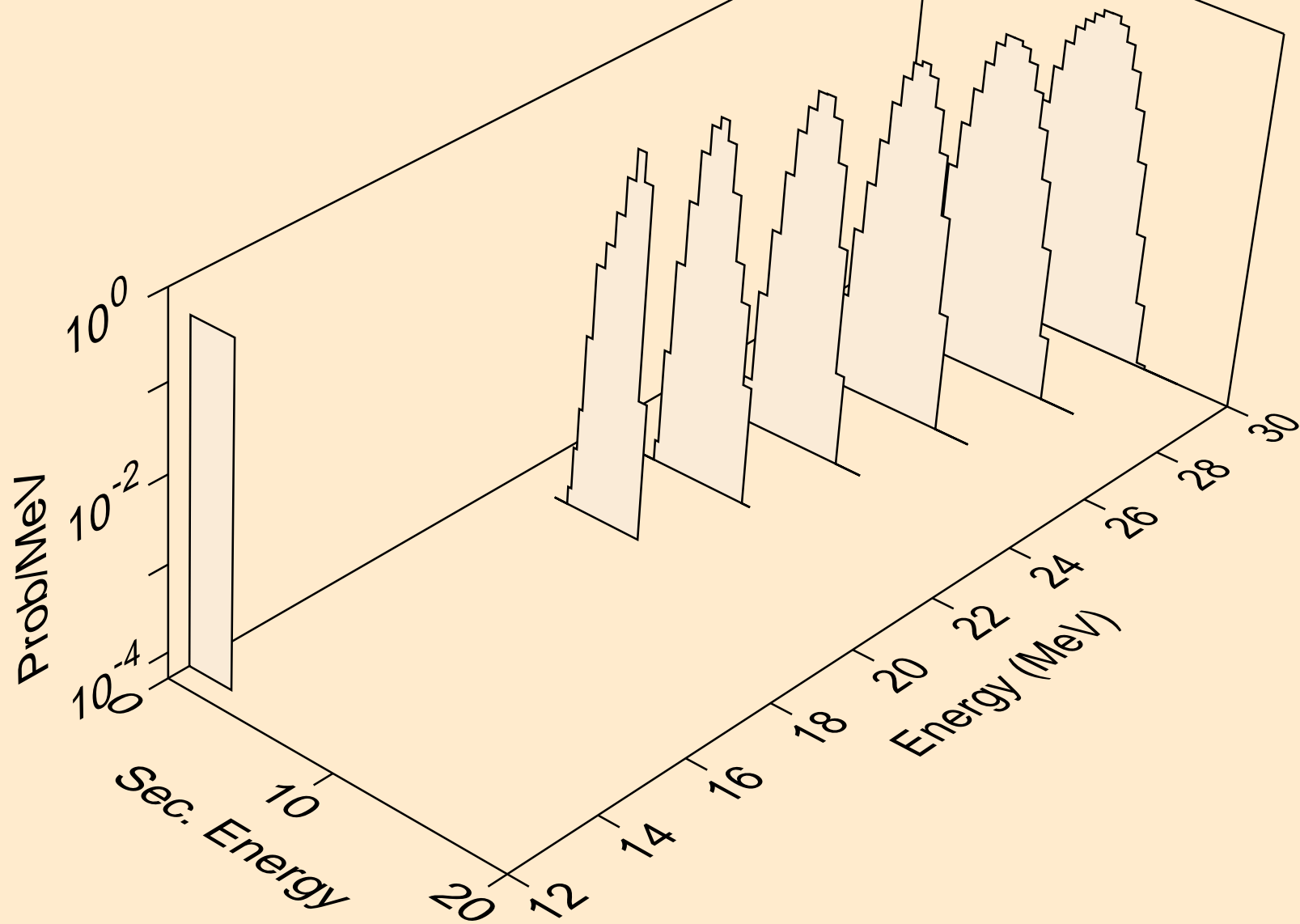

AG111 PROTON ACER TENDL-2021 LIBRARY; T=0.K  
alphas from (p,a)

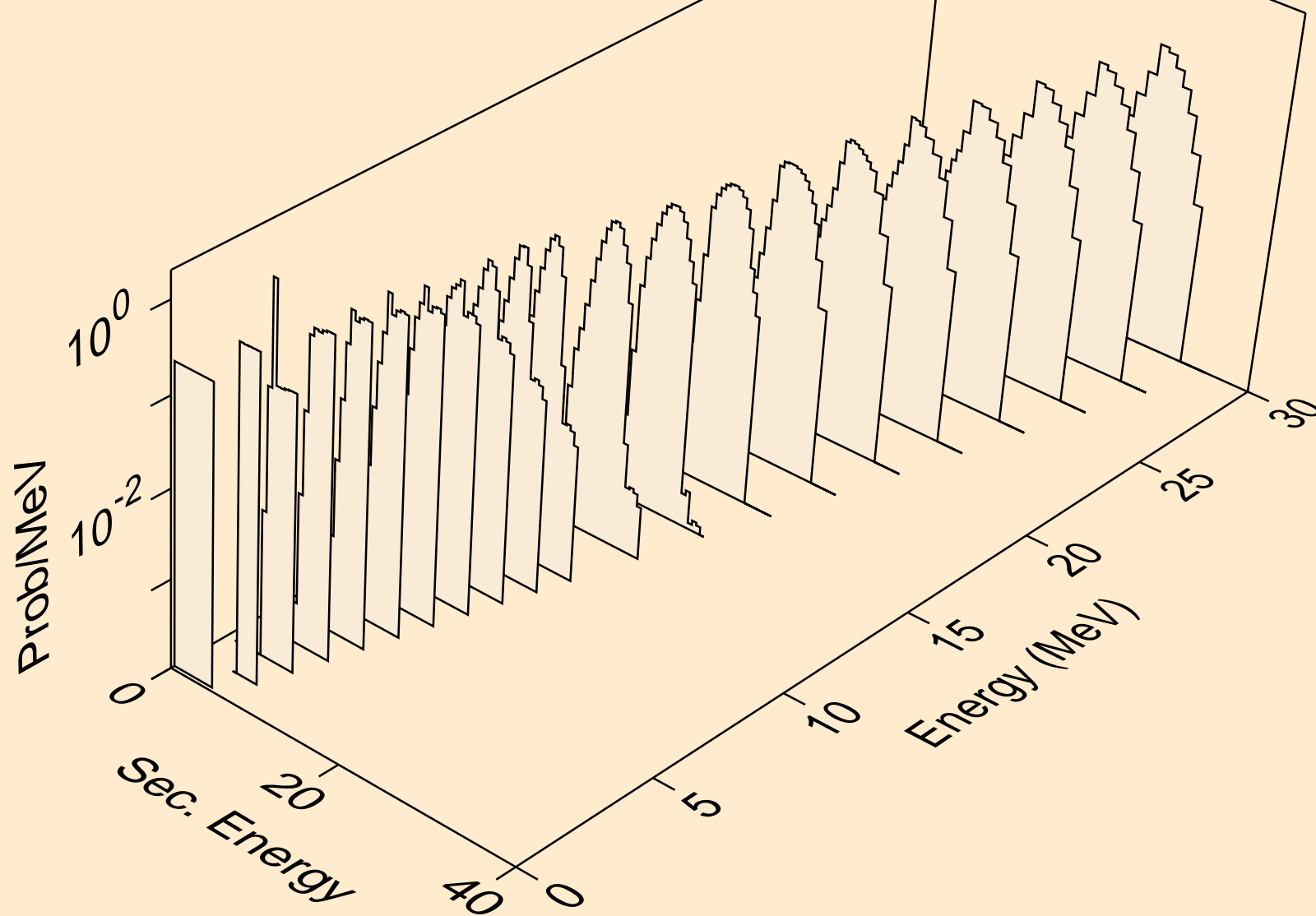

AG111 PROTON ACER TENDL-2021 LIBRARY; T=0.K  
alphas from (p,2a)

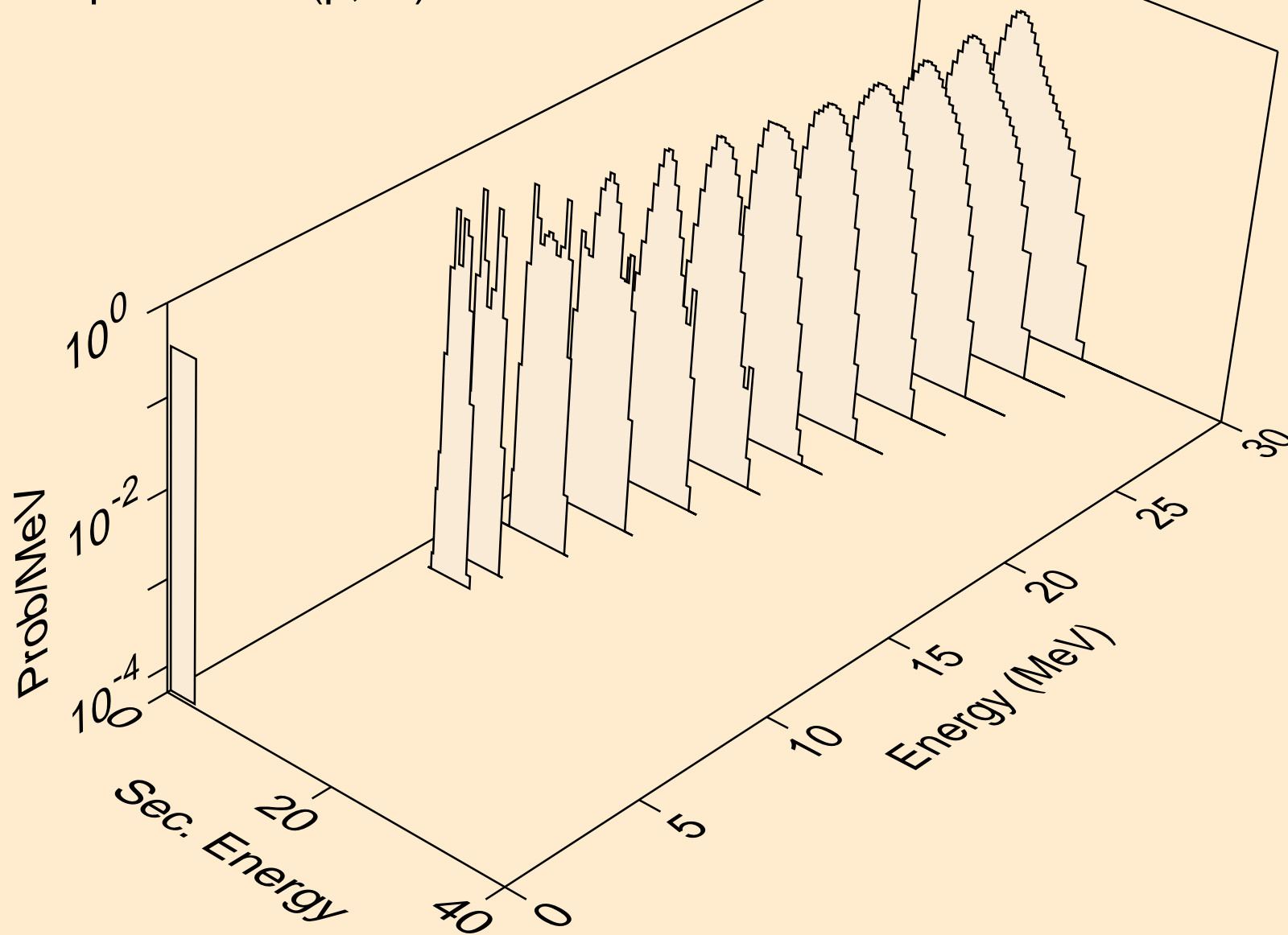

AG111 PROTON ACER TENDL-2021 LIBRARY; T=0.K  
alphas from (p,pa)

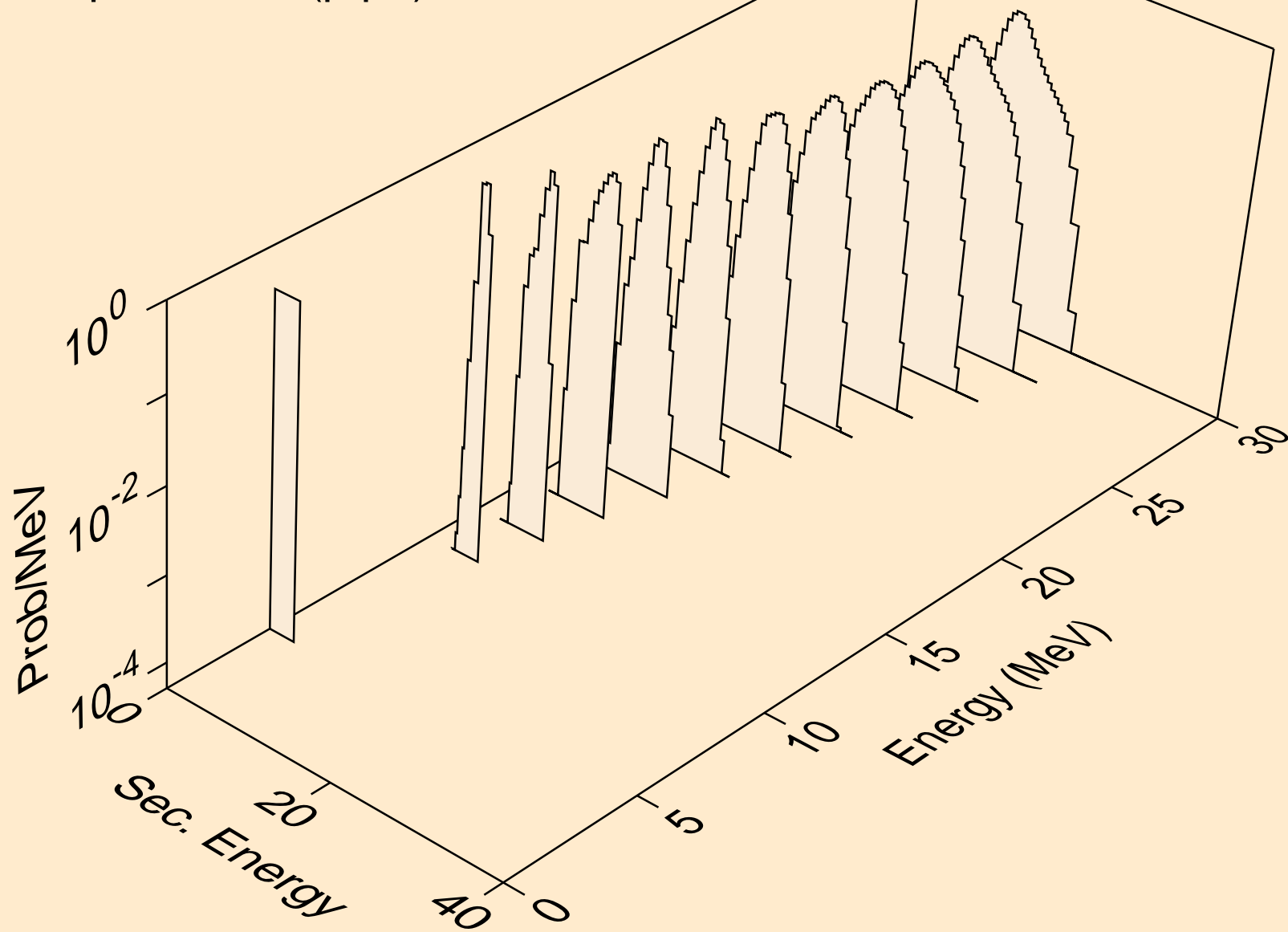

AG111 PROTON ACER TENDL-2021 LIBRARY; T=0.K  
alphas from (p,da)

