

MD250 PROTON ACER TENDL-2021 LIBRARY; T=0.K
Principal cross sections

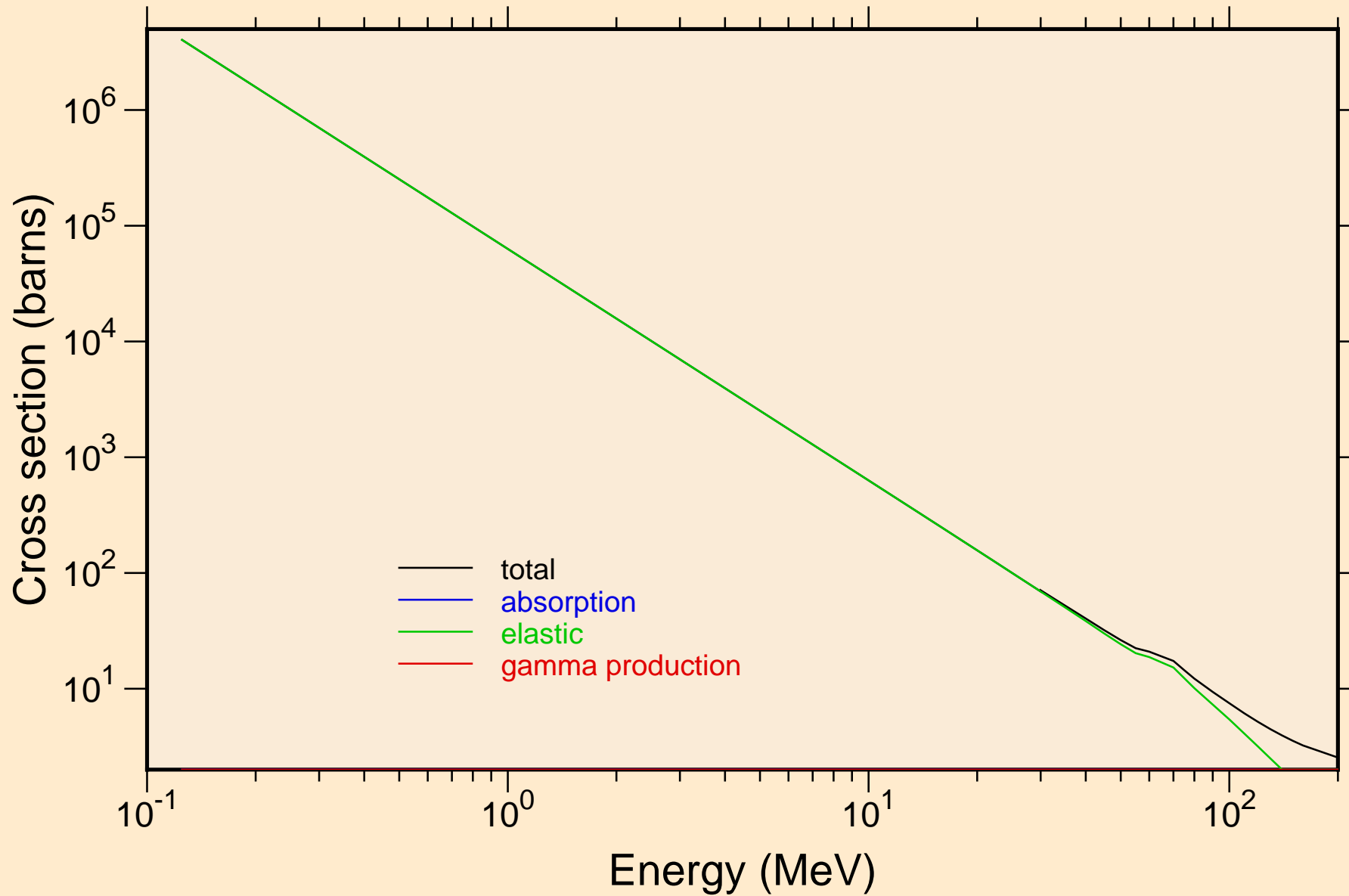

MD250 PROTON ACER TENDL-2021 LIBRARY; T=0.K

Heating

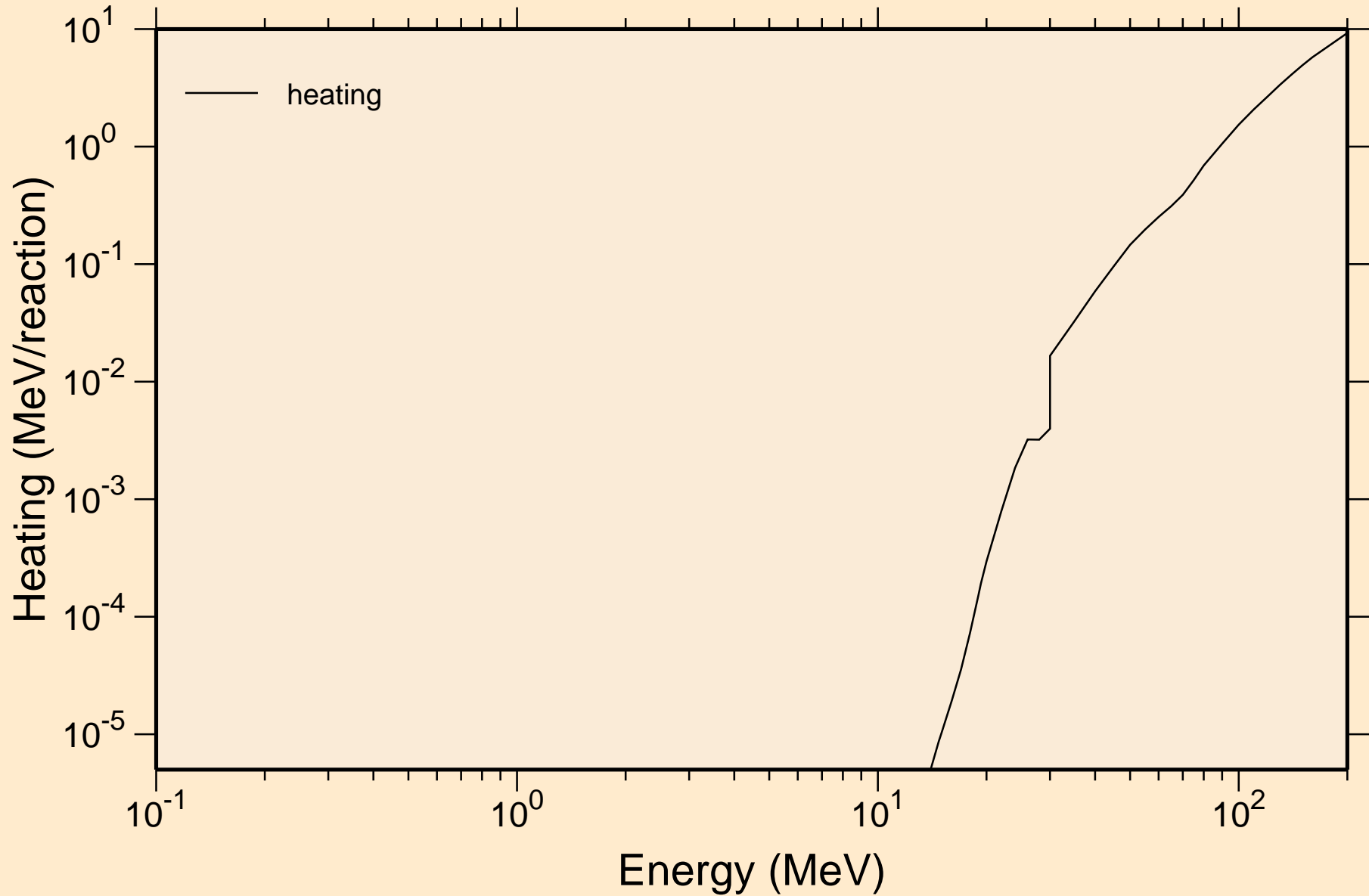

MD250 PROTON ACER TENDL-2021 LIBRARY; T=0.K

Principal cross sections

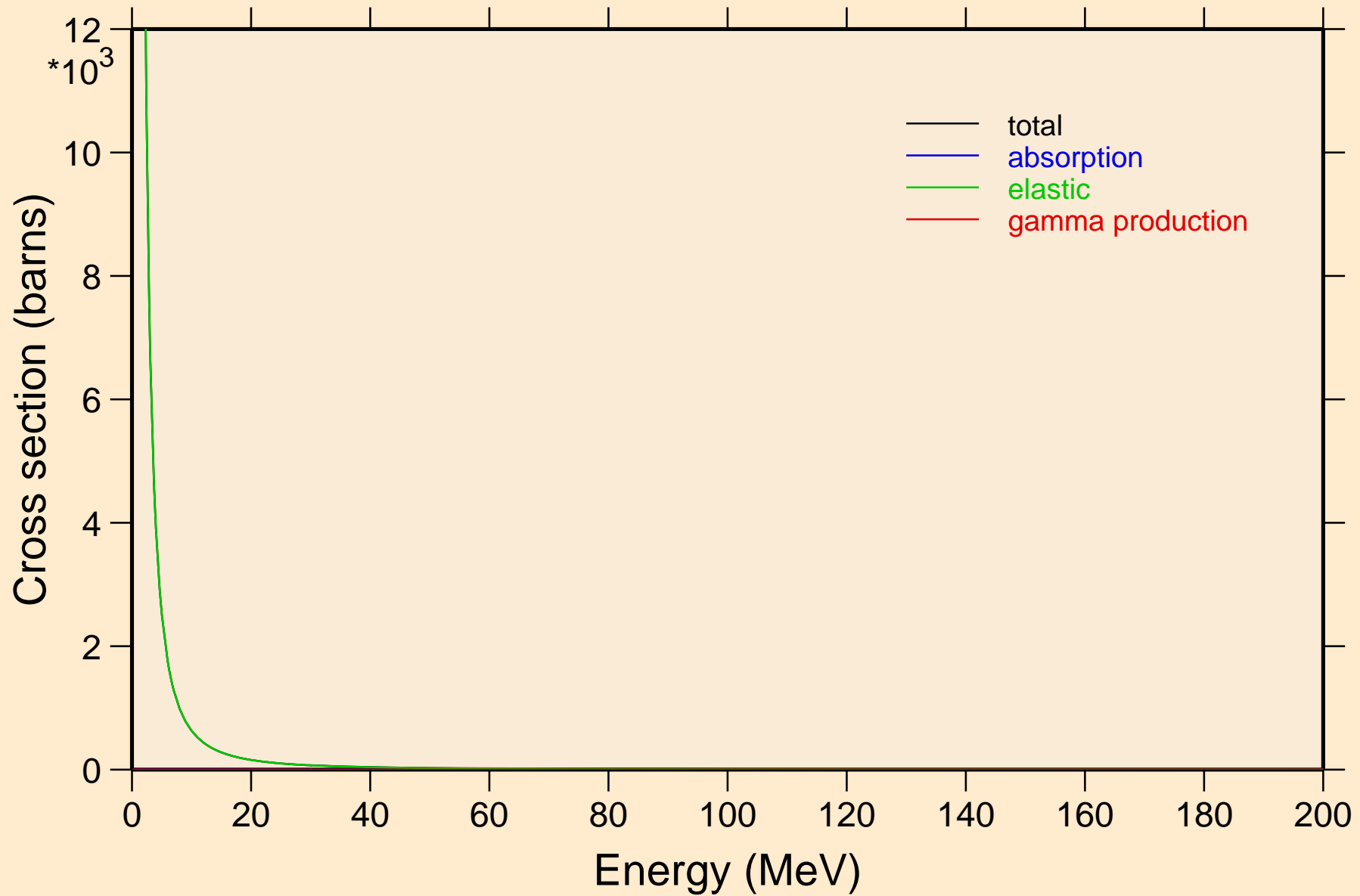

MD250 PROTON ACER TENDL-2021 LIBRARY; T=0.K

Heating

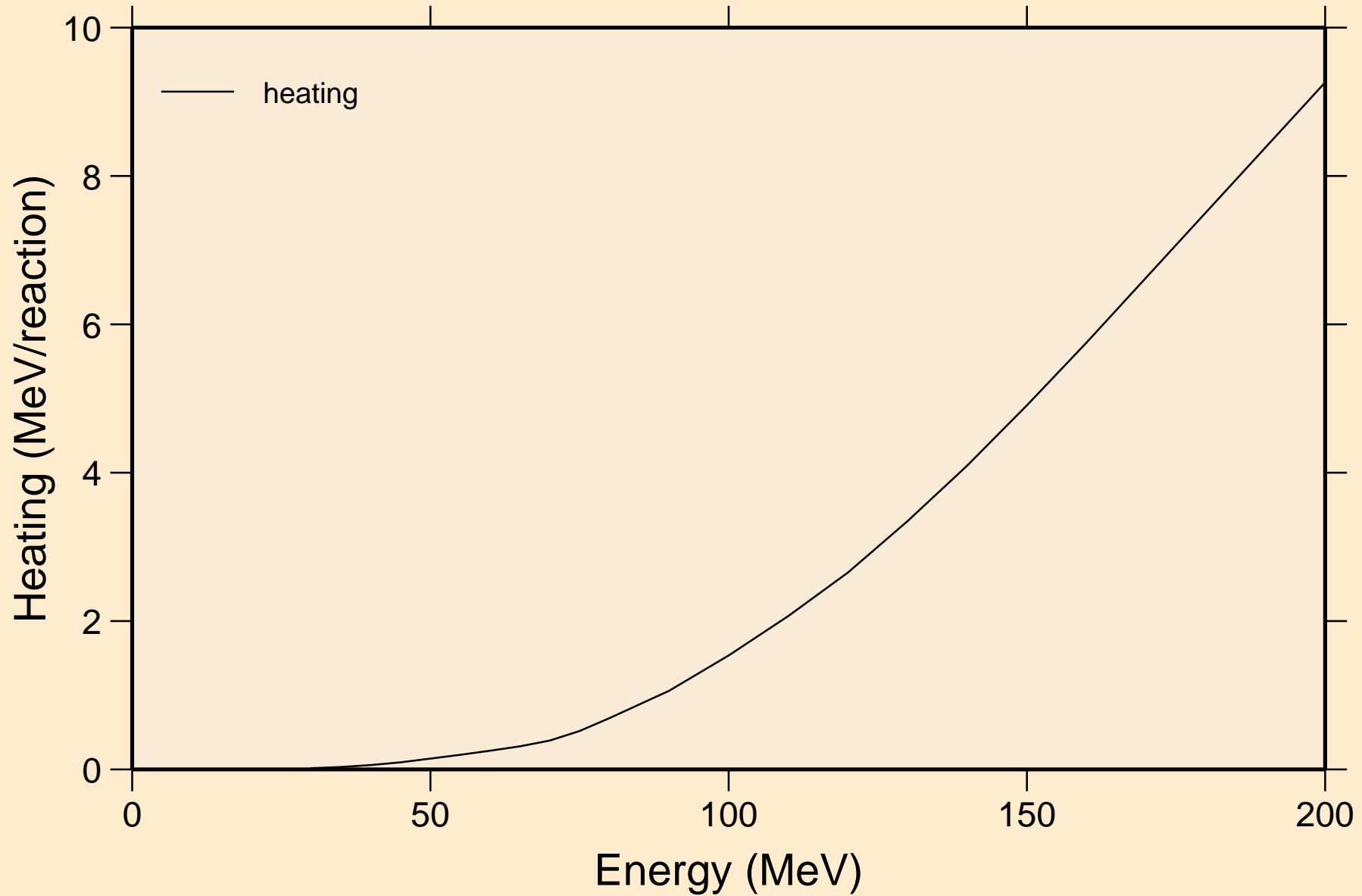

MD250 PROTON ACER TENDL-2021 LIBRARY; T=0.K
Threshold reactions

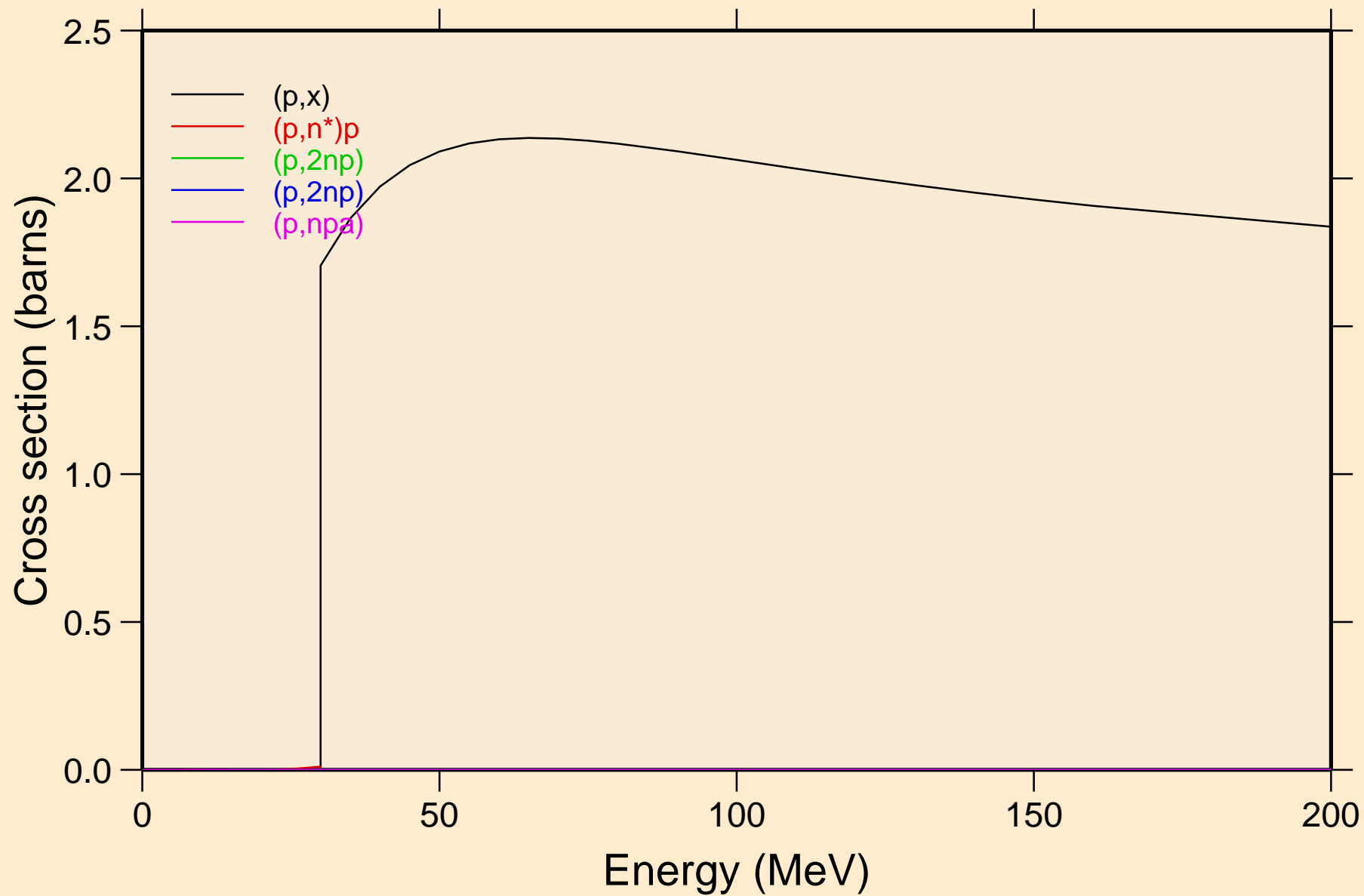

MD250 PROTON ACER TENDL-2021 LIBRARY; T=0.K
Threshold reactions

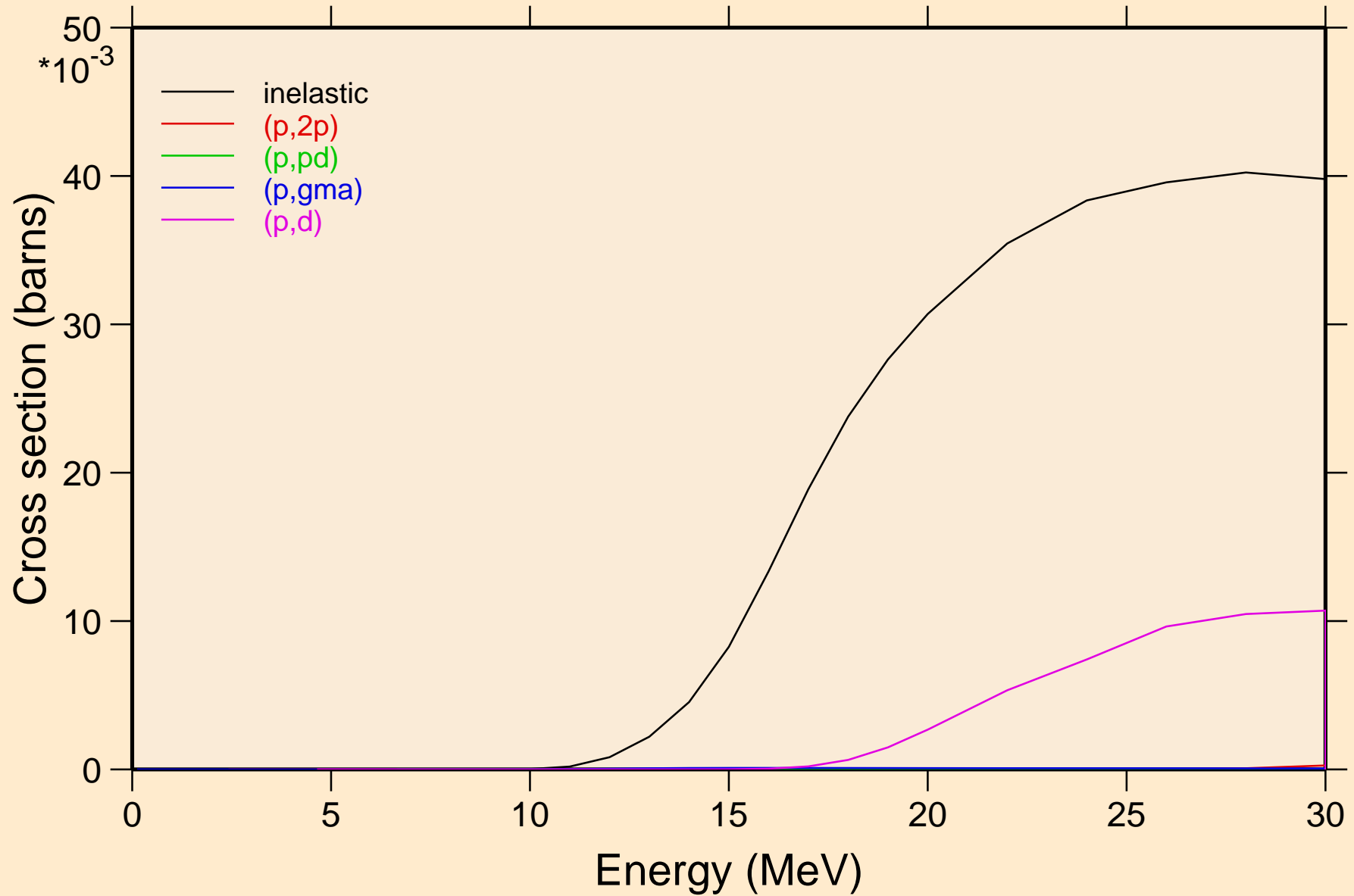

MD250 PROTON ACER TENDL-2021 LIBRARY; T=0.K
Threshold reactions

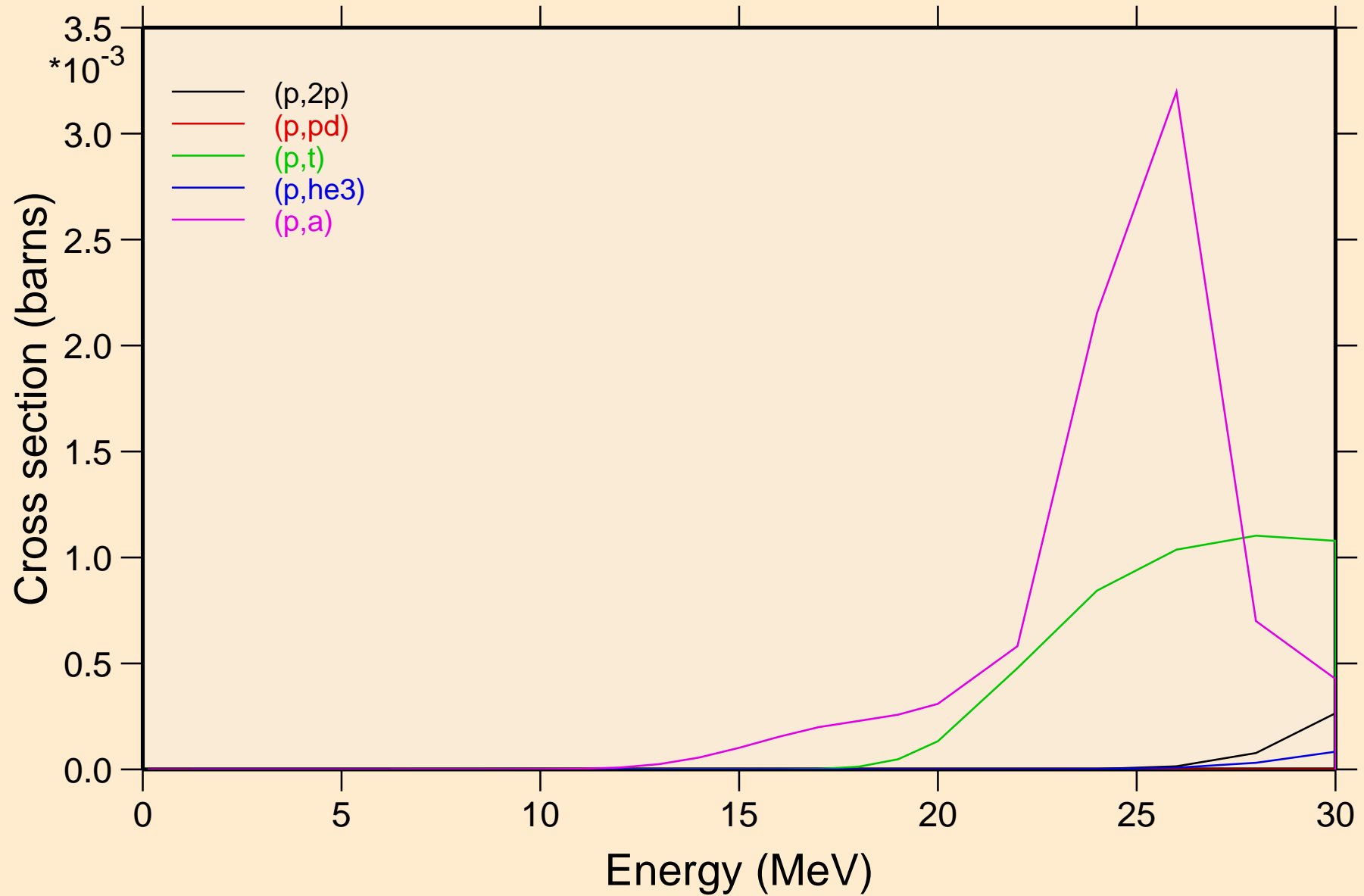

MD250 PROTON ACER TENDL-2021 LIBRARY; T=0.K
Threshold reactions

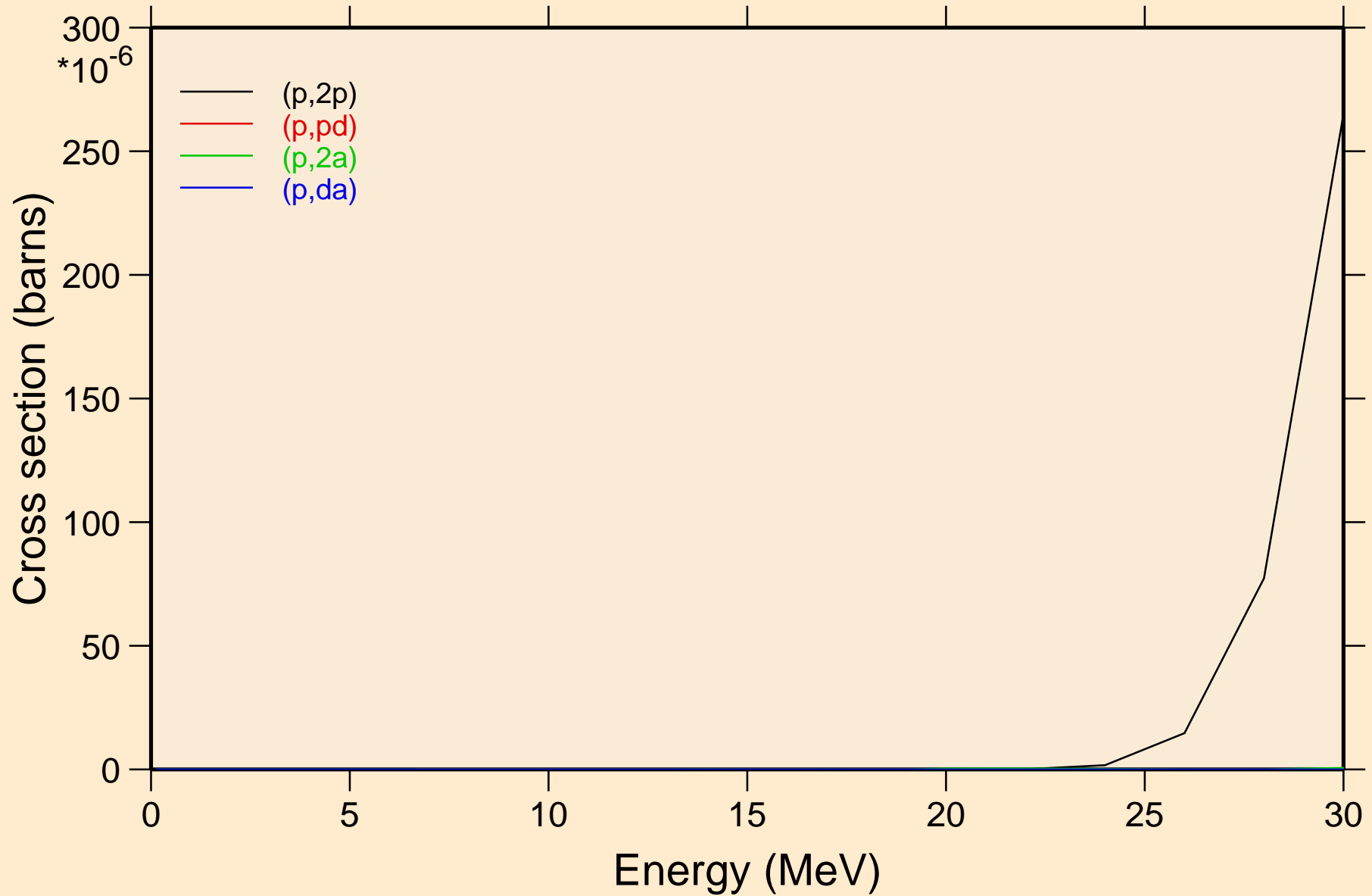

MD250 PROTON ACER TENDL-2021 LIBRARY; T=0.K
angular distribution for elastic

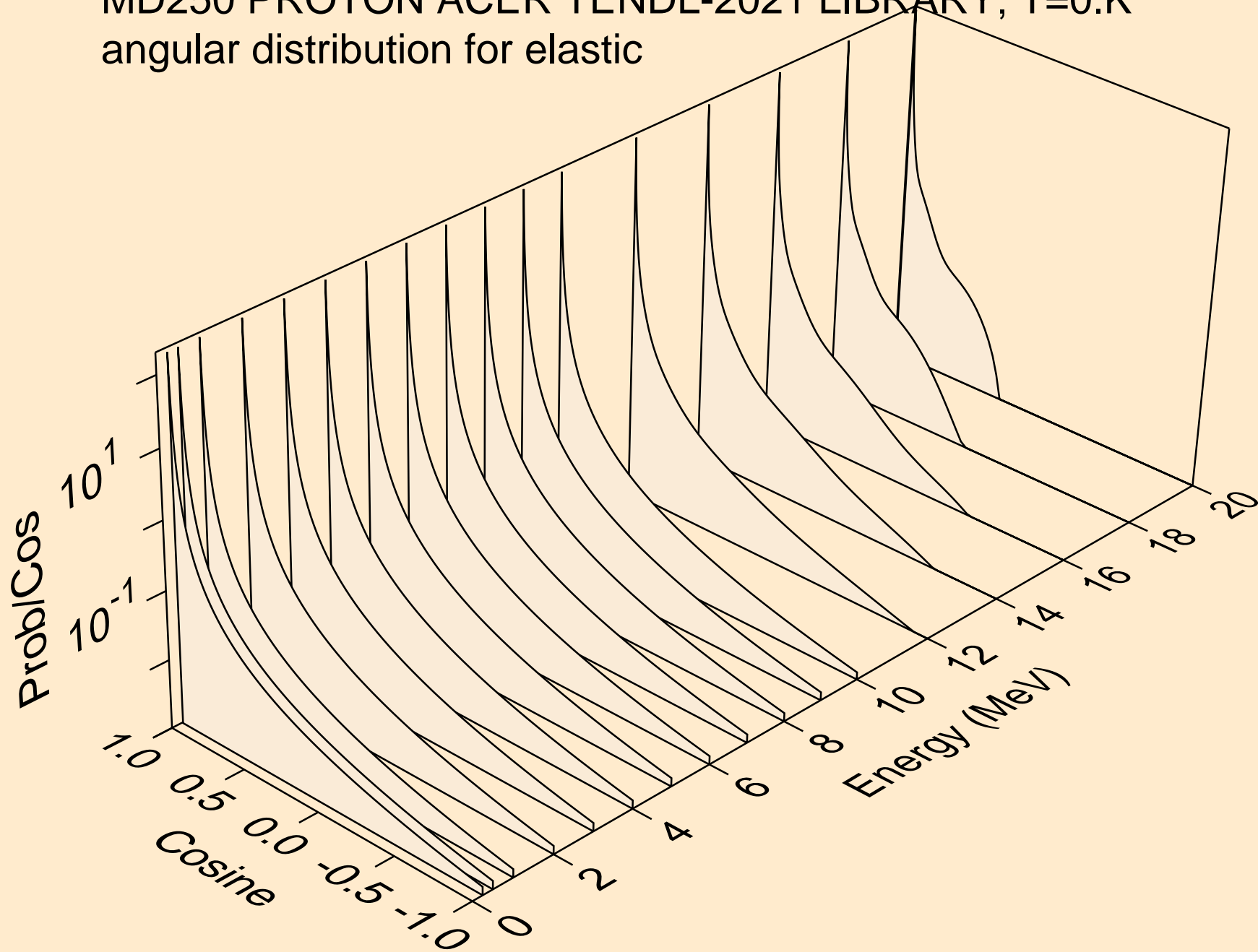

MD250 PROTON ACER TENDL-2021 LIBRARY; T=0.K
angular distribution for elastic

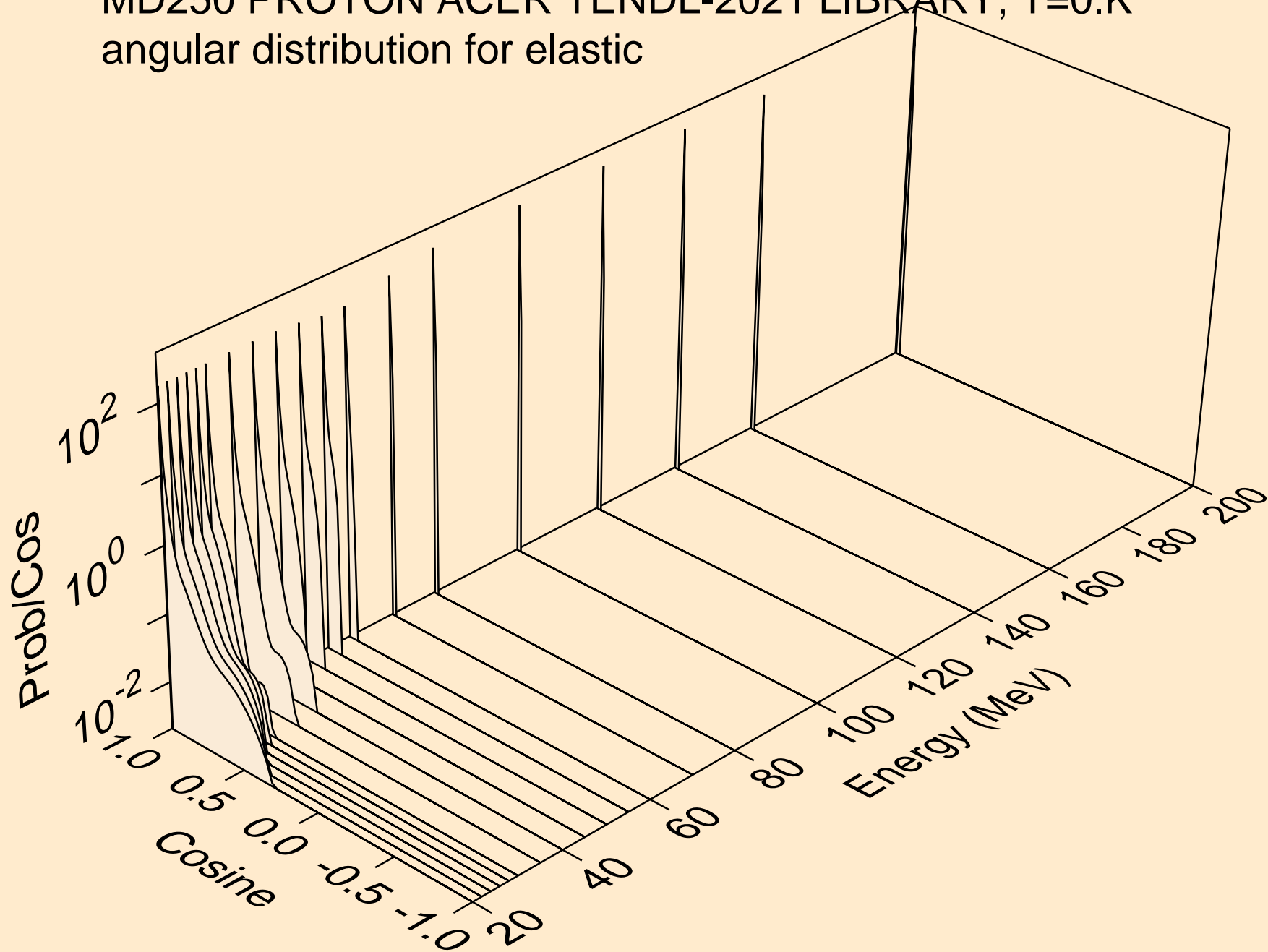

MD250 PROTON ACER TENDL-2021 LIBRARY; T=0.K
Proton emission for (p,x)

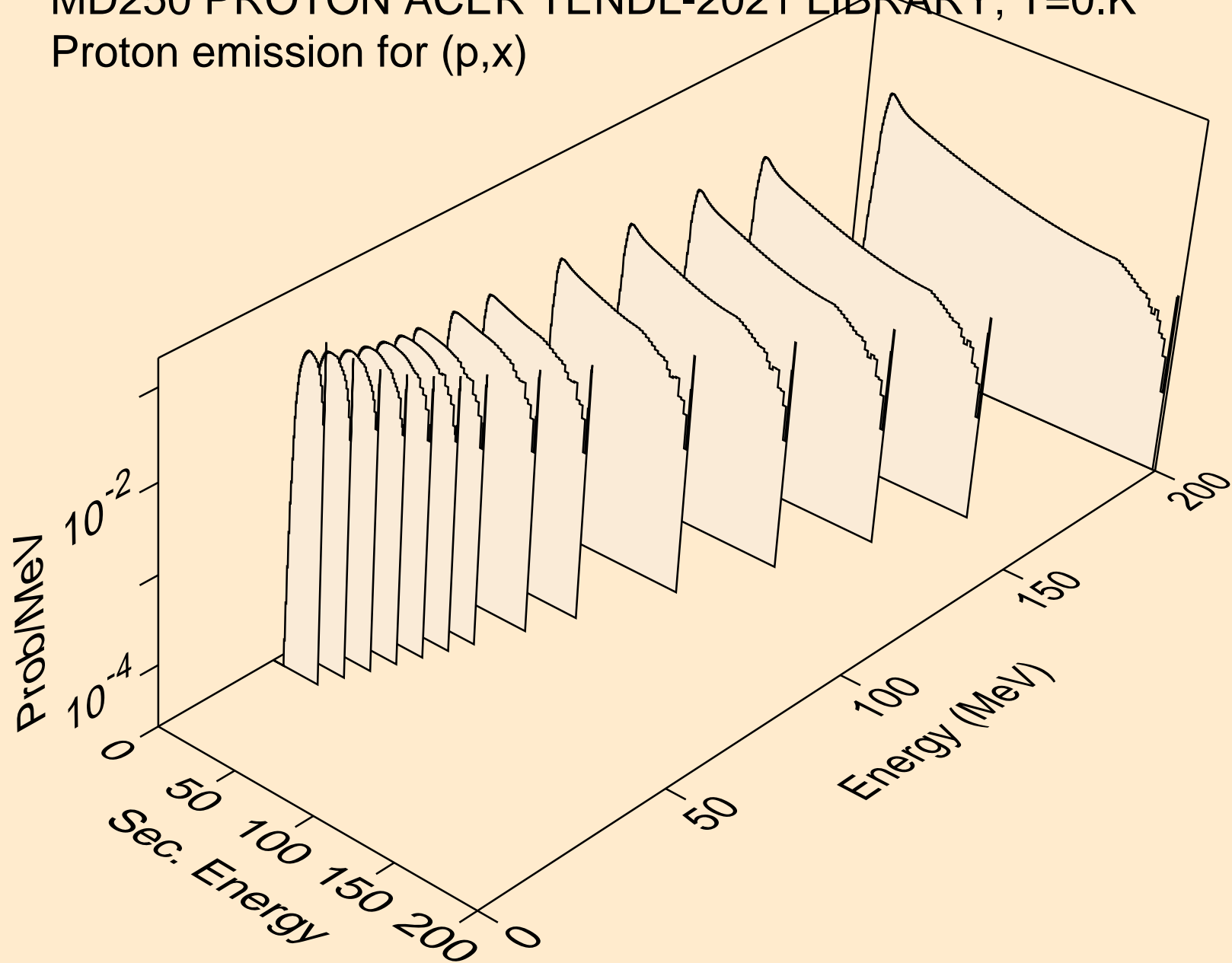

MD250 PROTON ACER TENDL-2021 LIBRARY; T=0.K
Proton emission for (p,n*)p

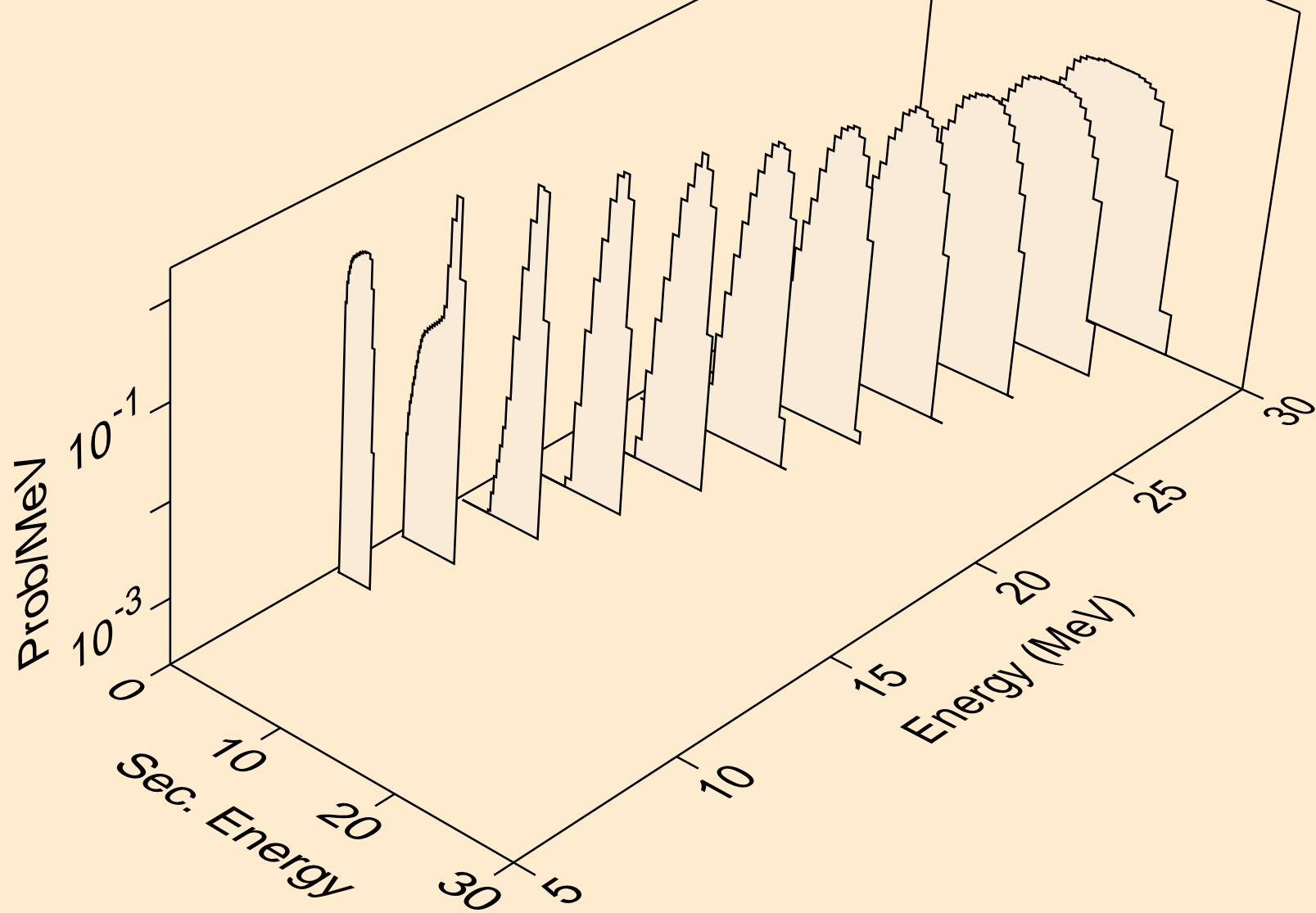

MD250 PROTON ACER TENDL-2021 LIBRARY; T=0.K
Proton emission for (p,2np)

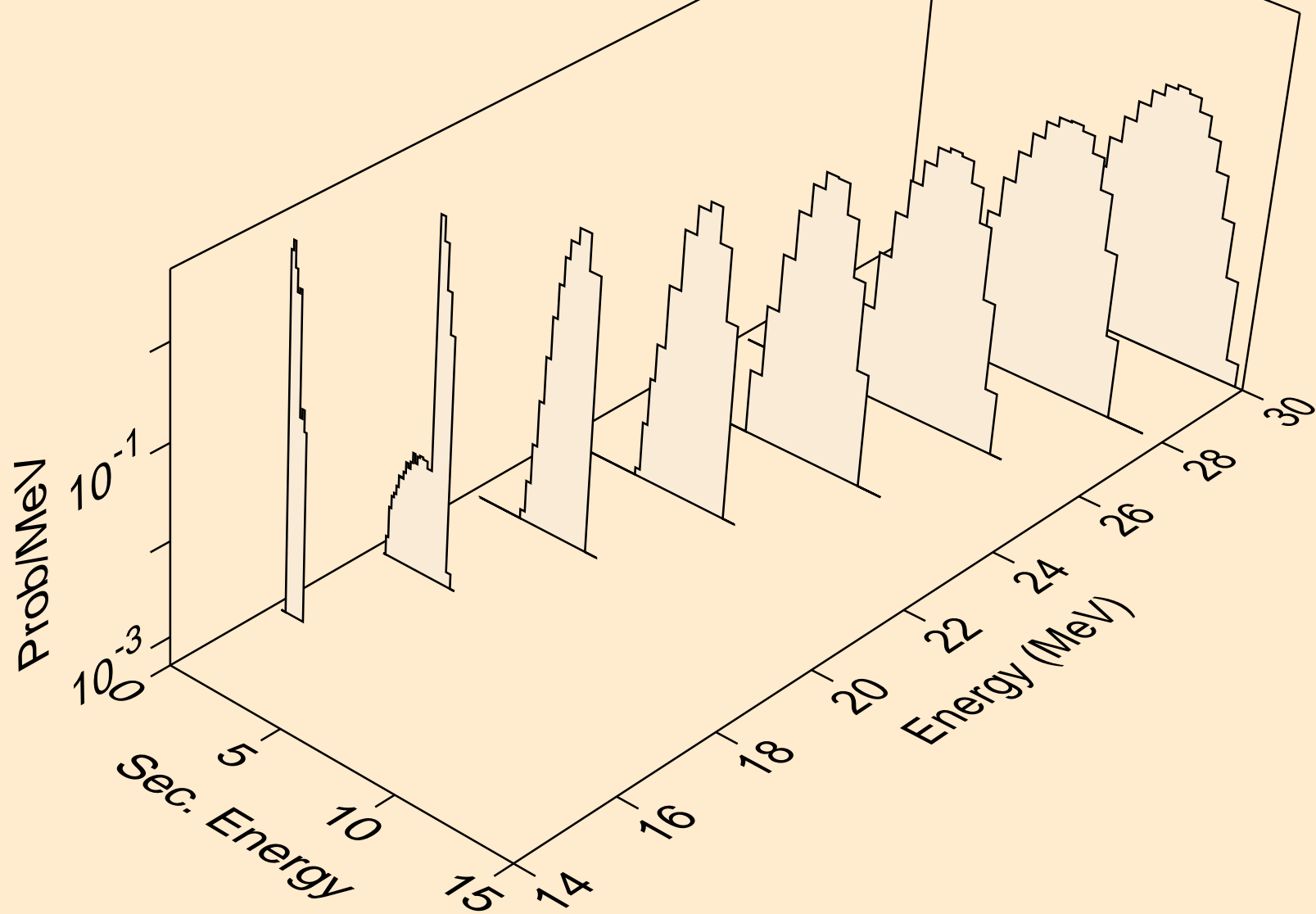

MD250 PROTON ACER TENDL-2021 LIBRARY; T=0.K
Proton emission for (p,2np)

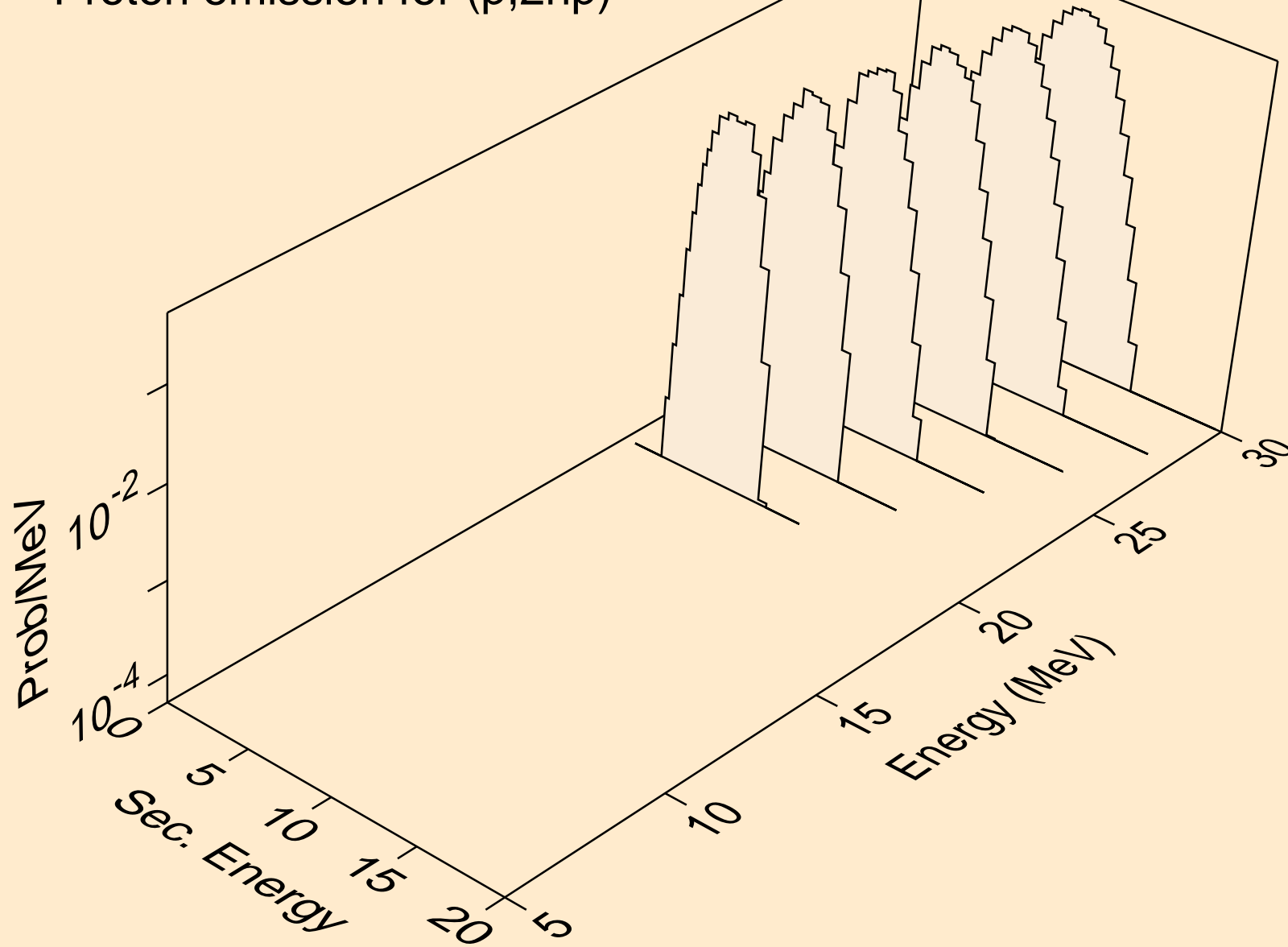

MD250 PROTON ACER TENDL-2021 LIBRARY; T=0.K
Proton emission for (p,npa)

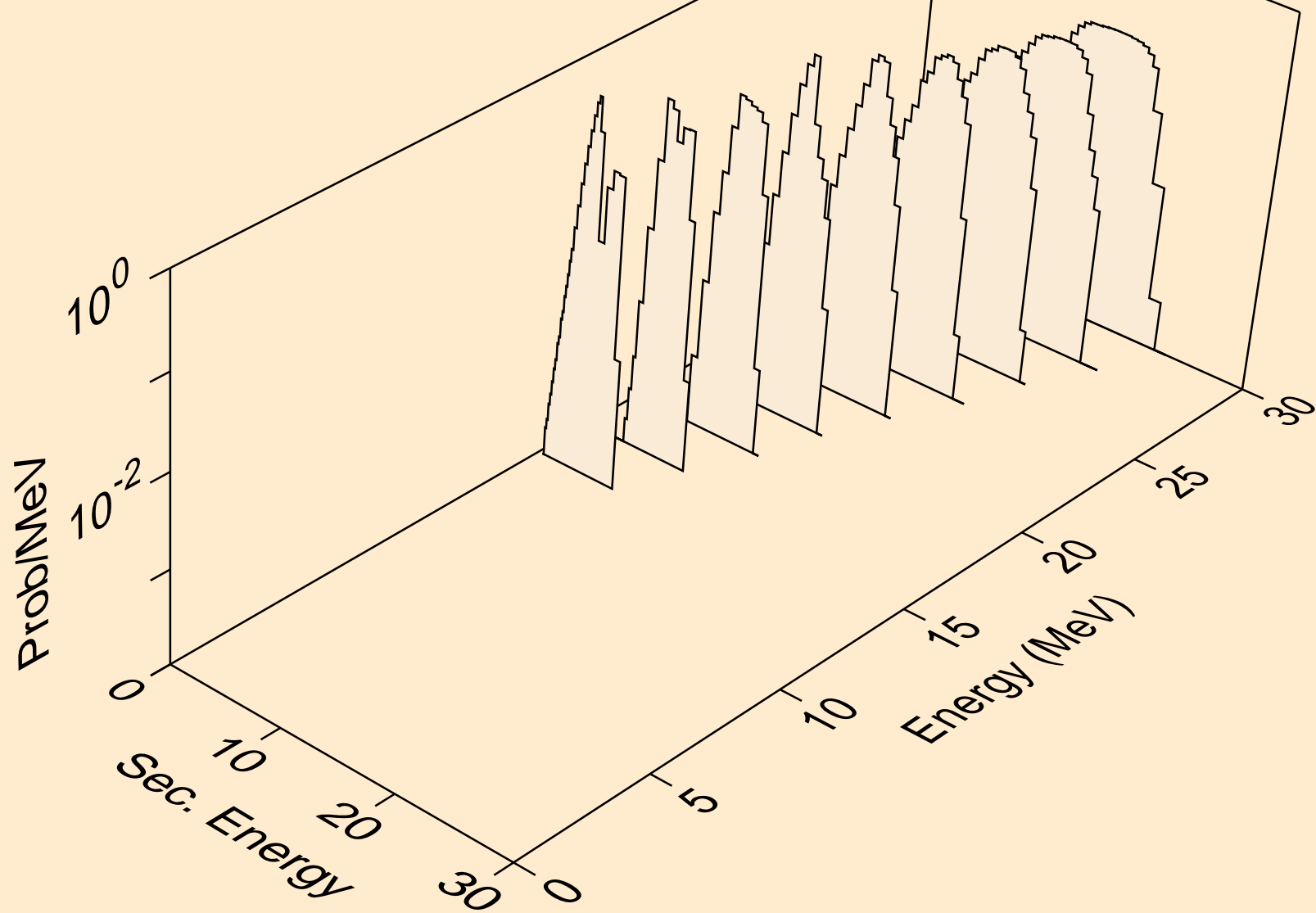

MD250 PROTON ACER TENDL-2021 LIBRARY; T=0.K
Proton emission for inelastic

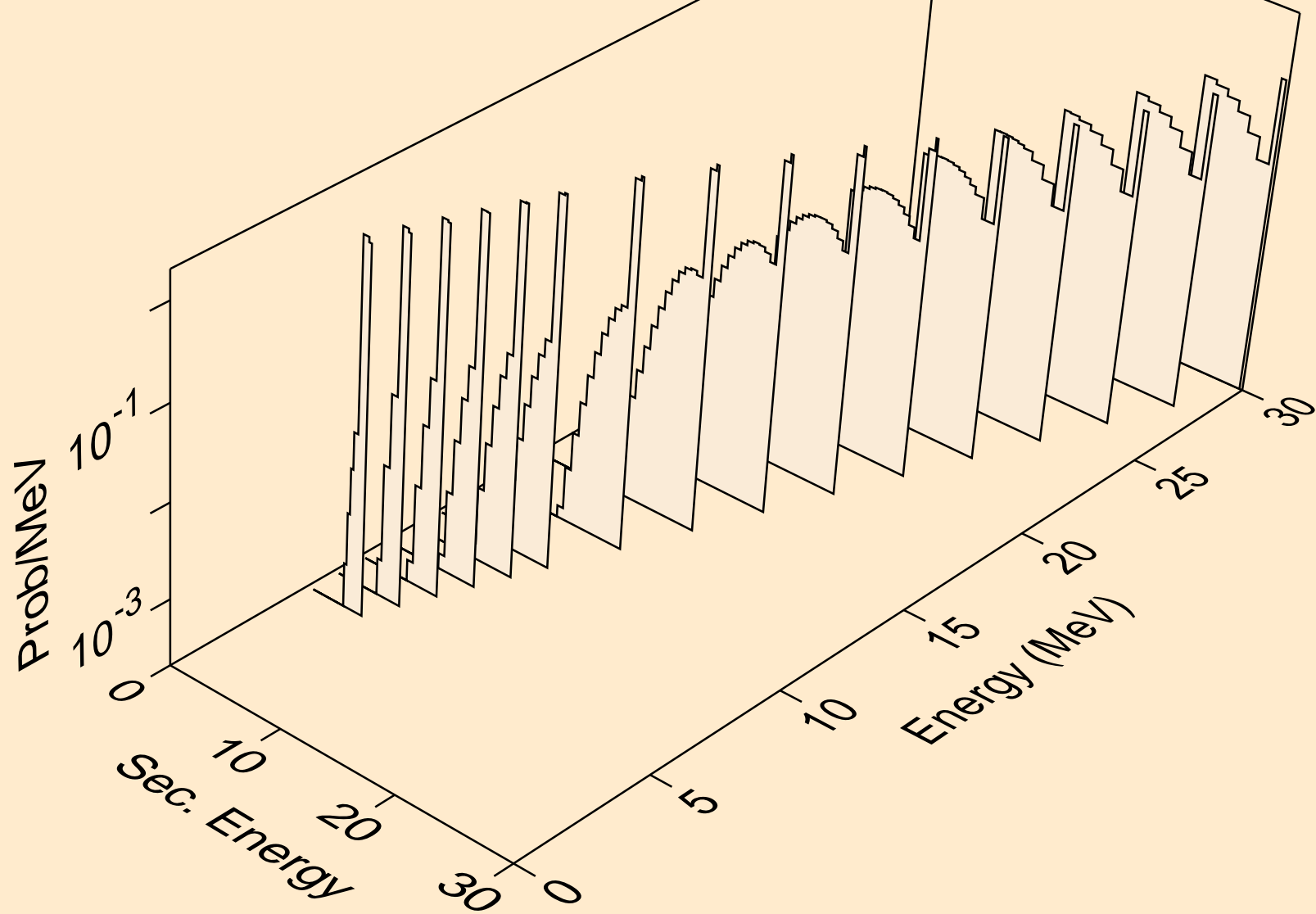

MD250 PROTON ACER TENDL-2021 LIBRARY; T=0.K
Proton emission for (p,2p)

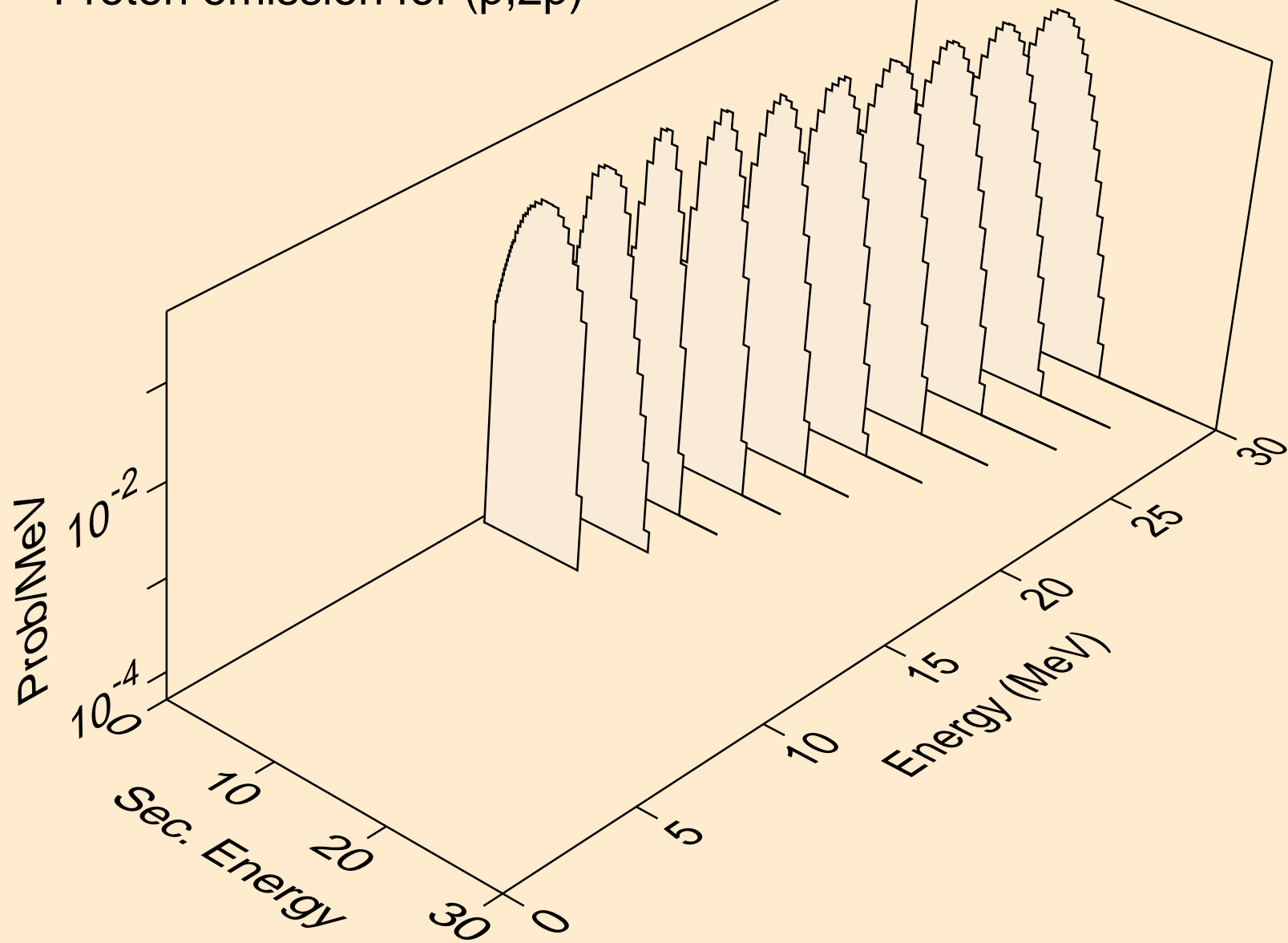

MD250 PROTON ACER TENDL-2021 LIBRARY; T=0.K
Proton emission for (p,pd)

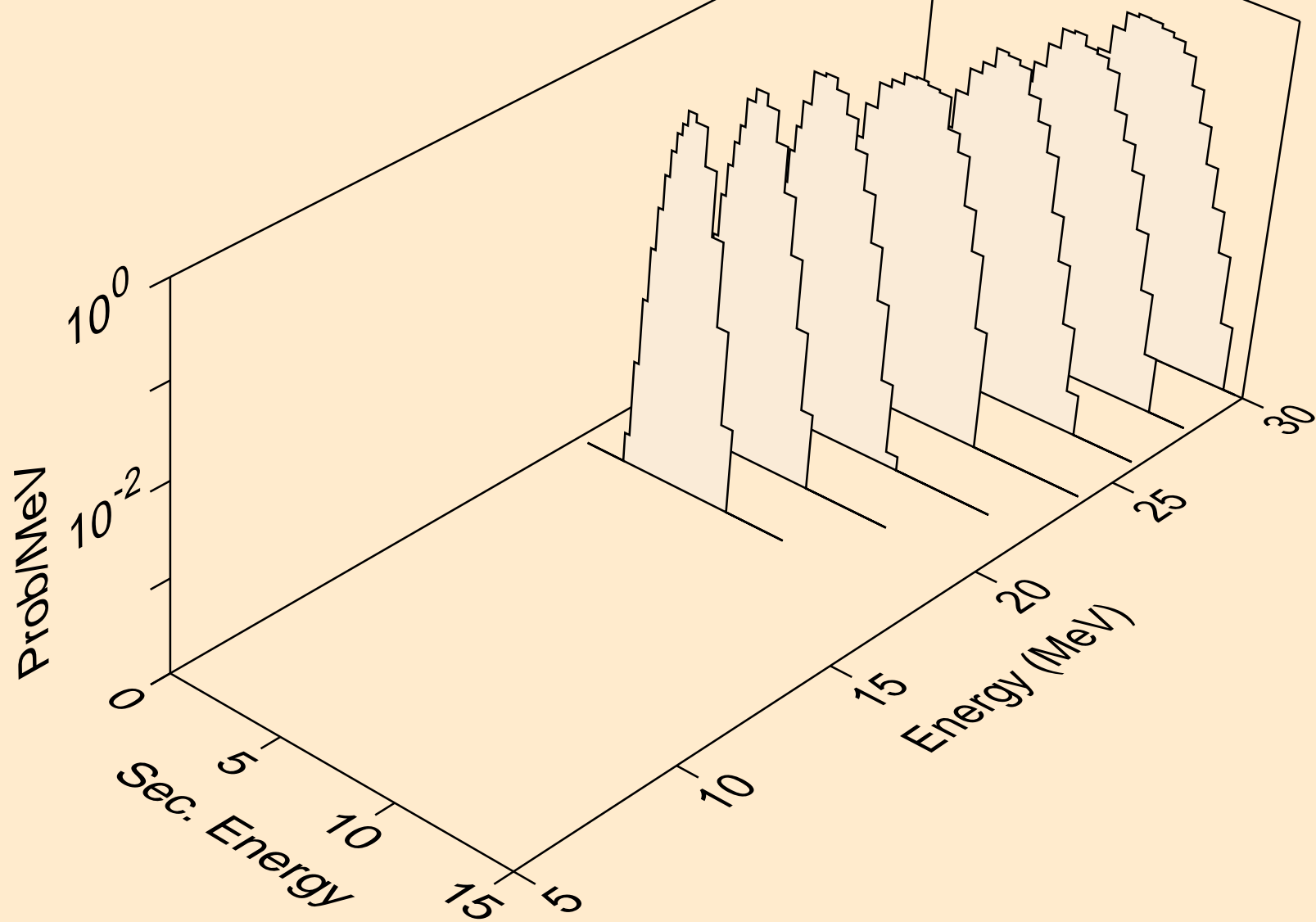

MD250 PROTON ACER TENDL-2021 LIBRARY; T=0.K
Photon emission for (z,n)

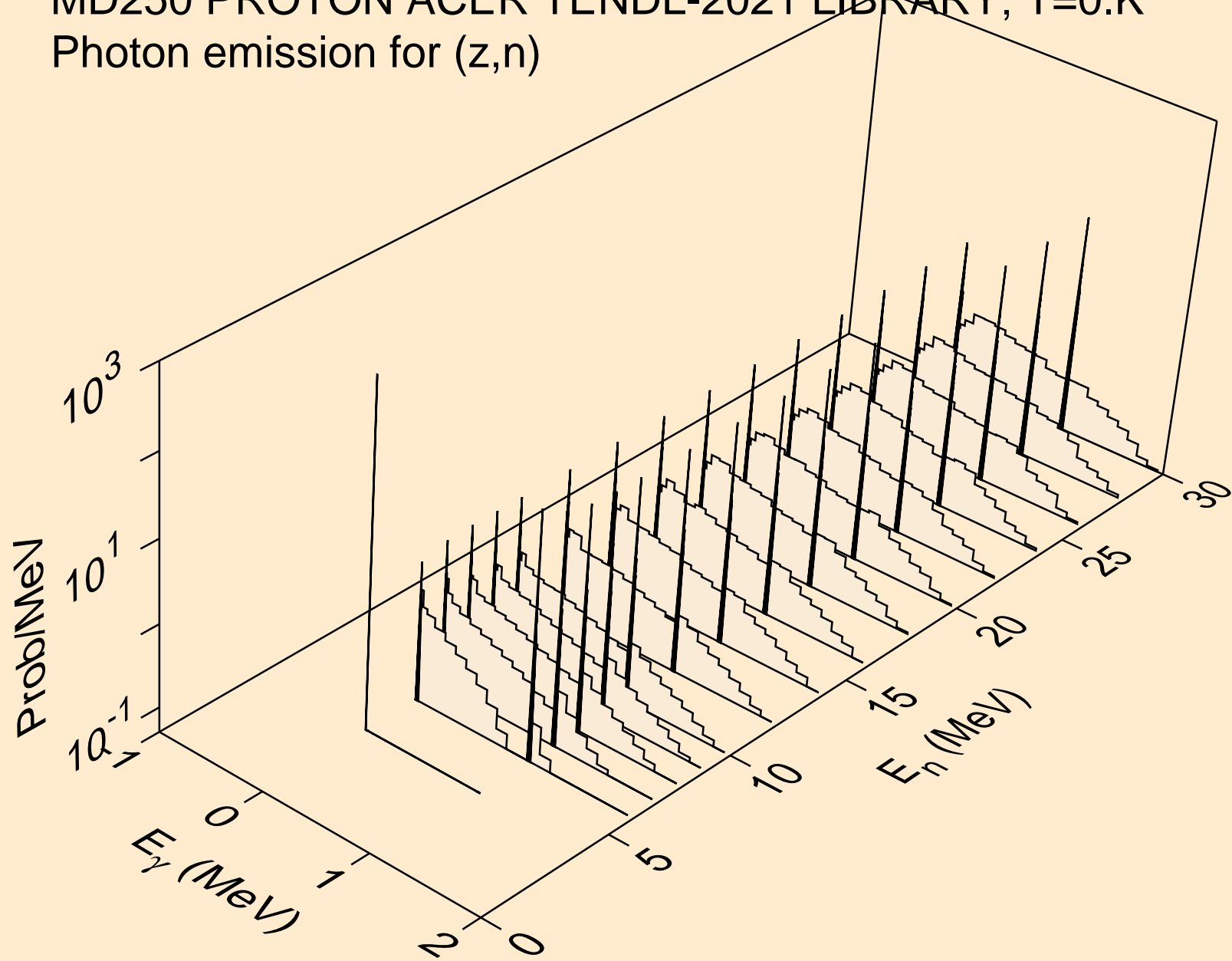

MD250 PROTON ACER TENDL-2021 LIBRARY; T=0.K
Photon emission for (n,x)

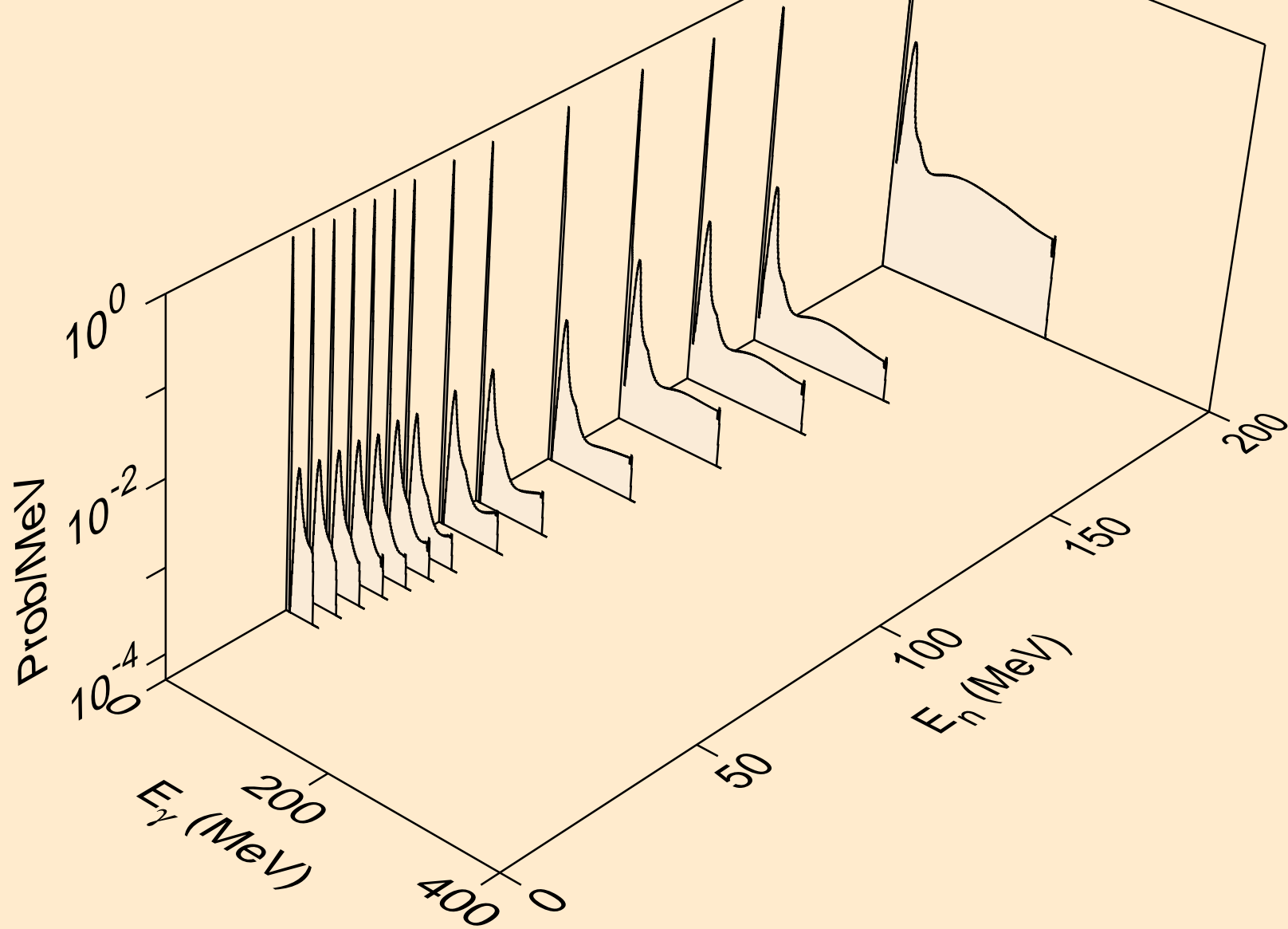

MD250 PROTON ACER TENDL-2021 LIBRARY; T=0.K
Photon emission for (n,2n)

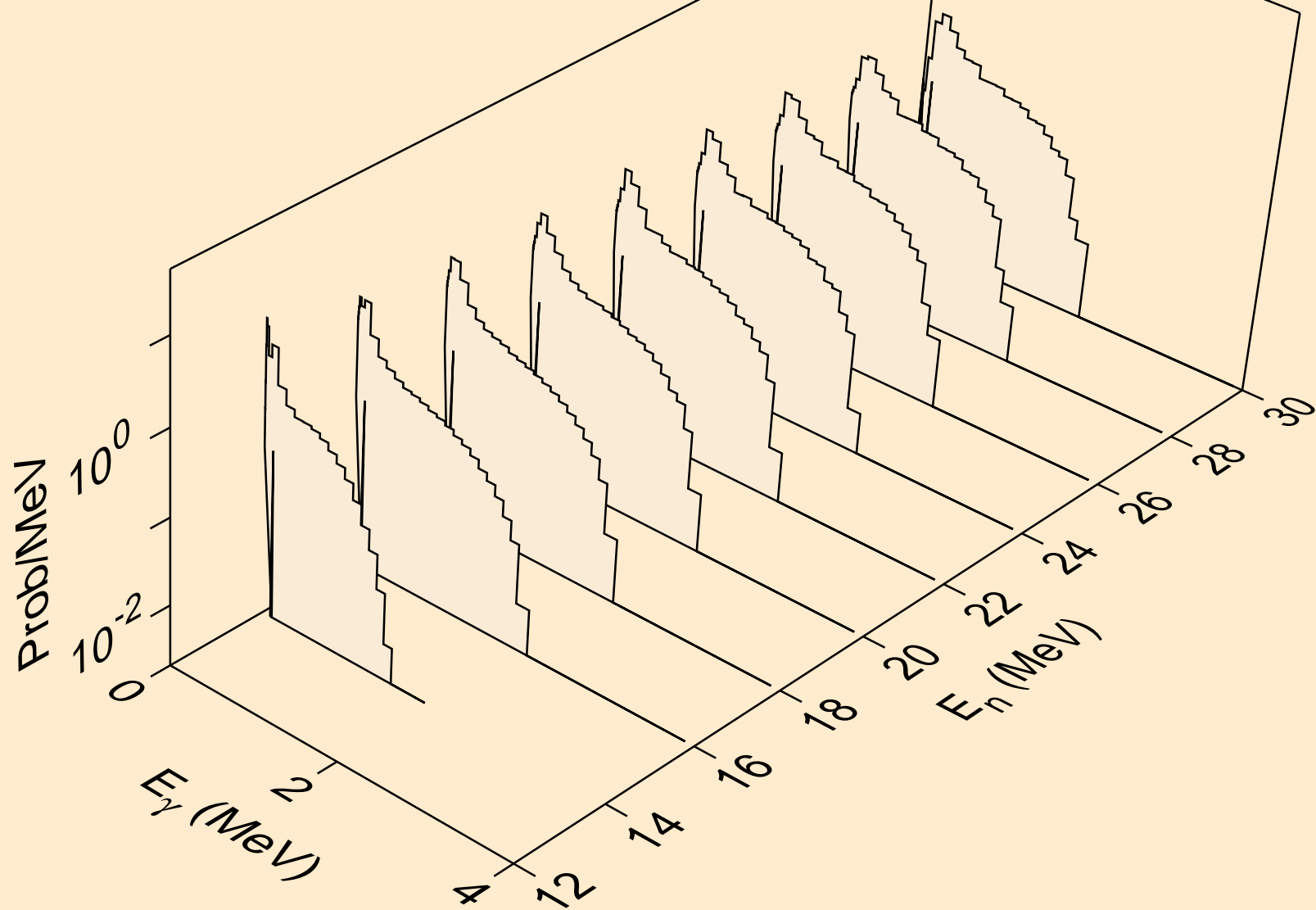

MD250 PROTON ACER TENDL-2021 LIBRARY; T=0.K
Photon emission for (n,3n)

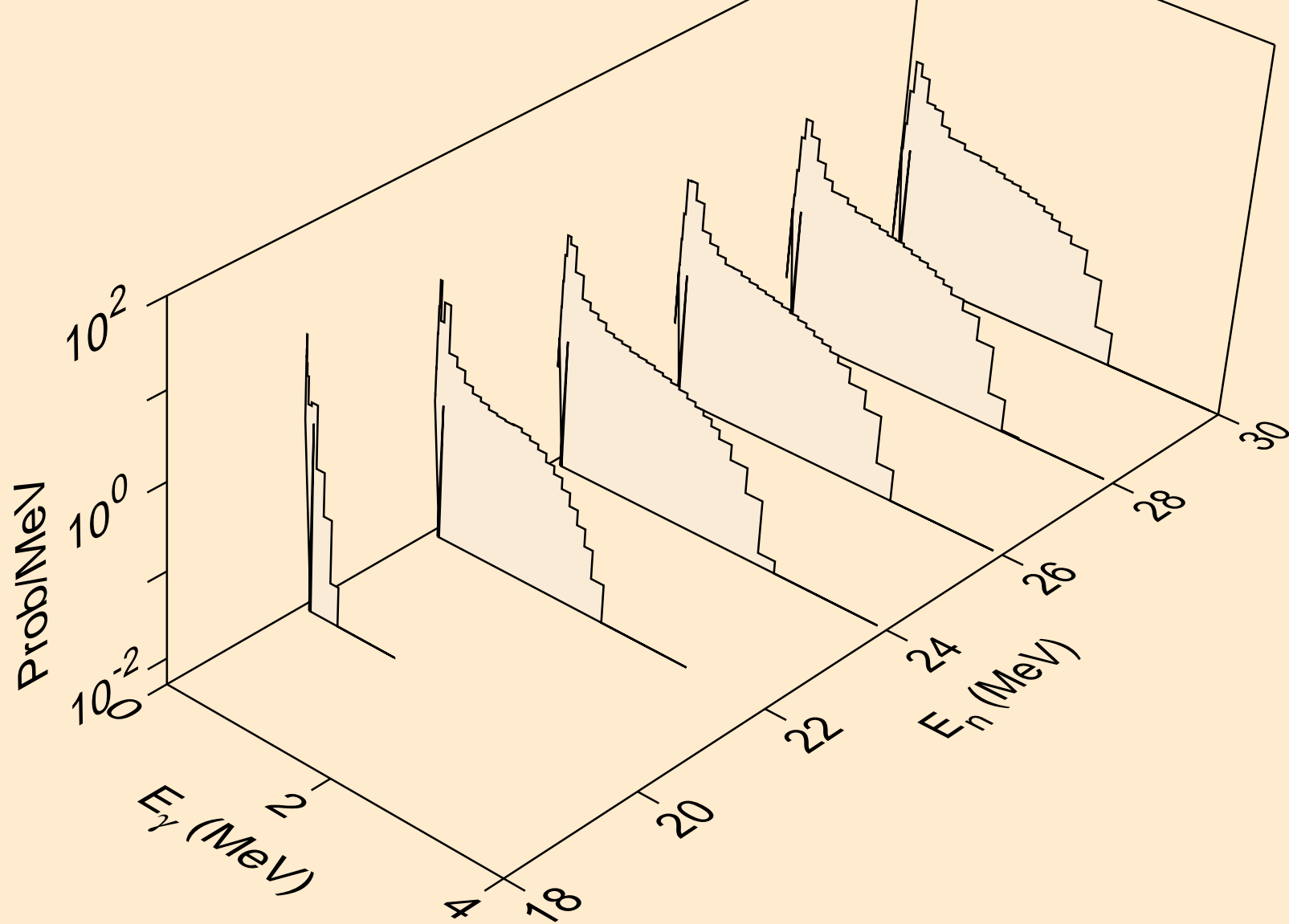

MD250 PROTON ACER TENDL-2021 LIBRARY; T=0.K
Photon emission for (n,n*)a

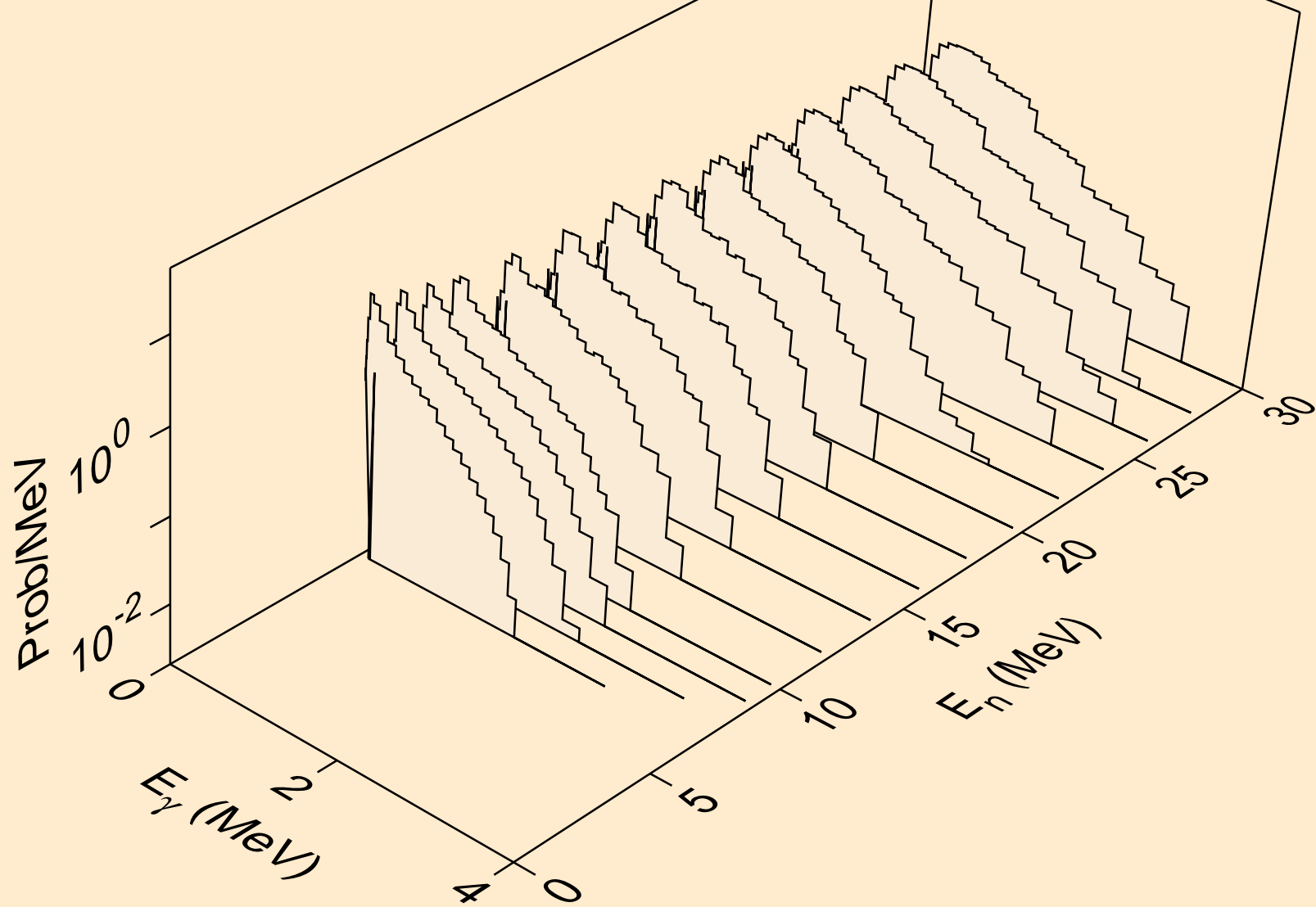

MD250 PROTON ACER TENDL-2021 LIBRARY; T=0.K
Photon emission for (n,2n)a

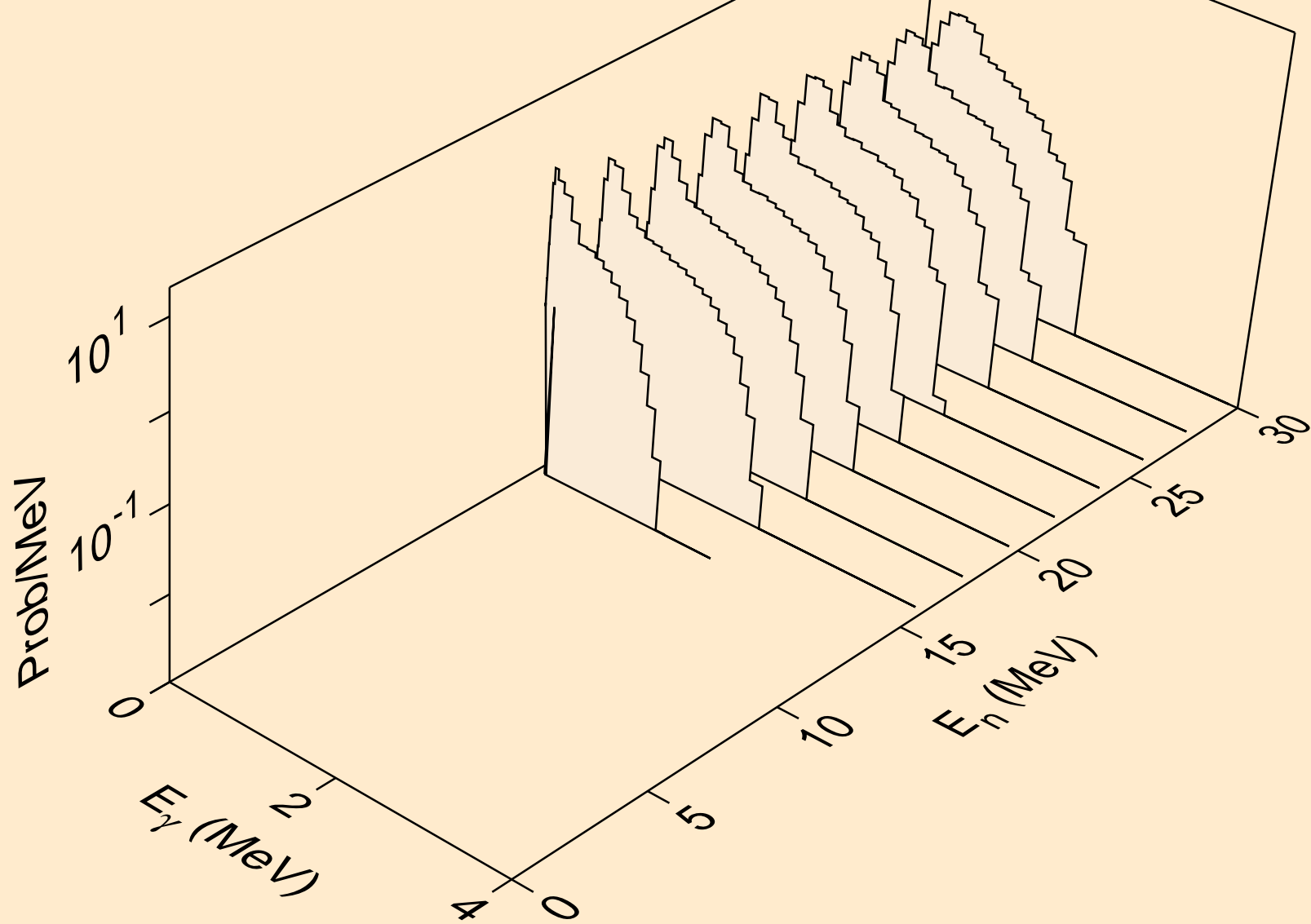

MD250 PROTON ACER TENDL-2021 LIBRARY; T=0.K
Photon emission for (n,n*)p

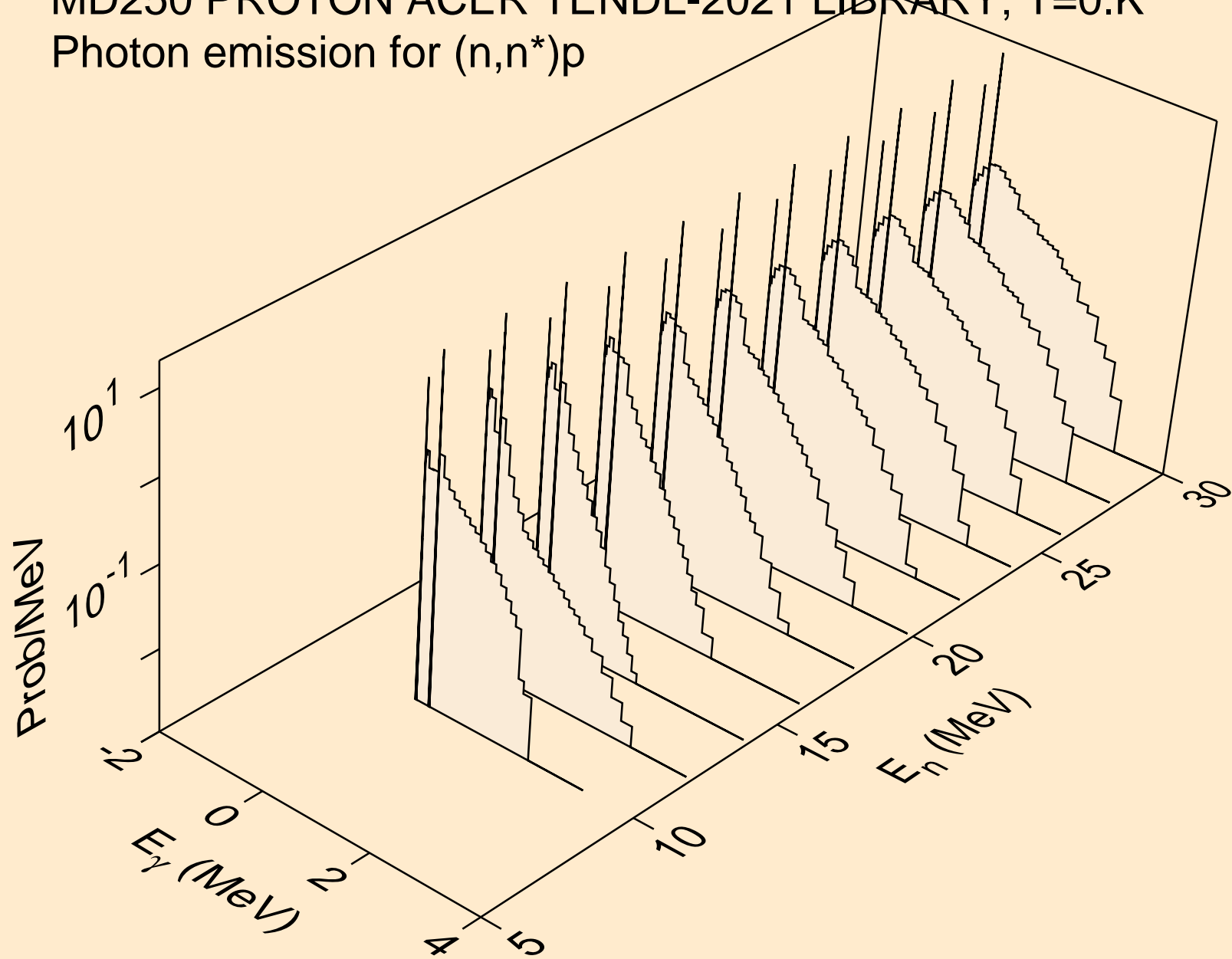

MD250 PROTON ACER TENDL-2021 LIBRARY; T=0.K
Photon emission for (n,n*)d

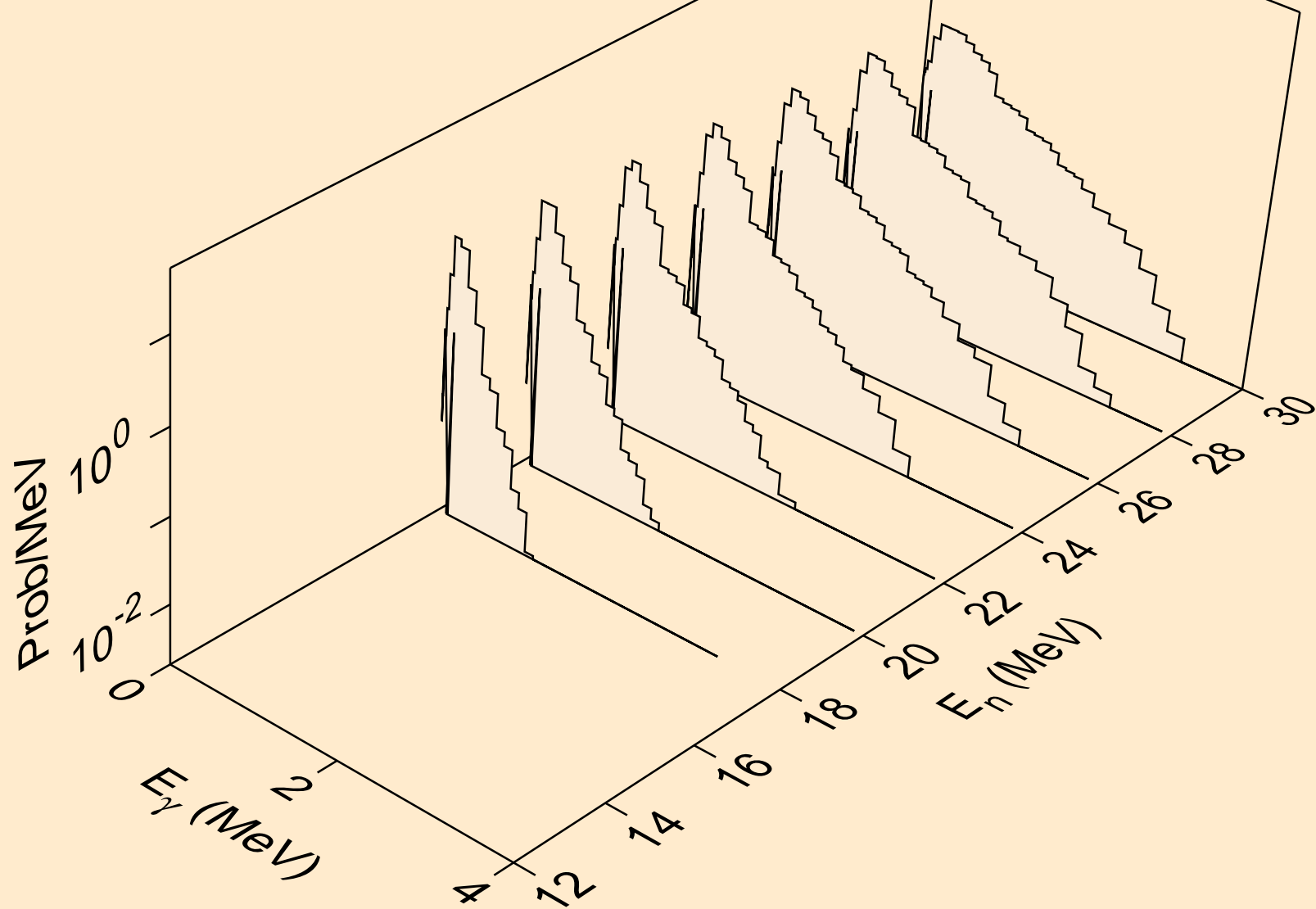

MD250 PROTON ACER TENDL-2021 LIBRARY; T=0.K
Photon emission for (n,n*)t

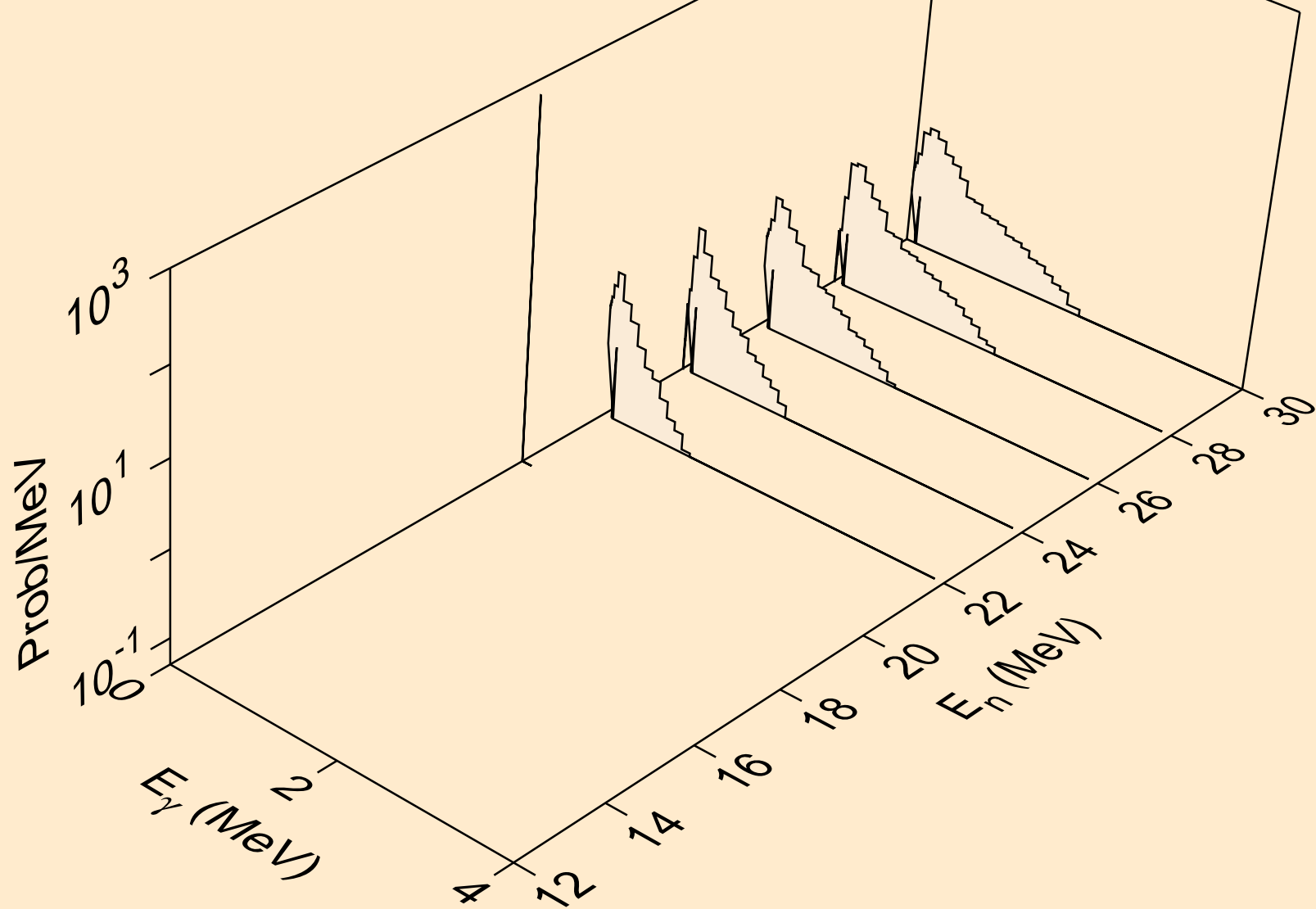

MD250 PROTON ACER TENDL-2021 LIBRARY; T=0.K
Photon emission for (n,2np)

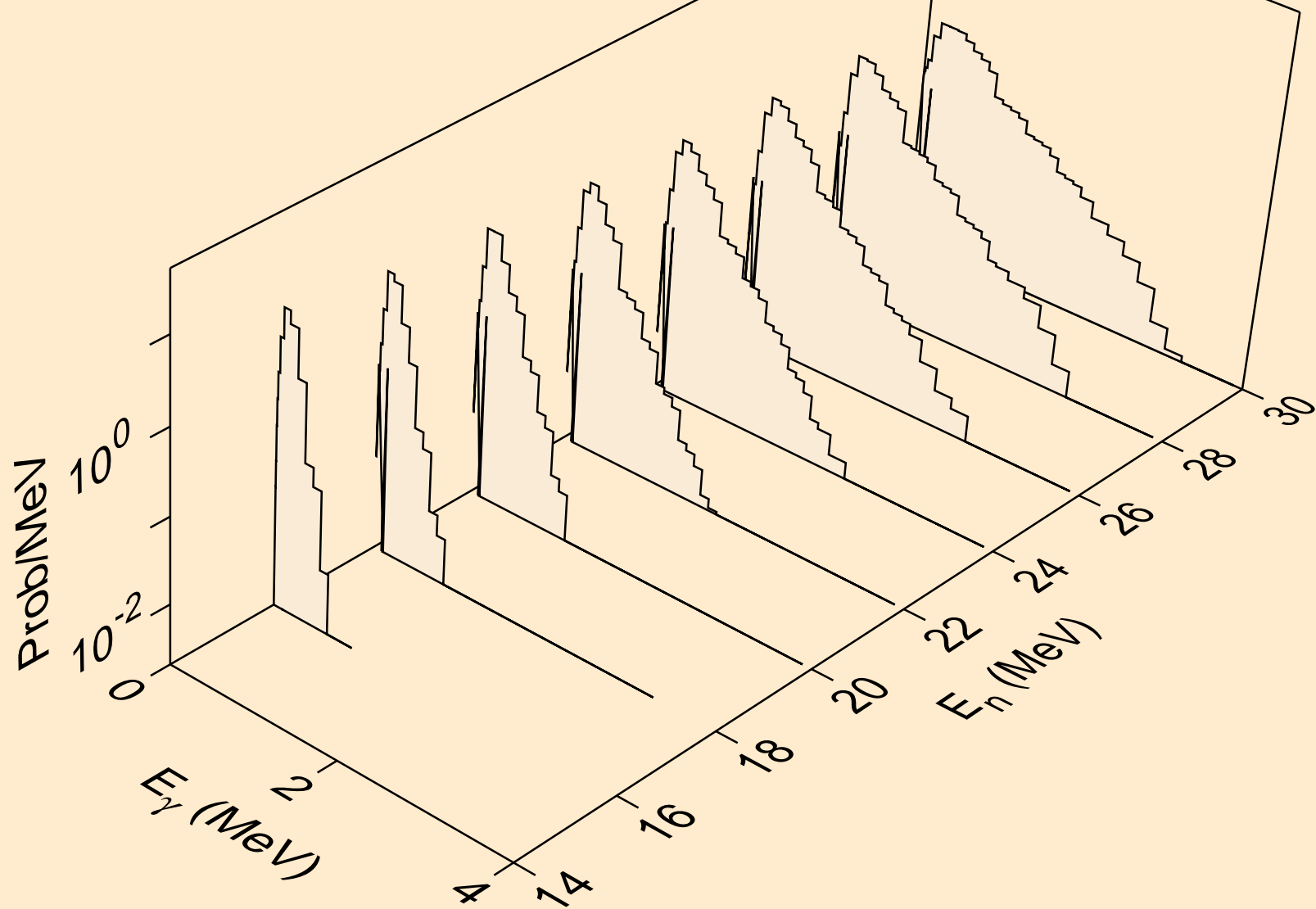

MD250 PROTON ACER TENDL-2021 LIBRARY; T=0.K
Photon emission for (n,2np)

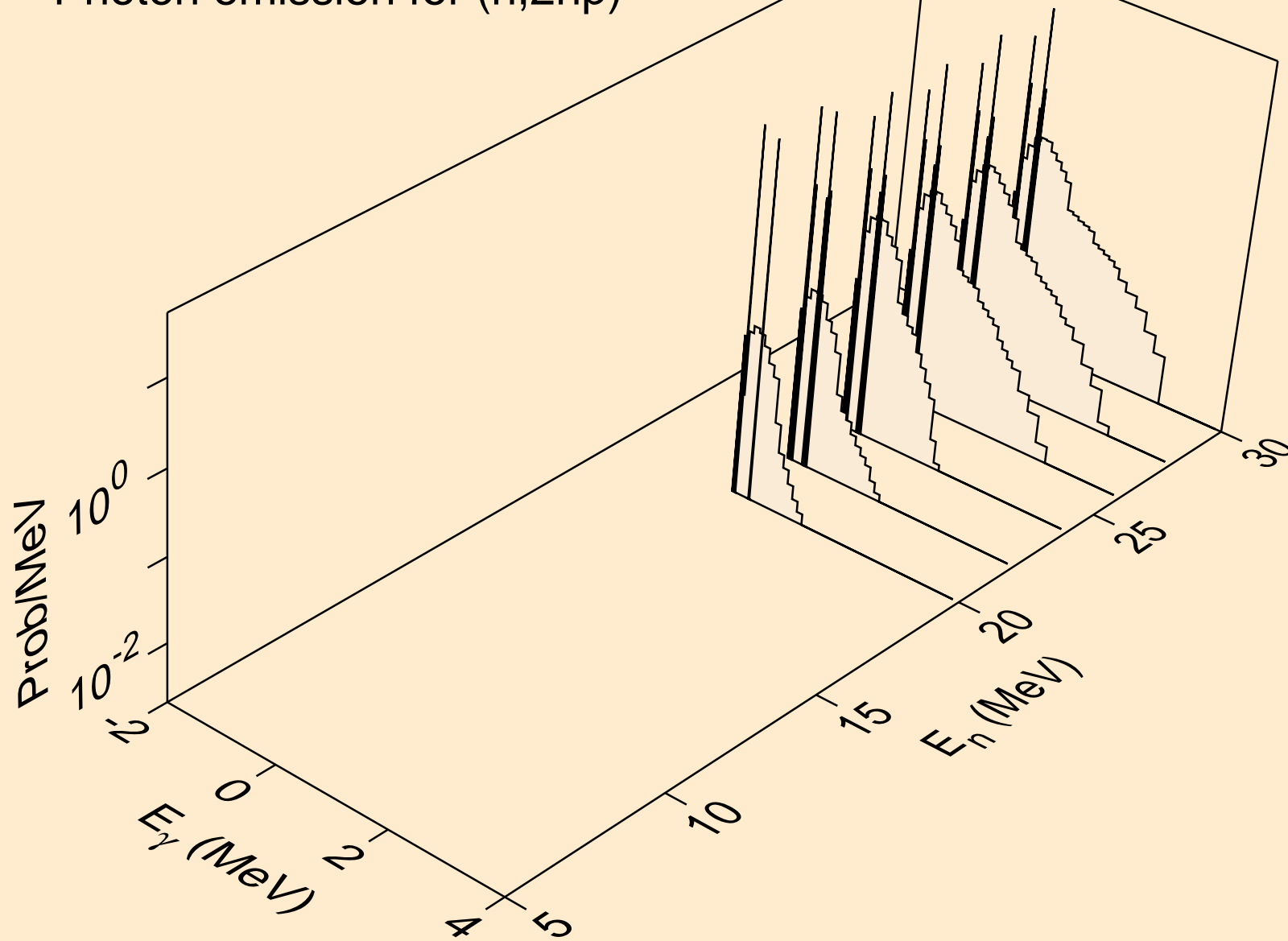

MD250 PROTON ACER TENDL-2021 LIBRARY; T=0.K
Photon emission for (n,npa)

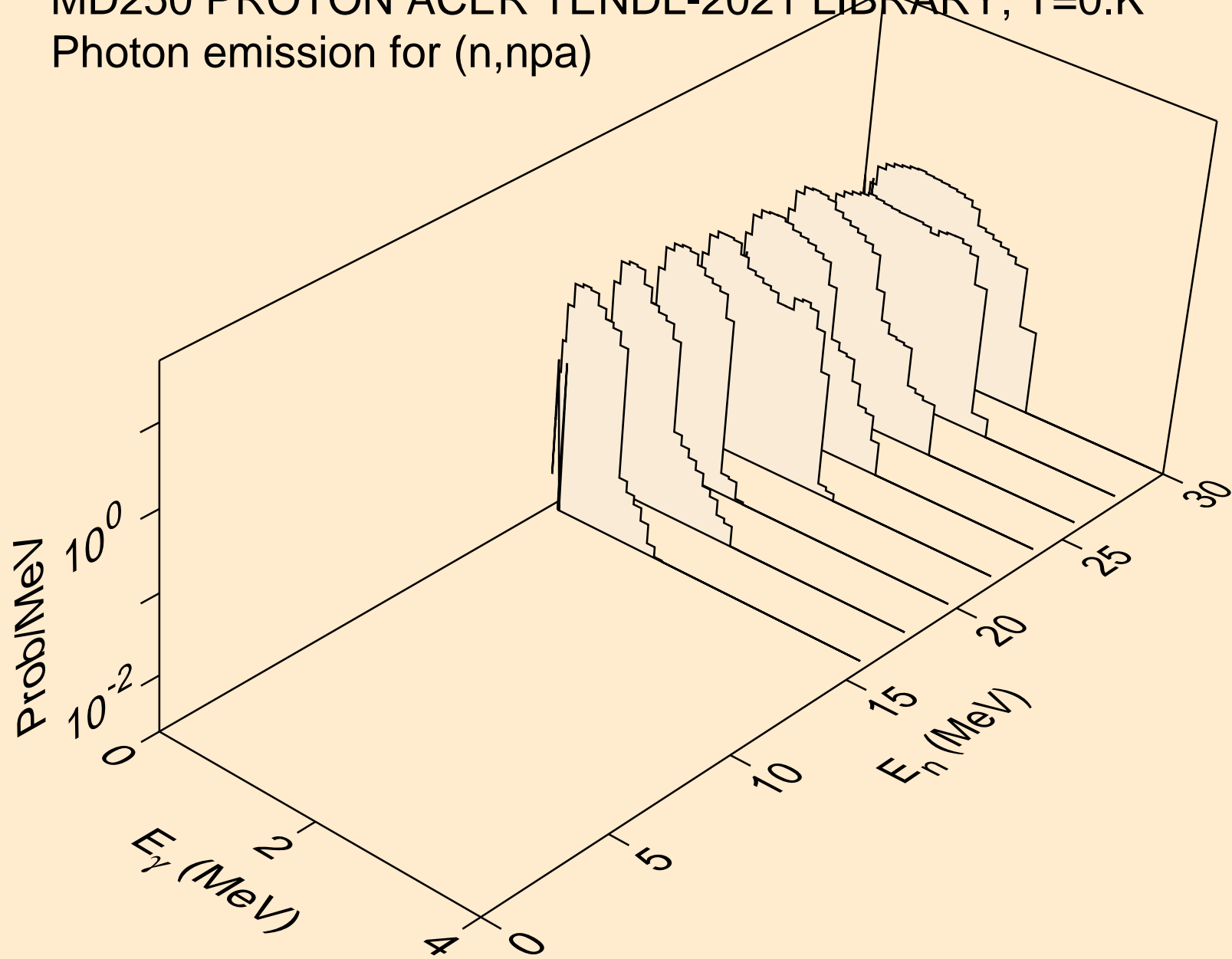

MD250 PROTON ACER TENDL-2021 LIBRARY; T=0.K
Photon emission for (n,gma)

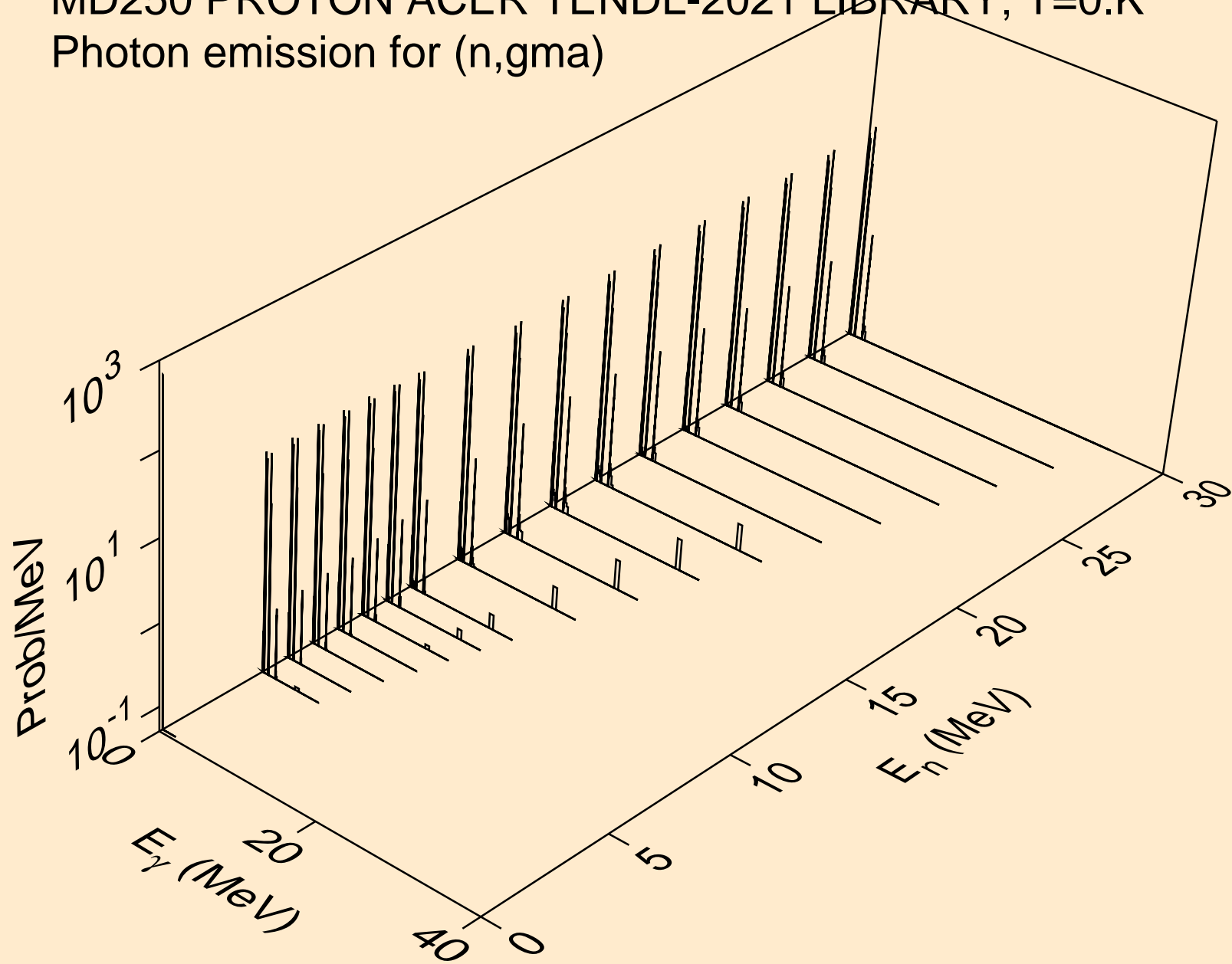

MD250 PROTON ACER TENDL-2021 LIBRARY; T=0.K
Photon emission for inelastic

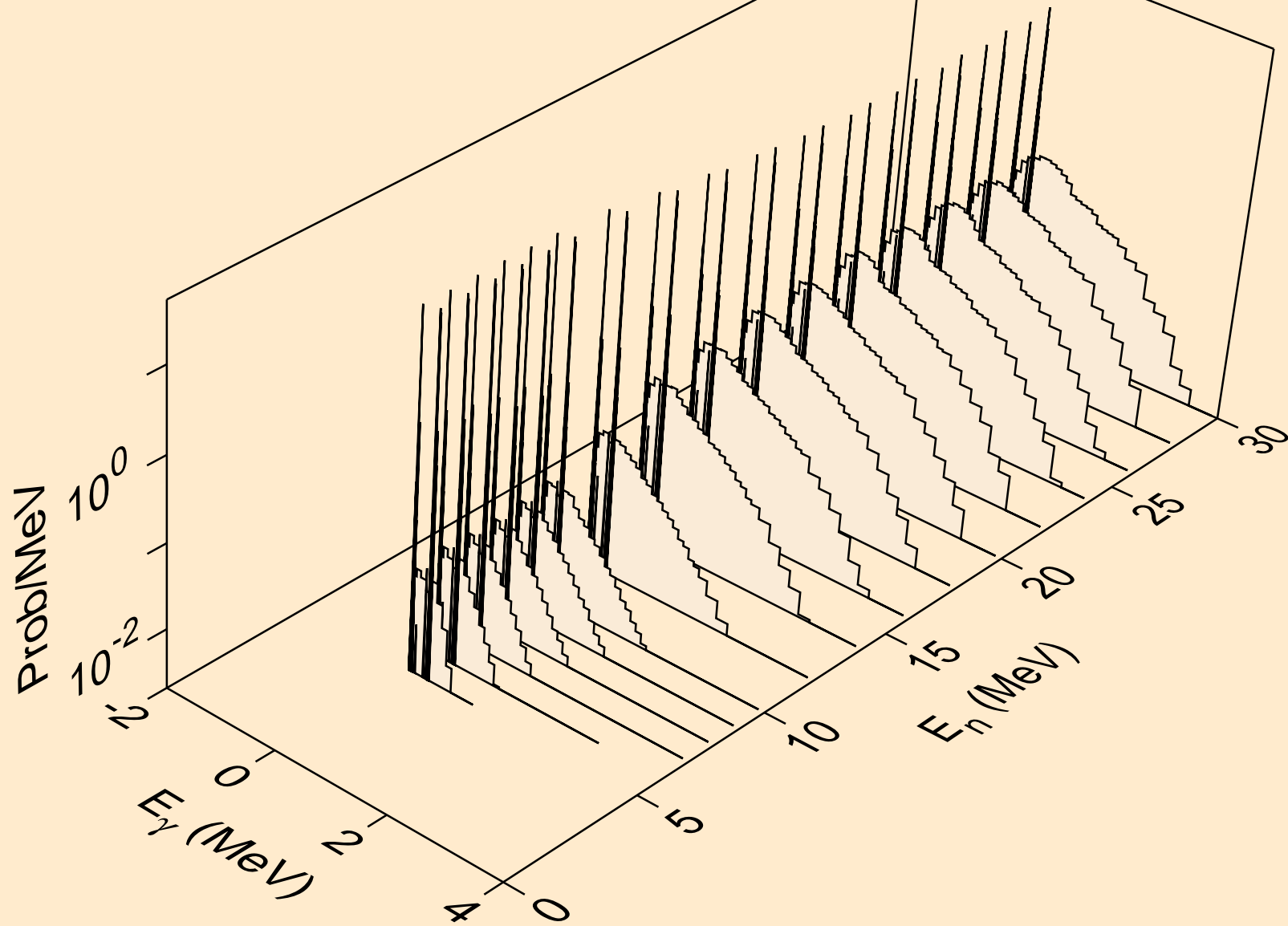

MD250 PROTON ACER TENDL-2021 LIBRARY; T=0.K
Photon emission for (n,d)

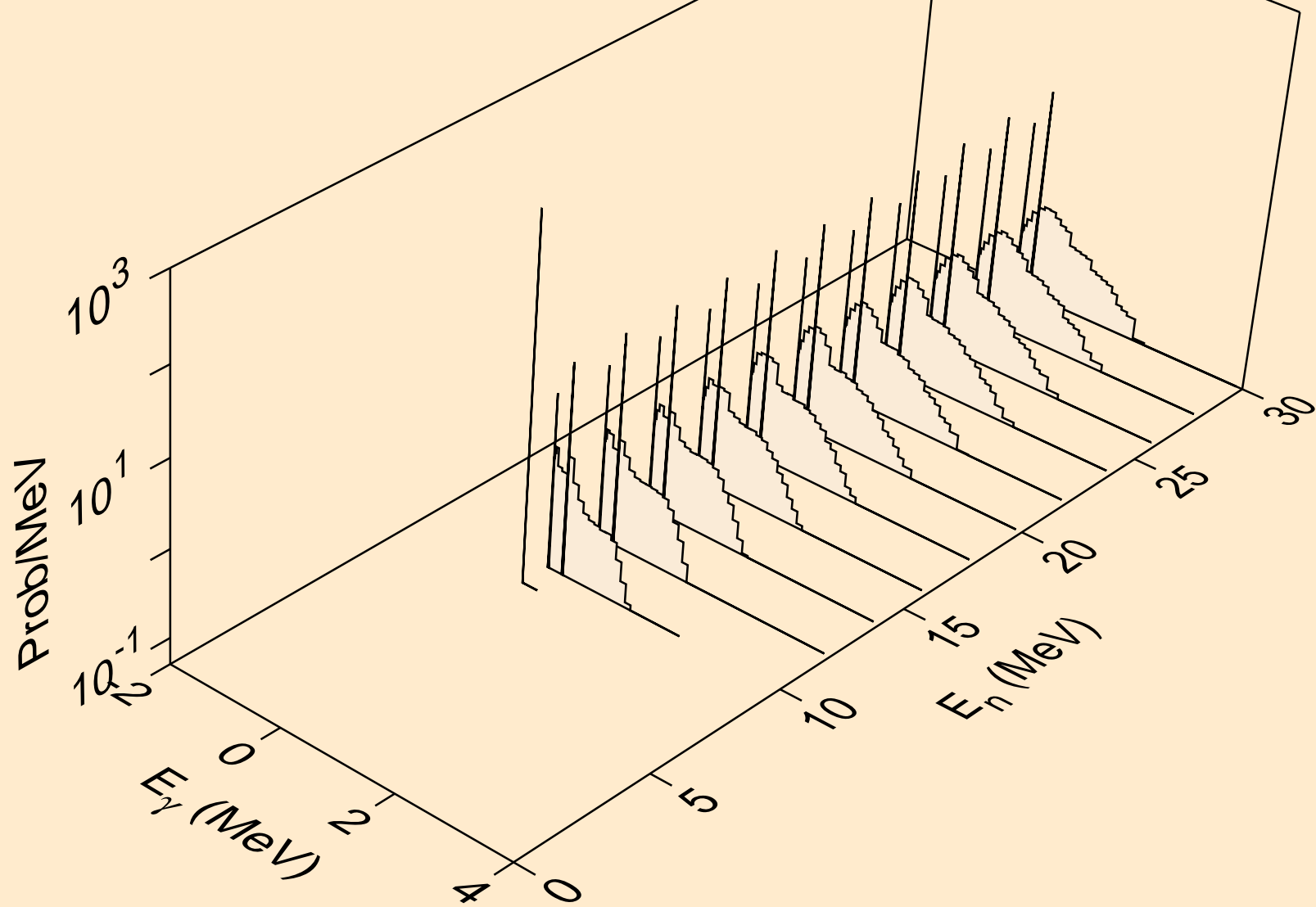

MD250 PROTON ACER TENDL-2021 LIBRARY; T=0.K
Photon emission for (n,t)

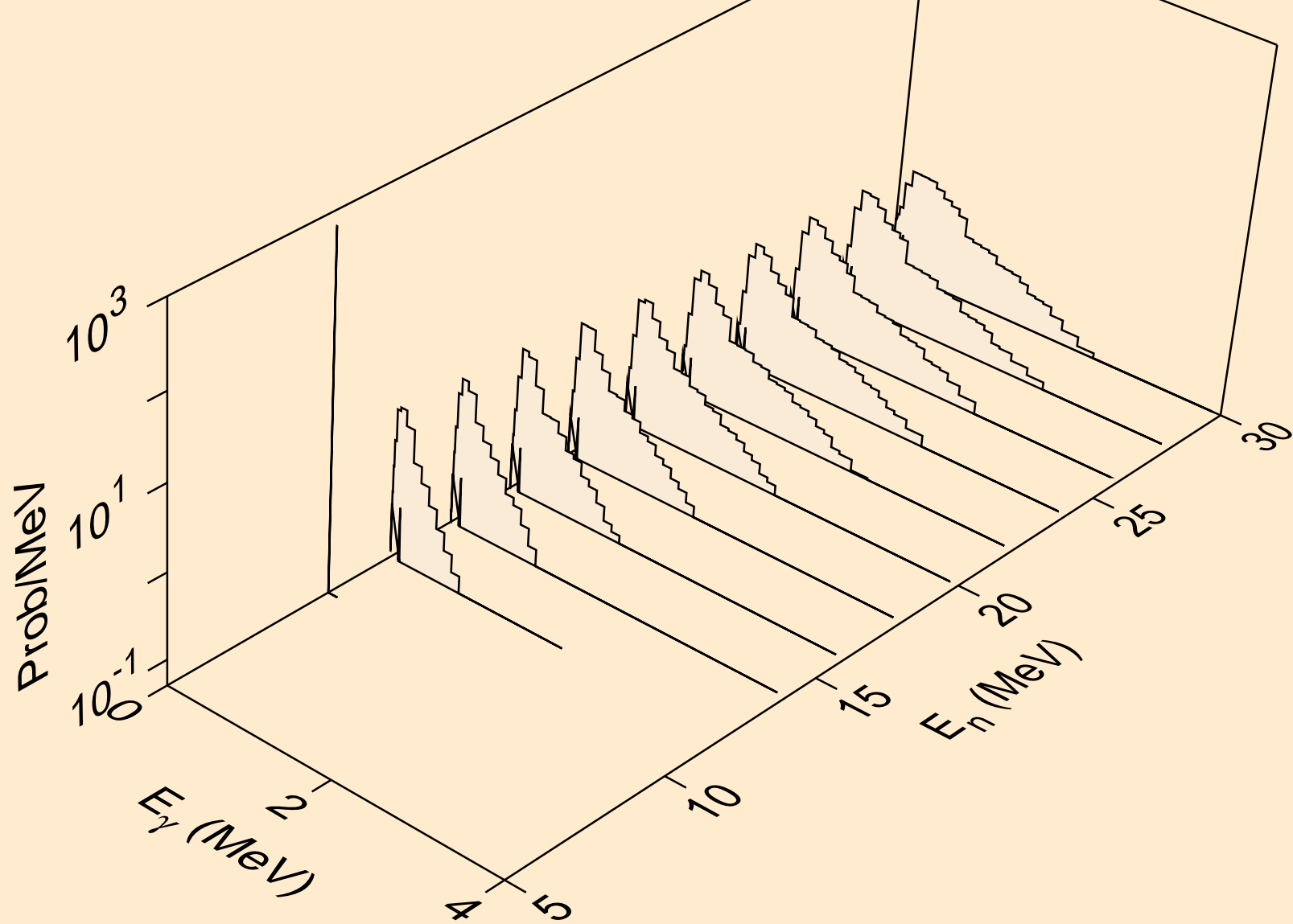

MD250 PROTON ACER TENDL-2021 LIBRARY; T=0.K
Photon emission for (n,he3)

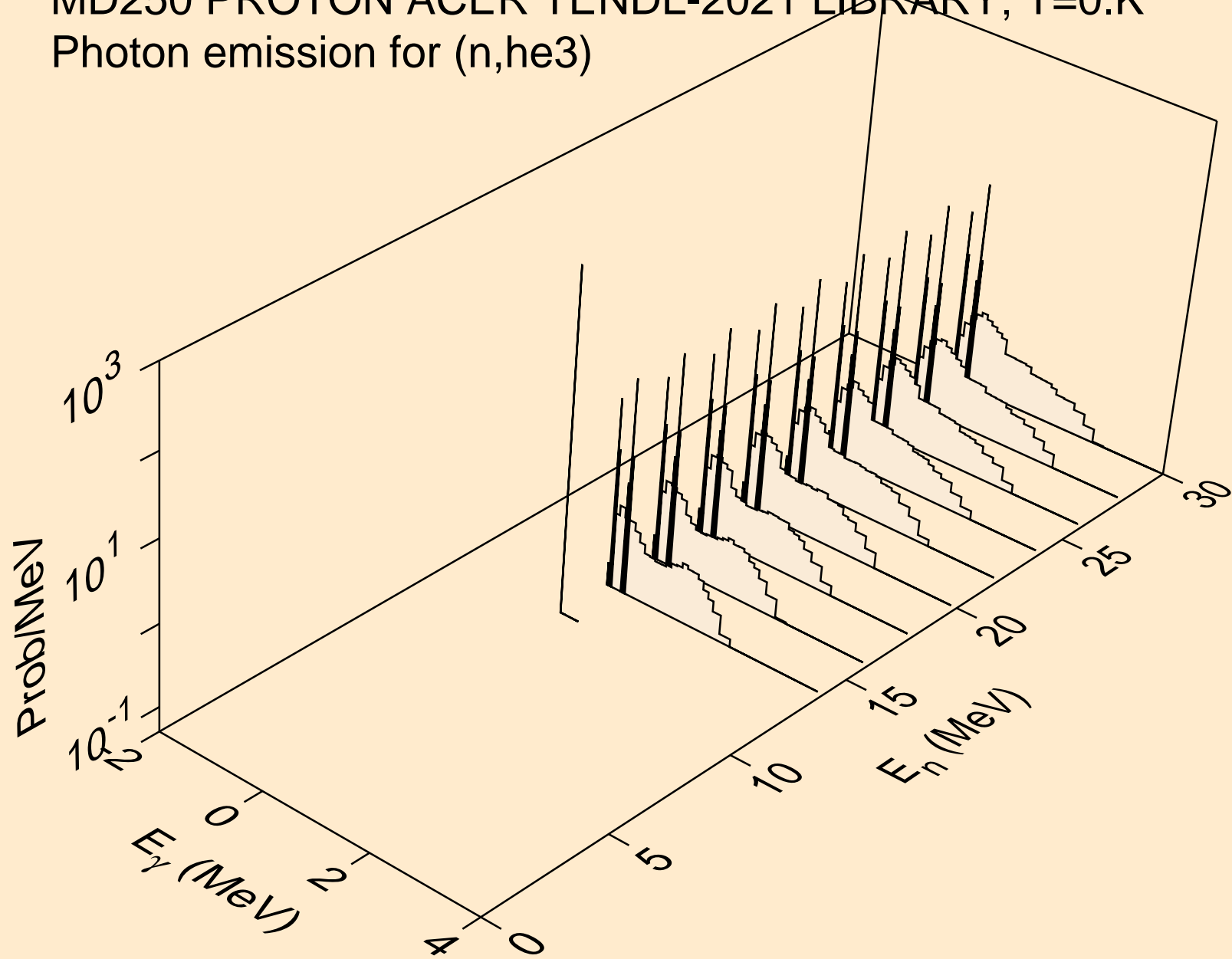

MD250 PROTON ACER TENDL-2021 LIBRARY; T=0.K
Photon emission for (n,a)

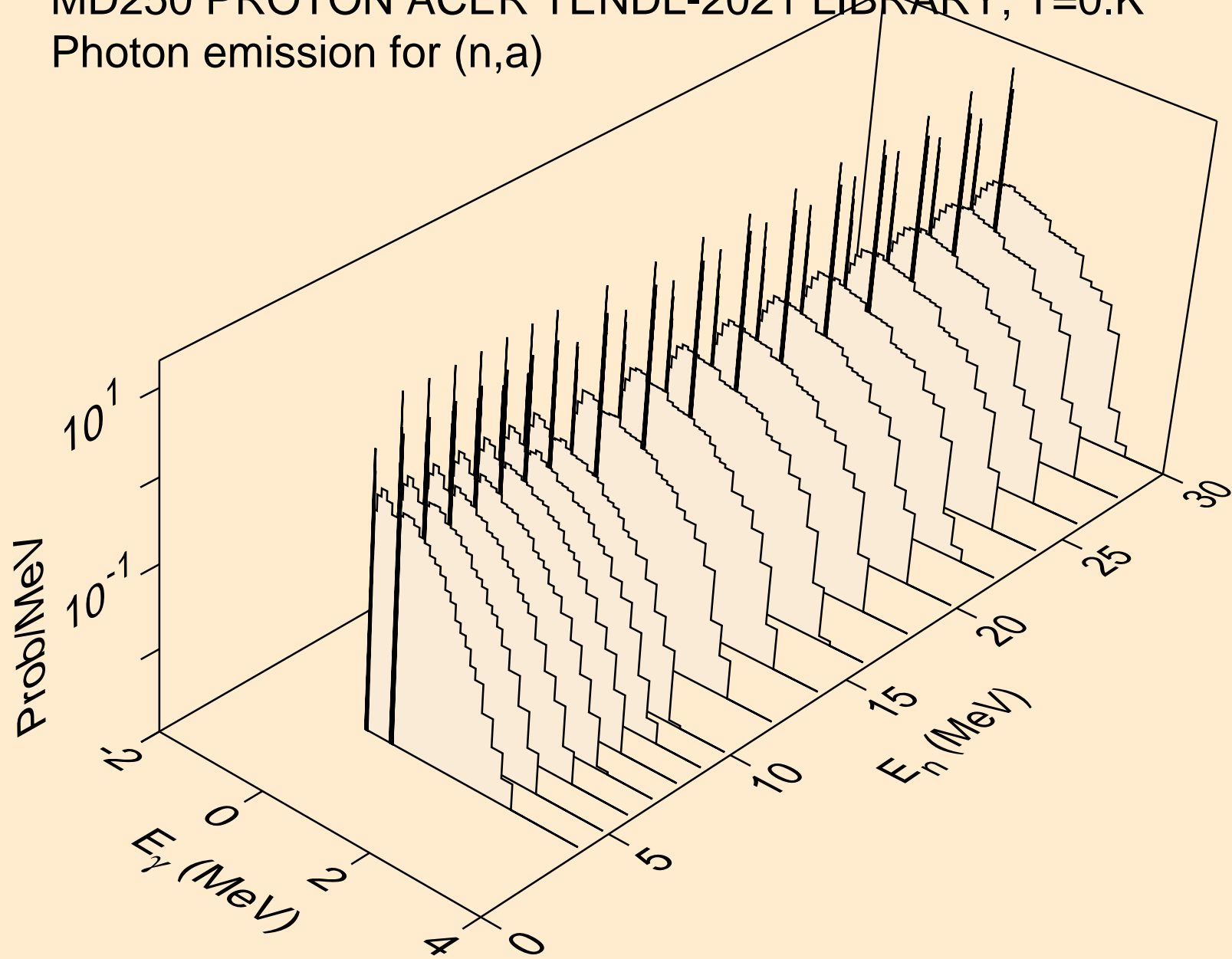

MD250 PROTON ACER TENDL-2021 LIBRARY; T=0.K
Photon emission for (n,2a)

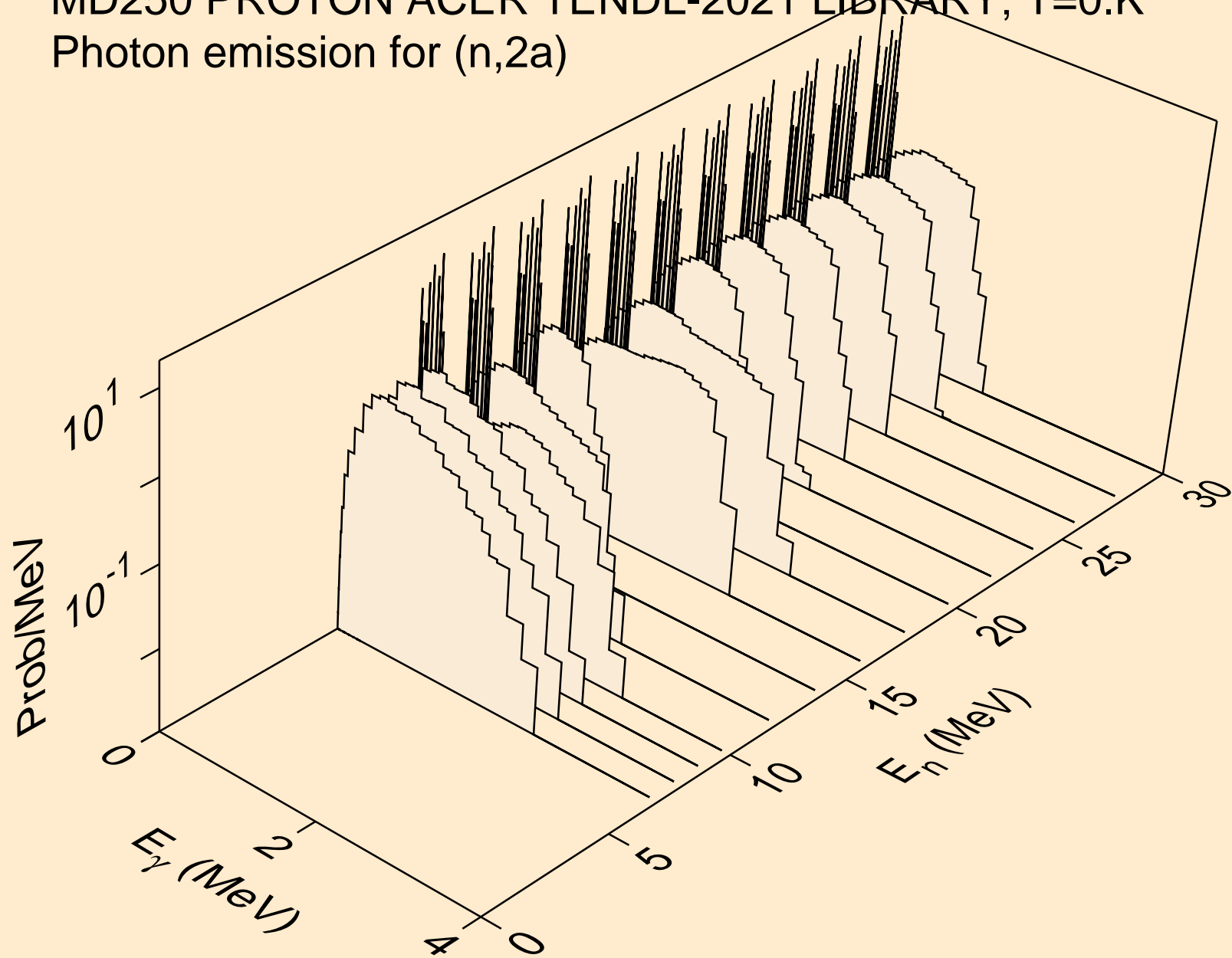

MD250 PROTON ACER TENDL-2021 LIBRARY; T=0.K
Photon emission for (n,2p)



MD250 PROTON ACER TENDL-2021 LIBRARY; T=0.K
Photon emission for (n,pd)

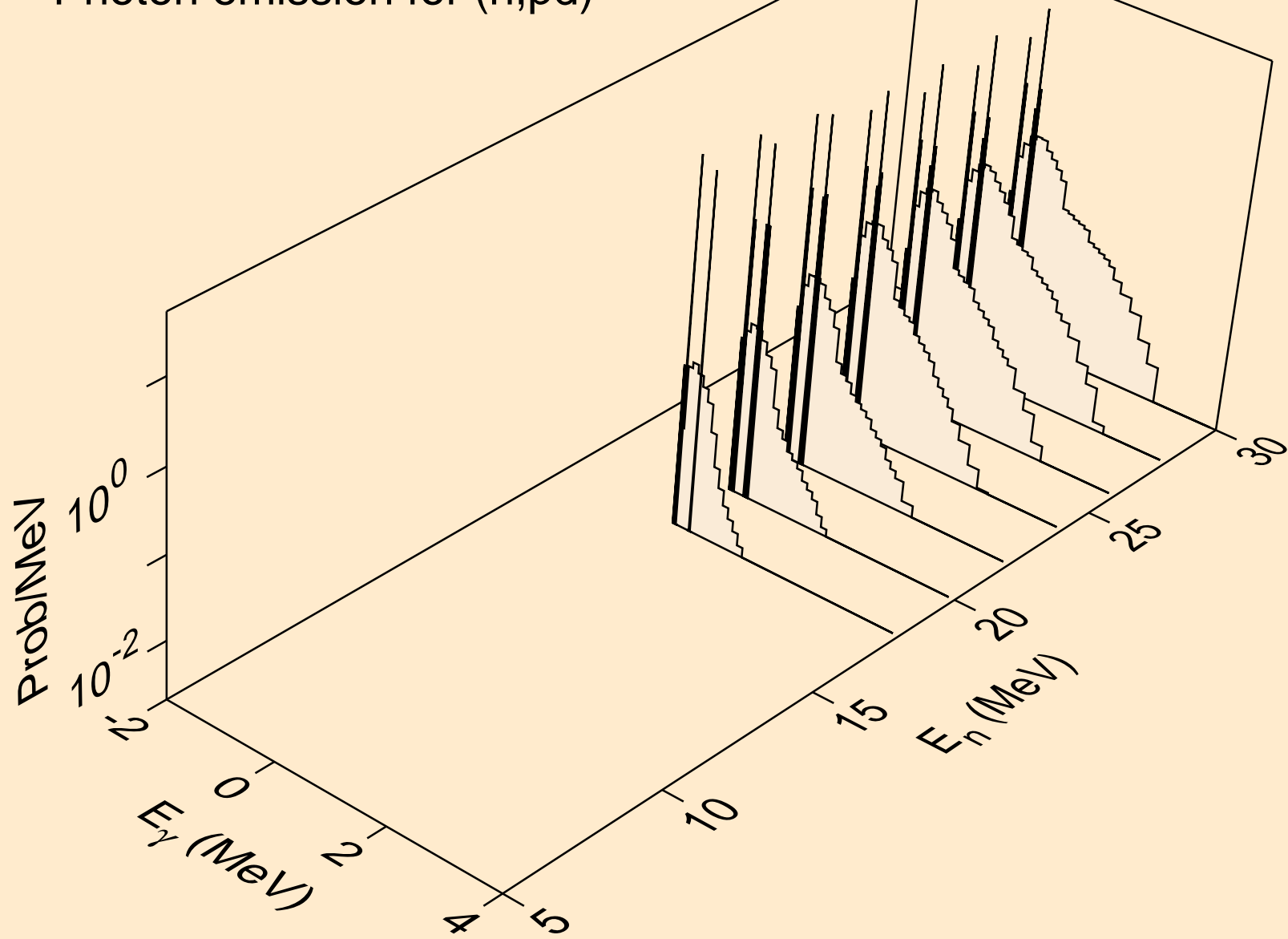

MD250 PROTON ACER TENDL-2021 LIBRARY; T=0.K
Photon emission for (n,da)

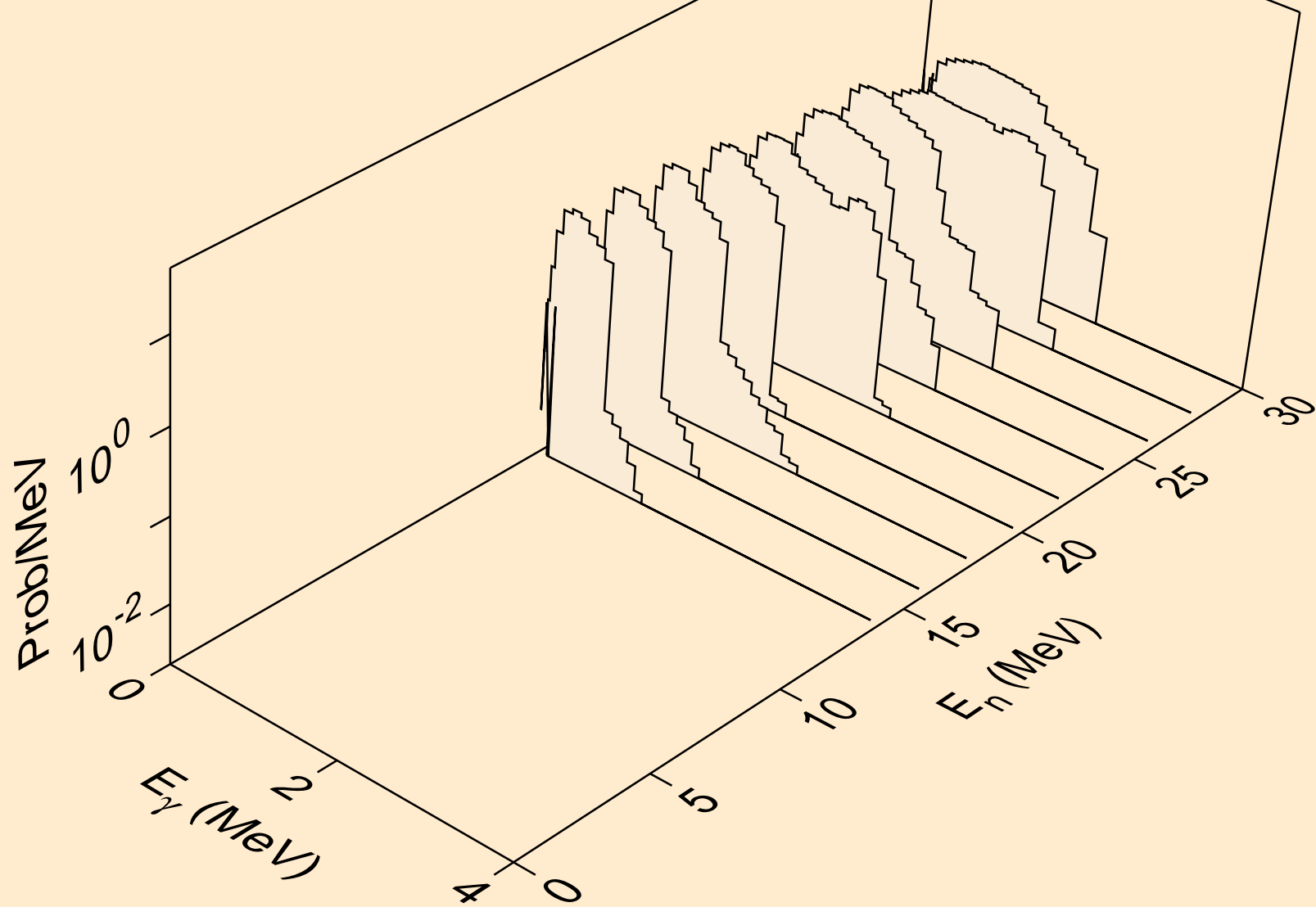

MD250 PROTON ACER TENDL-2021 LIBRARY; T=0.K

Particle heating contributions

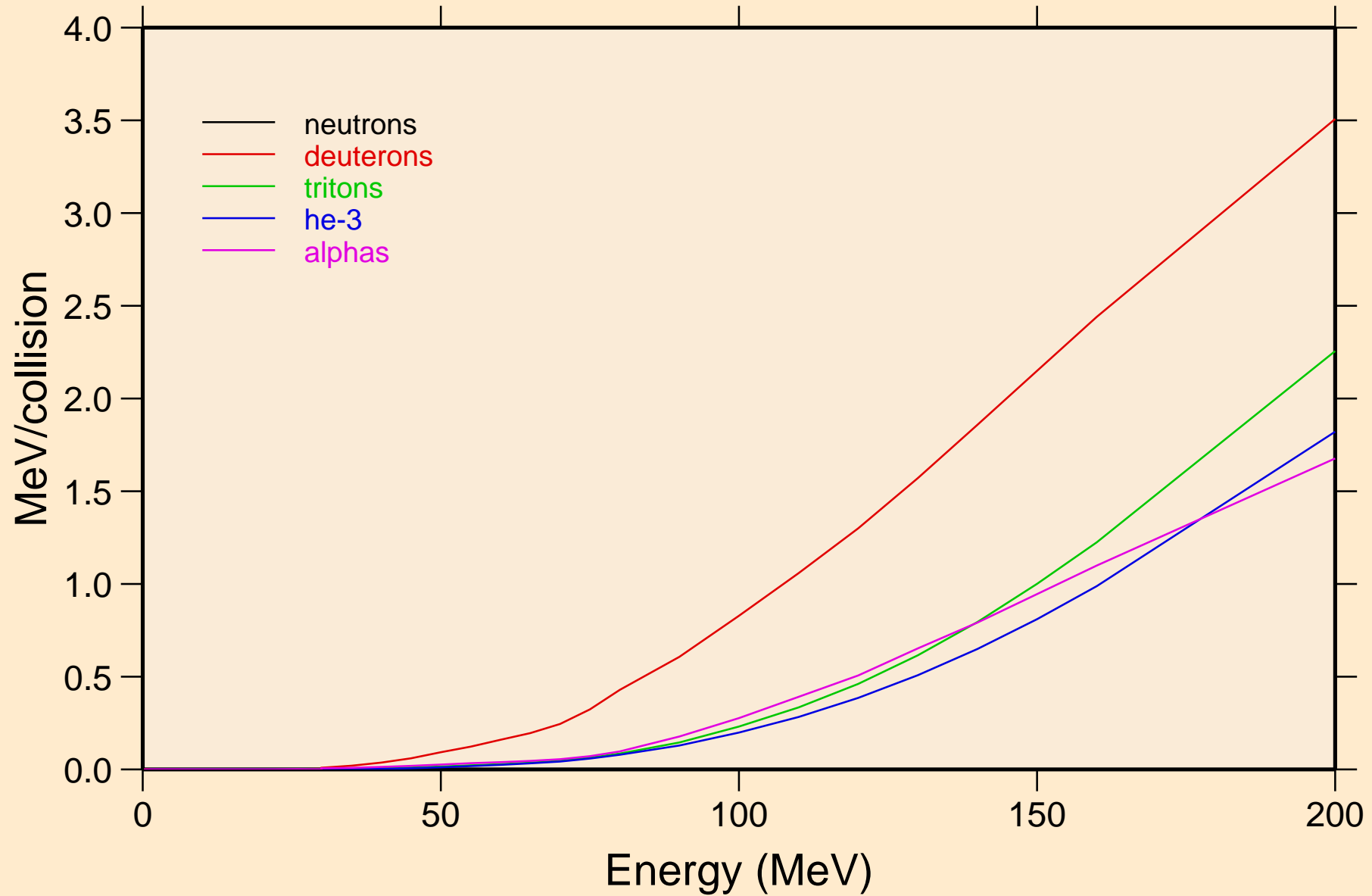

MD250 PROTON ACER TENDL-2021 LIBRARY; T=0.K
Recoil Heating

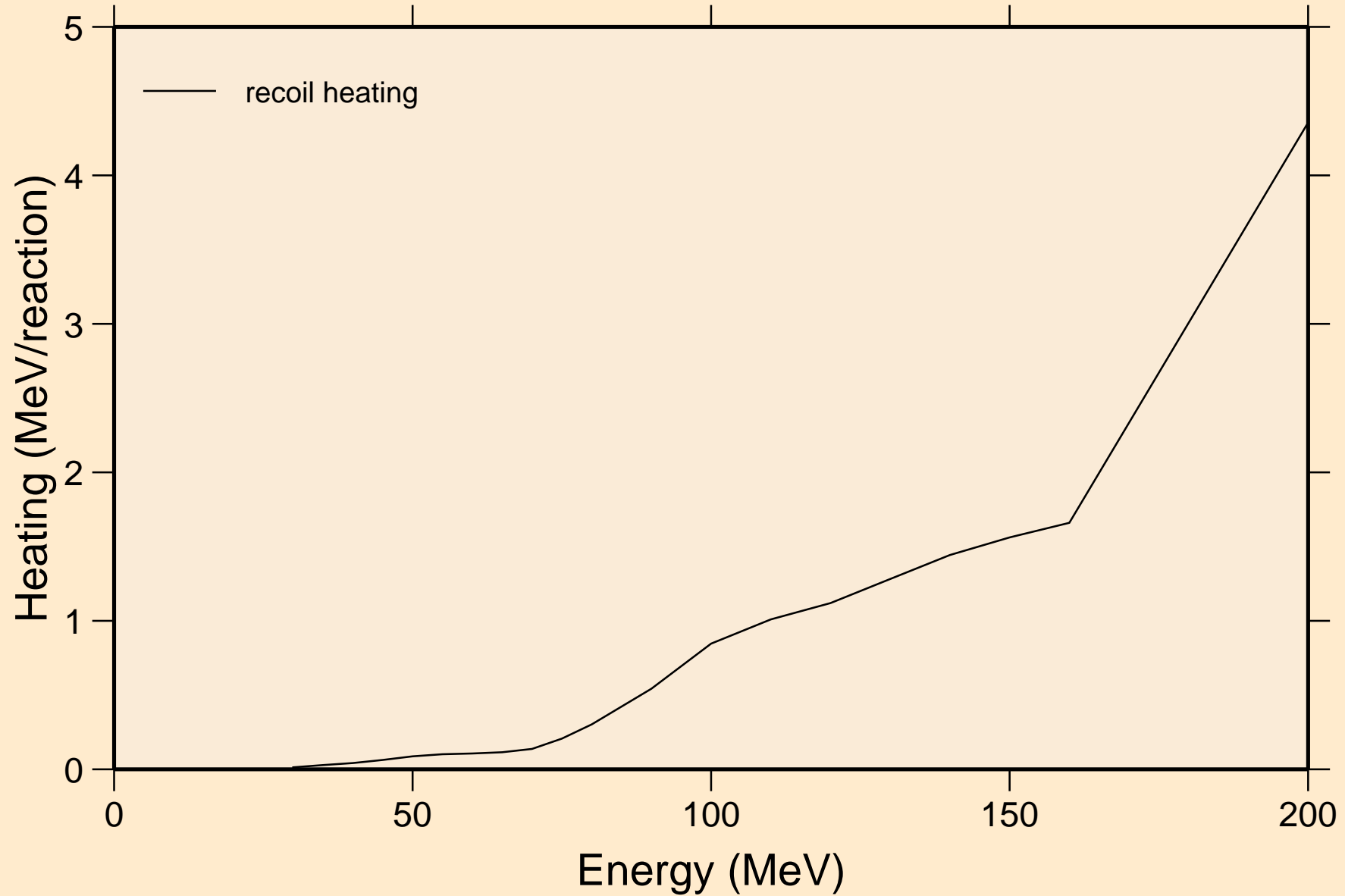

MD250 PROTON ACER TENDL-2021 LIBRARY; T=0.K
Particle production cross sections

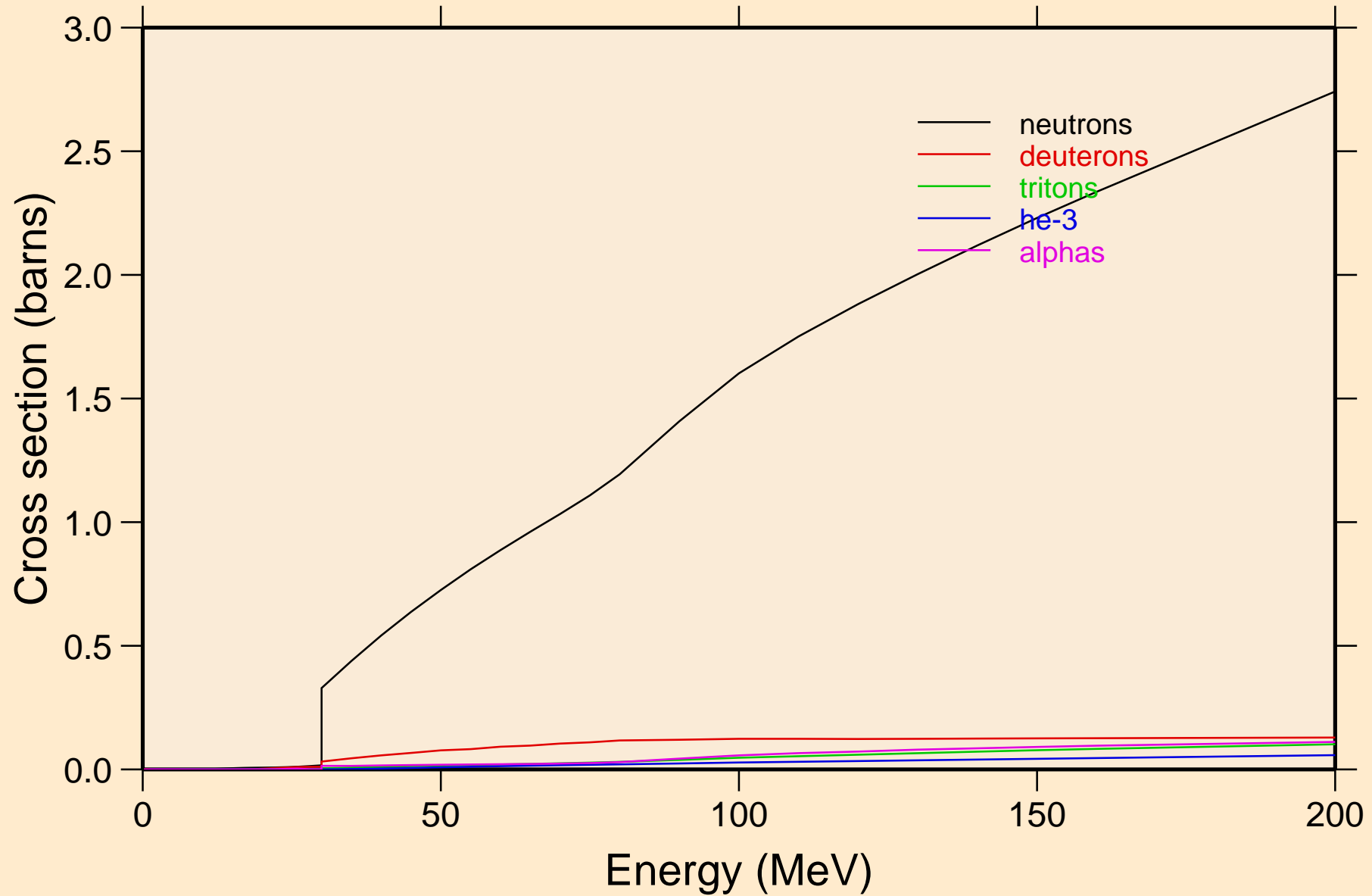

MD250 PROTON ACER TENDL-2021 LIBRARY; T=0.K
neutrons from (p,n)

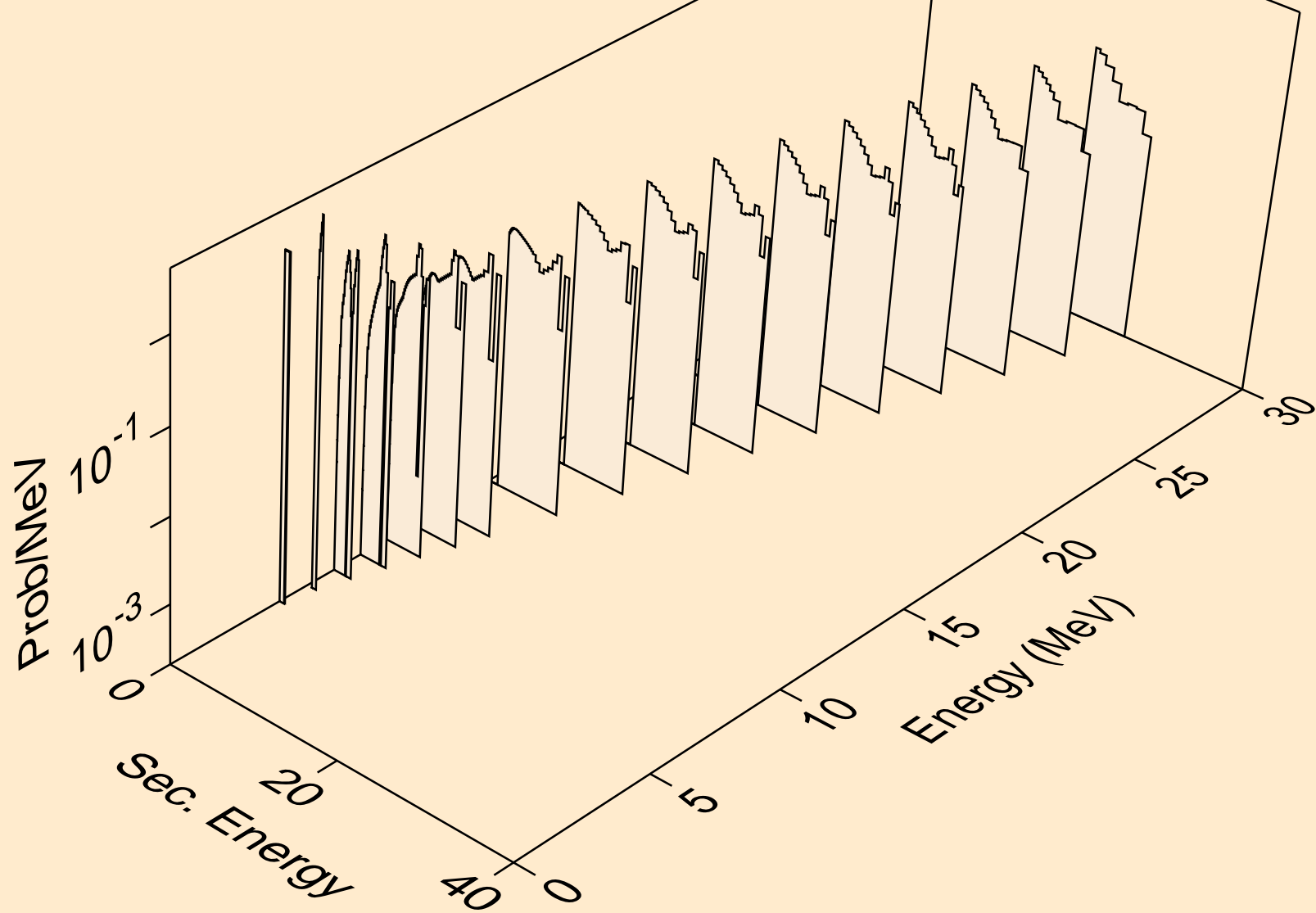

MD250 PROTON ACER TENDL-2021 LIBRARY; T=0.K
neutrons from (p,x)

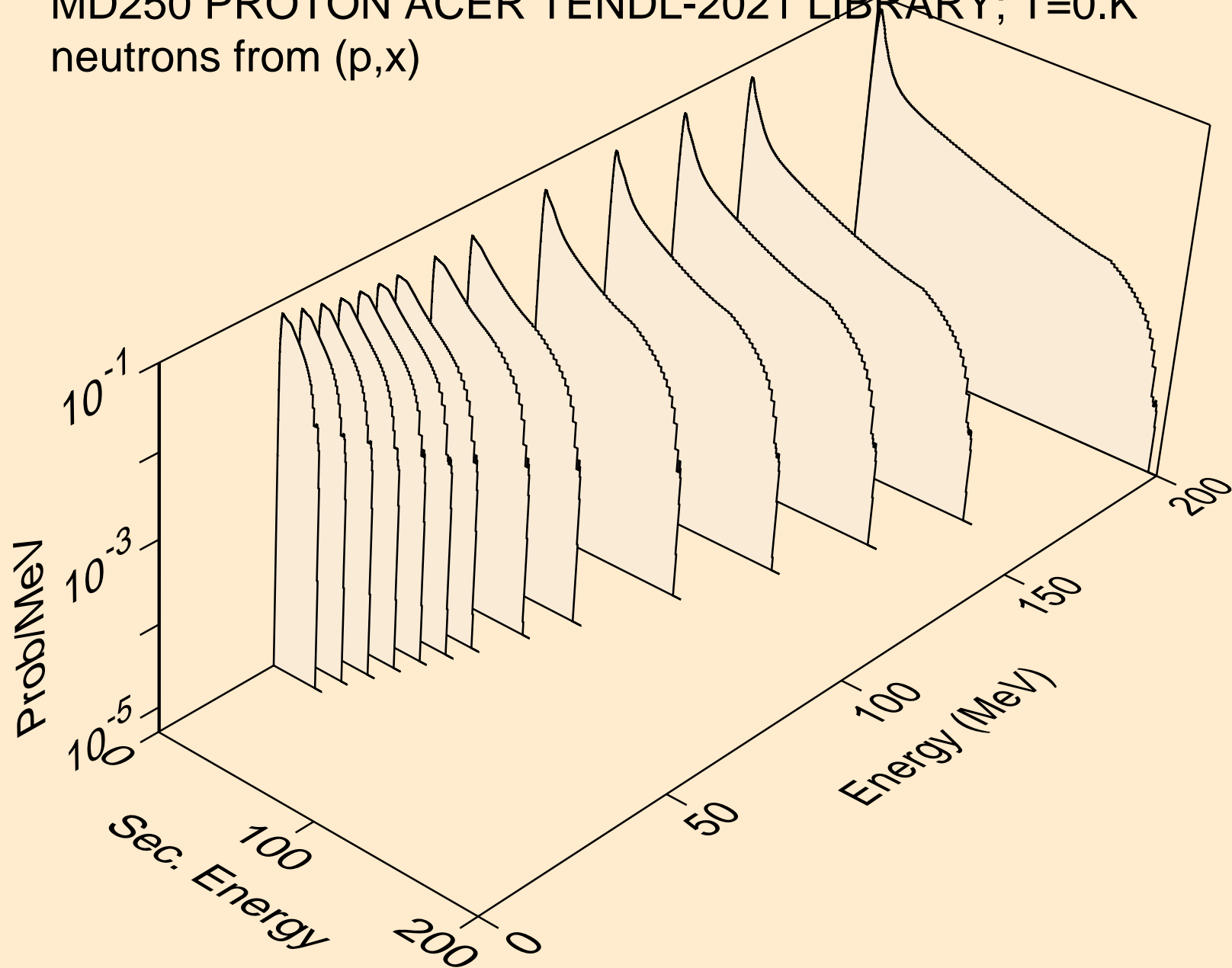

MD250 PROTON ACER TENDL-2021 LIBRARY; T=0.K
neutrons from (p,2n)

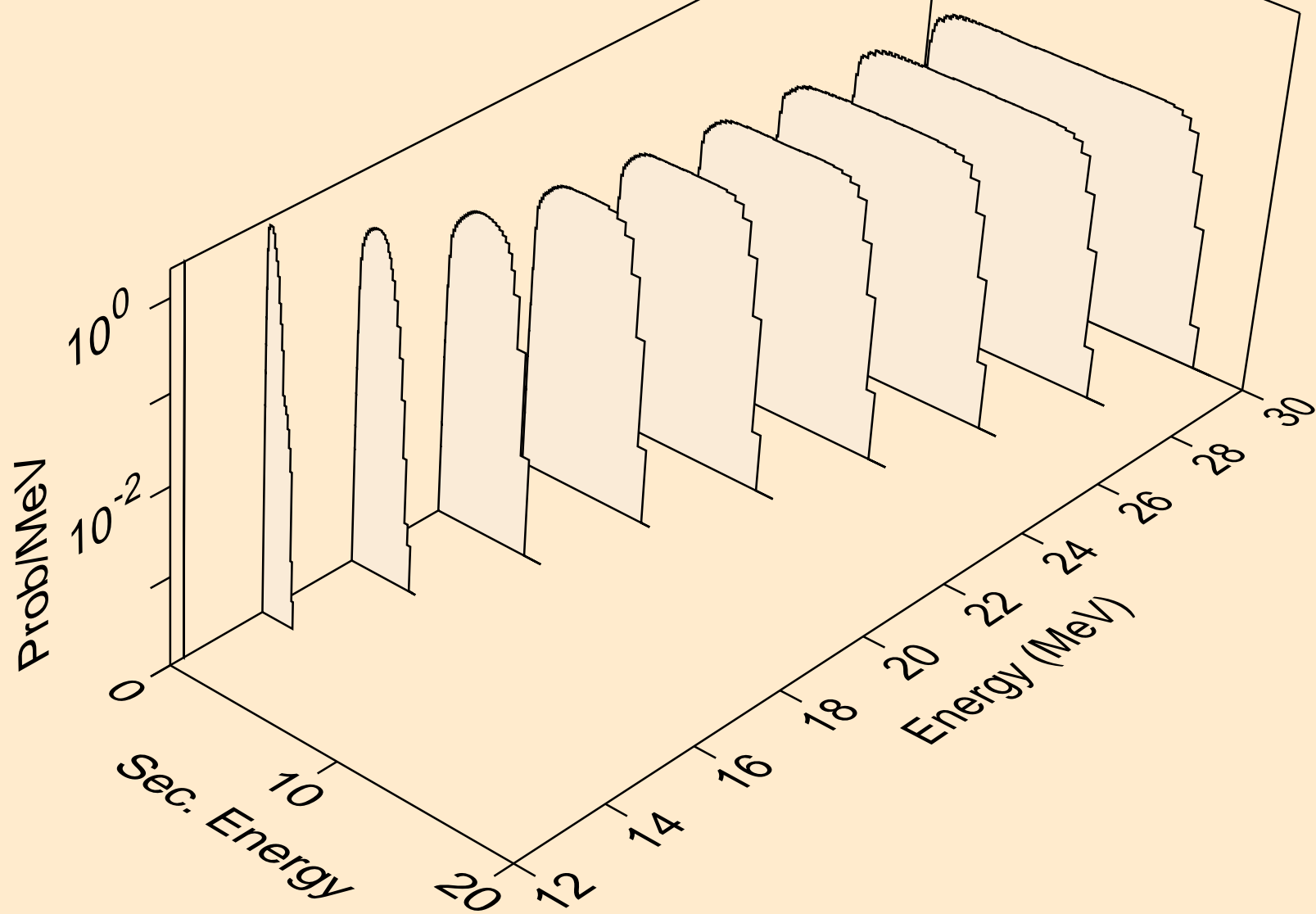

MD250 PROTON ACER TENDL-2021 LIBRARY; T=0.K
neutrons from (p,3n)

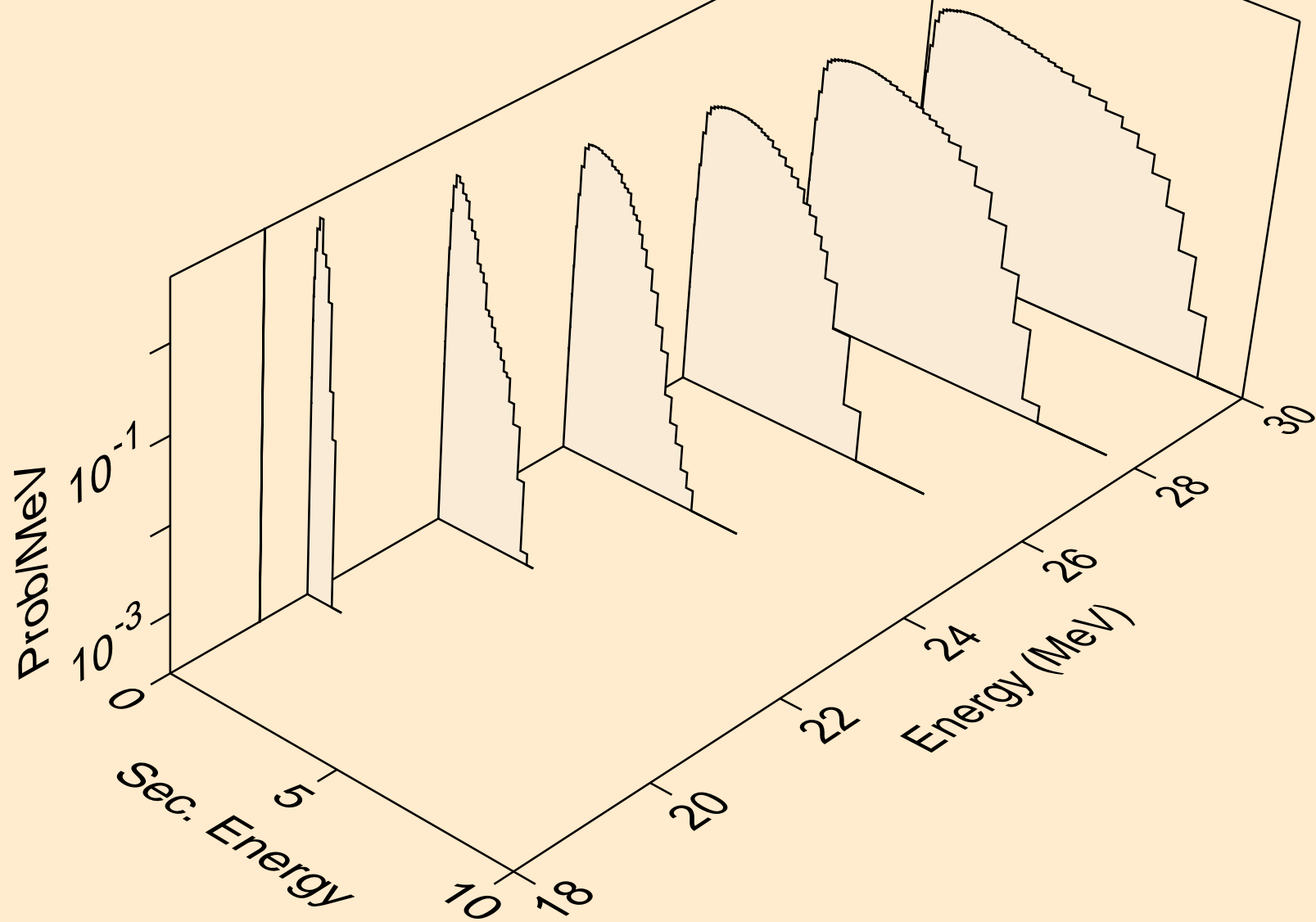

MD250 PROTON ACER TENDL-2021 LIBRARY; T=0.K
neutrons from (p,n*)a

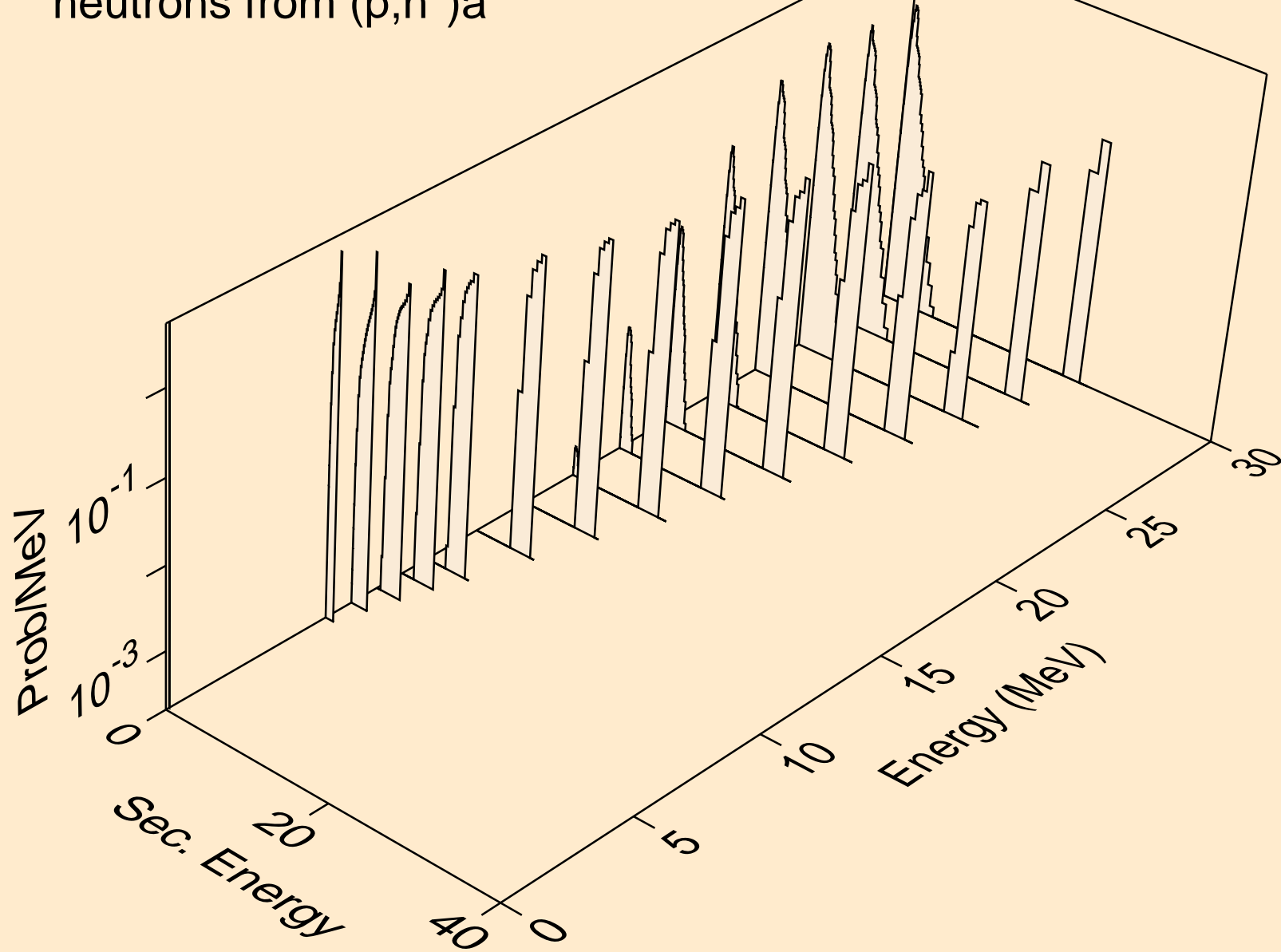

MD250 PROTON ACER TENDL-2021 LIBRARY; T=0.K
neutrons from (p,2n)a

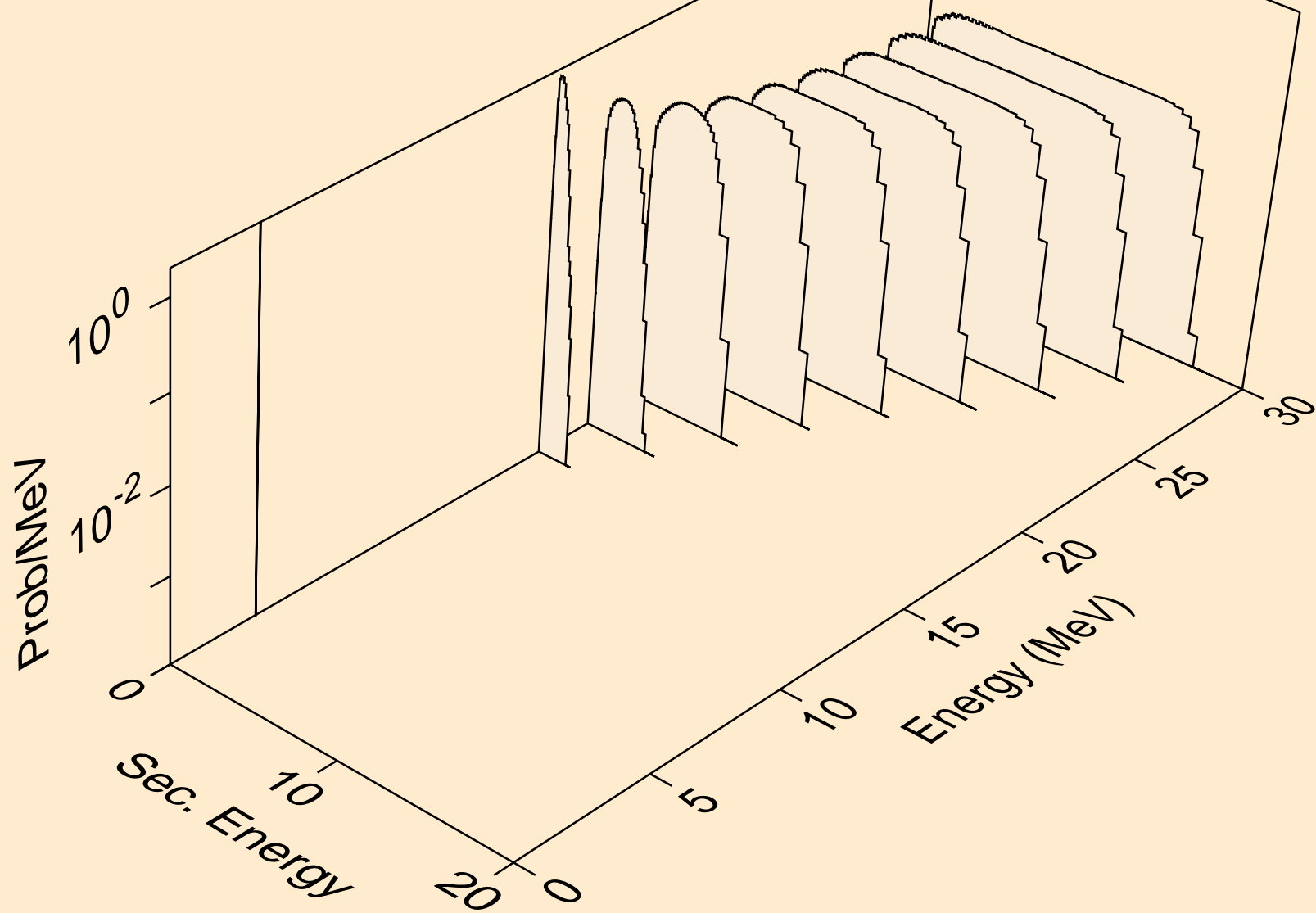

MD250 PROTON ACER TENDL-2021 LIBRARY; T=0.K
neutrons from (p,n*)p

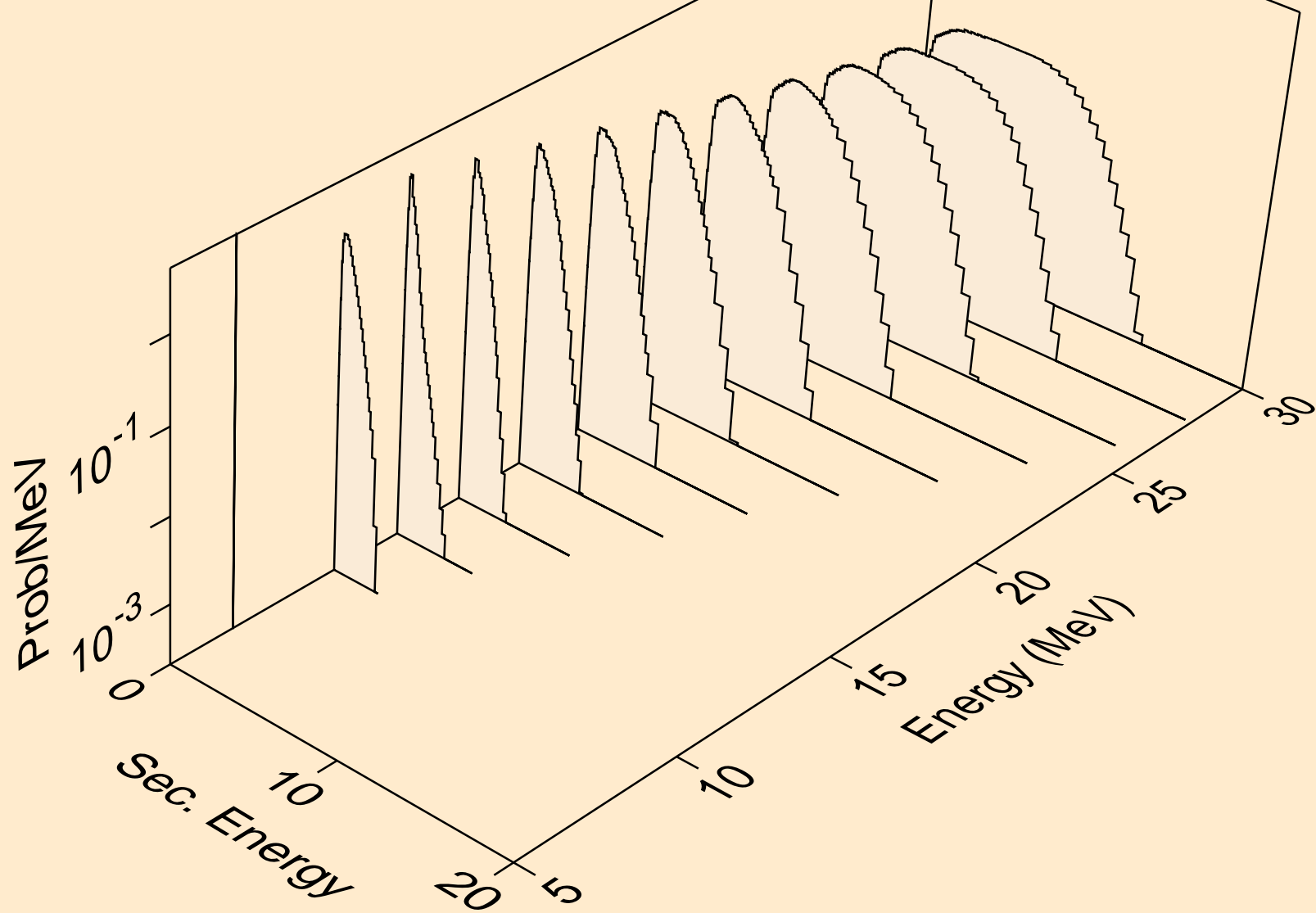

MD250 PROTON ACER TENDL-2021 LIBRARY; T=0.K
neutrons from (p,n*)d

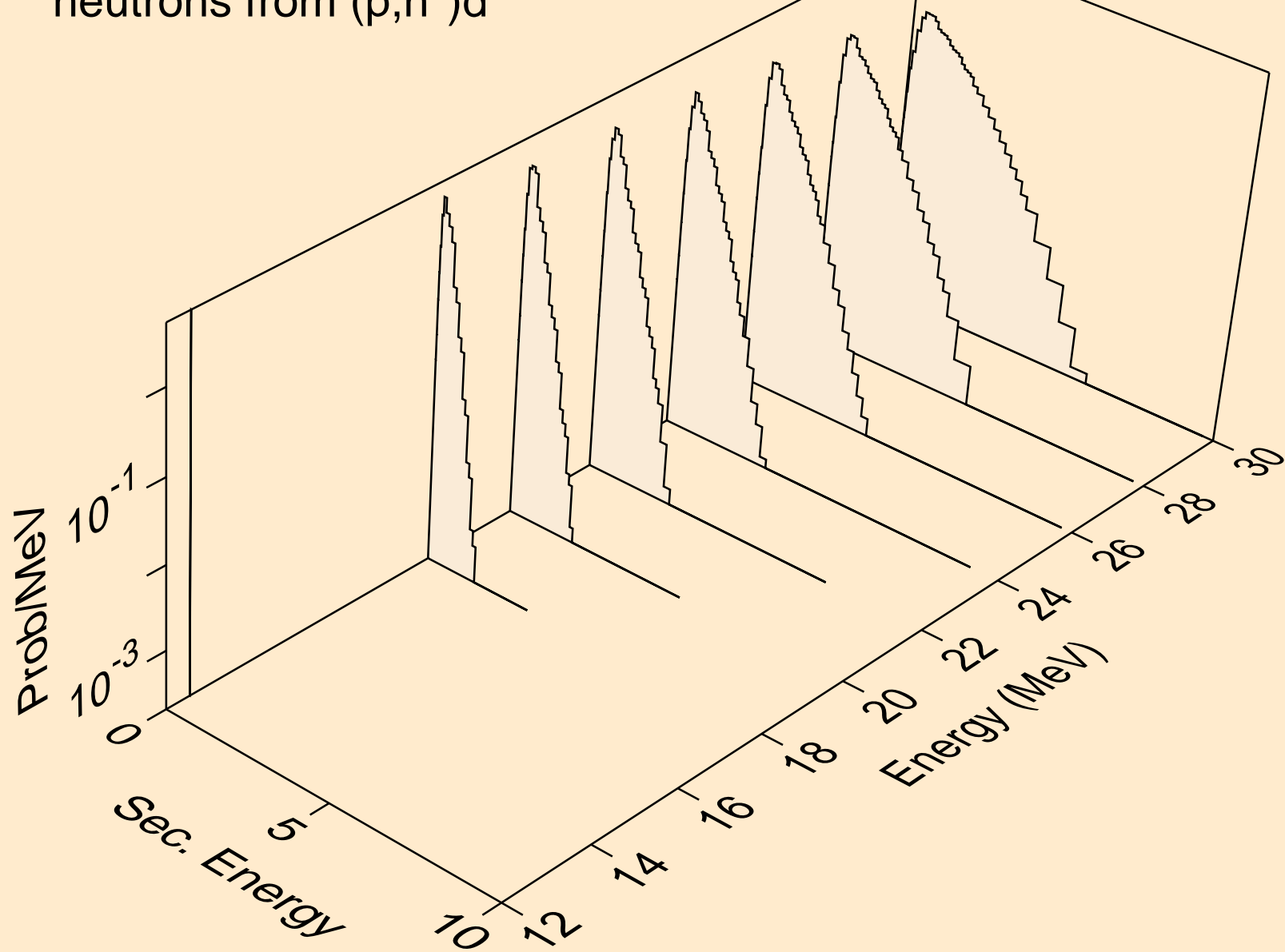

MD250 PROTON ACER TENDL-2021 LIBRARY; T=0.K
neutrons from (p,n*)t

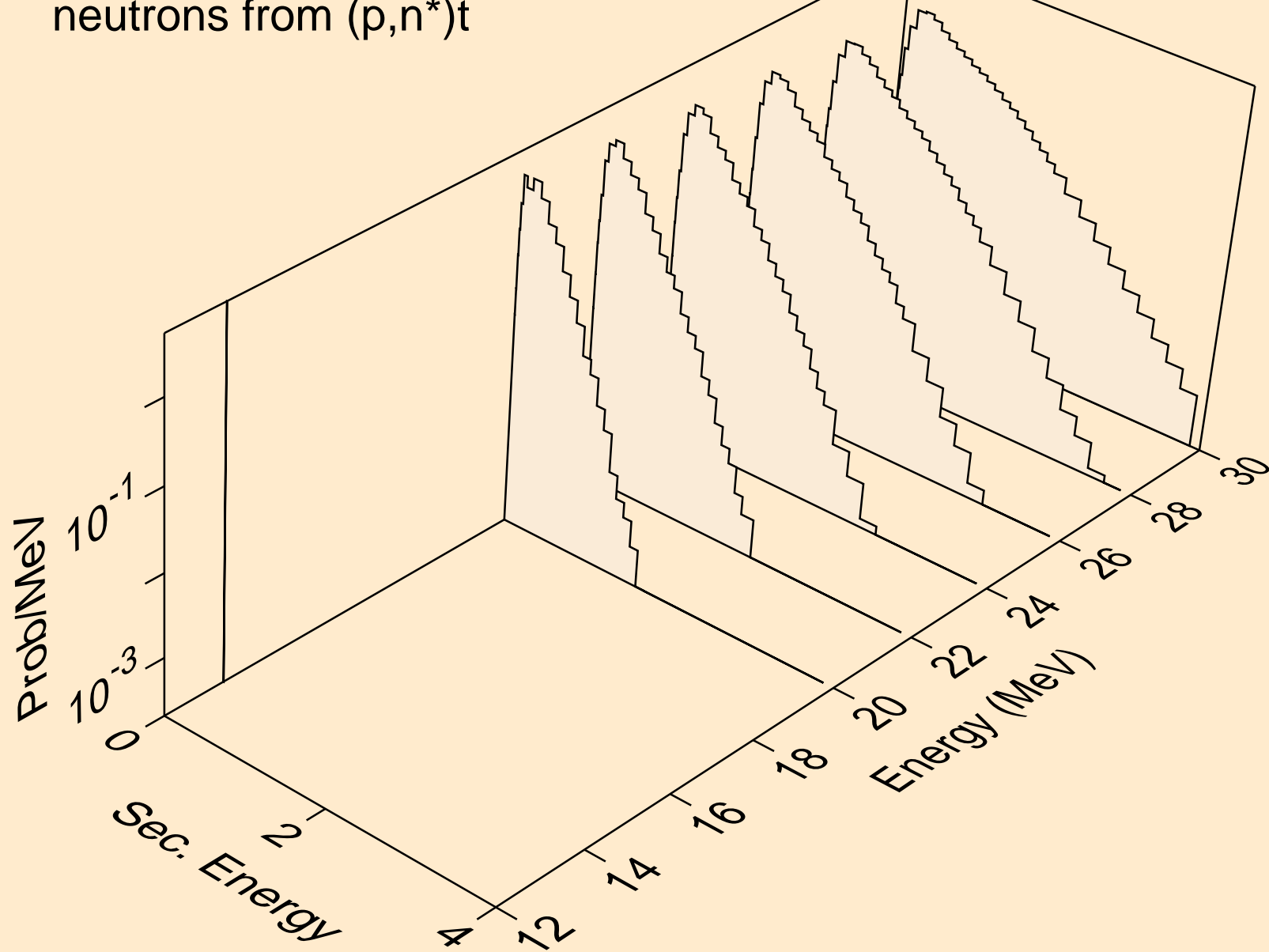

MD250 PROTON ACER TENDL-2021 LIBRARY; T=0.K
neutrons from (p,2np)

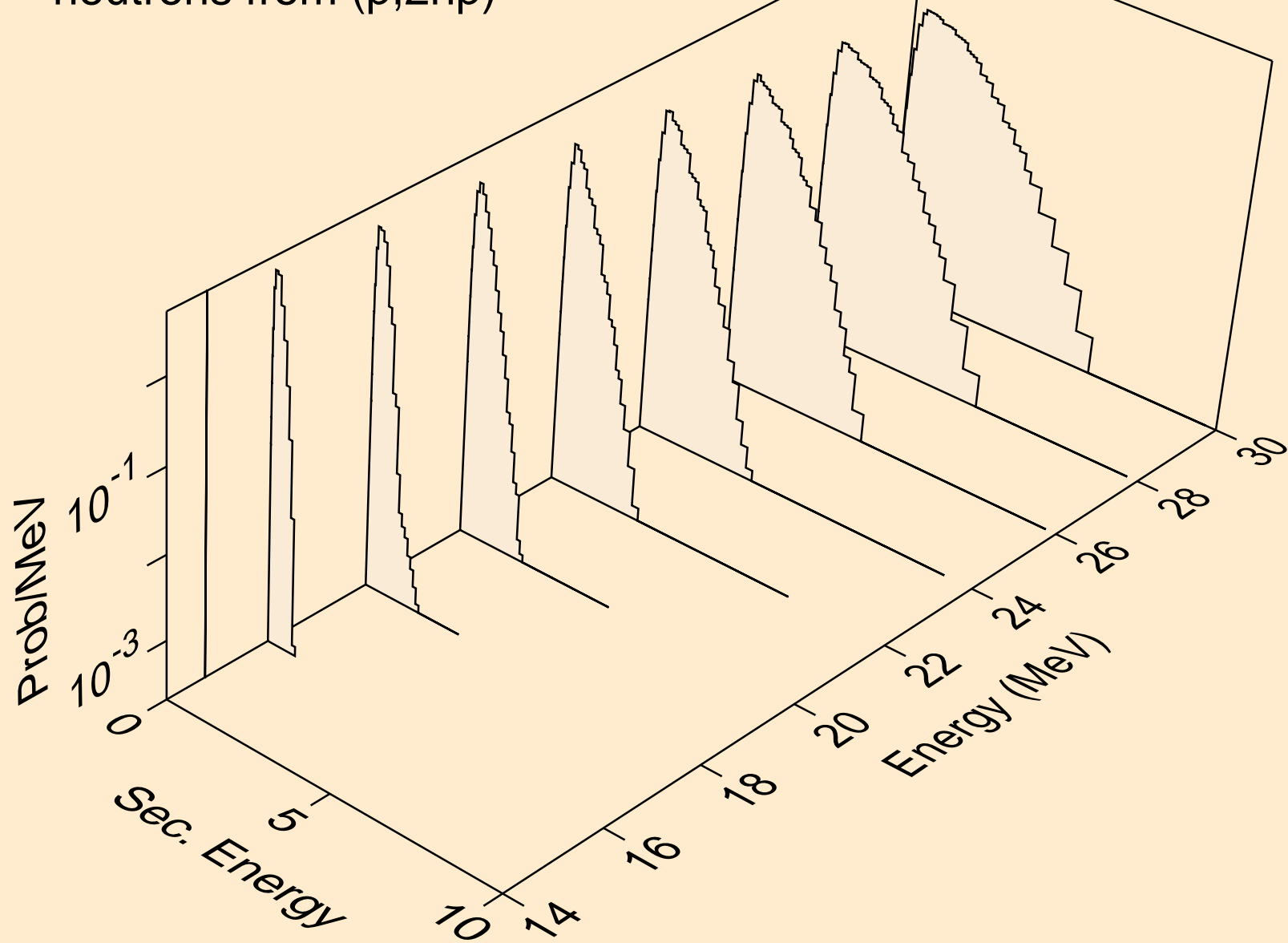

MD250 PROTON ACER TENDL-2021 LIBRARY; T=0.K
neutrons from (p,2np)

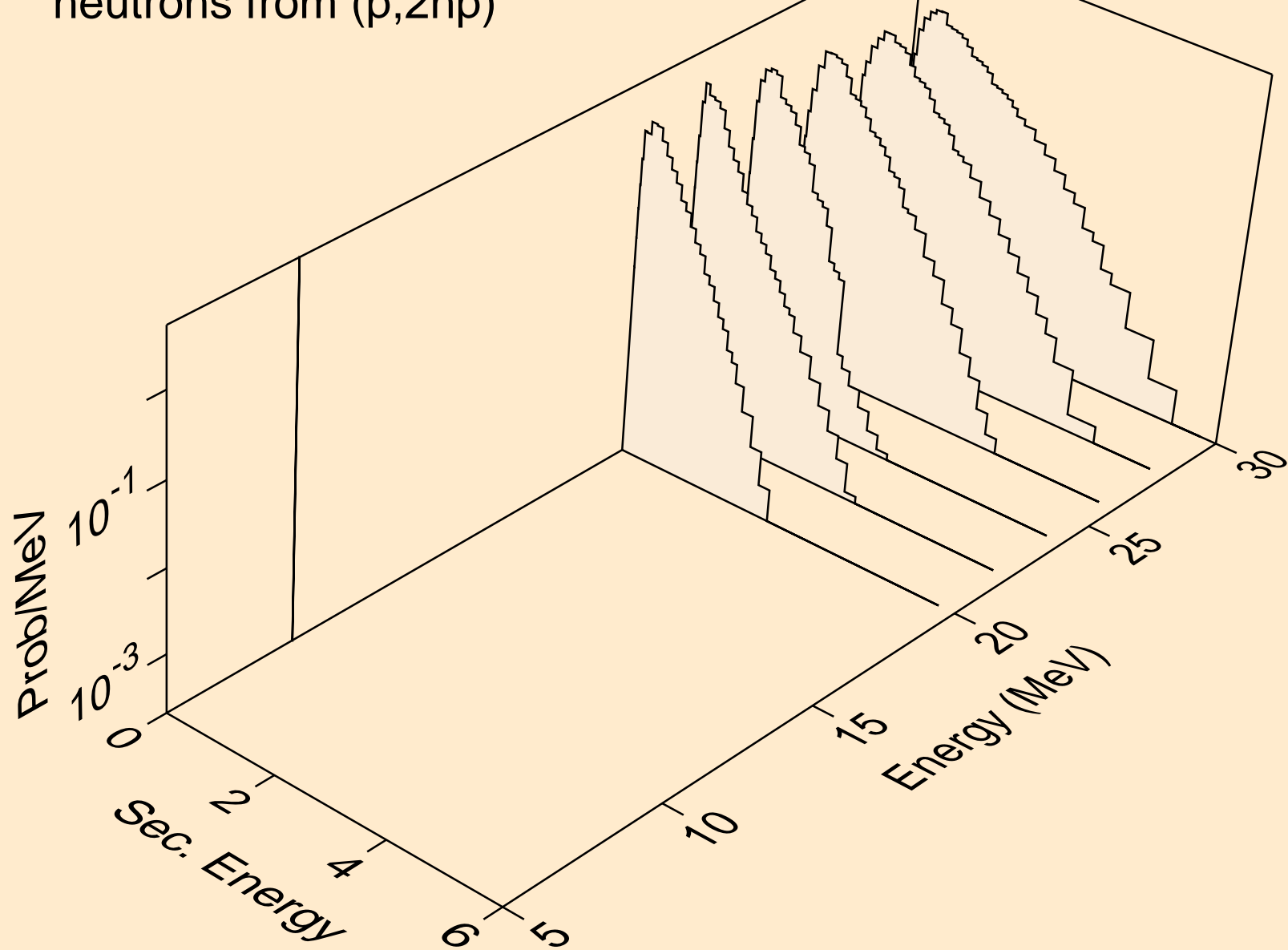

MD250 PROTON ACER TENDL-2021 LIBRARY; T=0.K
neutrons from (p,npa)

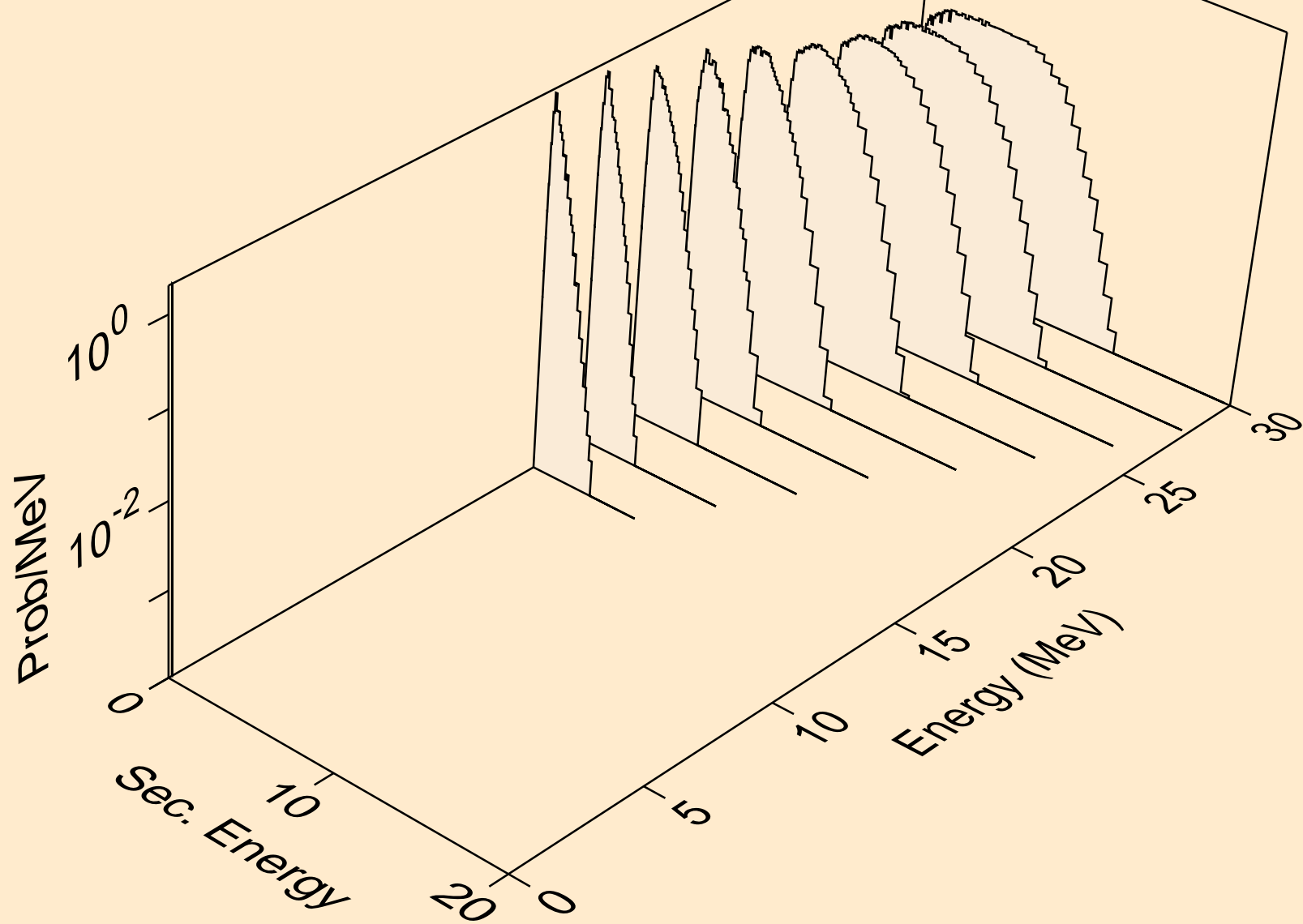

MD250 PROTON ACER TENDL-2021 LIBRARY; T=0.K
deuterons from (p,x)

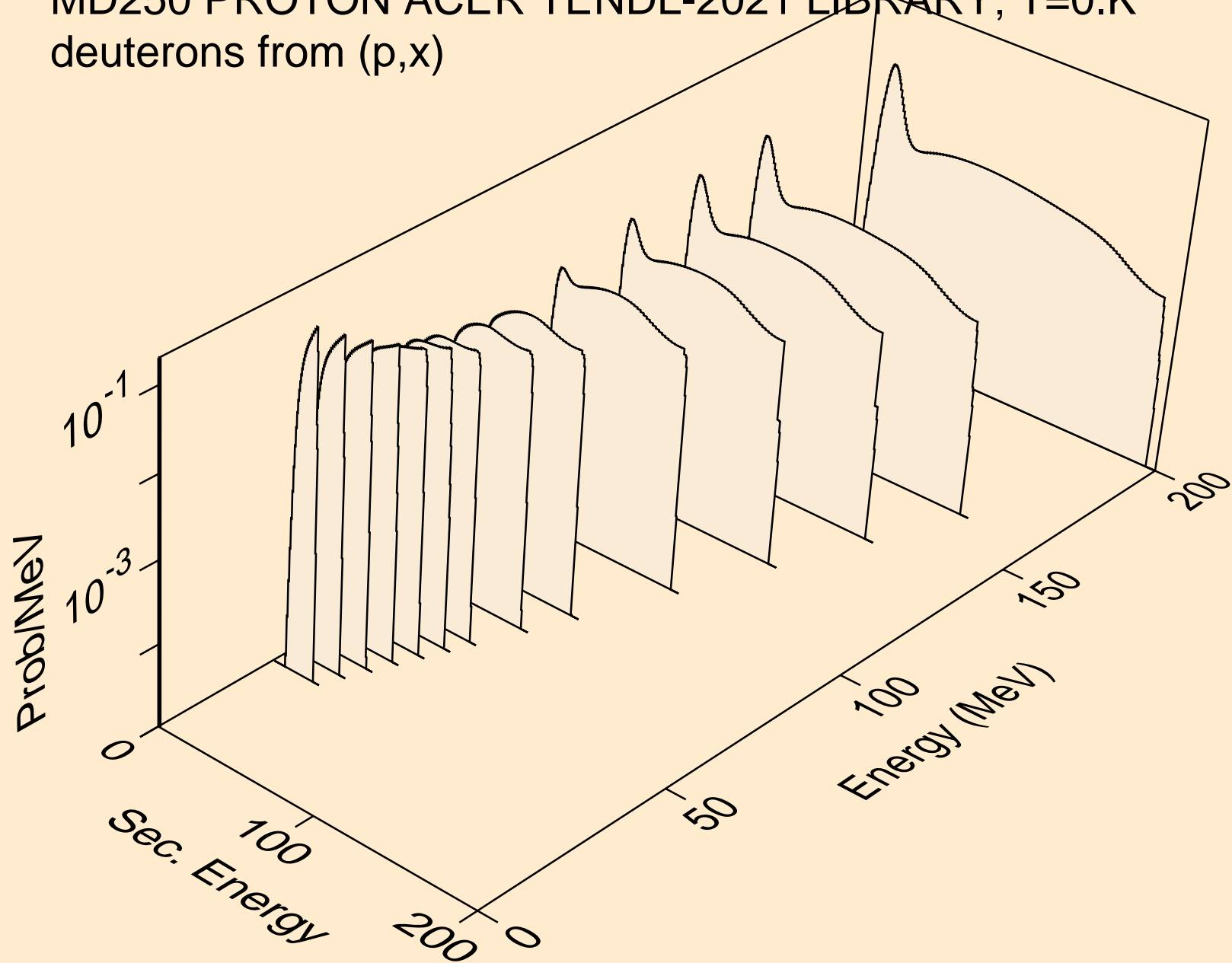

MD250 PROTON ACER TENDL-2021 LIBRARY; T=0.K
deuterons from (p,n*)d

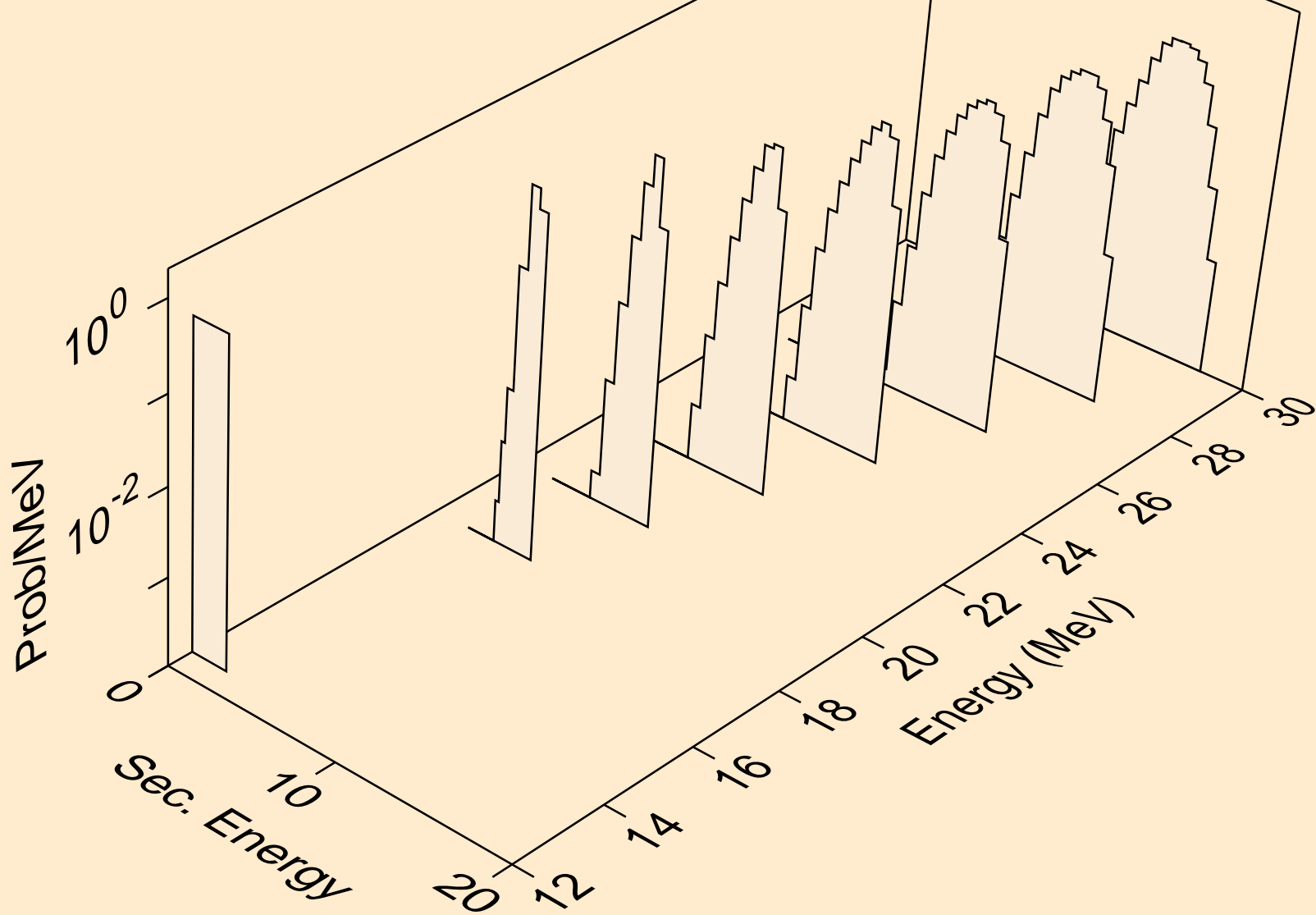

MD250 PROTON ACER TENDL-2021 LIBRARY; T=0.K
deuterons from (p,d)

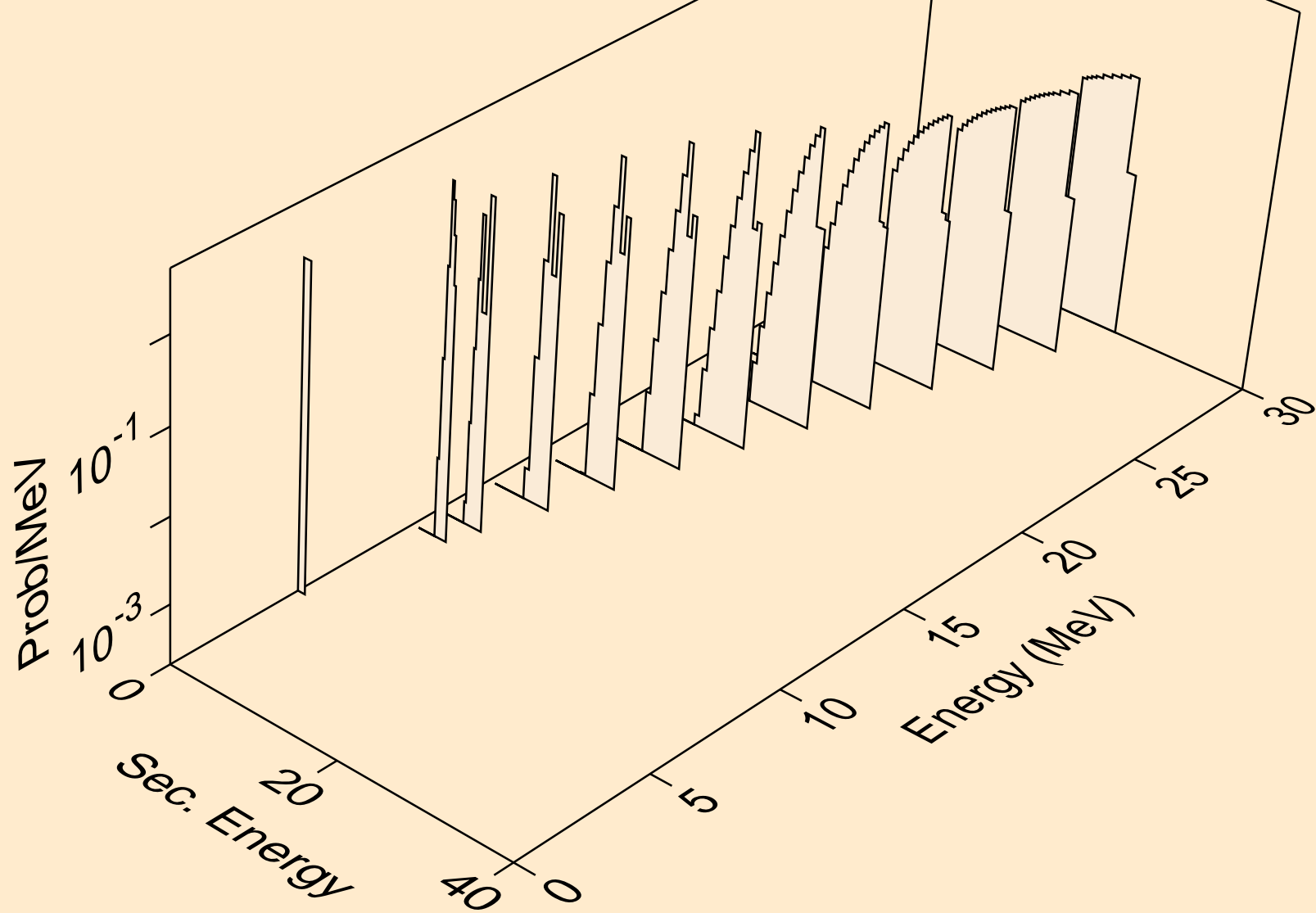

MD250 PROTON ACER TENDL-2021 LIBRARY; T=0.K
deuterons from (p,pd)

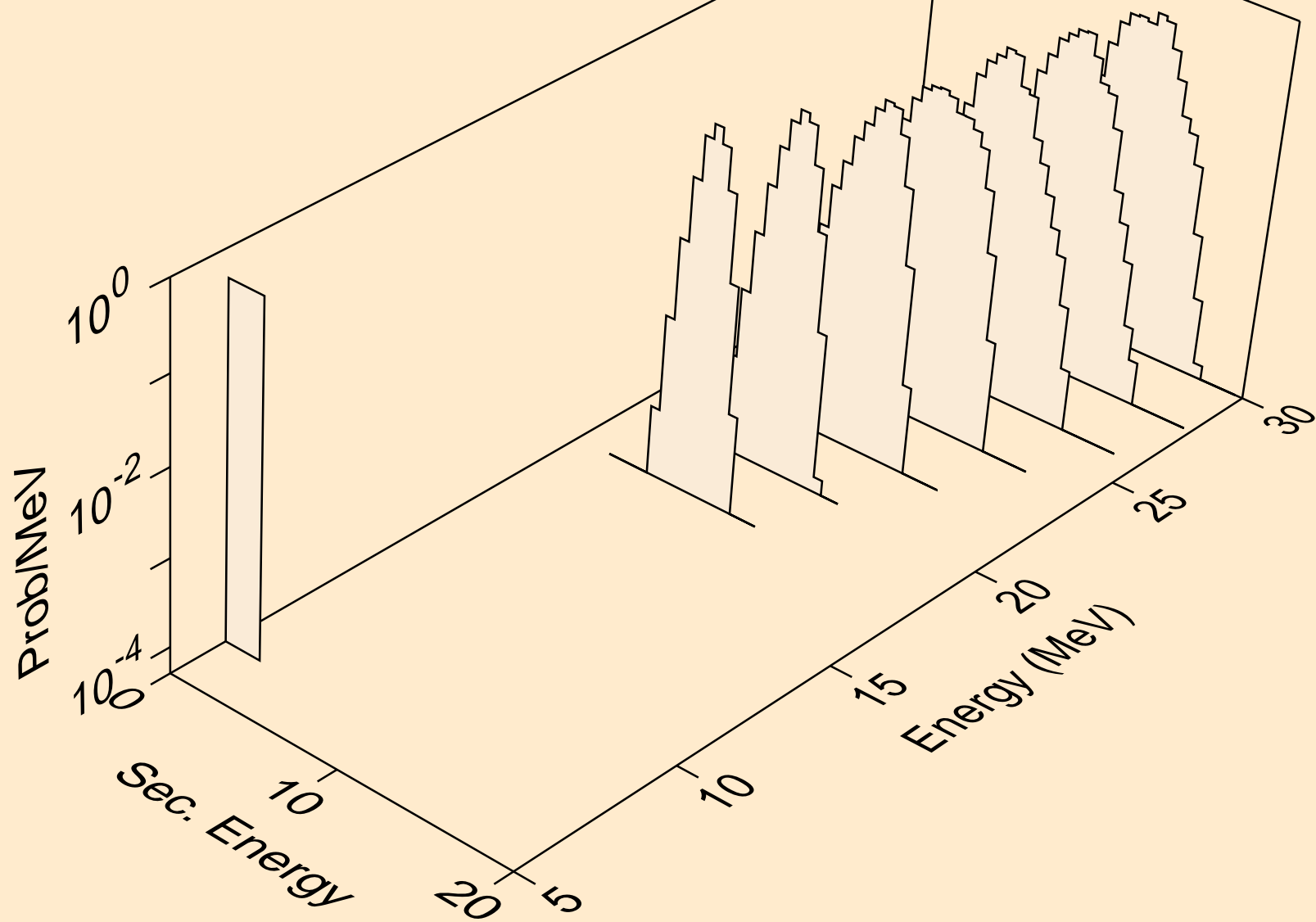

MD250 PROTON ACER TENDL-2021 LIBRARY; T=0.K
deuterons from (p,da)

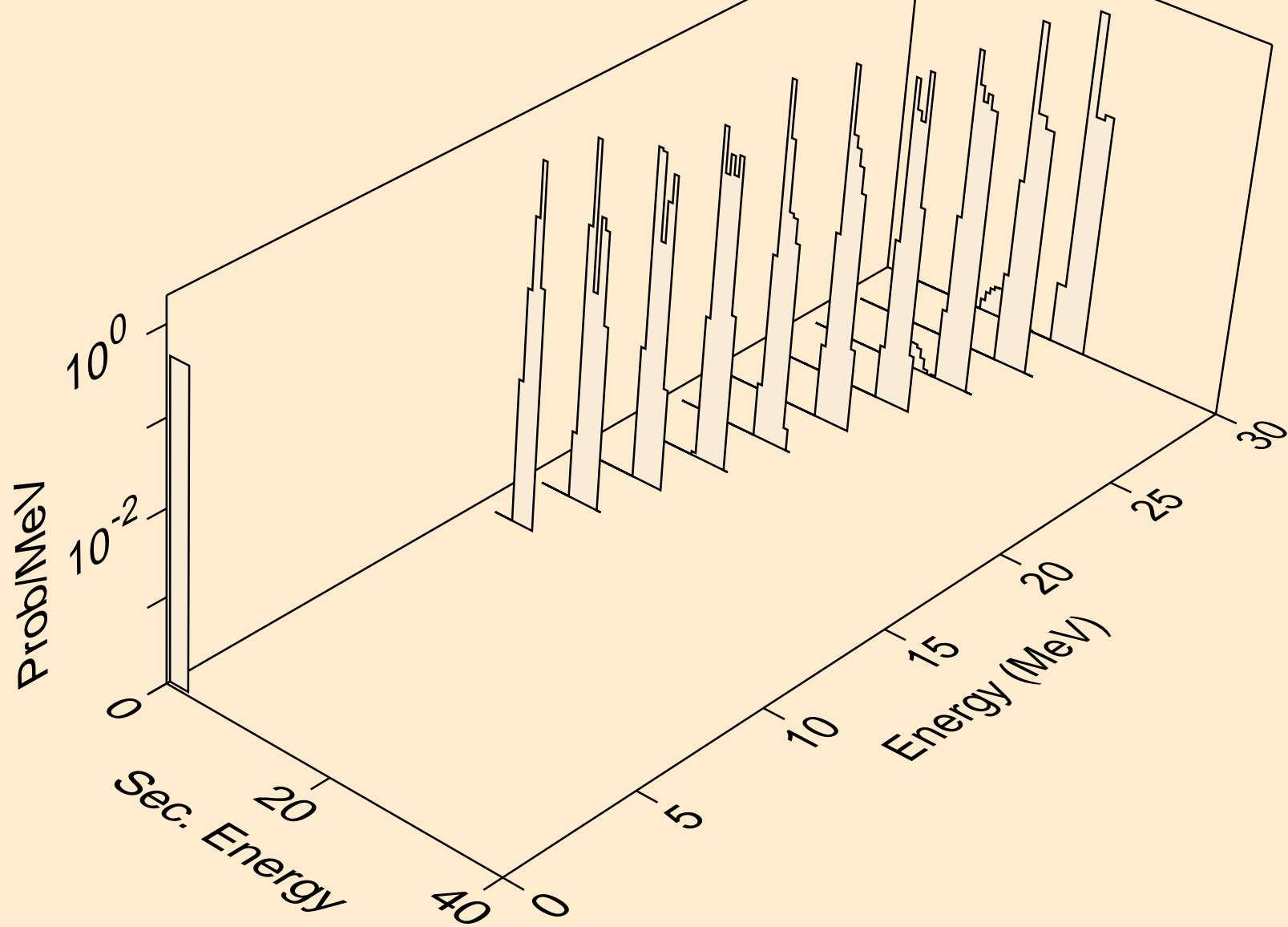

MD250 PROTON ACER TENDL-2021 LIBRARY; T=0.K
tritons from (p,x)

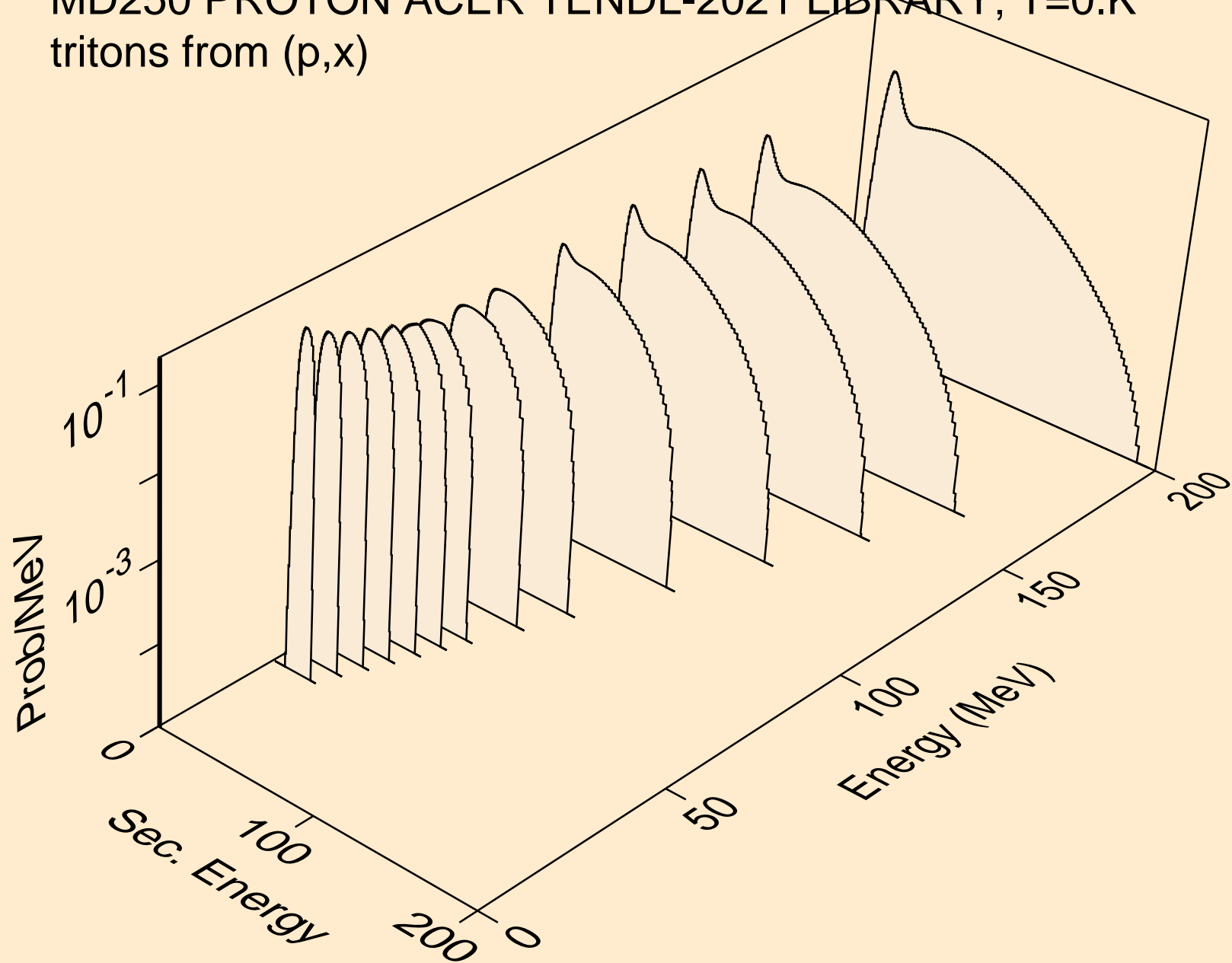

MD250 PROTON ACER TENDL-2021 LIBRARY; T=0.K
tritons from (p,n*)t

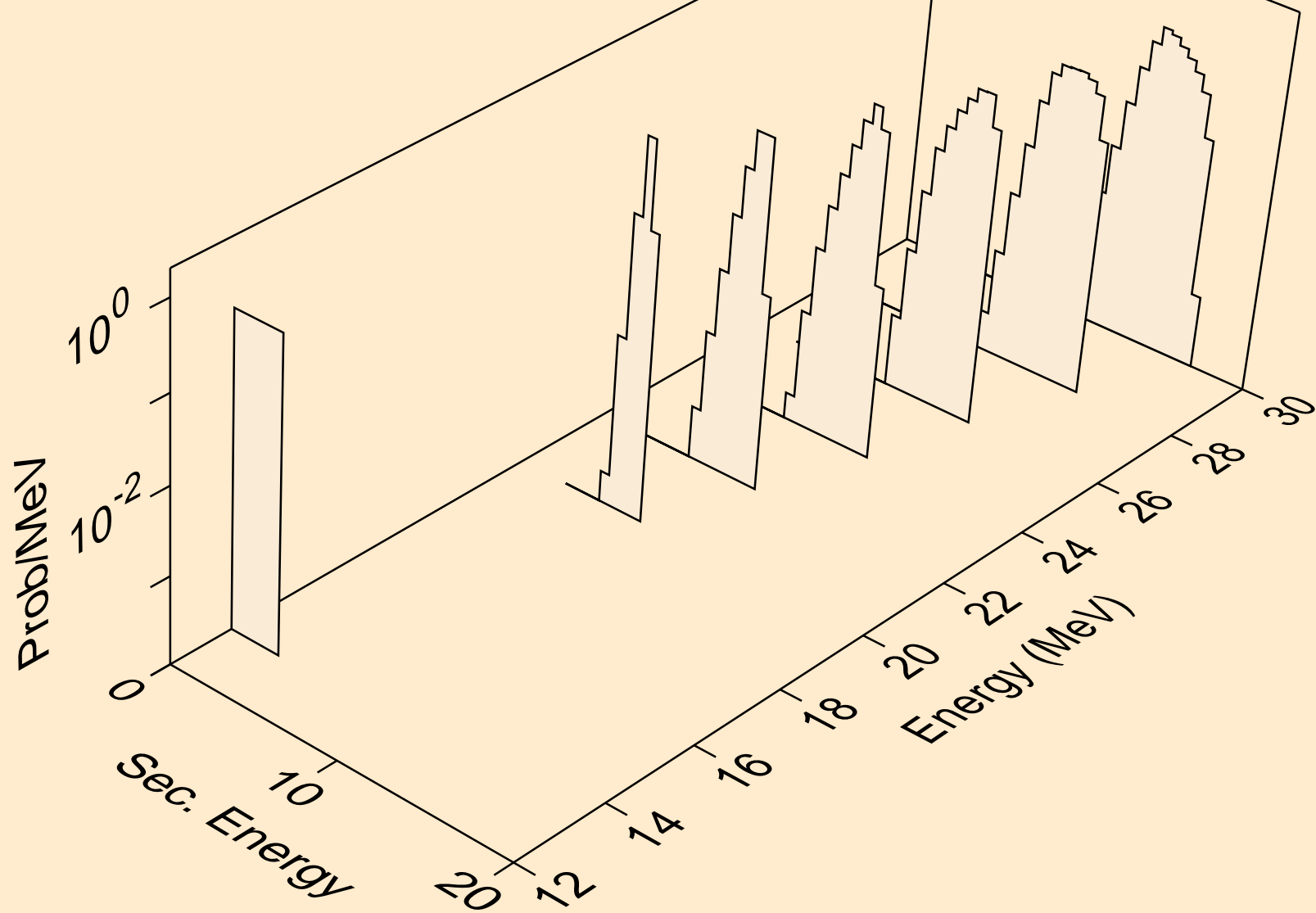

MD250 PROTON ACER TENDL-2021 LIBRARY; T=0.K
tritons from (p,t)

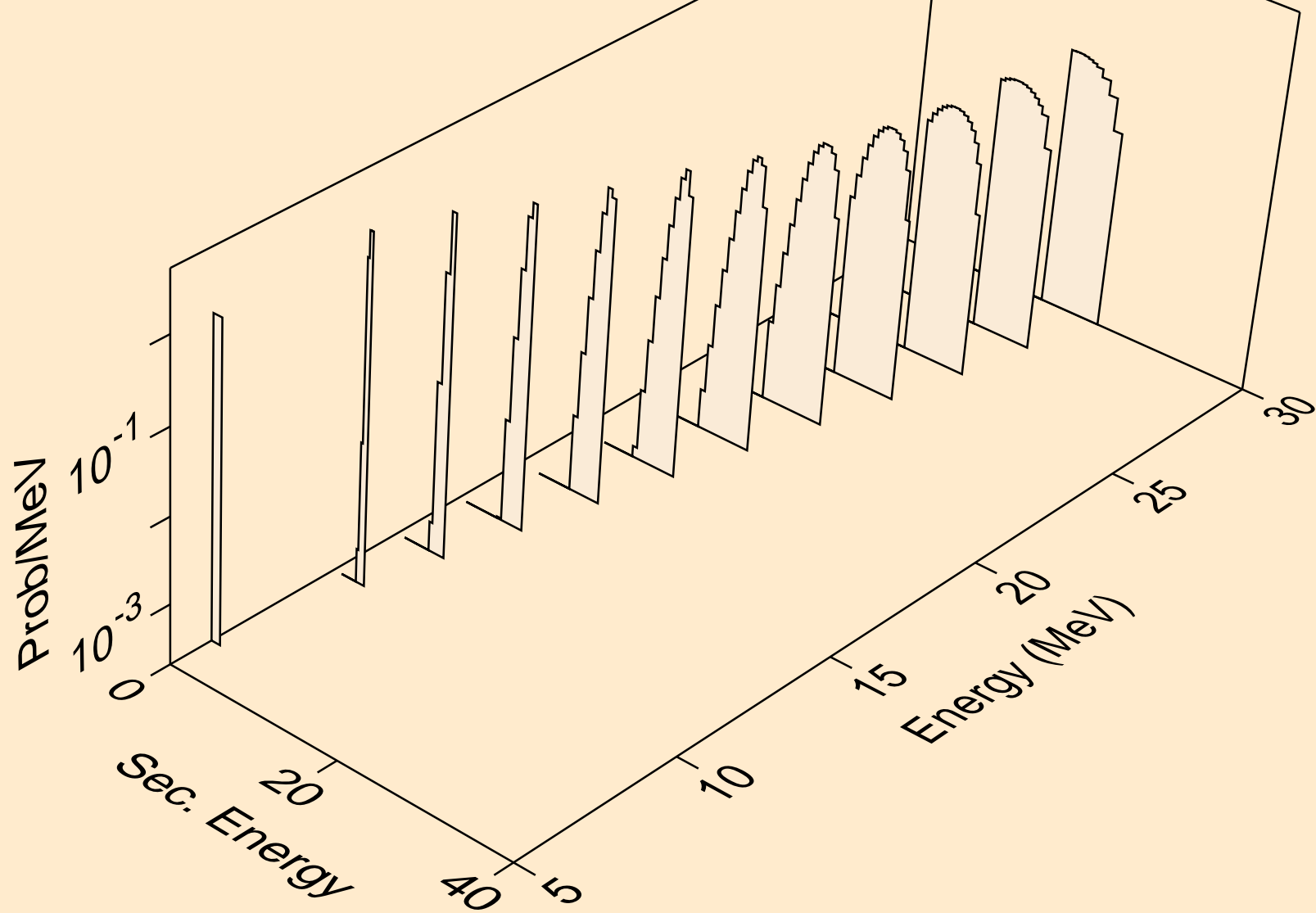

MD250 PROTON ACER TENDL-2021 LIBRARY; T=0.K
he3s from (p,x)

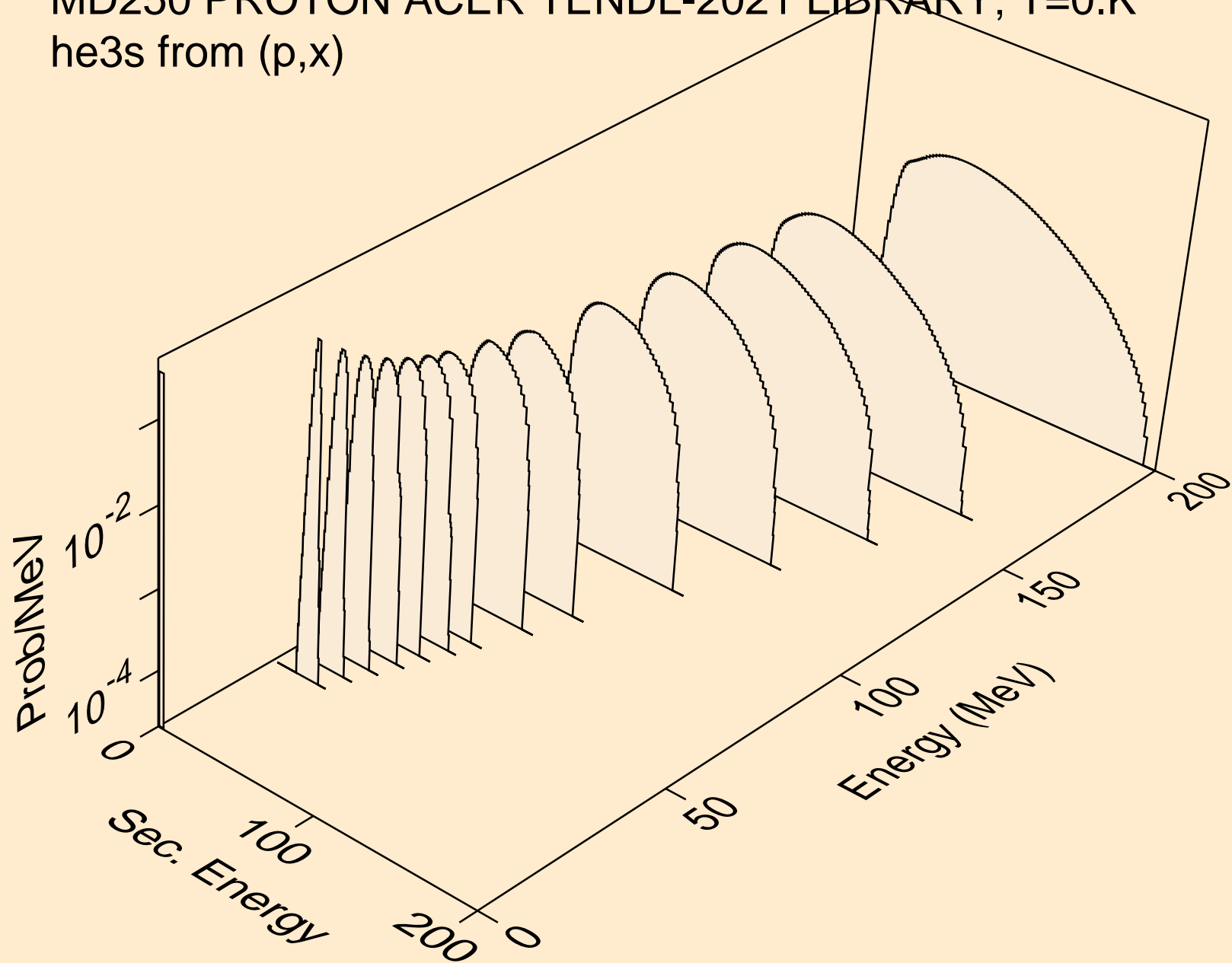

MD250 PROTON ACER TENDL-2021 LIBRARY; T=0.K
he3s from (p,he3)

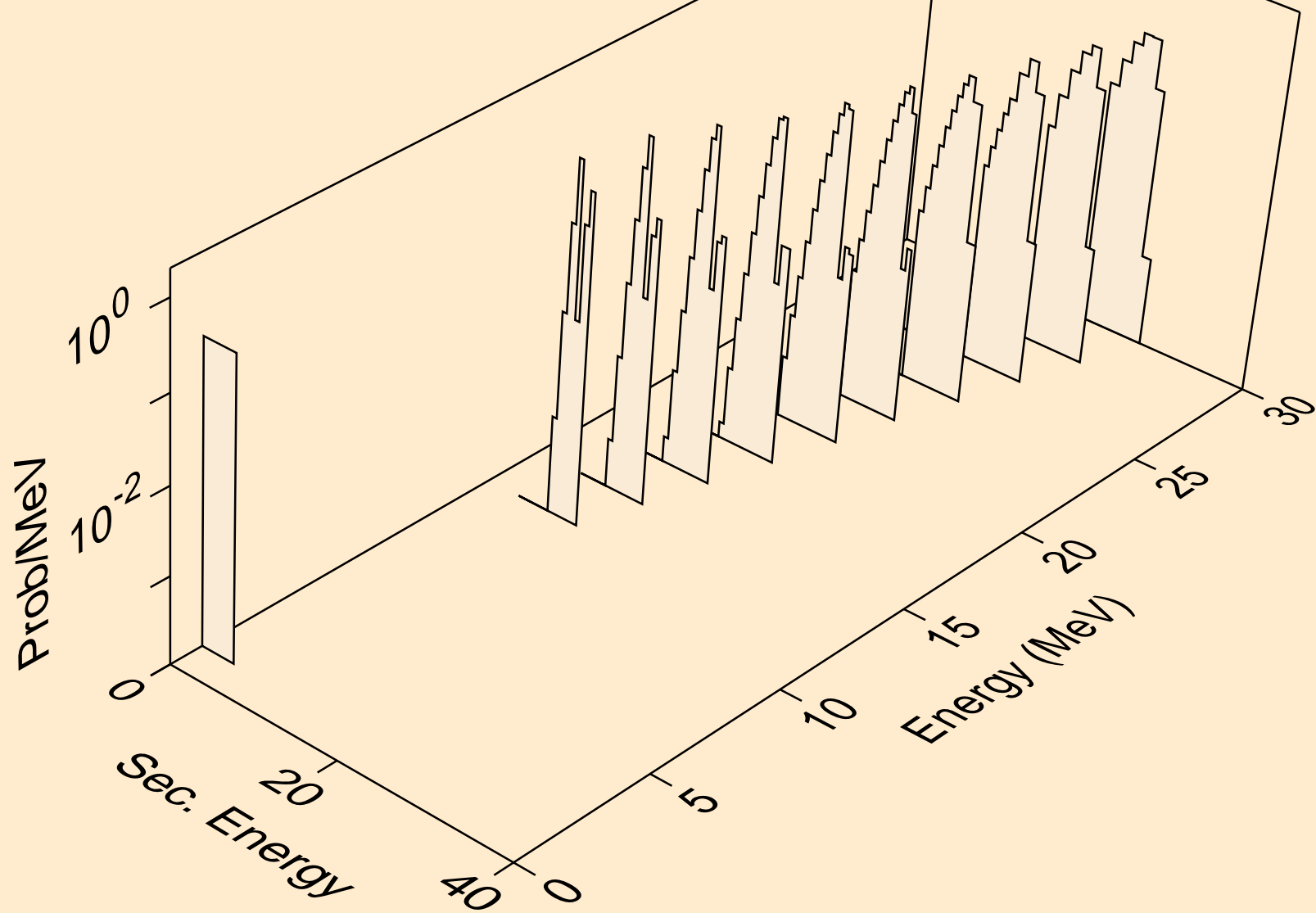

MD250 PROTON ACER TENDL-2021 LIBRARY; T=0.K
alphas from (p,x)

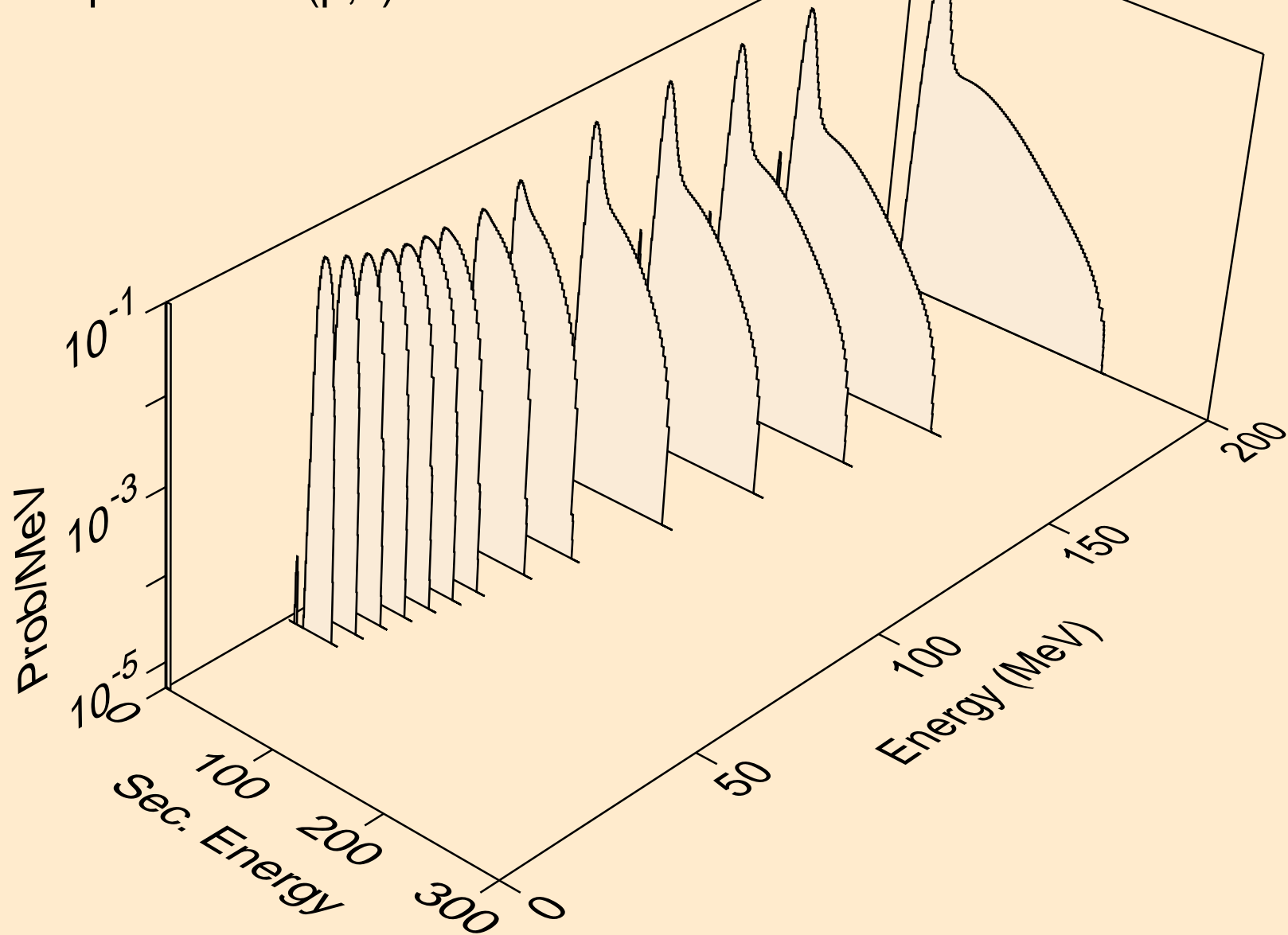

MD250 PROTON ACER TENDL-2021 LIBRARY; T=0.K
alphas from (p,n*)a

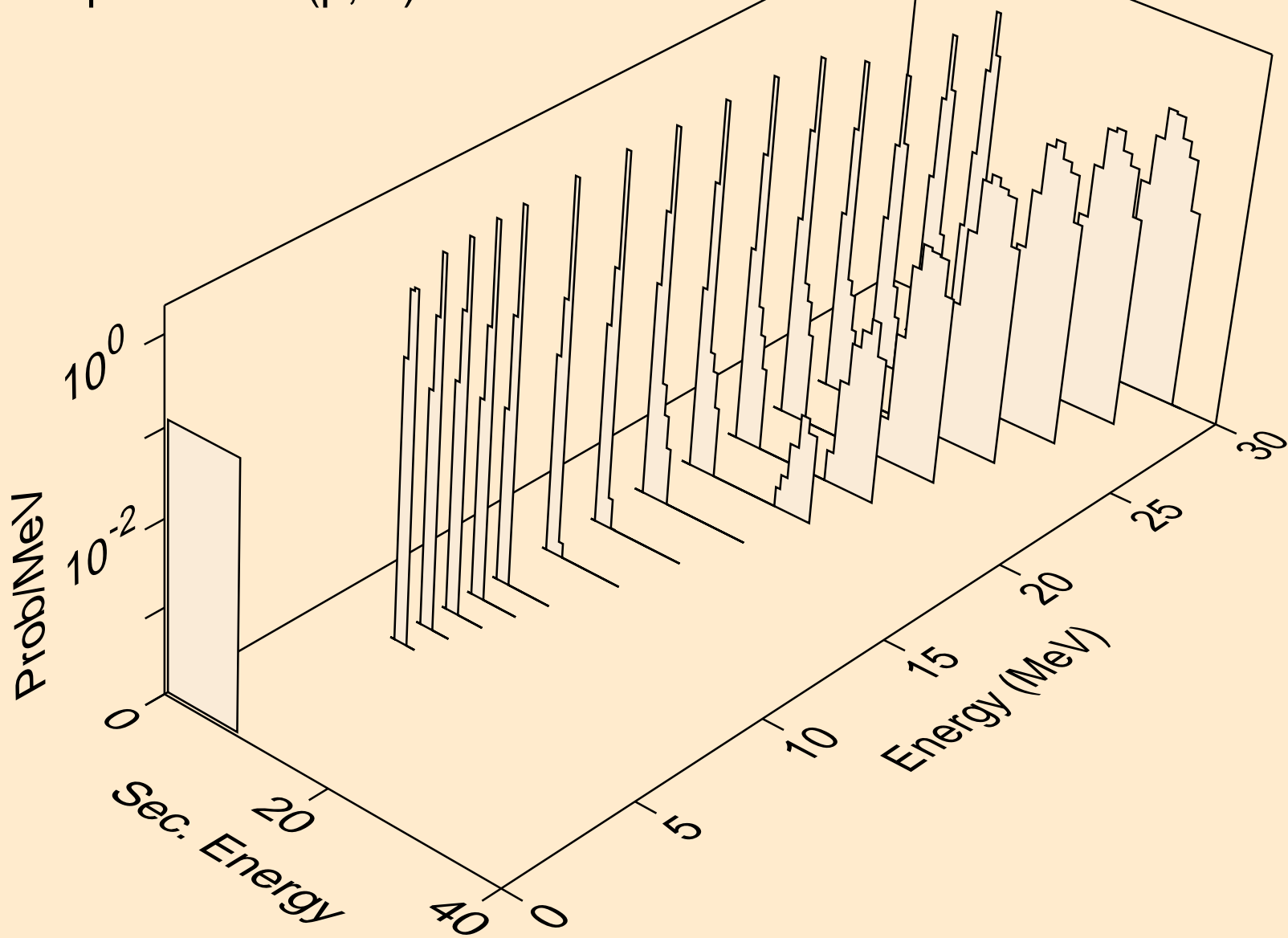

MD250 PROTON ACER TENDL-2021 LIBRARY; T=0.K
alphas from (p,2n)a

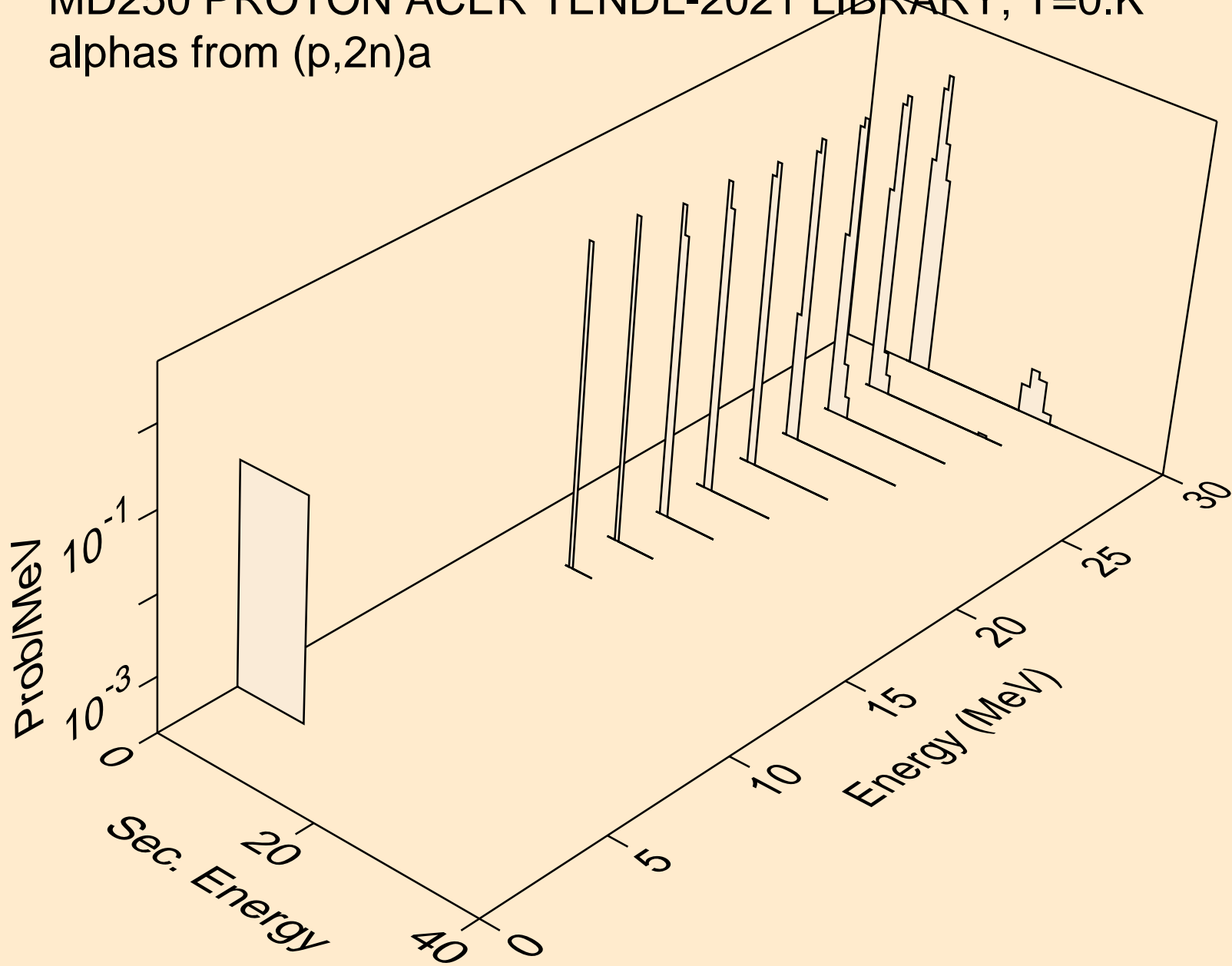

MD250 PROTON ACER TENDL-2021 LIBRARY; T=0.K
alphas from (p,npa)

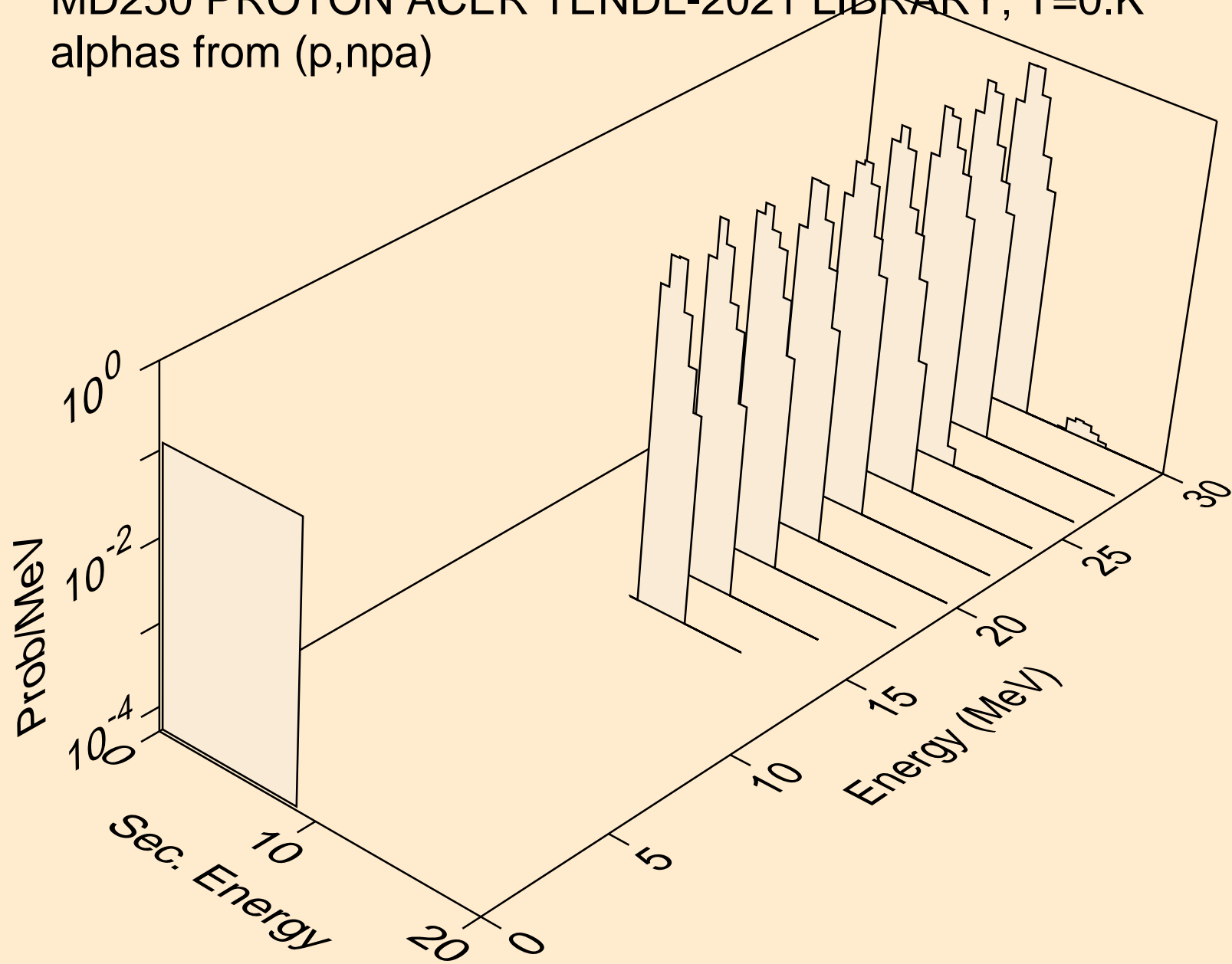

MD250 PROTON ACER TENDL-2021 LIBRARY; T=0.K
alphas from (p,a)

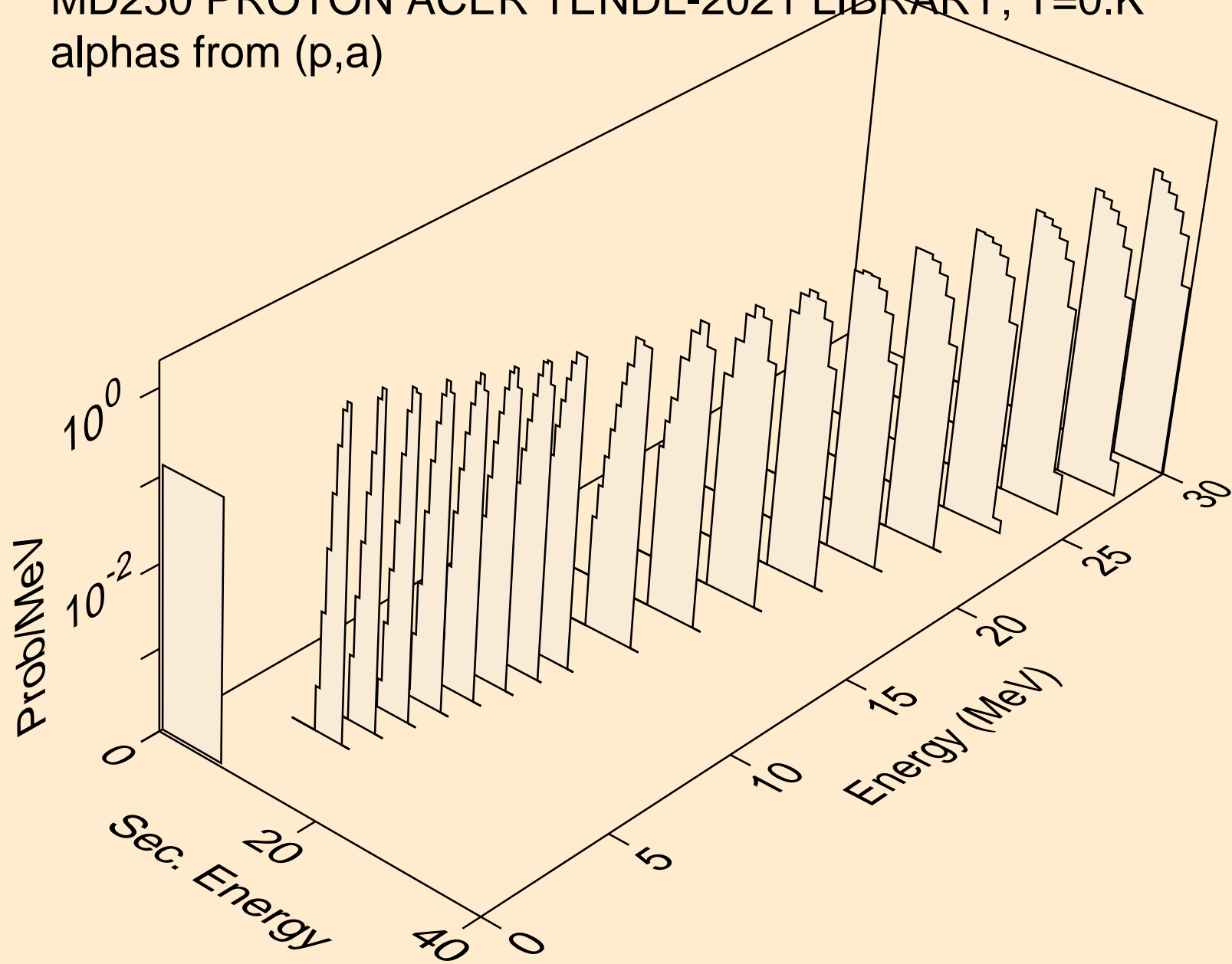

MD250 PROTON ACER TENDL-2021 LIBRARY; T=0.K
alphas from (p,2a)

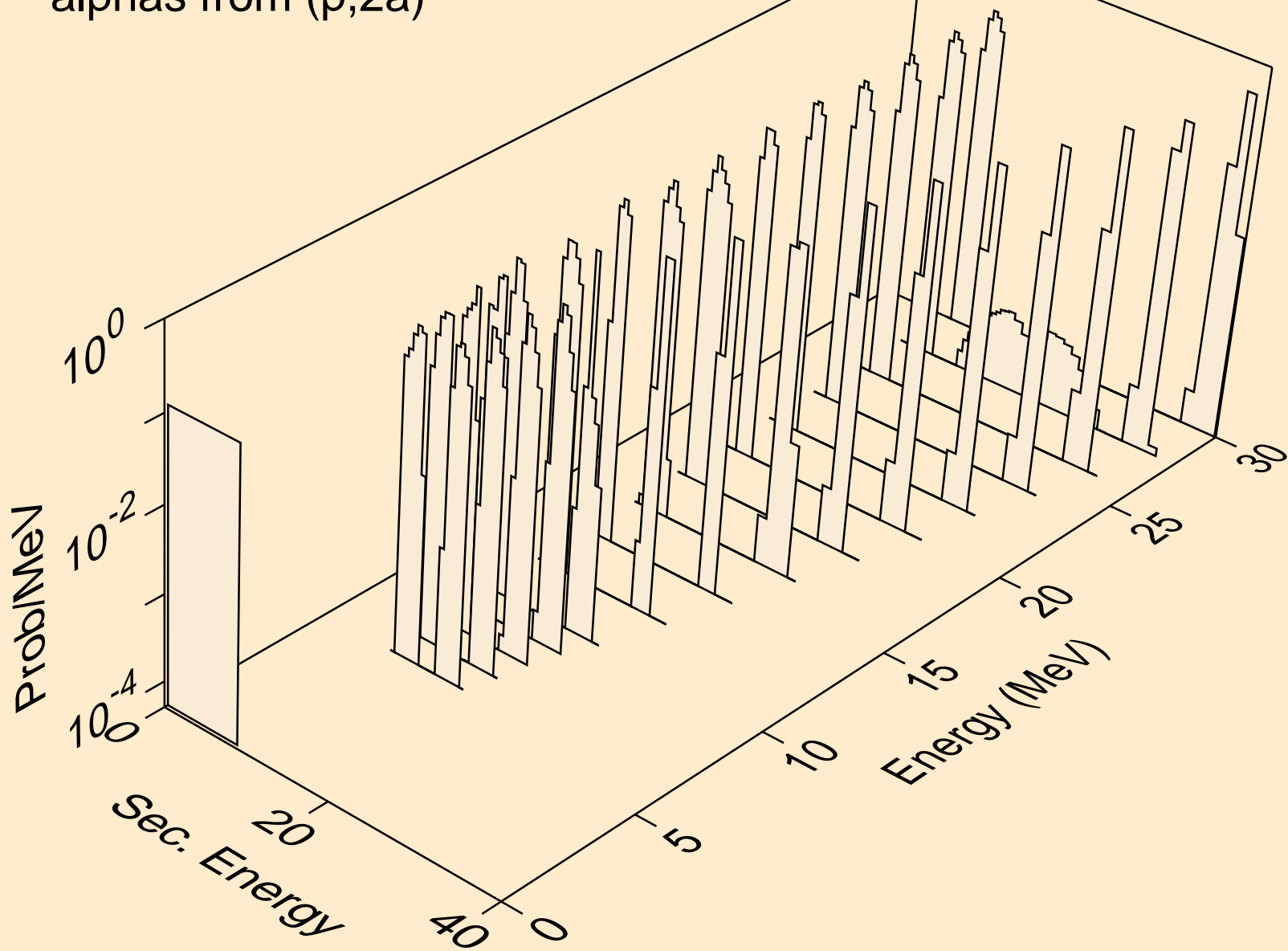

MD250 PROTON ACER TENDL-2021 LIBRARY; T=0.K
alphas from (p,da)

