

# PM154M PROTON ACER TENDL-2021 LIBRARY; T=0.K

## Principal cross sections

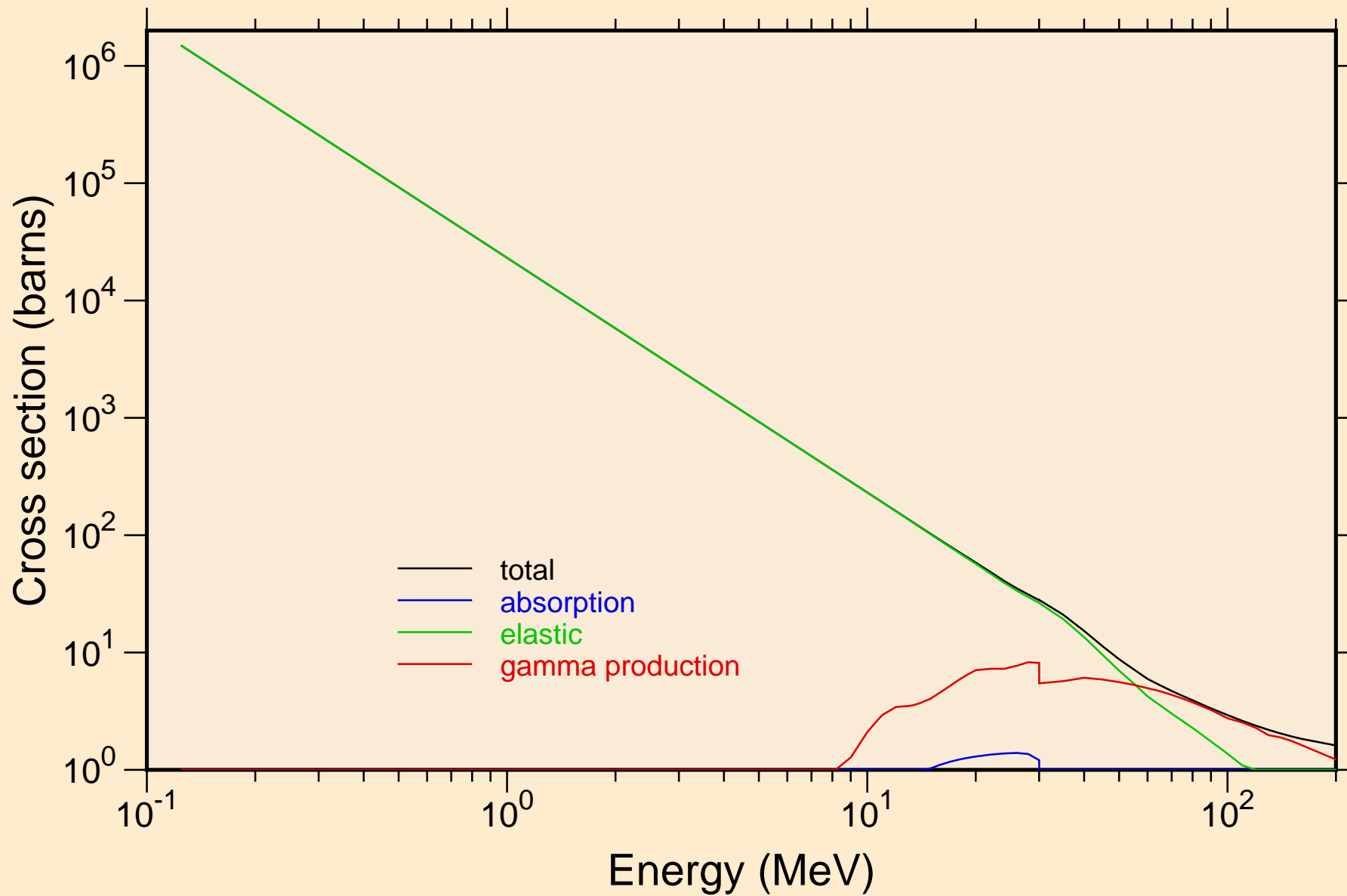

PM154M PROTON ACER TENDL-2021 LIBRARY; T=0.K  
Heating

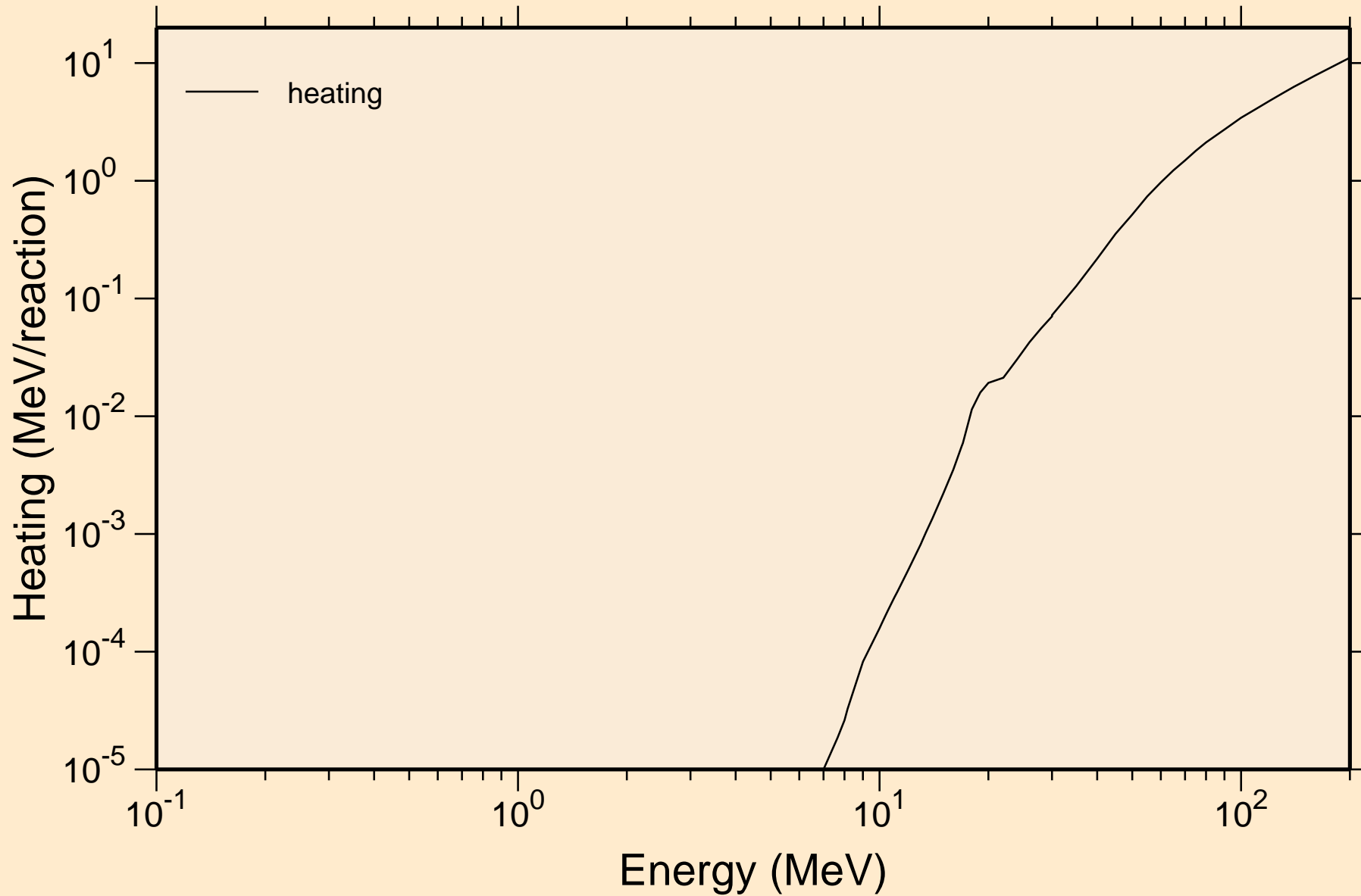

PM154M PROTON ACER TENDL-2021 LIBRARY; T=0.K  
Principal cross sections

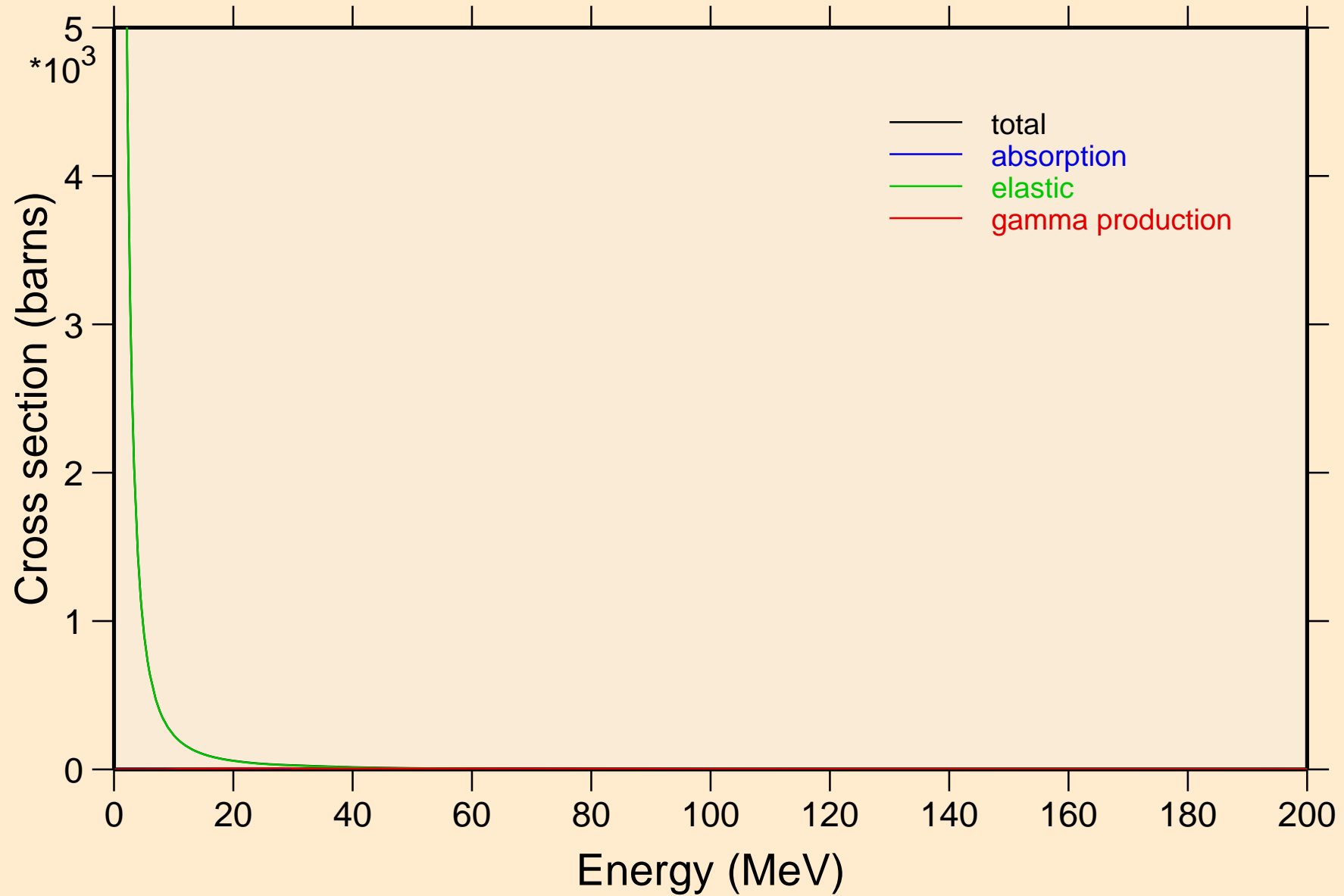

# PM154M PROTON ACER TENDL-2021 LIBRARY; T=0.K

## Heating

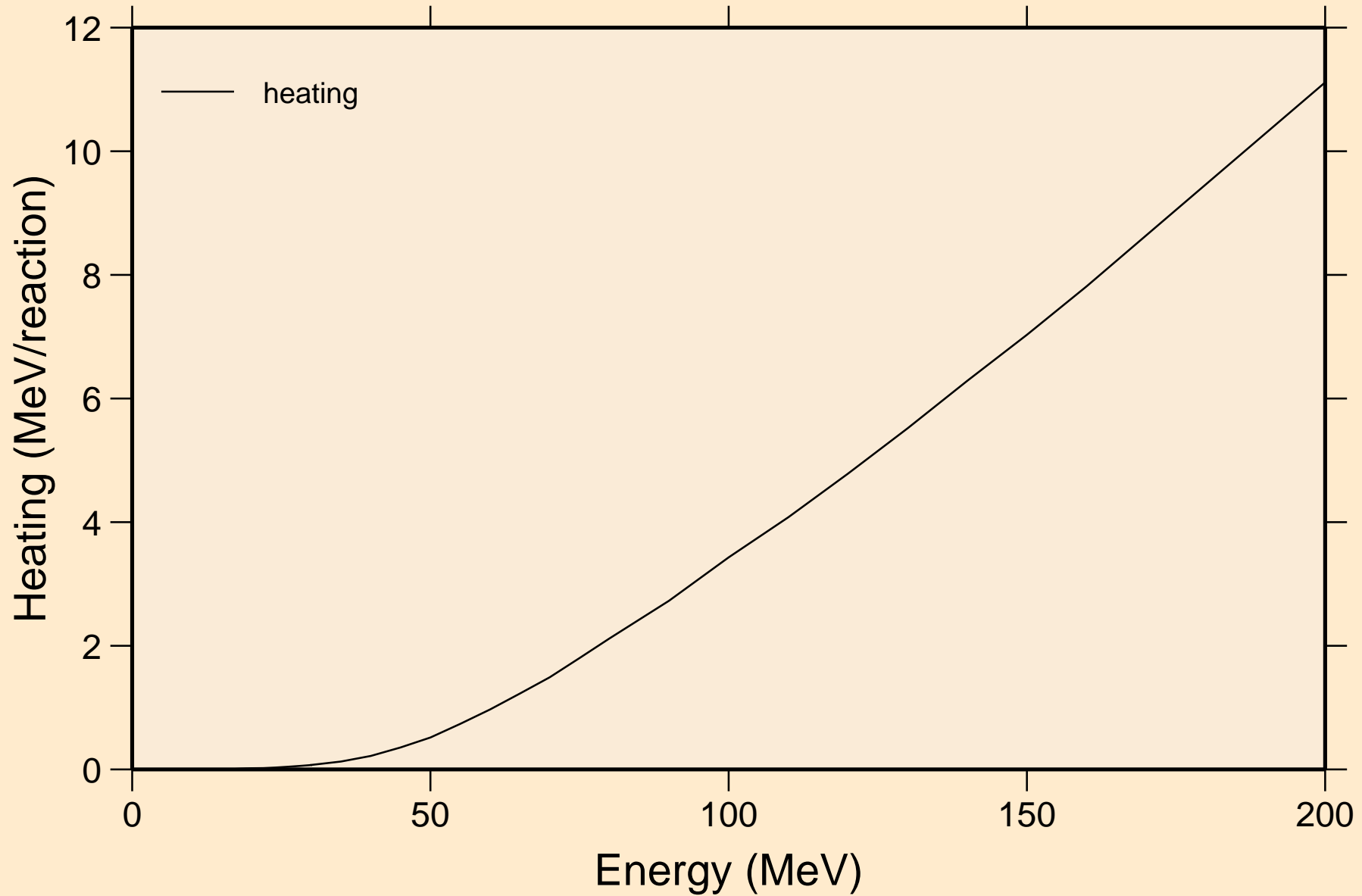

PM154M PROTON ACER TENDL-2021 LIBRARY; T=0.K  
Threshold reactions

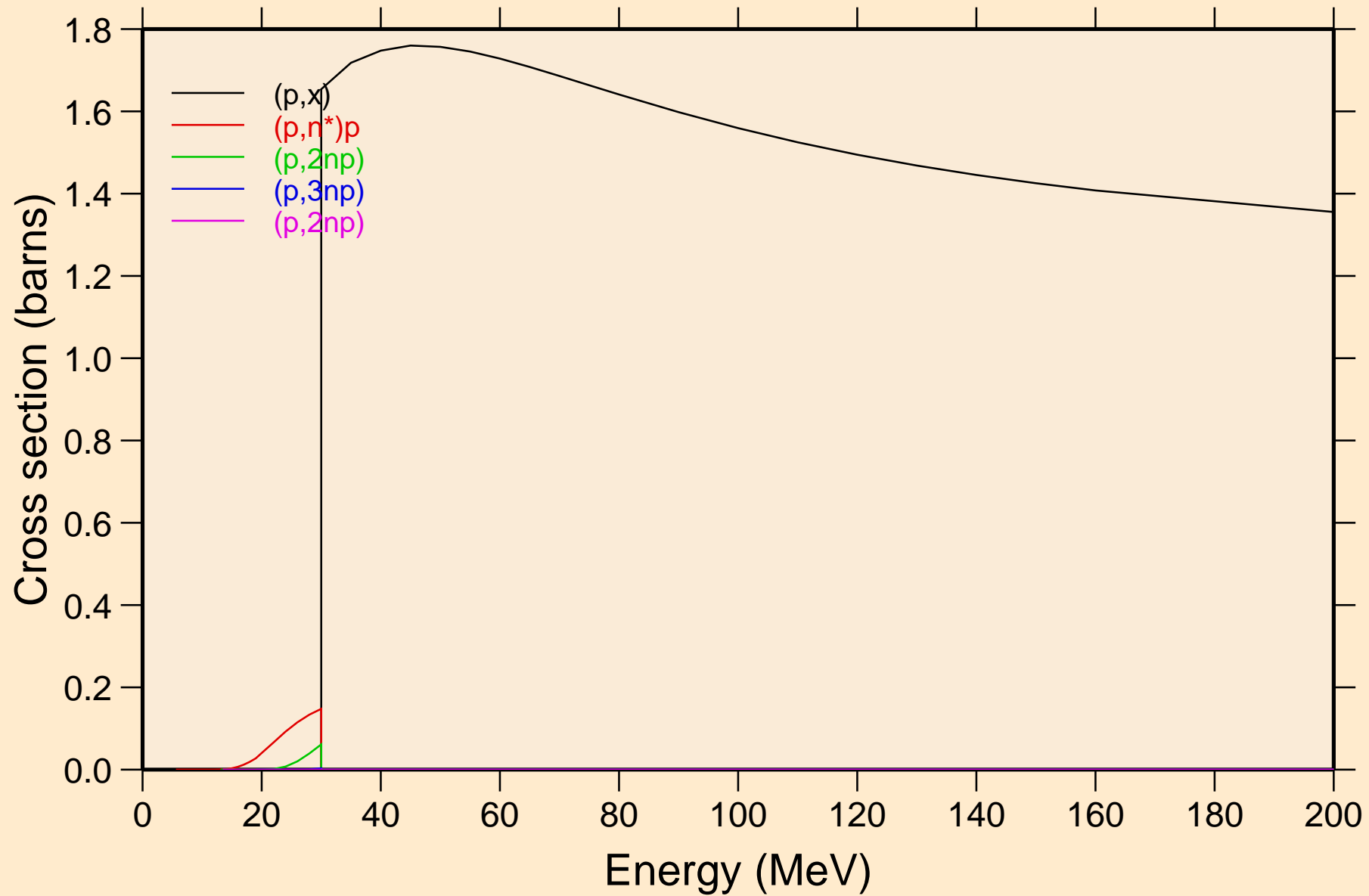

PM154M PROTON ACER TENDL-2021 LIBRARY; T=0.K  
Threshold reactions

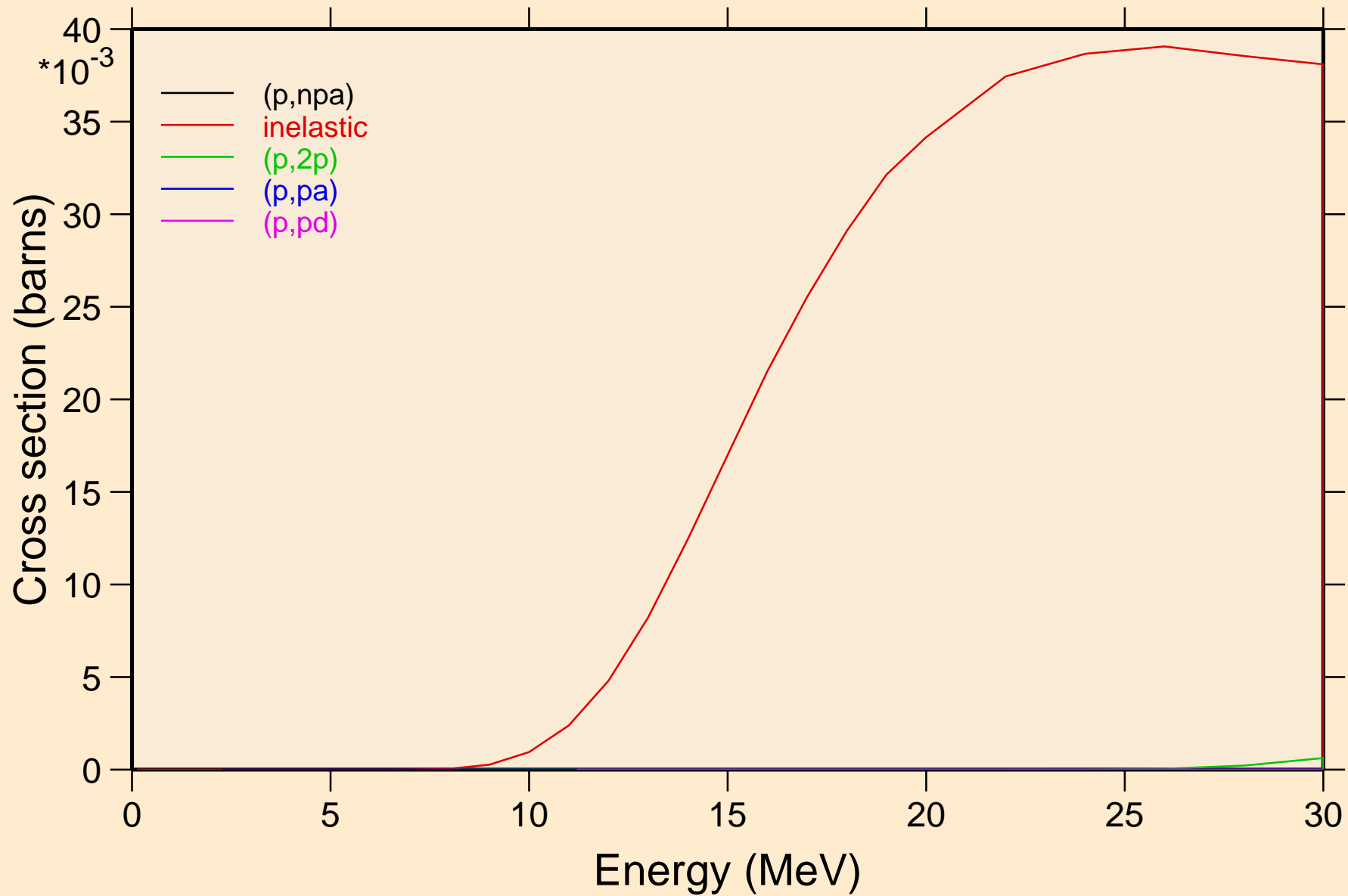

PM154M PROTON ACER TENDL-2021 LIBRARY; T=0.K  
angular distribution for elastic

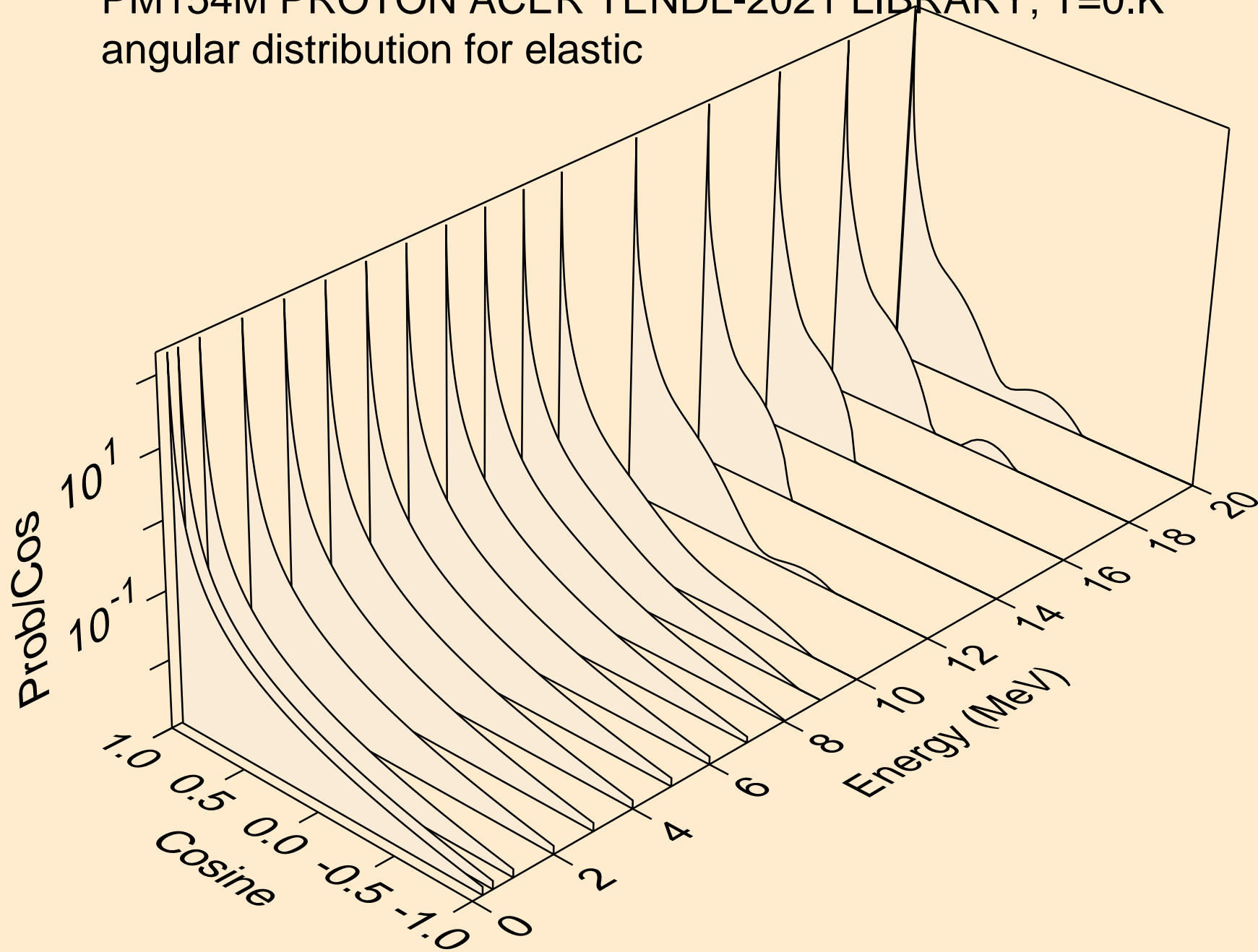

PM154M PROTON ACER TENDL-2021 LIBRARY; T=0.K  
angular distribution for elastic

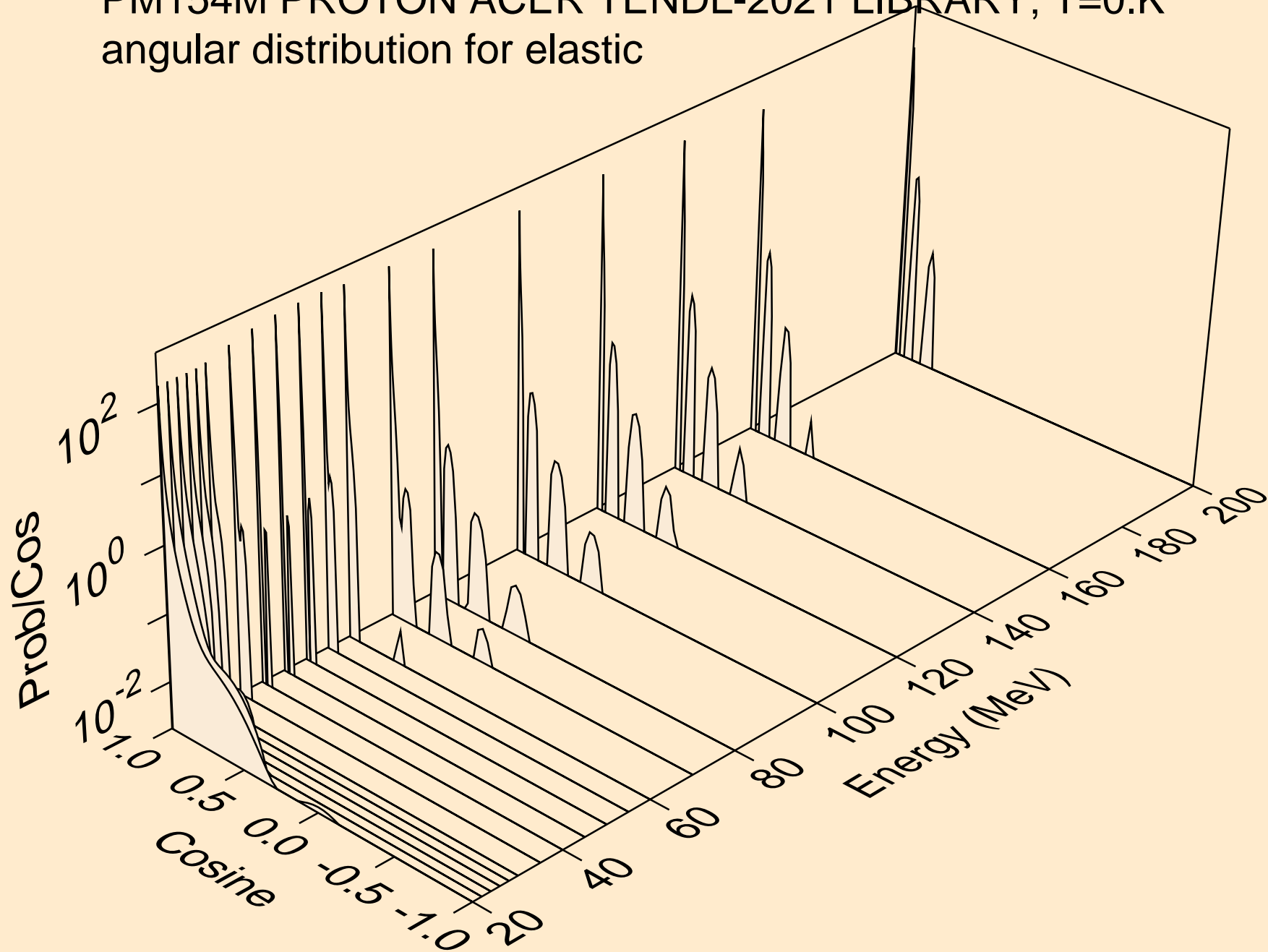

PM154M PROTON ACER TENDL-2021 LIBRARY; T=0.K  
Proton emission for (p,x)

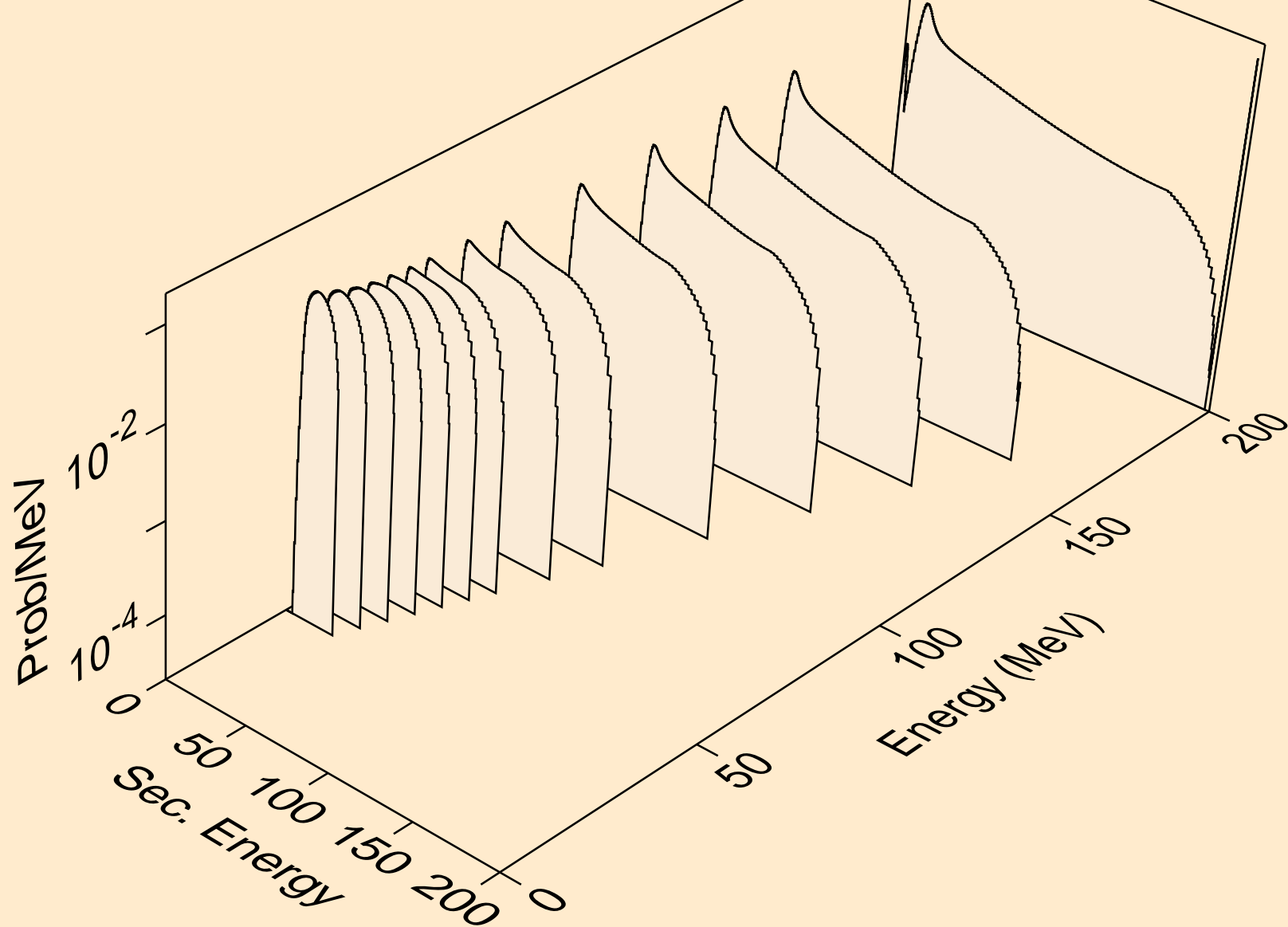

PM154M PROTON ACER TENDL-2021 LIBRARY; T=0.K  
Proton emission for (p,n\*)p

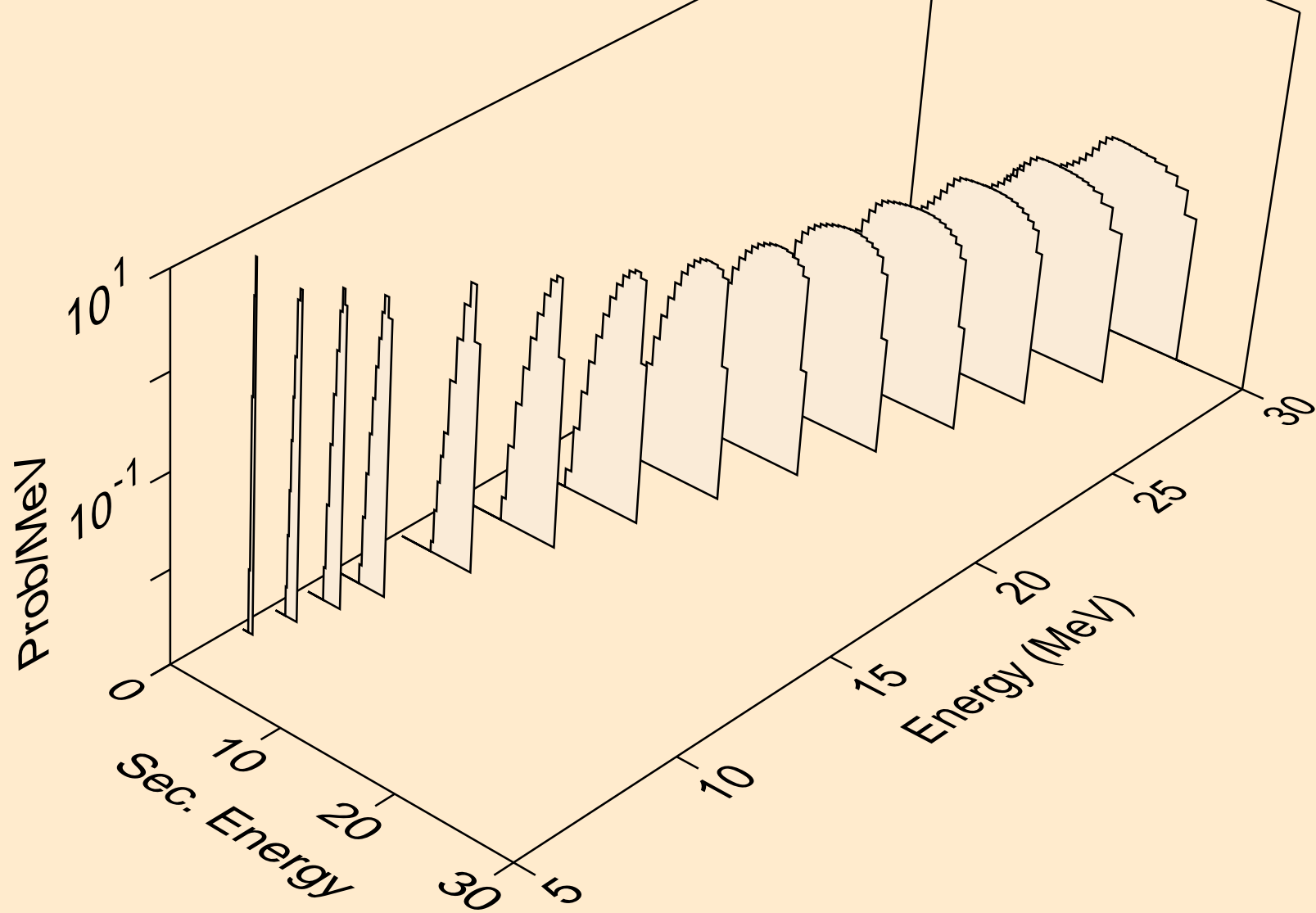

PM154M PROTON ACER TENDL-2021 LIBRARY; T=0.K  
Proton emission for (p,2np)

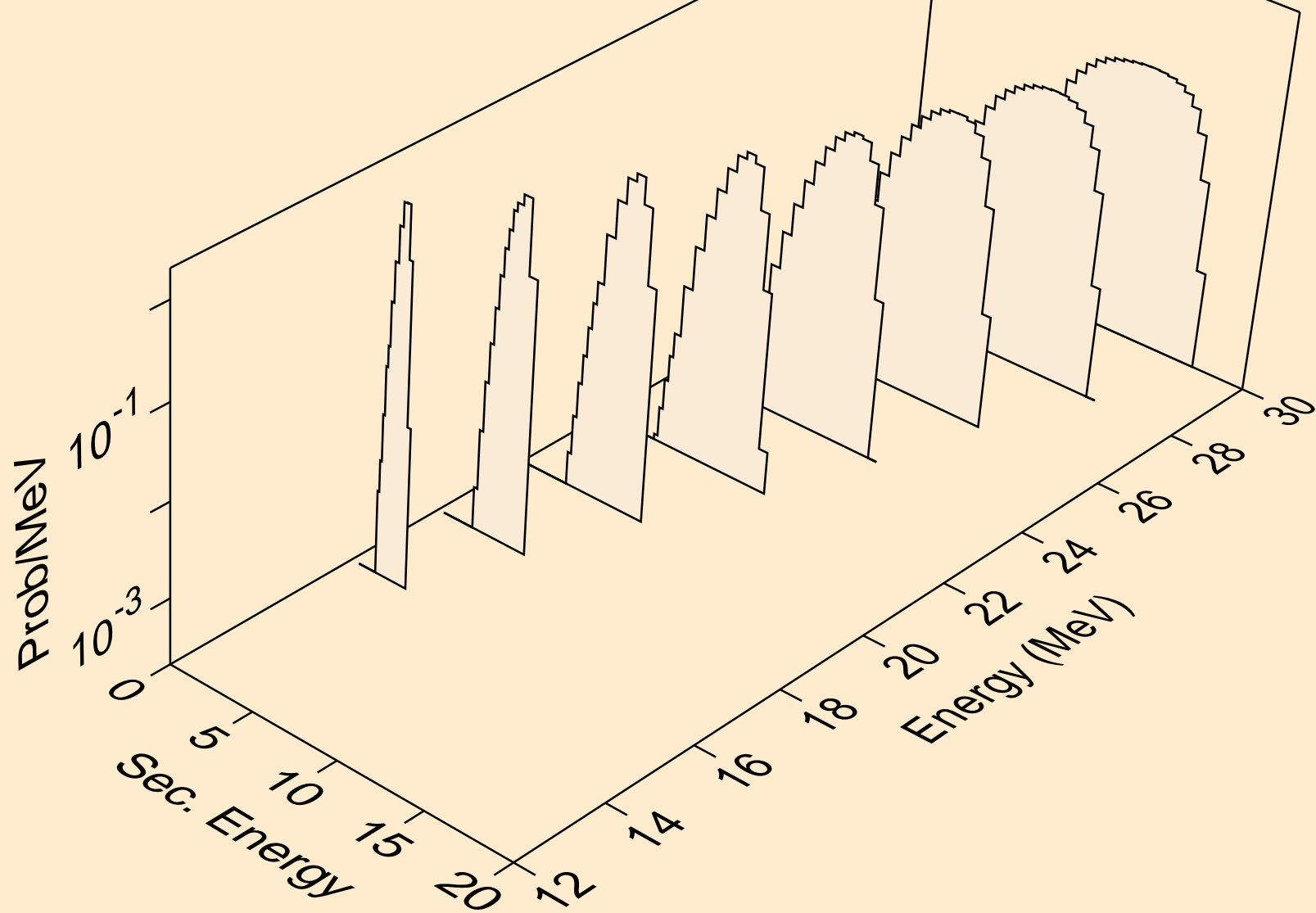

PM154M PROTON ACER TENDL-2021 LIBRARY; T=0.K  
Proton emission for (p,3np)

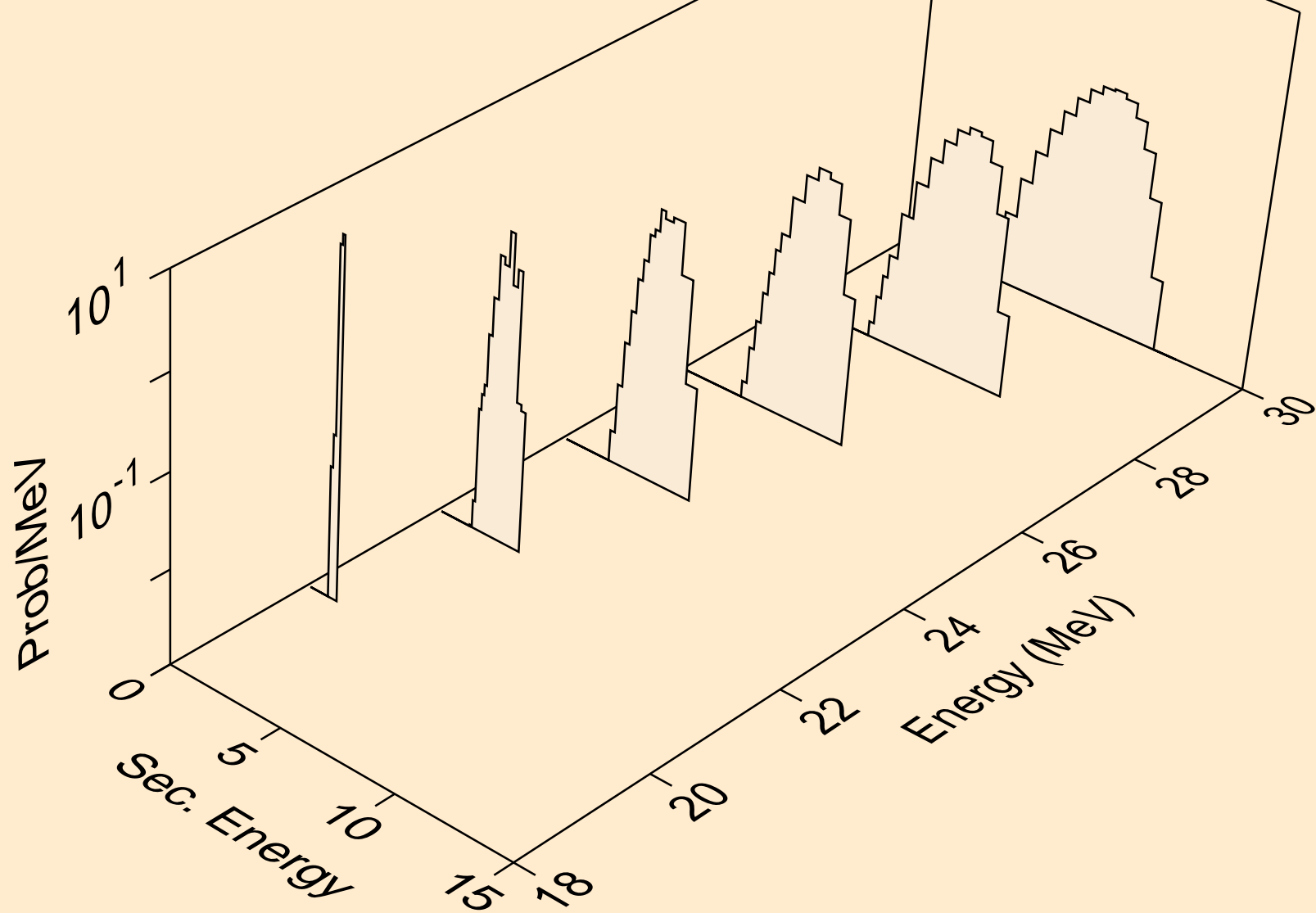

PM154M PROTON ACER TENDL-2021 LIBRARY; T=0.K  
Proton emission for (p,2np)

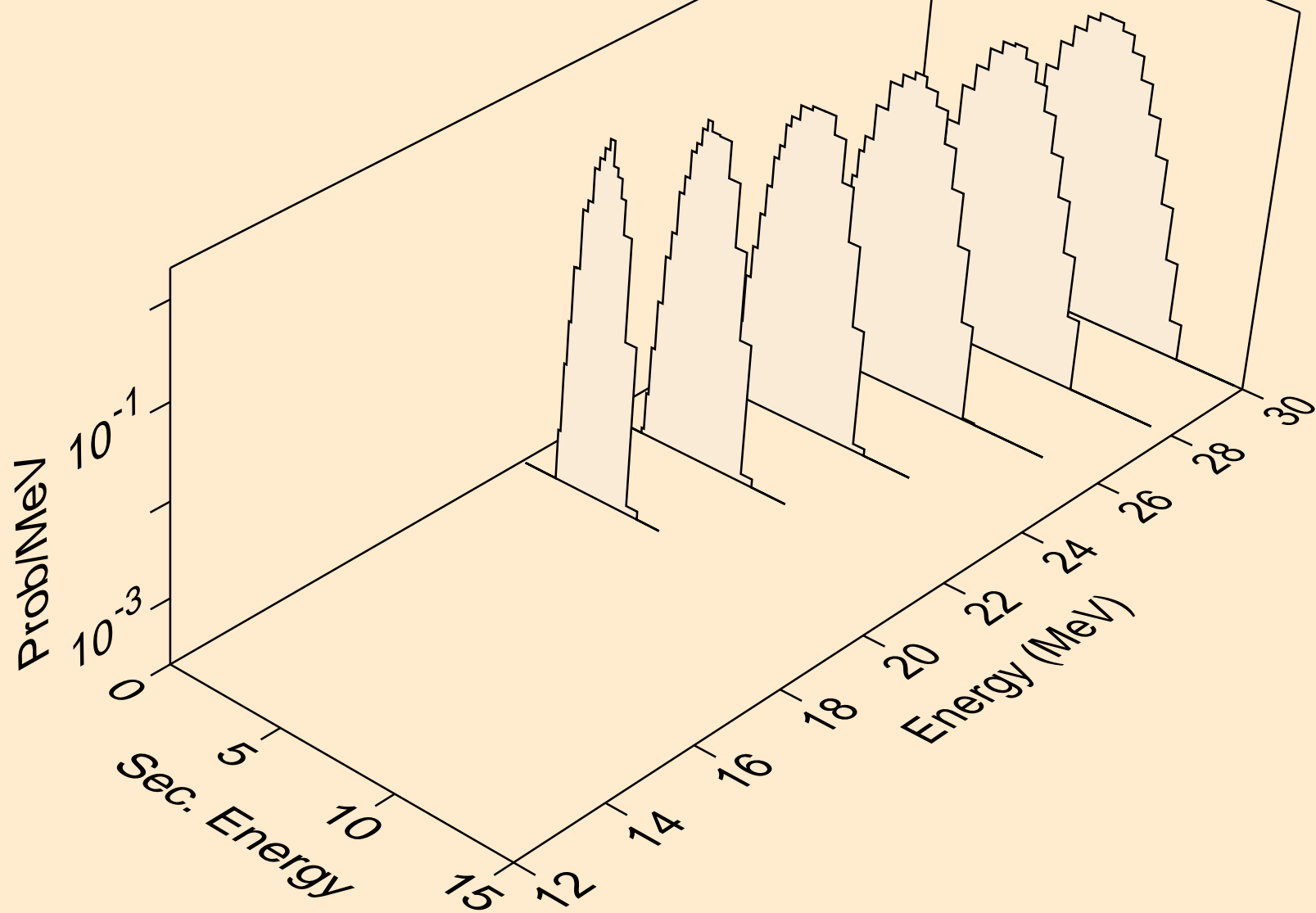

PM154M PROTON ACER TENDL-2021 LIBRARY; T=0.K  
Proton emission for (p,npa)

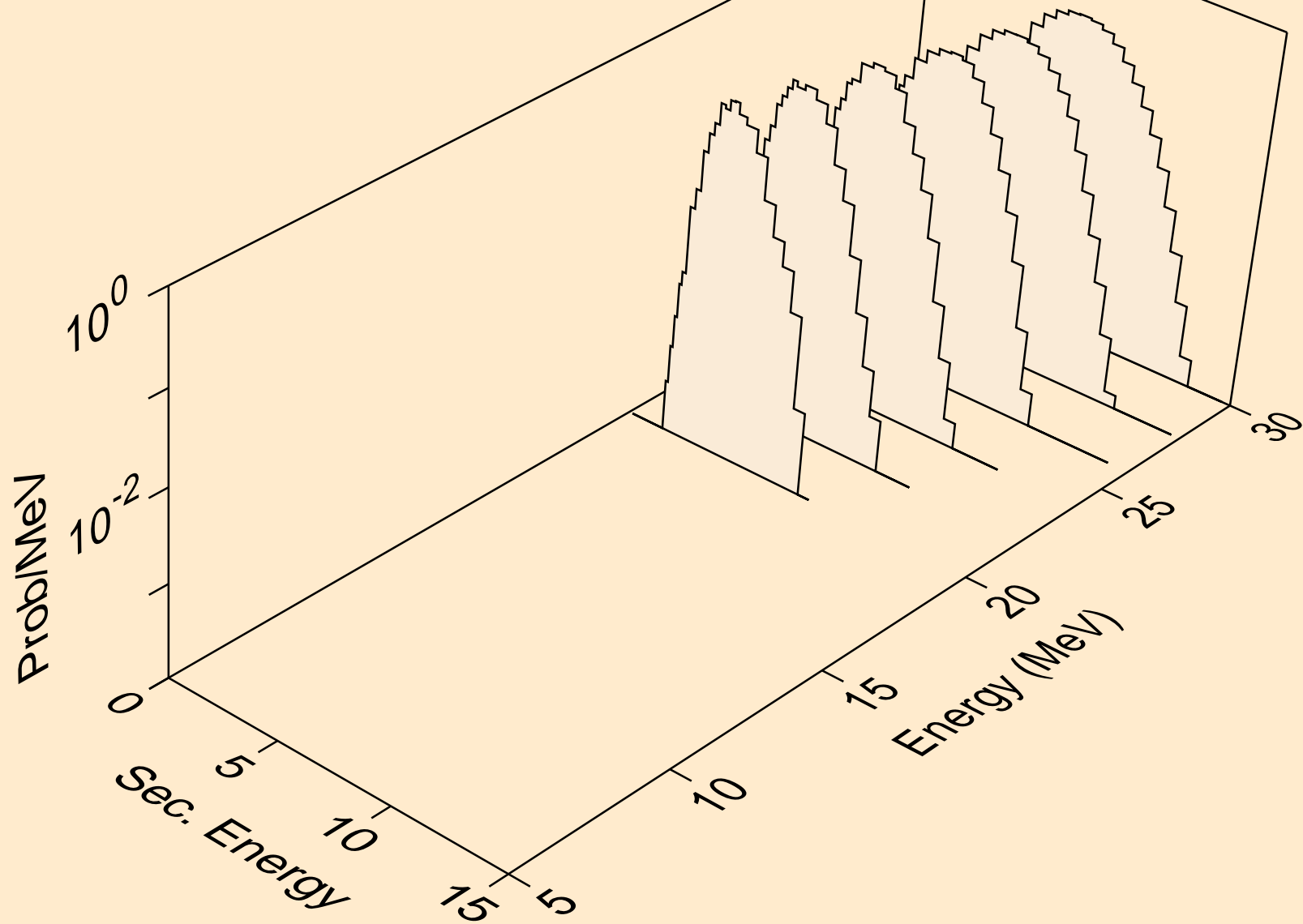

PM154M PROTON ACER TENDL-2021 LIBRARY; T=0.K  
Proton emission for inelastic

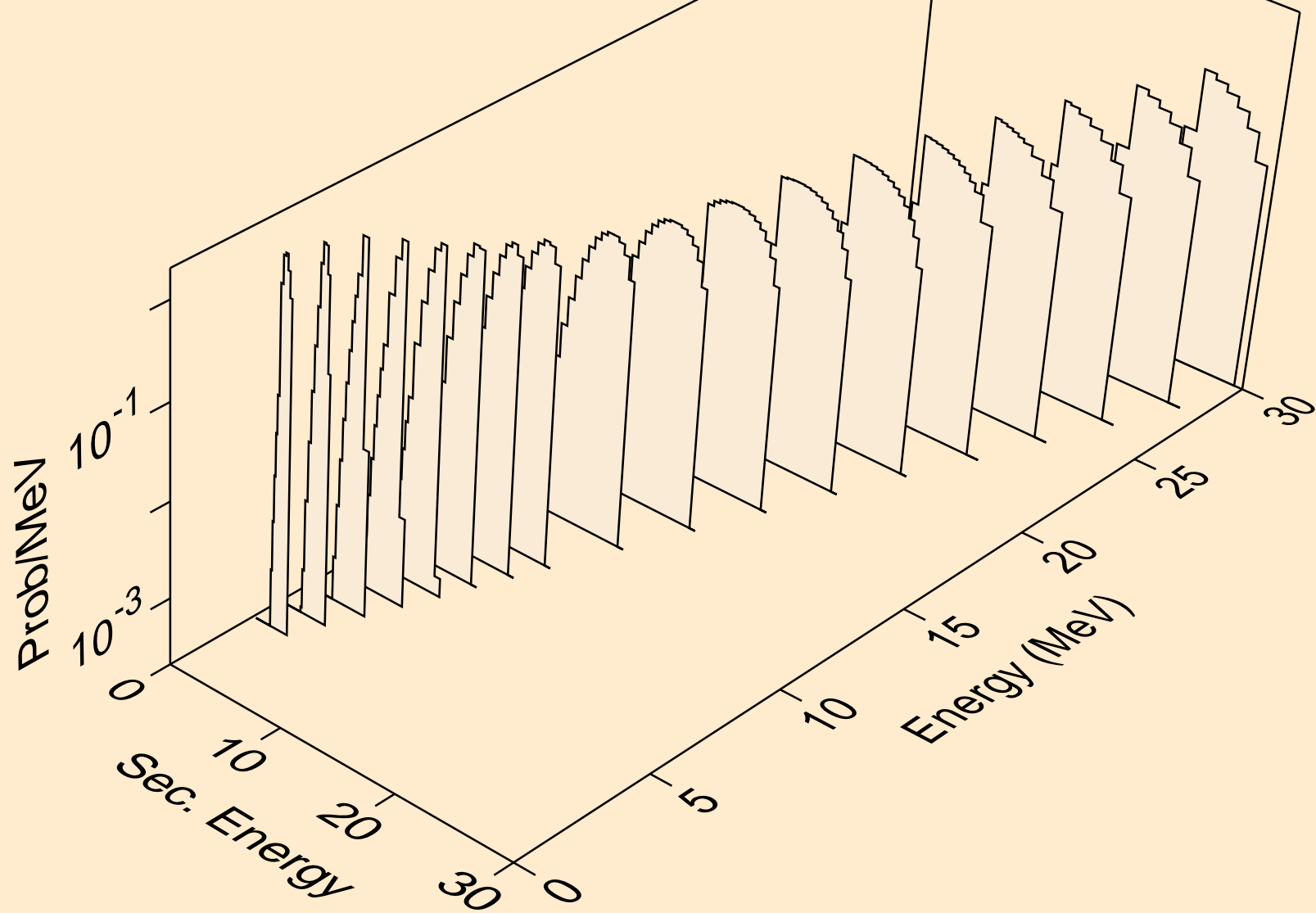

PM154M PROTON ACER TENDL-2021 LIBRARY; T=0.K  
Proton emission for (p,2p)

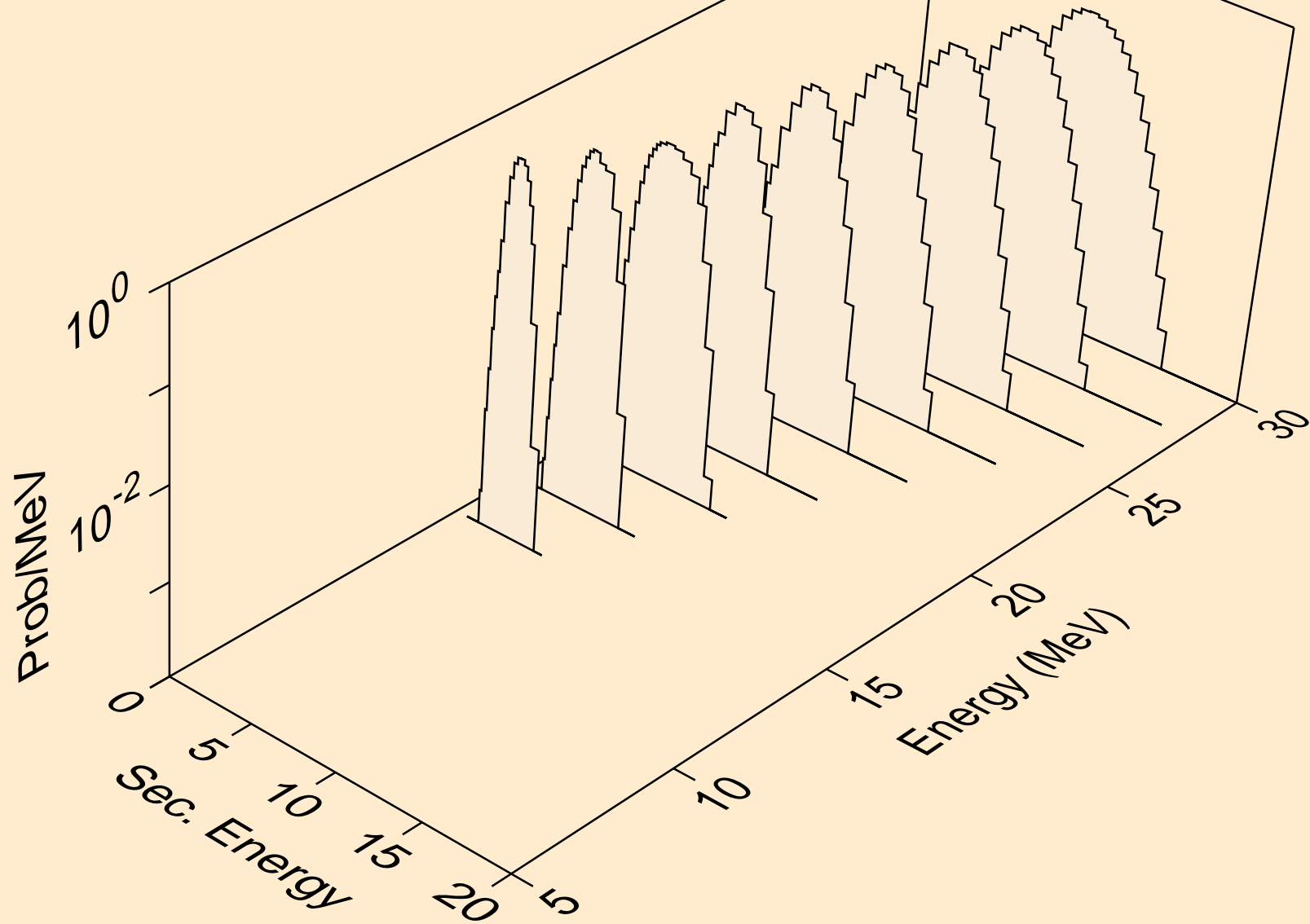

PM154M PROTON ACER TENDL-2021 LIBRARY; T=0.K  
Proton emission for (p,pa)

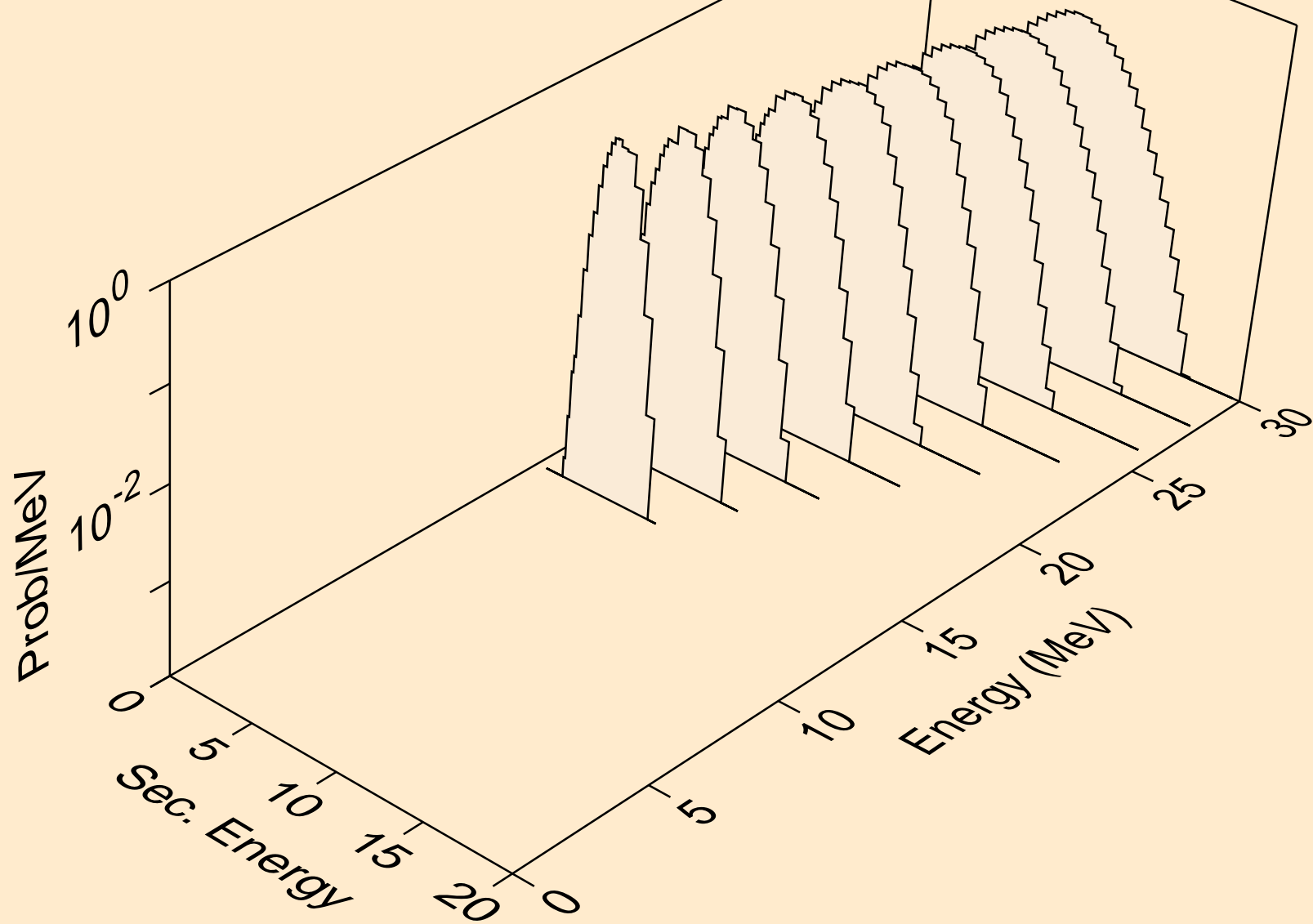

PM154M PROTON ACER TENDL-2021 LIBRARY; T=0.K  
Proton emission for (p,pd)

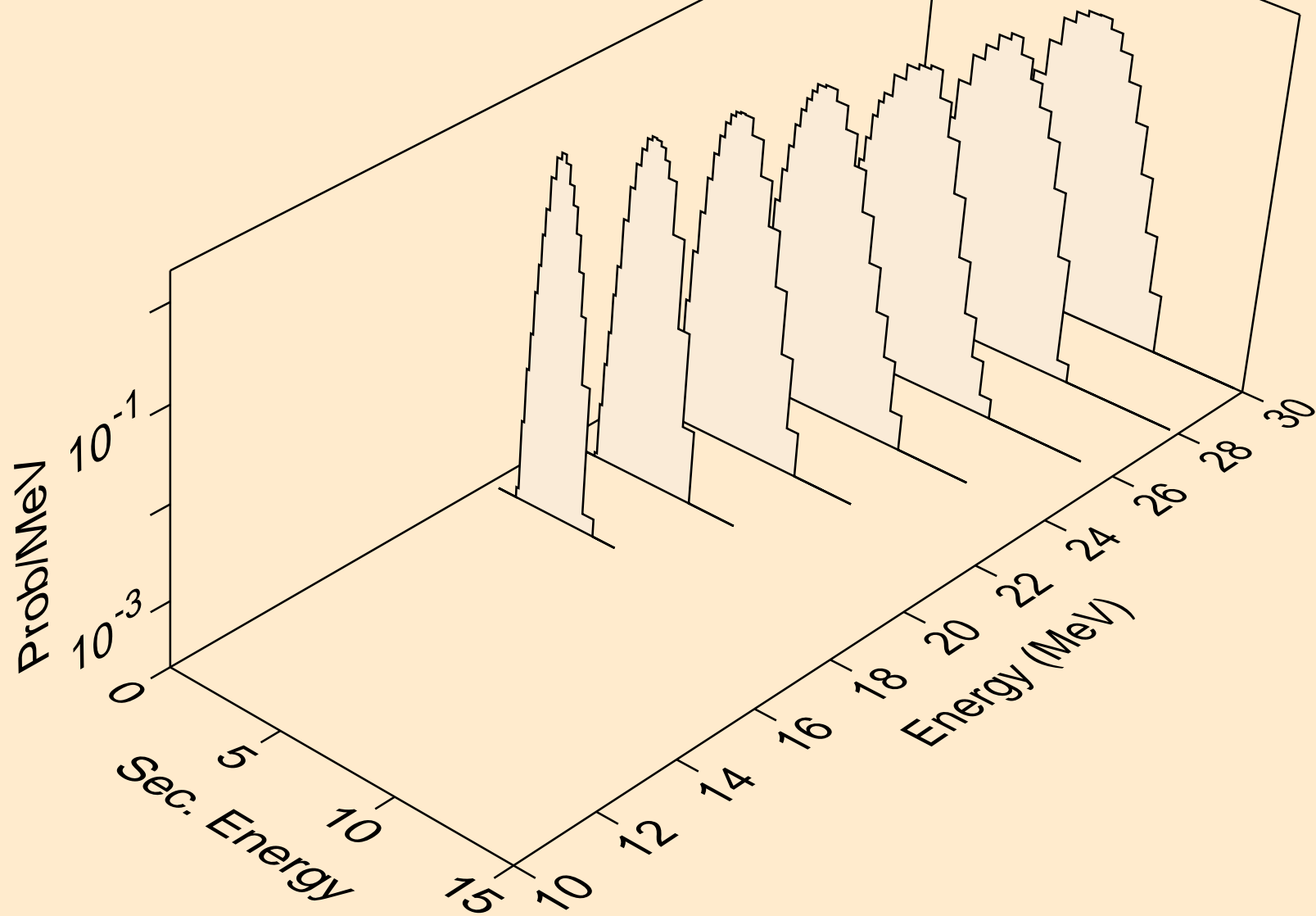

PM154M PROTON ACER TENDL-2021 LIBRARY; T=0.K  
Photon emission for (z,n)

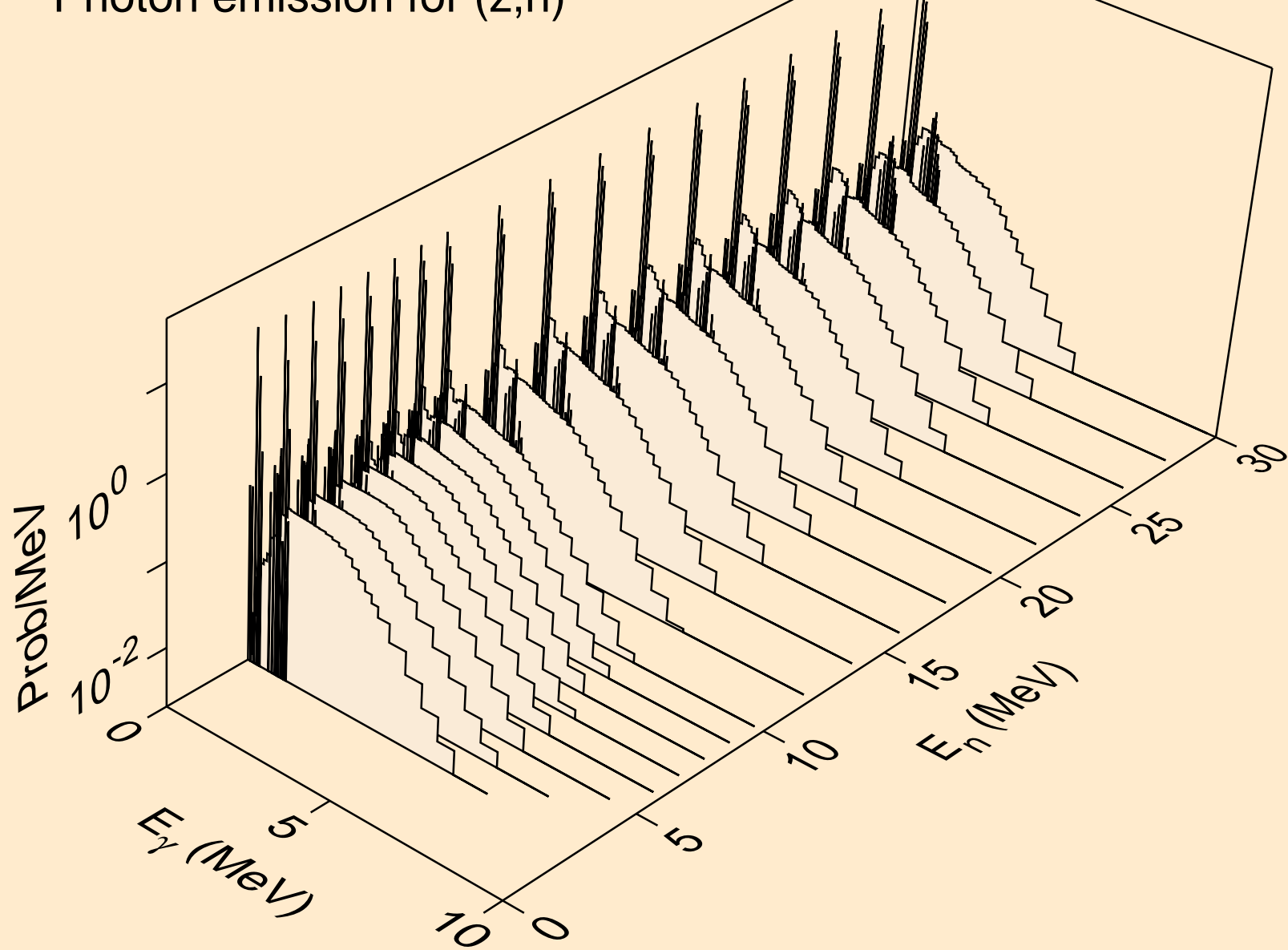

PM154M PROTON ACER TENDL-2021 LIBRARY; T=0.K  
Photon emission for (n,x)

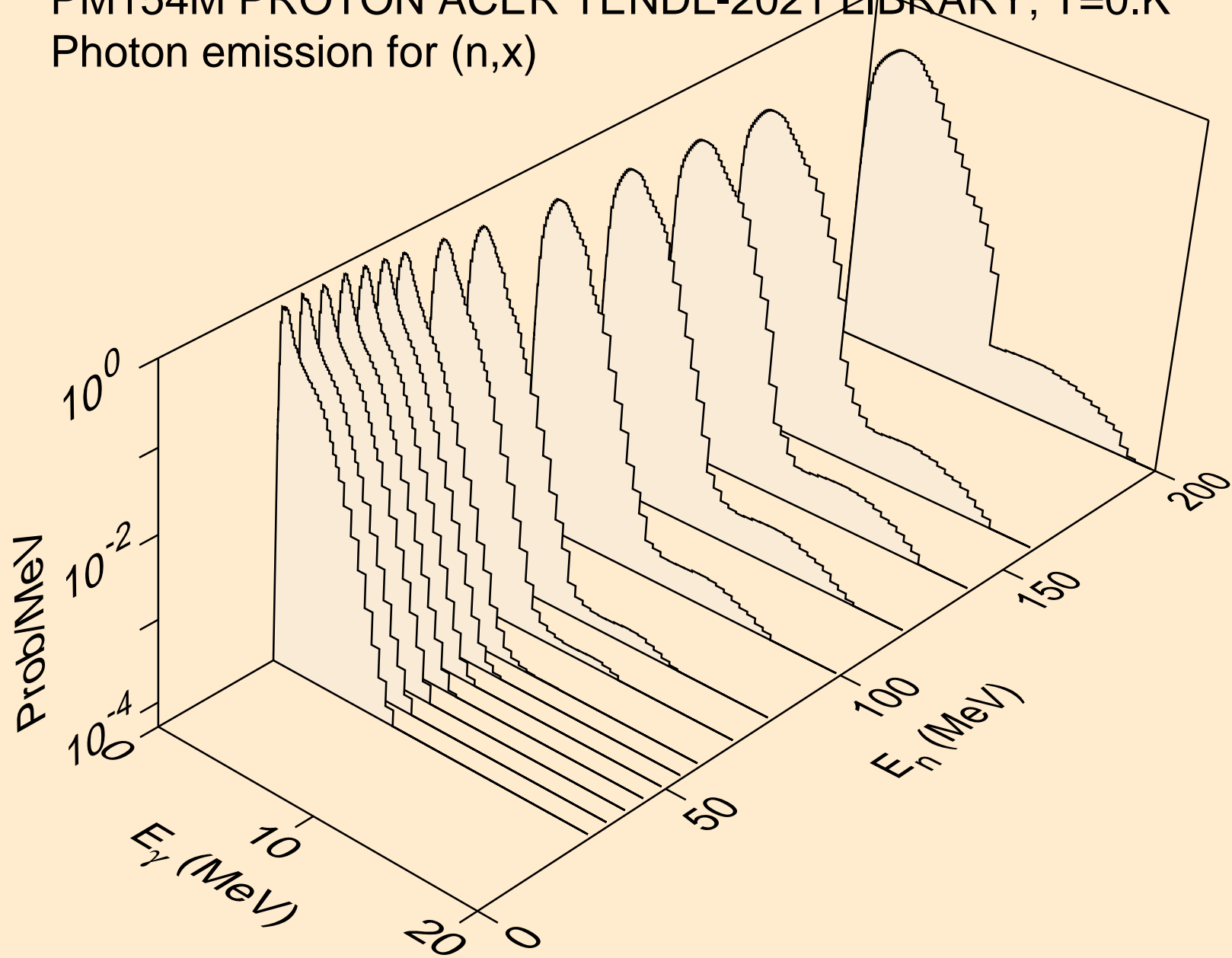

PM154M PROTON ACER TENDL-2021 LIBRARY; T=0.K  
Photon emission for (n,2nd)

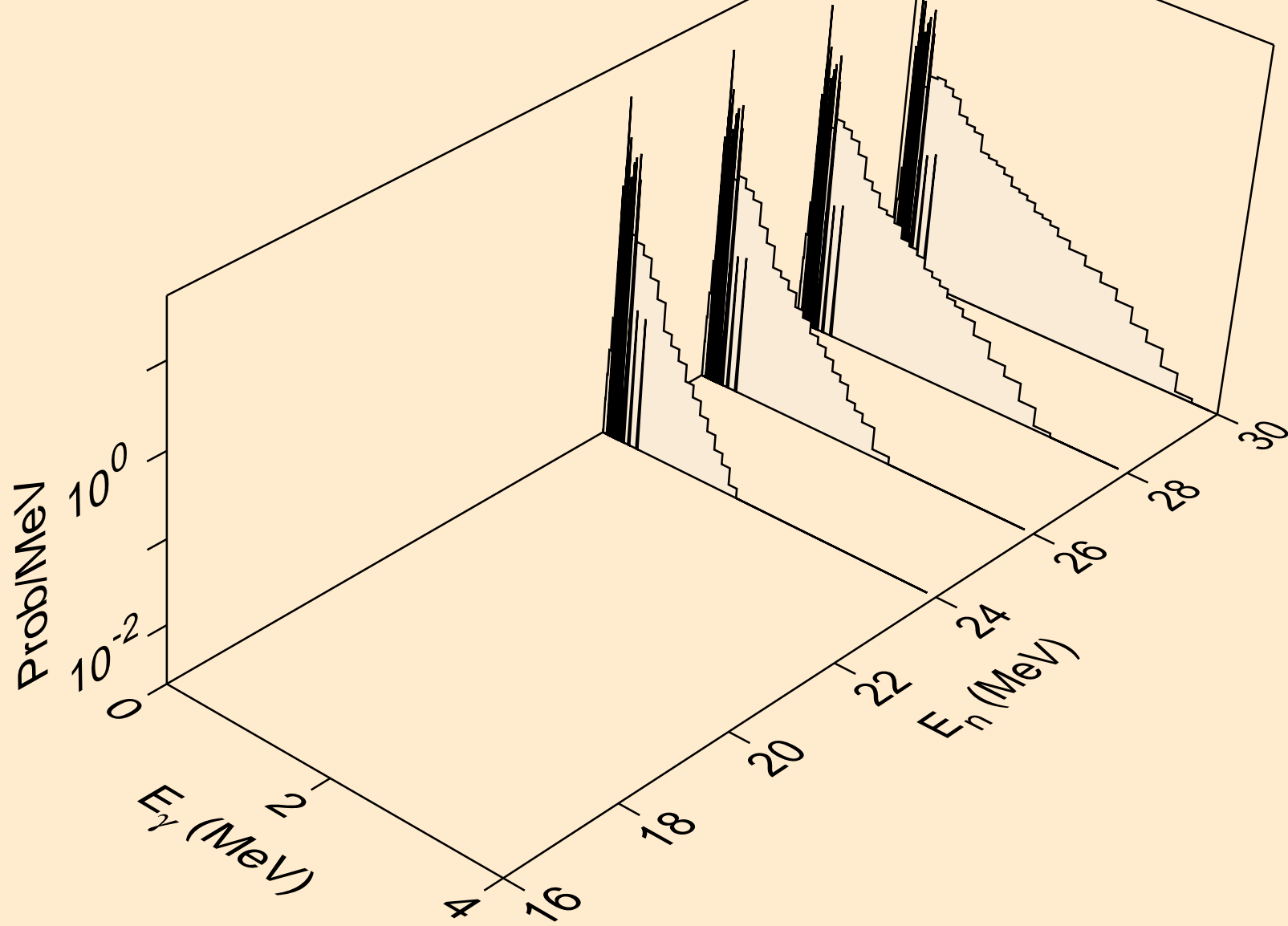

PM154M PROTON ACER TENDL-2021 LIBRARY; T=0.K  
Photon emission for (n,2n)

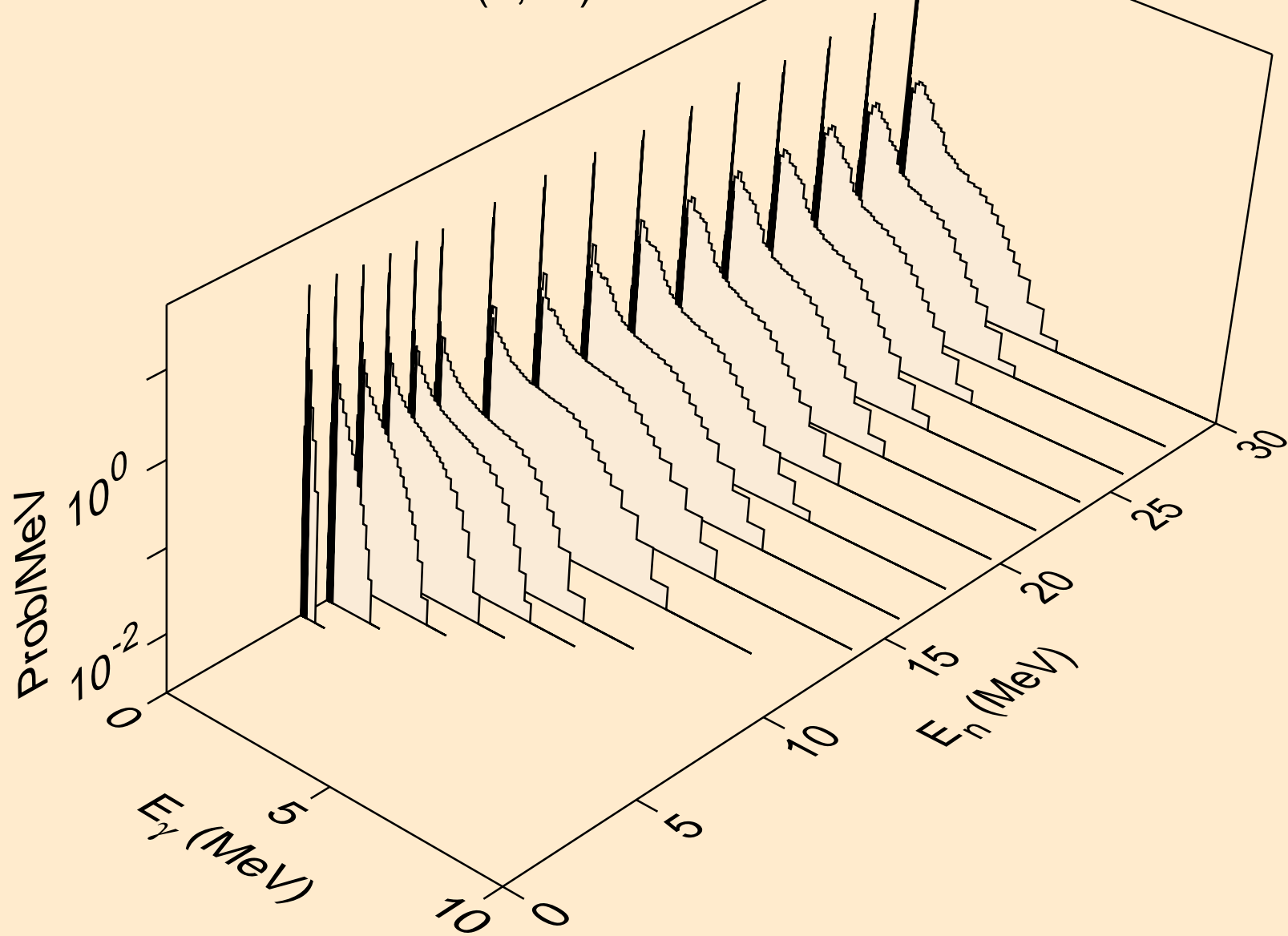

PM154M PROTON ACER TENDL-2021 LIBRARY; T=0.K  
Photon emission for (n,3n)

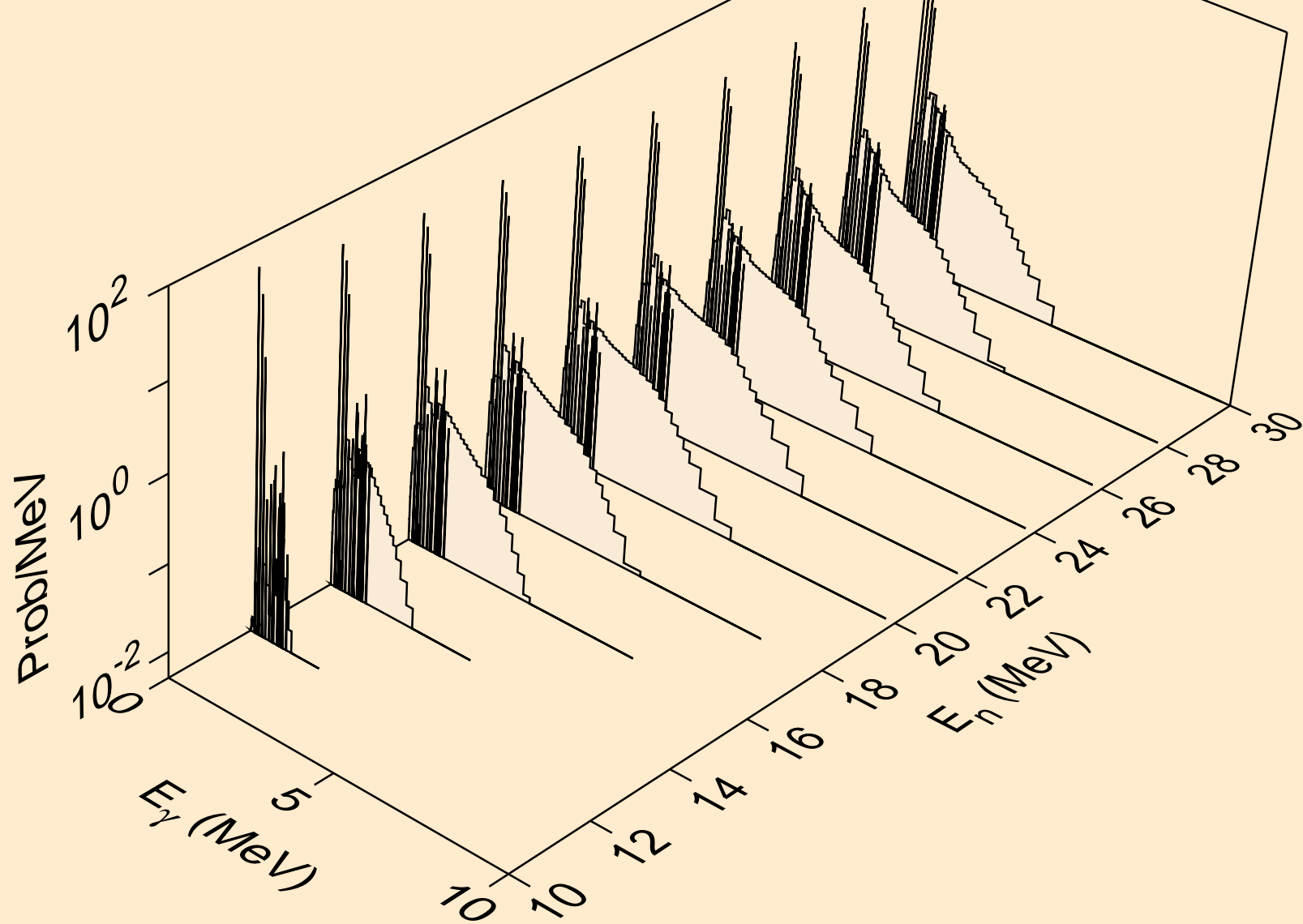

PM154M PROTON ACER TENDL-2021 LIBRARY; T=0.K  
Photon emission for (n,n\*)a

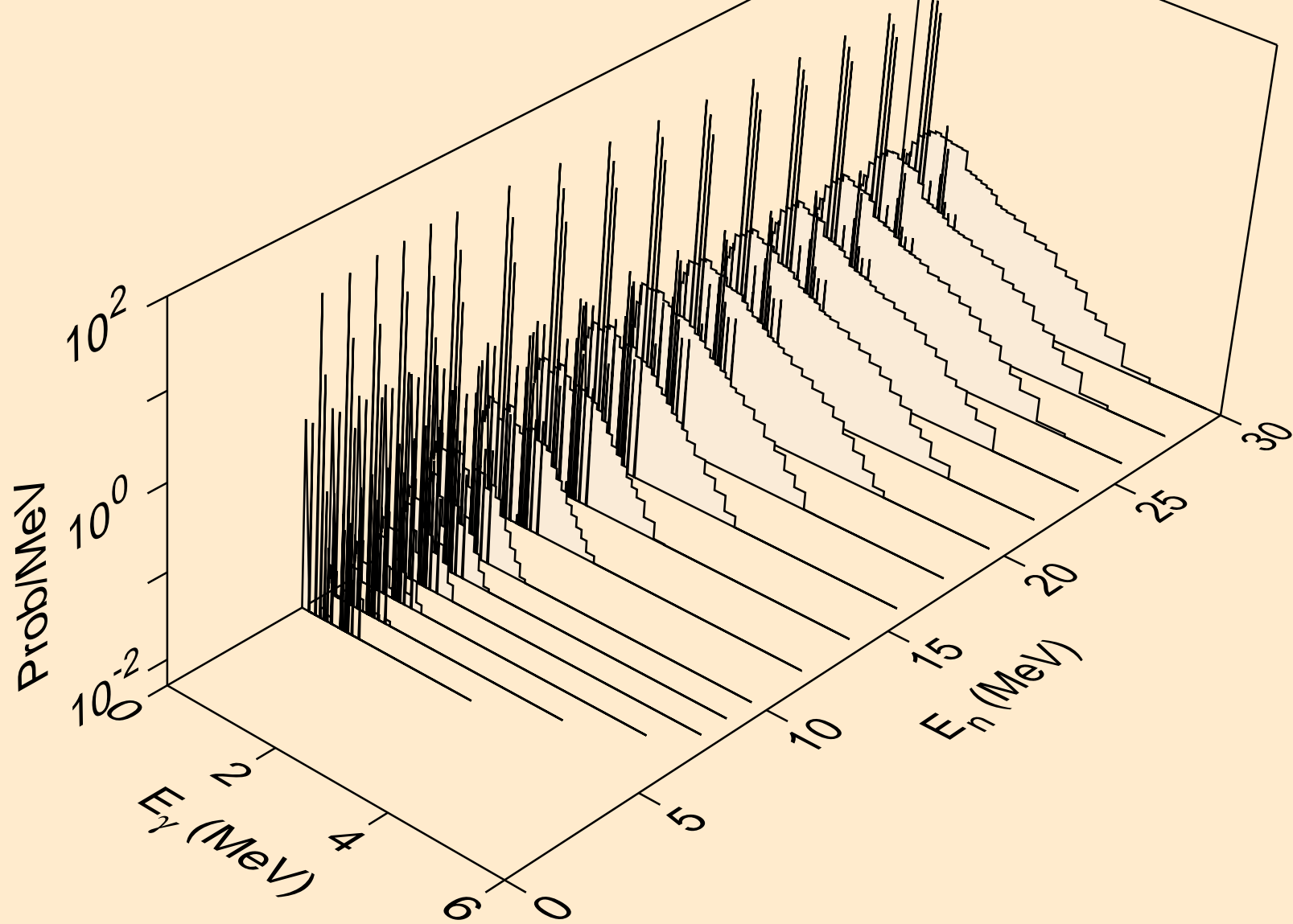

PM154M PROTON ACER TENDL-2021 LIBRARY; T=0.K  
Photon emission for (n,2n)a

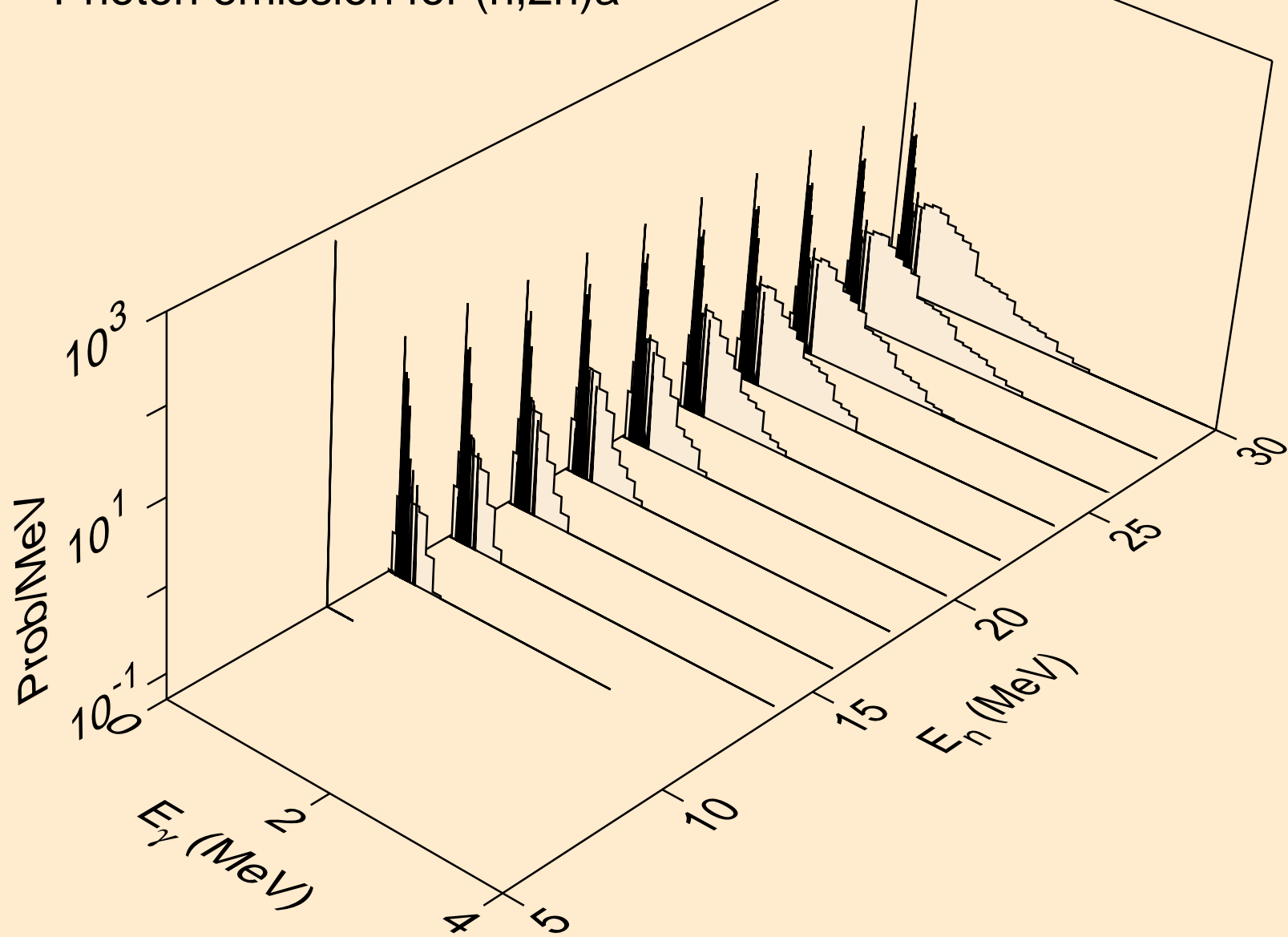

PM154M PROTON ACER TENDL-2021 LIBRARY; T=0.K  
Photon emission for (n,3n)a

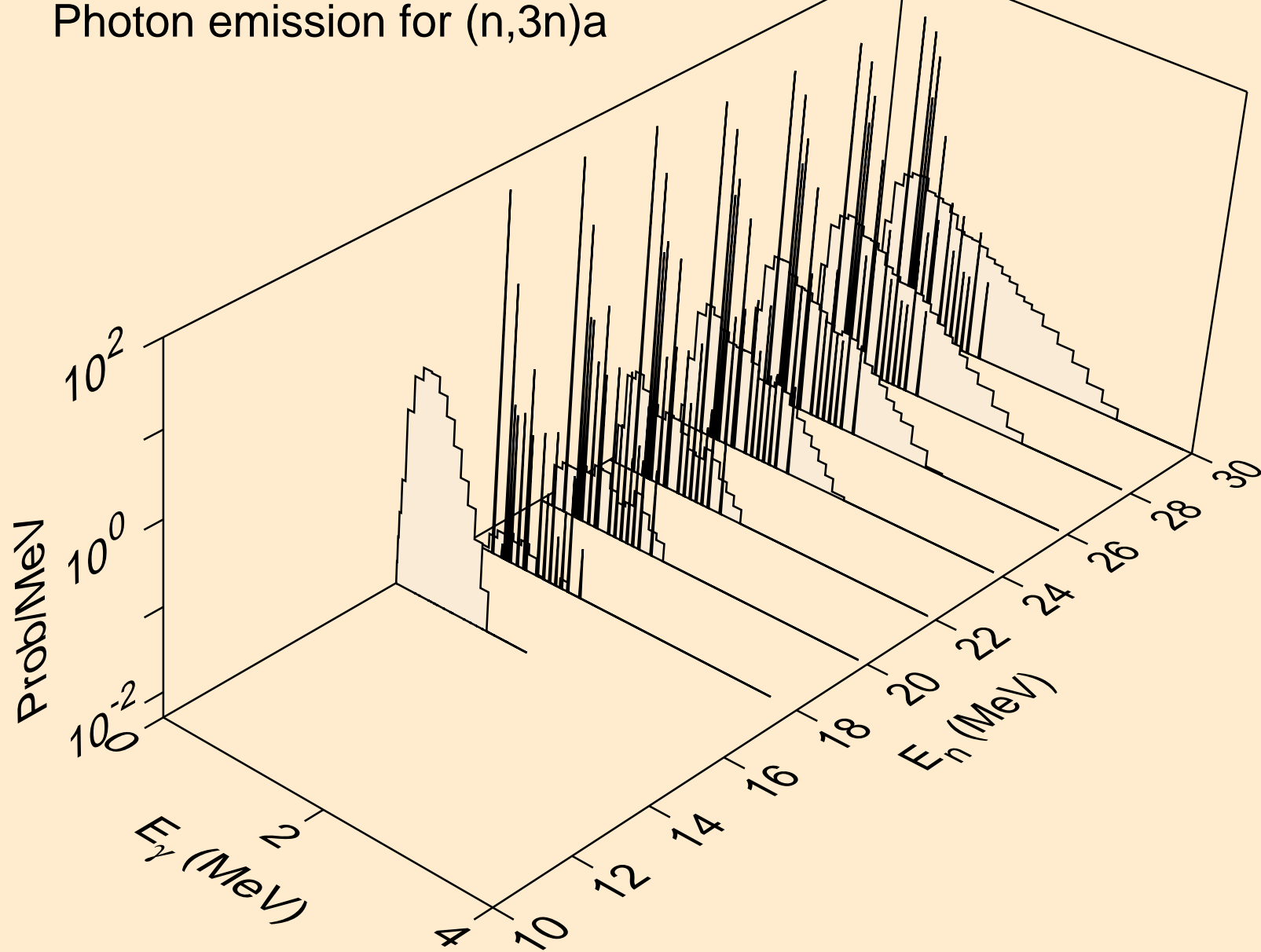

PM154M PROTON ACER TENDL-2021 LIBRARY; T=0.K  
Photon emission for (n,n\*)p

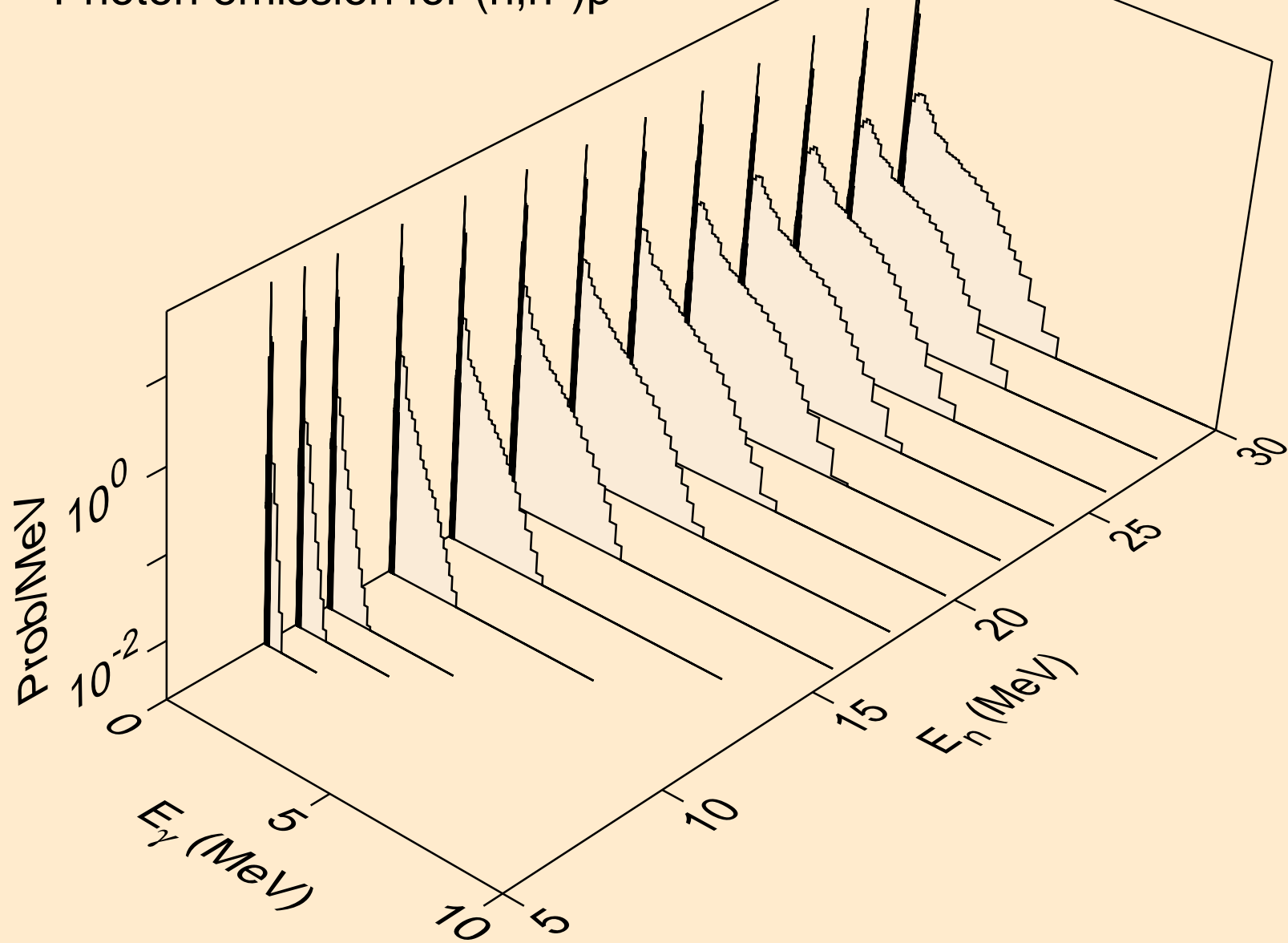

PM154M PROTON ACER TENDL-2021 LIBRARY; T=0.K  
Photon emission for (n,n\*)2a

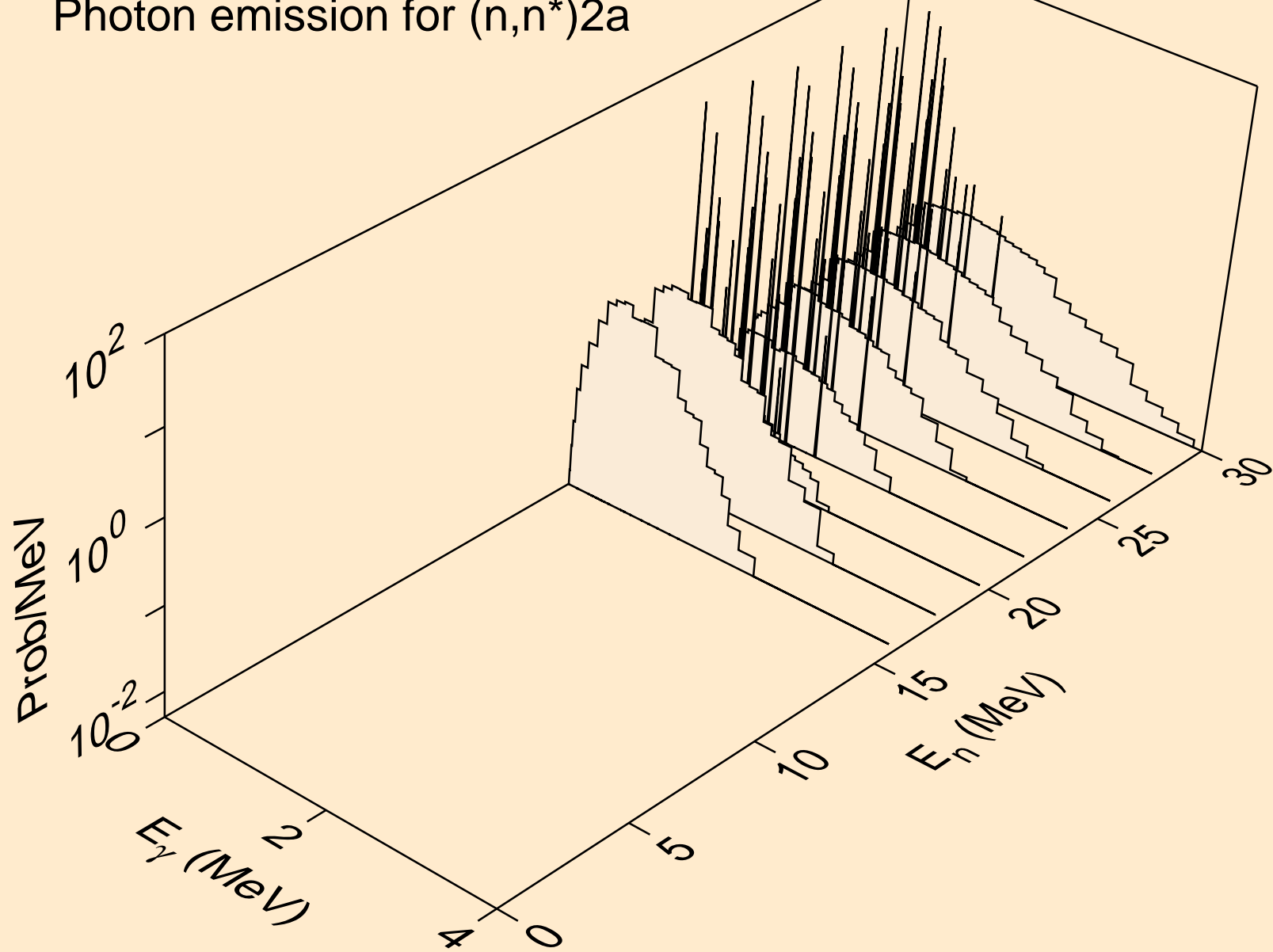

PM154M PROTON ACER TENDL-2021 LIBRARY; T=0.K  
Photon emission for (n,n\*)d

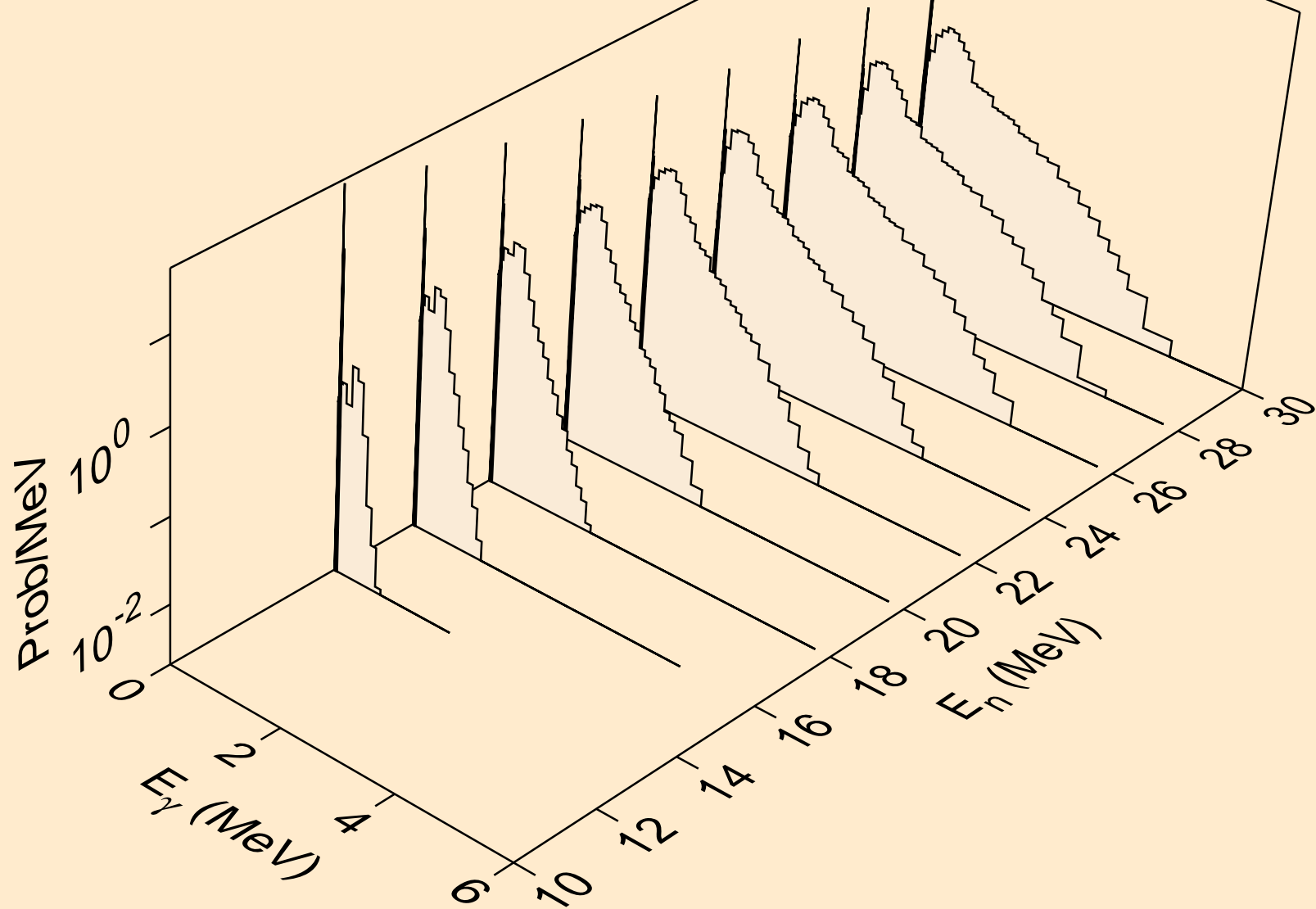

PM154M PROTON ACER TENDL-2021 LIBRARY; T=0.K  
Photon emission for (n,n\*)t

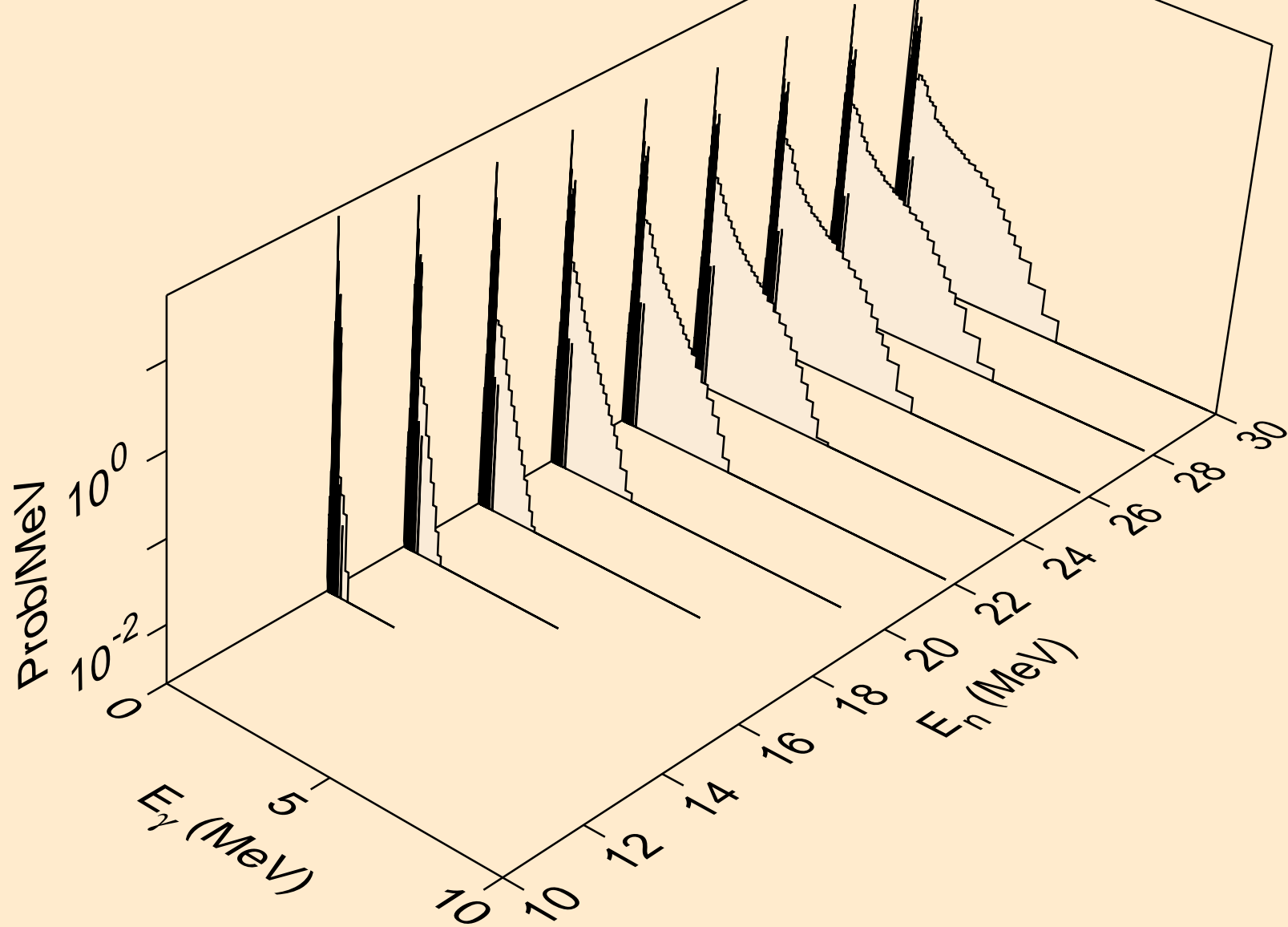

PM154M PROTON ACER TENDL-2021 LIBRARY; T=0.K  
Photon emission for (n,n\*)he3

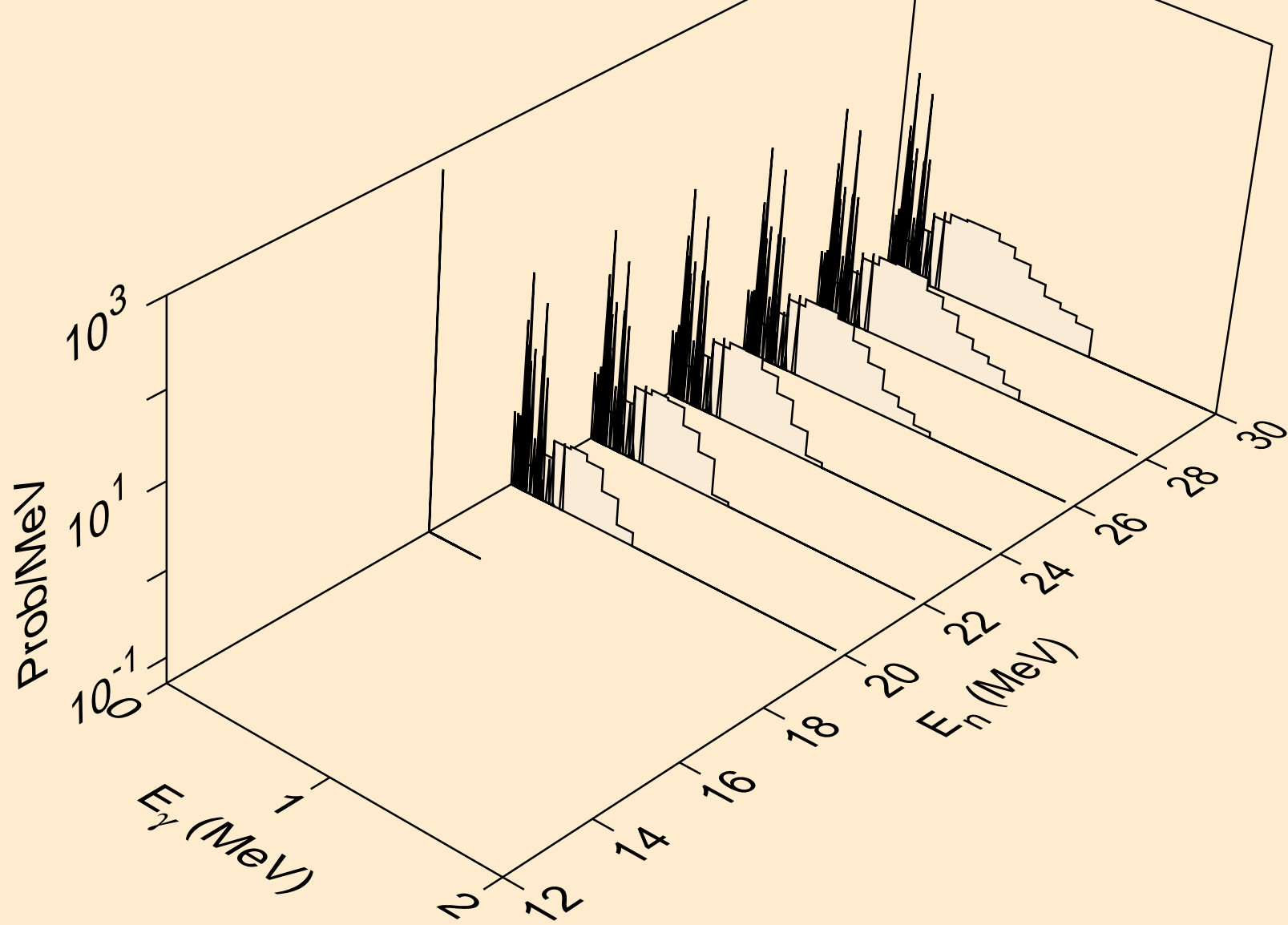

PM154M PROTON ACER TENDL-2021 LIBRARY; T=0.K  
Photon emission for (n,4n)

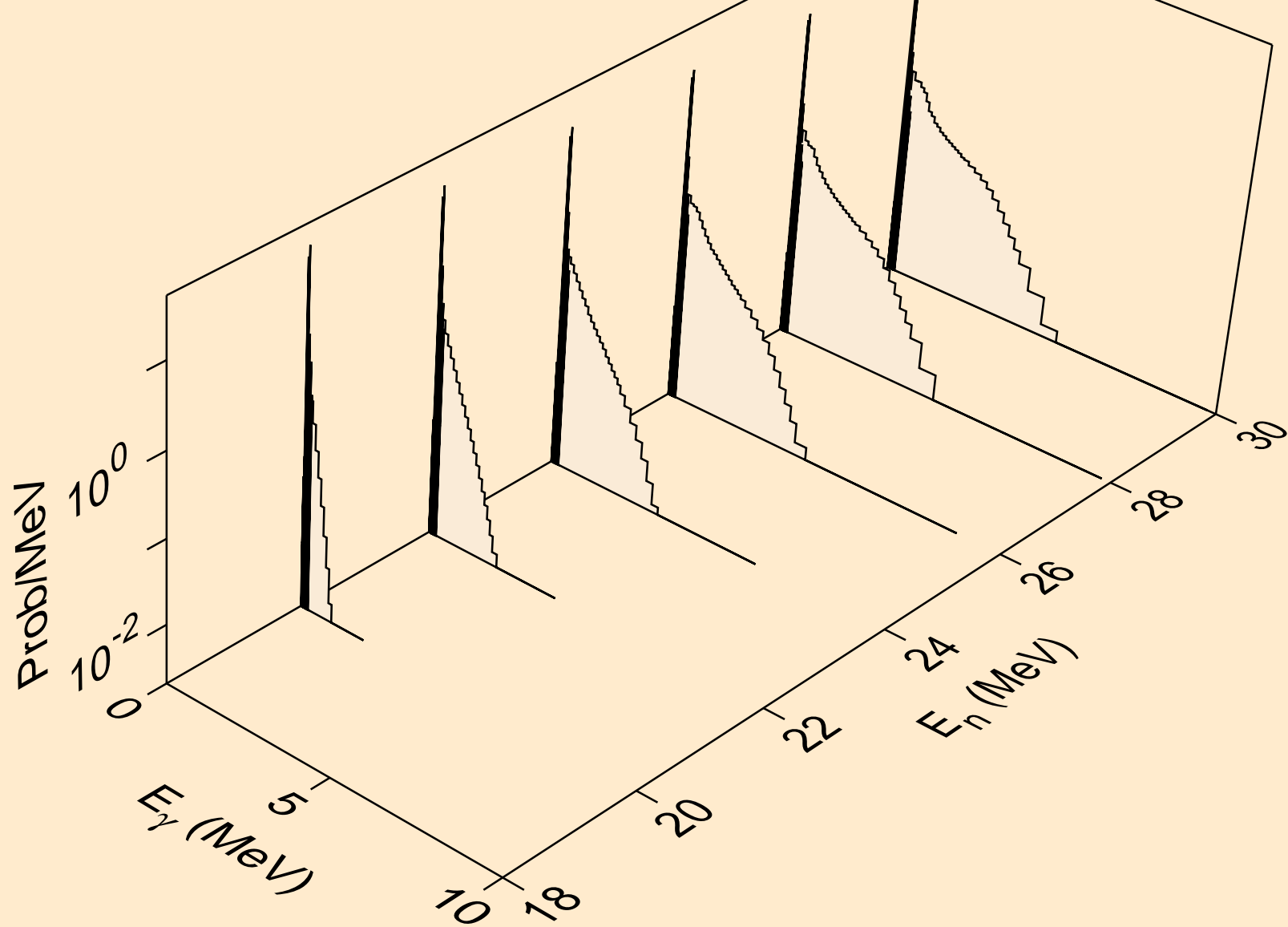

PM154M PROTON ACER TENDL-2021 LIBRARY; T=0.K  
Photon emission for (n,2np)

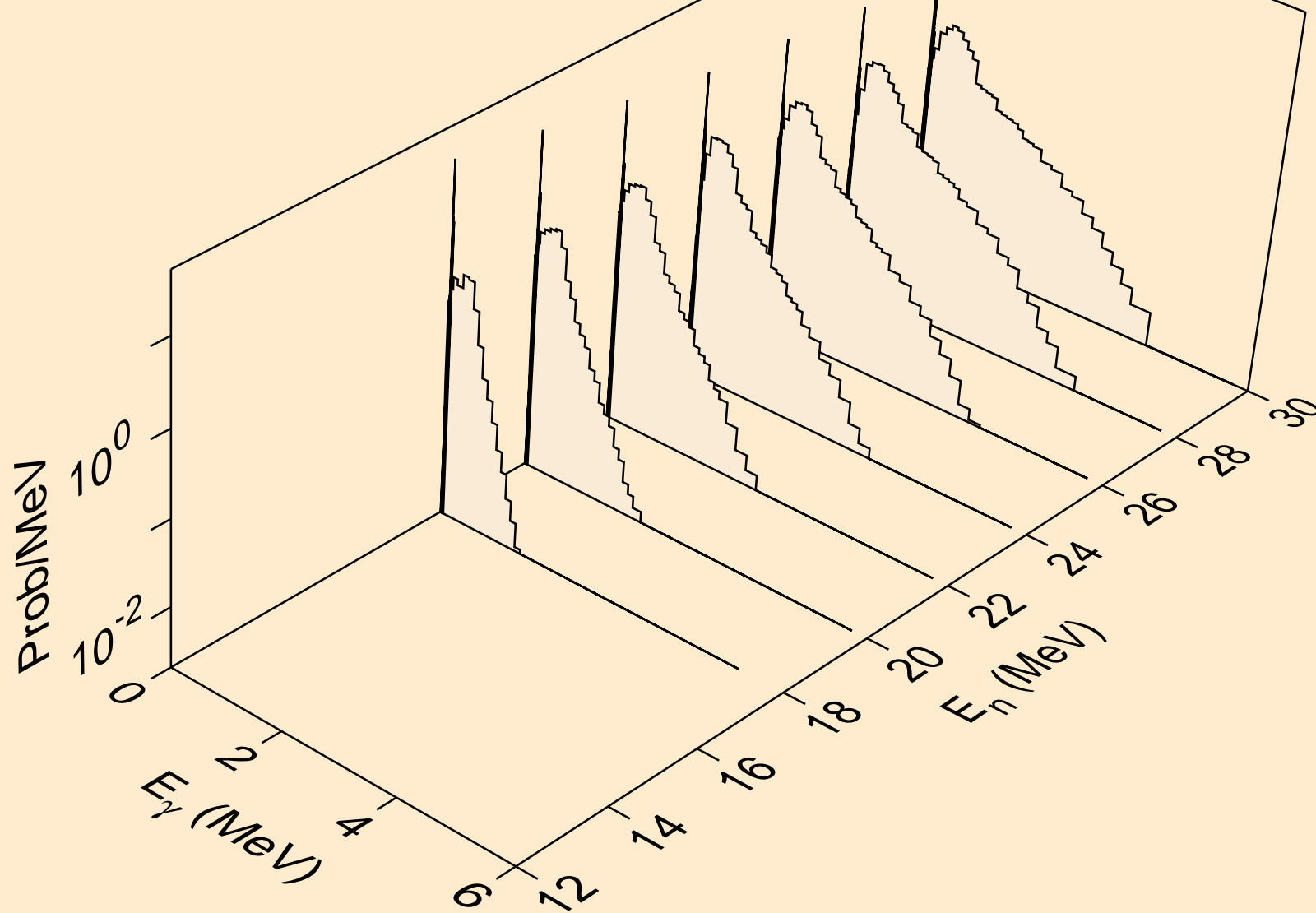

PM154M PROTON ACER TENDL-2021 LIBRARY; T=0.K  
Photon emission for (n,3np)

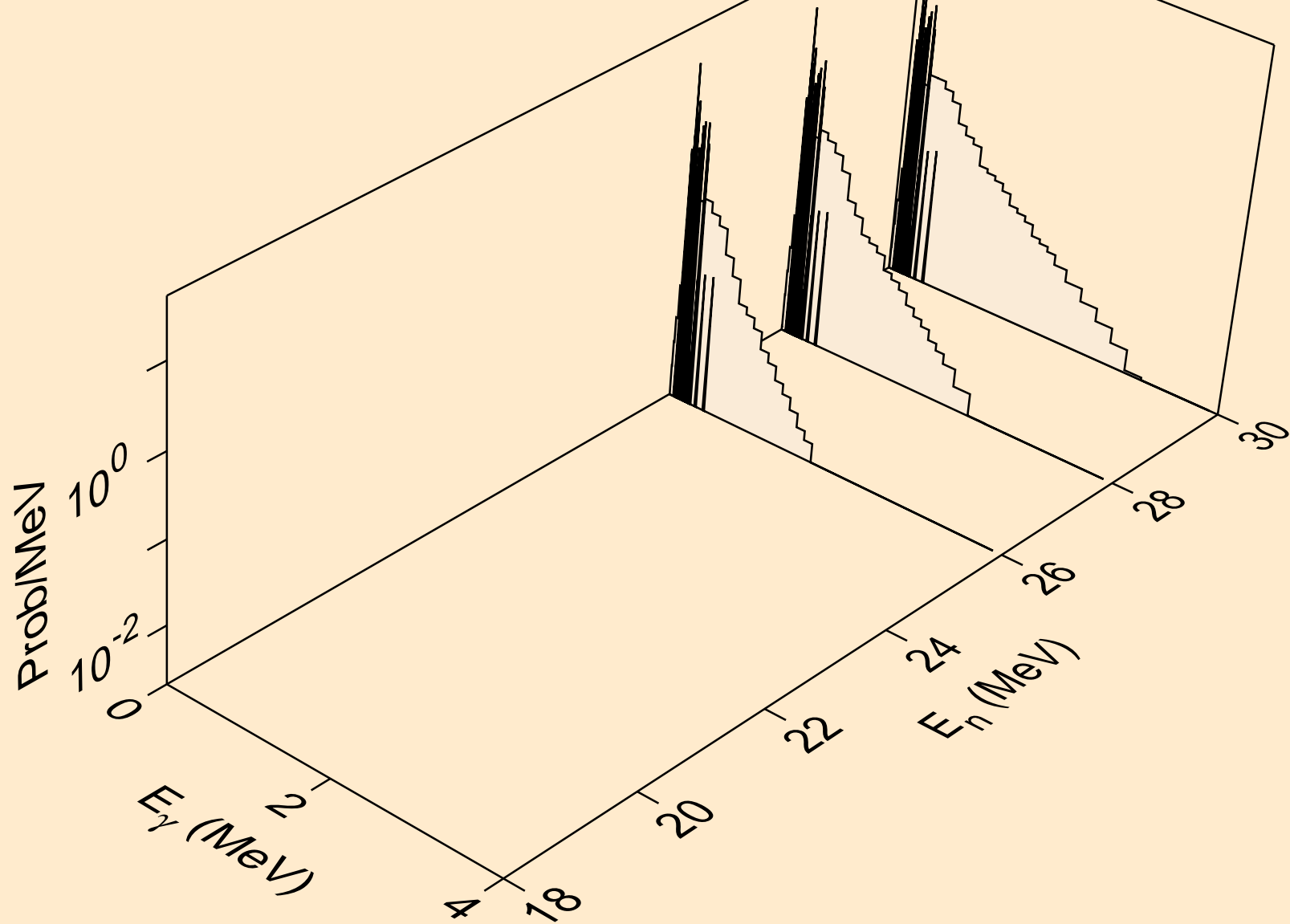

PM154M PROTON ACER TENDL-2021 LIBRARY; T=0.K  
Photon emission for (n,2np)

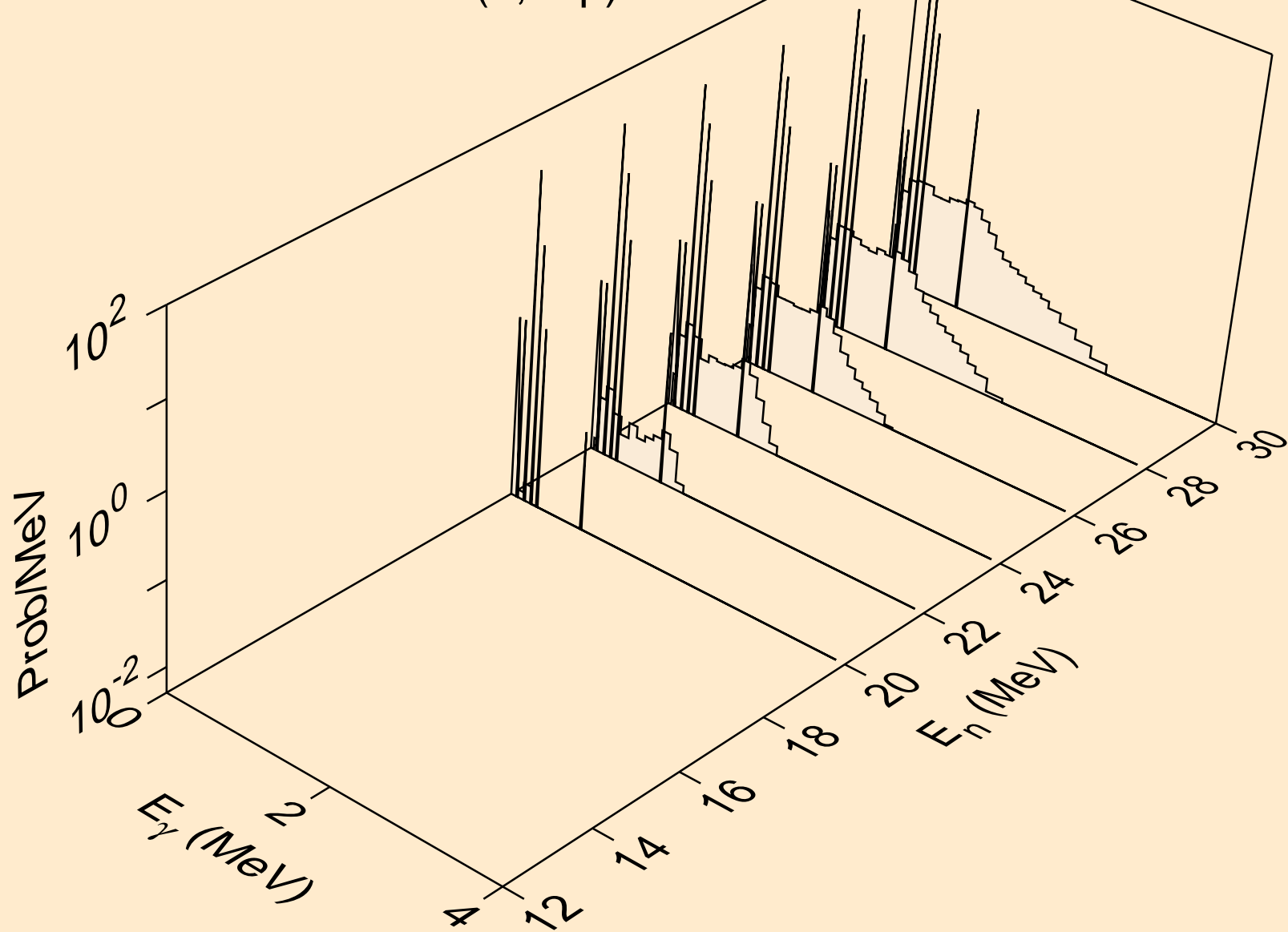

PM154M PROTON ACER TENDL-2021 LIBRARY; T=0.K  
Photon emission for (n,npa)

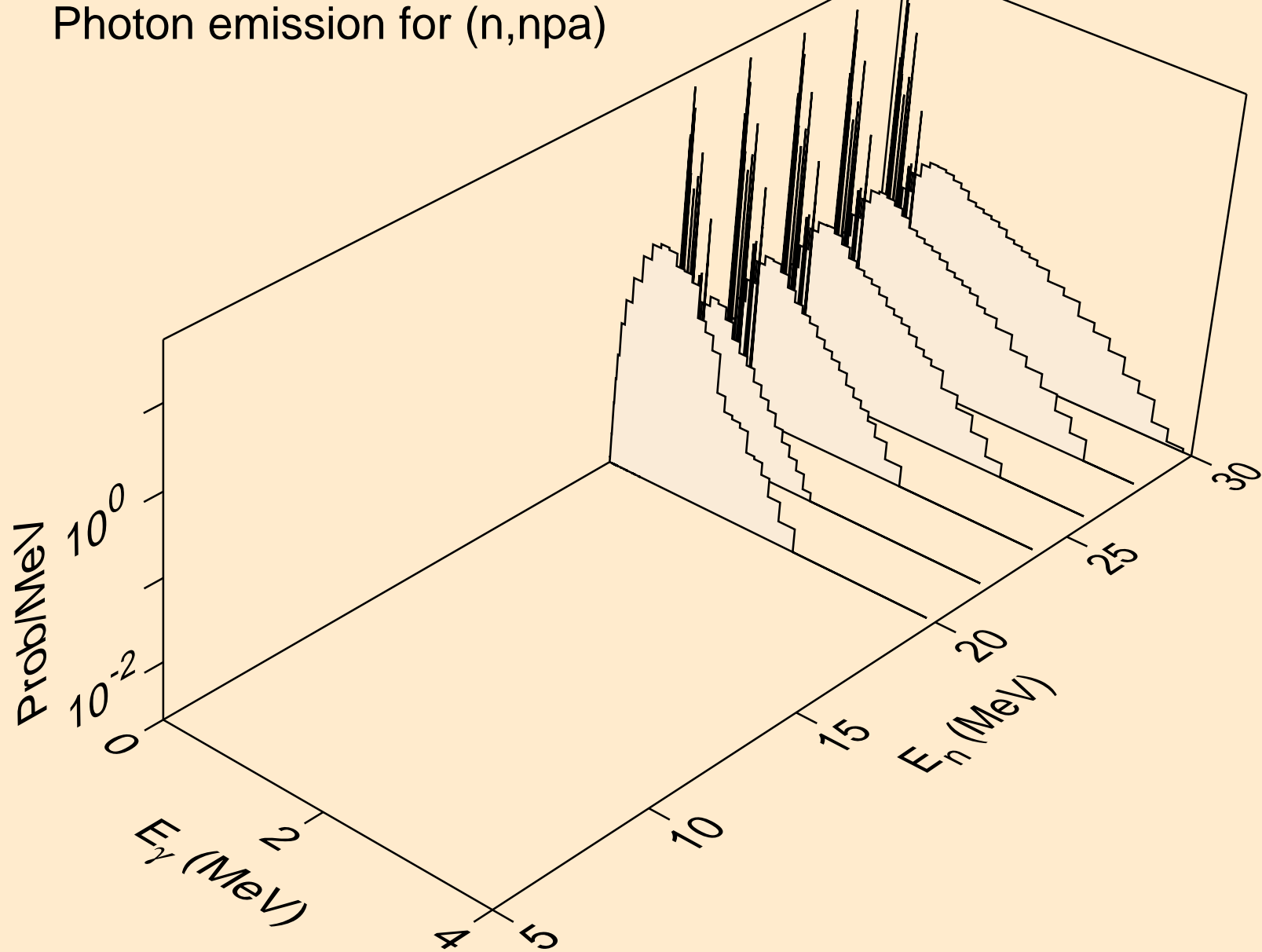

PM154M PROTON ACER TENDL-2021 LIBRARY; T=0.K  
Photon emission for (n,gma)

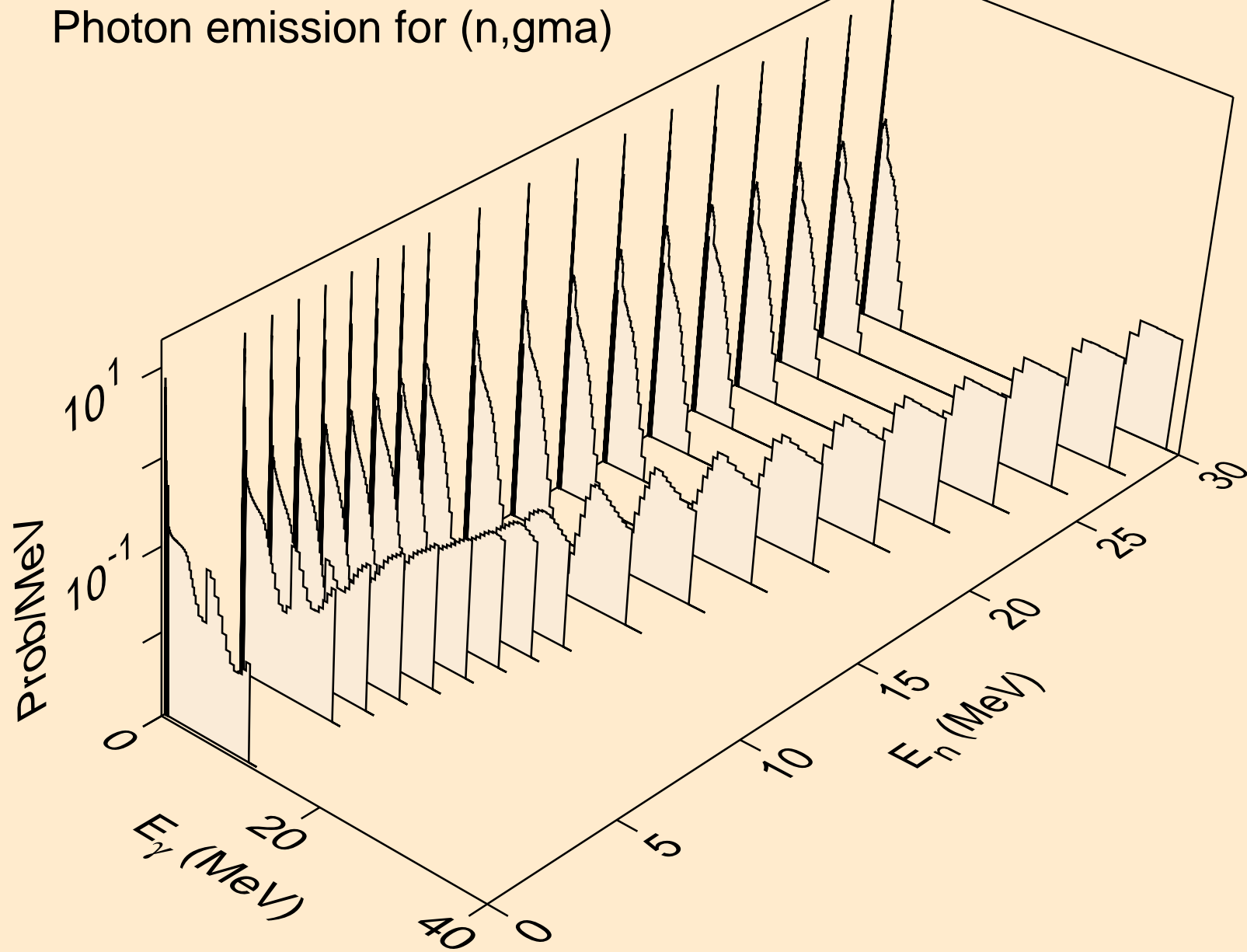

PM154M PROTON ACER TENDL-2021 LIBRARY; T=0.K  
Photon emission for inelastic

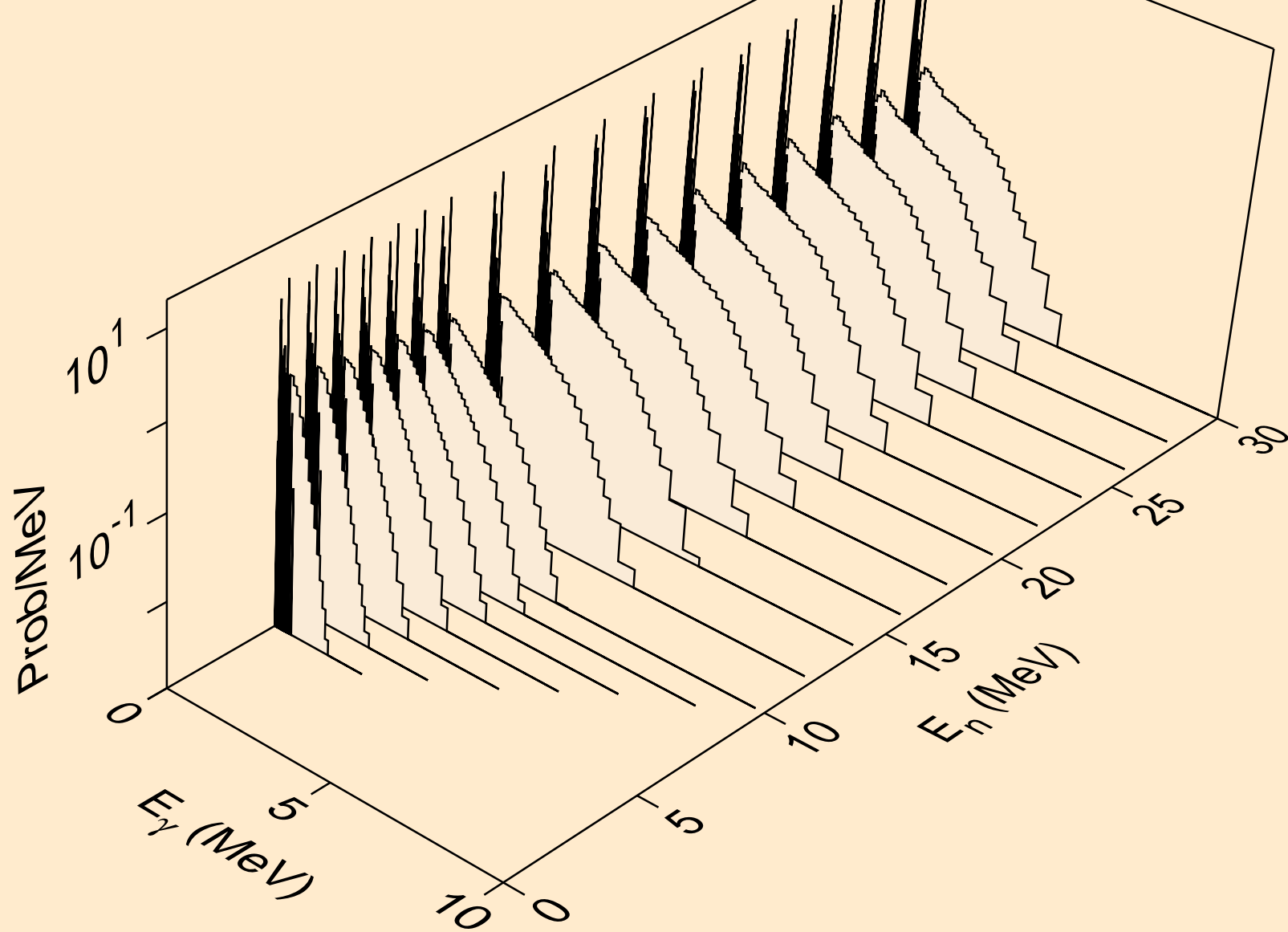

PM154M PROTON ACER TENDL-2021 LIBRARY; T=0.K  
Photon emission for (n,d)

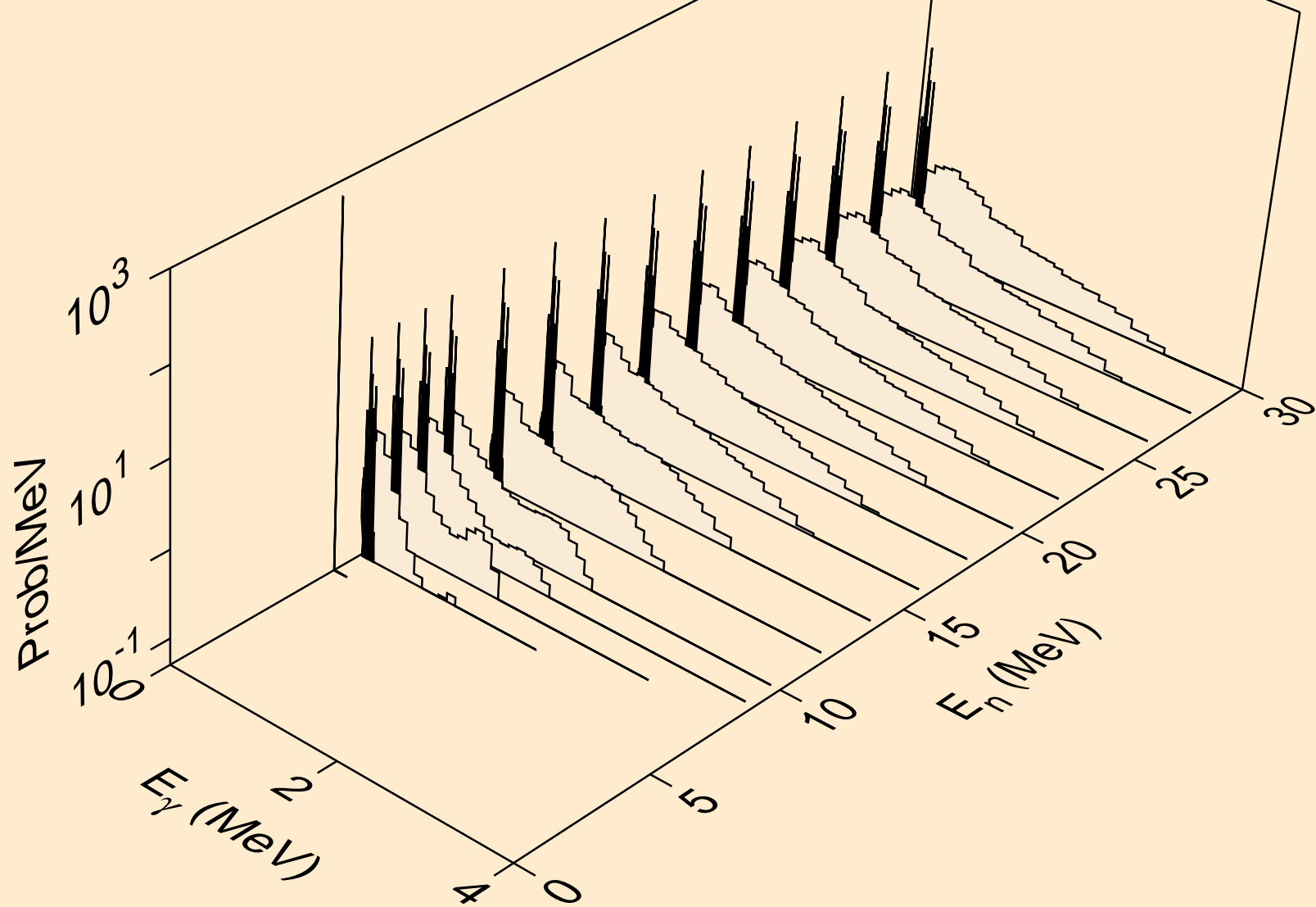

PM154M PROTON ACER TENDL-2021 LIBRARY; T=0.K  
Photon emission for (n,t)

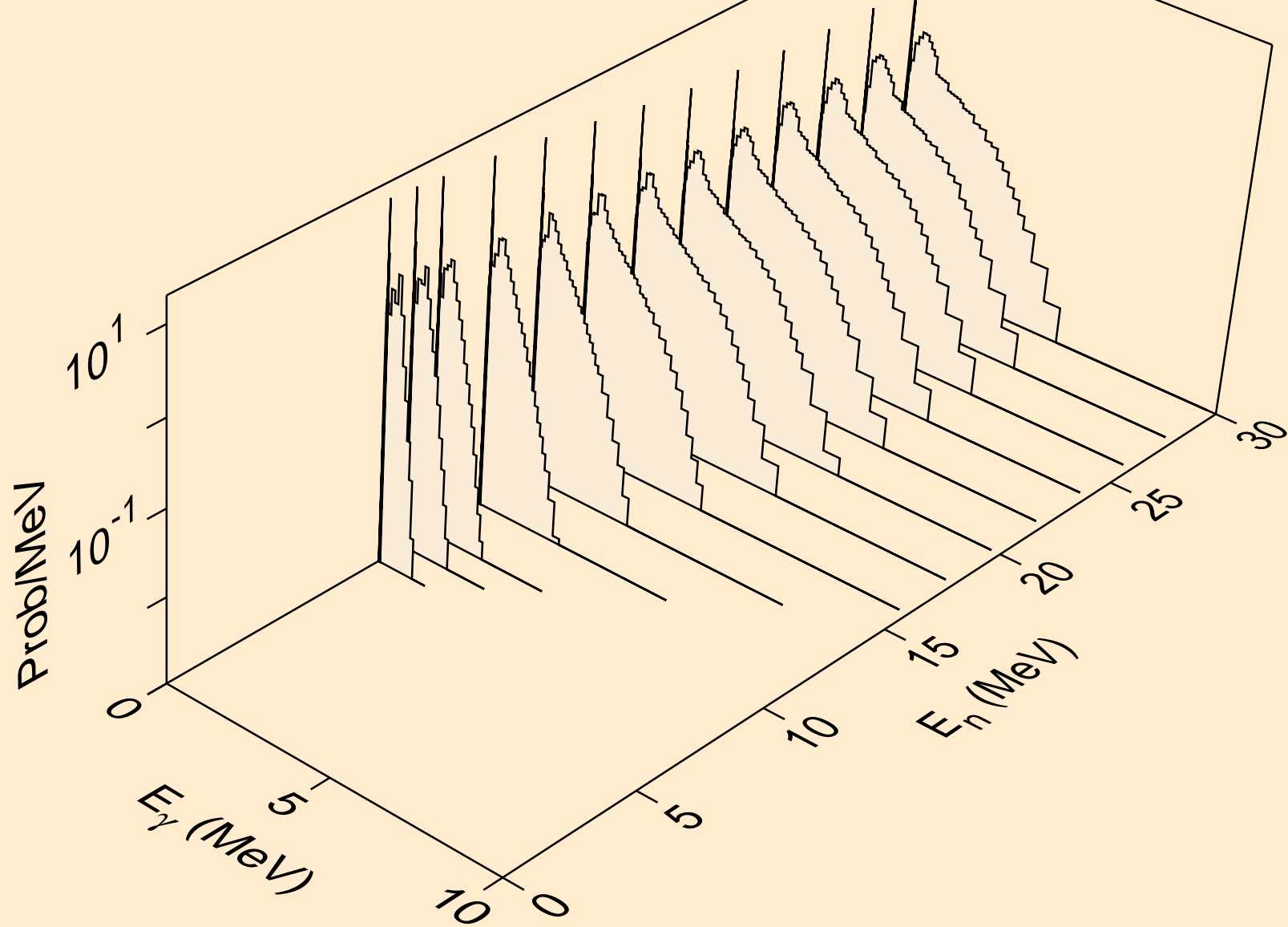

PM154M PROTON ACER TENDL-2021 LIBRARY; T=0.K  
Photon emission for (n,he3)

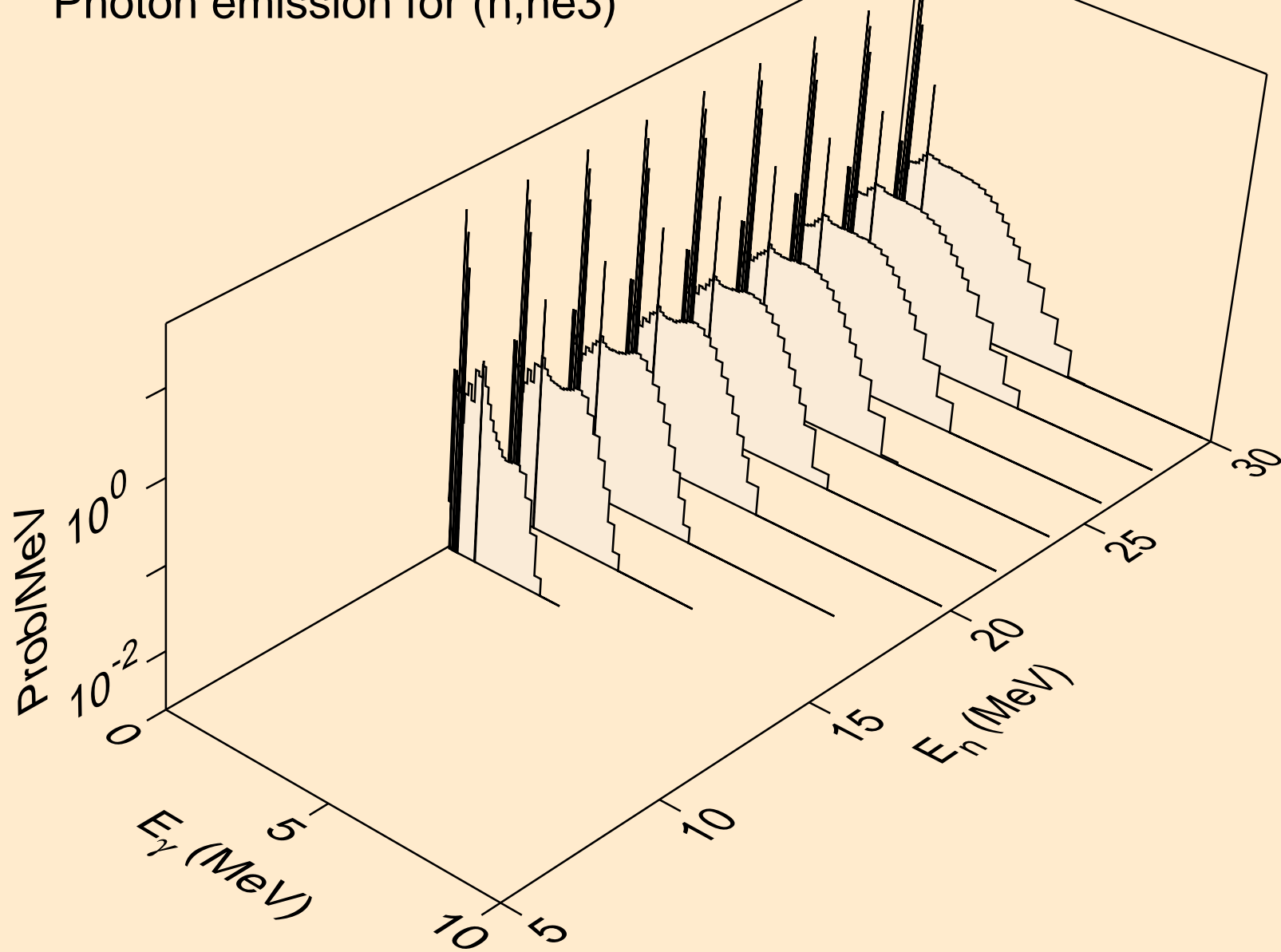

PM154M PROTON ACER TENDL-2021 LIBRARY; T=0.K  
Photon emission for (n,a)

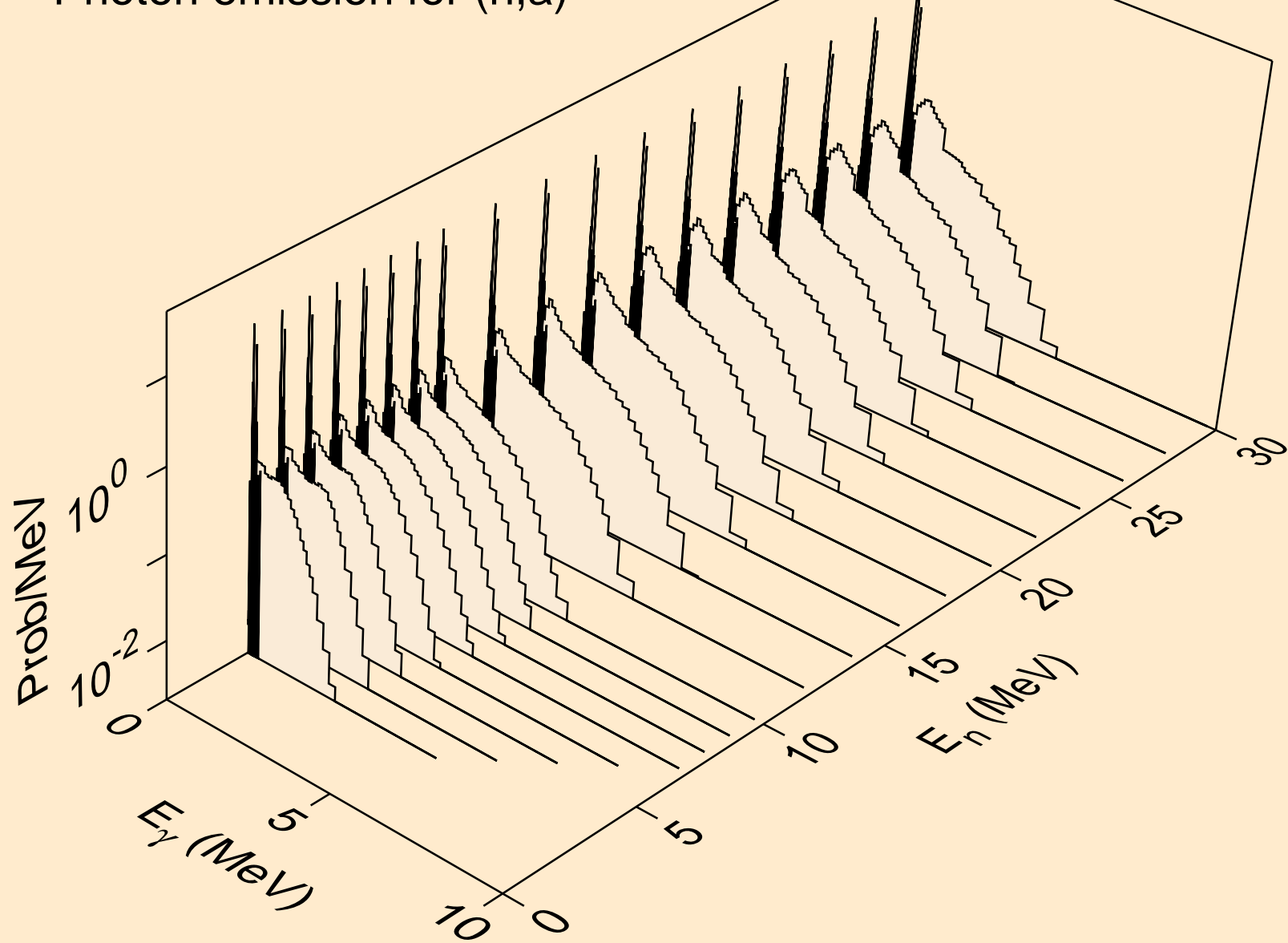

PM154M PROTON ACER TENDL-2021 LIBRARY; T=0.K  
Photon emission for (n,2a)

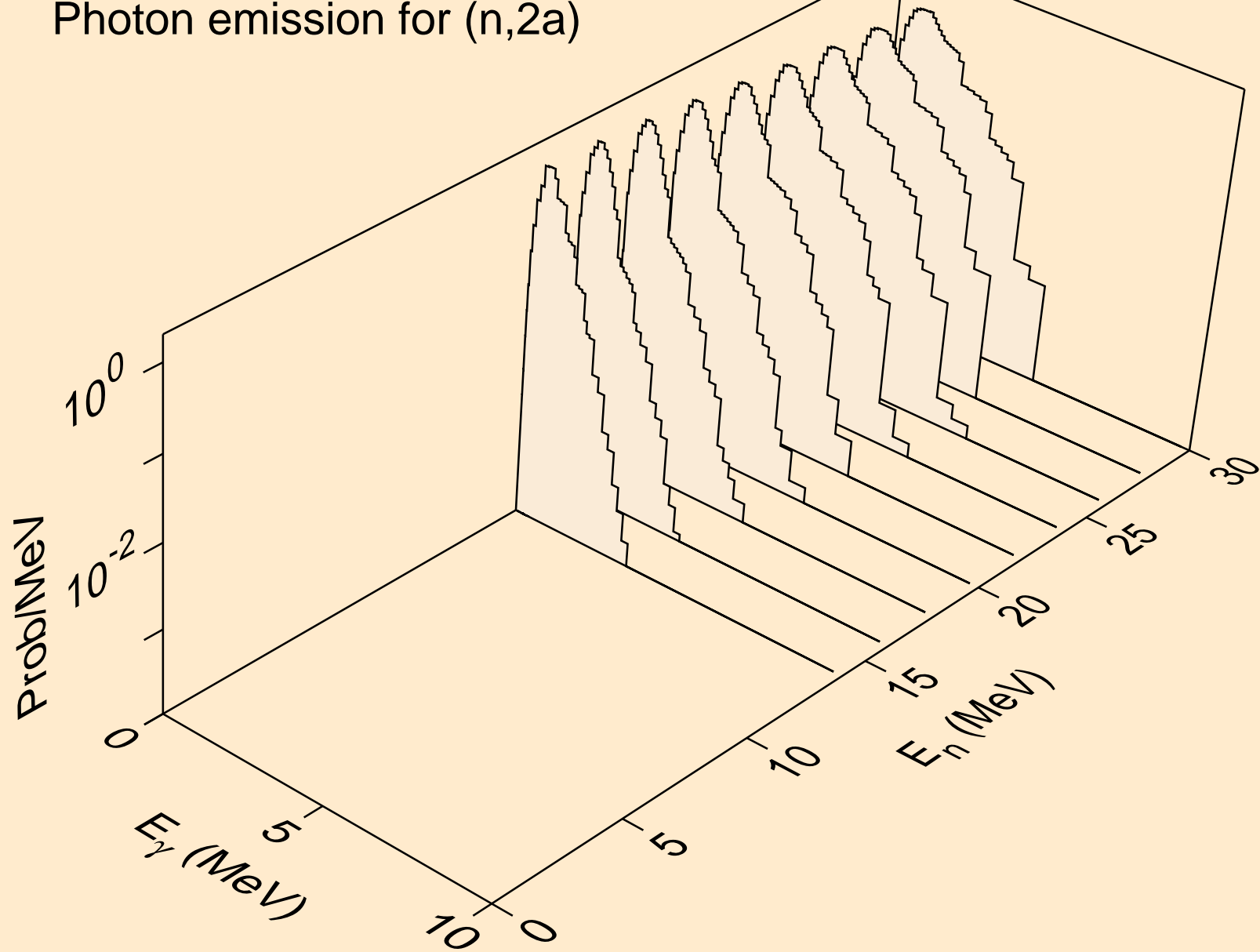

PM154M PROTON ACER TENDL-2021 LIBRARY; T=0.K  
Photon emission for (n,2p)

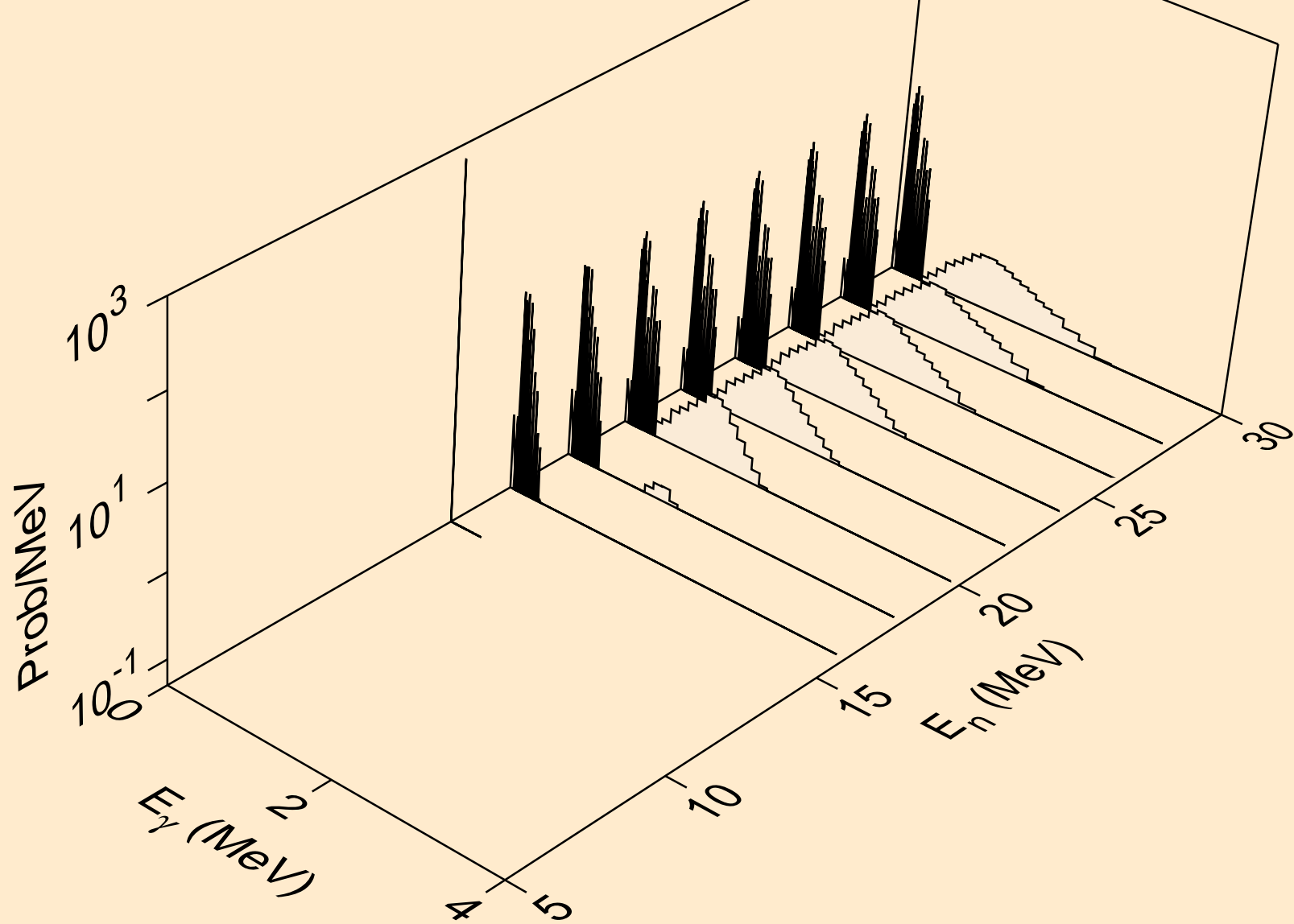

PM154M PROTON ACER TENDL-2021 LIBRARY; T=0.K  
Photon emission for (n,pa)

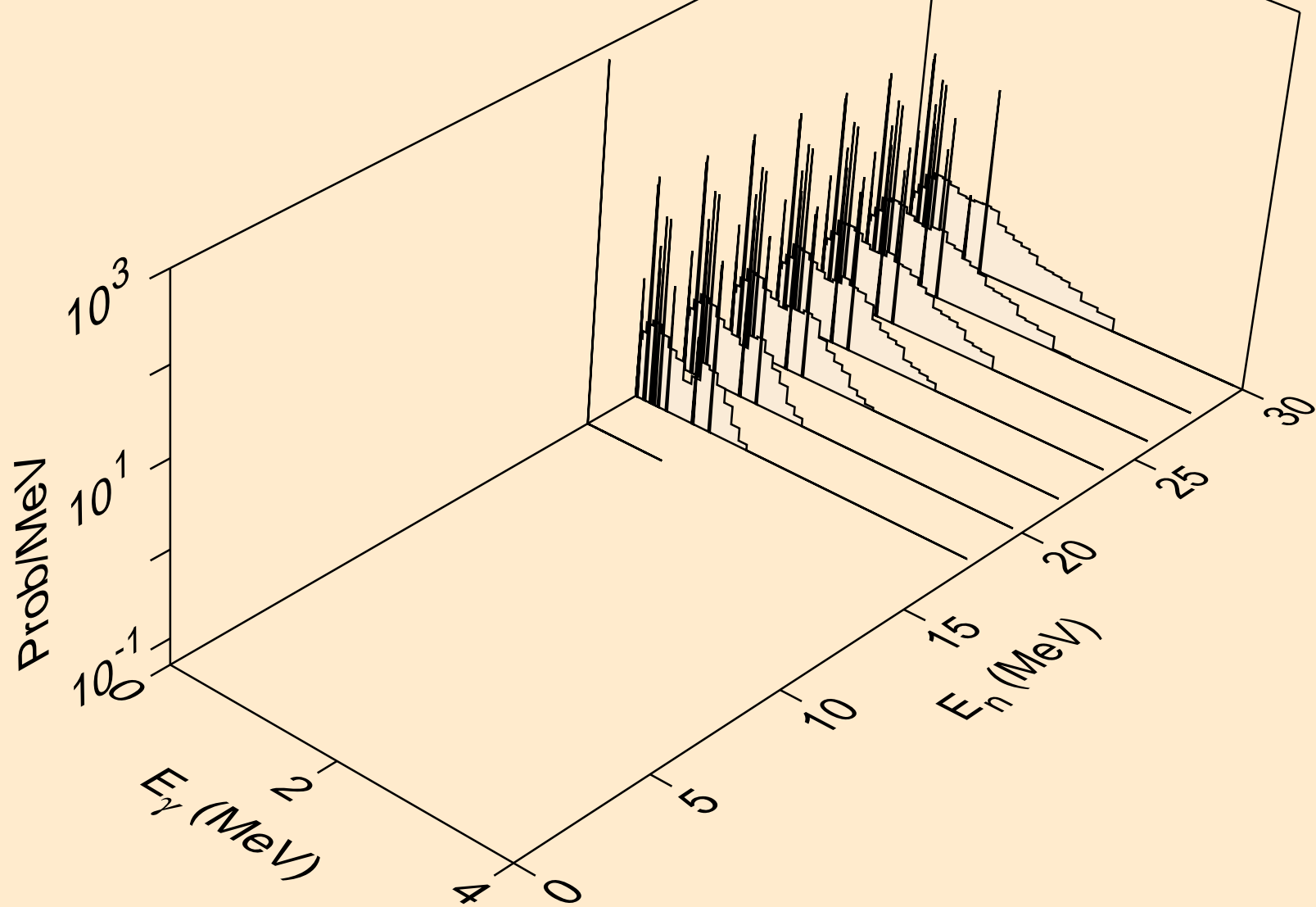

PM154M PROTON ACER TENDL-2021 LIBRARY; T=0.K  
Photon emission for (n,pd)

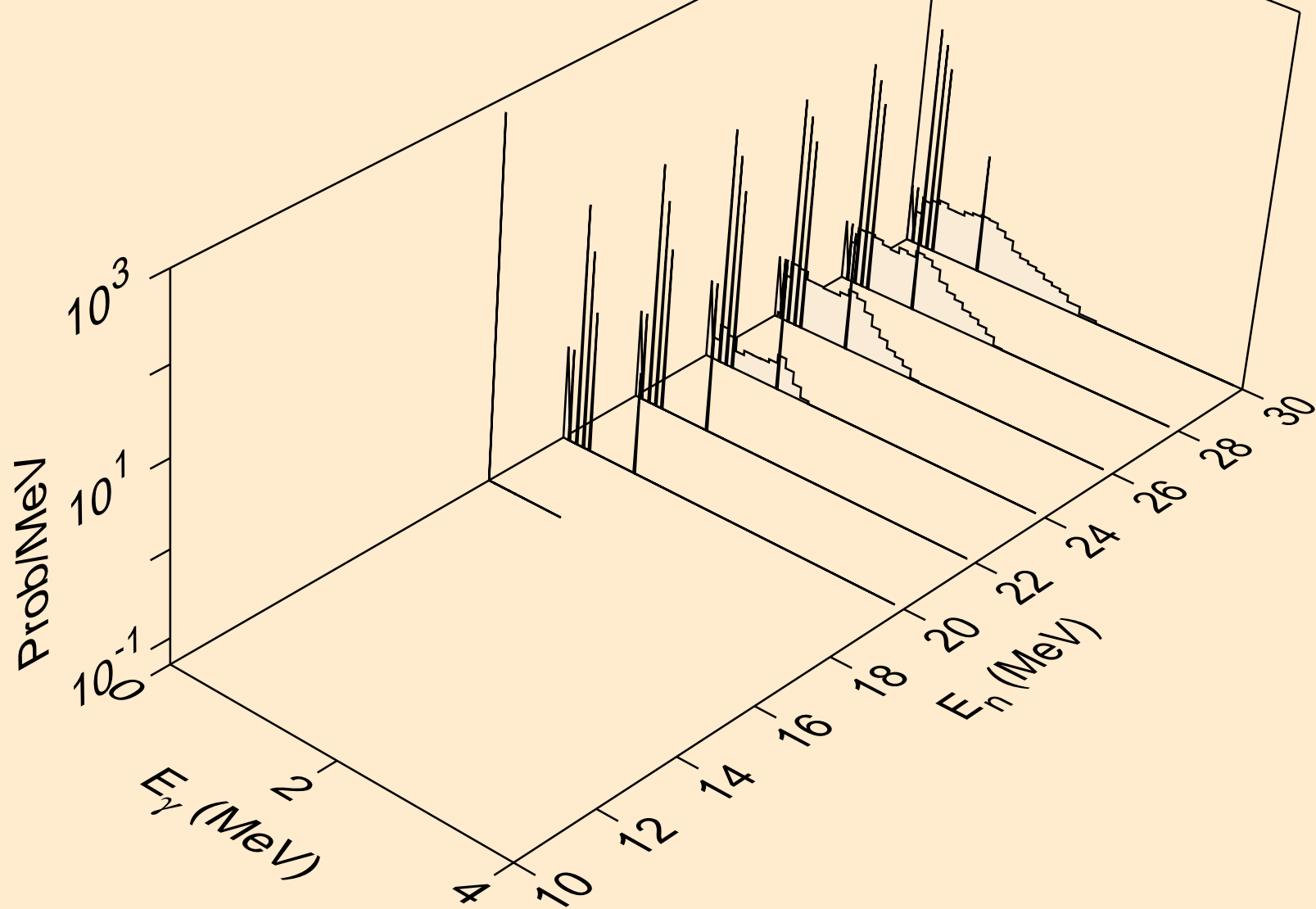

PM154M PROTON ACER TENDL-2021 LIBRARY; T=0.K  
Particle heating contributions

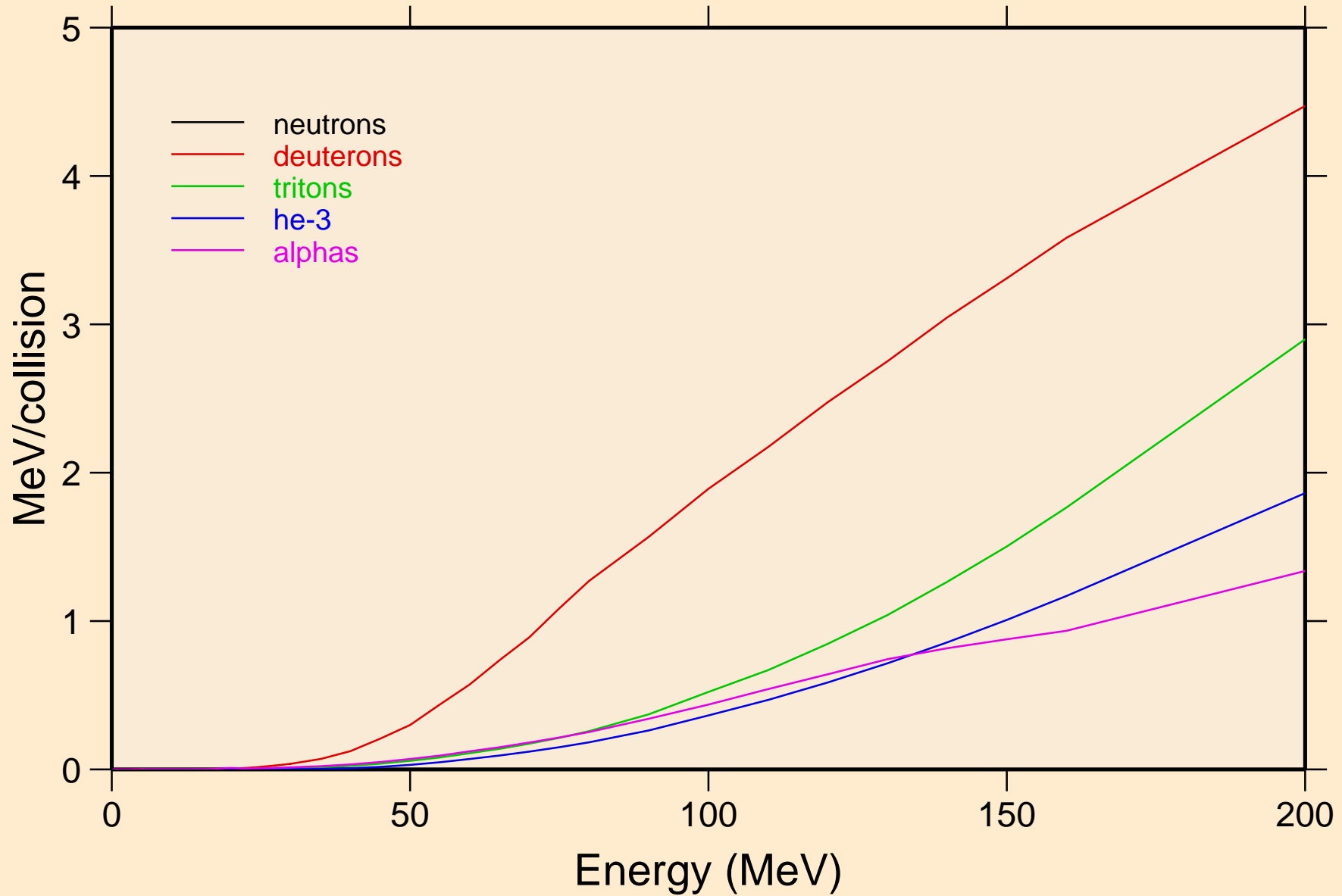

PM154M PROTON ACER TENDL-2021 LIBRARY; T=0.K  
Recoil Heating

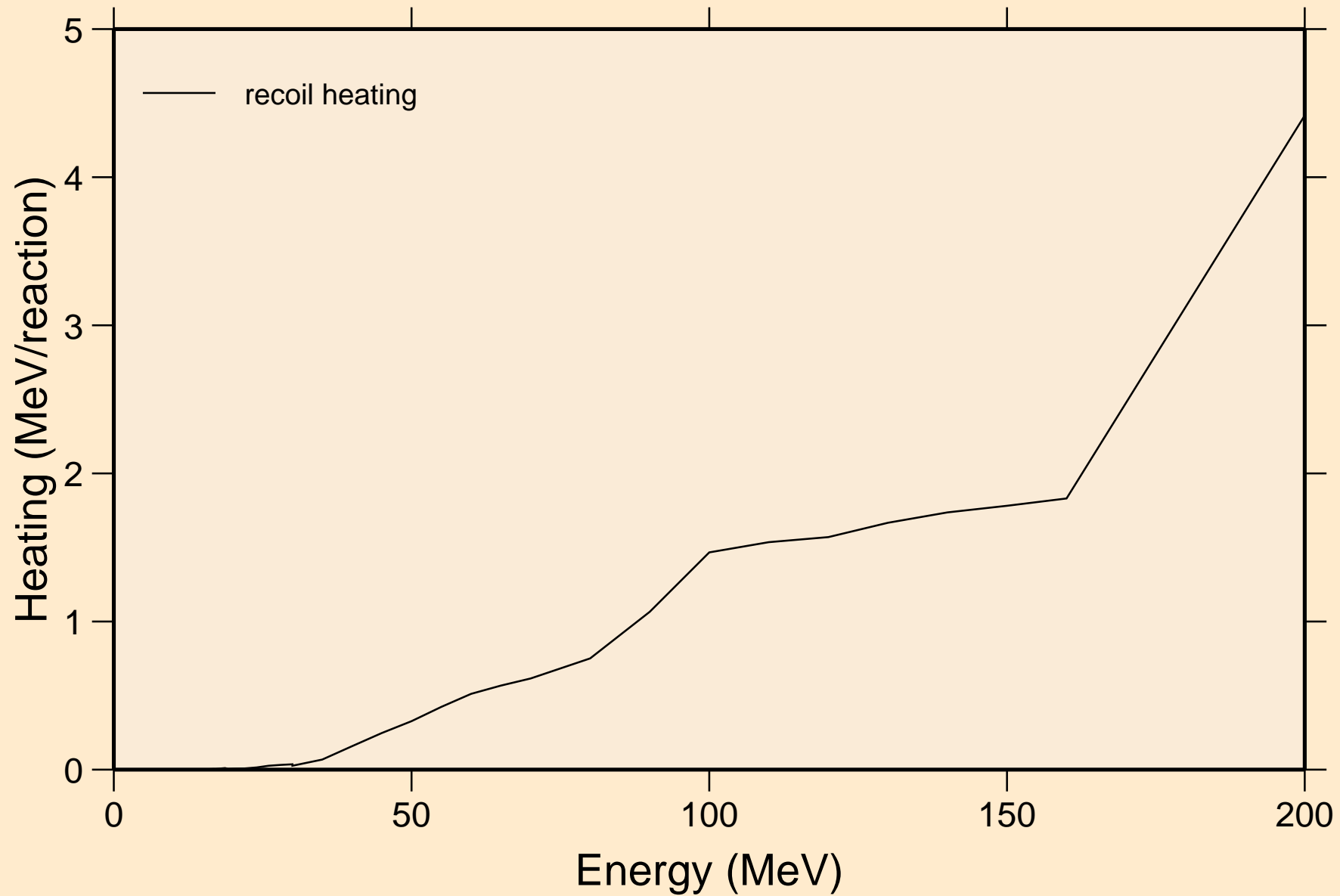

PM154M PROTON ACER TENDL-2021 LIBRARY; T=0.K  
Particle production cross sections

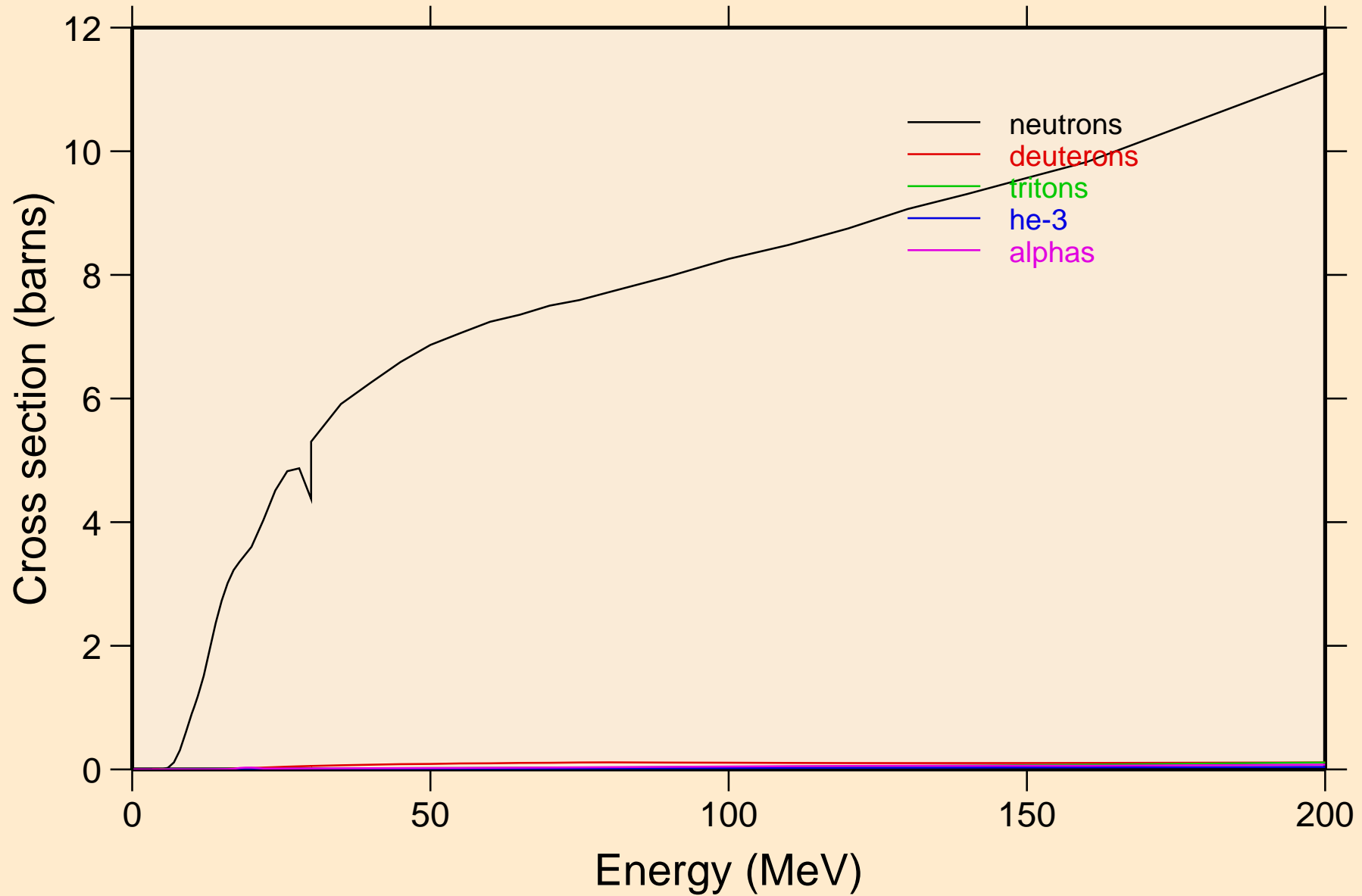

PM154M PROTON ACER TENDL-2021 LIBRARY; T=0.K  
neutrons from (p,n)

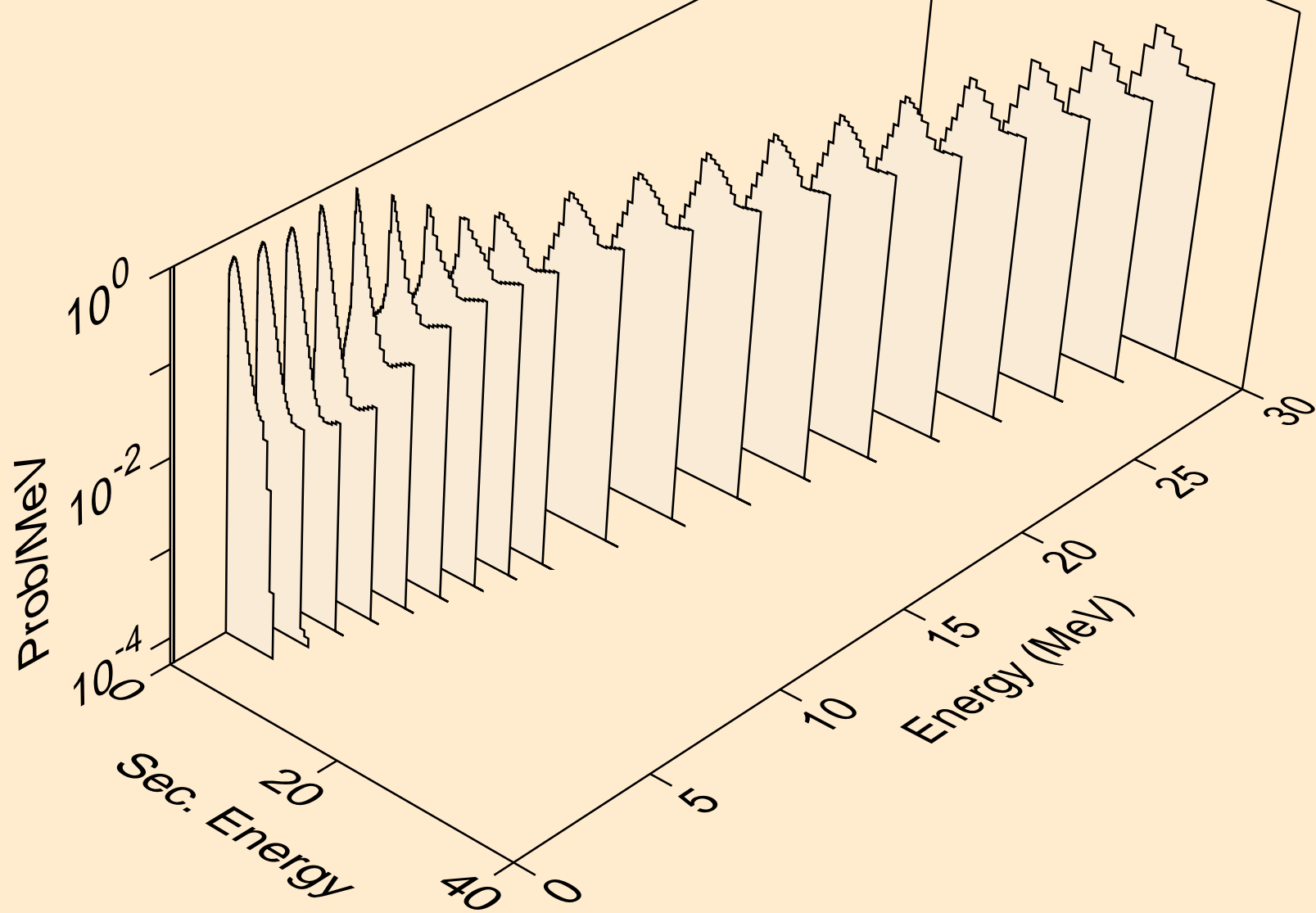

PM154M PROTON ACER TENDL-2021 LIBRARY; T=0.K  
neutrons from (p,x)

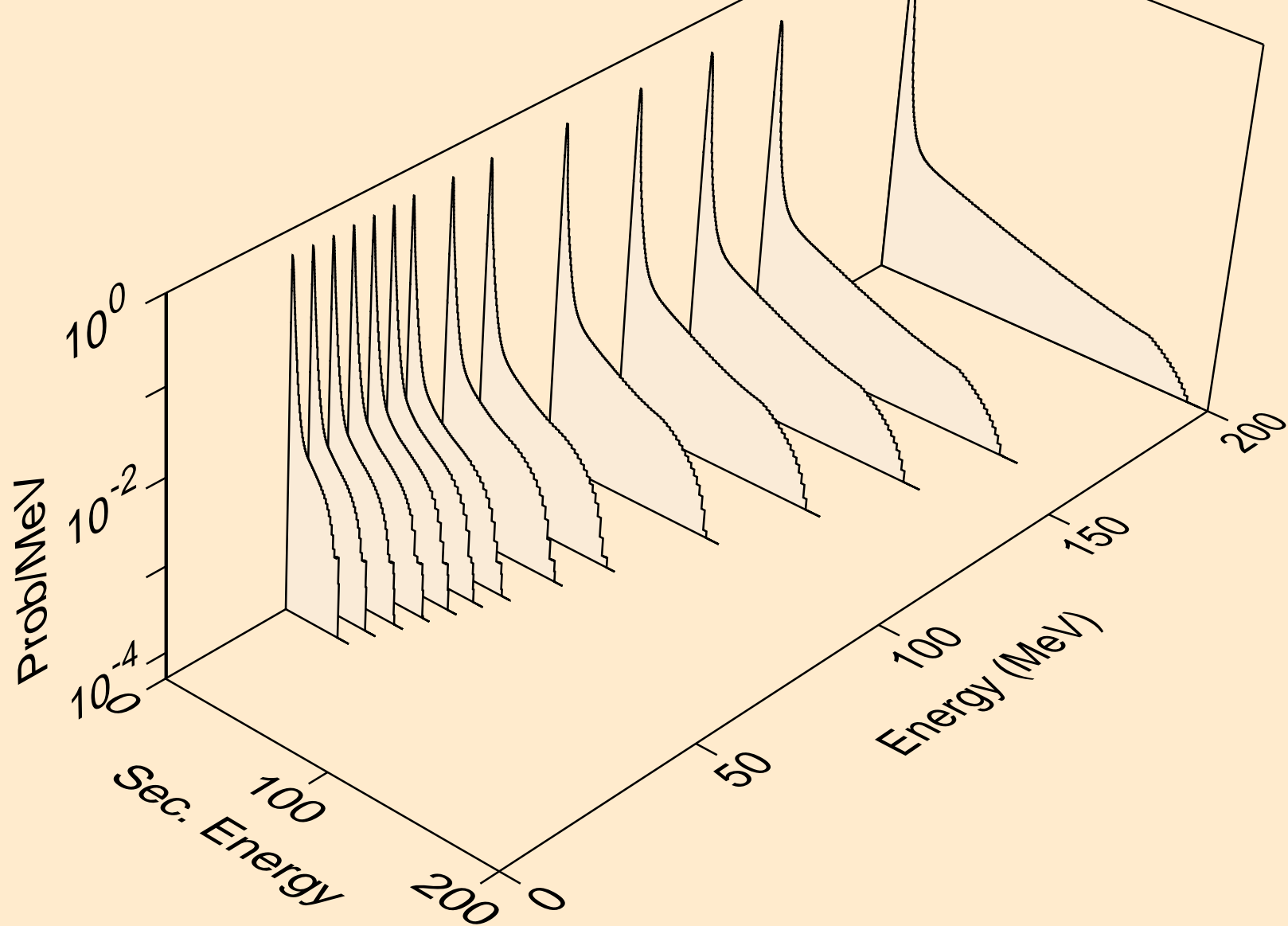

PM154M PROTON ACER TENDL-2021 LIBRARY; T=0.K  
neutrons from (p,2nd)

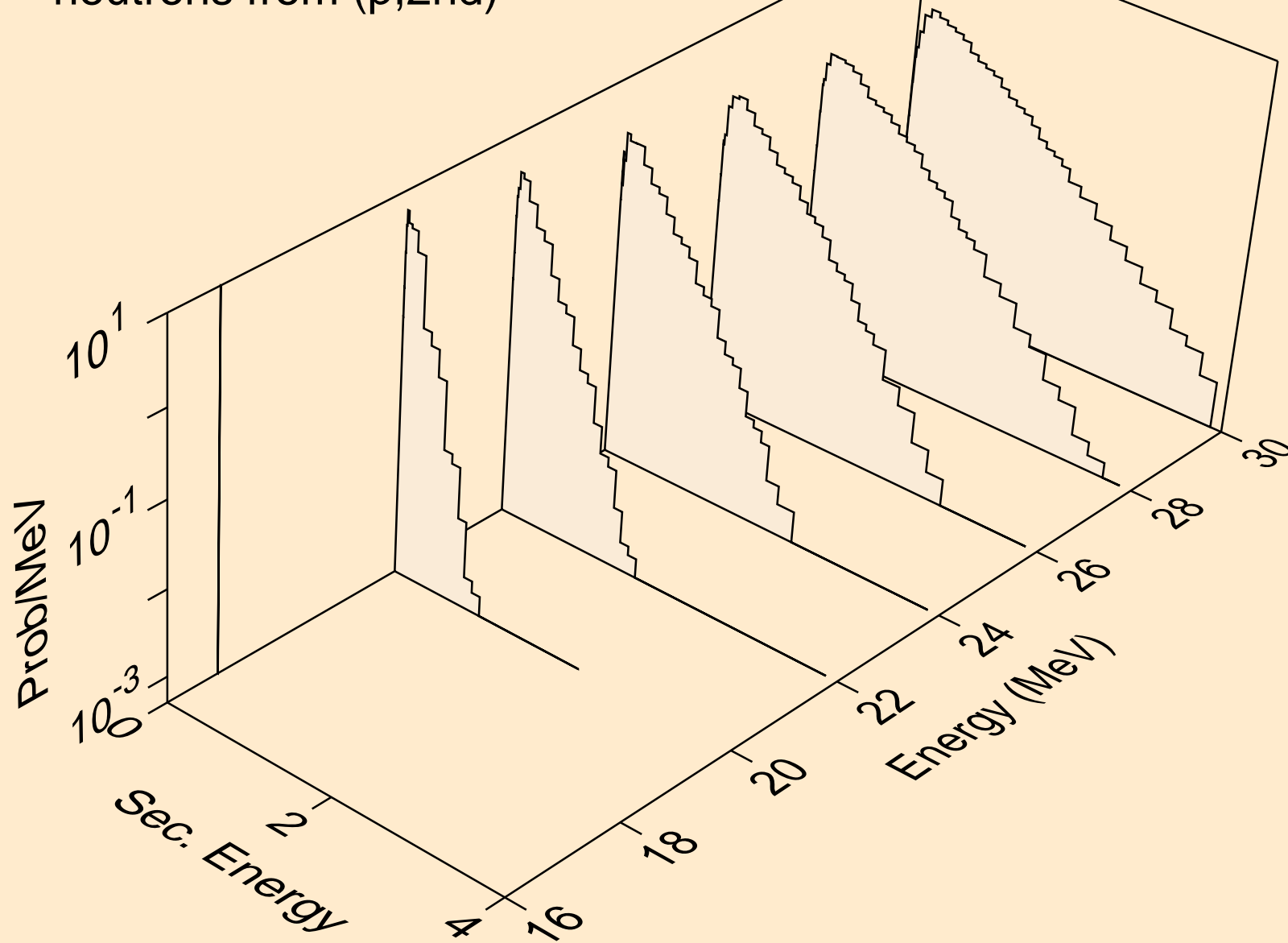

PM154M PROTON ACER TENDL-2021 LIBRARY; T=0.K  
neutrons from (p,2n)

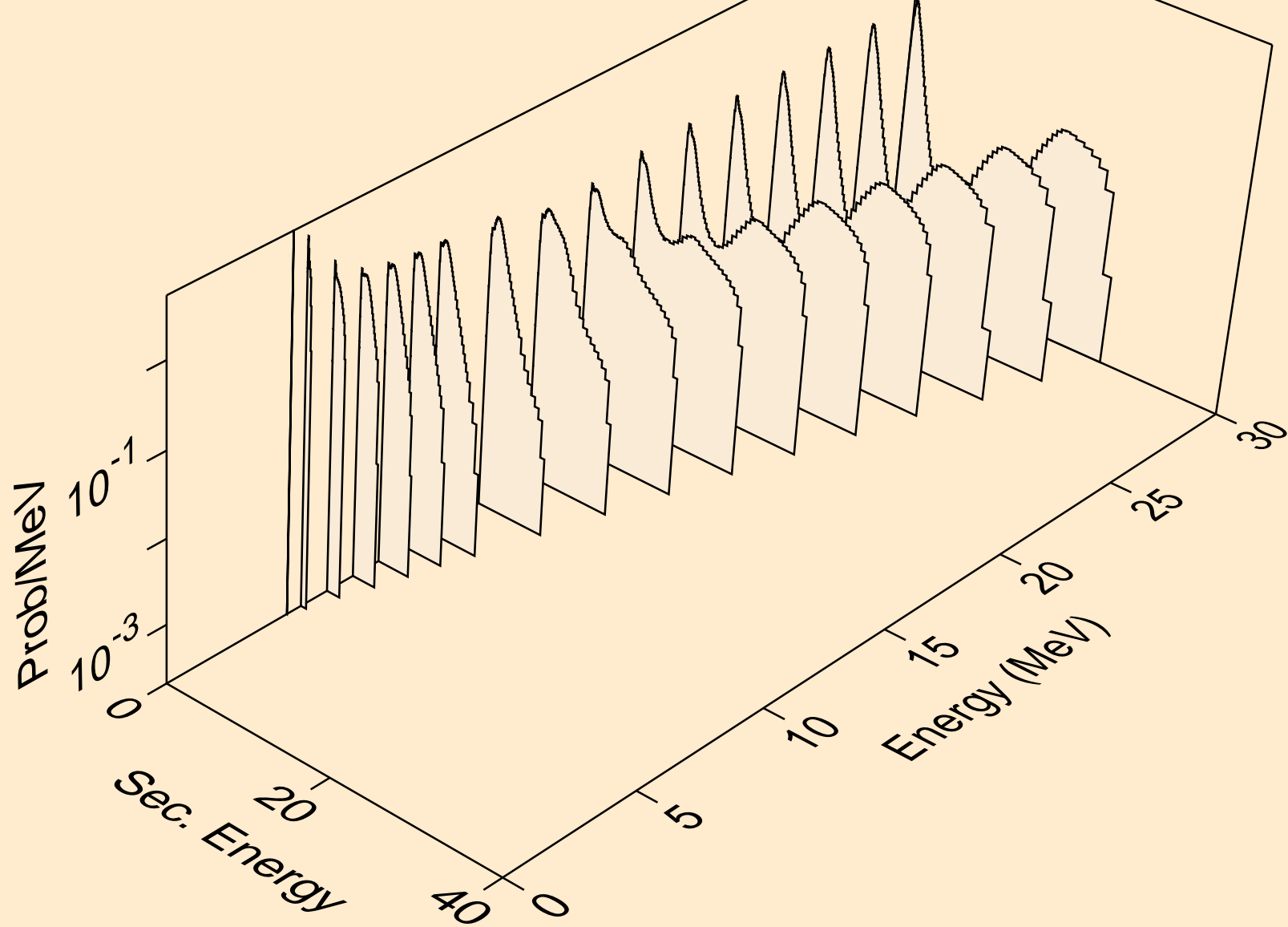

PM154M PROTON ACER TENDL-2021 LIBRARY; T=0.K  
neutrons from (p,3n)

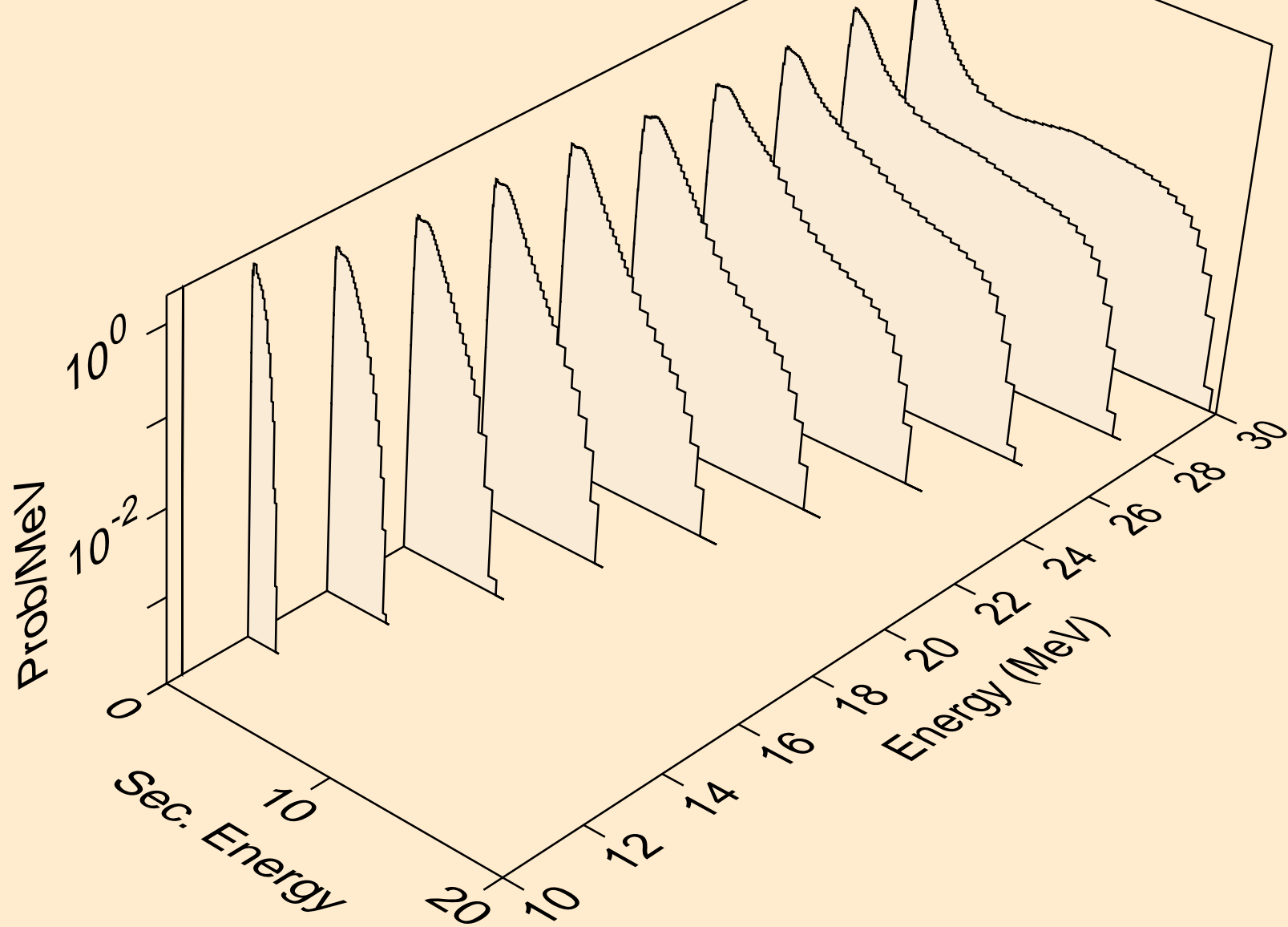

PM154M PROTON ACER TENDL-2021 LIBRARY; T=0.K  
neutrons from (p,n\*)a

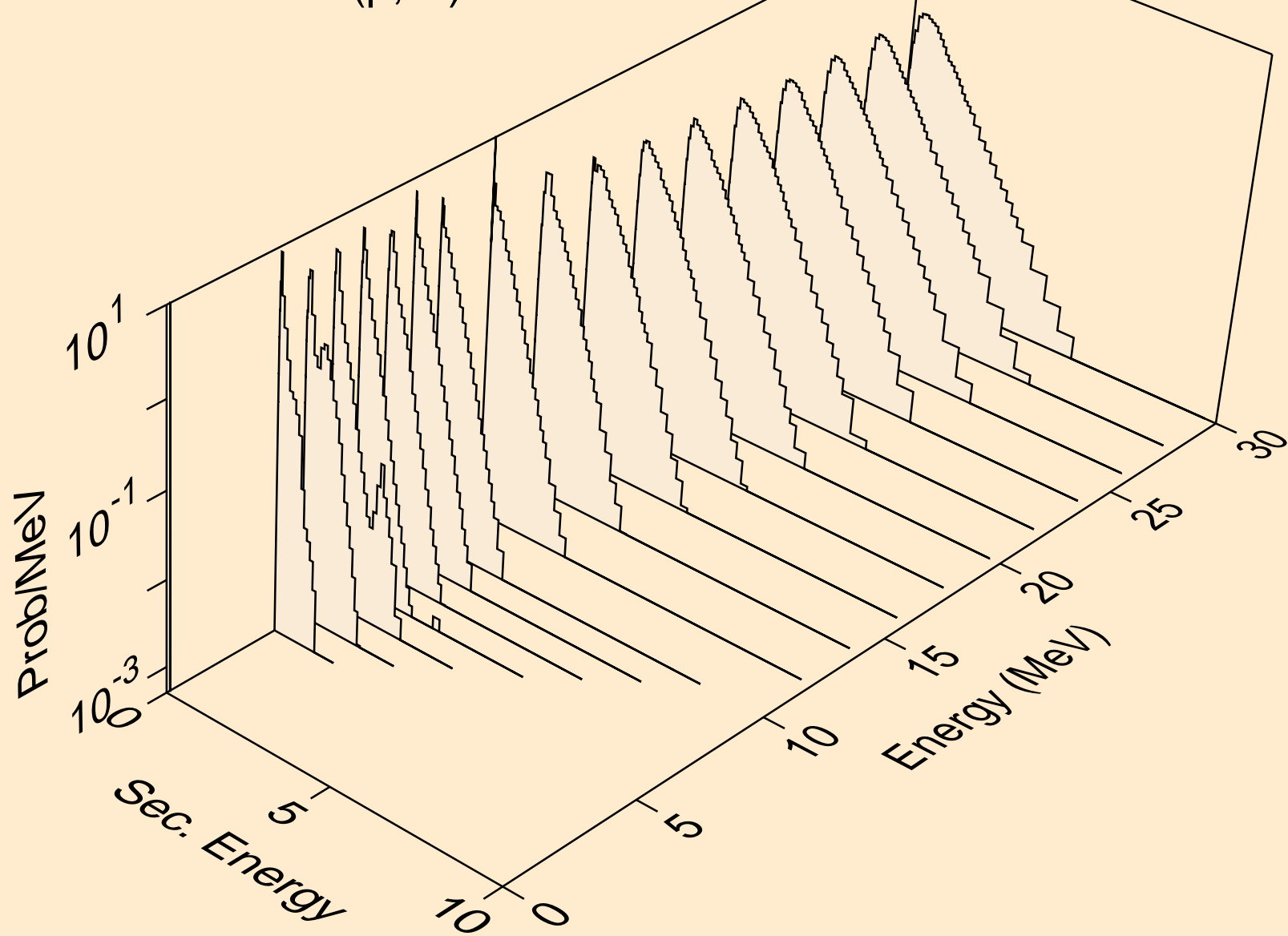

PM154M PROTON ACER TENDL-2021 LIBRARY; T=0.K  
neutrons from (p,2n)a

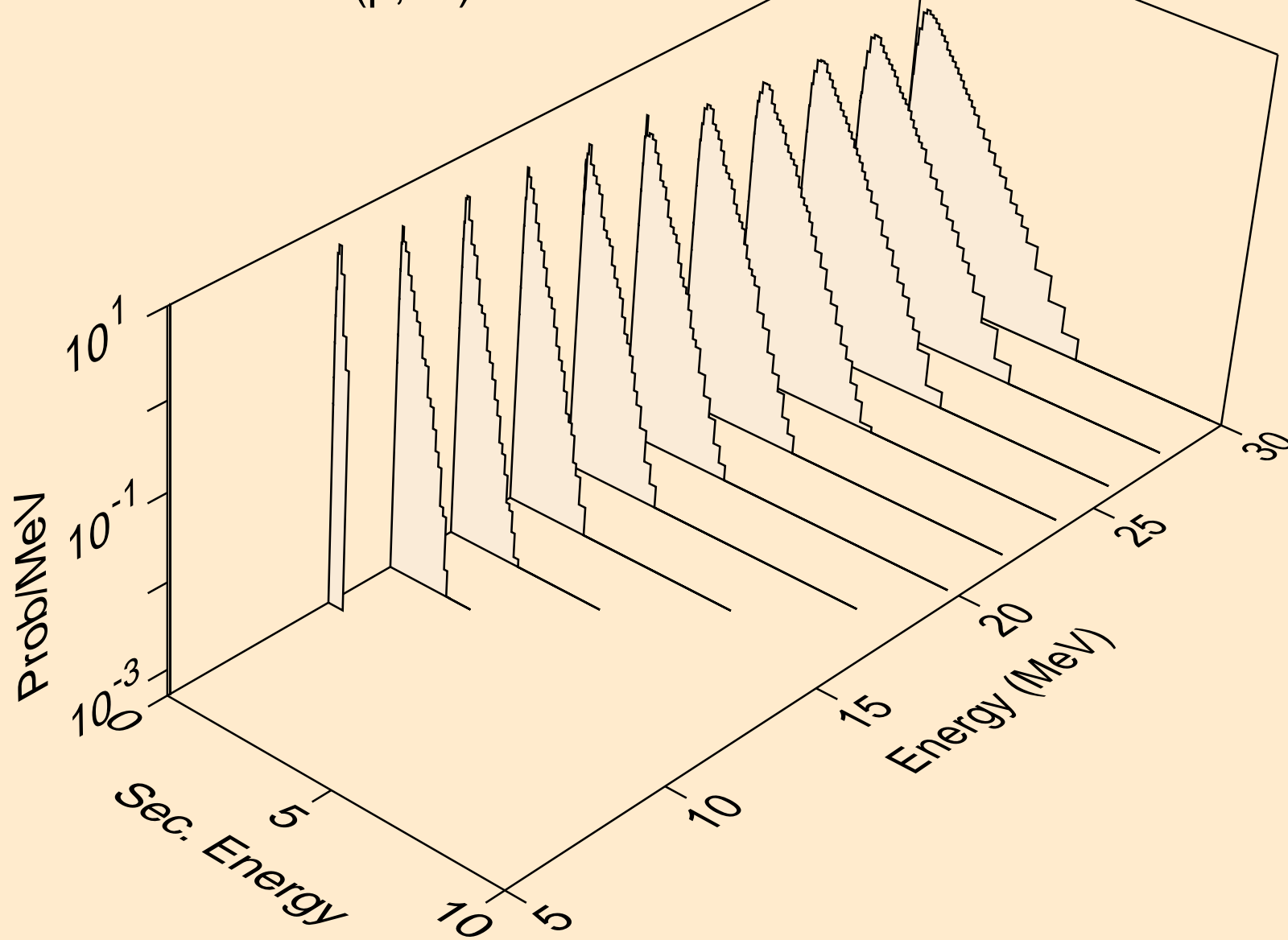

PM154M PROTON ACER TENDL-2021 LIBRARY; T=0.K  
neutrons from (p,3n)a

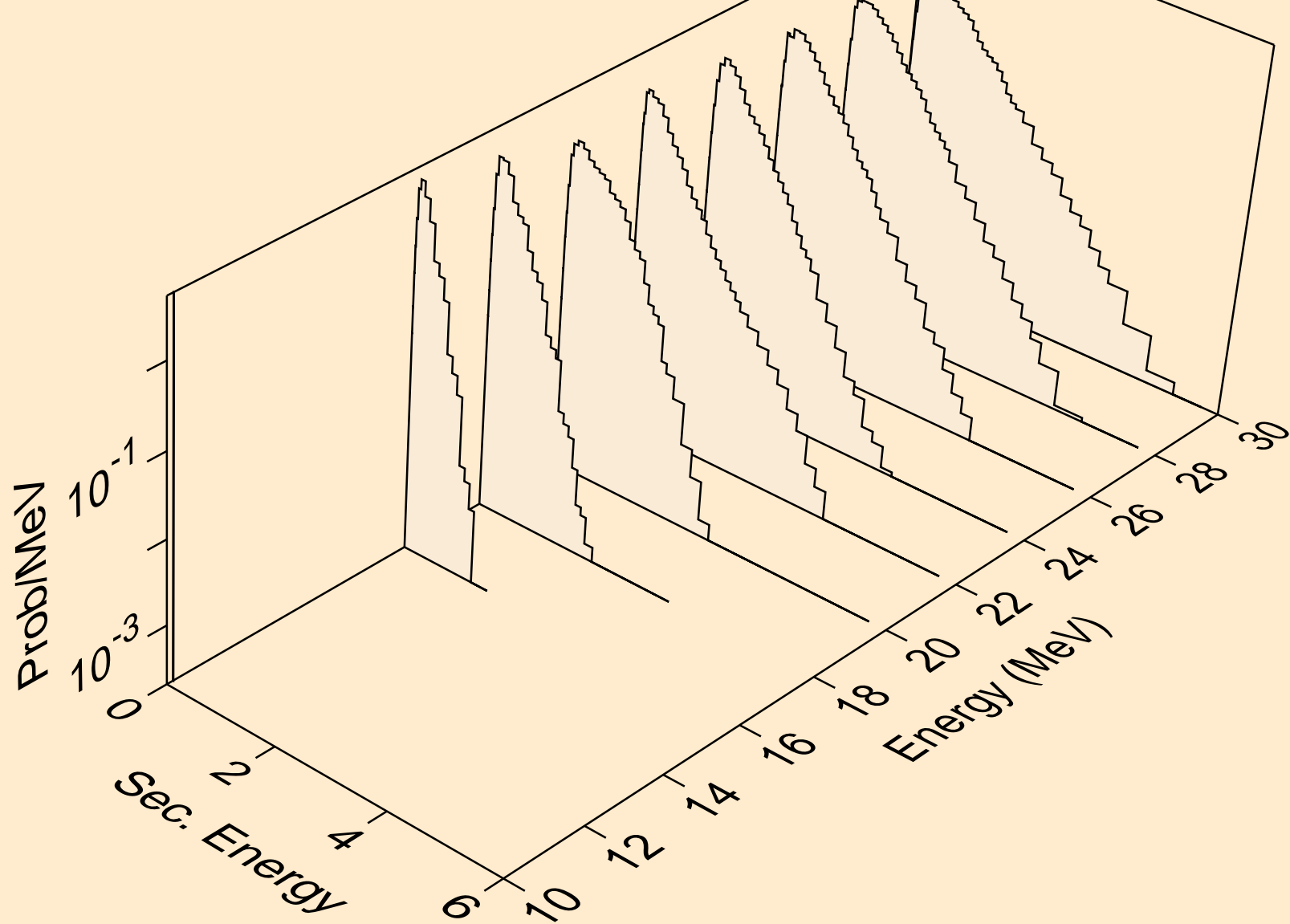

PM154M PROTON ACER TENDL-2021 LIBRARY; T=0.K  
neutrons from (p,n\*)p

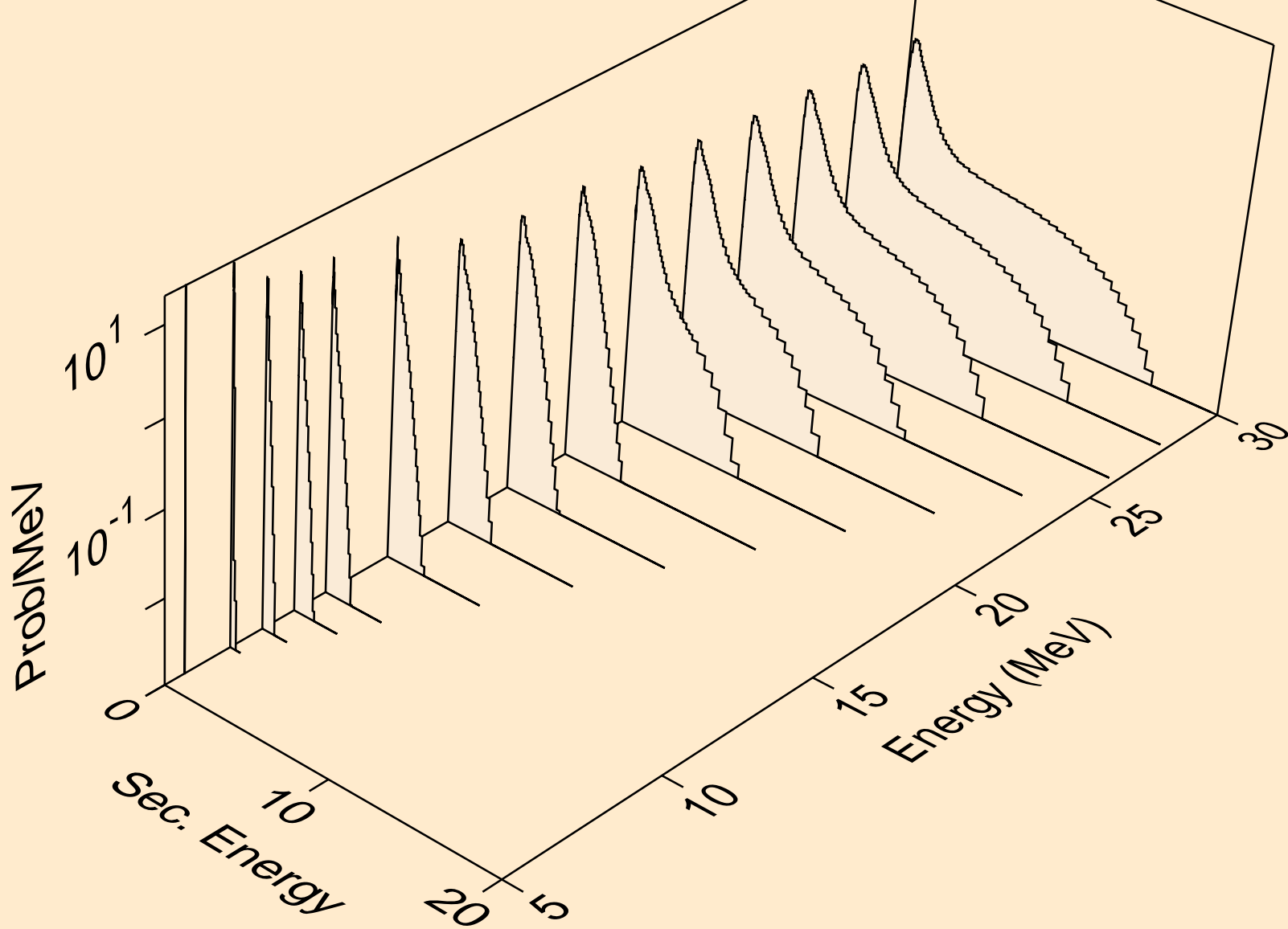

PM154M PROTON ACER TENDL-2021 LIBRARY; T=0.K  
neutrons from (p,n\*)2a

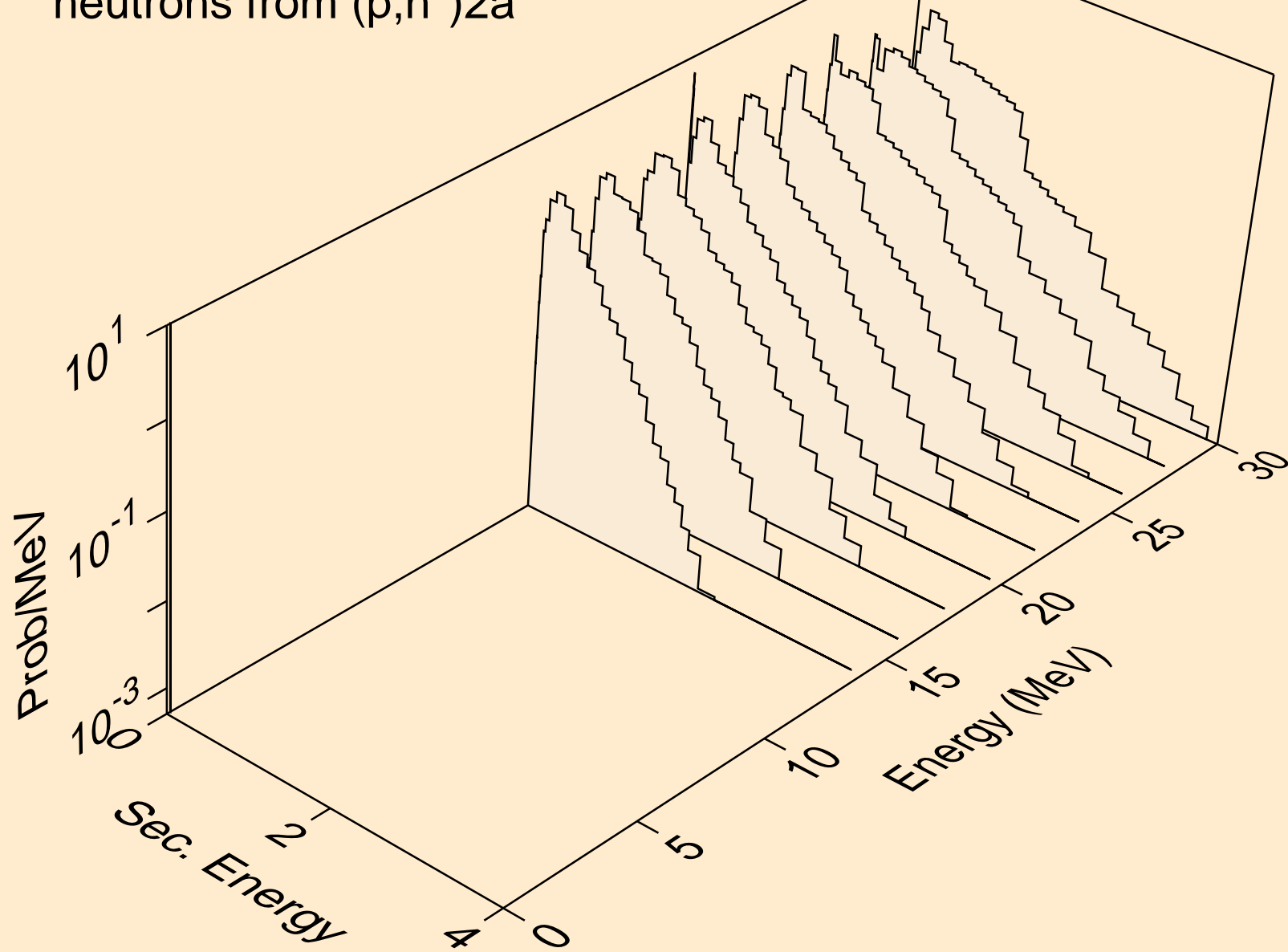

PM154M PROTON ACER TENDL-2021 LIBRARY; T=0.K  
neutrons from (p,n\*)d

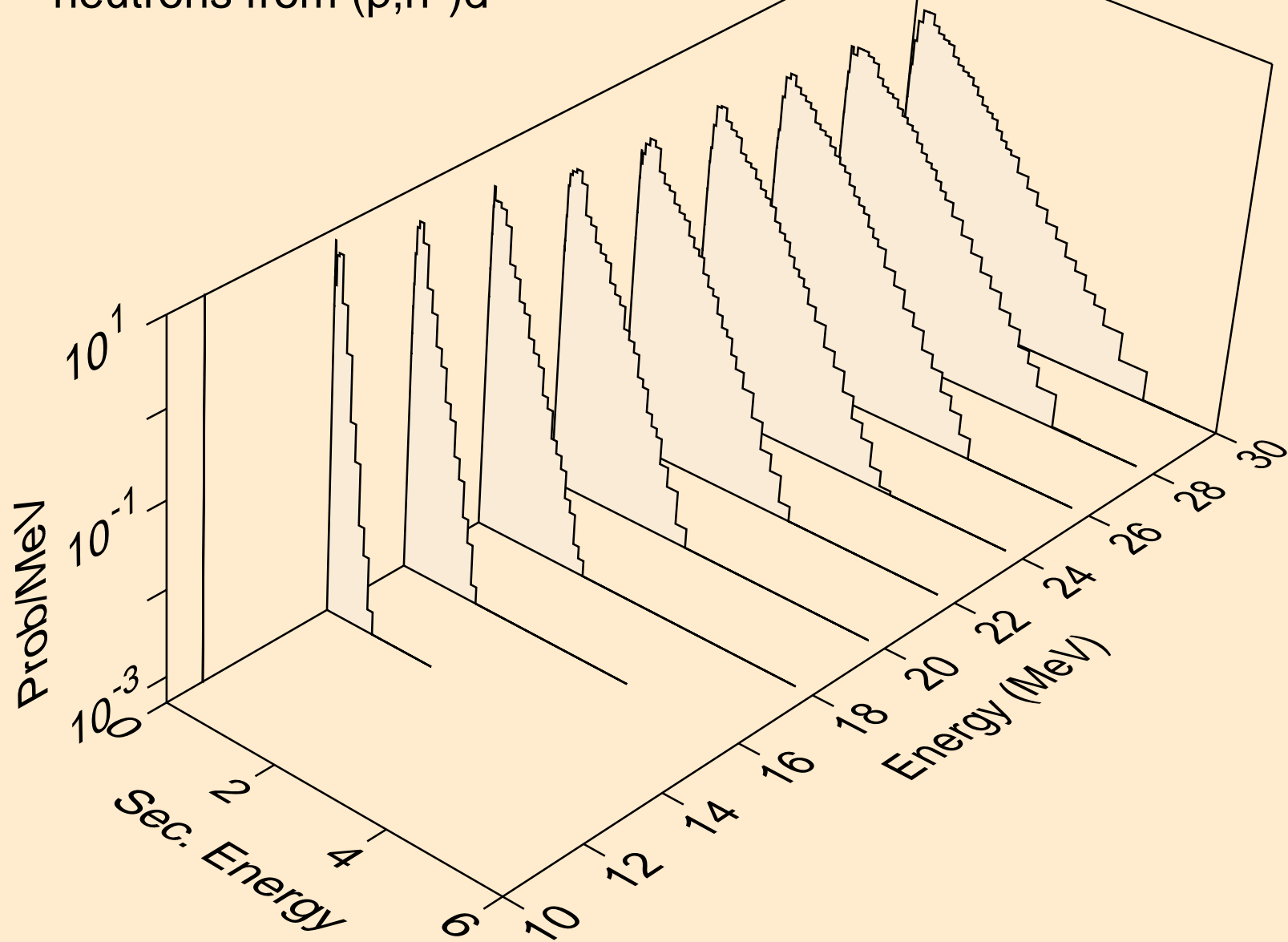

PM154M PROTON ACER TENDL-2021 LIBRARY; T=0.K  
neutrons from (p,n\*)t

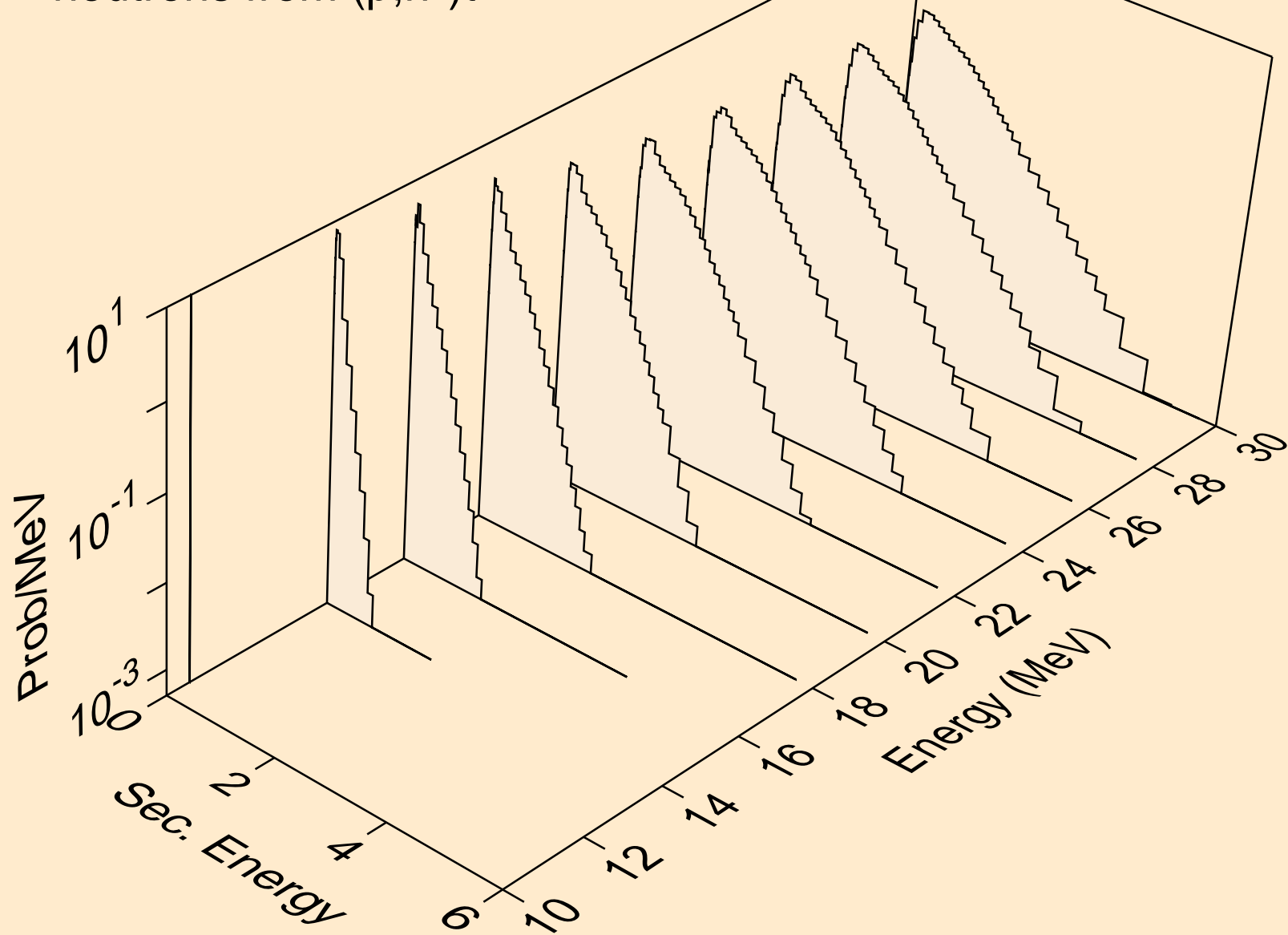

PM154M PROTON ACER TENDL-2021 LIBRARY; T=0.K  
neutrons from (p,n\*)he3

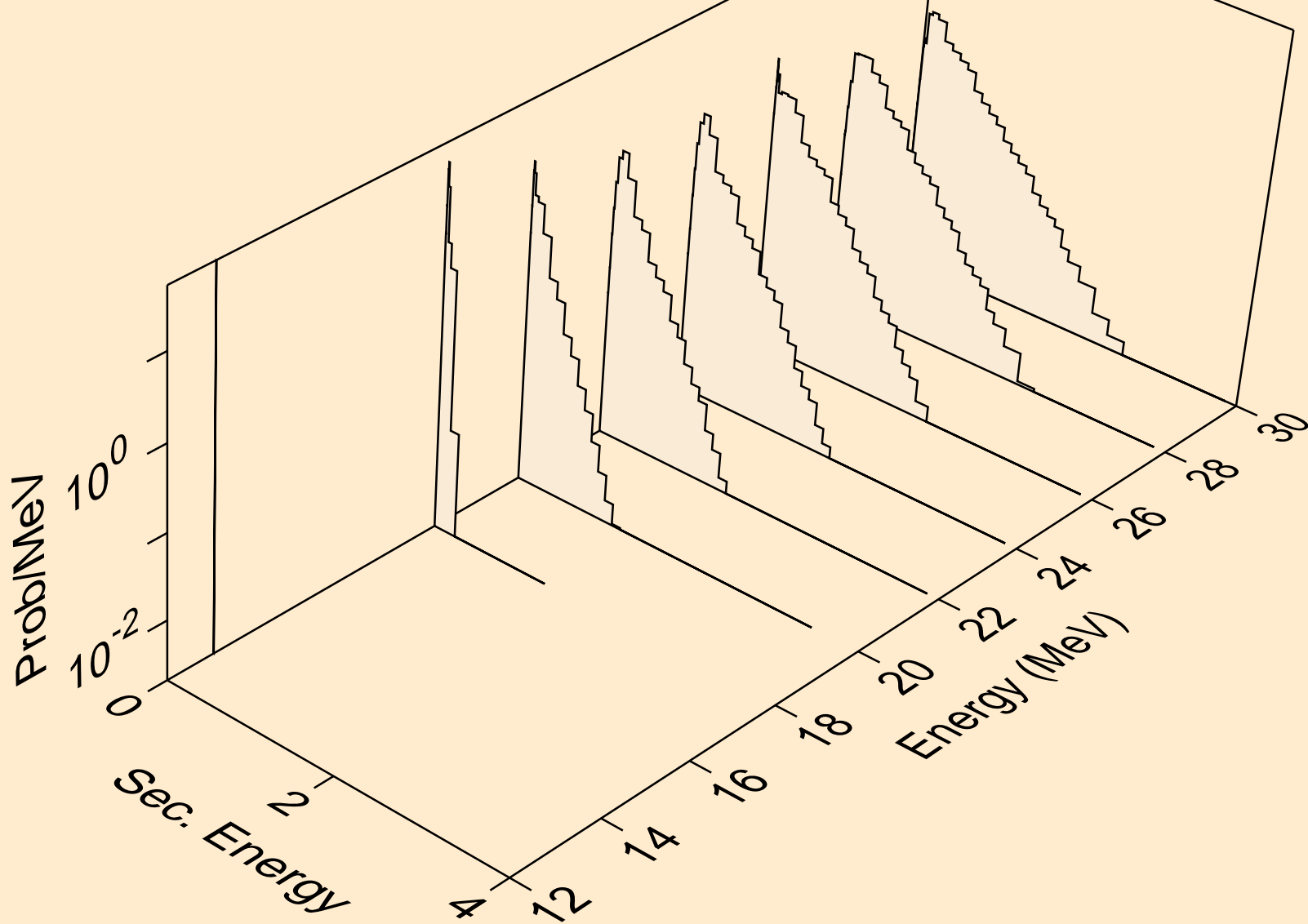

PM154M PROTON ACER TENDL-2021 LIBRARY; T=0.K  
neutrons from (p,4n)

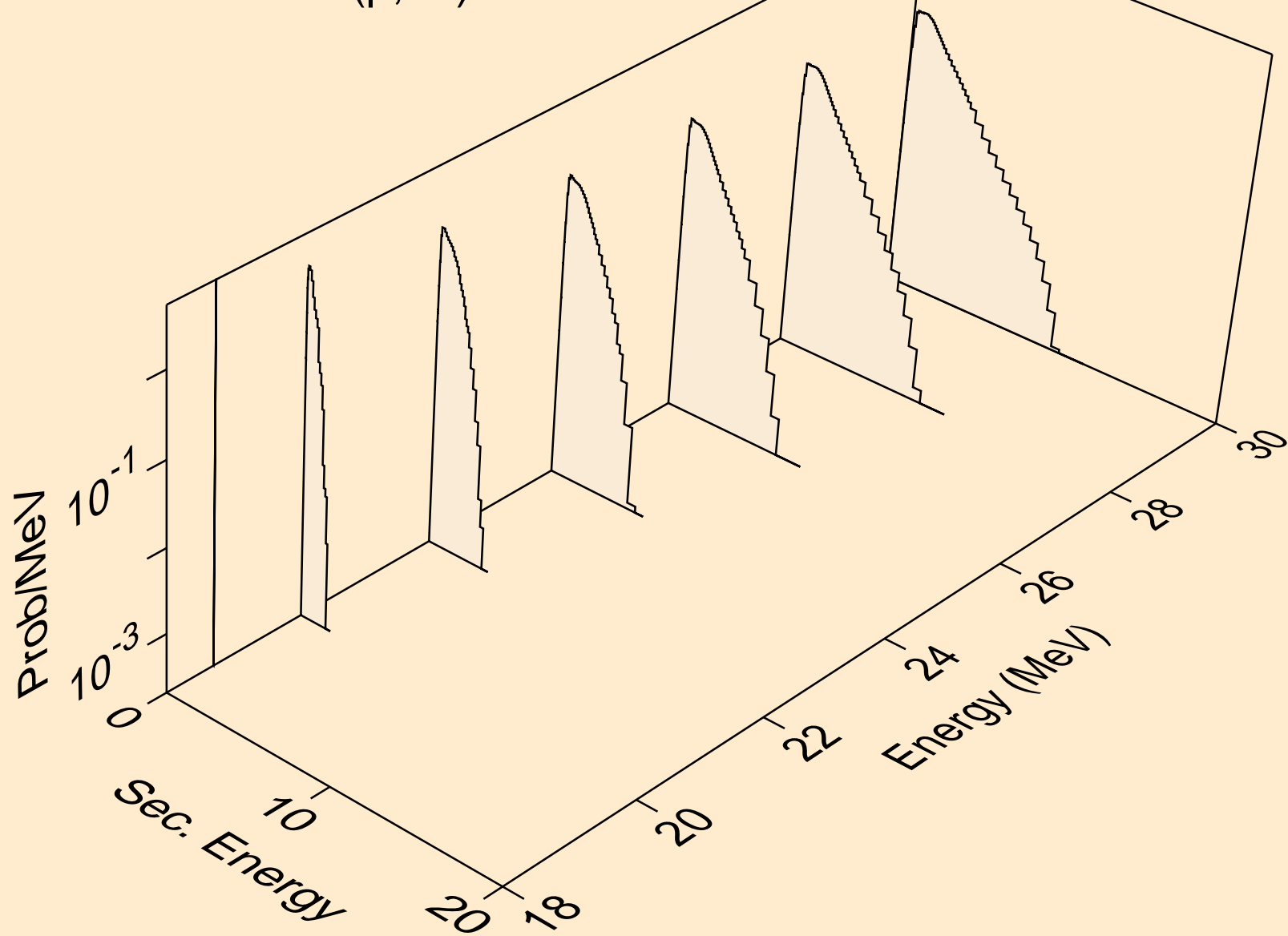

PM154M PROTON ACER TENDL-2021 LIBRARY; T=0.K  
neutrons from (p,2np)

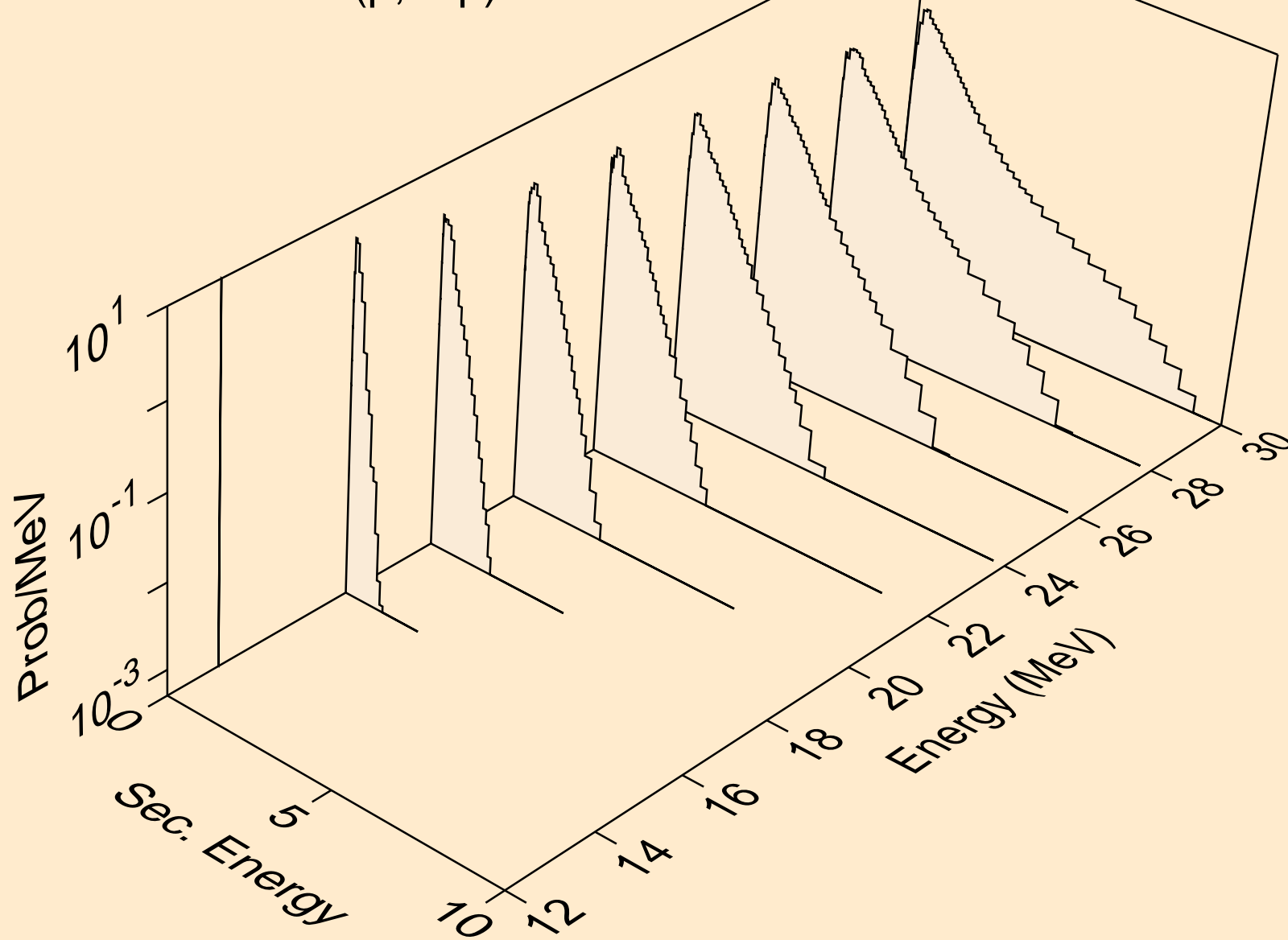

PM154M PROTON ACER TENDL-2021 LIBRARY; T=0.K  
neutrons from (p,3np)

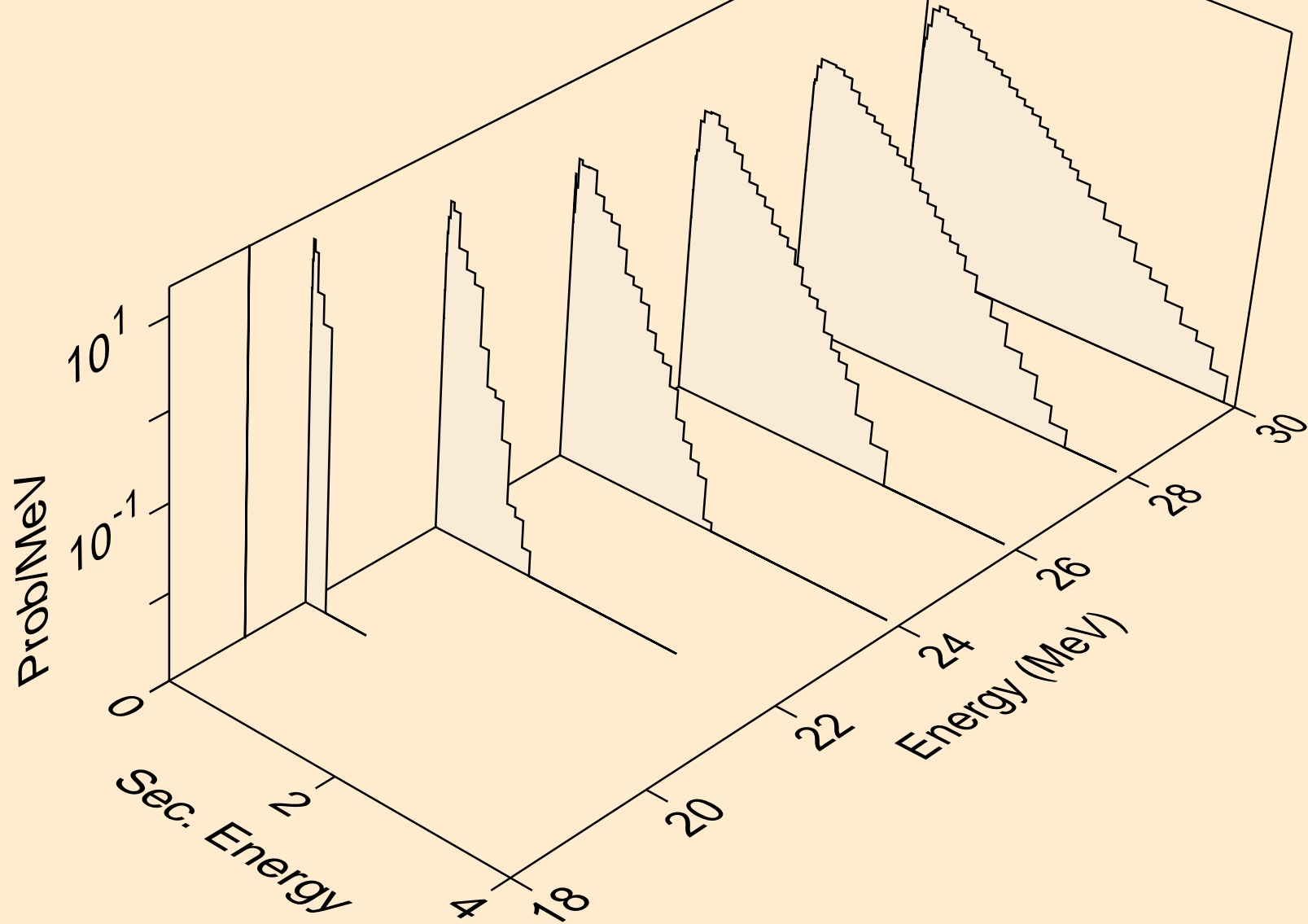

PM154M PROTON ACER TENDL-2021 LIBRARY; T=0.K  
neutrons from (p,2np)

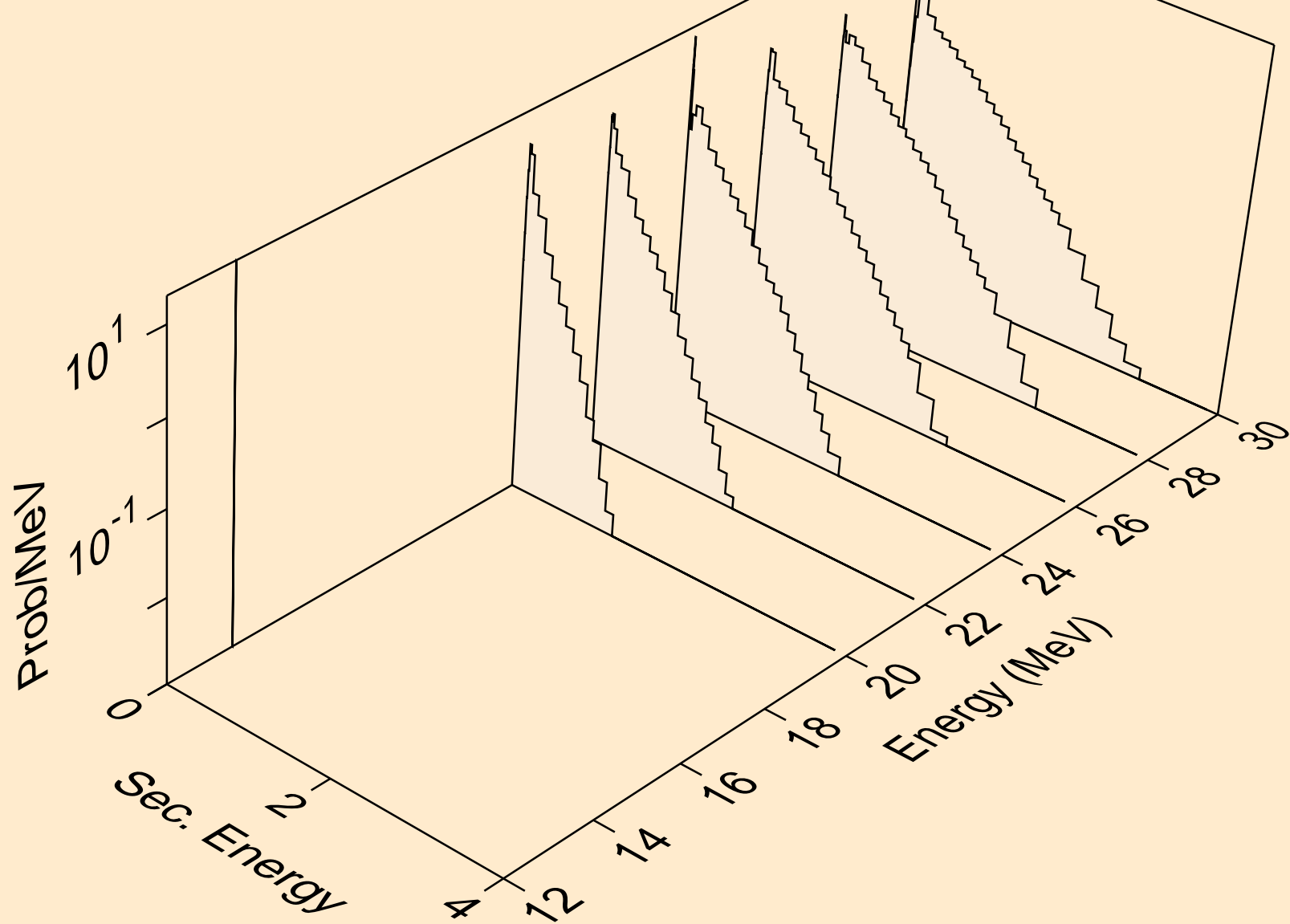

PM154M PROTON ACER TENDL-2021 LIBRARY; T=0.K  
neutrons from (p,npa)

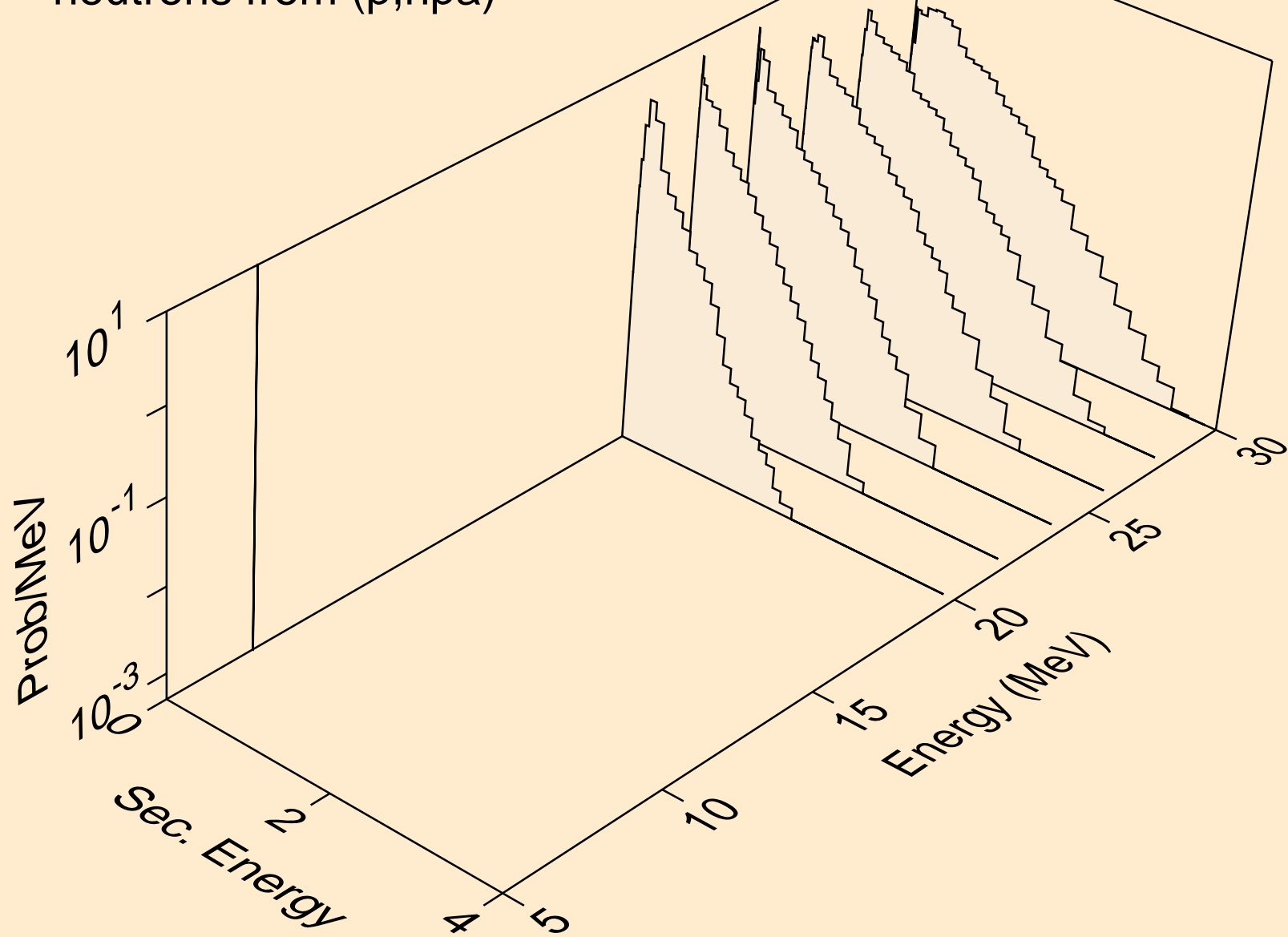

PM154M PROTON ACER TENDL-2021 LIBRARY; T=0.K  
deuterons from (p,x)

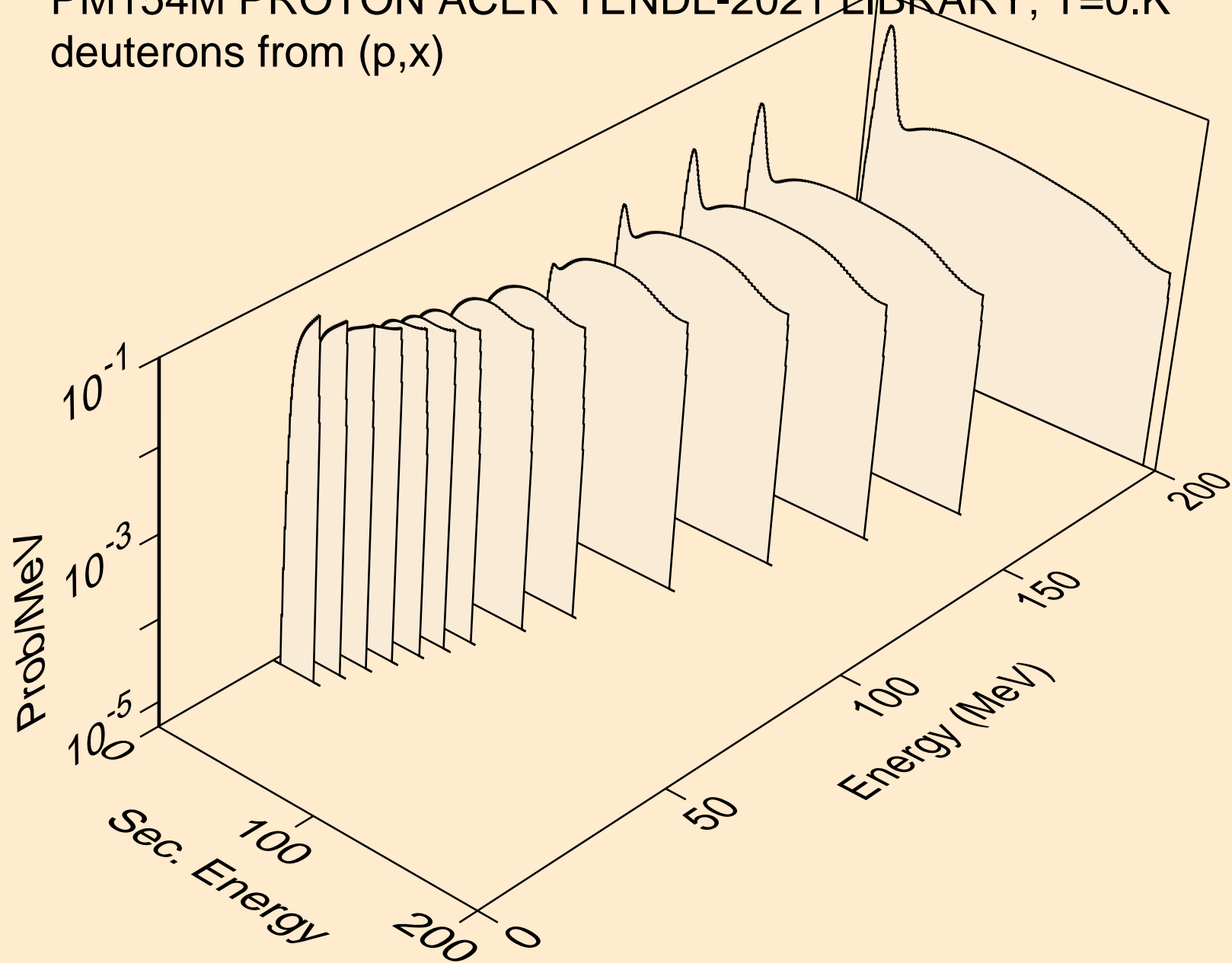

PM154M PROTON ACER TENDL-2021 LIBRARY; T=0.K  
deuterons from (p,2nd)

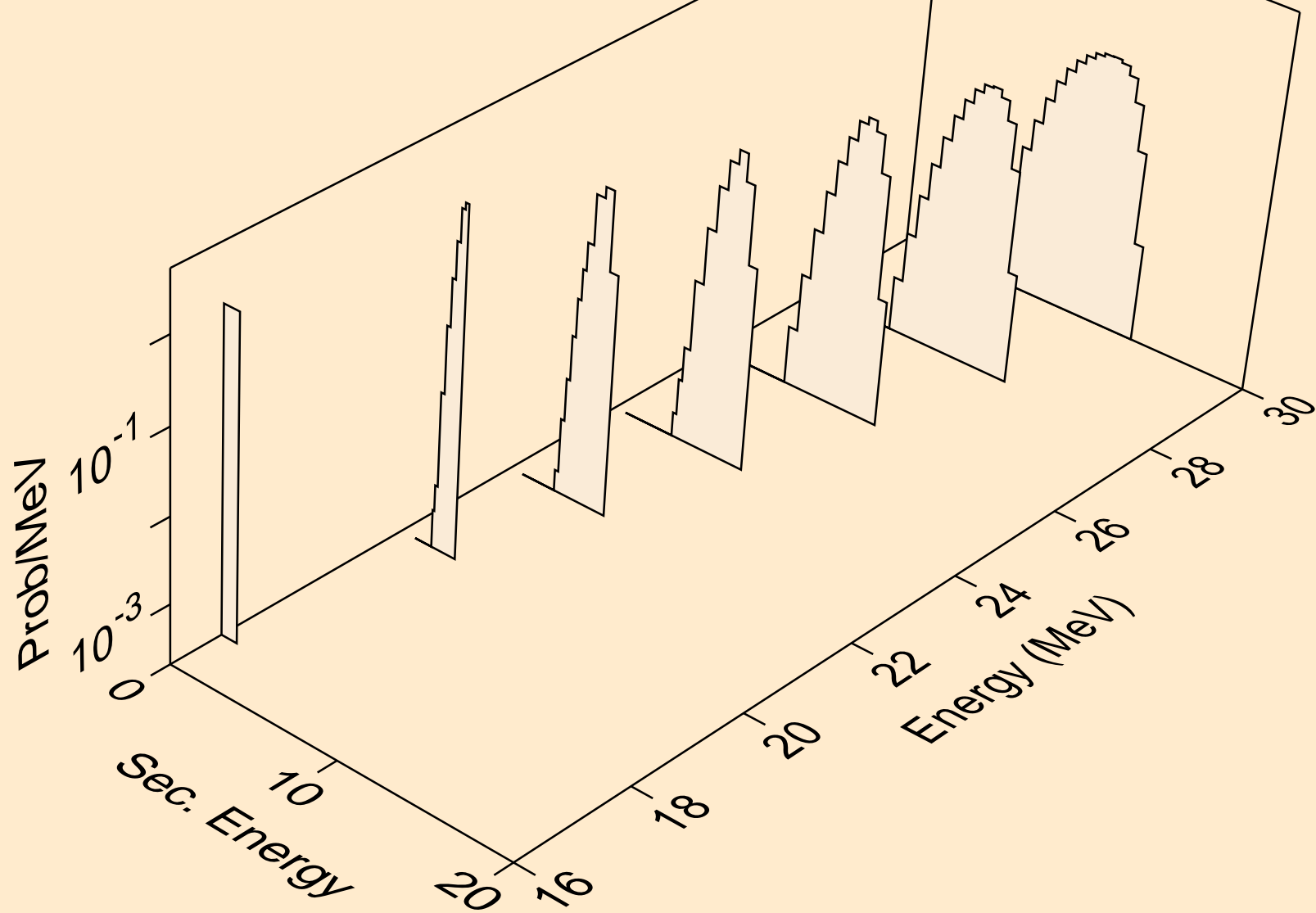

PM154M PROTON ACER TENDL-2021 LIBRARY; T=0.K  
deuterons from (p,n\*)d

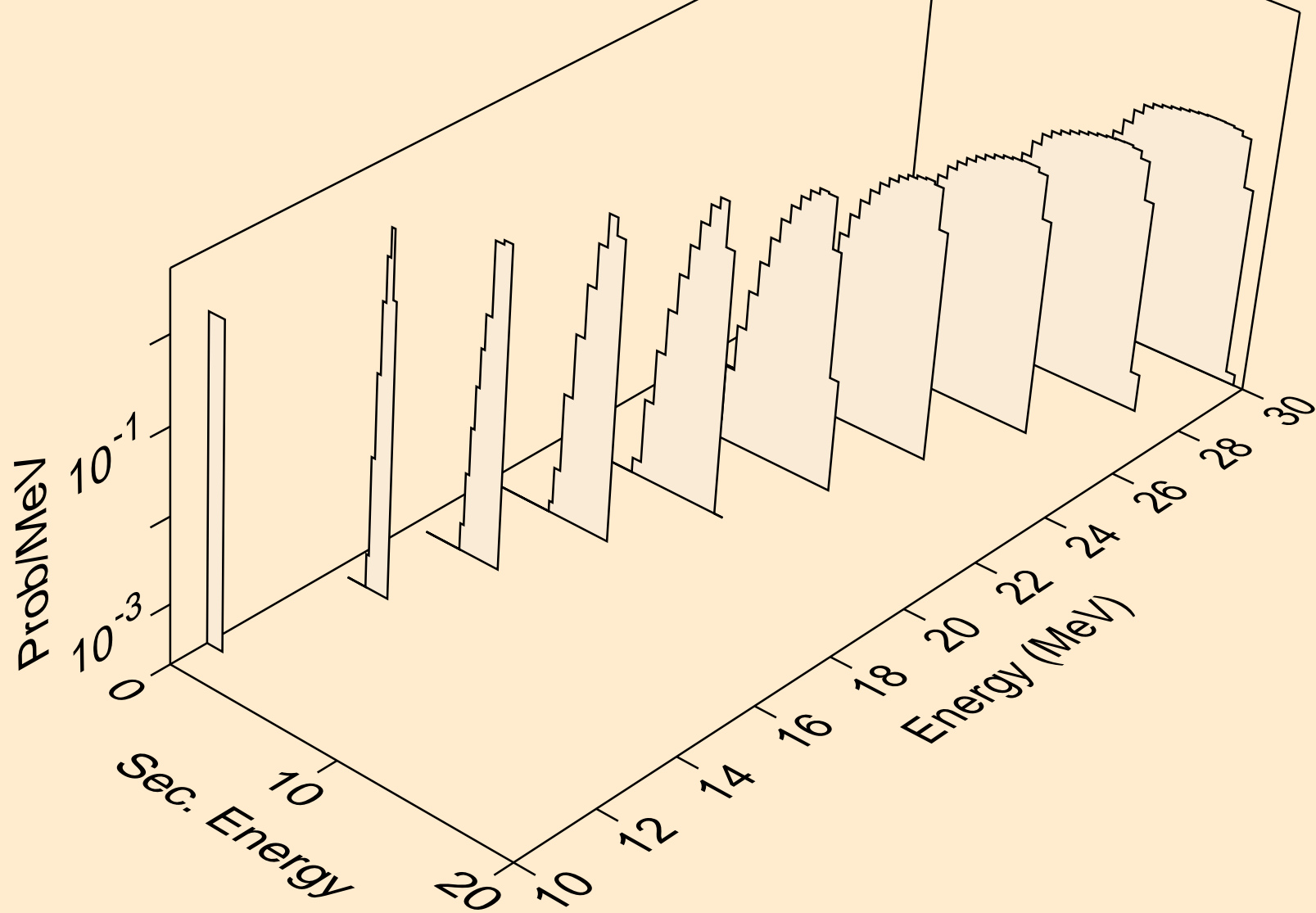

PM154M PROTON ACER TENDL-2021 LIBRARY; T=0.K  
deuterons from (p,d)

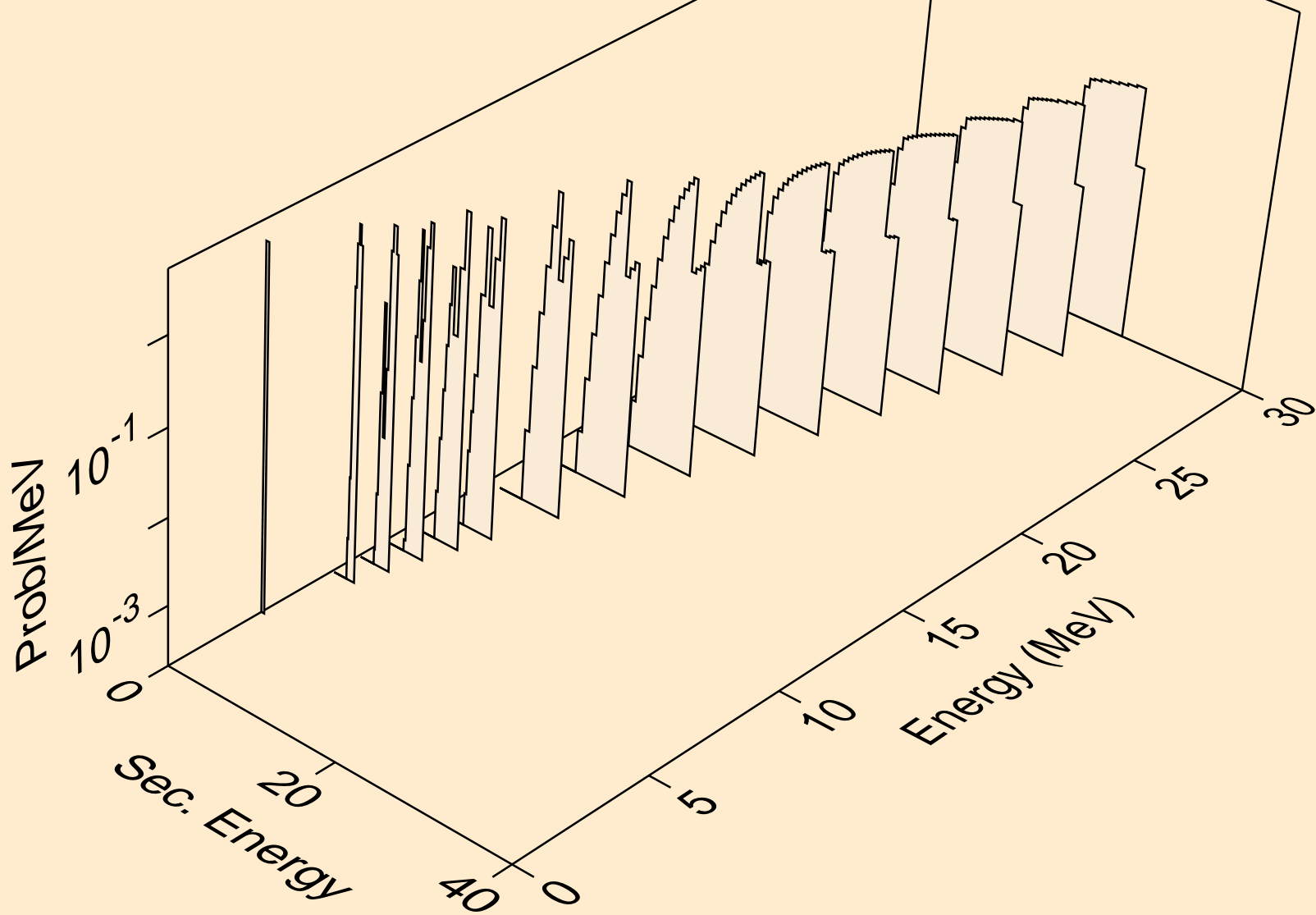

PM154M PROTON ACER TENDL-2021 LIBRARY; T=0.K  
deuterons from (p,pd)

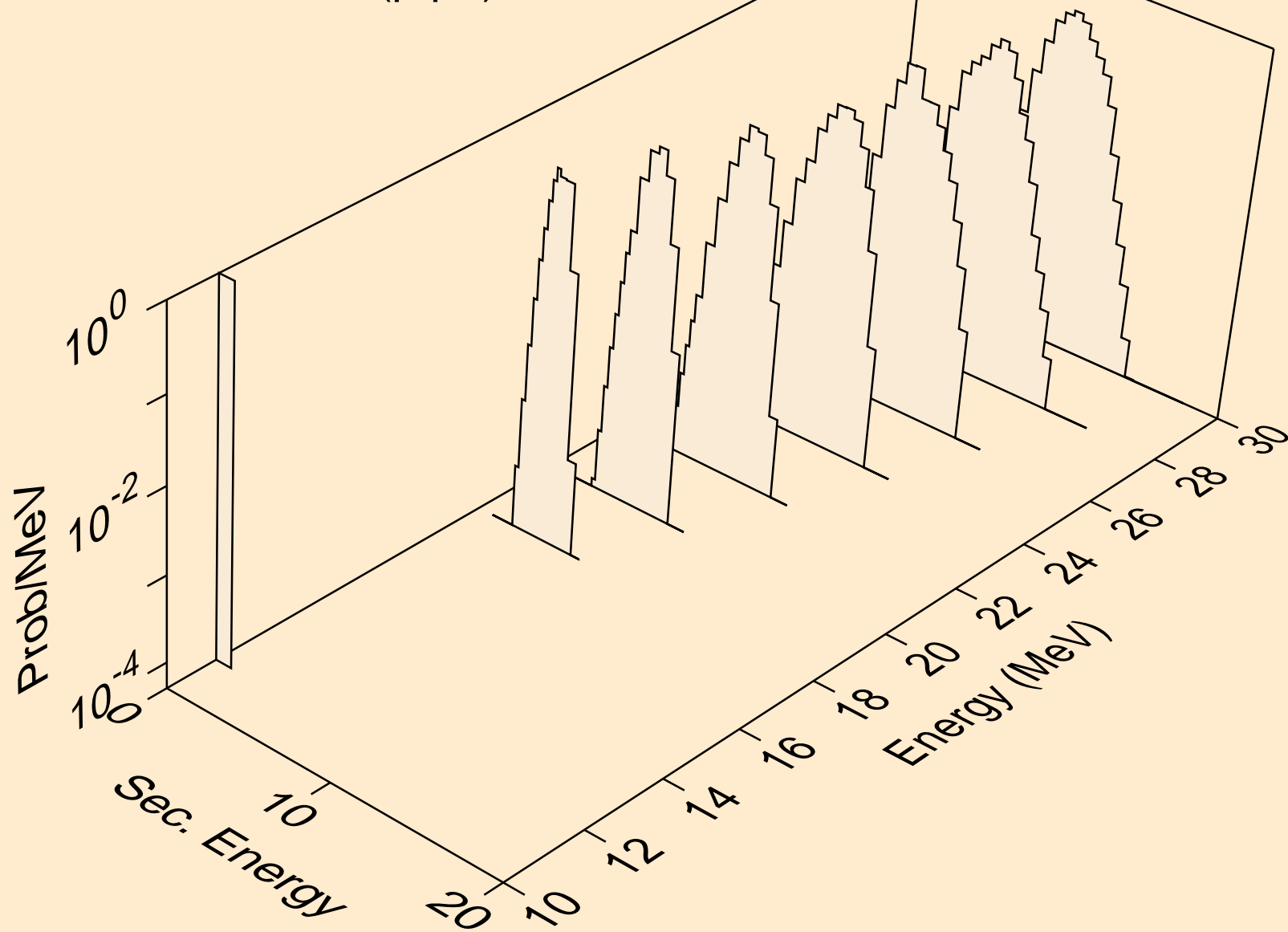

PM154M PROTON ACER TENDL-2021 LIBRARY; T=0.K  
tritons from (p,x)

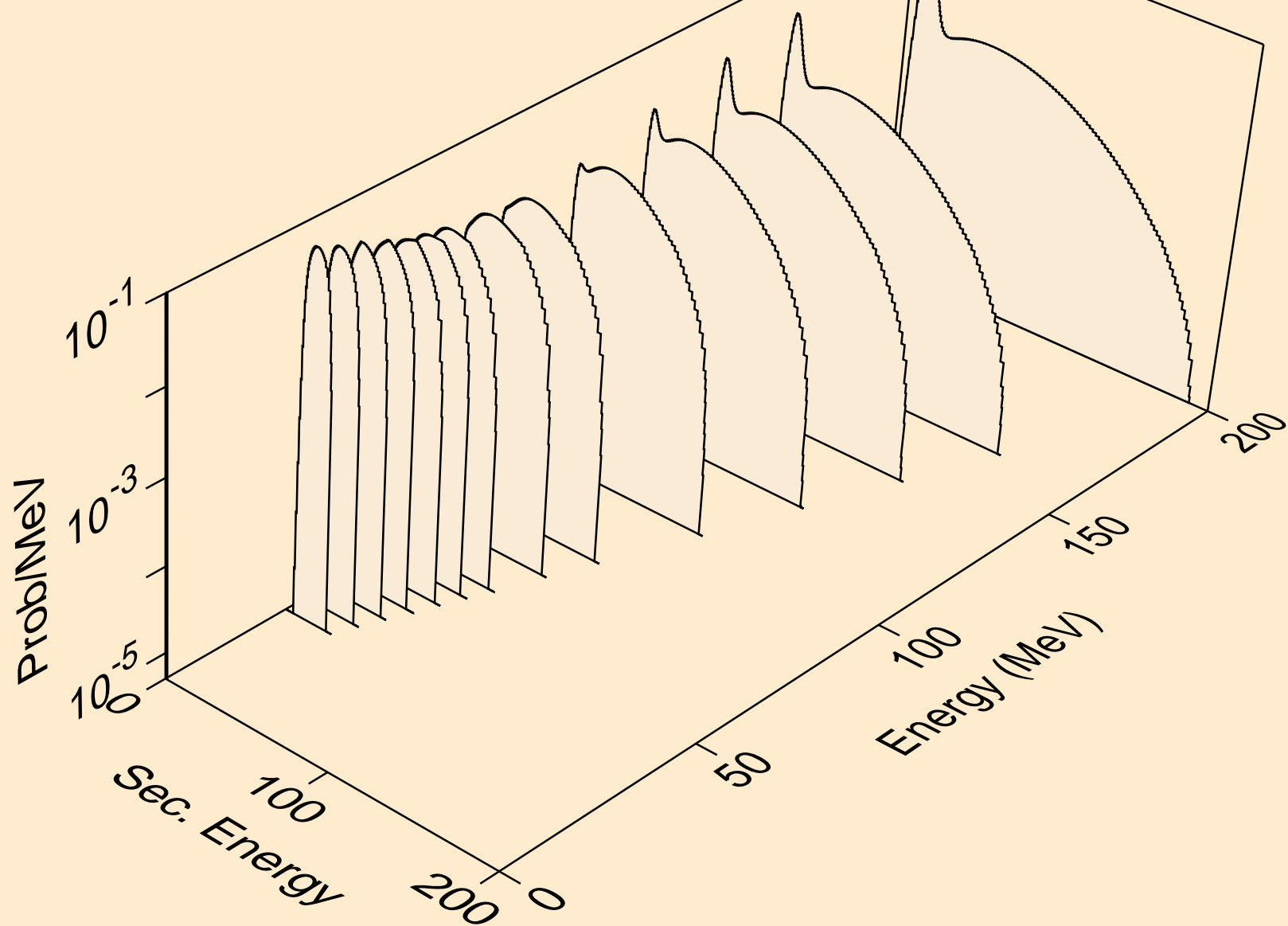

PM154M PROTON ACER TENDL-2021 LIBRARY; T=0.K  
tritons from (p,n\*)t

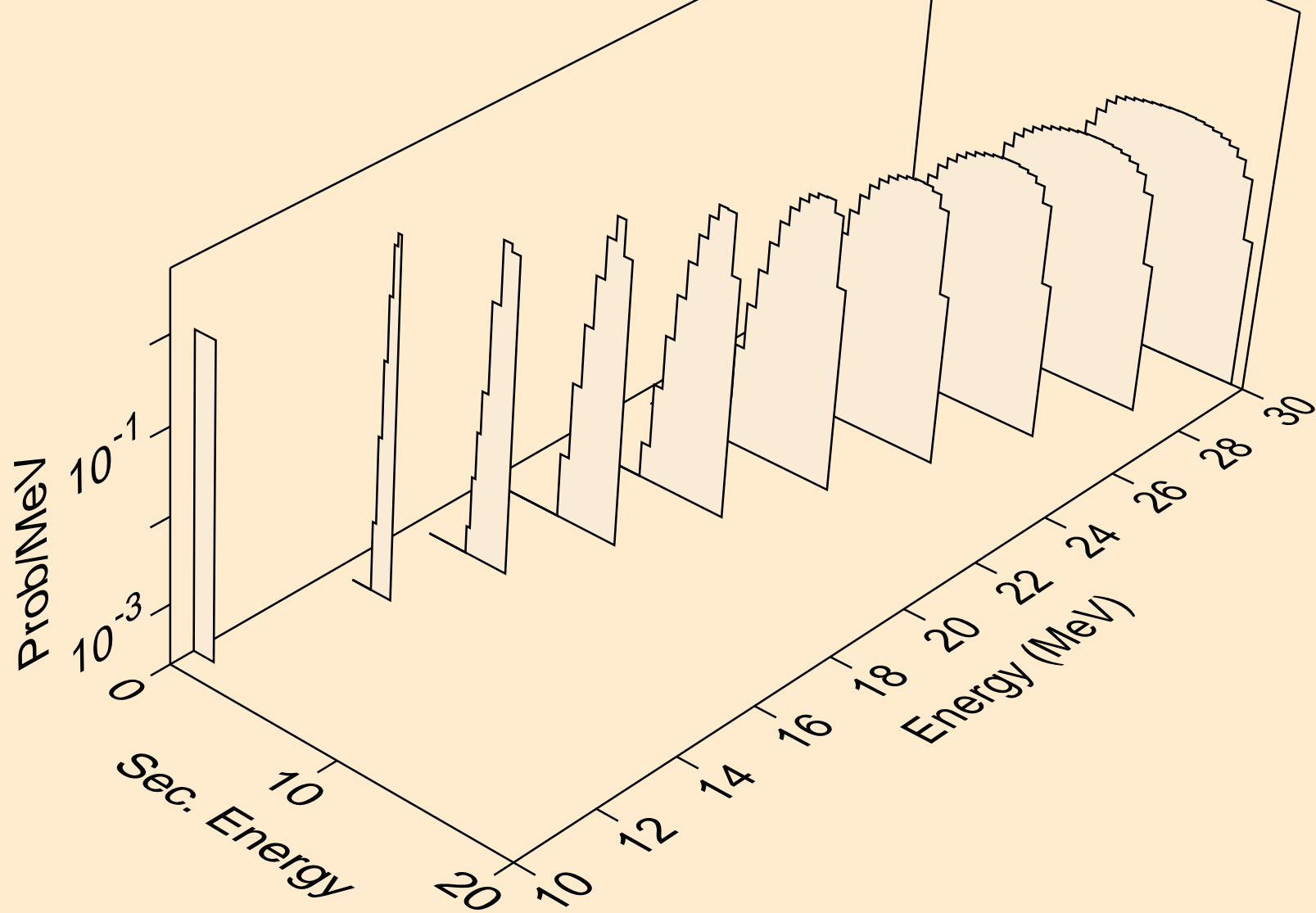

PM154M PROTON ACER TENDL-2021 LIBRARY; T=0.K  
tritons from (p,t)

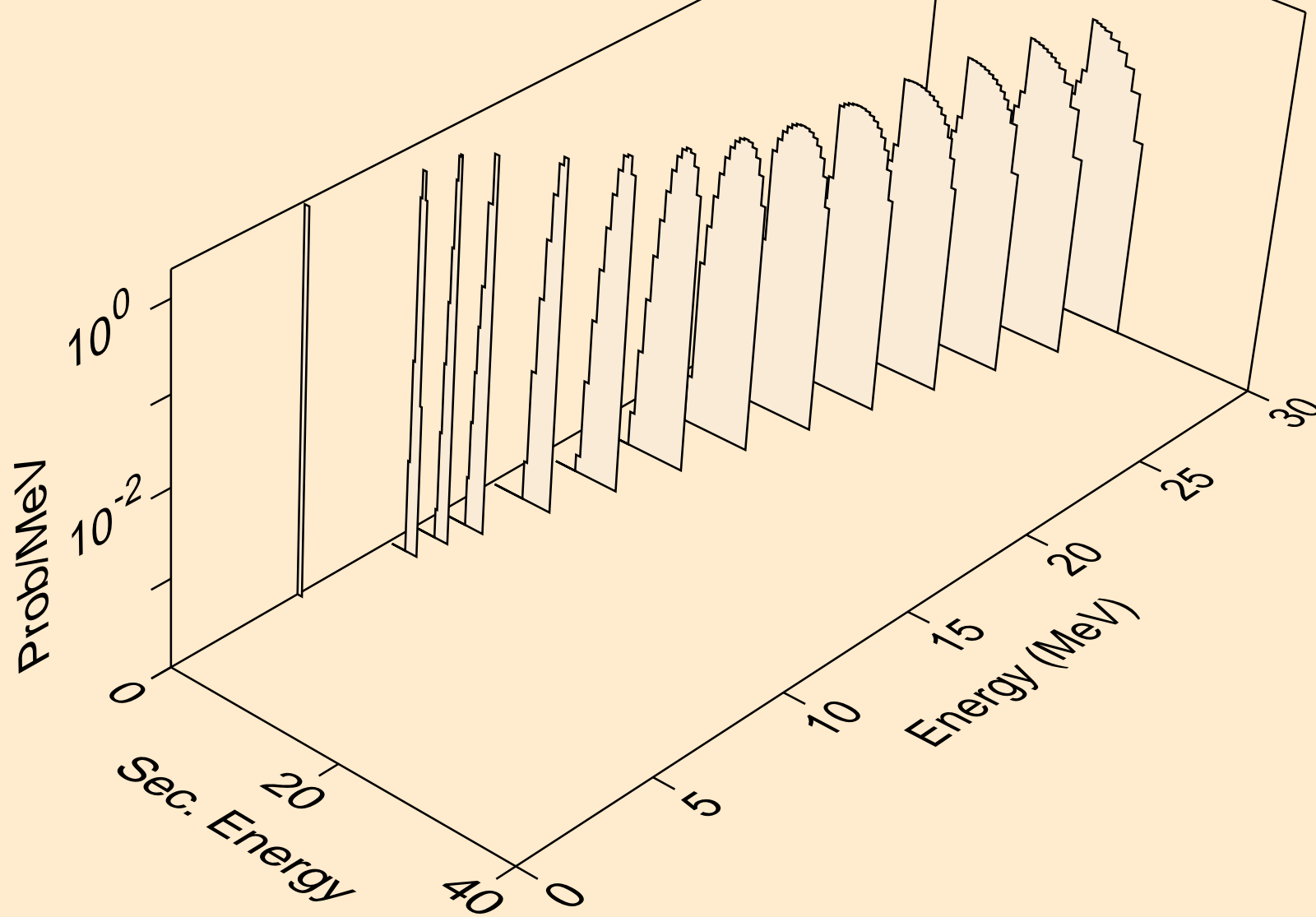

PM154M PROTON ACER TENDL-2021 LIBRARY; T=0.K  
he3s from (p,x)

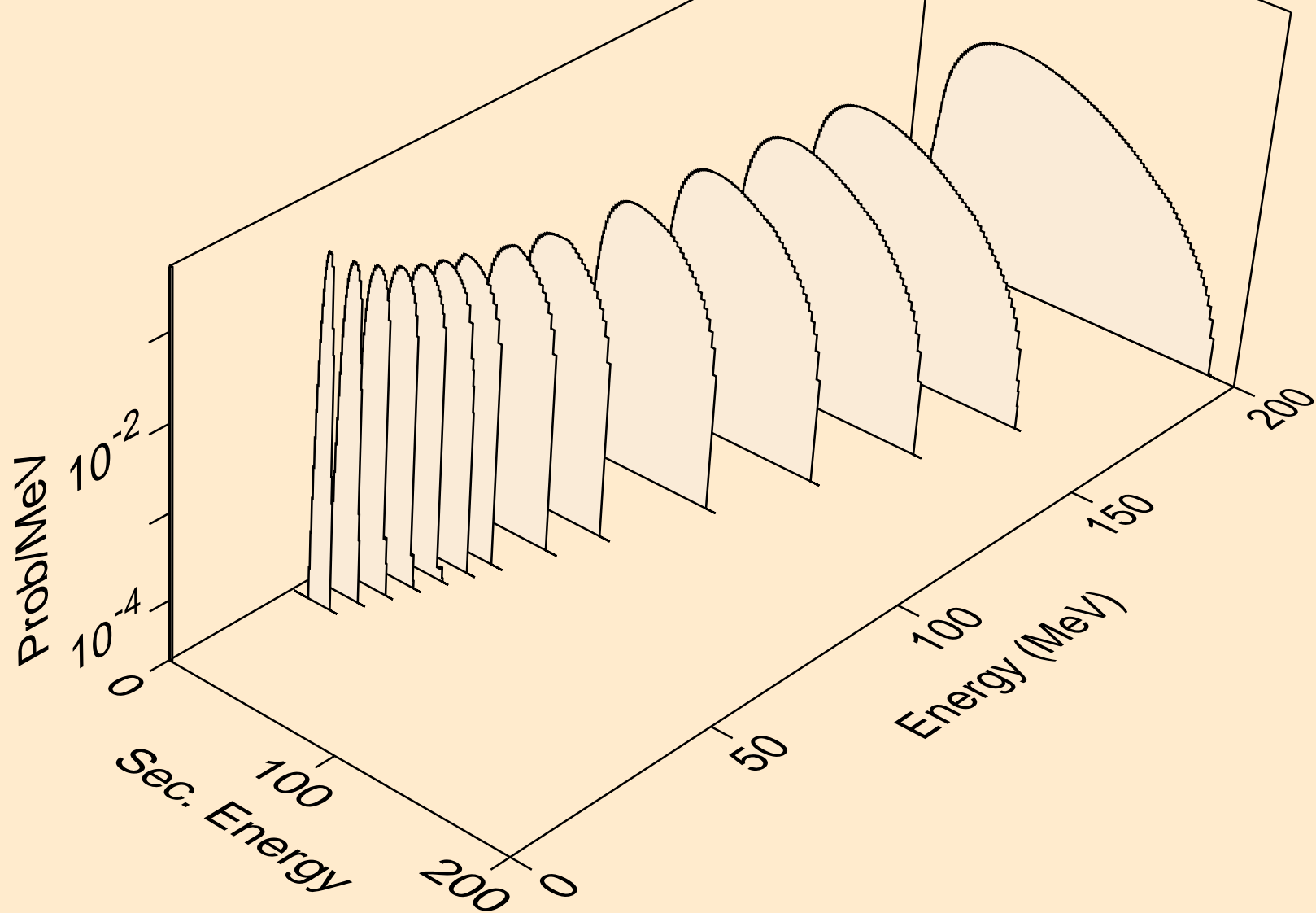

PM154M PROTON ACER TENDL-2021 LIBRARY; T=0.K  
he3s from (p,n\*)he3

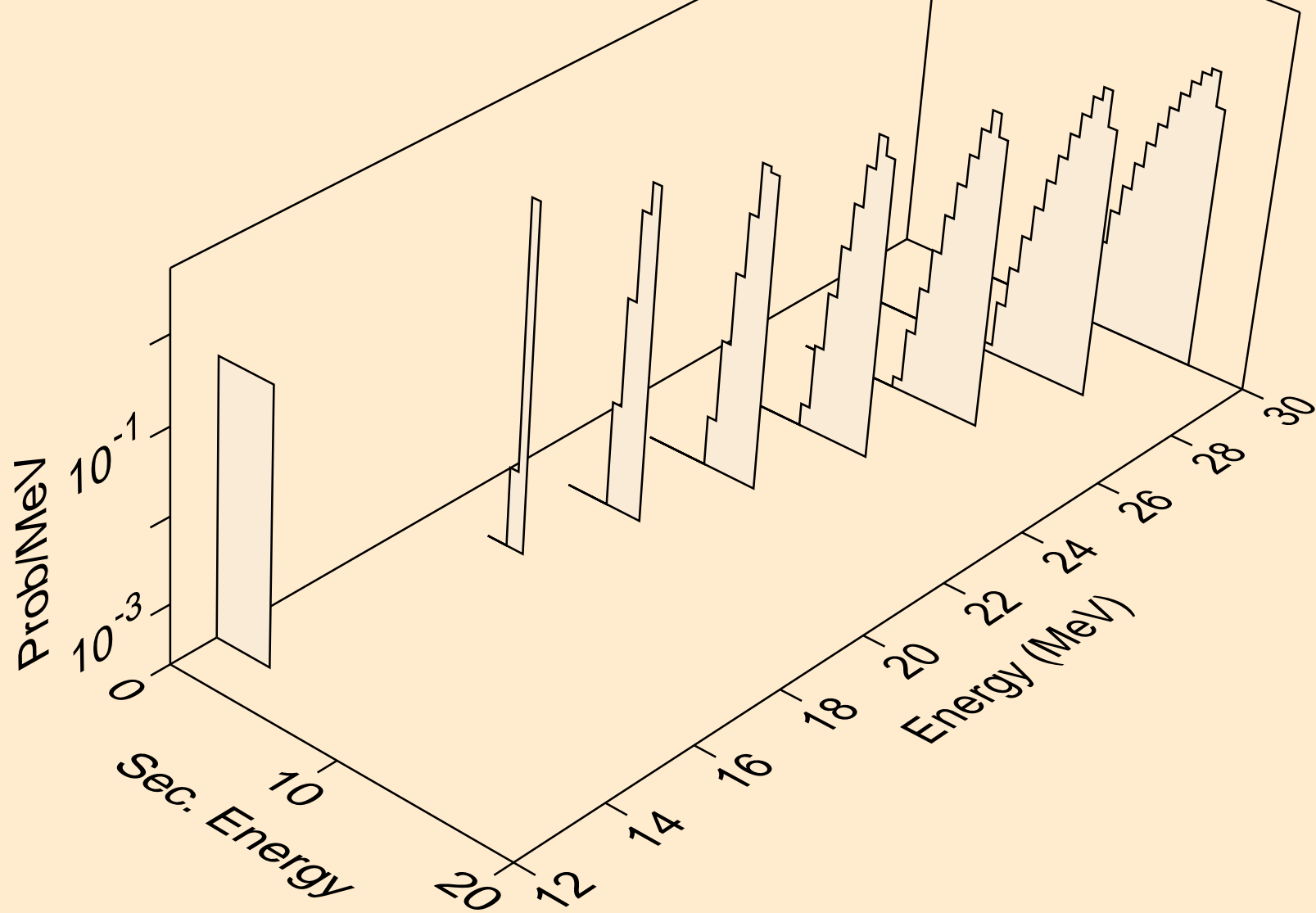

PM154M PROTON ACER TENDL-2021 LIBRARY; T=0.K  
he3s from (p,he3)

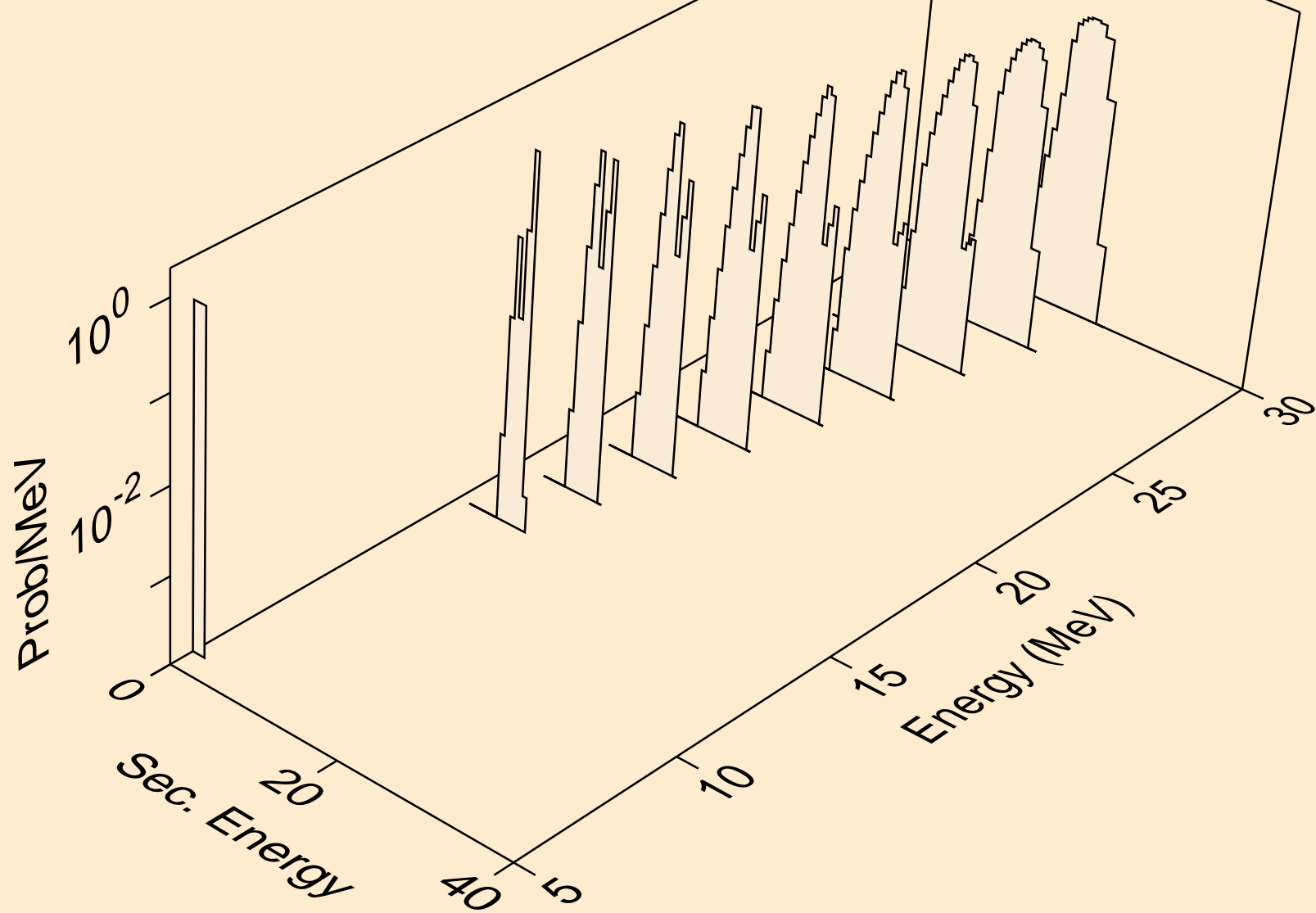

PM154M PROTON ACER TENDL-2021 LIBRARY; T=0.K  
alphas from (p,x)

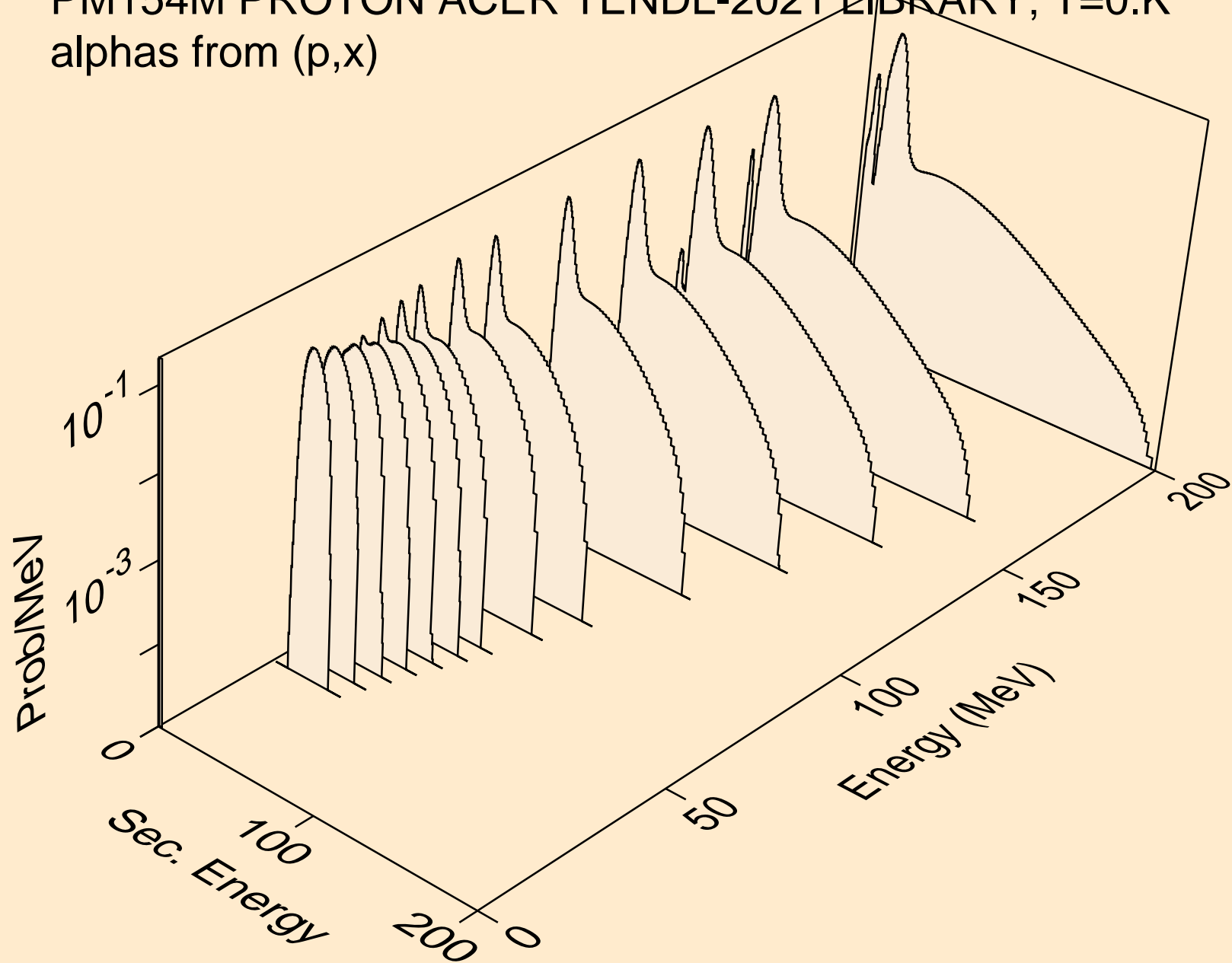

PM154M PROTON ACER TENDL-2021 LIBRARY; T=0.K  
alphas from (p,n\*)a

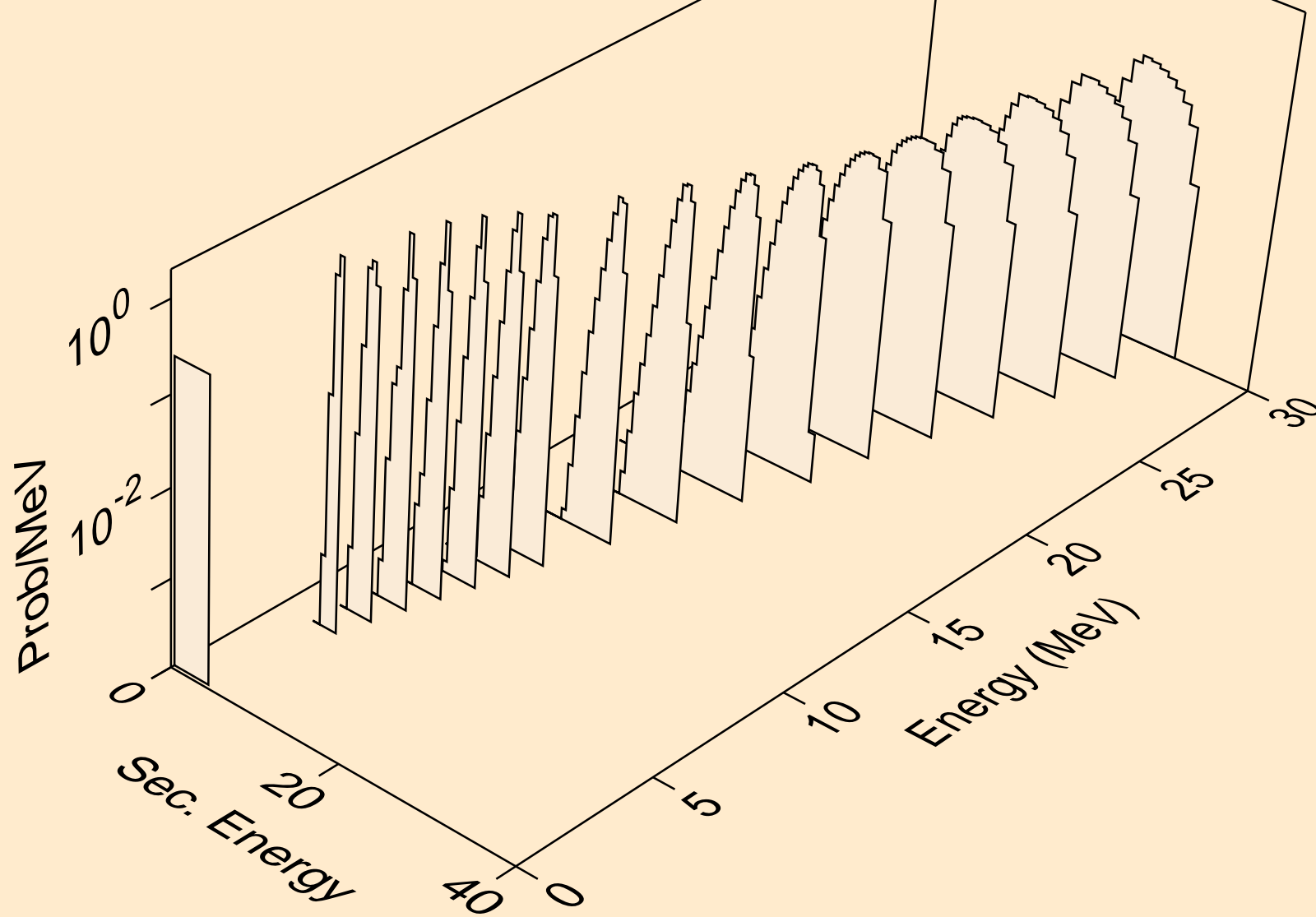

PM154M PROTON ACER TENDL-2021 LIBRARY; T=0.K  
alphas from (p,2n)a

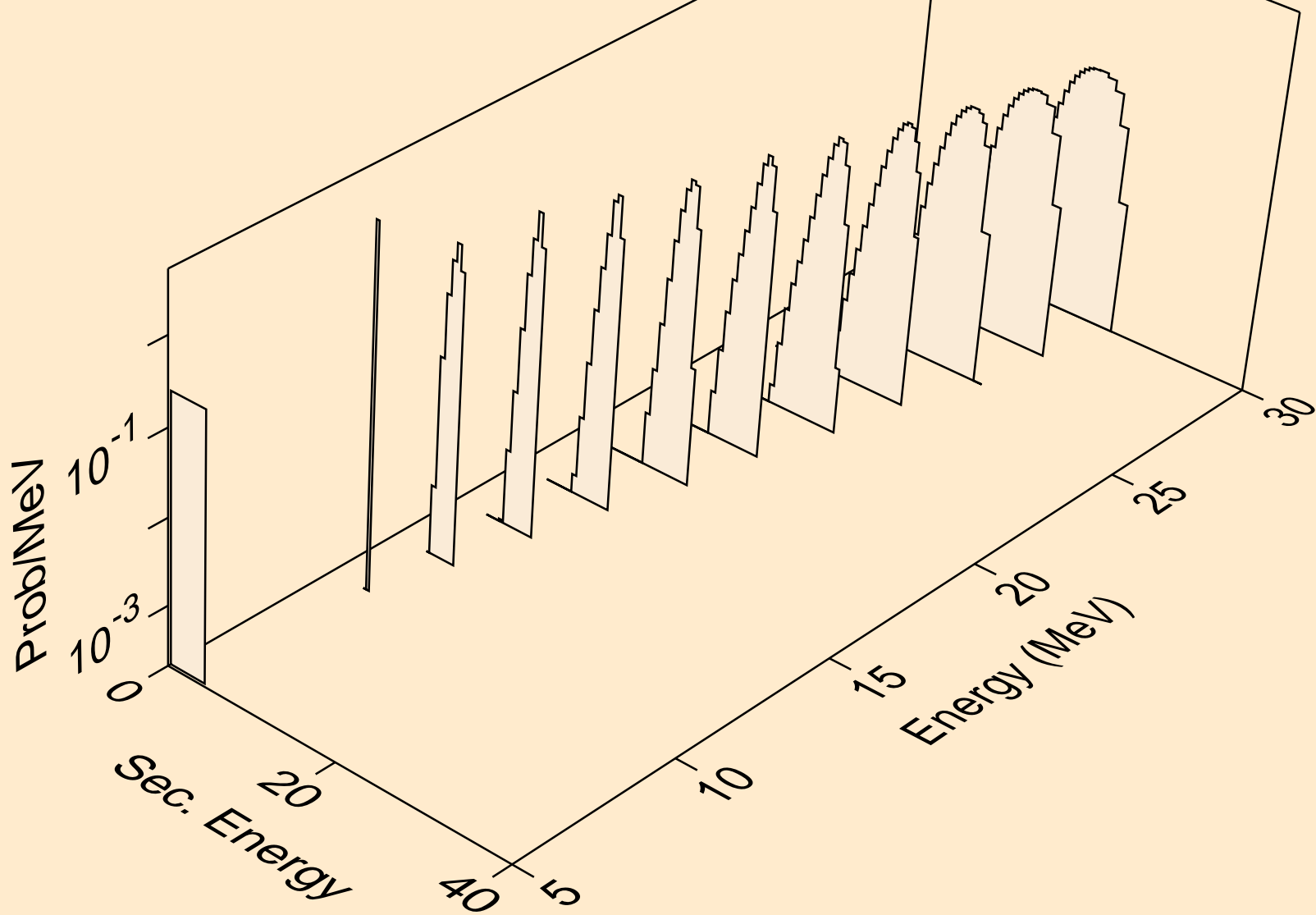

PM154M PROTON ACER TENDL-2021 LIBRARY; T=0.K  
alphas from (p,3n)a

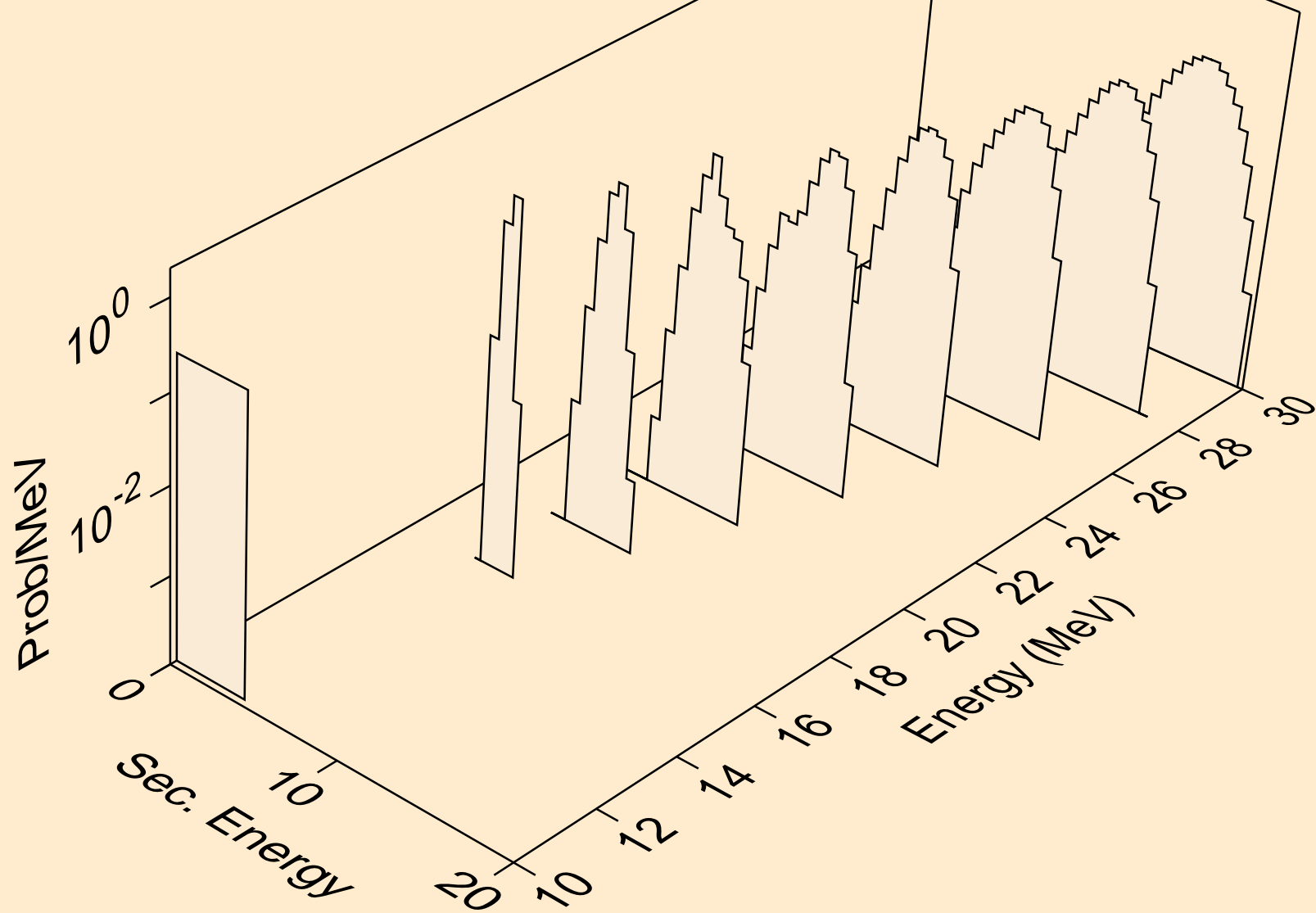

PM154M PROTON ACER TENDL-2021 LIBRARY; T=0.K  
alphas from (p,n\*)2a

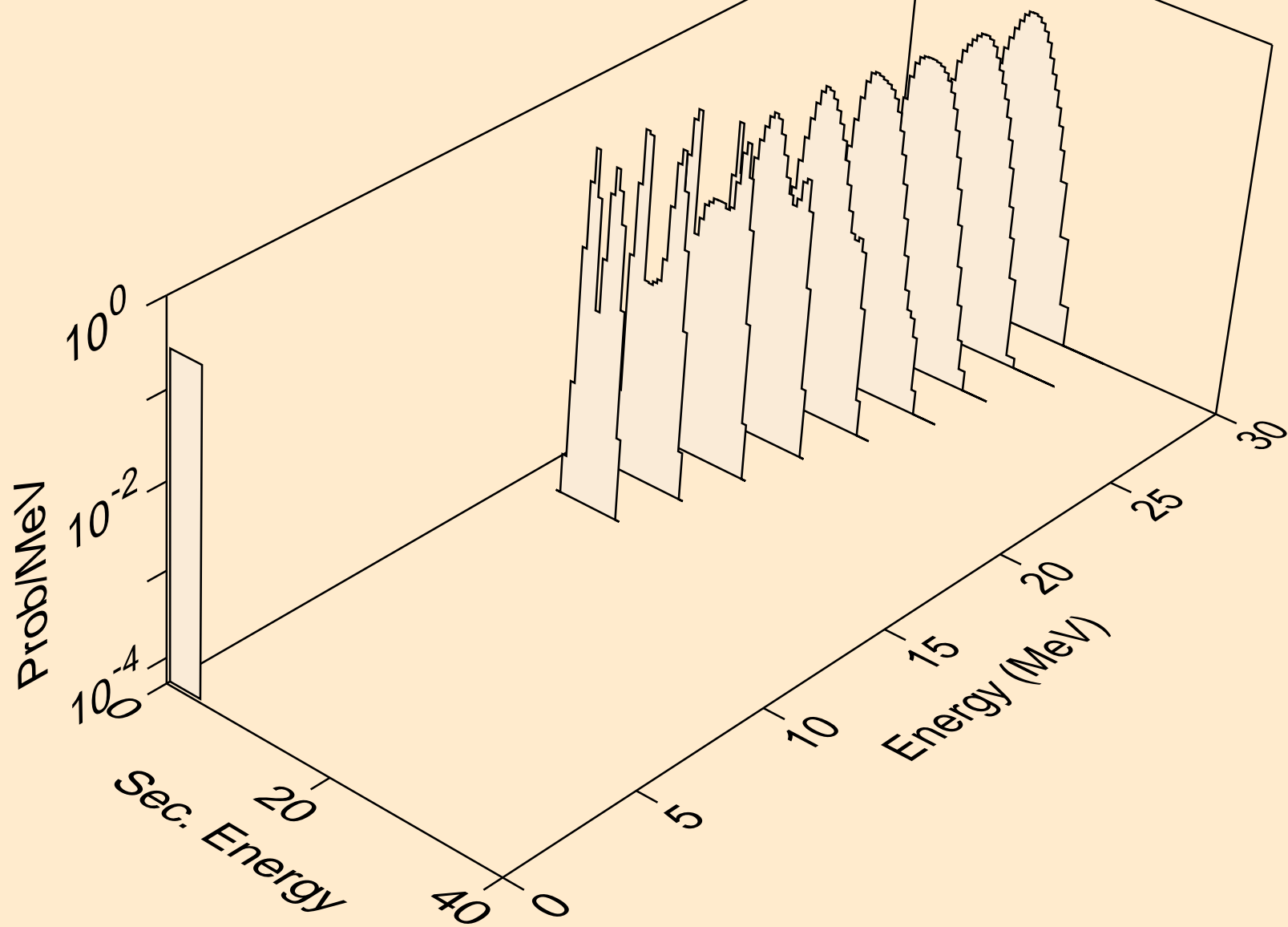

PM154M PROTON ACER TENDL-2021 LIBRARY; T=0.K  
alphas from (p,npa)

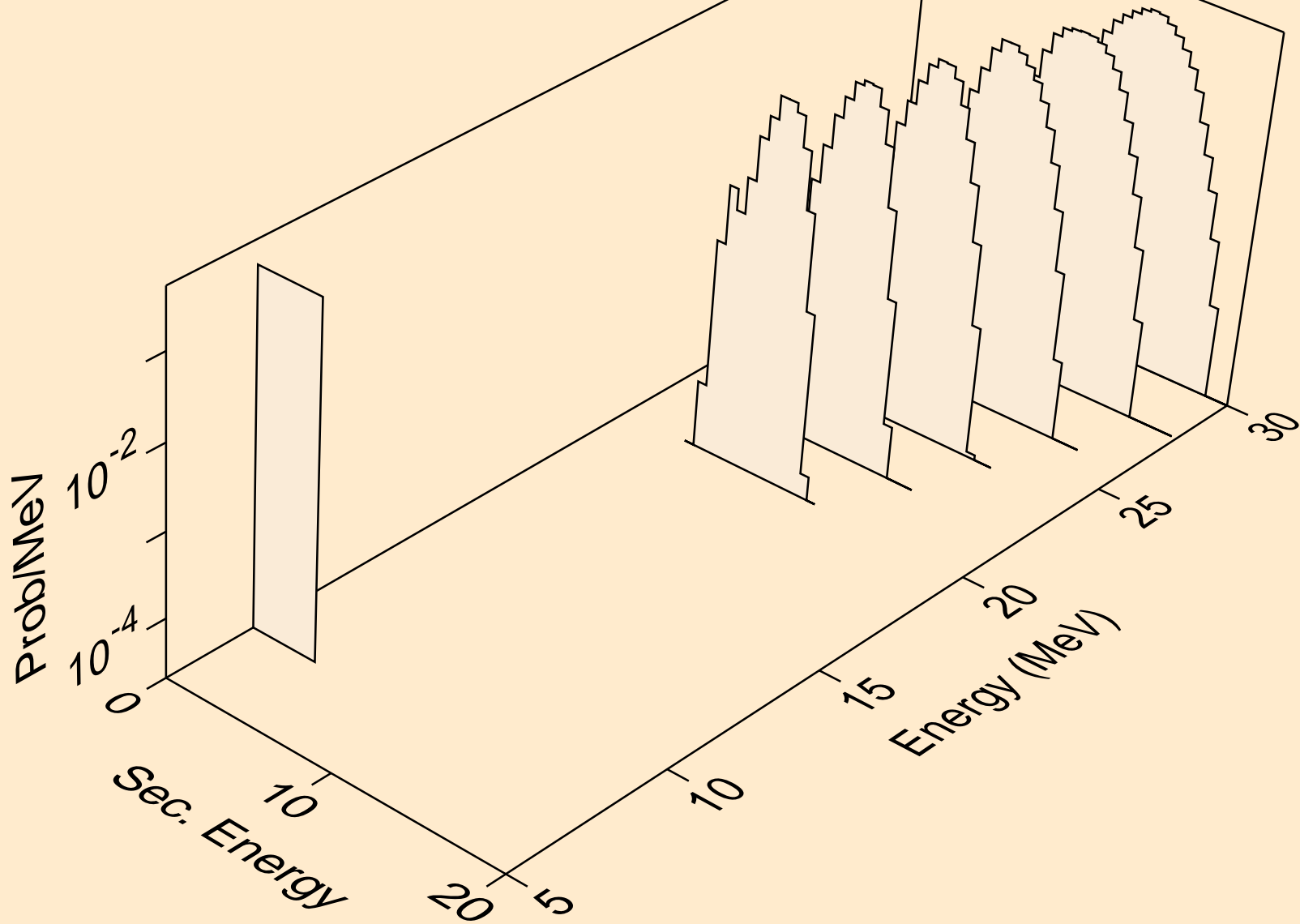

PM154M PROTON ACER TENDL-2021 LIBRARY; T=0.K  
alphas from (p,a)

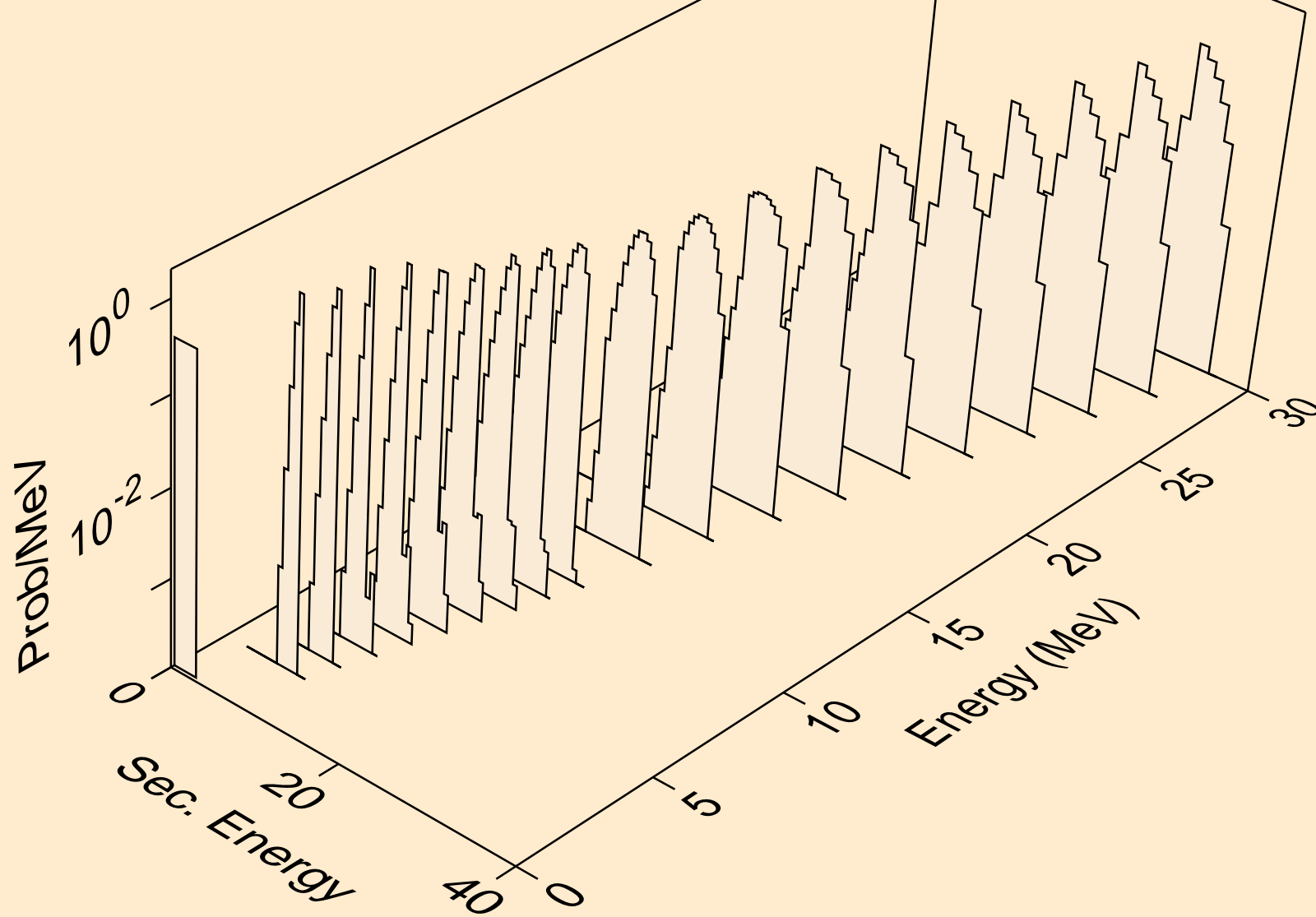

PM154M PROTON ACER TENDL-2021 LIBRARY; T=0.K  
alphas from (p,2a)

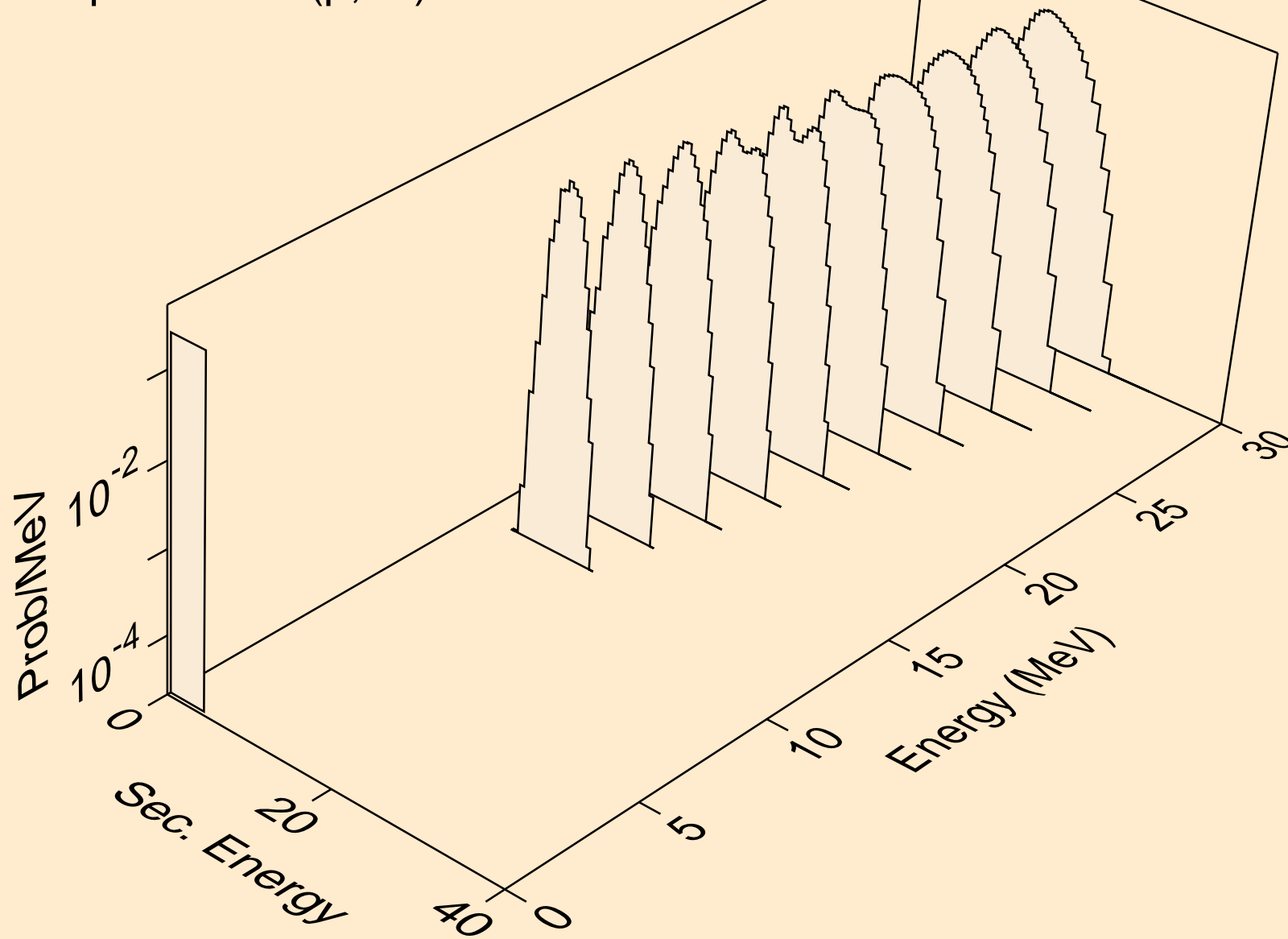

PM154M PROTON ACER TENDL-2021 LIBRARY; T=0.K  
alphas from (p,pa)

