

# XE135M PROTON ACER TENDL-2021 LIBRARY; T=0.K

## Principal cross sections

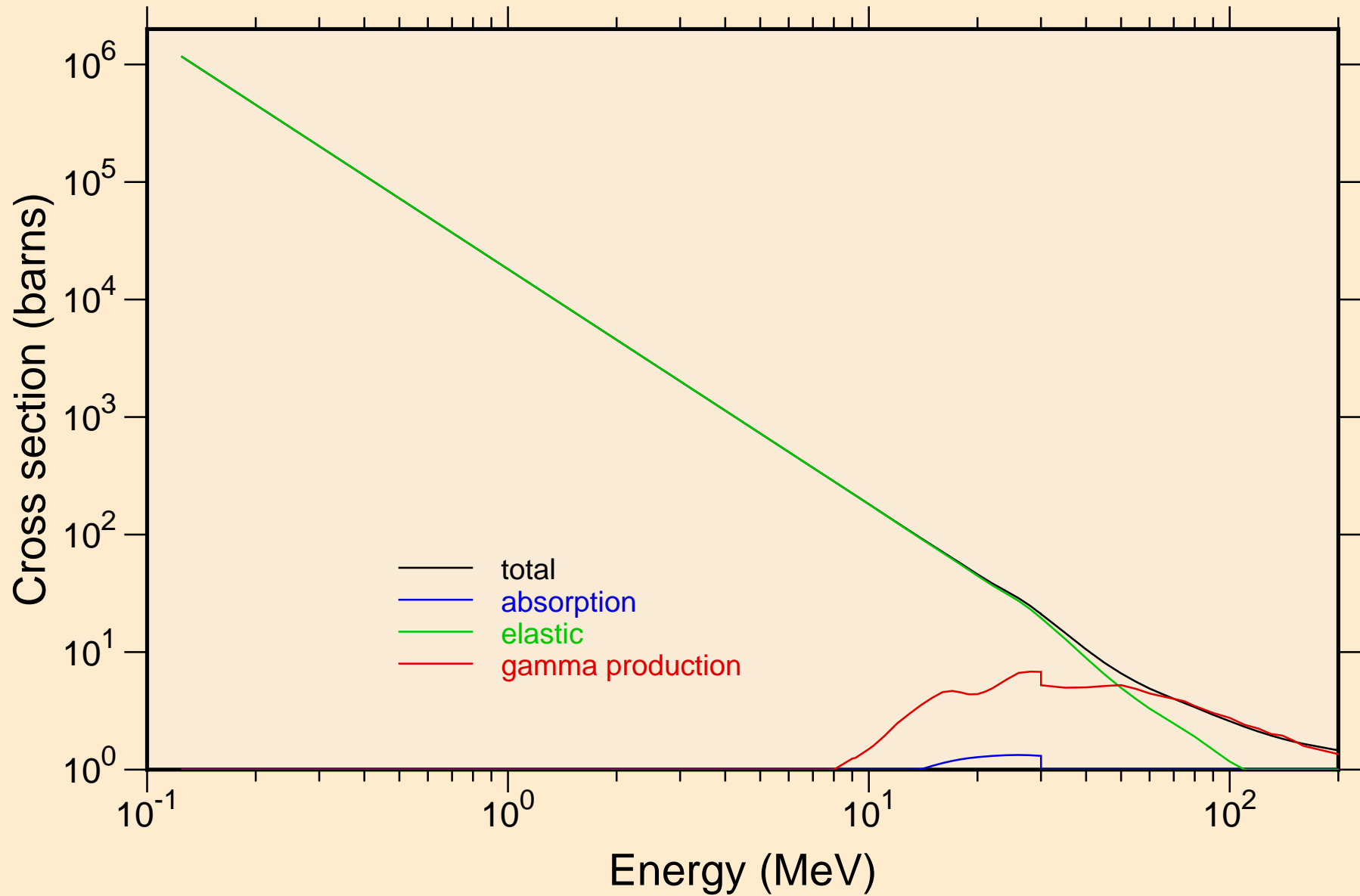

XE135M PROTON ACER TENDL-2021 LIBRARY; T=0.K  
Heating

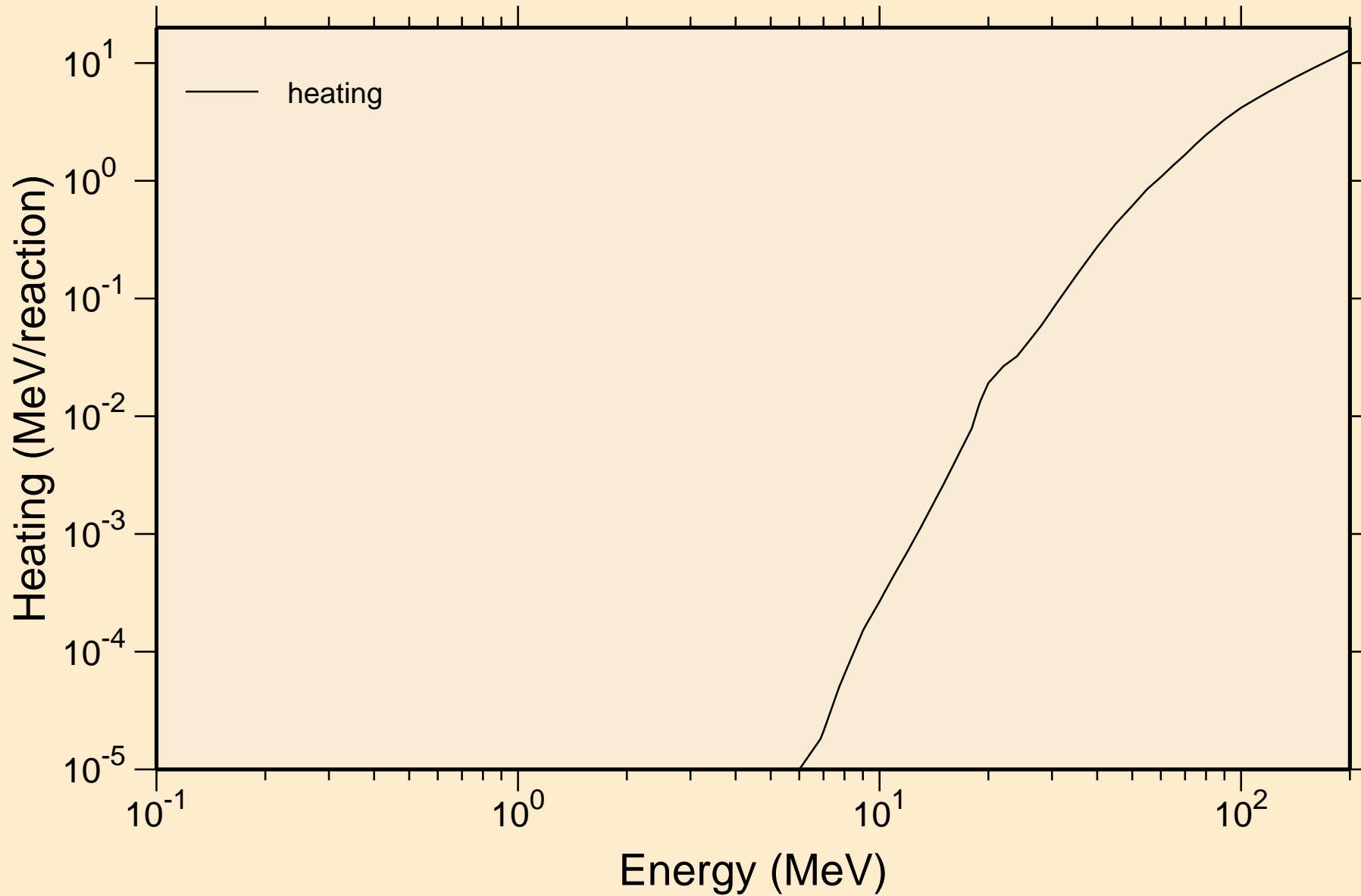

# XE135M PROTON ACER TENDL-2021 LIBRARY; T=0.K

## Principal cross sections

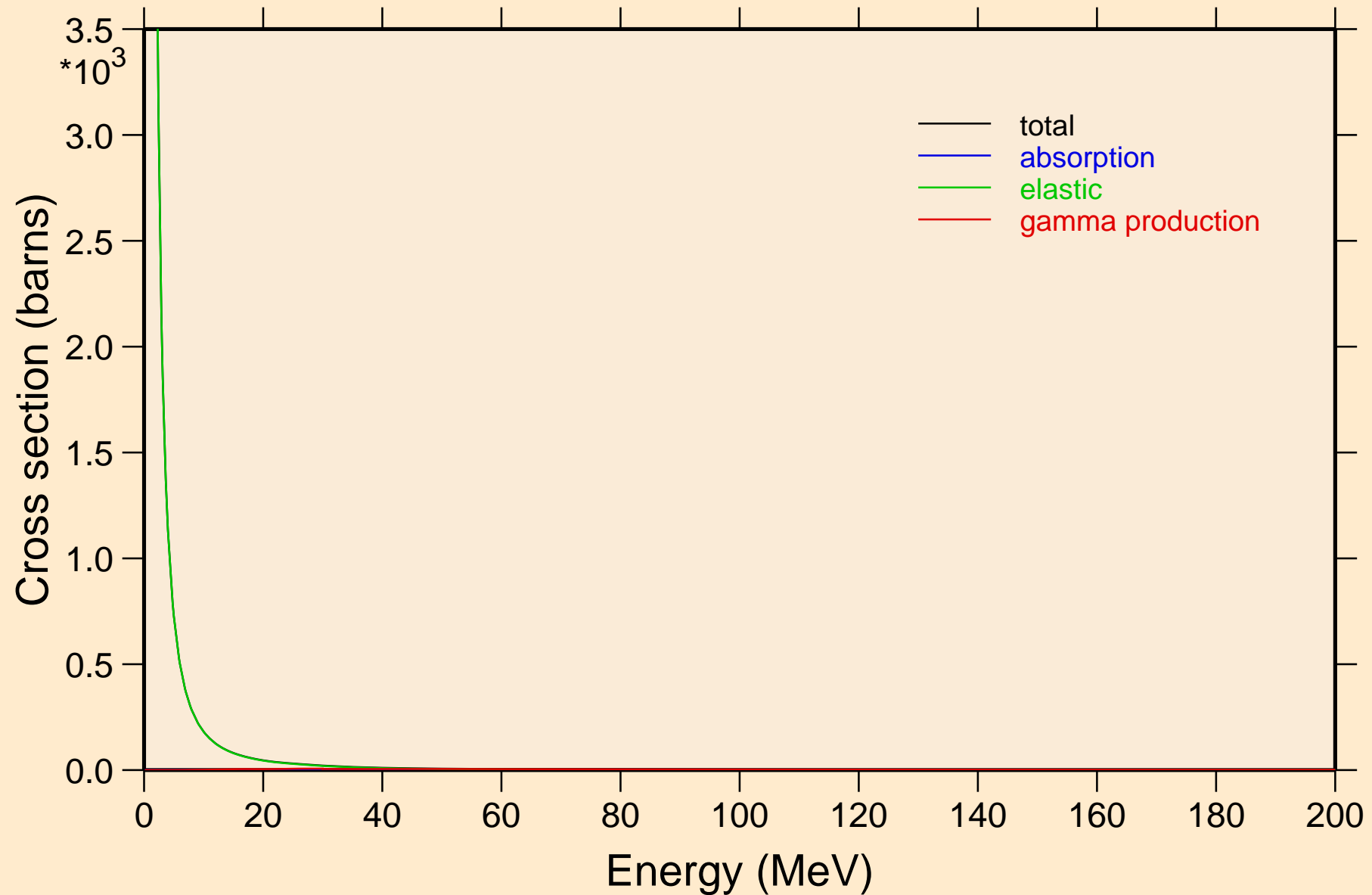

XE135M PROTON ACER TENDL-2021 LIBRARY; T=0.K

Heating

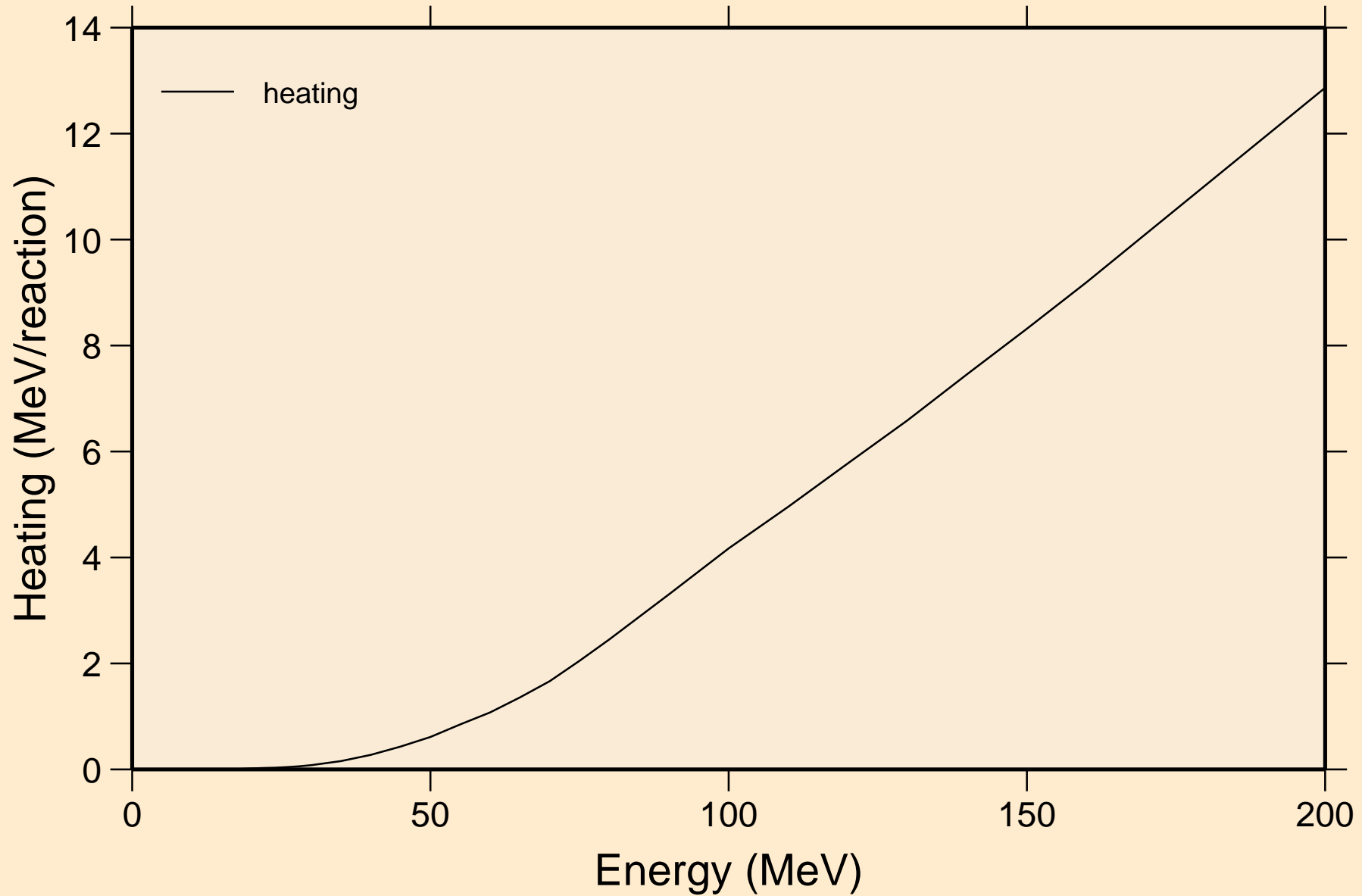

XE135M PROTON ACER TENDL-2021 LIBRARY; T=0.K  
Threshold reactions

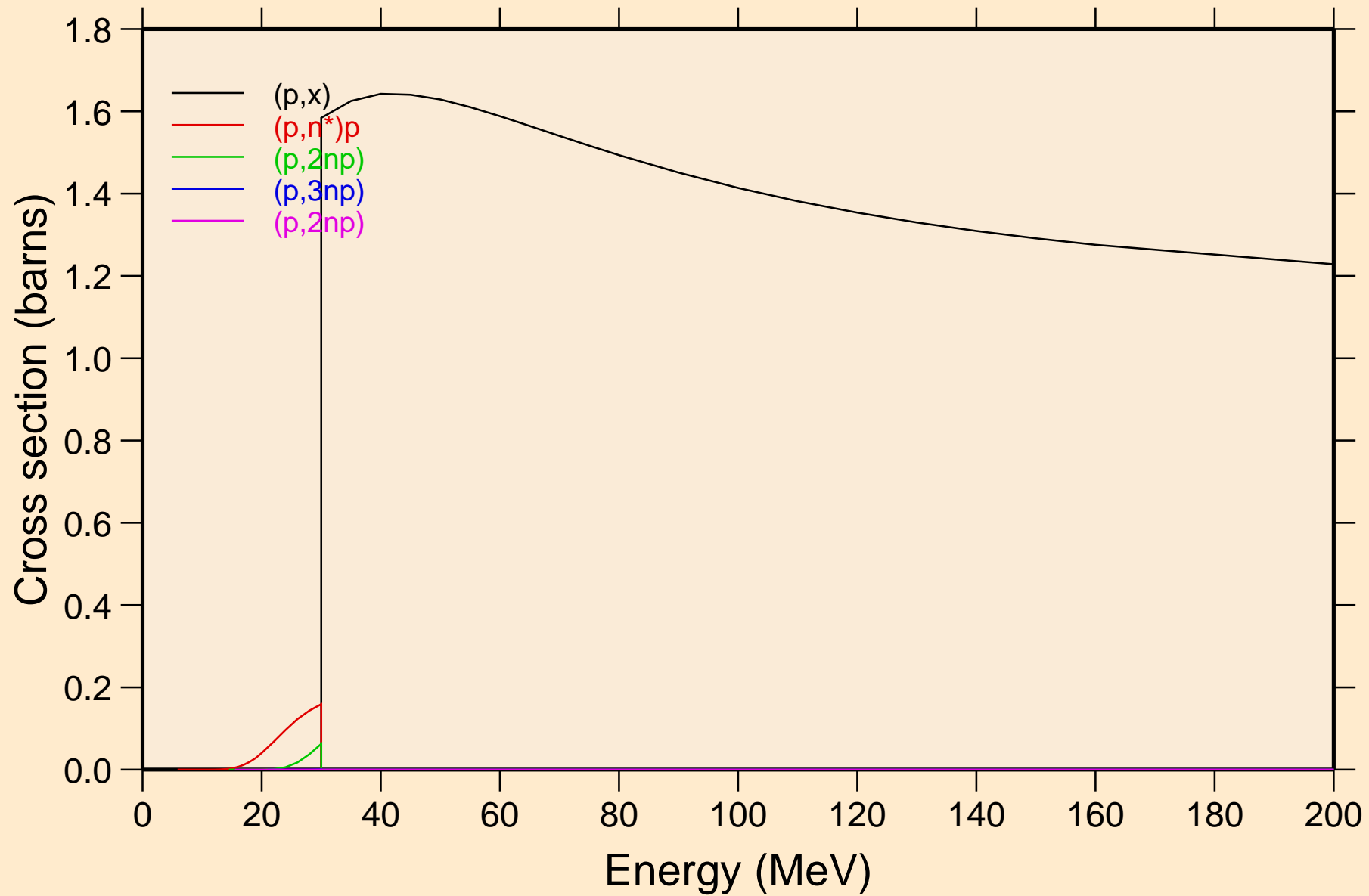

XE135M PROTON ACER TENDL-2021 LIBRARY; T=0.K  
Threshold reactions

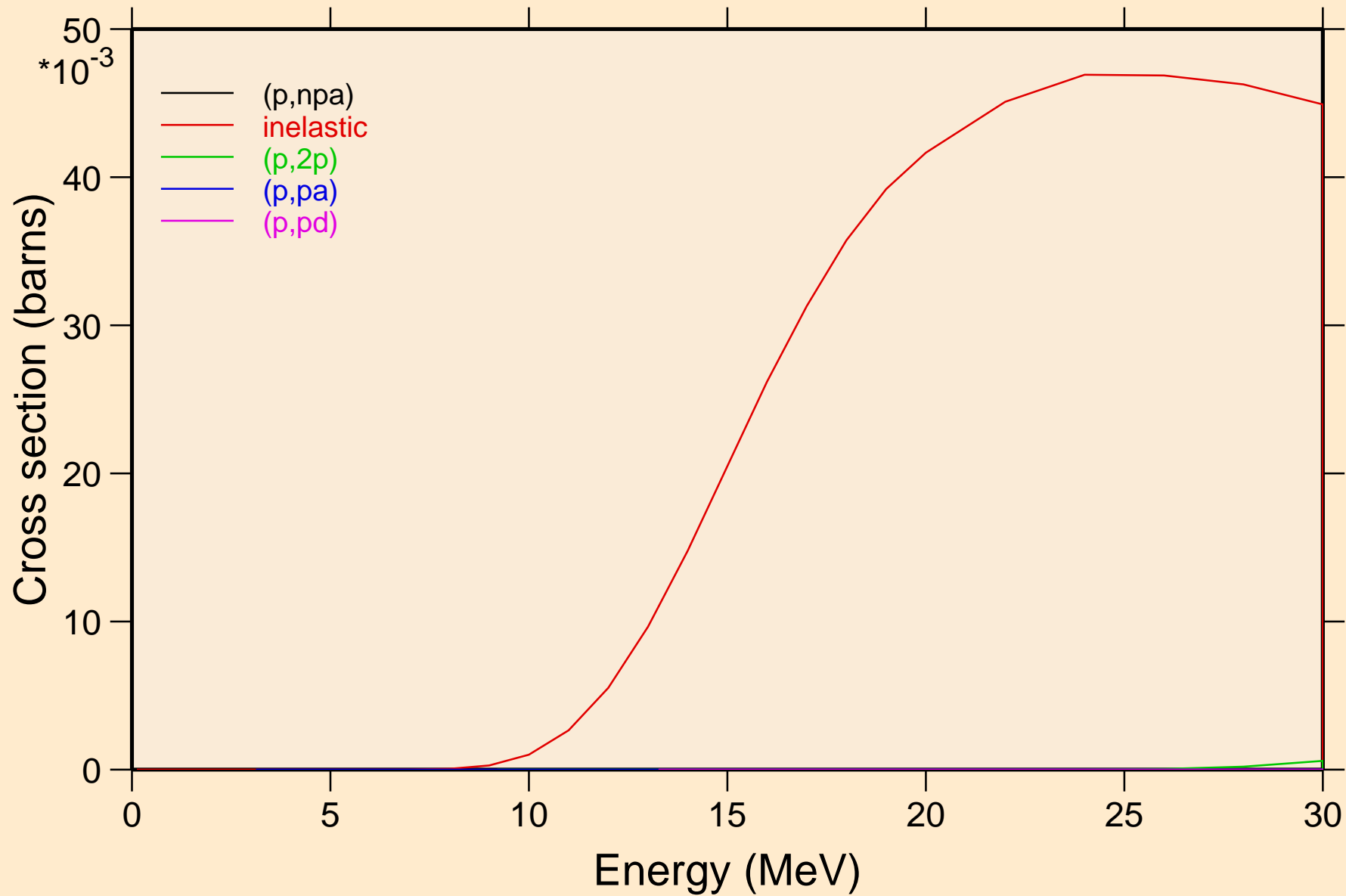

XE135M PROTON ACER TENDL-2021 LIBRARY; T=0.K  
Threshold reactions

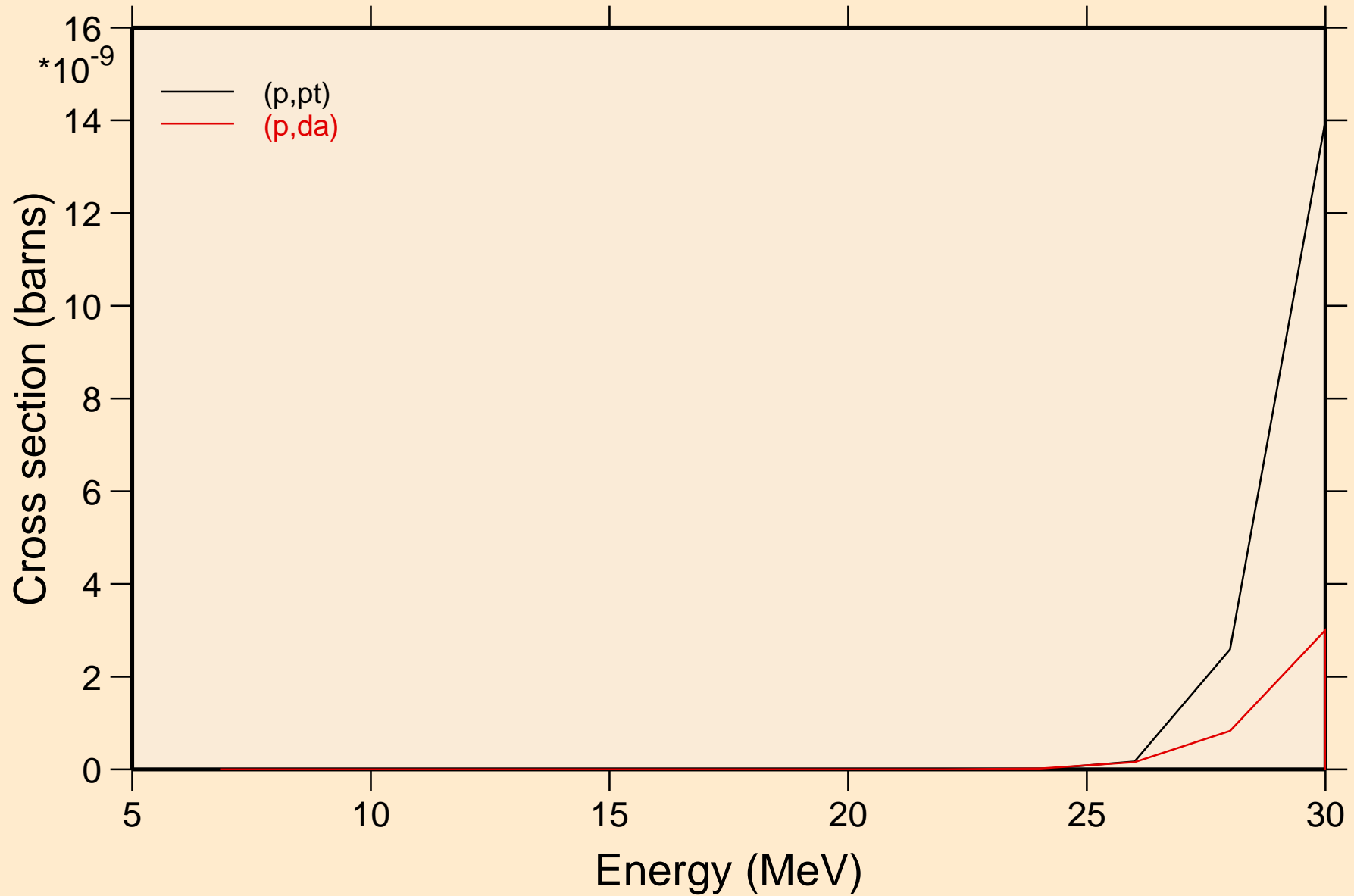

XE135M PROTON ACER TENDL-2021 LIBRARY; T=0.K  
angular distribution for elastic

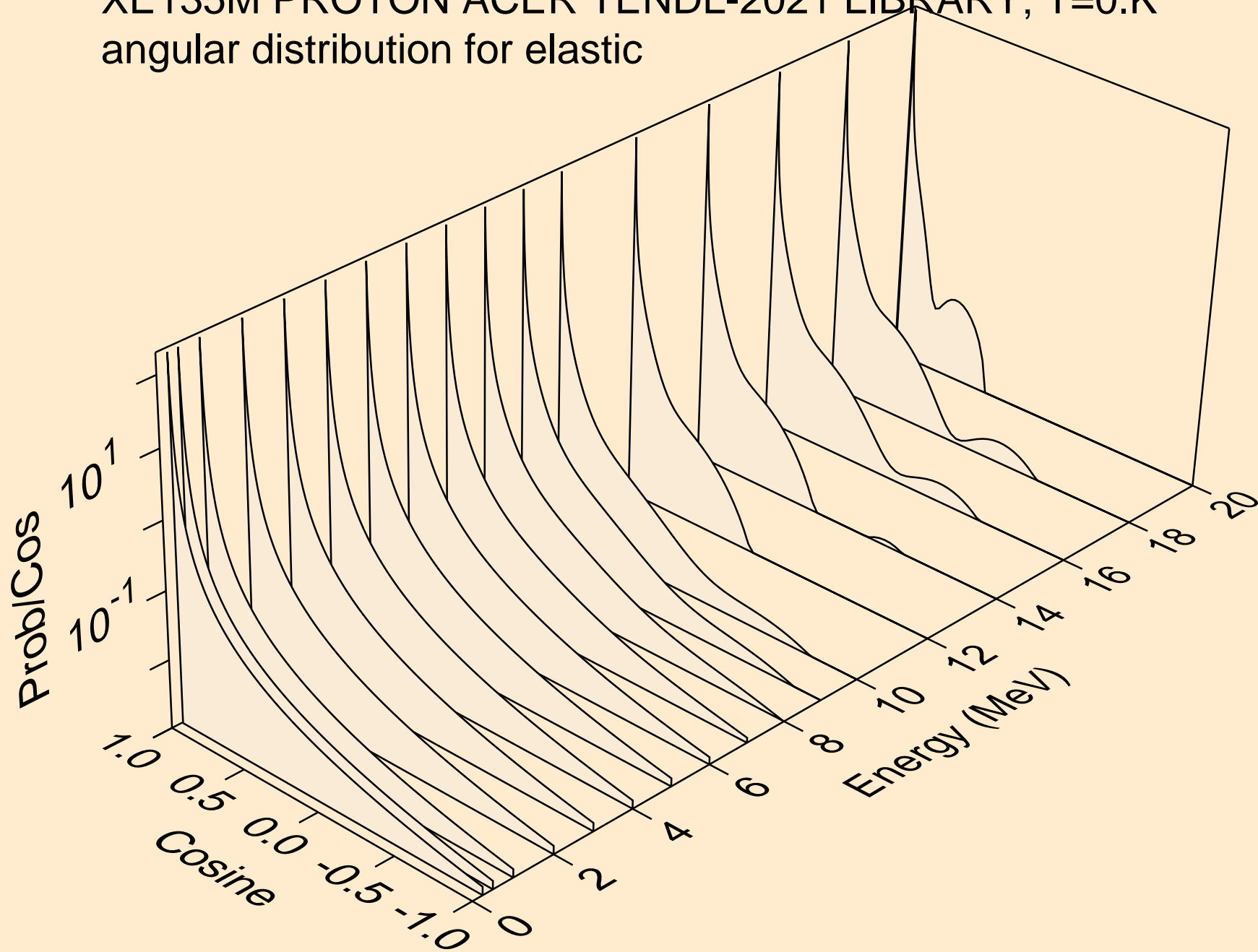

XE135M PROTON ACER TENDL-2021 LIBRARY; T=0.K  
angular distribution for elastic

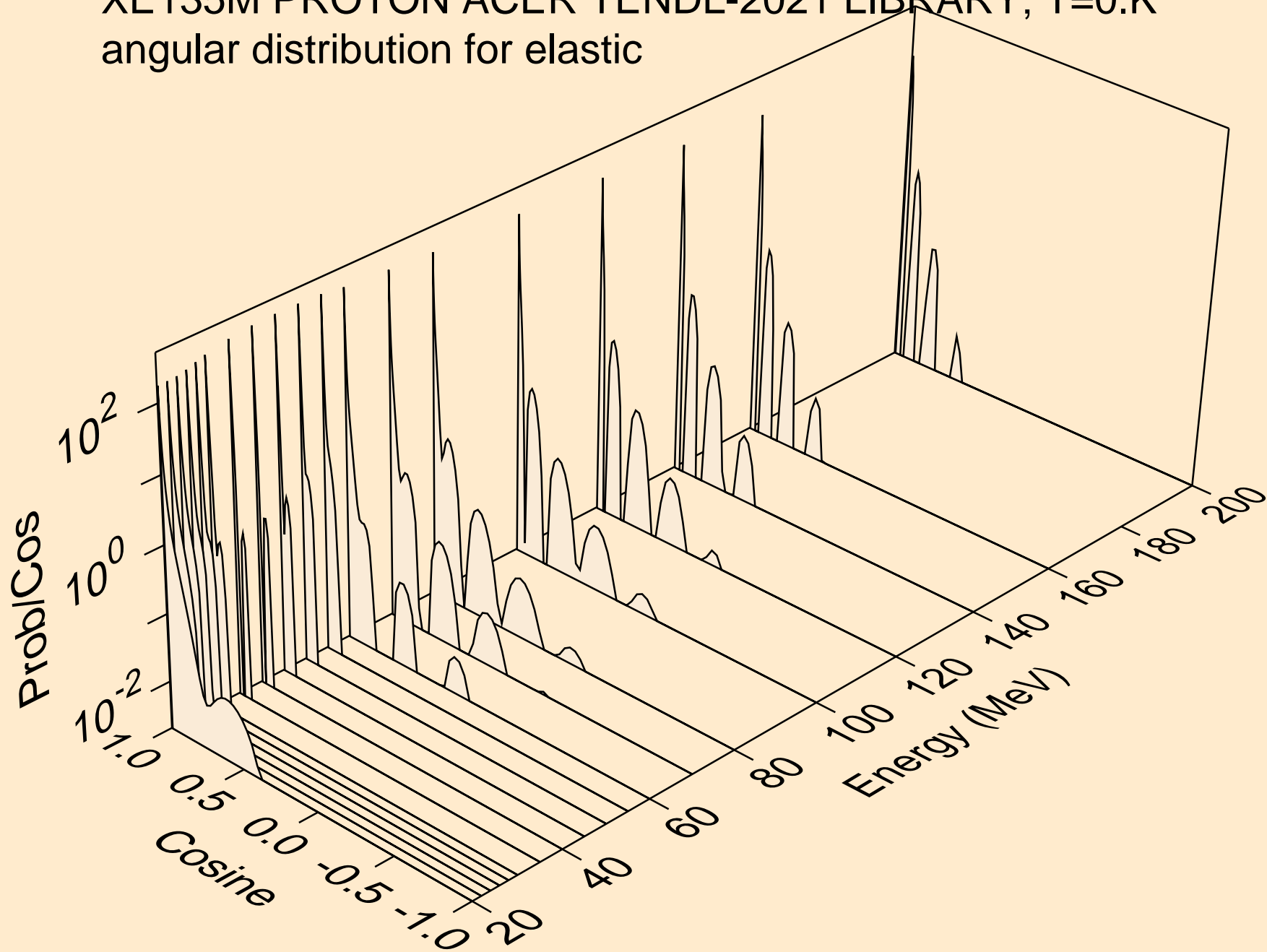

XE135M PROTON ACER TENDL-2021 LIBRARY; T=0.K  
Proton emission for (p,x)

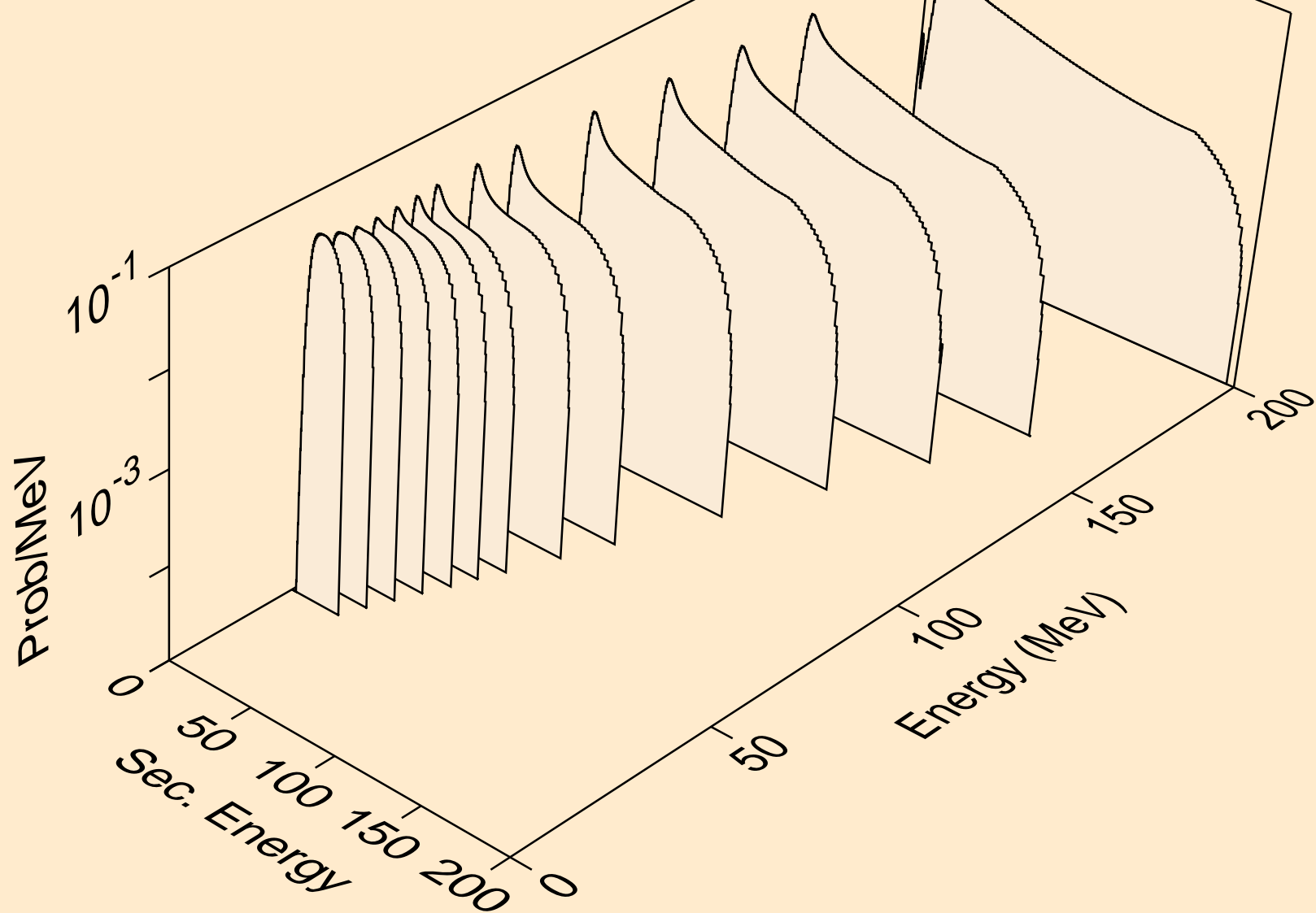

XE135M PROTON ACER TENDL-2021 LIBRARY; T=0.K  
Proton emission for (p,n\*)p

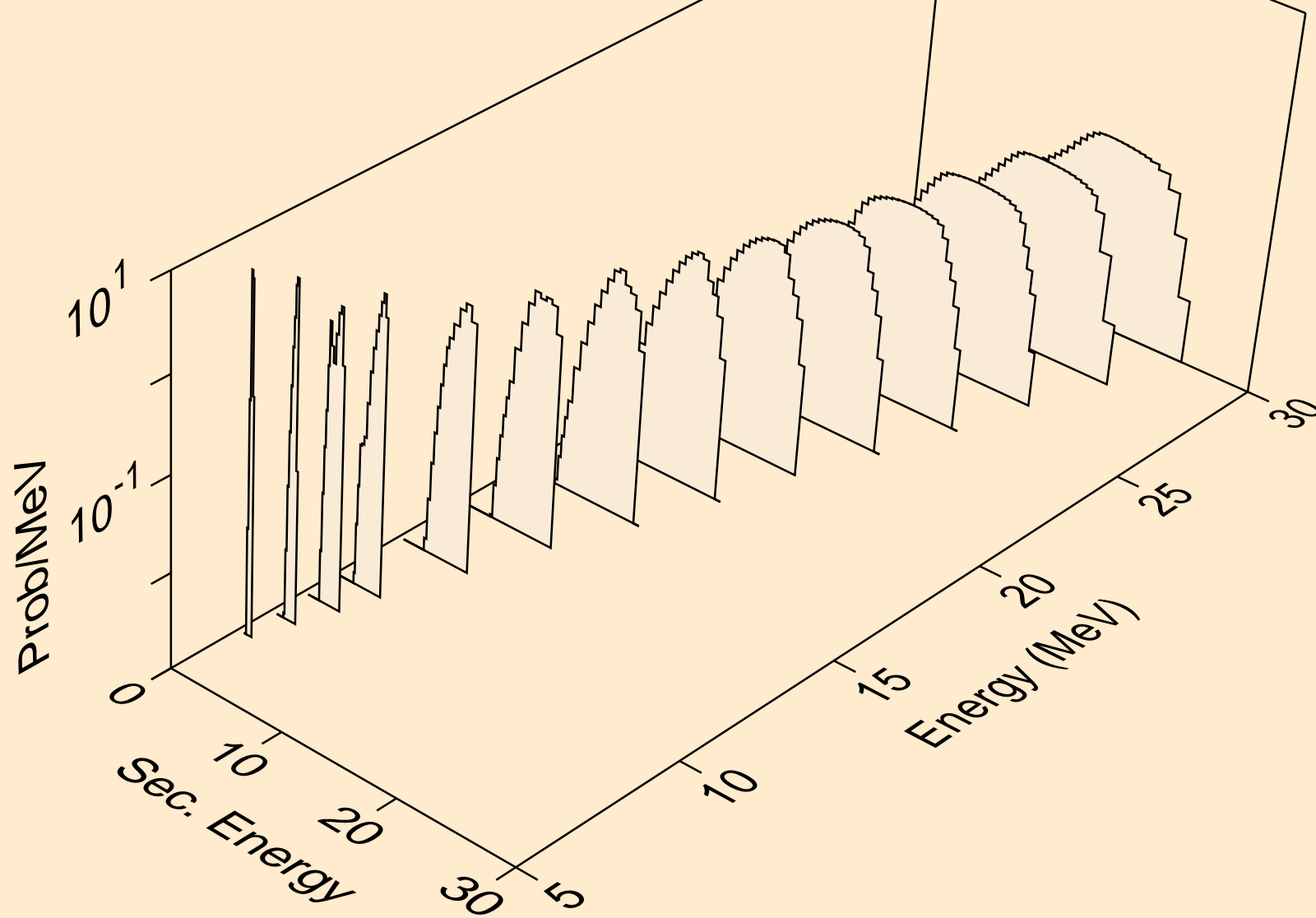

XE135M PROTON ACER TENDL-2021 LIBRARY; T=0.K  
Proton emission for (p,2np)

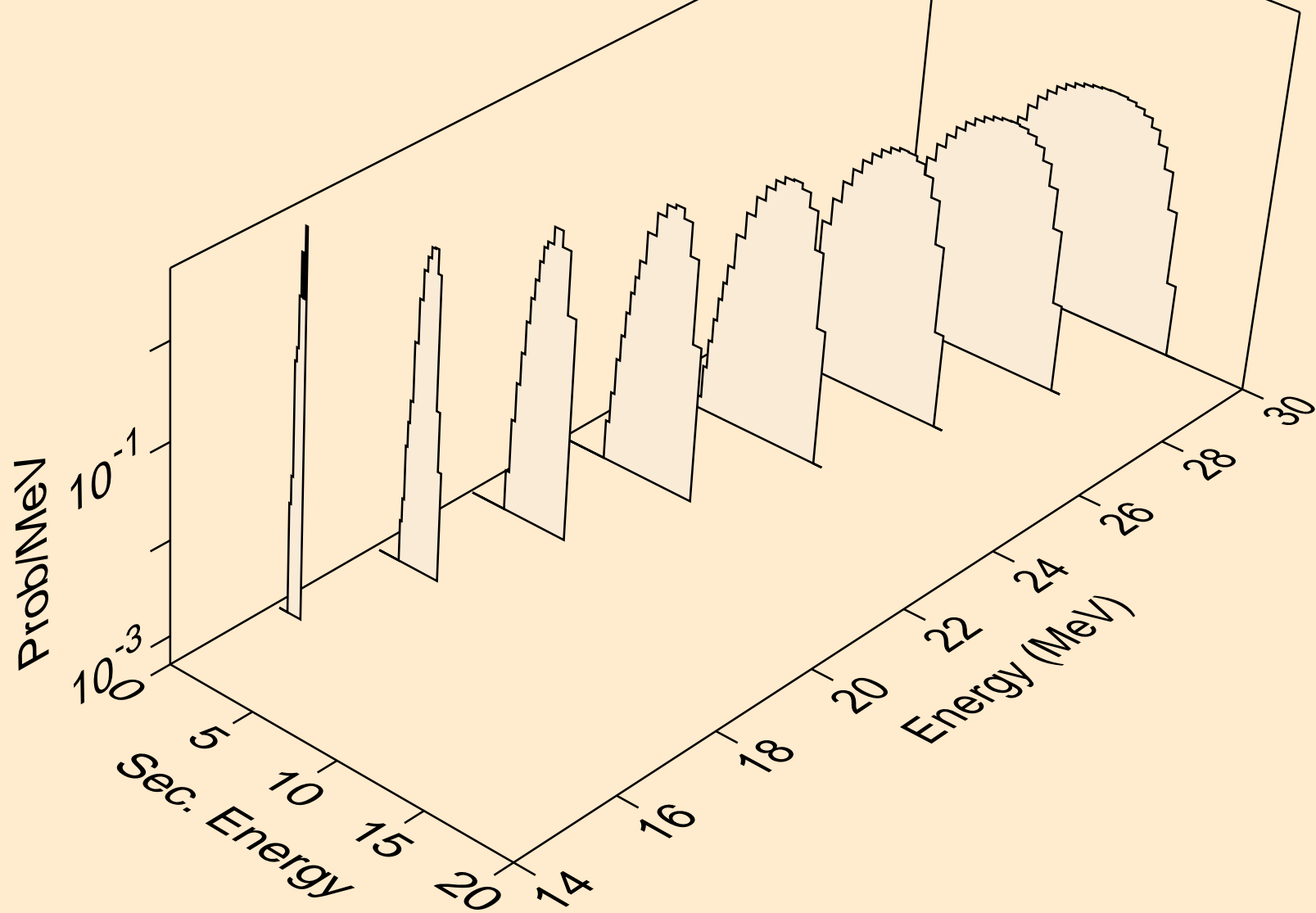

XE135M PROTON ACER TENDL-2021 LIBRARY; T=0.K  
Proton emission for (p,3np)

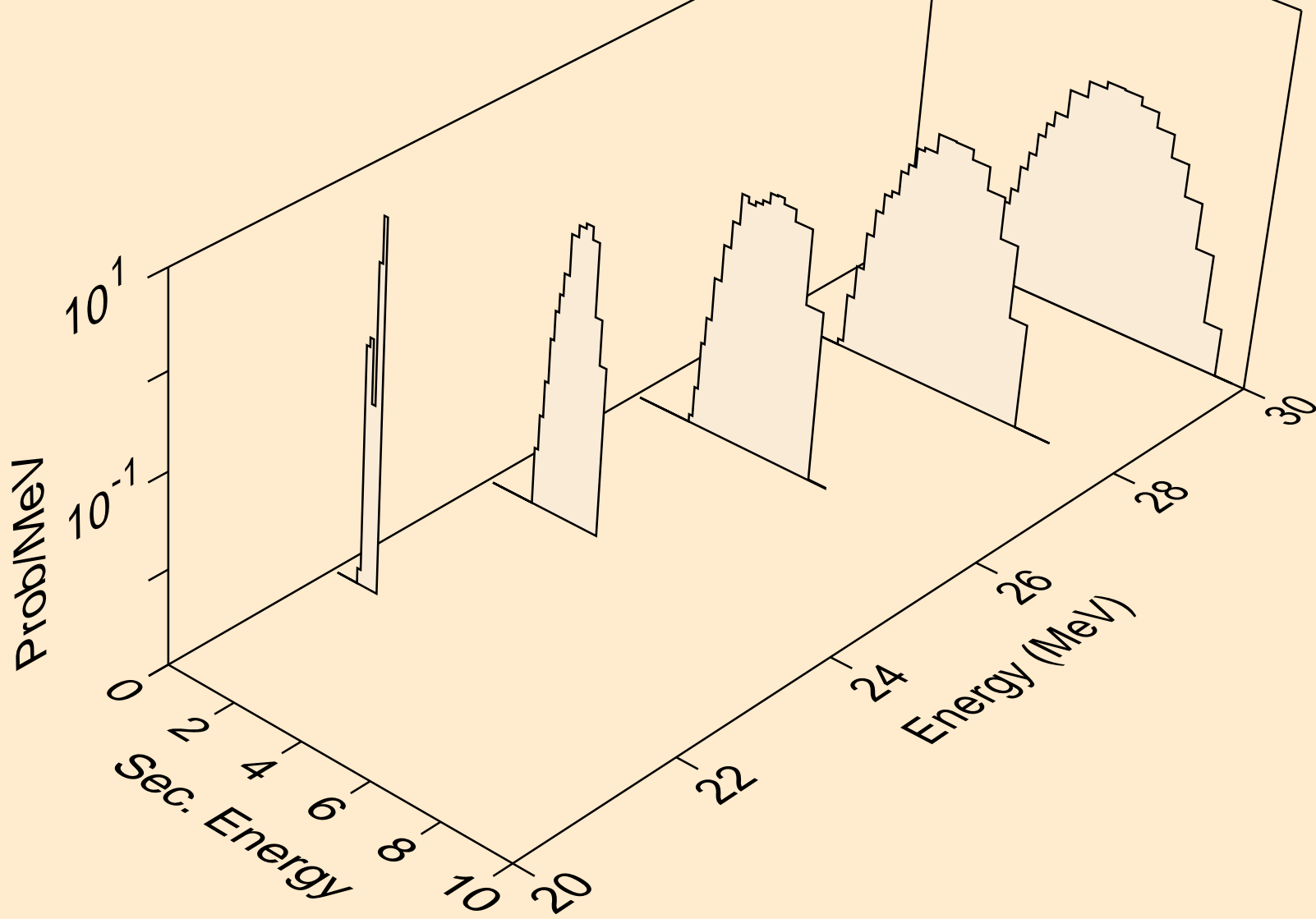

XE135M PROTON ACER TENDL-2021 LIBRARY; T=0.K  
Proton emission for (p,2np)

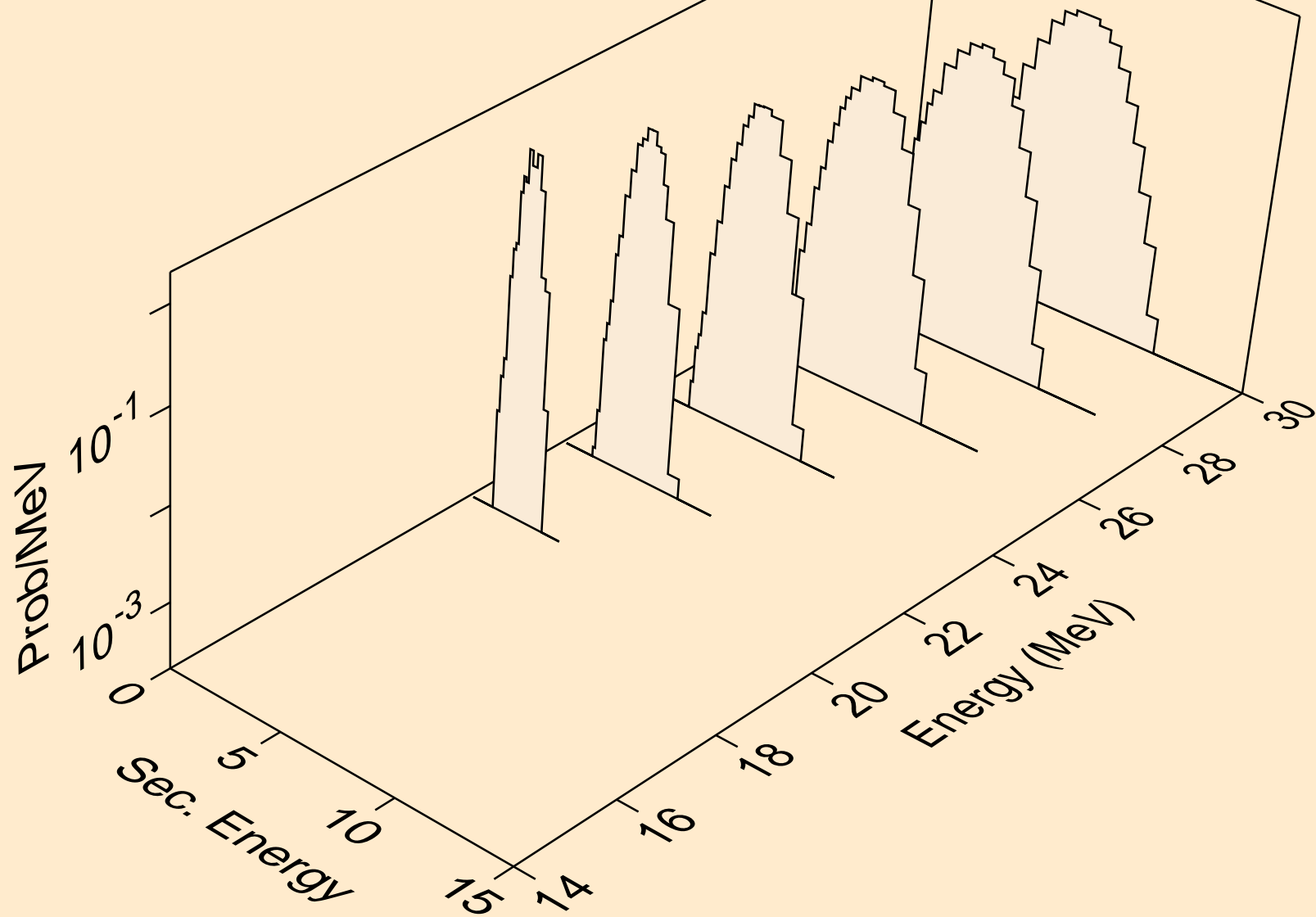

XE135M PROTON ACER TENDL-2021 LIBRARY; T=0.K  
Proton emission for (p,npa)

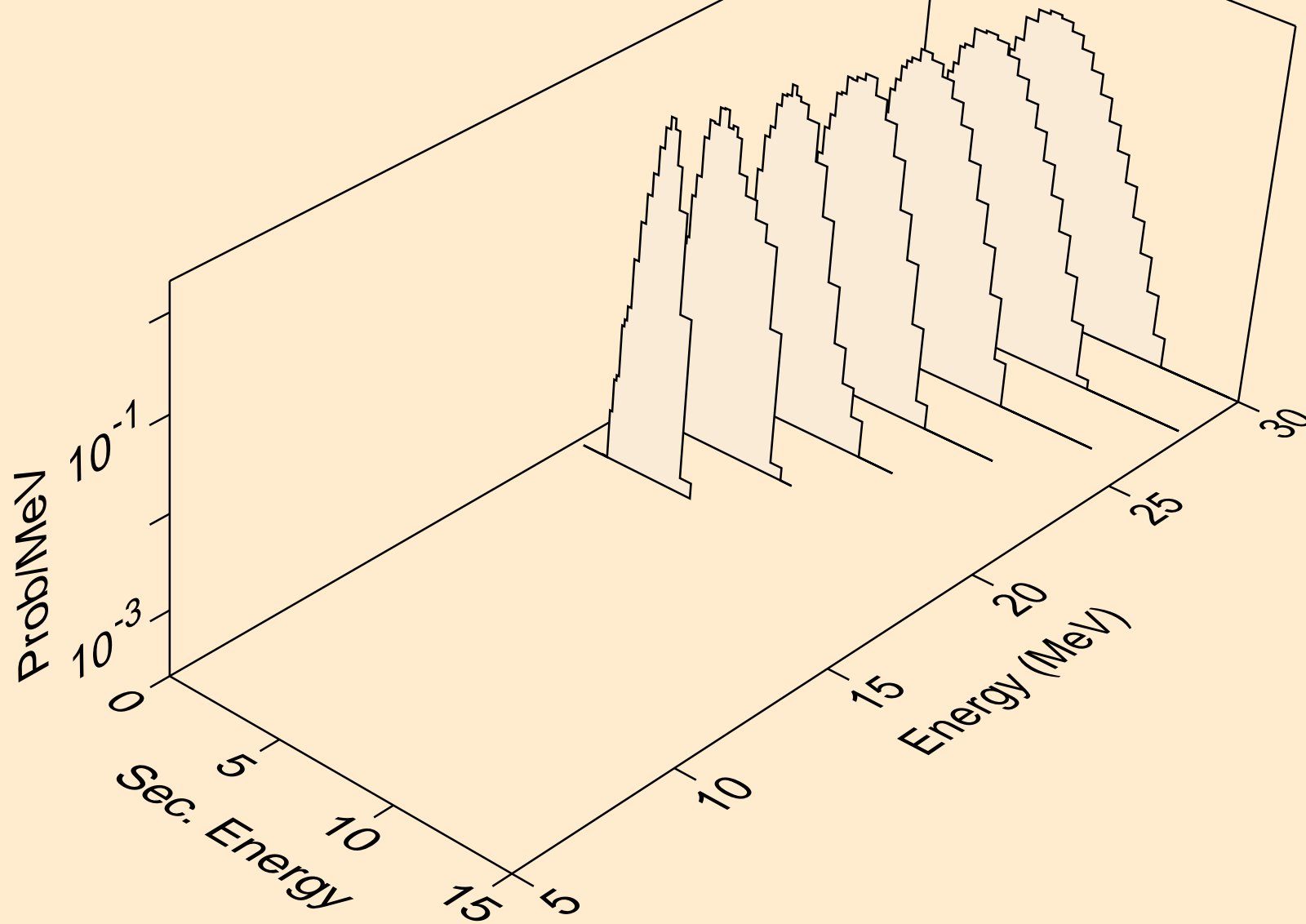

XE135M PROTON ACER TENDL-2021 LIBRARY; T=0.K  
Proton emission for inelastic

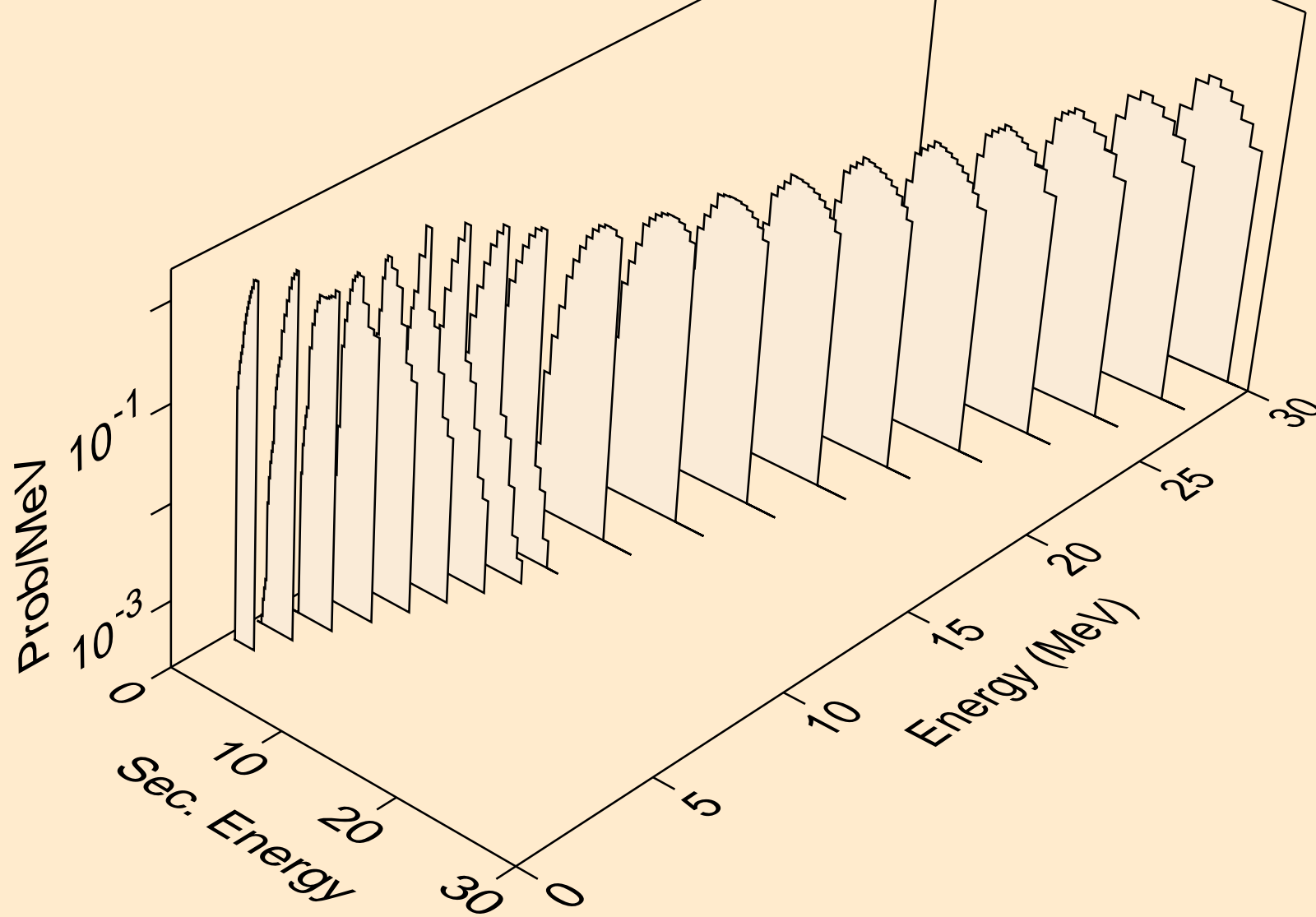

XE135M PROTON ACER TENDL-2021 LIBRARY; T=0.K  
Proton emission for (p,2p)

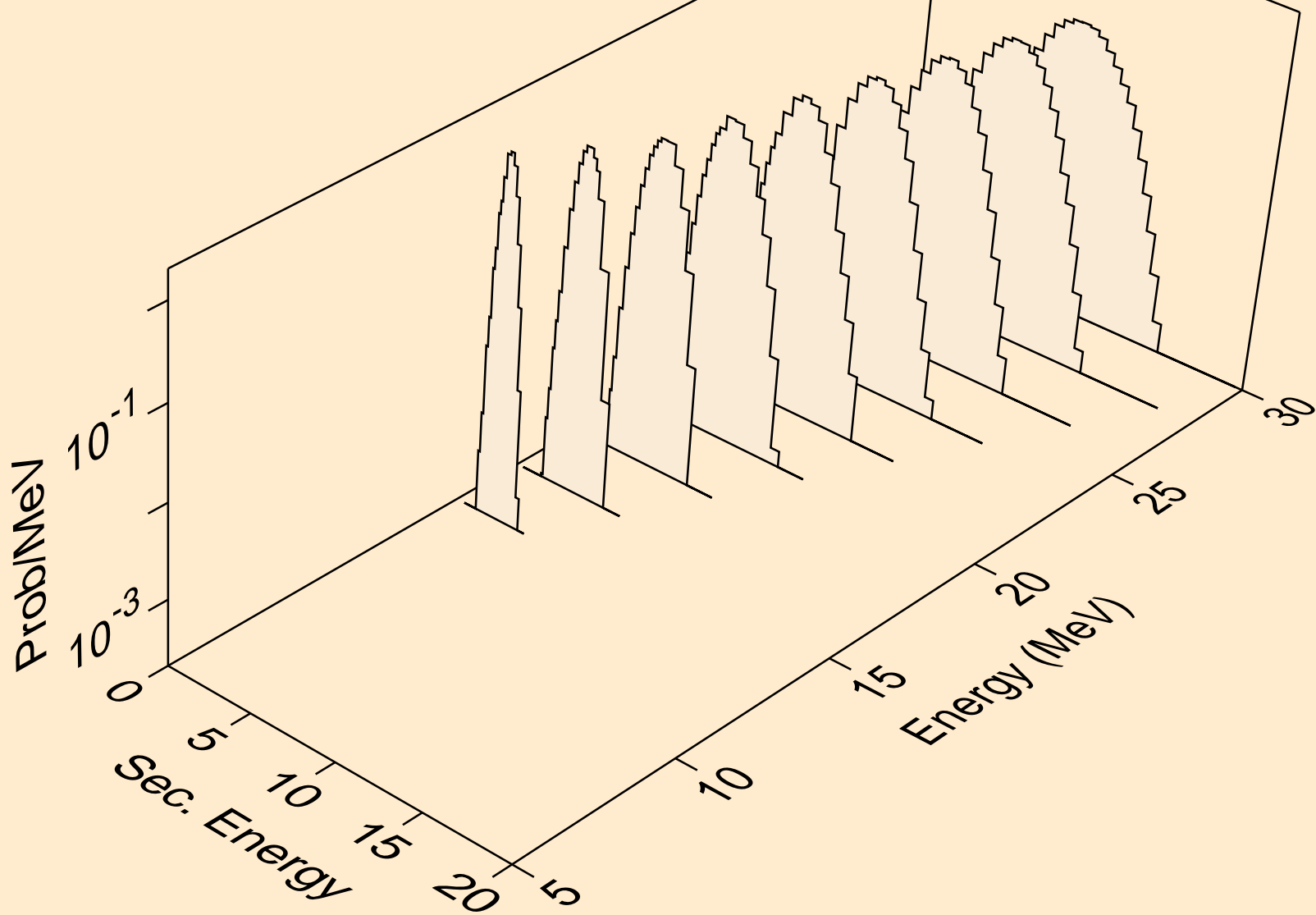

XE135M PROTON ACER TENDL-2021 LIBRARY; T=0.K  
Proton emission for (p,pa)

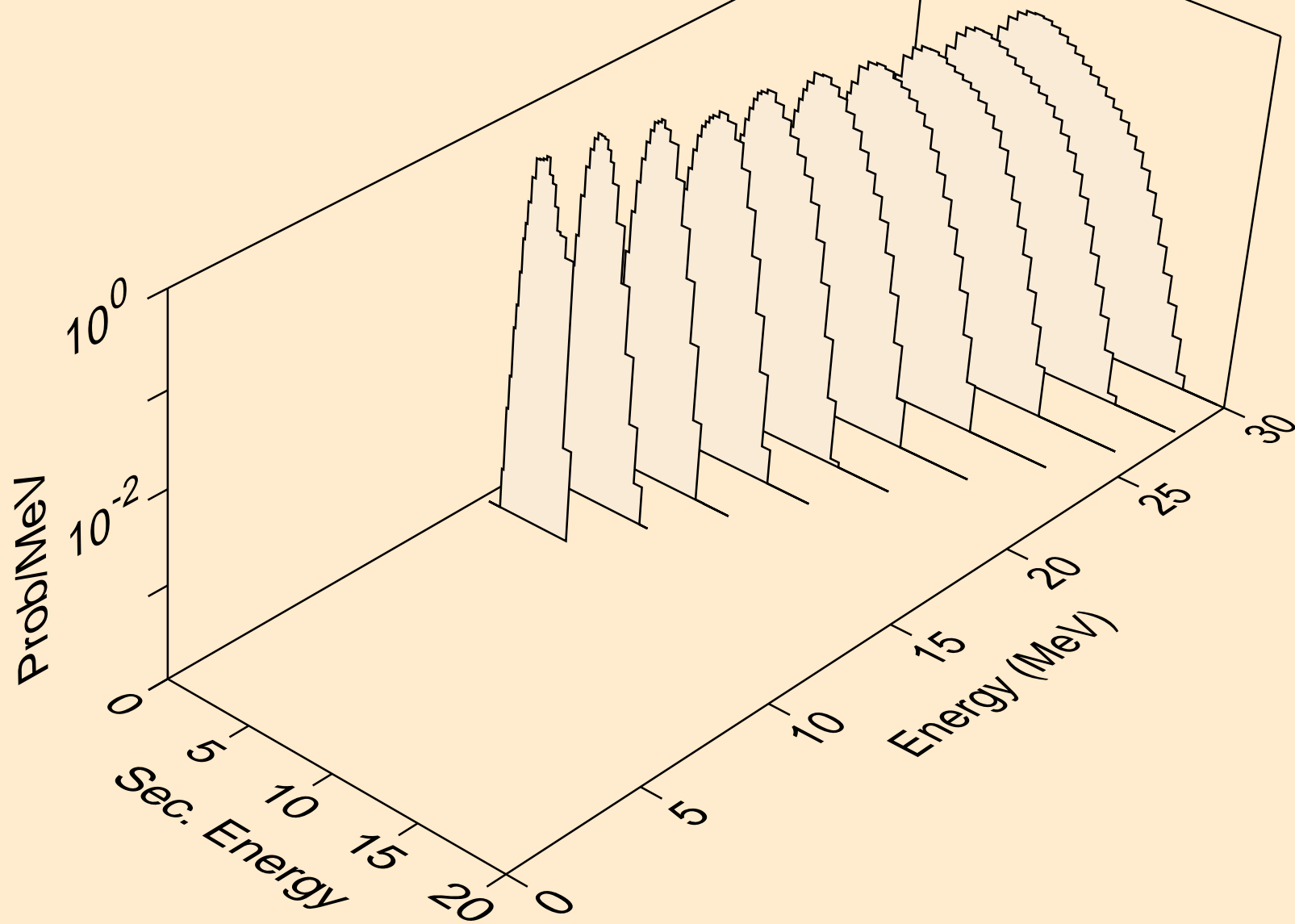

XE135M PROTON ACER TENDL-2021 LIBRARY; T=0.K  
Proton emission for (p,pd)

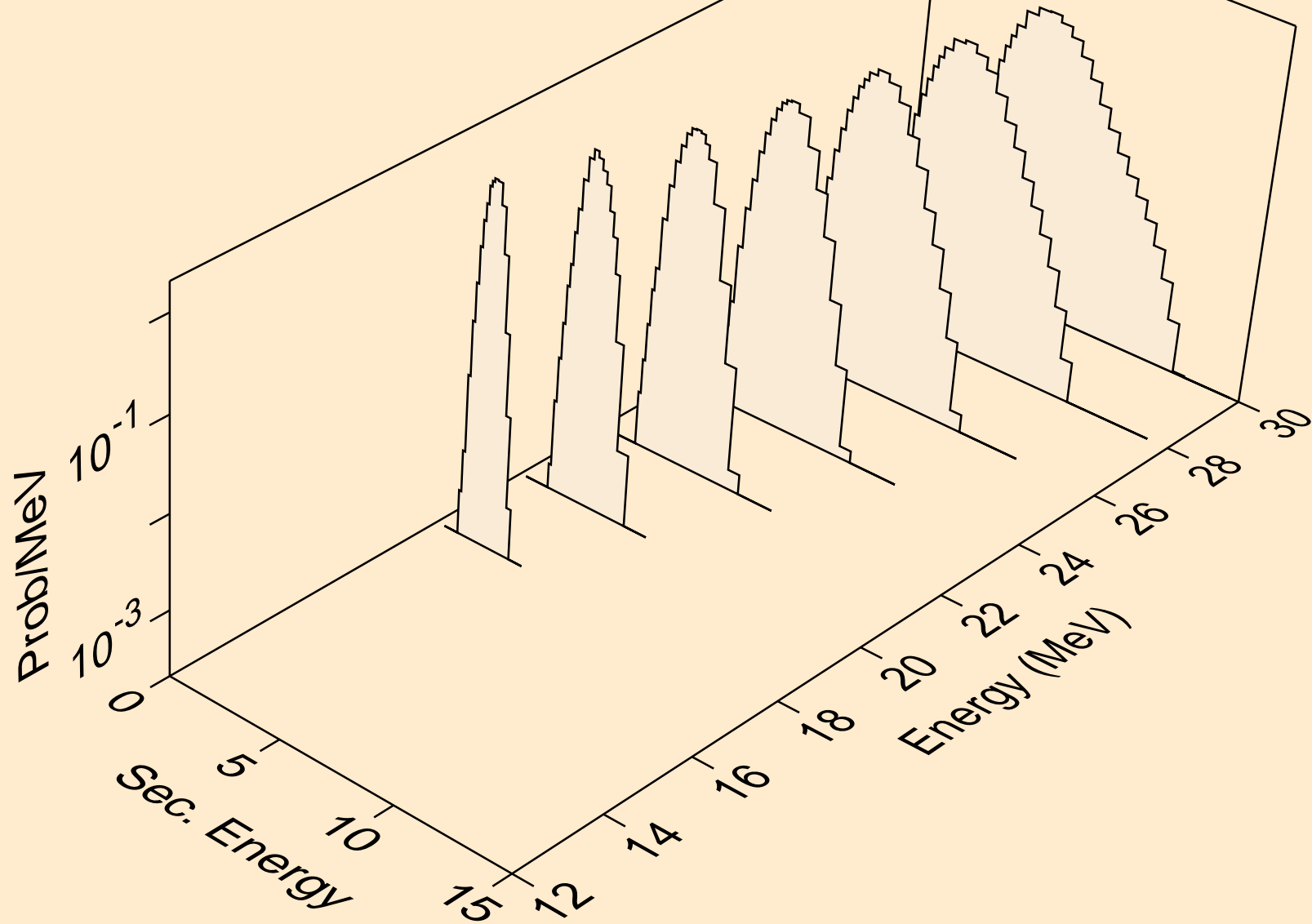

XE135M PROTON ACER TENDL-2021 LIBRARY; T=0.K  
Proton emission for (p,pt)

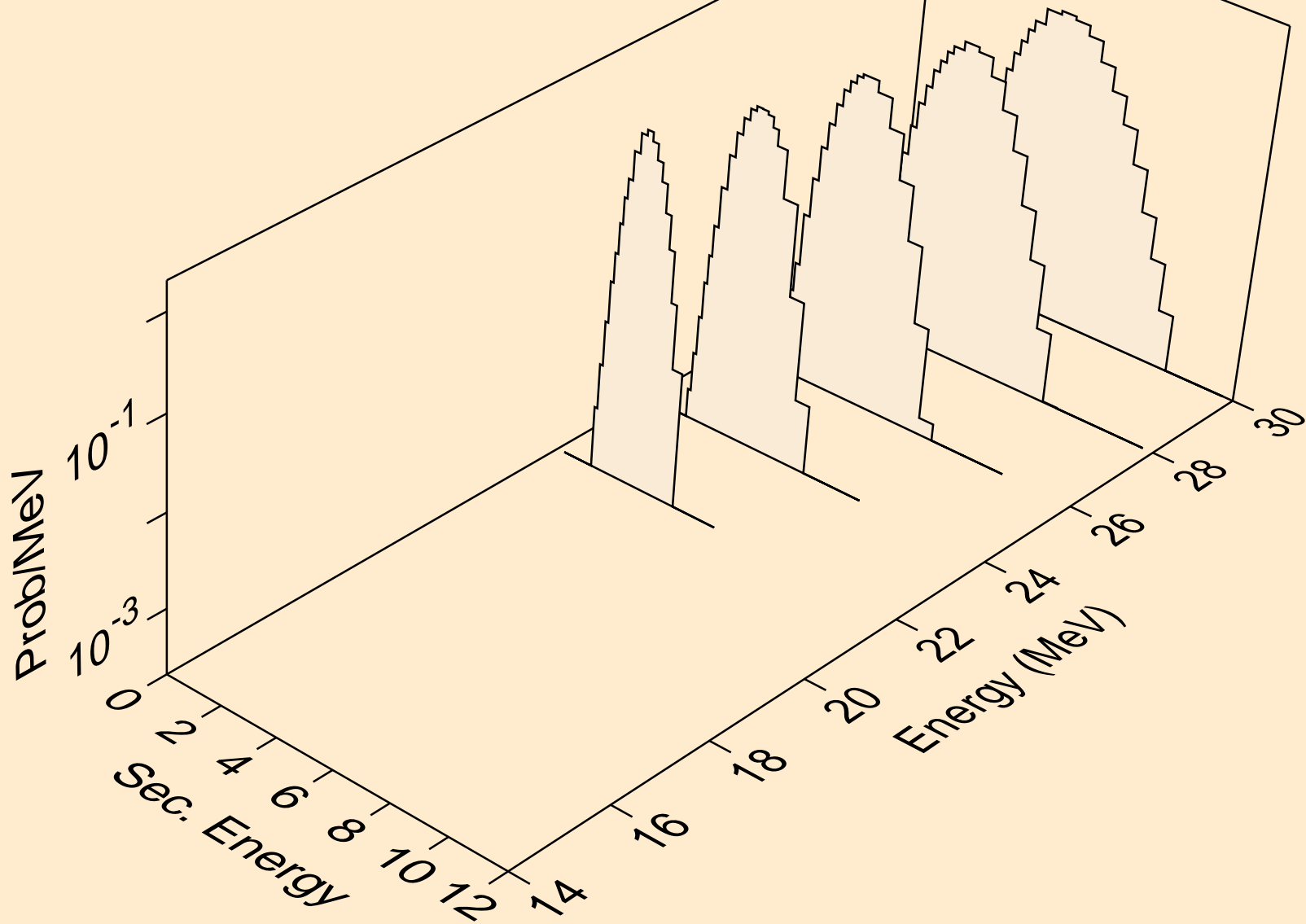

XE135M PROTON ACER TENDL-2021 LIBRARY; T=0.K  
Photon emission for (z,n)

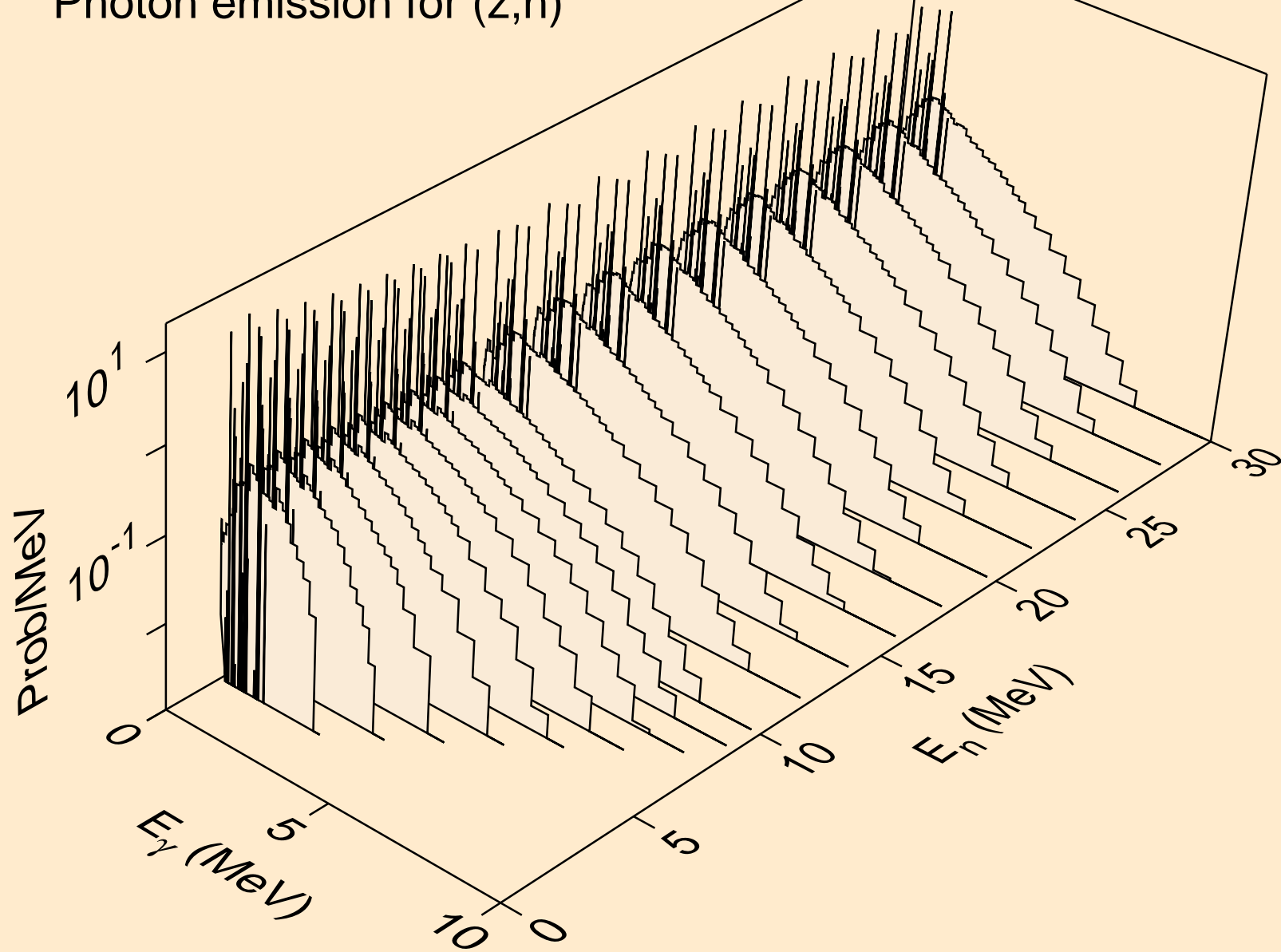

XE135M PROTON ACER TENDL-2021 LIBRARY; T=0.K  
Photon emission for (n,x)

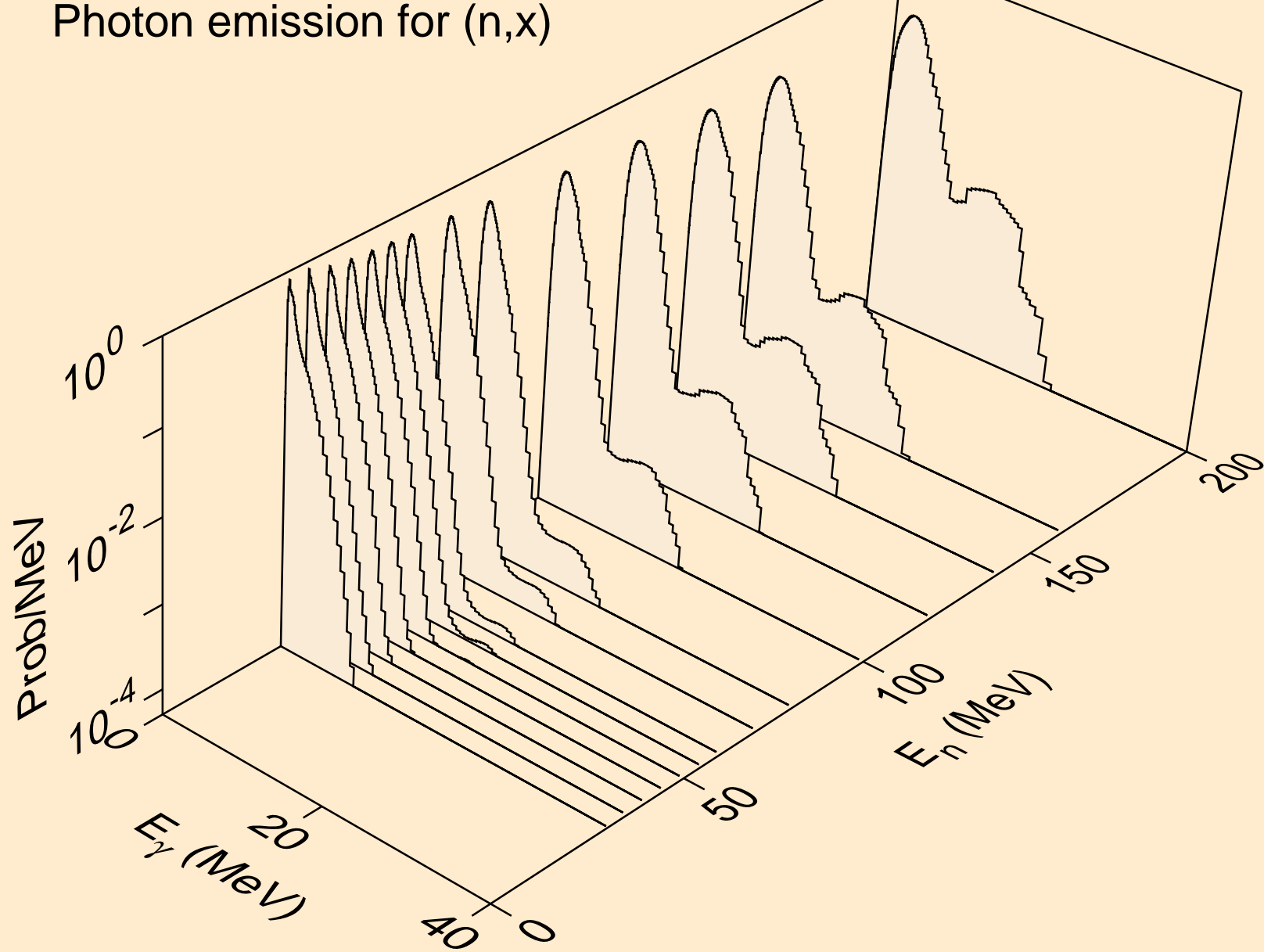

XE135M PROTON ACER TENDL-2021 LIBRARY; T=0.K  
Photon emission for (n,2nd)

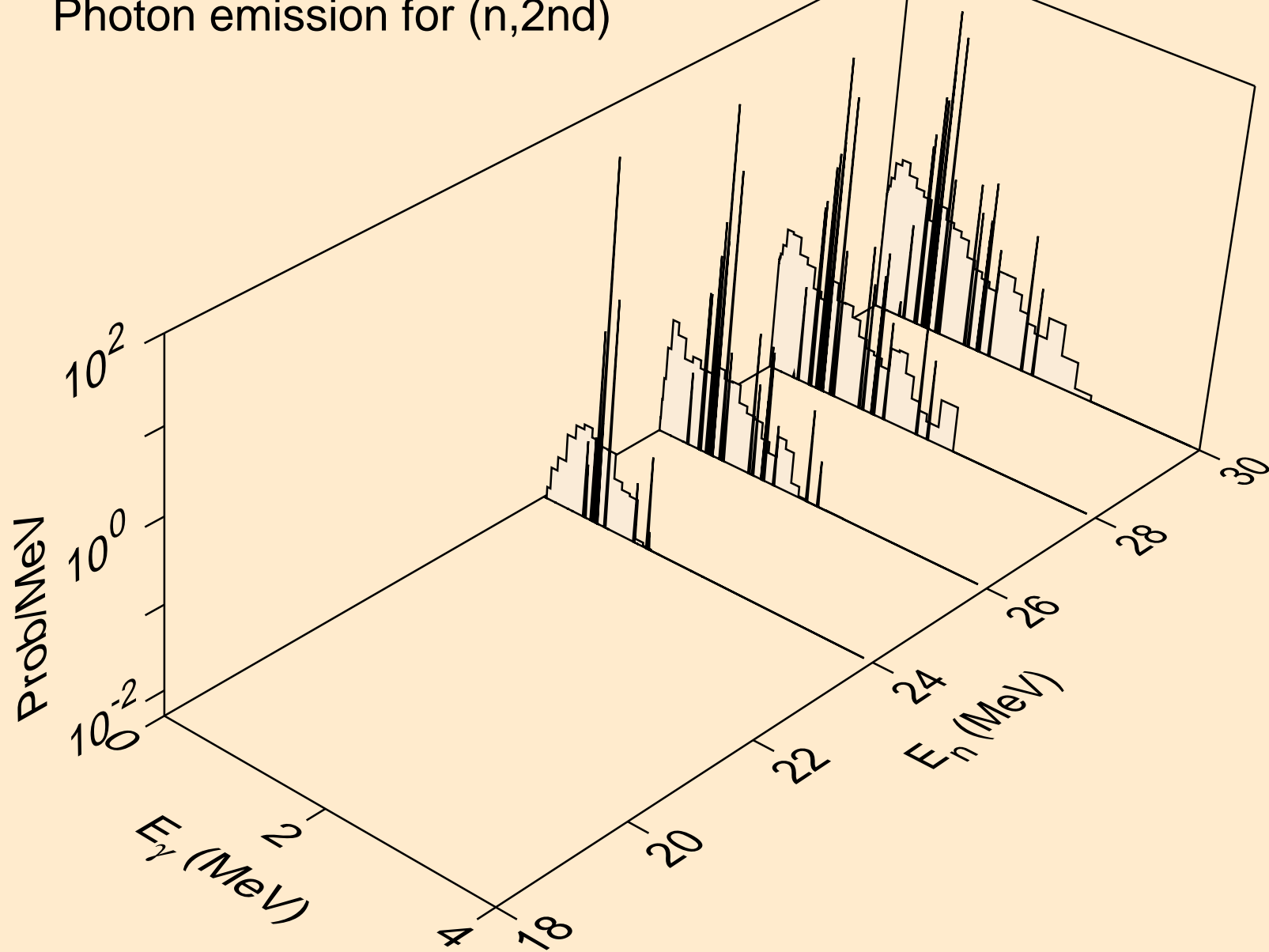

XE135M PROTON ACER TENDL-2021 LIBRARY; T=0.K  
Photon emission for (n,2n)

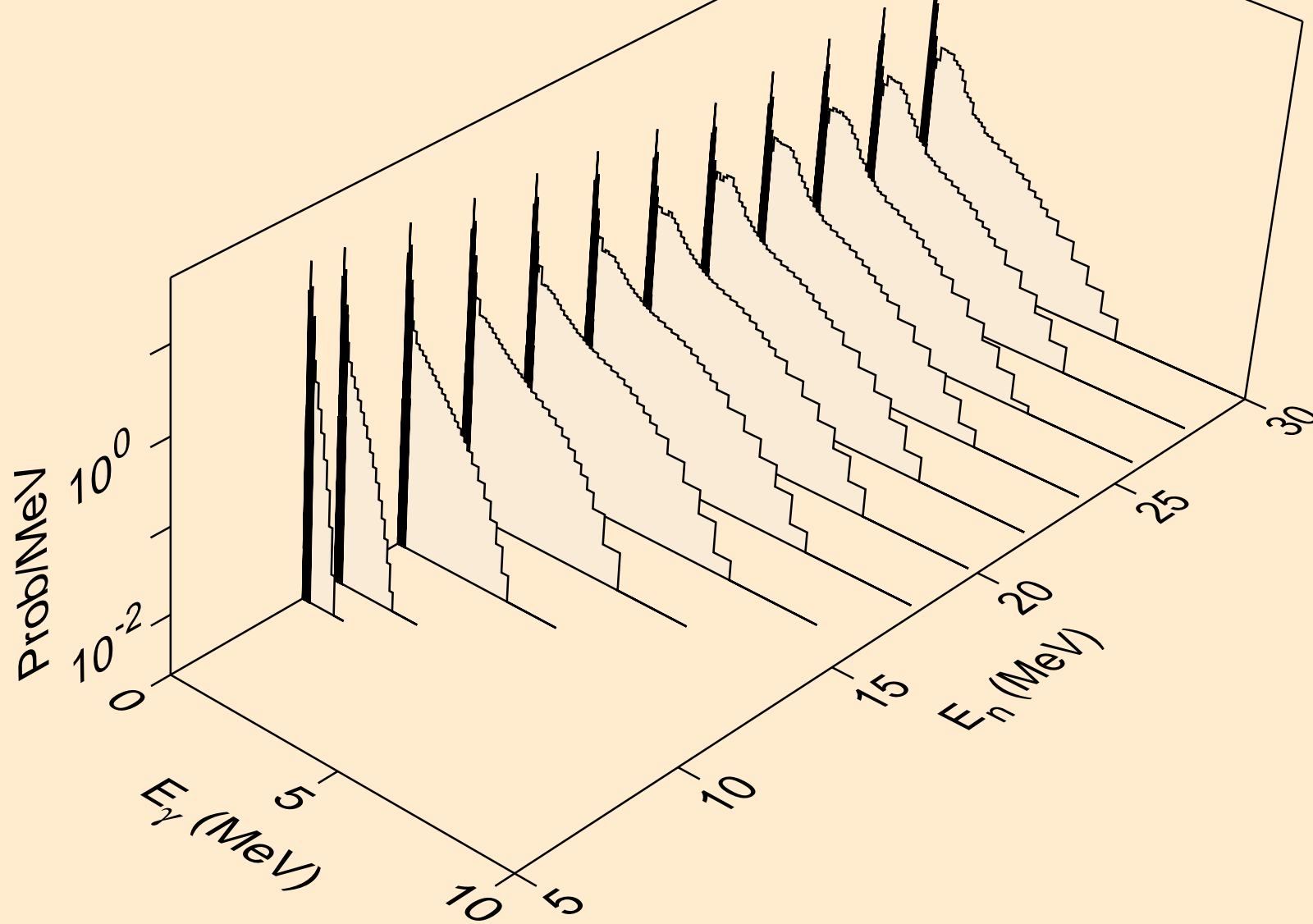

XE135M PROTON ACER TENDL-2021 LIBRARY; T=0.K  
Photon emission for (n,3n)

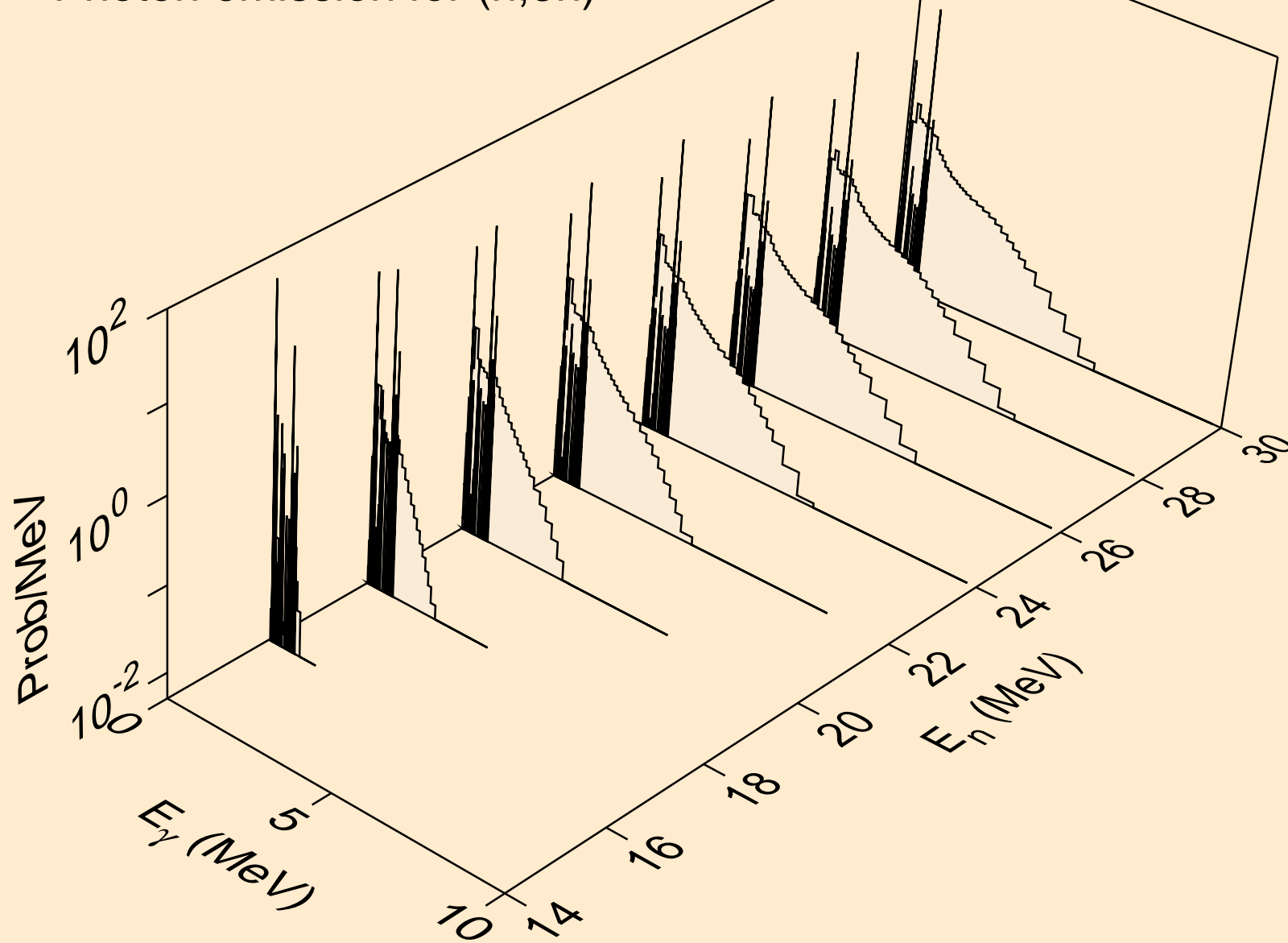

XE135M PROTON ACER TENDL-2021 LIBRARY; T=0.K  
Photon emission for (n,n\*)a

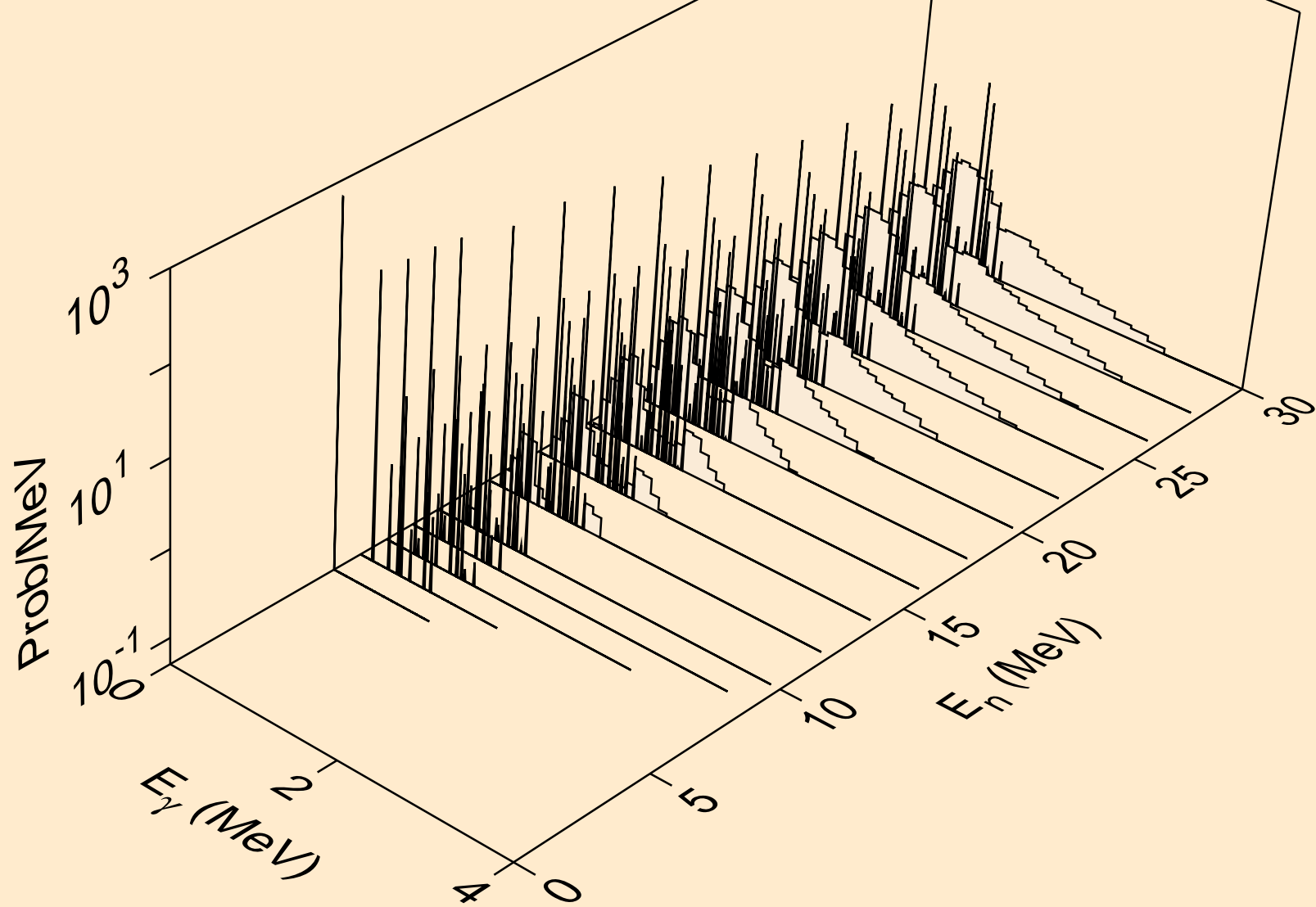

XE135M PROTON ACER TENDL-2021 LIBRARY; T=0.K  
Photon emission for (n,2n) $\alpha$

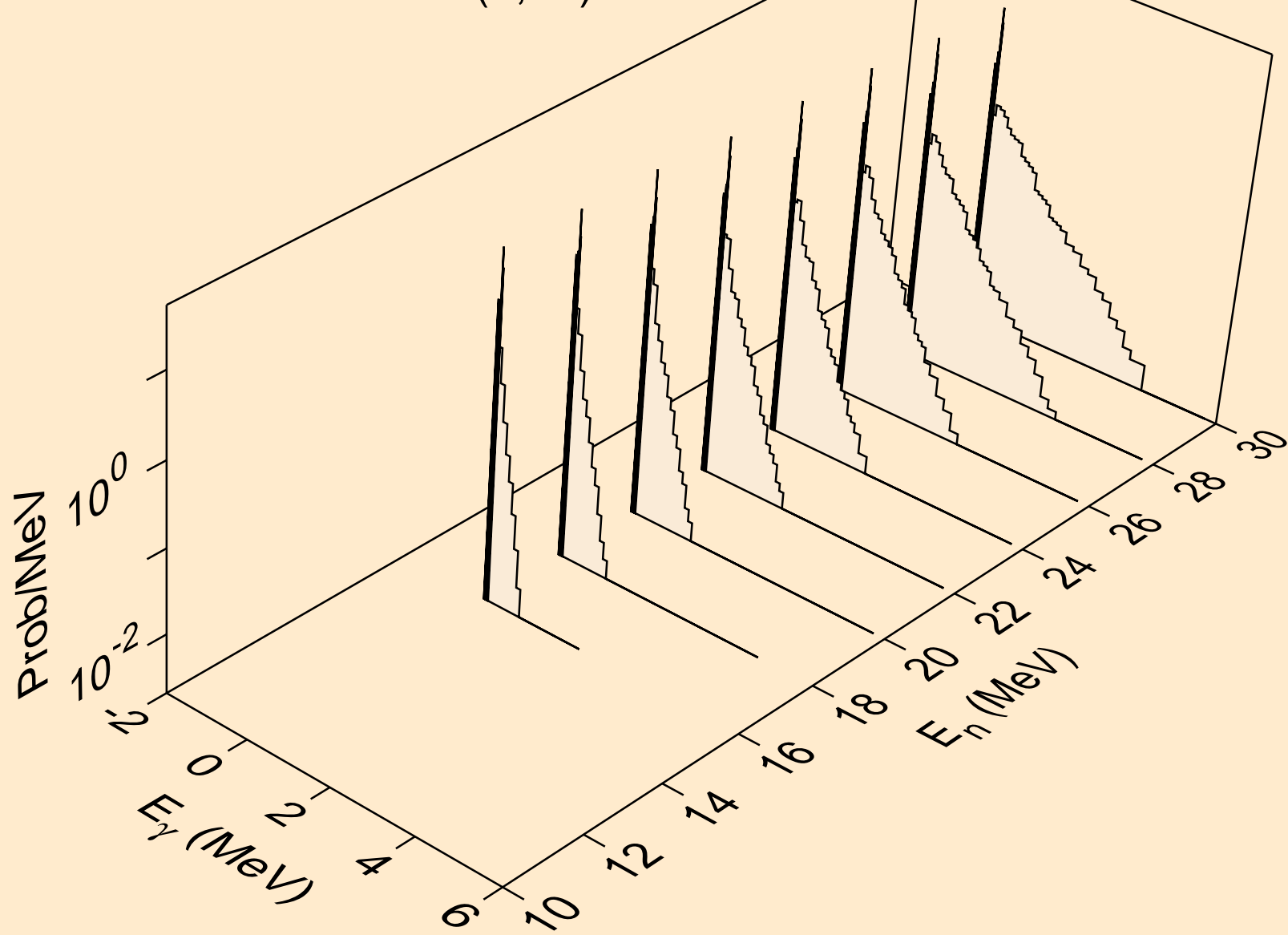

XE135M PROTON ACER TENDL-2021 LIBRARY; T=0.K  
Photon emission for (n,3n)a

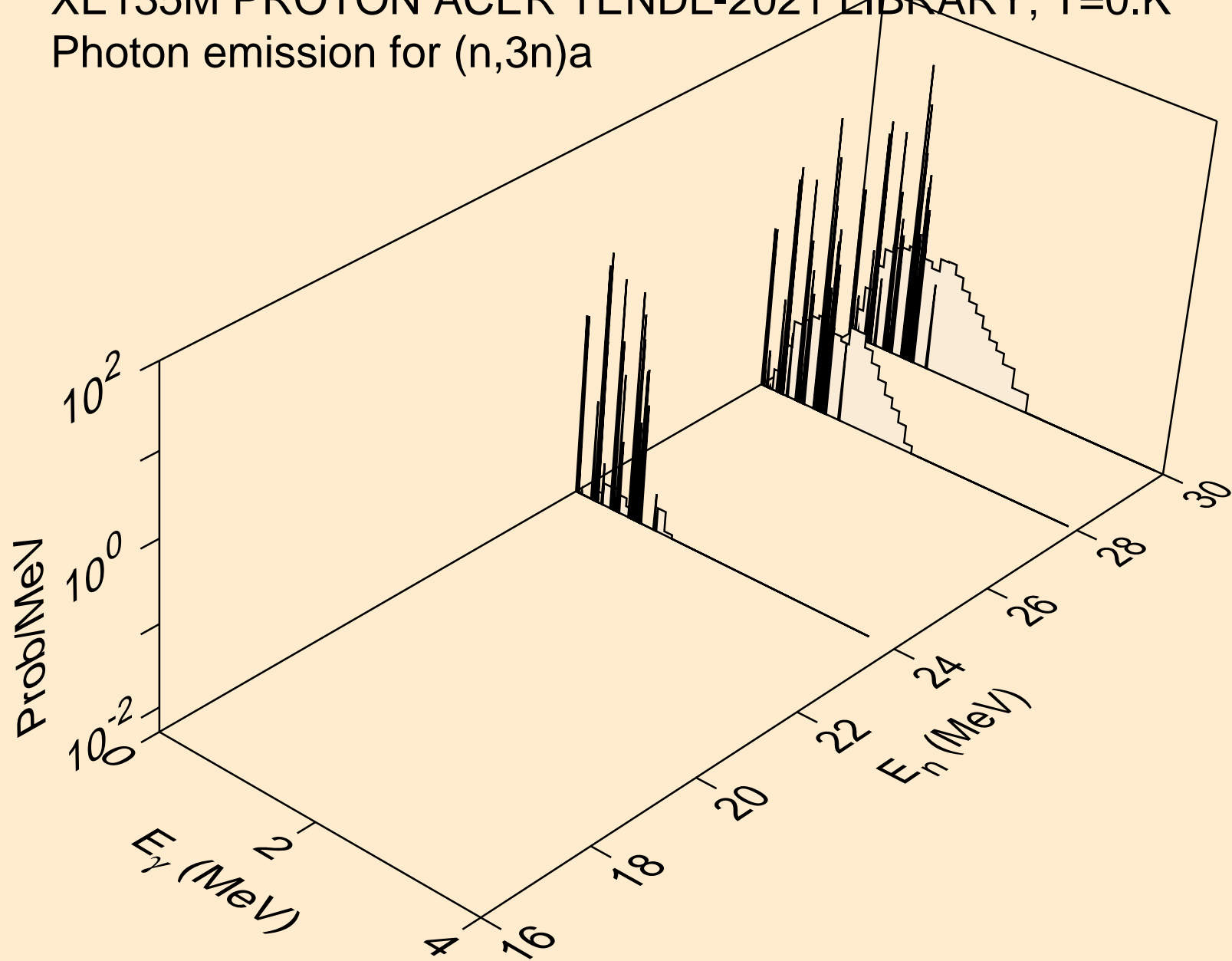

XE135M PROTON ACER TENDL-2021 LIBRARY; T=0.K  
Photon emission for (n,n\*)p

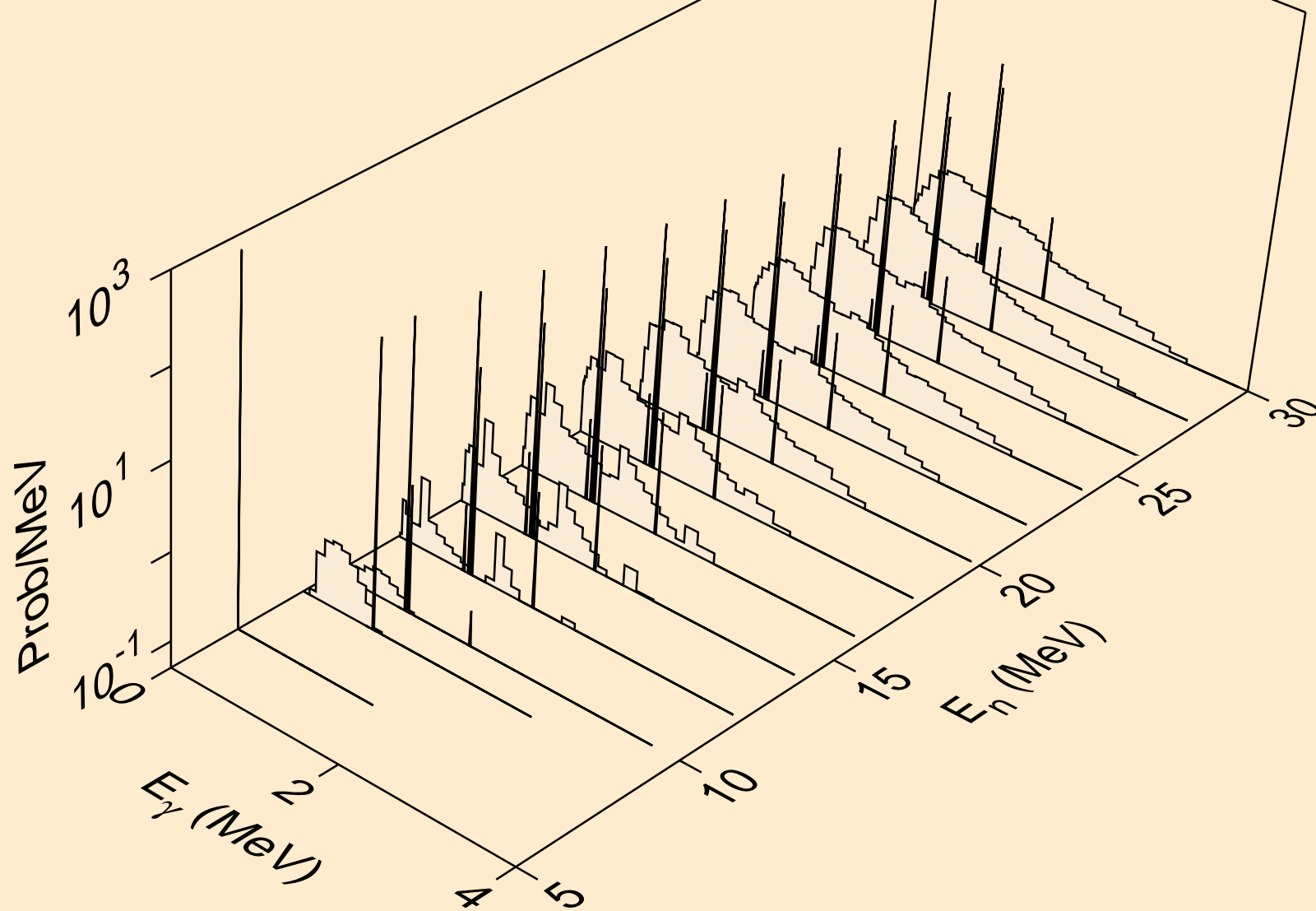

XE135M PROTON ACER TENDL-2021 LIBRARY; T=0.K  
Photon emission for (n,n\*)d

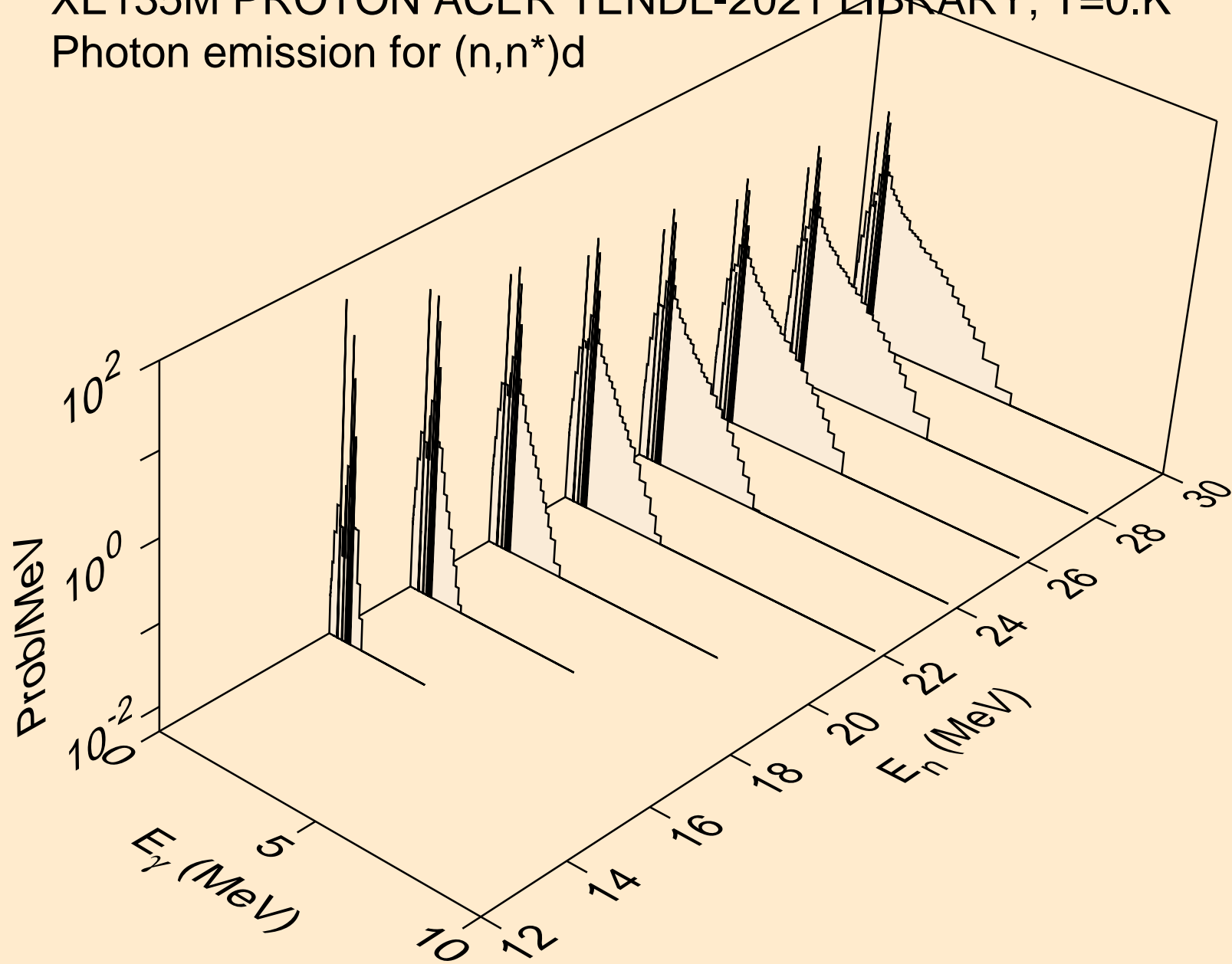

XE135M PROTON ACER TENDL-2021 LIBRARY; T=0.K  
Photon emission for (n,n\*)t

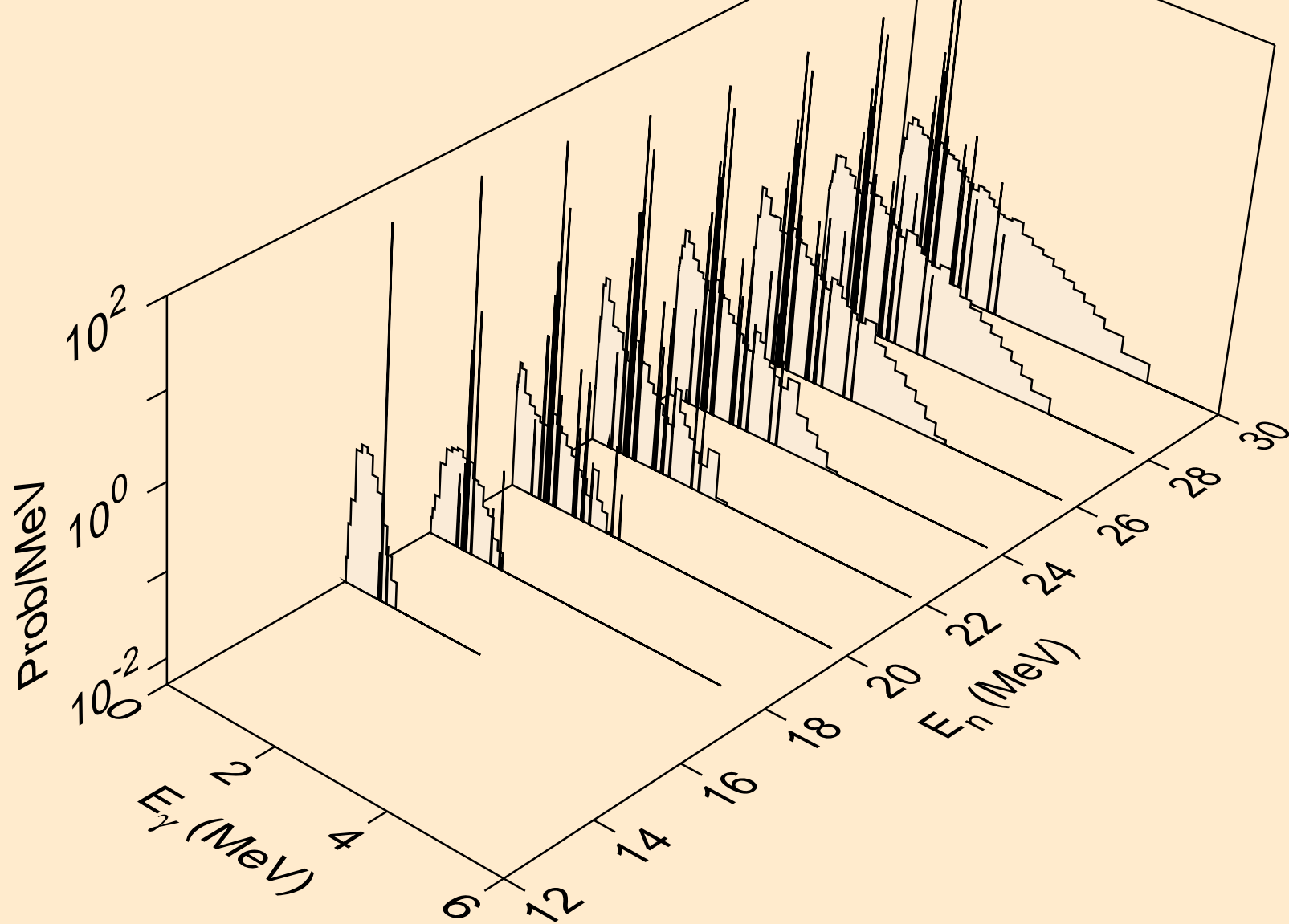

XE135M PROTON ACER TENDL-2021 LIBRARY; T=0.K  
Photon emission for (n,n\*)he3

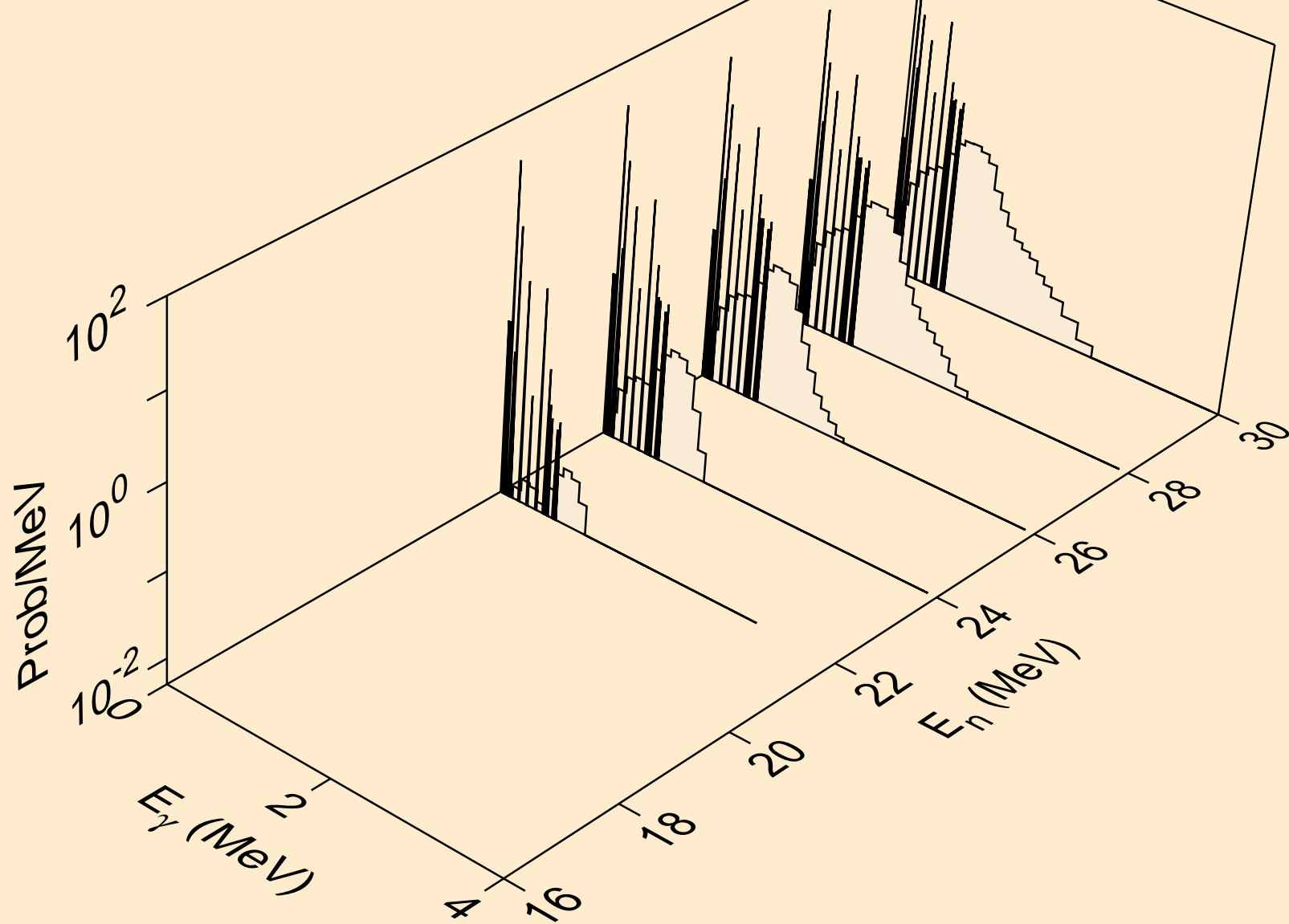

XE135M PROTON ACER TENDL-2021 LIBRARY; T=0.K  
Photon emission for (n,4n)

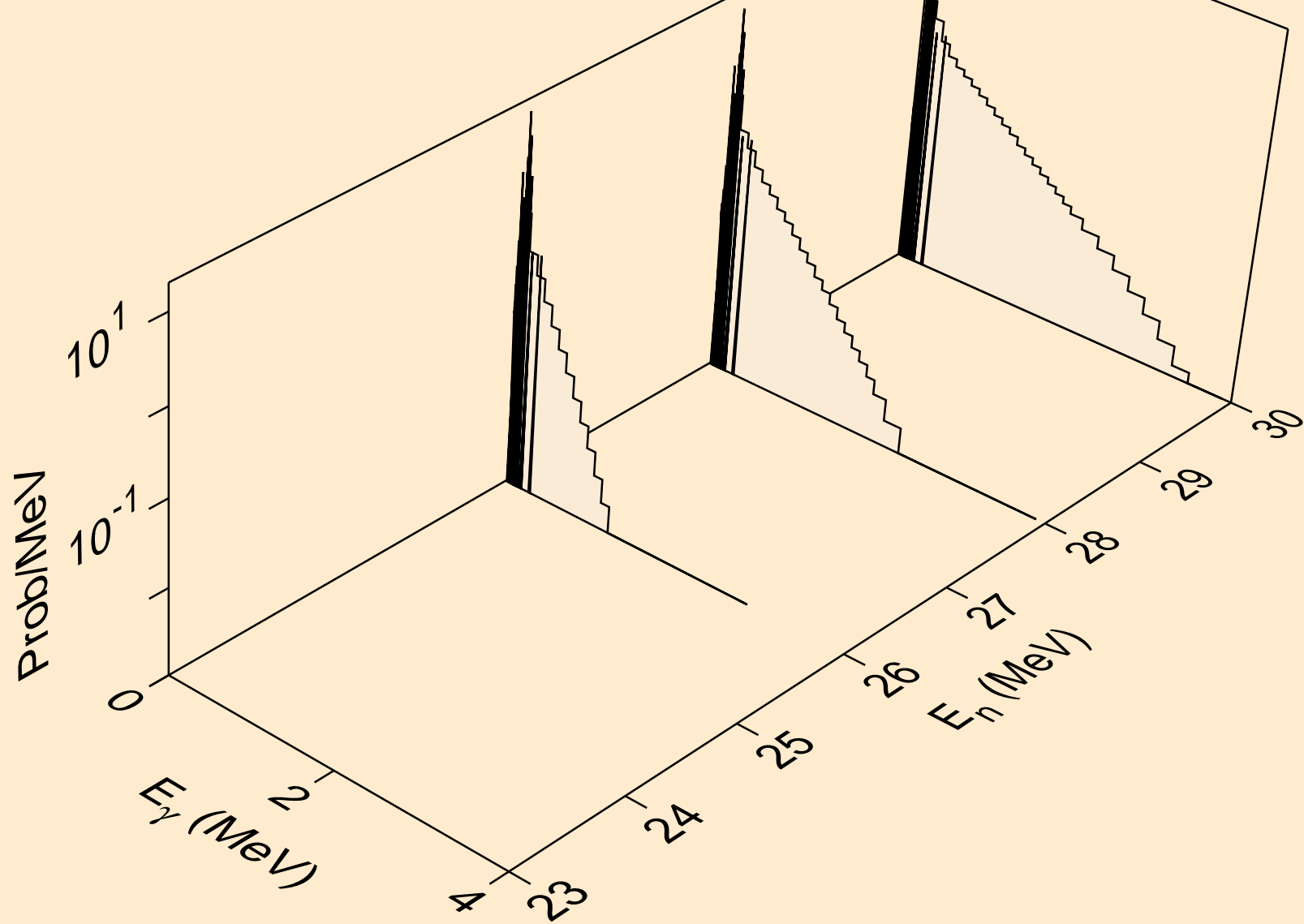

XE135M PROTON ACER TENDL-2021 LIBRARY; T=0.K  
Photon emission for (n,2np)

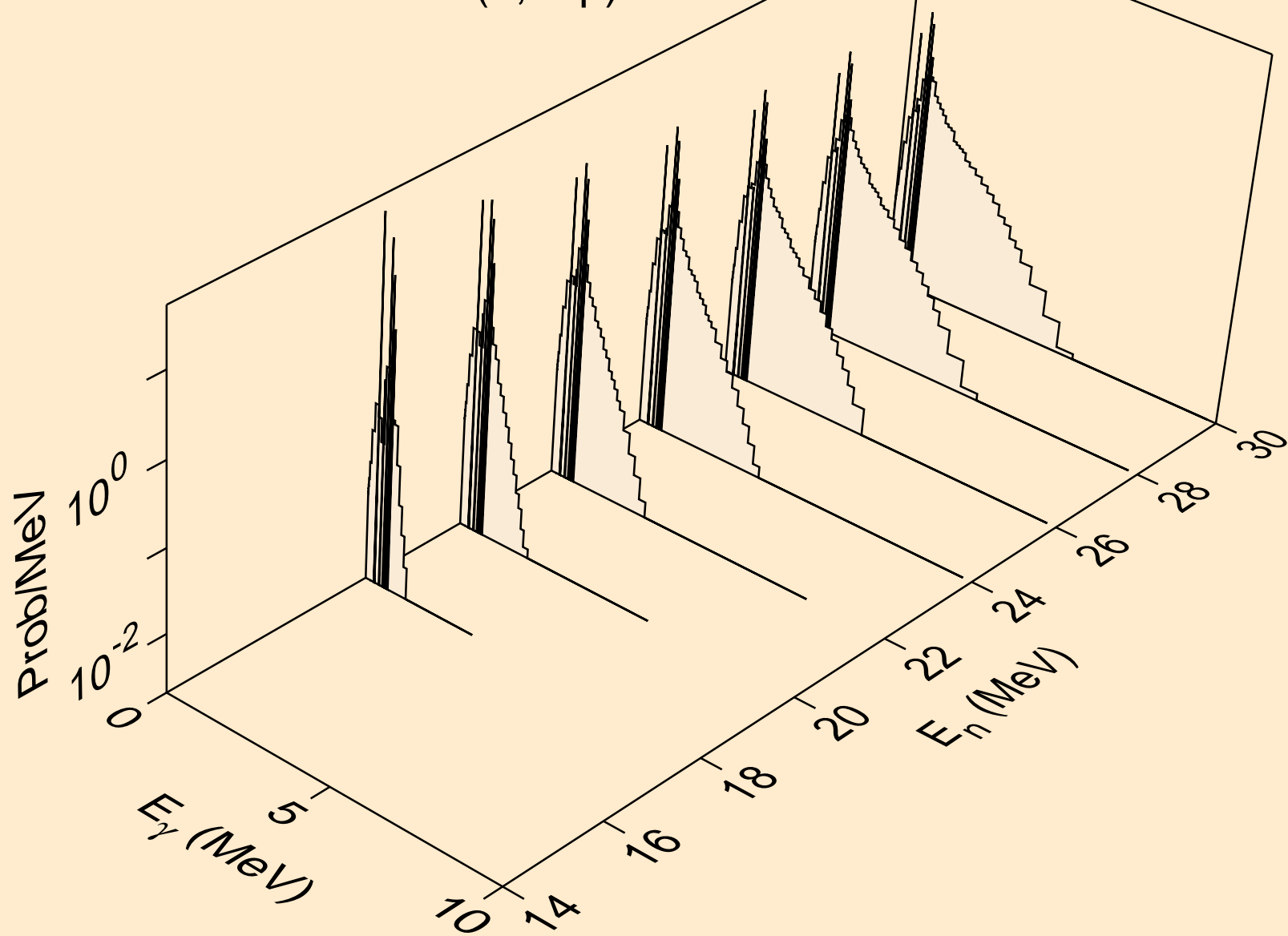

XE135M PROTON ACER TENDL-2021 LIBRARY; T=0.K  
Photon emission for (n,3np)

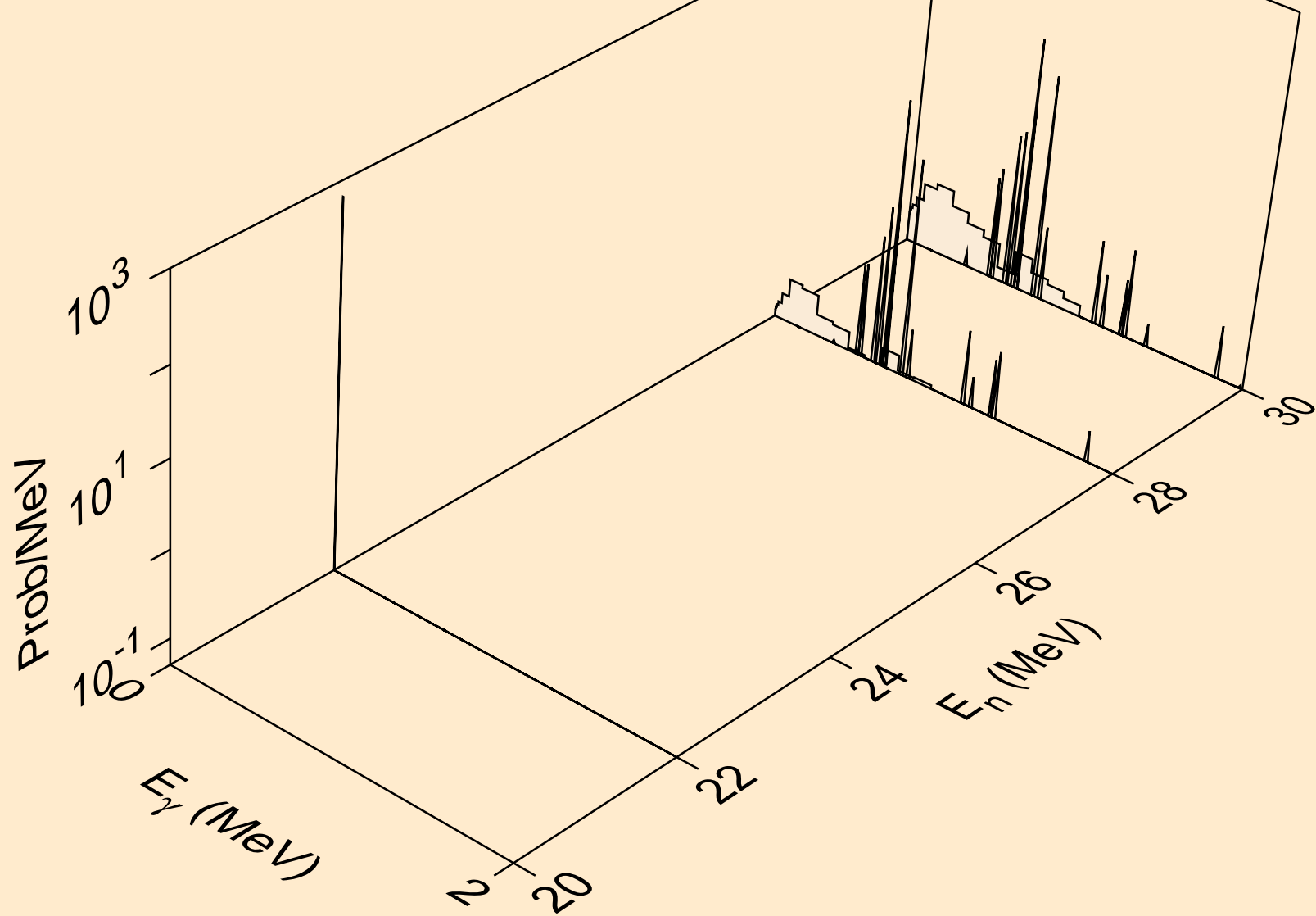

XE135M PROTON ACER TENDL-2021 LIBRARY; T=0.K  
Photon emission for (n,2np)

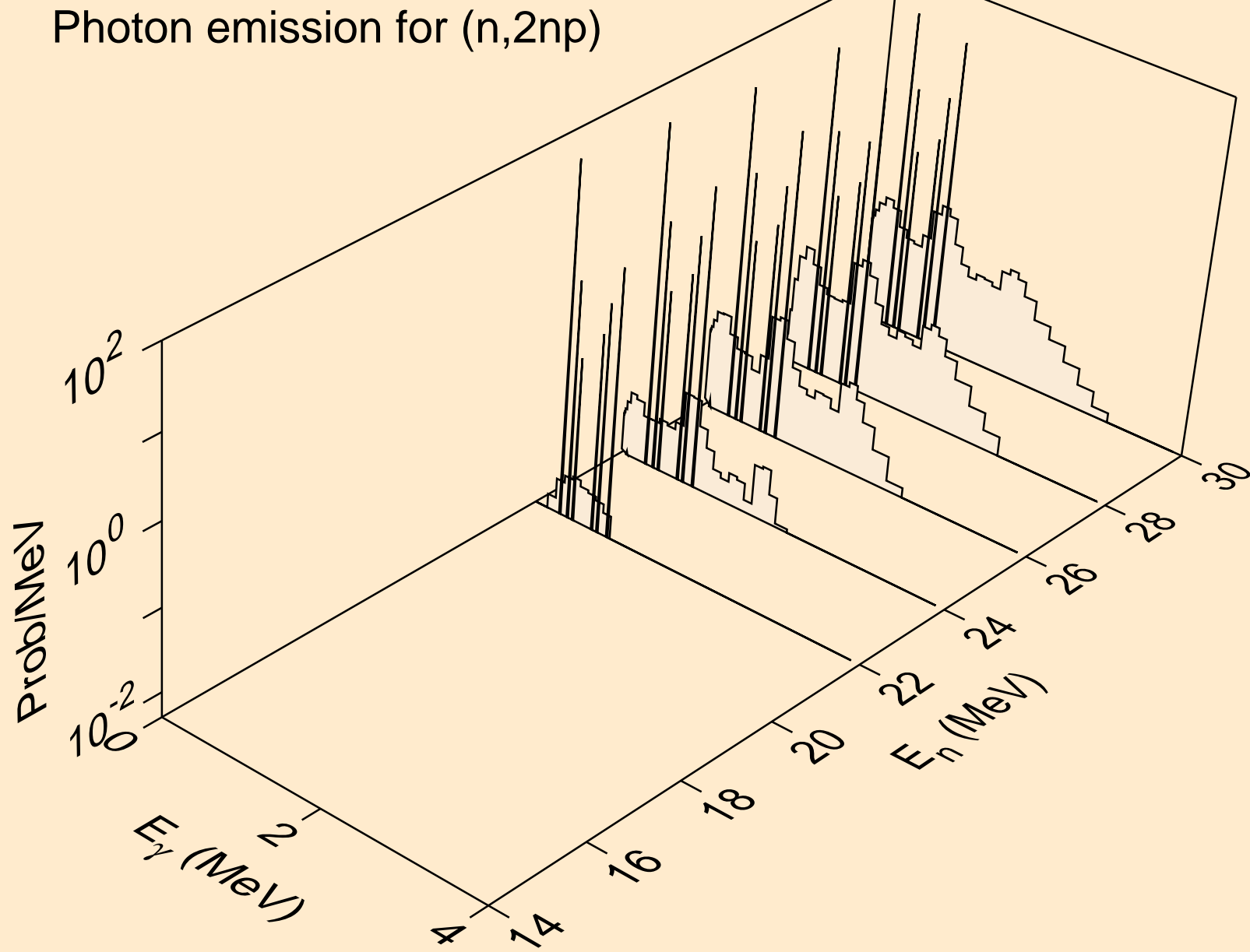

XE135M PROTON ACER TENDL-2021 LIBRARY; T=0.K  
Photon emission for (n,npa)

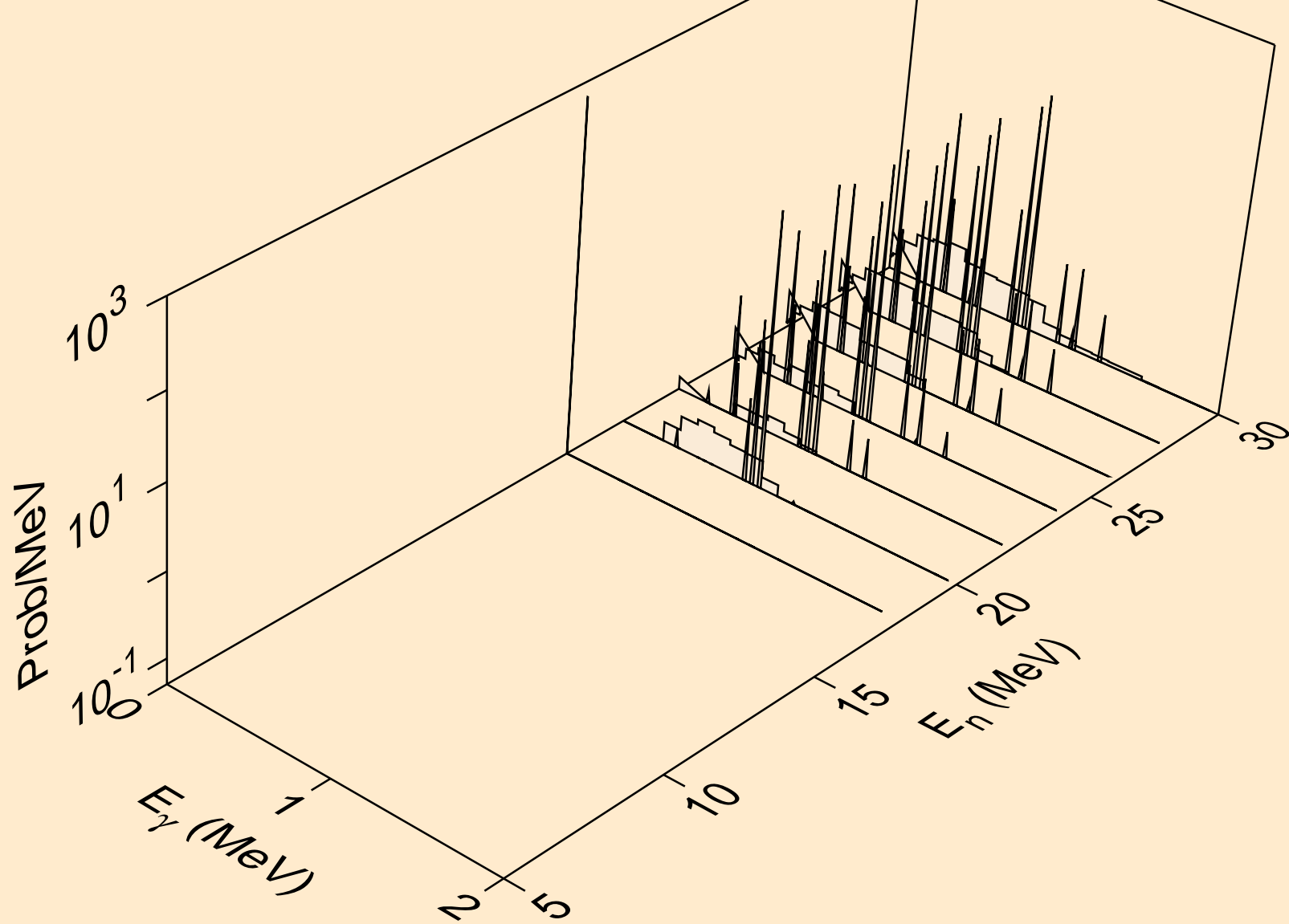

XE135M PROTON ACER TENDL-2021 LIBRARY; T=0.K  
Photon emission for (n,gma)

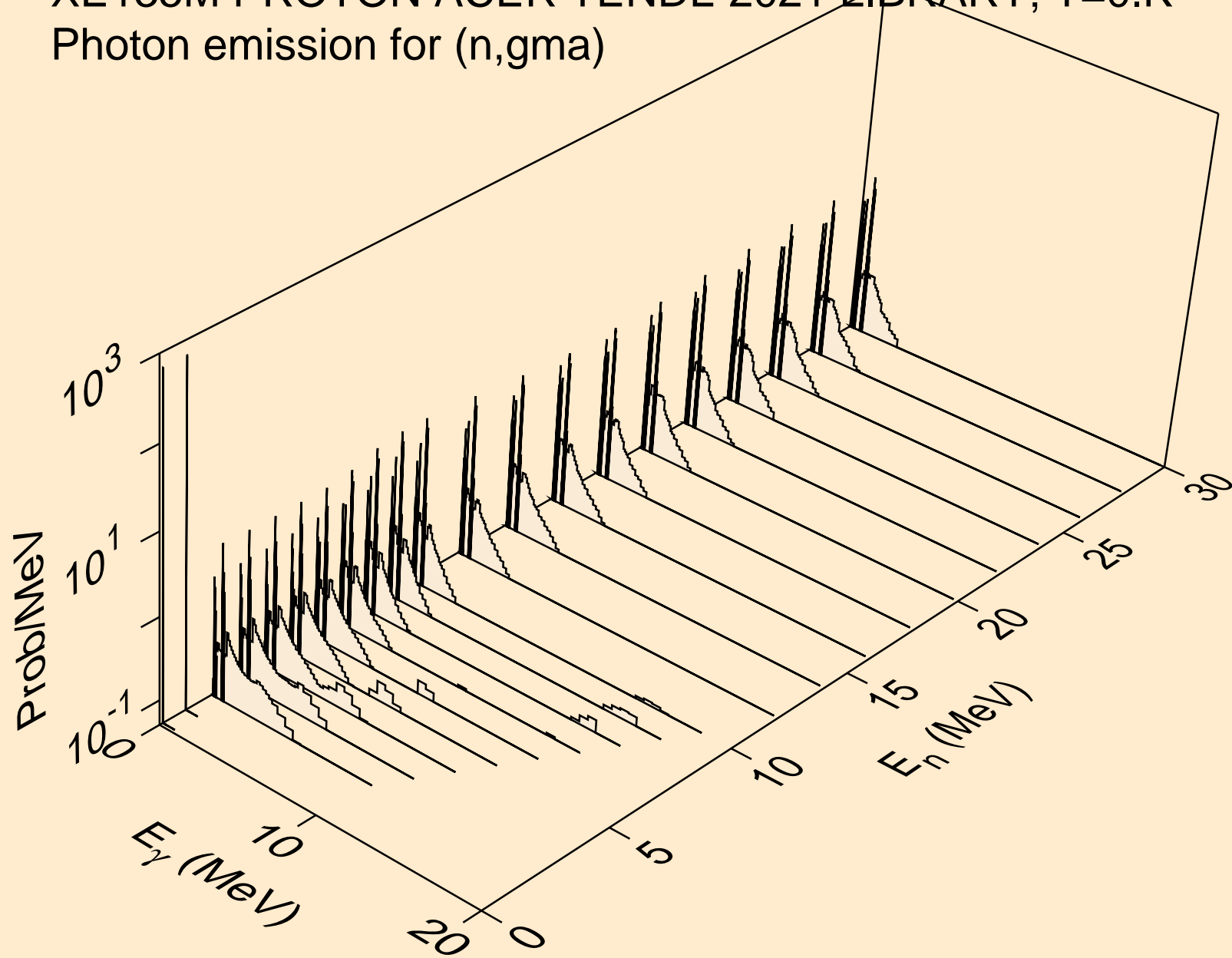

XE135M PROTON ACER TENDL-2021 LIBRARY; T=0.K  
Photon emission for inelastic

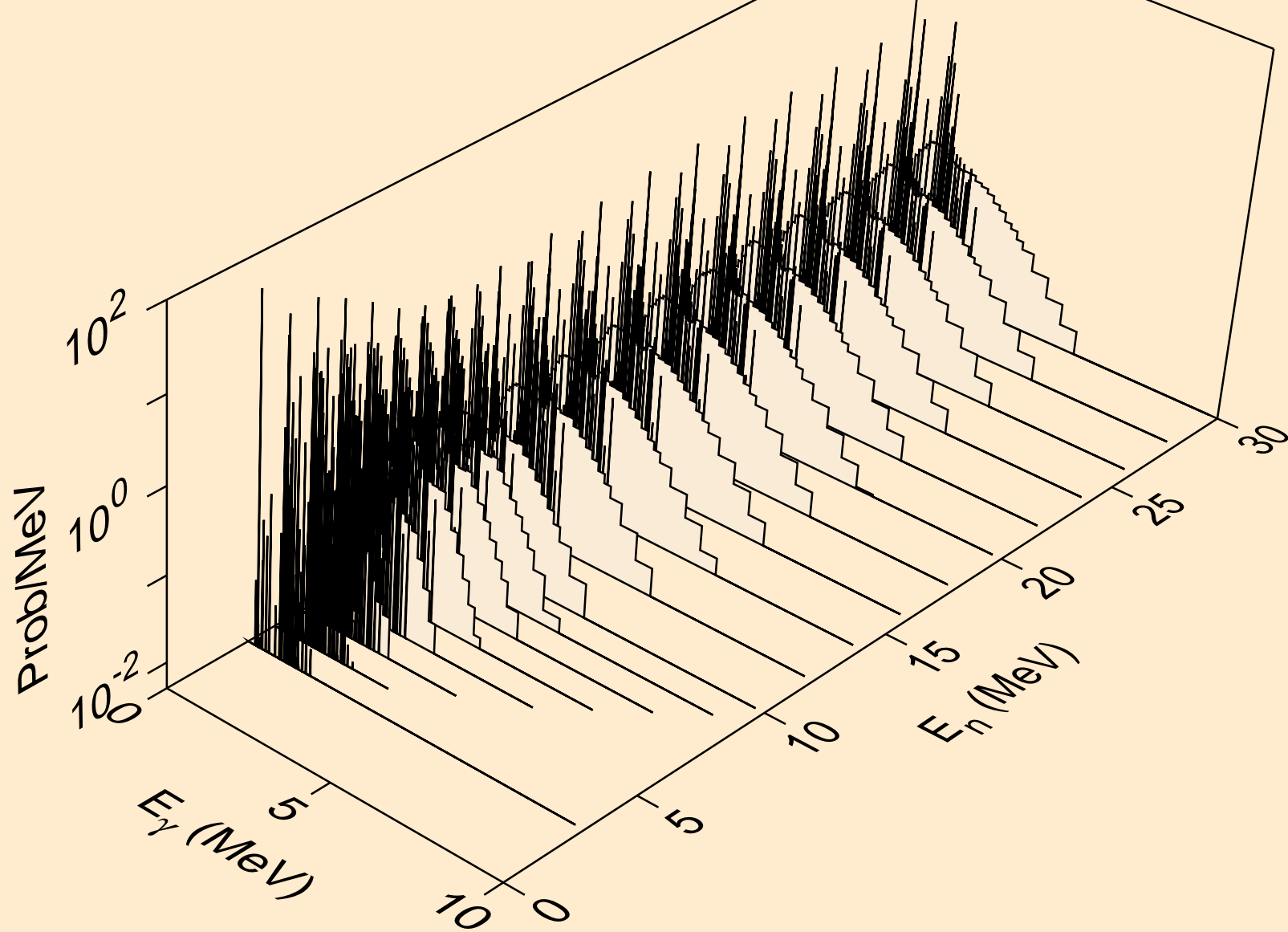

XE135M PROTON ACER TENDL-2021 LIBRARY; T=0.K  
Photon emission for (n,d)

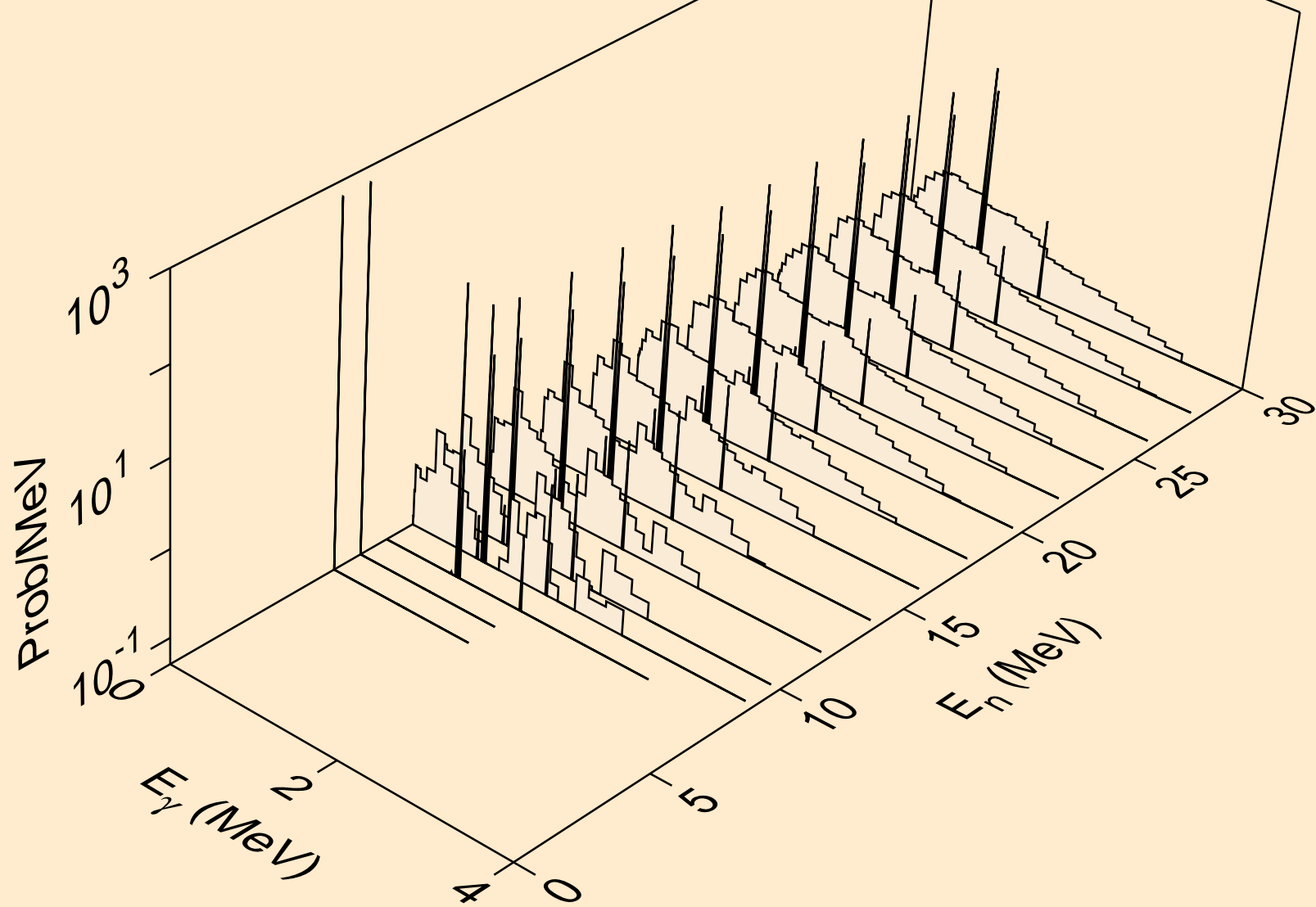

XE135M PROTON ACER TENDL-2021 LIBRARY; T=0.K  
Photon emission for (n,t)

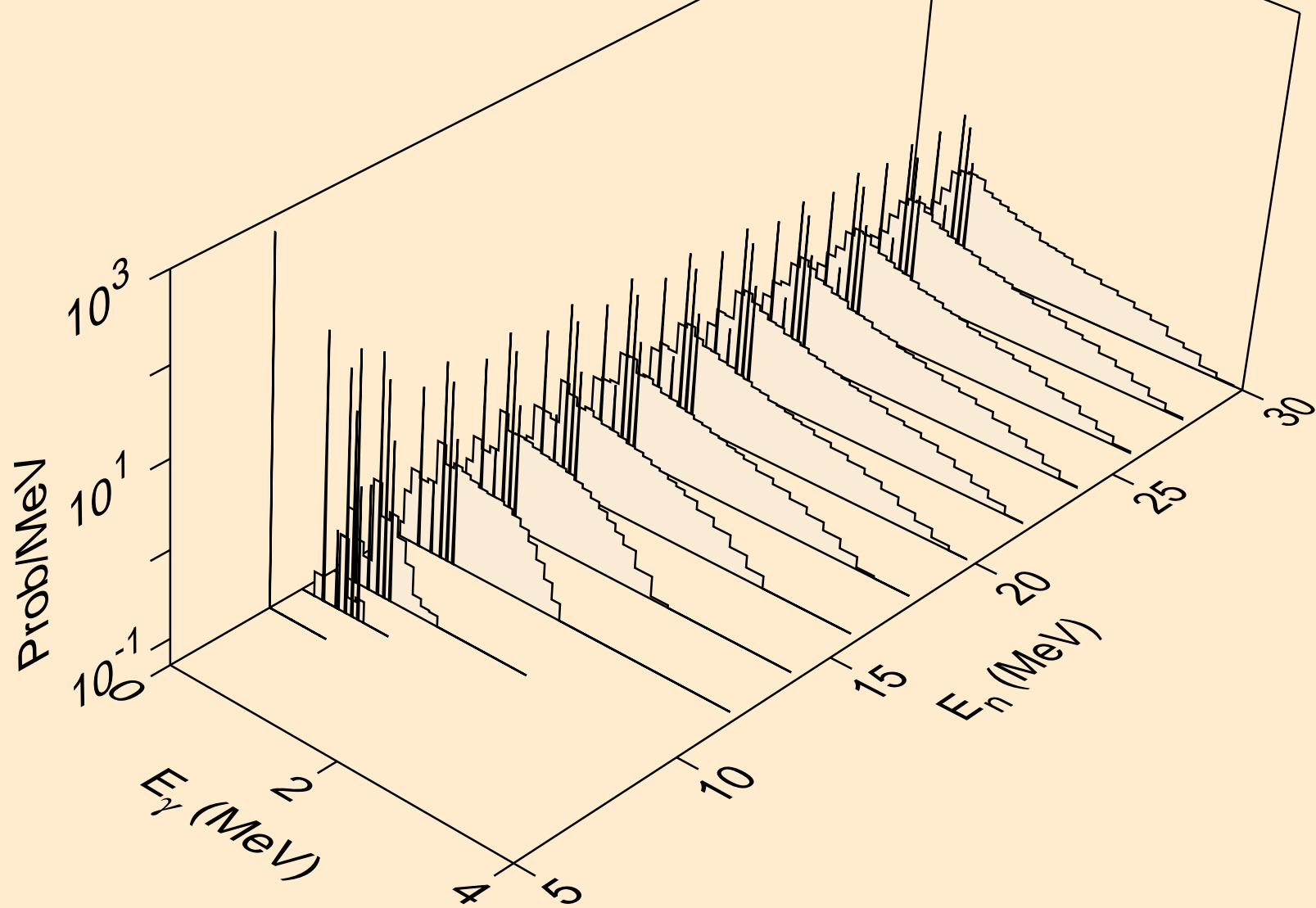

XE135M PROTON ACER TENDL-2021 LIBRARY; T=0.K  
Photon emission for (n,he3)

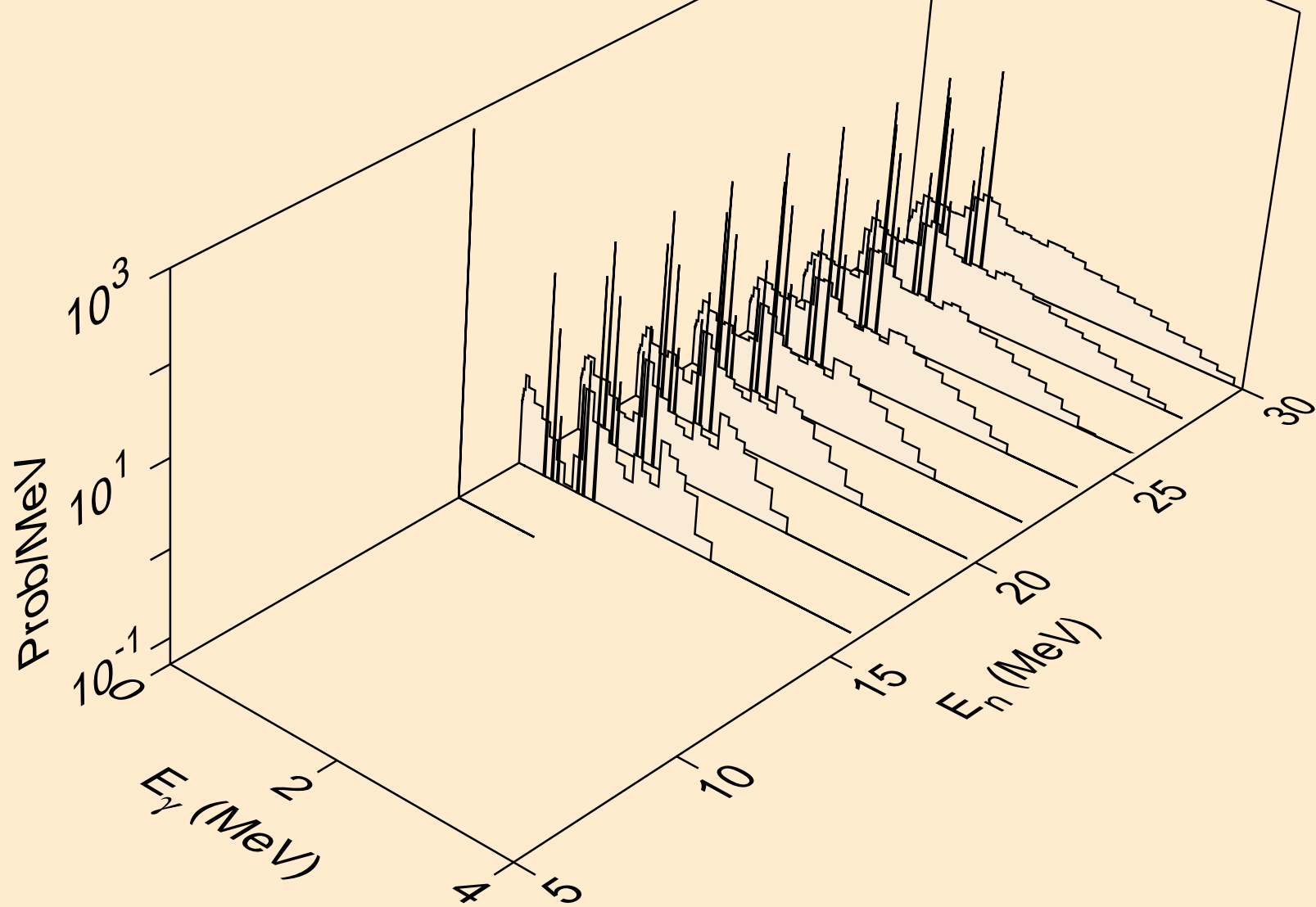

XE135M PROTON ACER TENDL-2021 LIBRARY; T=0.K  
Photon emission for (n,a)

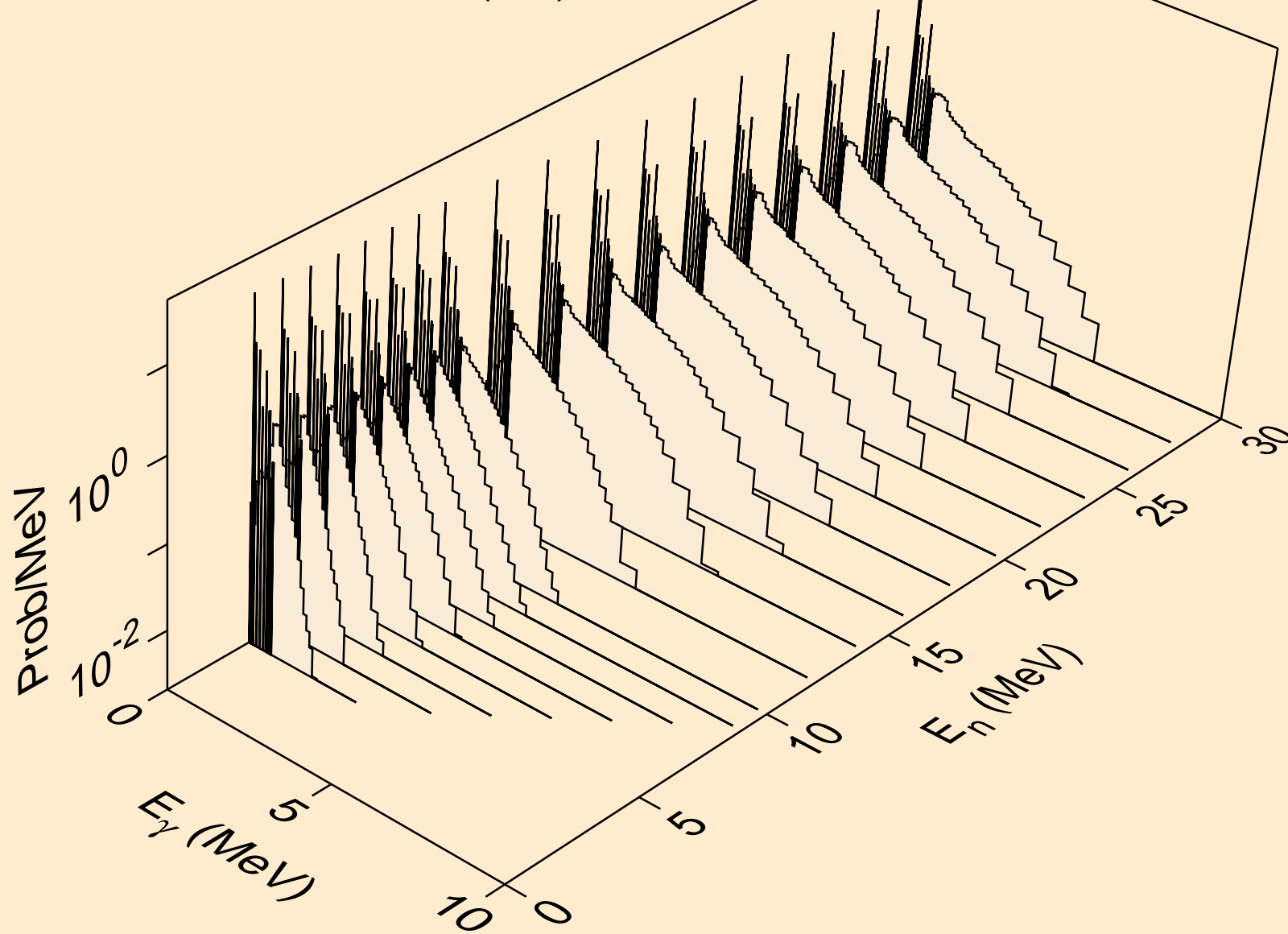

XE135M PROTON ACER TENDL-2021 LIBRARY; T=0.K  
Photon emission for (n,2a)

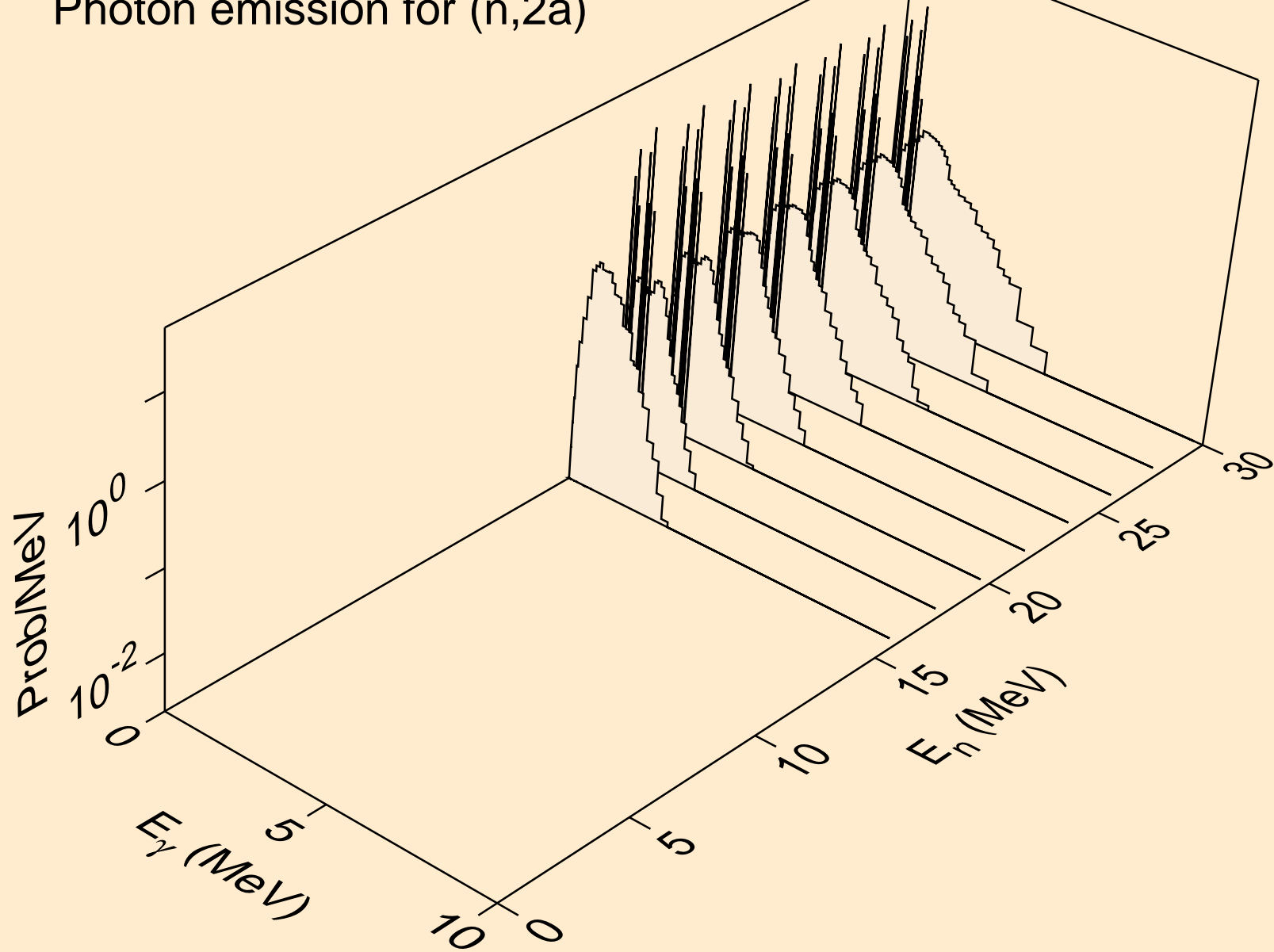

XE135M PROTON ACER TENDL-2021 LIBRARY; T=0.K  
Photon emission for (n,2p)

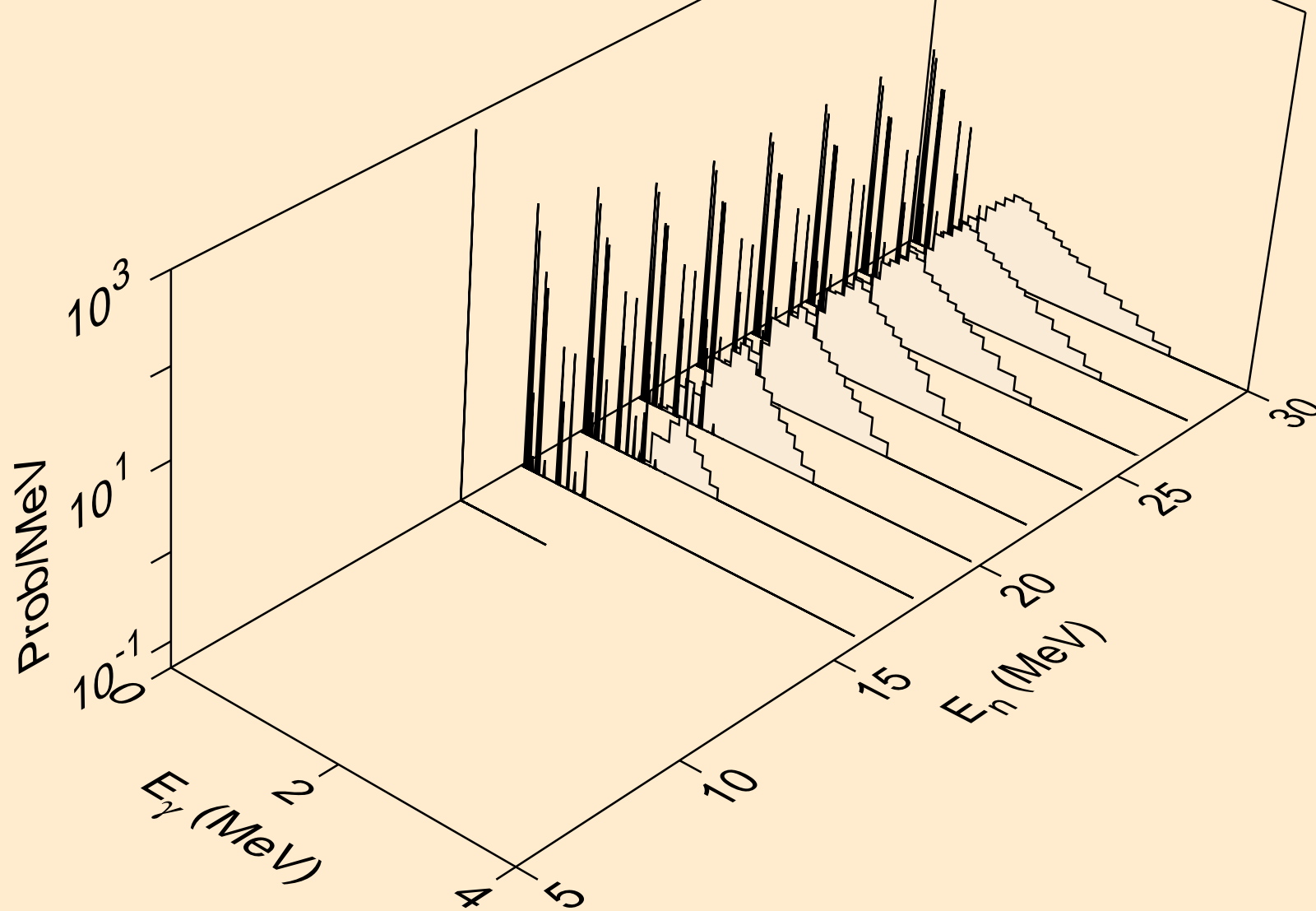

XE135M PROTON ACER TENDL-2021 LIBRARY; T=0.K  
Photon emission for (n,pa)

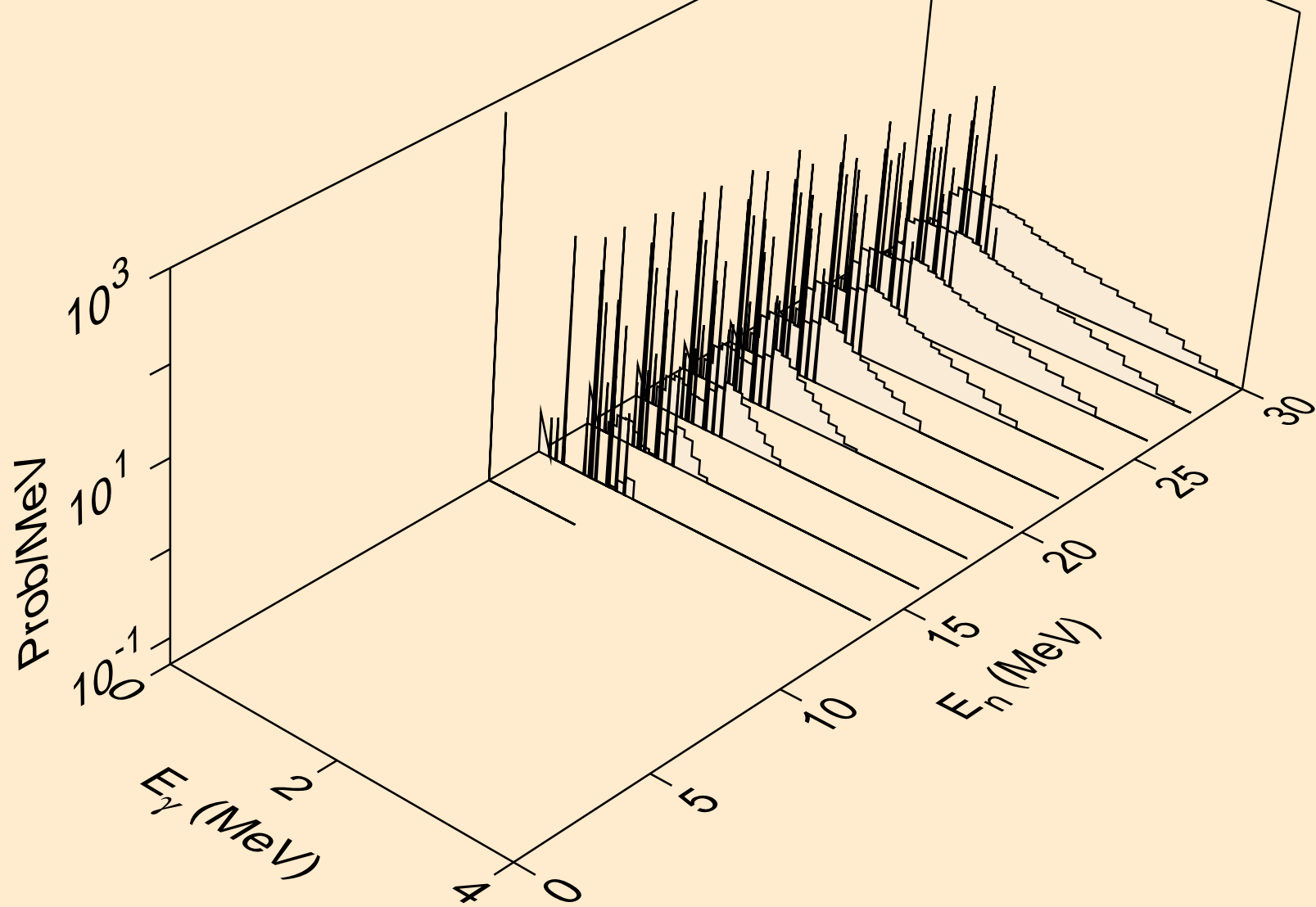

XE135M PROTON ACER TENDL-2021 LIBRARY; T=0.K  
Photon emission for (n,pd)

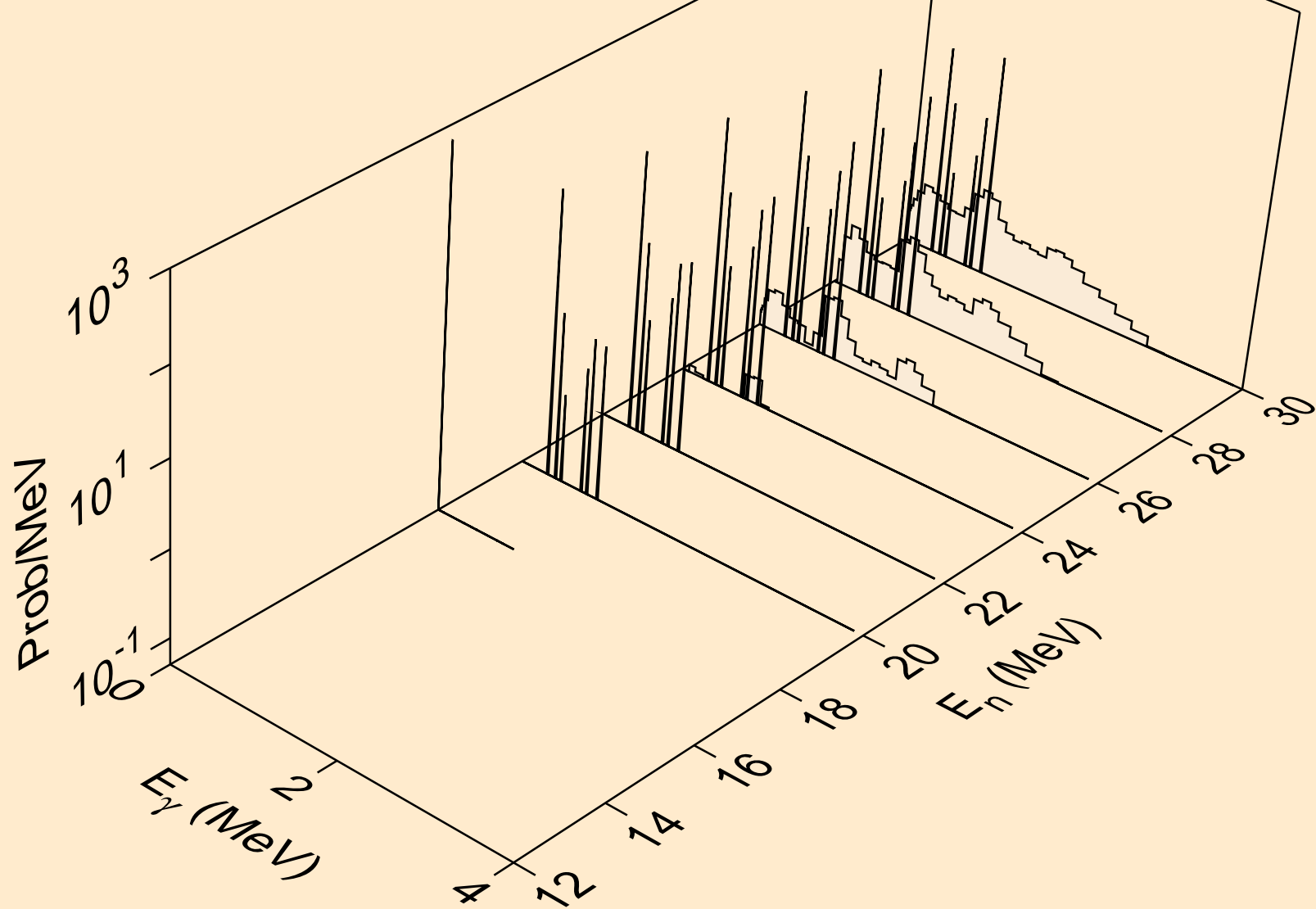

XE135M PROTON ACER TENDL-2021 LIBRARY; T=0.K  
Photon emission for (n,pt)

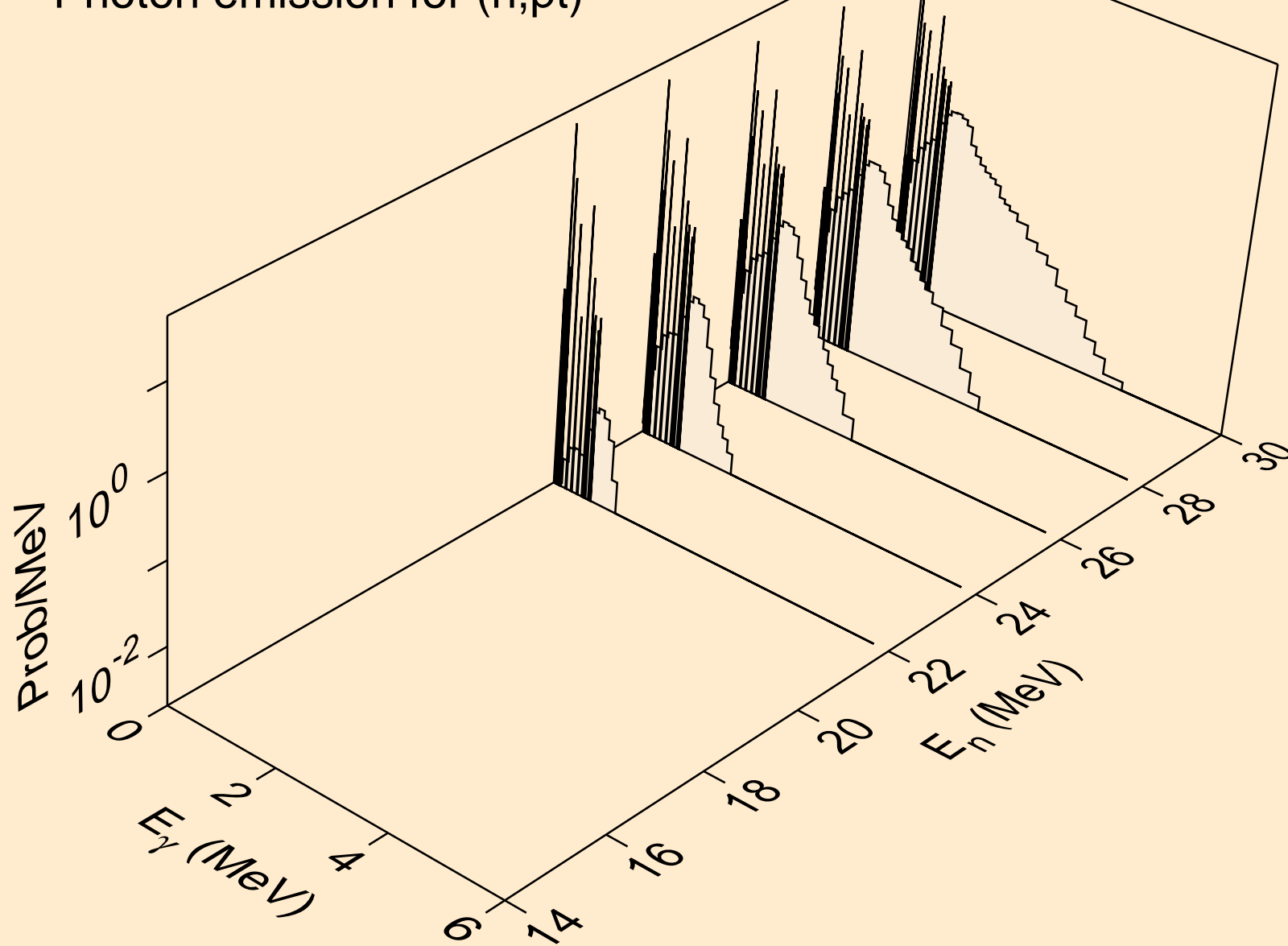

XE135M PROTON ACER TENDL-2021 LIBRARY; T=0.K  
Photon emission for (n,da)

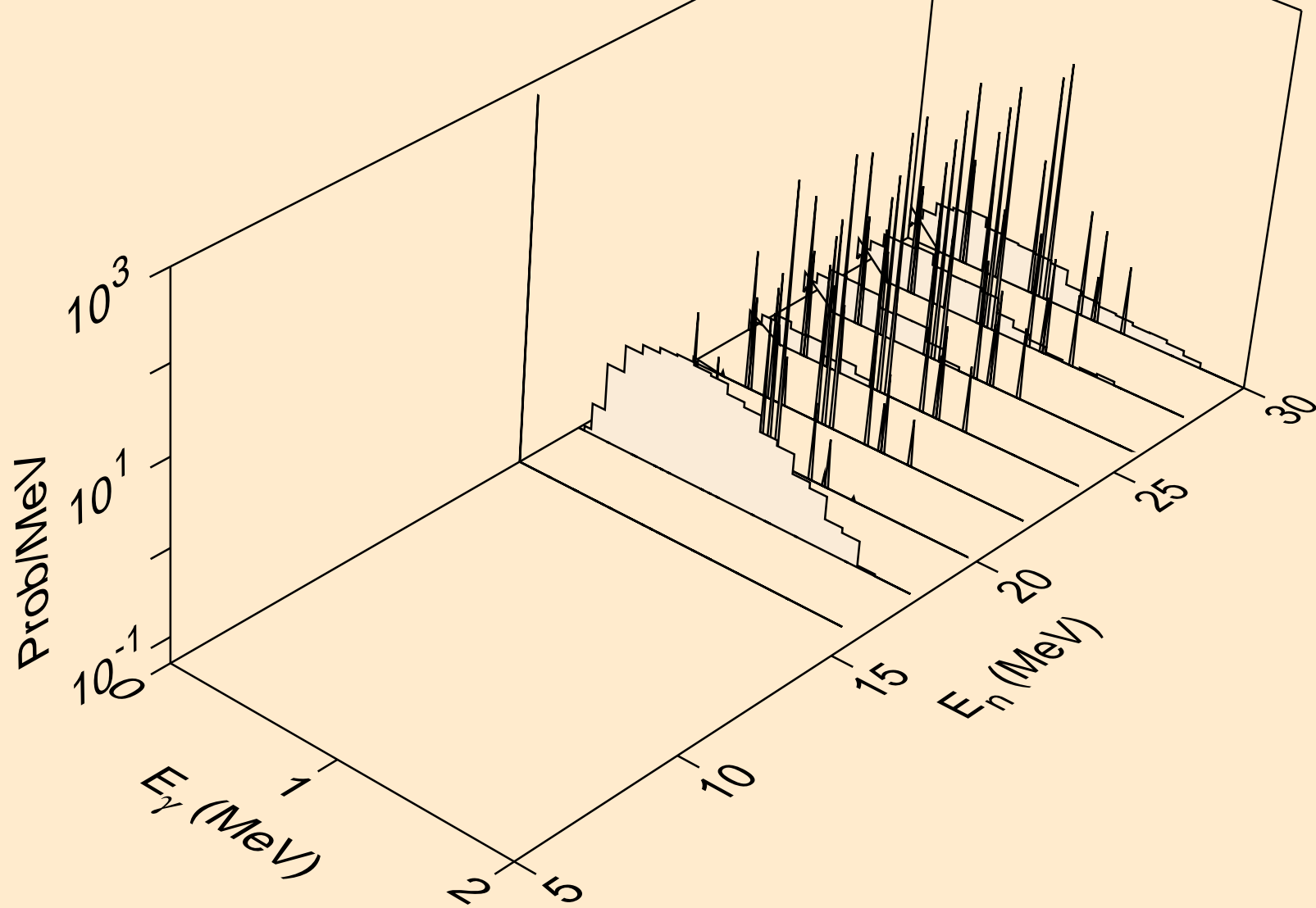

XE135M PROTON ACER TENDL-2021 LIBRARY; T=0.K  
Particle heating contributions

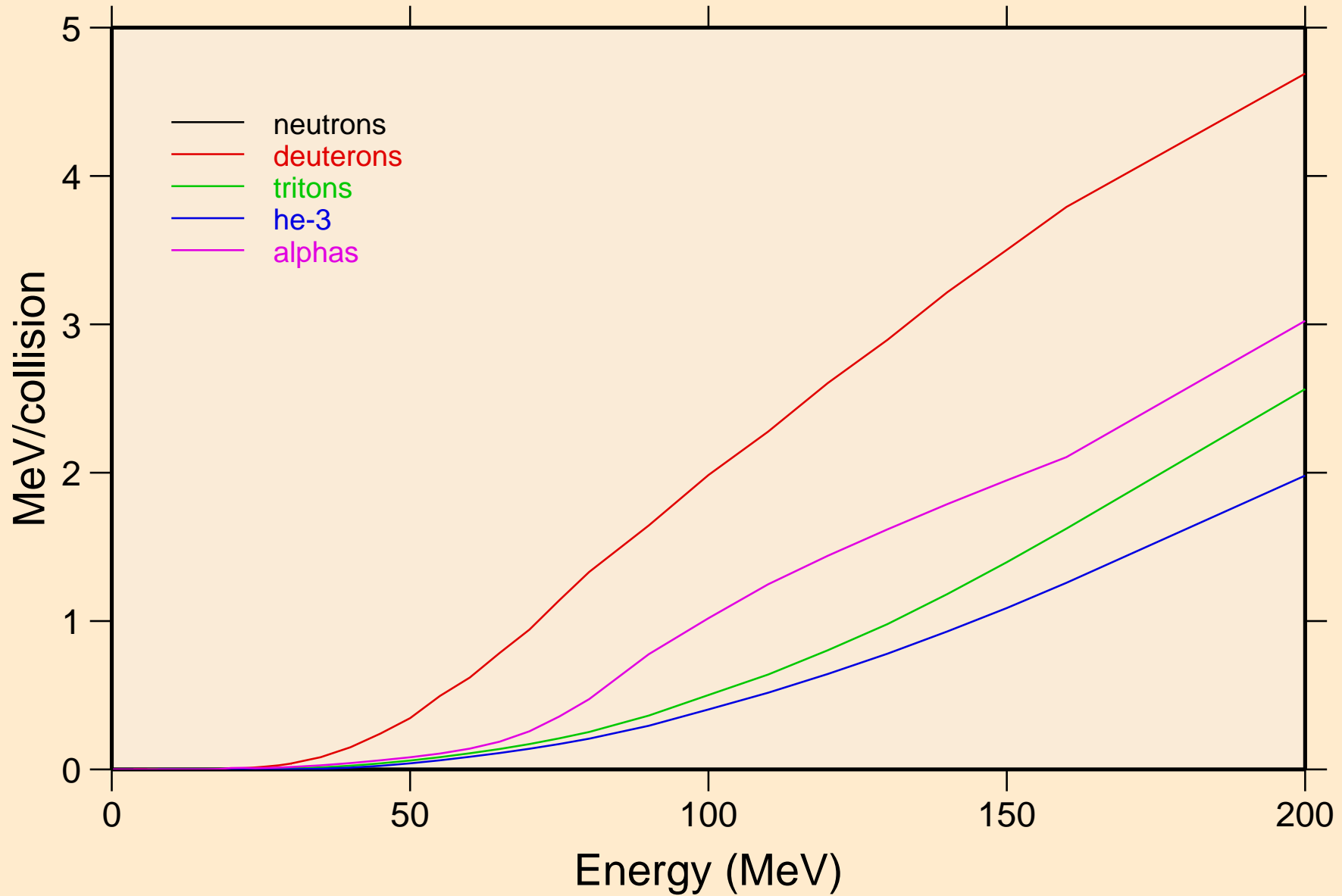

XE135M PROTON ACER TENDL-2021 LIBRARY; T=0.K  
Recoil Heating

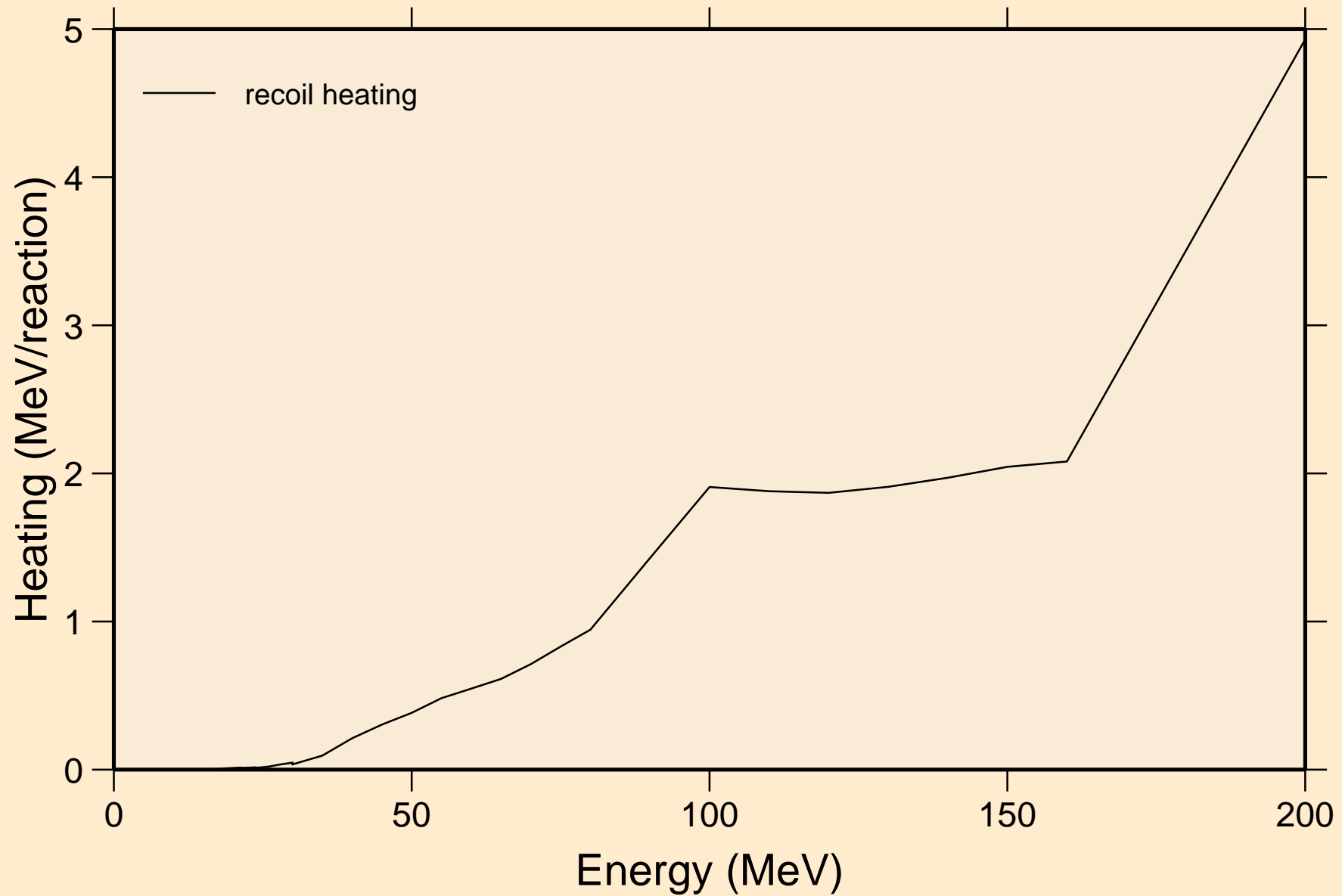

XE135M PROTON ACER TENDL-2021 LIBRARY; T=0.K  
Particle production cross sections

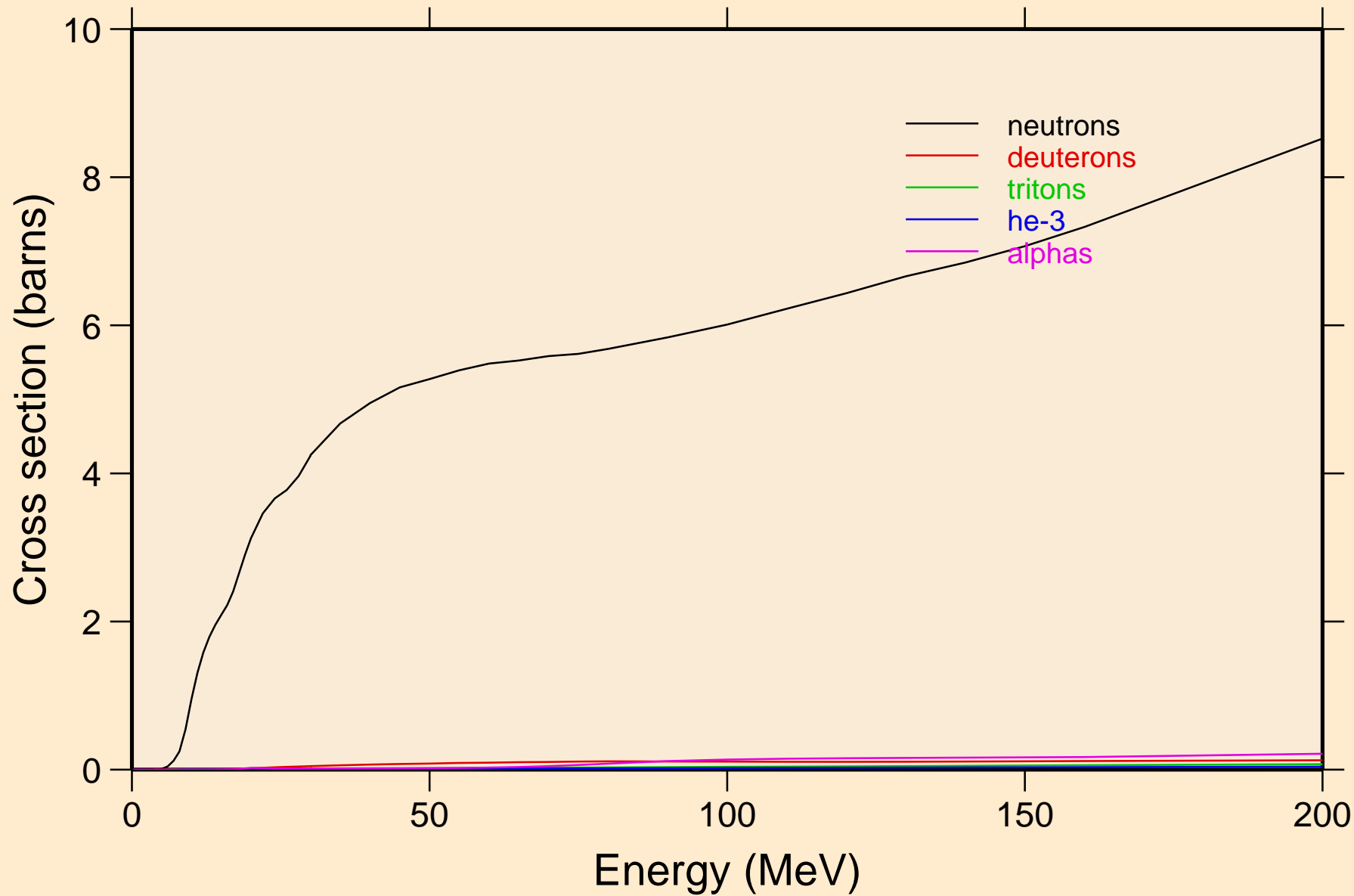

XE135M PROTON ACER TENDL-2021 LIBRARY; T=0.K  
neutrons from (p,n)

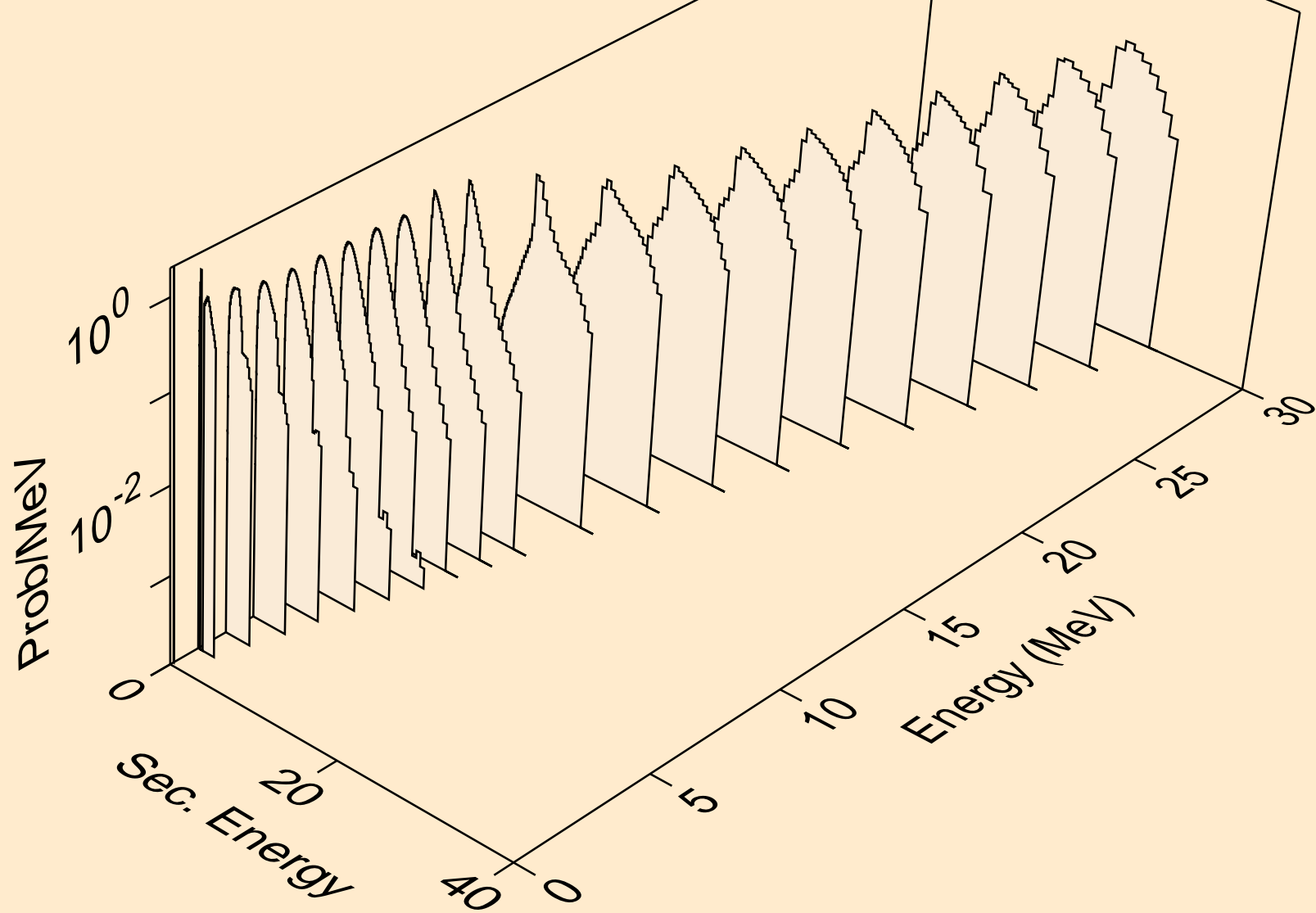

XE135M PROTON ACER TENDL-2021 LIBRARY; T=0.K  
neutrons from (p,x)

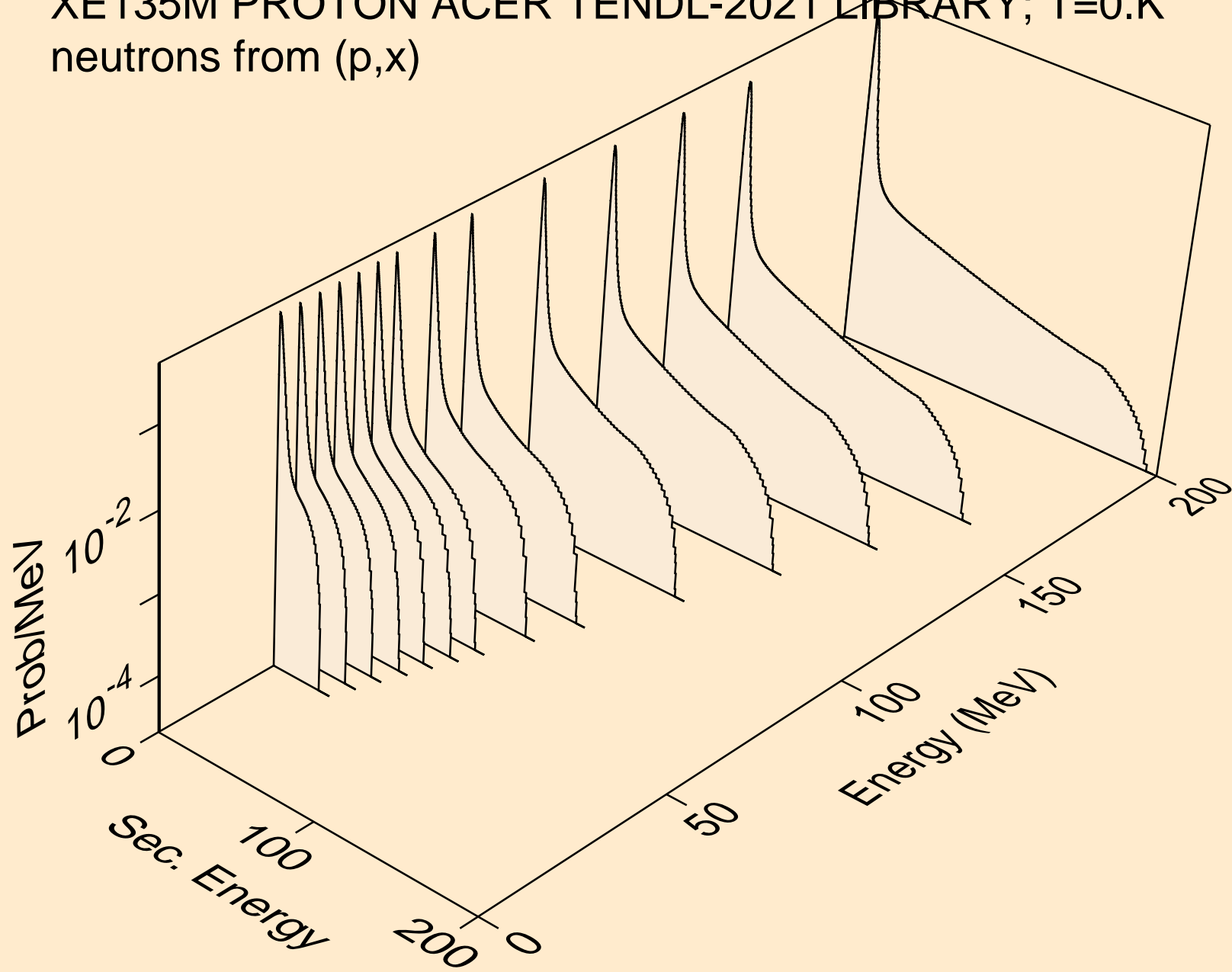

XE135M PROTON ACER TENDL-2021 LIBRARY; T=0.K  
neutrons from (p,2nd)

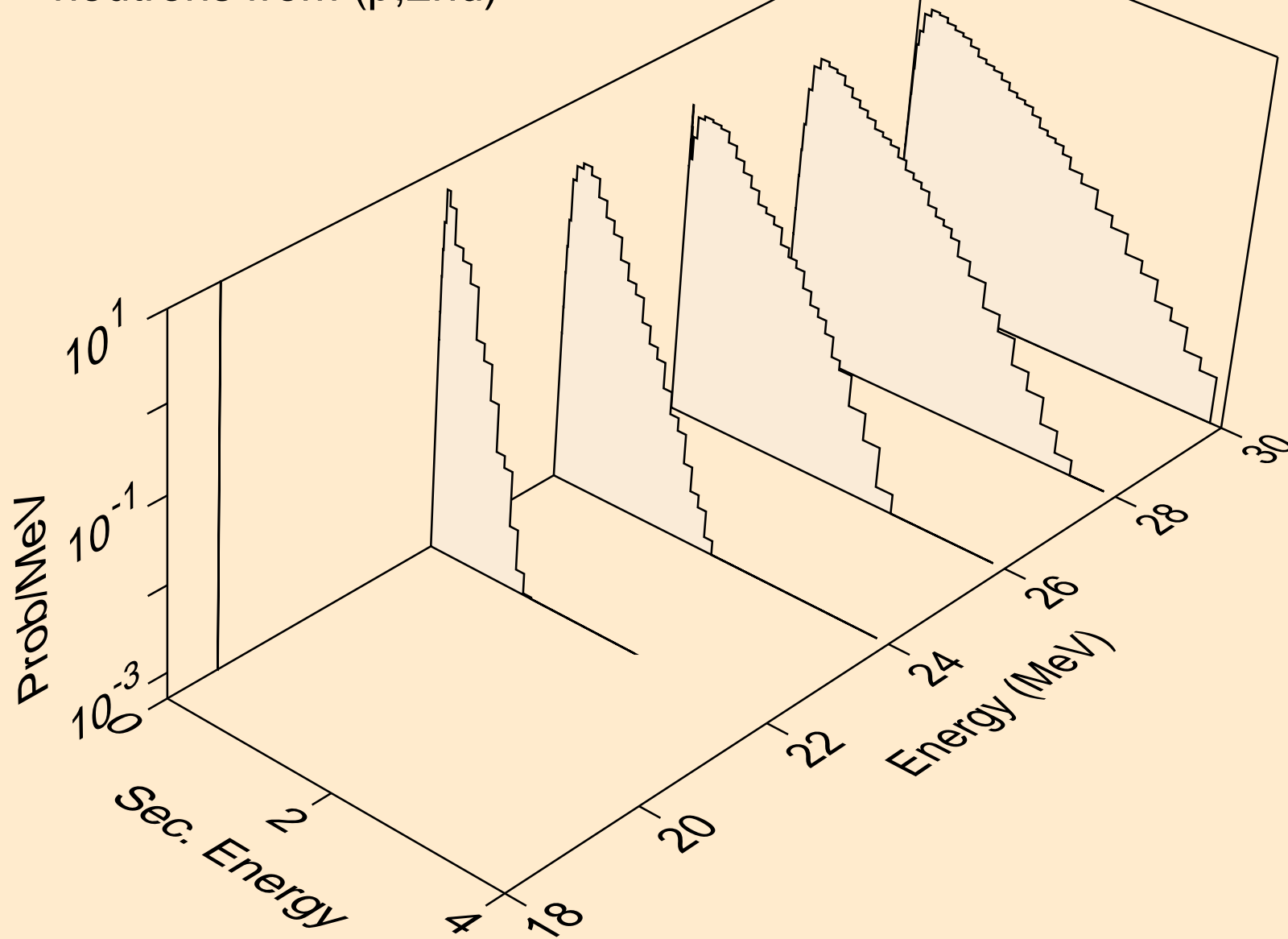

XE135M PROTON ACER TENDL-2021 LIBRARY; T=0.K  
neutrons from (p,2n)

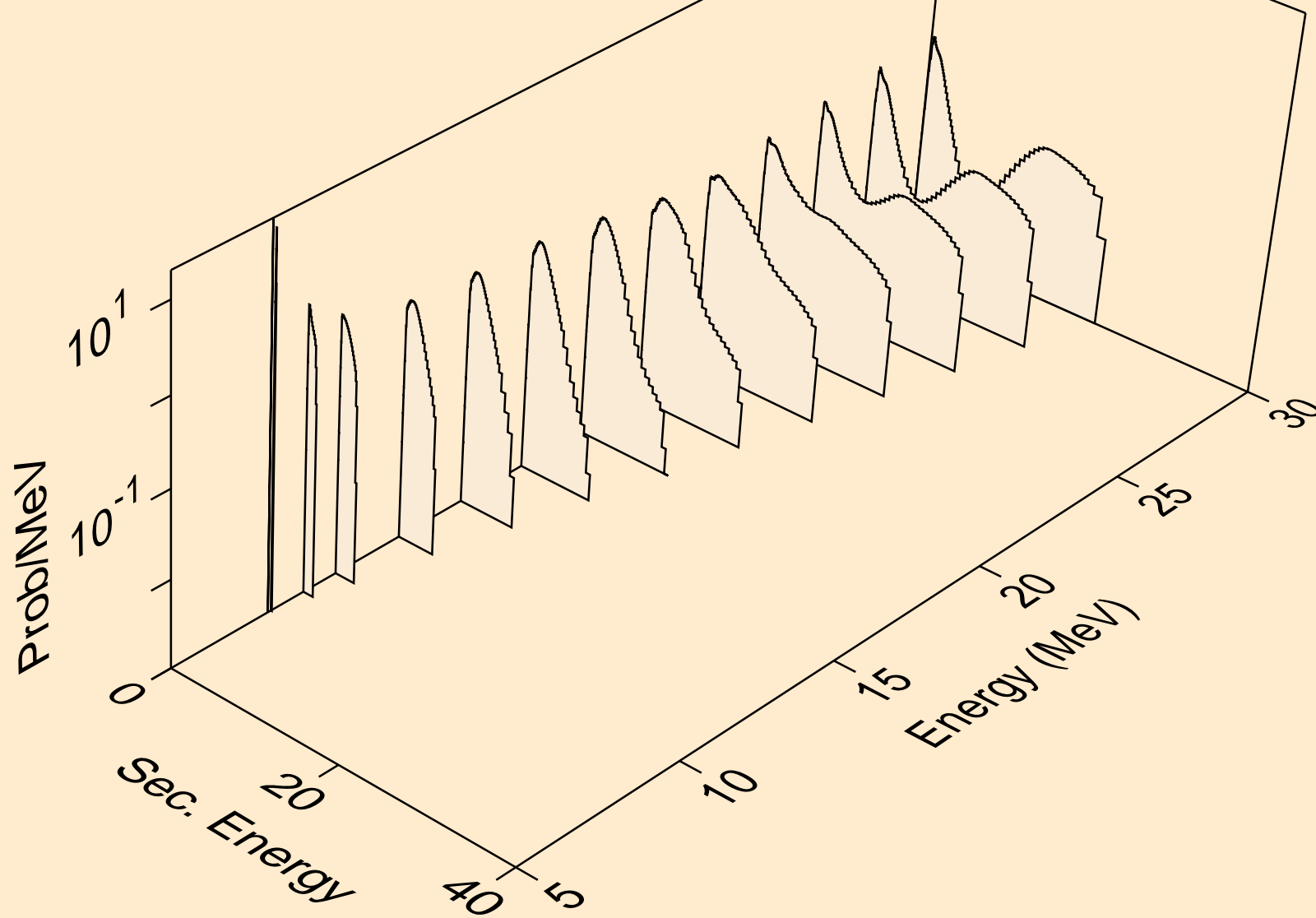

XE135M PROTON ACER TENDL-2021 LIBRARY; T=0.K  
neutrons from (p,3n)

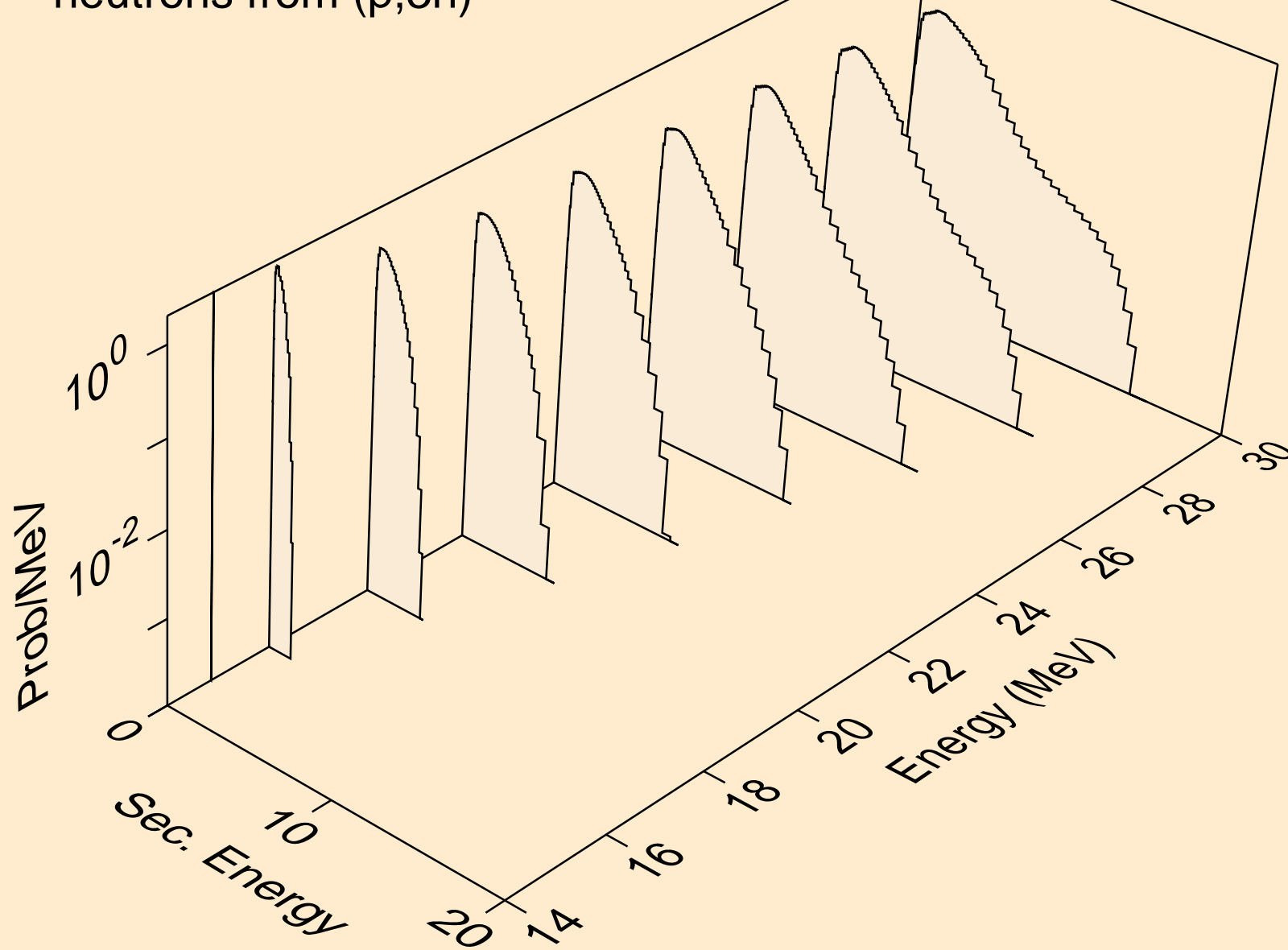

XE135M PROTON ACER TENDL-2021 LIBRARY; T=0.K  
neutrons from (p,n\*)a

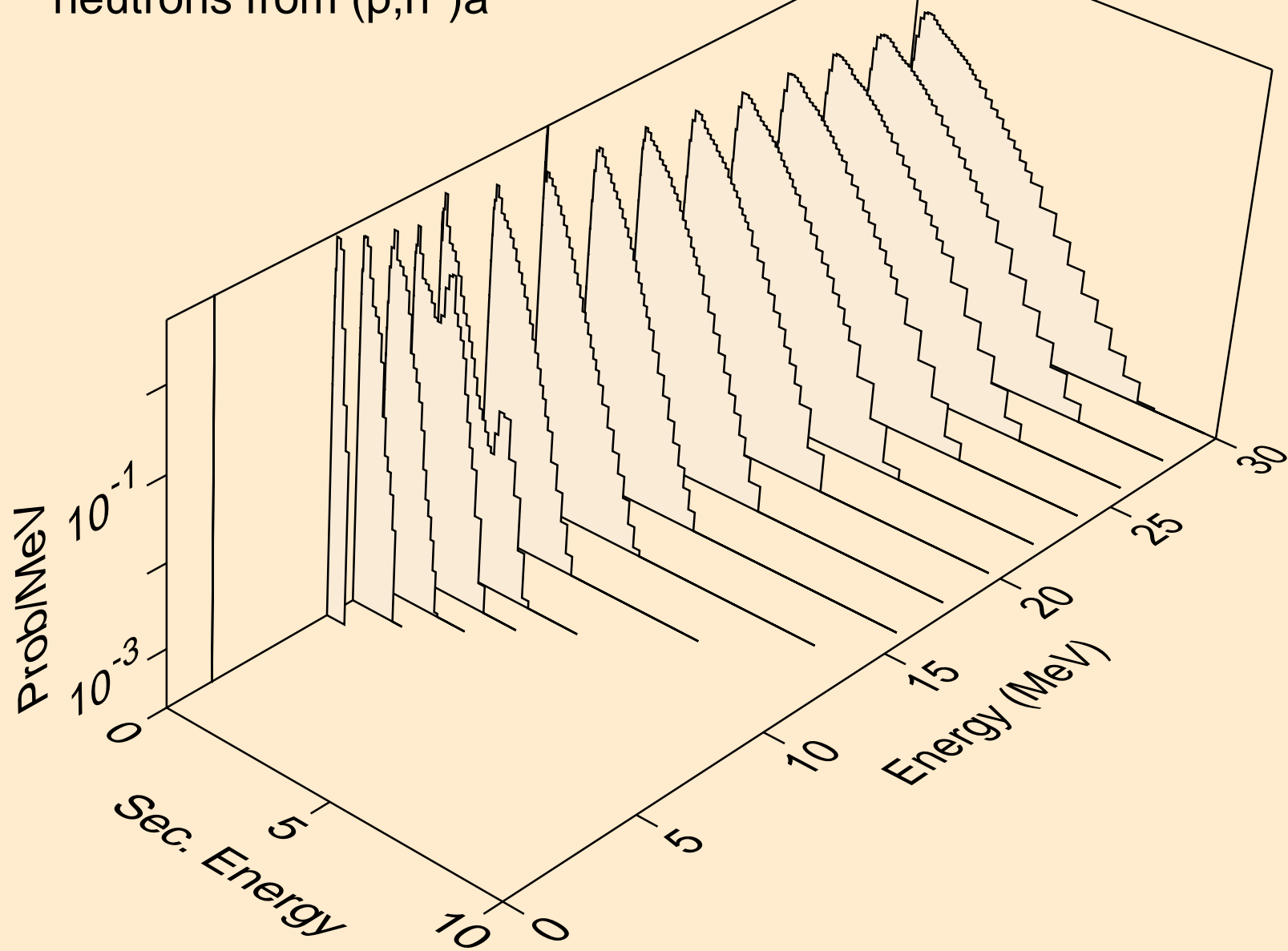

XE135M PROTON ACER TENDL-2021 LIBRARY; T=0.K  
neutrons from (p,2n)a

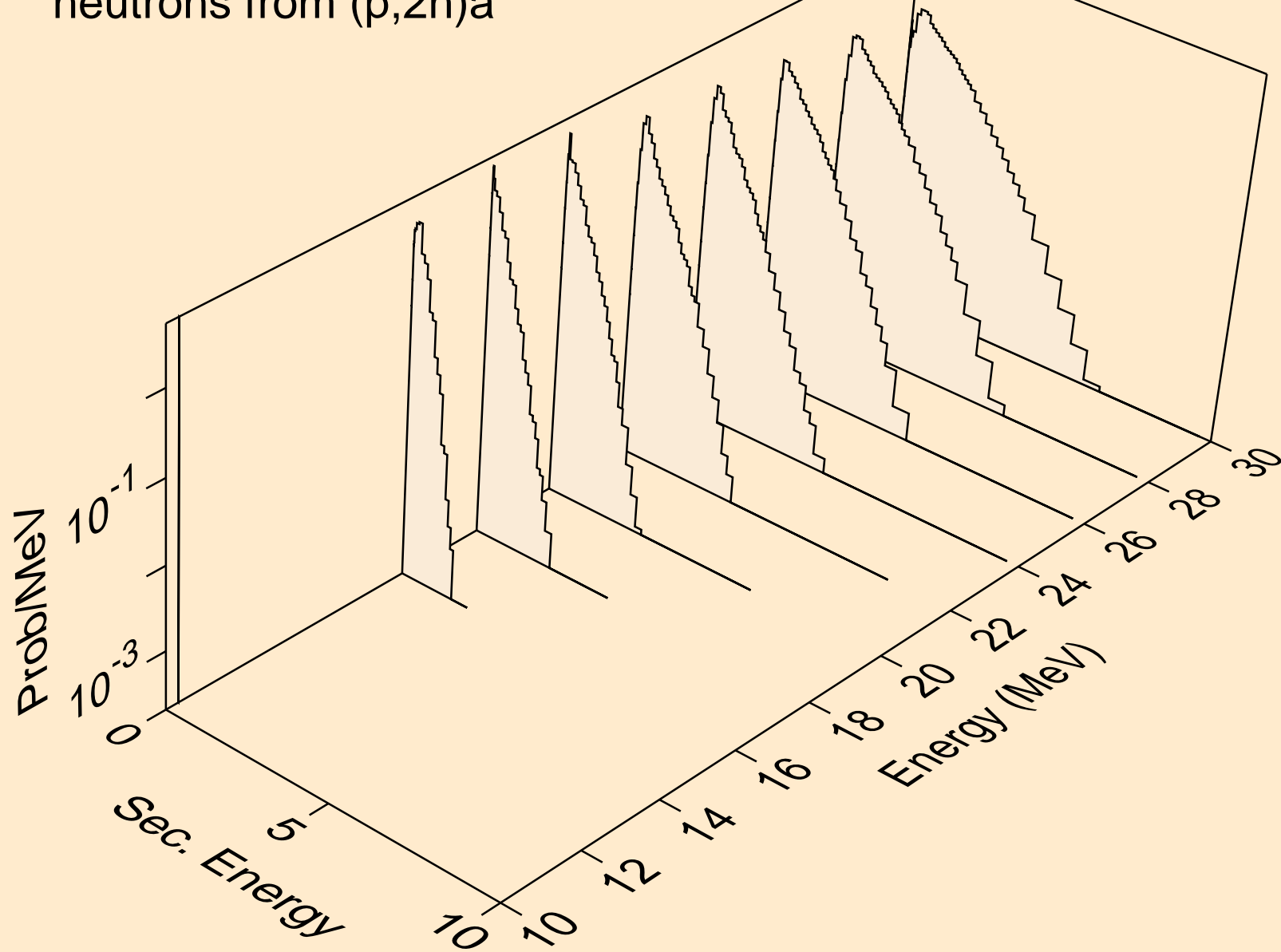

XE135M PROTON ACER TENDL-2021 LIBRARY; T=0.K  
neutrons from (p,3n)a

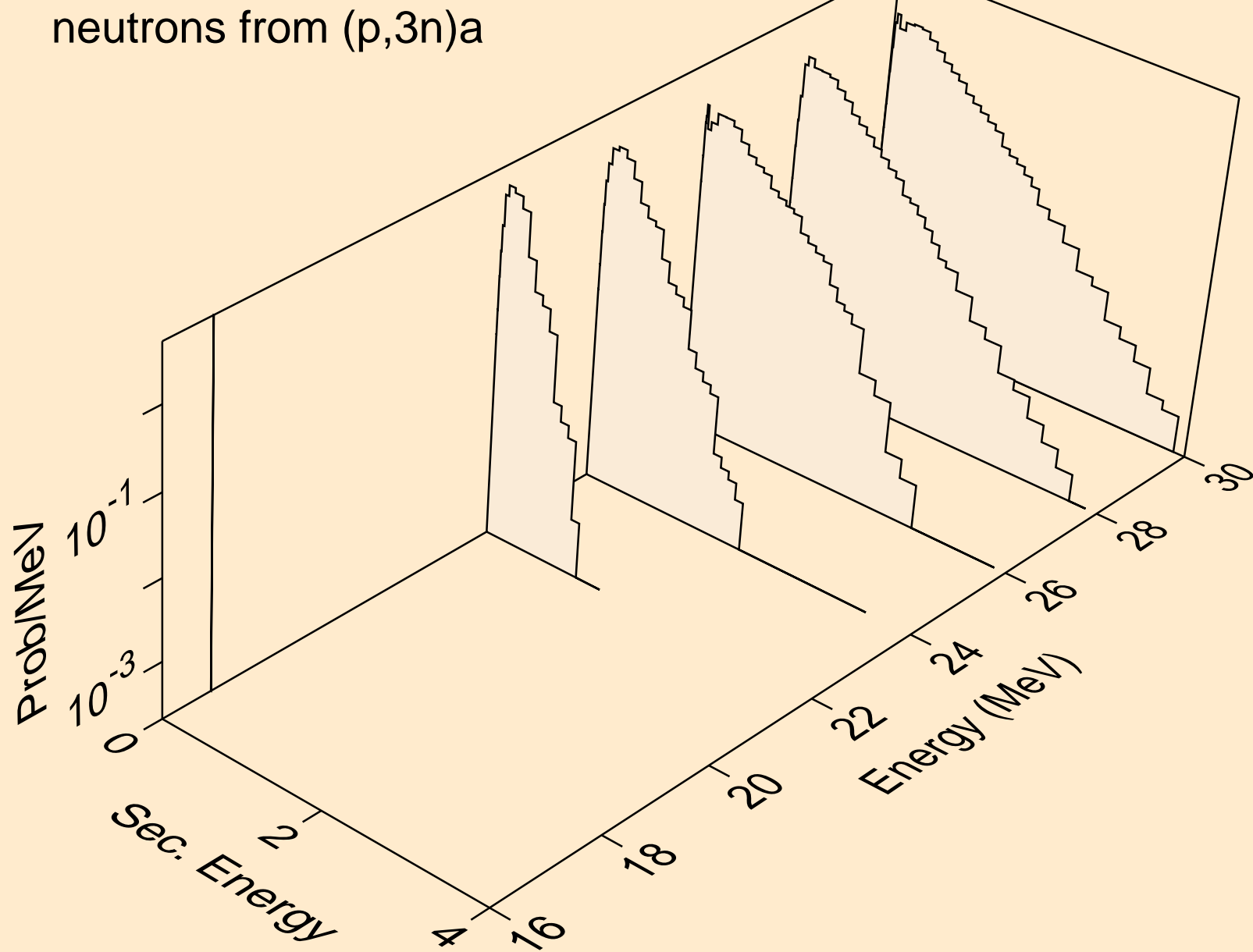

XE135M PROTON ACER TENDL-2021 LIBRARY; T=0.K  
neutrons from (p,n\*)p

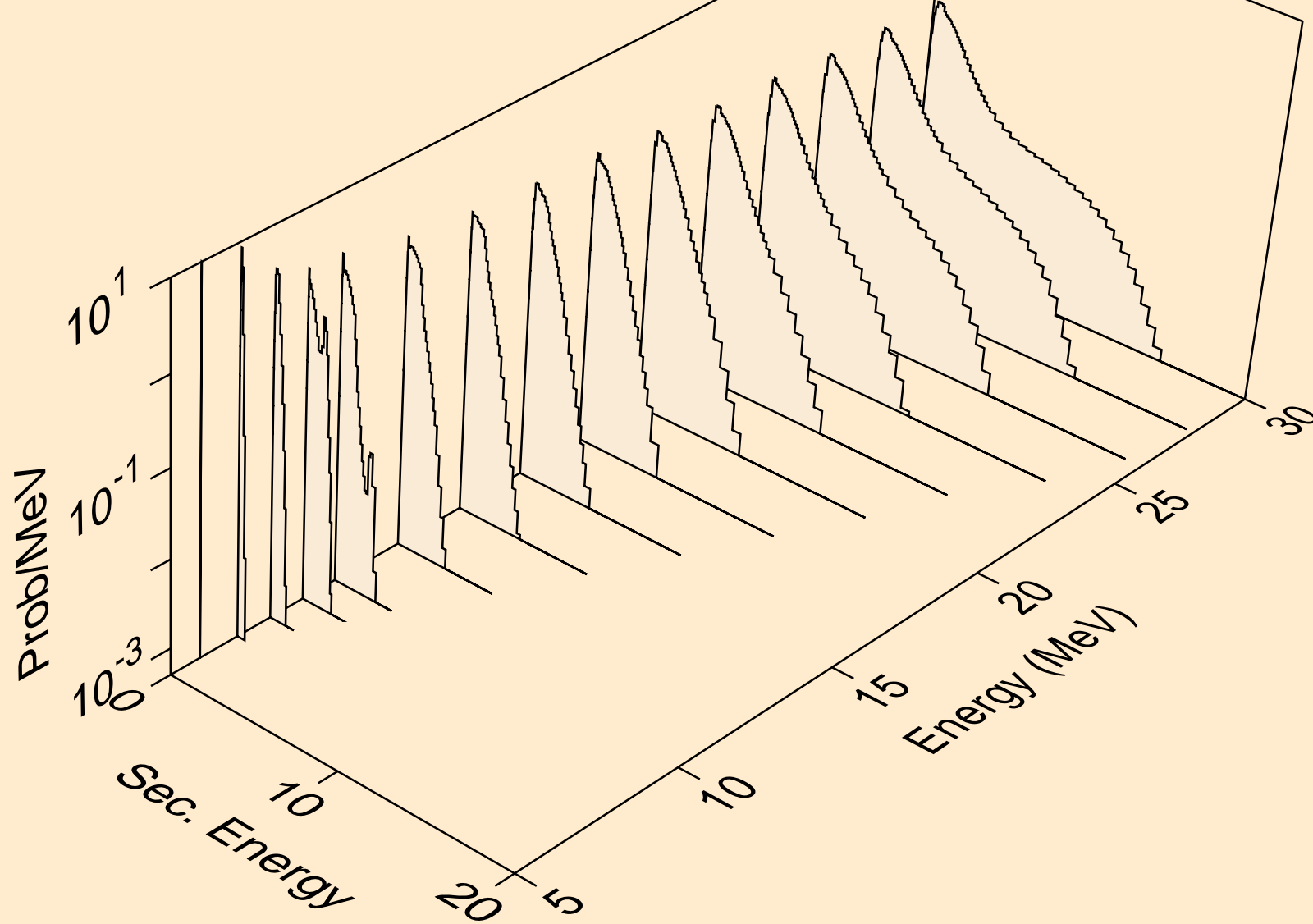

XE135M PROTON ACER TENDL-2021 LIBRARY; T=0.K  
neutrons from (p,n\*)d

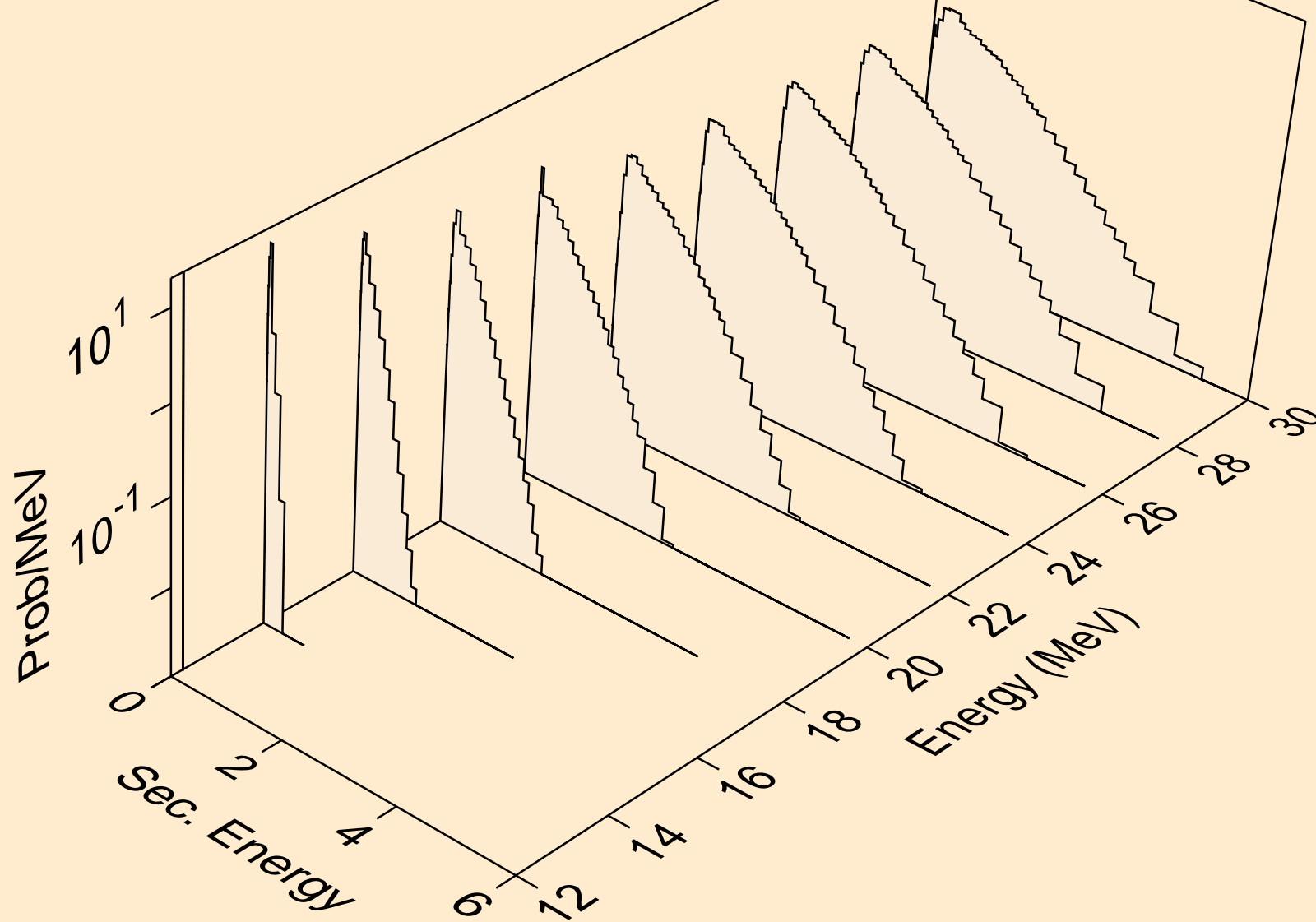

XE135M PROTON ACER TENDL-2021 LIBRARY; T=0.K  
neutrons from (p,n\*)t

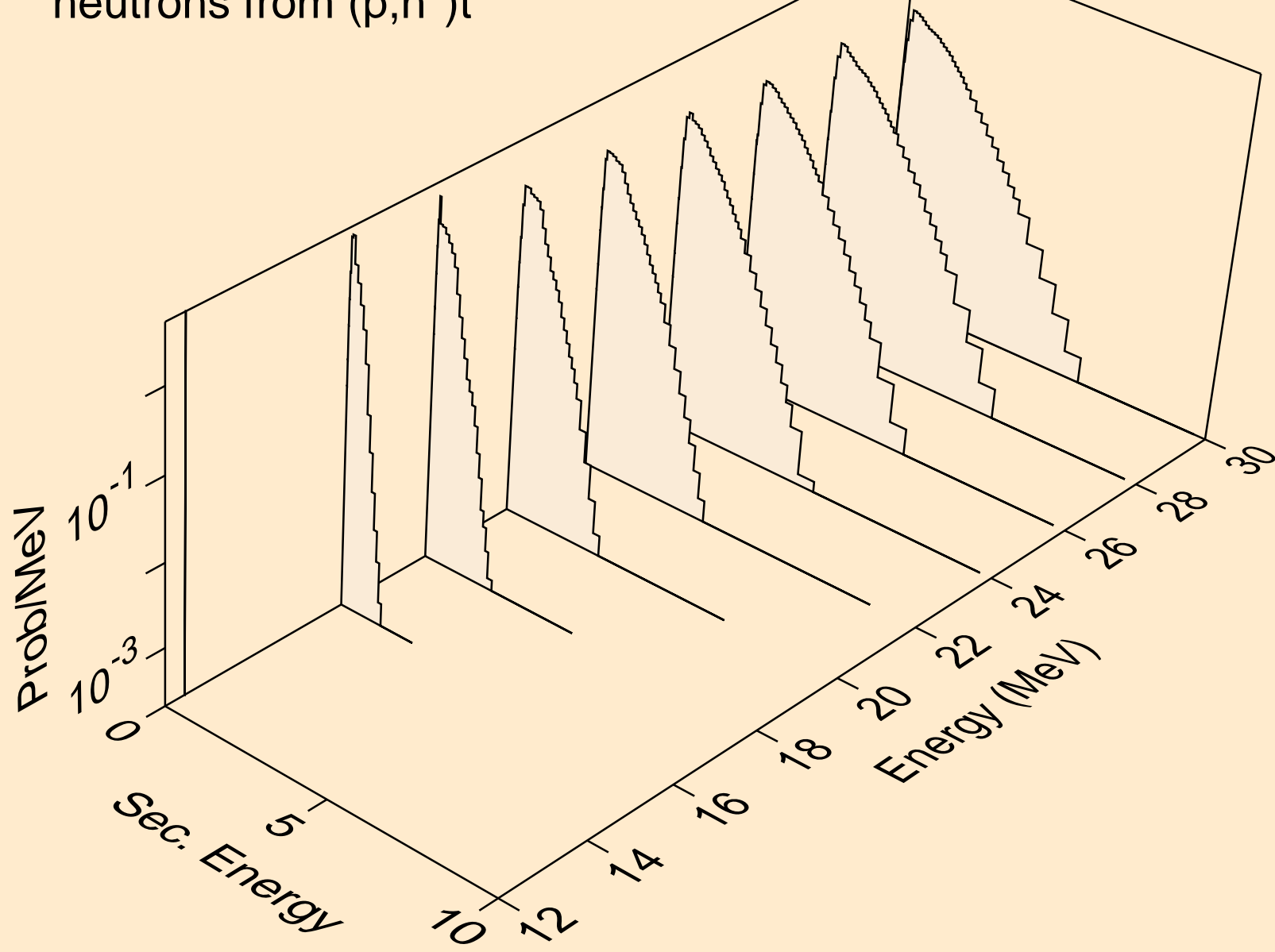

XE135M PROTON ACER TENDL-2021 LIBRARY; T=0.K  
neutrons from (p,n\*)he3

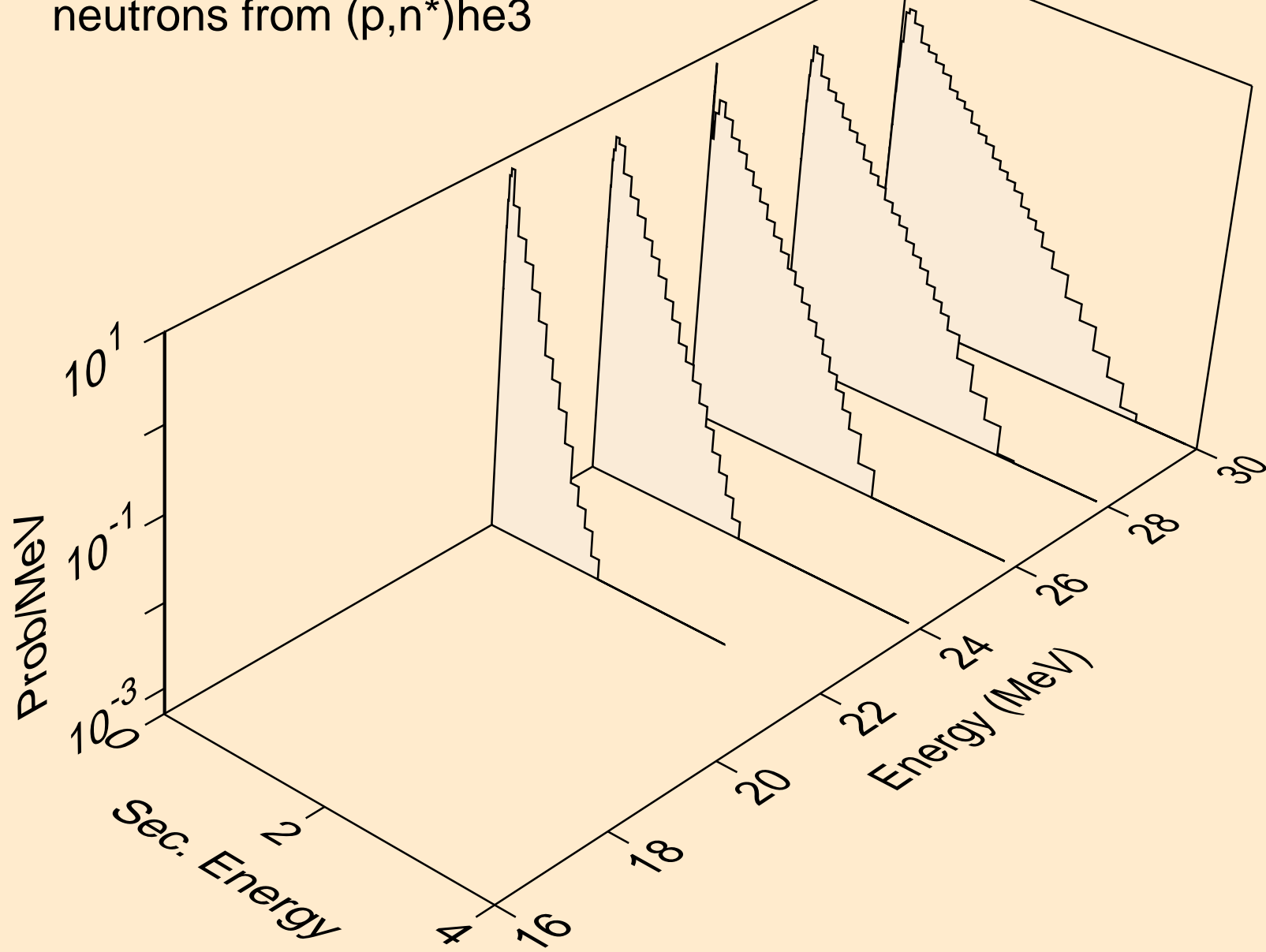

XE135M PROTON ACER TENDL-2021 LIBRARY; T=0.K  
neutrons from (p,4n)

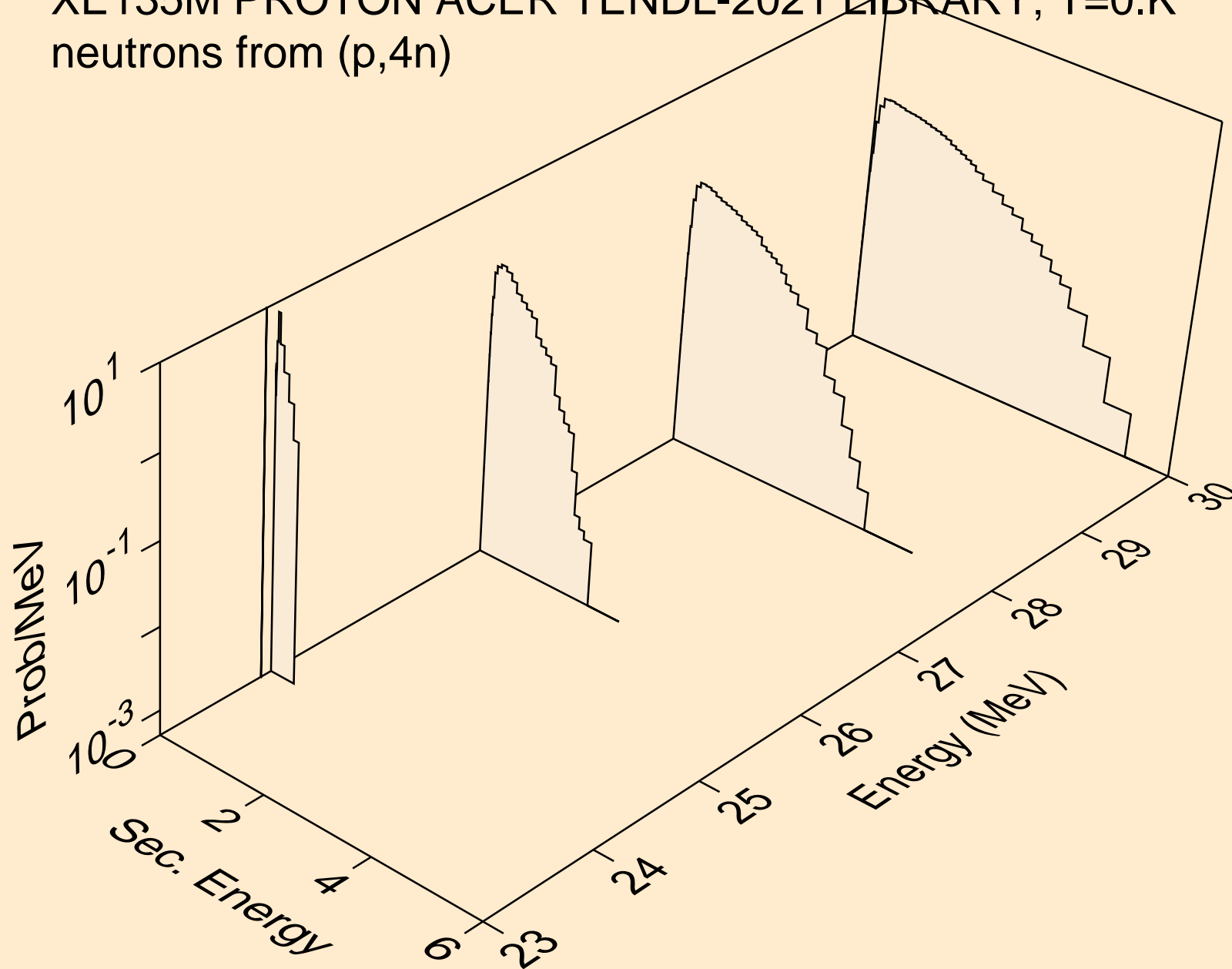

XE135M PROTON ACER TENDL-2021 LIBRARY; T=0.K  
neutrons from (p,2np)

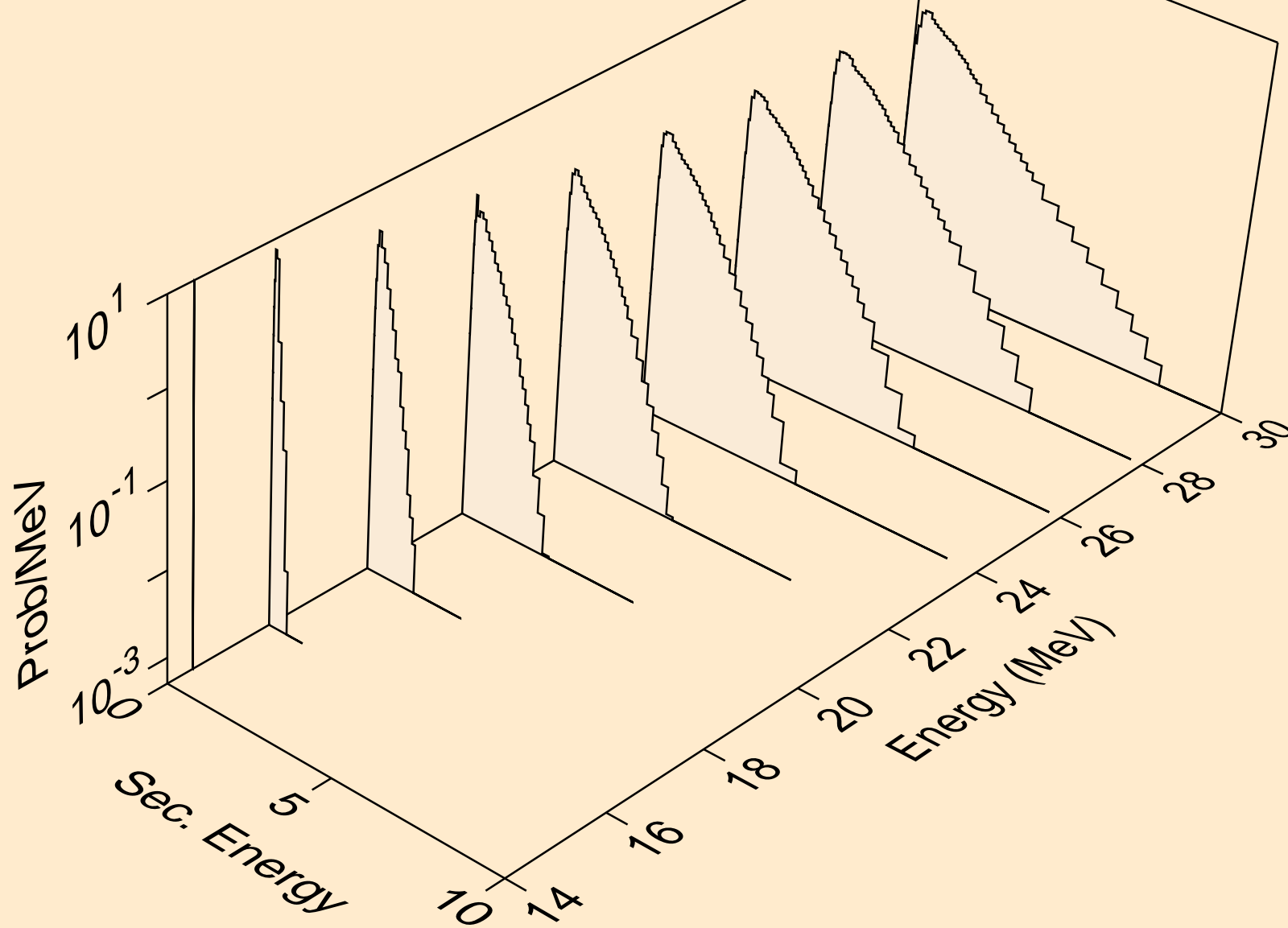

XE135M PROTON ACER TENDL-2021 LIBRARY; T=0.K  
neutrons from (p,3np)

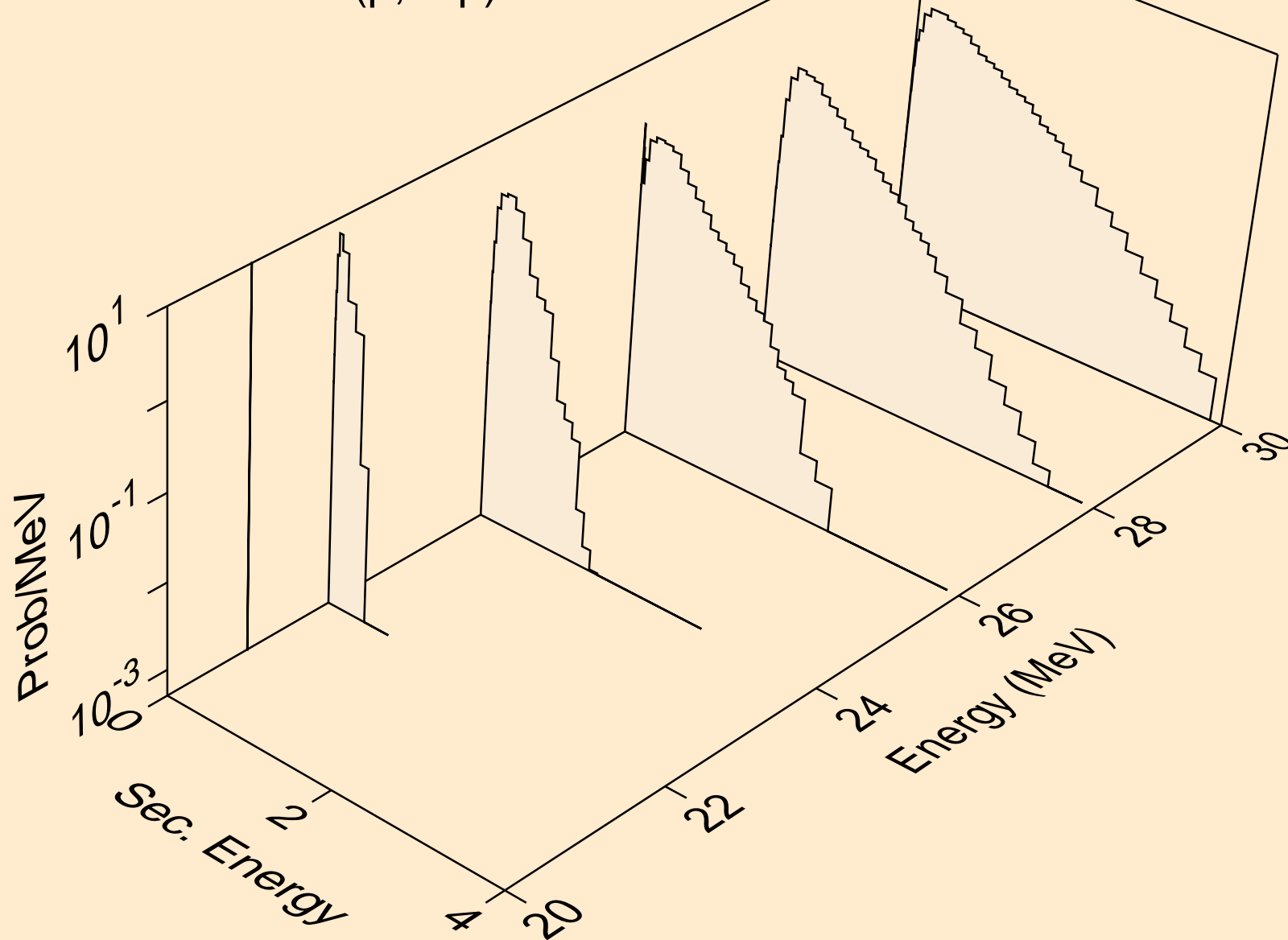

XE135M PROTON ACER TENDL-2021 LIBRARY; T=0.K  
neutrons from (p,2np)

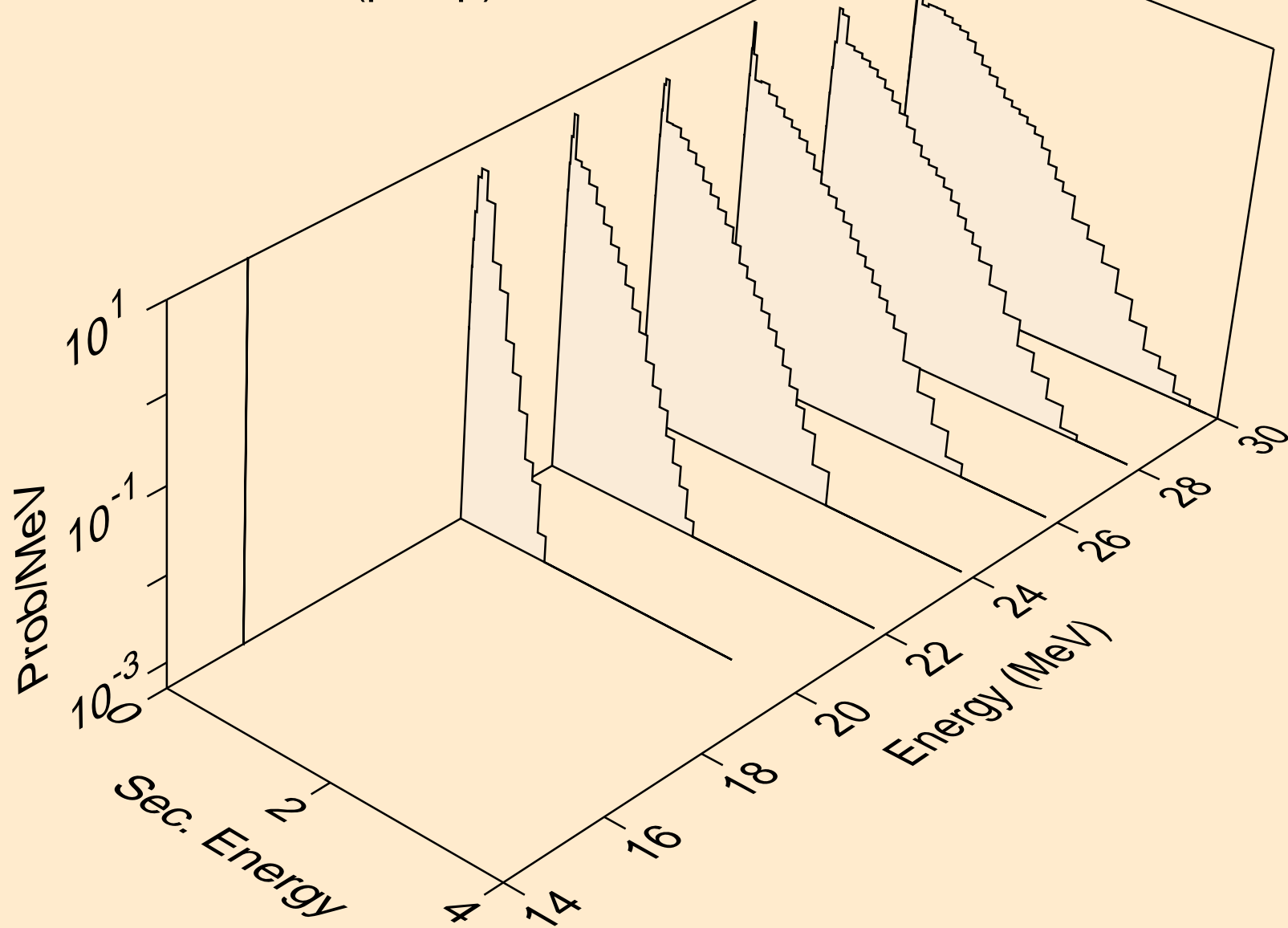

XE135M PROTON ACER TENDL-2021 LIBRARY; T=0.K  
neutrons from (p,npa)

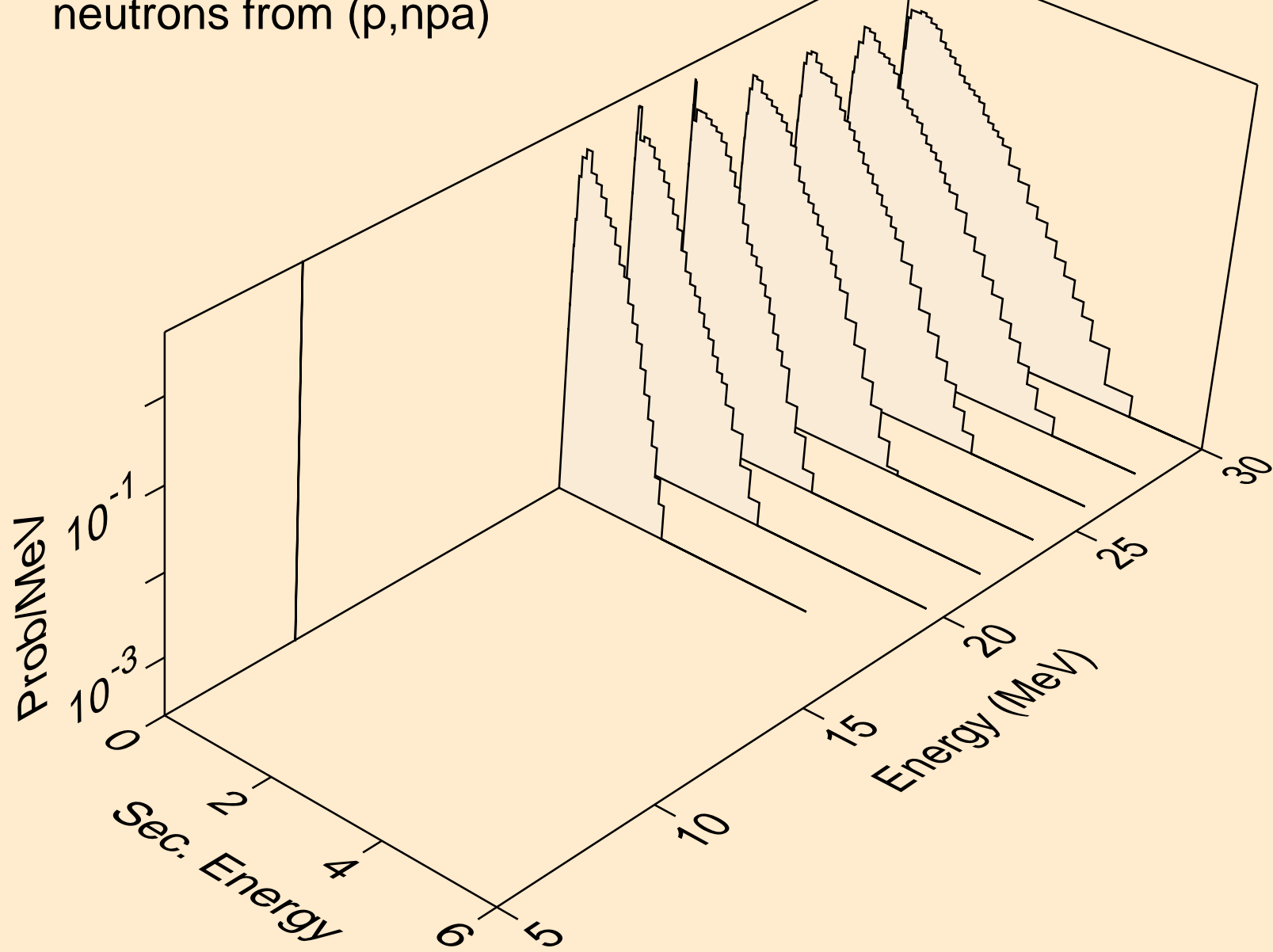

XE135M PROTON ACER TENDL-2021 LIBRARY; T=0.K  
deuterons from (p,x)

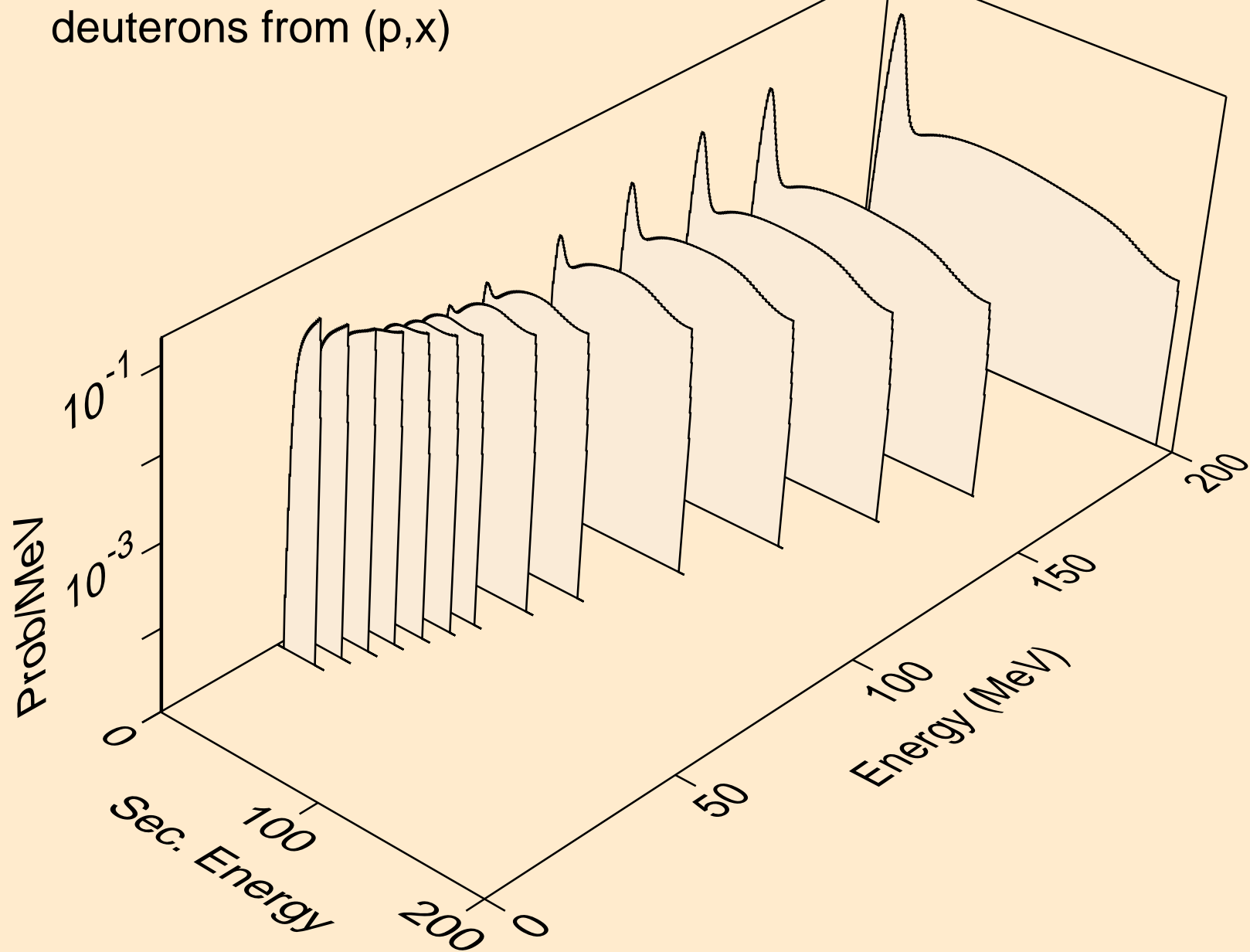

XE135M PROTON ACER TENDL-2021 LIBRARY; T=0.K  
deuterons from (p,2nd)

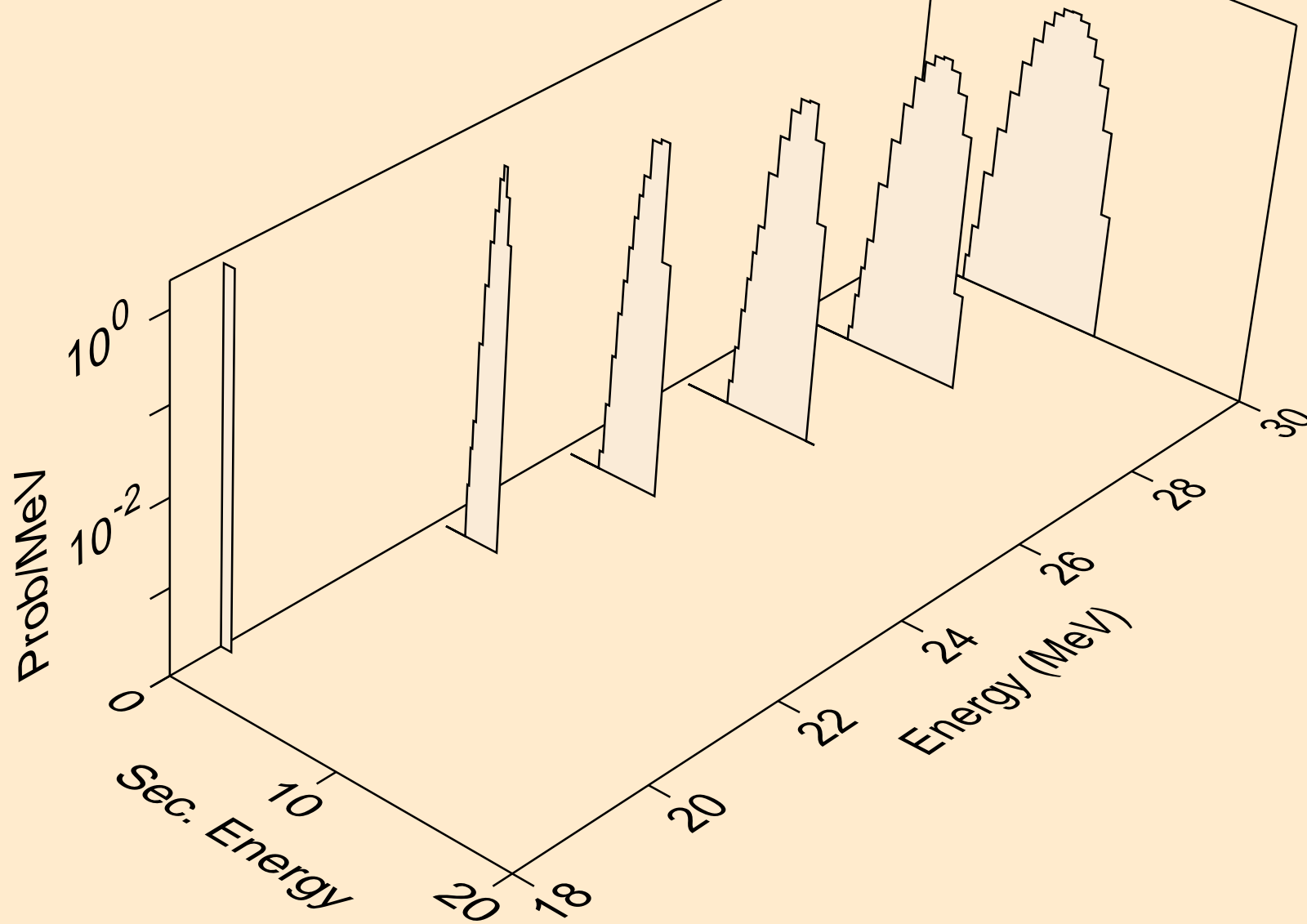

XE135M PROTON ACER TENDL-2021 LIBRARY; T=0.K  
deuterons from (p,n\*)d

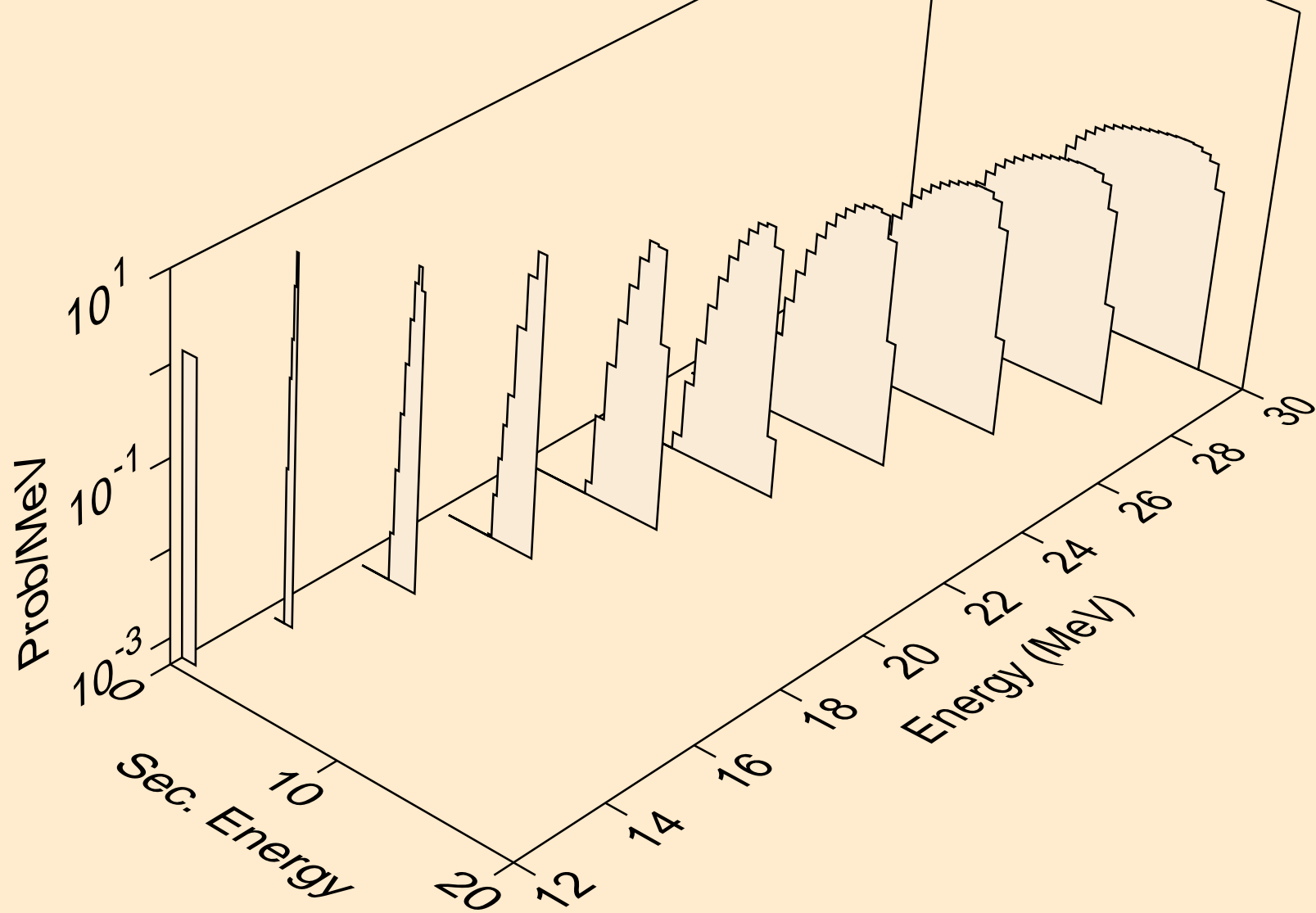

XE135M PROTON ACER TENDL-2021 LIBRARY; T=0.K  
deuterons from (p,d)

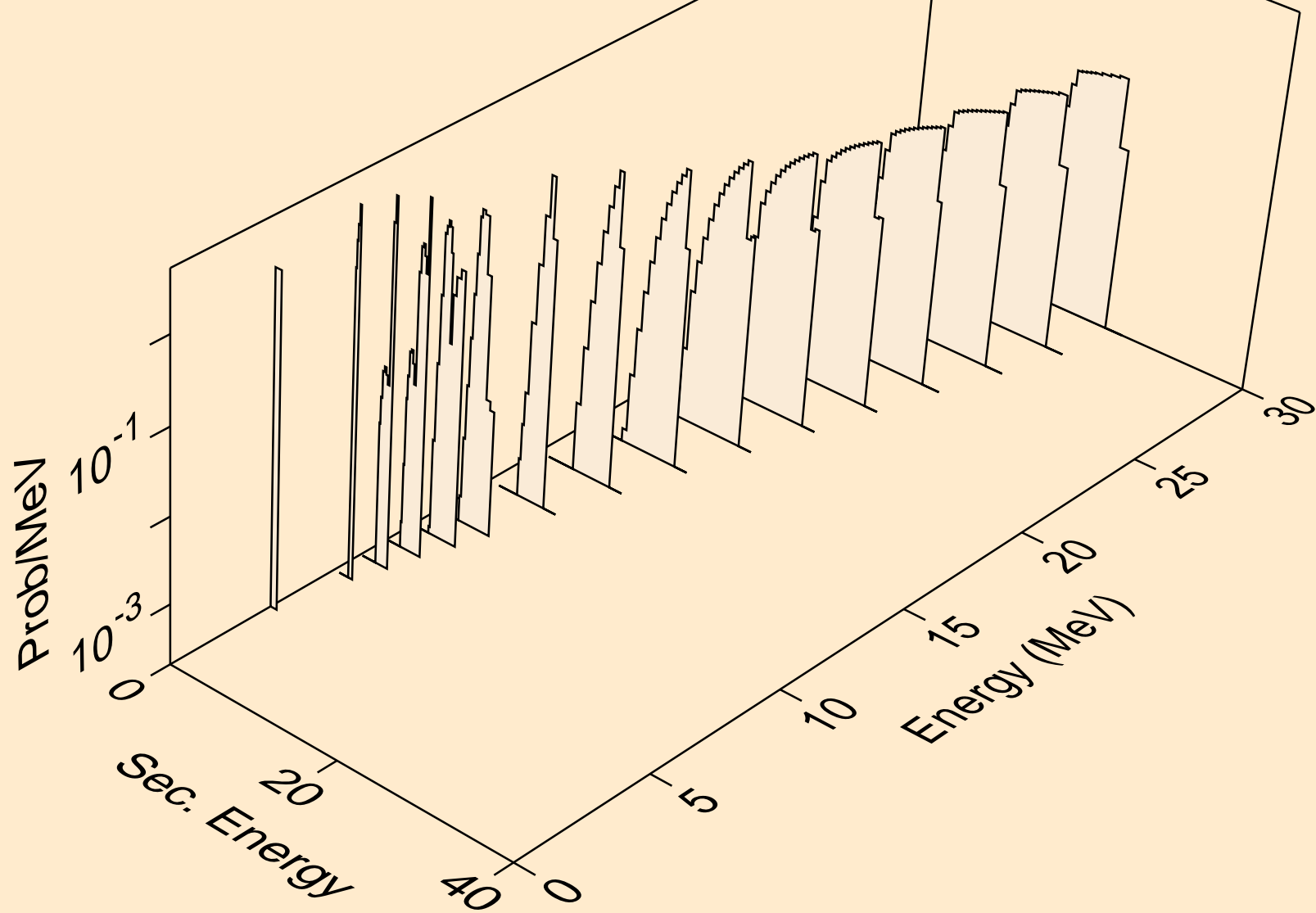

XE135M PROTON ACER TENDL-2021 LIBRARY; T=0.K  
deuterons from (p,pd)

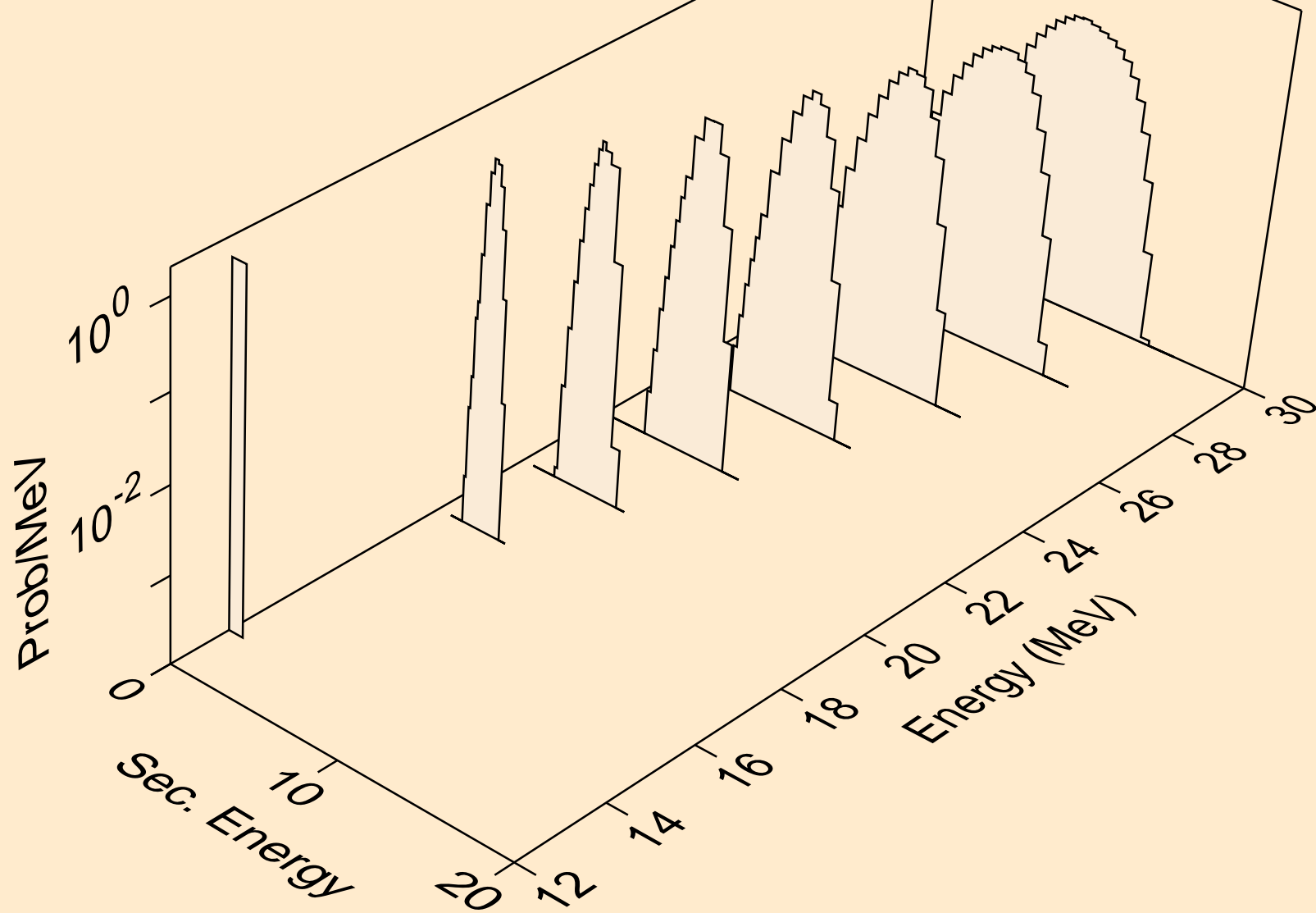

XE135M PROTON ACER TENDL-2021 LIBRARY; T=0.K  
deuterons from (p,da)

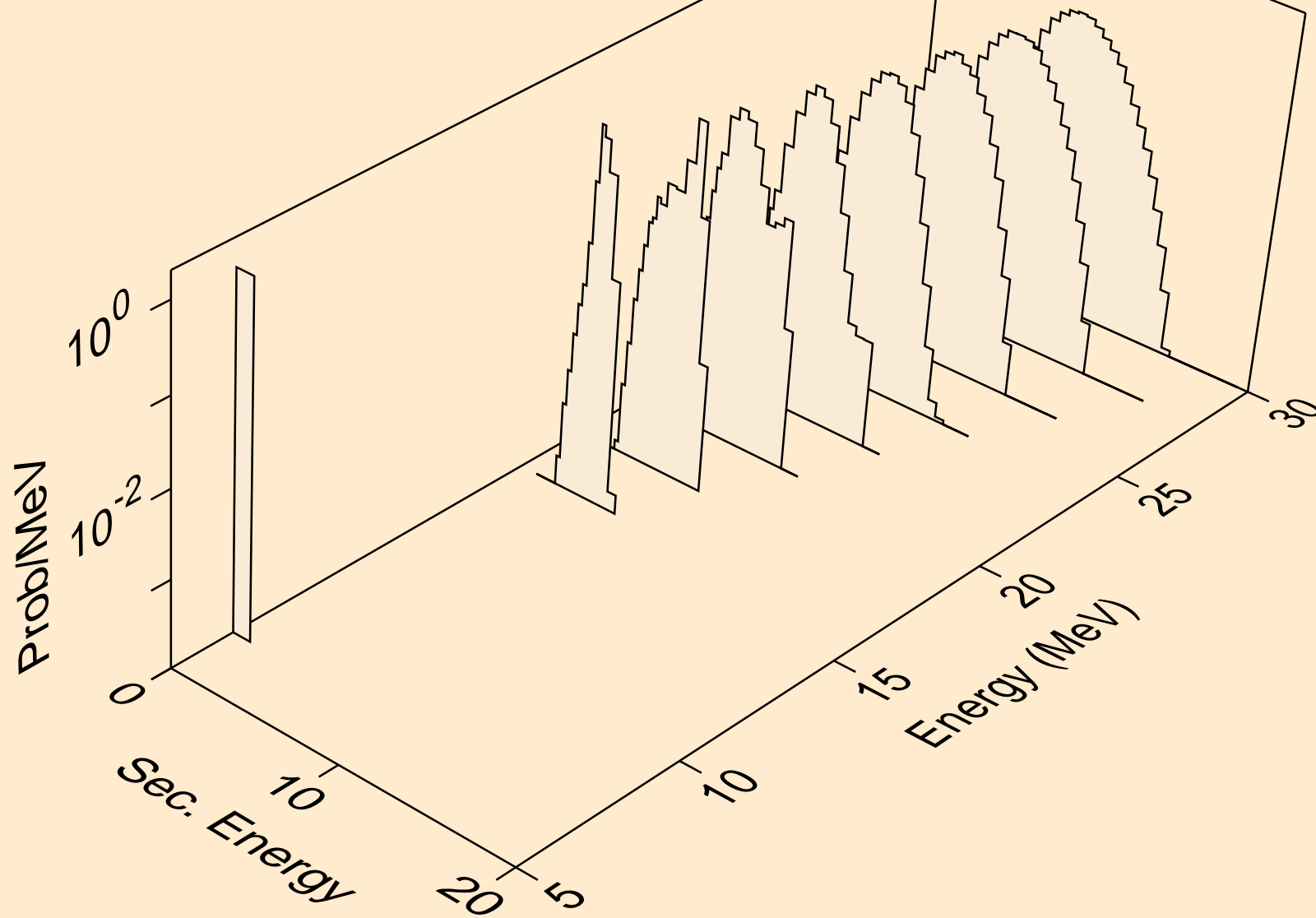

XE135M PROTON ACER TENDL-2021 LIBRARY; T=0.K  
tritons from (p,x)

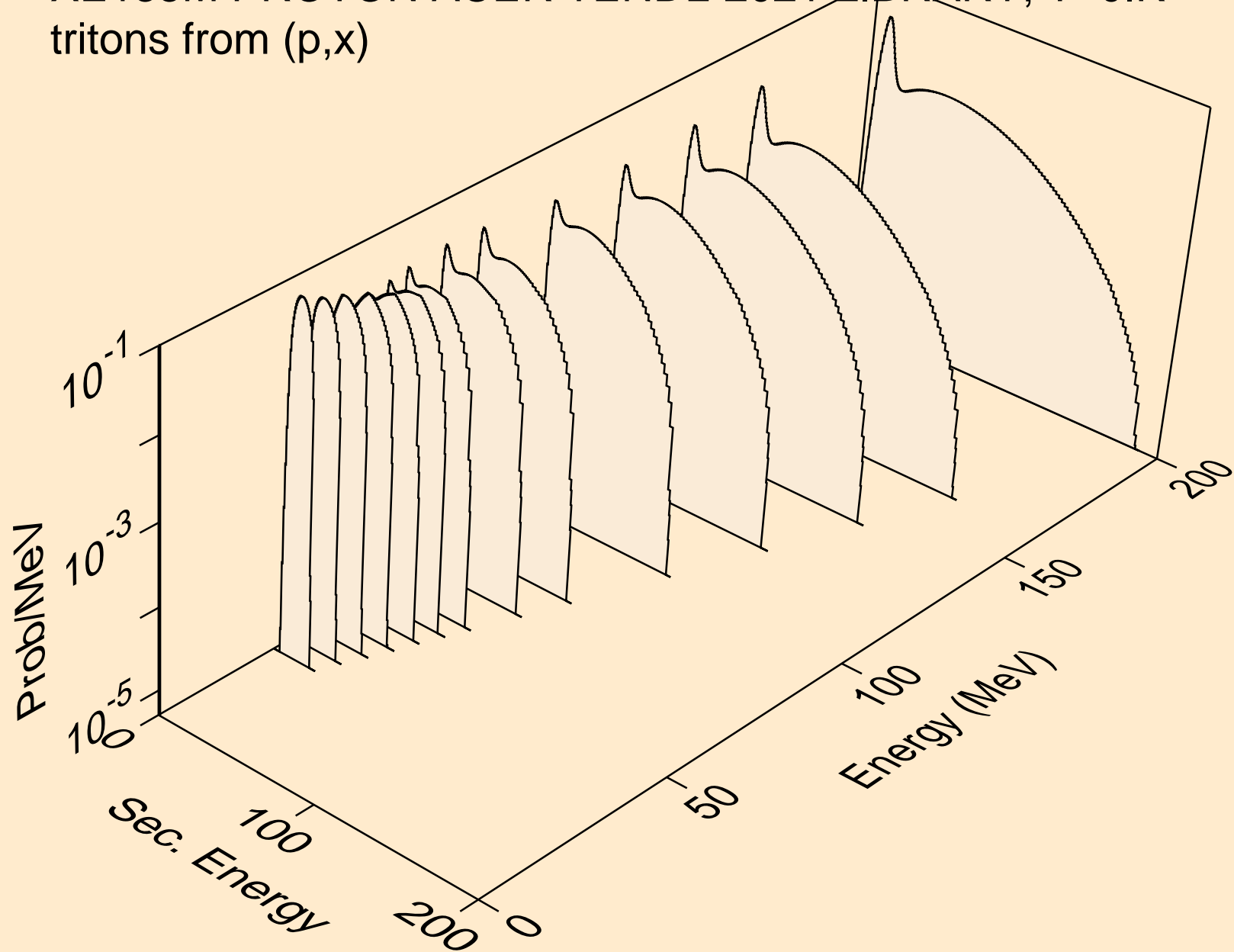

XE135M PROTON ACER TENDL-2021 LIBRARY; T=0.K  
tritons from (p,n\*)t

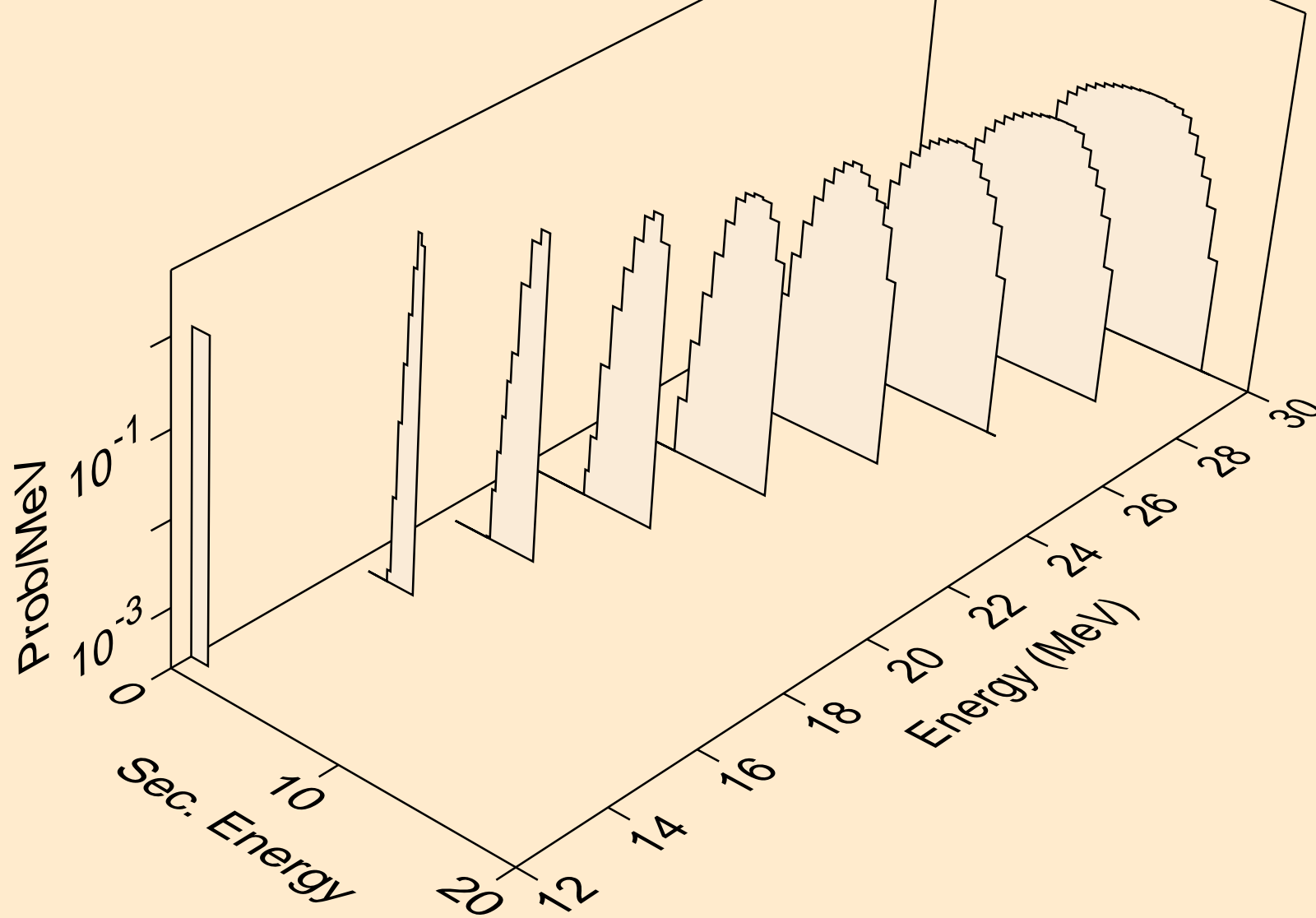

XE135M PROTON ACER TENDL-2021 LIBRARY; T=0.K  
tritons from (p,t)

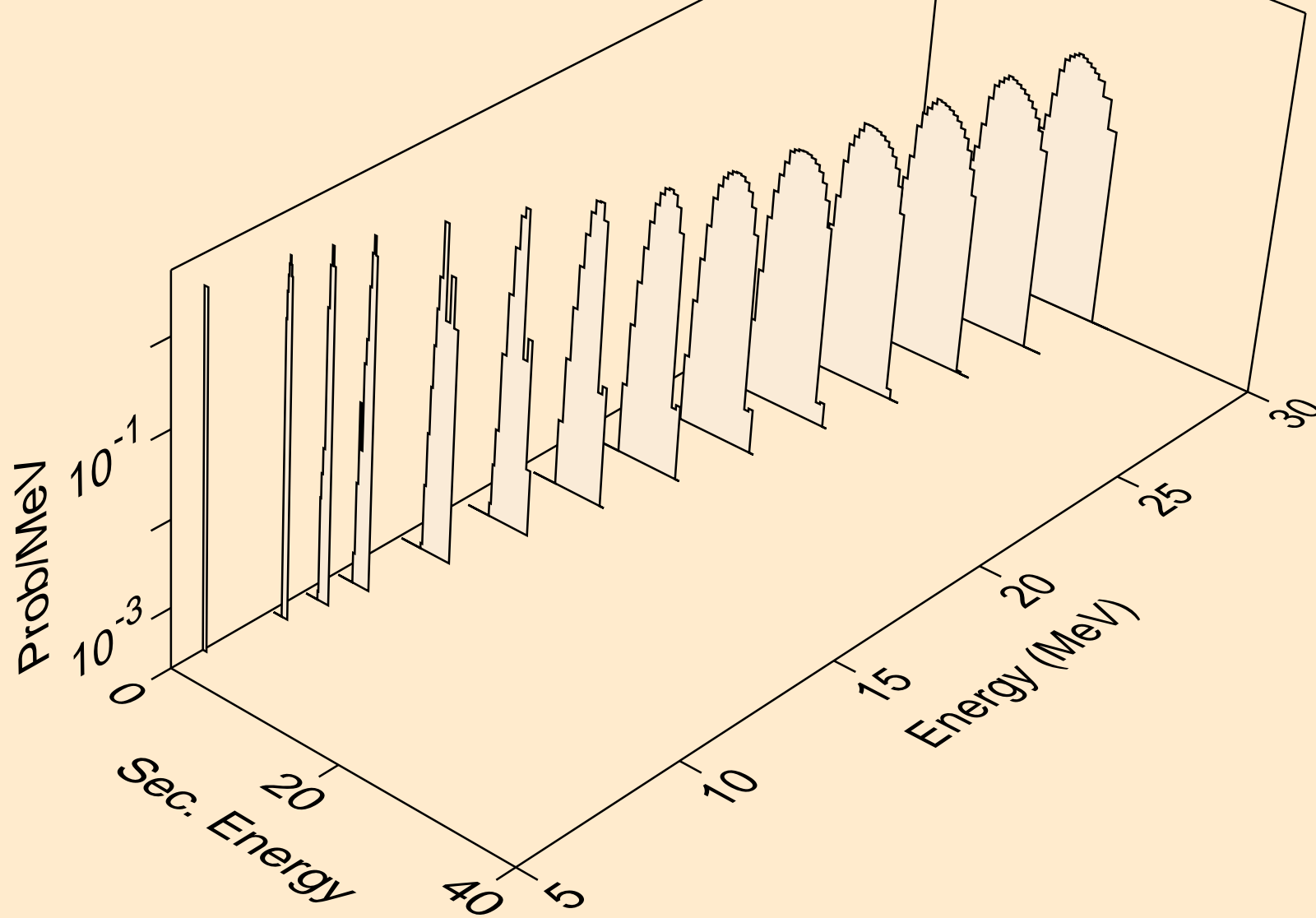

XE135M PROTON ACER TENDL-2021 LIBRARY; T=0.K  
tritons from (p,pt)

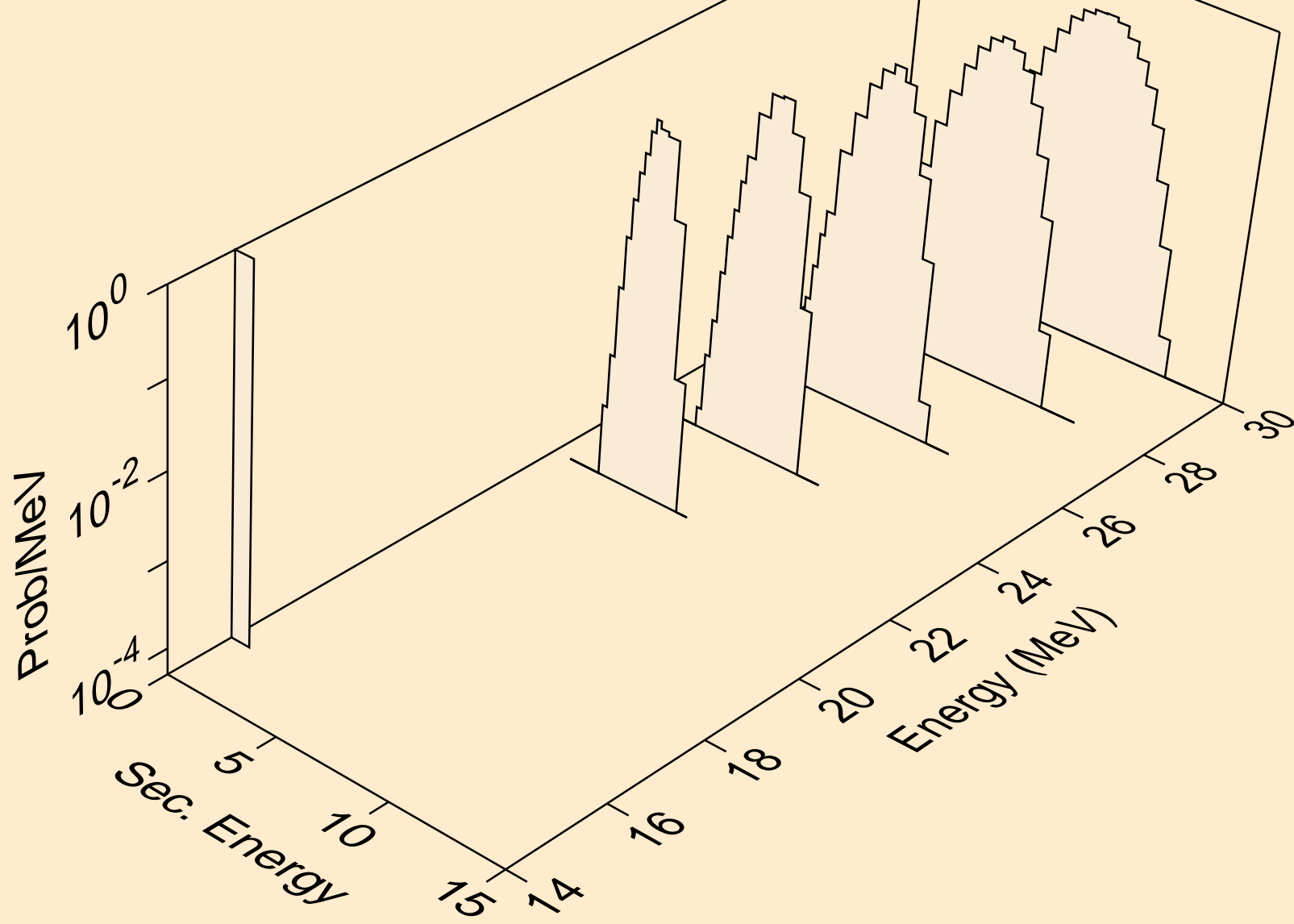

XE135M PROTON ACER TENDL-2021 LIBRARY; T=0.K  
he3s from (p,x)

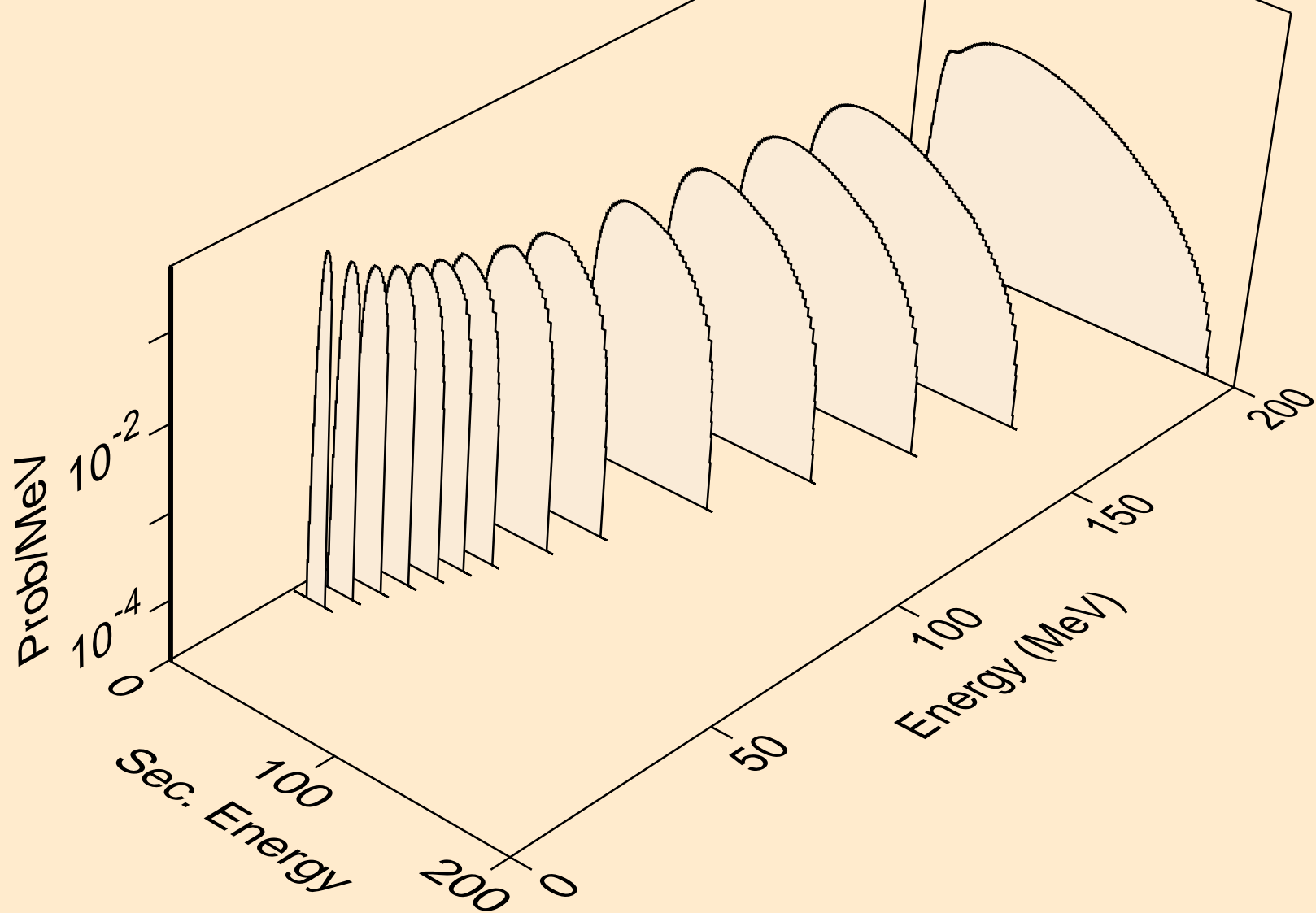

XE135M PROTON ACER TENDL-2021 LIBRARY; T=0.K  
he3s from (p,n\*)he3

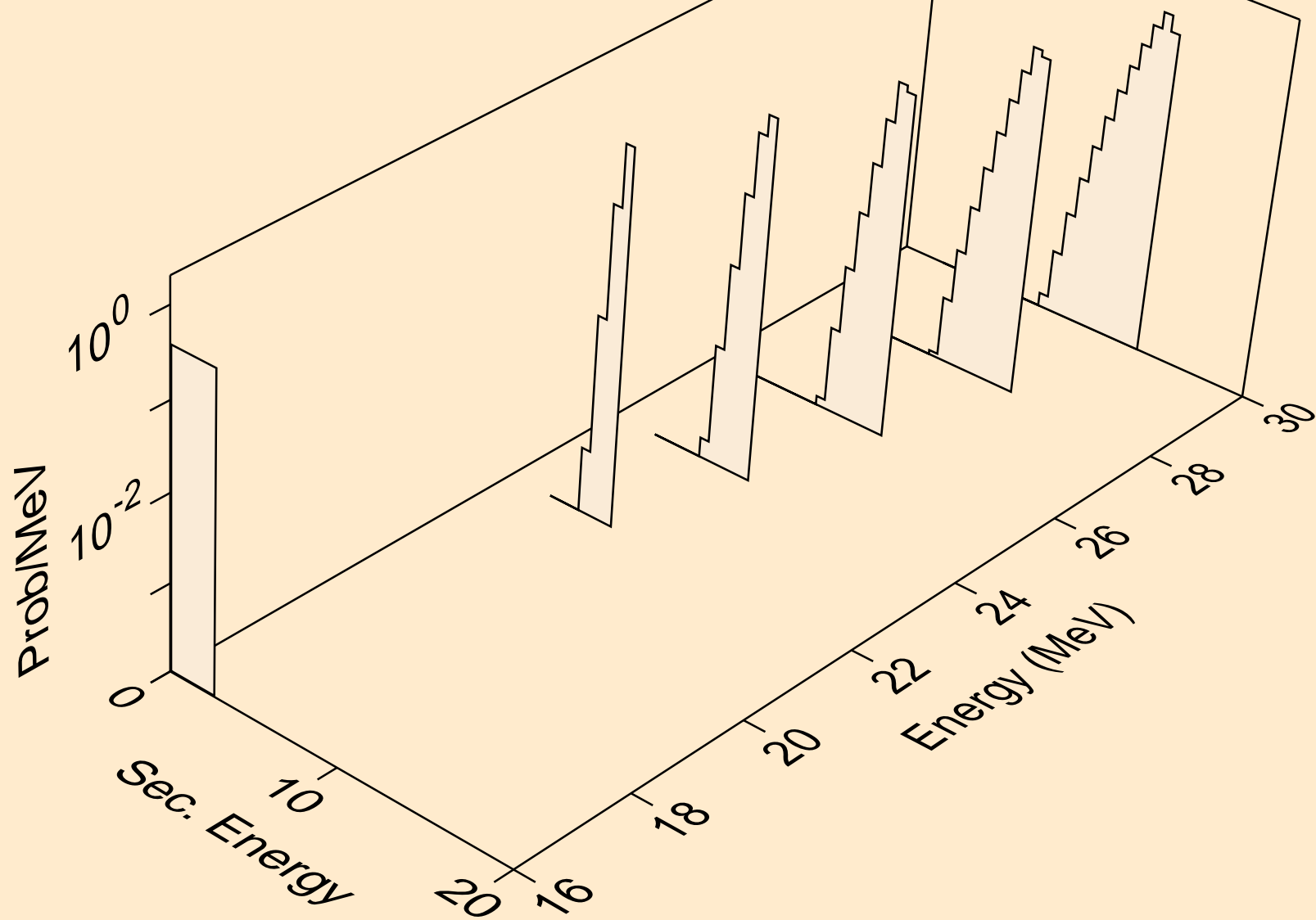

XE135M PROTON ACER TENDL-2021 LIBRARY; T=0.K  
he3s from (p,he3)

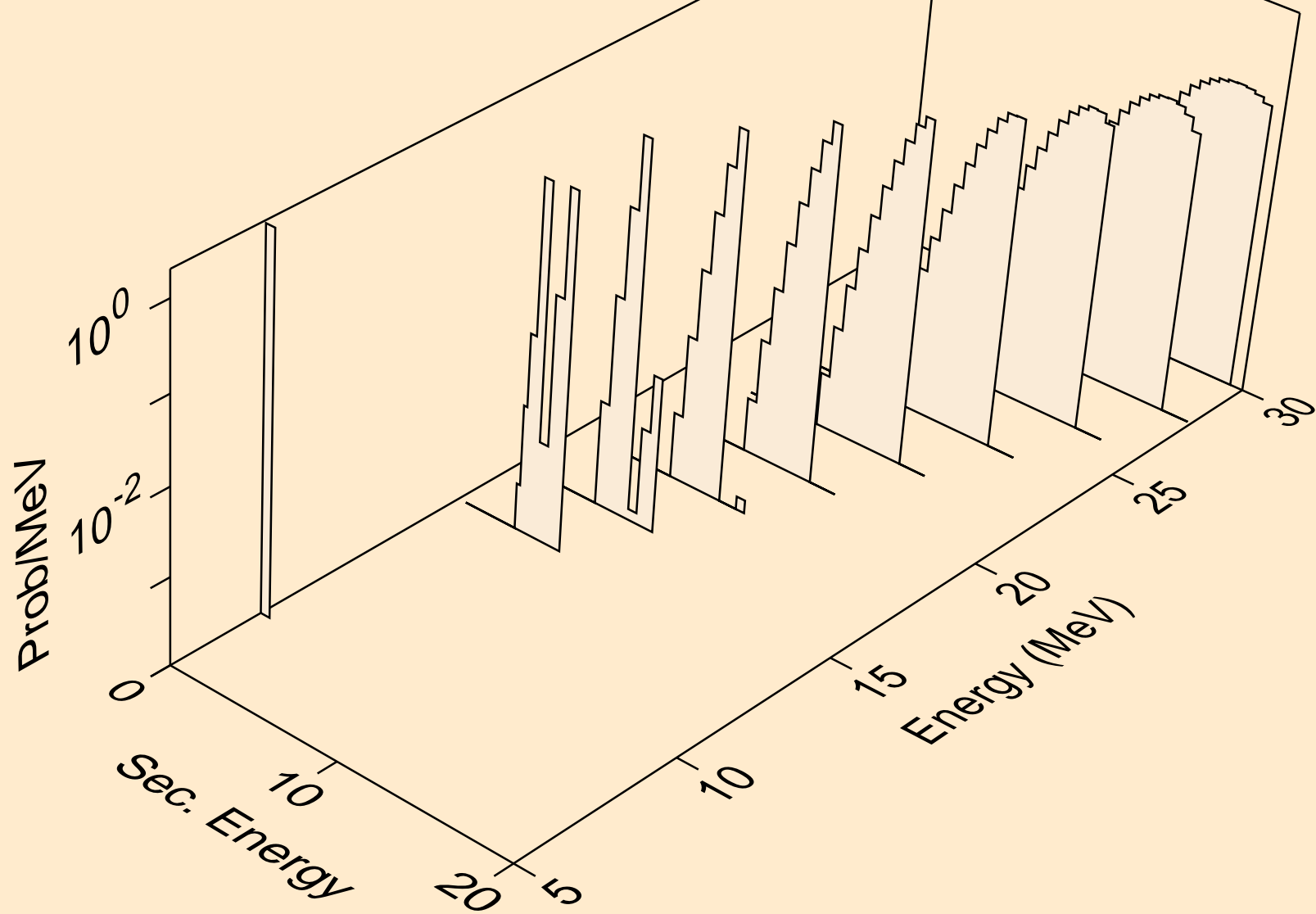

XE135M PROTON ACER TENDL-2021 LIBRARY; T=0.K  
alphas from (p,x)

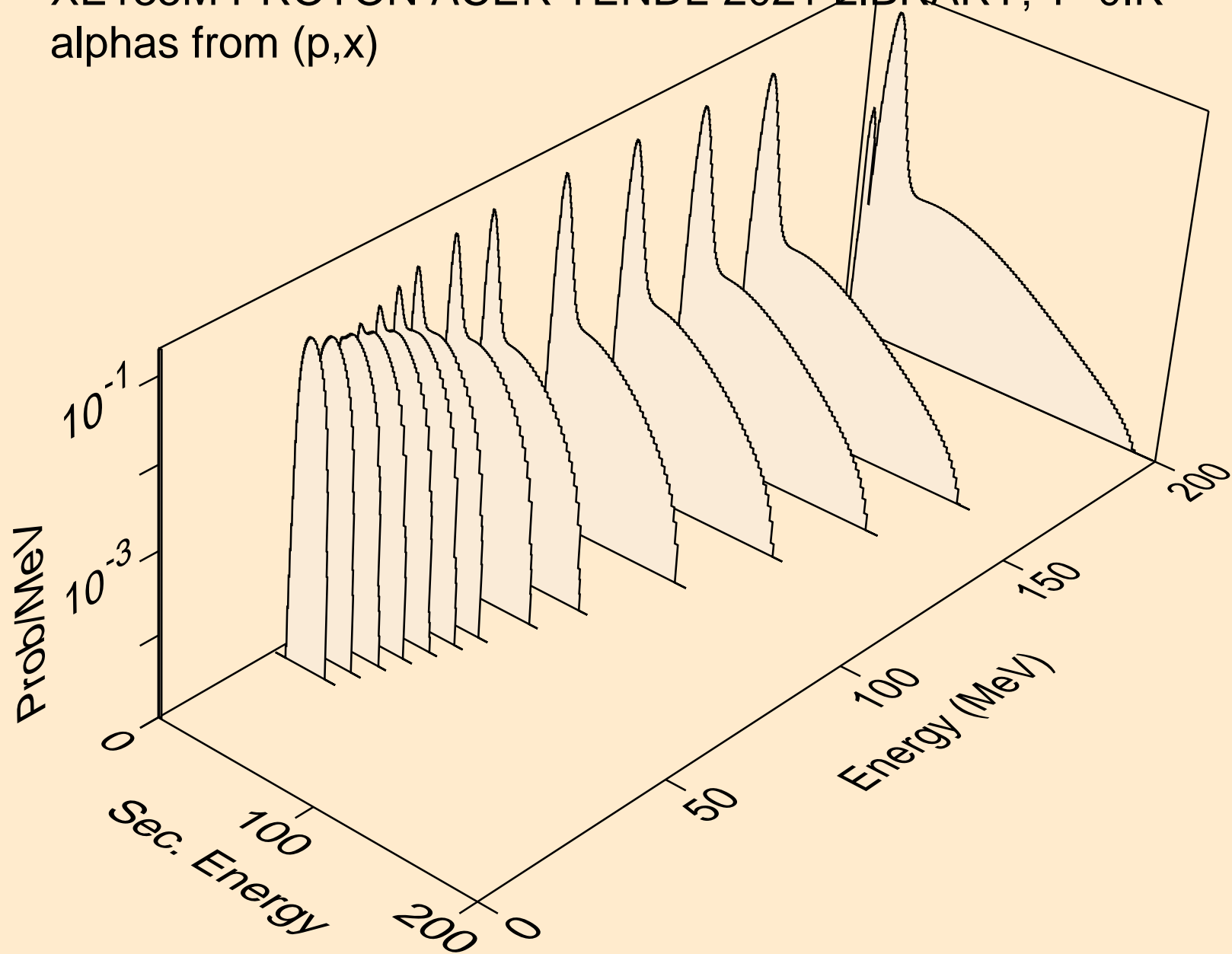

XE135M PROTON ACER TENDL-2021 LIBRARY; T=0.K  
alphas from (p,n\*)a

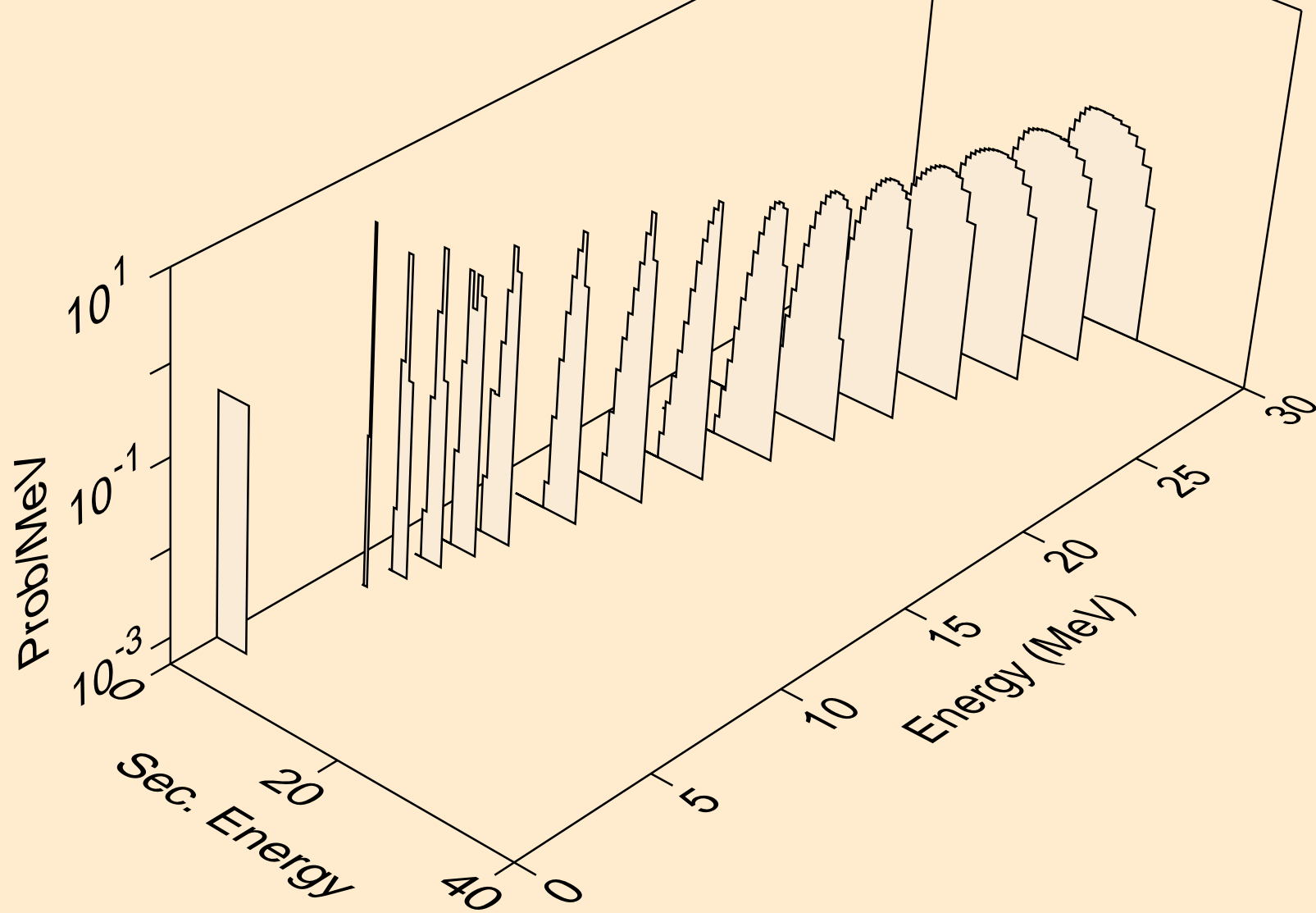

XE135M PROTON ACER TENDL-2021 LIBRARY; T=0.K  
alphas from (p,2n)a

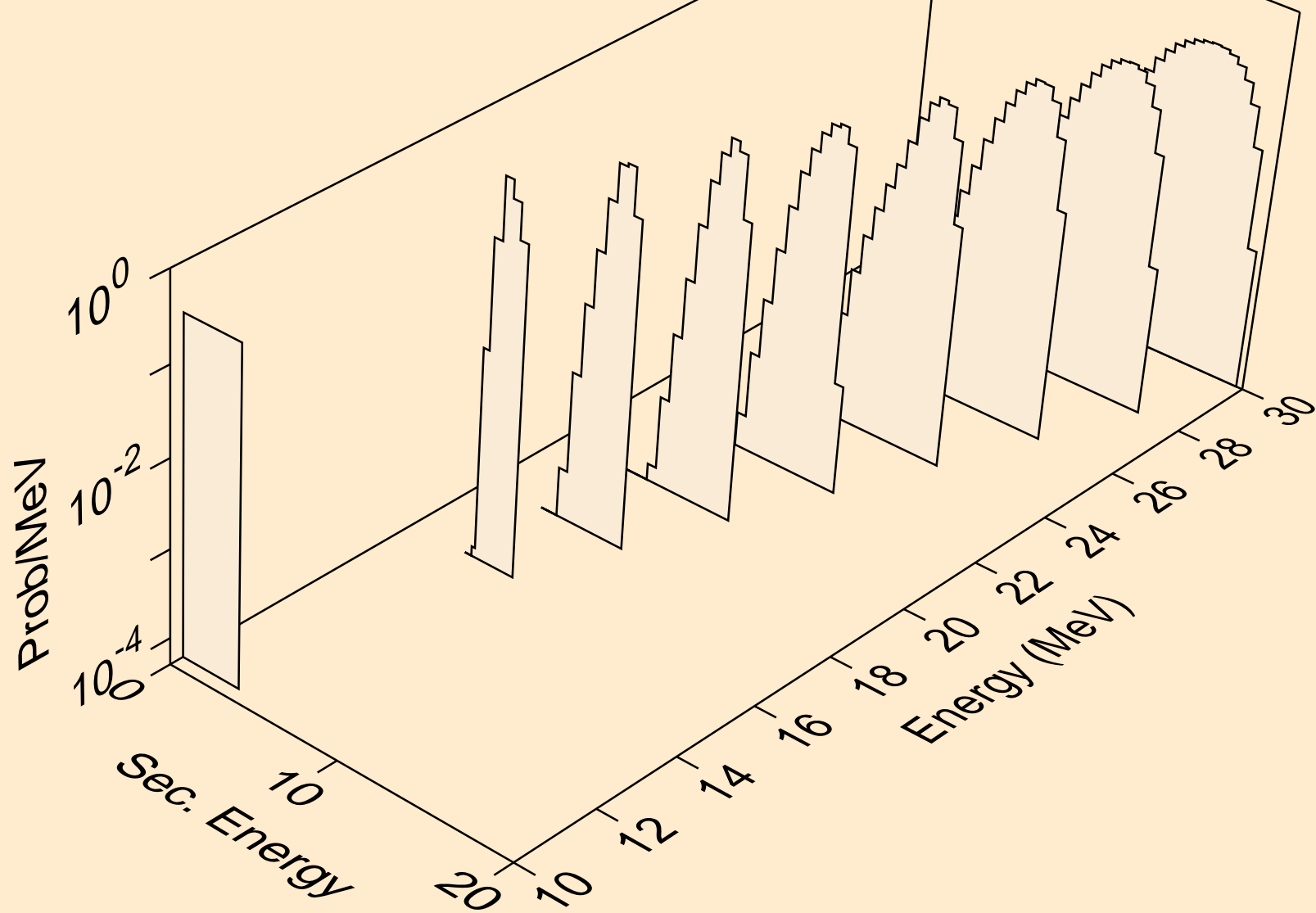

XE135M PROTON ACER TENDL-2021 LIBRARY; T=0.K  
alphas from (p,3n)a

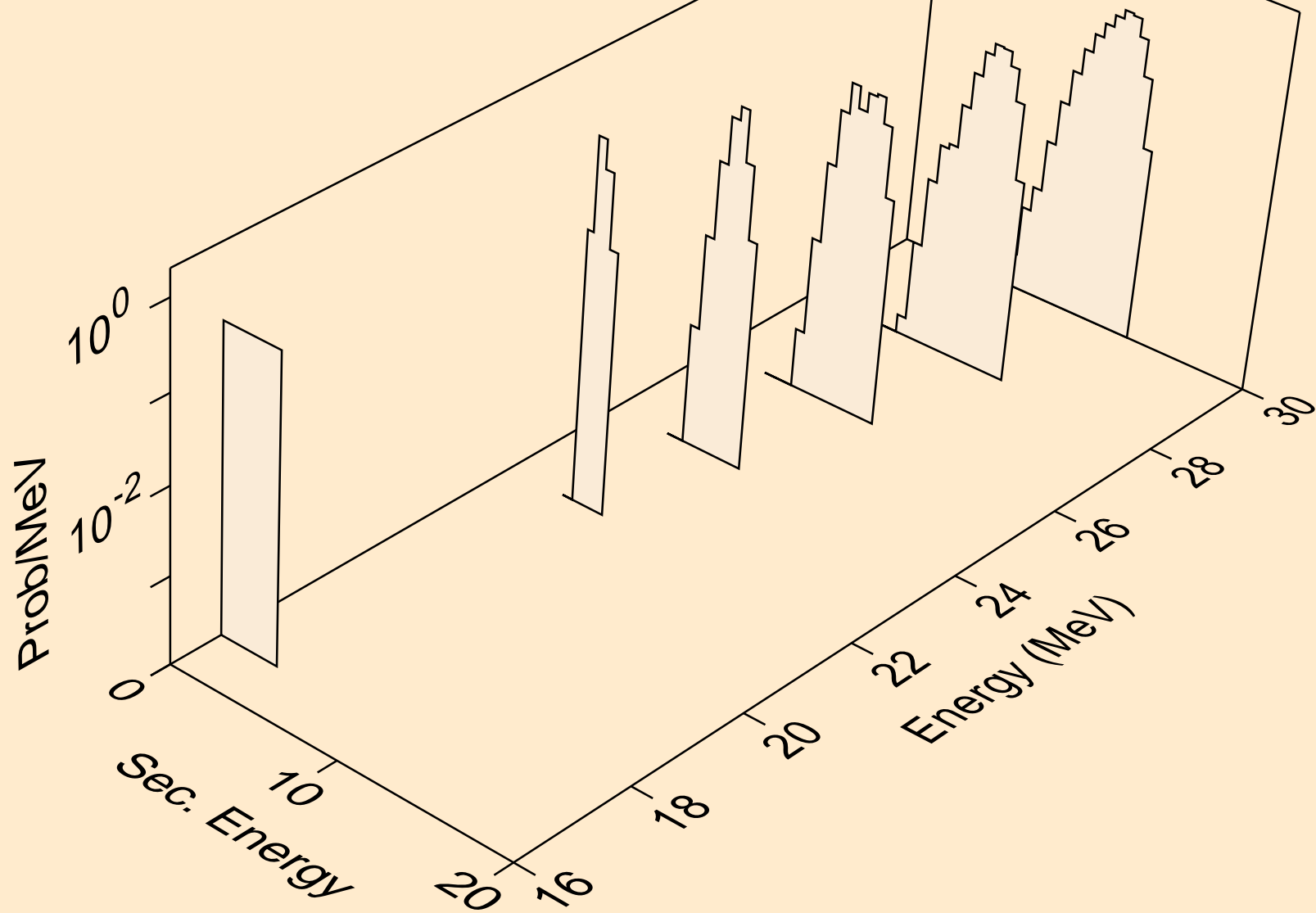

XE135M PROTON ACER TENDL-2021 LIBRARY; T=0.K  
alphas from (p,npa)

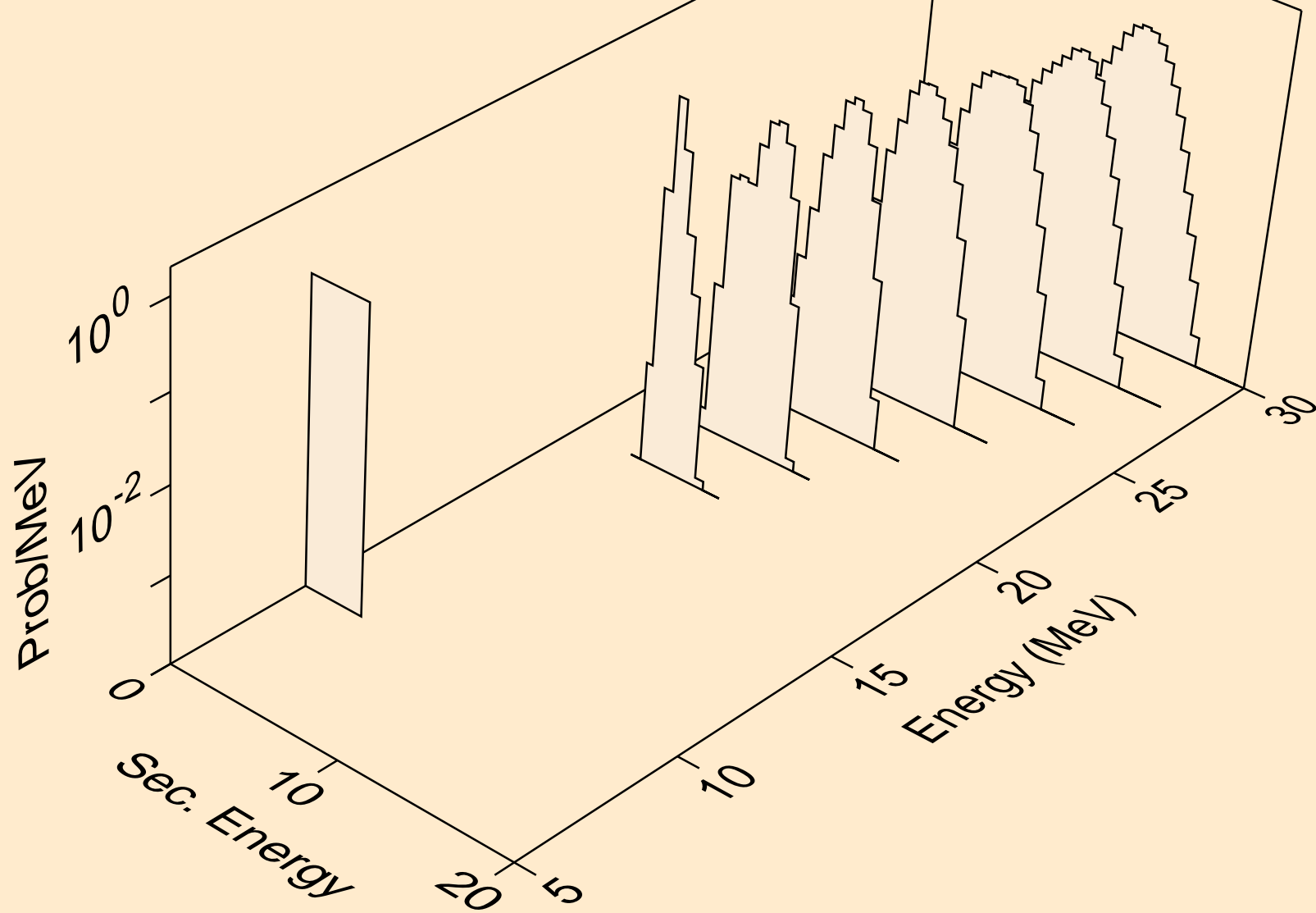

XE135M PROTON ACER TENDL-2021 LIBRARY; T=0.K  
alphas from (p,a)

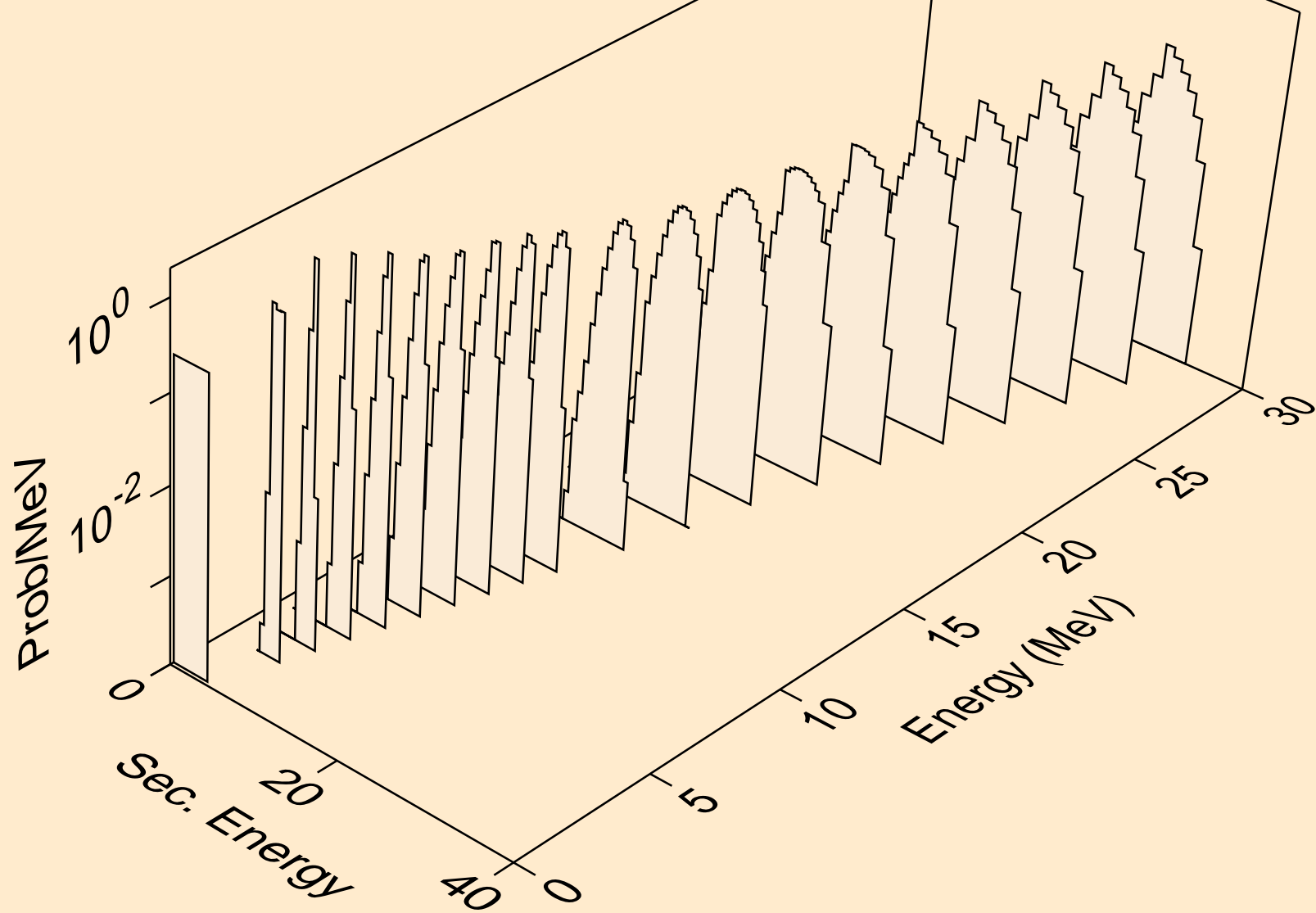

XE135M PROTON ACER TENDL-2021 LIBRARY; T=0.K  
alphas from (p,2a)

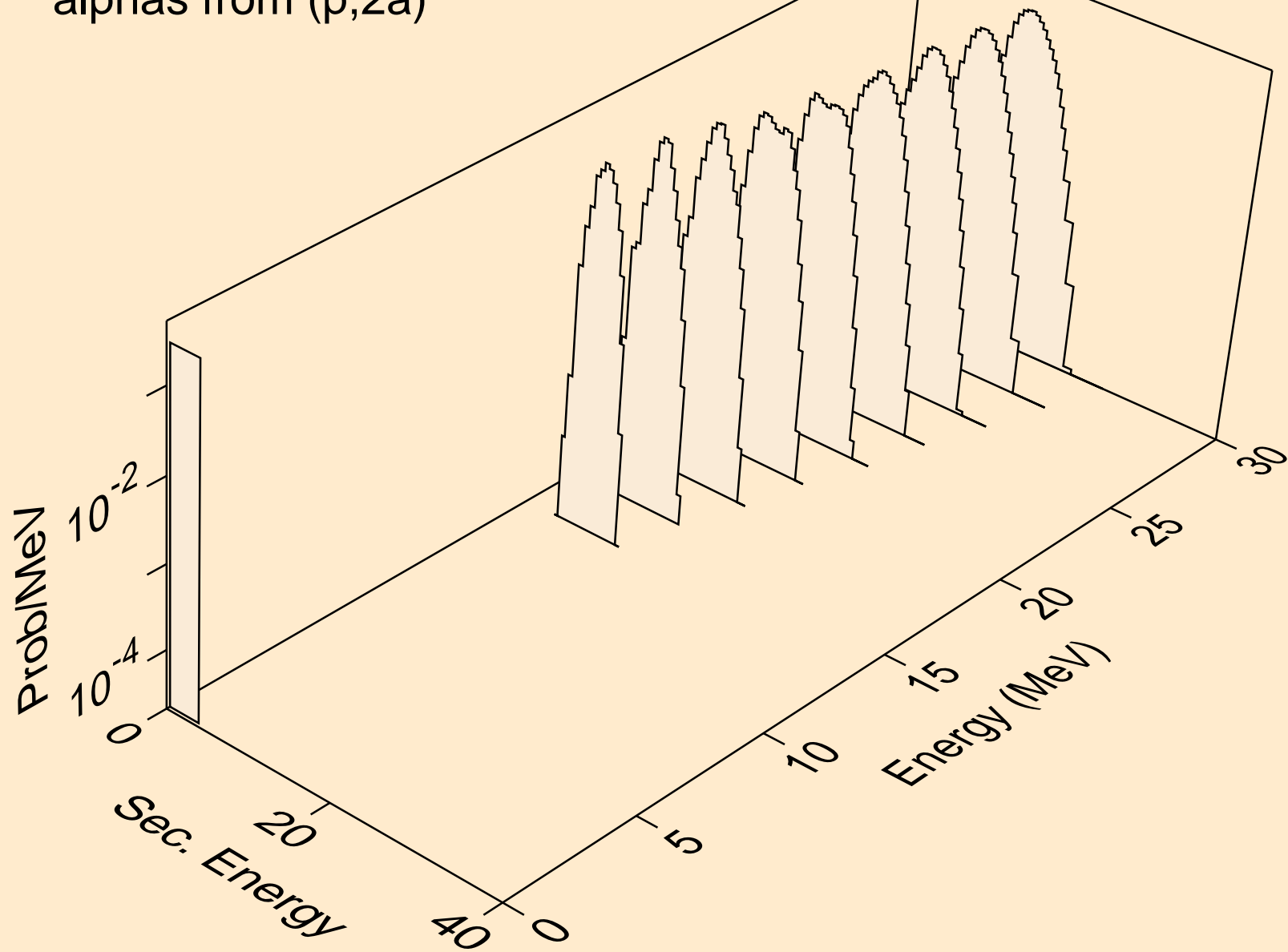

XE135M PROTON ACER TENDL-2021 LIBRARY; T=0.K  
alphas from (p,pa)

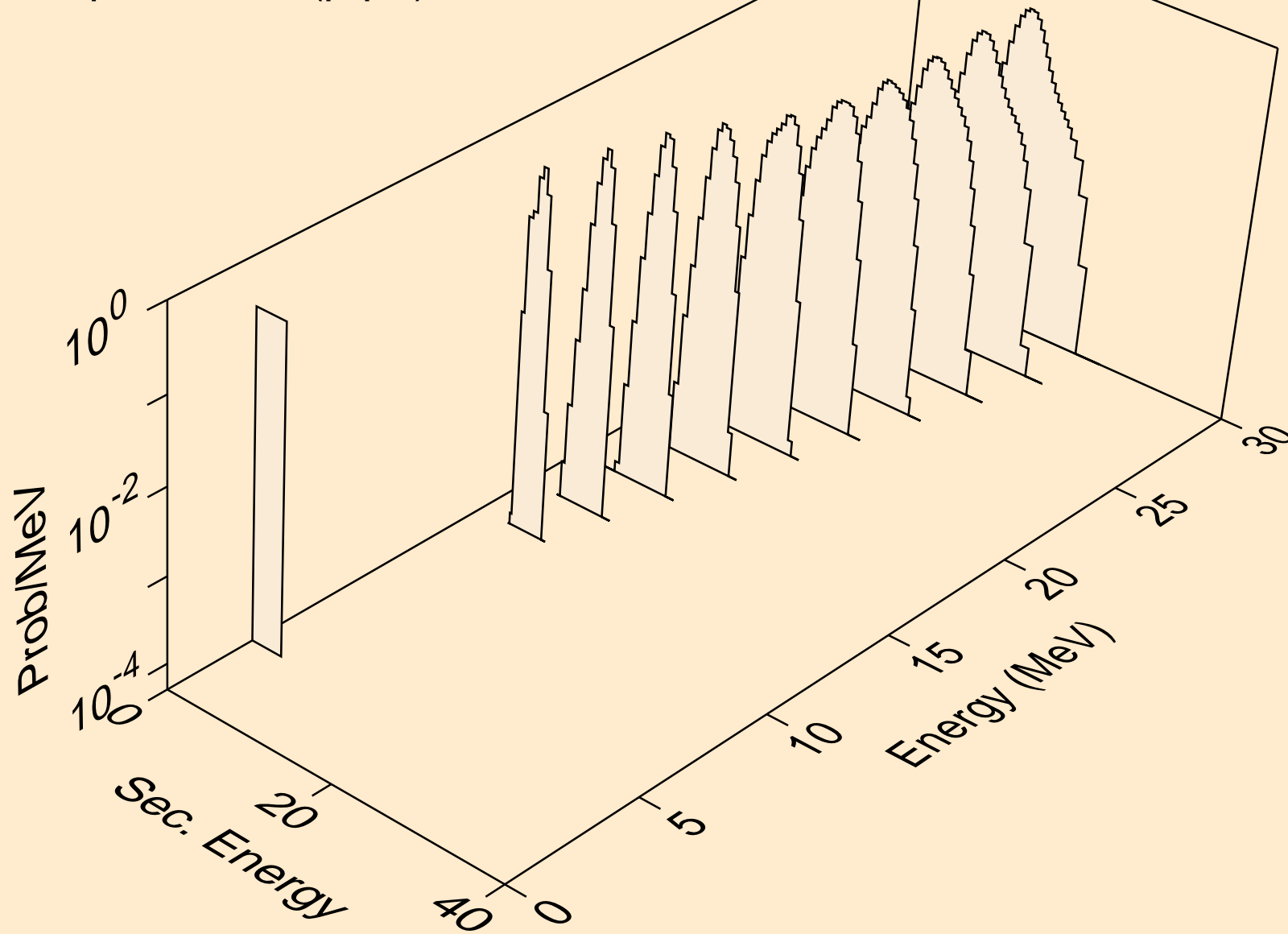

XE135M PROTON ACER TENDL-2021 LIBRARY; T=0.K  
alphas from (p,da)

