

BK240 TRITON ACER TENDL-2021 LIBRARY; T=0.K  
Principal cross sections

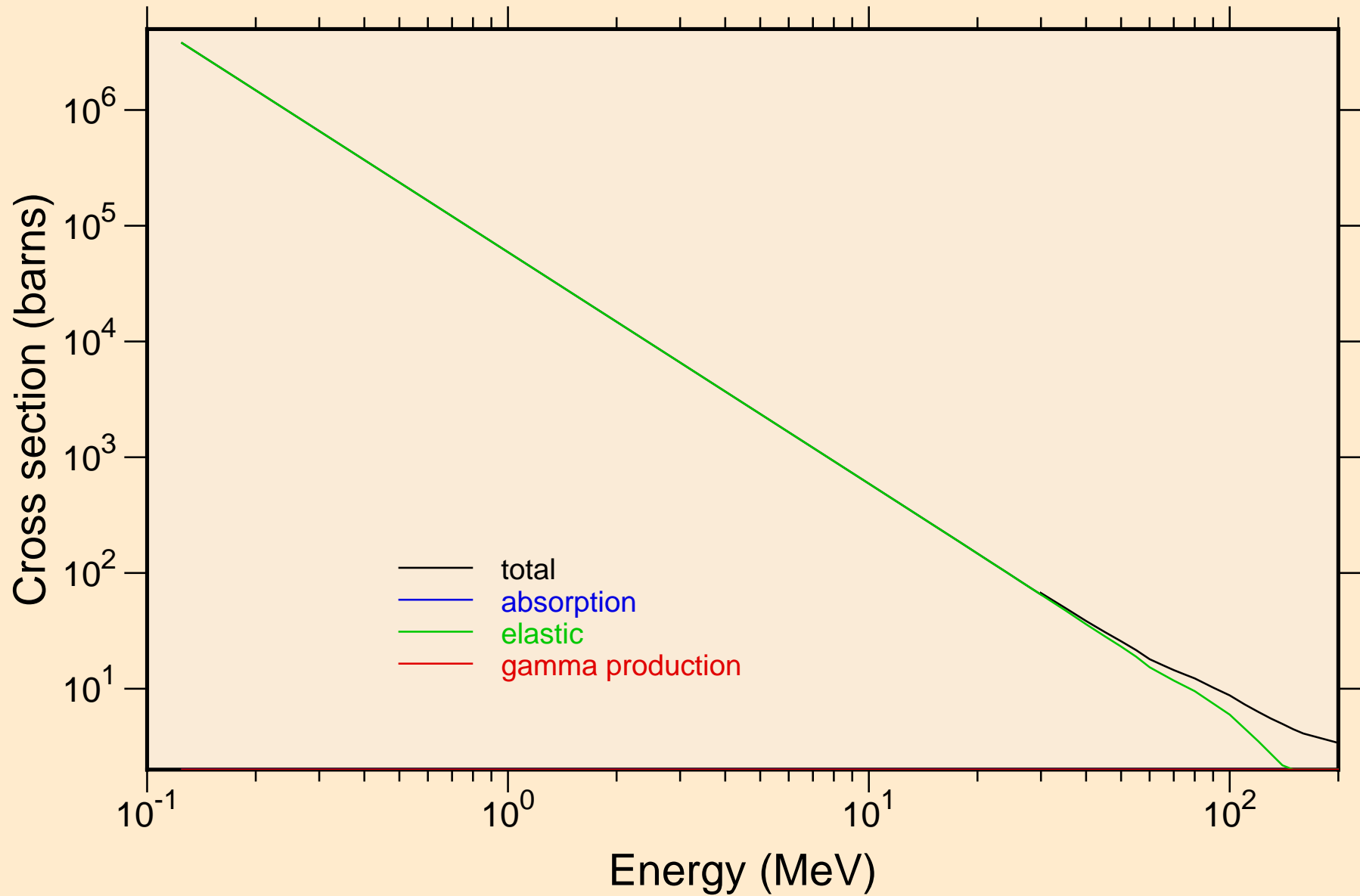

BK240 TRITON ACER TENDL-2021 LIBRARY; T=0.K

Heating

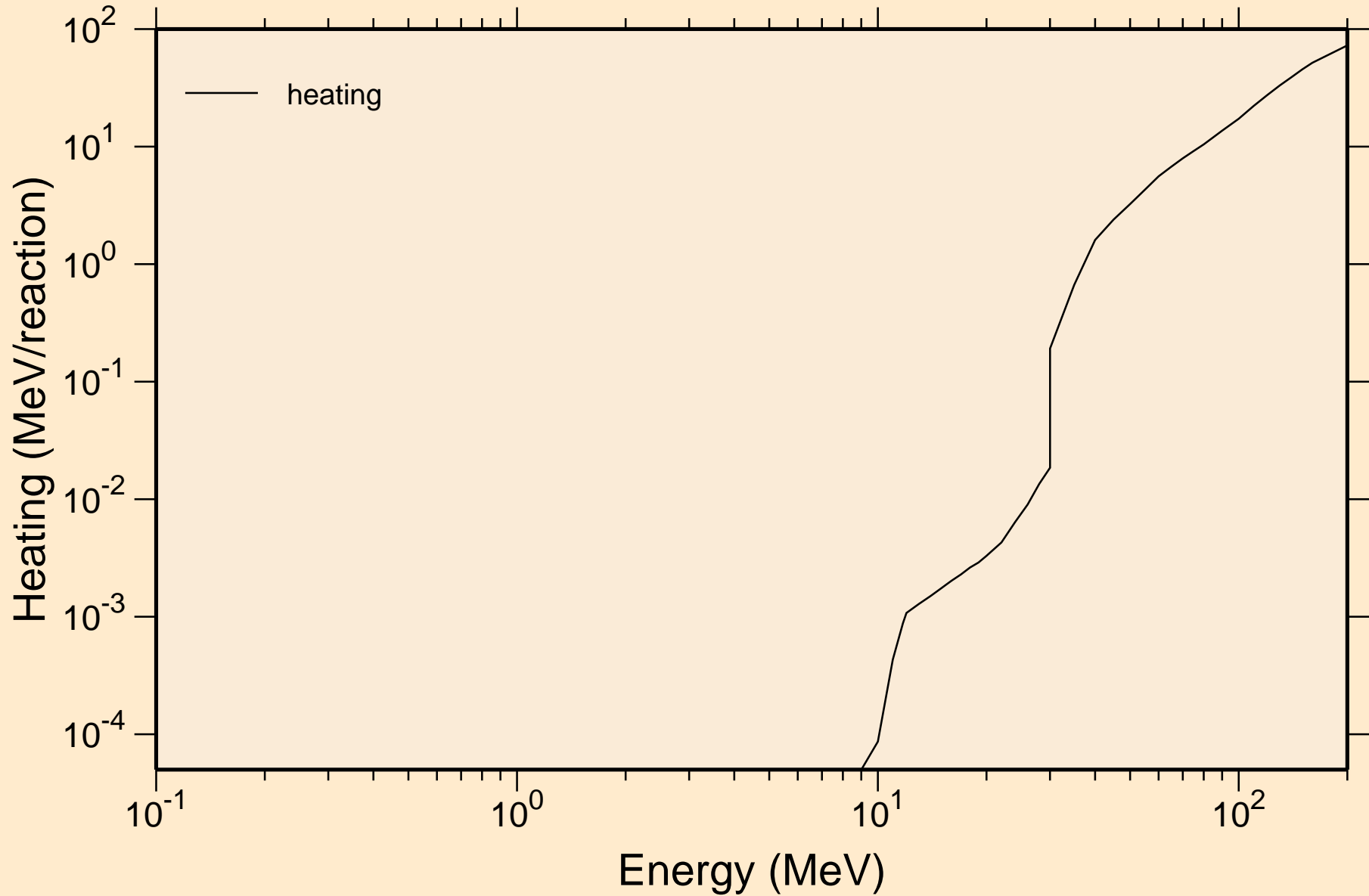

BK240 TRITON ACER TENDL-2021 LIBRARY; T=0.K

Principal cross sections

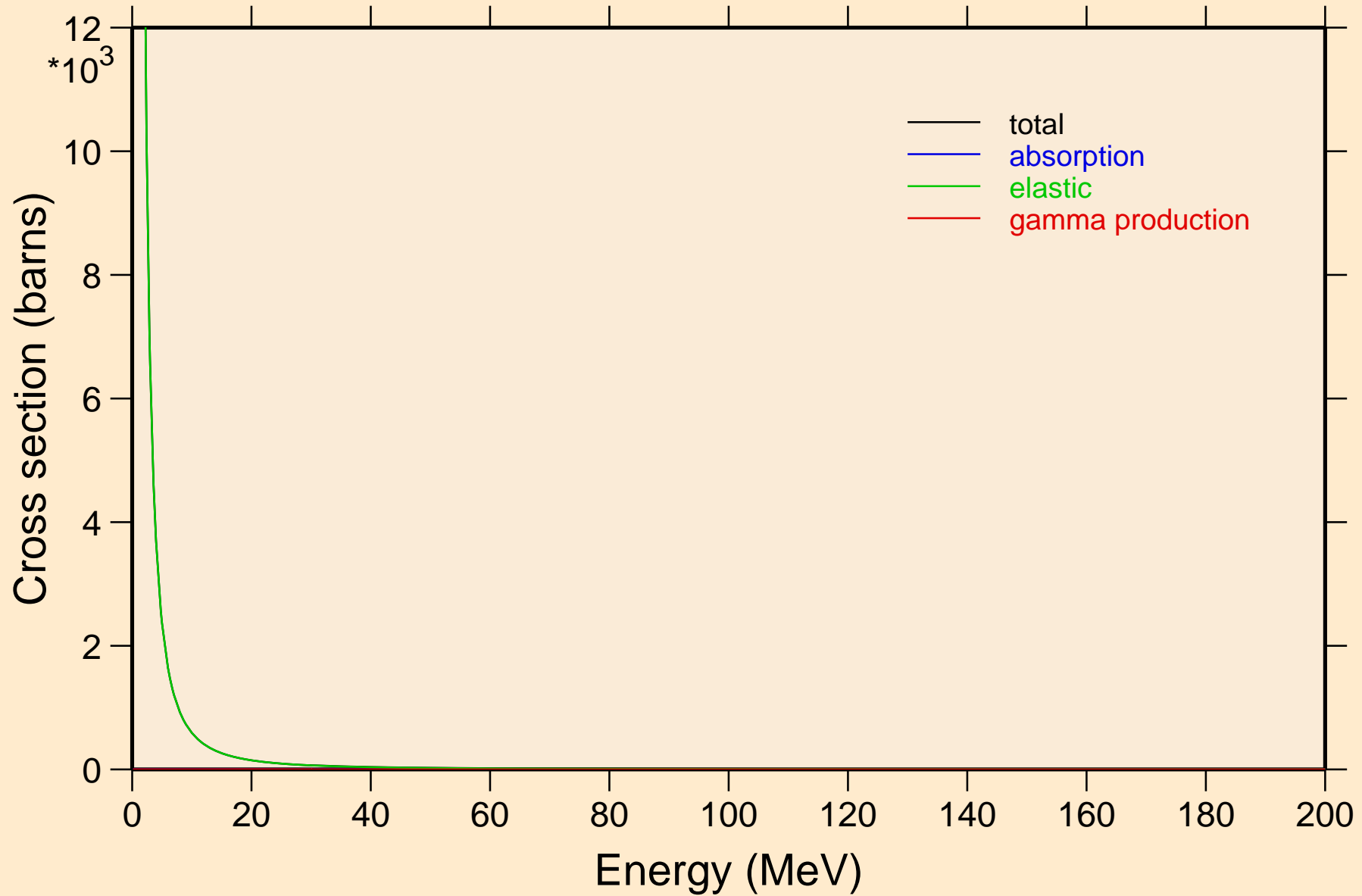

BK240 TRITON ACER TENDL-2021 LIBRARY; T=0.K

Heating

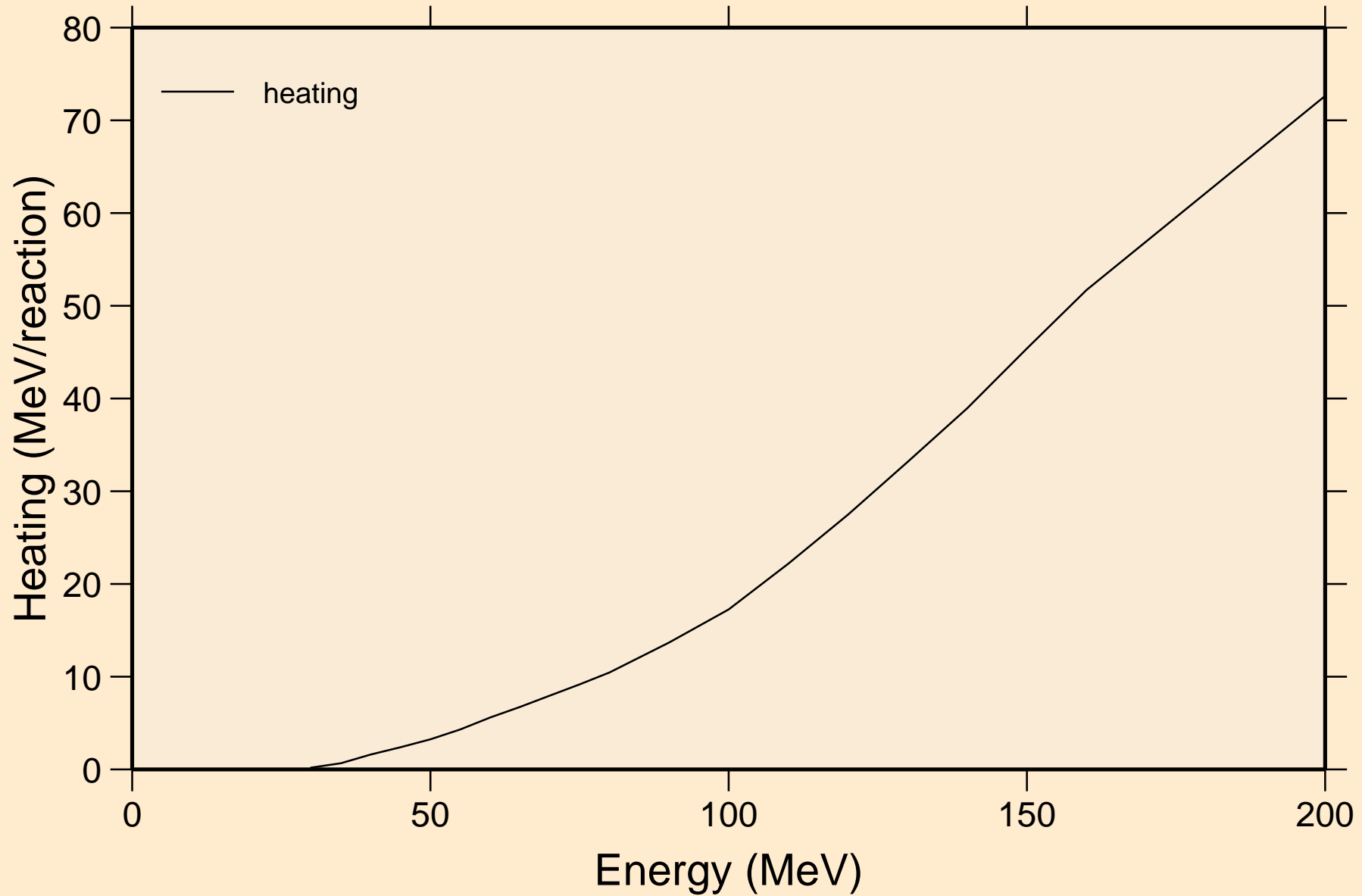

BK240 TRITON ACER TENDL-2021 LIBRARY; T=0.K  
Threshold reactions

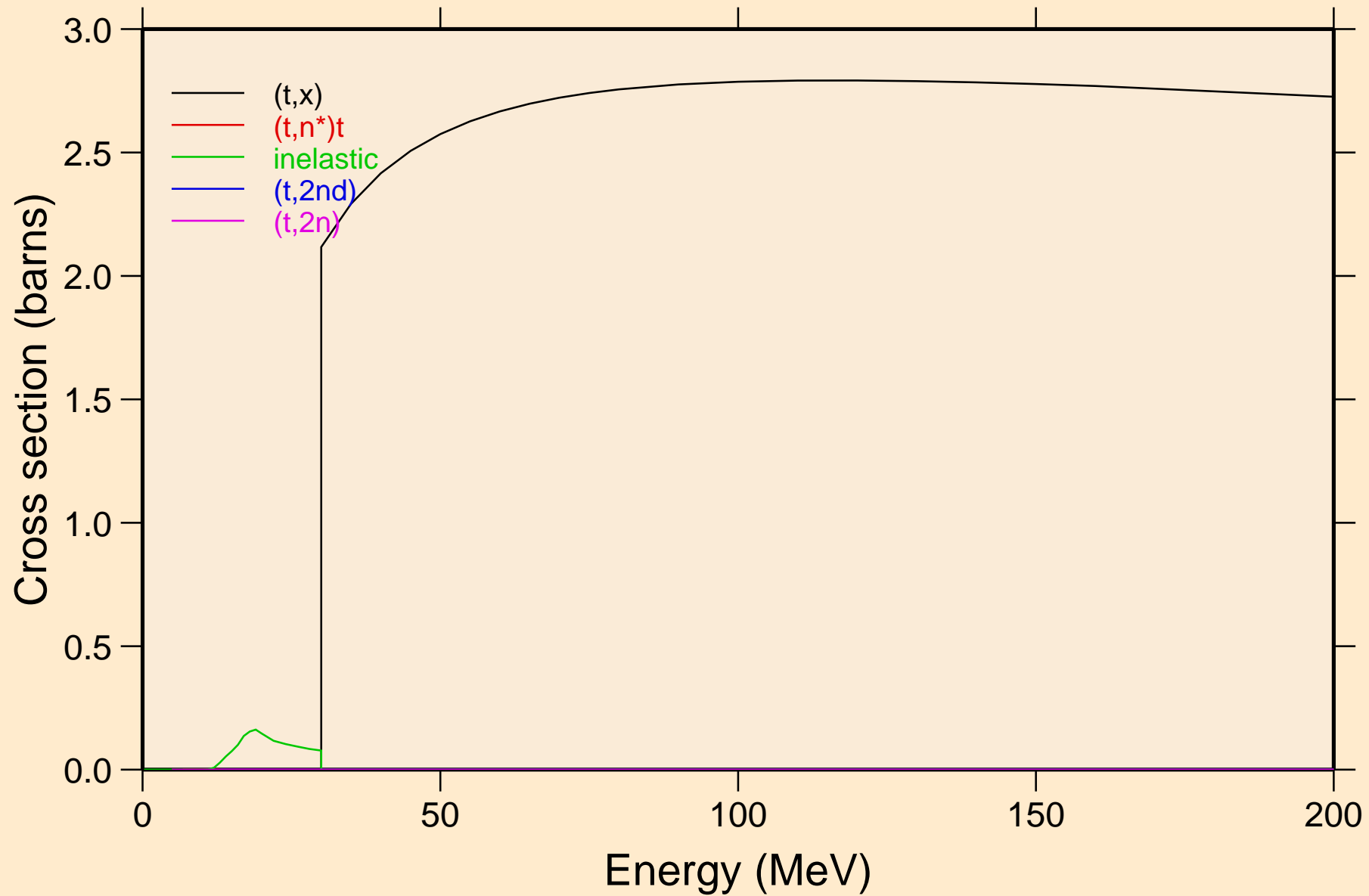

BK240 TRITON ACER TENDL-2021 LIBRARY; T=0.K  
Threshold reactions

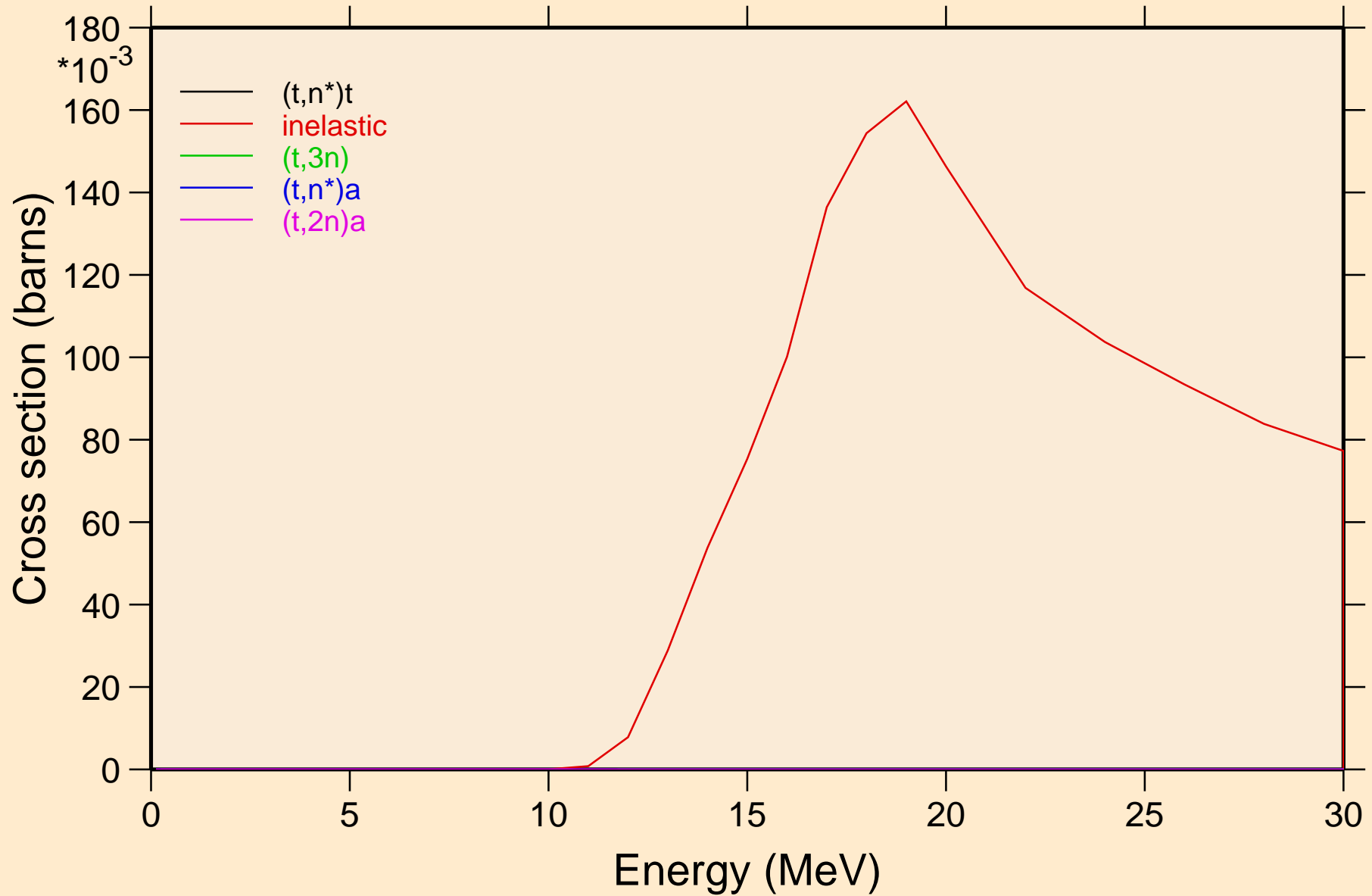

BK240 TRITON ACER TENDL-2021 LIBRARY; T=0.K  
Threshold reactions

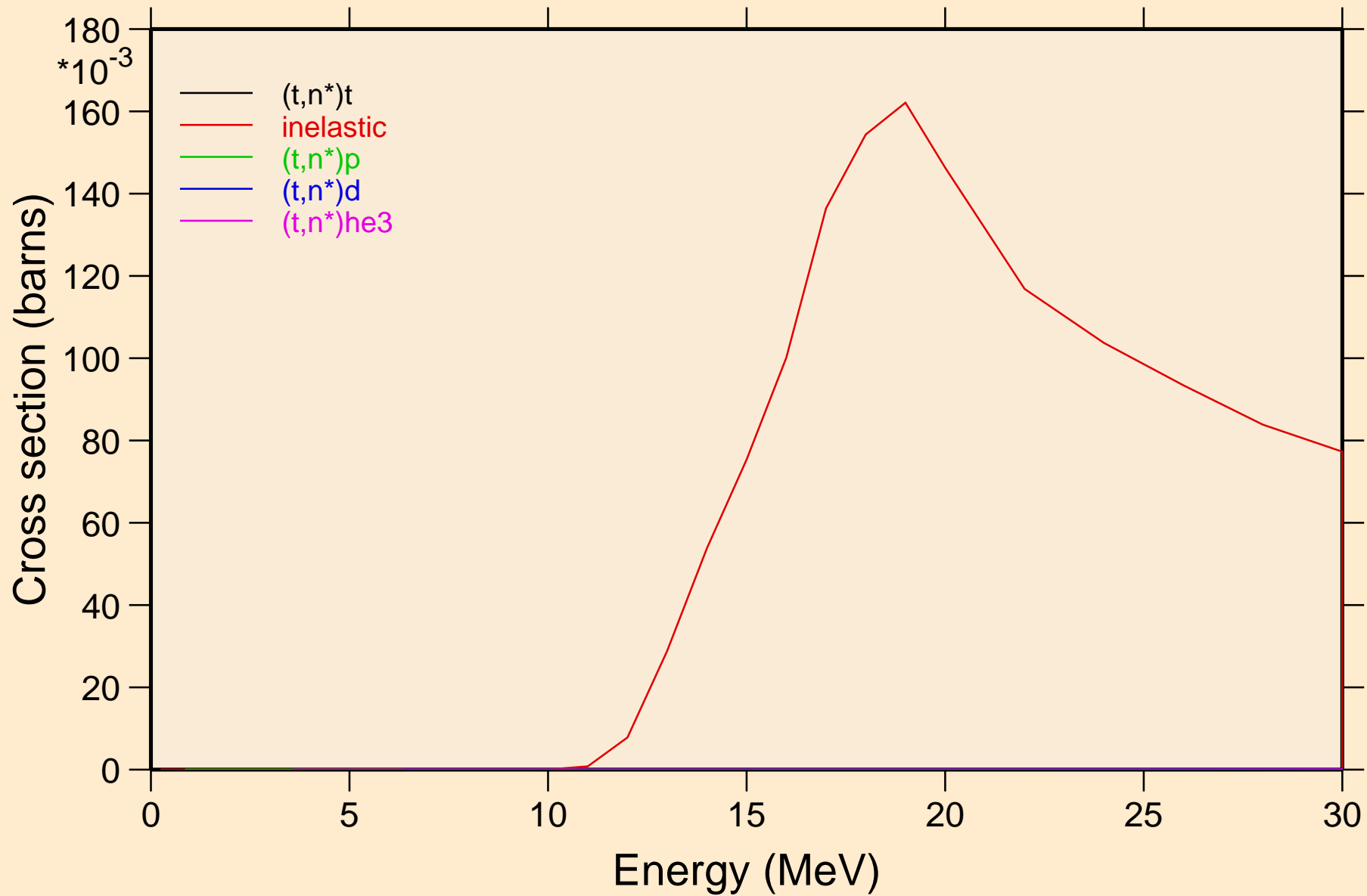

BK240 TRITON ACER TENDL-2021 LIBRARY; T=0.K  
Threshold reactions

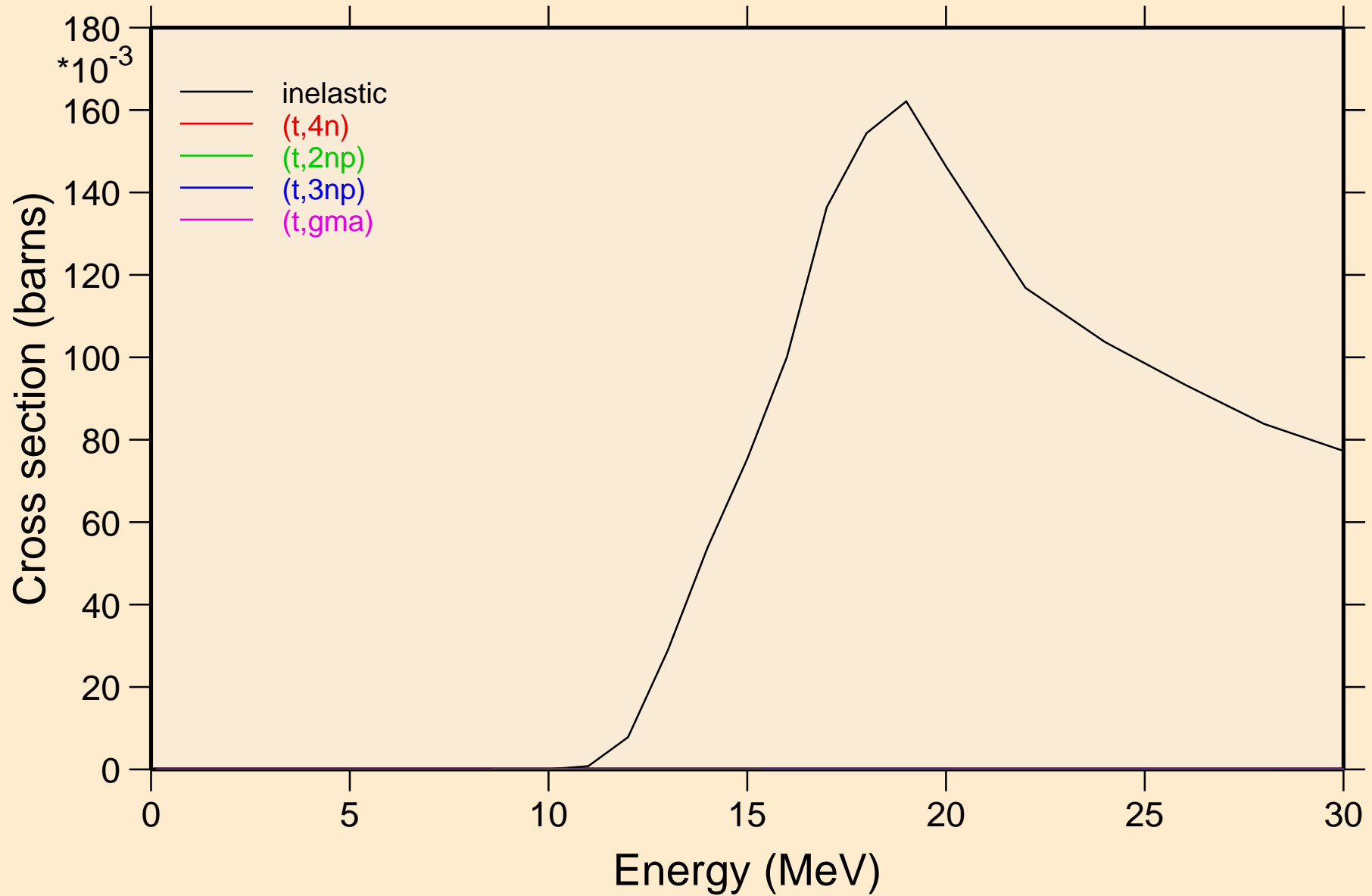

BK240 TRITON ACER TENDL-2021 LIBRARY; T=0.K  
Threshold reactions

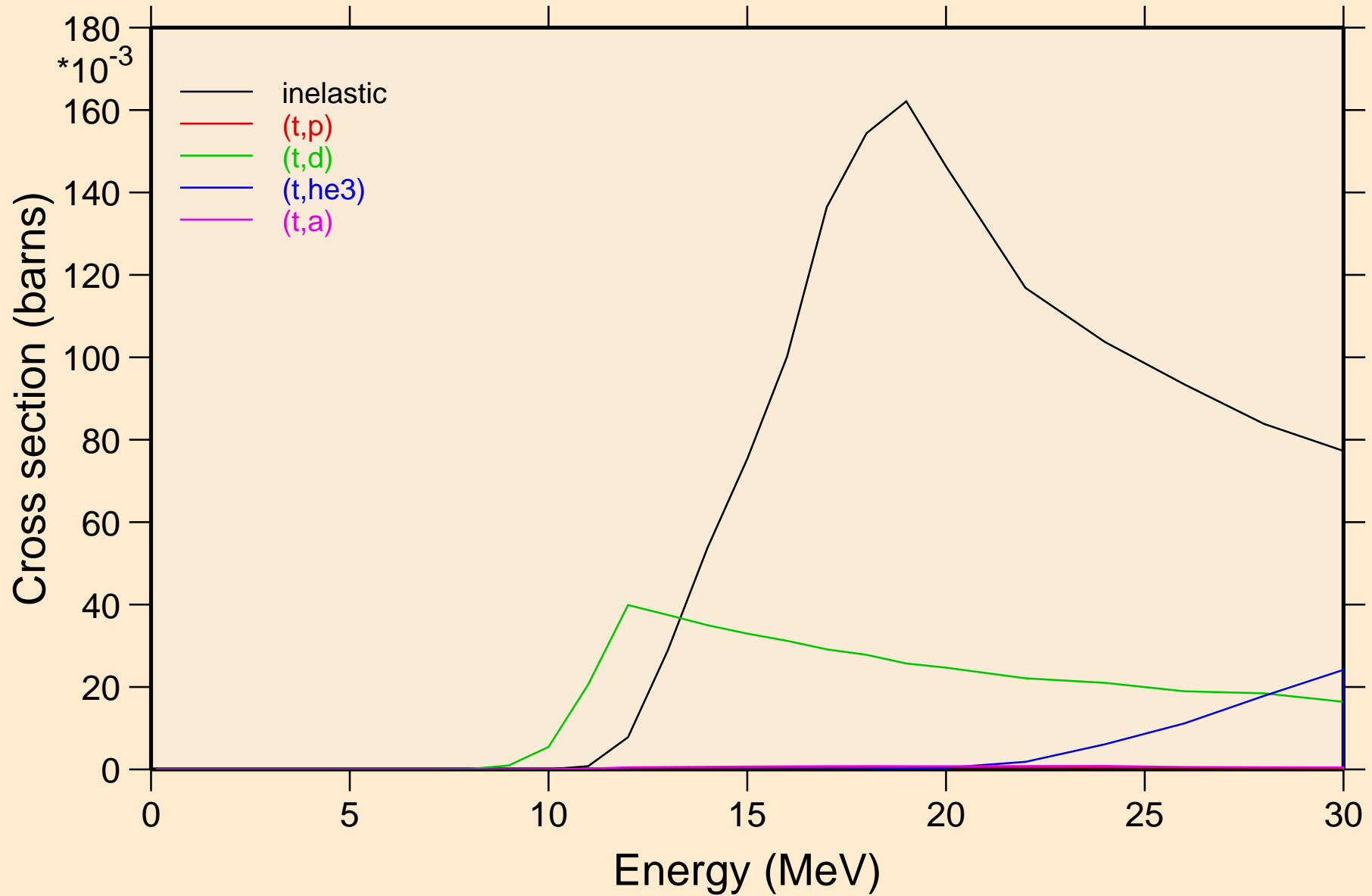

BK240 TRITON ACER TENDL-2021 LIBRARY; T=0.K  
Threshold reactions

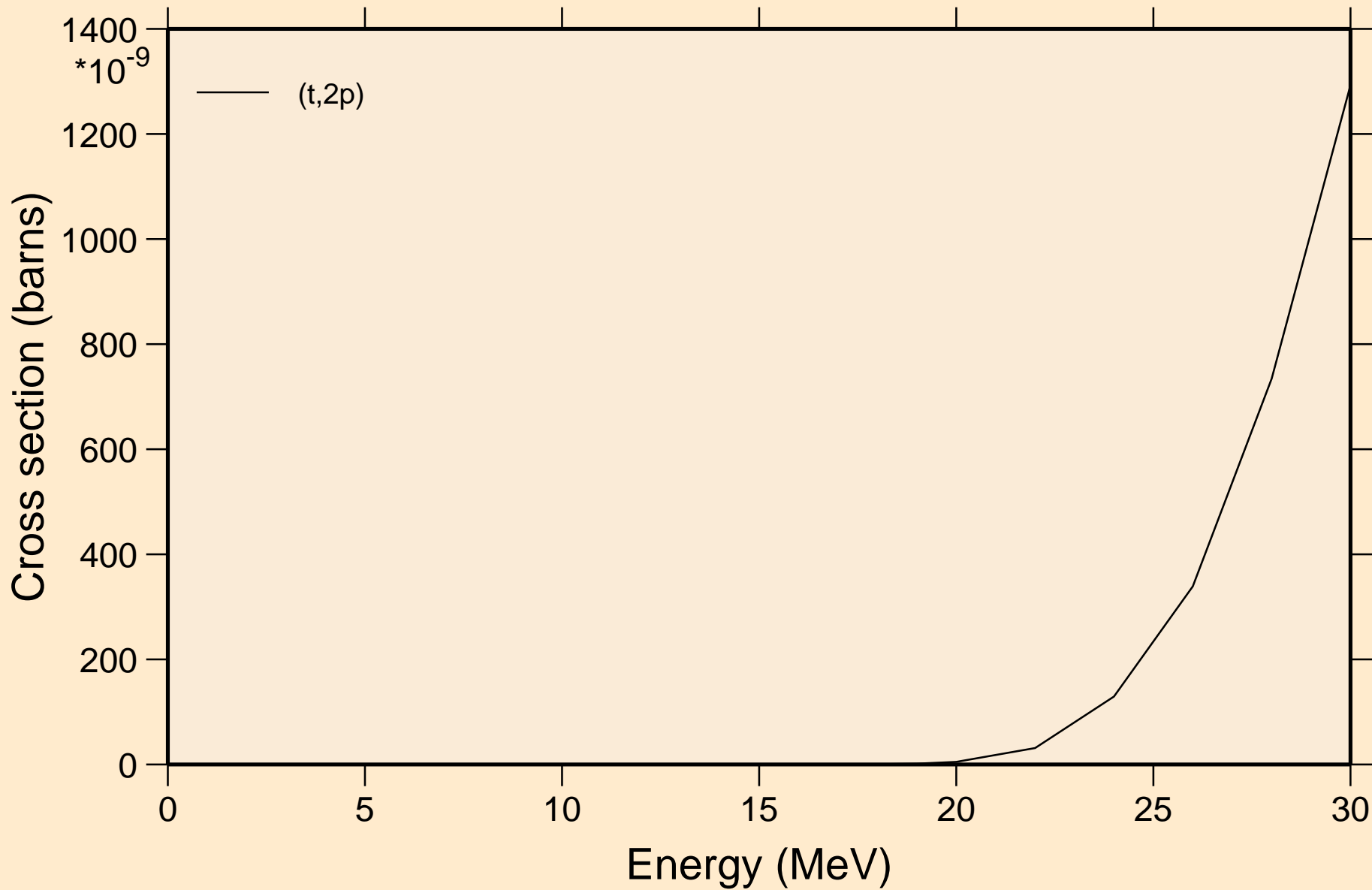

BK240 TRITON ACER TENDL-2021 LIBRARY; T=0.K  
angular distribution for elastic

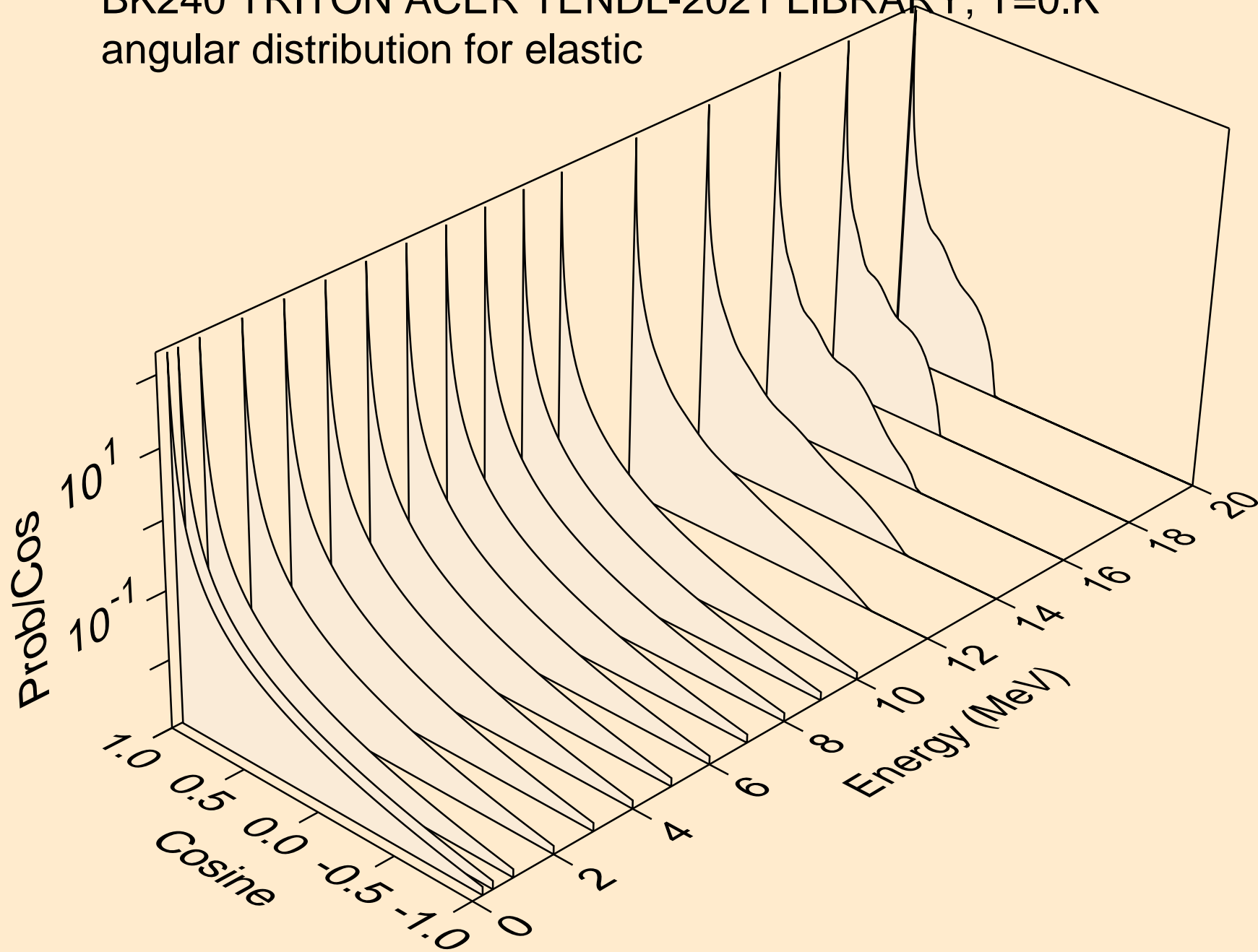

BK240 TRITON ACER TENDL-2021 LIBRARY; T=0.K  
angular distribution for elastic

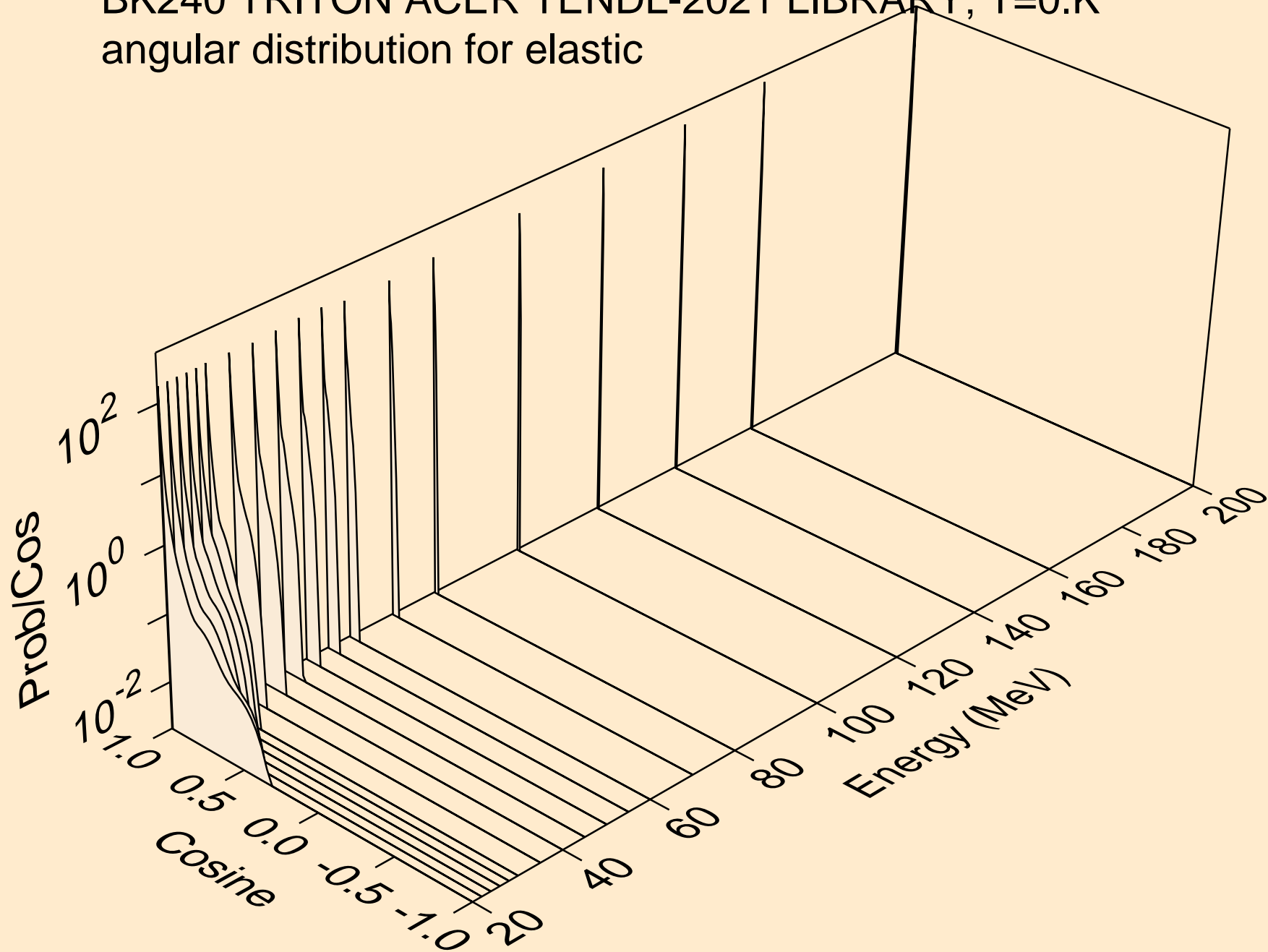

BK240 TRITON ACER TENDL-2021 LIBRARY; T=0.K  
Triton emission for (t,x)

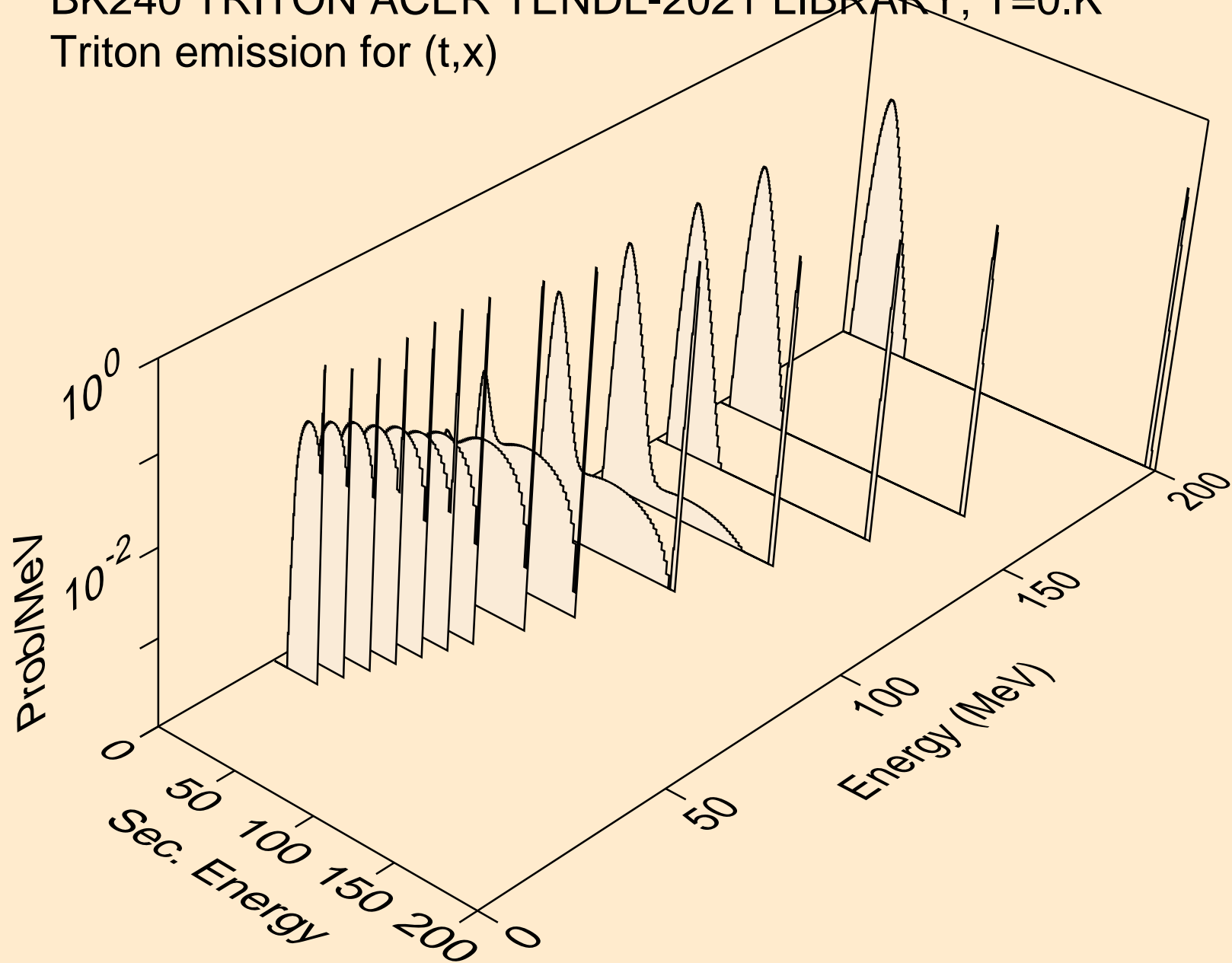

BK240 TRITON ACER TENDL-2021 LIBRARY; T=0.K  
Triton emission for (t,n\*)t

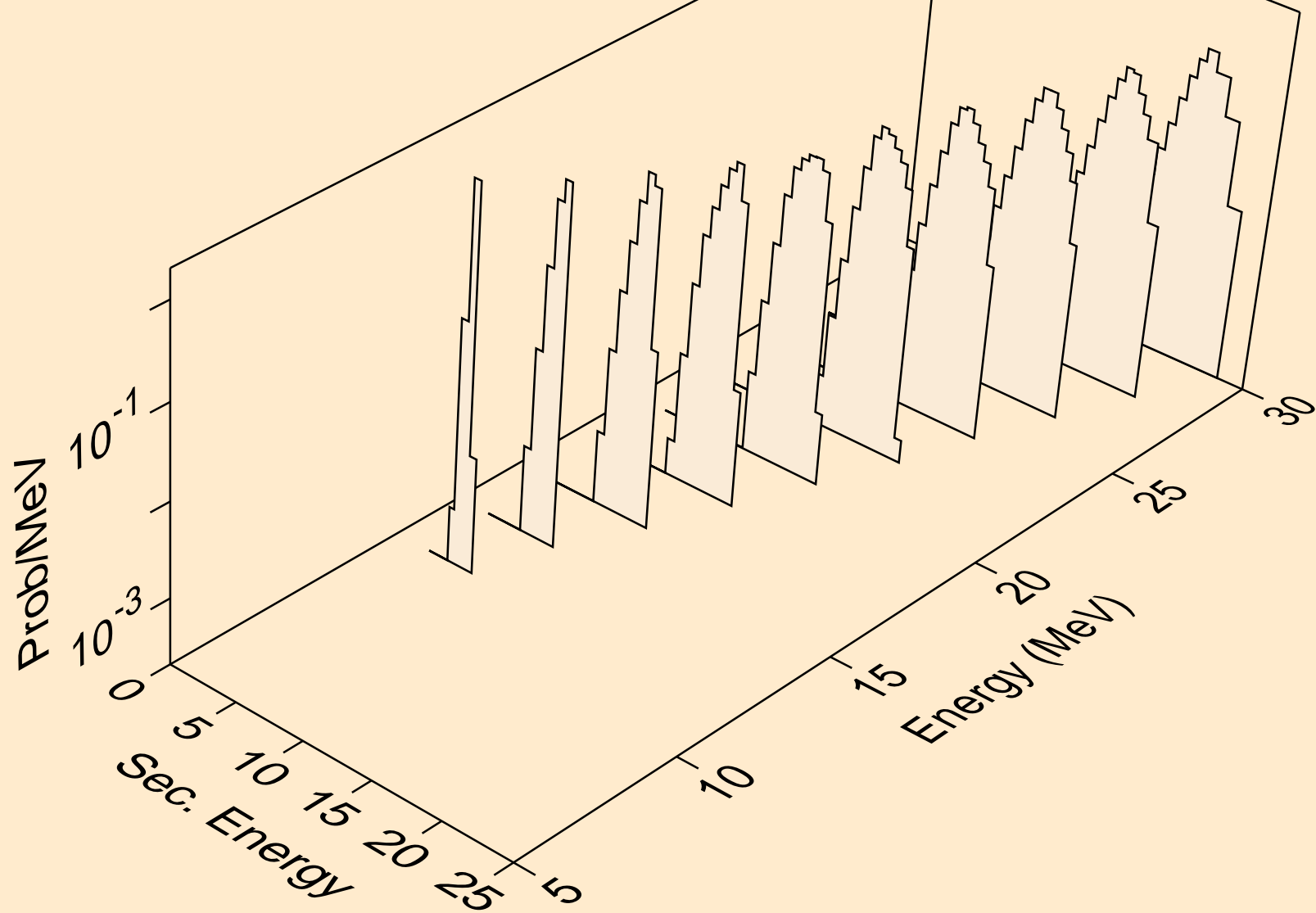

BK240 TRITON ACER TENDL-2021 LIBRARY; T=0.K  
Triton emission for inelastic

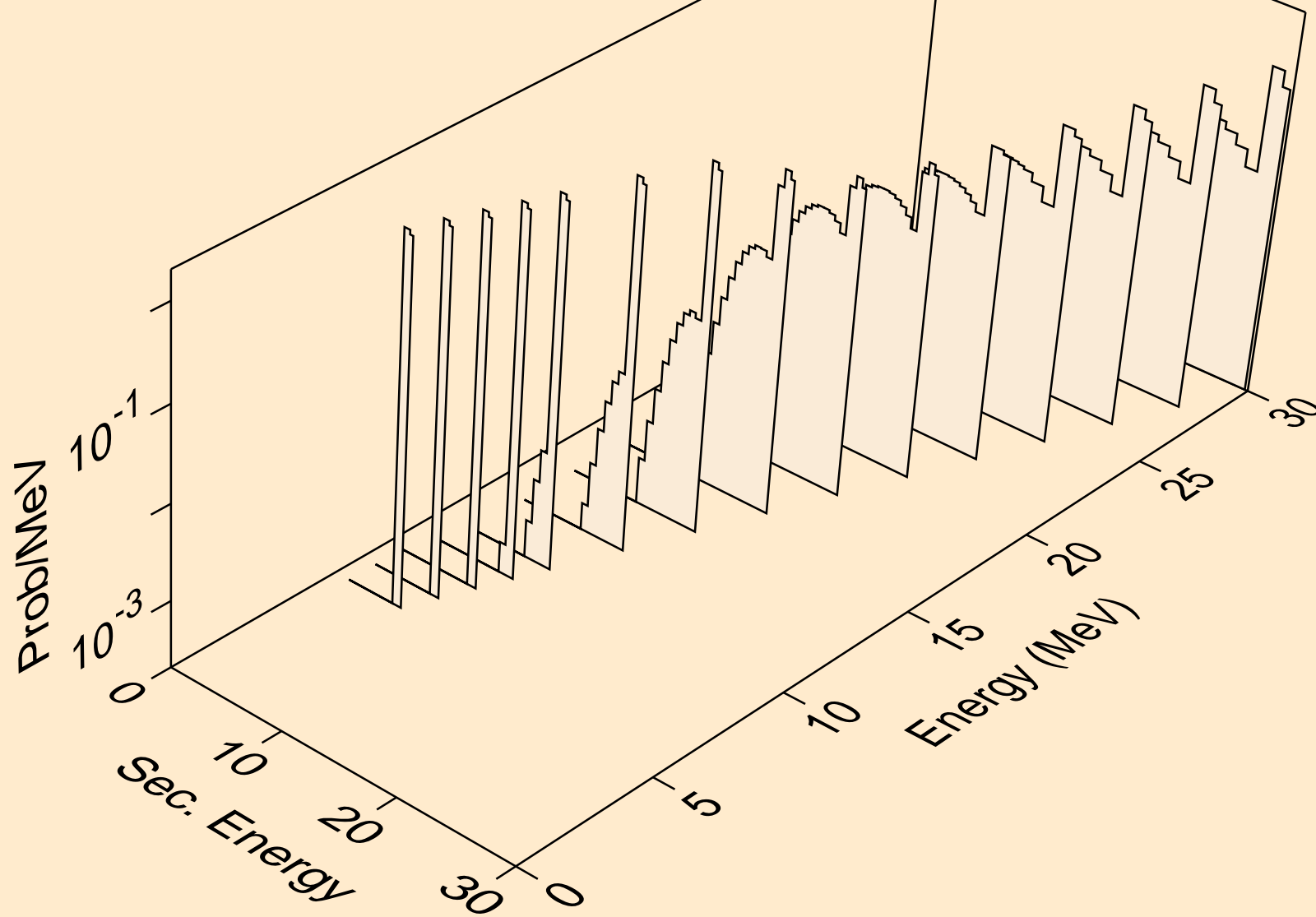

BK240 TRITON ACER TENDL-2021 LIBRARY; T=0.K  
Photon emission for (z,n)

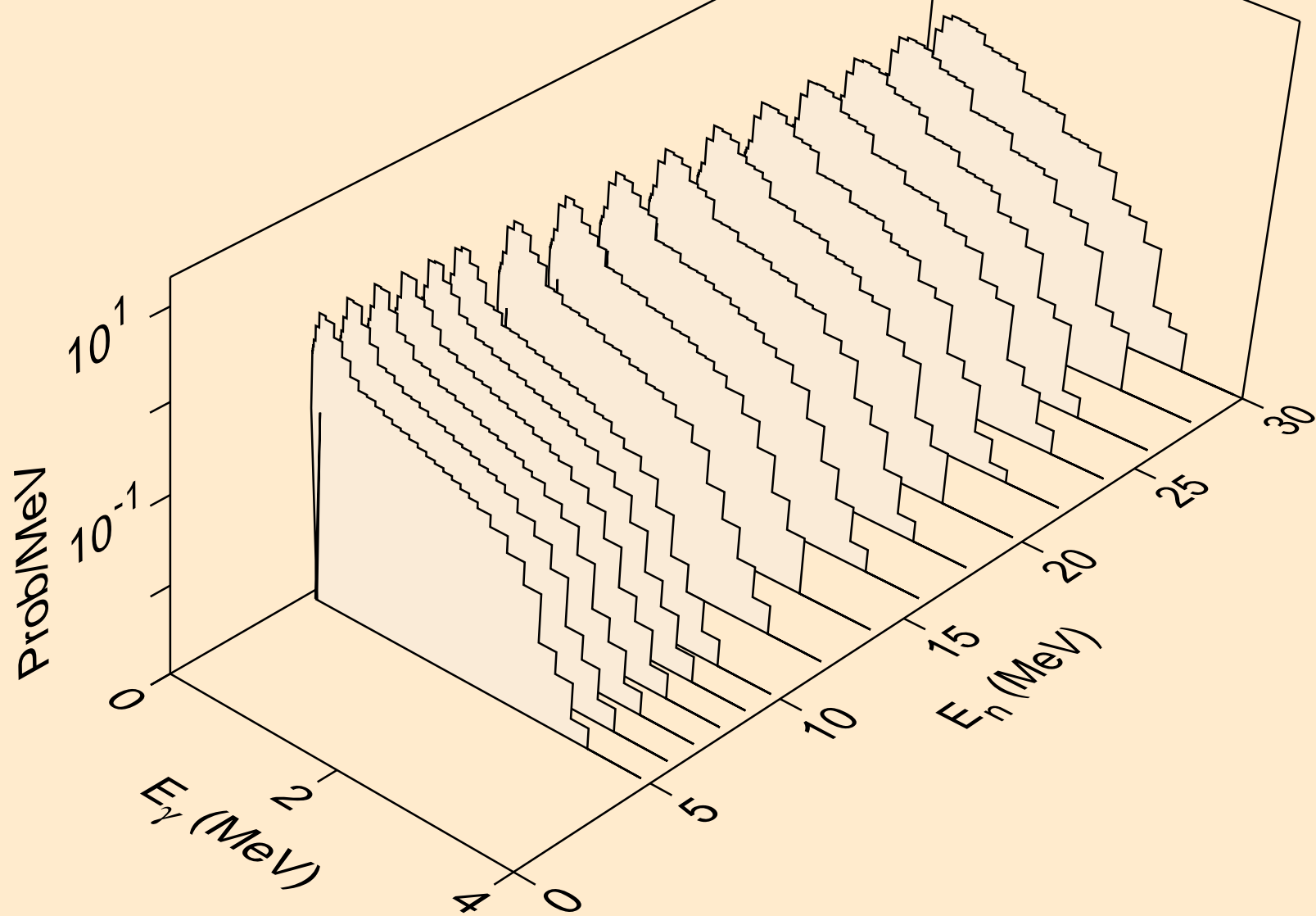

BK240 TRITON ACER TENDL-2021 LIBRARY; T=0.K  
Photon emission for (n,x)

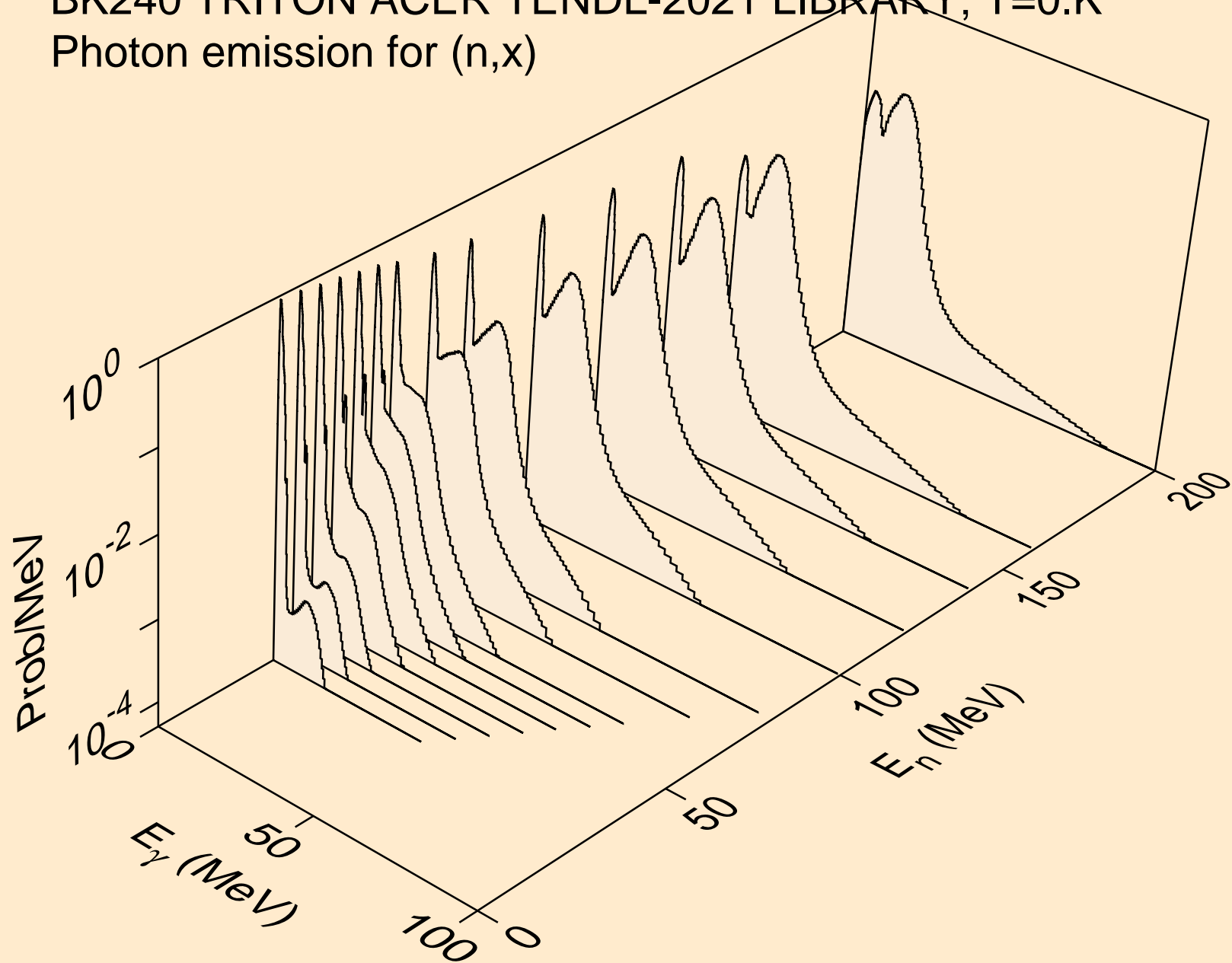

BK240 TRITON ACER TENDL-2021 LIBRARY; T=0.K  
Photon emission for (n,2nd)

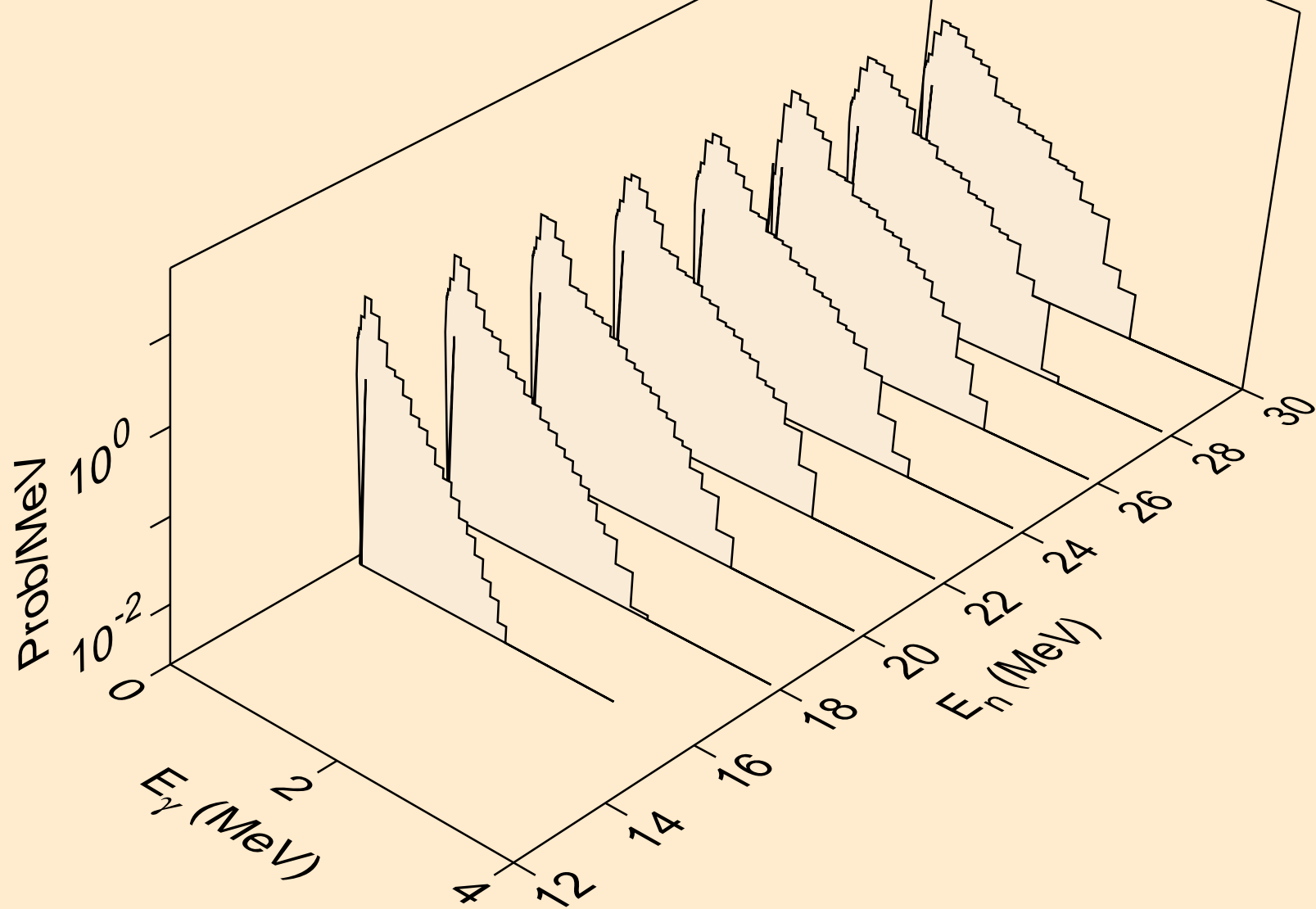

BK240 TRITON ACER TENDL-2021 LIBRARY; T=0.K  
Photon emission for (n,2n)

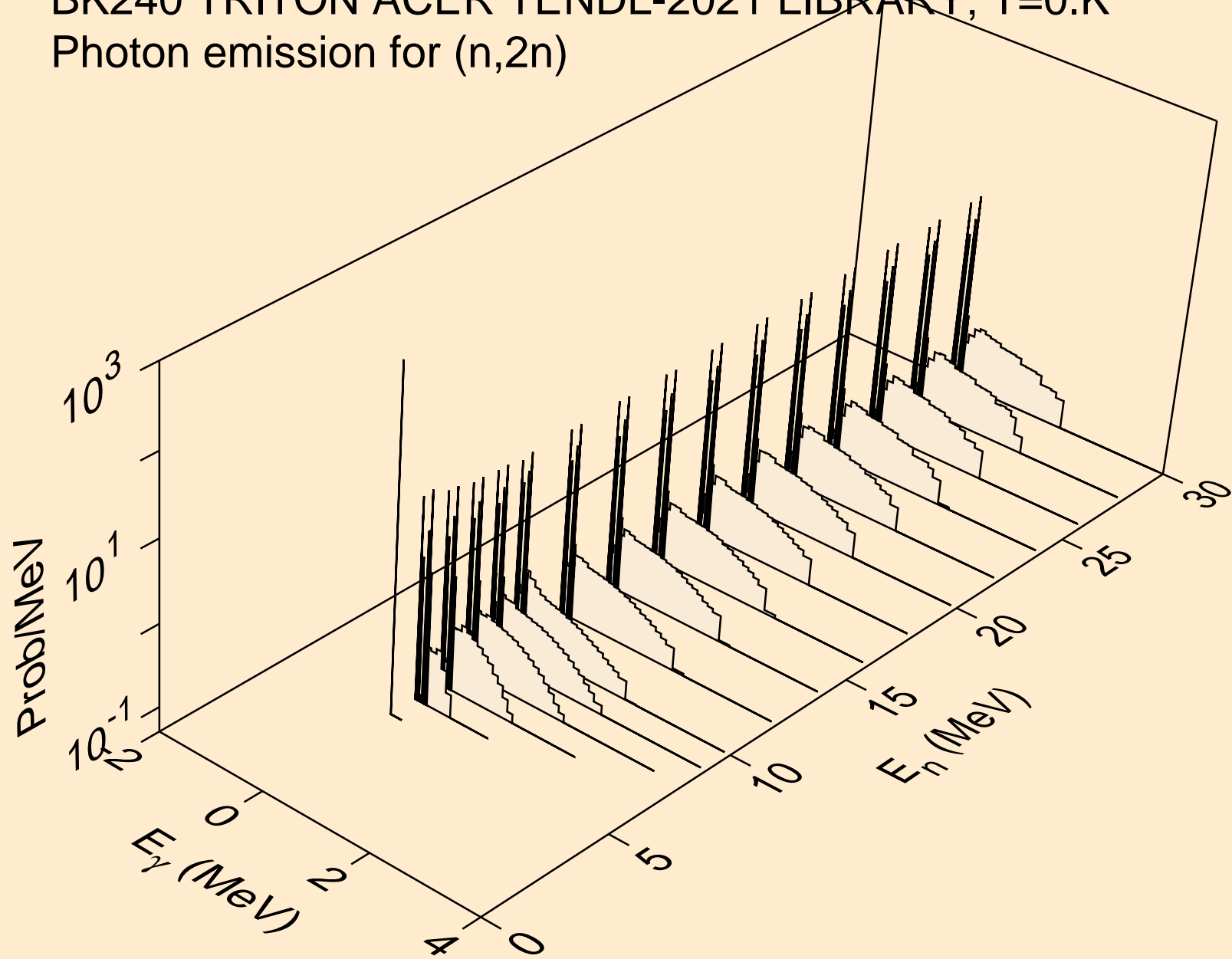

BK240 TRITON ACER TENDL-2021 LIBRARY; T=0.K  
Photon emission for (n,3n)

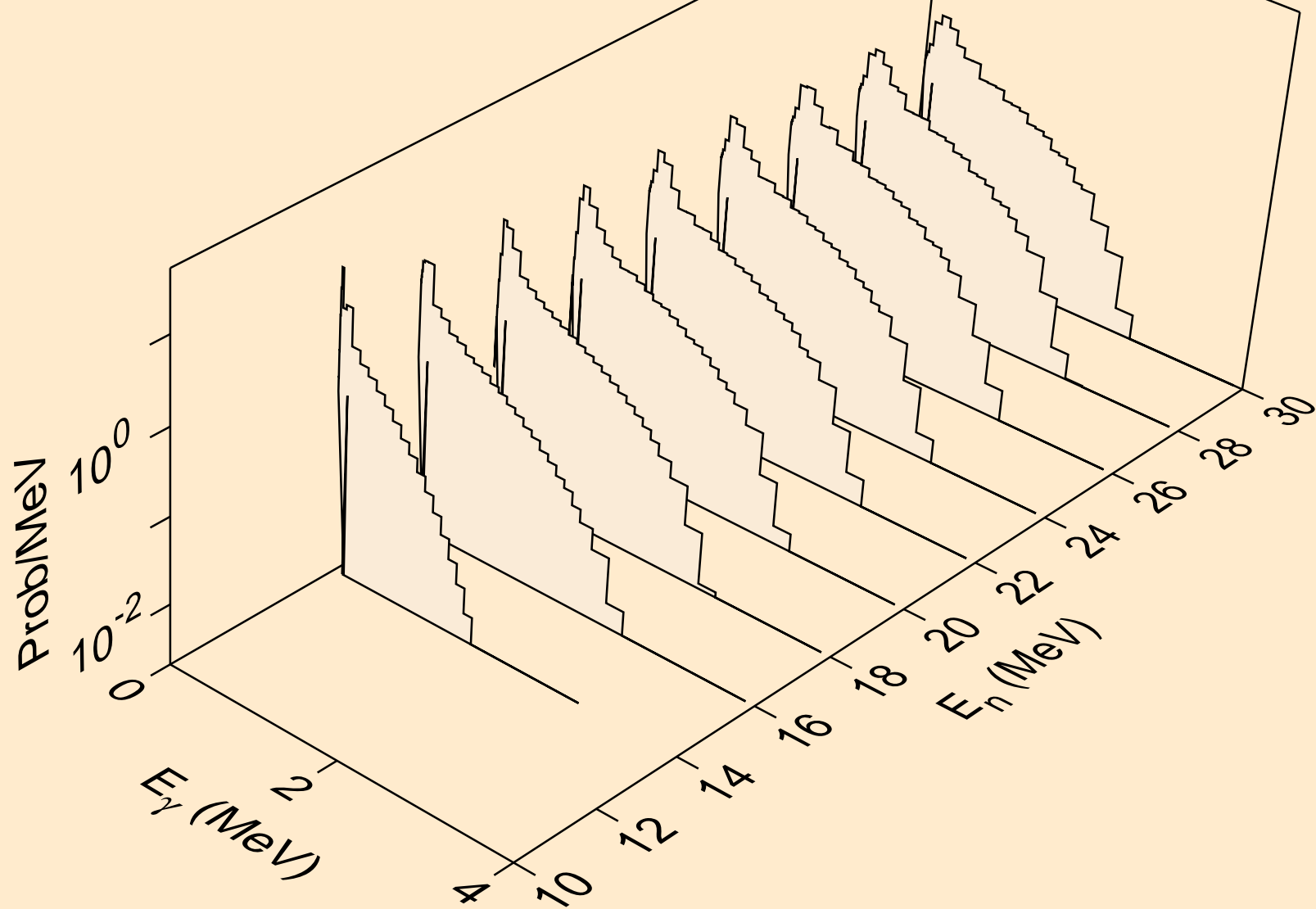

BK240 TRITON ACER TENDL-2021 LIBRARY; T=0.K  
Photon emission for (n,n\*)a

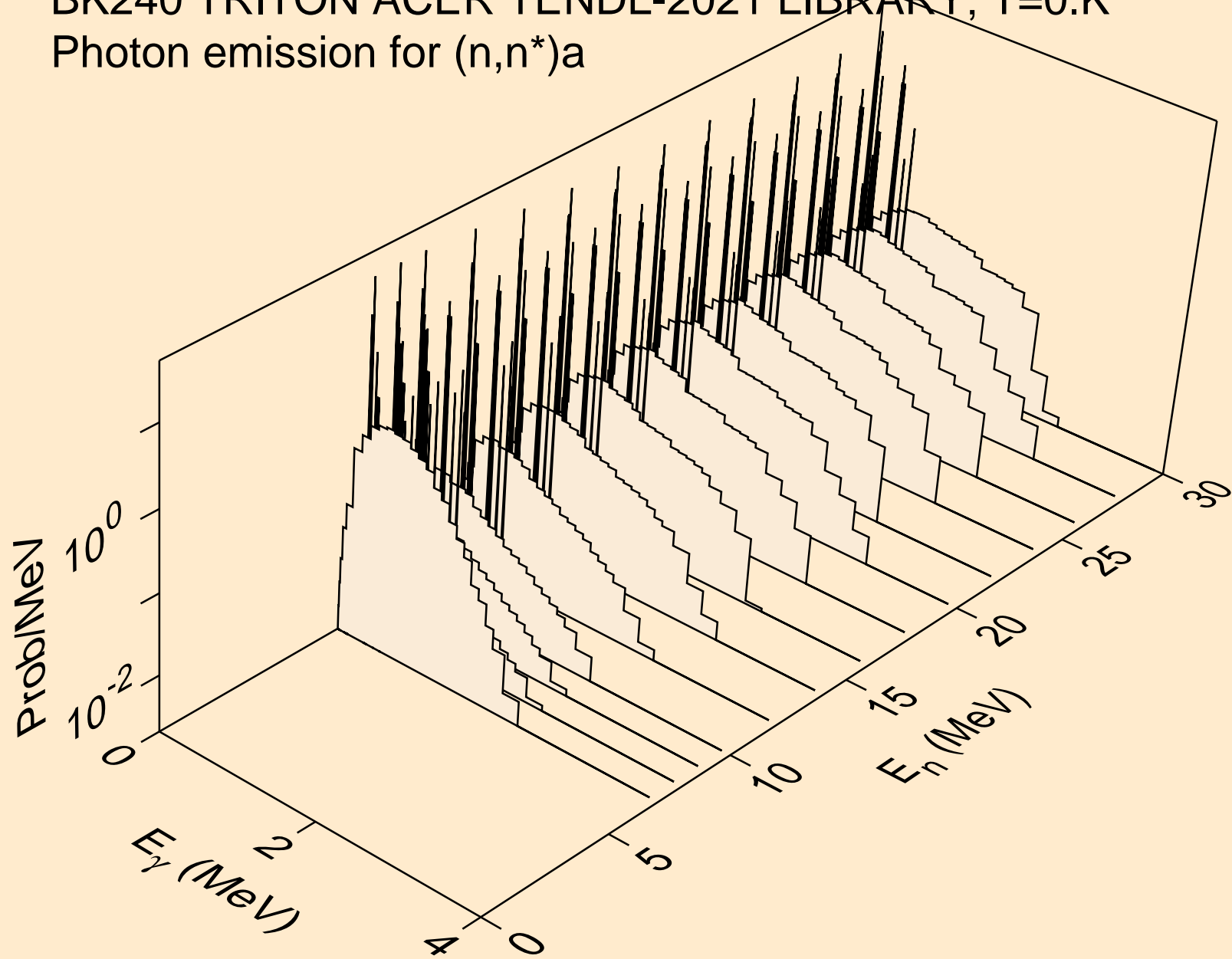

BK240 TRITON ACER TENDL-2021 LIBRARY; T=0.K  
Photon emission for (n,2n)a

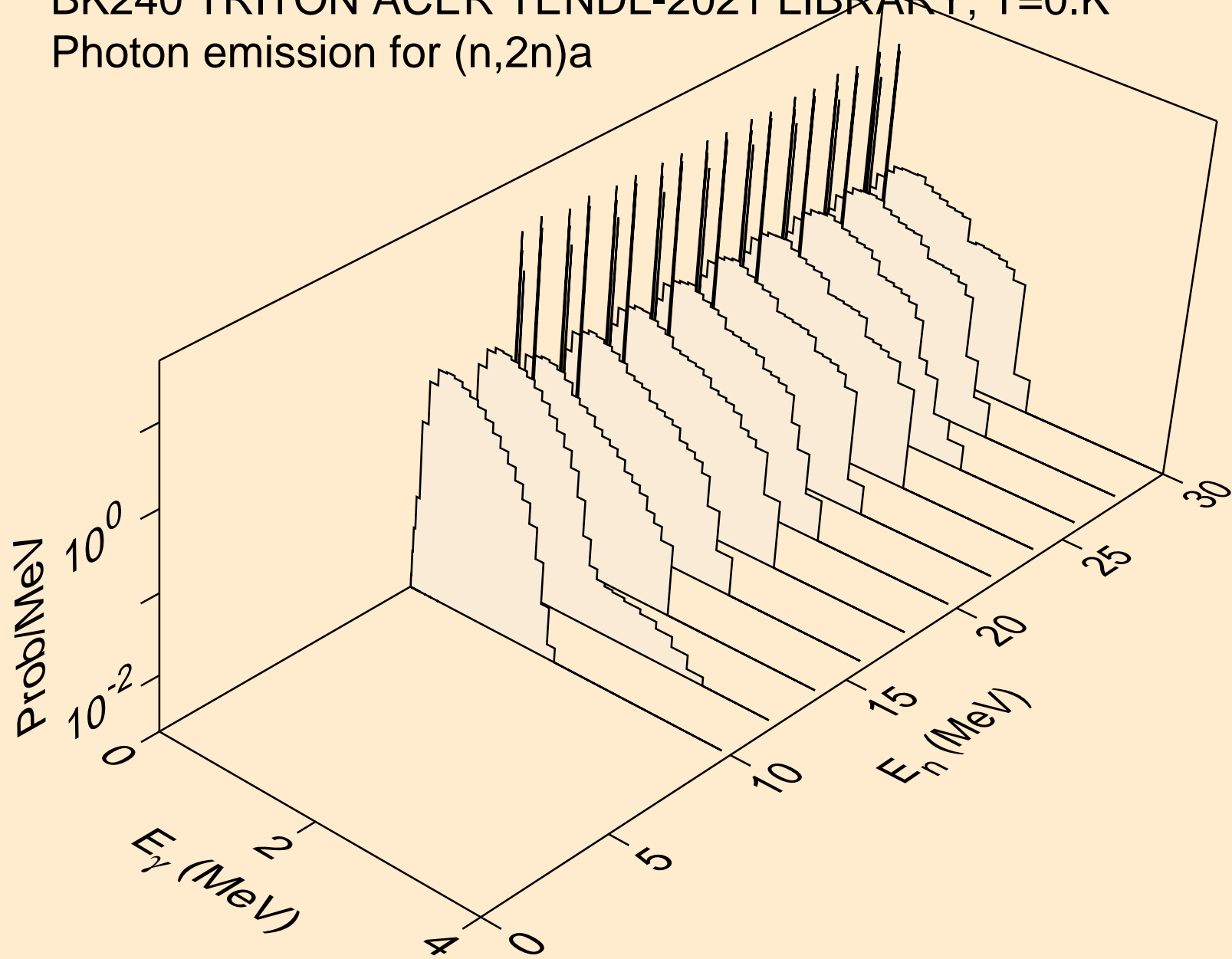

BK240 TRITON ACER TENDL-2021 LIBRARY; T=0.K  
Photon emission for (n,n\*)p

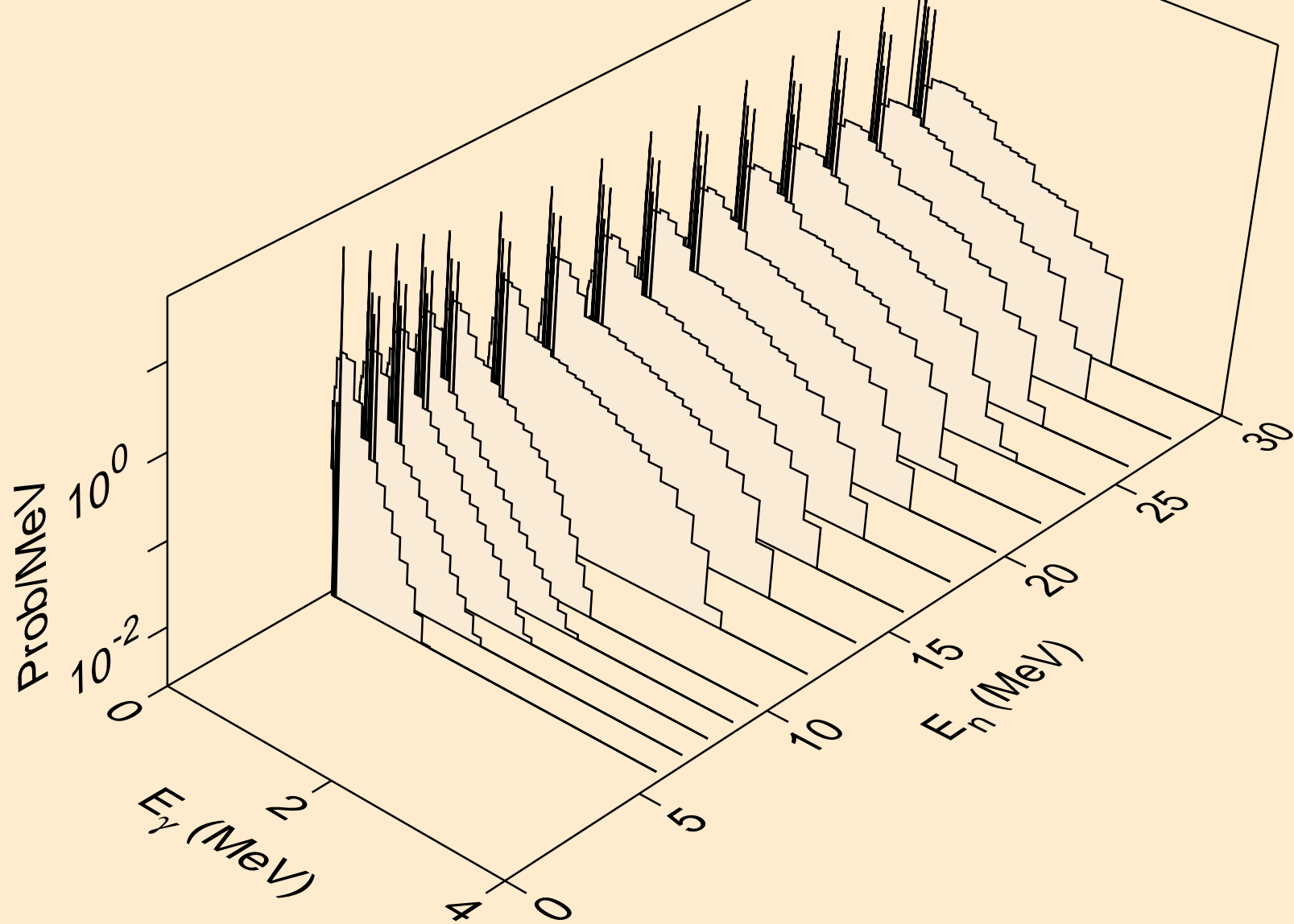

BK240 TRITON ACER TENDL-2021 LIBRARY; T=0.K  
Photon emission for (n,n\*)d

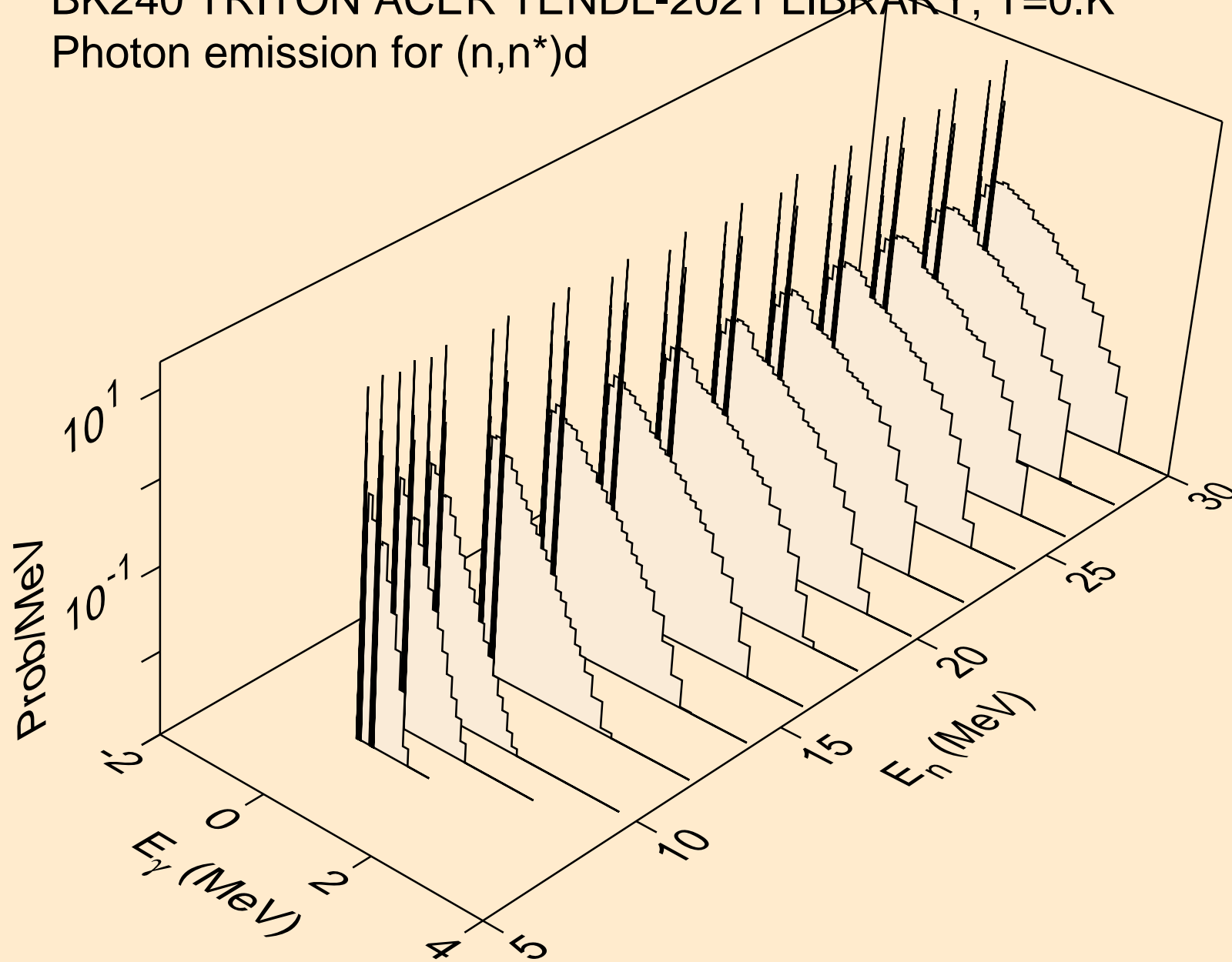

BK240 TRITON ACER TENDL-2021 LIBRARY; T=0.K  
Photon emission for (n,n\*)t

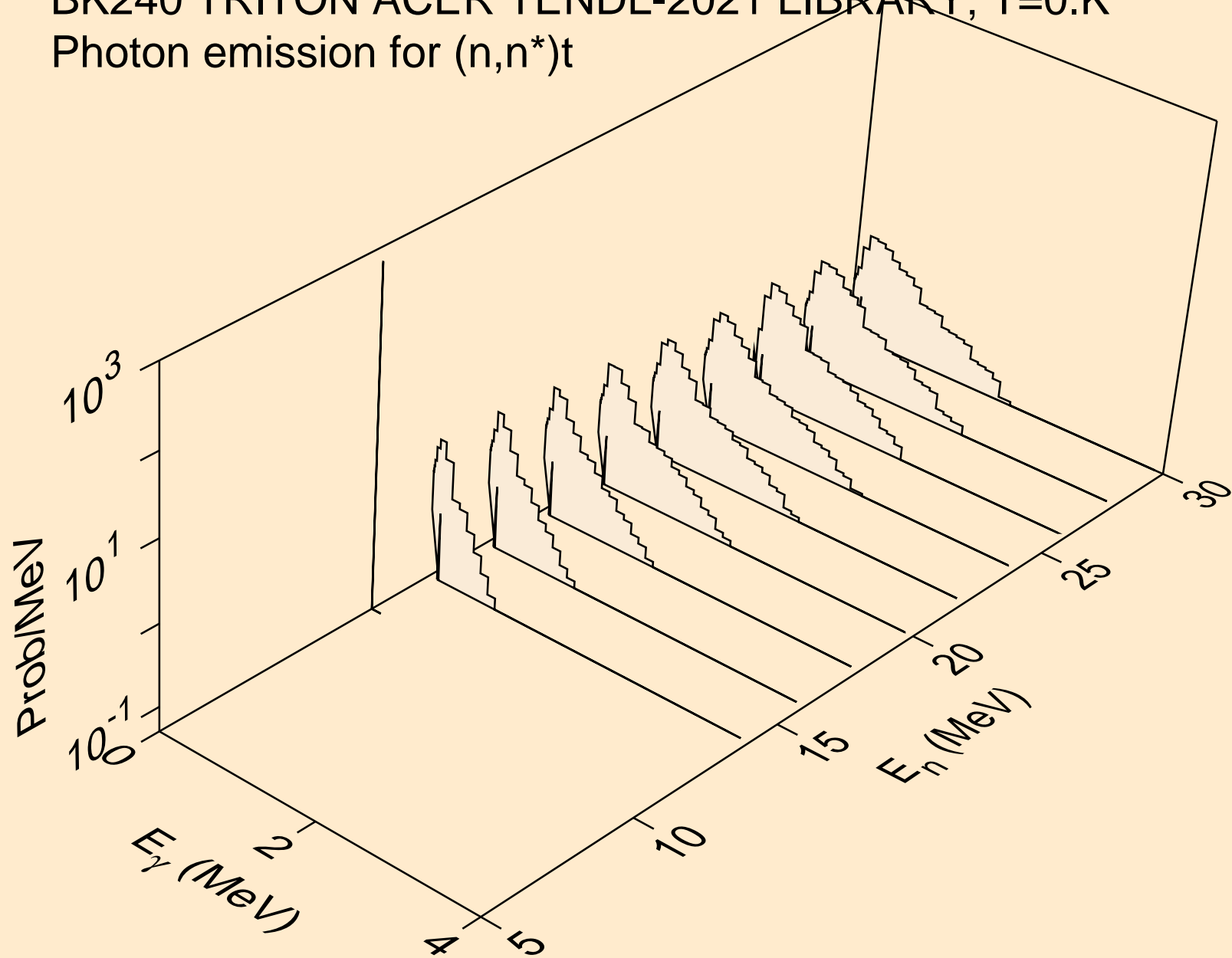

BK240 TRITON ACER TENDL-2021 LIBRARY; T=0.K  
Photon emission for (n,n\*)he3

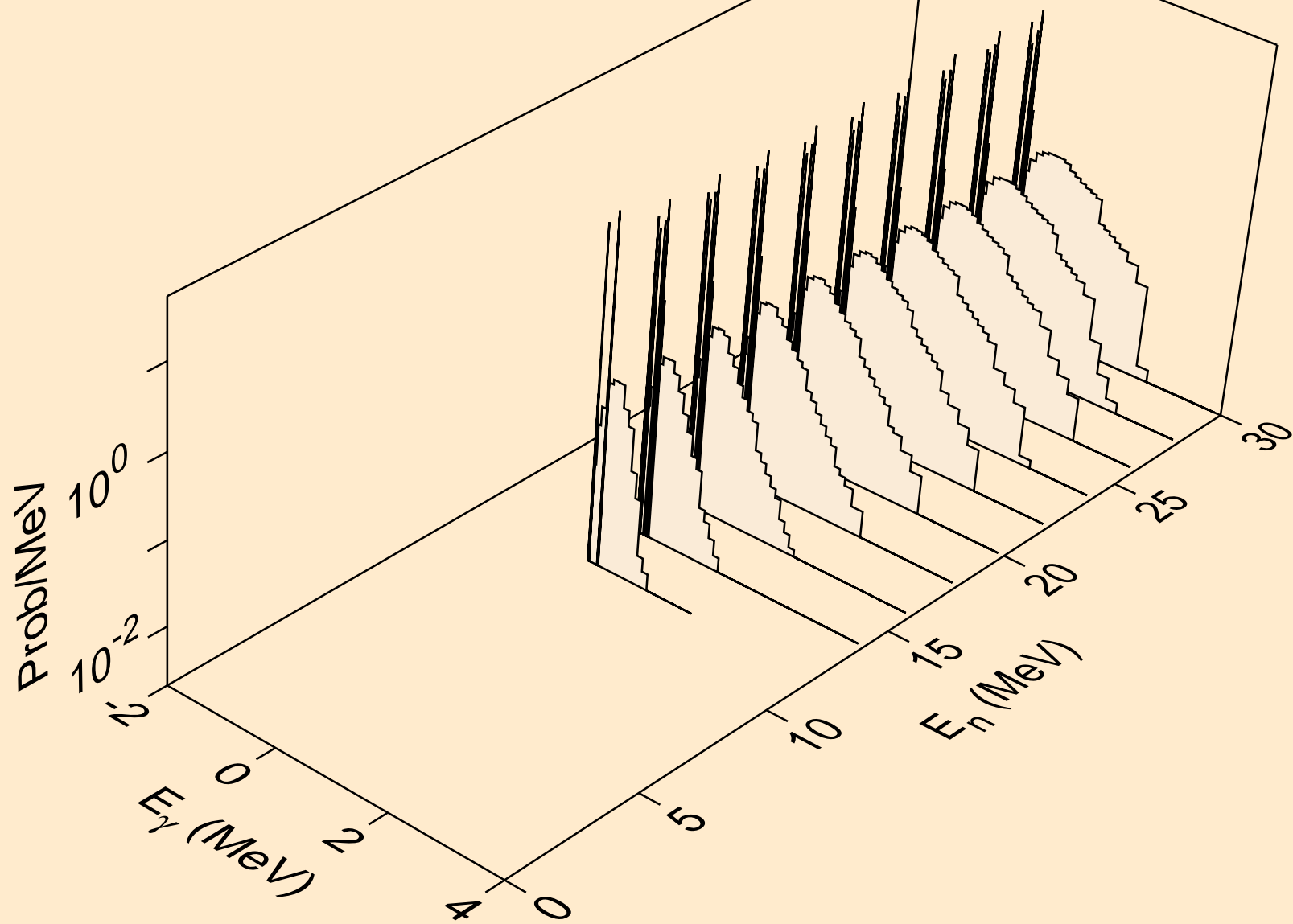

BK240 TRITON ACER TENDL-2021 LIBRARY; T=0.K  
Photon emission for (n,4n)

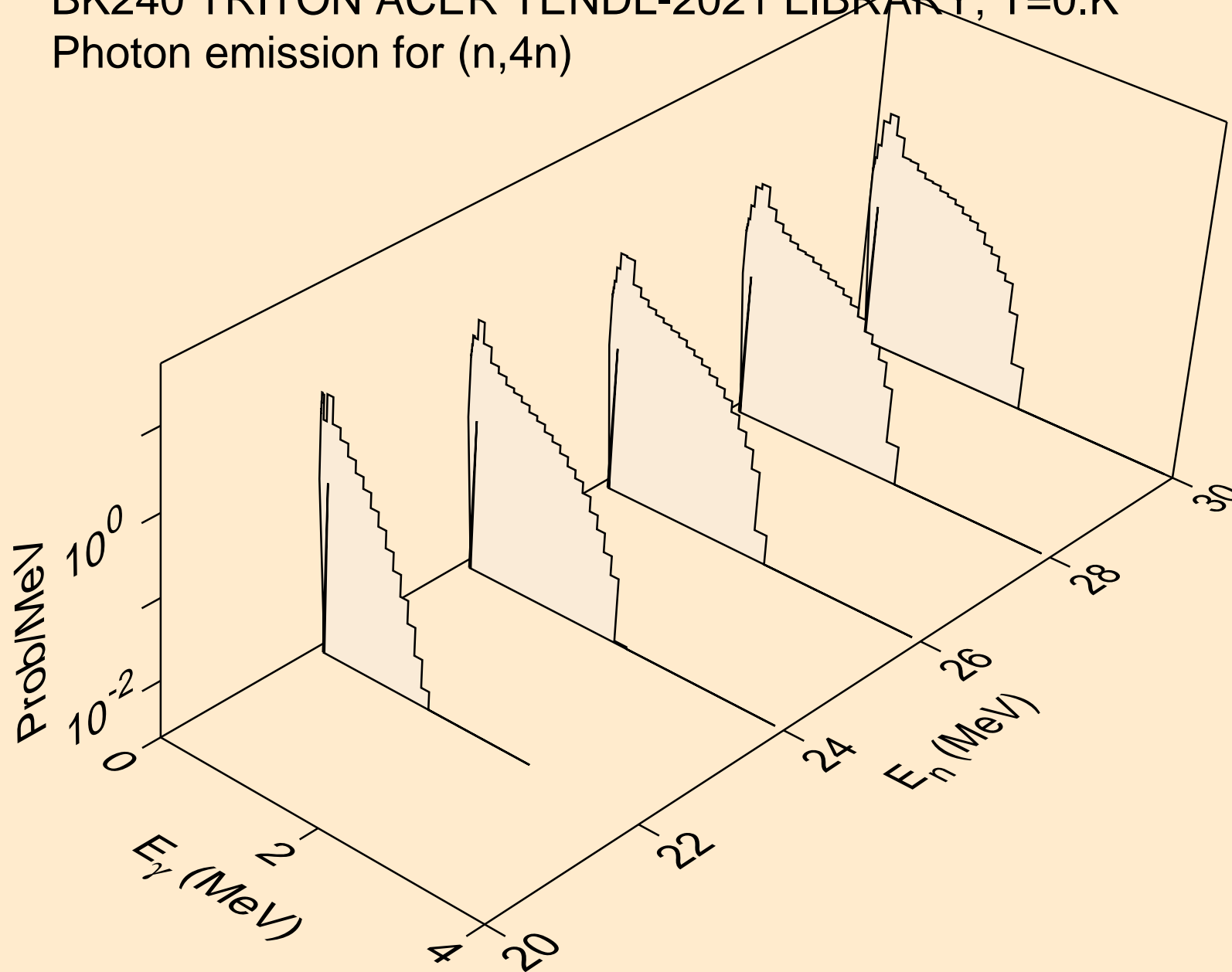

BK240 TRITON ACER TENDL-2021 LIBRARY; T=0.K  
Photon emission for (n,2np)

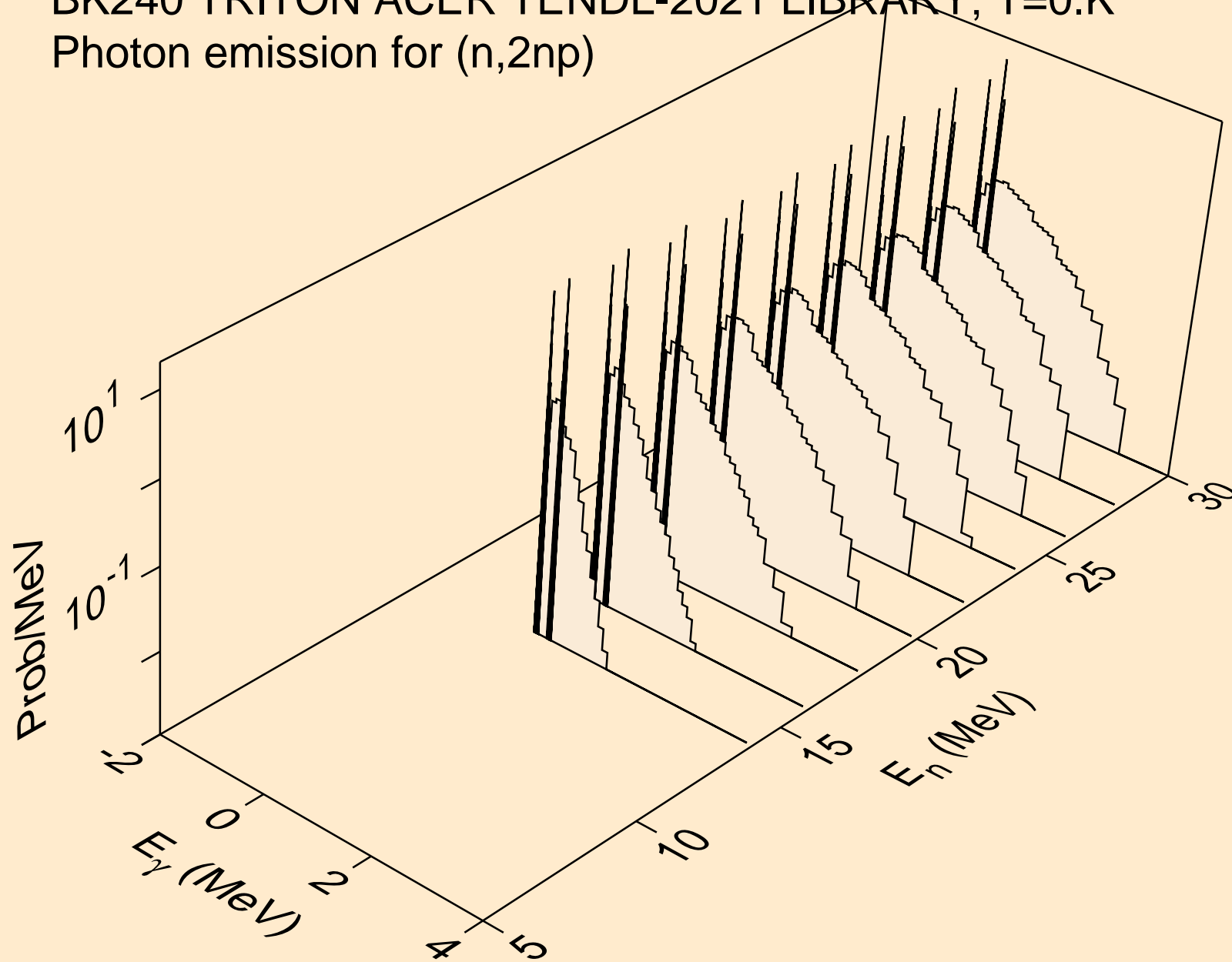

BK240 TRITON ACER TENDL-2021 LIBRARY; T=0.K  
Photon emission for (n,3np)

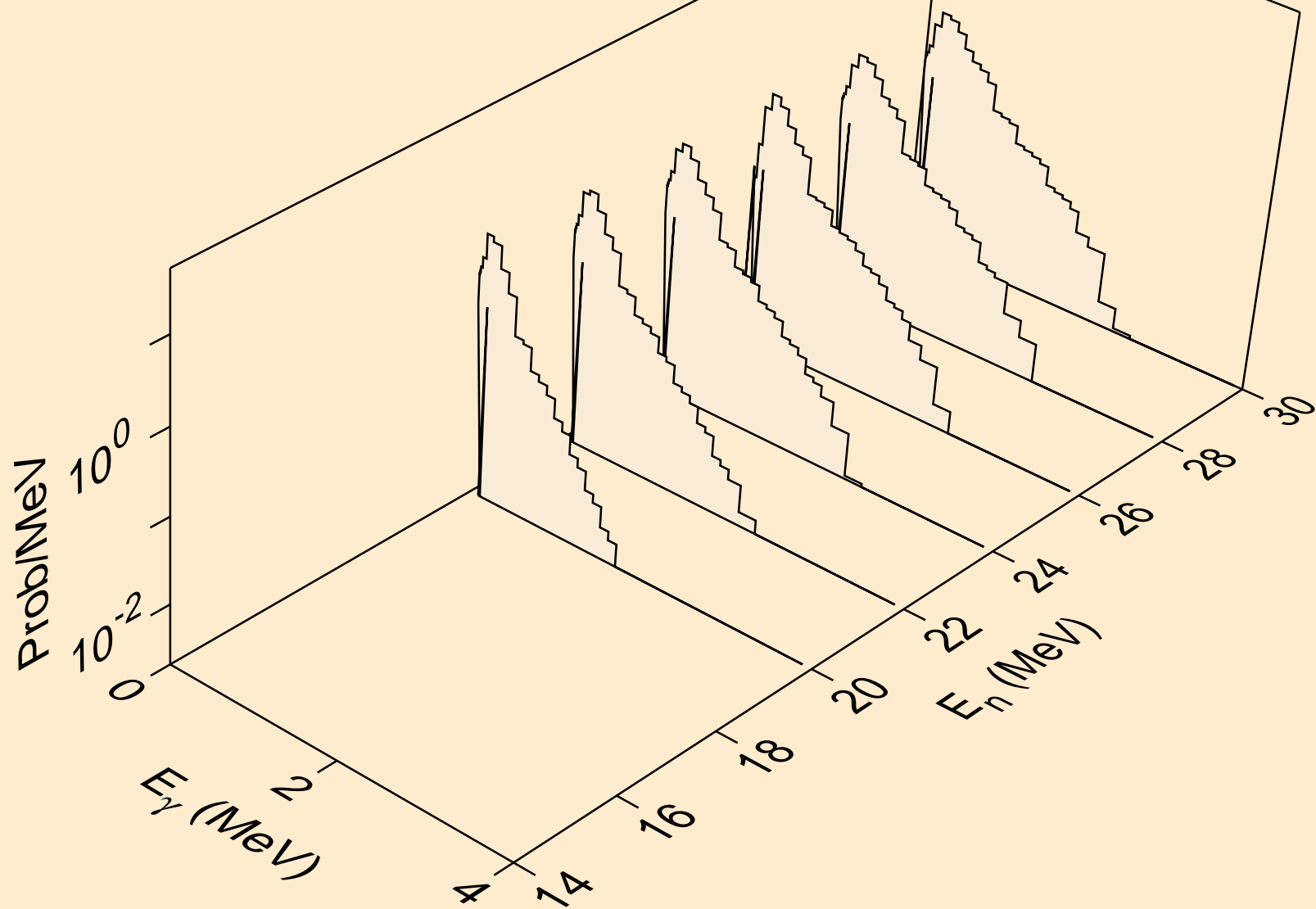

BK240 TRITON ACER TENDL-2021 LIBRARY; T=0.K  
Photon emission for (n,gma)

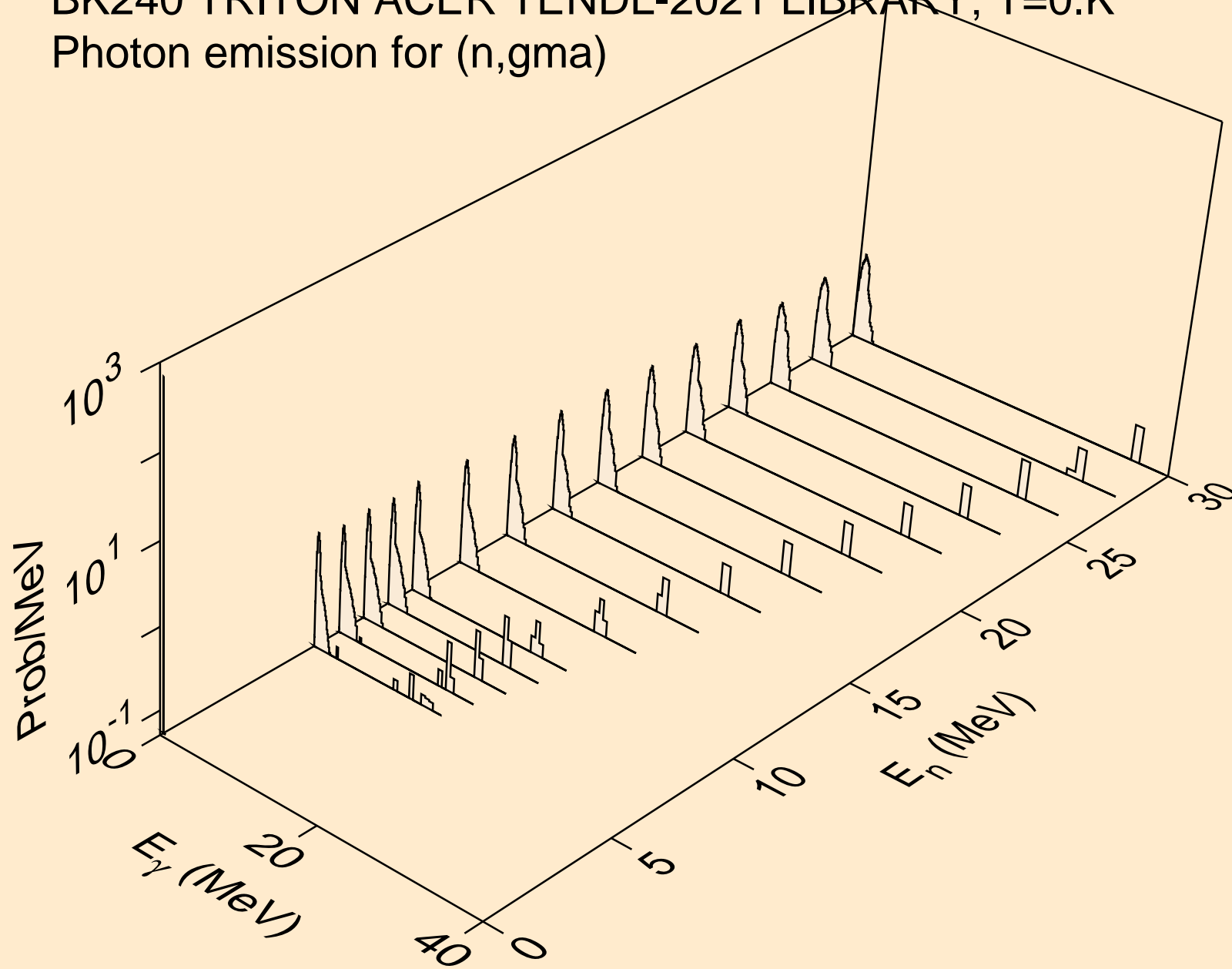

BK240 TRITON ACER TENDL-2021 LIBRARY; T=0.K  
Photon emission for (n,p)

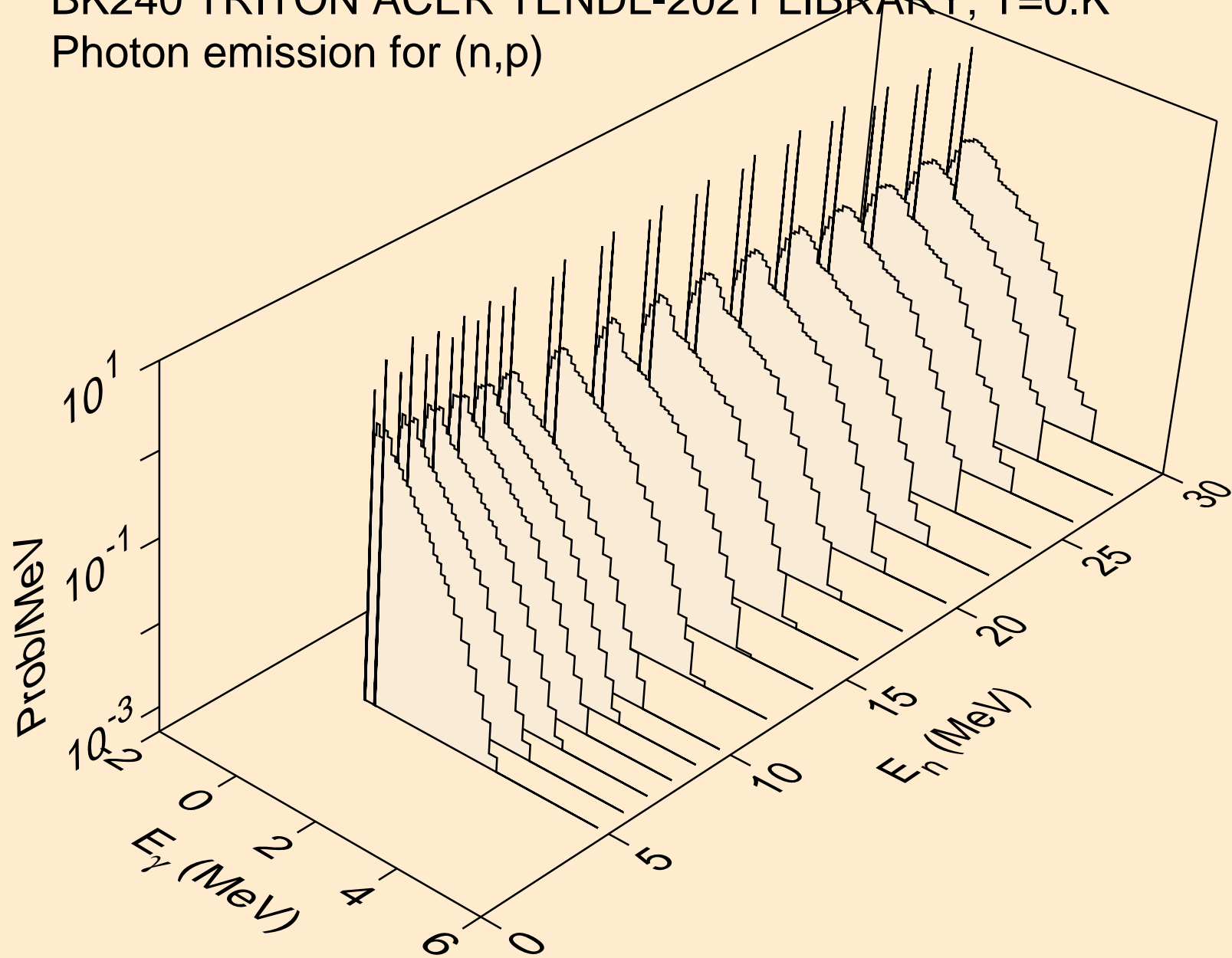

BK240 TRITON ACER TENDL-2021 LIBRARY; T=0.K  
Photon emission for (n,d)

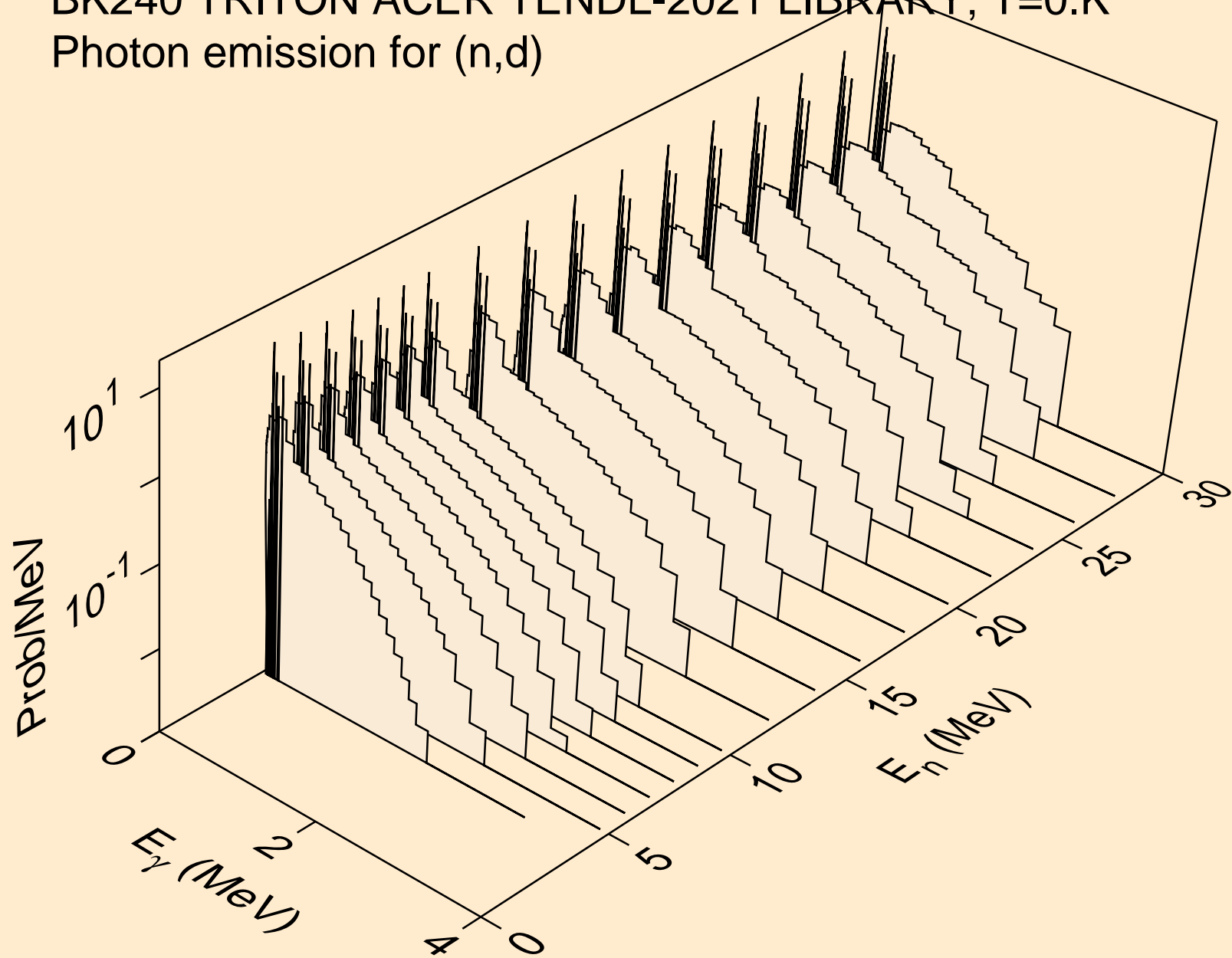

BK240 TRITON ACER TENDL-2021 LIBRARY; T=0.K  
Photon emission for inelastic

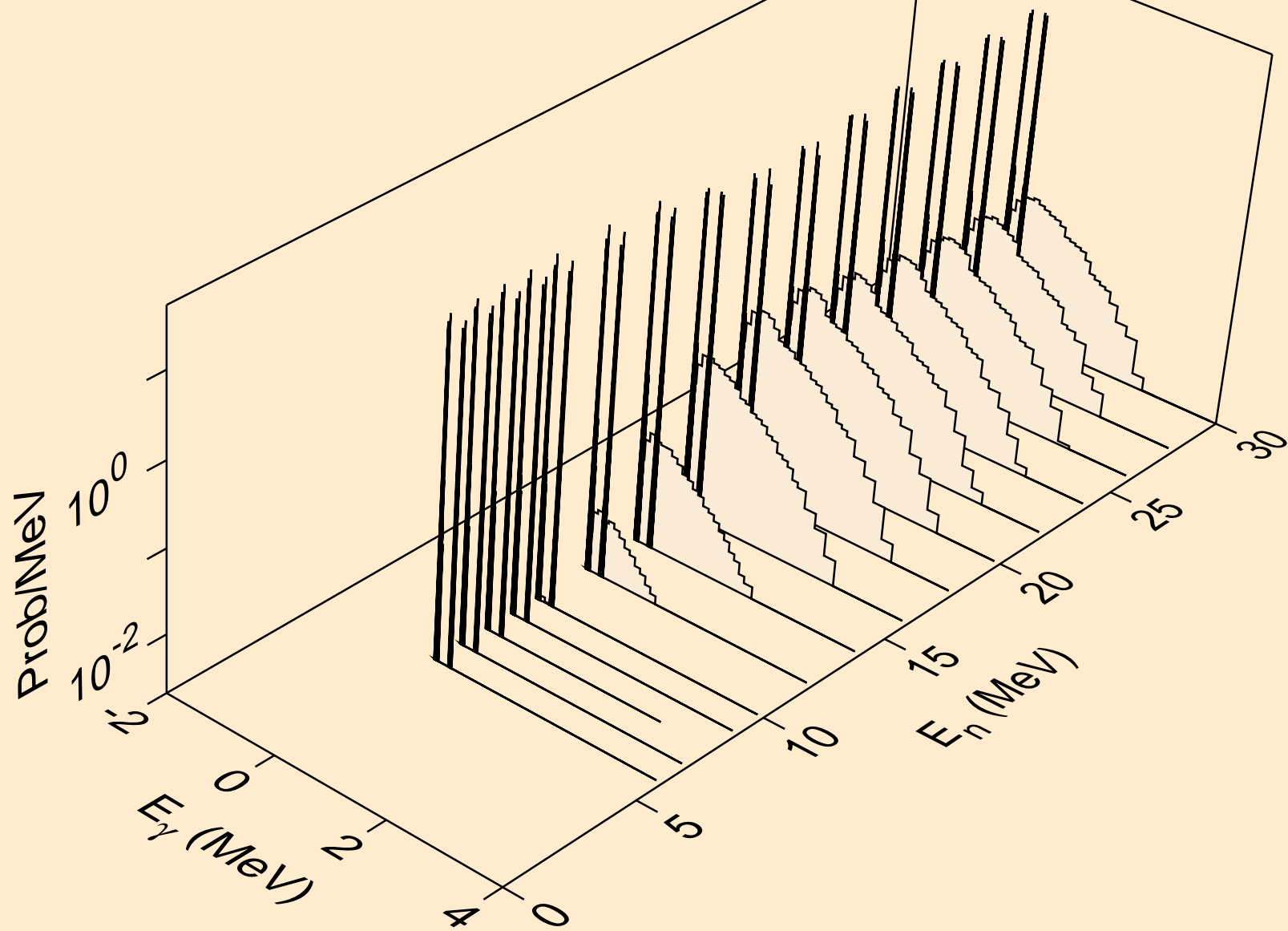

BK240 TRITON ACER TENDL-2021 LIBRARY; T=0.K  
Photon emission for (n,he3)

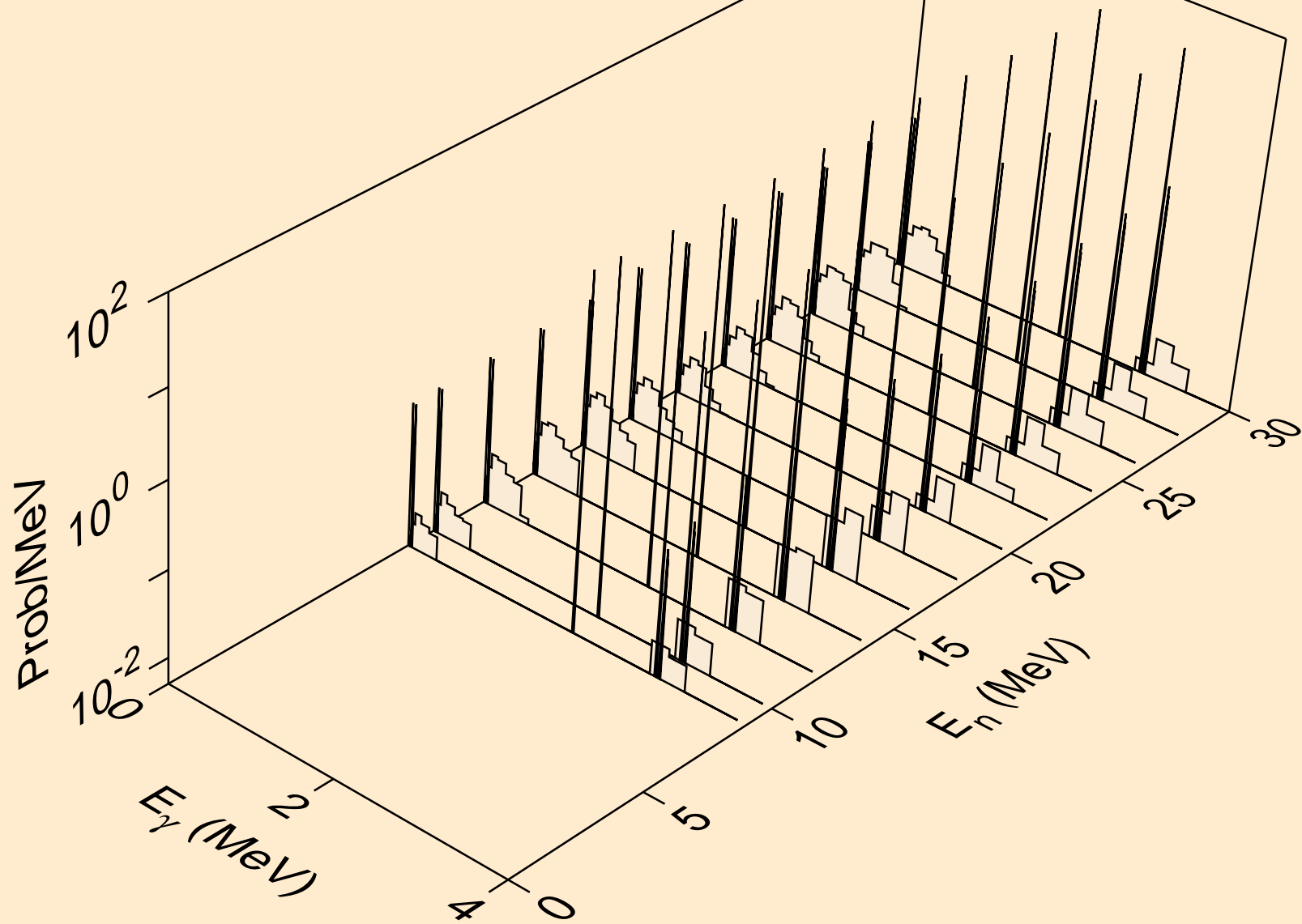

BK240 TRITON ACER TENDL-2021 LIBRARY; T=0.K  
Photon emission for (n,a)

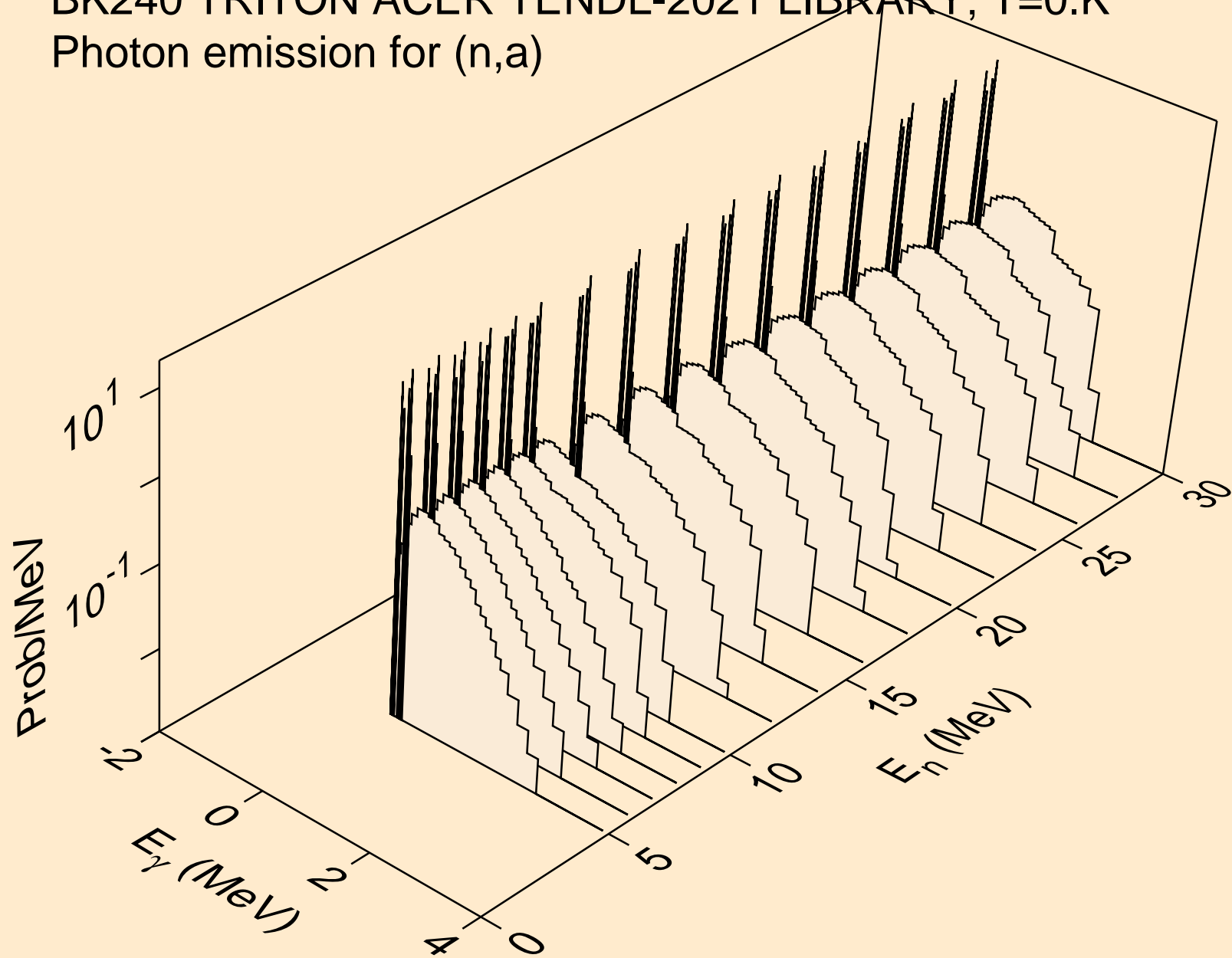

BK240 TRITON ACER TENDL-2021 LIBRARY; T=0.K  
Photon emission for (n,2p)

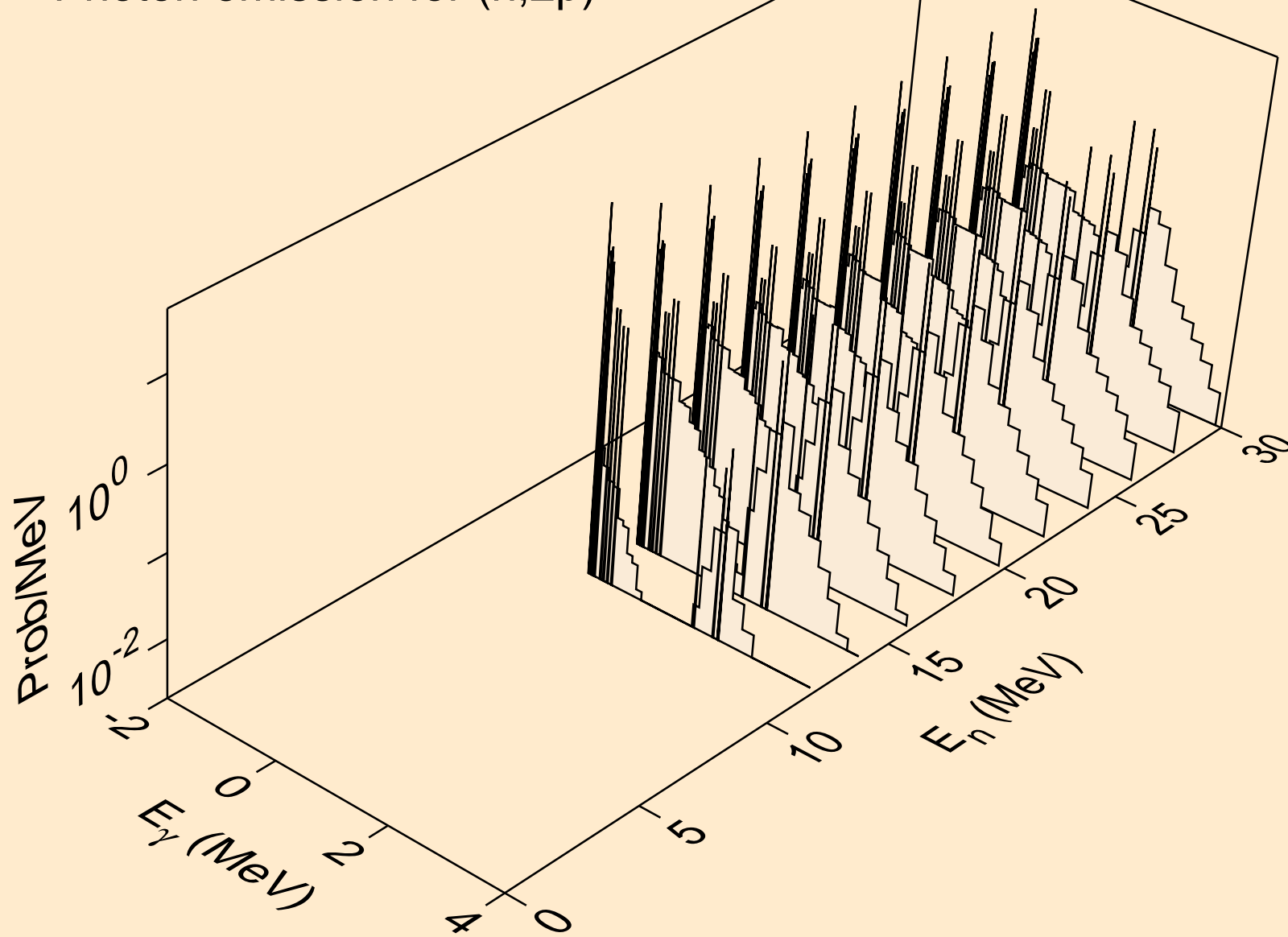

BK240 TRITON ACER TENDL-2021 LIBRARY; T=0.K  
Particle heating contributions

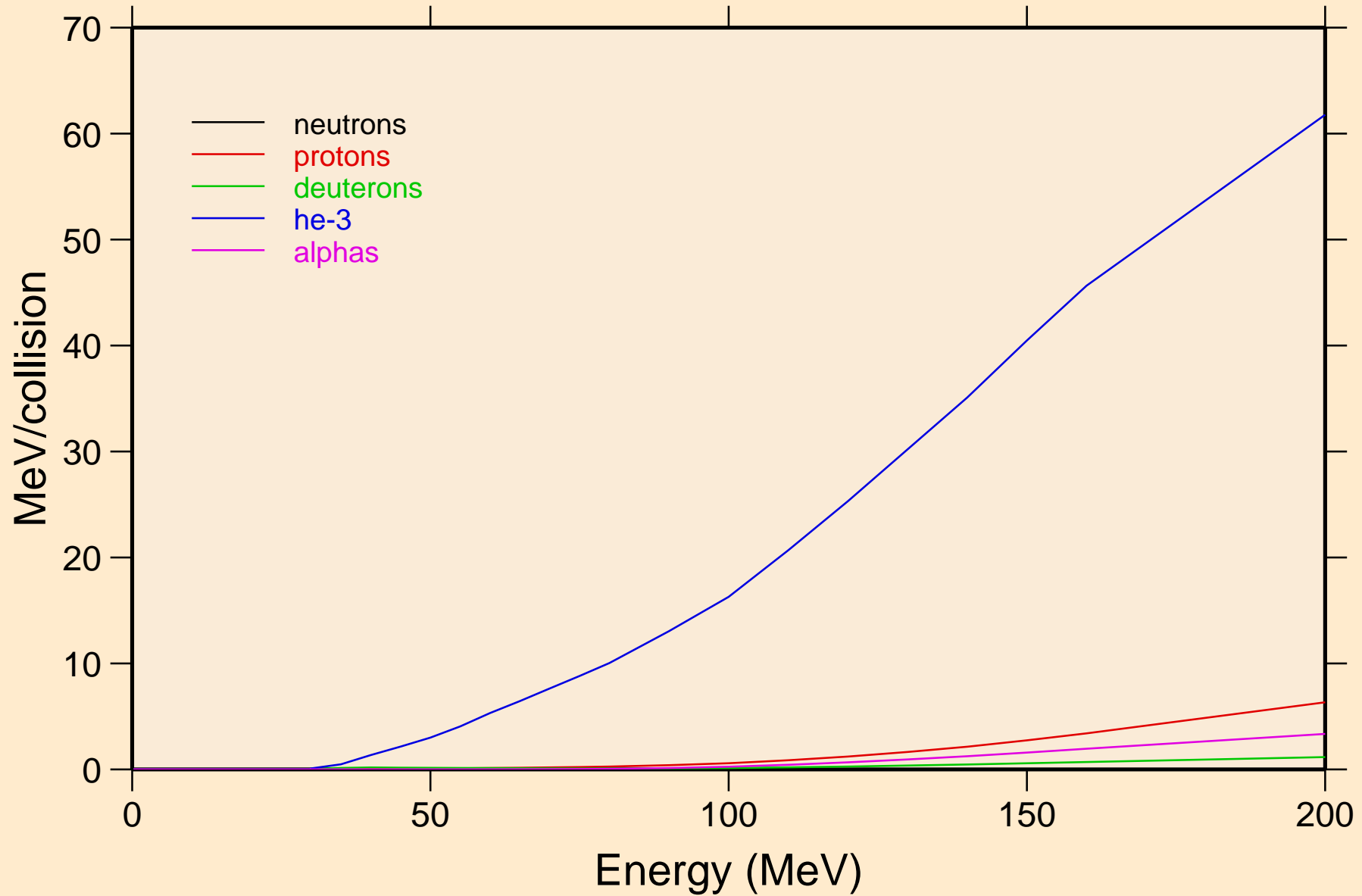

BK240 TRITON ACER TENDL-2021 LIBRARY; T=0.K  
Recoil Heating

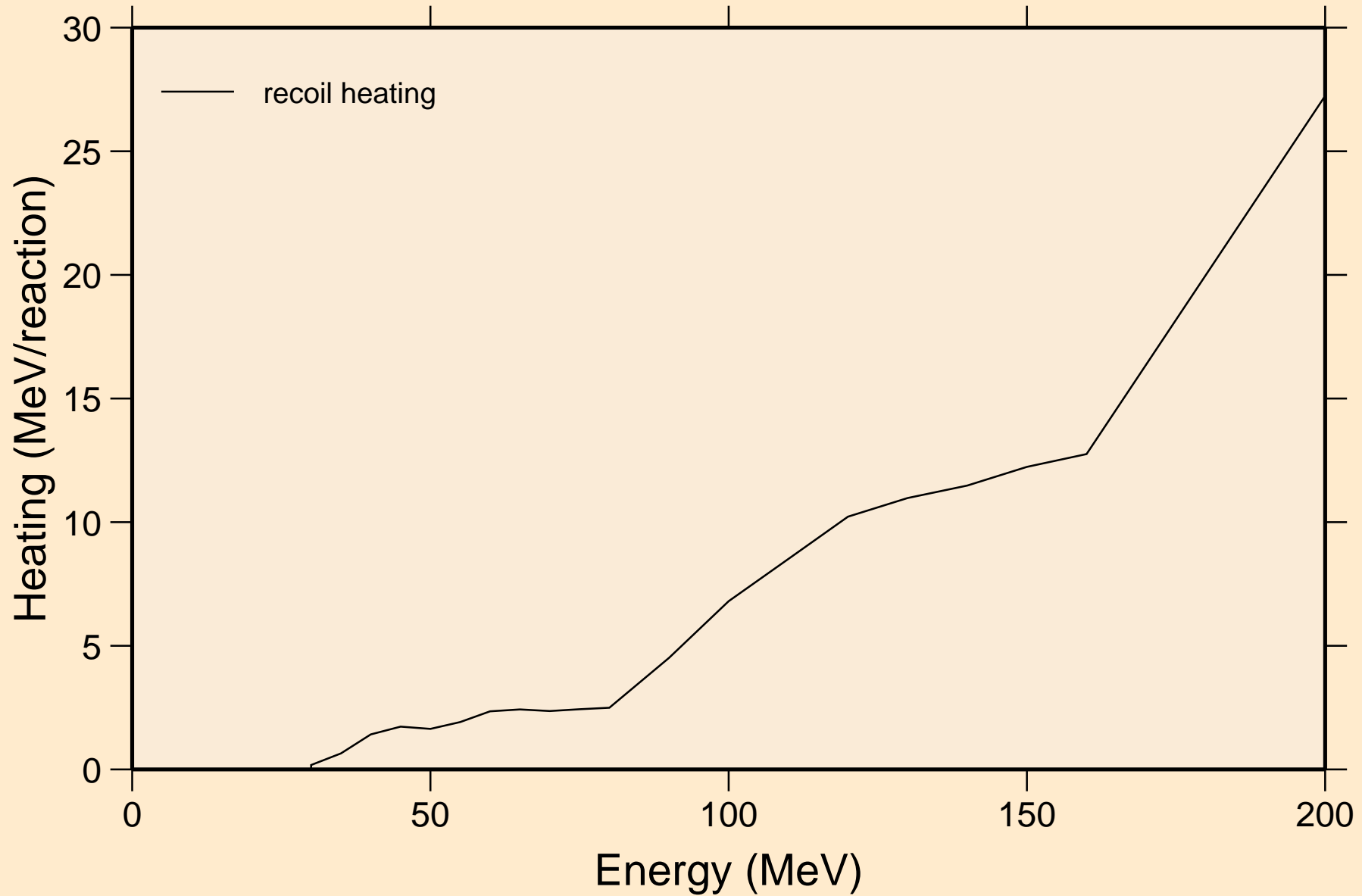

BK240 TRITON ACER TENDL-2021 LIBRARY; T=0.K  
Particle production cross sections

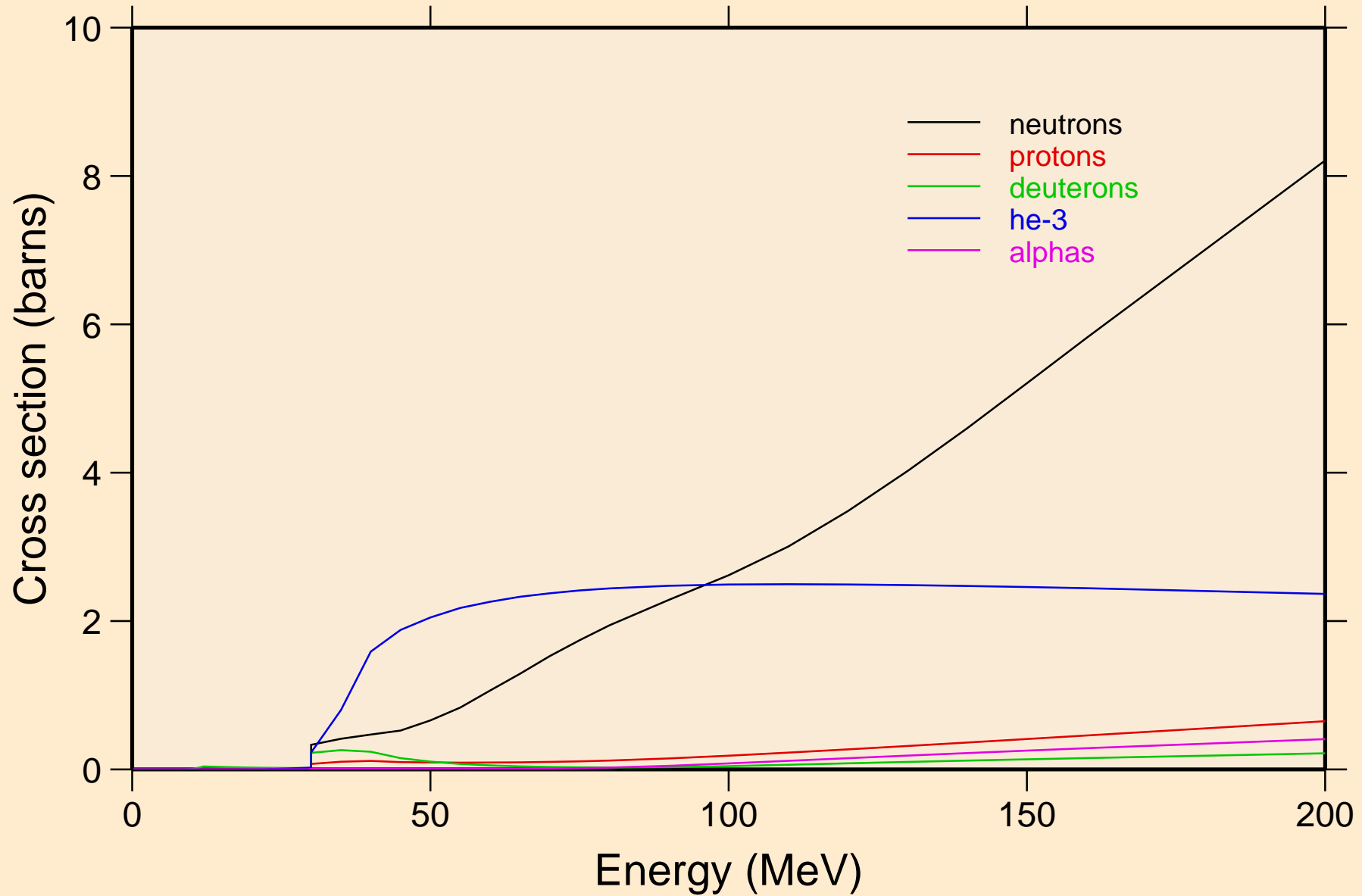

BK240 TRITON ACER TENDL-2021 LIBRARY; T=0.K  
neutrons from (t,n)

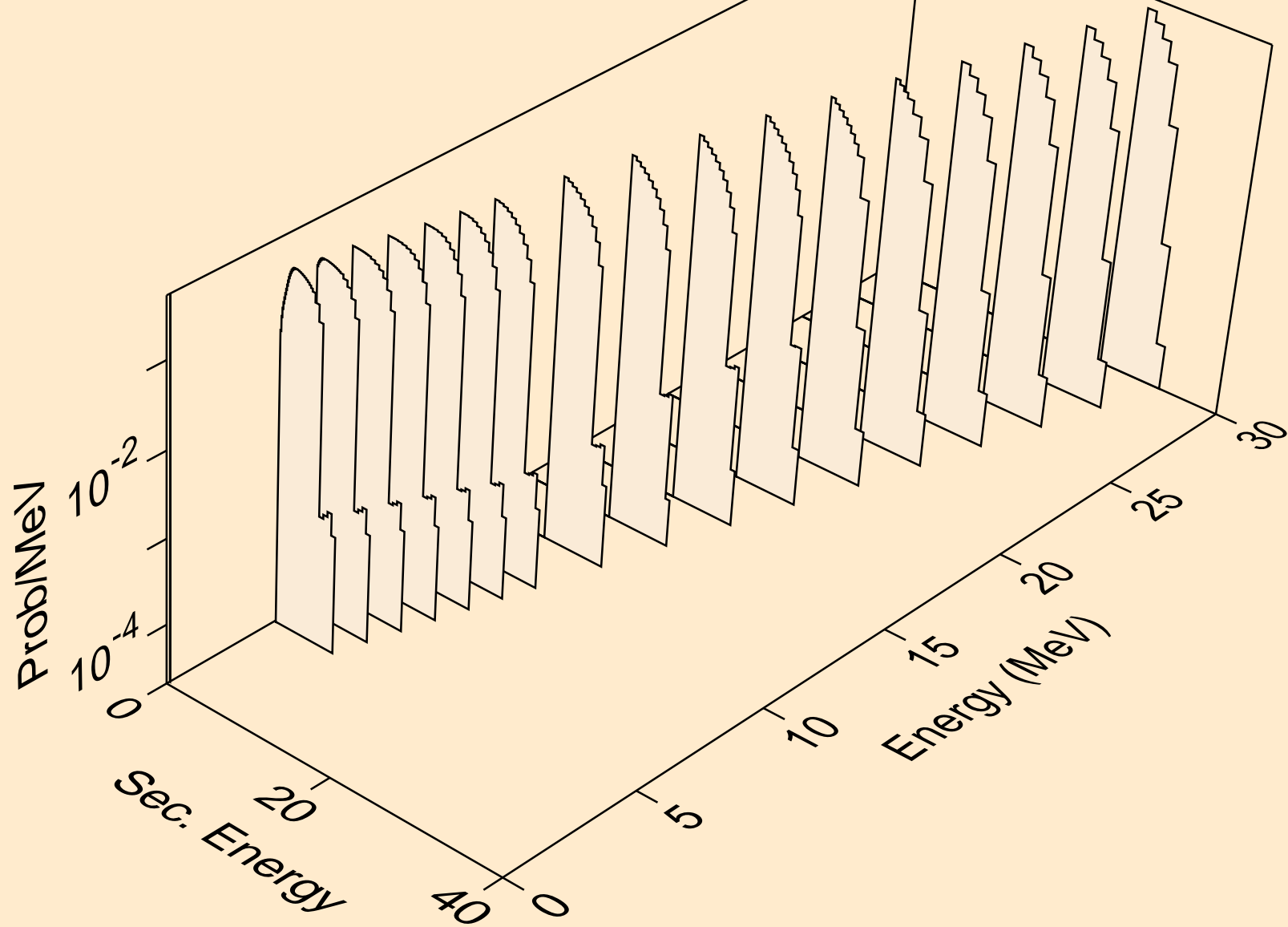

BK240 TRITON ACER TENDL-2021 LIBRARY; T=0.K  
neutrons from (t,x)

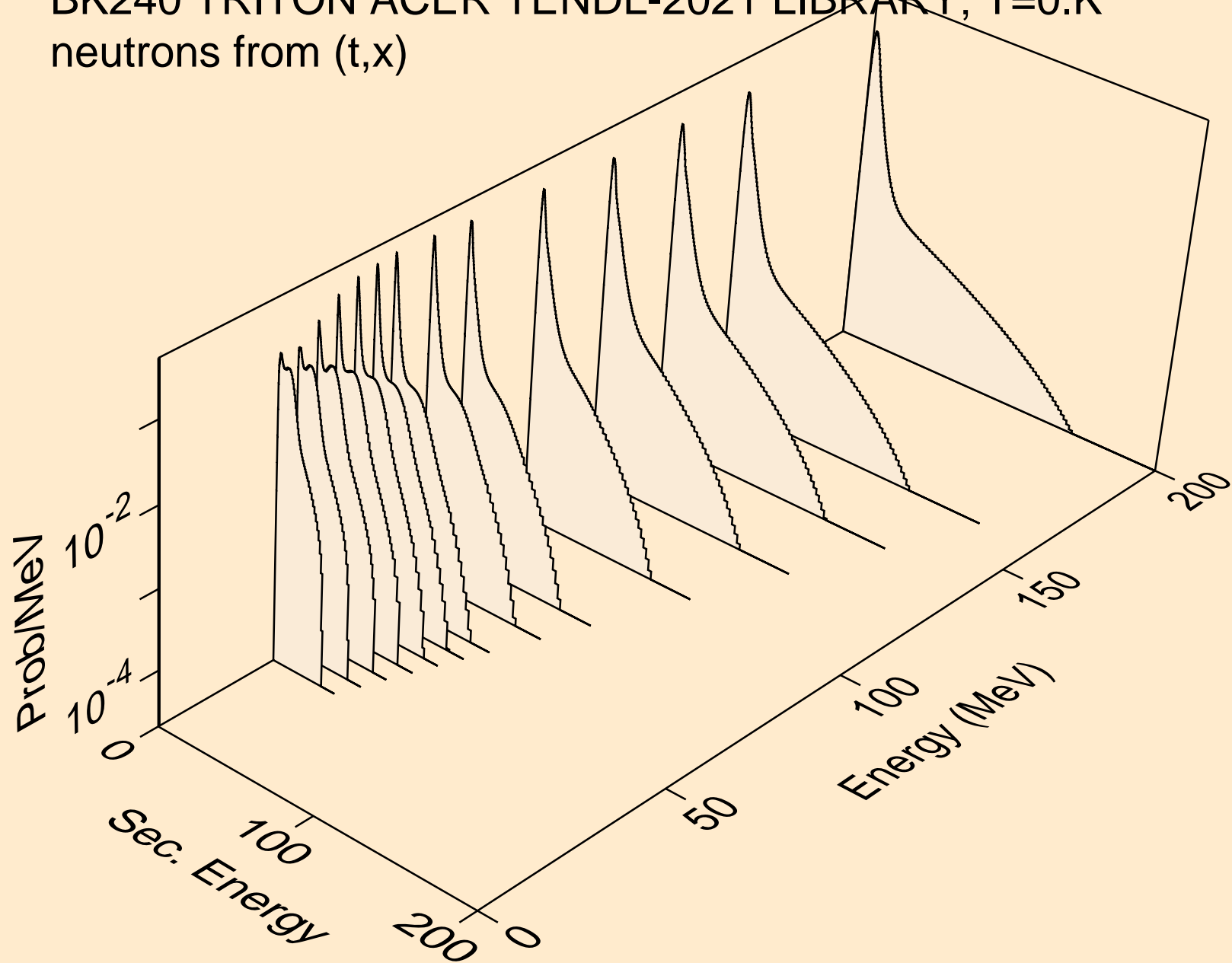

BK240 TRITON ACER TENDL-2021 LIBRARY; T=0.K  
neutrons from (t,2nd)

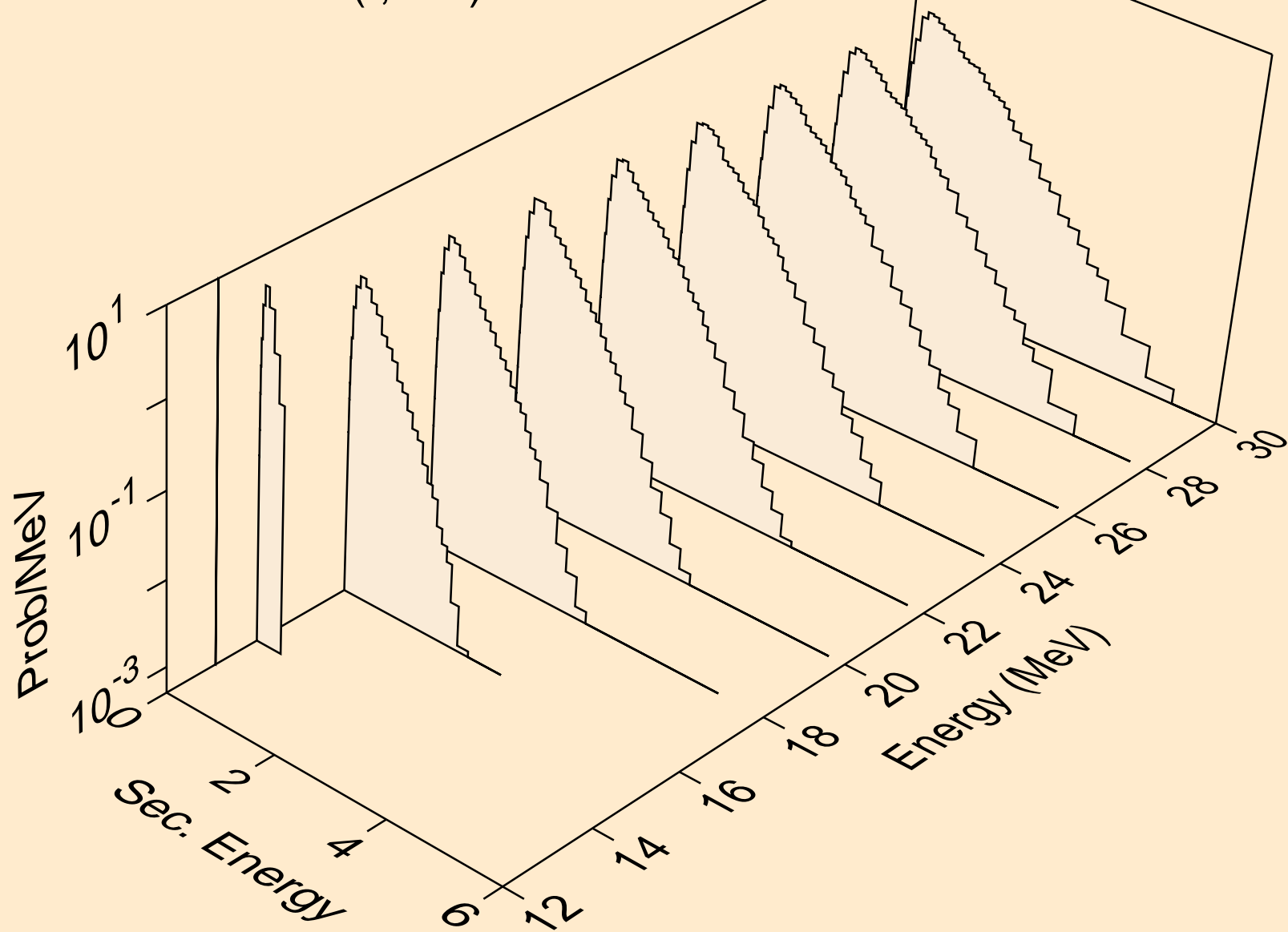

BK240 TRITON ACER TENDL-2021 LIBRARY; T=0.K  
neutrons from (t,2n)

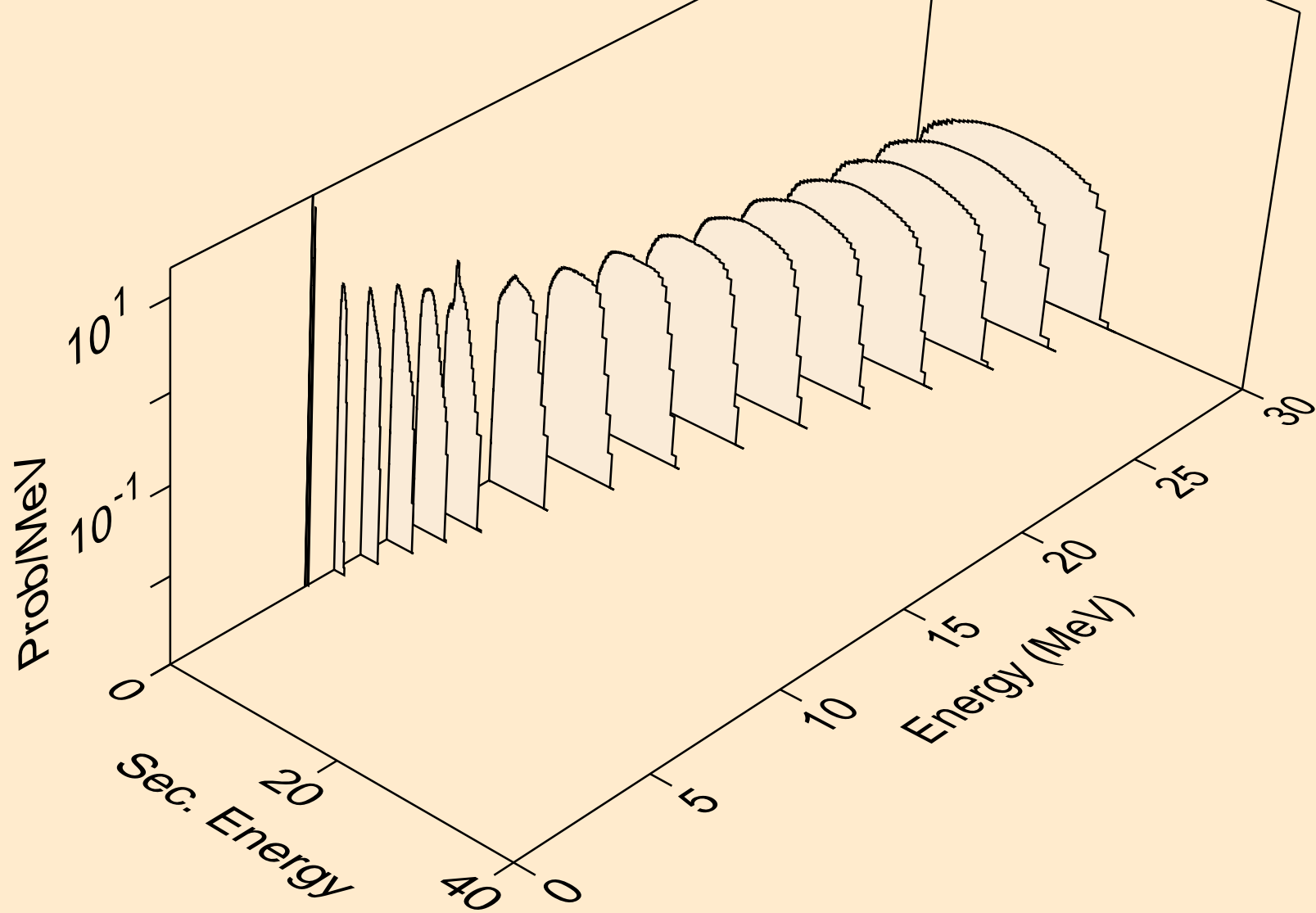

BK240 TRITON ACER TENDL-2021 LIBRARY; T=0.K  
neutrons from (t,3n)

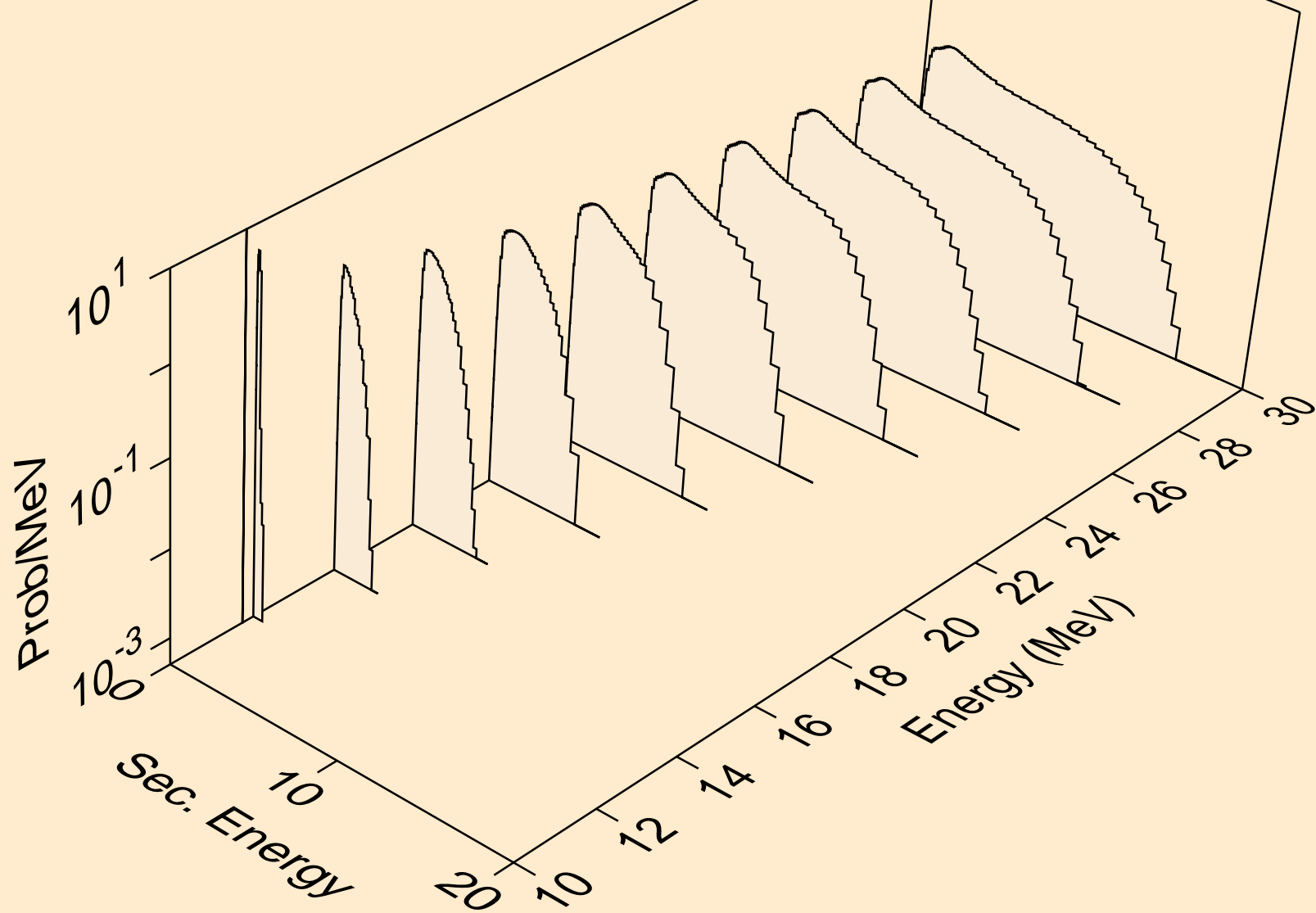

BK240 TRITON ACER TENDL-2021 LIBRARY; T=0.K  
neutrons from (t,n\*)a

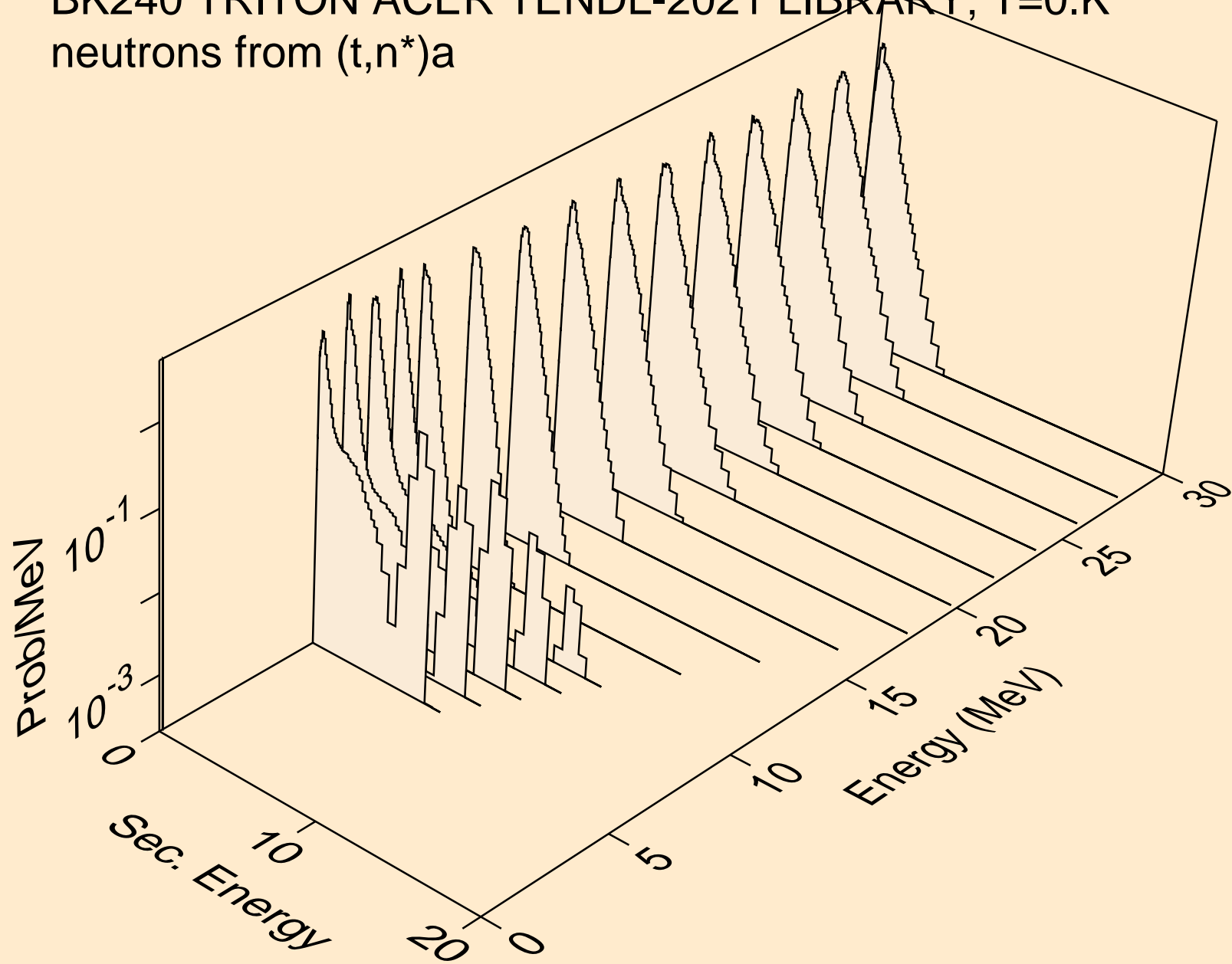

BK240 TRITON ACER TENDL-2021 LIBRARY; T=0.K  
neutrons from (t,2n)a

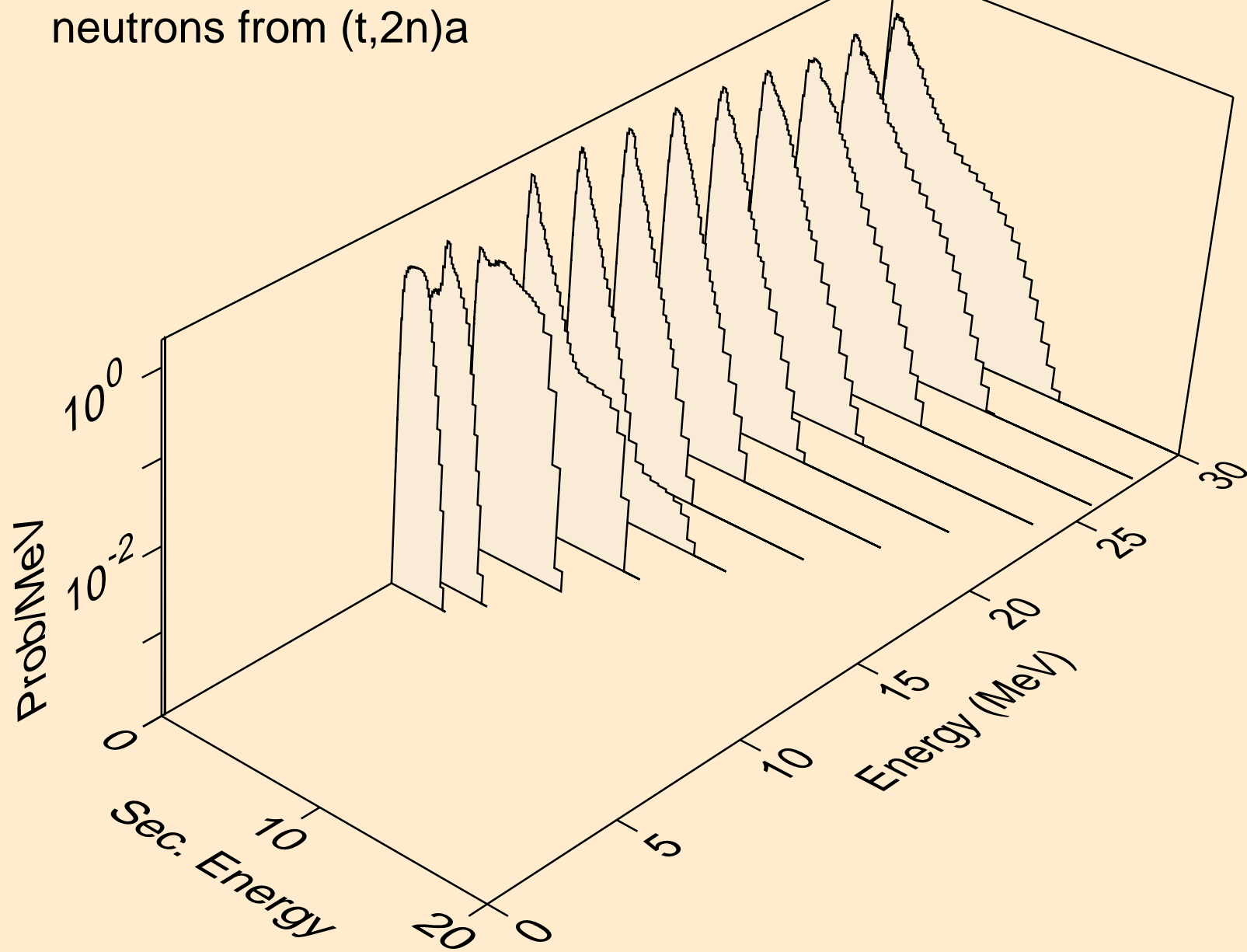

BK240 TRITON ACER TENDL-2021 LIBRARY; T=0.K  
neutrons from (t,n\*)p

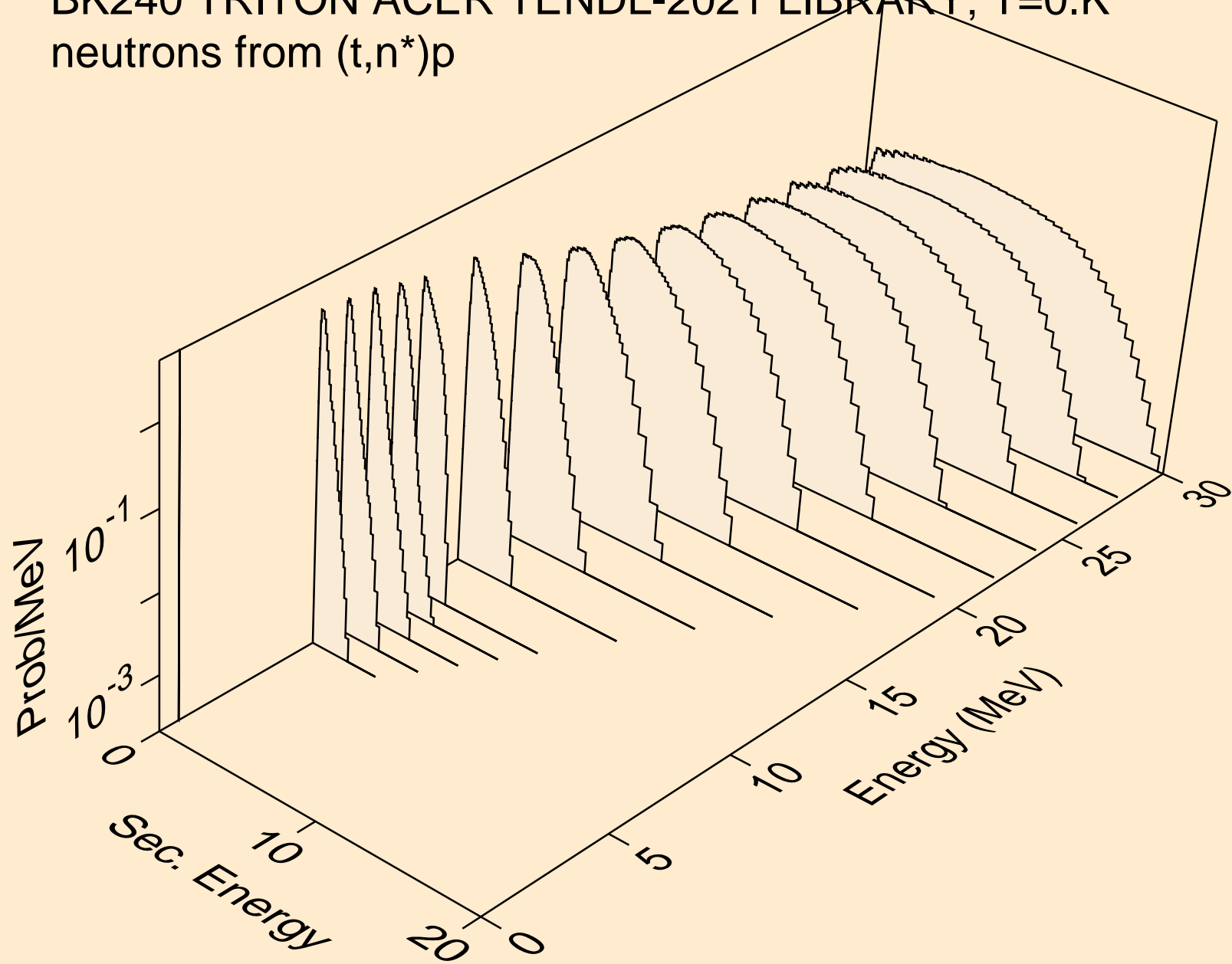

BK240 TRITON ACER TENDL-2021 LIBRARY; T=0.K  
neutrons from (t,n\*)d

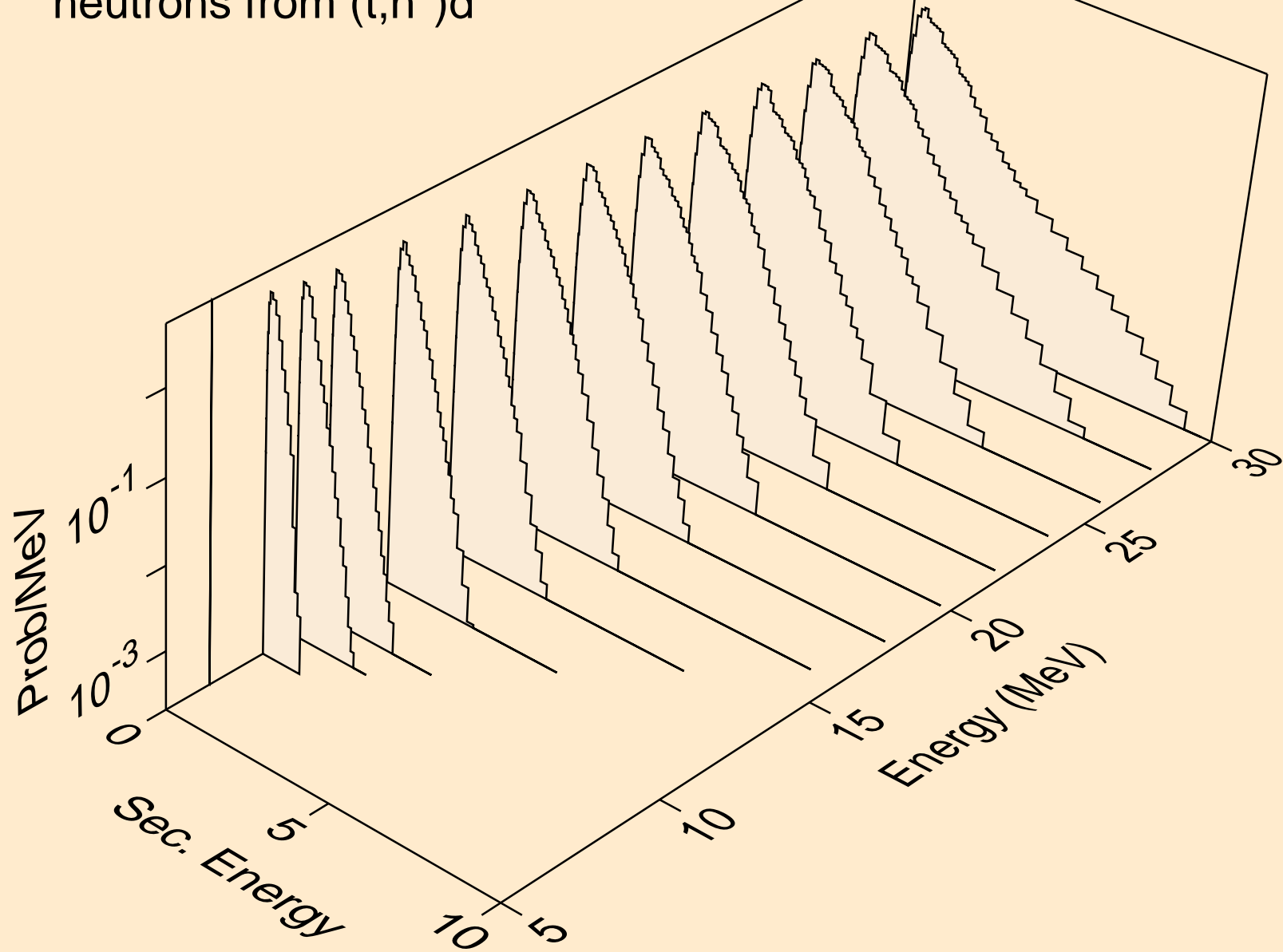

BK240 TRITON ACER TENDL-2021 LIBRARY; T=0.K  
neutrons from (t,n\*)t

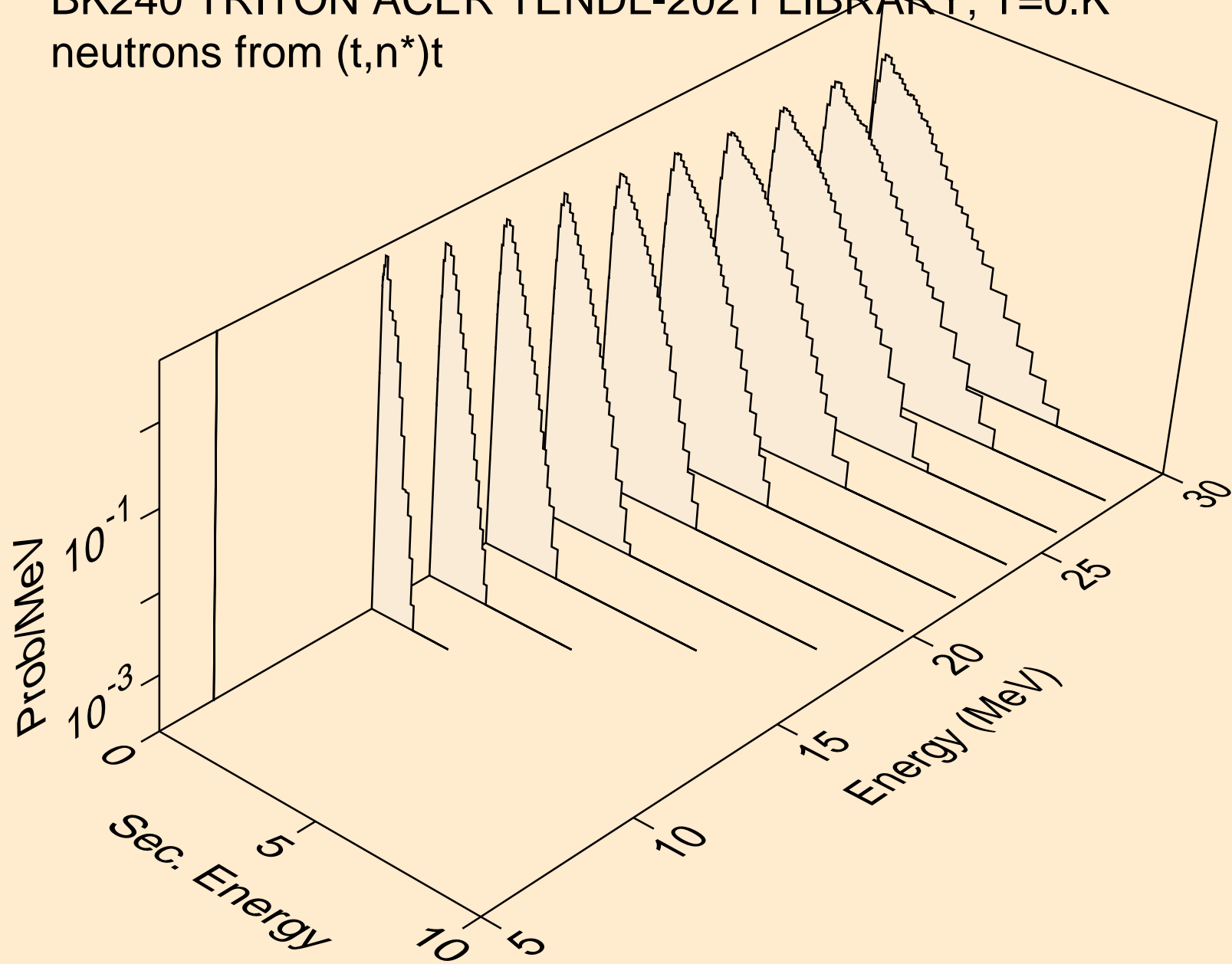

BK240 TRITON ACER TENDL-2021 LIBRARY; T=0.K  
neutrons from (t,n\*)he3

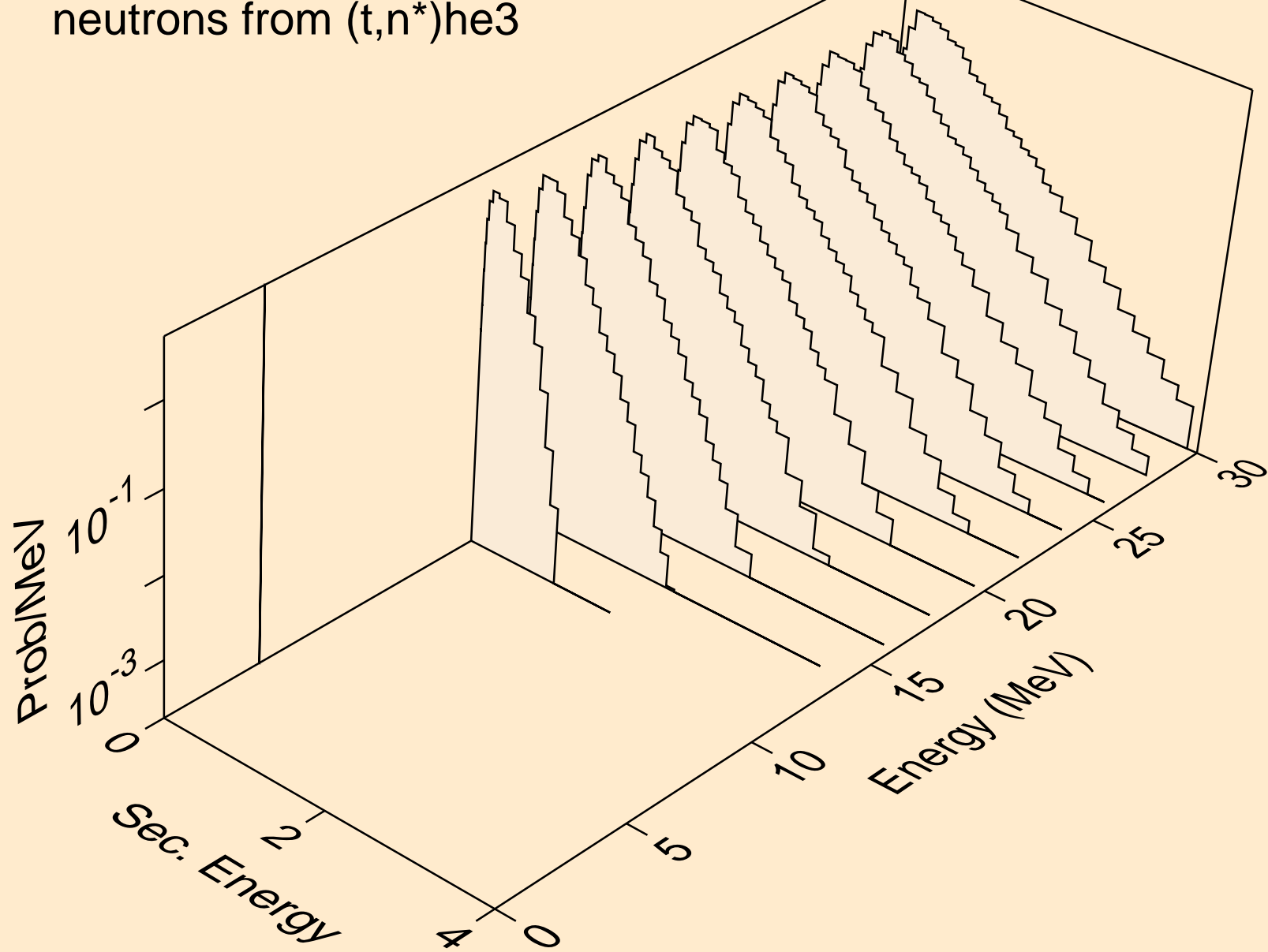

BK240 TRITON ACER TENDL-2021 LIBRARY; T=0.K  
neutrons from (t,4n)

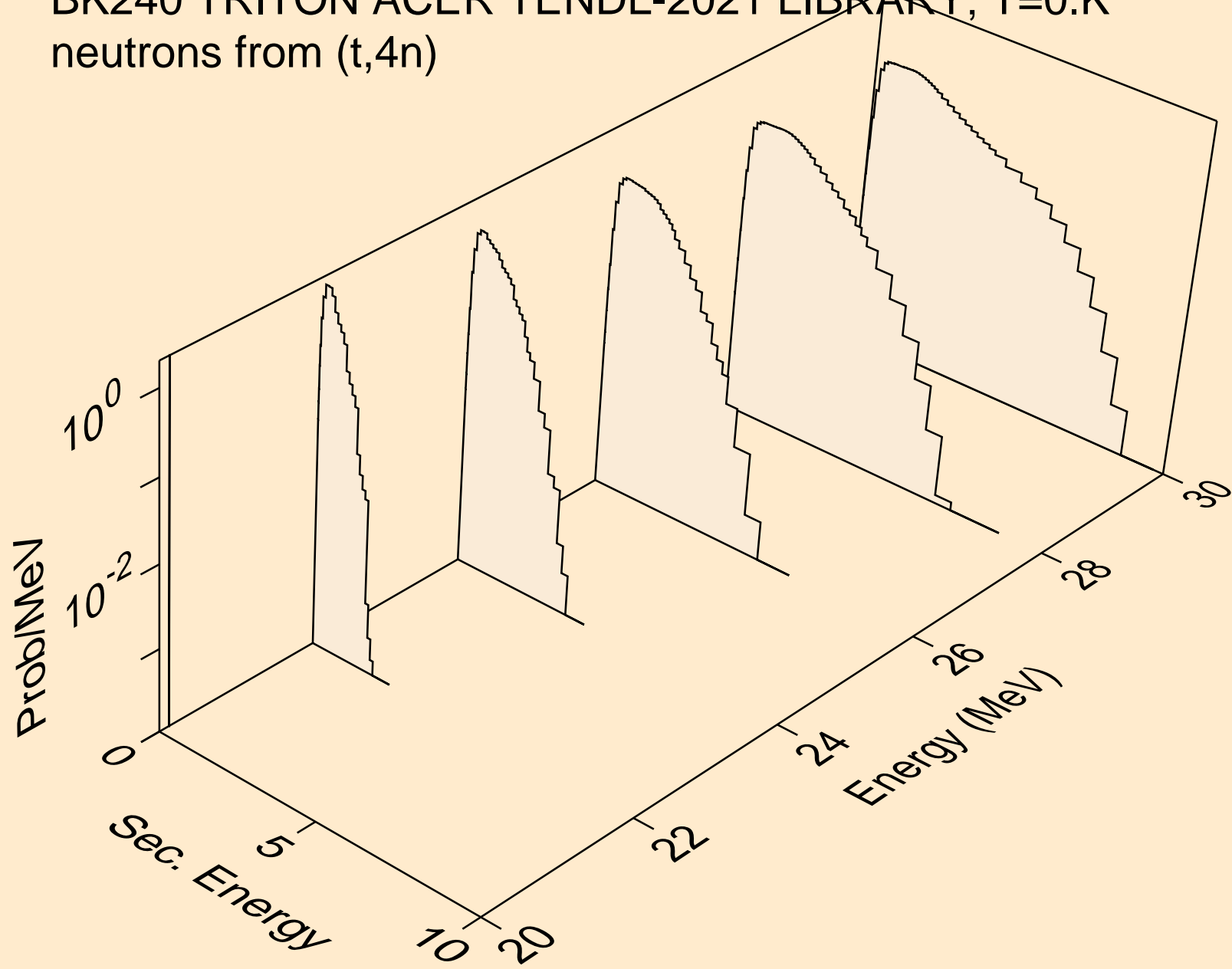

BK240 TRITON ACER TENDL-2021 LIBRARY; T=0.K  
neutrons from (t,2np)

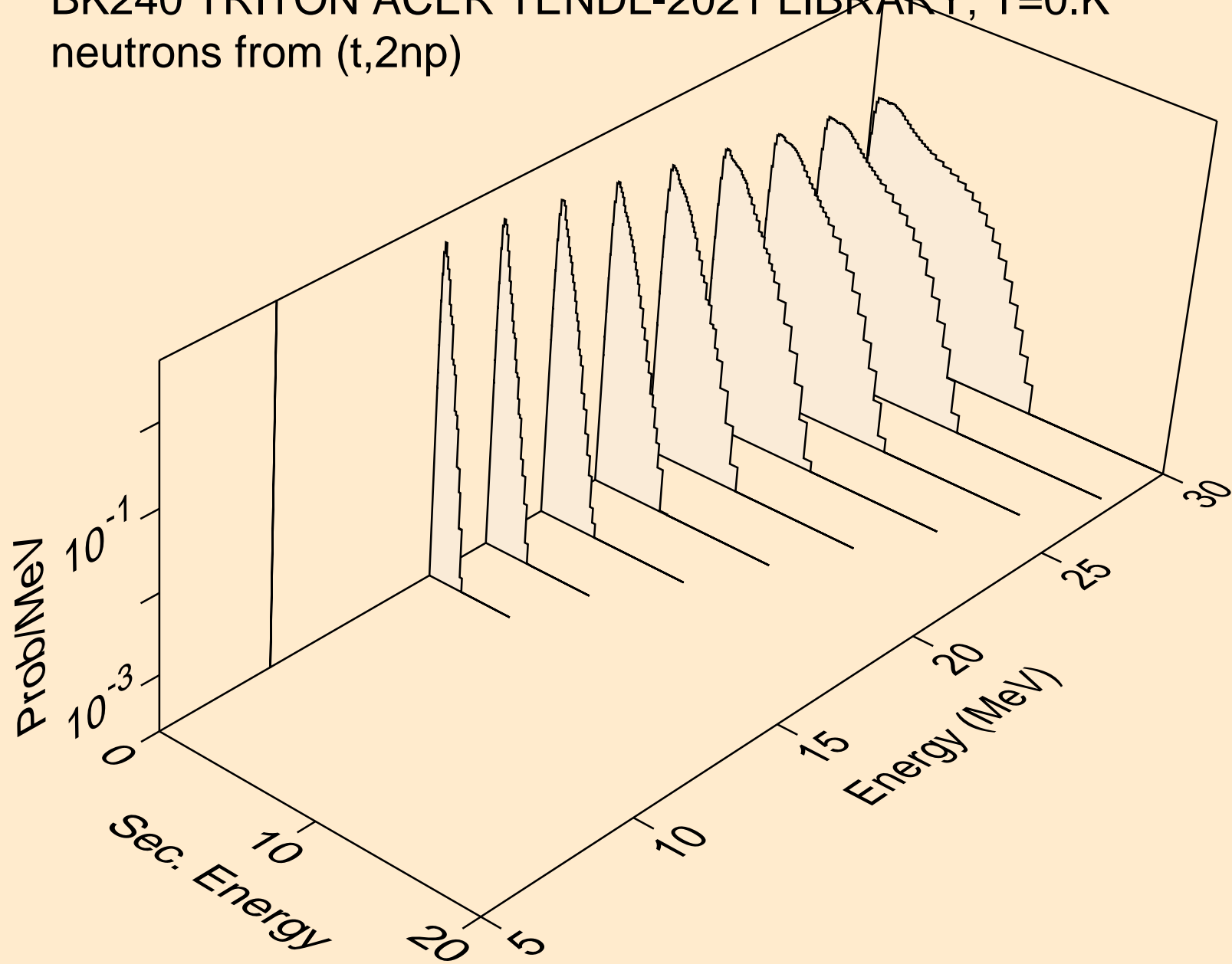

BK240 TRITON ACER TENDL-2021 LIBRARY; T=0.K  
neutrons from (t,3np)

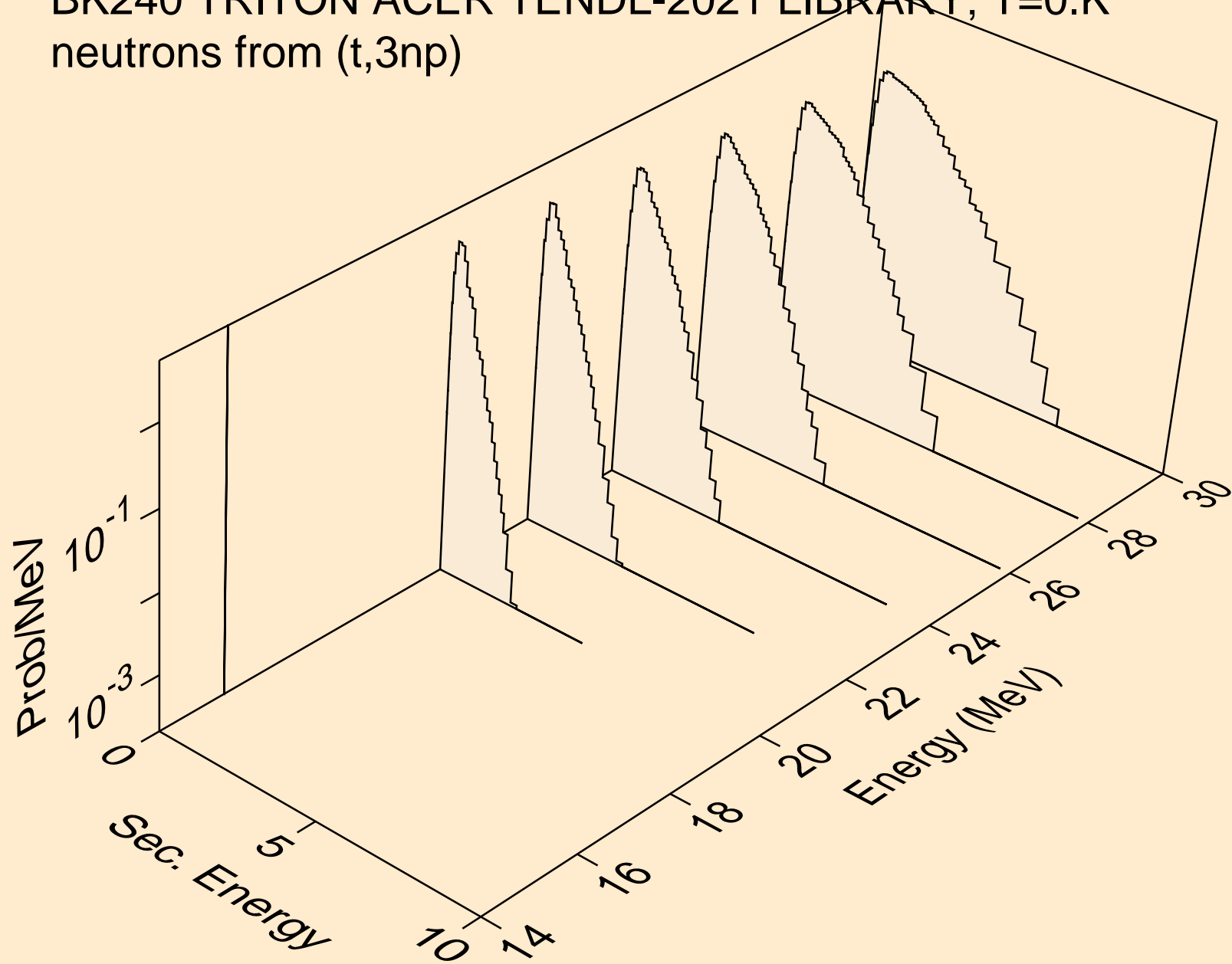

BK240 TRITON ACER TENDL-2021 LIBRARY; T=0.K  
protons from (t,x)

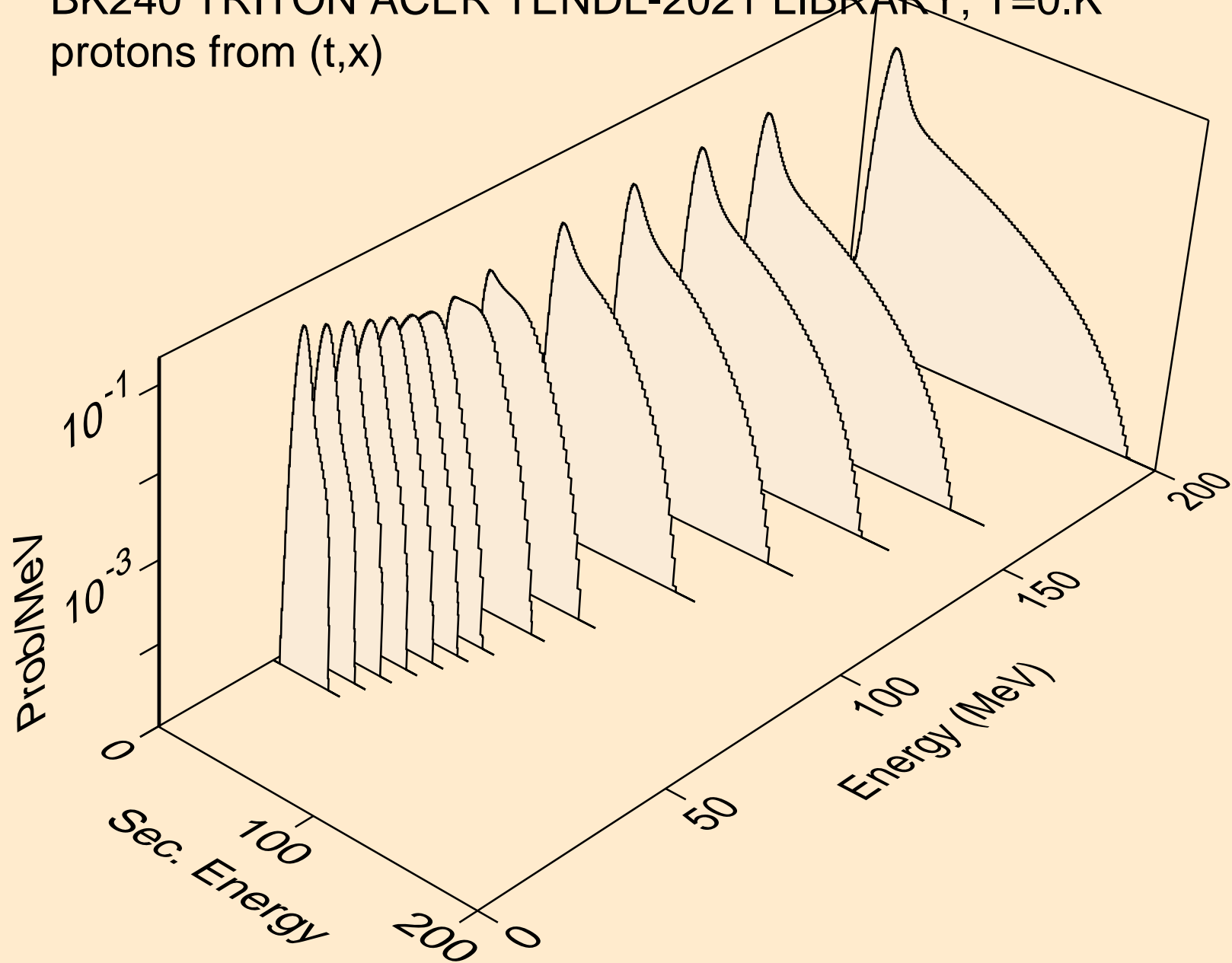

BK240 TRITON ACER TENDL-2021 LIBRARY; T=0.K  
protons from (t,n\*)p

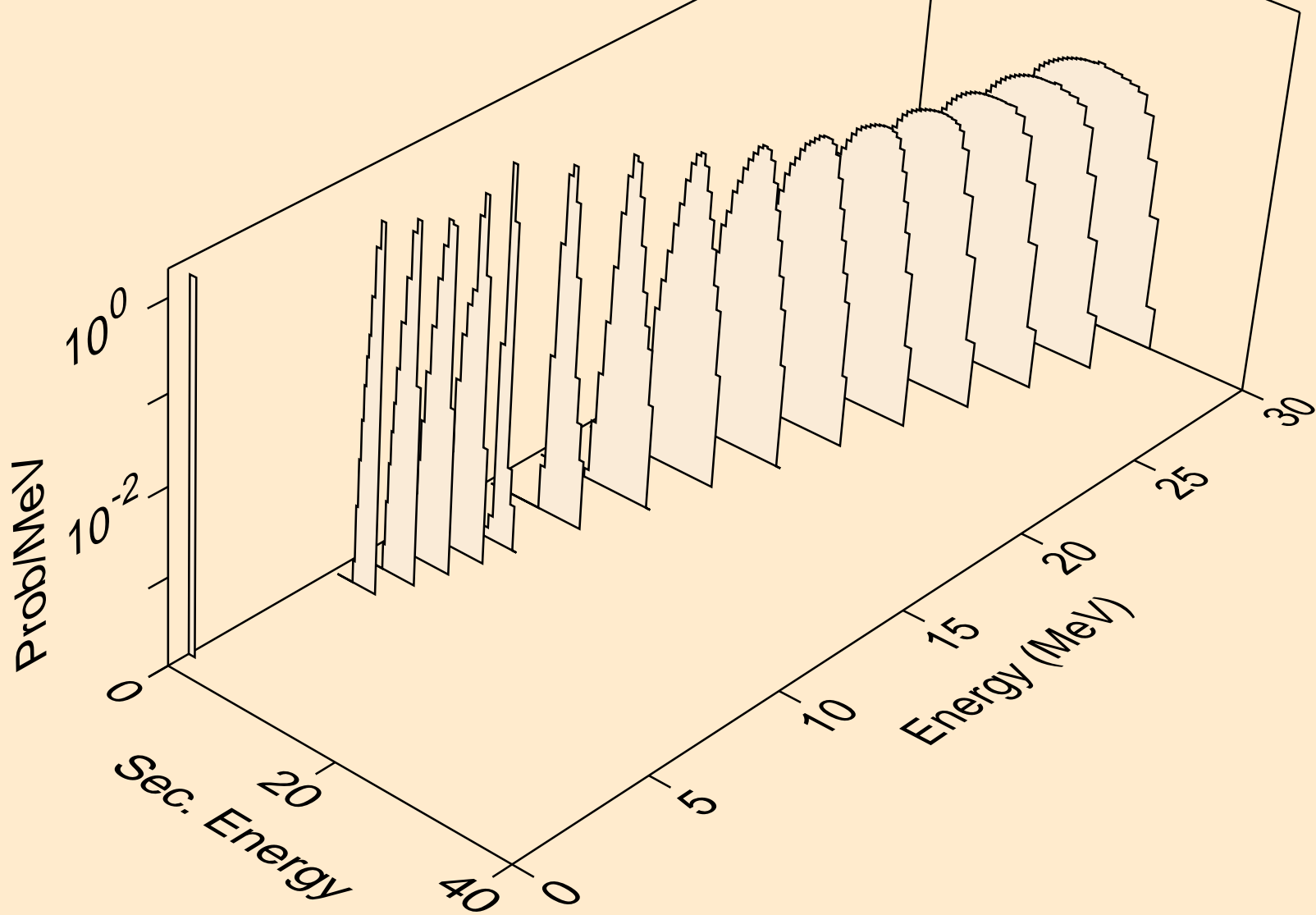

BK240 TRITON ACER TENDL-2021 LIBRARY; T=0.K  
protons from (t,2np)

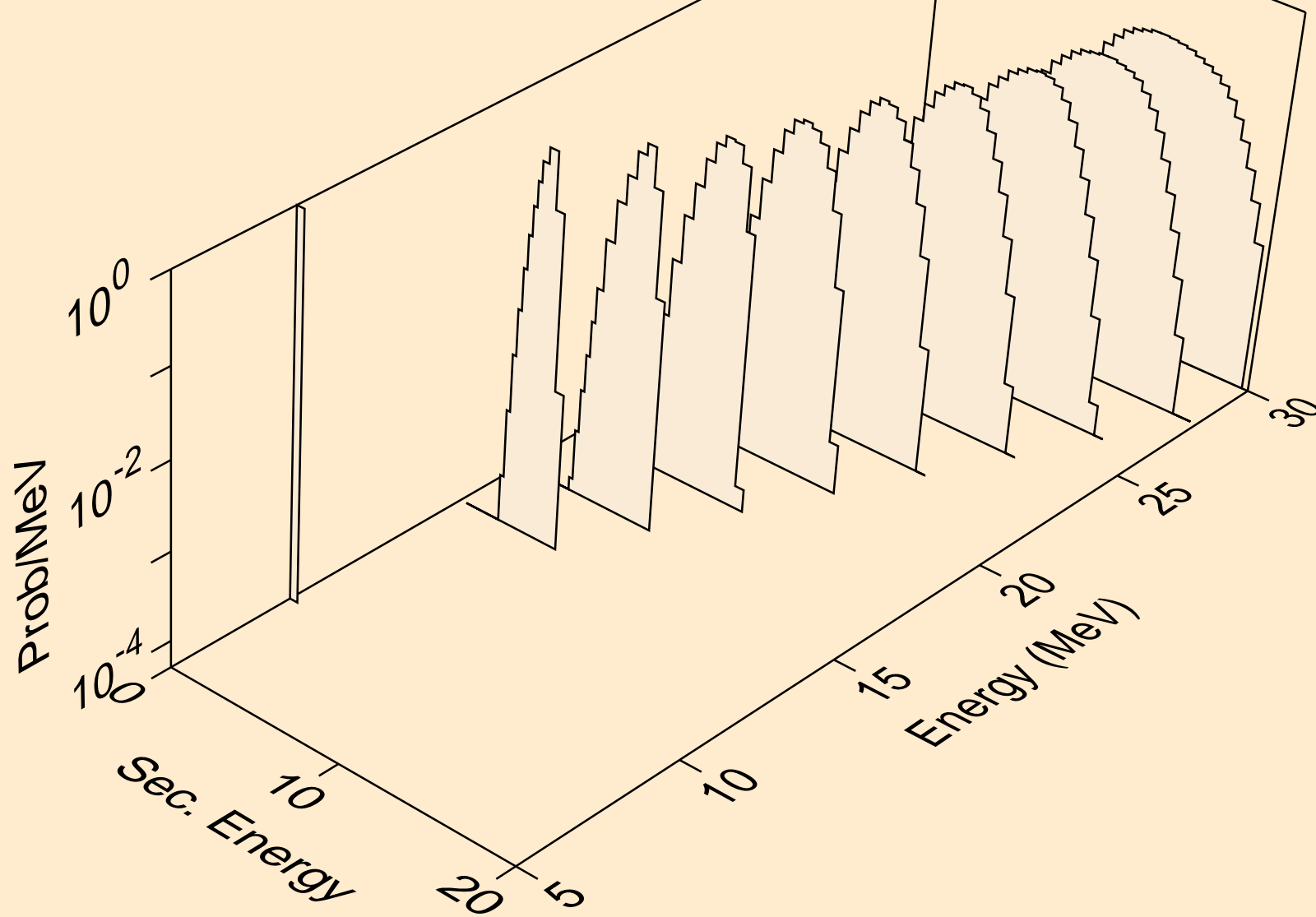

BK240 TRITON ACER TENDL-2021 LIBRARY; T=0.K  
protons from (t,3np)

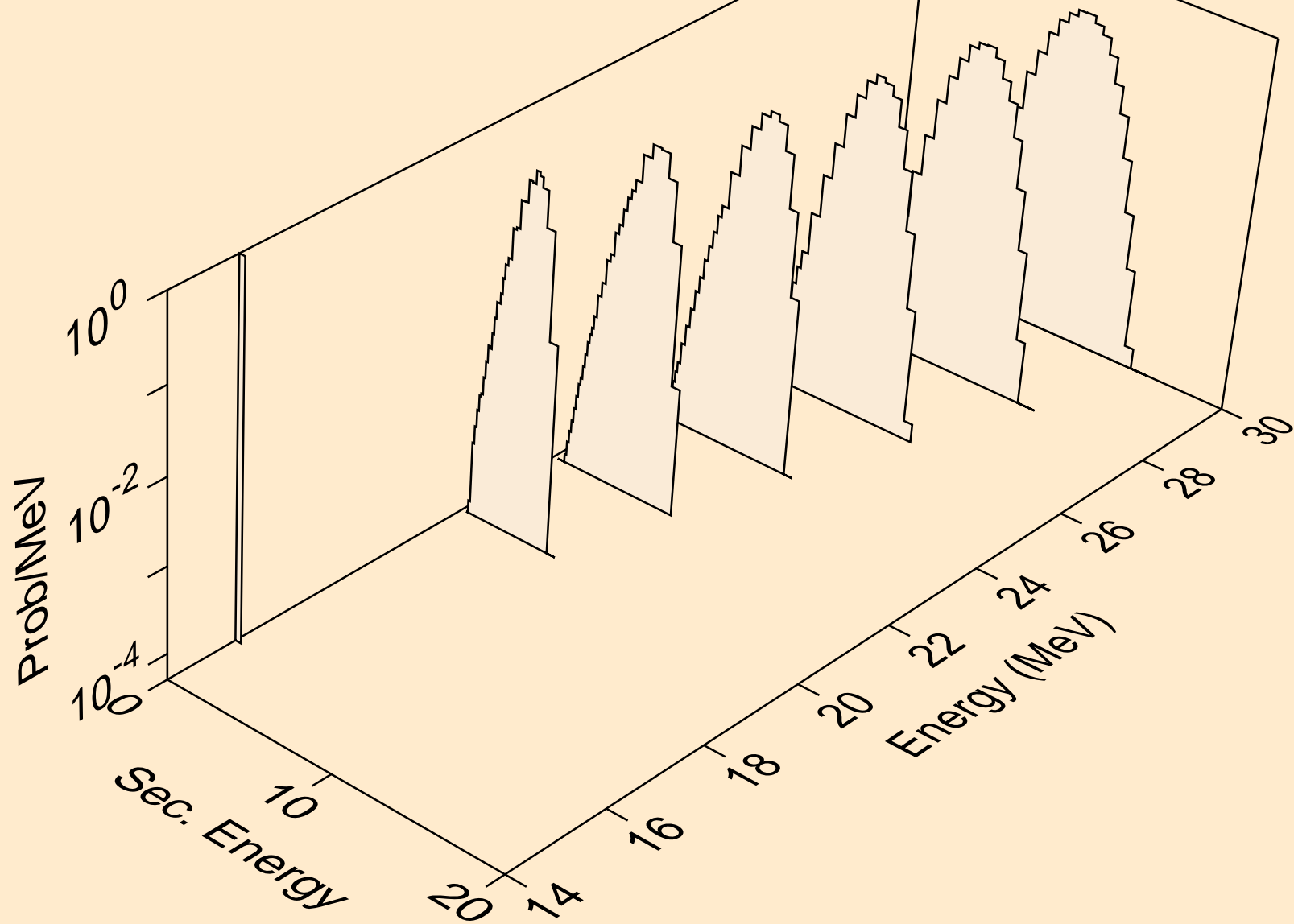

BK240 TRITON ACER TENDL-2021 LIBRARY; T=0.K  
protons from (t,p)

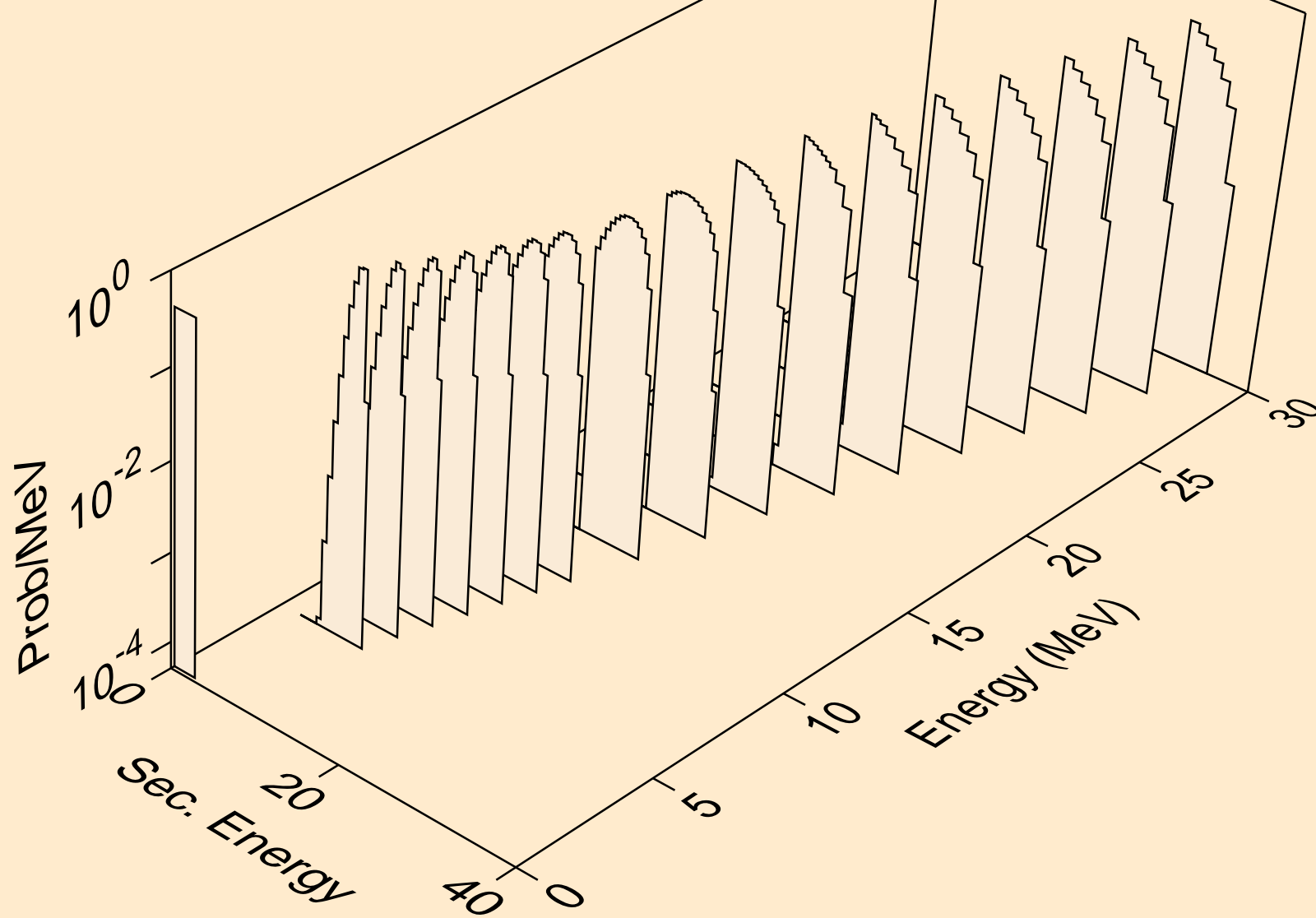

BK240 TRITON ACER TENDL-2021 LIBRARY; T=0.K  
protons from (t,2p)

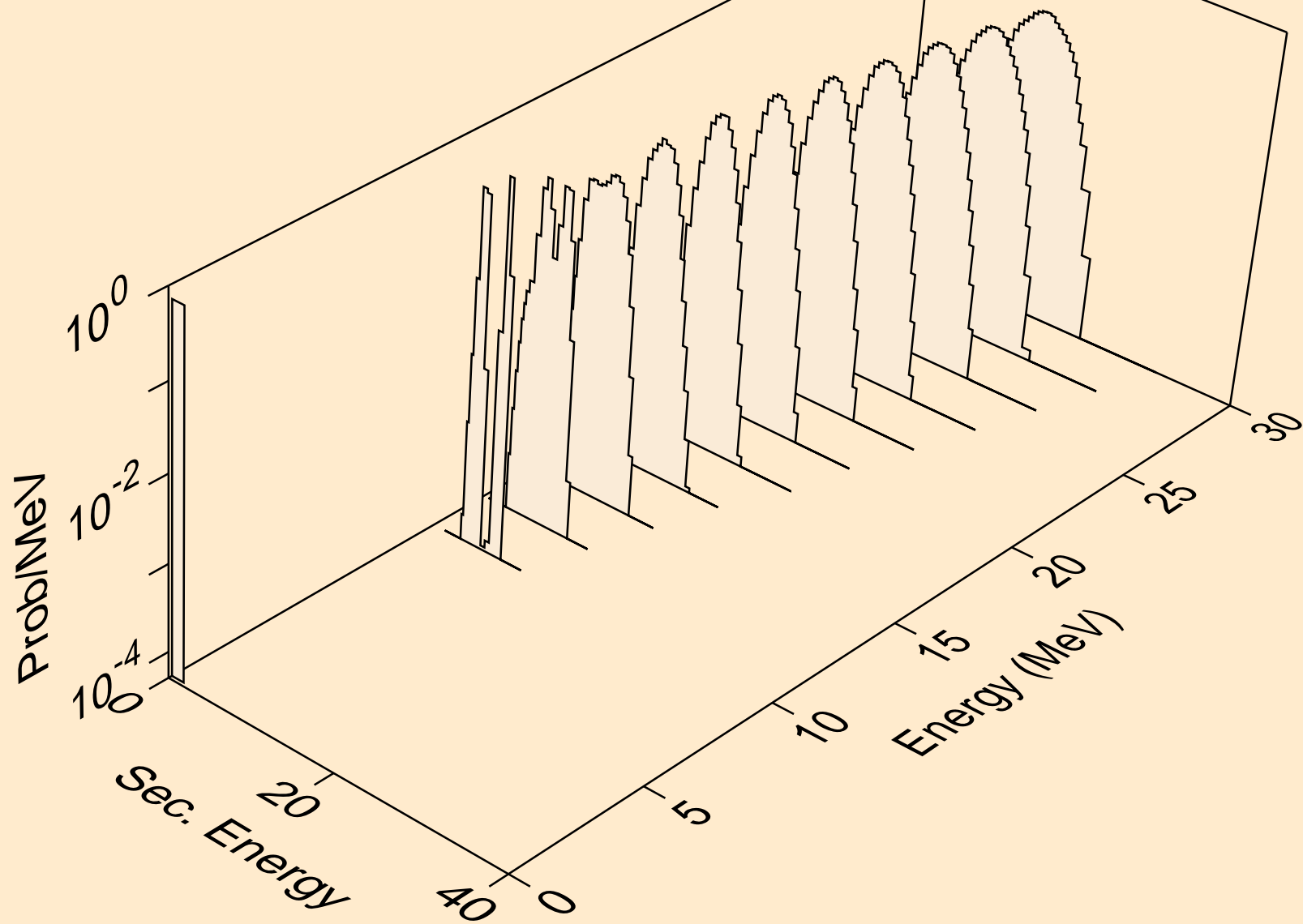

BK240 TRITON ACER TENDL-2021 LIBRARY; T=0.K  
deuterons from (t,x)

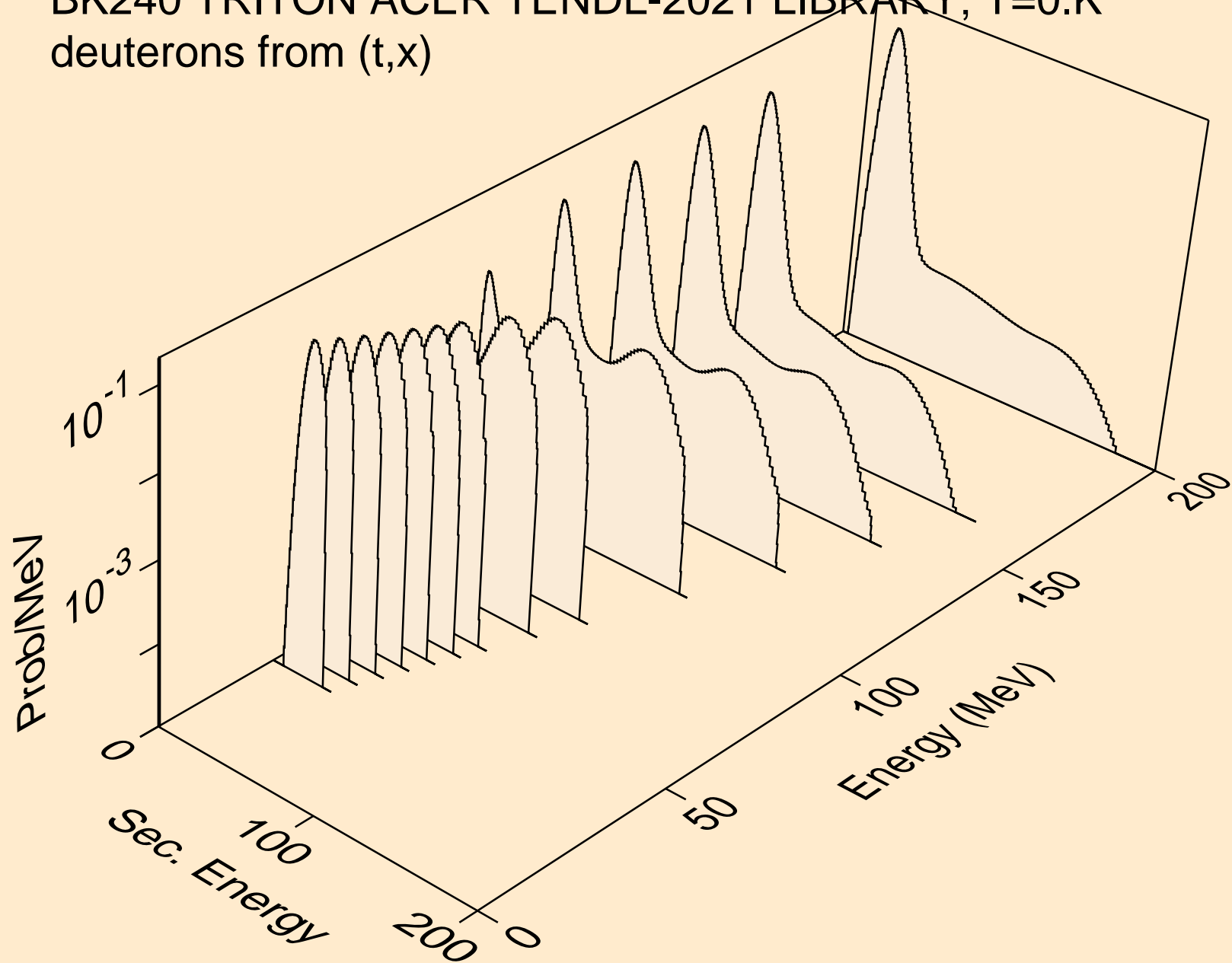

BK240 TRITON ACER TENDL-2021 LIBRARY; T=0.K  
deuterons from (t,2nd)

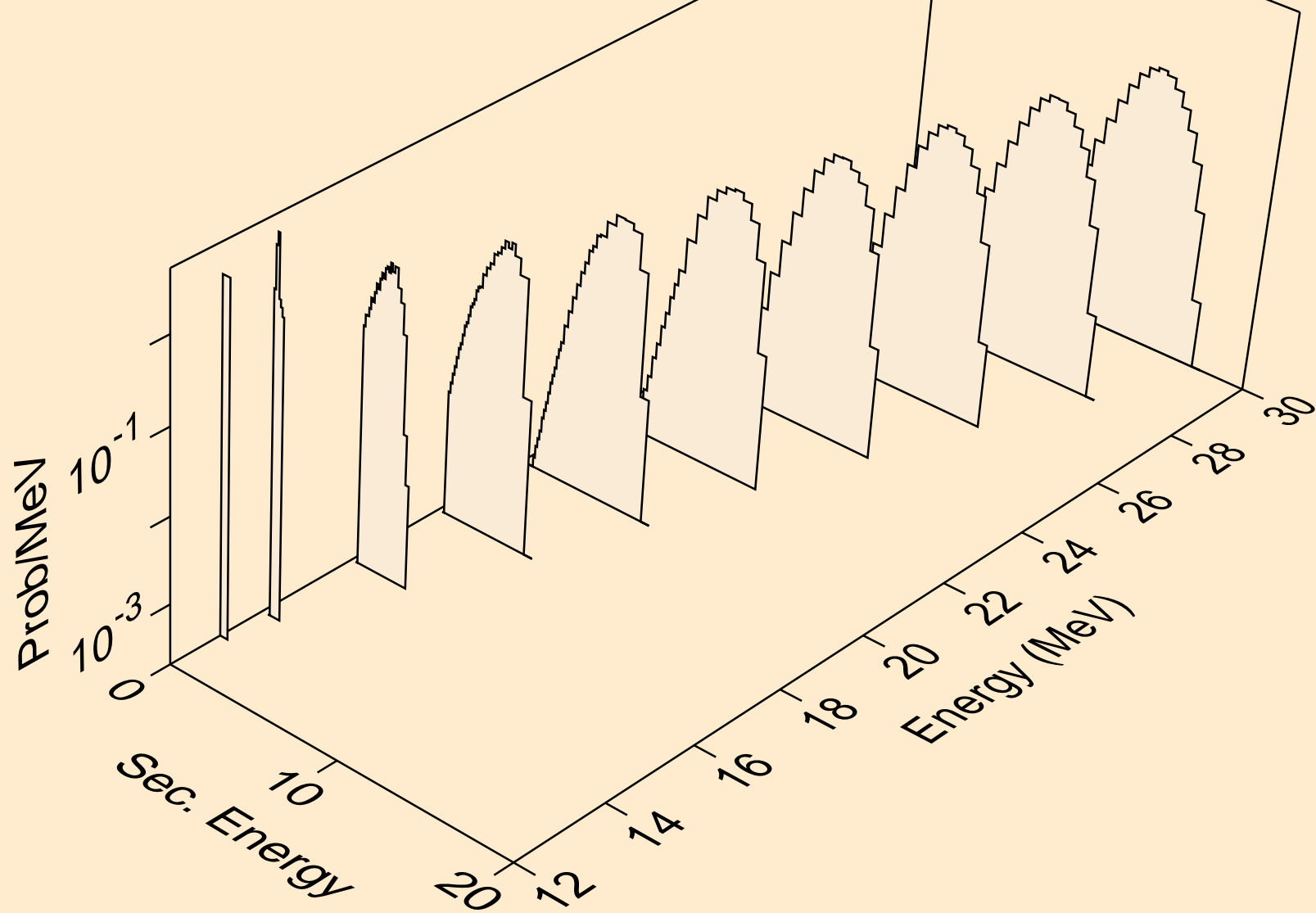

BK240 TRITON ACER TENDL-2021 LIBRARY; T=0.K  
deuterons from (t,n\*)d

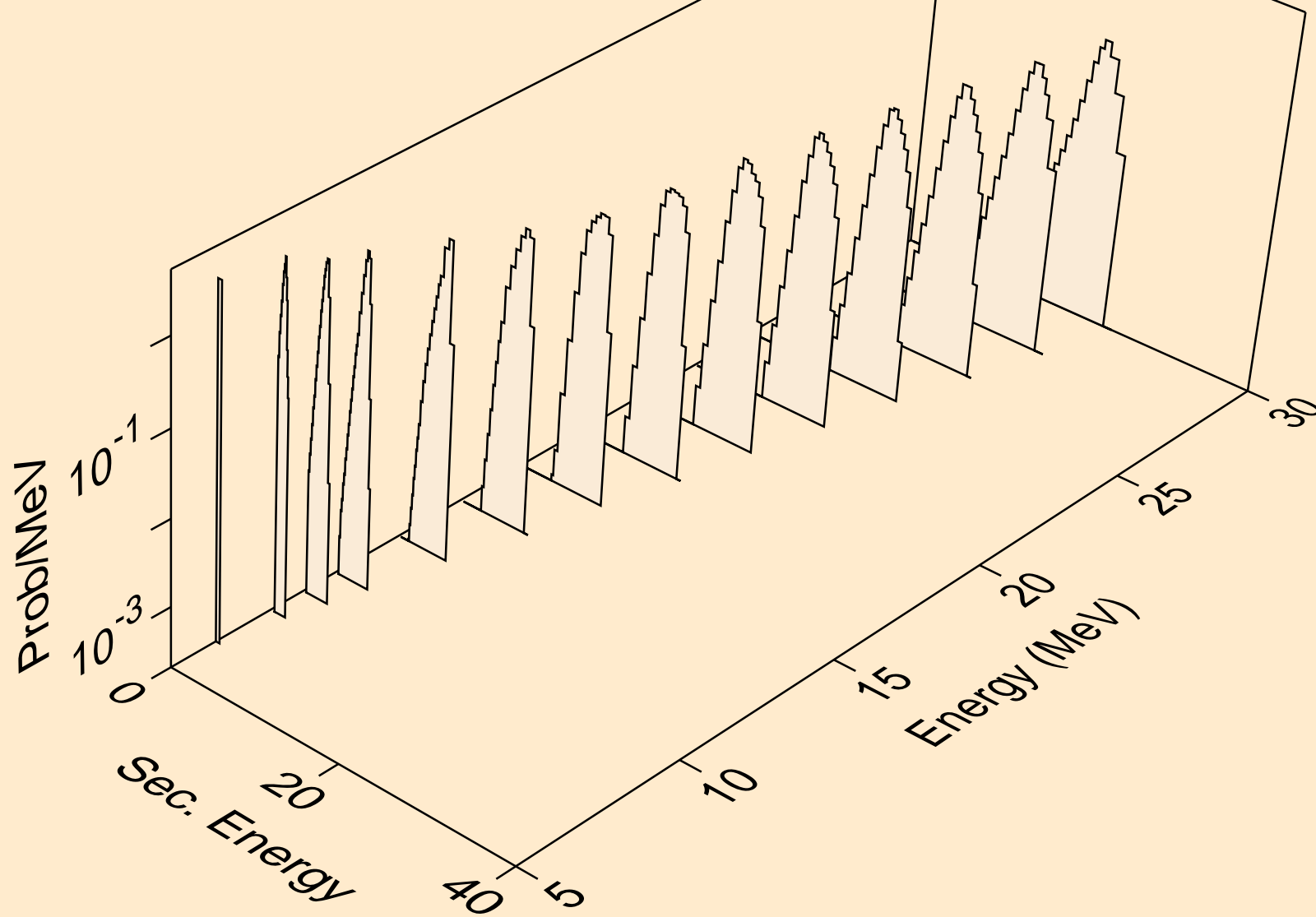

BK240 TRITON ACER TENDL-2021 LIBRARY; T=0.K  
deuterons from (t,d)

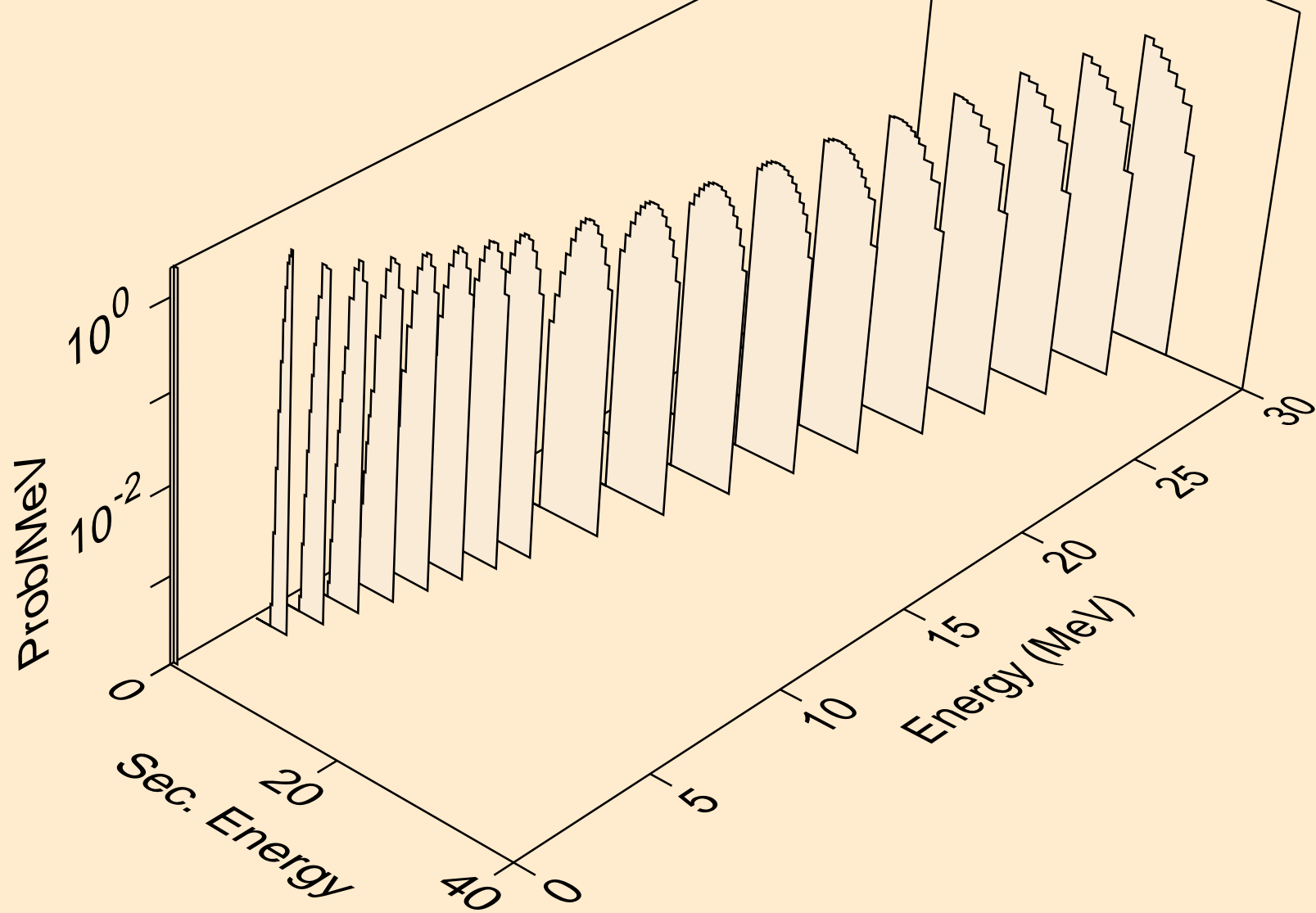

BK240 TRITON ACER TENDL-2021 LIBRARY; T=0.K  
he3s from (t,x)

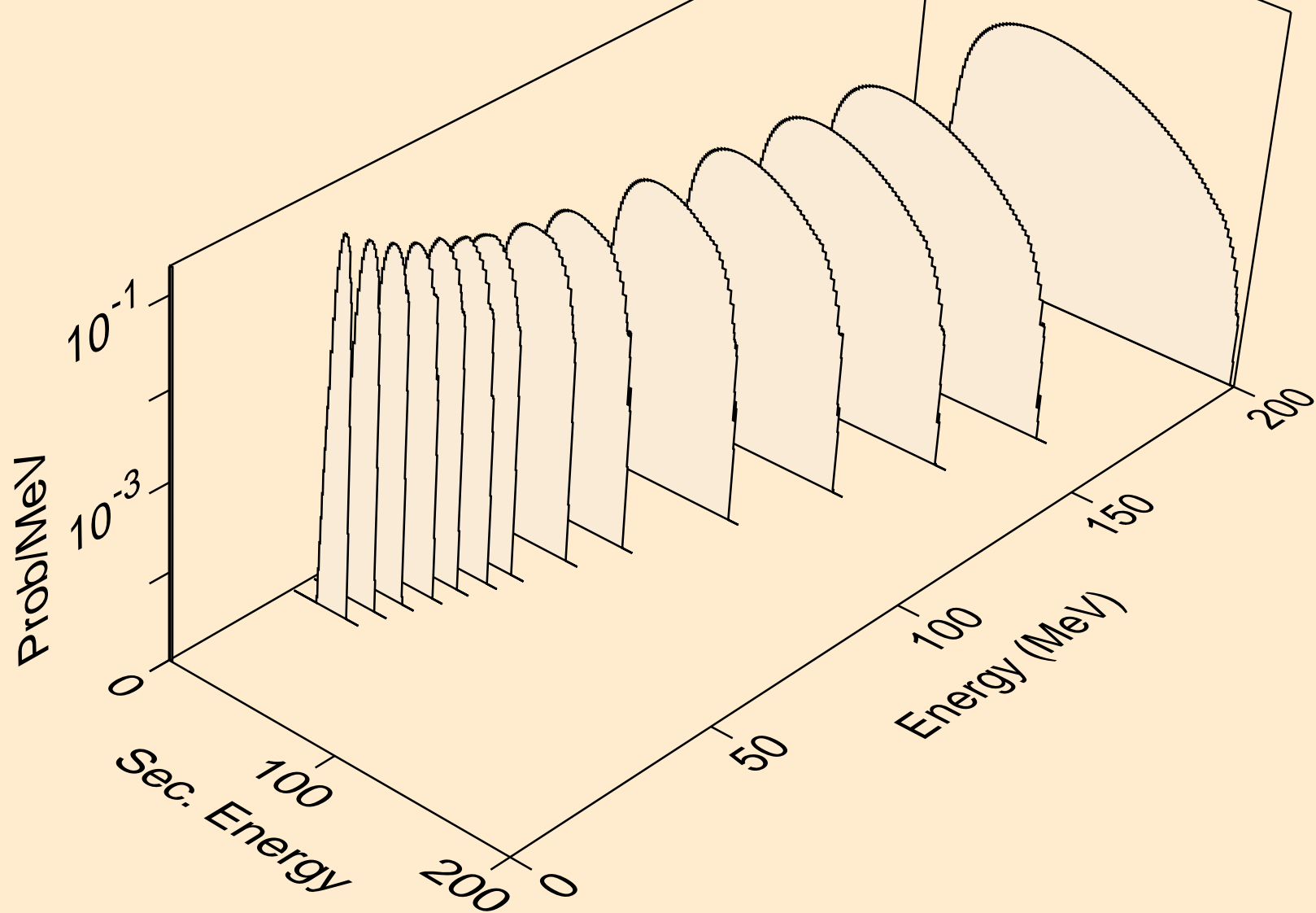

BK240 TRITON ACER TENDL-2021 LIBRARY; T=0.K  
he3s from (t,n\*)he3

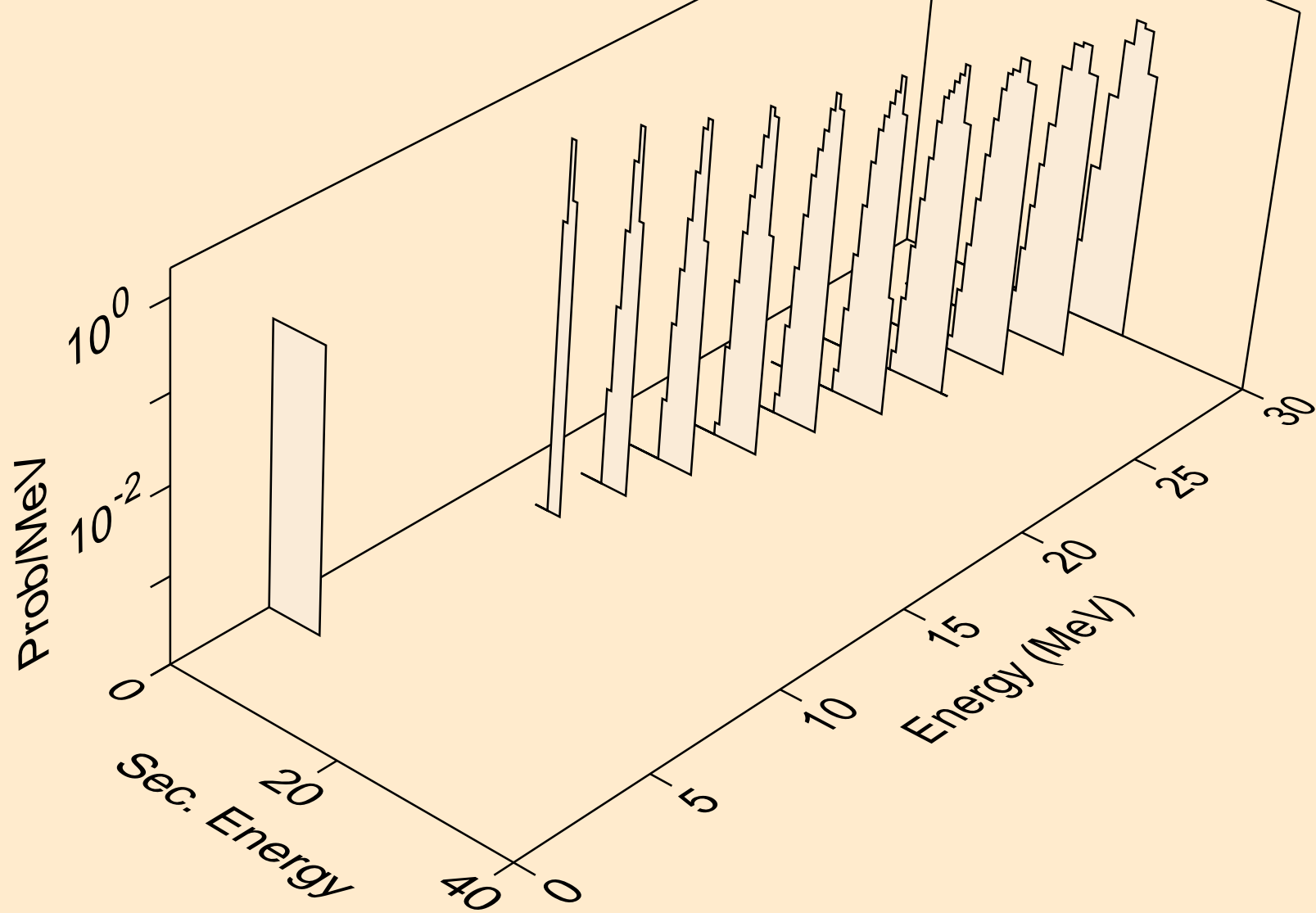

BK240 TRITON ACER TENDL-2021 LIBRARY; T=0.K  
he3s from (t,he3)

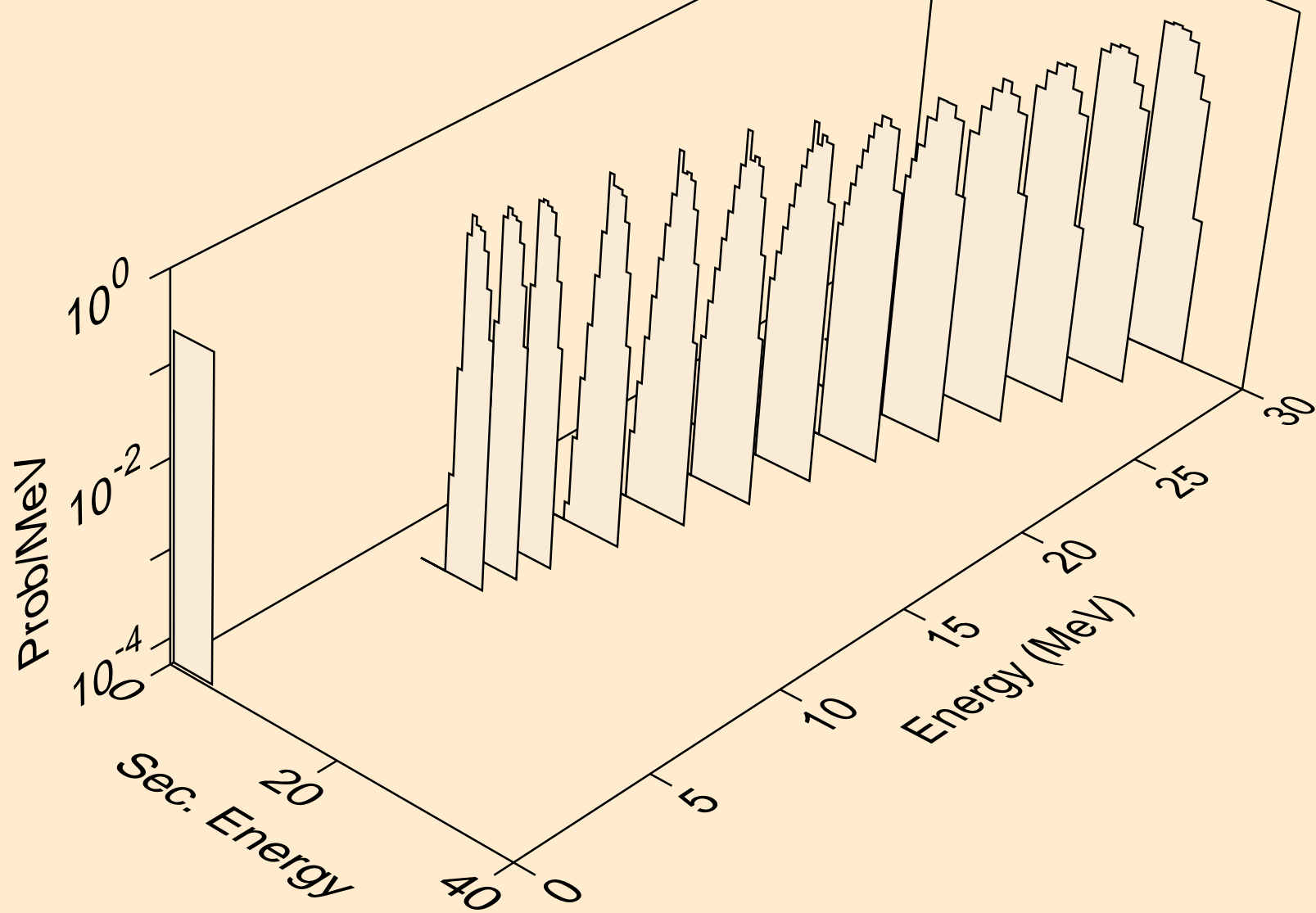

BK240 TRITON ACER TENDL-2021 LIBRARY; T=0.K  
alphas from (t,x)

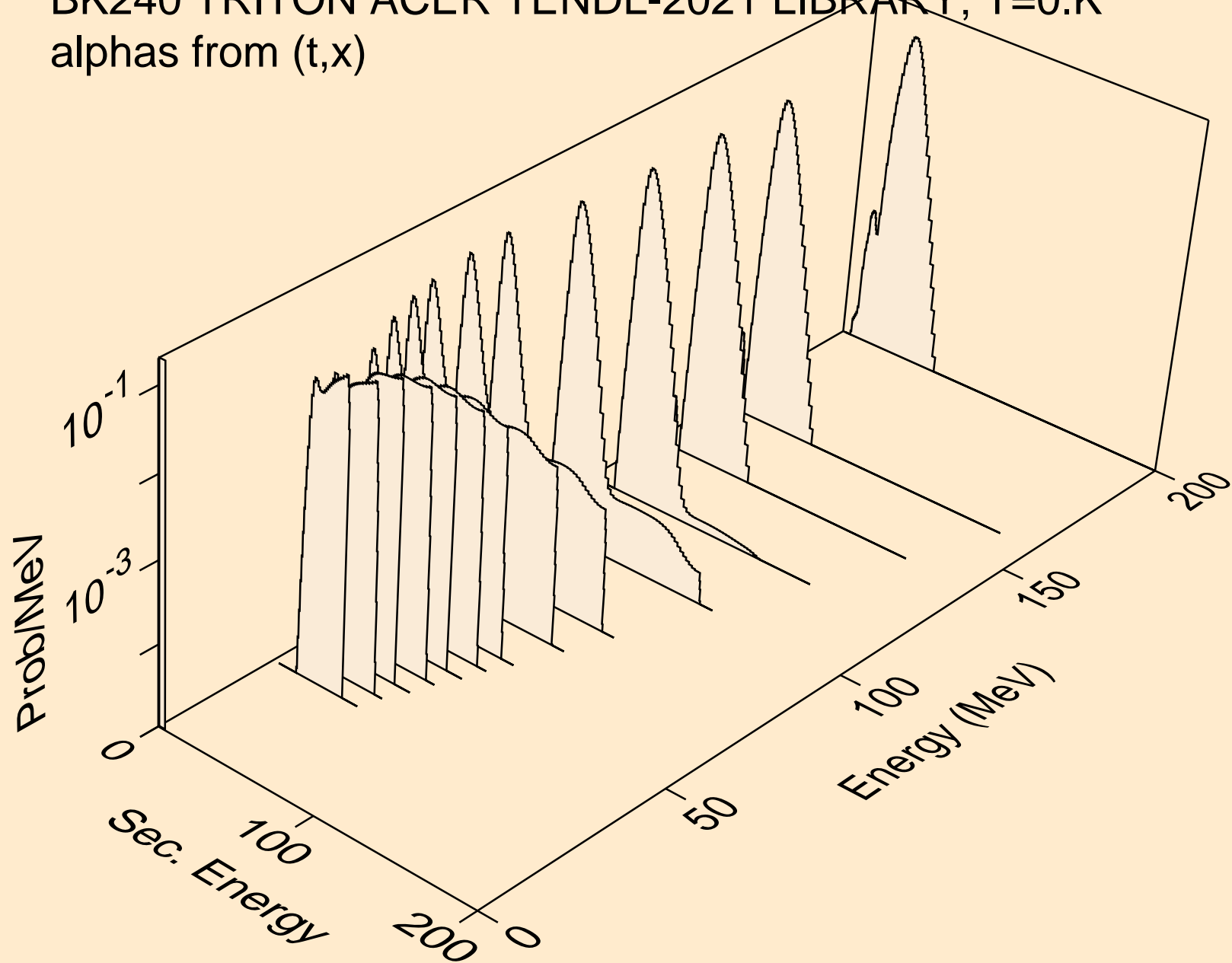

BK240 TRITON ACER TENDL-2021 LIBRARY; T=0.K  
alphas from (t,n\*)a

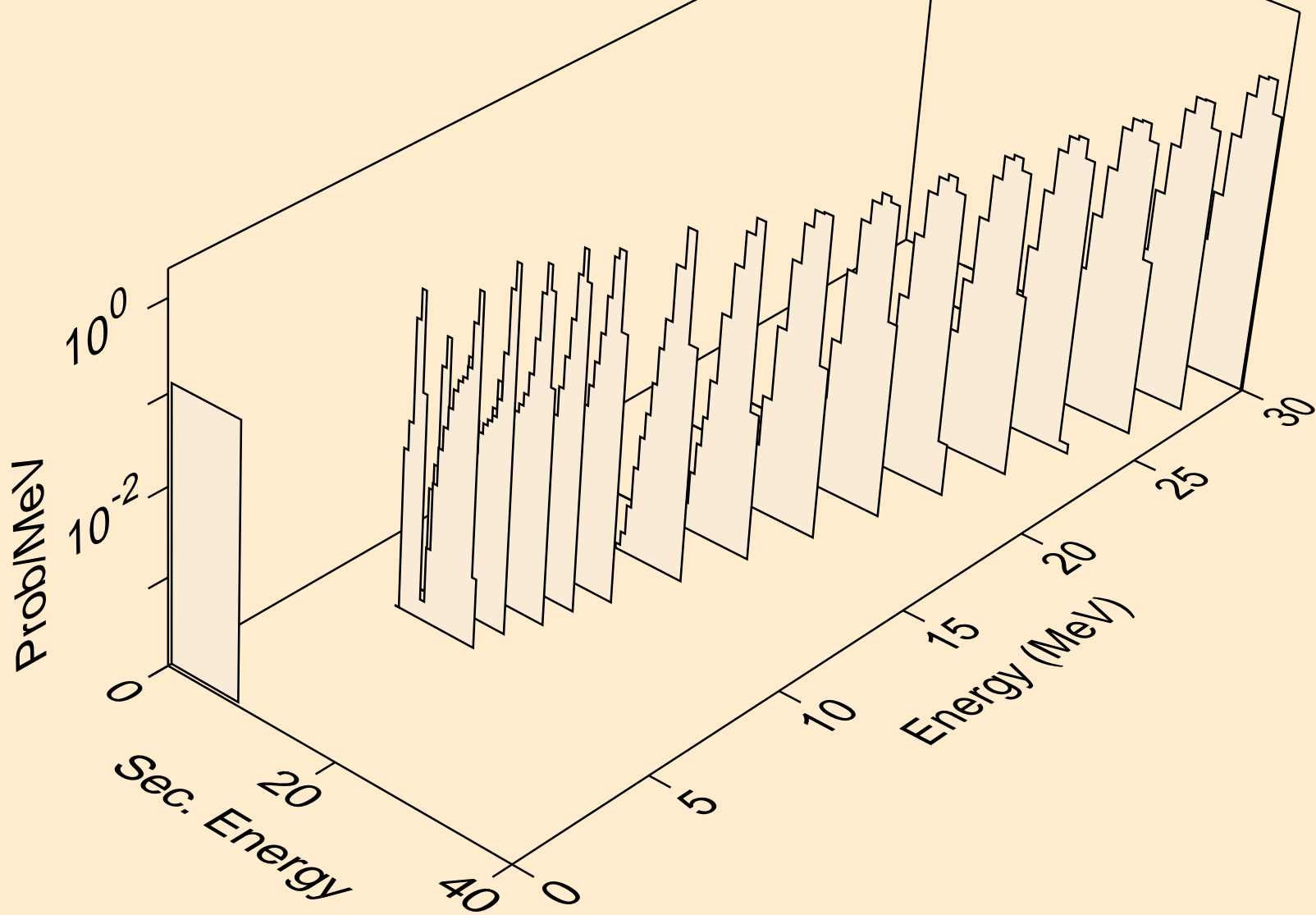

BK240 TRITON ACER TENDL-2021 LIBRARY; T=0.K  
alphas from (t,2n)a

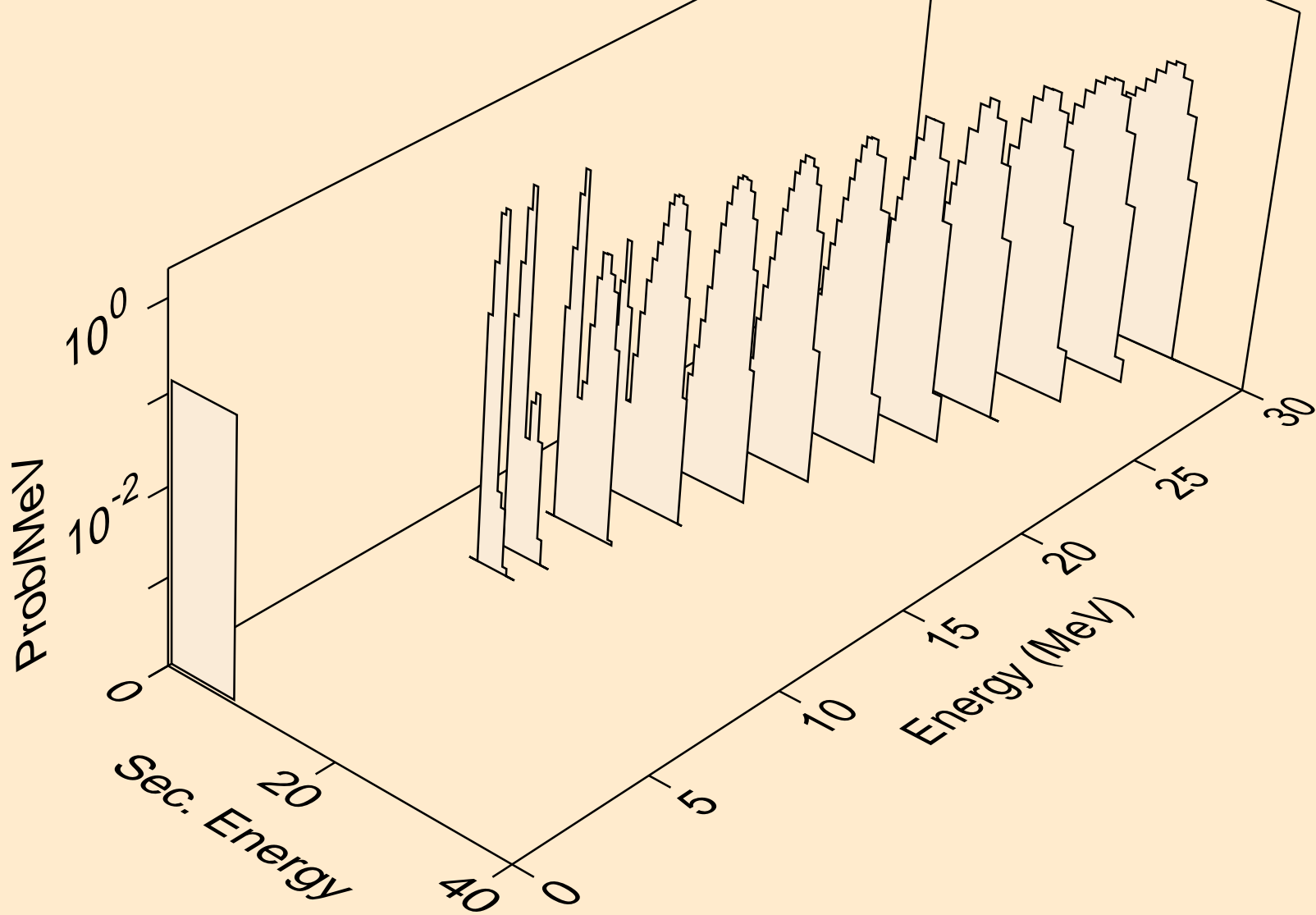

BK240 TRITON ACER TENDL-2021 LIBRARY; T=0.K  
alphas from (t,a)

