

HO169 TRITON ACER TENDL-2021 LIBRARY; T=0.K  
Principal cross sections

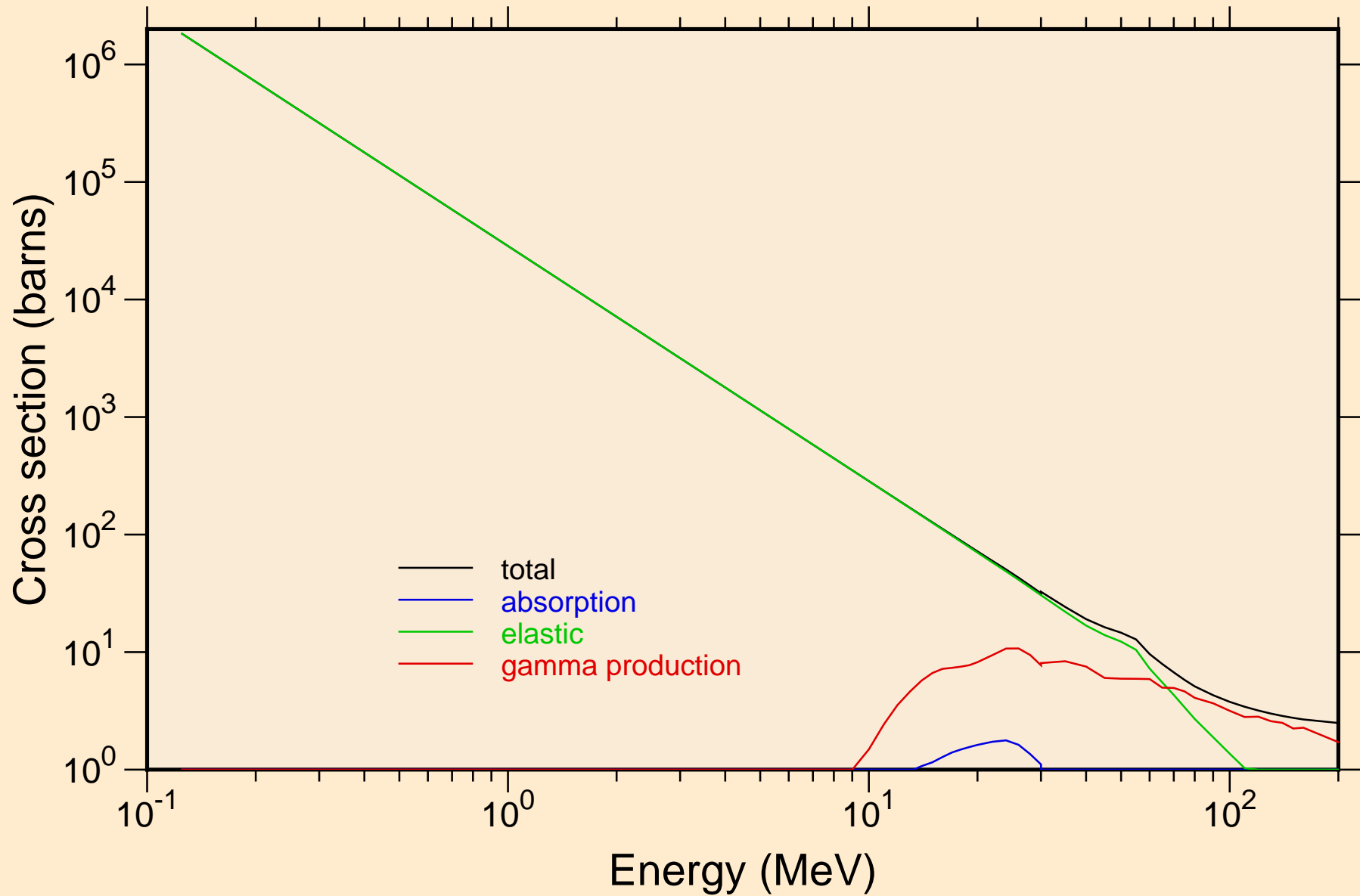

HO169 TRITON ACER TENDL-2021 LIBRARY; T=0.K

Heating

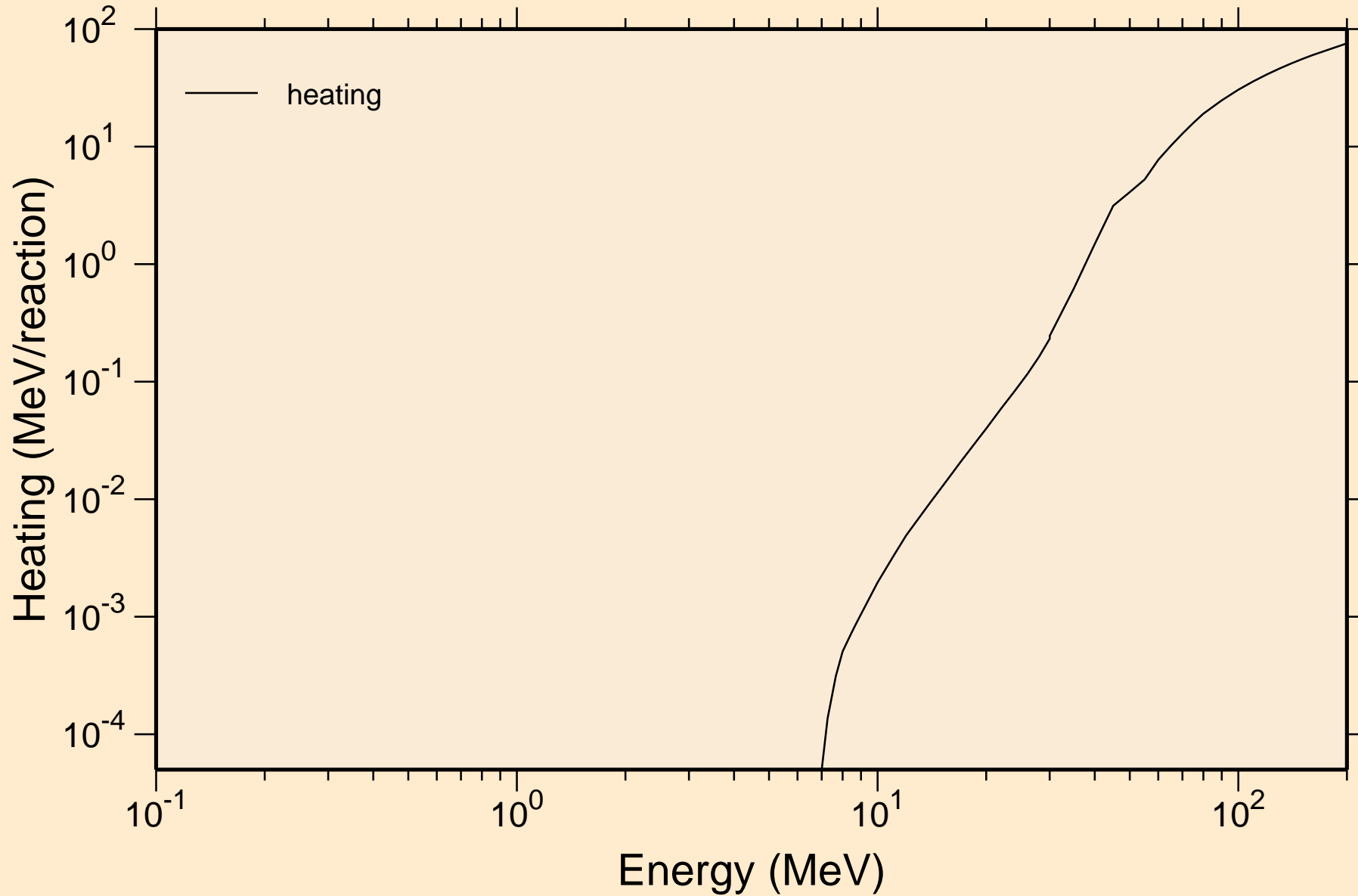

# HO169 TRITON ACER TENDL-2021 LIBRARY; T=0.K

## Principal cross sections

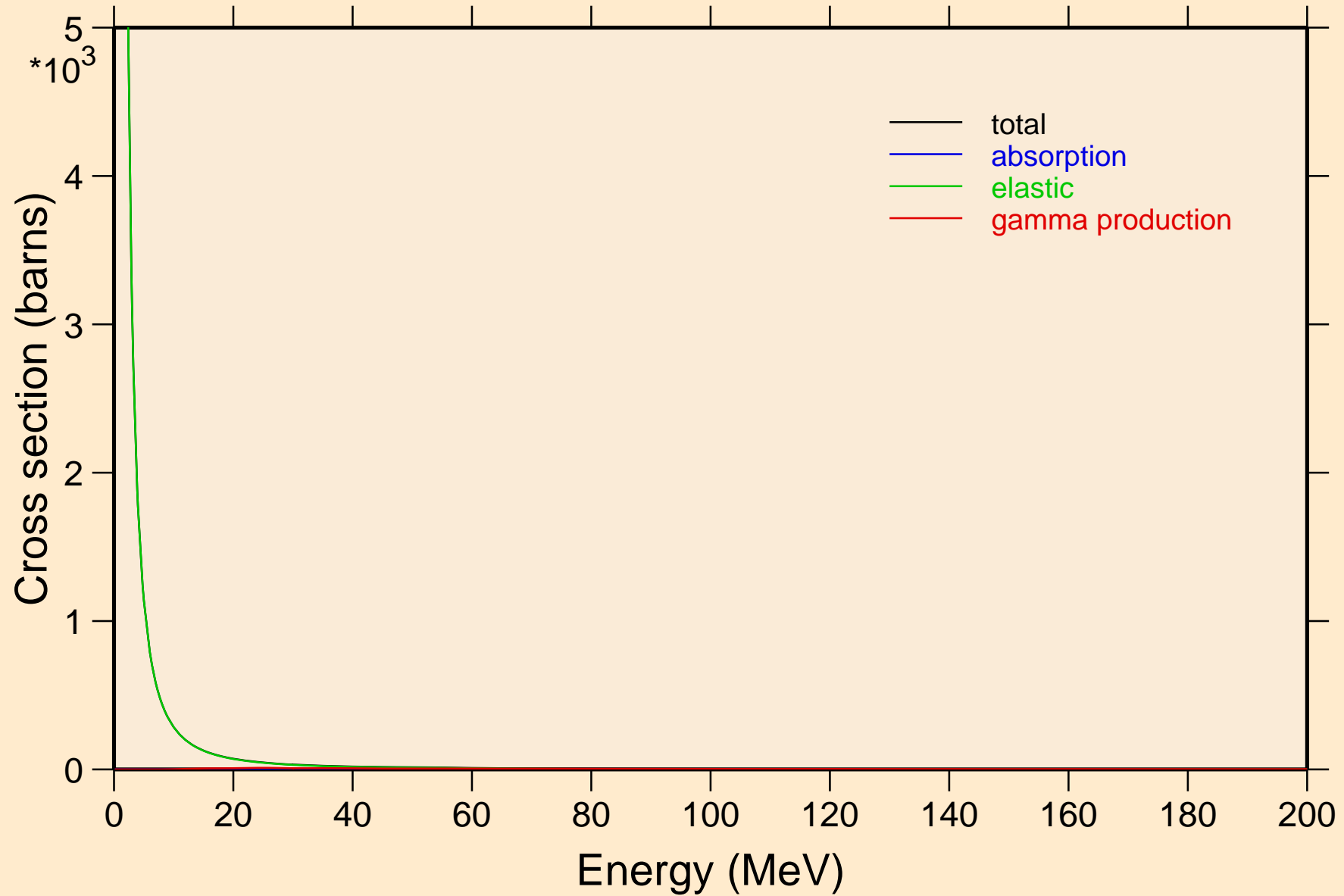

HO169 TRITON ACER TENDL-2021 LIBRARY; T=0.K

Heating

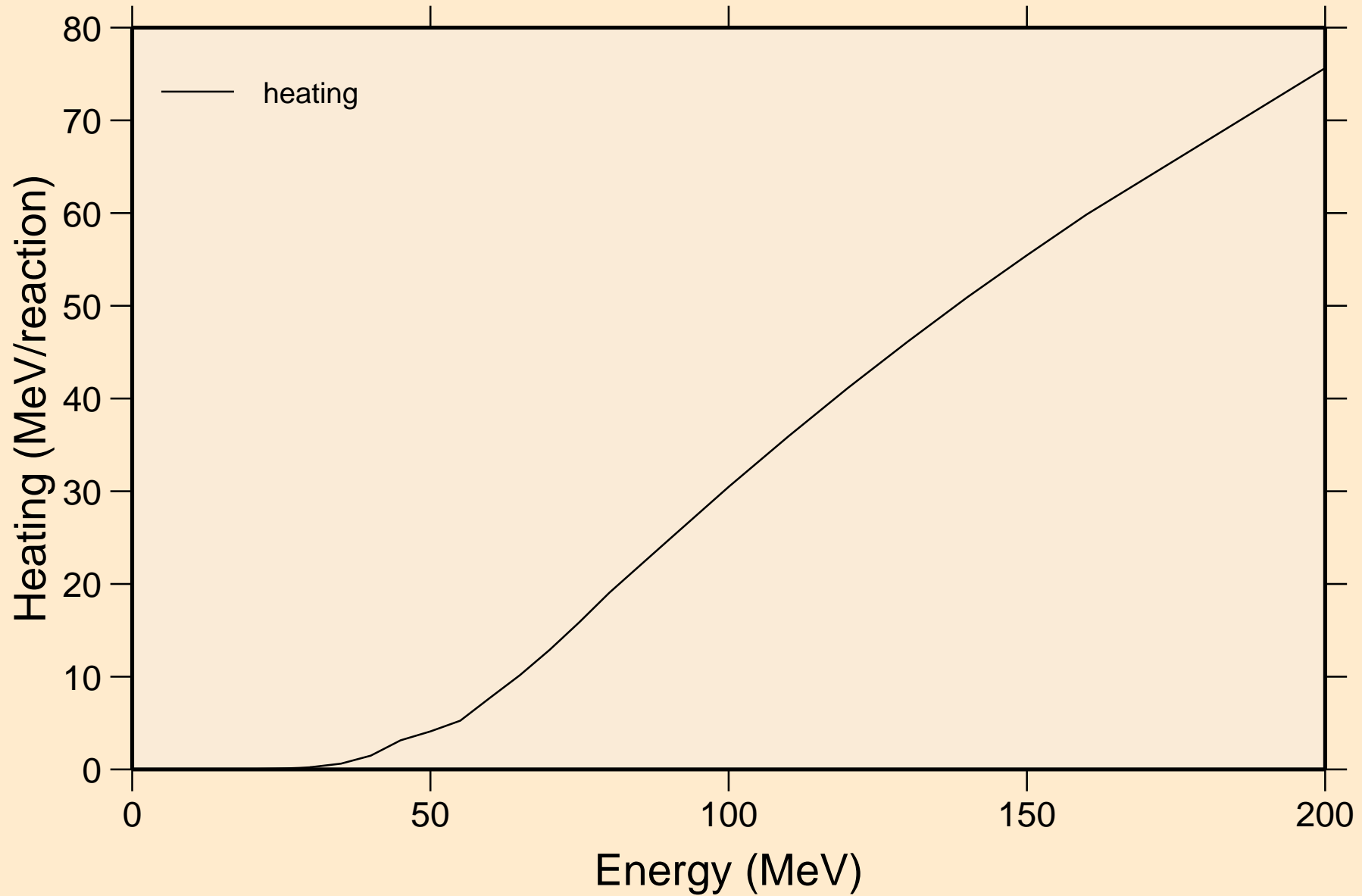

HO169 TRITON ACER TENDL-2021 LIBRARY; T=0.K  
Threshold reactions

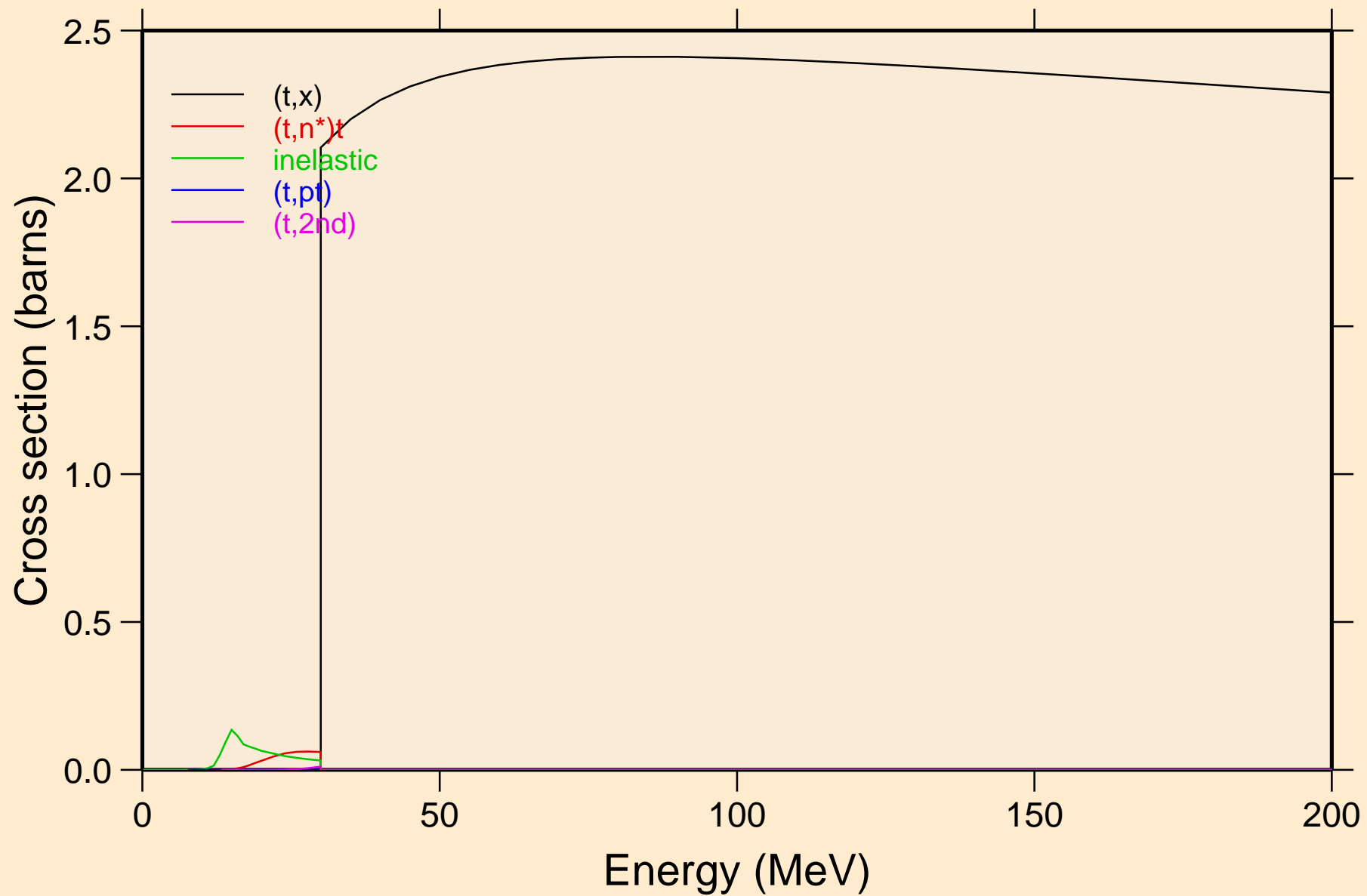

HO169 TRITON ACER TENDL-2021 LIBRARY; T=0.K  
Threshold reactions

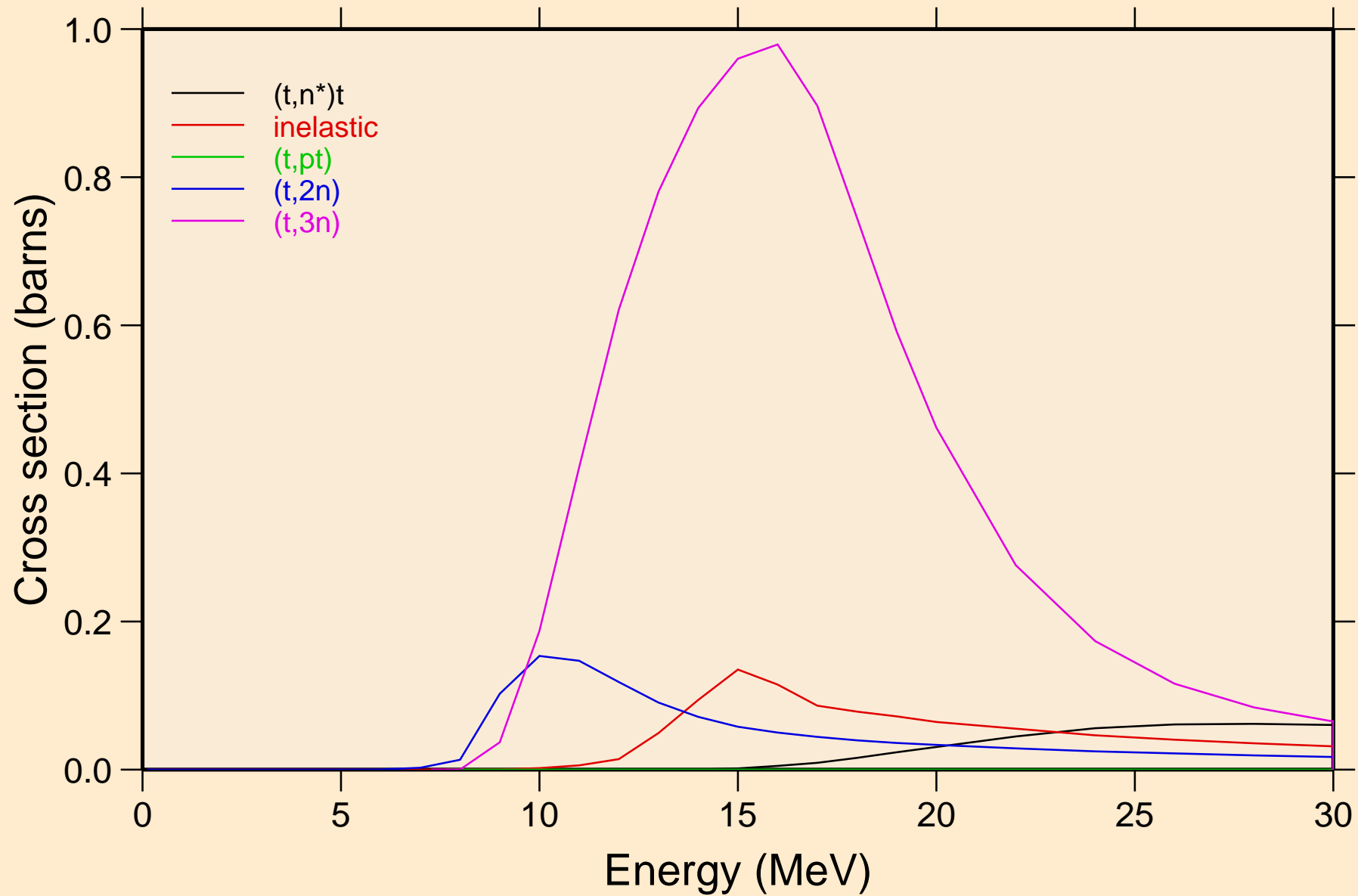

HO169 TRITON ACER TENDL-2021 LIBRARY; T=0.K  
Threshold reactions

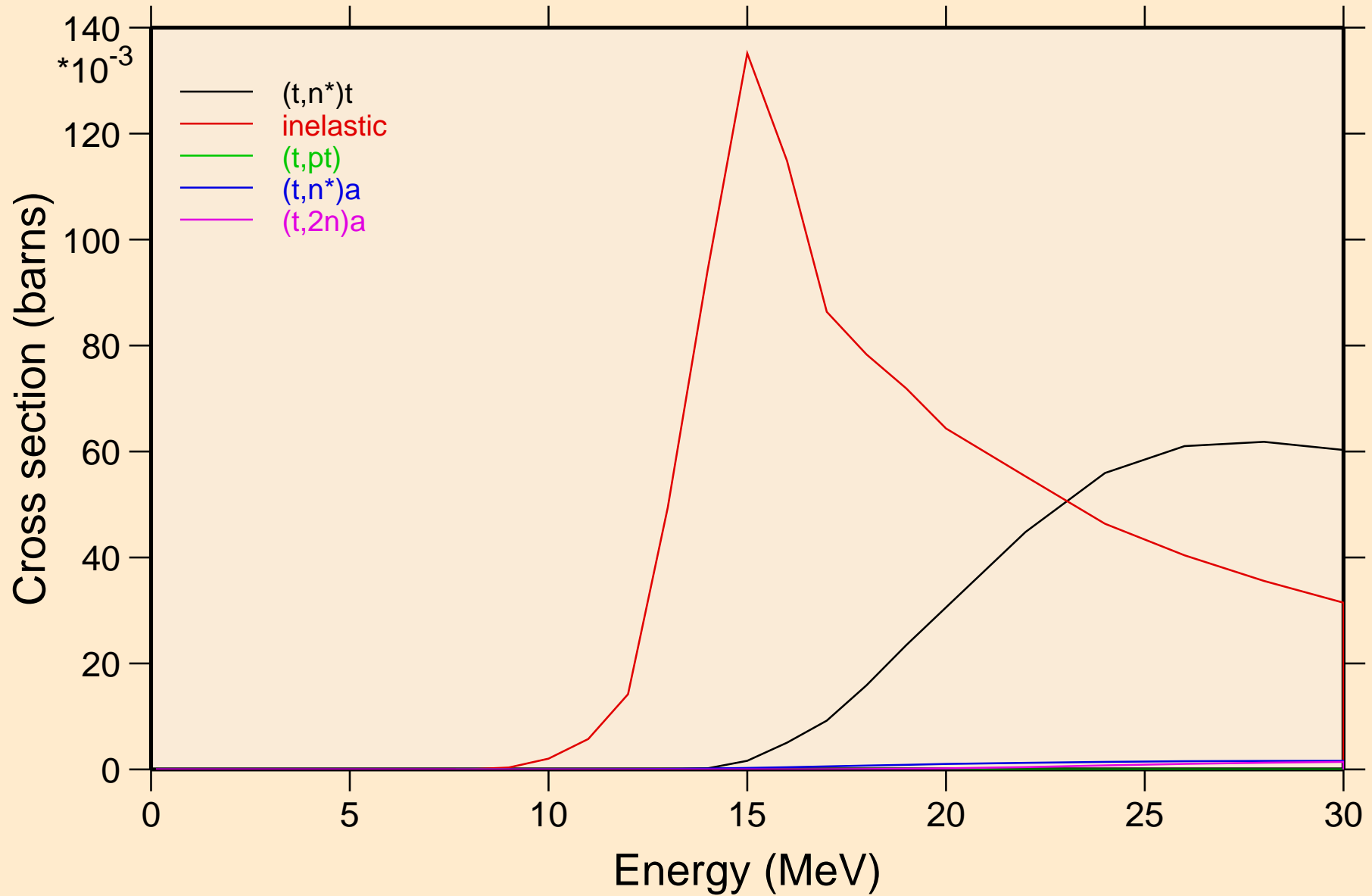

HO169 TRITON ACER TENDL-2021 LIBRARY; T=0.K  
Threshold reactions

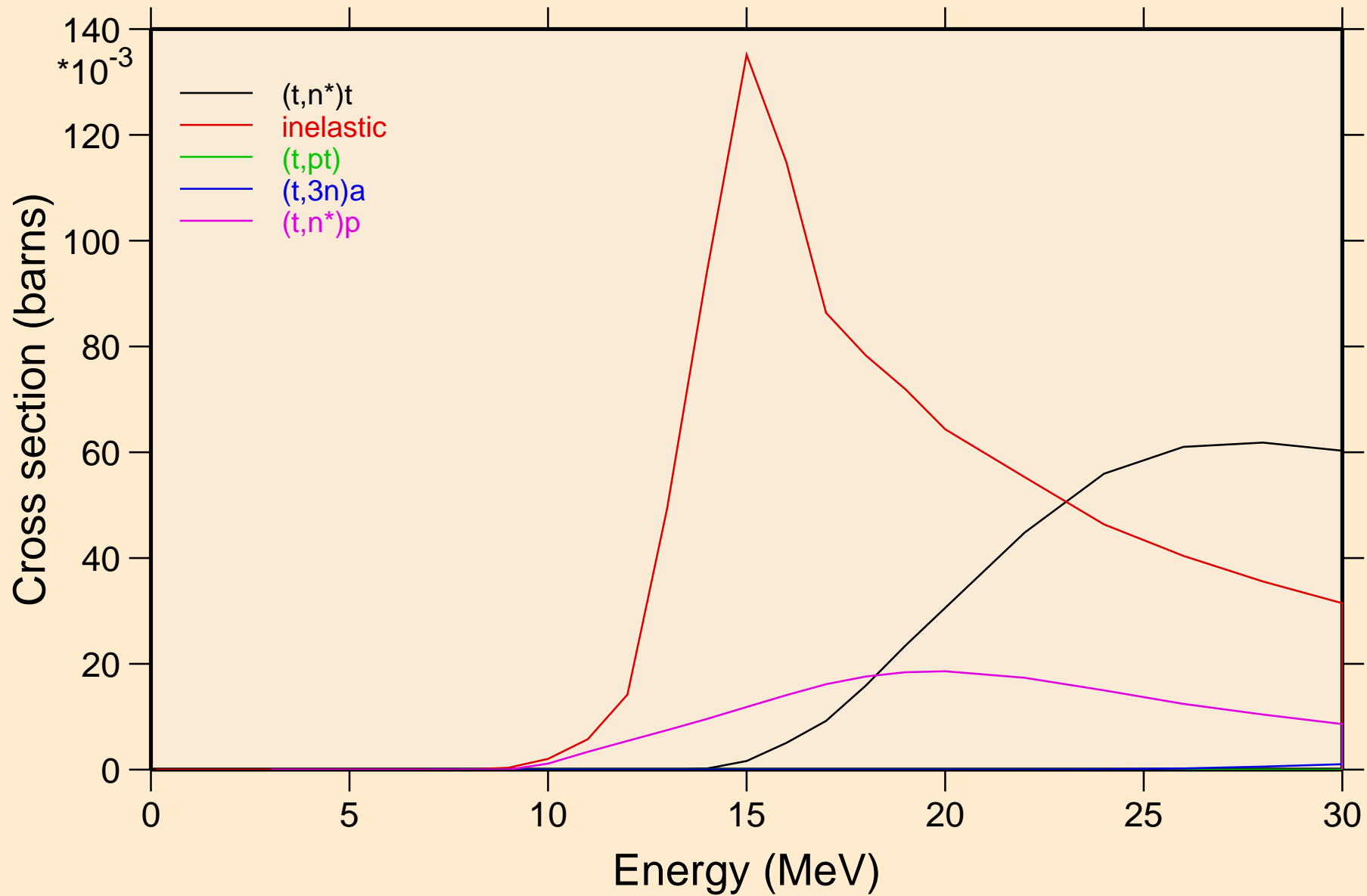

HO169 TRITON ACER TENDL-2021 LIBRARY; T=0.K  
Threshold reactions

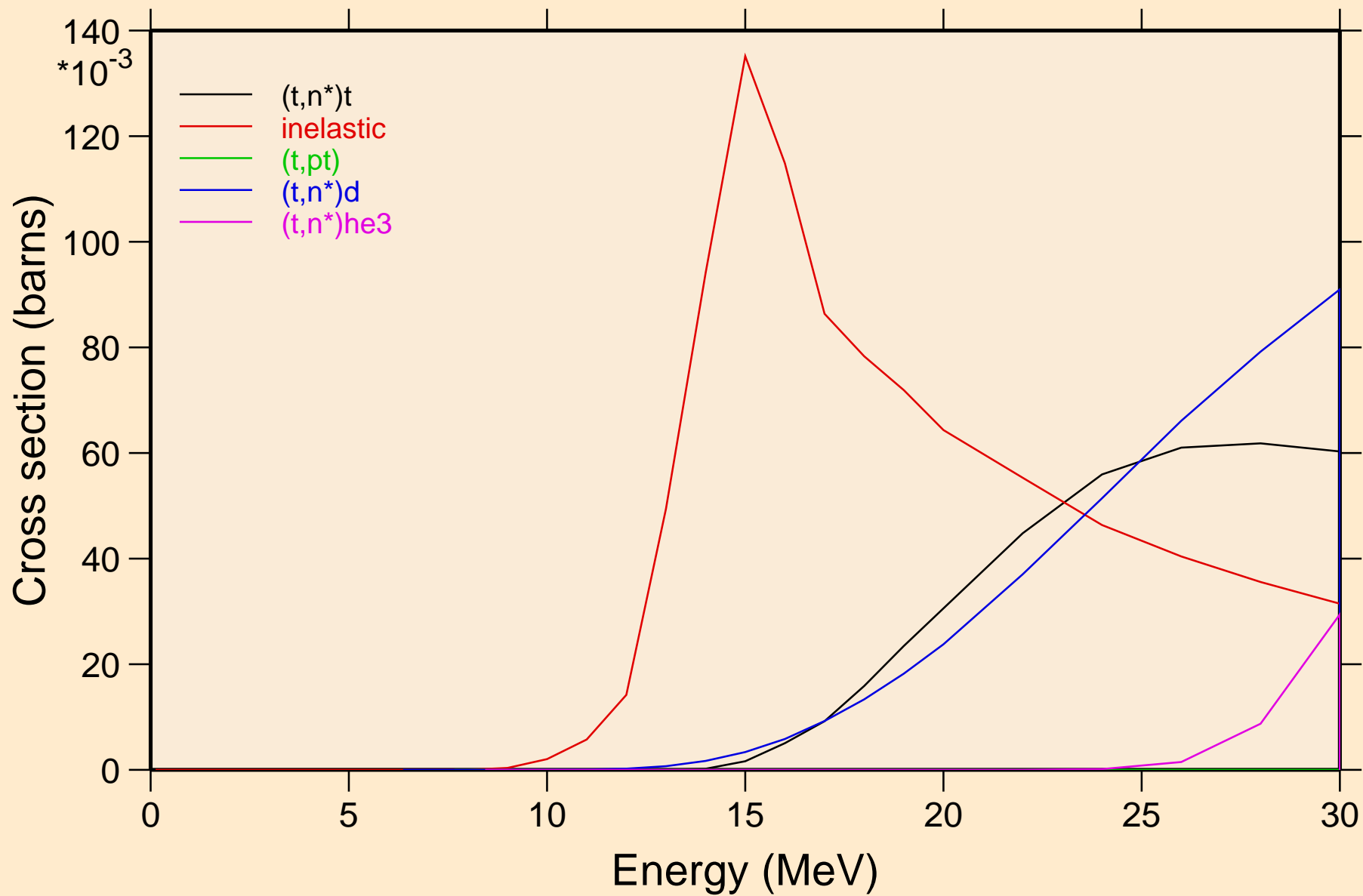

HO169 TRITON ACER TENDL-2021 LIBRARY; T=0.K  
Threshold reactions

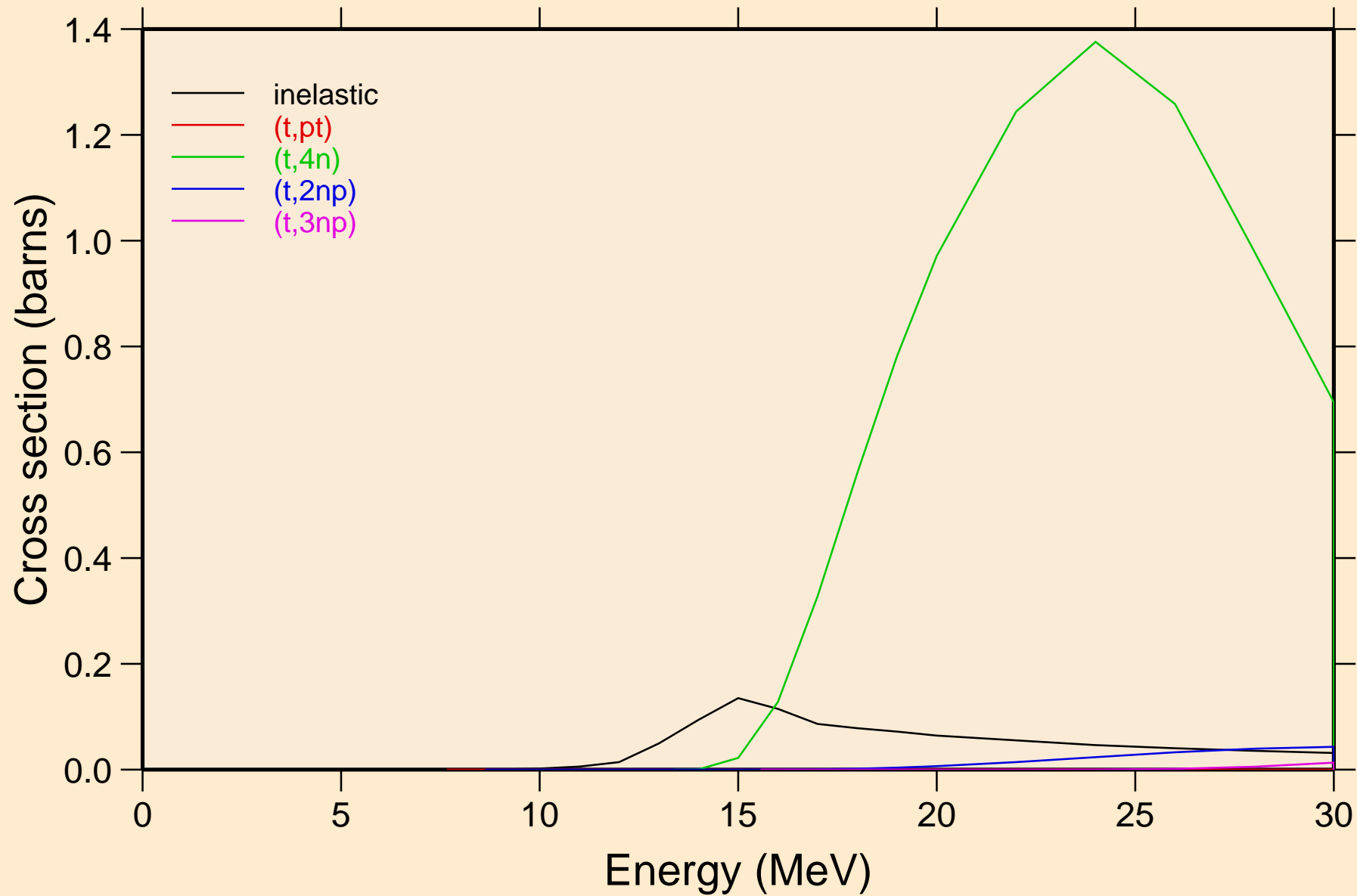

HO169 TRITON ACER TENDL-2021 LIBRARY; T=0.K  
Threshold reactions

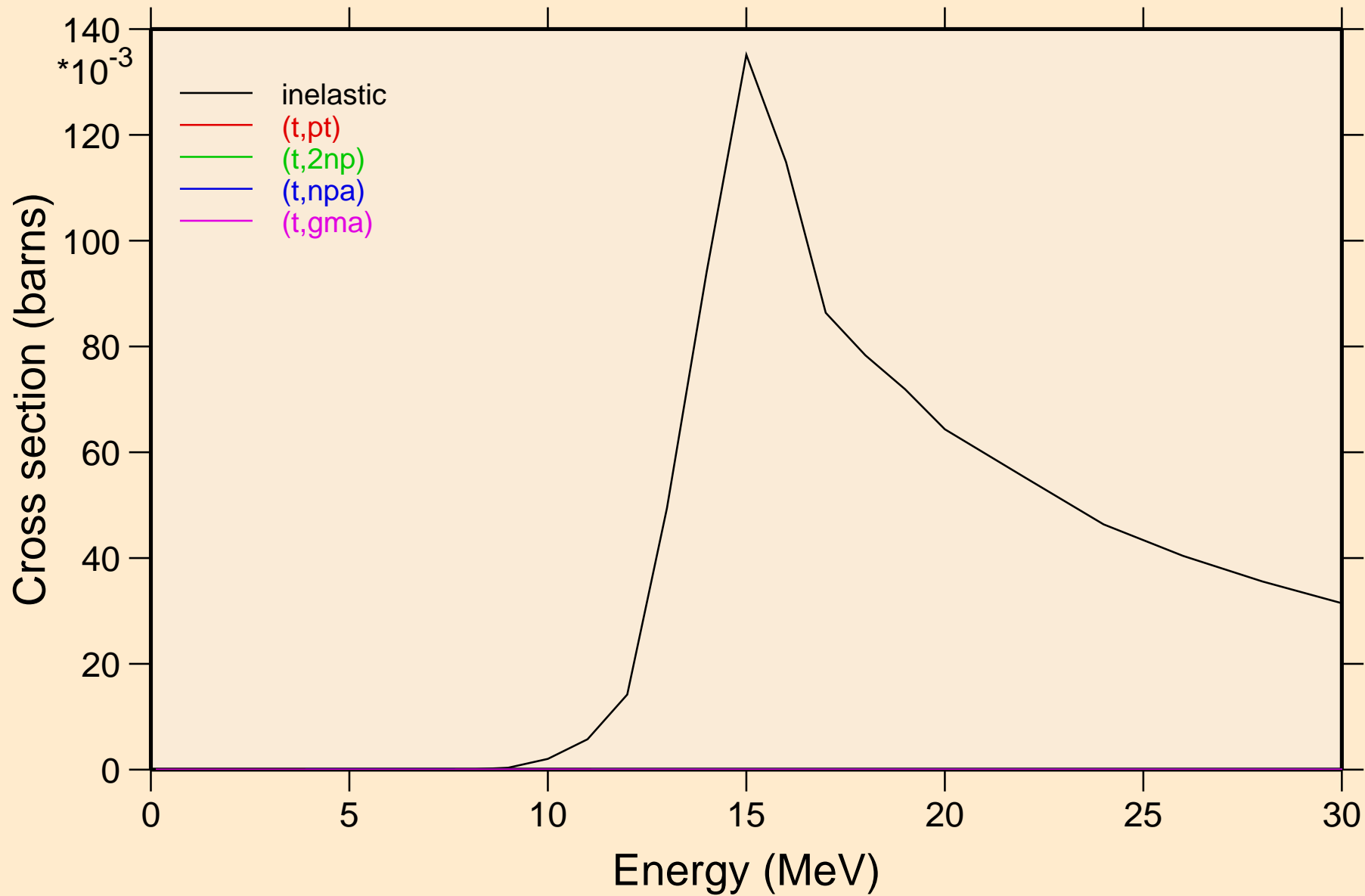

HO169 TRITON ACER TENDL-2021 LIBRARY; T=0.K  
Threshold reactions

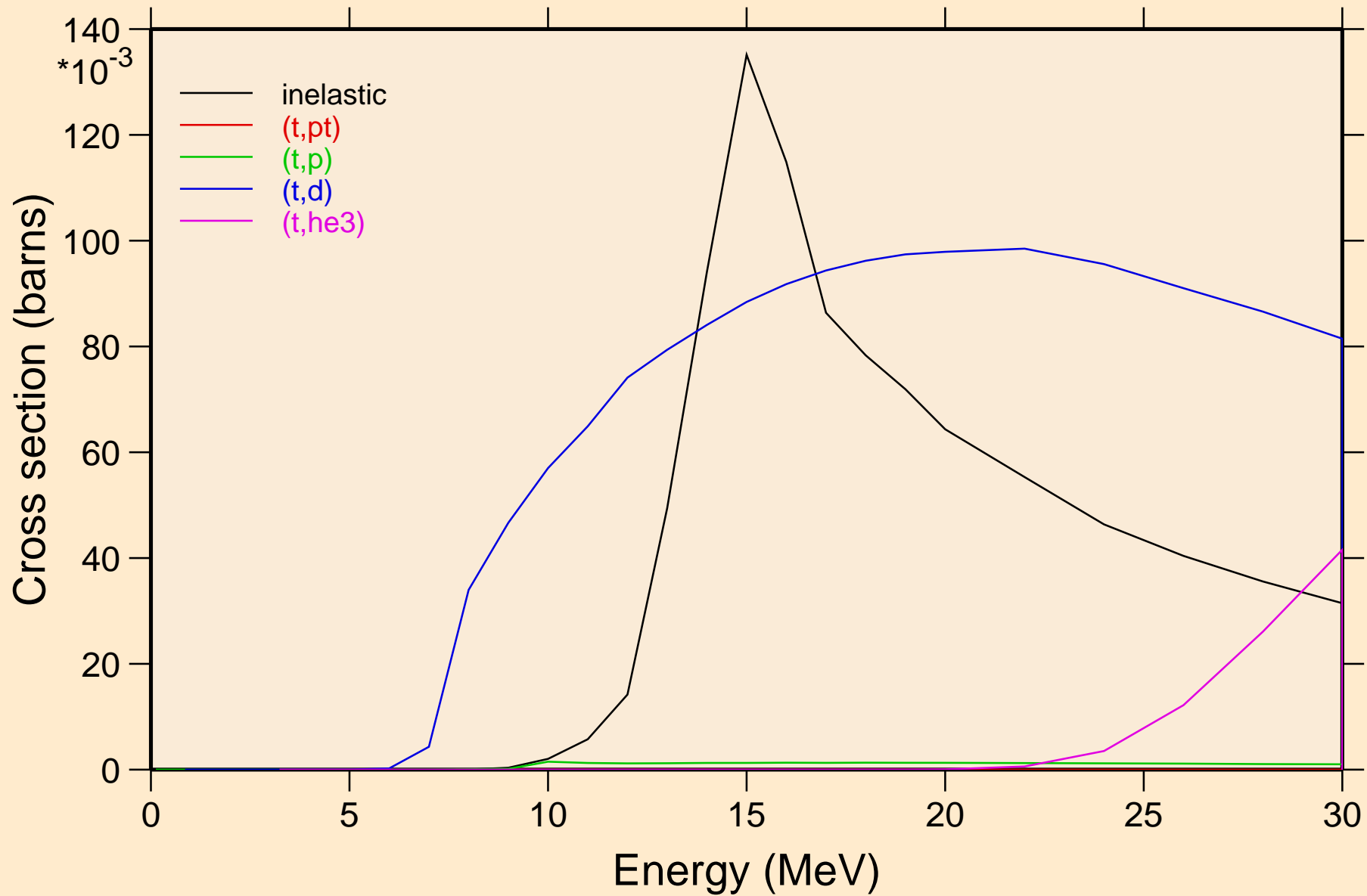

HO169 TRITON ACER TENDL-2021 LIBRARY; T=0.K  
Threshold reactions

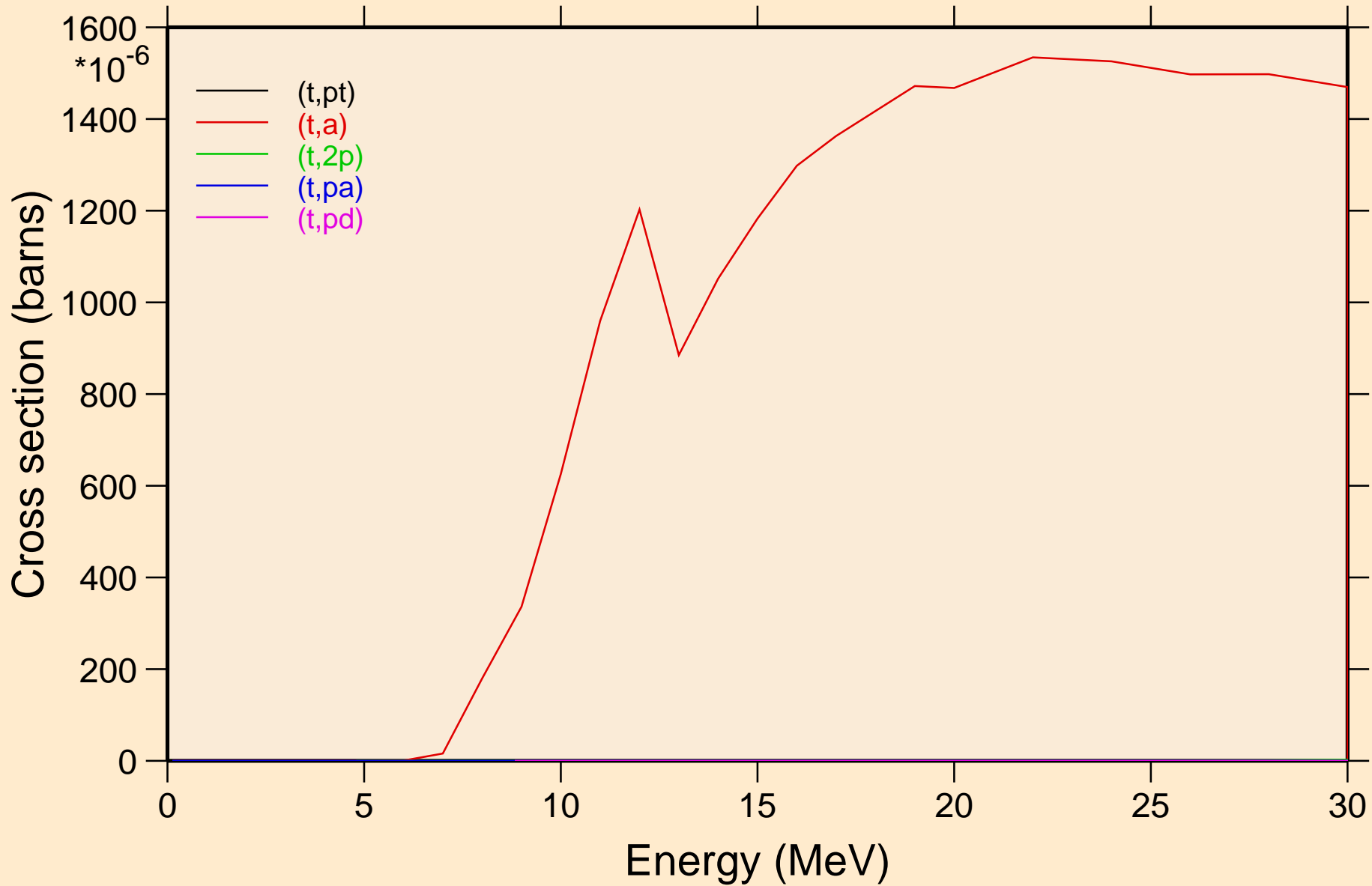

HO169 TRITON ACER TENDL-2021 LIBRARY; T=0.K  
Threshold reactions

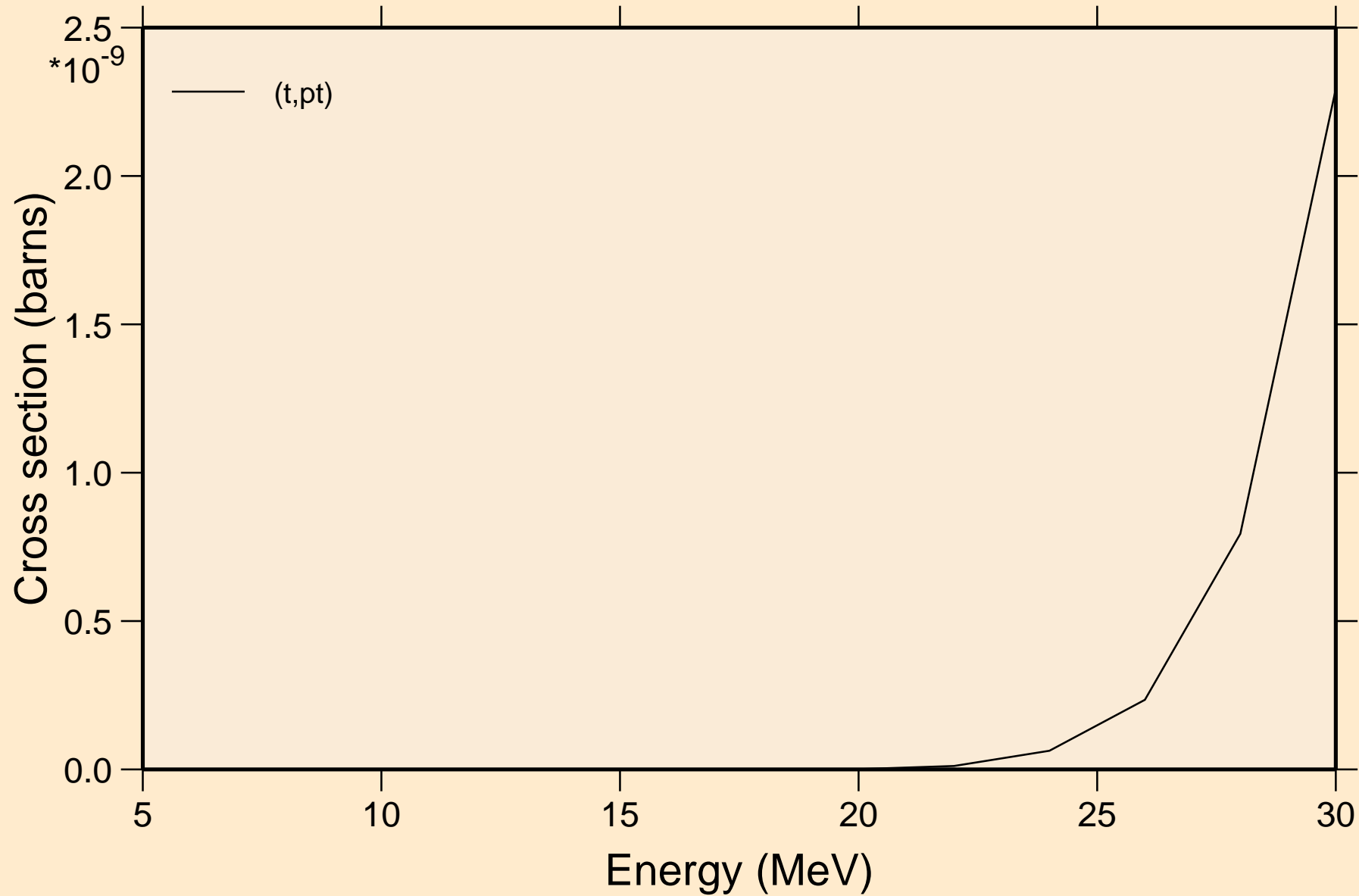

HO169 TRITON ACER TENDL-2021 LIBRARY; T=0.K  
angular distribution for elastic

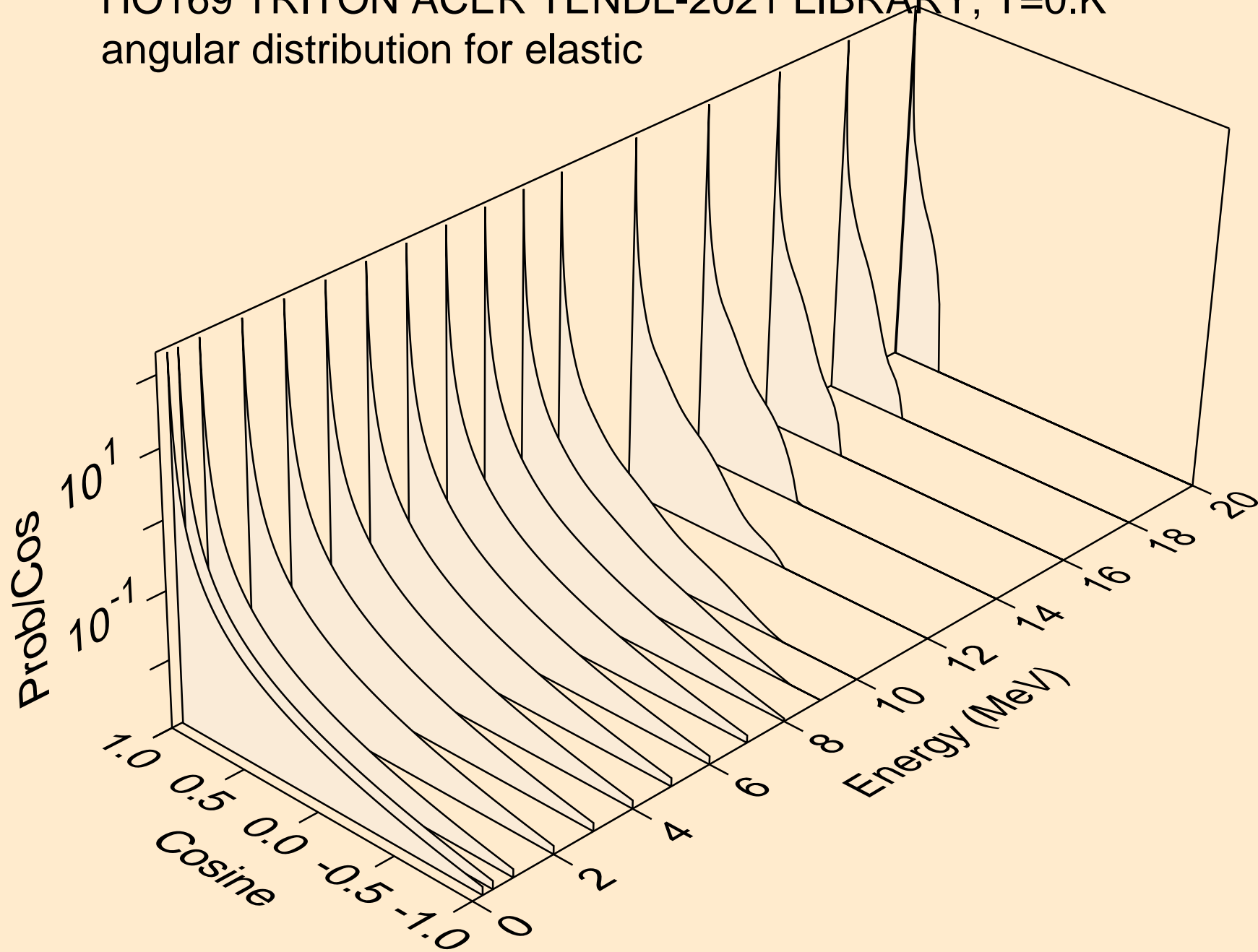

HO169 TRITON ACER TENDL-2021 LIBRARY; T=0.K  
angular distribution for elastic

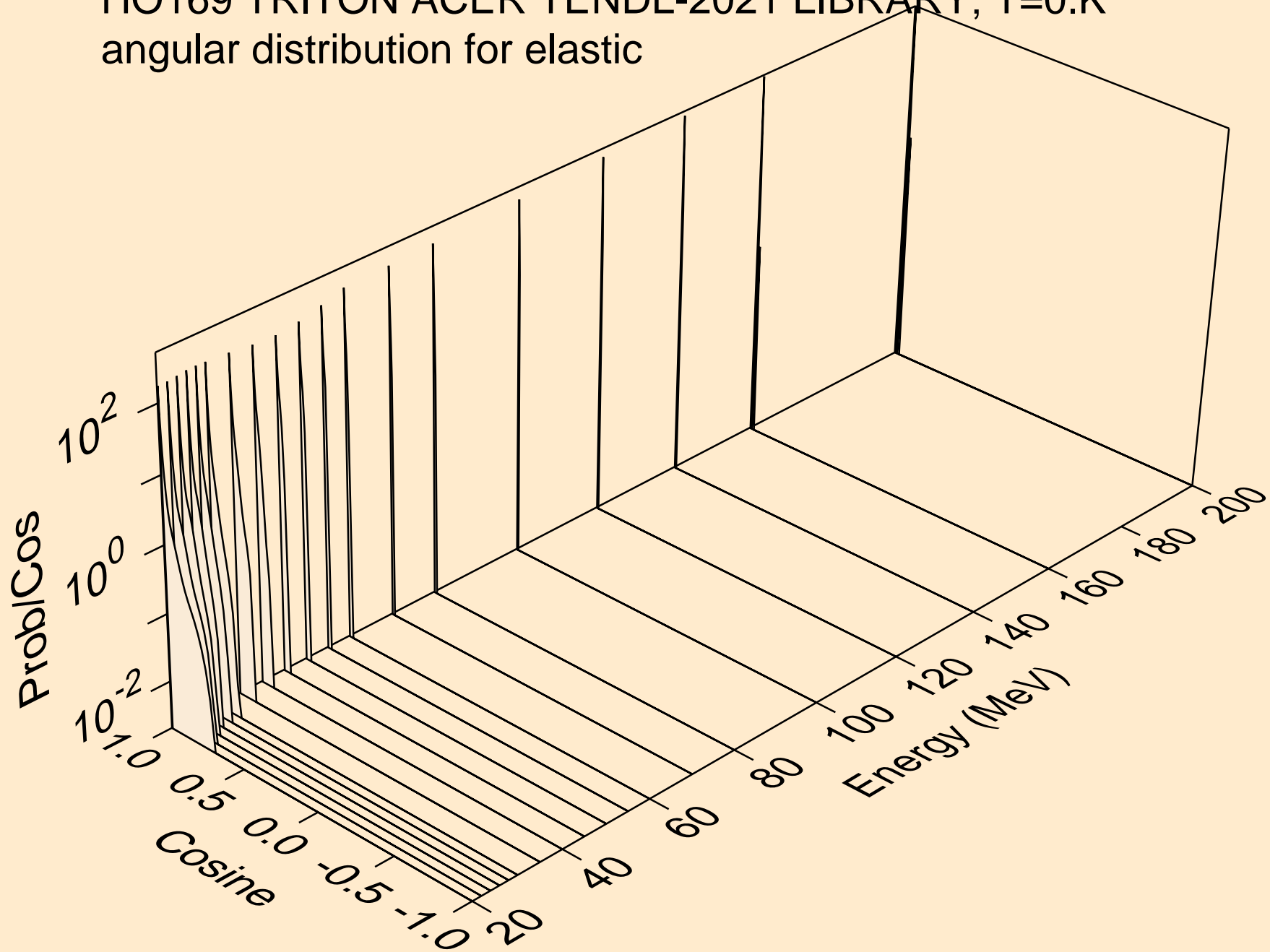

HO169 TRITON ACER TENDL-2021 LIBRARY; T=0.K  
Triton emission for (t,x)

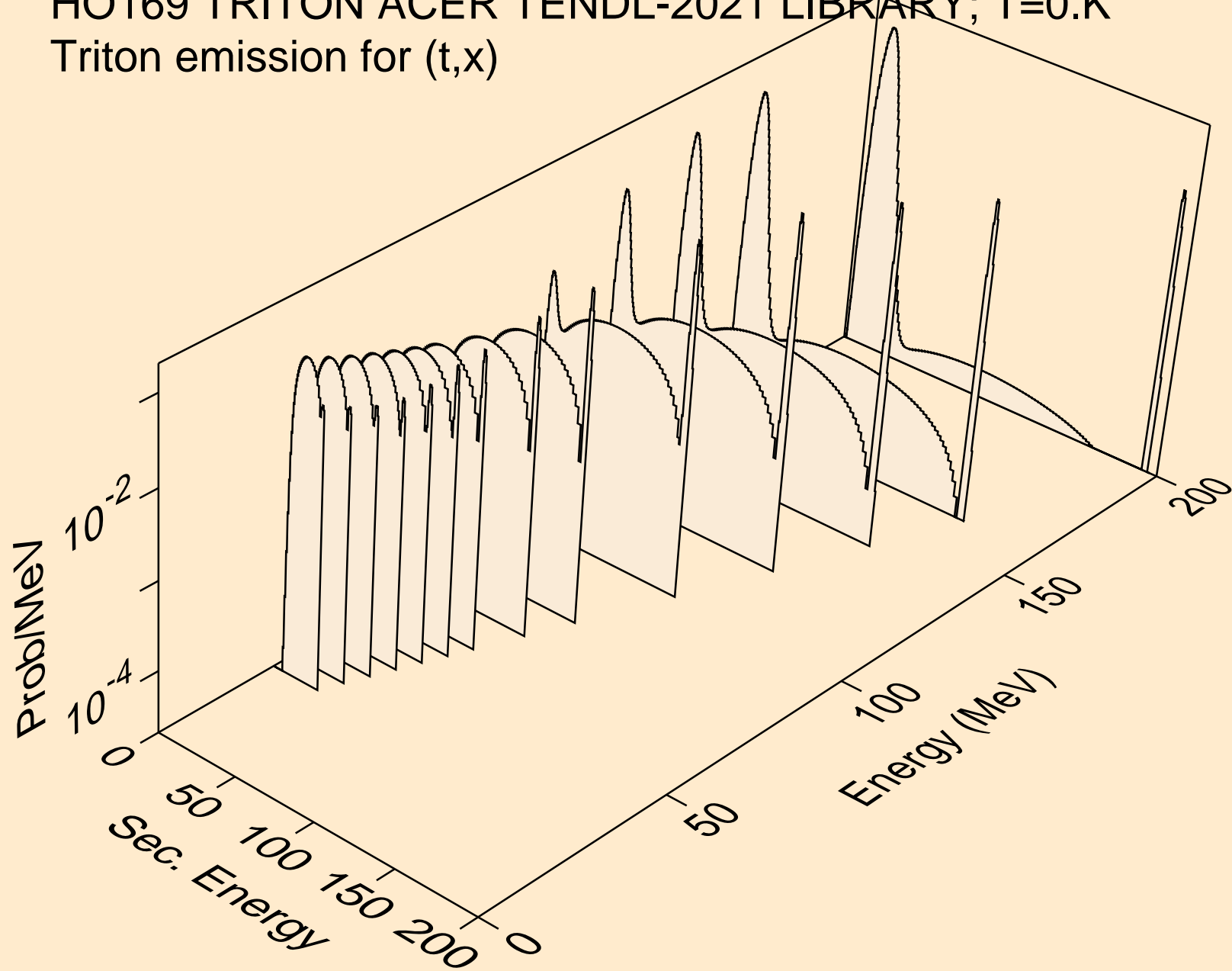

HO169 TRITON ACER TENDL-2021 LIBRARY; T=0.K  
Triton emission for (t,n\*)t

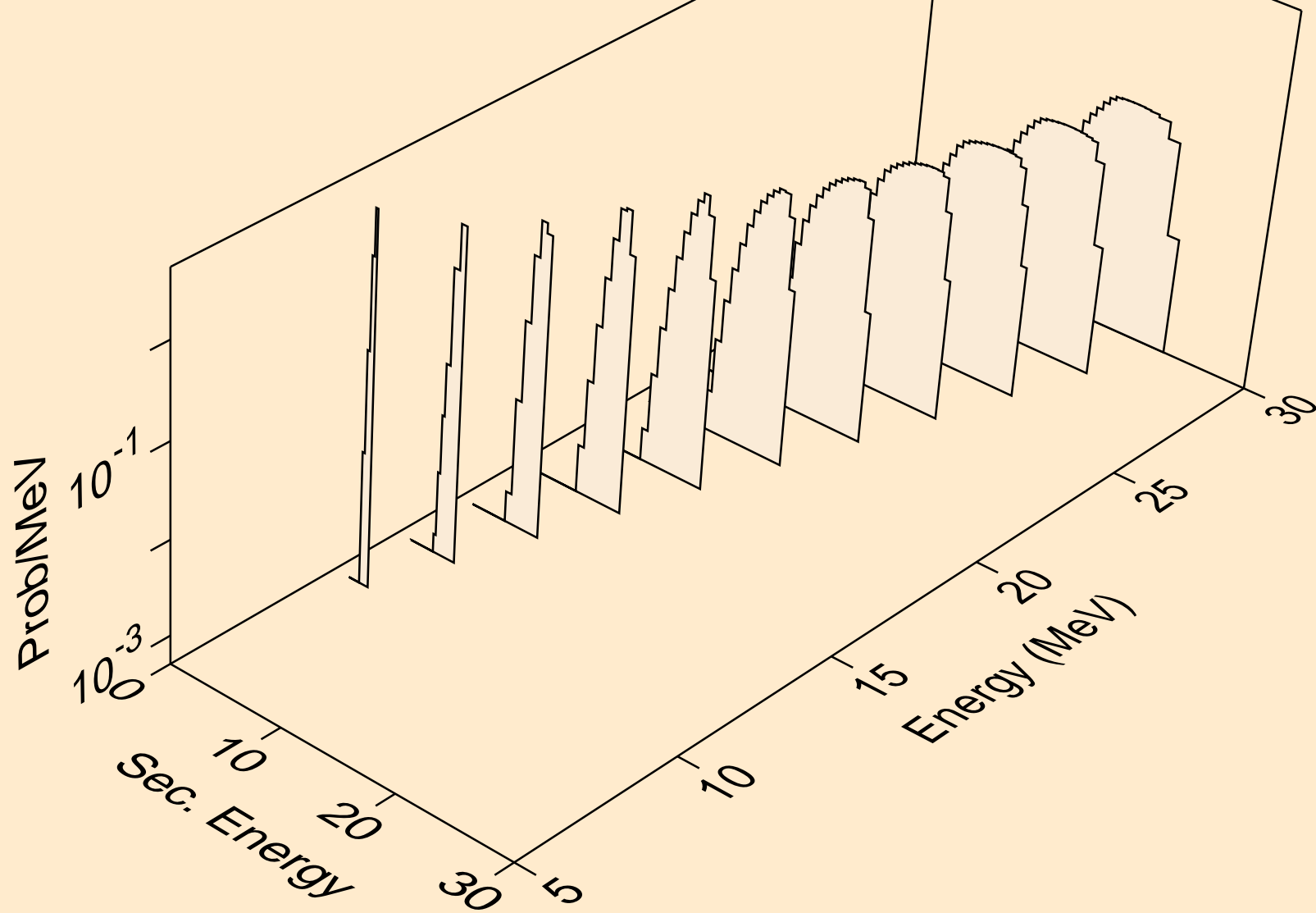

HO169 TRITON ACER TENDL-2021 LIBRARY; T=0.K  
Triton emission for inelastic

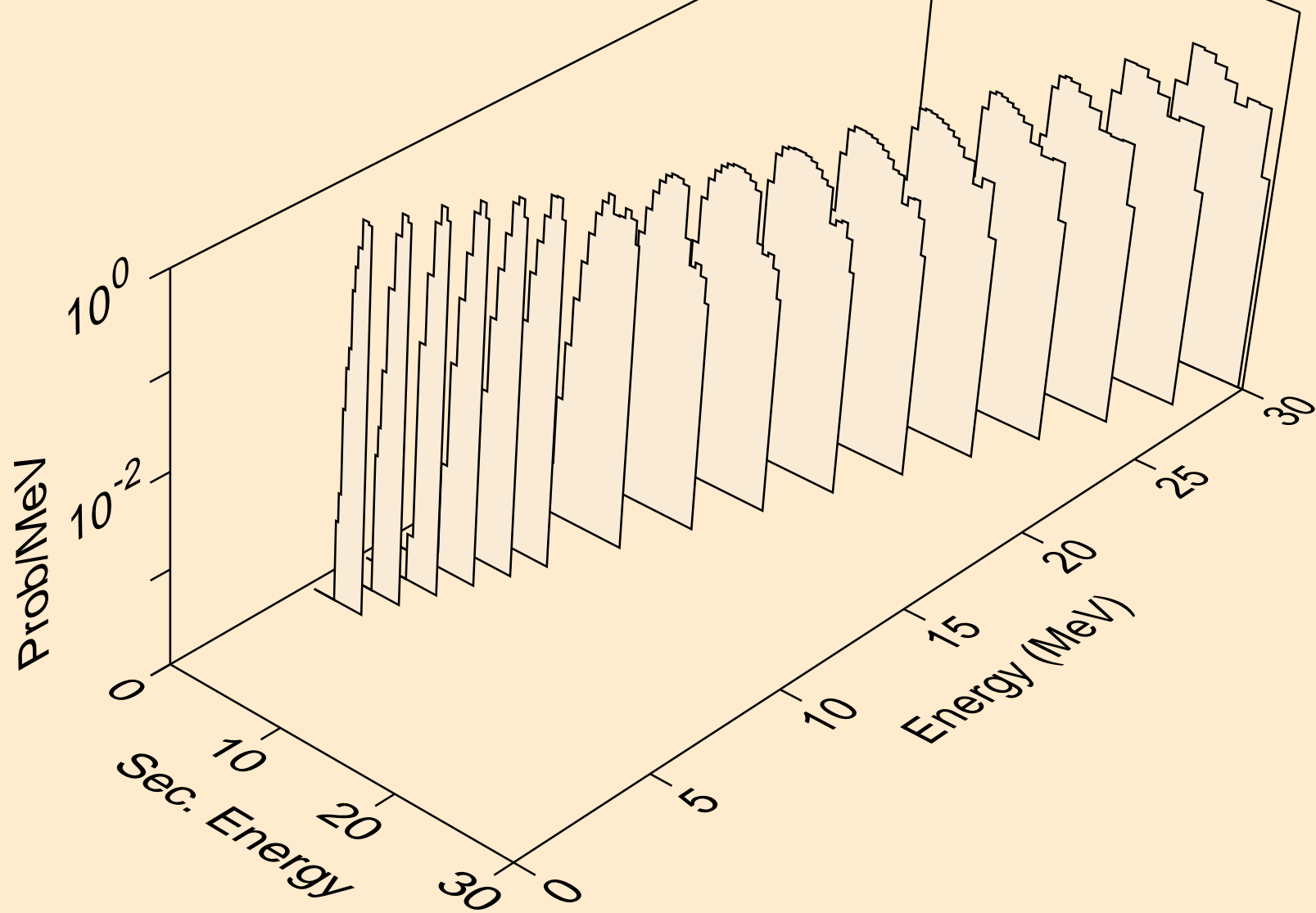

HO169 TRITON ACER TENDL-2021 LIBRARY; T=0.K  
Triton emission for (t,pt)

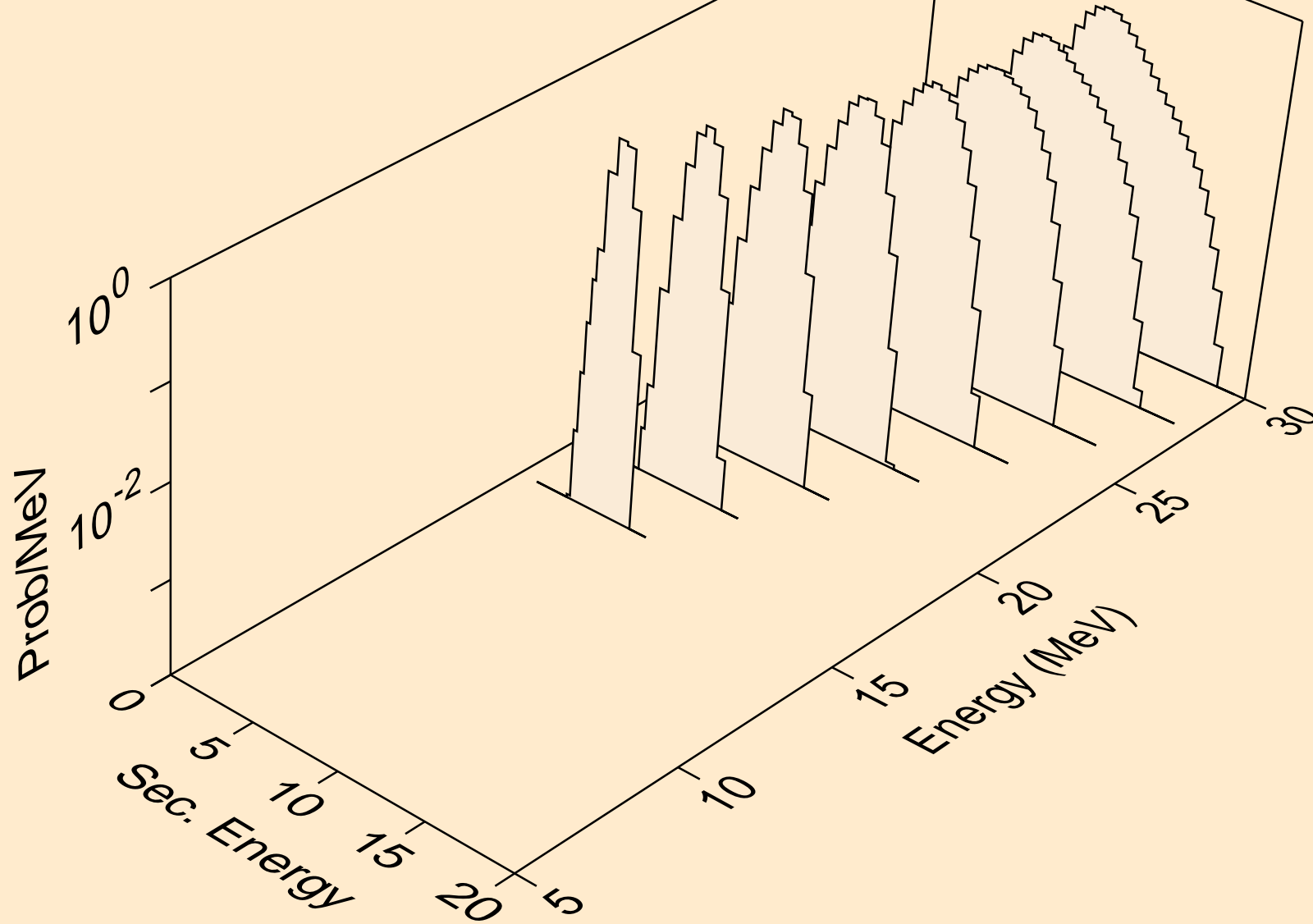

HO169 TRITON ACER TENDL-2021 LIBRARY; T=0.K  
Photon emission for (z,n)

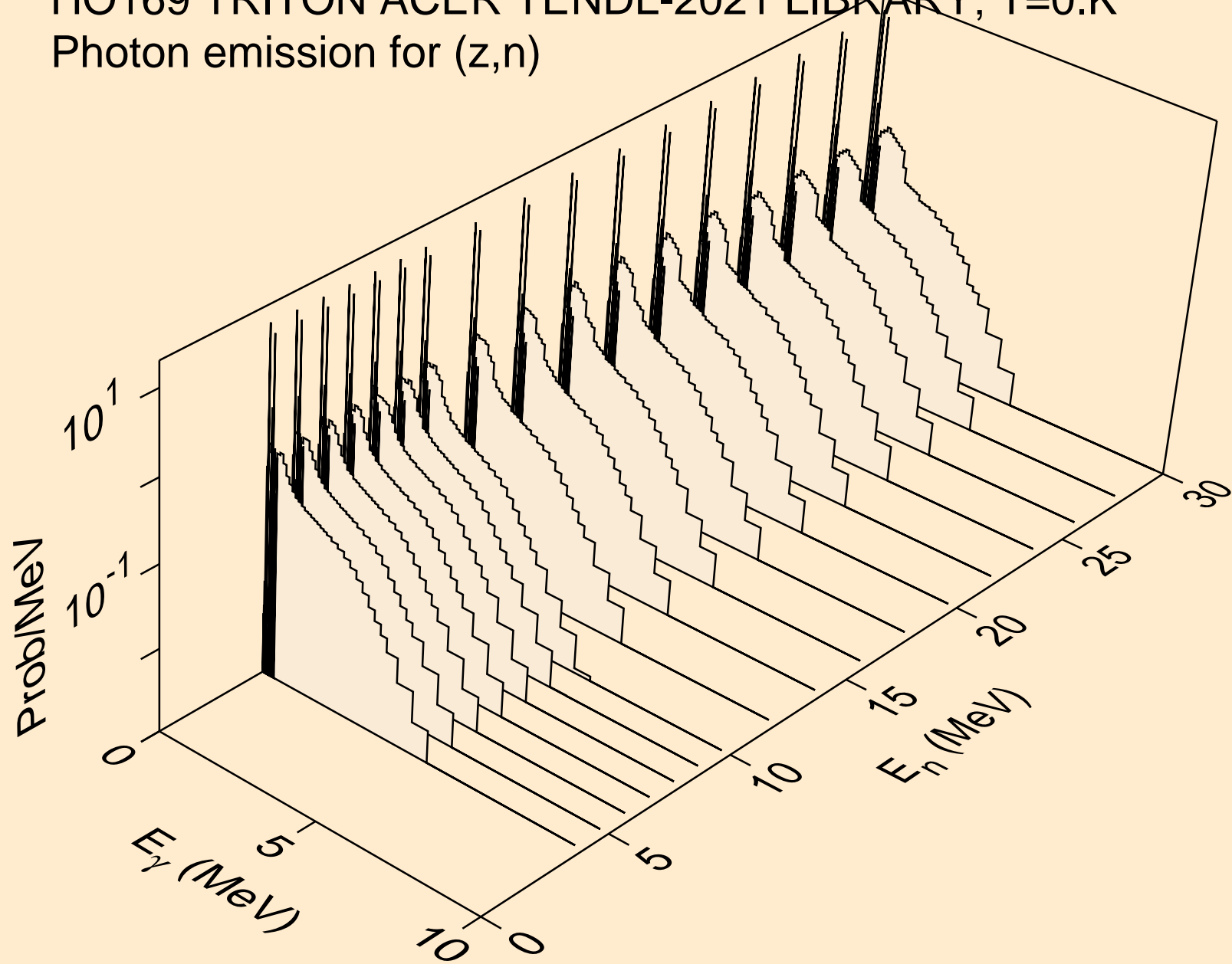

HO169 TRITON ACER TENDL-2021 LIBRARY; T=0.K  
Photon emission for (n,x)

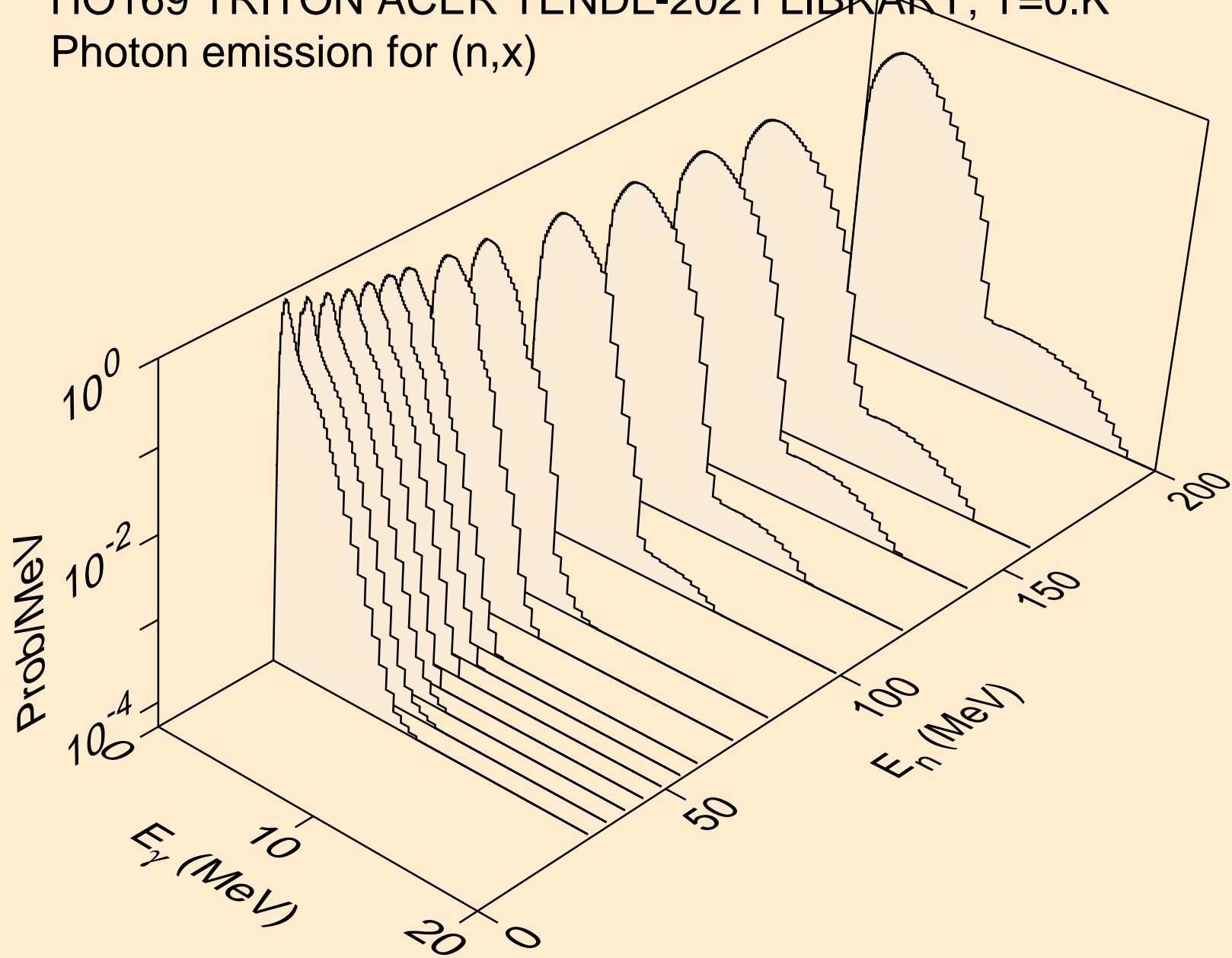

HO169 TRITON ACER TENDL-2021 LIBRARY; T=0.K  
Photon emission for (n,2nd)

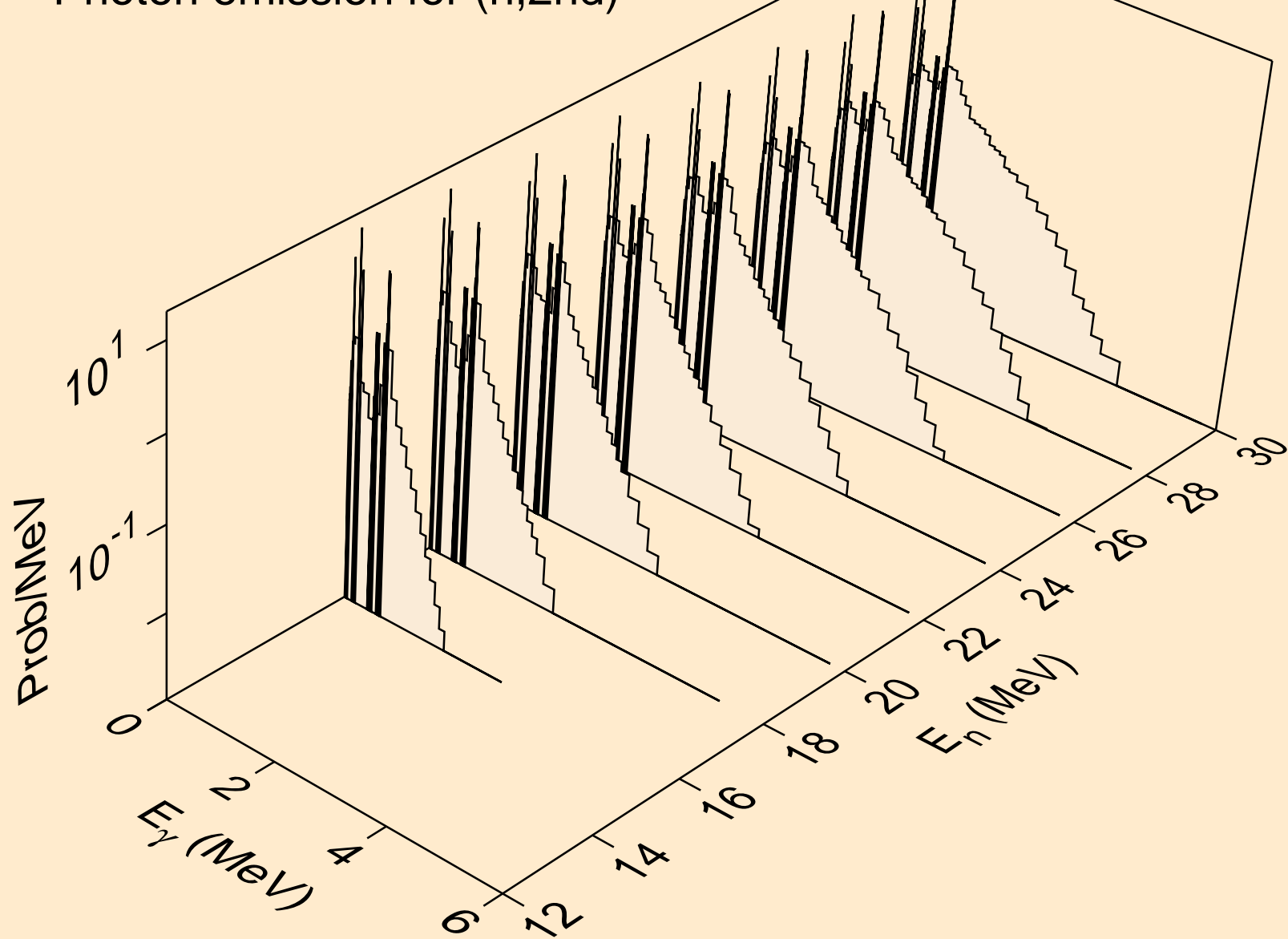

HO169 TRITON ACER TENDL-2021 LIBRARY; T=0.K  
Photon emission for (n,2n)

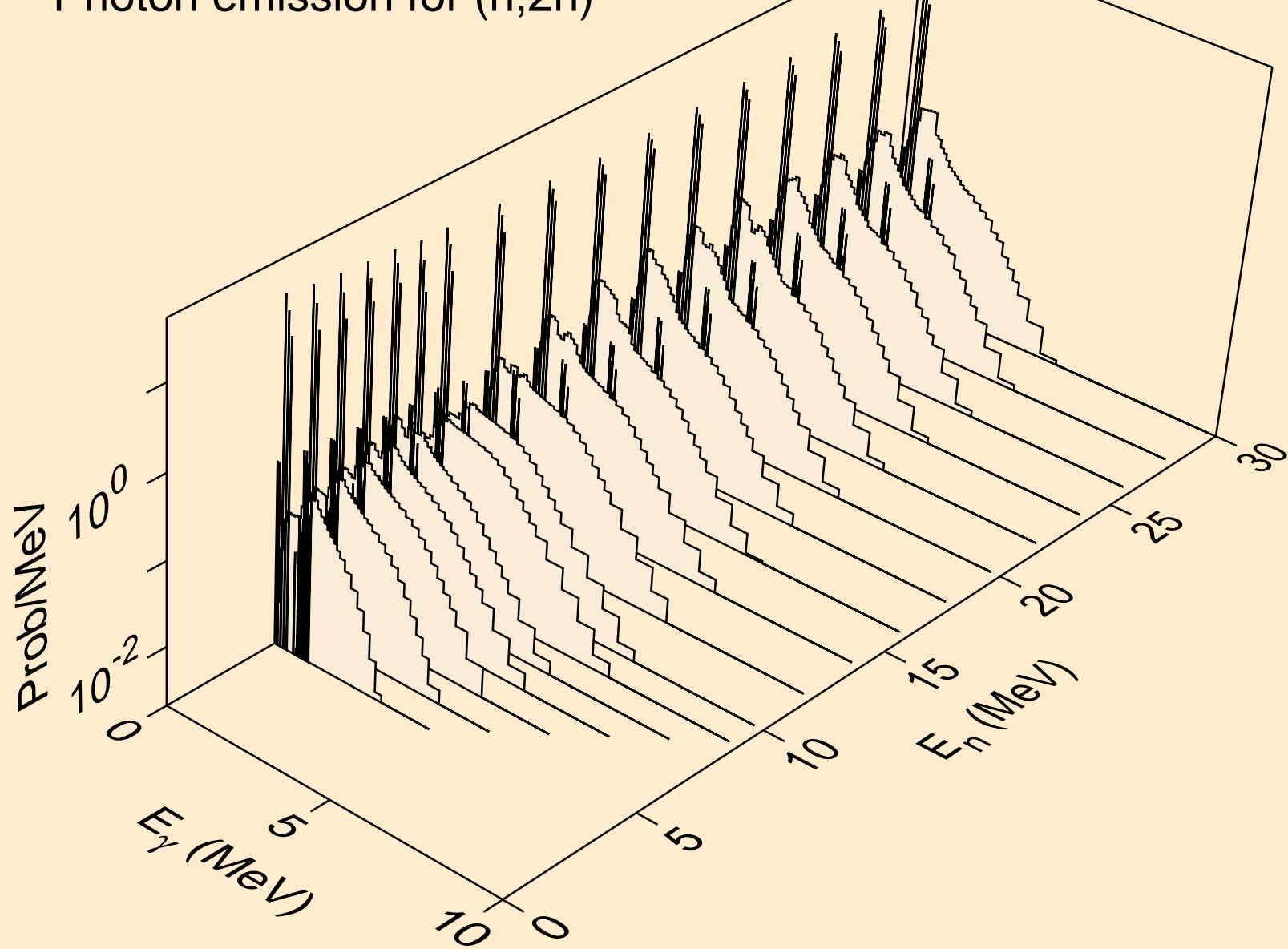

HO169 TRITON ACER TENDL-2021 LIBRARY; T=0.K  
Photon emission for (n,3n)

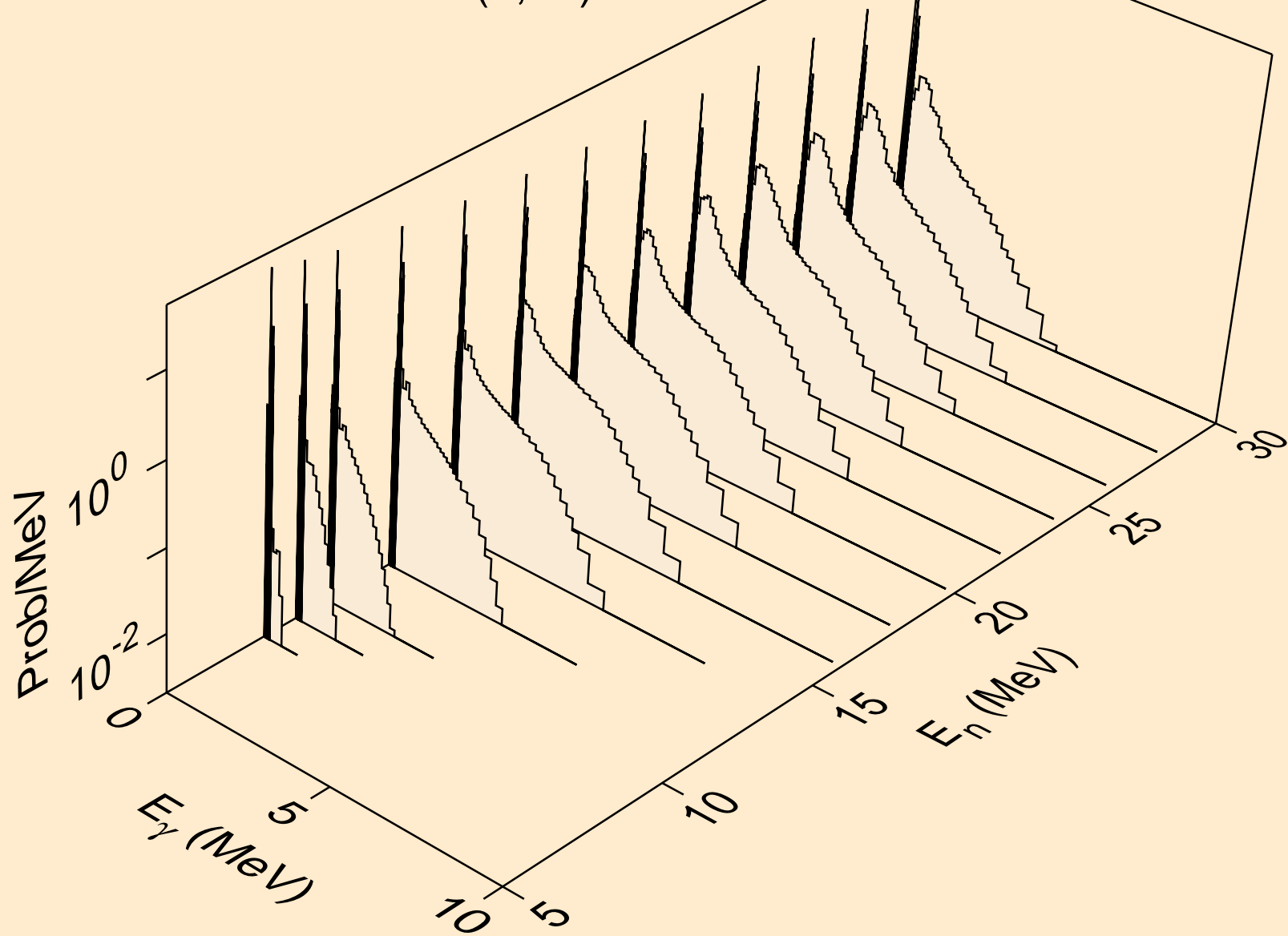

HO169 TRITON ACER TENDL-2021 LIBRARY; T=0.K  
Photon emission for (n,n\*)a

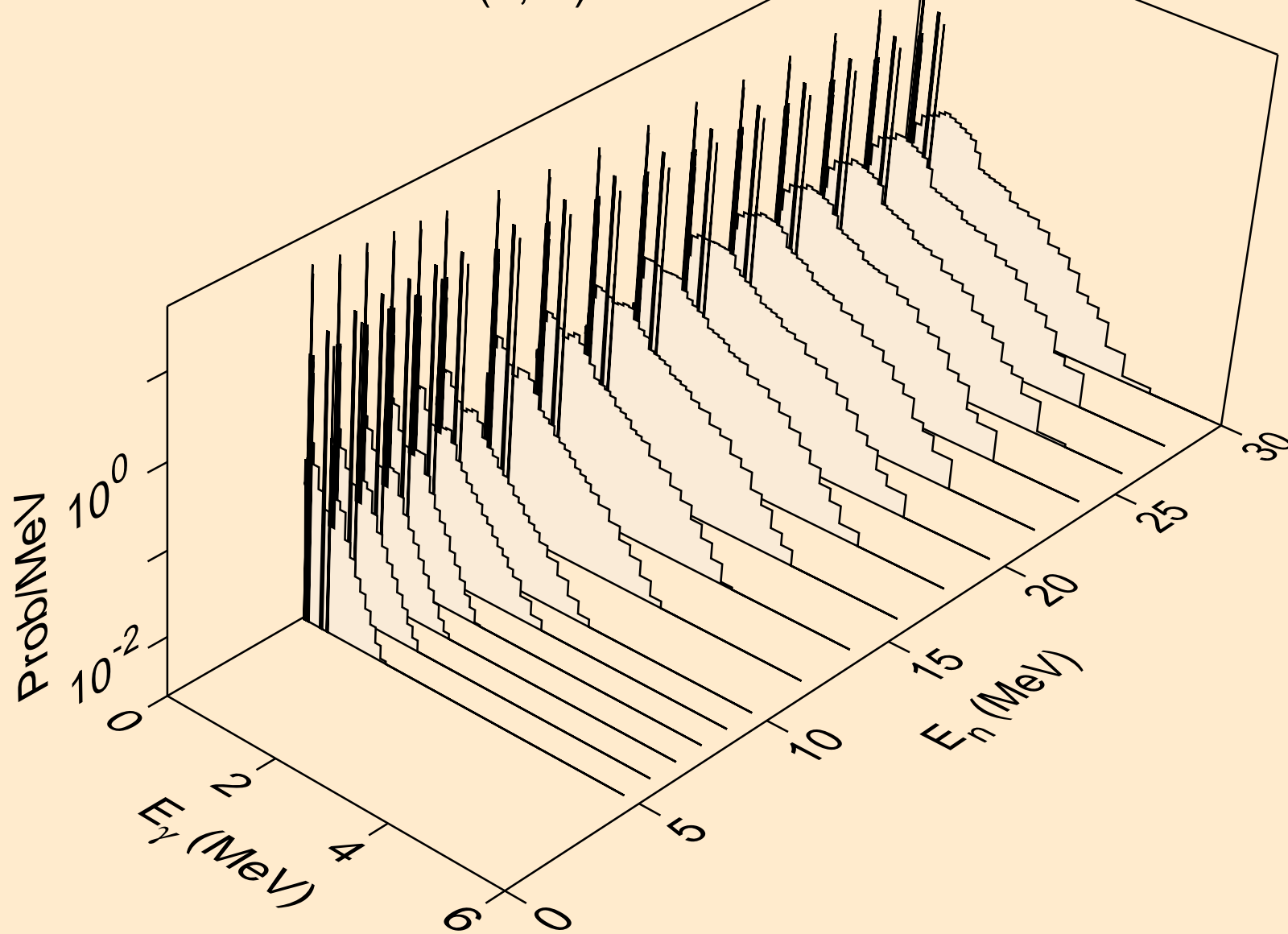

HO169 TRITON ACER TENDL-2021 LIBRARY; T=0.K  
Photon emission for (n,2n)a

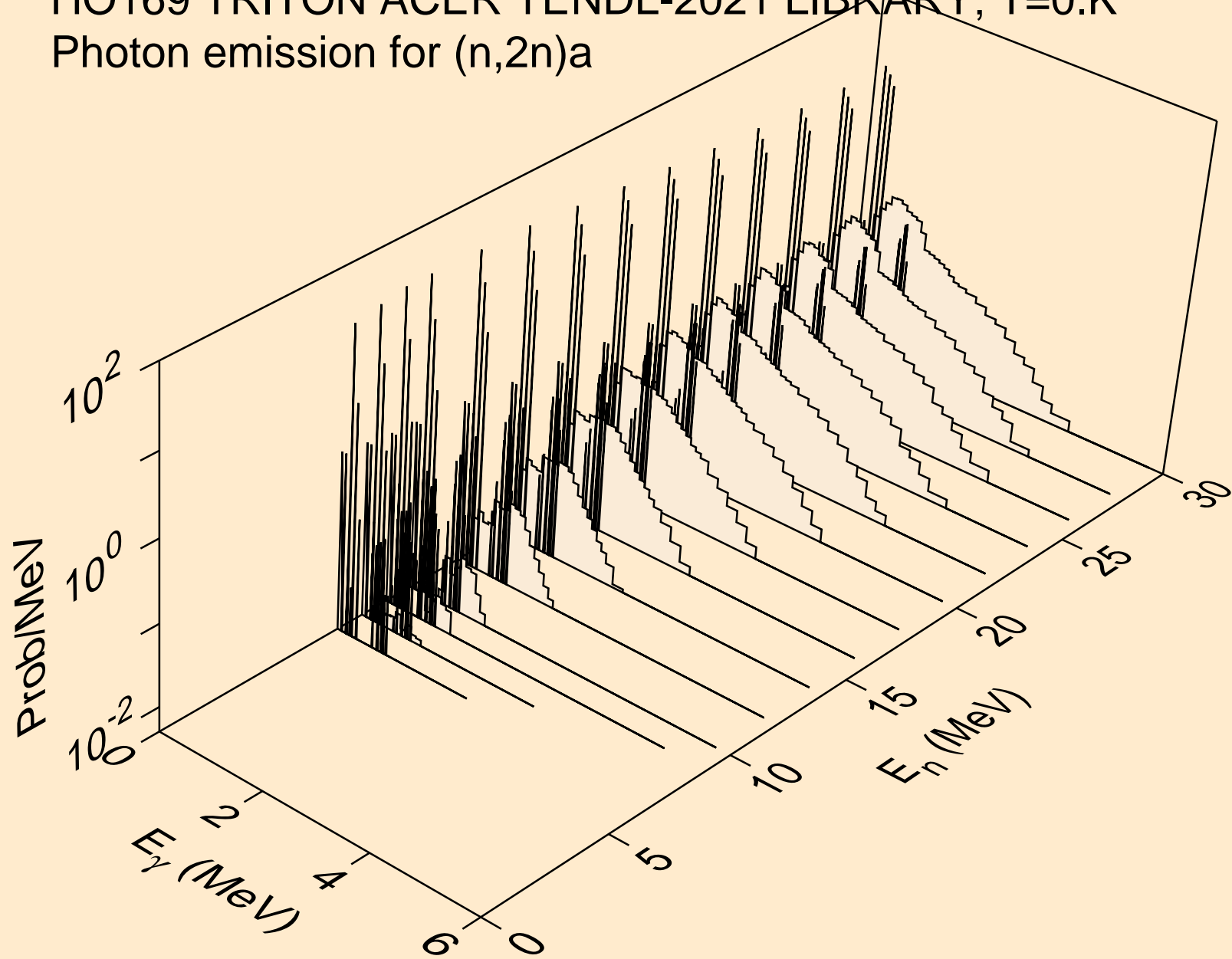

HO169 TRITON ACER TENDL-2021 LIBRARY; T=0.K  
Photon emission for (n,3n)a

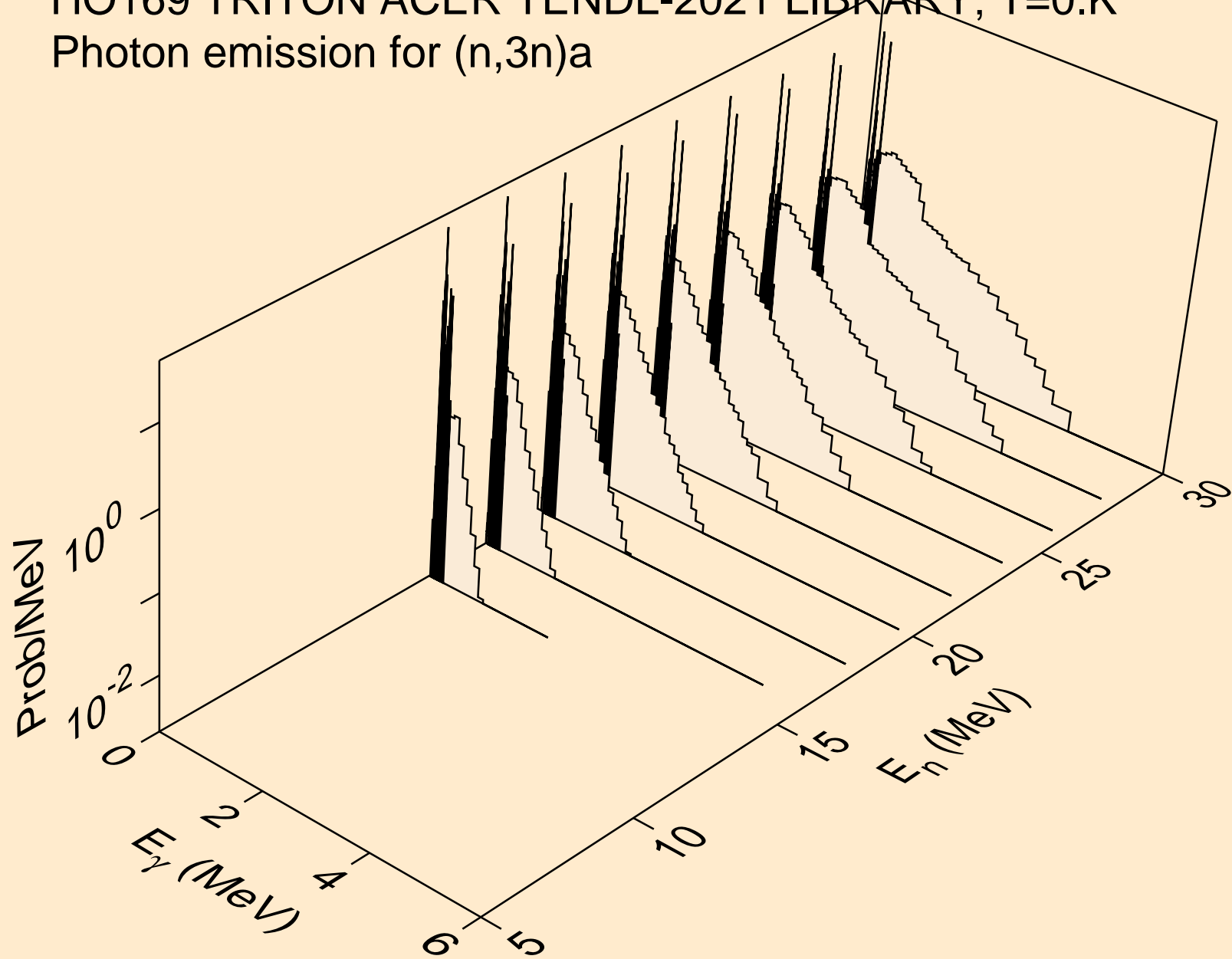

HO169 TRITON ACER TENDL-2021 LIBRARY; T=0.K  
Photon emission for (n,n\*)p

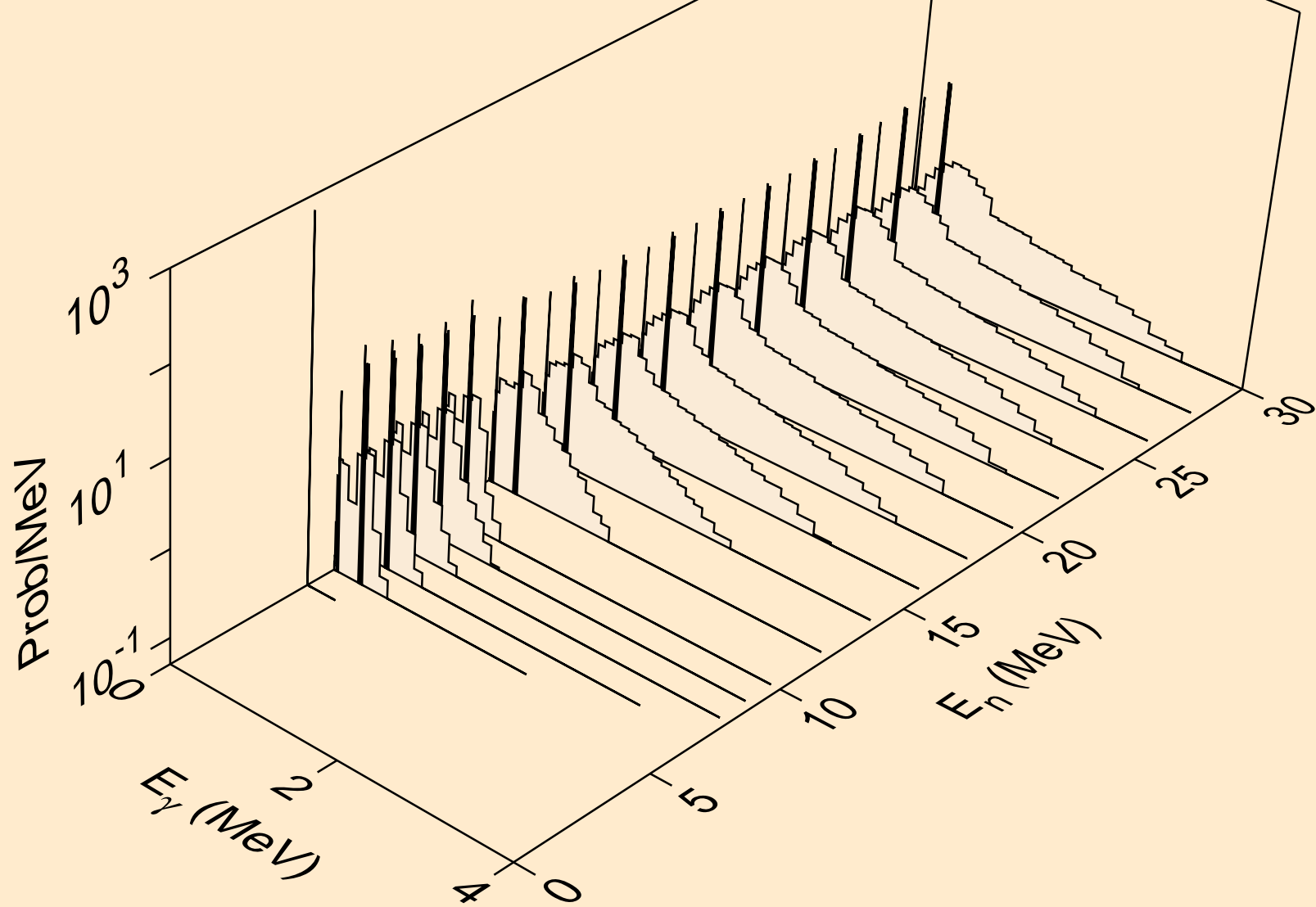

HO169 TRITON ACER TENDL-2021 LIBRARY; T=0.K  
Photon emission for (n,n\*)d

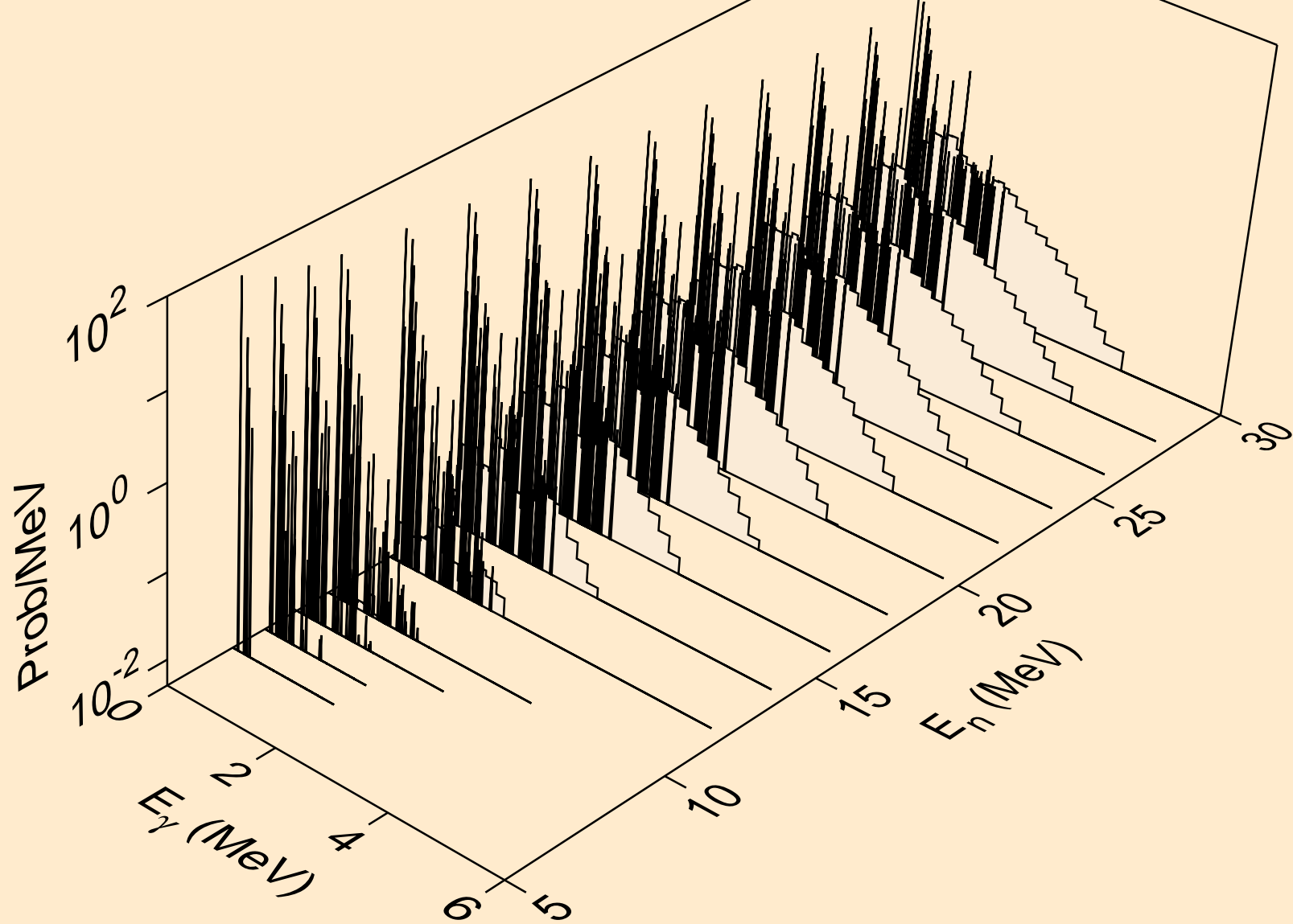

HO169 TRITON ACER TENDL-2021 LIBRARY; T=0.K  
Photon emission for (n,n\*)t

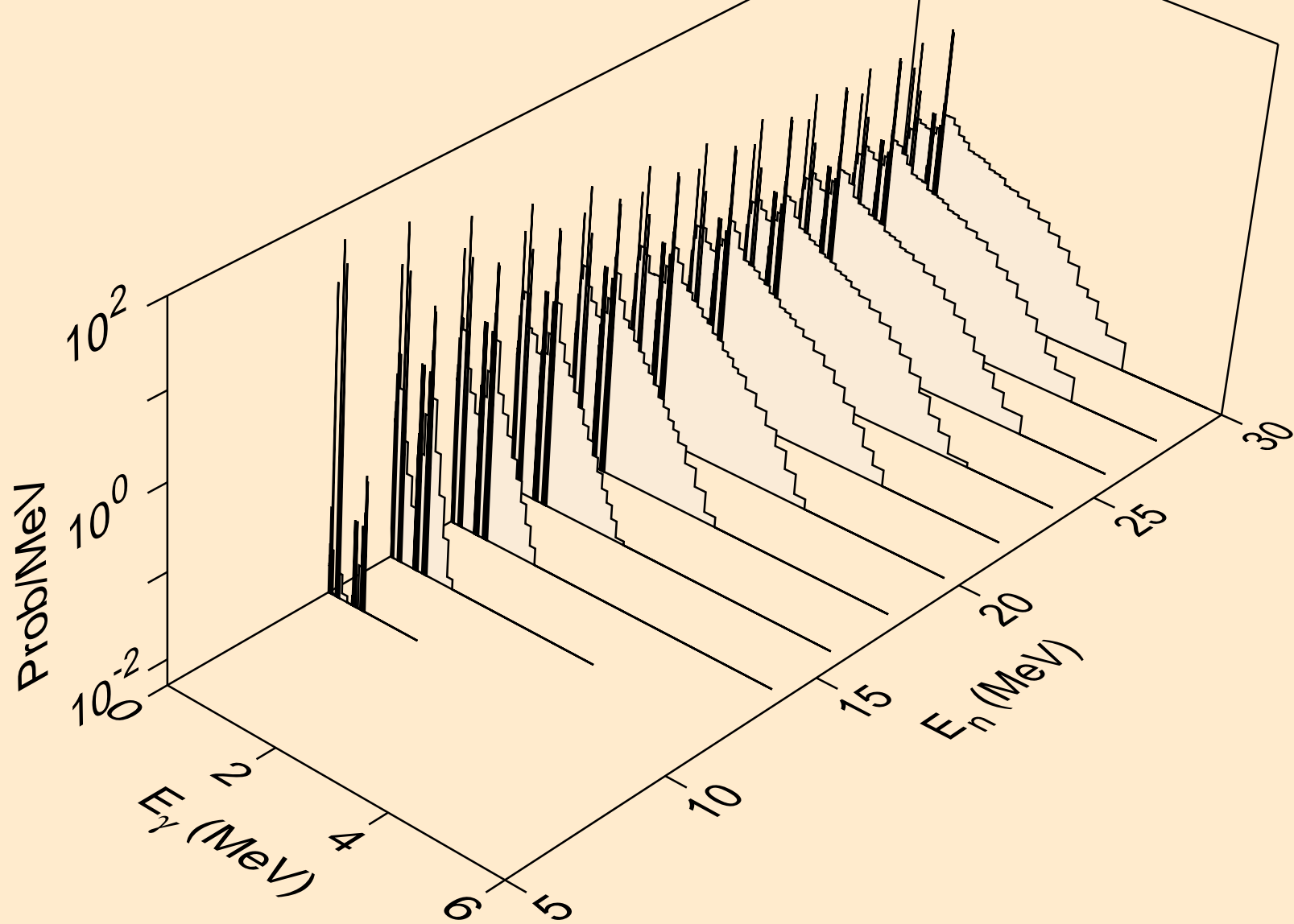

HO169 TRITON ACER TENDL-2021 LIBRARY; T=0.K  
Photon emission for (n,n\*)he3

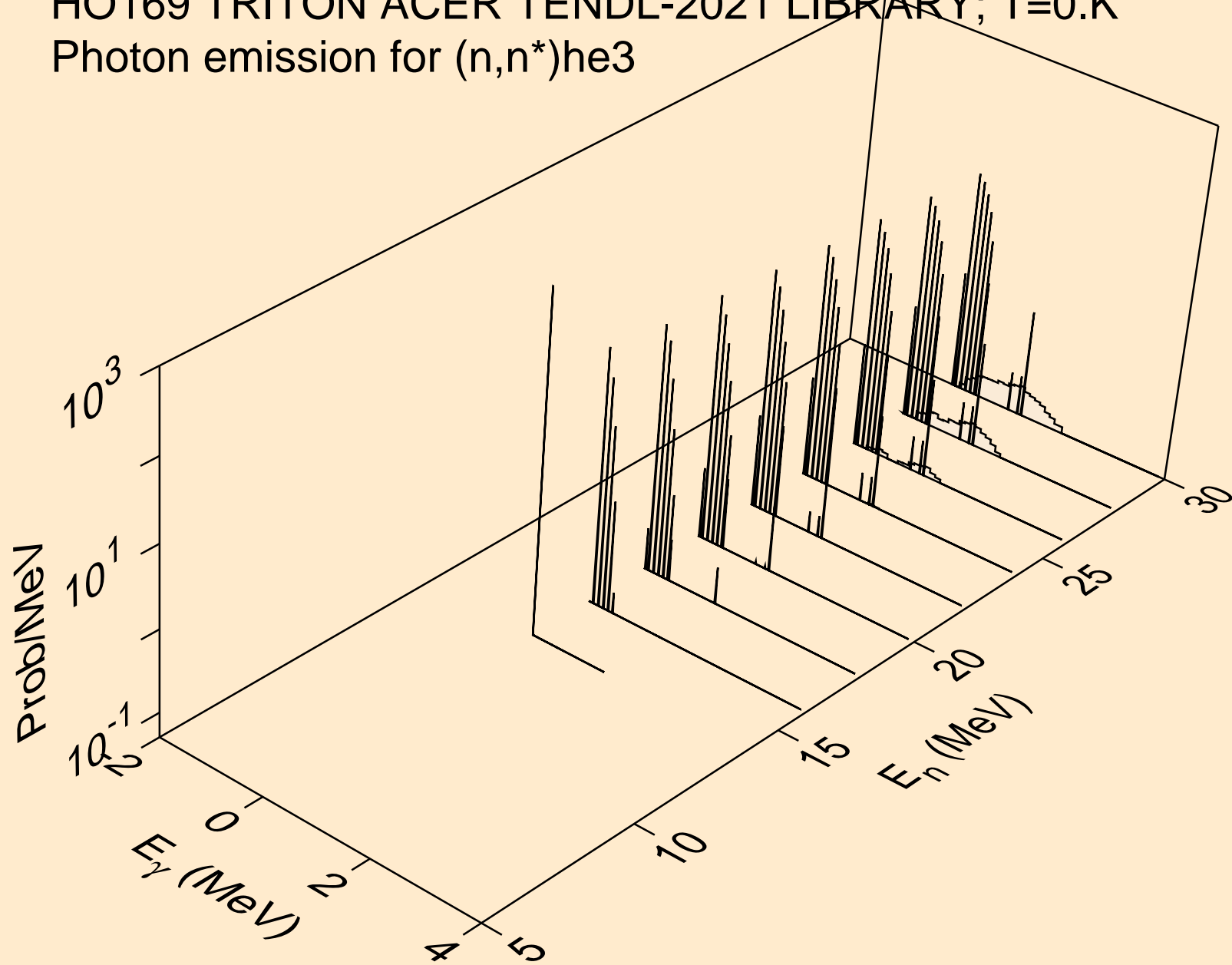

HO169 TRITON ACER TENDL-2021 LIBRARY; T=0.K  
Photon emission for (n,4n)

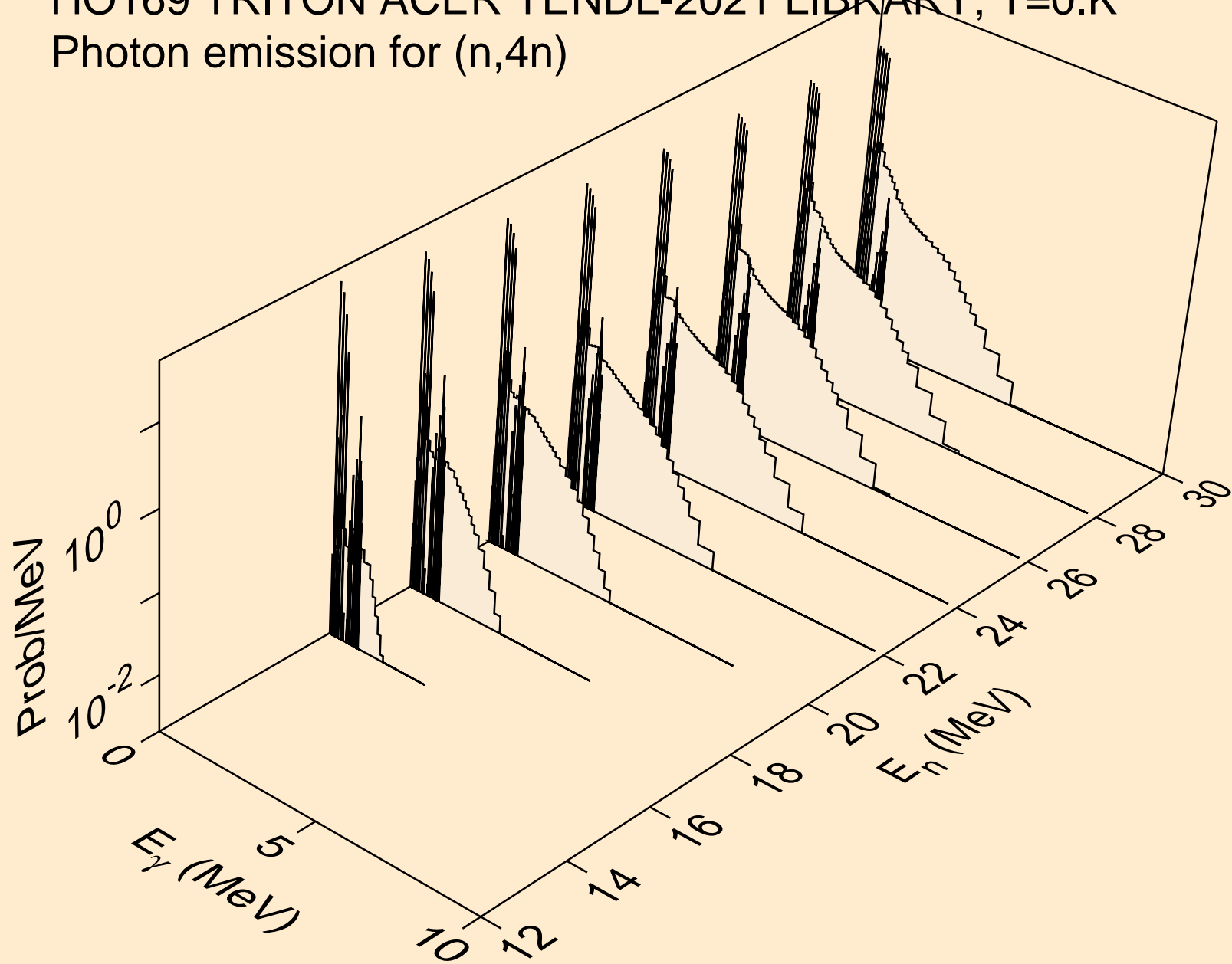

HO169 TRITON ACER TENDL-2021 LIBRARY; T=0.K  
Photon emission for (n,2np)

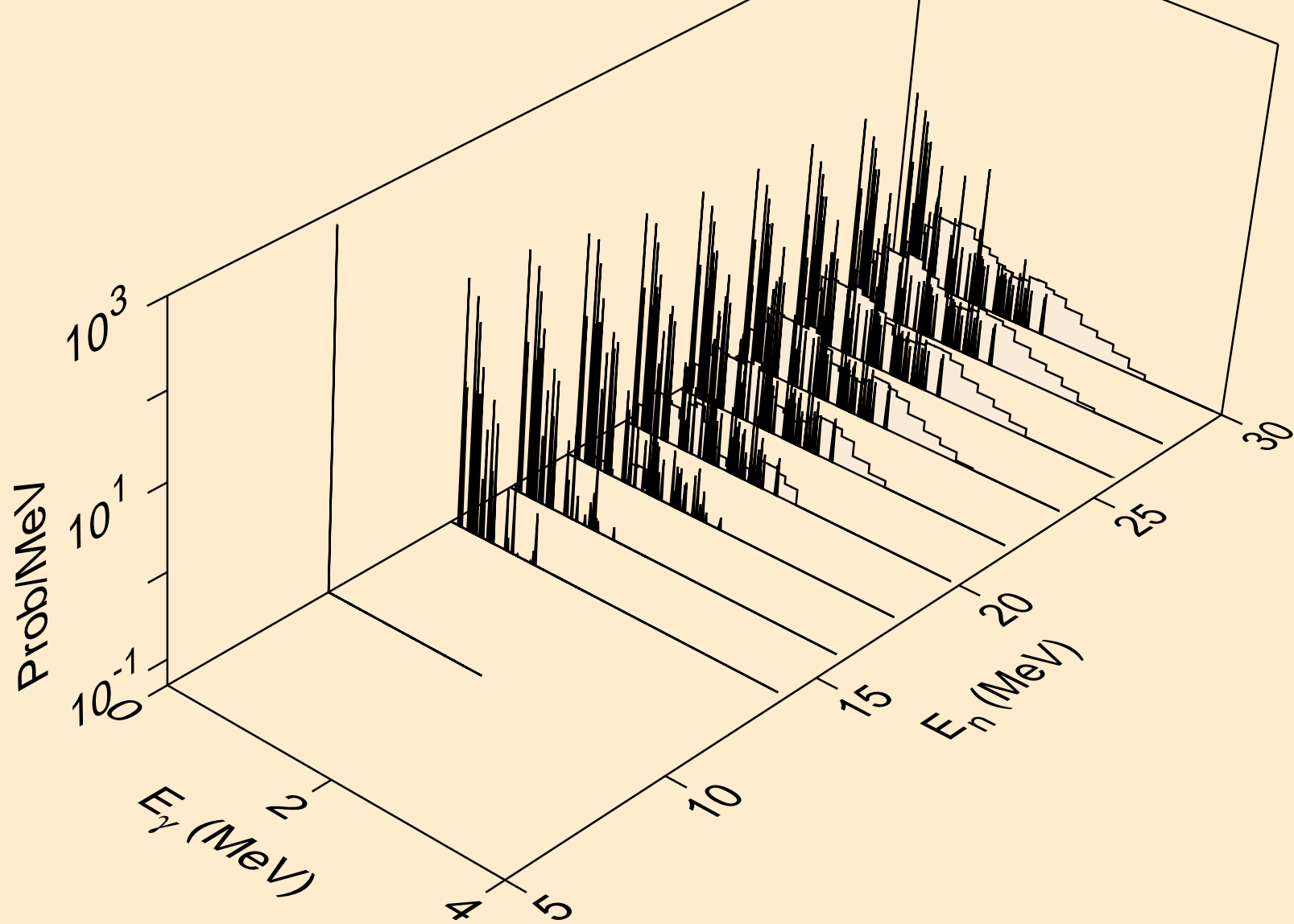

HO169 TRITON ACER TENDL-2021 LIBRARY; T=0.K  
Photon emission for (n,3np)

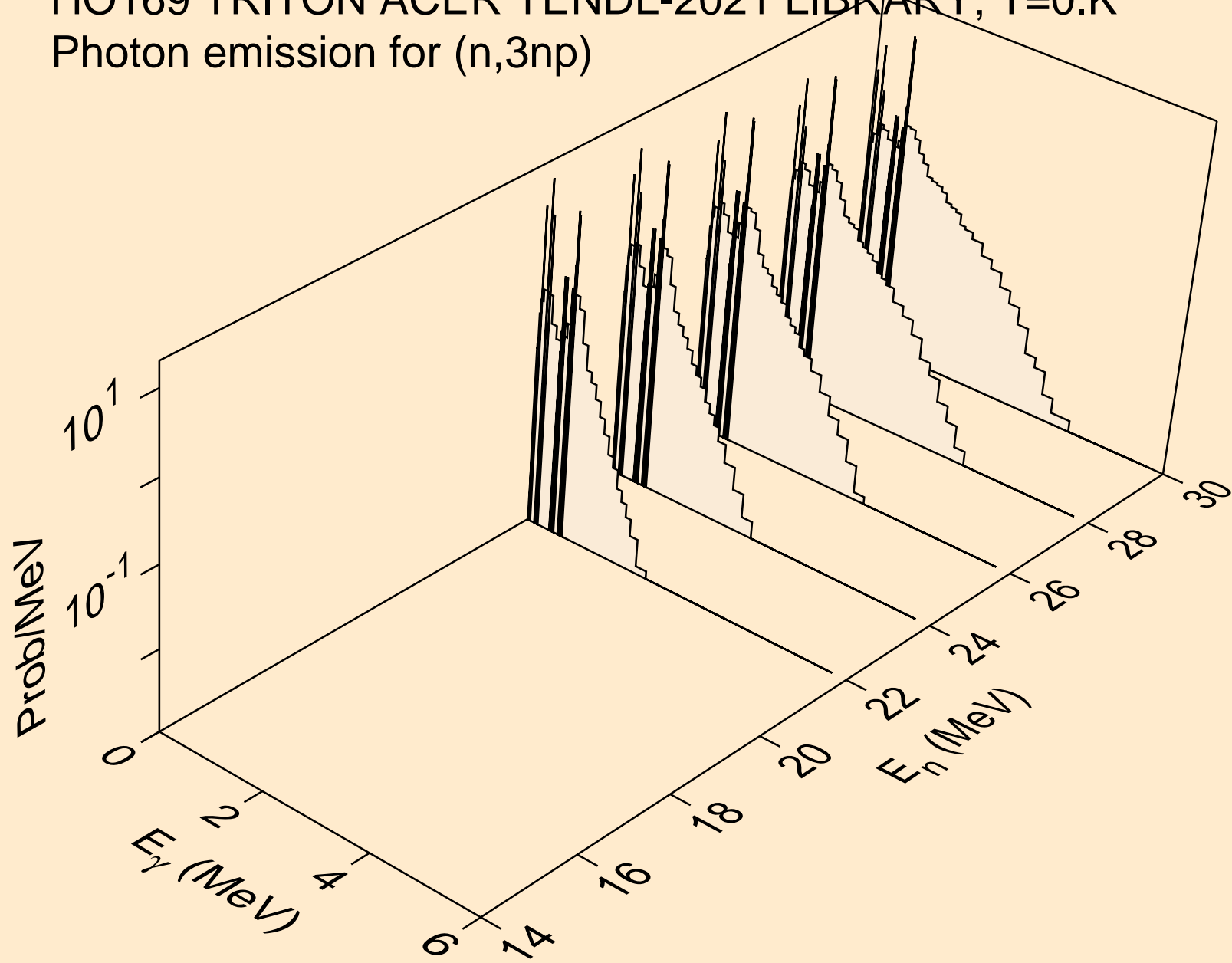

HO169 TRITON ACER TENDL-2021 LIBRARY; T=0.K  
Photon emission for (n,2np)

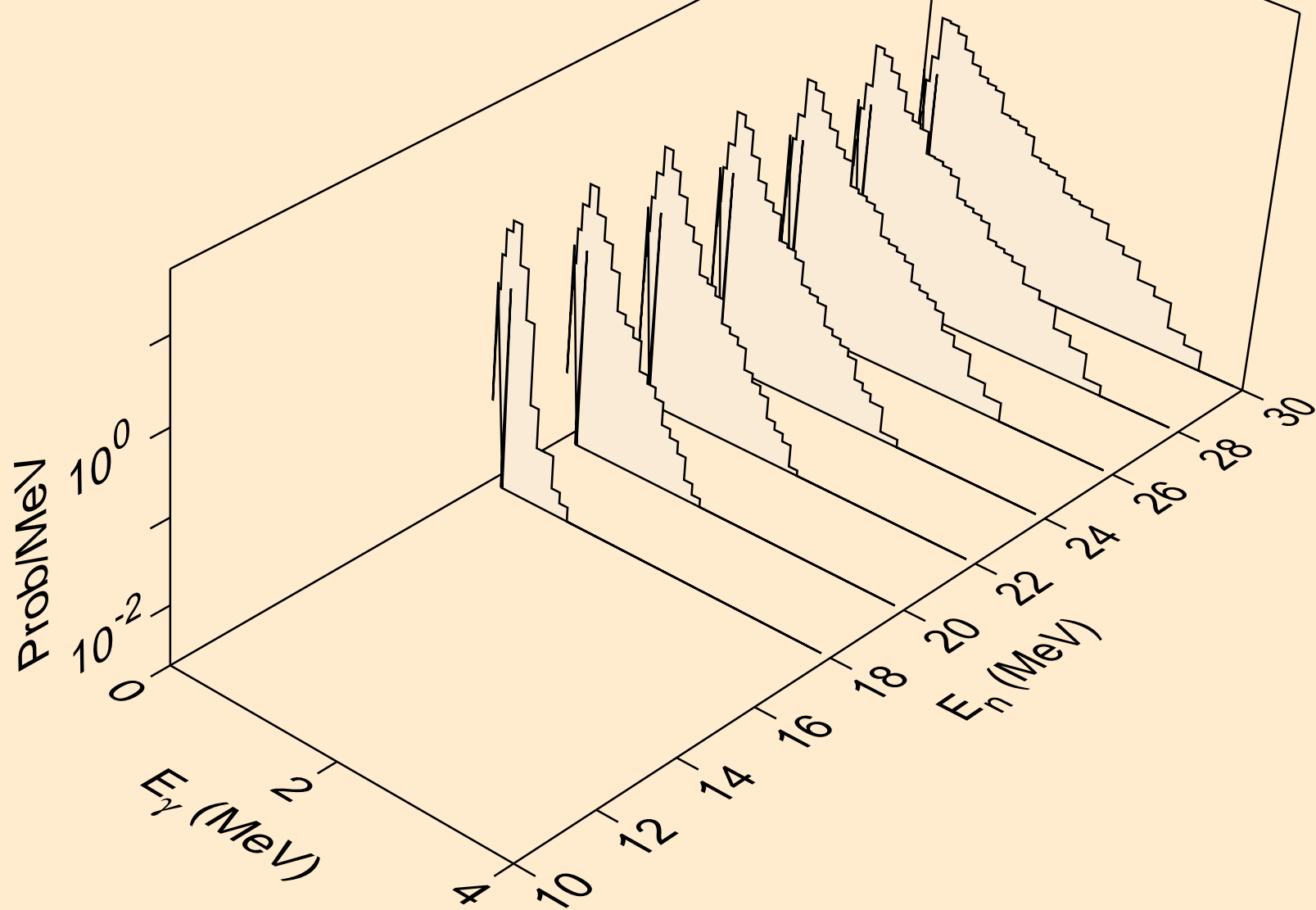

HO169 TRITON ACER TENDL-2021 LIBRARY; T=0.K  
Photon emission for (n,npa)

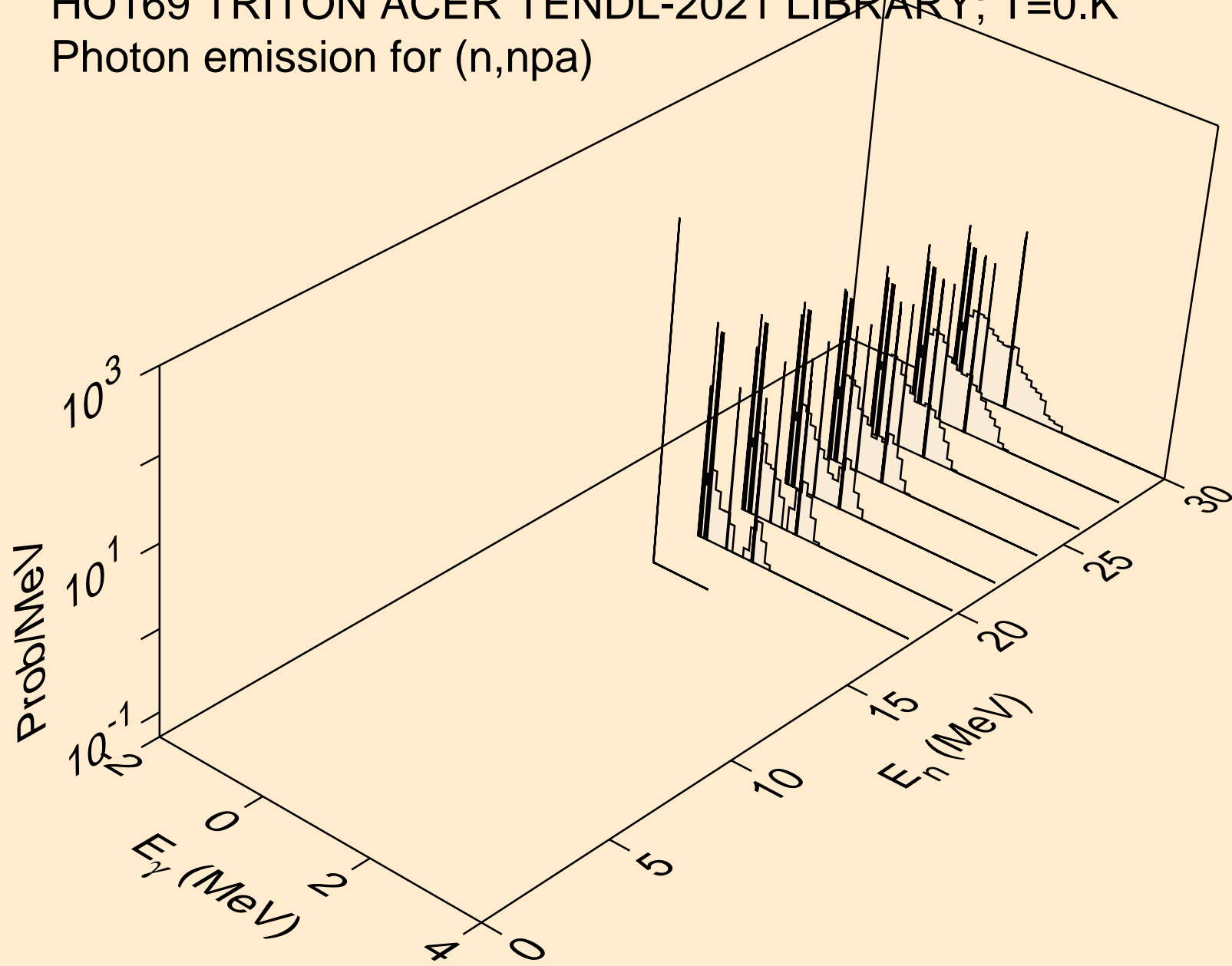

HO169 TRITON ACER TENDL-2021 LIBRARY; T=0.K  
Photon emission for (n,gma)

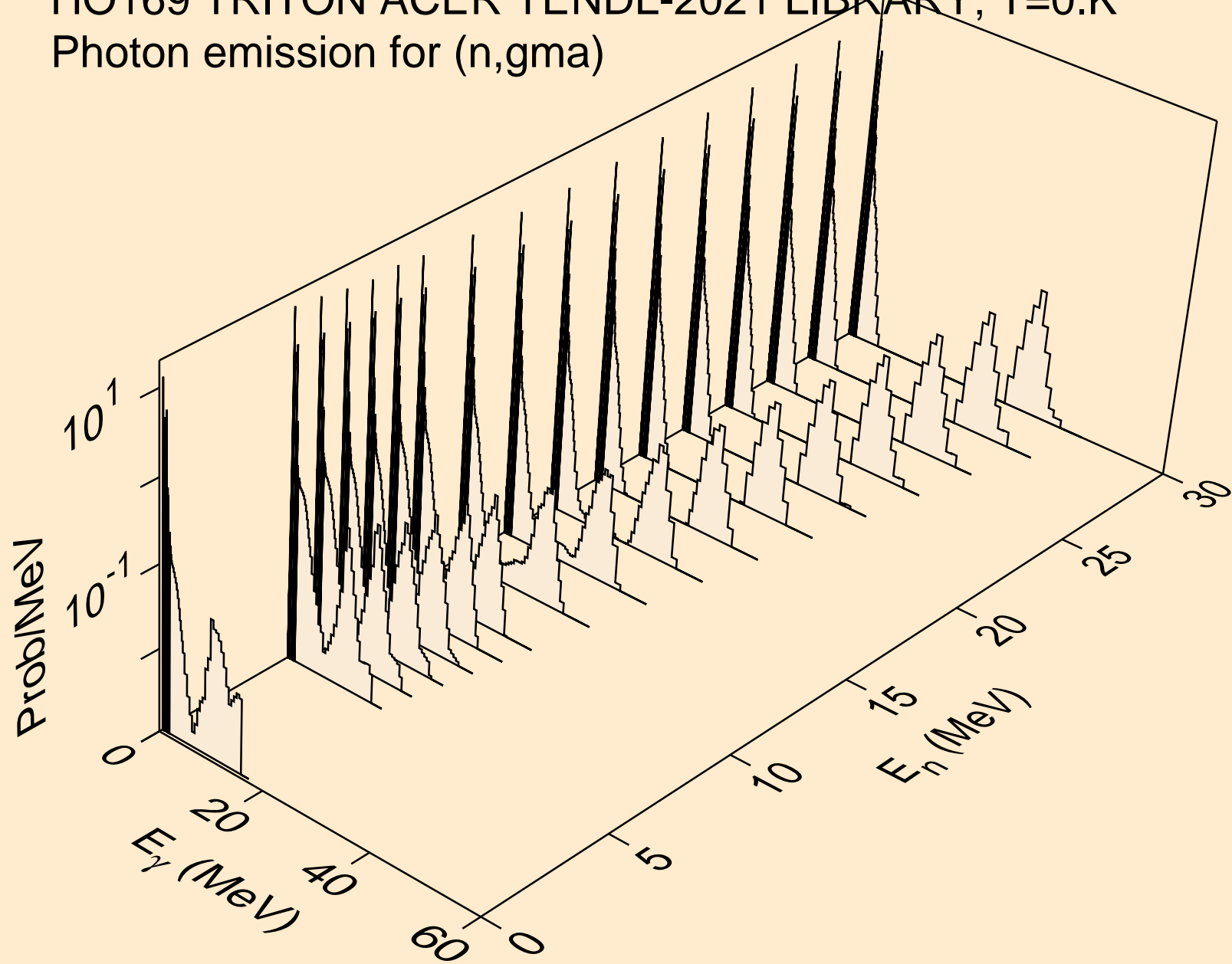

HO169 TRITON ACER TENDL-2021 LIBRARY; T=0.K  
Photon emission for (n,p)

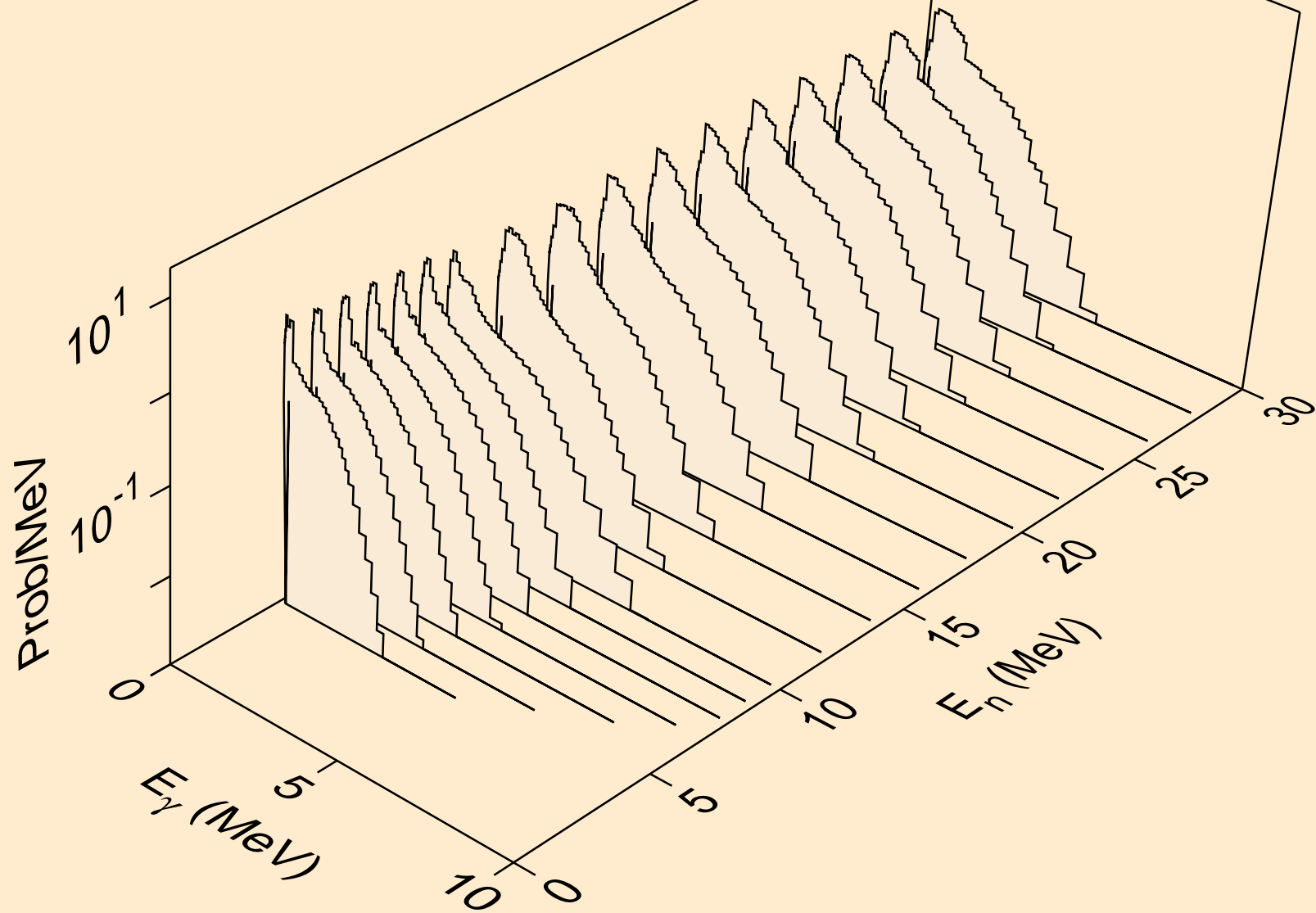

HO169 TRITON ACER TENDL-2021 LIBRARY; T=0.K  
Photon emission for (n,d)

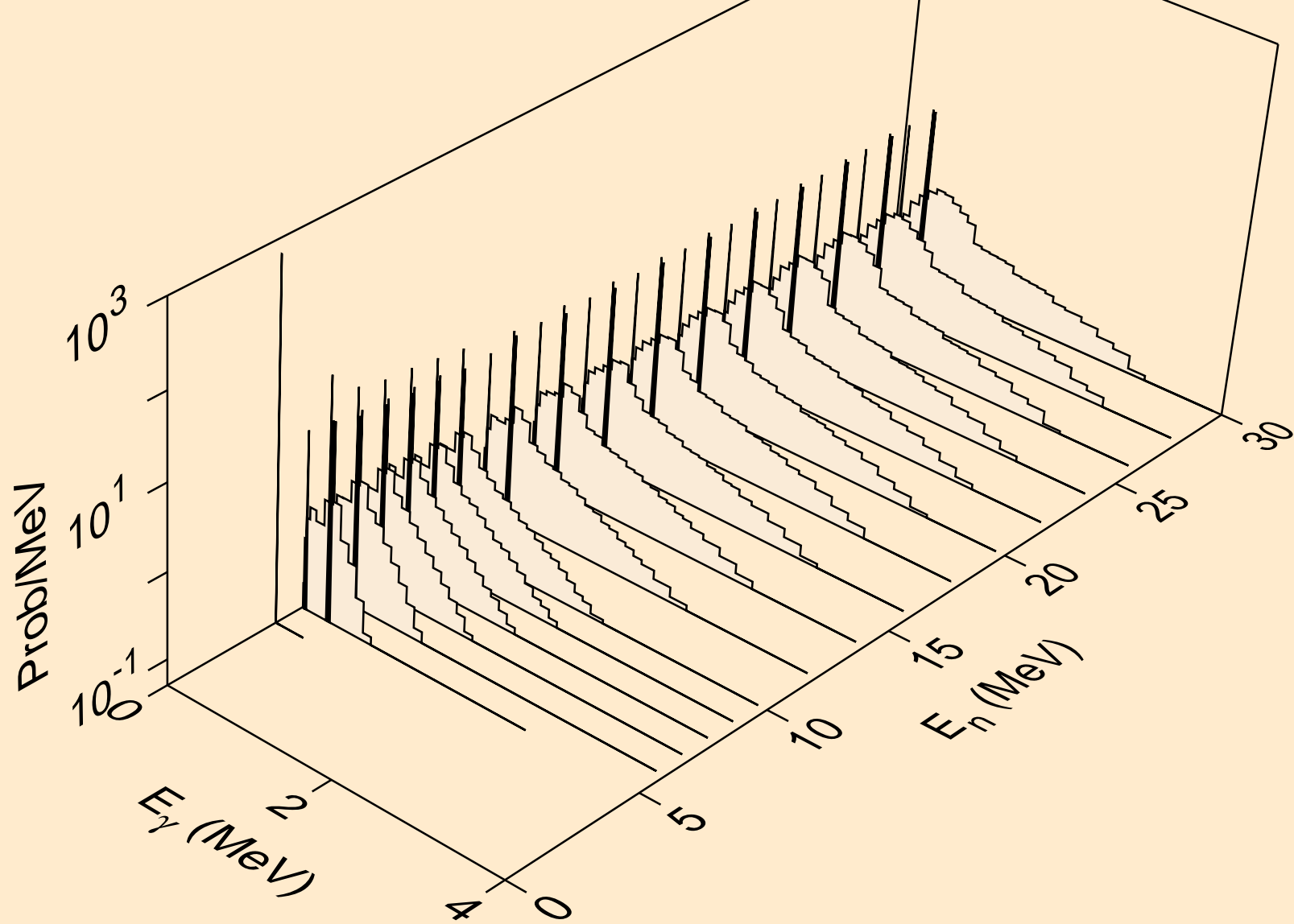

HO169 TRITON ACER TENDL-2021 LIBRARY; T=0.K  
Photon emission for inelastic

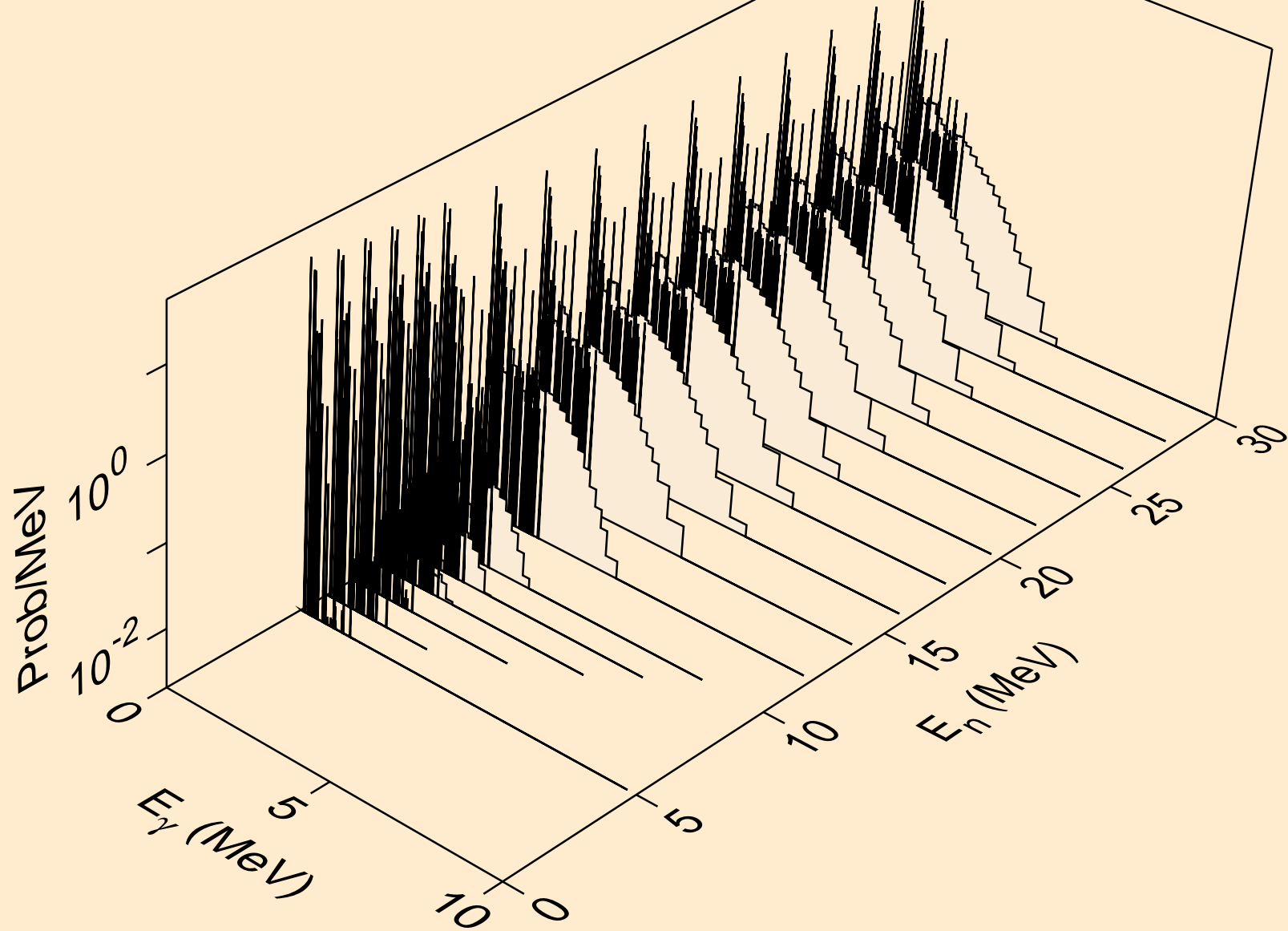

HO169 TRITON ACER TENDL-2021 LIBRARY; T=0.K  
Photon emission for (n,he3)

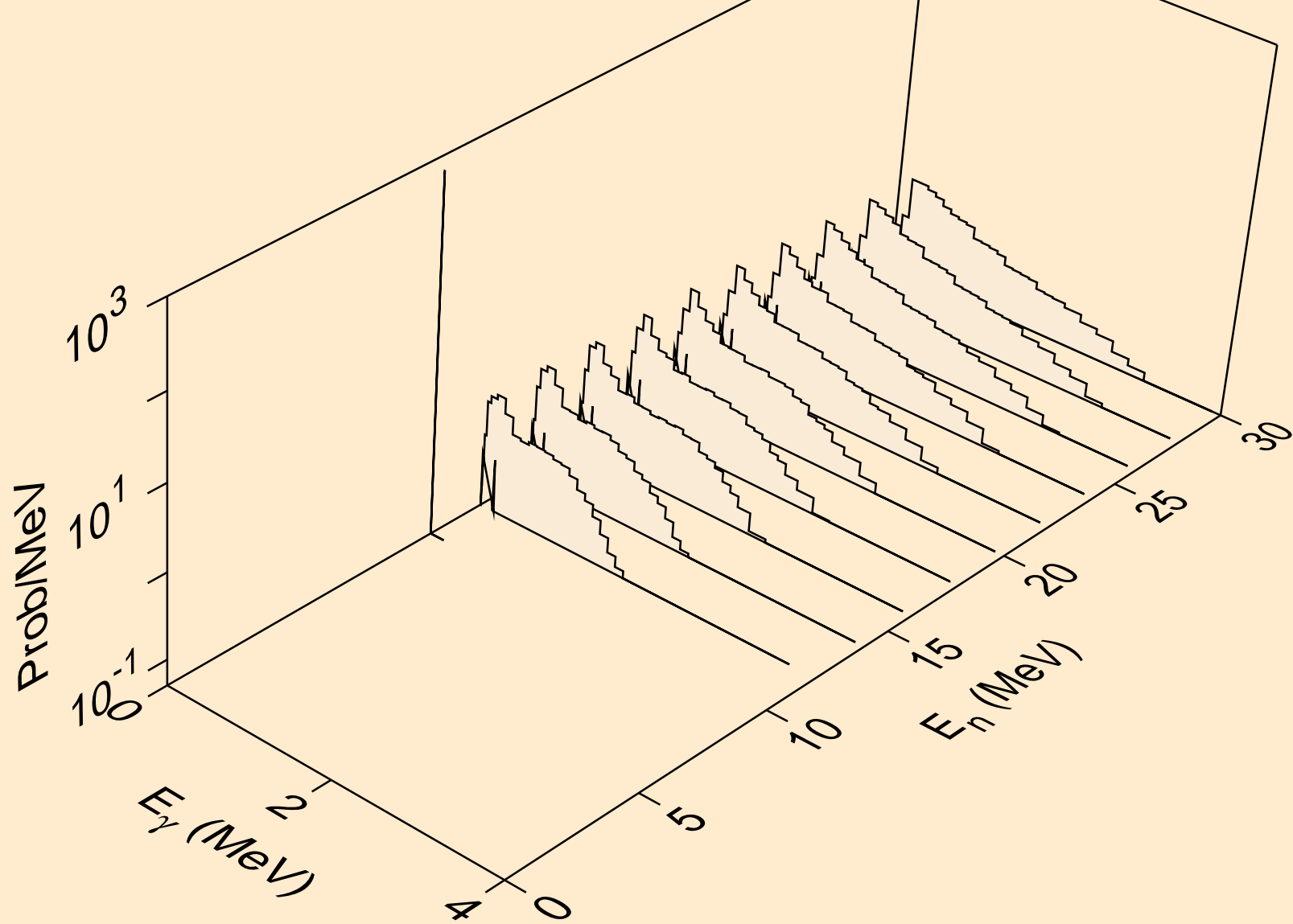

HO169 TRITON ACER TENDL-2021 LIBRARY; T=0.K  
Photon emission for (n,a)

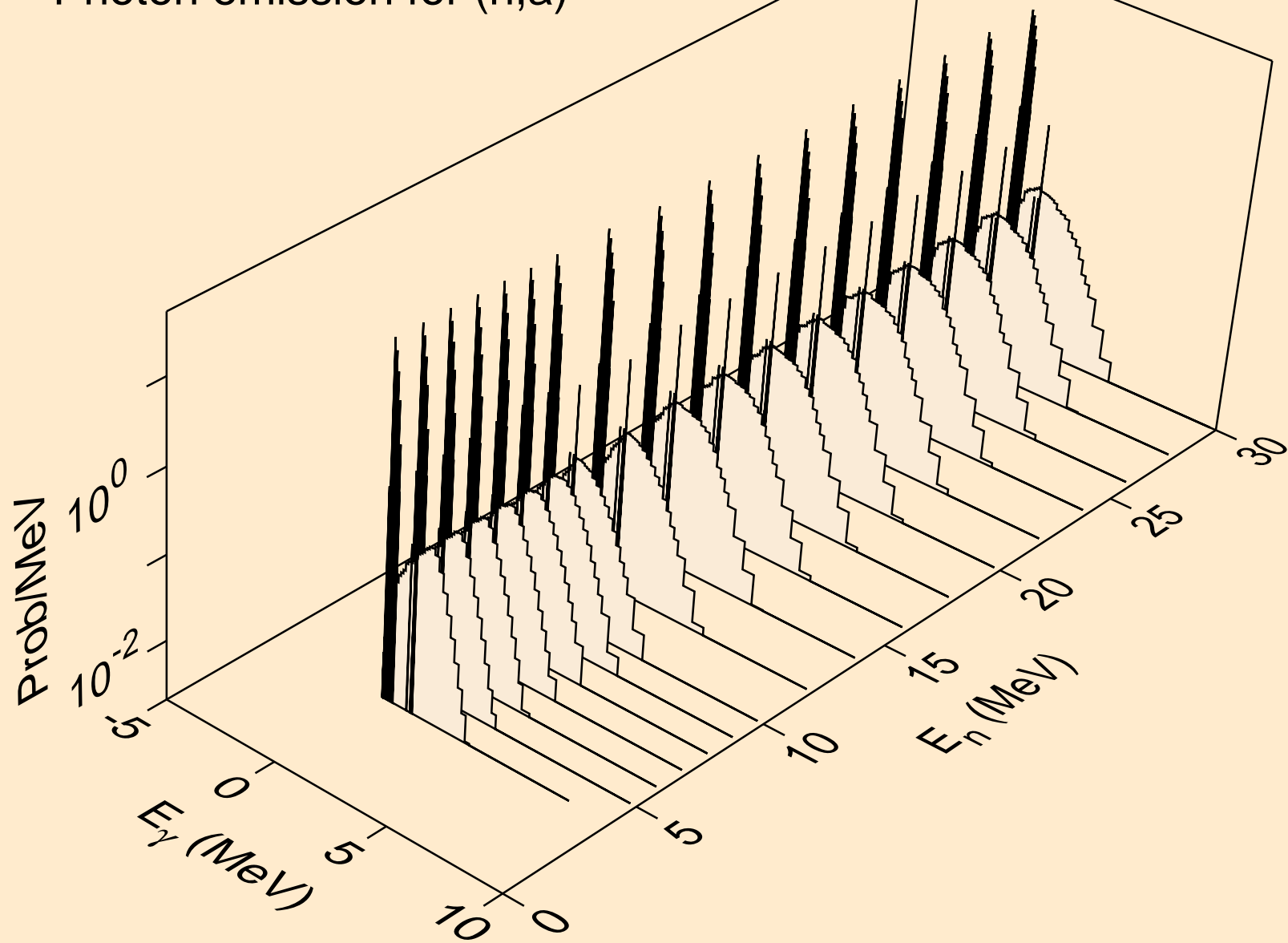

HO169 TRITON ACER TENDL-2021 LIBRARY; T=0.K  
Photon emission for (n,2p)

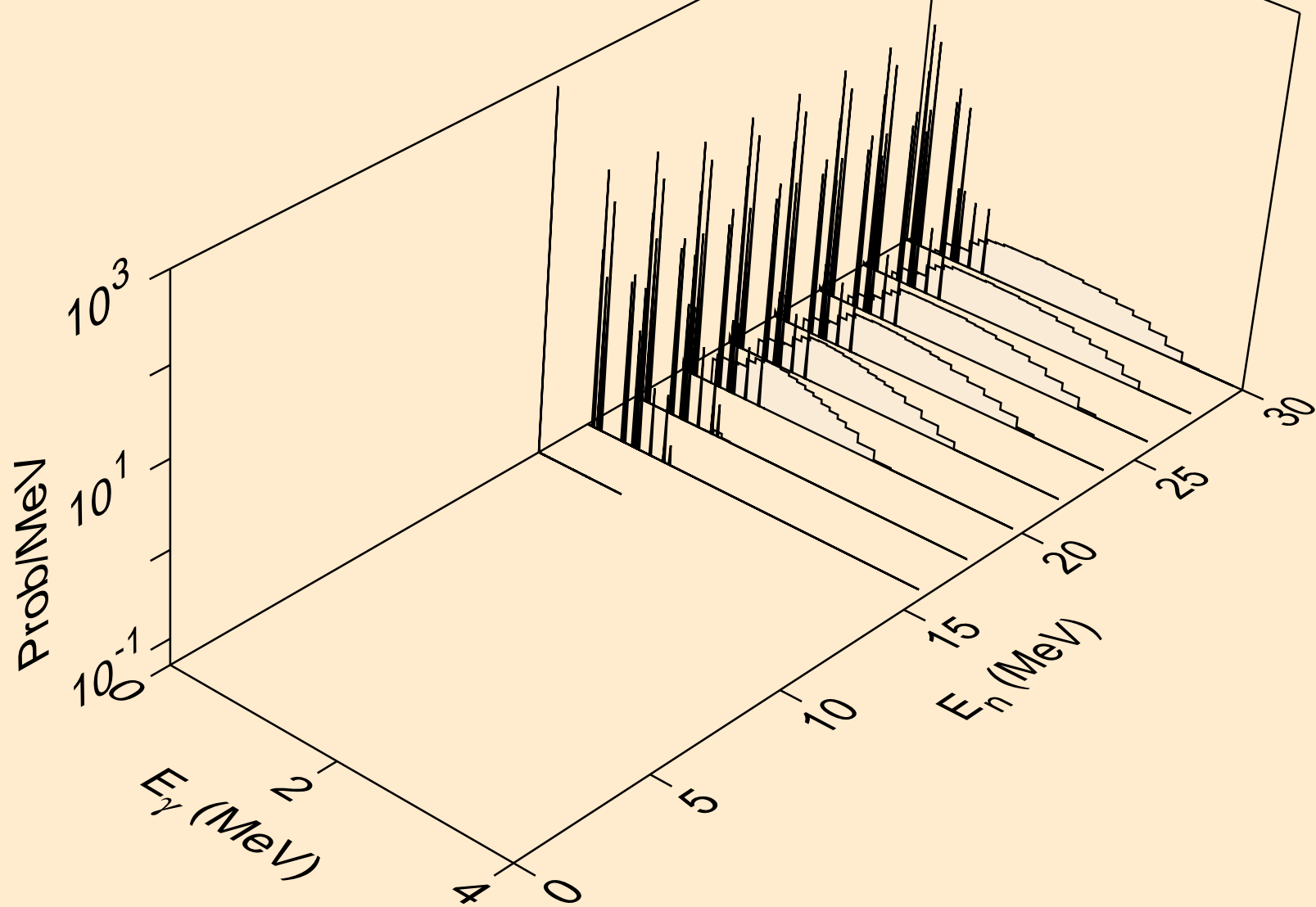

HO169 TRITON ACER TENDL-2021 LIBRARY; T=0.K  
Photon emission for (n,pa)

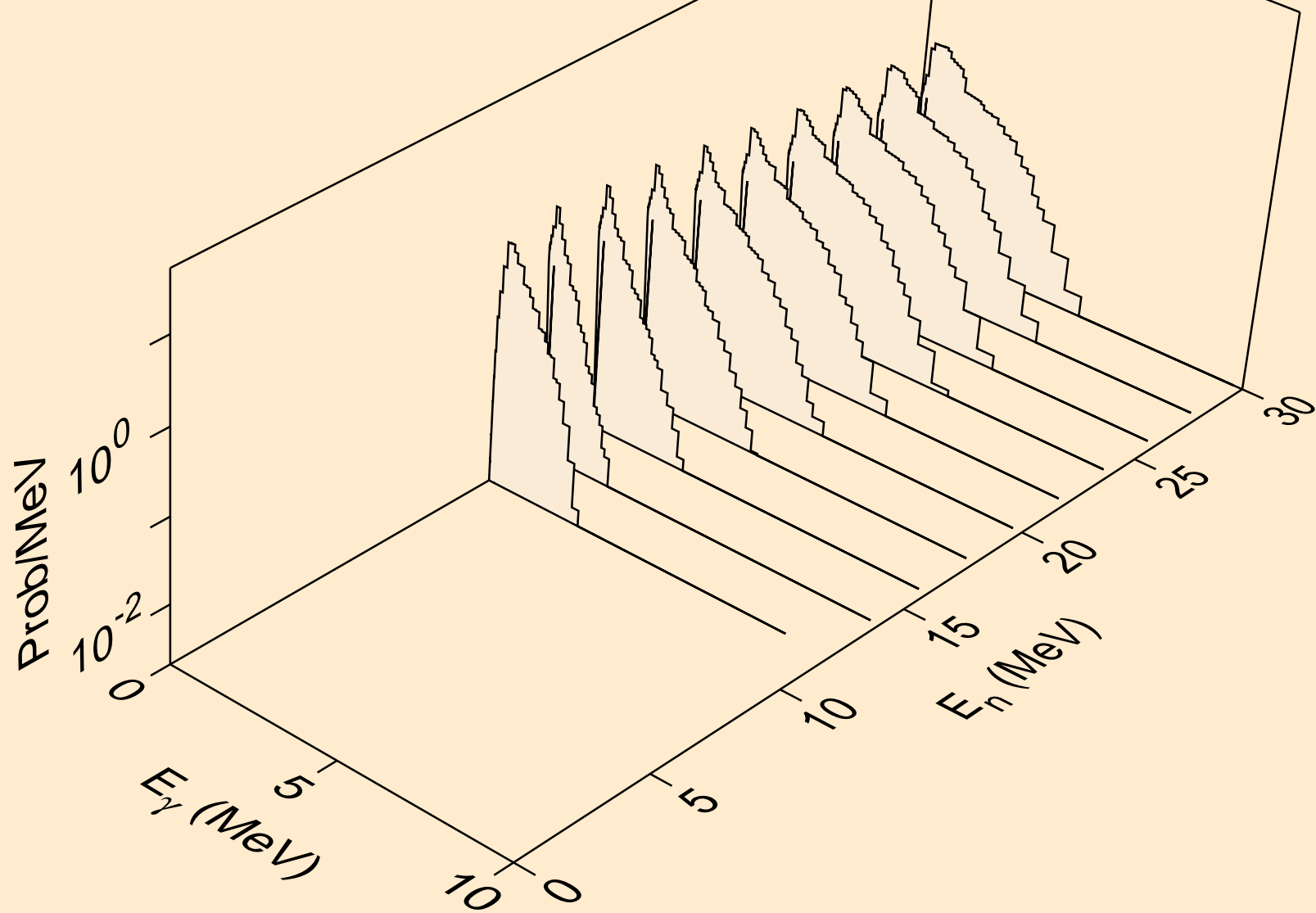

HO169 TRITON ACER TENDL-2021 LIBRARY; T=0.K  
Photon emission for (n,pd)

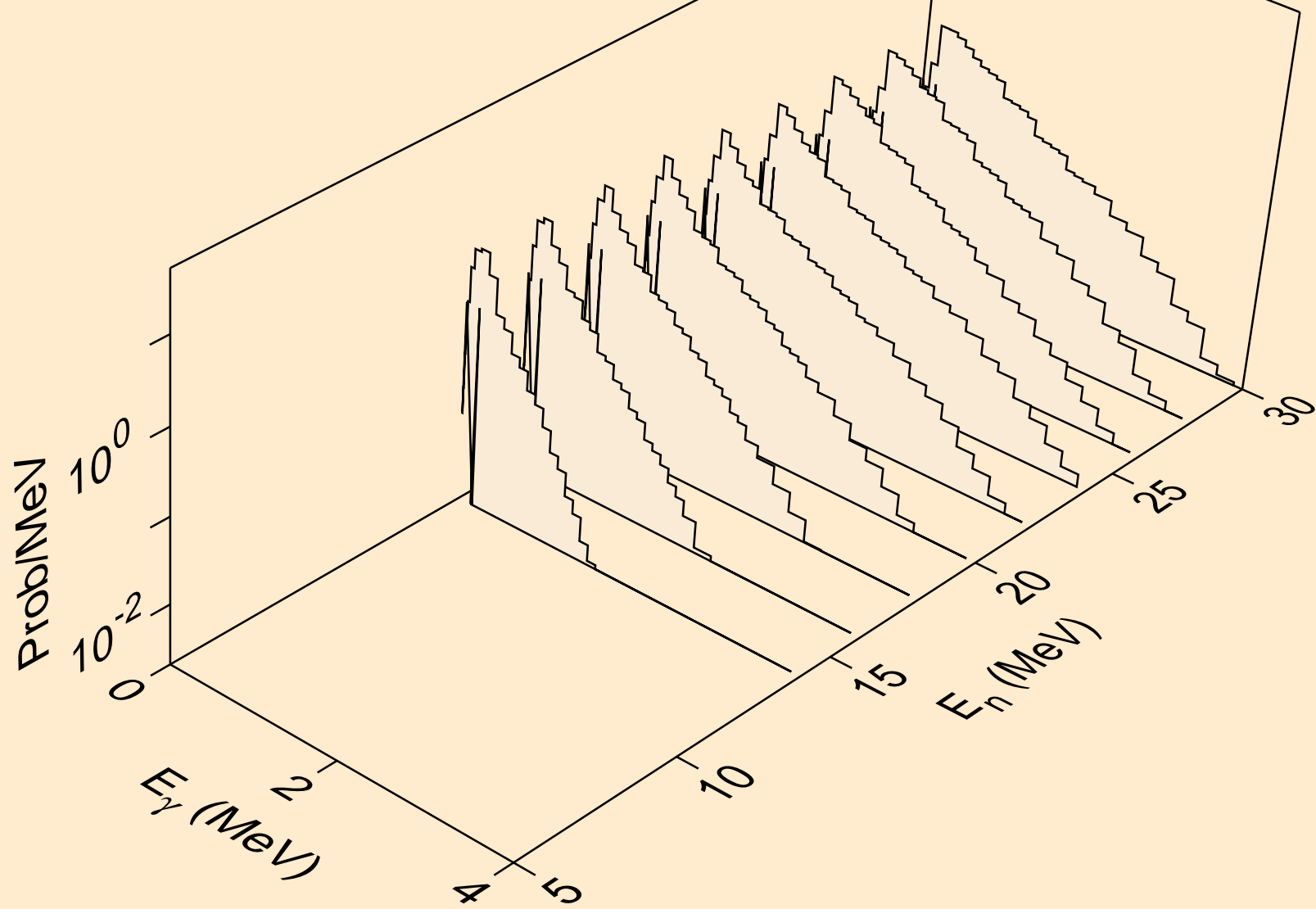

HO169 TRITON ACER TENDL-2021 LIBRARY; T=0.K  
Photon emission for (n,pt)

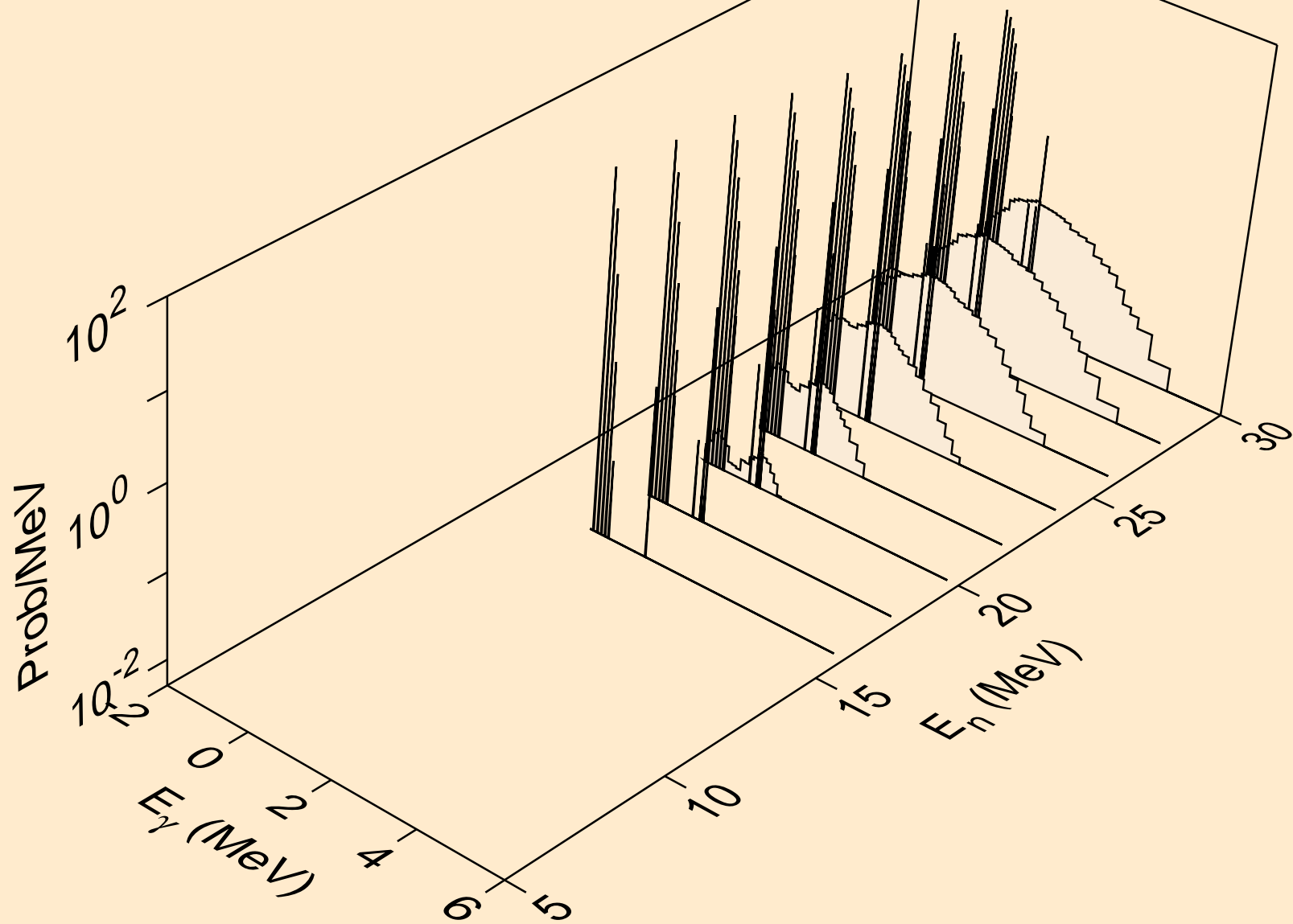

HO169 TRITON ACER TENDL-2021 LIBRARY; T=0.K  
Particle heating contributions

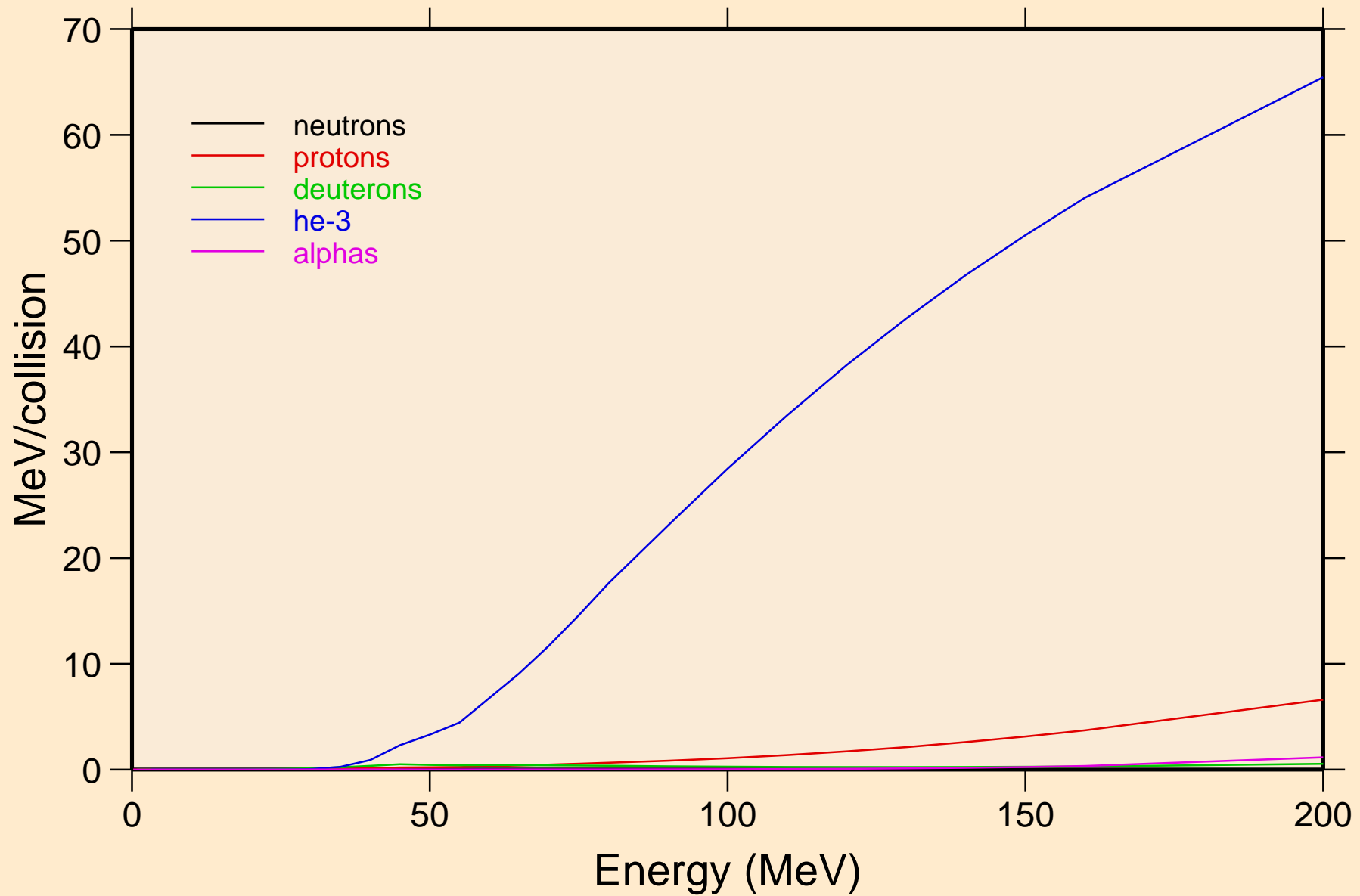

HO169 TRITON ACER TENDL-2021 LIBRARY; T=0.K  
Recoil Heating

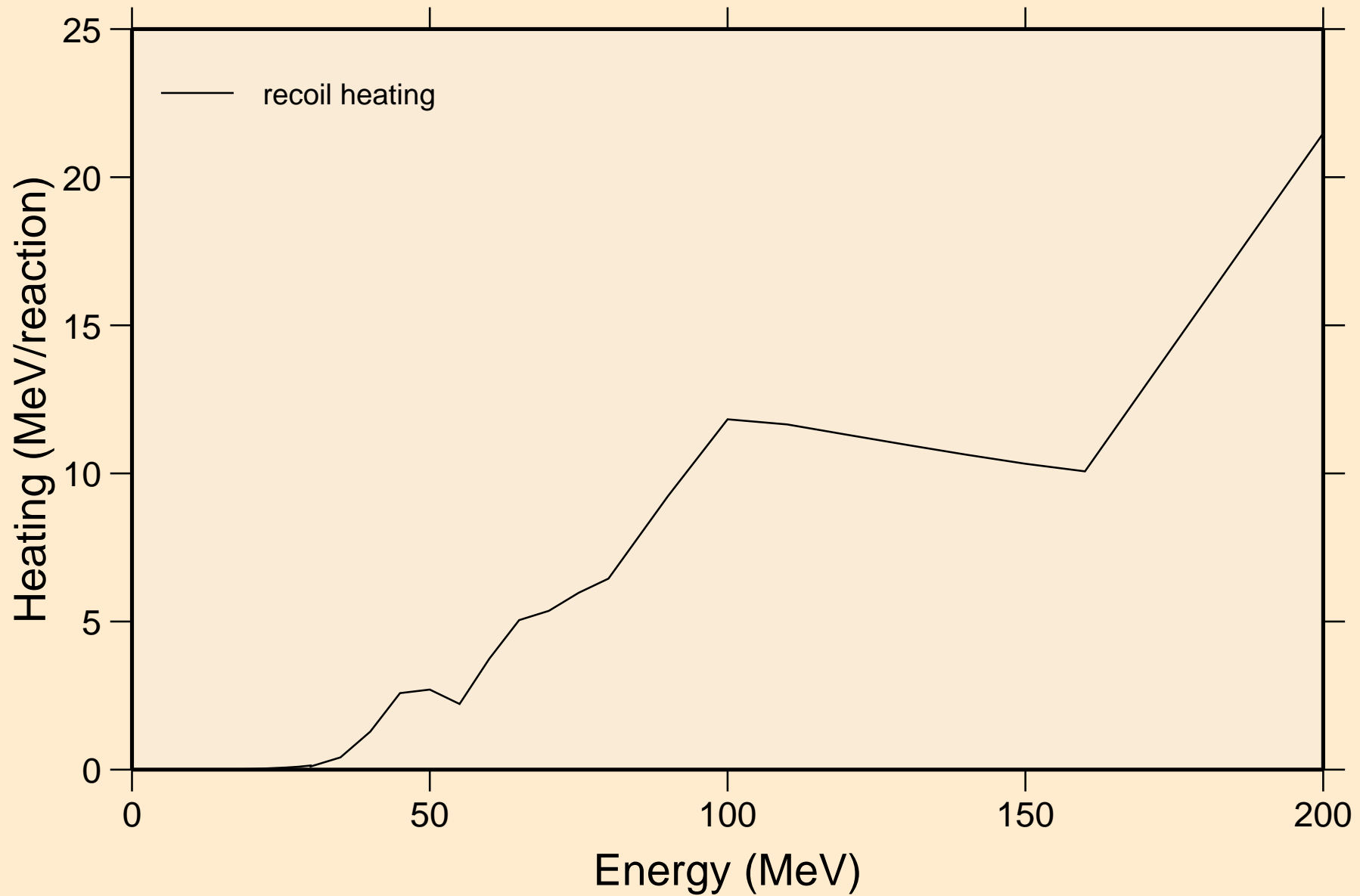

HO169 TRITON ACER TENDL-2021 LIBRARY; T=0.K  
Particle production cross sections

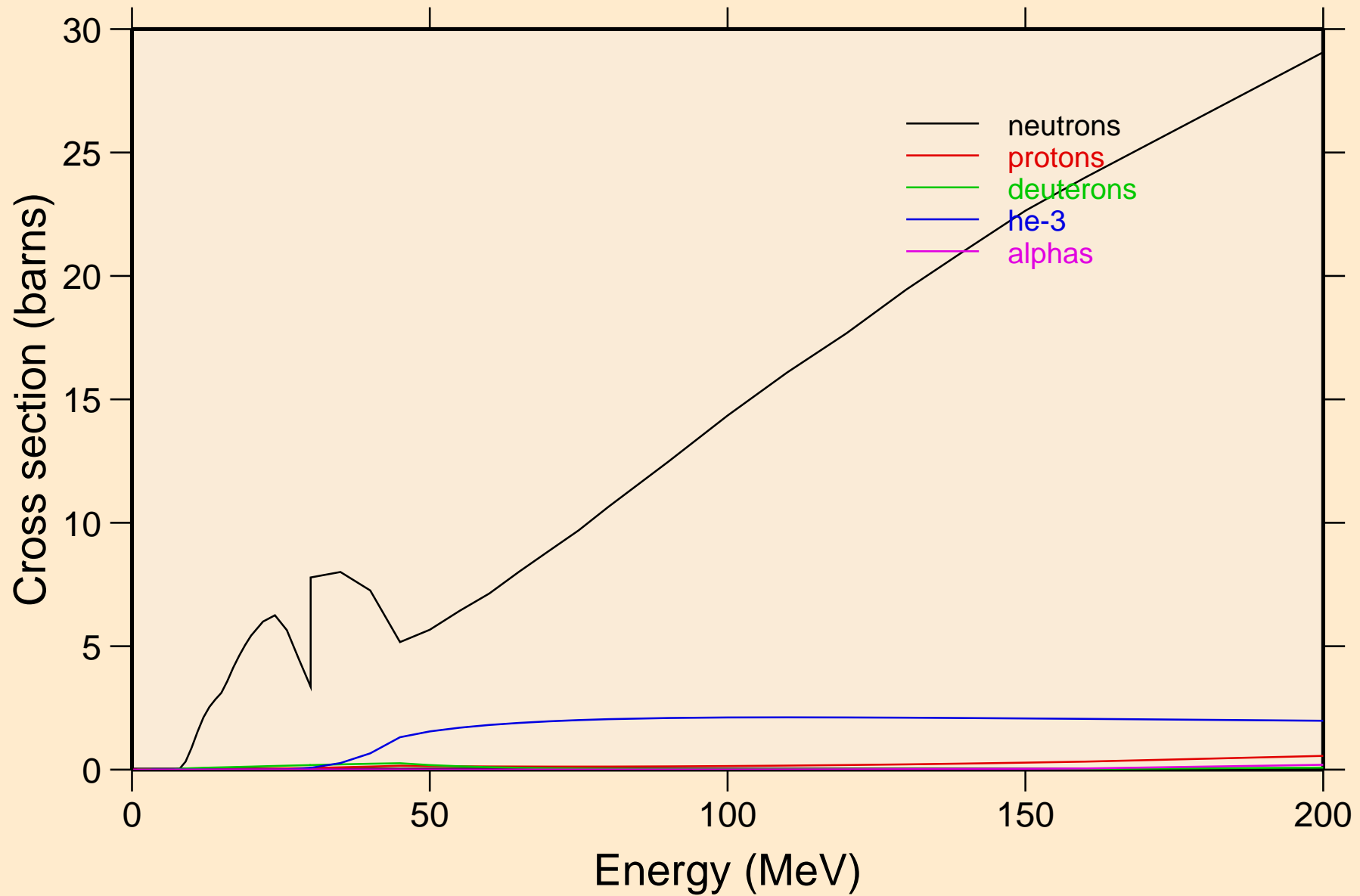

HO169 TRITON ACER TENDL-2021 LIBRARY; T=0.K  
neutrons from (t,n)

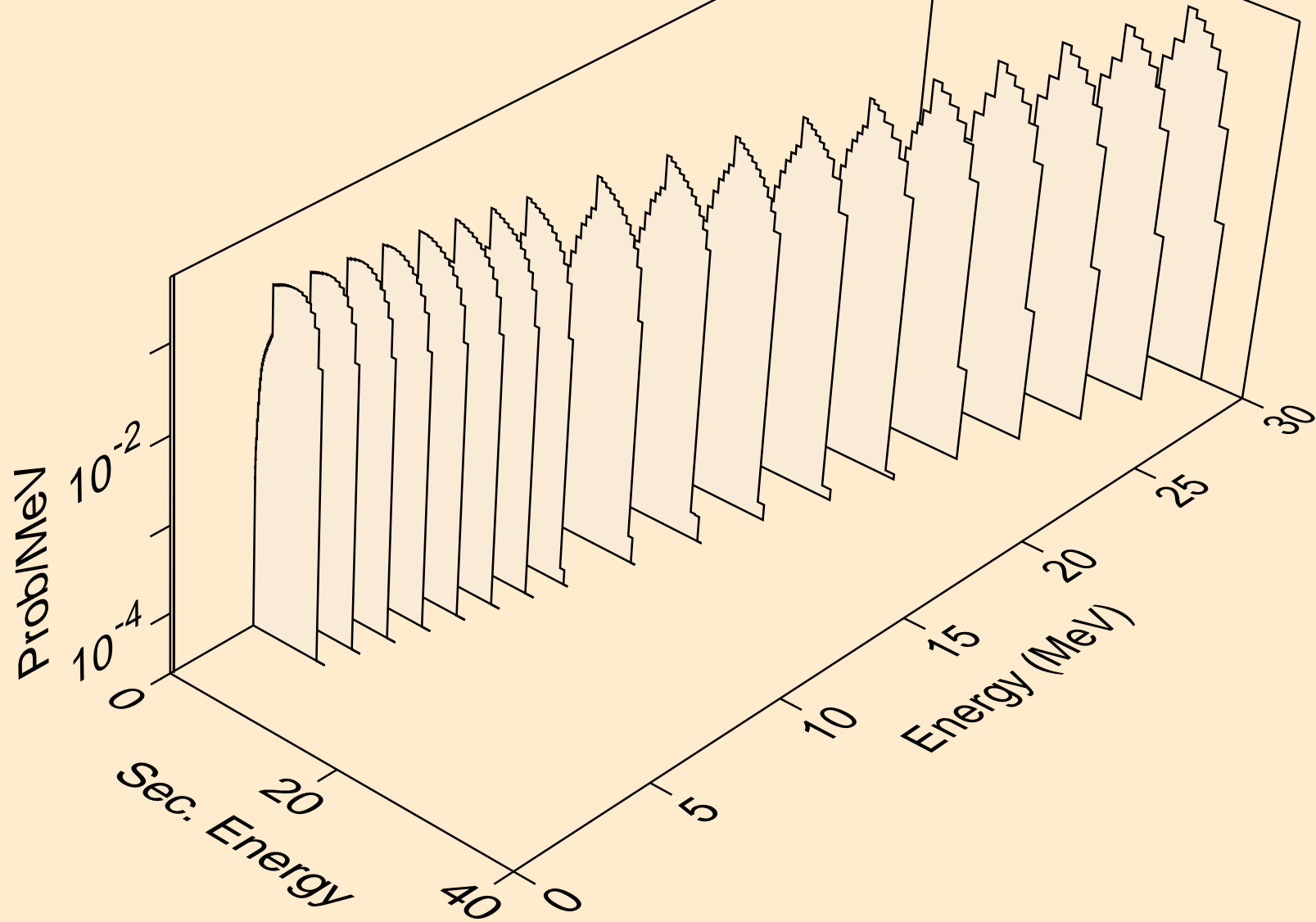

HO169 TRITON ACER TENDL-2021 LIBRARY; T=0.K  
neutrons from (t,x)

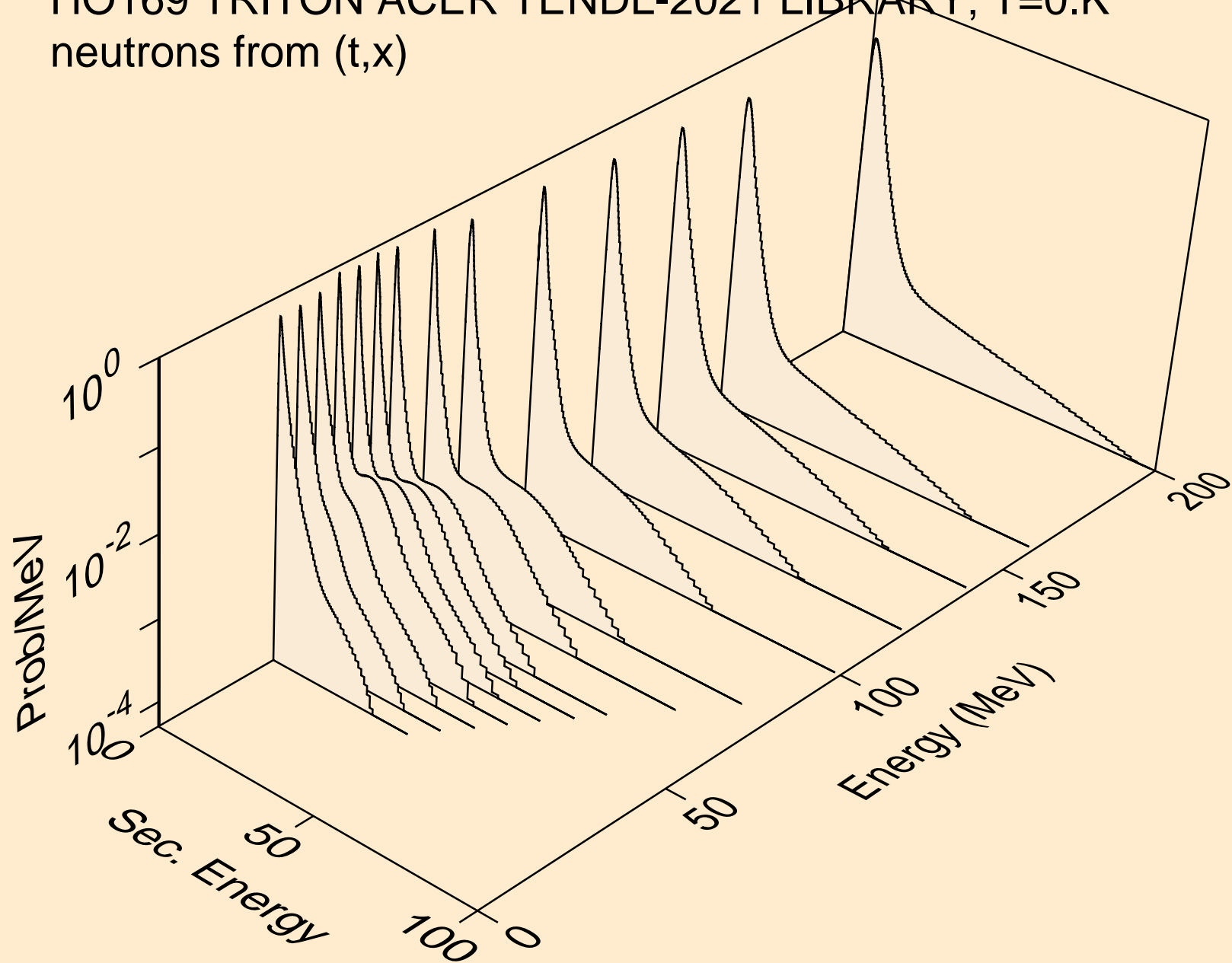

HO169 TRITON ACER TENDL-2021 LIBRARY; T=0.K  
neutrons from (t,2nd)

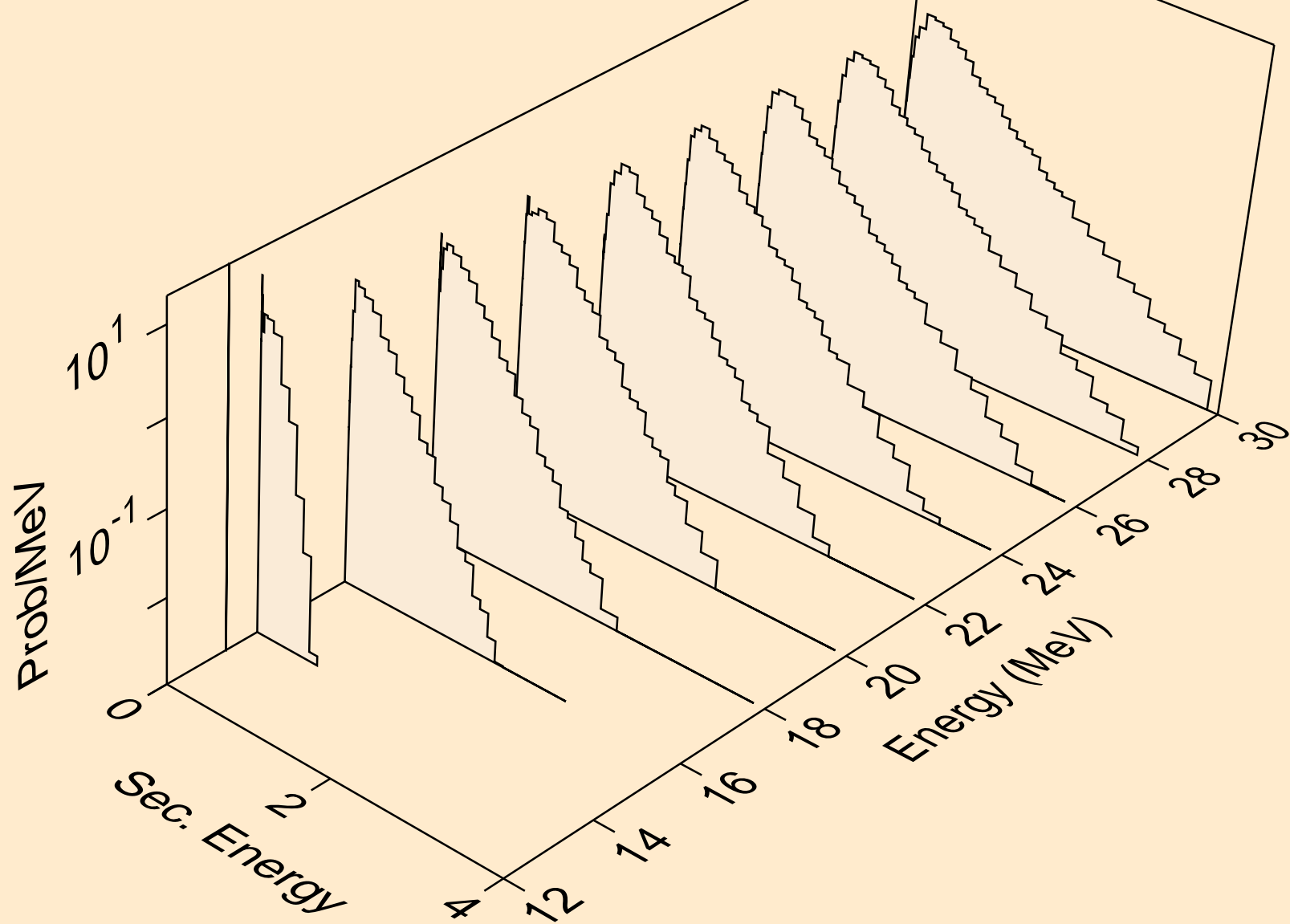

HO169 TRITON ACER TENDL-2021 LIBRARY; T=0.K  
neutrons from (t,2n)

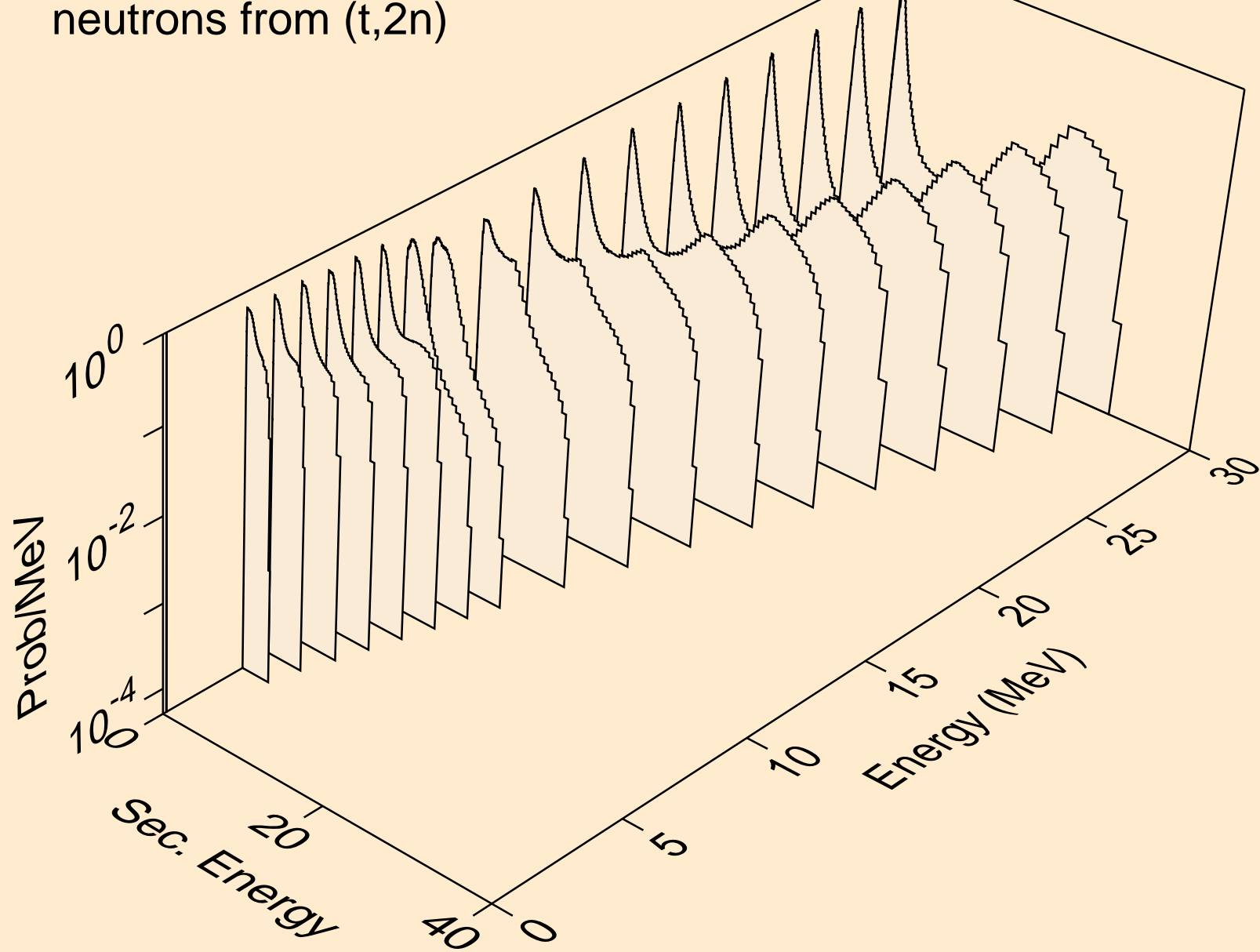

HO169 TRITON ACER TENDL-2021 LIBRARY; T=0.K  
neutrons from (t,3n)

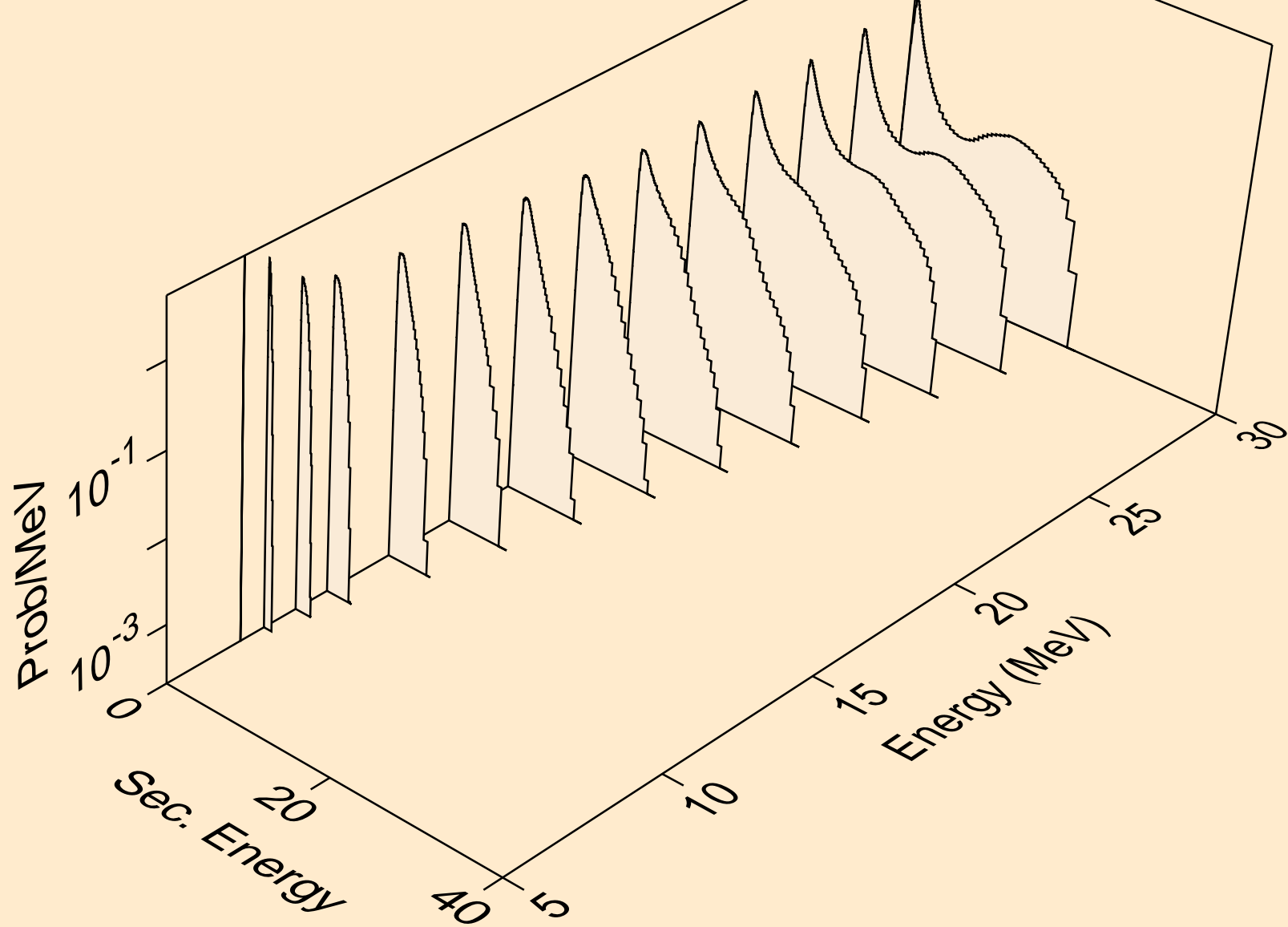

HO169 TRITON ACER TENDL-2021 LIBRARY; T=0.K  
neutrons from (t,n\*)a

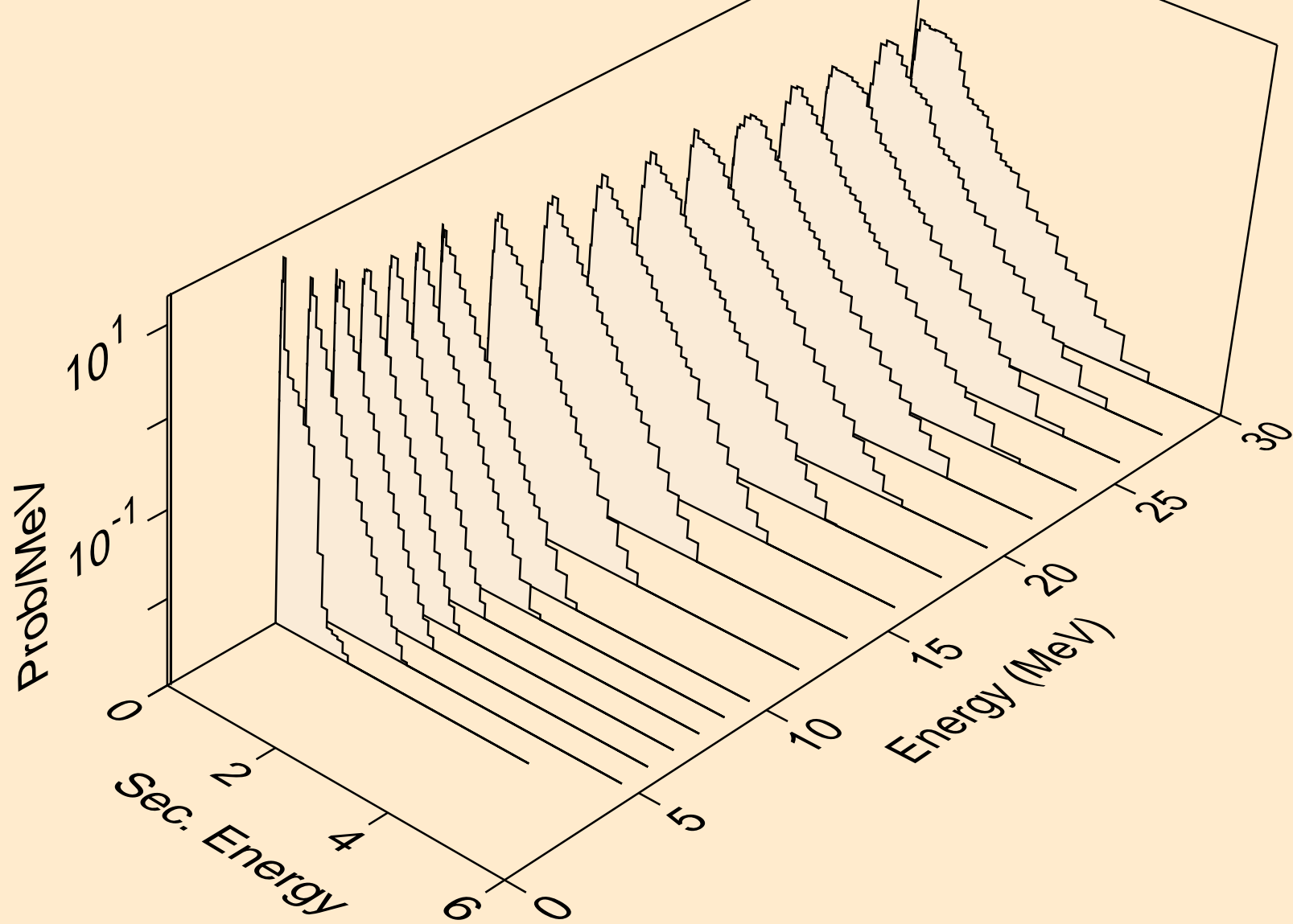

HO169 TRITON ACER TENDL-2021 LIBRARY; T=0.K  
neutrons from (t,2n)a

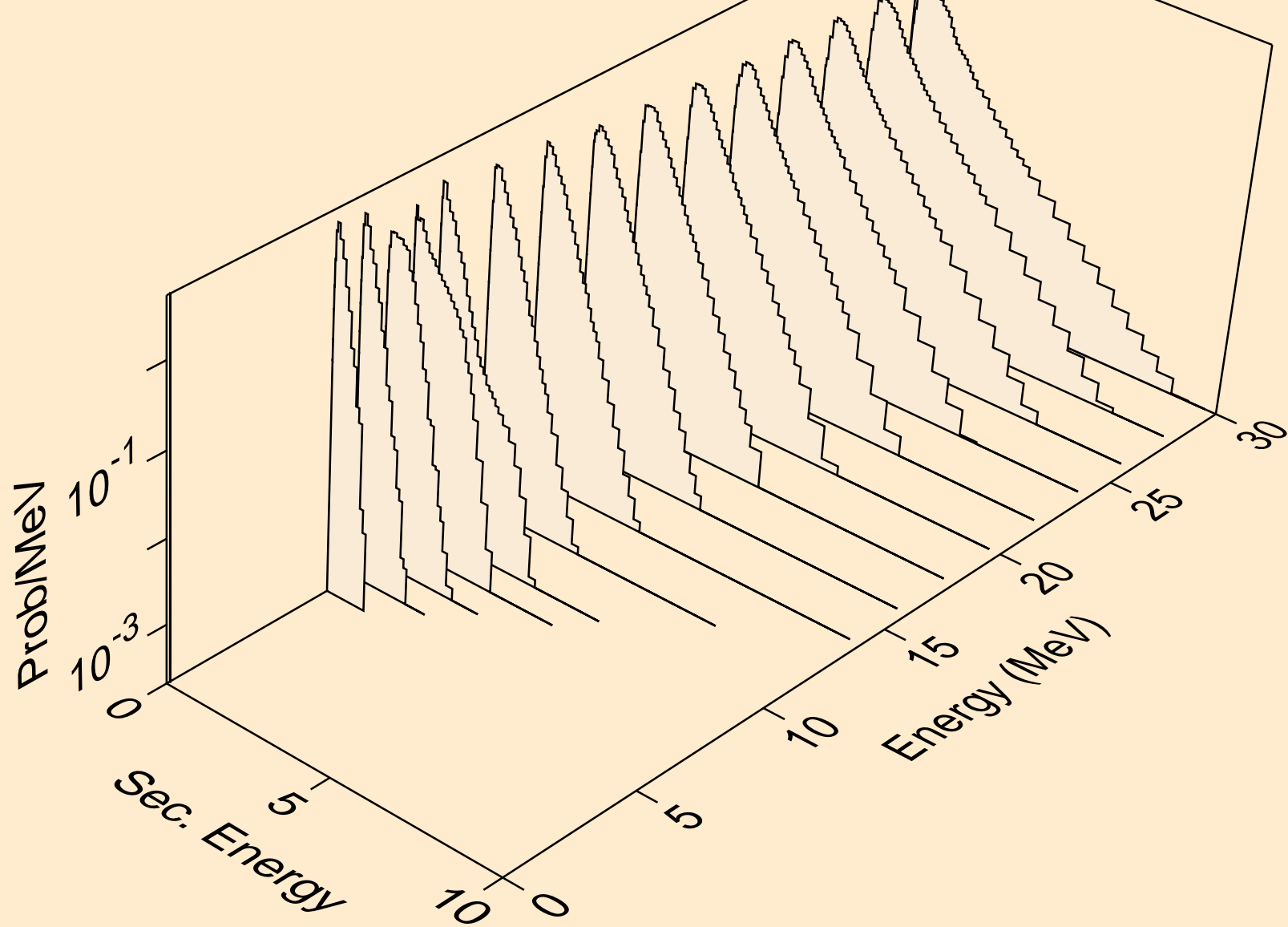

HO169 TRITON ACER TENDL-2021 LIBRARY; T=0.K  
neutrons from (t,3n)a

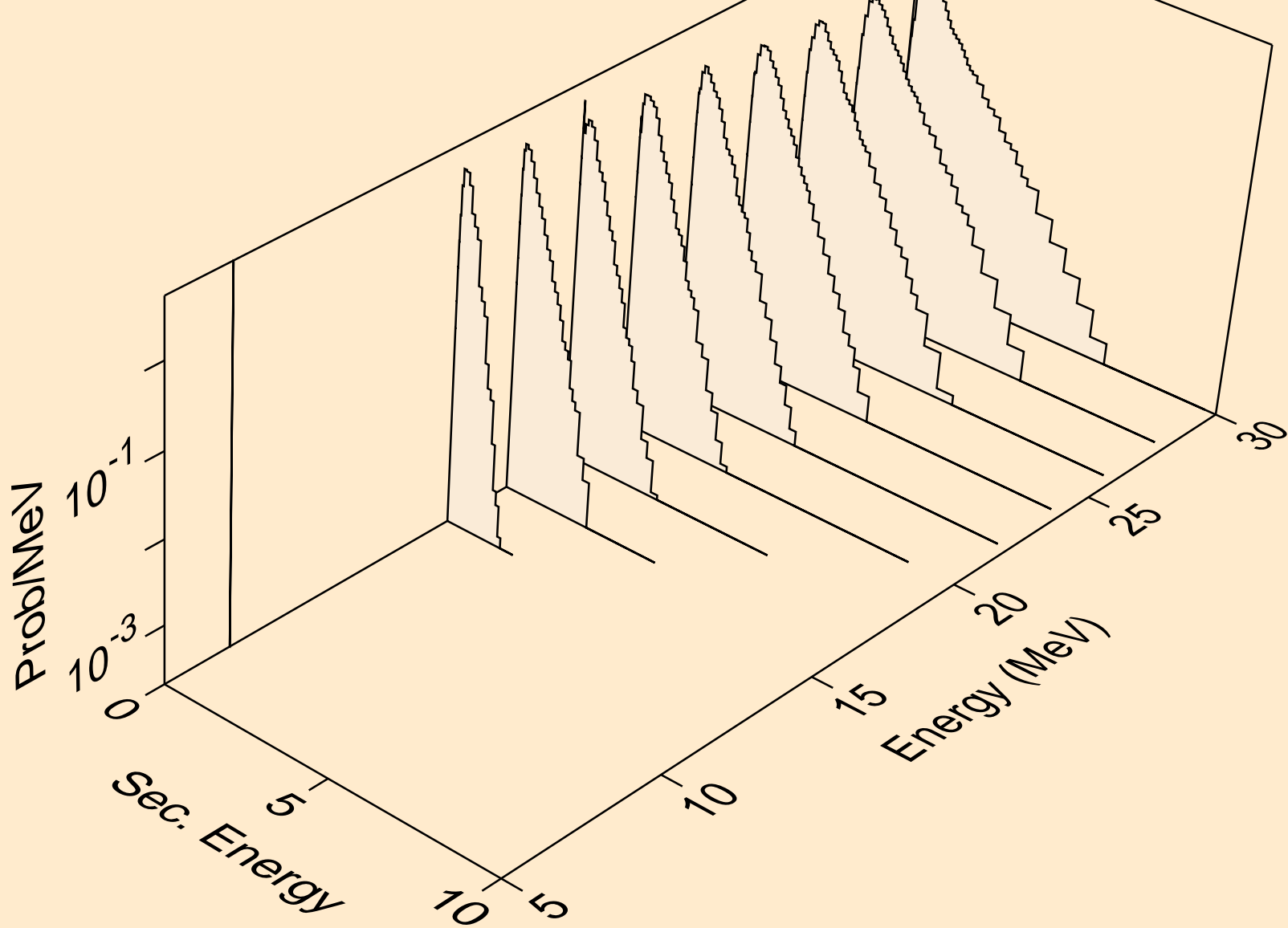

HO169 TRITON ACER TENDL-2021 LIBRARY; T=0.K  
neutrons from (t,n\*)p

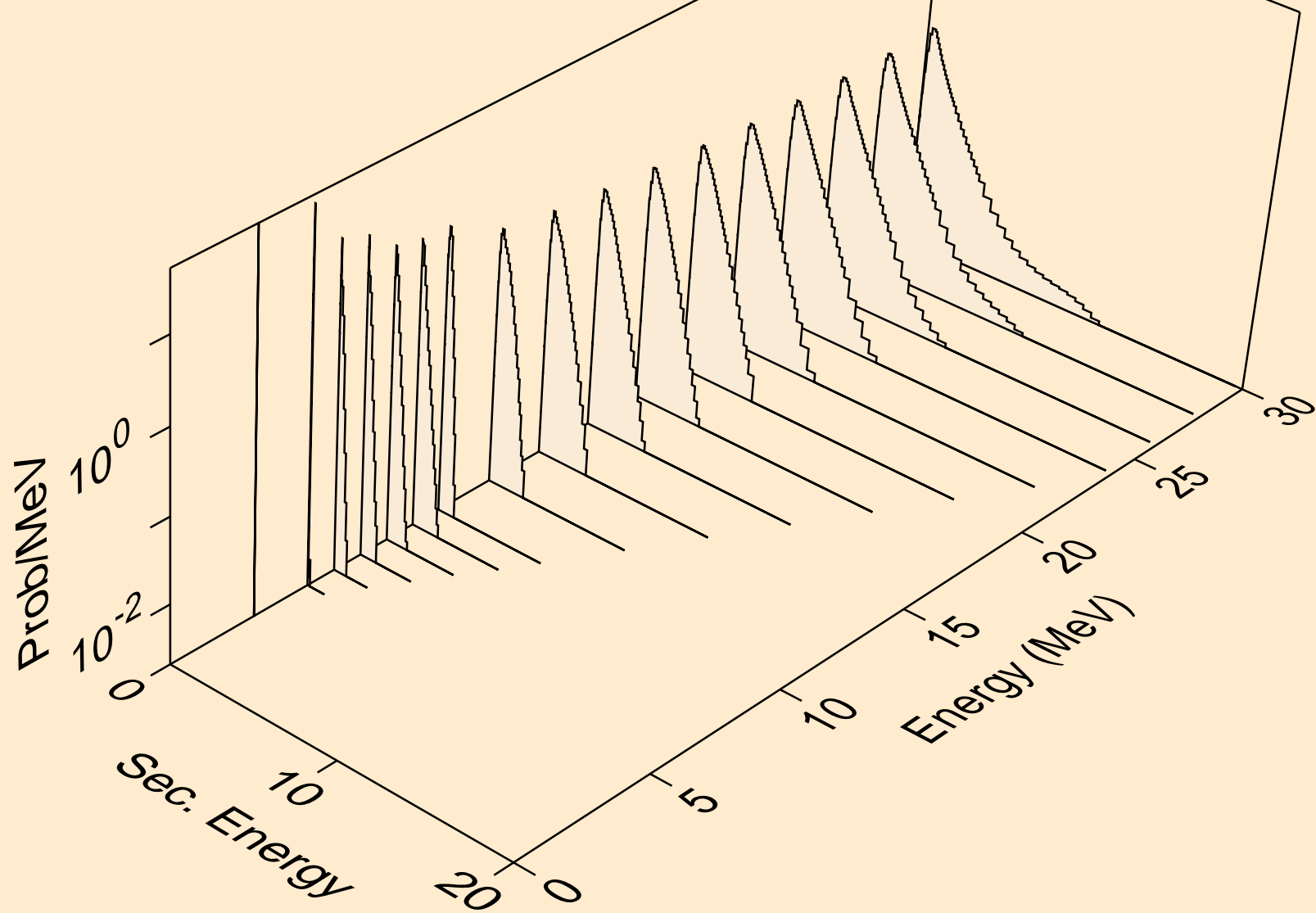

HO169 TRITON ACER TENDL-2021 LIBRARY; T=0.K  
neutrons from (t,n\*)d

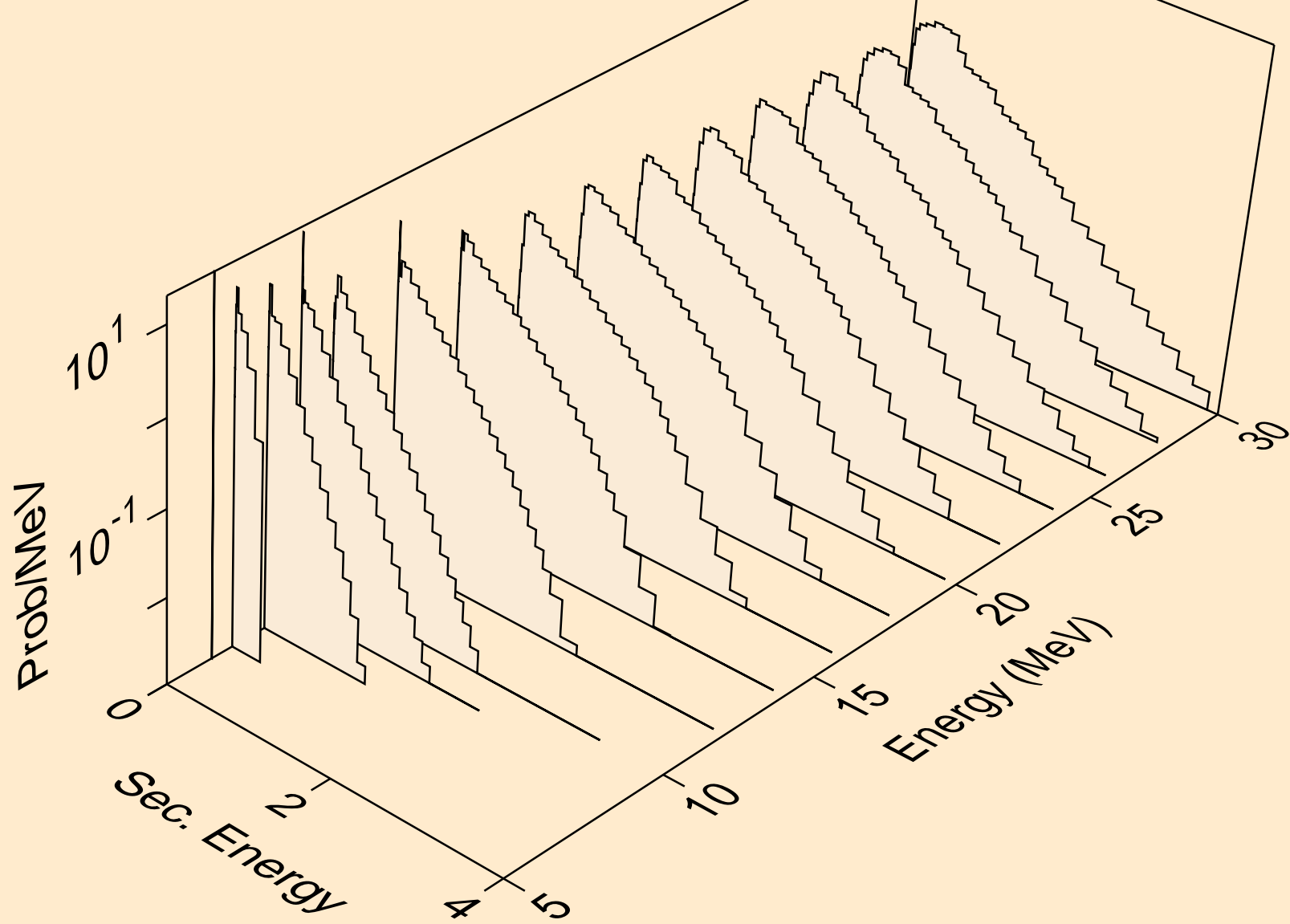

HO169 TRITON ACER TENDL-2021 LIBRARY; T=0.K  
neutrons from (t,n\*)t

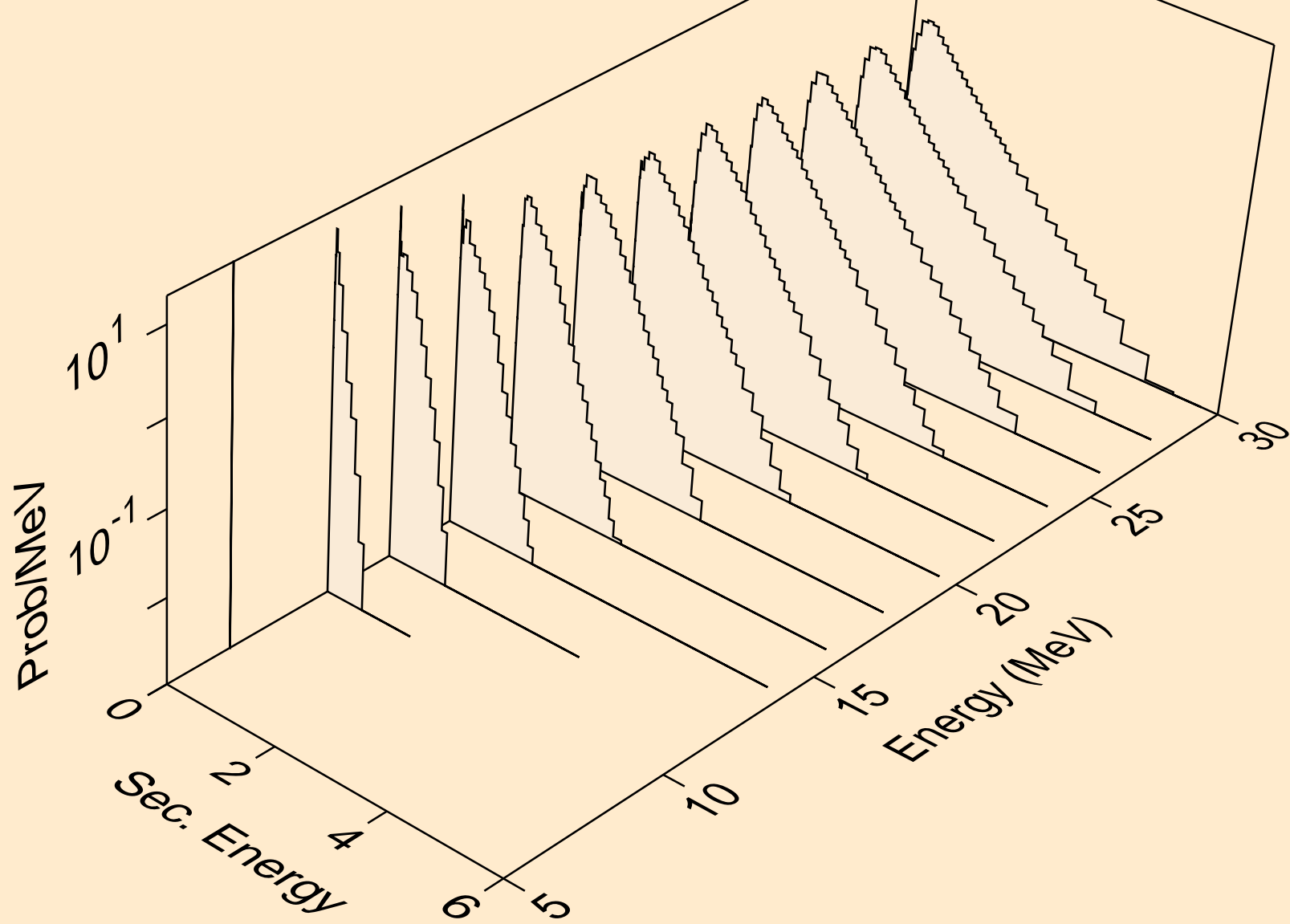

HO169 TRITON ACER TENDL-2021 LIBRARY; T=0.K  
neutrons from (t,n\*)he3

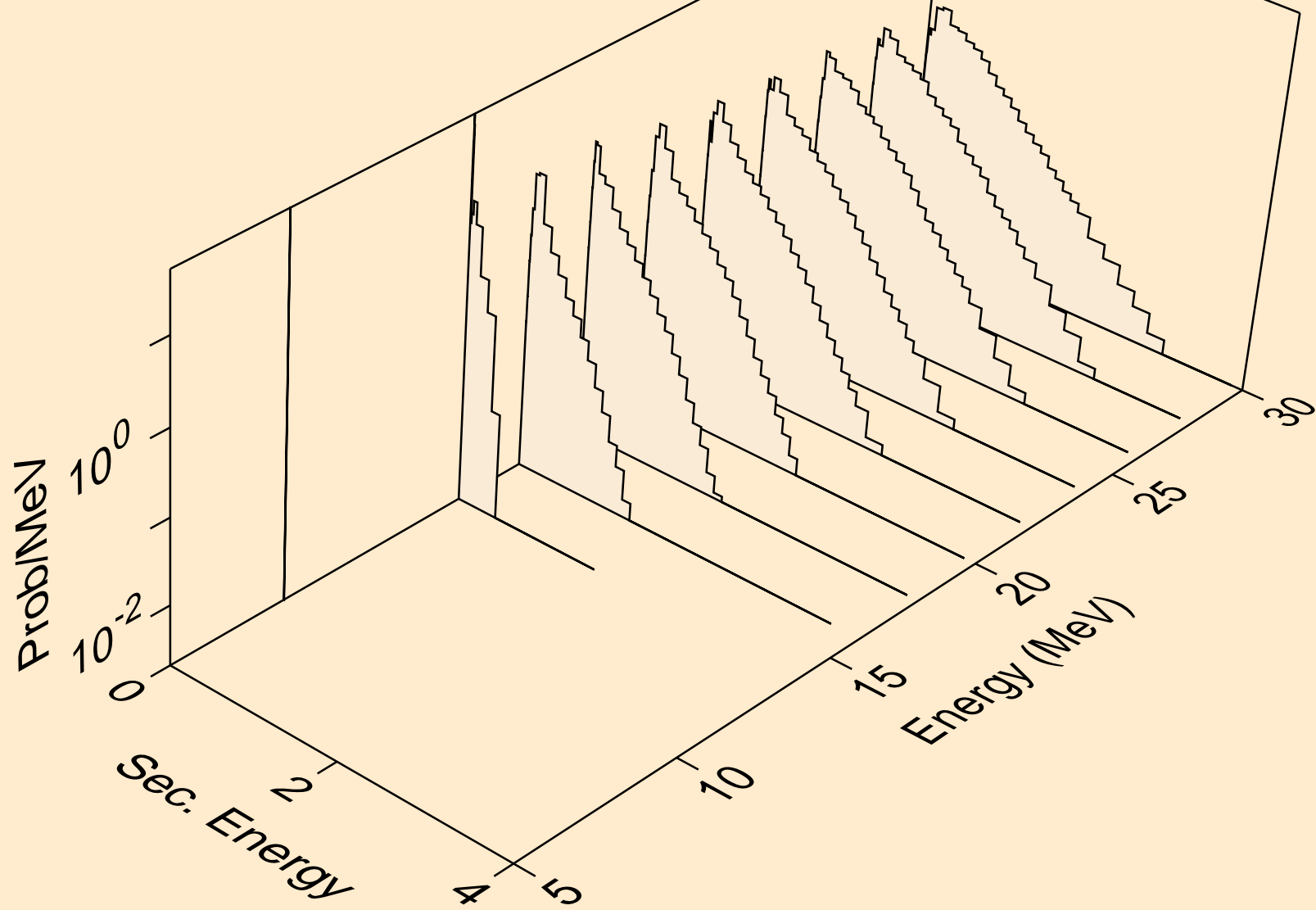

HO169 TRITON ACER TENDL-2021 LIBRARY; T=0.K  
neutrons from (t,4n)

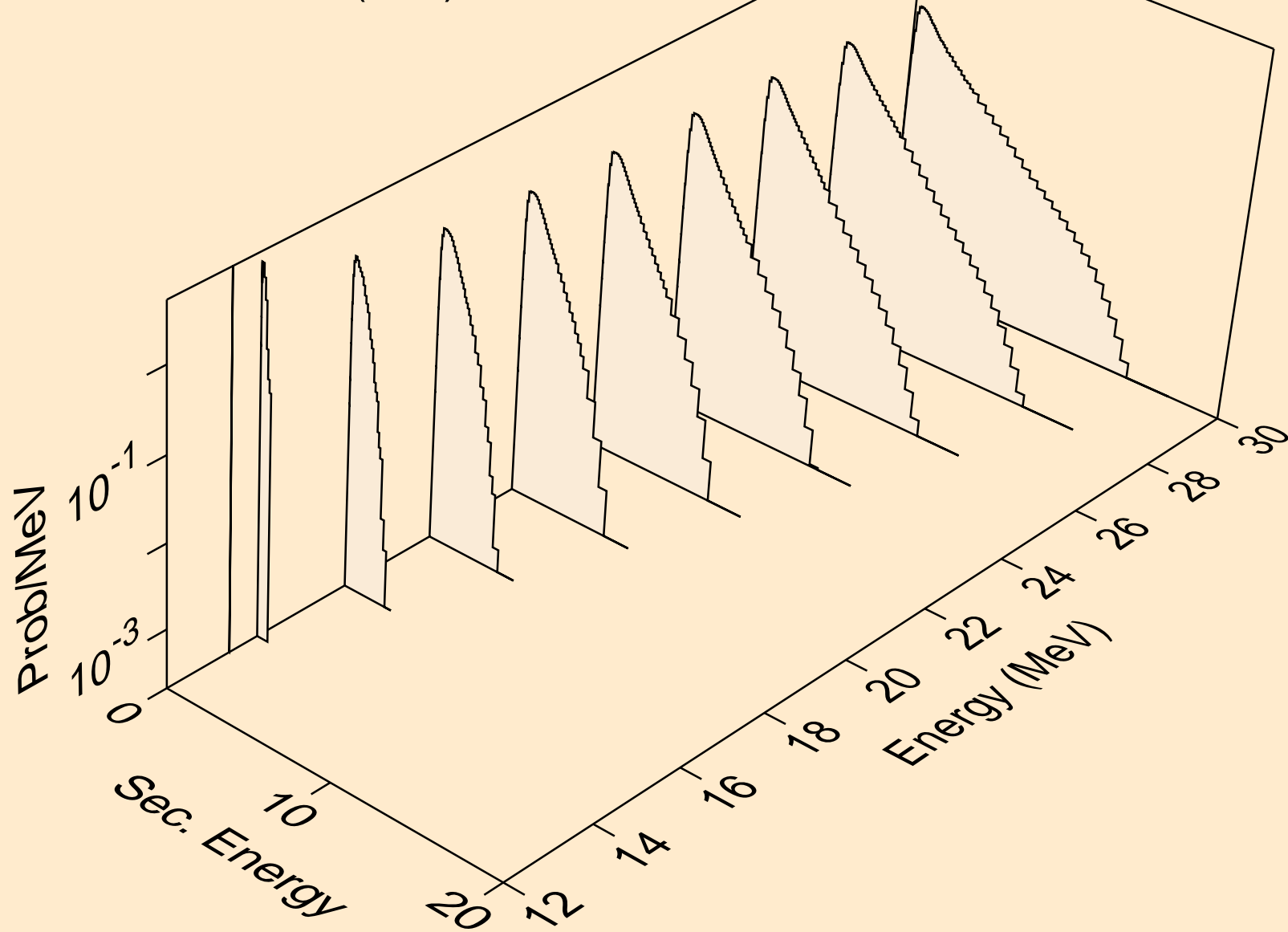

HO169 TRITON ACER TENDL-2021 LIBRARY; T=0.K  
neutrons from (t,2np)

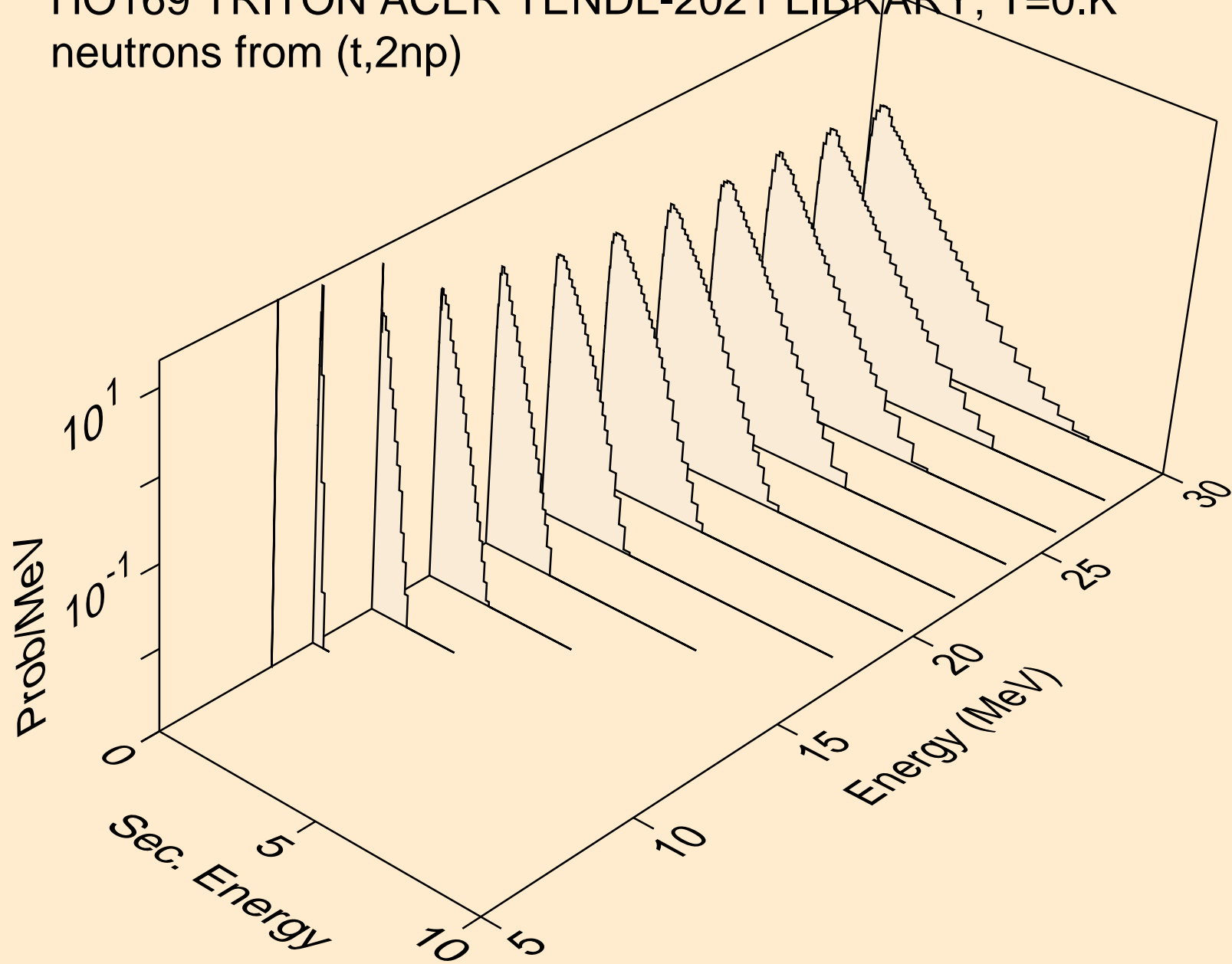

HO169 TRITON ACER TENDL-2021 LIBRARY; T=0.K  
neutrons from (t,3np)

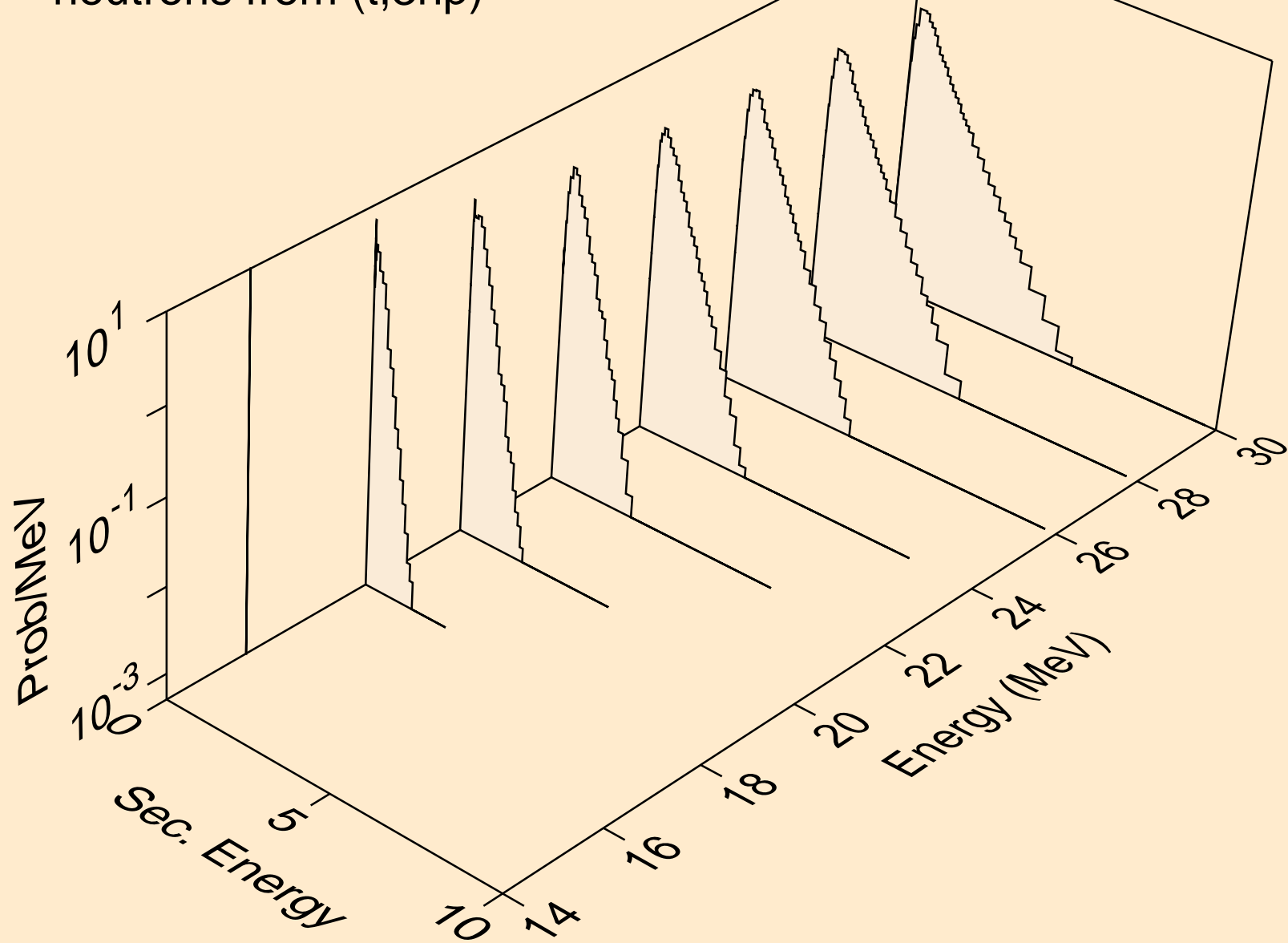

HO169 TRITON ACER TENDL-2021 LIBRARY; T=0.K  
neutrons from (t,2np)

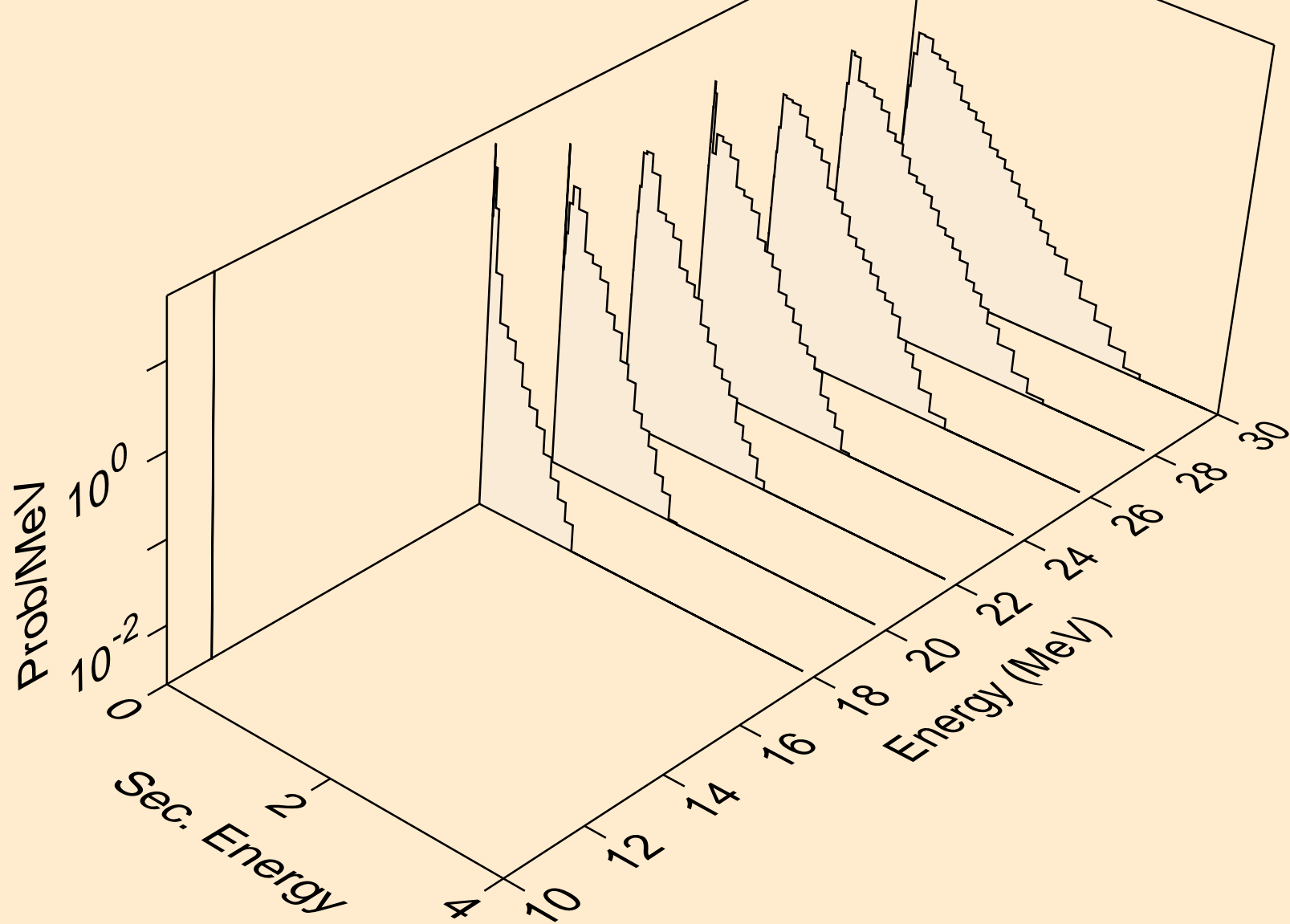

HO169 TRITON ACER TENDL-2021 LIBRARY; T=0.K  
neutrons from (t,npa)

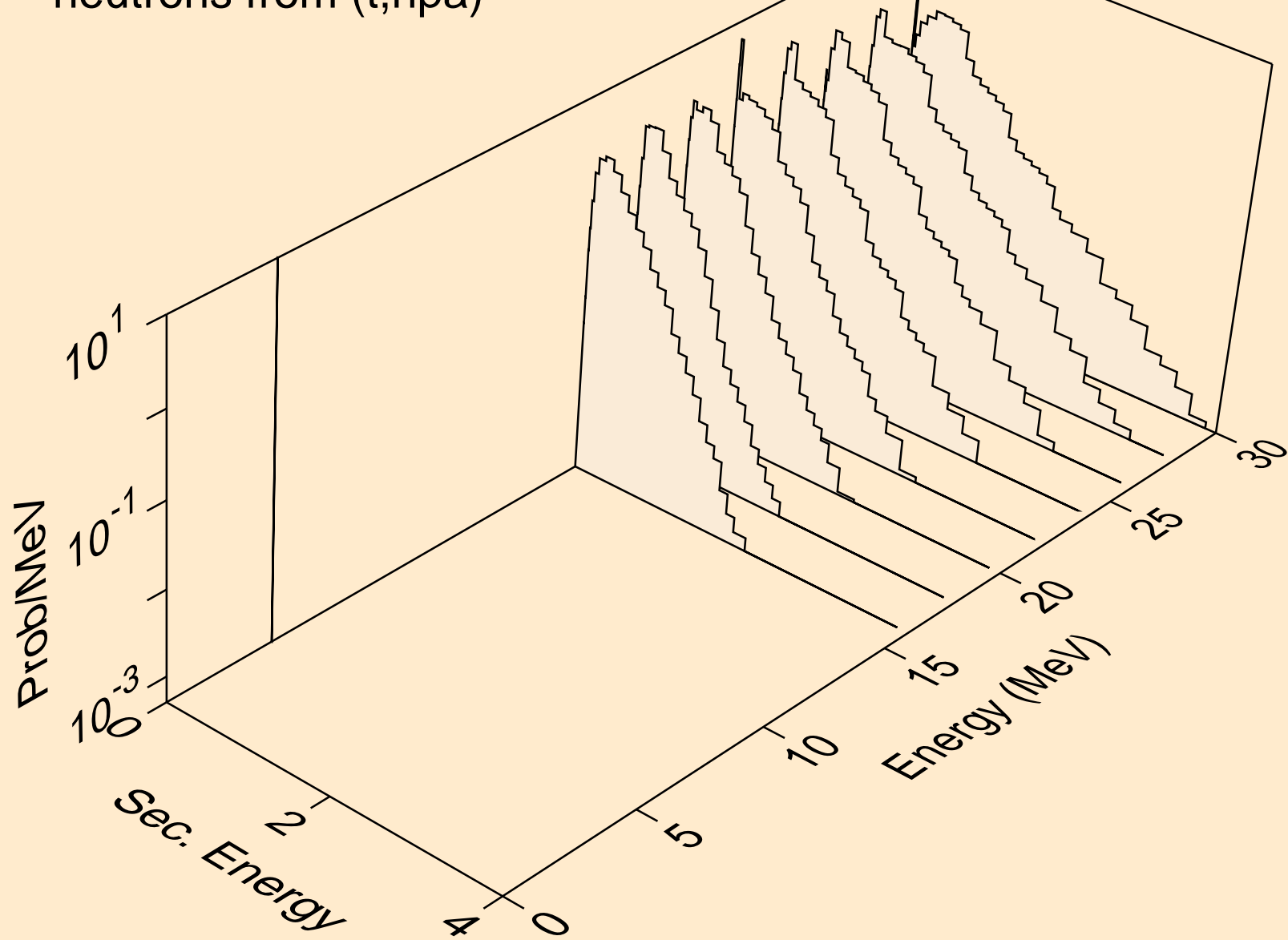

HO169 TRITON ACER TENDL-2021 LIBRARY; T=0.K  
protons from (t,x)

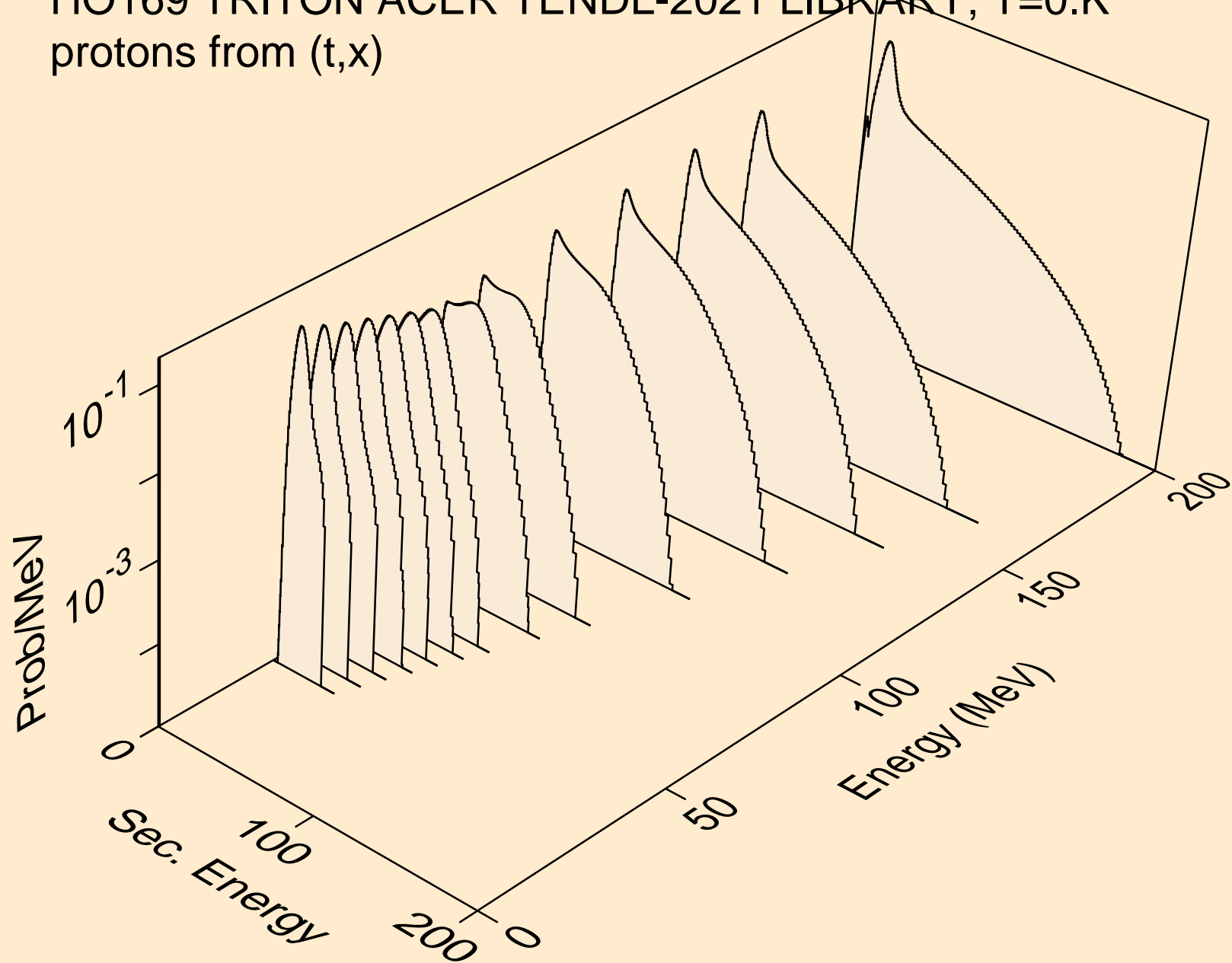

HO169 TRITON ACER TENDL-2021 LIBRARY; T=0.K  
protons from (t,n\*)p

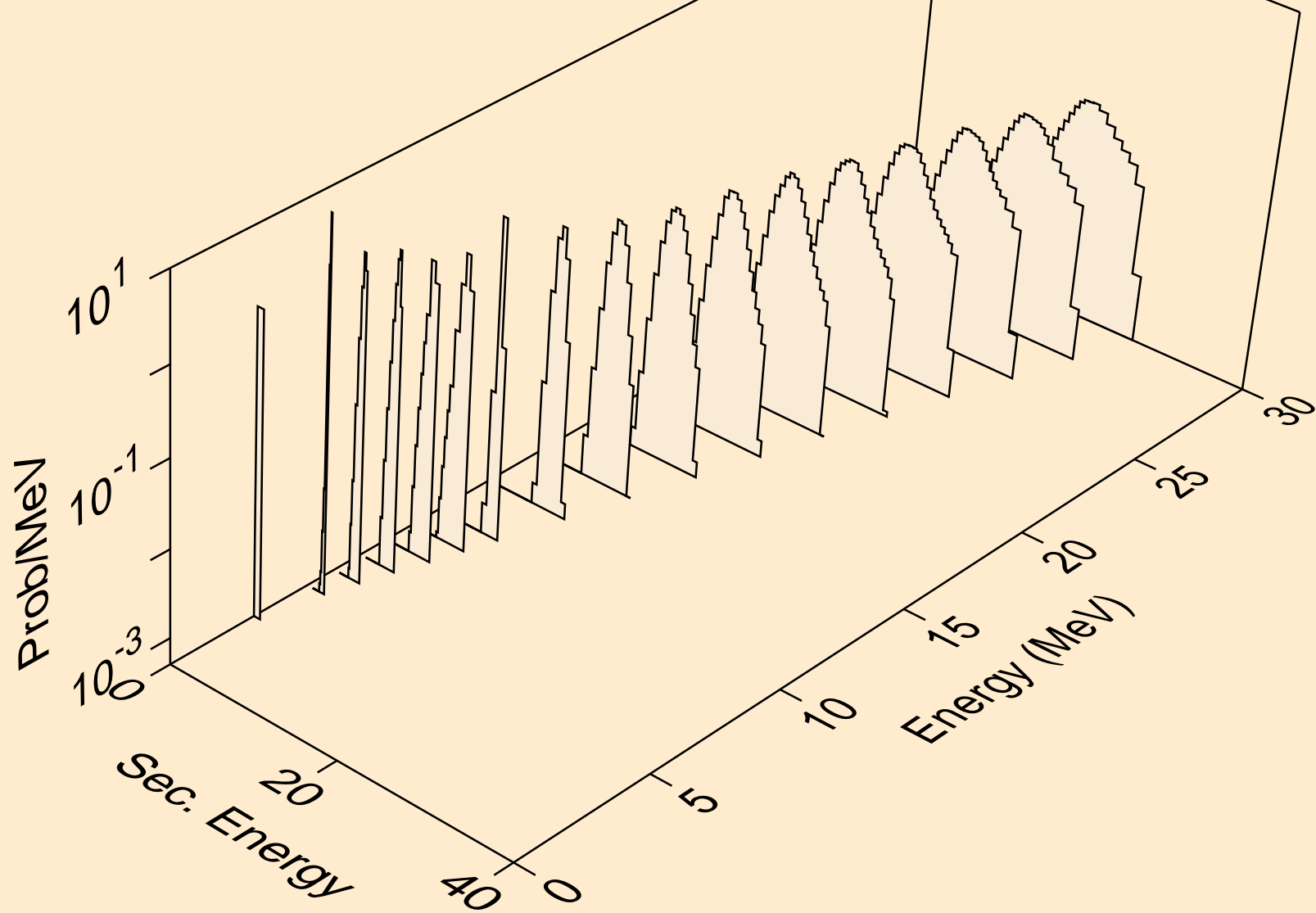

HO169 TRITON ACER TENDL-2021 LIBRARY; T=0.K  
protons from (t,2np)

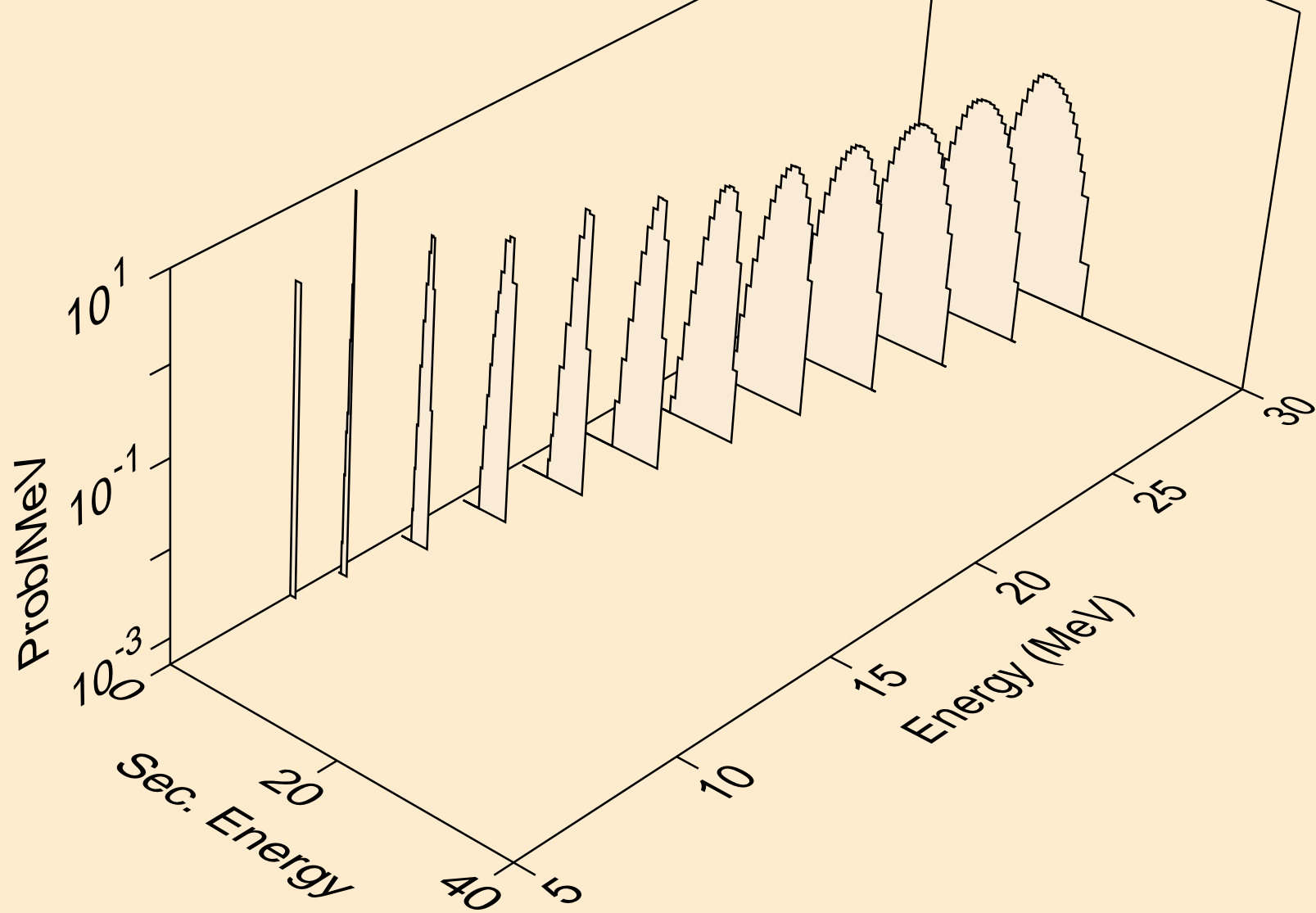

HO169 TRITON ACER TENDL-2021 LIBRARY; T=0.K  
protons from (t,3np)

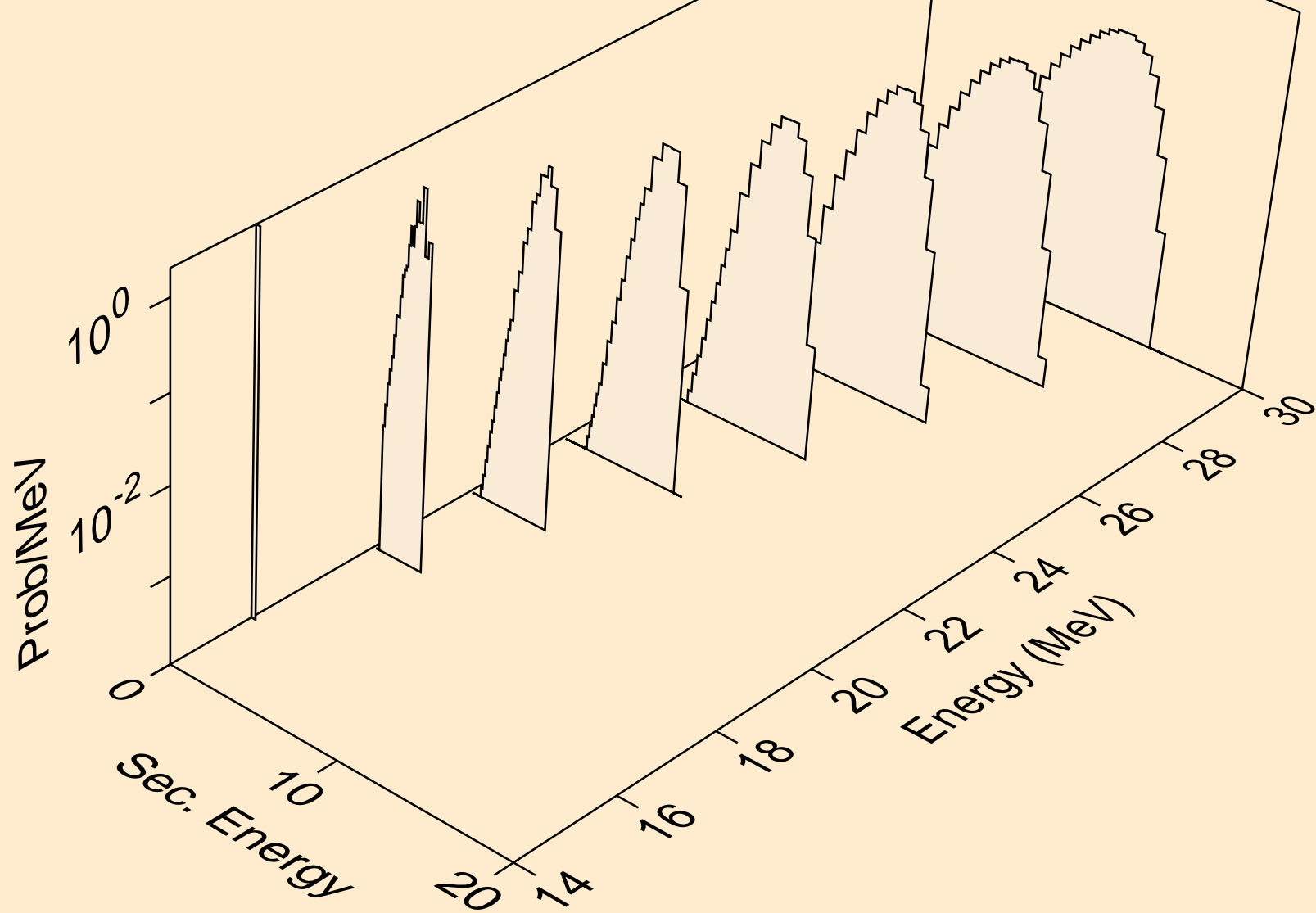

HO169 TRITON ACER TENDL-2021 LIBRARY; T=0.K  
protons from (t,2np)

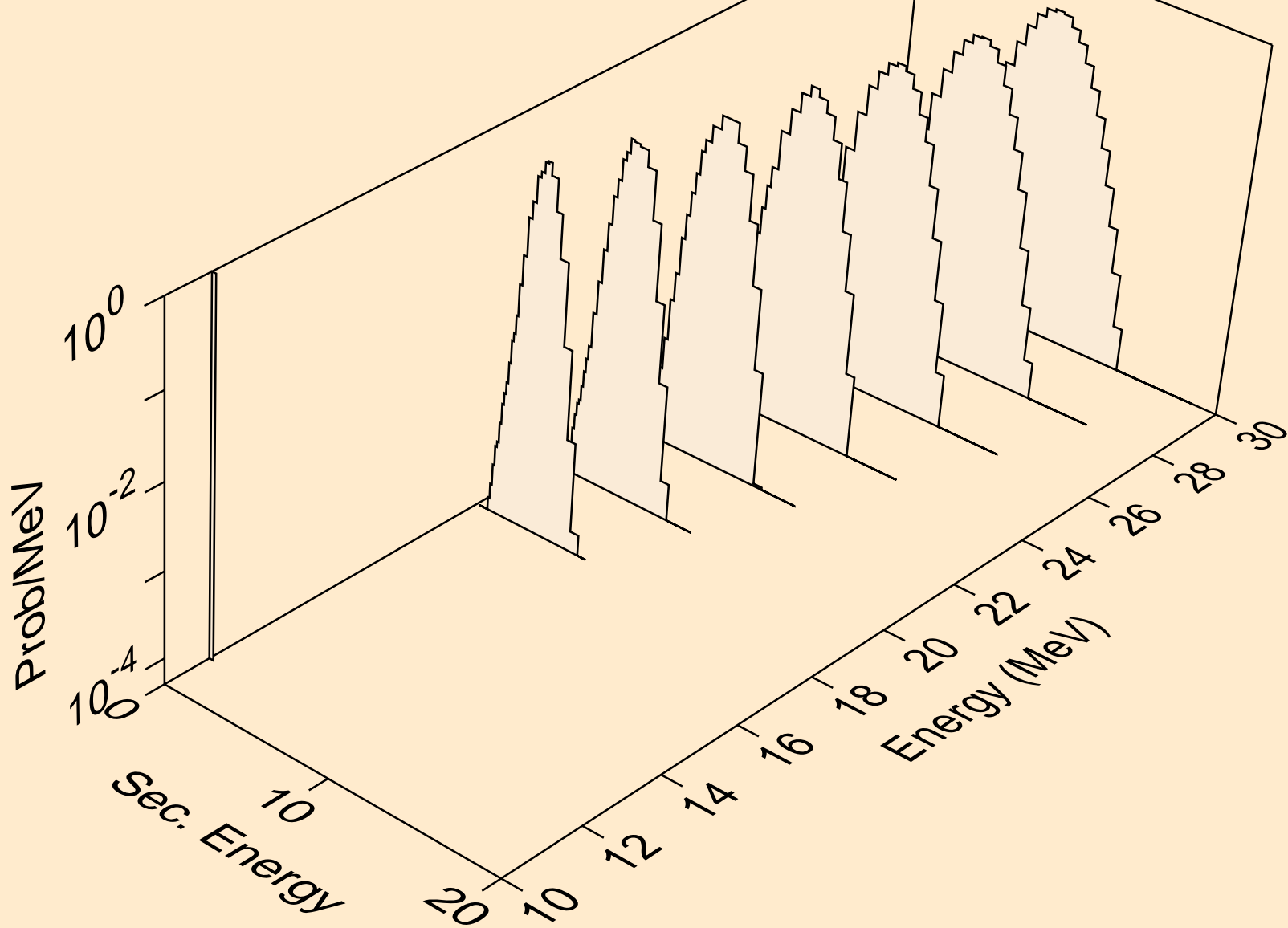

HO169 TRITON ACER TENDL-2021 LIBRARY; T=0.K  
protons from (t,npa)

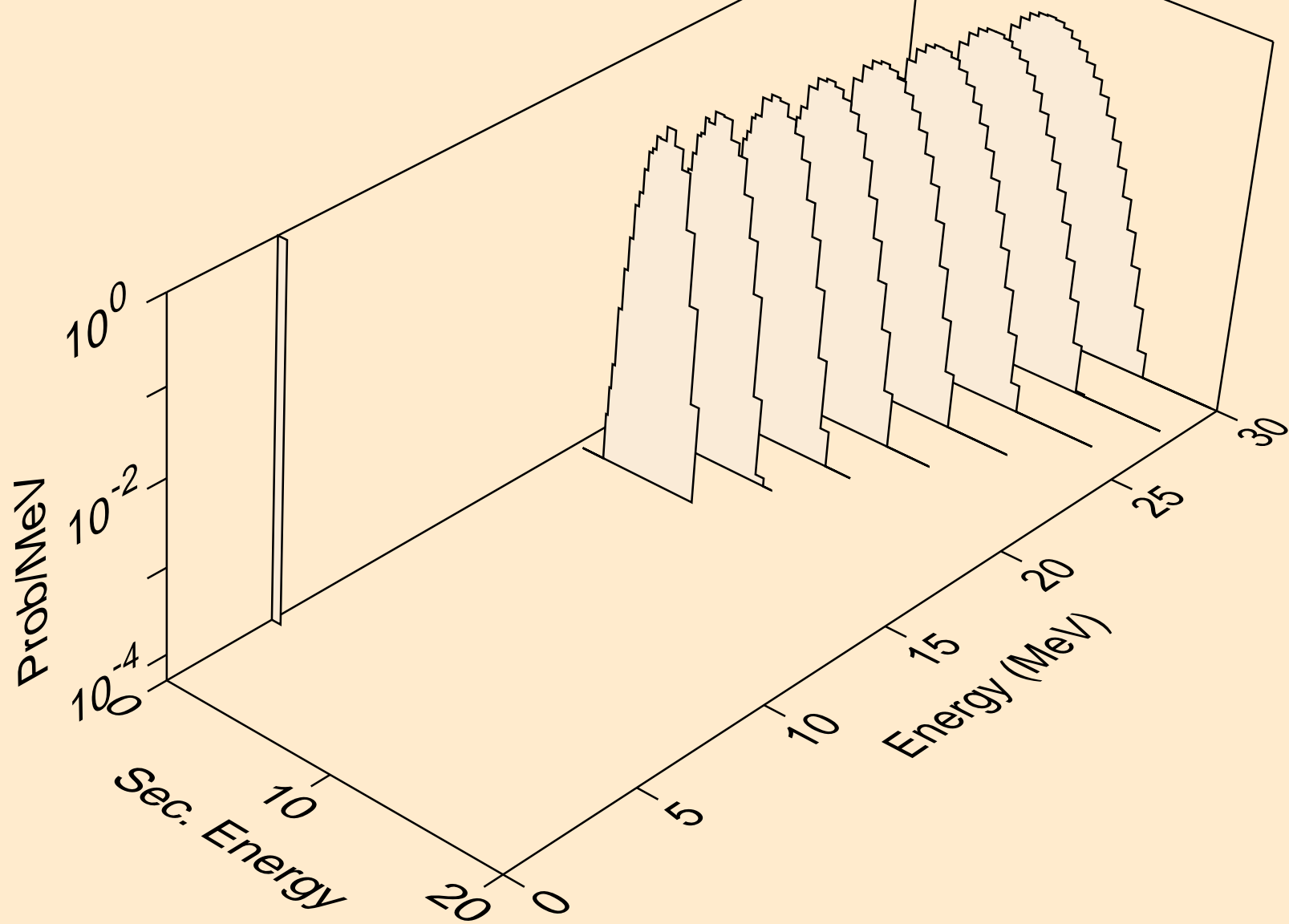

HO169 TRITON ACER TENDL-2021 LIBRARY; T=0.K  
protons from (t,p)

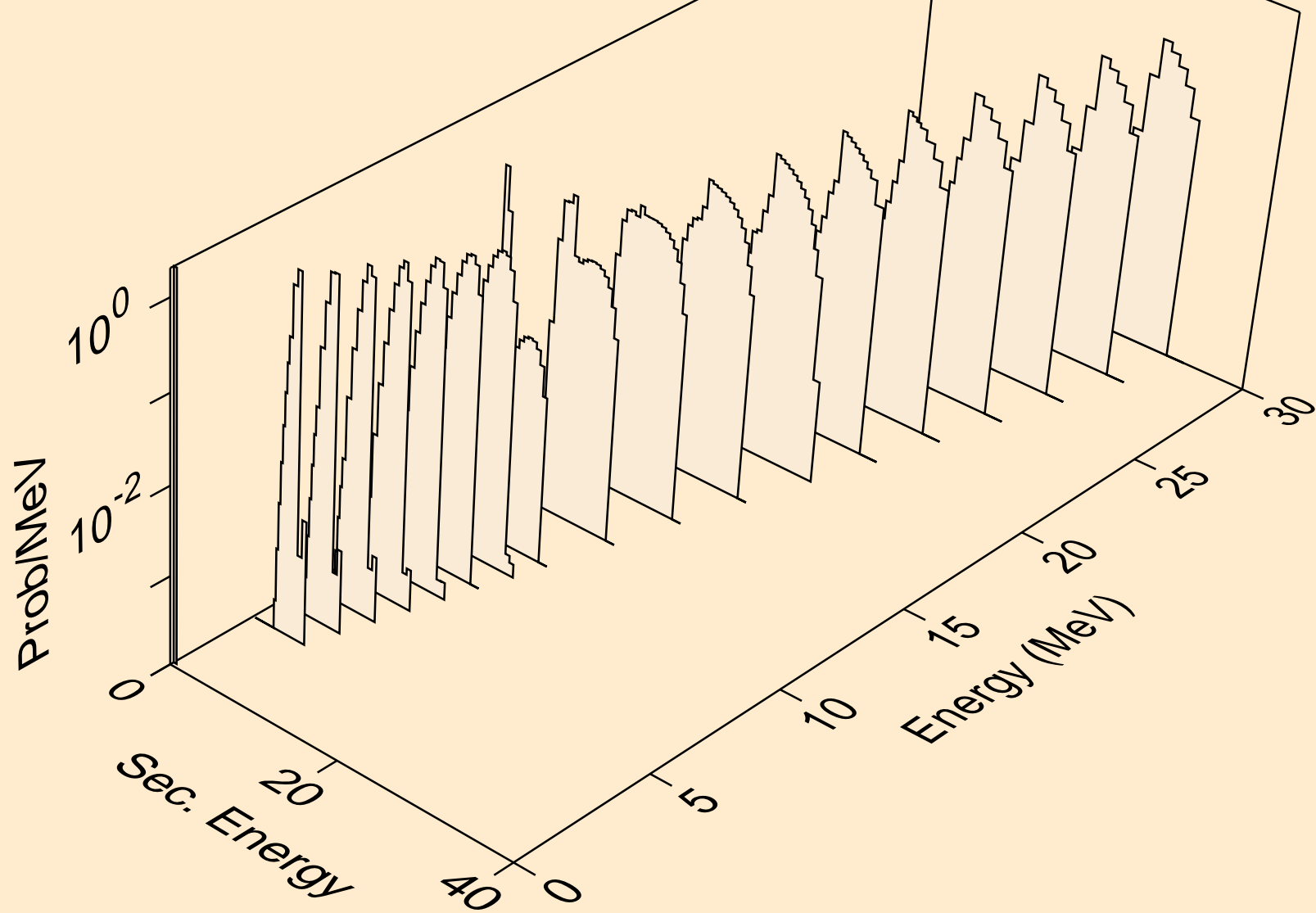

HO169 TRITON ACER TENDL-2021 LIBRARY; T=0.K  
protons from (t,2p)

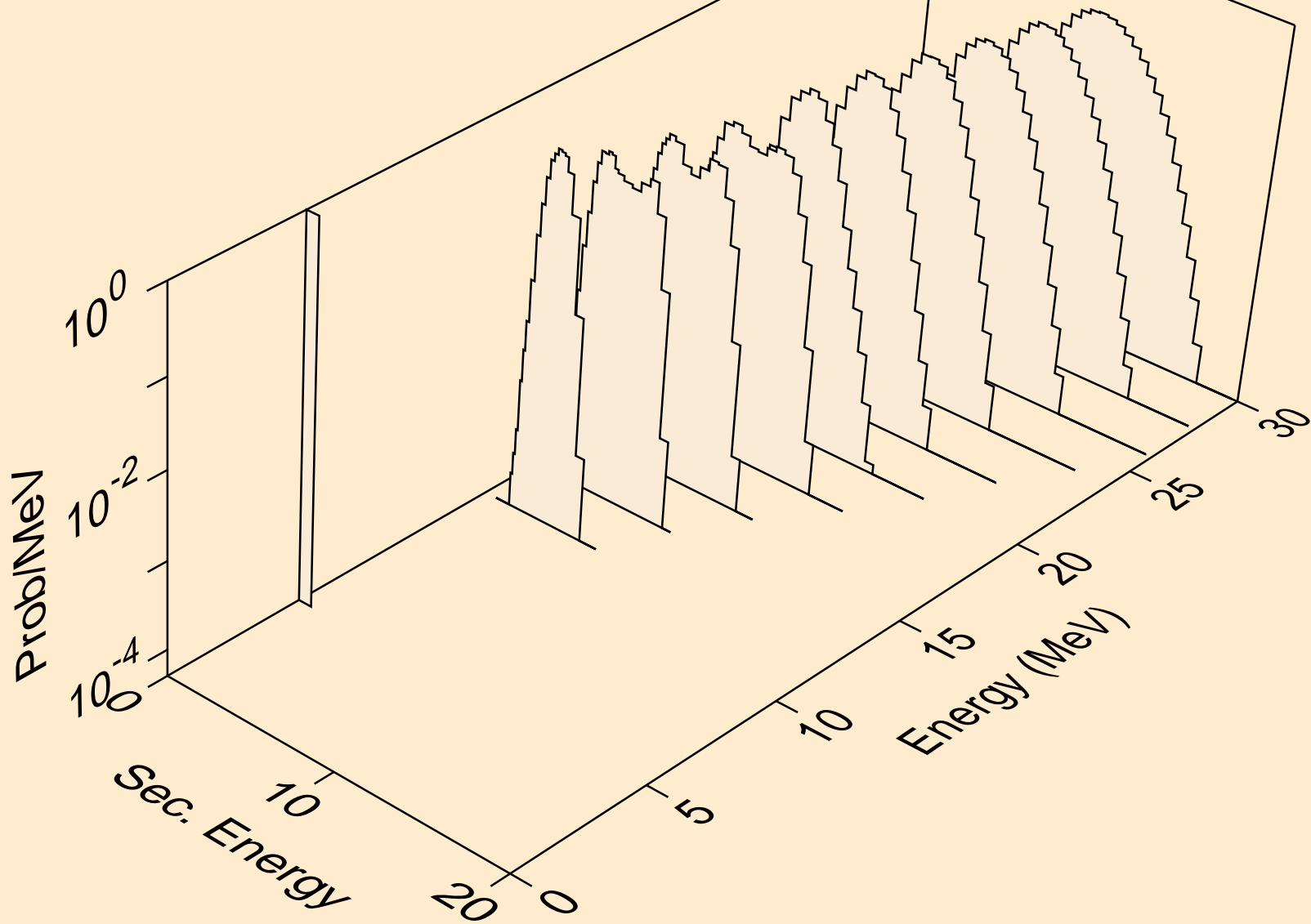

HO169 TRITON ACER TENDL-2021 LIBRARY; T=0.K  
protons from (t,pa)

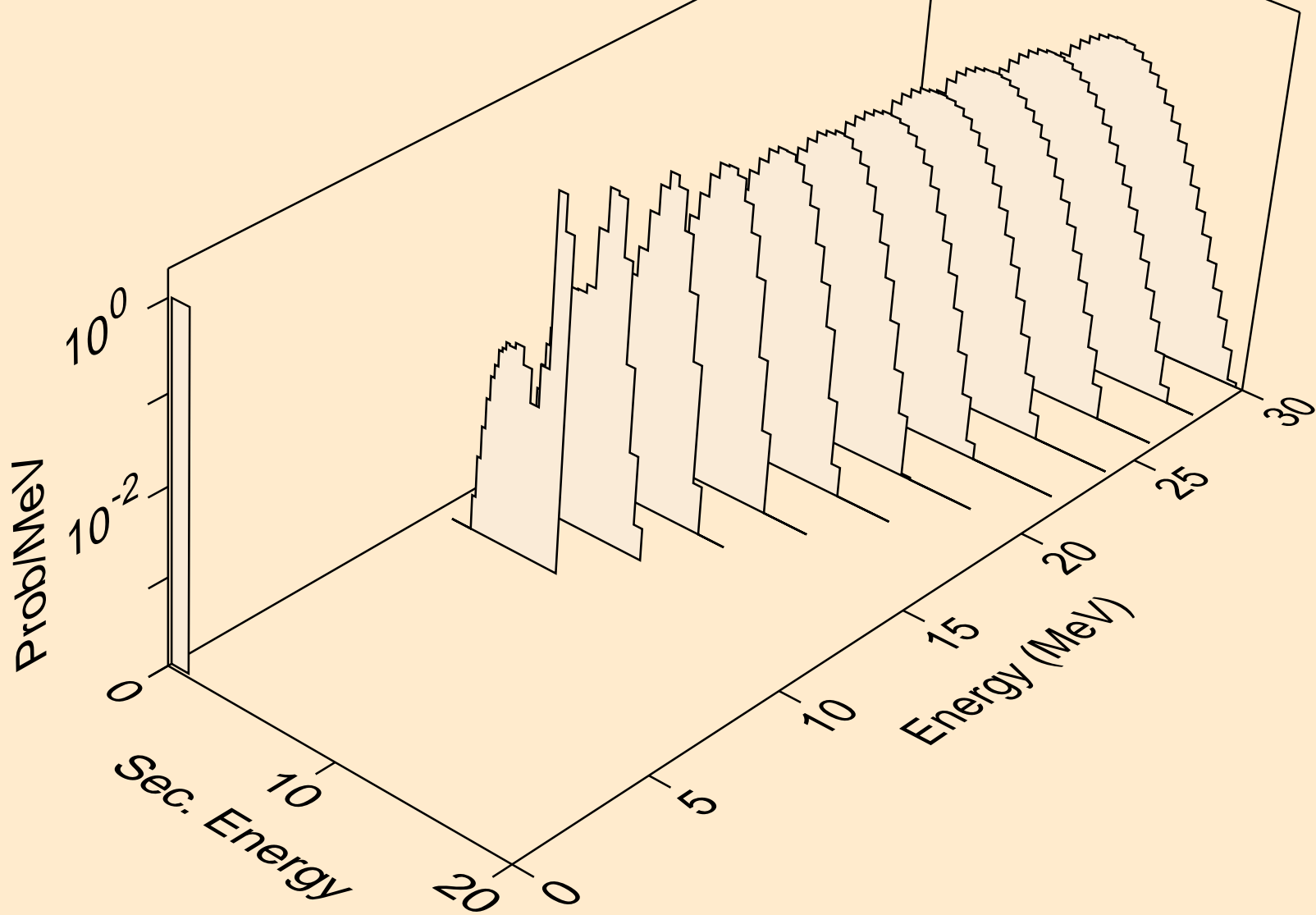

HO169 TRITON ACER TENDL-2021 LIBRARY; T=0.K  
protons from (t,pd)

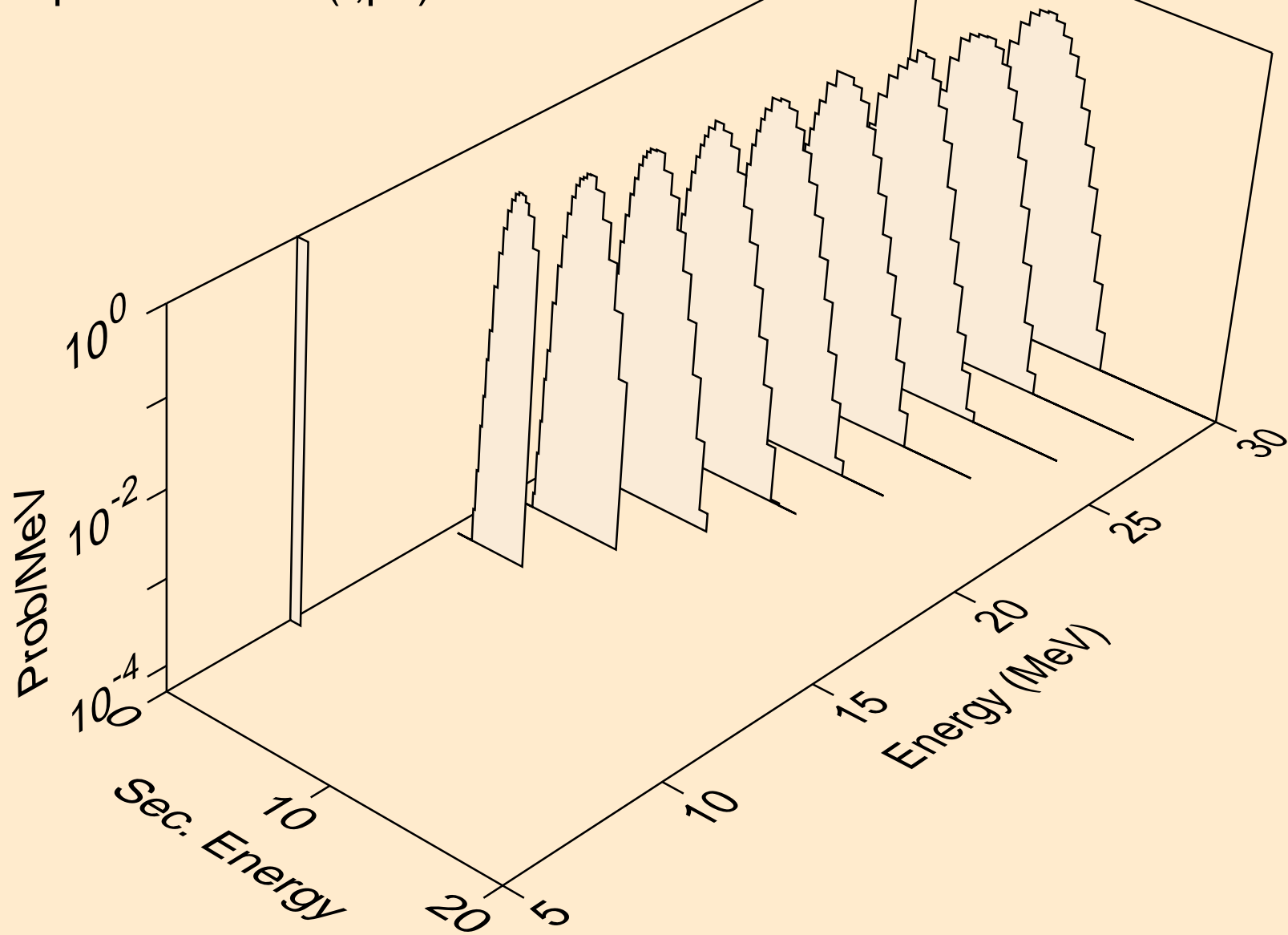

HO169 TRITON ACER TENDL-2021 LIBRARY; T=0.K  
protons from (t,pt)

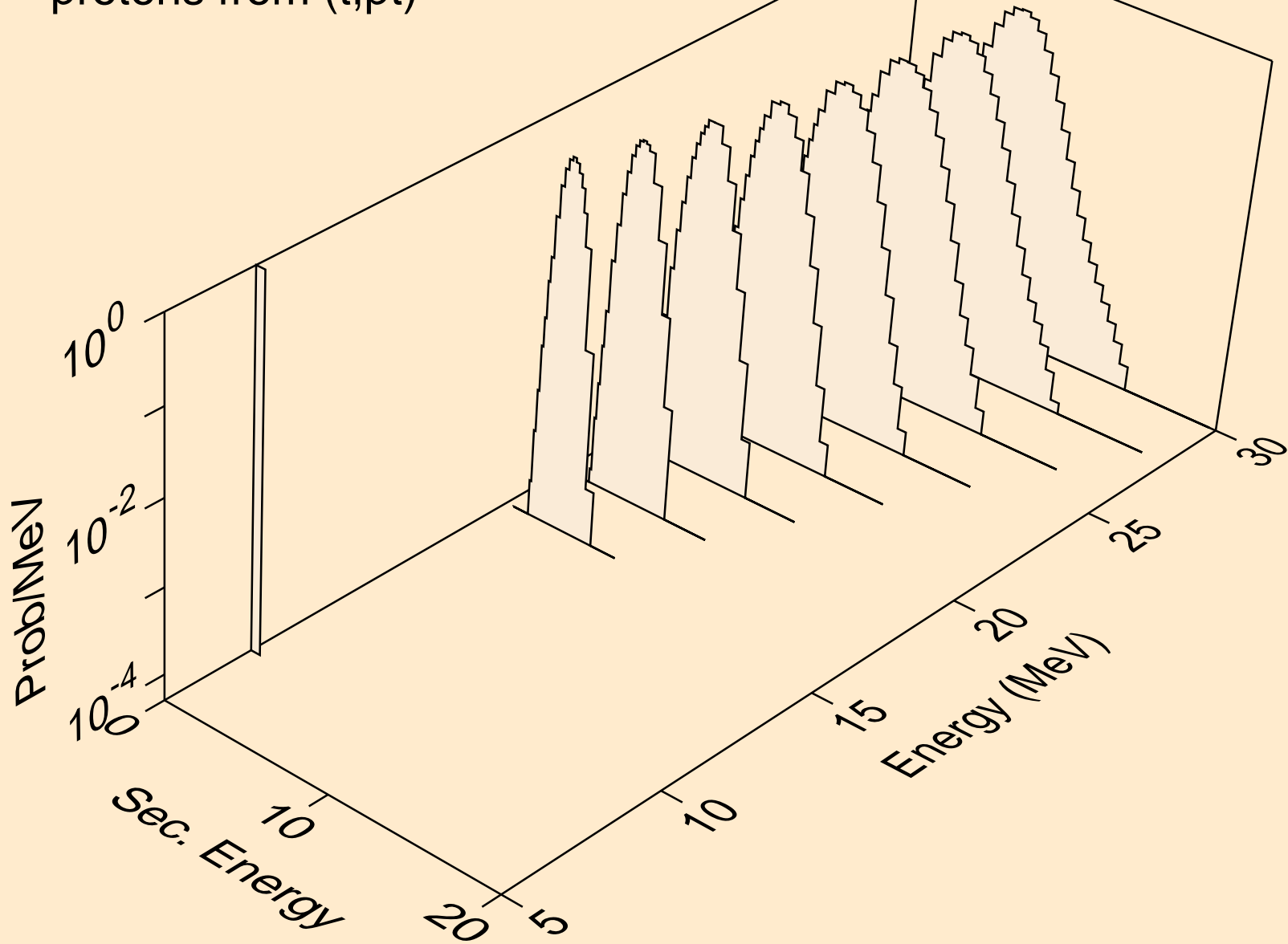

HO169 TRITON ACER TENDL-2021 LIBRARY; T=0.K  
deuterons from (t,x)

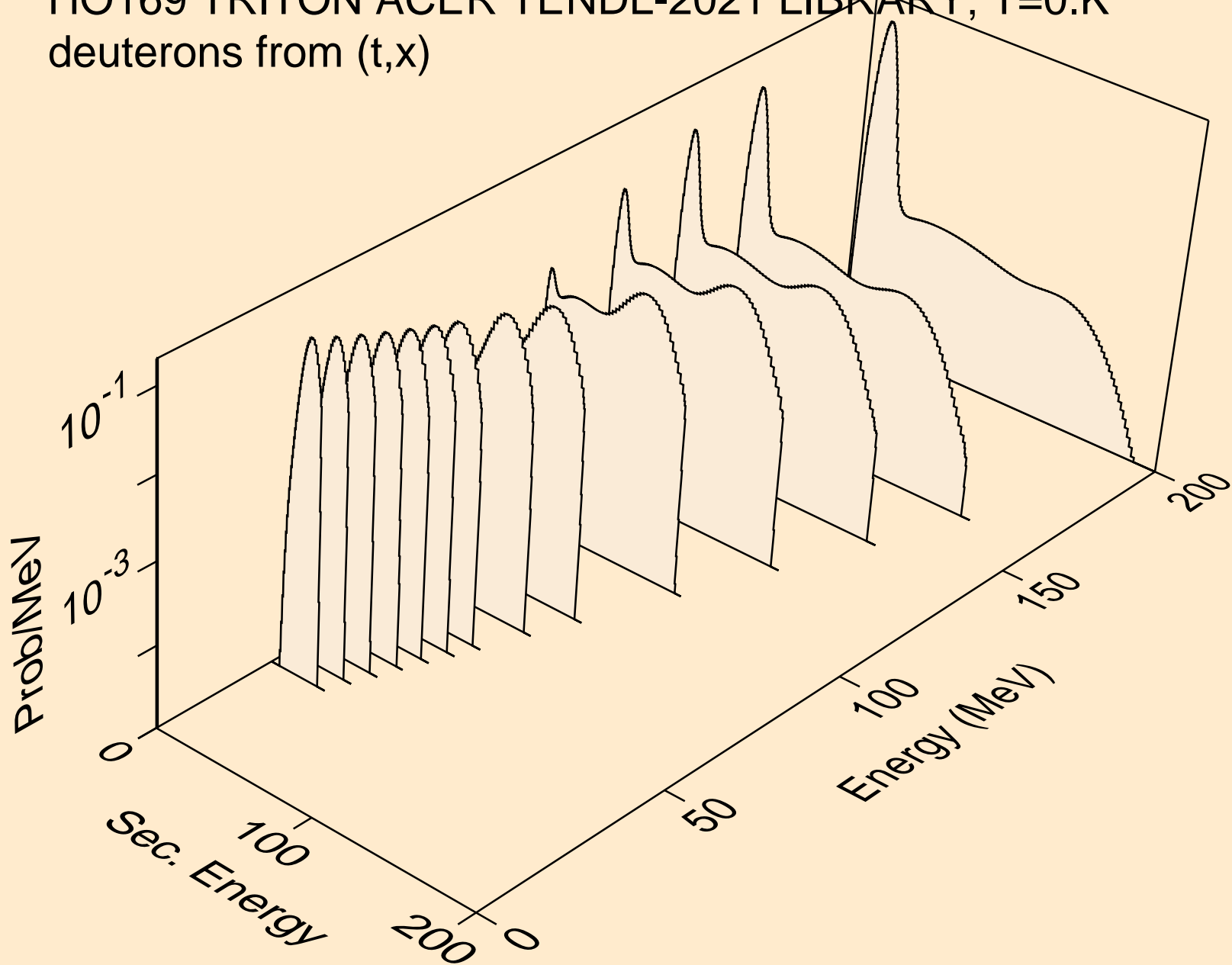

HO169 TRITON ACER TENDL-2021 LIBRARY; T=0.K  
deuterons from (t,2nd)

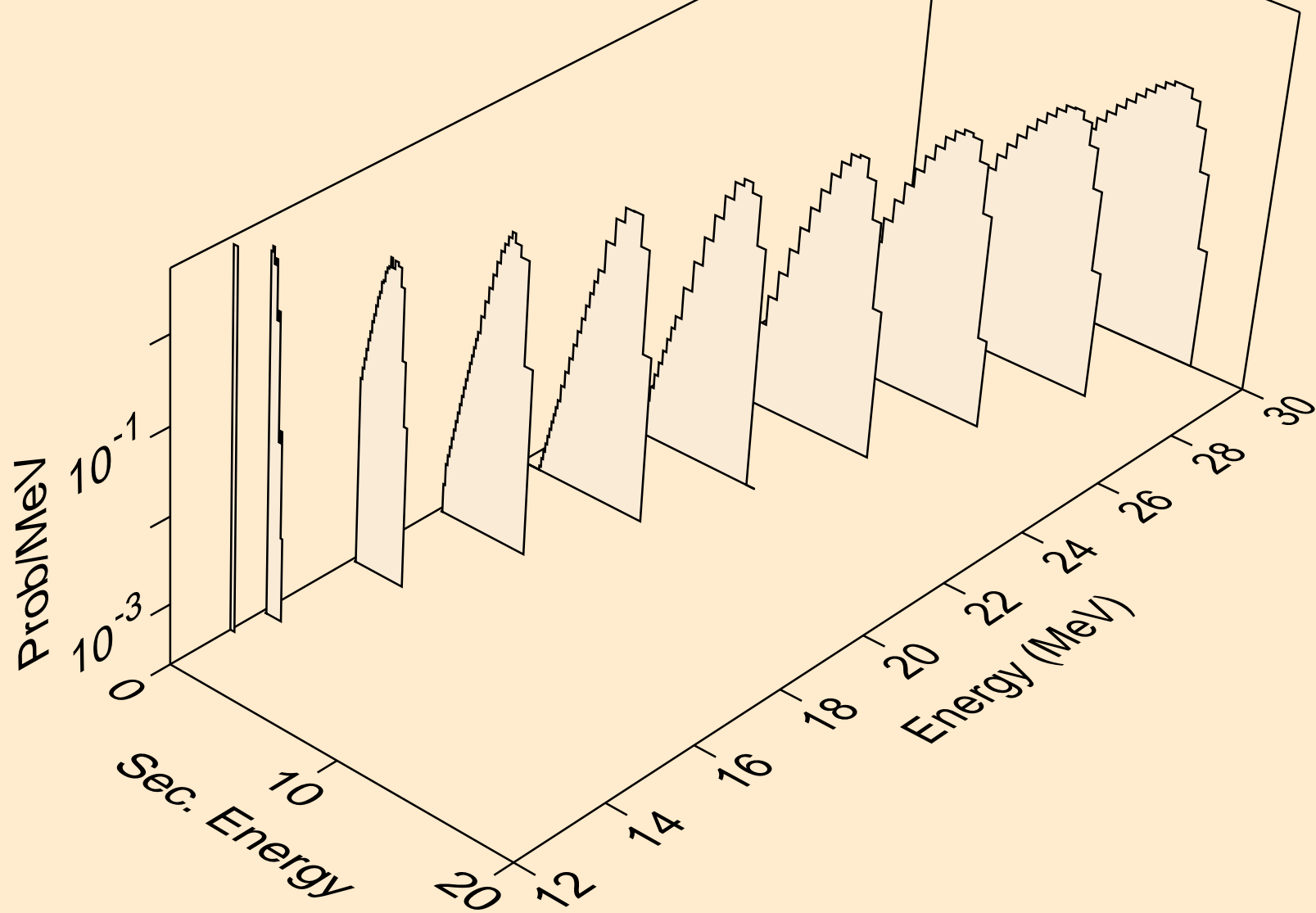

HO169 TRITON ACER TENDL-2021 LIBRARY; T=0.K  
deuterons from (t,n\*)d

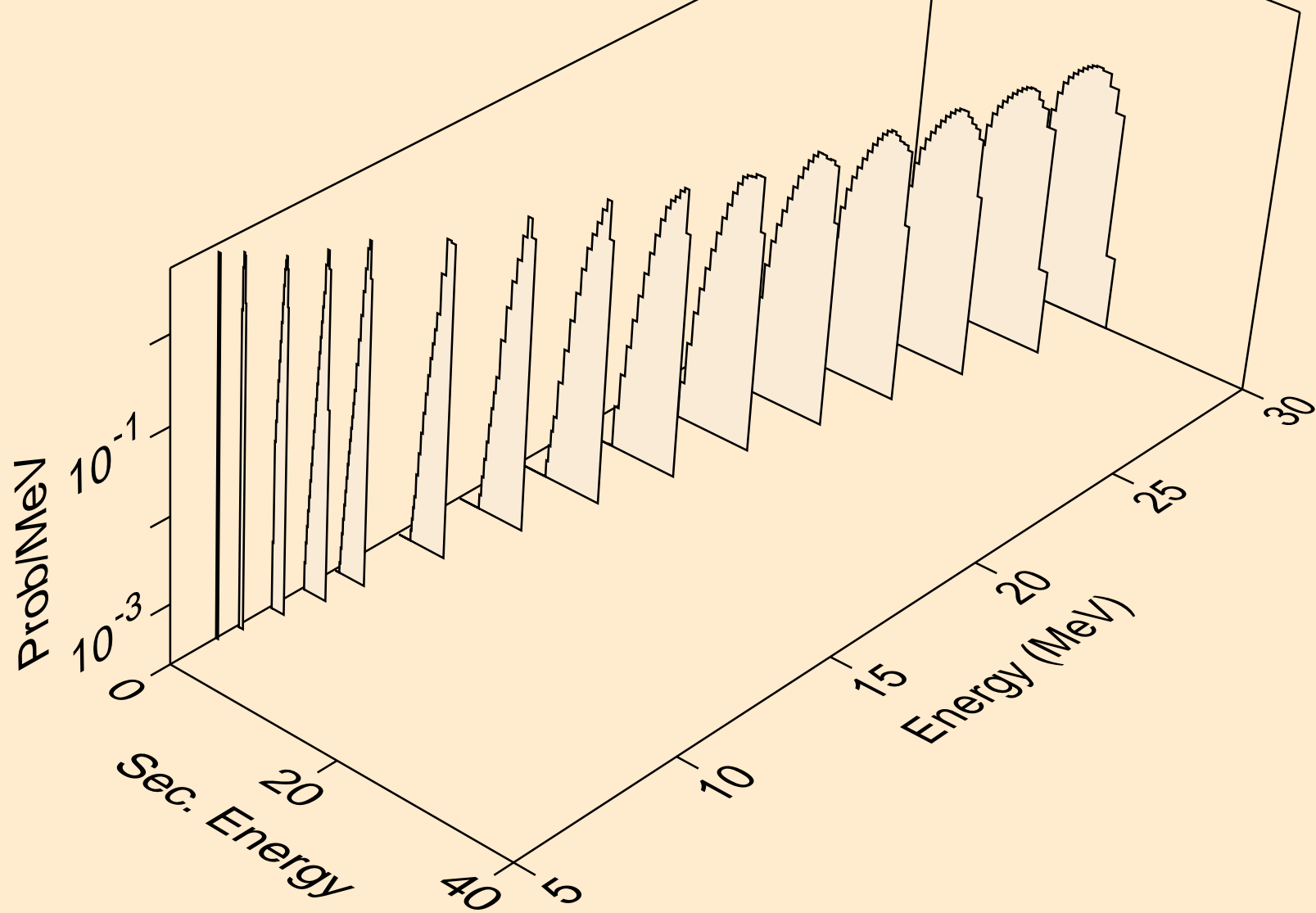

HO169 TRITON ACER TENDL-2021 LIBRARY; T=0.K  
deuterons from (t,d)

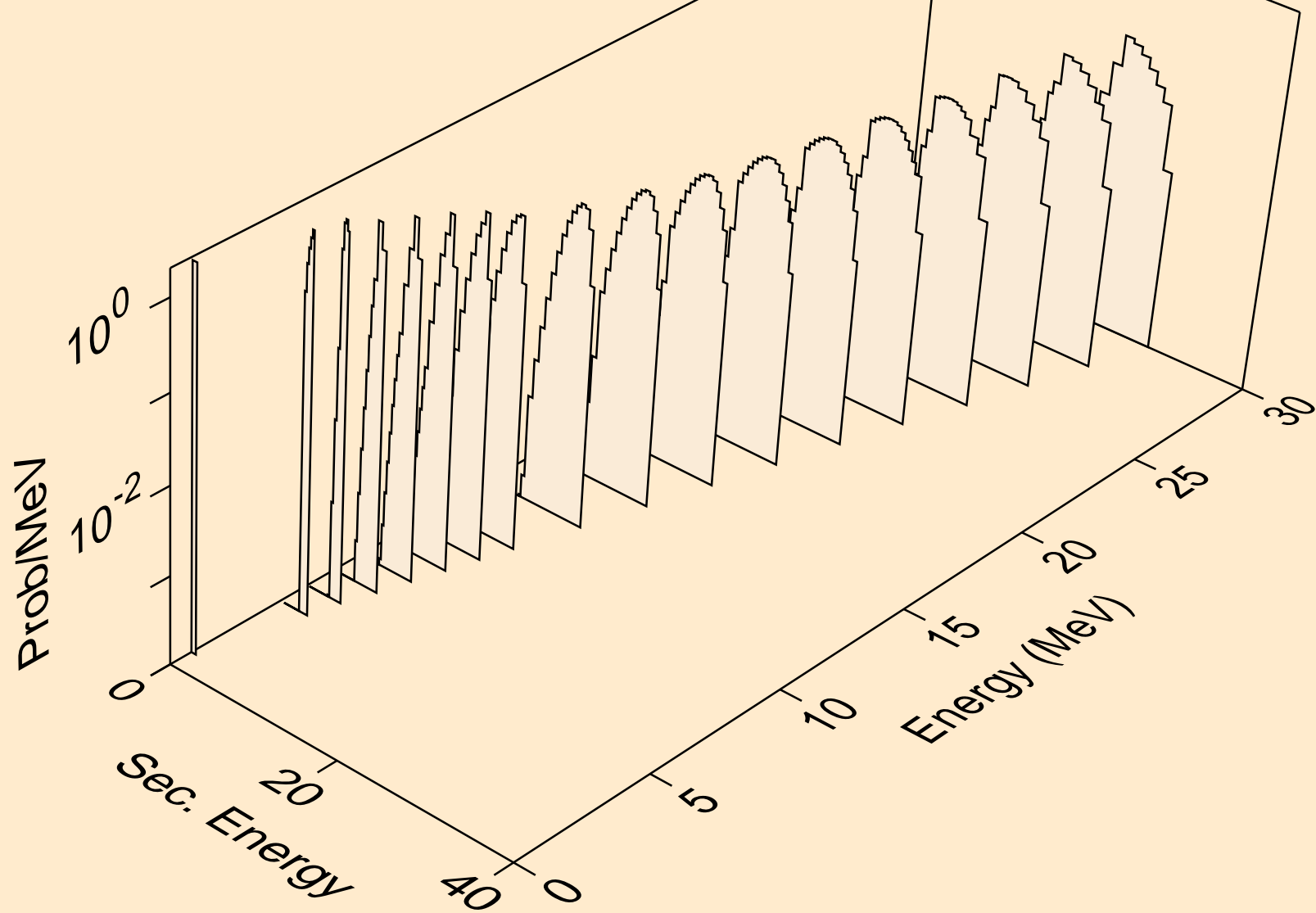

HO169 TRITON ACER TENDL-2021 LIBRARY; T=0.K  
deuterons from (t,pd)

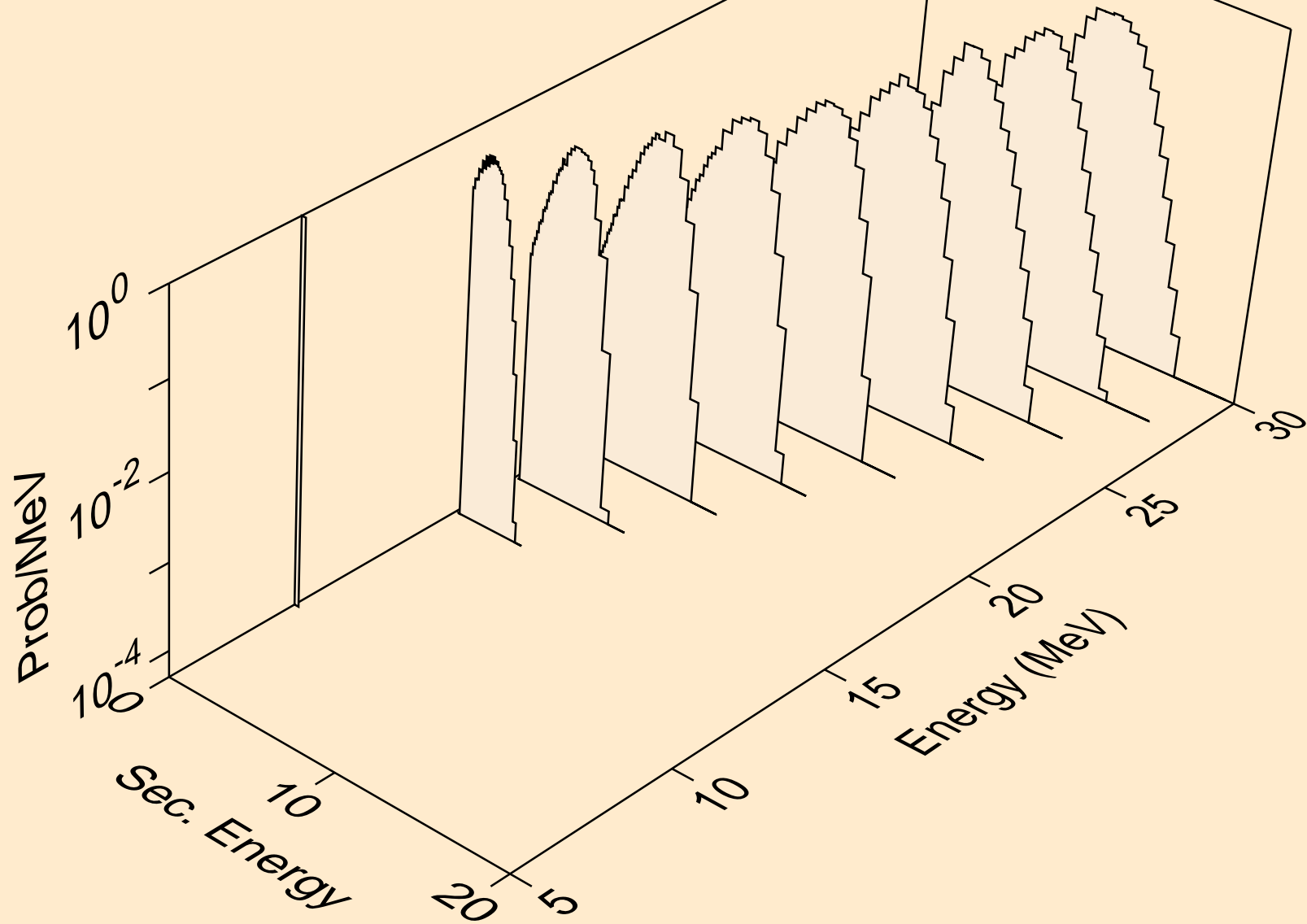

HO169 TRITON ACER TENDL-2021 LIBRARY; T=0.K  
he3s from (t,x)

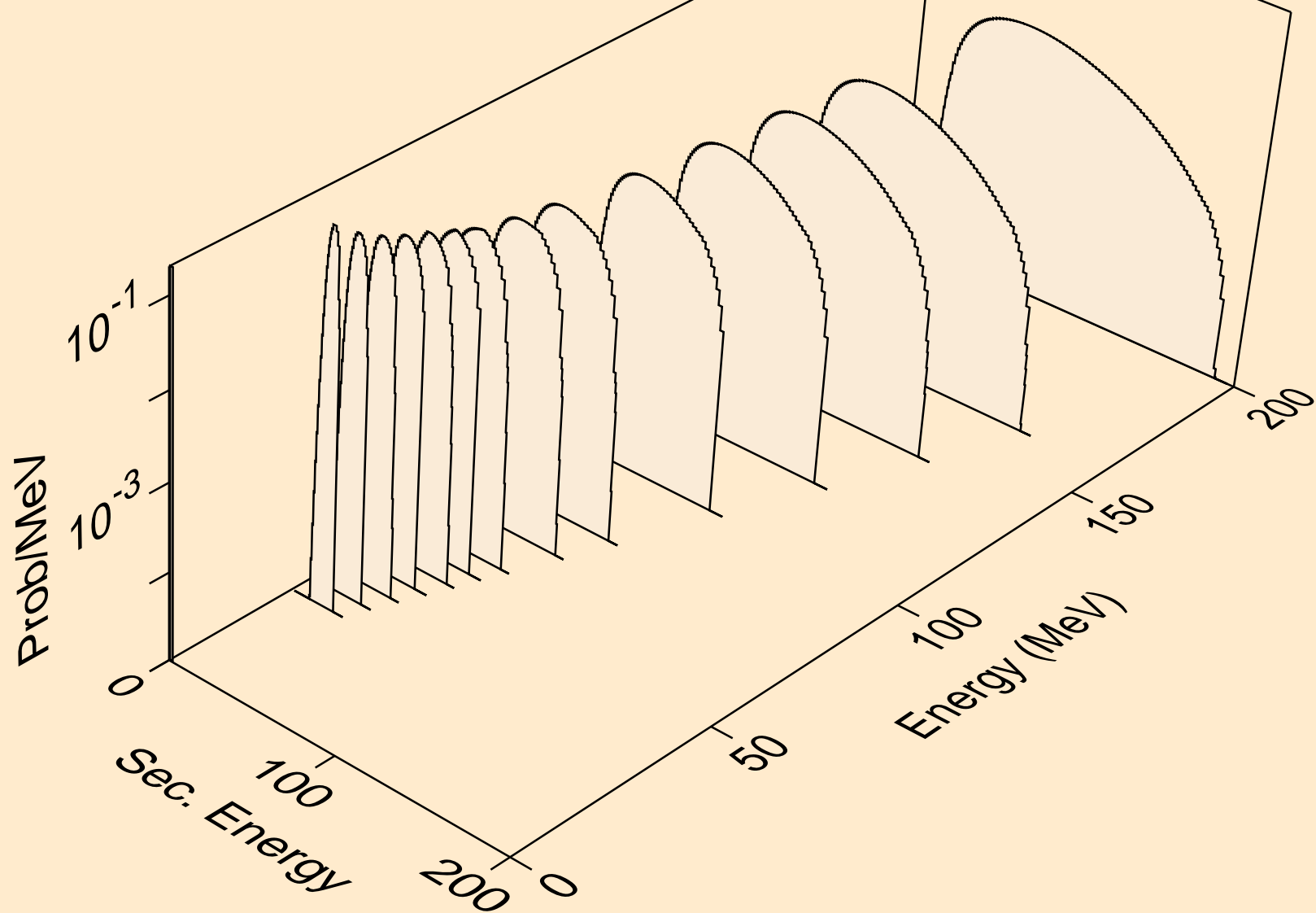

HO169 TRITON ACER TENDL-2021 LIBRARY; T=0.K  
he3s from (t,n\*)he3

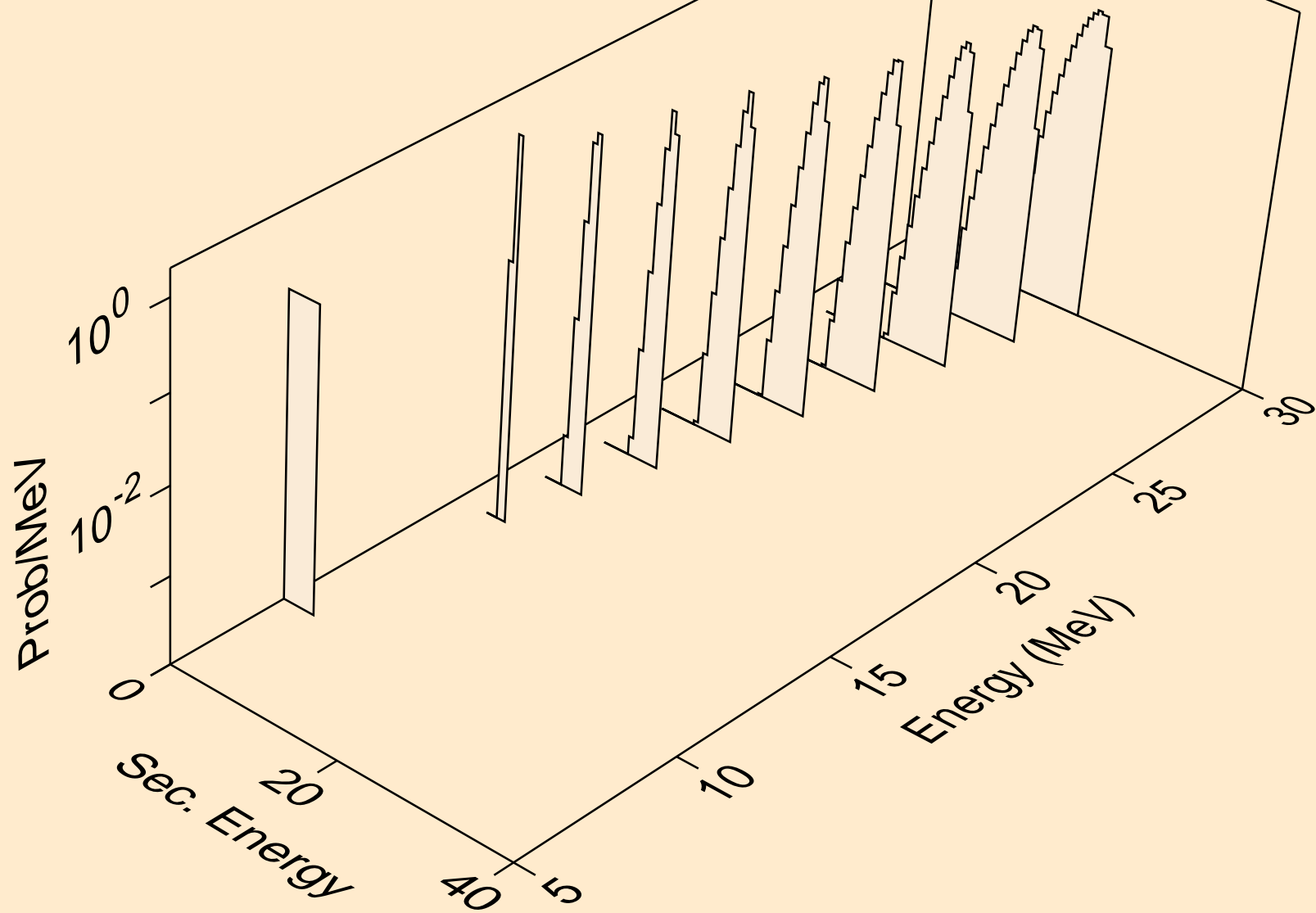

HO169 TRITON ACER TENDL-2021 LIBRARY; T=0.K  
he3s from (t,he3)

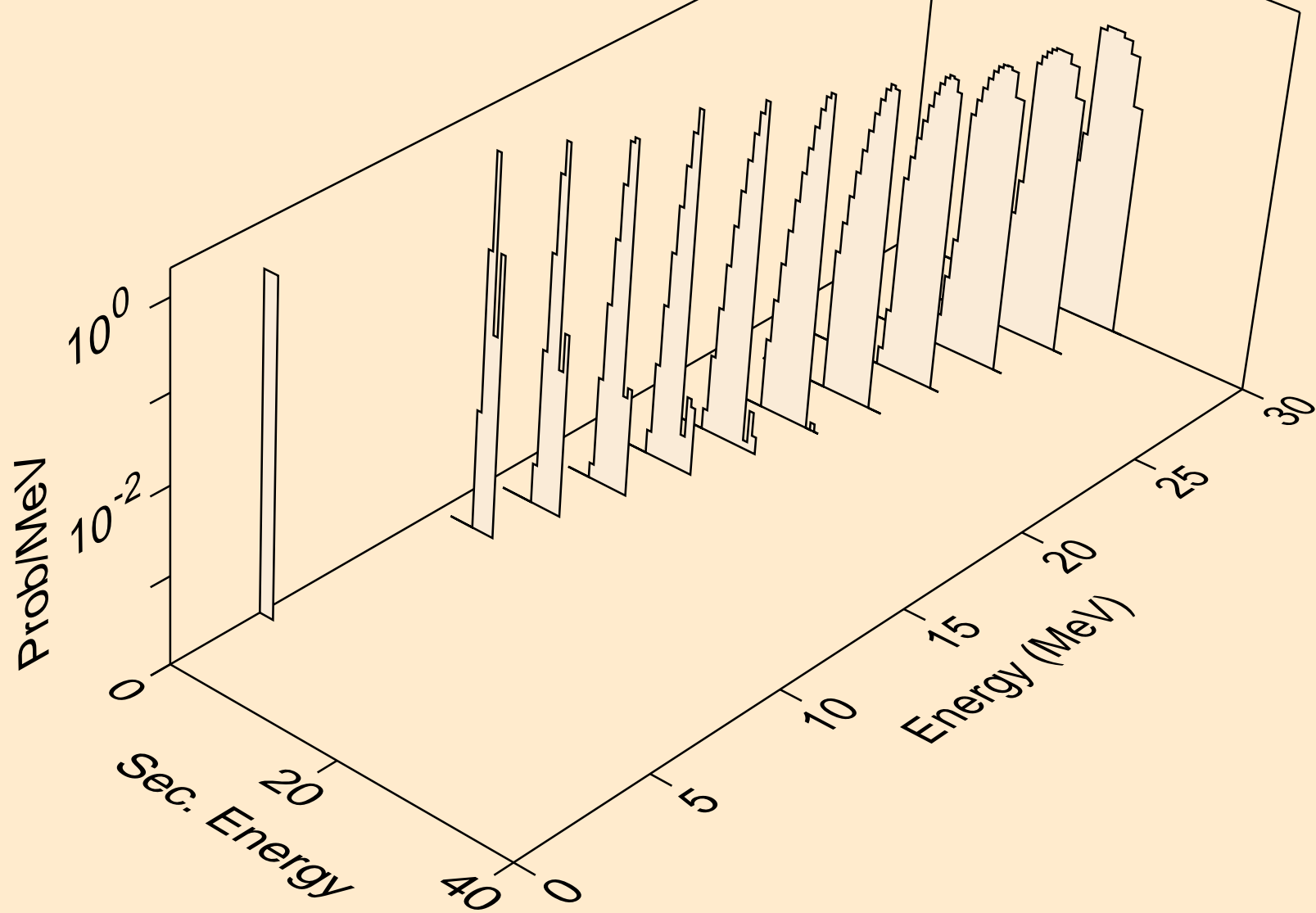

HO169 TRITON ACER TENDL-2021 LIBRARY; T=0.K  
alphas from (t,x)

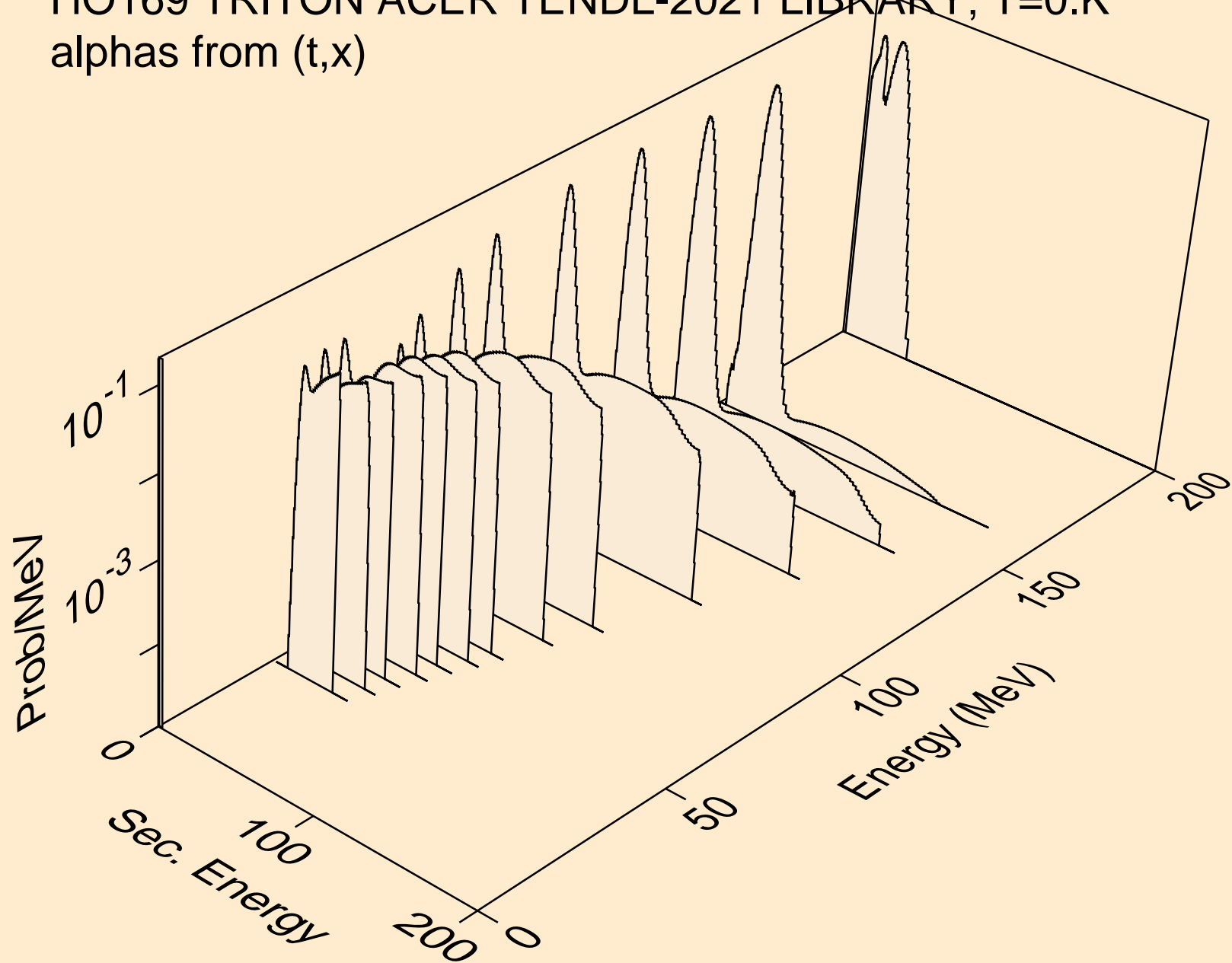

HO169 TRITON ACER TENDL-2021 LIBRARY; T=0.K  
alphas from (t,n\*)a

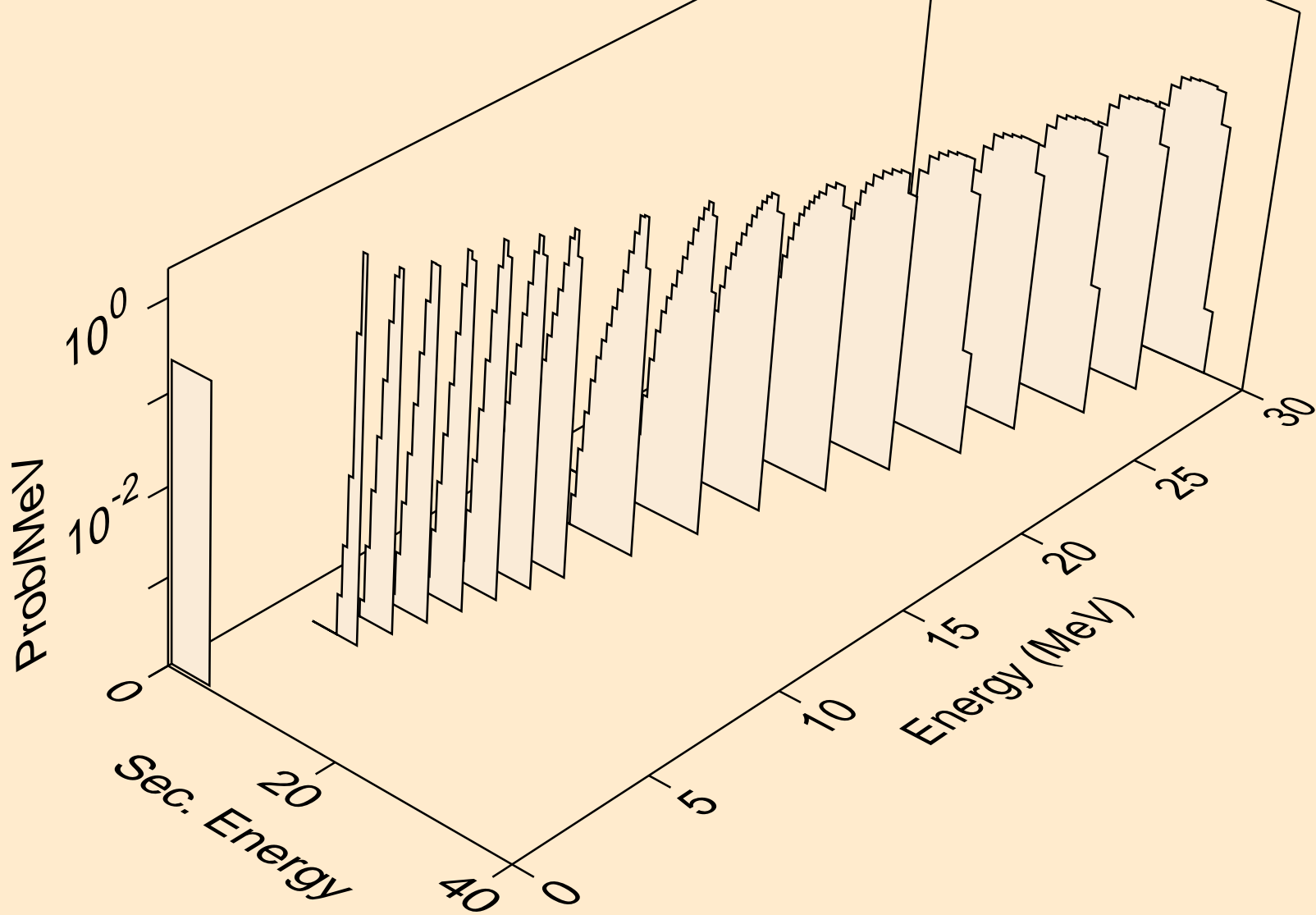

HO169 TRITON ACER TENDL-2021 LIBRARY; T=0.K  
alphas from (t,2n)a

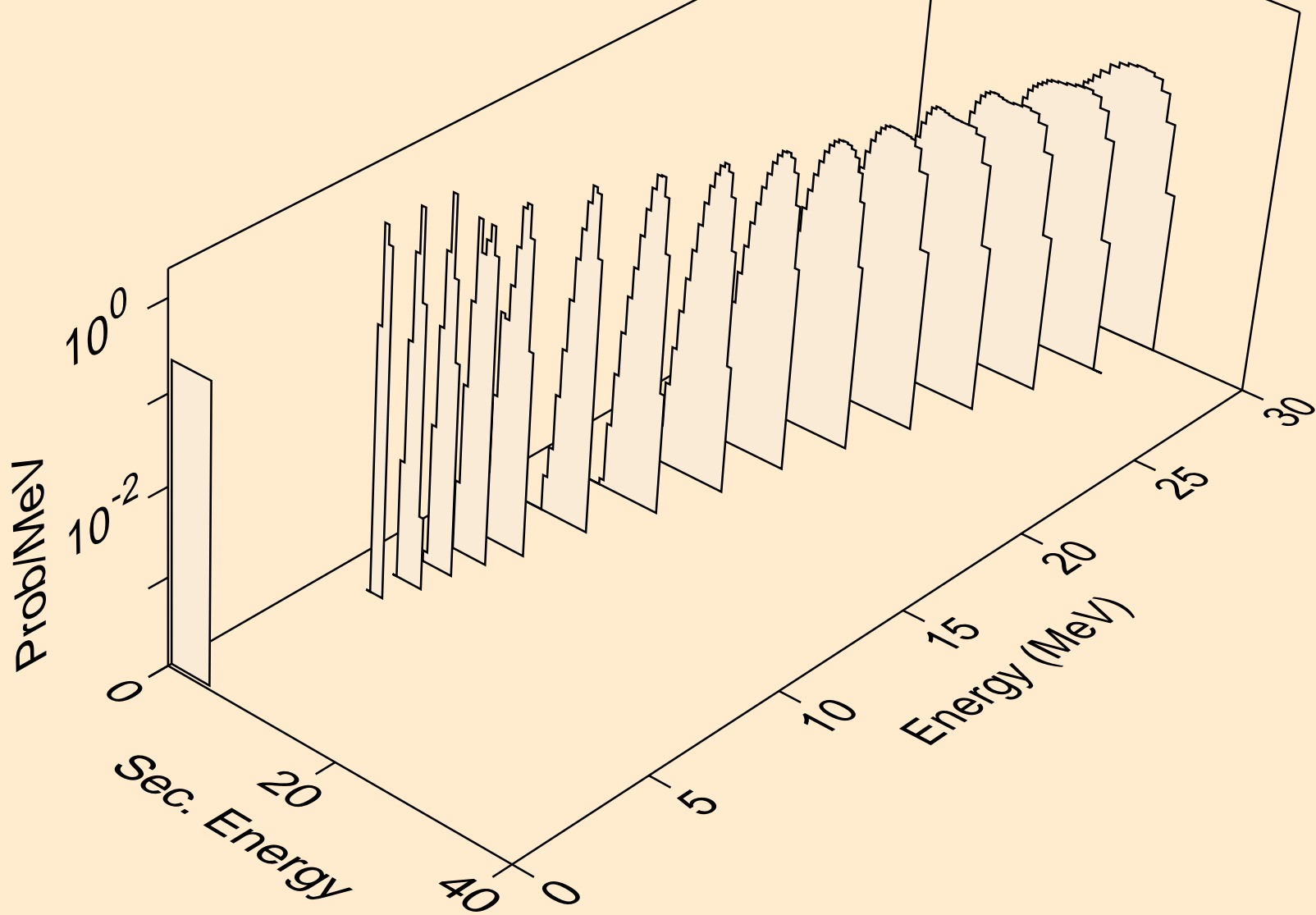

HO169 TRITON ACER TENDL-2021 LIBRARY; T=0.K  
alphas from (t,3n)a

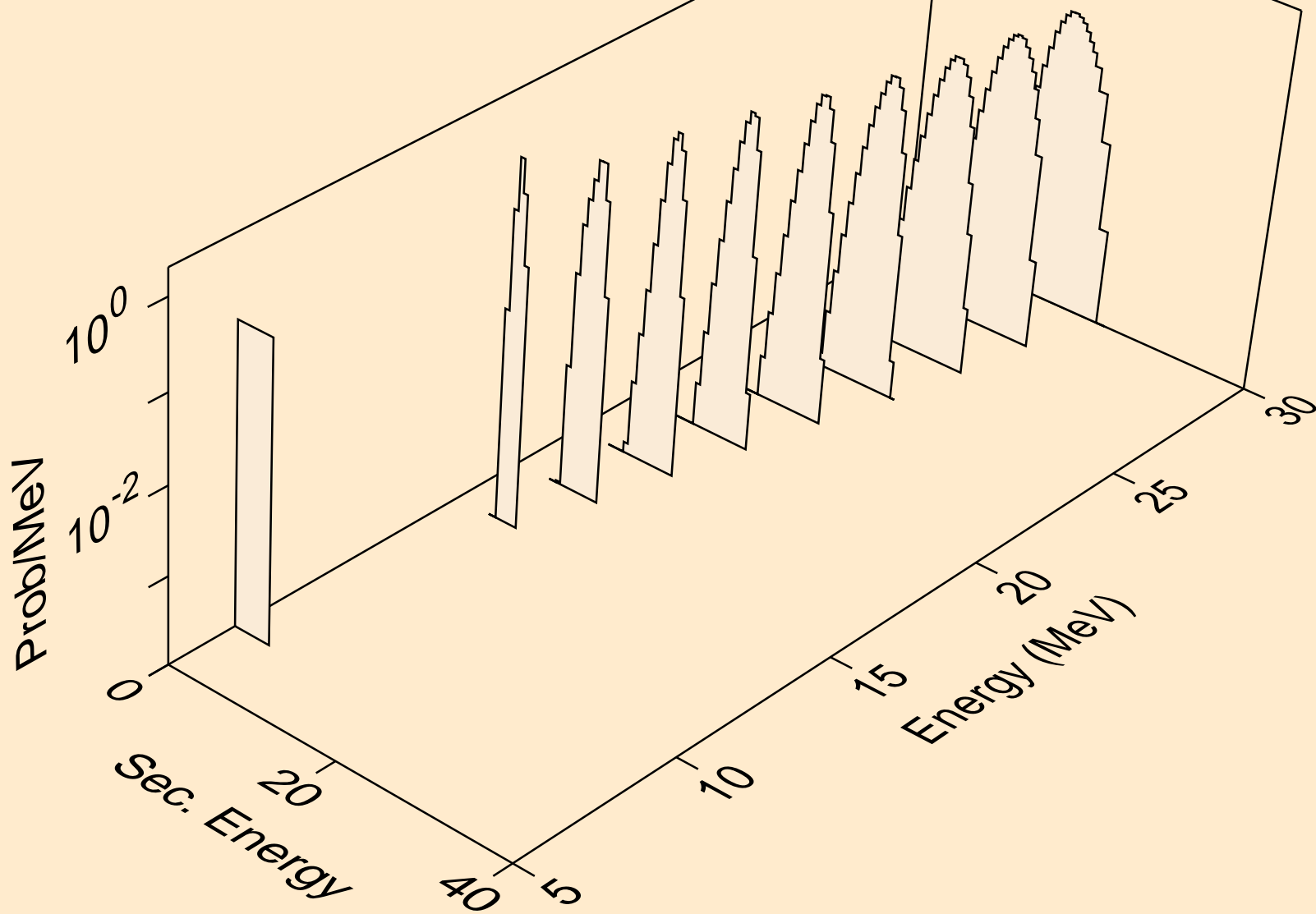

HO169 TRITON ACER TENDL-2021 LIBRARY; T=0.K  
alphas from (t,npa)

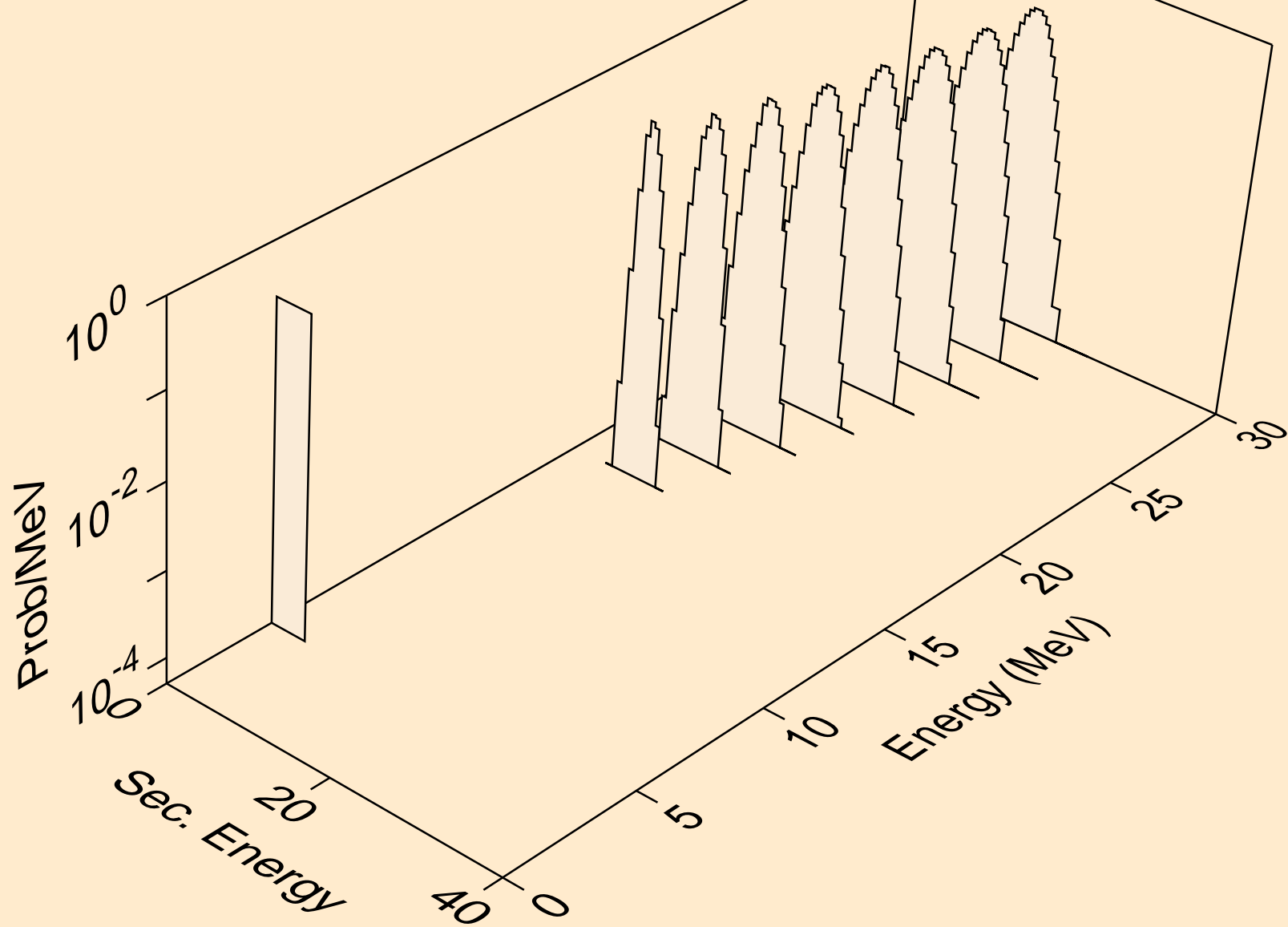

HO169 TRITON ACER TENDL-2021 LIBRARY; T=0.K  
alphas from (t,a)

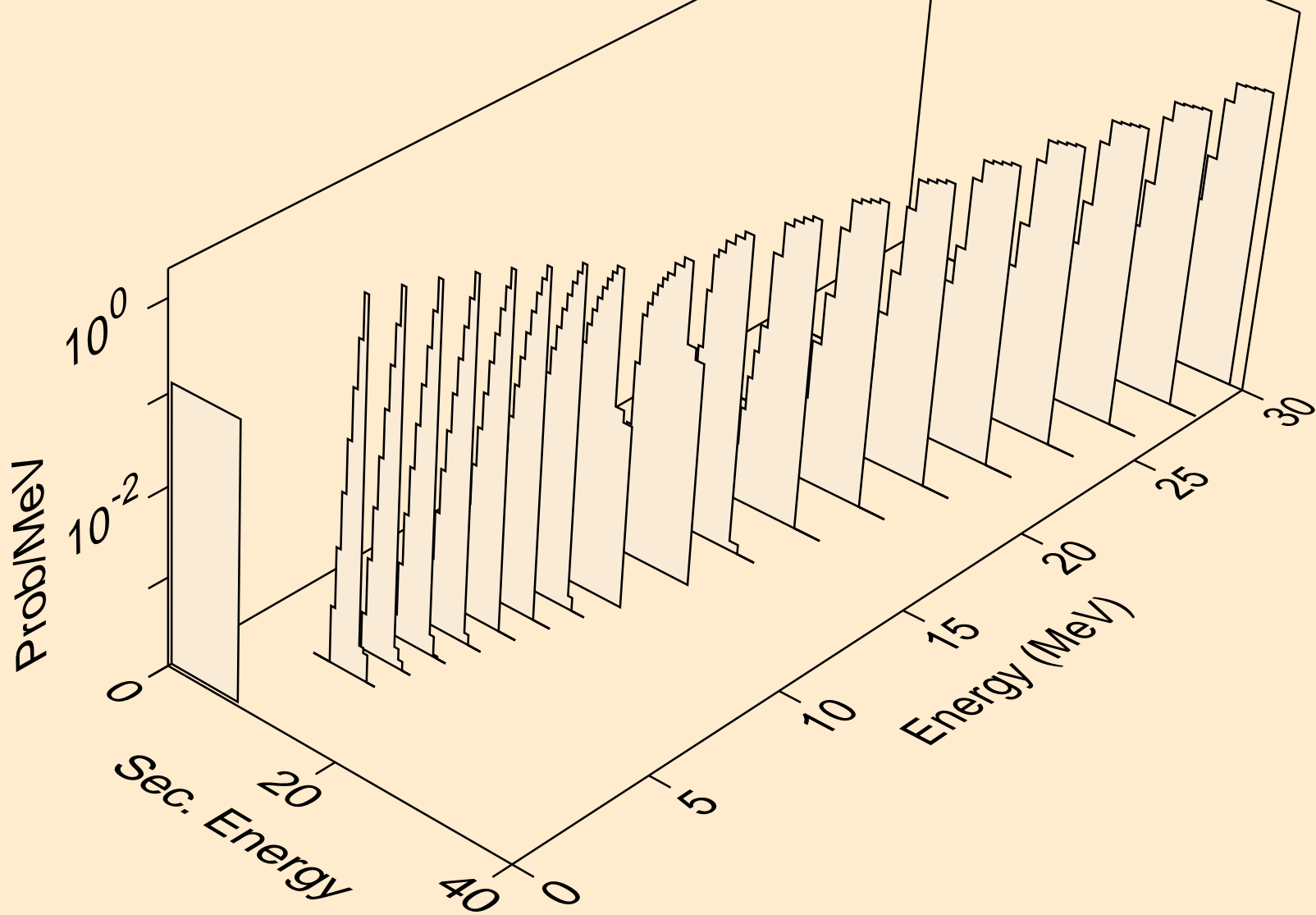

HO169 TRITON ACER TENDL-2021 LIBRARY; T=0.K  
alphas from (t,pa)

