

# ER151 ALPHA ACER TENDL-2023 LIBRARY; T=0.K

## Principal cross sections

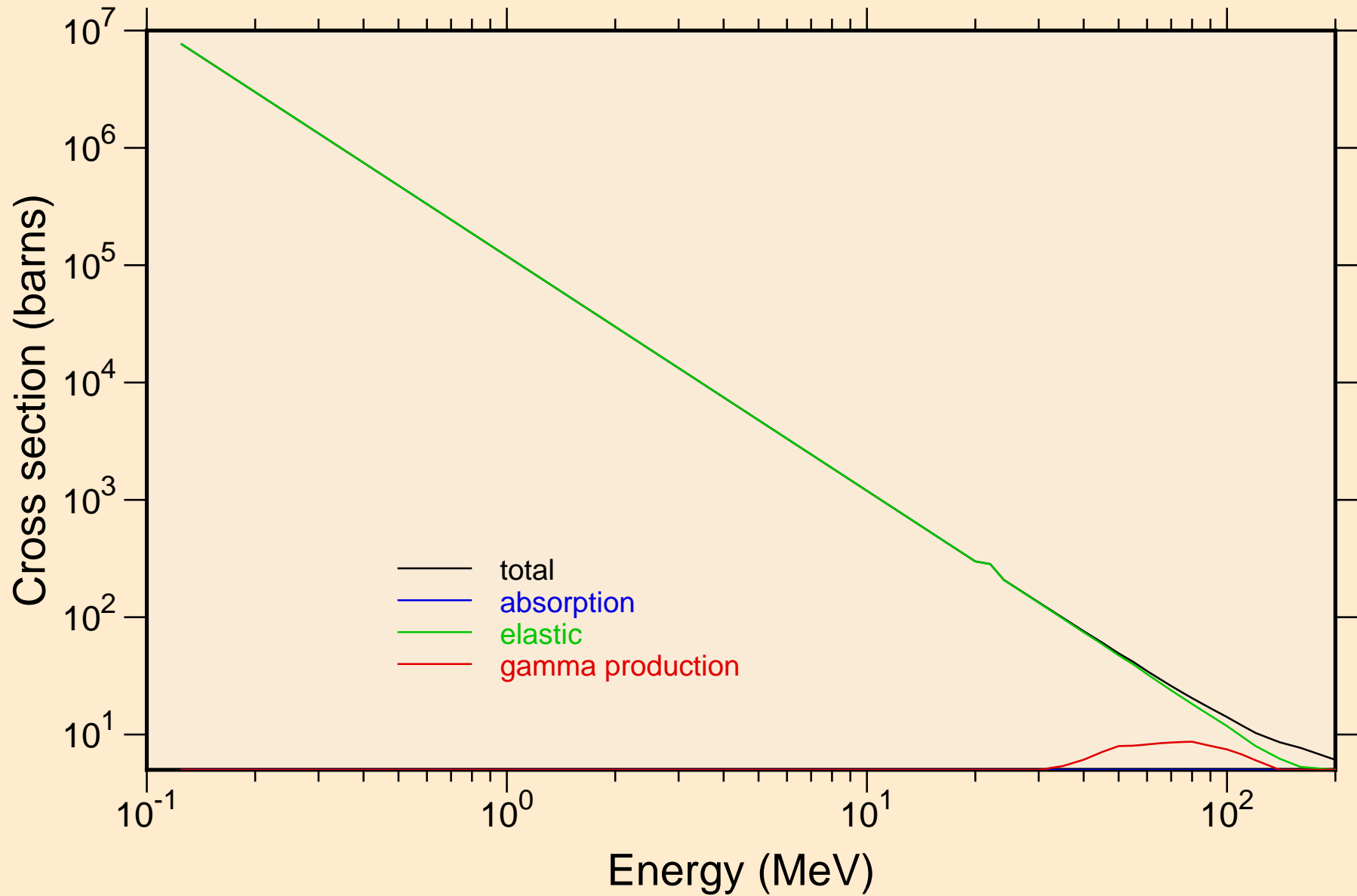

ER151 ALPHA ACER TENDL-2023 LIBRARY; T=0.K

Heating

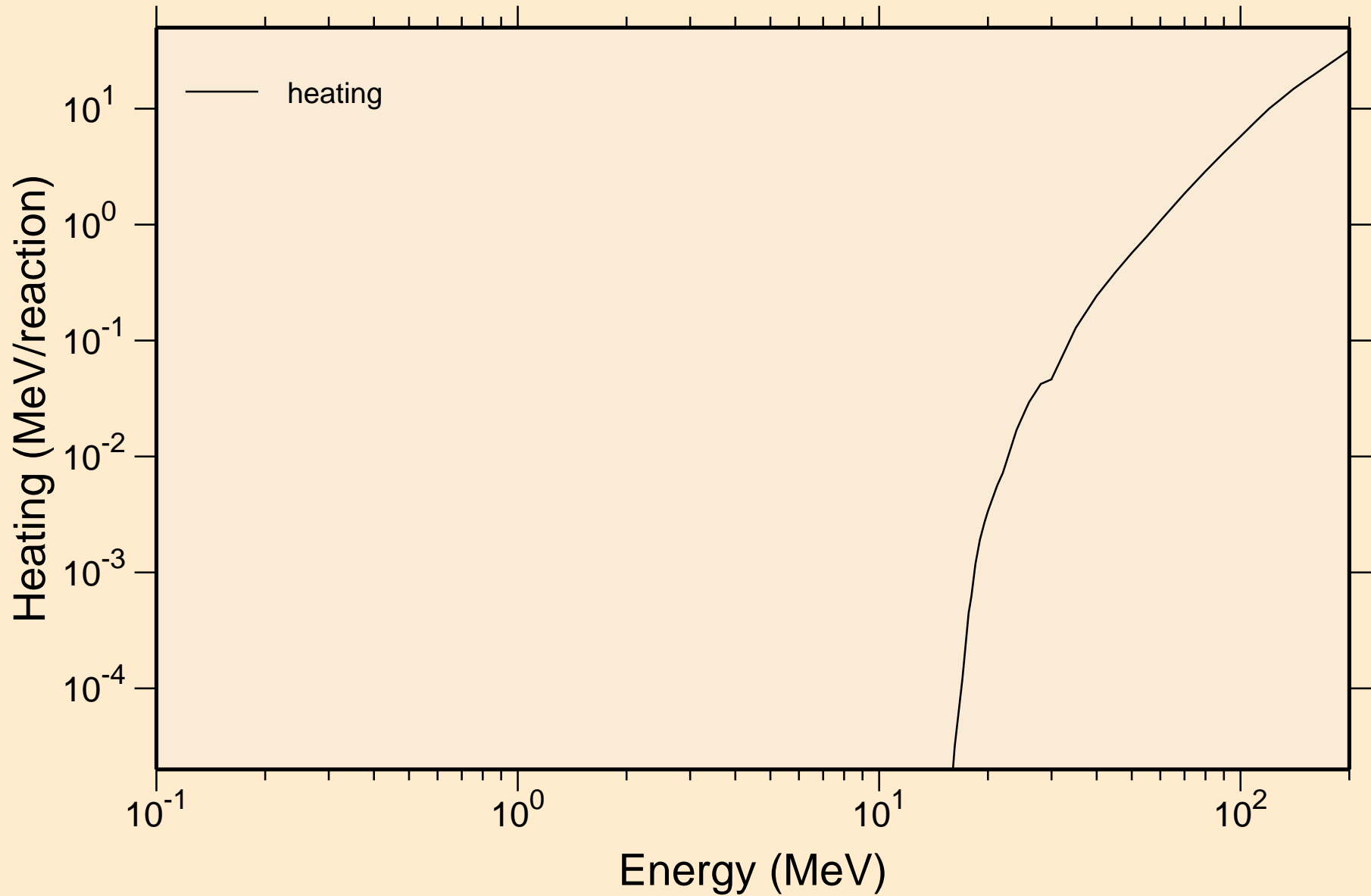

# ER151 ALPHA ACER TENDL-2023 LIBRARY; T=0.K

## Principal cross sections

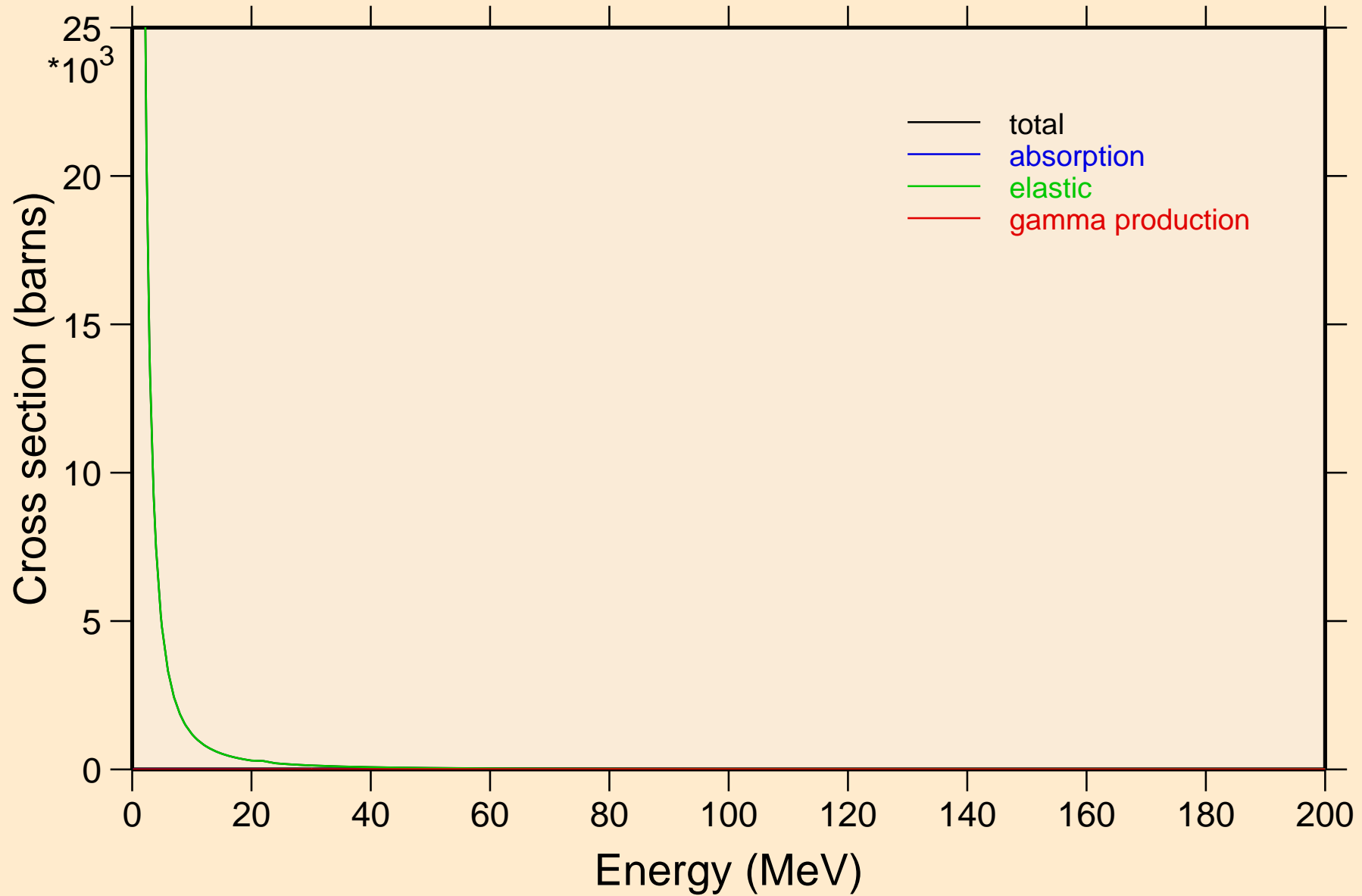

ER151 ALPHA ACER TENDL-2023 LIBRARY; T=0.K

Heating

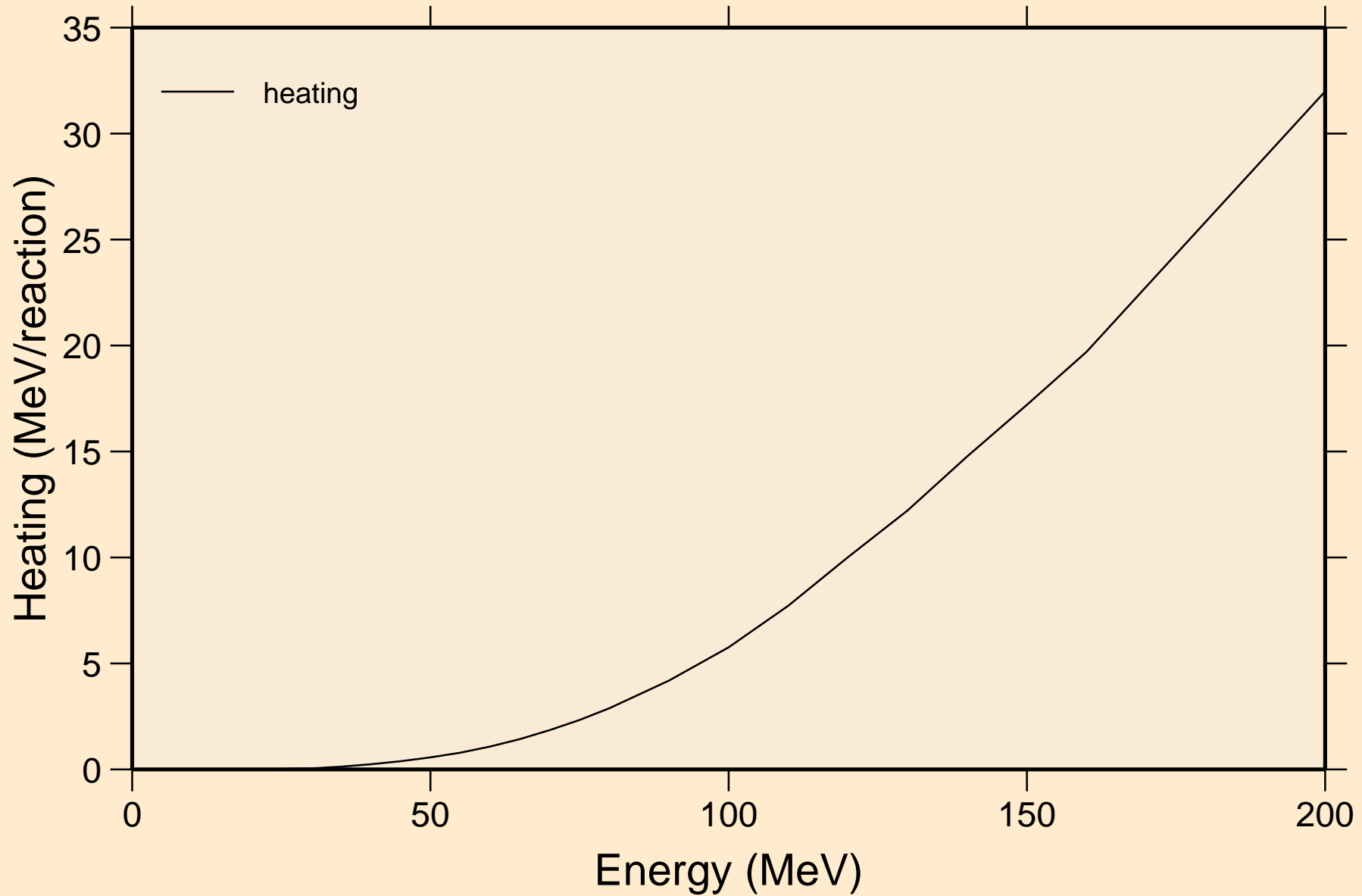

ER151 ALPHA ACER TENDL-2023 LIBRARY; T=0.K  
Threshold reactions

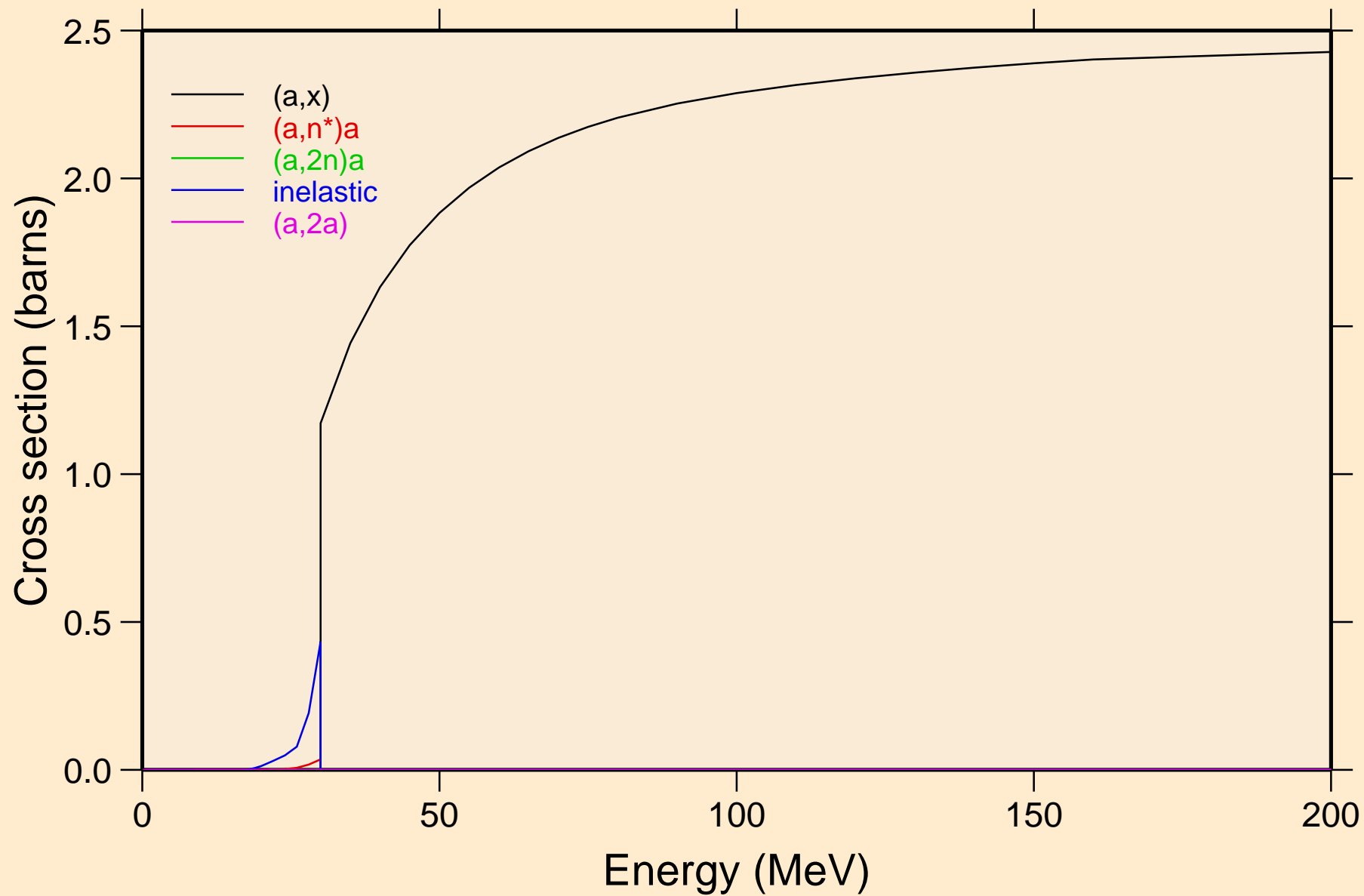

ER151 ALPHA ACER TENDL-2023 LIBRARY; T=0.K  
Threshold reactions

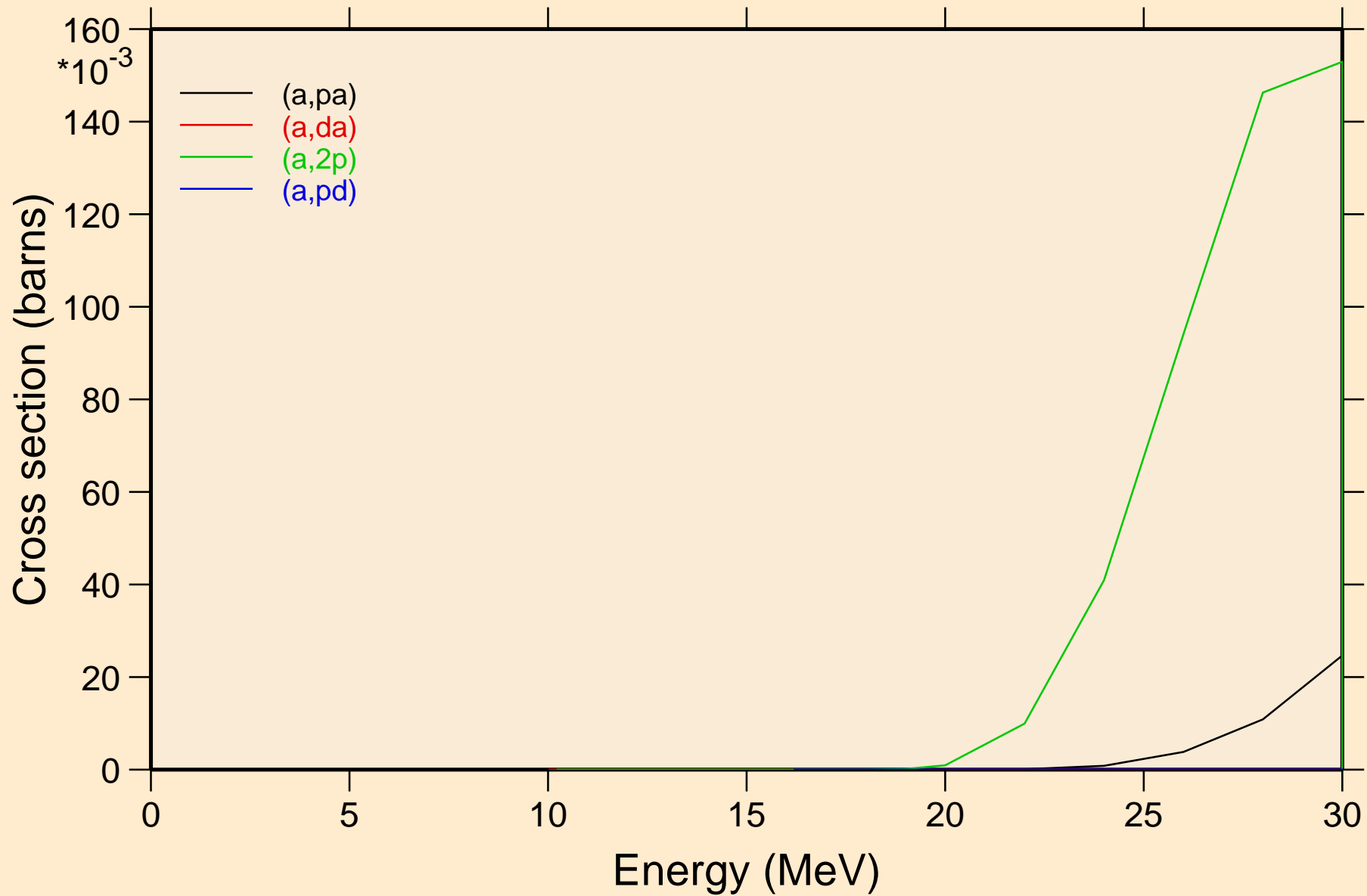

ER151 ALPHA ACER TENDL-2023 LIBRARY; T=0.K  
Threshold reactions

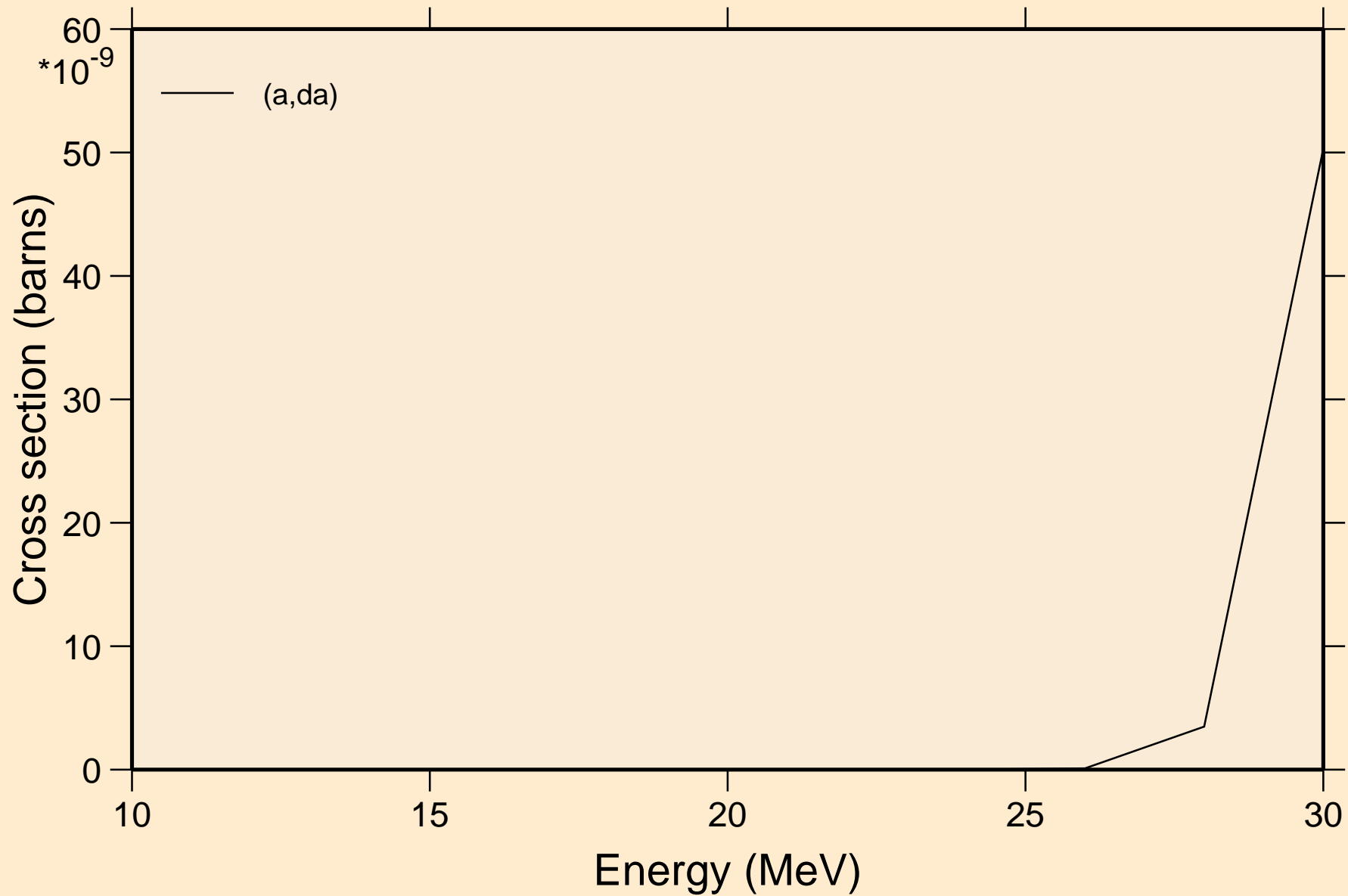

ER151 ALPHA ACER TENDL-2023 LIBRARY; T=0.K  
angular distribution for elastic

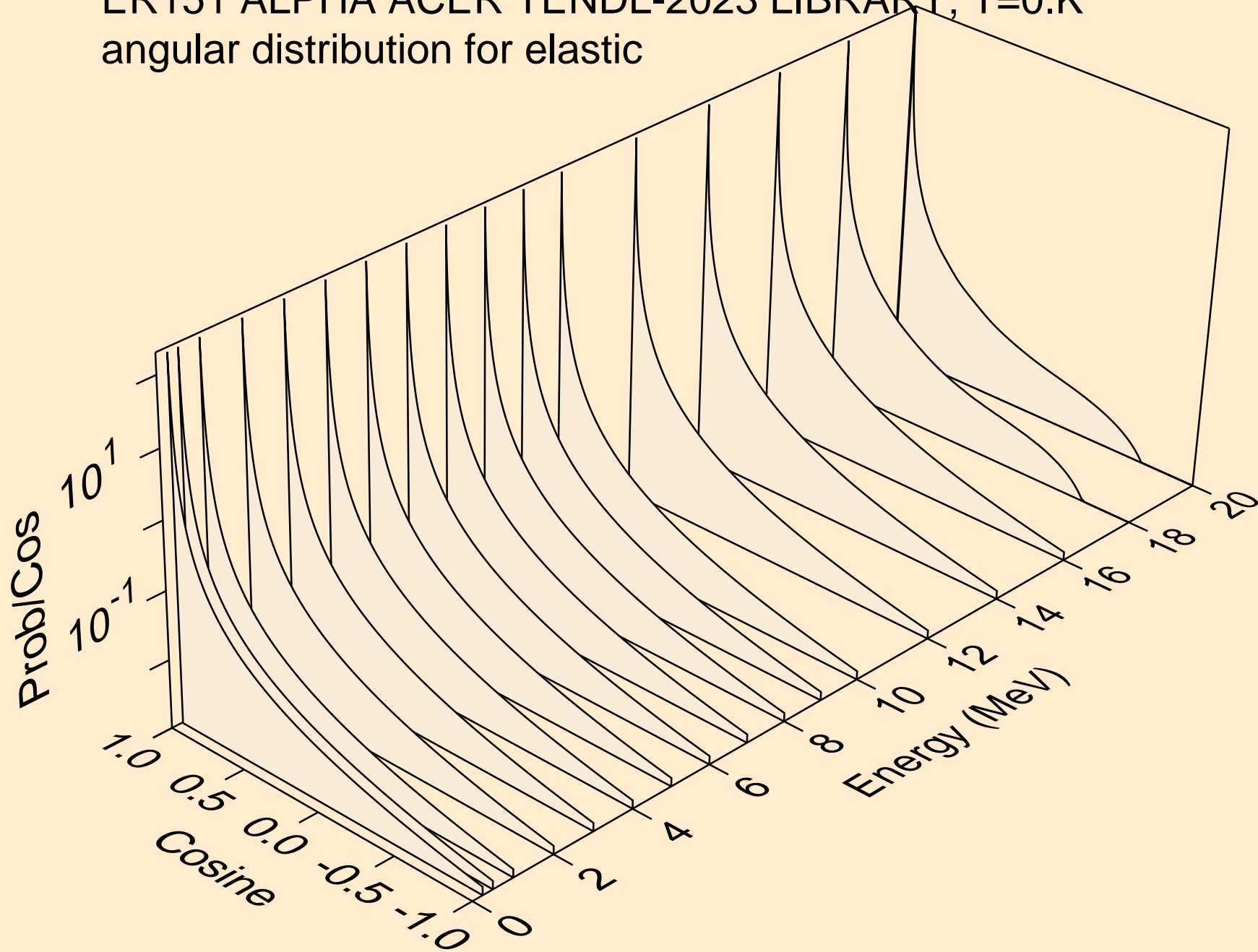

ER151 ALPHA ACER TENDL-2023 LIBRARY; T=0.K  
angular distribution for elastic

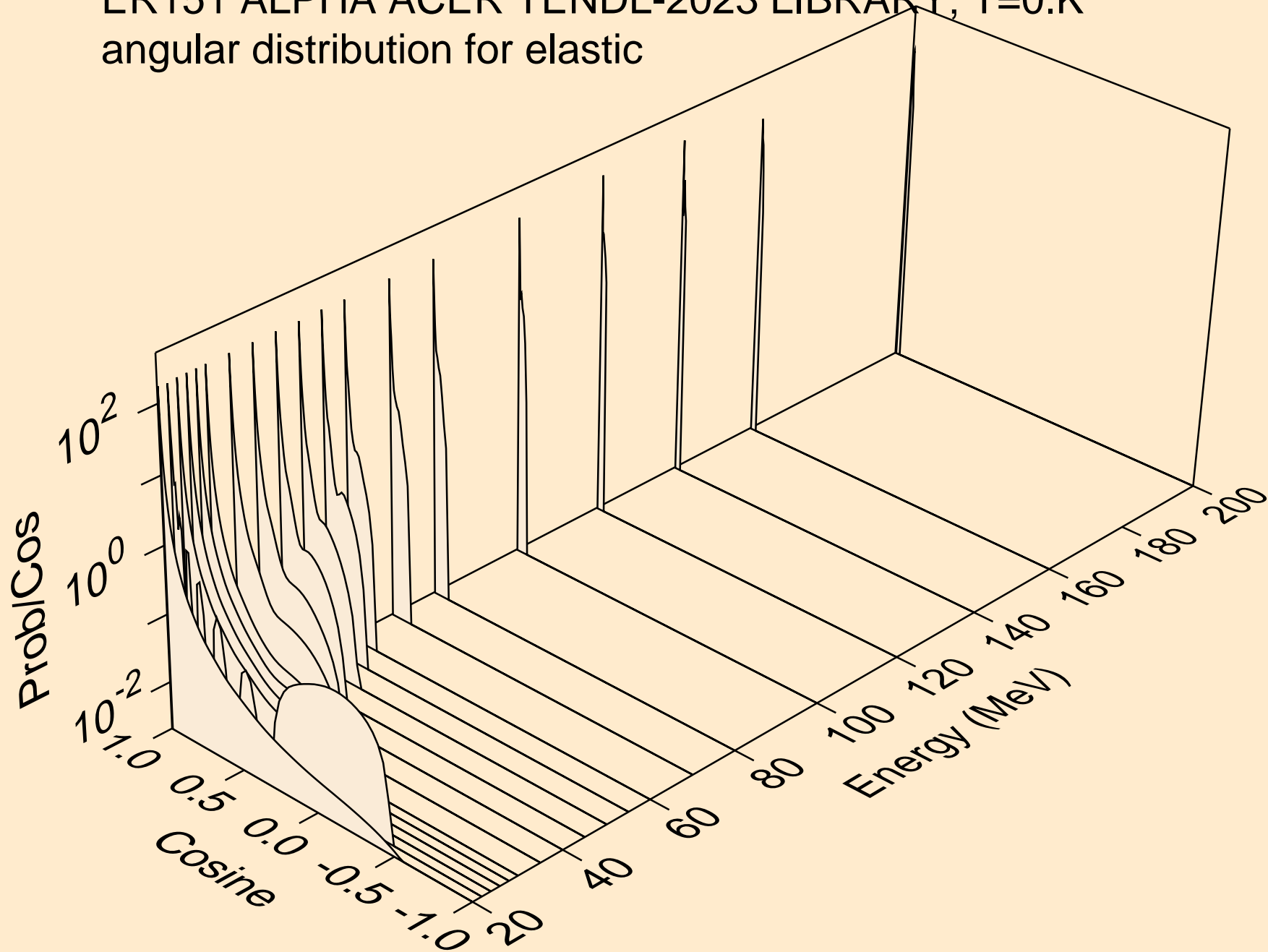

ER151 ALPHA ACER TENDL-2023 LIBRARY; T=0.K

Alpha emission for (a,x)

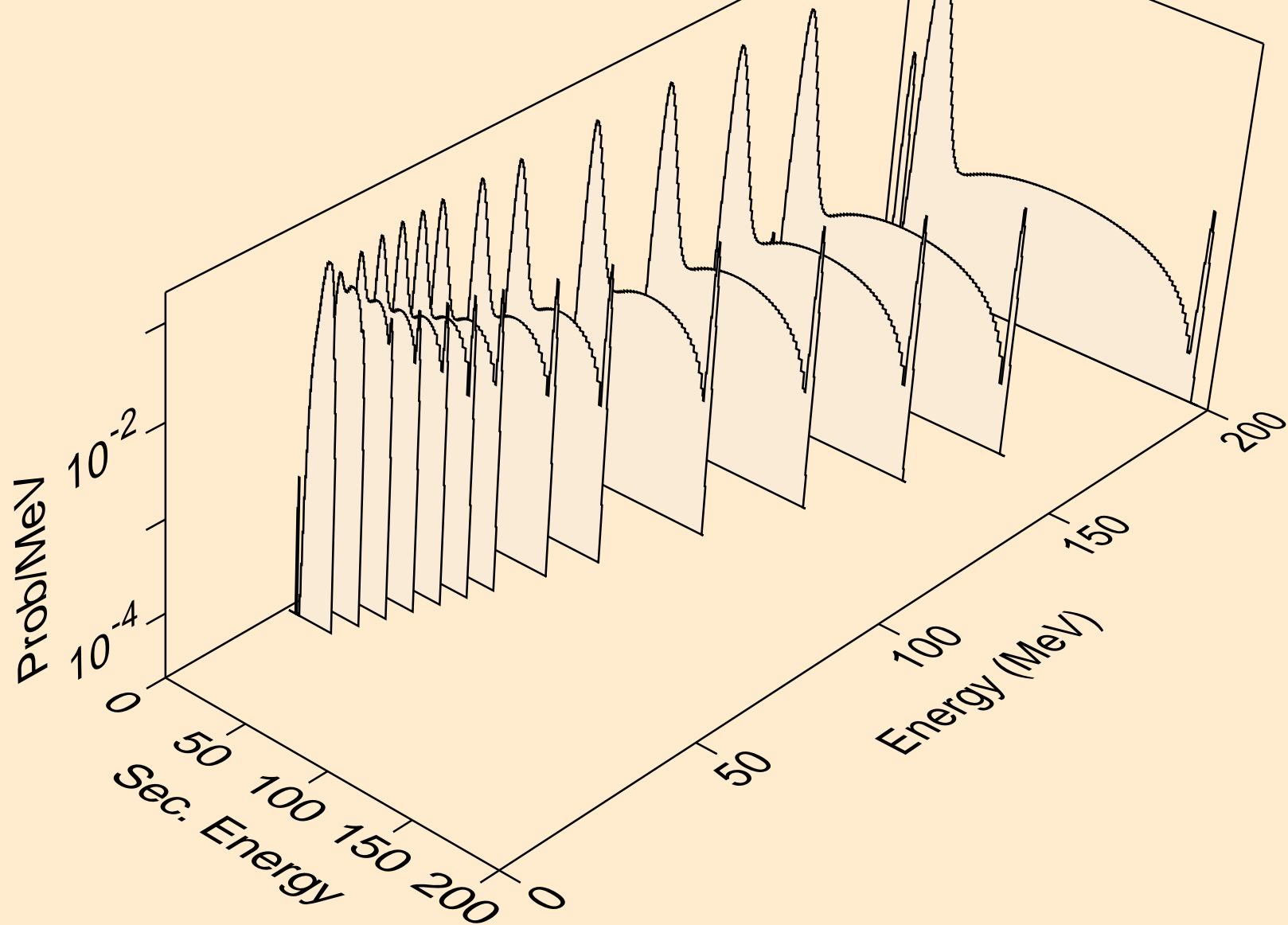

ER151 ALPHA ACER TENDL-2023 LIBRARY; T=0.K  
Alpha emission for (a,n\*)a

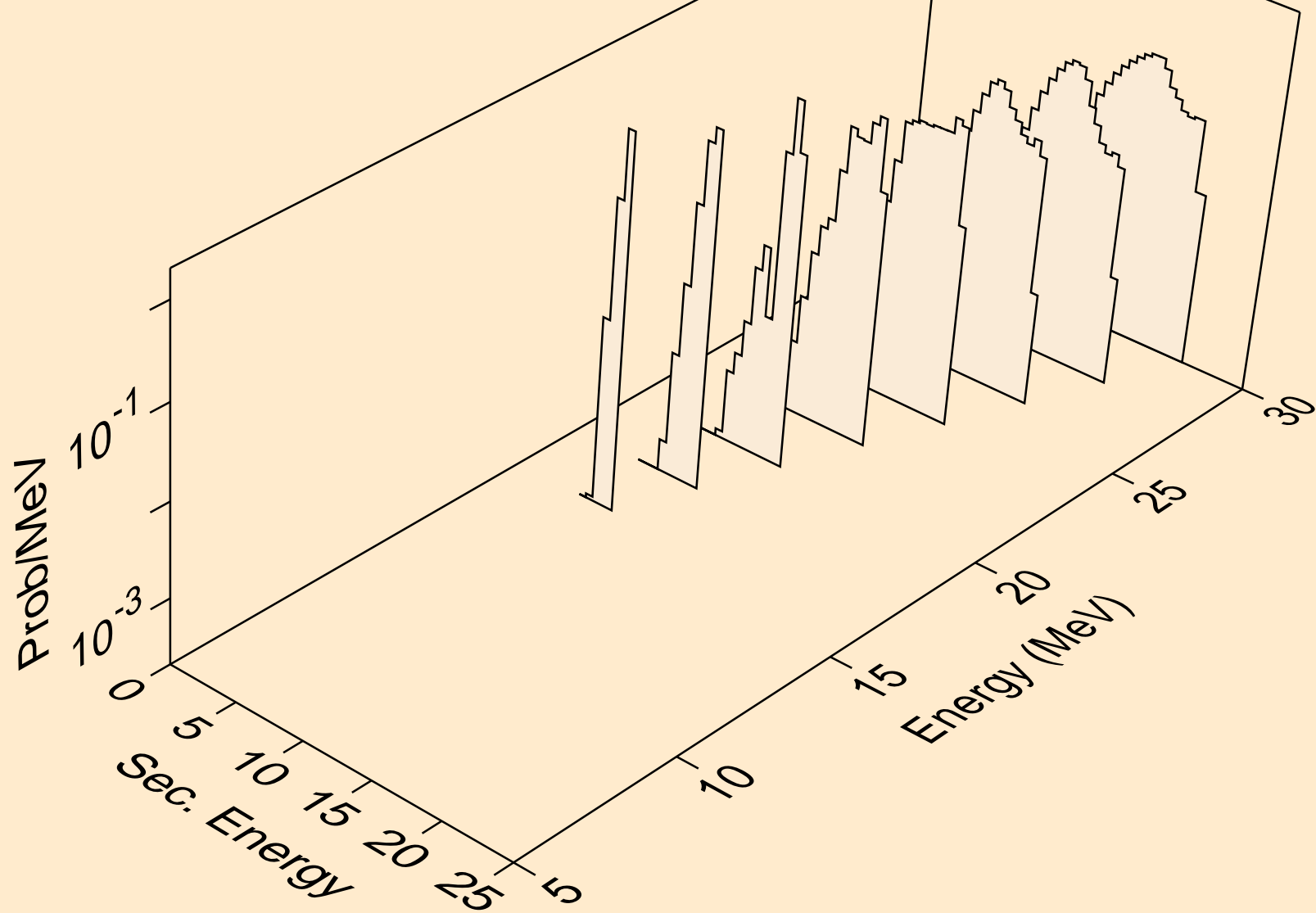

ER151 ALPHA ACER TENDL-2023 LIBRARY; T=0.K  
Alpha emission for (a,2n)a

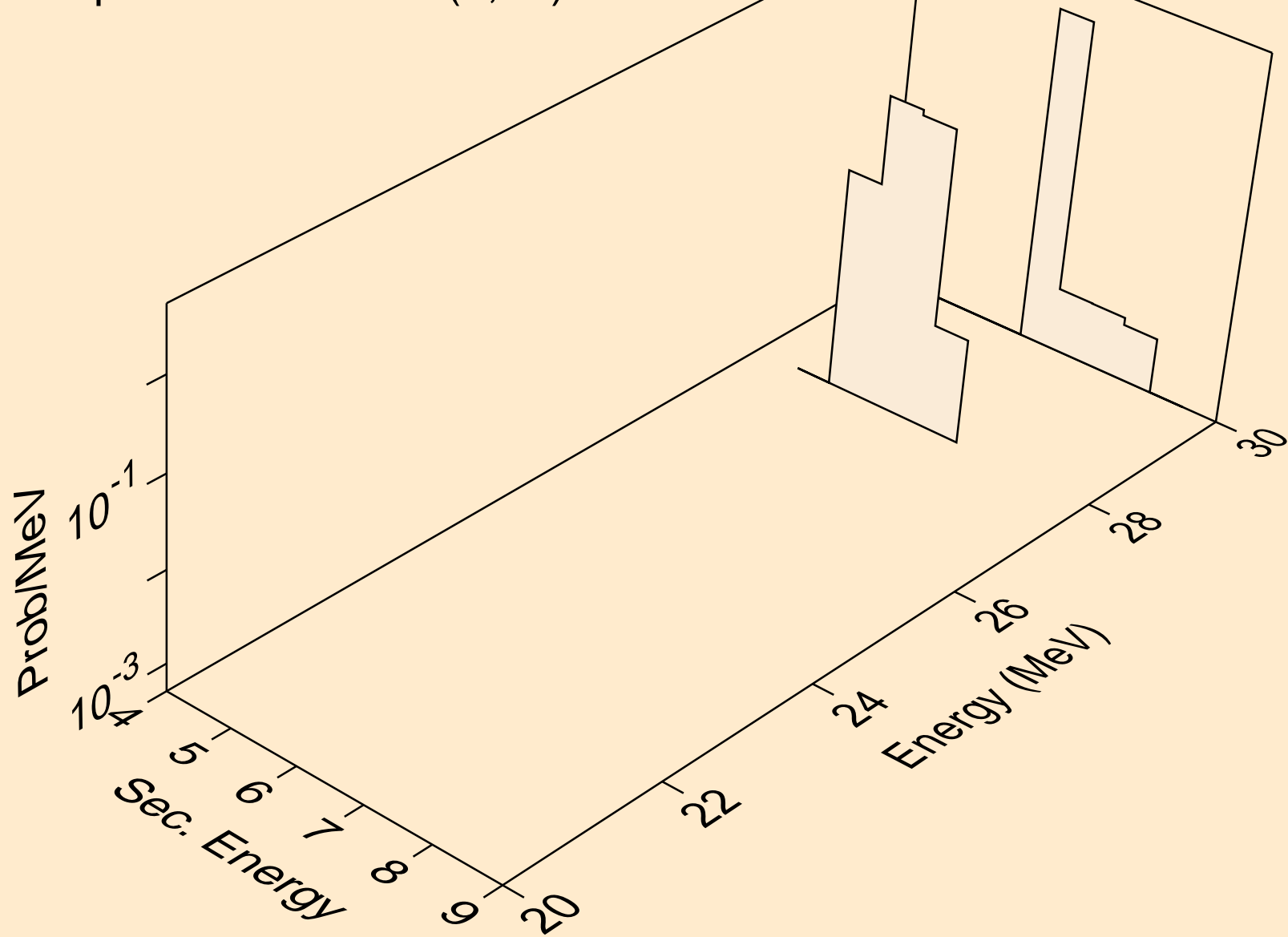

ER151 ALPHA ACER TENDL-2023 LIBRARY; T=0.K  
Alpha emission for inelastic

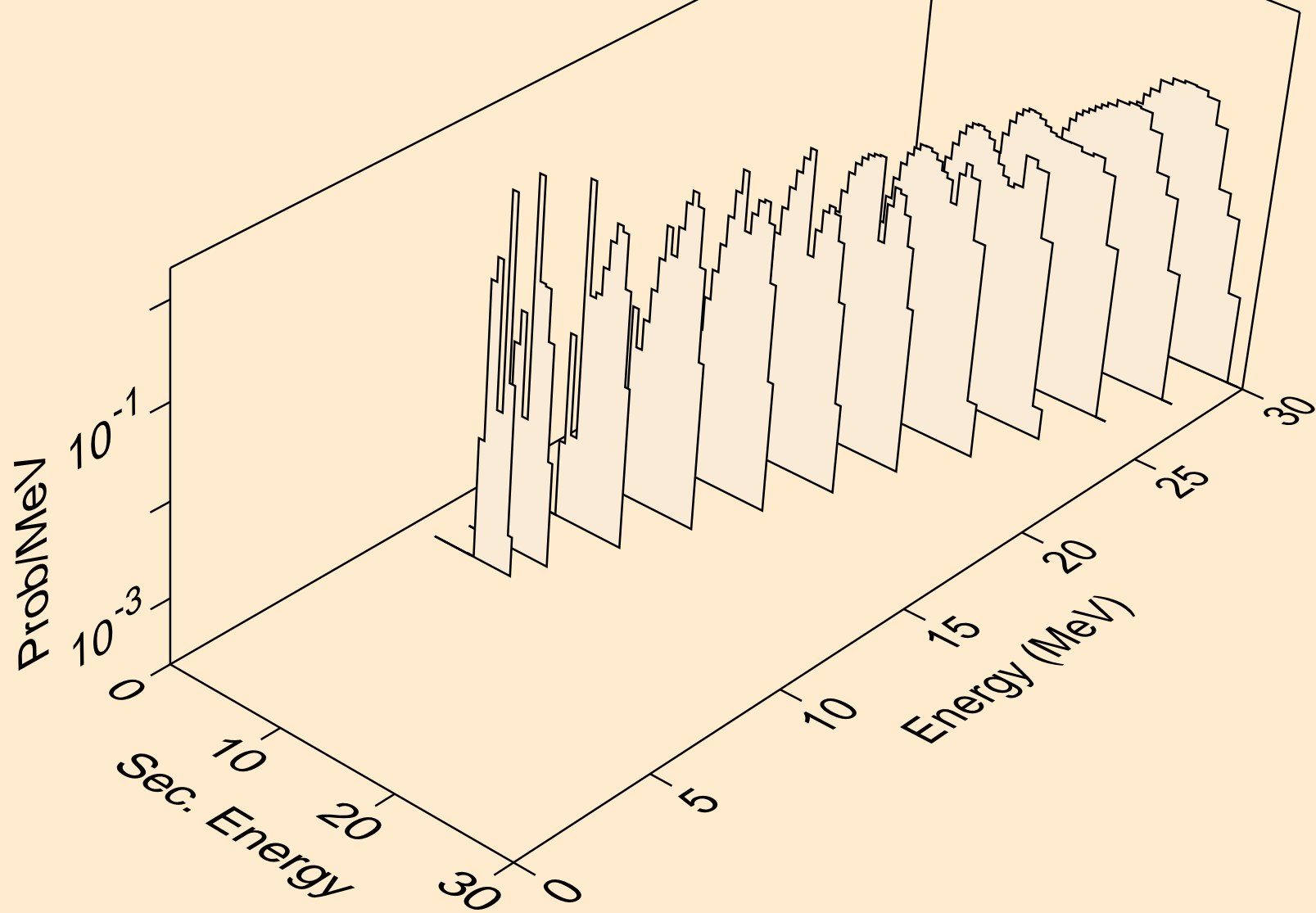

ER151 ALPHA ACER TENDL-2023 LIBRARY; T=0.K  
Alpha emission for (a,2a)

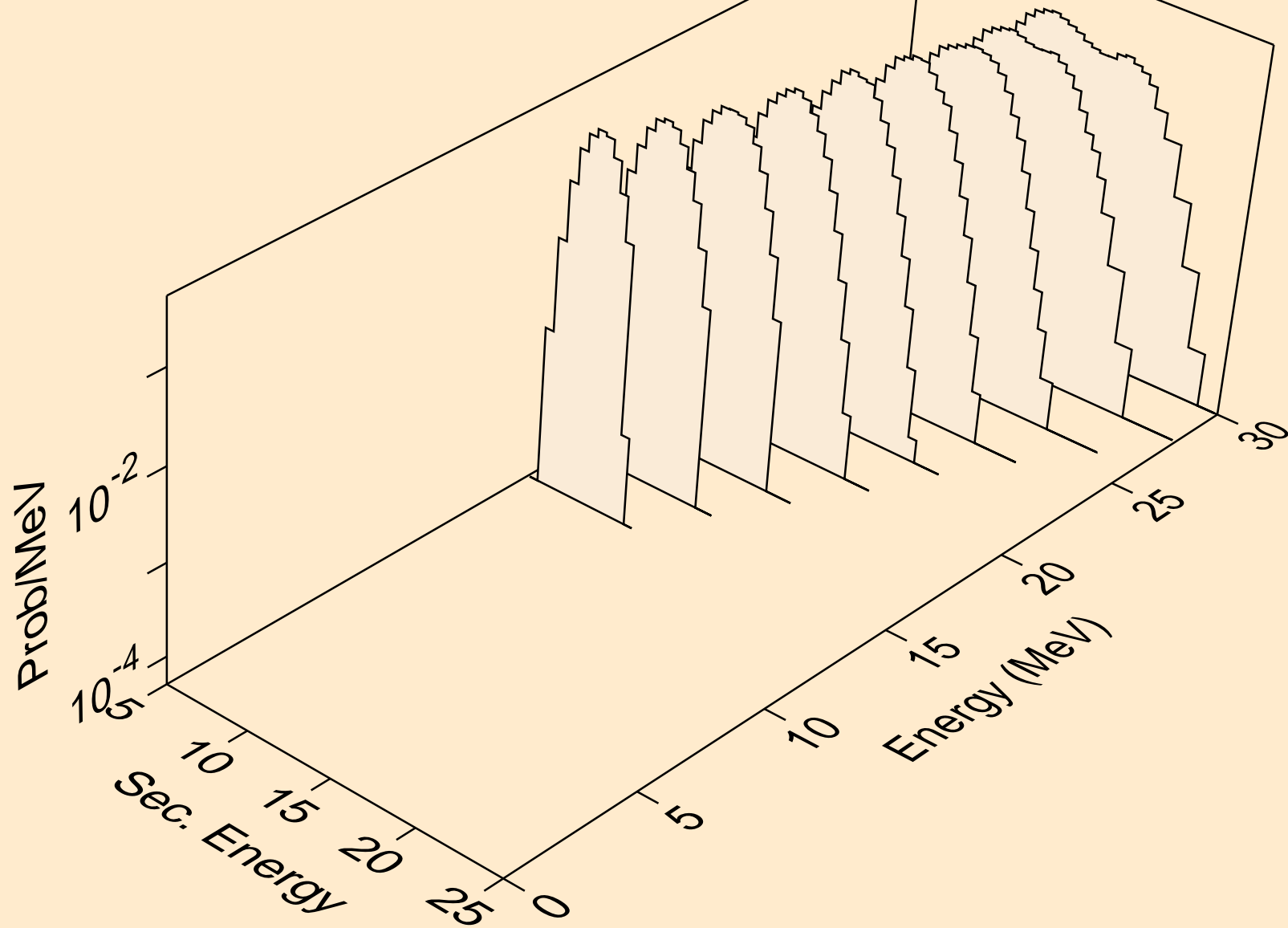

# ER151 ALPHA ACER TENDL-2023 LIBRARY; T=0.K

Alpha emission for (a,pa)

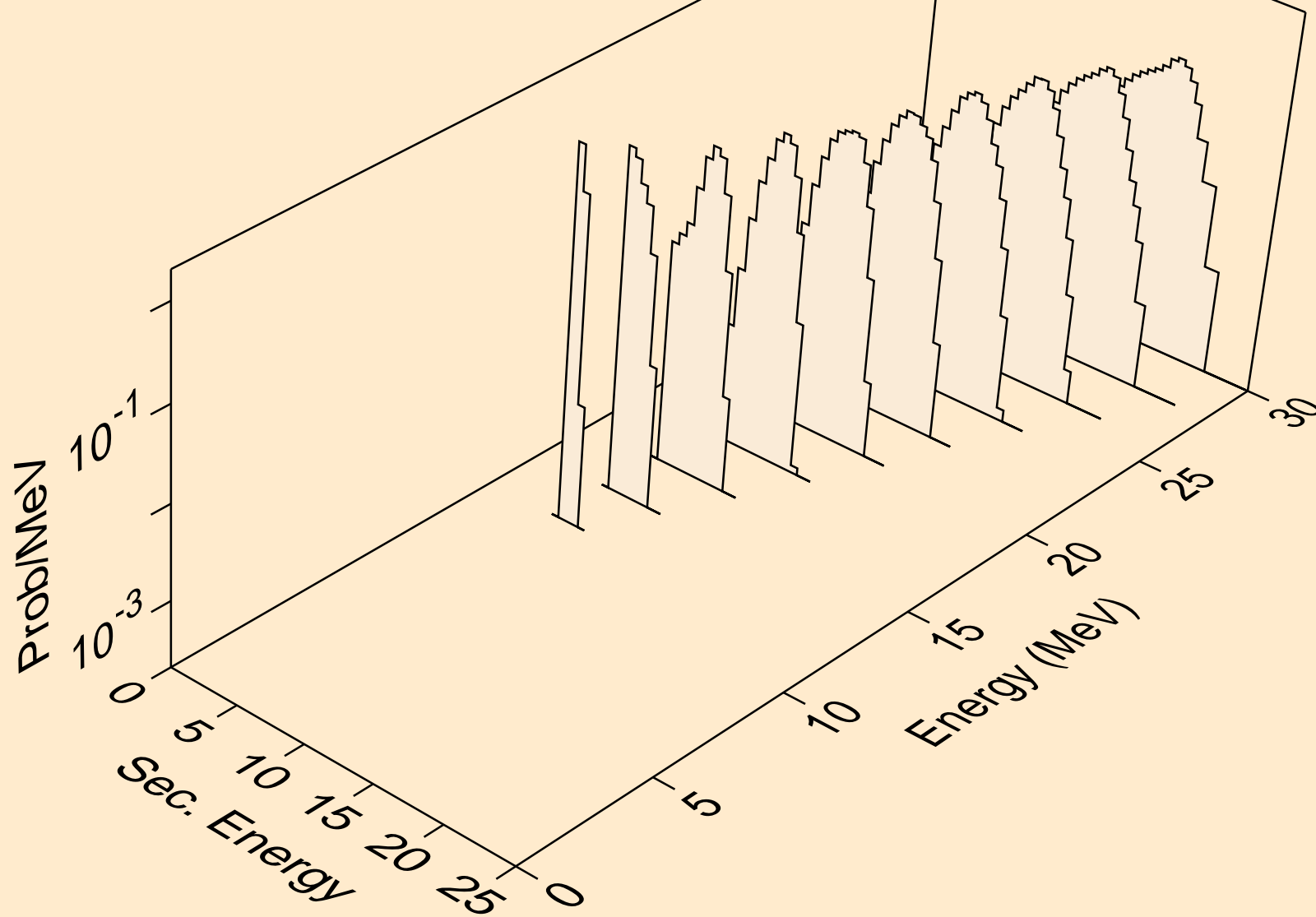

ER151 ALPHA ACER TENDL-2023 LIBRARY; T=0.K  
Alpha emission for (a,da)

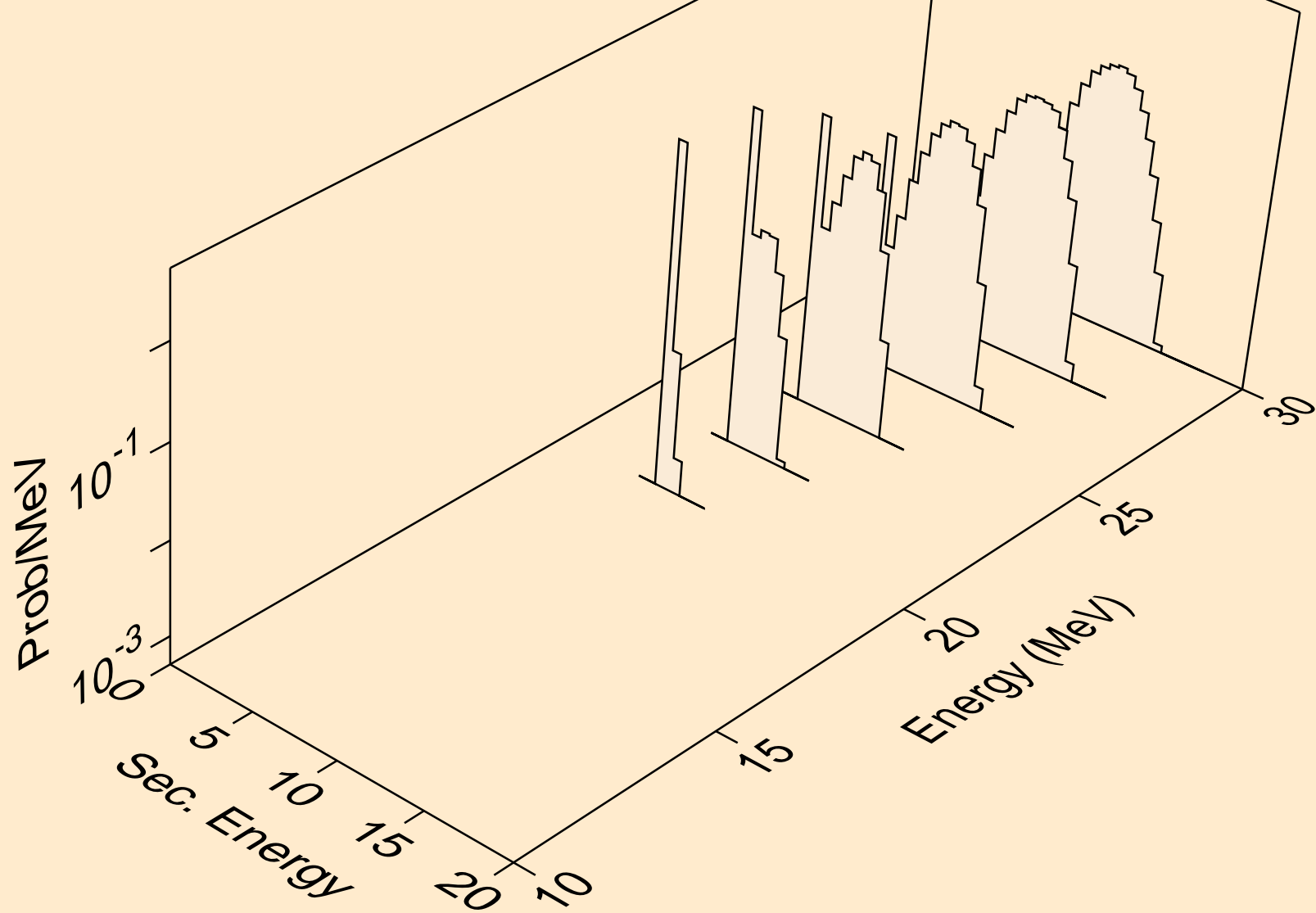

ER151 ALPHA ACER TENDL-2023 LIBRARY; T=0.K  
Photon emission for (z,n)

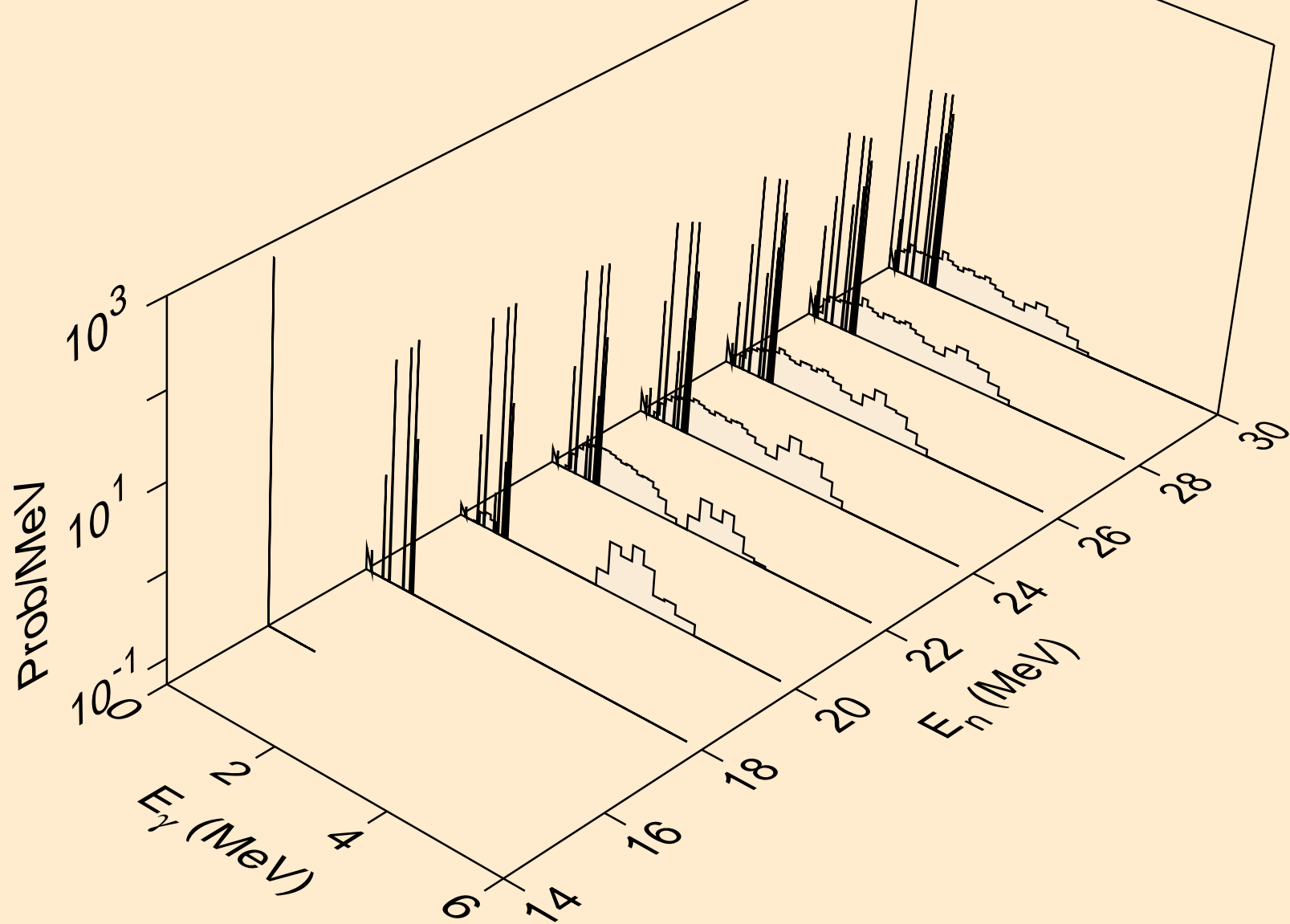

ER151 ALPHA ACER TENDL-2023 LIBRARY; T=0.K  
Photon emission for (z,x)

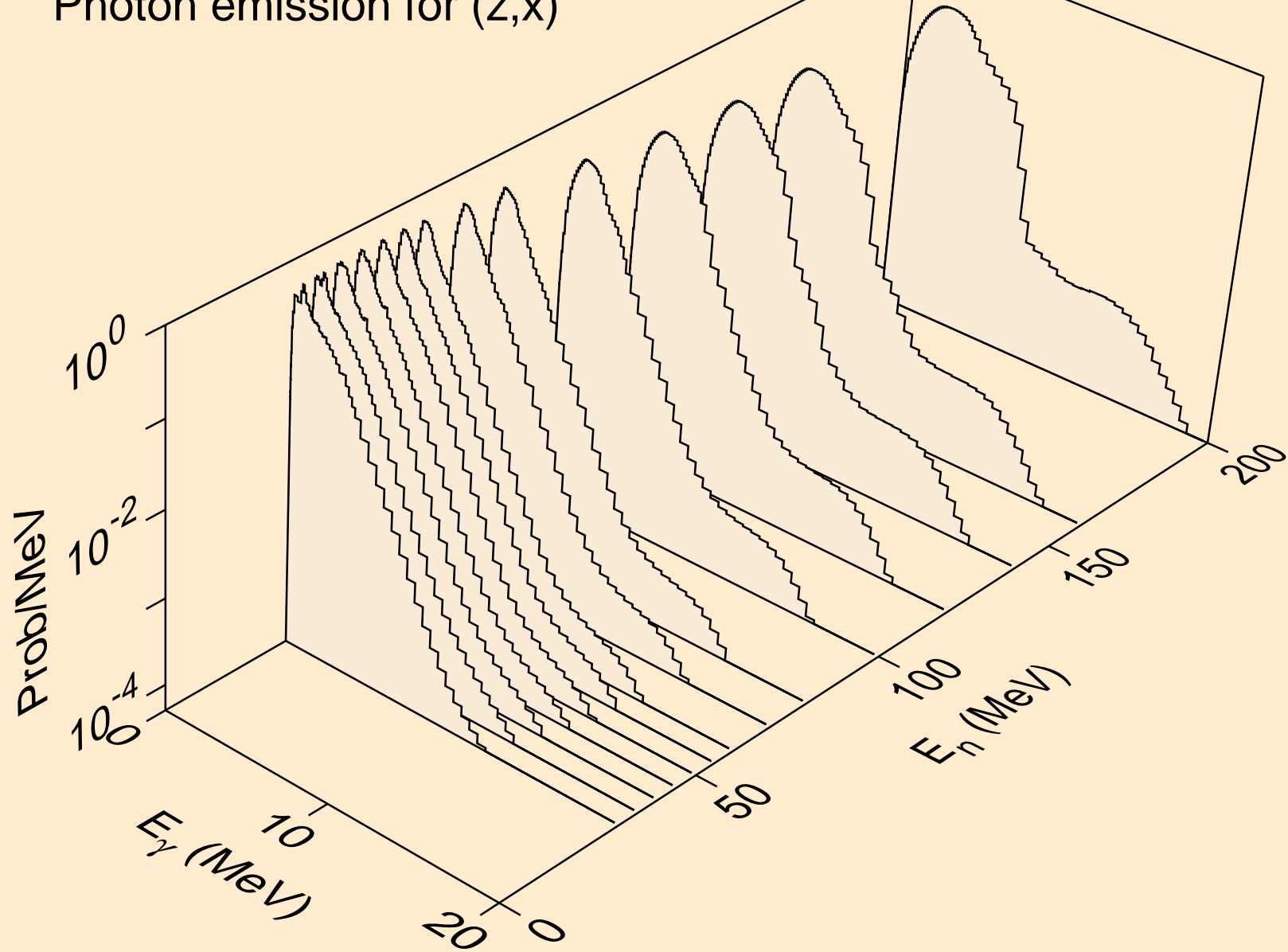

ER151 ALPHA ACER TENDL-2023 LIBRARY; T=0.K  
Photon emission for (n,2n)

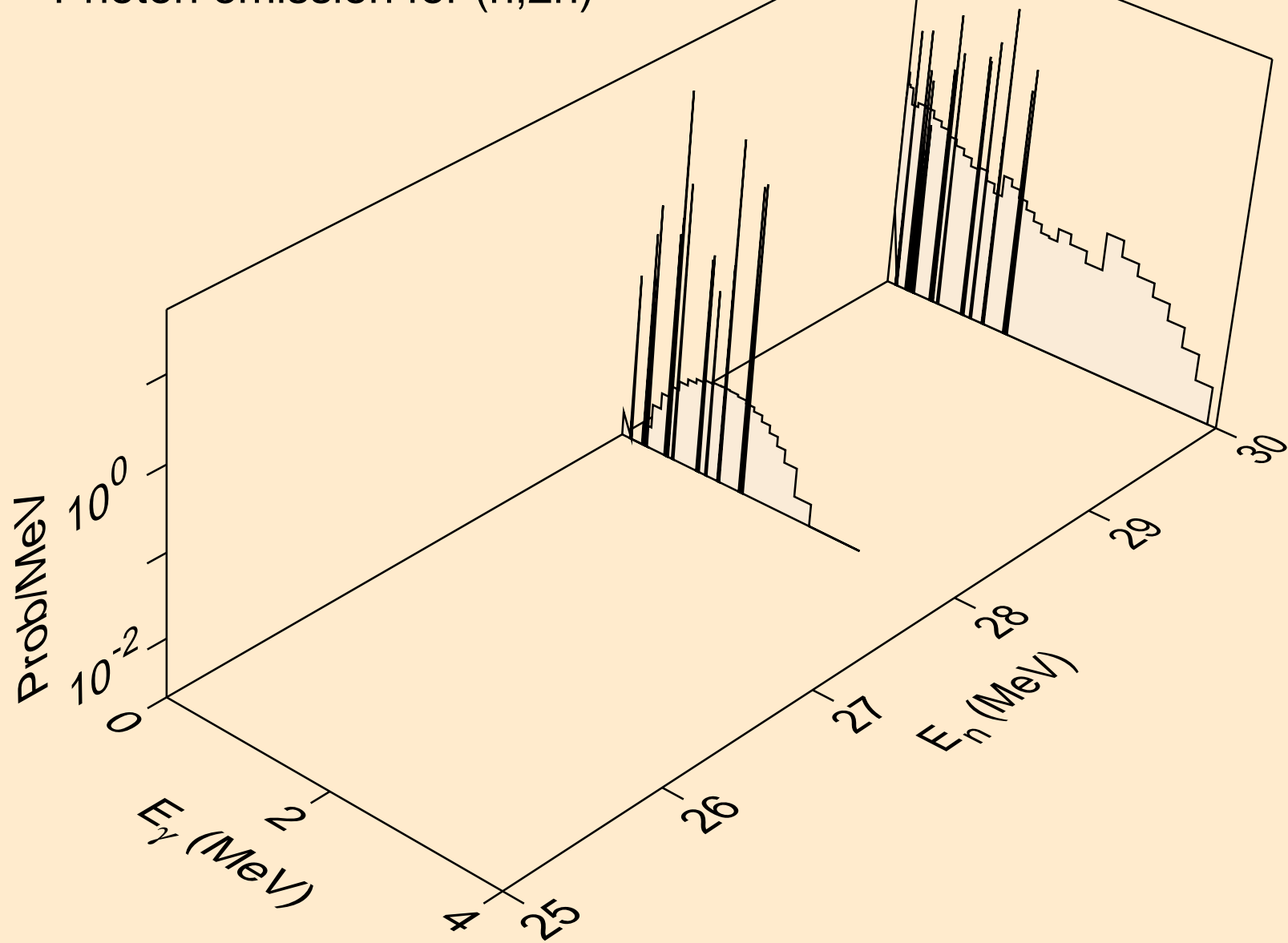

ER151 ALPHA ACER TENDL-2023 LIBRARY; T=0.K  
Photon emission for (n,n\*)a

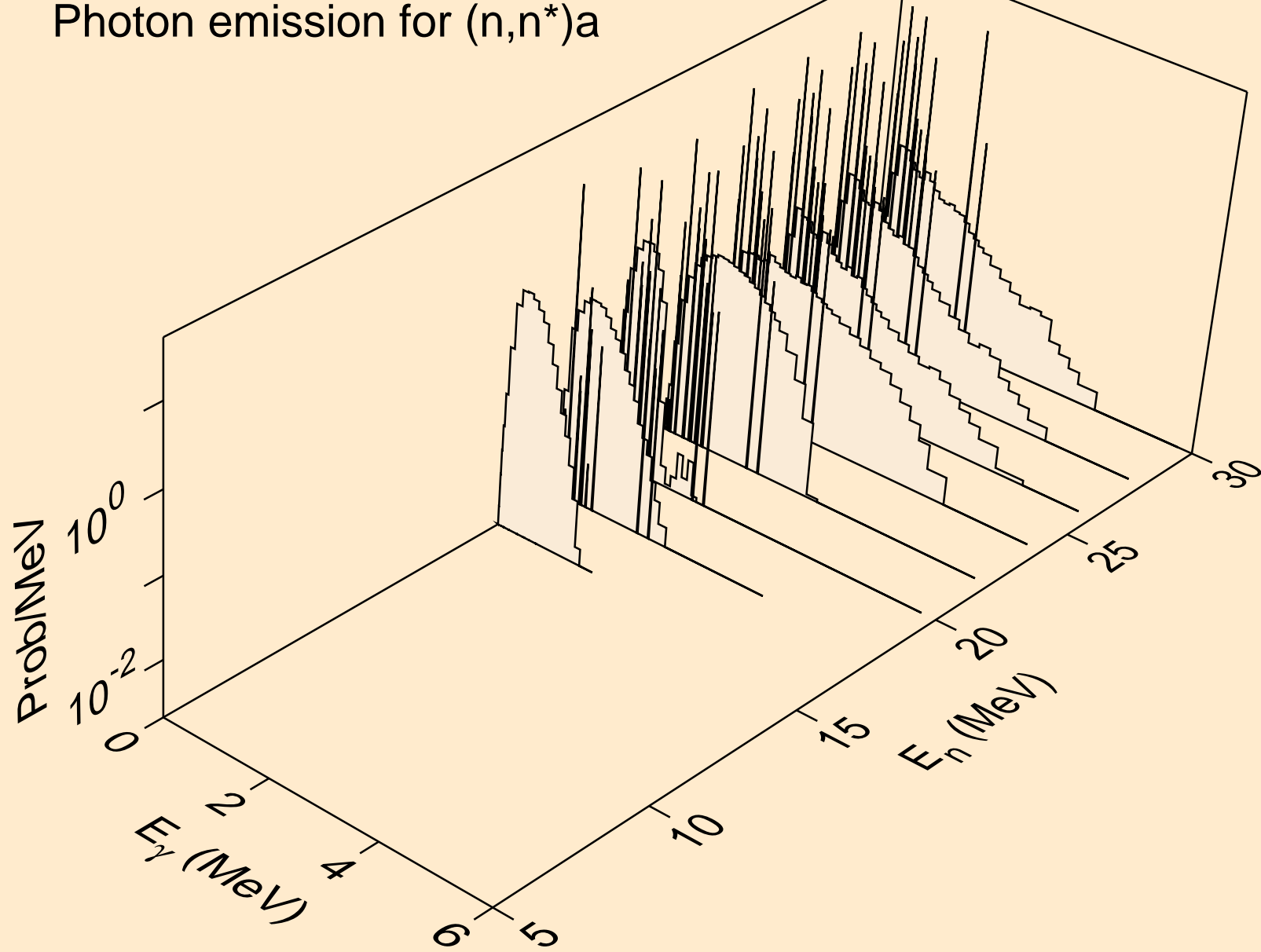

ER151 ALPHA ACER TENDL-2023 LIBRARY; T=0.K  
Photon emission for (n,2n)a

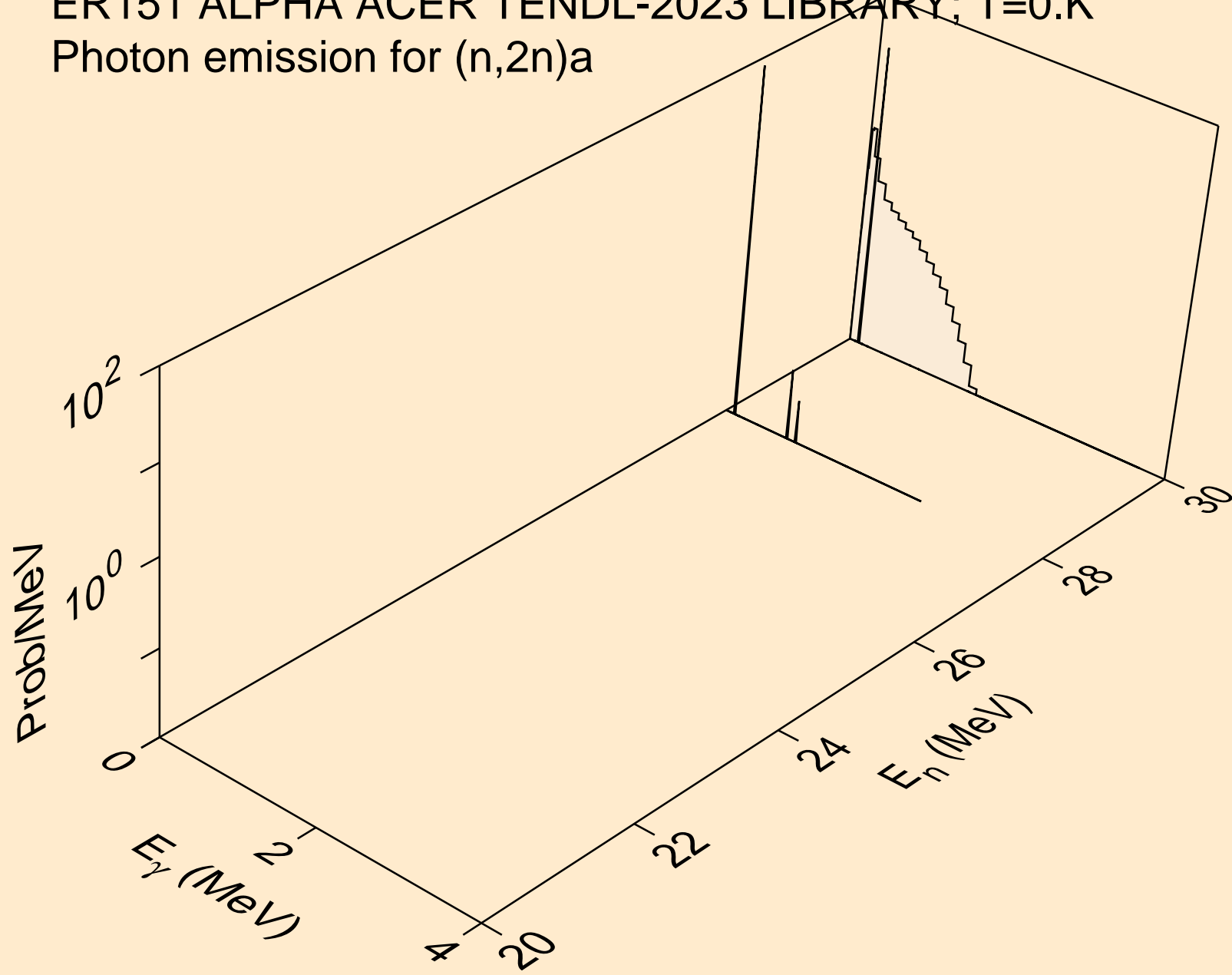

ER151 ALPHA ACER TENDL-2023 LIBRARY; T=0.K  
Photon emission for (n,n\*)p

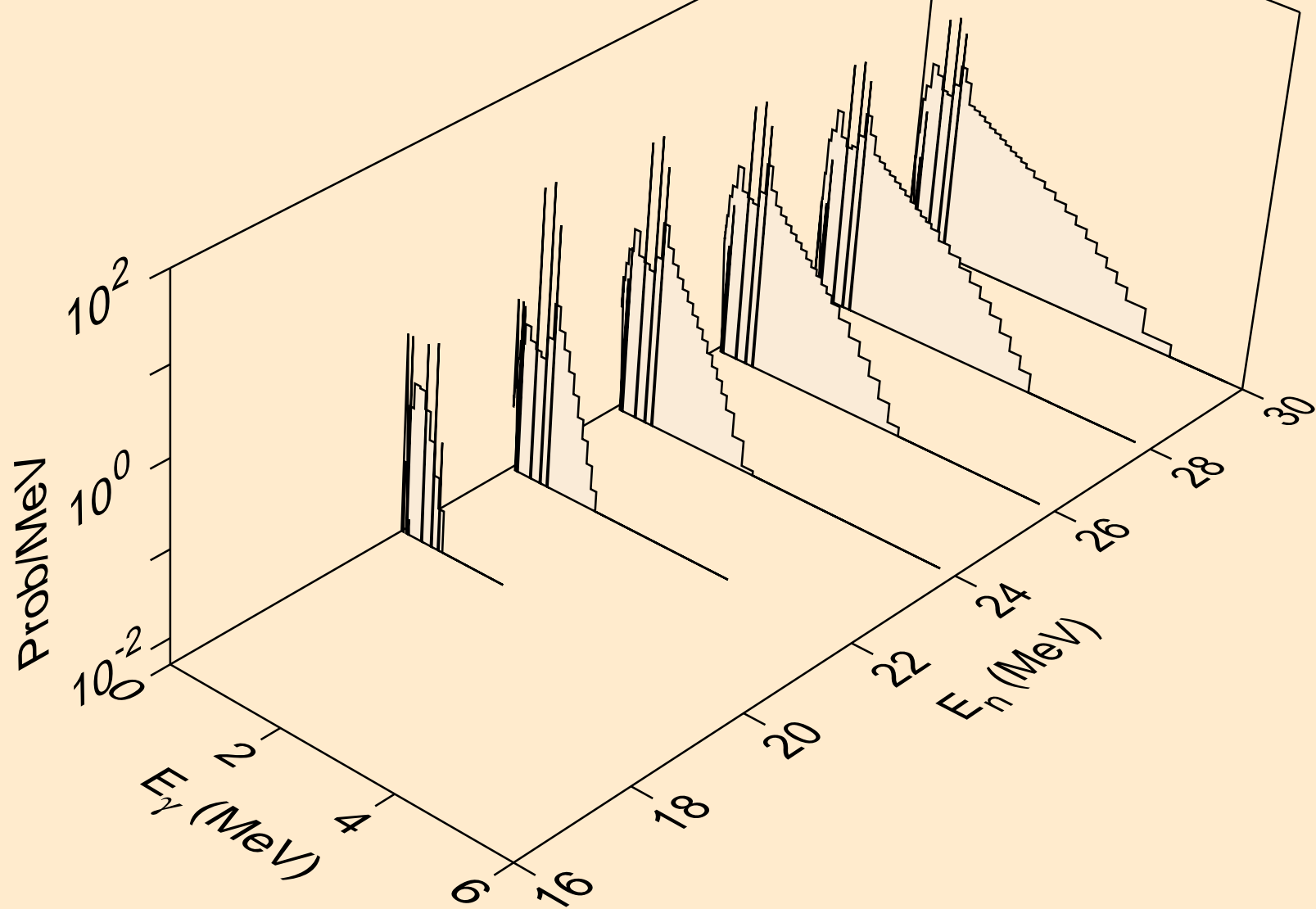

ER151 ALPHA ACER TENDL-2023 LIBRARY; T=0.K  
Photon emission for (n,n2p)

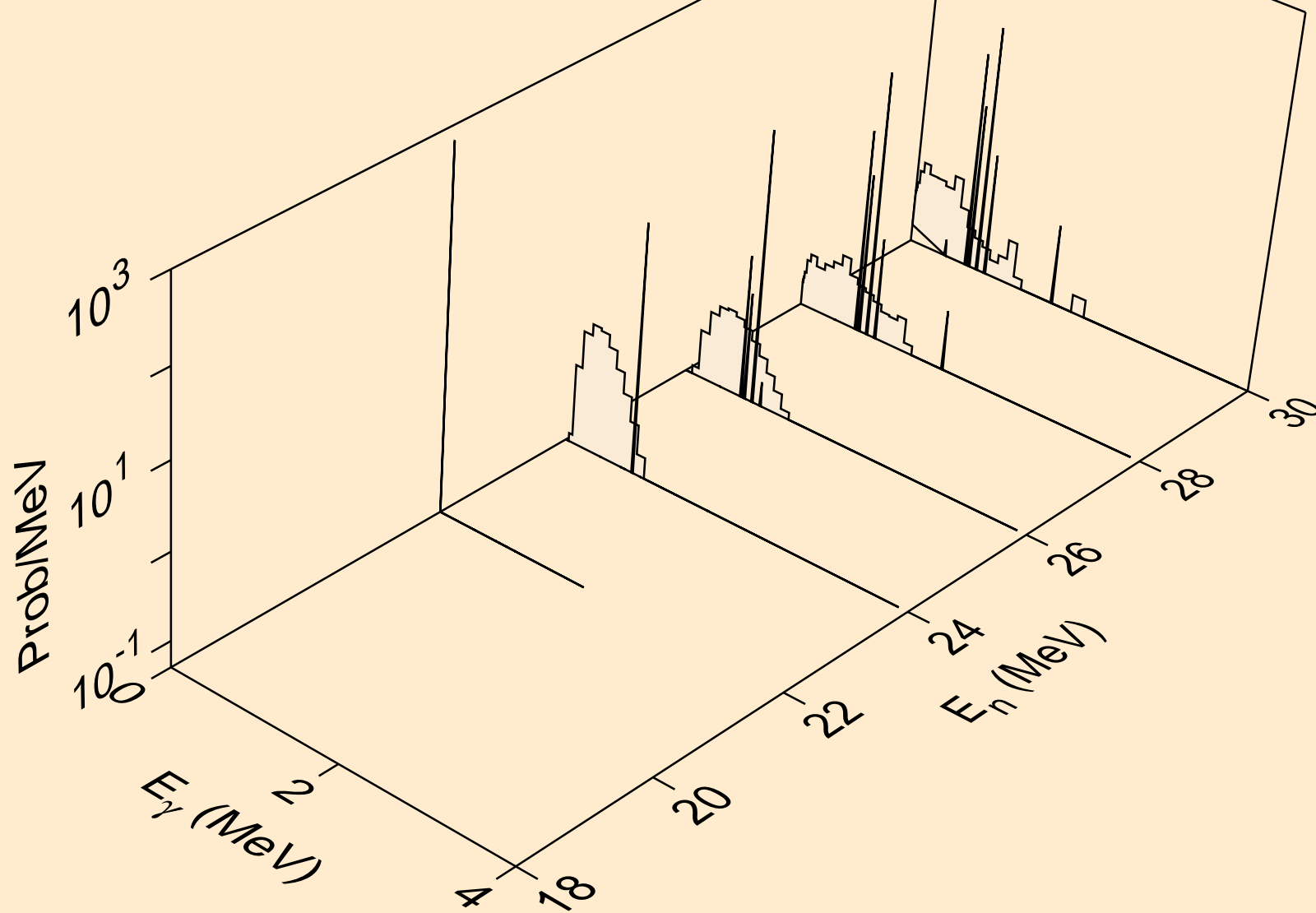

ER151 ALPHA ACER TENDL-2023 LIBRARY; T=0.K  
Photon emission for (n,npa)

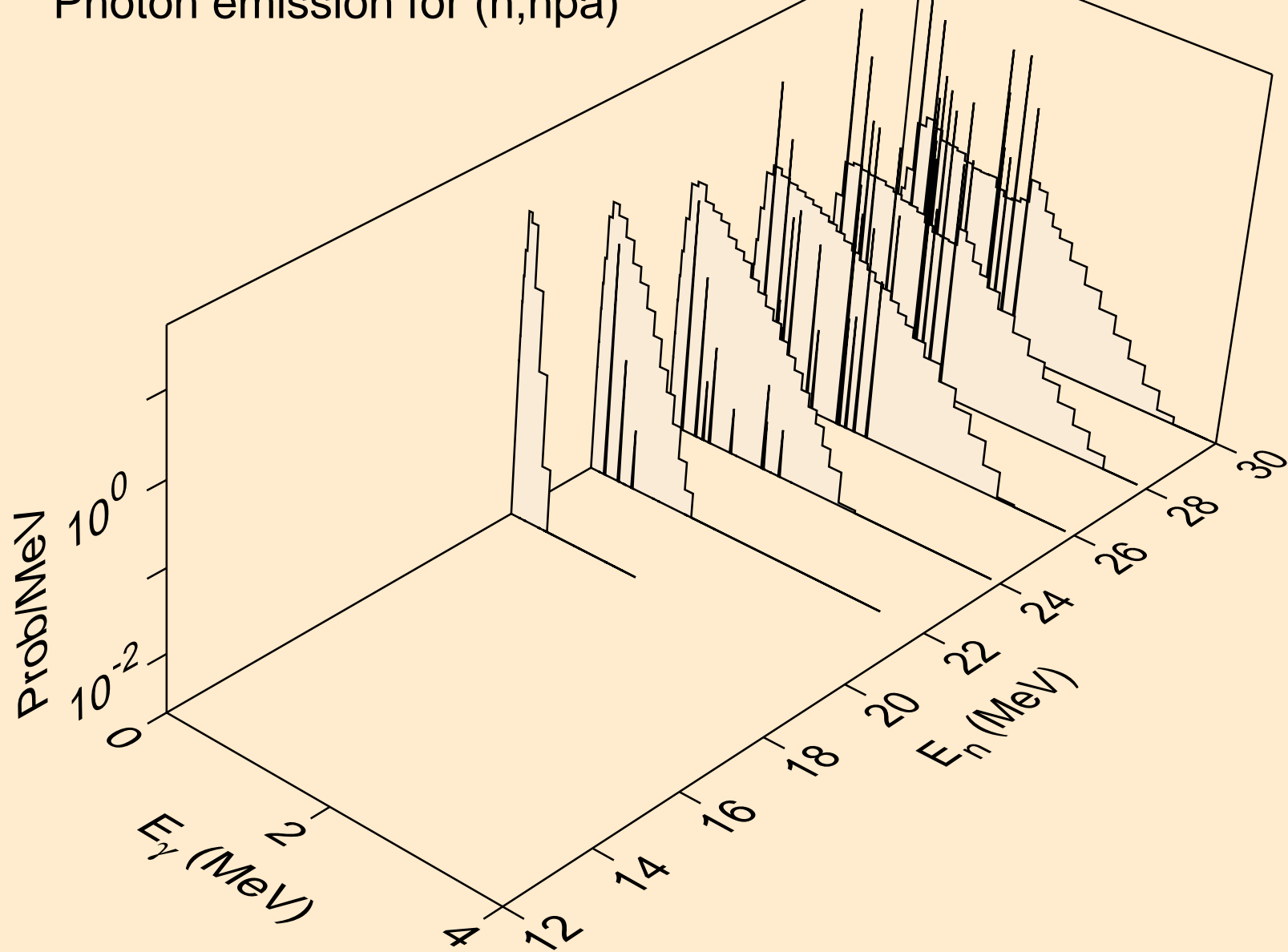

ER151 ALPHA ACER TENDL-2023 LIBRARY; T=0.K  
Photon emission for (n,gma)

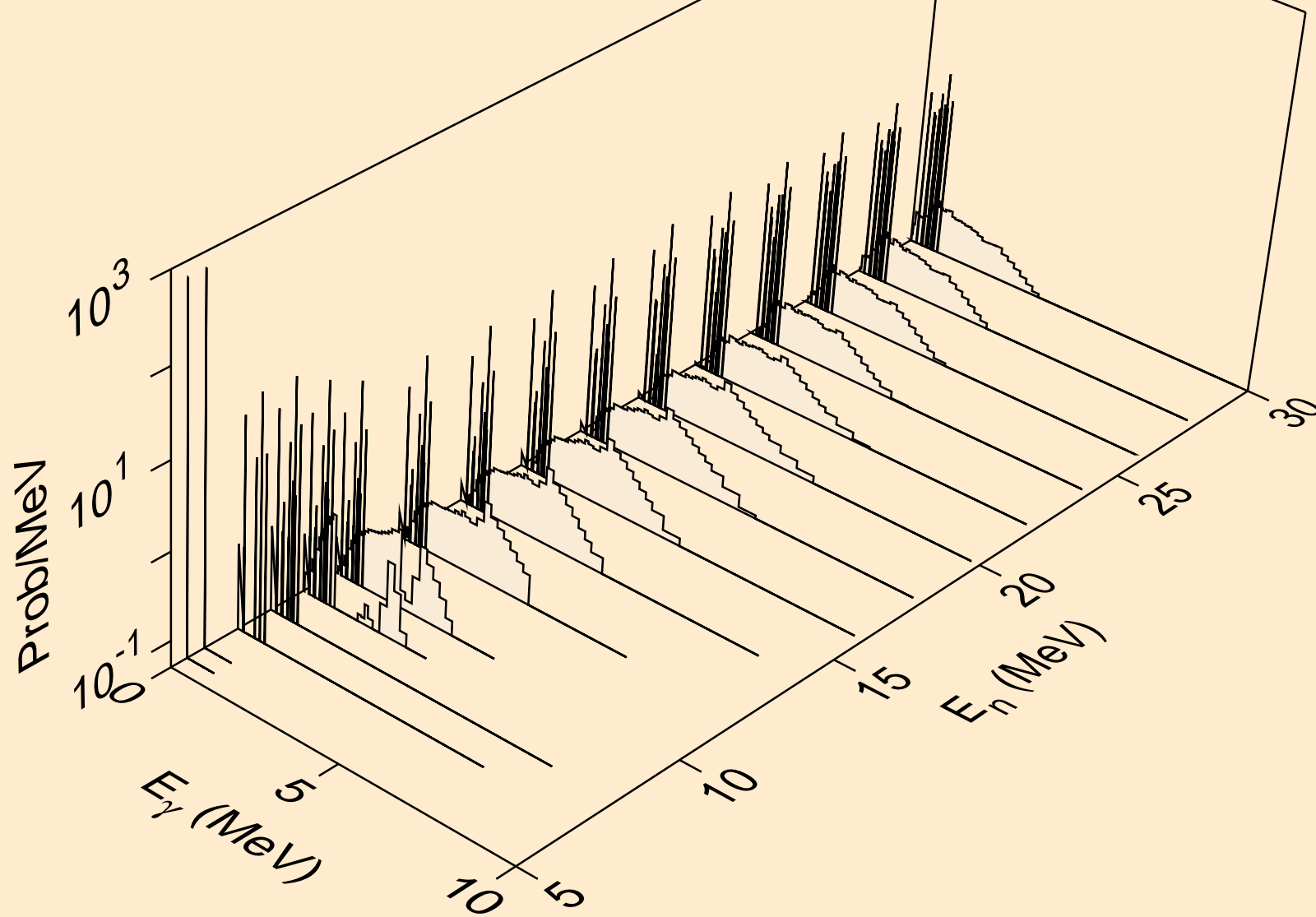

ER151 ALPHA ACER TENDL-2023 LIBRARY; T=0.K  
Photon emission for (n,p)

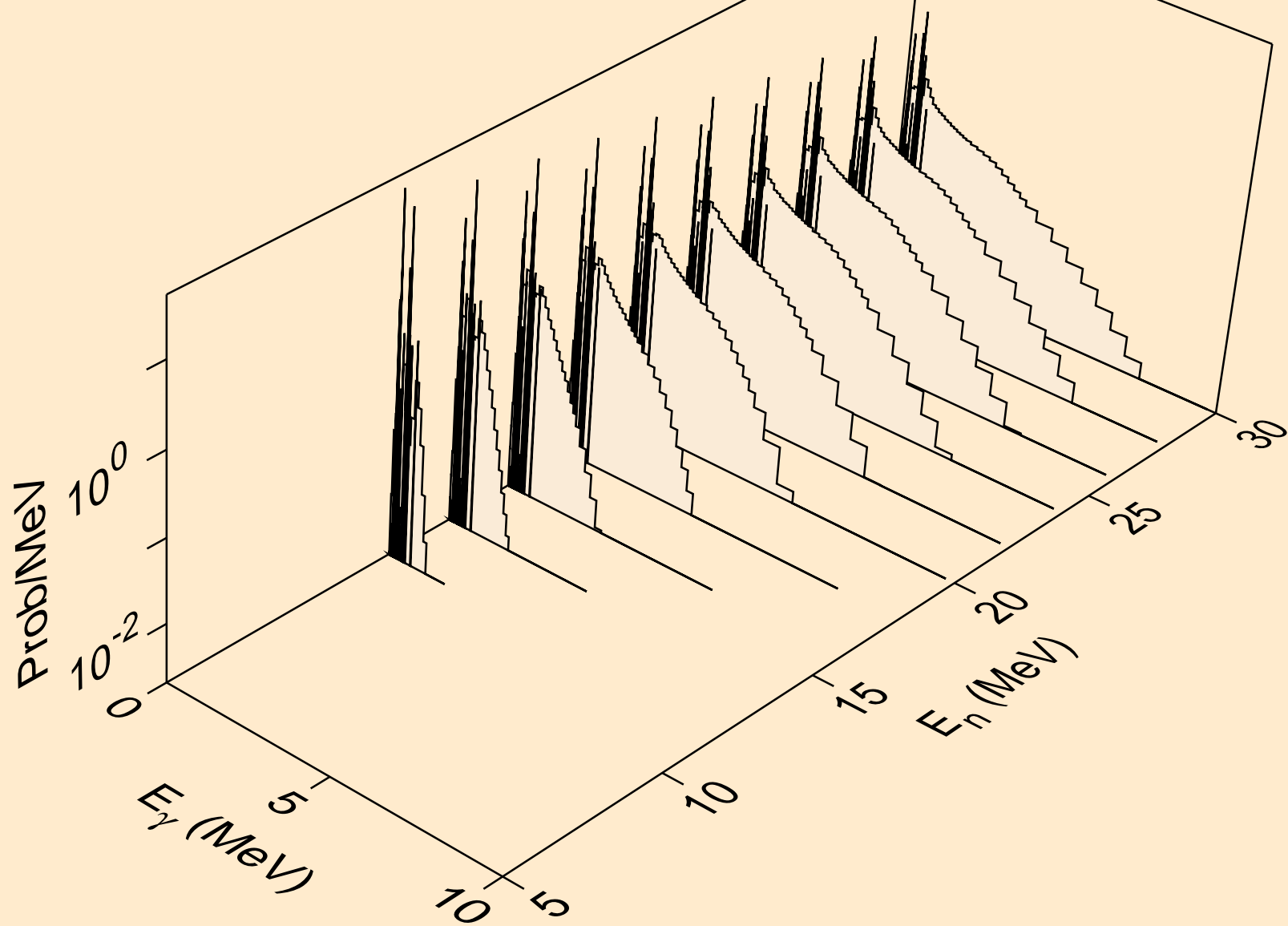

ER151 ALPHA ACER TENDL-2023 LIBRARY; T=0.K  
Photon emission for (n,d)

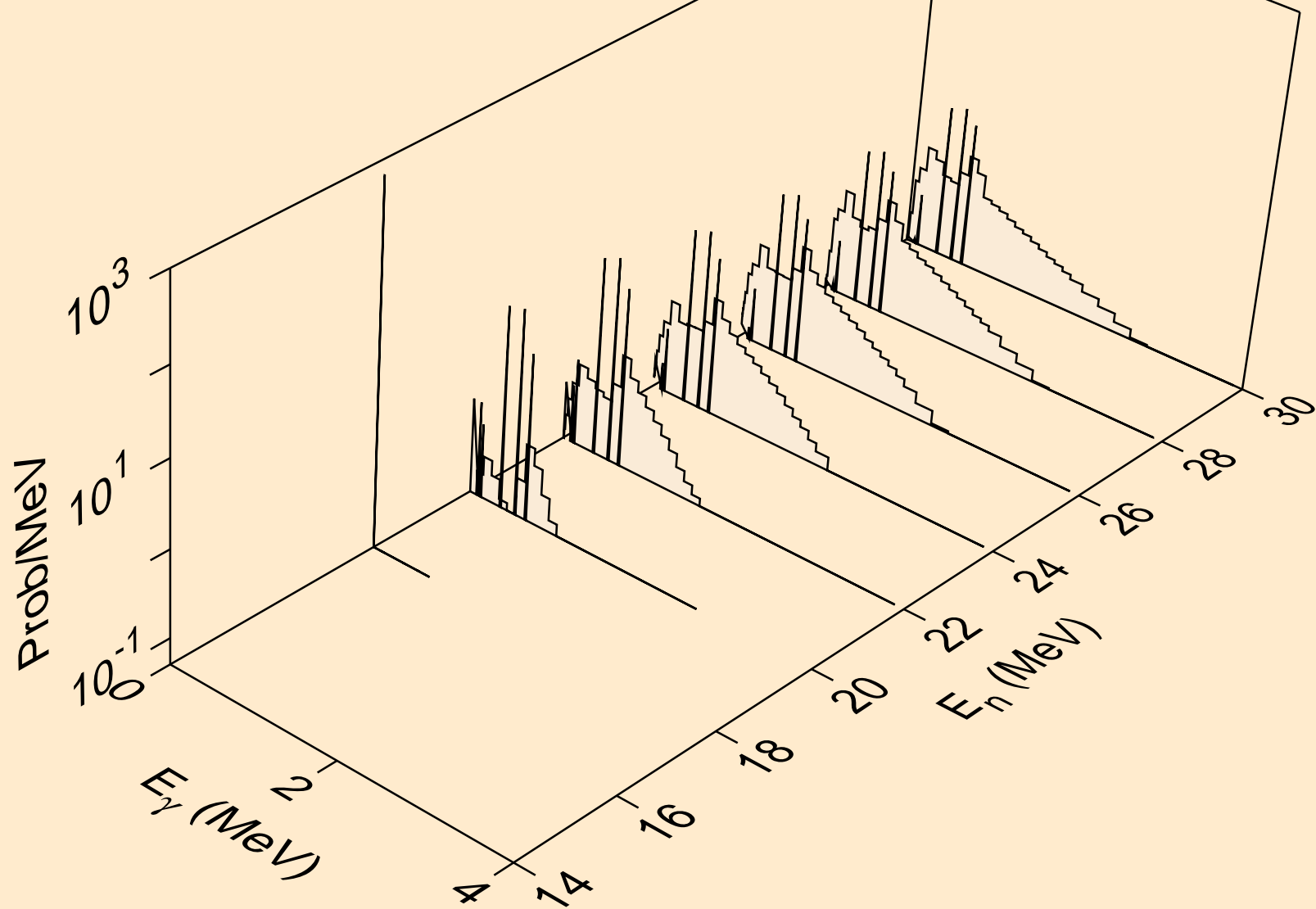

ER151 ALPHA ACER TENDL-2023 LIBRARY; T=0.K  
Photon emission for (n,t)

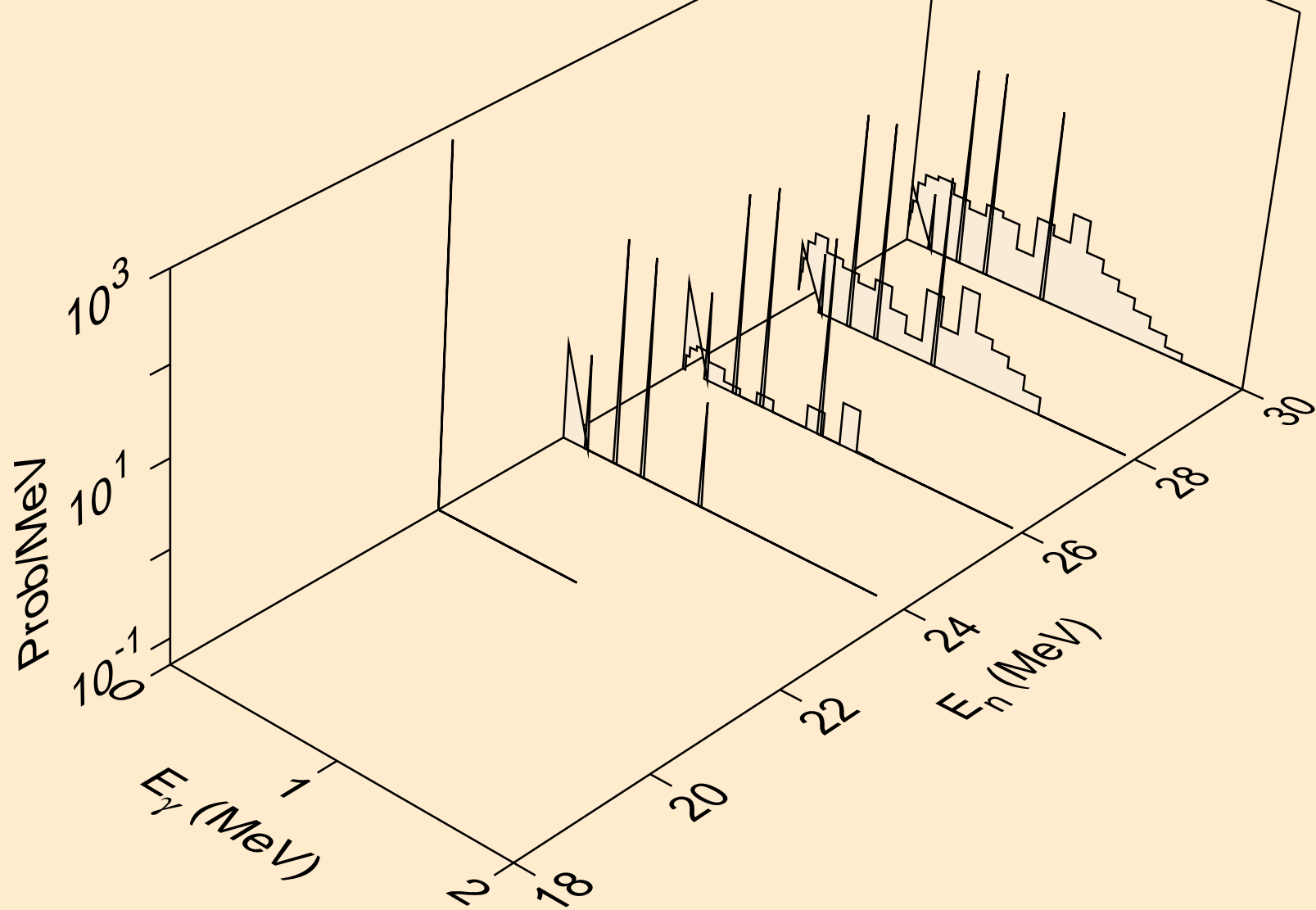

ER151 ALPHA ACER TENDL-2023 LIBRARY; T=0.K  
Photon emission for (n,he3)

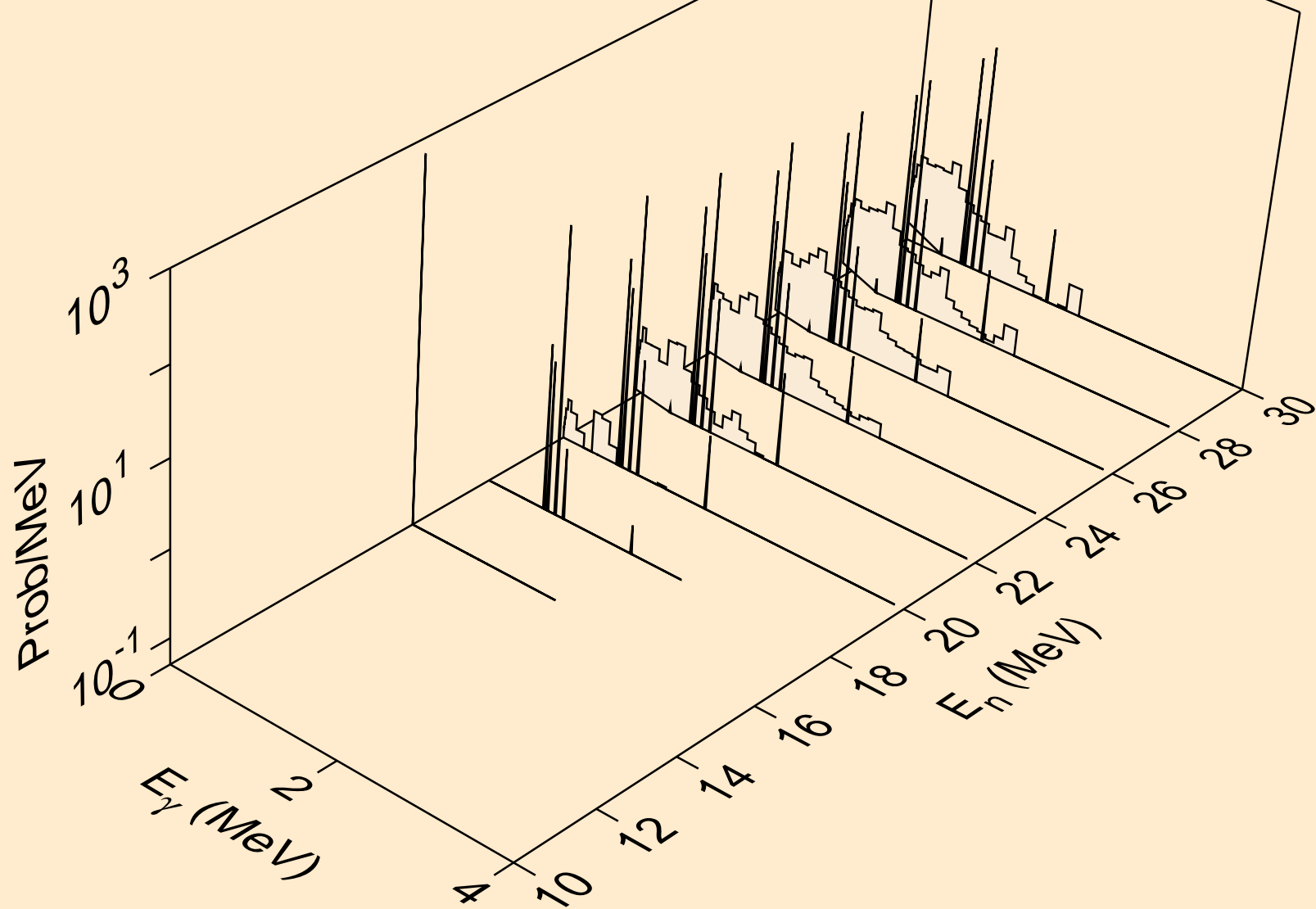

ER151 ALPHA ACER TENDL-2023 LIBRARY; T=0.K  
Photon emission for inelastic

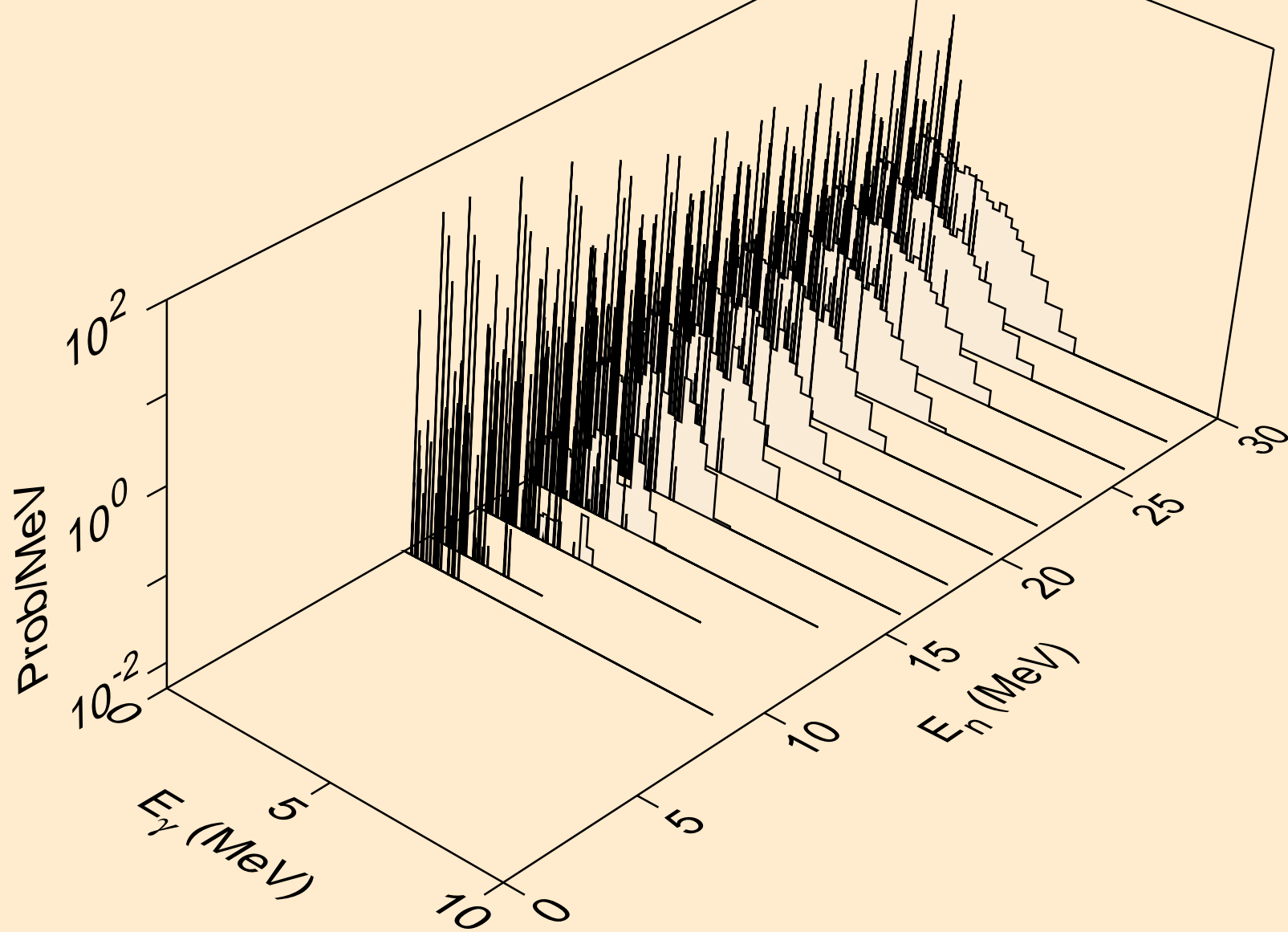

ER151 ALPHA ACER TENDL-2023 LIBRARY; T=0.K  
Photon emission for (n,2a)

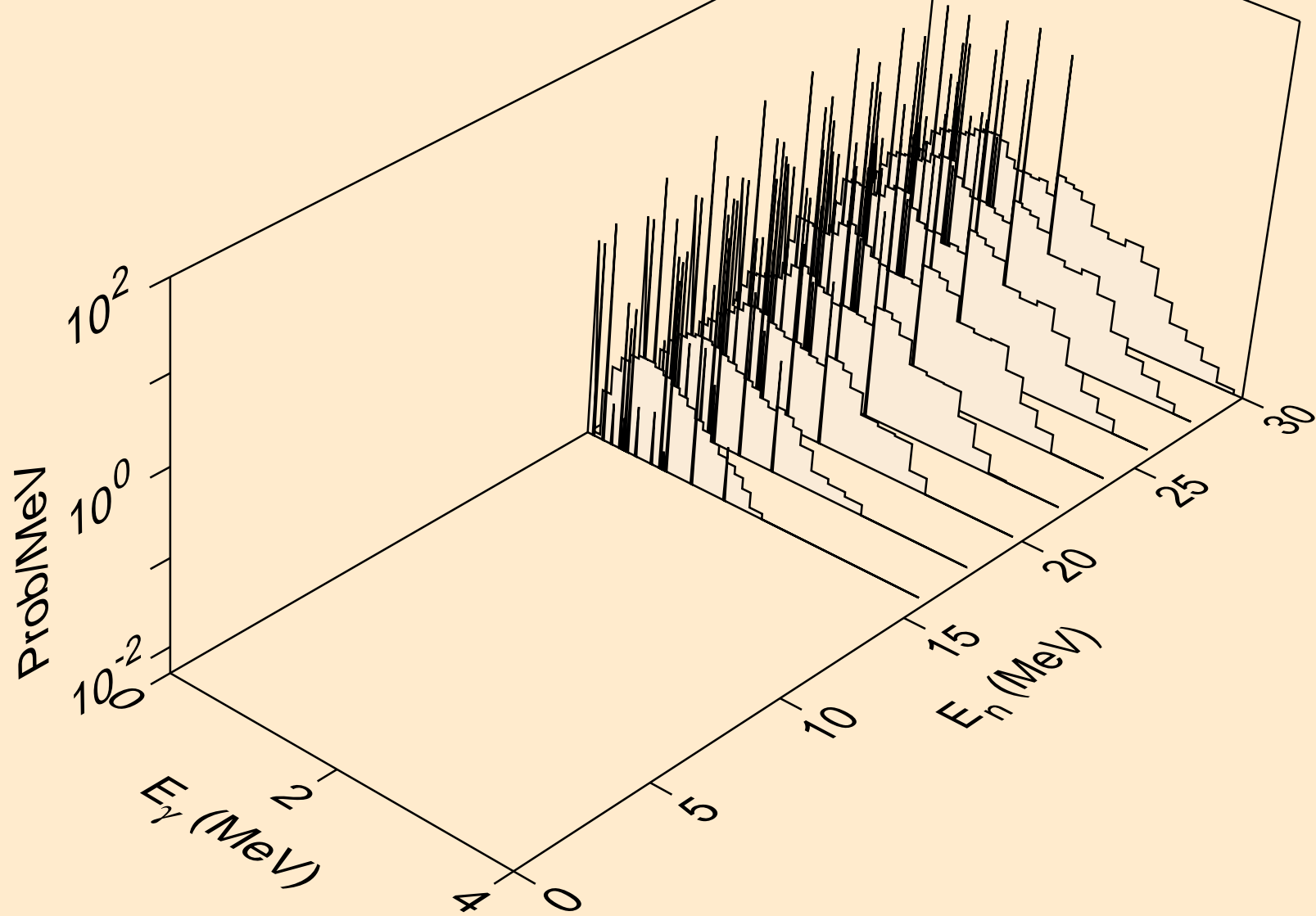

ER151 ALPHA ACER TENDL-2023 LIBRARY; T=0.K  
Photon emission for (n,2p)

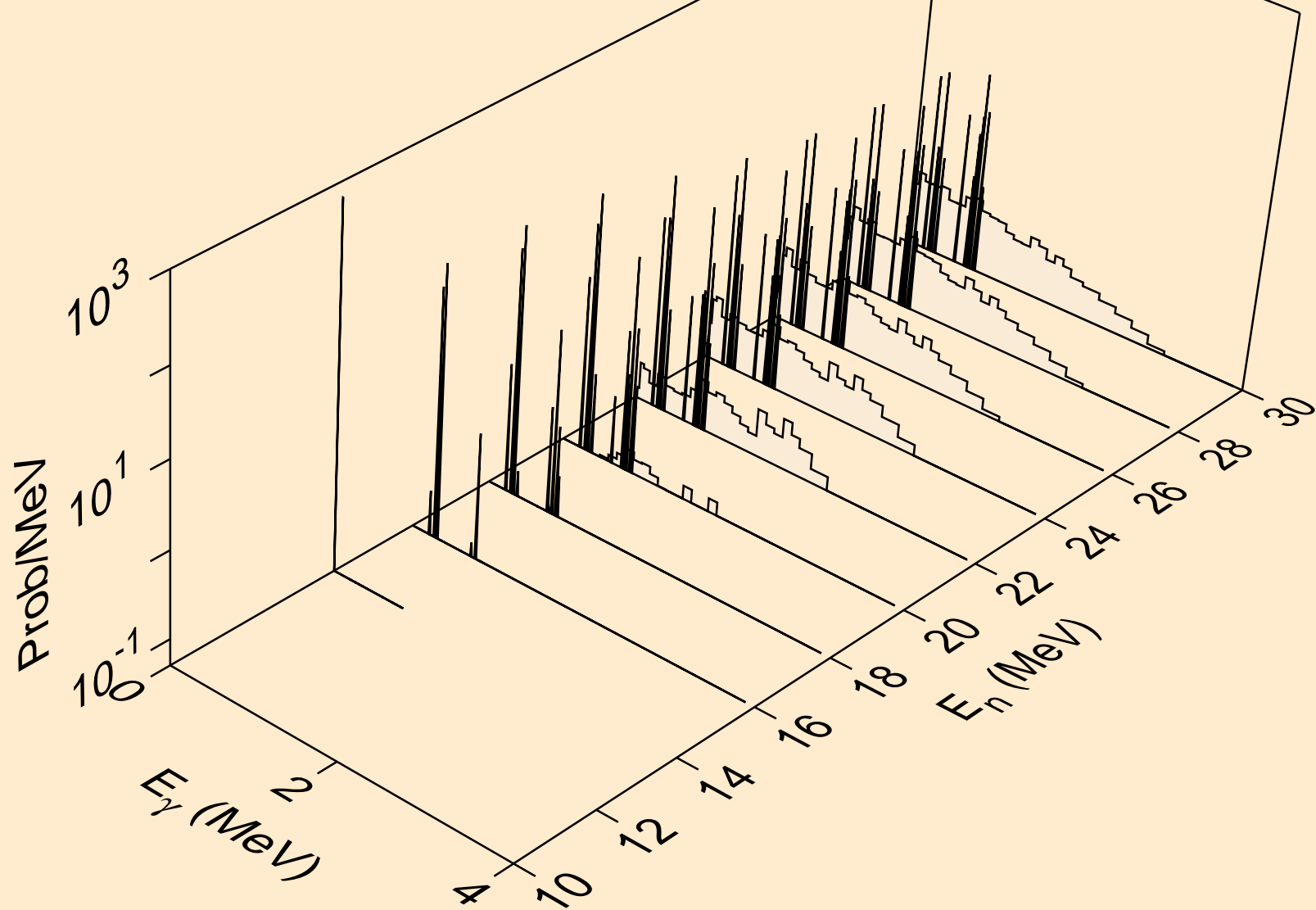

ER151 ALPHA ACER TENDL-2023 LIBRARY; T=0.K  
Photon emission for (n,pa)

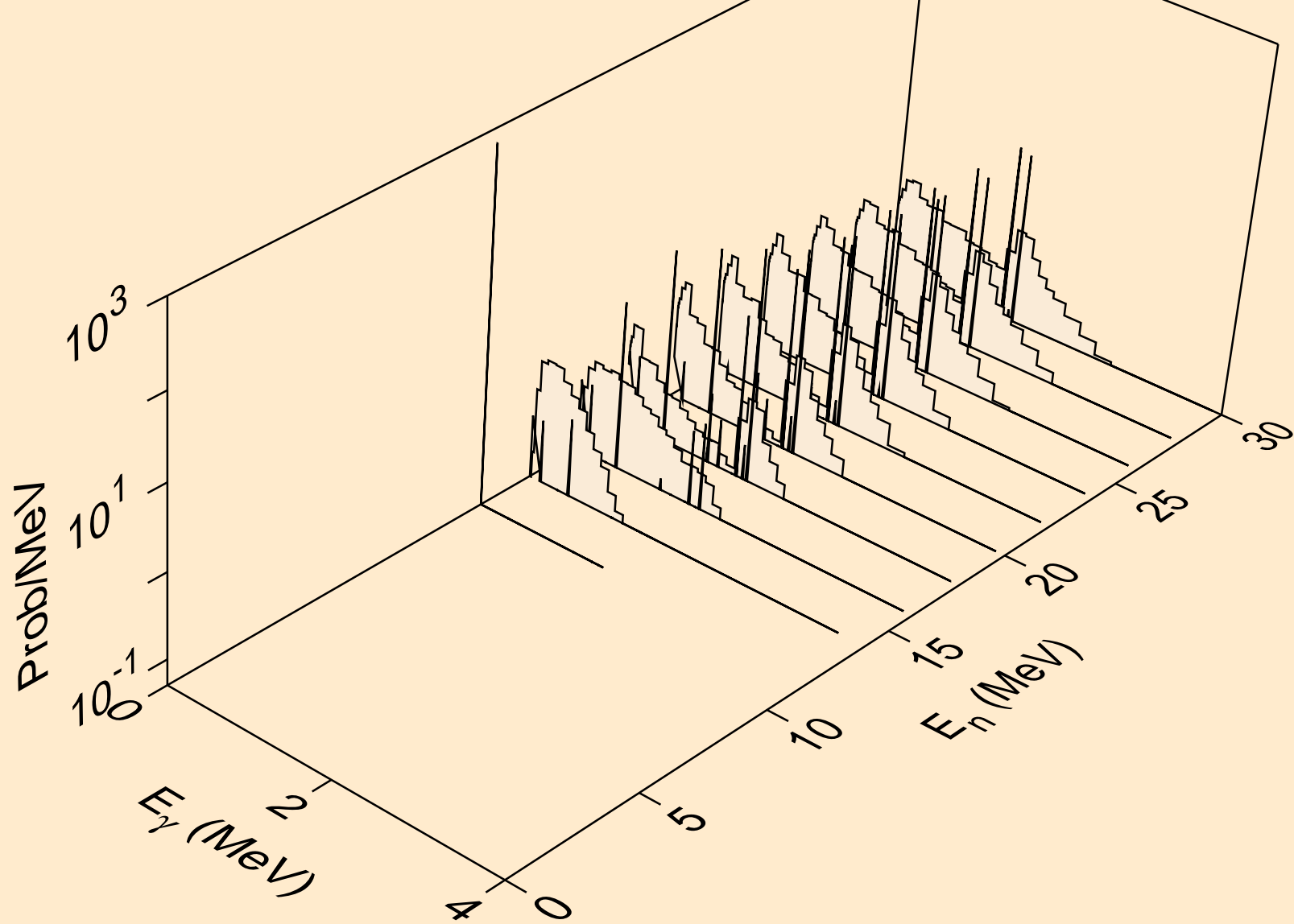

ER151 ALPHA ACER TENDL-2023 LIBRARY; T=0.K  
Photon emission for (n,pd)

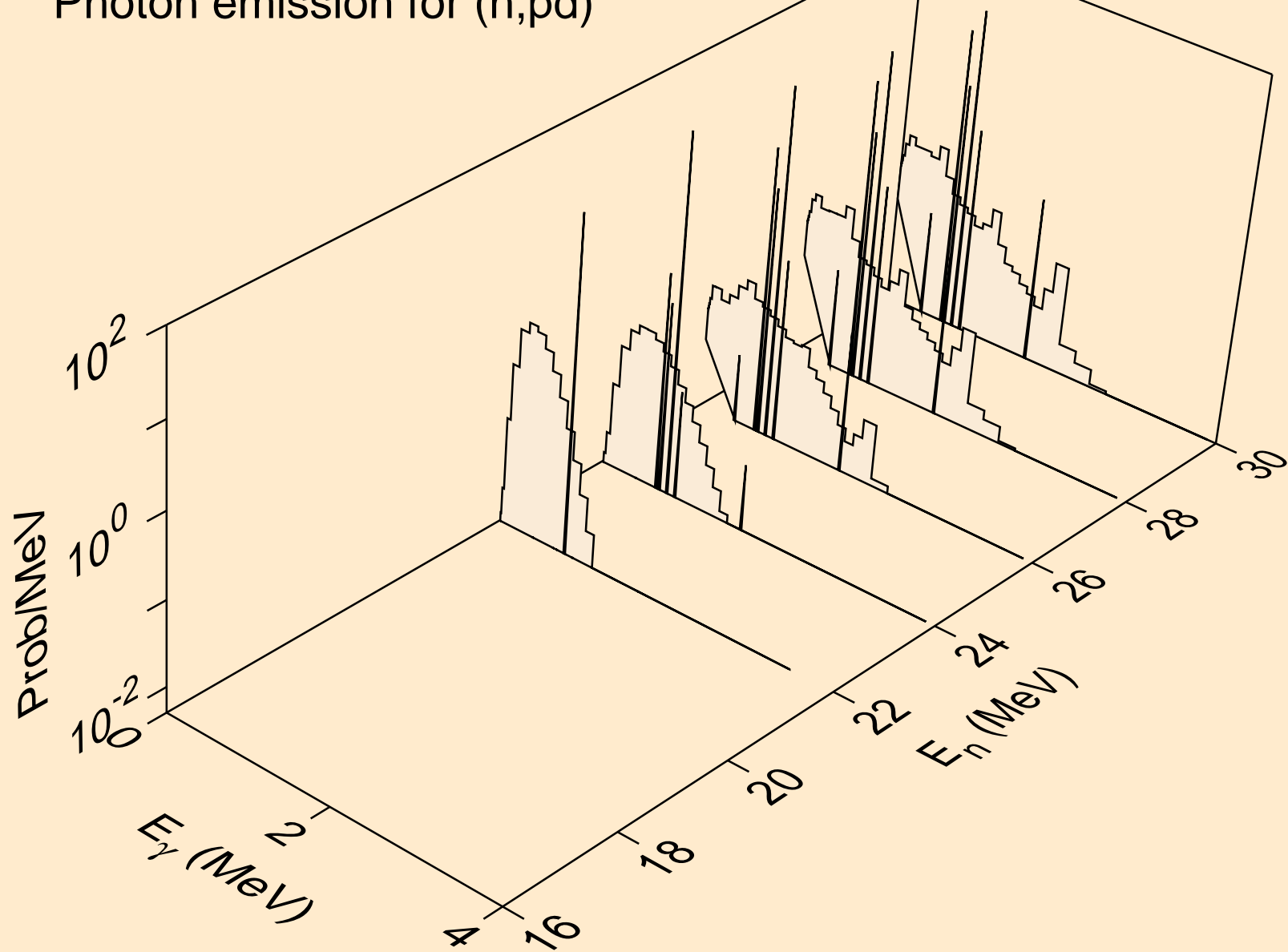

ER151 ALPHA ACER TENDL-2023 LIBRARY; T=0.K  
Photon emission for (n,da)

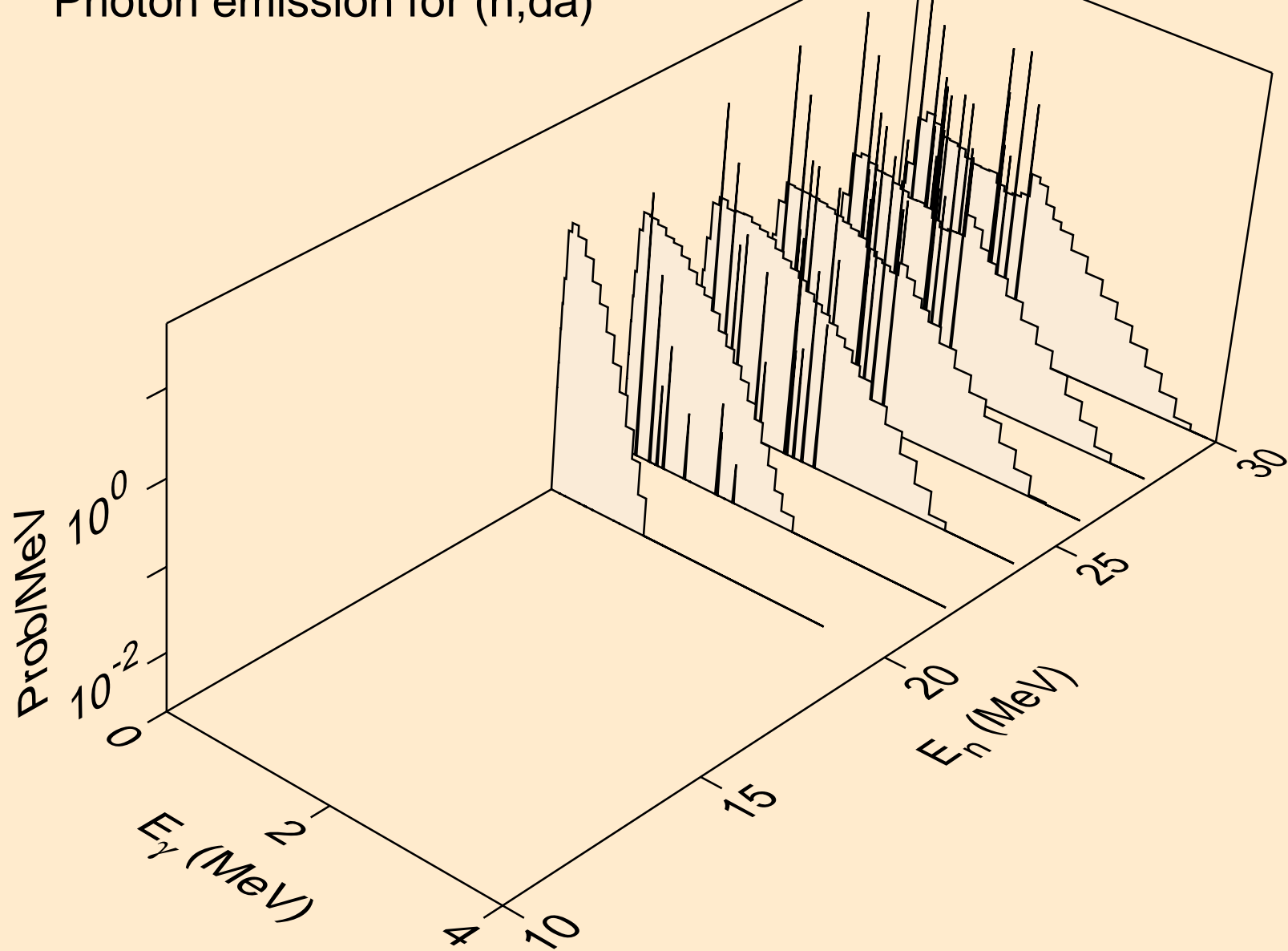

# ER151 ALPHA ACER TENDL-2023 LIBRARY; T=0.K

## Particle heating contributions

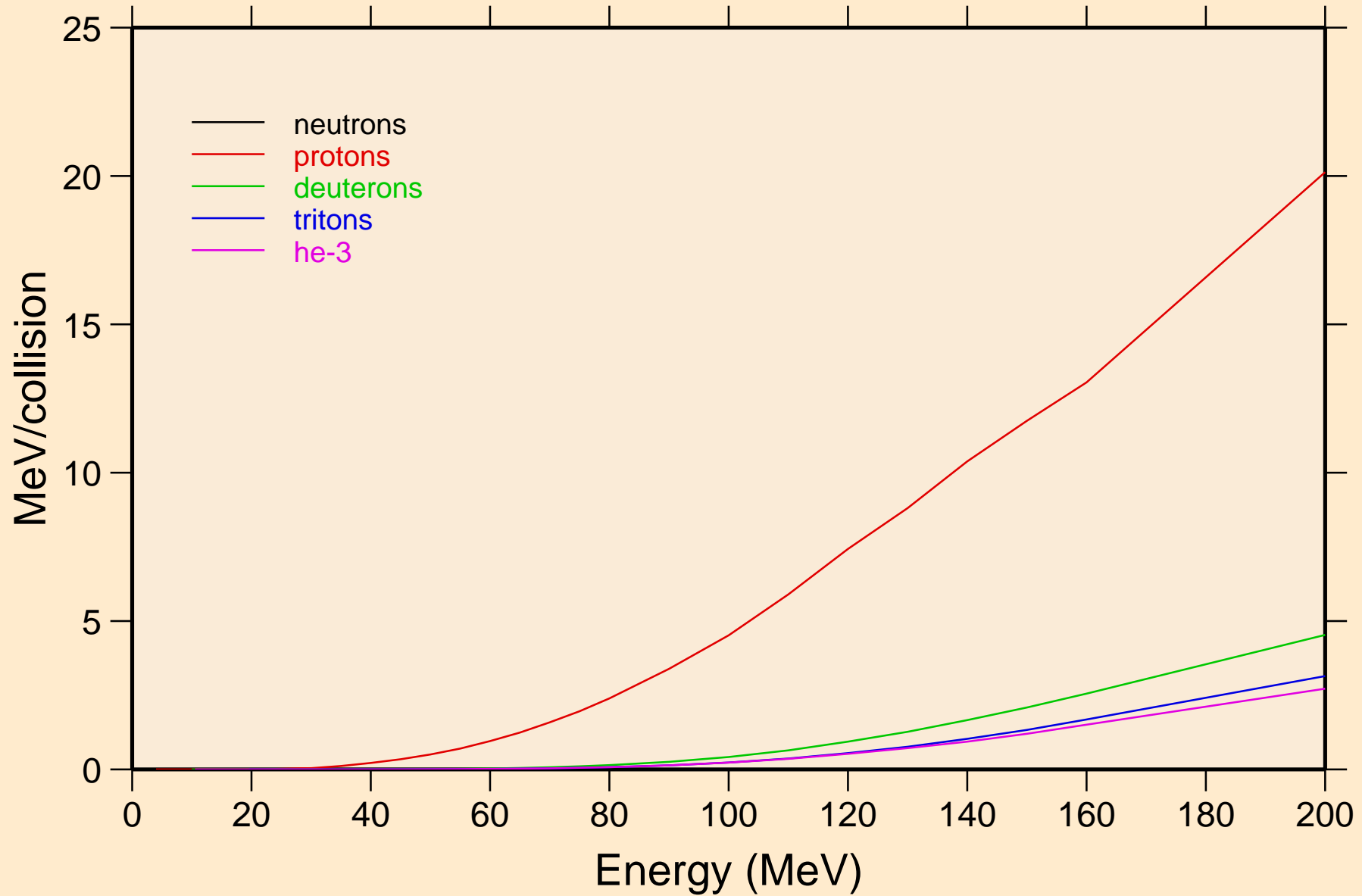

ER151 ALPHA ACER TENDL-2023 LIBRARY; T=0.K  
Recoil Heating

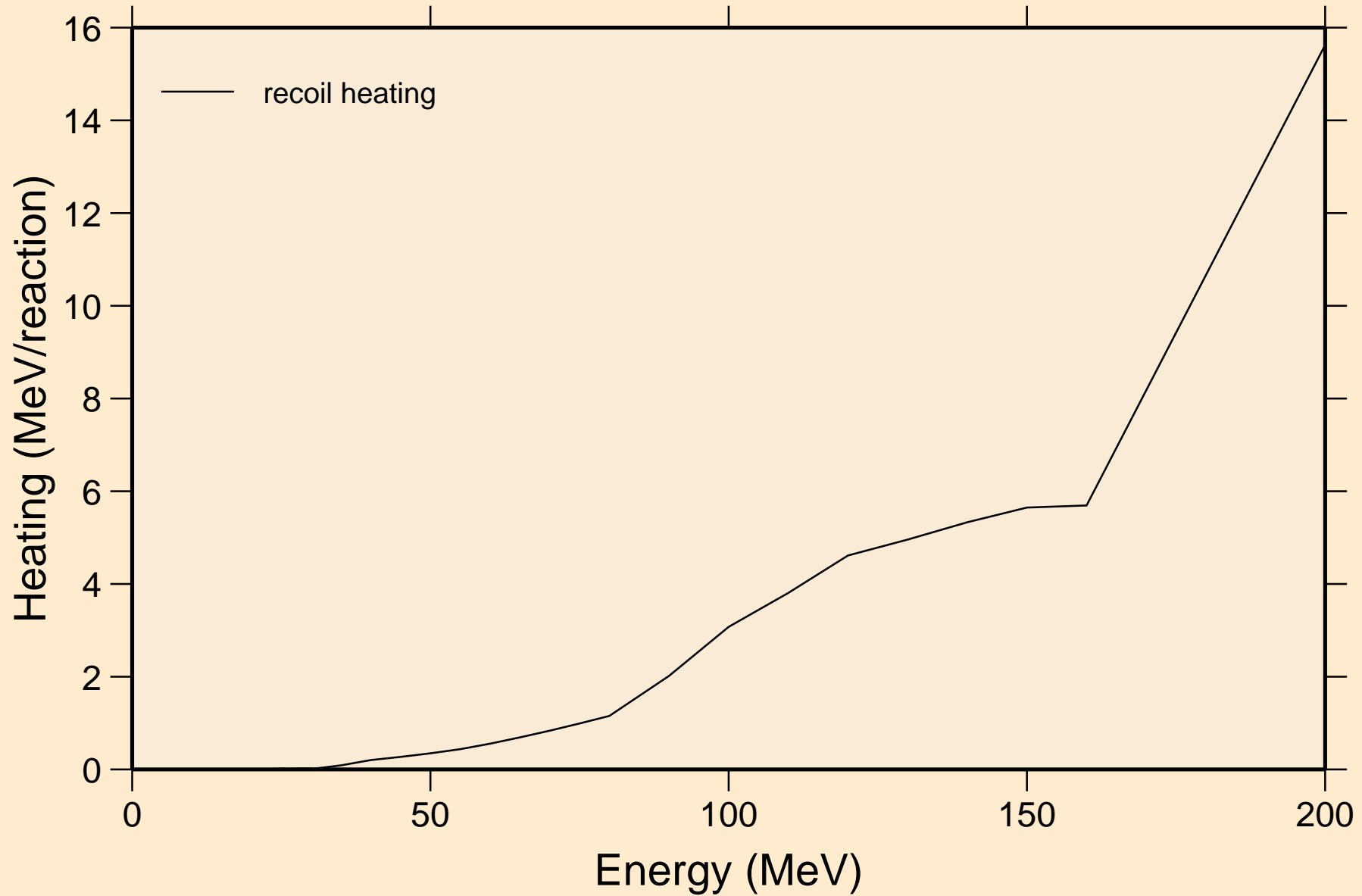

ER151 ALPHA ACER TENDL-2023 LIBRARY; T=0.K  
Particle production cross sections

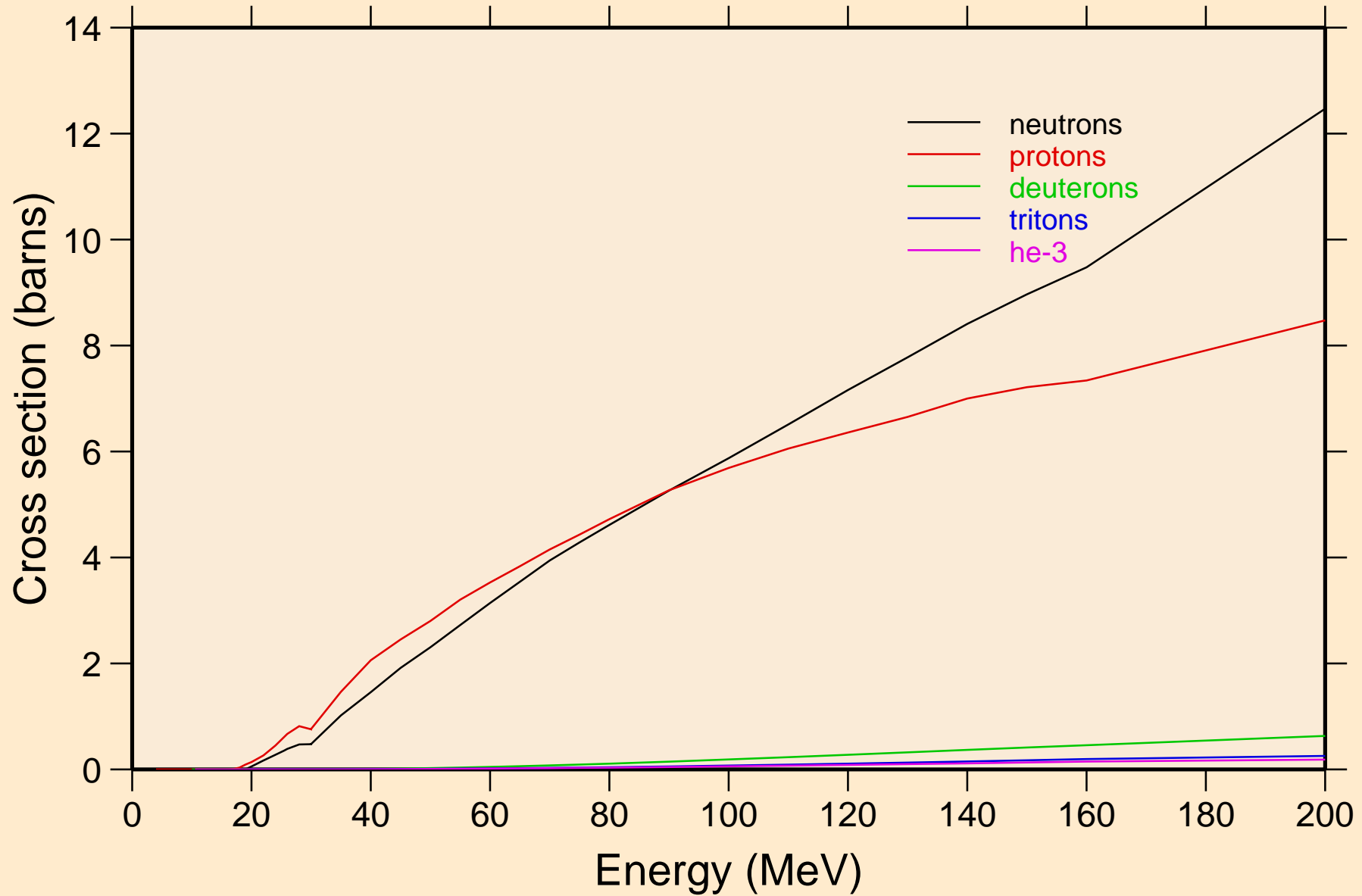

ER151 ALPHA ACER TENDL-2023 LIBRARY; T=0.K  
neutrons from (a,n)

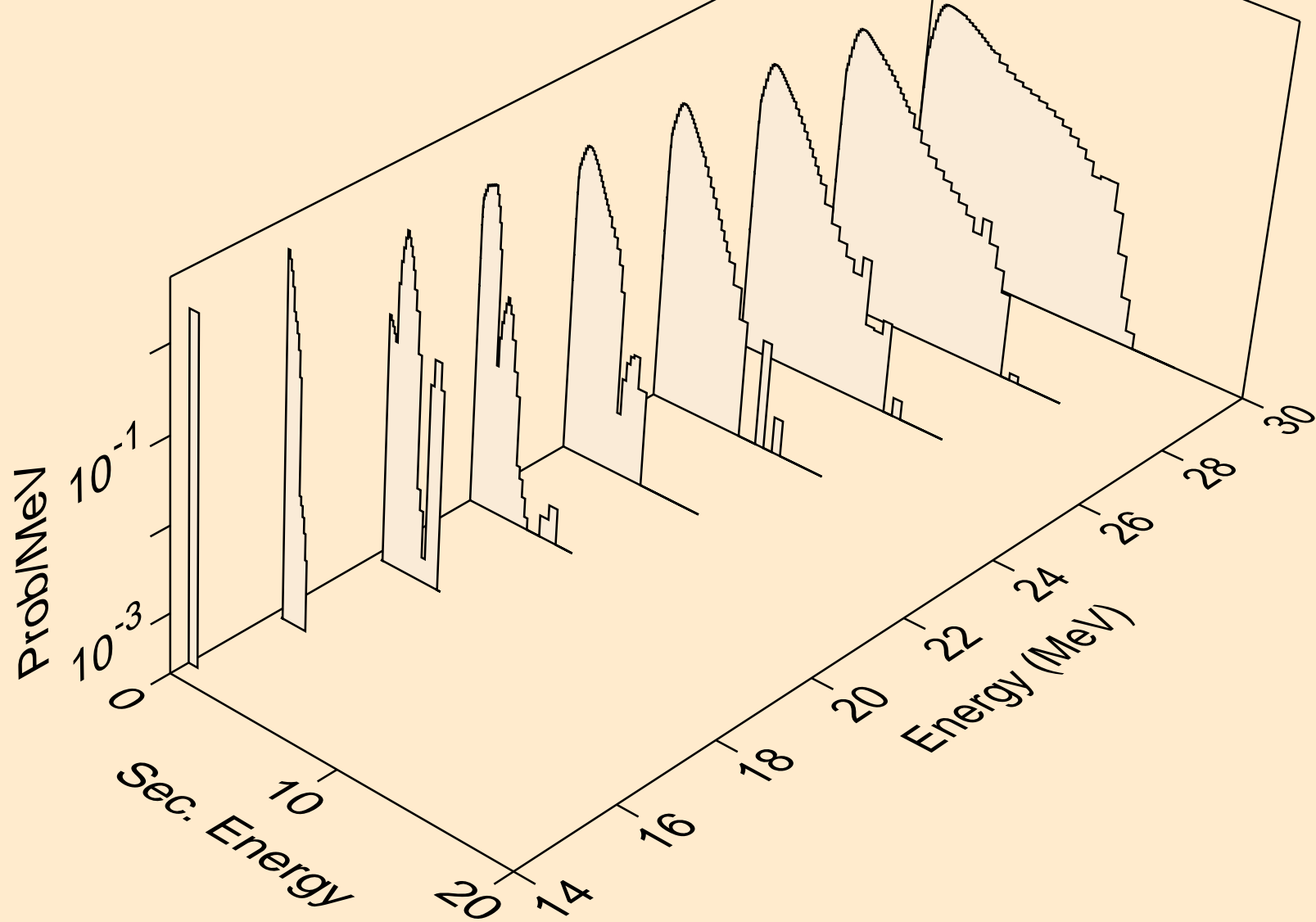

ER151 ALPHA ACER TENDL-2023 LIBRARY; T=0.K  
neutrons from (a,x)

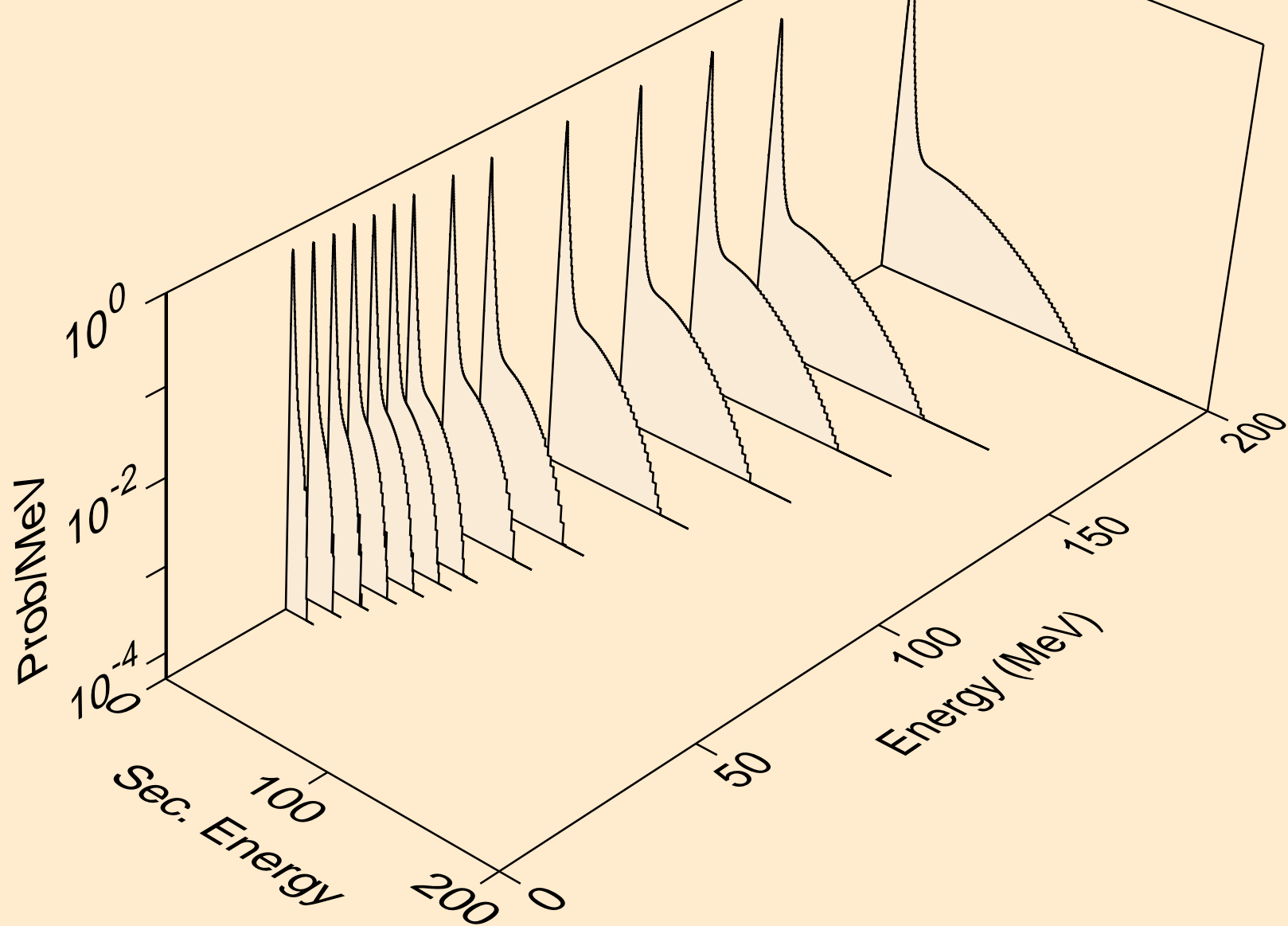

ER151 ALPHA ACER TENDL-2023 LIBRARY; T=0.K  
neutrons from (a,2n)

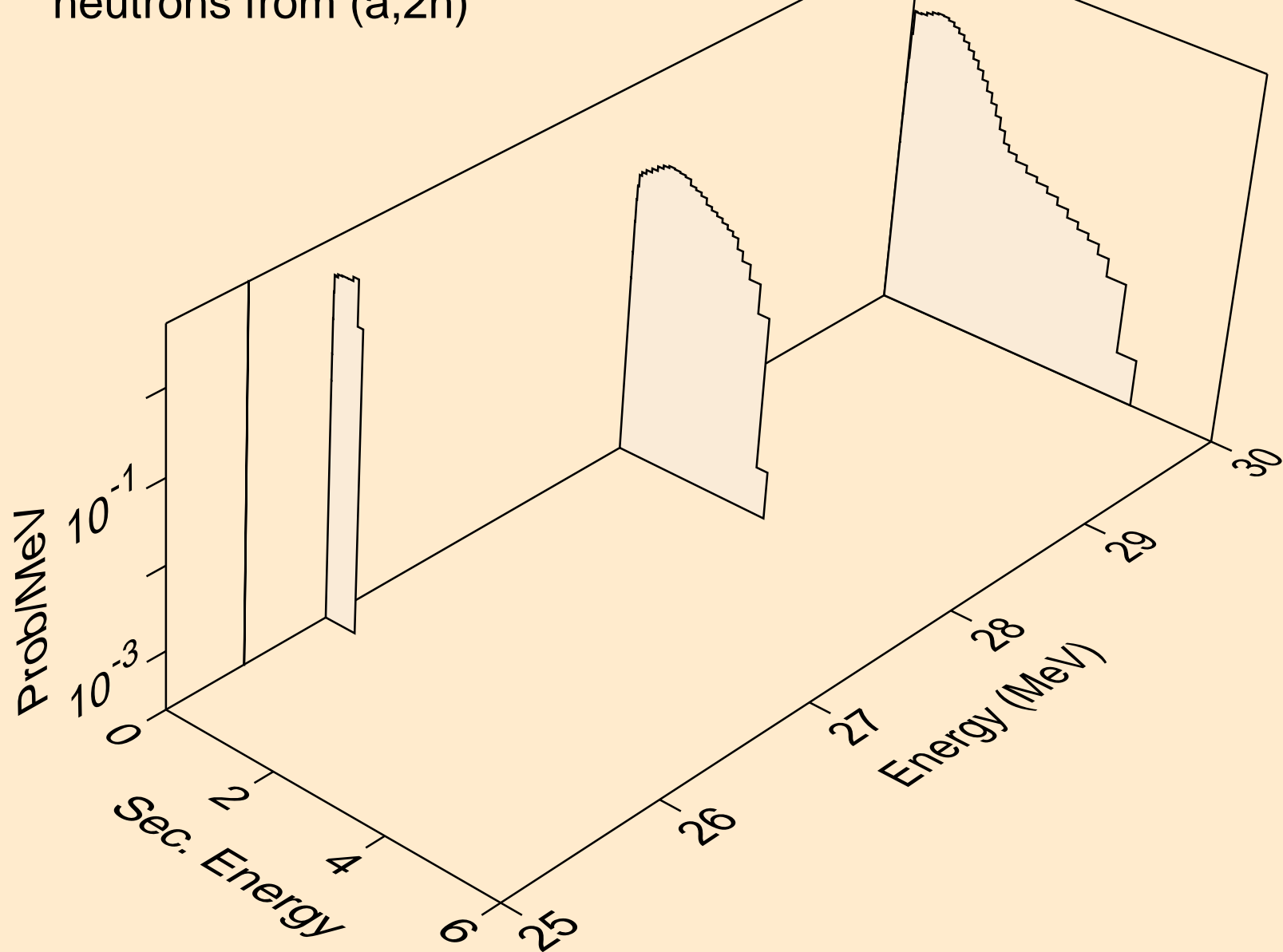

ER151 ALPHA ACER TENDL-2023 LIBRARY; T=0.K  
neutrons from (a,n\*)a

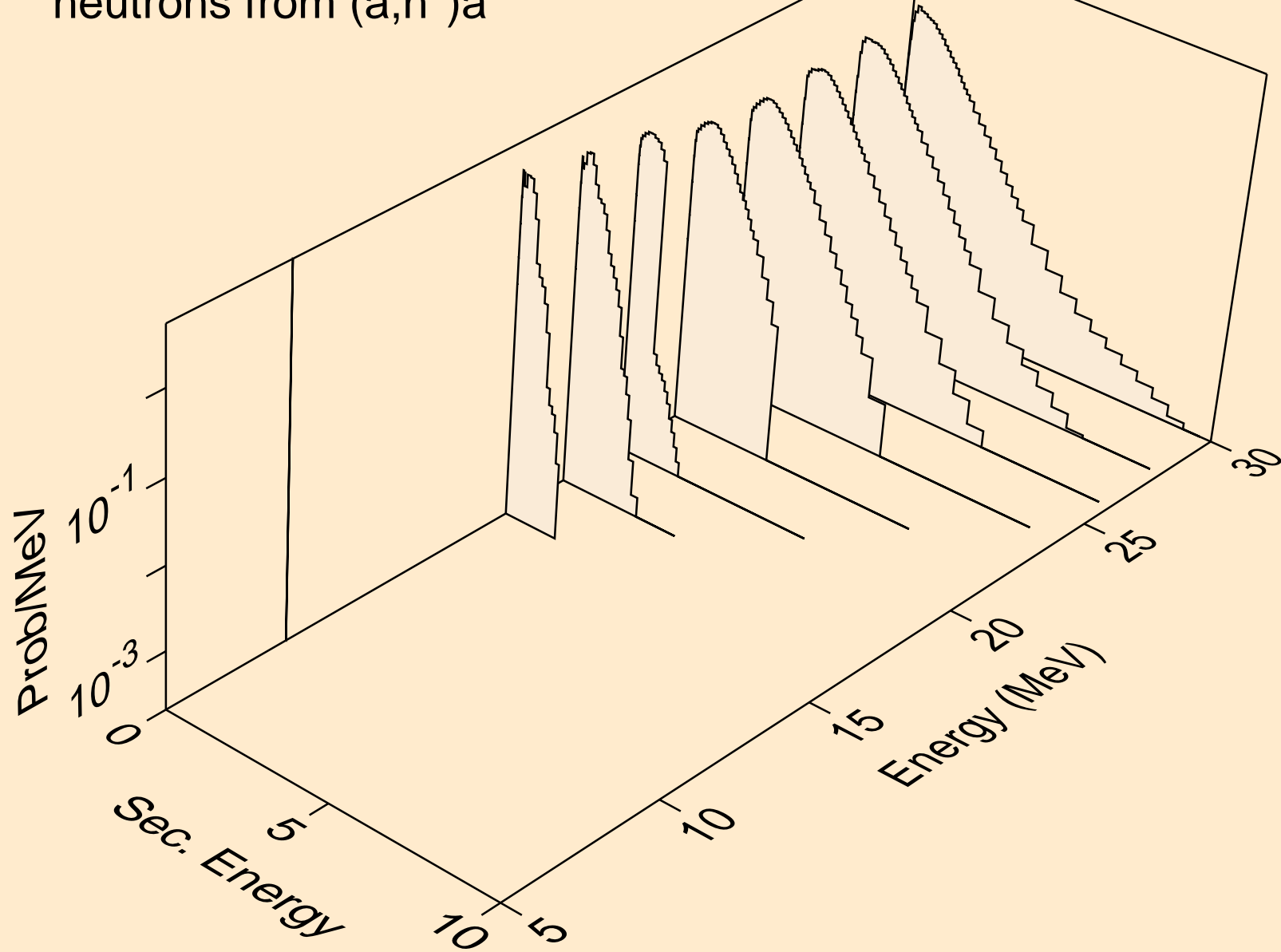

ER151 ALPHA ACER TENDL-2023 LIBRARY; T=0.K  
neutrons from (a,2n)a

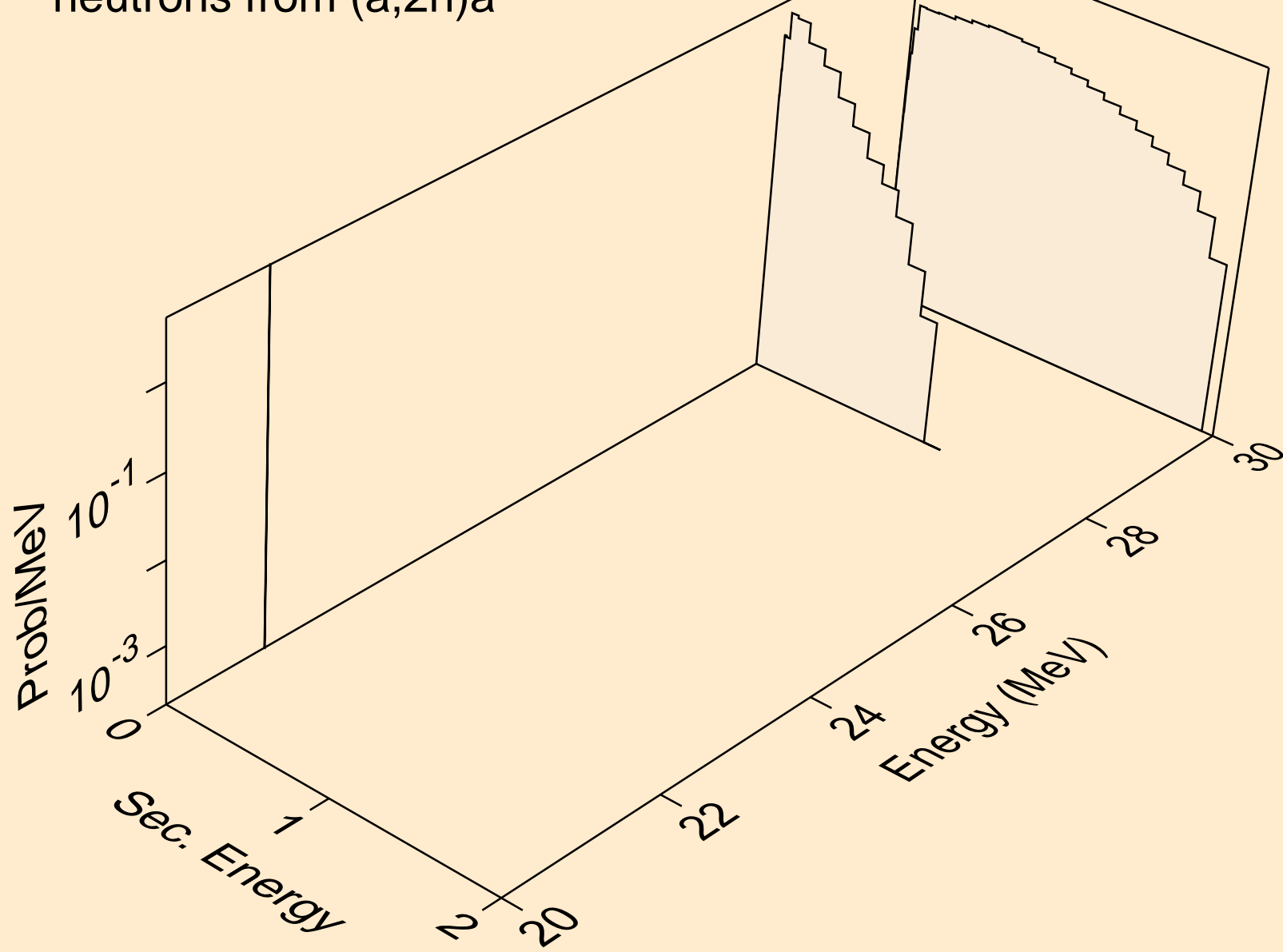

ER151 ALPHA ACER TENDL-2023 LIBRARY; T=0.K  
neutrons from (a,n\*)p

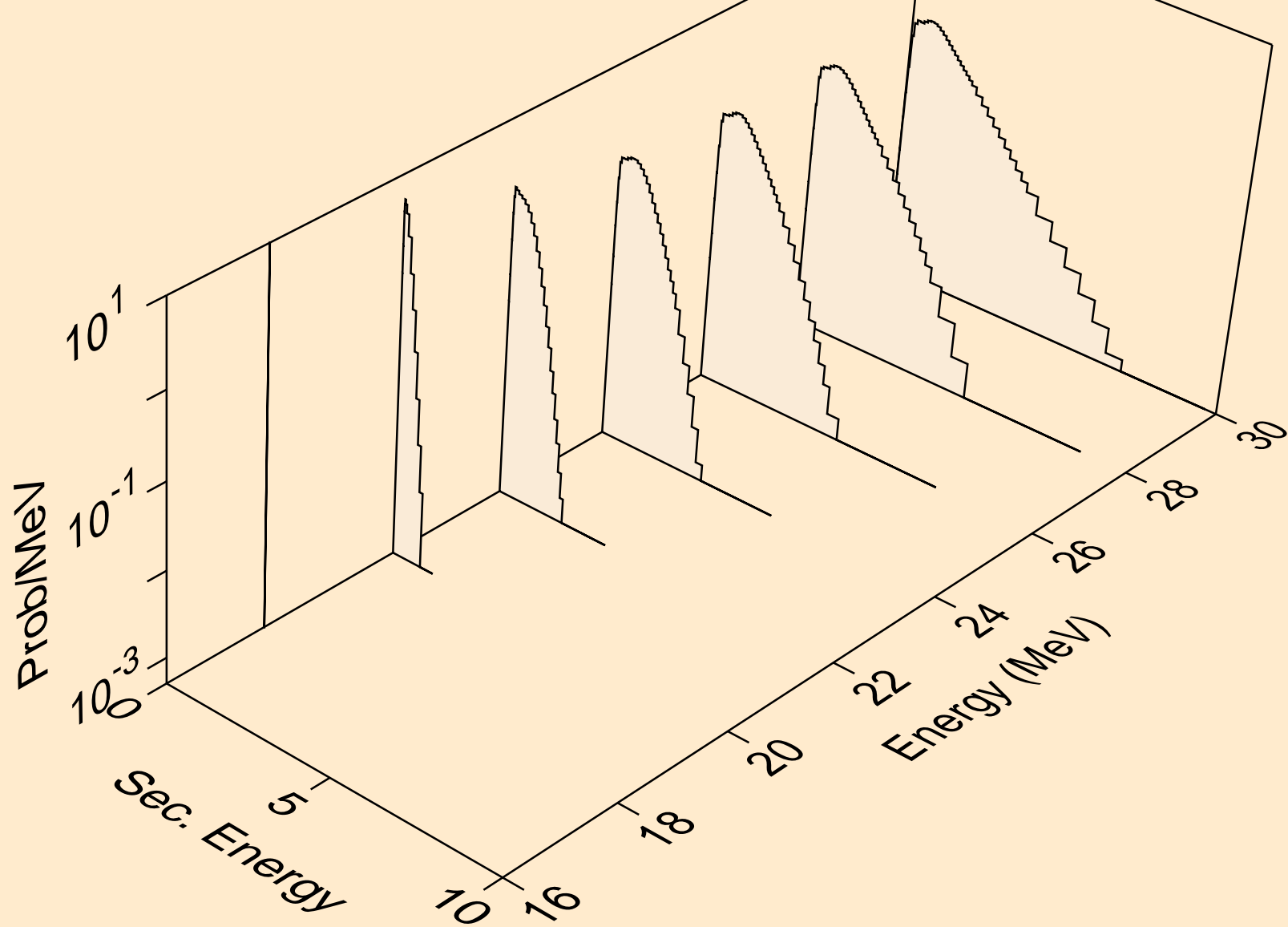

ER151 ALPHA ACER TENDL-2023 LIBRARY; T=0.K  
neutrons from (a,n2p)

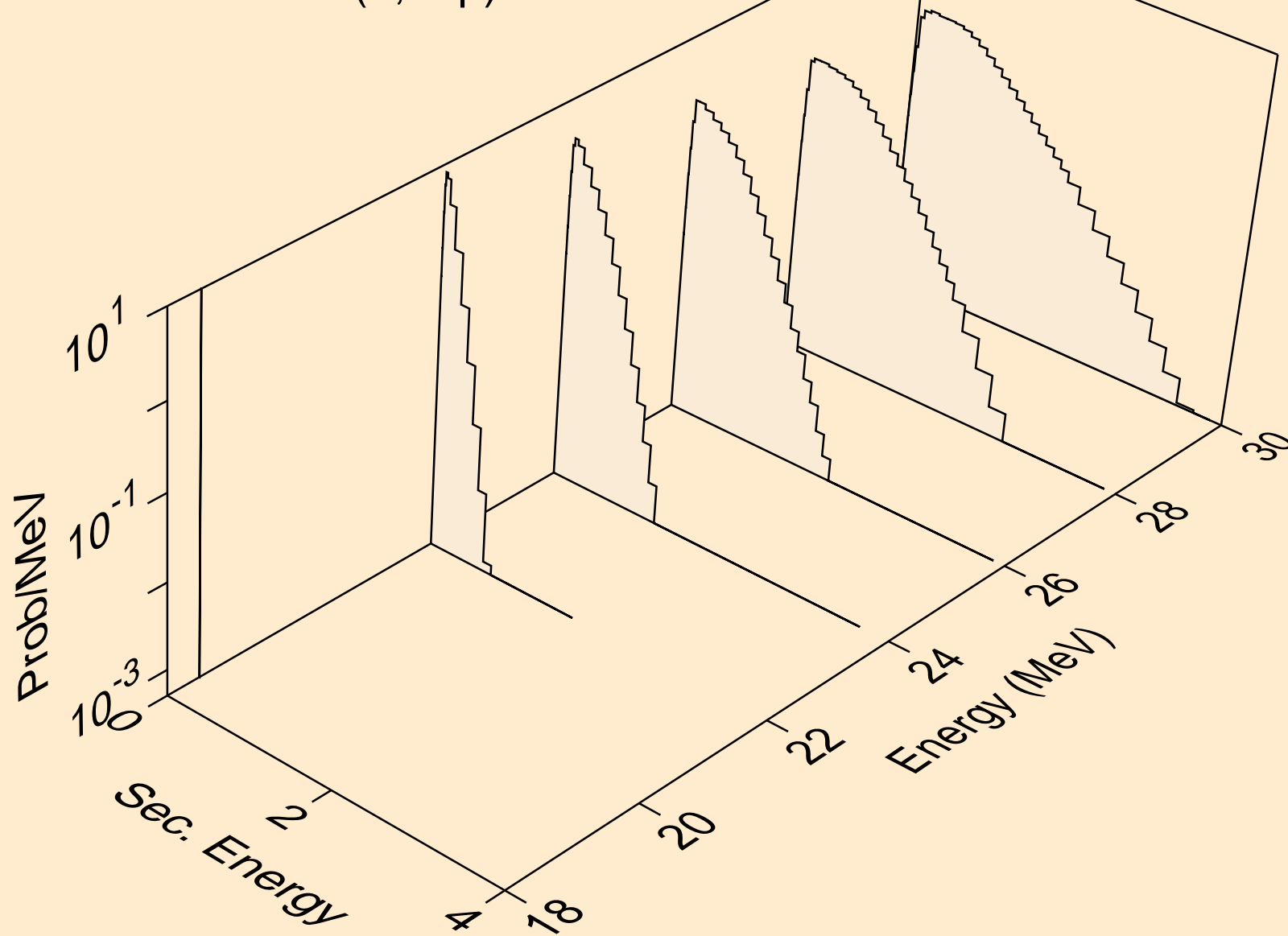

ER151 ALPHA ACER TENDL-2023 LIBRARY; T=0.K  
neutrons from (a,npa)

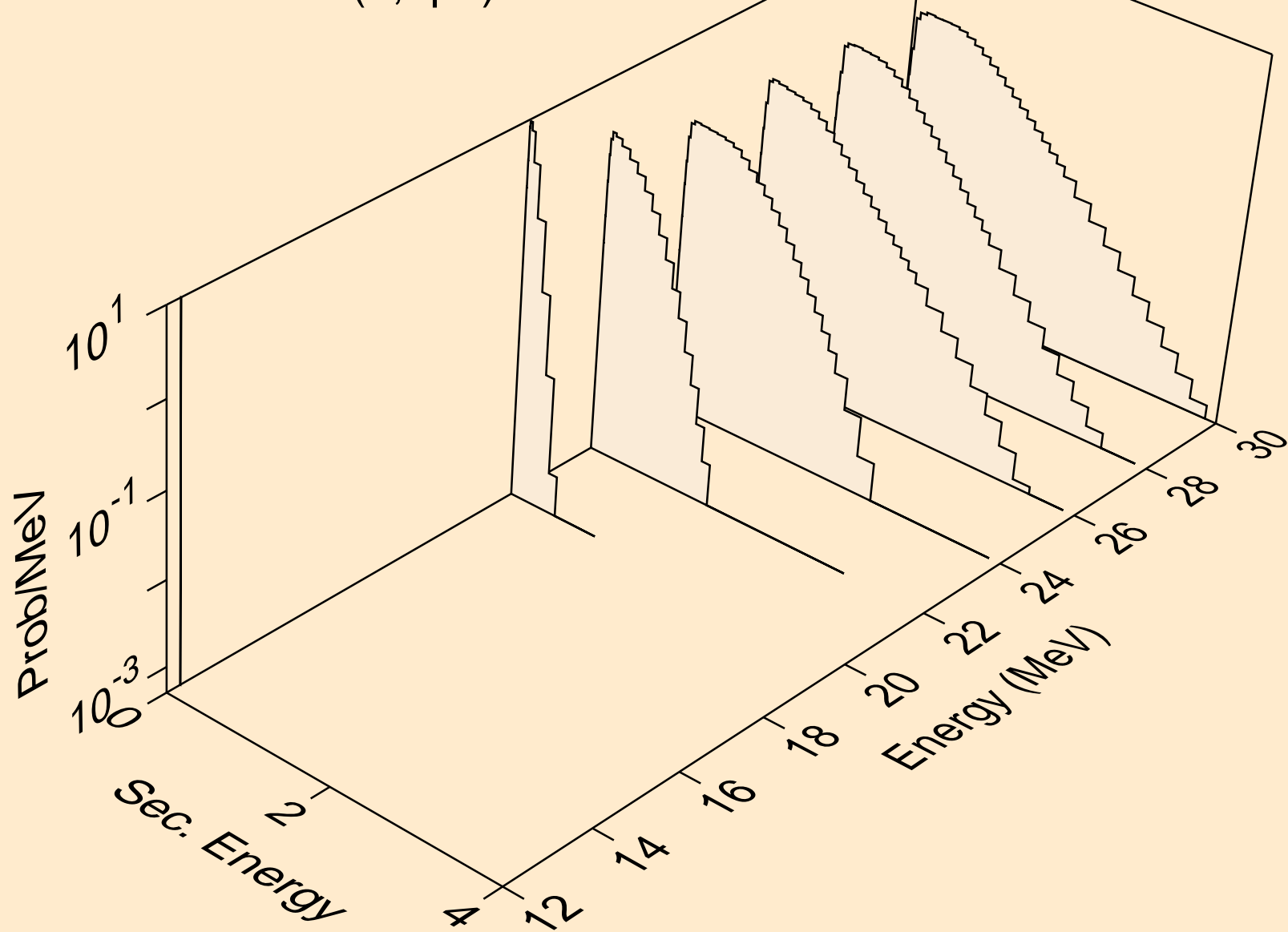

ER151 ALPHA ACER TENDL-2023 LIBRARY; T=0.K  
protons from (a,x)

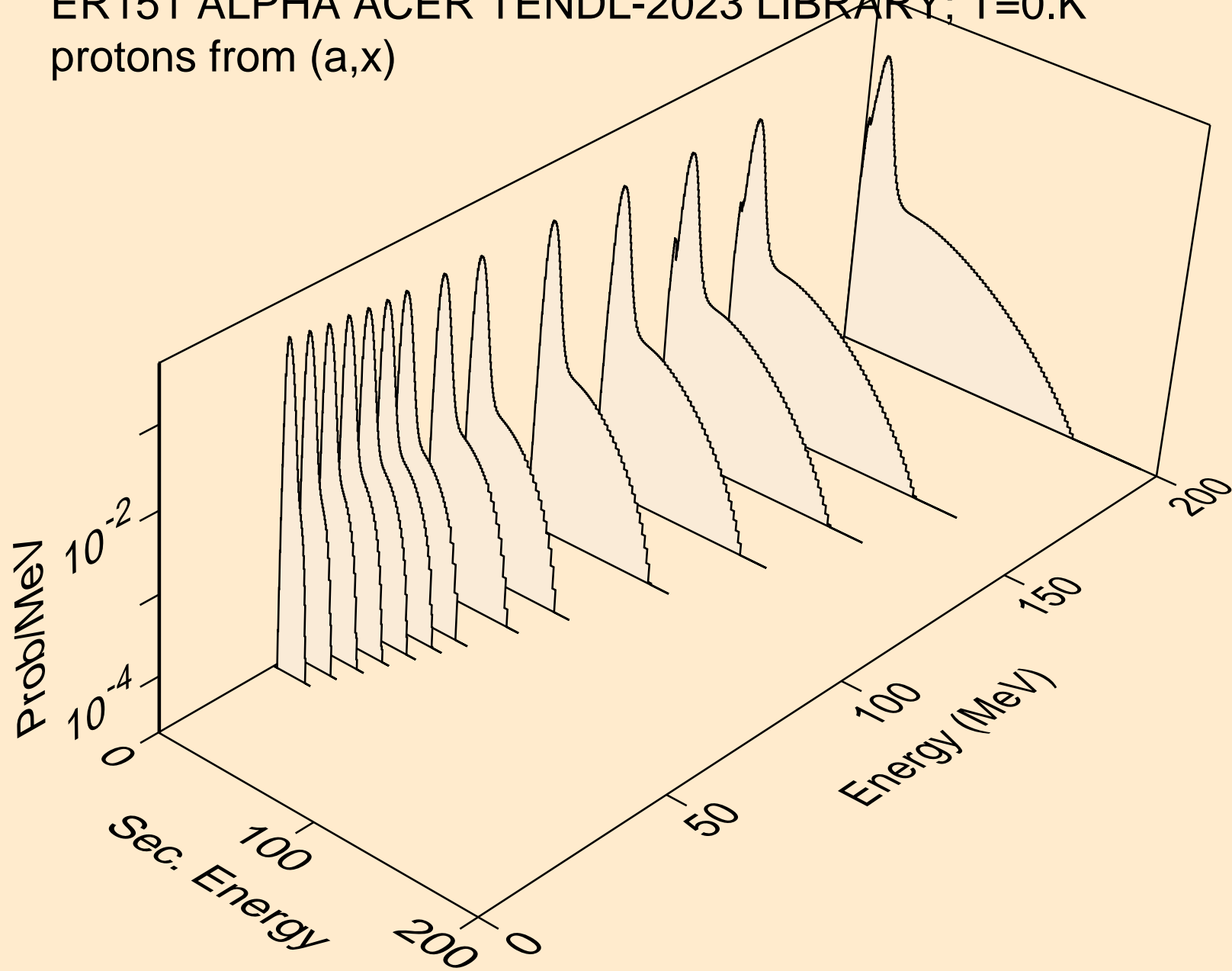

ER151 ALPHA ACER TENDL-2023 LIBRARY; T=0.K  
protons from (a,n\*)p

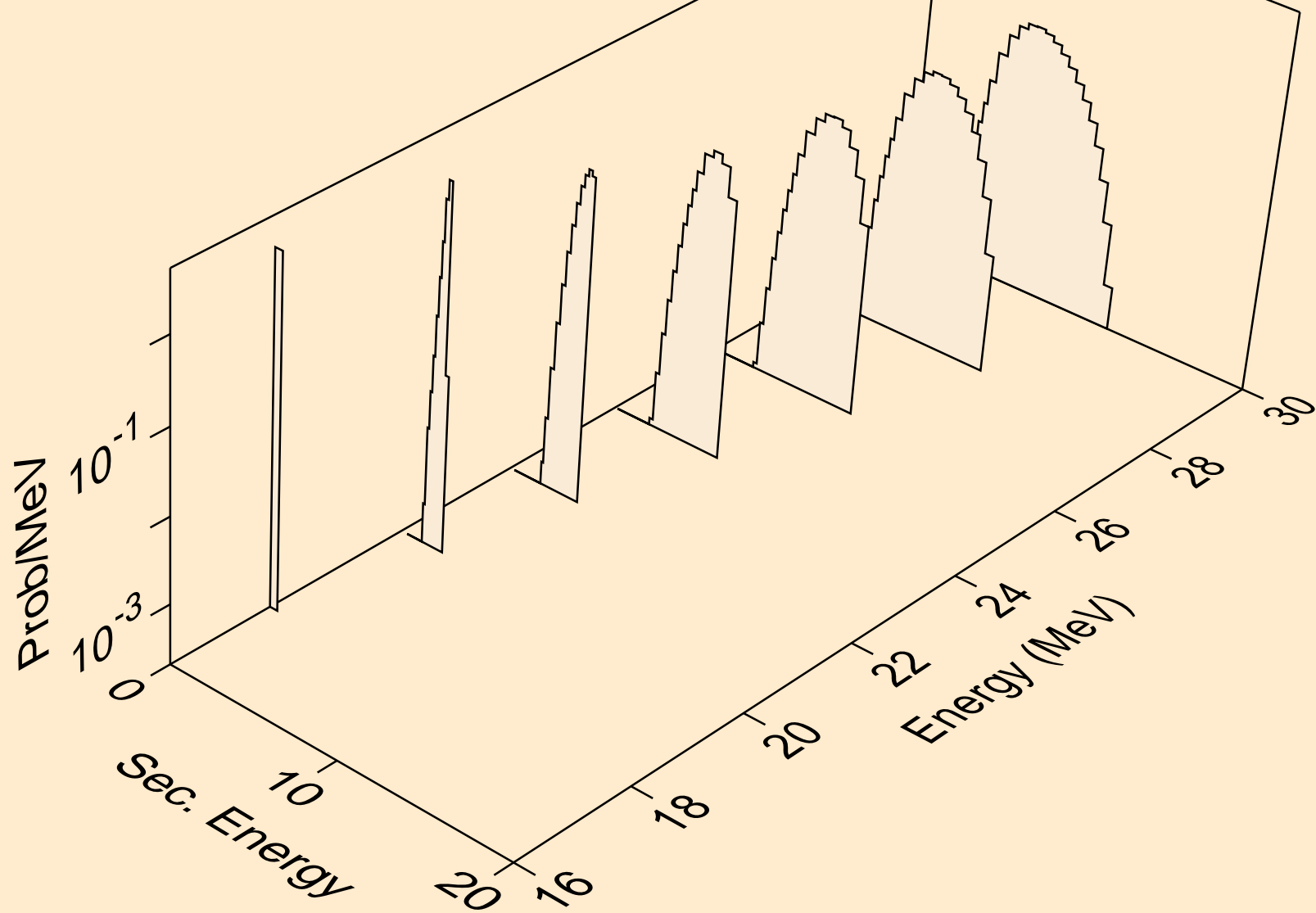

ER151 ALPHA ACER TENDL-2023 LIBRARY; T=0.K  
protons from (a,n2p)

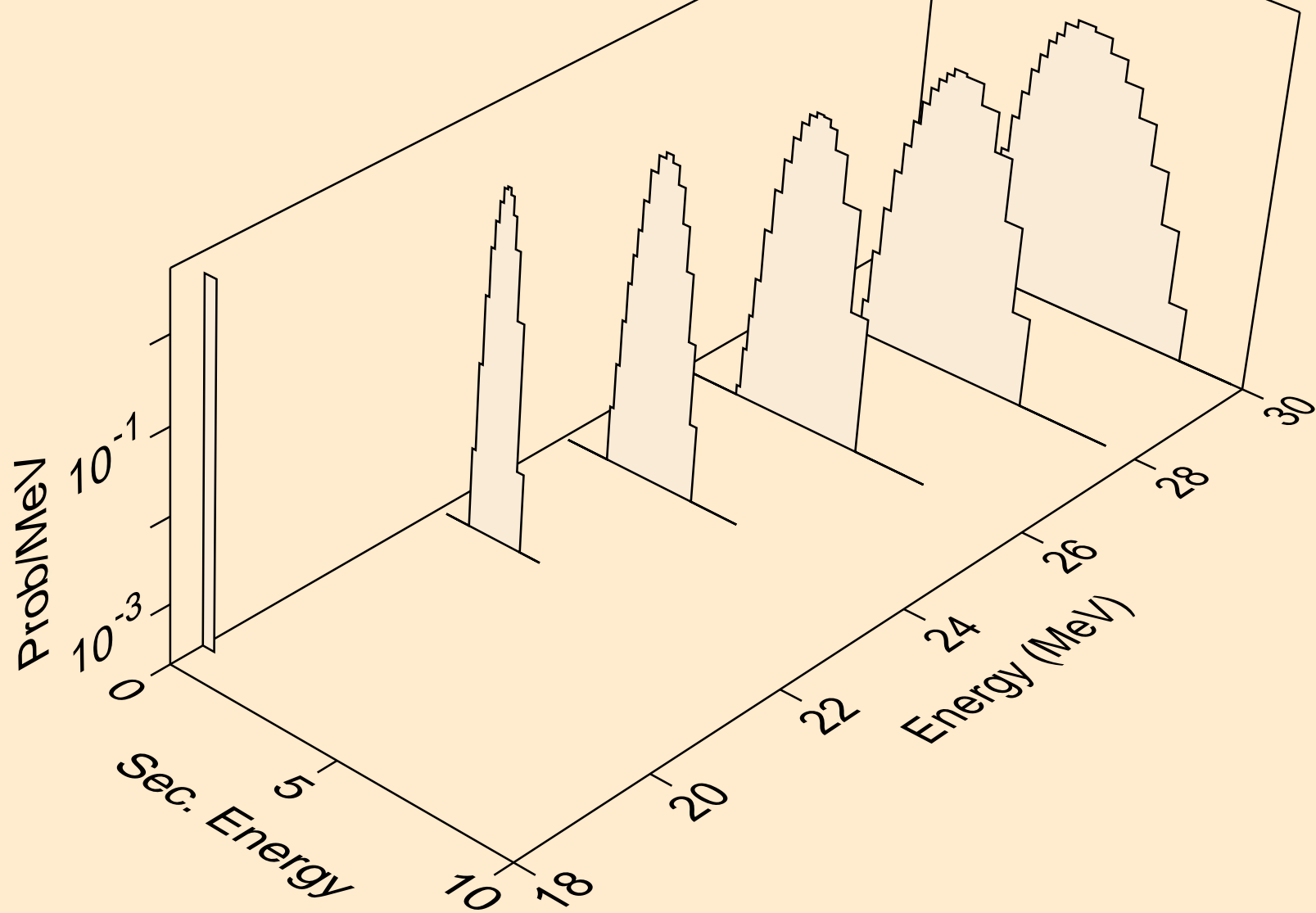

ER151 ALPHA ACER TENDL-2023 LIBRARY; T=0.K  
protons from (a,npa)

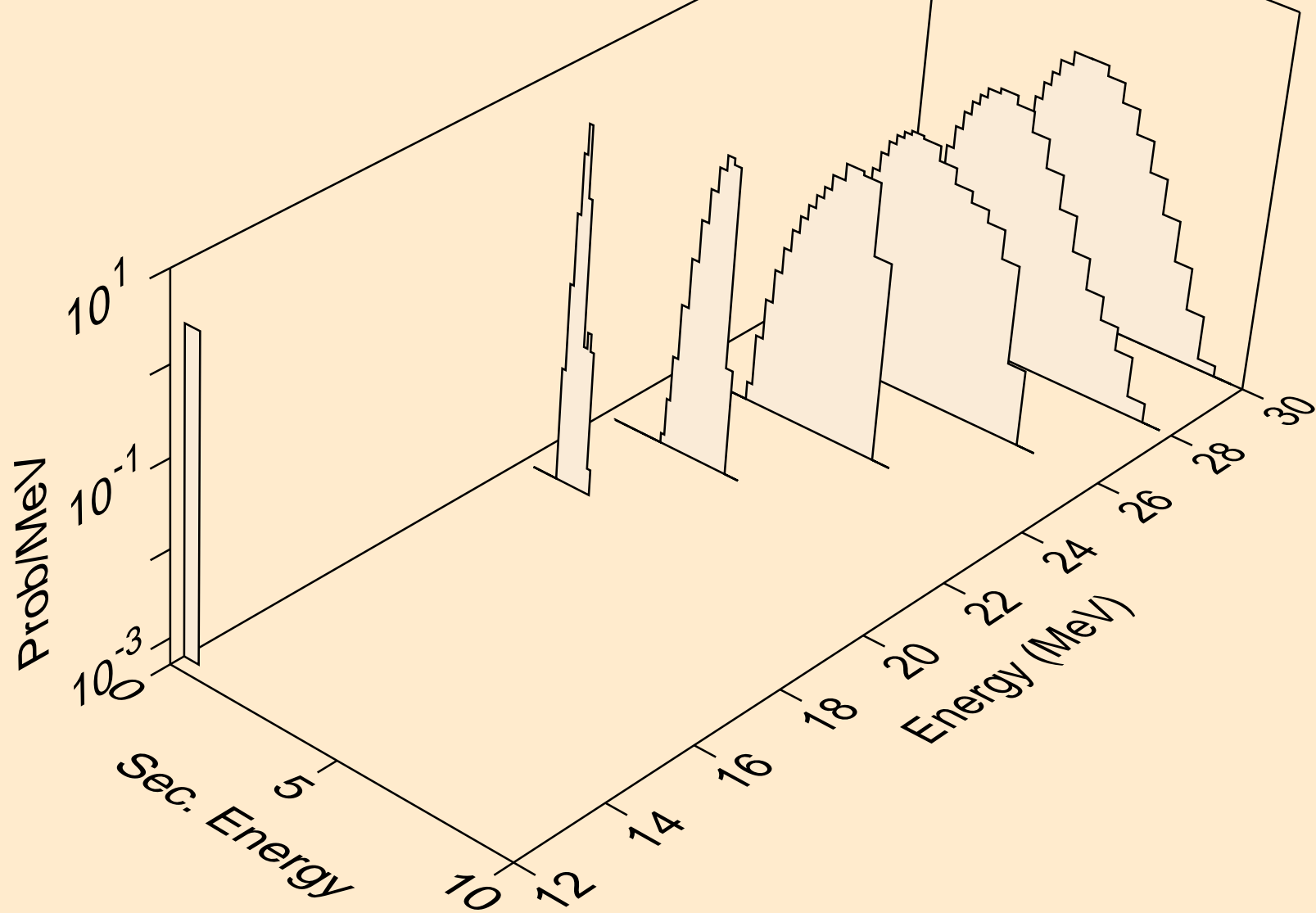

ER151 ALPHA ACER TENDL-2023 LIBRARY; T=0.K  
protons from (a,p)

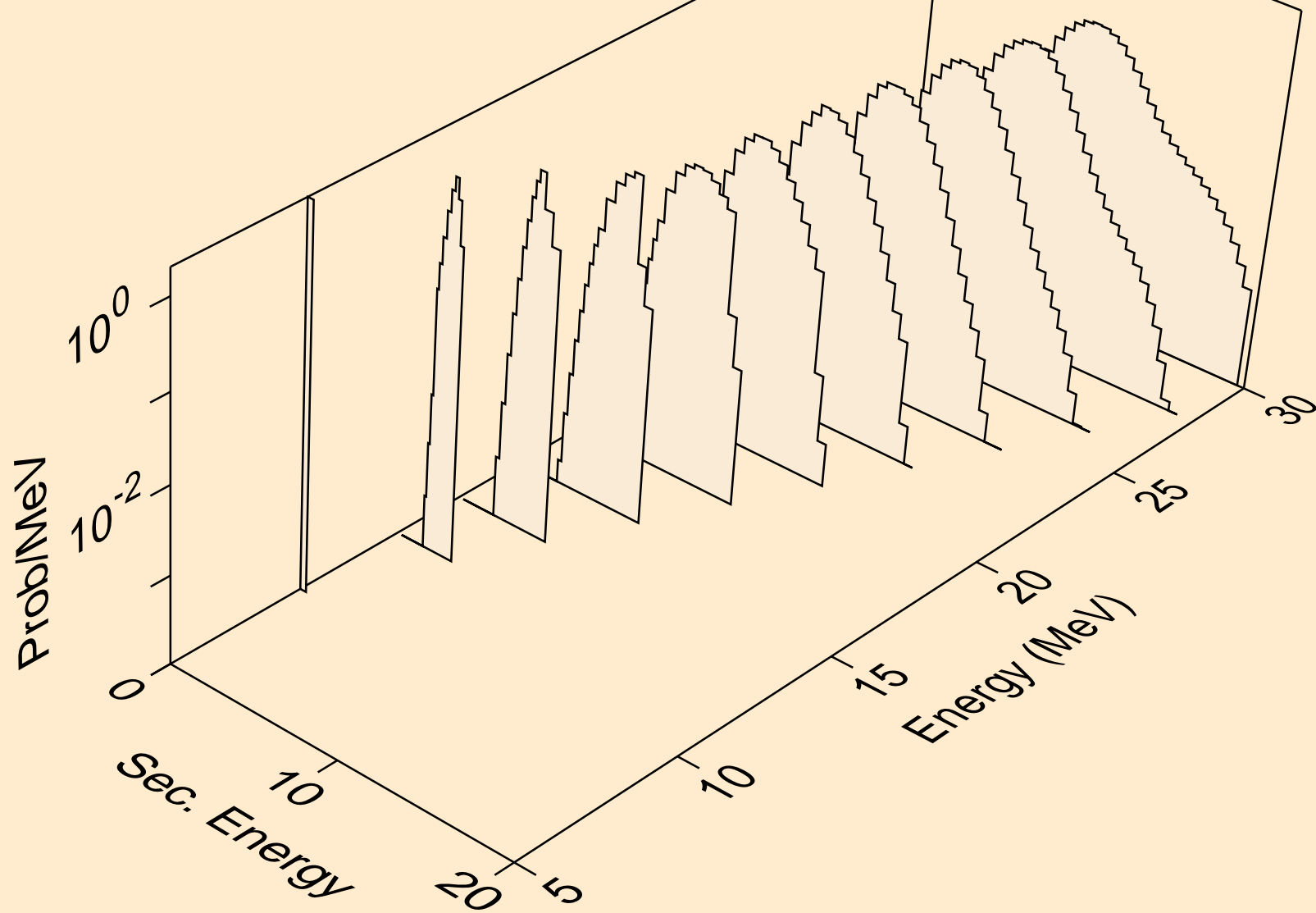

ER151 ALPHA ACER TENDL-2023 LIBRARY; T=0.K  
protons from (a,2p)

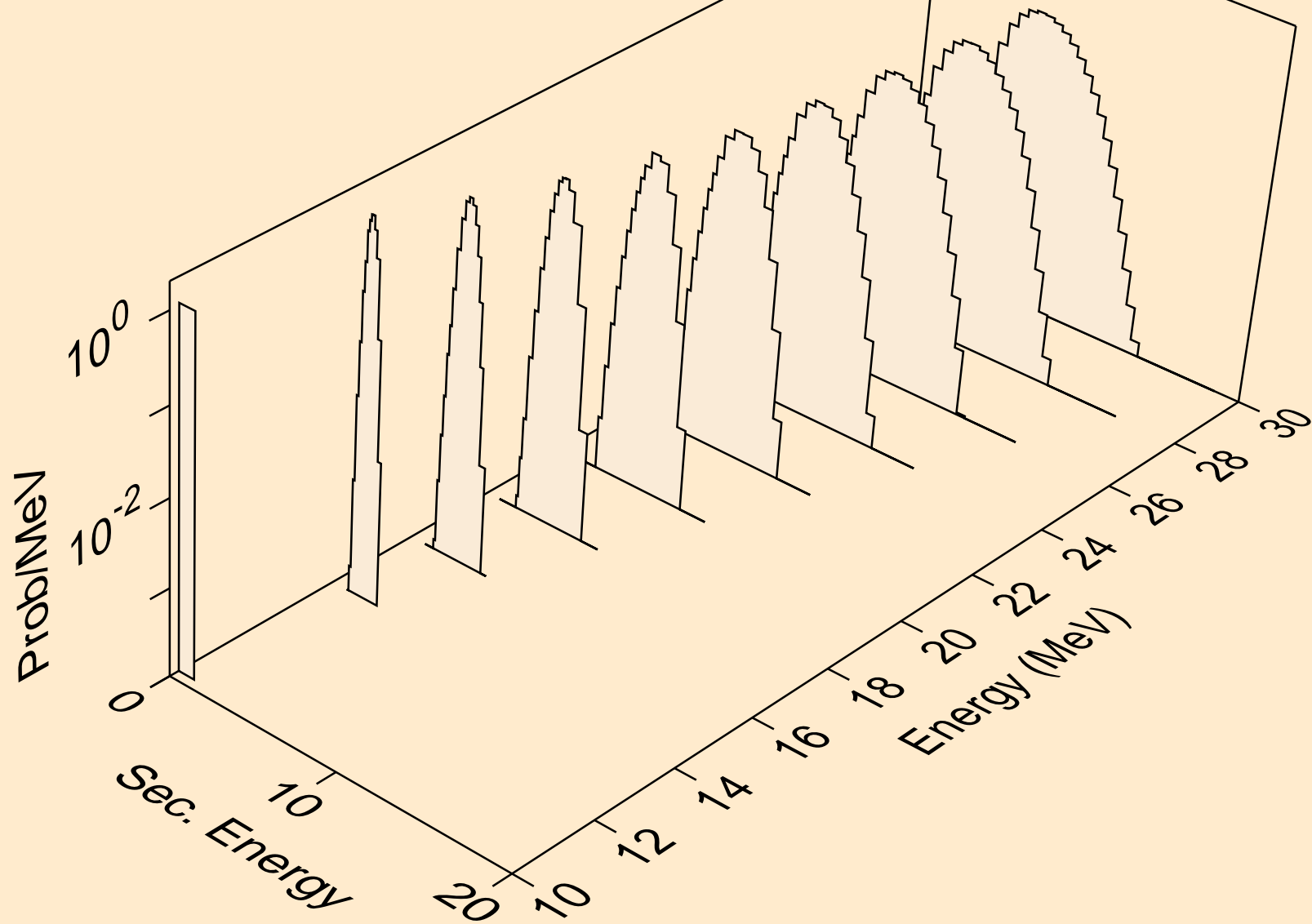

ER151 ALPHA ACER TENDL-2023 LIBRARY; T=0.K  
protons from (a,pa)

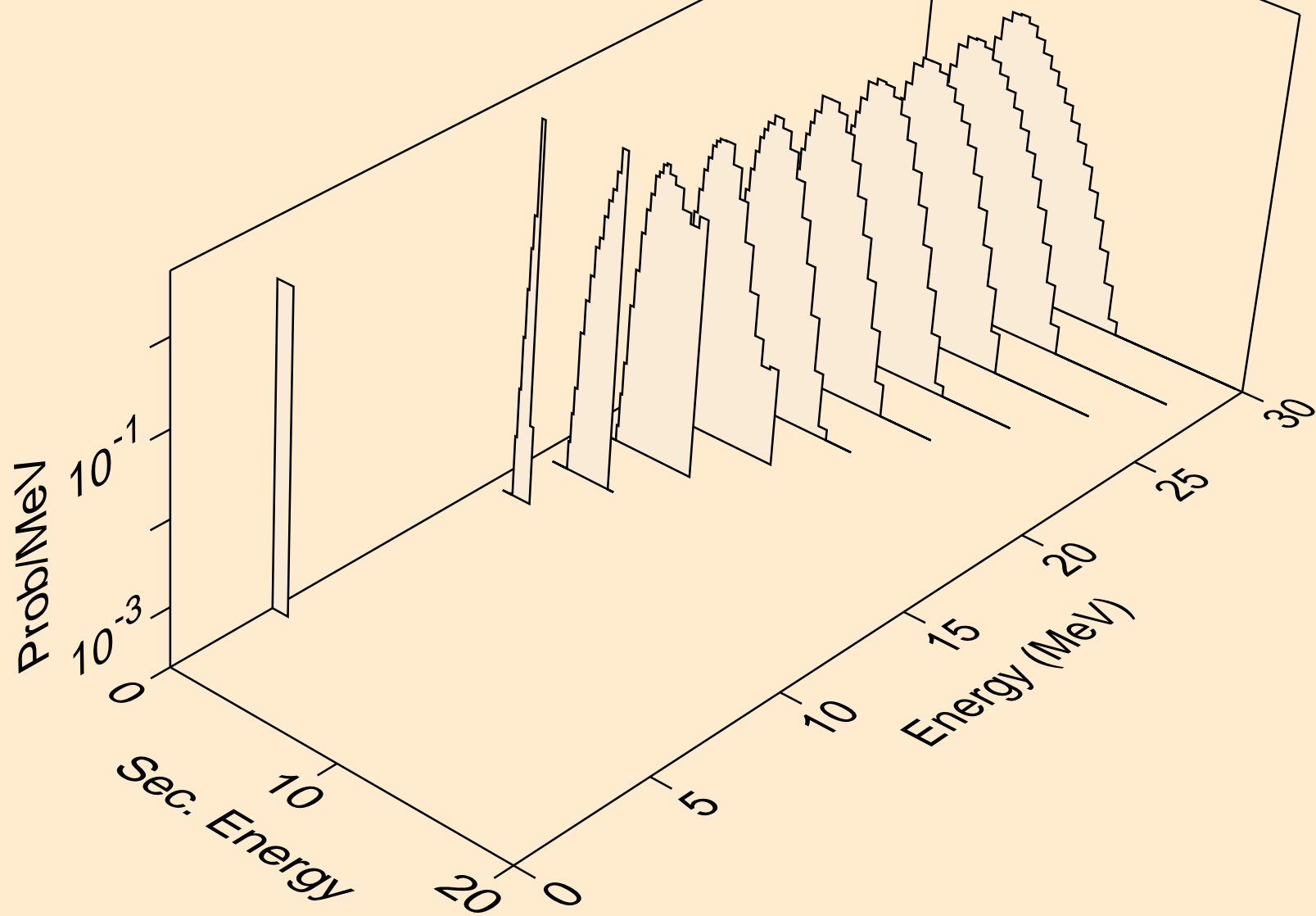

ER151 ALPHA ACER TENDL-2023 LIBRARY; T=0.K  
protons from (a,pd)

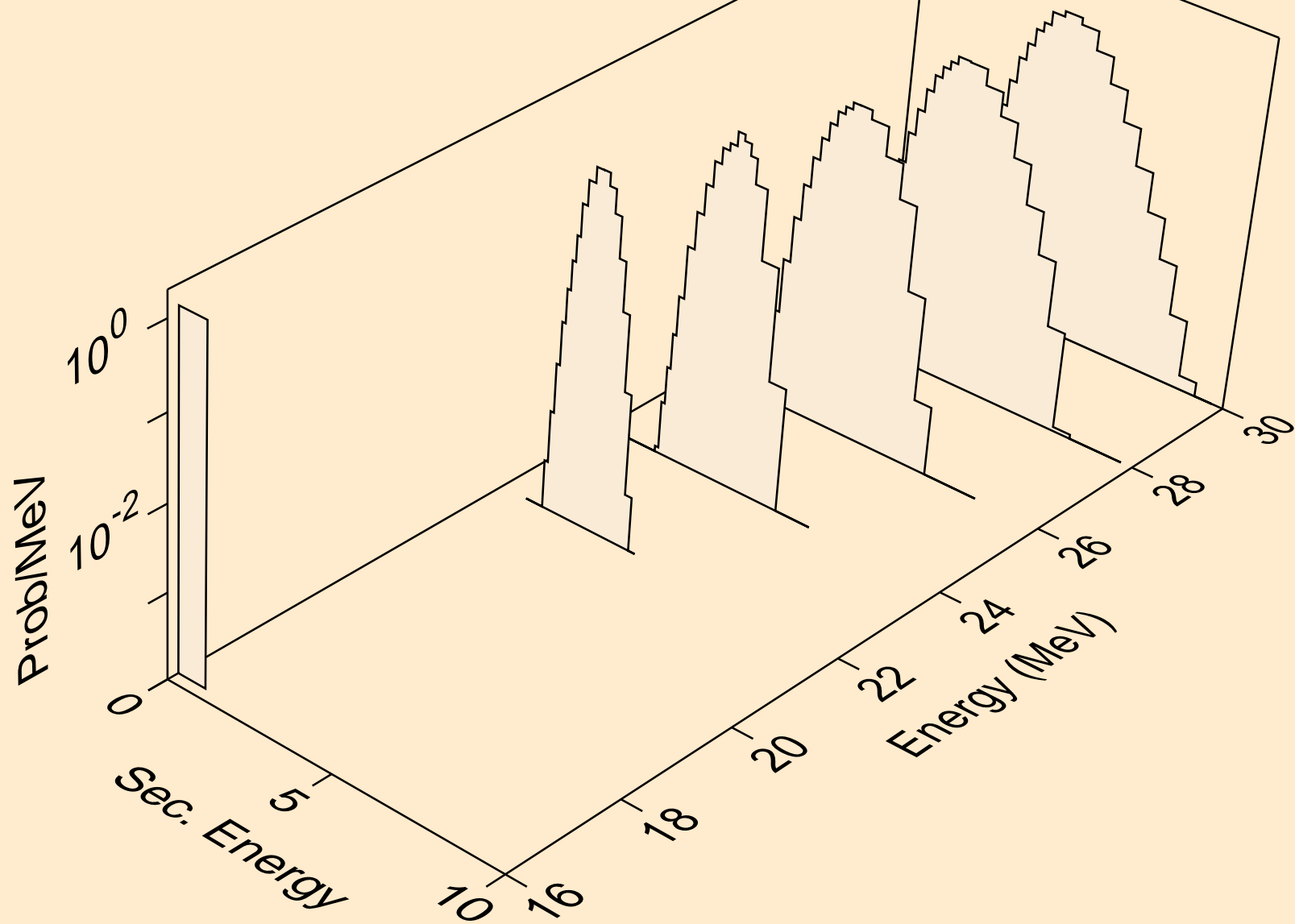

ER151 ALPHA ACER TENDL-2023 LIBRARY; T=0.K  
deuterons from (a,x)

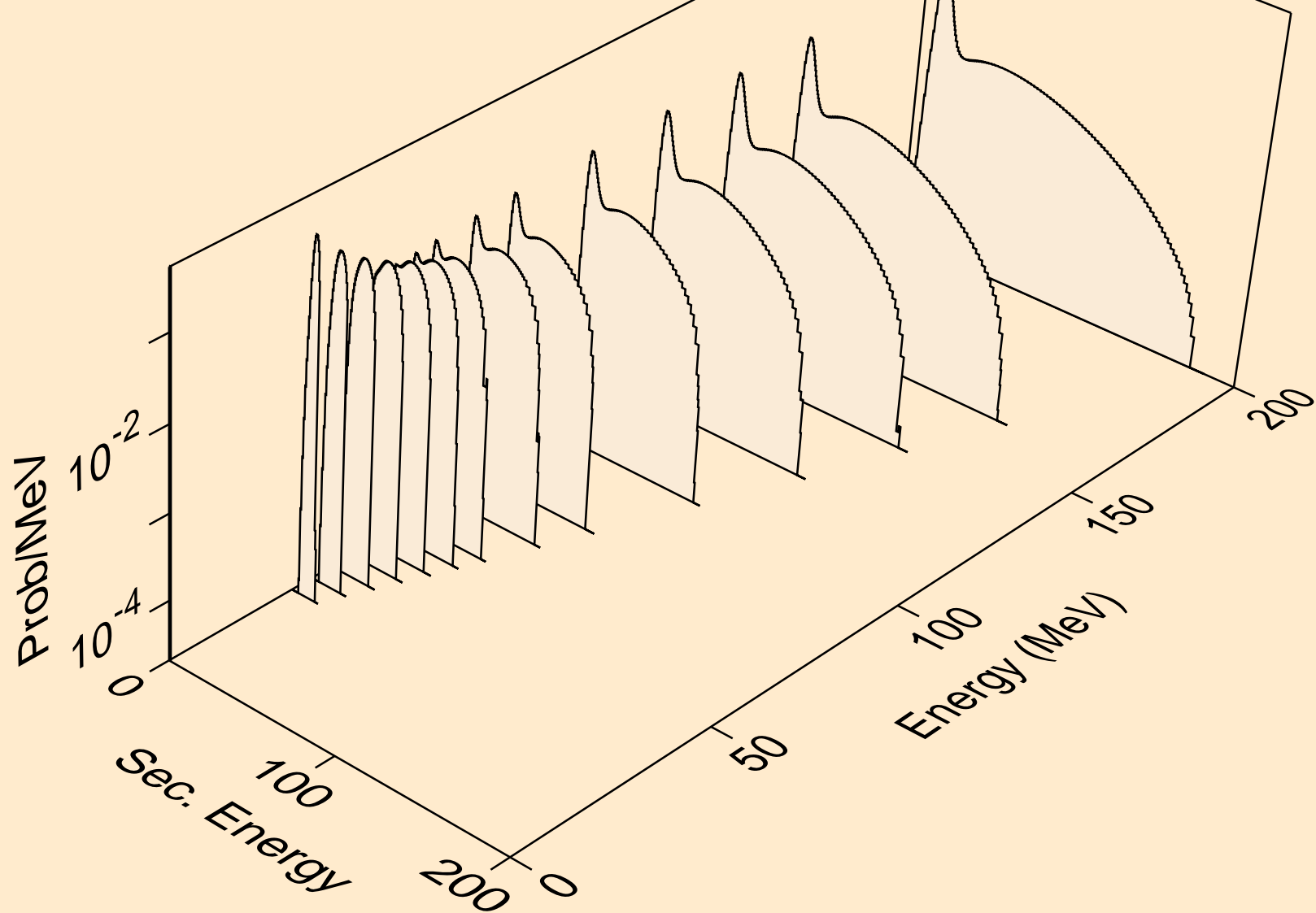

ER151 ALPHA ACER TENDL-2023 LIBRARY; T=0.K  
deuterons from (a,d)

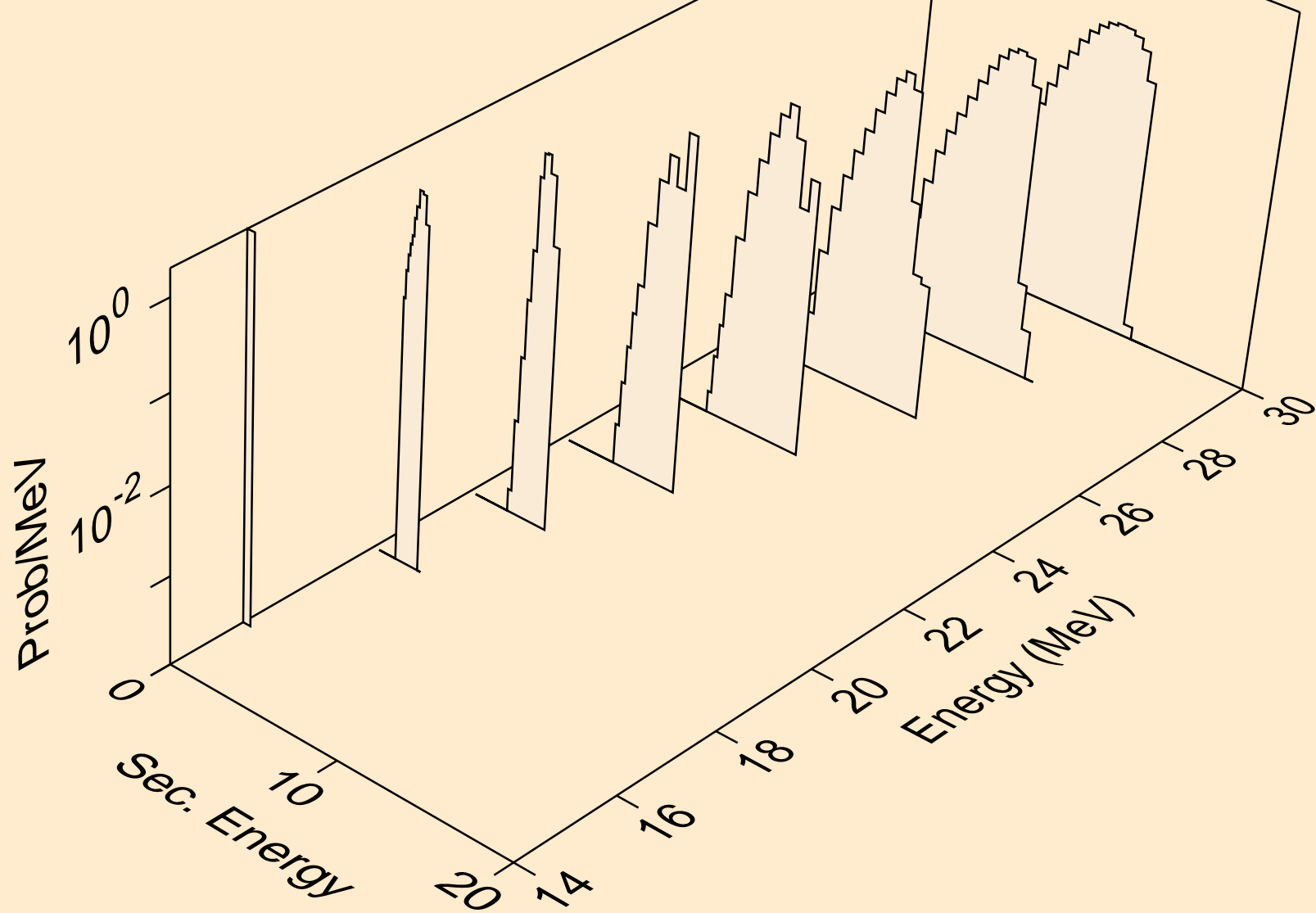

ER151 ALPHA ACER TENDL-2023 LIBRARY; T=0.K  
deuterons from (a,pd)

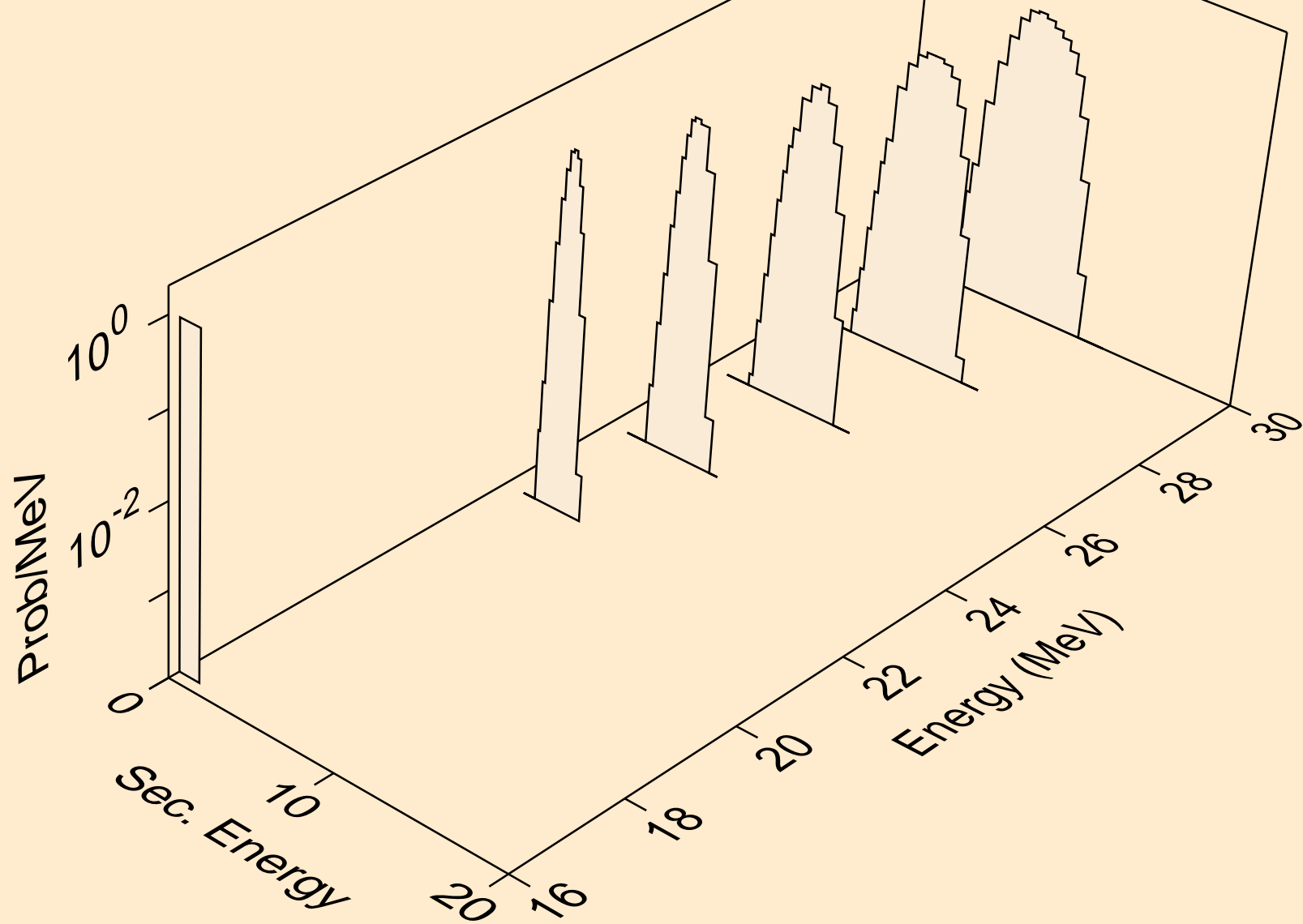

ER151 ALPHA ACER TENDL-2023 LIBRARY; T=0.K  
deuterons from (a,da)

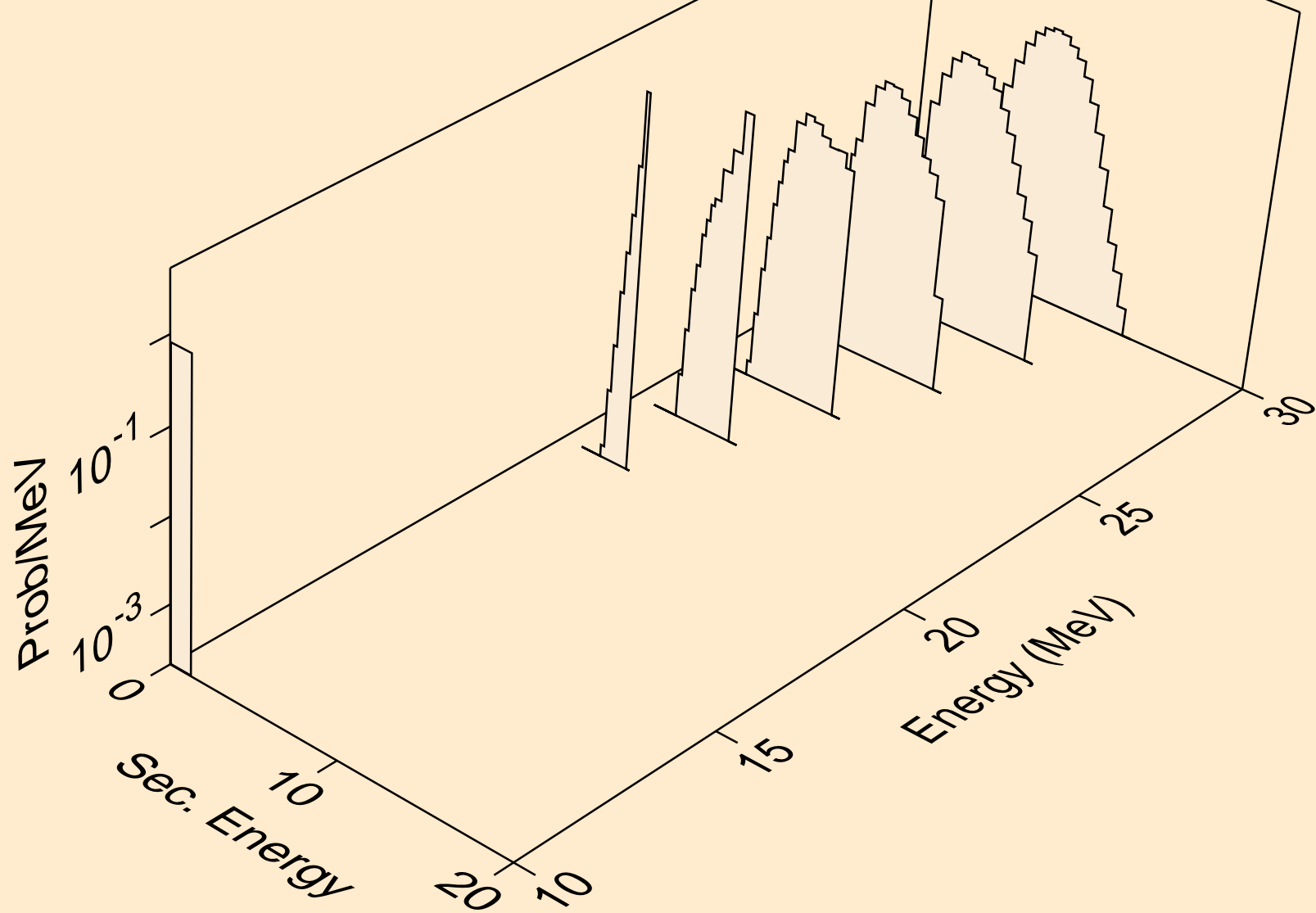

ER151 ALPHA ACER TENDL-2023 LIBRARY; T=0.K  
tritons from (a,x)

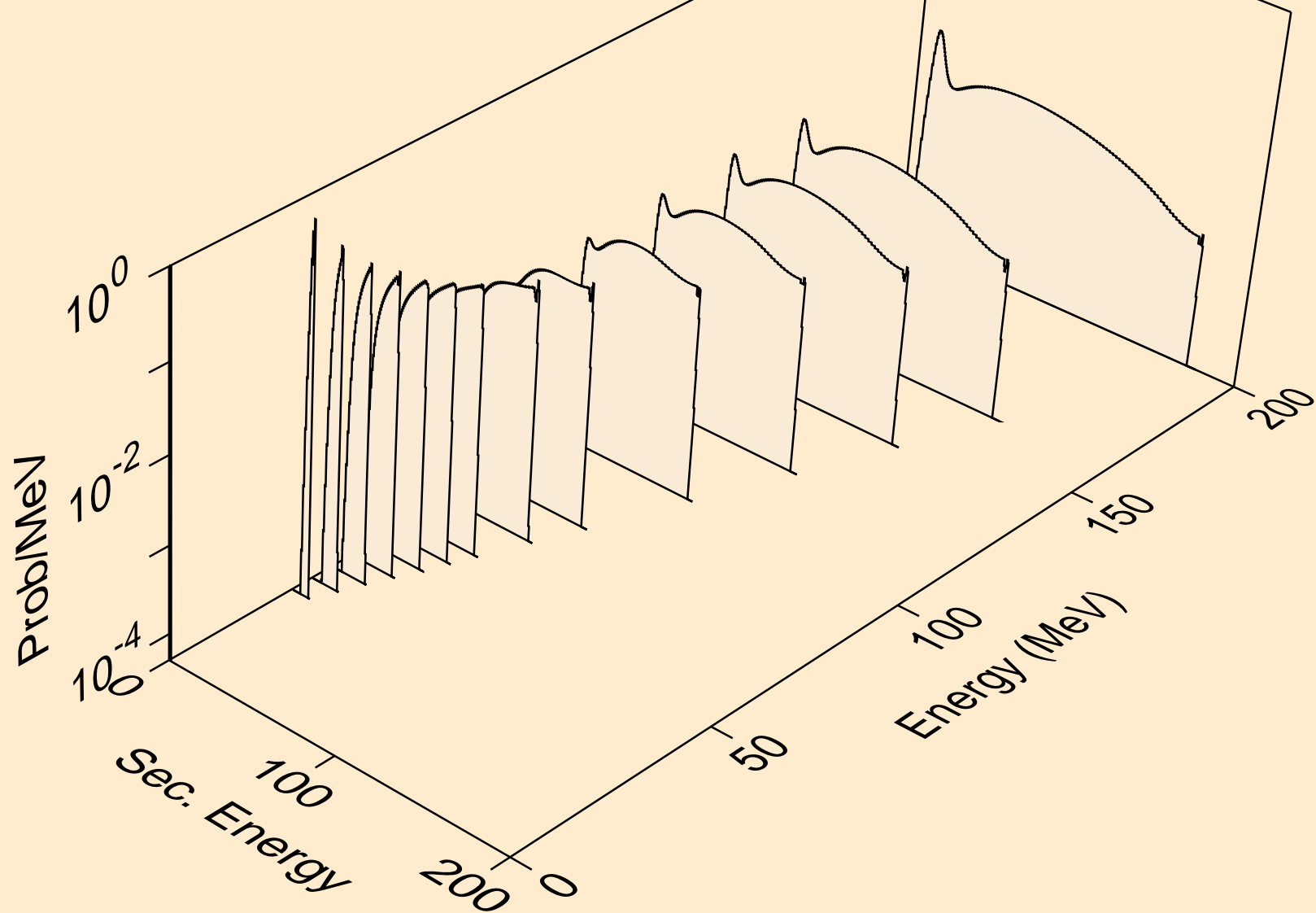

ER151 ALPHA ACER TENDL-2023 LIBRARY; T=0.K  
tritons from (a,t)

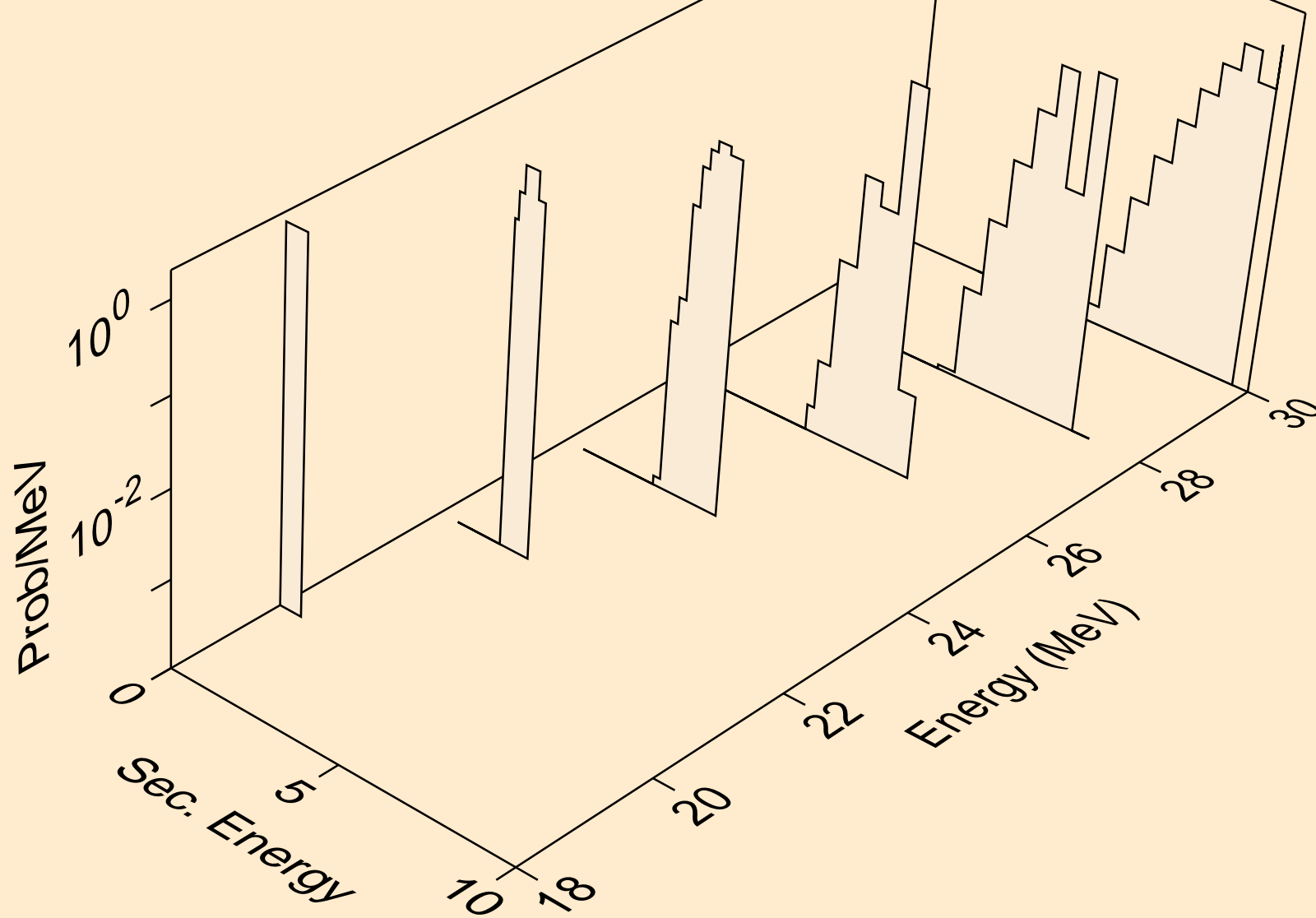

ER151 ALPHA ACER TENDL-2023 LIBRARY; T=0.K  
he3s from (a,x)

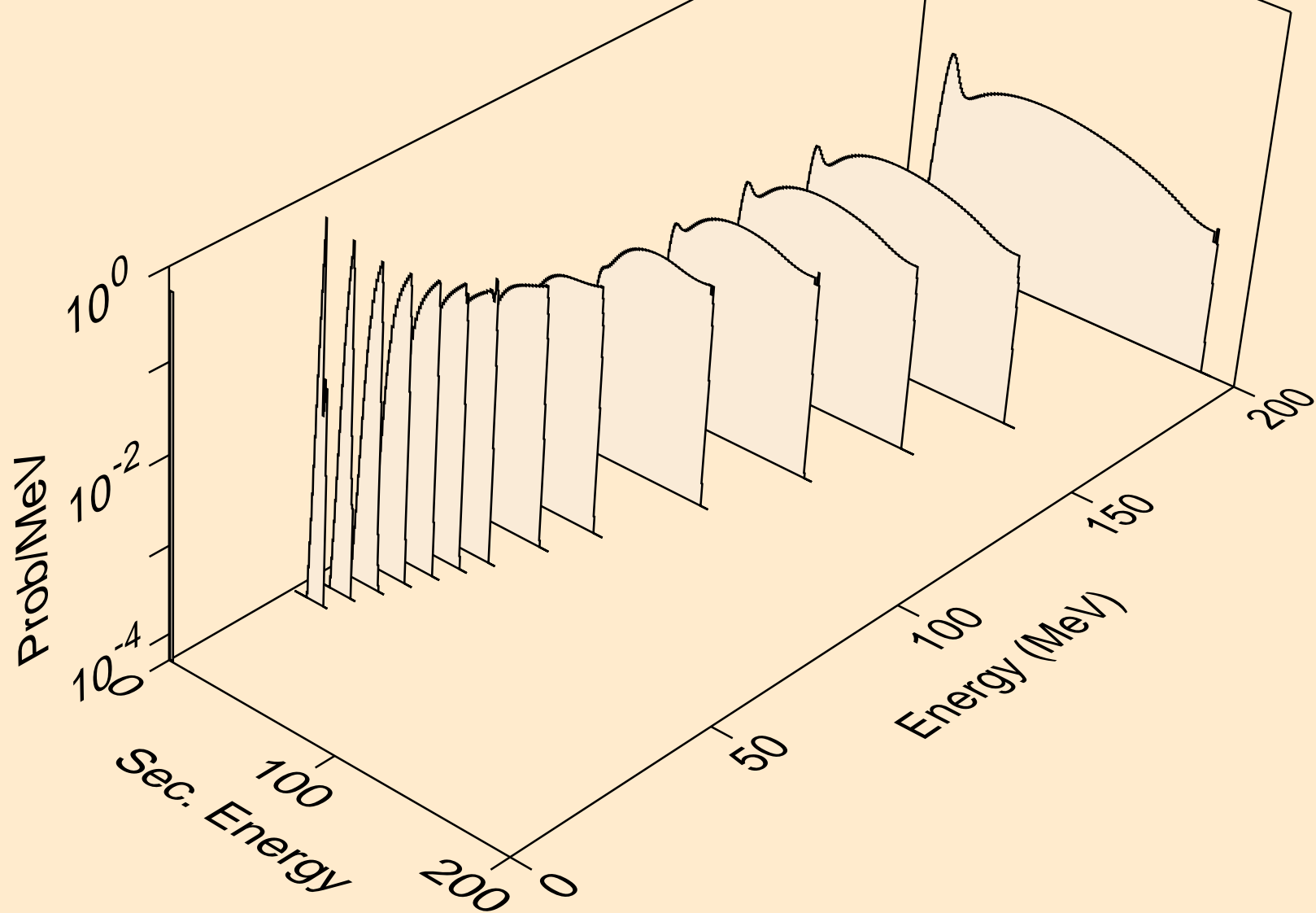

ER151 ALPHA ACER TENDL-2023 LIBRARY; T=0.K  
he3s from (a,he3)

