

IR173 ALPHA ACER TENDL-2023 LIBRARY; T=0.K  
Principal cross sections

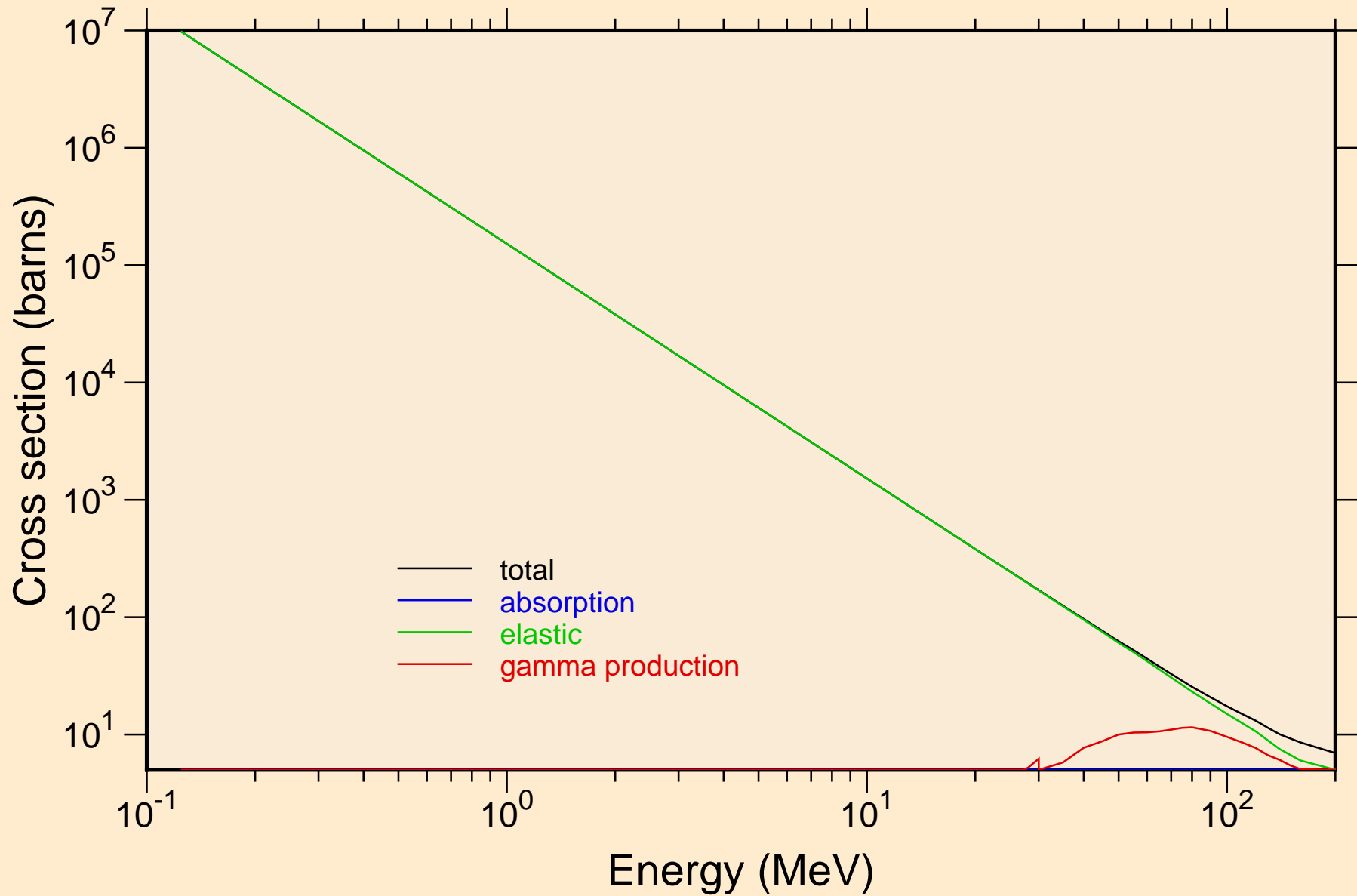

IR173 ALPHA ACER TENDL-2023 LIBRARY; T=0.K  
Heating

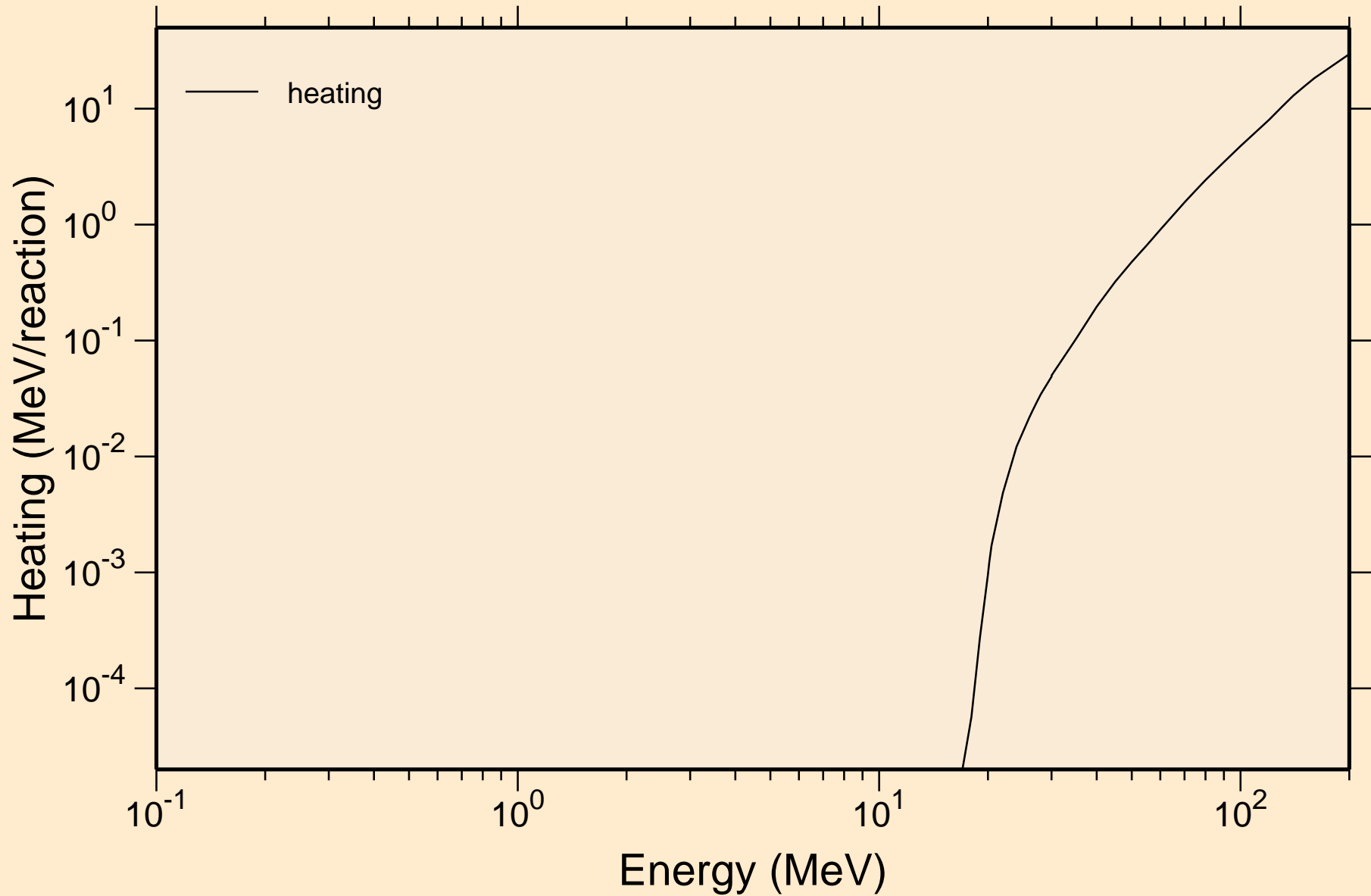

# IR173 ALPHA ACER TENDL-2023 LIBRARY; T=0.K

## Principal cross sections

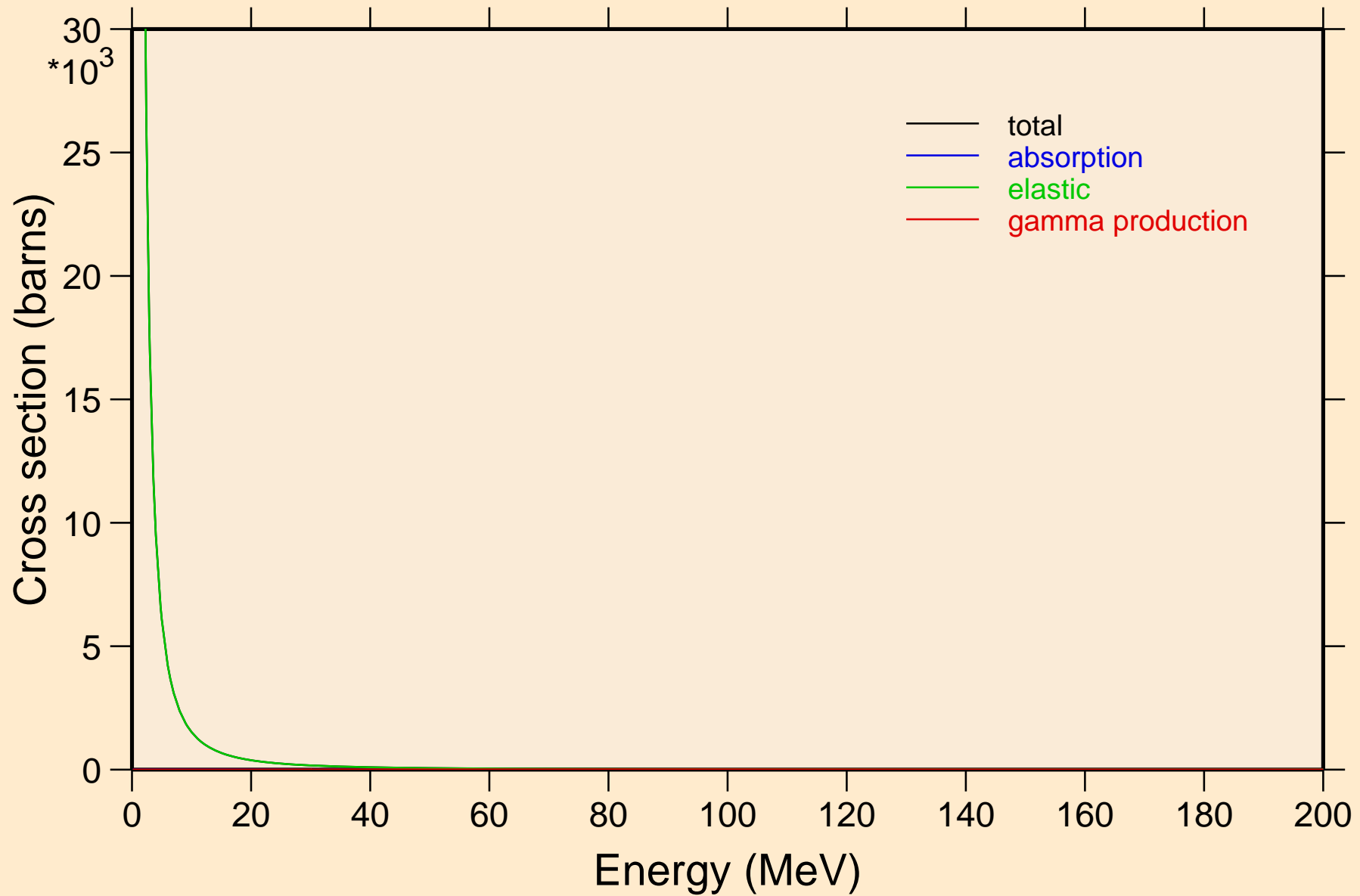

IR173 ALPHA ACER TENDL-2023 LIBRARY; T=0.K

Heating

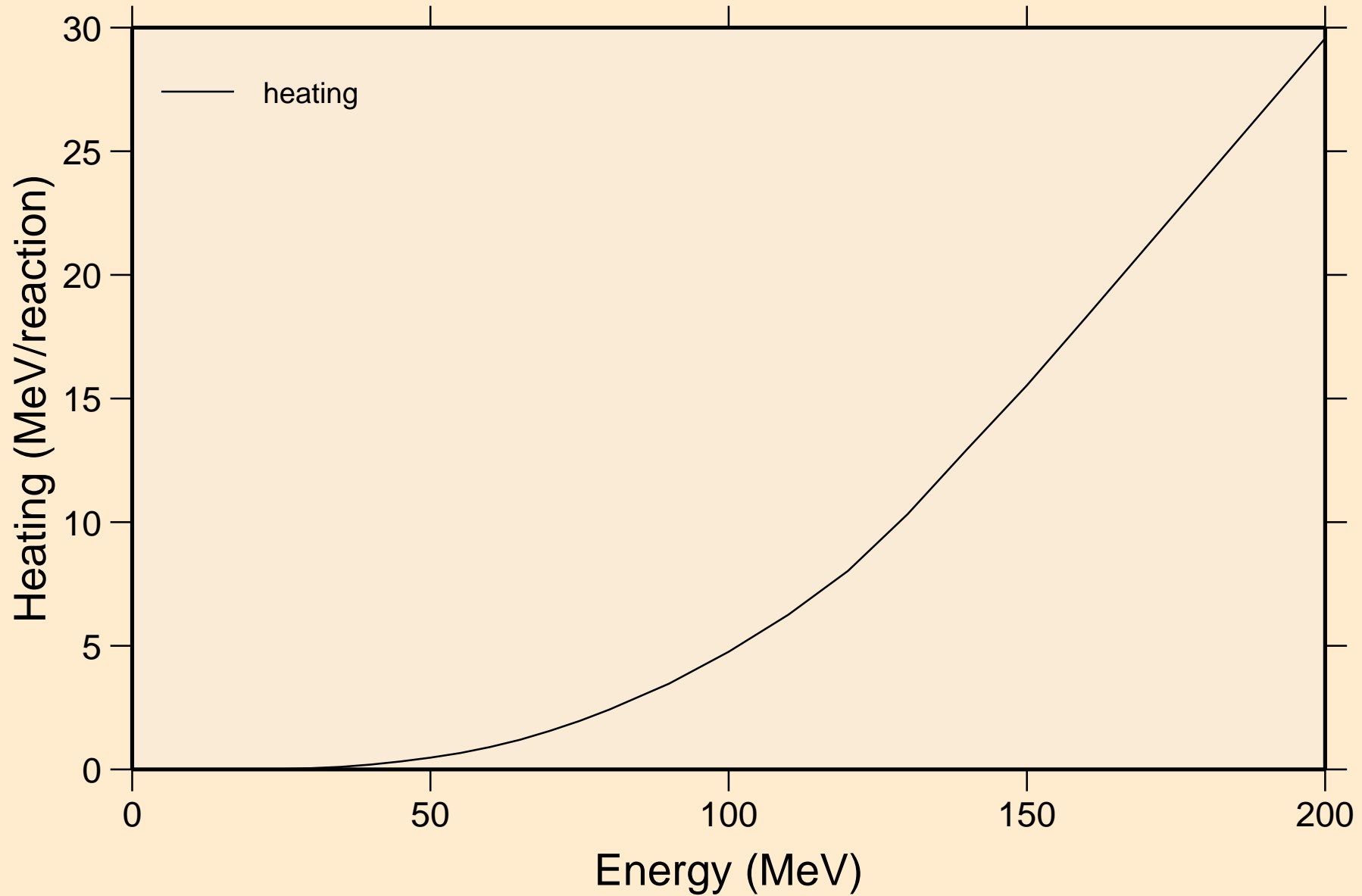

IR173 ALPHA ACER TENDL-2023 LIBRARY; T=0.K  
Threshold reactions

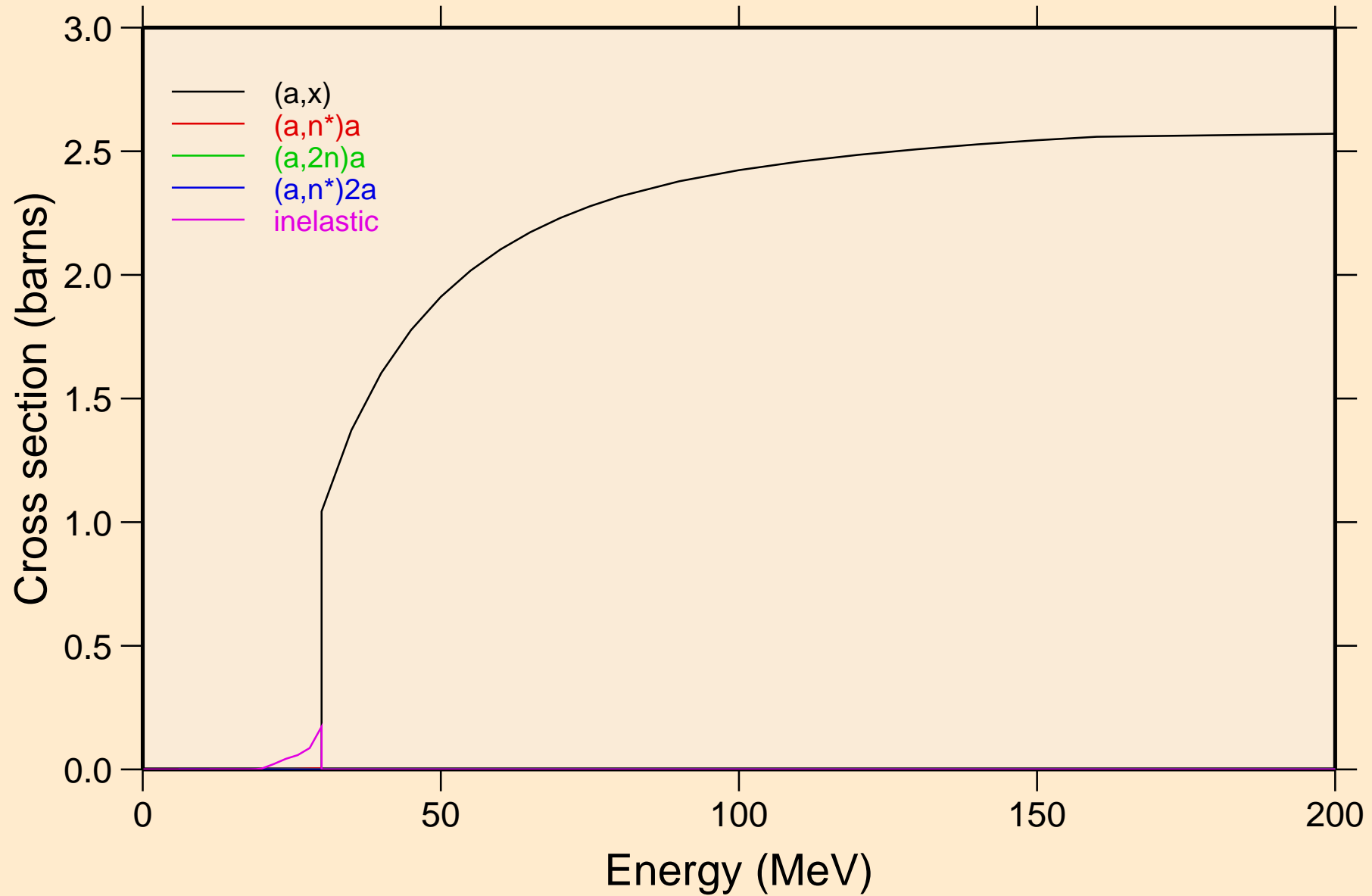

IR173 ALPHA ACER TENDL-2023 LIBRARY; T=0.K  
Threshold reactions

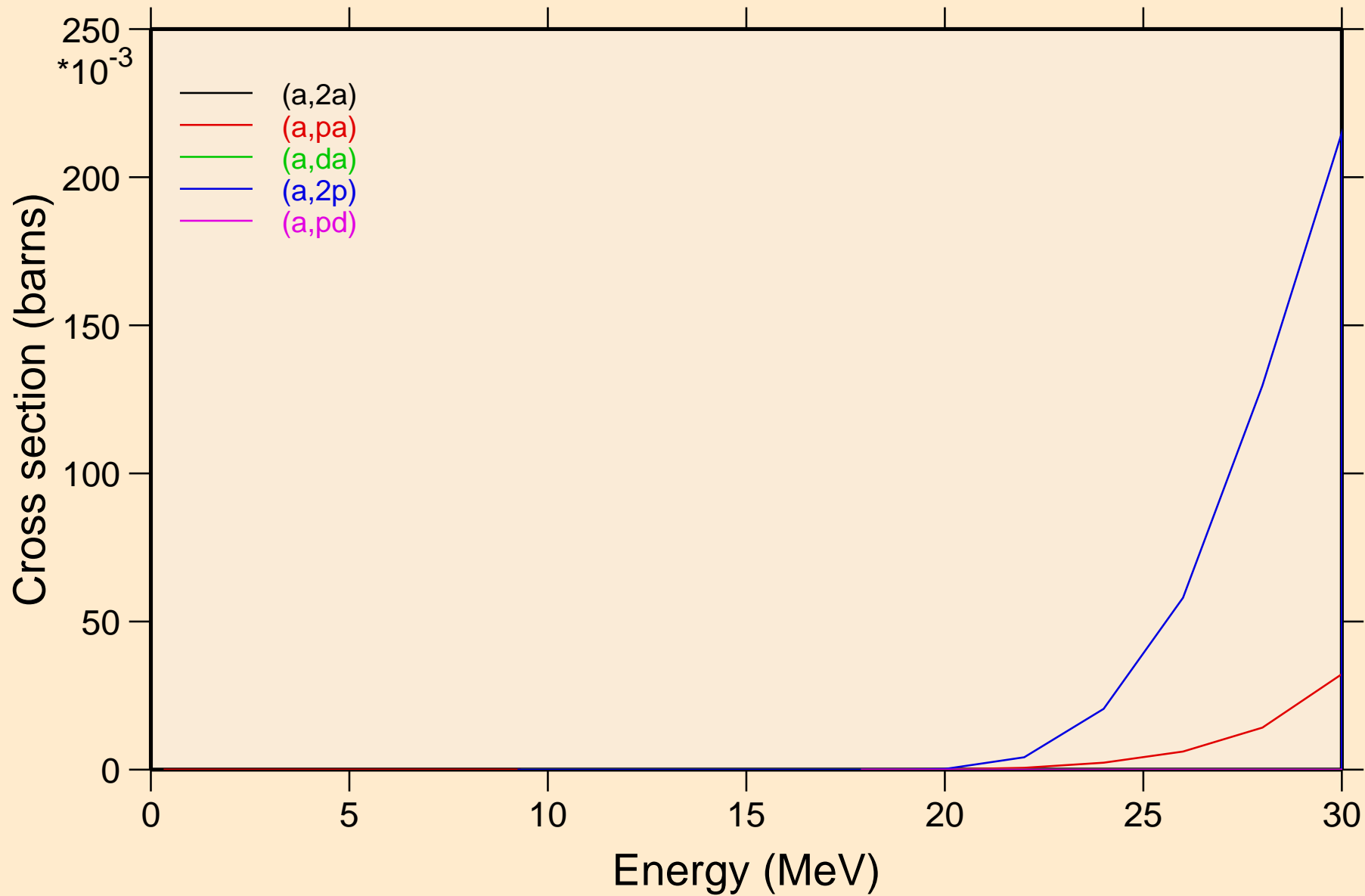

IR173 ALPHA ACER TENDL-2023 LIBRARY; T=0.K  
Threshold reactions

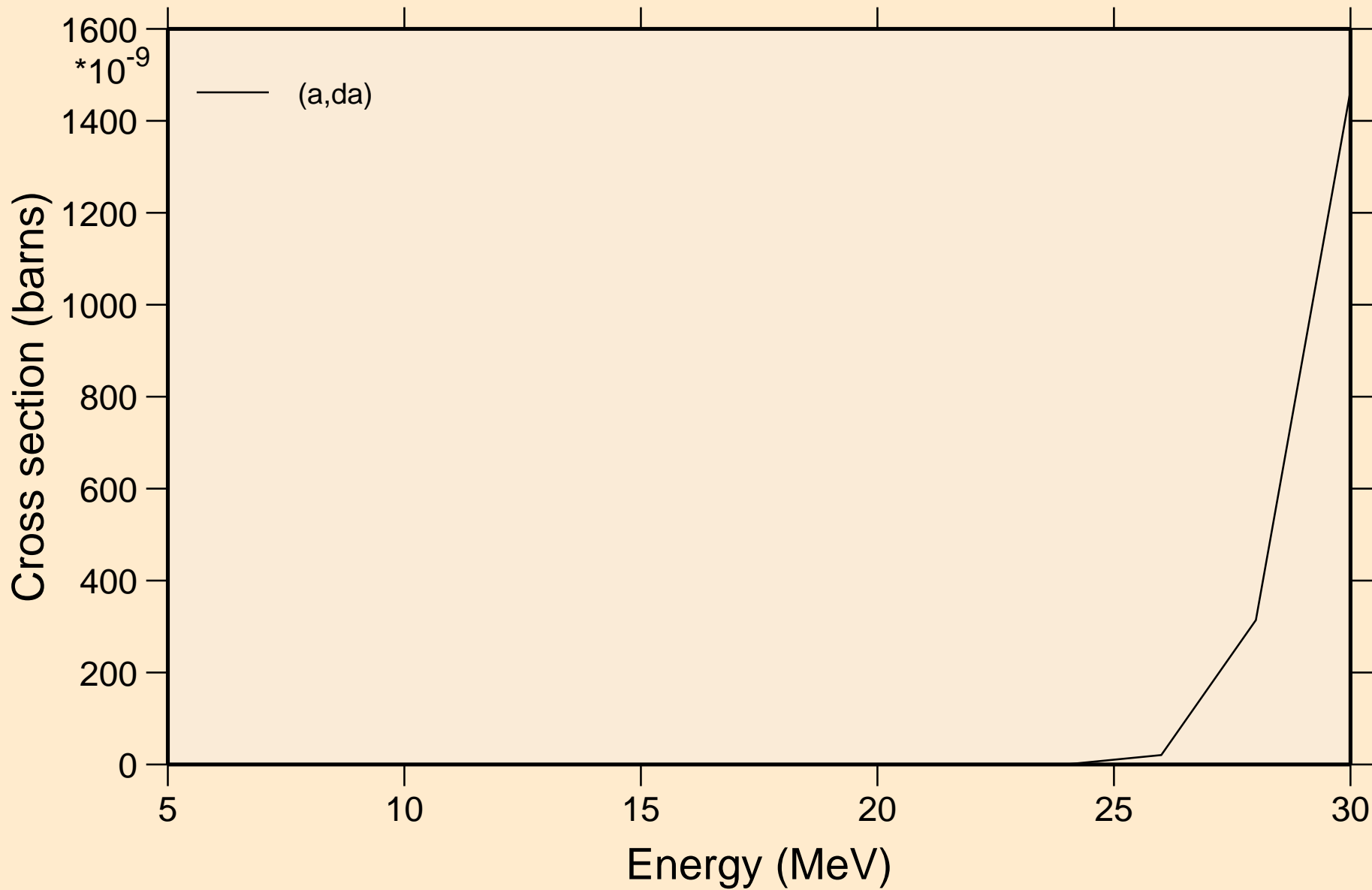

IR173 ALPHA ACER TENDL-2023 LIBRARY; T=0.K  
angular distribution for elastic

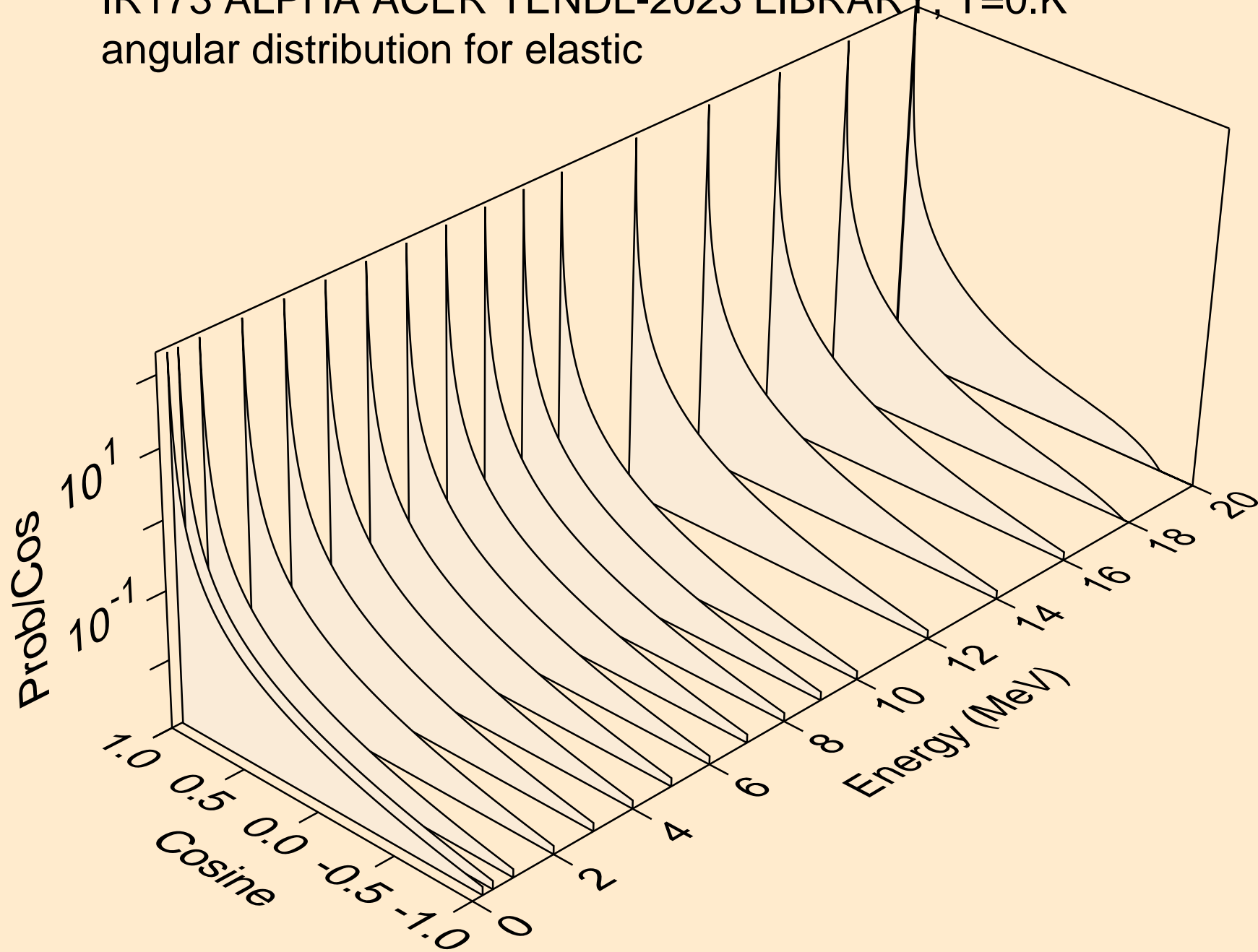

IR173 ALPHA ACER TENDL-2023 LIBRARY; T=0.K  
angular distribution for elastic

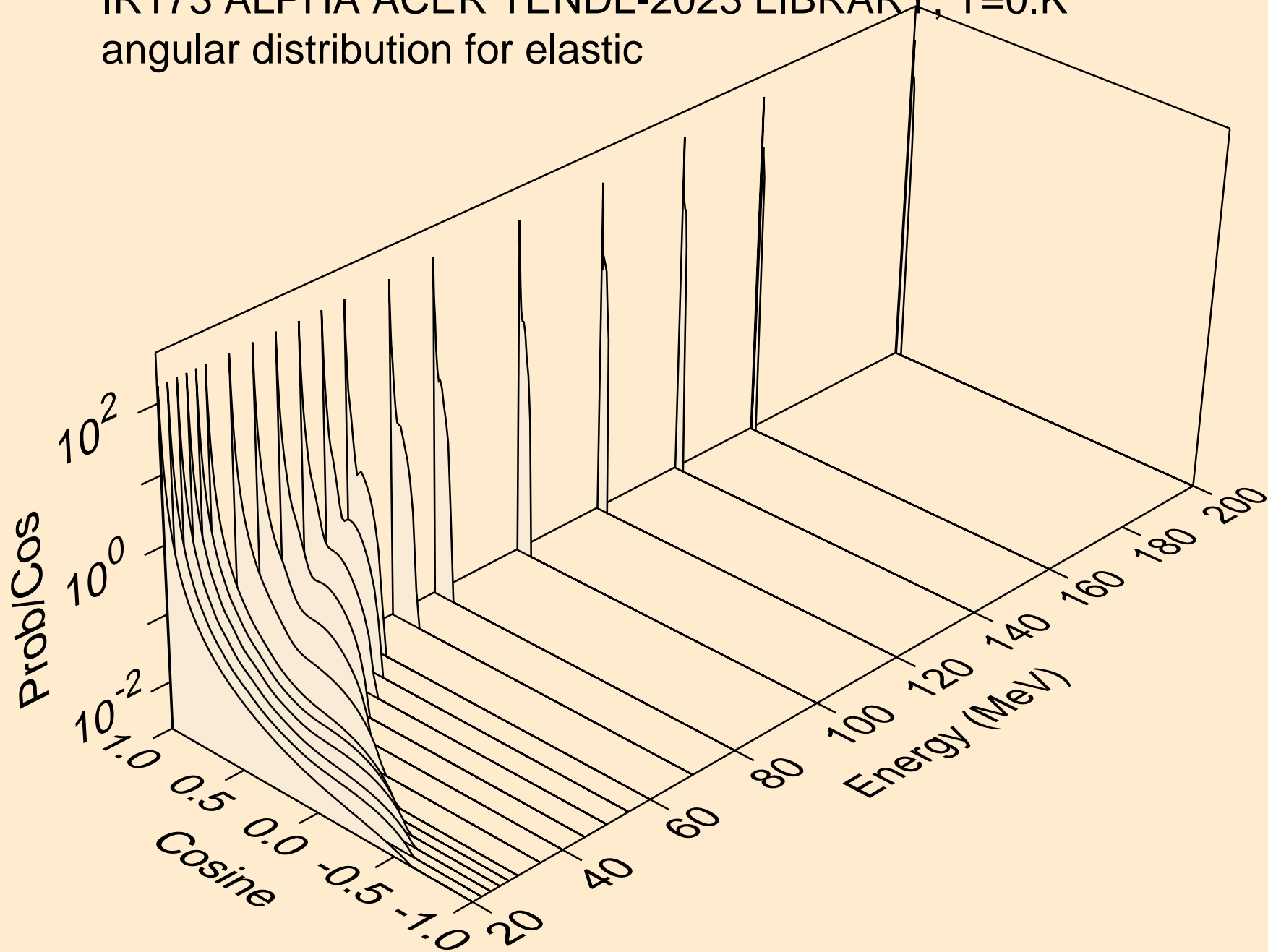

IR173 ALPHA ACER TENDL-2023 LIBRARY; T=0.K  
Alpha emission for (a,x)

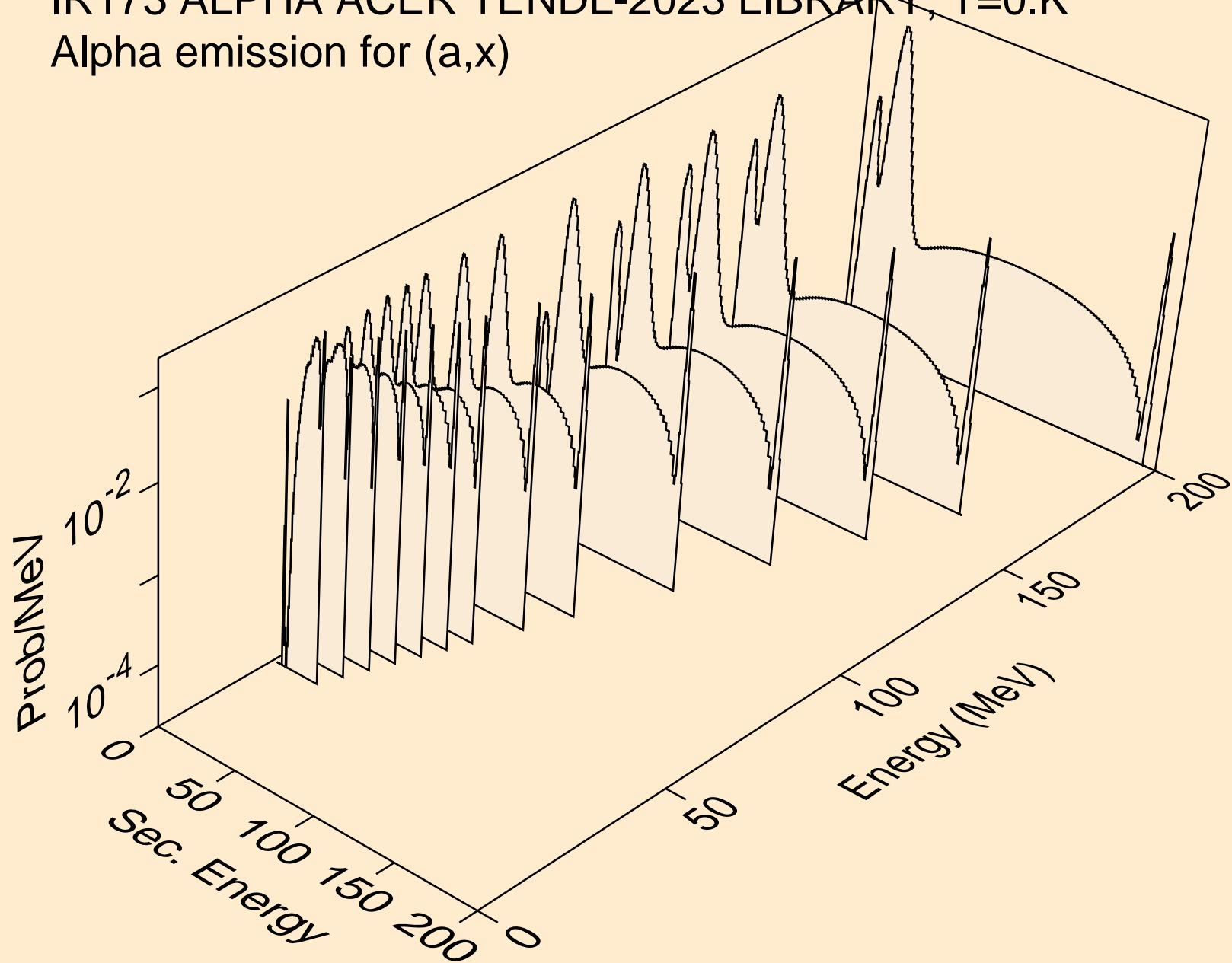

IR173 ALPHA ACER TENDL-2023 LIBRARY; T=0.K  
Alpha emission for (a,n\*)a

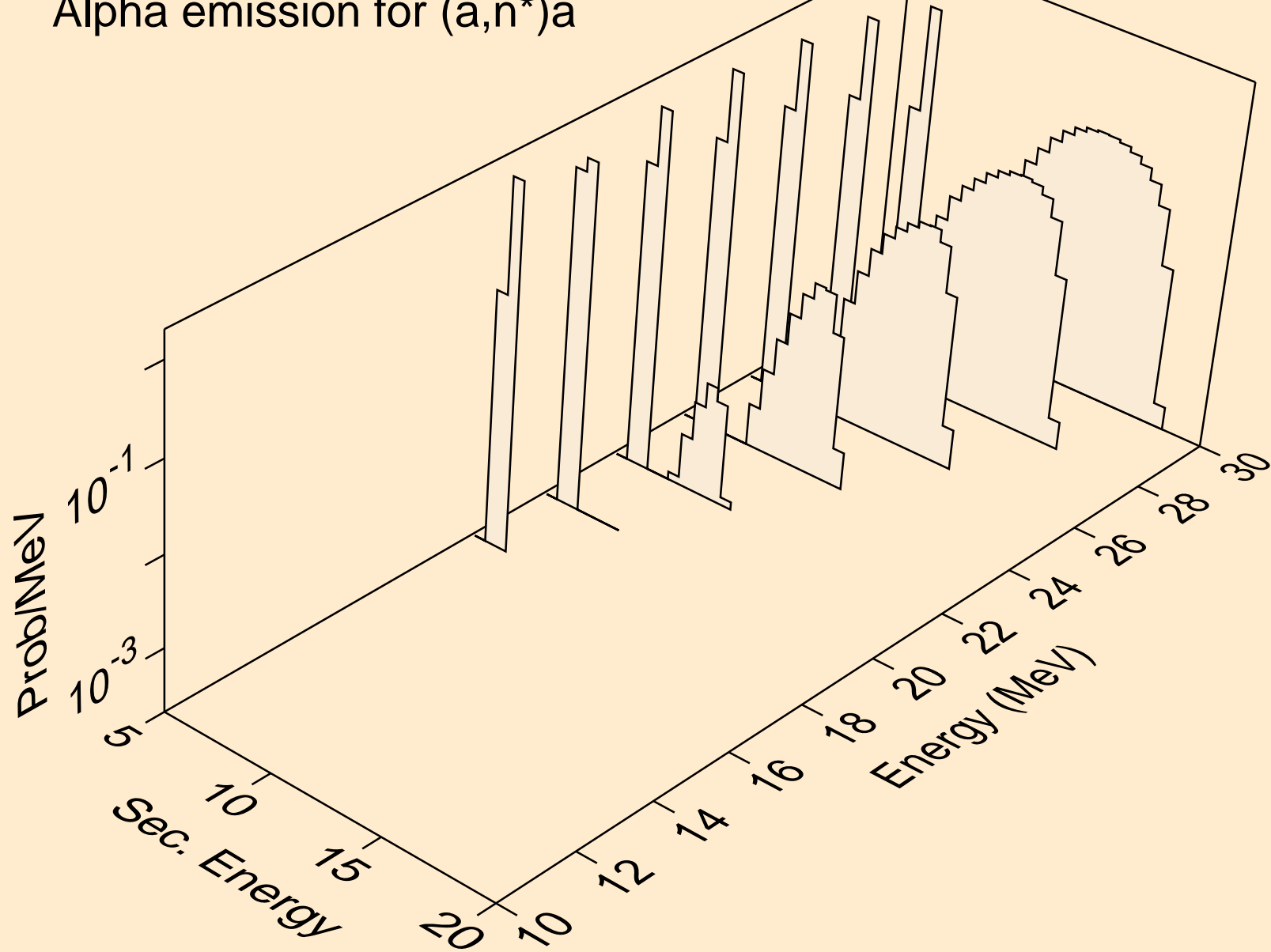

IR173 ALPHA ACER TENDL-2023 LIBRARY: T=0.K  
Alpha emission for (a,2n)a

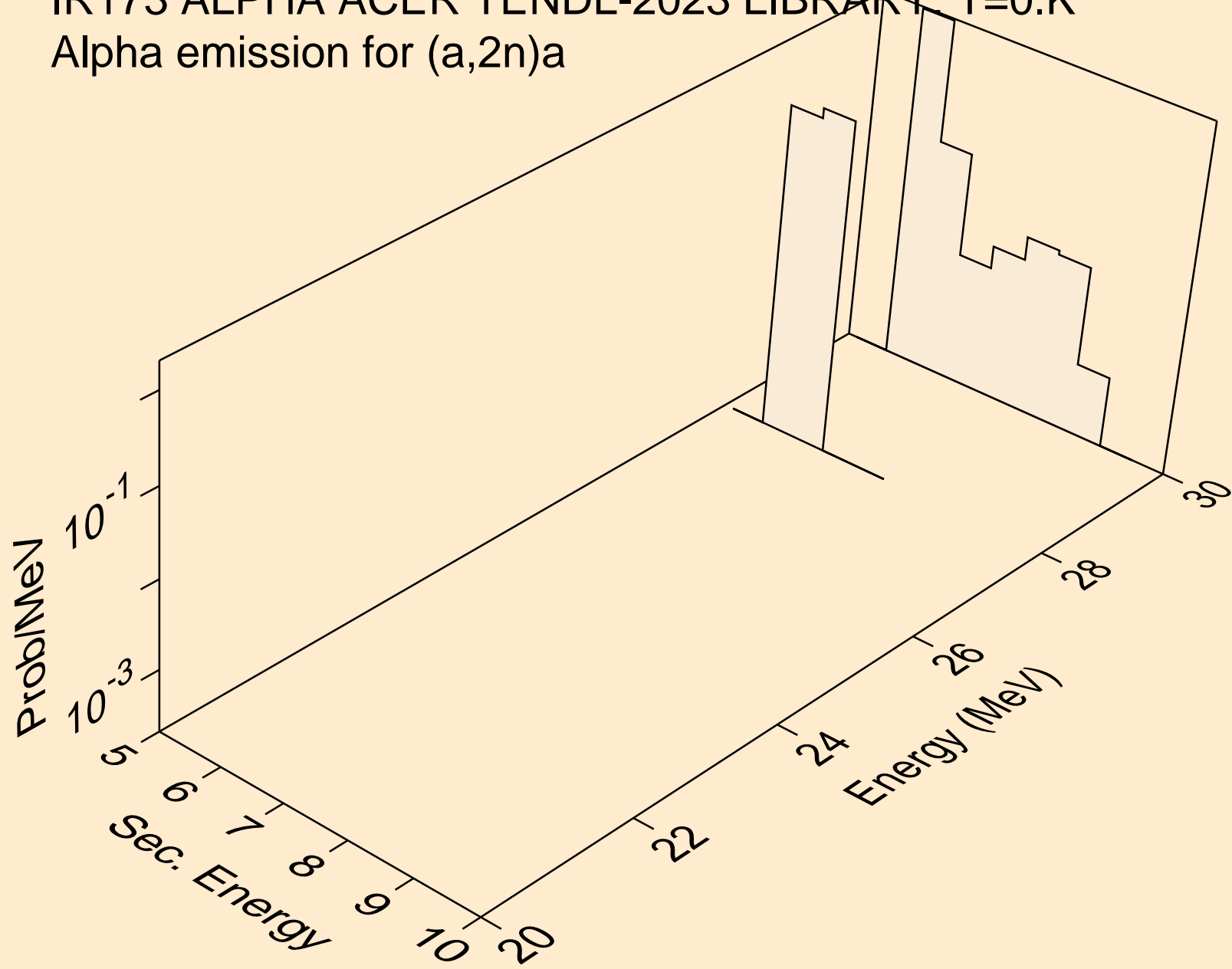

IR173 ALPHA ACER TENDL-2023 LIBRARY; T=0.K  
Alpha emission for (a,n\*)2a

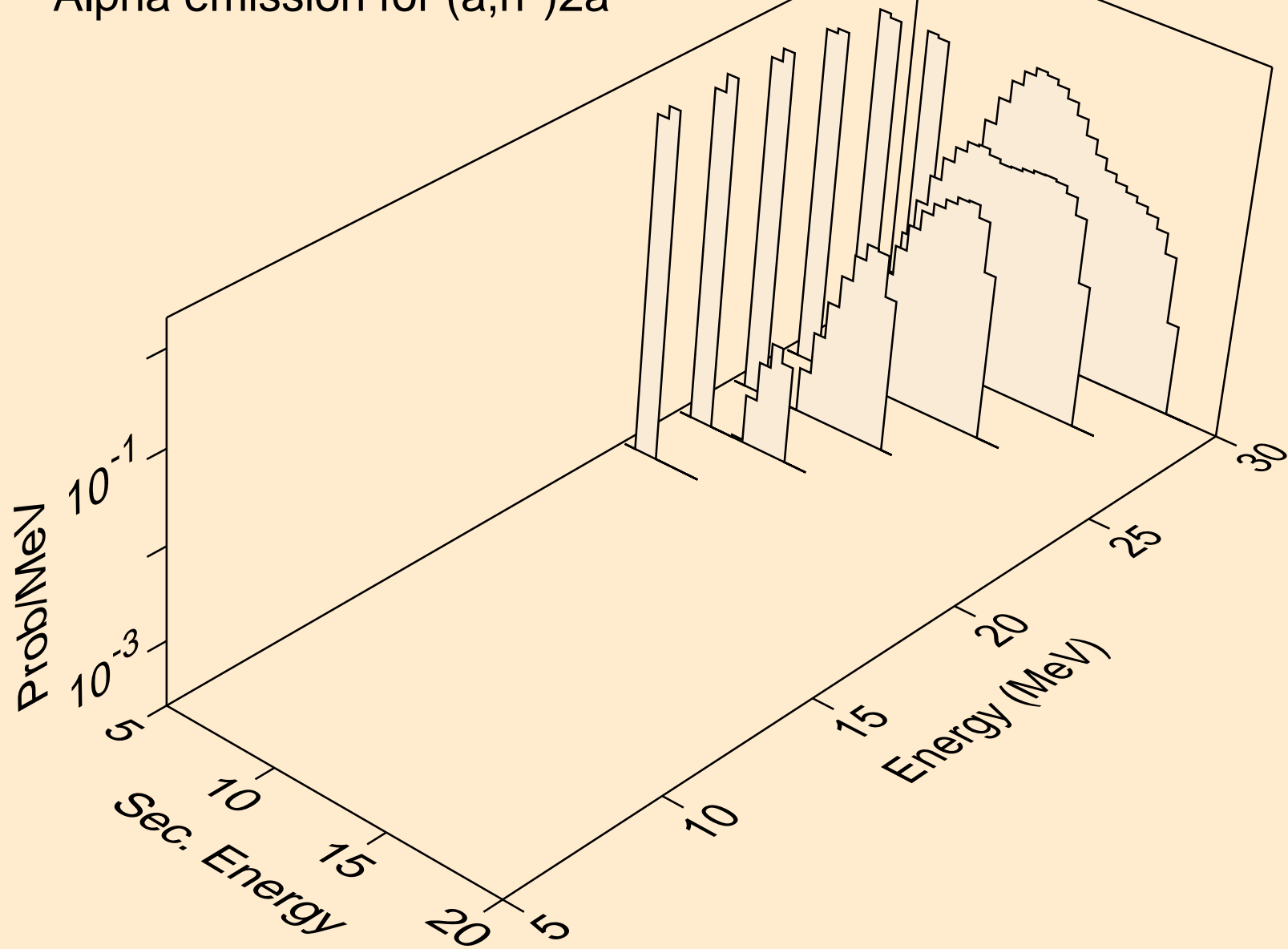

IR173 ALPHA ACER TENDL-2023 LIBRARY; T=0.K  
Alpha emission for inelastic

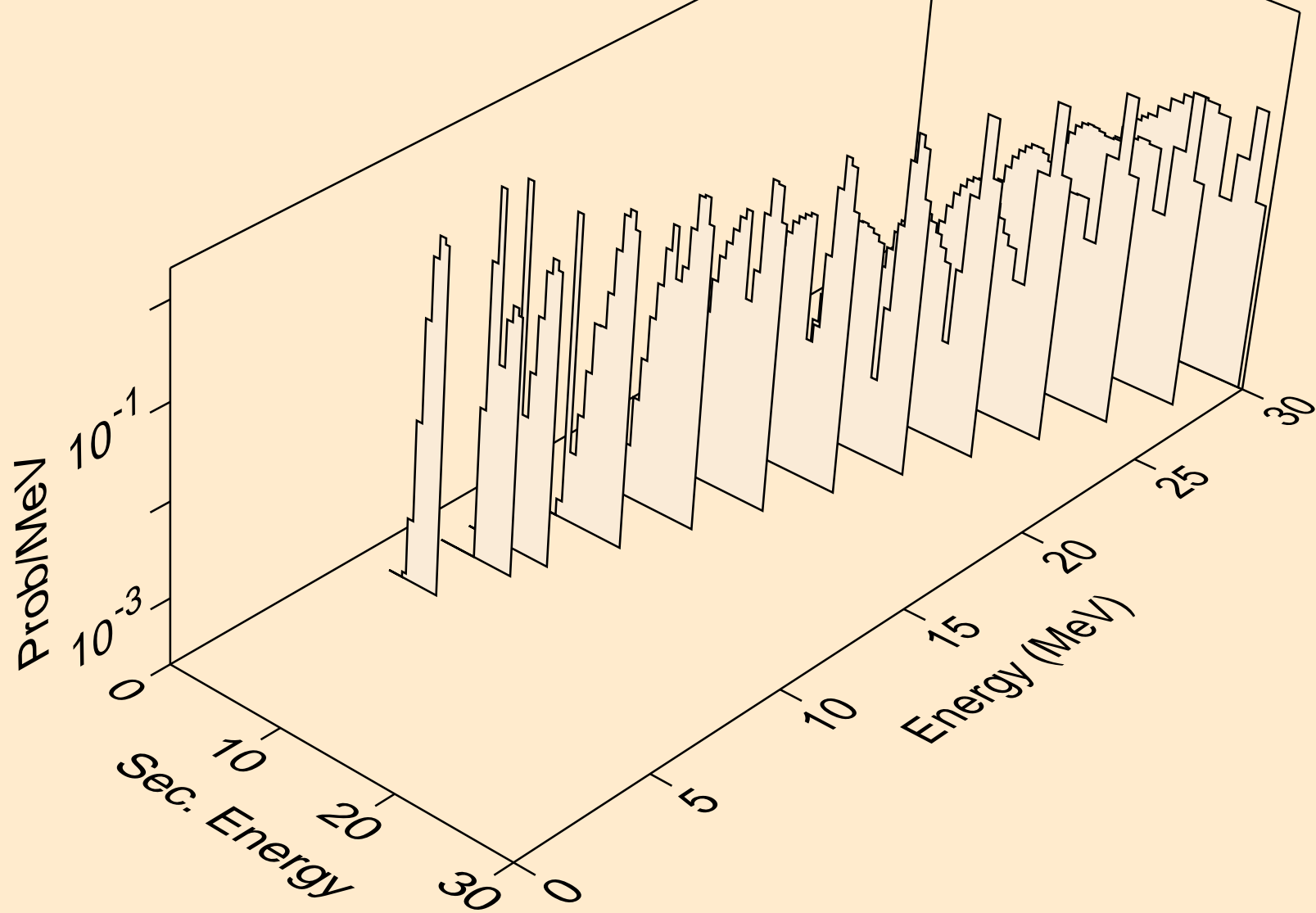

IR173 ALPHA ACER TENDL-2023 LIBRARY; T=0.K  
Alpha emission for (a,2a)

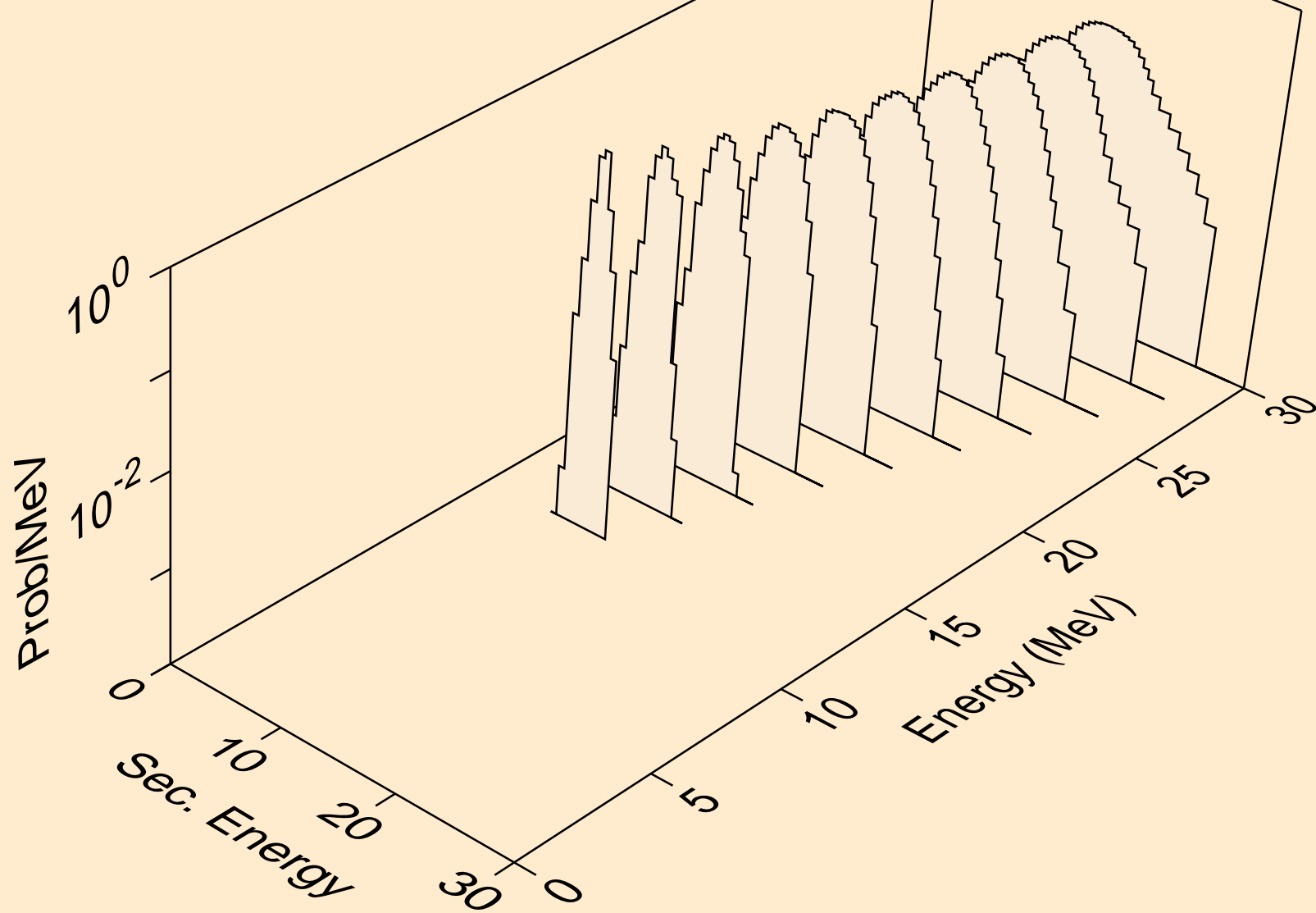

IR173 ALPHA ACER TENDL-2023 LIBRARY; T=0.K  
Alpha emission for (a,pa)

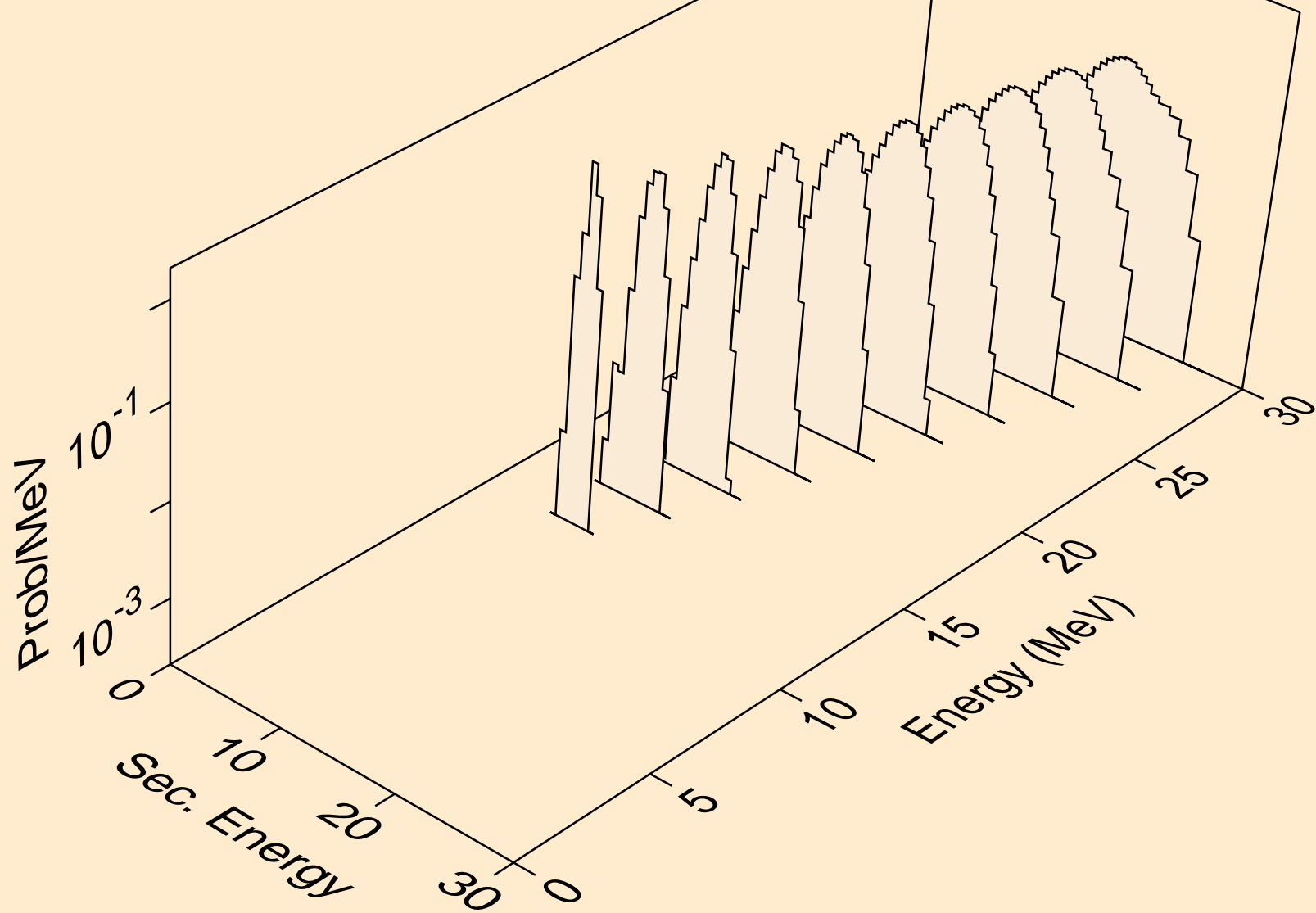

IR173 ALPHA ACER TENDL-2023 LIBRARY; T=0.K  
Alpha emission for (a,da)

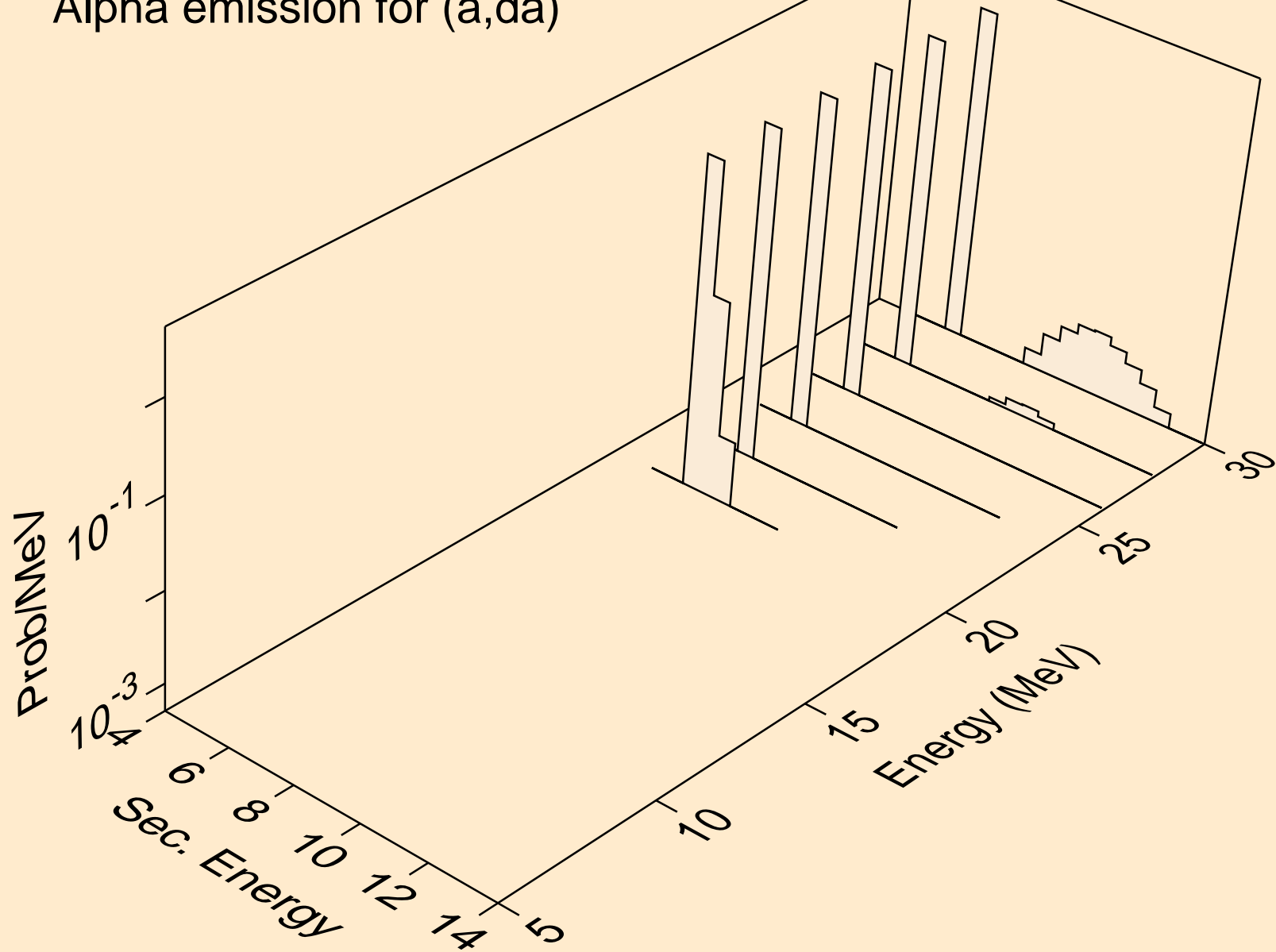

IR173 ALPHA ACER TENDL-2023 LIBRARY; T=0.K  
Photon emission for (z,n)

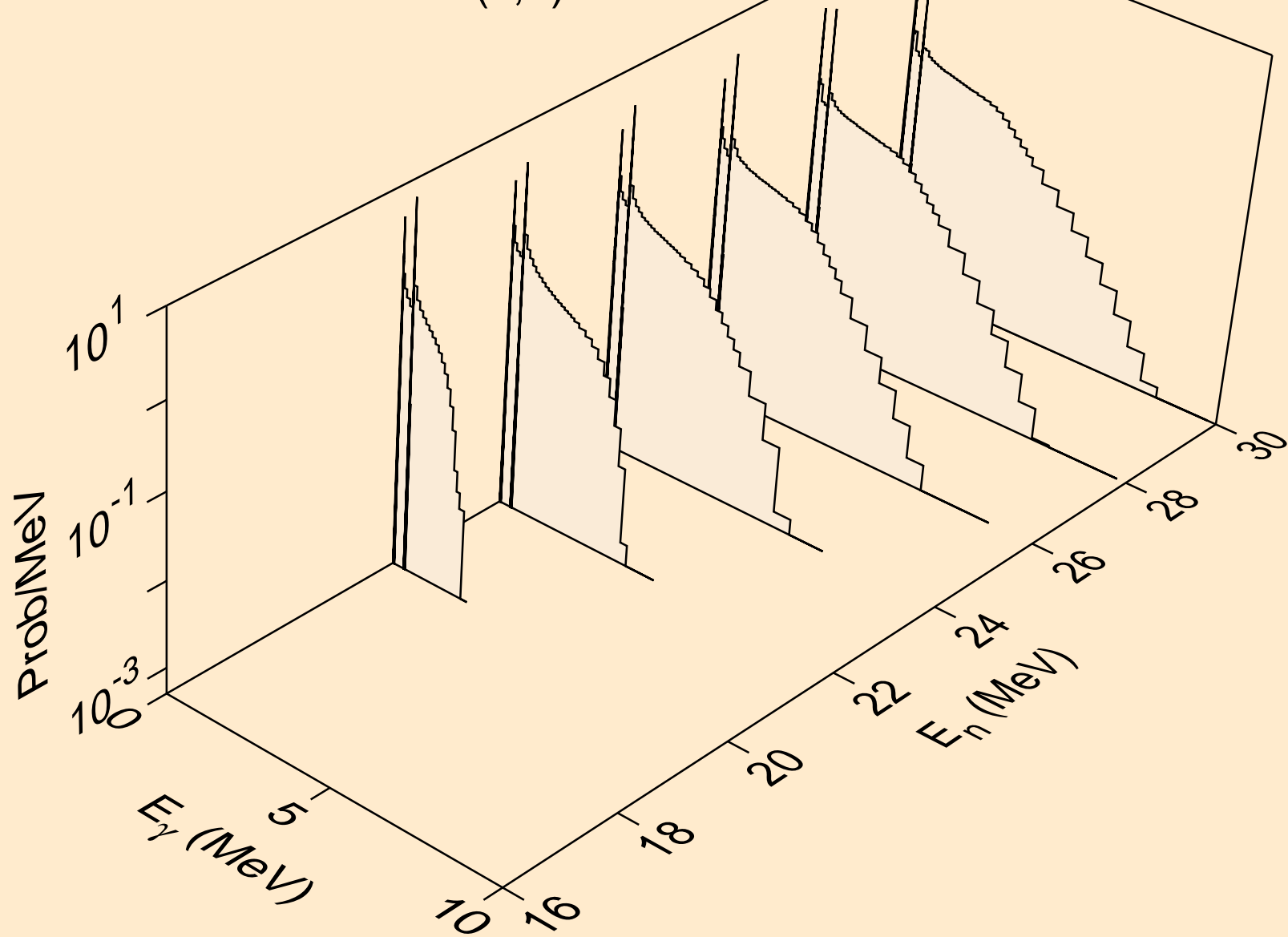

IR173 ALPHA ACER TENDL-2023 LIBRARY; T=0.K  
Photon emission for (z,x)

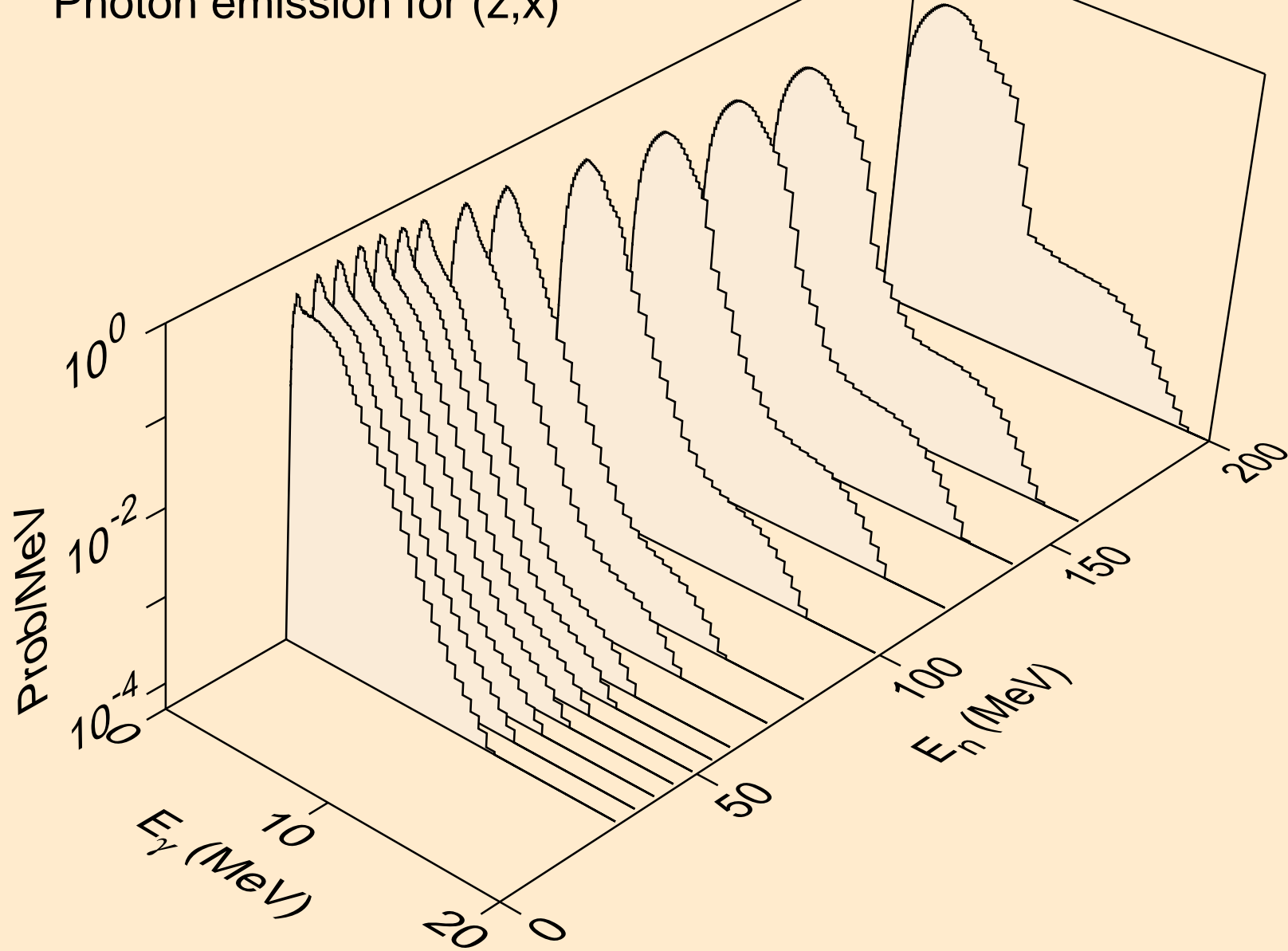

IR173 ALPHA ACER TENDL-2023 LIBRARY; T=0.K  
Photon emission for (n,2n)

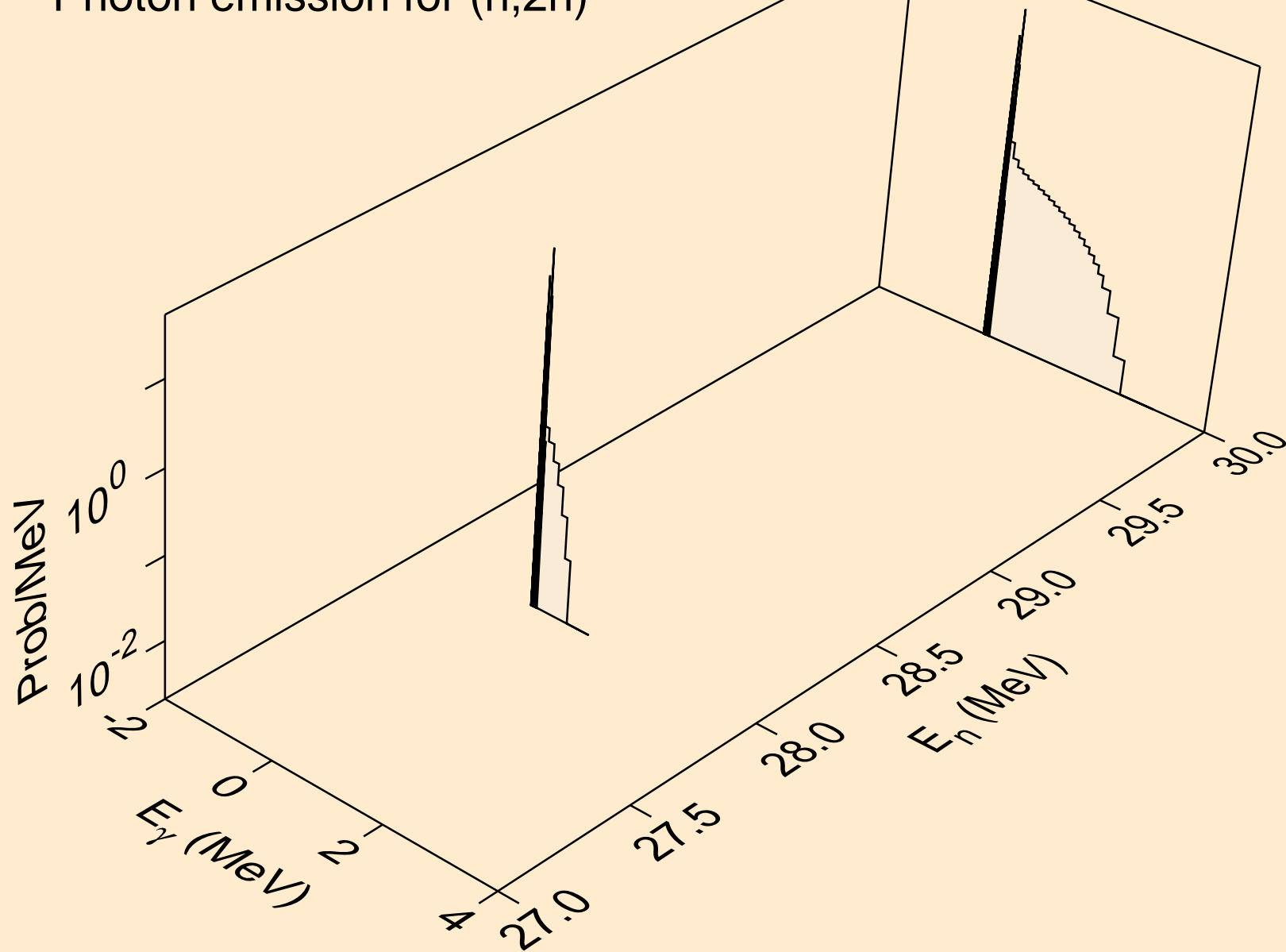

IR173 ALPHA ACER TENDL-2023 LIBRARY; T=0.K  
Photon emission for (n,n\*)a

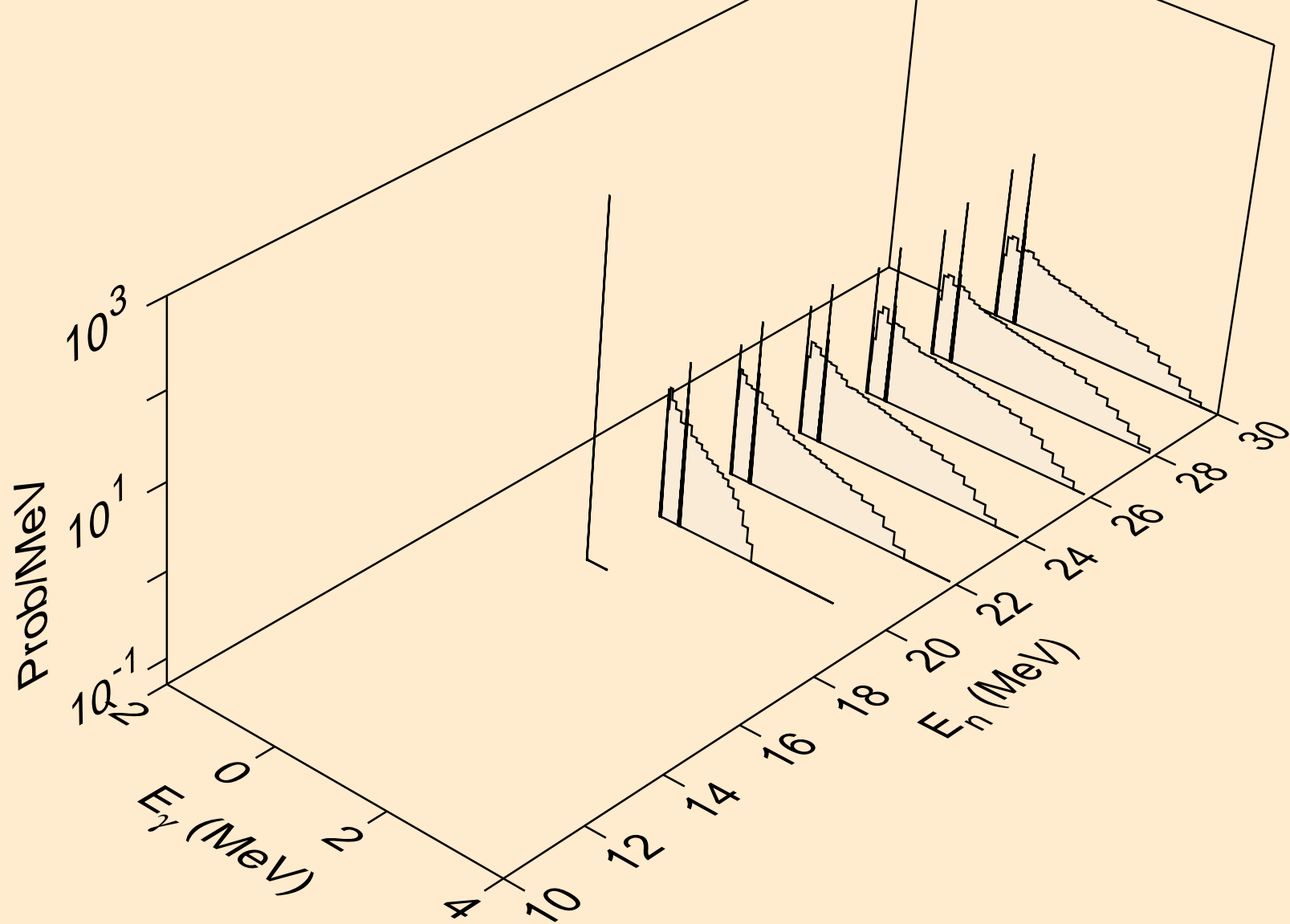

IR173 ALPHA ACER TENDL-2023 LIBRARY; T=0.K  
Photon emission for (n,2n)a

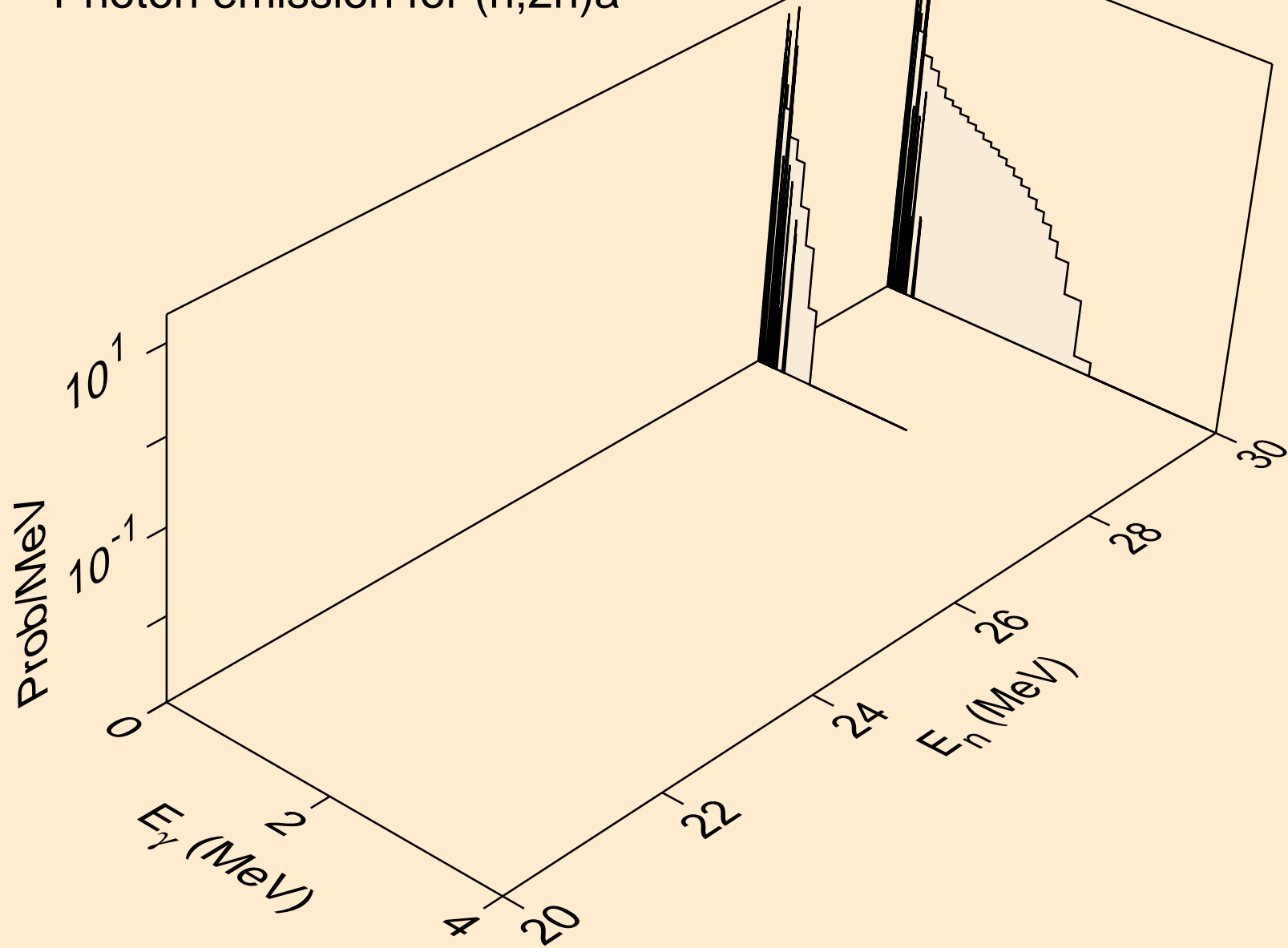

IR173 ALPHA ACER TENDL-2023 LIBRARY; T=0.K  
Photon emission for (n,n\*)p

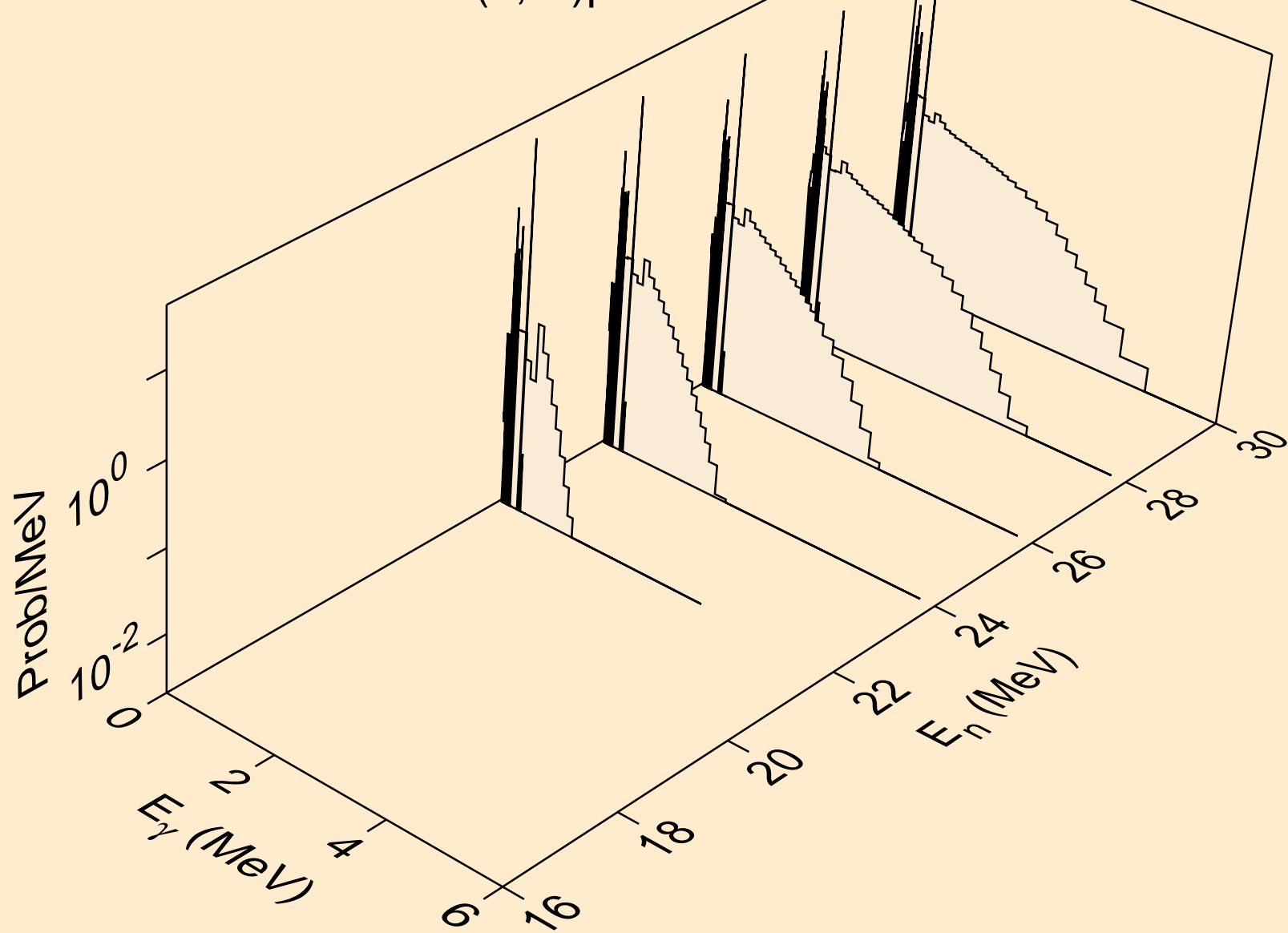

IR173 ALPHA ACER TENDL-2023 LIBRARY; T=0.K  
Photon emission for (n,n\*)2a

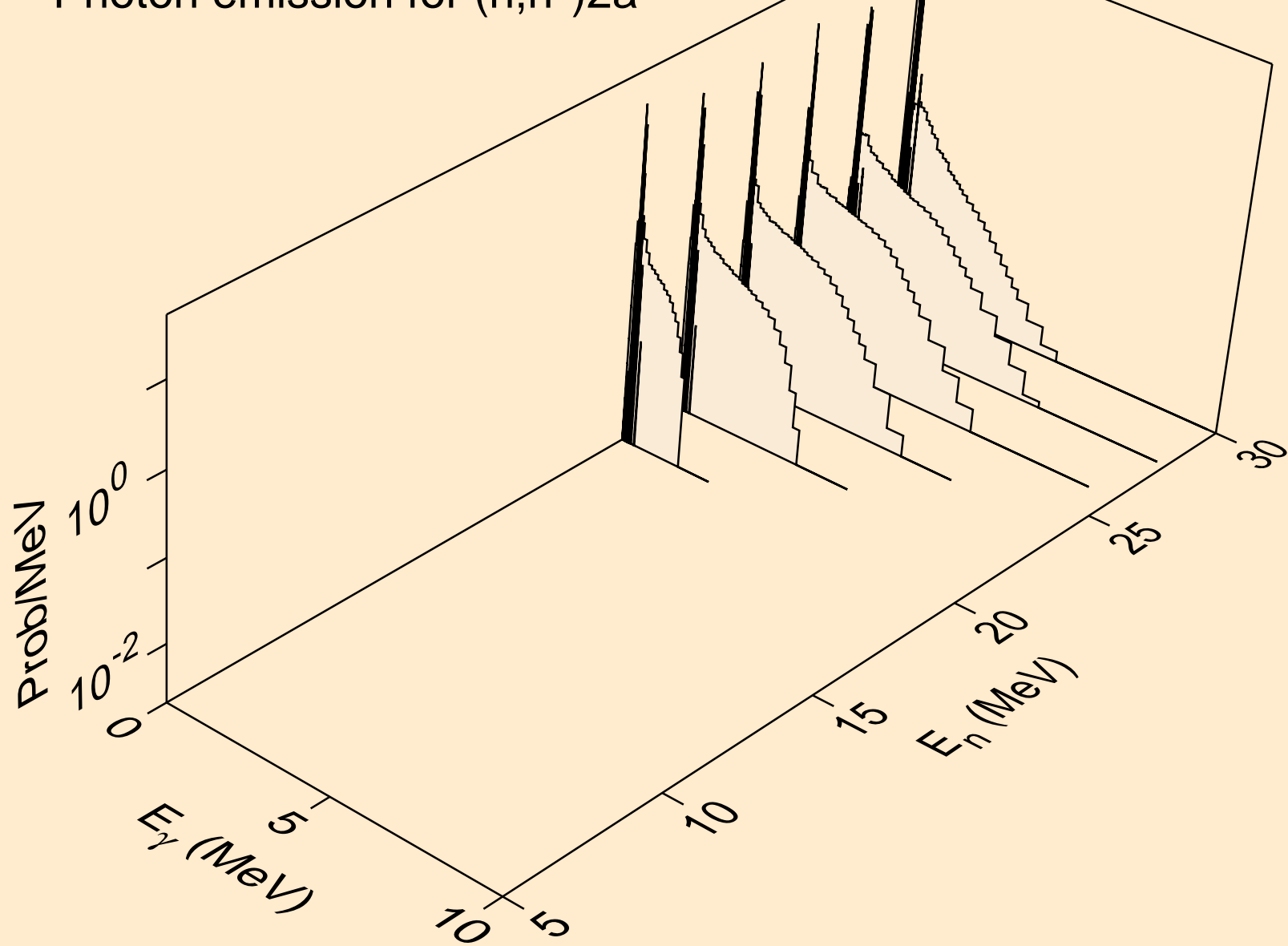

IR173 ALPHA ACER TENDL-2023 LIBRARY; T=0.K  
Photon emission for (n,2np)

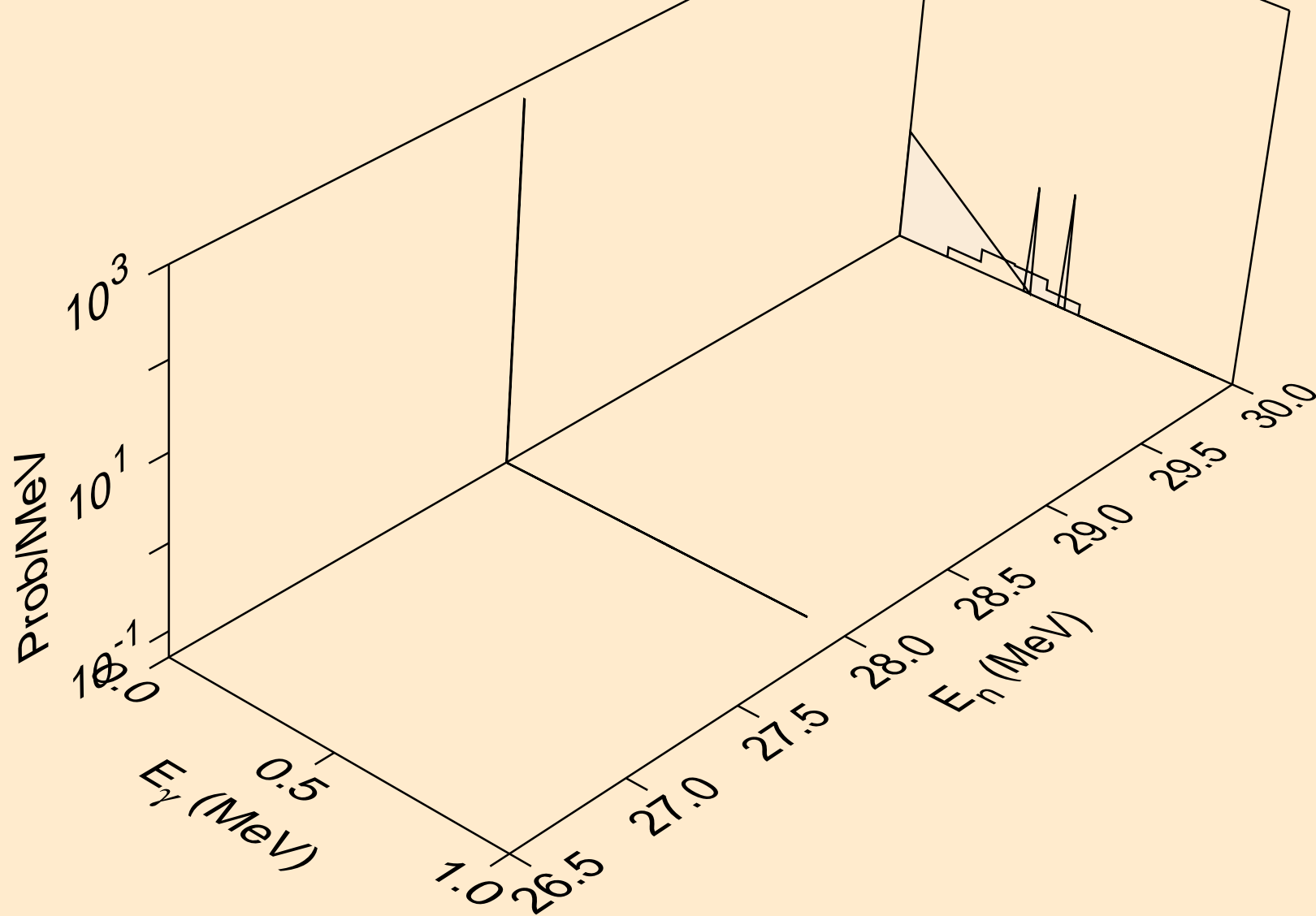

IR173 ALPHA ACER TENDL-2023 LIBRARY; T=0.K  
Photon emission for (n,n2p)

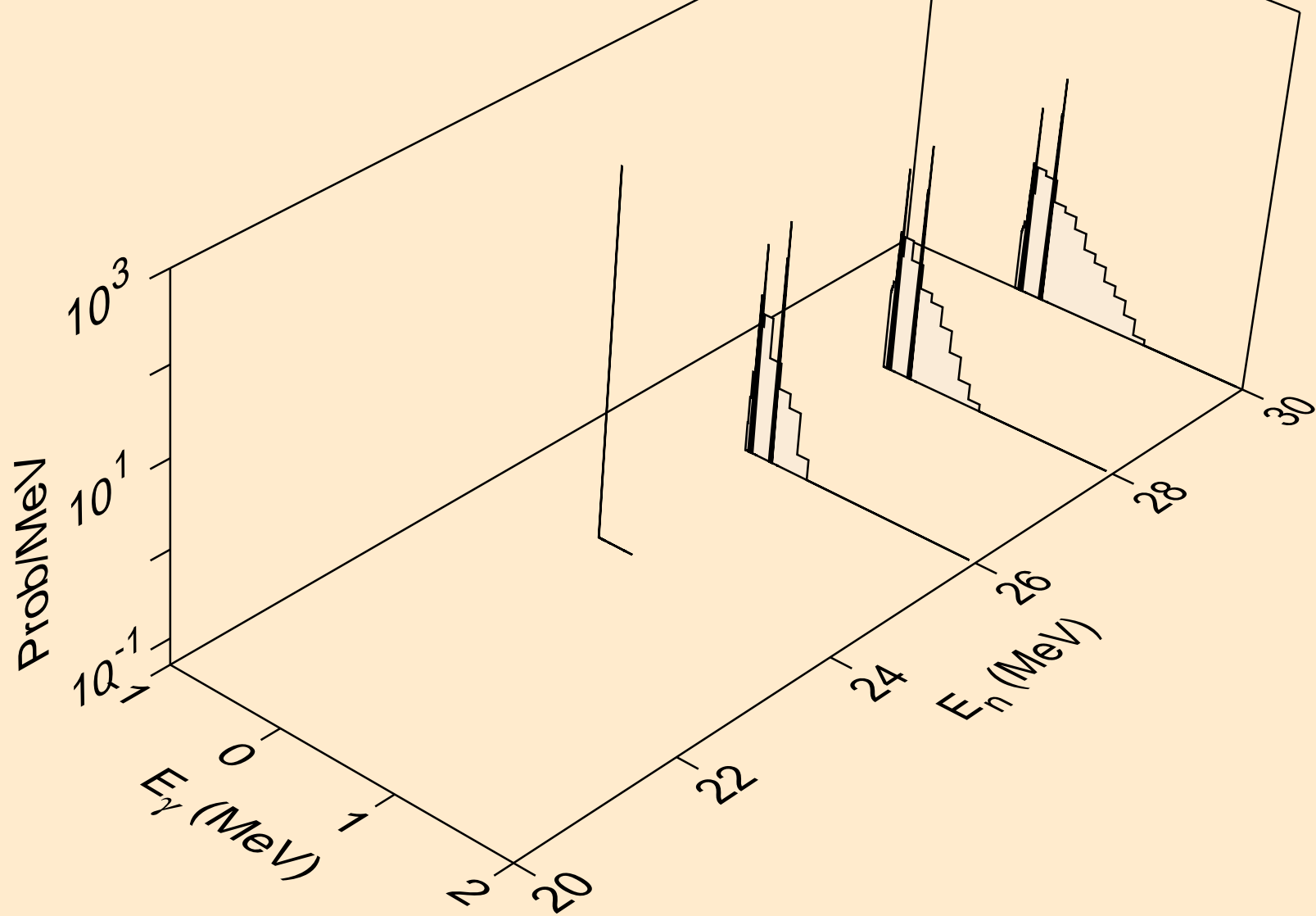

IR173 ALPHA ACER TENDL-2023 LIBRARY; T=0.K  
Photon emission for (n,npa)

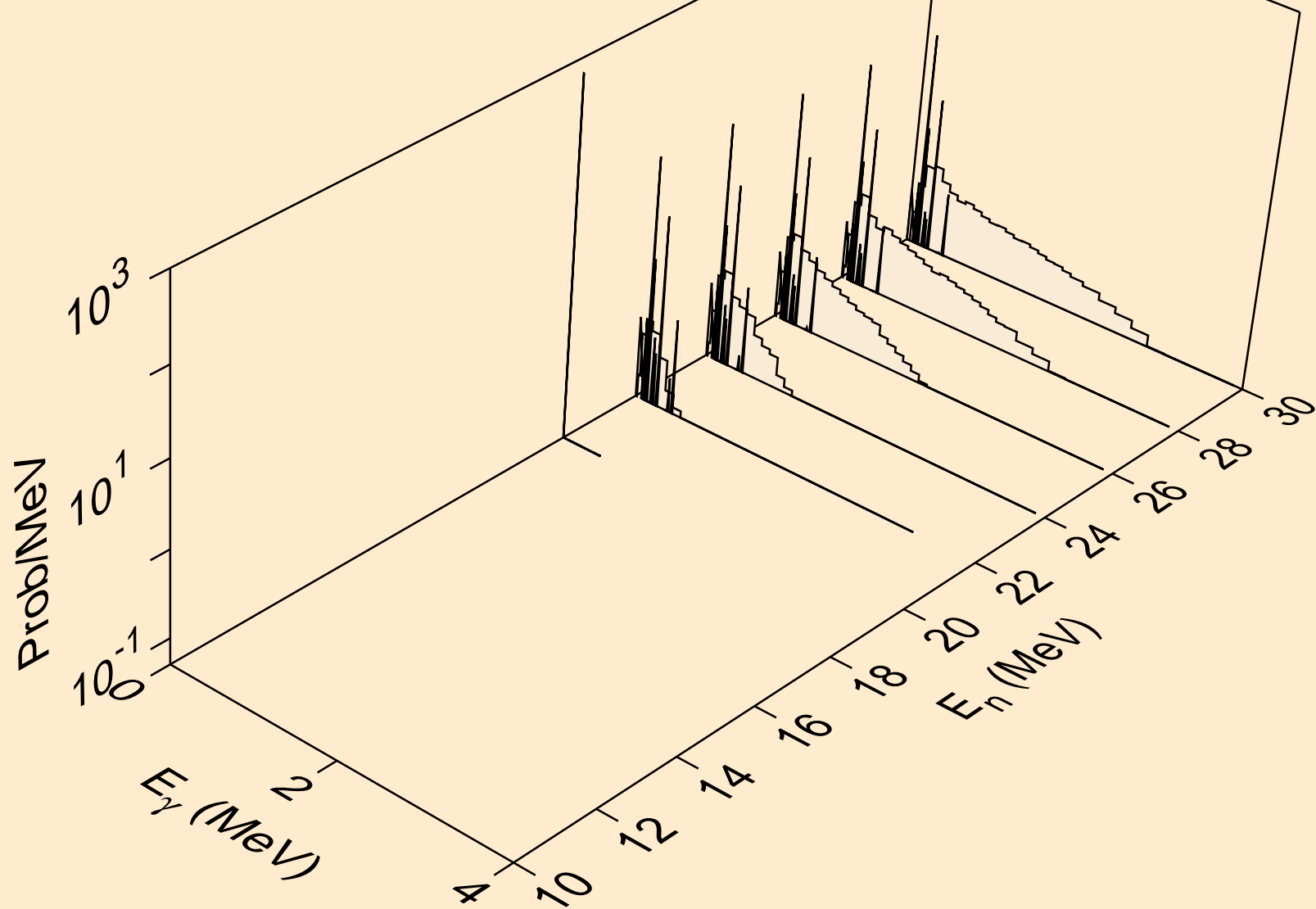

IR173 ALPHA ACER TENDL-2023 LIBRARY; T=0.K  
Photon emission for (n,gma)

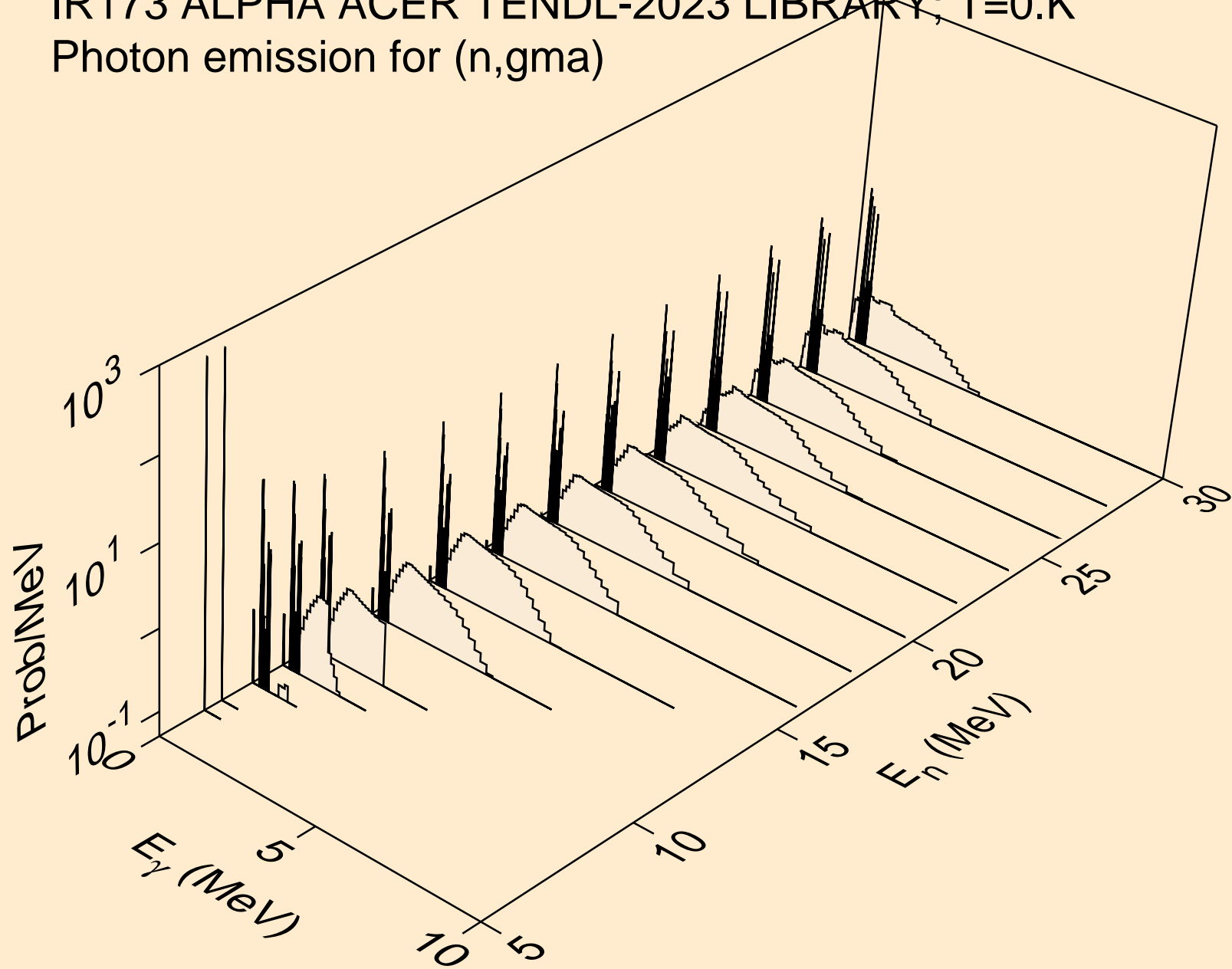

IR173 ALPHA ACER TENDL-2023 LIBRARY; T=0.K  
Photon emission for (n,p)

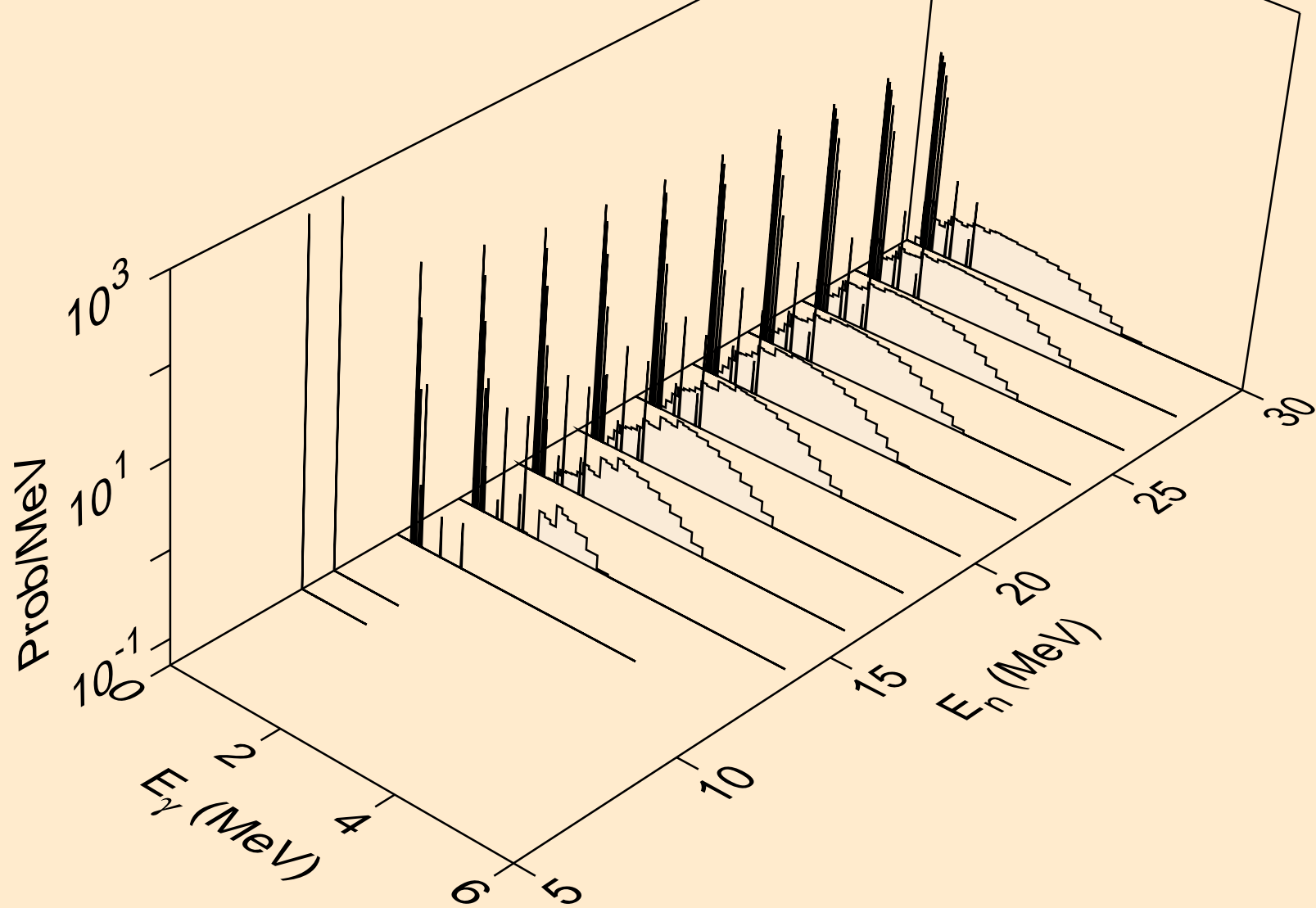

IR173 ALPHA ACER TENDL-2023 LIBRARY; T=0.K  
Photon emission for (n,d)

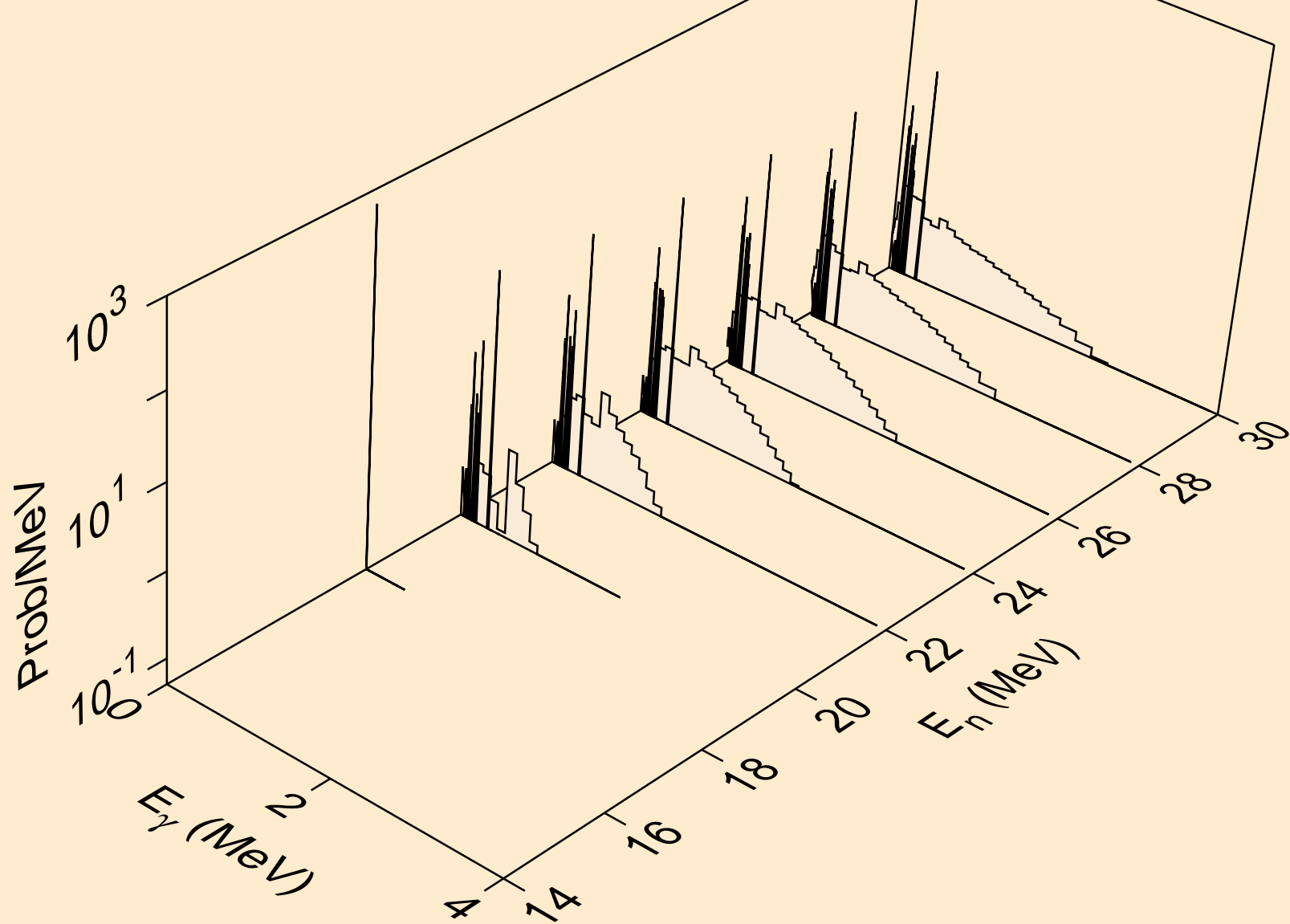

IR173 ALPHA ACER TENDL-2023 LIBRARY; T=0.K  
Photon emission for (n,t)

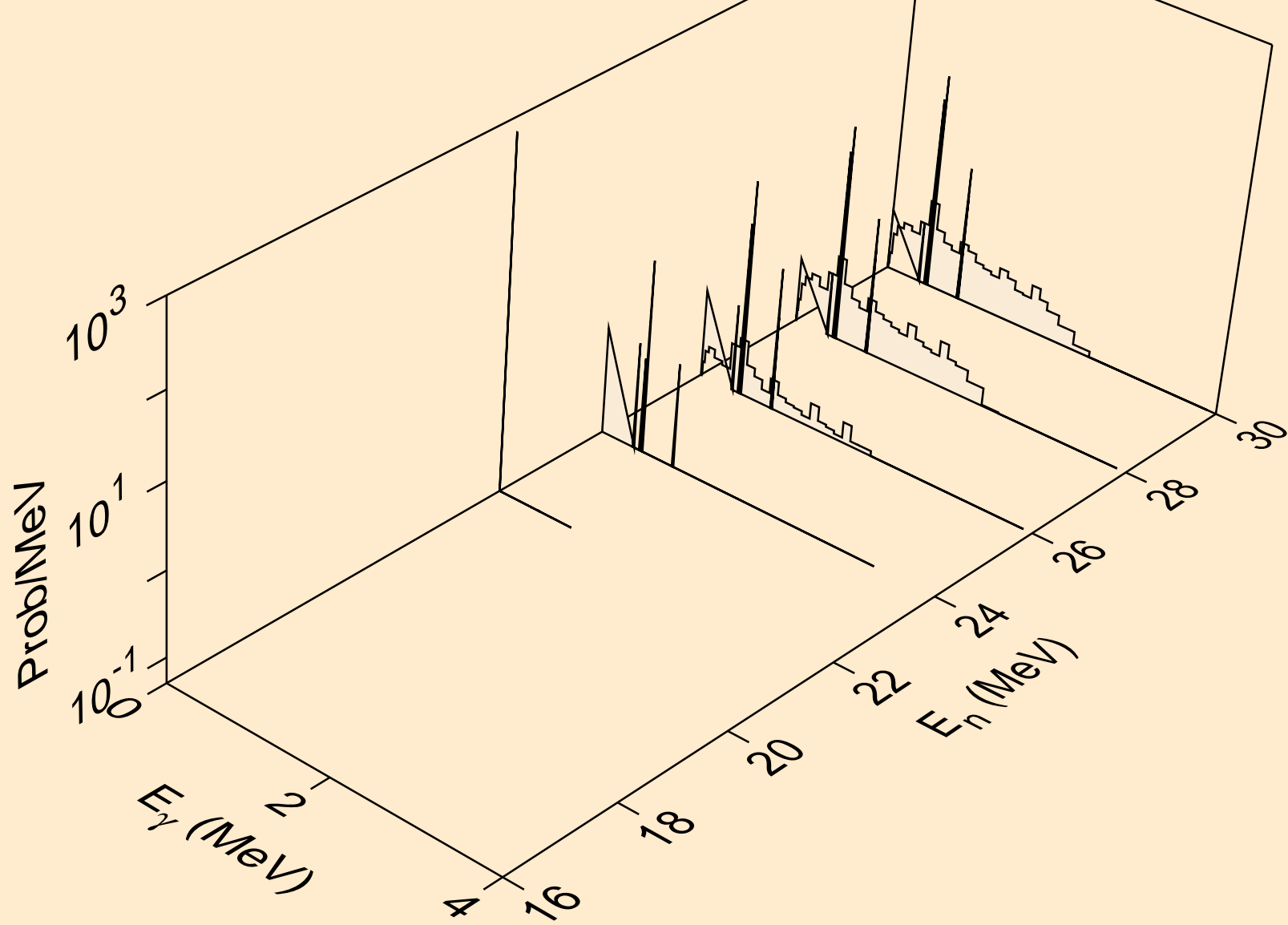

IR173 ALPHA ACER TENDL-2023 LIBRARY; T=0.K  
Photon emission for (n,he3)

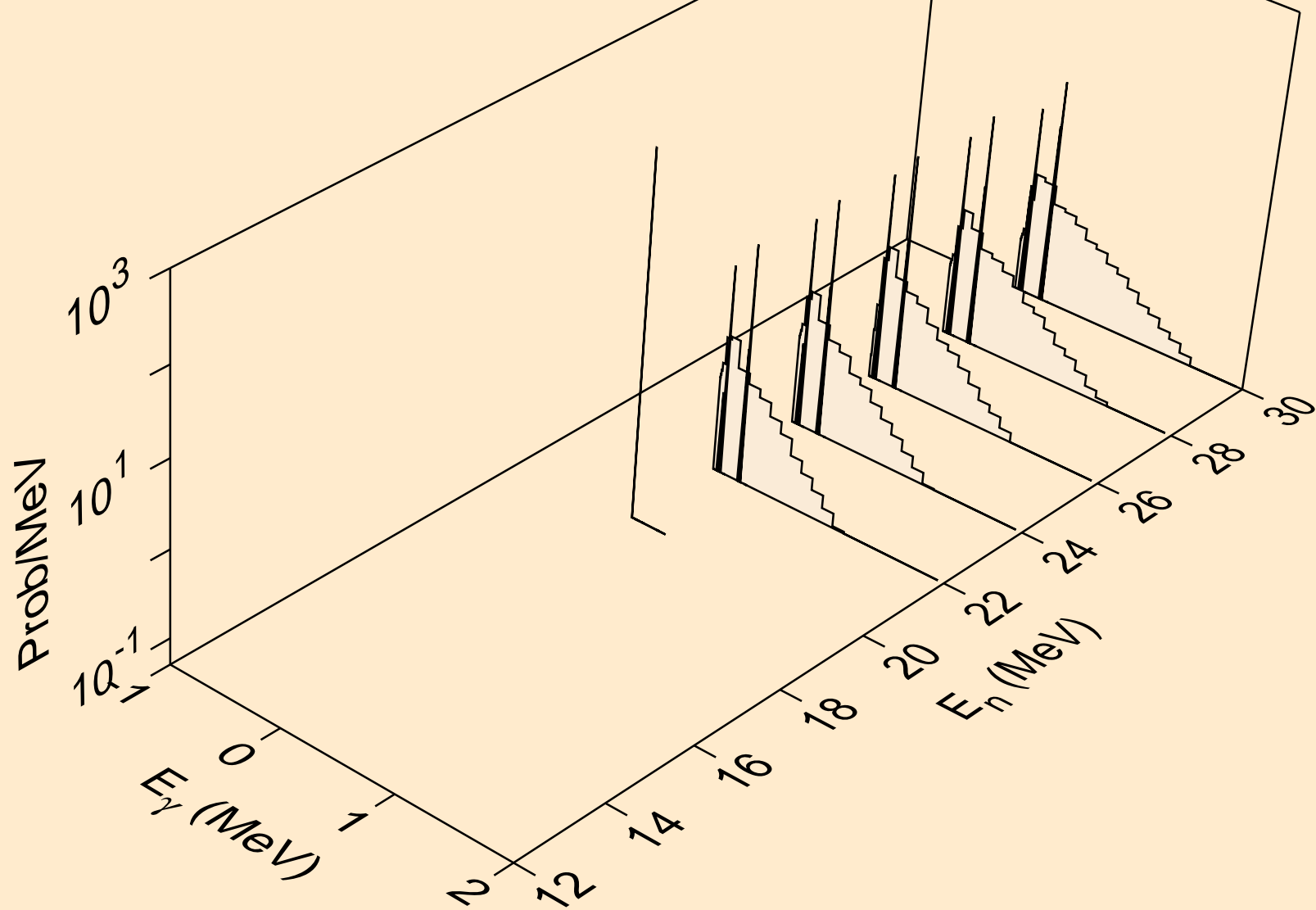

IR173 ALPHA ACER TENDL-2023 LIBRARY; T=0.K  
Photon emission for inelastic

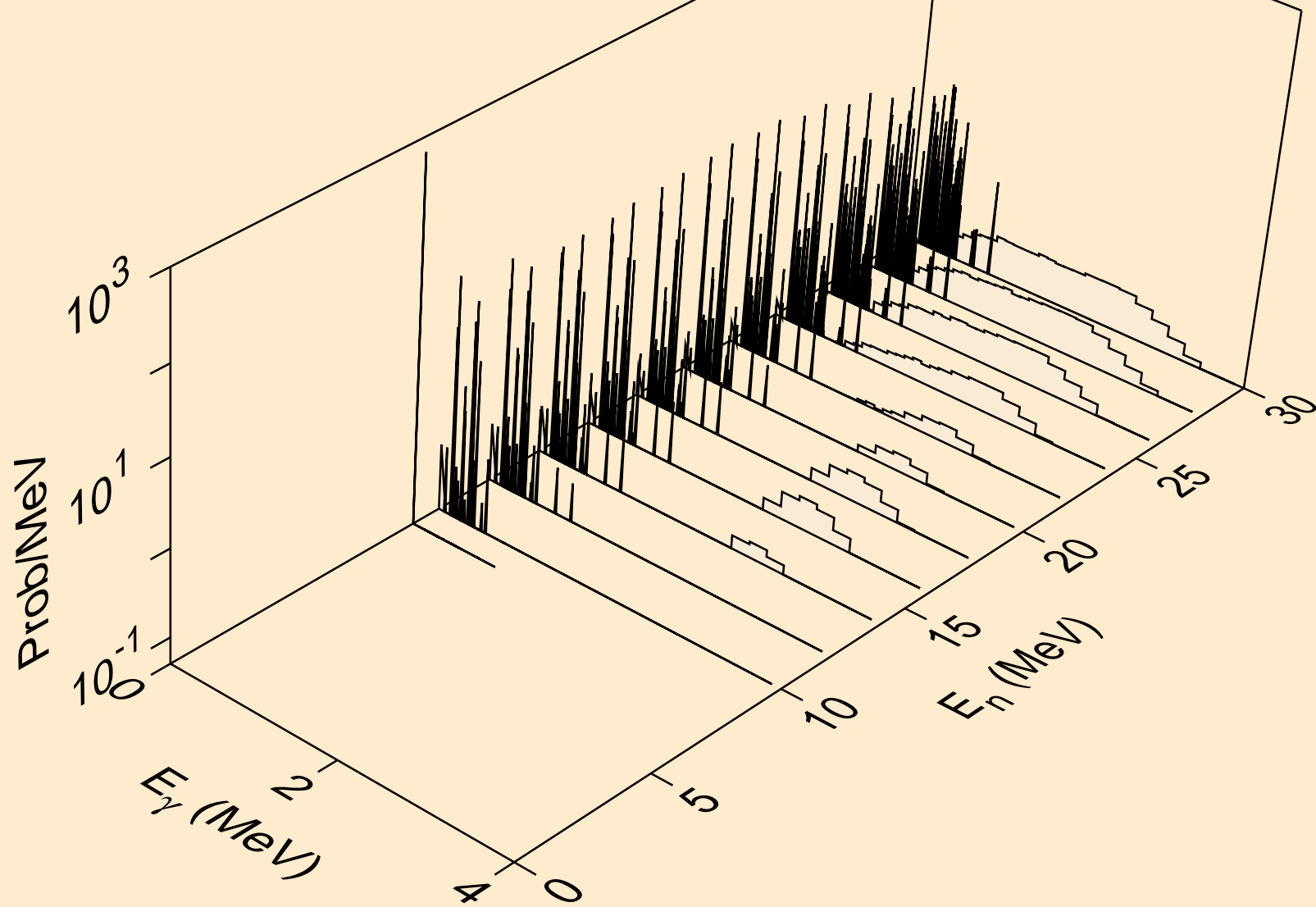

IR173 ALPHA ACER TENDL-2023 LIBRARY; T=0.K  
Photon emission for (n,2a)

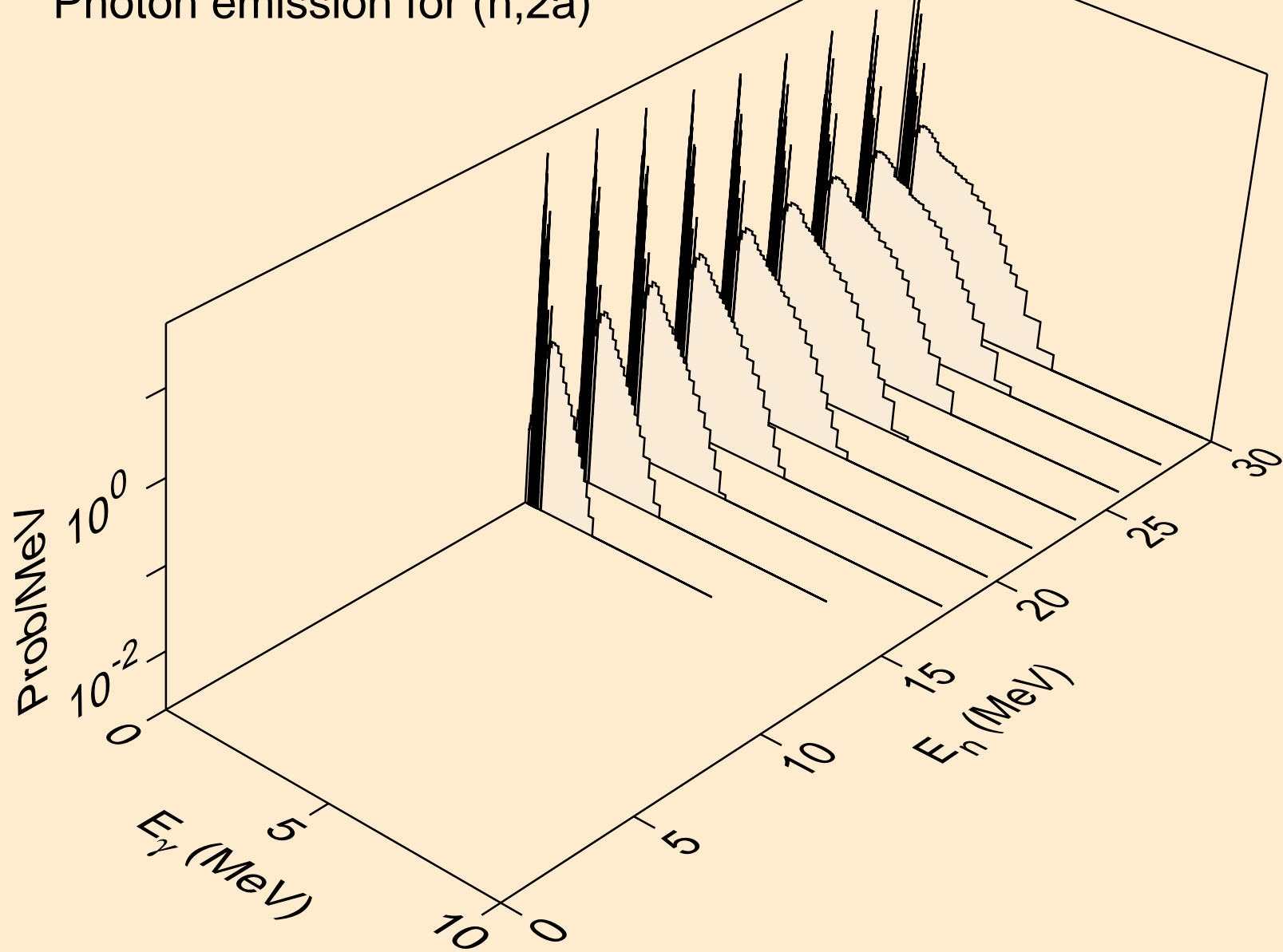

IR173 ALPHA ACER TENDL-2023 LIBRARY; T=0.K  
Photon emission for (n,2p)

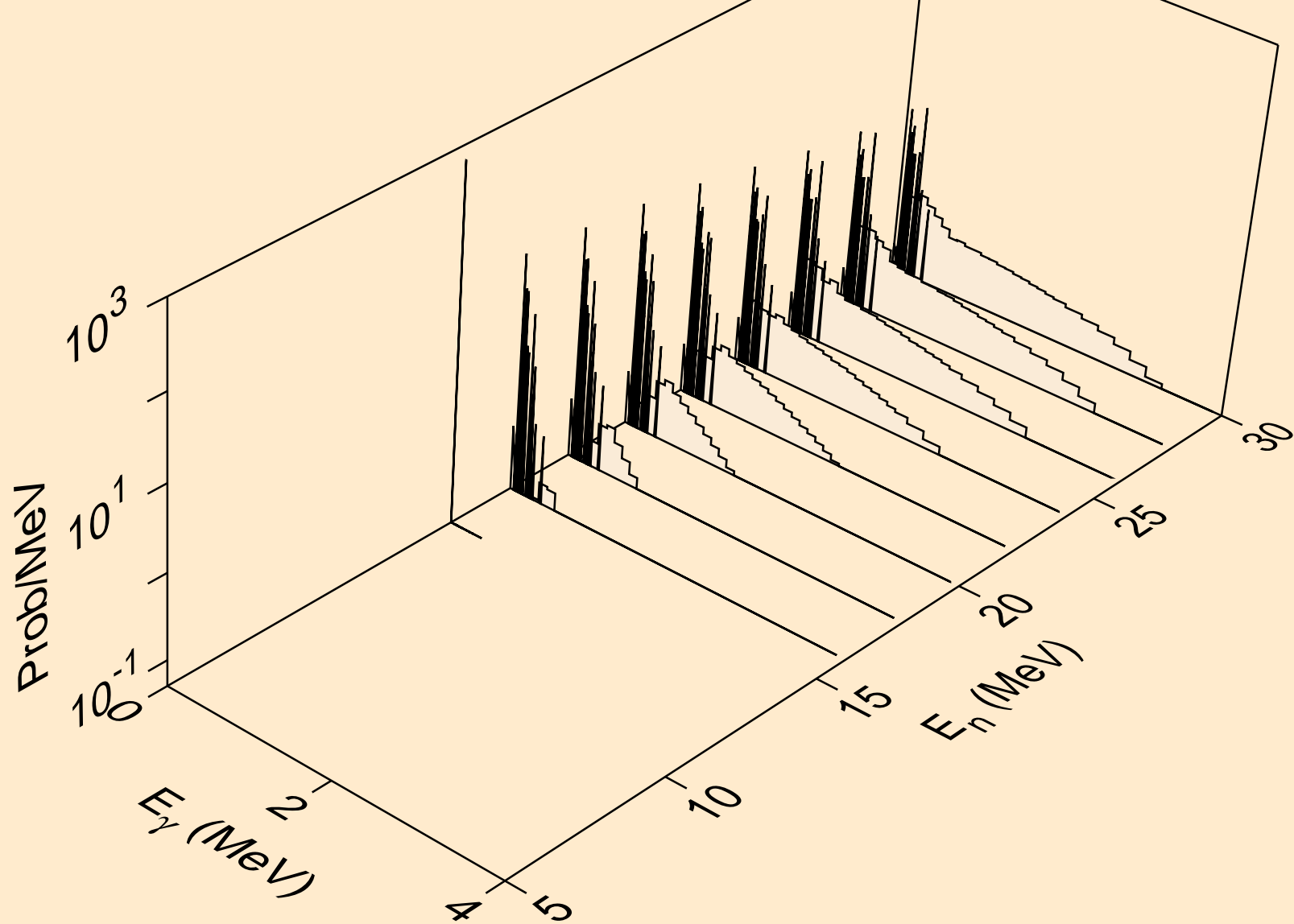

IR173 ALPHA ACER TENDL-2023 LIBRARY; T=0.K  
Photon emission for (n,pa)

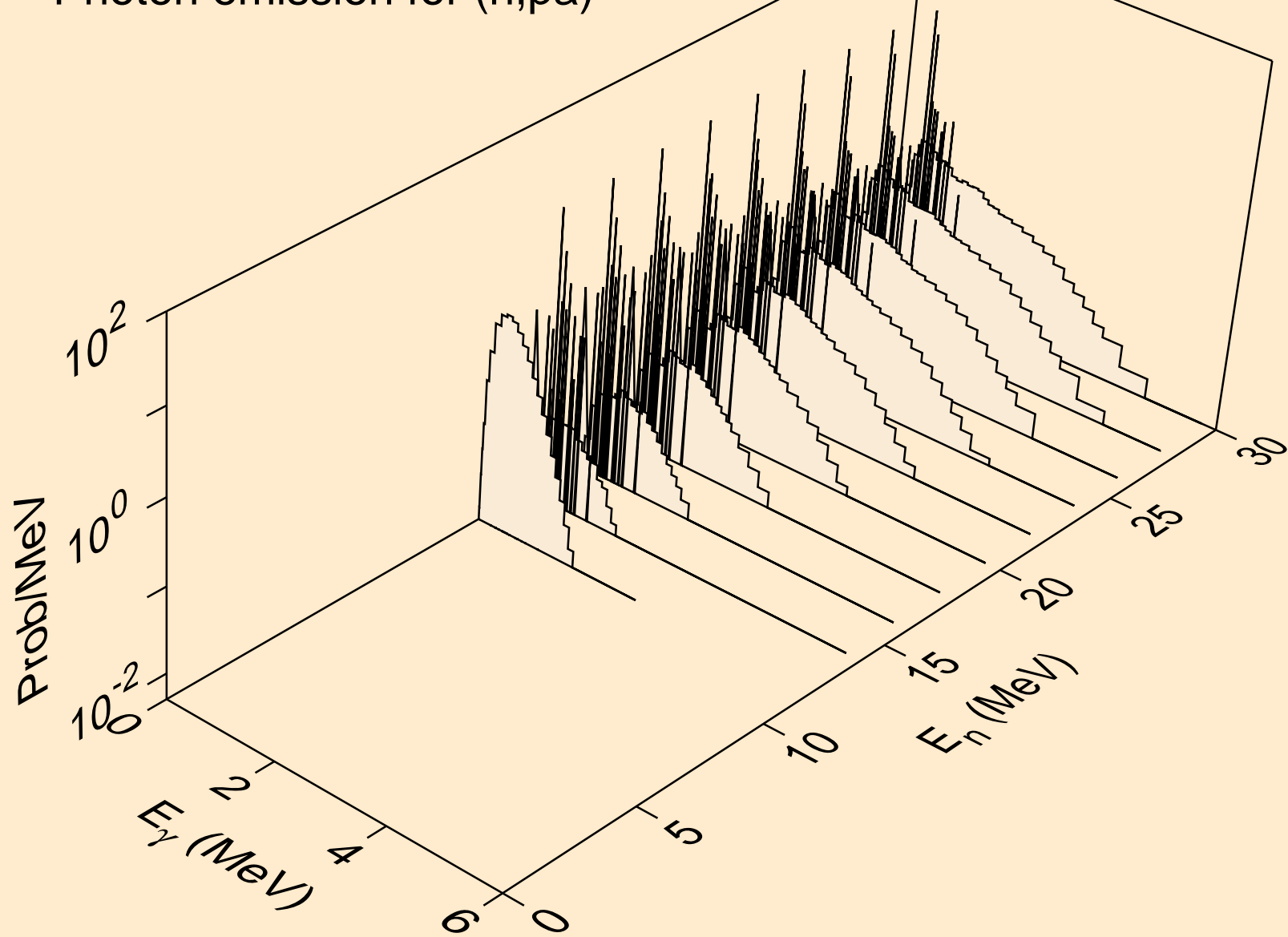

IR173 ALPHA ACER TENDL-2023 LIBRARY; T=0.K  
Photon emission for (n,pd)

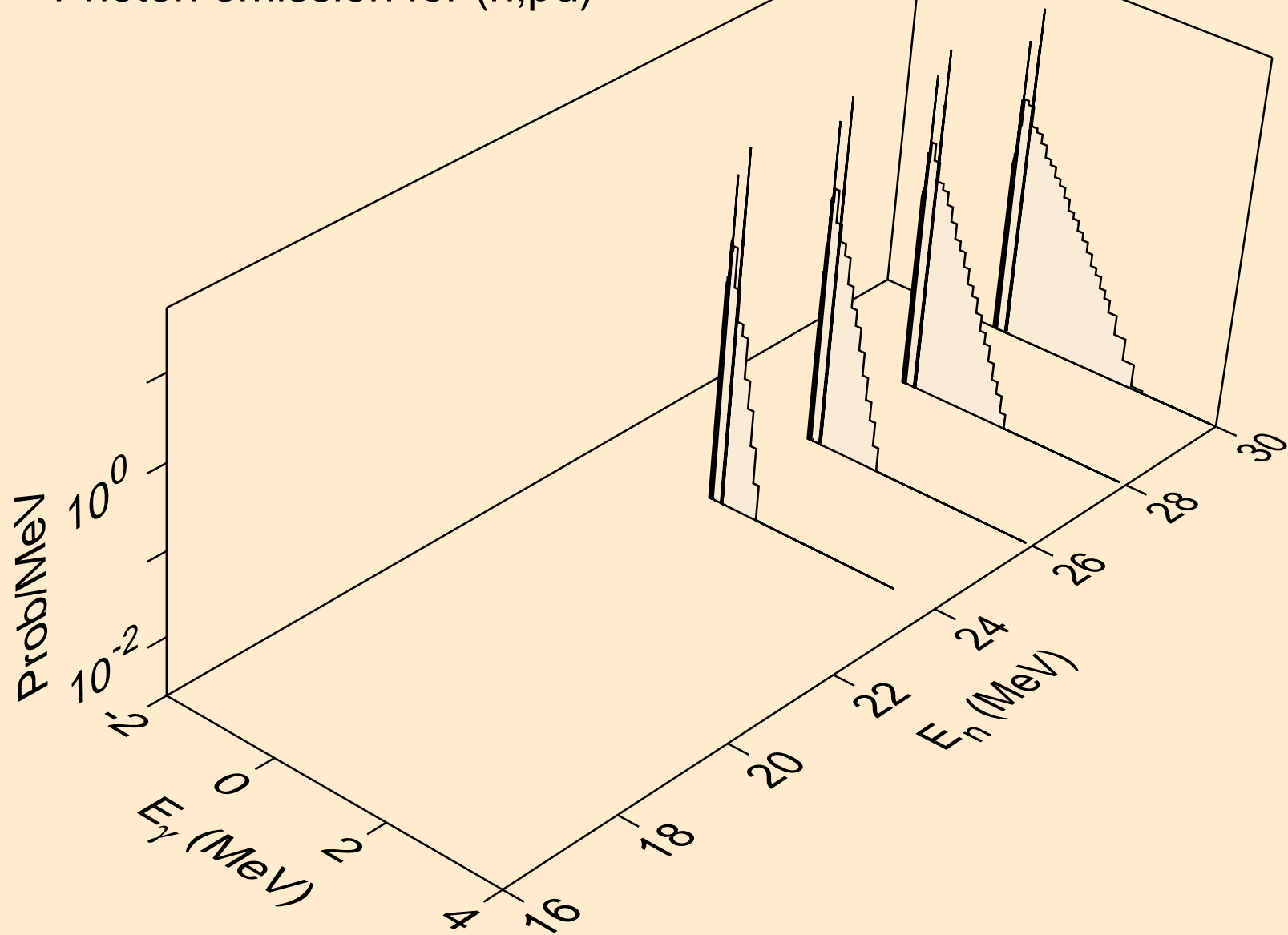

IR173 ALPHA ACER TENDL-2023 LIBRARY; T=0.K  
Photon emission for (n,da)

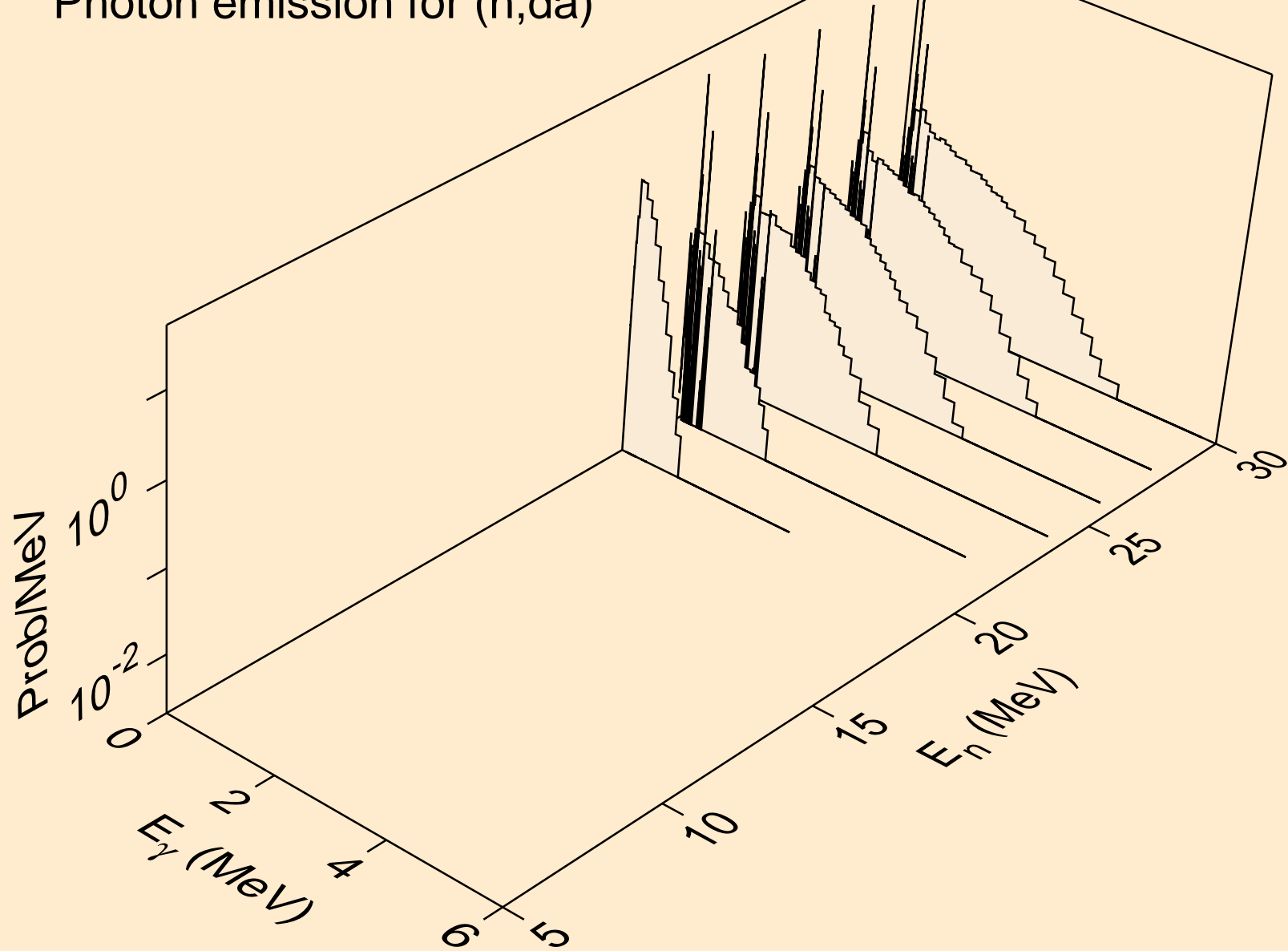

IR173 ALPHA ACER TENDL-2023 LIBRARY; T=0.K  
Particle heating contributions

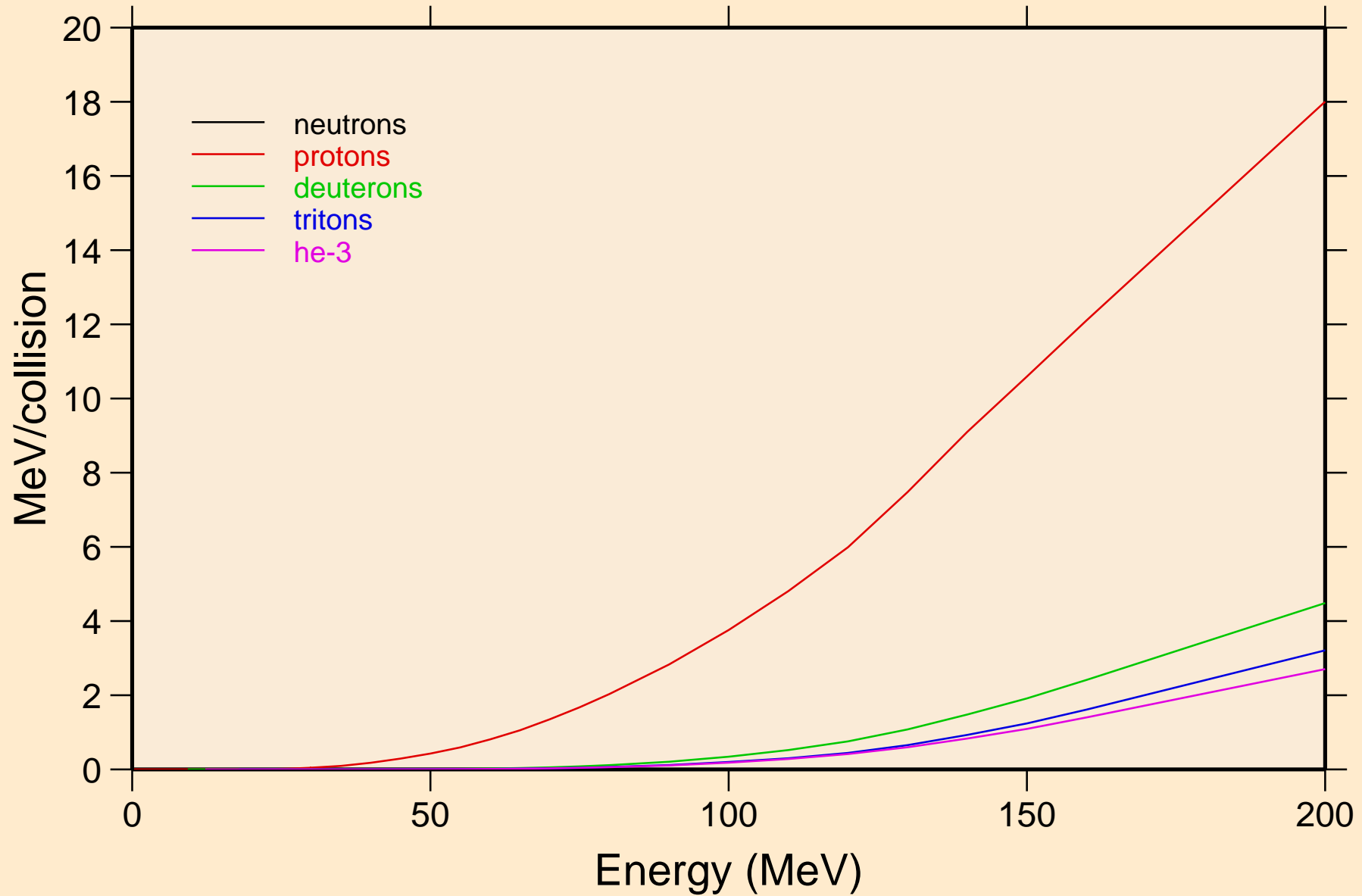

IR173 ALPHA ACER TENDL-2023 LIBRARY; T=0.K  
Recoil Heating

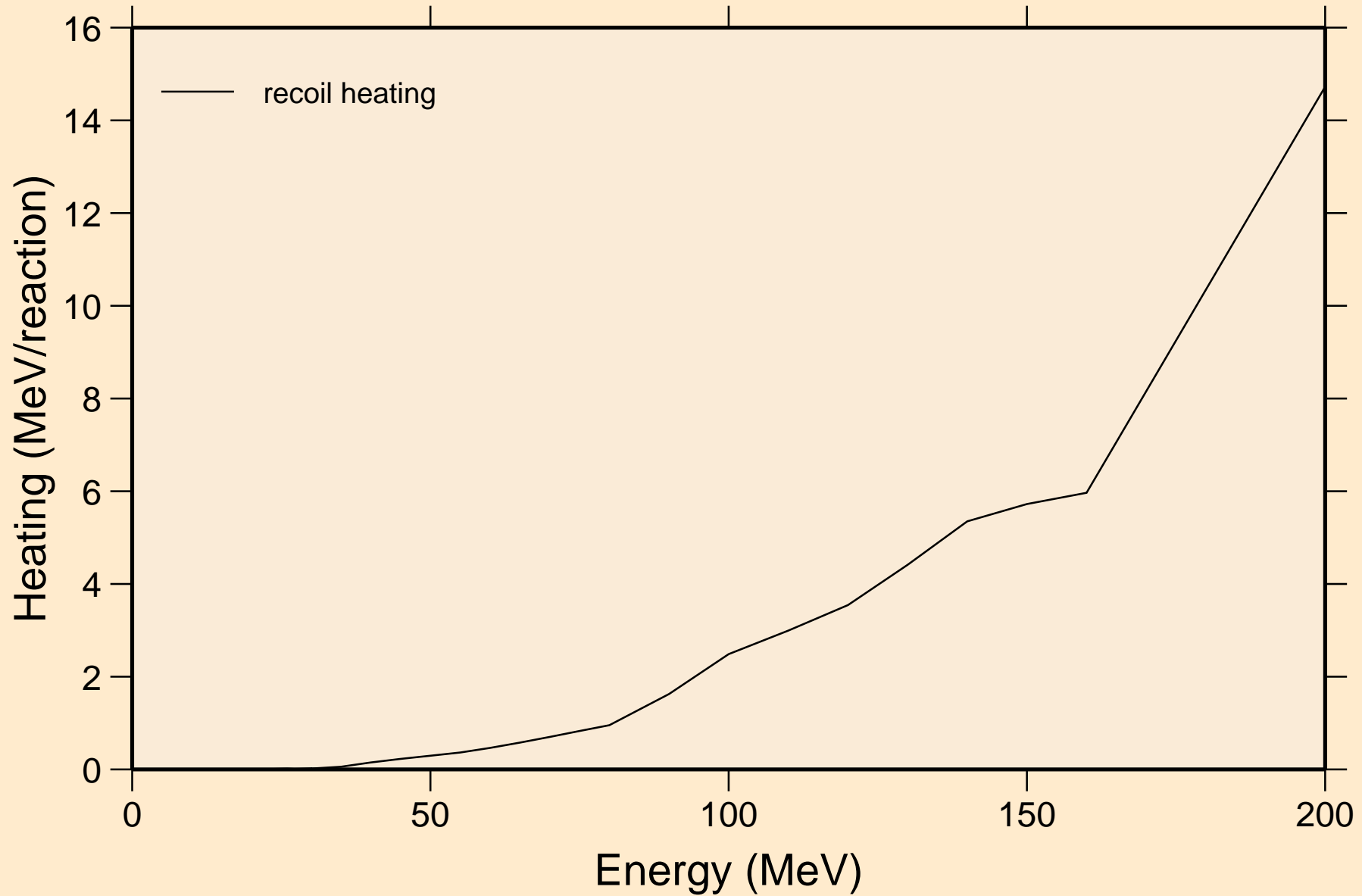

IR173 ALPHA ACER TENDL-2023 LIBRARY; T=0.K  
Particle production cross sections

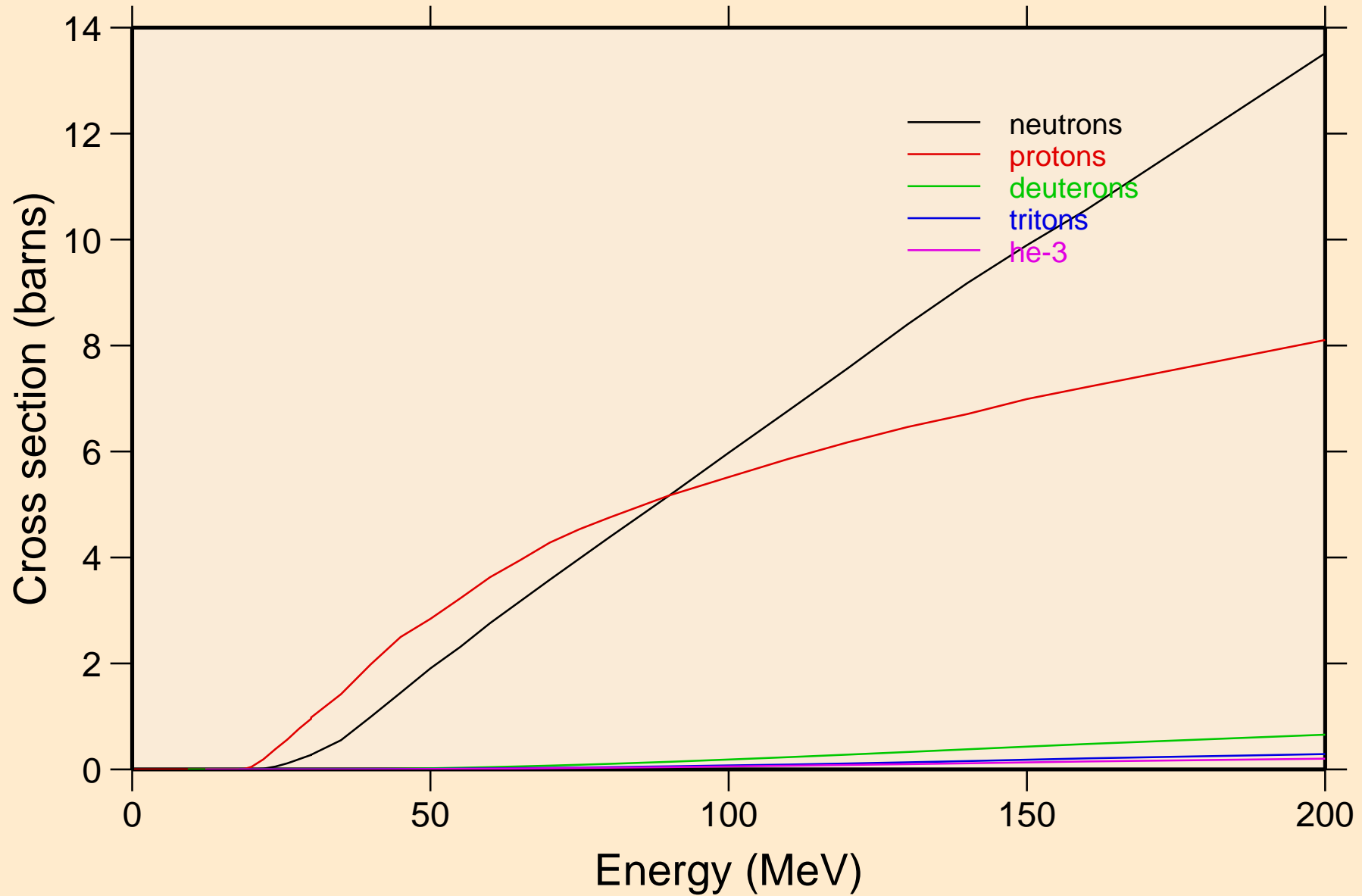

IR173 ALPHA ACER TENDL-2023 LIBRARY; T=0.K  
neutrons from (a,n)

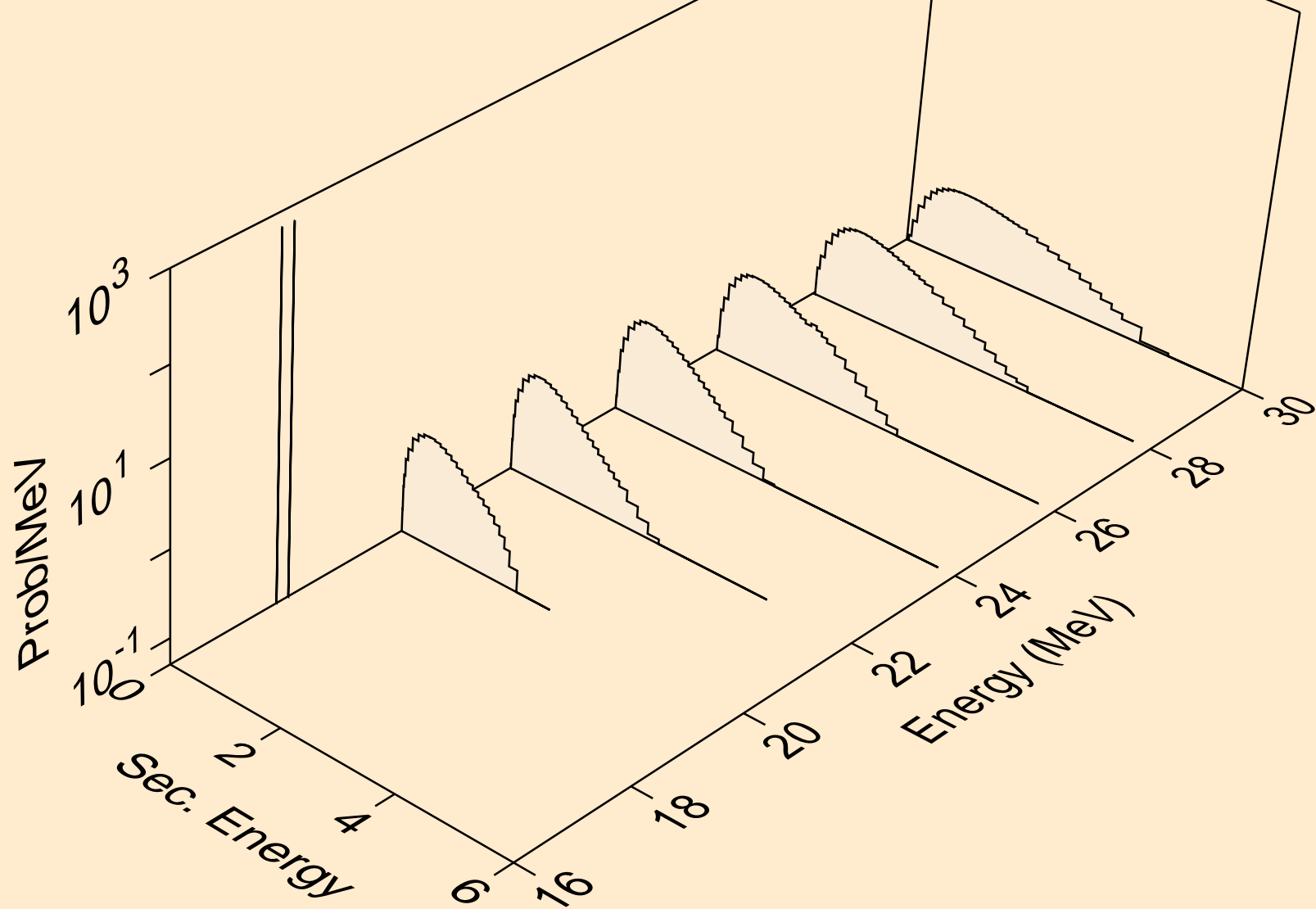

IR173 ALPHA ACER TENDL-2023 LIBRARY; T=0.K  
neutrons from (a,x)

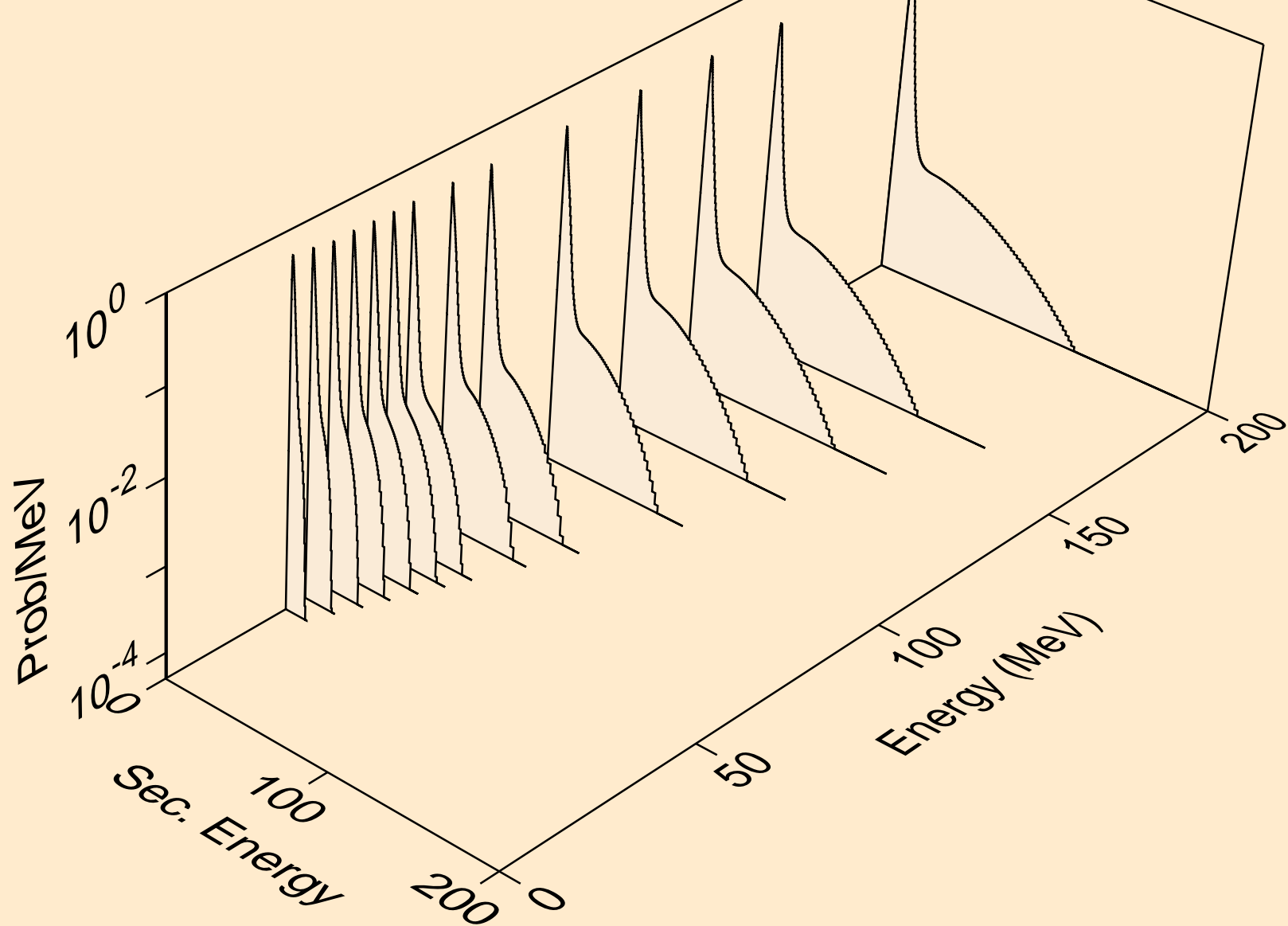

IR173 ALPHA ACER TENDL-2023 LIBRARY; T=0.K  
neutrons from (a,2n)

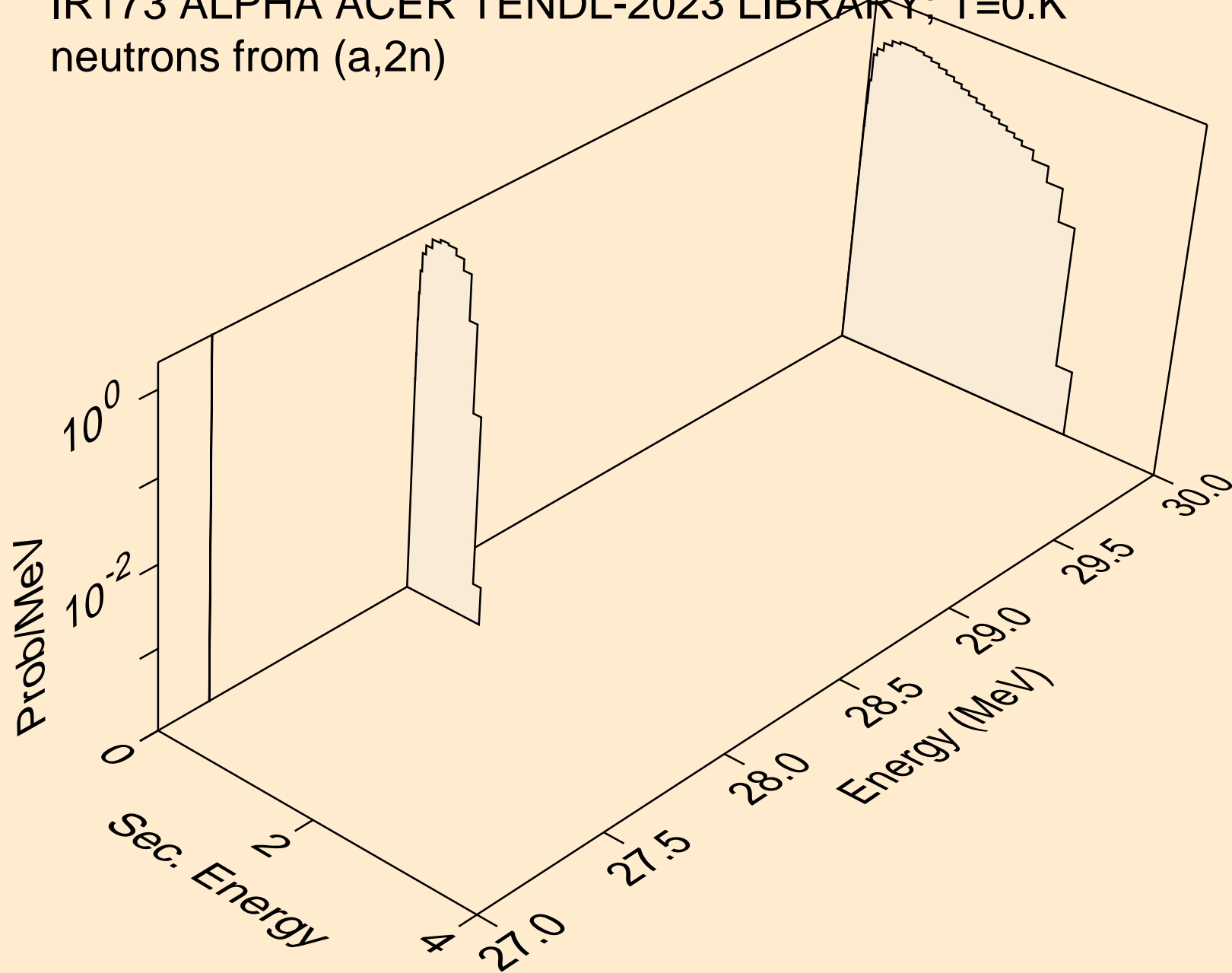

IR173 ALPHA ACER TENDL-2023 LIBRARY; T=0.K  
neutrons from (a,n\*)a

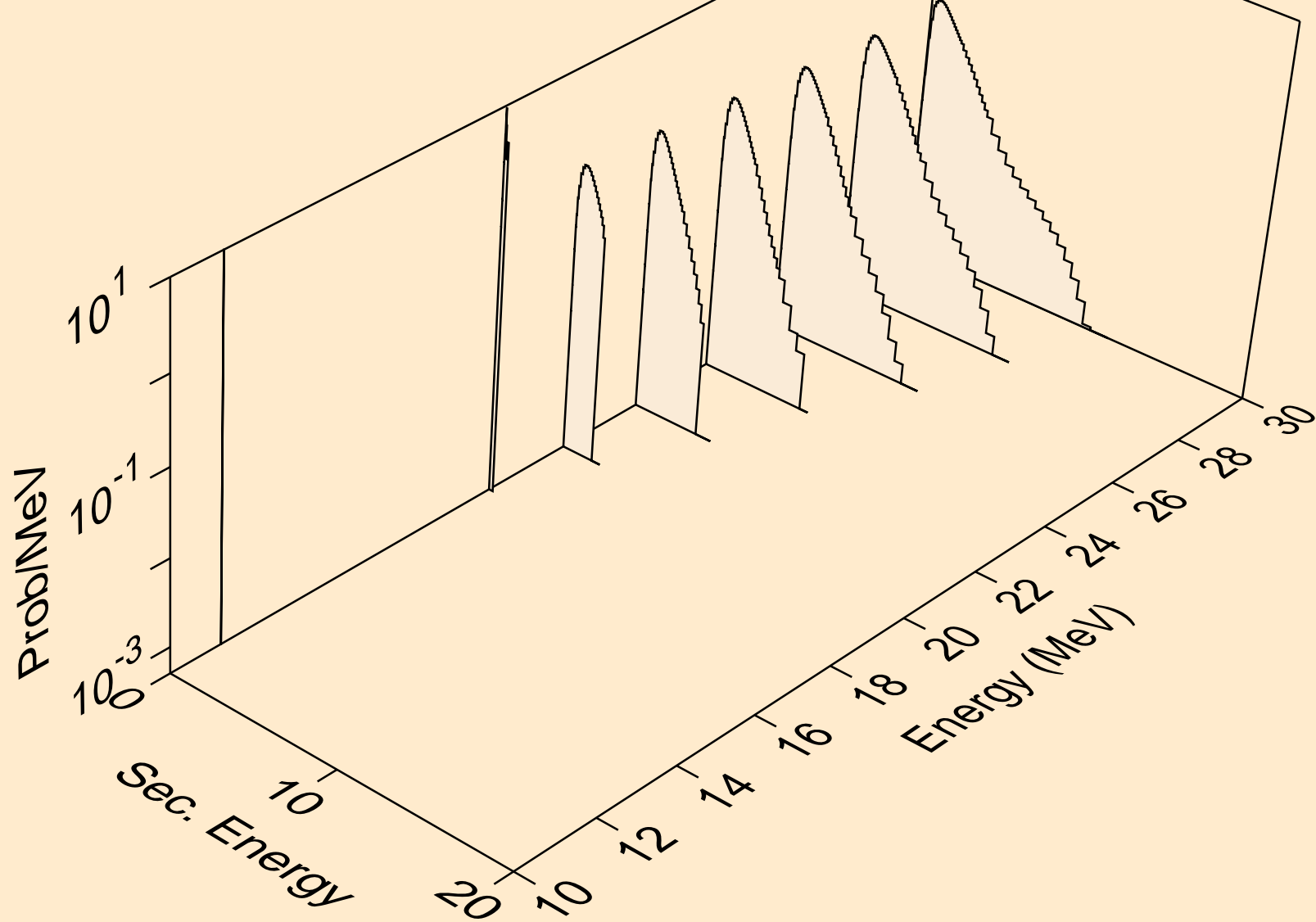

IR173 ALPHA ACER TENDL-2023 LIBRARY; T=0.K  
neutrons from (a,2n)a

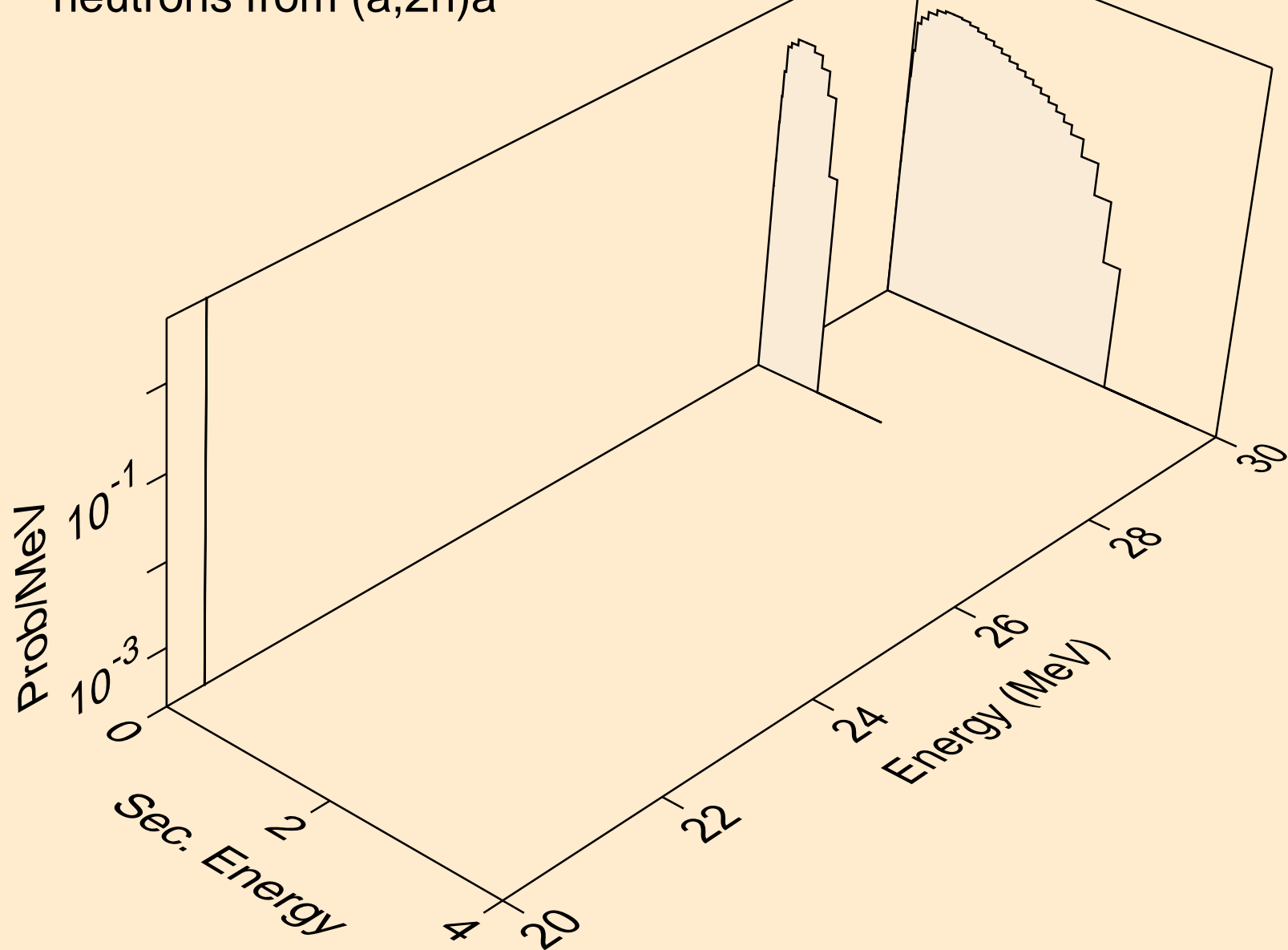

IR173 ALPHA ACER TENDL-2023 LIBRARY; T=0.K  
neutrons from (a,n\*)p

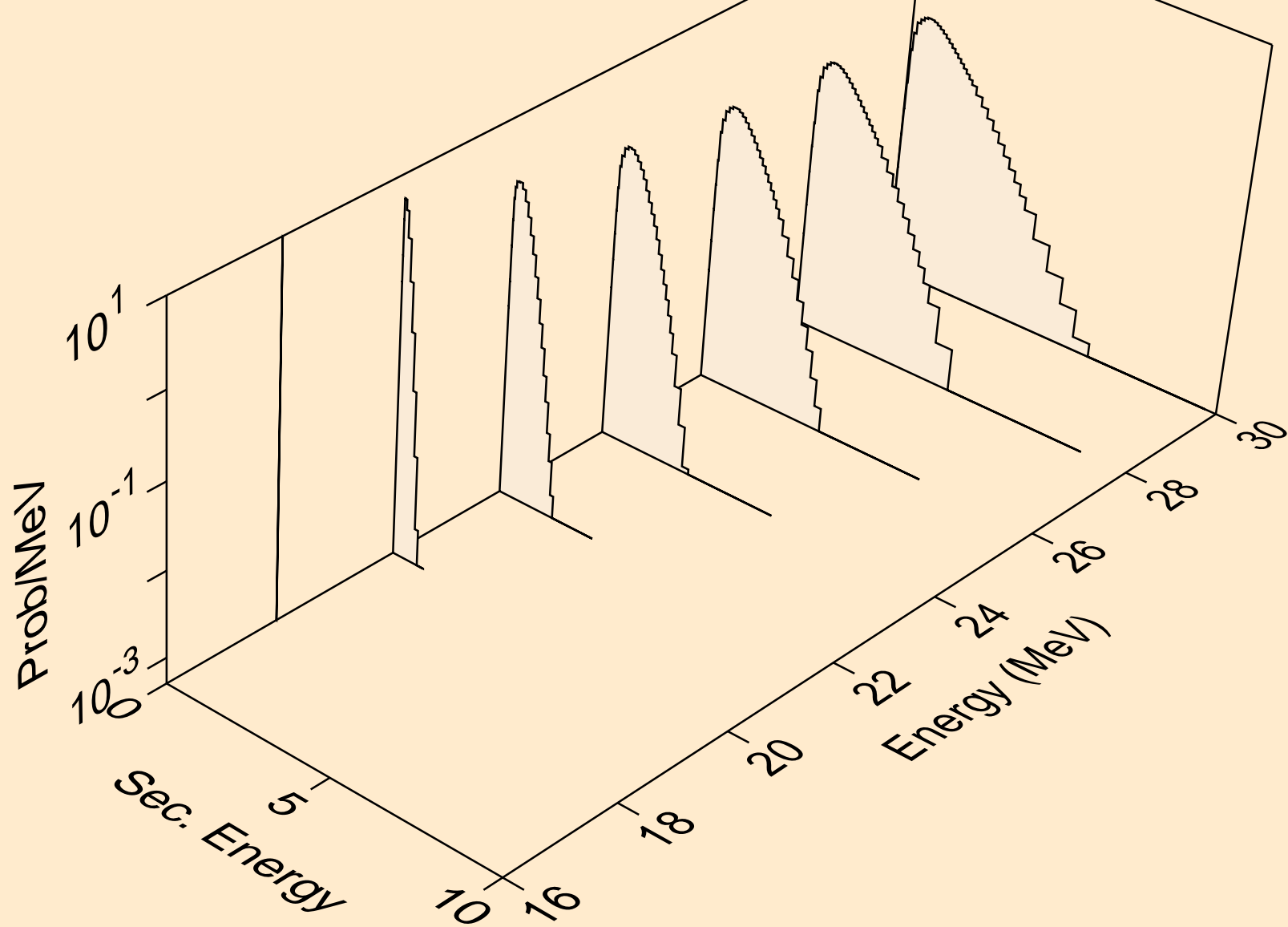

IR173 ALPHA ACER TENDL-2023 LIBRARY; T=0.K  
neutrons from (a,n\*)2a

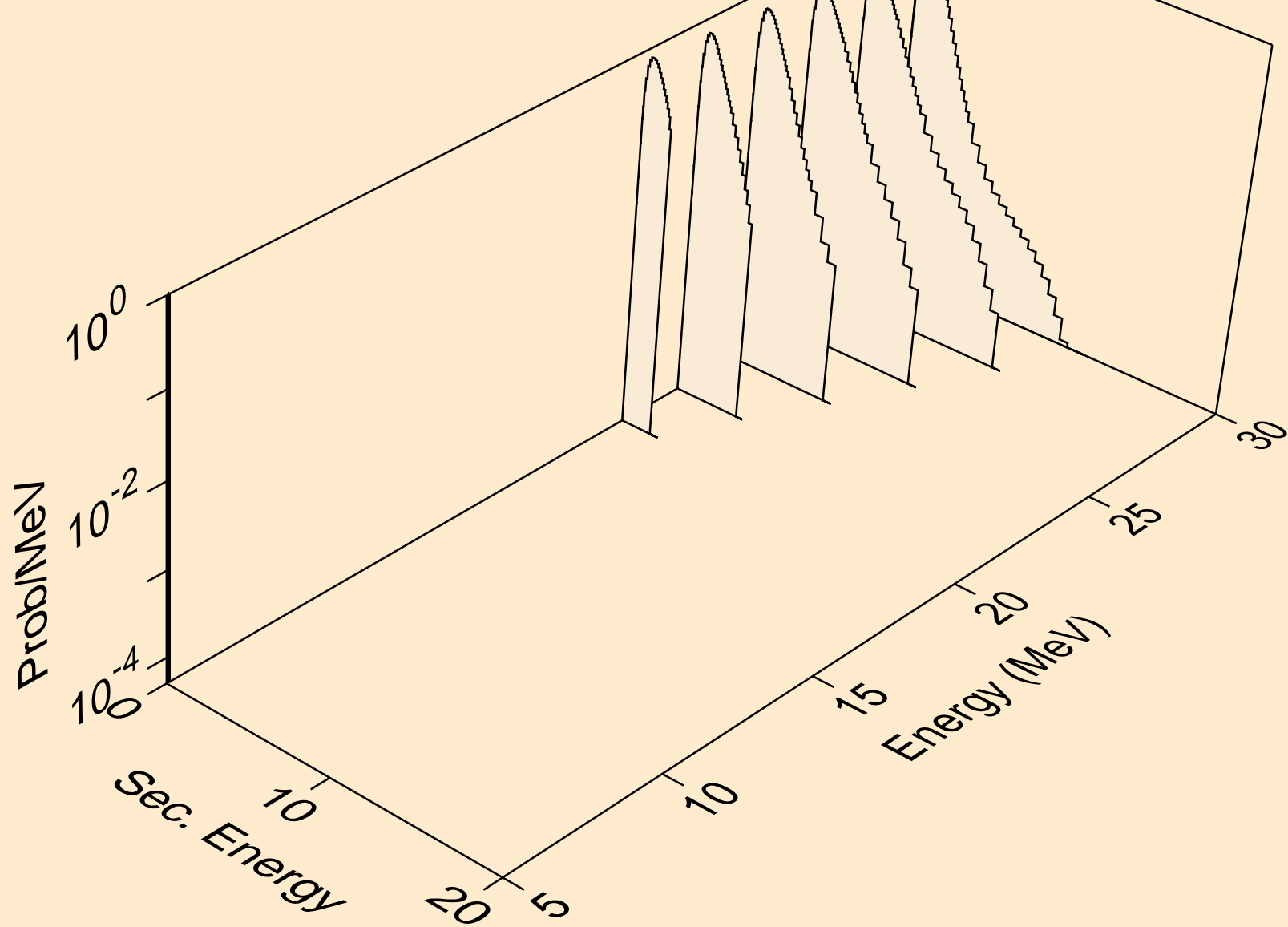

IR173 ALPHA ACER TENDL-2023 LIBRARY; T=0.K  
neutrons from (a,2np)

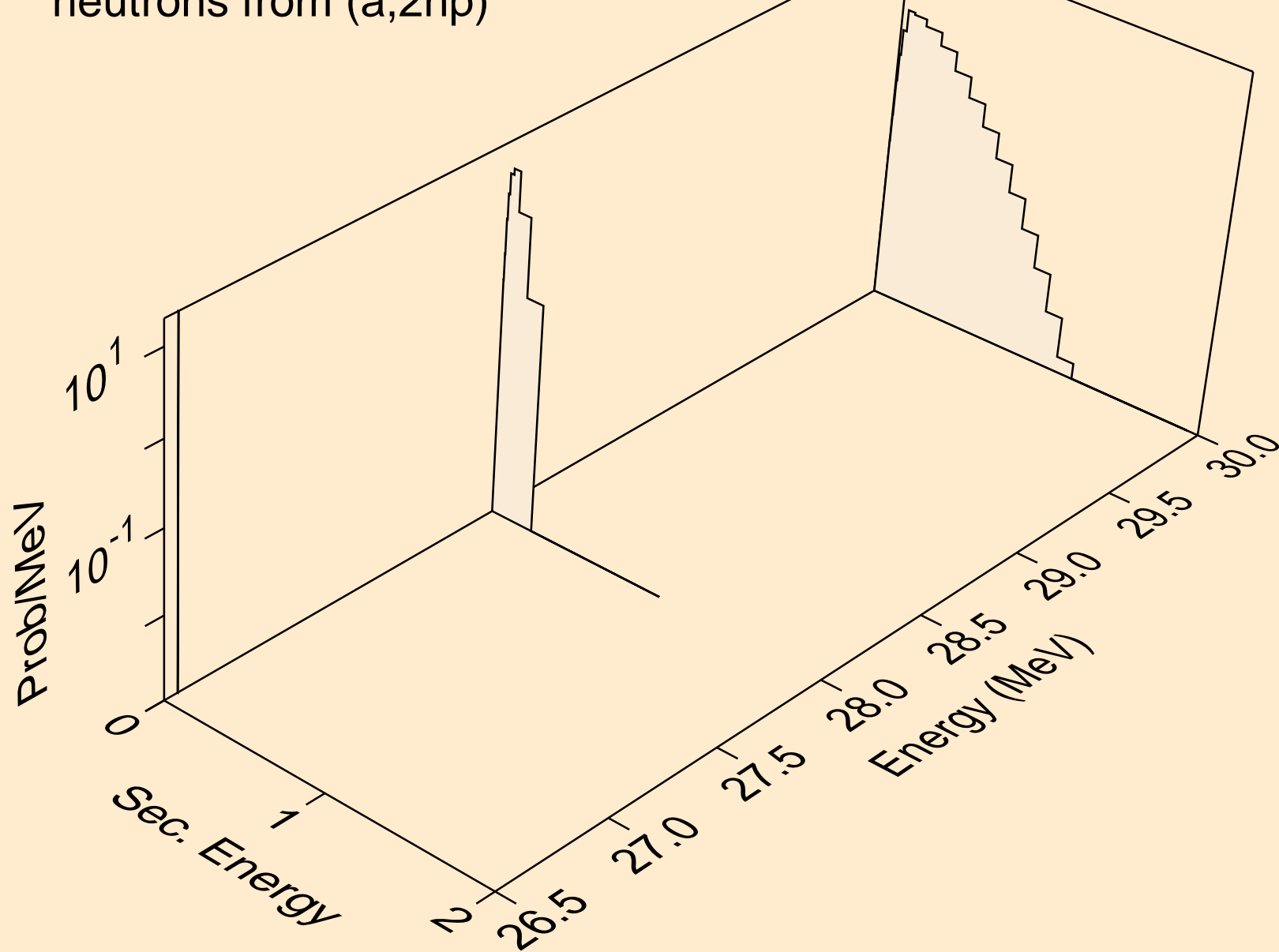

IR173 ALPHA ACER TENDL-2023 LIBRARY; T=0.K  
neutrons from (a,n2p)

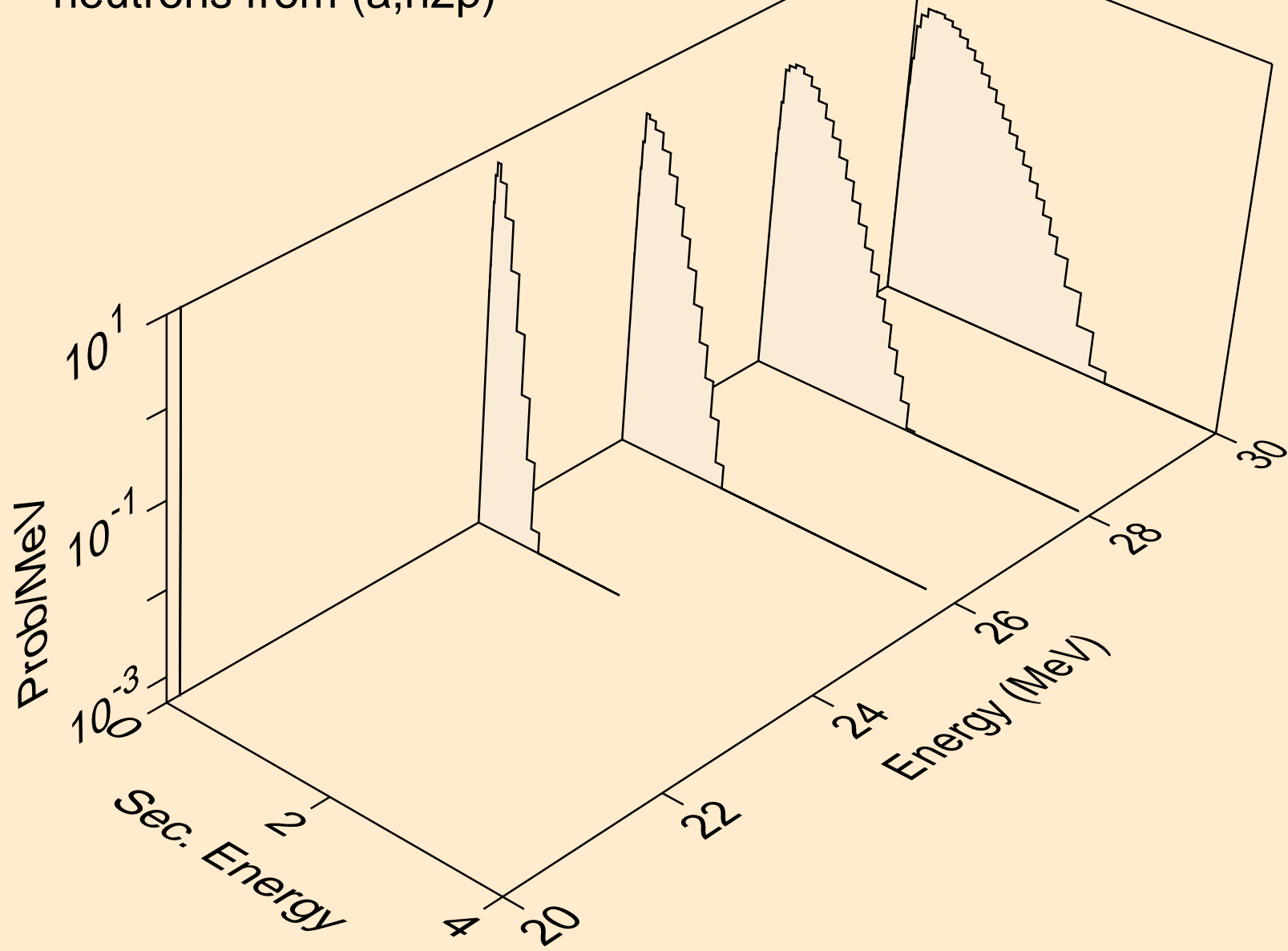

IR173 ALPHA ACER TENDL-2023 LIBRARY; T=0.K  
neutrons from (a,npa)

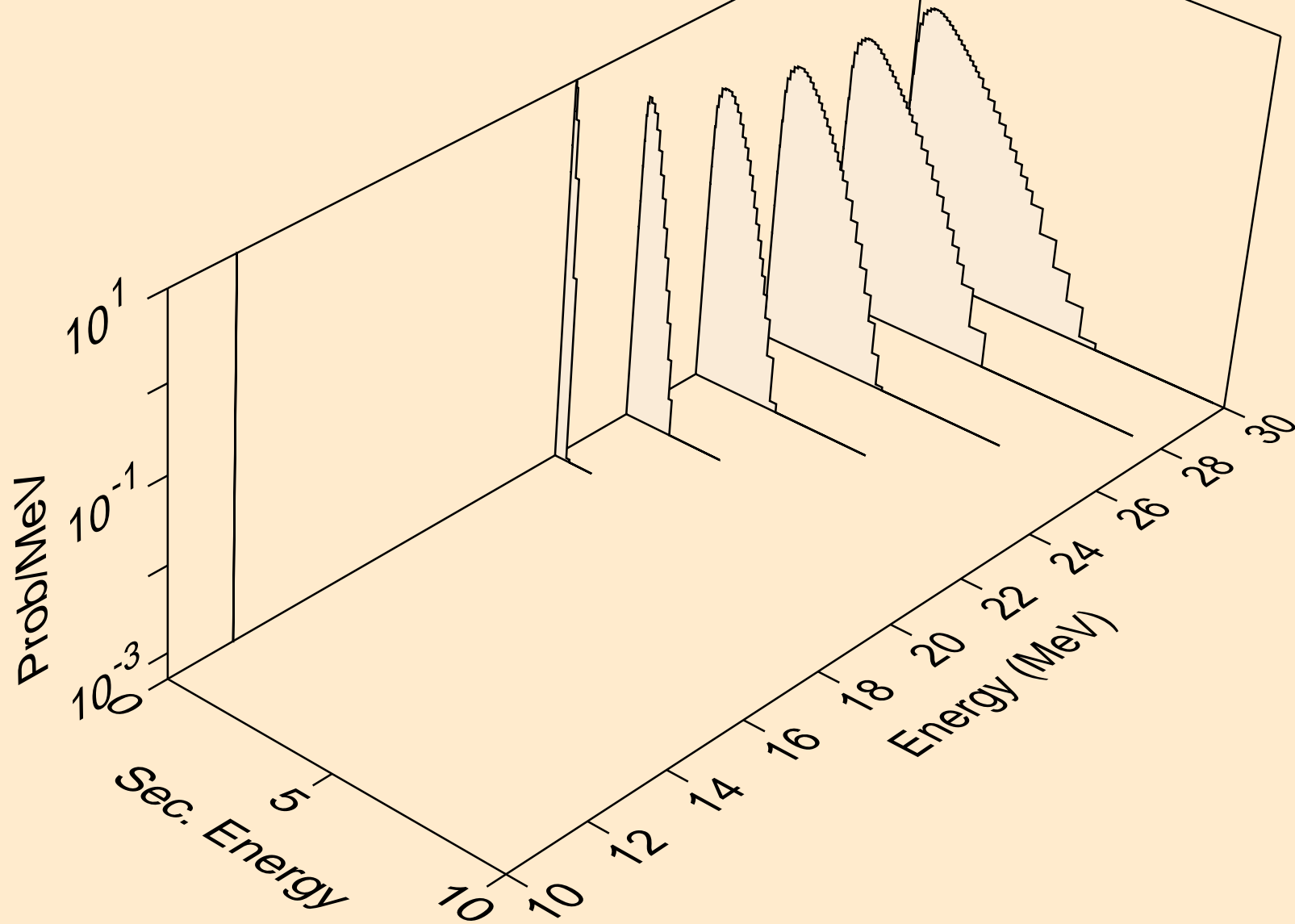

IR173 ALPHA ACER TENDL-2023 LIBRARY; T=0.K  
protons from (a,x)

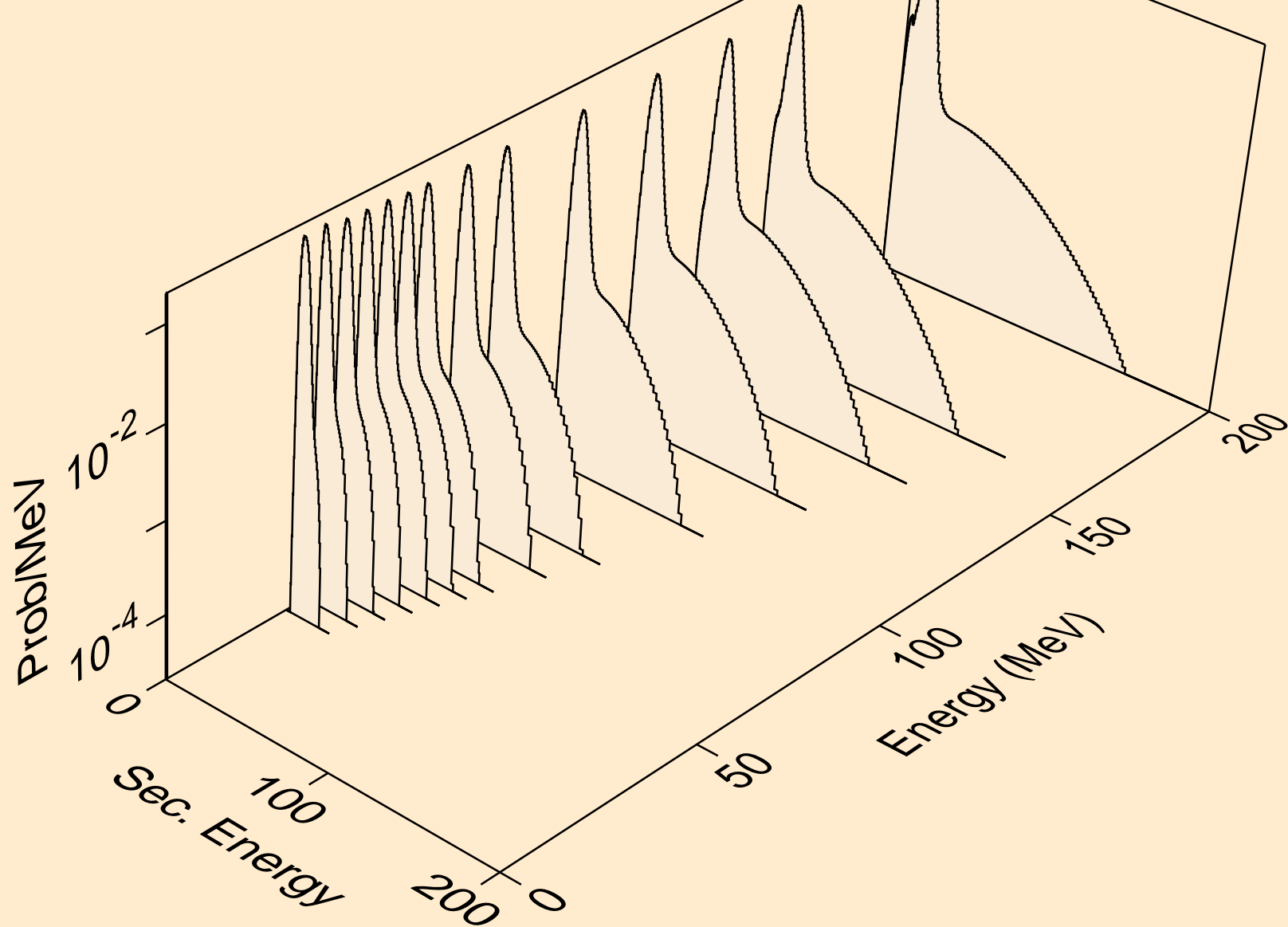

IR173 ALPHA ACER TENDL-2023 LIBRARY; T=0.K  
protons from (a,n\*)p

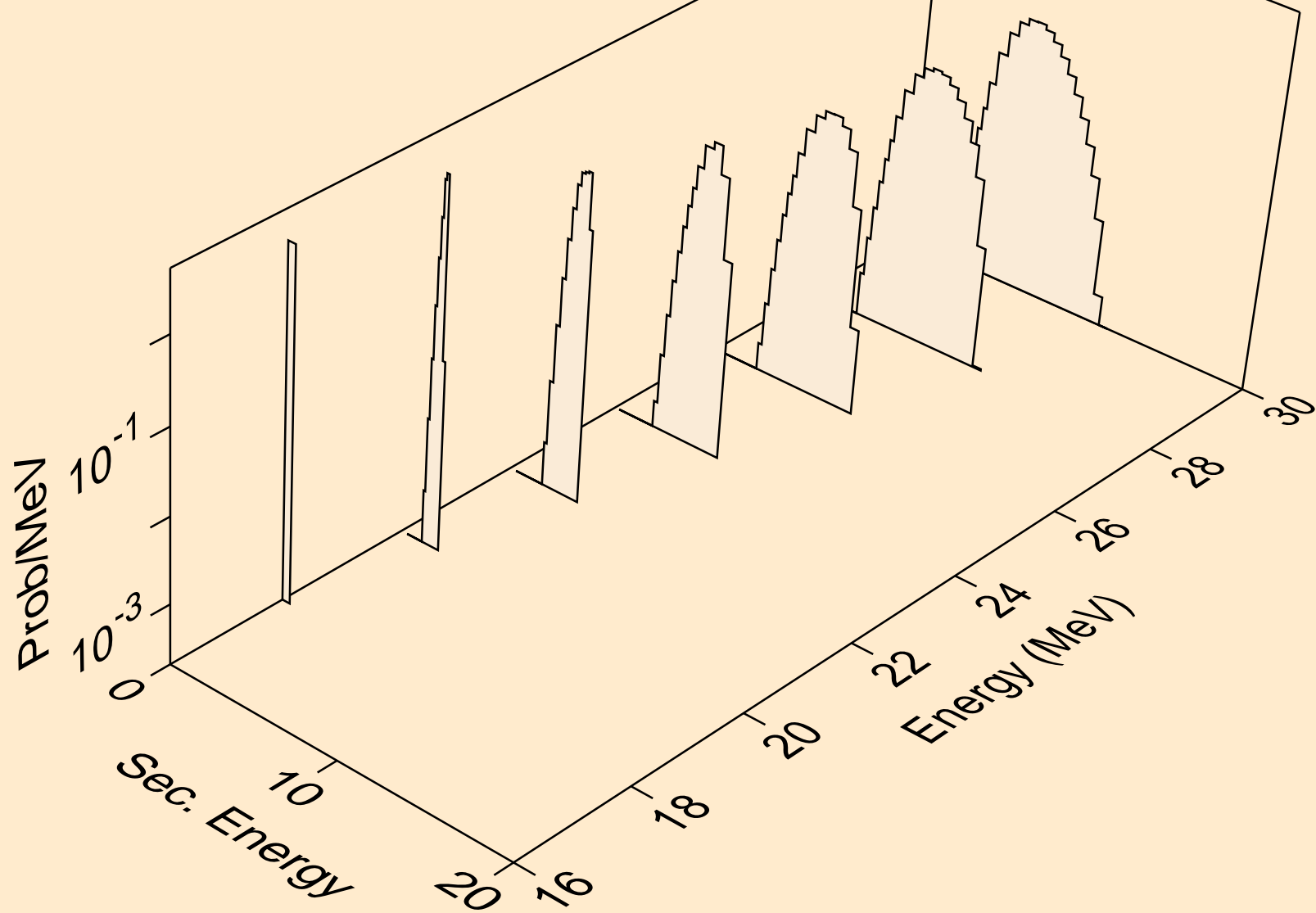

IR173 ALPHA ACER TENDL-2023 LIBRARY; T=0.K  
protons from (a,2np)

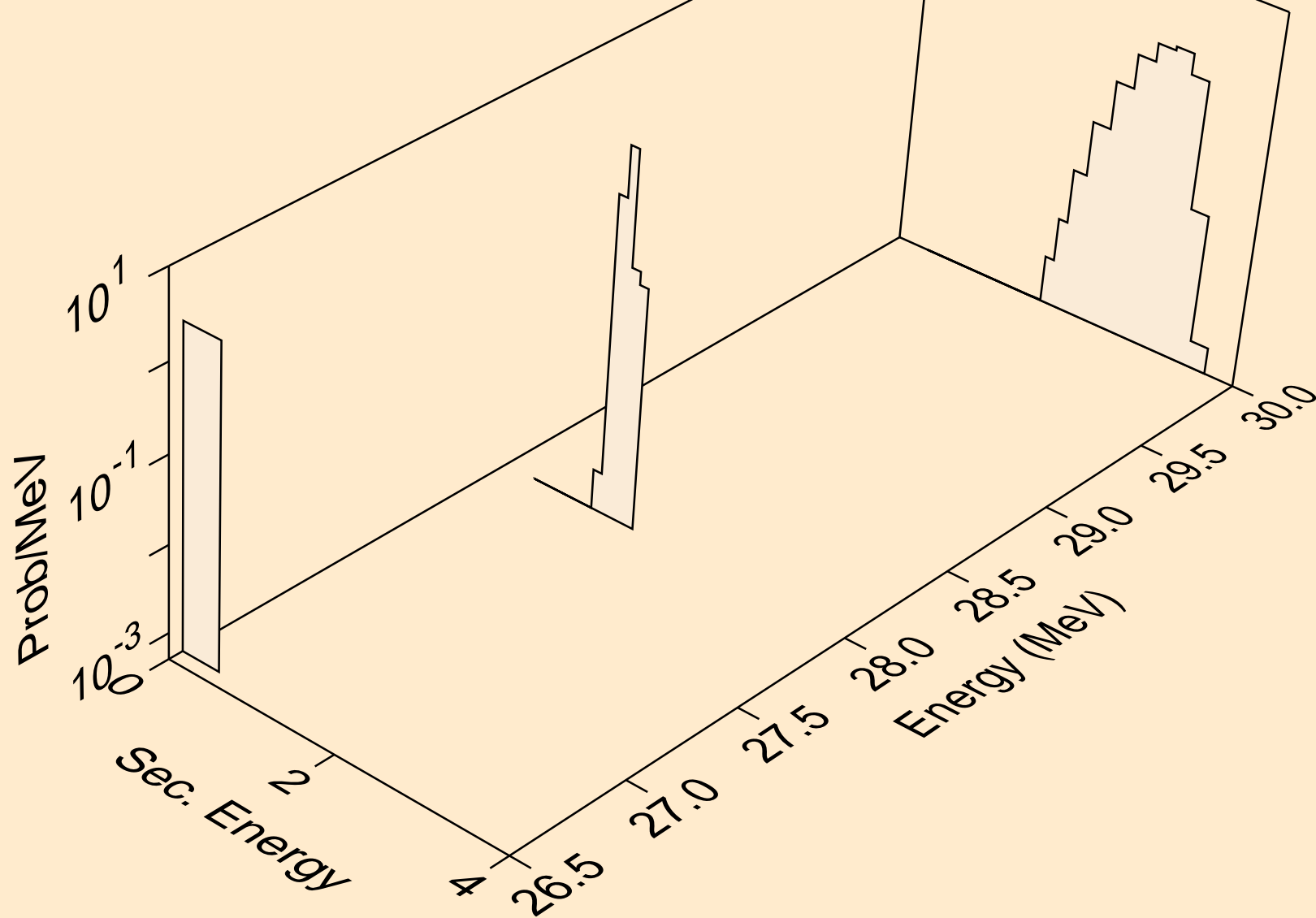

IR173 ALPHA ACER TENDL-2023 LIBRARY; T=0.K  
protons from (a,n2p)

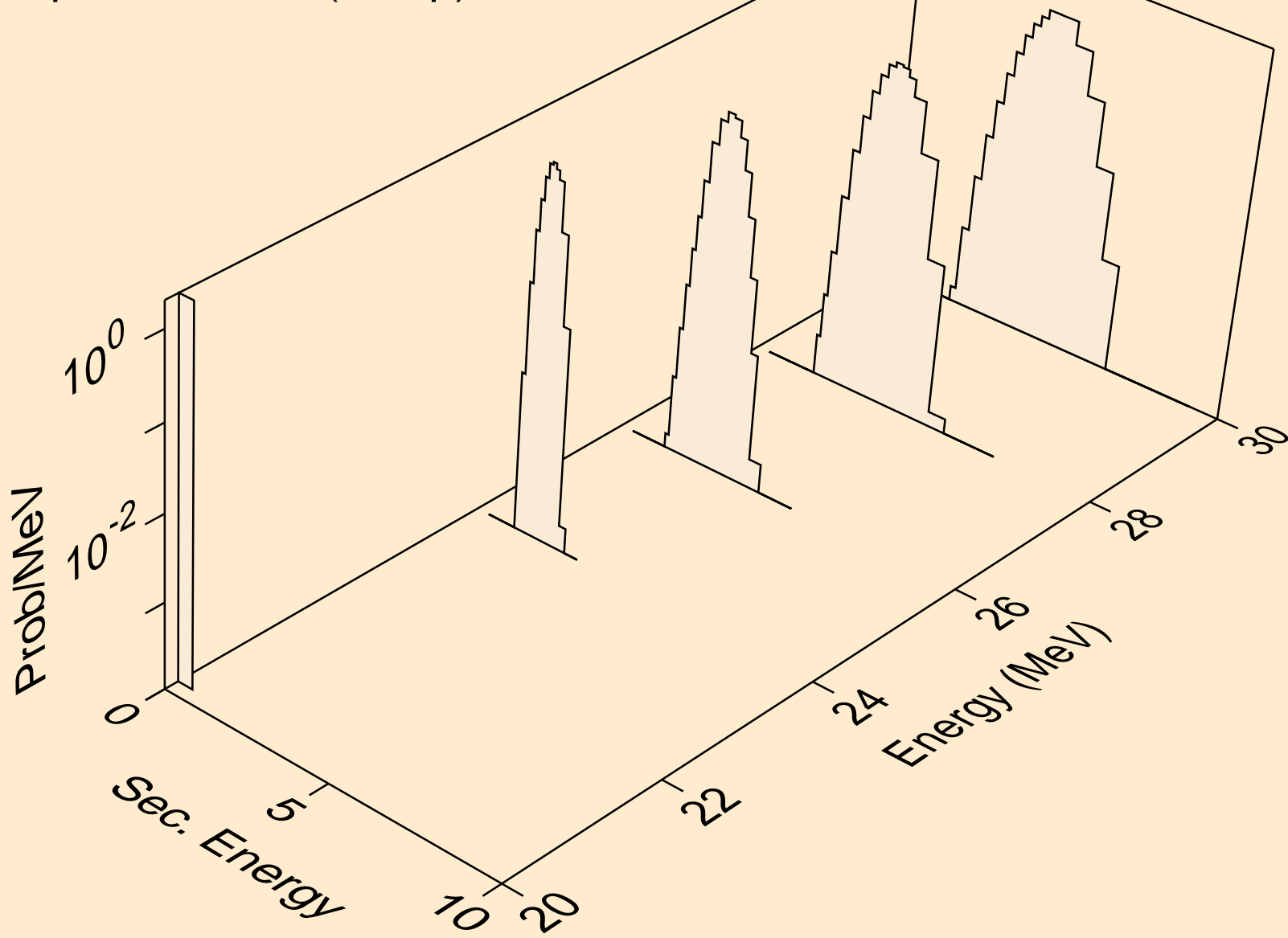

IR173 ALPHA ACER TENDL-2023 LIBRARY; T=0.K  
protons from (a,npa)

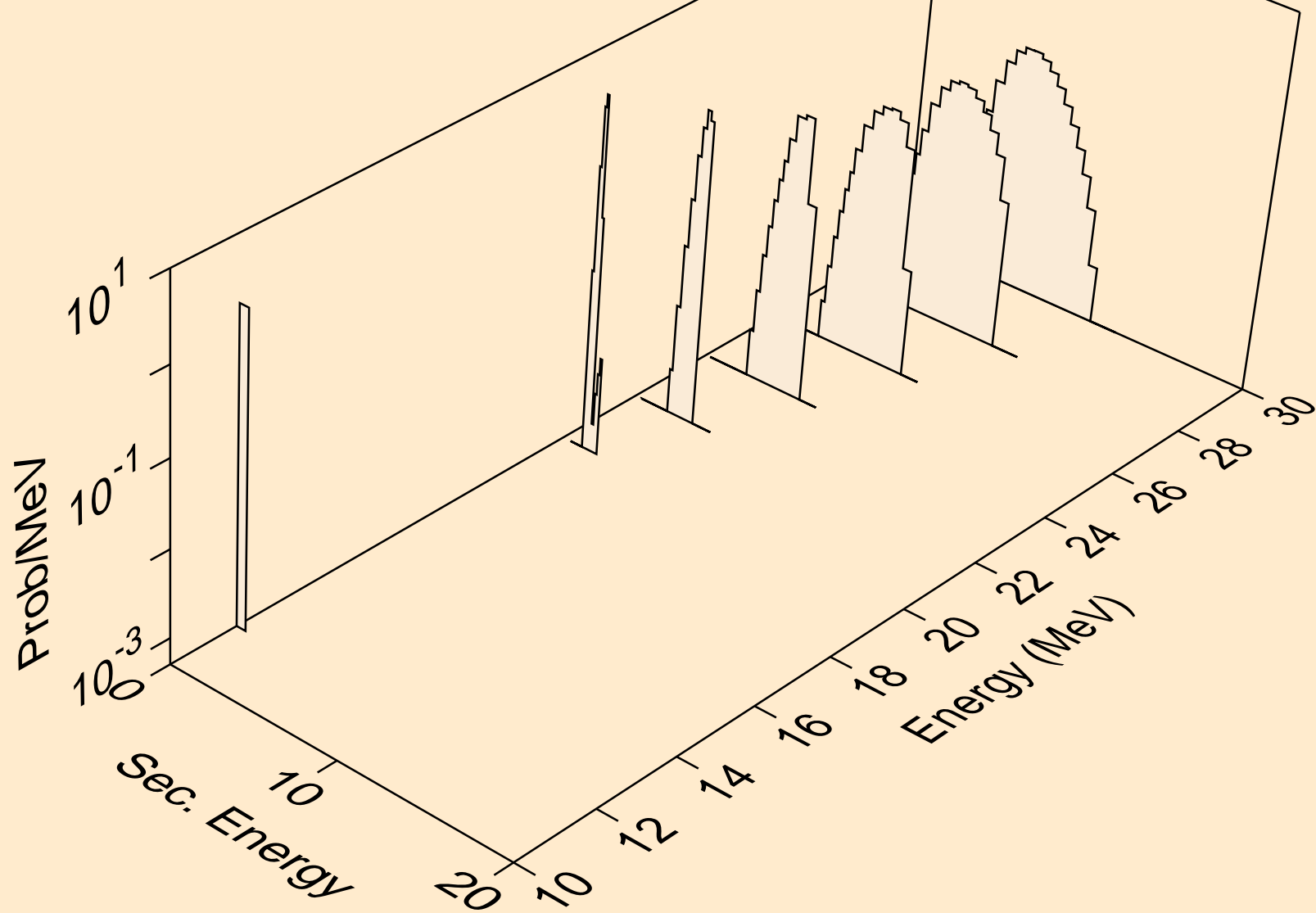

IR173 ALPHA ACER TENDL-2023 LIBRARY; T=0.K  
protons from (a,p)

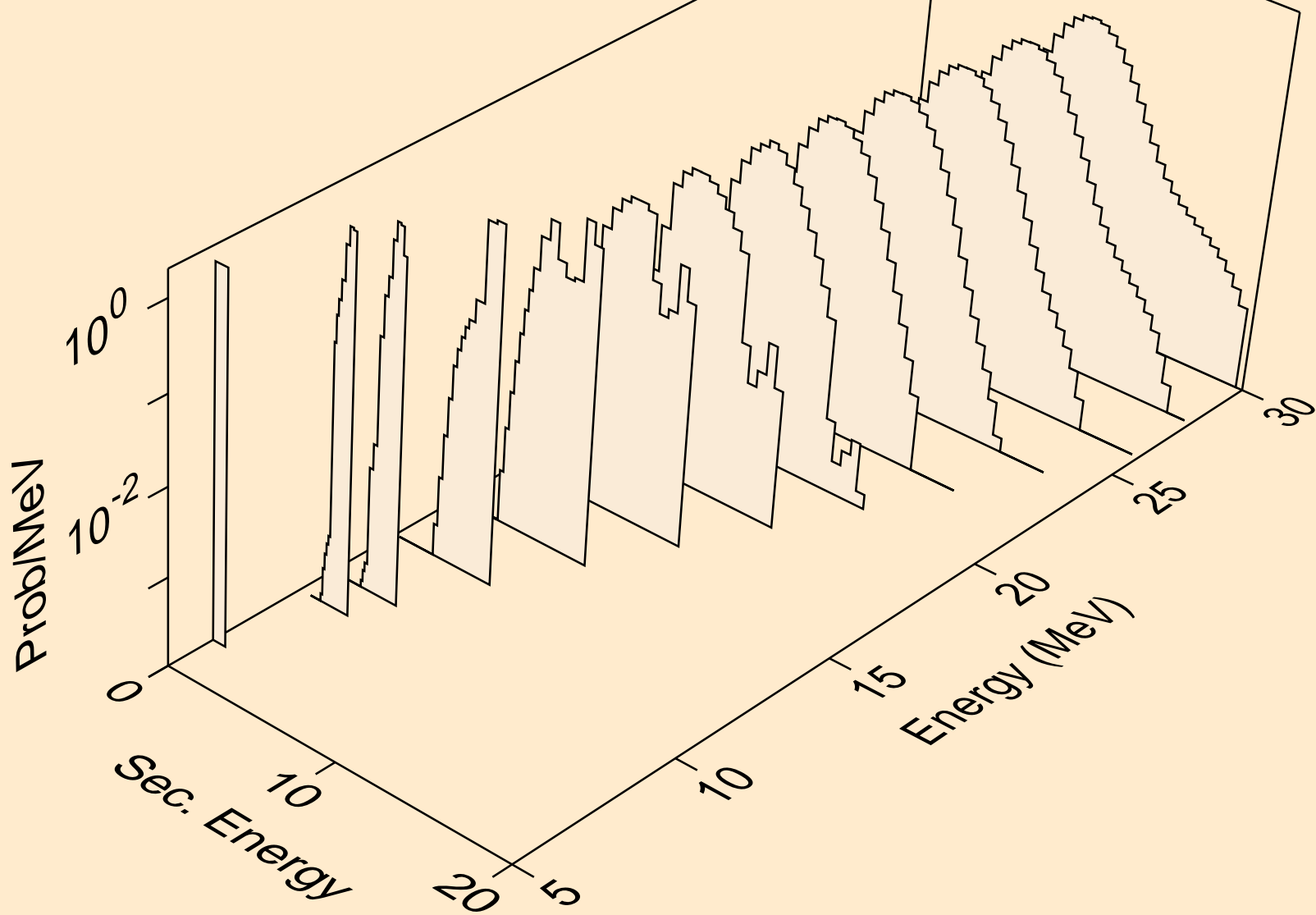

IR173 ALPHA ACER TENDL-2023 LIBRARY; T=0.K  
protons from (a,2p)

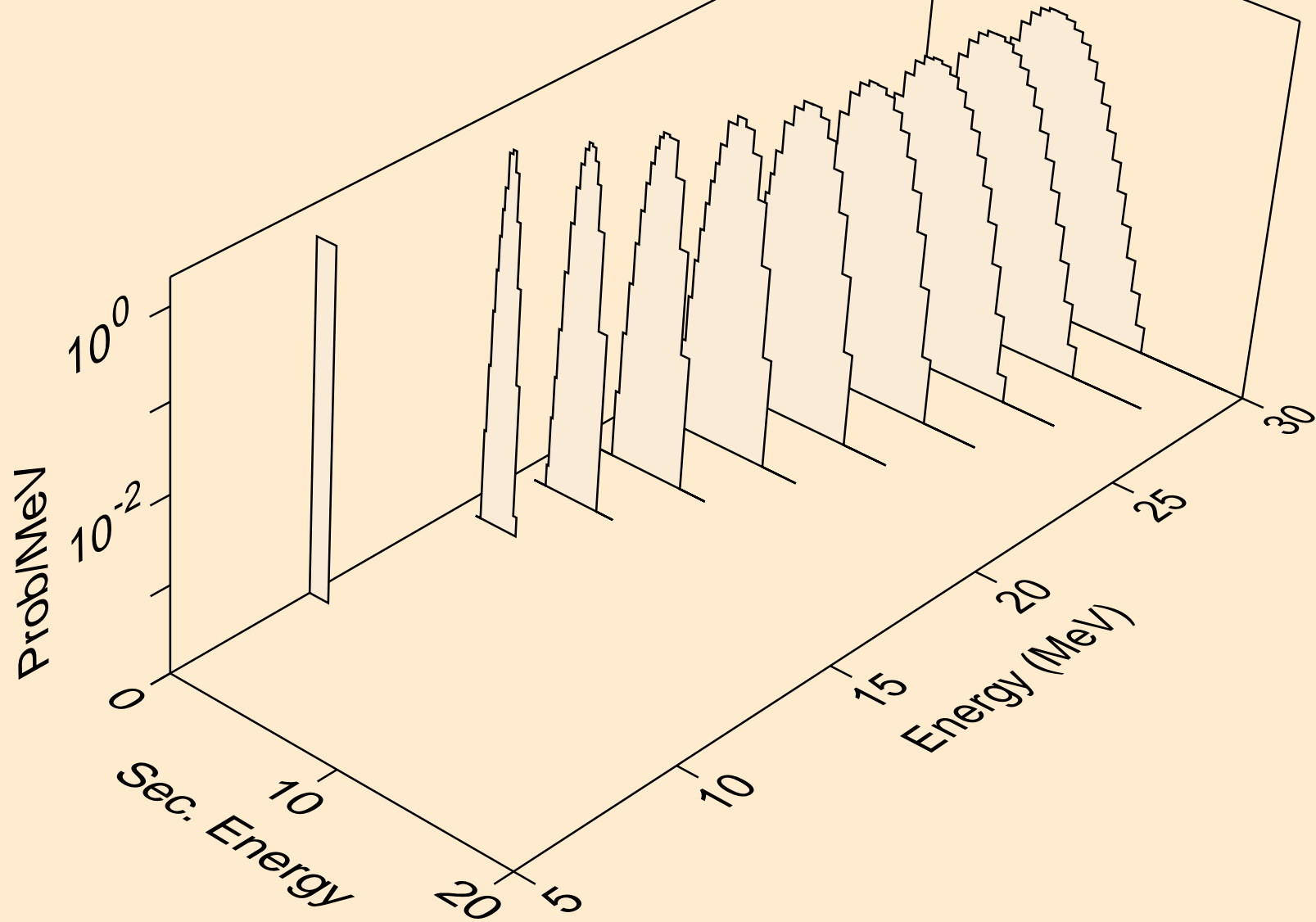

IR173 ALPHA ACER TENDL-2023 LIBRARY; T=0.K  
protons from (a,pa)

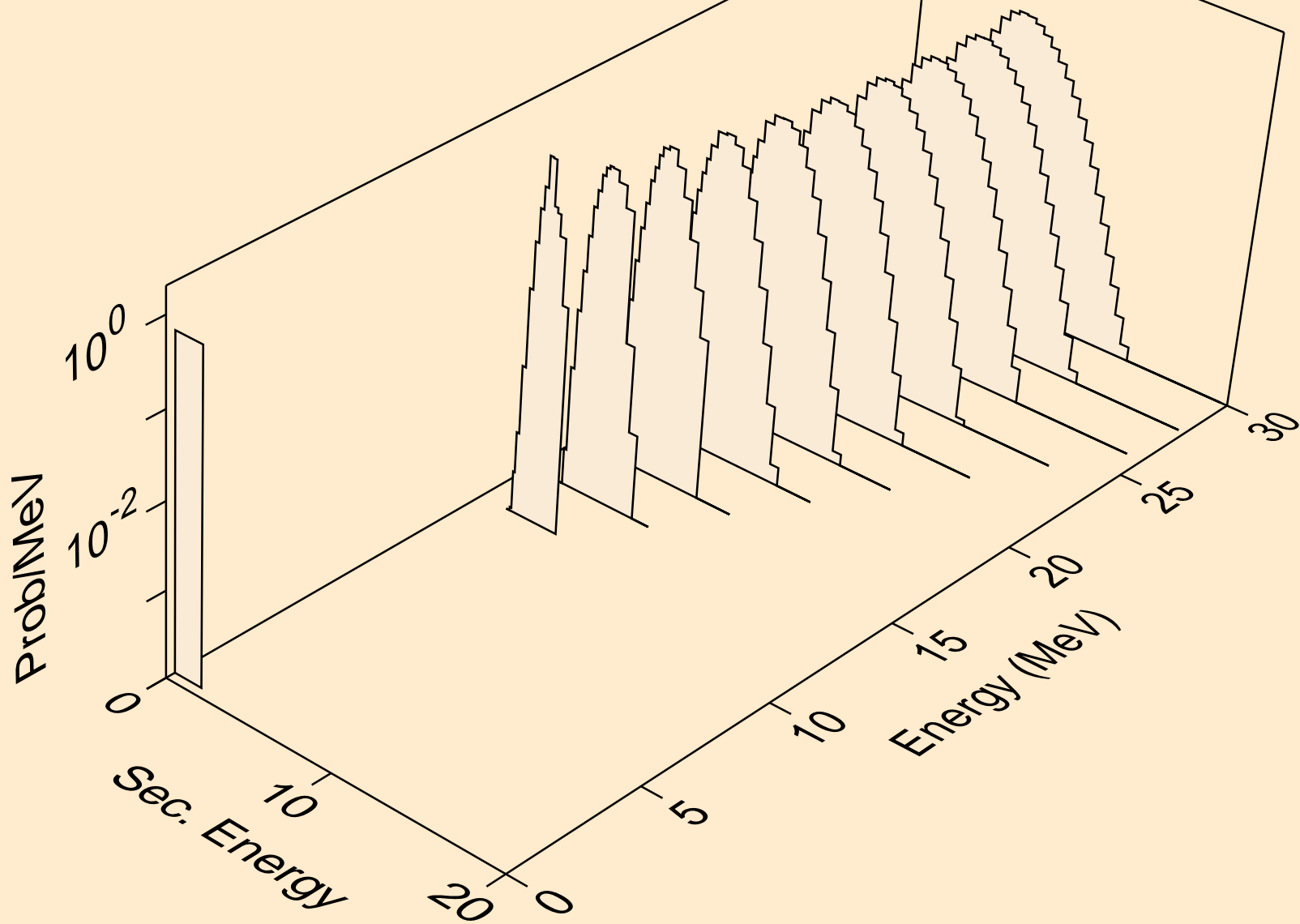

IR173 ALPHA ACER TENDL-2023 LIBRARY; T=0.K  
protons from (a,pd)

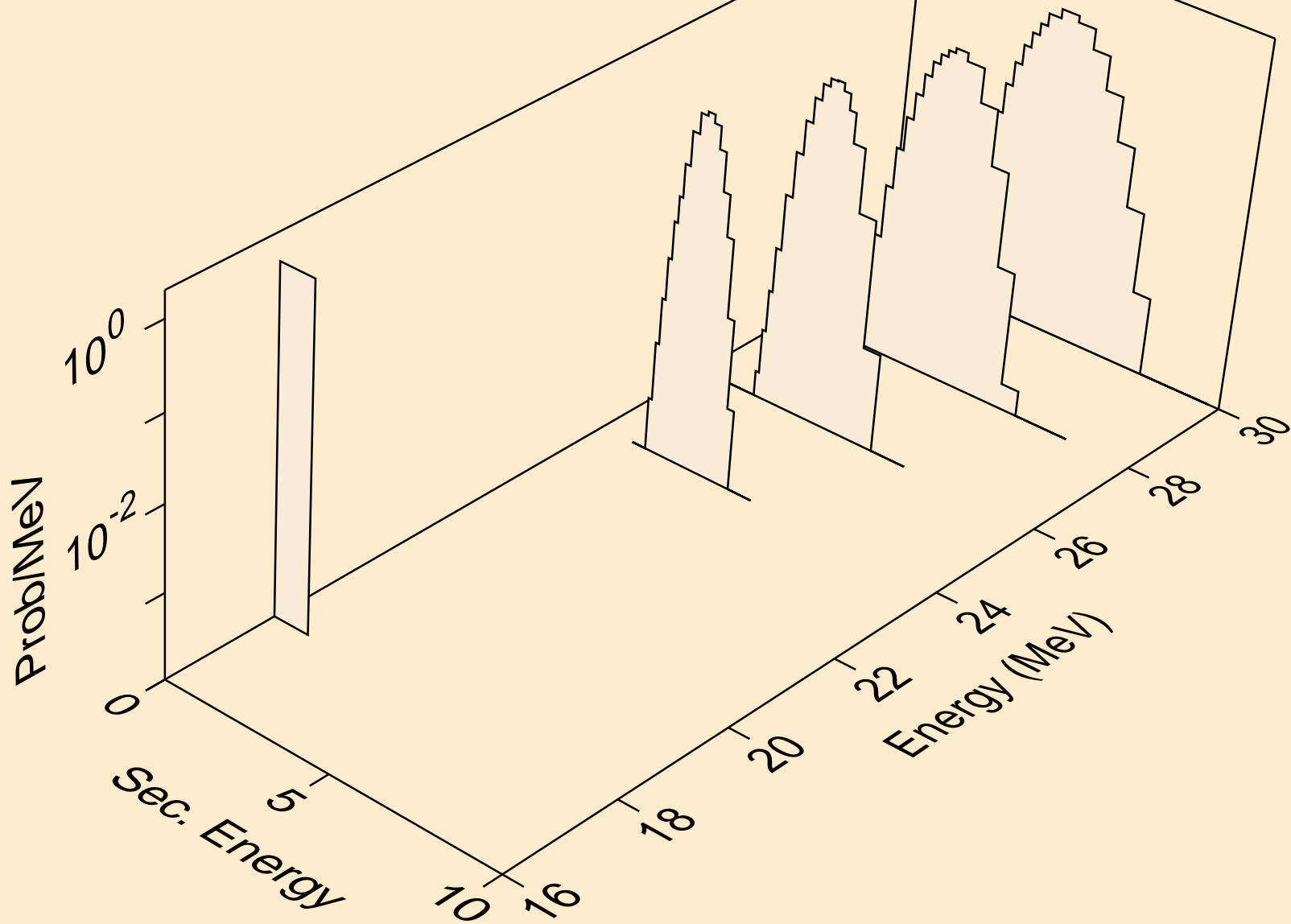

IR173 ALPHA ACER TENDL-2023 LIBRARY; T=0.K  
deuterons from (a,x)

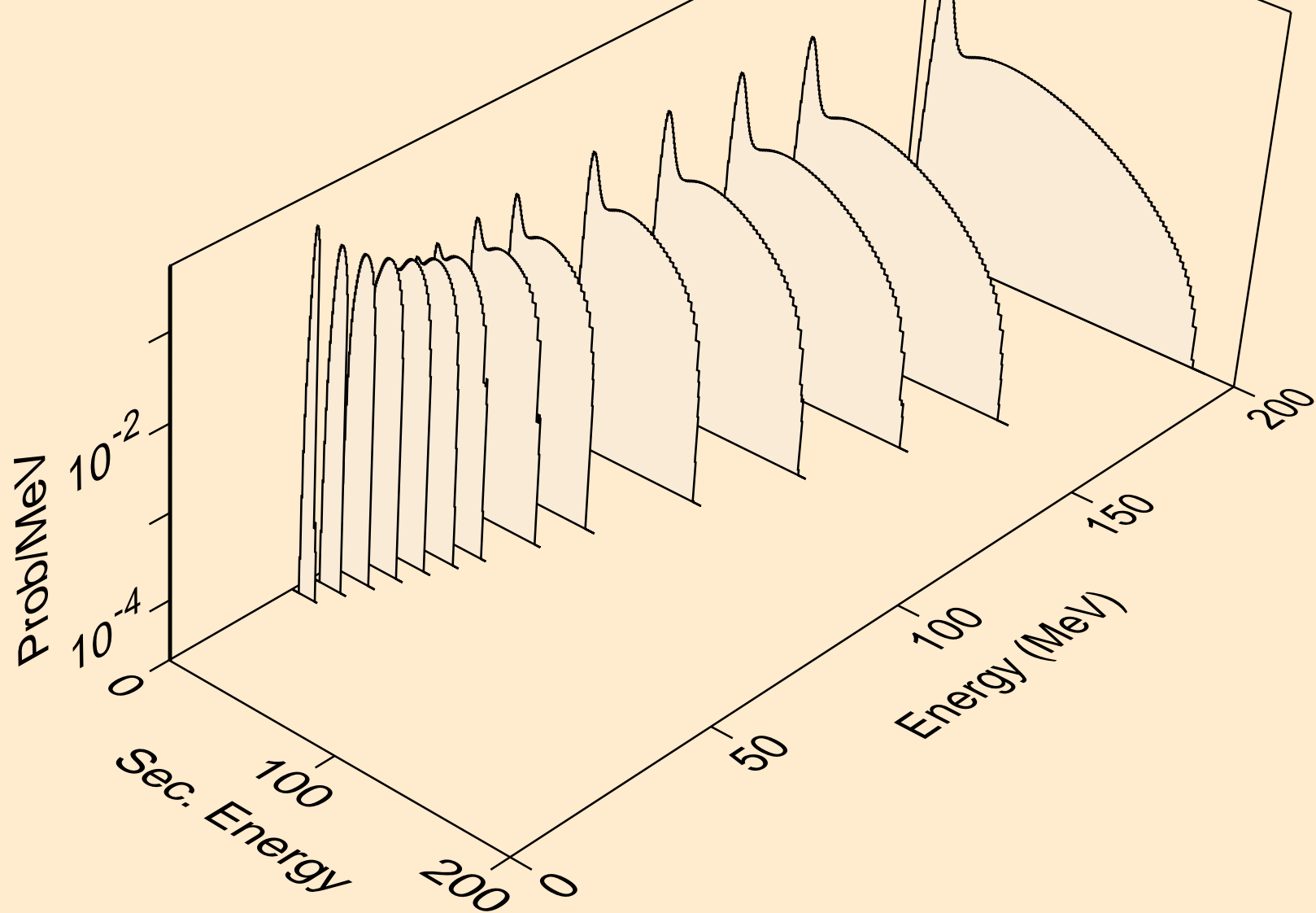

IR173 ALPHA ACER TENDL-2023 LIBRARY; T=0.K  
deuterons from (a,d)

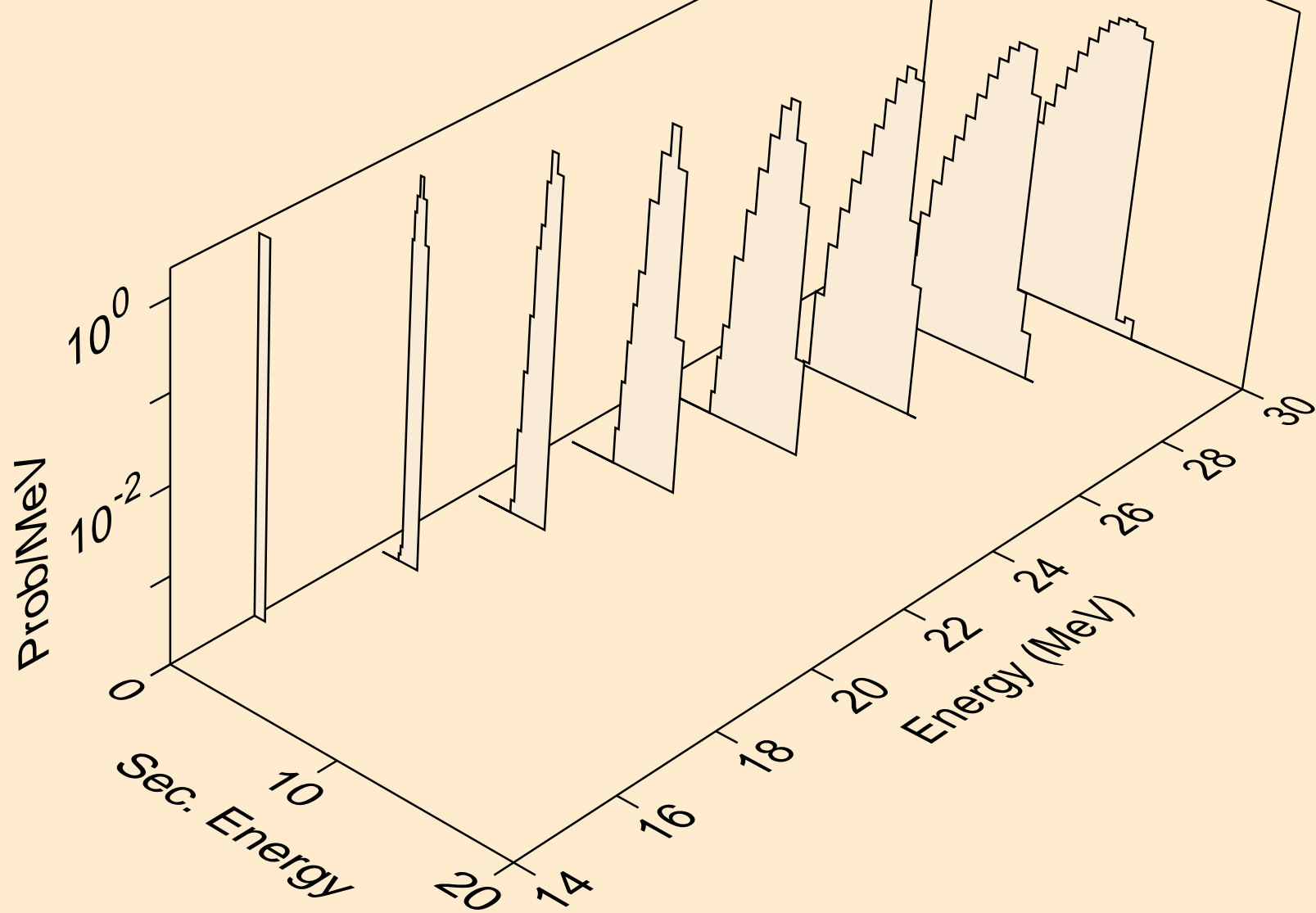

IR173 ALPHA ACER TENDL-2023 LIBRARY; T=0.K  
deuterons from (a,pd)

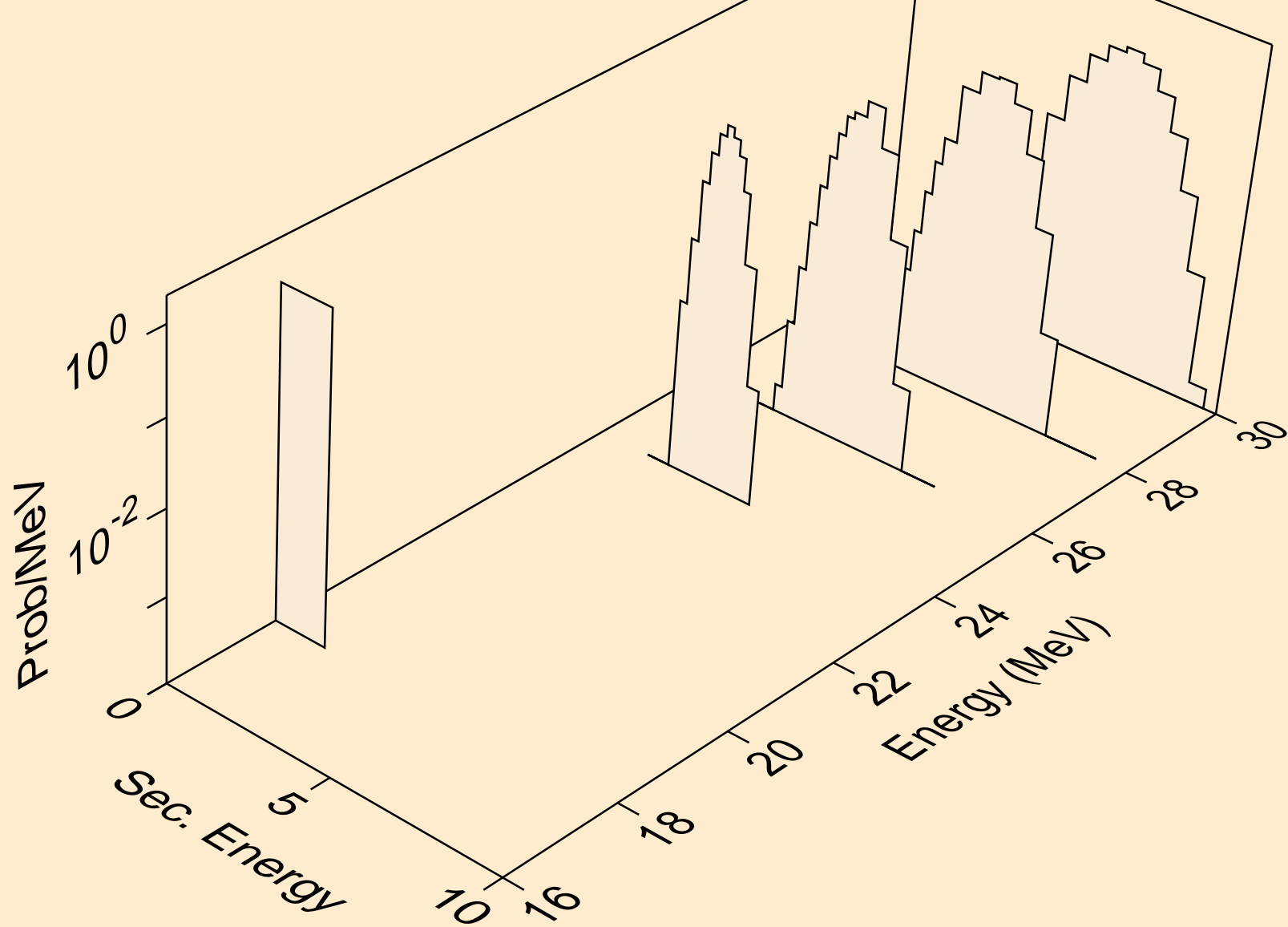

IR173 ALPHA ACER TENDL-2023 LIBRARY; T=0.K  
deuterons from (a,da)

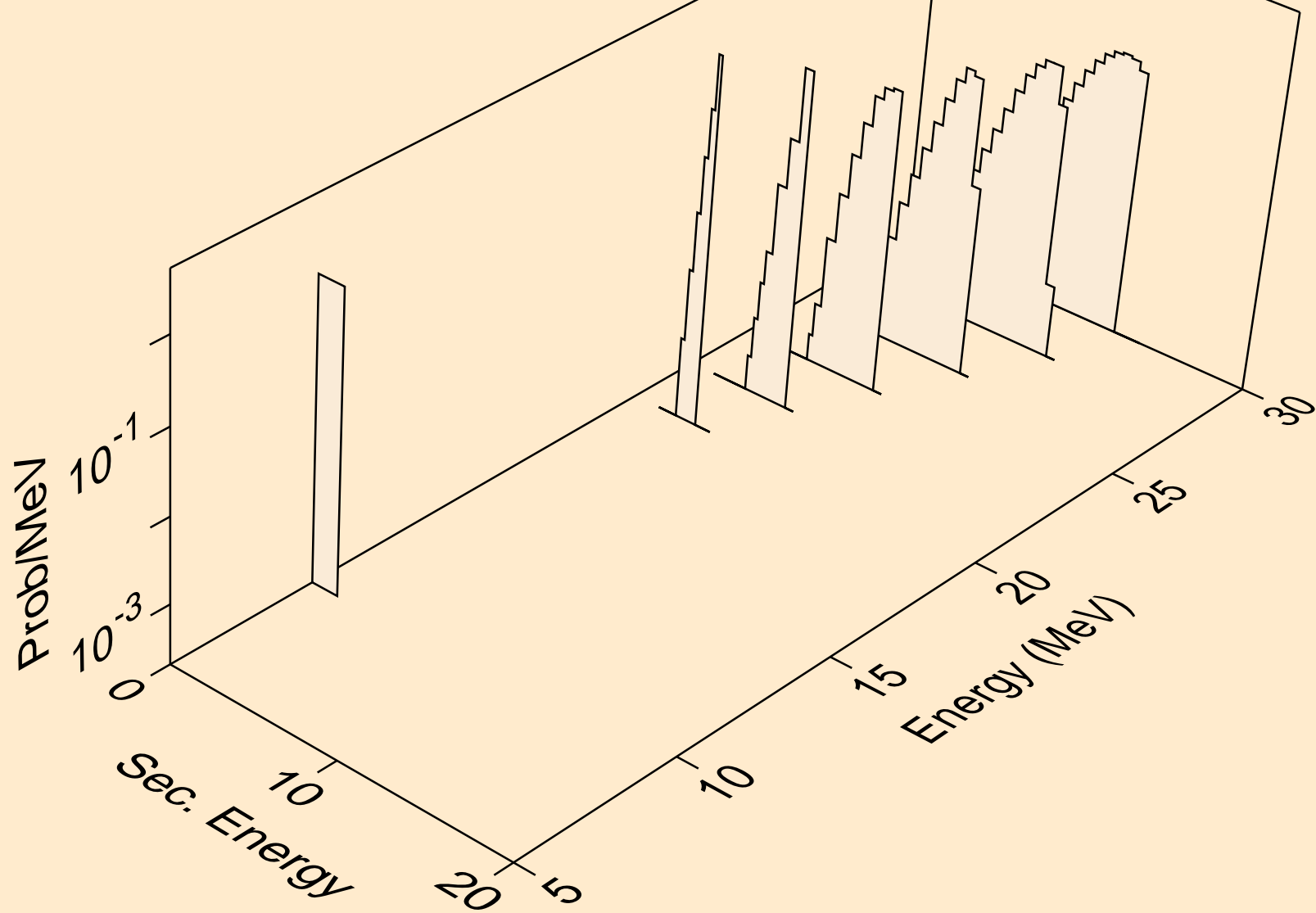

IR173 ALPHA ACER TENDL-2023 LIBRARY; T=0.K  
tritons from (a,x)

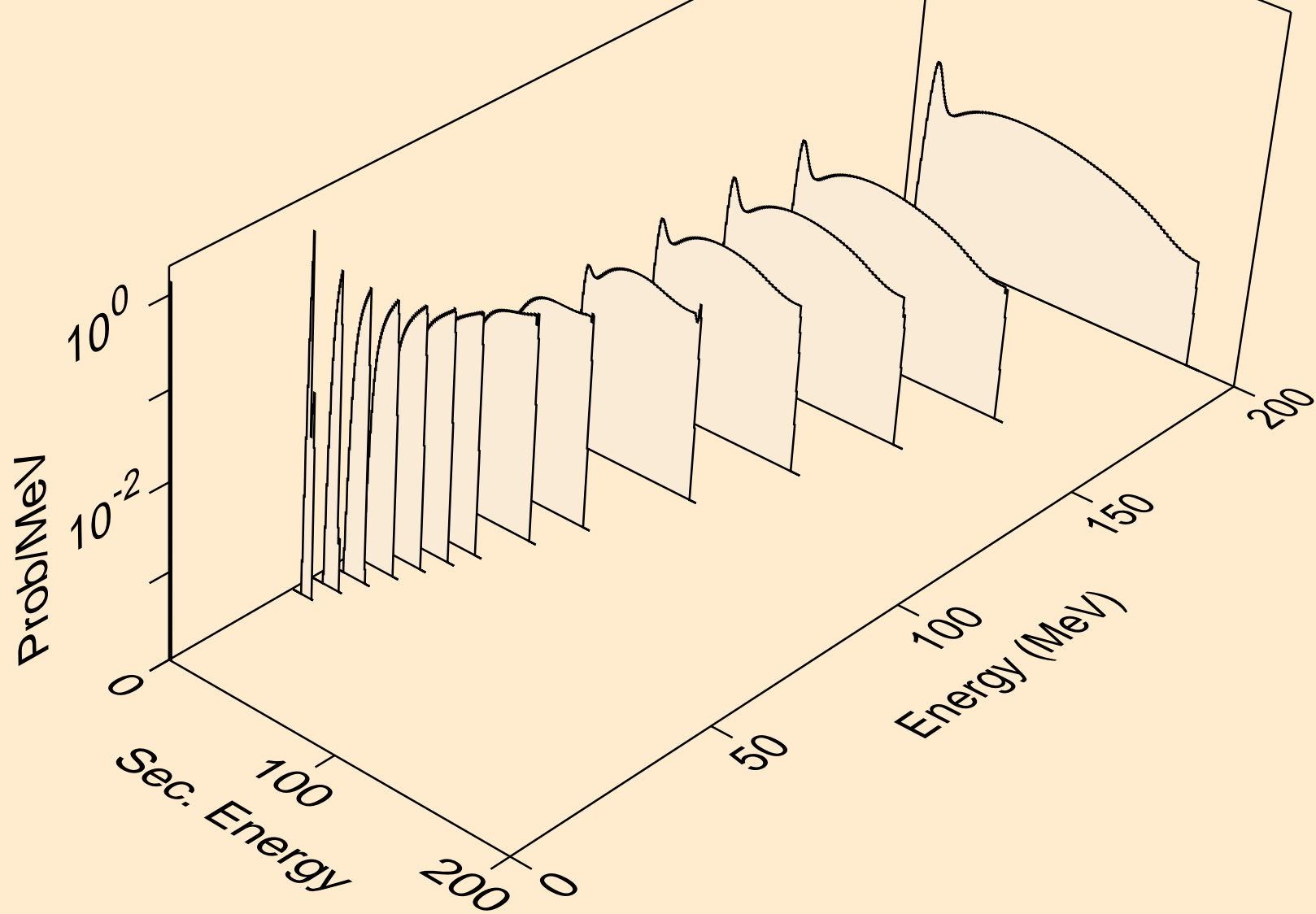

IR173 ALPHA ACER TENDL-2023 LIBRARY; T=0.K  
tritons from (a,t)

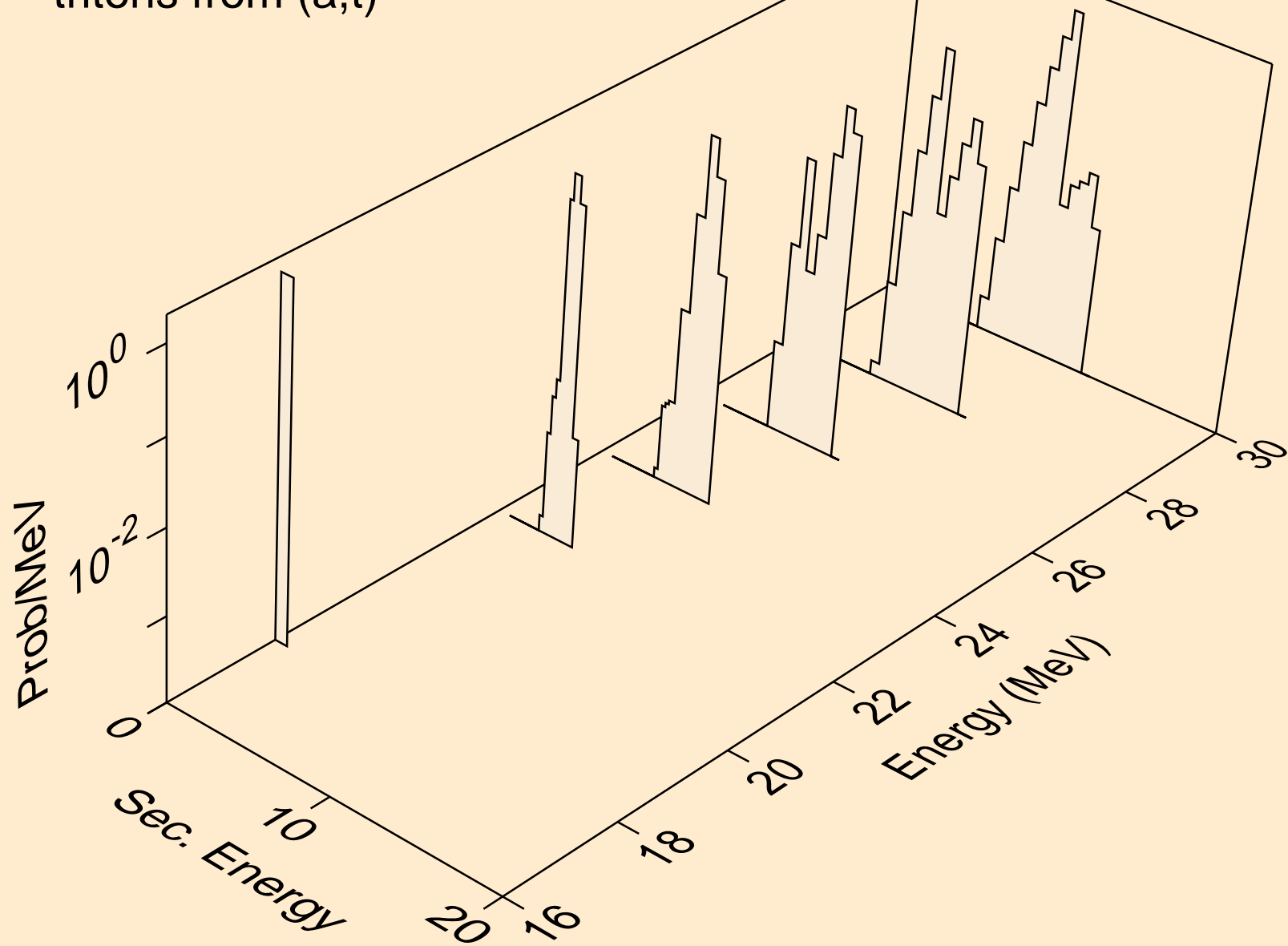

IR173 ALPHA ACER TENDL-2023 LIBRARY; T=0.K  
he3s from (a,x)

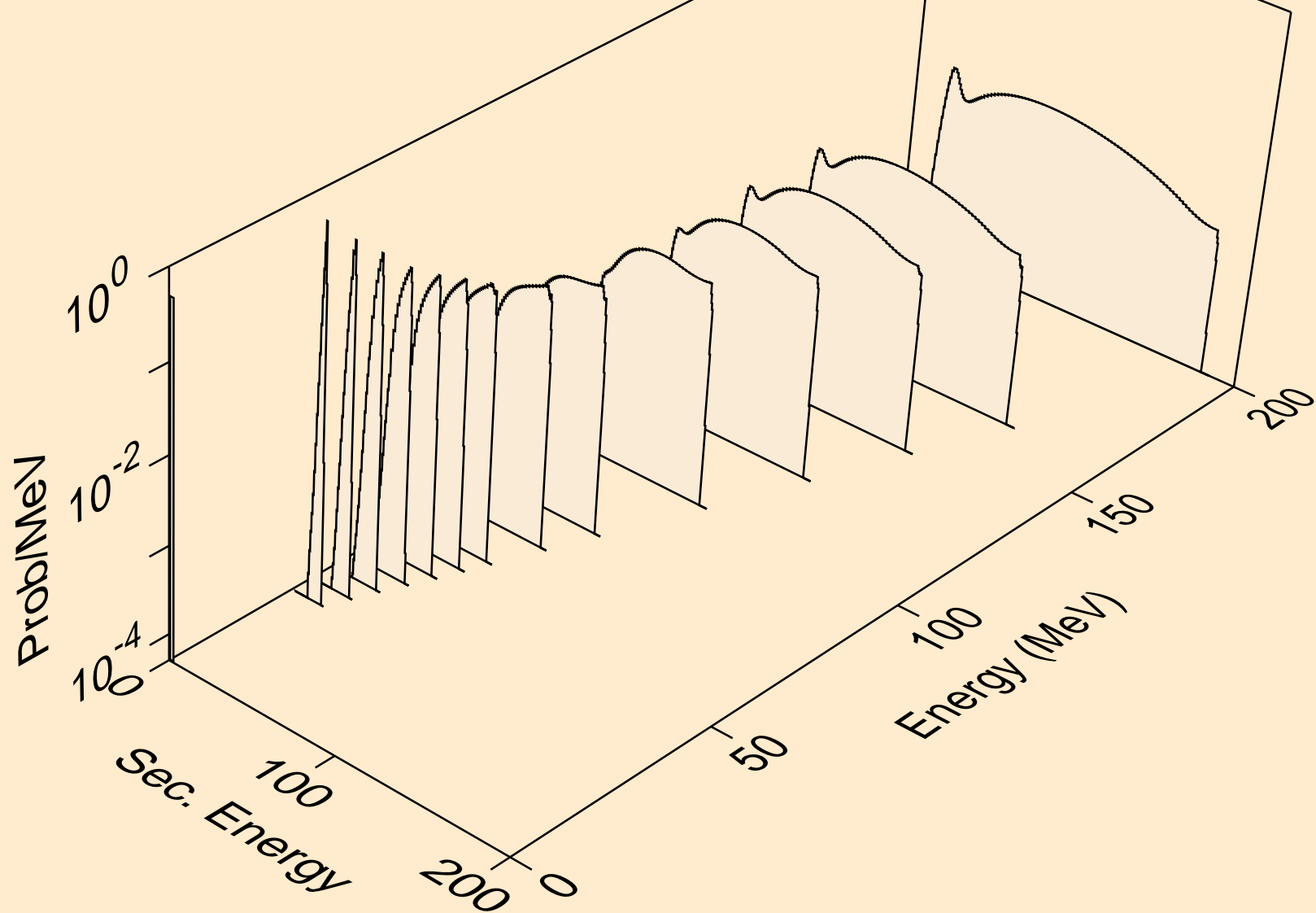

IR173 ALPHA ACER TENDL-2023 LIBRARY; T=0.K  
he3s from (a,he3)

