

IR193M ALPHA ACER TENDL-2023 LIBRARY; T=0.K  
Principal cross sections

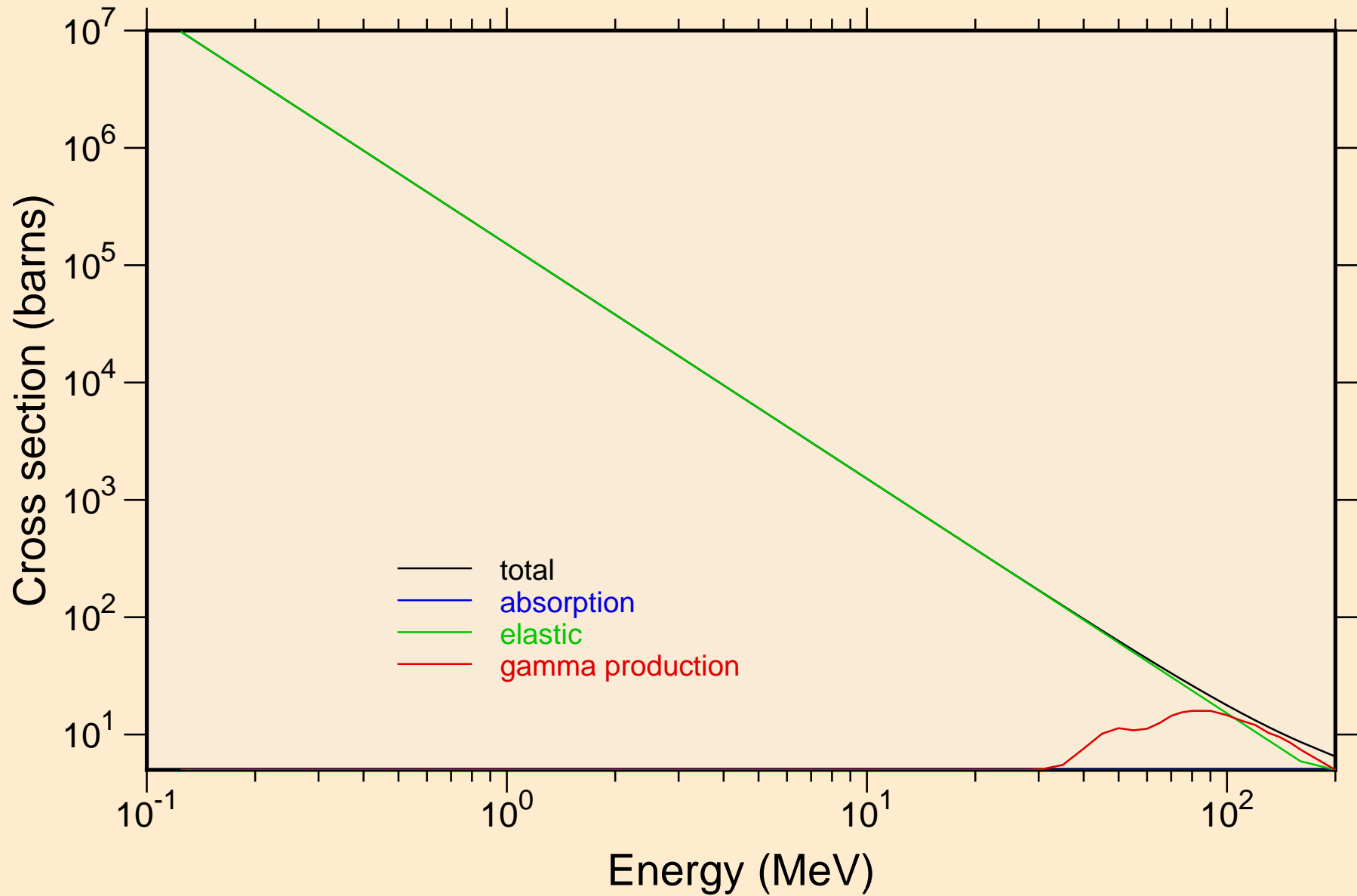

IR193M ALPHA ACER TENDL-2023 LIBRARY; T=0.K

Heating

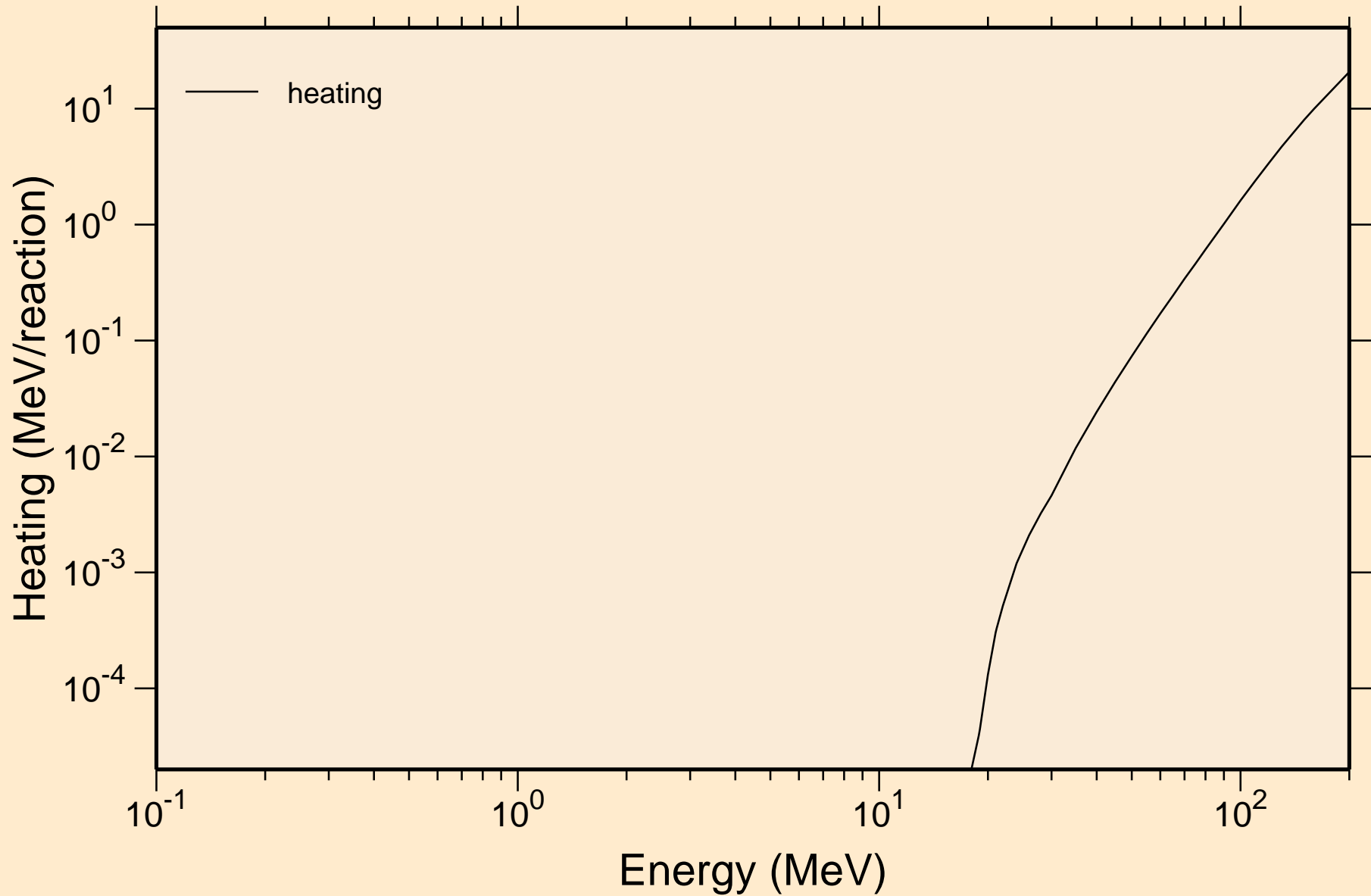

# IR193M ALPHA ACER TENDL-2023 LIBRARY; T=0.K

## Principal cross sections

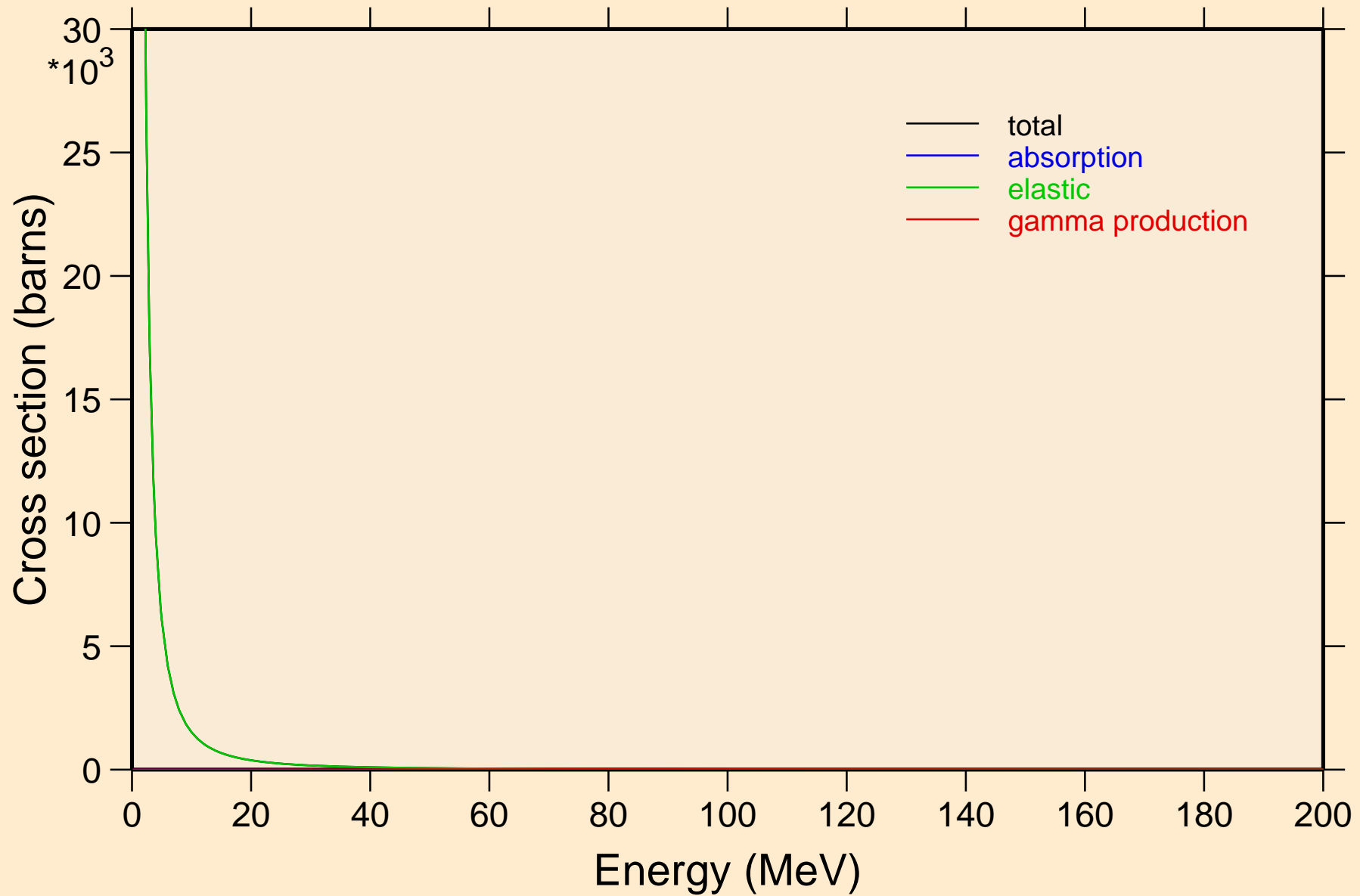

IR193M ALPHA ACER TENDL-2023 LIBRARY; T=0.K

Heating

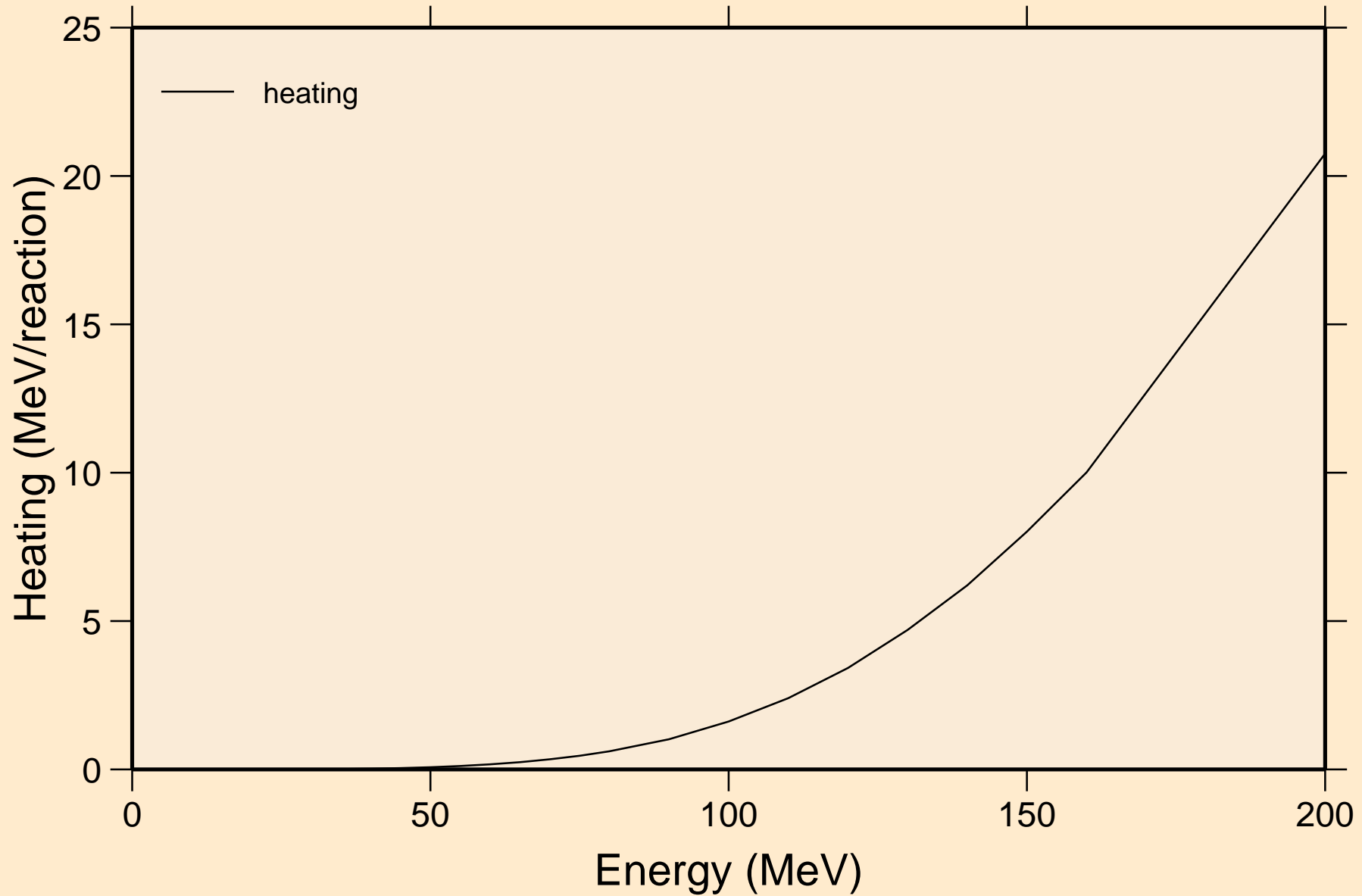

IR193M ALPHA ACER TENDL-2023 LIBRARY; T=0.K  
Threshold reactions

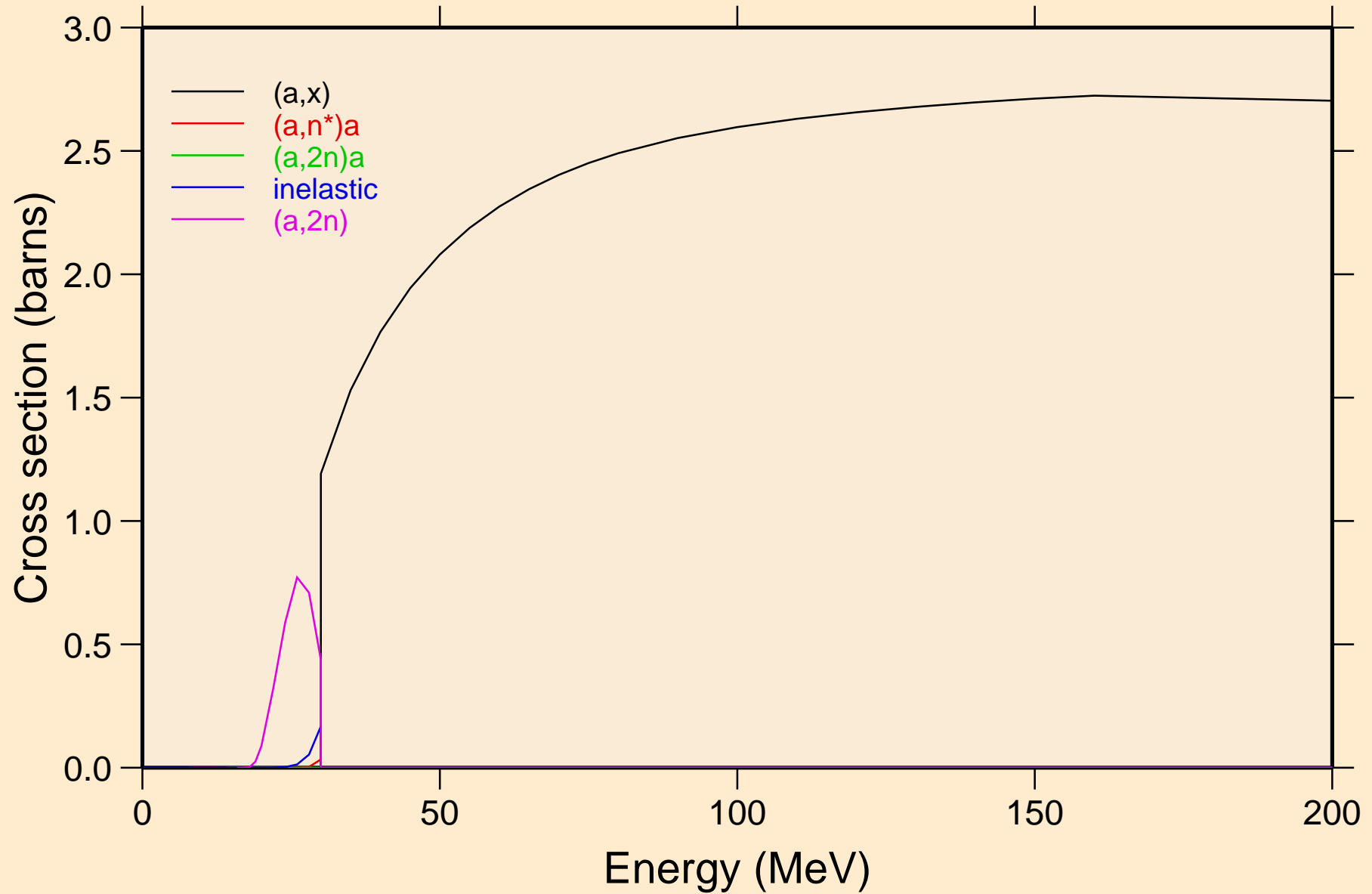

IR193M ALPHA ACER TENDL-2023 LIBRARY; T=0.K  
Threshold reactions

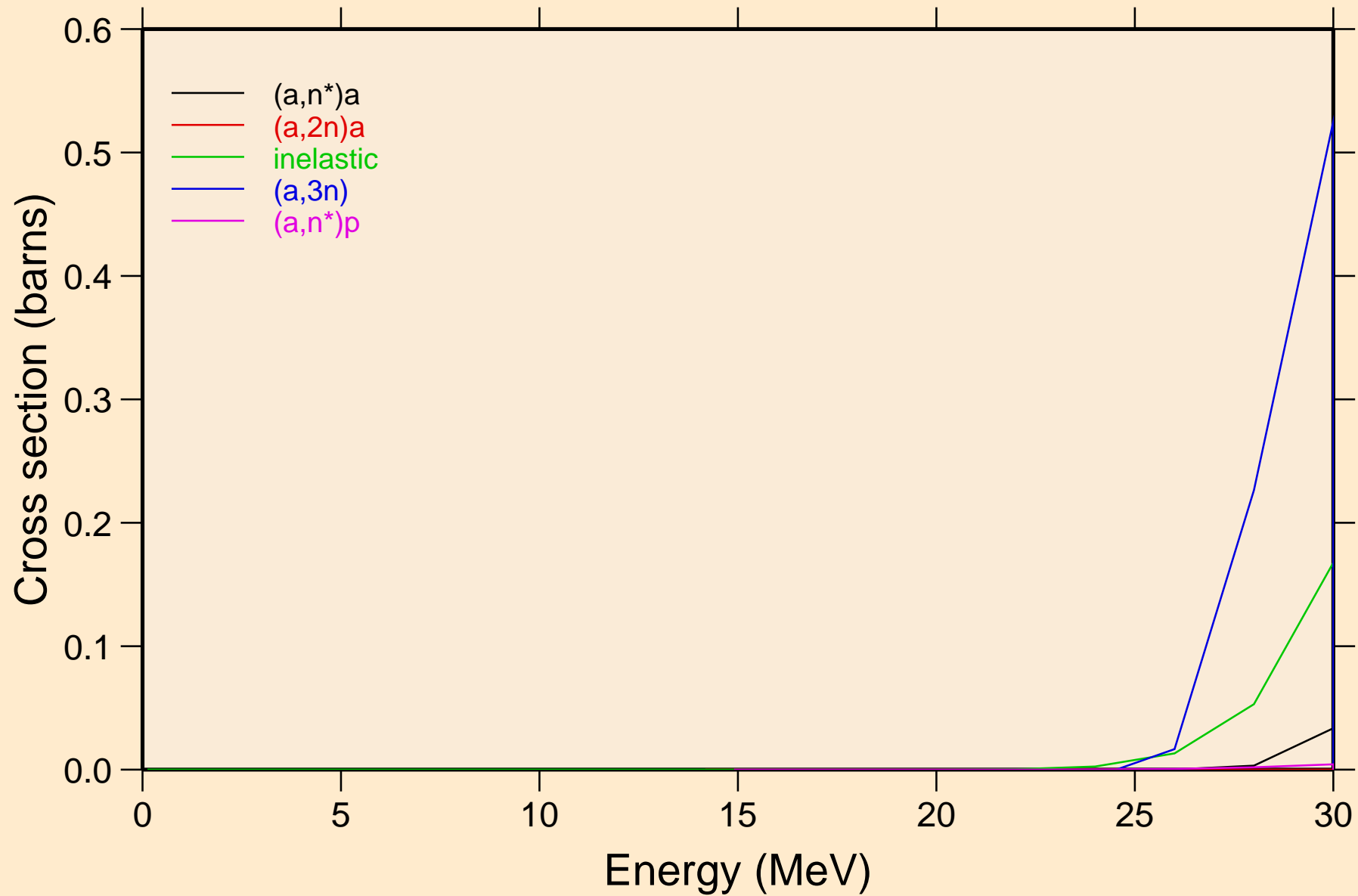

IR193M ALPHA ACER TENDL-2023 LIBRARY; T=0.K  
Threshold reactions

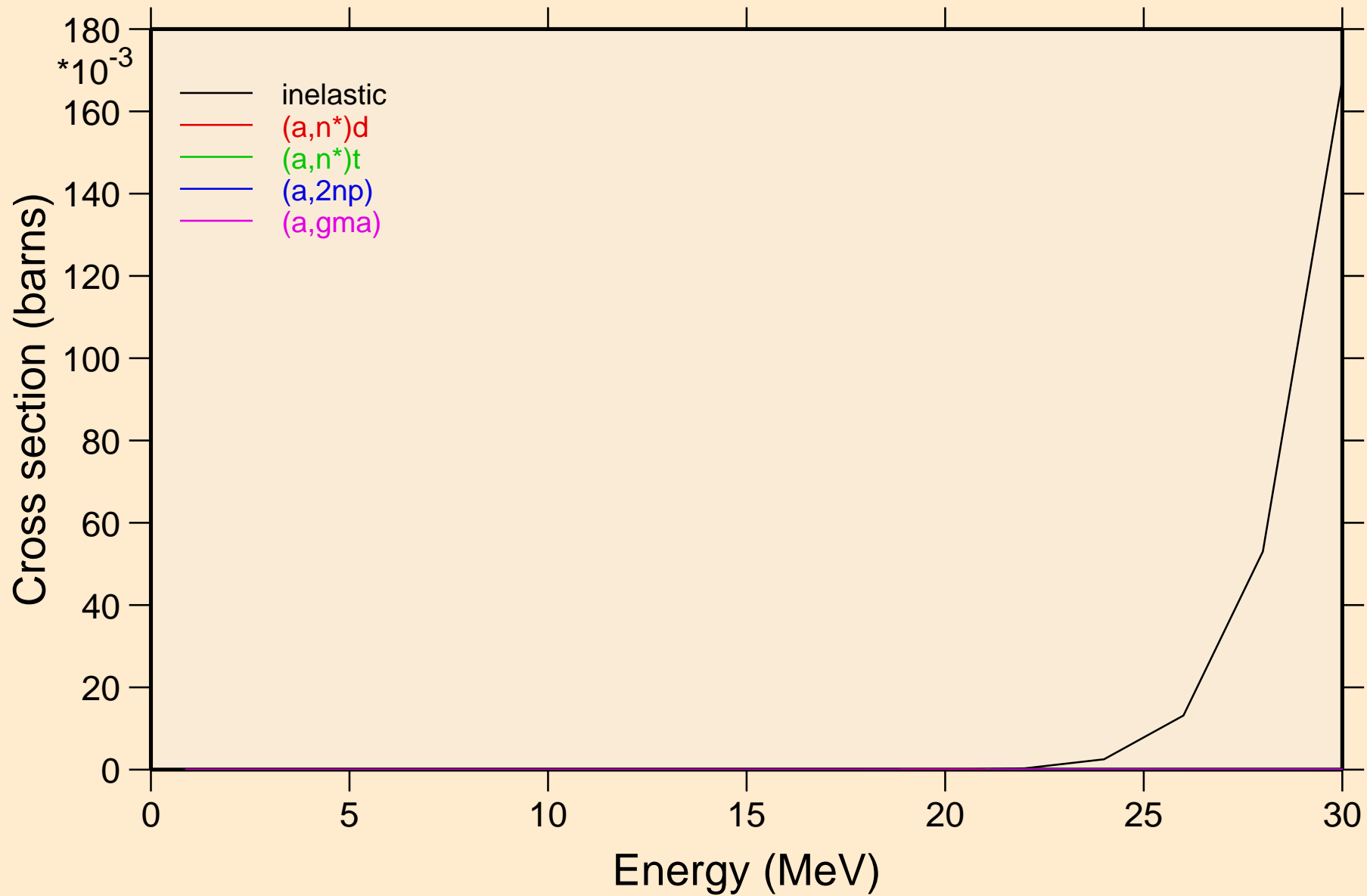

IR193M ALPHA ACER TENDL-2023 LIBRARY; T=0.K  
Threshold reactions

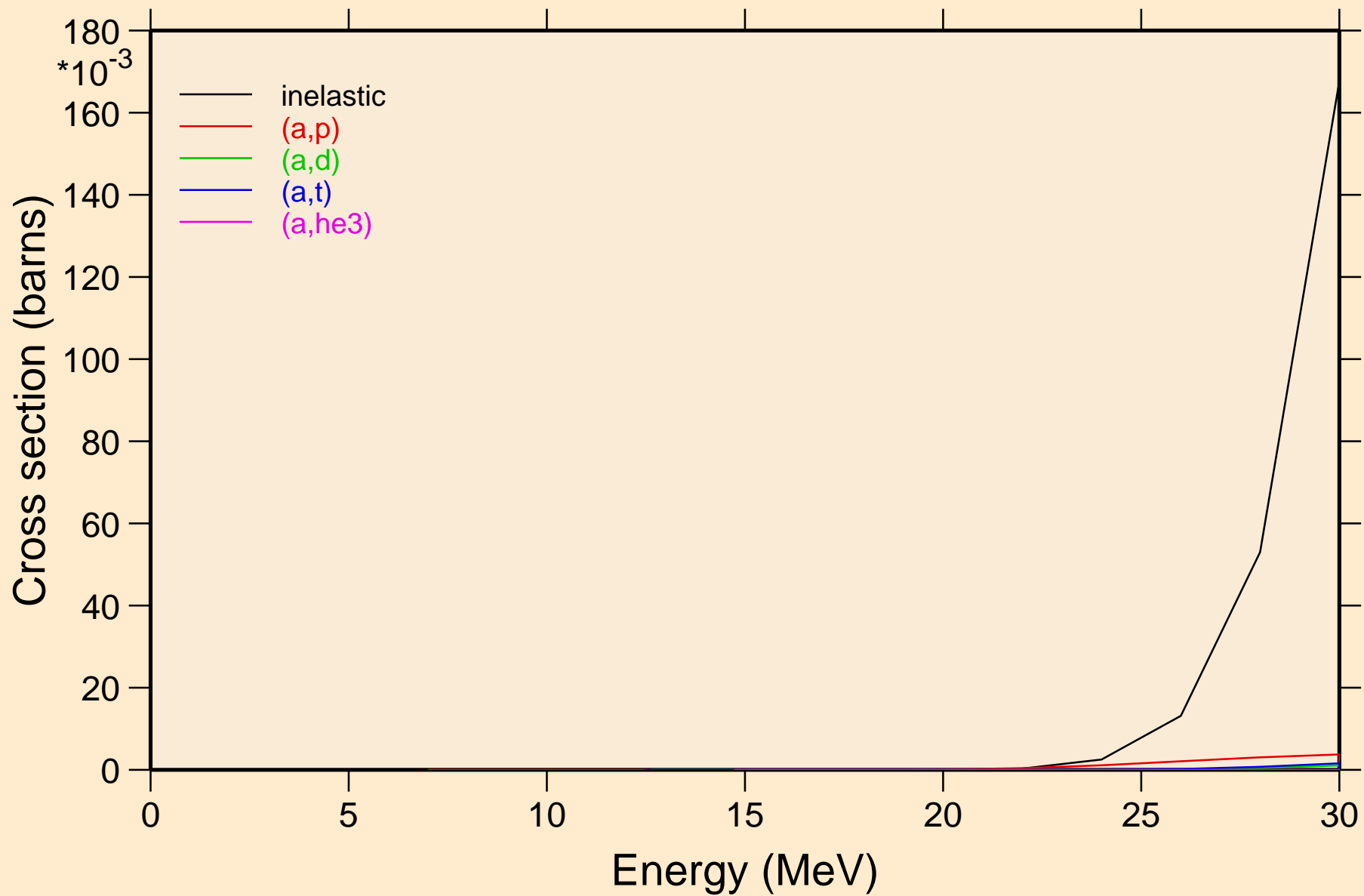

IR193M ALPHA ACER TENDL-2023 LIBRARY; T=0.K  
Threshold reactions

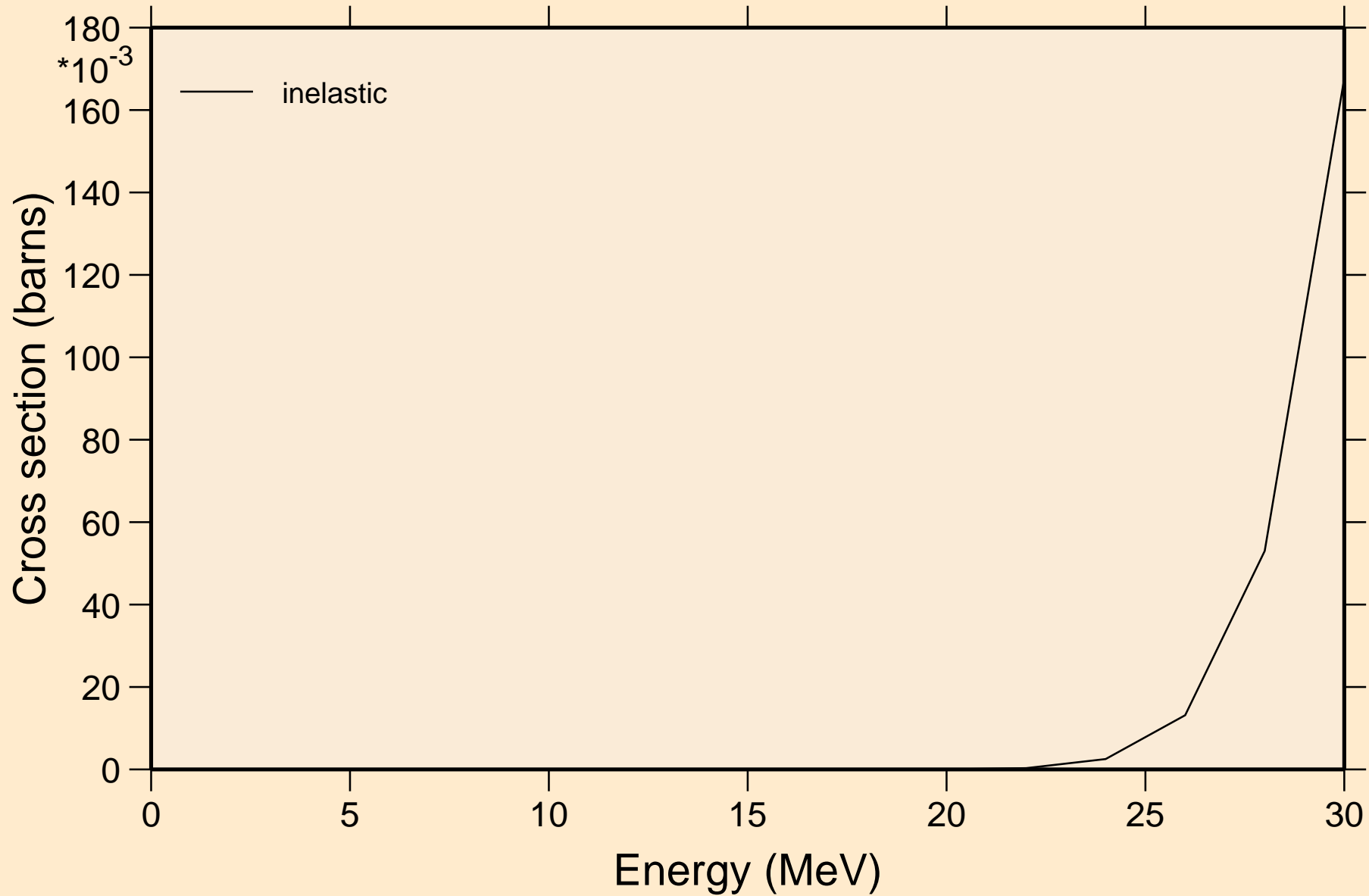

IR193M ALPHA ACER TENDL-2023 LIBRARY; T=0.K  
angular distribution for elastic

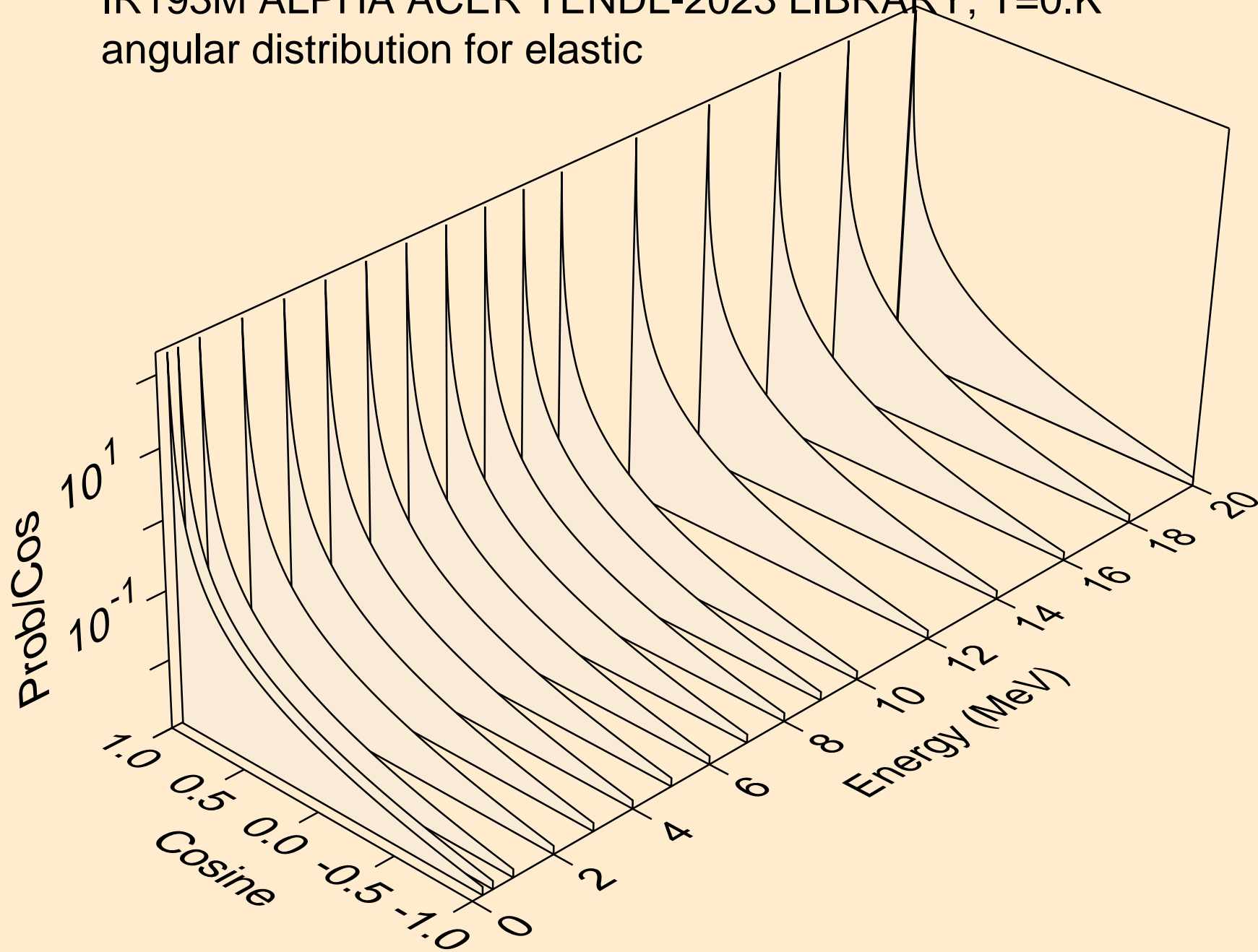

IR193M ALPHA ACER TENDL-2023 LIBRARY; T=0.K  
angular distribution for elastic

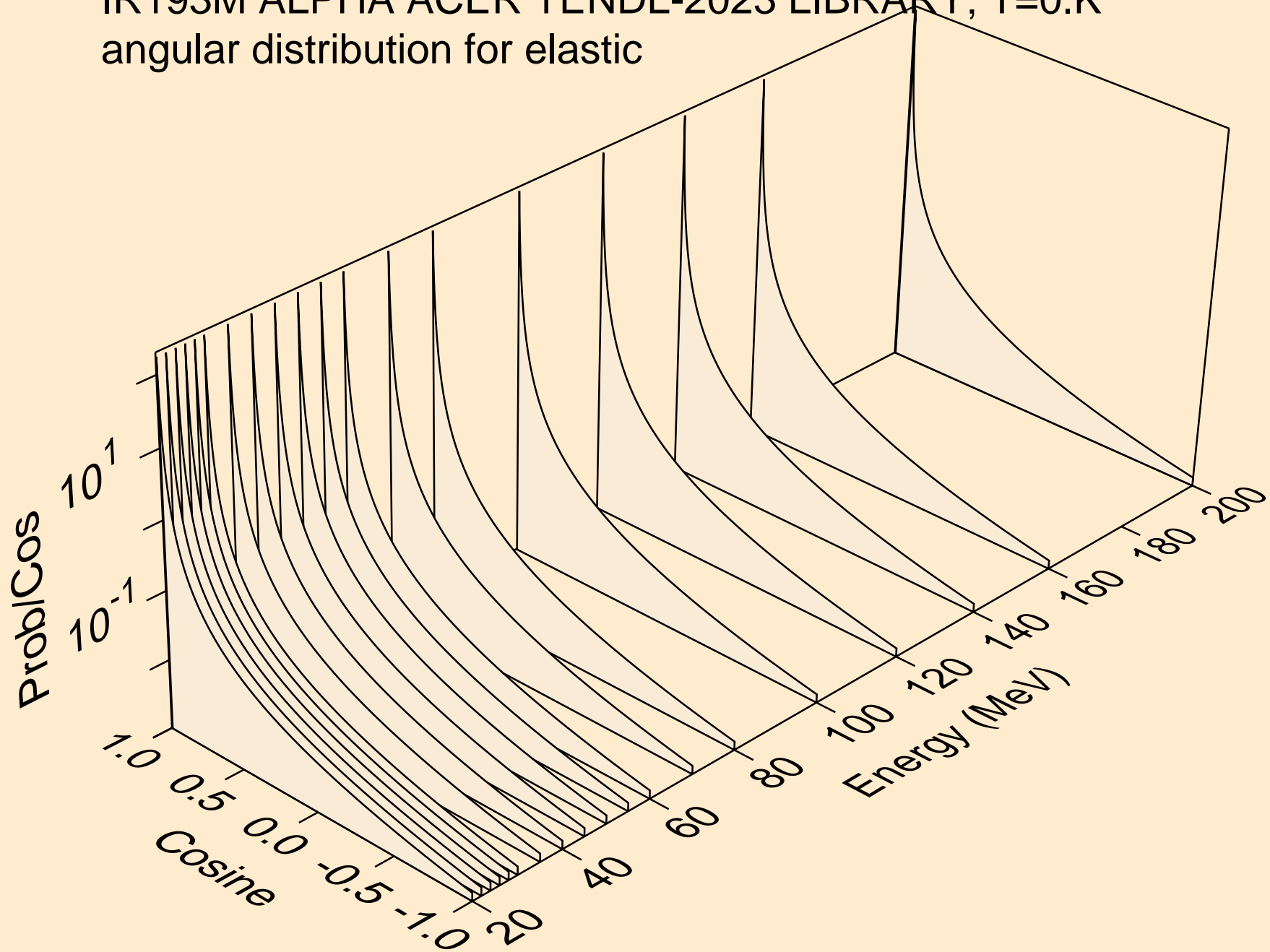

IR193M ALPHA ACER TENDL-2023 LIBRARY; T=0.K  
Alpha emission for (a,x)

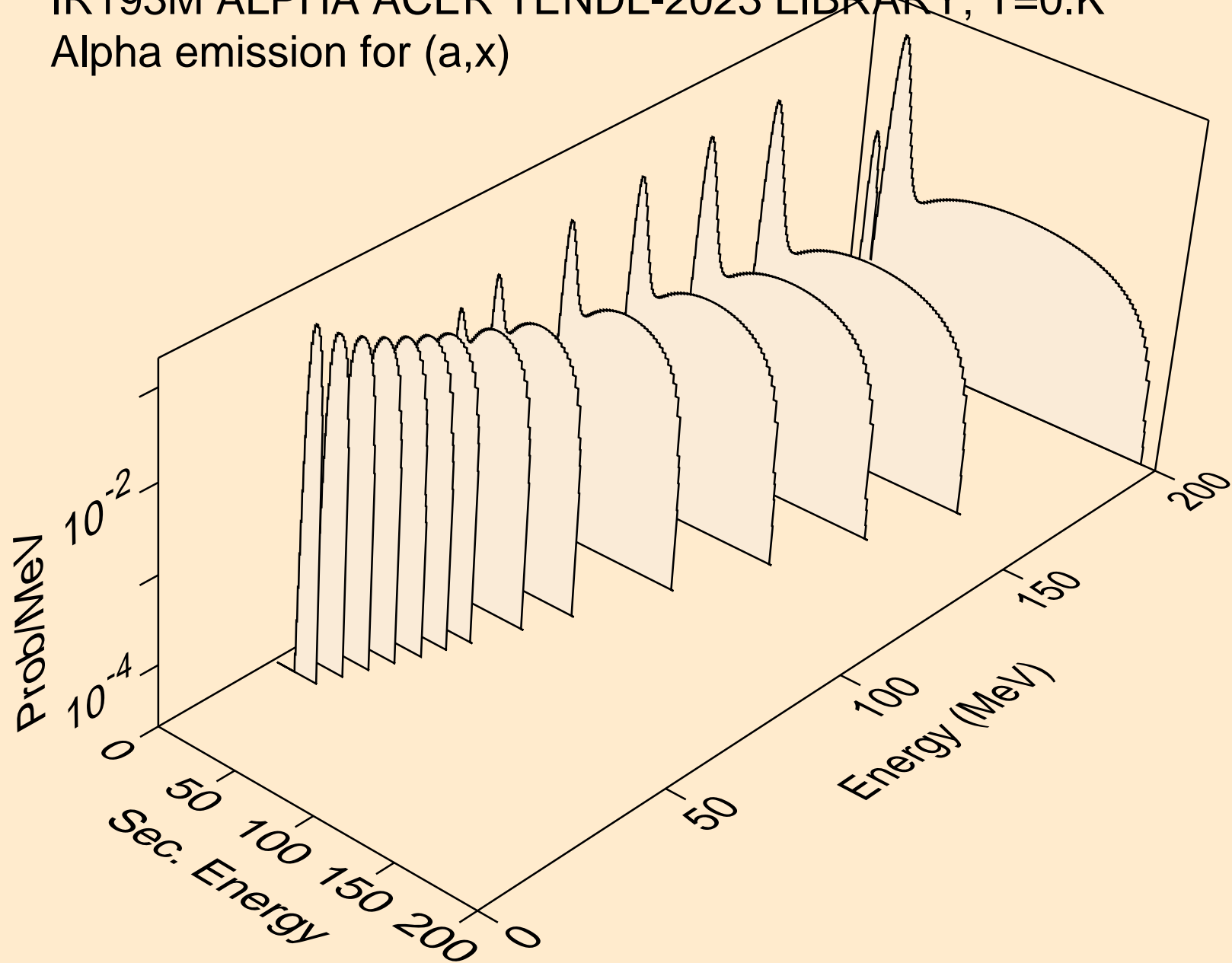

IR193M ALPHA ACER TENDL-2023 LIBRARY; T=0.K  
Alpha emission for (a,n\*)a

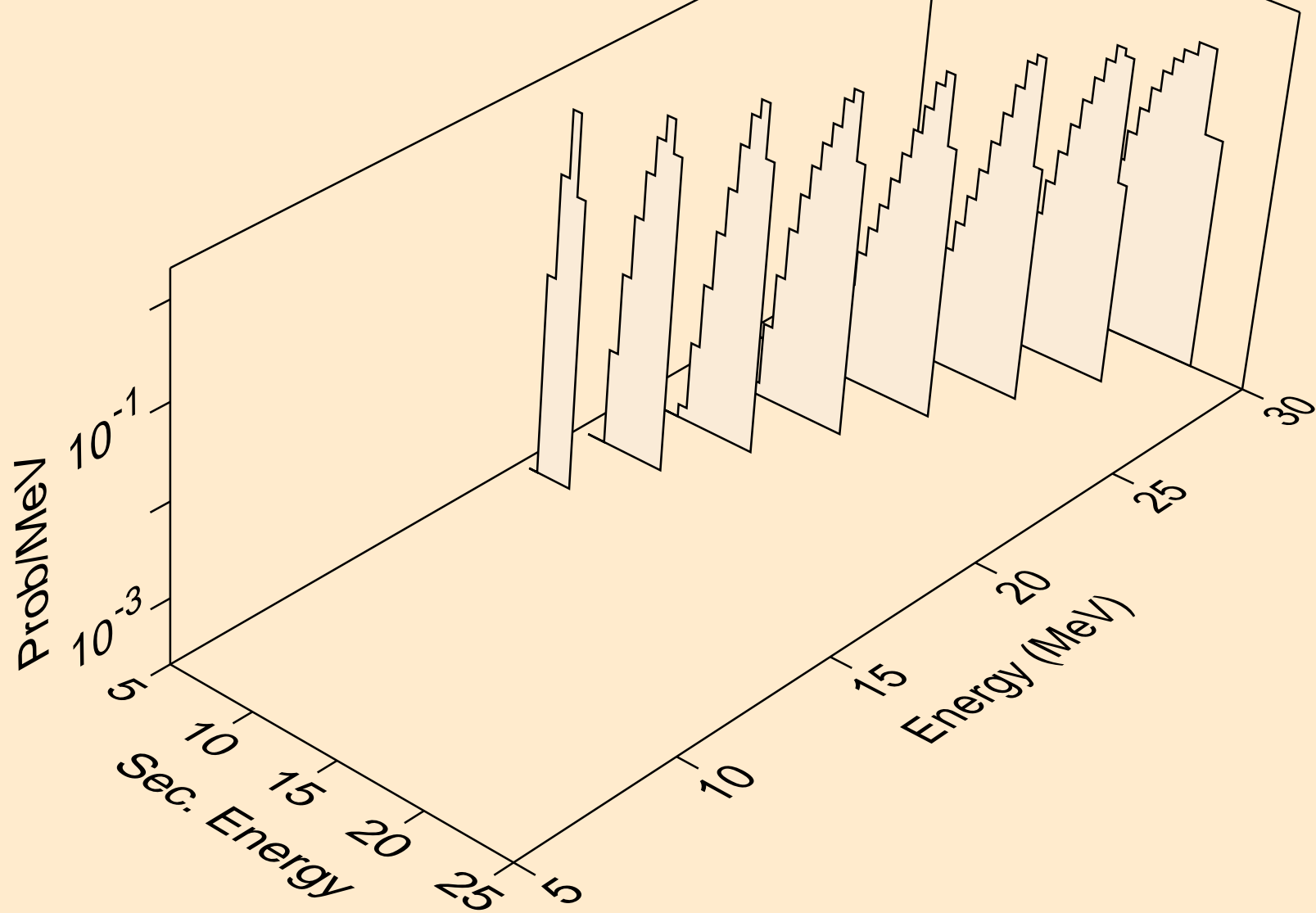

IR193M ALPHA ACER TENDL-2023 LIBRARY; T=0.K  
Alpha emission for (a,2n)a

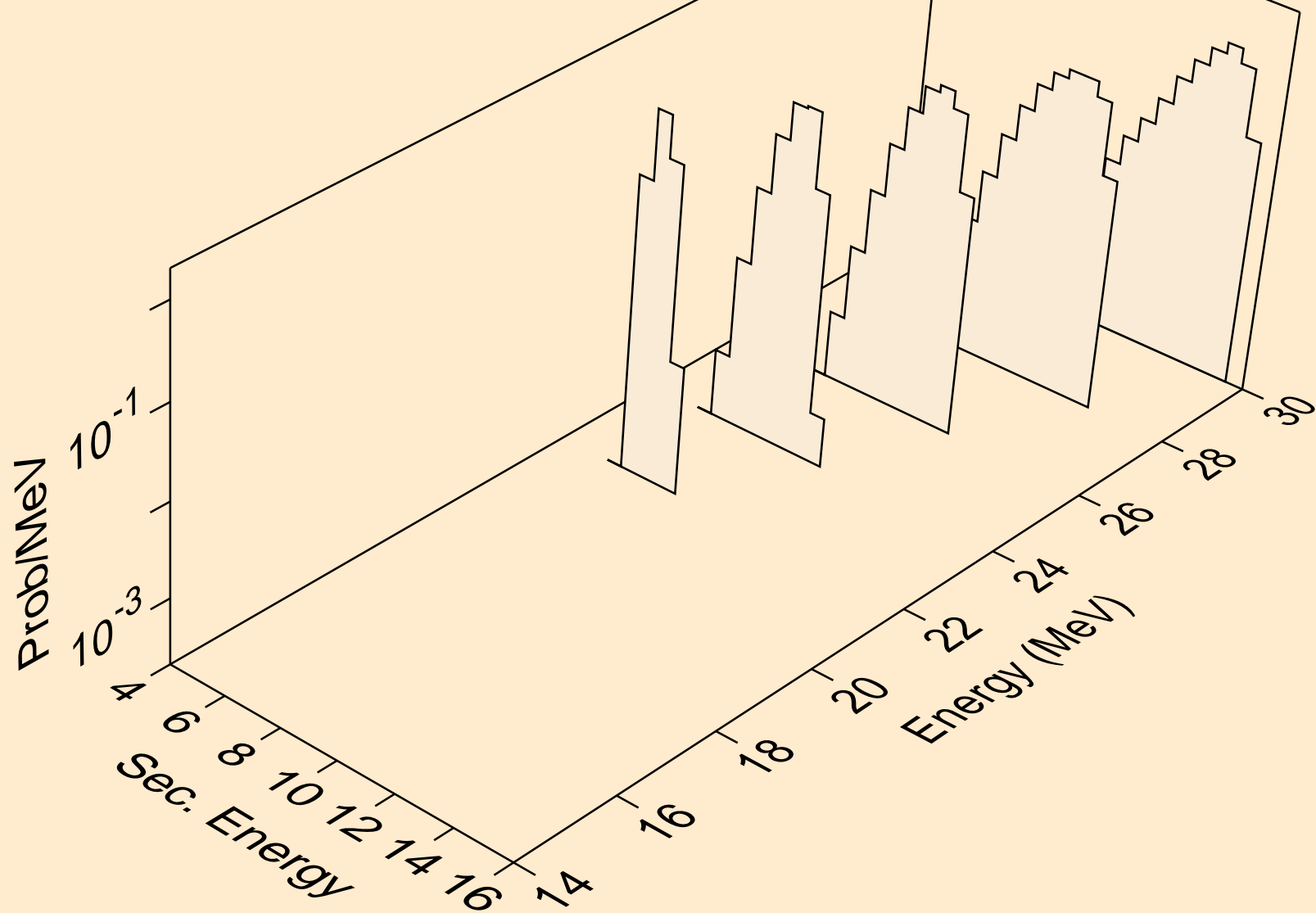

IR193M ALPHA ACER TENDL-2023 LIBRARY; T=0.K  
Alpha emission for inelastic

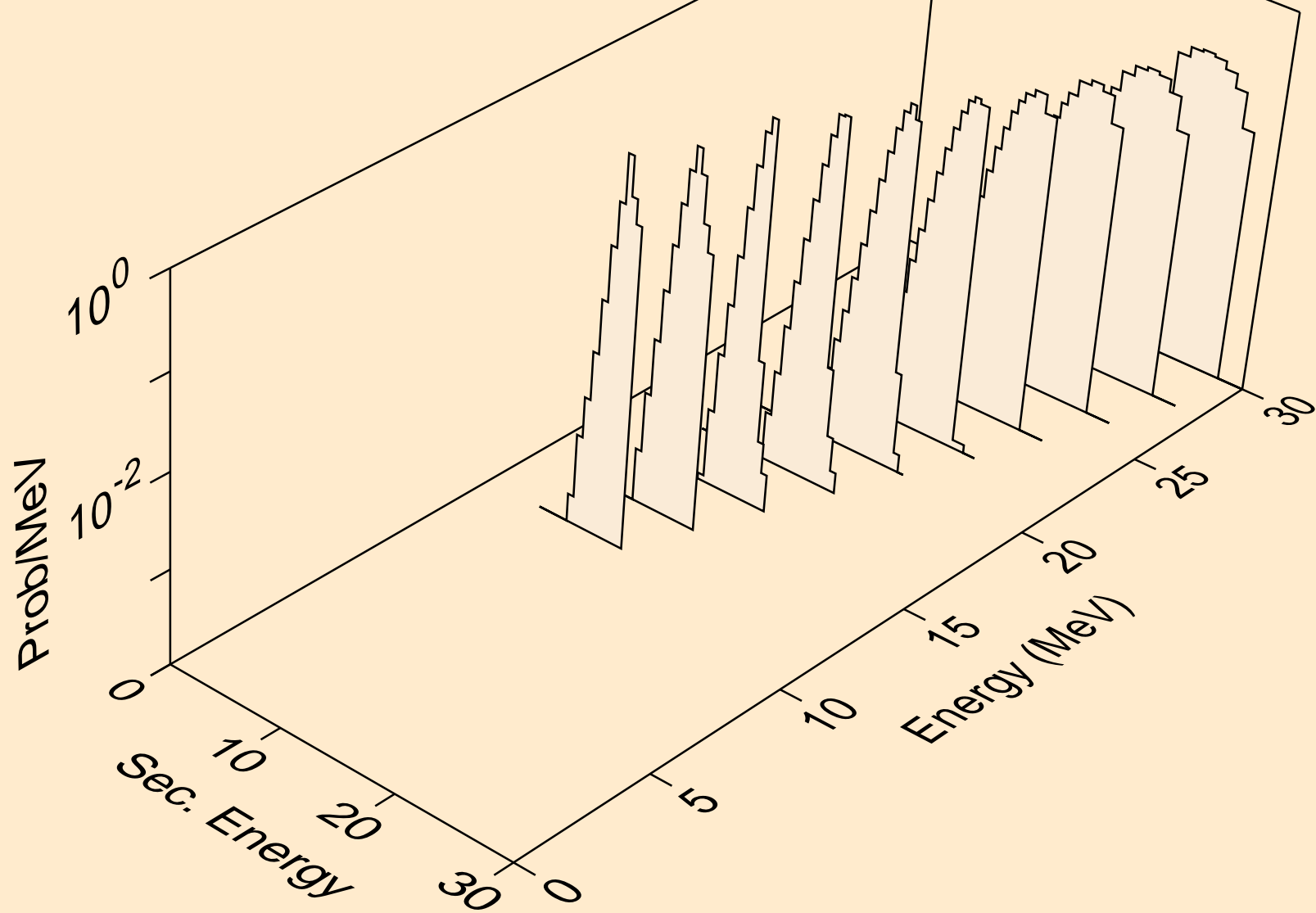

IR193M ALPHA ACER TENDL-2023 LIBRARY; T=0.K  
Photon emission for (z,n)

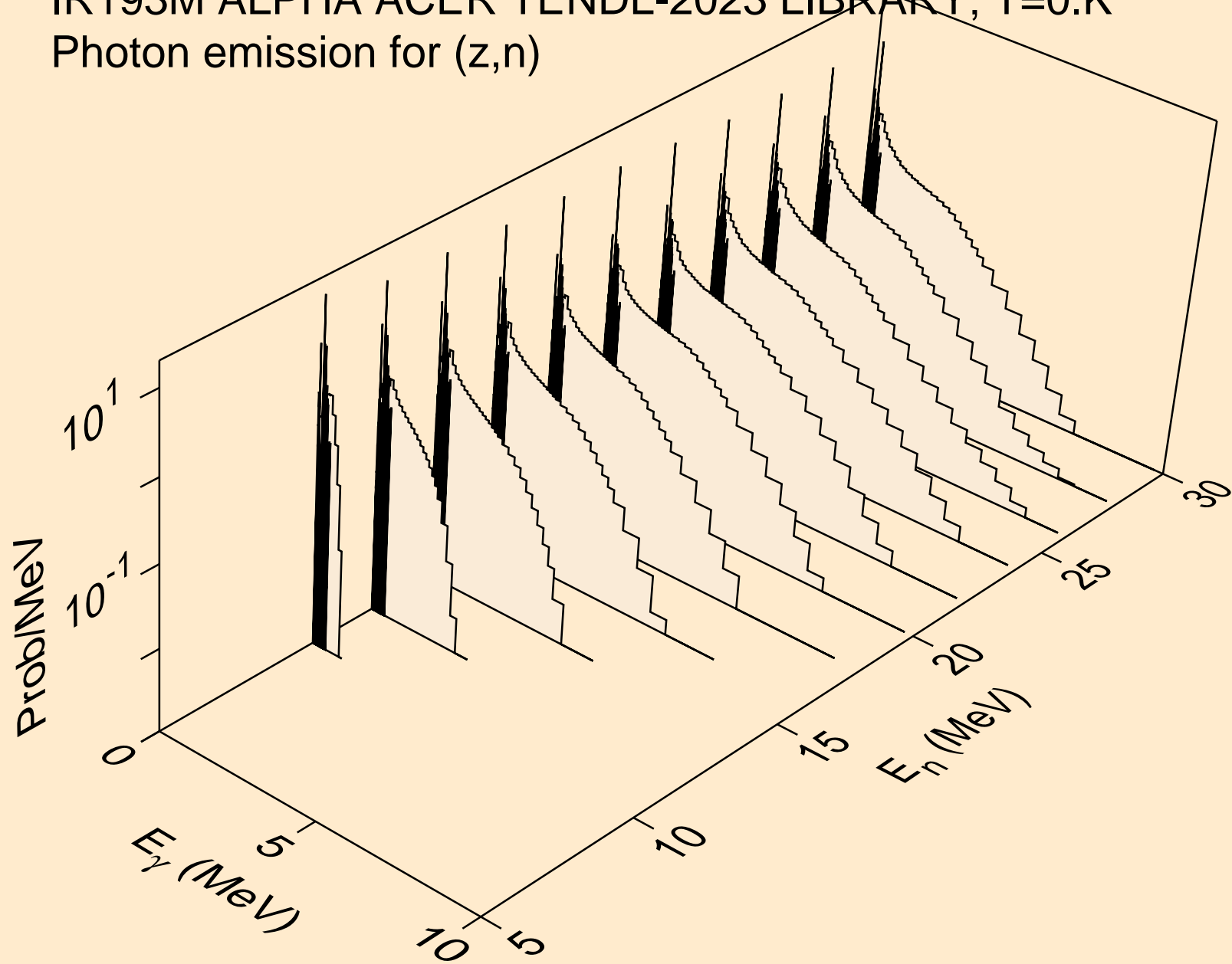

IR193M ALPHA ACER TENDL-2023 LIBRARY; T=0.K  
Photon emission for (z,x)

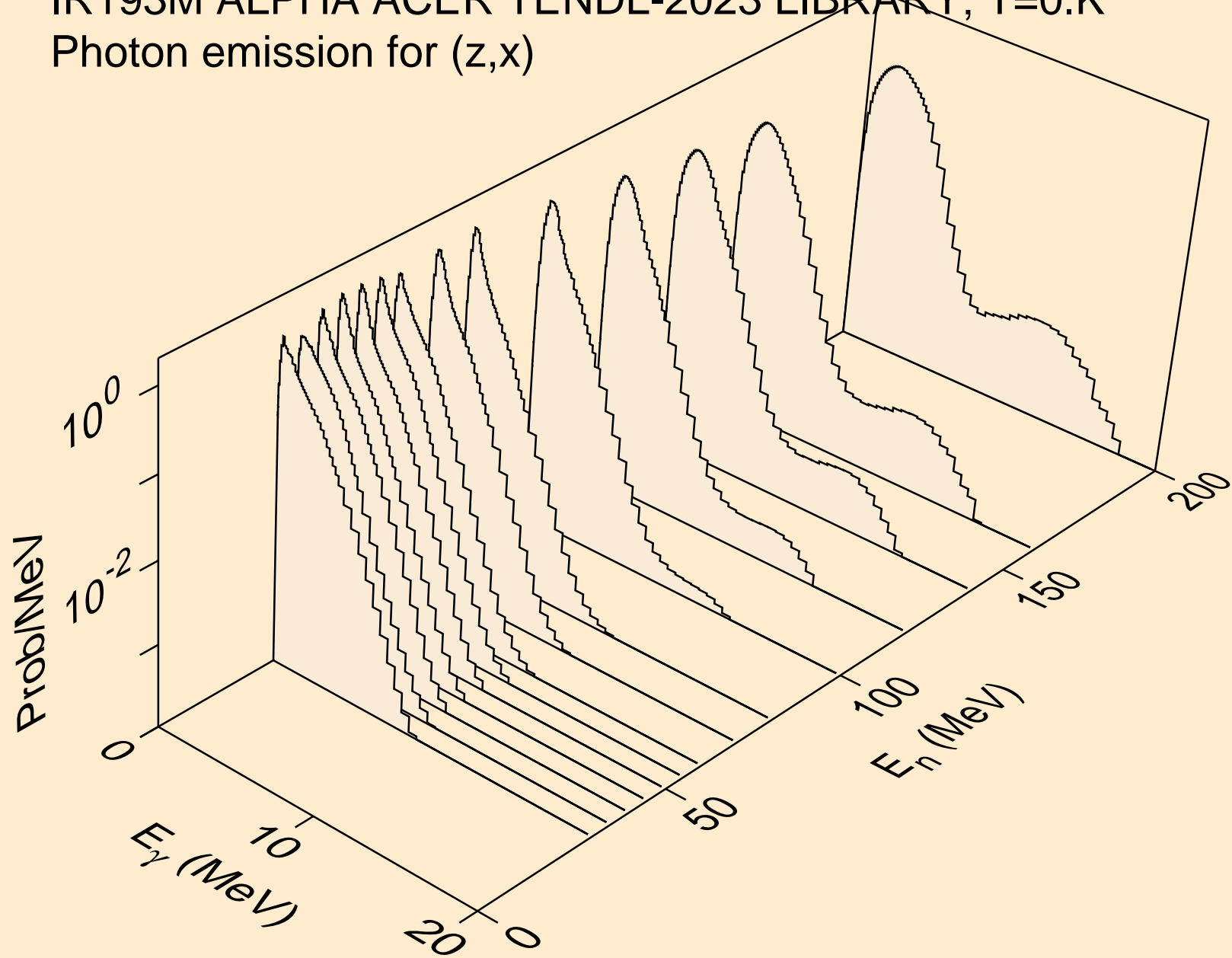

IR193M ALPHA ACER TENDL-2023 LIBRARY; T=0.K  
Photon emission for (n,2n)

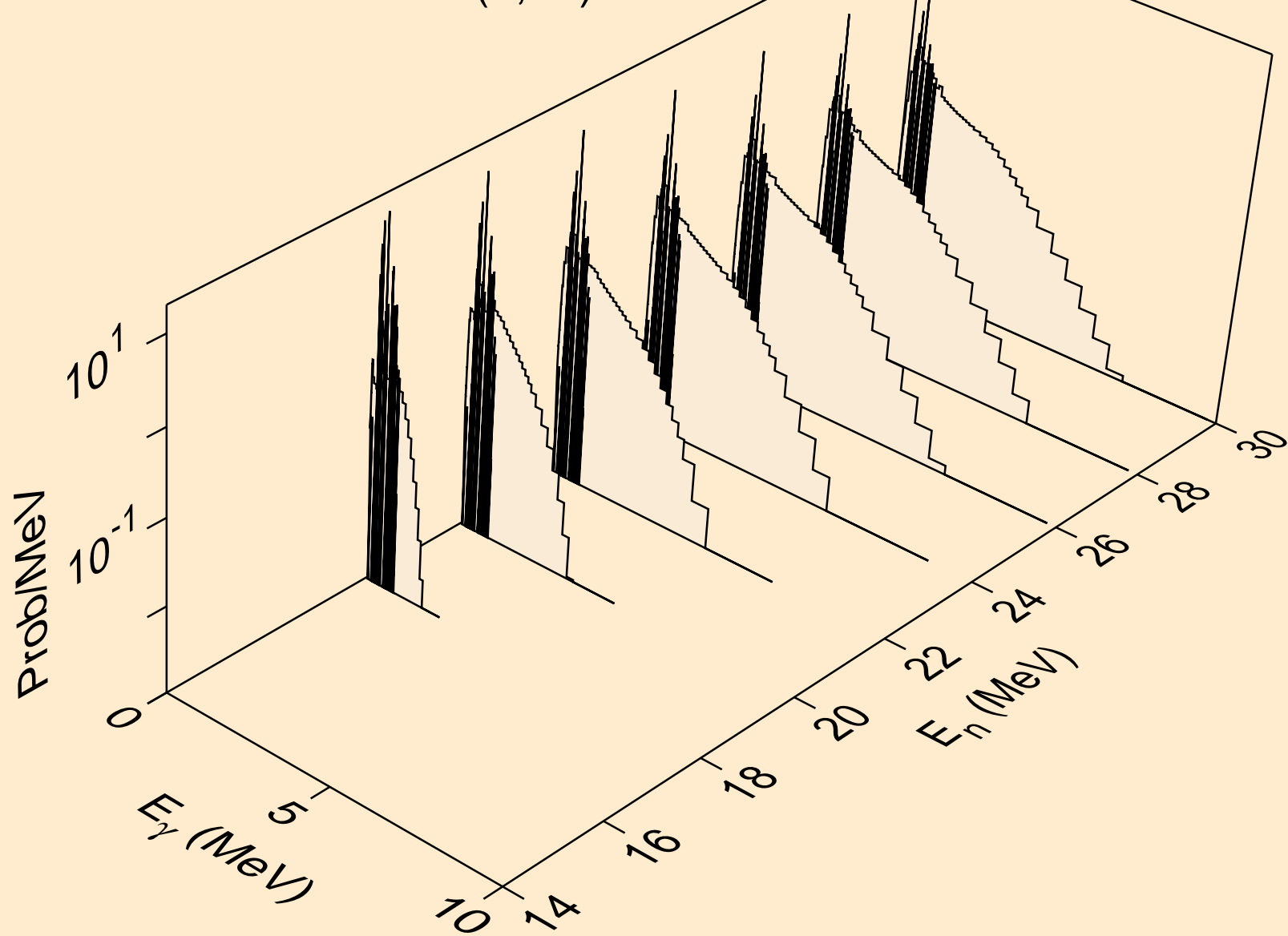

IR193M ALPHA ACER TENDL-2023 LIBRARY; T=0.K  
Photon emission for (n,3n)

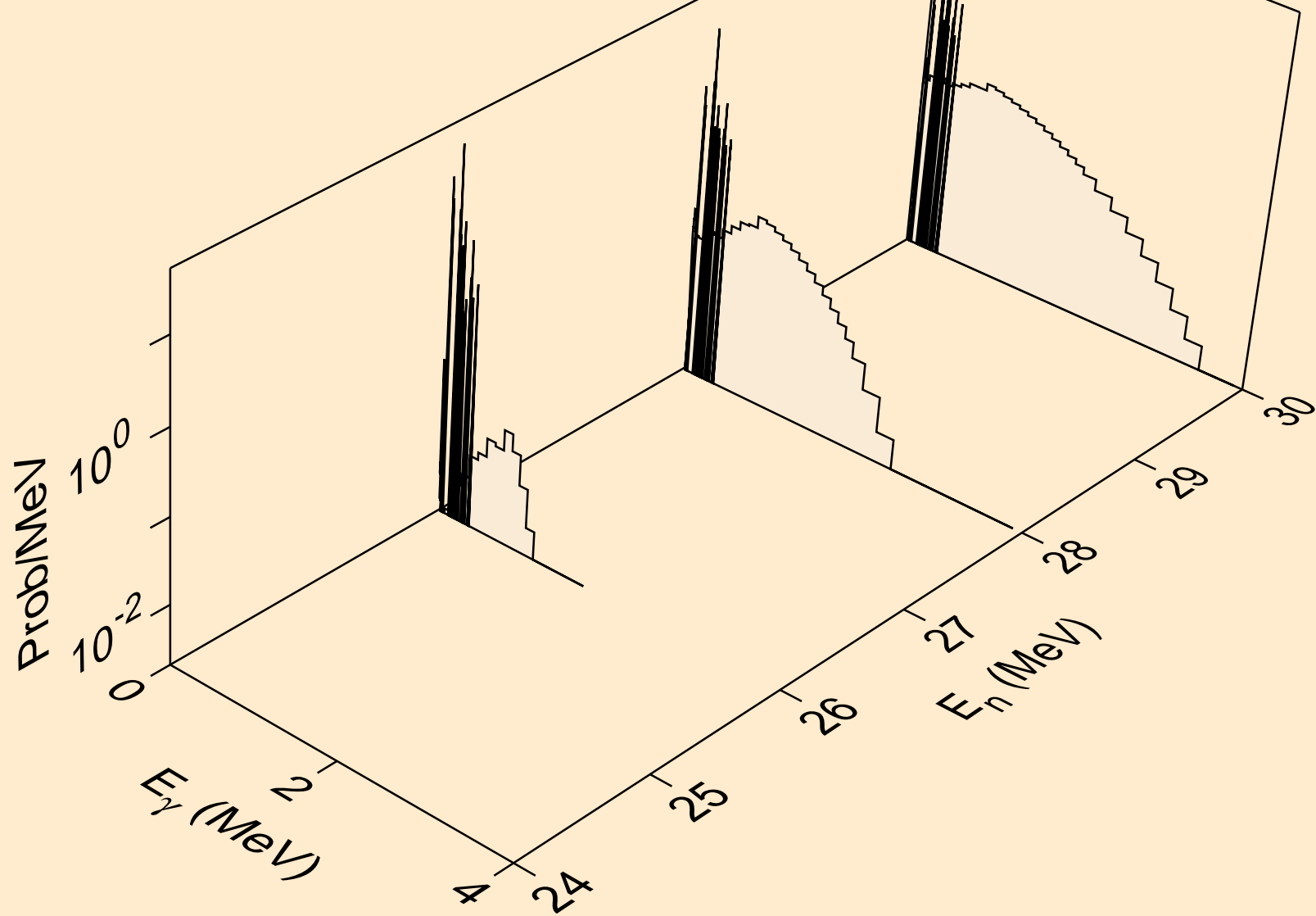

IR193M ALPHA ACER TENDL-2023 LIBRARY; T=0.K  
Photon emission for (n,n\*)a

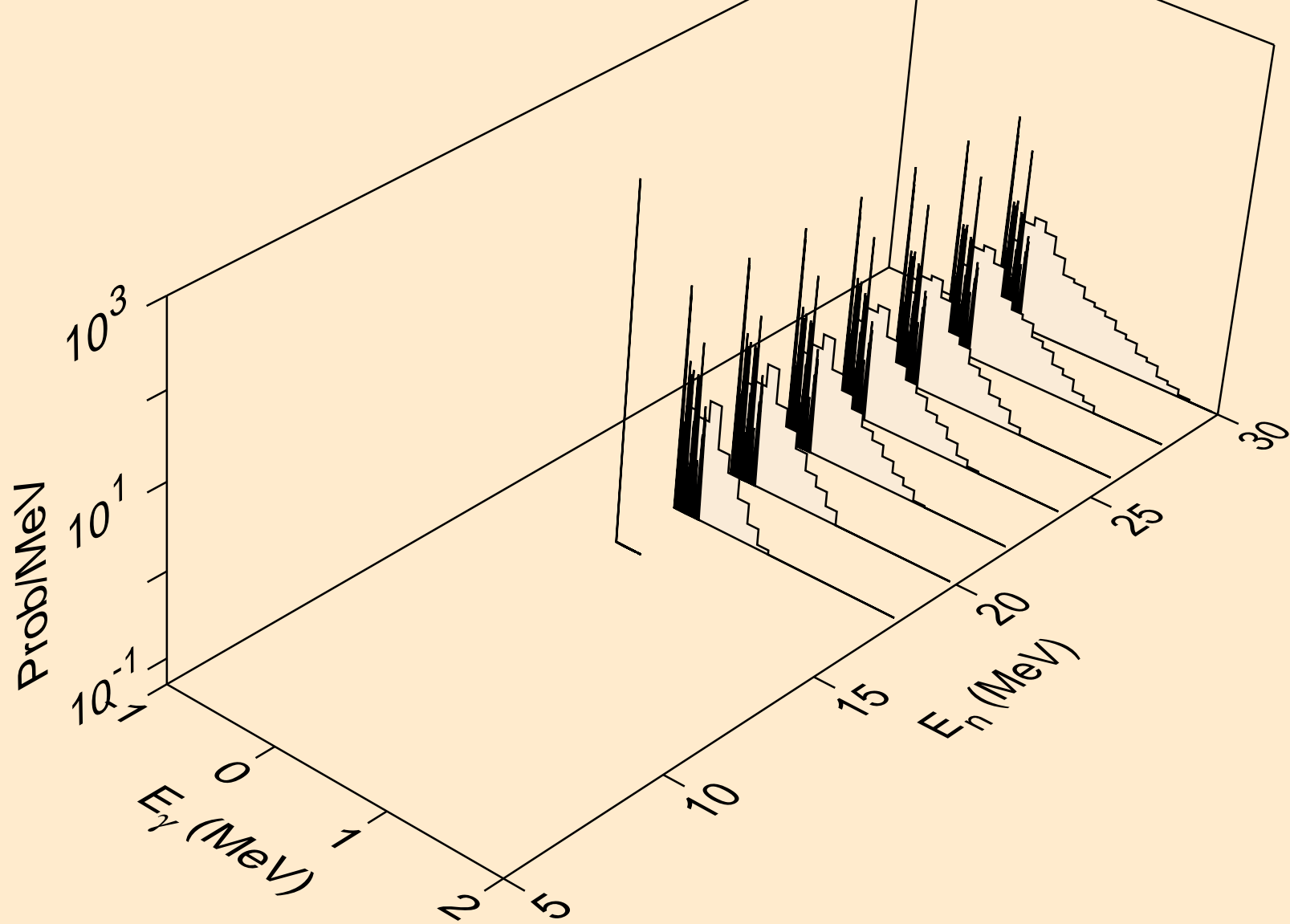

IR193M ALPHA ACER TENDL-2023 LIBRARY; T=0.K  
Photon emission for (n,2n)a

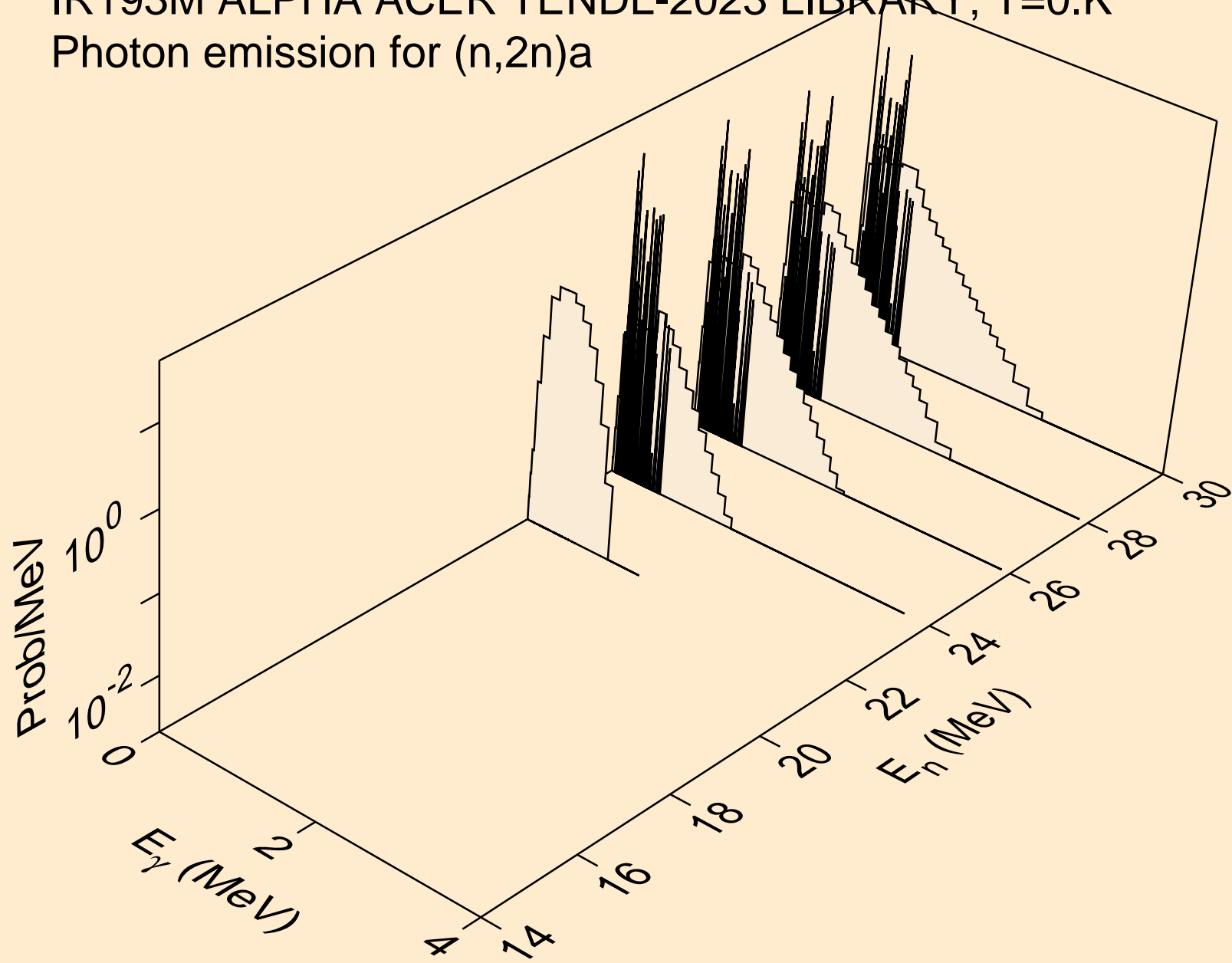

IR193M ALPHA ACER TENDL-2023 LIBRARY; T=0.K  
Photon emission for (n,n\*)p

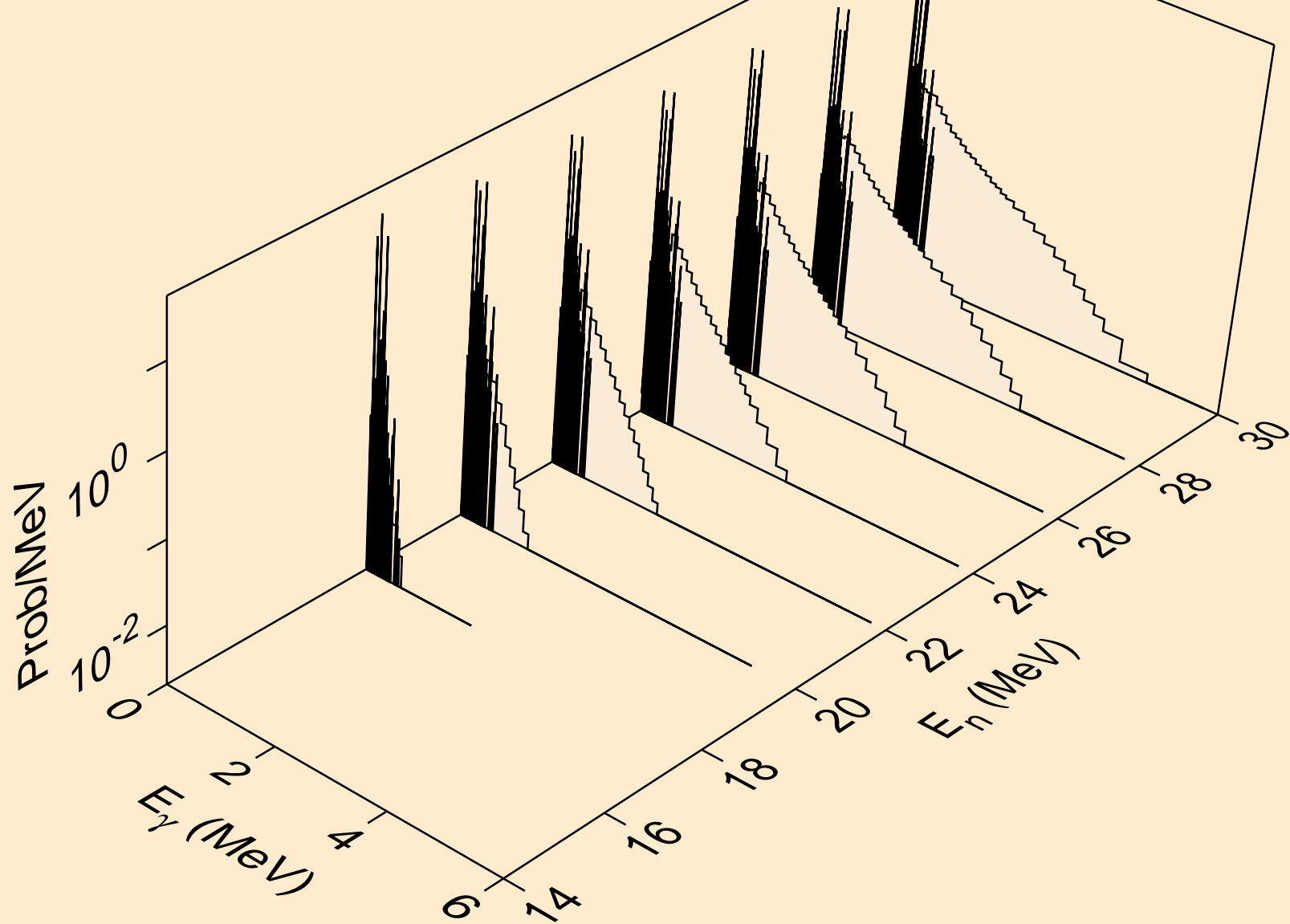

IR193M ALPHA ACER TENDL-2023 LIBRARY; T=0.K  
Photon emission for (n,n\*)d

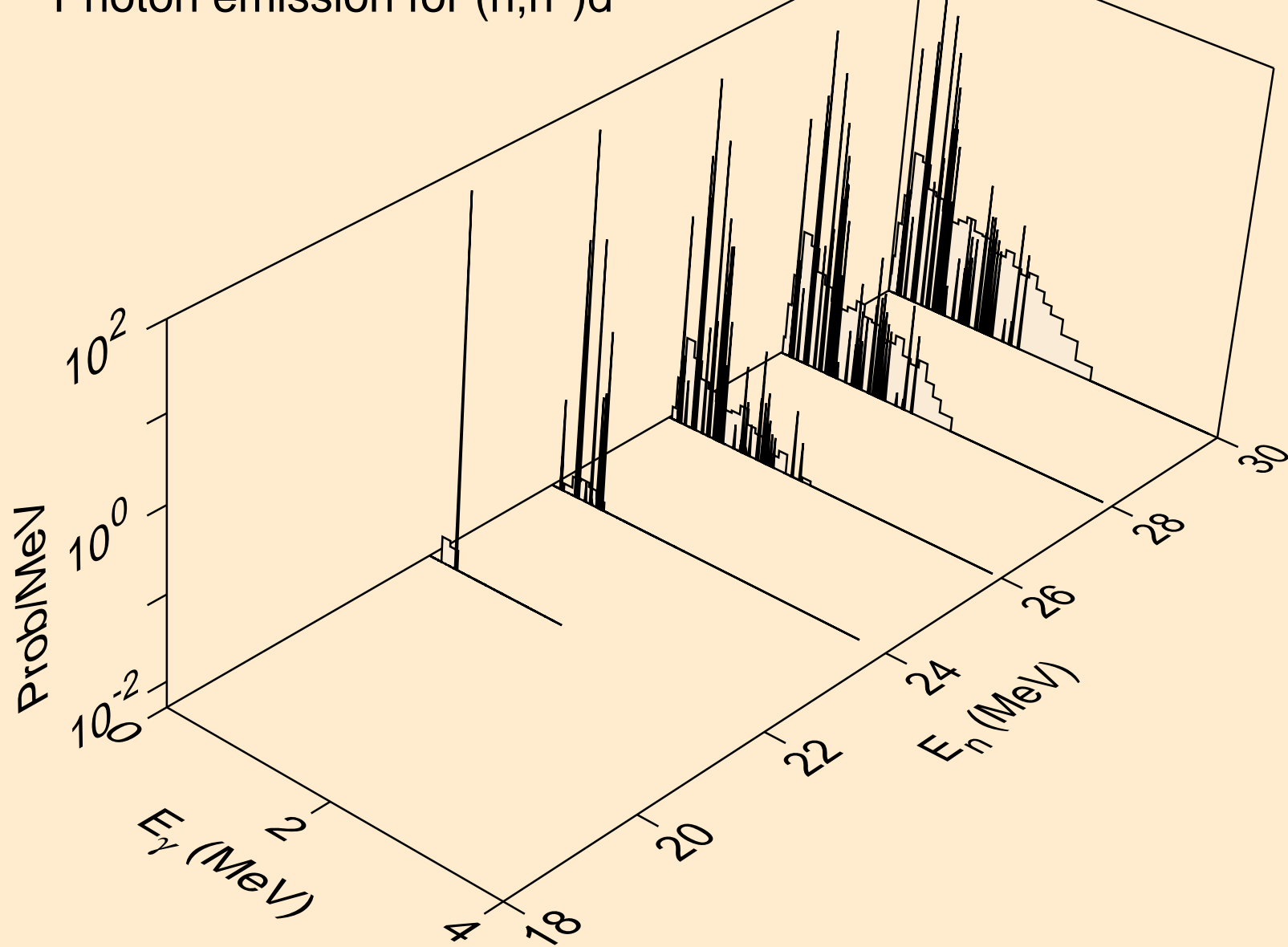

IR193M ALPHA ACER TENDL-2023 LIBRARY; T=0.K  
Photon emission for (n,n\*)t

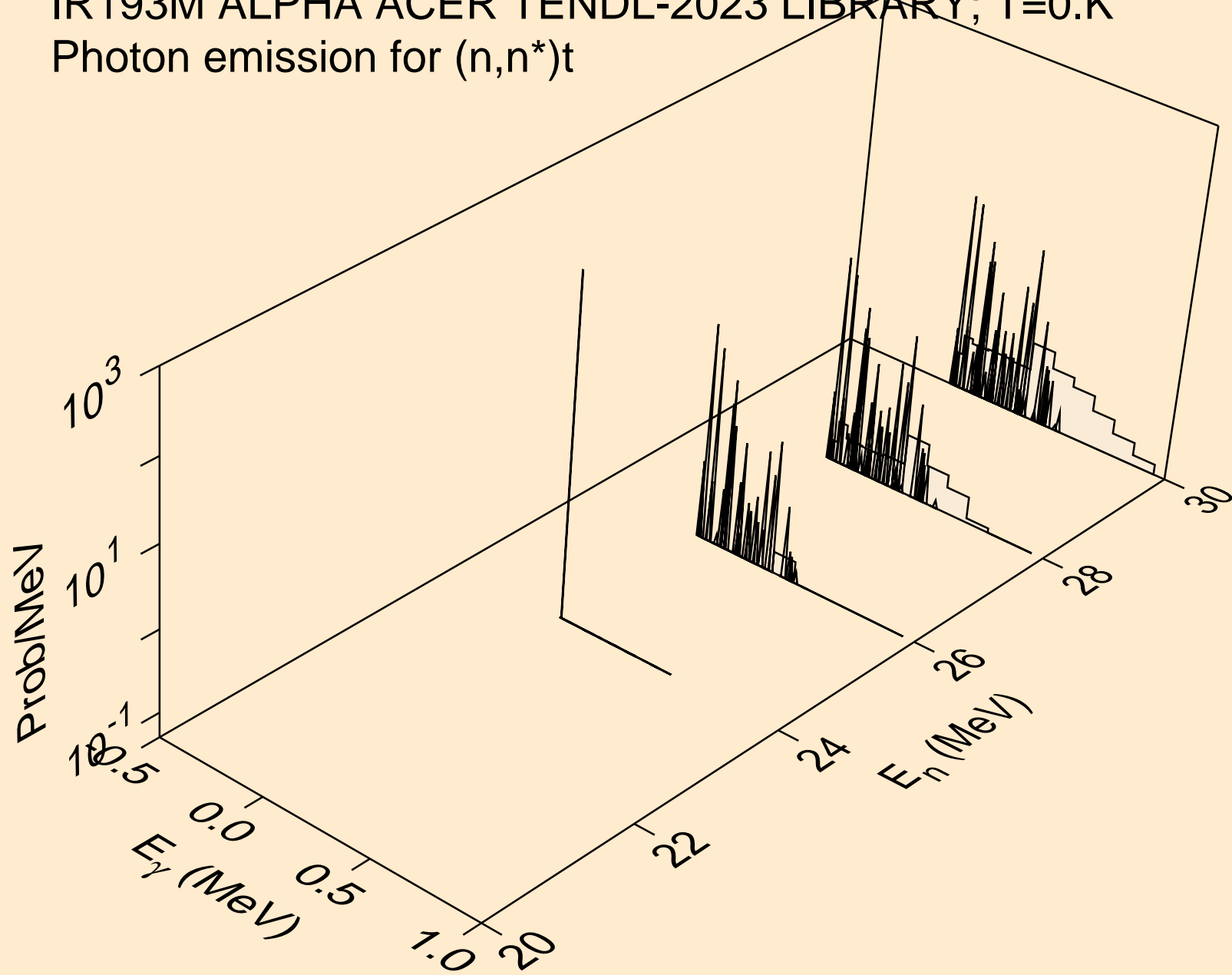

IR193M ALPHA ACER TENDL-2023 LIBRARY; T=0.K  
Photon emission for (n,2np)

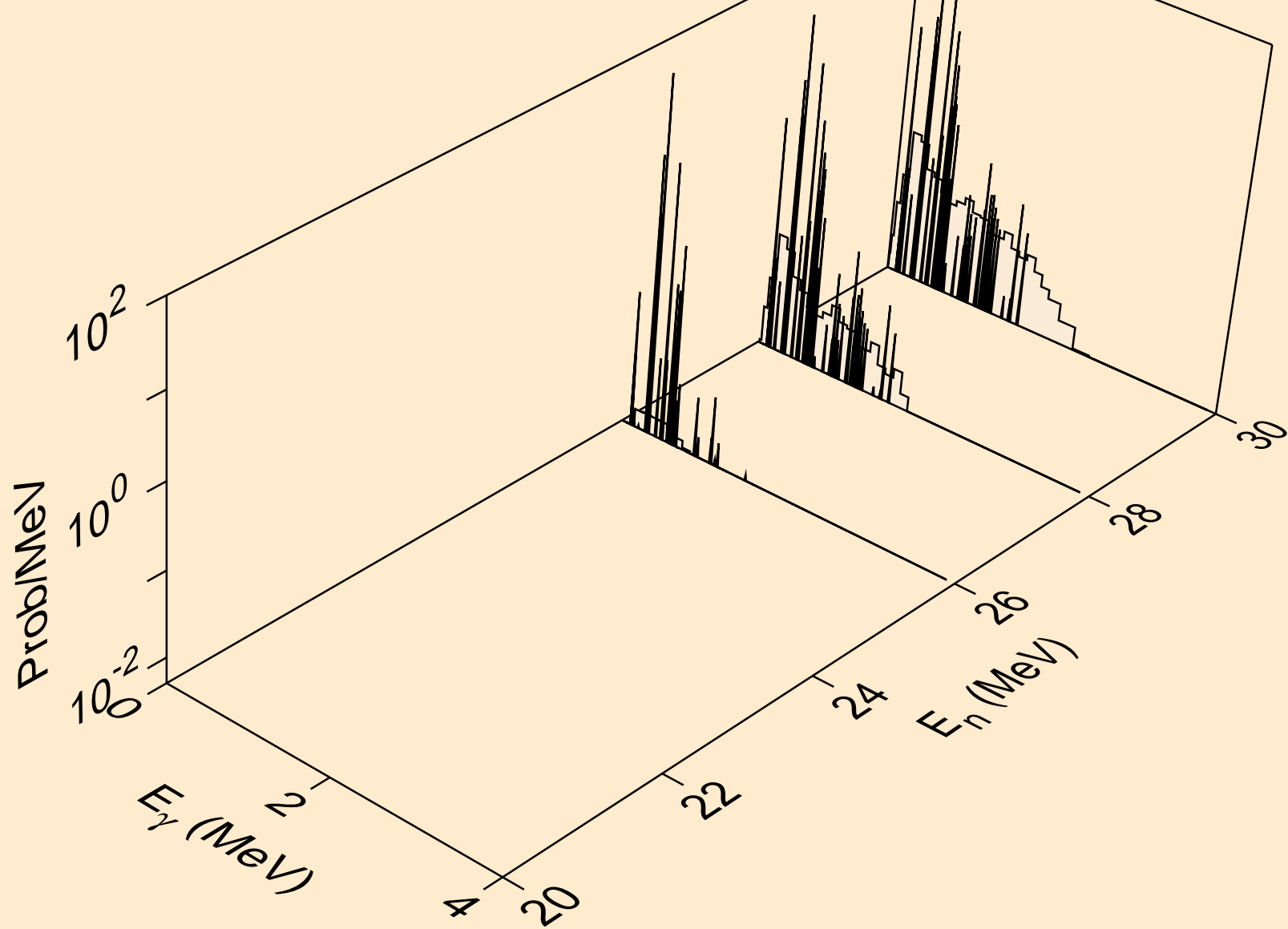

IR193M ALPHA ACER TENDL-2023 LIBRARY; T=0.K  
Photon emission for (n,gma)

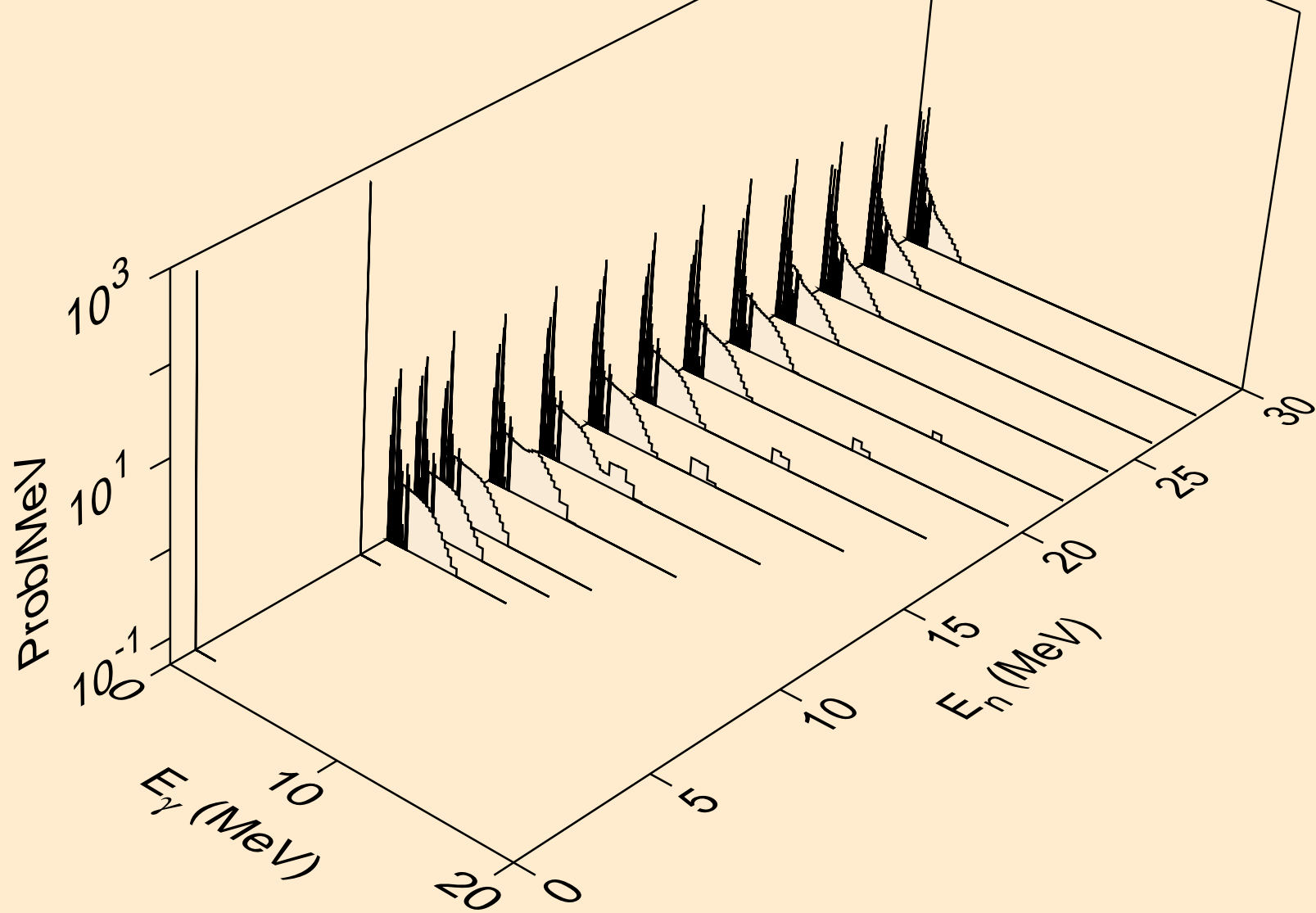

IR193M ALPHA ACER TENDL-2023 LIBRARY; T=0.K  
Photon emission for (n,p)

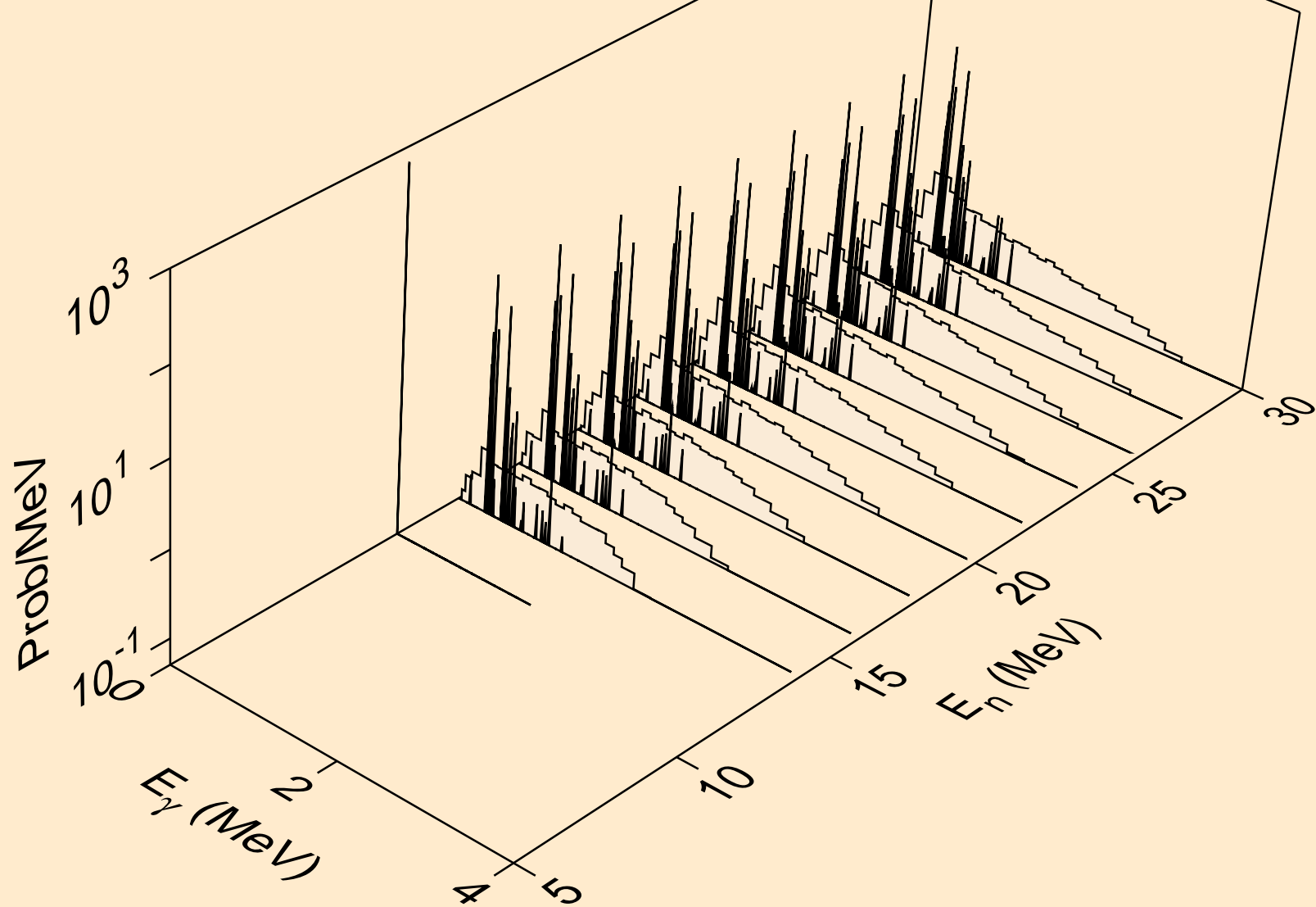

IR193M ALPHA ACER TENDL-2023 LIBRARY; T=0.K  
Photon emission for (n,d)

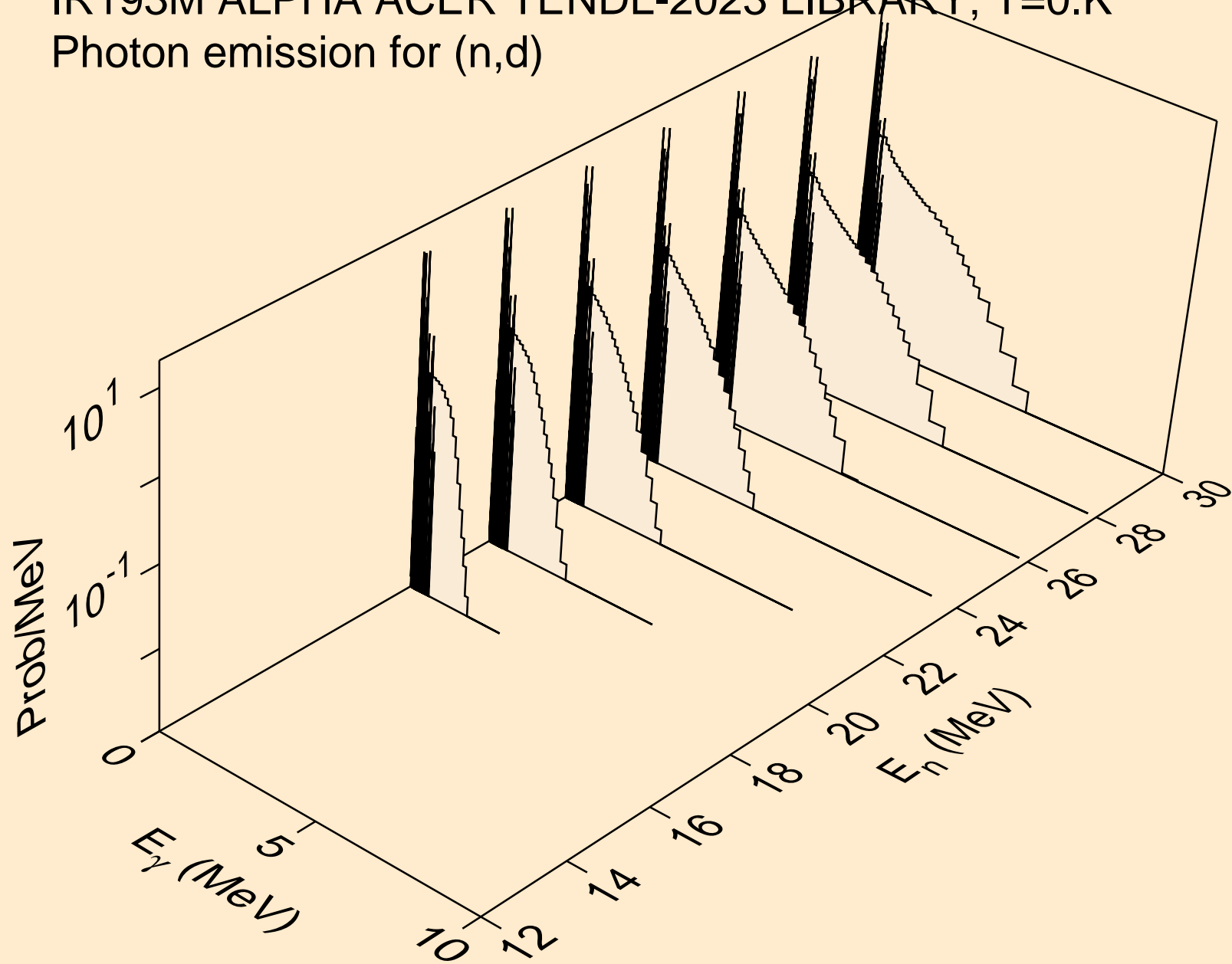

IR193M ALPHA ACER TENDL-2023 LIBRARY; T=0.K  
Photon emission for (n,t)

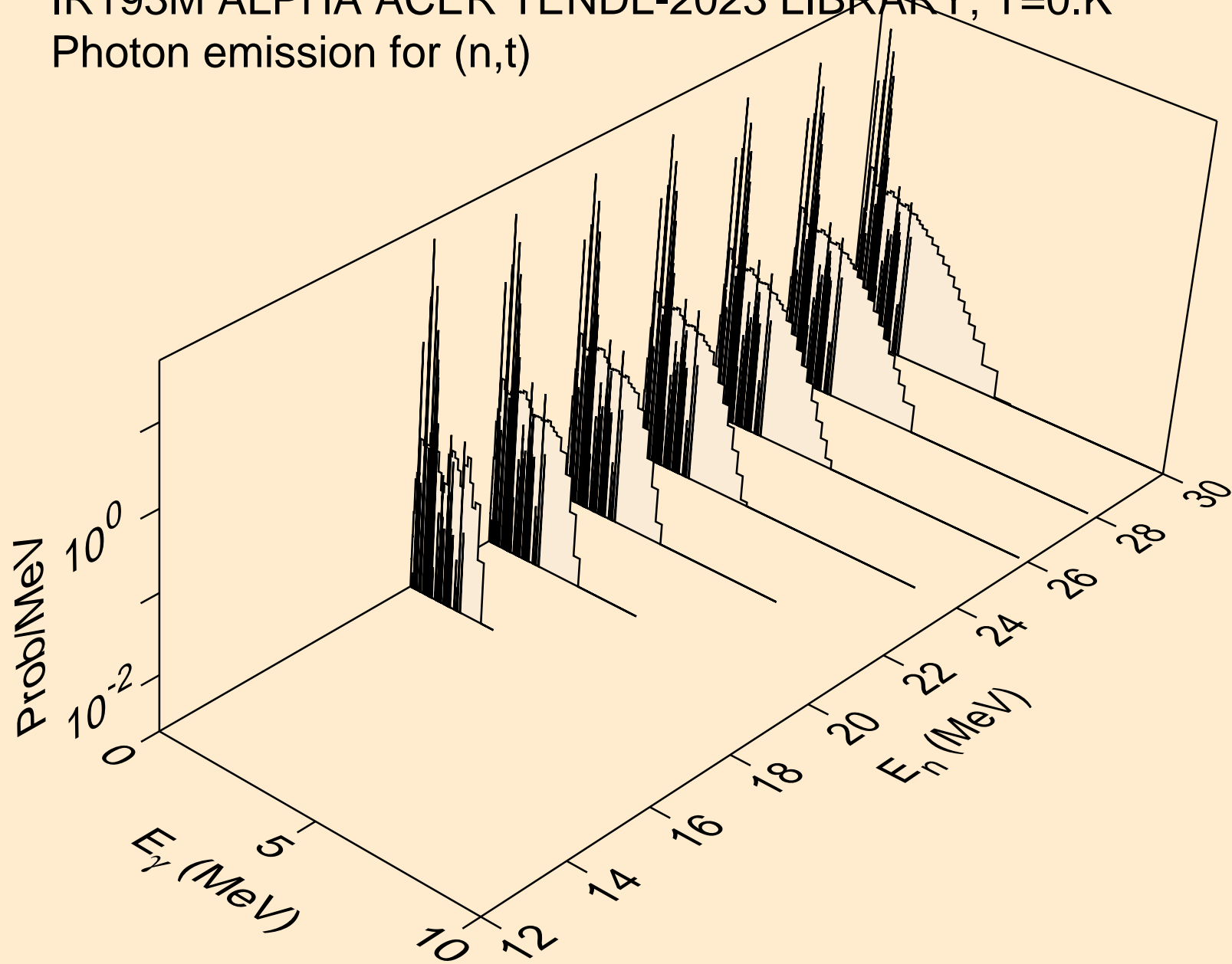

IR193M ALPHA ACER TENDL-2023 LIBRARY; T=0.K  
Photon emission for (n,he3)

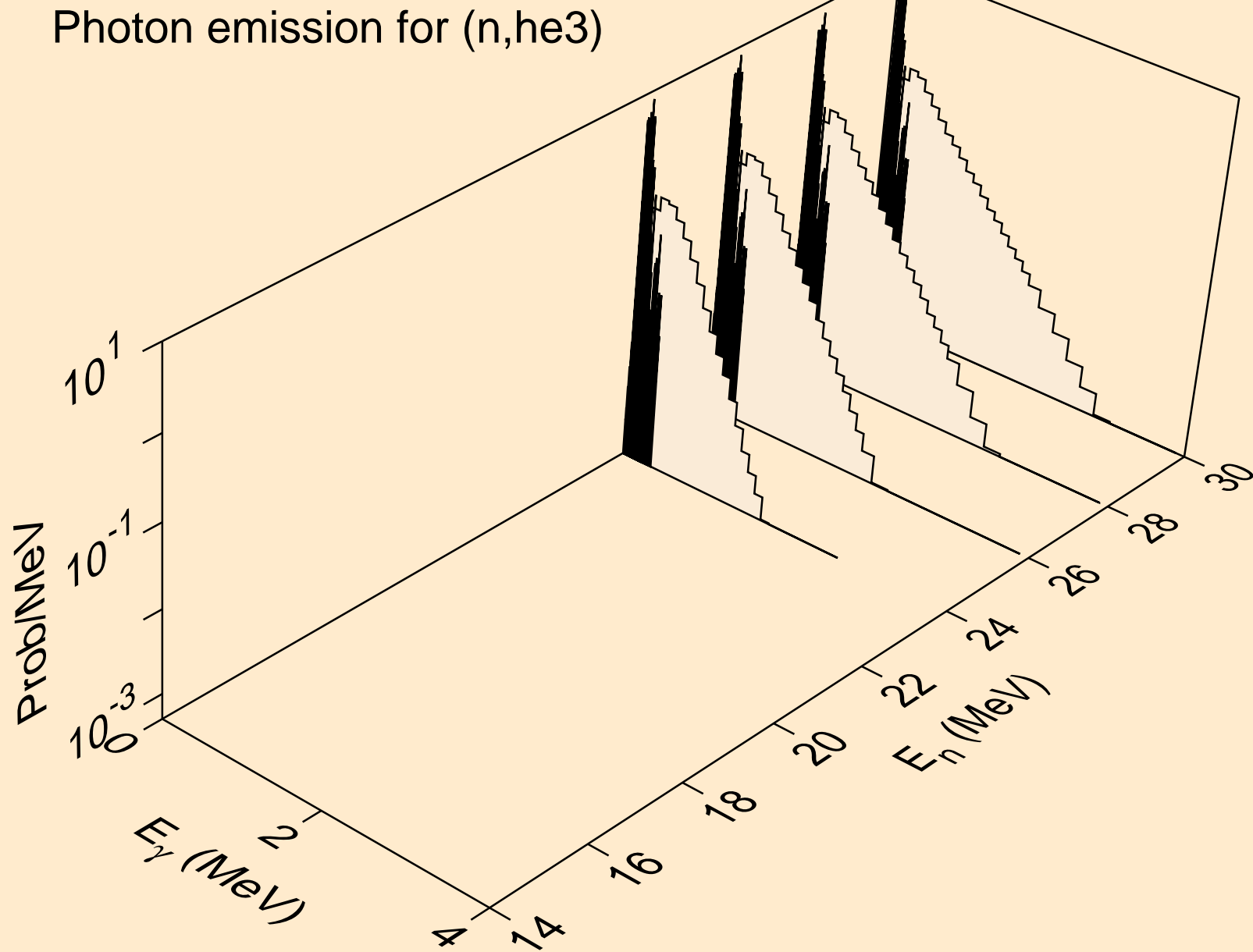

IR193M ALPHA ACER TENDL-2023 LIBRARY; T=0.K  
Photon emission for inelastic

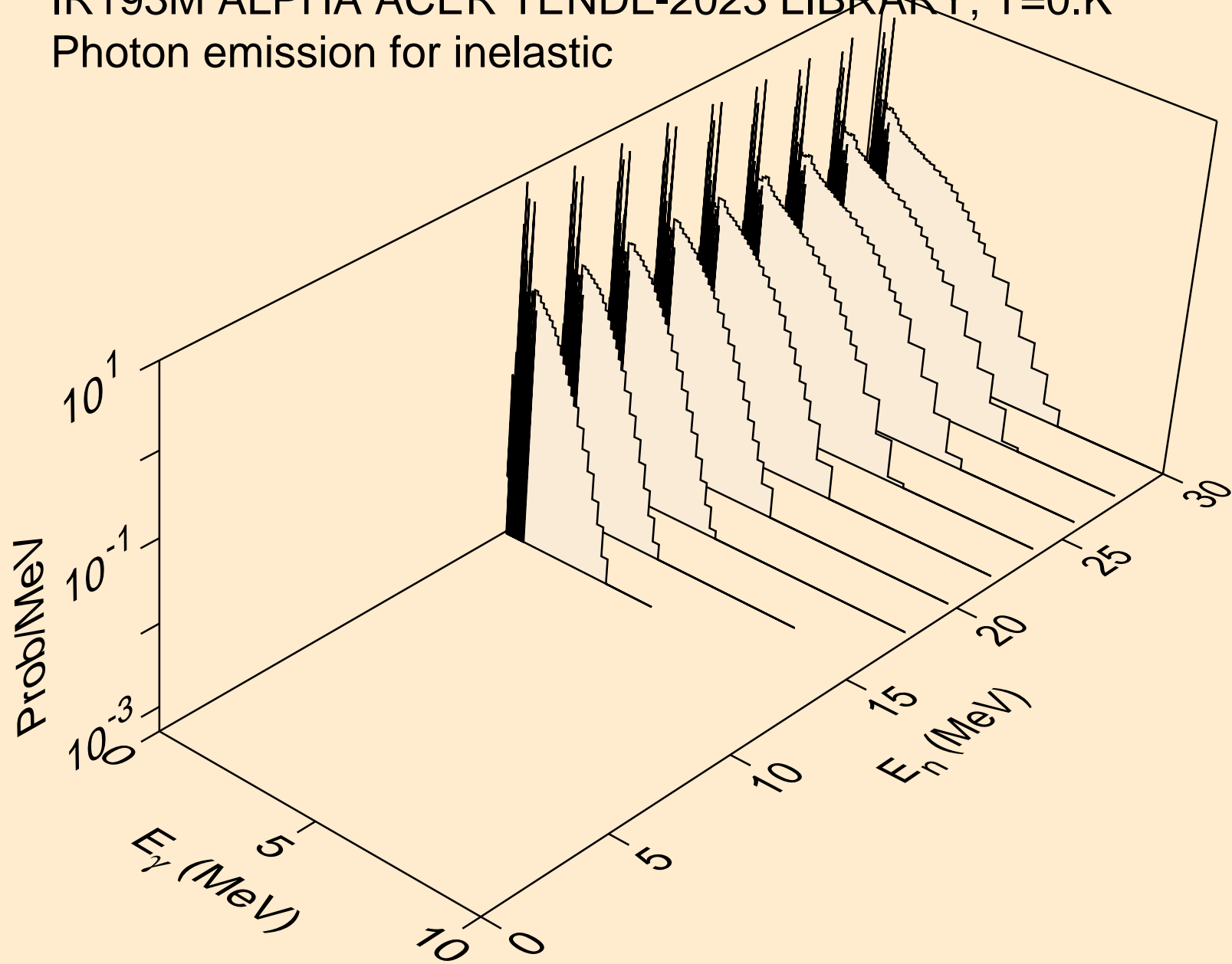

IR193M ALPHA ACER TENDL-2023 LIBRARY; T=0.K  
Particle heating contributions

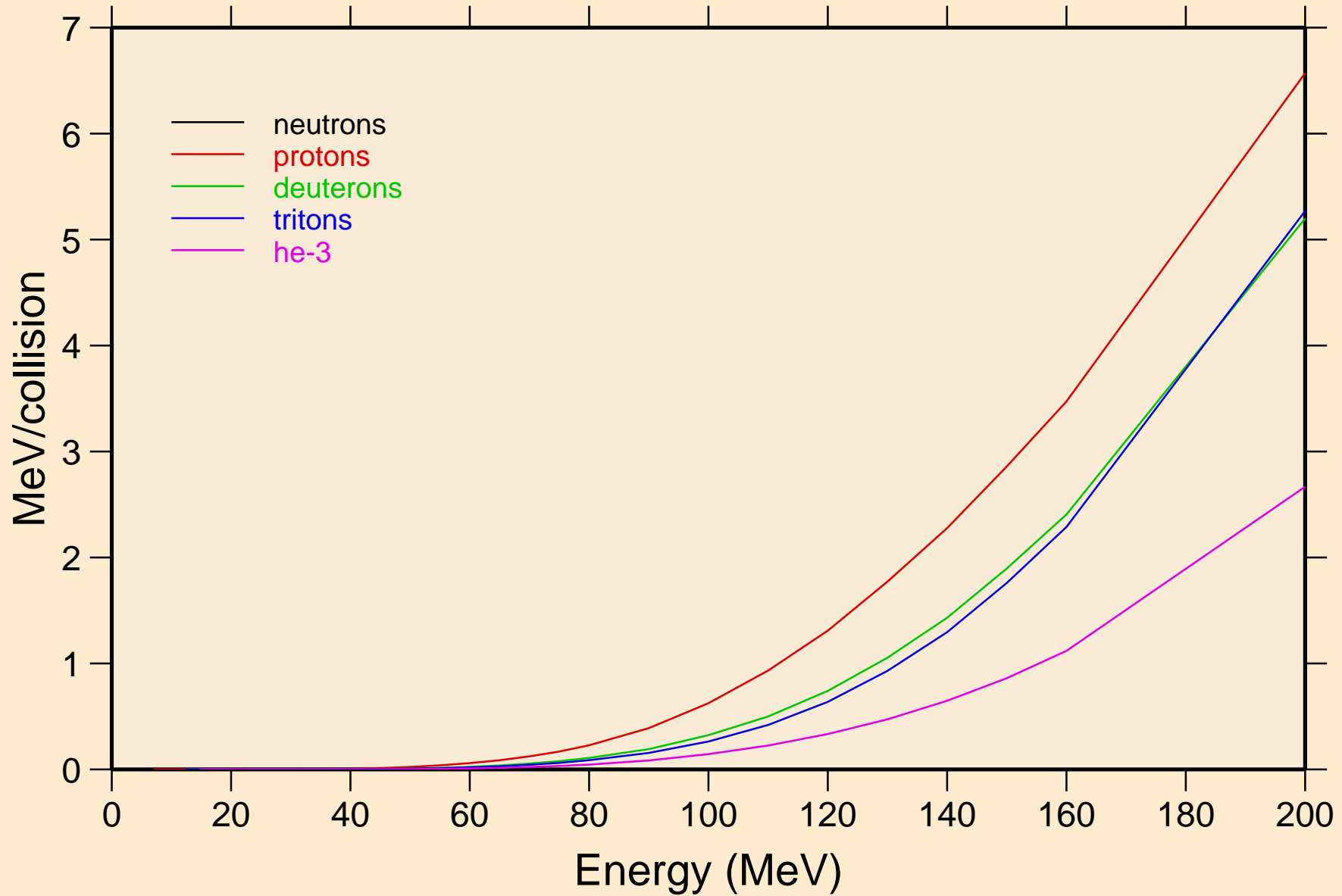

IR193M ALPHA ACER TENDL-2023 LIBRARY; T=0.K  
Recoil Heating

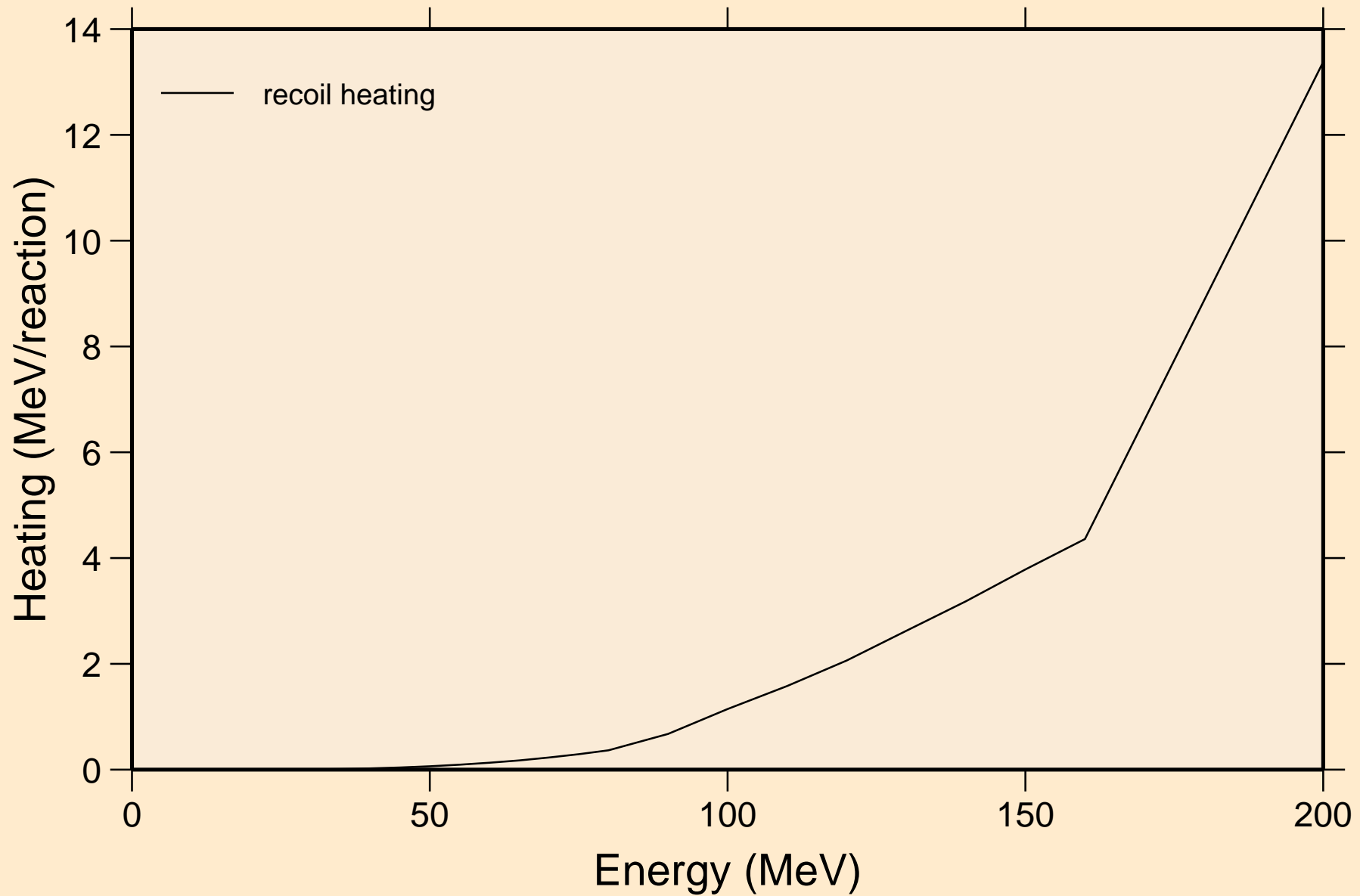

IR193M ALPHA ACER TENDL-2023 LIBRARY; T=0.K  
Particle production cross sections

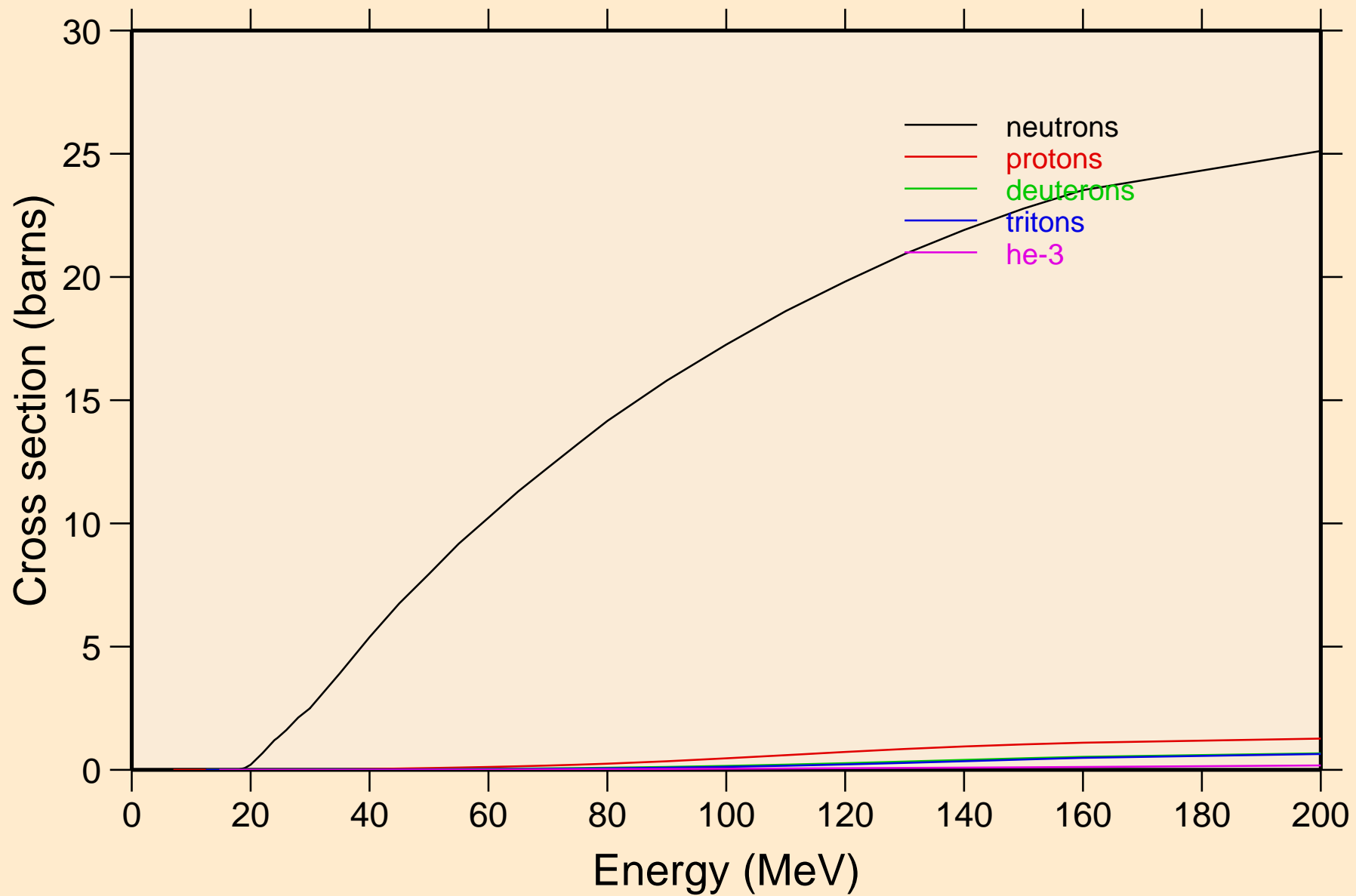

IR193M ALPHA ACER TENDL-2023 LIBRARY; T=0.K  
neutrons from (a,n)

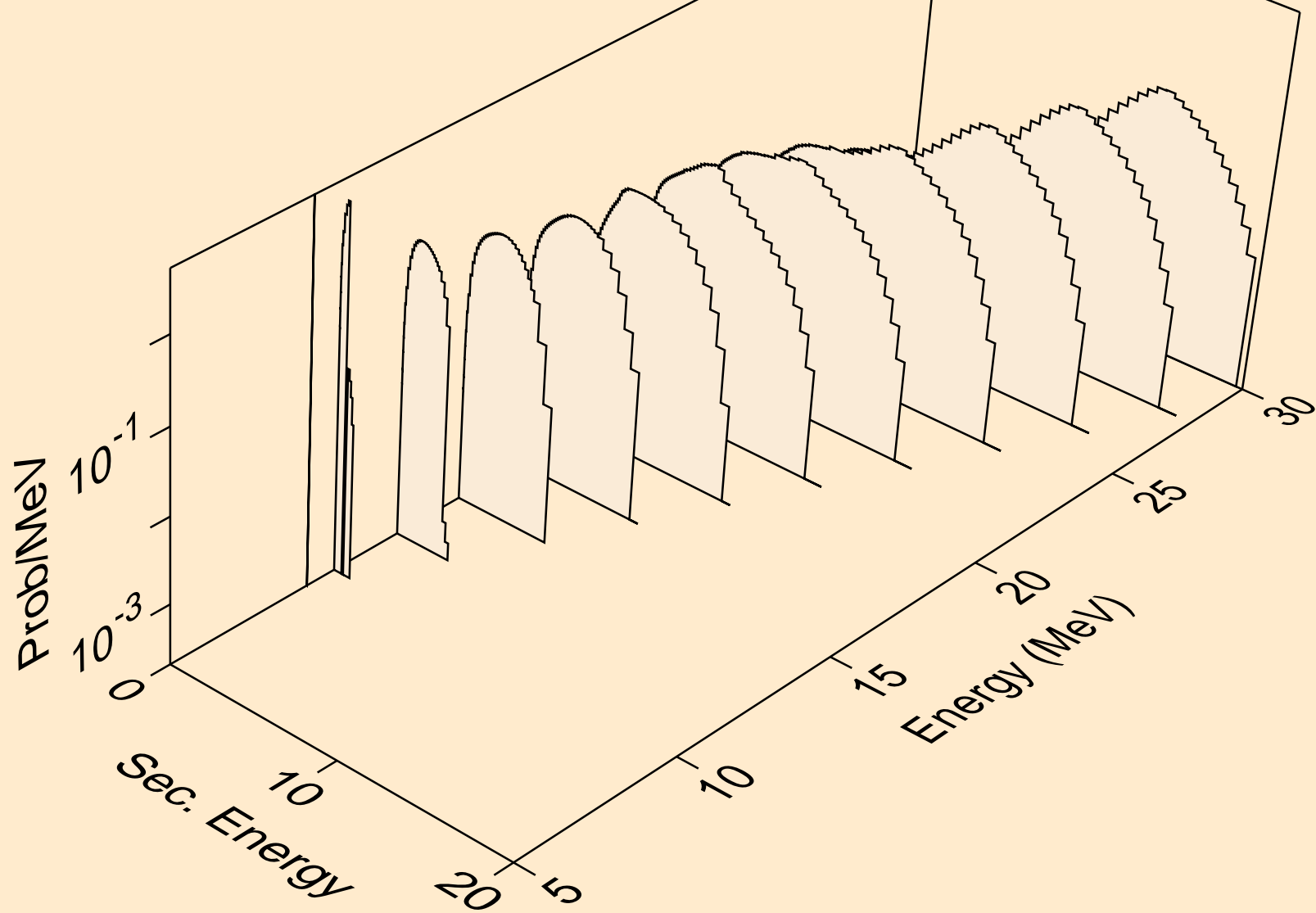

IR193M ALPHA ACER TENDL-2023 LIBRARY; T=0.K  
neutrons from (a,x)

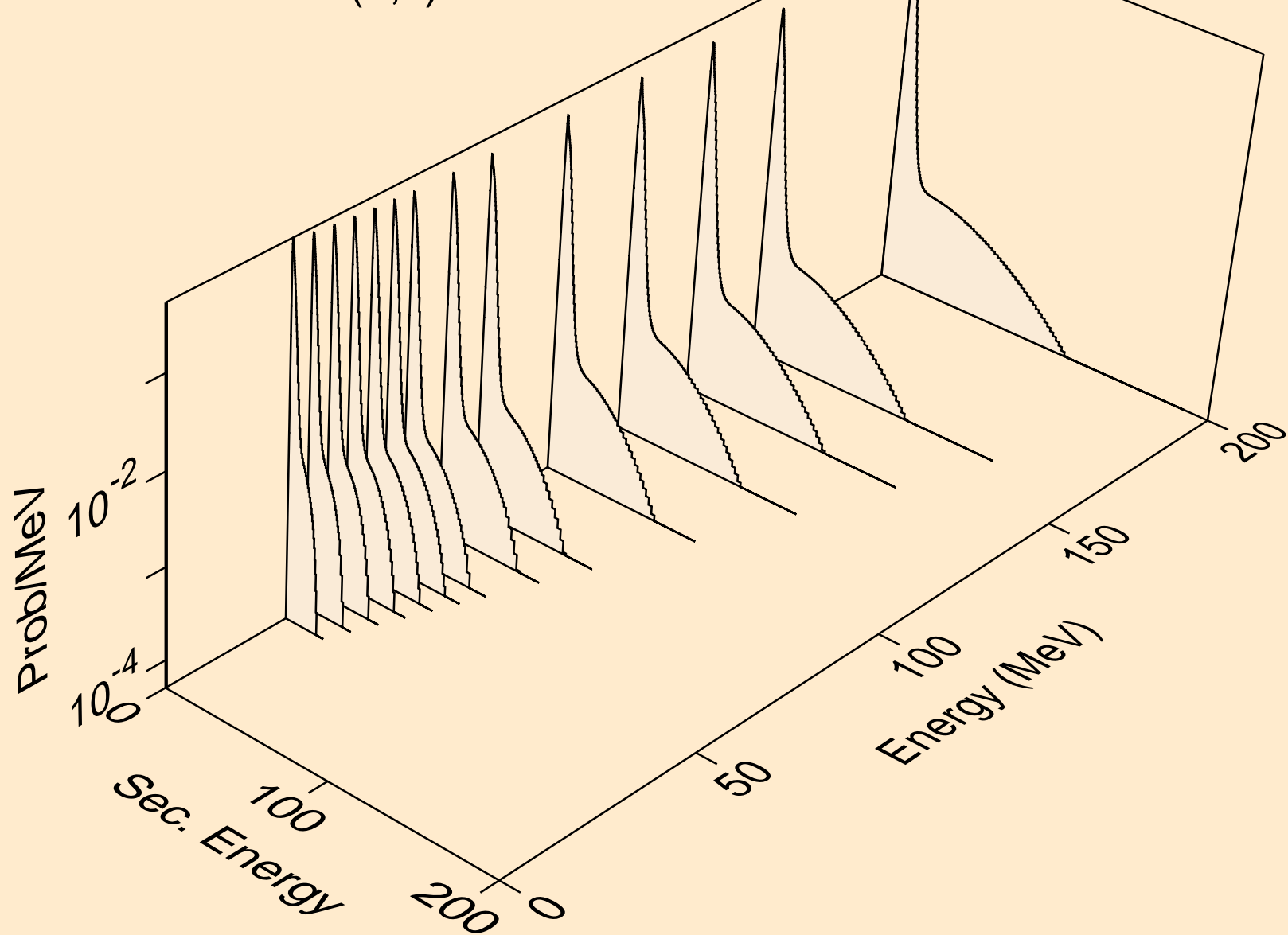

IR193M ALPHA ACER TENDL-2023 LIBRARY; T=0.K  
neutrons from (a,2n)

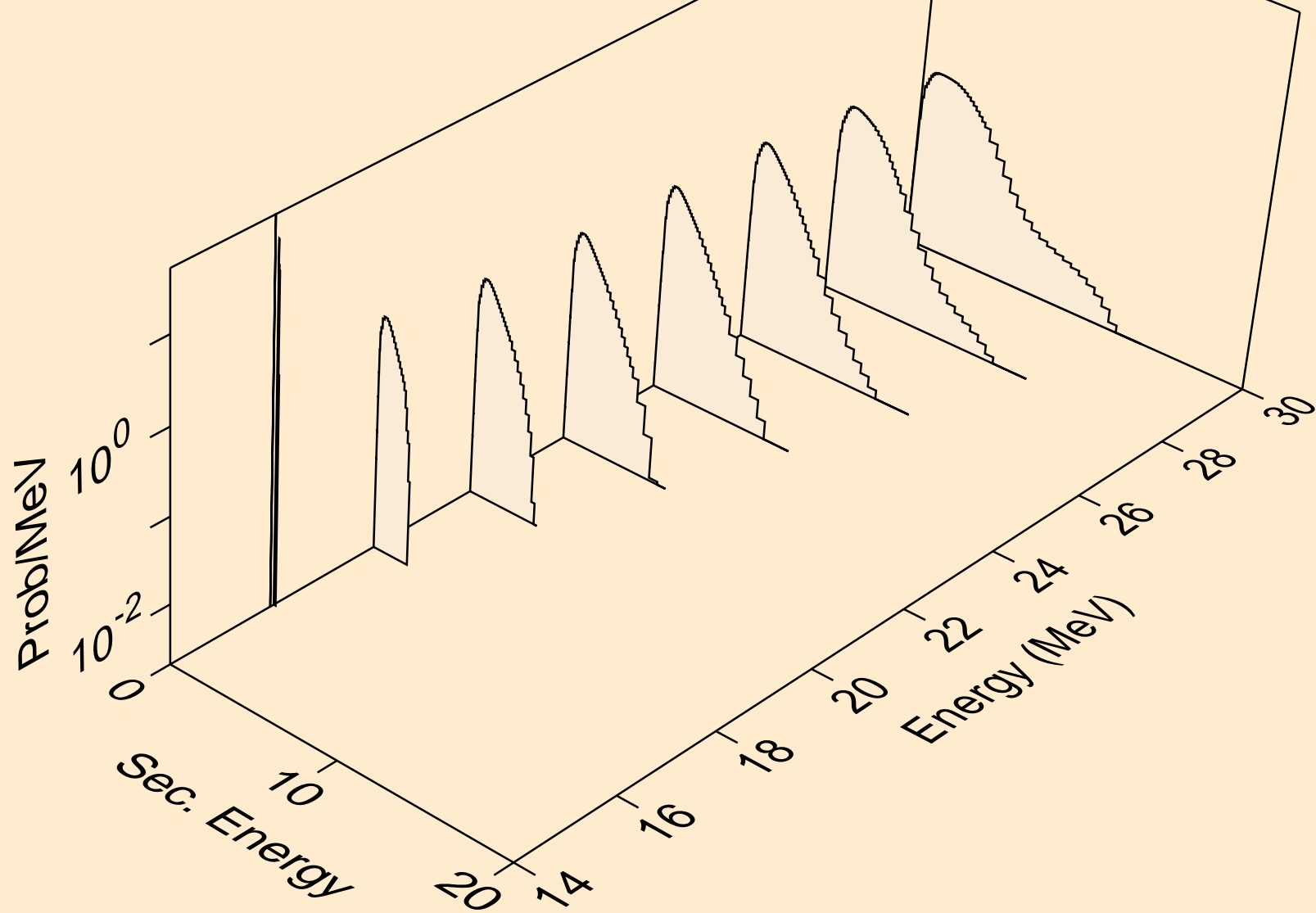

IR193M ALPHA ACER TENDL-2023 LIBRARY; T=0.K  
neutrons from (a,3n)

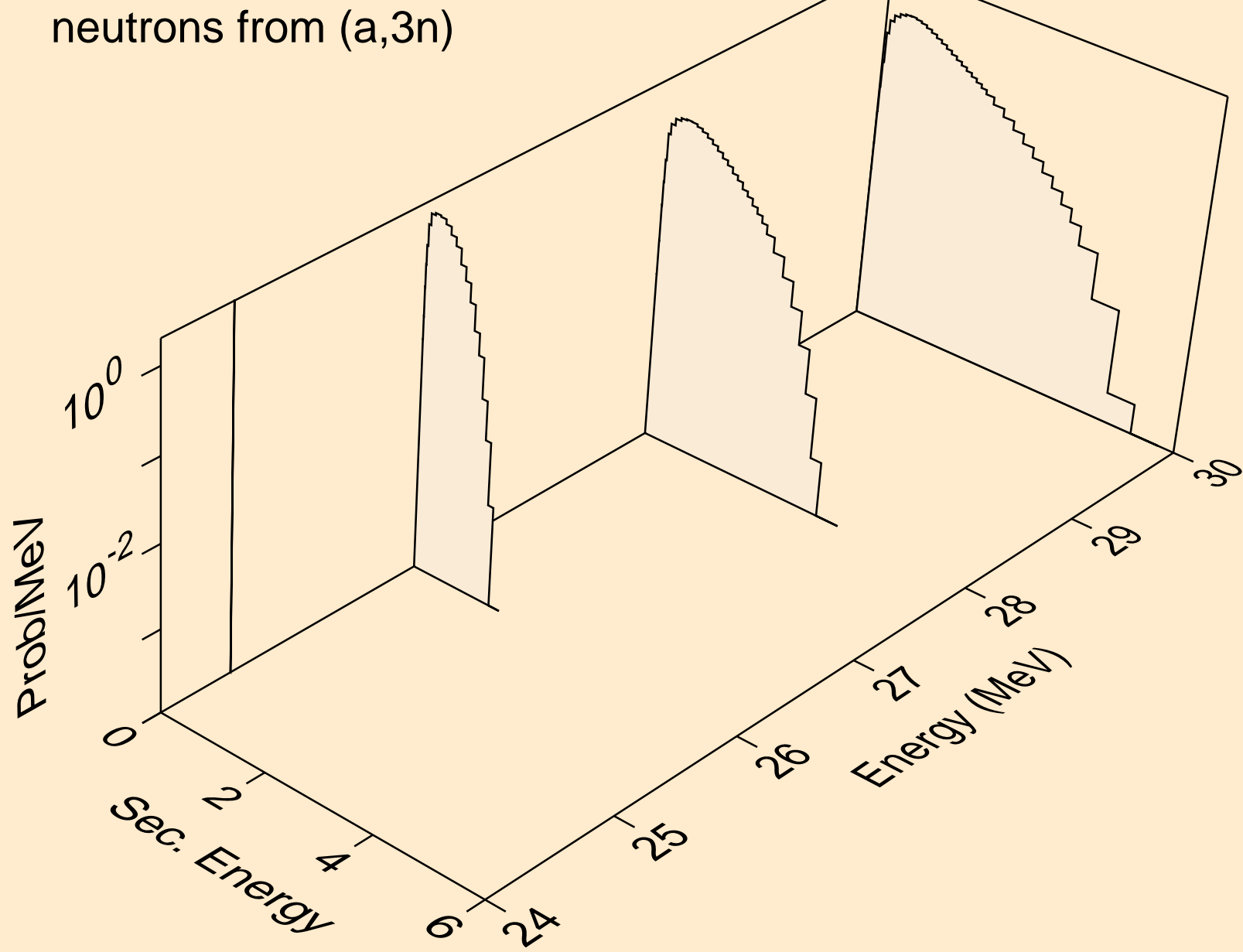

IR193M ALPHA ACER TENDL-2023 LIBRARY; T=0.K  
neutrons from (a,n\*)a

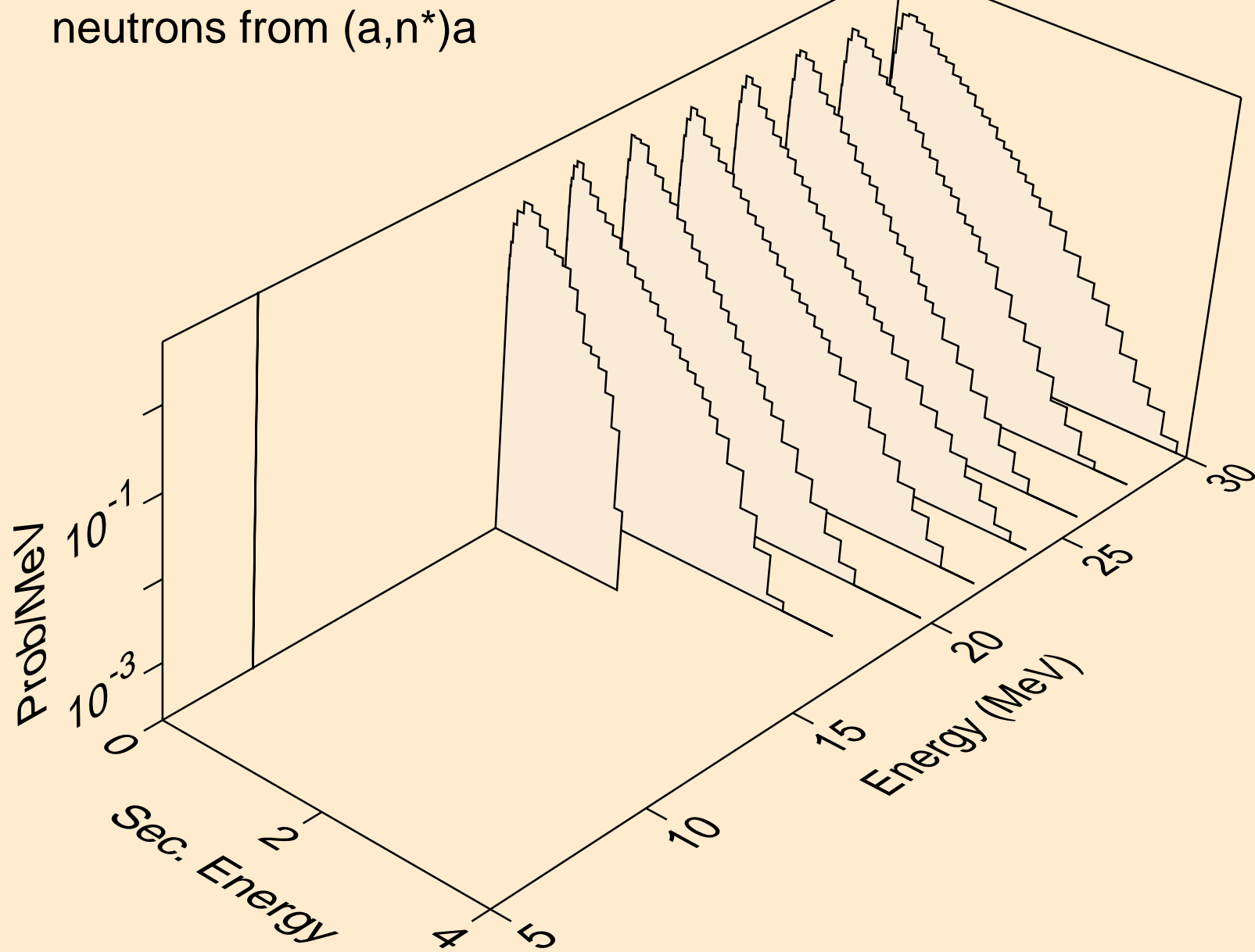

IR193M ALPHA ACER TENDL-2023 LIBRARY; T=0.K  
neutrons from (a,2n)a

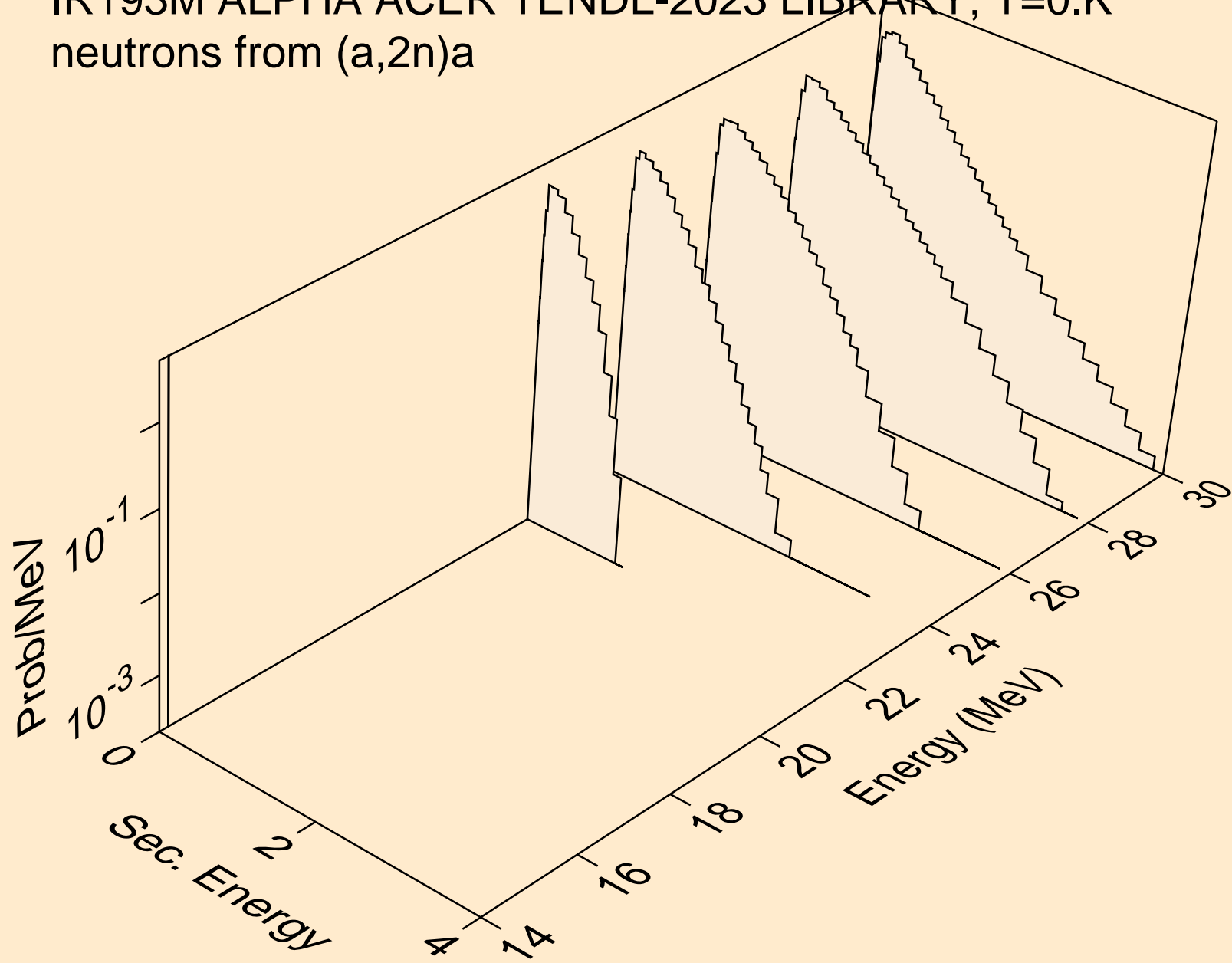

IR193M ALPHA ACER TENDL-2023 LIBRARY; T=0.K  
neutrons from (a,n\*)p

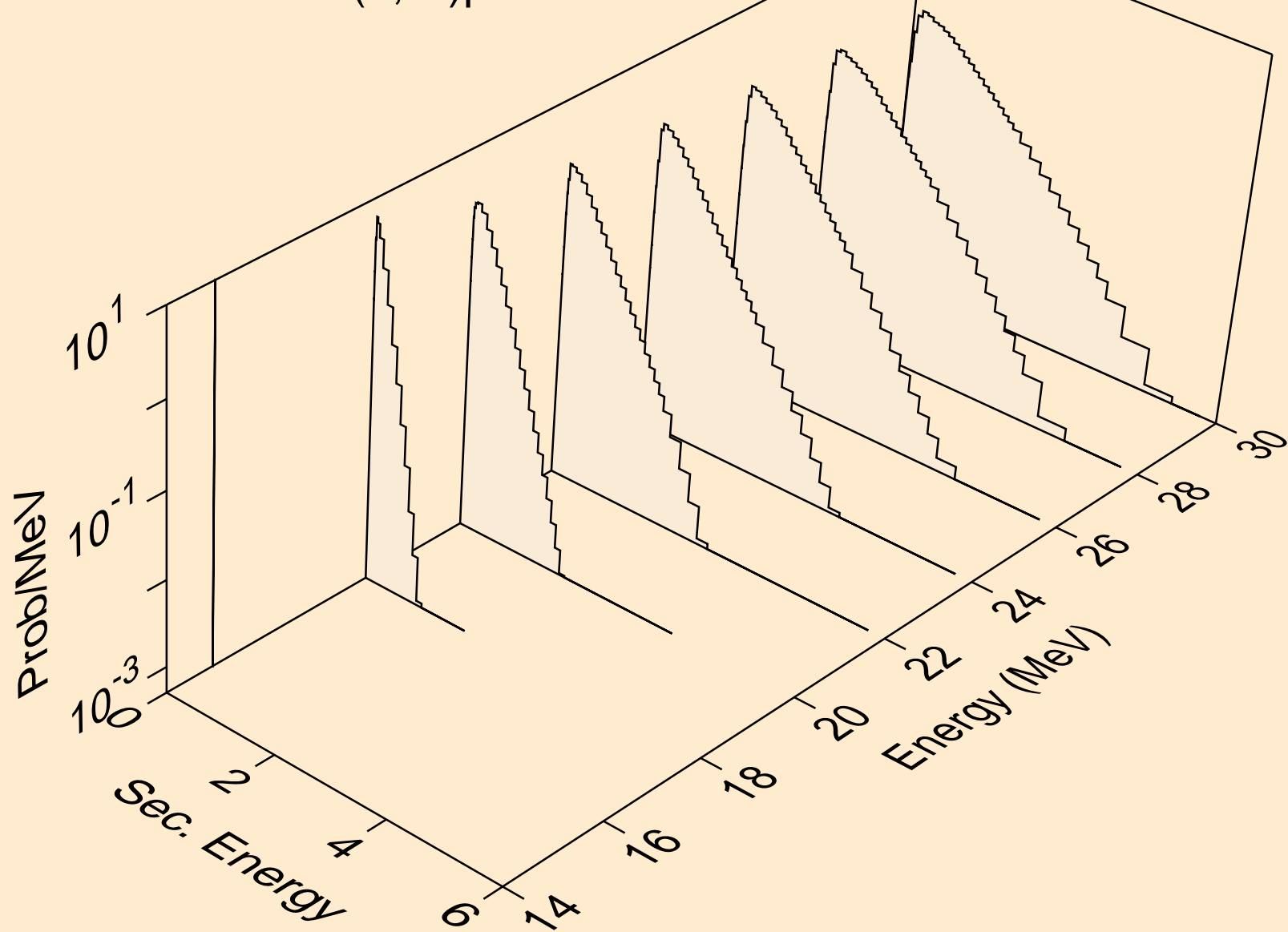

IR193M ALPHA ACER TENDL-2023 LIBRARY; T=0.K  
neutrons from (a,n\*)d

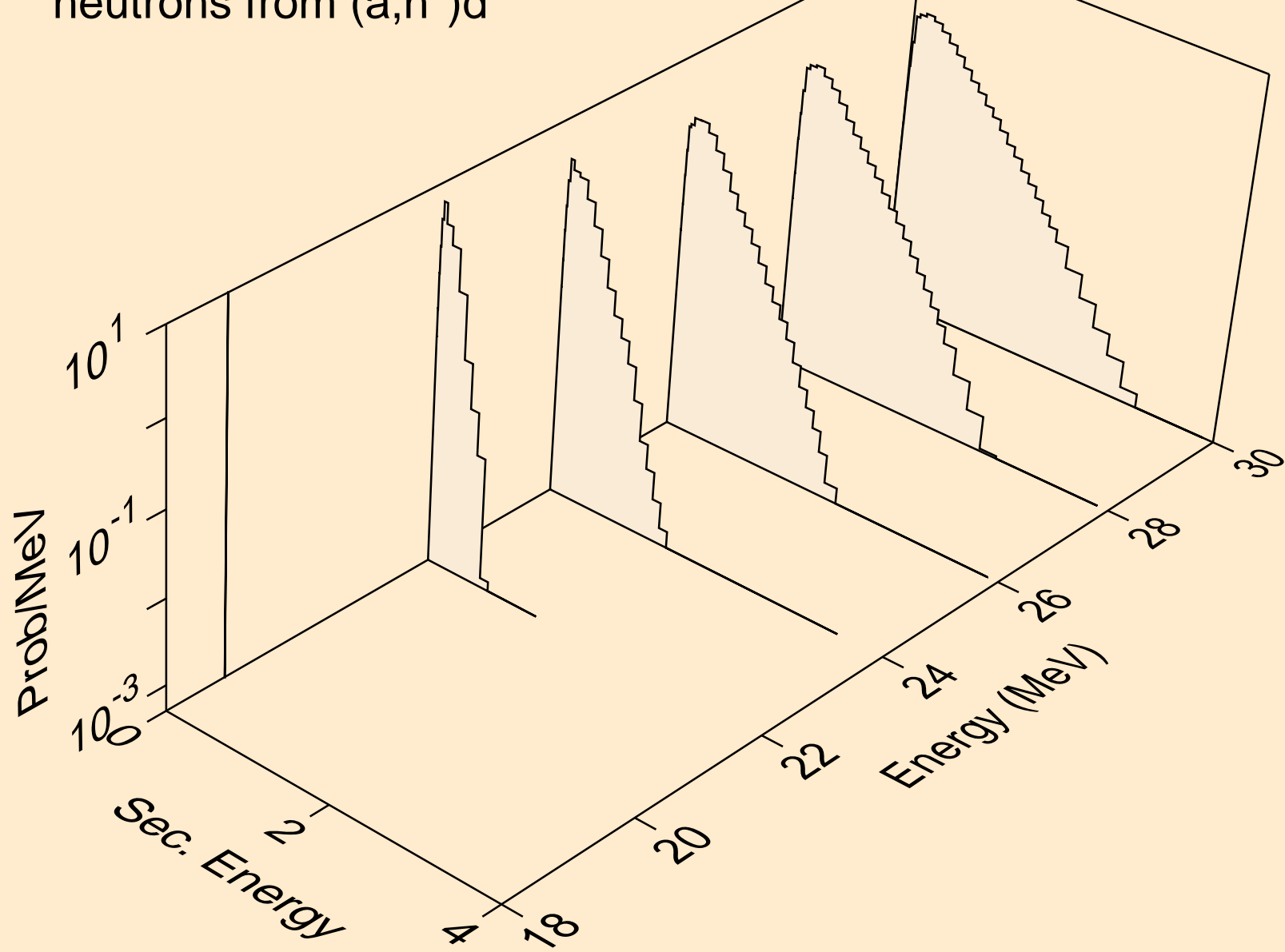

IR193M ALPHA ACER TENDL-2023 LIBRARY; T=0.K  
neutrons from (a,n\*)t

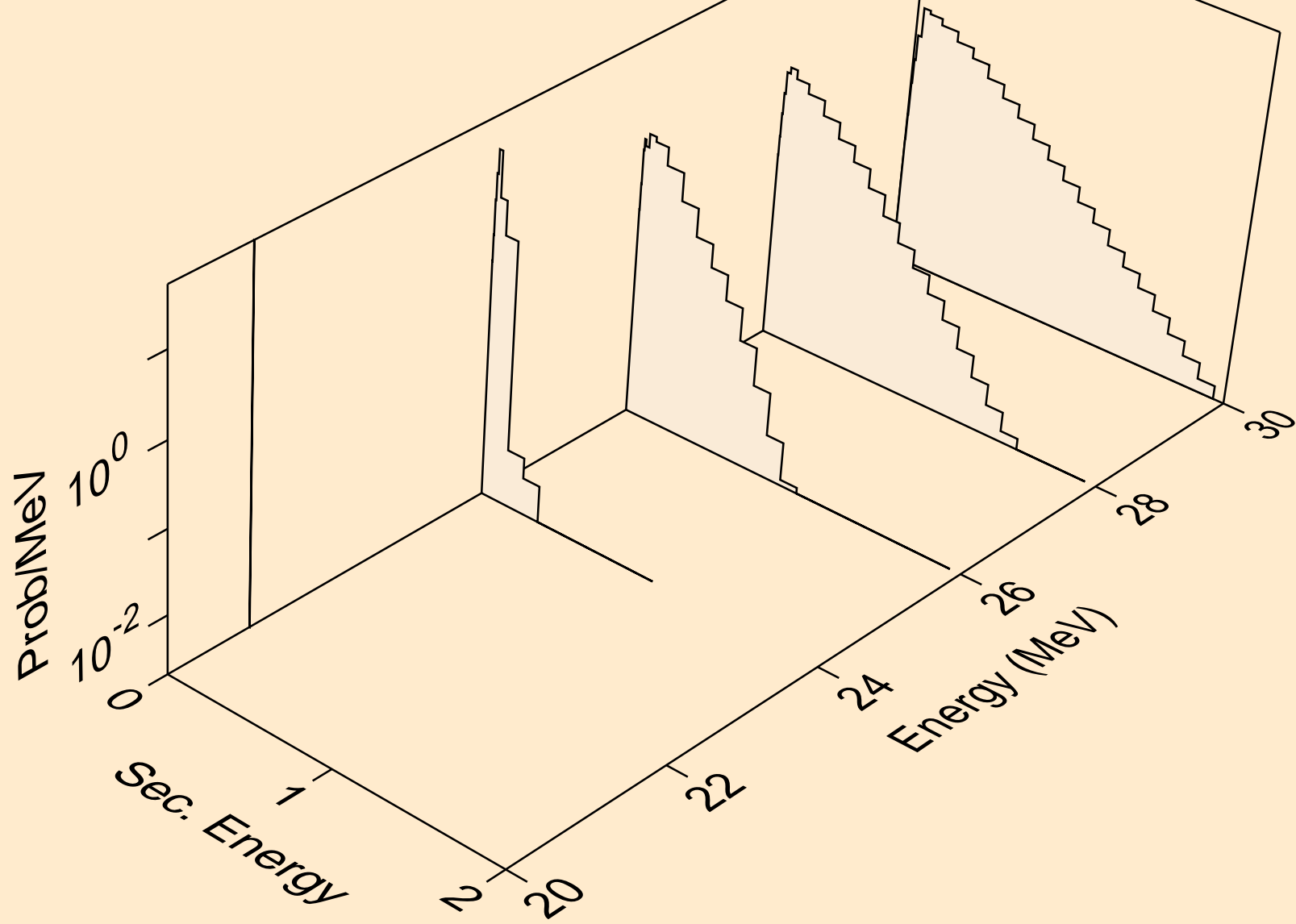

IR193M ALPHA ACER TENDL-2023 LIBRARY; T=0.K  
neutrons from (a,2np)

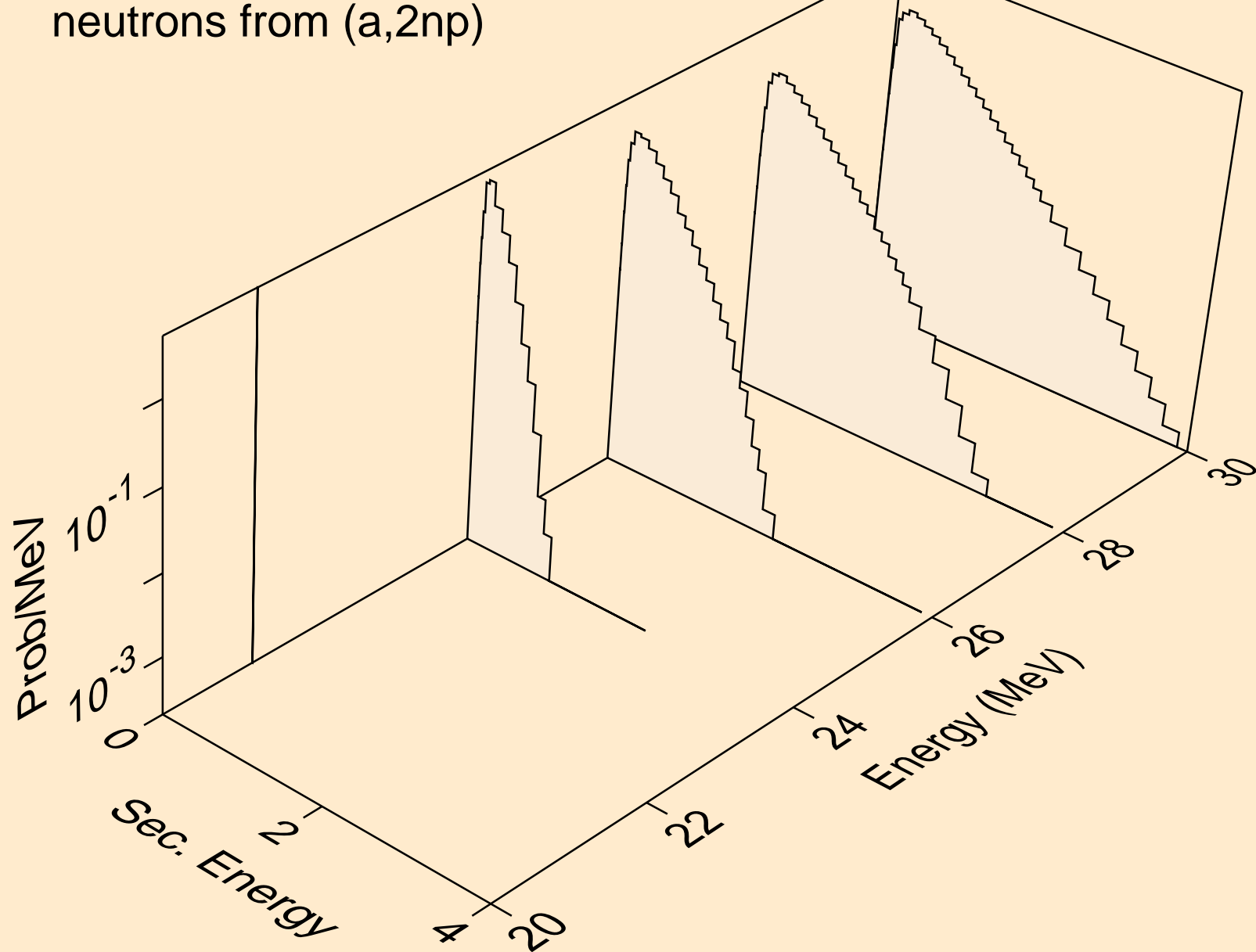

IR193M ALPHA ACER TENDL-2023 LIBRARY; T=0.K  
protons from (a,x)

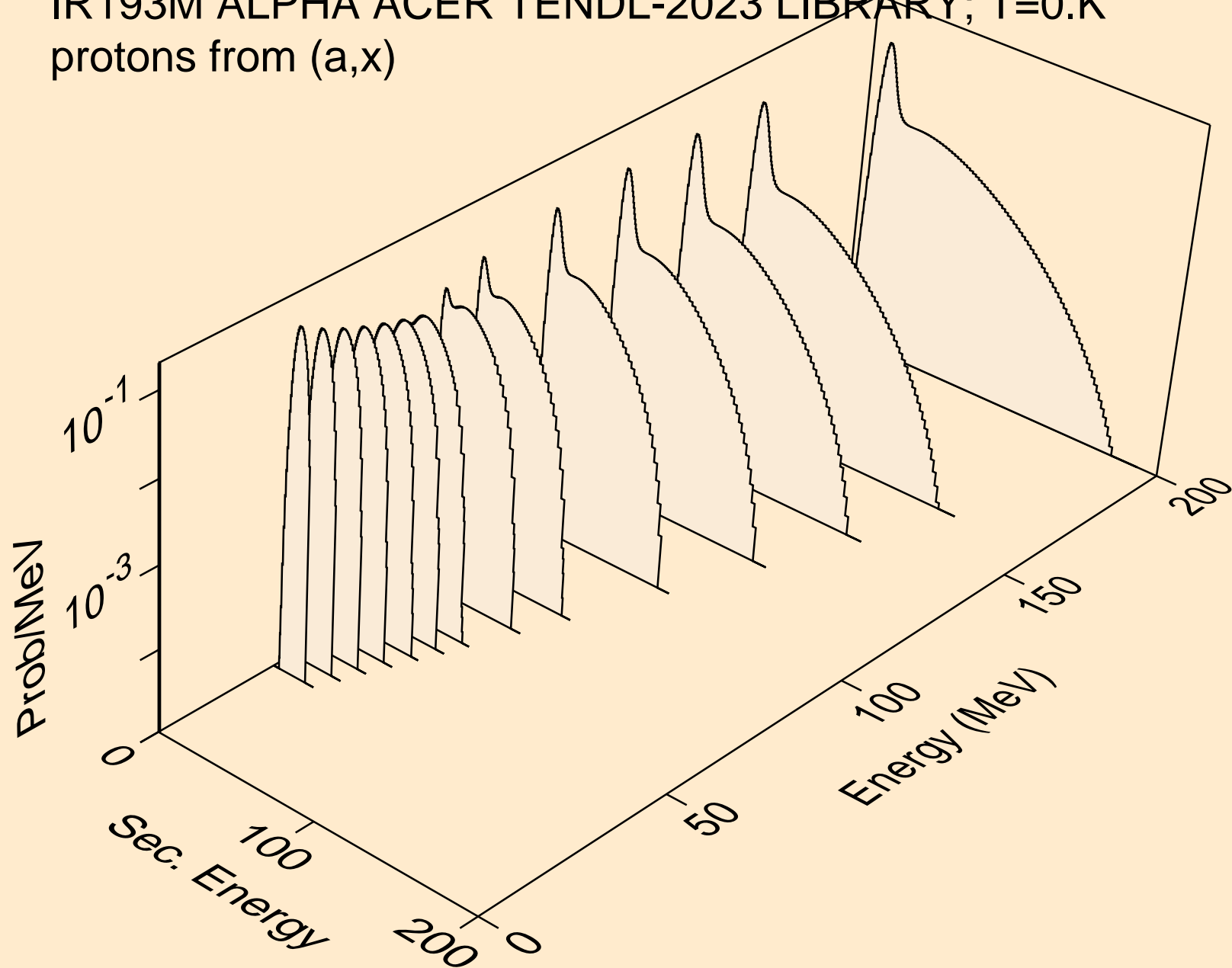

IR193M ALPHA ACER TENDL-2023 LIBRARY; T=0.K  
protons from (a,n\*)p

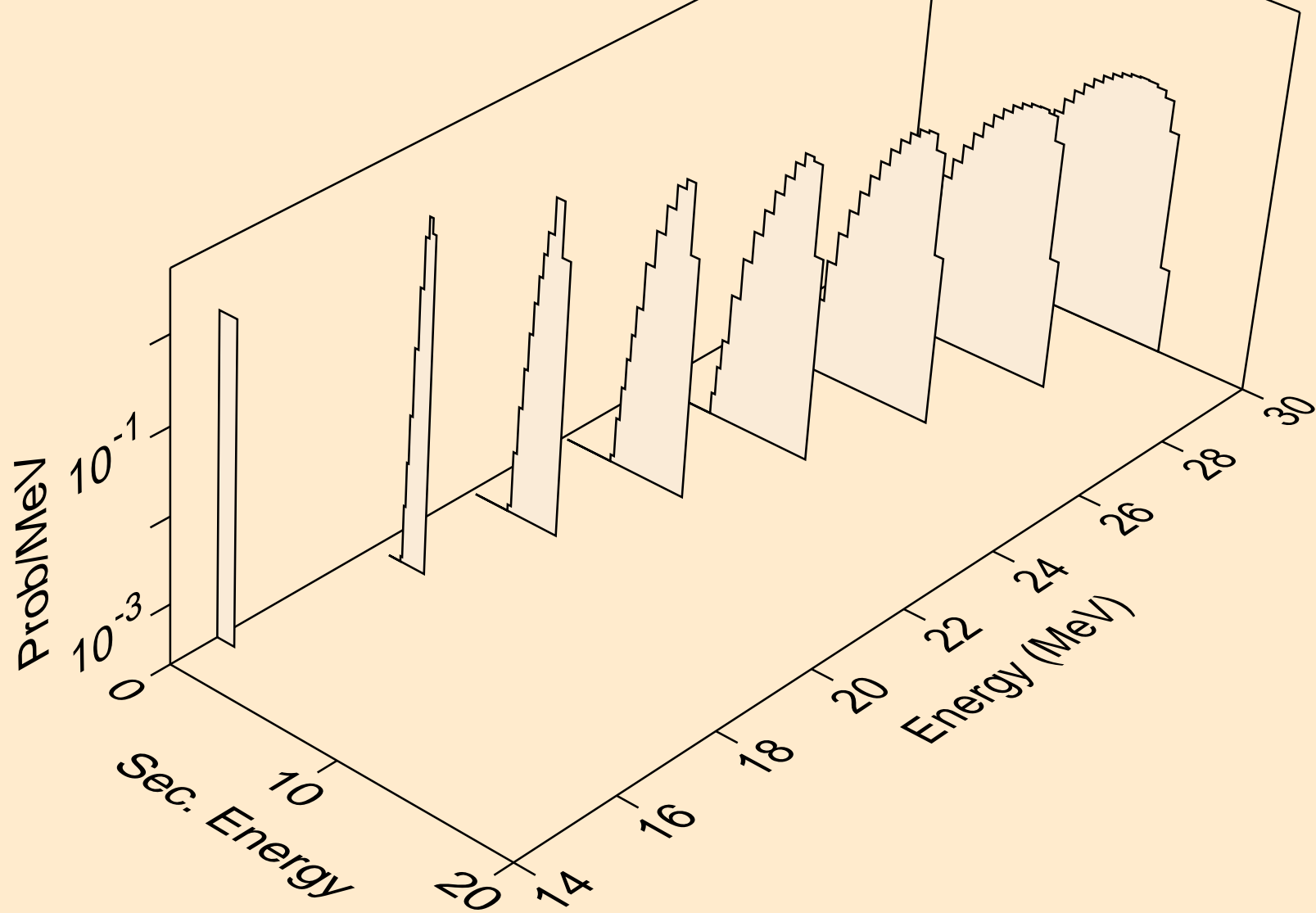

IR193M ALPHA ACER TENDL-2023 LIBRARY; T=0.K  
protons from (a,2np)

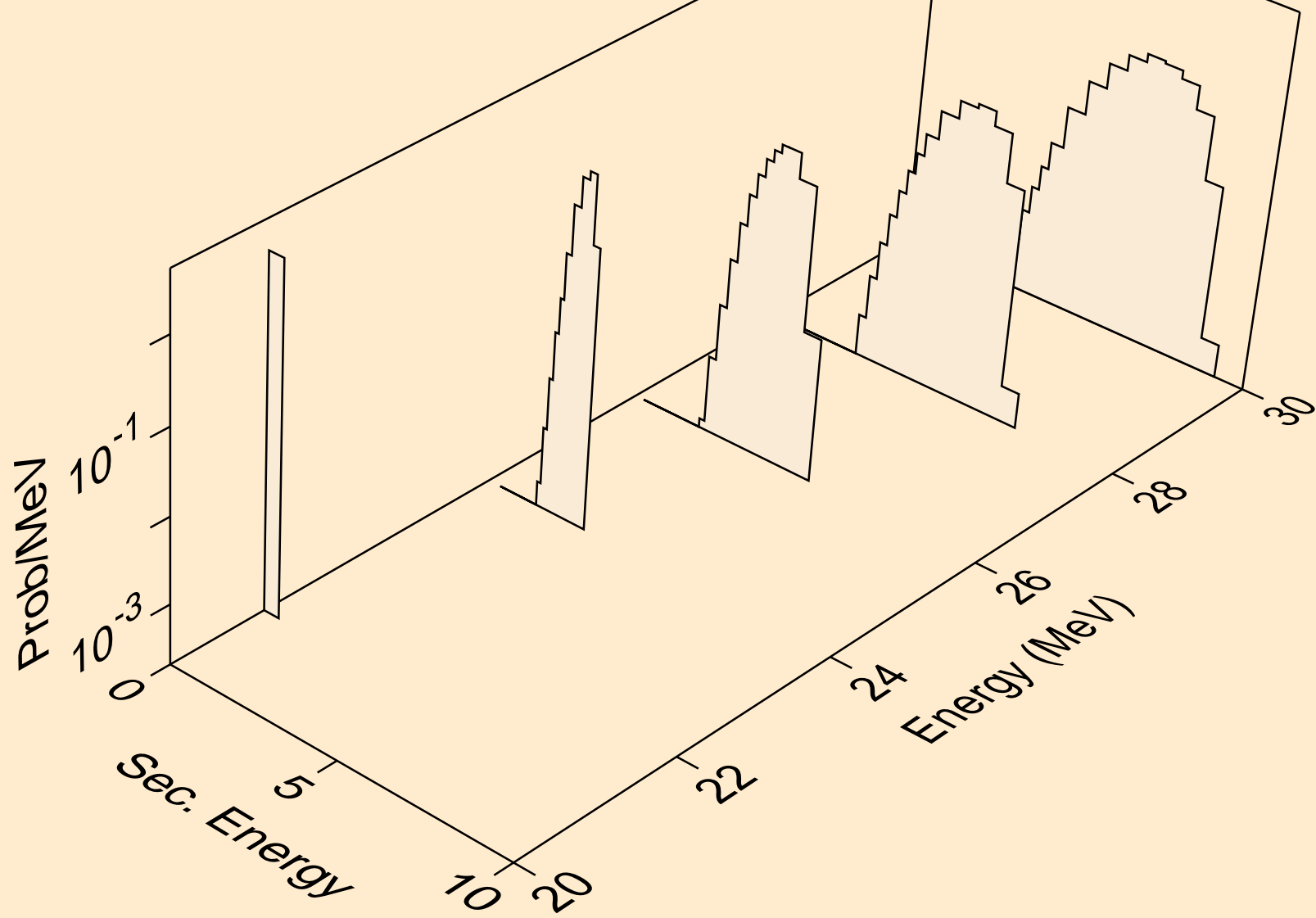

IR193M ALPHA ACER TENDL-2023 LIBRARY; T=0.K  
protons from (a,p)

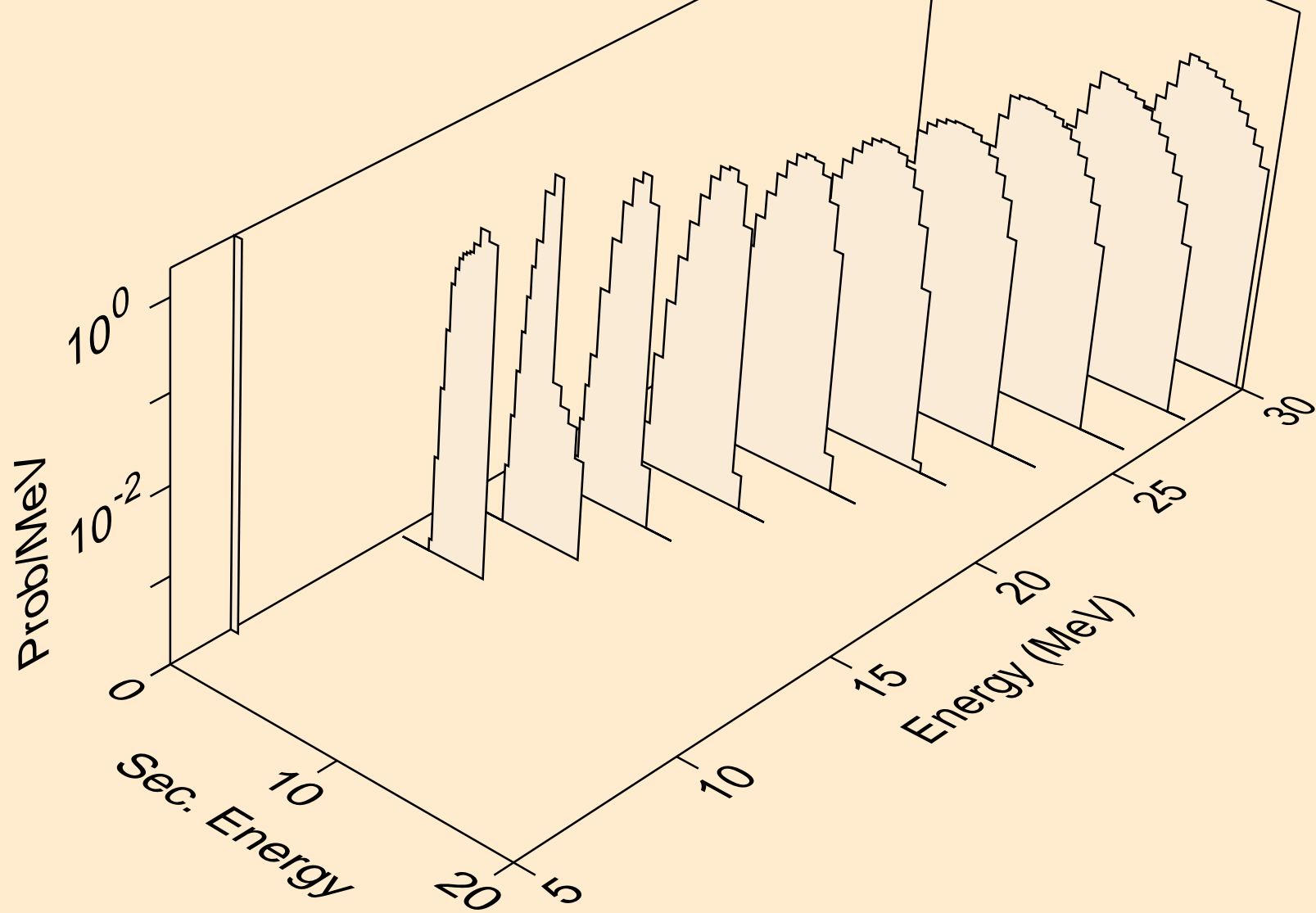

IR193M ALPHA ACER TENDL-2023 LIBRARY; T=0.K  
deuterons from (a,x)

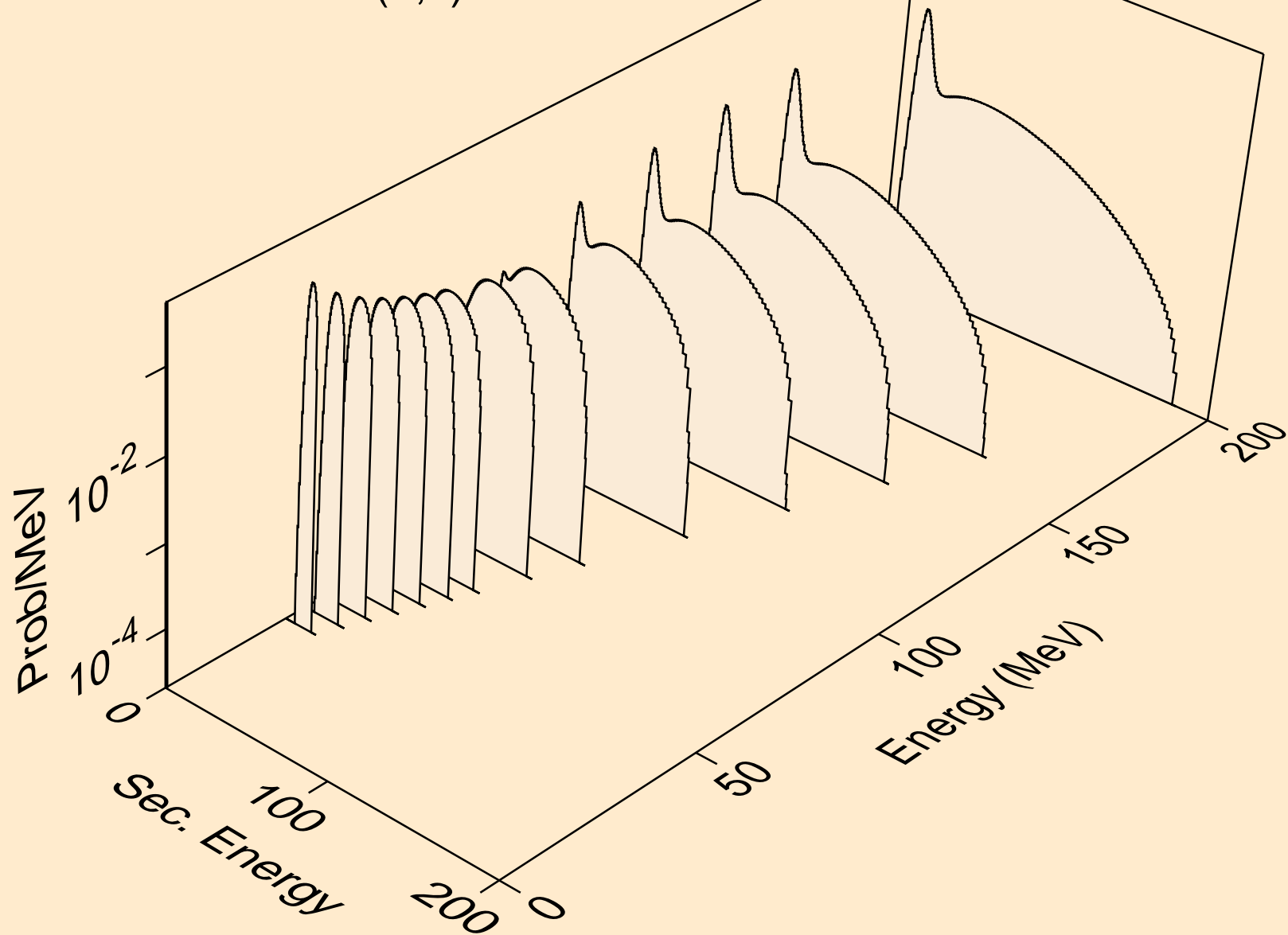

IR193M ALPHA ACER TENDL-2023 LIBRARY; T=0.K  
deuterons from (a,n\*)d

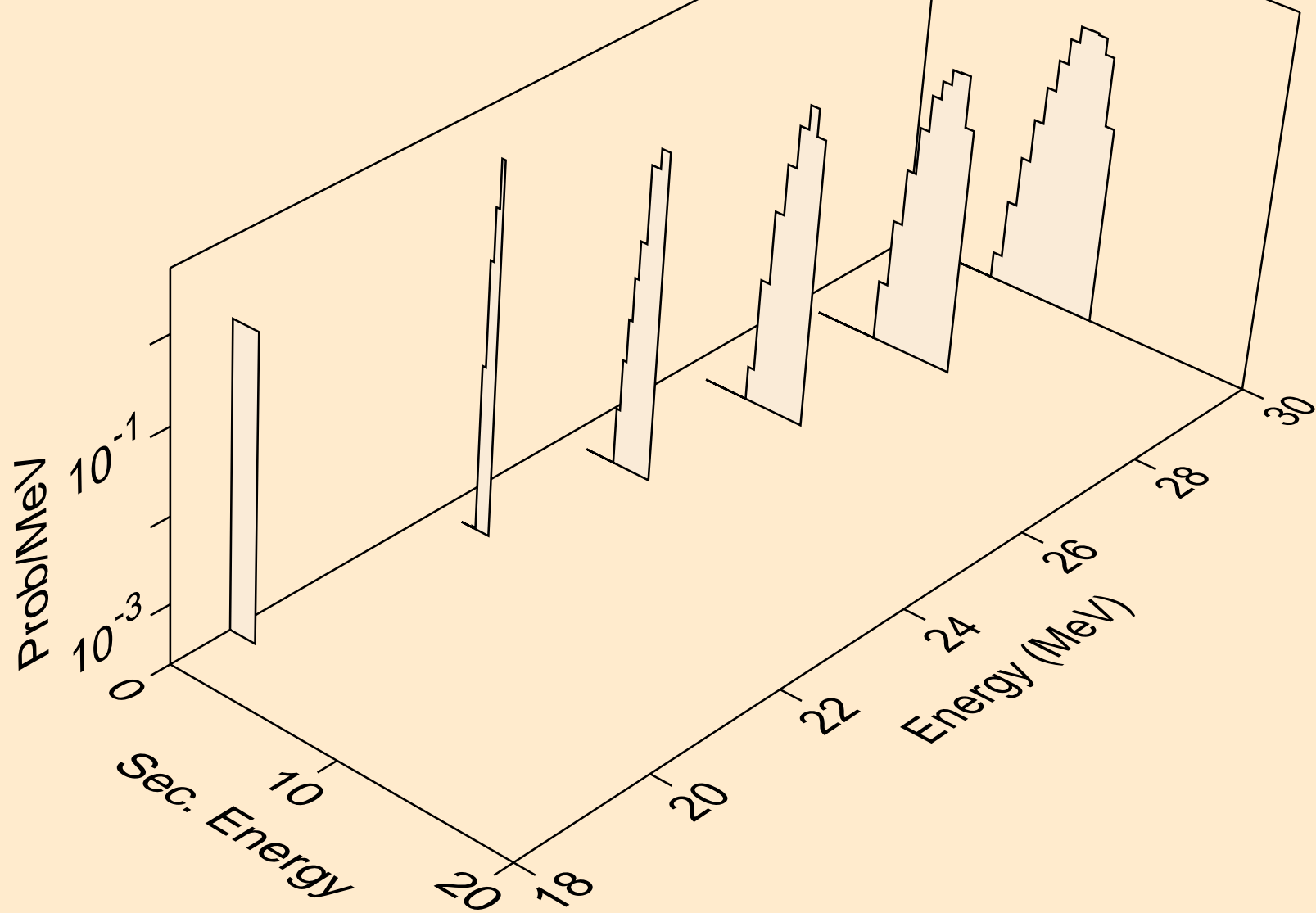

IR193M ALPHA ACER TENDL-2023 LIBRARY; T=0.K  
deuterons from (a,d)

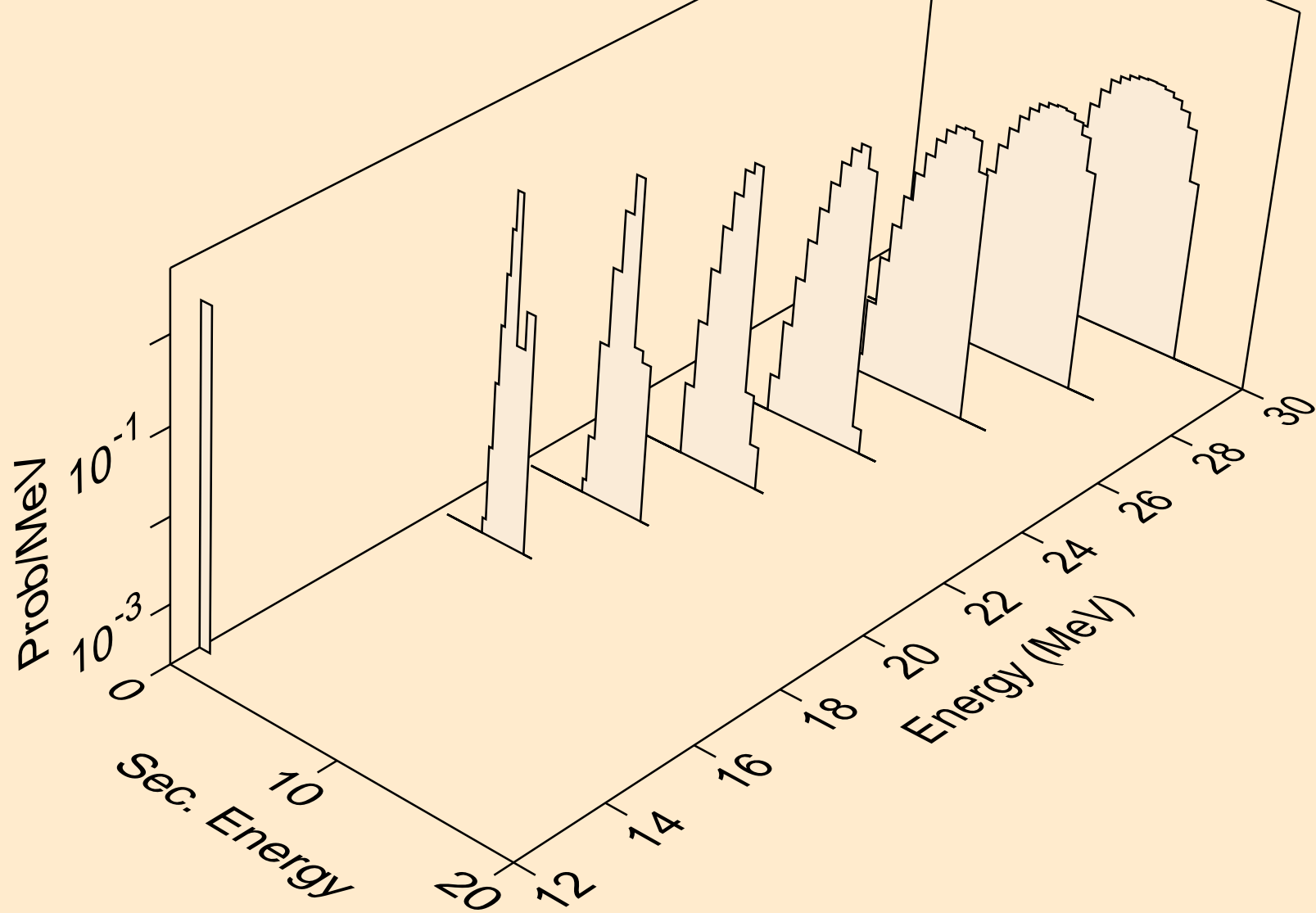

IR193M ALPHA ACER TENDL-2023 LIBRARY; T=0.K  
tritons from (a,x)

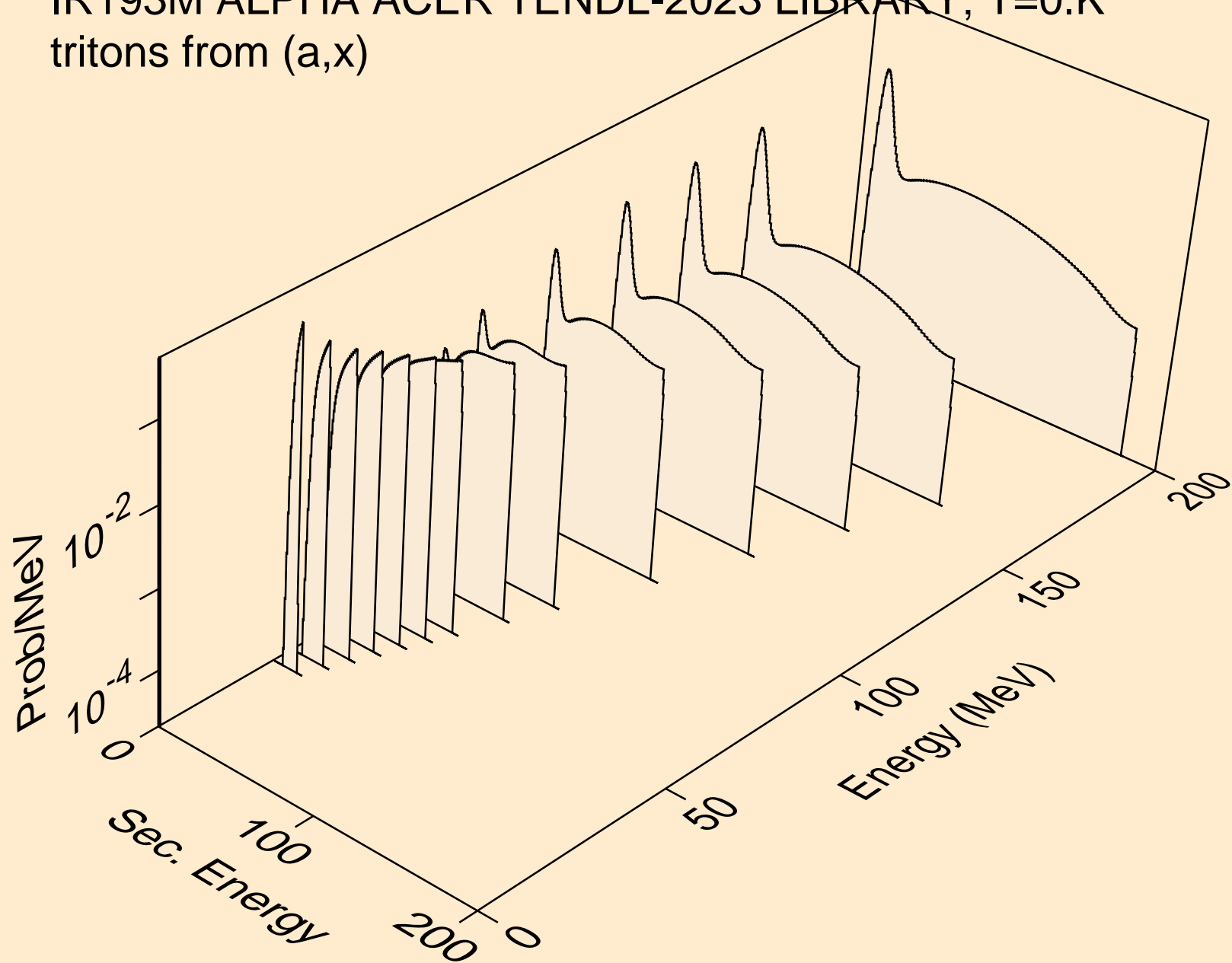

IR193M ALPHA ACER TENDL-2023 LIBRARY; T=0.K  
tritons from (a,n\*)t

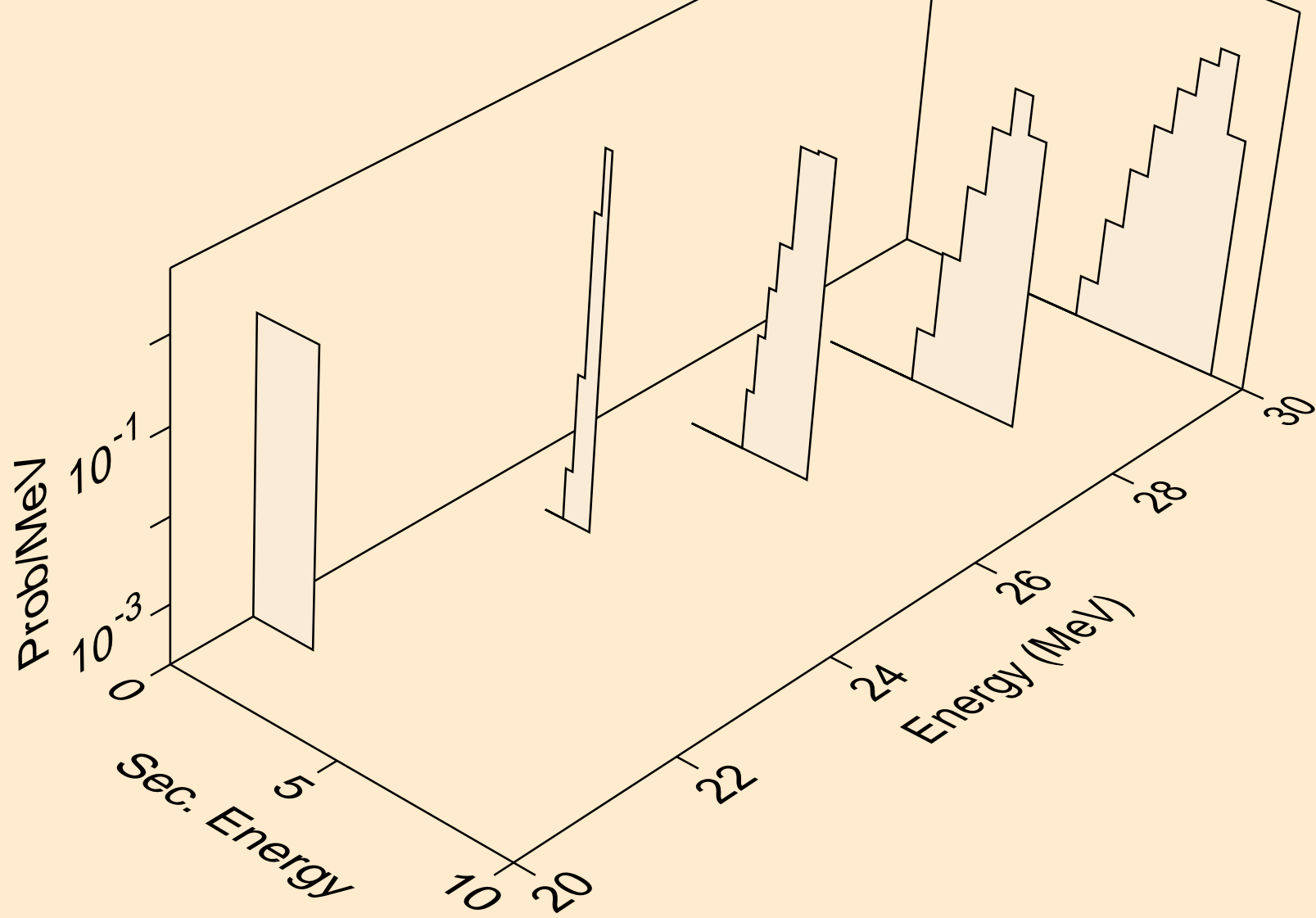

IR193M ALPHA ACER TENDL-2023 LIBRARY; T=0.K  
tritons from (a,t)

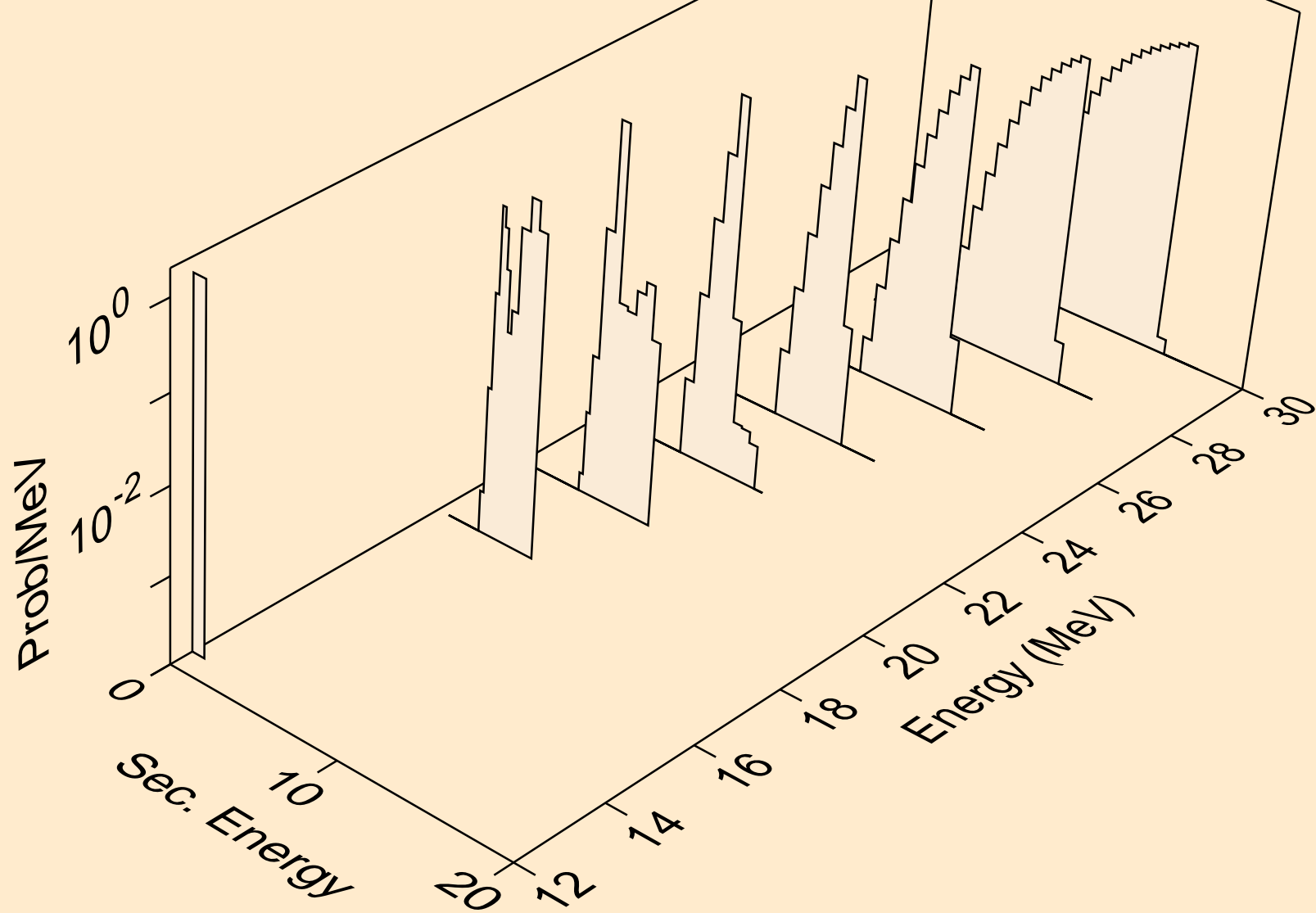

IR193M ALPHA ACER TENDL-2023 LIBRARY; T=0.K  
he3s from (a,x)

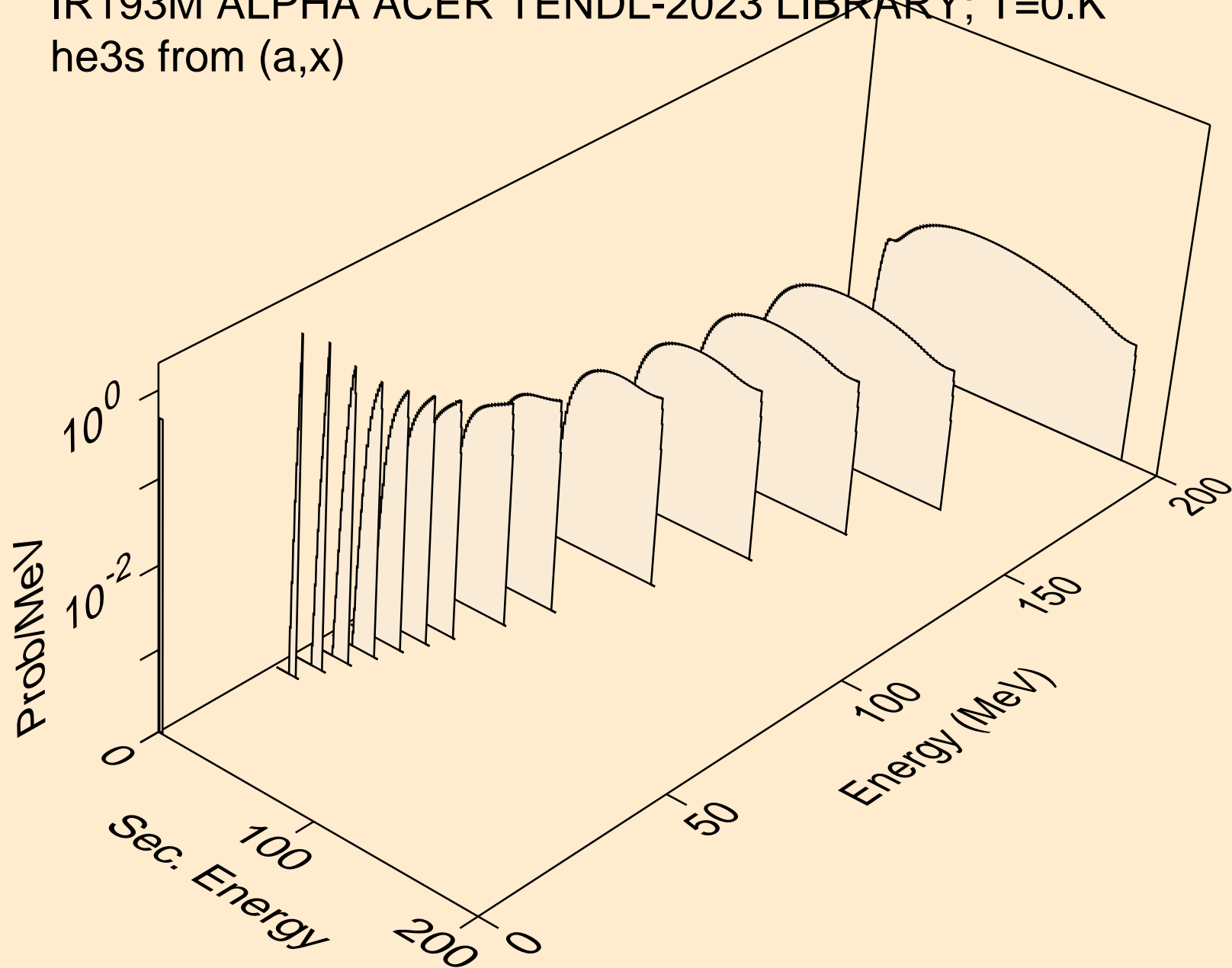

IR193M ALPHA ACER TENDL-2023 LIBRARY; T=0.K  
he3s from (a,he3)

