

SB124M ALPHA ACER TENDL-2023 LIBRARY; T=0.K  
Principal cross sections

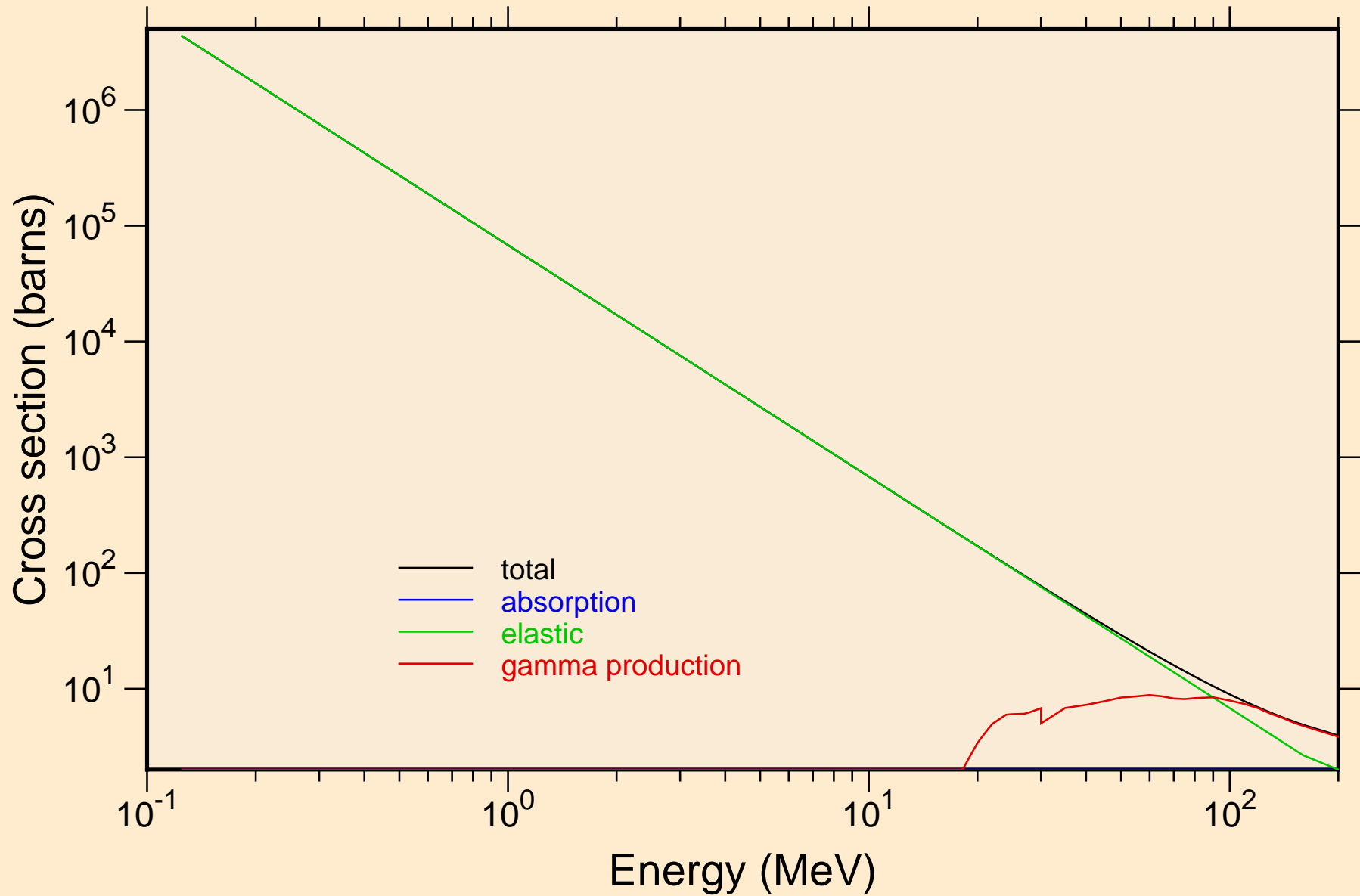

# SB124M ALPHA ACER TENDL-2023 LIBRARY; T=0.K

## Heating

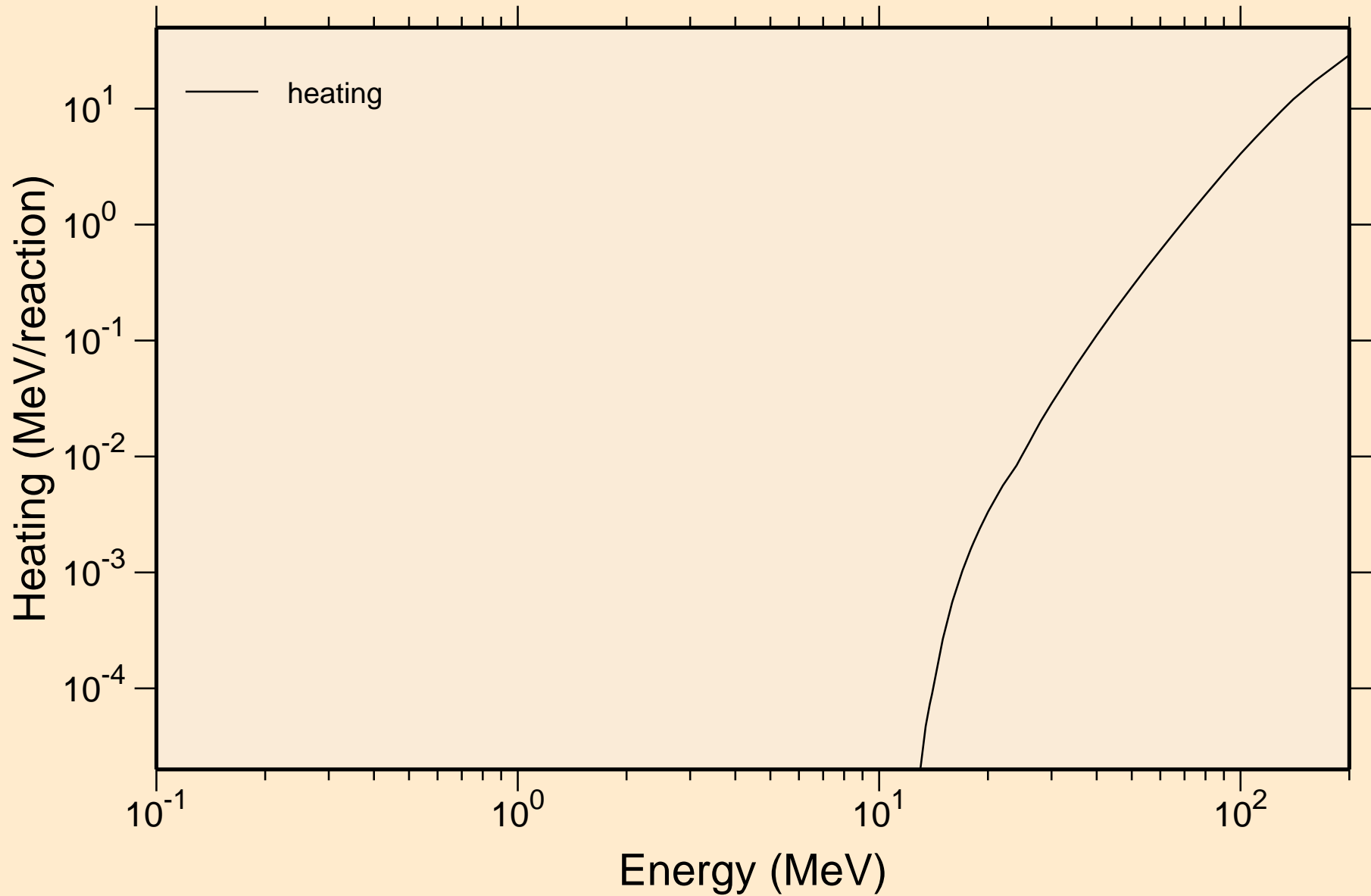

# SB124M ALPHA ACER TENDL-2023 LIBRARY; T=0.K

## Principal cross sections

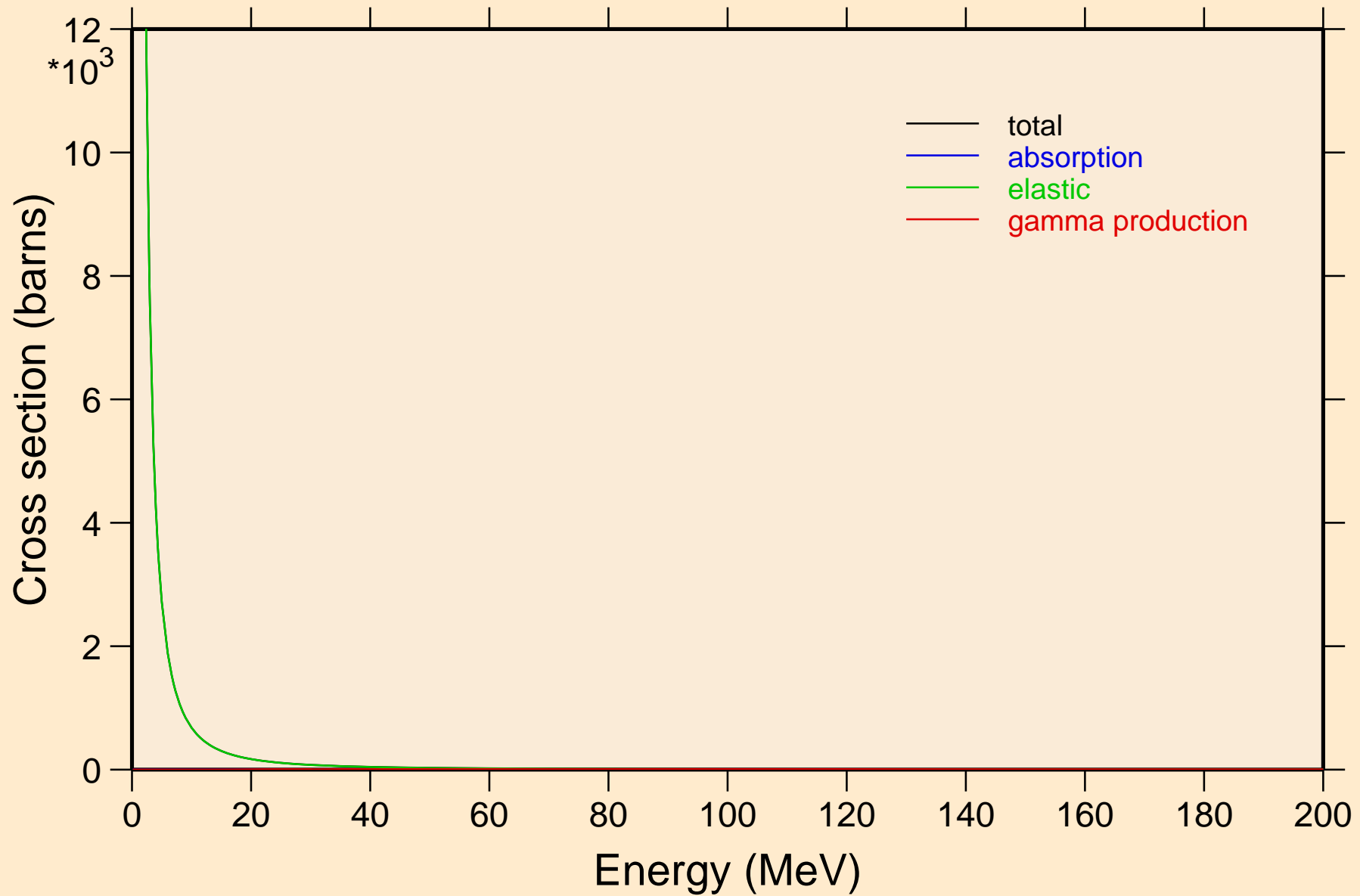

SB124M ALPHA ACER TENDL-2023 LIBRARY; T=0.K

Heating

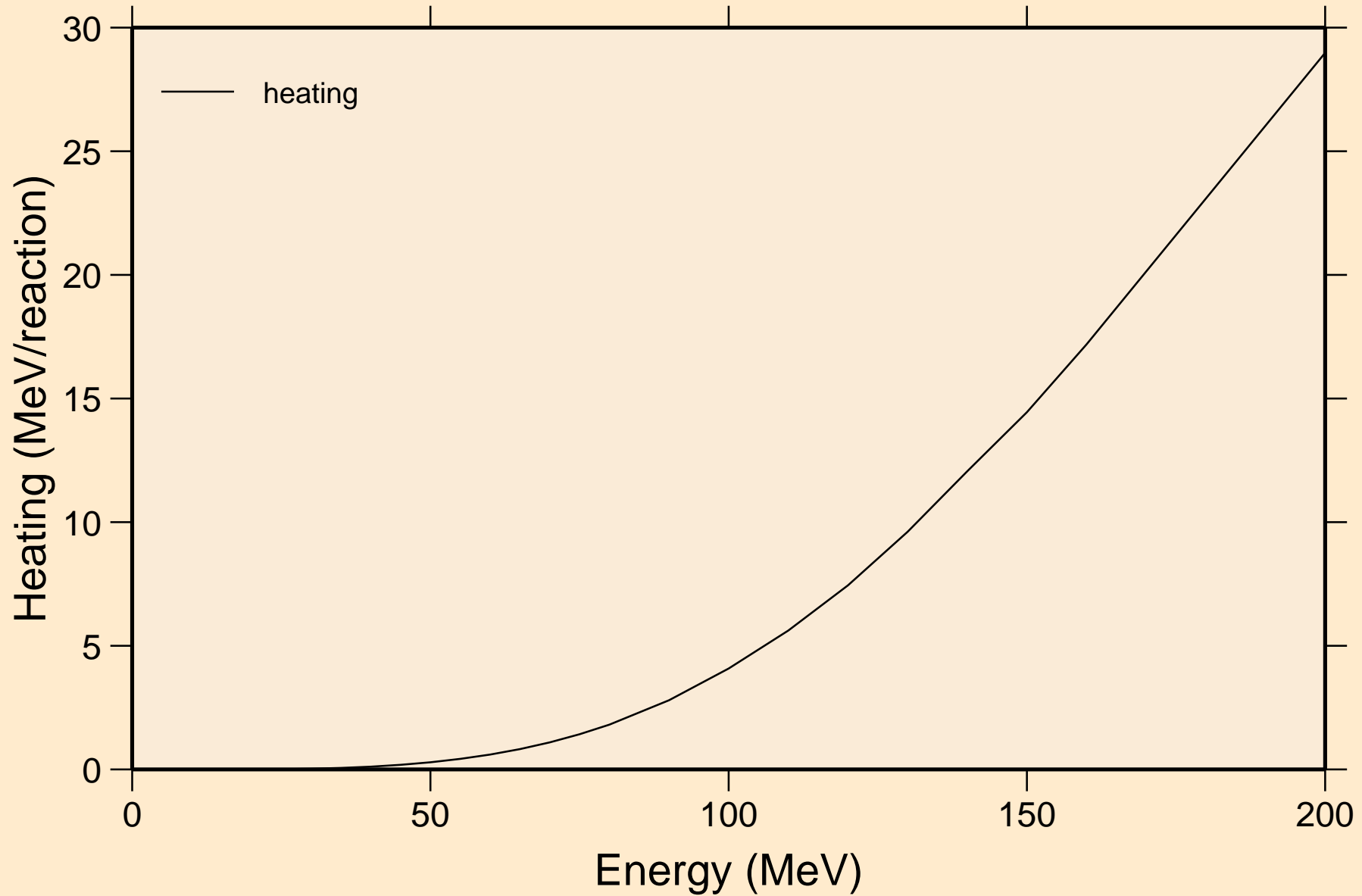

SB124M ALPHA ACER TENDL-2023 LIBRARY; T=0.K  
Threshold reactions

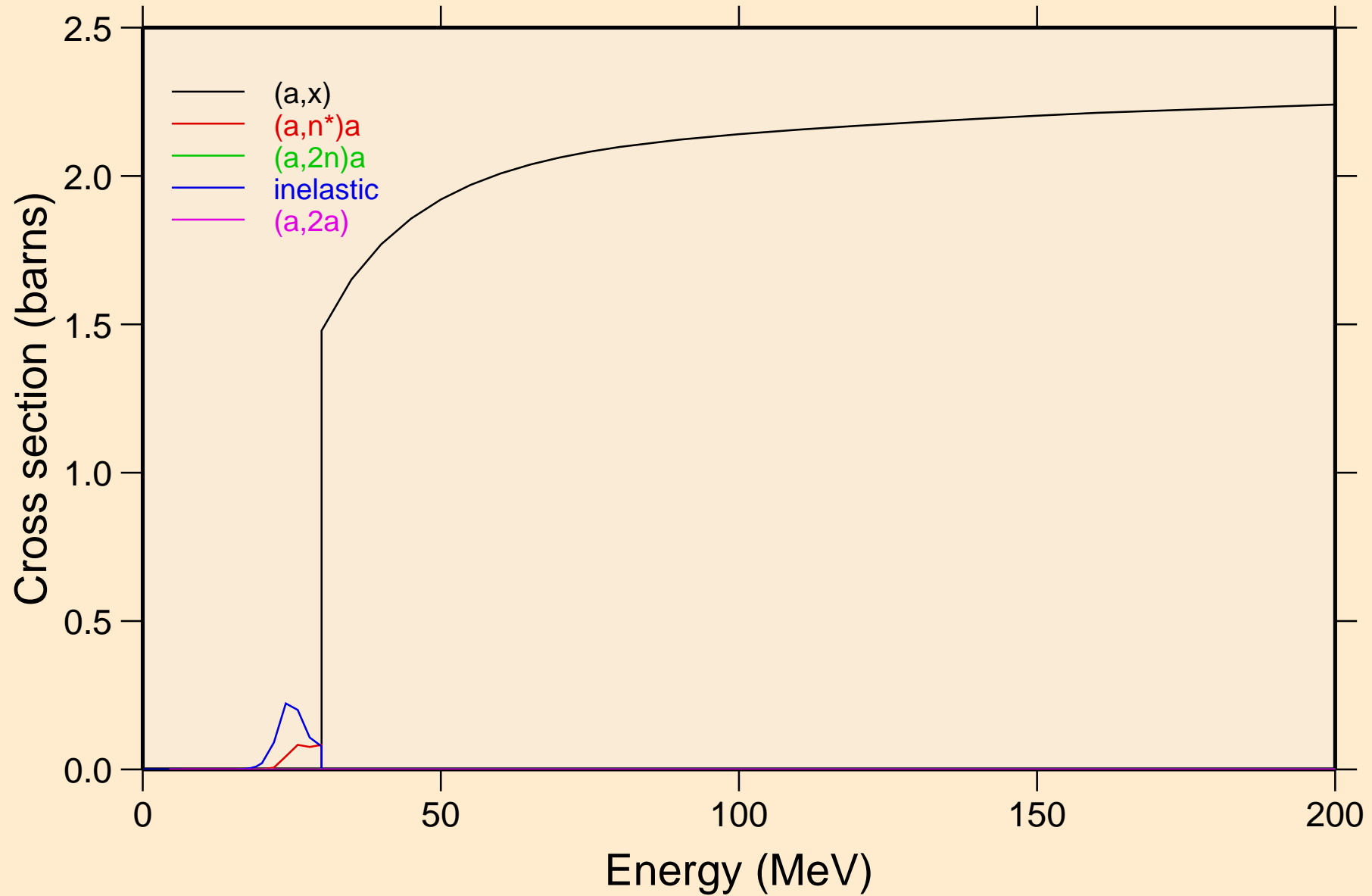

# SB124M ALPHA ACER TENDL-2023 LIBRARY; T=0.K

## Threshold reactions

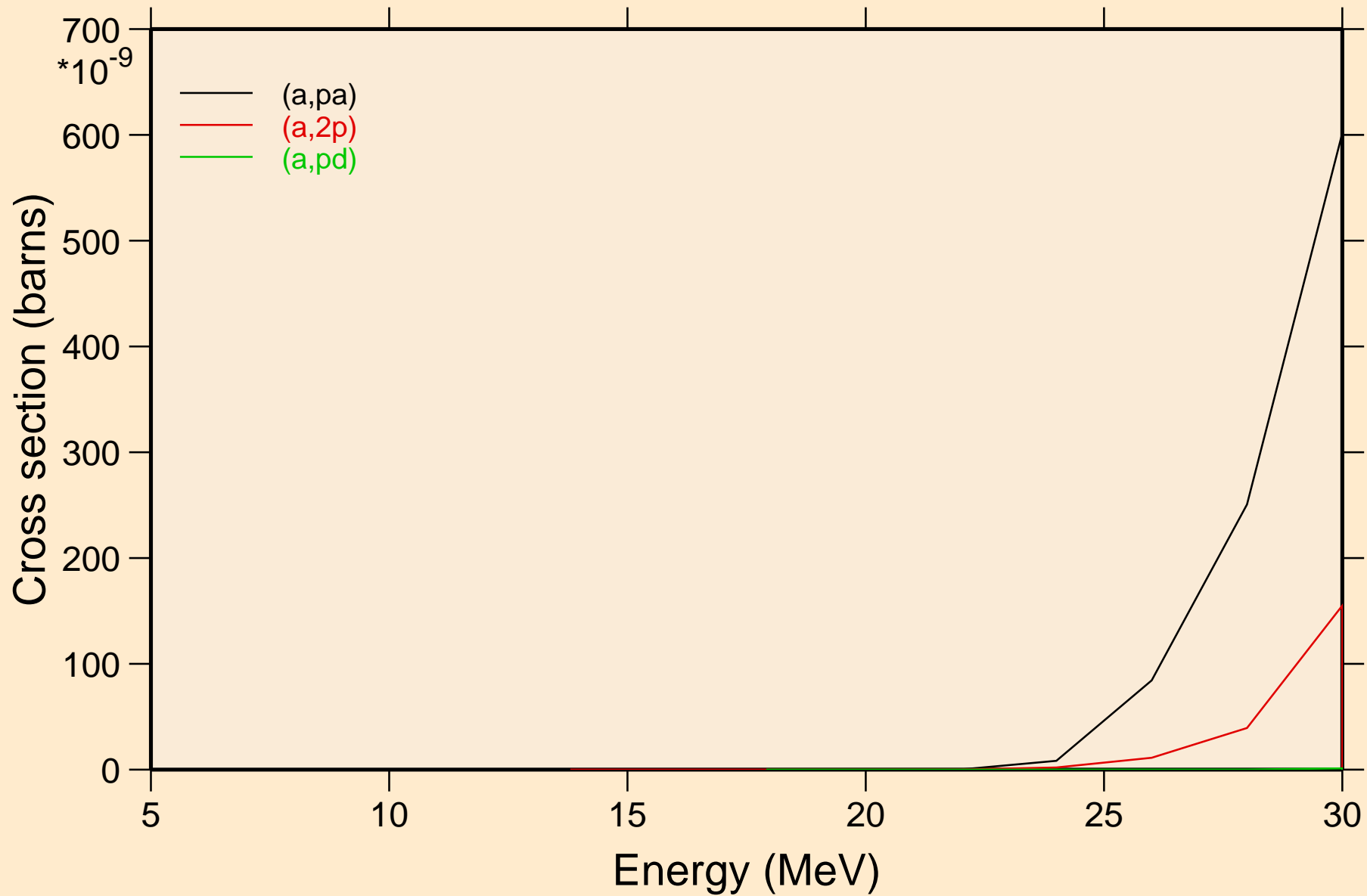

SB124M ALPHA ACER TENDL-2023 LIBRARY; T=0.K  
angular distribution for elastic

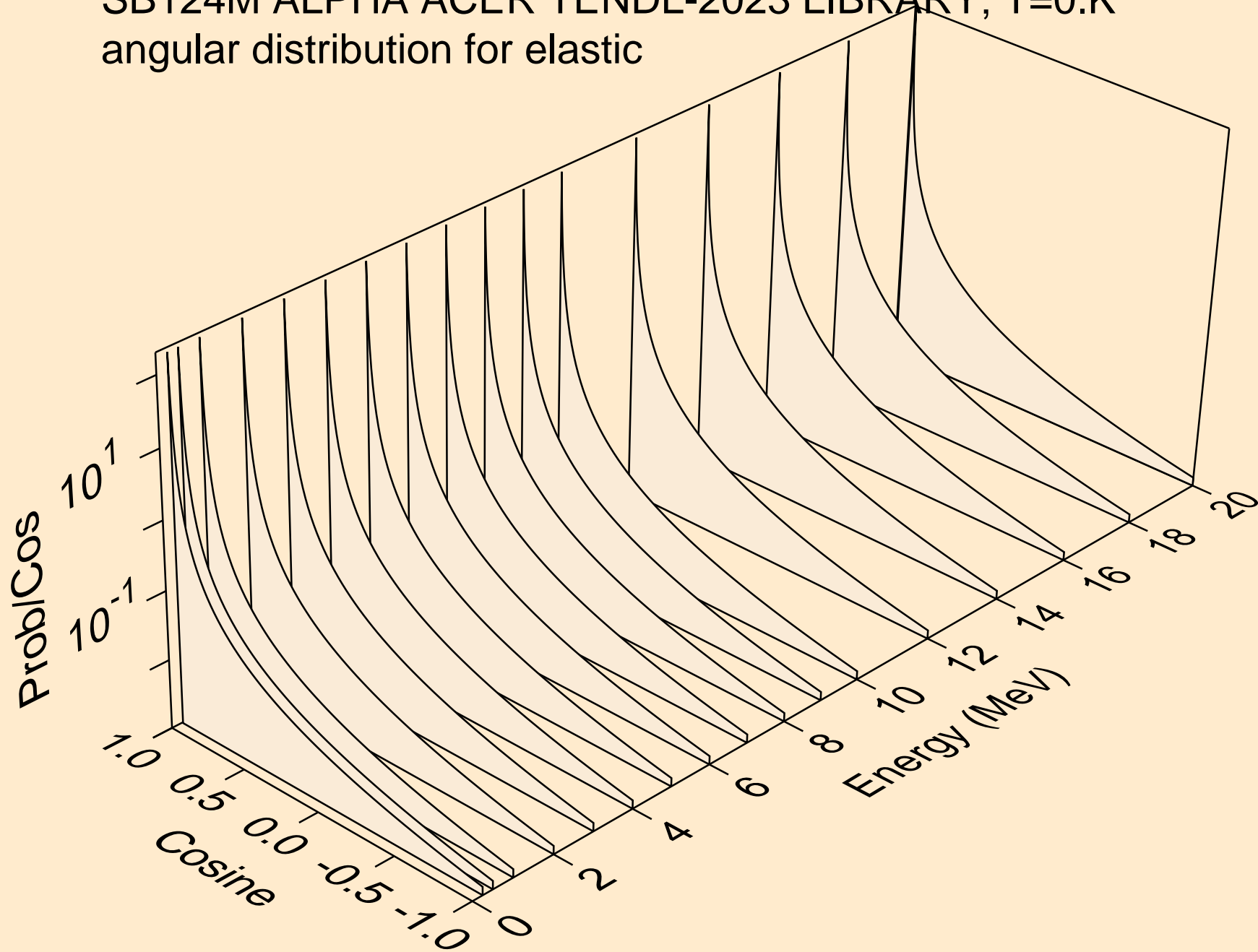

SB124M ALPHA ACER TENDL-2023 LIBRARY; T=0.K  
angular distribution for elastic

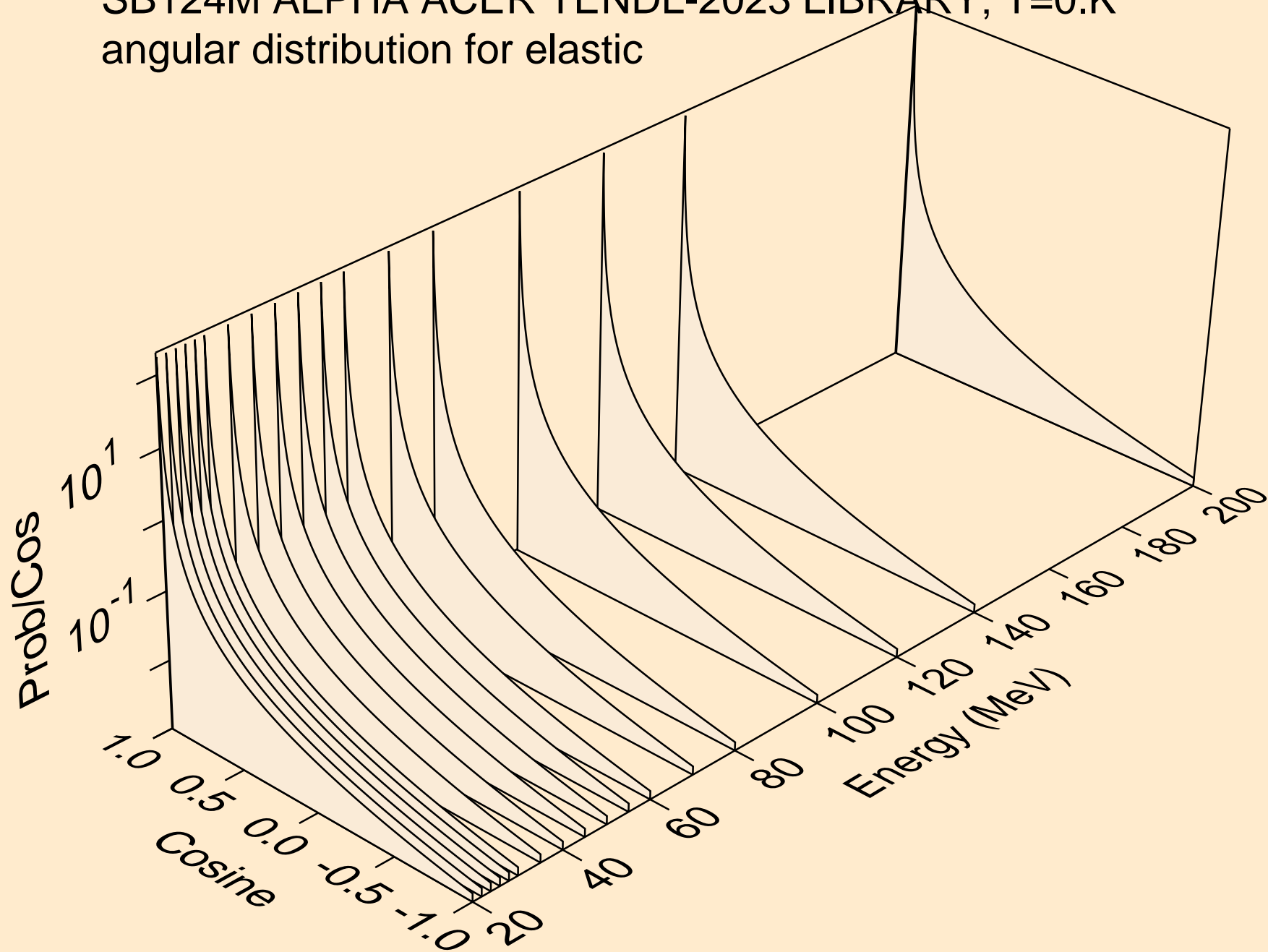

SB124M ALPHA ACER TENDL-2023 LIBRARY; T=0.K  
Alpha emission for (a,x)

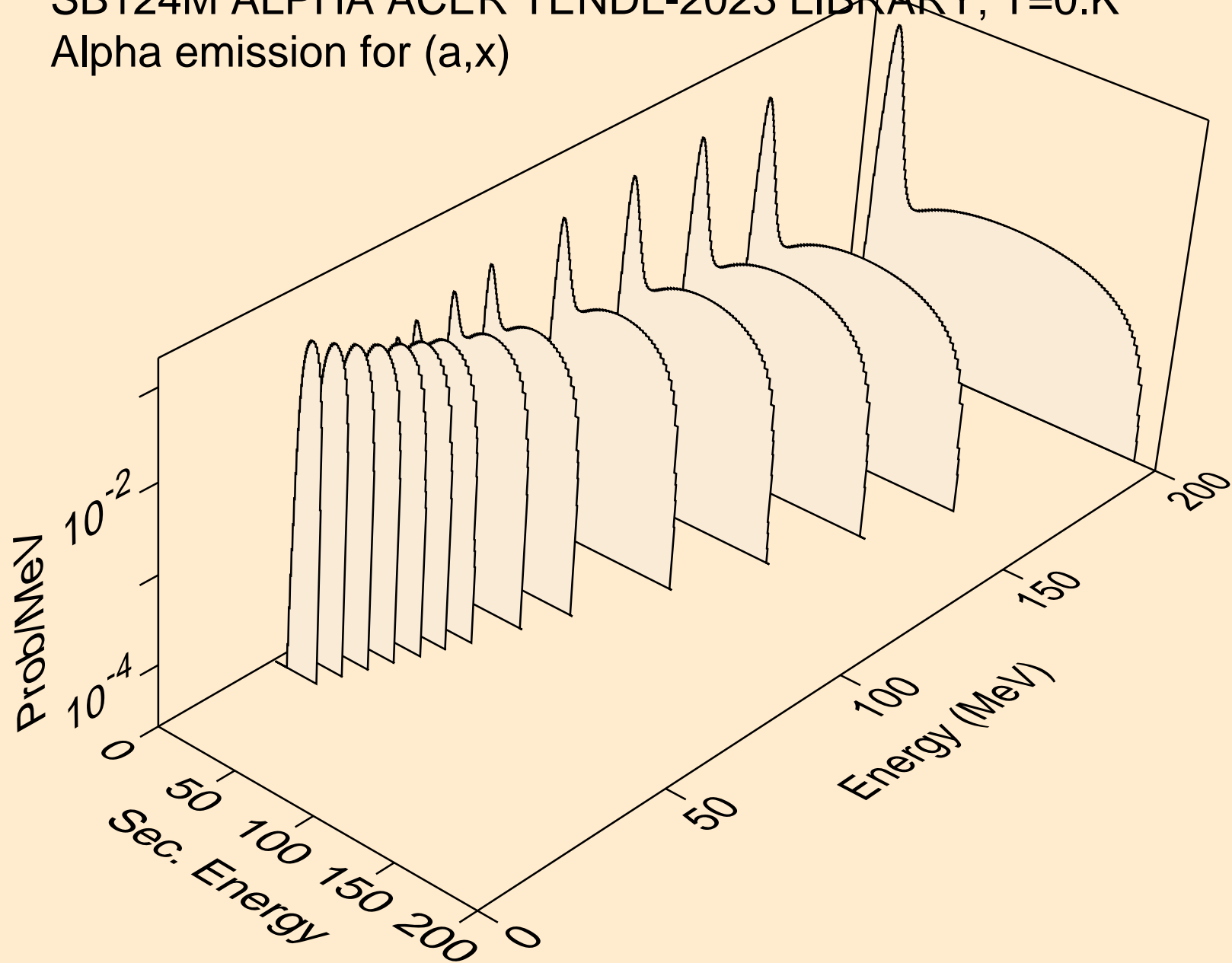

SB124M ALPHA ACER TENDL-2023 LIBRARY; T=0.K  
Alpha emission for (a,n\*)a

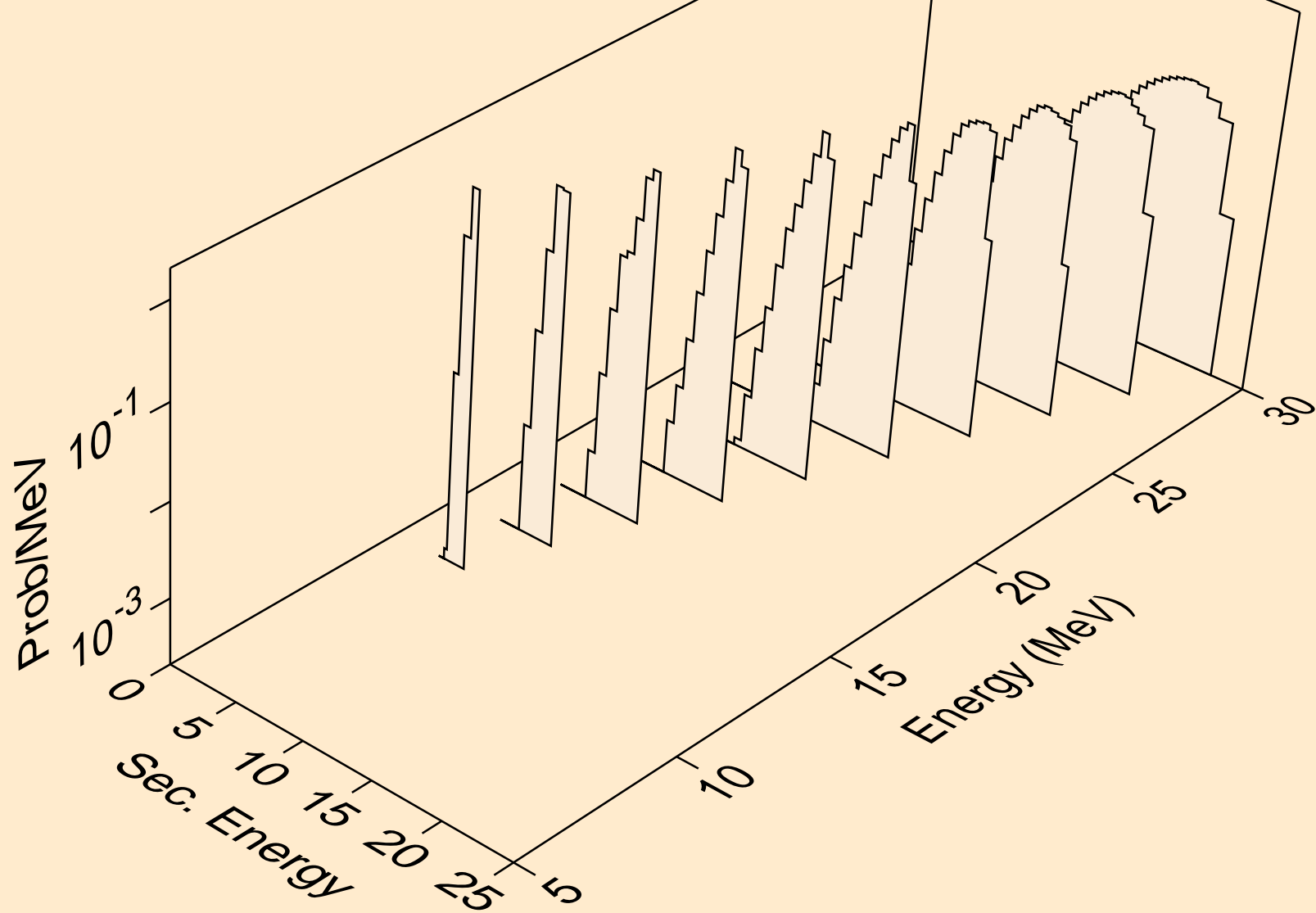

SB124M ALPHA ACER TENDL-2023 LIBRARY; T=0.K  
Alpha emission for (a,2n)a

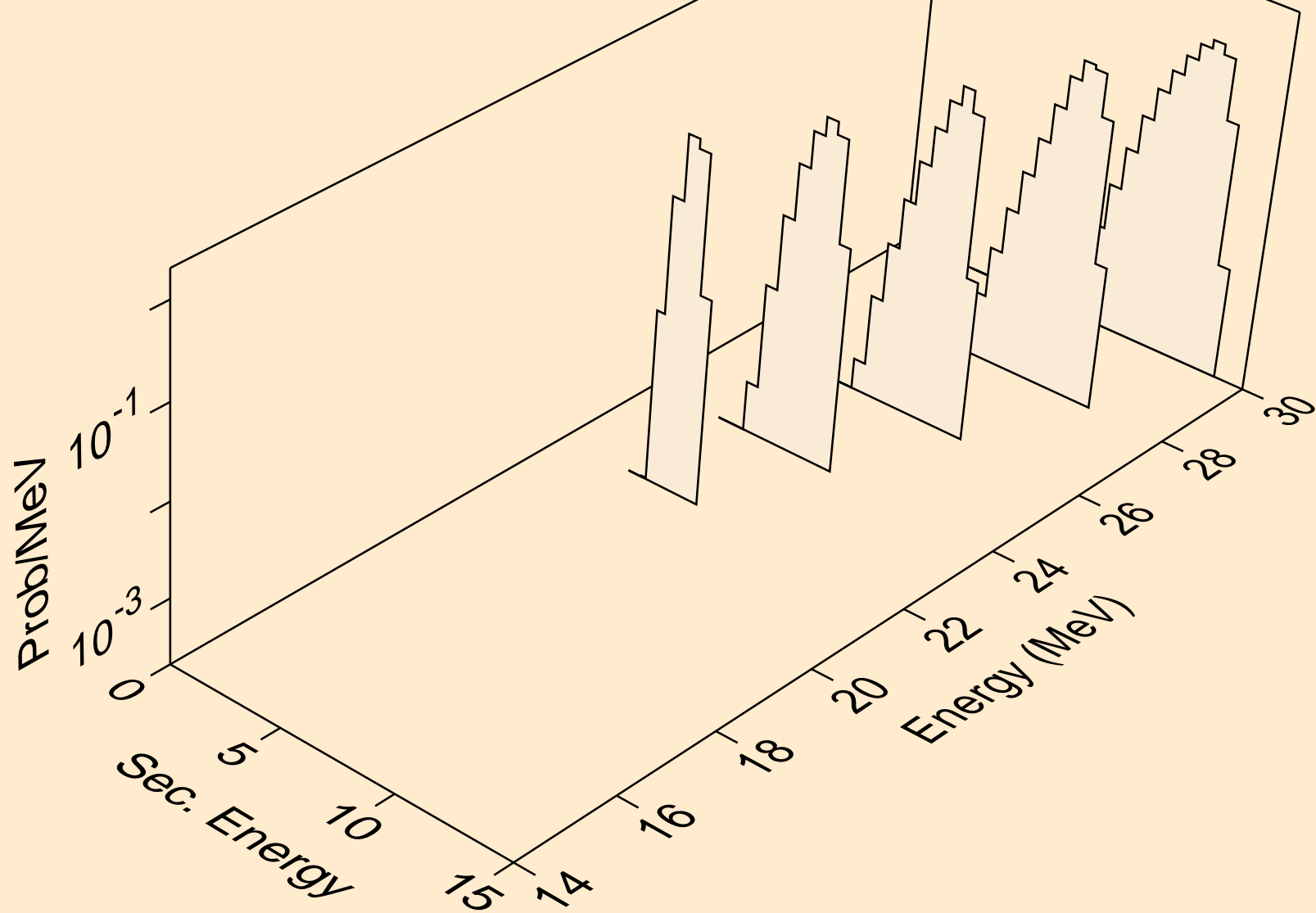

SB124M ALPHA ACER TENDL-2023 LIBRARY; T=0.K  
Alpha emission for inelastic

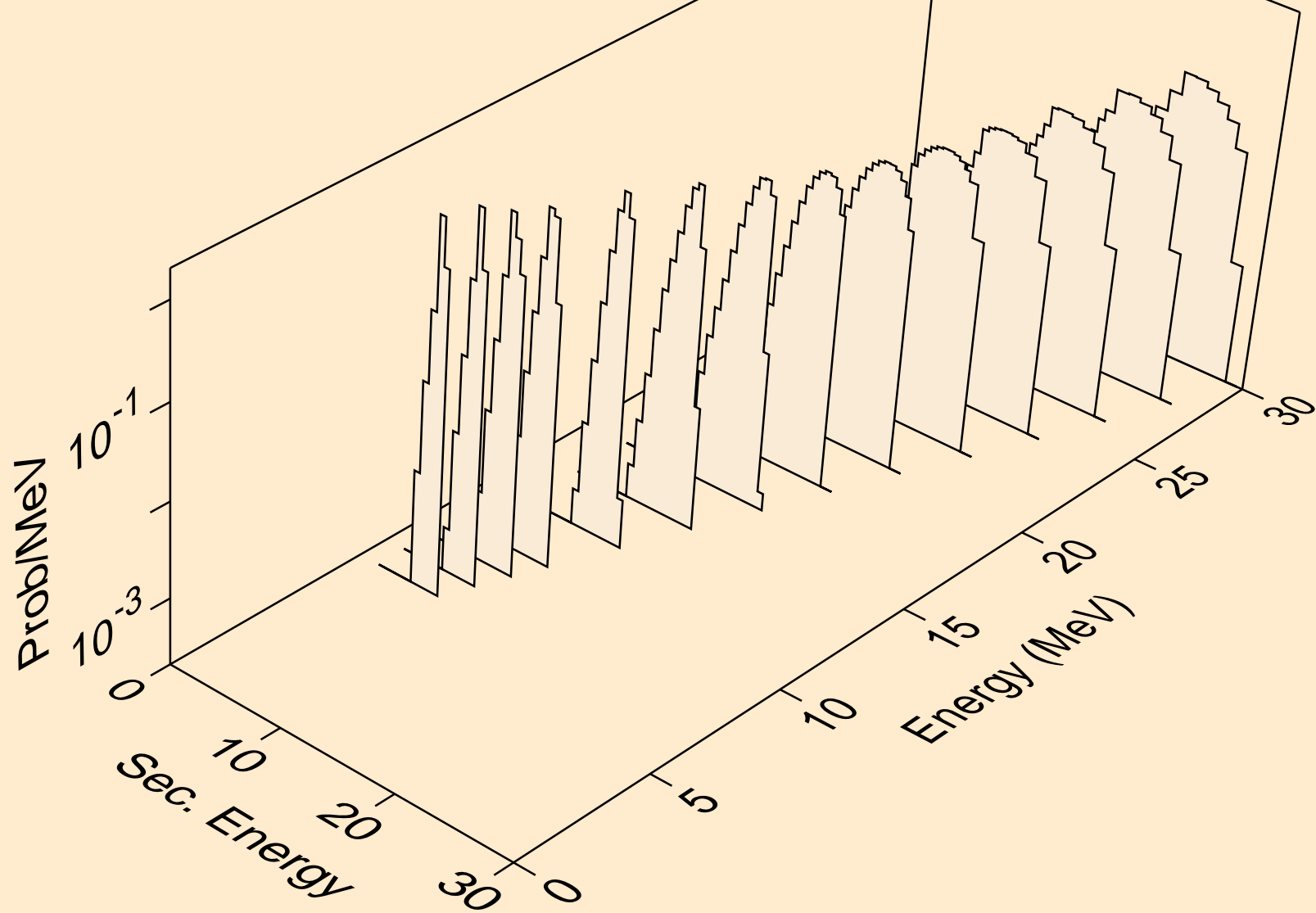

SB124M ALPHA ACER TENDL-2023 LIBRARY; T=0.K  
Alpha emission for (a,2a)

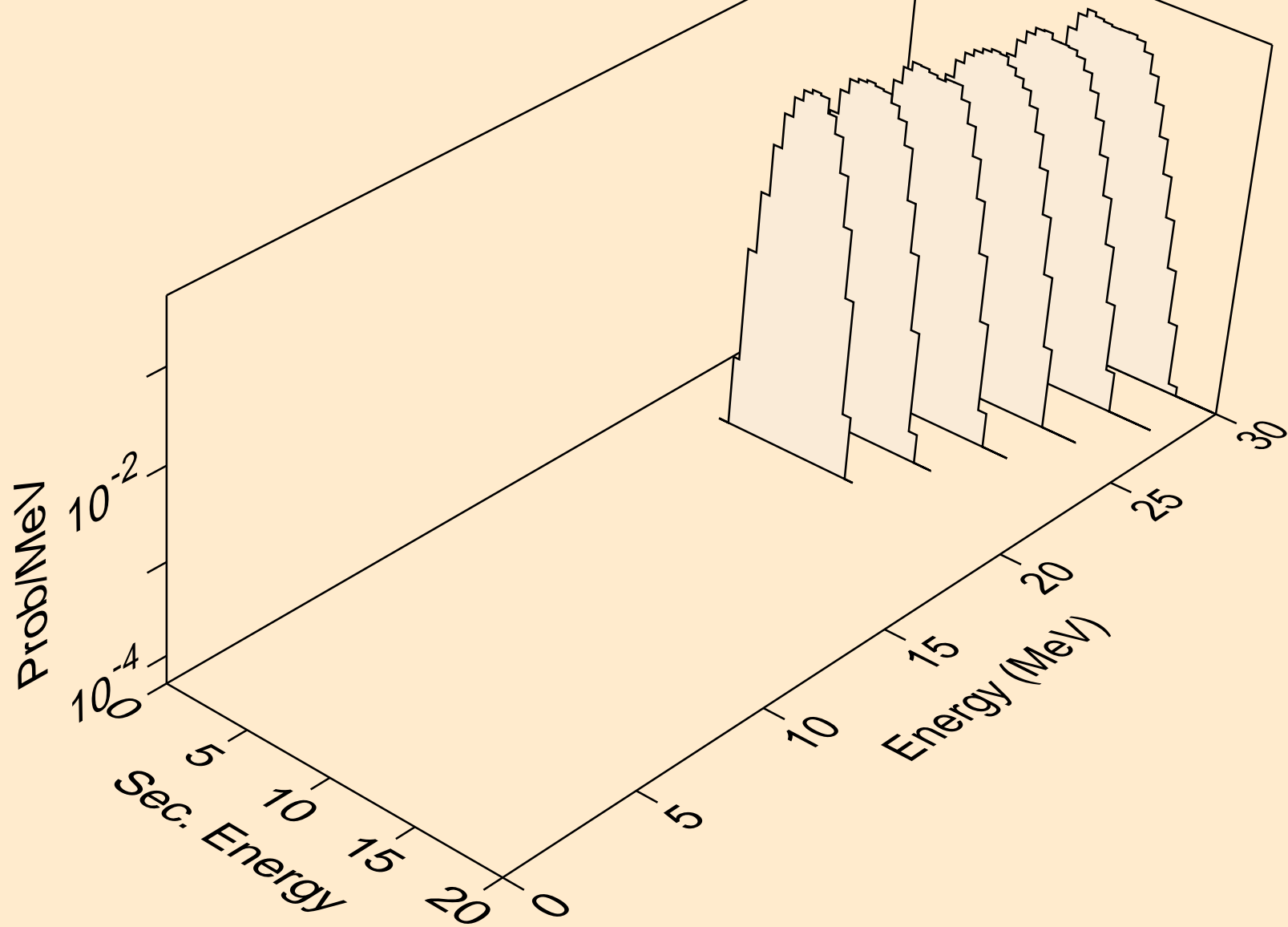

SB124M ALPHA ACER TENDL-2023 LIBRARY; T=0.K  
Alpha emission for (a,pa)

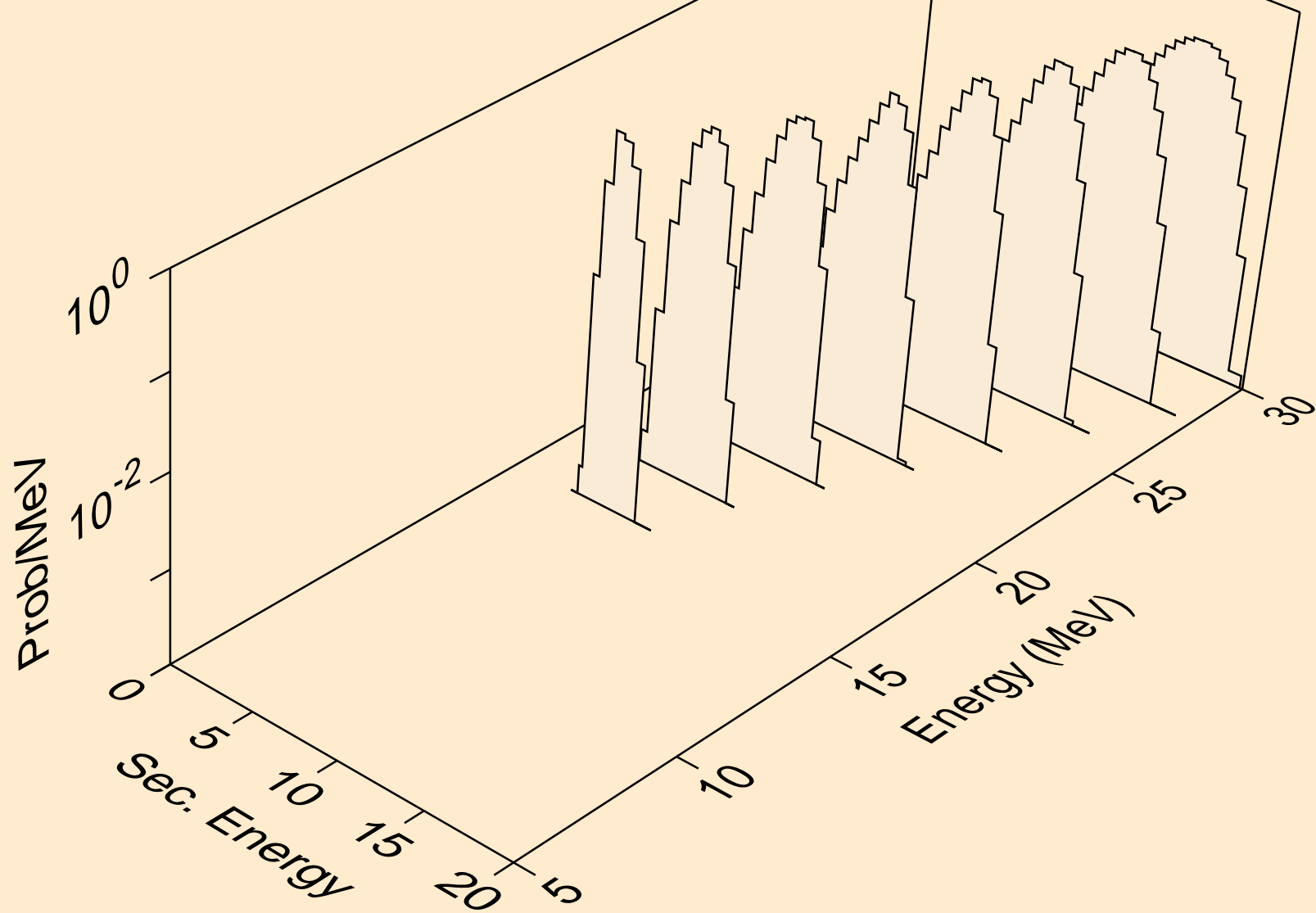

SB124M ALPHA ACER TENDL-2023 LIBRARY; T=0.K  
Photon emission for (z,n)

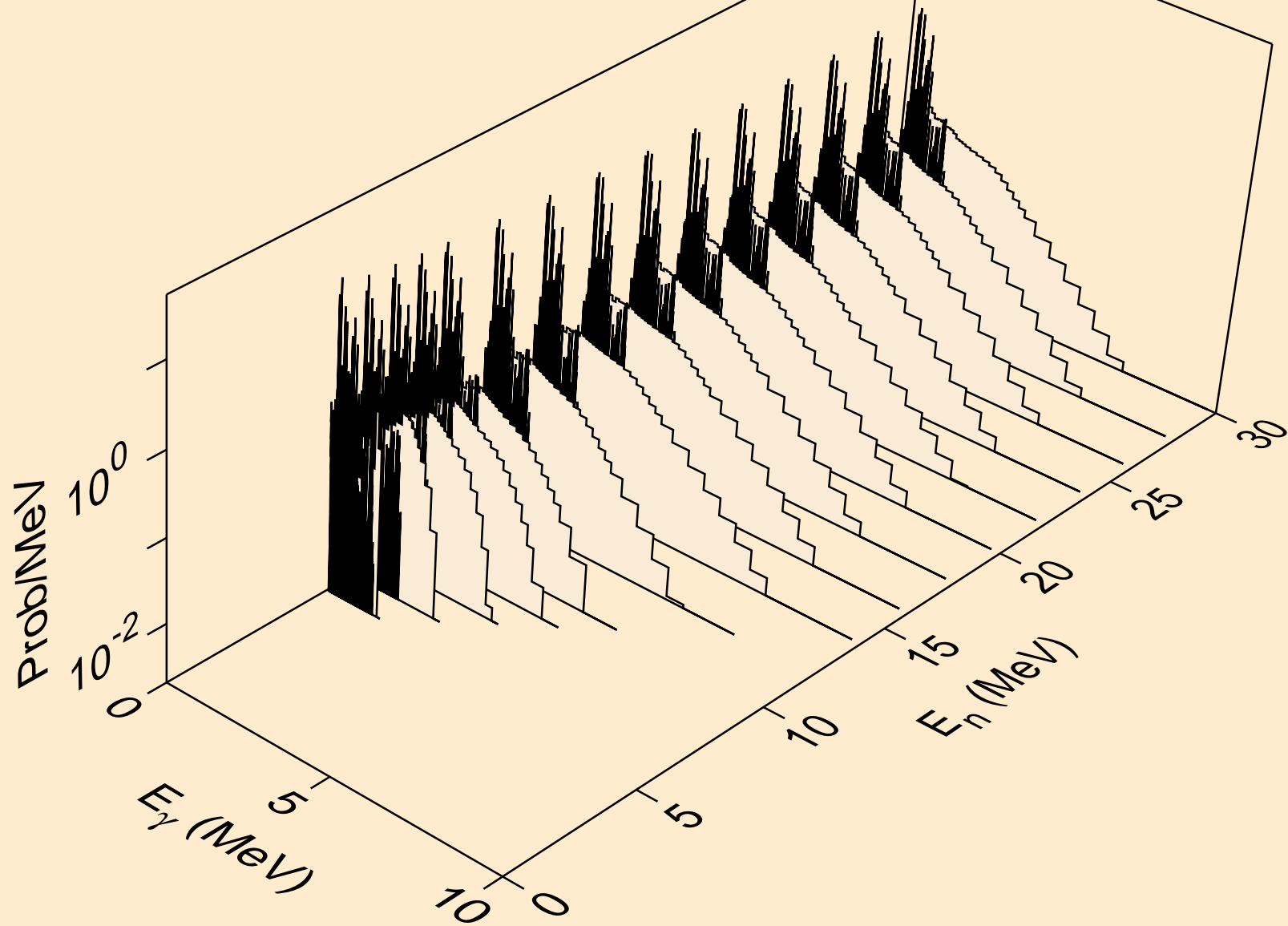

SB124M ALPHA ACER TENDL-2023 LIBRARY; T=0.K  
Photon emission for (z,x)

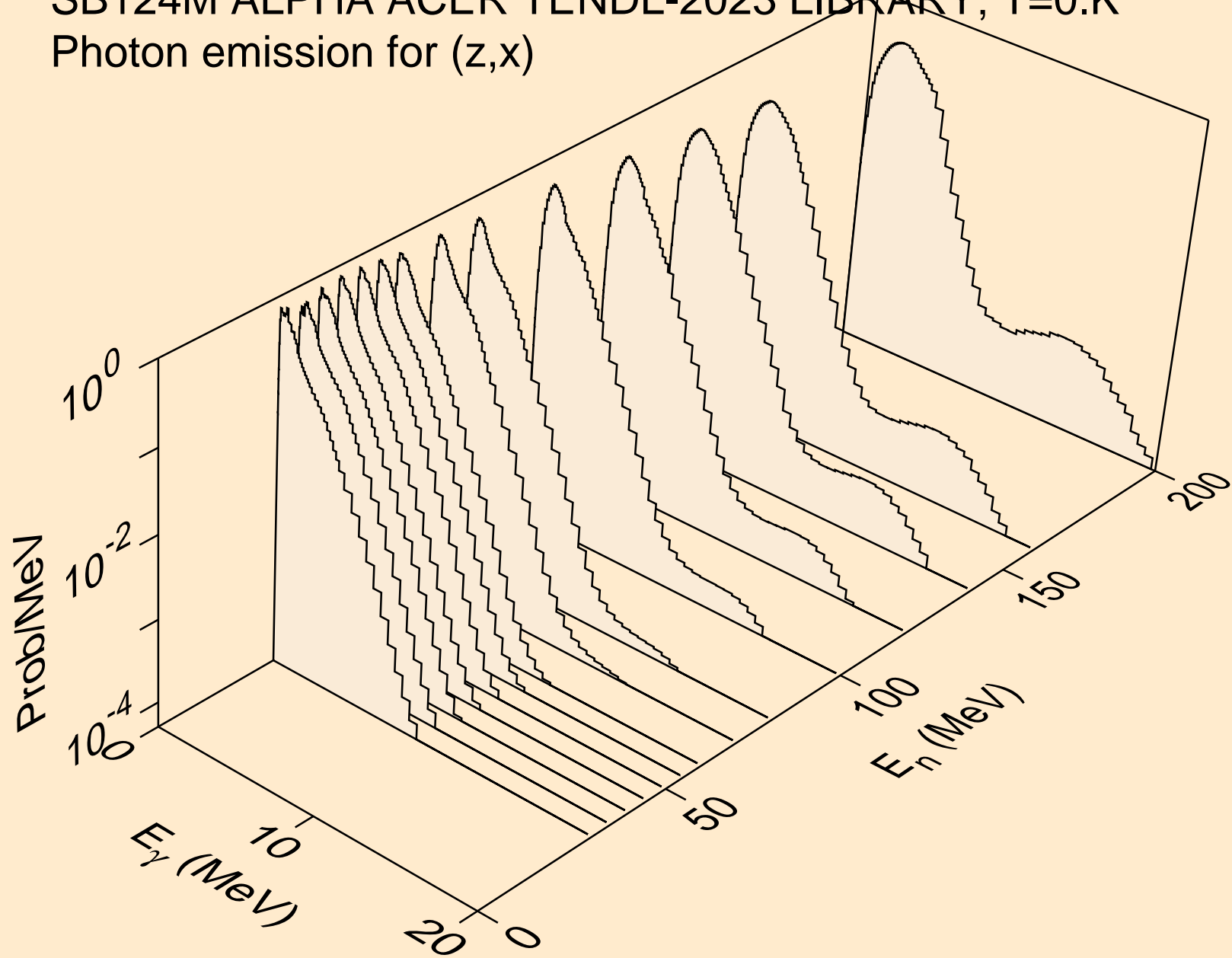

SB124M ALPHA ACER TENDL-2023 LIBRARY; T=0.K  
Photon emission for (n,2nd)

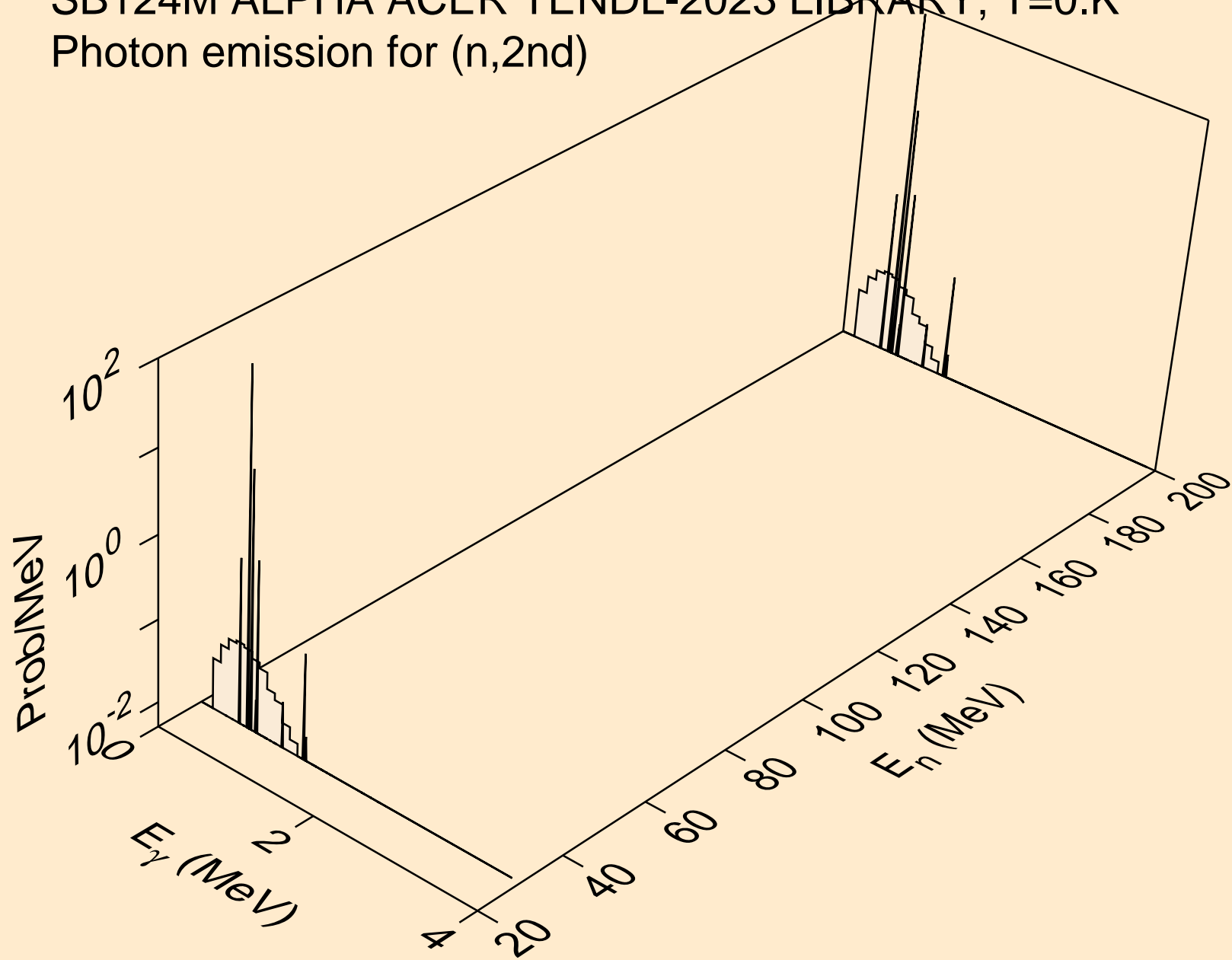

SB124M ALPHA ACER TENDL-2023 LIBRARY; T=0.K  
Photon emission for (n,2n)

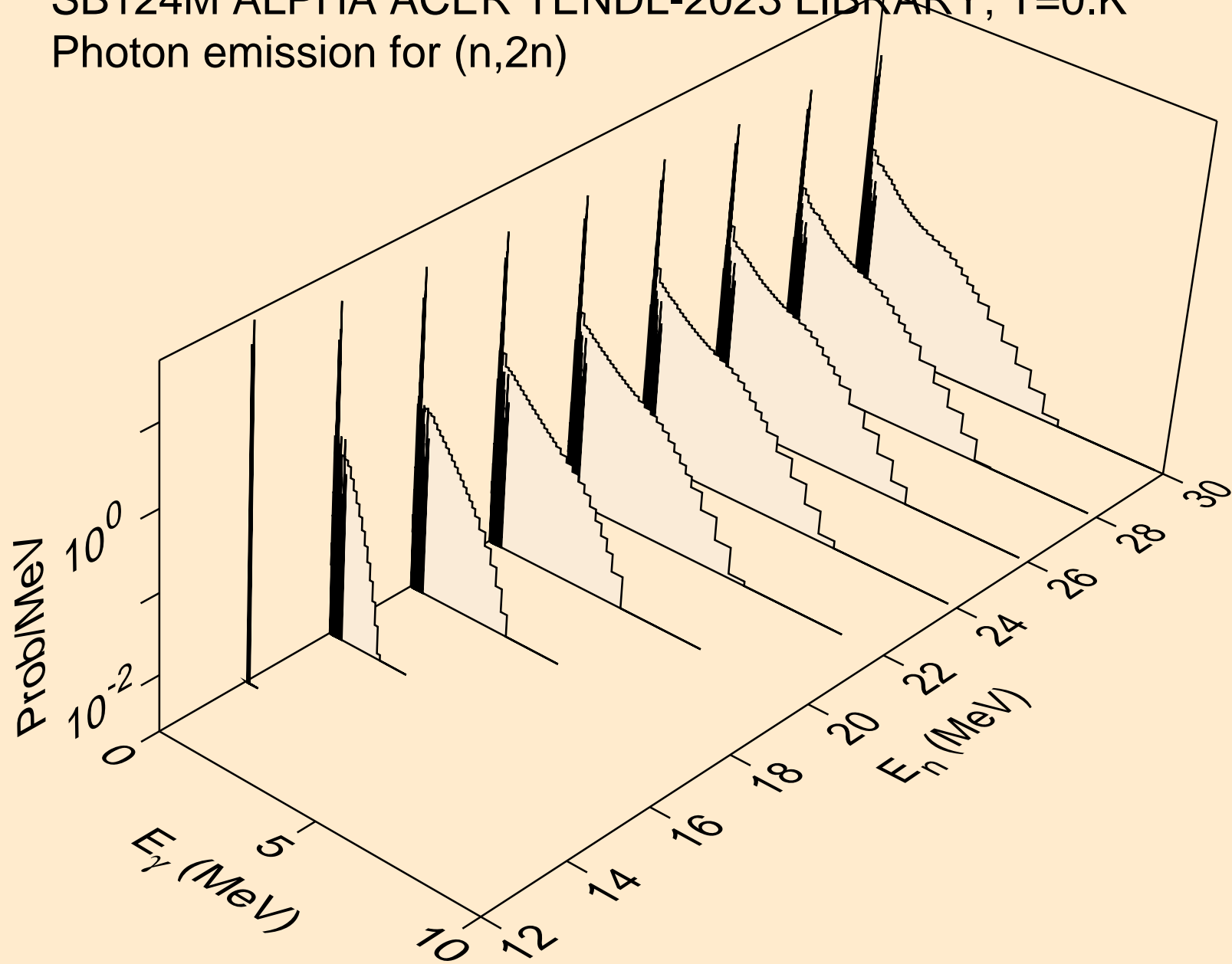

SB124M ALPHA ACER TENDL-2023 LIBRARY; T=0.K  
Photon emission for (n,3n)

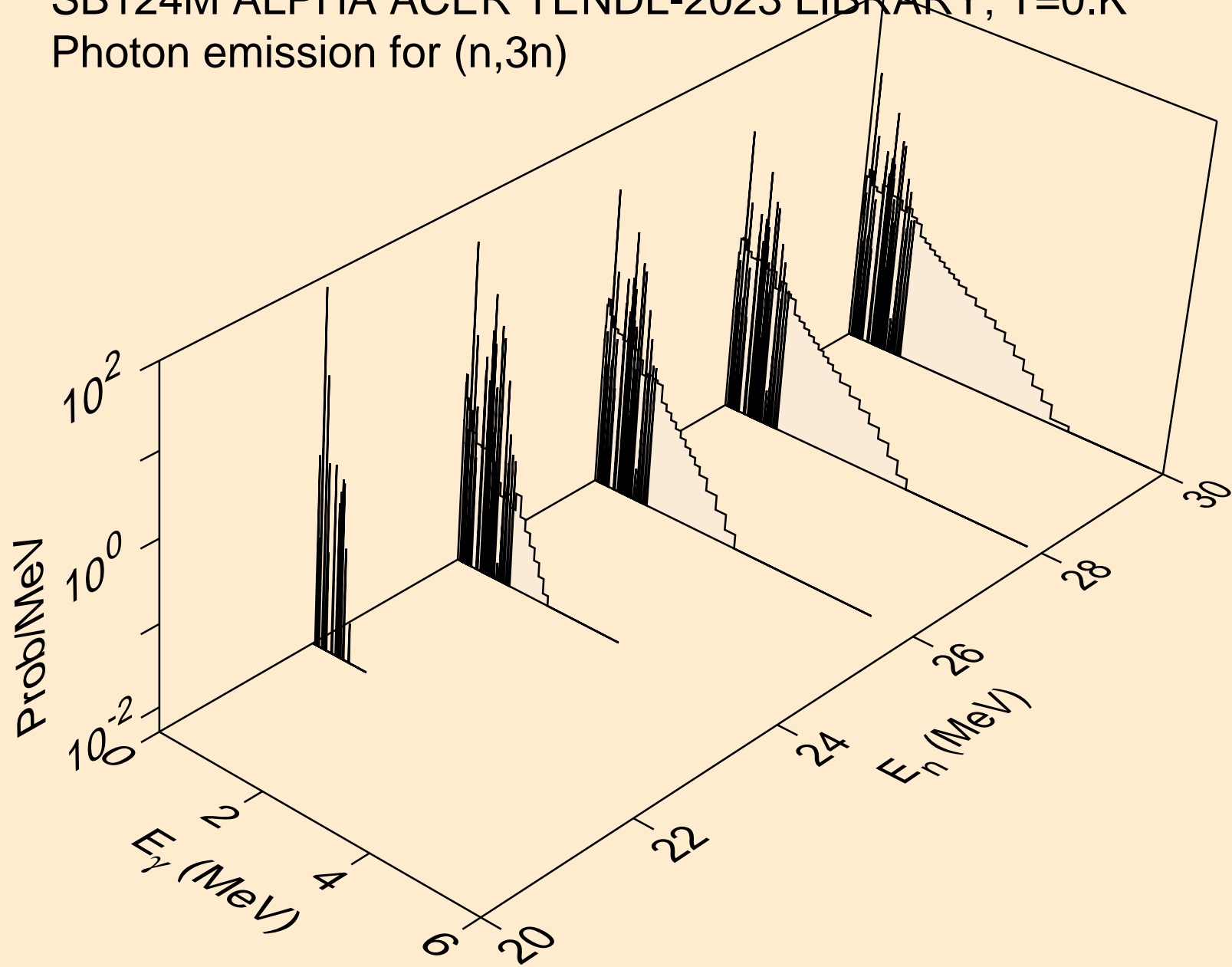

SB124M ALPHA ACER TENDL-2023 LIBRARY; T=0.K  
Photon emission for (n,n\*)a

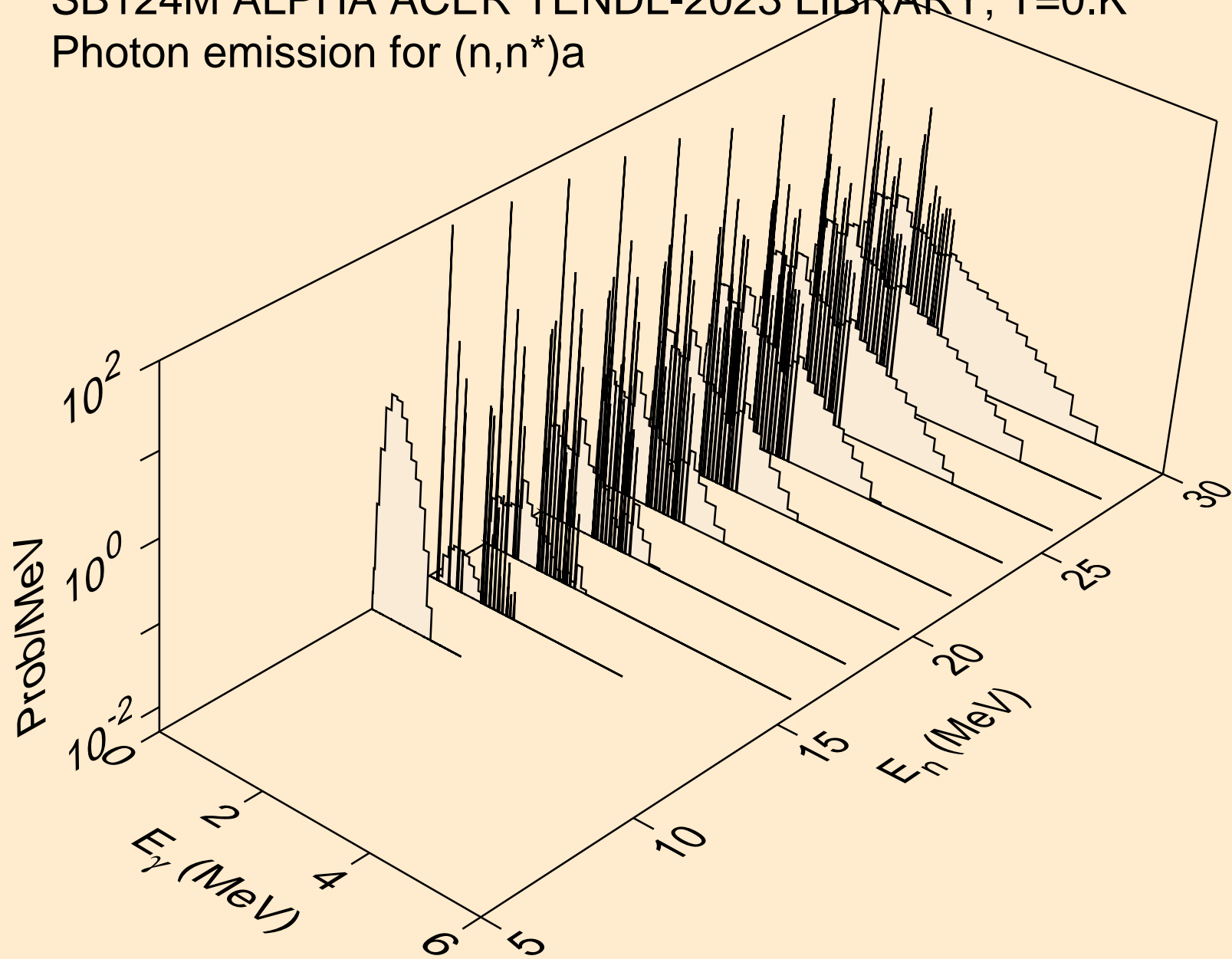

SB124M ALPHA ACER TENDL-2023 LIBRARY; T=0.K  
Photon emission for (n,2n)a

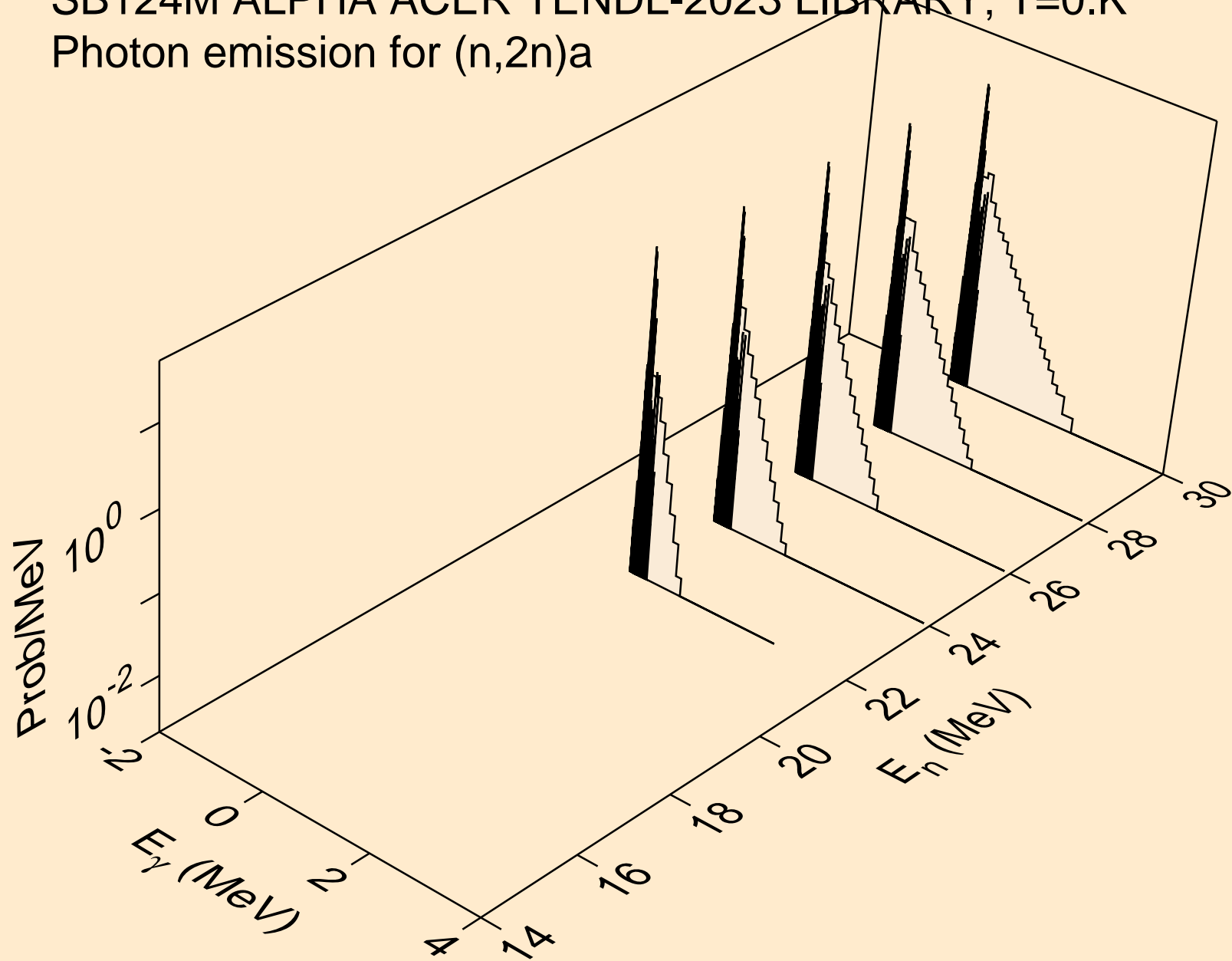

SB124M ALPHA ACER TENDL-2023 LIBRARY; T=0.K  
Photon emission for (n,n\*)p

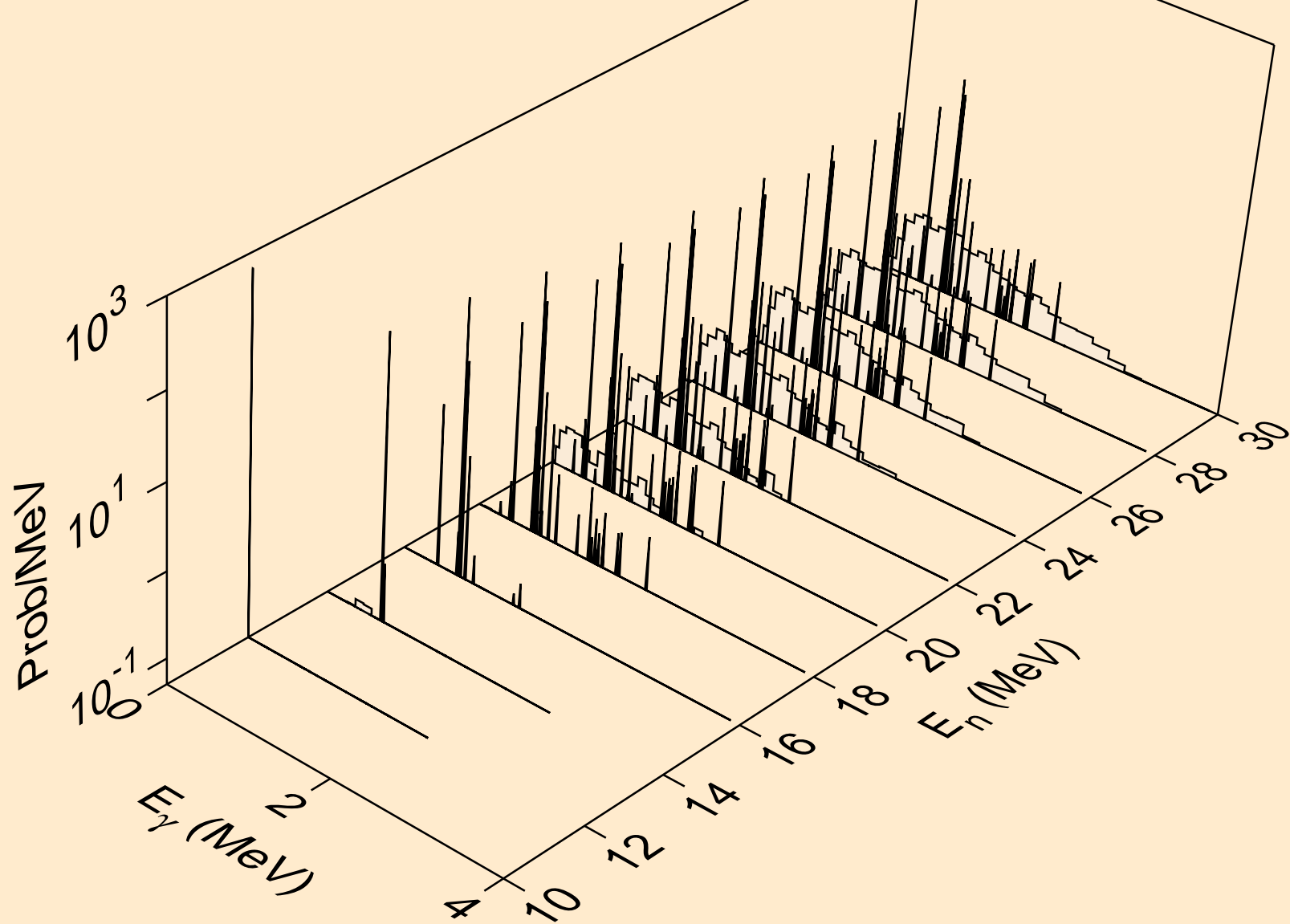

SB124M ALPHA ACER TENDL-2023 LIBRARY; T=0.K  
Photon emission for (n,n\*)d

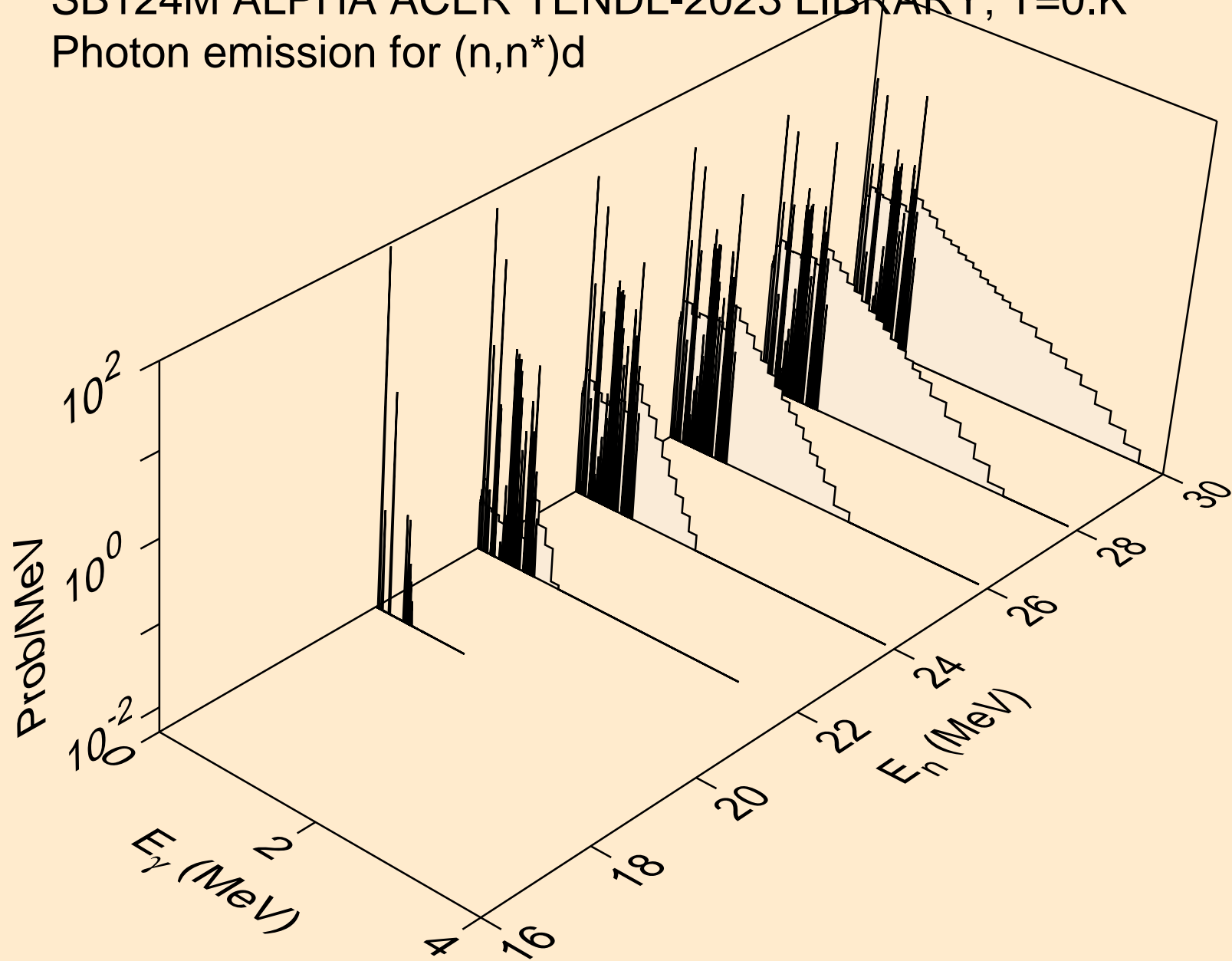

SB124M ALPHA ACER TENDL-2023 LIBRARY; T=0.K  
Photon emission for (n,n\*)t

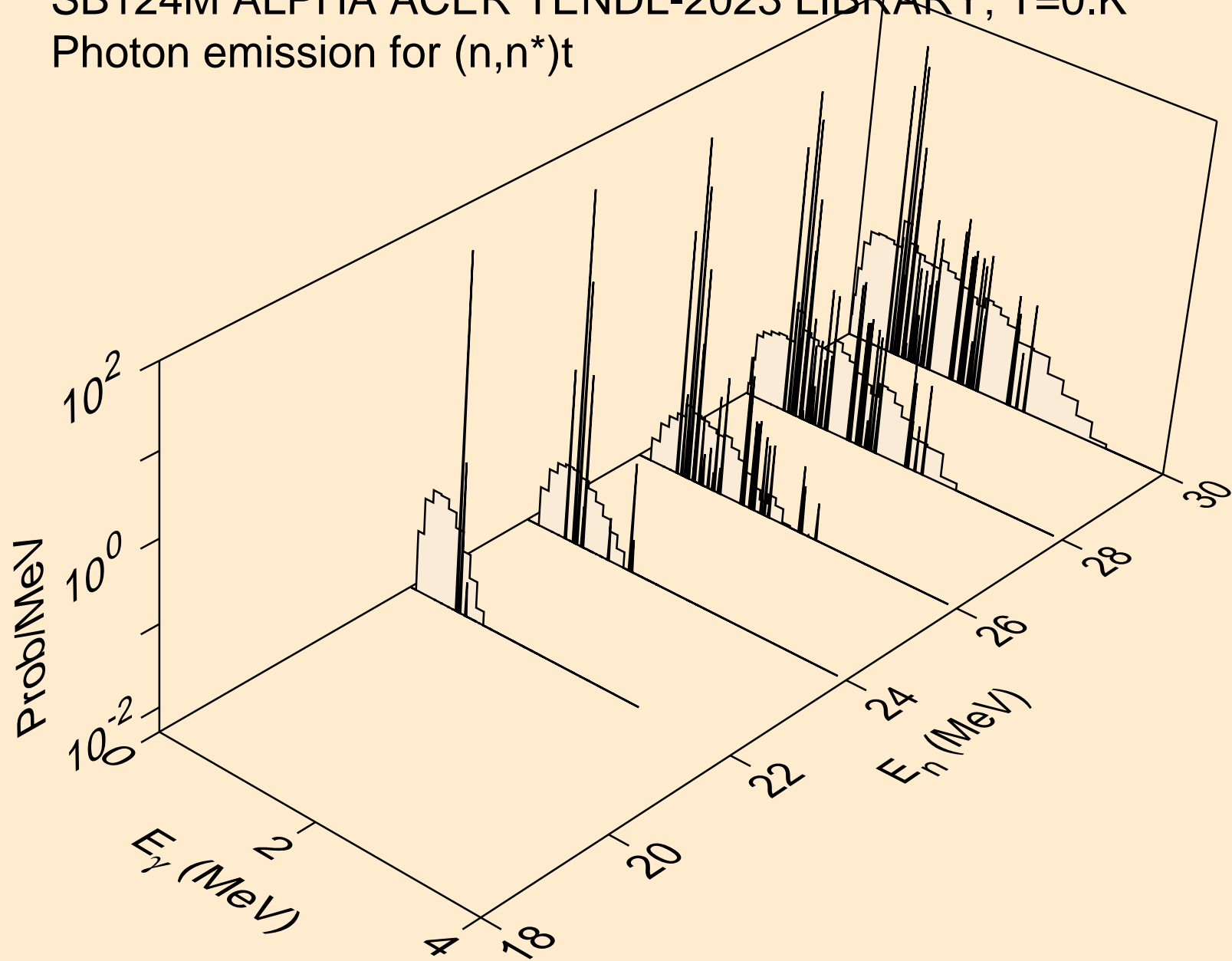

SB124M ALPHA ACER TENDL-2023 LIBRARY; T=0.K  
Photon emission for (n,n\*)he3

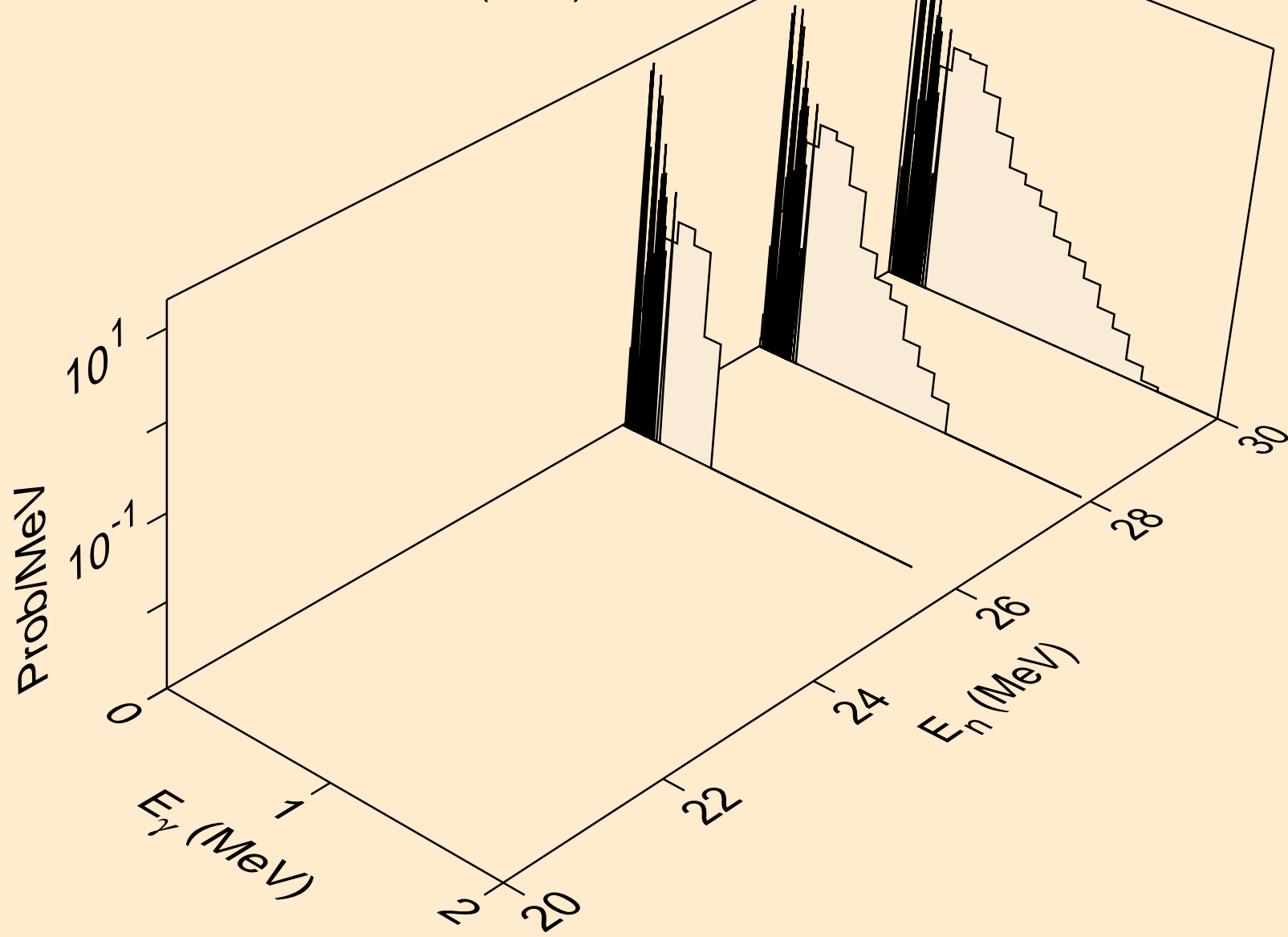

SB124M ALPHA ACER TENDL-2023 LIBRARY; T=0.K  
Photon emission for (n,2np)

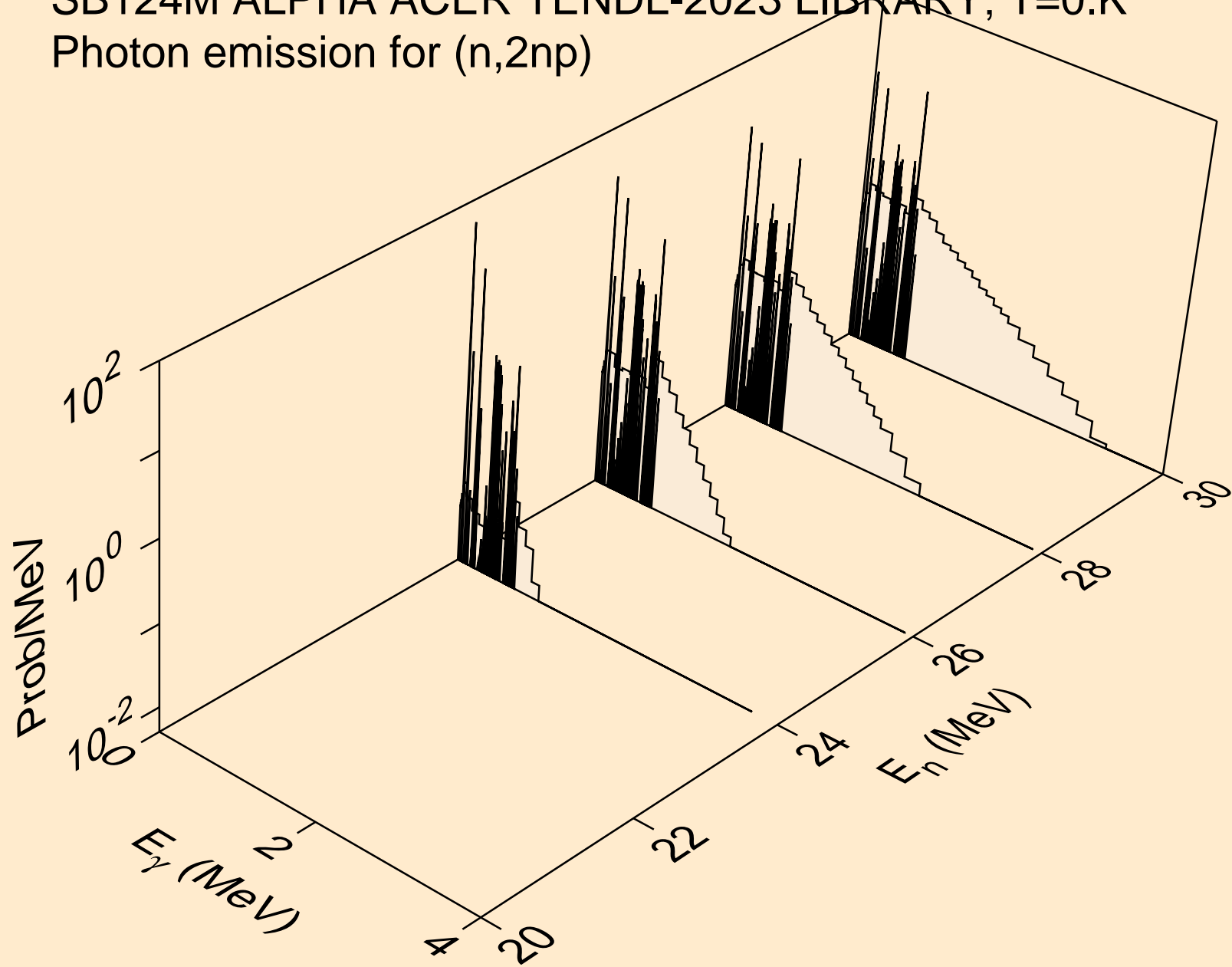

SB124M ALPHA ACER TENDL-2023 LIBRARY; T=0.K  
Photon emission for (n,3np)

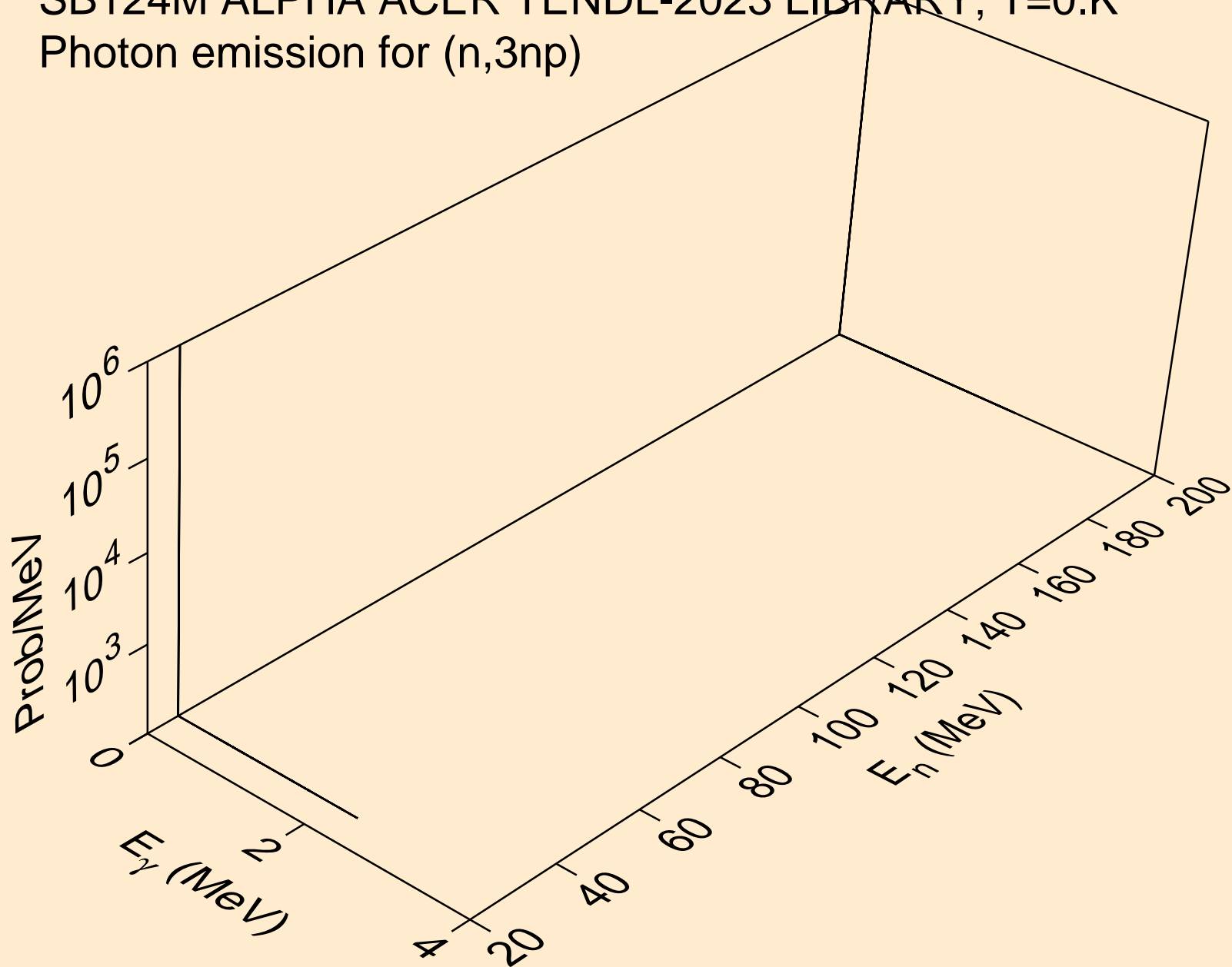

SB124M ALPHA ACER TENDL-2023 LIBRARY; T=0.K  
Photon emission for (n,n2p)

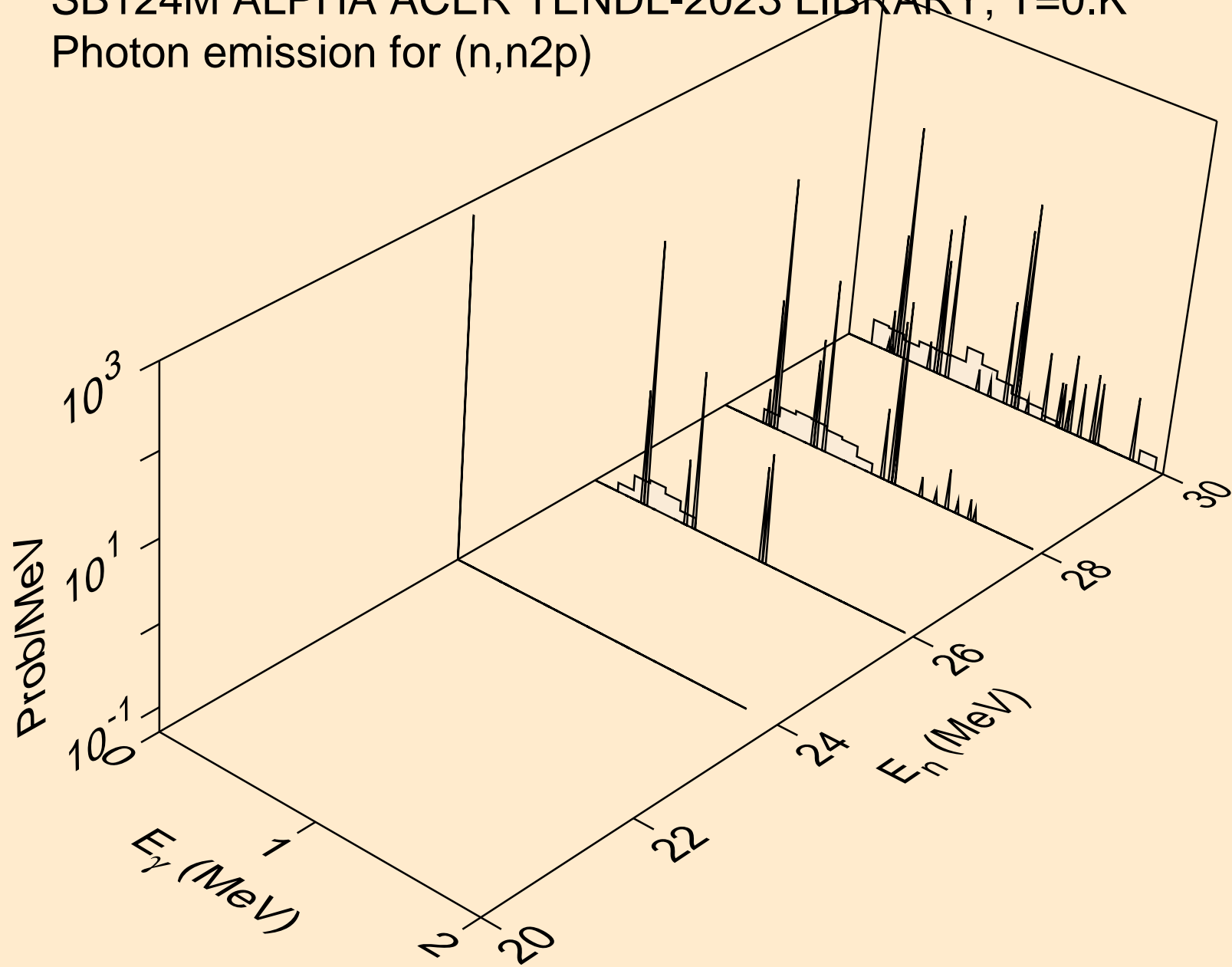

SB124M ALPHA ACER TENDL-2023 LIBRARY; T=0.K  
Photon emission for (n,npa)

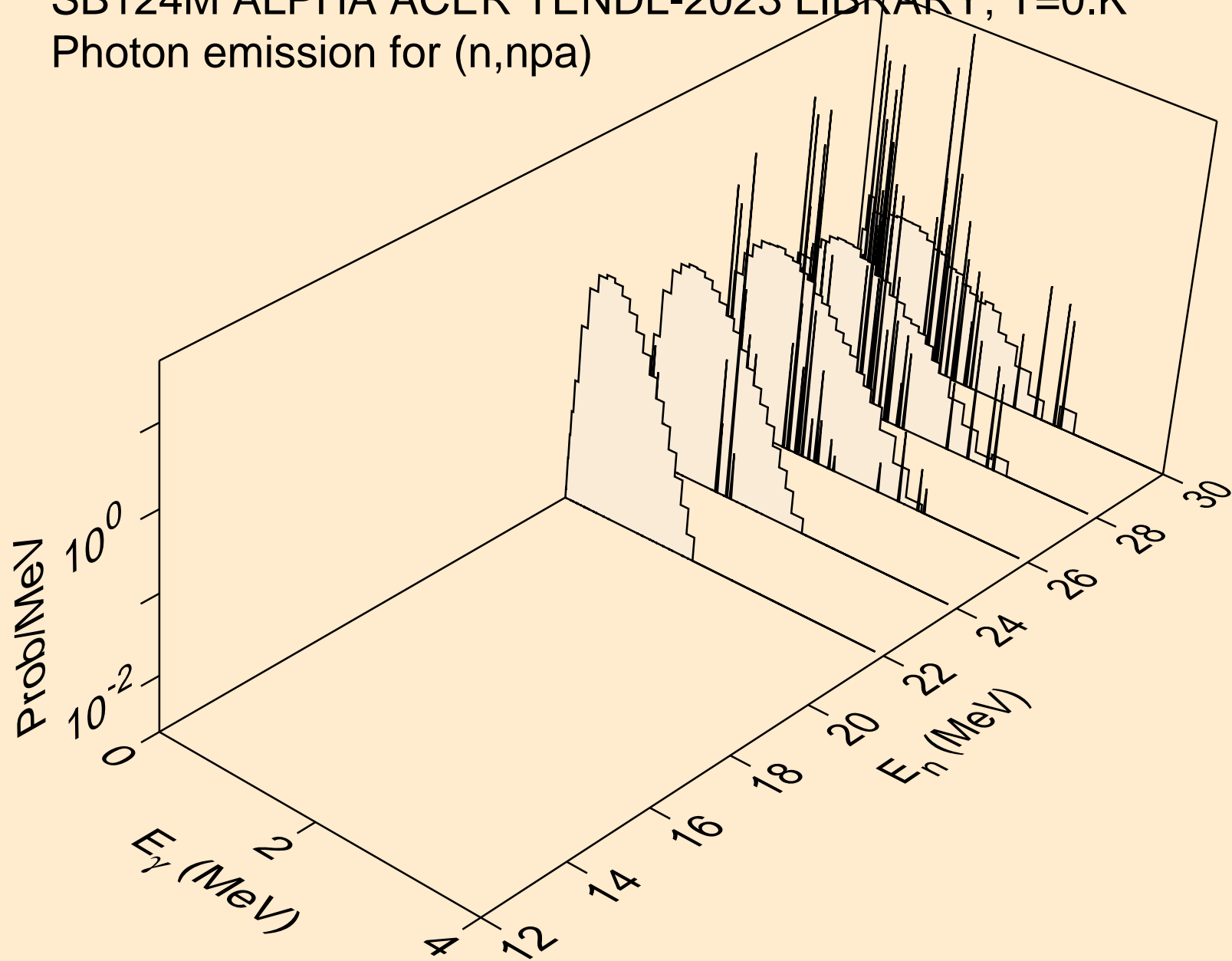

SB124M ALPHA ACER TENDL-2023 LIBRARY; T=0.K  
Photon emission for (n,gma)

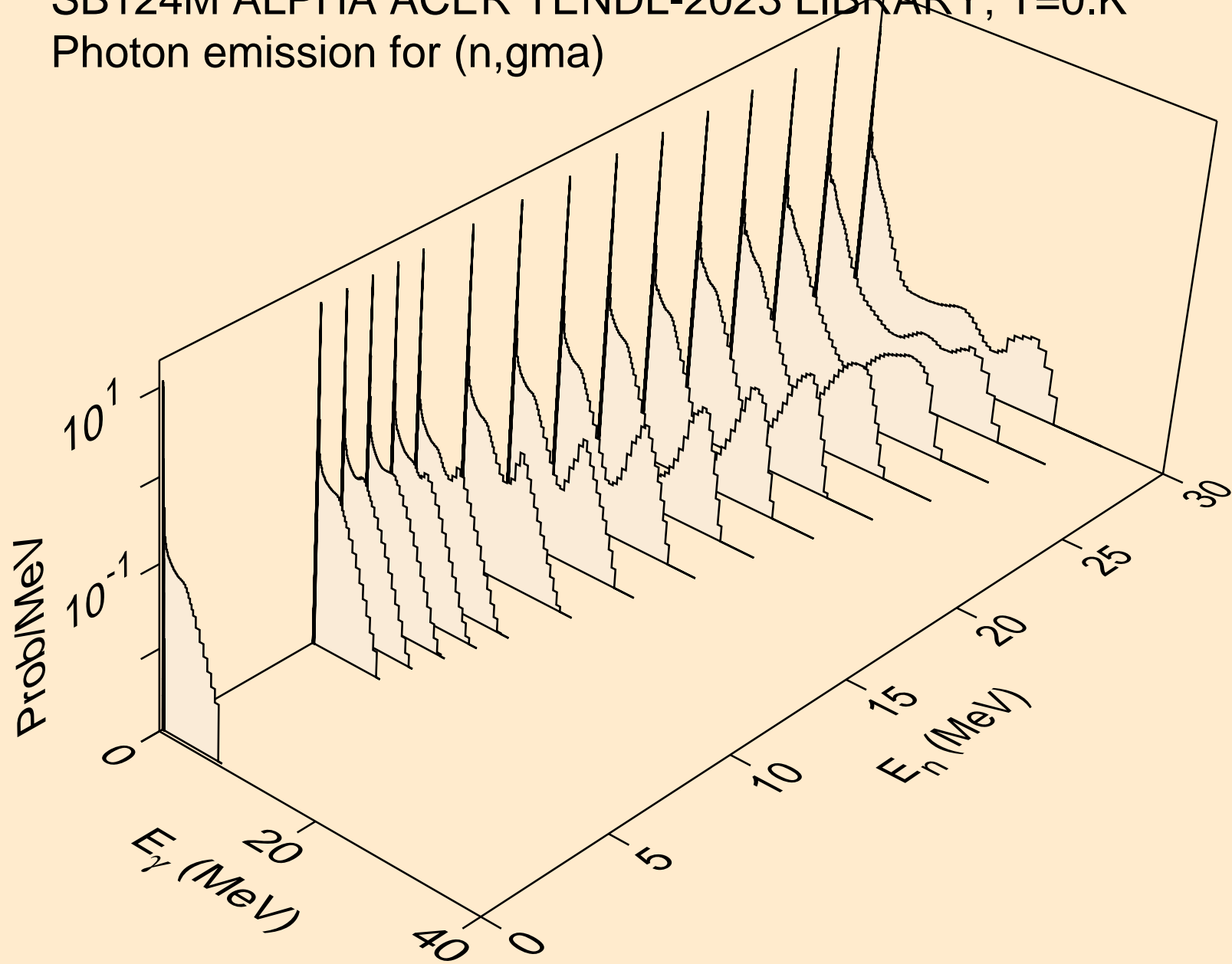

SB124M ALPHA ACER TENDL-2023 LIBRARY; T=0.K  
Photon emission for (n,p)

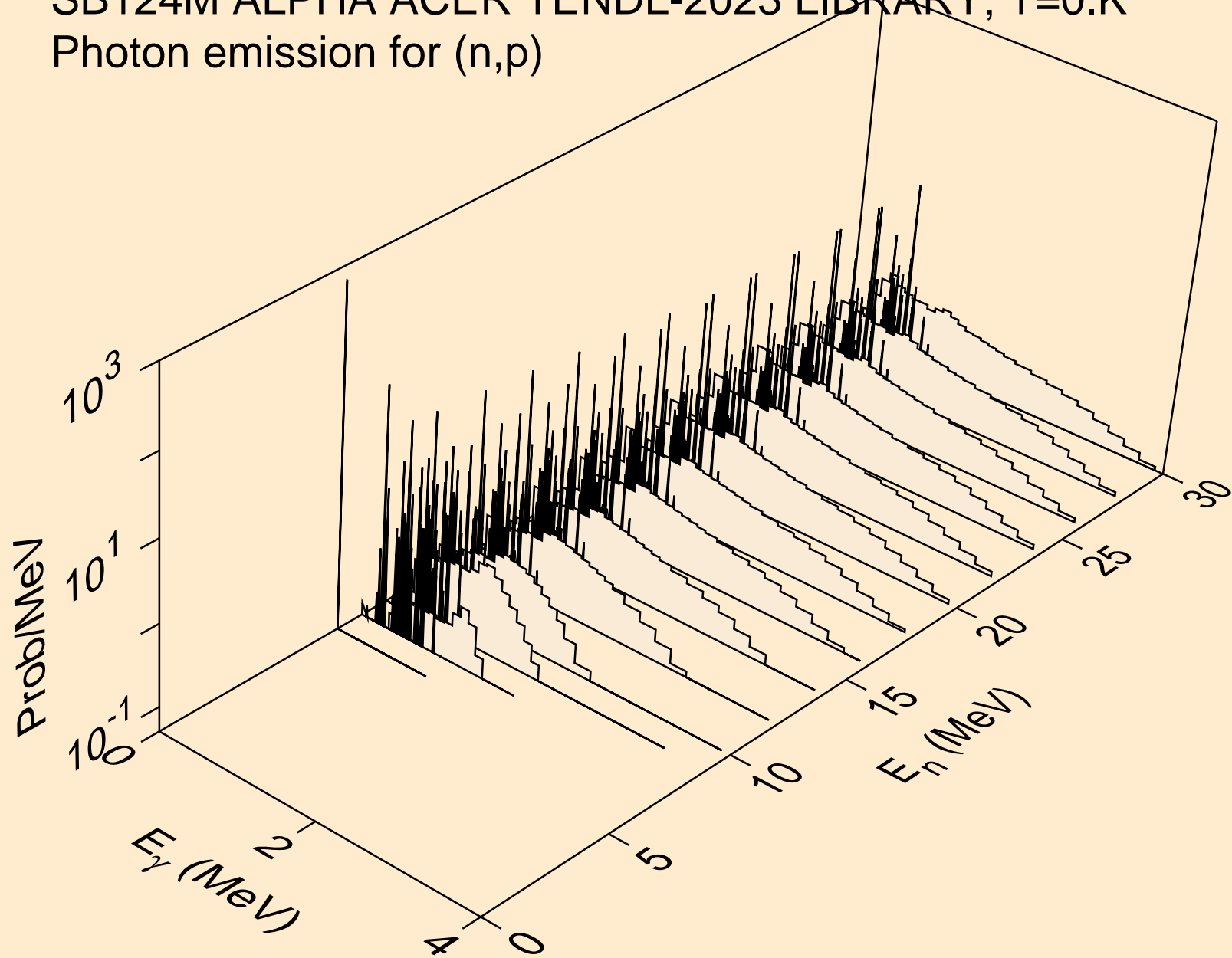

SB124M ALPHA ACER TENDL-2023 LIBRARY; T=0.K  
Photon emission for (n,d)

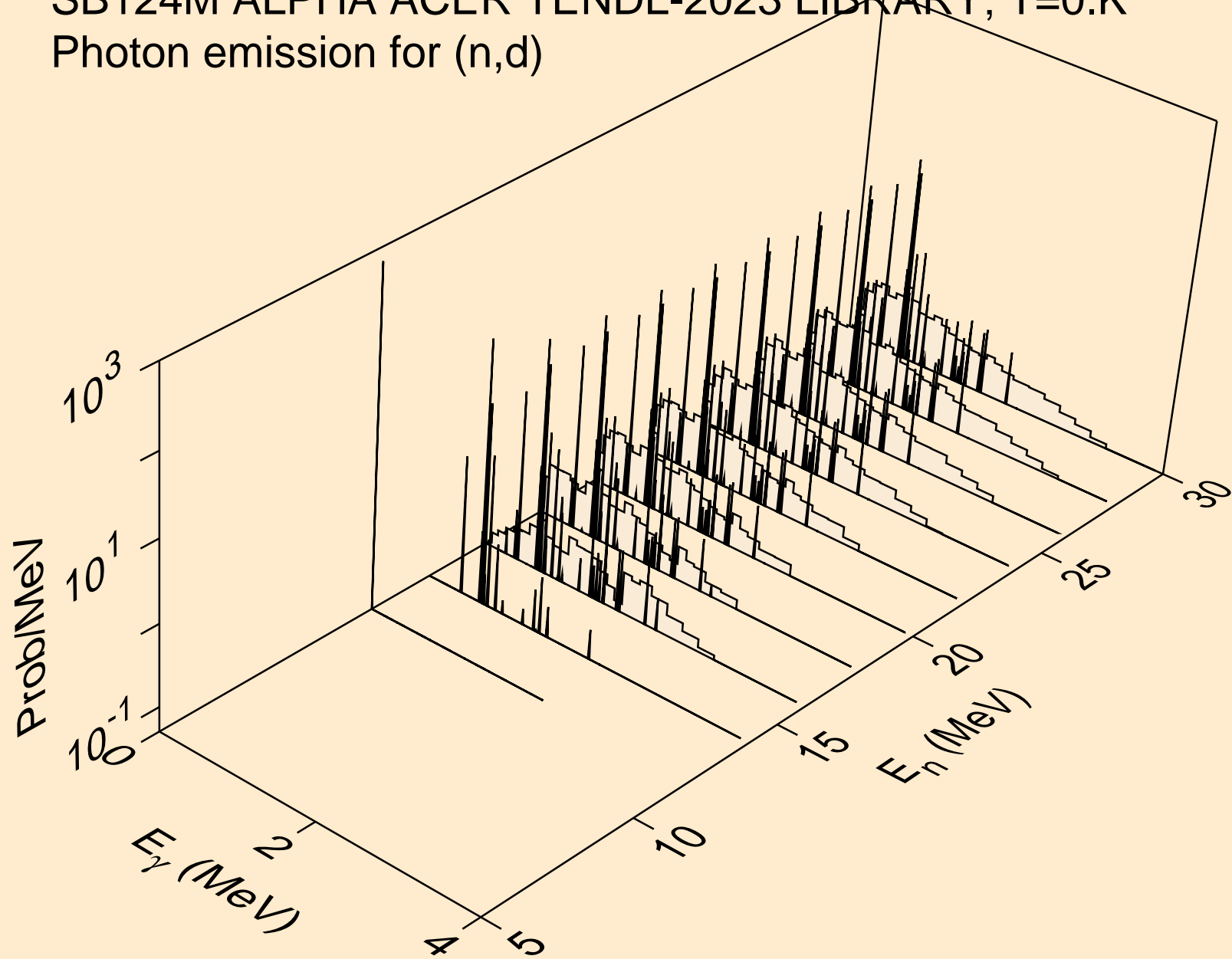

SB124M ALPHA ACER TENDL-2023 LIBRARY; T=0.K  
Photon emission for (n,t)

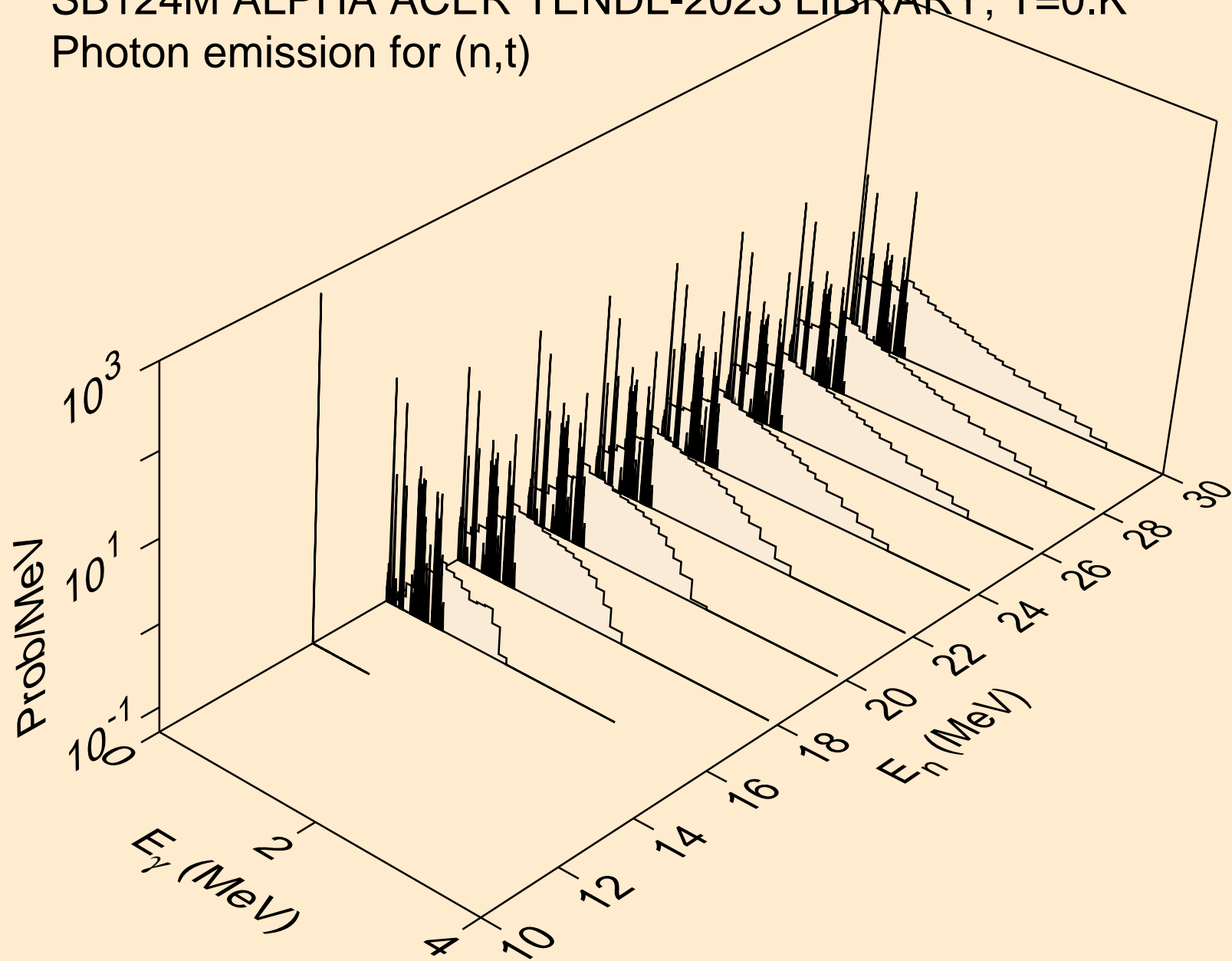

SB124M ALPHA ACER TENDL-2023 LIBRARY; T=0.K  
Photon emission for (n,he3)

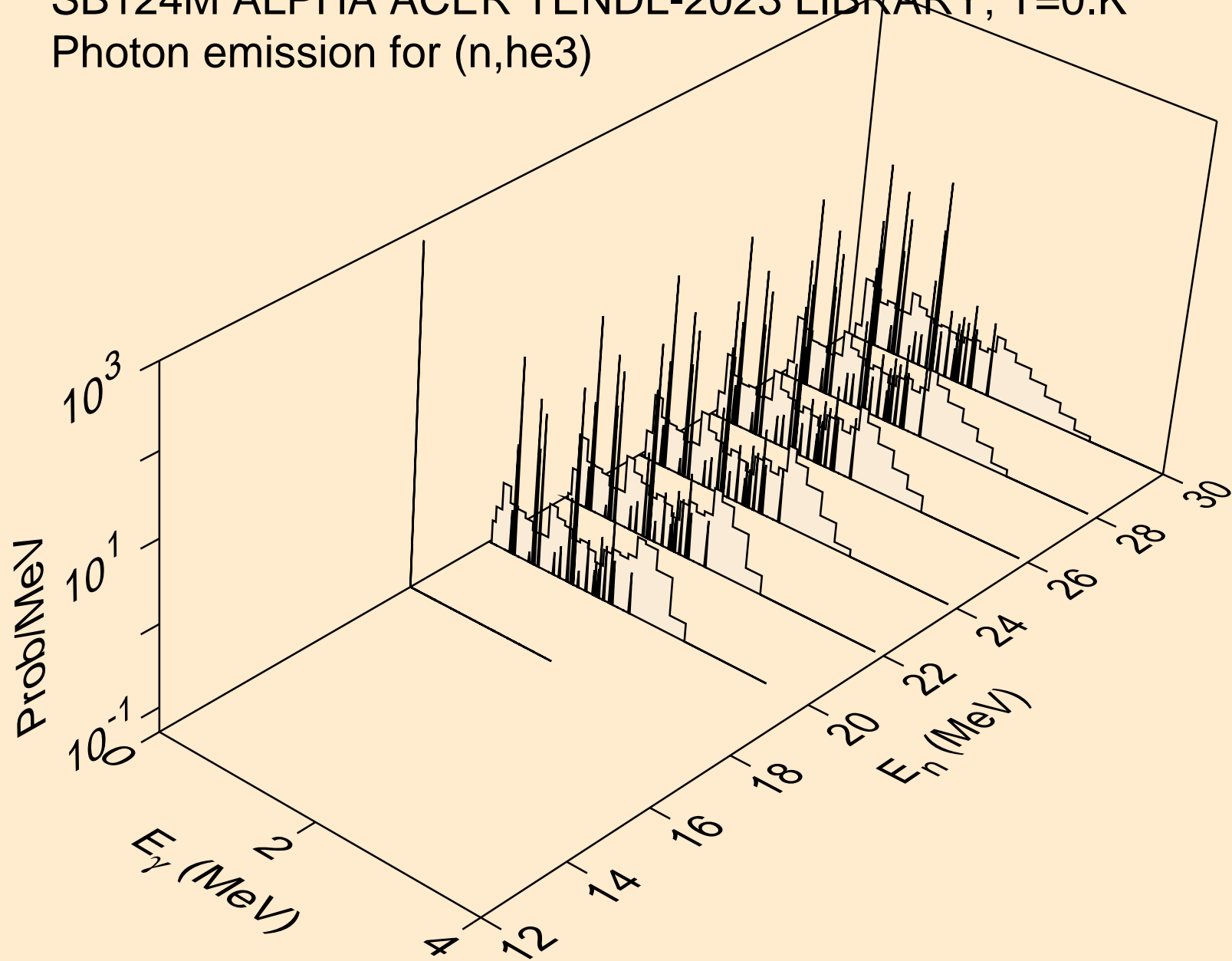

SB124M ALPHA ACER TENDL-2023 LIBRARY; T=0.K  
Photon emission for inelastic

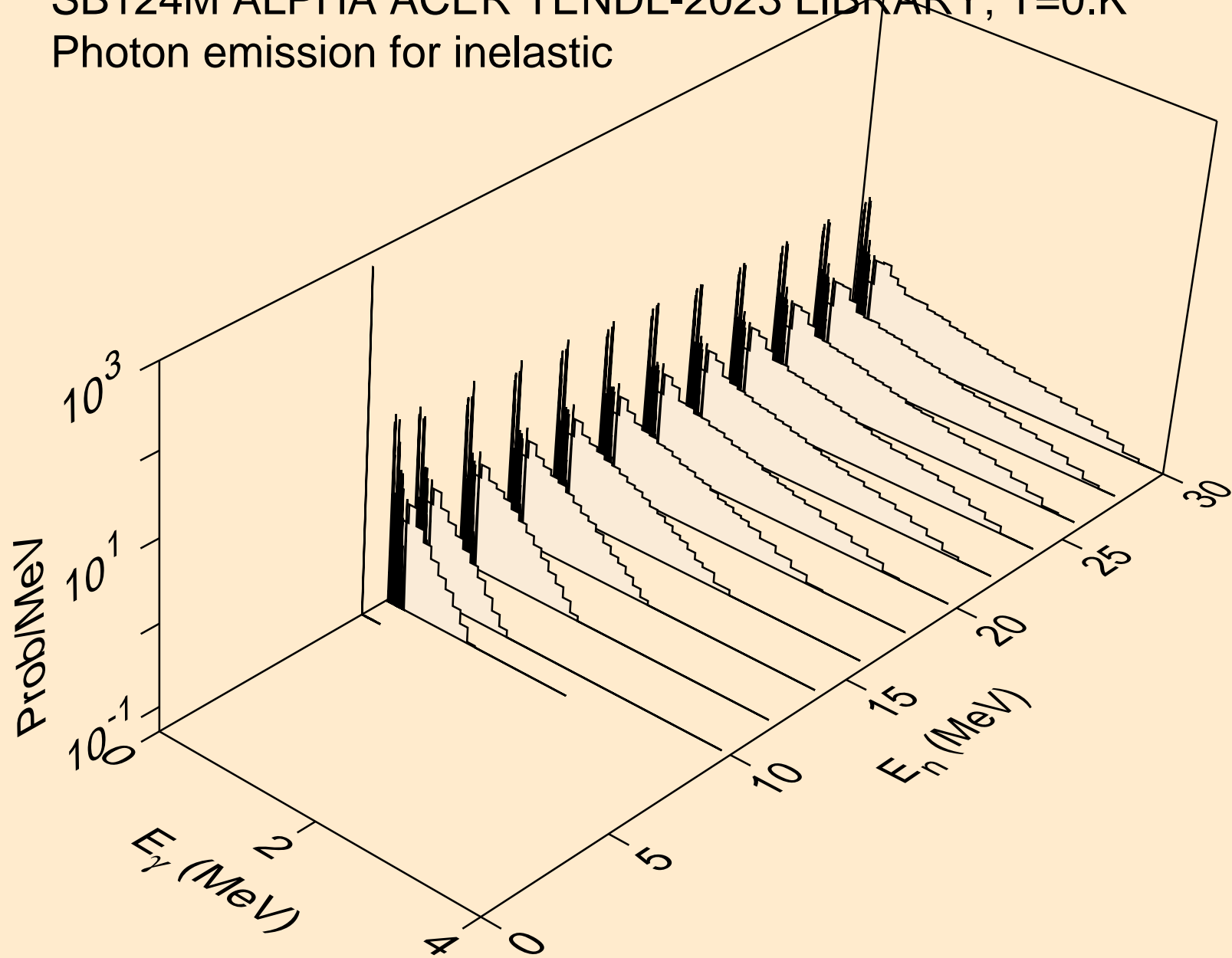

SB124M ALPHA ACER TENDL-2023 LIBRARY; T=0.K  
Photon emission for (n,2a)

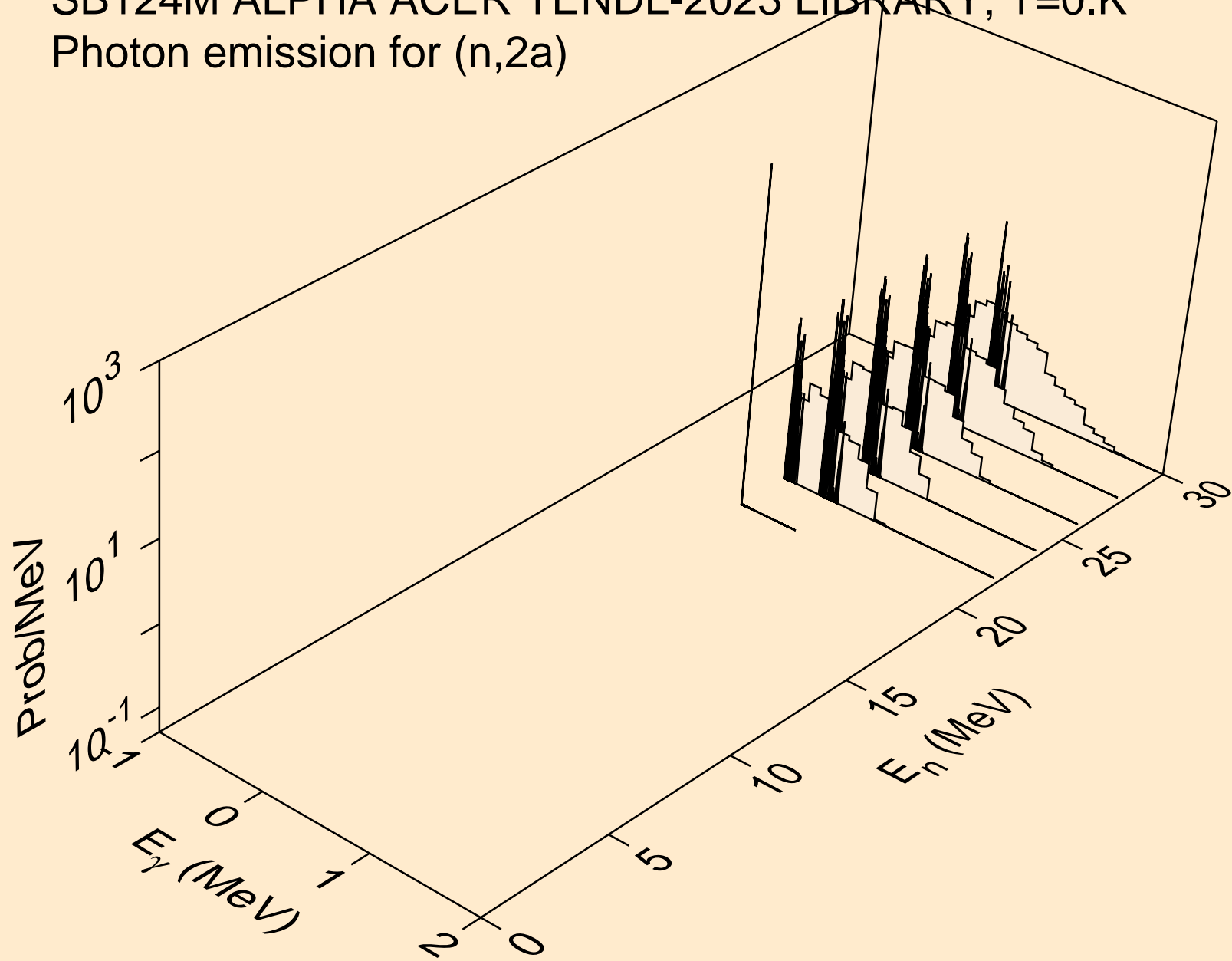

SB124M ALPHA ACER TENDL-2023 LIBRARY; T=0.K  
Photon emission for (n,2p)

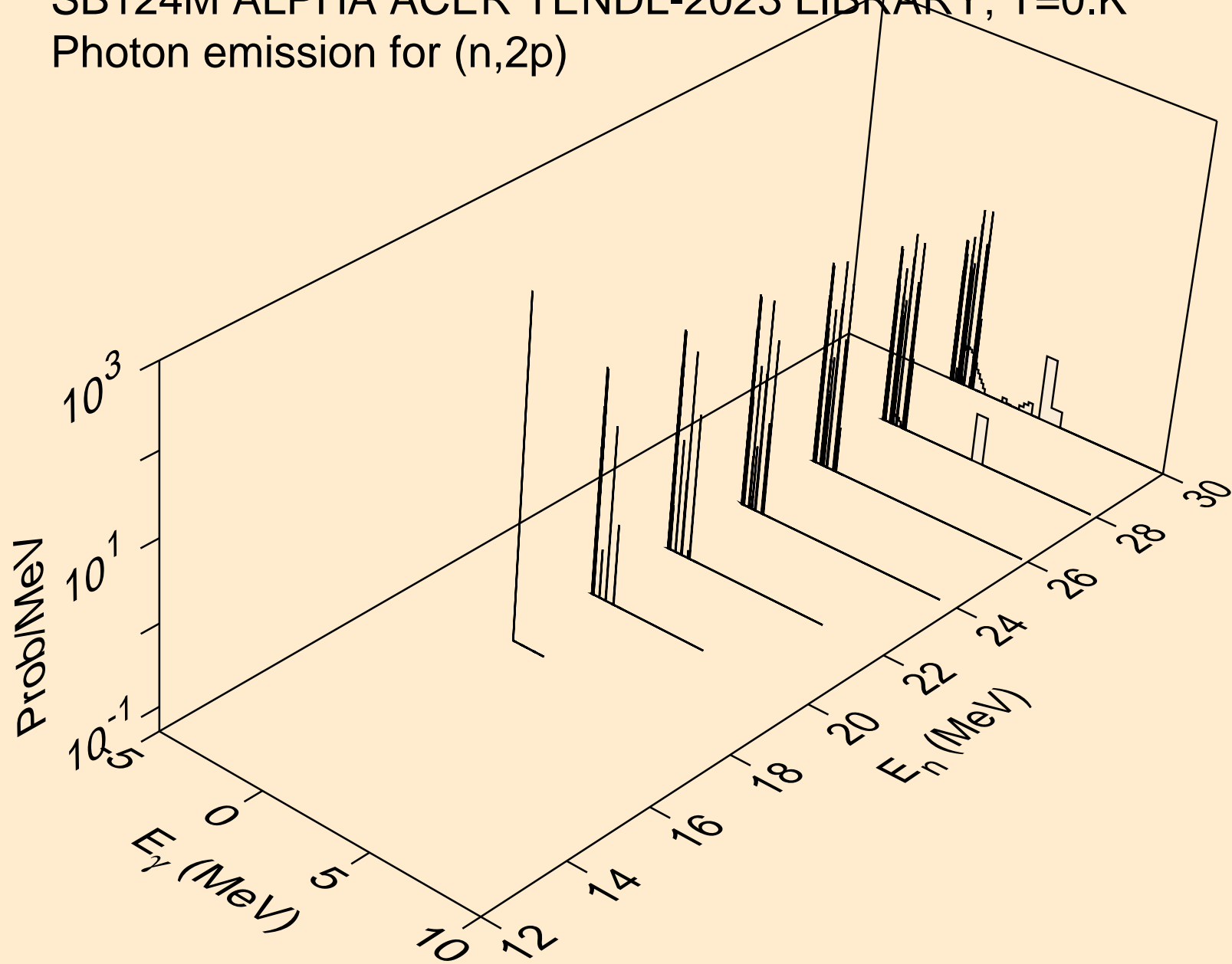

SB124M ALPHA ACER TENDL-2023 LIBRARY; T=0.K  
Photon emission for (n,pa)

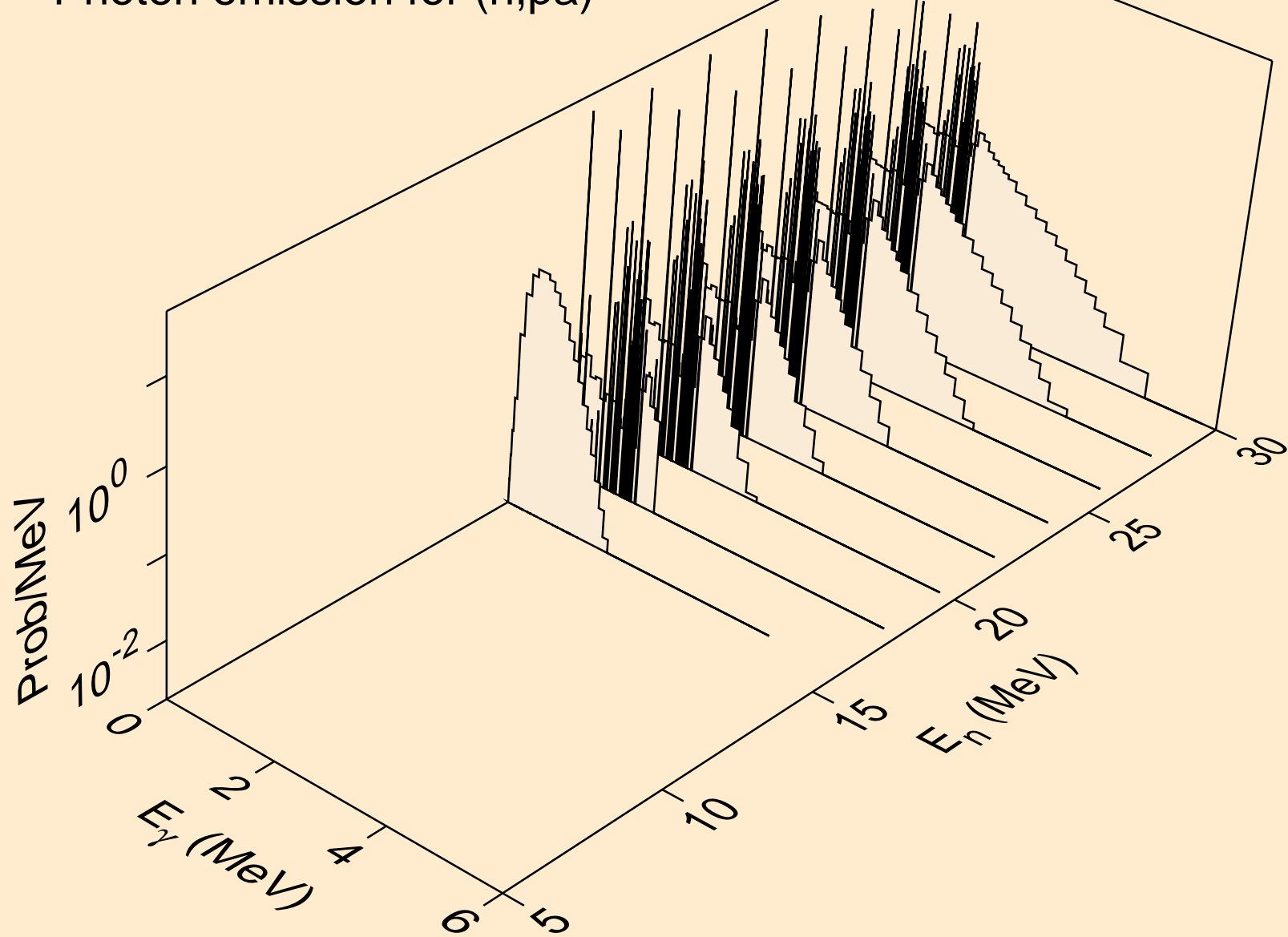

SB124M ALPHA ACER TENDL-2023 LIBRARY; T=0.K  
Photon emission for (n,pd)

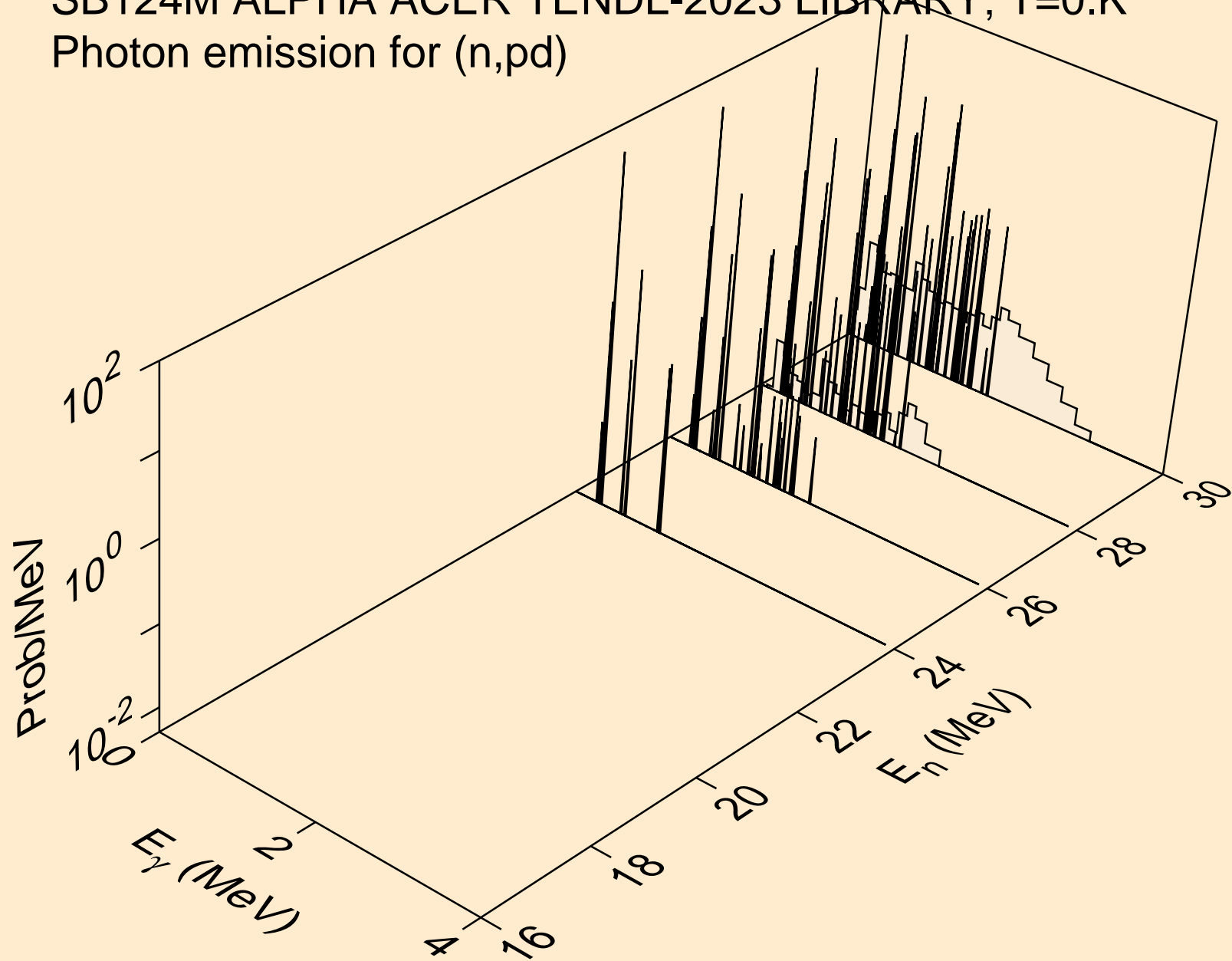

SB124M ALPHA ACER TENDL-2023 LIBRARY; T=0.K  
Particle heating contributions

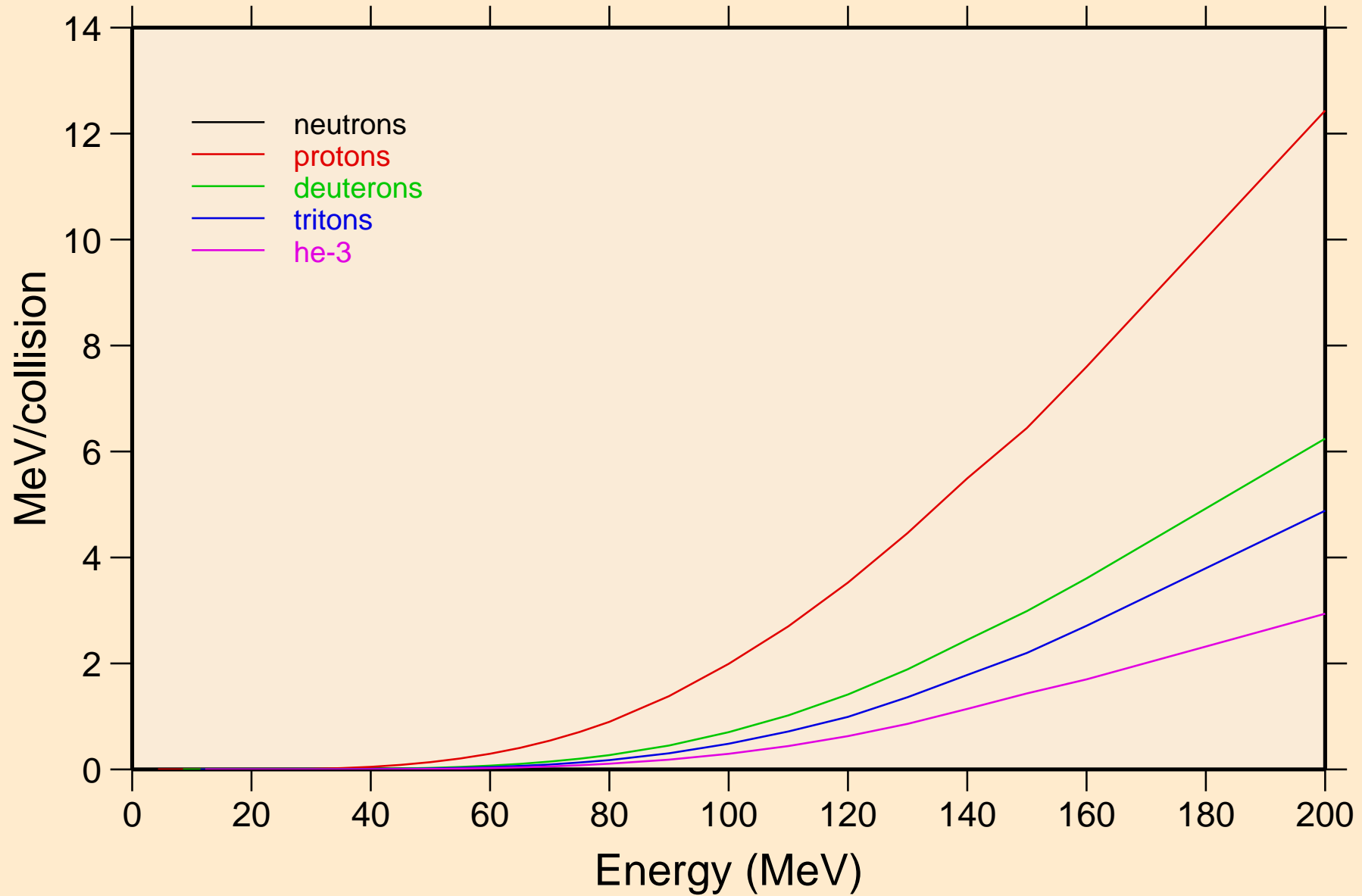

SB124M ALPHA ACER TENDL-2023 LIBRARY; T=0.K  
Recoil Heating

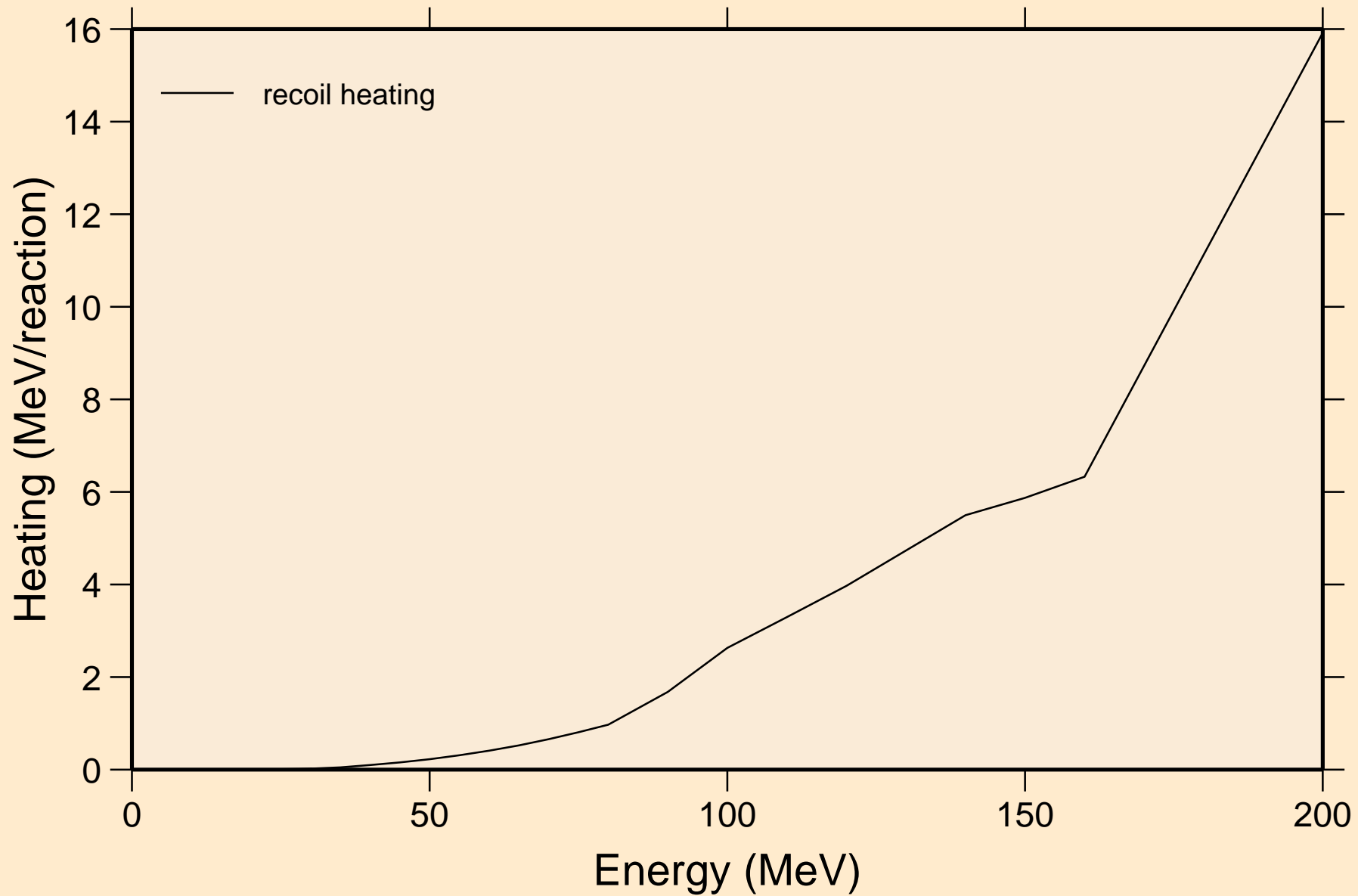

SB124M ALPHA ACER TENDL-2023 LIBRARY; T=0.K  
Particle production cross sections

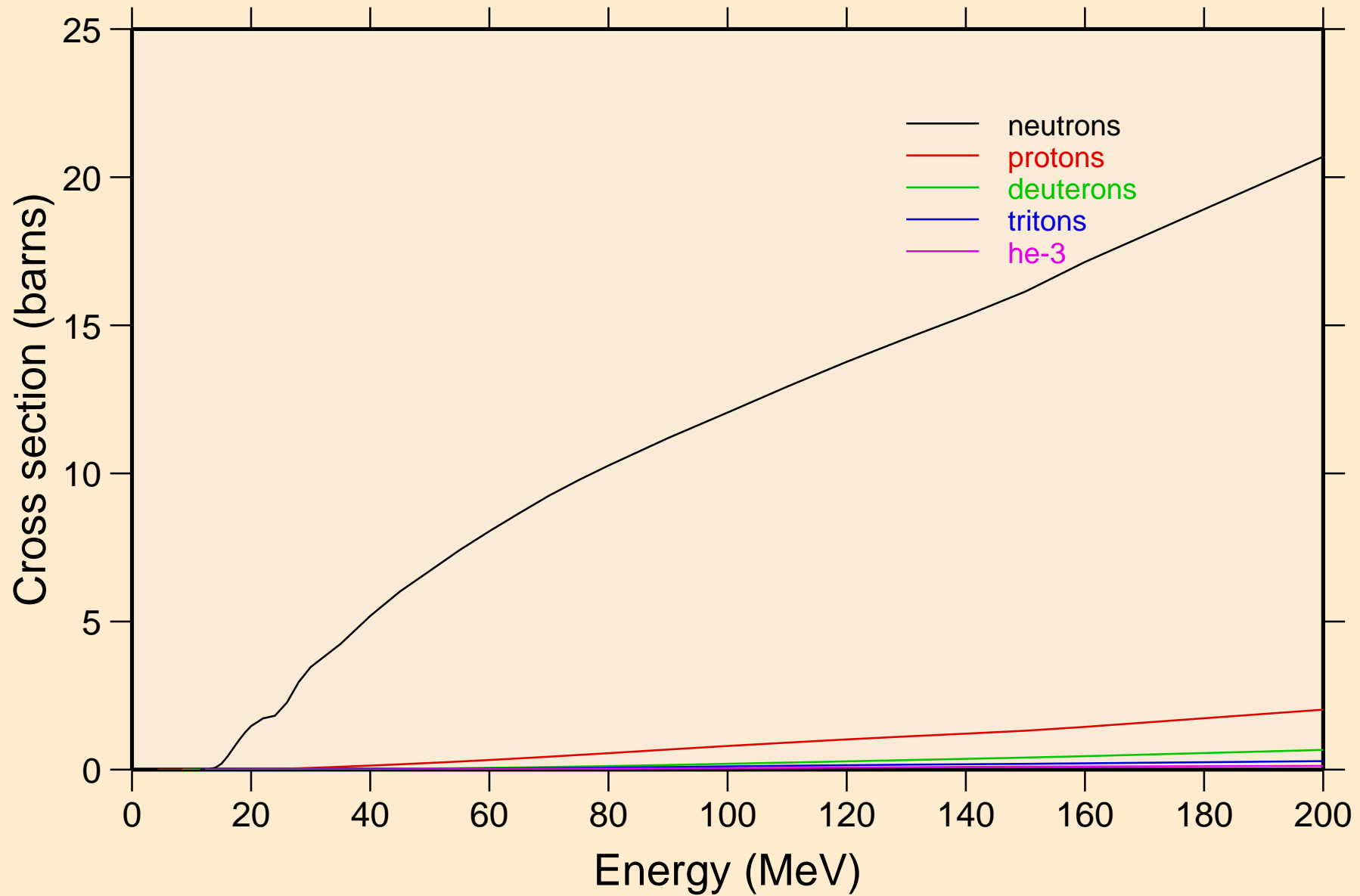

SB124M ALPHA ACER TENDL-2023 LIBRARY; T=0.K  
neutrons from (a,n)

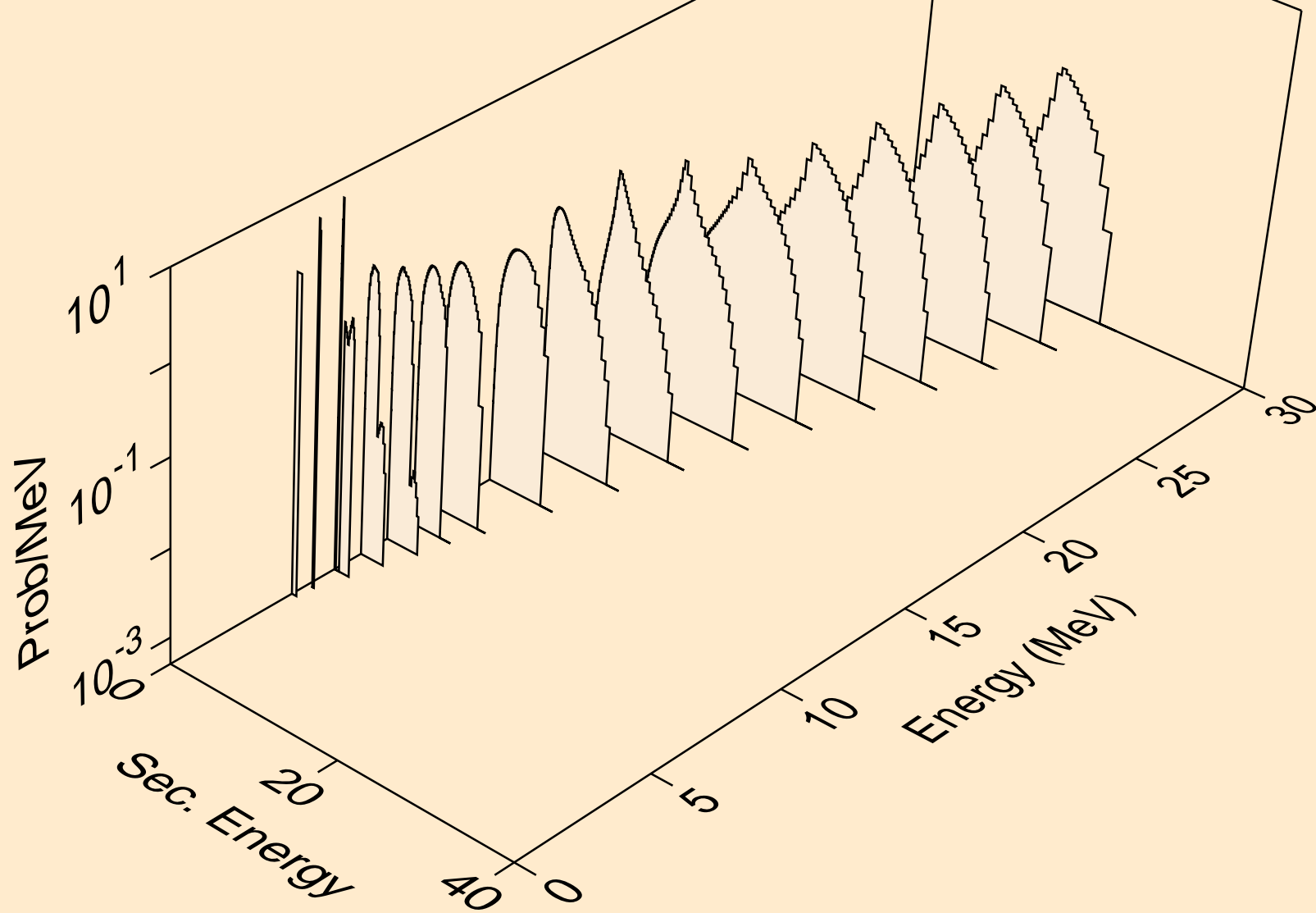

SB124M ALPHA ACER TENDL-2023 LIBRARY; T=0.K  
neutrons from (a,x)

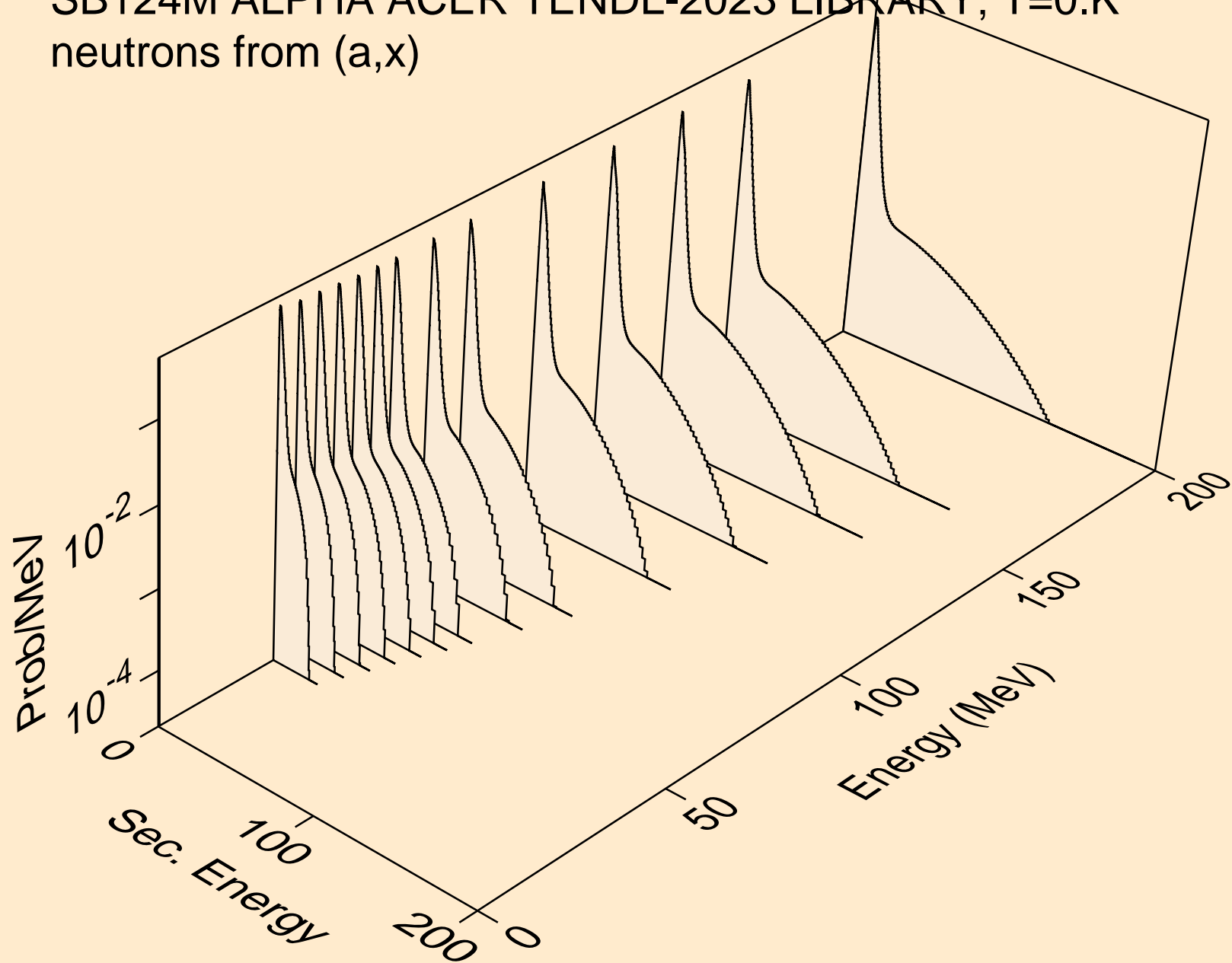

SB124M ALPHA ACER TENDL-2023 LIBRARY; T=0.K  
neutrons from (a,2nd)

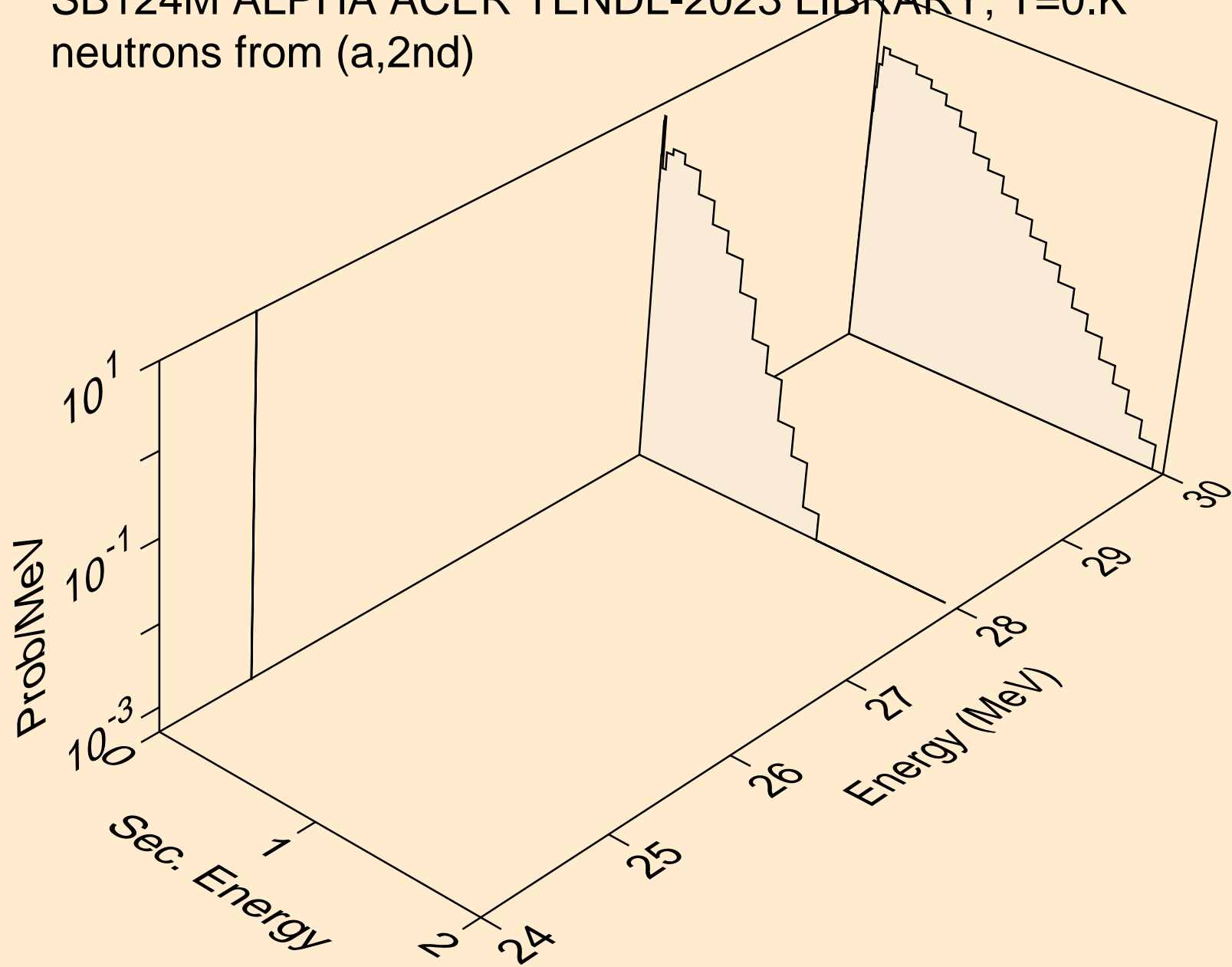

SB124M ALPHA ACER TENDL-2023 LIBRARY; T=0.K  
neutrons from (a,2n)

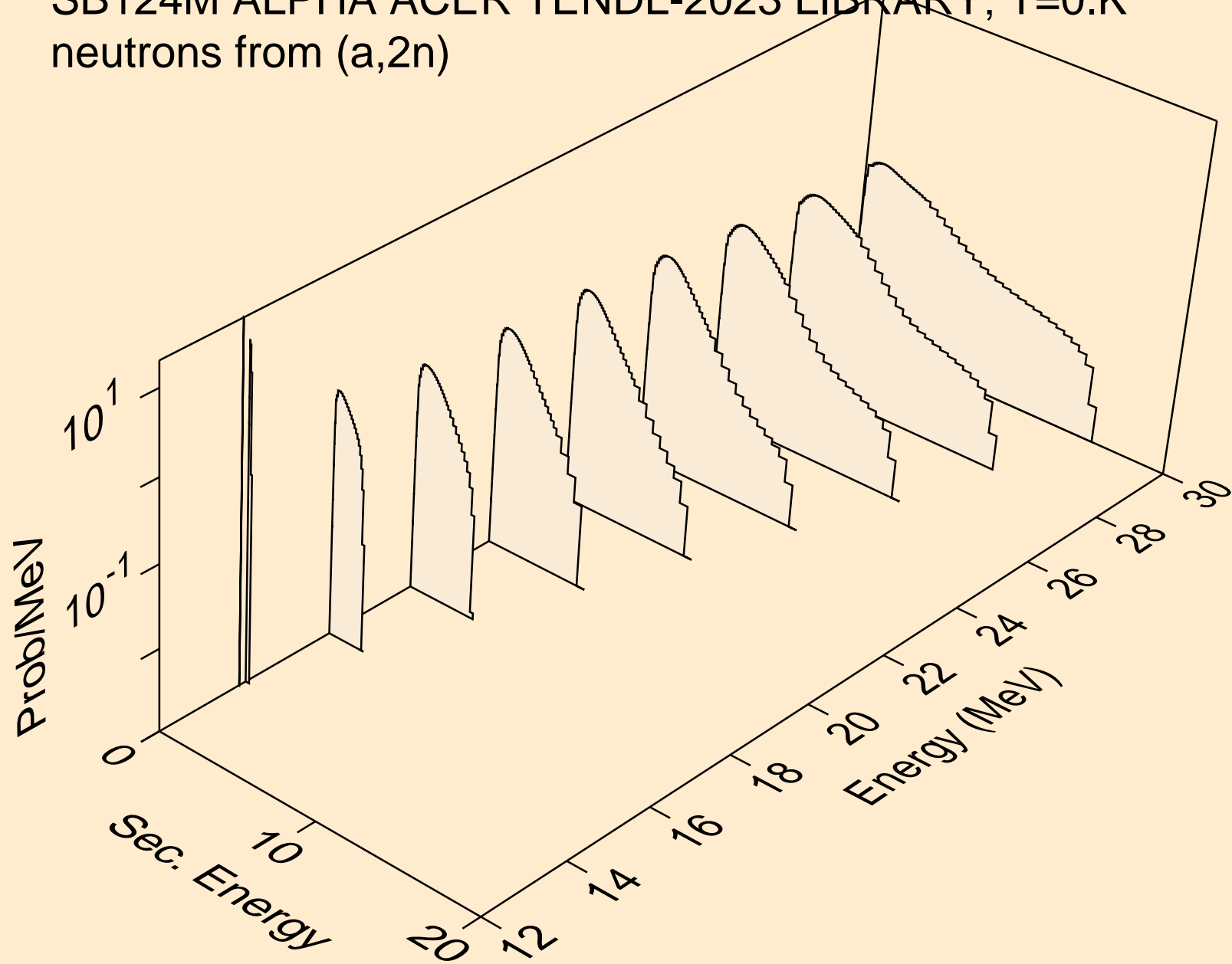

SB124M ALPHA ACER TENDL-2023 LIBRARY; T=0.K  
neutrons from (a,3n)

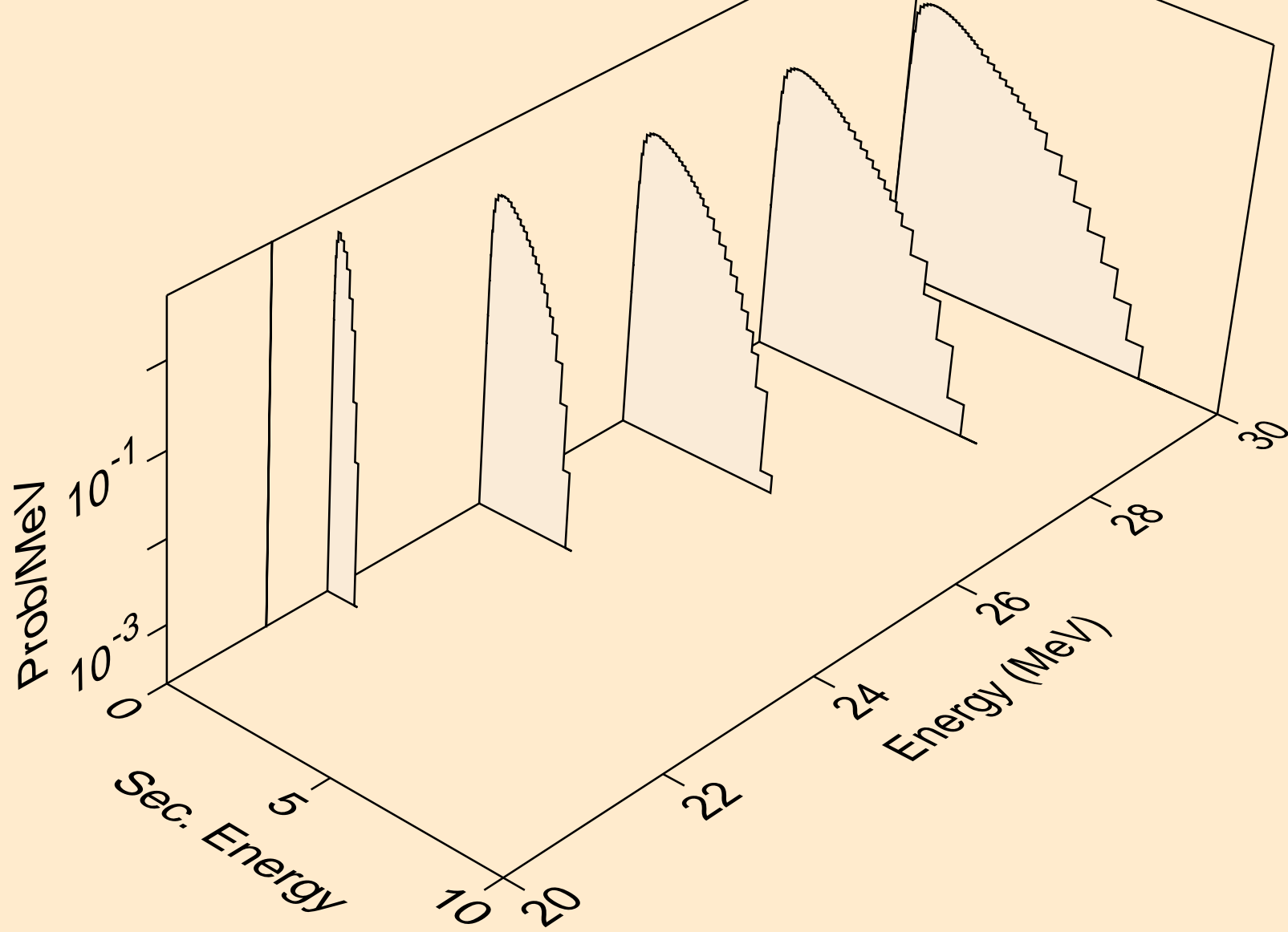

SB124M ALPHA ACER TENDL-2023 LIBRARY; T=0.K  
neutrons from (a,n\*)a

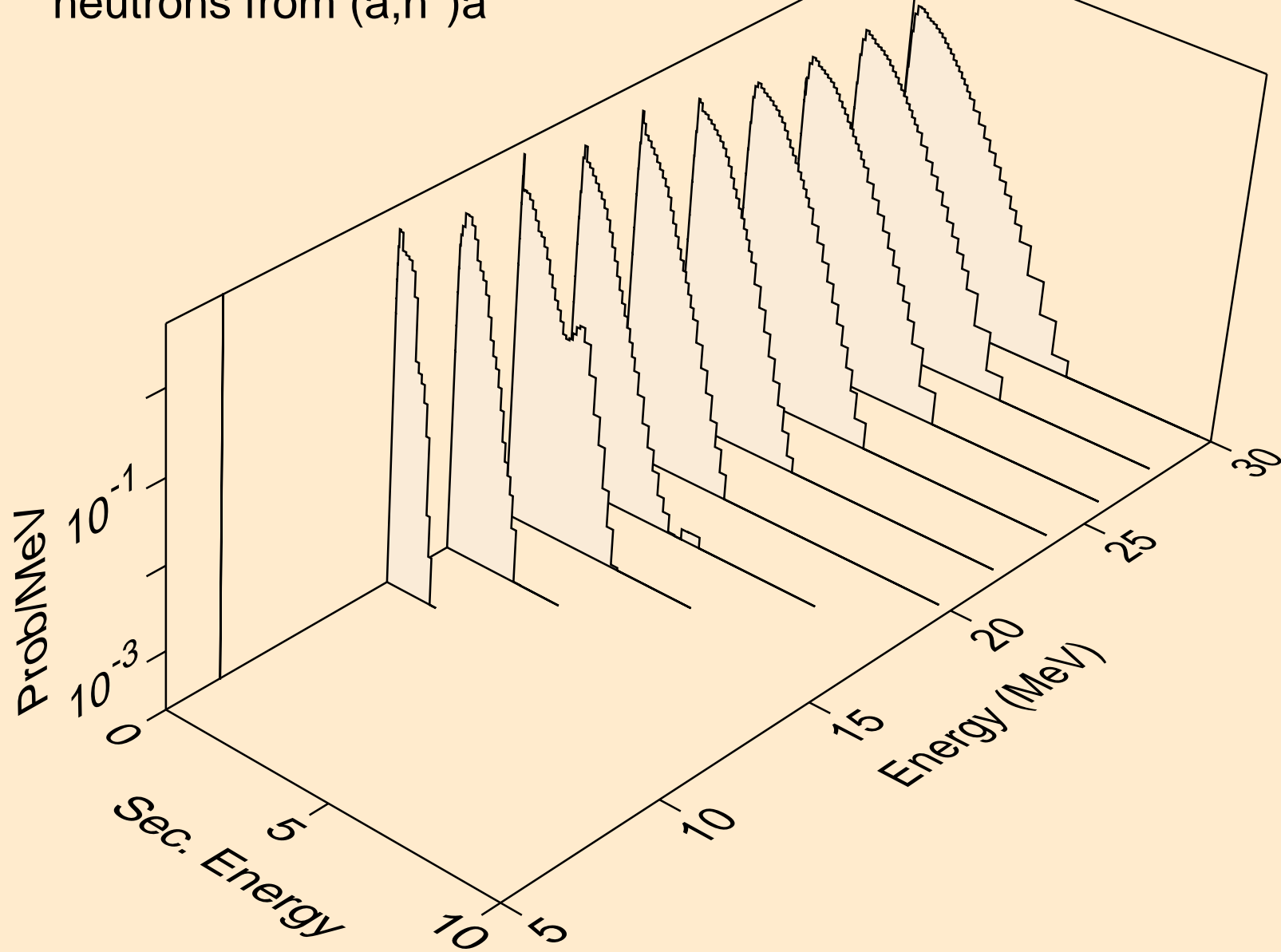

SB124M ALPHA ACER TENDL-2023 LIBRARY; T=0.K  
neutrons from (a,2n)a

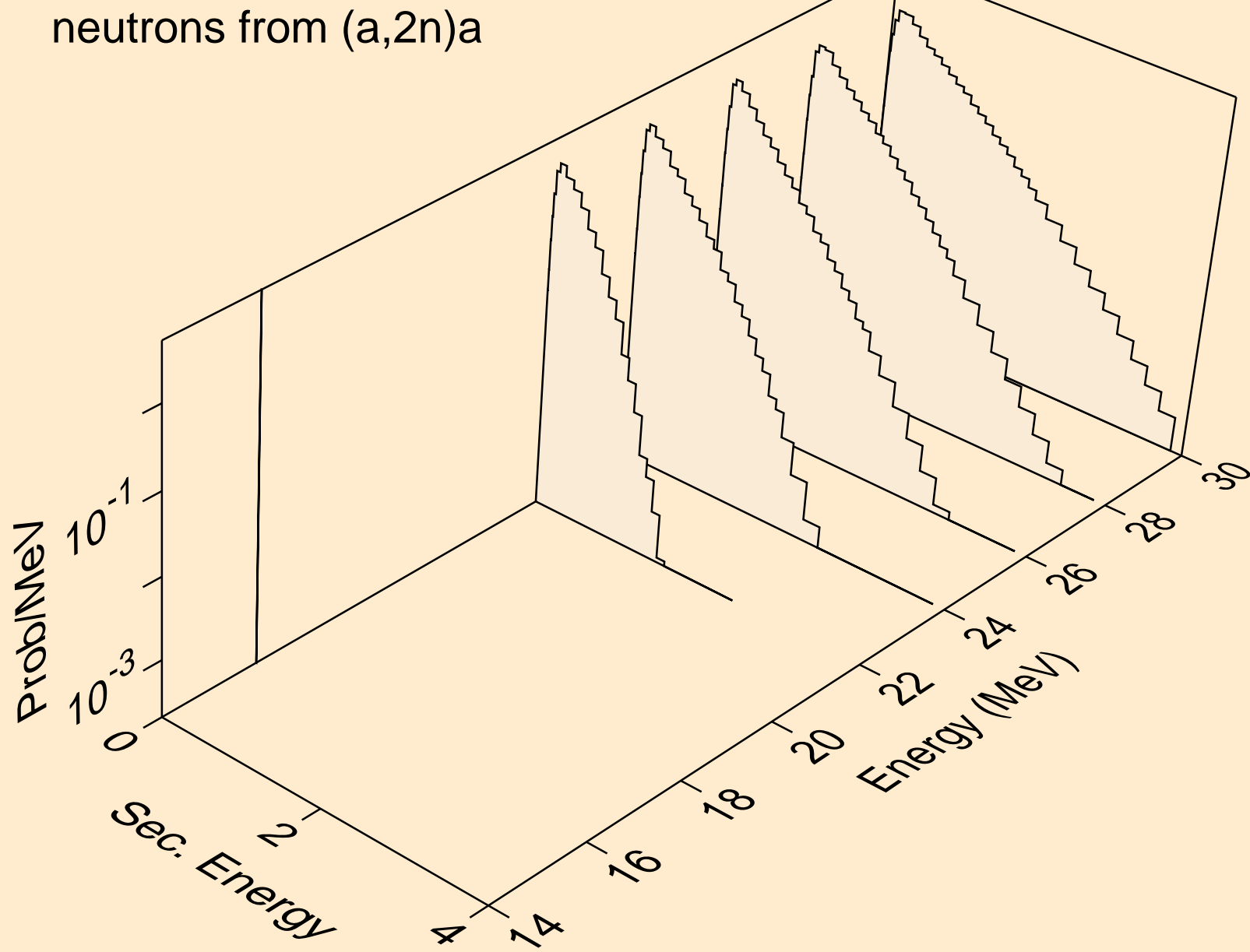

SB124M ALPHA ACER TENDL-2023 LIBRARY; T=0.K  
neutrons from (a,n\*)p

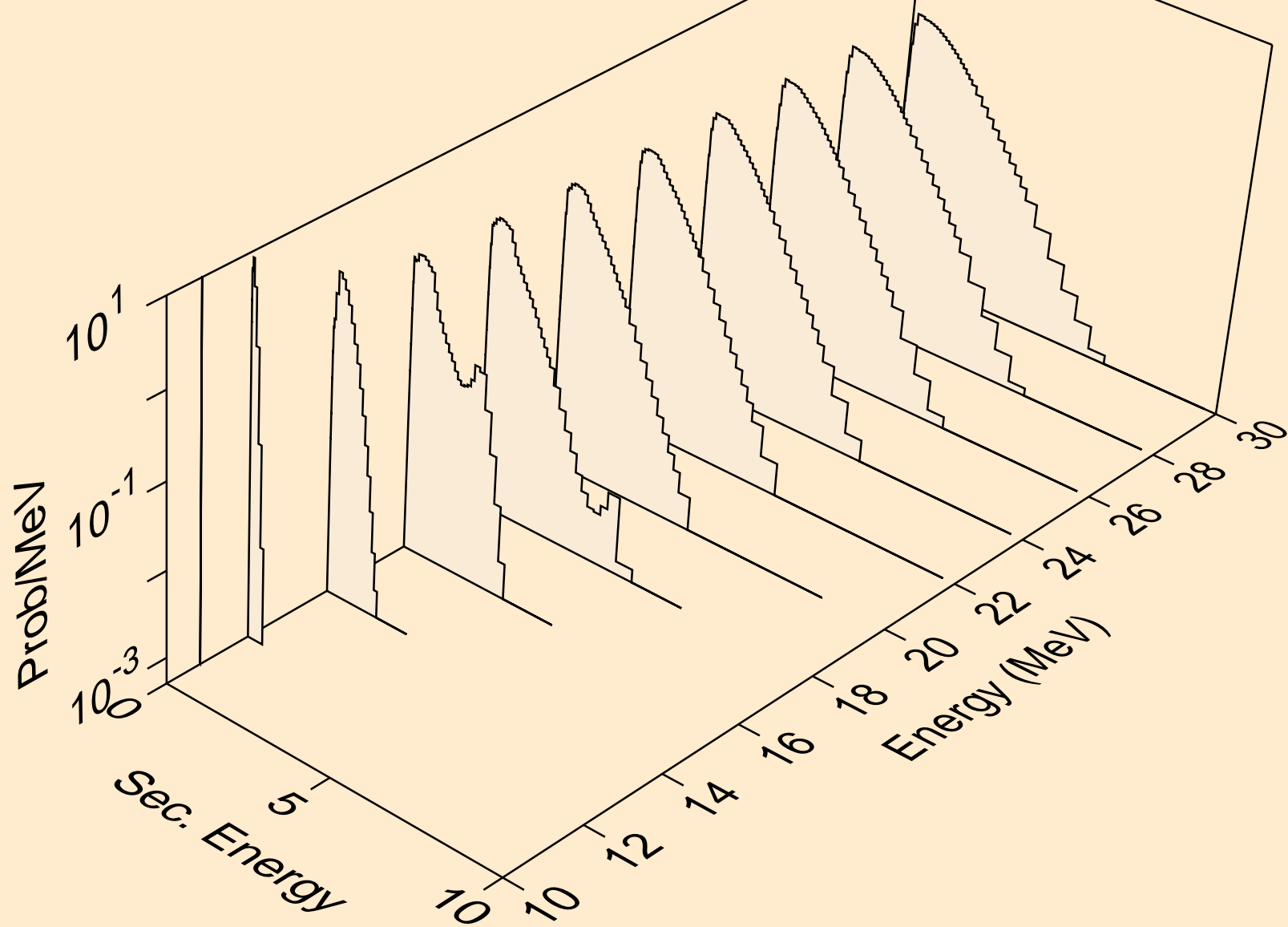

SB124M ALPHA ACER TENDL-2023 LIBRARY; T=0.K  
neutrons from (a,n\*)d

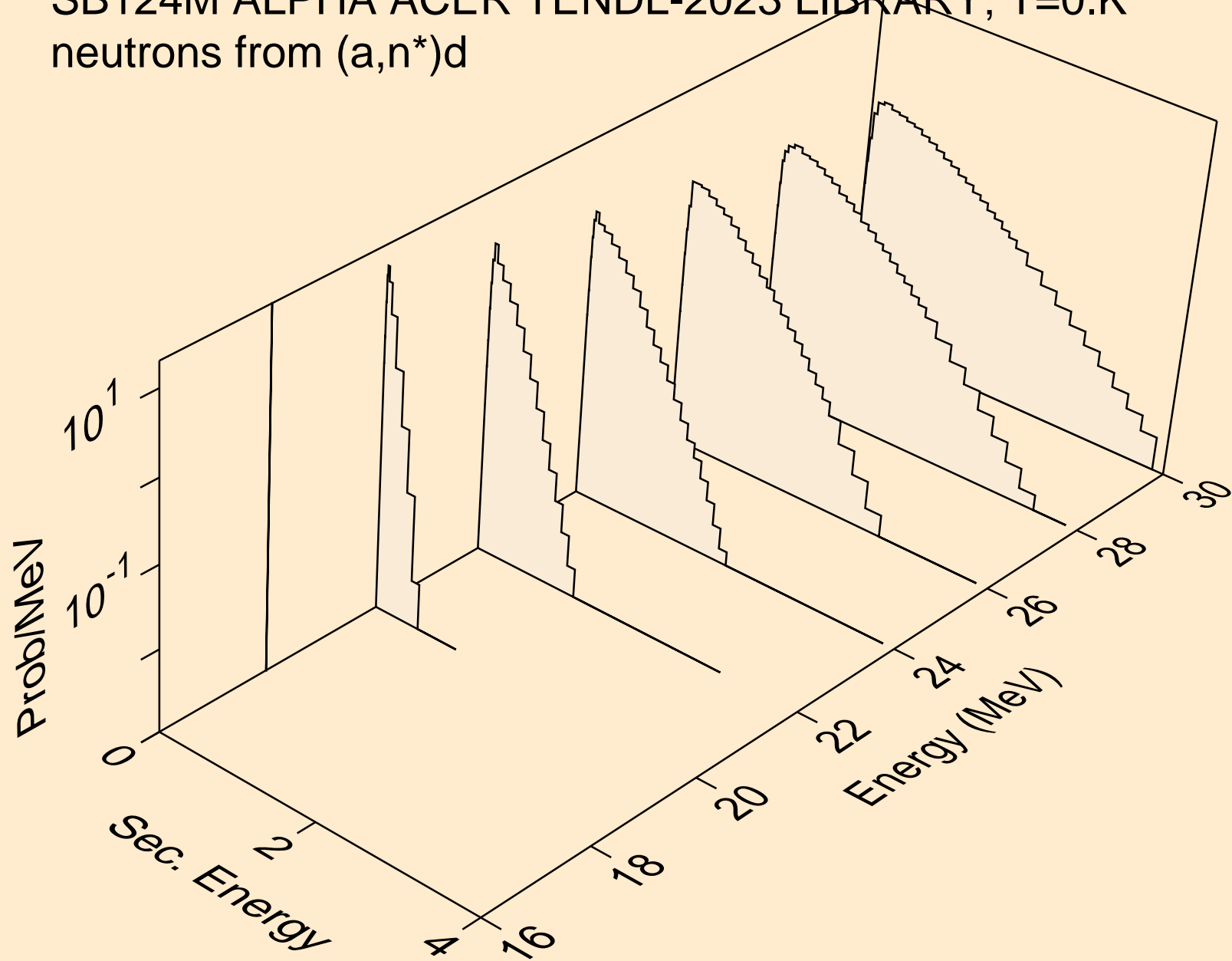

SB124M ALPHA ACER TENDL-2023 LIBRARY; T=0.K  
neutrons from (a,n\*)t

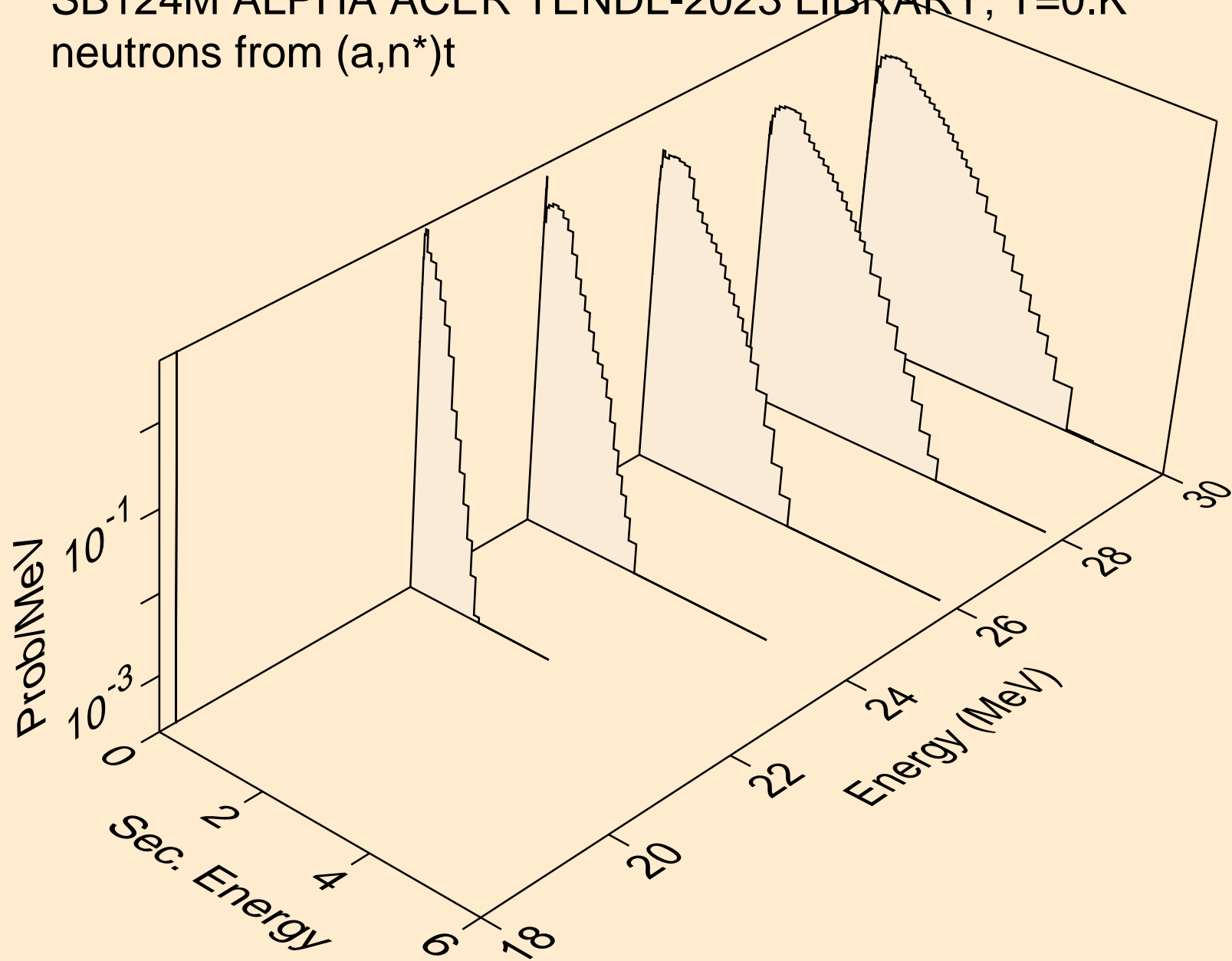

SB124M ALPHA ACER TENDL-2023 LIBRARY; T=0.K  
neutrons from (a,n\*)he3

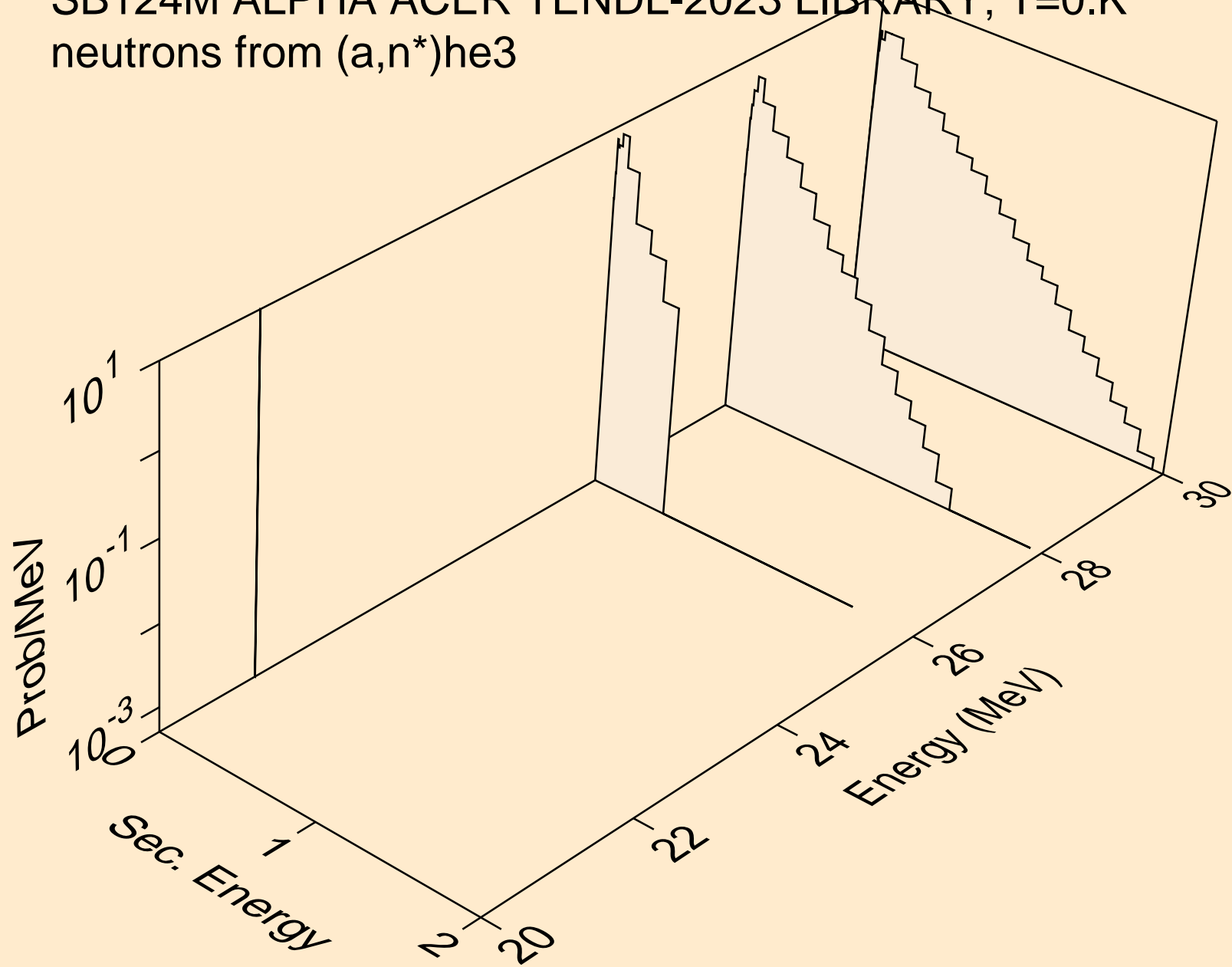

SB124M ALPHA ACER TENDL-2023 LIBRARY; T=0.K  
neutrons from (a,2np)

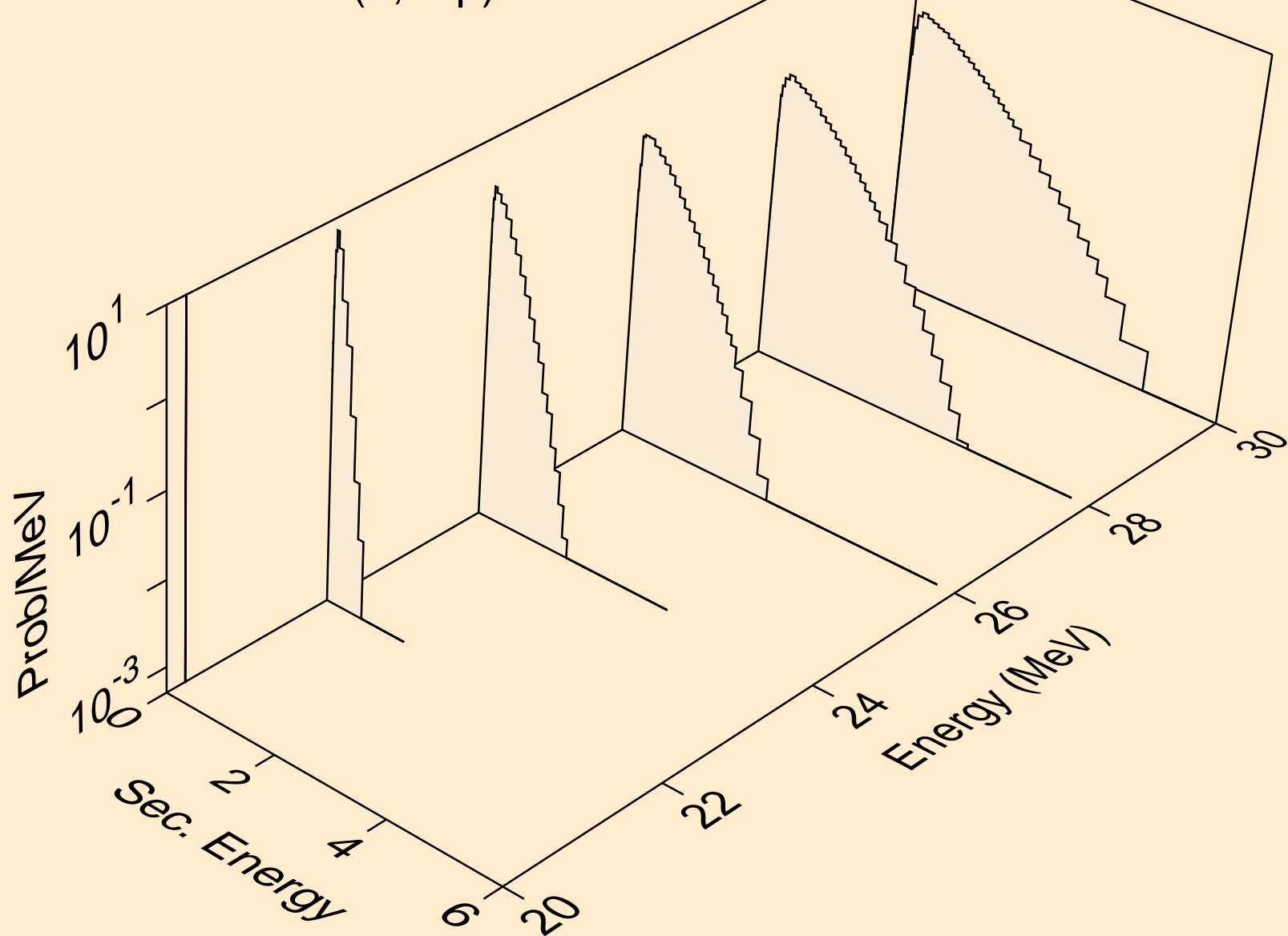

SB124M ALPHA ACER TENDL-2023 LIBRARY; T=0.K  
neutrons from (a,3np)

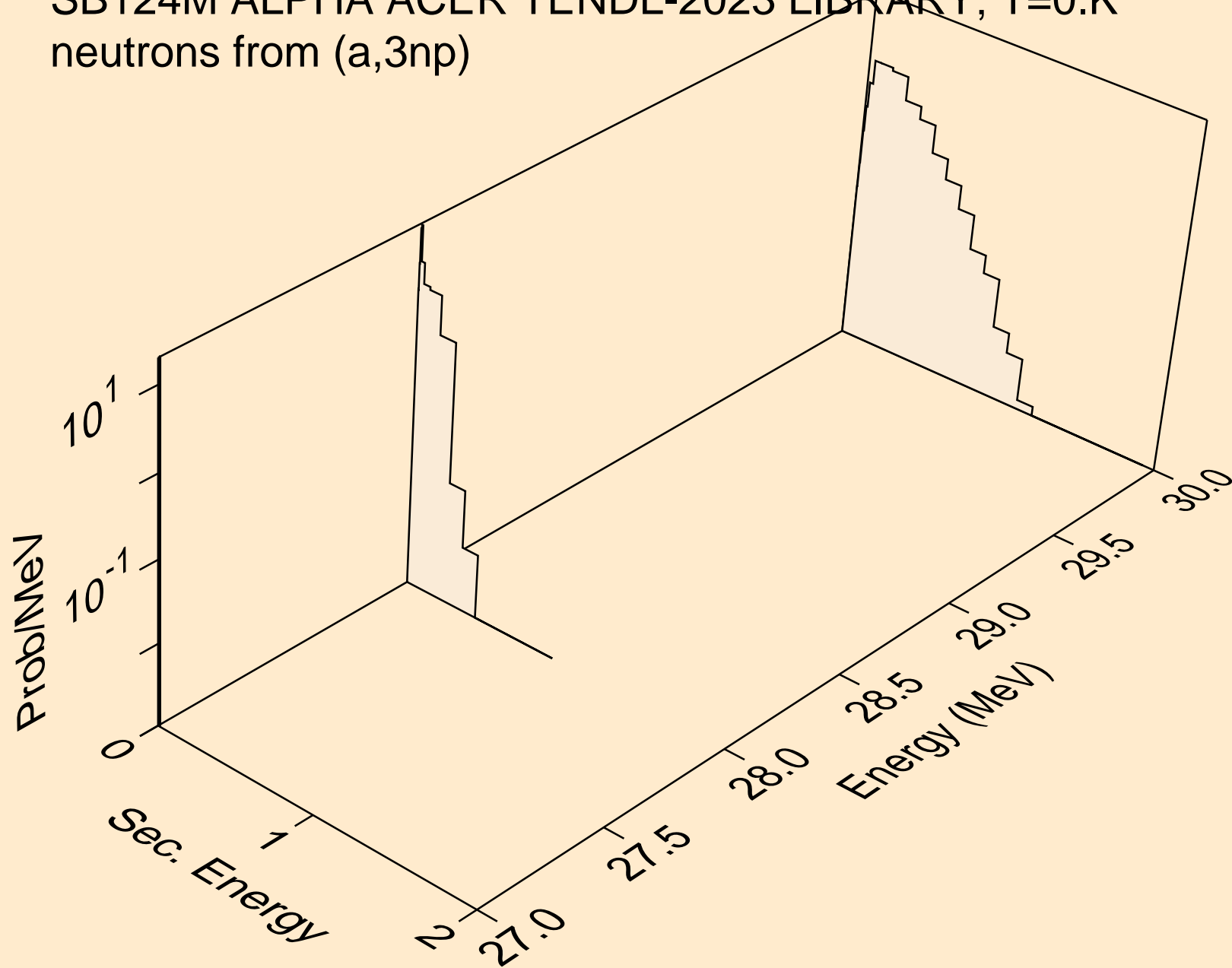

SB124M ALPHA ACER TENDL-2023 LIBRARY; T=0.K  
neutrons from (a,n2p)

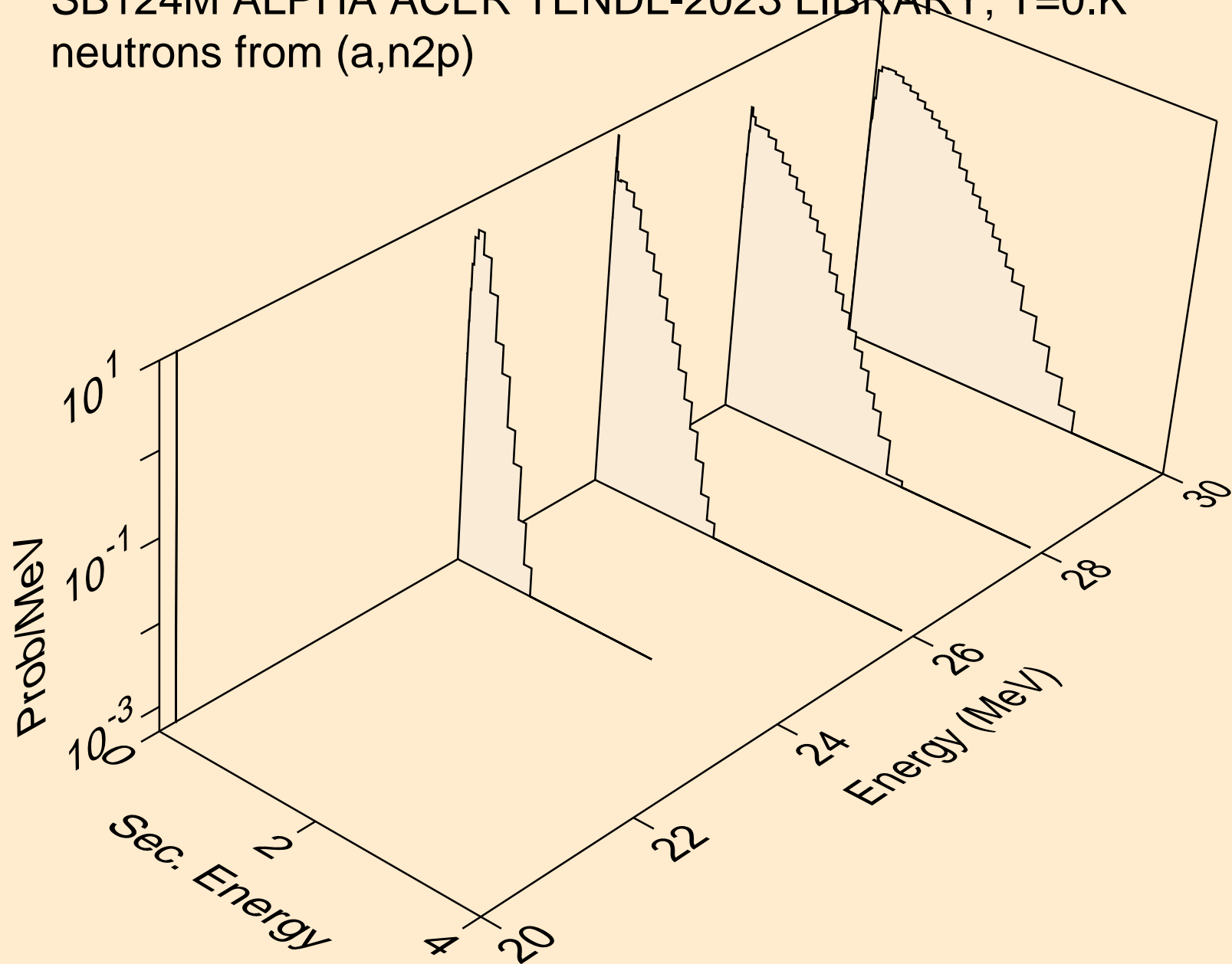

SB124M ALPHA ACER TENDL-2023 LIBRARY; T=0.K  
neutrons from (a,npa)

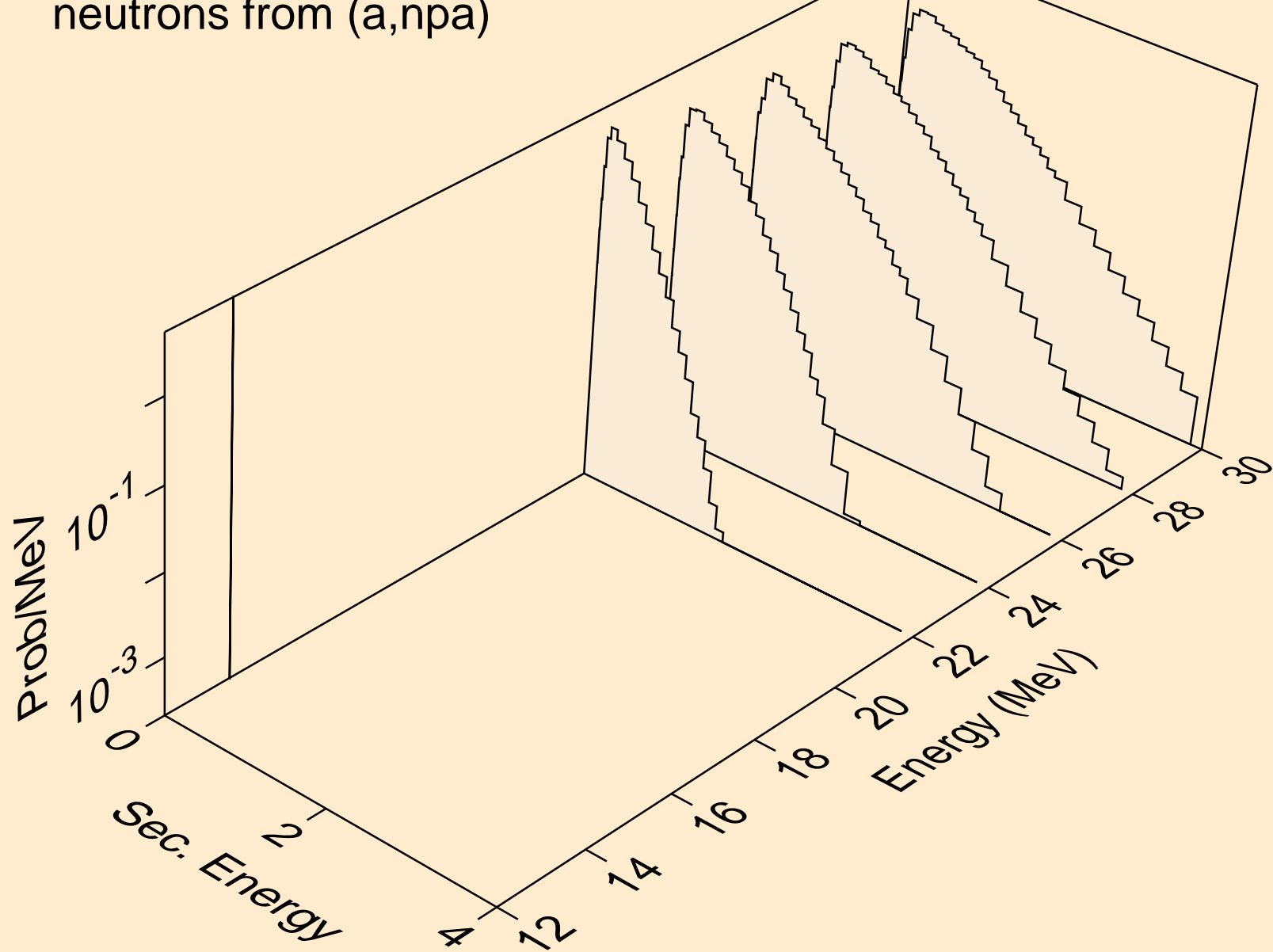

SB124M ALPHA ACER TENDL-2023 LIBRARY; T=0.K  
protons from (a,x)

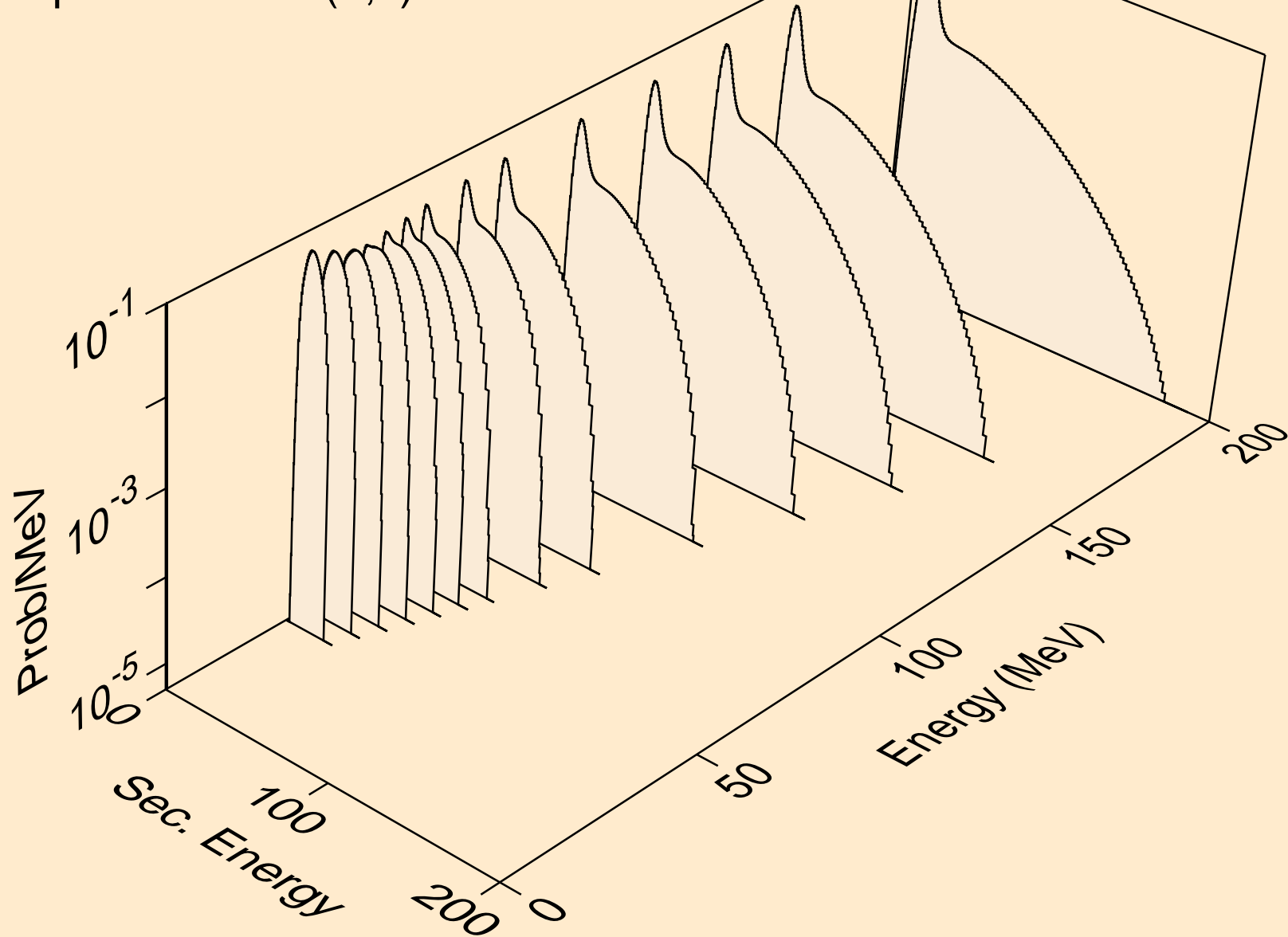

SB124M ALPHA ACER TENDL-2023 LIBRARY; T=0.K  
protons from (a,n\*)p

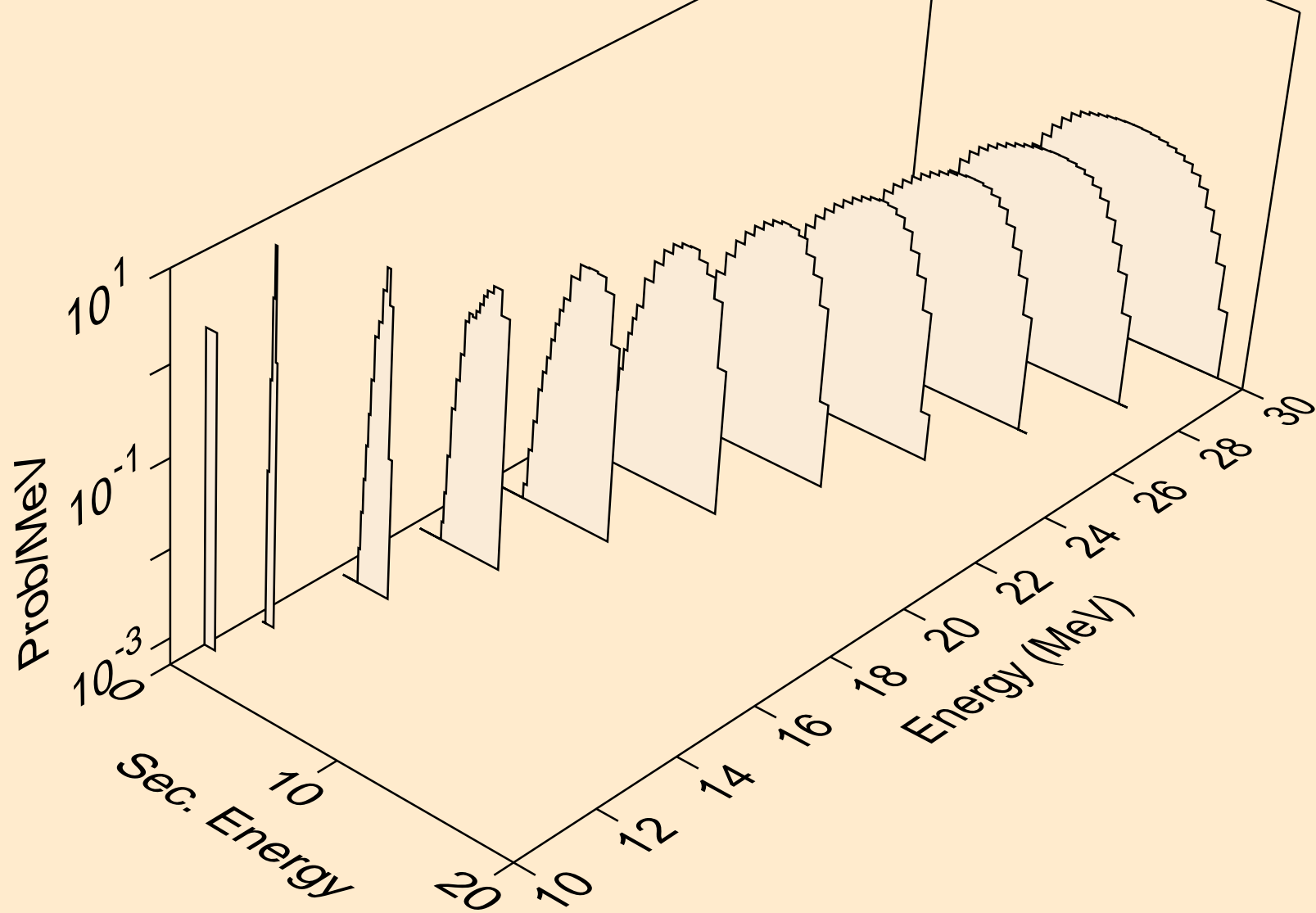

SB124M ALPHA ACER TENDL-2023 LIBRARY; T=0.K  
protons from (a,2np)

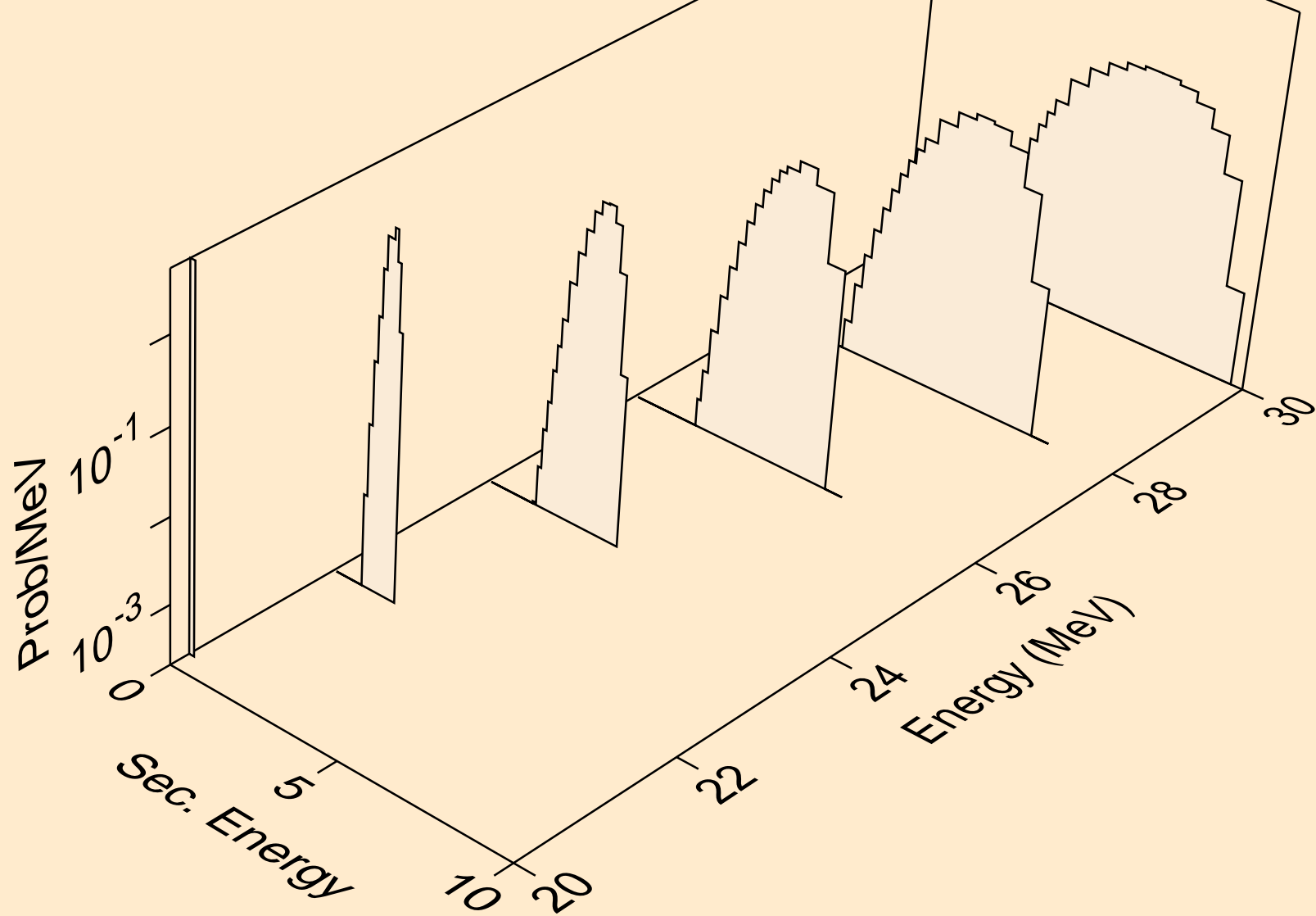

SB124M ALPHA ACER TENDL-2023 LIBRARY; T=0.K  
protons from (a,3np)

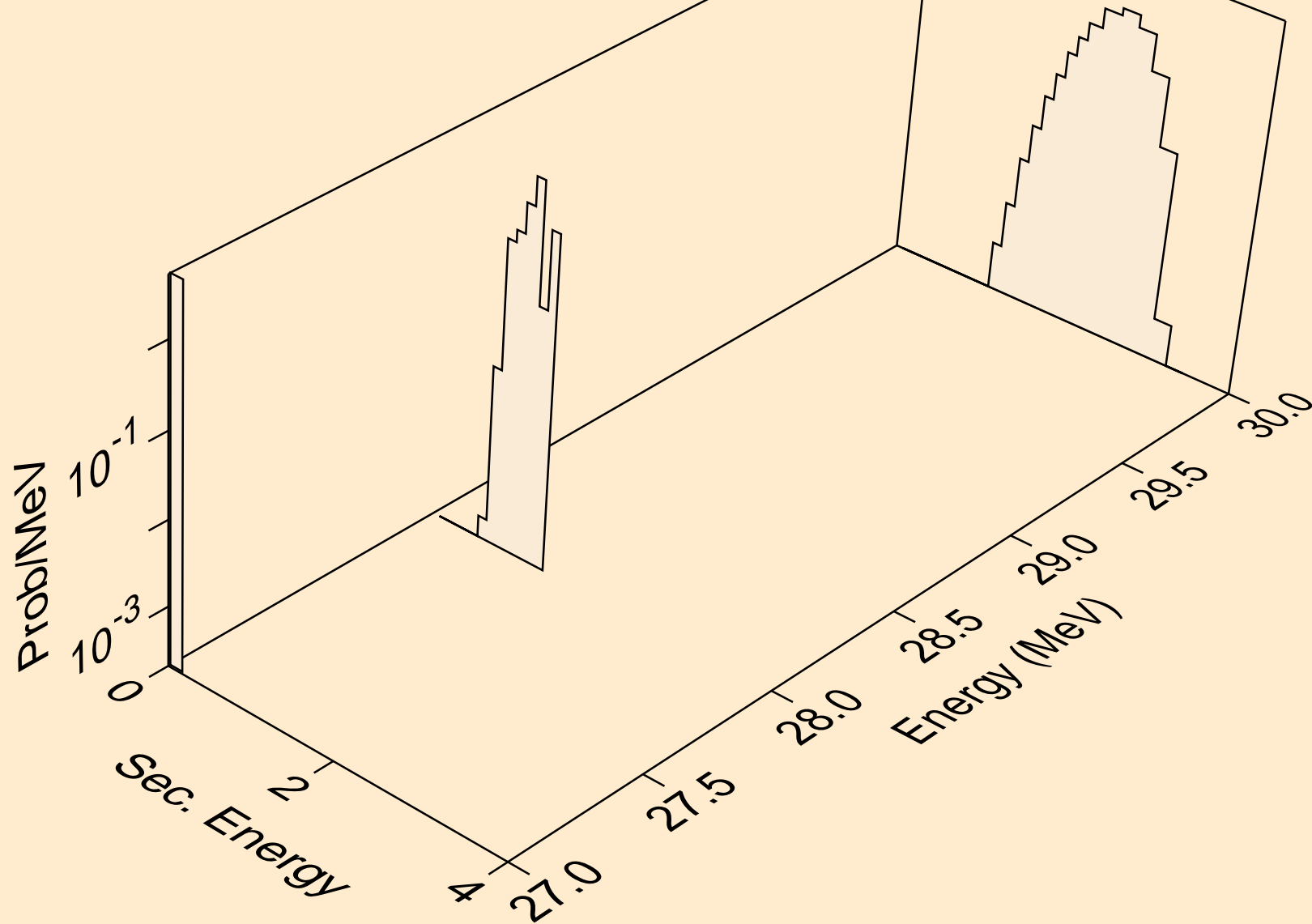

SB124M ALPHA ACER TENDL-2023 LIBRARY; T=0.K  
protons from (a,n2p)

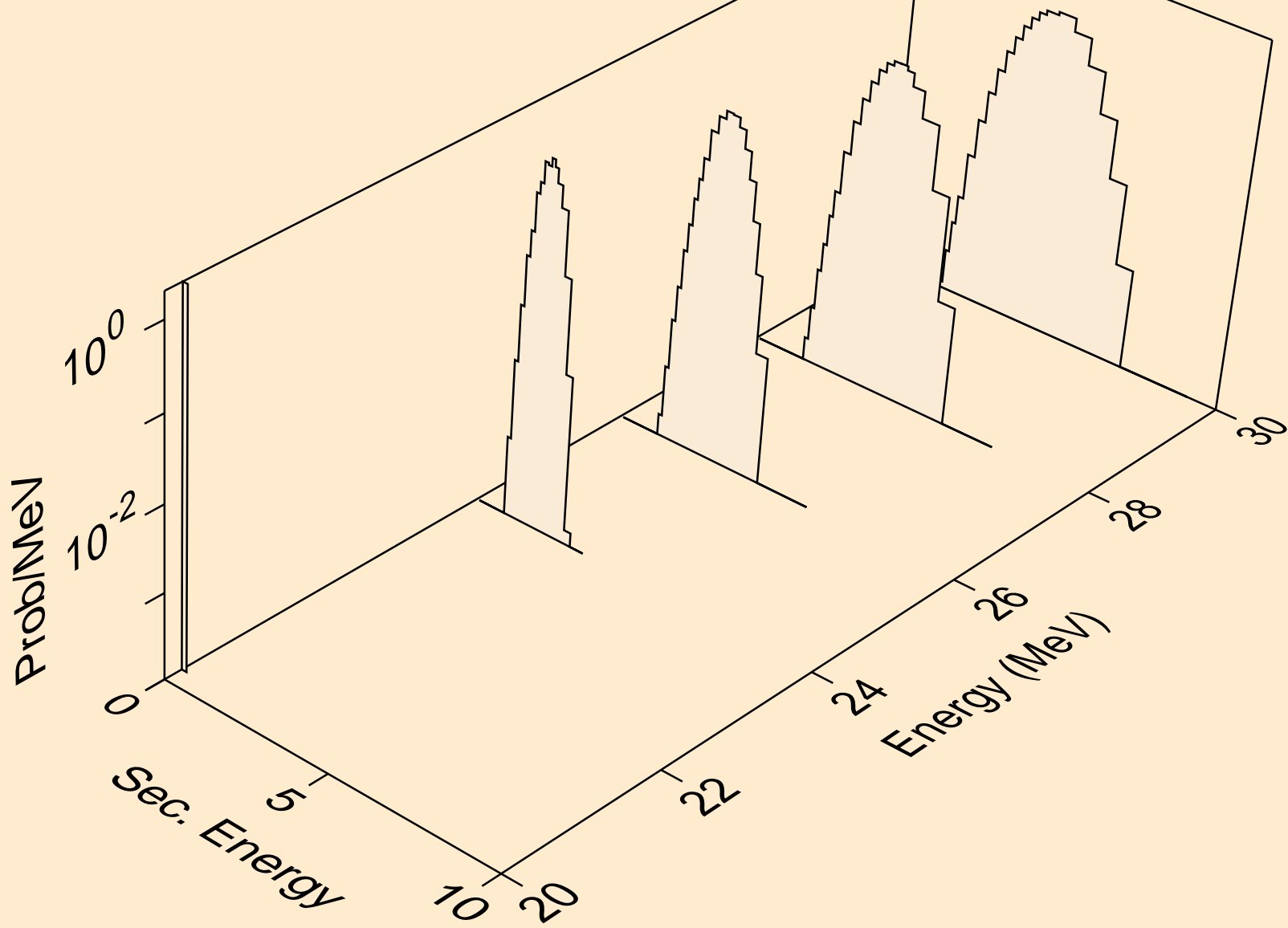

SB124M ALPHA ACER TENDL-2023 LIBRARY; T=0.K  
protons from (a,npa)

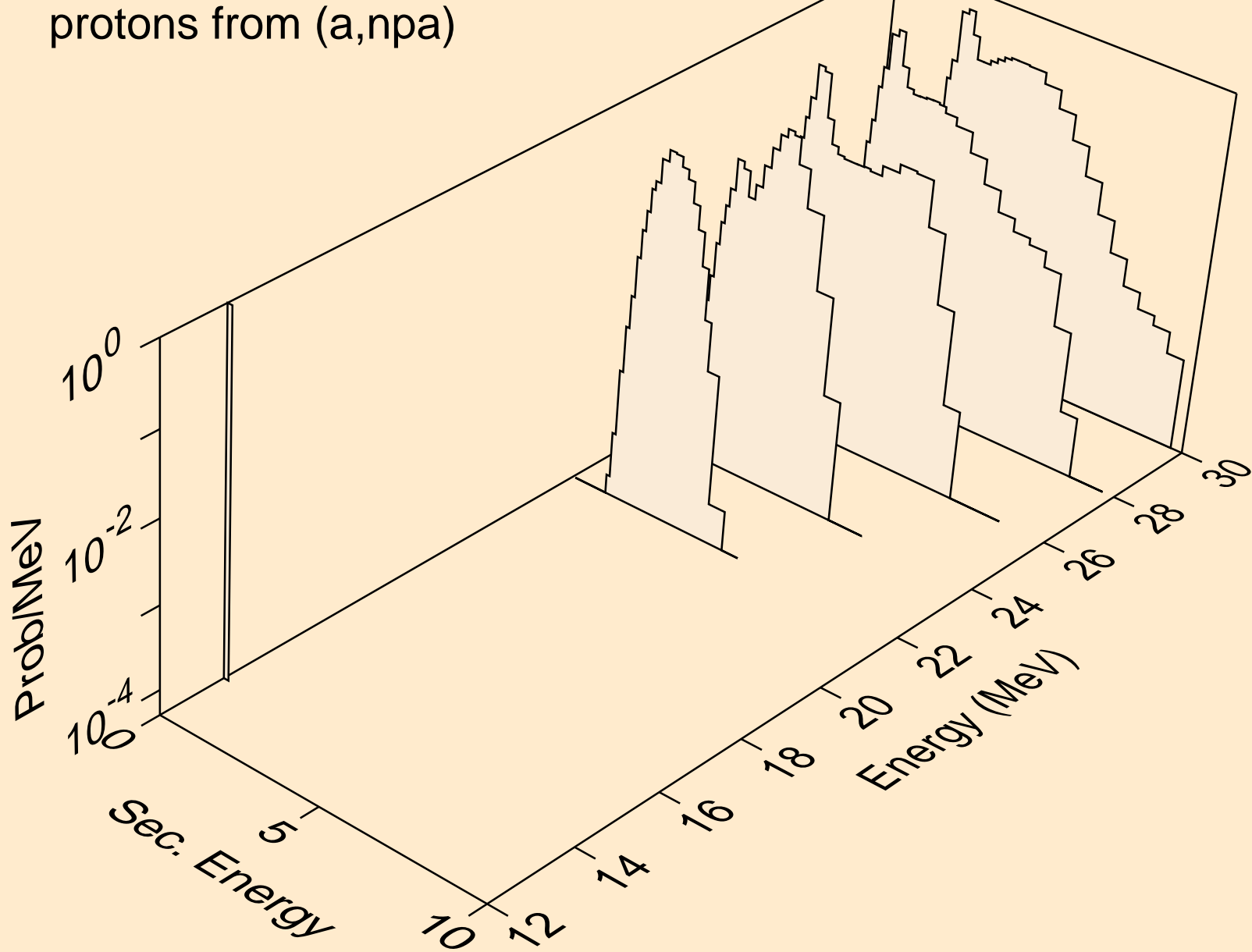

SB124M ALPHA ACER TENDL-2023 LIBRARY; T=0.K  
protons from (a,p)

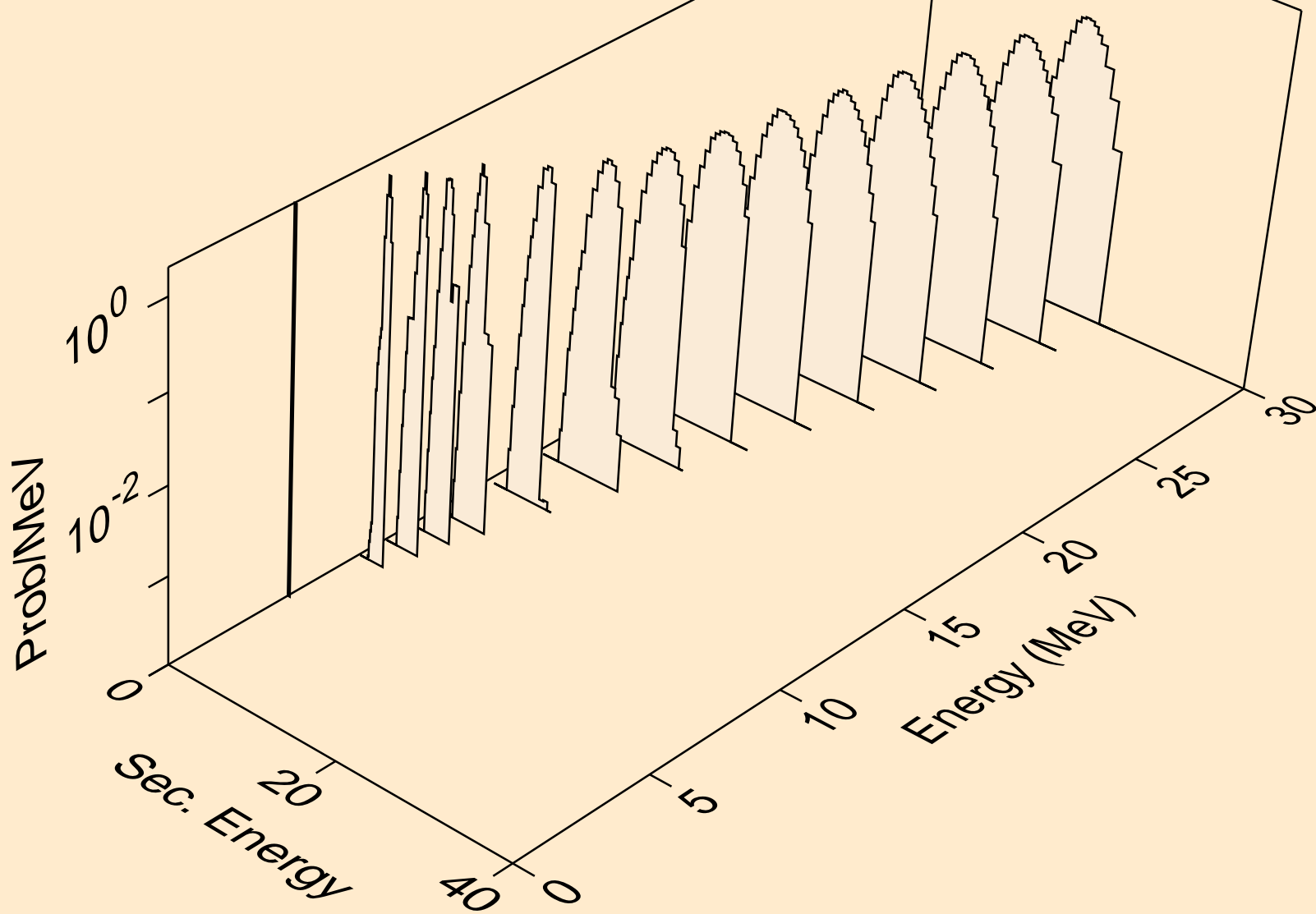

SB124M ALPHA ACER TENDL-2023 LIBRARY; T=0.K  
protons from (a,2p)

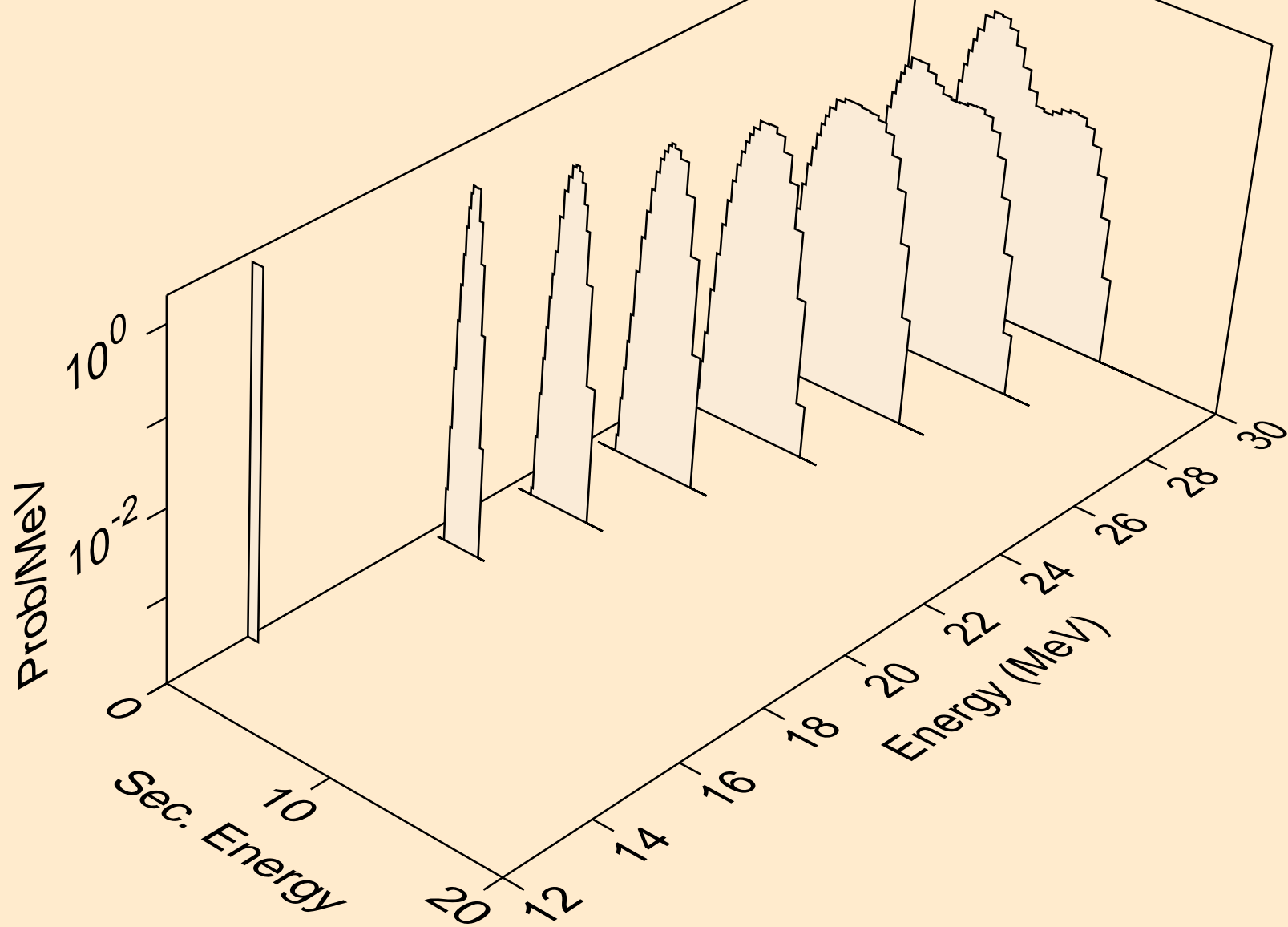

SB124M ALPHA ACER TENDL-2023 LIBRARY; T=0.K  
protons from (a,pa)

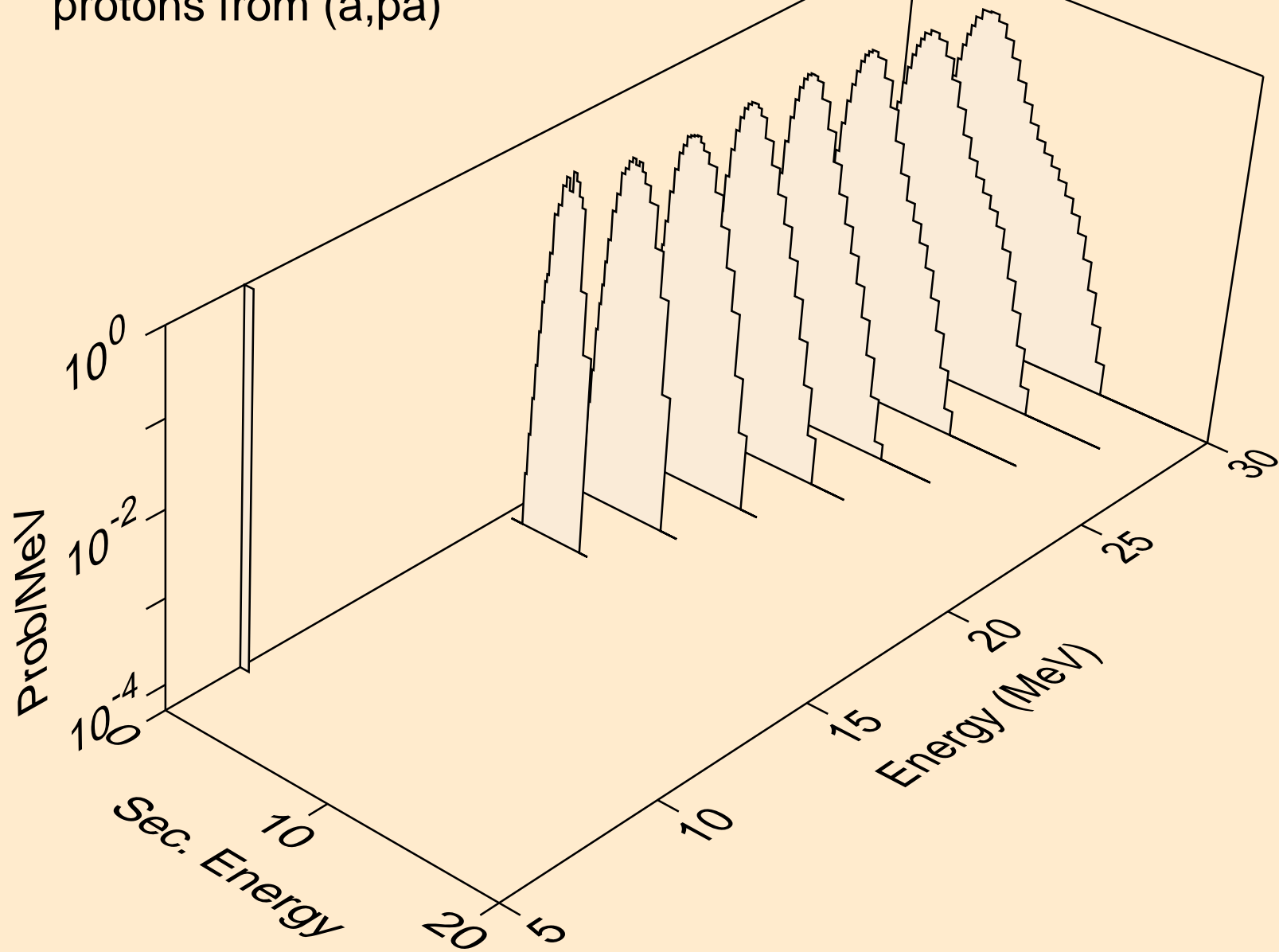

SB124M ALPHA ACER TENDL-2023 LIBRARY; T=0.K  
protons from (a,pd)

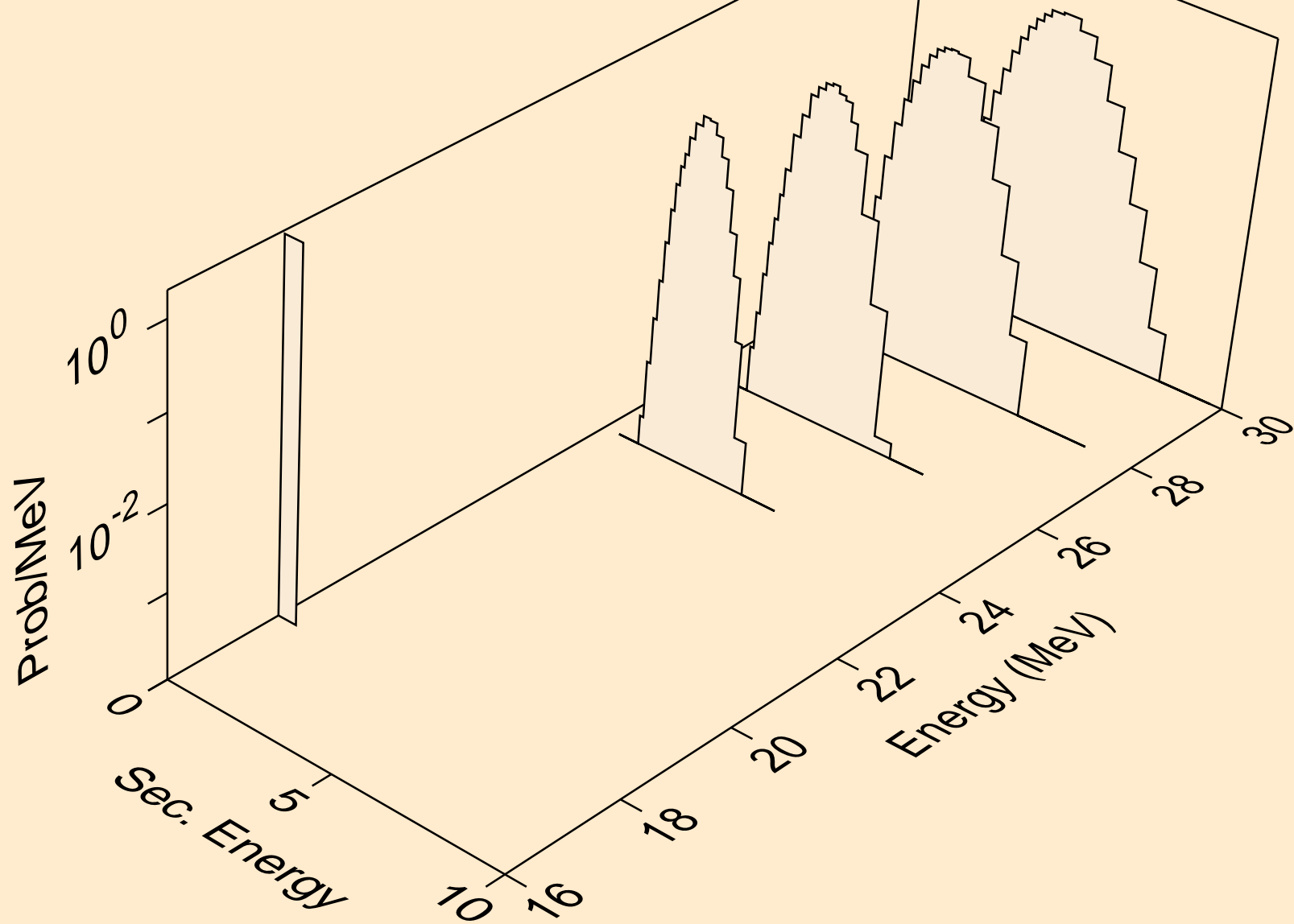

SB124M ALPHA ACER TENDL-2023 LIBRARY; T=0.K  
deuterons from (a,x)

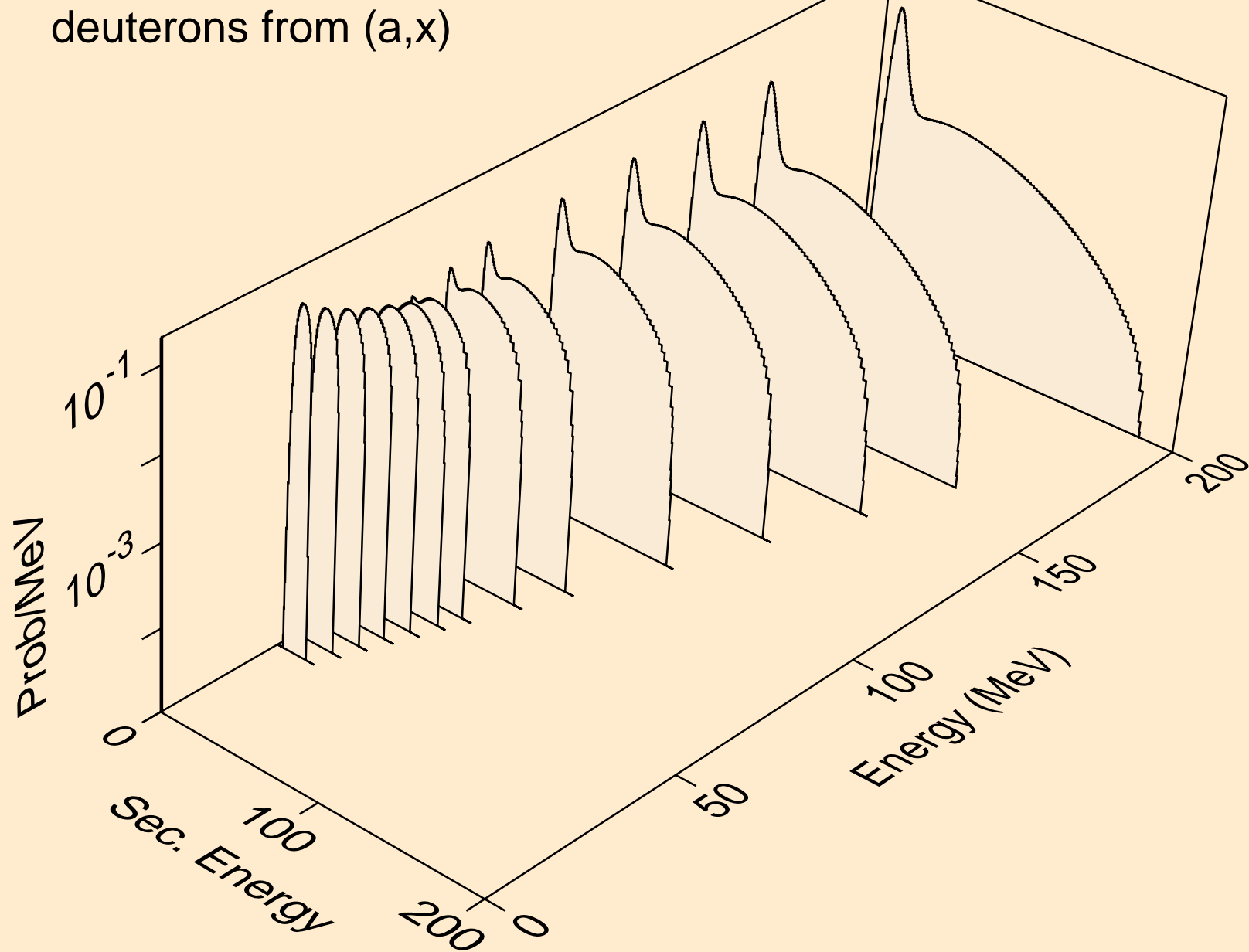

SB124M ALPHA ACER TENDL-2023 LIBRARY; T=0.K  
deuterons from (a,2nd)

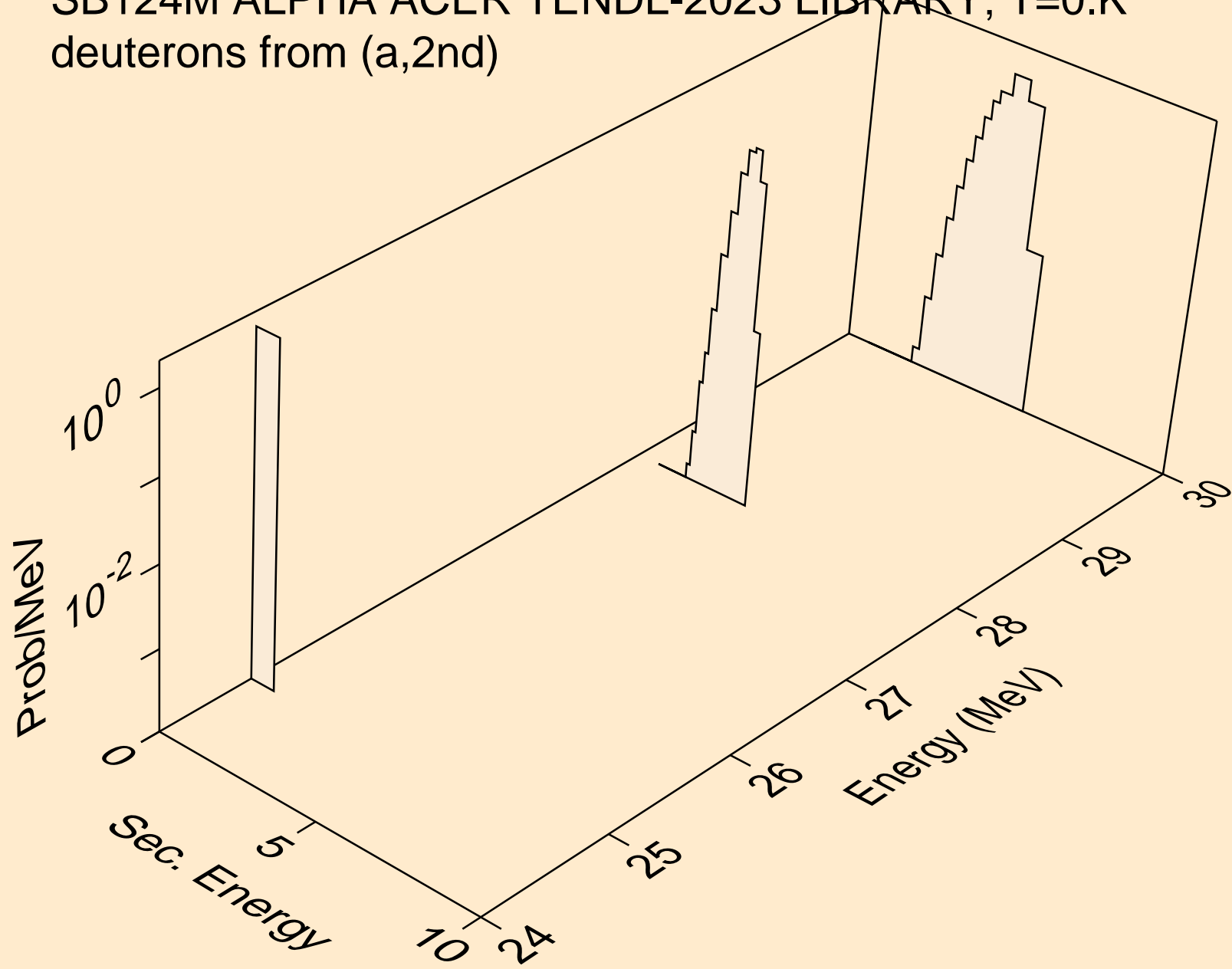

SB124M ALPHA ACER TENDL-2023 LIBRARY; T=0.K  
deuterons from (a,n\*)d

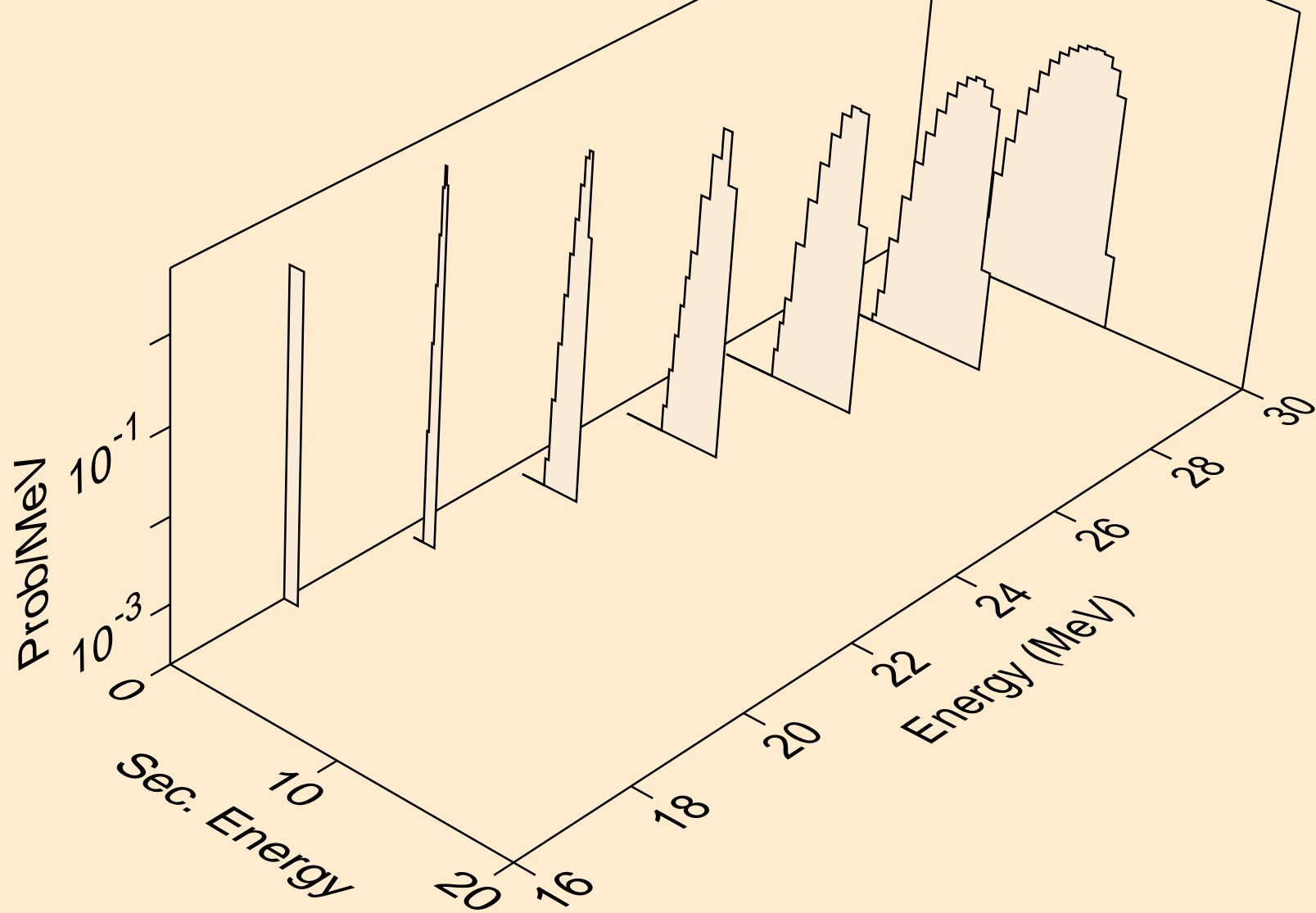

SB124M ALPHA ACER TENDL-2023 LIBRARY; T=0.K  
deuterons from (a,d)

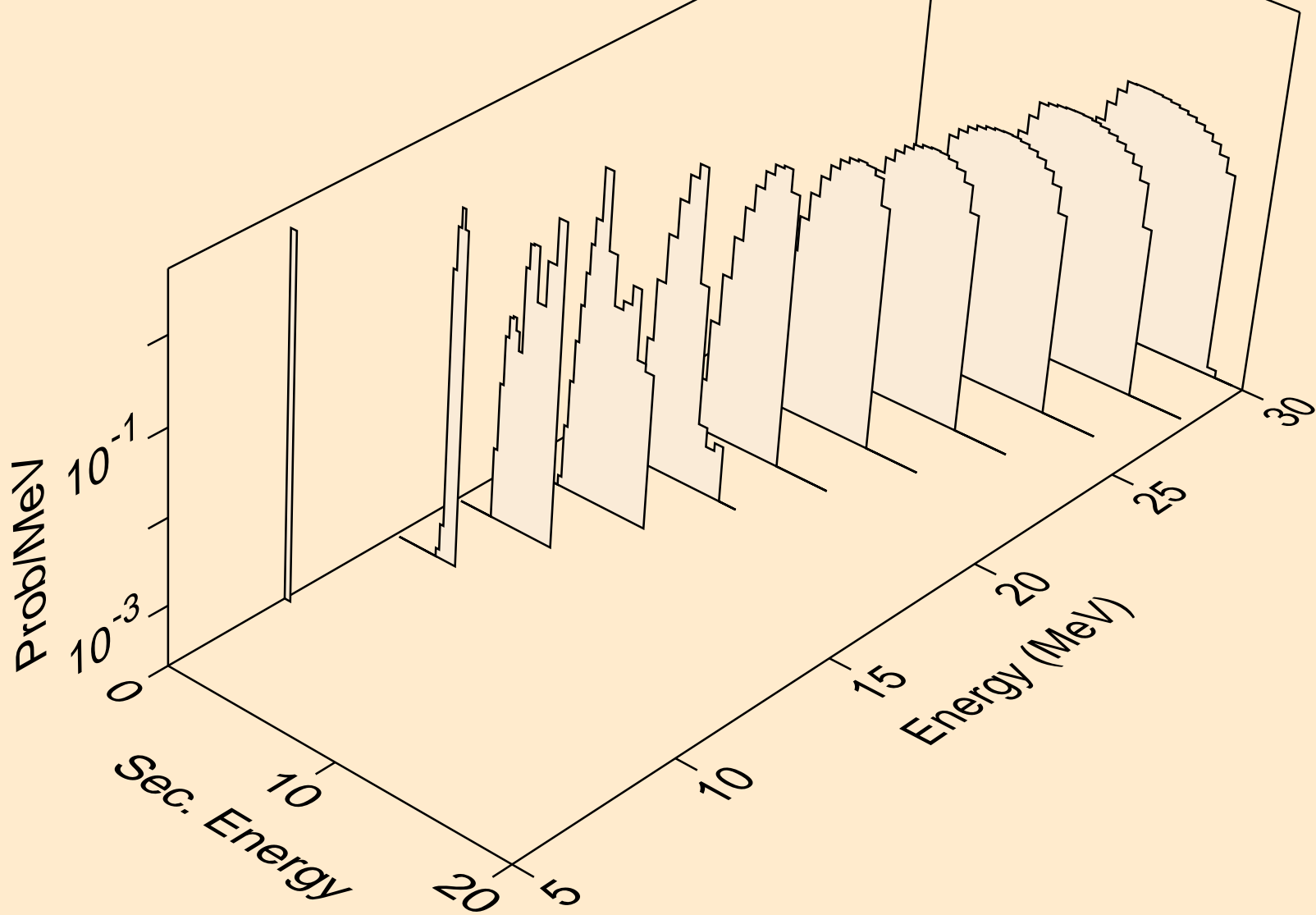

SB124M ALPHA ACER TENDL-2023 LIBRARY; T=0.K  
deuterons from (a,pd)

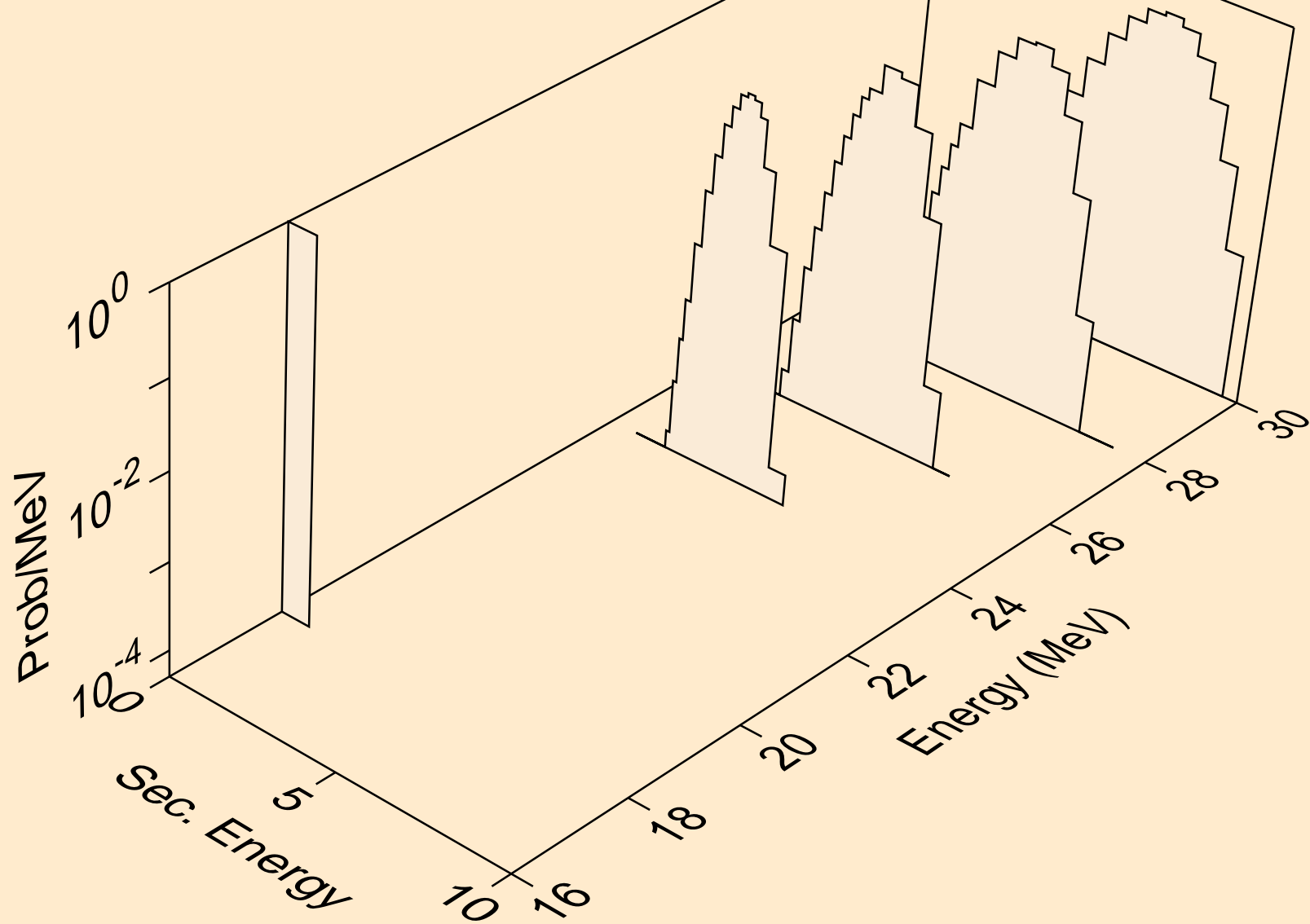

SB124M ALPHA ACER TENDL-2023 LIBRARY; T=0.K  
tritons from (a,x)

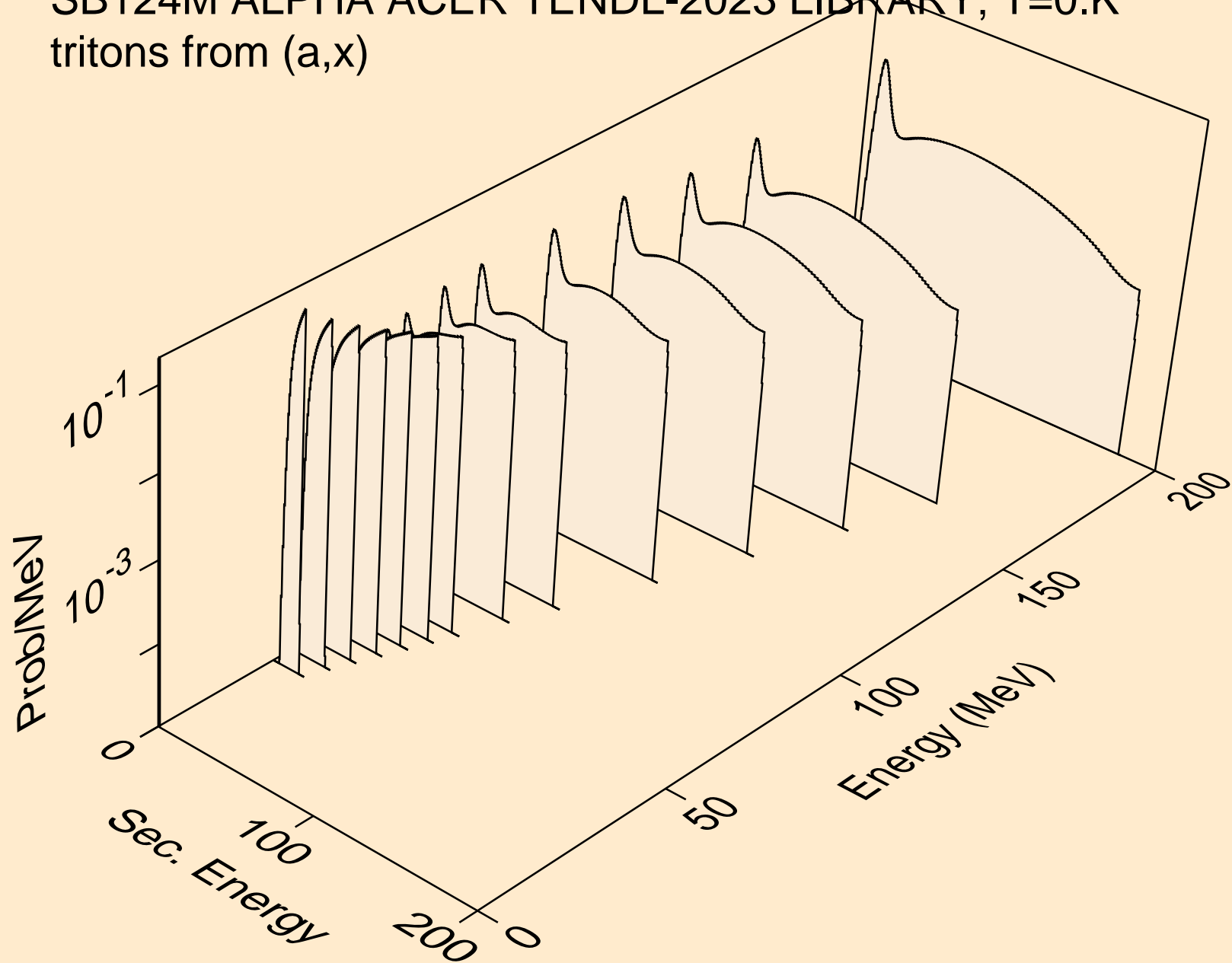

SB124M ALPHA ACER TENDL-2023 LIBRARY; T=0.K  
tritons from (a,n\*)t

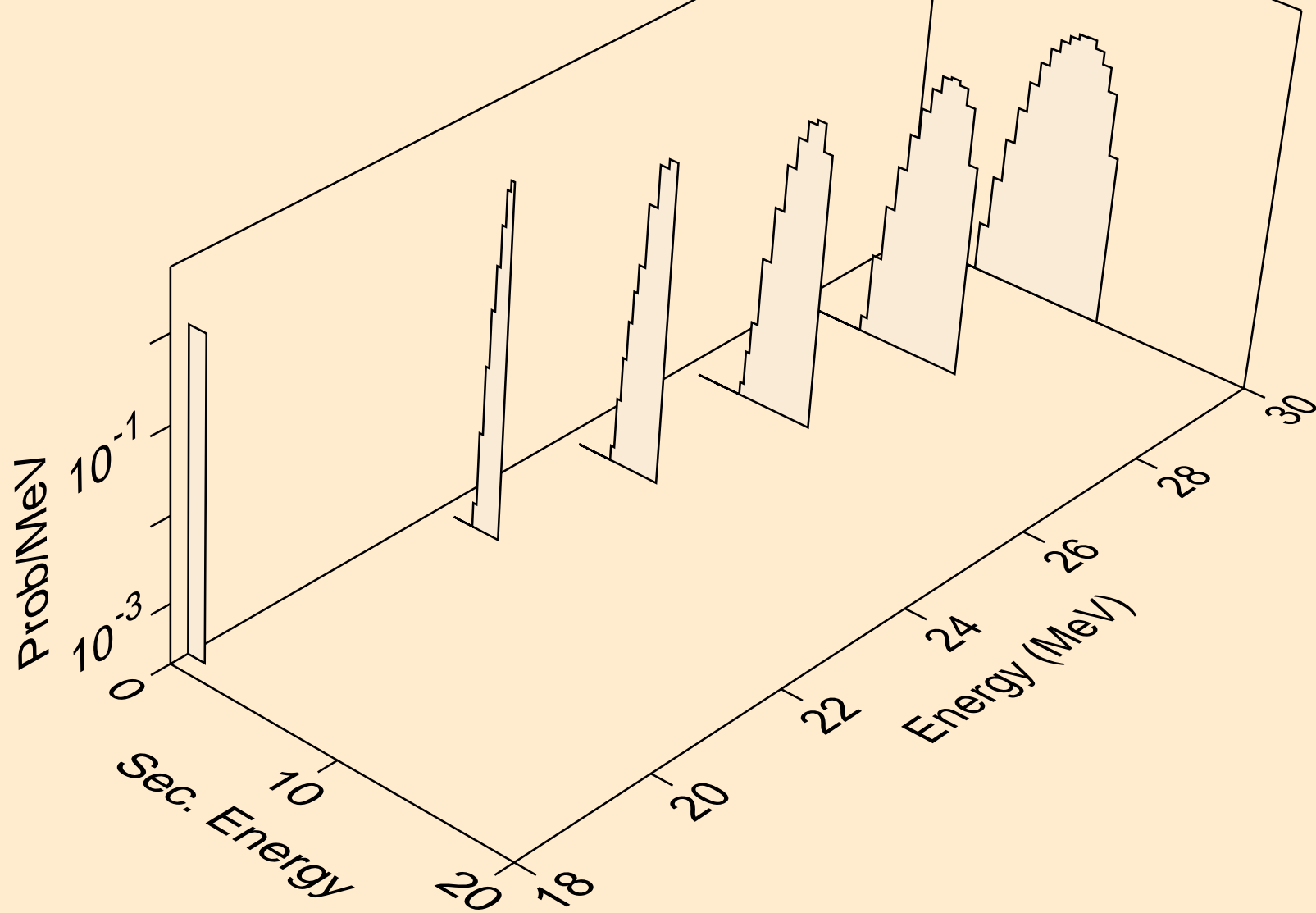

SB124M ALPHA ACER TENDL-2023 LIBRARY; T=0.K  
tritons from (a,t)

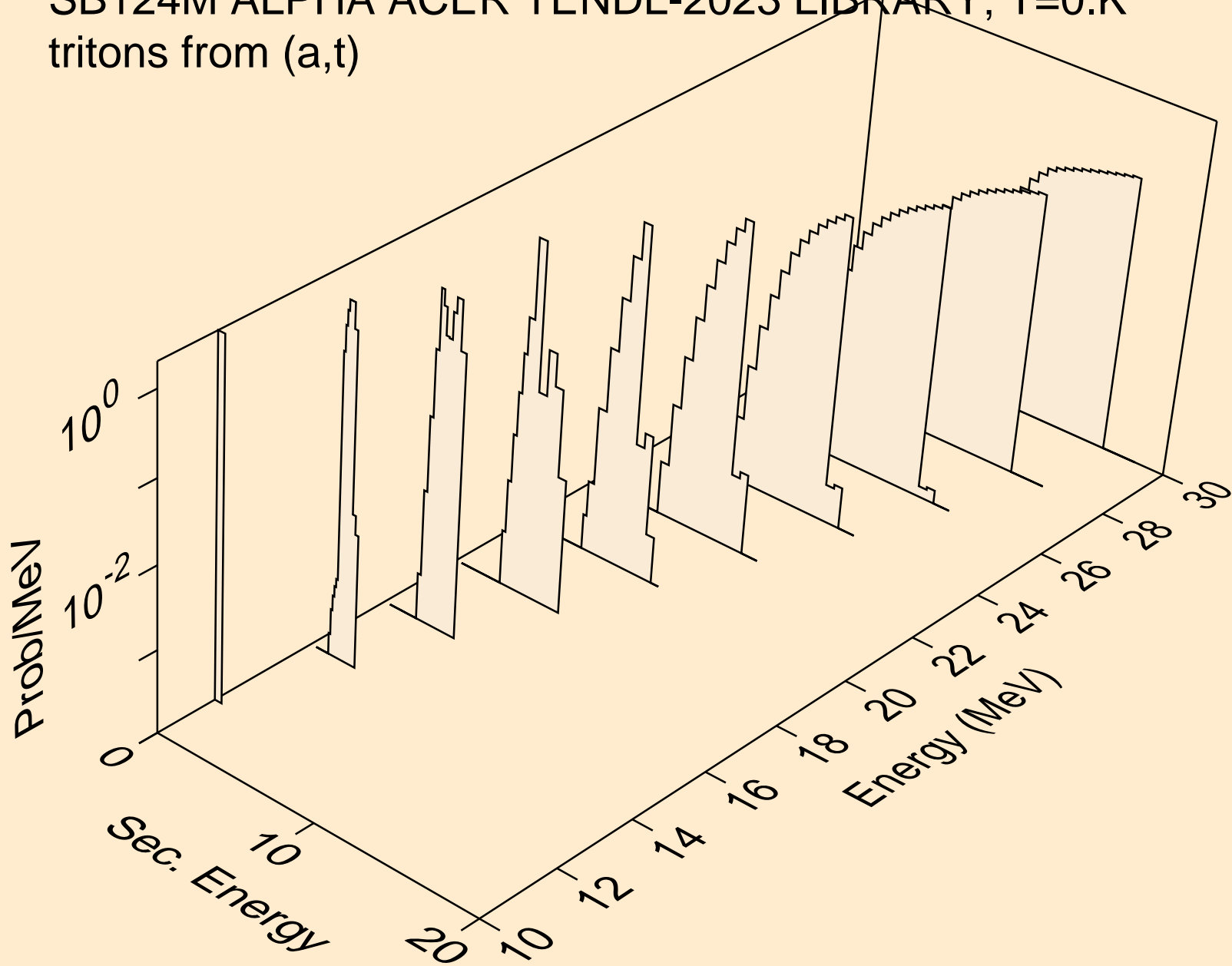

SB124M ALPHA ACER TENDL-2023 LIBRARY; T=0.K  
he3s from (a,x)

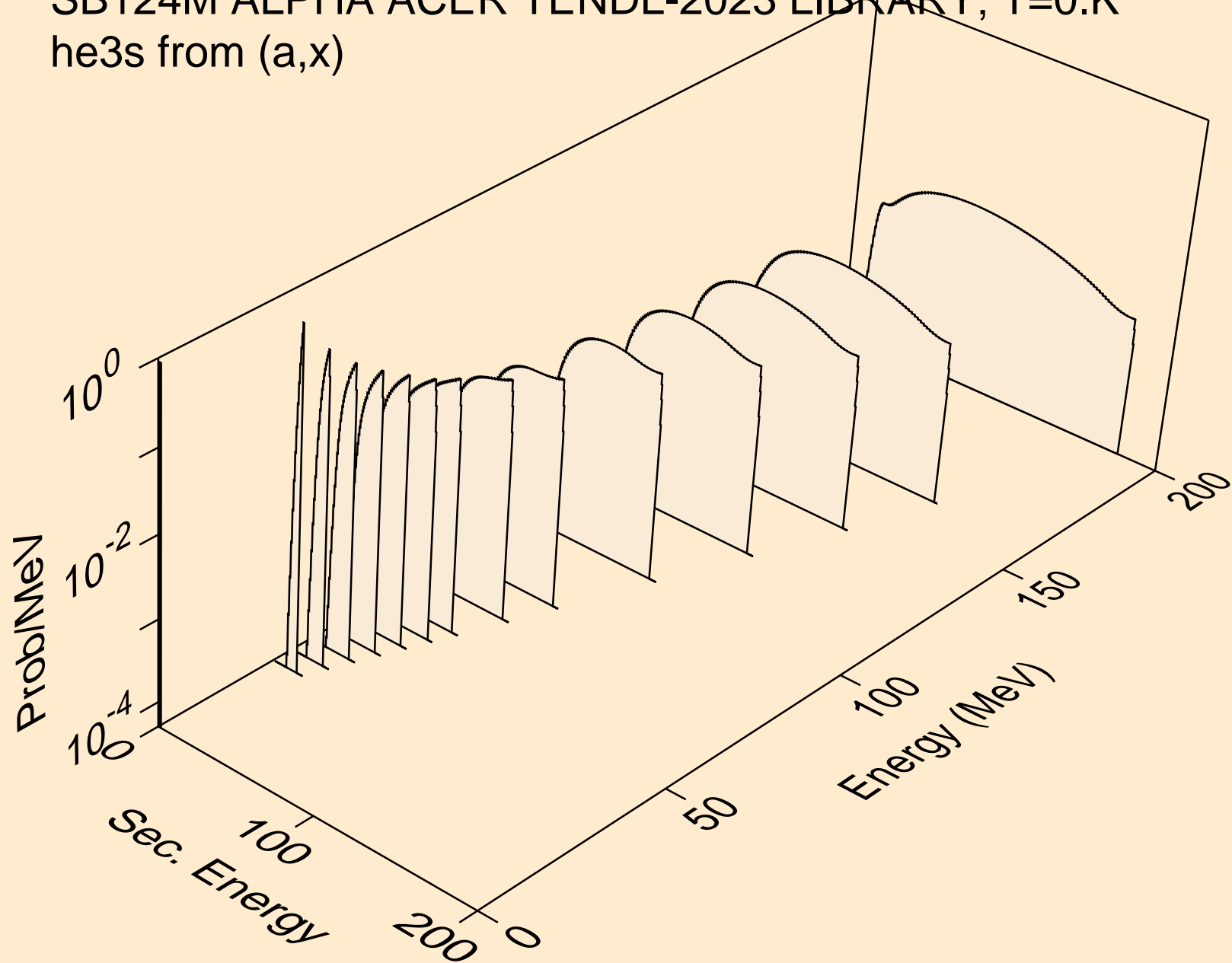

SB124M ALPHA ACER TENDL-2023 LIBRARY; T=0.K  
he3s from (a,n\*)he3

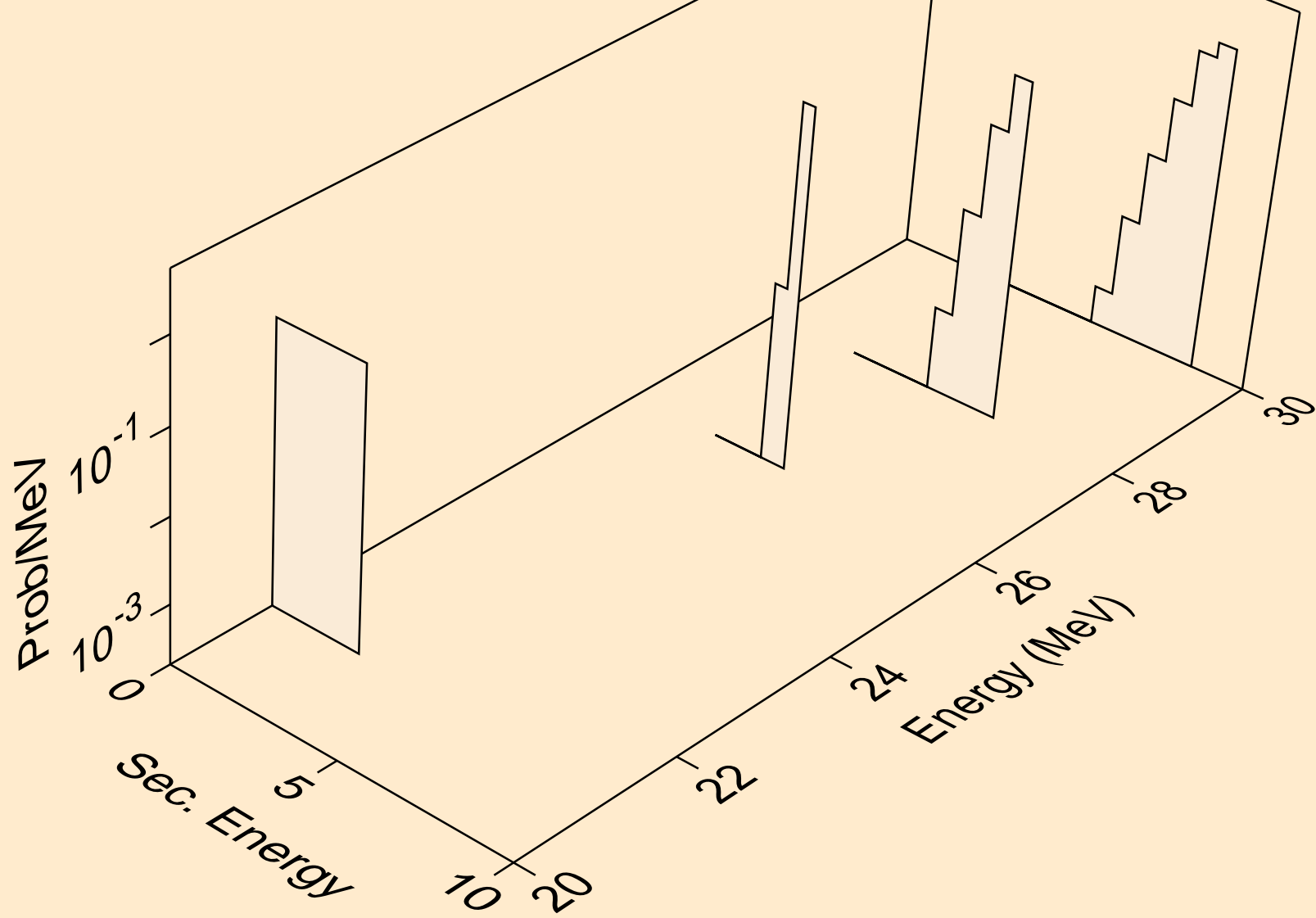

SB124M ALPHA ACER TENDL-2023 LIBRARY; T=0.K  
he3s from (a,he3)

