

SN117M ALPHA ACER TENDL-2023 LIBRARY; T=0.K

Principal cross sections

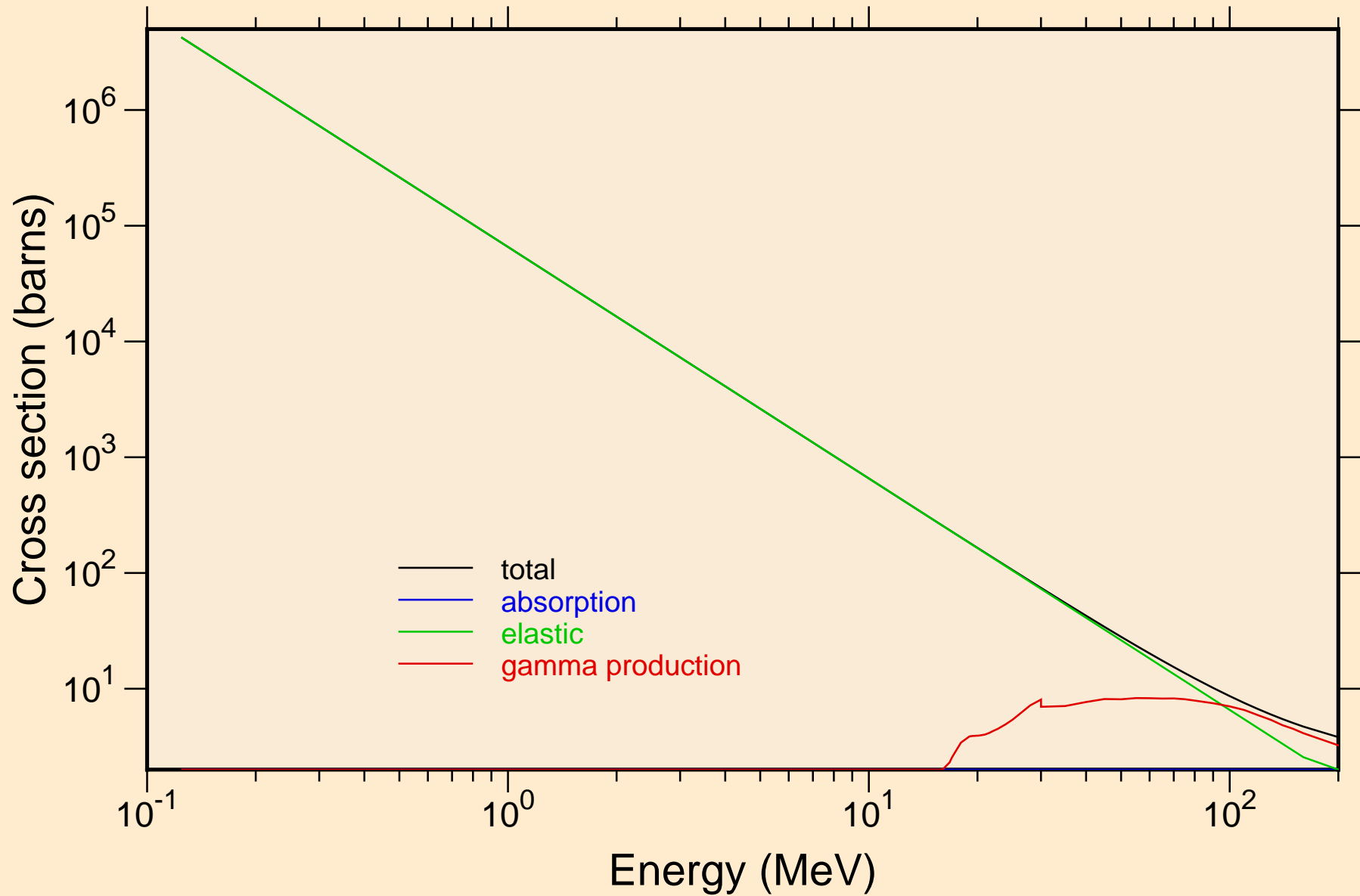

SN117M ALPHA ACER TENDL-2023 LIBRARY; T=0.K

Heating

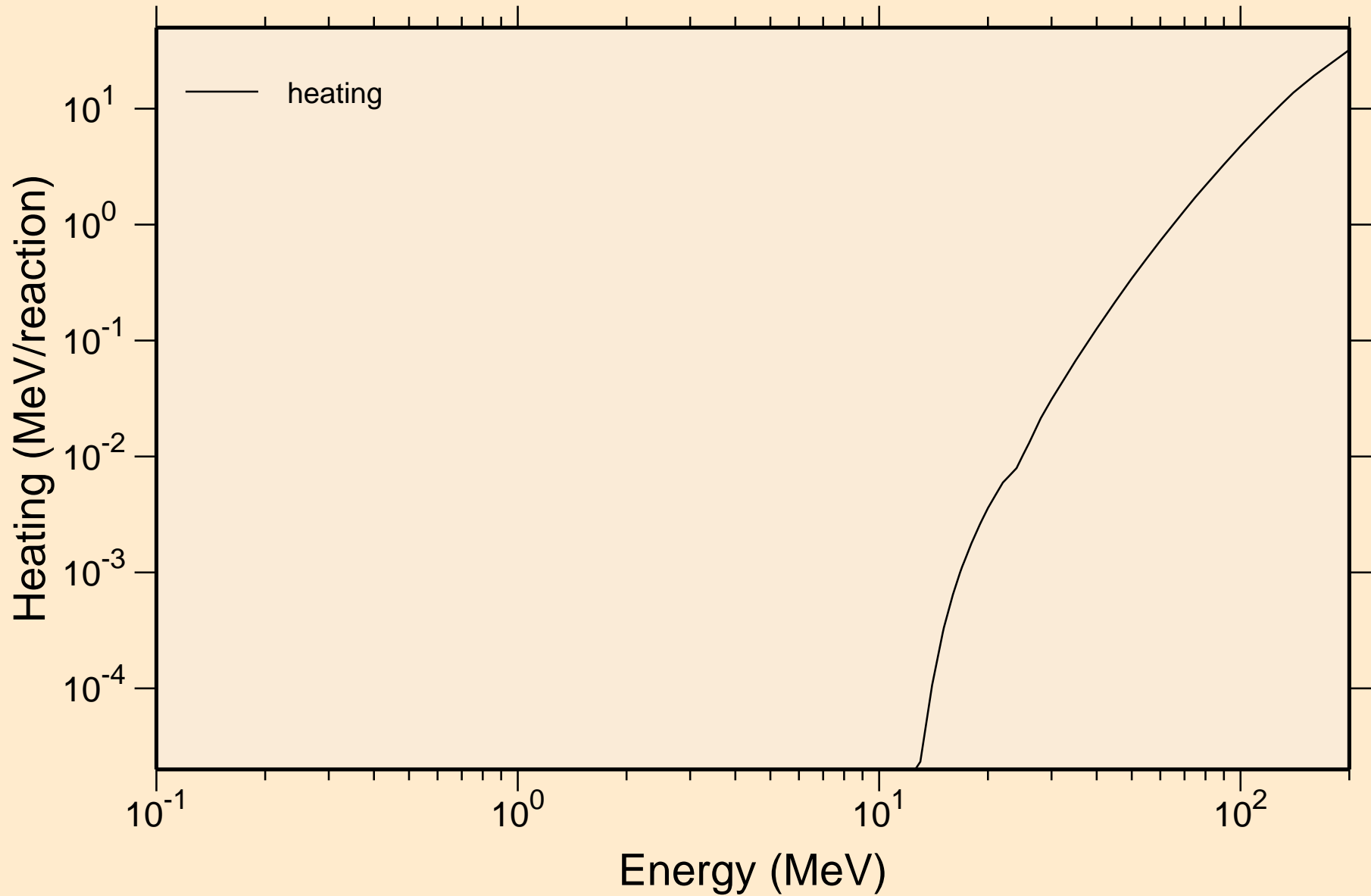

SN117M ALPHA ACER TENDL-2023 LIBRARY; T=0.K

Principal cross sections

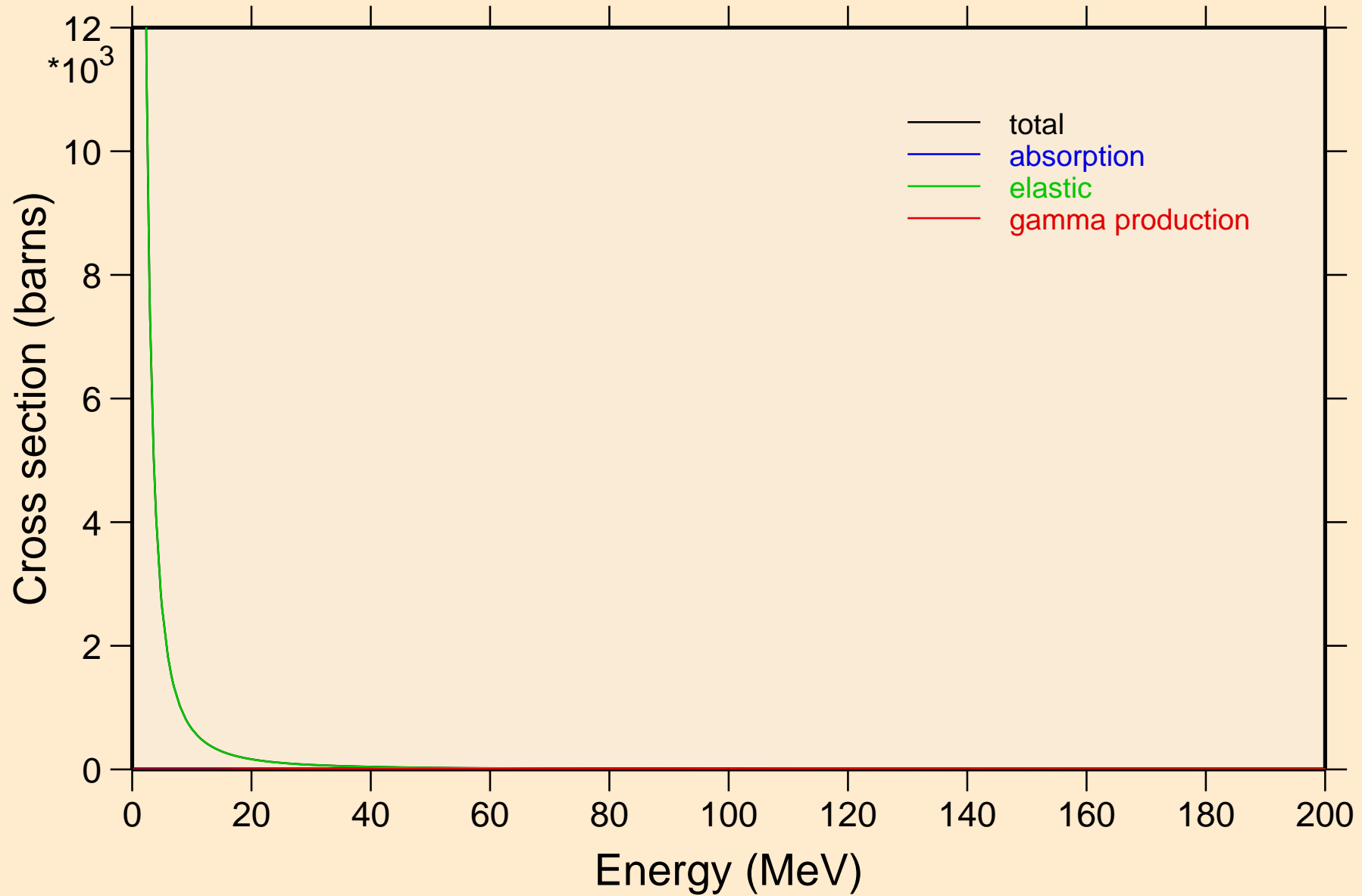

SN117M ALPHA ACER TENDL-2023 LIBRARY; T=0.K

Heating

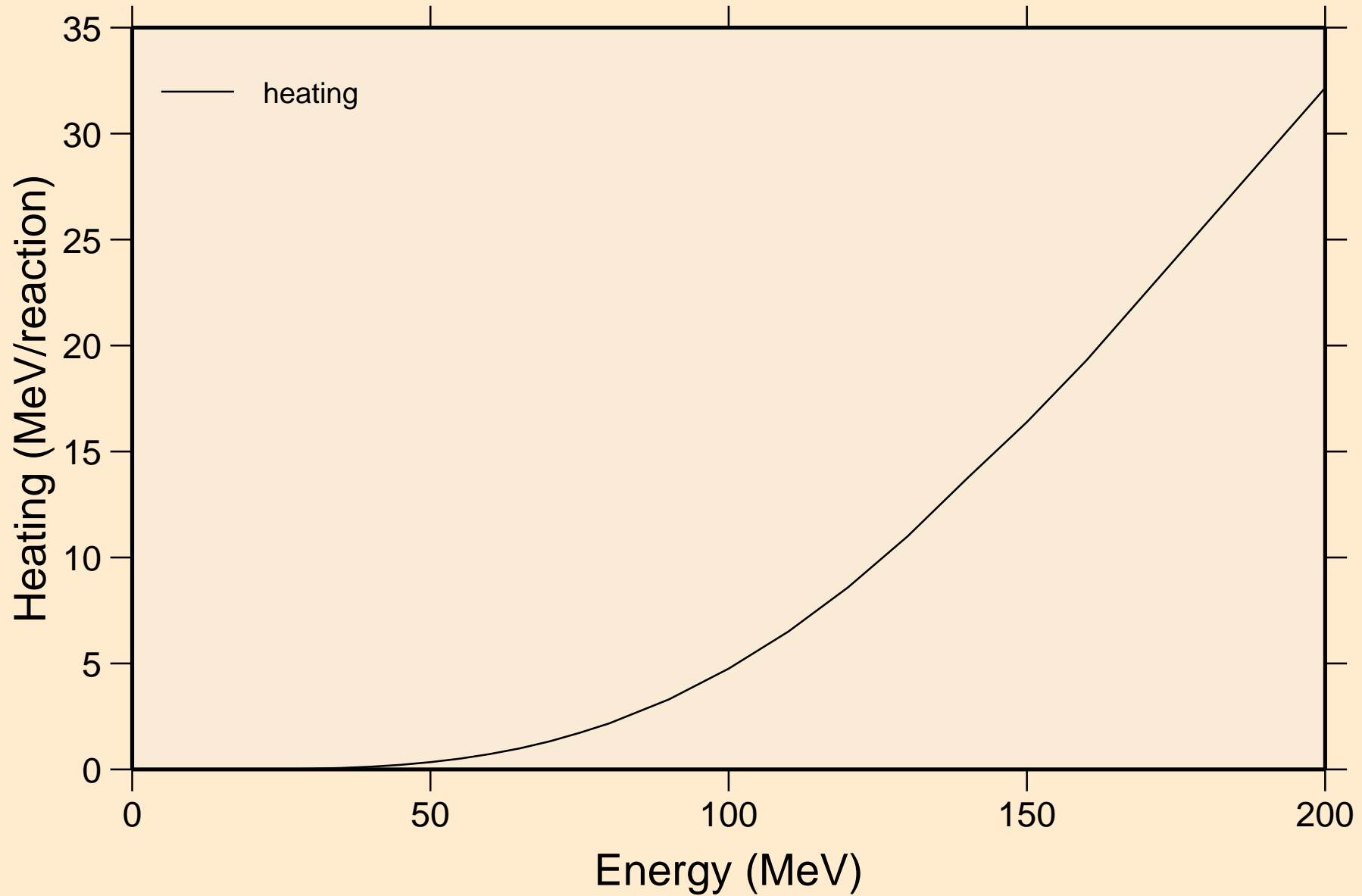

SN117M ALPHA ACER TENDL-2023 LIBRARY; T=0.K

Threshold reactions

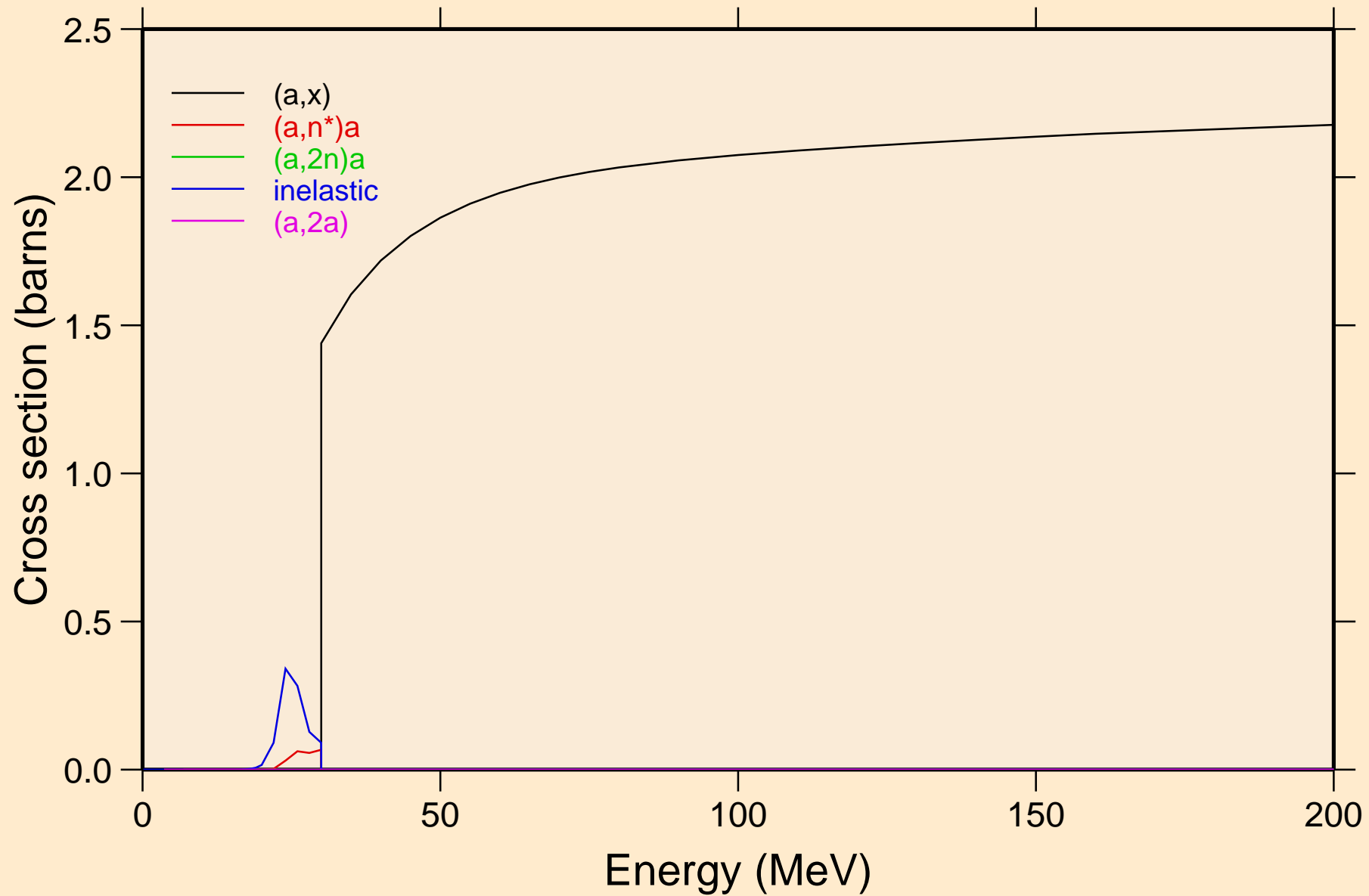

SN117M ALPHA ACER TENDL-2023 LIBRARY; T=0.K

Threshold reactions

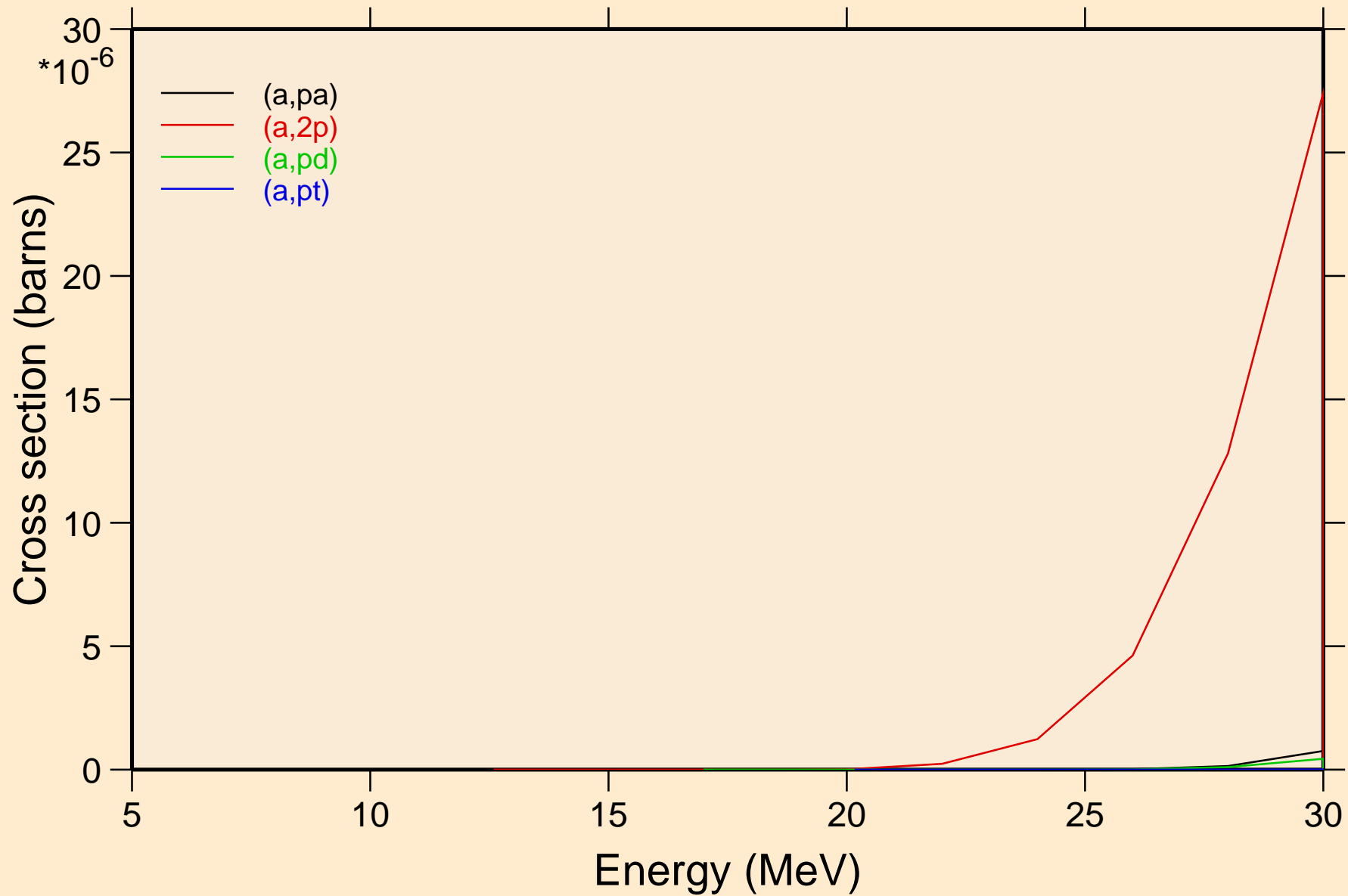

SN117M ALPHA ACER TENDL-2023 LIBRARY; T=0.K
angular distribution for elastic

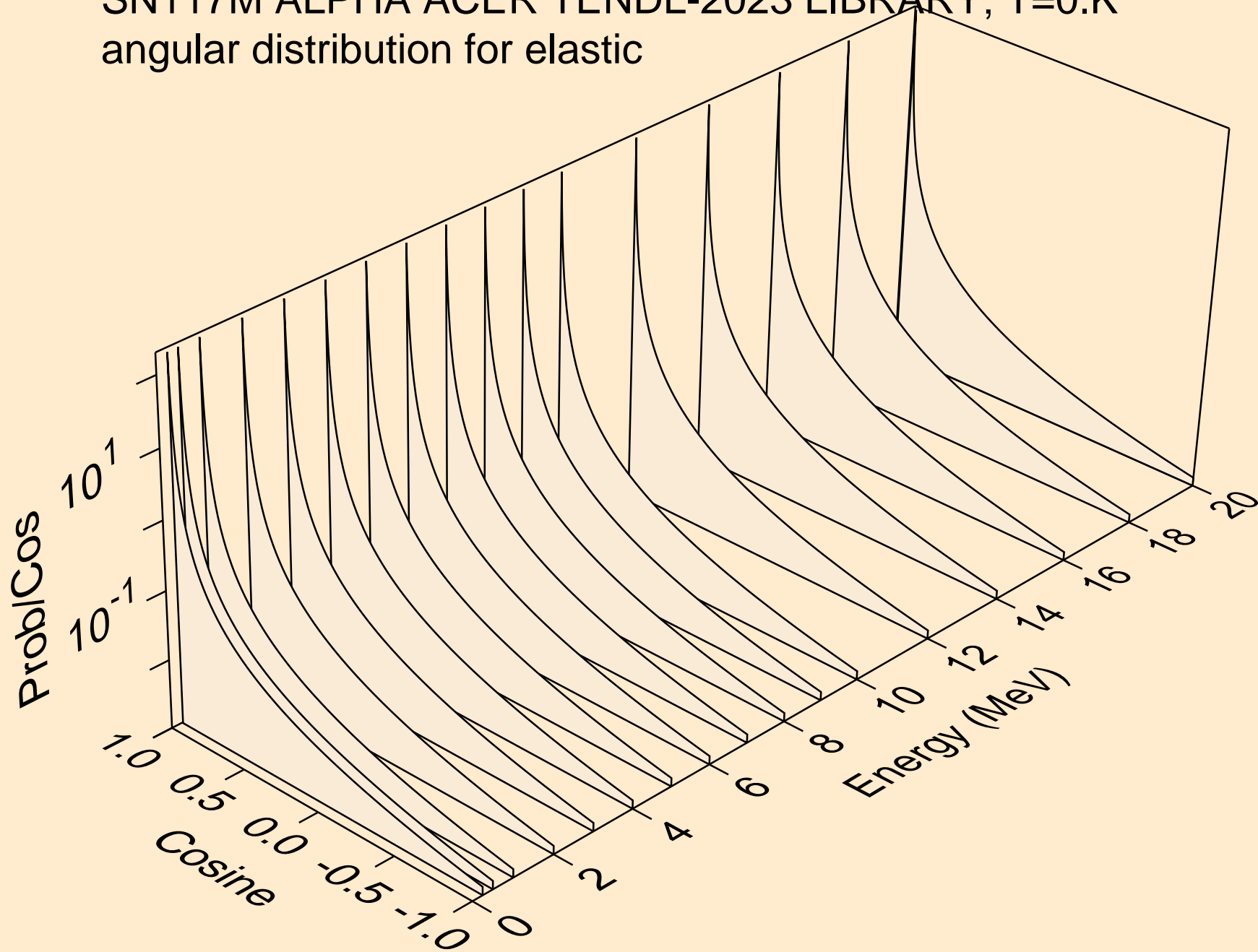

SN117M ALPHA ACER TENDL-2023 LIBRARY; T=0.K
angular distribution for elastic

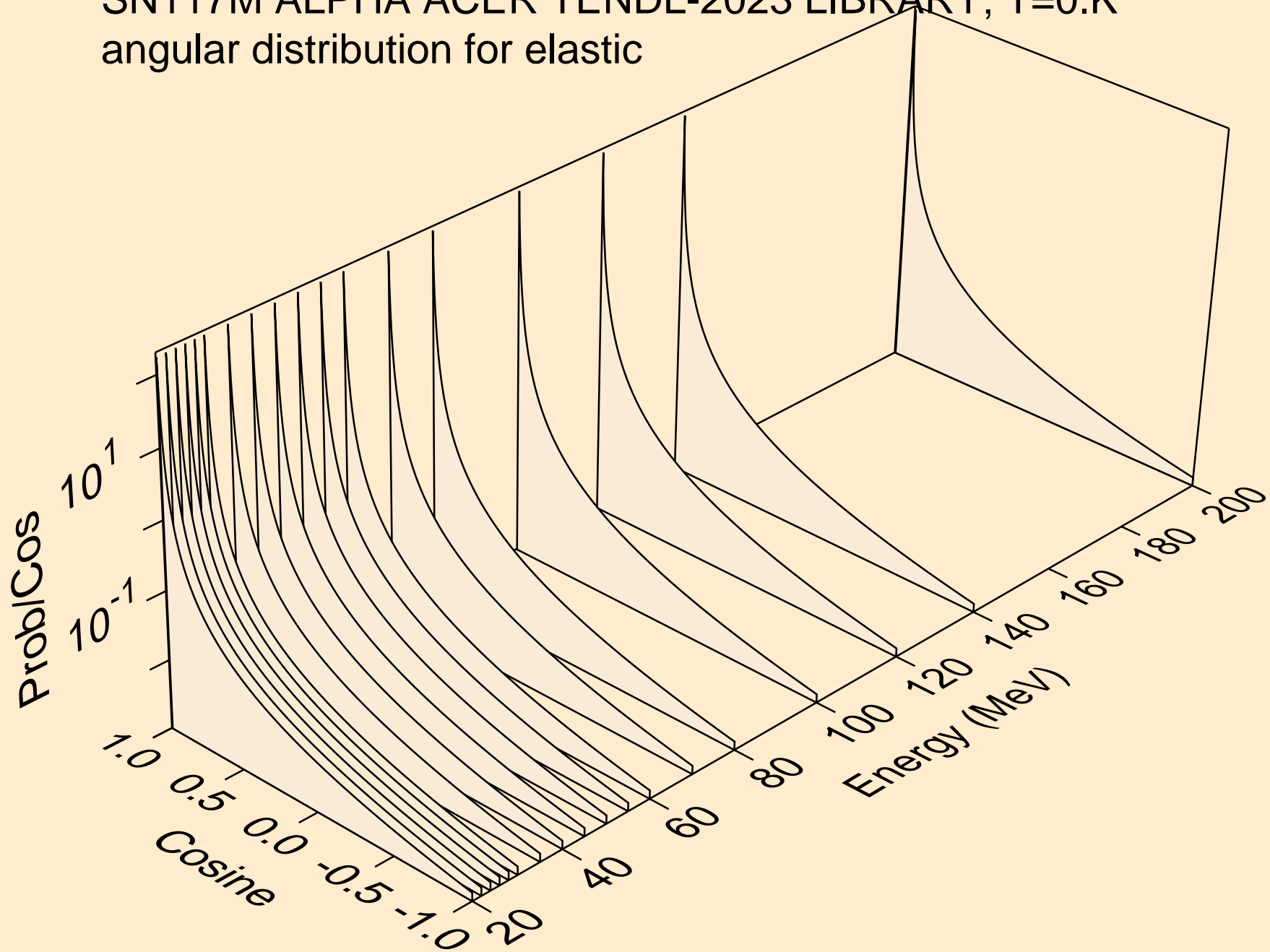

SN117M ALPHA ACER TENDL-2023 LIBRARY; T=0.K
Alpha emission for (a,x)

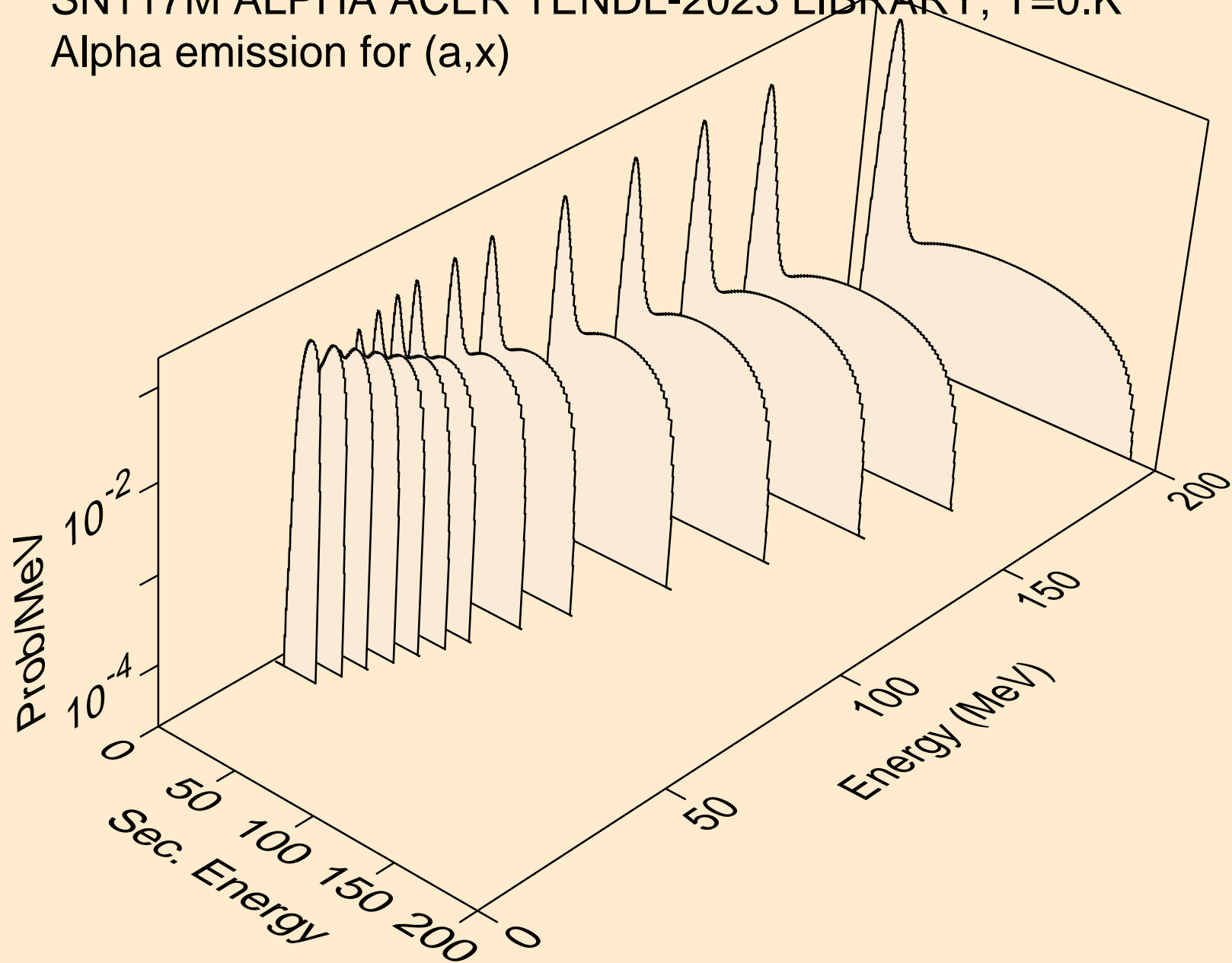

SN117M ALPHA ACER TENDL-2023 LIBRARY; T=0.K
Alpha emission for (a,n*)a

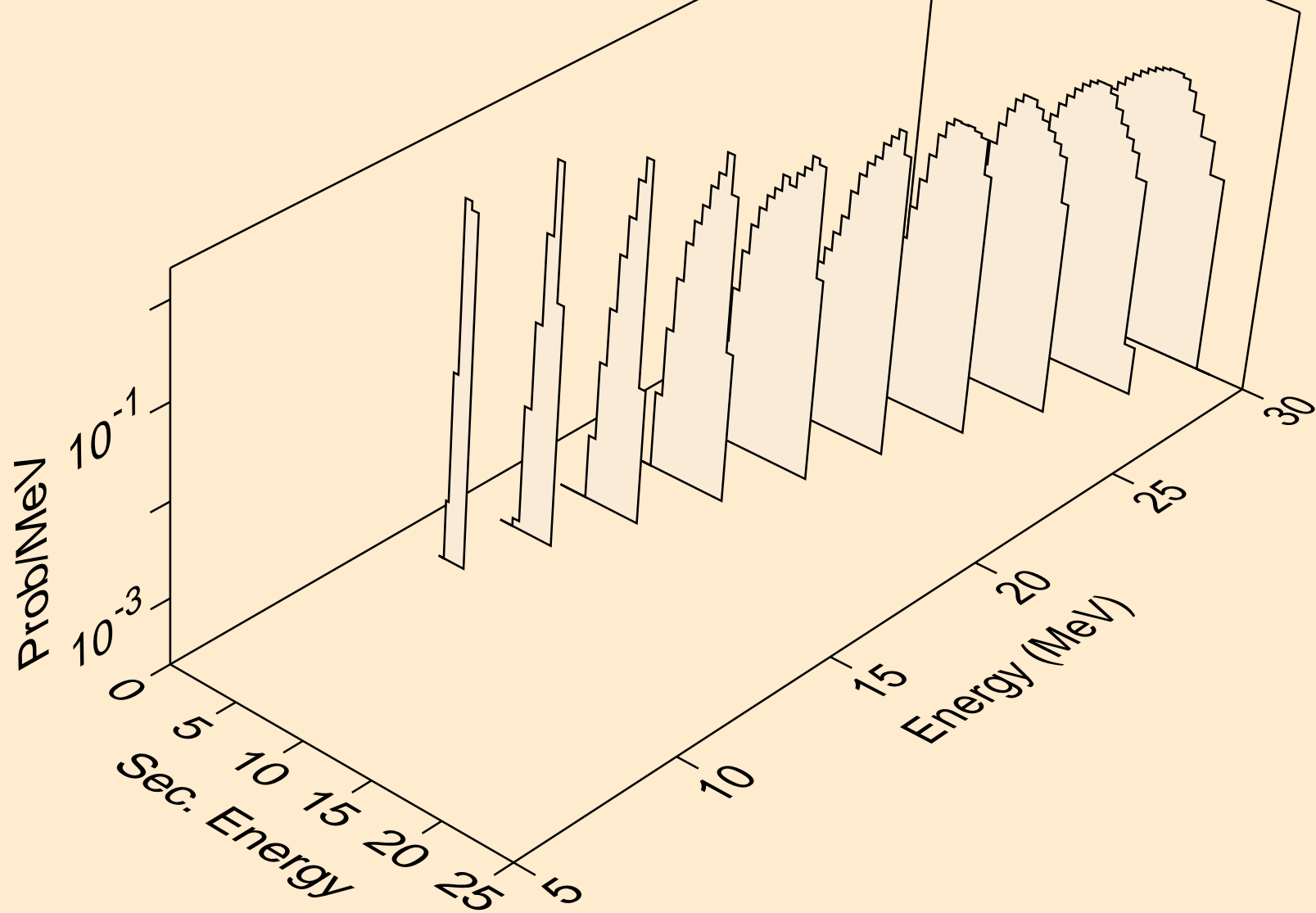

SN117M ALPHA ACER TENDL-2023 LIBRARY; T=0.K
Alpha emission for (a,2n)a

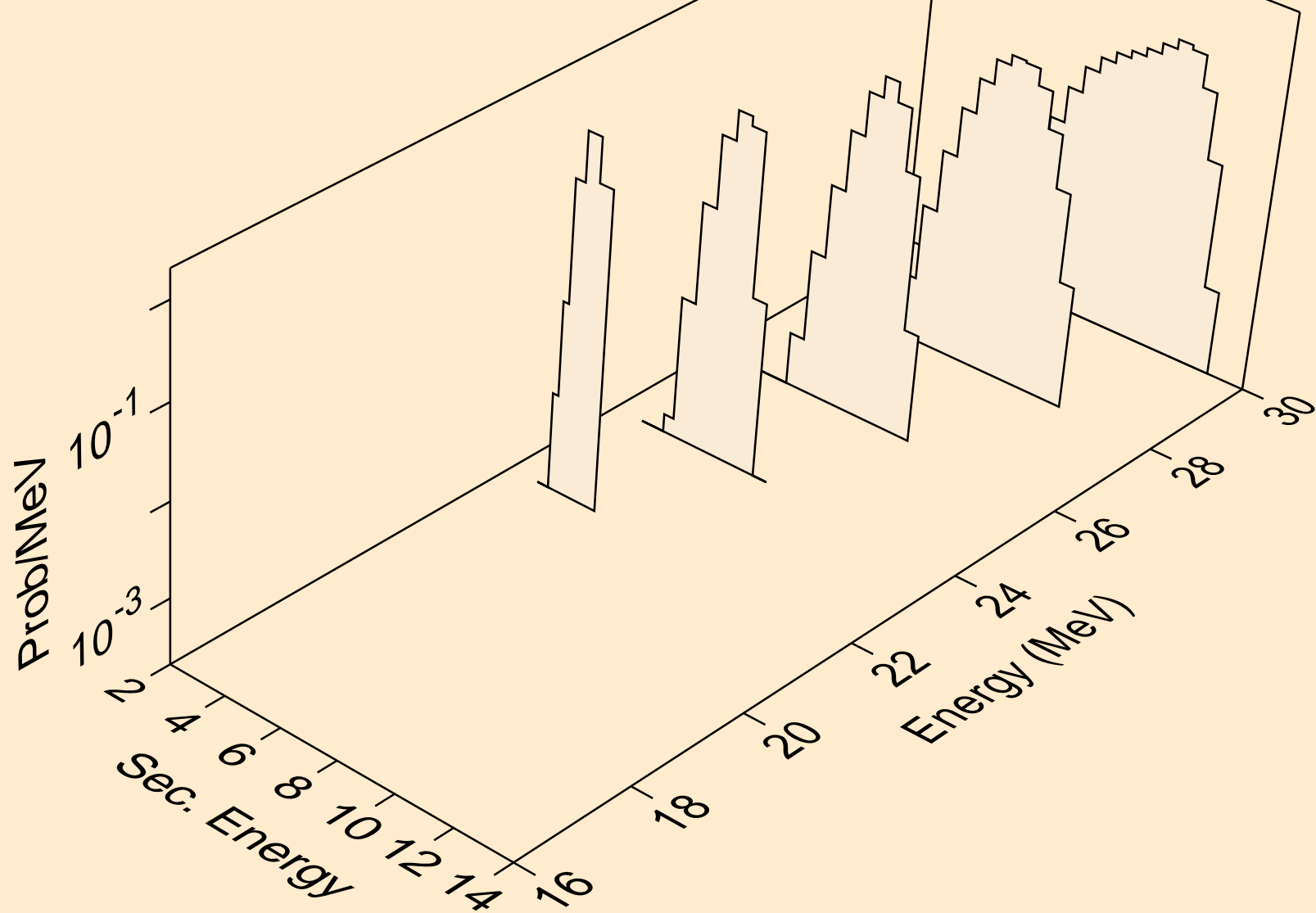

SN117M ALPHA ACER TENDL-2023 LIBRARY; T=0.K
Alpha emission for inelastic

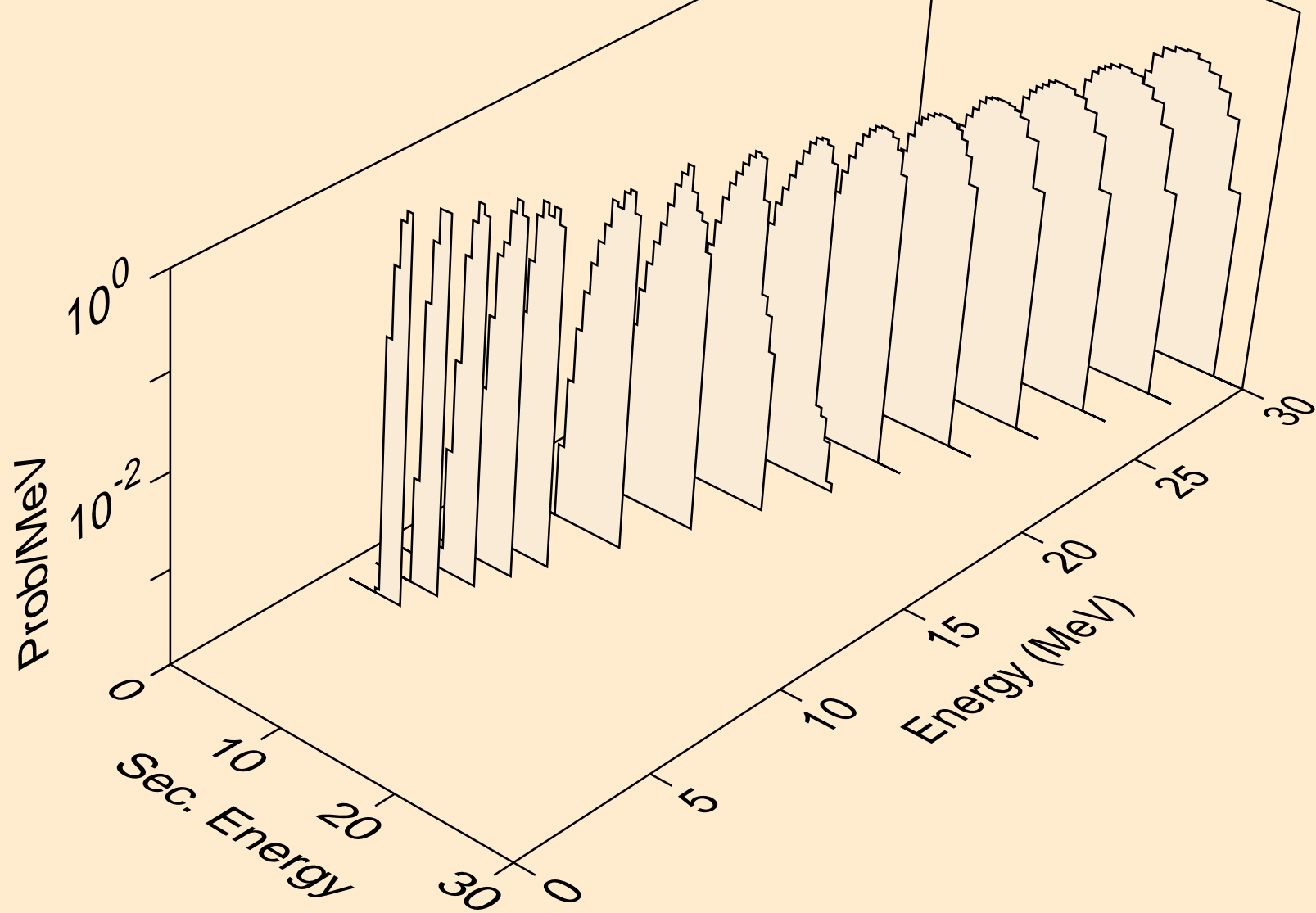

SN117M ALPHA ACER TENDL-2023 LIBRARY; T=0.K
Alpha emission for (a,2a)

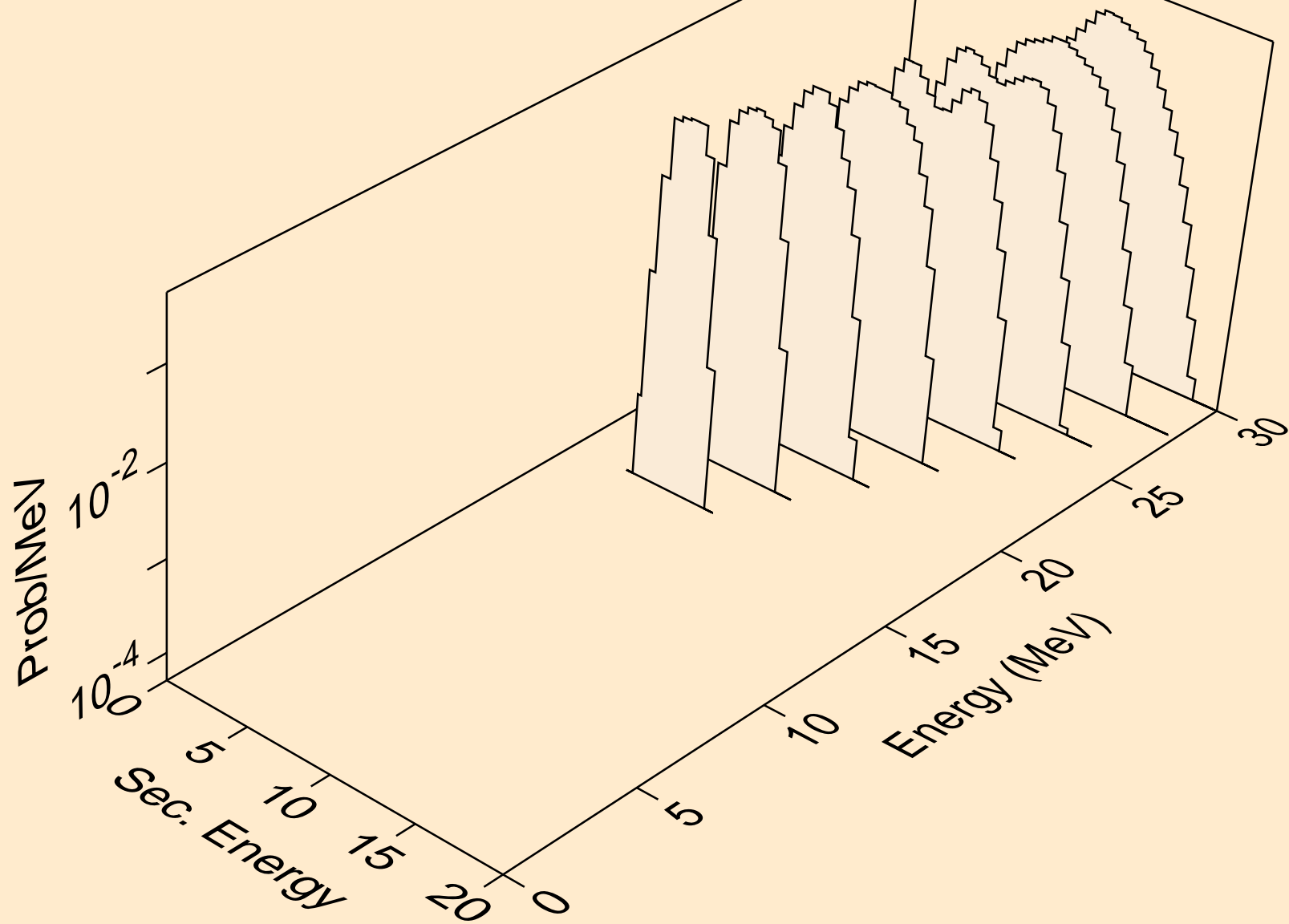

SN117M ALPHA ACER TENDL-2023 LIBRARY; T=0.K
Alpha emission for (a,pa)

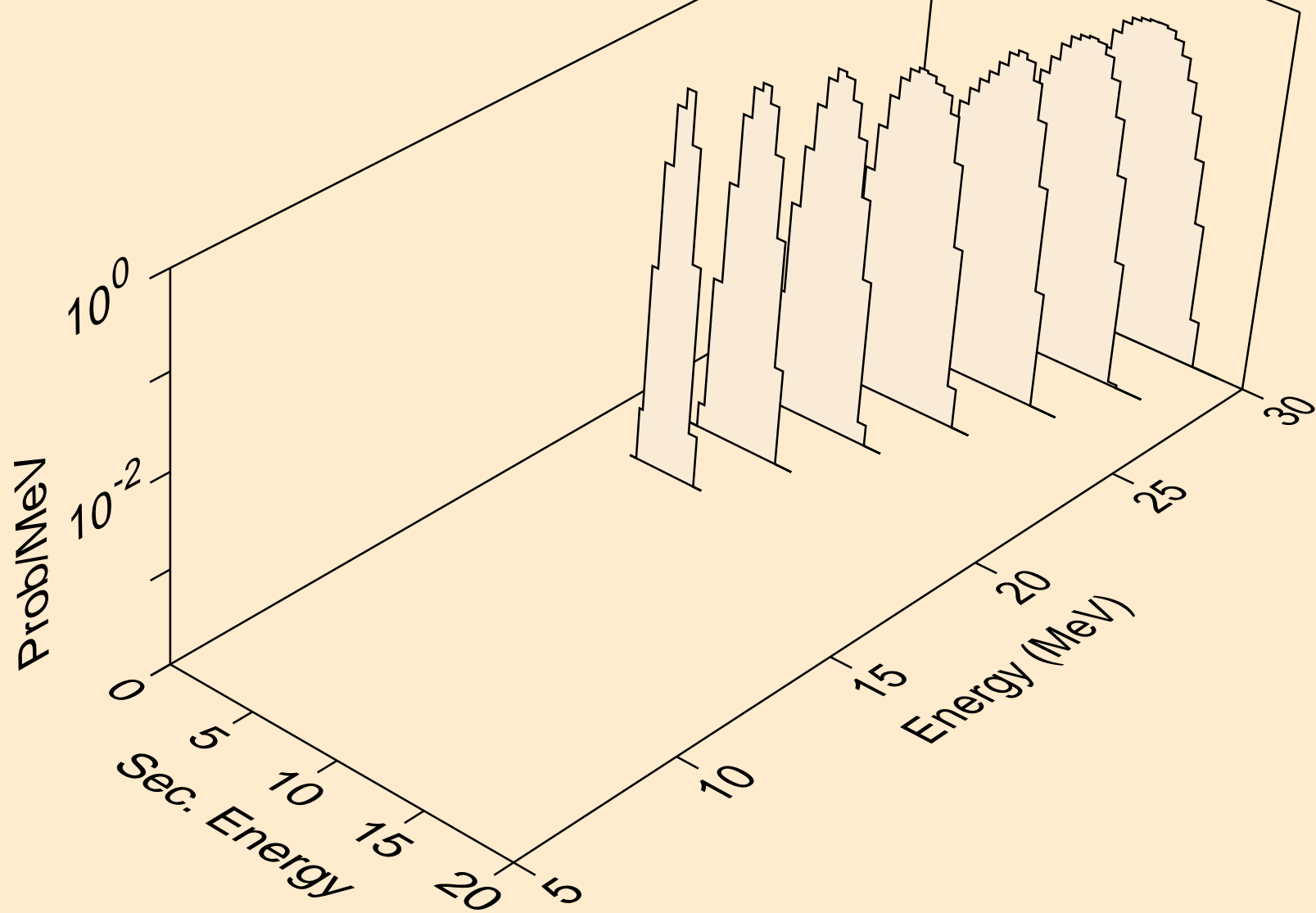

SN117M ALPHA ACER TENDL-2023 LIBRARY; T=0.K
Photon emission for (z,n)

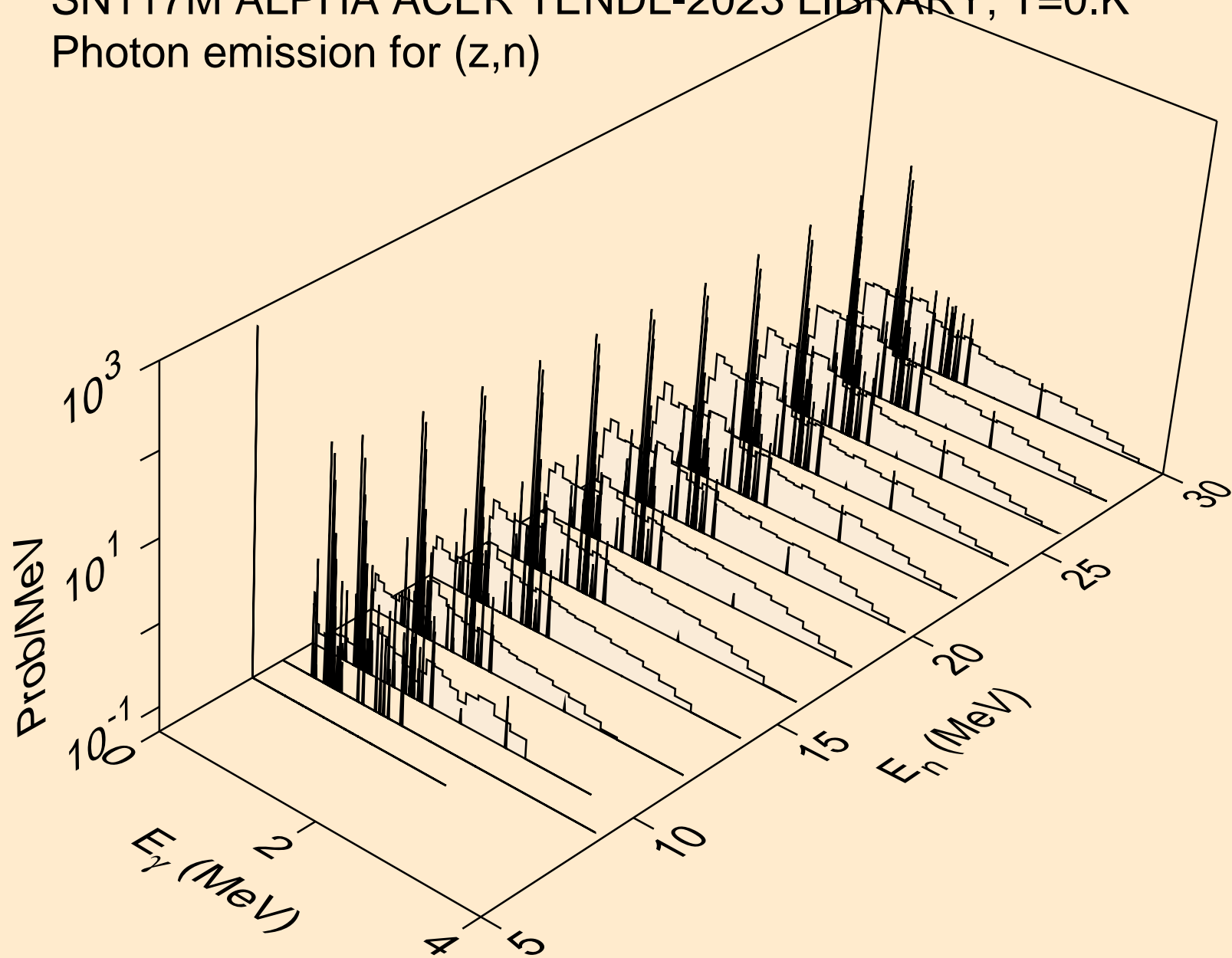

SN117M ALPHA ACER TENDL-2023 LIBRARY; T=0.K
Photon emission for (z,x)

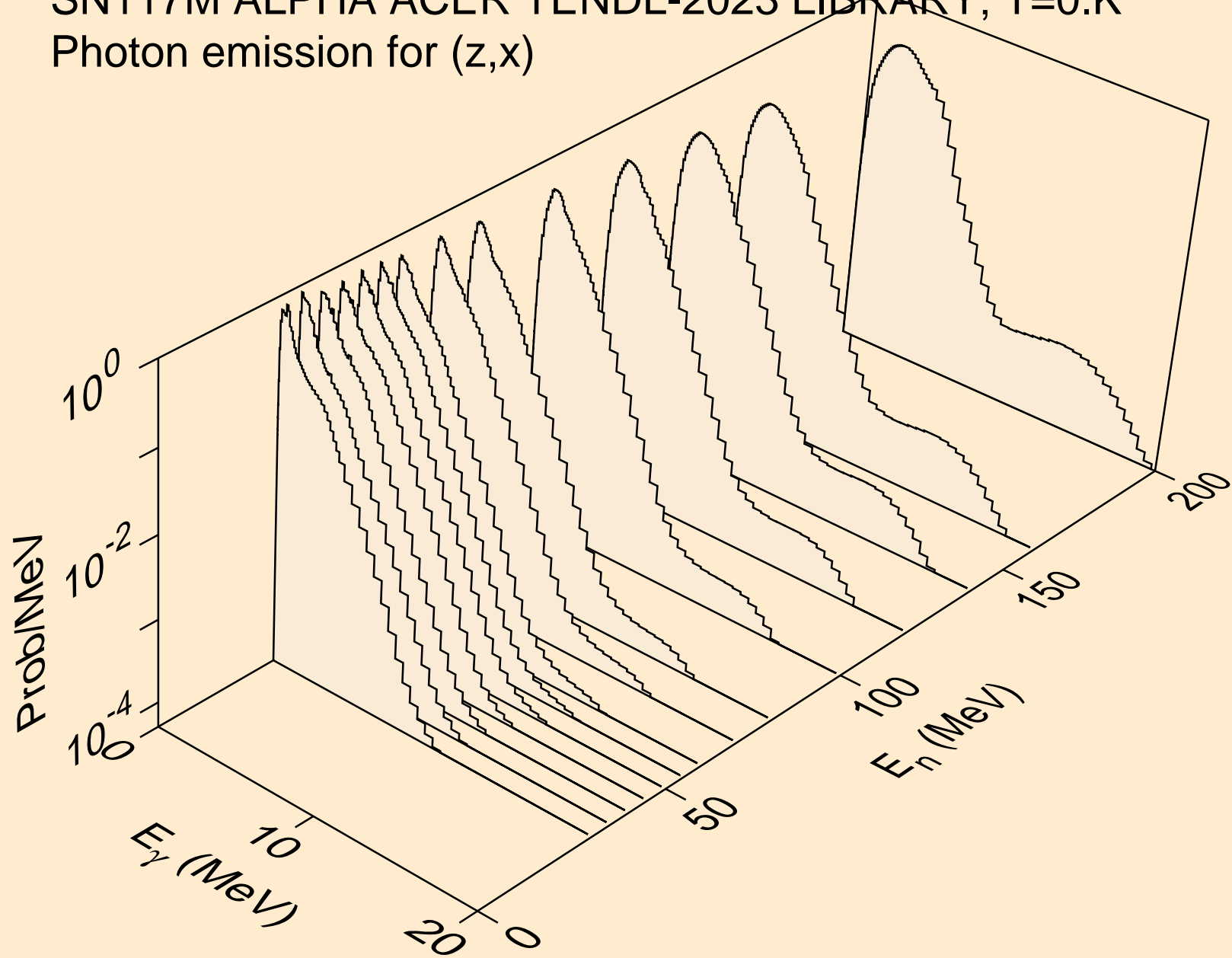

SN117M ALPHA ACER TENDL-2023 LIBRARY; T=0.K
Photon emission for (n,2n)

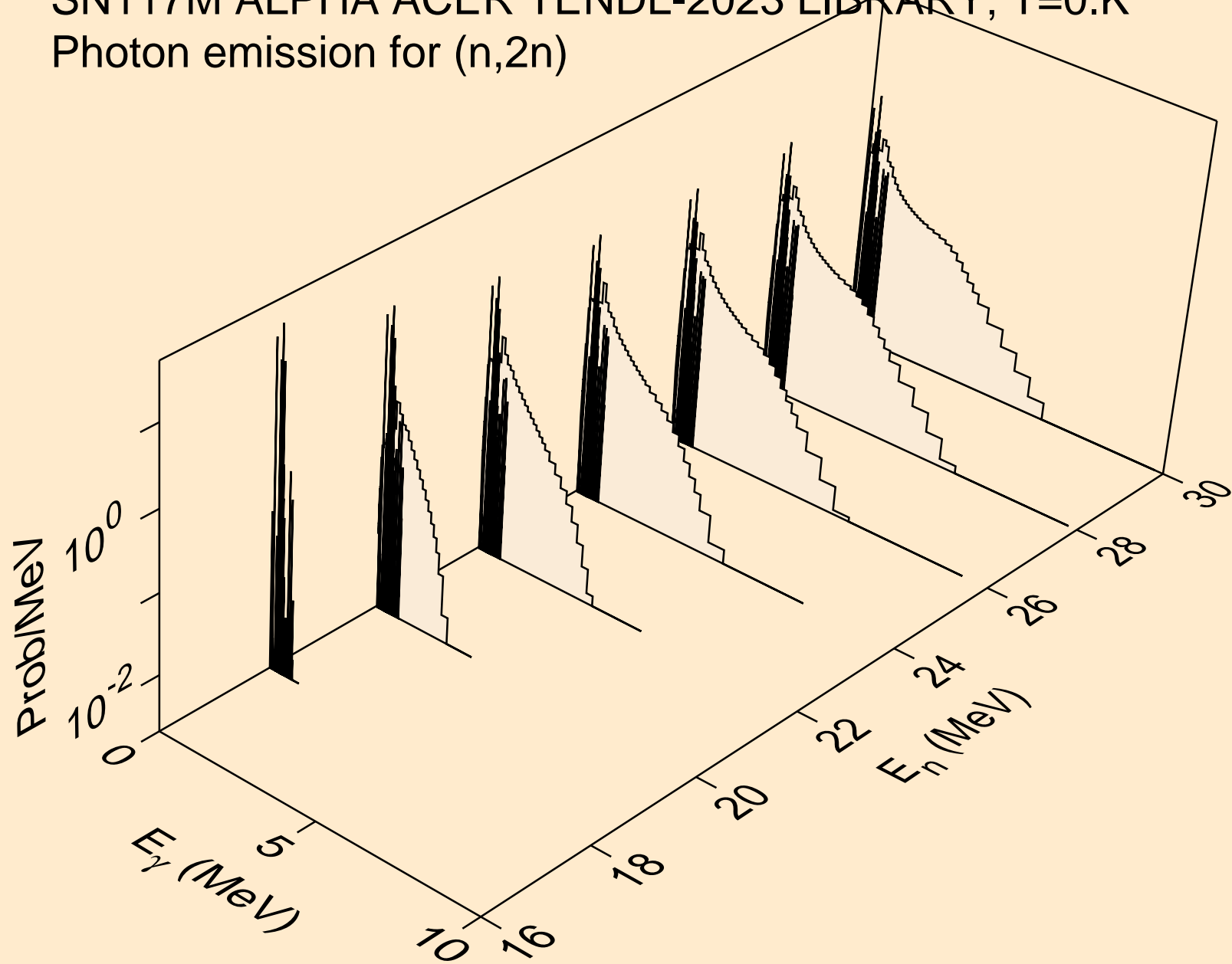

SN117M ALPHA ACER TENDL-2023 LIBRARY; T=0.K
Photon emission for (n,3n)

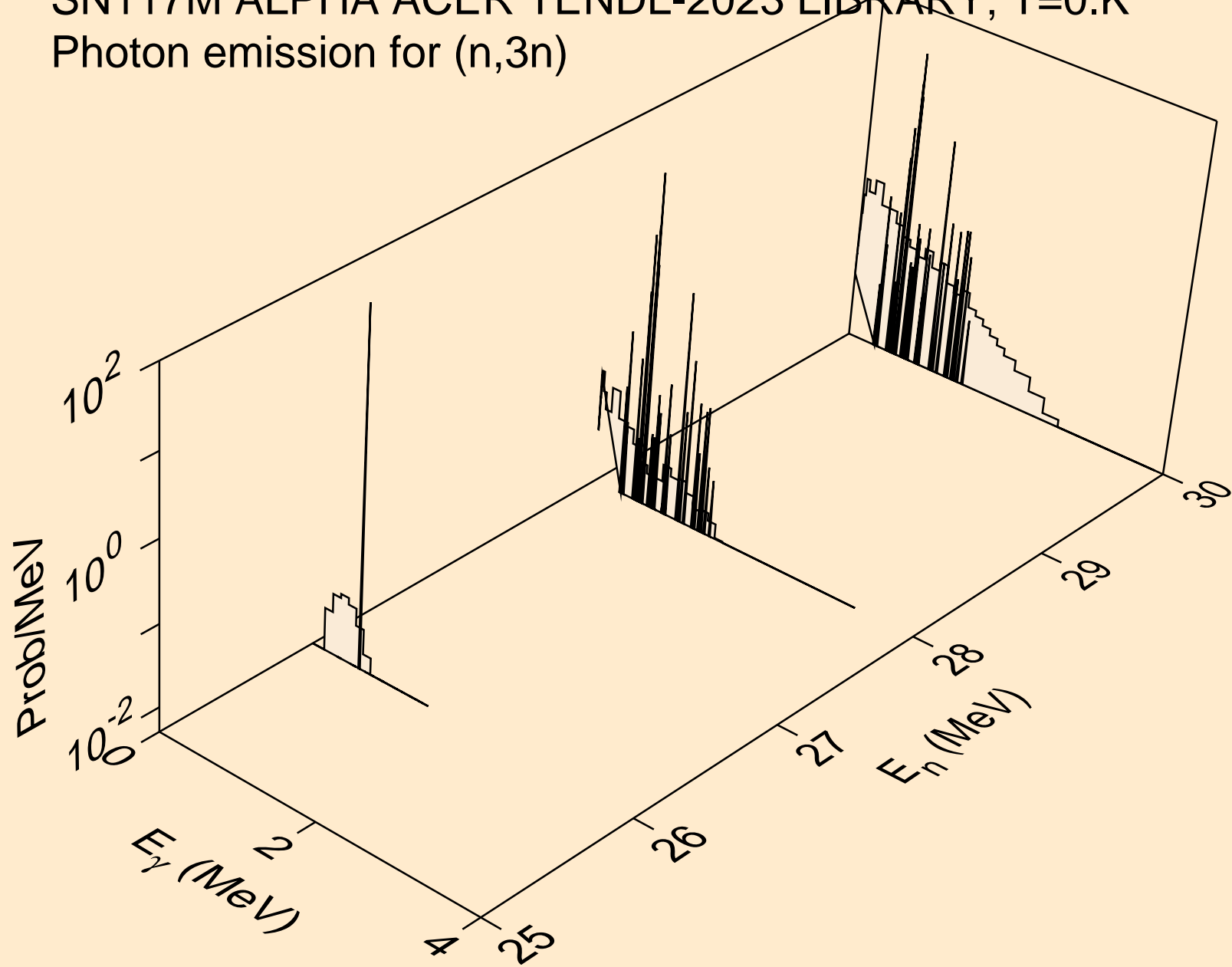

SN117M ALPHA ACER TENDL-2023 LIBRARY; T=0.K
Photon emission for (n,n*)a

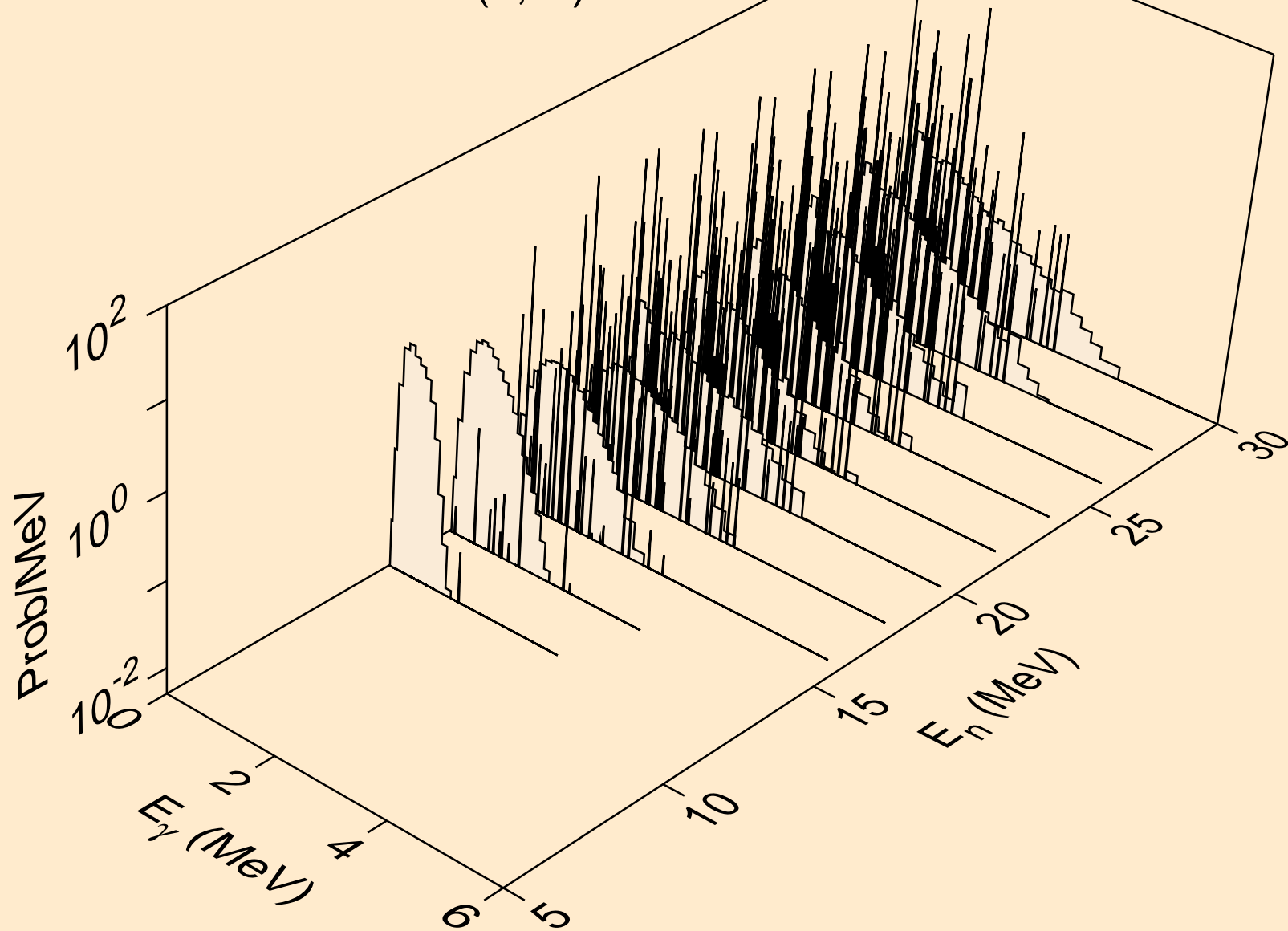

SN117M ALPHA ACER TENDL-2023 LIBRARY; T=0.K
Photon emission for (n,2n)a

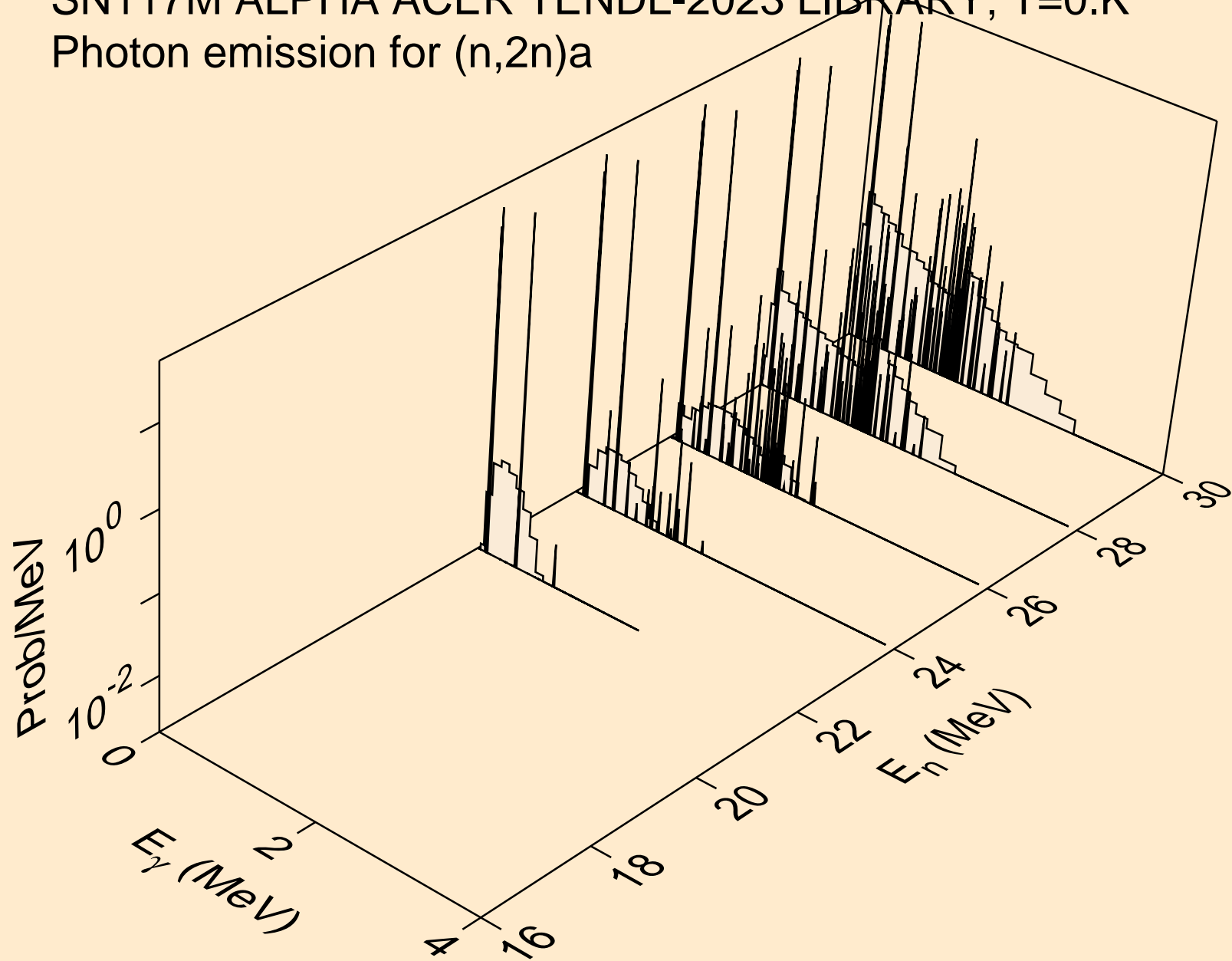

SN117M ALPHA ACER TENDL-2023 LIBRARY; T=0.K
Photon emission for (n,n*)p

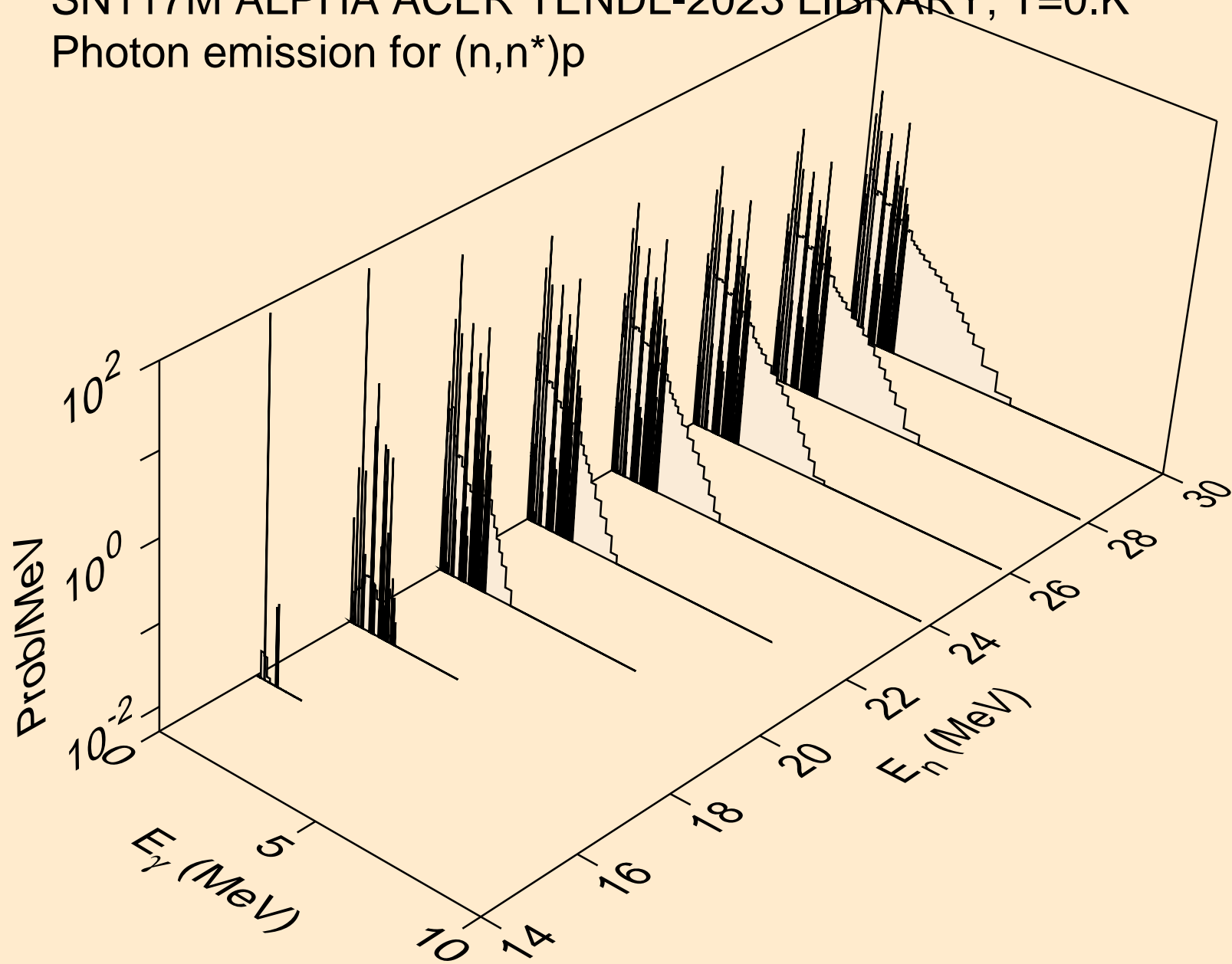

SN117M ALPHA ACER TENDL-2023 LIBRARY; T=0.K
Photon emission for (n,n*)d

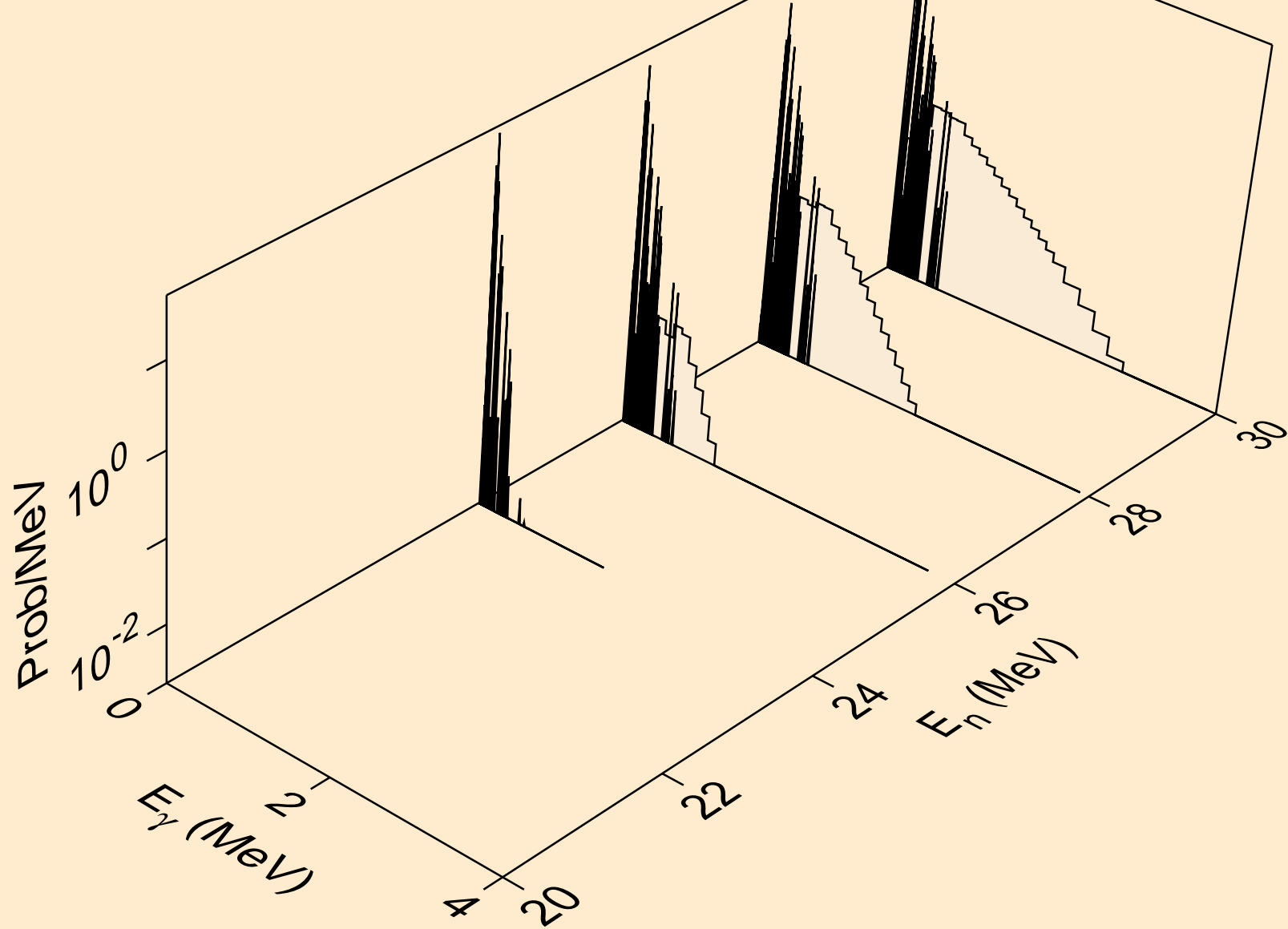

SN117M ALPHA ACER TENDL-2023 LIBRARY; T=0.K
Photon emission for (n,n*)t

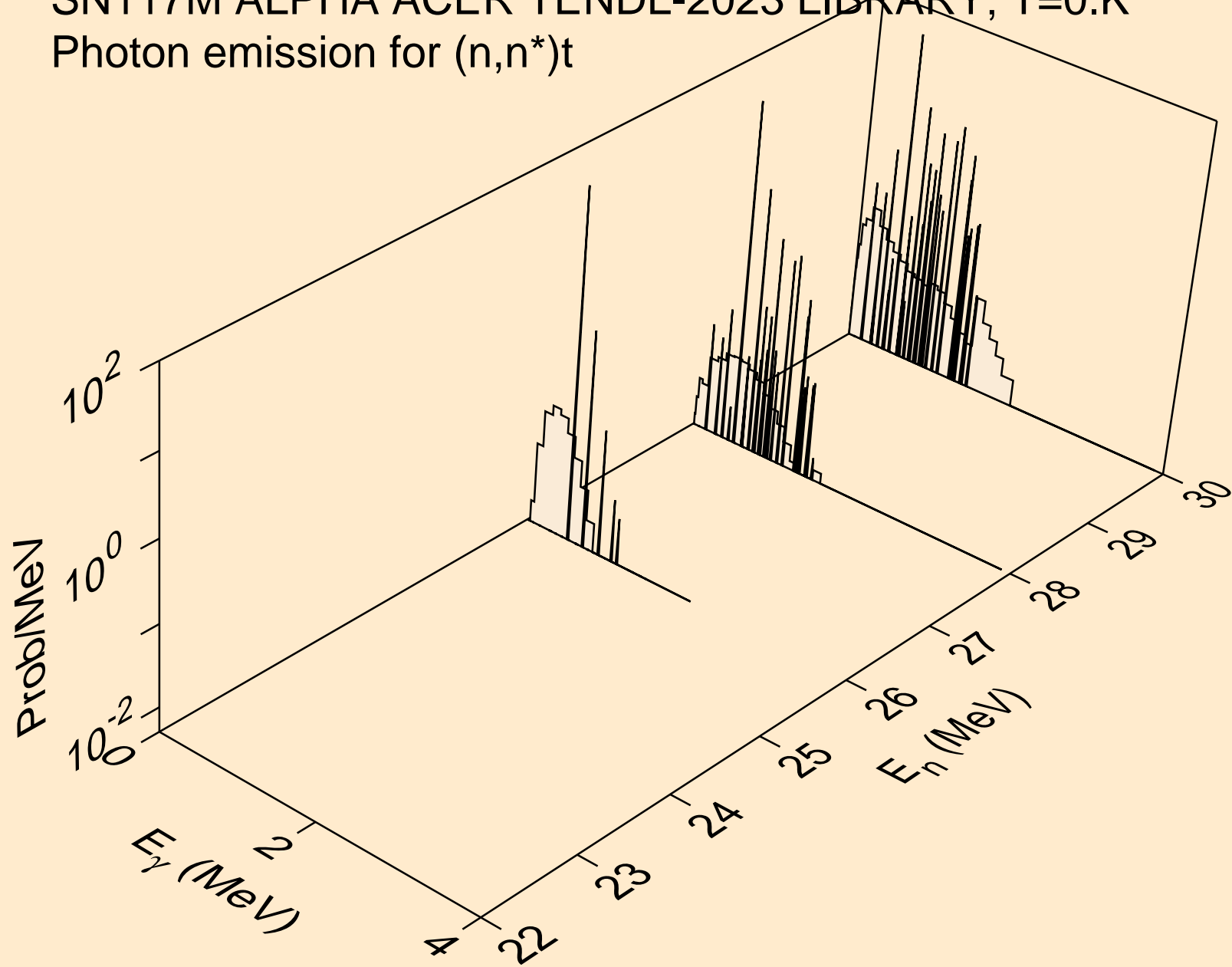

SN117M ALPHA ACER TENDL-2023 LIBRARY; T=0.K
Photon emission for (n,n*)he3

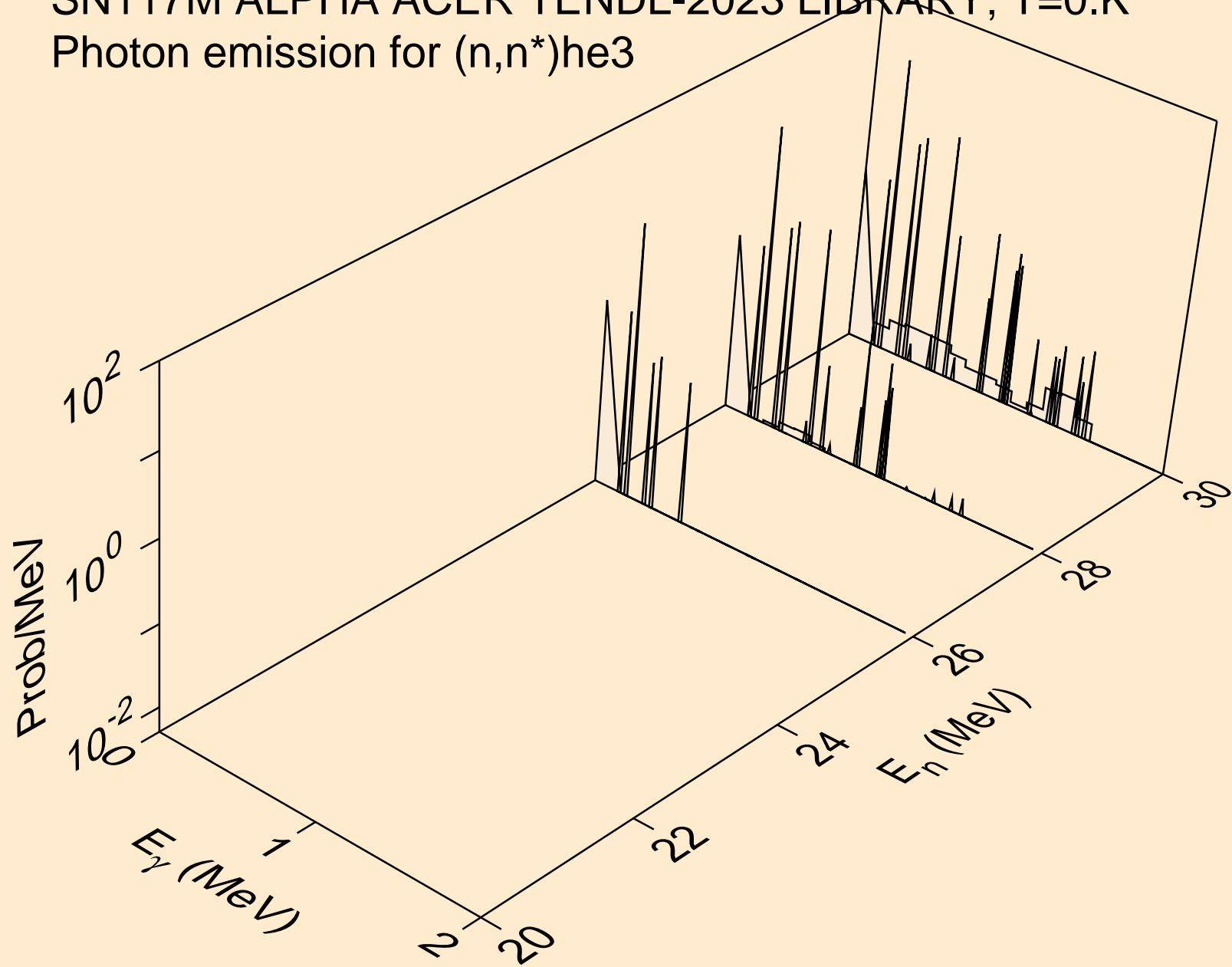

SN117M ALPHA ACER TENDL-2023 LIBRARY; T=0.K
Photon emission for (n,2np)

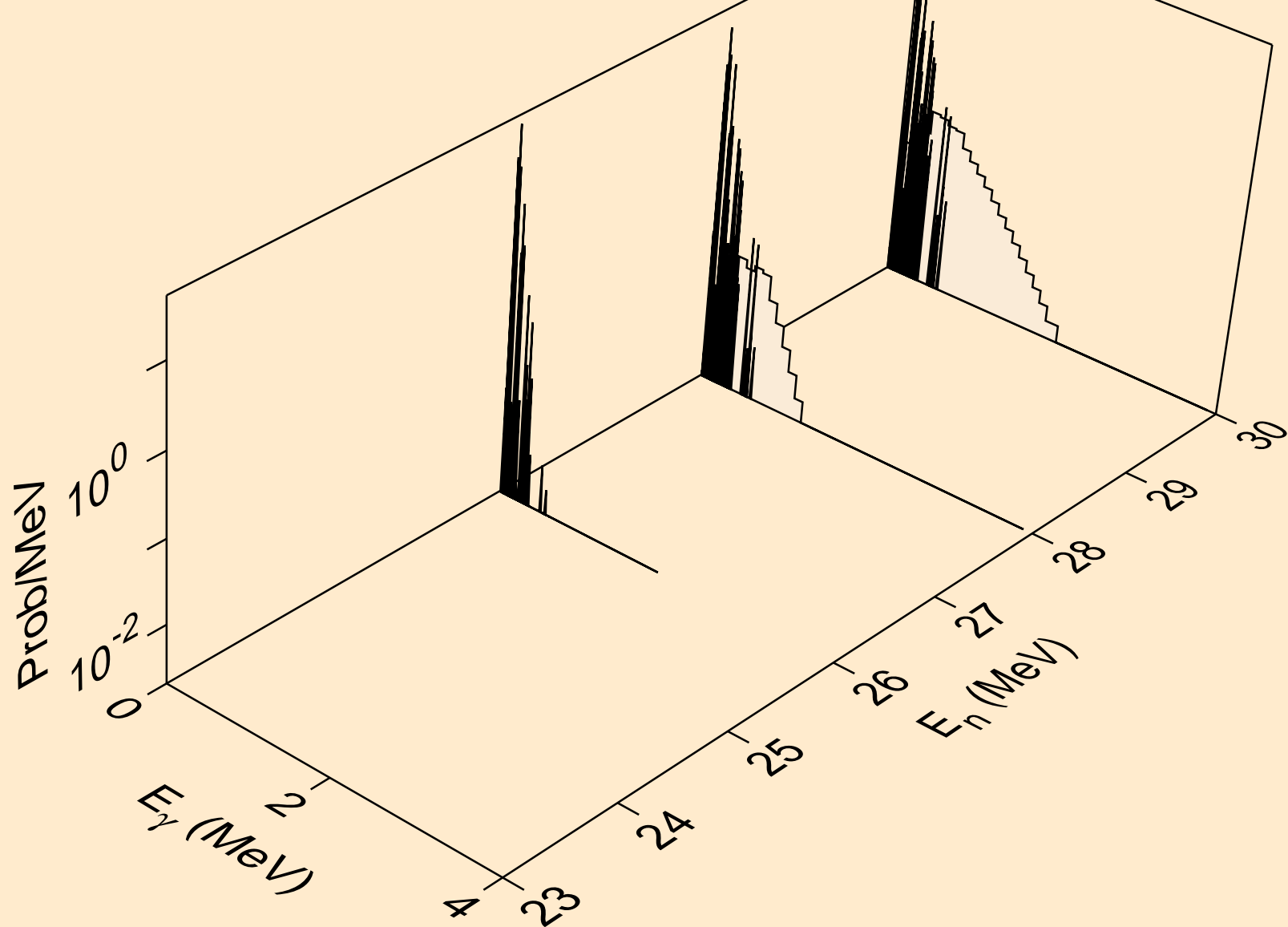

SN117M ALPHA ACER TENDL-2023 LIBRARY; T=0.K
Photon emission for (n,n2p)

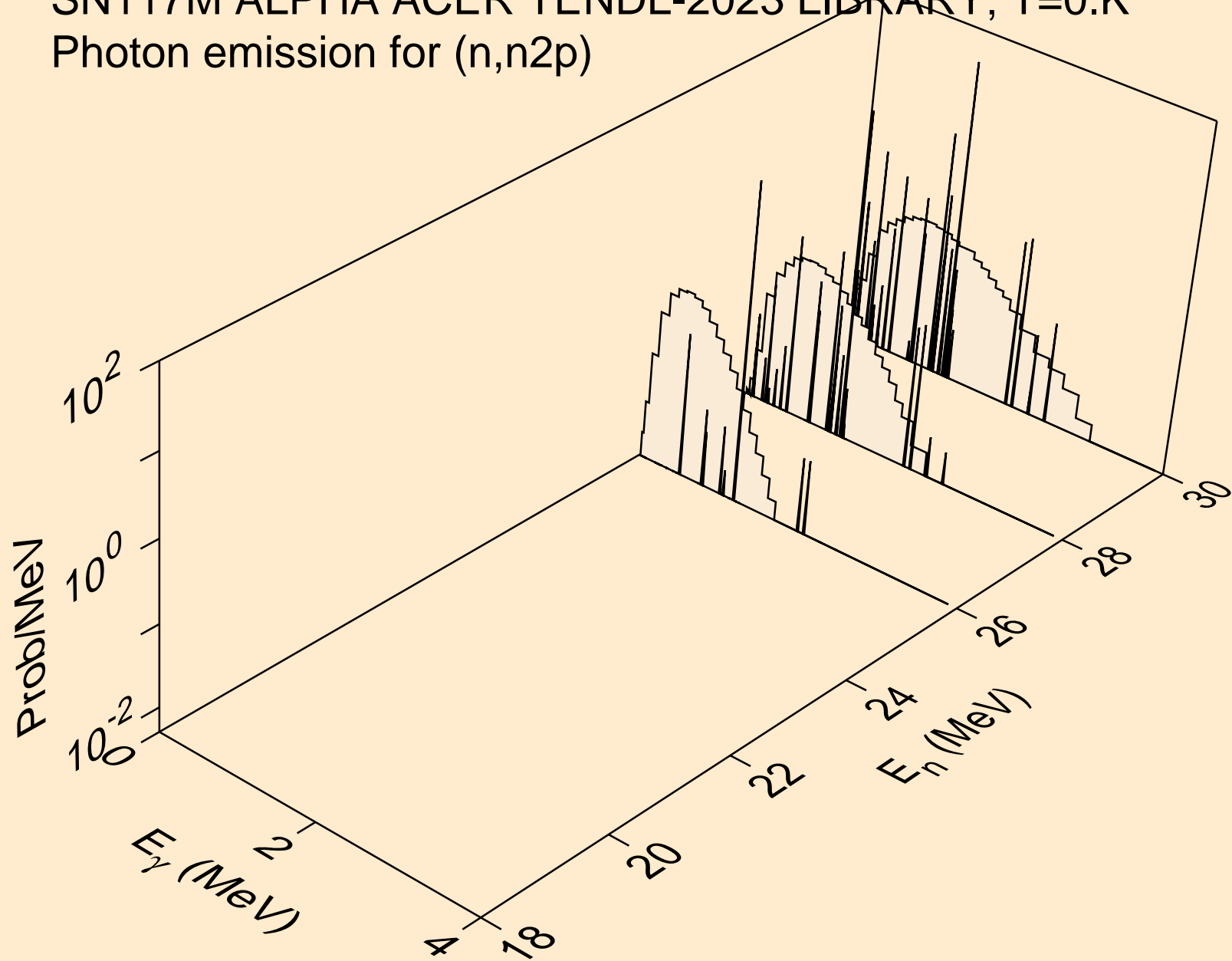

SN117M ALPHA ACER TENDL-2023 LIBRARY; T=0.K
Photon emission for (n,gma)

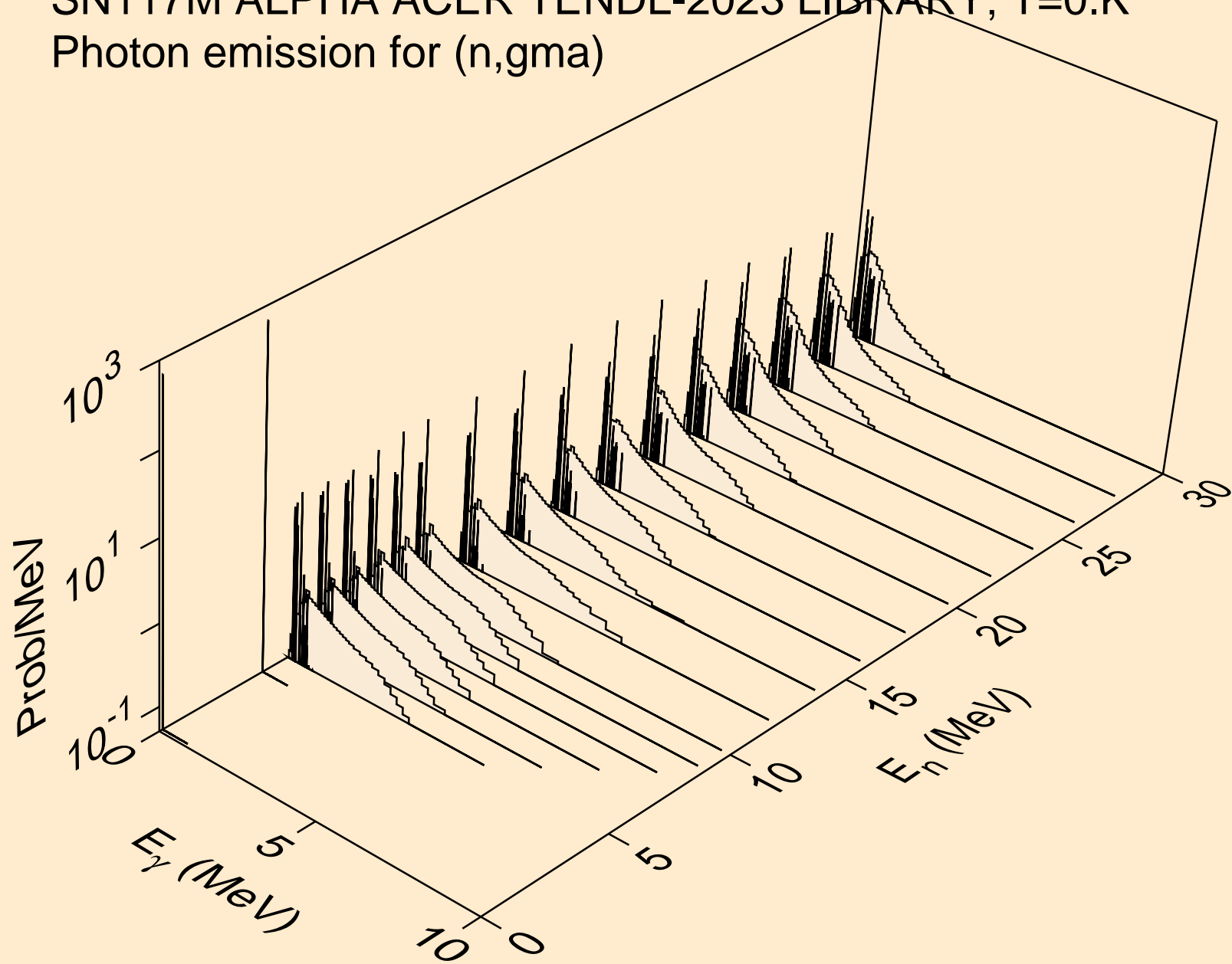

SN117M ALPHA ACER TENDL-2023 LIBRARY; T=0.K
Photon emission for (n,p)

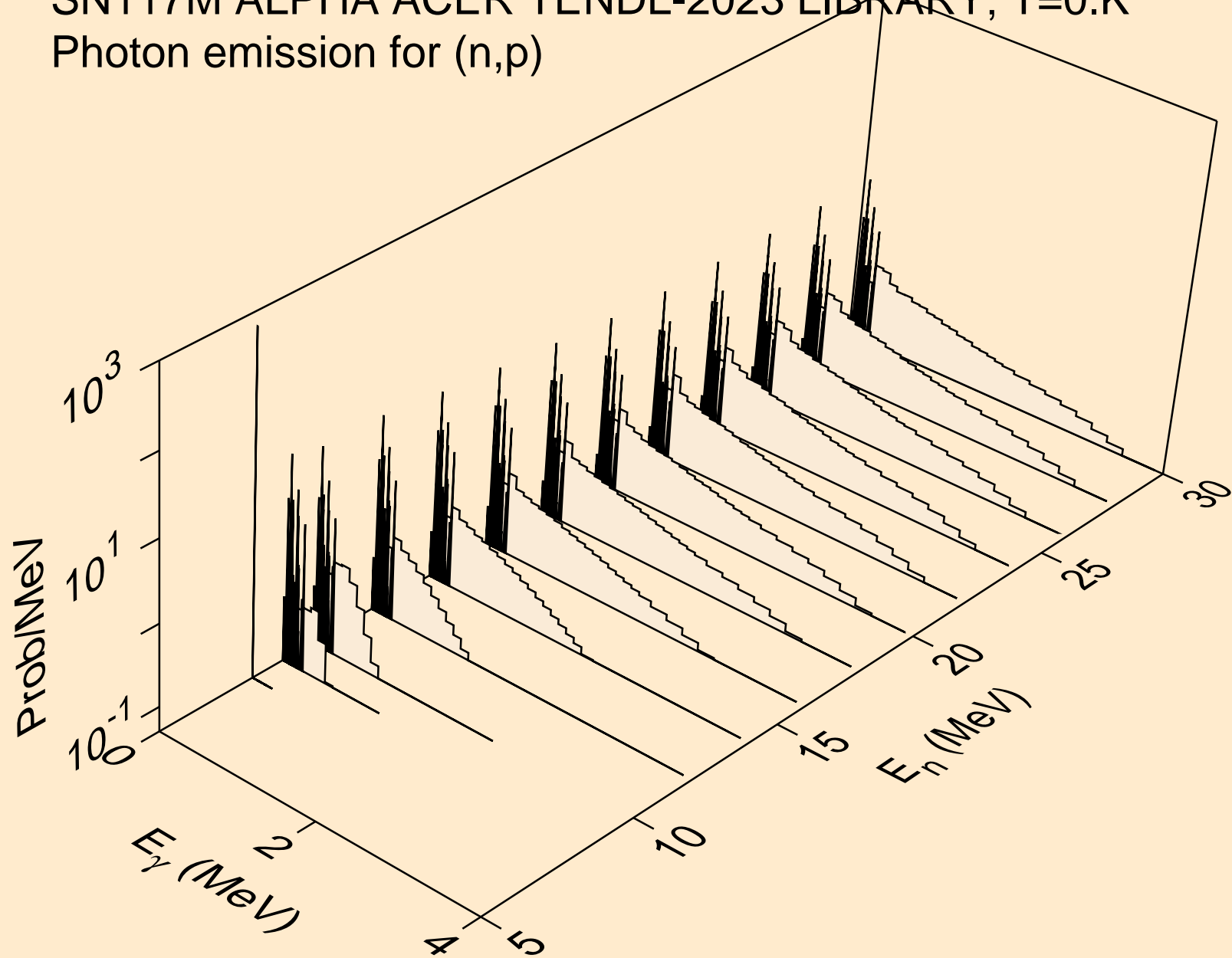

SN117M ALPHA ACER TENDL-2023 LIBRARY; T=0.K
Photon emission for (n,d)

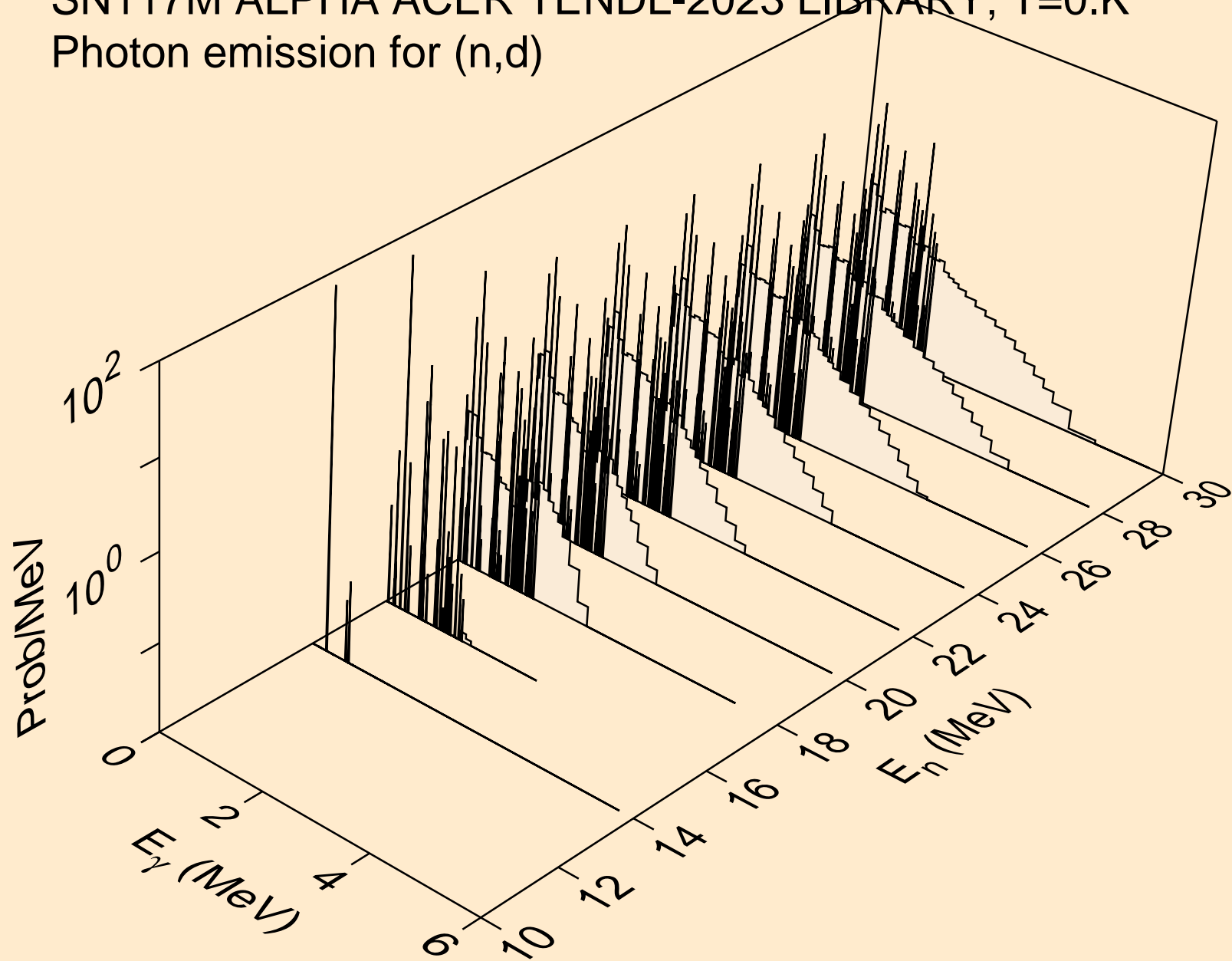

SN117M ALPHA ACER TENDL-2023 LIBRARY; T=0.K
Photon emission for (n,t)

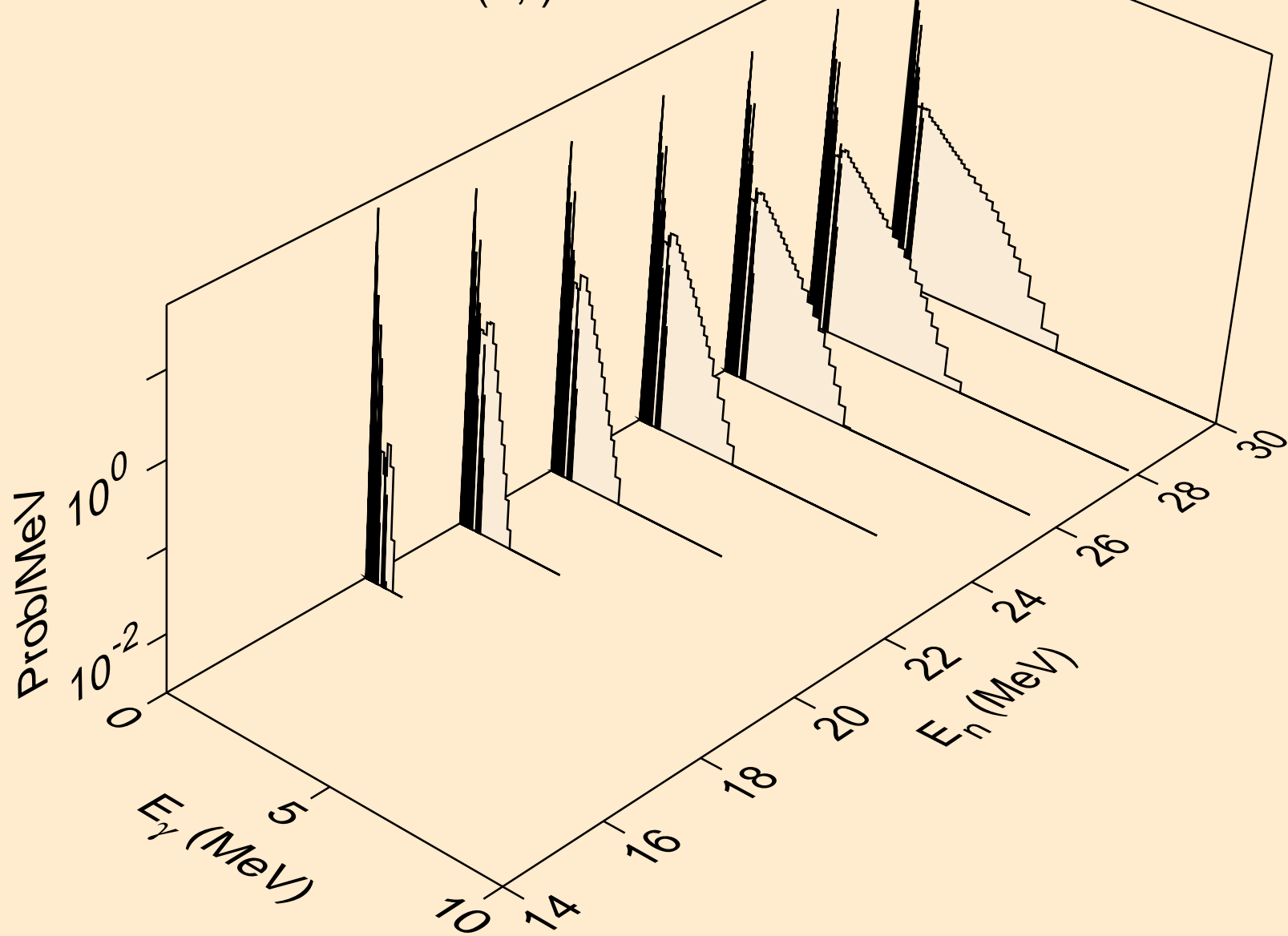

SN117M ALPHA ACER TENDL-2023 LIBRARY; T=0.K
Photon emission for (n,he3)

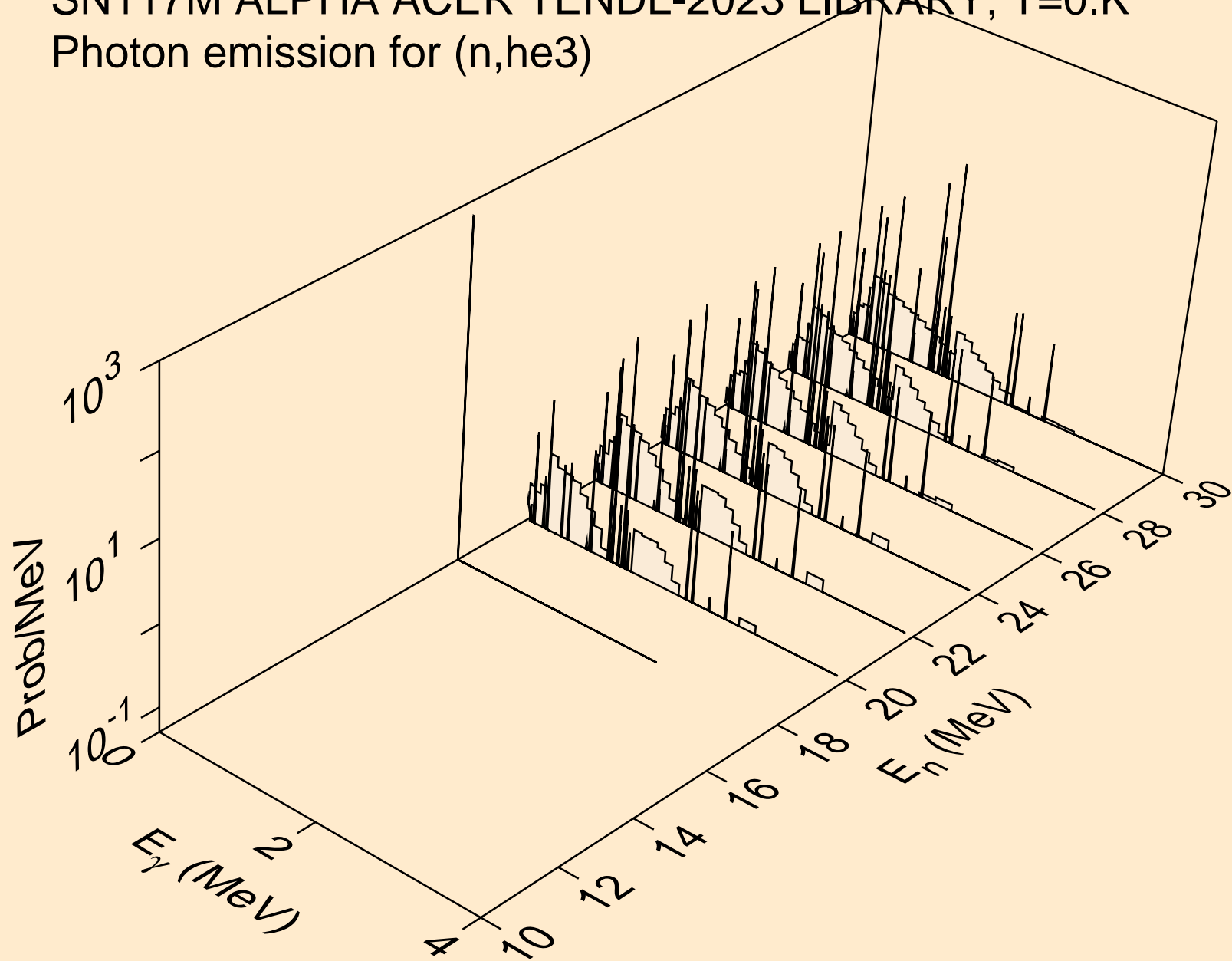

SN117M ALPHA ACER TENDL-2023 LIBRARY; T=0.K
Photon emission for inelastic

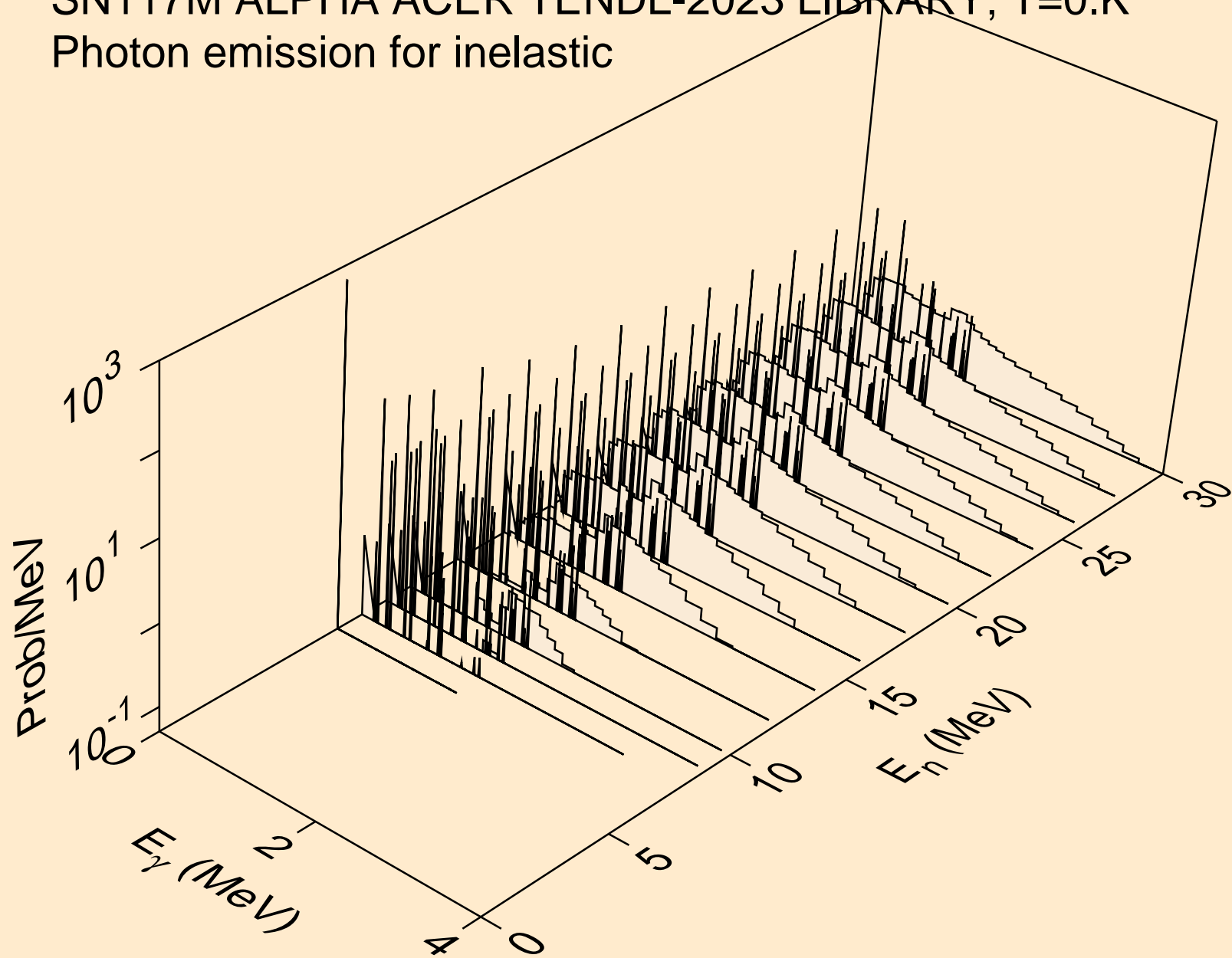

SN117M ALPHA ACER TENDL-2023 LIBRARY; T=0.K
Photon emission for (n,2a)

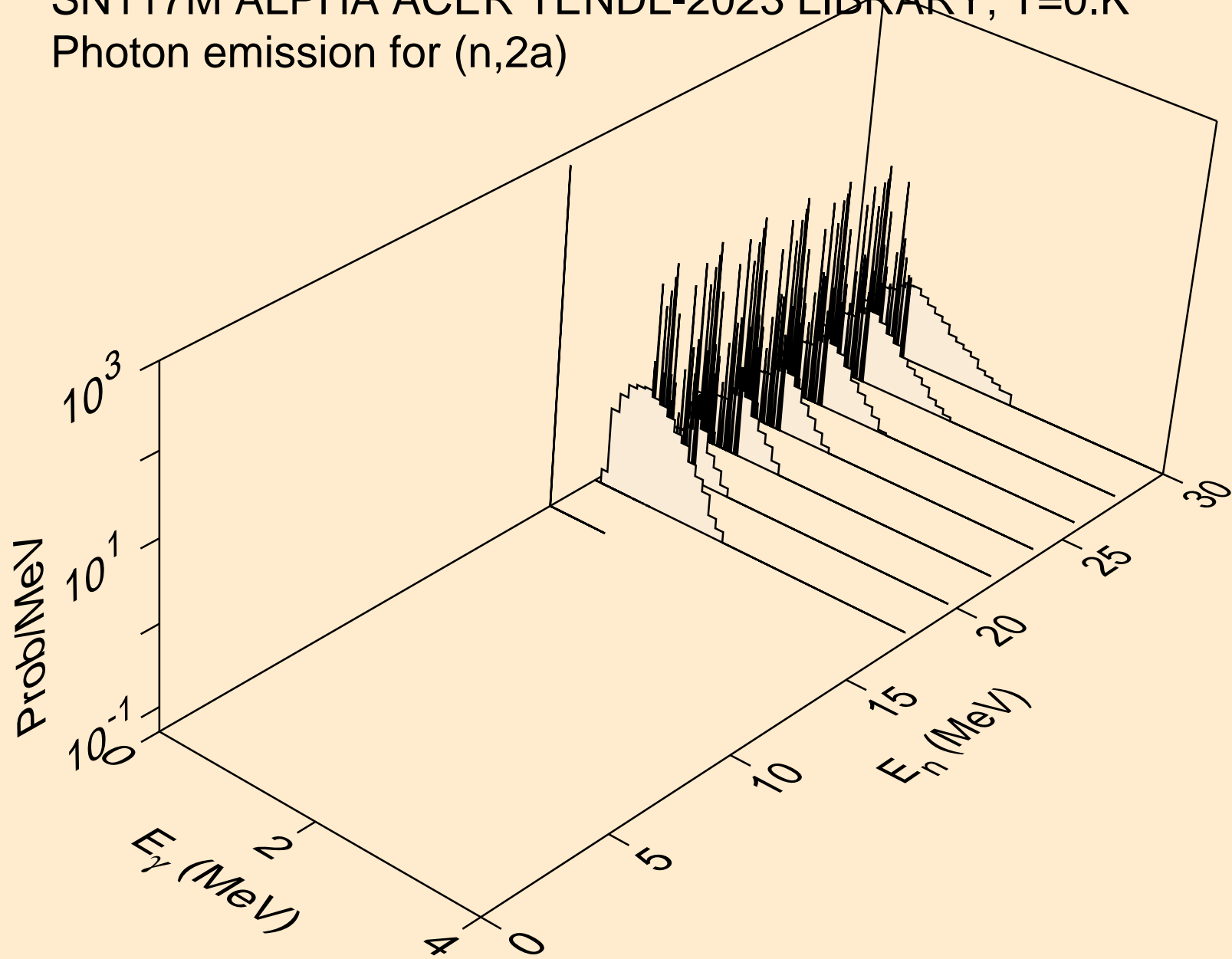

SN117M ALPHA ACER TENDL-2023 LIBRARY; T=0.K
Photon emission for (n,2p)

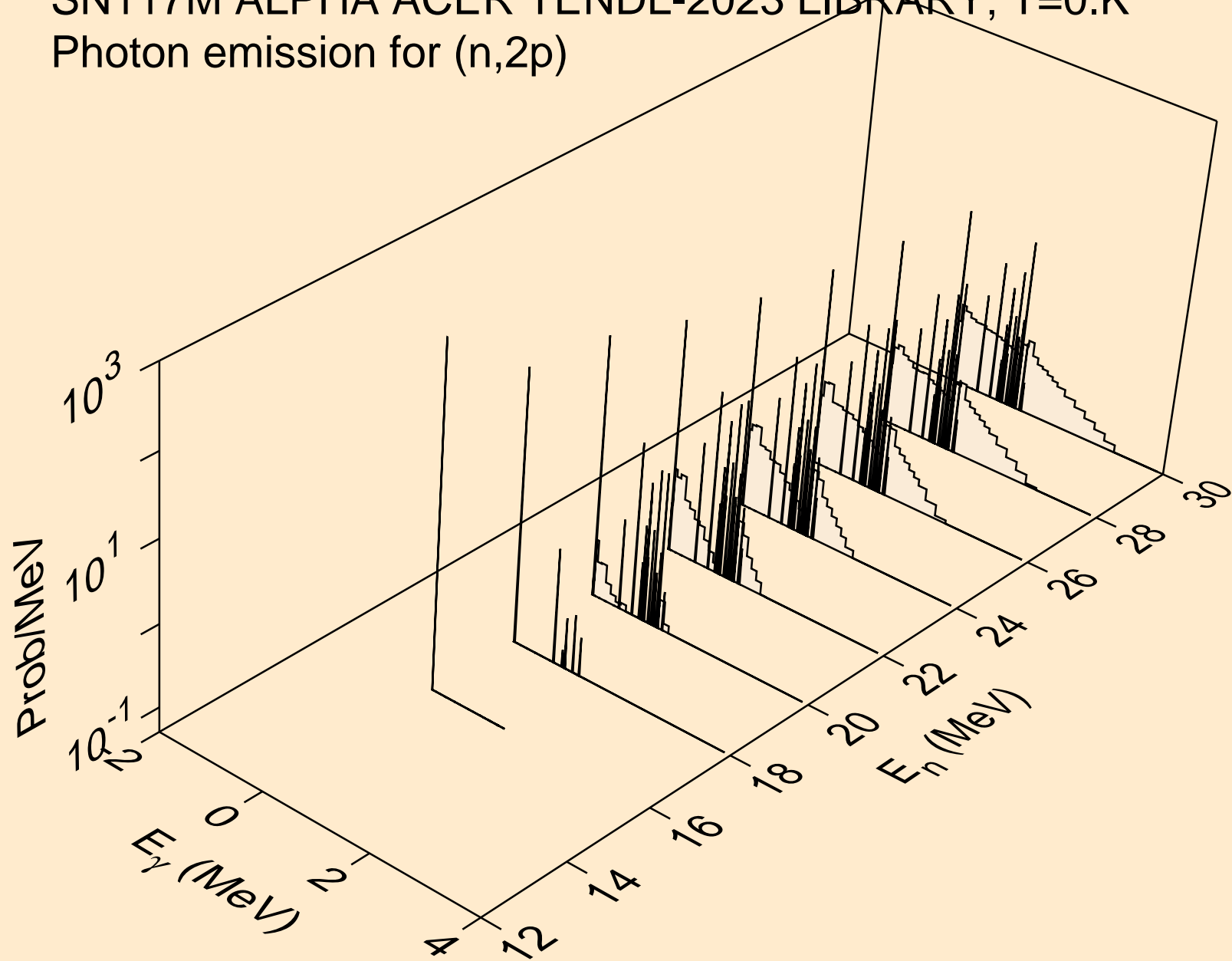

SN117M ALPHA ACER TENDL-2023 LIBRARY; T=0.K
Photon emission for (n,pa)

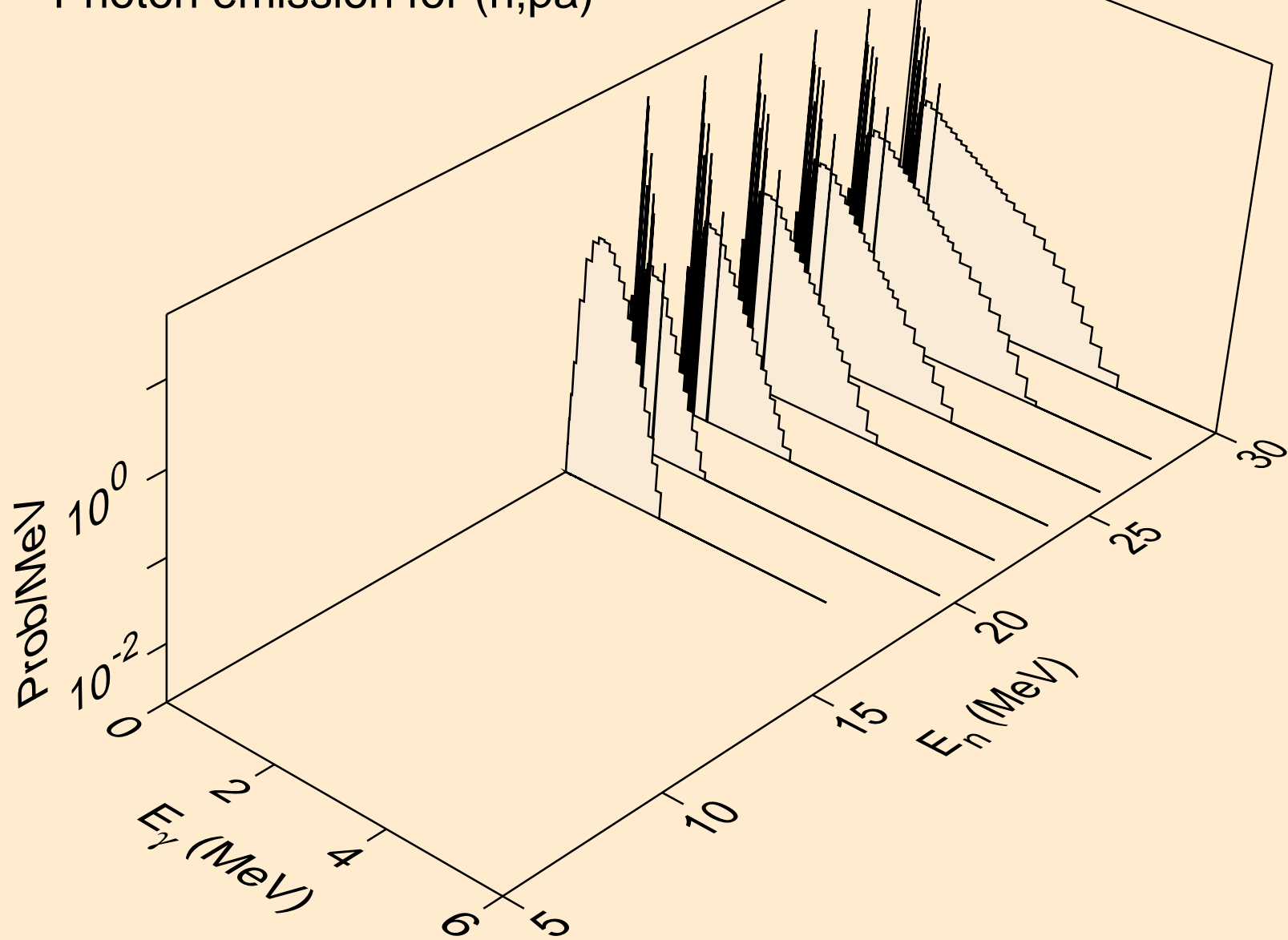

SN117M ALPHA ACER TENDL-2023 LIBRARY; T=0.K
Photon emission for (n,pd)

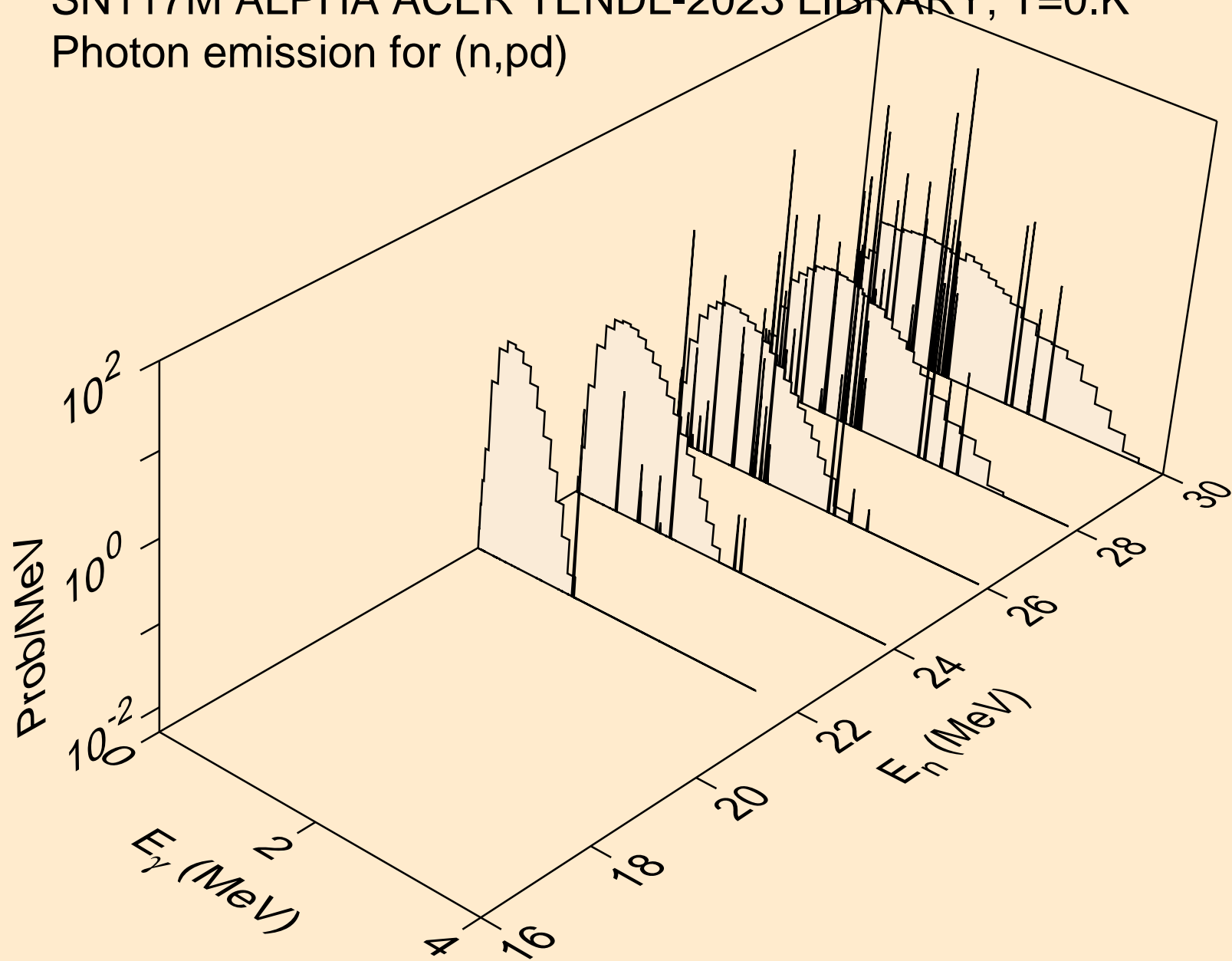

SN117M ALPHA ACER TENDL-2023 LIBRARY; T=0.K
Photon emission for (n,pt)

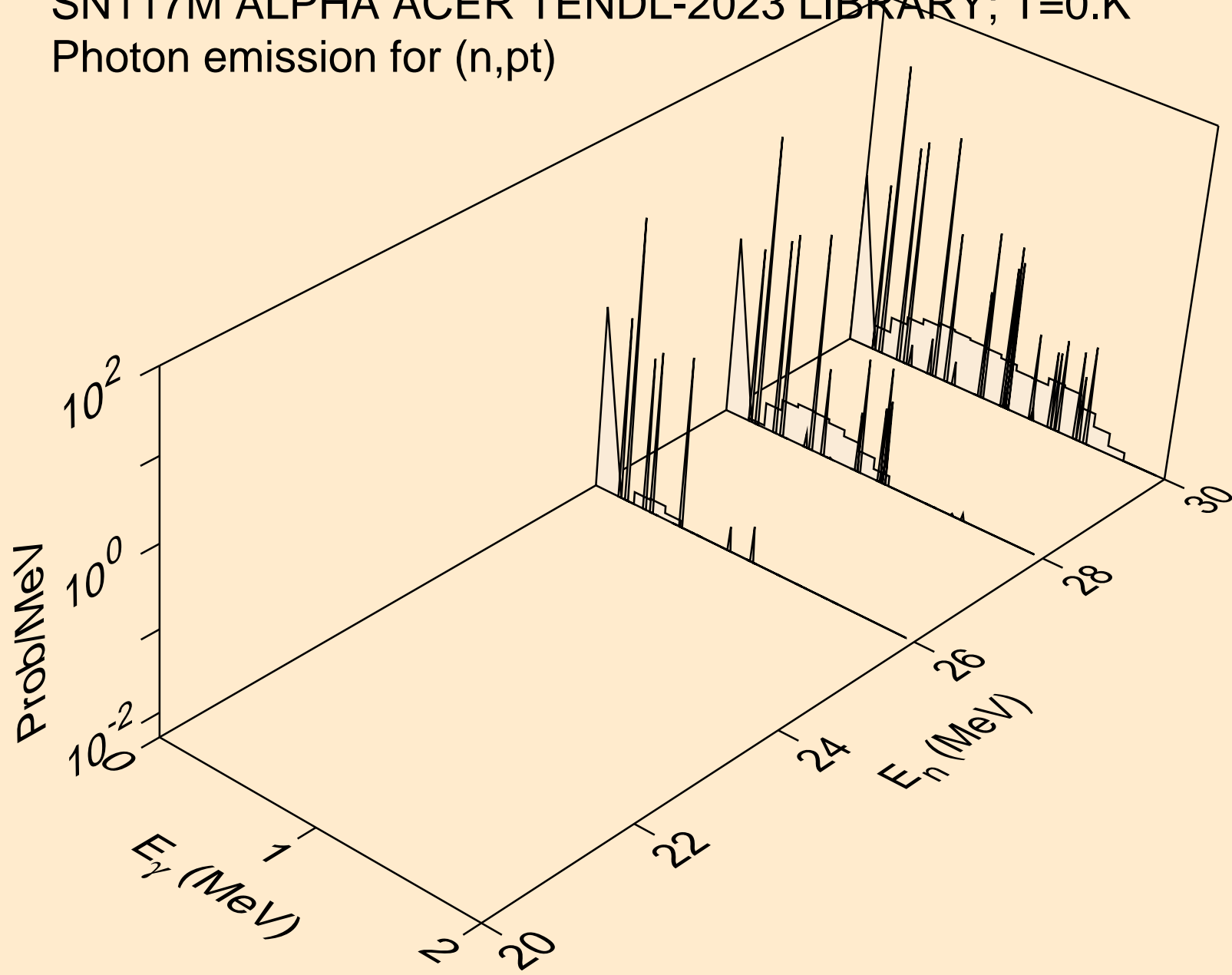

SN117M ALPHA ACER TENDL-2023 LIBRARY; T=0.K

Particle heating contributions

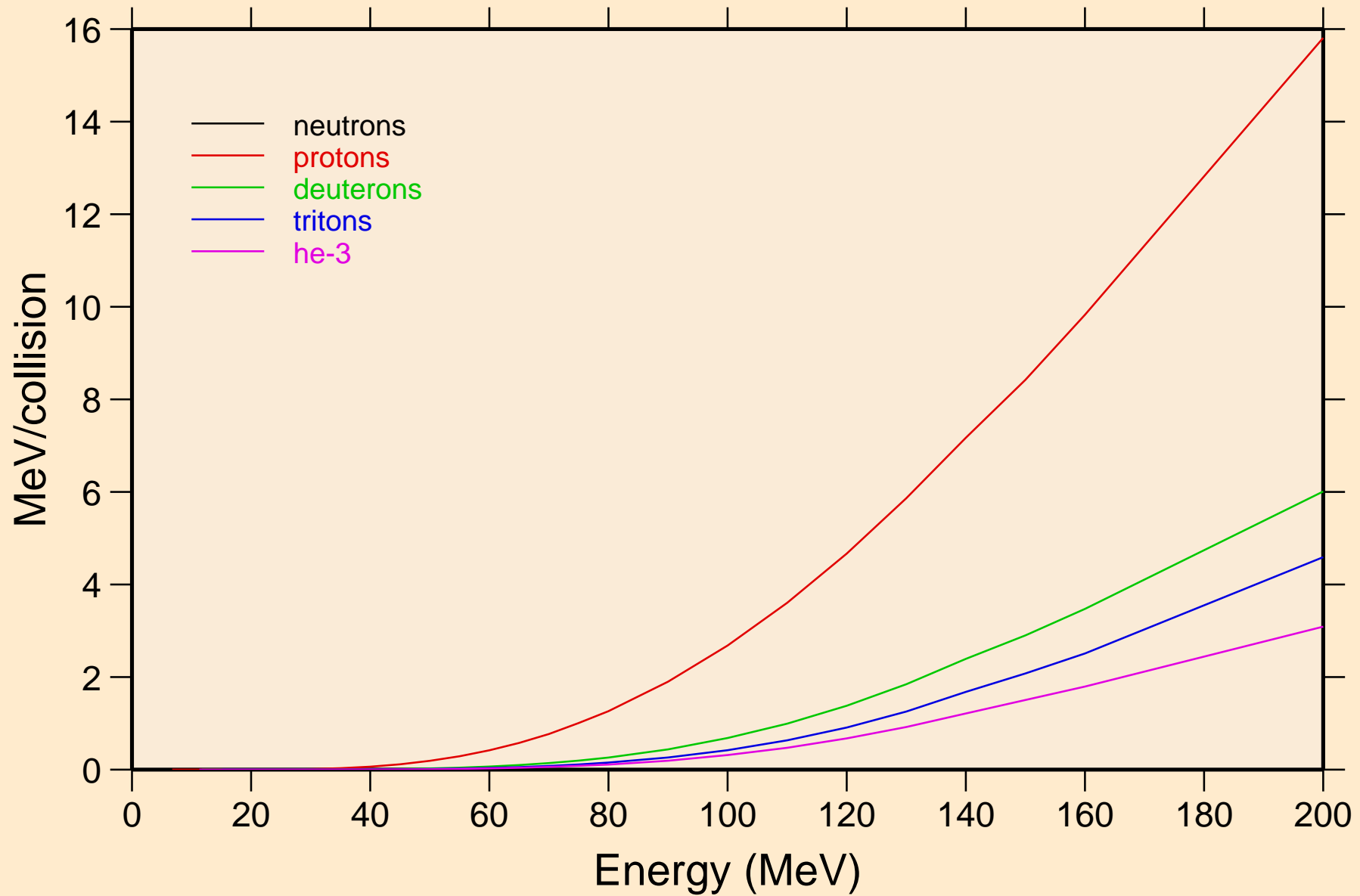

SN117M ALPHA ACER TENDL-2023 LIBRARY; T=0.K
Recoil Heating

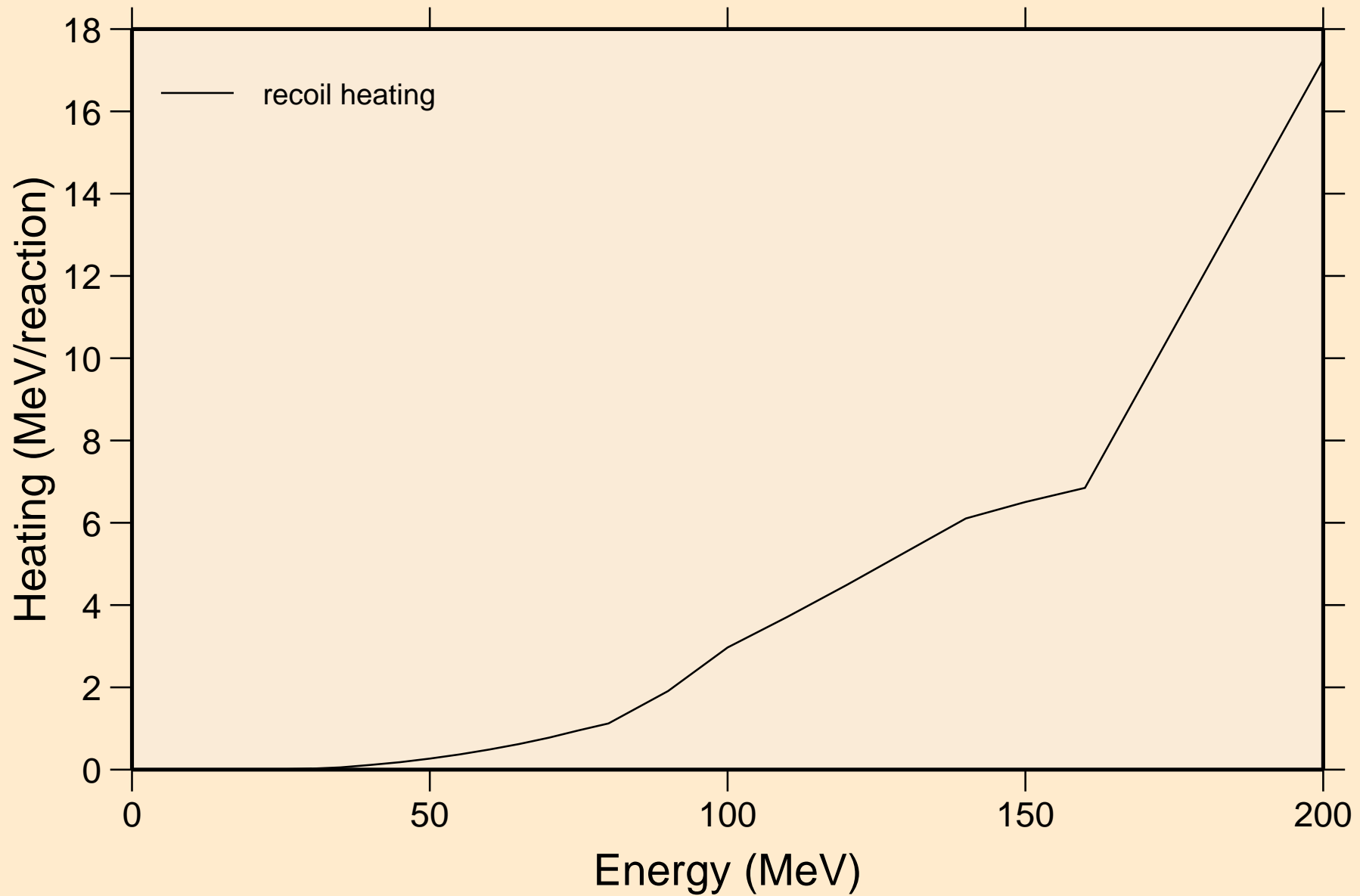

SN117M ALPHA ACER TENDL-2023 LIBRARY; T=0.K
Particle production cross sections

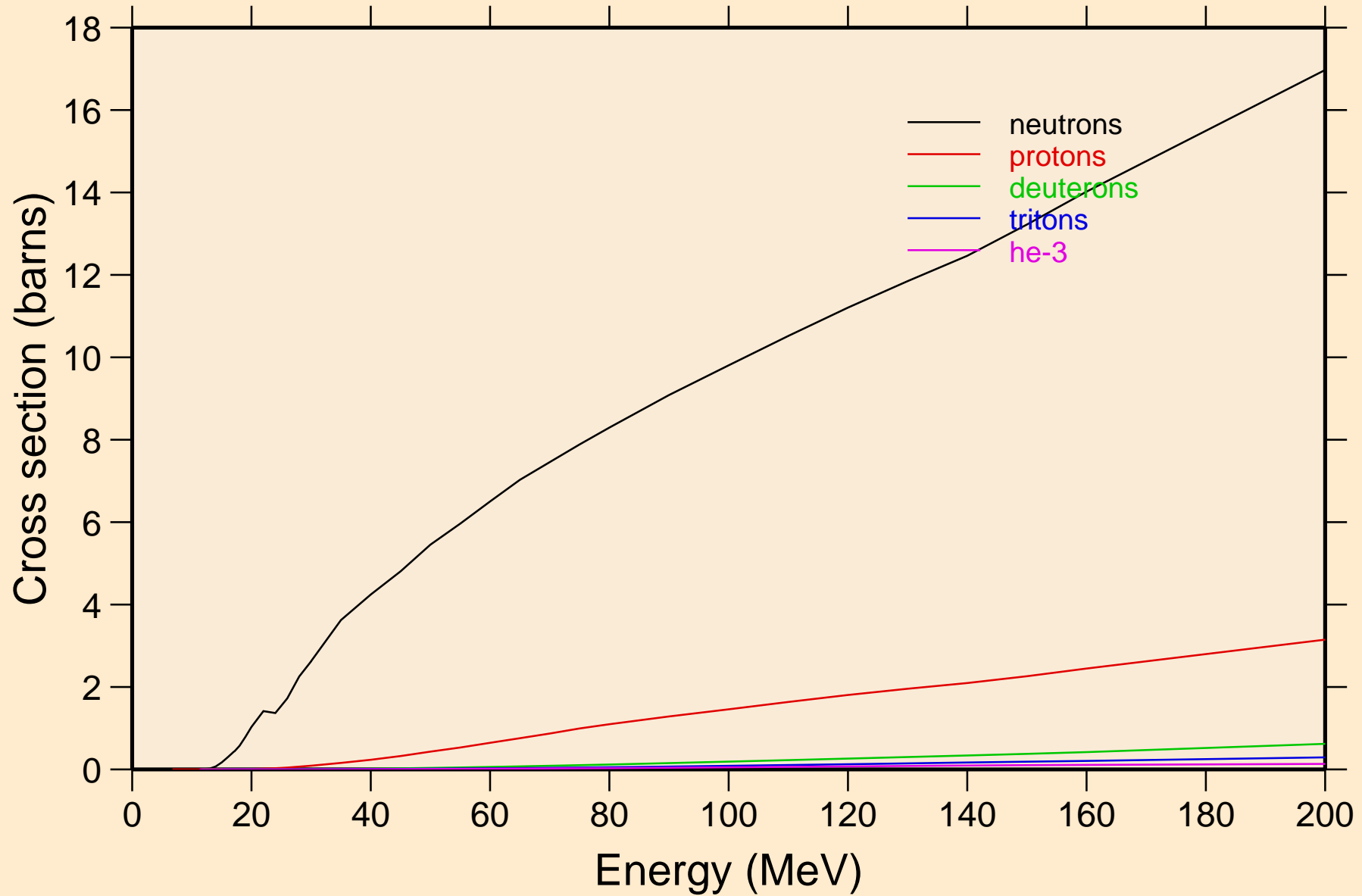

SN117M ALPHA ACER TENDL-2023 LIBRARY; T=0.K
neutrons from (a,n)

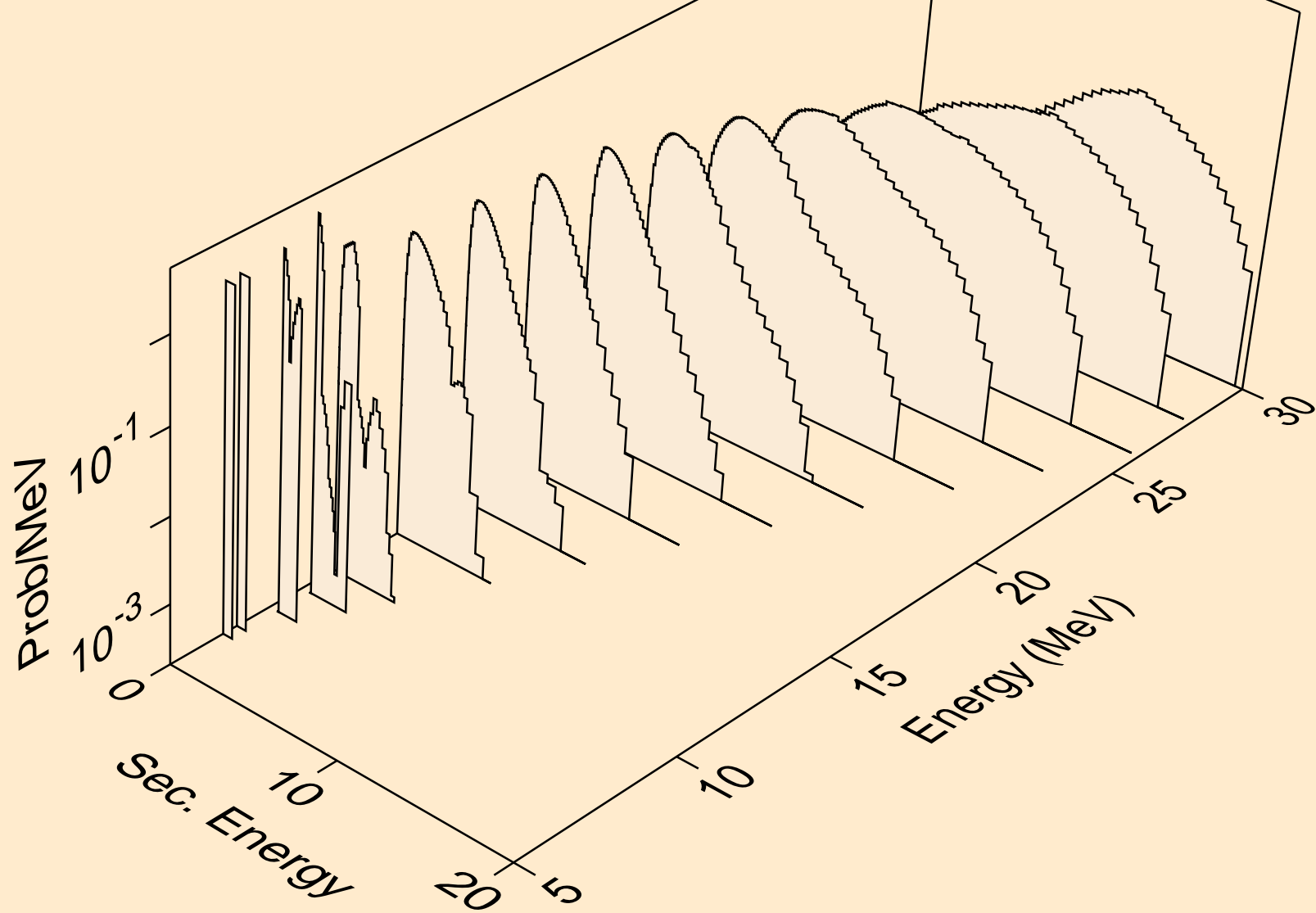

SN117M ALPHA ACER TENDL-2023 LIBRARY; T=0.K
neutrons from (a,x)

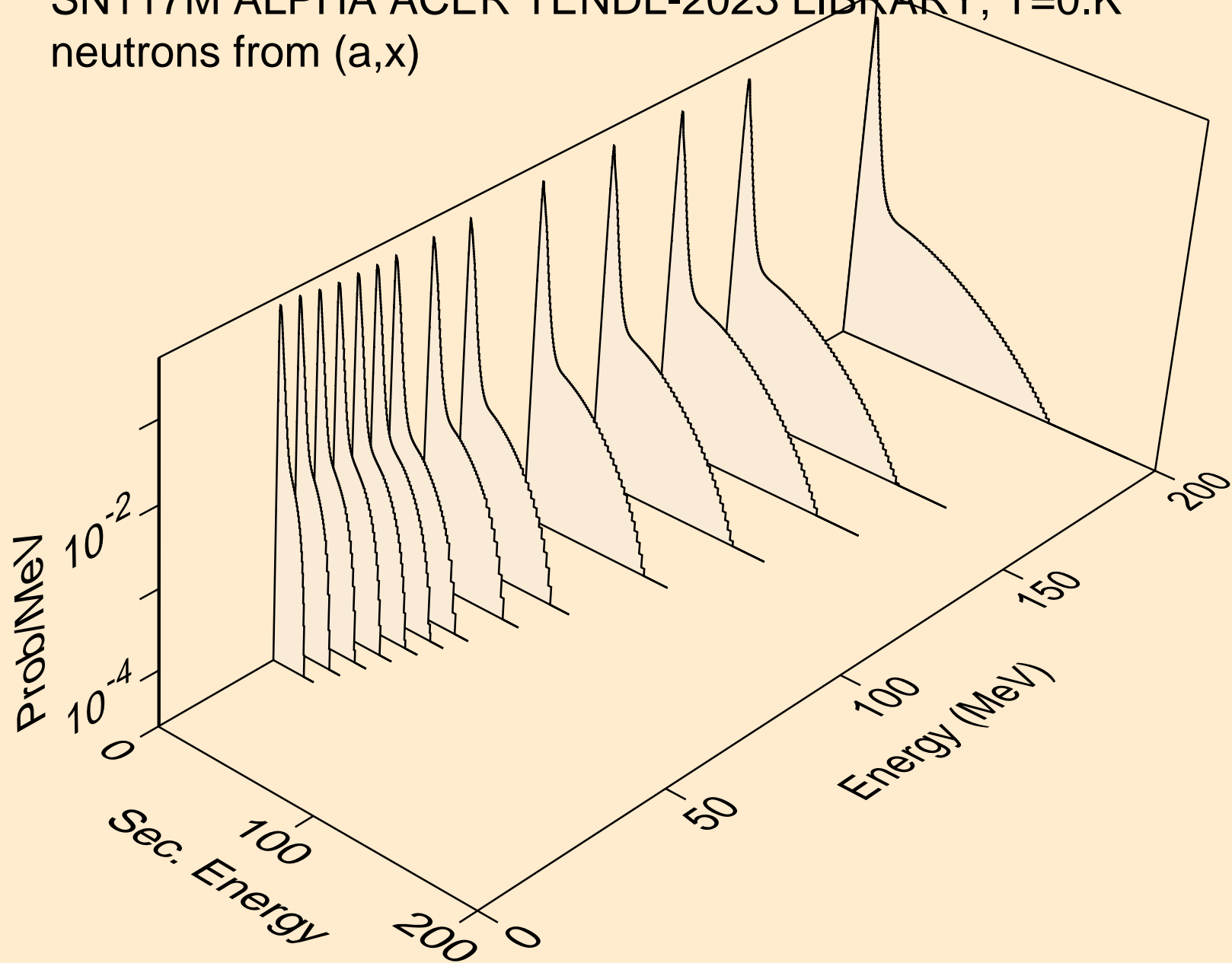

SN117M ALPHA ACER TENDL-2023 LIBRARY; T=0.K
neutrons from (a,2n)

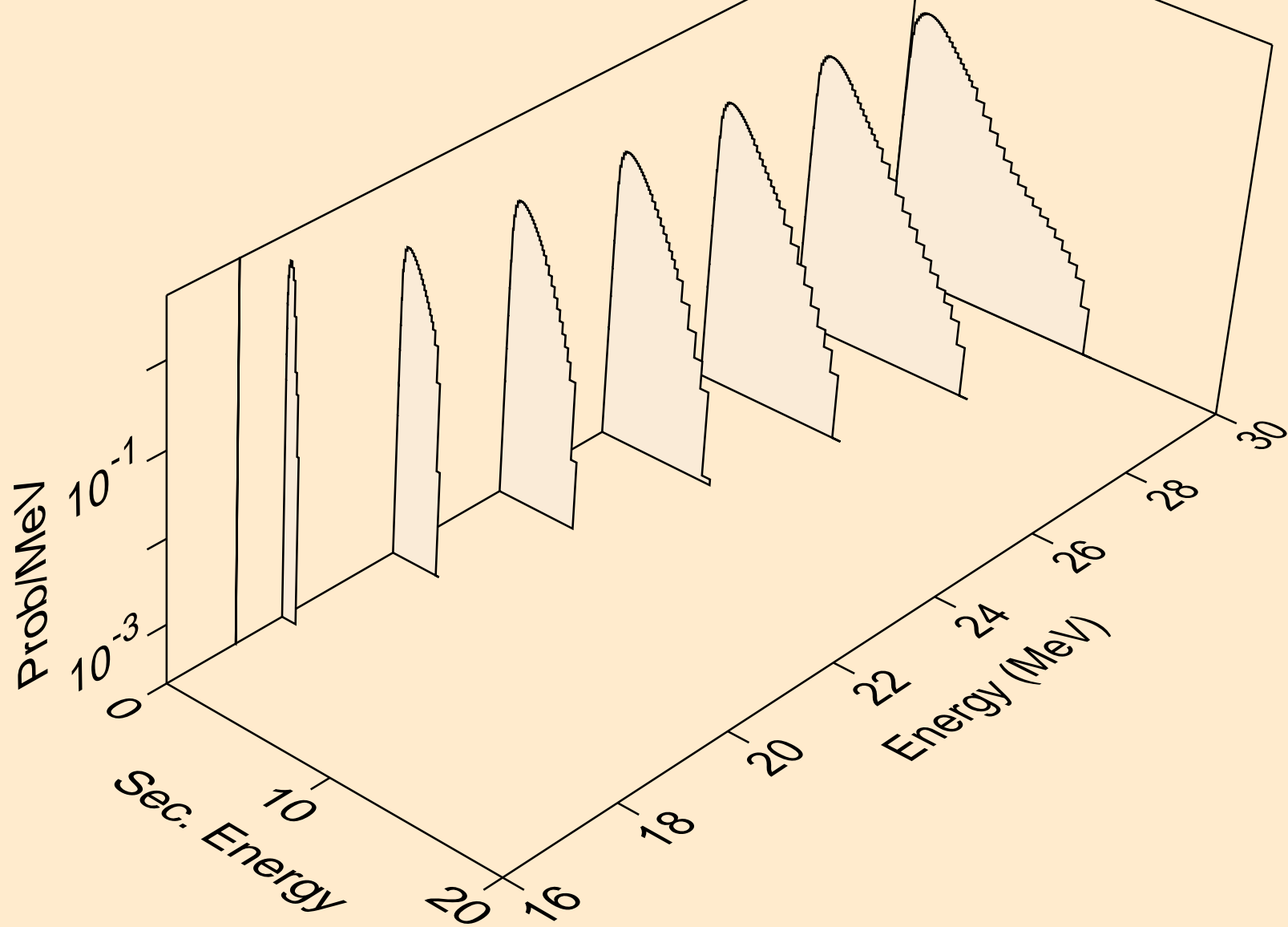

SN117M ALPHA ACER TENDL-2023 LIBRARY; T=0.K
neutrons from (a,3n)

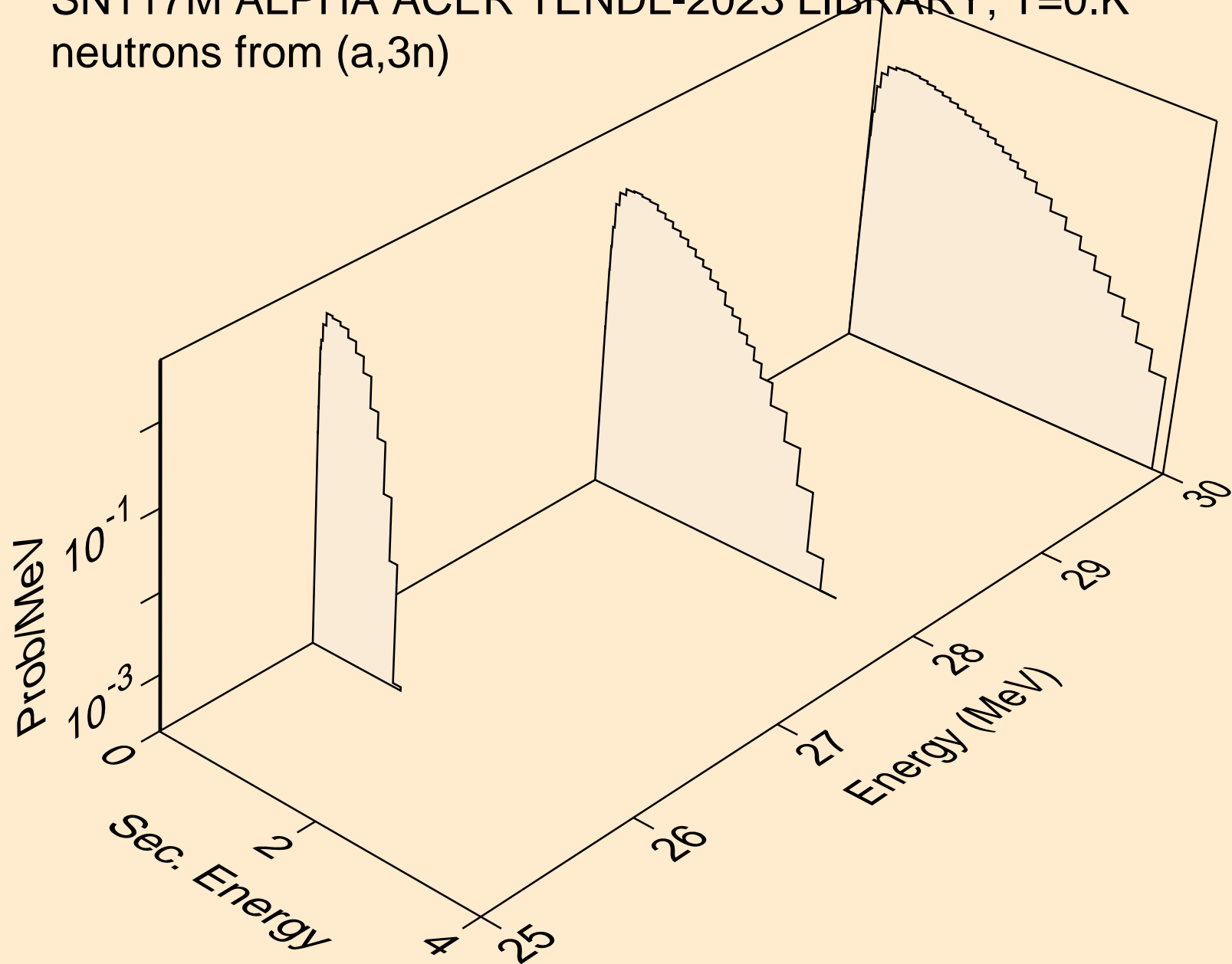

SN117M ALPHA ACER TENDL-2023 LIBRARY; T=0.K
neutrons from (a,n*)a

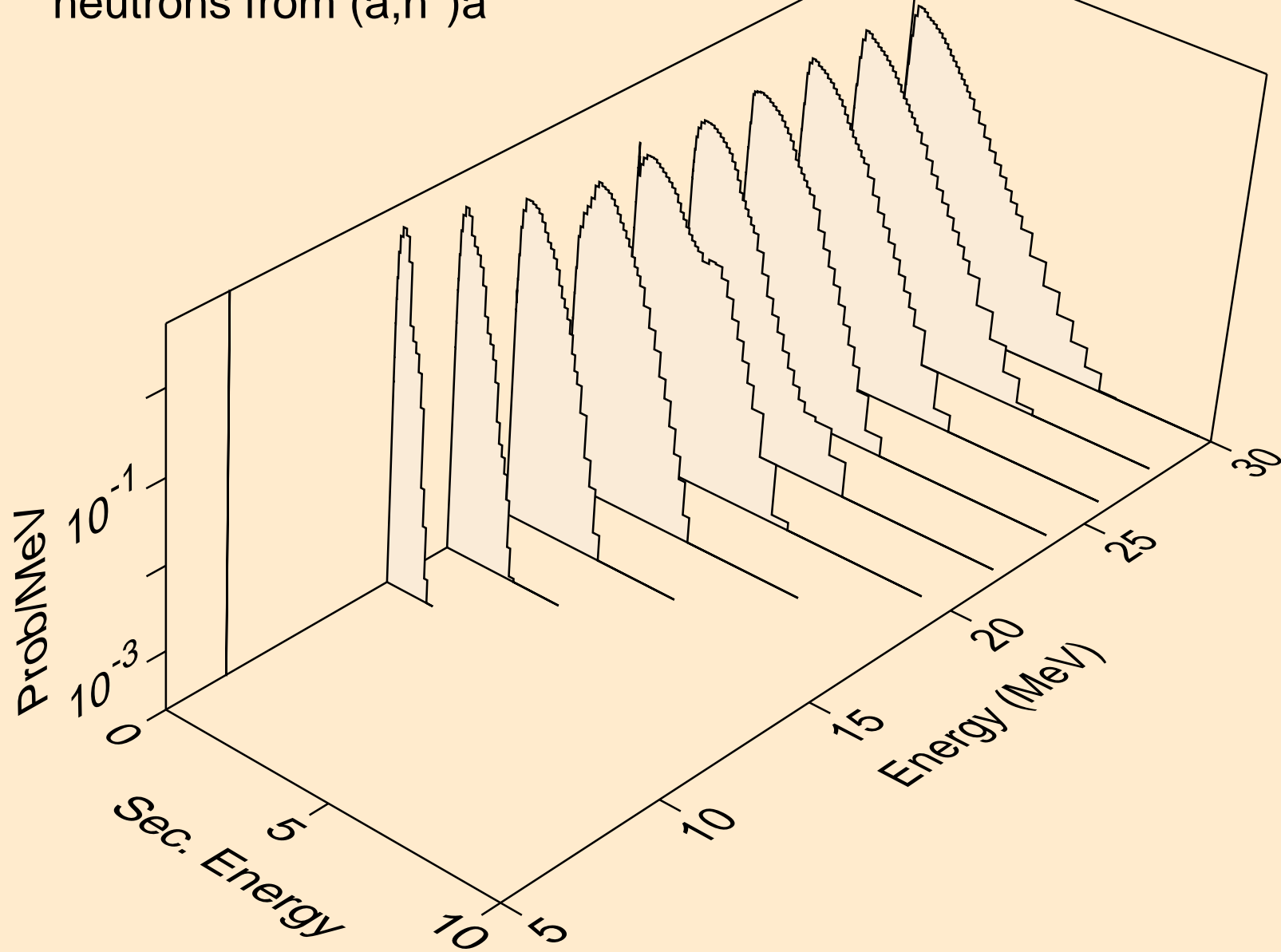

SN117M ALPHA ACER TENDL-2023 LIBRARY; T=0.K
neutrons from (a,2n)a

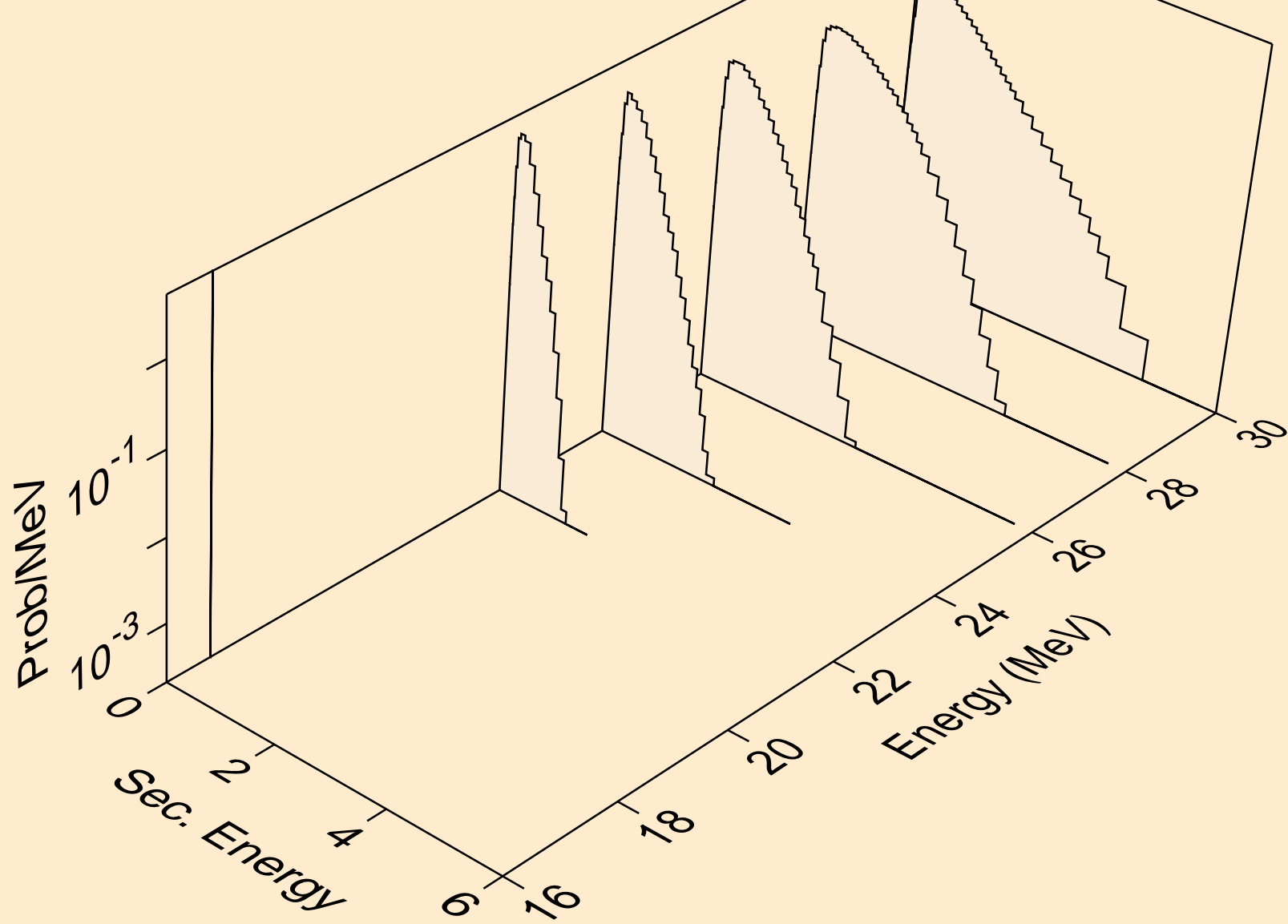

SN117M ALPHA ACER TENDL-2023 LIBRARY; T=0.K
neutrons from (a,n*)p

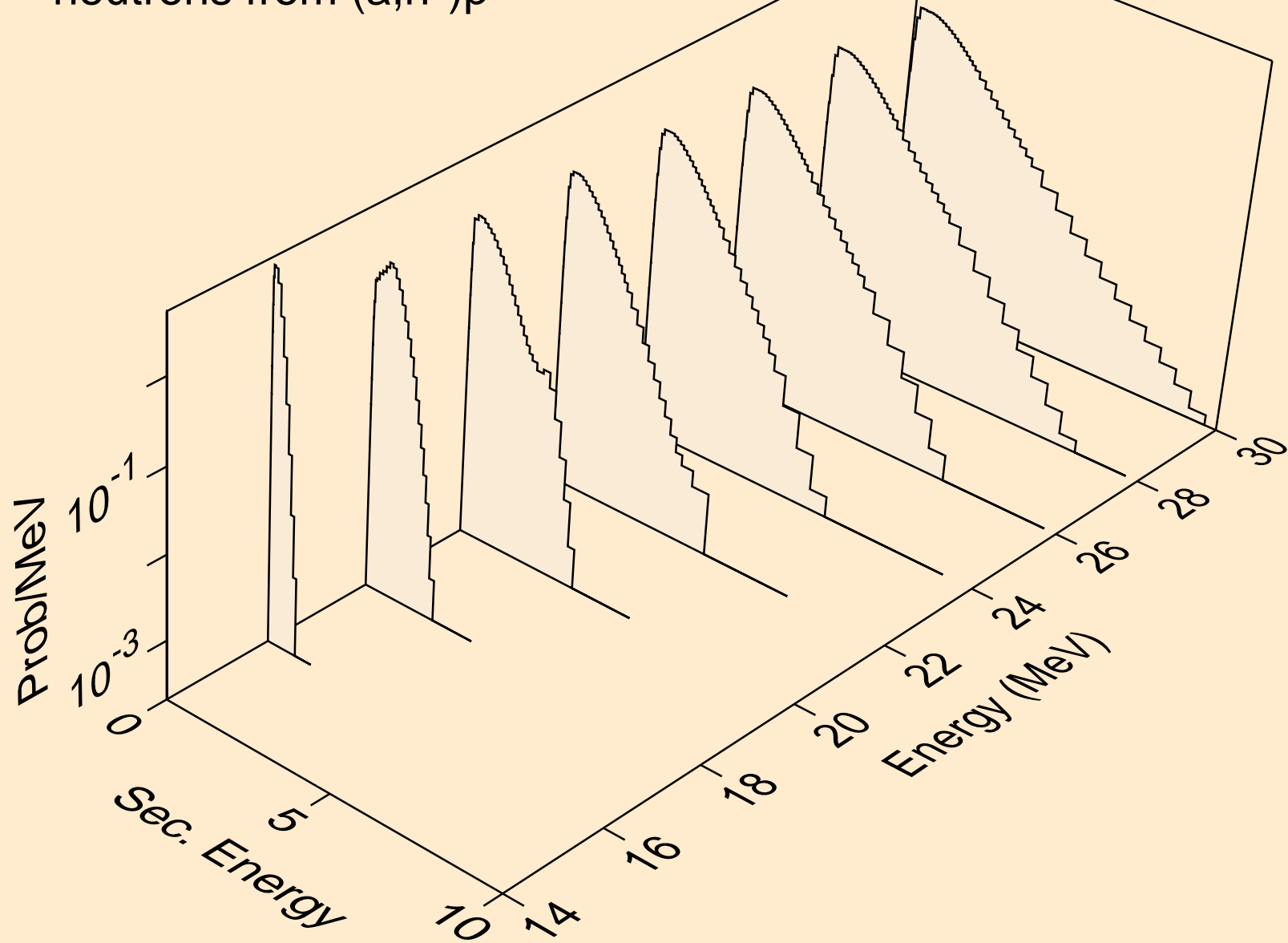

SN117M ALPHA ACER TENDL-2023 LIBRARY; T=0.K
neutrons from (a,n*)d

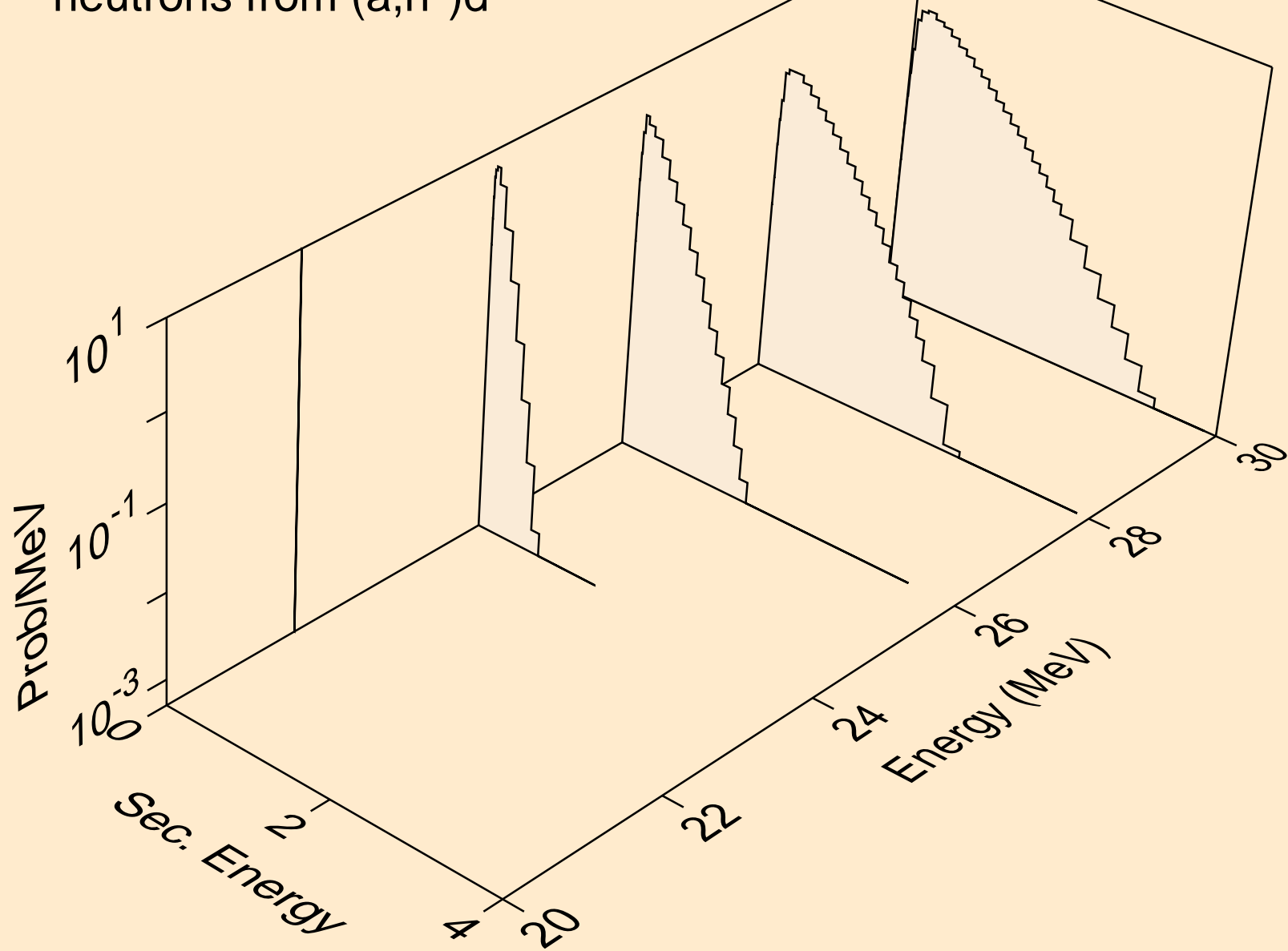

SN117M ALPHA ACER TENDL-2023 LIBRARY; T=0.K
neutrons from (a,n*)t

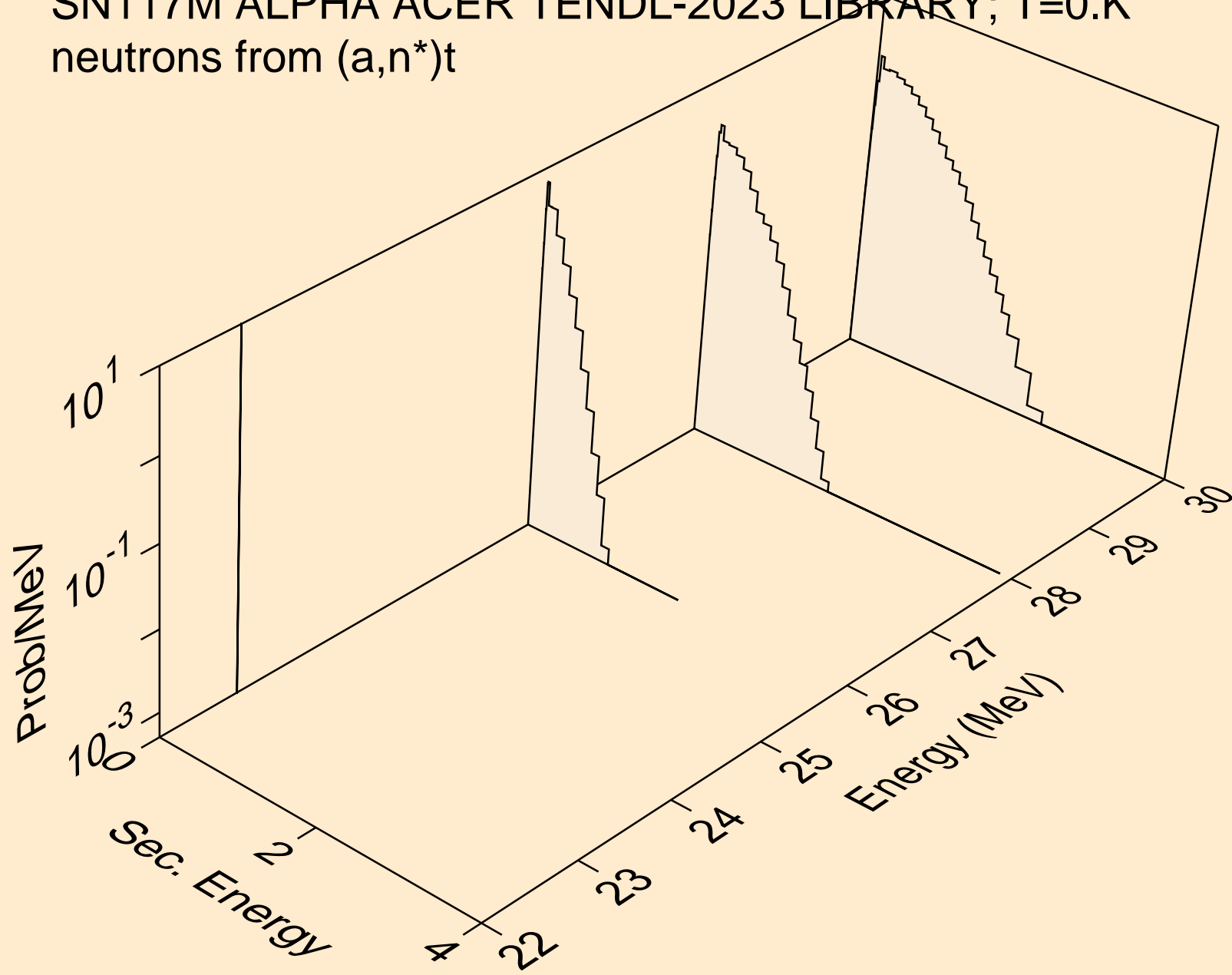

SN117M ALPHA ACER TENDL-2023 LIBRARY; T=0.K
neutrons from (a,n*)he3

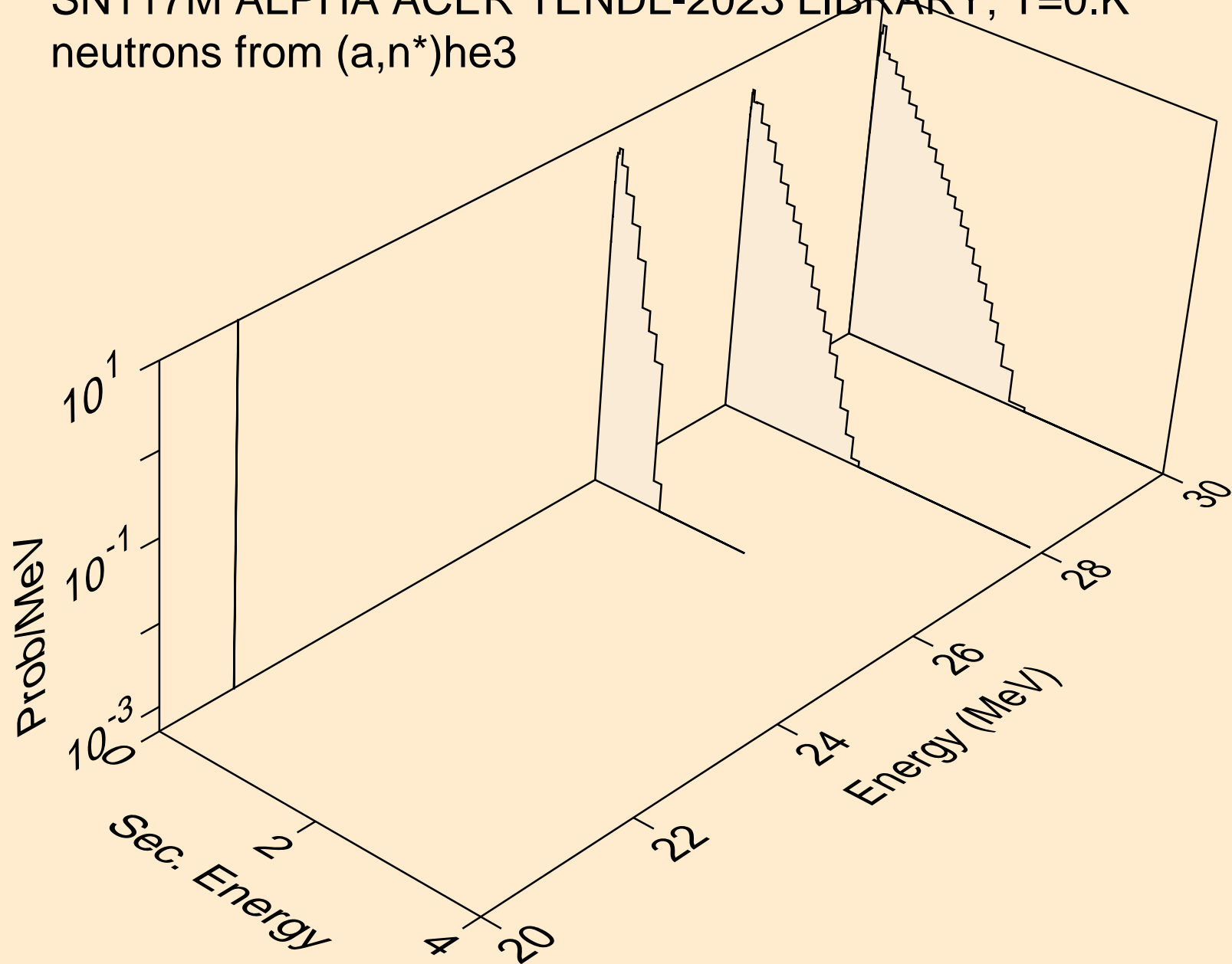

SN117M ALPHA ACER TENDL-2023 LIBRARY; T=0.K
neutrons from (a,2np)

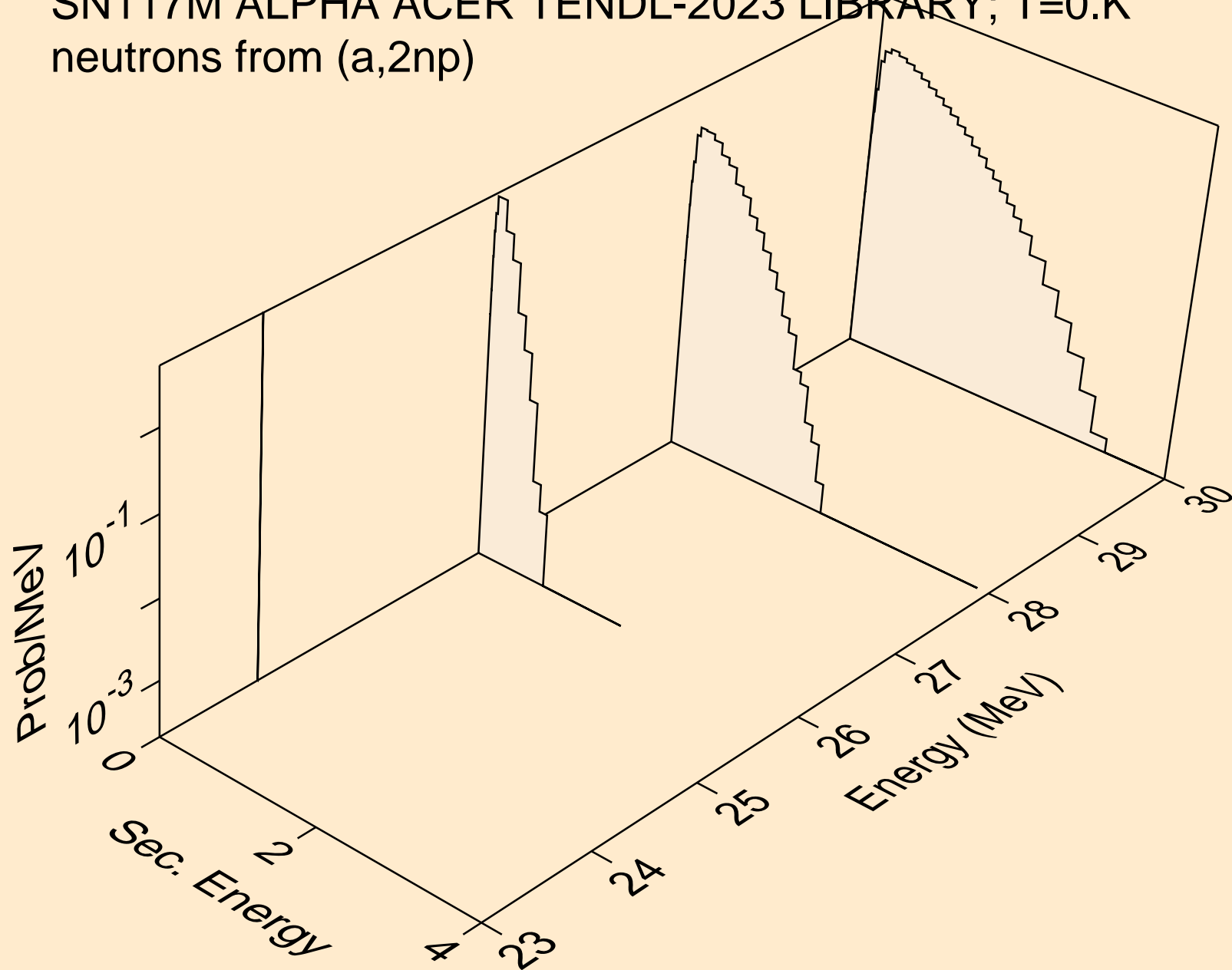

SN117M ALPHA ACER TENDL-2023 LIBRARY; T=0.K
neutrons from (a,n2p)

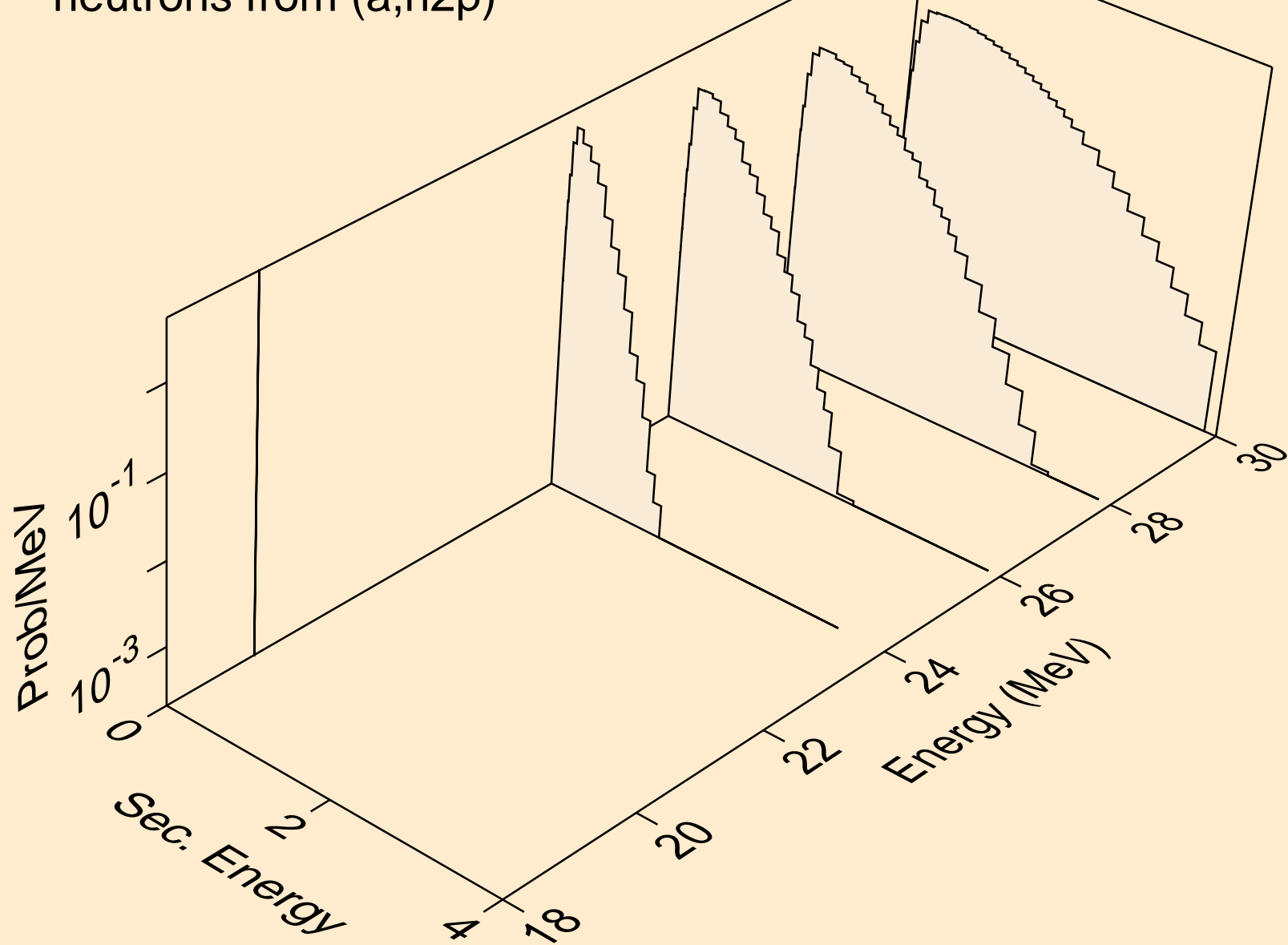

SN117M ALPHA ACER TENDL-2023 LIBRARY; T=0.K
protons from (a,x)

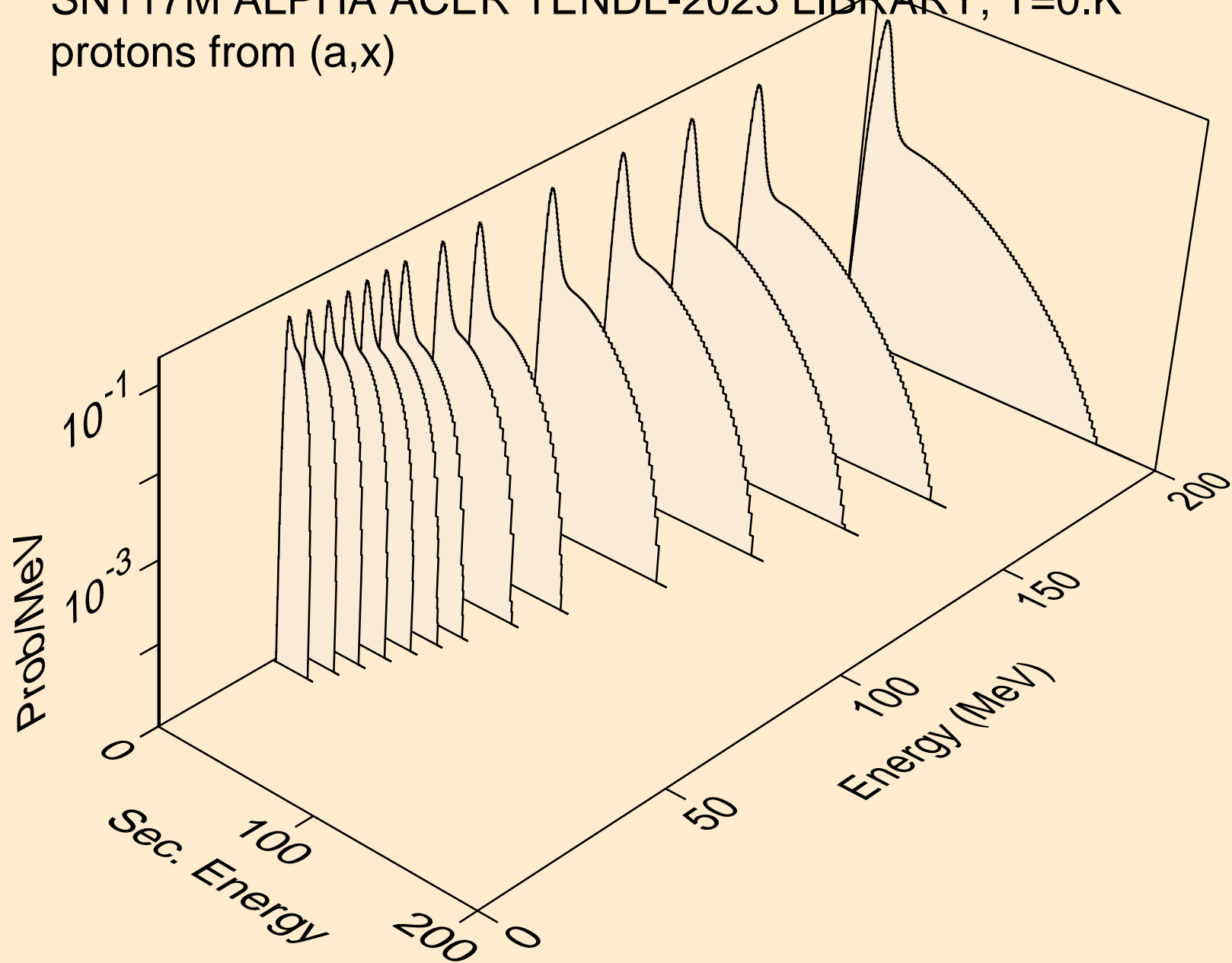

SN117M ALPHA ACER TENDL-2023 LIBRARY; T=0.K
protons from (a,n*)p

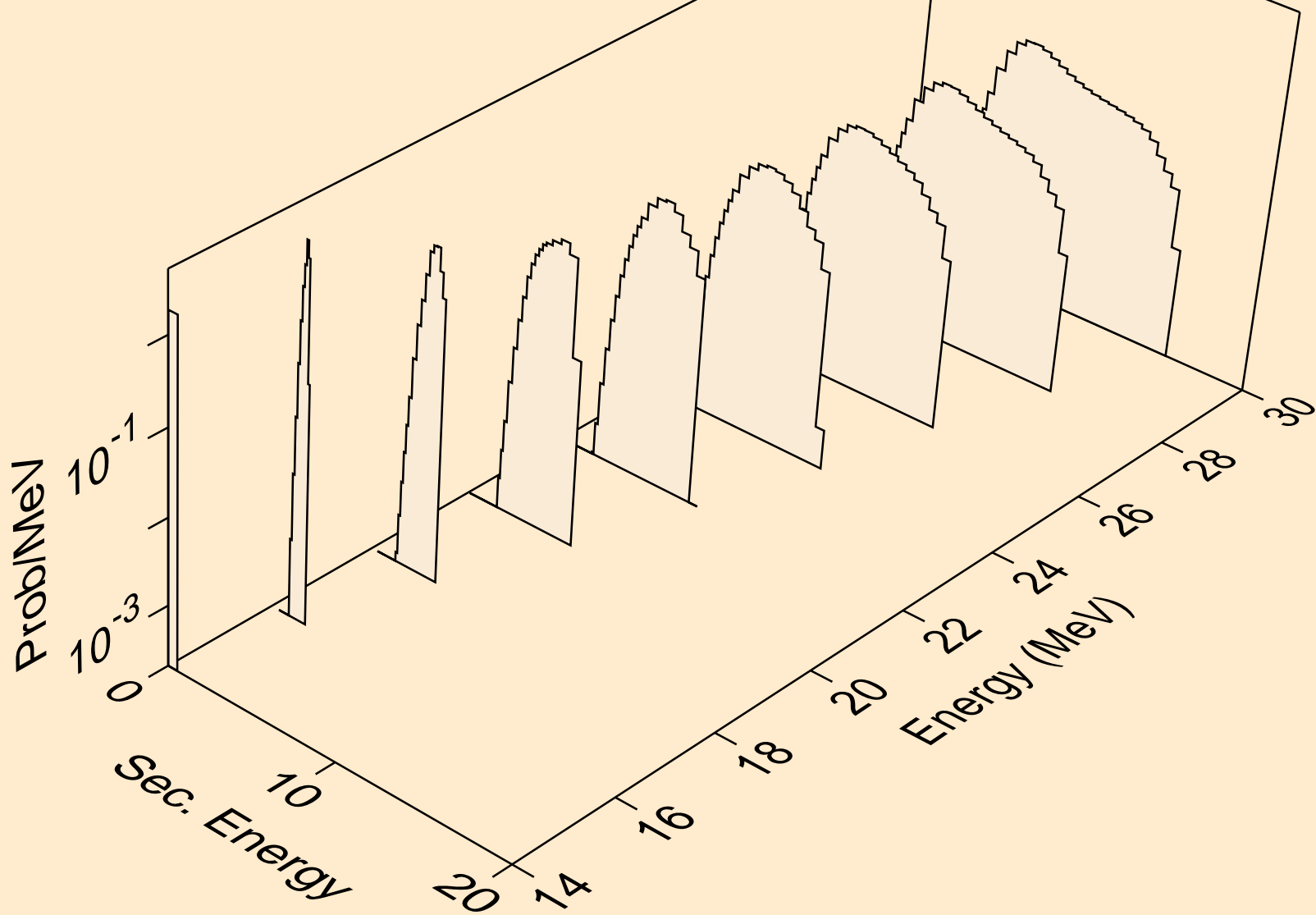

SN117M ALPHA ACER TENDL-2023 LIBRARY; T=0.K
protons from (a,2np)

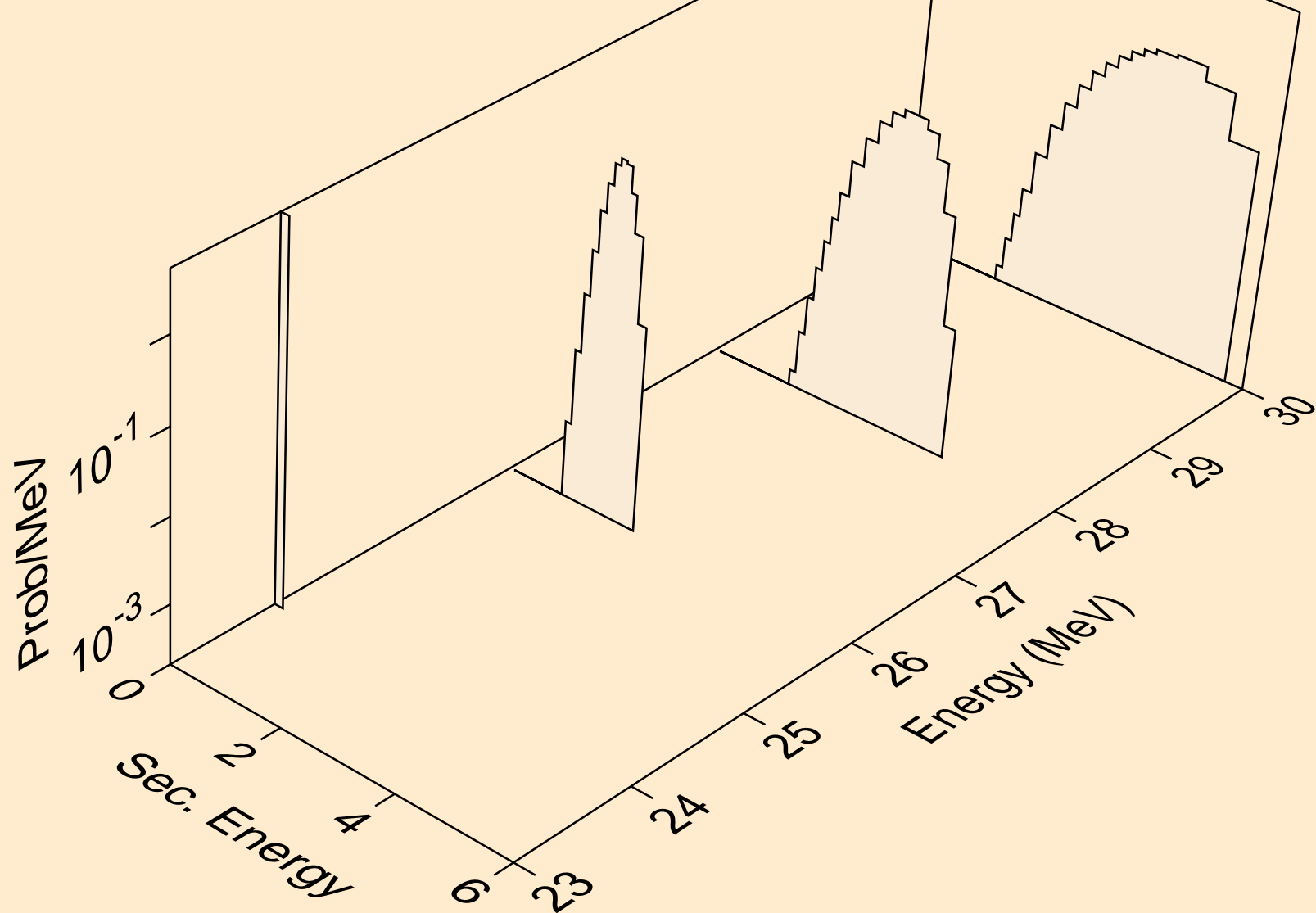

SN117M ALPHA ACER TENDL-2023 LIBRARY; T=0.K
protons from (a,n2p)

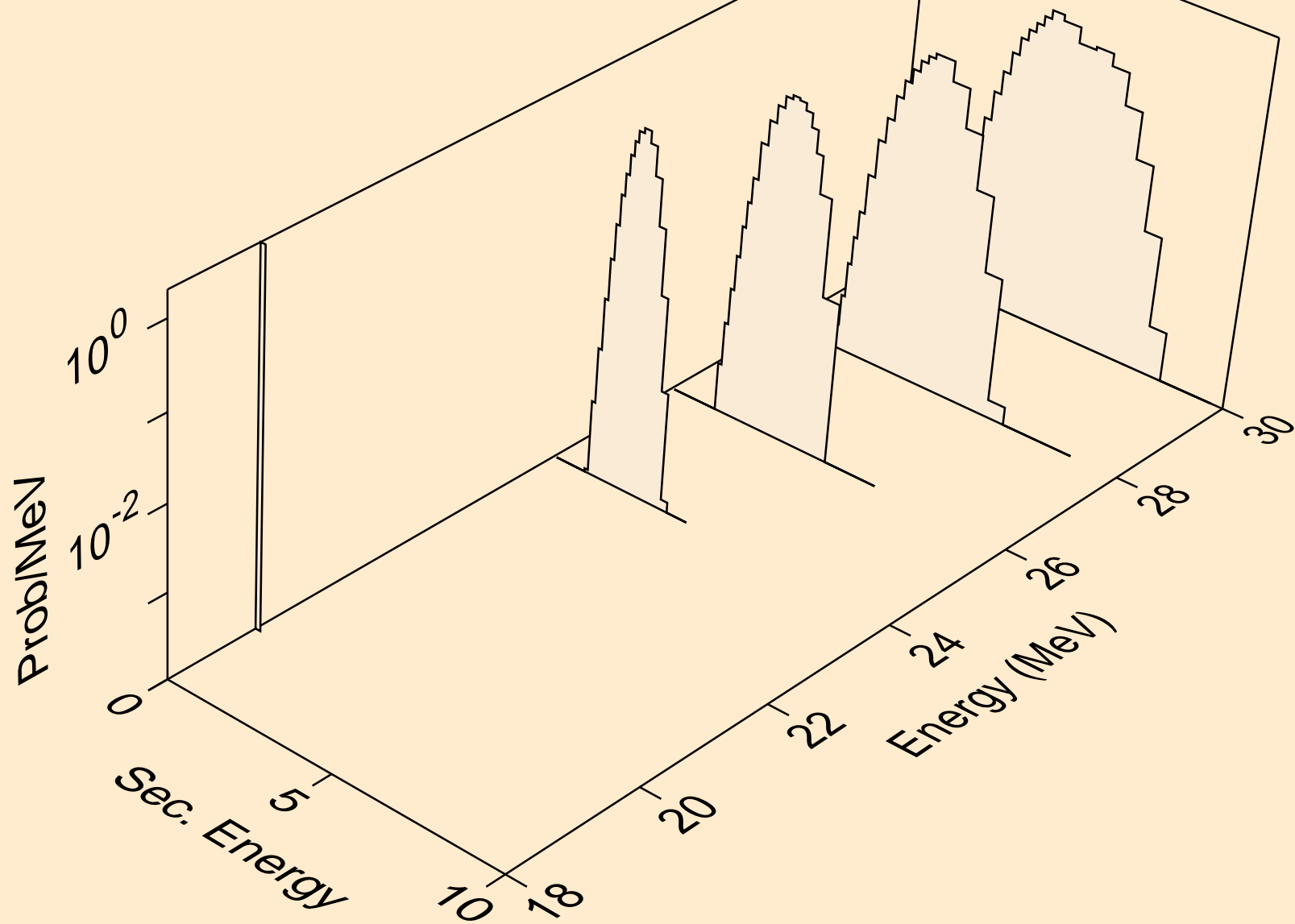

SN117M ALPHA ACER TENDL-2023 LIBRARY; T=0.K
protons from (a,p)

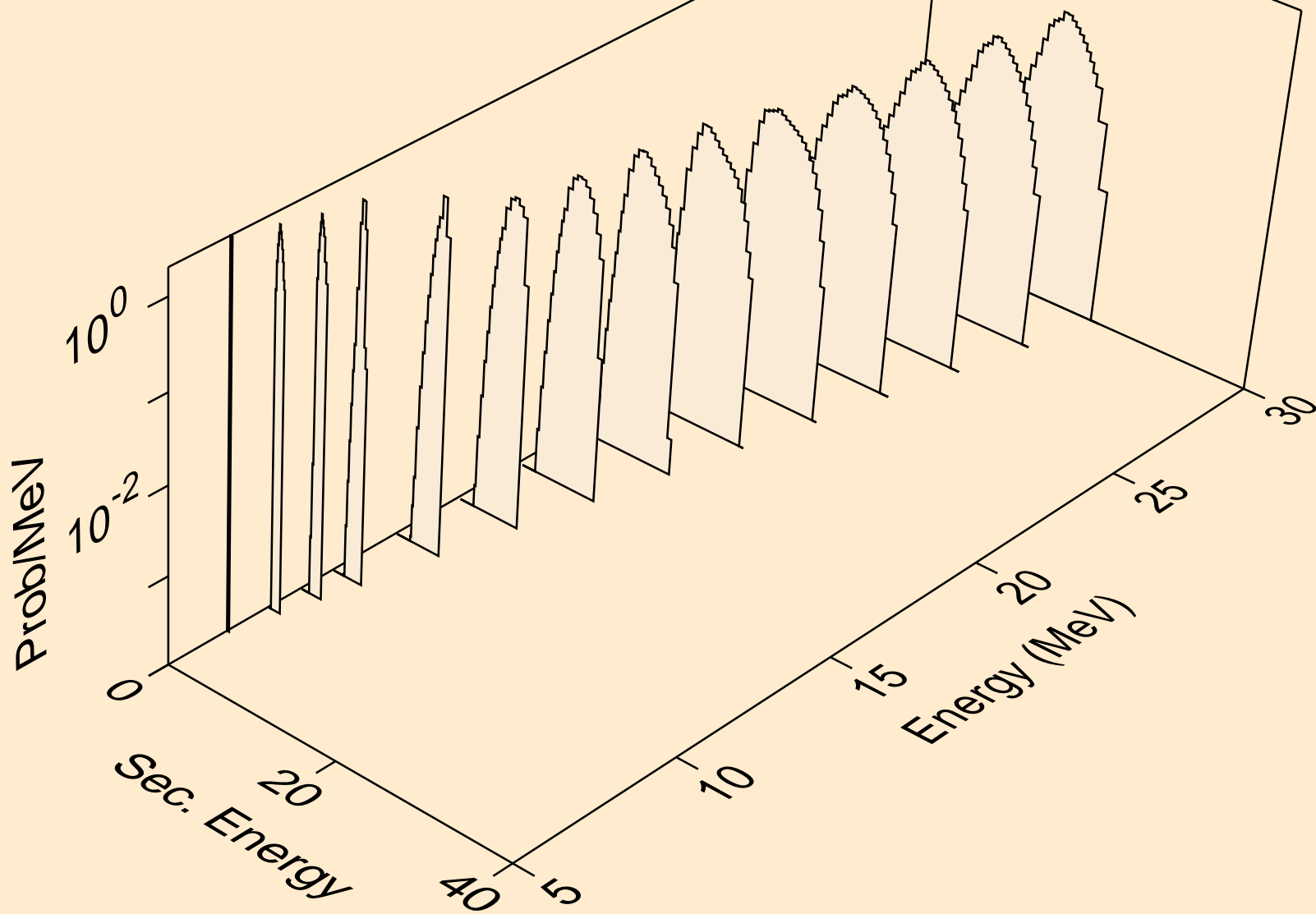

SN117M ALPHA ACER TENDL-2023 LIBRARY; T=0.K
protons from (a,2p)

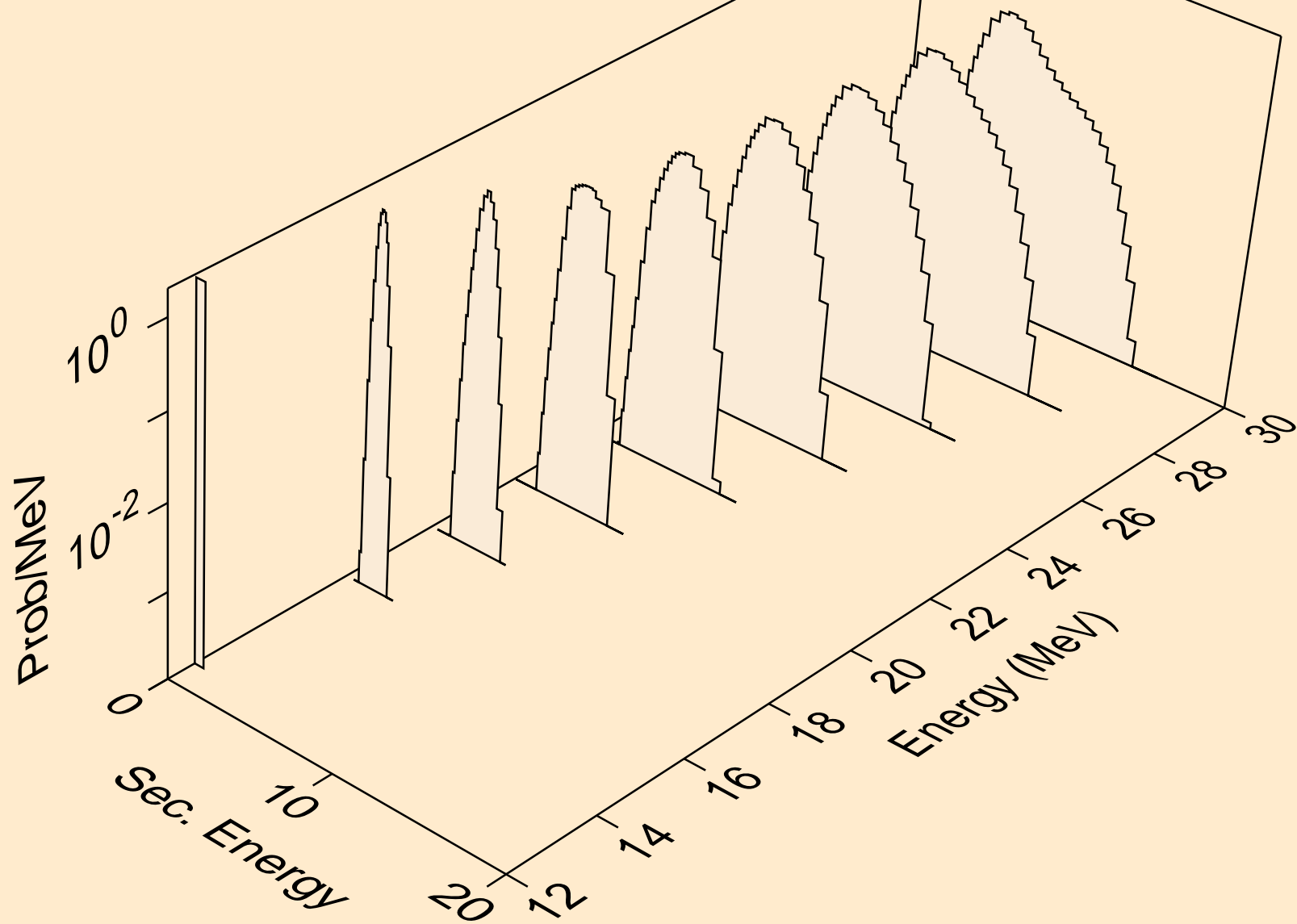

SN117M ALPHA ACER TENDL-2023 LIBRARY; T=0.K
protons from (a,pa)

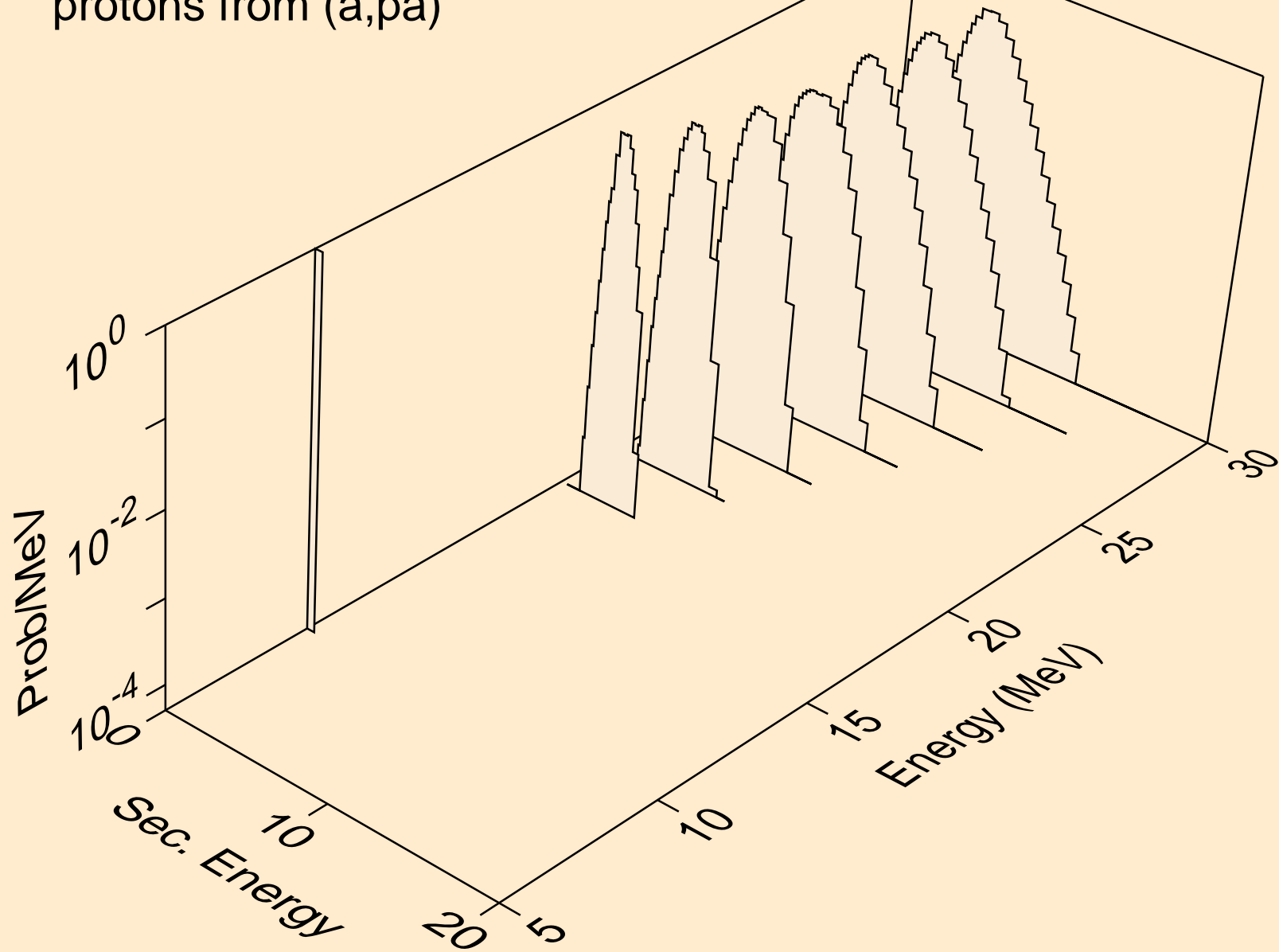

SN117M ALPHA ACER TENDL-2023 LIBRARY; T=0.K
protons from (a,pd)

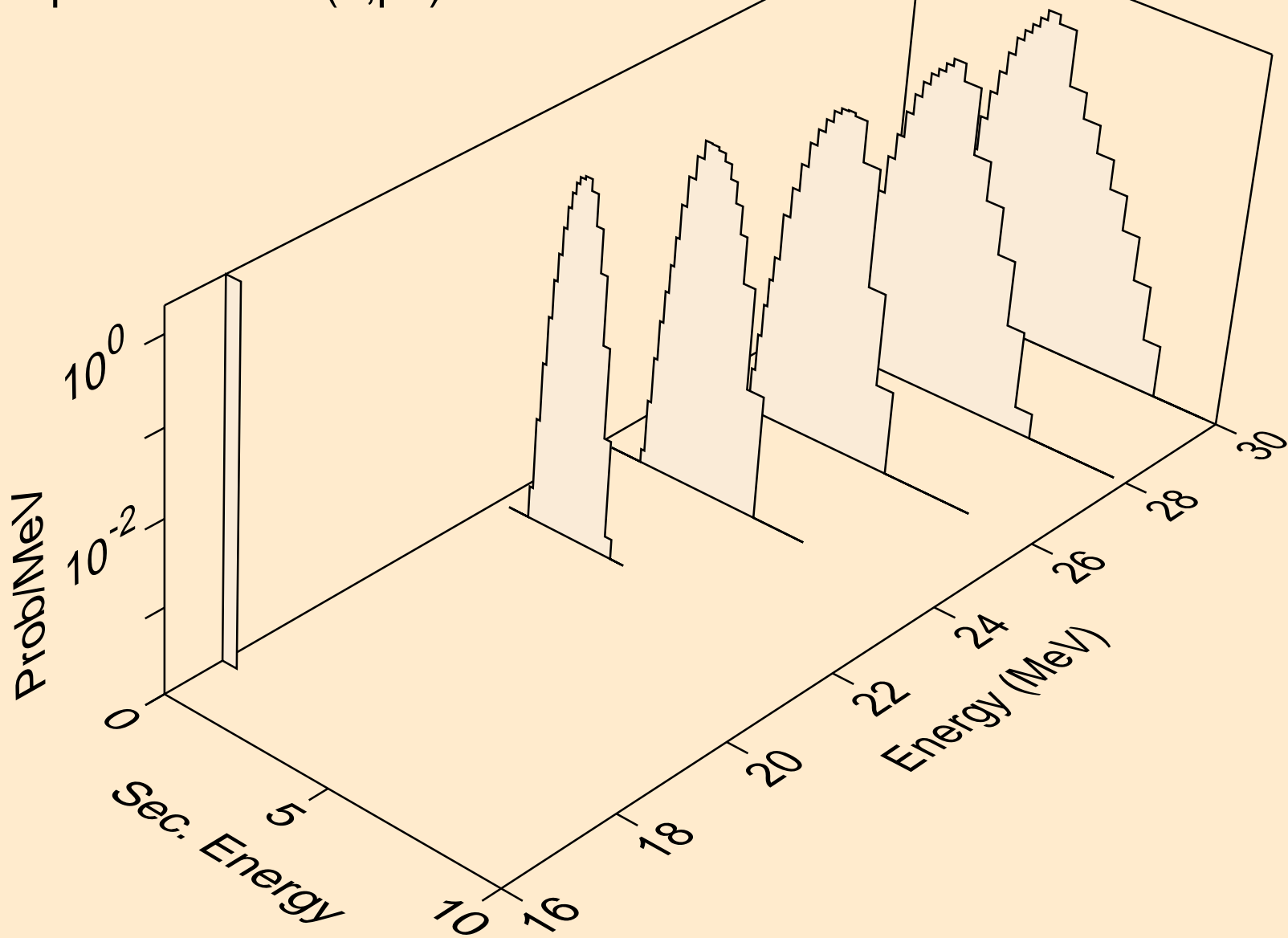

SN117M ALPHA ACER TENDL-2023 LIBRARY; T=0.K
protons from (a,pt)

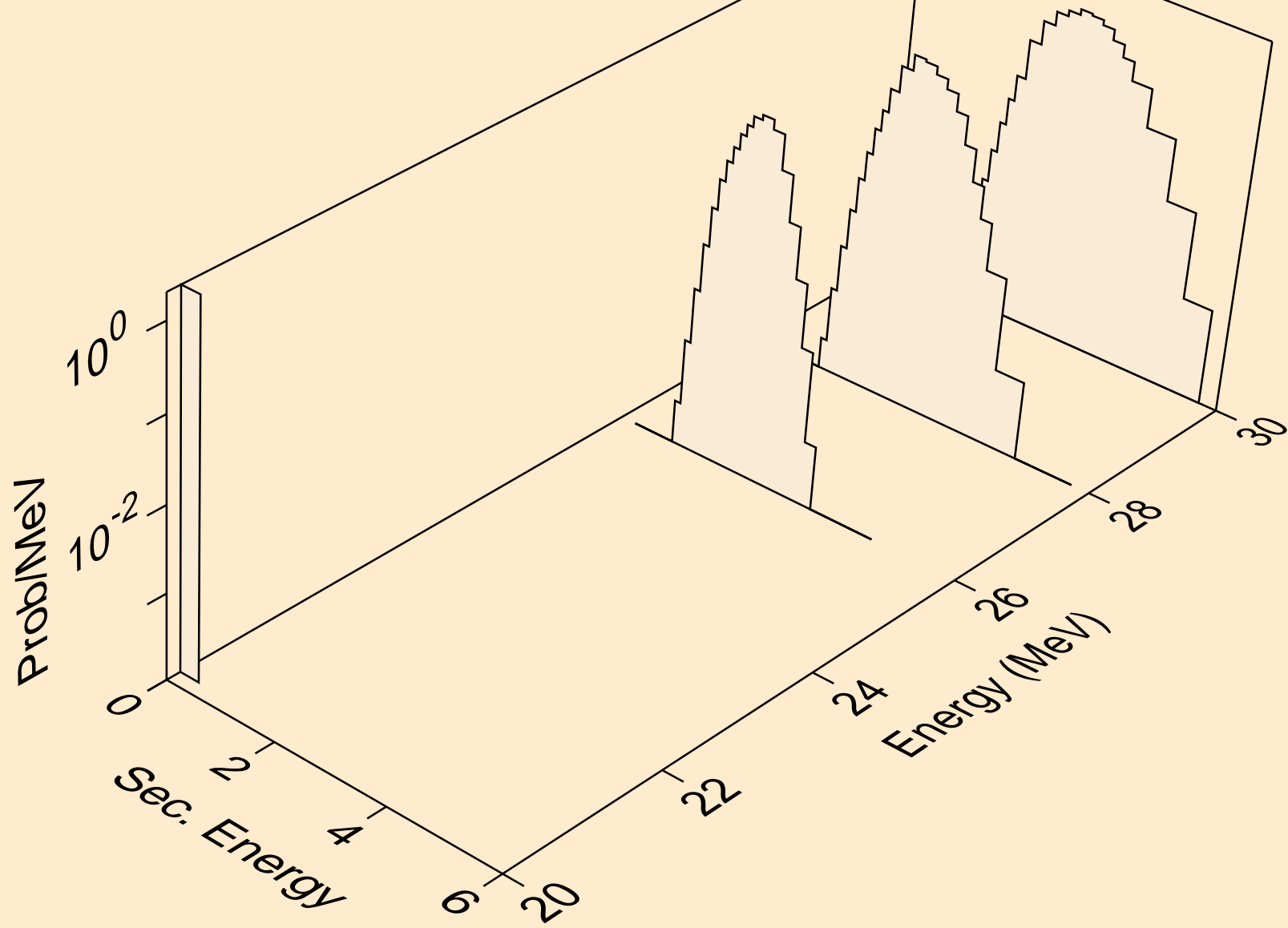

SN117M ALPHA ACER TENDL-2023 LIBRARY; T=0.K
deuterons from (a,x)

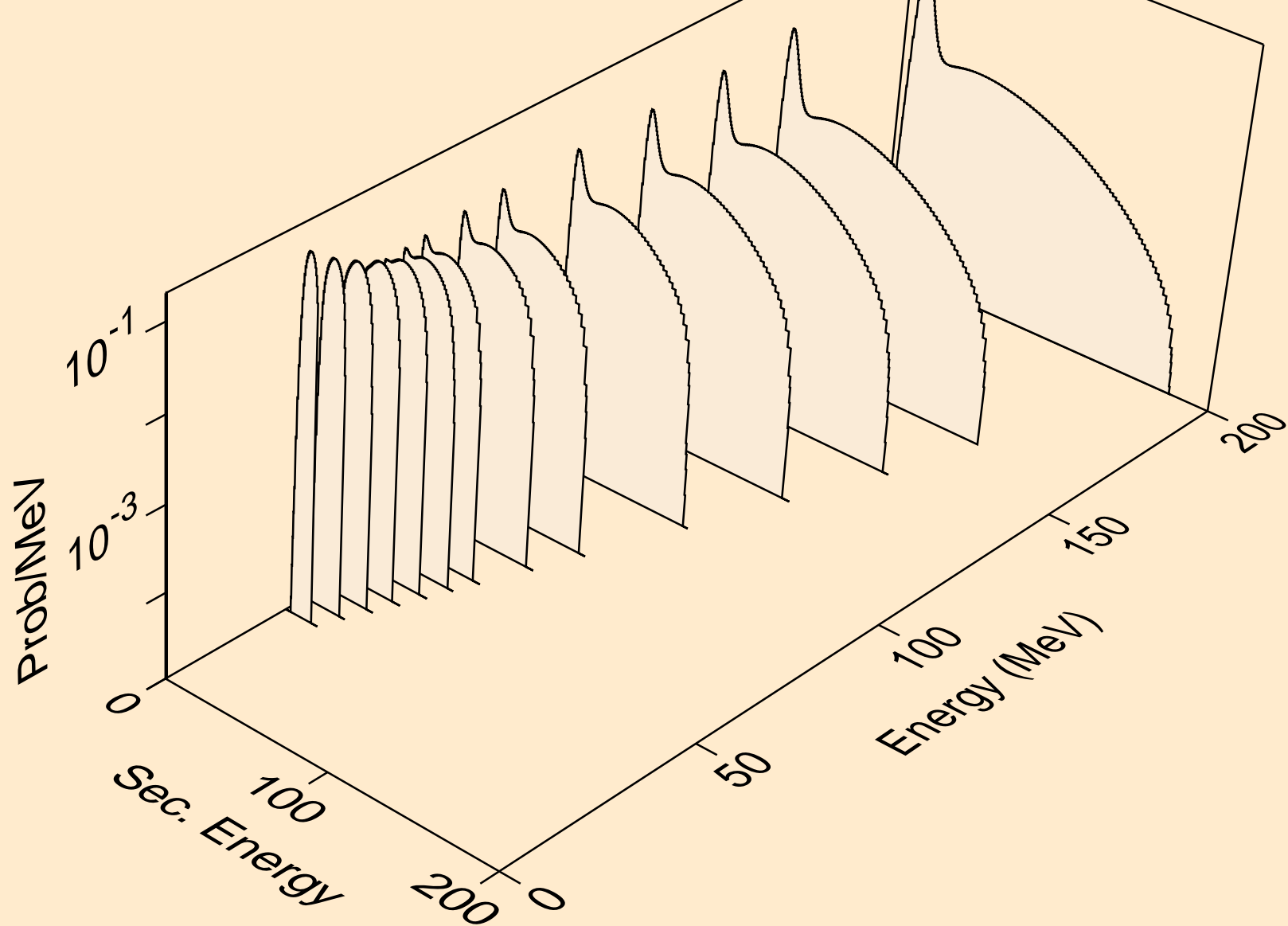

SN117M ALPHA ACER TENDL-2023 LIBRARY; T=0.K
deuterons from (a,n*)d

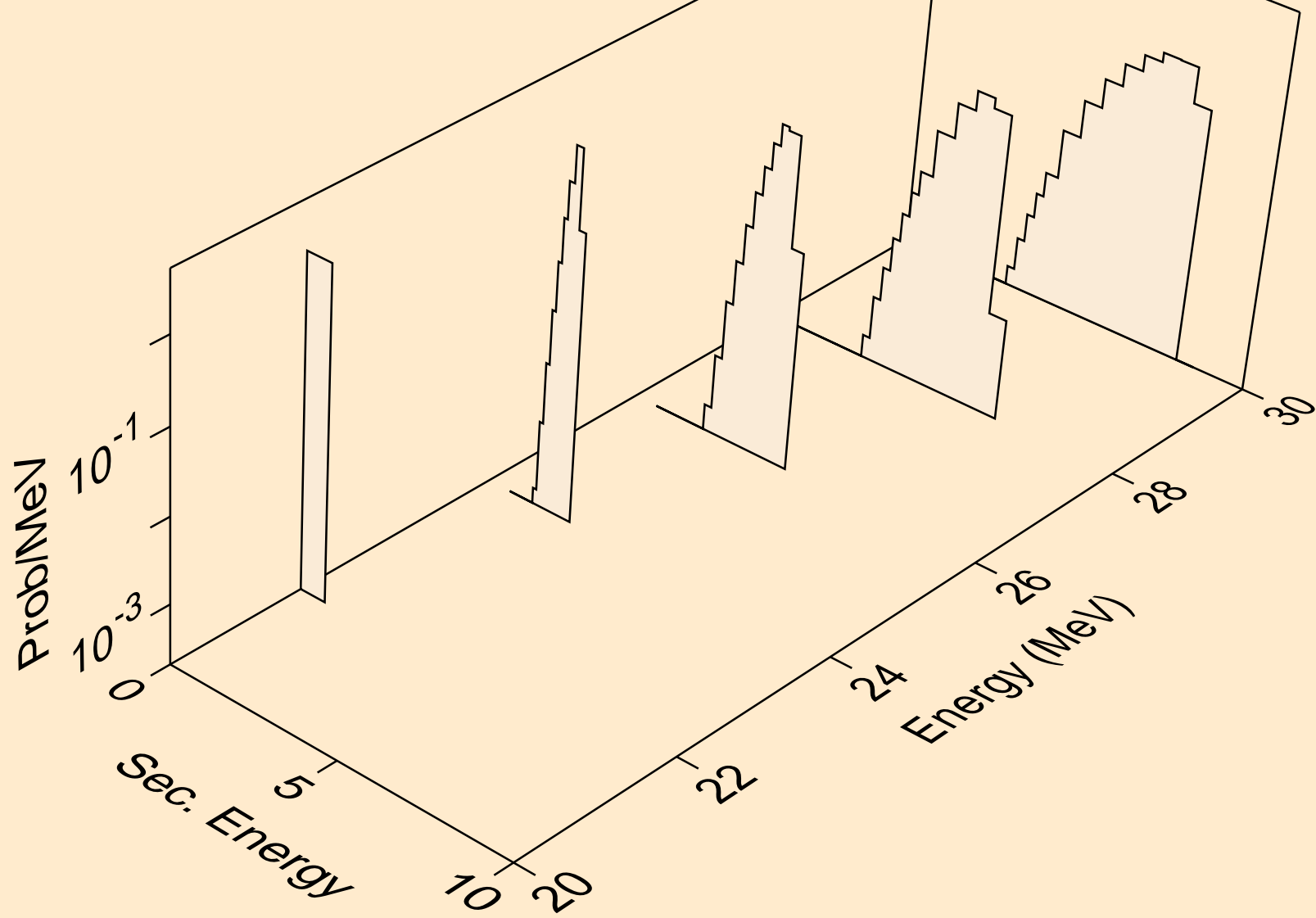

SN117M ALPHA ACER TENDL-2023 LIBRARY; T=0.K
deuterons from (a,d)

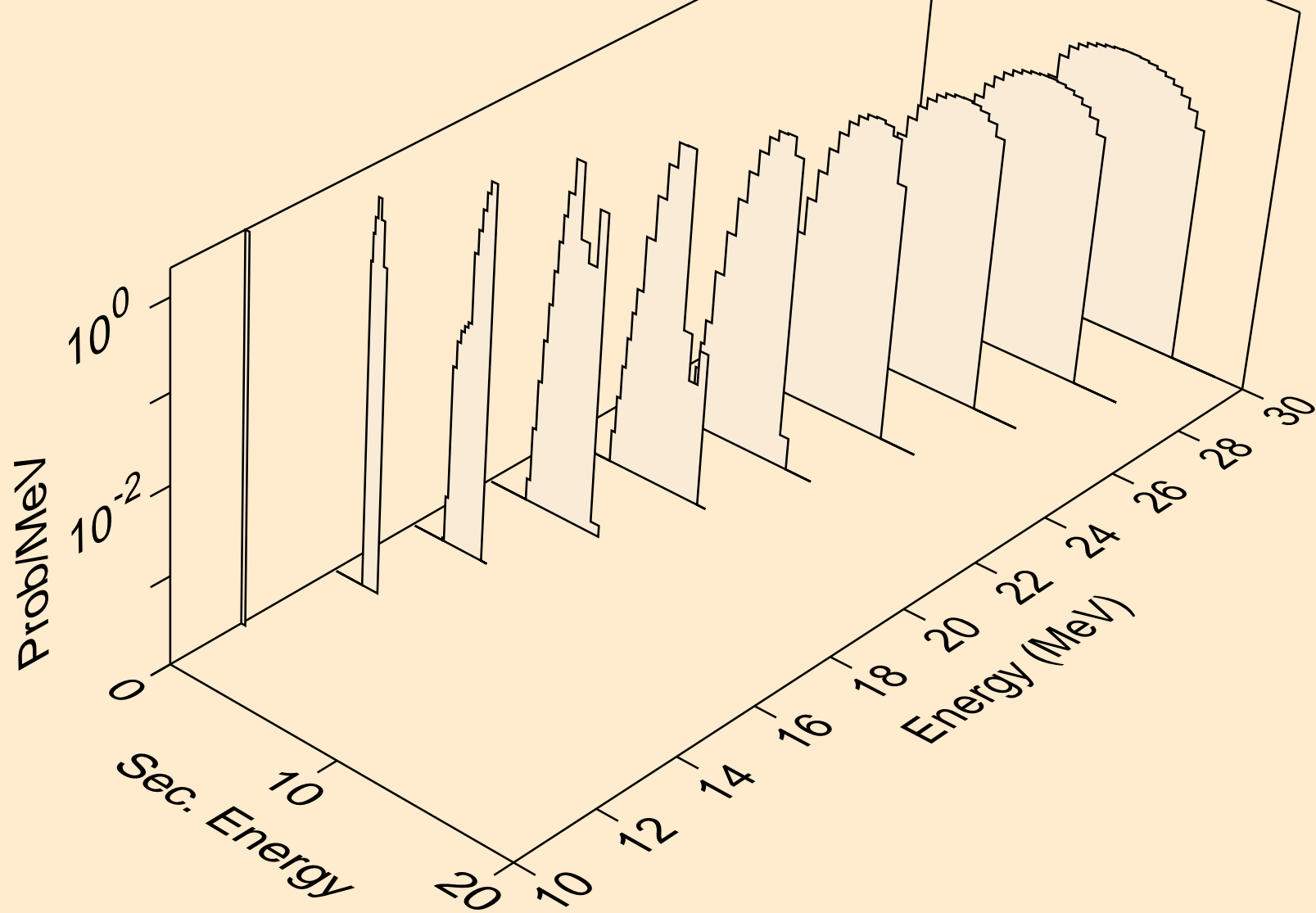

SN117M ALPHA ACER TENDL-2023 LIBRARY; T=0.K
deuterons from (a,pd)

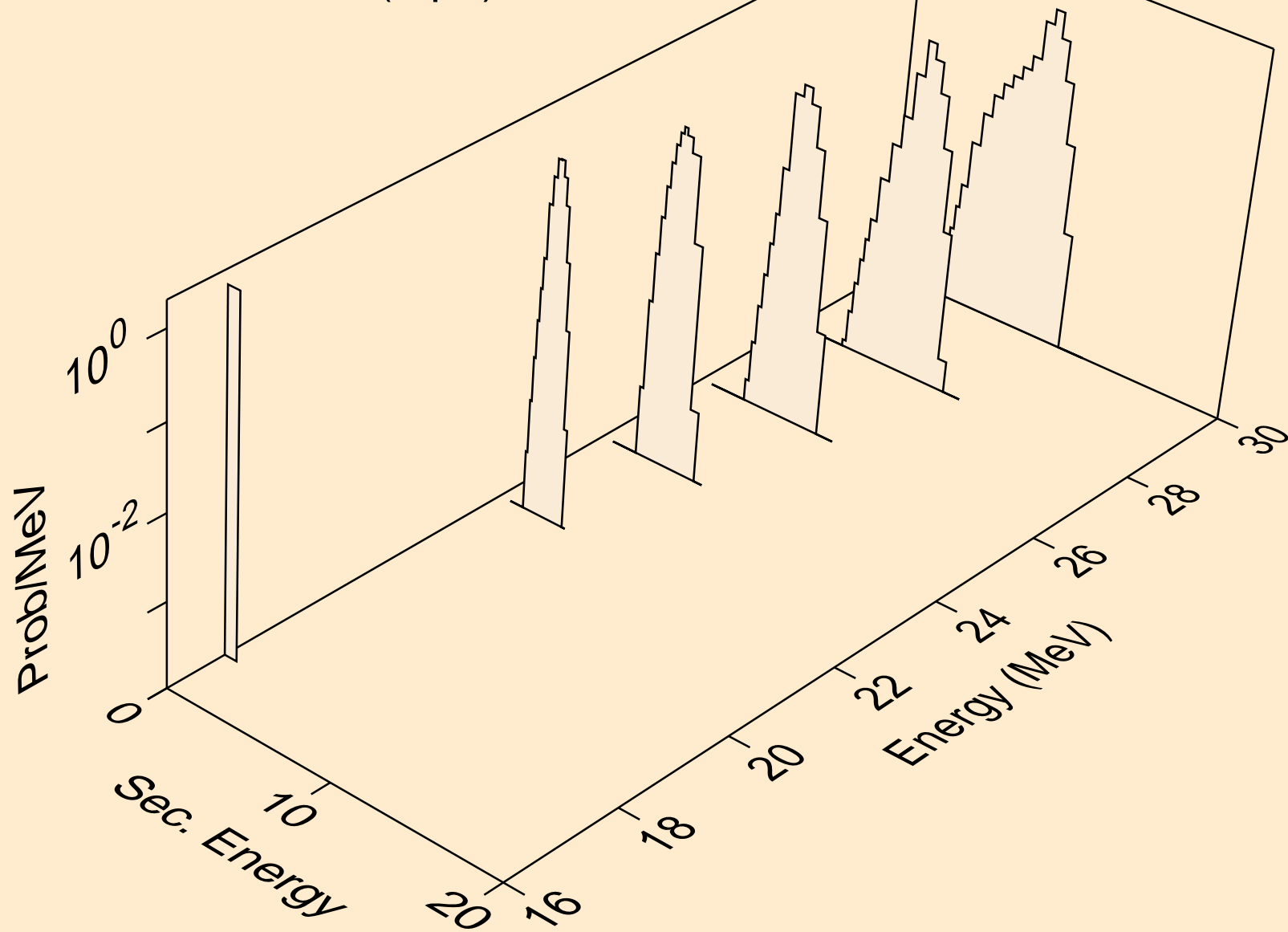

SN117M ALPHA ACER TENDL-2023 LIBRARY; T=0.K
tritons from (a,x)

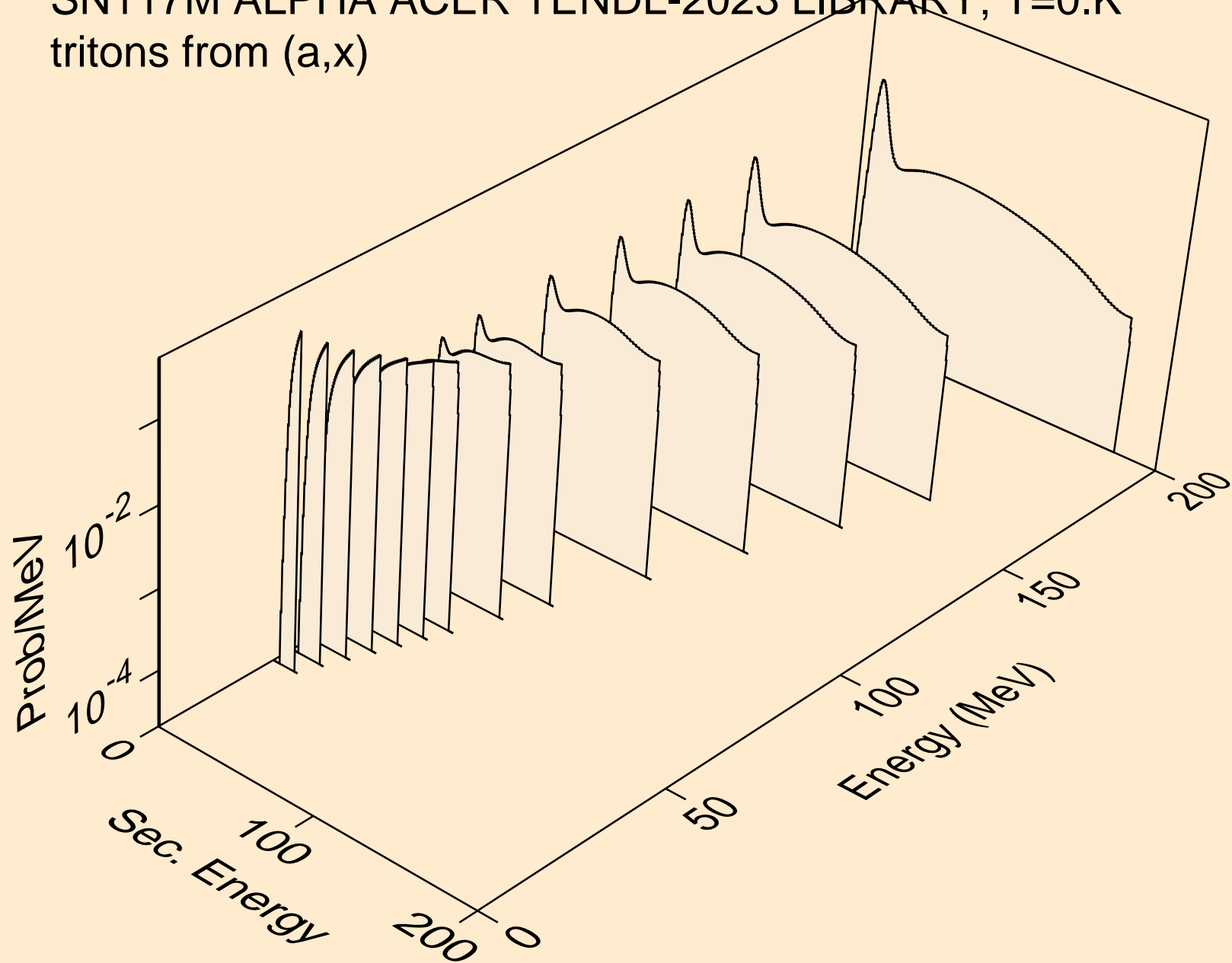

SN117M ALPHA ACER TENDL-2023 LIBRARY; T=0.K
tritons from (a,n*)t

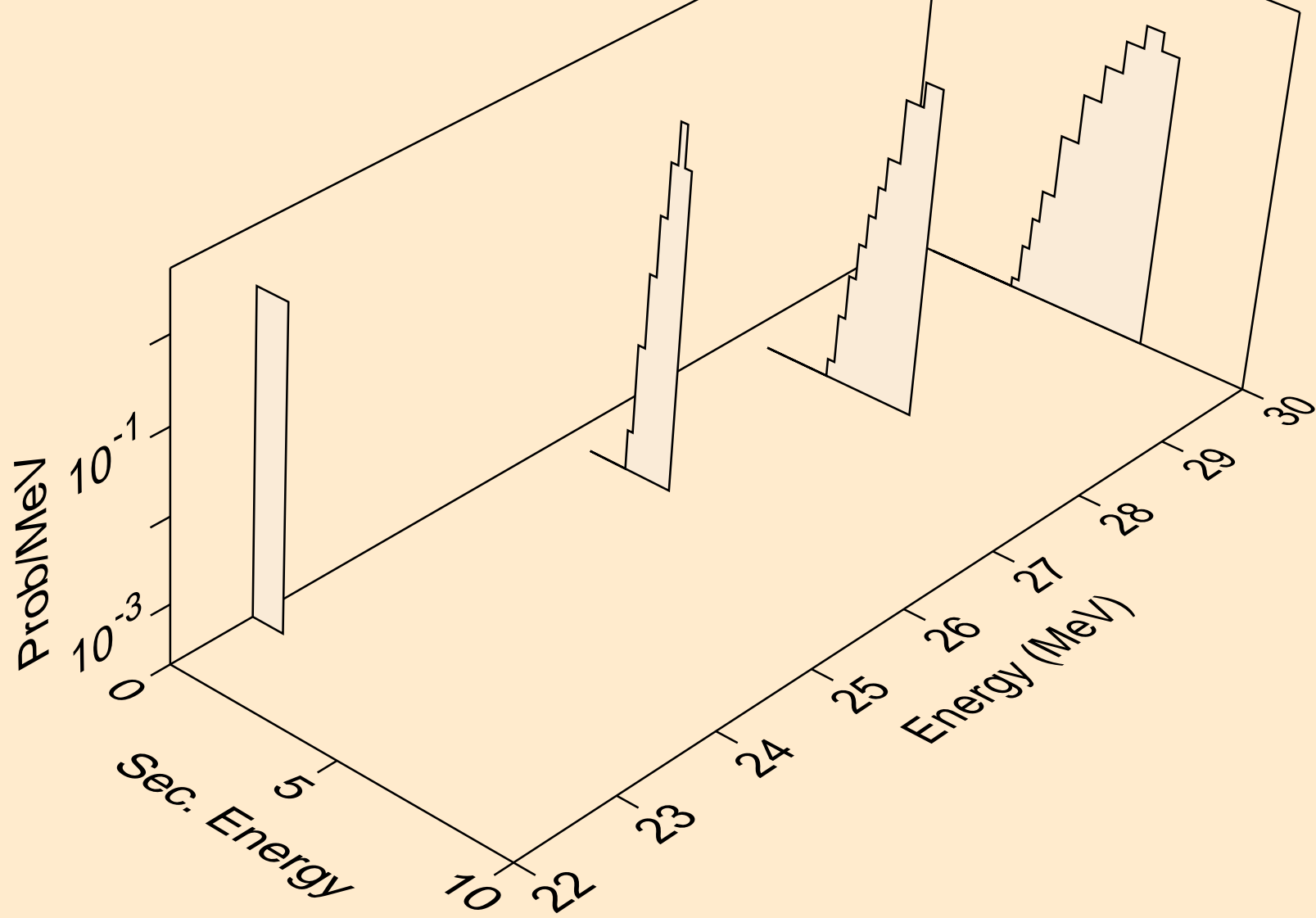

SN117M ALPHA ACER TENDL-2023 LIBRARY; T=0.K
tritons from (a,t)

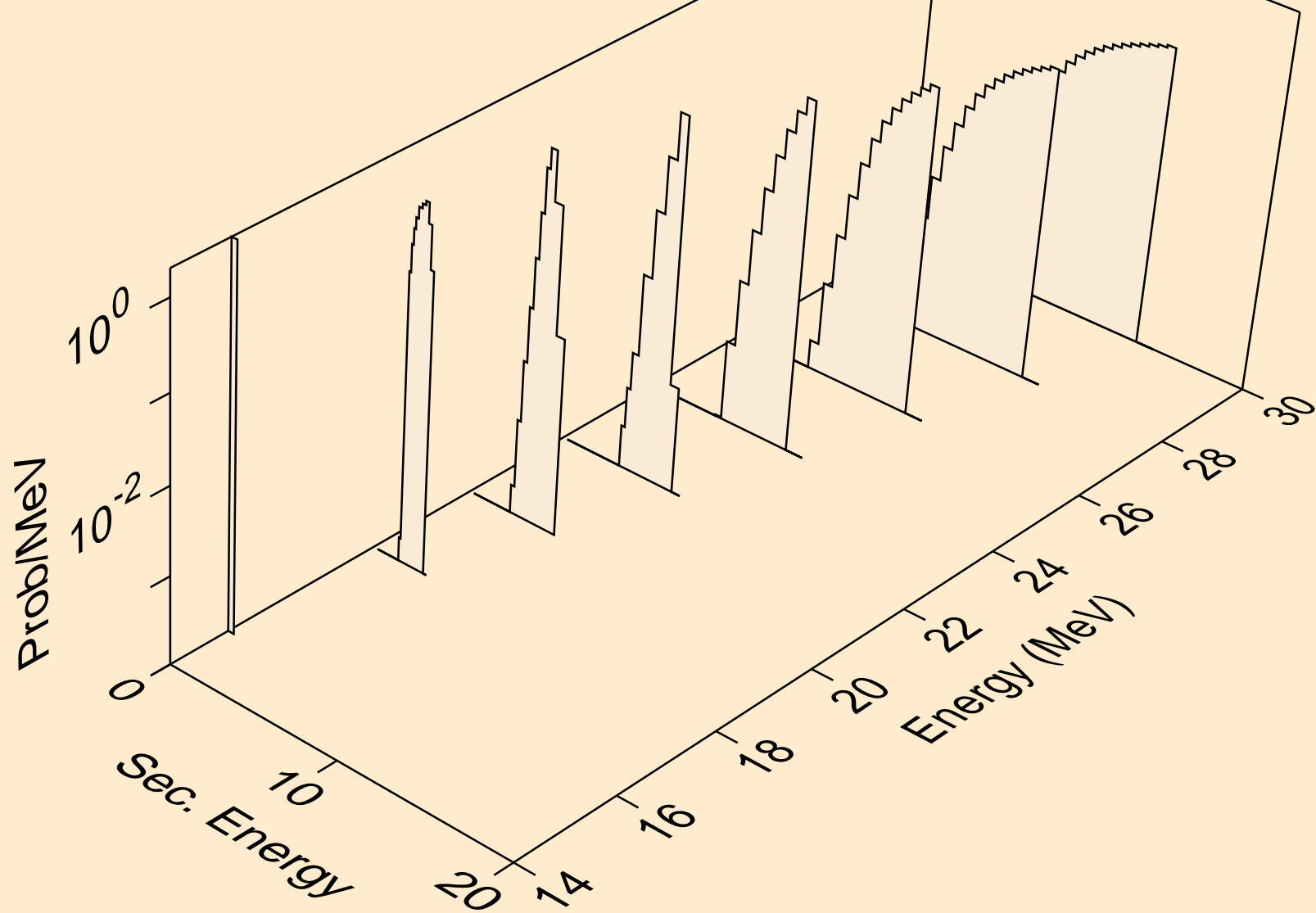

SN117M ALPHA ACER TENDL-2023 LIBRARY; T=0.K
tritons from (a,pt)

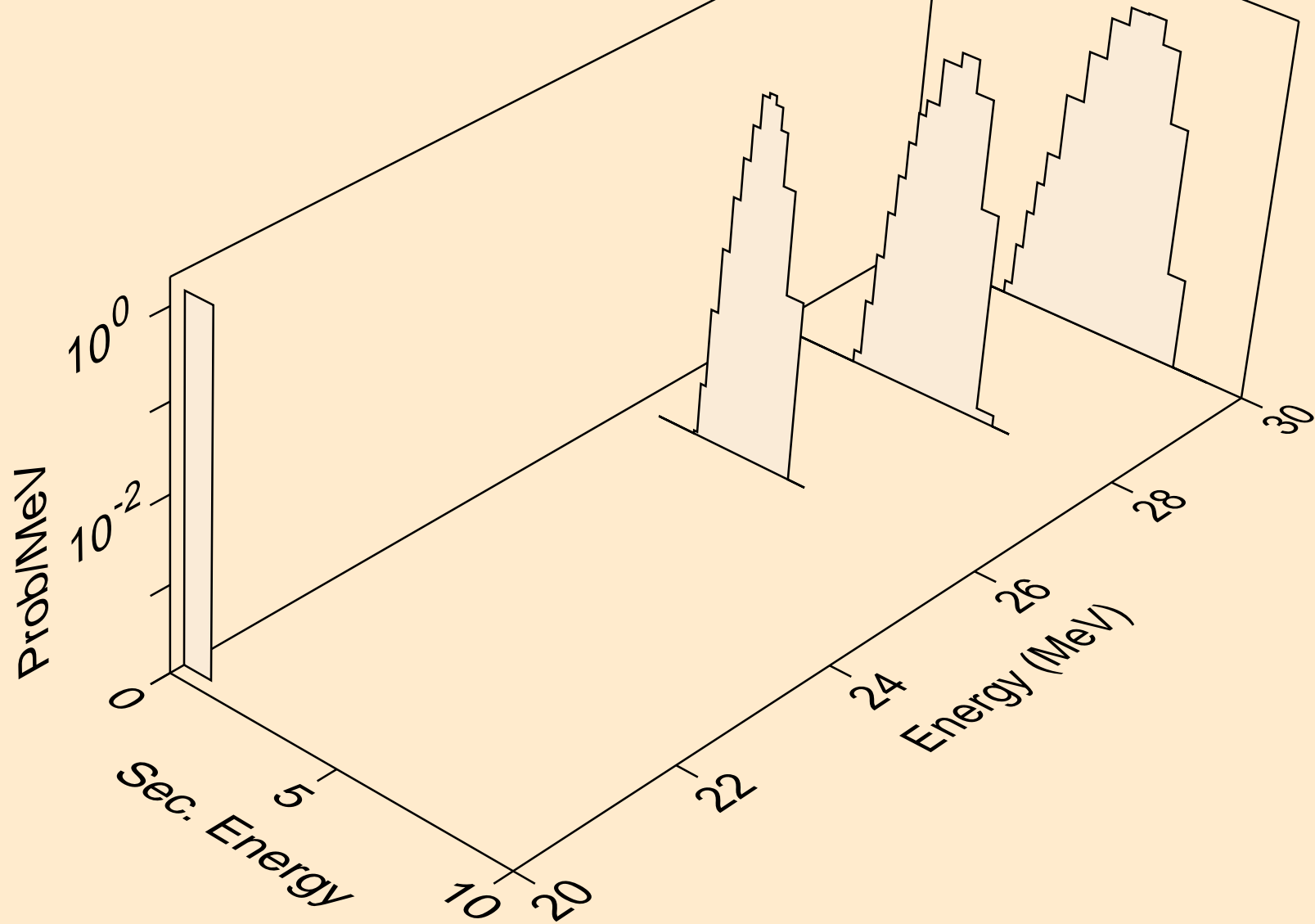

SN117M ALPHA ACER TENDL-2023 LIBRARY; T=0.K
he3s from (a,x)

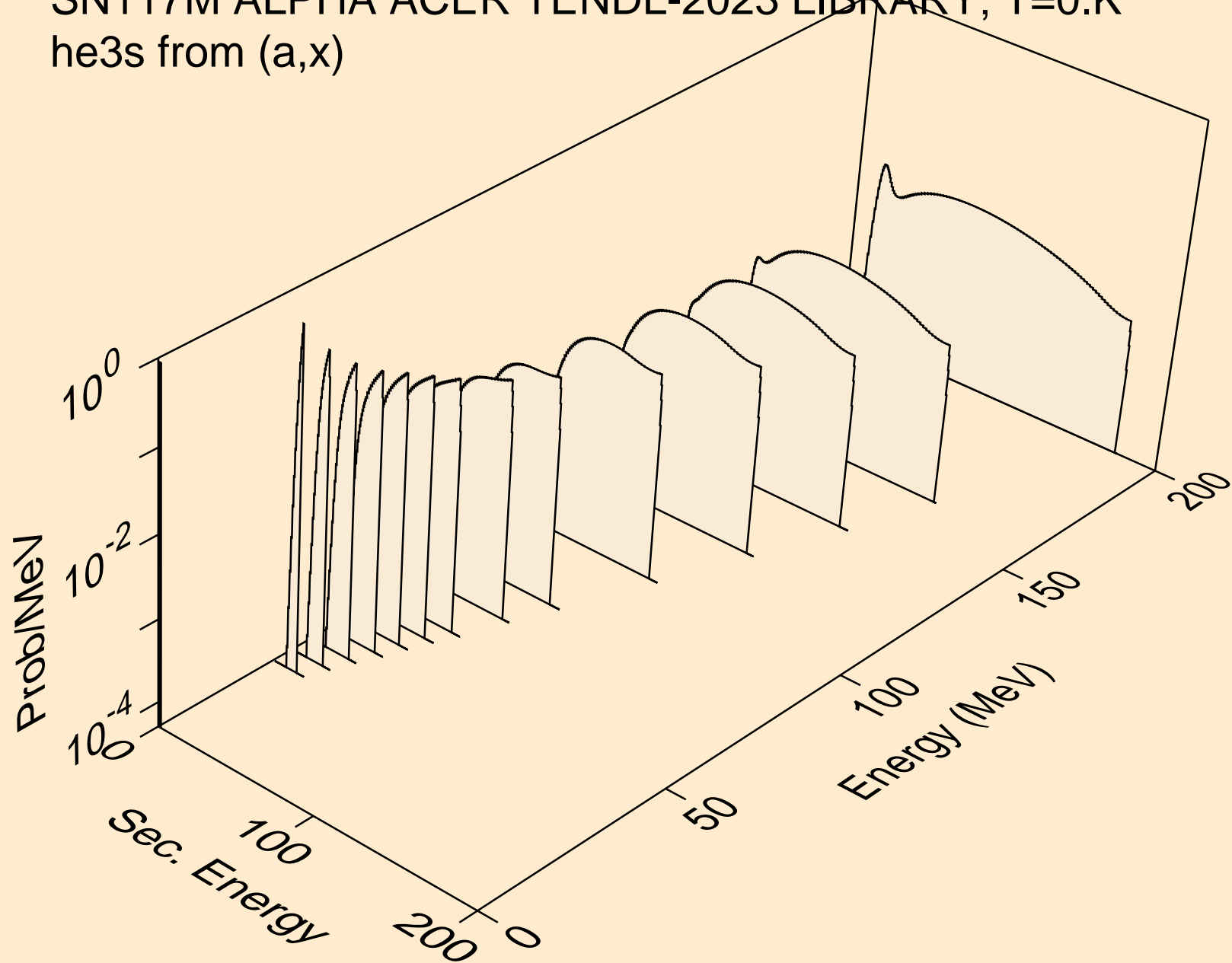

SN117M ALPHA ACER TENDL-2023 LIBRARY; T=0.K
he3s from (a,n*)he3

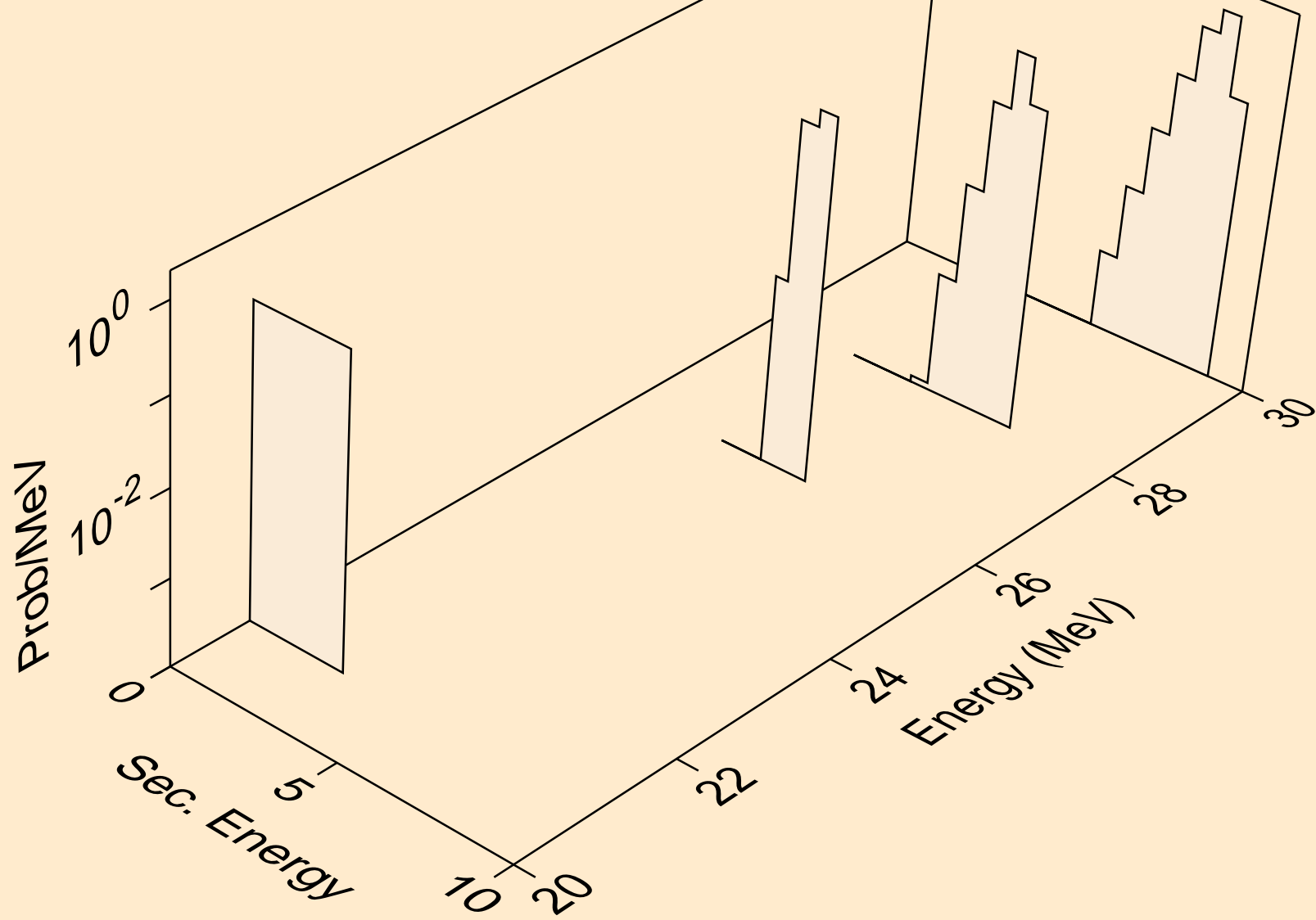

SN117M ALPHA ACER TENDL-2023 LIBRARY; T=0.K
he3s from (a,he3)

