

YB156 ALPHA ACER TENDL-2023 LIBRARY; T=0.K

Principal cross sections

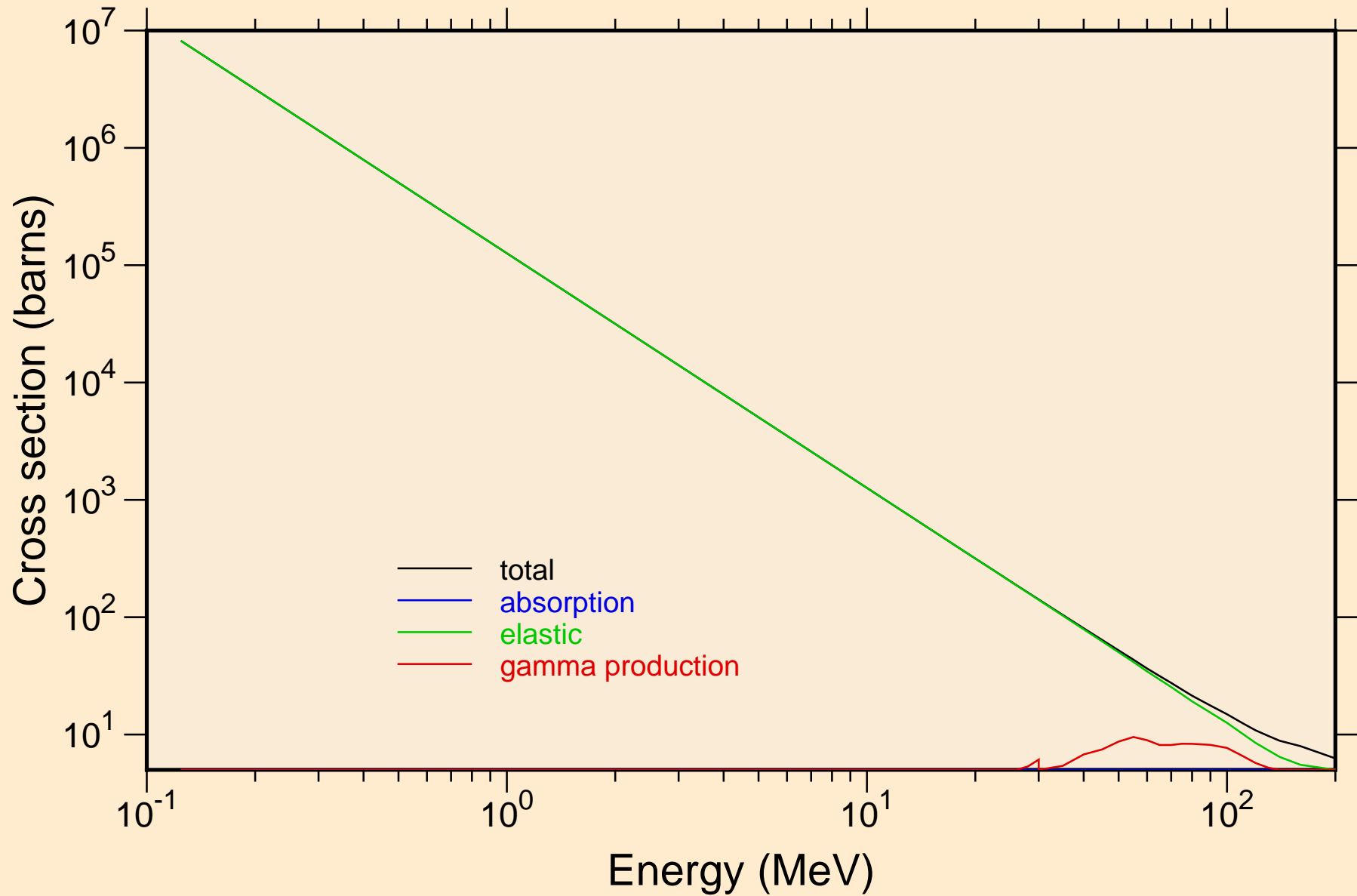

YB156 ALPHA ACER TENDL-2023 LIBRARY; T=0.K

Heating

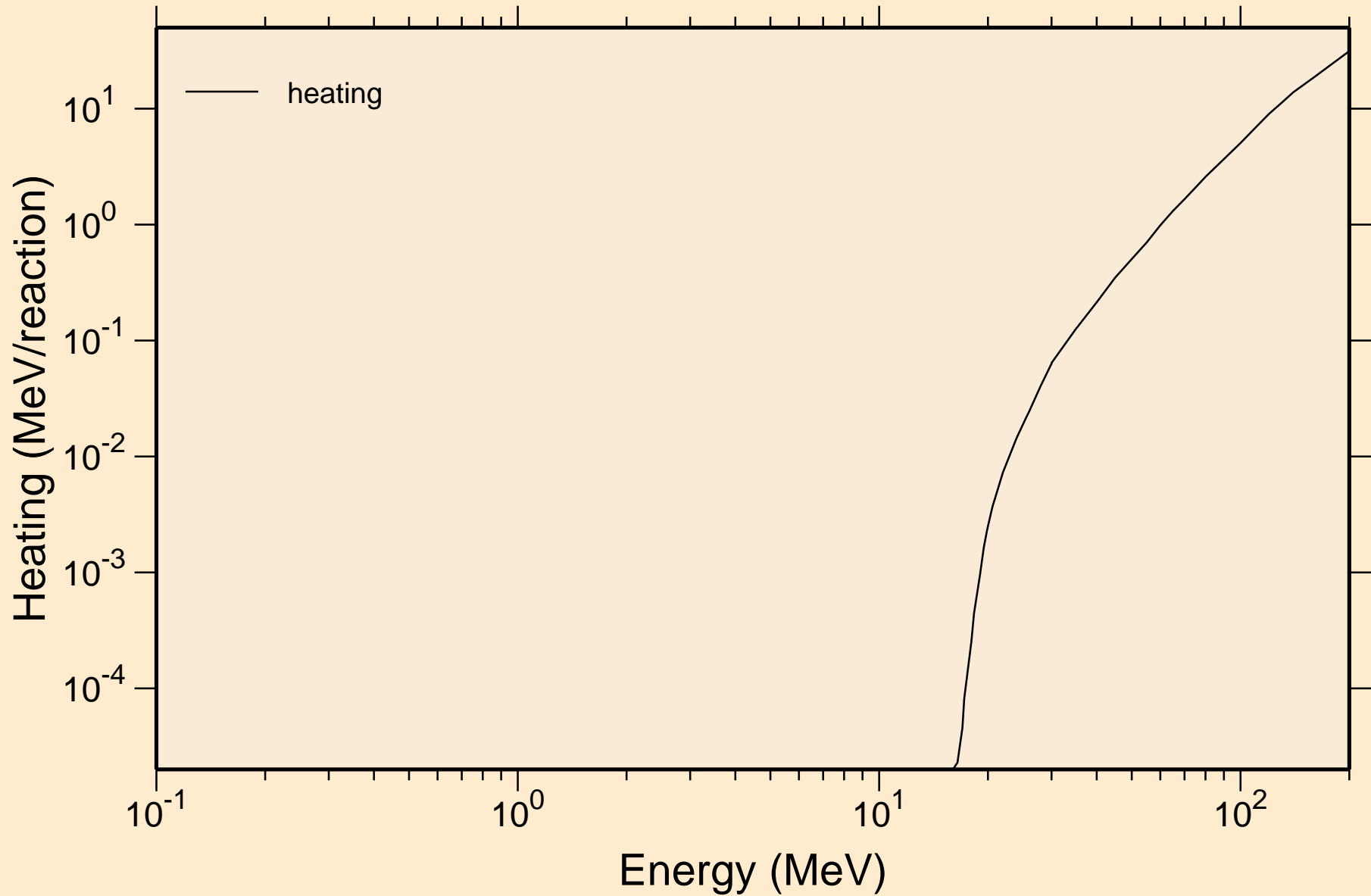

YB156 ALPHA ACER TENDL-2023 LIBRARY; T=0.K

Principal cross sections

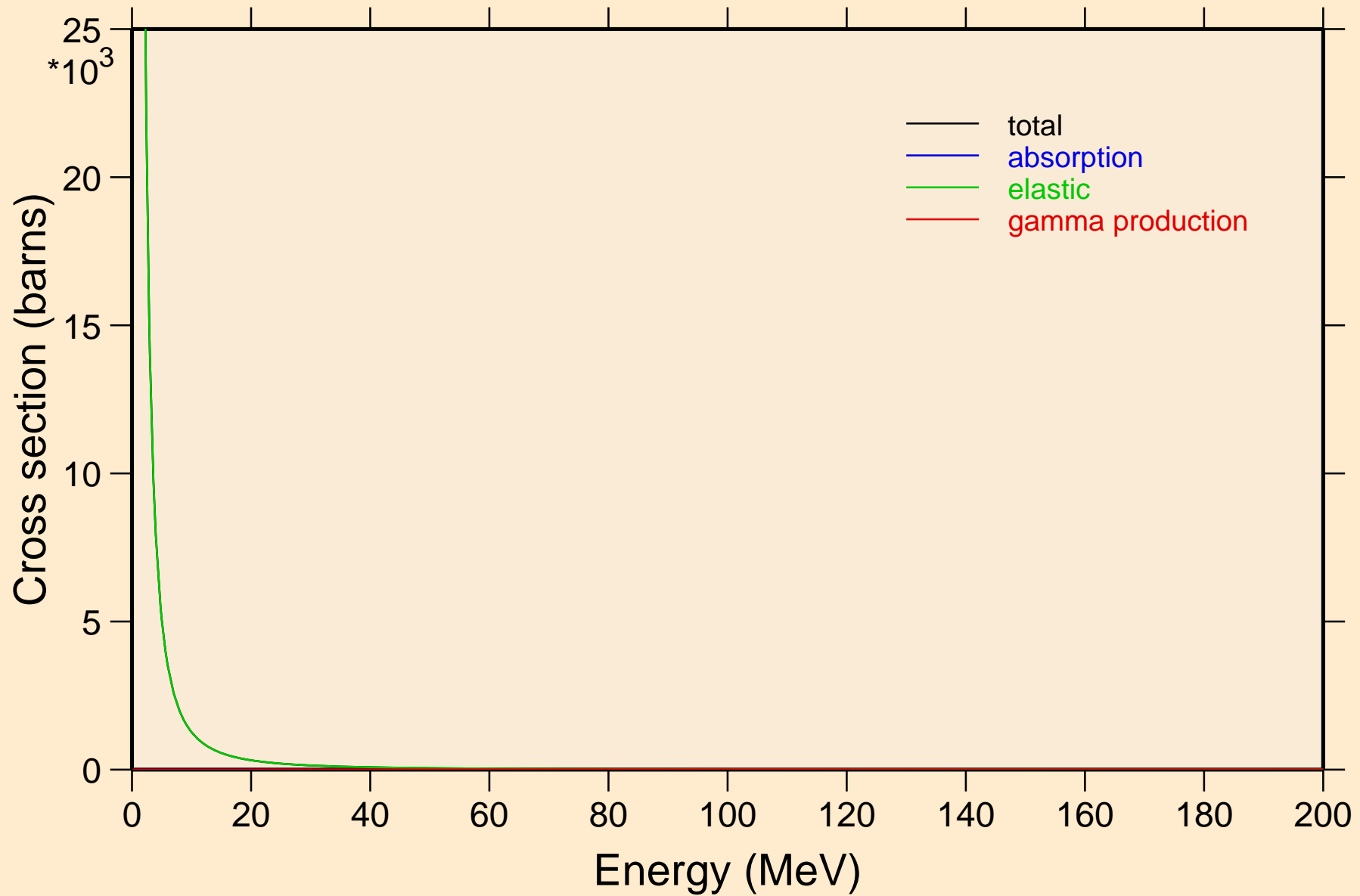

YB156 ALPHA ACER TENDL-2023 LIBRARY; T=0.K

Heating

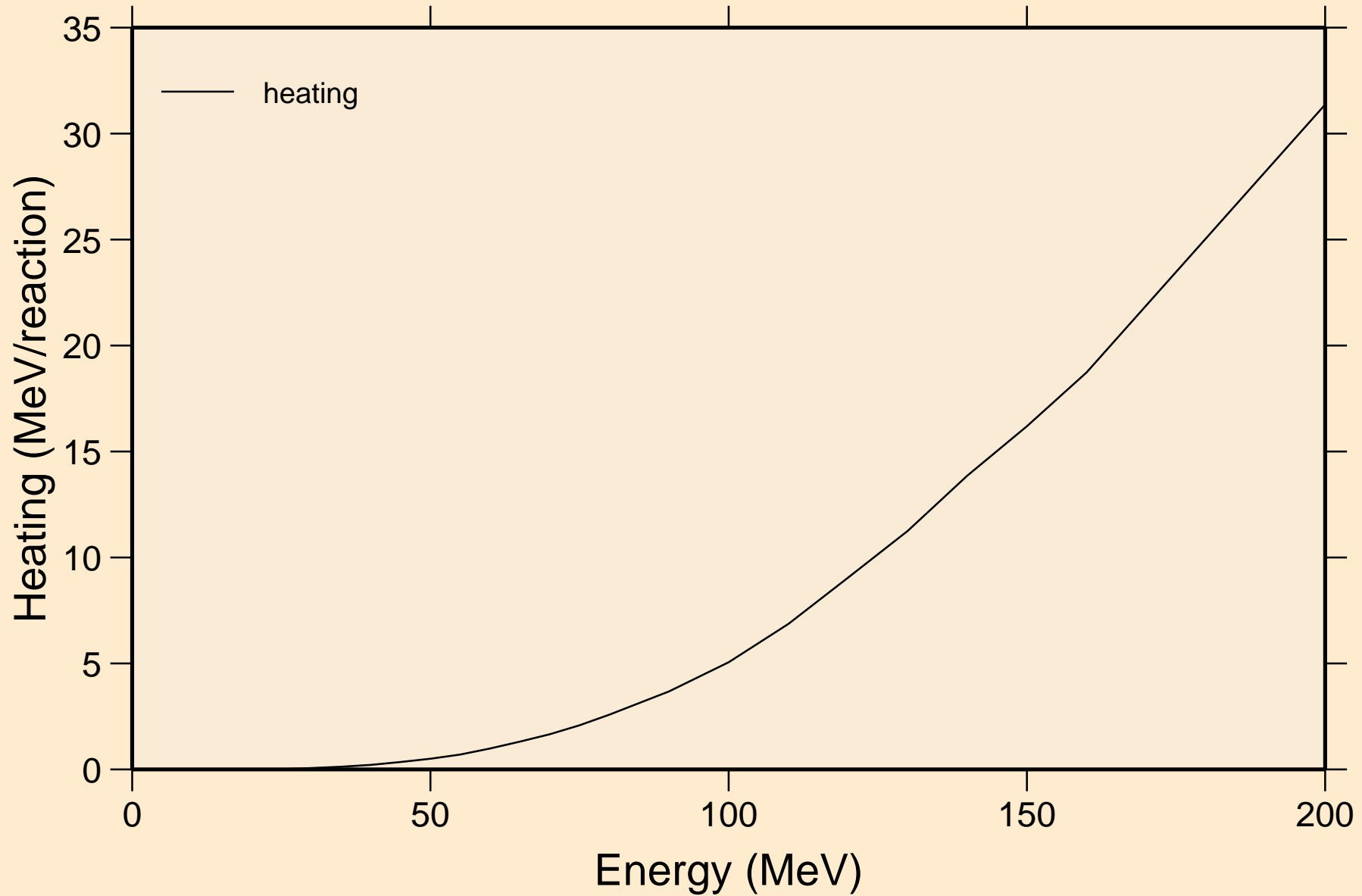

YB156 ALPHA ACER TENDL-2023 LIBRARY; T=0.K
Threshold reactions

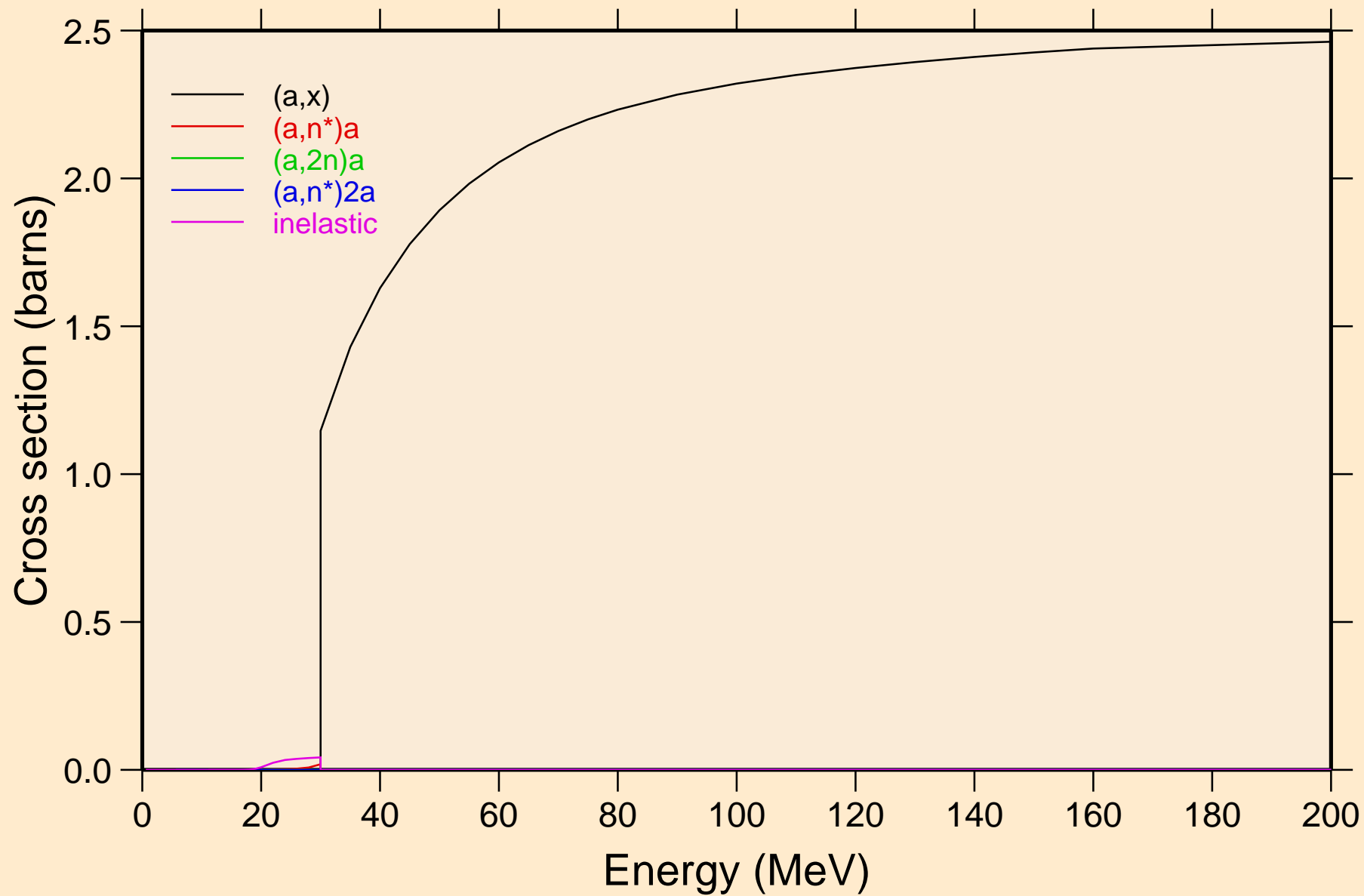

YB156 ALPHA ACER TENDL-2023 LIBRARY; T=0.K
Threshold reactions

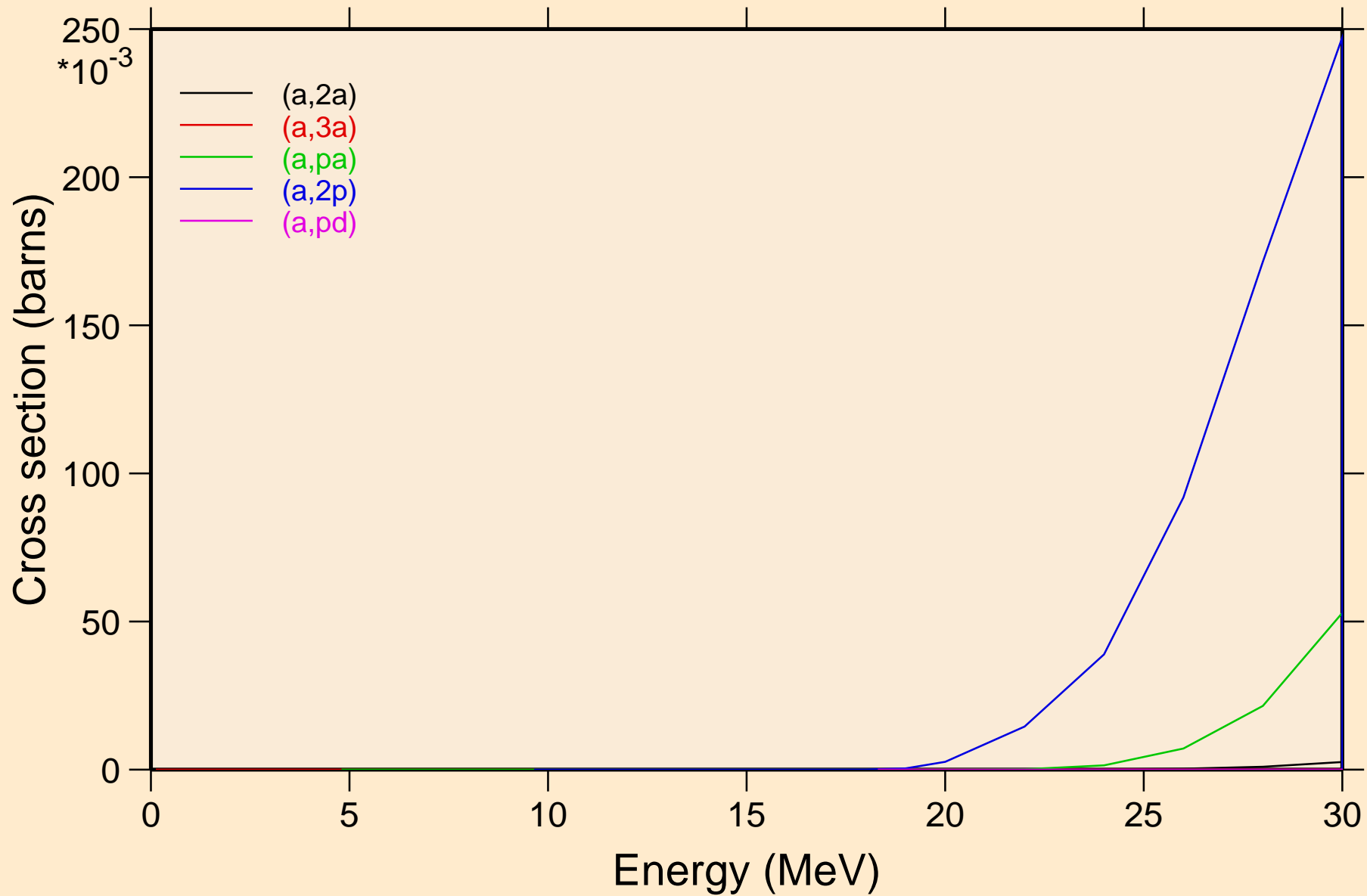

YB156 ALPHA ACER TENDL-2023 LIBRARY; T=0.K
angular distribution for elastic

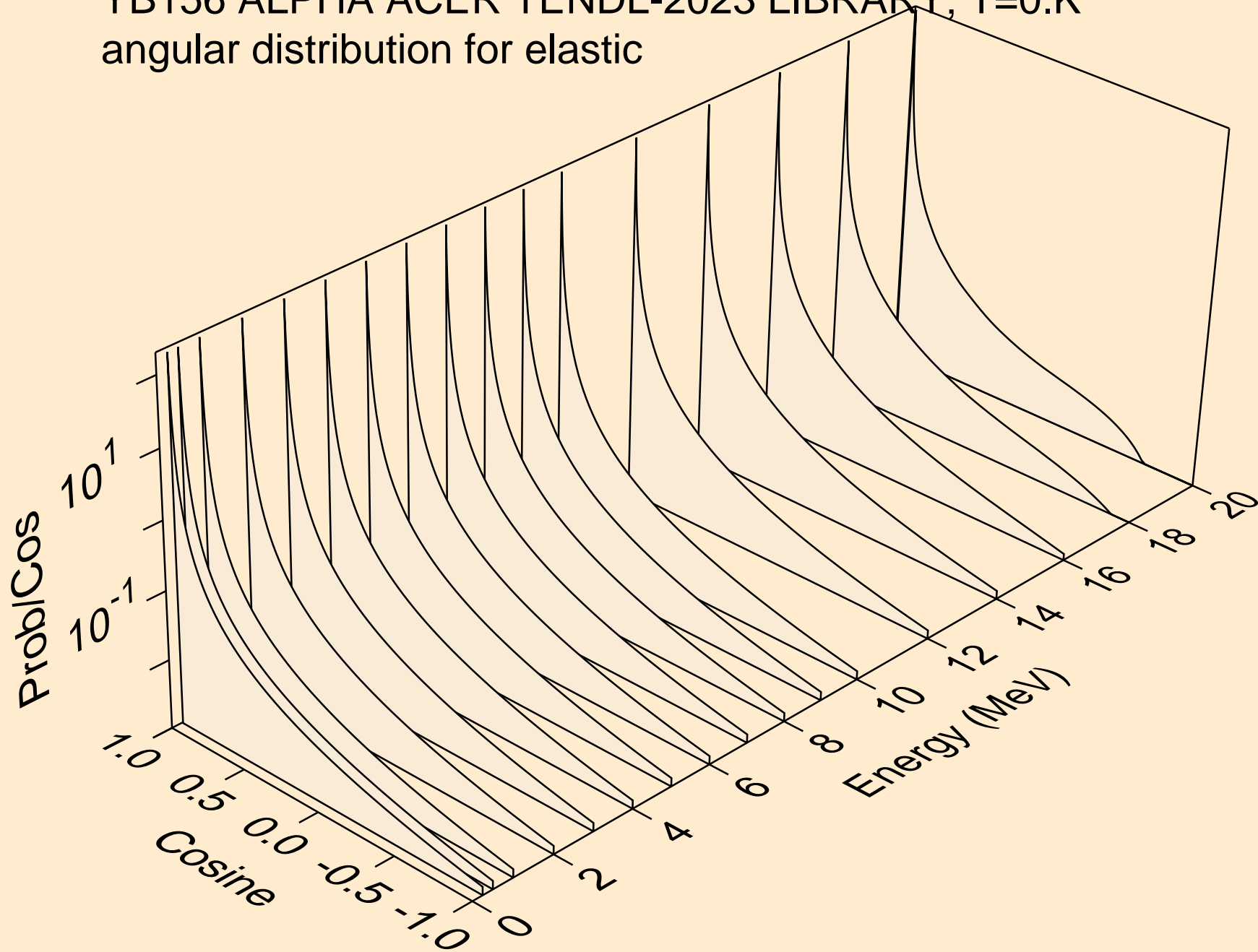

YB156 ALPHA ACER TENDL-2023 LIBRARY; T=0.K
angular distribution for elastic

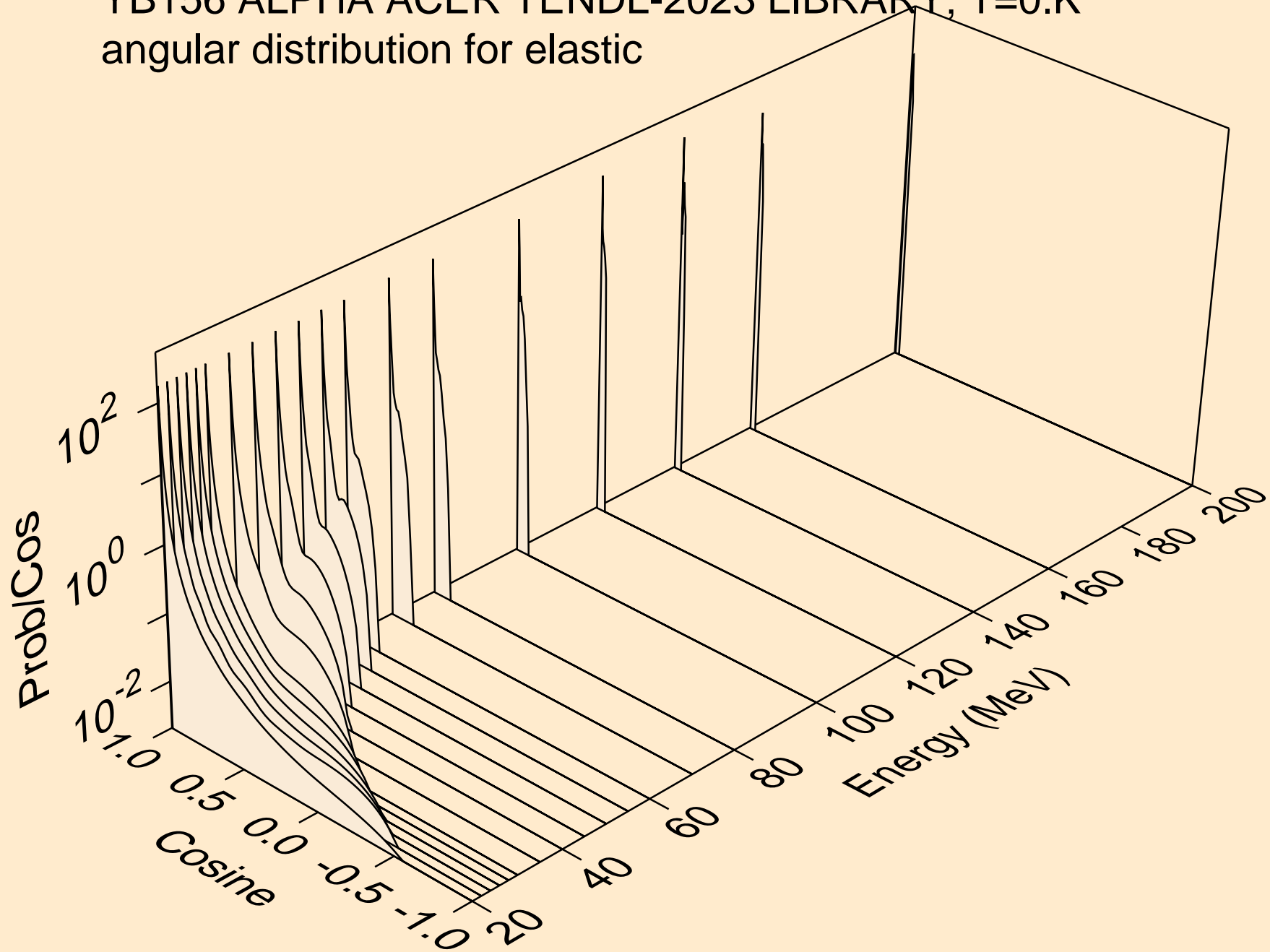

YB156 ALPHA ACER TENDL-2023 LIBRARY; T=0.K
Alpha emission for (a,x)

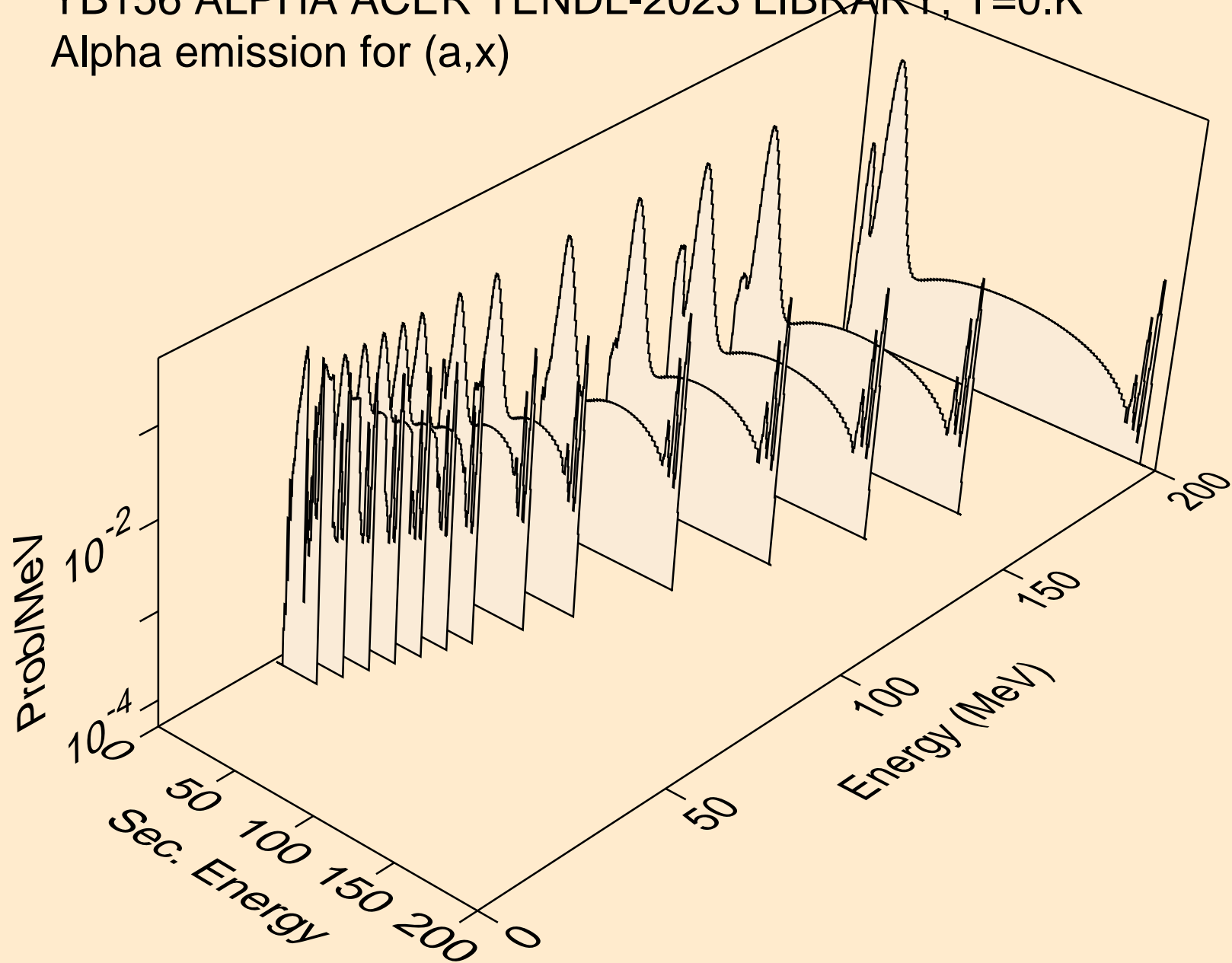

YB156 ALPHA ACER TENDL-2023 LIBRARY; T=0.K
Alpha emission for (a,n*)a

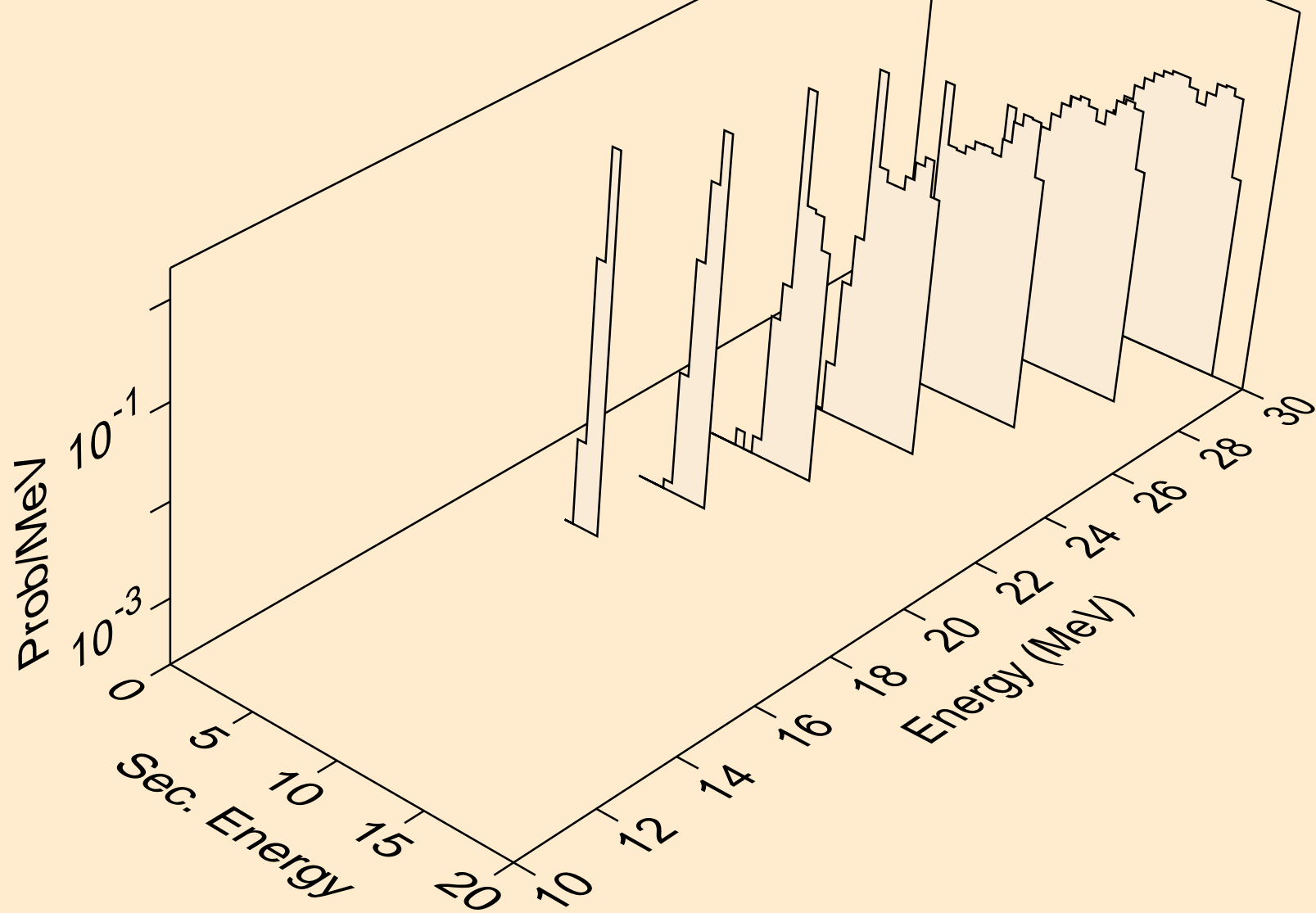

YB156 ALPHA ACER TENDL-2023 LIBRARY; T=0.K

Alpha emission for (a,2n)a

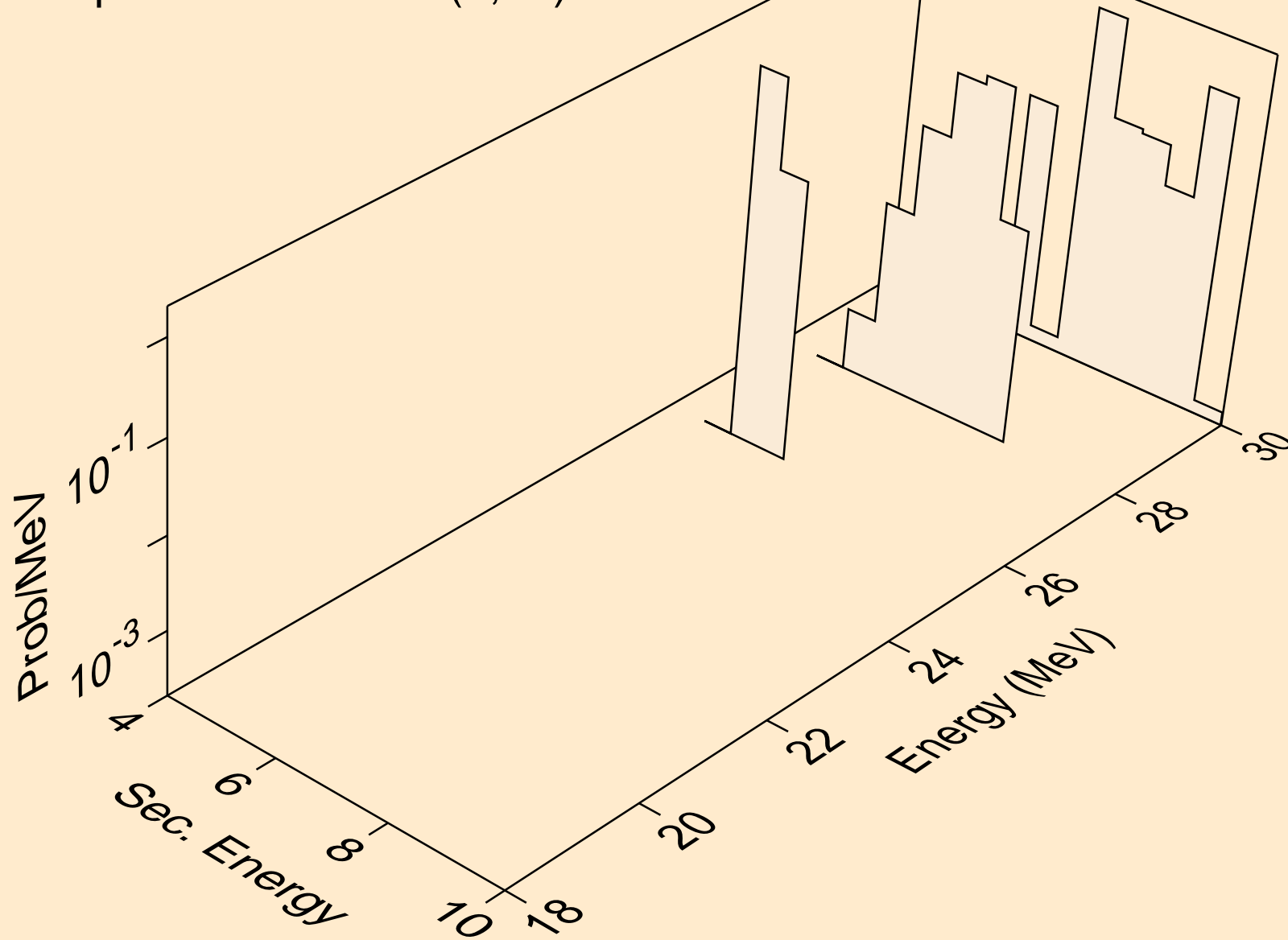

YB156 ALPHA ACER TENDL-2023 LIBRARY; T=0.K
Alpha emission for (a,n*)2a

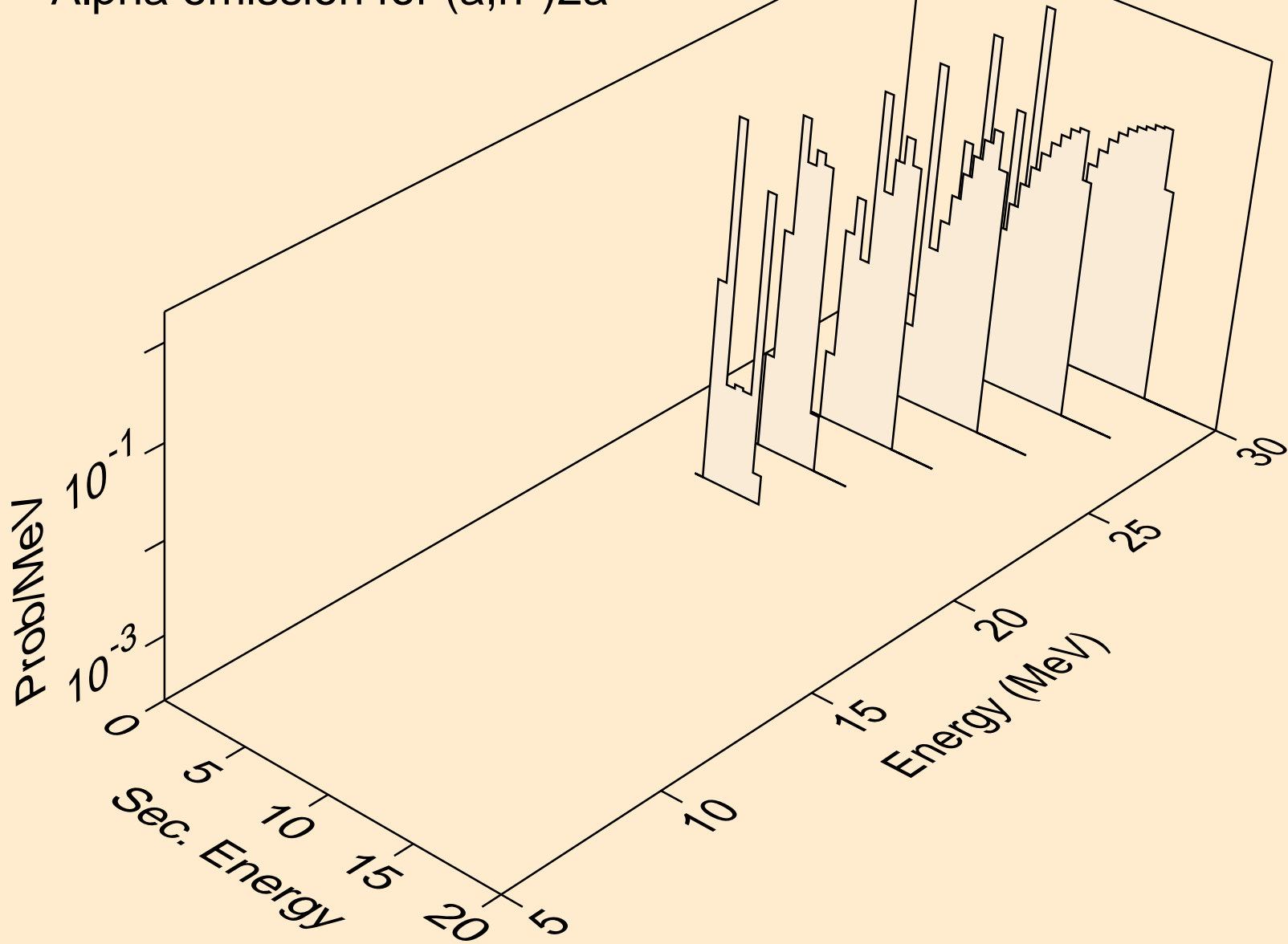

YB156 ALPHA ACER TENDL-2023 LIBRARY; T=0.K
Alpha emission for inelastic

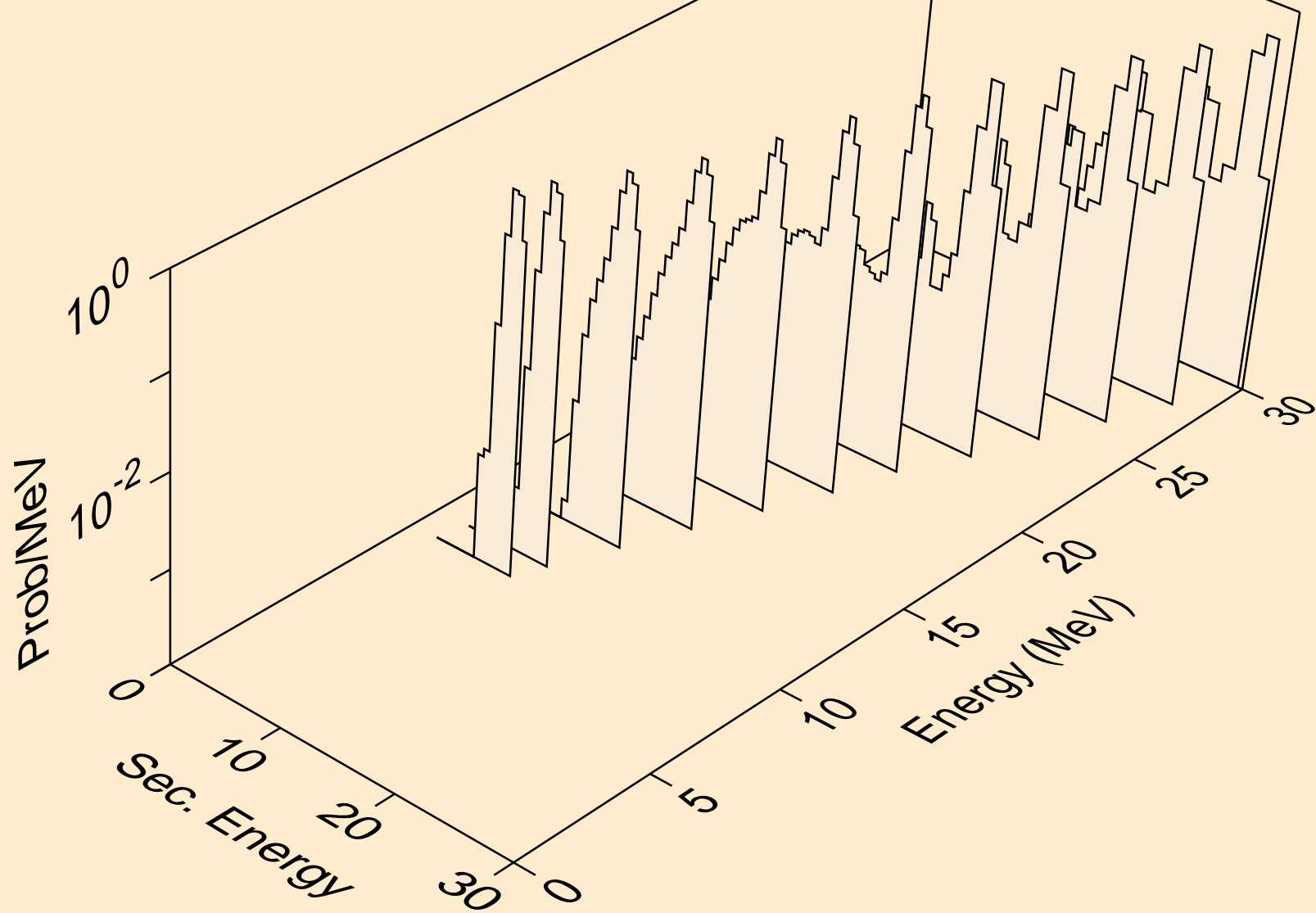

YB156 ALPHA ACER TENDL-2023 LIBRARY; T=0.K
Alpha emission for (a,2a)

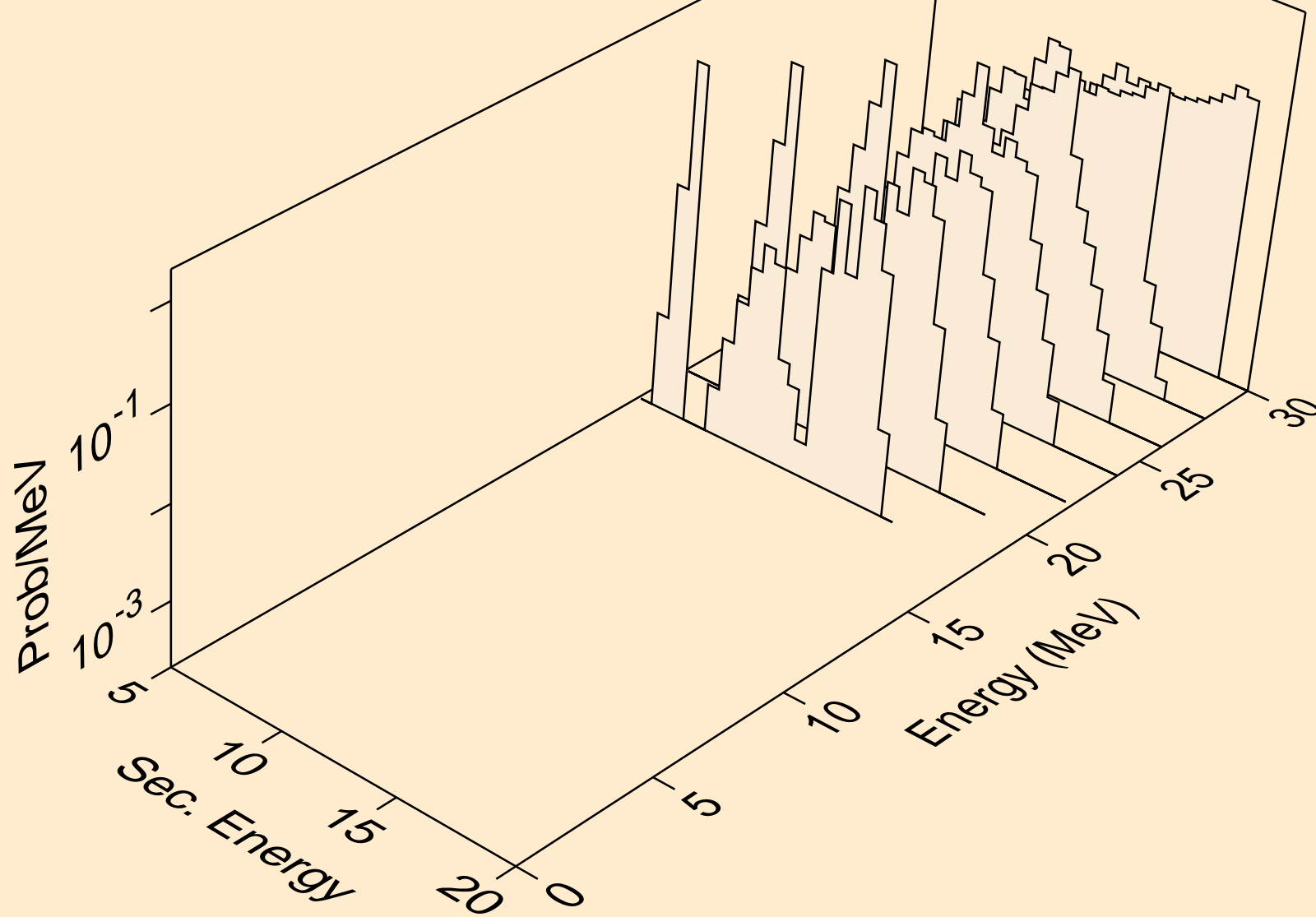

YB156 ALPHA ACER TENDL-2023 LIBRARY; T=0.K
Alpha emission for (a,3a)

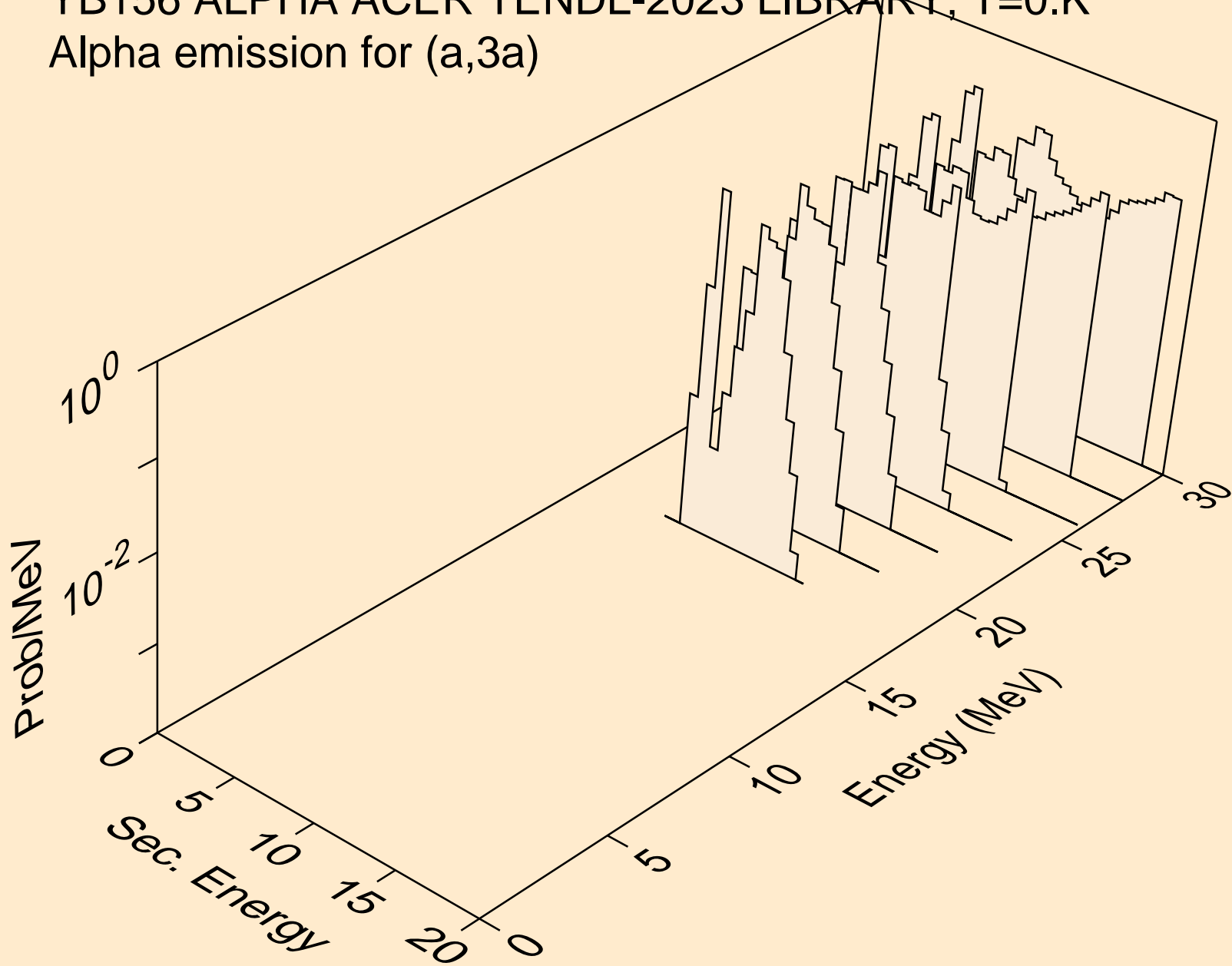

YB156 ALPHA ACER TENDL-2023 LIBRARY; T=0.K

Alpha emission for (a,pa)

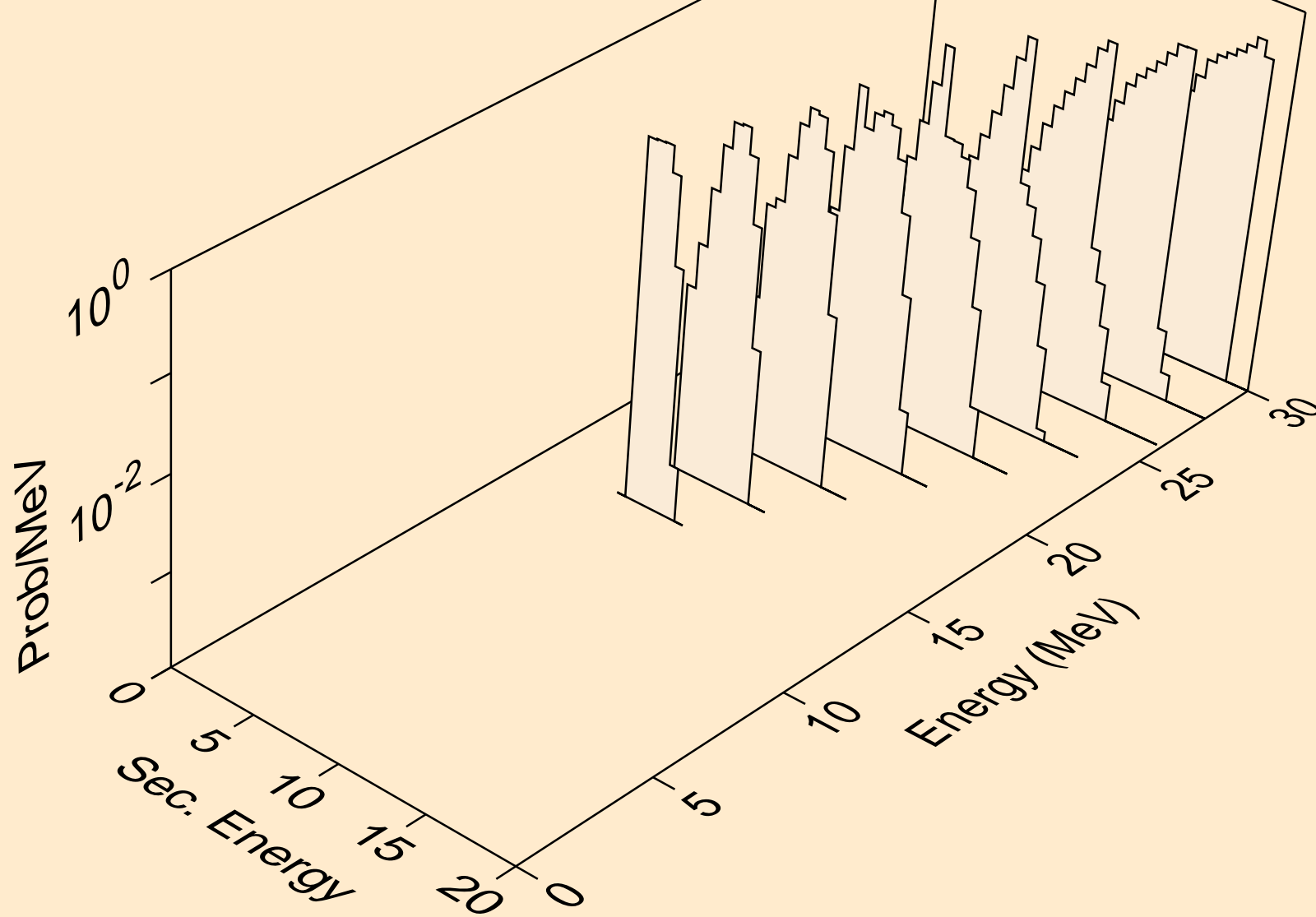

YB156 ALPHA ACER TENDL-2023 LIBRARY; T=0.K
Photon emission for (z,n)

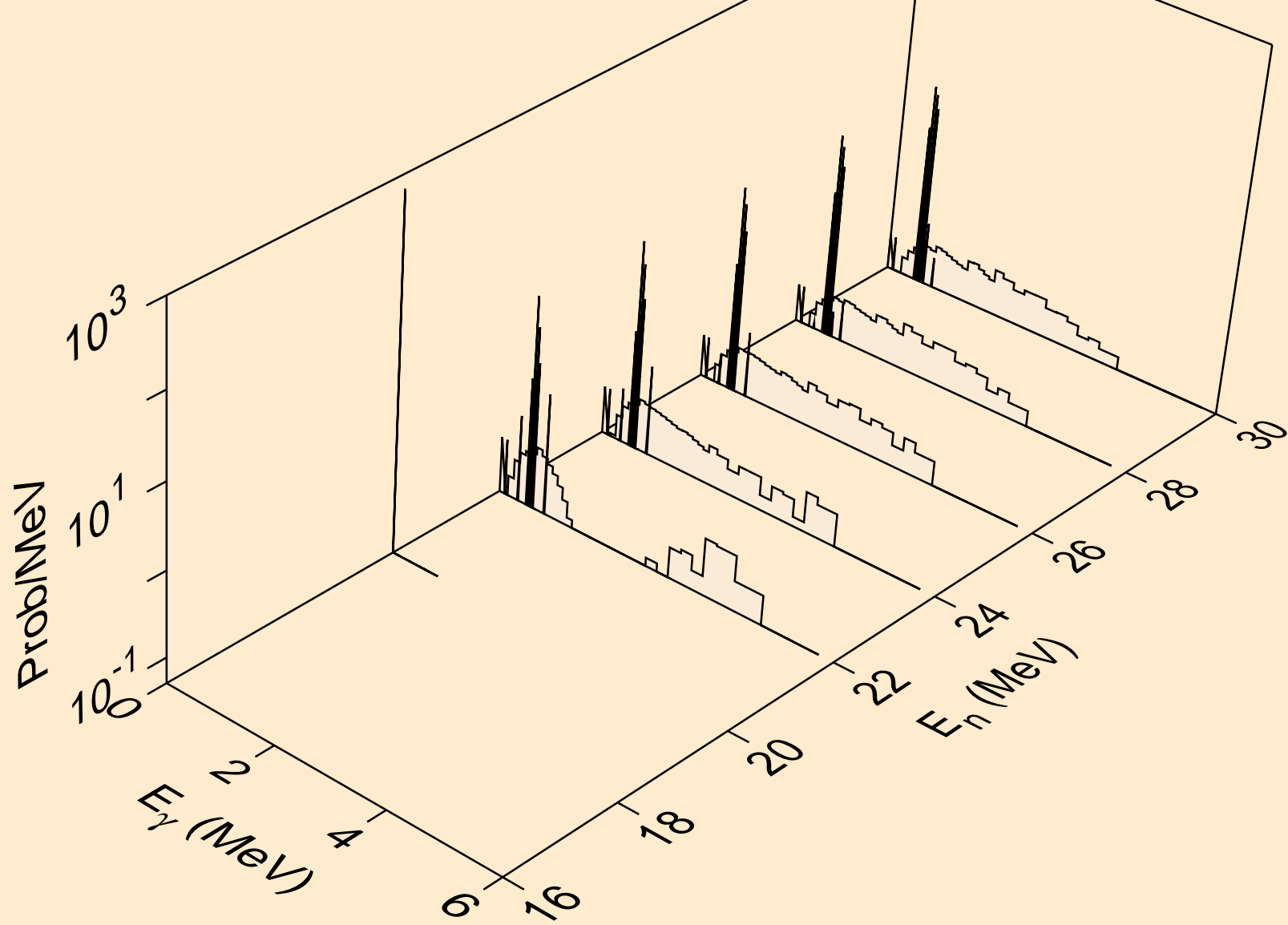

YB156 ALPHA ACER TENDL-2023 LIBRARY; T=0.K
Photon emission for (z,x)

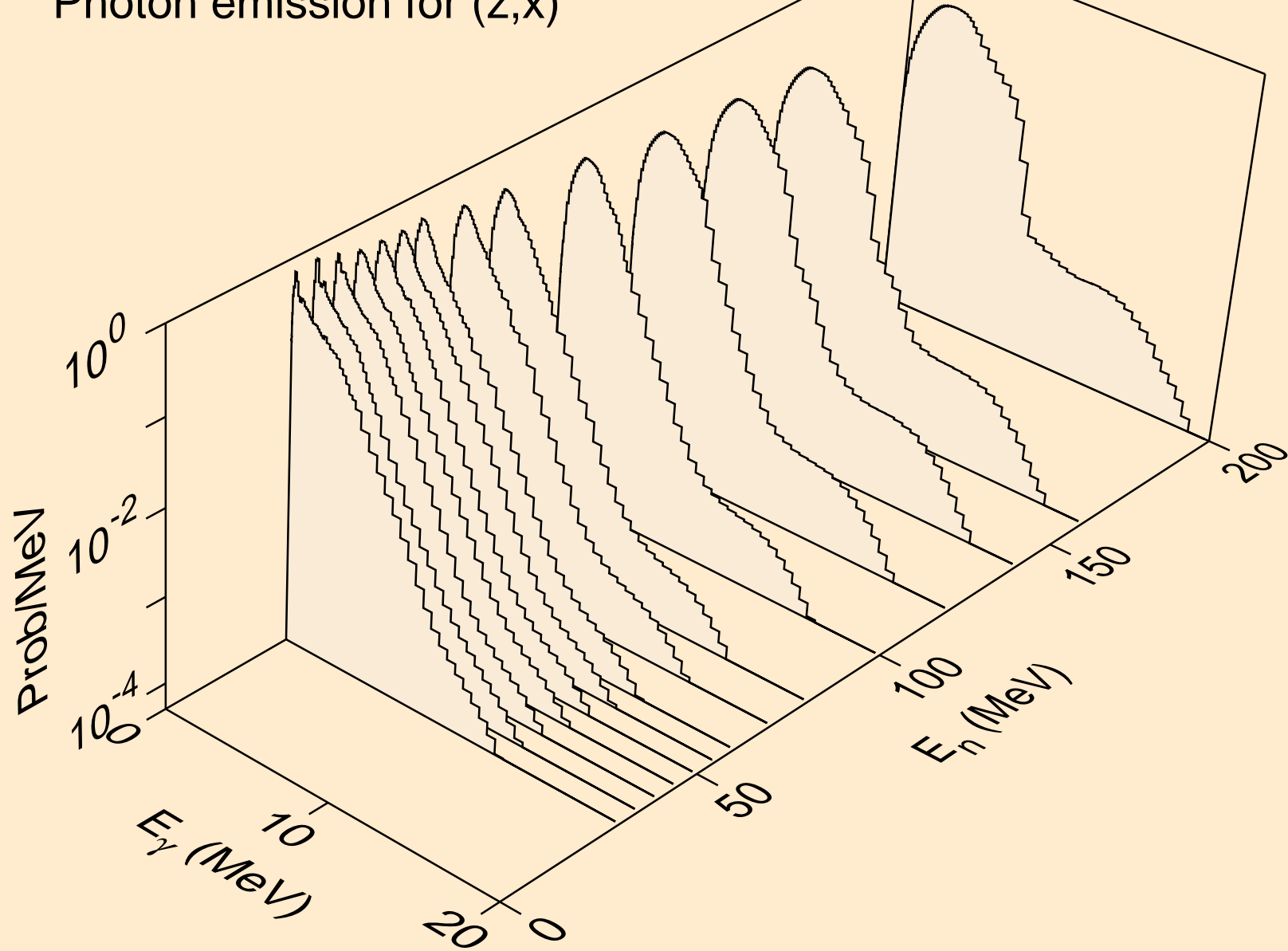

YB156 ALPHA ACER TENDL-2023 LIBRARY; T=0.K
Photon emission for (n,2n)

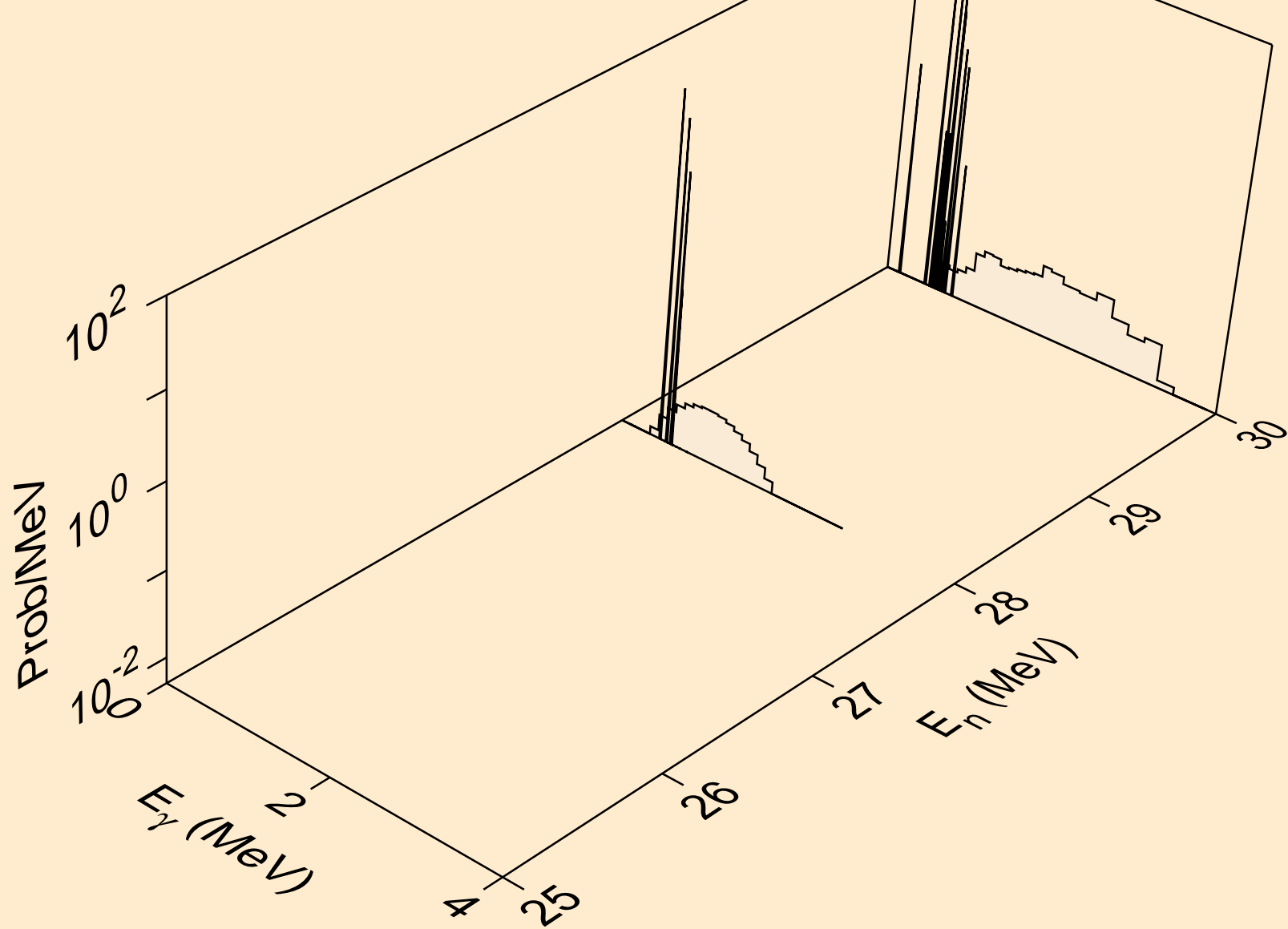

YB156 ALPHA ACER TENDL-2023 LIBRARY; T=0.K
Photon emission for (n,n*)a

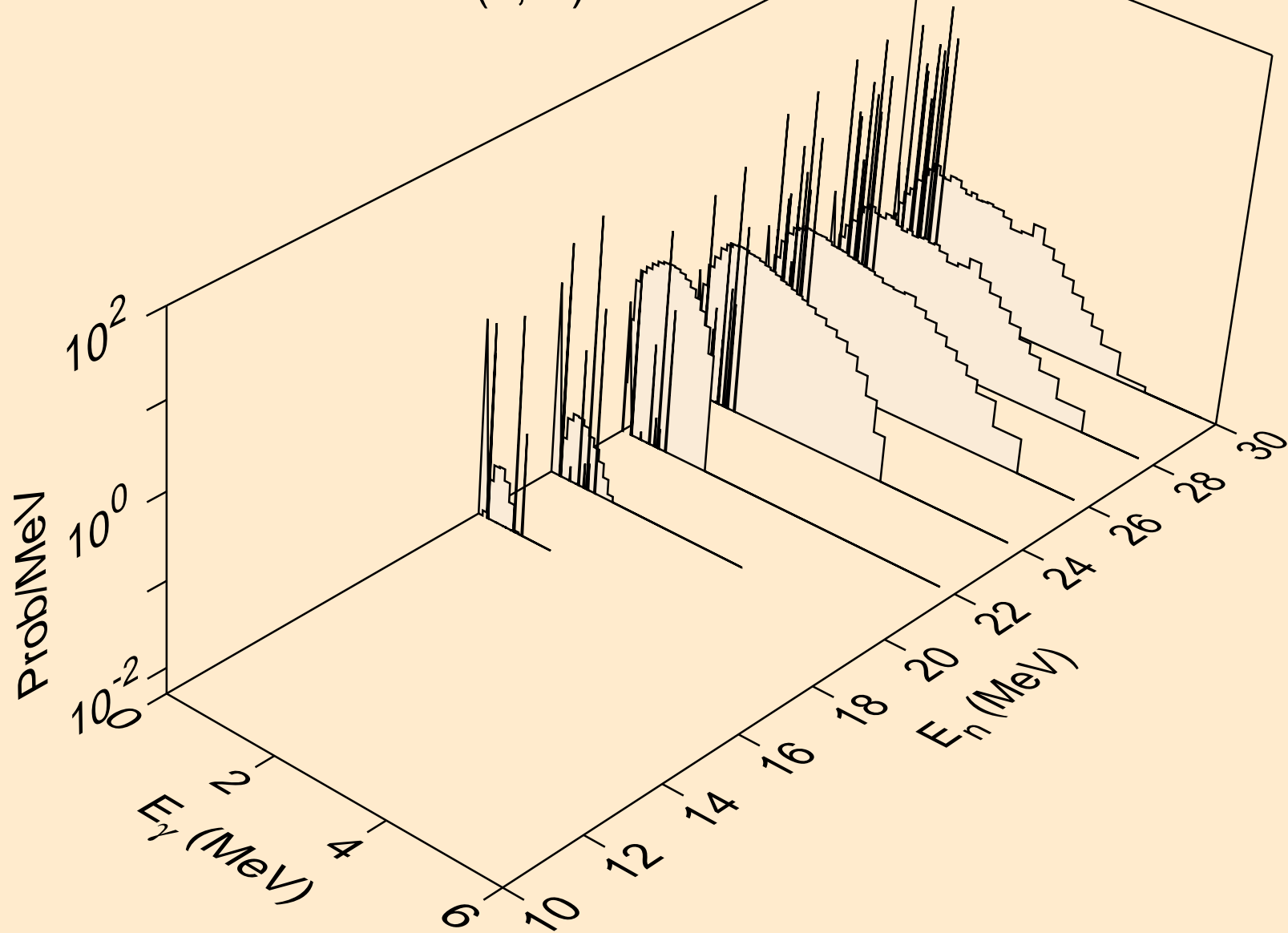

YB156 ALPHA ACER TENDL-2023 LIBRARY; T=0.K
Photon emission for (n,2n)a

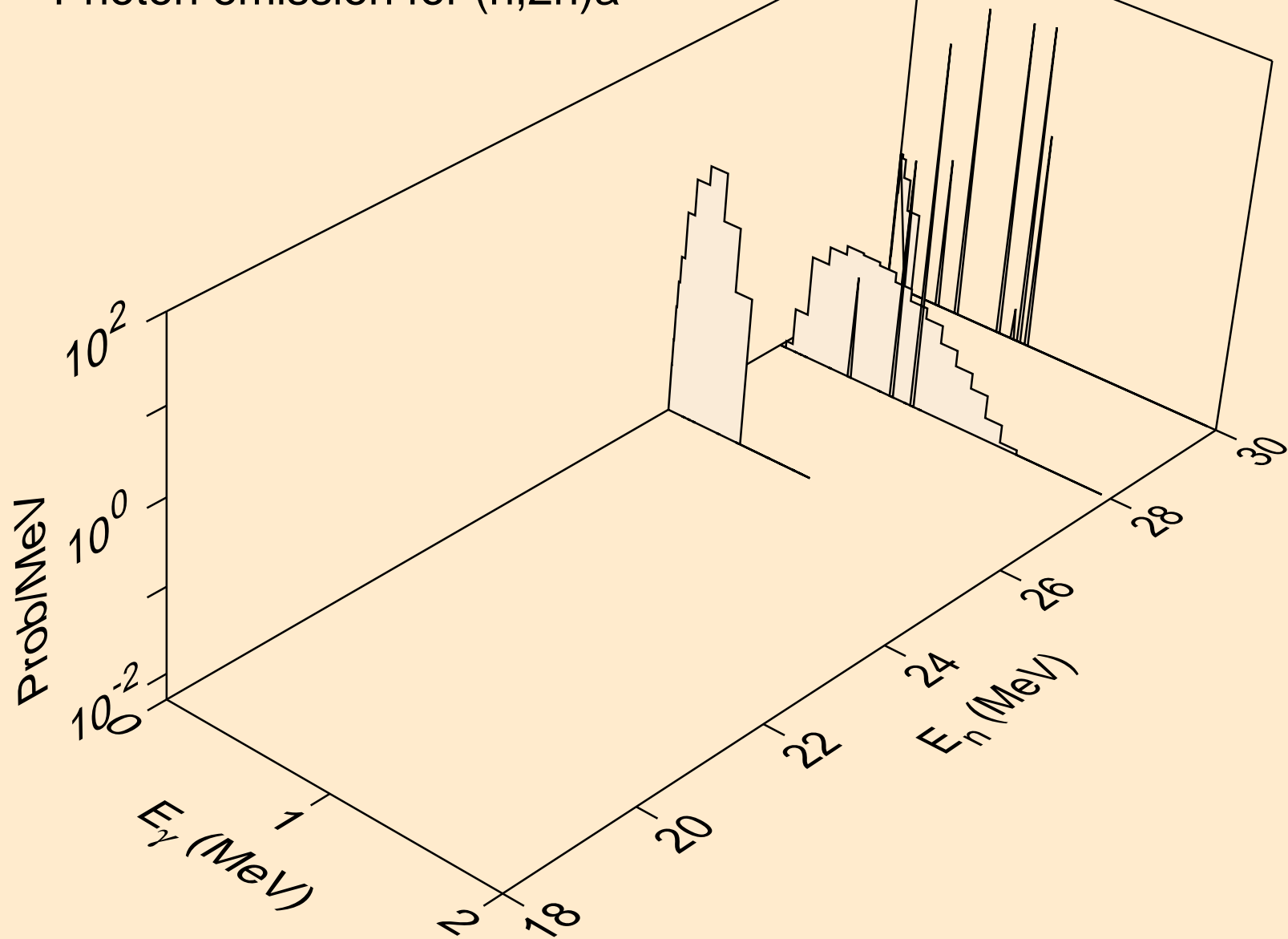

YB156 ALPHA ACER TENDL-2023 LIBRARY; T=0.K
Photon emission for (n,n*)p

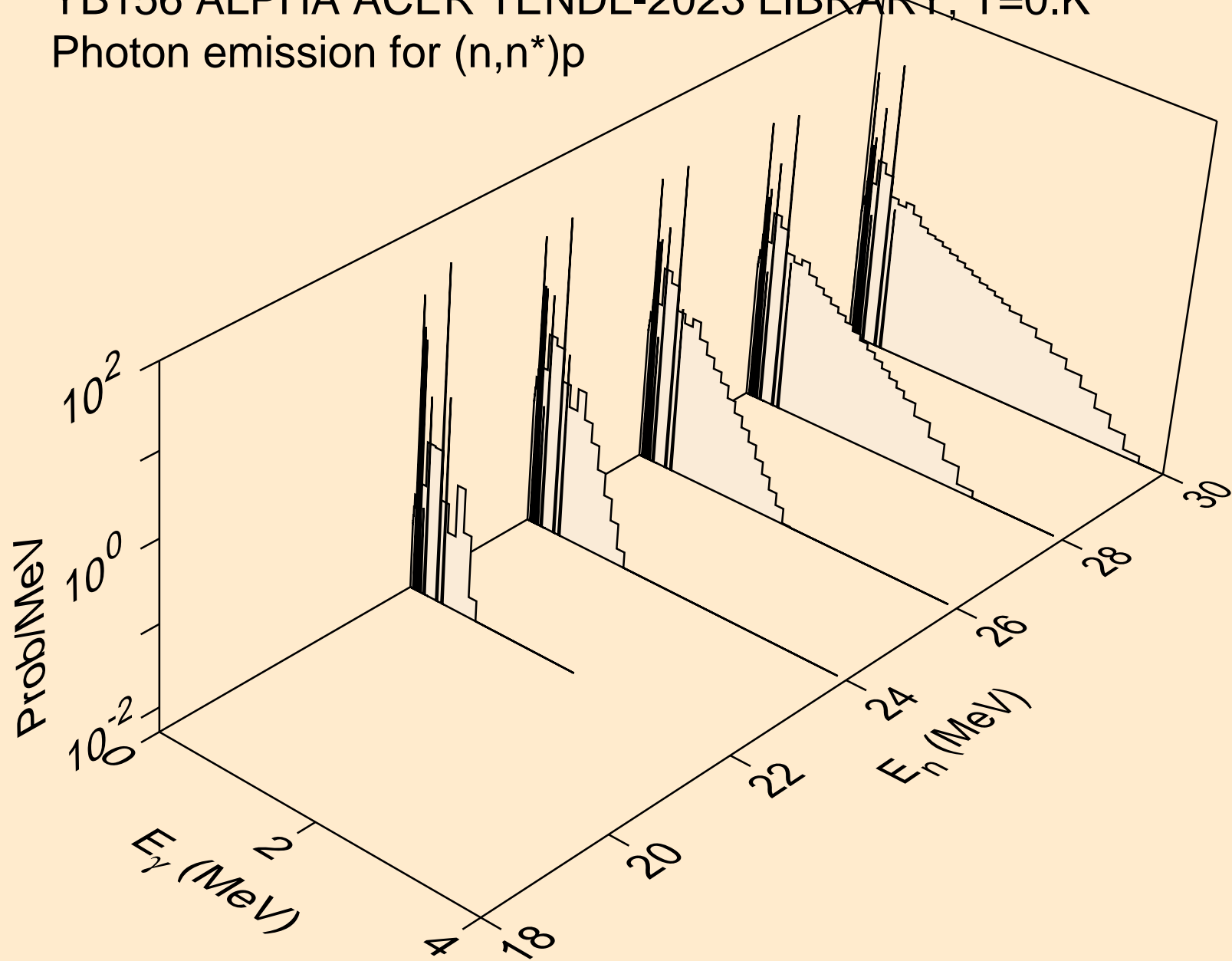

YB156 ALPHA ACER TENDL-2023 LIBRARY; T=0.K
Photon emission for (n,n*)2a

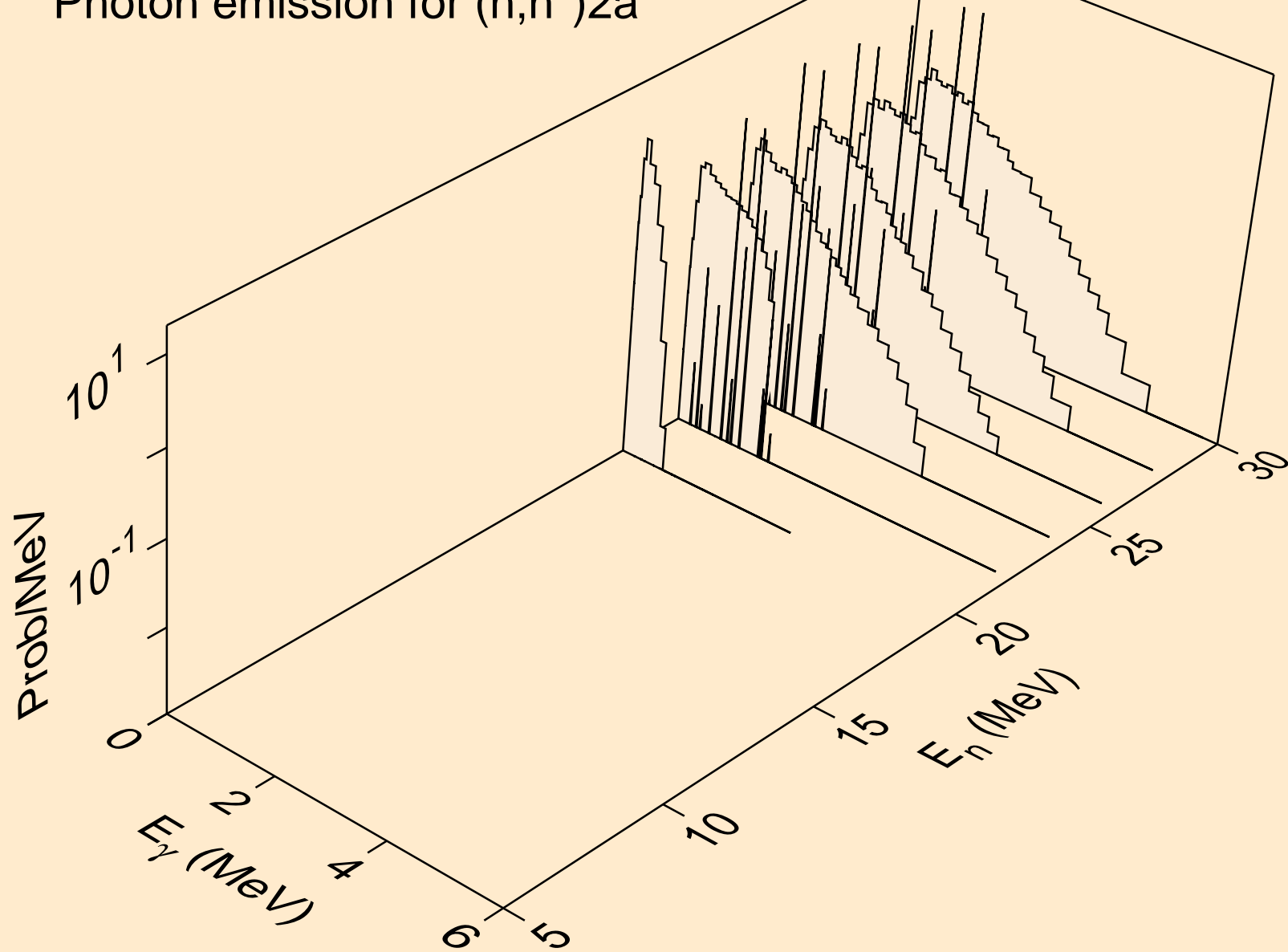

YB156 ALPHA ACER TENDL-2023 LIBRARY; T=0.K
Photon emission for (n,n2p)

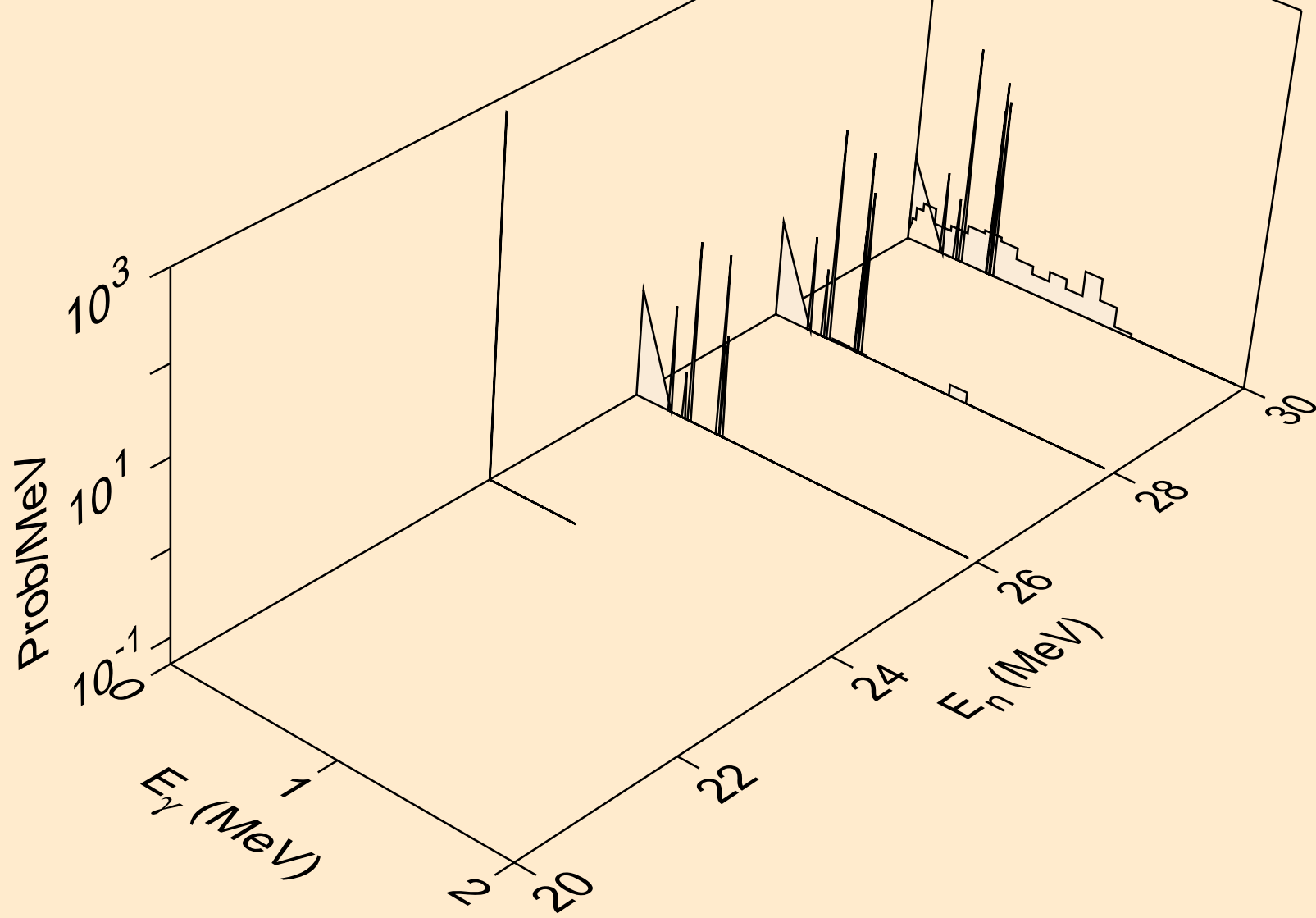

YB156 ALPHA ACER TENDL-2023 LIBRARY; T=0.K
Photon emission for (n,npa)

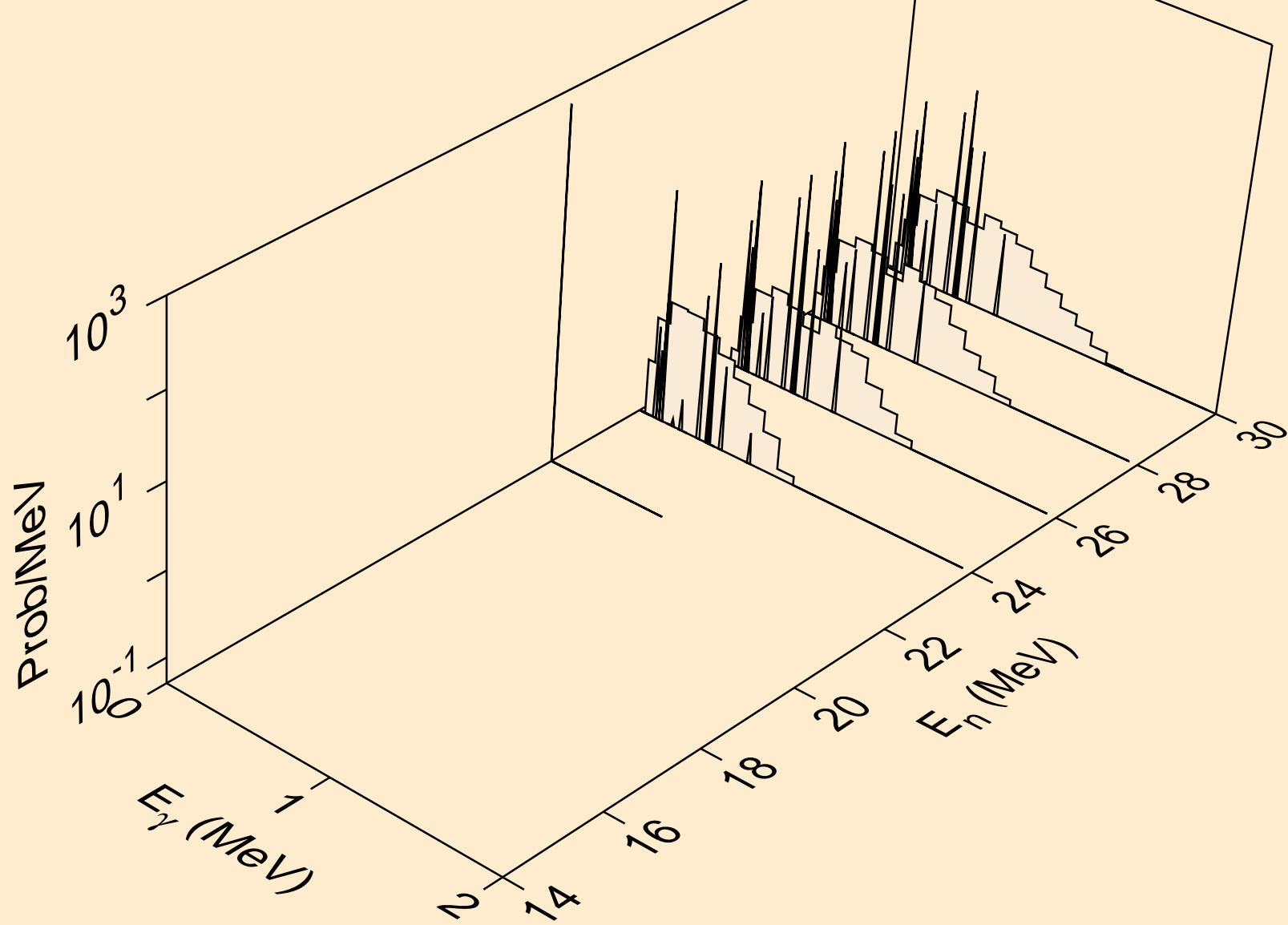

YB156 ALPHA ACER TENDL-2023 LIBRARY; T=0.K
Photon emission for (n,gma)

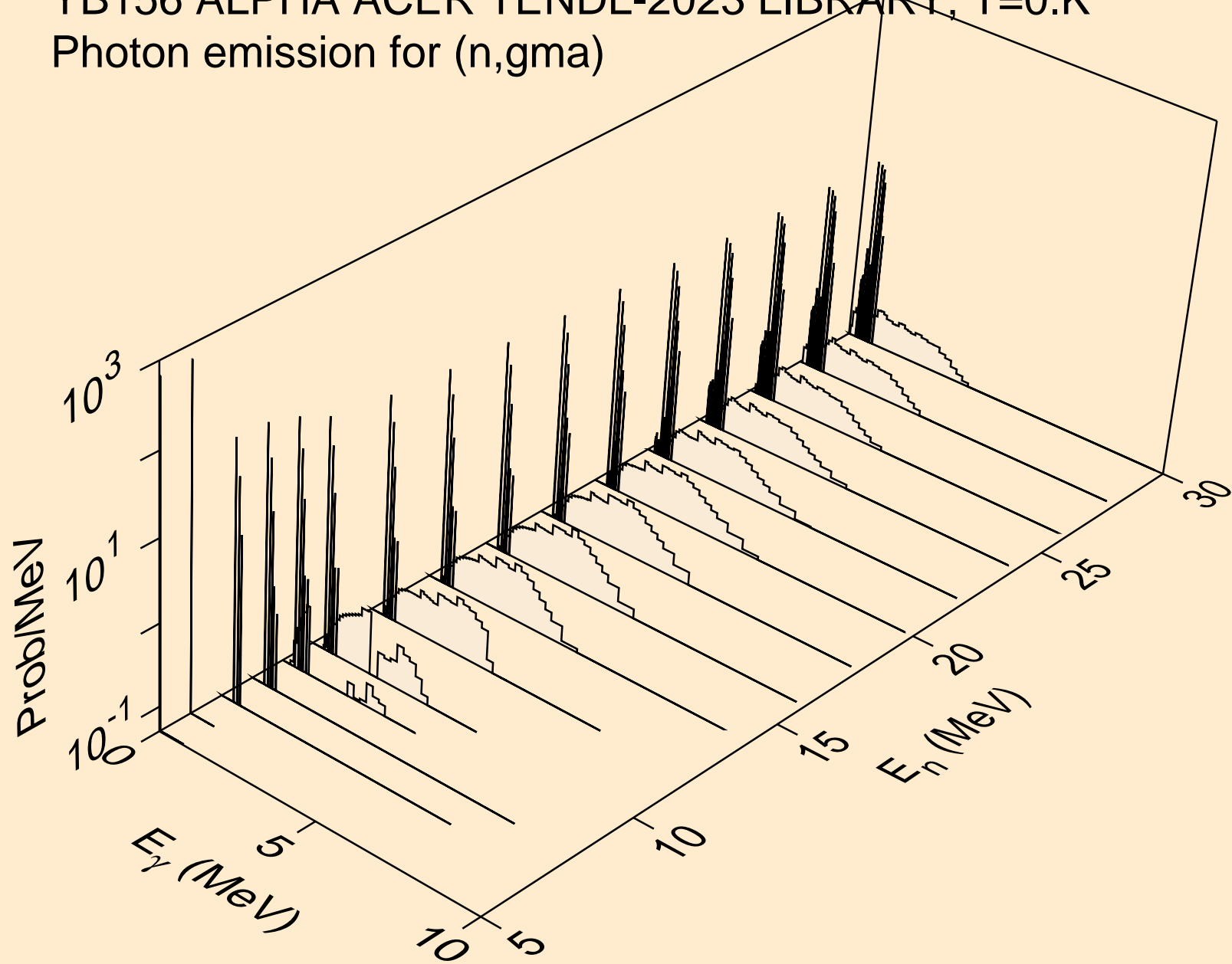

YB156 ALPHA ACER TENDL-2023 LIBRARY; T=0.K
Photon emission for (n,p)

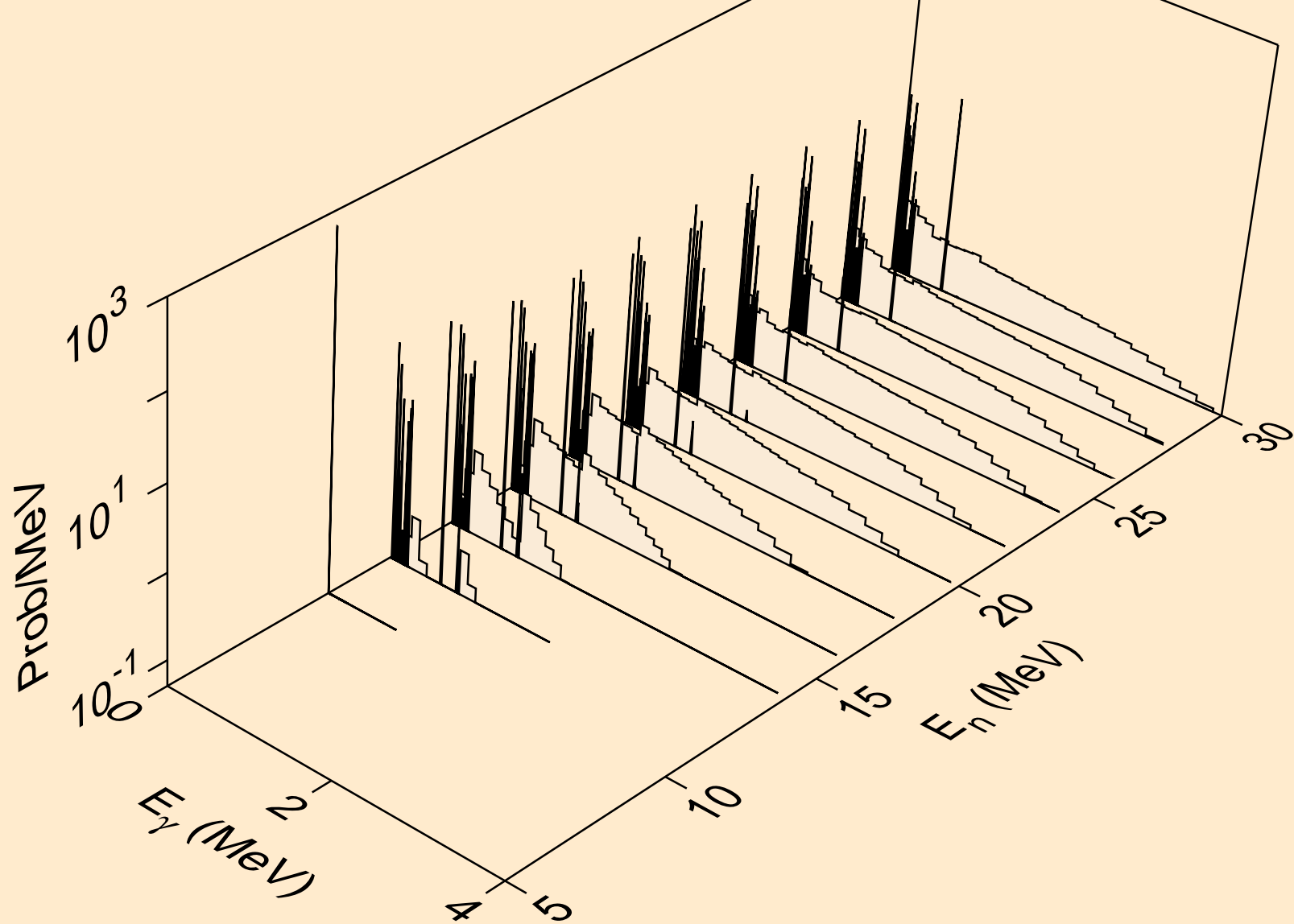

YB156 ALPHA ACER TENDL-2023 LIBRARY; T=0.K
Photon emission for (n,d)

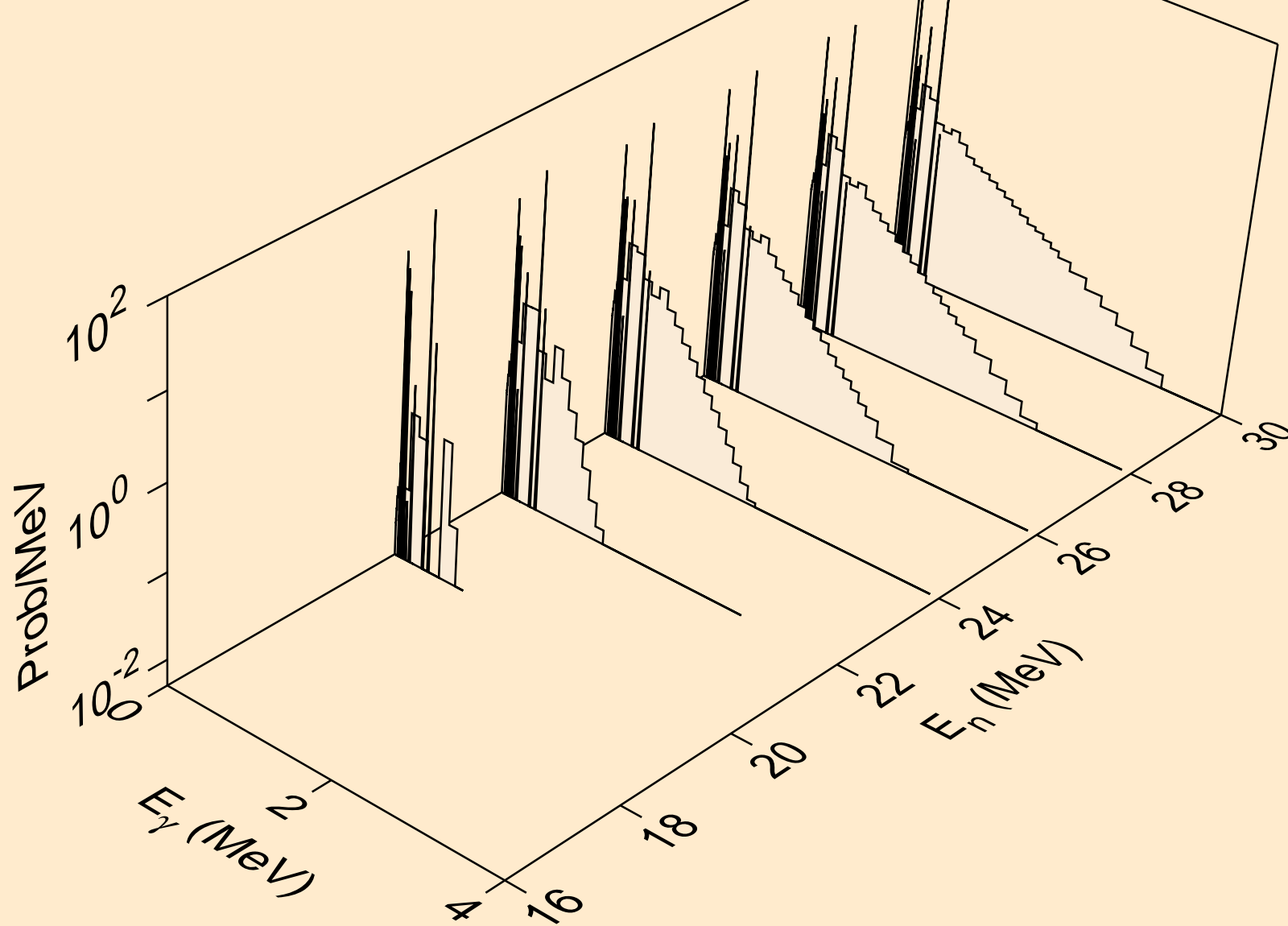

YB156 ALPHA ACER TENDL-2023 LIBRARY; T=0.K
Photon emission for (n,t)

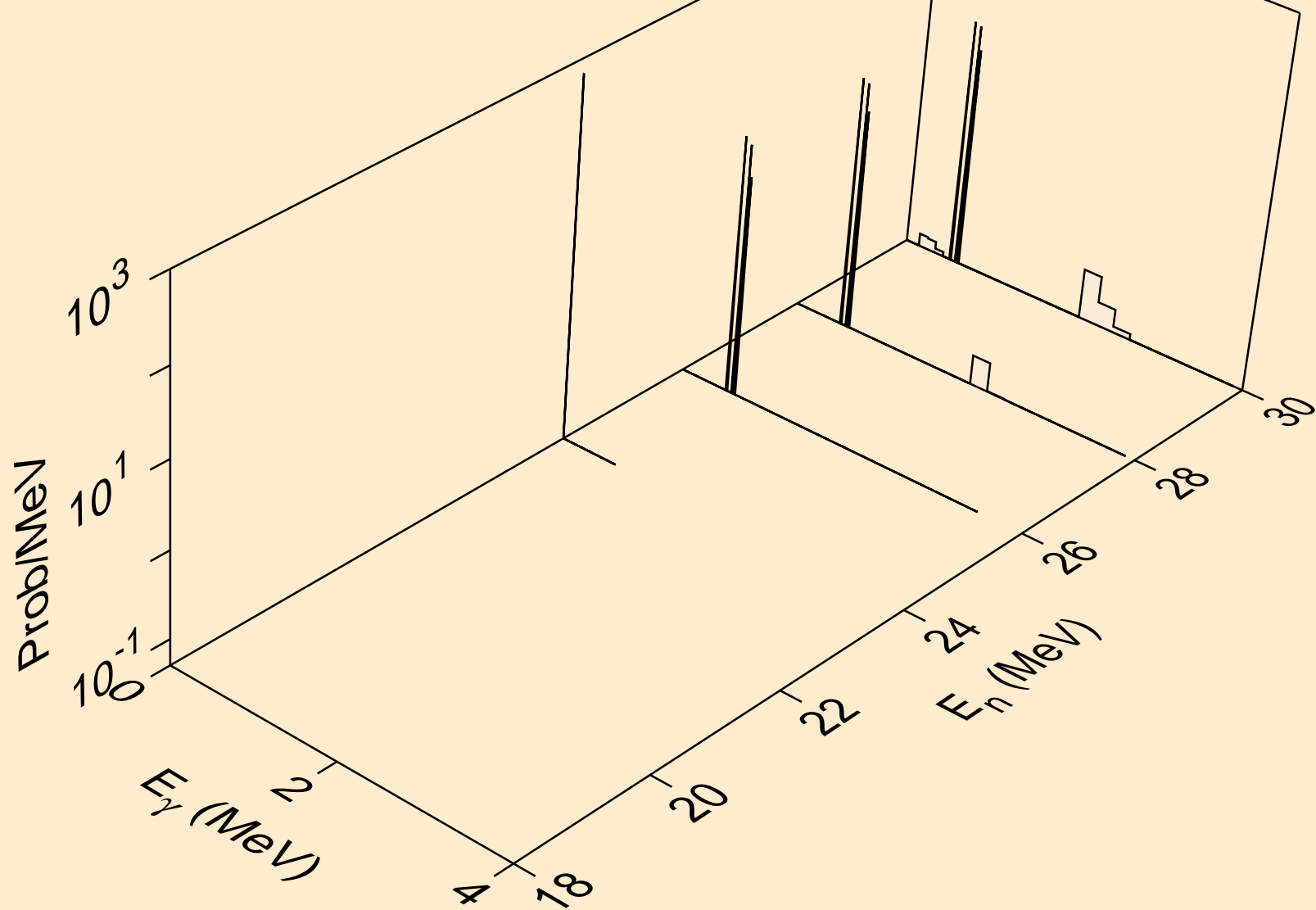

YB156 ALPHA ACER TENDL-2023 LIBRARY; T=0.K
Photon emission for (n,he3)

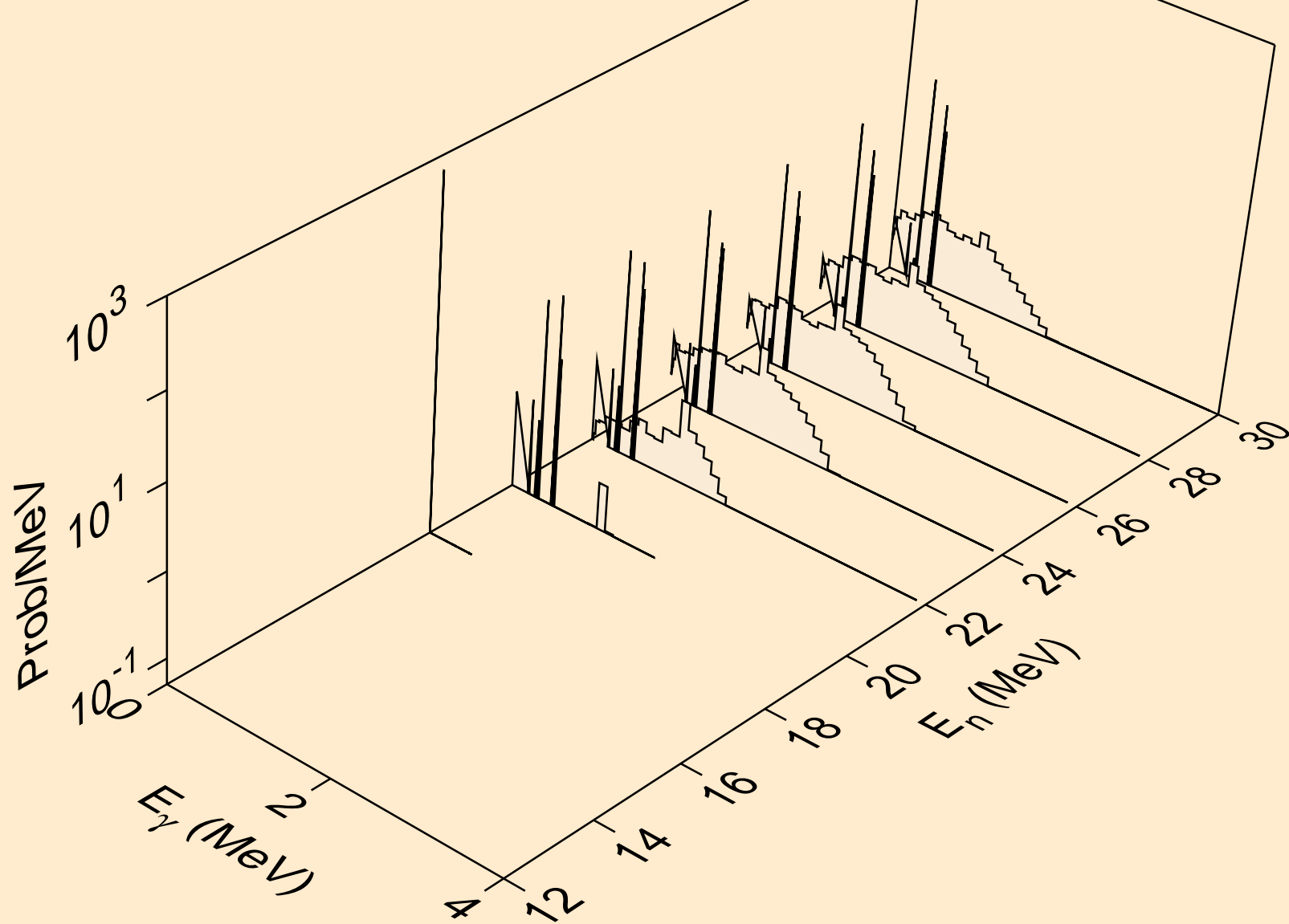

YB156 ALPHA ACER TENDL-2023 LIBRARY; T=0.K
Photon emission for inelastic

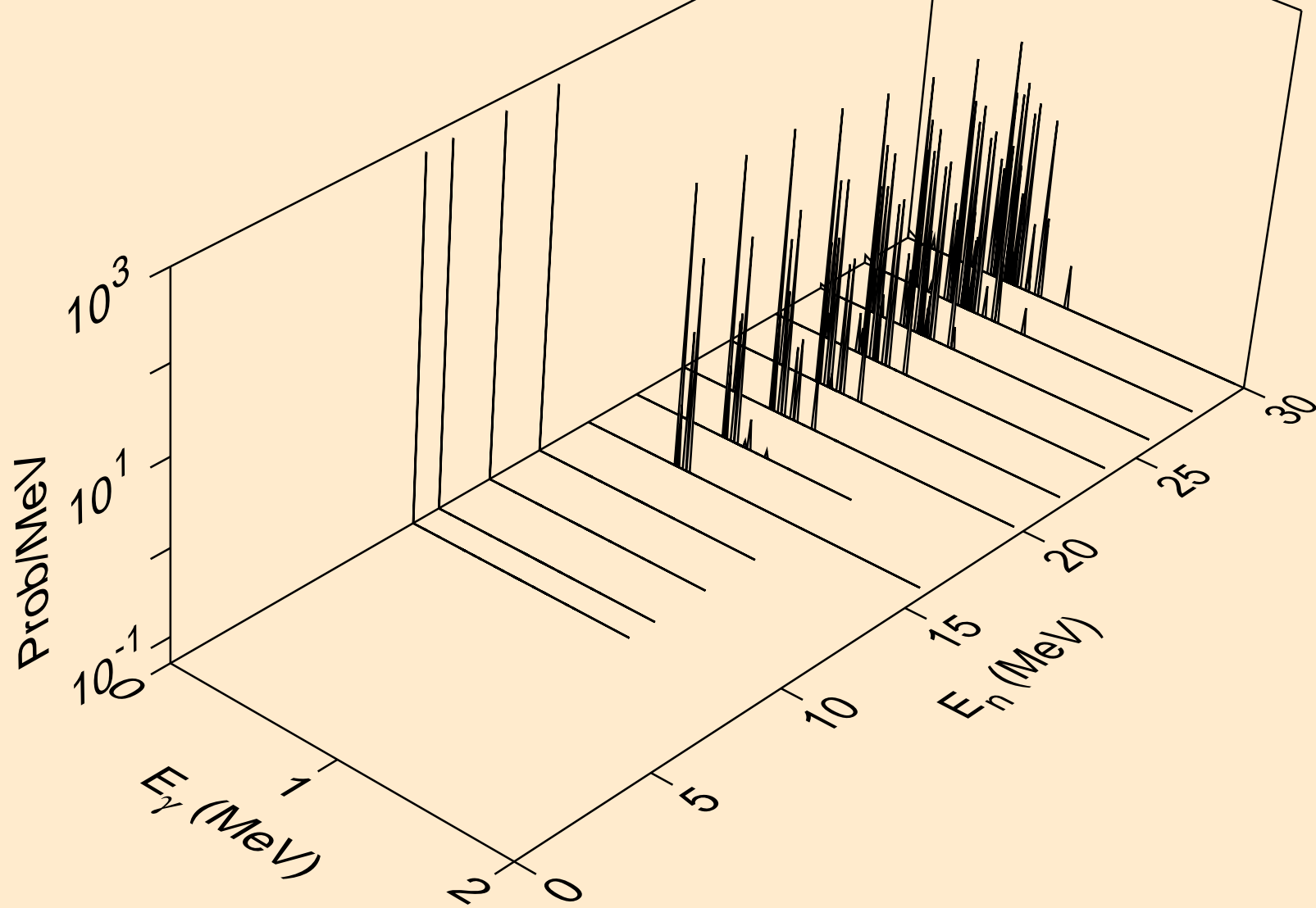

YB156 ALPHA ACER TENDL-2023 LIBRARY; T=0.K
Photon emission for (n,2a)

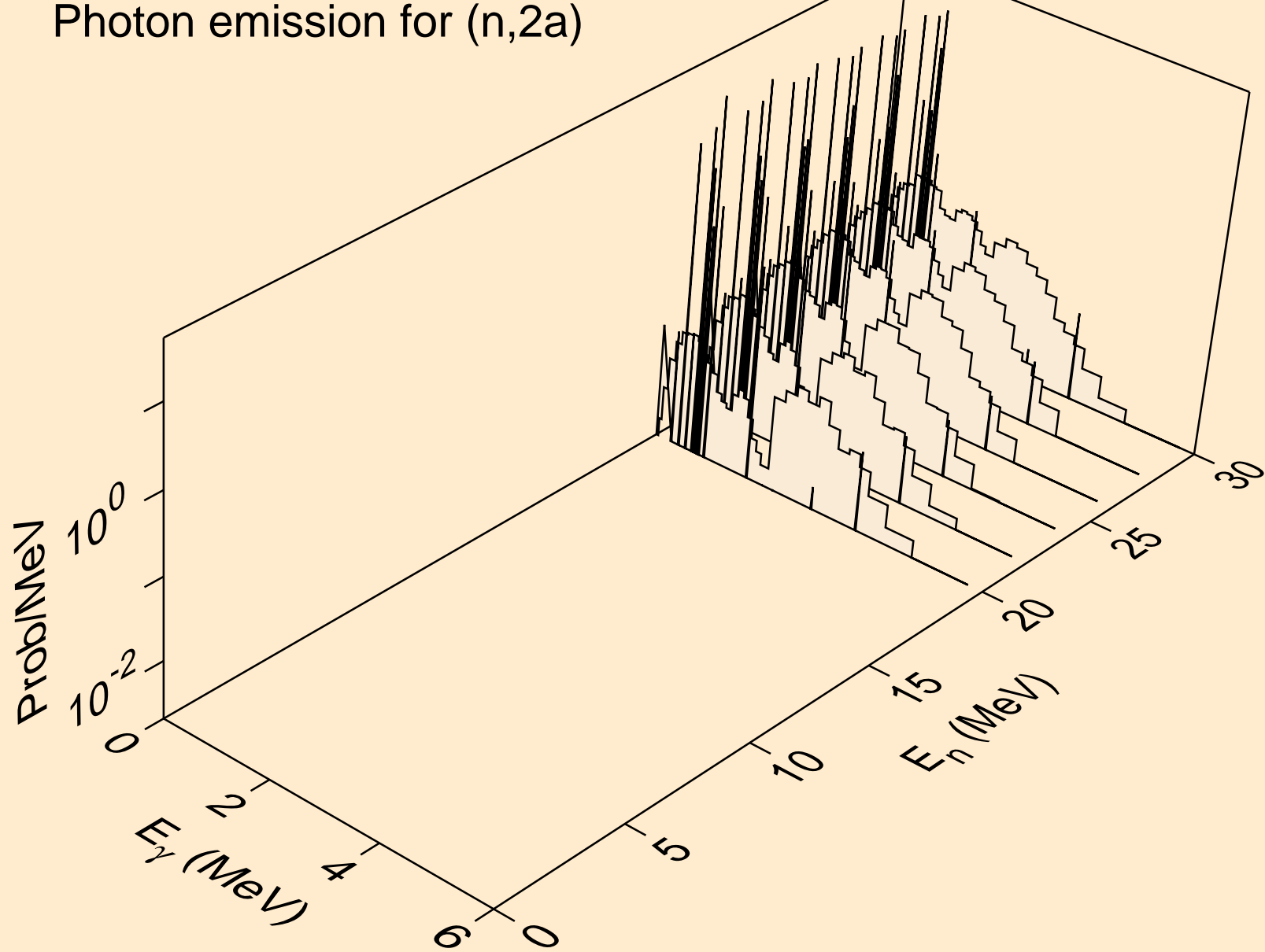

YB156 ALPHA ACER TENDL-2023 LIBRARY; T=0.K
Photon emission for (n,3a)

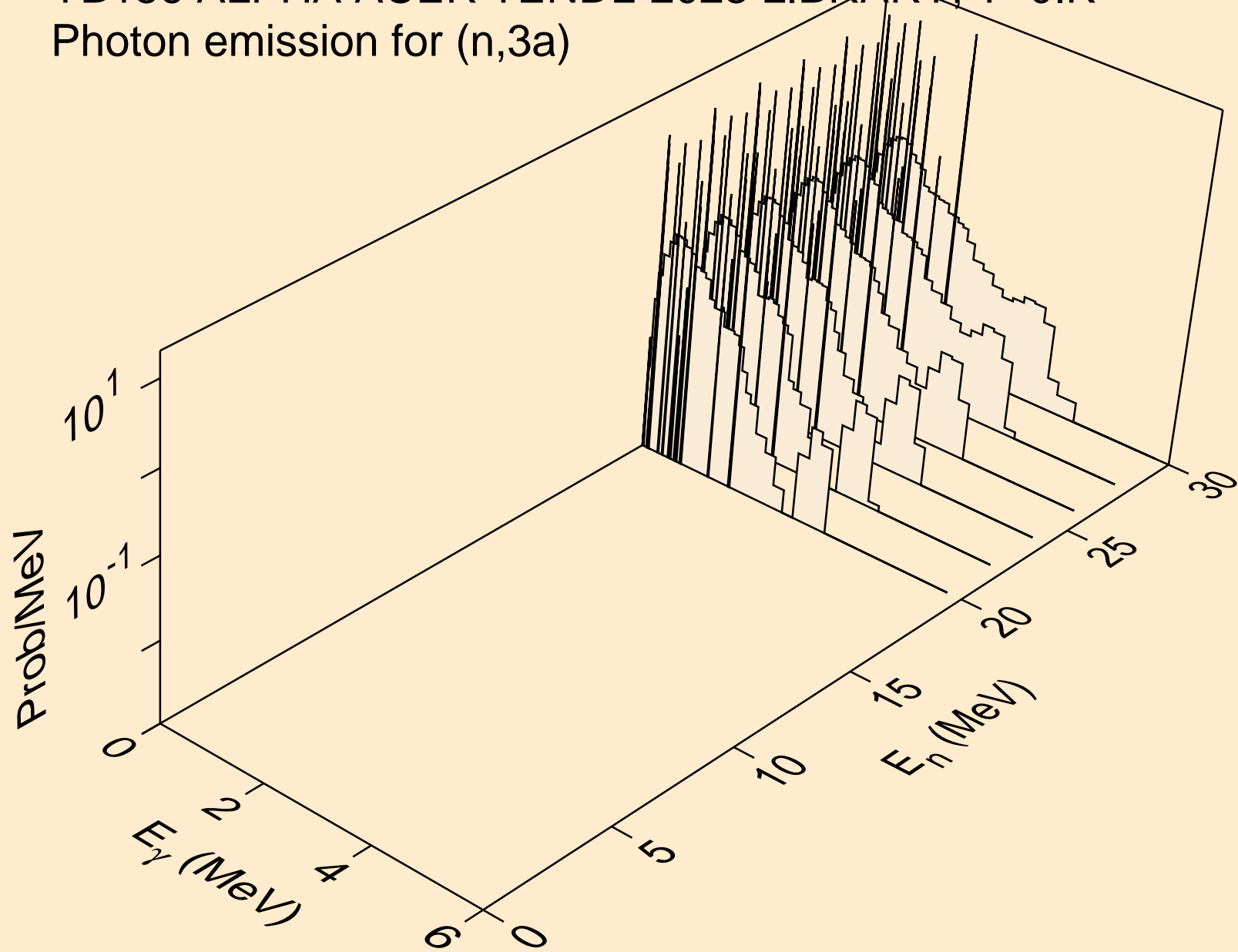

YB156 ALPHA ACER TENDL-2023 LIBRARY; T=0.K
Photon emission for (n,2p)

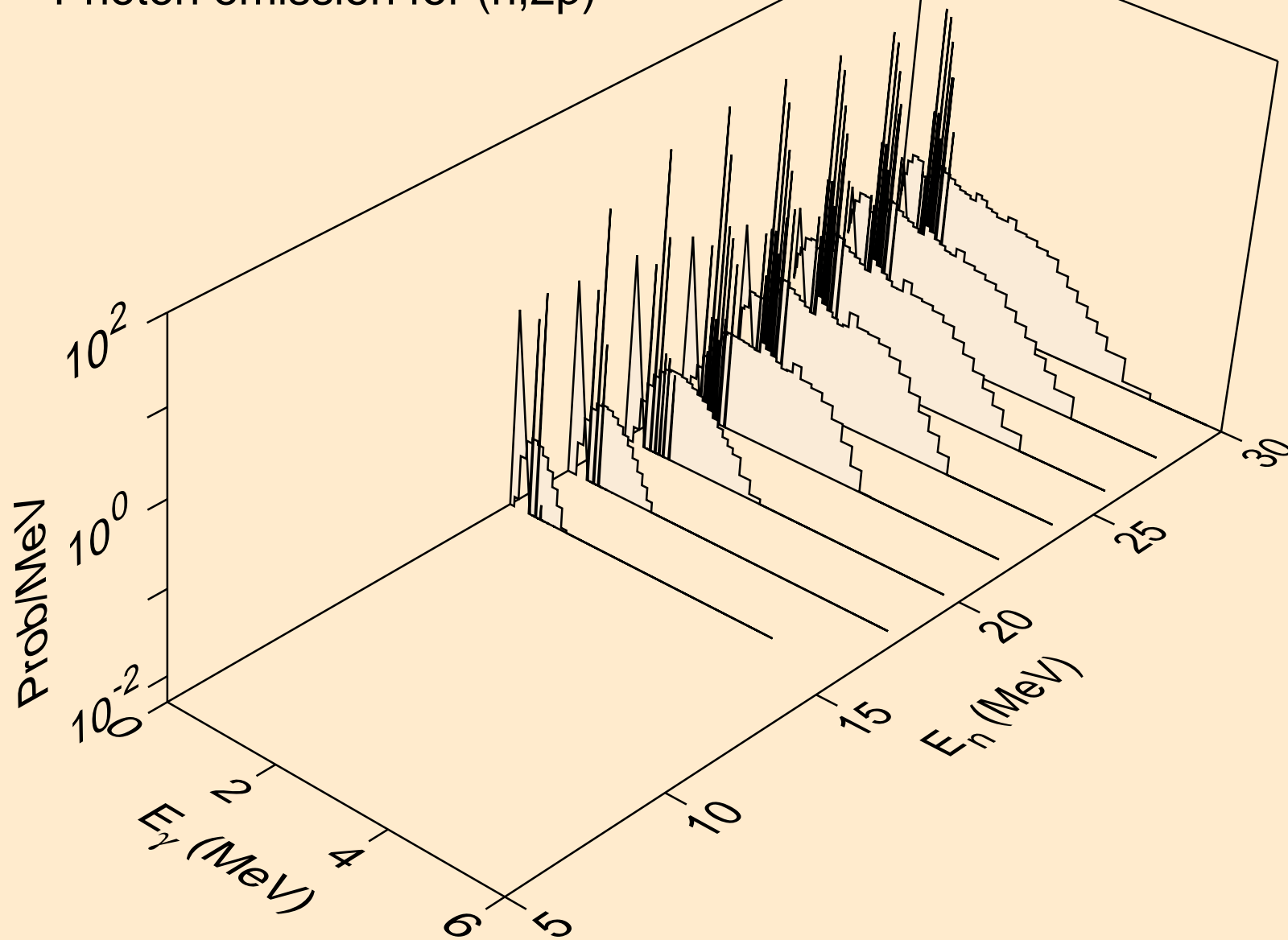

YB156 ALPHA ACER TENDL-2023 LIBRARY; T=0.K
Photon emission for (n,pa)

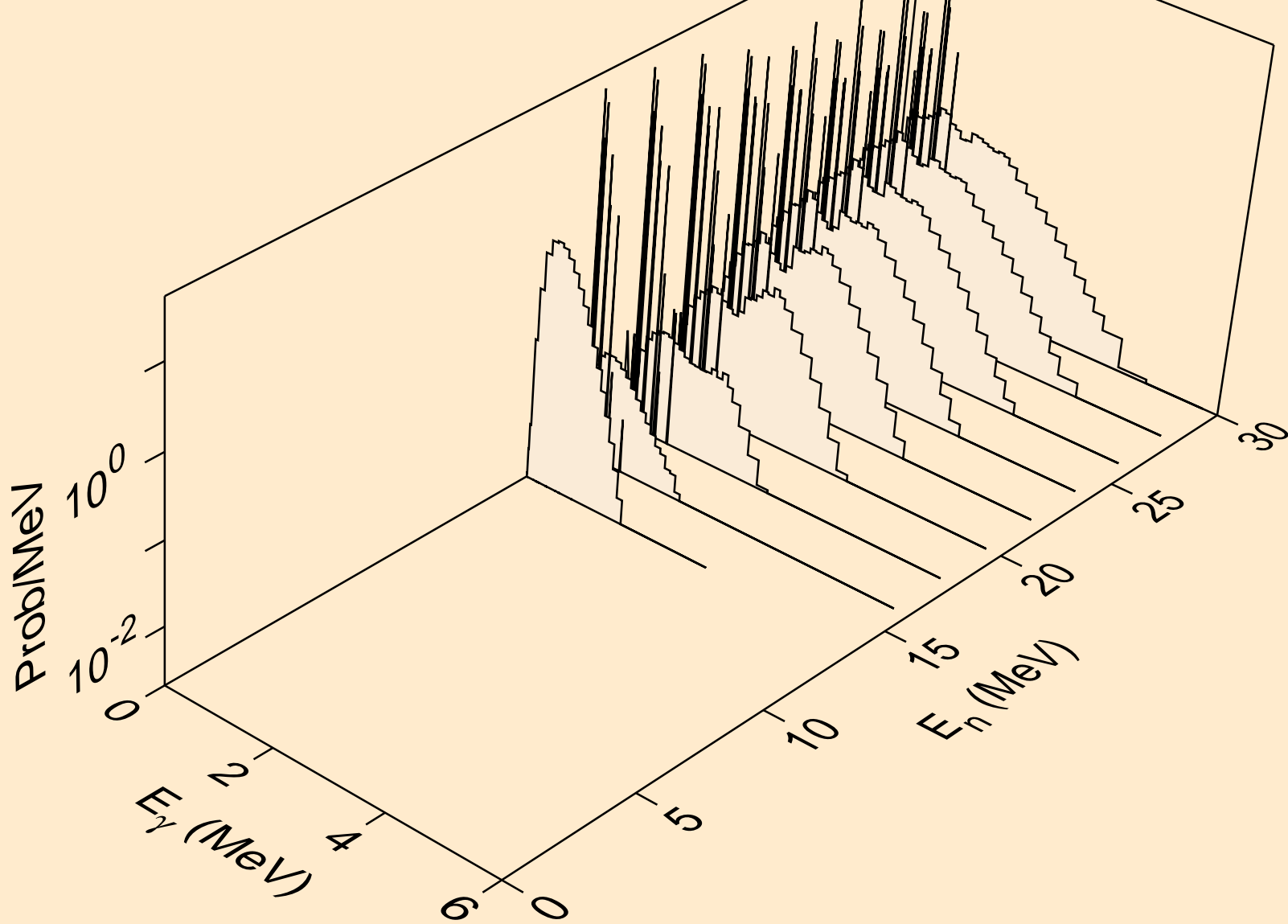

YB156 ALPHA ACER TENDL-2023 LIBRARY; T=0.K
Photon emission for (n,pd)

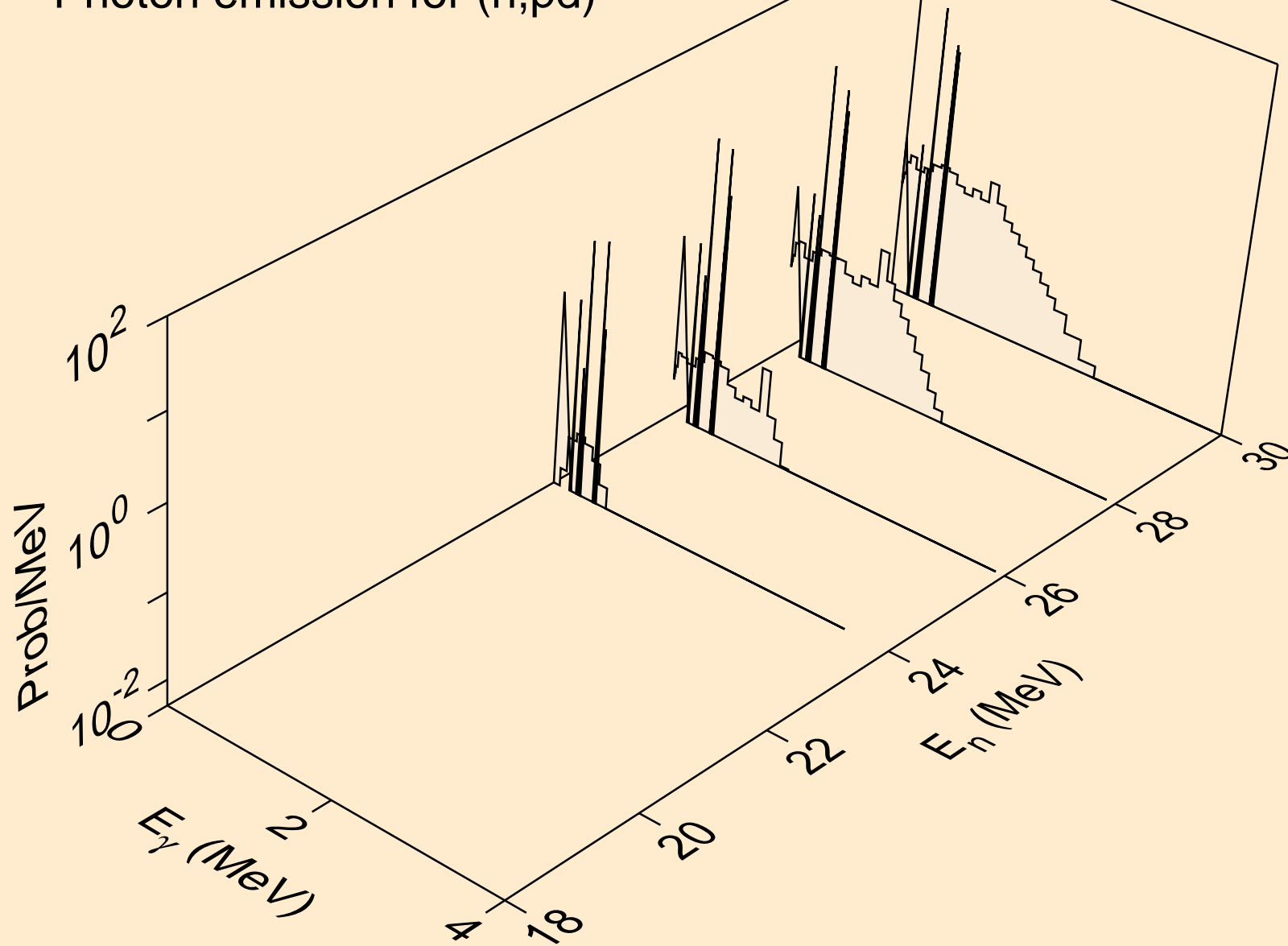

YB156 ALPHA ACER TENDL-2023 LIBRARY; T=0.K
Particle heating contributions

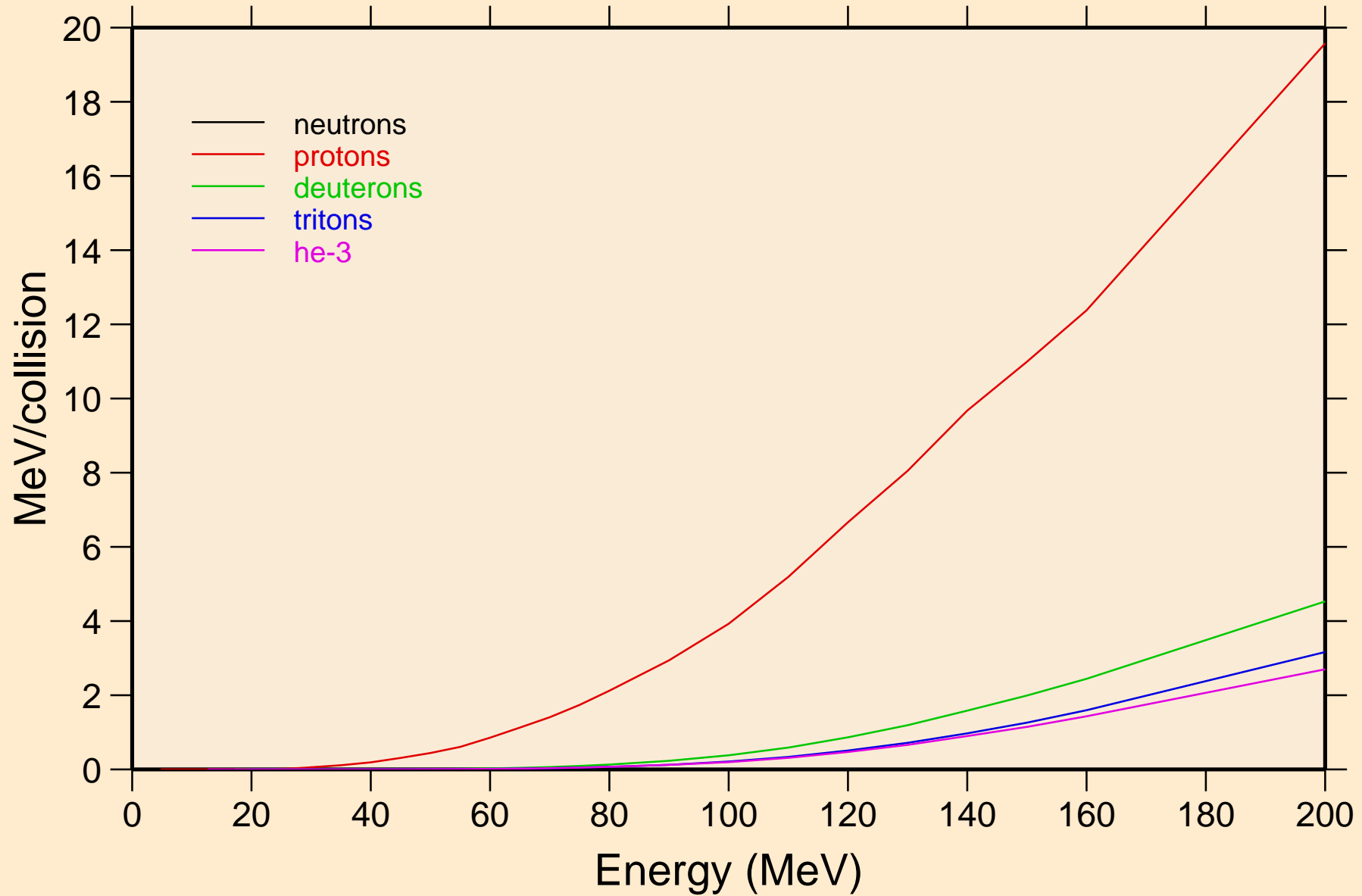

YB156 ALPHA ACER TENDL-2023 LIBRARY; T=0.K
Recoil Heating

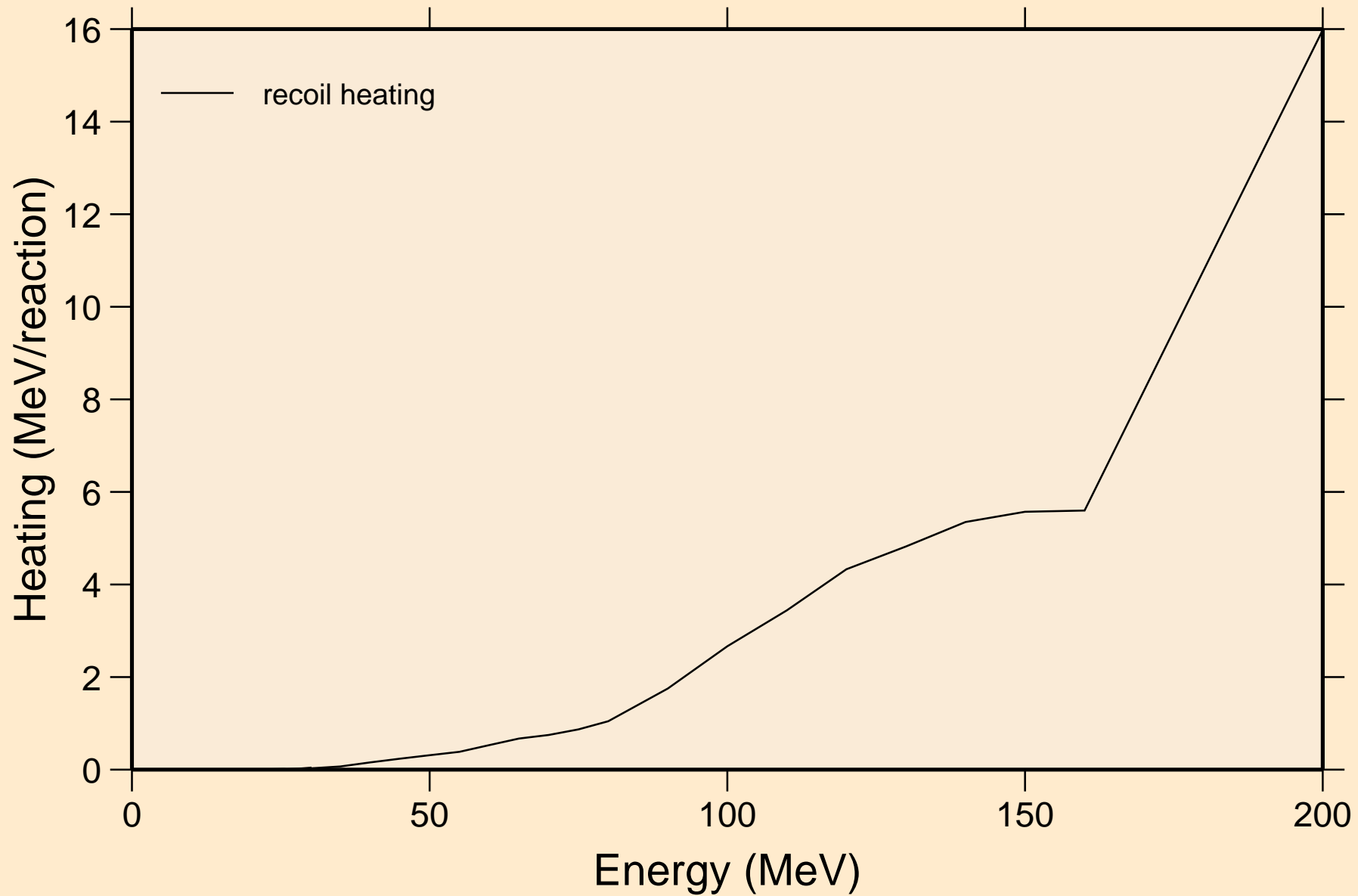

YB156 ALPHA ACER TENDL-2023 LIBRARY; T=0.K
Particle production cross sections

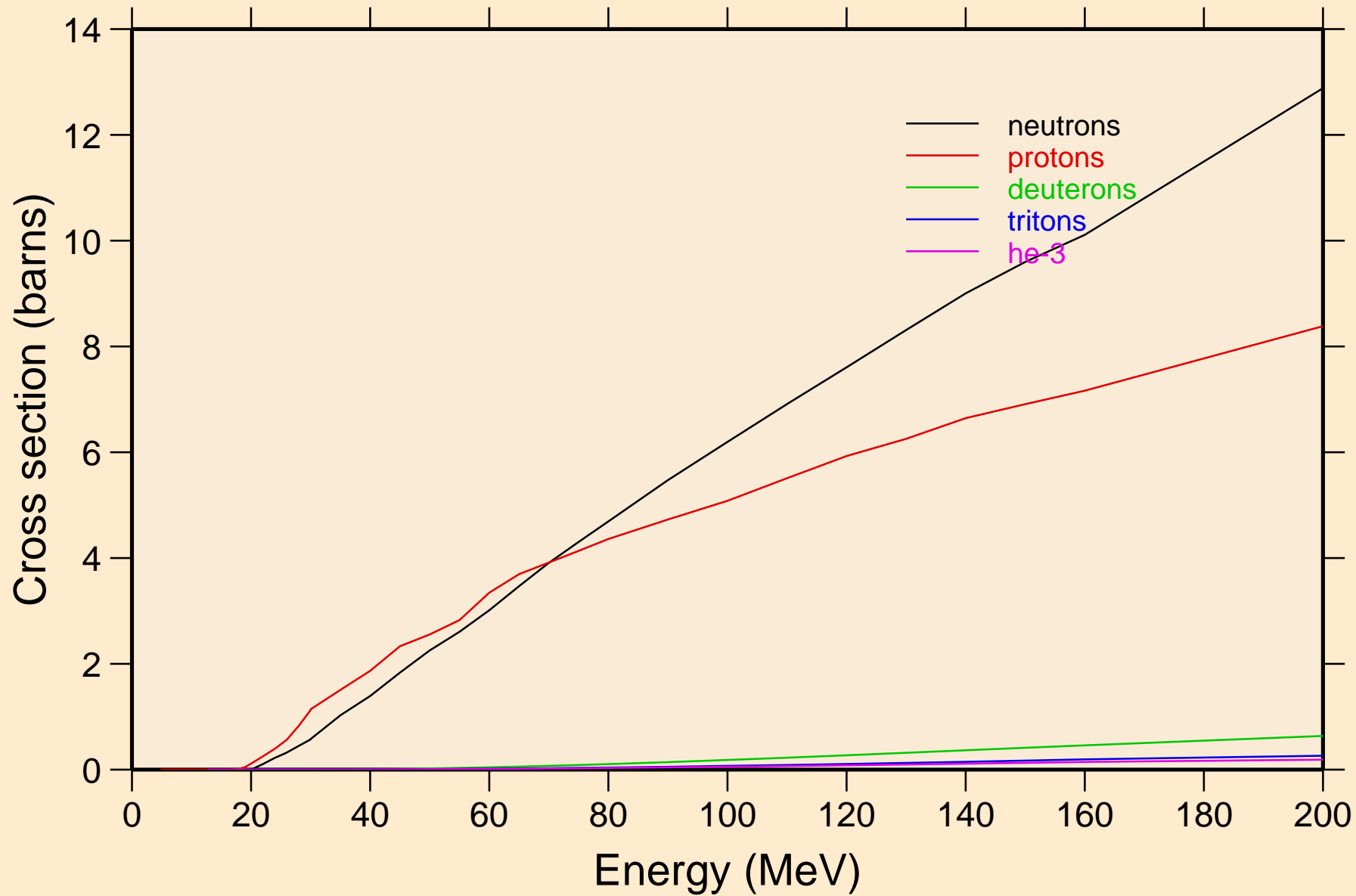

YB156 ALPHA ACER TENDL-2023 LIBRARY; T=0.K
neutrons from (a,n)

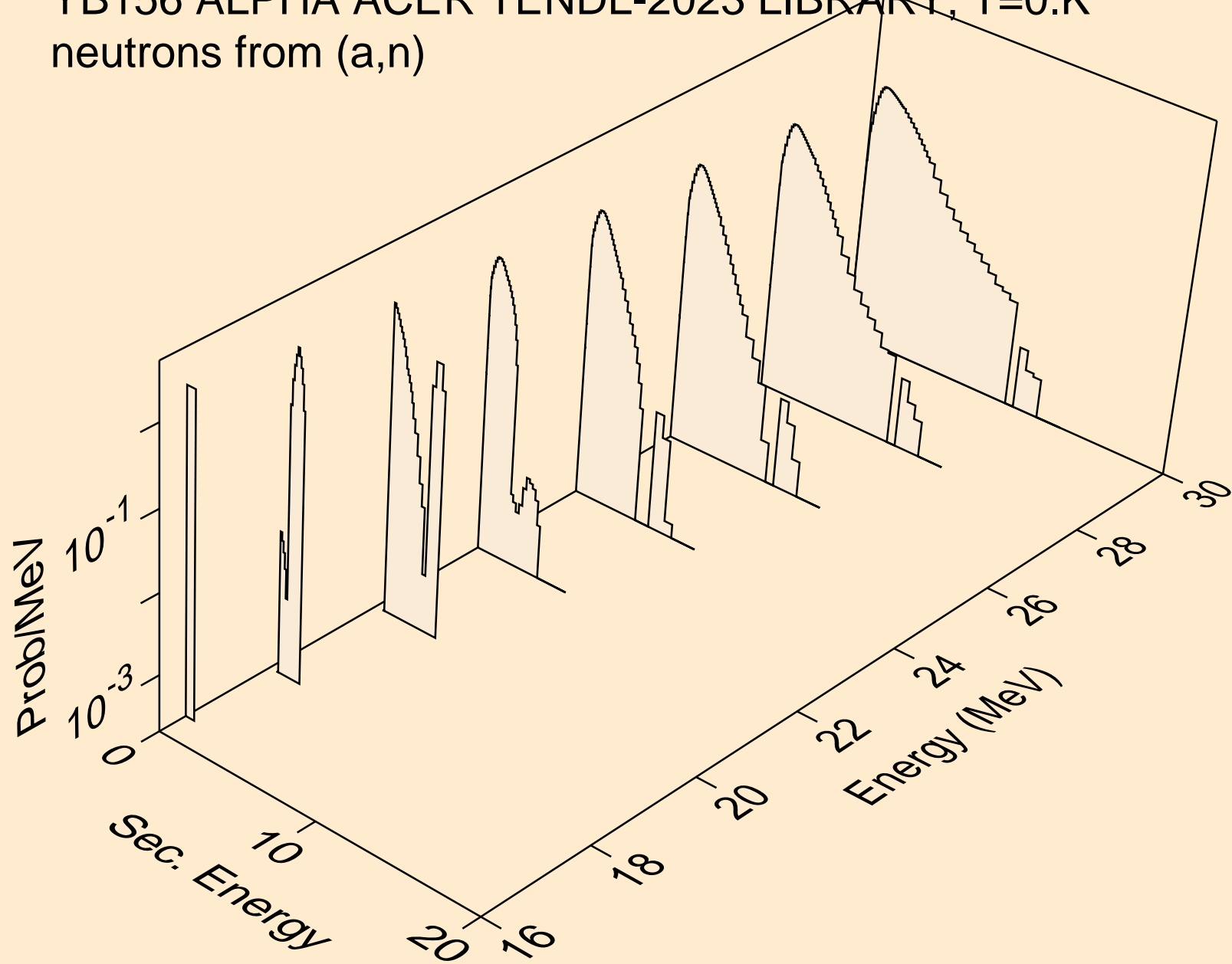

YB156 ALPHA ACER TENDL-2023 LIBRARY; T=0.K
neutrons from (a,x)

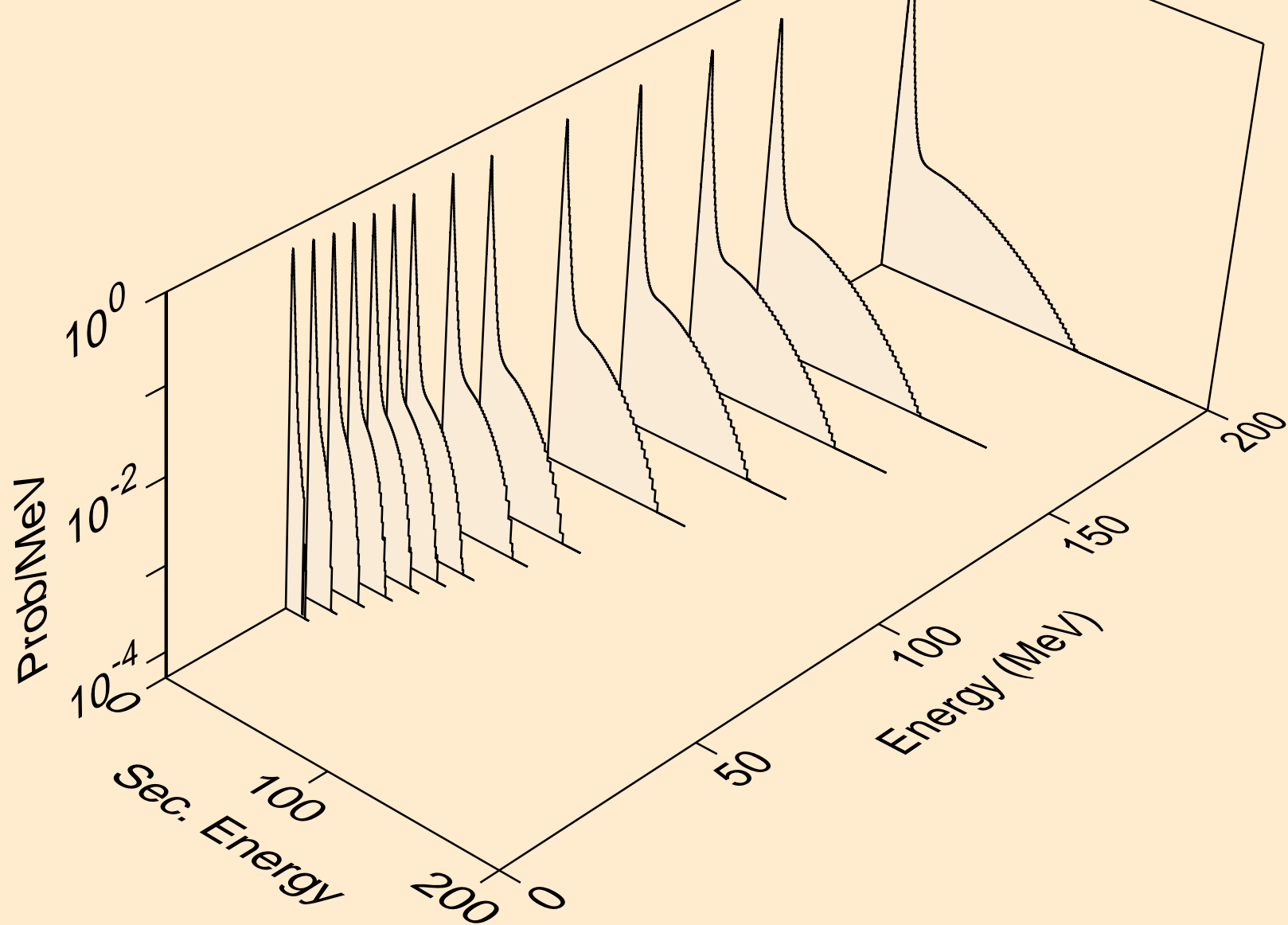

YB156 ALPHA ACER TENDL-2023 LIBRARY; T=0.K
neutrons from (a,2n)

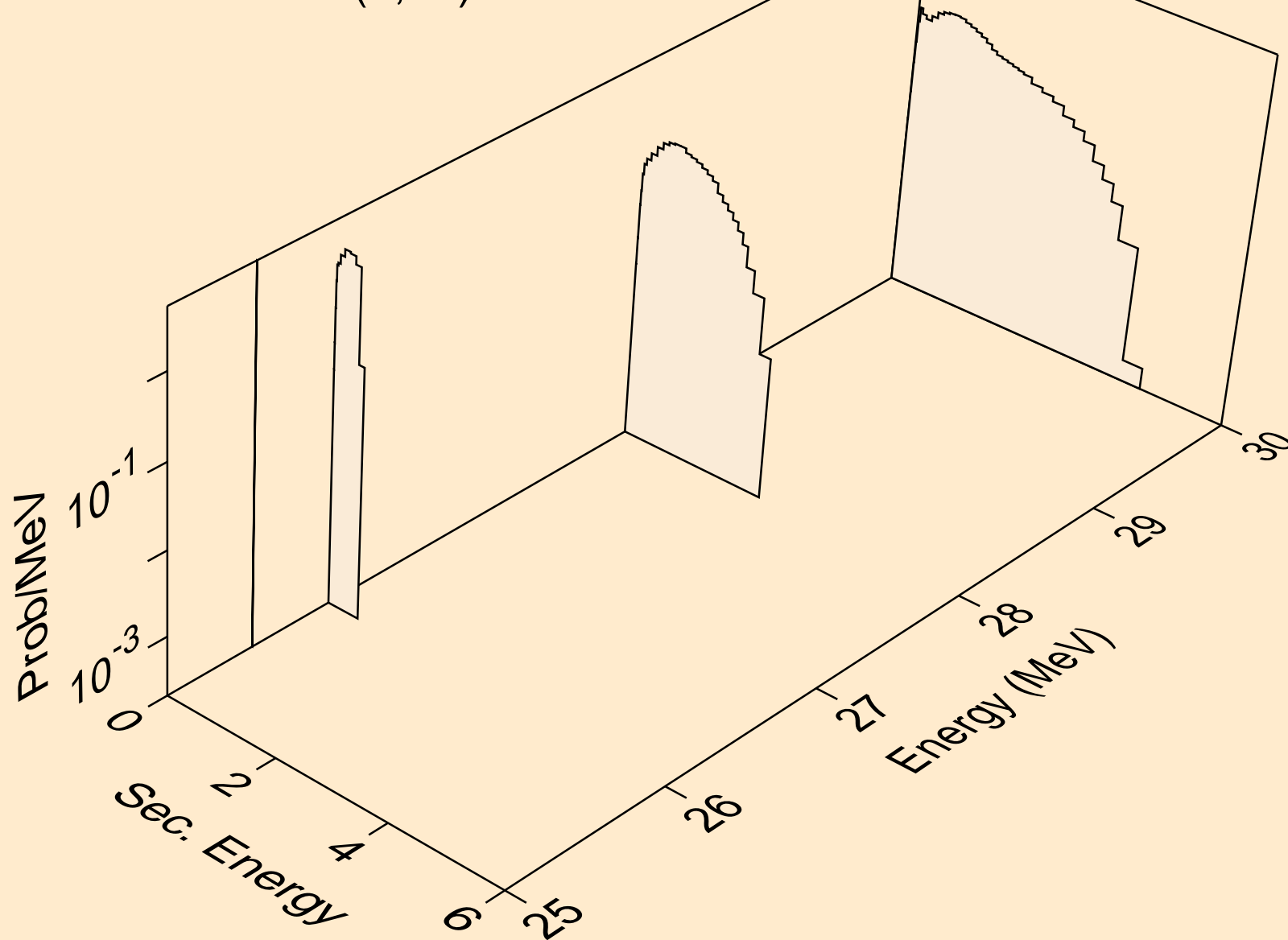

YB156 ALPHA ACER TENDL-2023 LIBRARY; T=0.K
neutrons from (a,n*)a

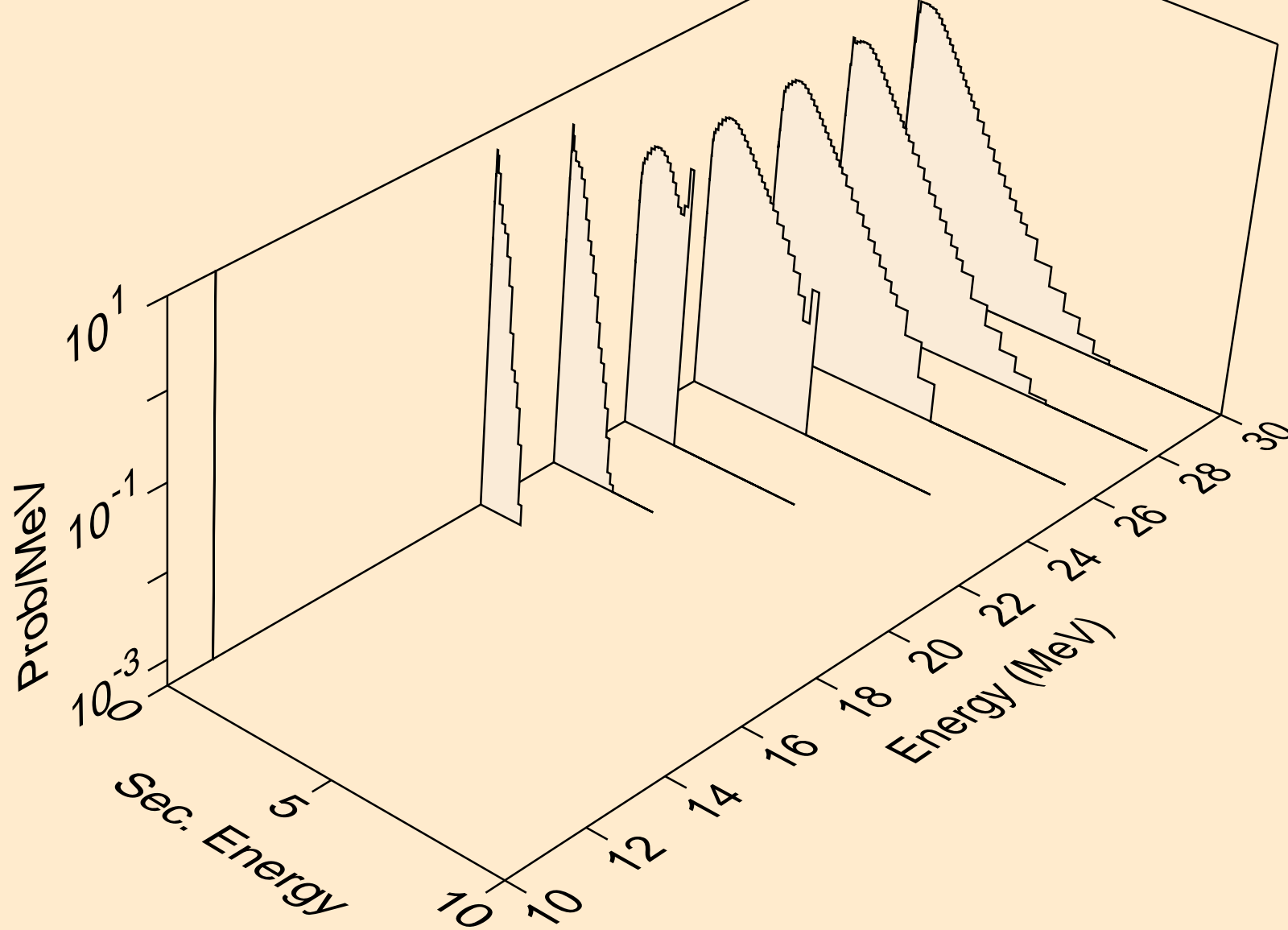

YB156 ALPHA ACER TENDL-2023 LIBRARY; T=0.K
neutrons from (a,2n)a

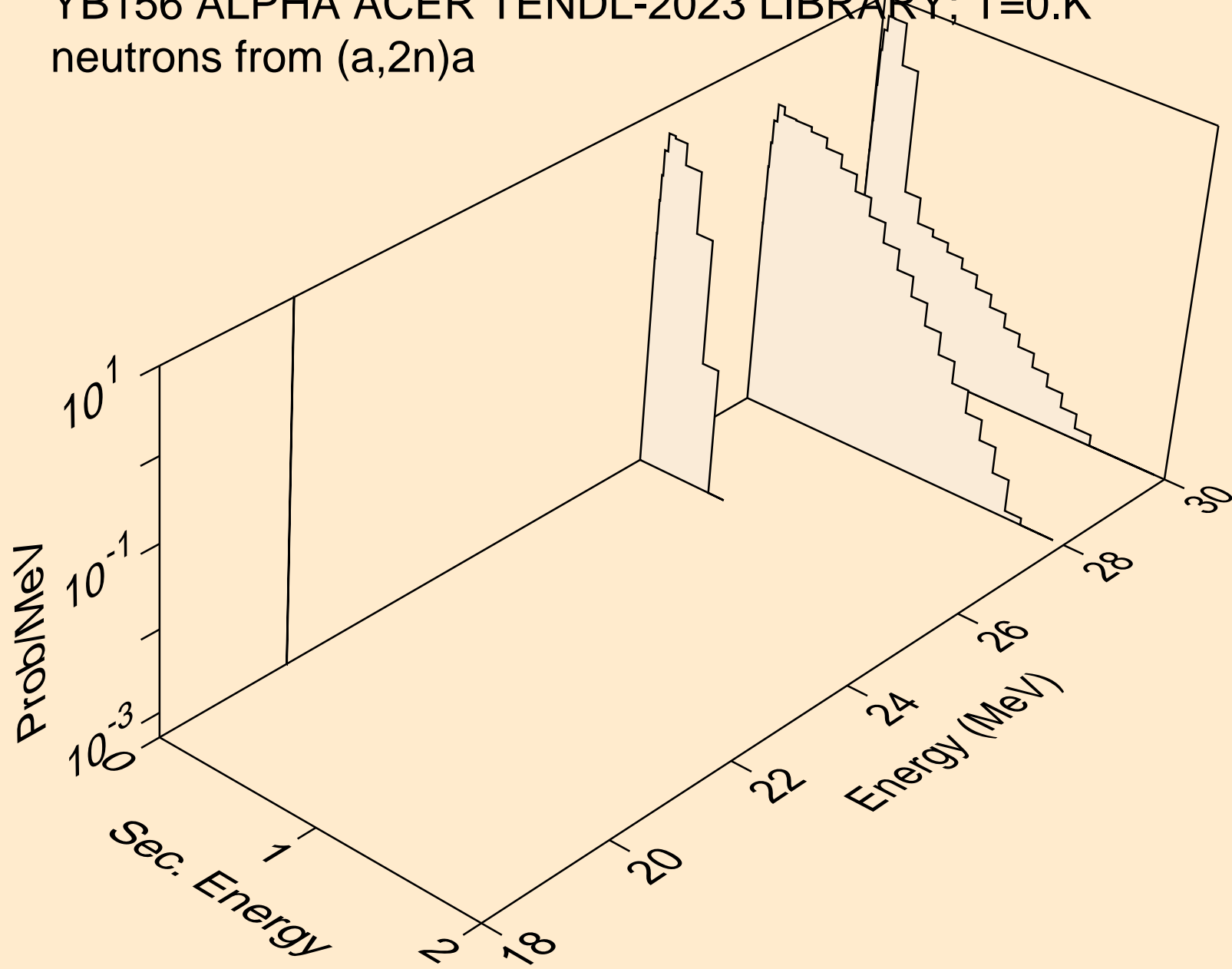

YB156 ALPHA ACER TENDL-2023 LIBRARY; T=0.K
neutrons from (a,n*)p

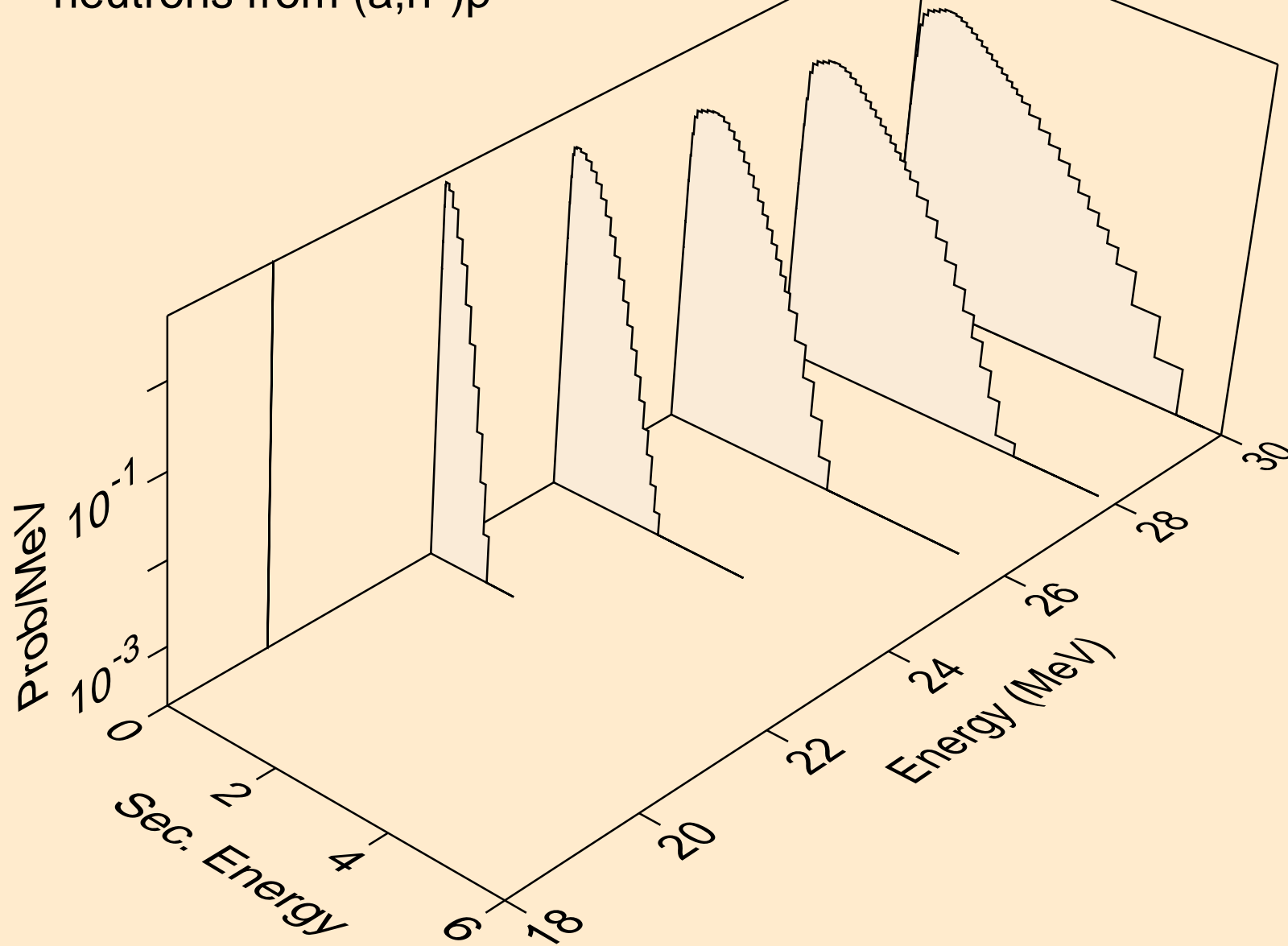

YB156 ALPHA ACER TENDL-2023 LIBRARY; T=0.K
neutrons from (a,n*)2a

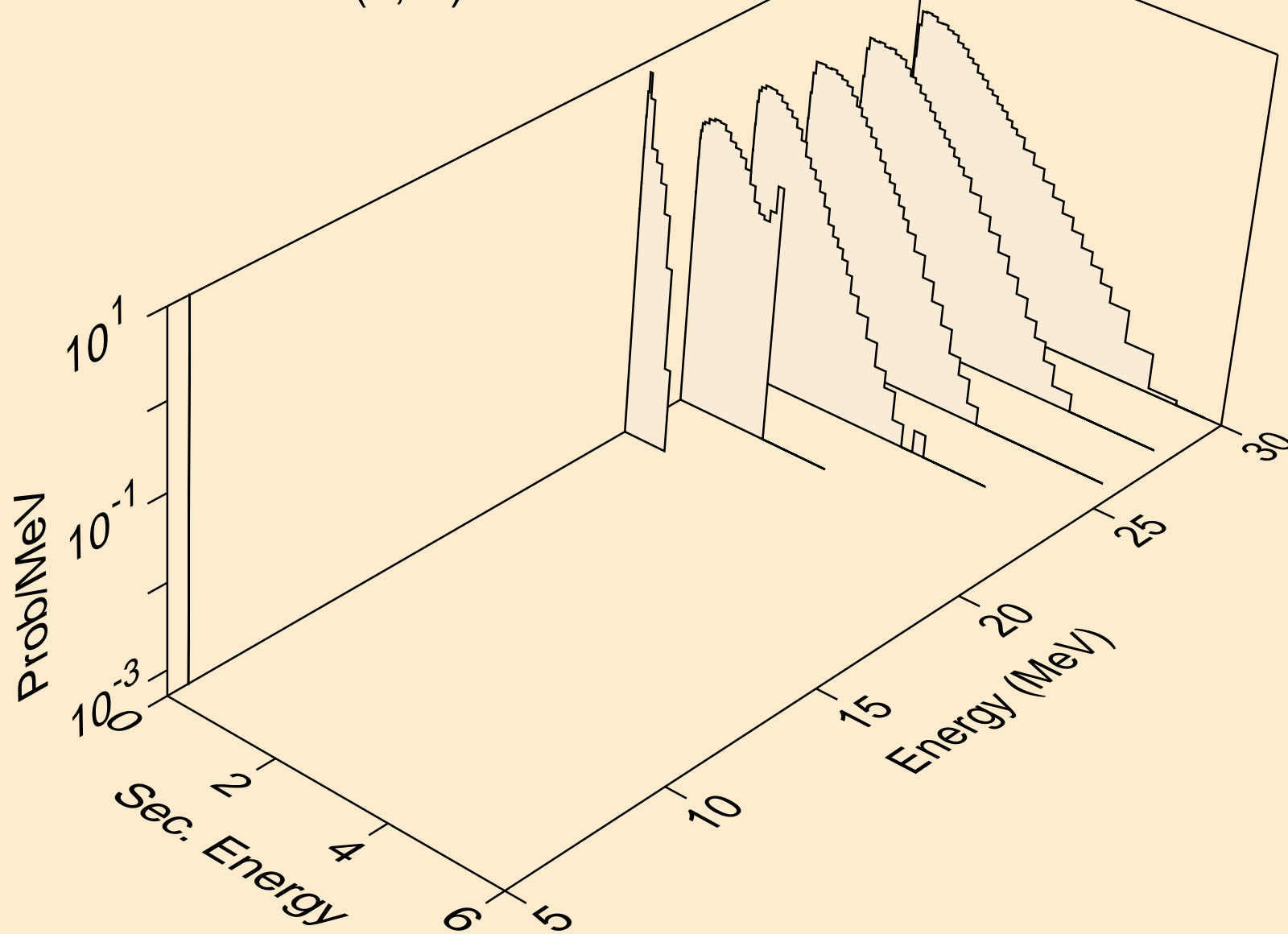

YB156 ALPHA ACER TENDL-2023 LIBRARY; T=0.K
neutrons from (a,n2p)

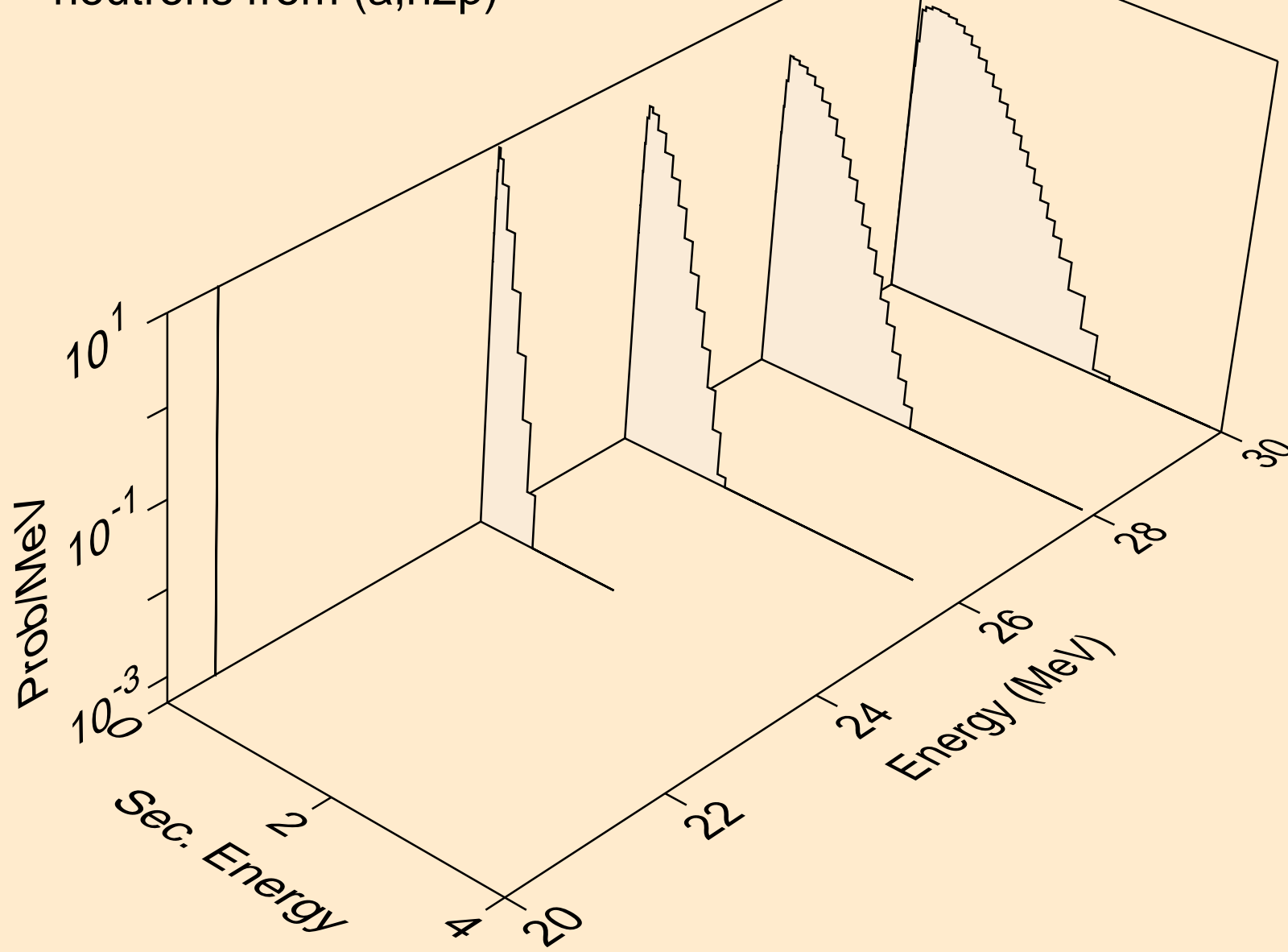

YB156 ALPHA ACER TENDL-2023 LIBRARY; T=0.K
neutrons from (a,npa)

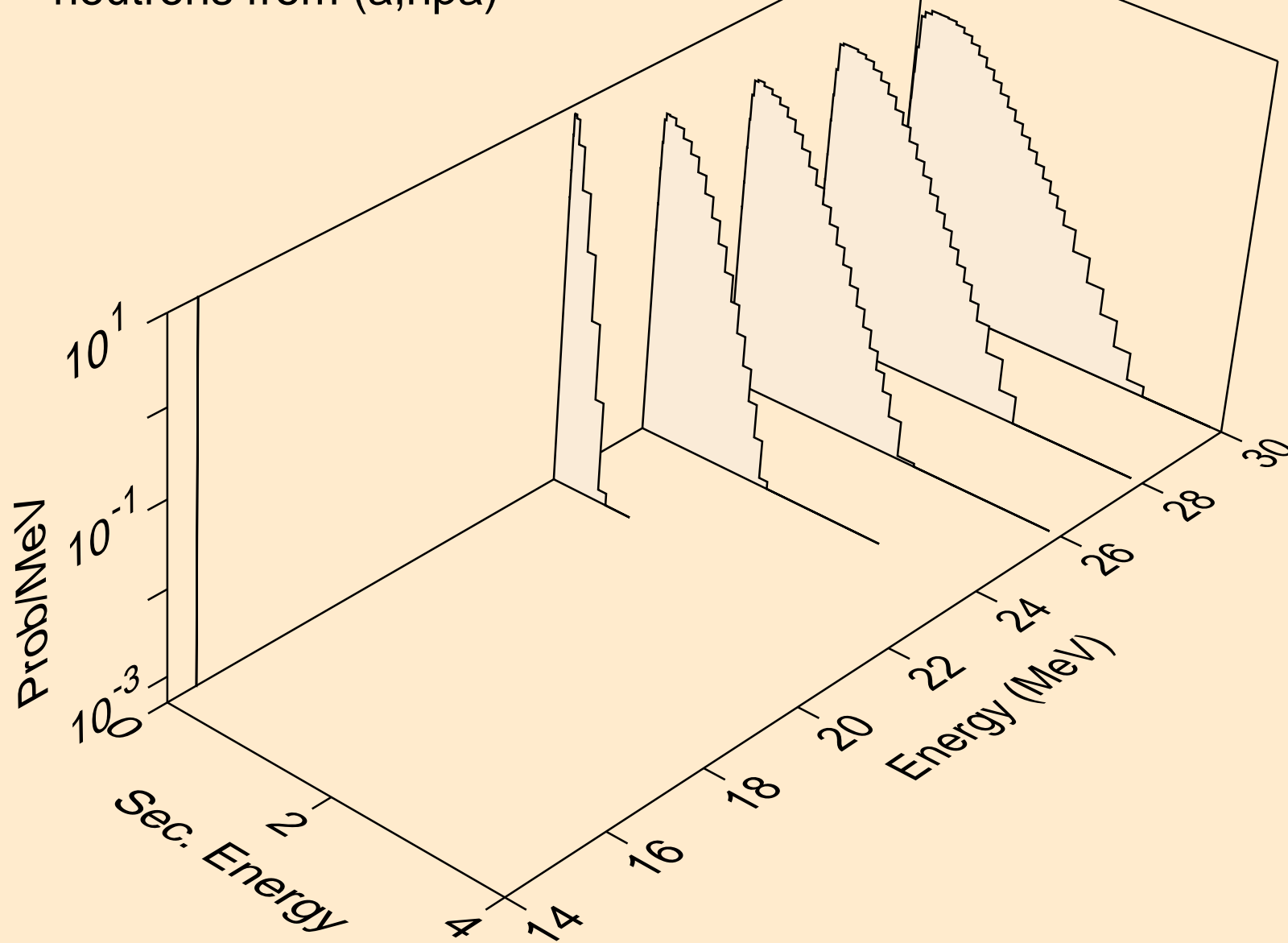

YB156 ALPHA ACER TENDL-2023 LIBRARY; T=0.K
protons from (a,x)

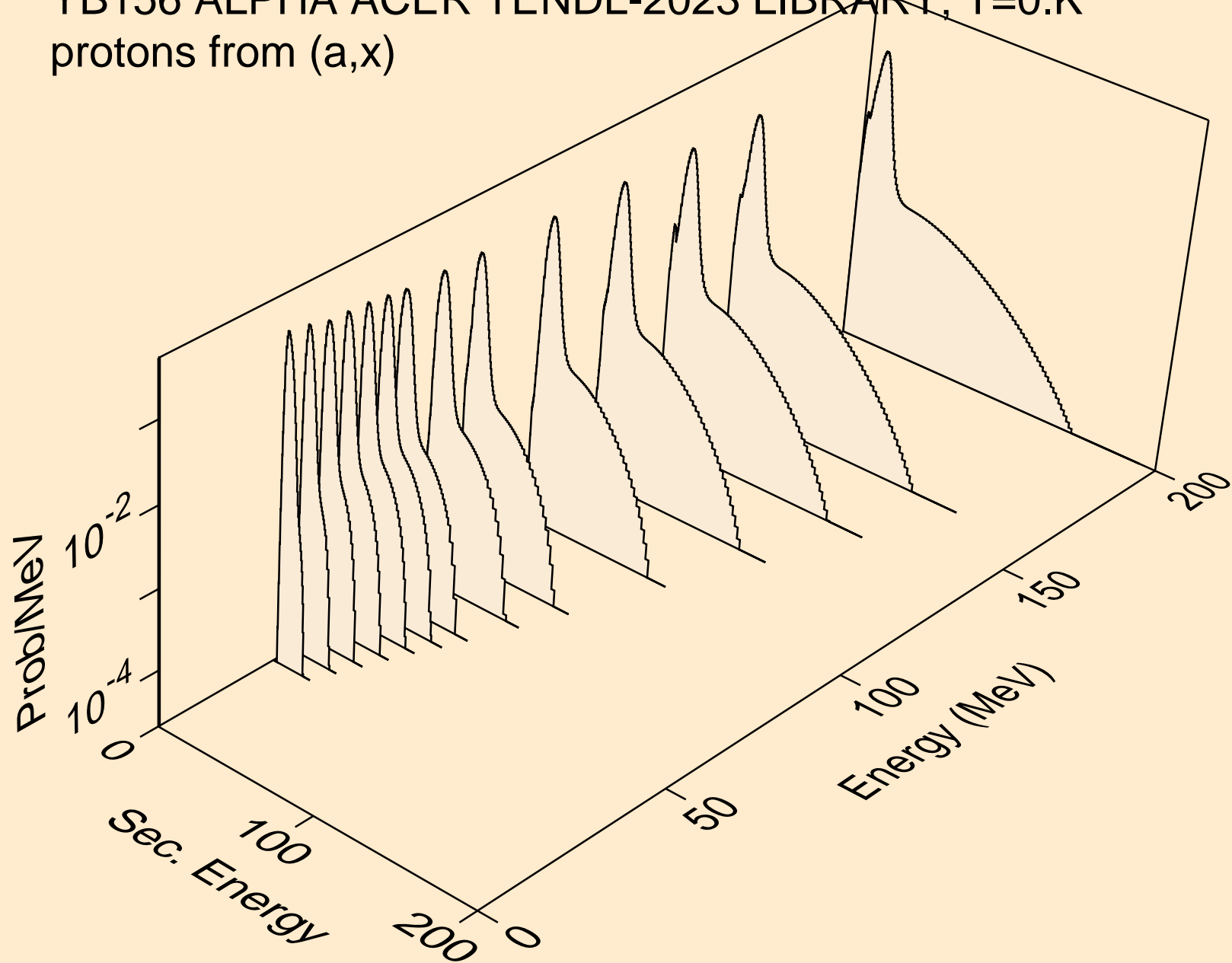

YB156 ALPHA ACER TENDL-2023 LIBRARY; T=0.K
protons from (a,n*)p

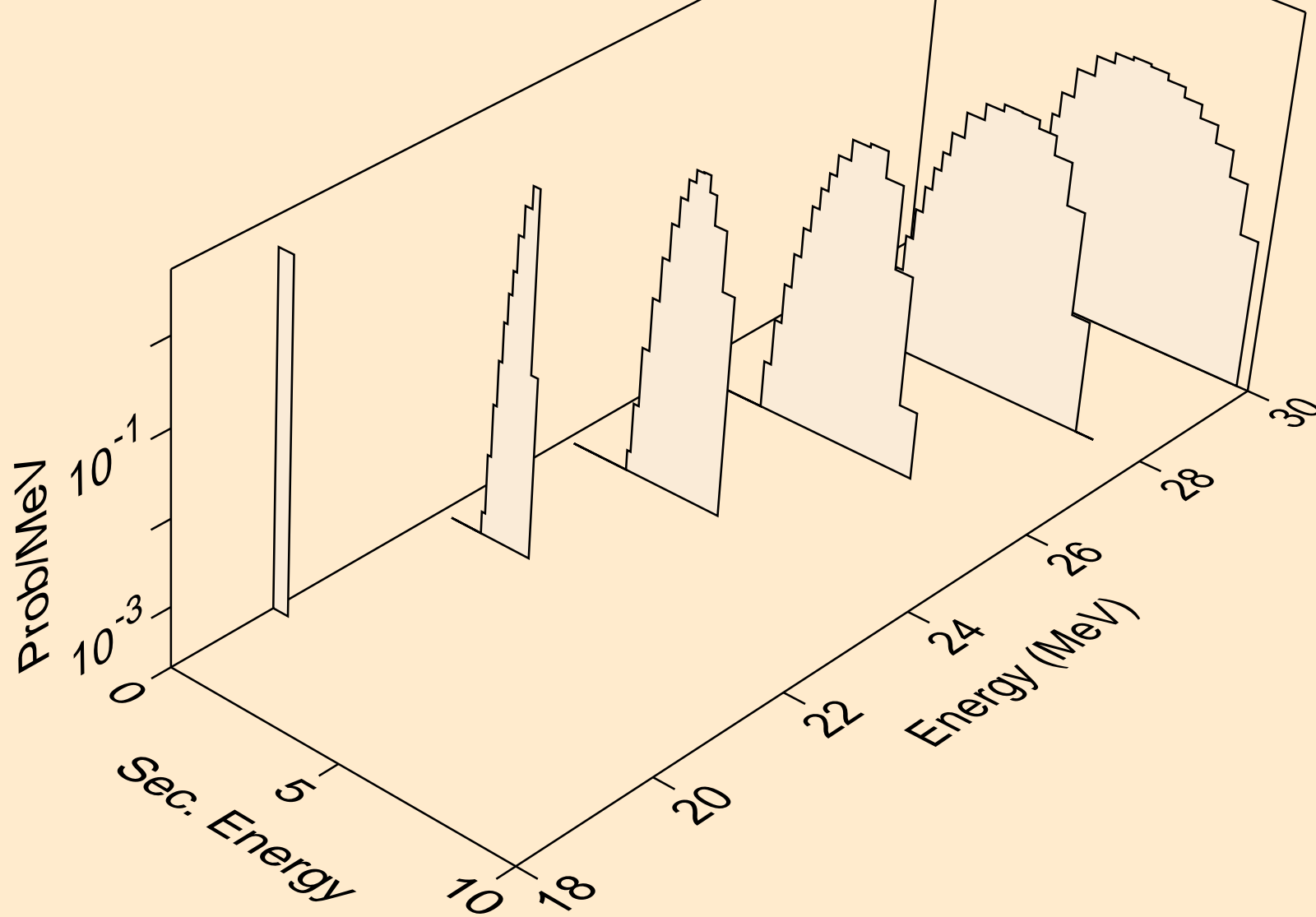

YB156 ALPHA ACER TENDL-2023 LIBRARY; T=0.K
protons from (a,n2p)

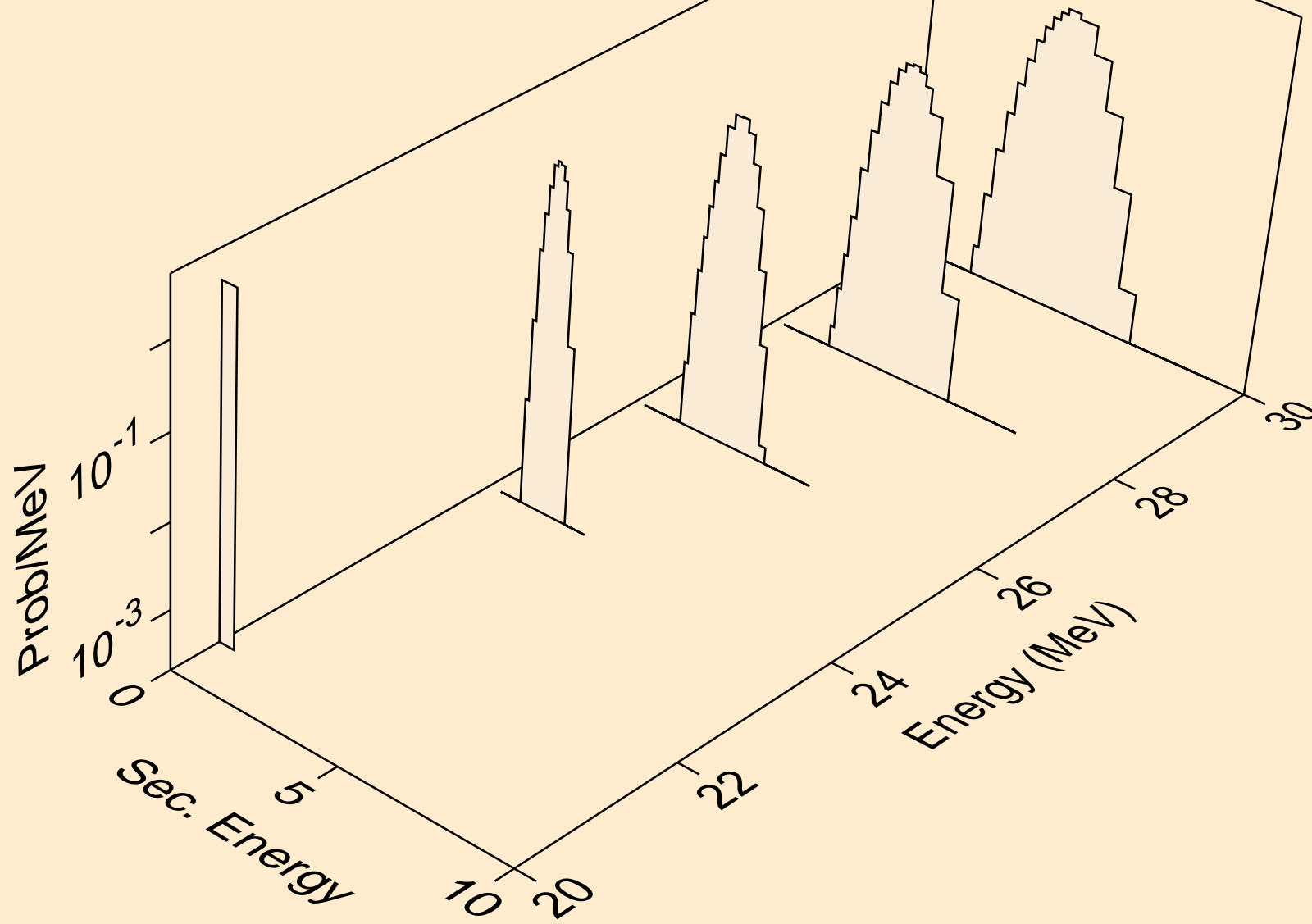

YB156 ALPHA ACER TENDL-2023 LIBRARY; T=0.K
protons from (a,npa)

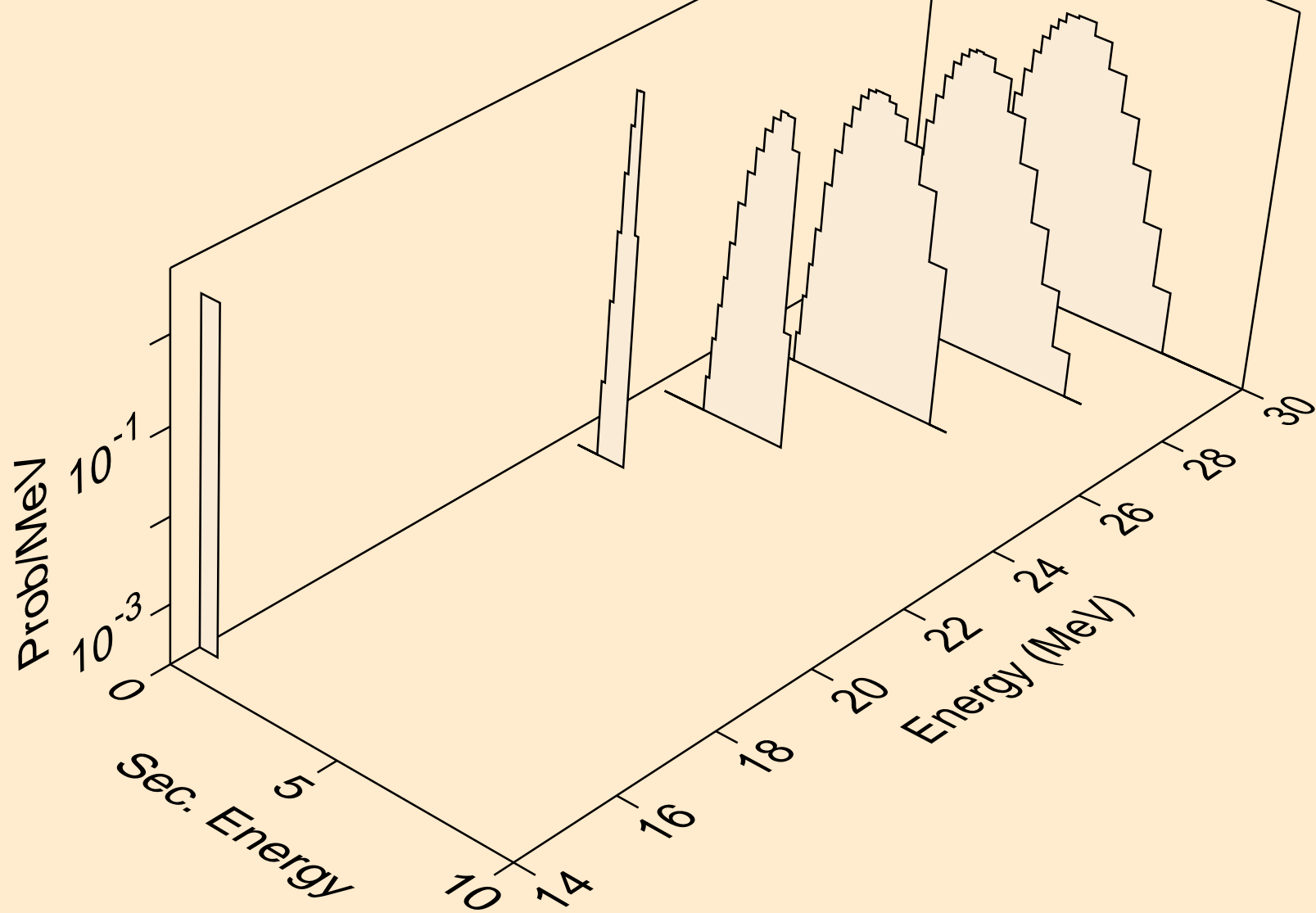

YB156 ALPHA ACER TENDL-2023 LIBRARY; T=0.K
protons from (a,p)

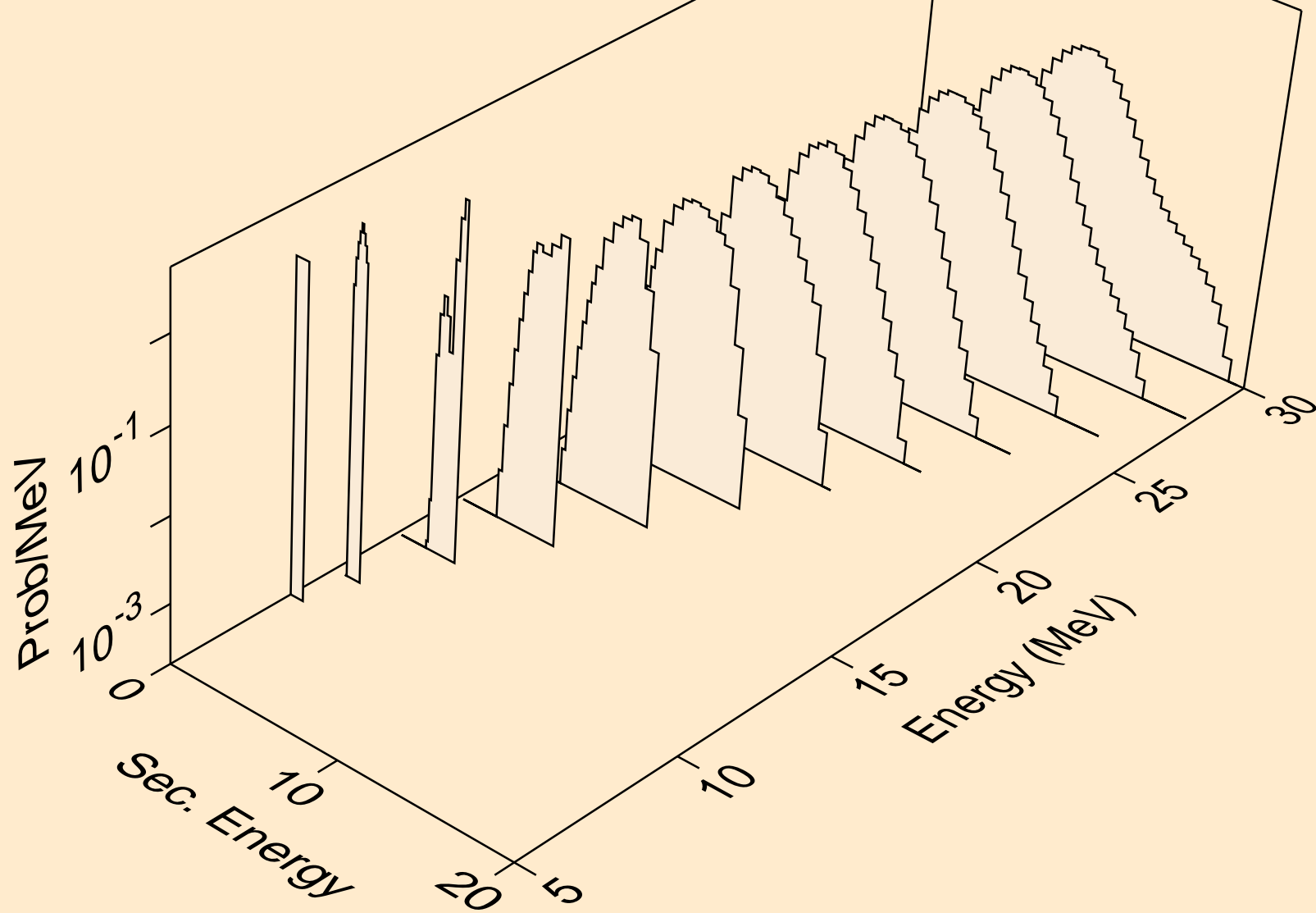

YB156 ALPHA ACER TENDL-2023 LIBRARY; T=0.K
protons from (a,2p)

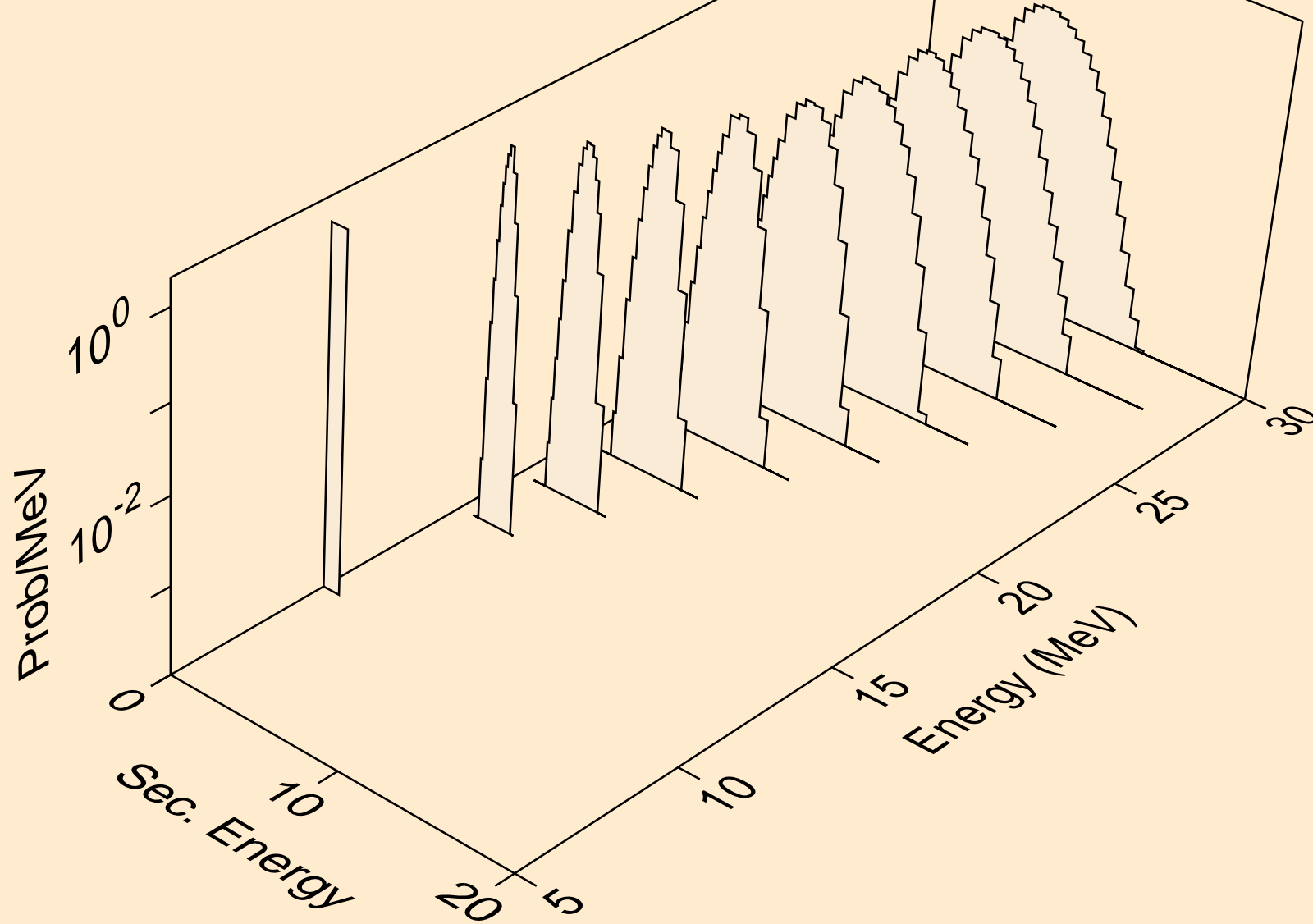

YB156 ALPHA ACER TENDL-2023 LIBRARY; T=0.K
protons from (a,pa)

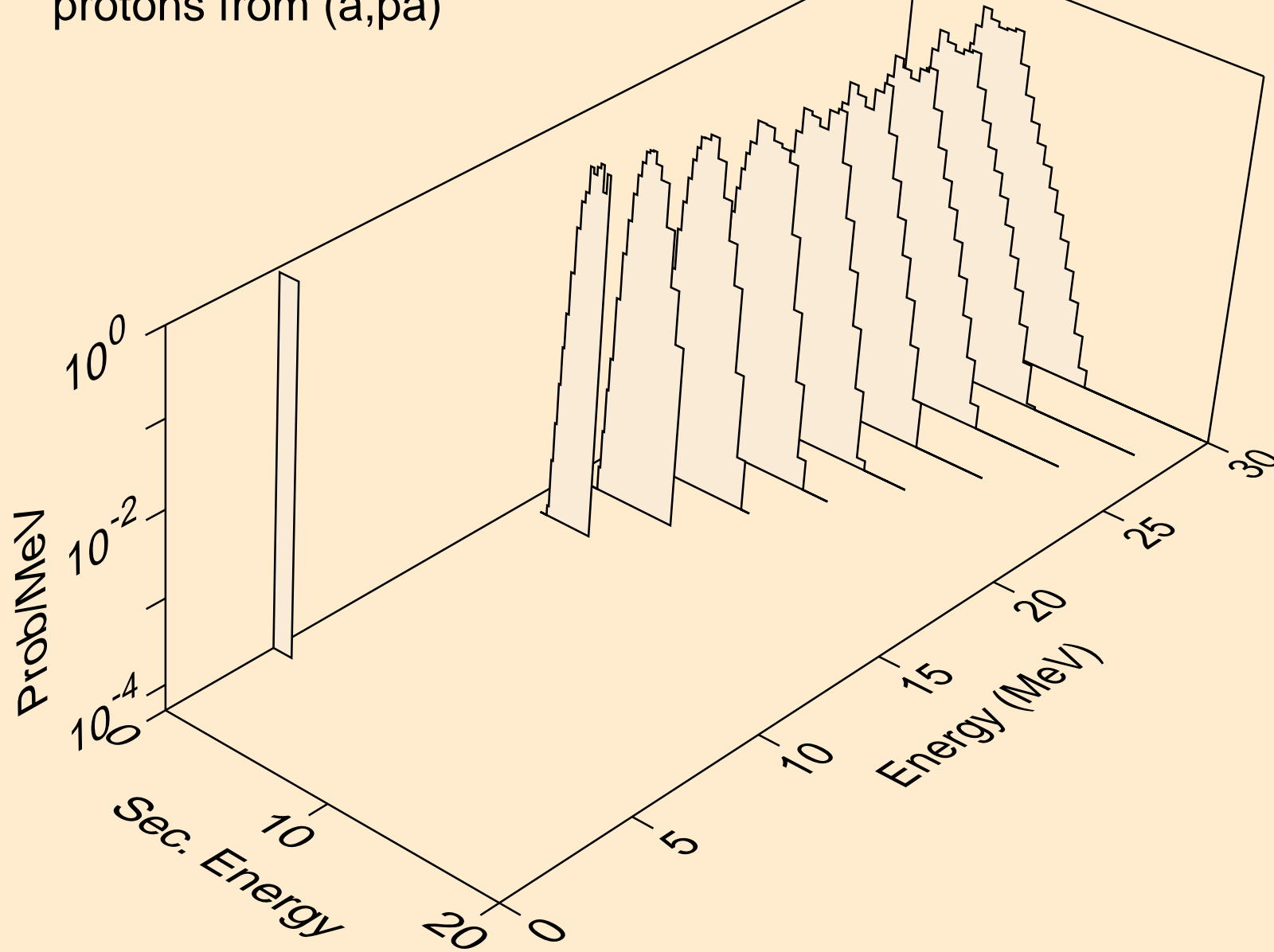

YB156 ALPHA ACER TENDL-2023 LIBRARY; T=0.K
protons from (a,pd)

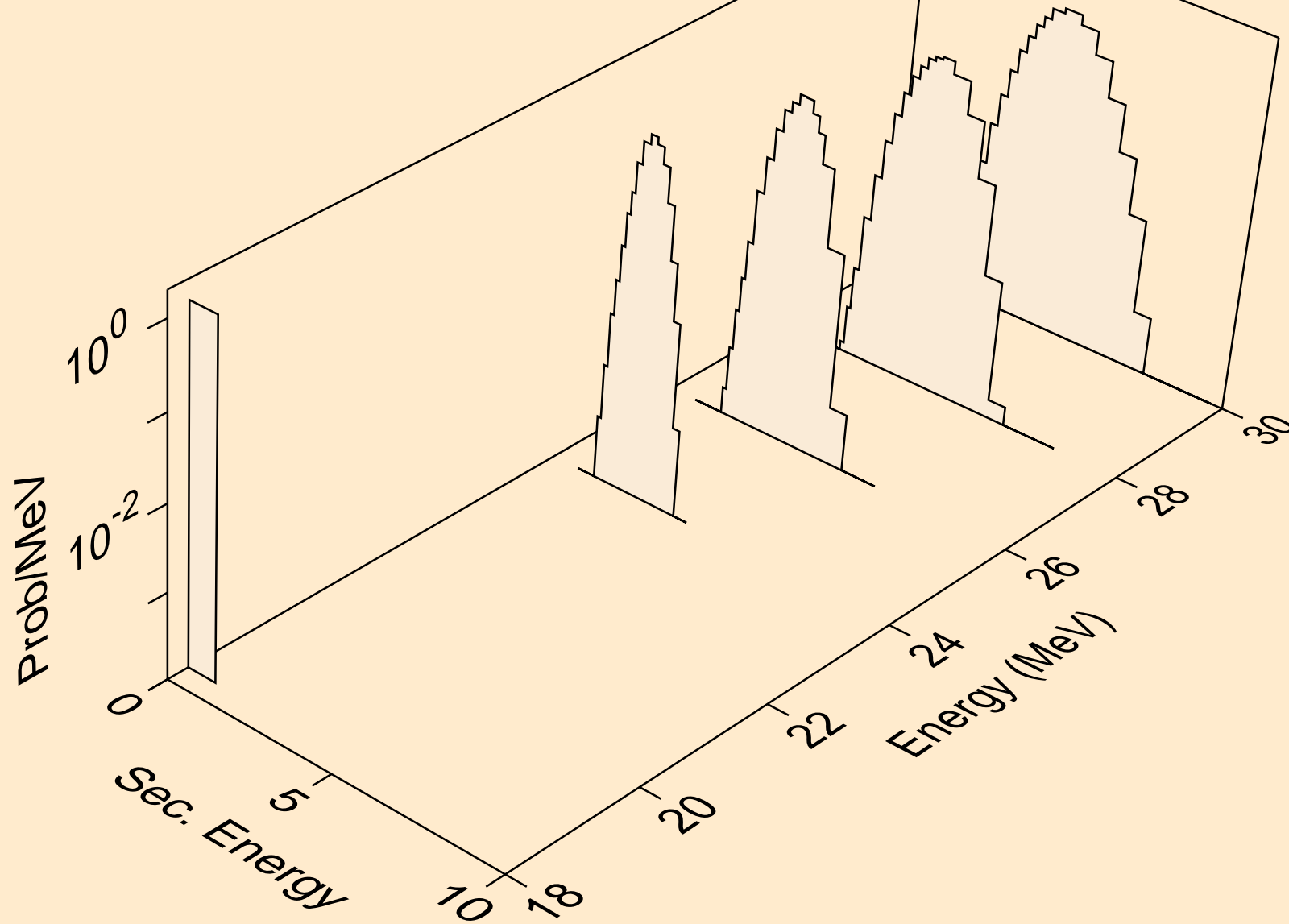

YB156 ALPHA ACER TENDL-2023 LIBRARY; T=0.K
deuterons from (a,x)

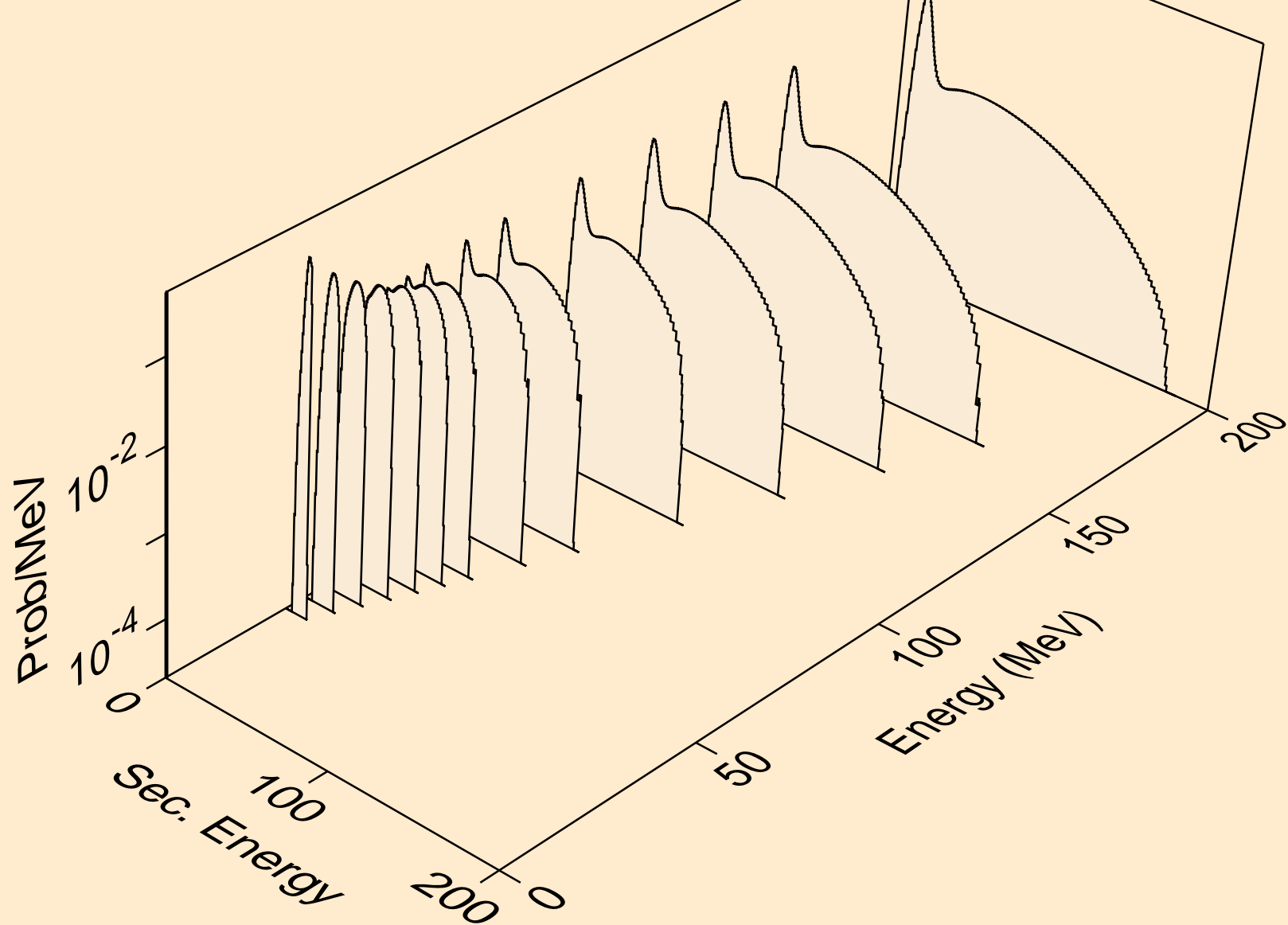

YB156 ALPHA ACER TENDL-2023 LIBRARY; T=0.K
deuterons from (a,d)

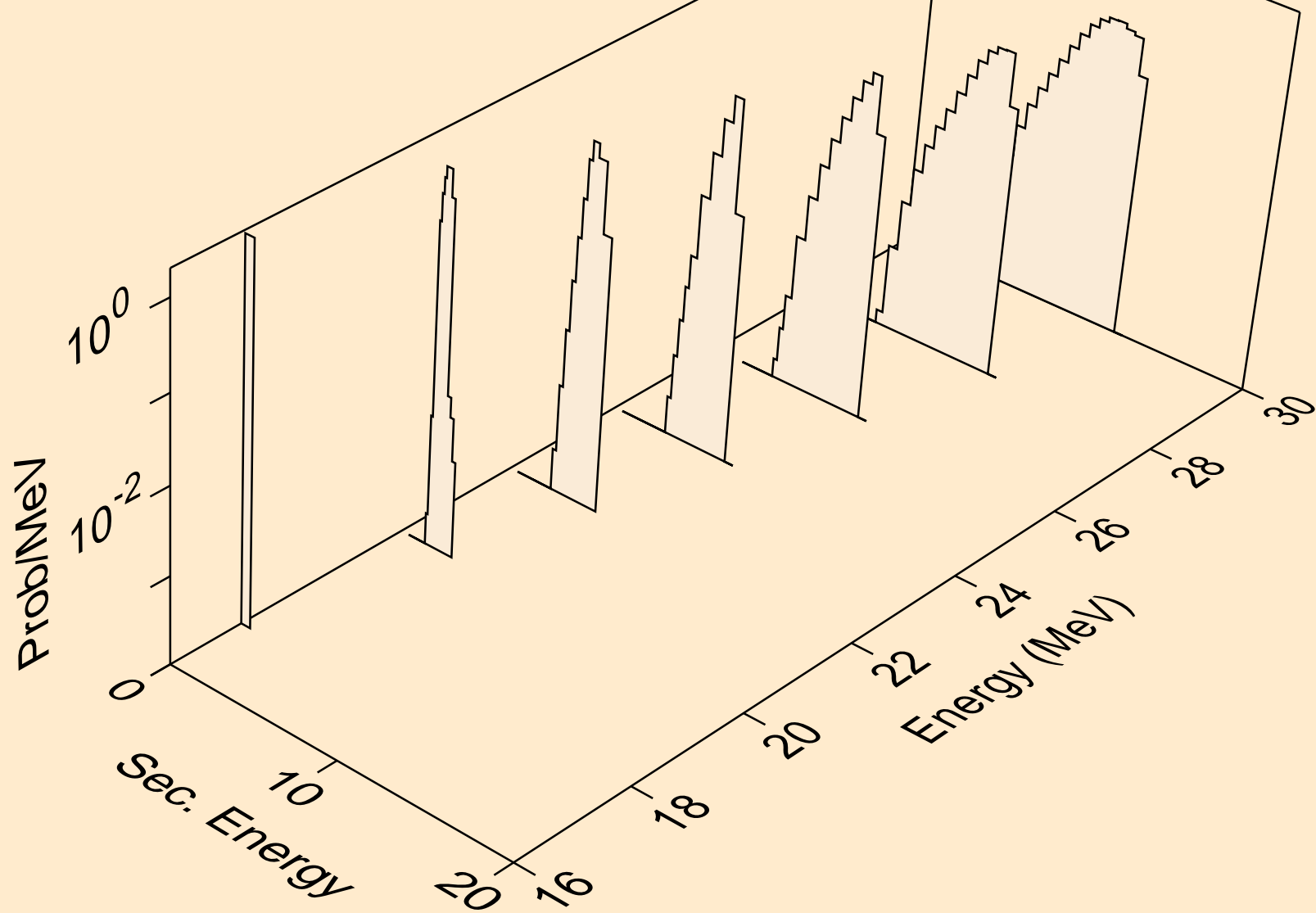

YB156 ALPHA ACER TENDL-2023 LIBRARY; T=0.K
deuterons from (a,pd)

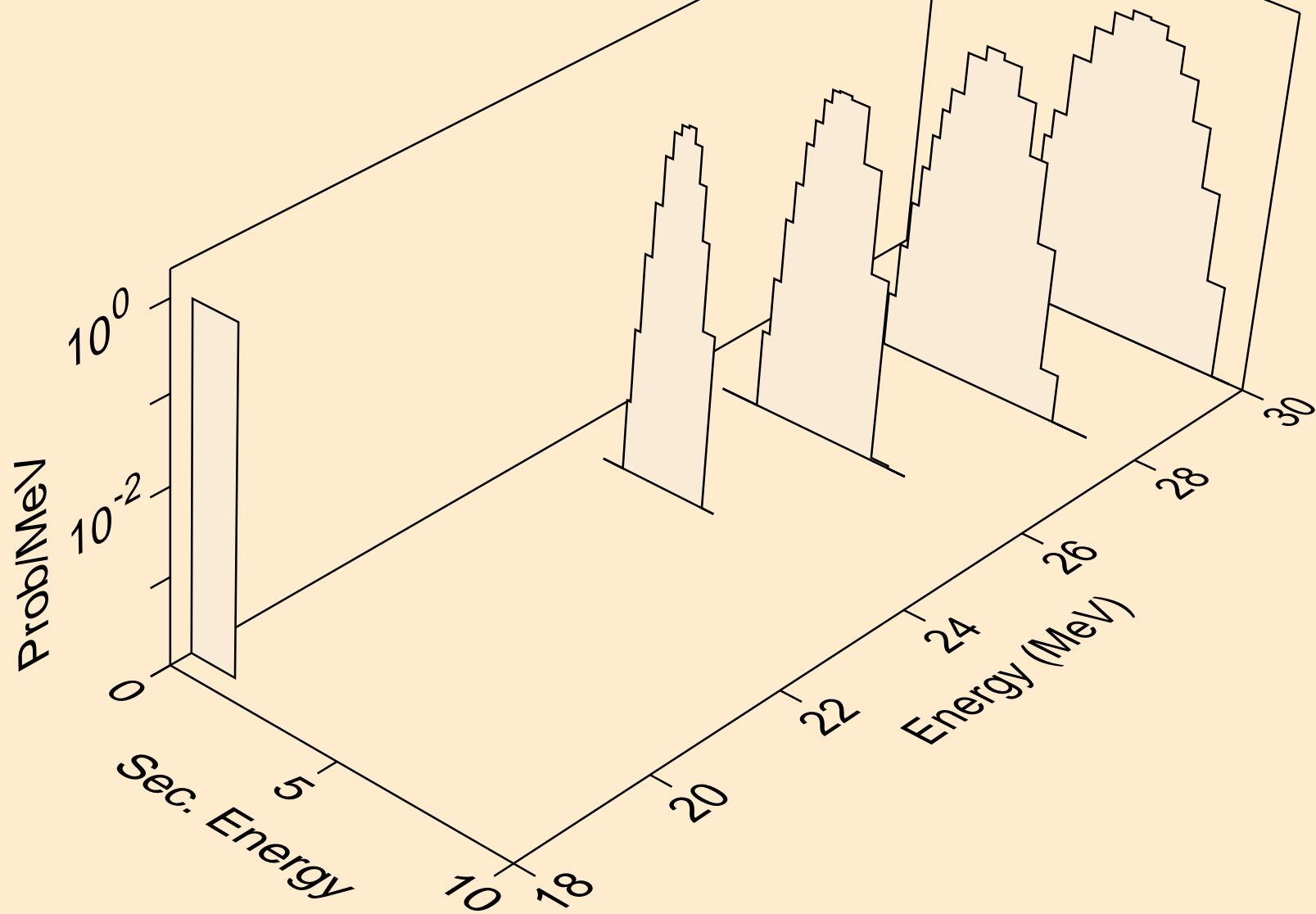

YB156 ALPHA ACER TENDL-2023 LIBRARY; T=0.K
tritons from (a,x)

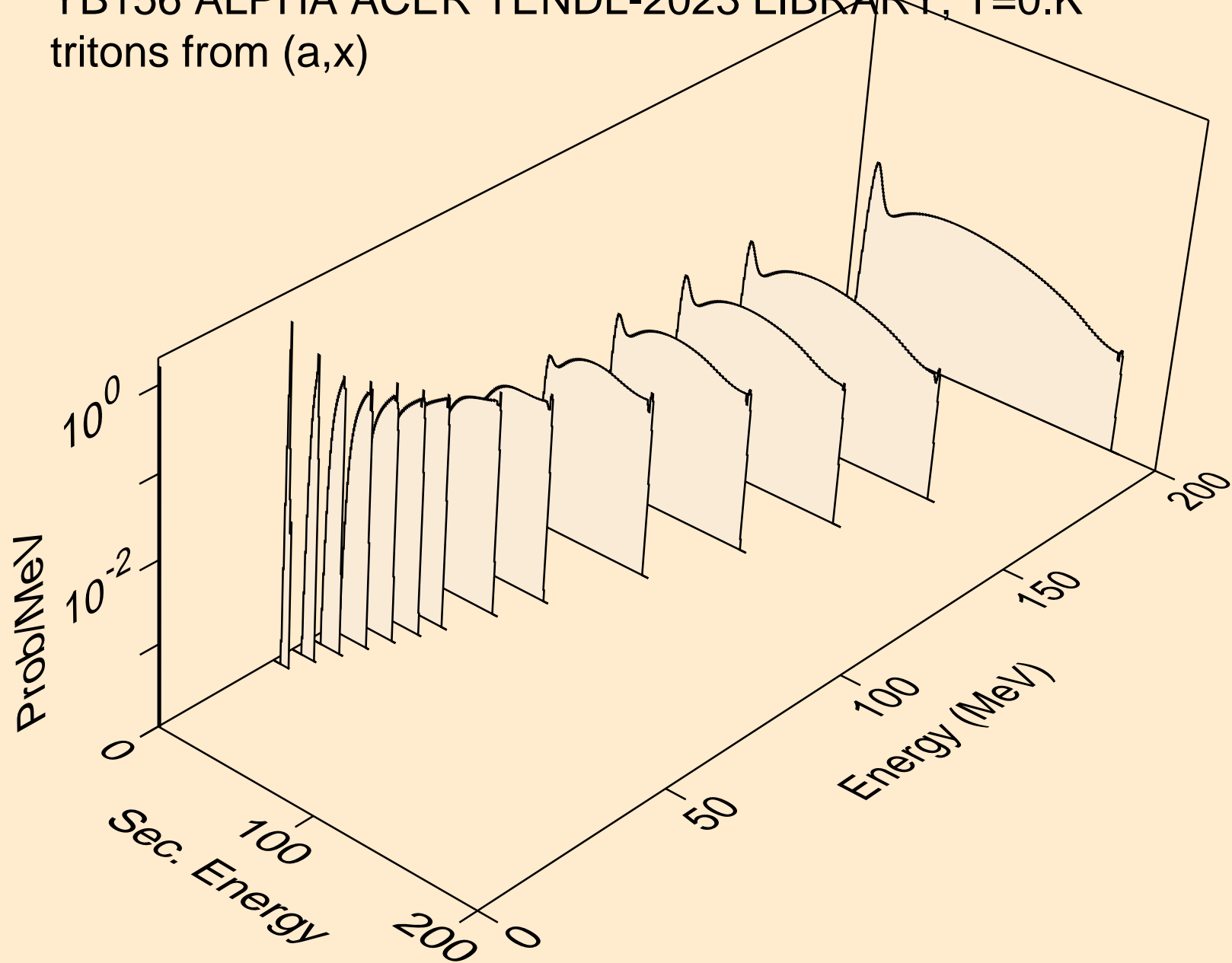

YB156 ALPHA ACER TENDL-2023 LIBRARY; T=0.K
tritons from (a,t)

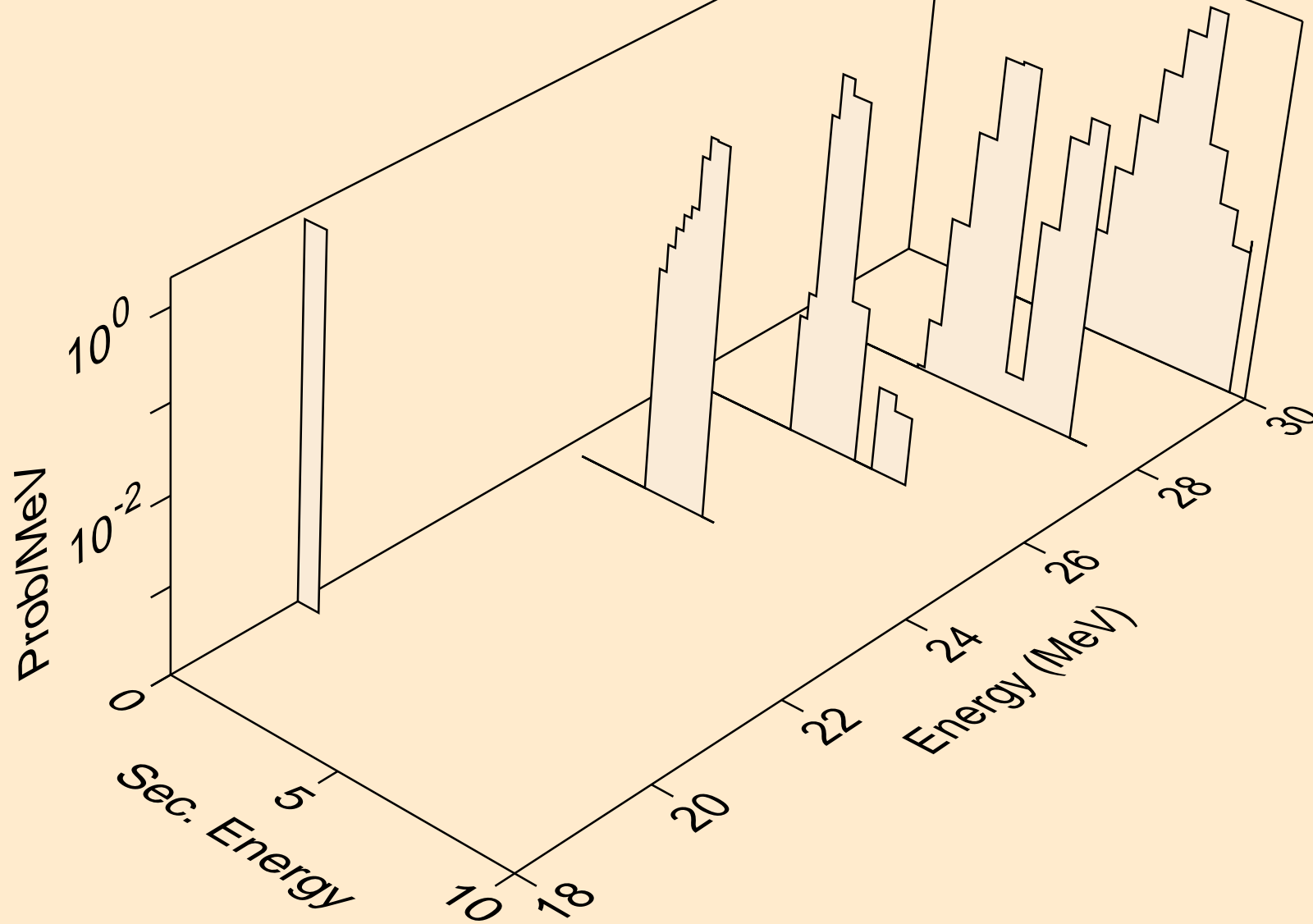

YB156 ALPHA ACER TENDL-2023 LIBRARY; T=0.K
he3s from (a,x)

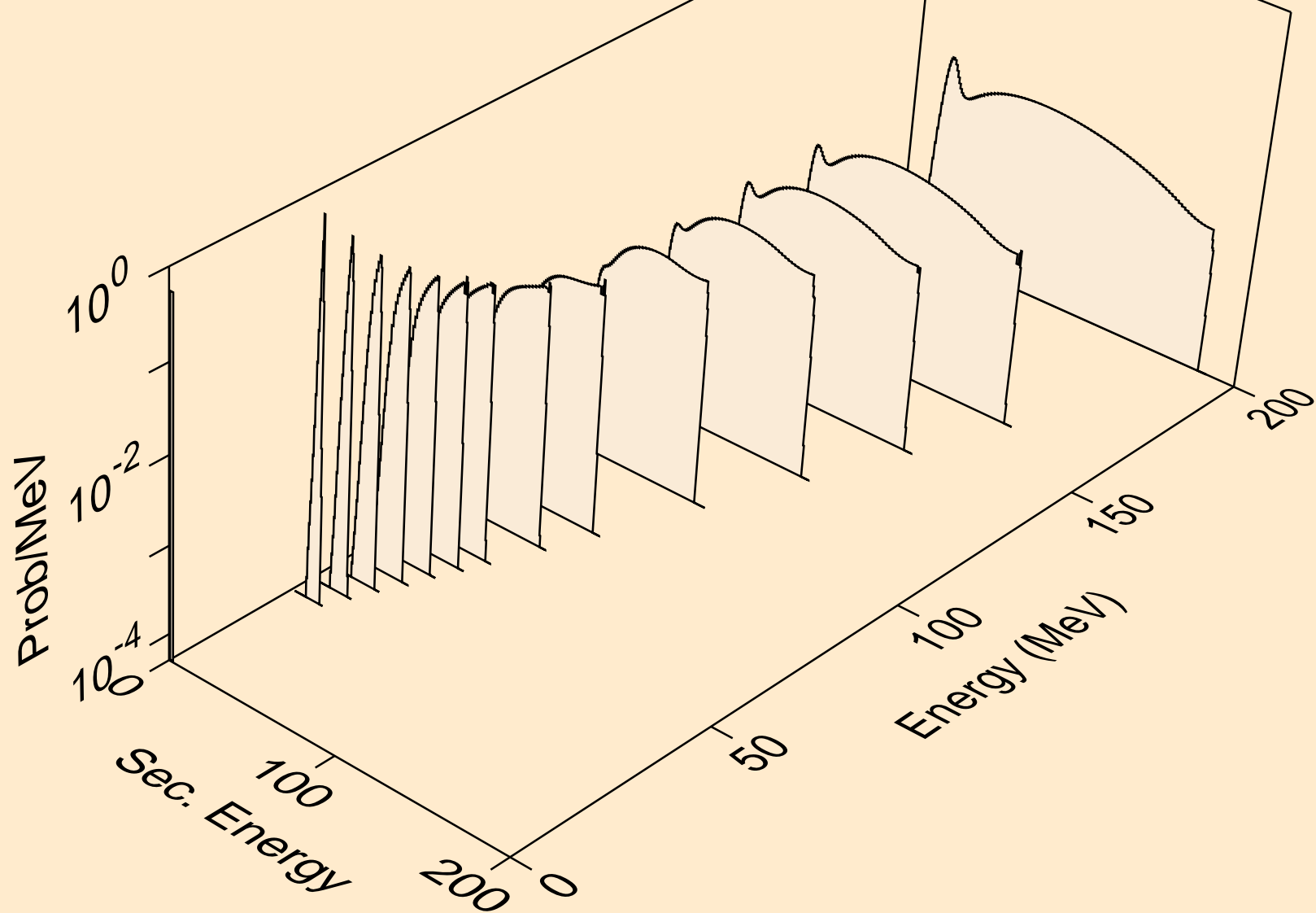

YB156 ALPHA ACER TENDL-2023 LIBRARY; T=0.K
he3s from (a,he3)

