

ER160 DEUTERON ACER TENDL-2023 LIBRARY; T=0.K

Principal cross sections

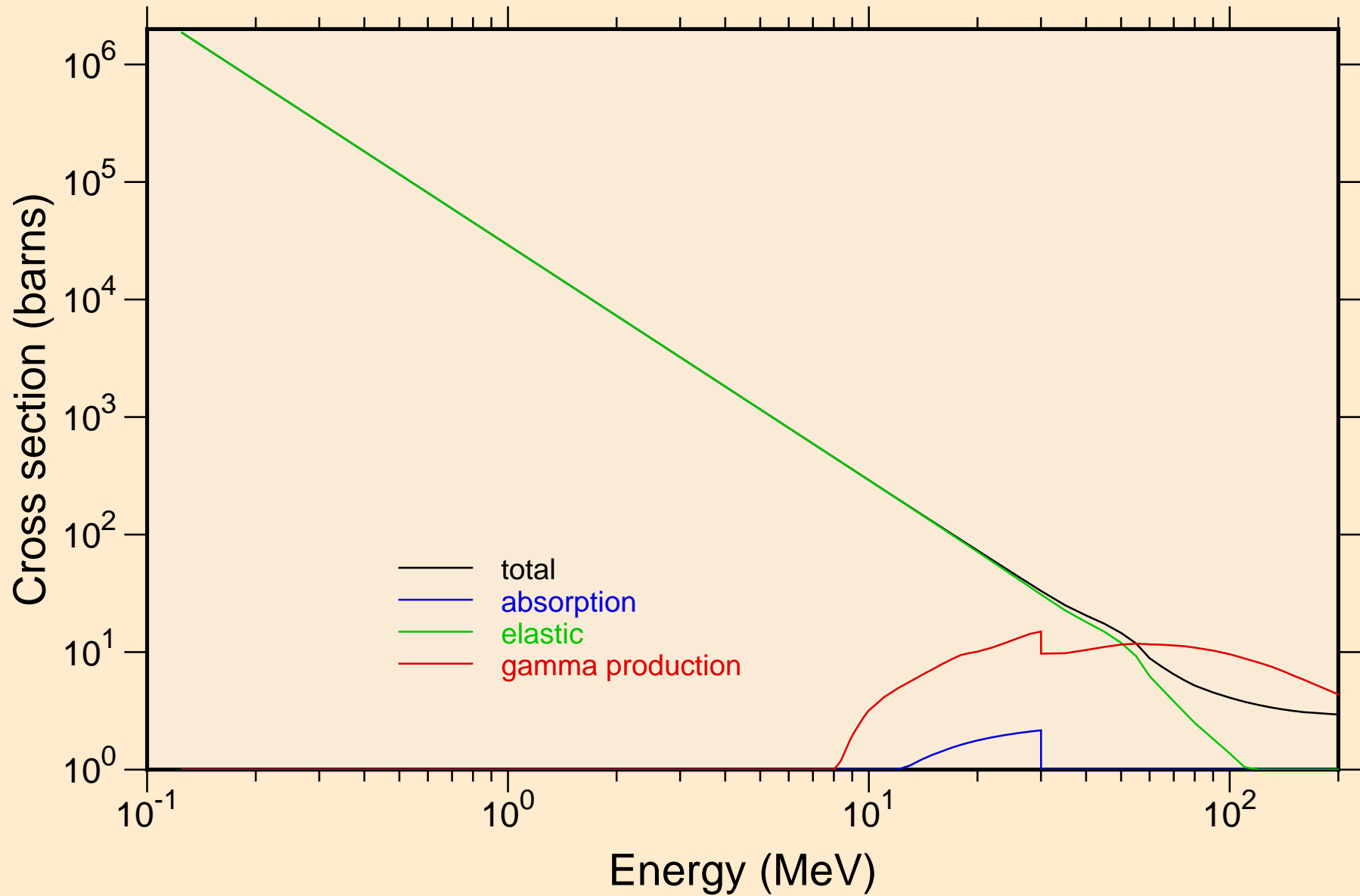

ER160 DEUTERON ACER TENDL-2023 LIBRARY; T=0.K

Heating

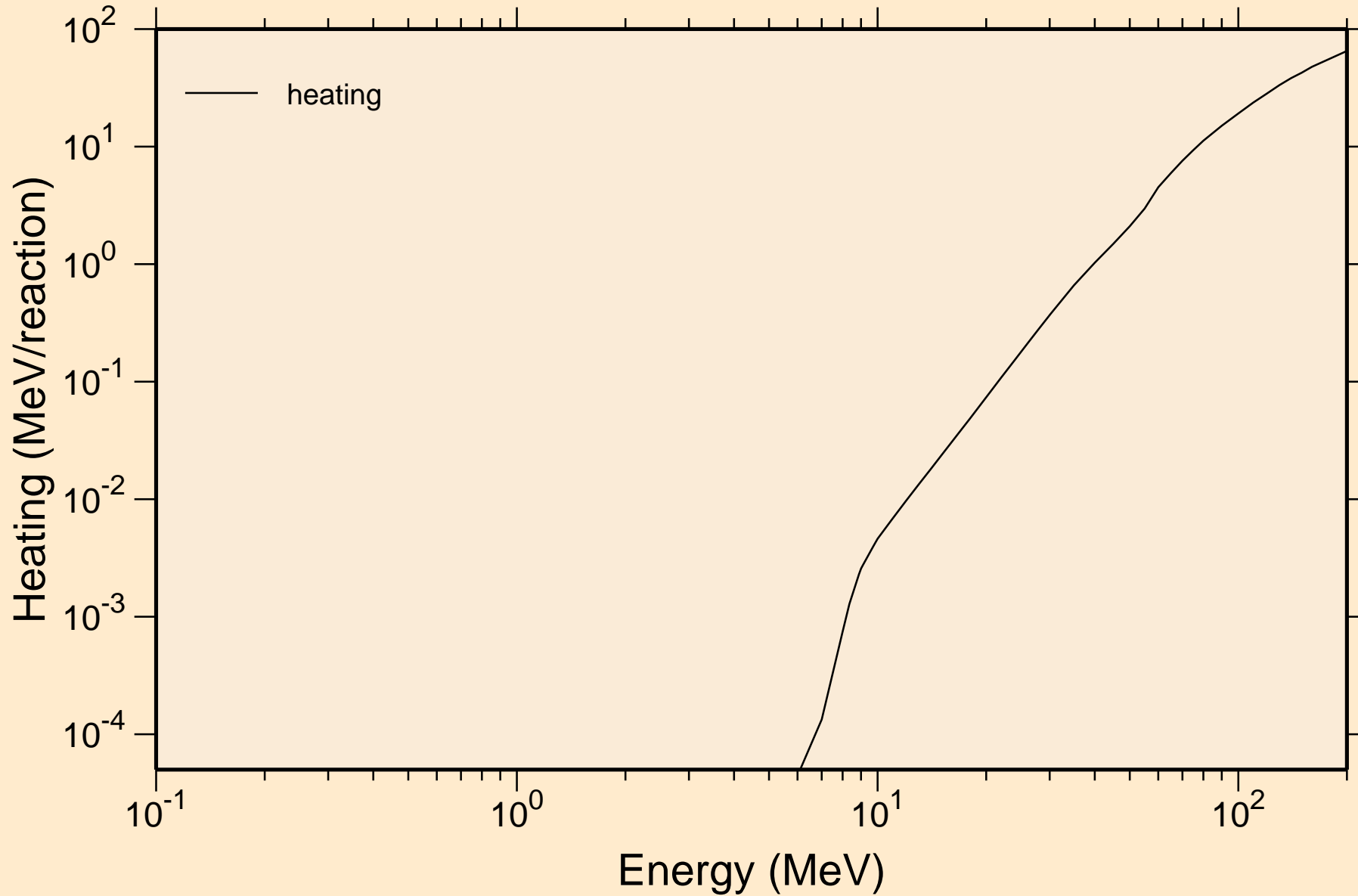

ER160 DEUTERON ACER TENDL-2023 LIBRARY; T=0.K
Principal cross sections

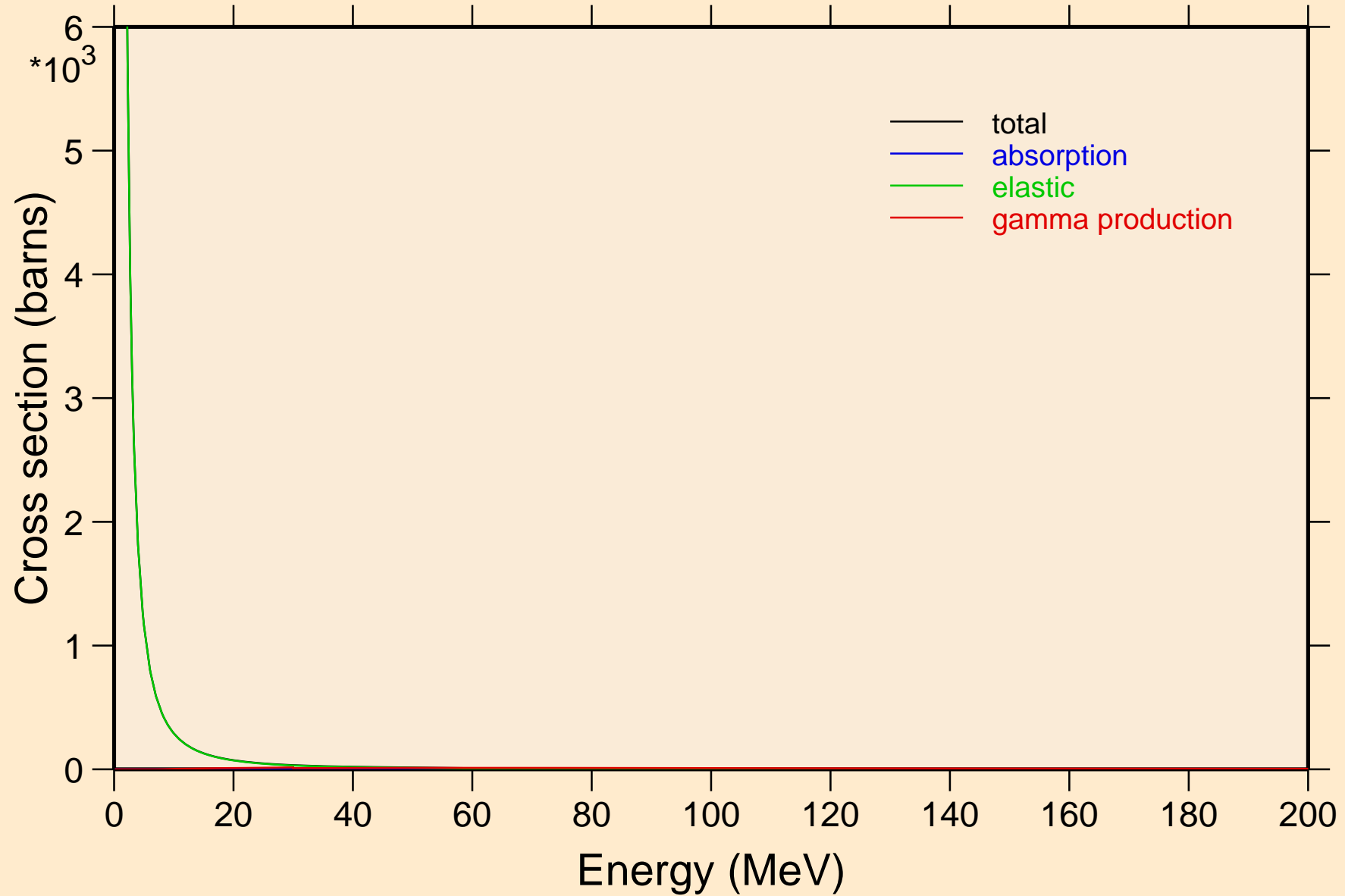

ER160 DEUTERON ACER TENDL-2023 LIBRARY; T=0.K

Heating

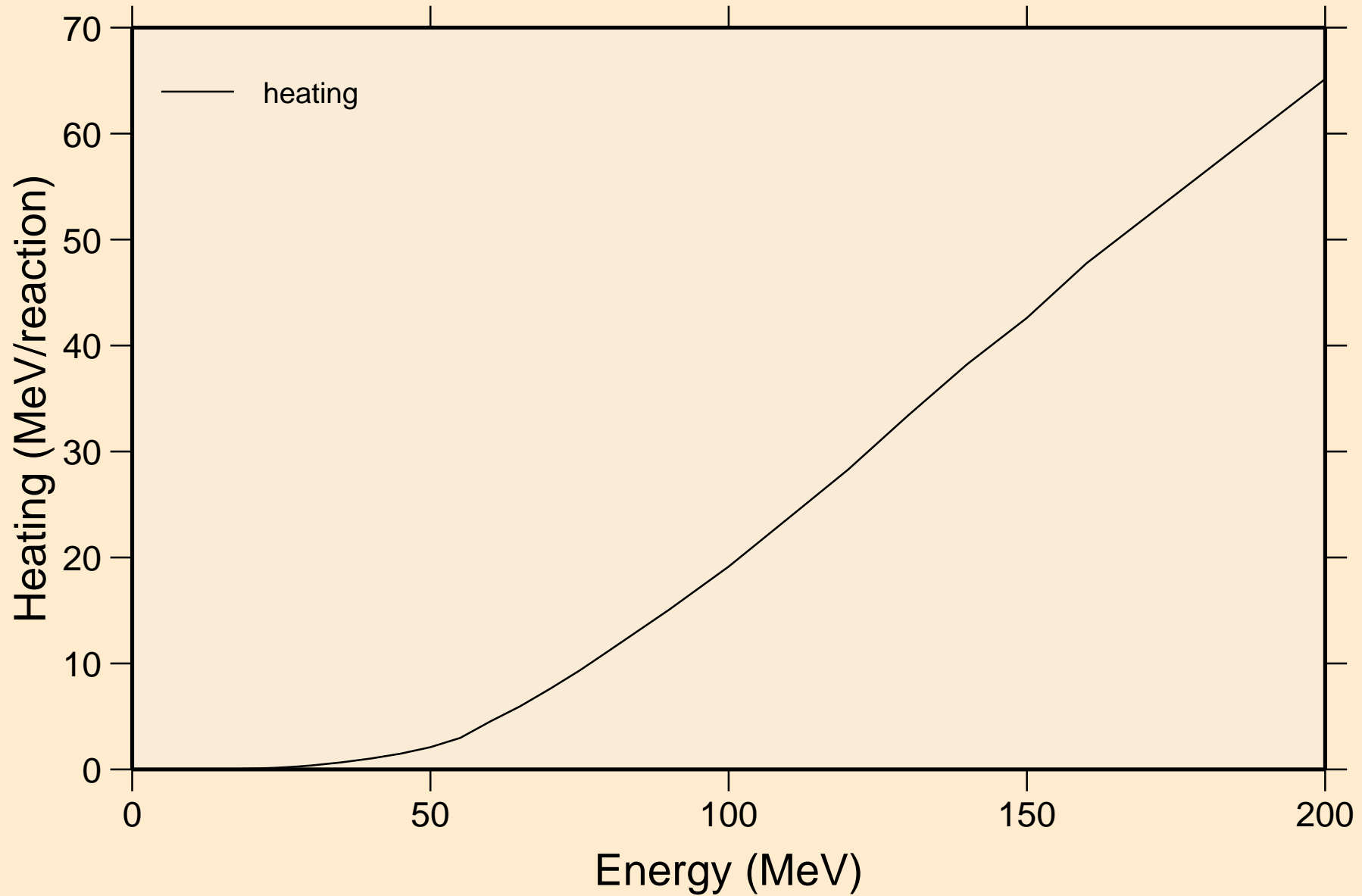

ER160 DEUTERON ACER TENDL-2023 LIBRARY; T=0.K
Threshold reactions

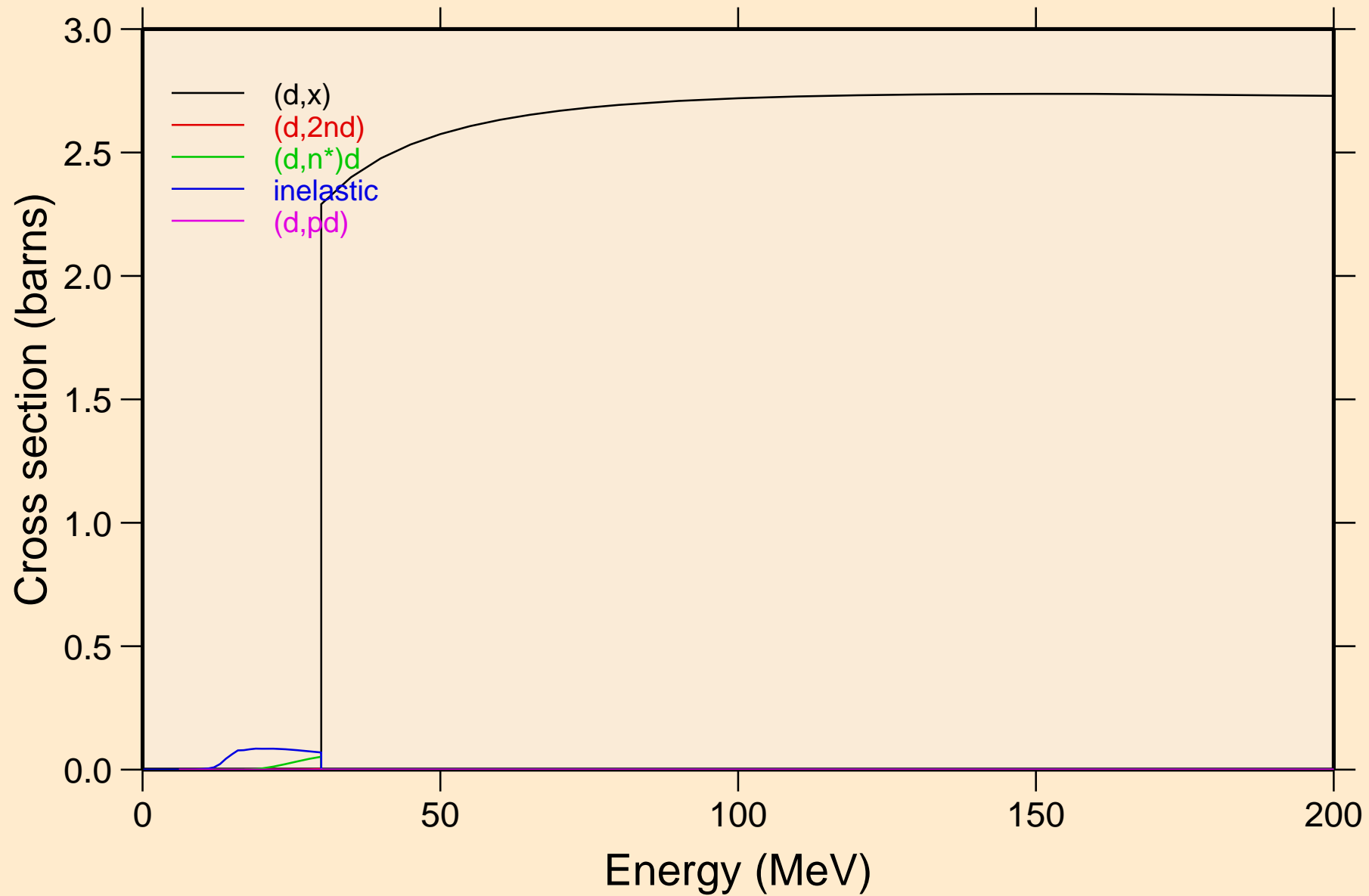

ER160 DEUTERON ACER TENDL-2023 LIBRARY; T=0.K
Threshold reactions

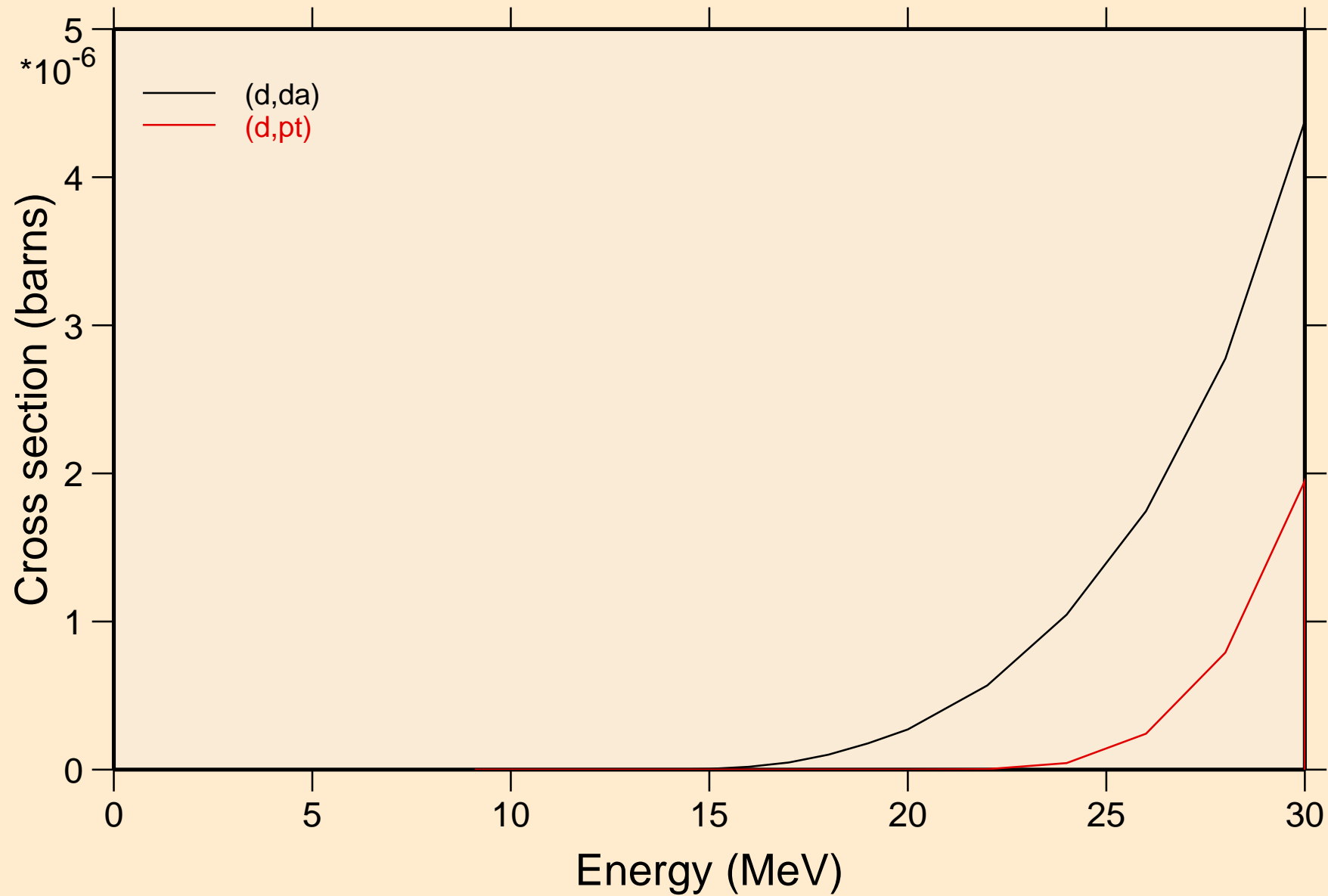

ER160 DEUTERON ACER TENDL-2023 LIBRARY; T=0.K
Threshold reactions

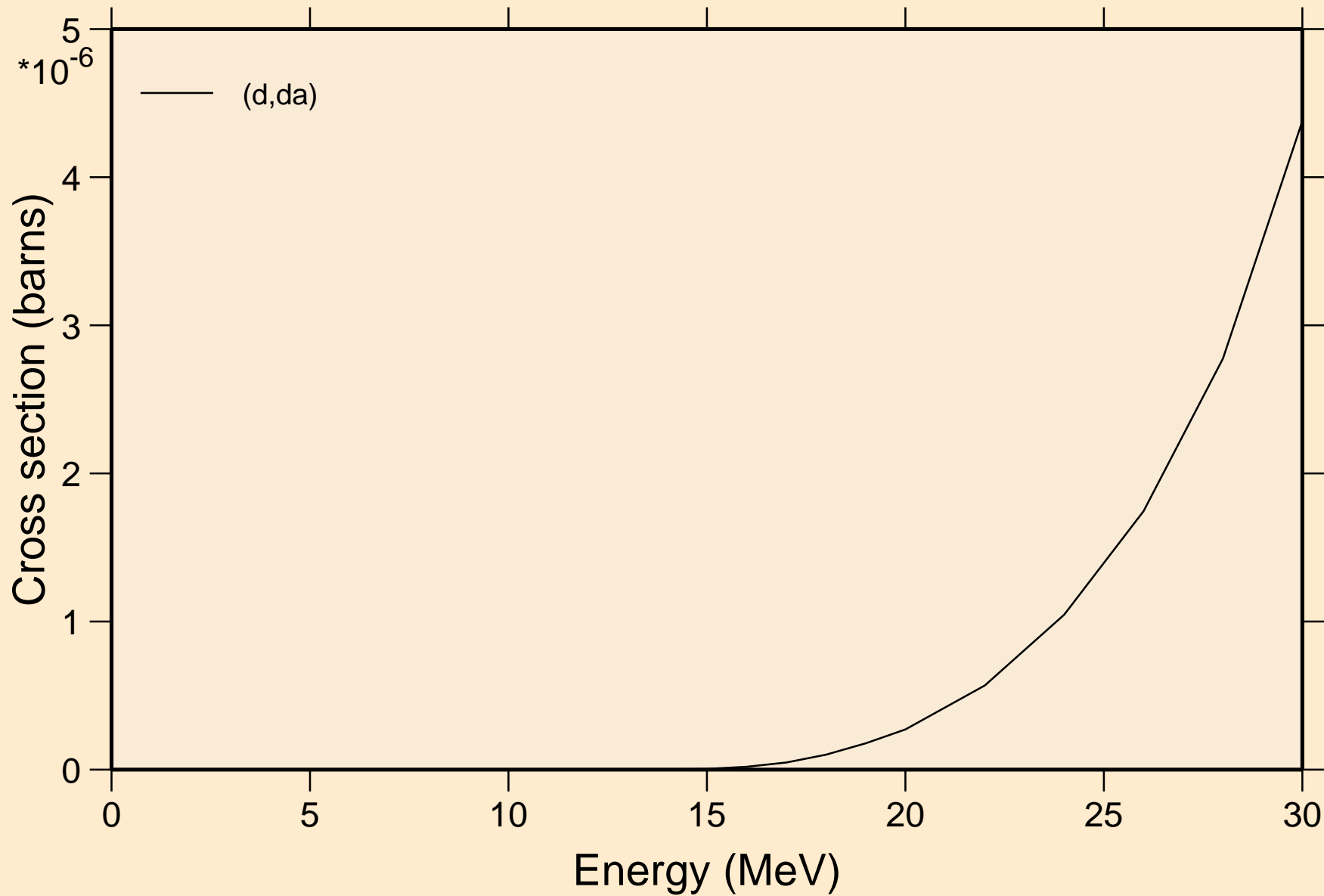

ER160 DEUTERON ACER TENDL-2023 LIBRARY; T=0.K
angular distribution for elastic

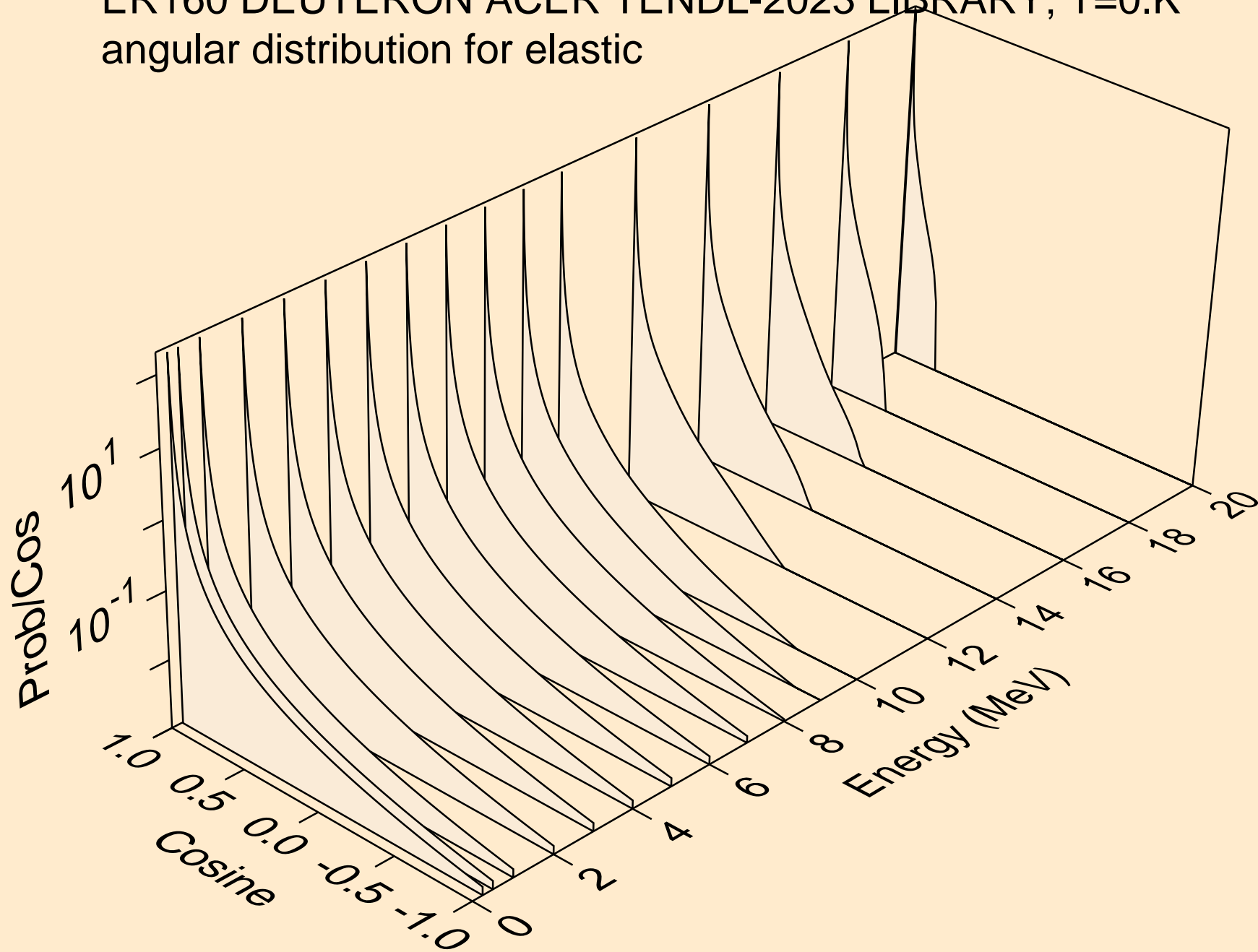

ER160 DEUTERON ACER TENDL-2023 LIBRARY; T=0.K
angular distribution for elastic

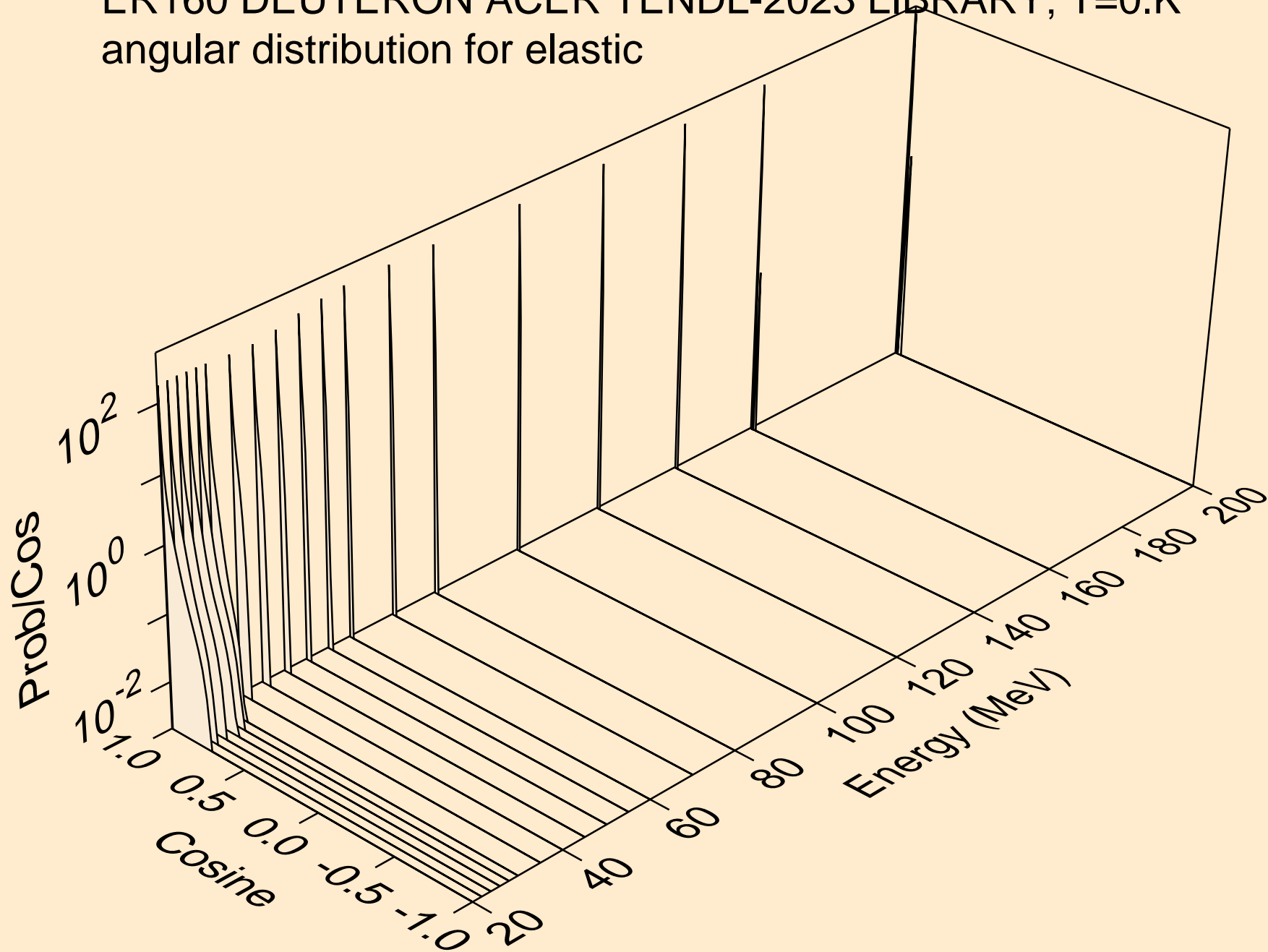

ER160 DEUTERON ACER TENDL-2023 LIBRARY; T=0.K
Deuteron emission for (d,x)

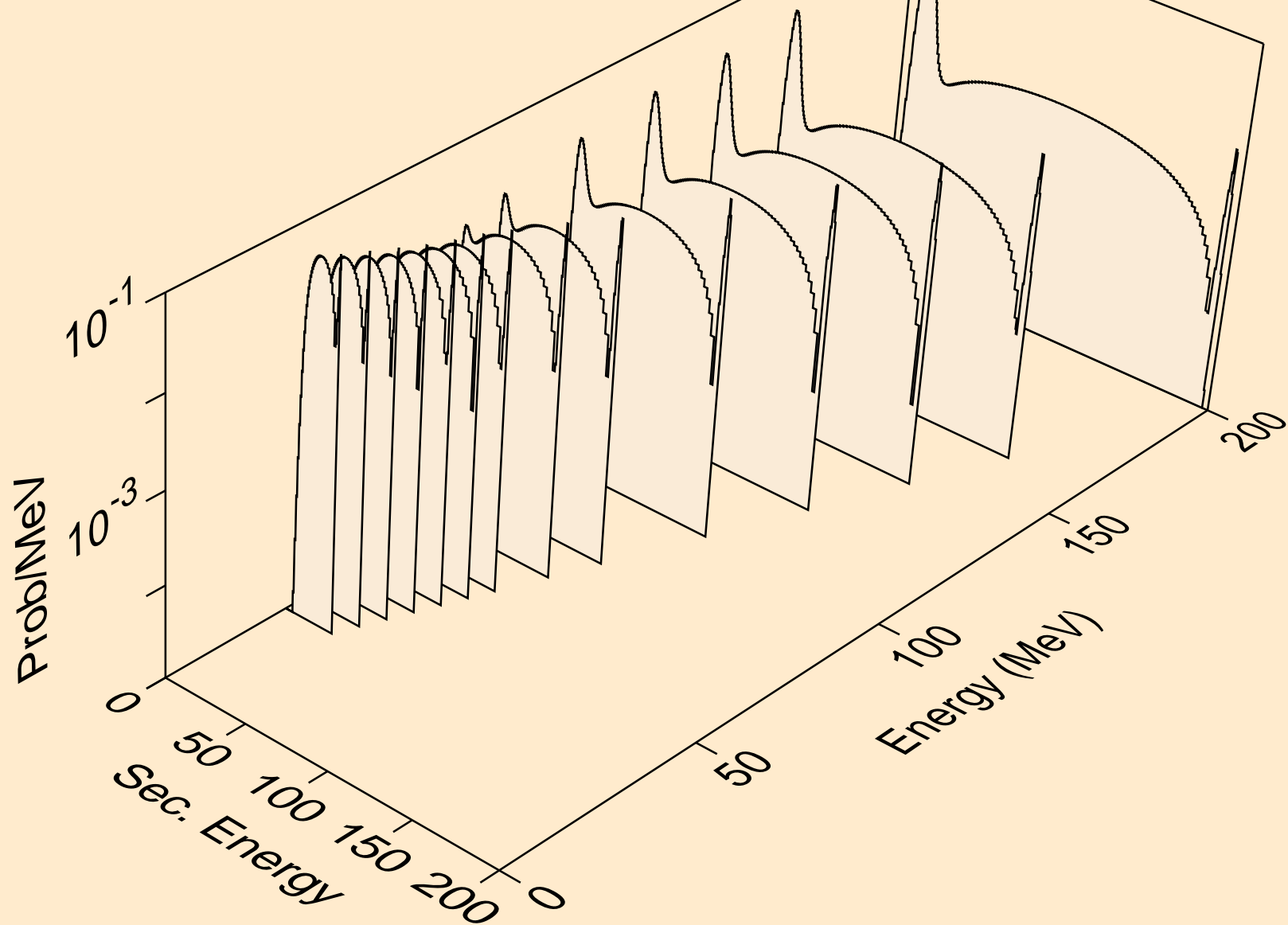

ER160 DEUTERON ACER TENDL-2023 LIBRARY; T=0.K
Deuteron emission for (d,2nd)

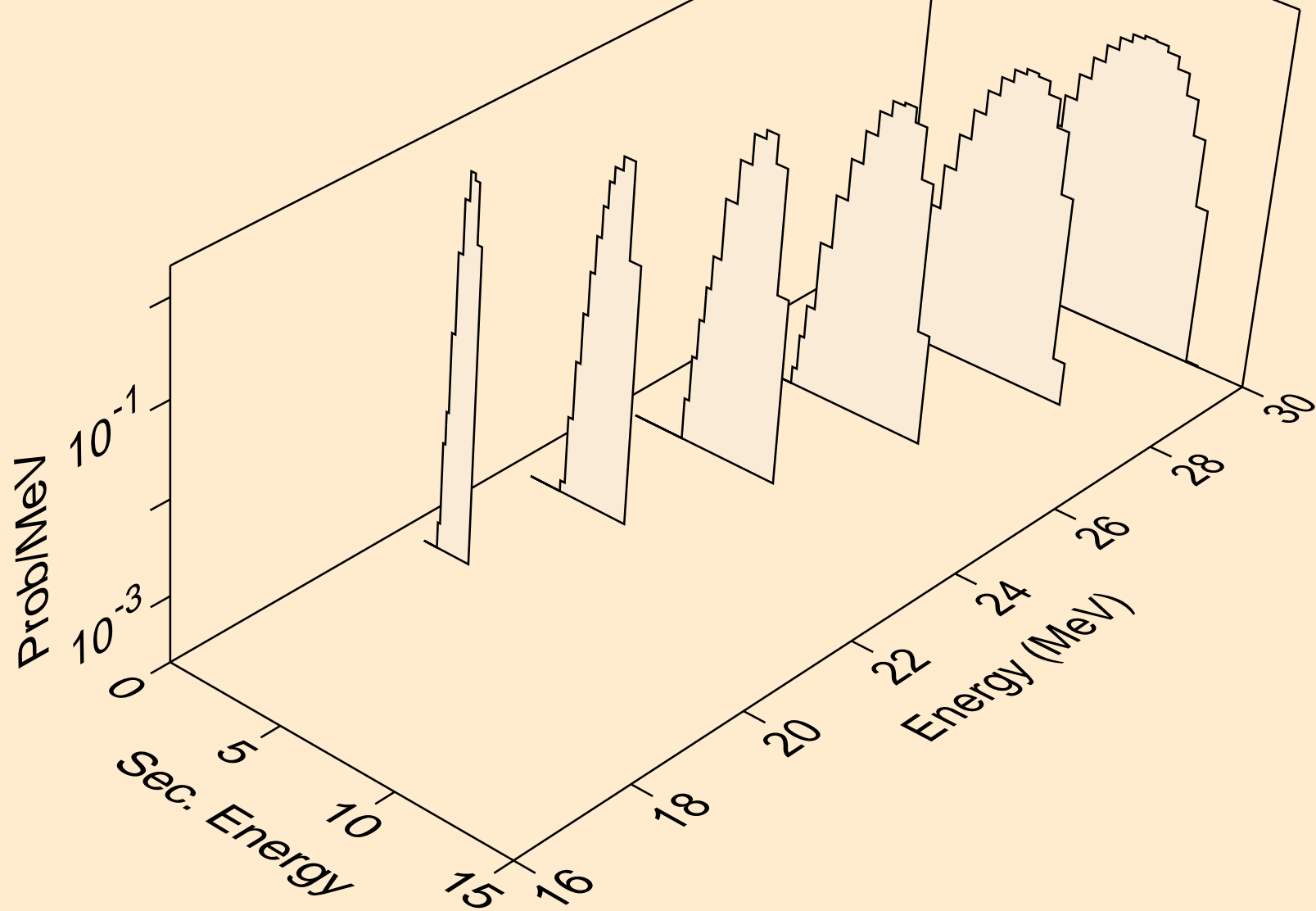

ER160 DEUTERON ACER TENDL-2023 LIBRARY; T=0.K
Deuteron emission for (d,n*)d

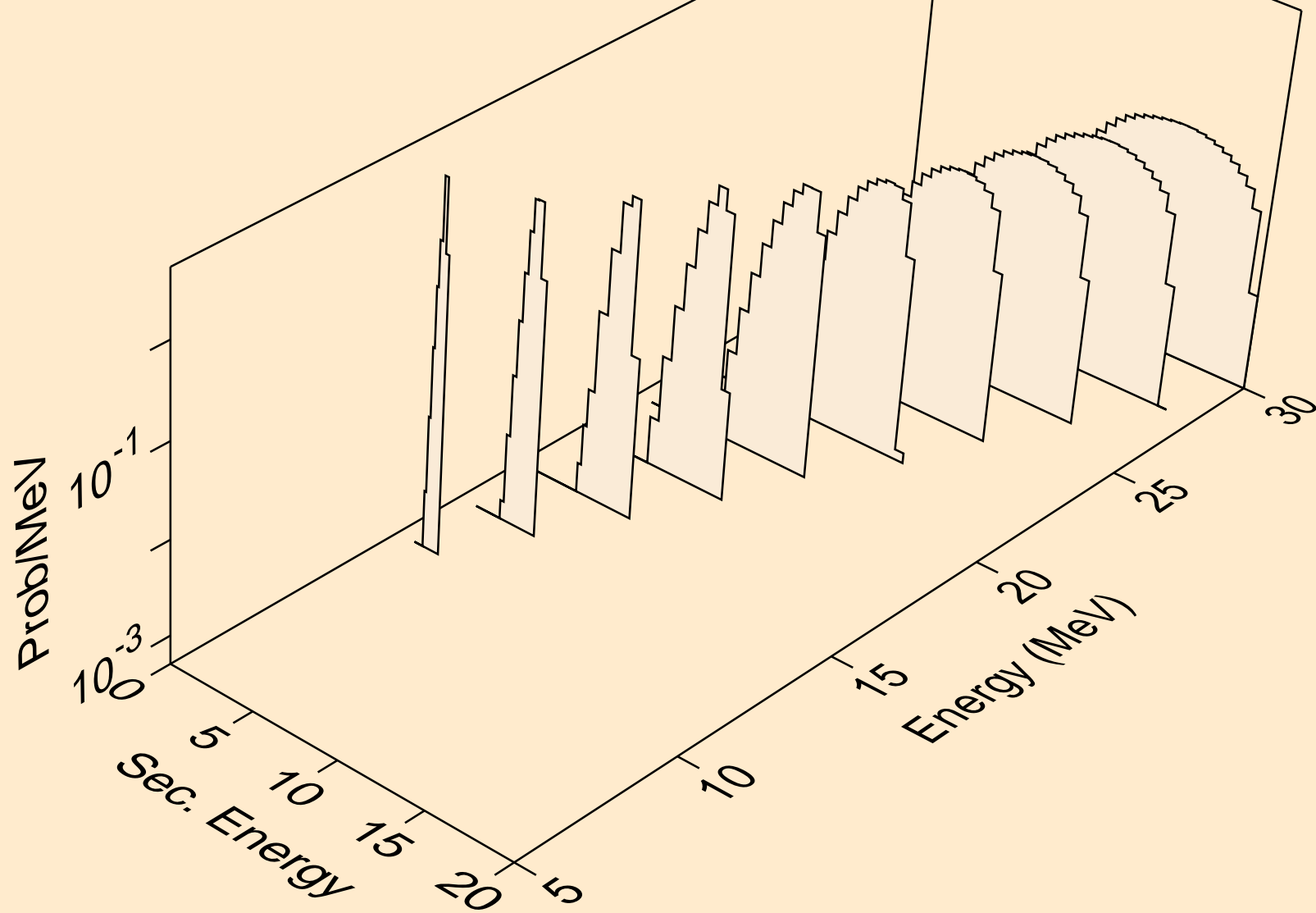

ER160 DEUTERON ACER TENDL-2023 LIBRARY; T=0.K
Deuteron emission for inelastic

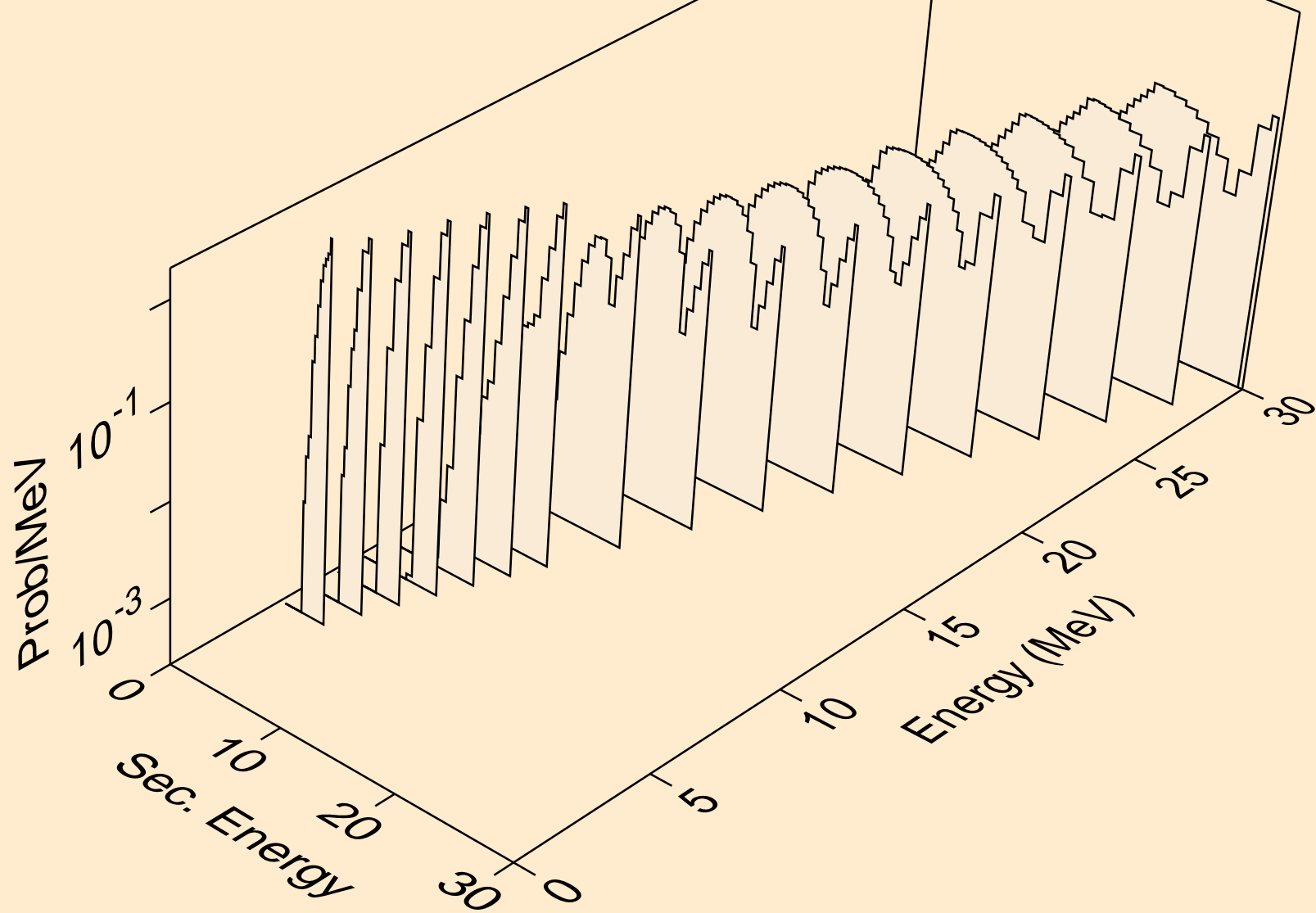

ER160 DEUTERON ACER TENDL-2023 LIBRARY; T=0.K
Deuteron emission for (d,pd)

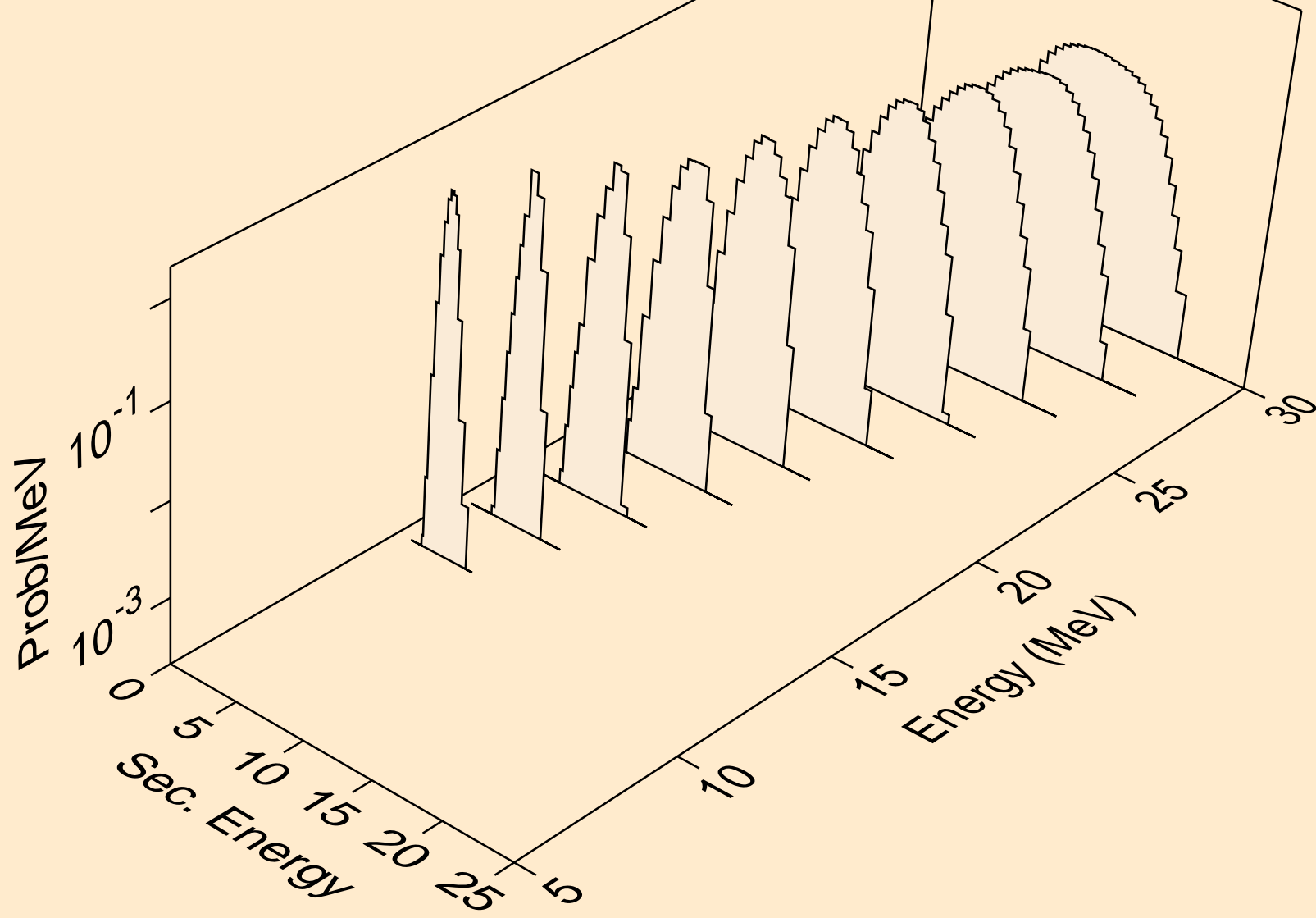

ER160 DEUTERON ACER TENDL-2023 LIBRARY; T=0.K
Deuteron emission for (d,da)

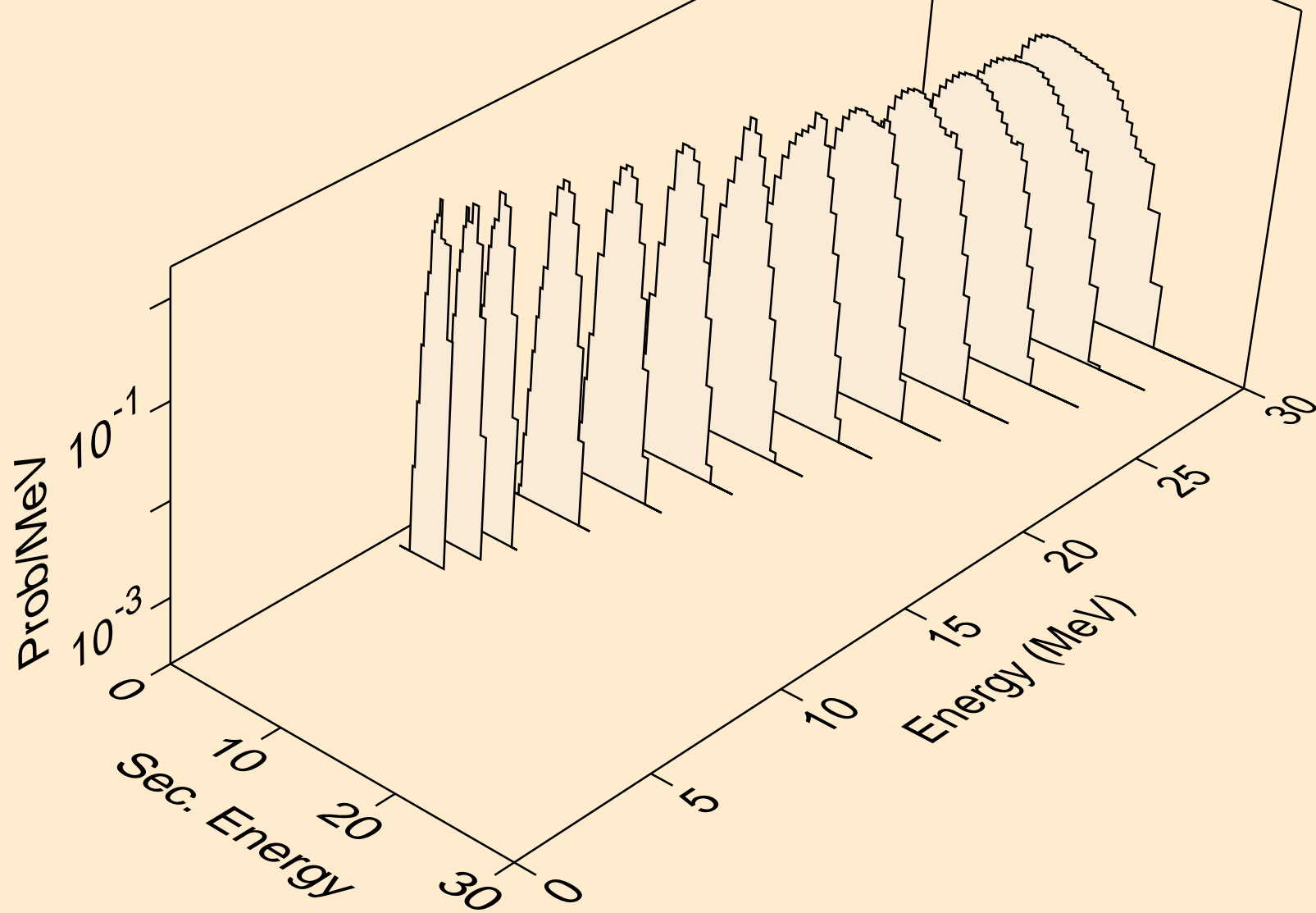

ER160 DEUTERON ACER TENDL-2023 LIBRARY; T=0.K
Photon emission for (z,n)

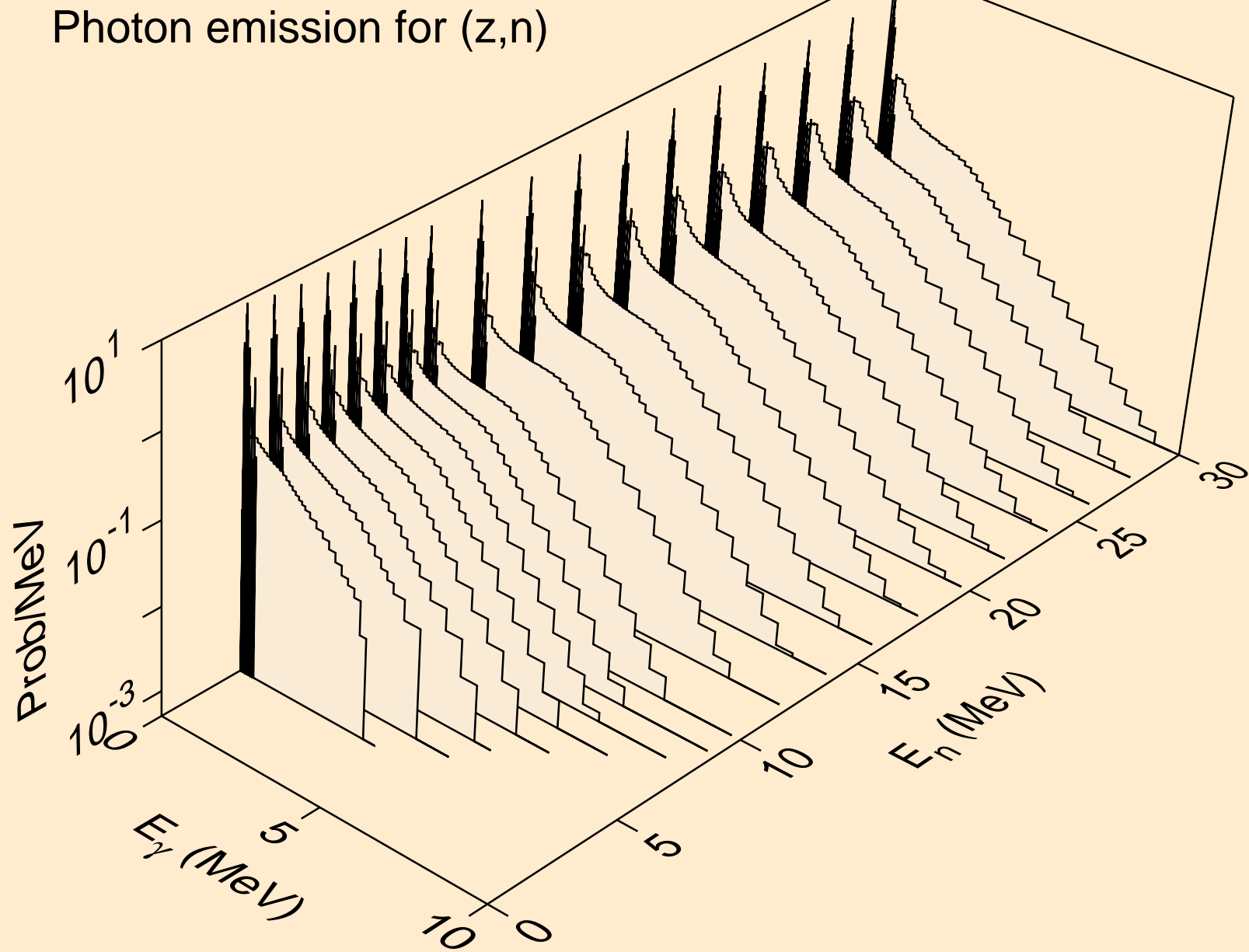

ER160 DEUTERON ACER TENDL-2023 LIBRARY; T=0.K
Photon emission for (z,x)

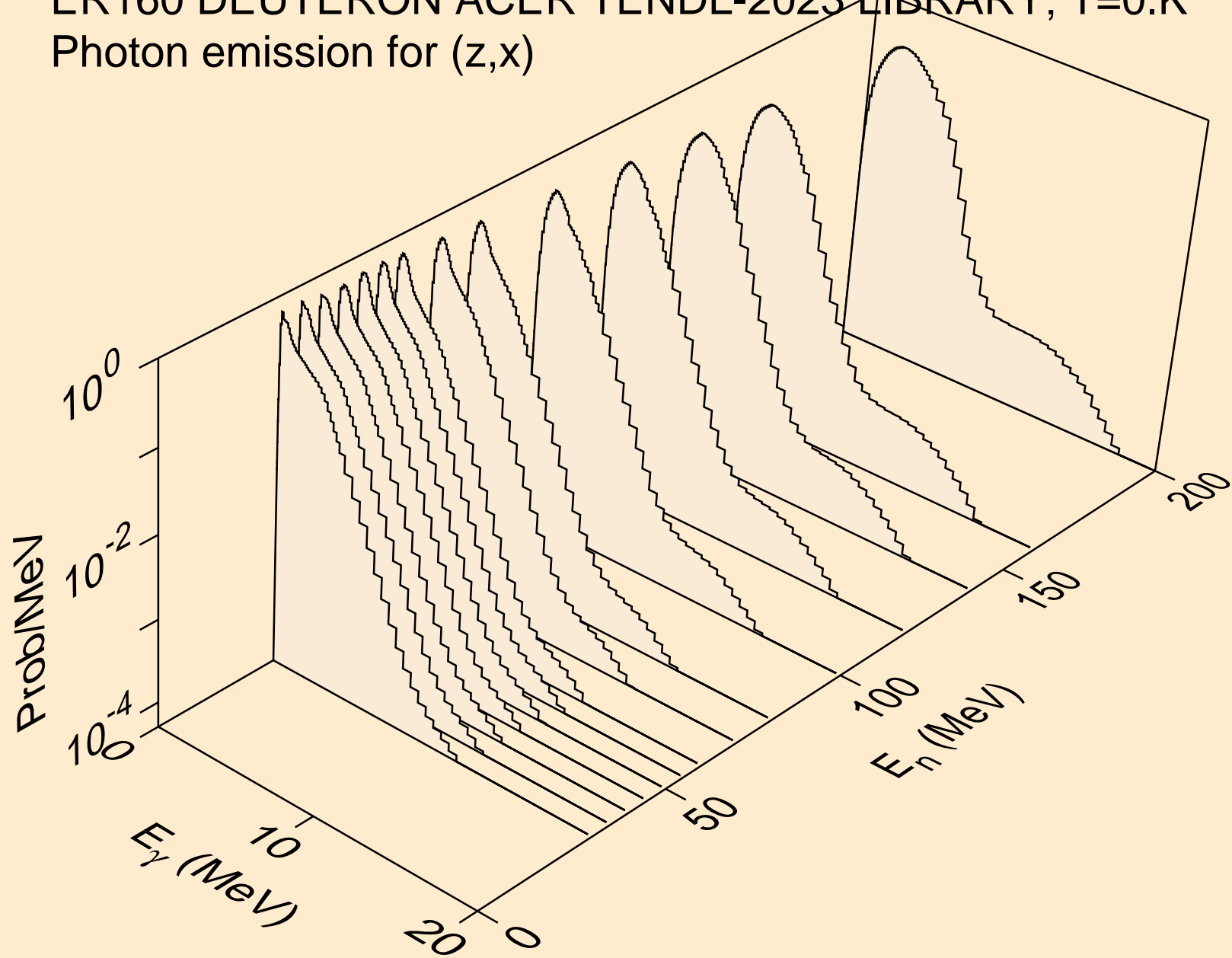

ER160 DEUTERON ACER TENDL-2023 LIBRARY; T=0.K
Photon emission for (n,2nd)

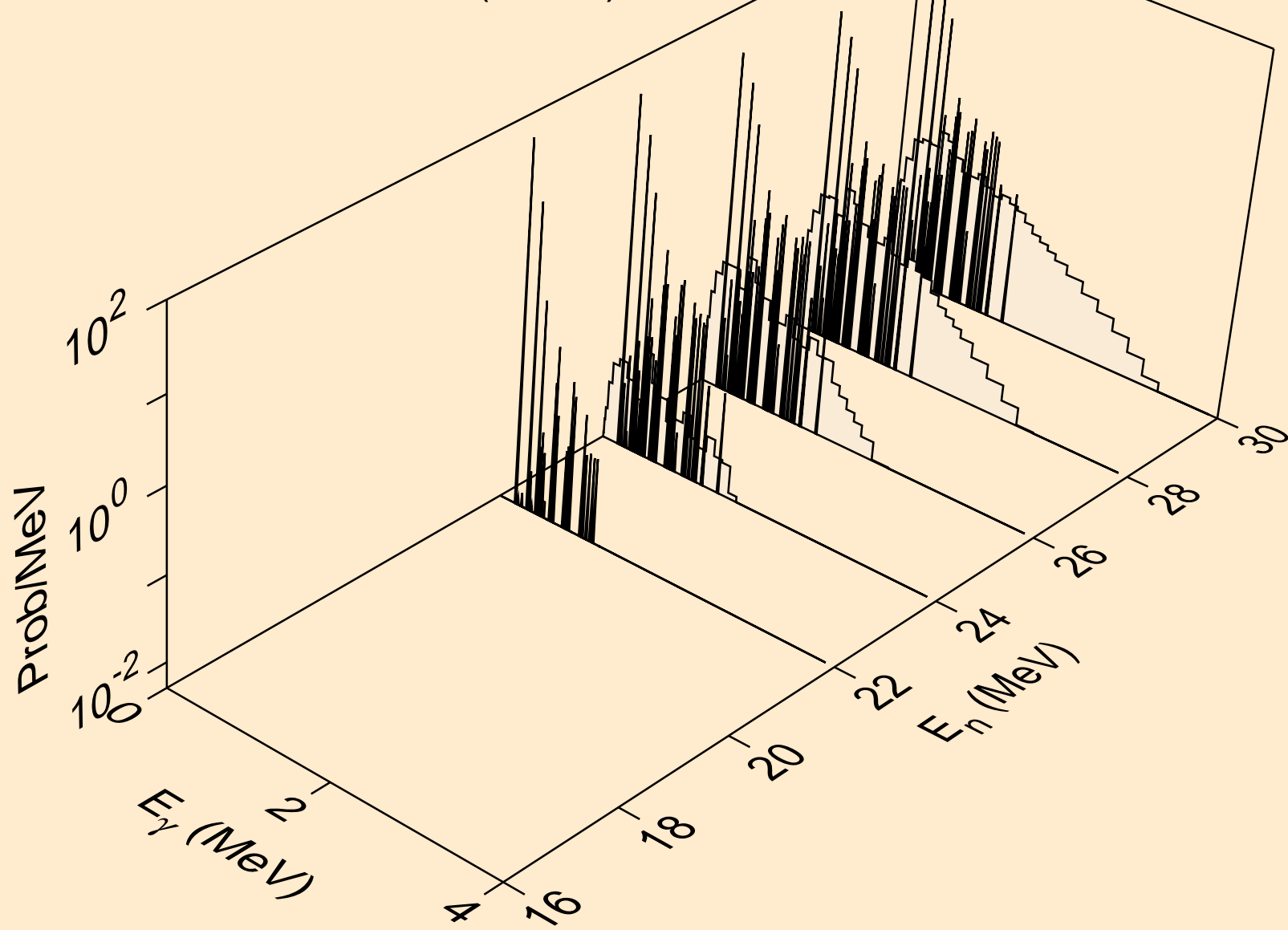

ER160 DEUTERON ACER TENDL-2023 LIBRARY; T=0.K
Photon emission for (n,2n)

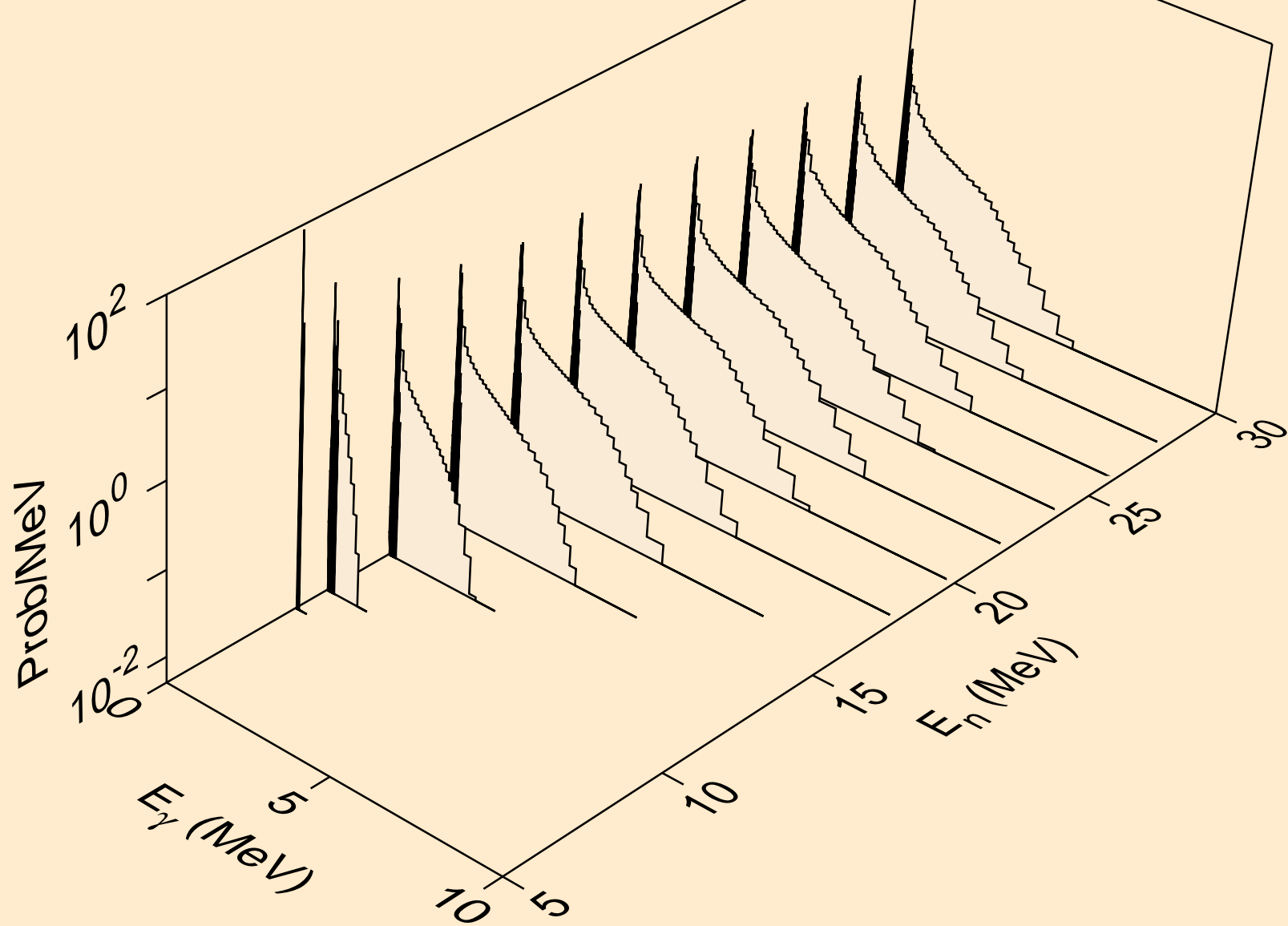

ER160 DEUTERON ACER TENDL-2023 LIBRARY; T=0.K
Photon emission for (n,3n)

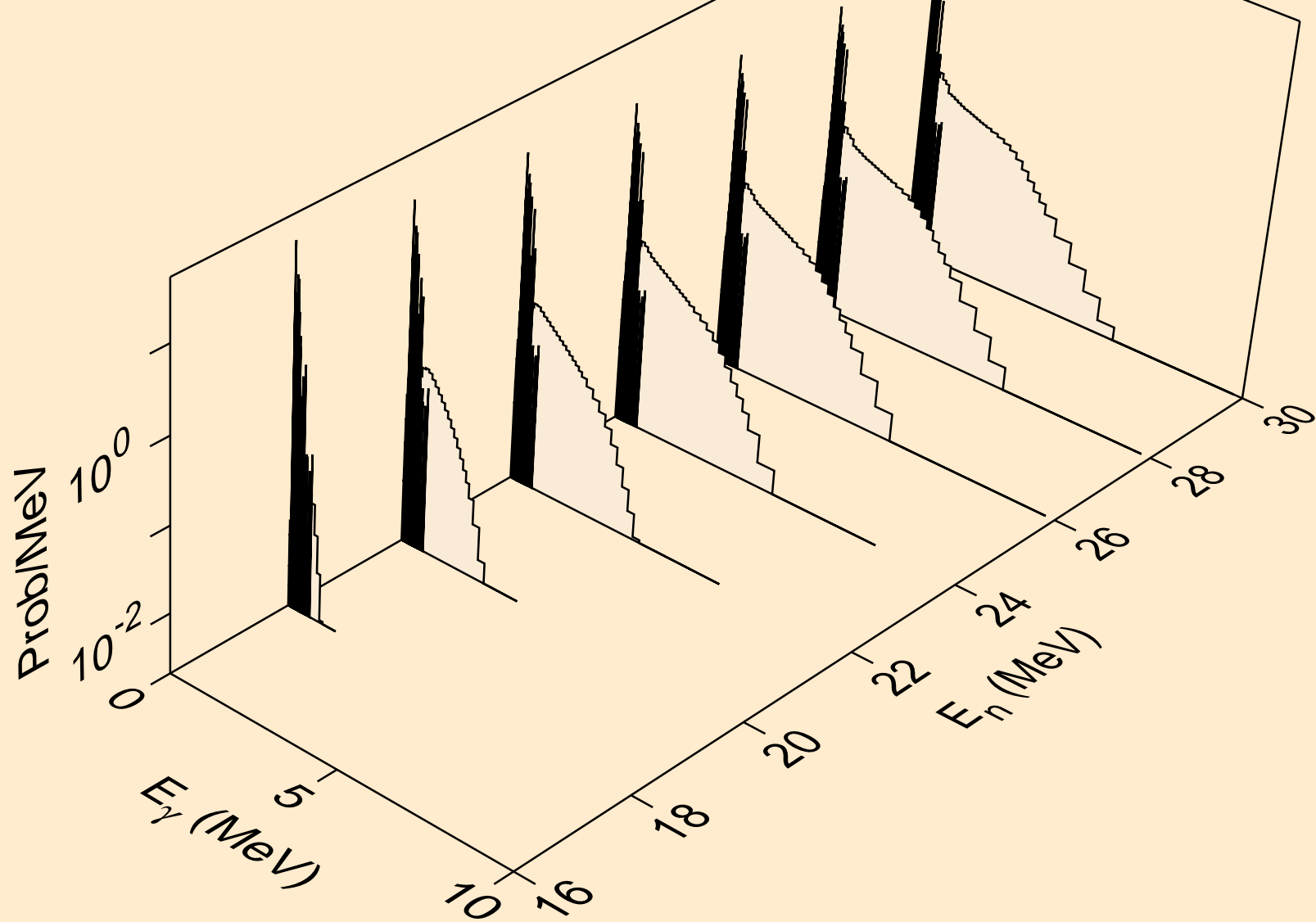

ER160 DEUTERON ACER TENDL-2023 LIBRARY; T=0.K
Photon emission for (n,n*)a

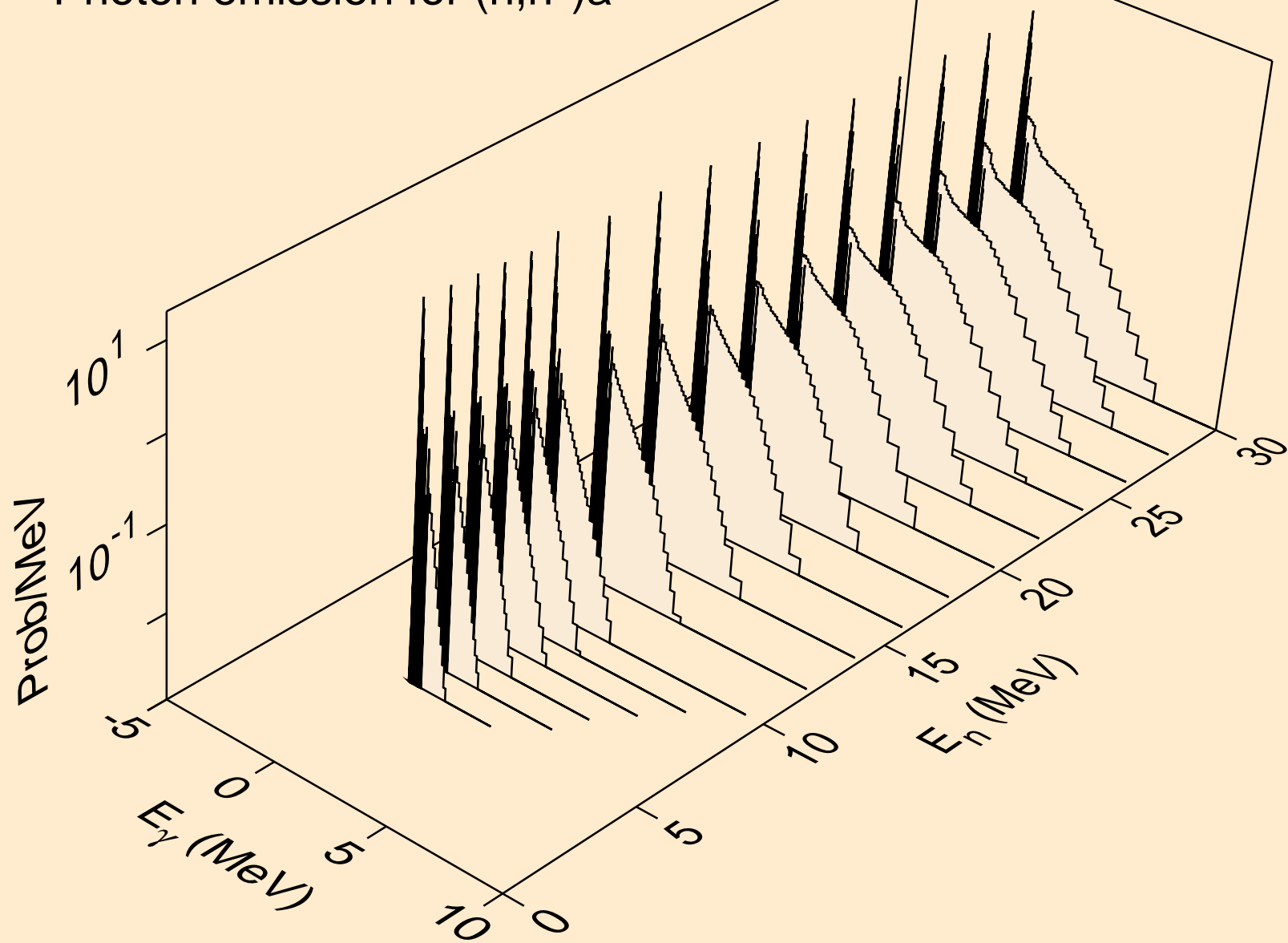

ER160 DEUTERON ACER TENDL-2023 LIBRARY; T=0.K
Photon emission for (n,2n)a

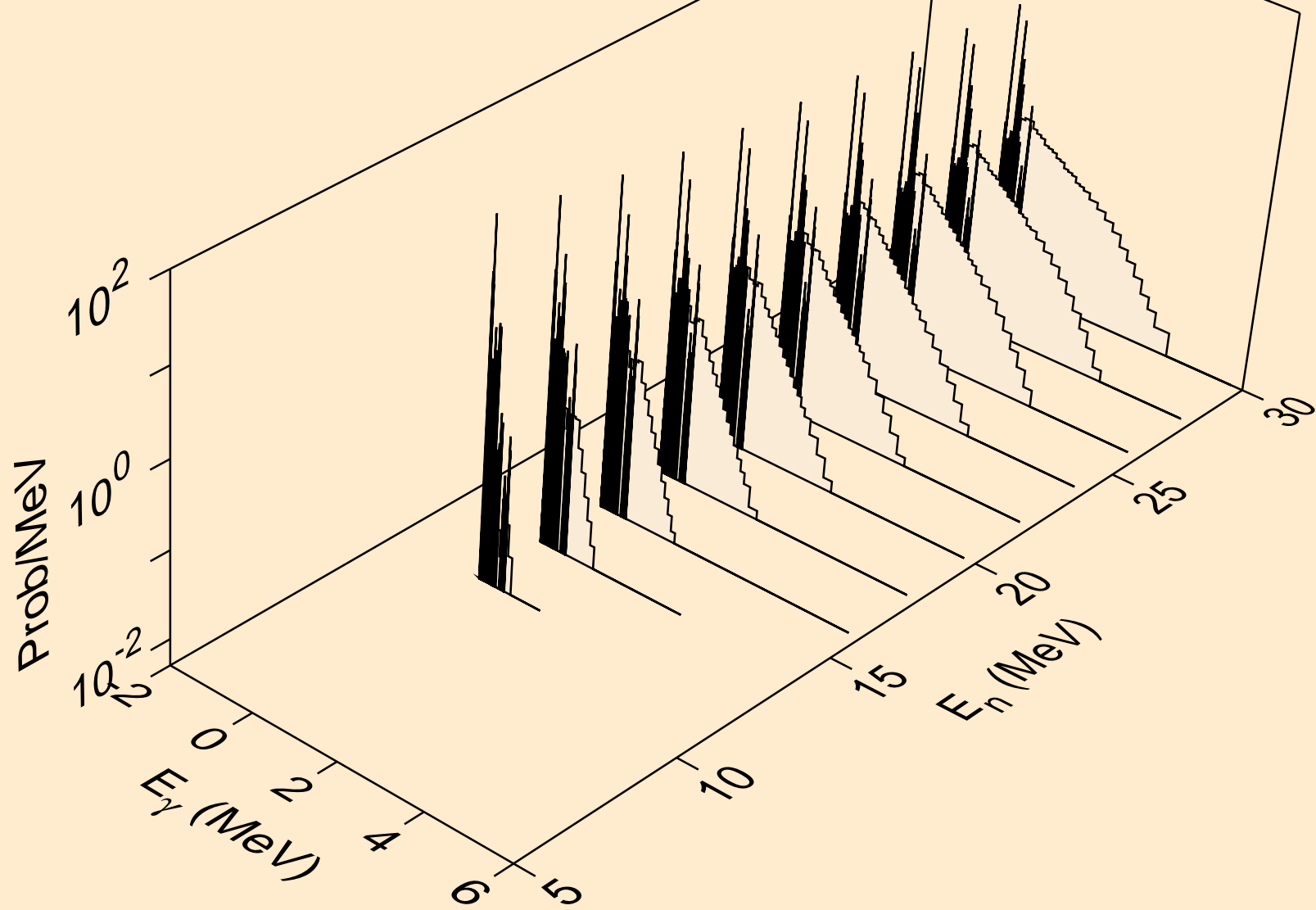

ER160 DEUTERON ACER TENDL-2023 LIBRARY; T=0.K
Photon emission for (n,3n)a

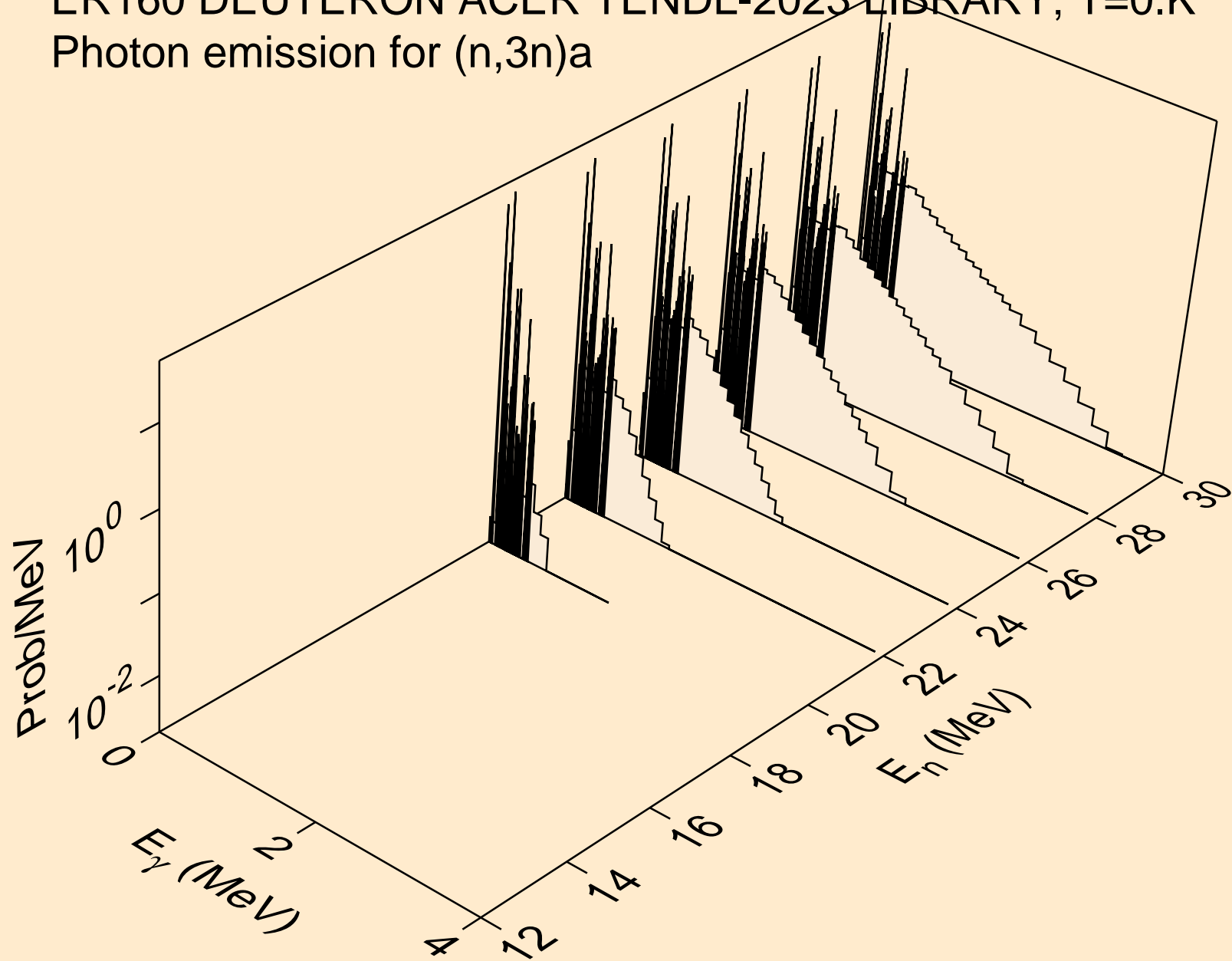

ER160 DEUTERON ACER TENDL-2023 LIBRARY; T=0.K
Photon emission for (n,n*)p

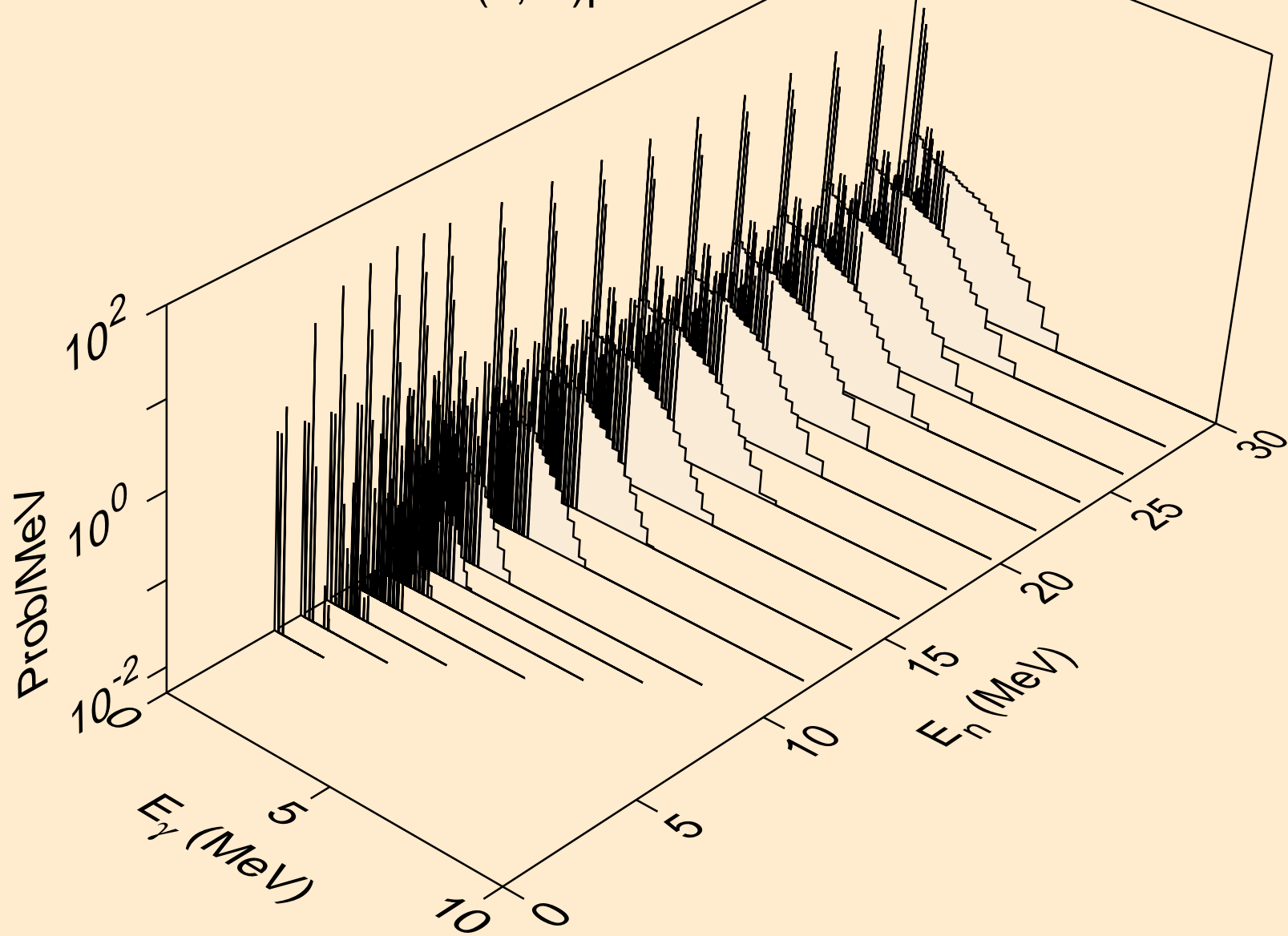

ER160 DEUTERON ACER TENDL-2023 LIBRARY; T=0.K
Photon emission for (n,n*)2a

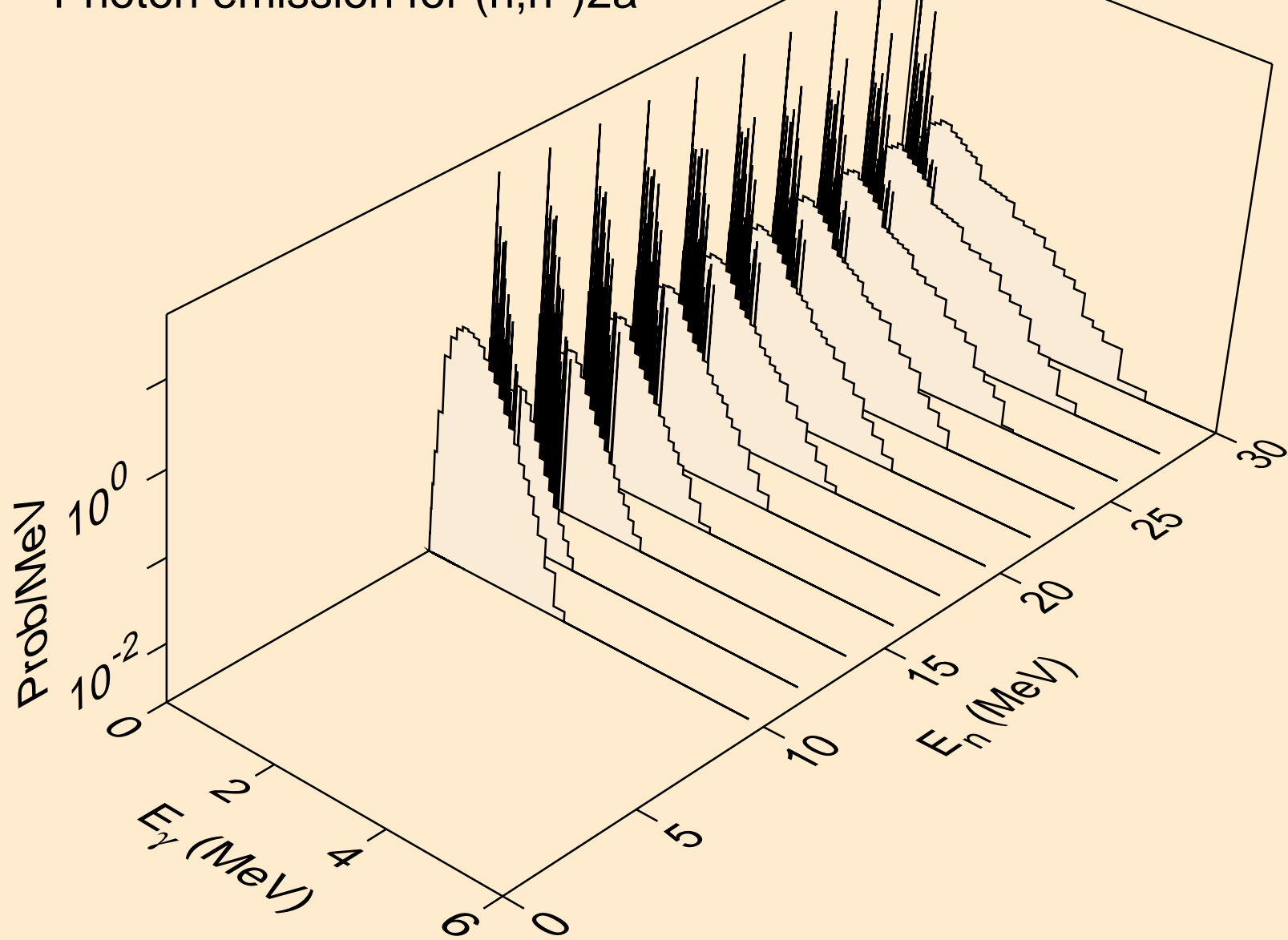

ER160 DEUTERON ACER TENDL-2023 LIBRARY; T=0.K
Photon emission for (n,2n)2a

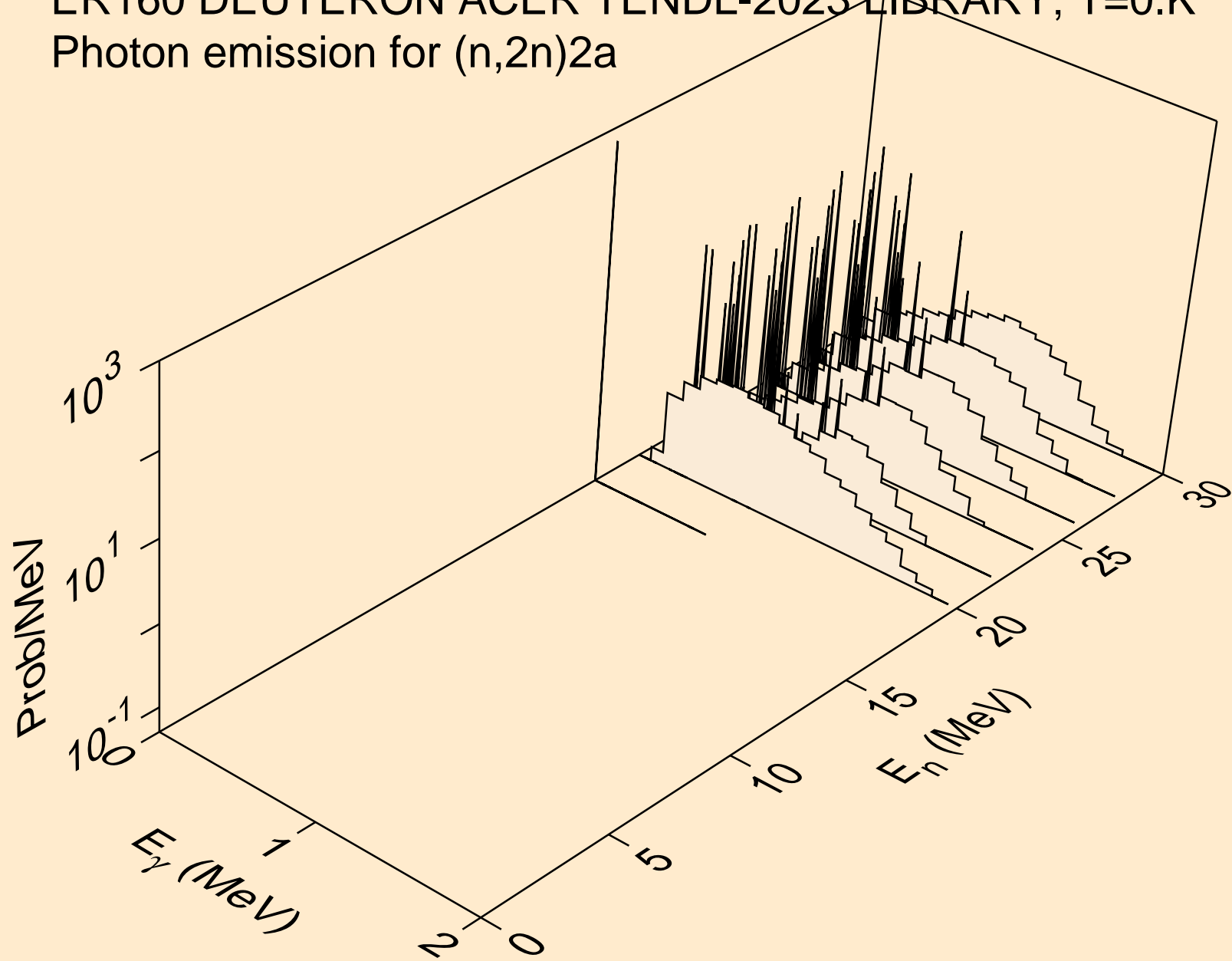

ER160 DEUTERON ACER TENDL-2023 LIBRARY; T=0.K
Photon emission for (n,n*)d

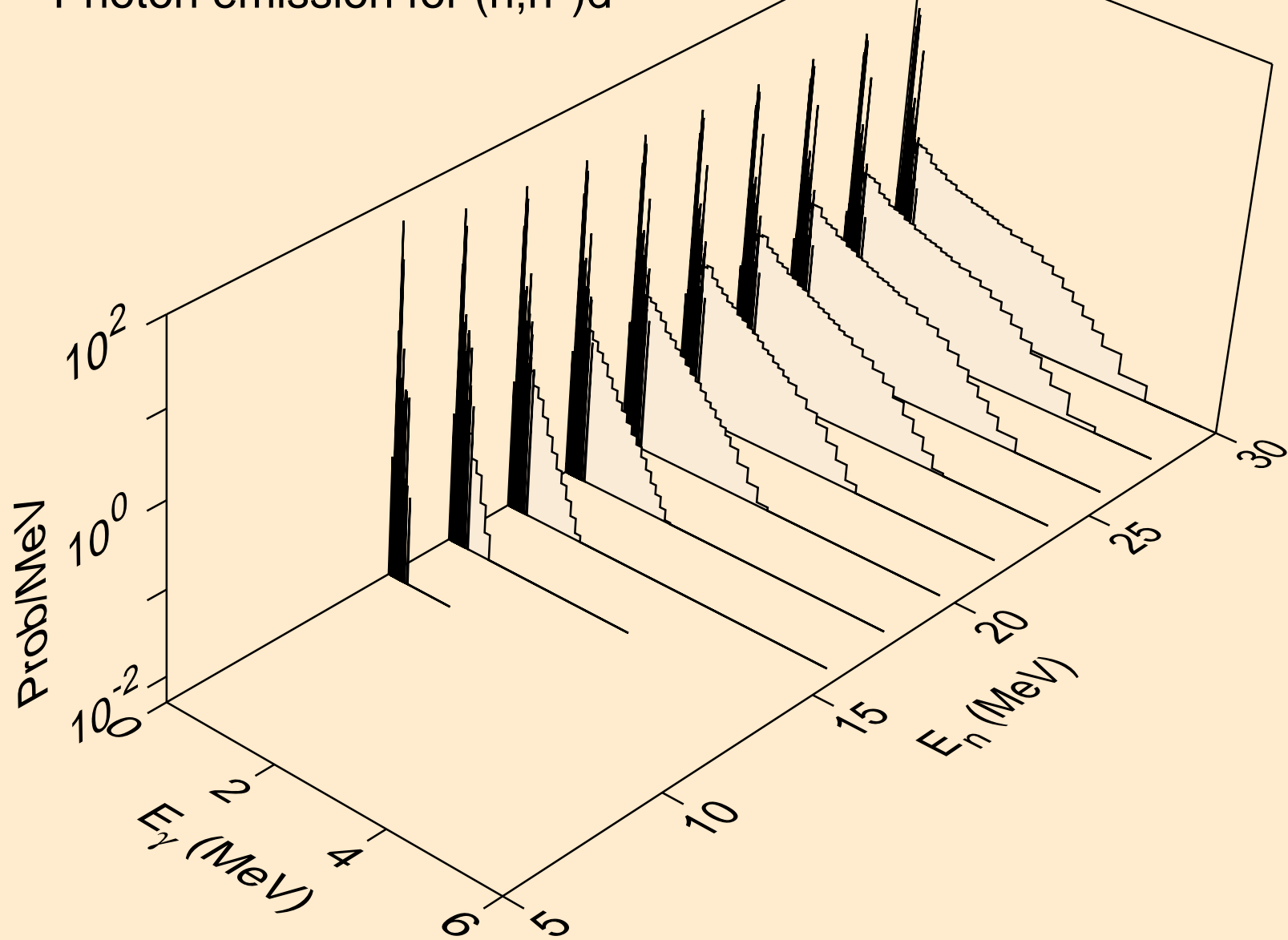

ER160 DEUTERON ACER TENDL-2023 LIBRARY; T=0.K
Photon emission for (n,n*)t

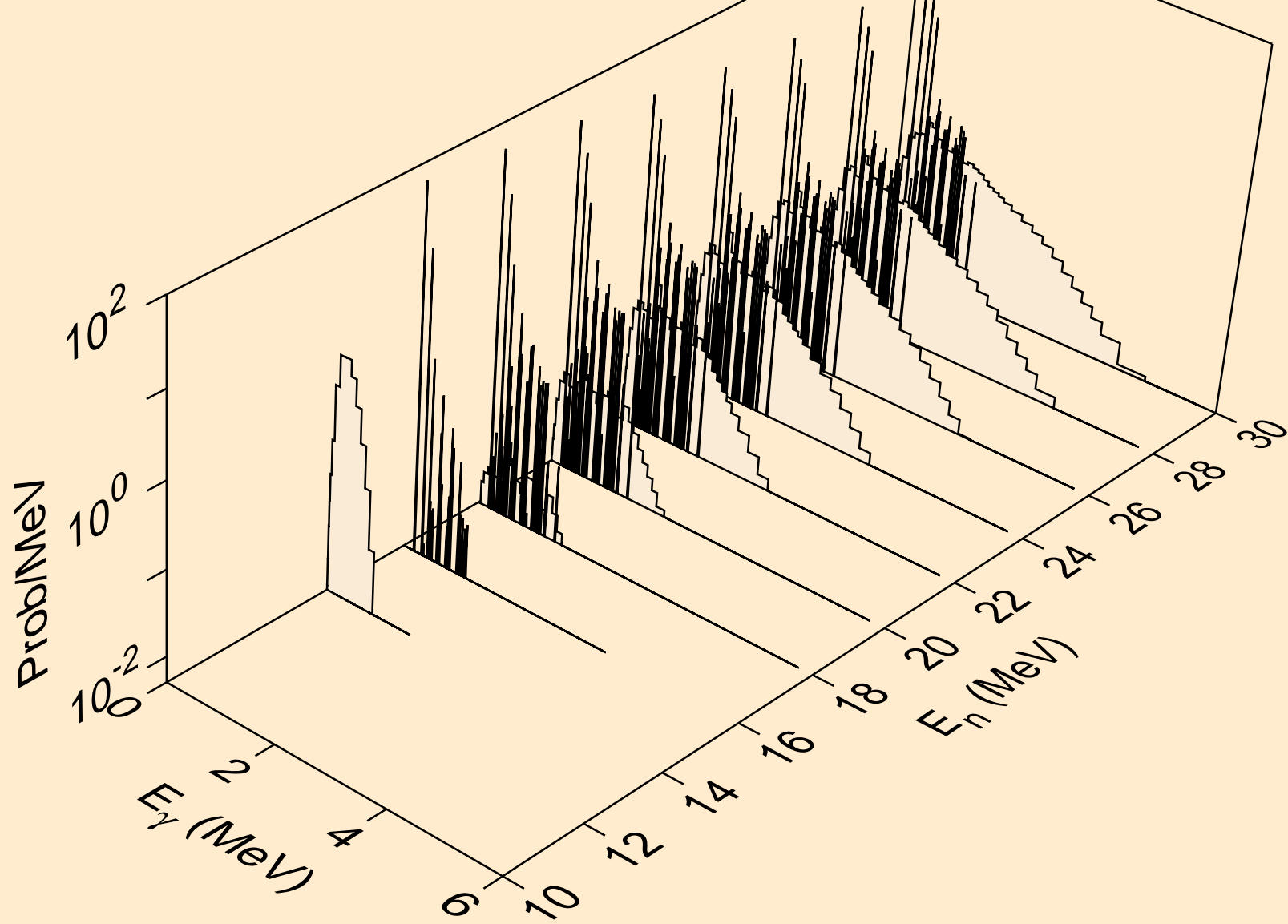

ER160 DEUTERON ACER TENDL-2023 LIBRARY; T=0.K
Photon emission for (n,n*)he3

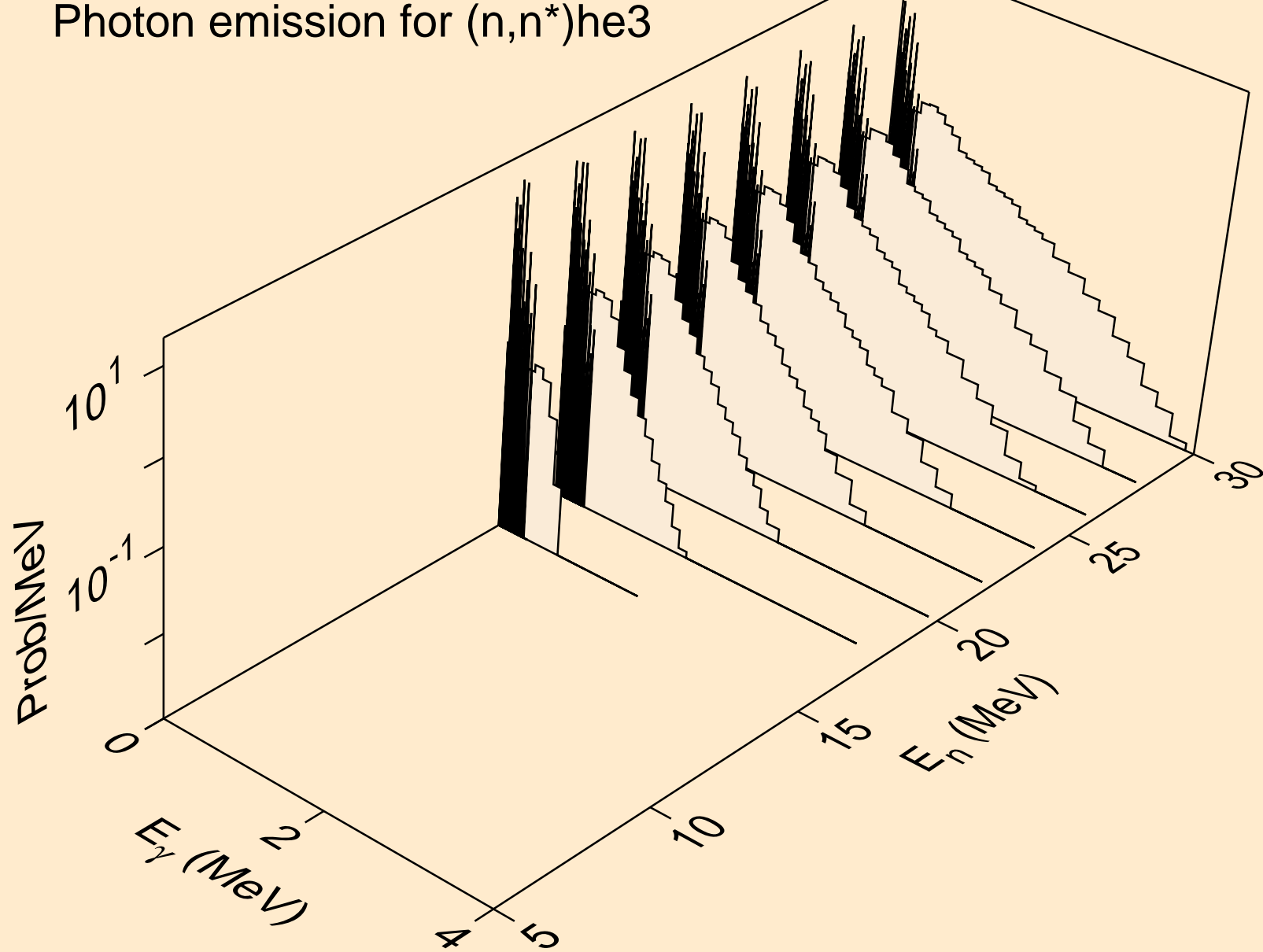

ER160 DEUTERON ACER TENDL-2023 LIBRARY; T=0.K
Photon emission for (n,4n)

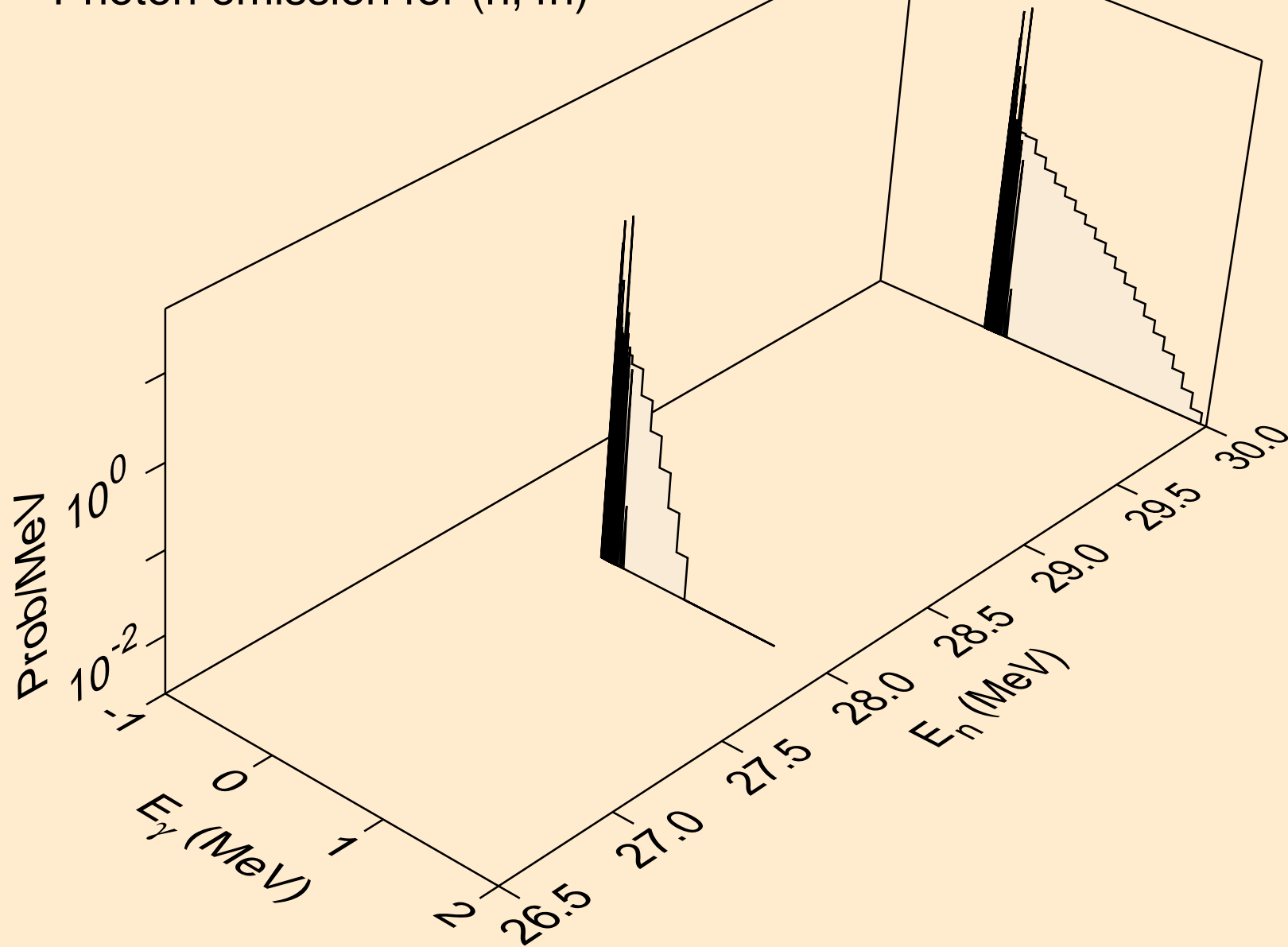

ER160 DEUTERON ACER TENDL-2023 LIBRARY; T=0.K
Photon emission for (n,2np)

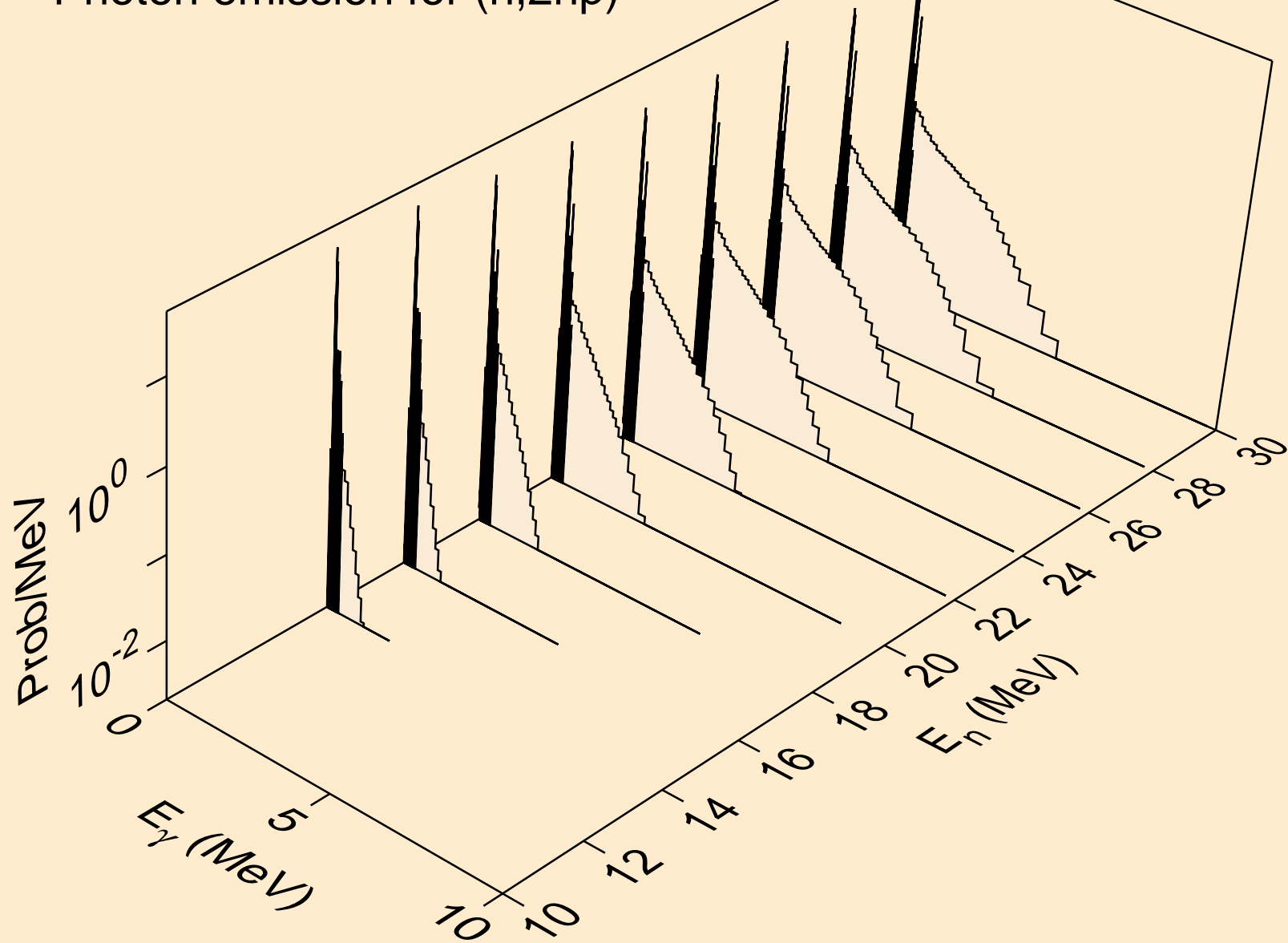

ER160 DEUTERON ACER TENDL-2023 LIBRARY; T=0.K
Photon emission for (n,3np)

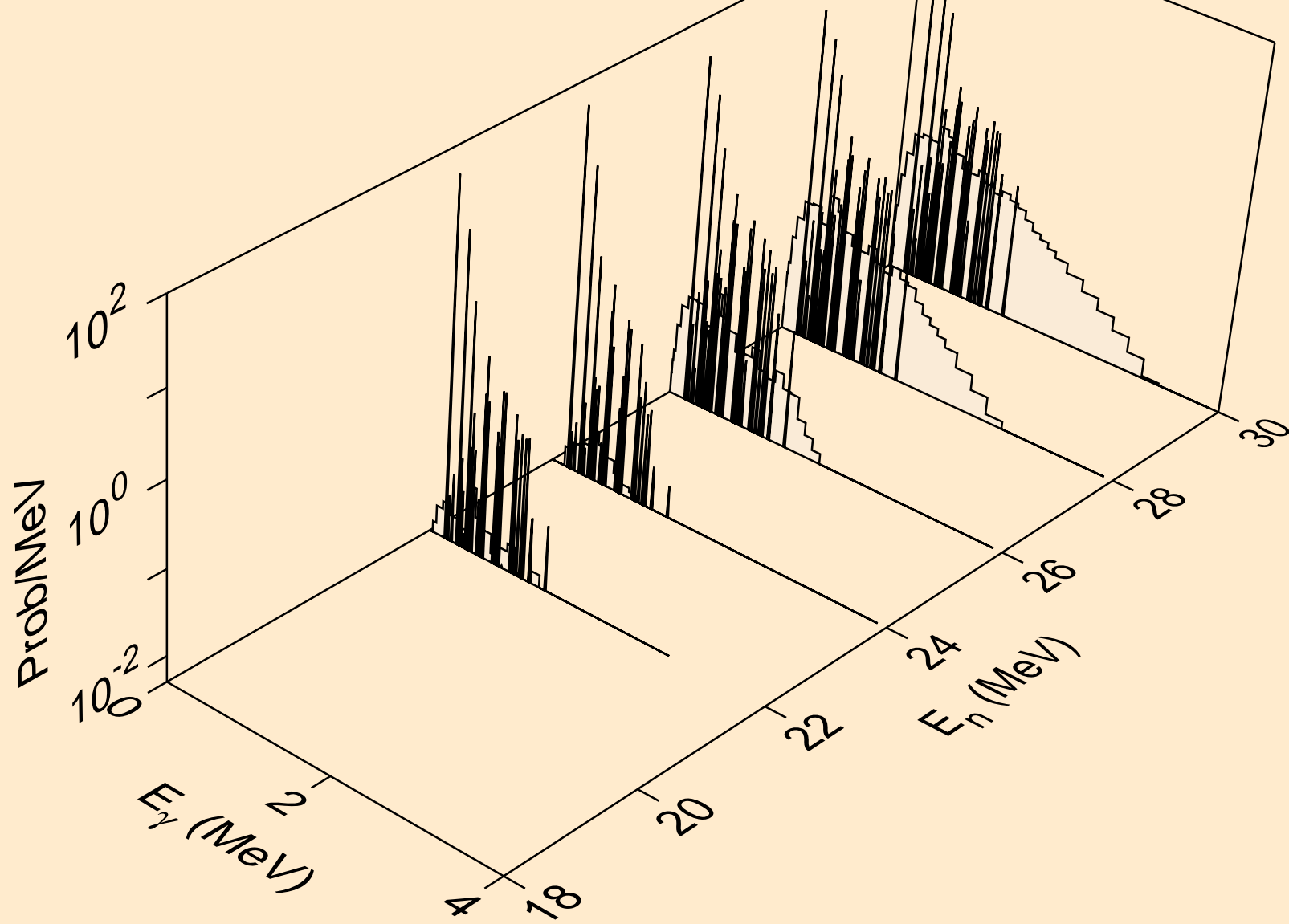

ER160 DEUTERON ACER TENDL-2023 LIBRARY; T=0.K
Photon emission for (n,n2p)

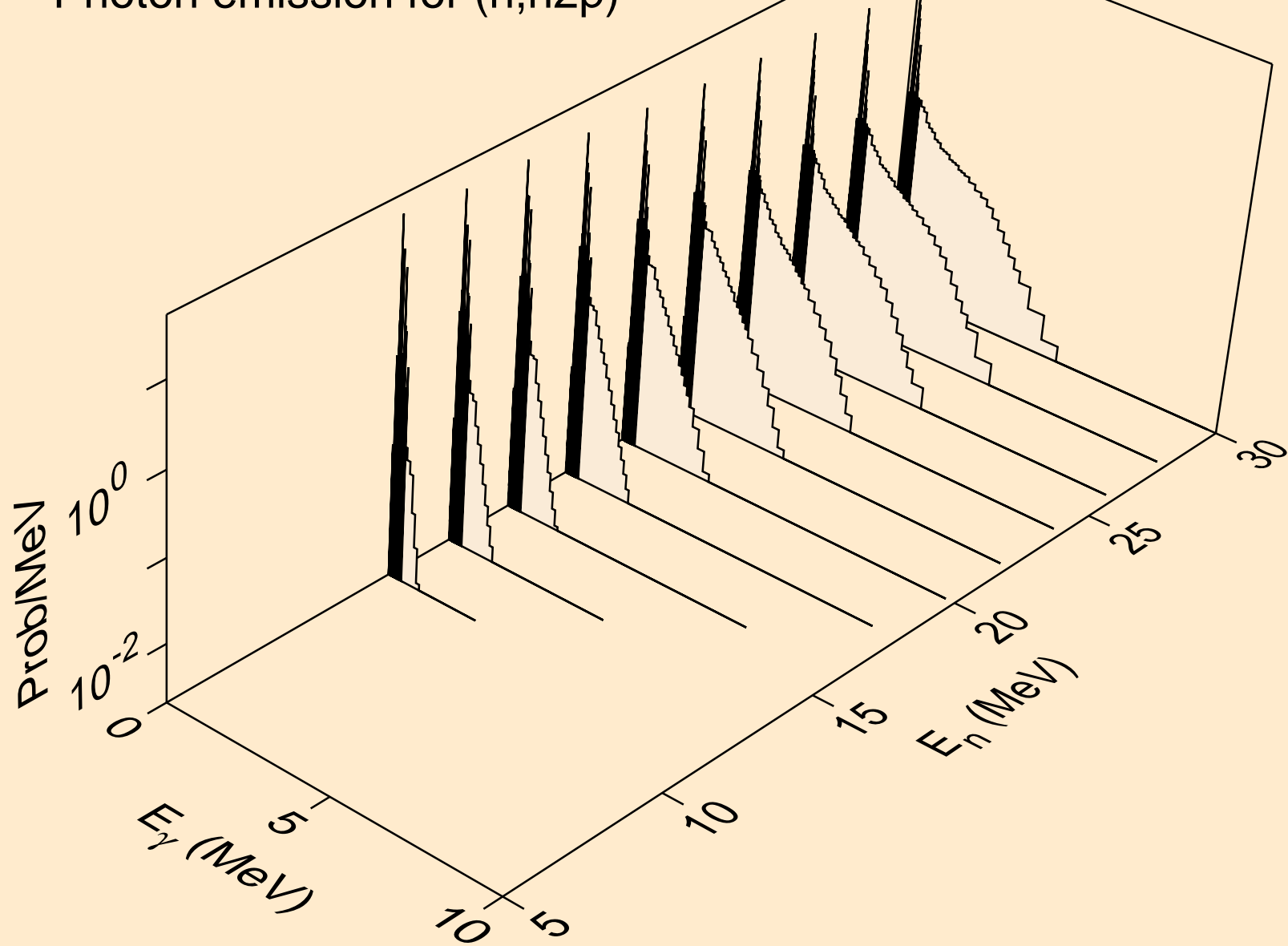

ER160 DEUTERON ACER TENDL-2023 LIBRARY; T=0.K
Photon emission for (n,npa)

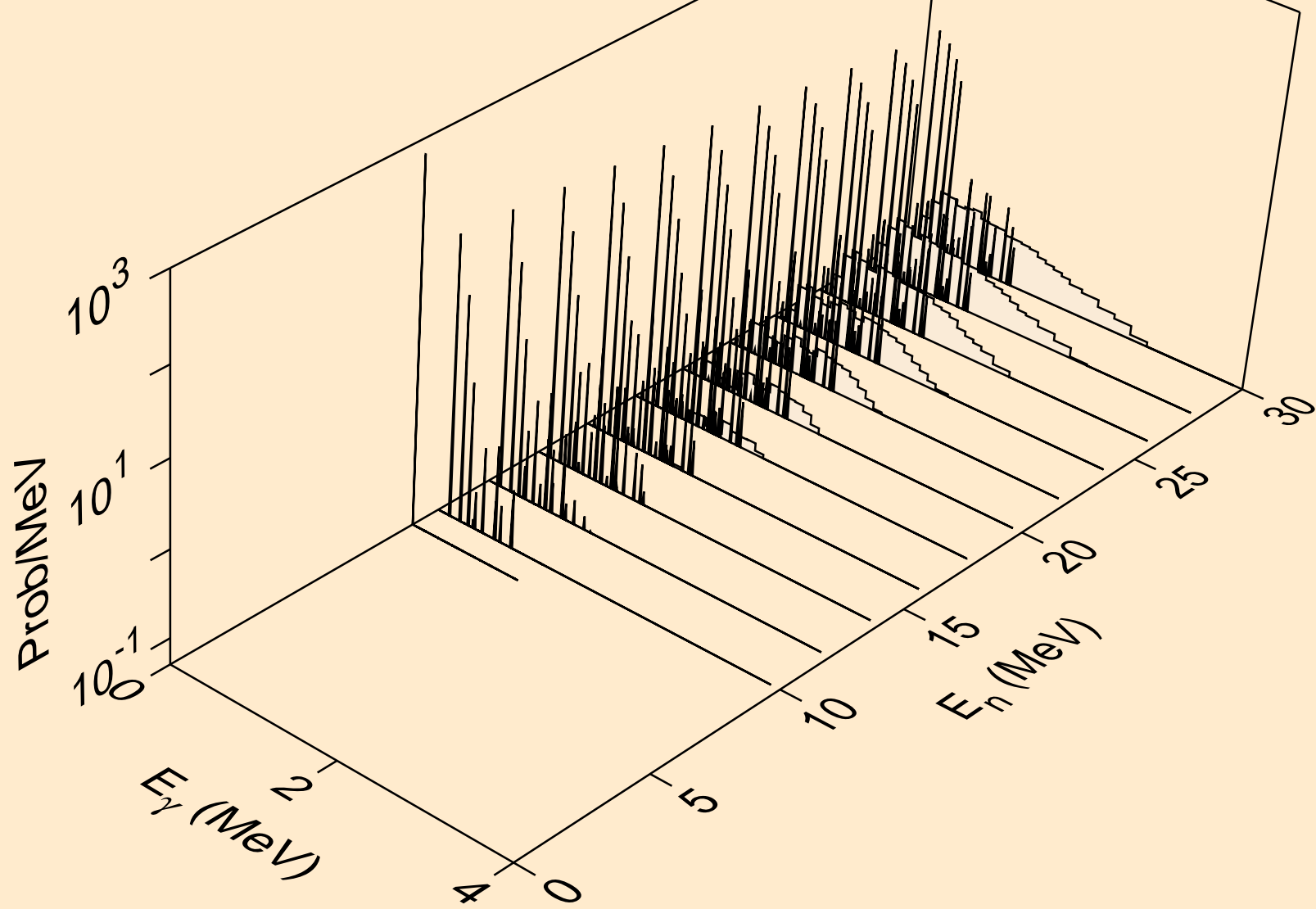

ER160 DEUTERON ACER TENDL-2023 LIBRARY; T=0.K
Photon emission for (n,gma)

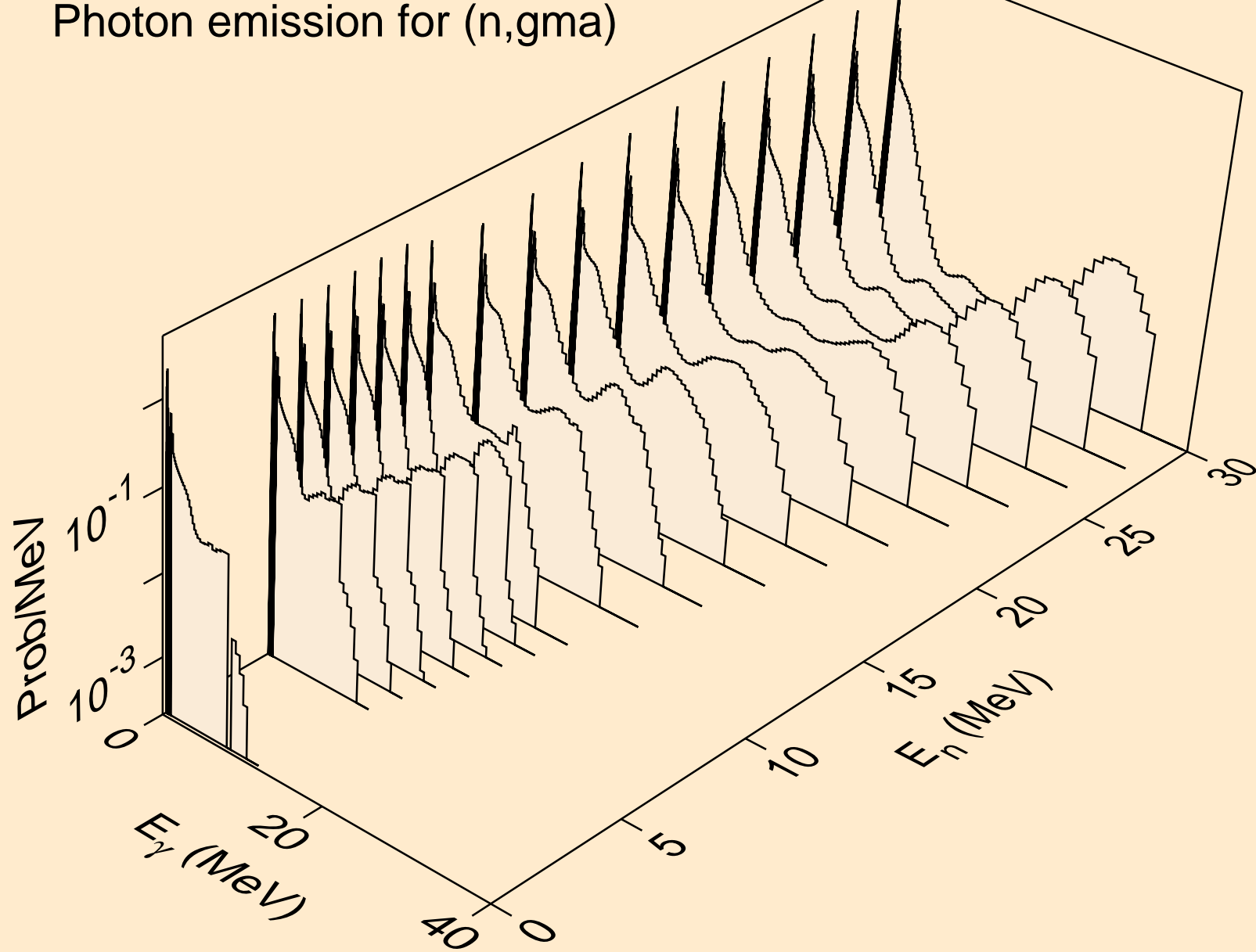

ER160 DEUTERON ACER TENDL-2023 LIBRARY; T=0.K
Photon emission for (n,p)

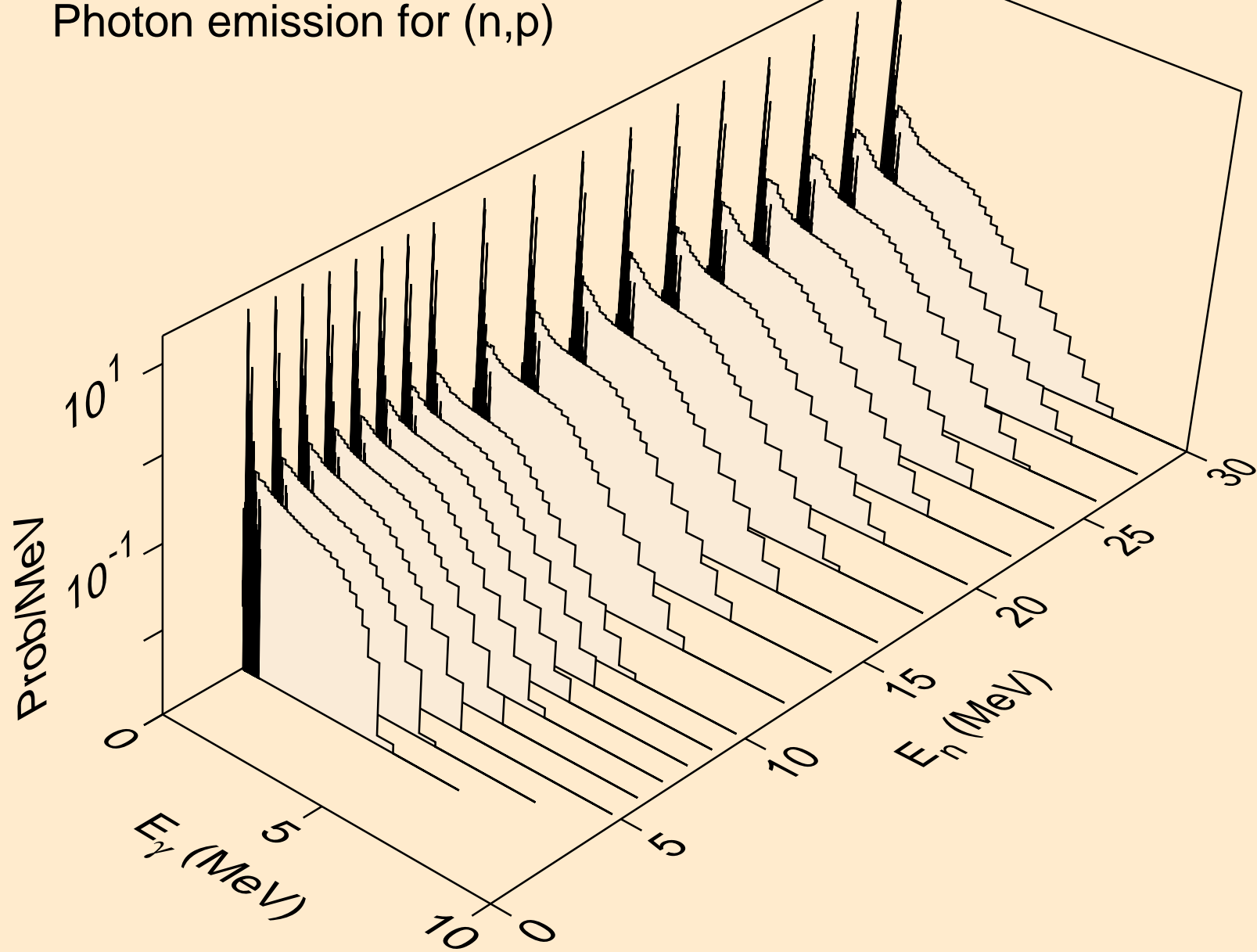

ER160 DEUTERON ACER TENDL-2023 LIBRARY; T=0.K
Photon emission for inelastic

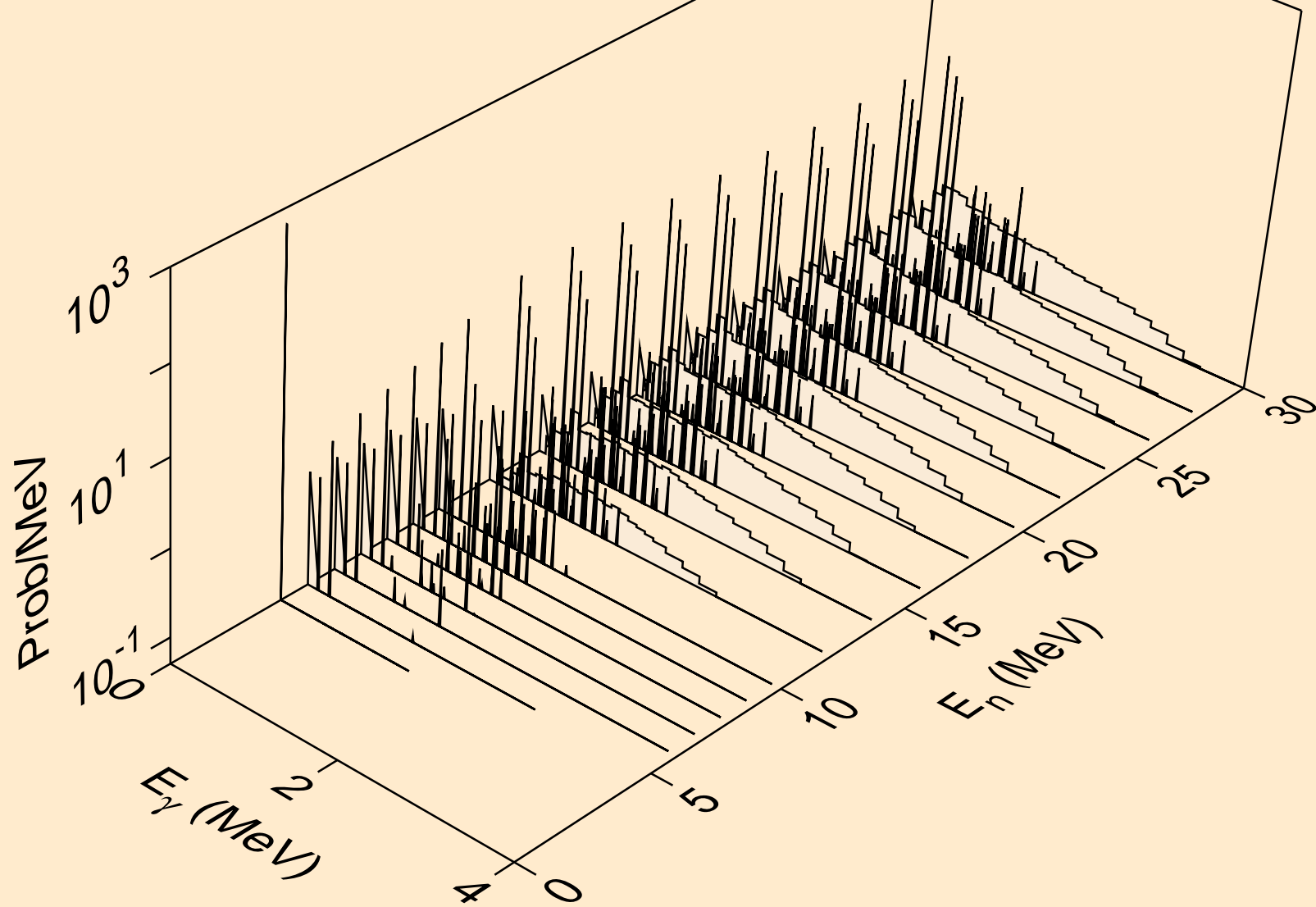

ER160 DEUTERON ACER TENDL-2023 LIBRARY; T=0.K
Photon emission for (n,t)

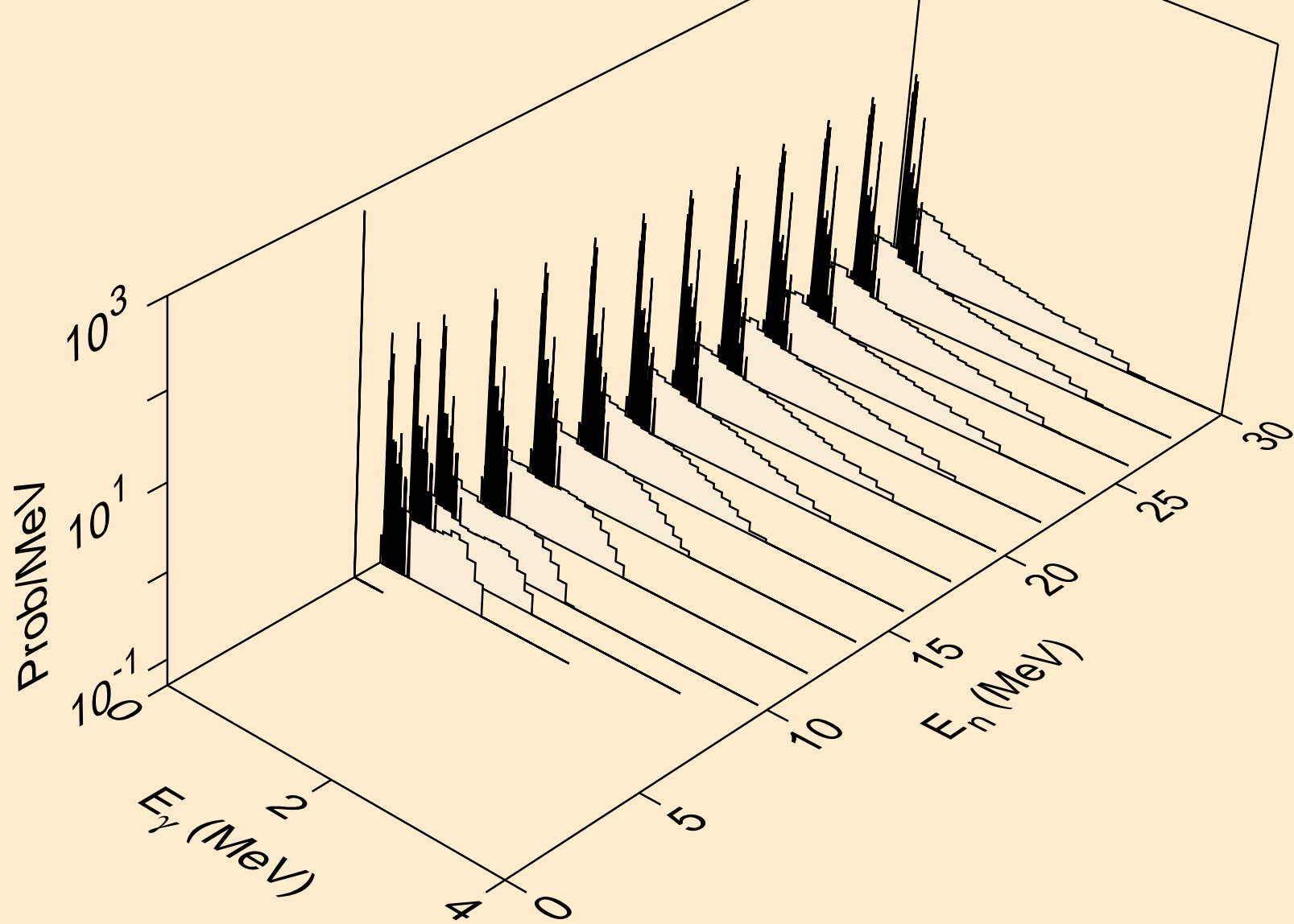

ER160 DEUTERON ACER TENDL-2023 LIBRARY; T=0.K
Photon emission for (n,he3)

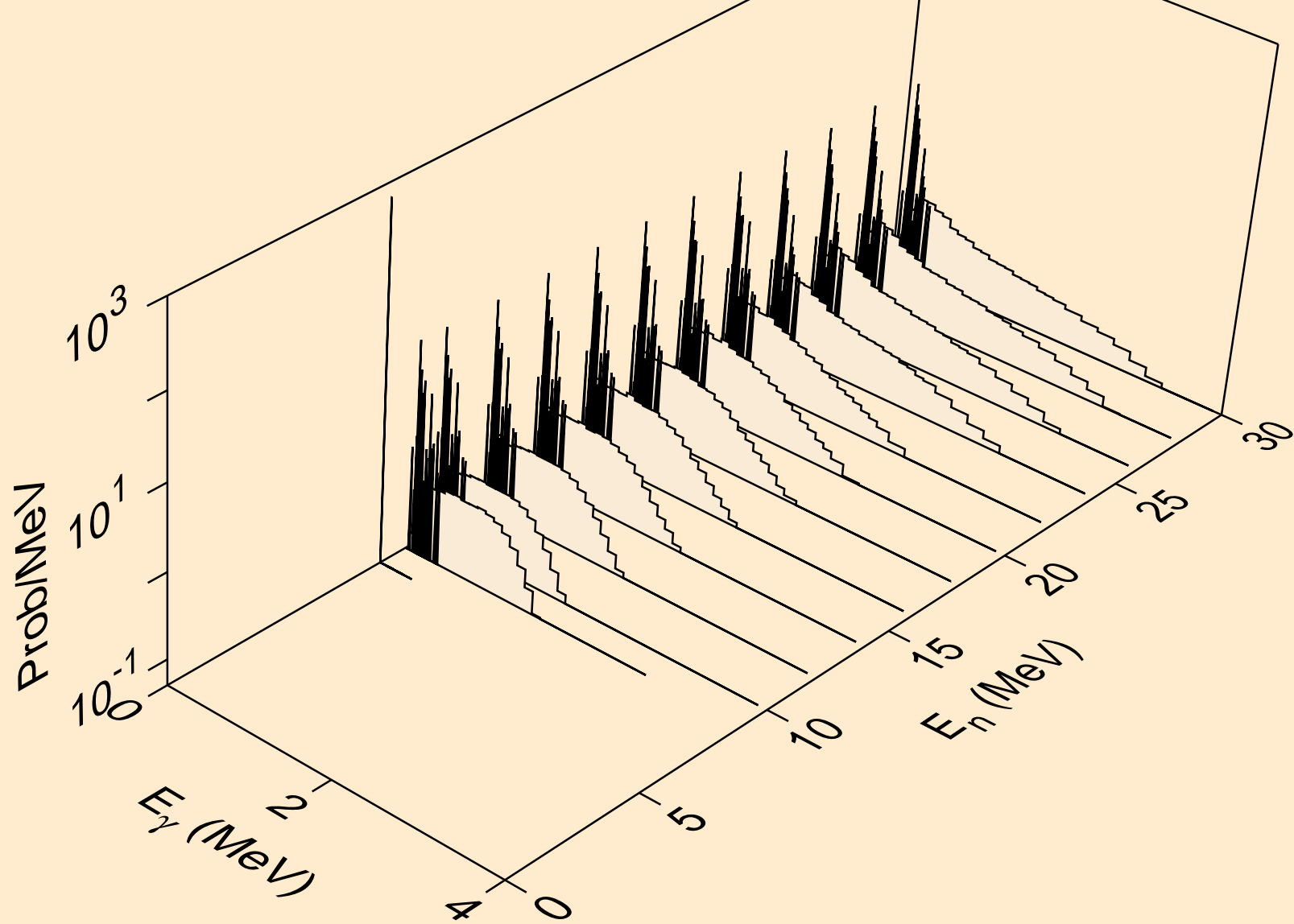

ER160 DEUTERON ACER TENDL-2023 LIBRARY; T=0.K
Photon emission for (n,a)

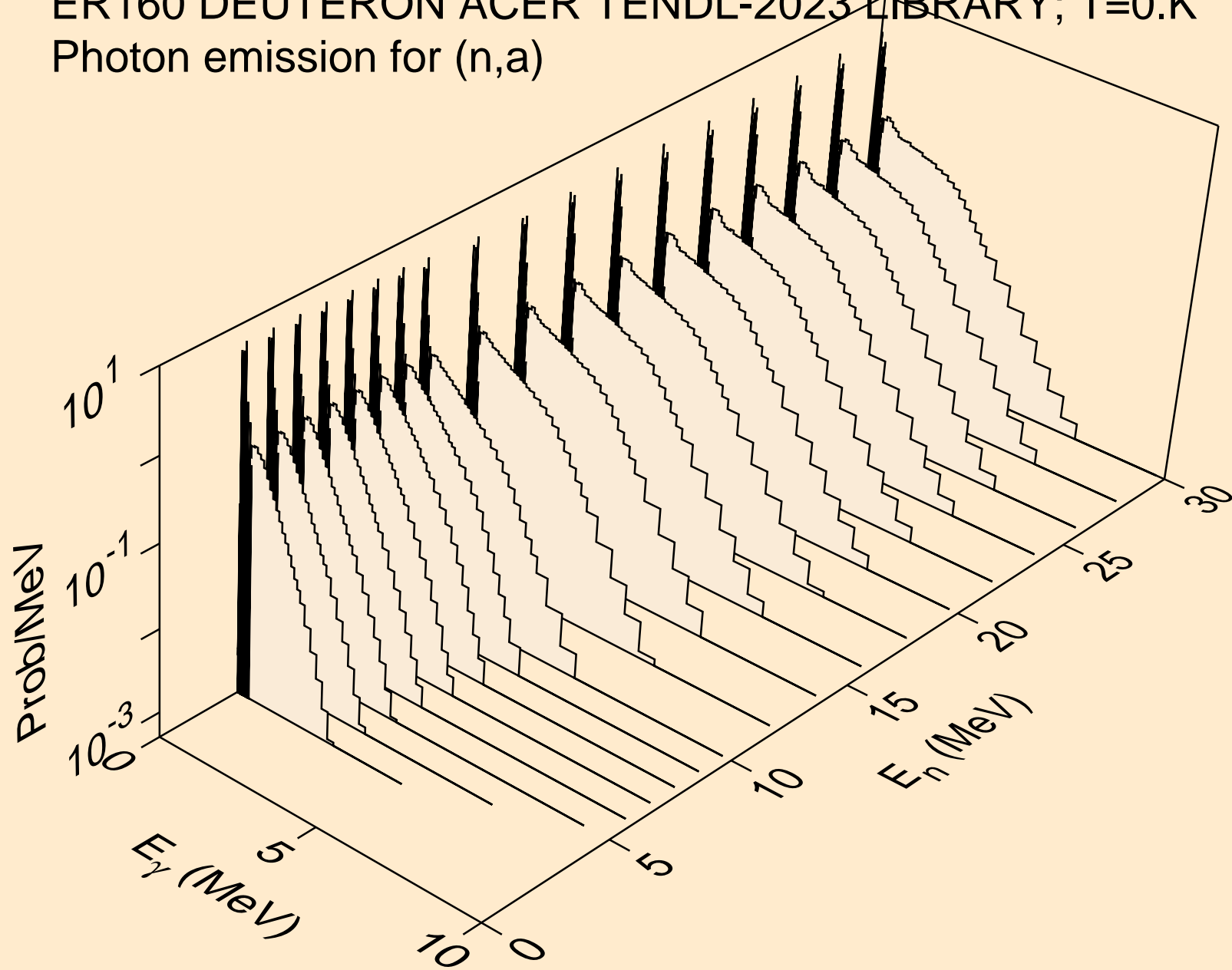

ER160 DEUTERON ACER TENDL-2023 LIBRARY; T=0.K
Photon emission for (n,2a)

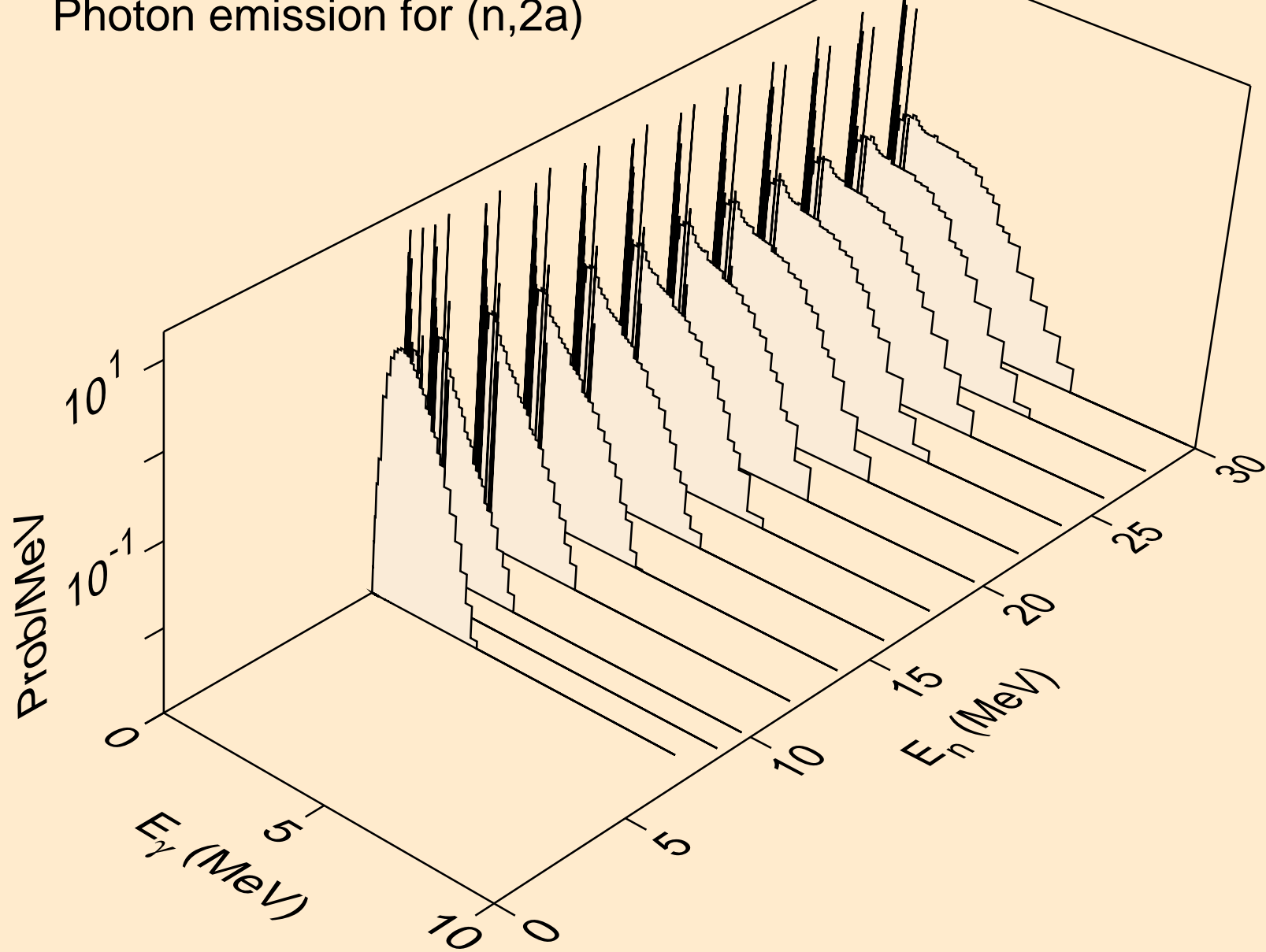

ER160 DEUTERON ACER TENDL-2023 LIBRARY; T=0.K
Photon emission for (n,2p)

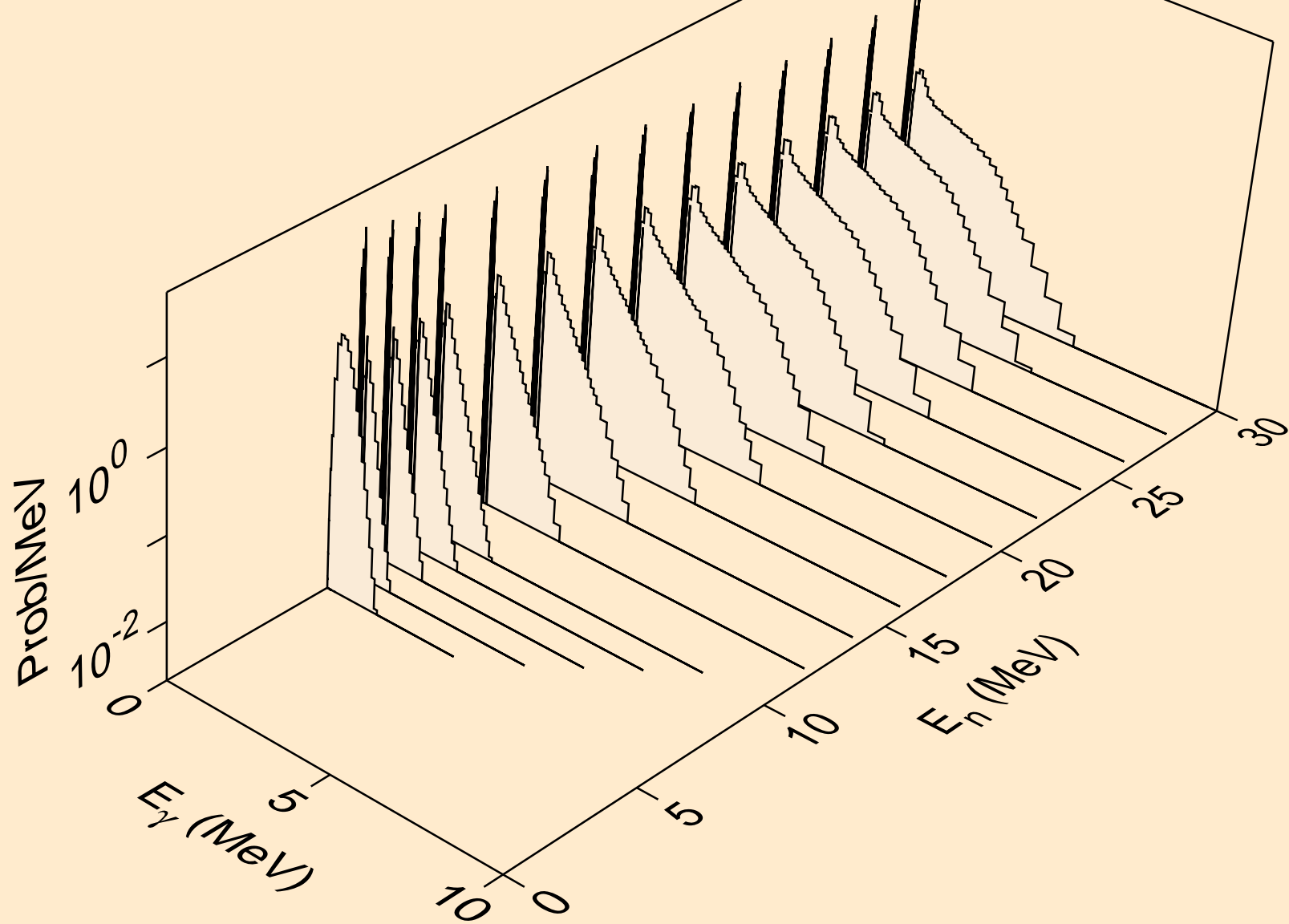

ER160 DEUTERON ACER TENDL-2023 LIBRARY; T=0.K
Photon emission for (n,p)

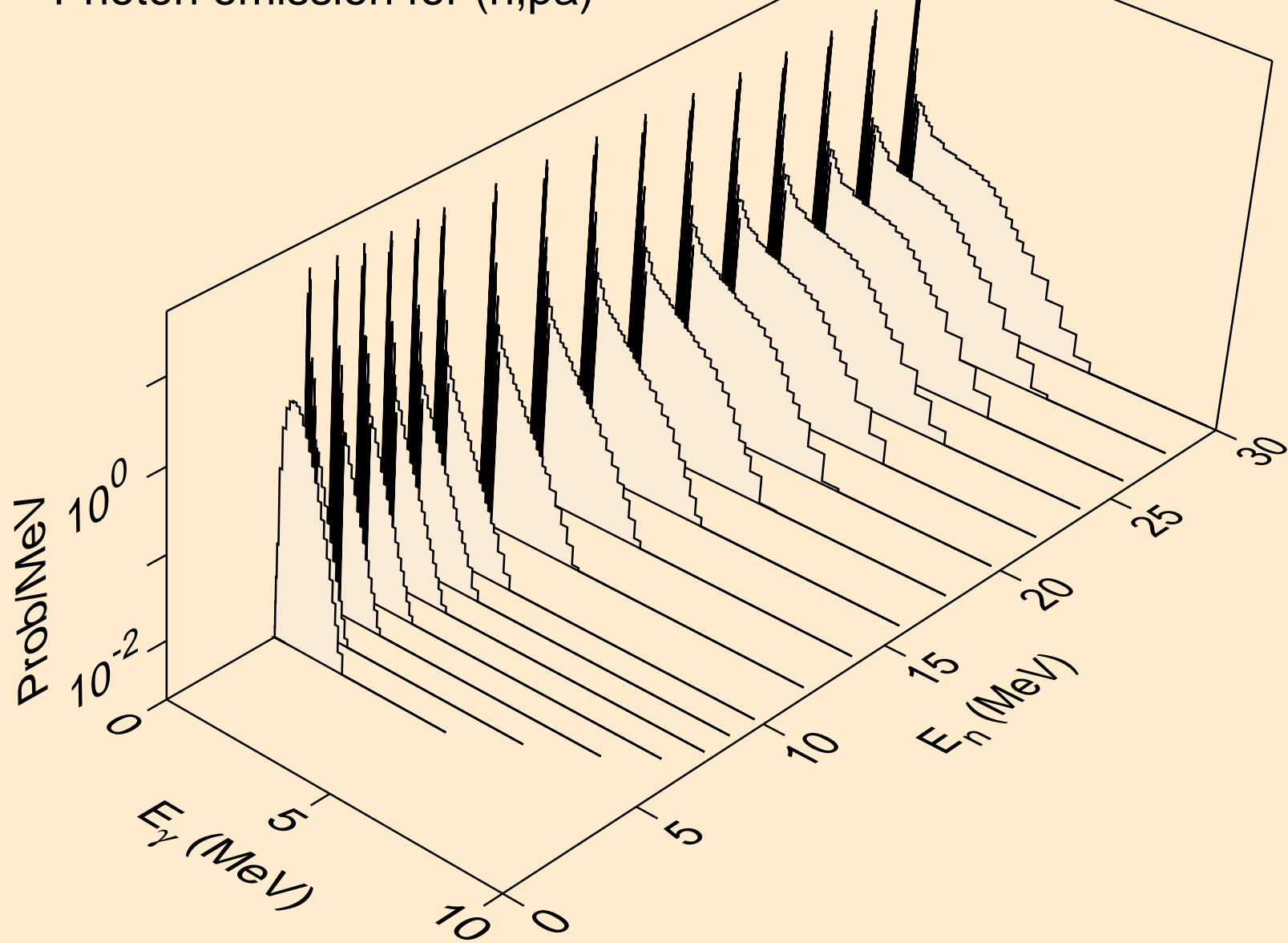

ER160 DEUTERON ACER TENDL-2023 LIBRARY; T=0.K
Photon emission for (n,pd)

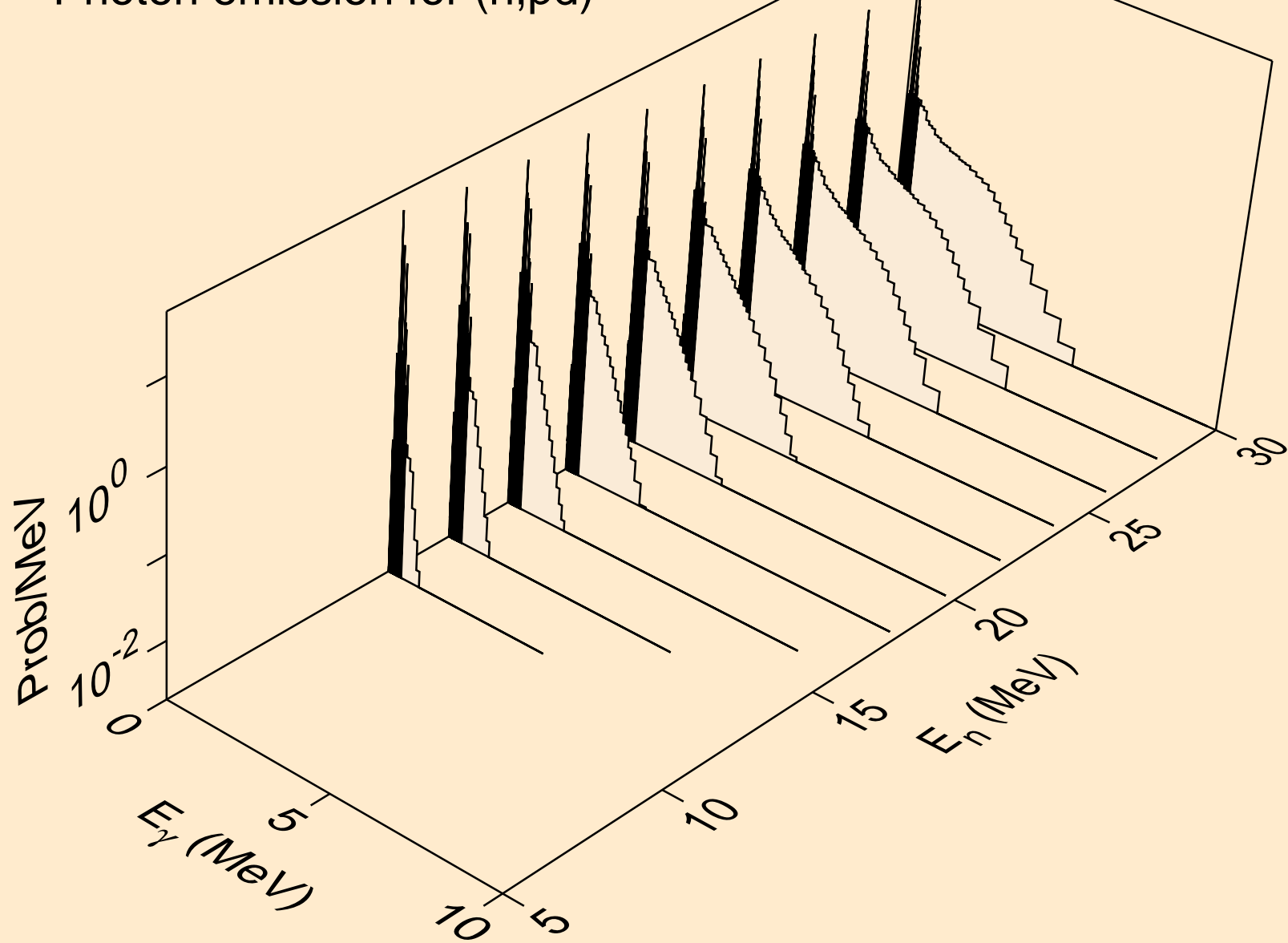

ER160 DEUTERON ACER TENDL-2023 LIBRARY; T=0.K
Photon emission for (n,pt)

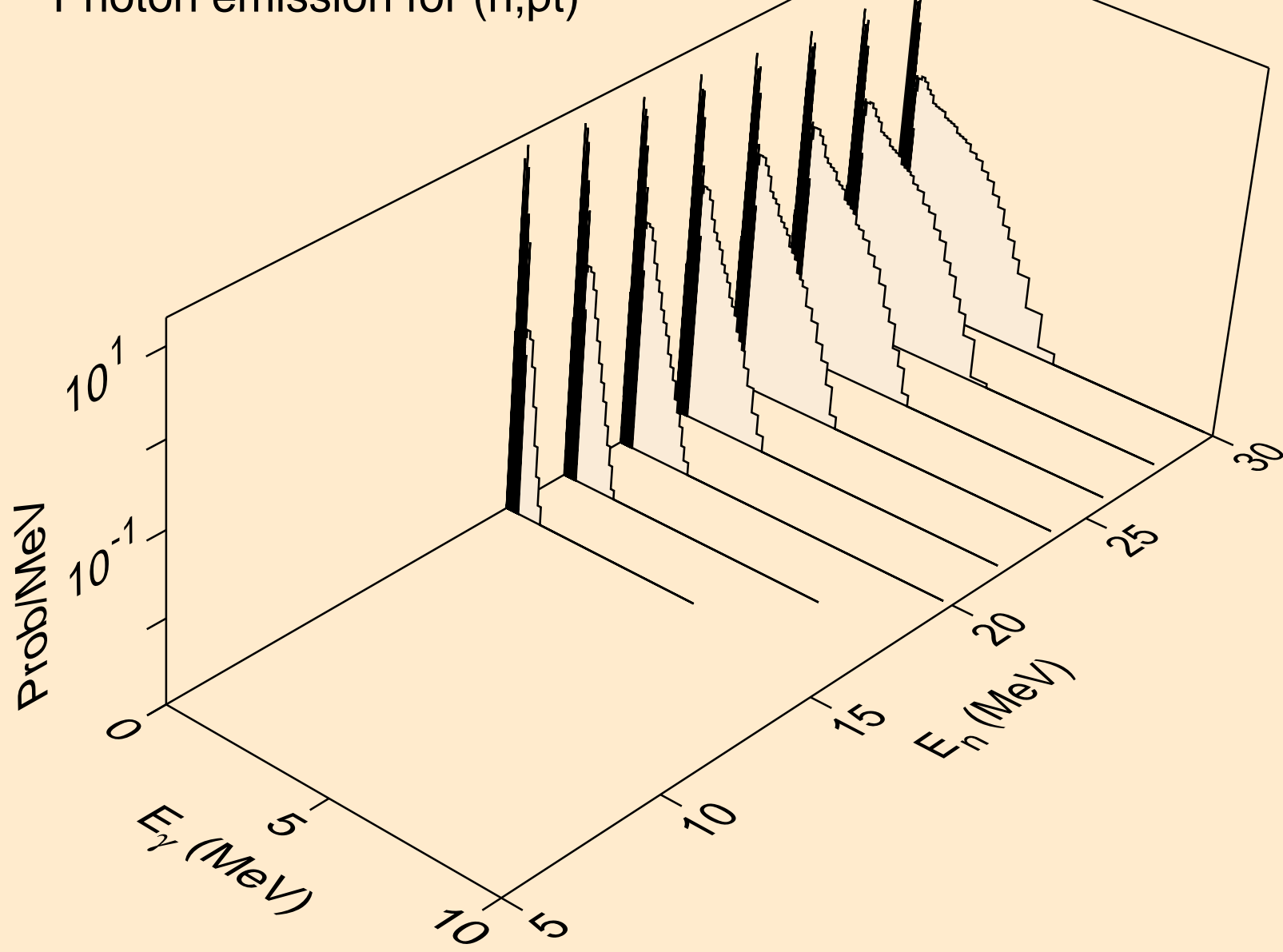

ER160 DEUTERON ACER TENDL-2023 LIBRARY; T=0.K
Photon emission for (n,da)

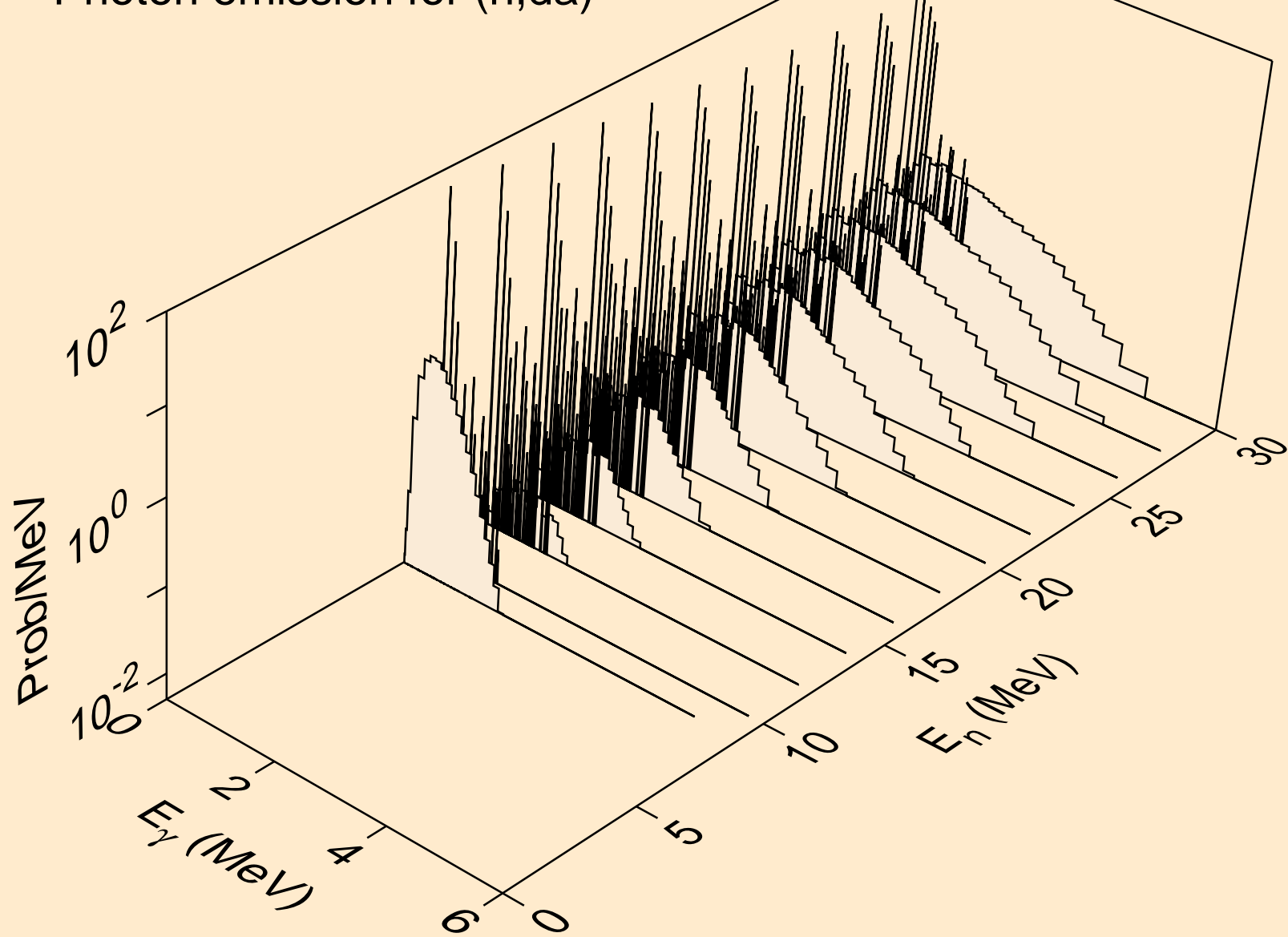

ER160 DEUTERON ACER TENDL-2023 LIBRARY; T=0.K

Particle heating contributions

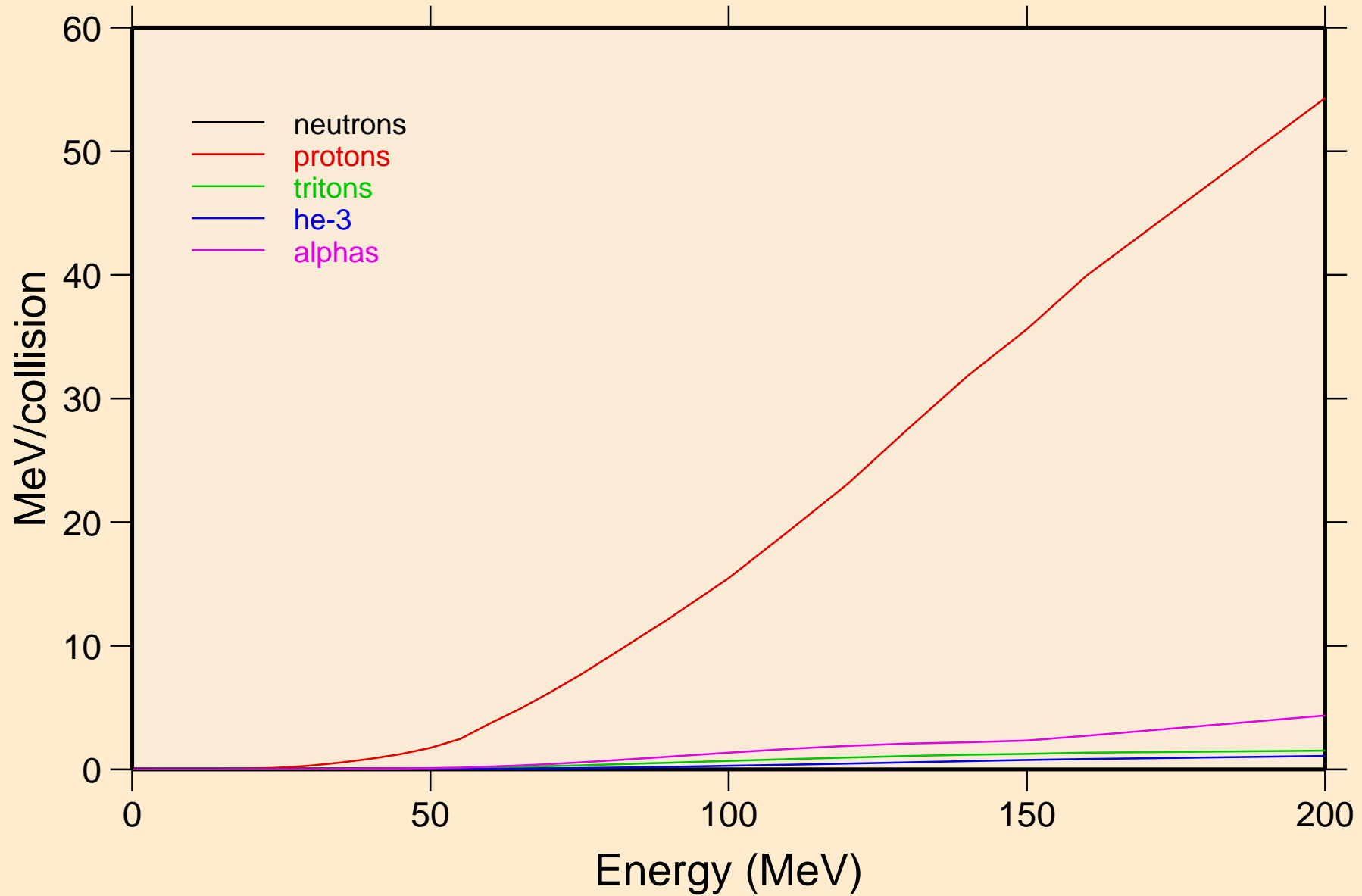

ER160 DEUTERON ACER TENDL-2023 LIBRARY; T=0.K
Recoil Heating

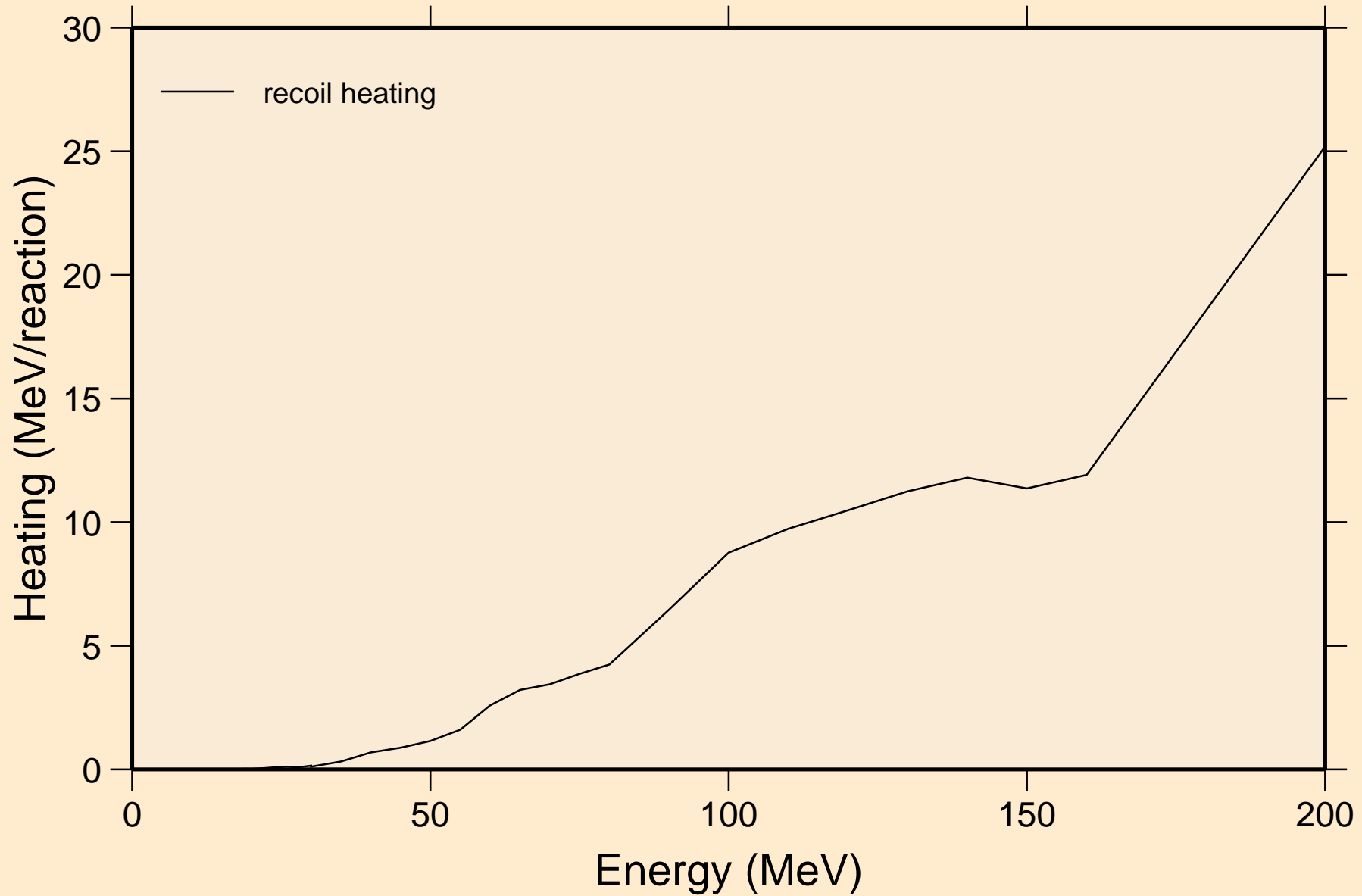

ER160 DEUTERON ACER TENDL-2023 LIBRARY; T=0.K

Particle production cross sections

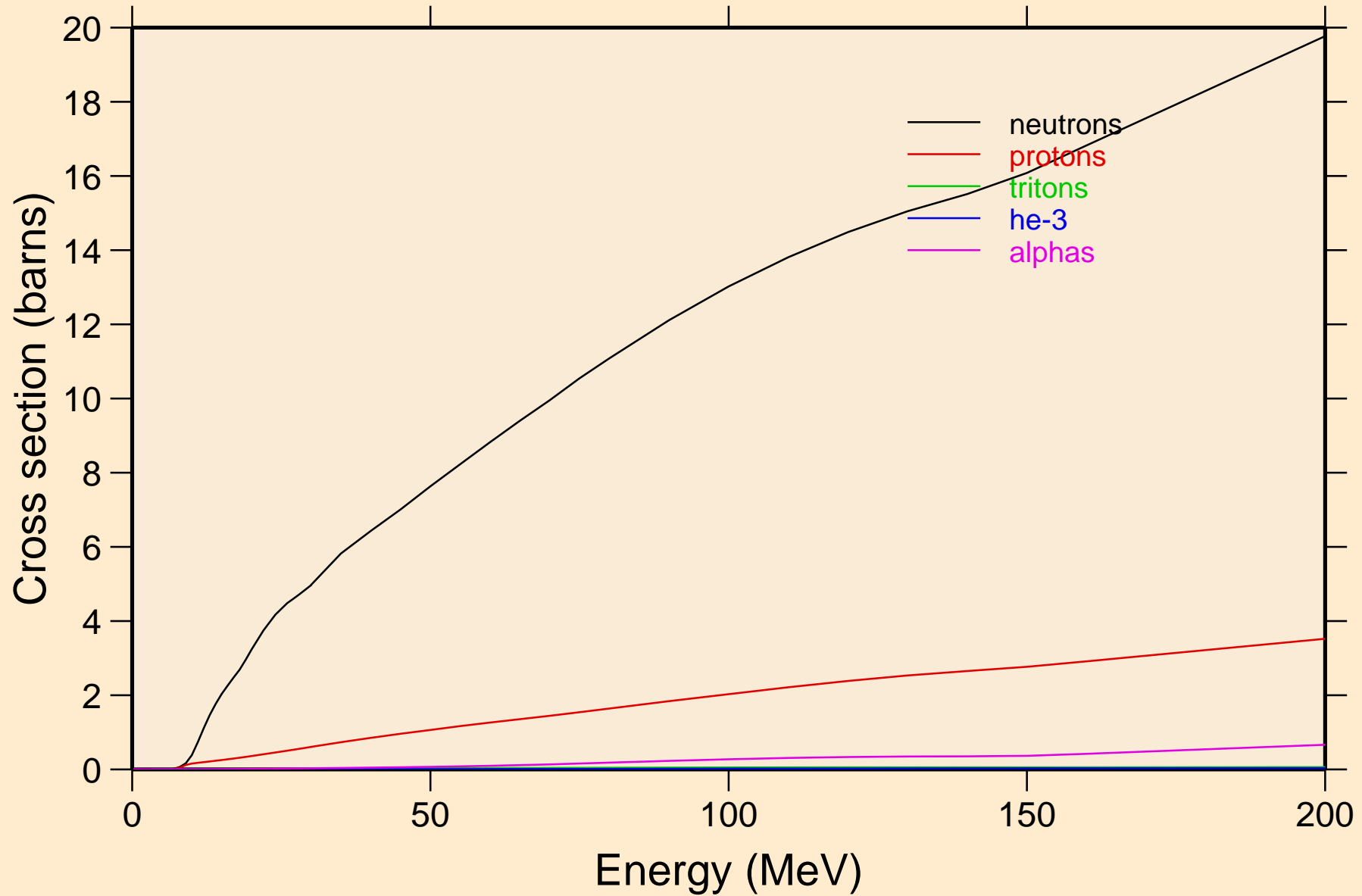

ER160 DEUTERON ACER TENDL-2023 LIBRARY; T=0.K
neutrons from (d,n)

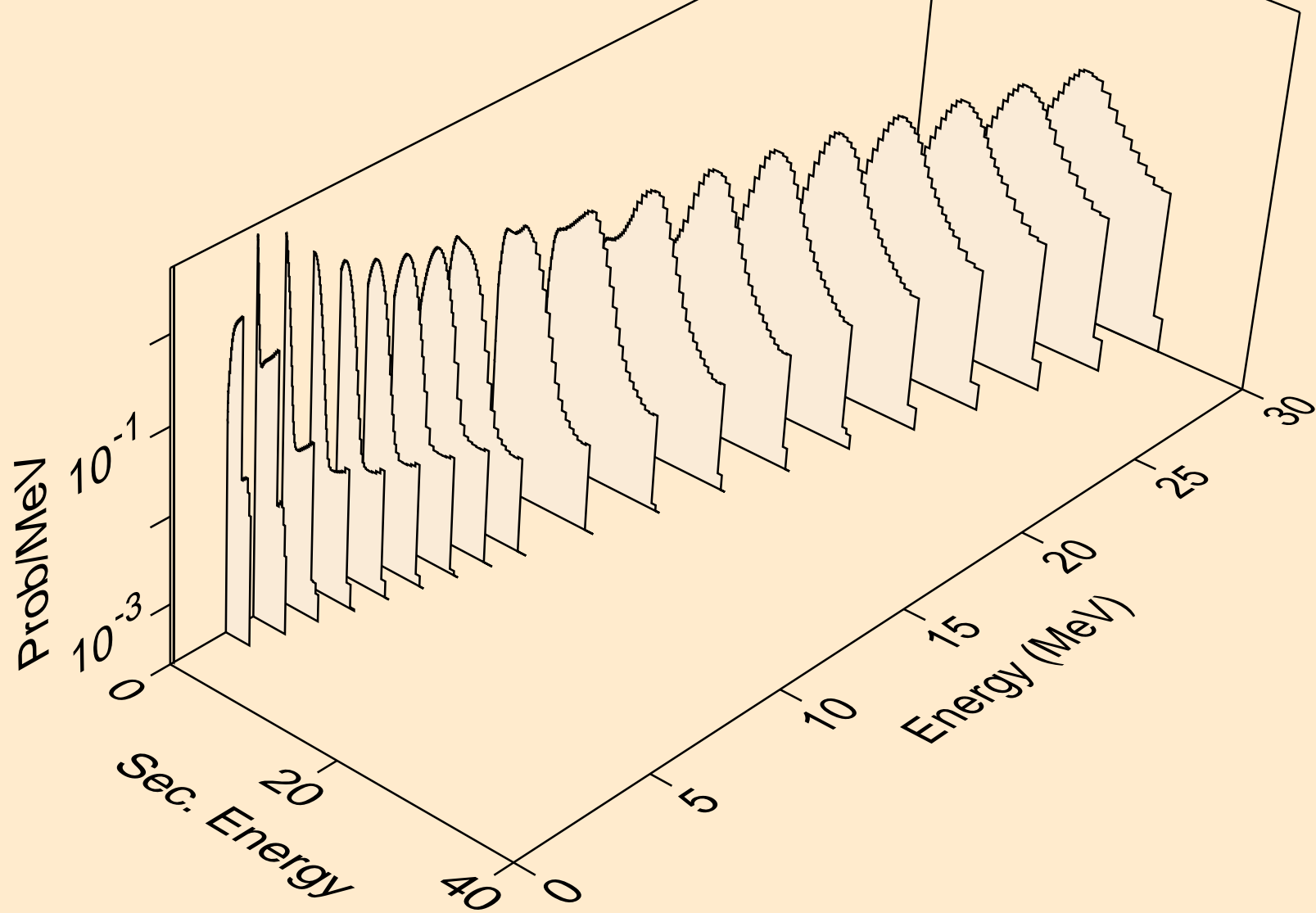

ER160 DEUTERON ACER TENDL-2023 LIBRARY; T=0.K
neutrons from (d,x)

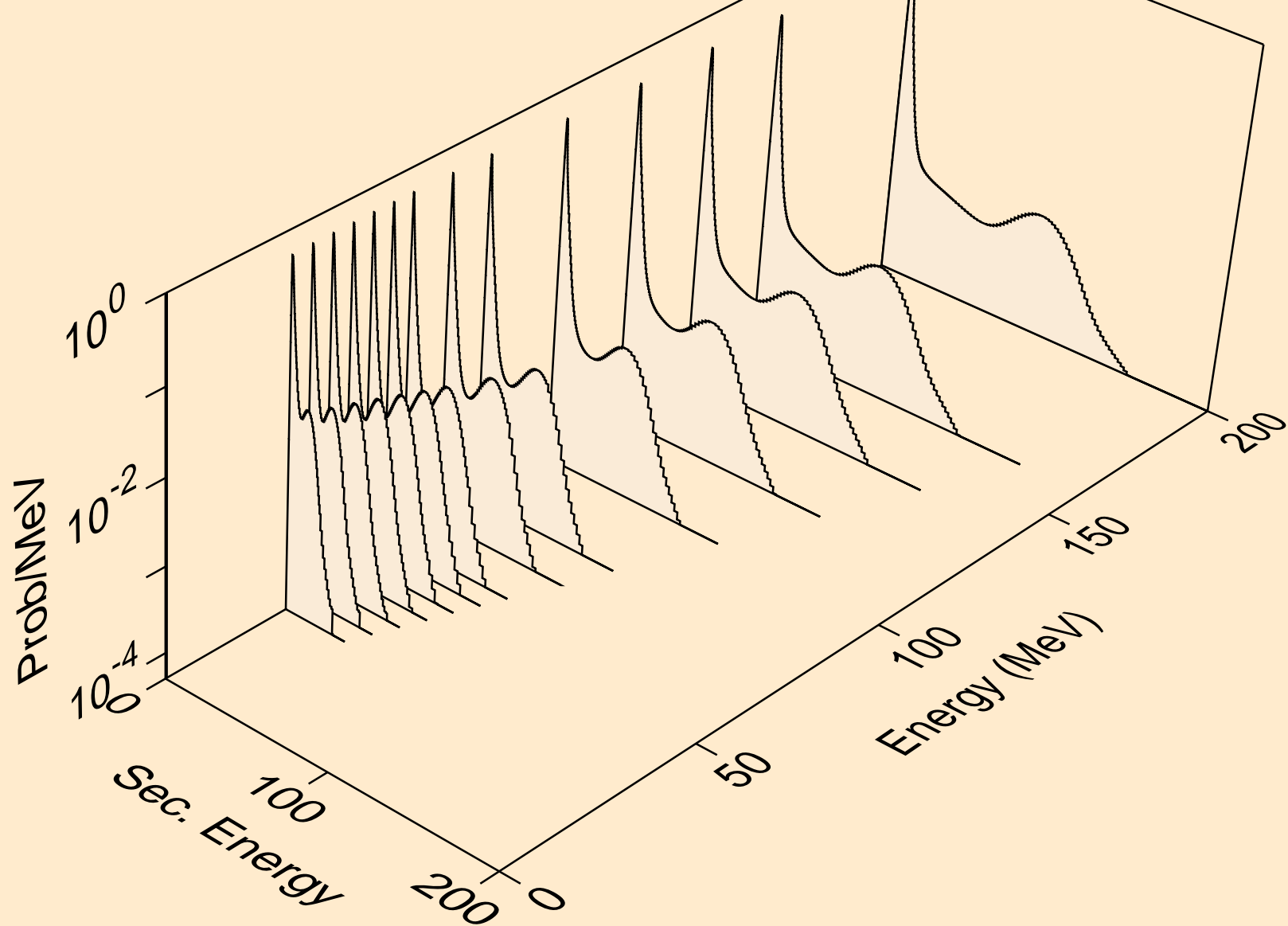

ER160 DEUTERON ACER TENDL-2023 LIBRARY; T=0.K
neutrons from (d,2nd)

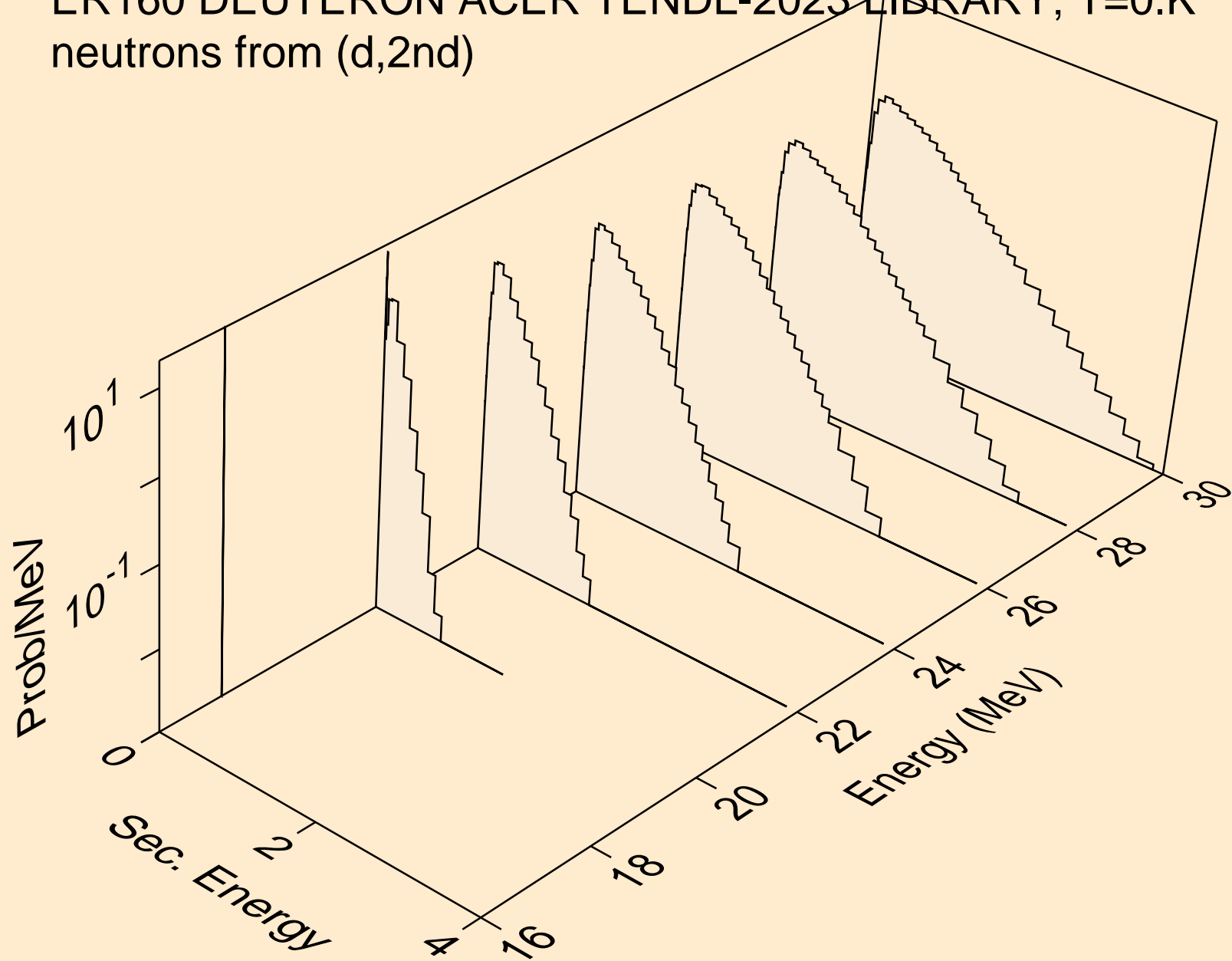

ER160 DEUTERON ACER TENDL-2023 LIBRARY; T=0.K
neutrons from (d,2n)

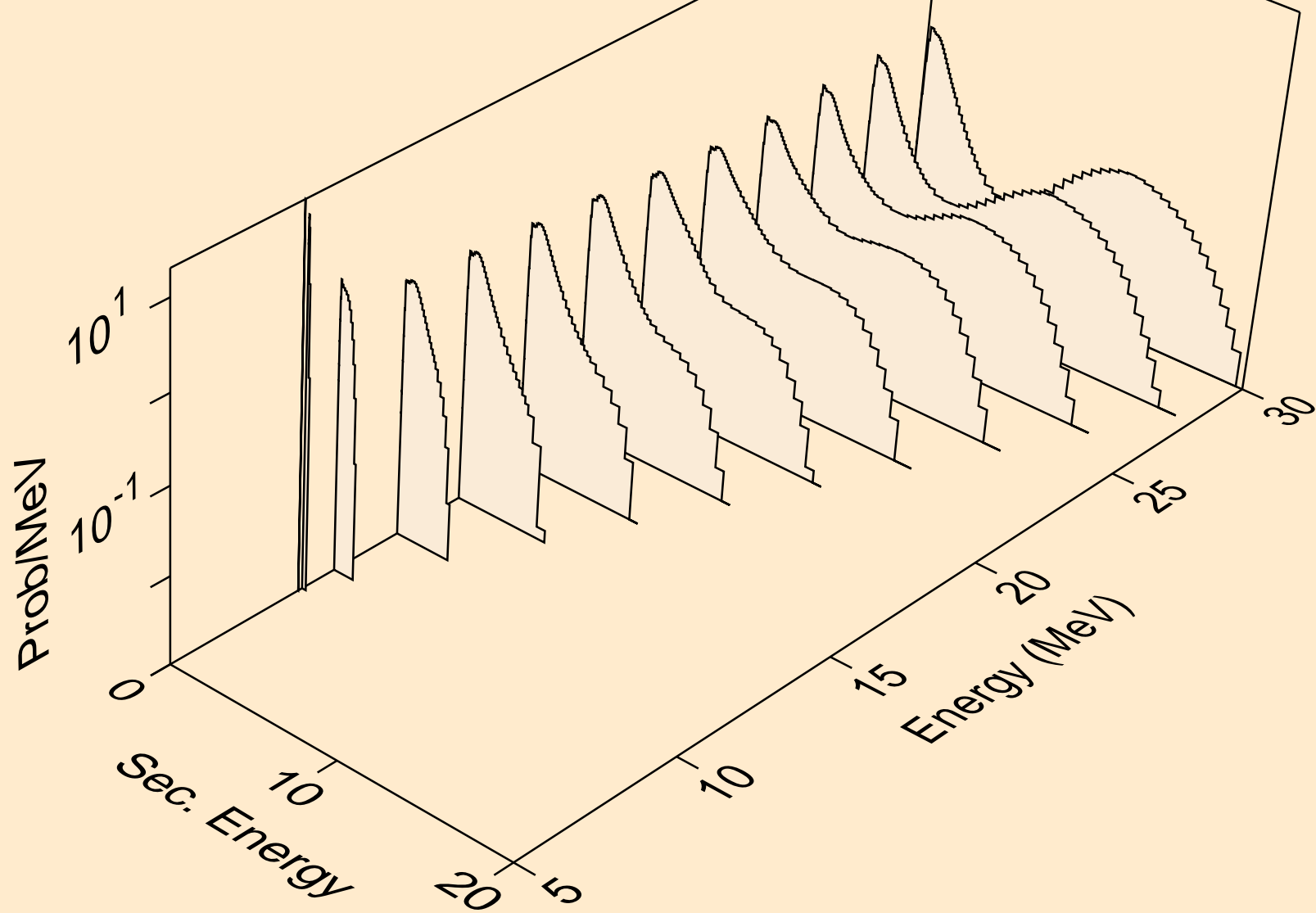

ER160 DEUTERON ACER TENDL-2023 LIBRARY; T=0.K
neutrons from (d,3n)

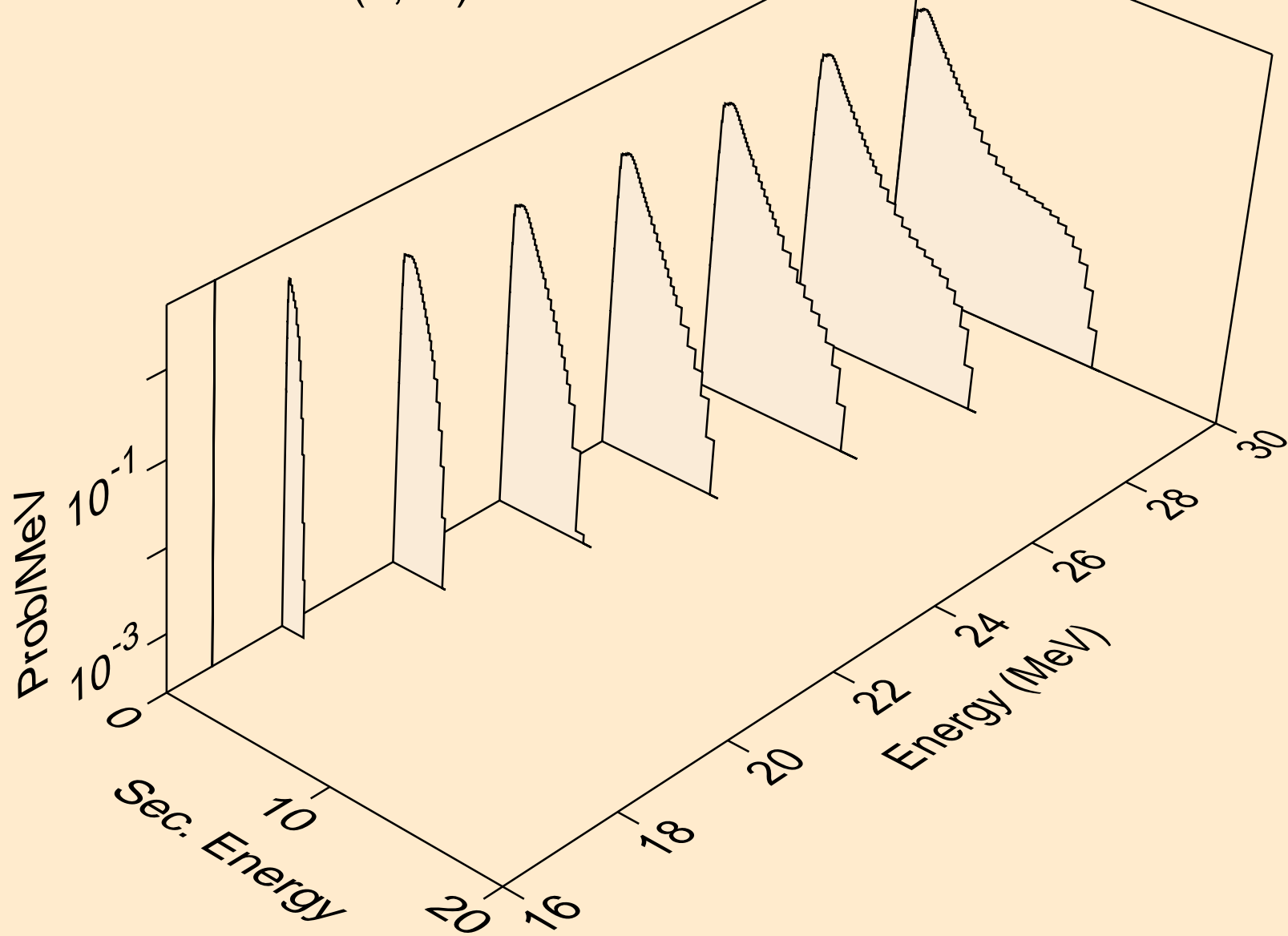

ER160 DEUTERON ACER TENDL-2023 LIBRARY; T=0.K
neutrons from (d,n*)a

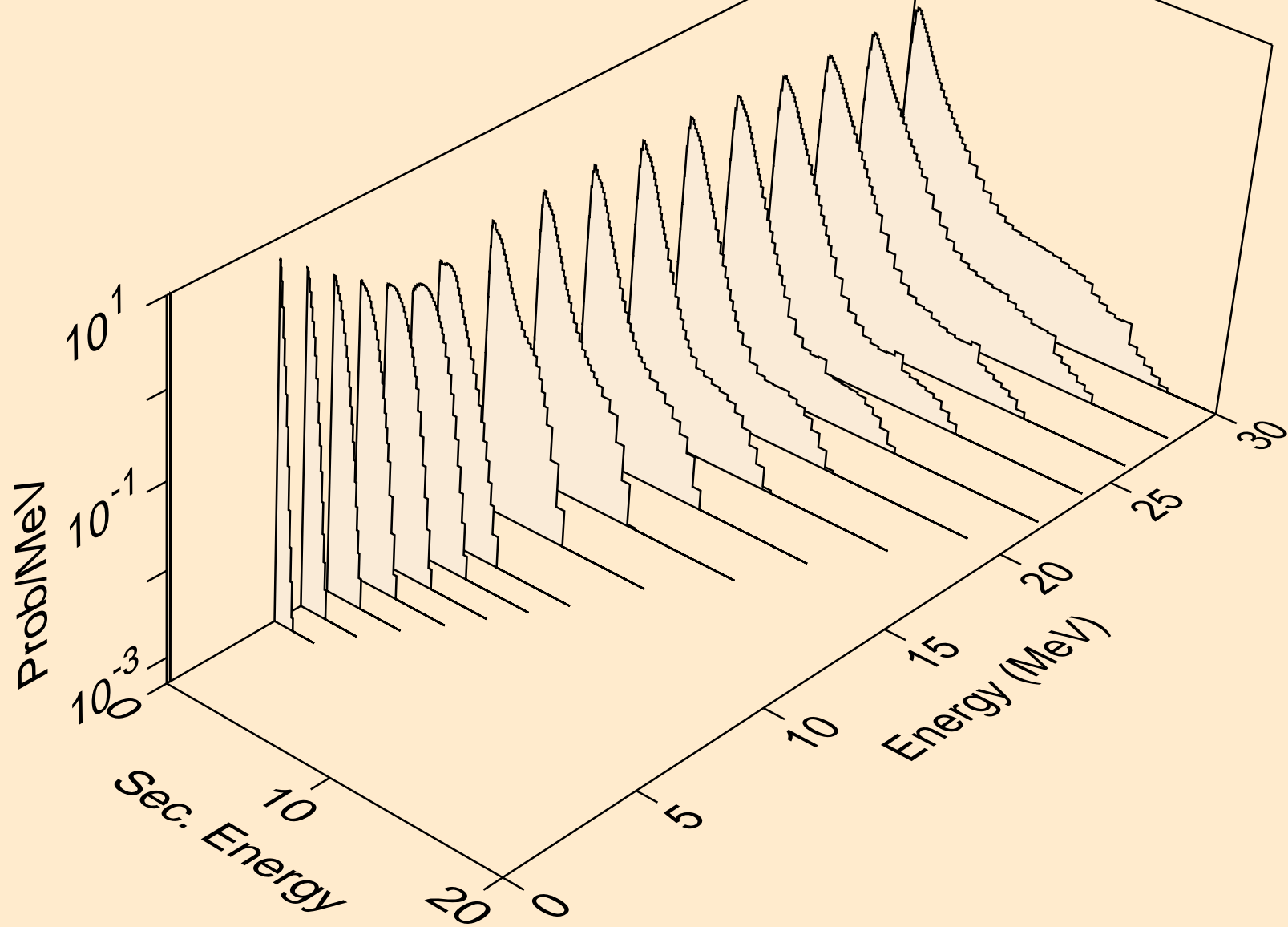

ER160 DEUTERON ACER TENDL-2023 LIBRARY; T=0.K
neutrons from (d,2n)a

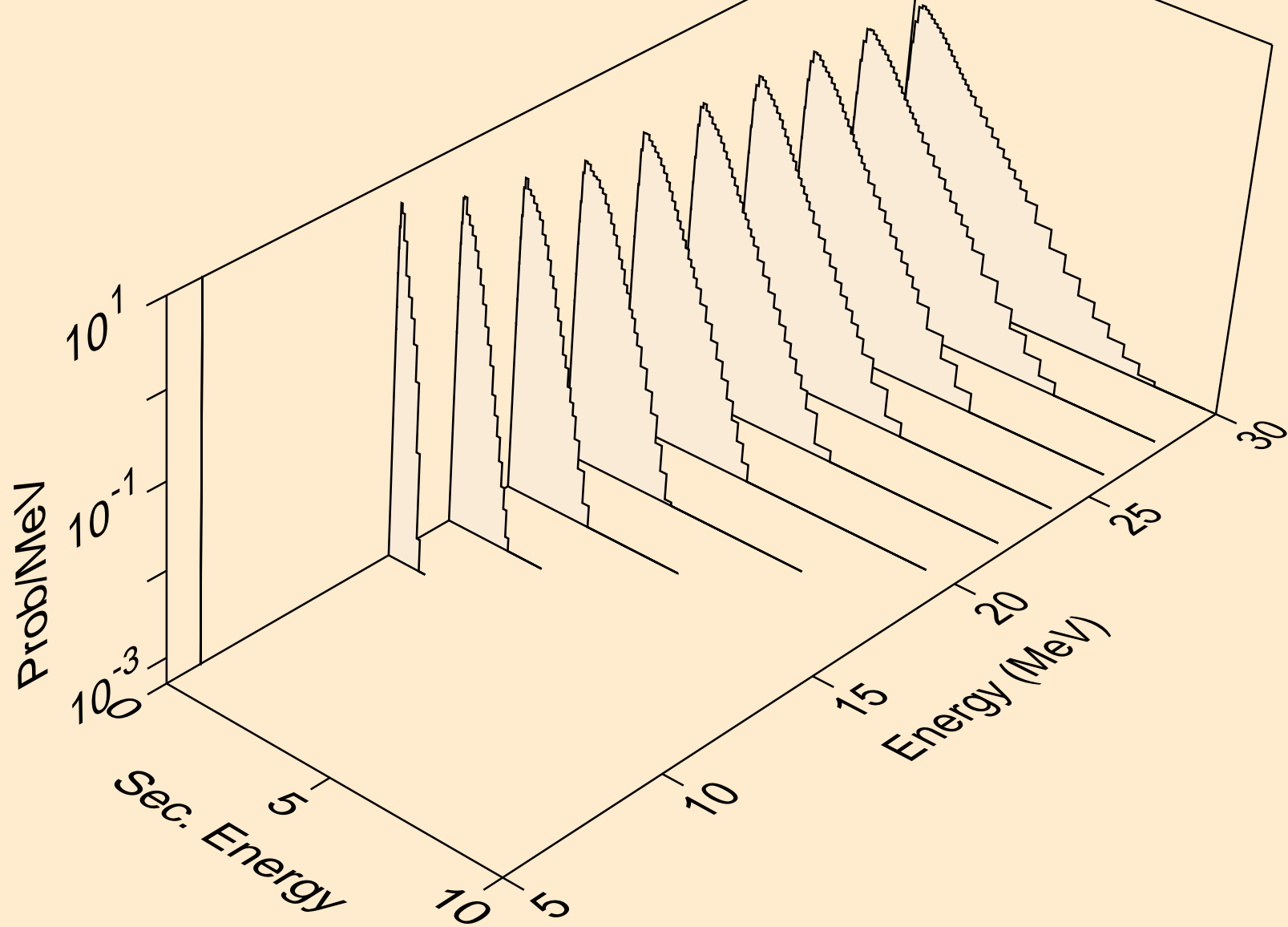

ER160 DEUTERON ACER TENDL-2023 LIBRARY; T=0.K
neutrons from (d,3n)a

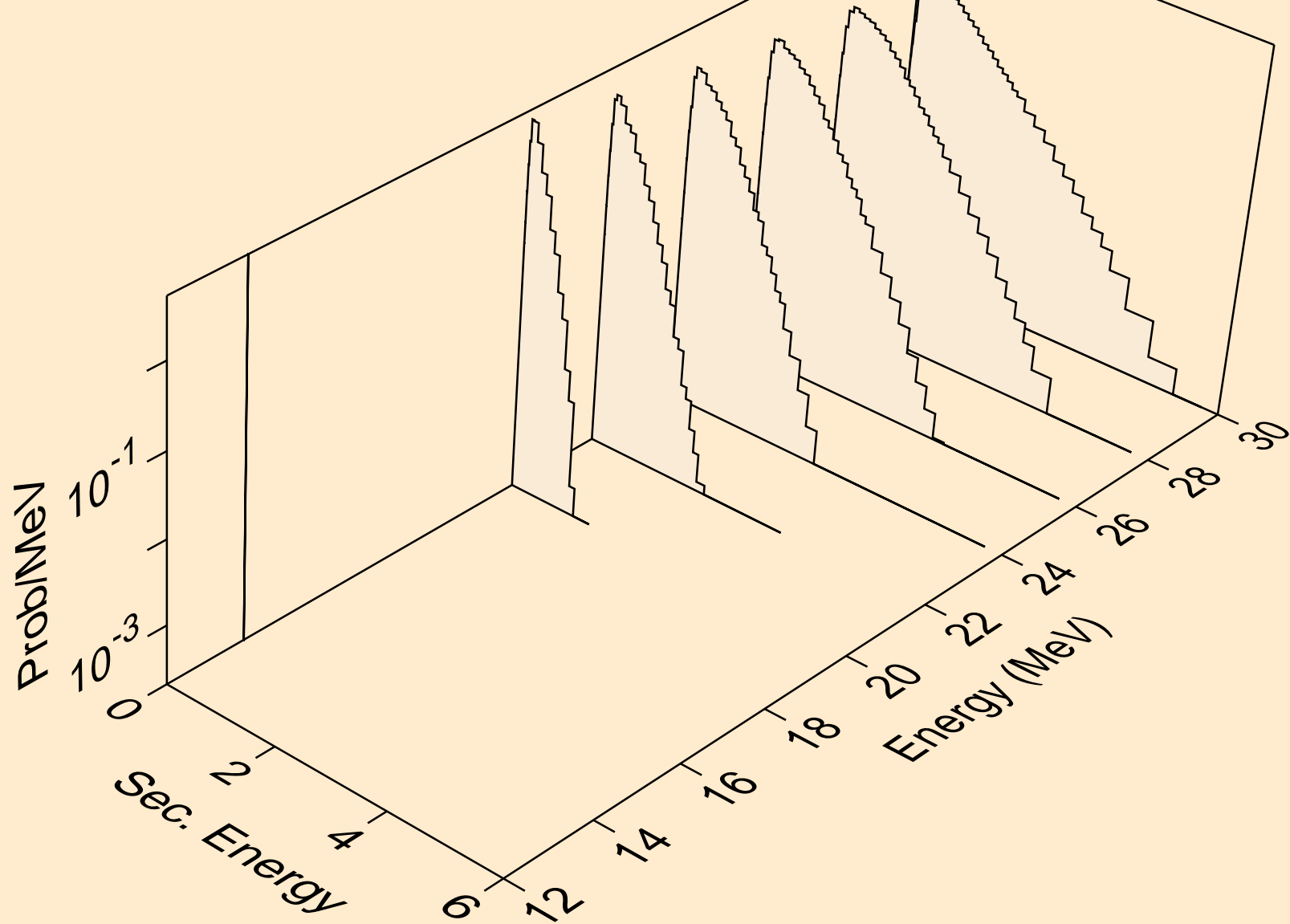

ER160 DEUTERON ACER TENDL-2023 LIBRARY; T=0.K
neutrons from (d,n*)p

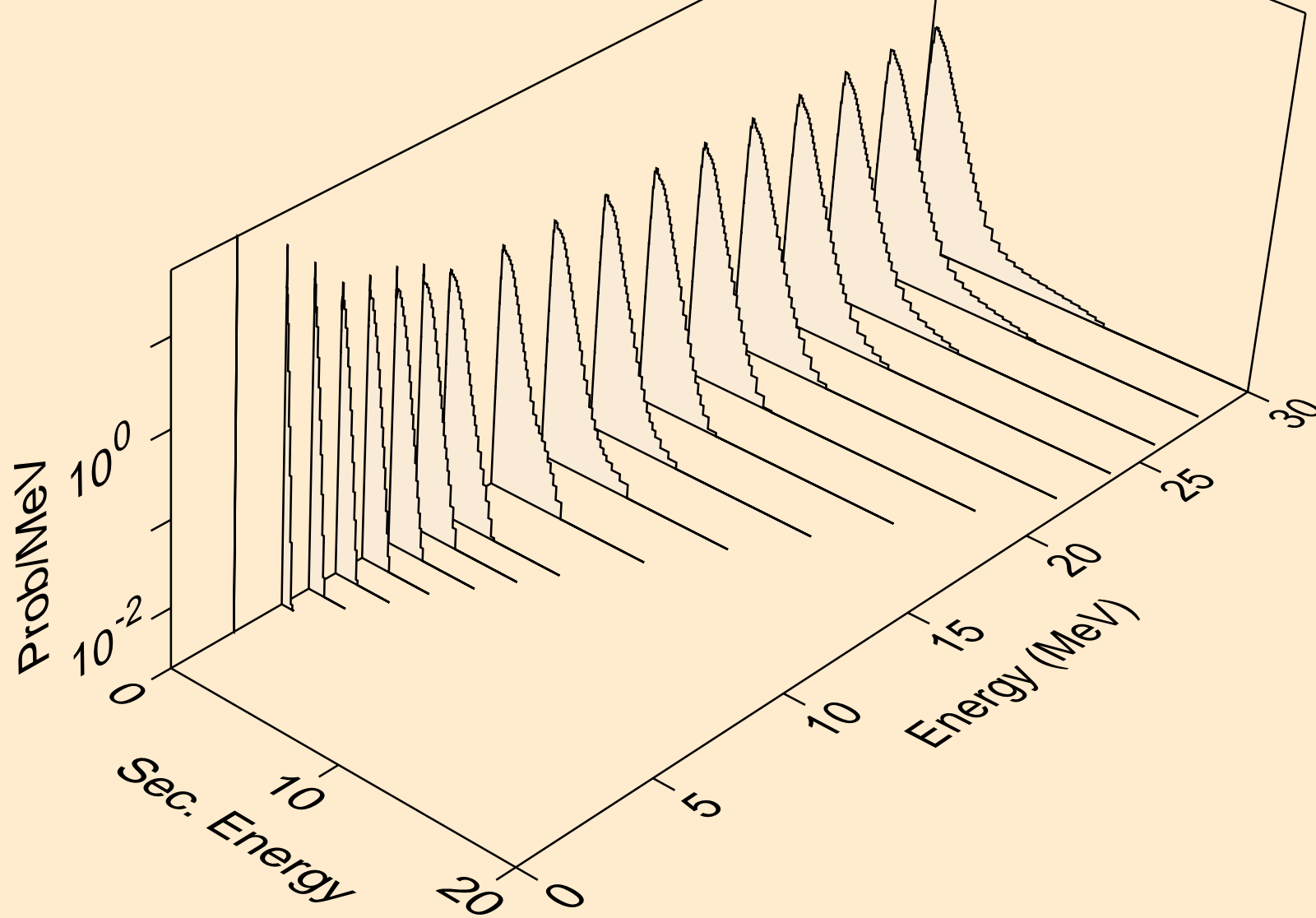

ER160 DEUTERON ACER TENDL-2023 LIBRARY; T=0.K
neutrons from (d,n*)2a

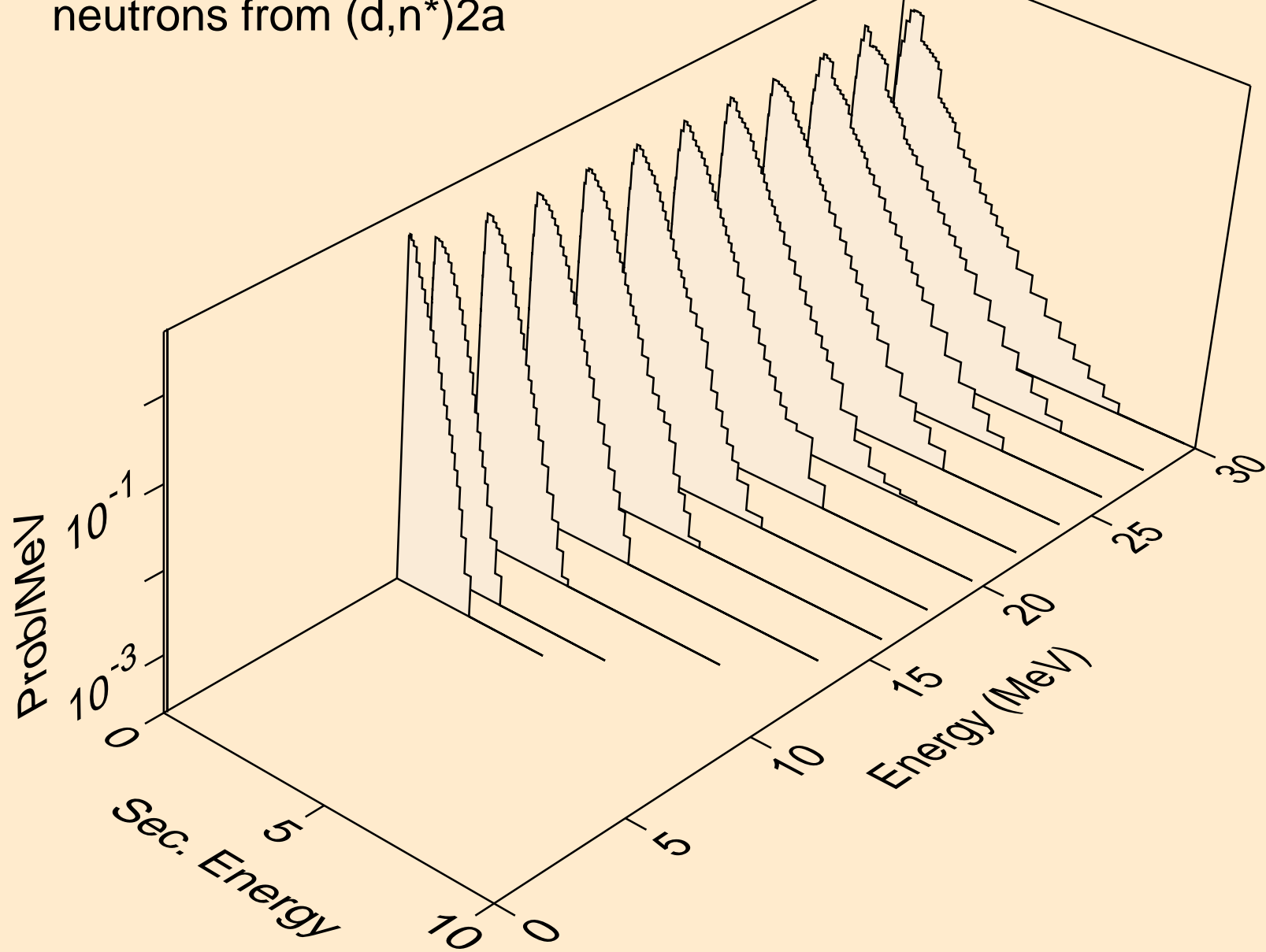

ER160 DEUTERON ACER TENDL-2023 LIBRARY; T=0.K
neutrons from (d,2n)2a

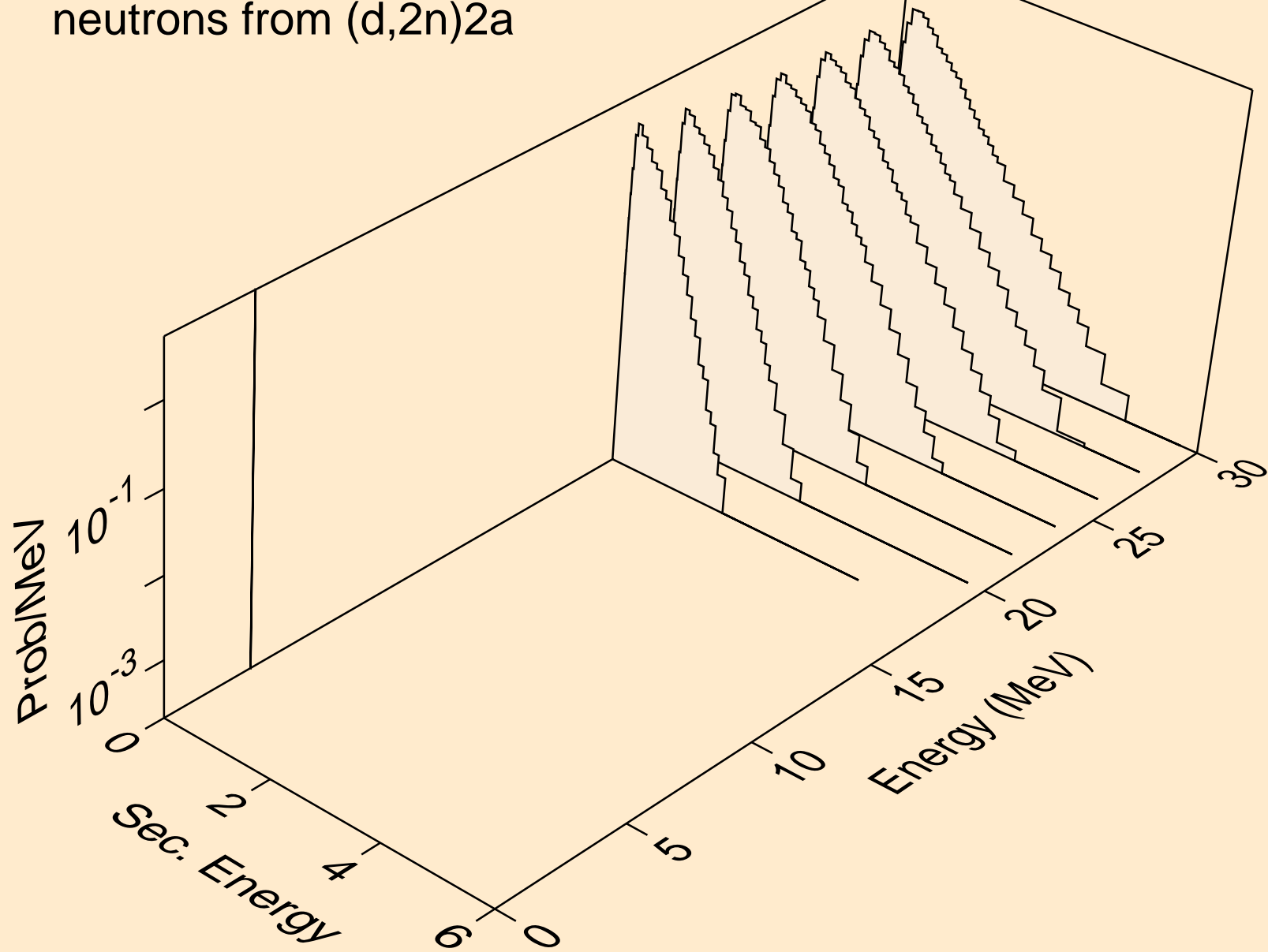

ER160 DEUTERON ACER TENDL-2023 LIBRARY; T=0.K
neutrons from (d,n*)d

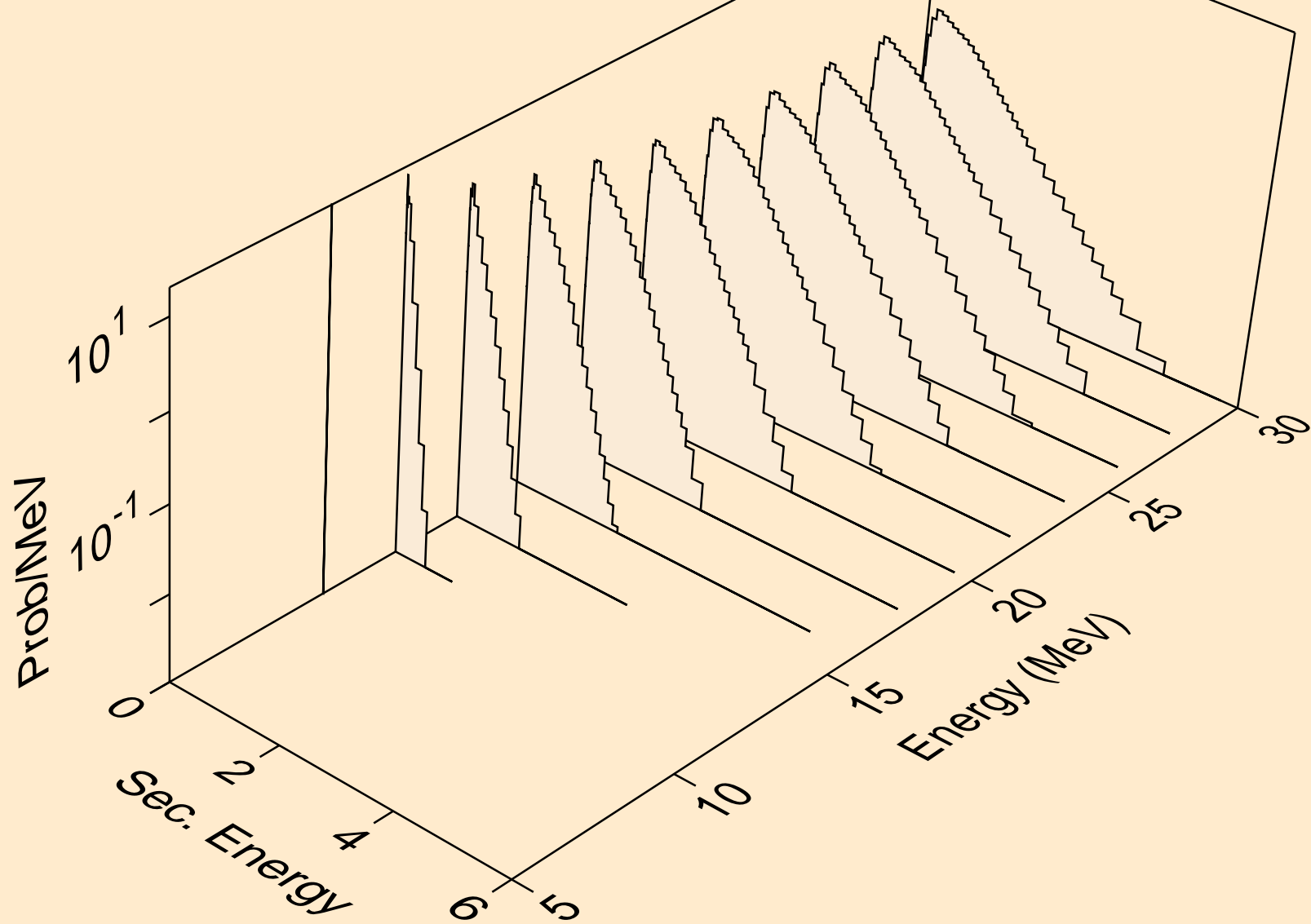

ER160 DEUTERON ACER TENDL-2023 LIBRARY; T=0.K
neutrons from (d,n*)t

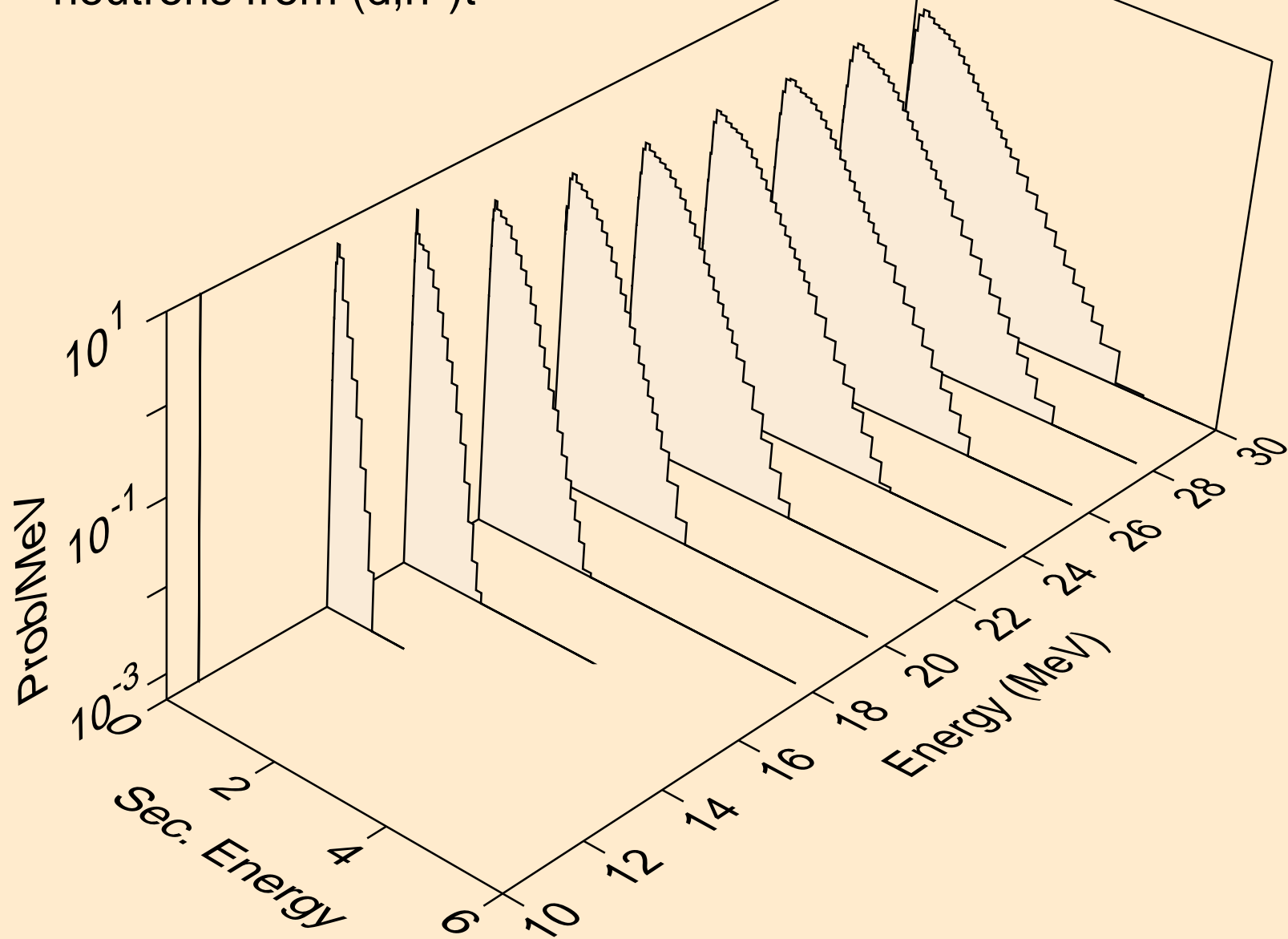

ER160 DEUTERON ACER TENDL-2023 LIBRARY; T=0.K
neutrons from (d,n*)he3

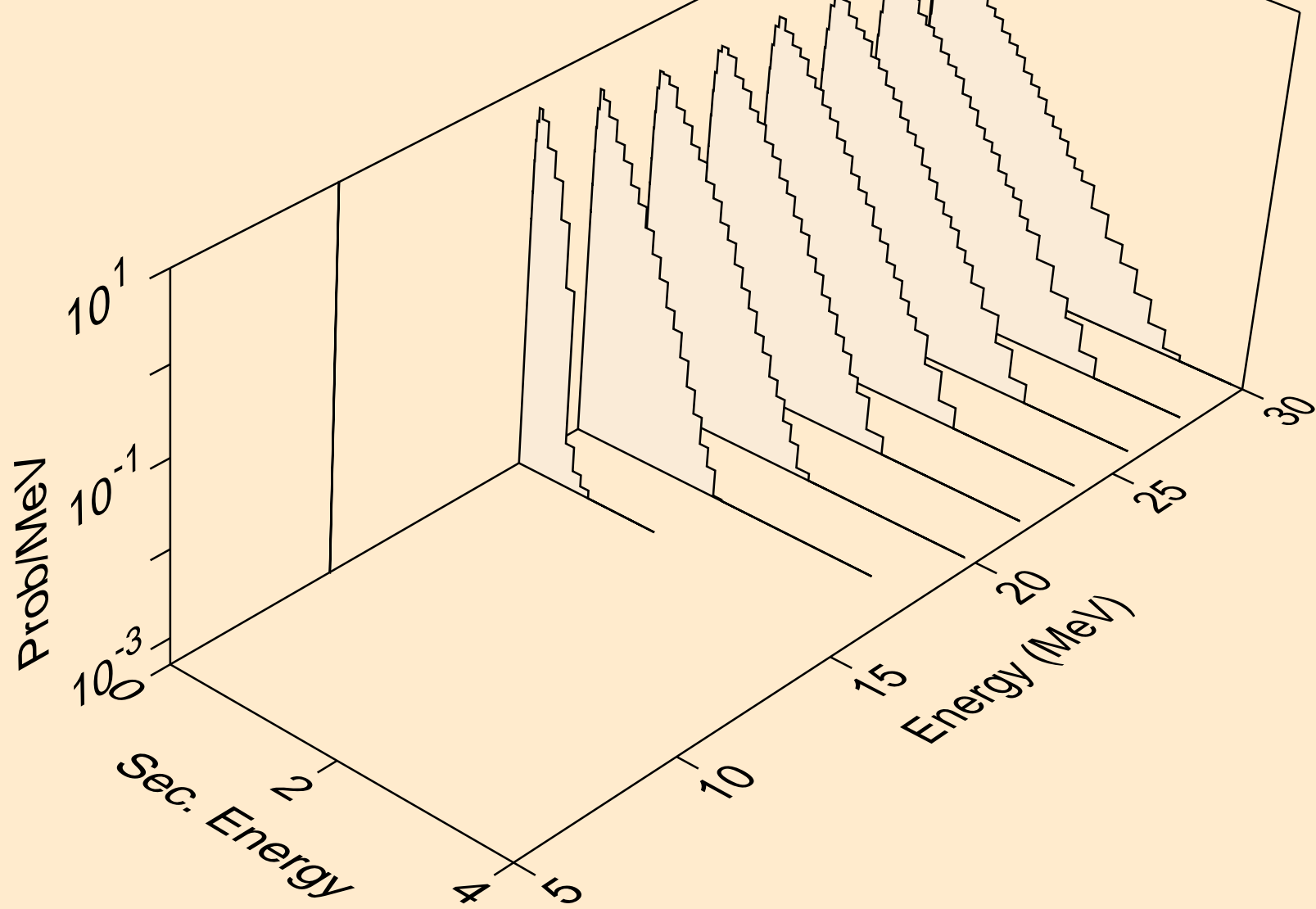

ER160 DEUTERON ACER TENDL-2023 LIBRARY; T=0.K
neutrons from (d,4n)

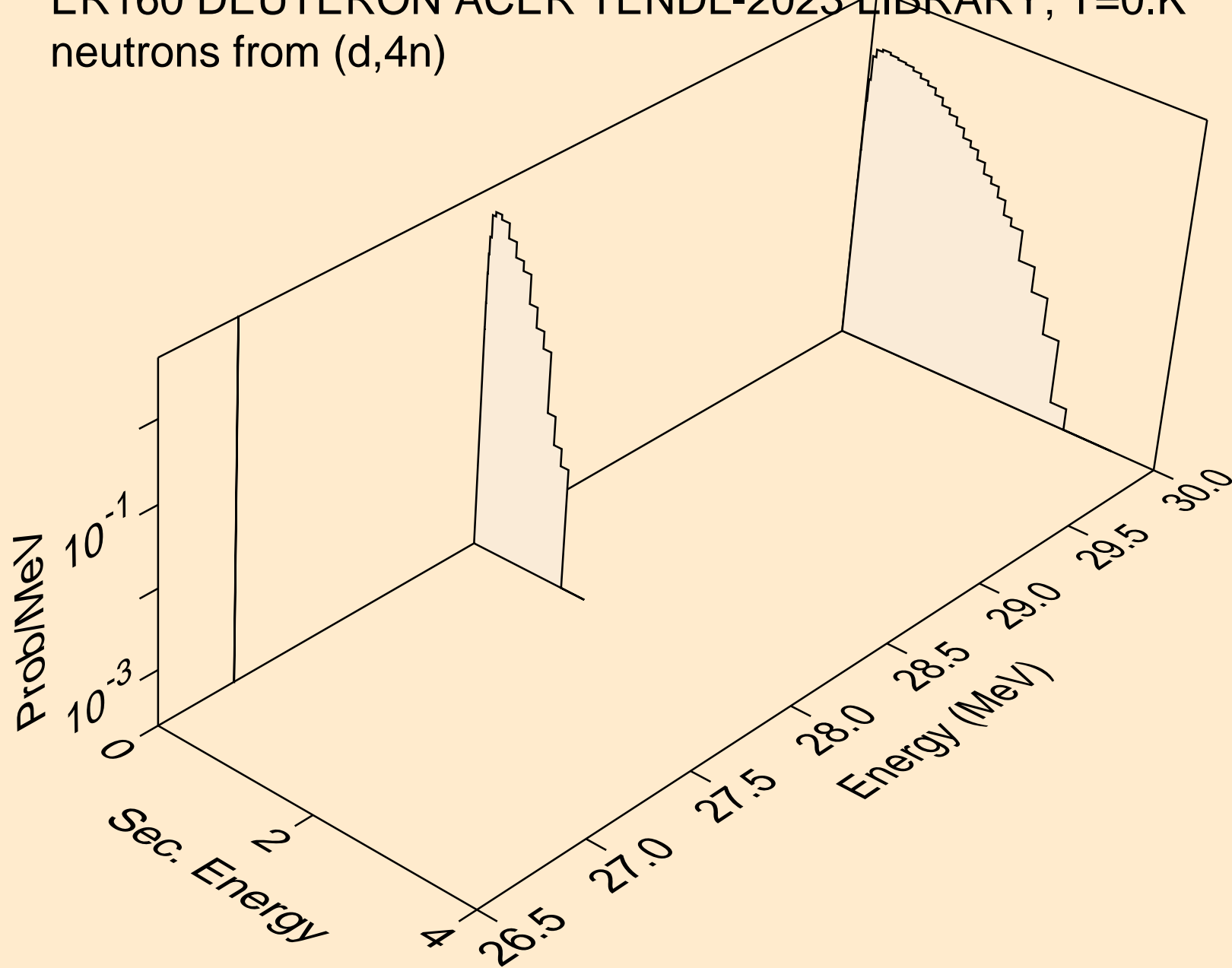

ER160 DEUTERON ACER TENDL-2023 LIBRARY; T=0.K
neutrons from (d,2np)

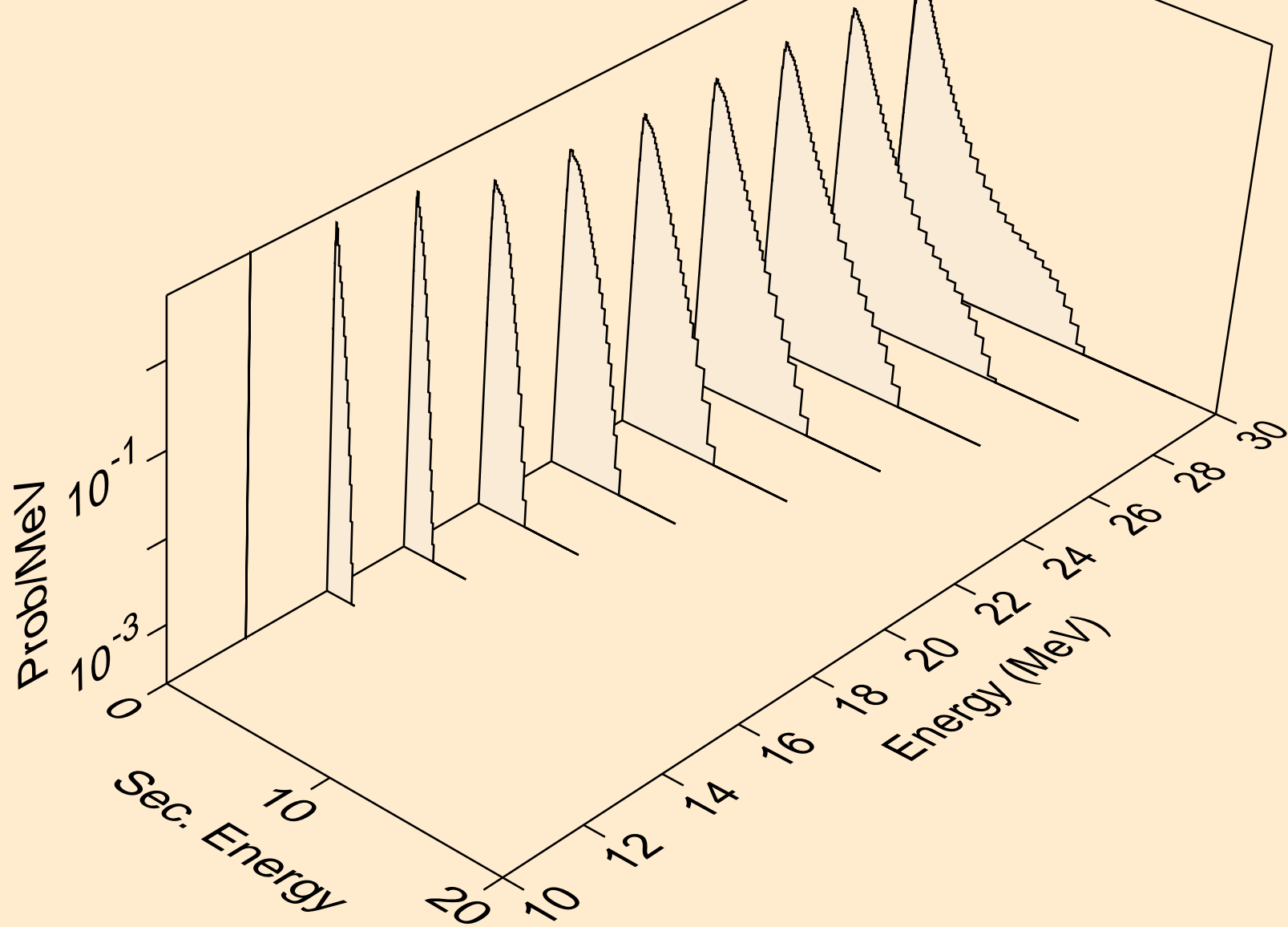

ER160 DEUTERON ACER TENDL-2023 LIBRARY; T=0.K
neutrons from (d,3np)

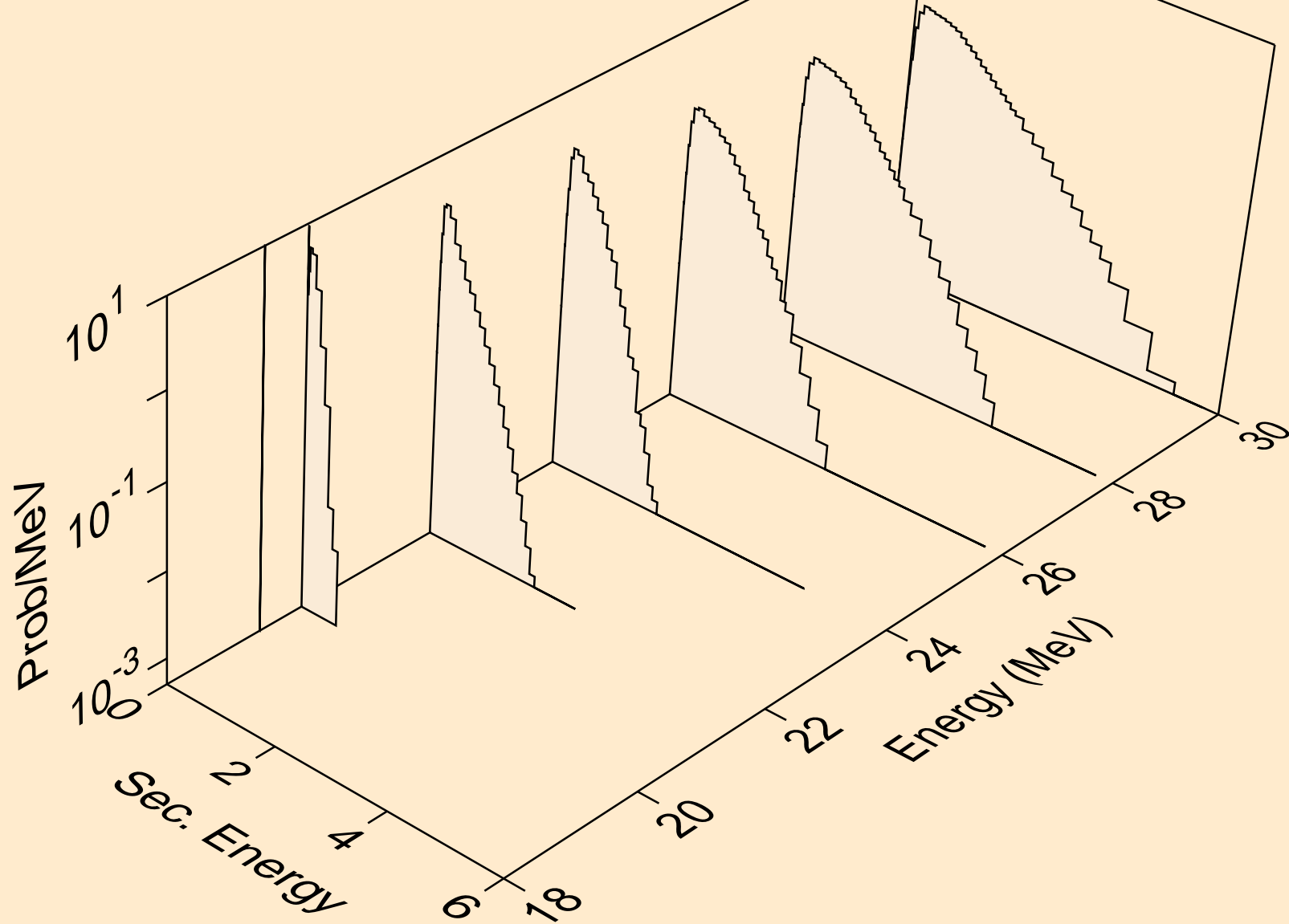

ER160 DEUTERON ACER TENDL-2023 LIBRARY; T=0.K
neutrons from (d,n2p)

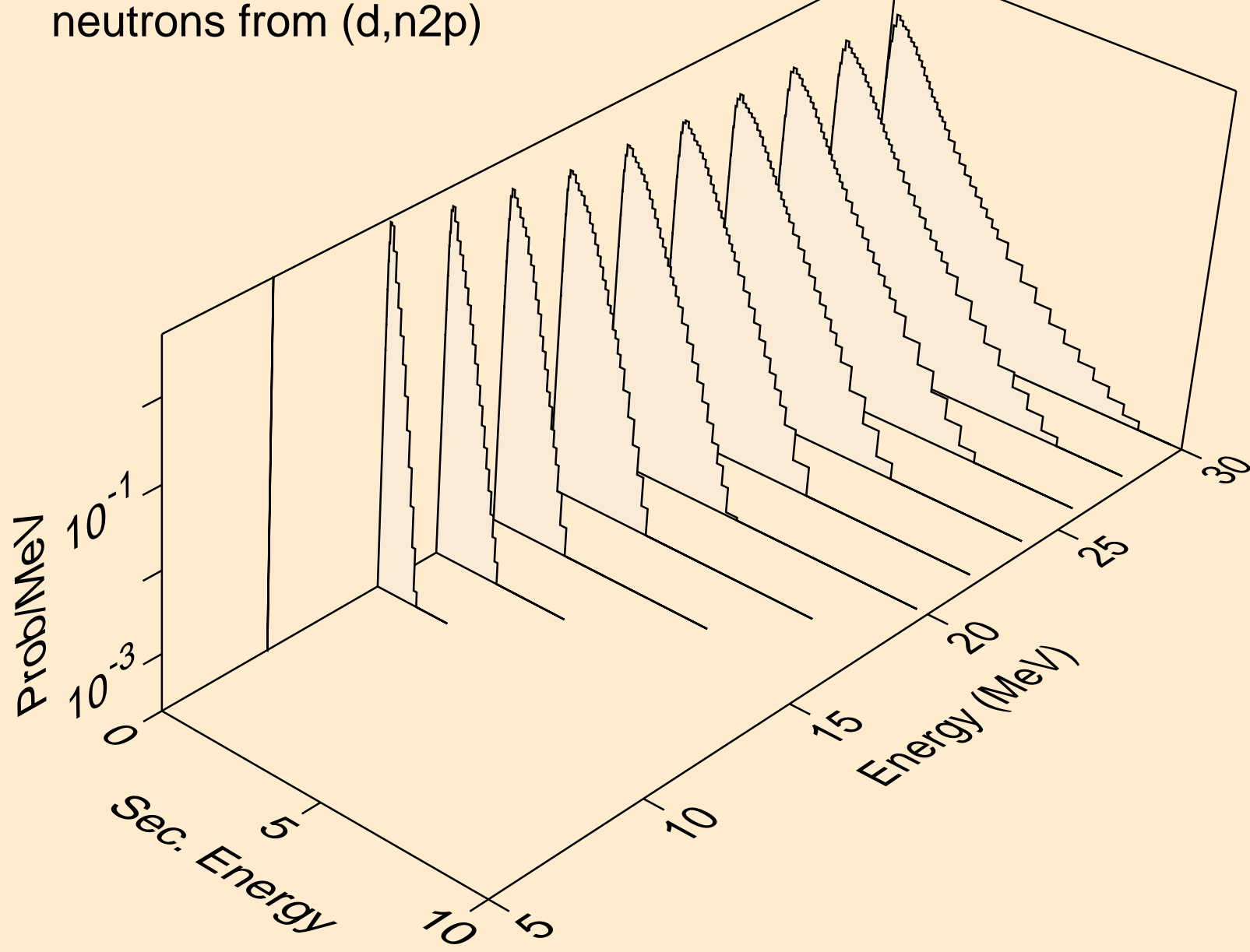

ER160 DEUTERON ACER TENDL-2023 LIBRARY; T=0.K
neutrons from (d,npa)

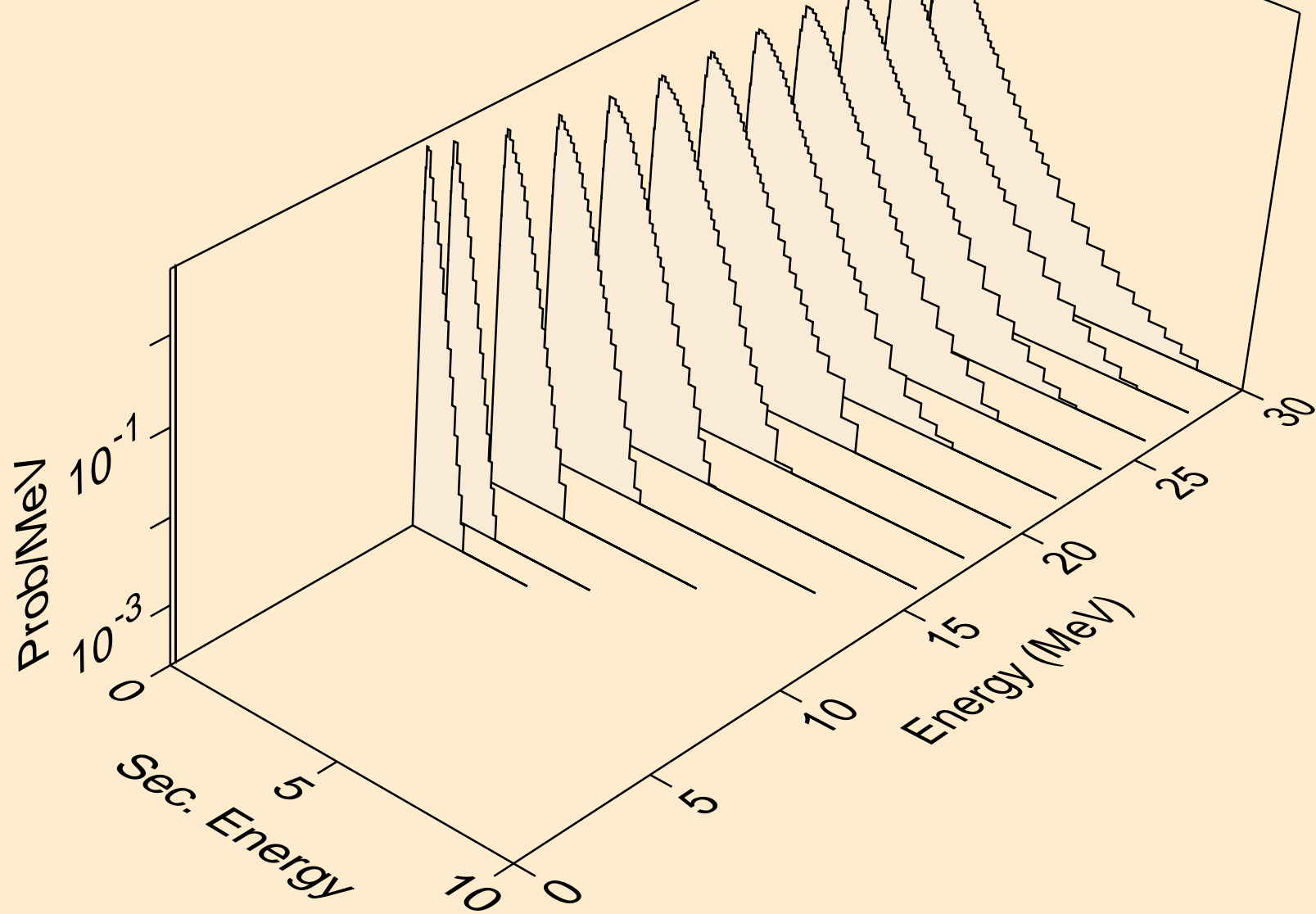

ER160 DEUTERON ACER TENDL-2023 LIBRARY; T=0.K
protons from (d,x)

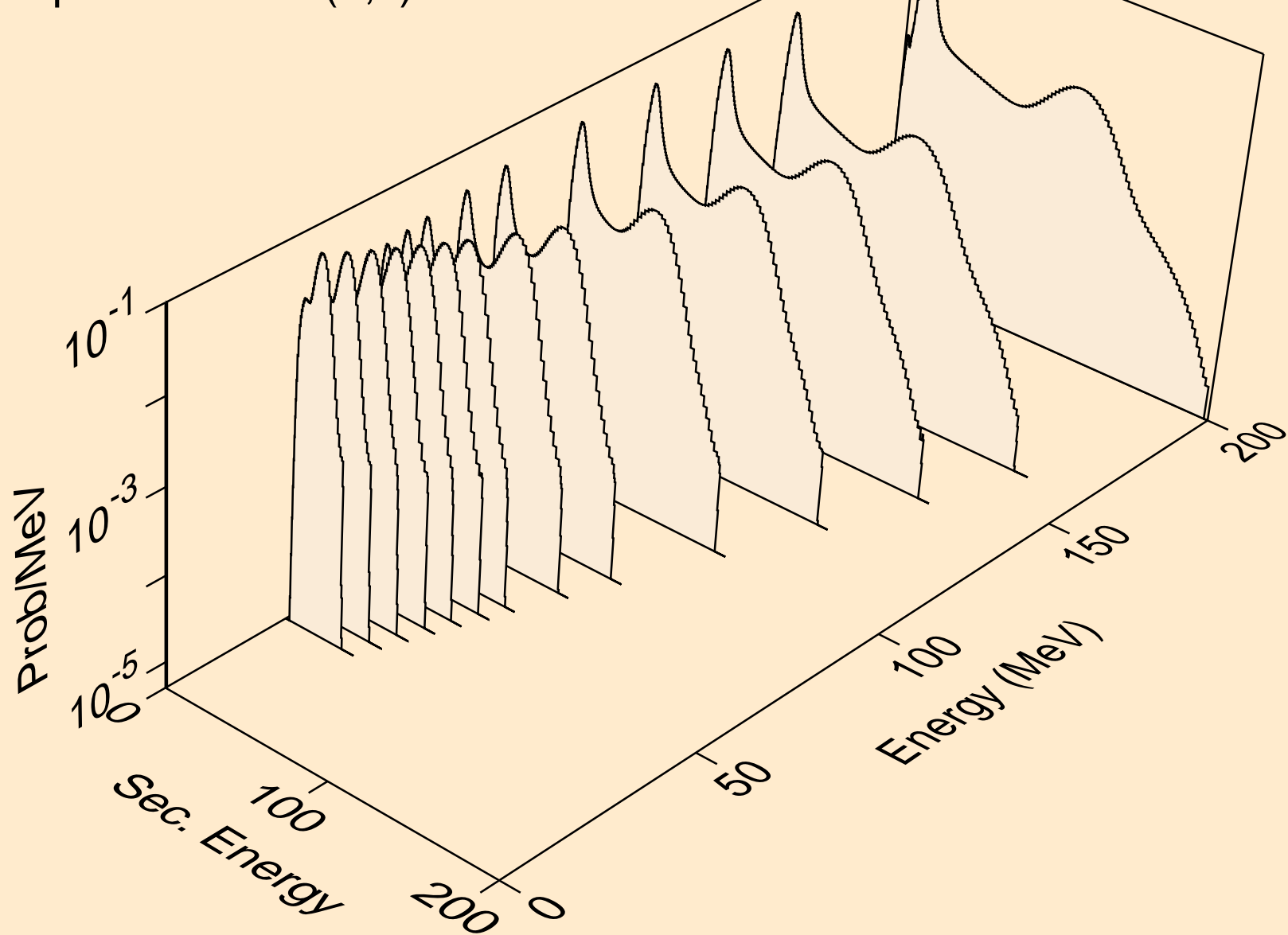

ER160 DEUTERON ACER TENDL-2023 LIBRARY; T=0.K
protons from (d,n*)p

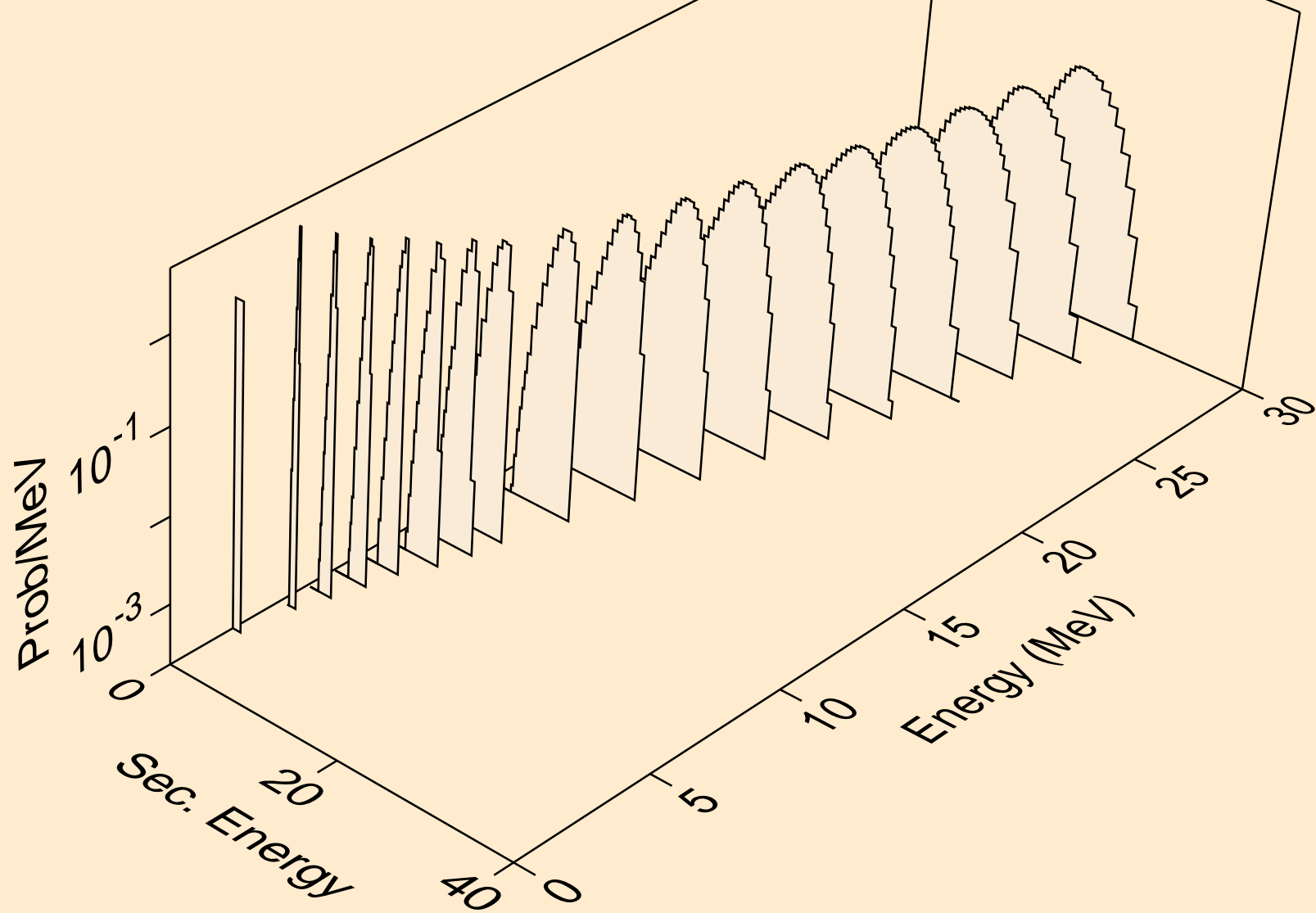

ER160 DEUTERON ACER TENDL-2023 LIBRARY; T=0.K
protons from (d,2np)

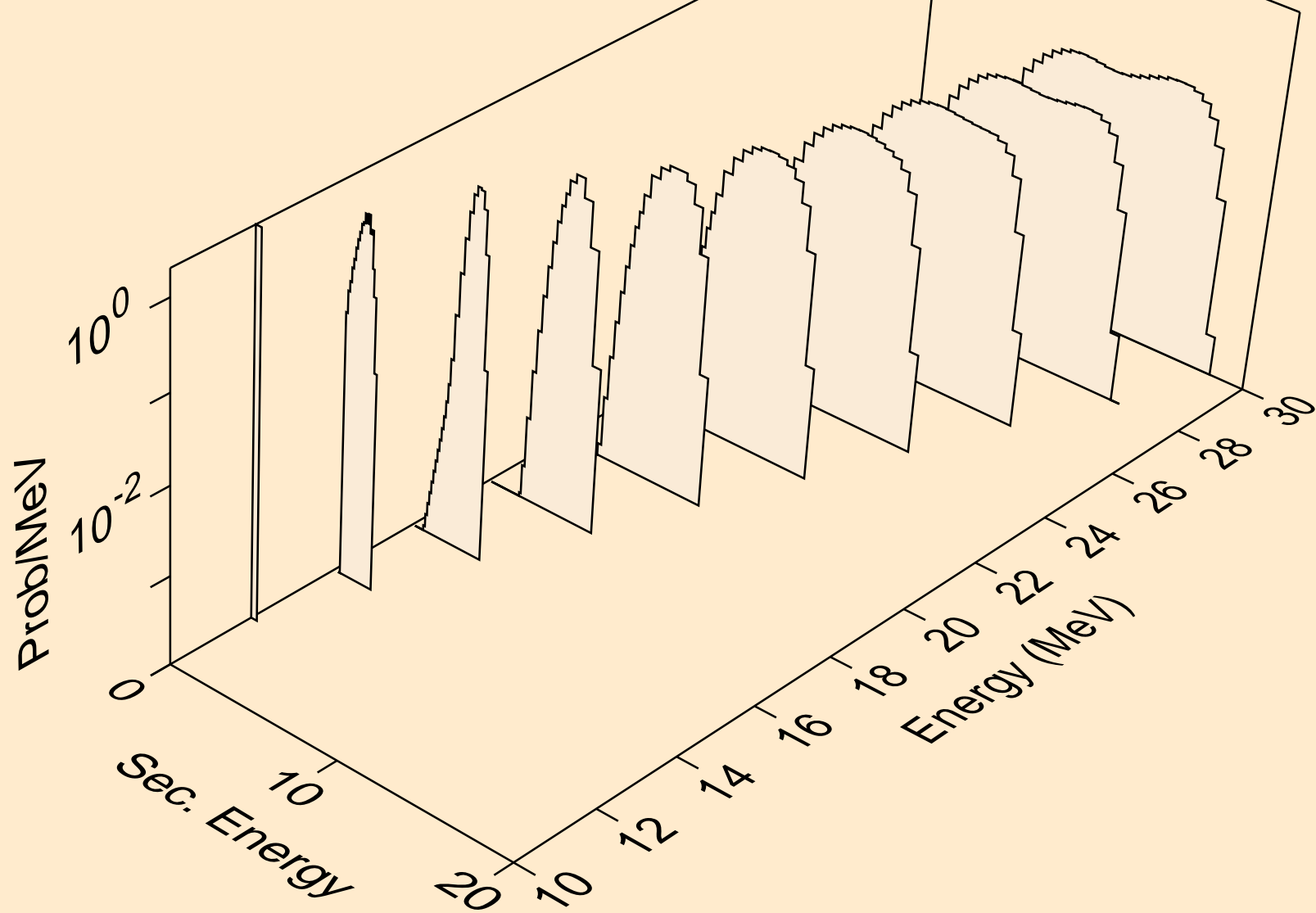

ER160 DEUTERON ACER TENDL-2023 LIBRARY; T=0.K
protons from (d,3np)

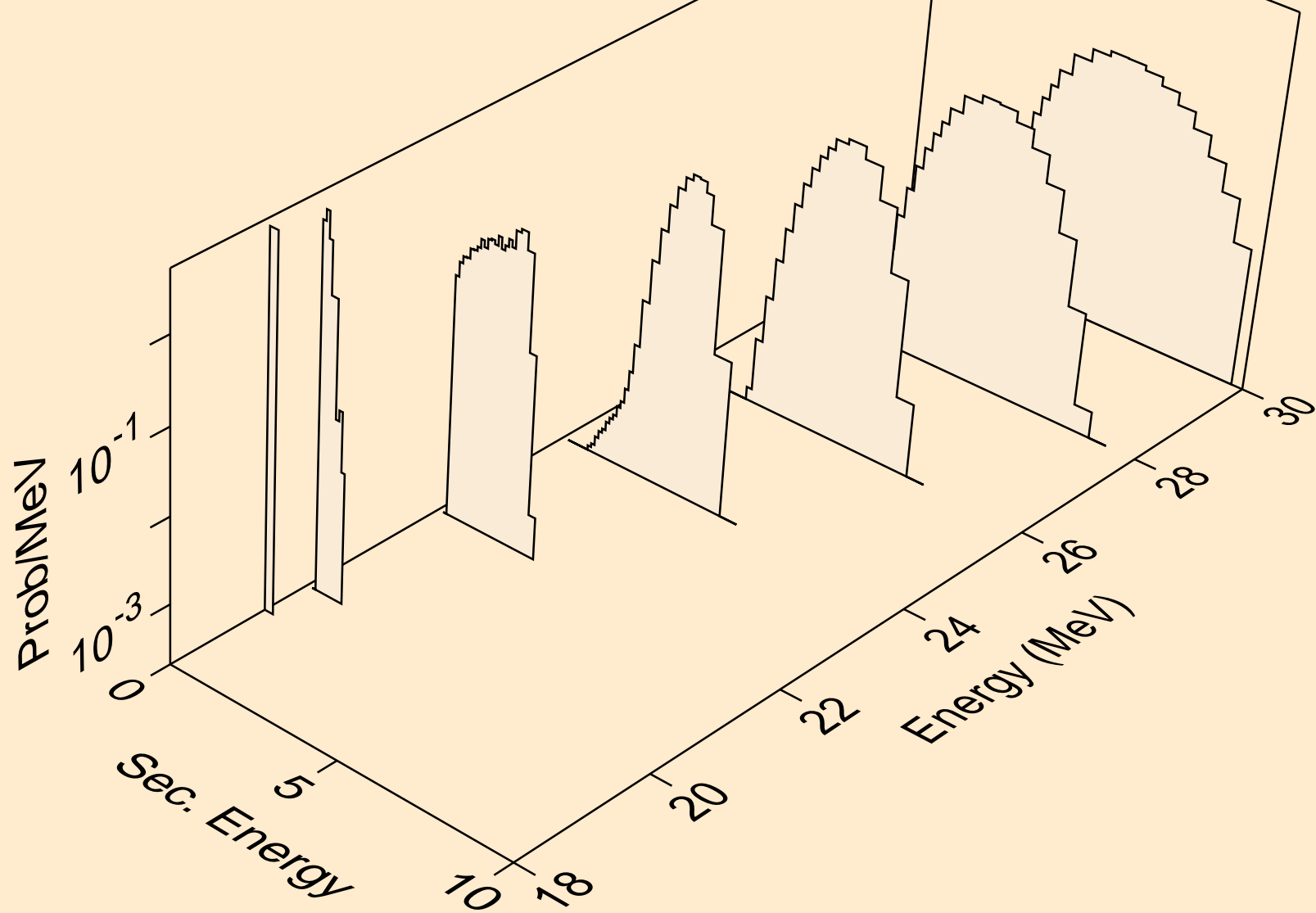

ER160 DEUTERON ACER TENDL-2023 LIBRARY; T=0.K
protons from (d,n2p)

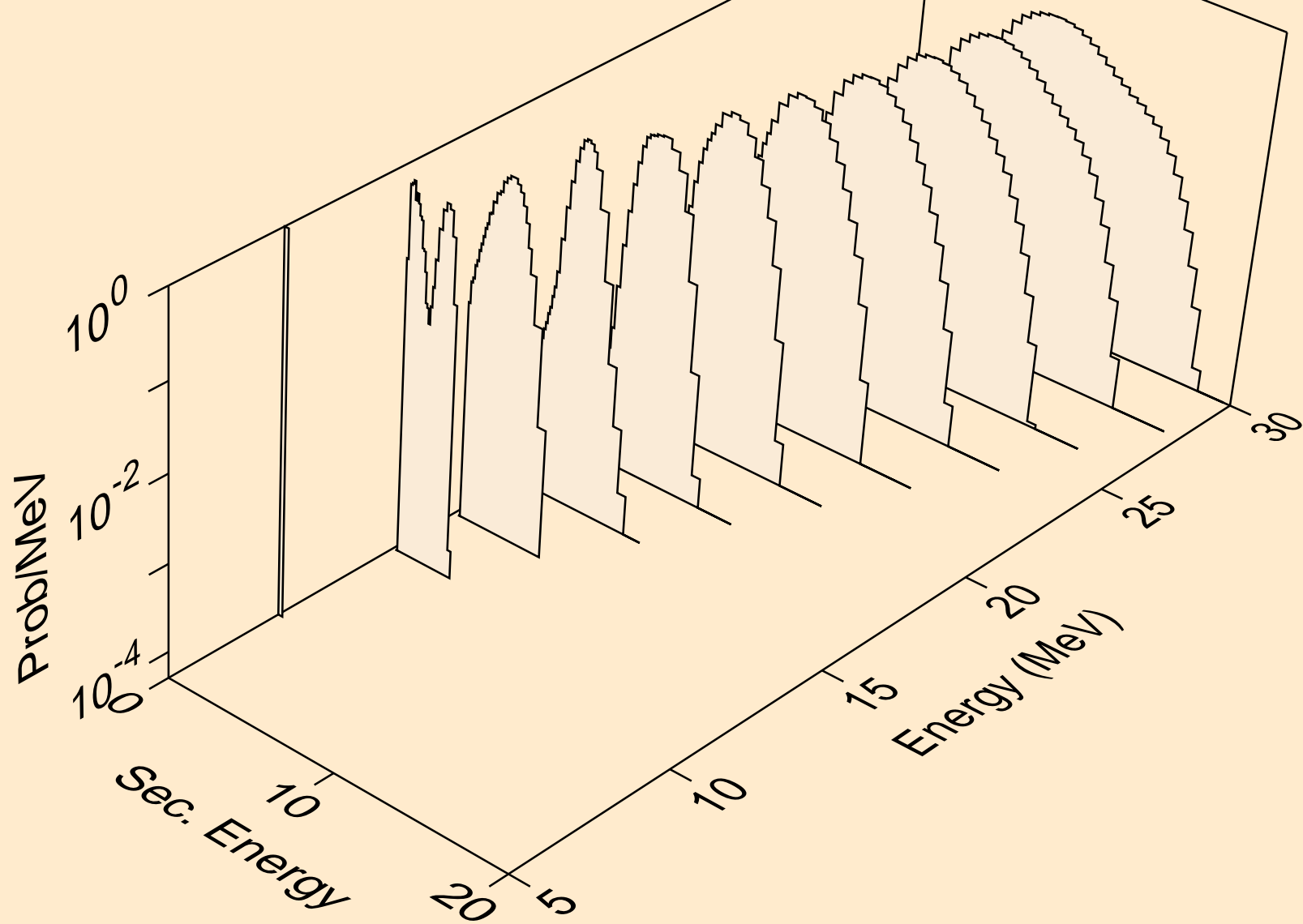

ER160 DEUTERON ACER TENDL-2023 LIBRARY; T=0.K
protons from (d,npa)

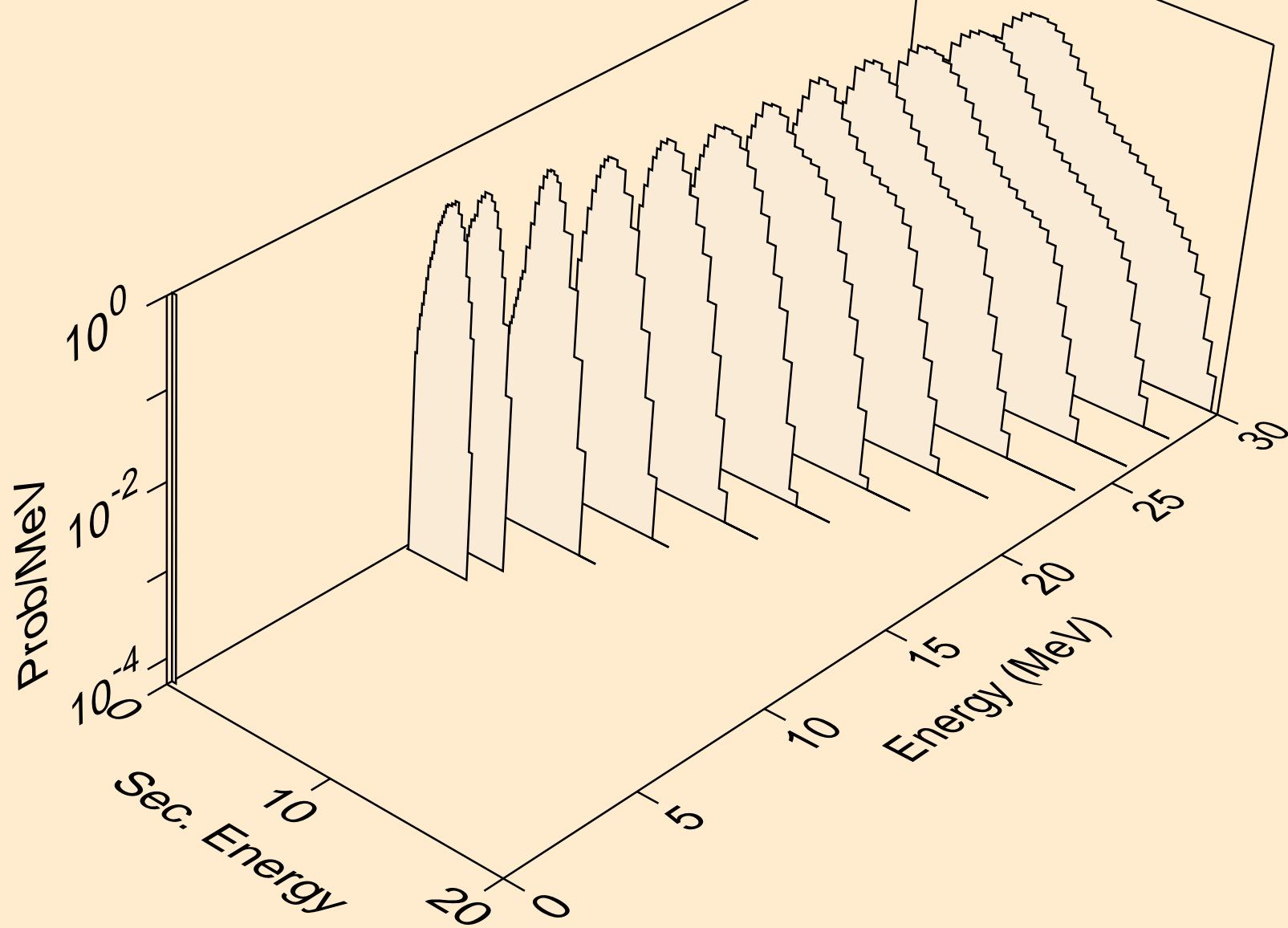

ER160 DEUTERON ACER TENDL-2023 LIBRARY; T=0.K
protons from (d,p)

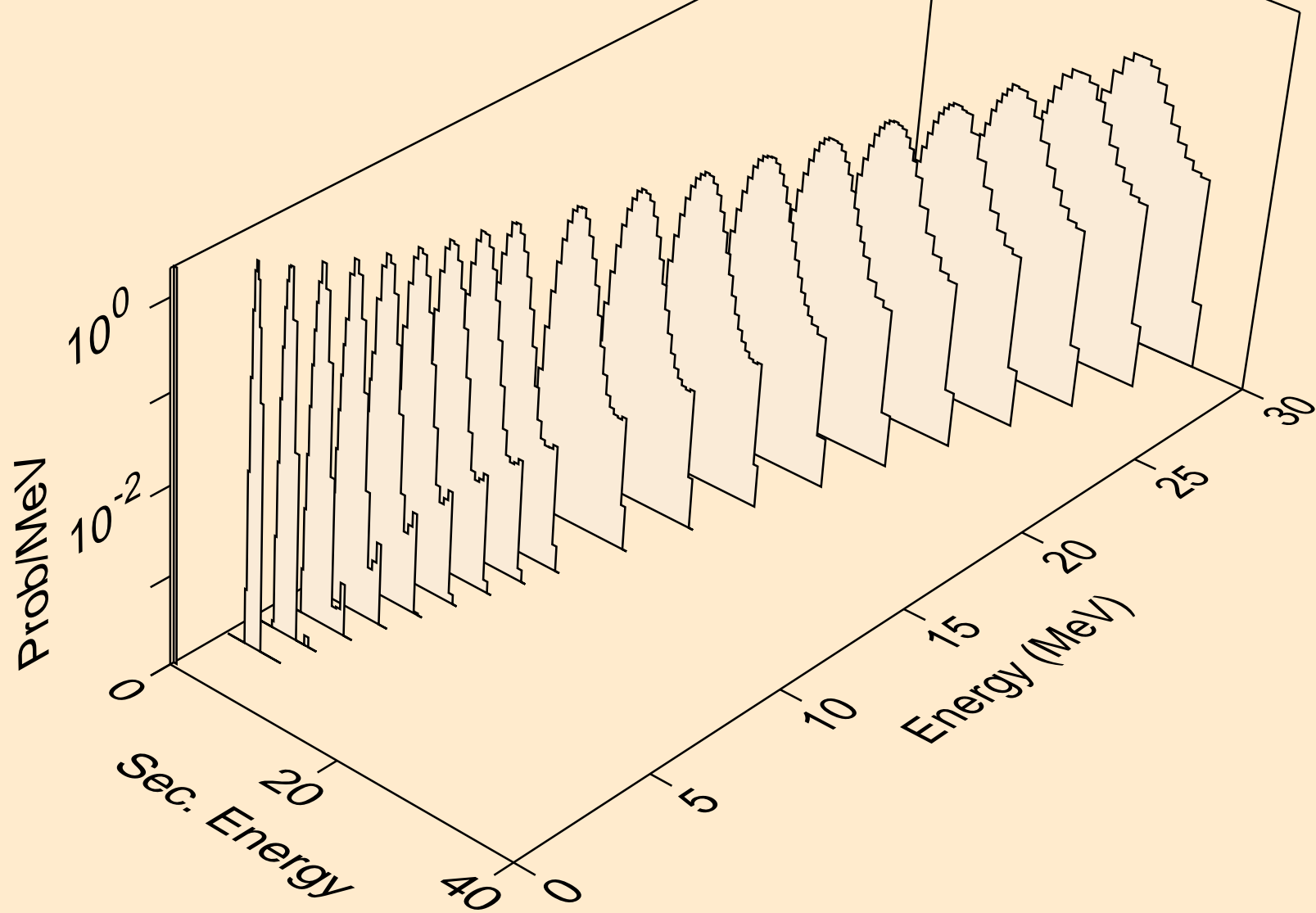

ER160 DEUTERON ACER TENDL-2023 LIBRARY; T=0.K
protons from (d,2p)

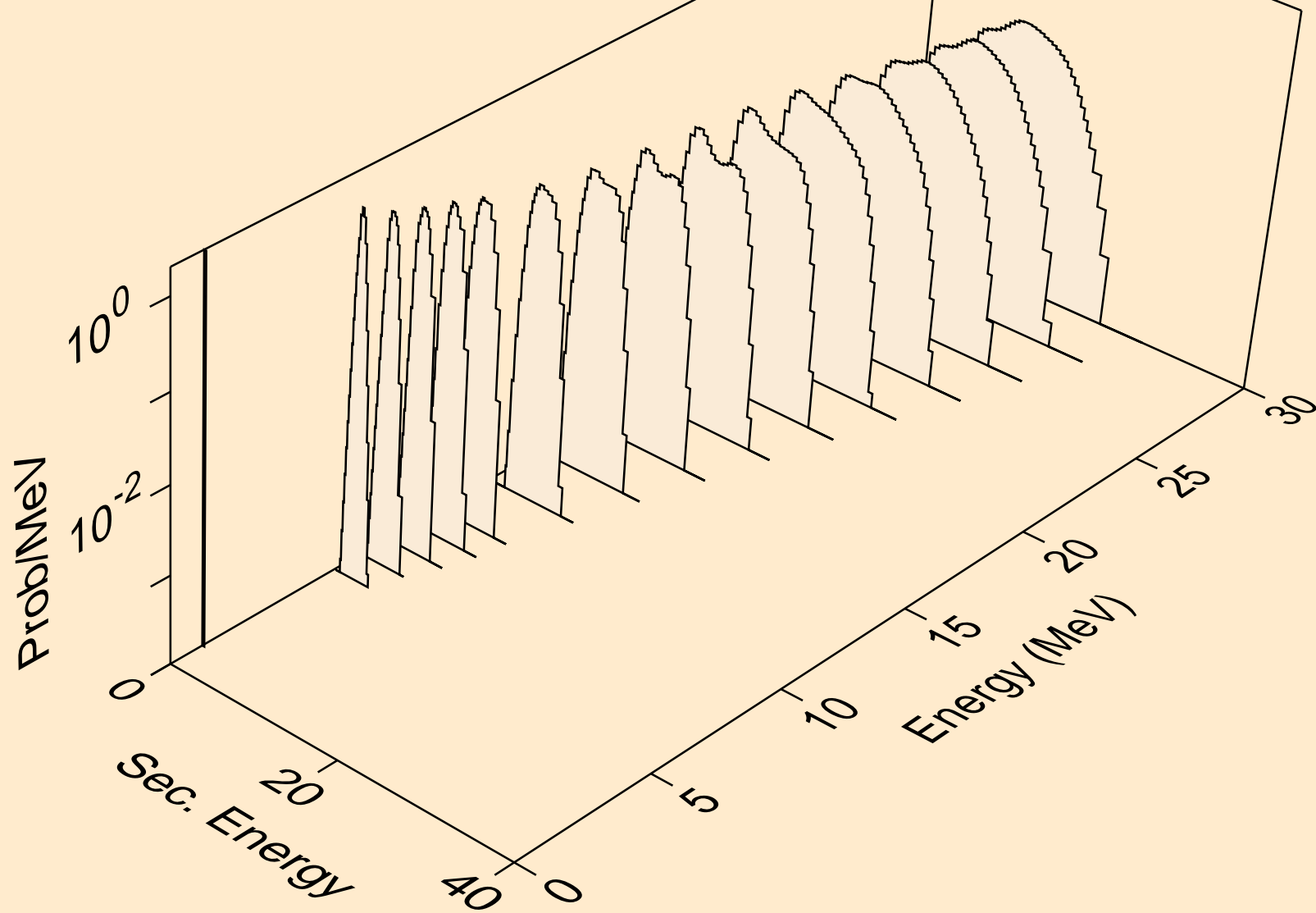

ER160 DEUTERON ACER TENDL-2023 LIBRARY; T=0.K
protons from (d,pa)

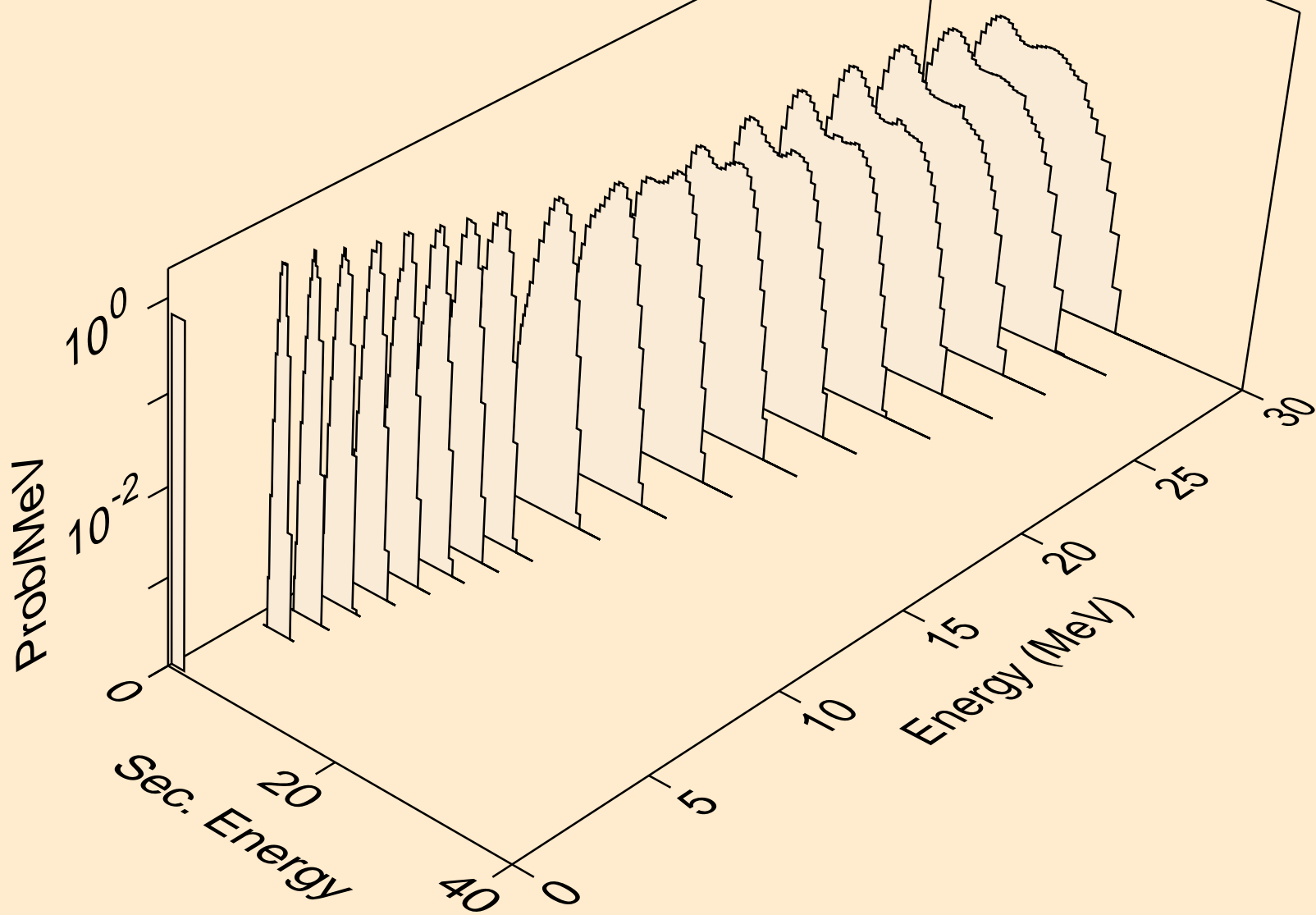

ER160 DEUTERON ACER TENDL-2023 LIBRARY; T=0.K
protons from (d,pd)

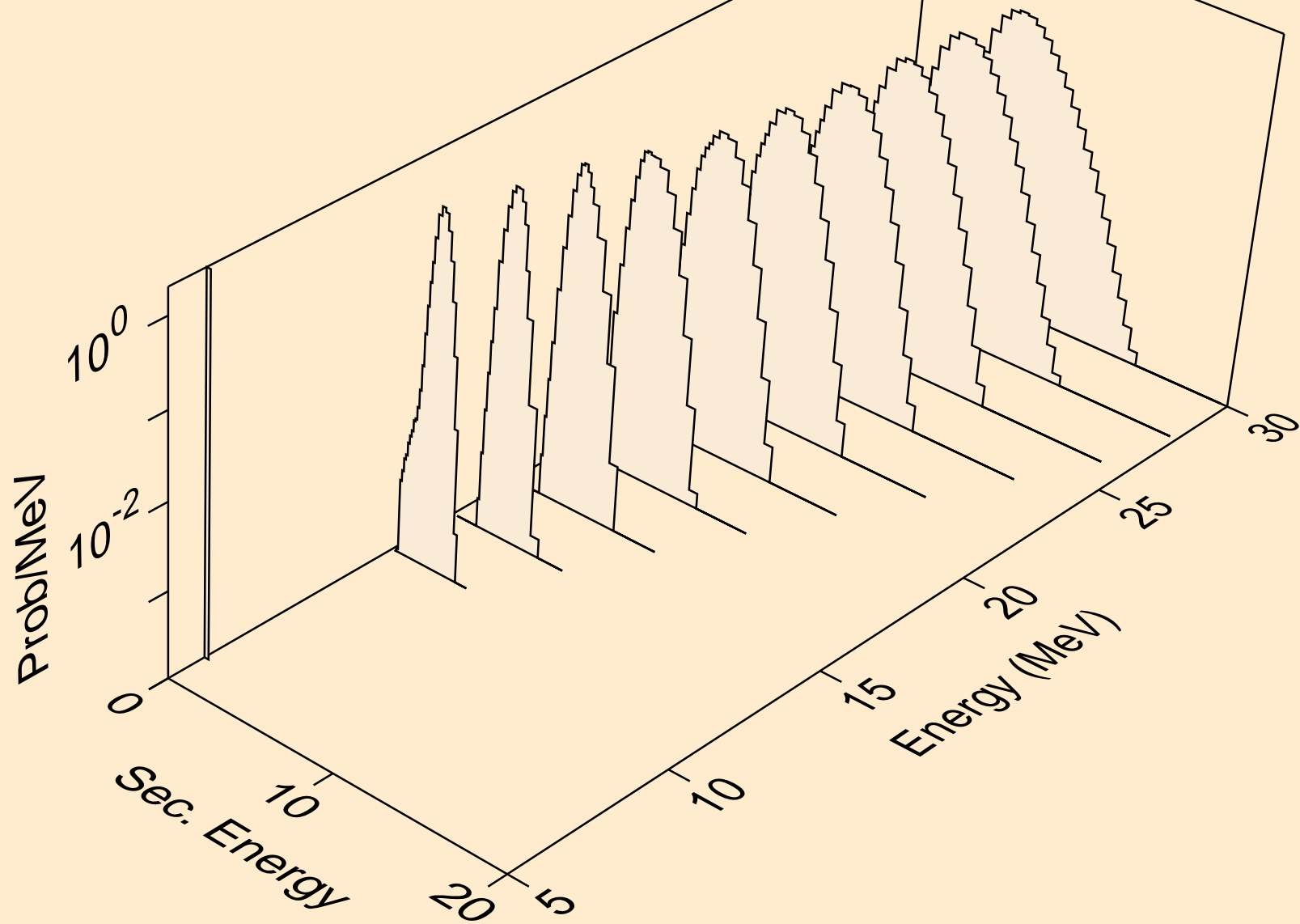

ER160 DEUTERON ACER TENDL-2023 LIBRARY; T=0.K
protons from (d,pt)

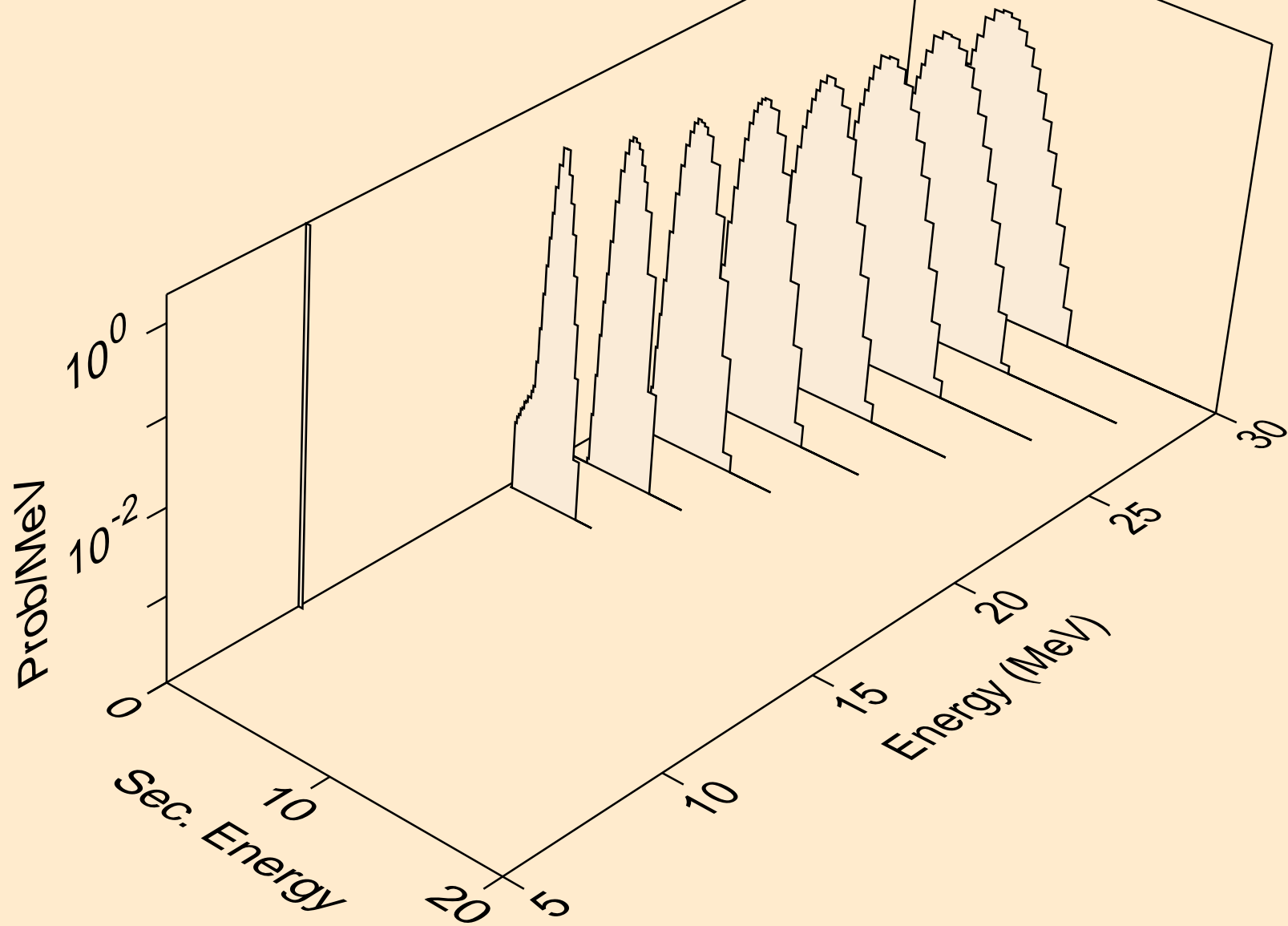

ER160 DEUTERON ACER TENDL-2023 LIBRARY; T=0.K
tritons from (d,x)

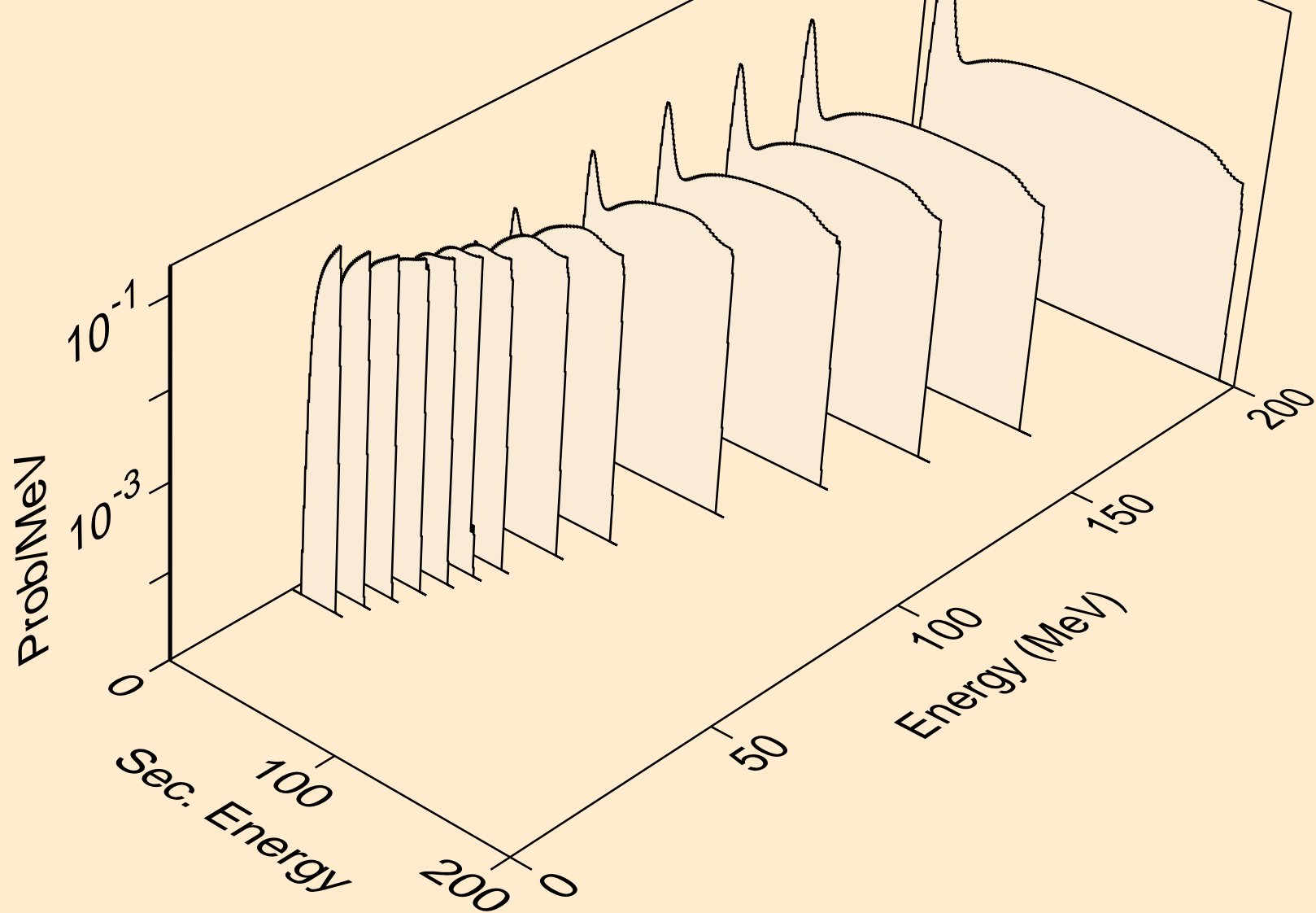

ER160 DEUTERON ACER TENDL-2023 LIBRARY; T=0.K
tritons from (d,n*)t

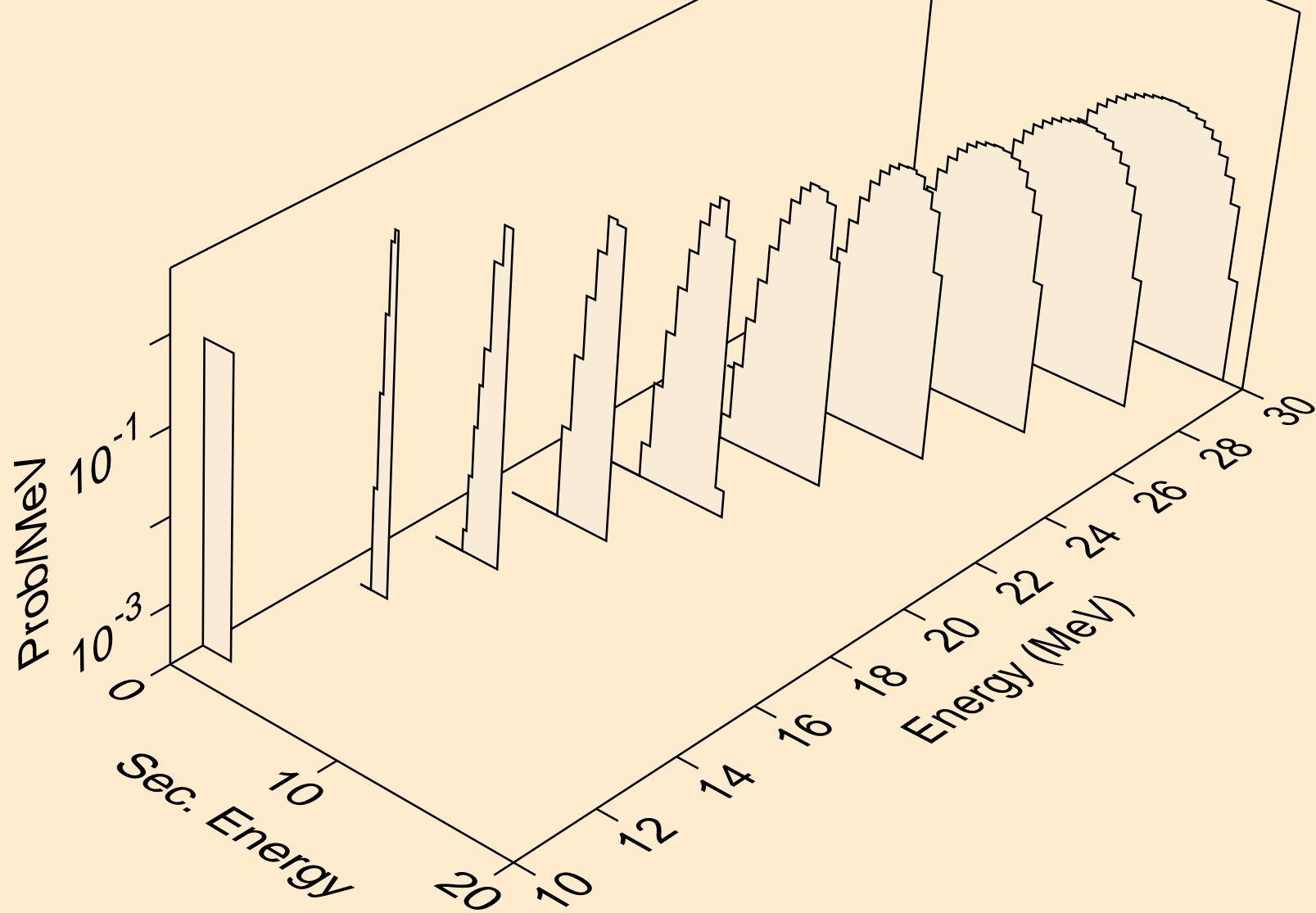

ER160 DEUTERON ACER TENDL-2023 LIBRARY; T=0.K
tritons from (d,t)

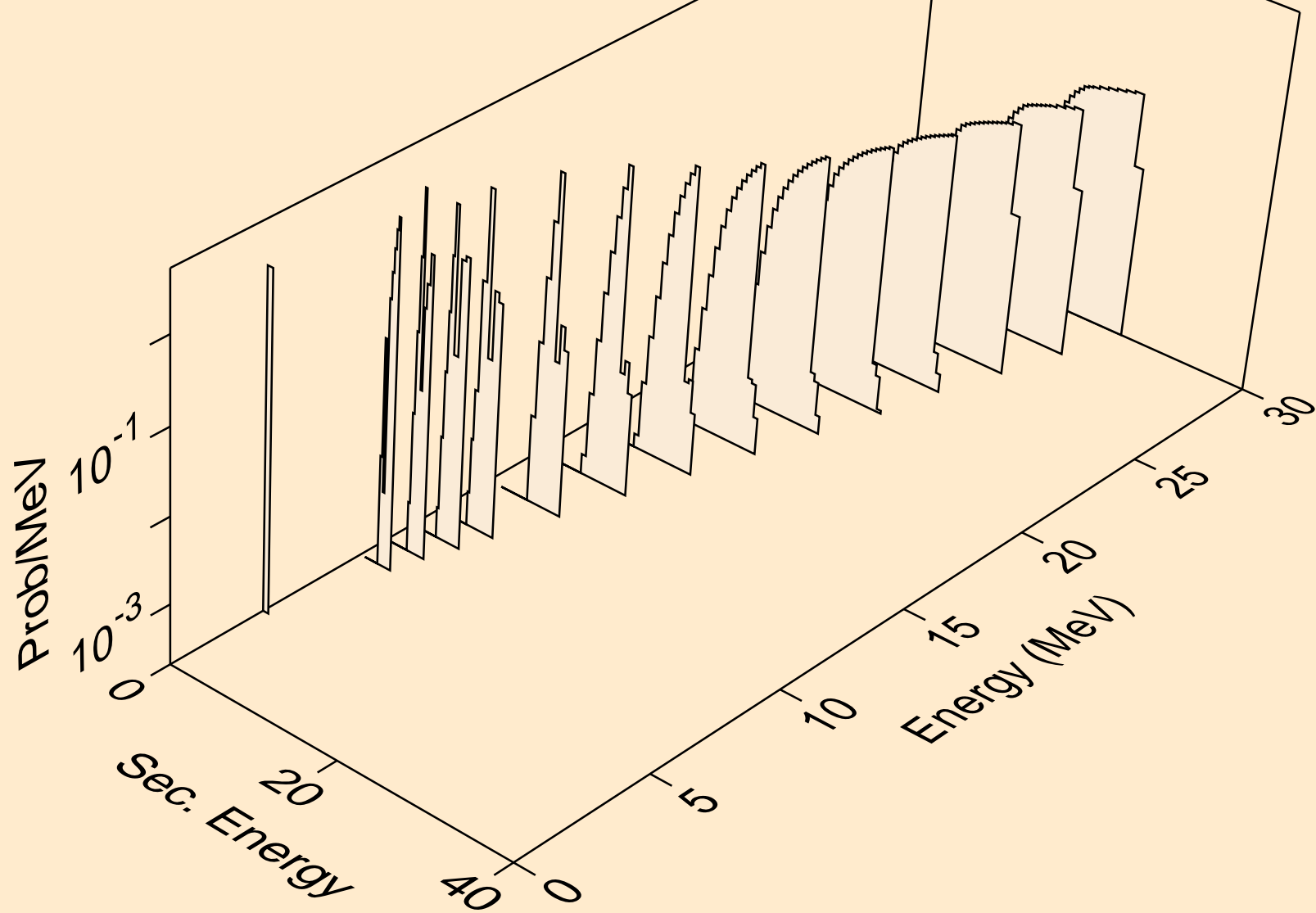

ER160 DEUTERON ACER TENDL-2023 LIBRARY; T=0.K
tritons from (d,pt)

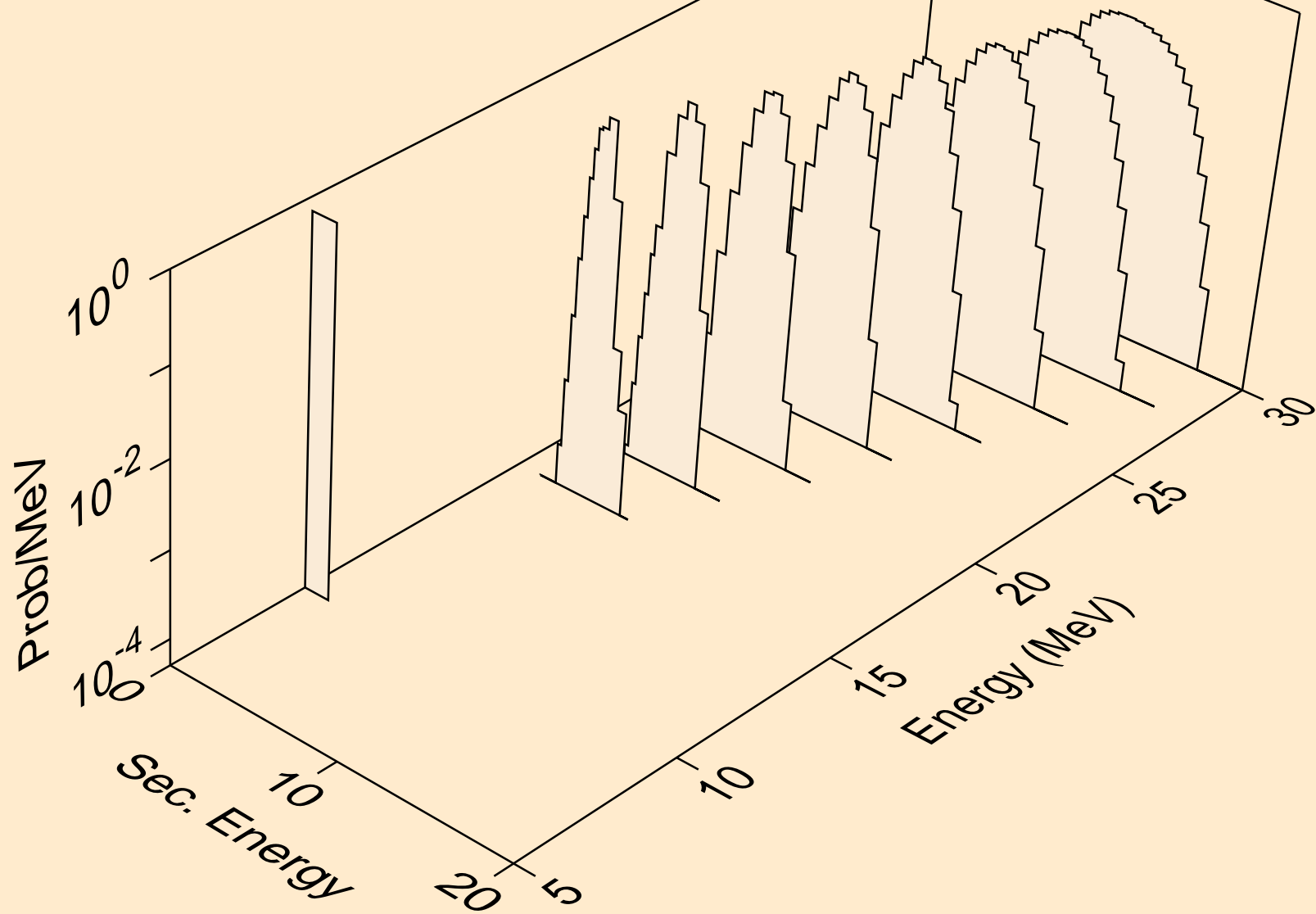

ER160 DEUTERON ACER TENDL-2023 LIBRARY; T=0.K
he3s from (d,x)

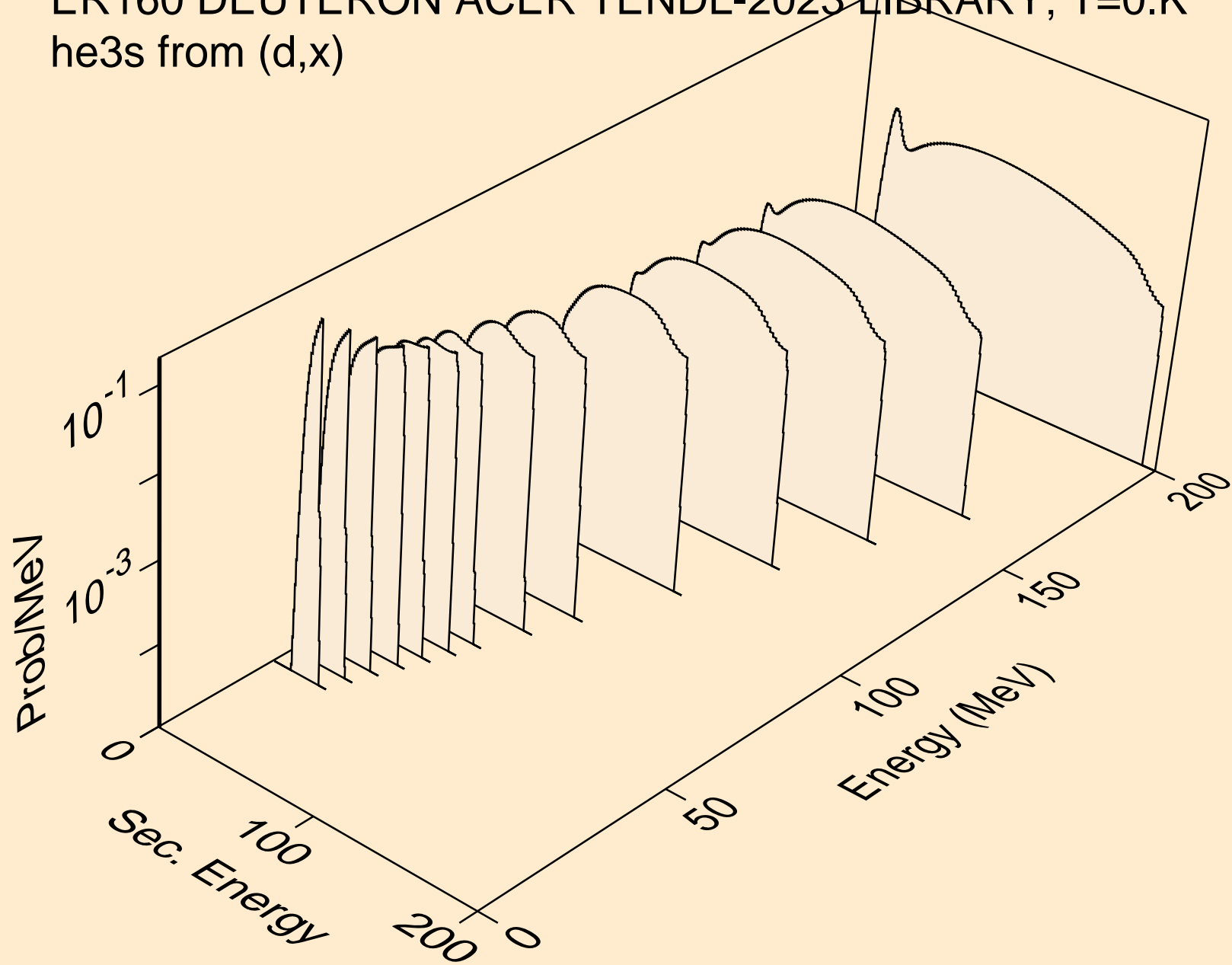

ER160 DEUTERON ACER TENDL-2023 LIBRARY; T=0.K
he3s from (d,n*)he3

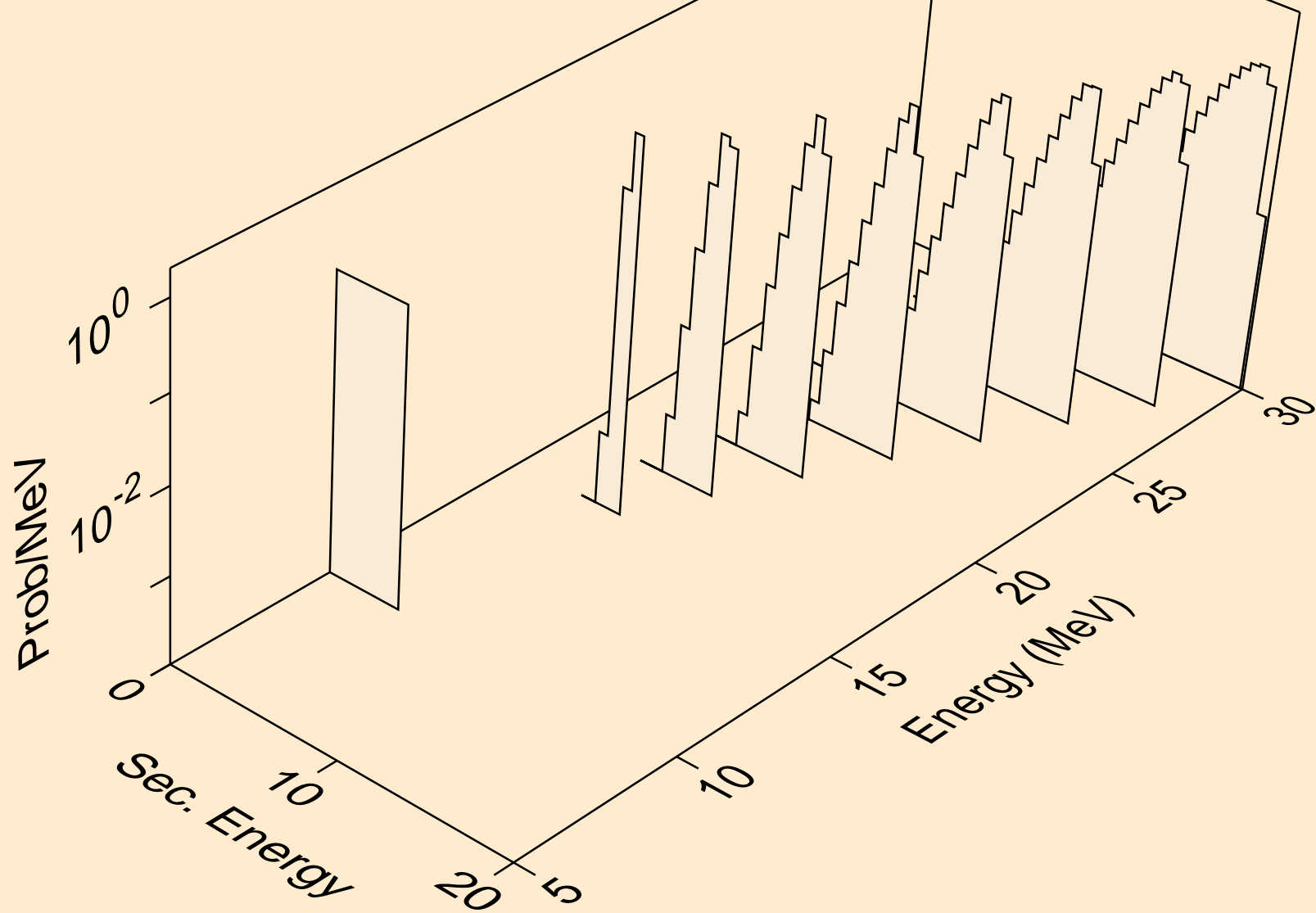

ER160 DEUTERON ACER TENDL-2023 LIBRARY; T=0.K
he3s from (d,he3)

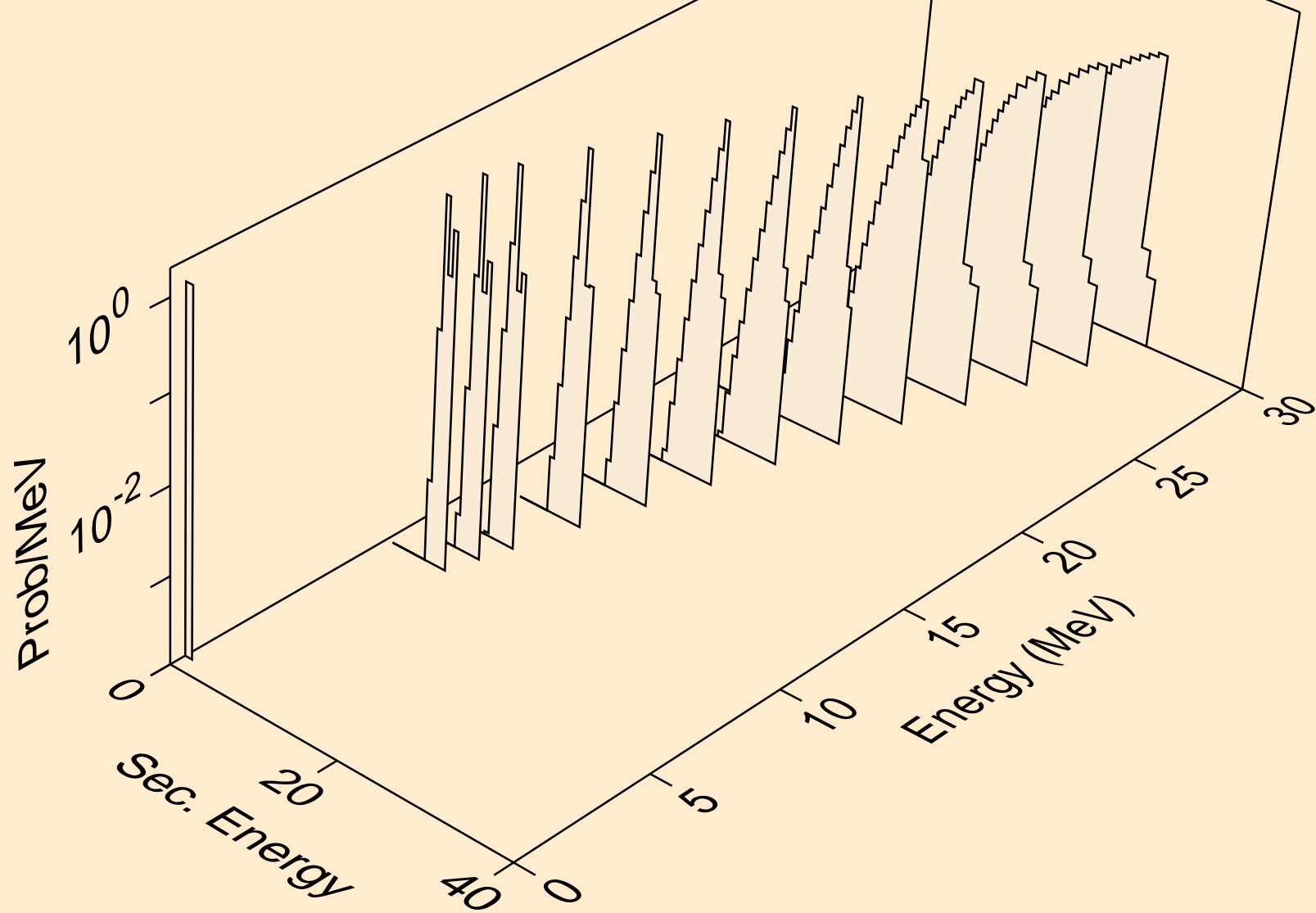

ER160 DEUTERON ACER TENDL-2023 LIBRARY; T=0.K
alphas from (d,x)

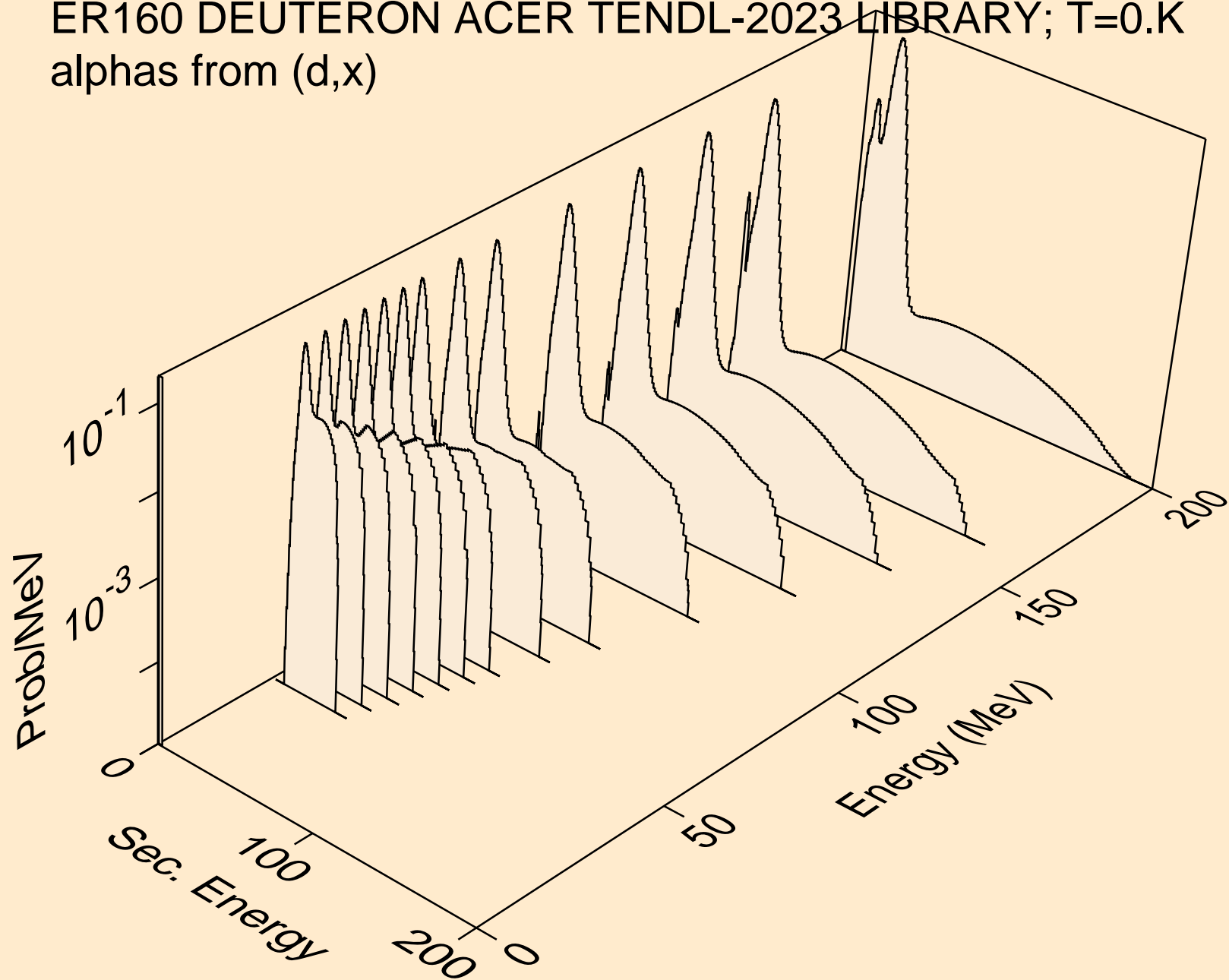

ER160 DEUTERON ACER TENDL-2023 LIBRARY; T=0.K
alphas from (d,n*)a

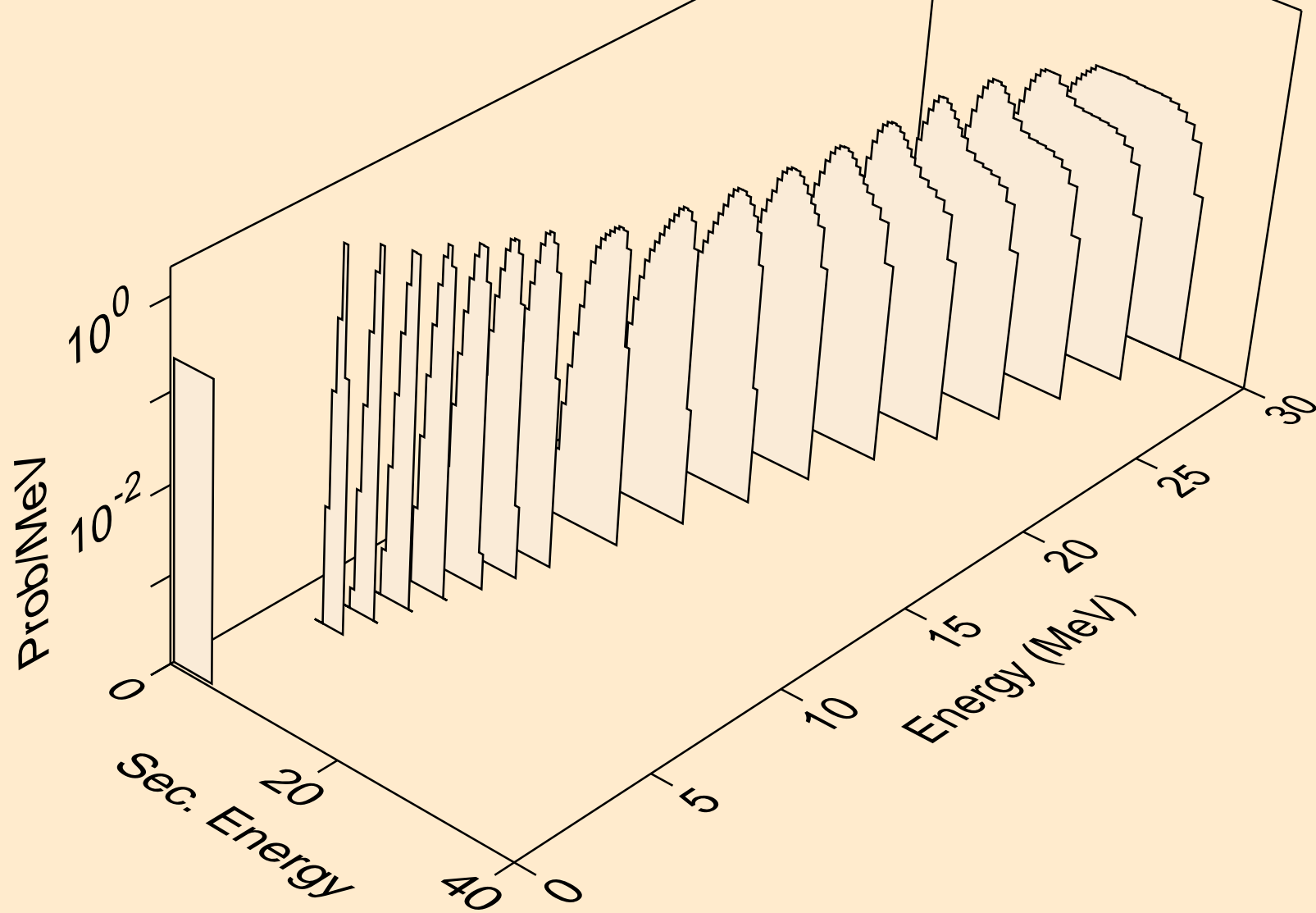

ER160 DEUTERON ACER TENDL-2023 LIBRARY; T=0.K
alphas from (d,2n)a

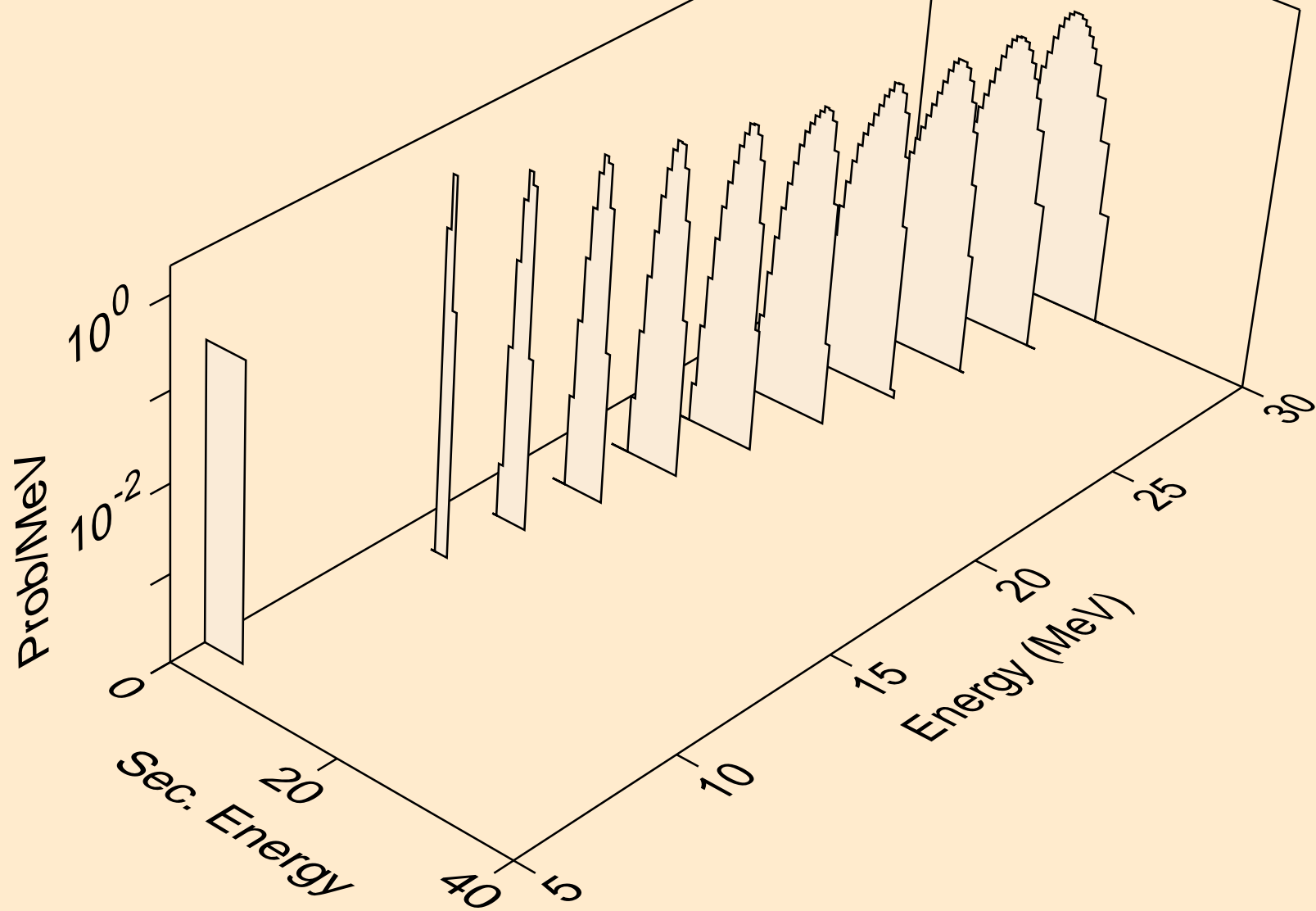

ER160 DEUTERON ACER TENDL-2023 LIBRARY; T=0.K
alphas from (d,3n)a

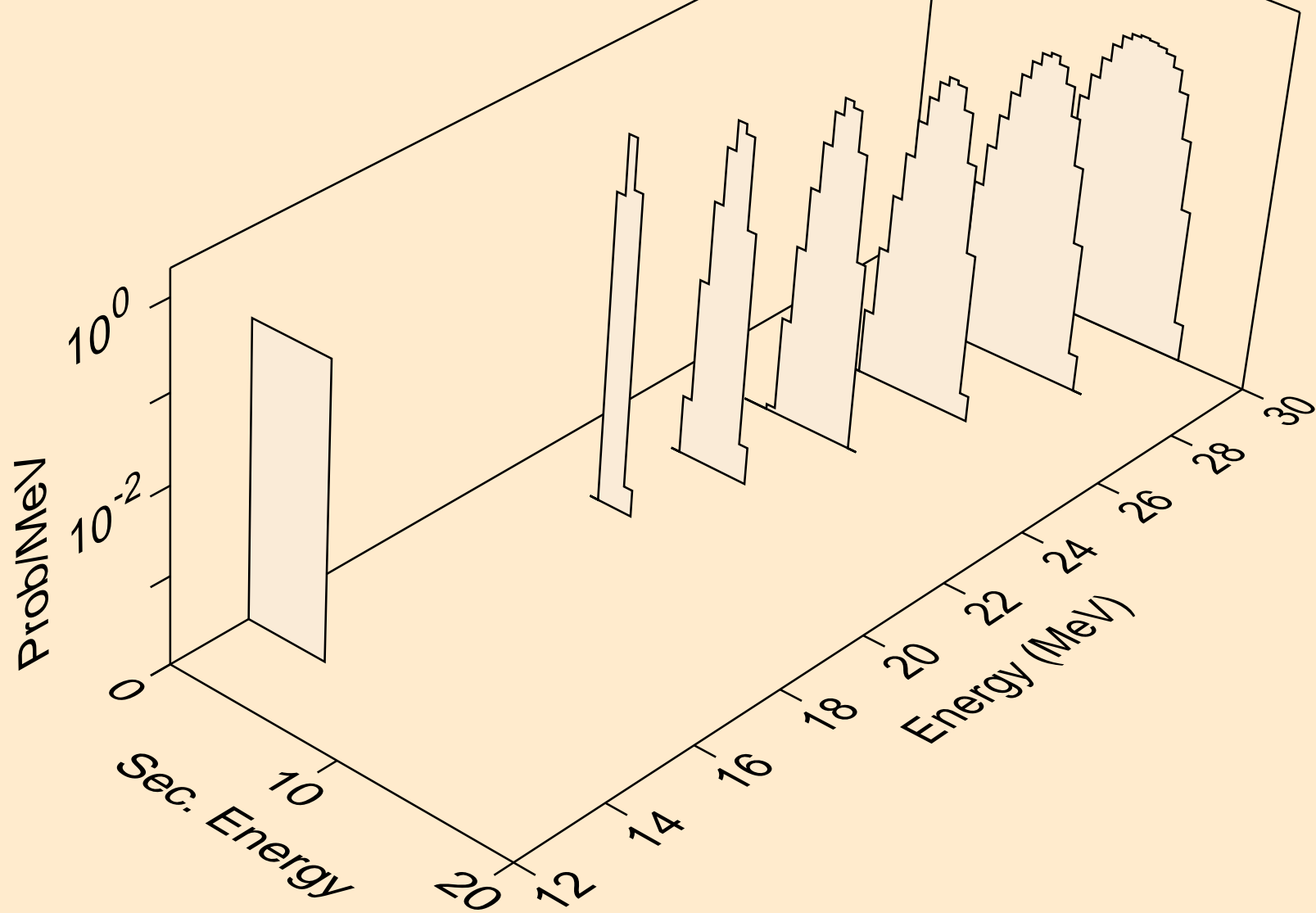

ER160 DEUTERON ACER TENDL-2023 LIBRARY; T=0.K
alphas from (d,n*)2a

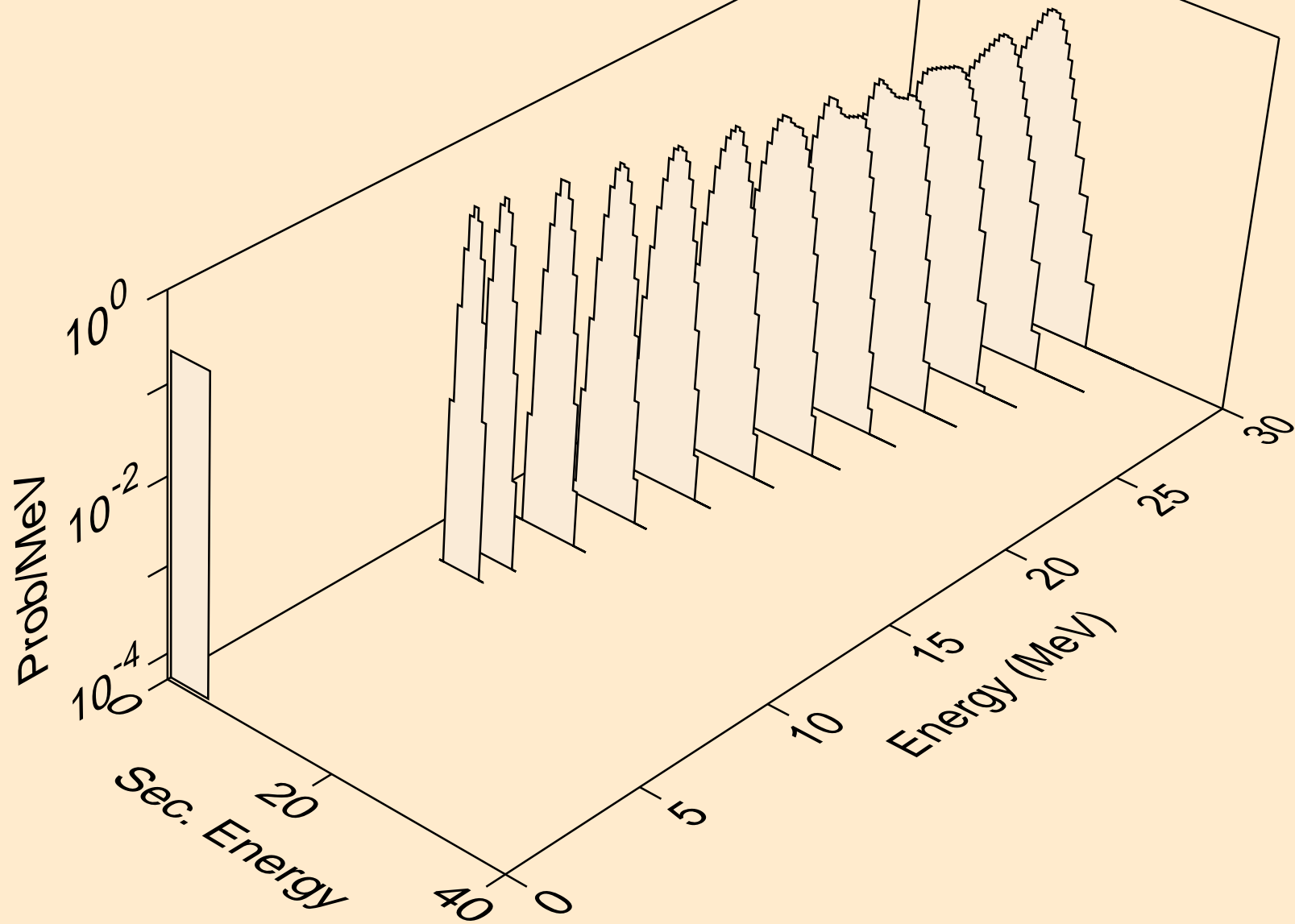

ER160 DEUTERON ACER TENDL-2023 LIBRARY; T=0.K
alphas from (d,2n)2a

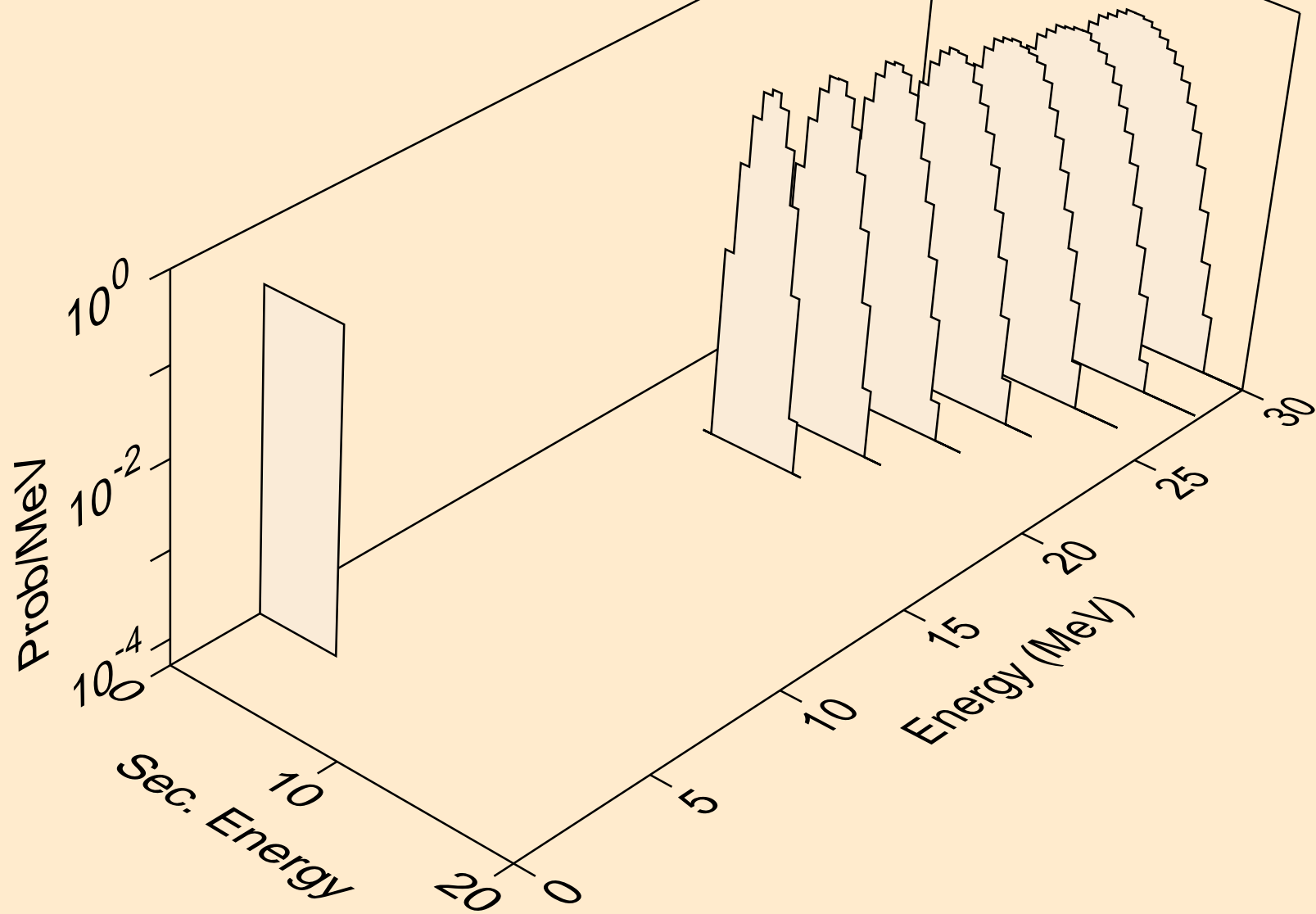

ER160 DEUTERON ACER TENDL-2023 LIBRARY; T=0.K
alphas from (d,npa)

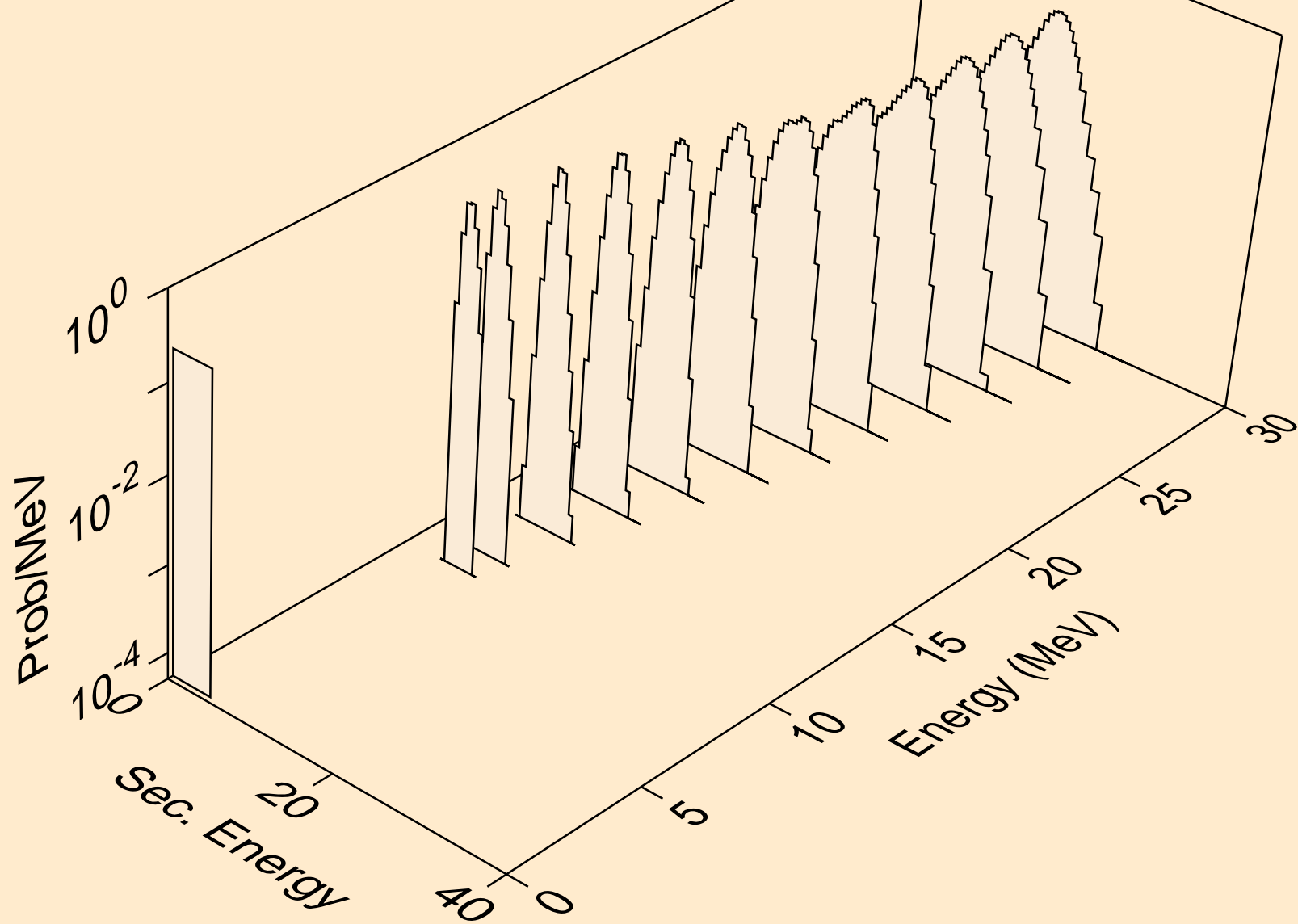

ER160 DEUTERON ACER TENDL-2023 LIBRARY; T=0.K
alphas from (d,a)

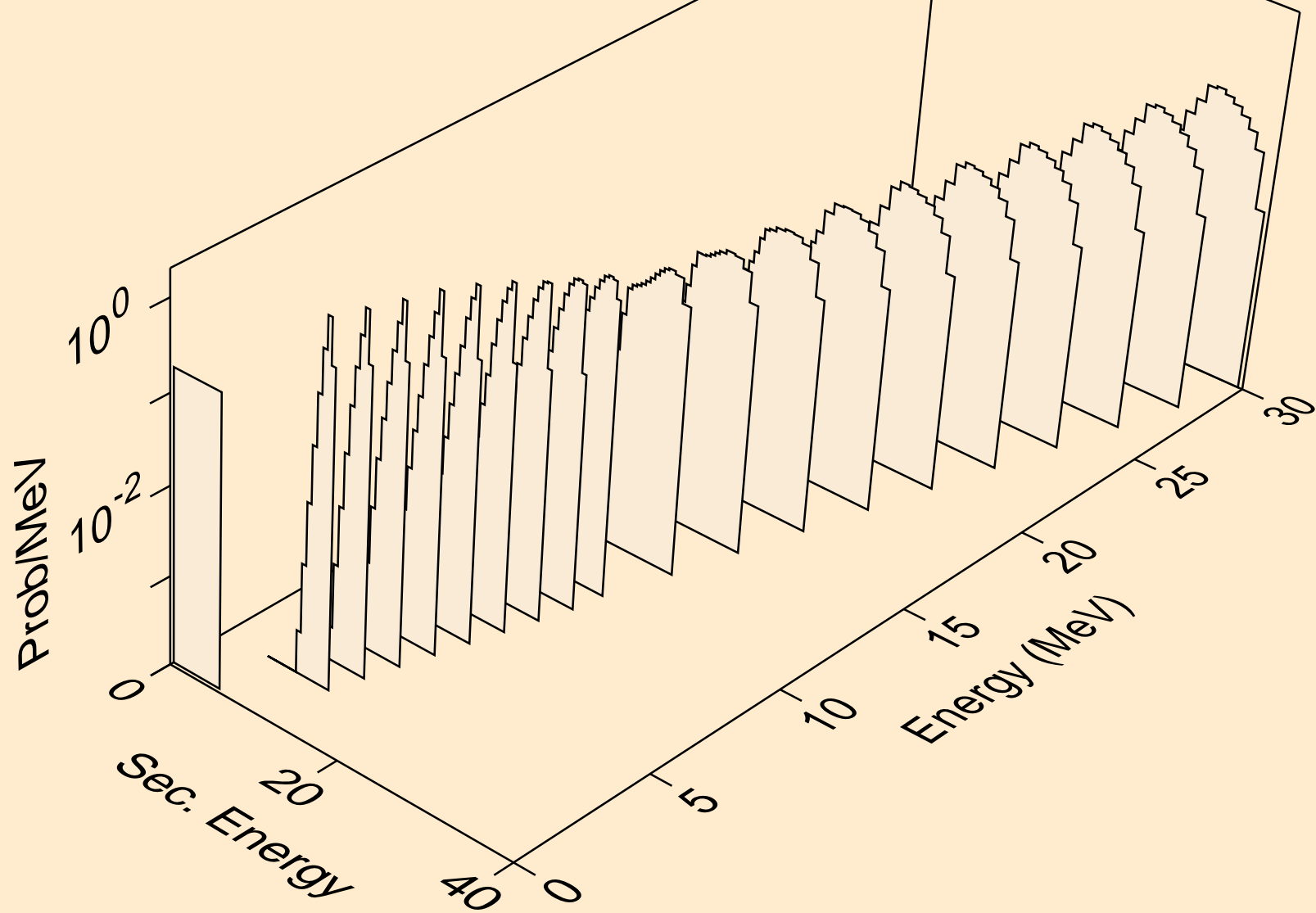

ER160 DEUTERON ACER TENDL-2023 LIBRARY; T=0.K
alphas from (d,2a)

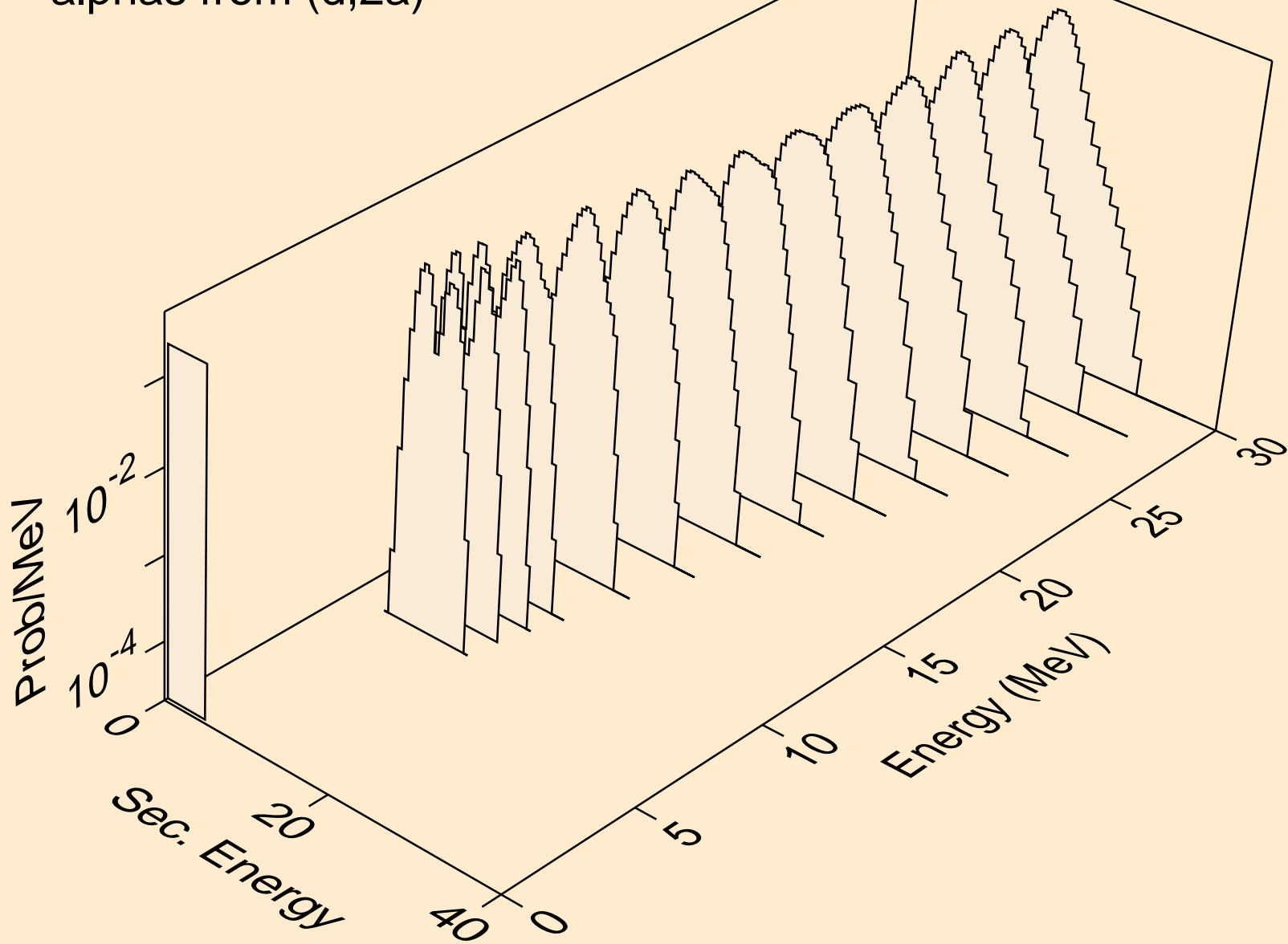

ER160 DEUTERON ACER TENDL-2023 LIBRARY; T=0.K
alphas from (d,pa)

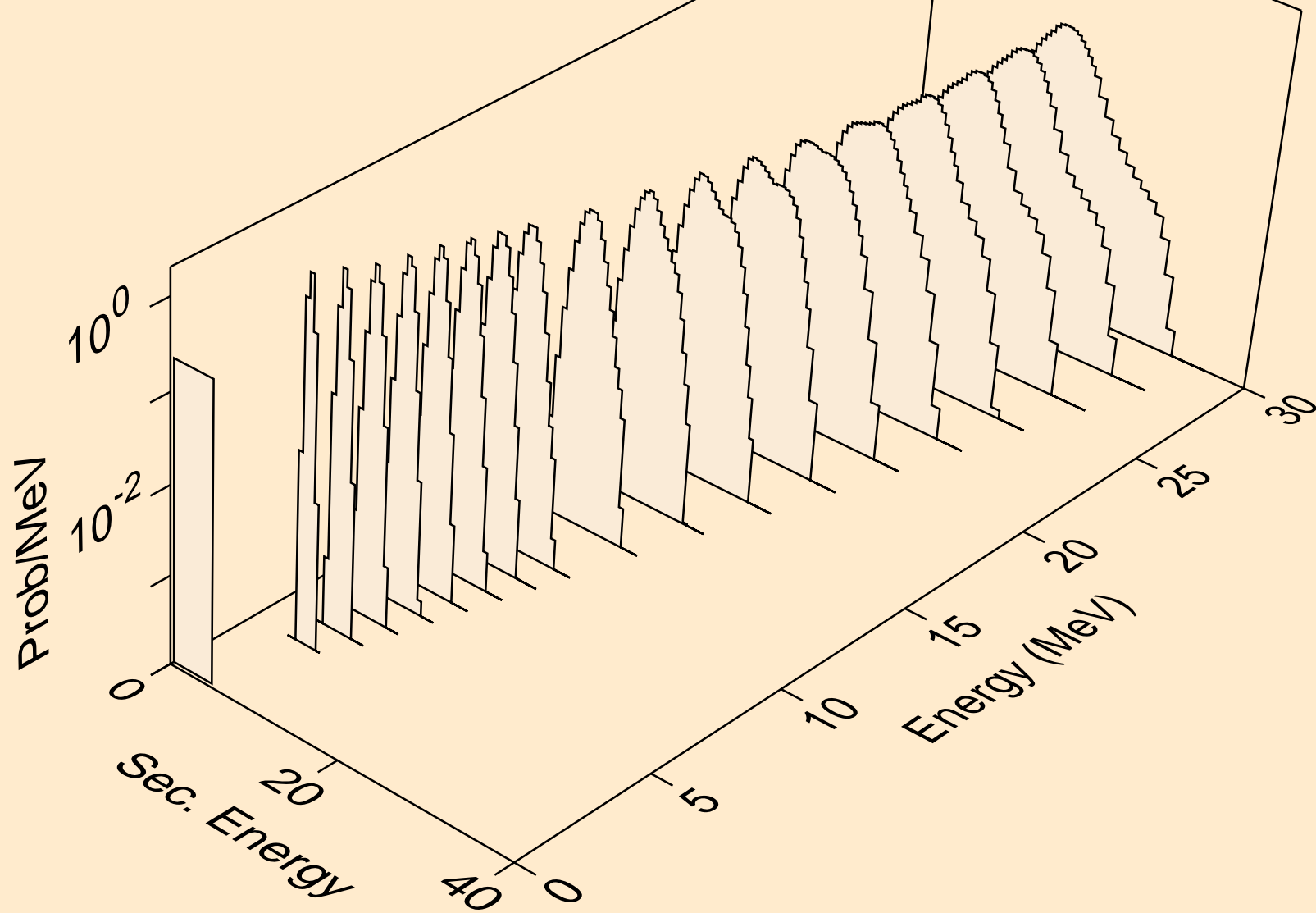

ER160 DEUTERON ACER TENDL-2023 LIBRARY; T=0.K
alphas from (d,da)

