

V050 DEUTERON ACER TENDL-2023 LIBRARY; T=0.K
Principal cross sections

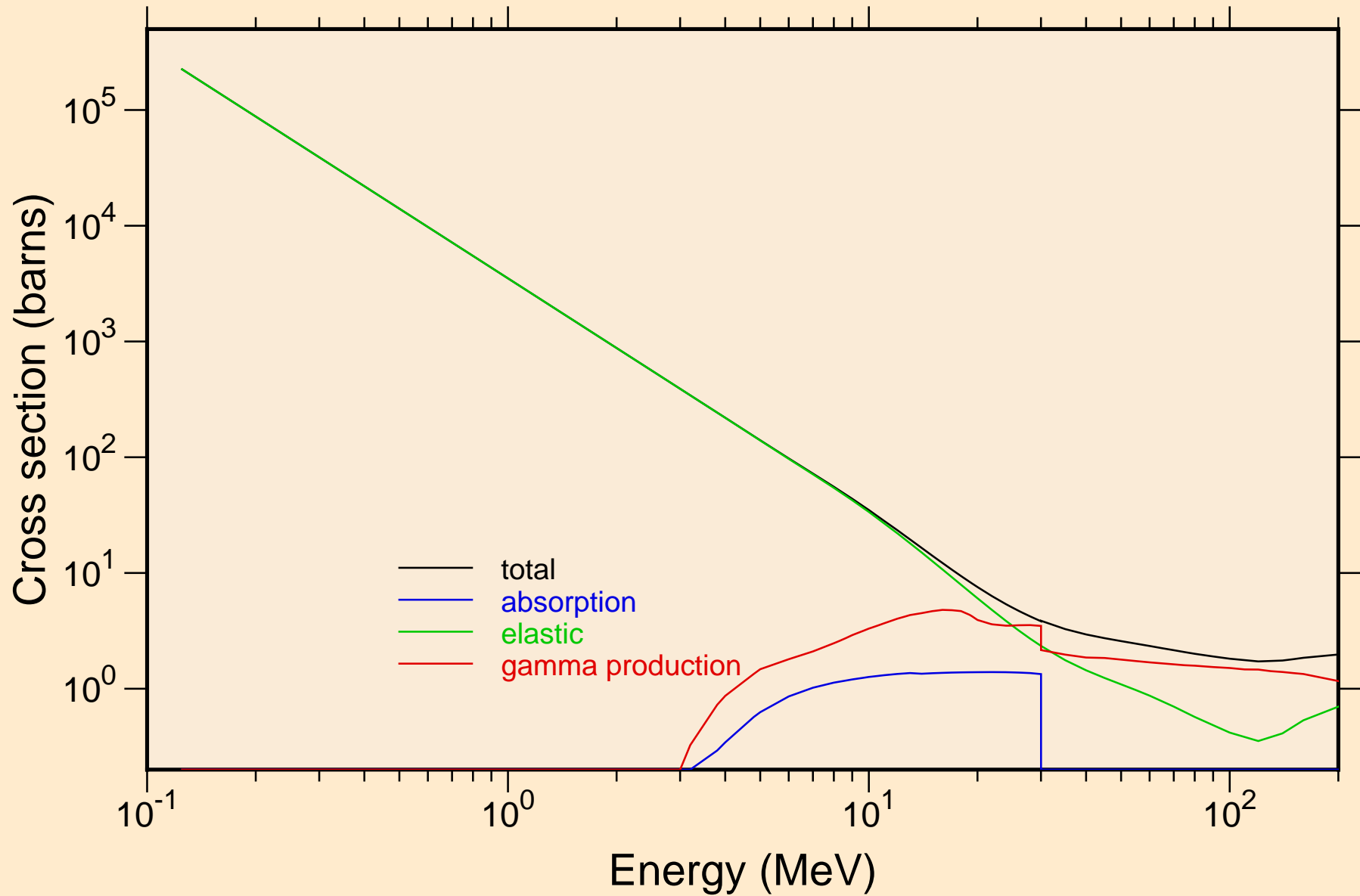

V050 DEUTERON ACER TENDL-2023 LIBRARY; T=0.K

Heating

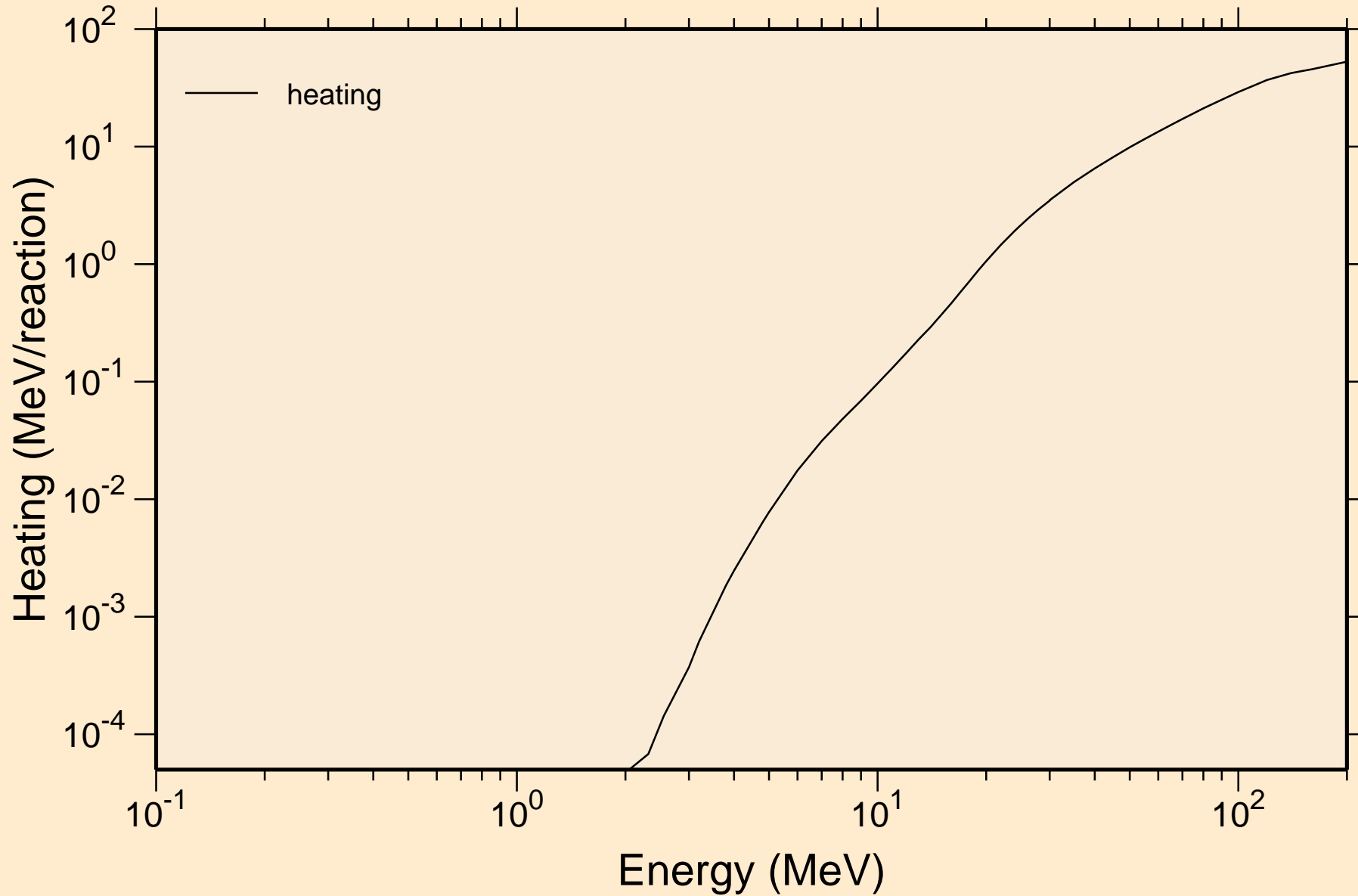

V050 DEUTERON ACER TENDL-2023 LIBRARY; T=0.K

Principal cross sections

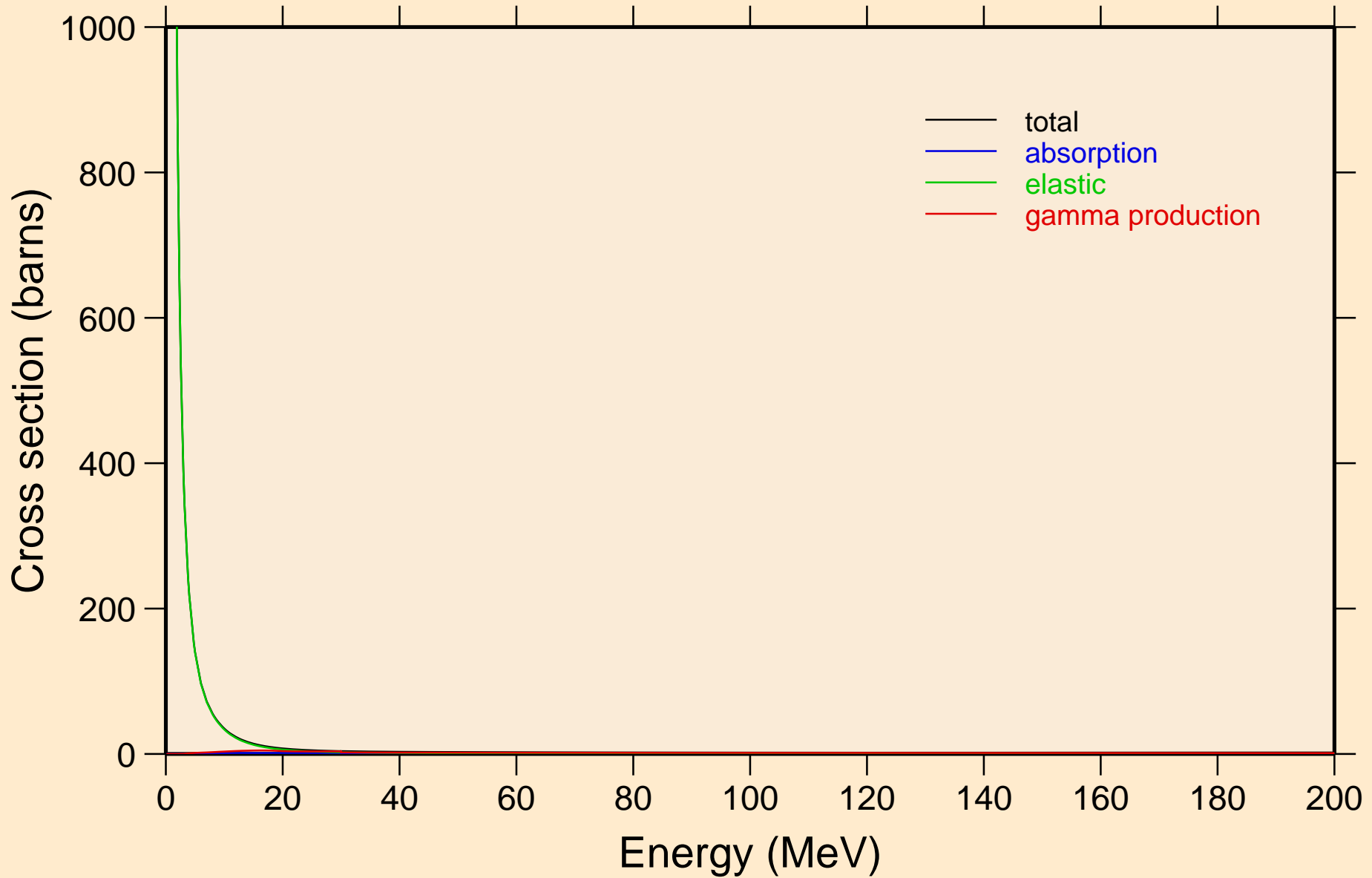

V050 DEUTERON ACER TENDL-2023 LIBRARY; T=0.K

Heating

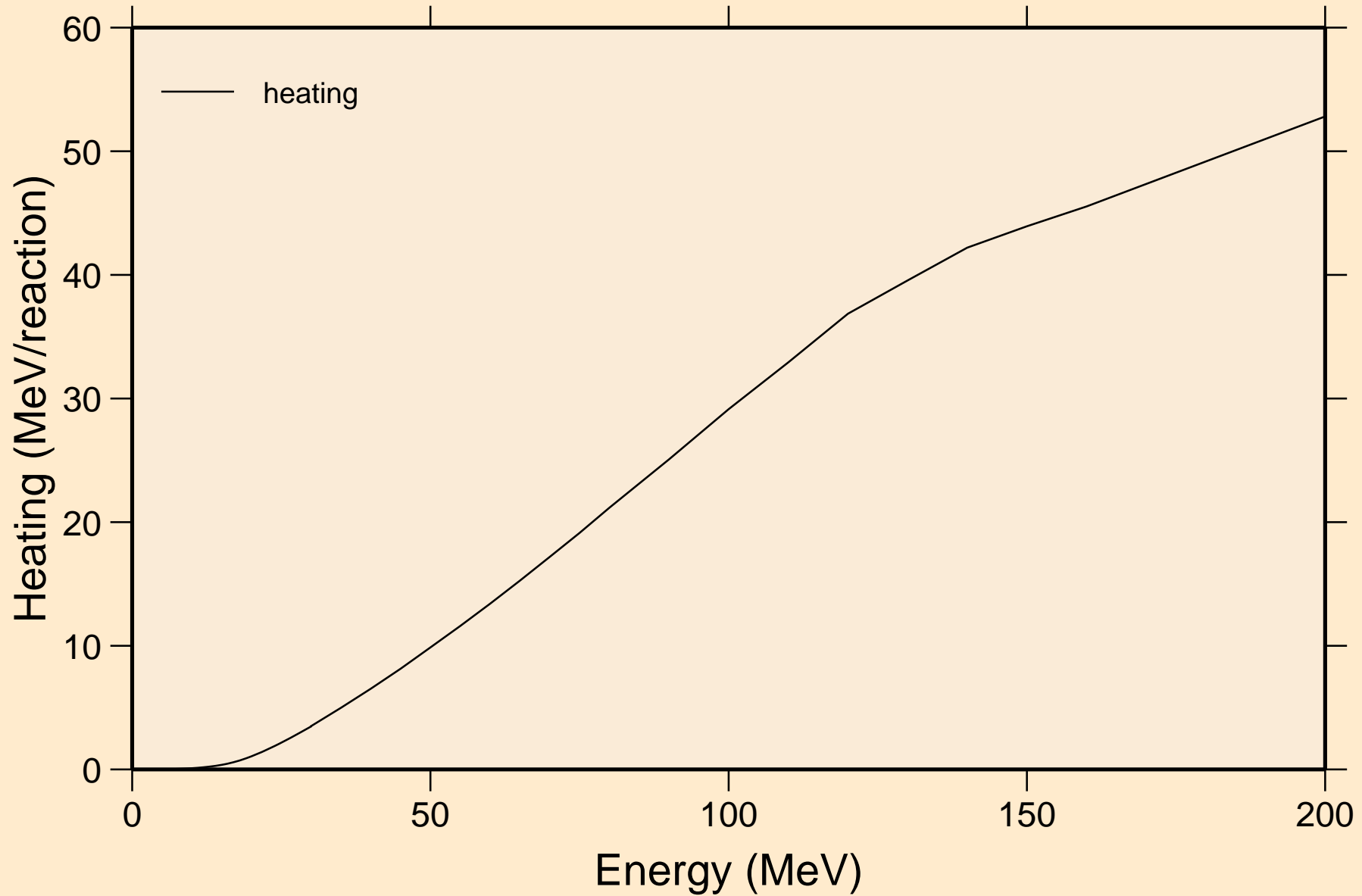

V050 DEUTERON ACER TENDL-2023 LIBRARY; T=0.K
Threshold reactions

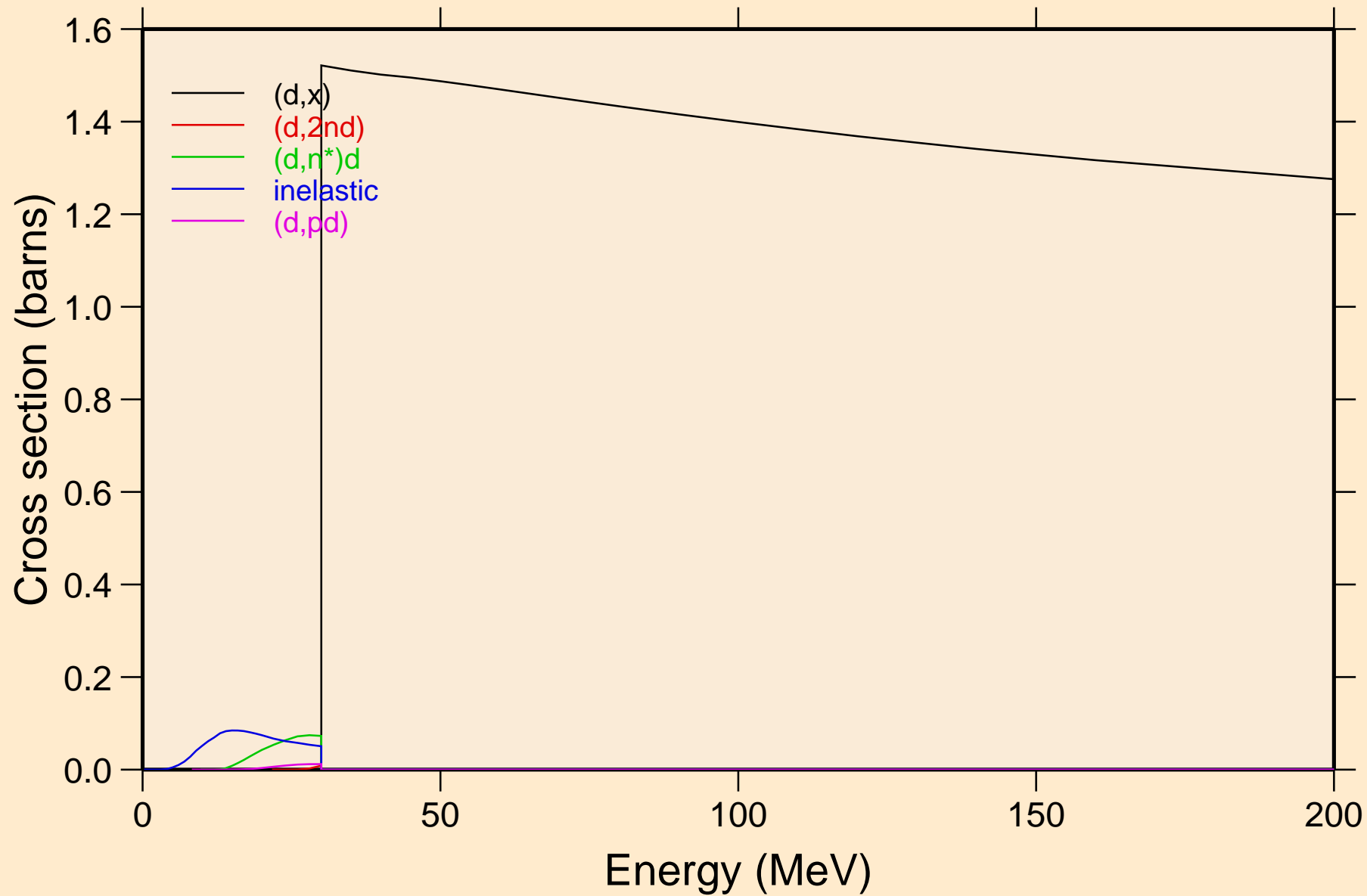

V050 DEUTERON ACER TENDL-2023 LIBRARY; T=0.K
Threshold reactions

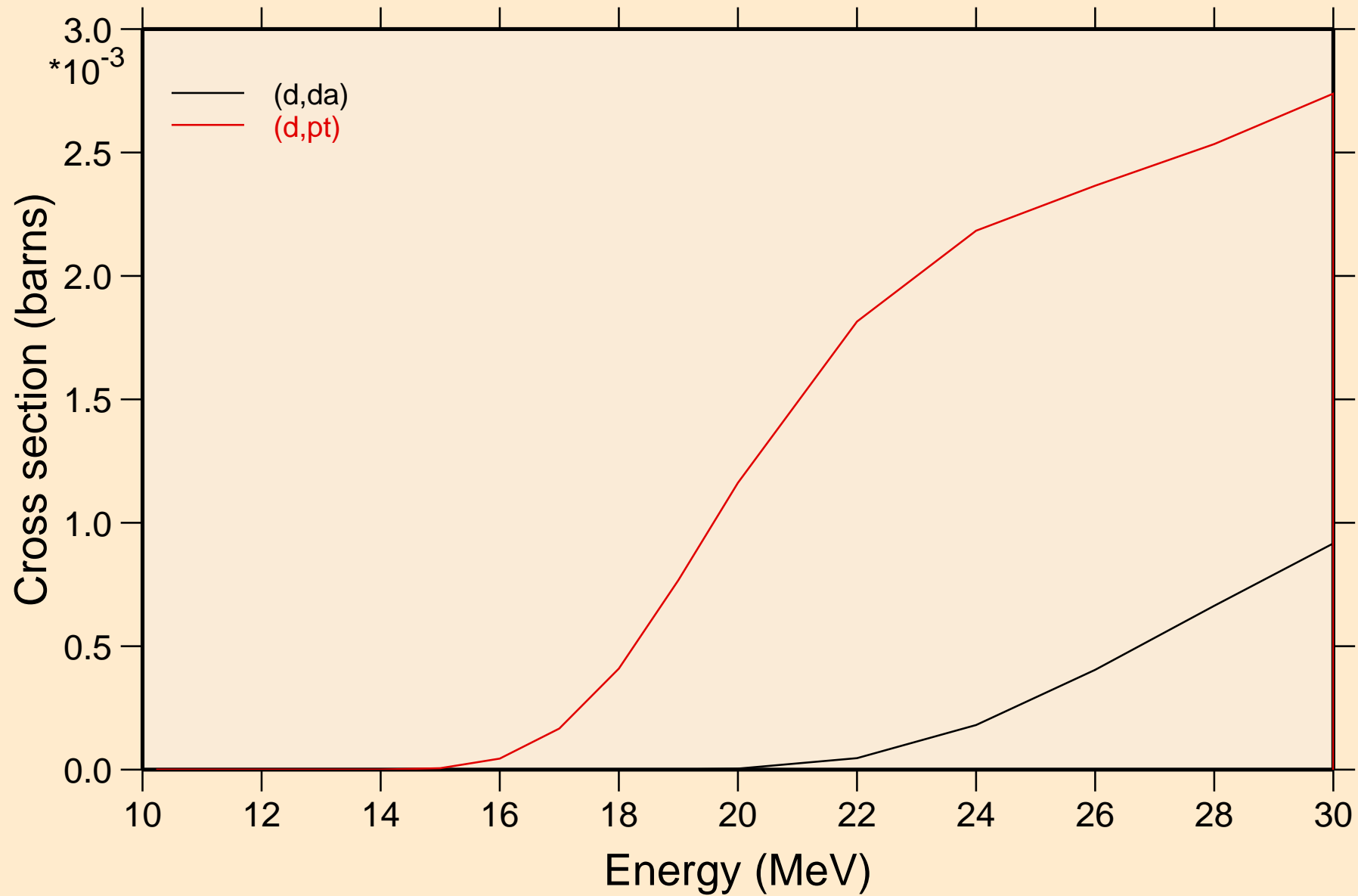

V050 DEUTERON ACER TENDL-2023 LIBRARY; T=0.K
Threshold reactions

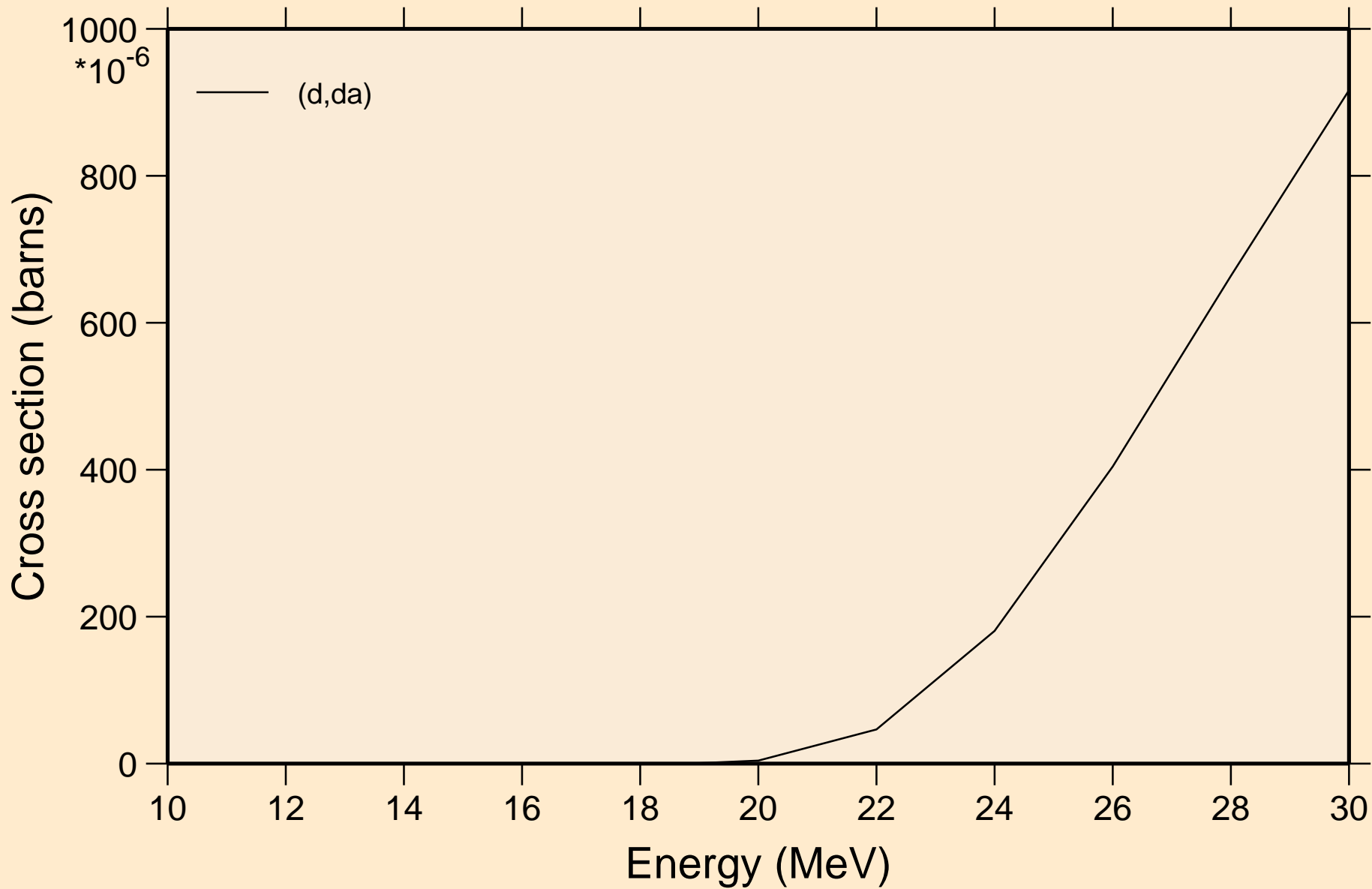

V050 DEUTERON ACER TENDL-2023 LIBRARY; T=0.K
angular distribution for elastic

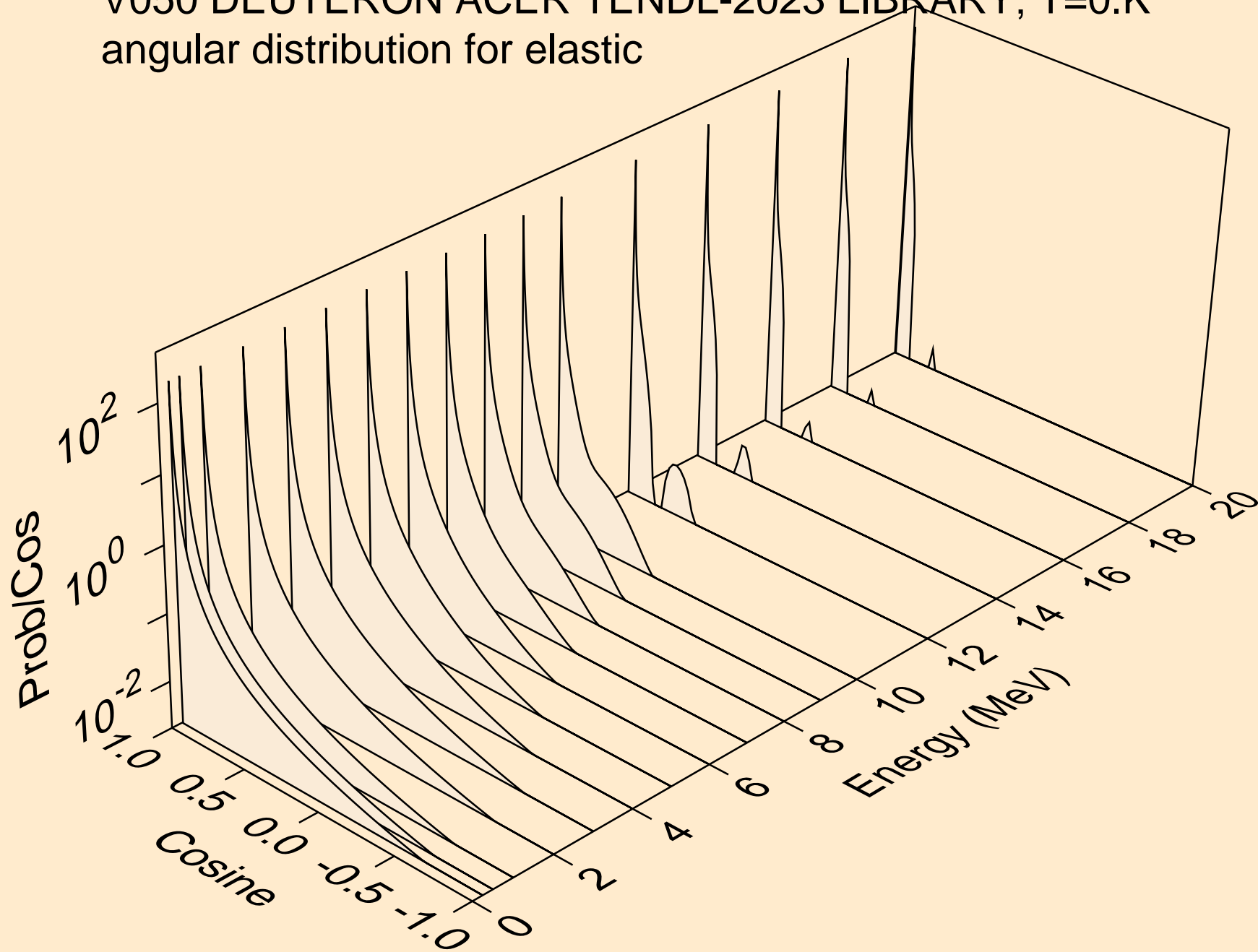

V050 DEUTERON ACER TENDL-2023 LIBRARY; T=0.K
angular distribution for elastic

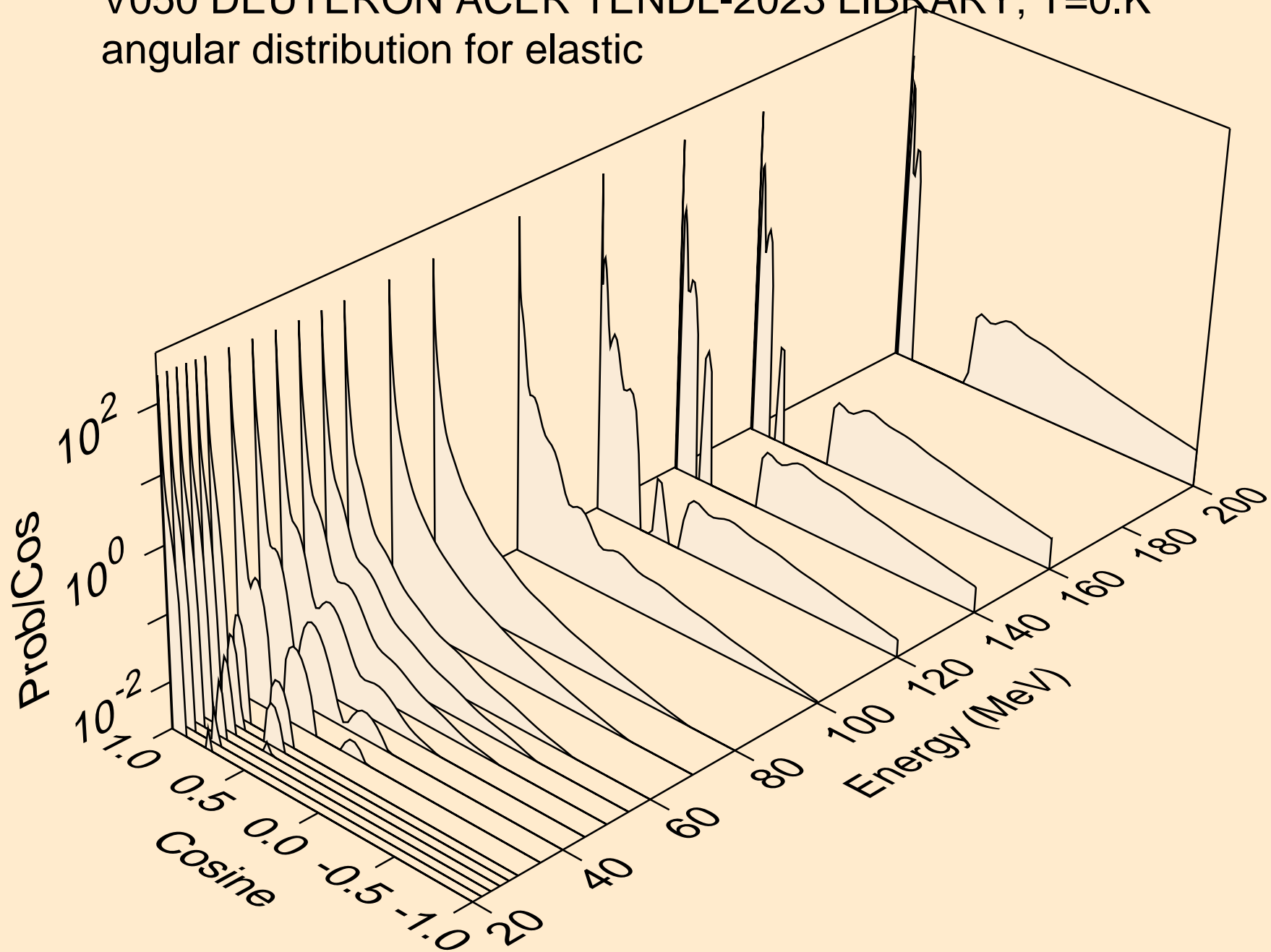

V050 DEUTERON ACER TENDL-2023 LIBRARY; T=0.K
Deuteron emission for (d,x)

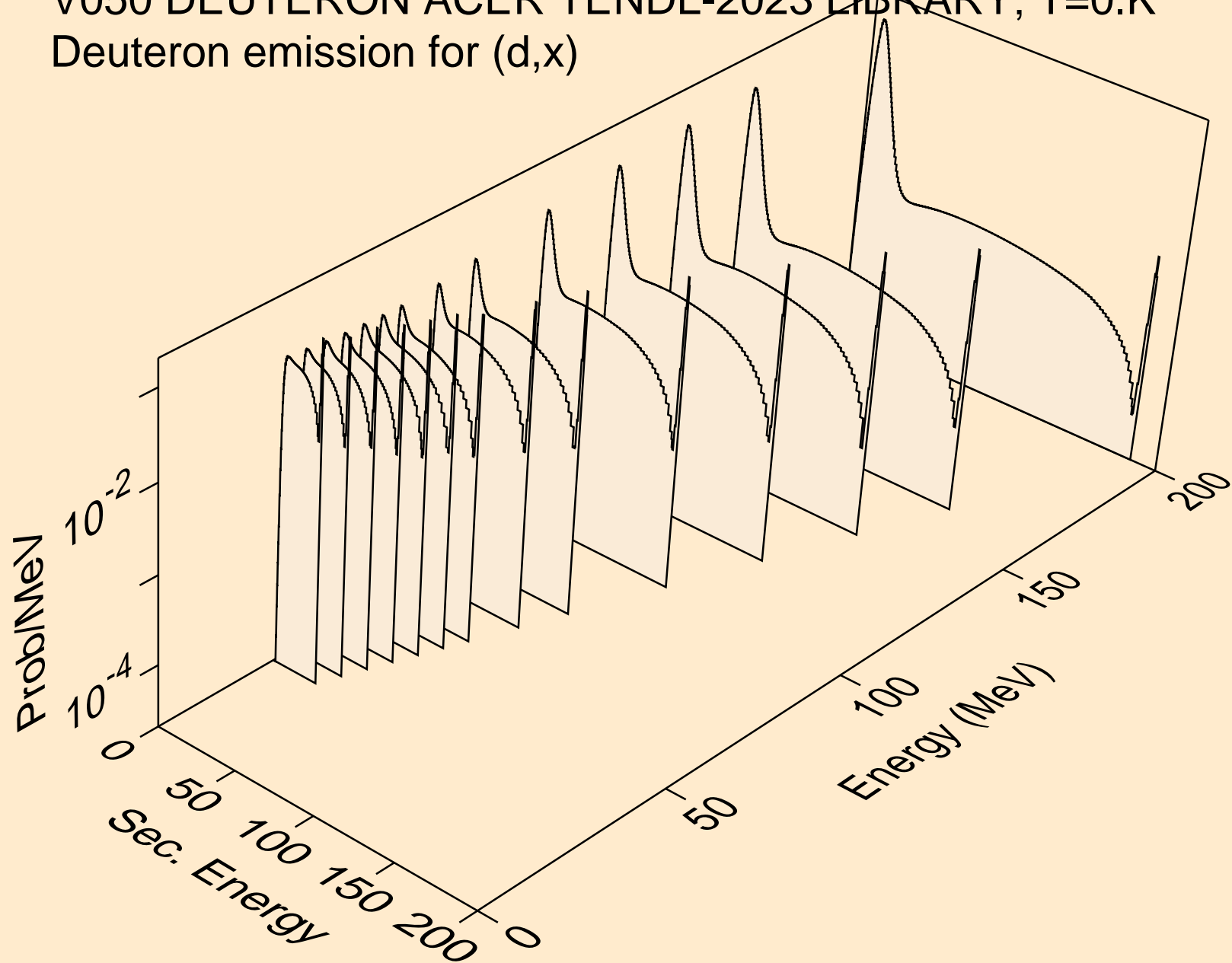

V050 DEUTERON ACER TENDL-2023 LIBRARY; T=0.K
Deuteron emission for (d,2nd)

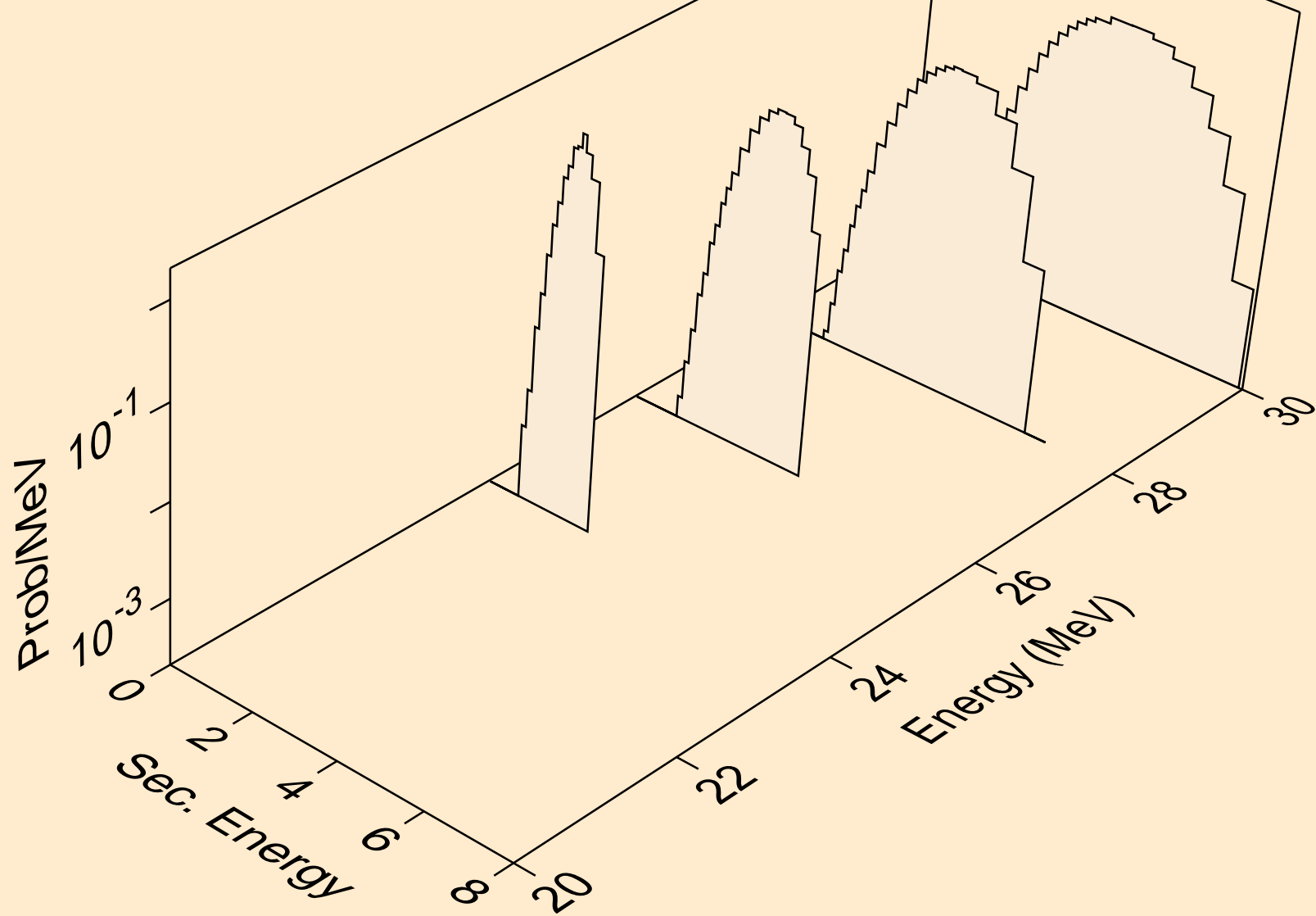

V050 DEUTERON ACER TENDL-2023 LIBRARY; T=0.K
Deuteron emission for (d,n*)d

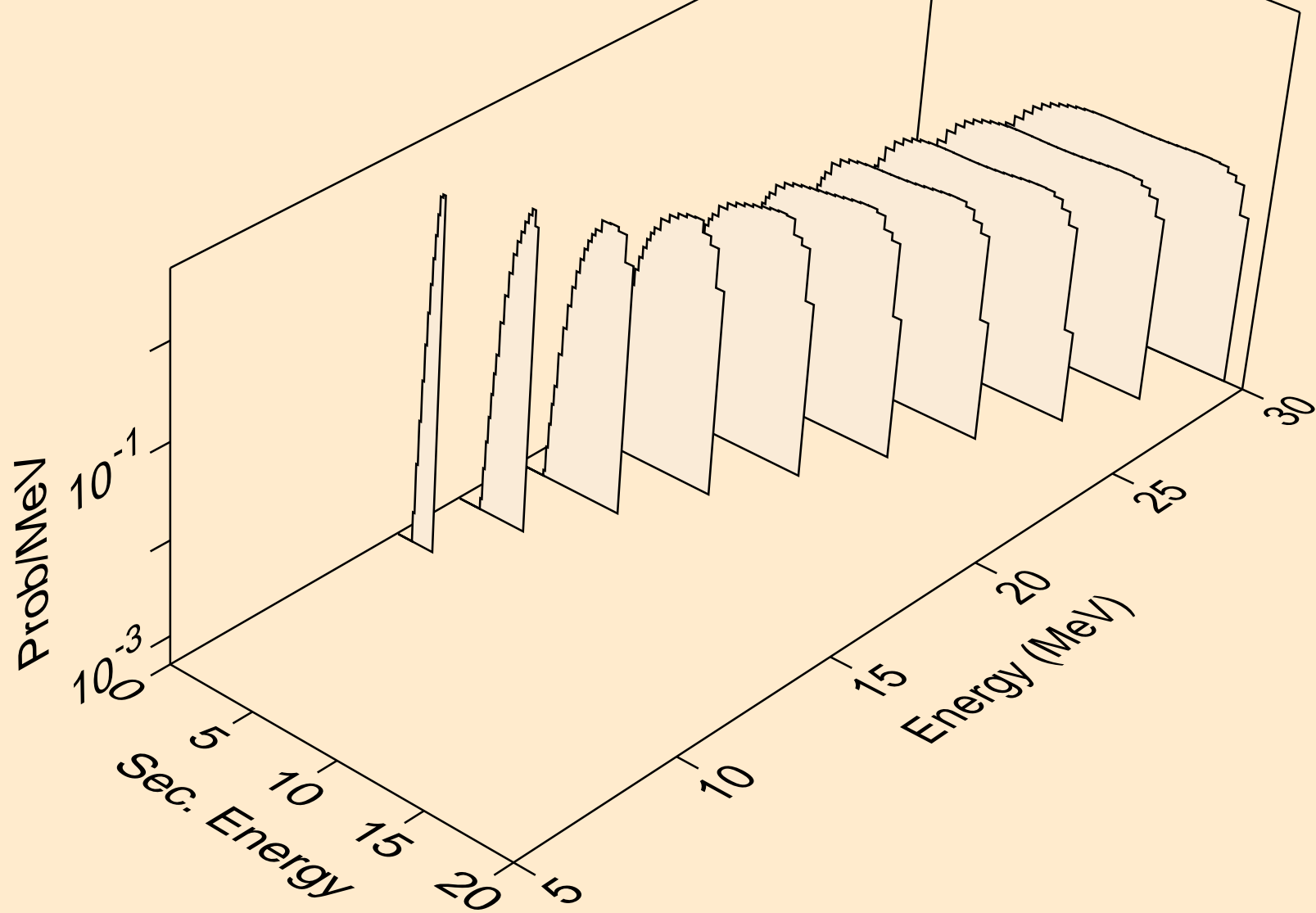

V050 DEUTERON ACER TENDL-2023 LIBRARY; T=0.K
Deuteron emission for inelastic

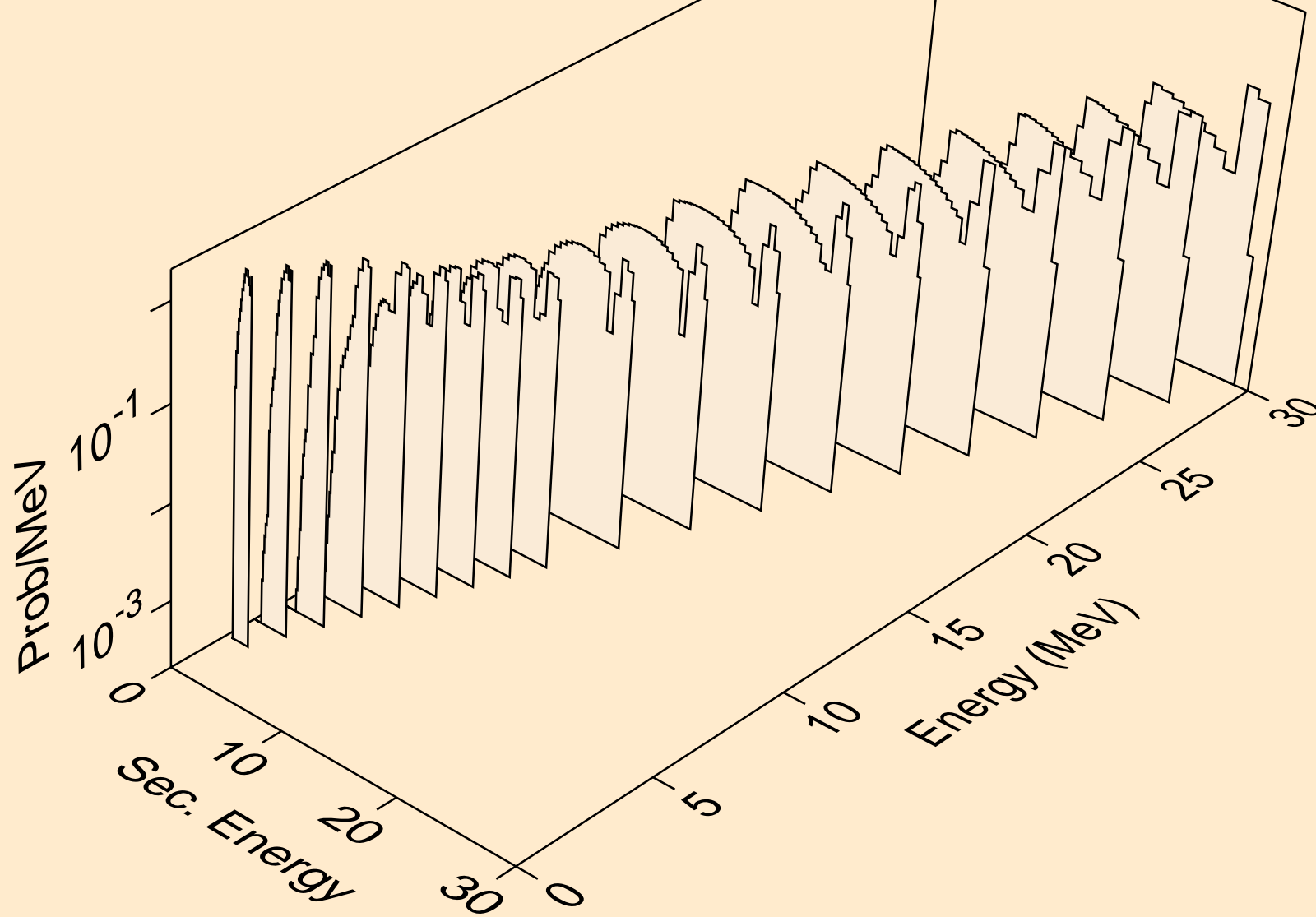

V050 DEUTERON ACER TENDL-2023 LIBRARY; T=0.K
Deuteron emission for (d,pd)

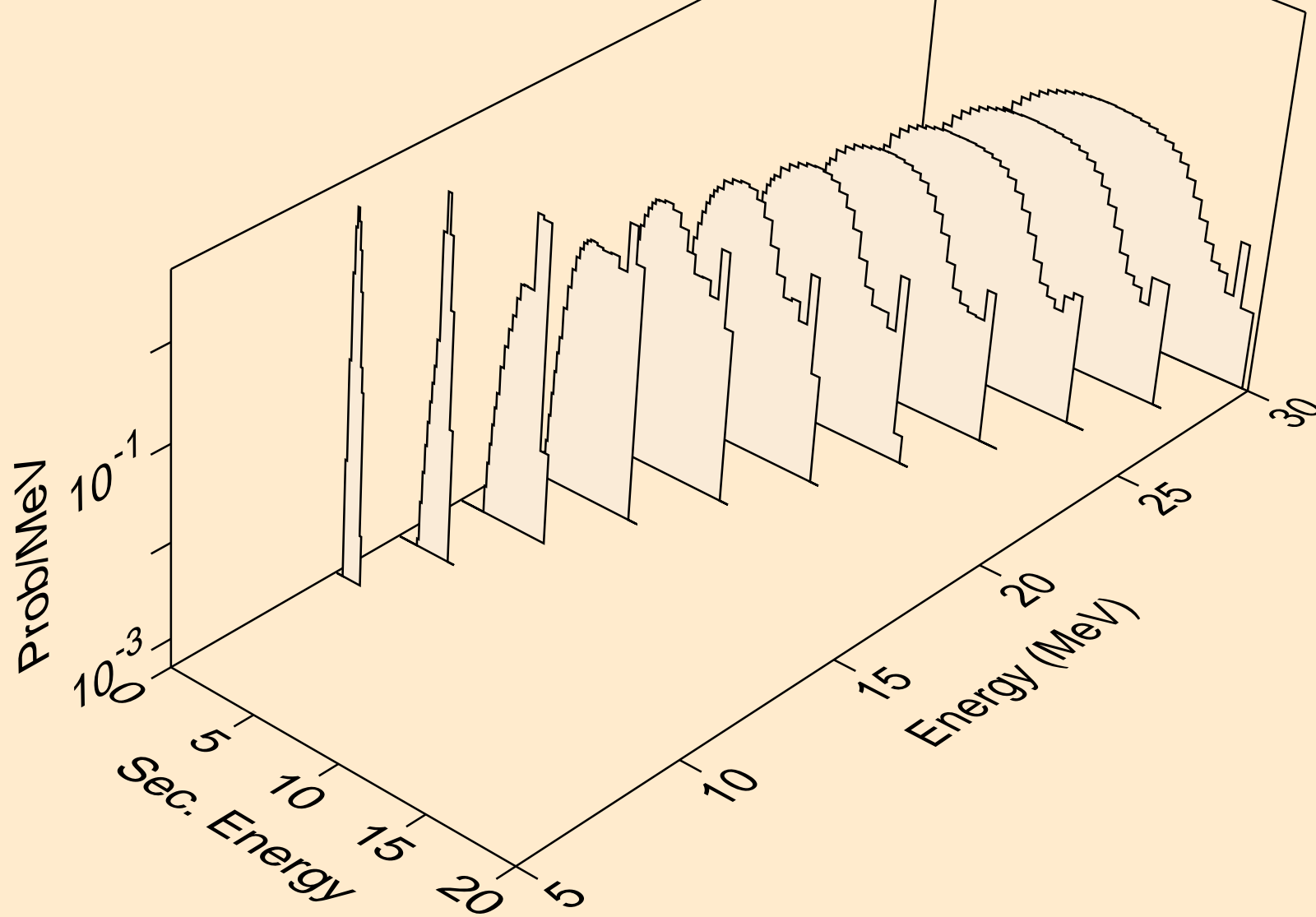

V050 DEUTERON ACER TENDL-2023 LIBRARY; T=0.K
Deuteron emission for (d,da)

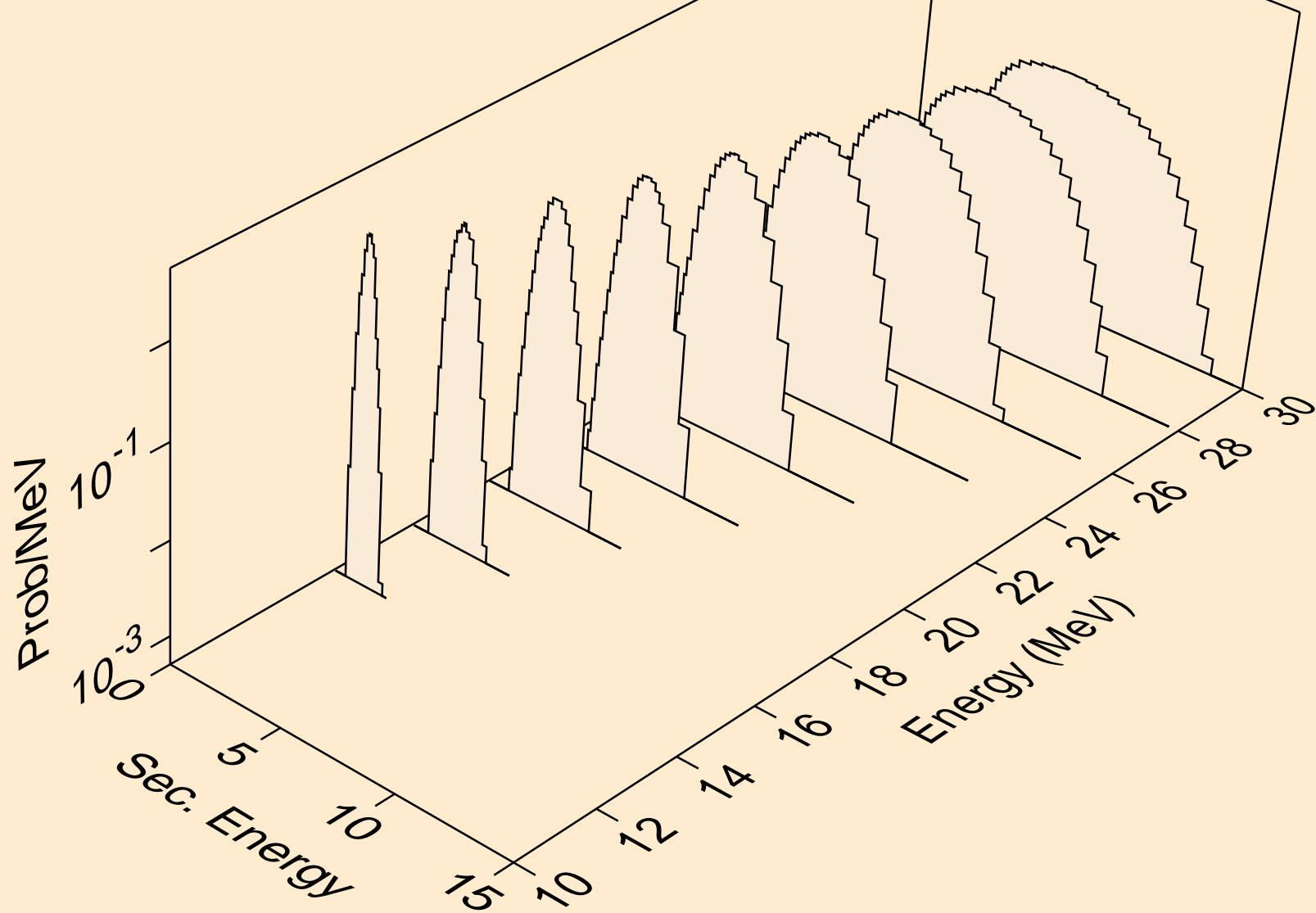

V050 DEUTERON ACER TENDL-2023 LIBRARY; T=0.K
Photon emission for (z,n)

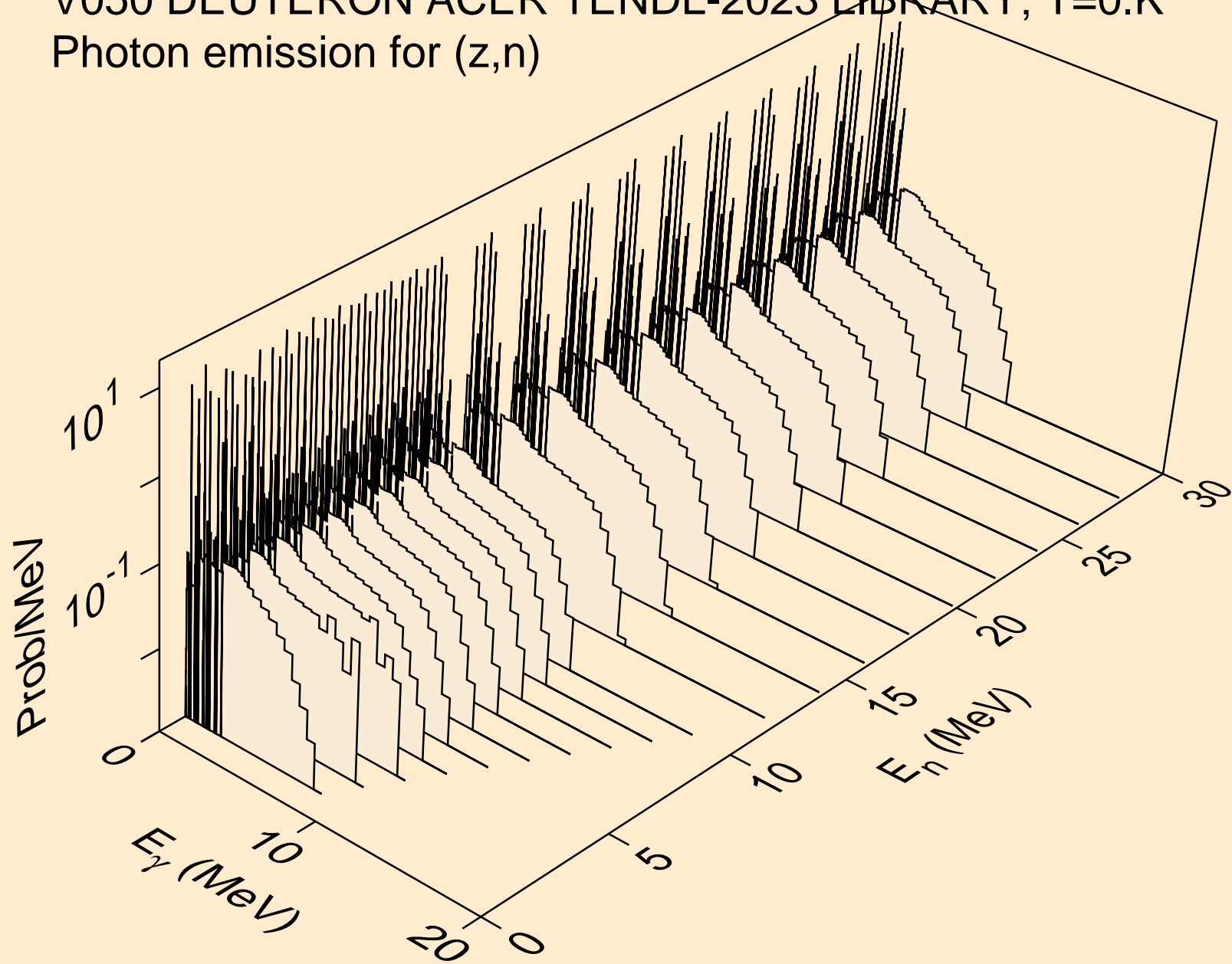

V050 DEUTERON ACER TENDL-2023 LIBRARY; T=0.K
Photon emission for (z,x)

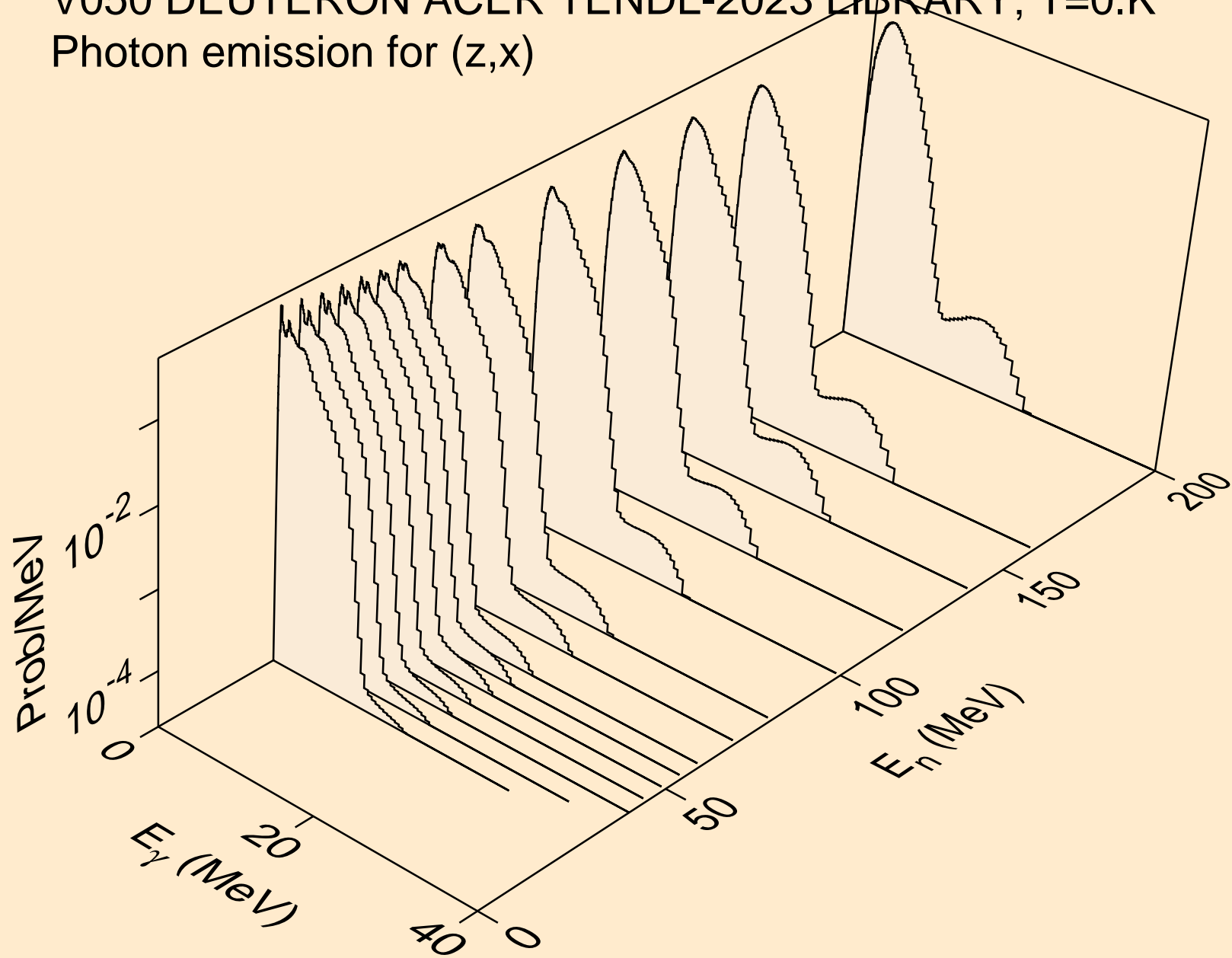

V050 DEUTERON ACER TENDL-2023 LIBRARY; T=0.K
Photon emission for (n,2nd)

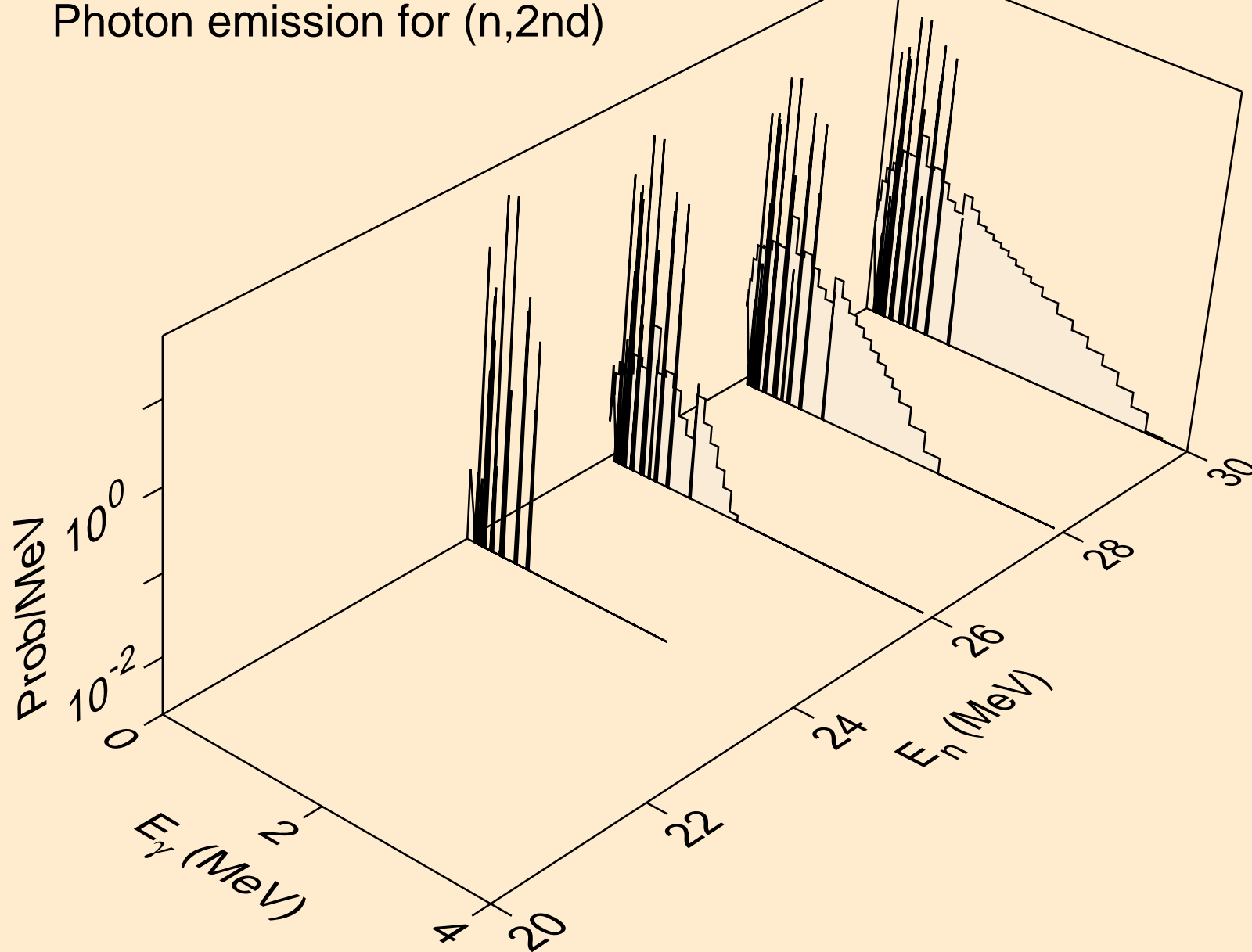

V050 DEUTERON ACER TENDL-2023 LIBRARY; T=0.K
Photon emission for (n,2n)

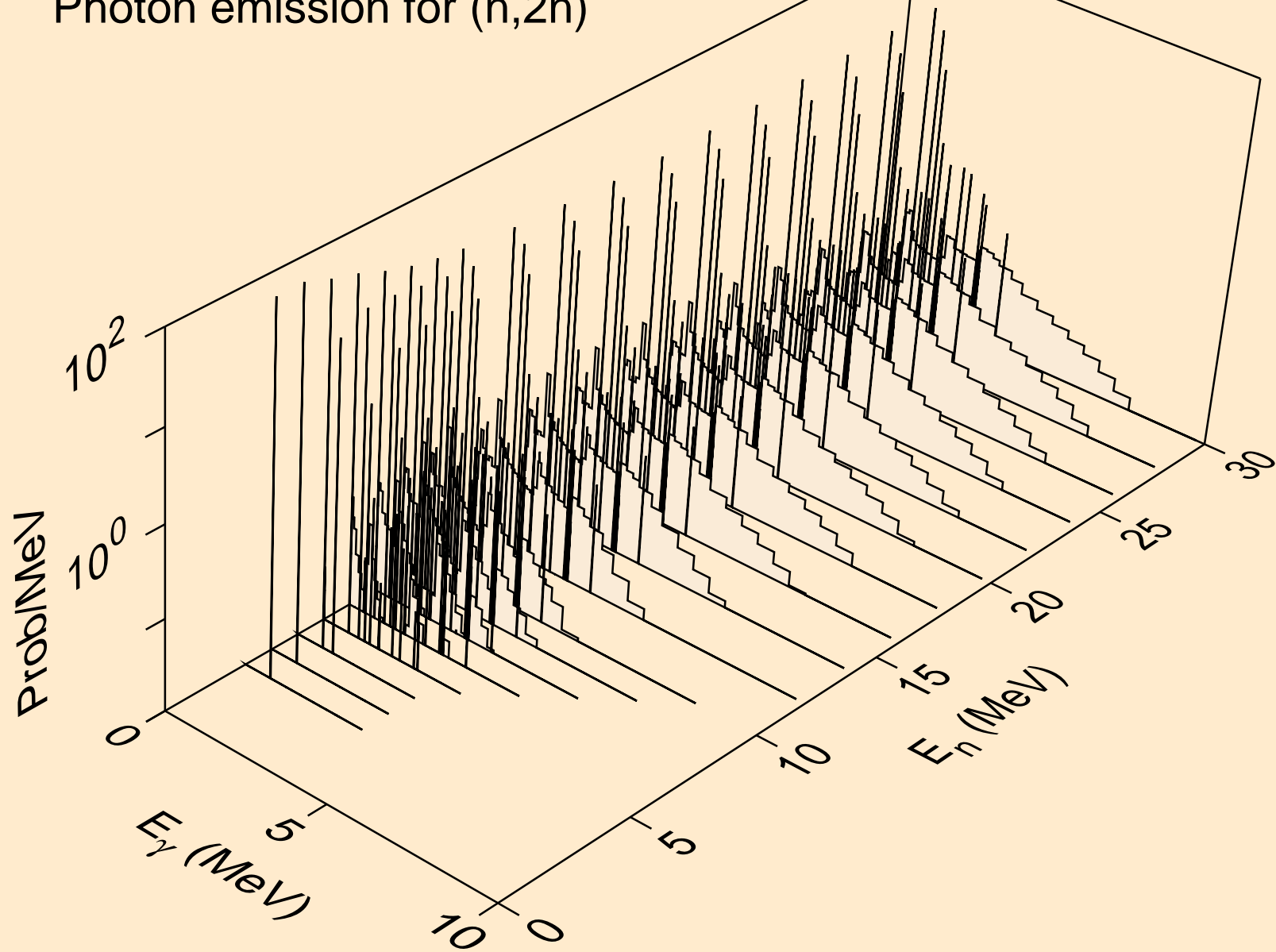

V050 DEUTERON ACER TENDL-2023 LIBRARY; T=0.K
Photon emission for (n,3n)

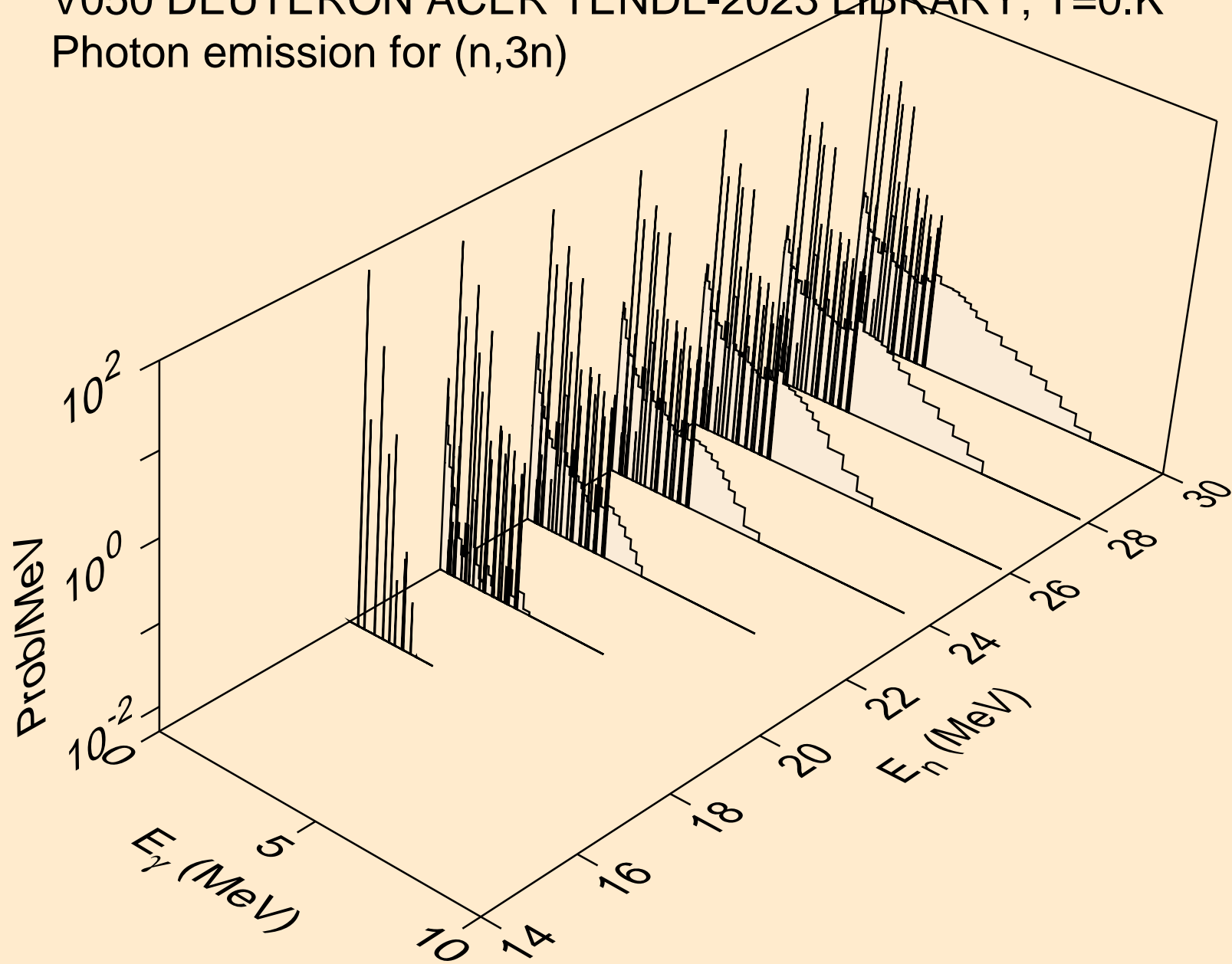

V050 DEUTERON ACER TENDL-2023 LIBRARY; T=0.K
Photon emission for (n,n*)a

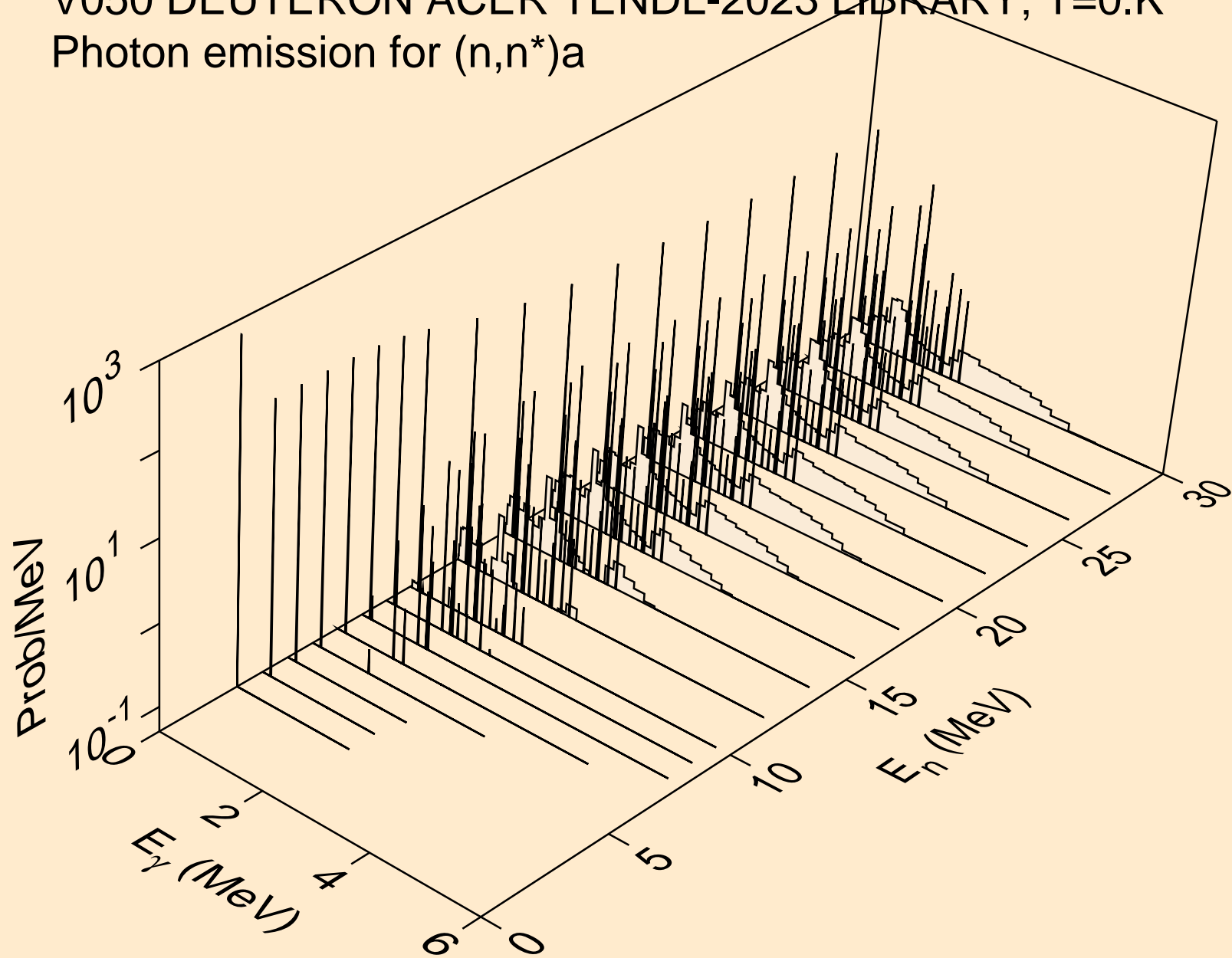

V050 DEUTERON ACER TENDL-2023 LIBRARY; T=0.K
Photon emission for (n,2n) α

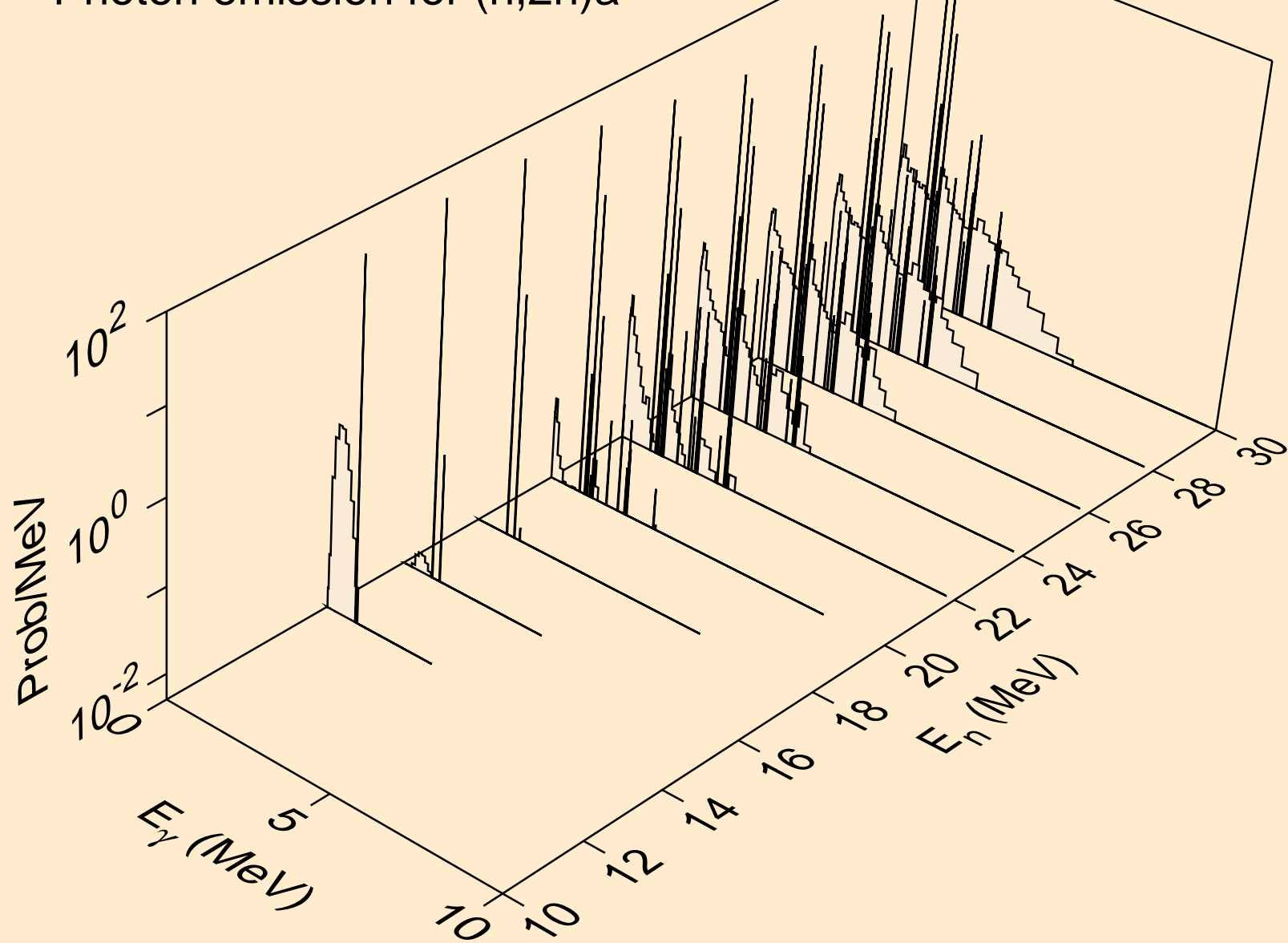

V050 DEUTERON ACER TENDL-2023 LIBRARY; T=0.K
Photon emission for (n,3n)a

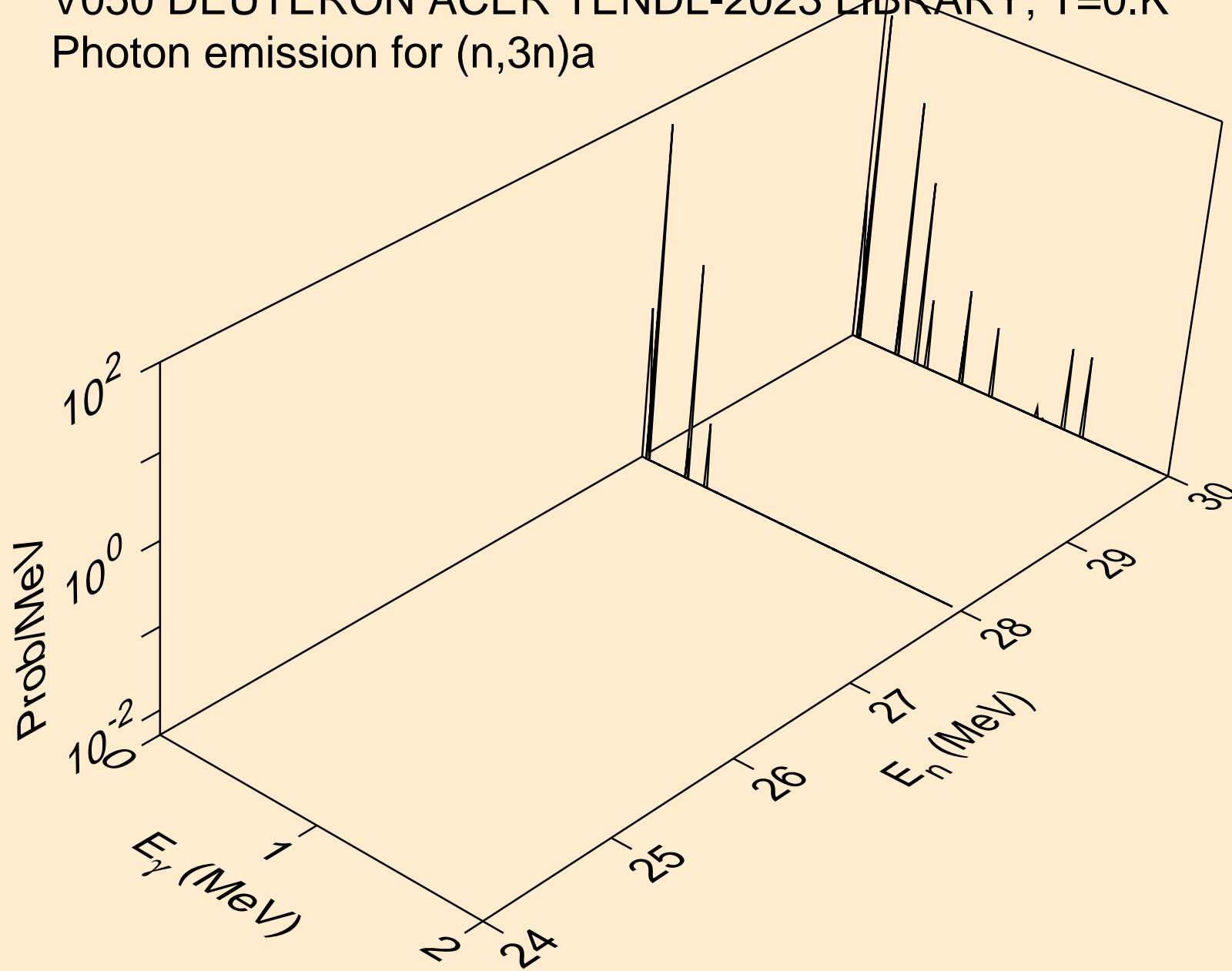

V050 DEUTERON ACER TENDL-2023 LIBRARY; T=0.K
Photon emission for (n,n*)p

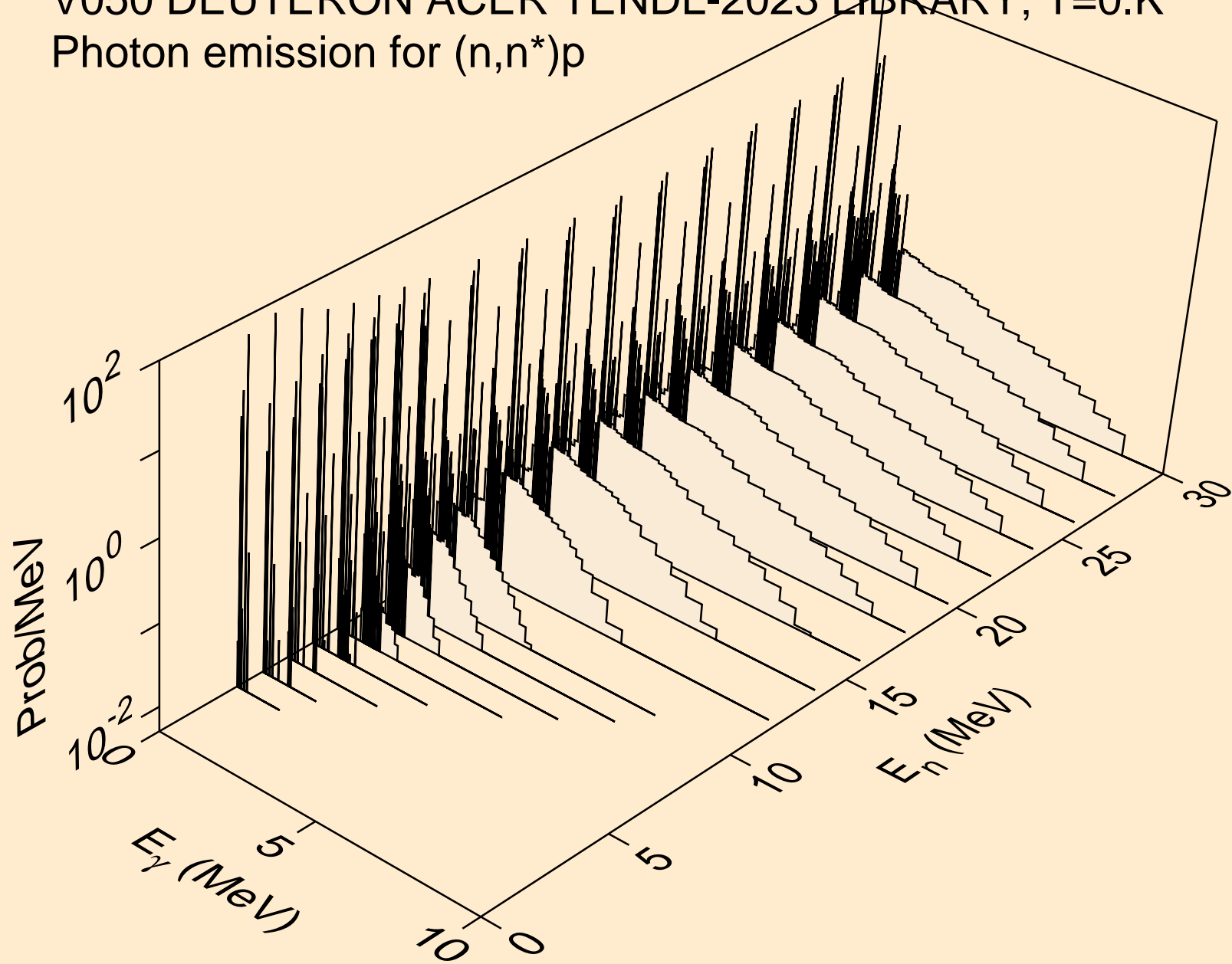

V050 DEUTERON ACER TENDL-2023 LIBRARY; T=0.K
Photon emission for (n,n*)2a

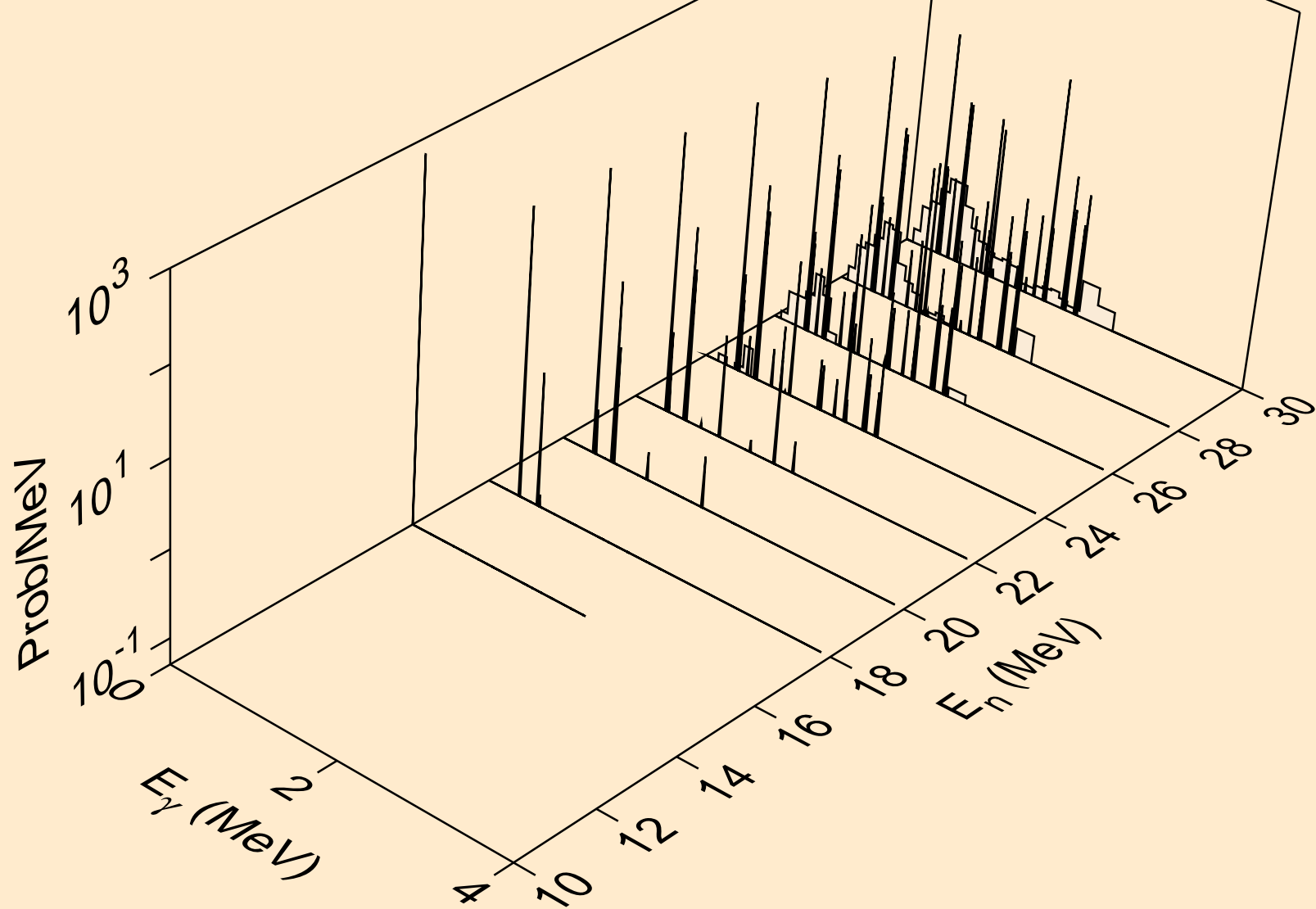

V050 DEUTERON ACER TENDL-2023 LIBRARY; T=0.K
Photon emission for (n,2n)2a

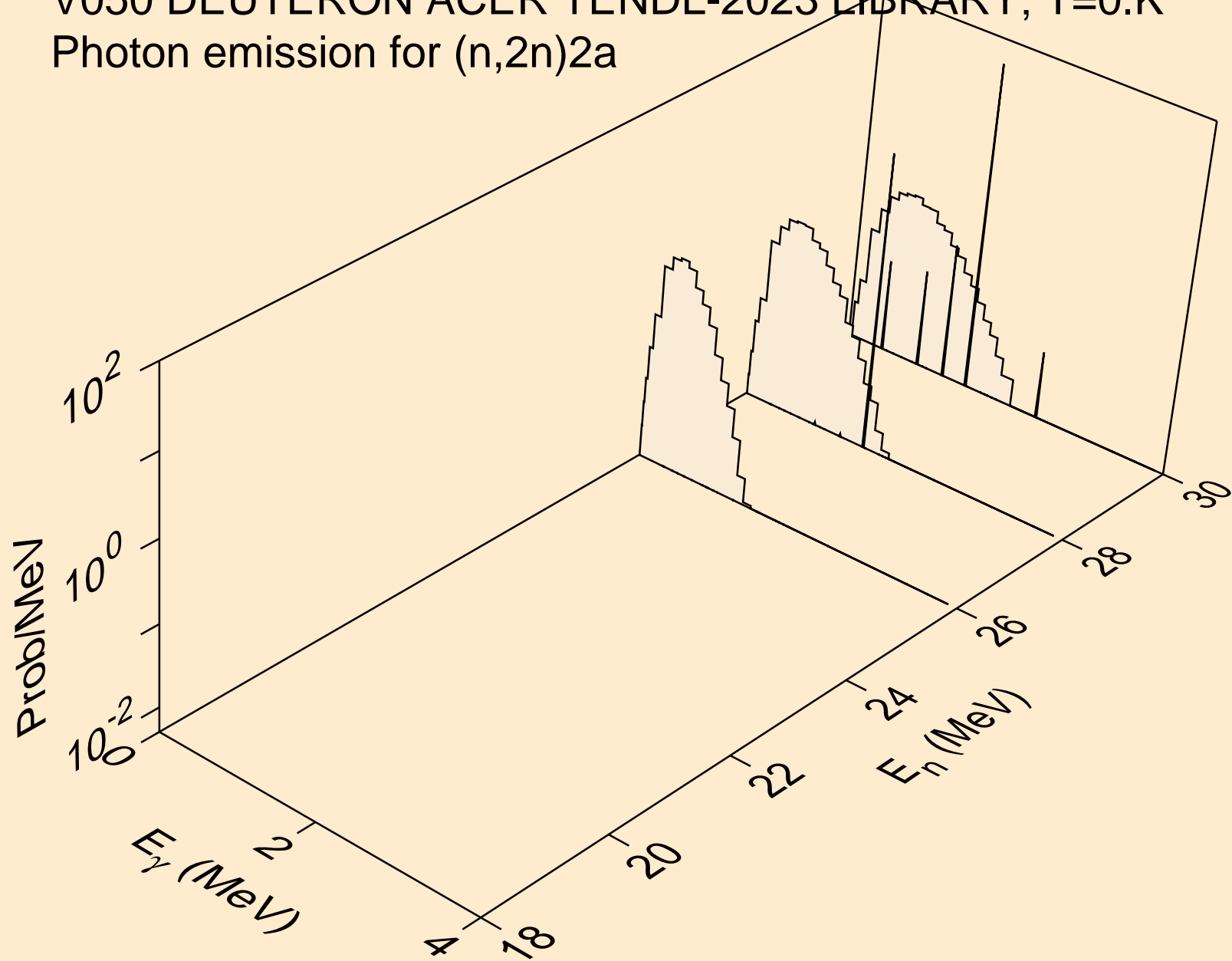

V050 DEUTERON ACER TENDL-2023 LIBRARY; T=0.K
Photon emission for (n,n*)d

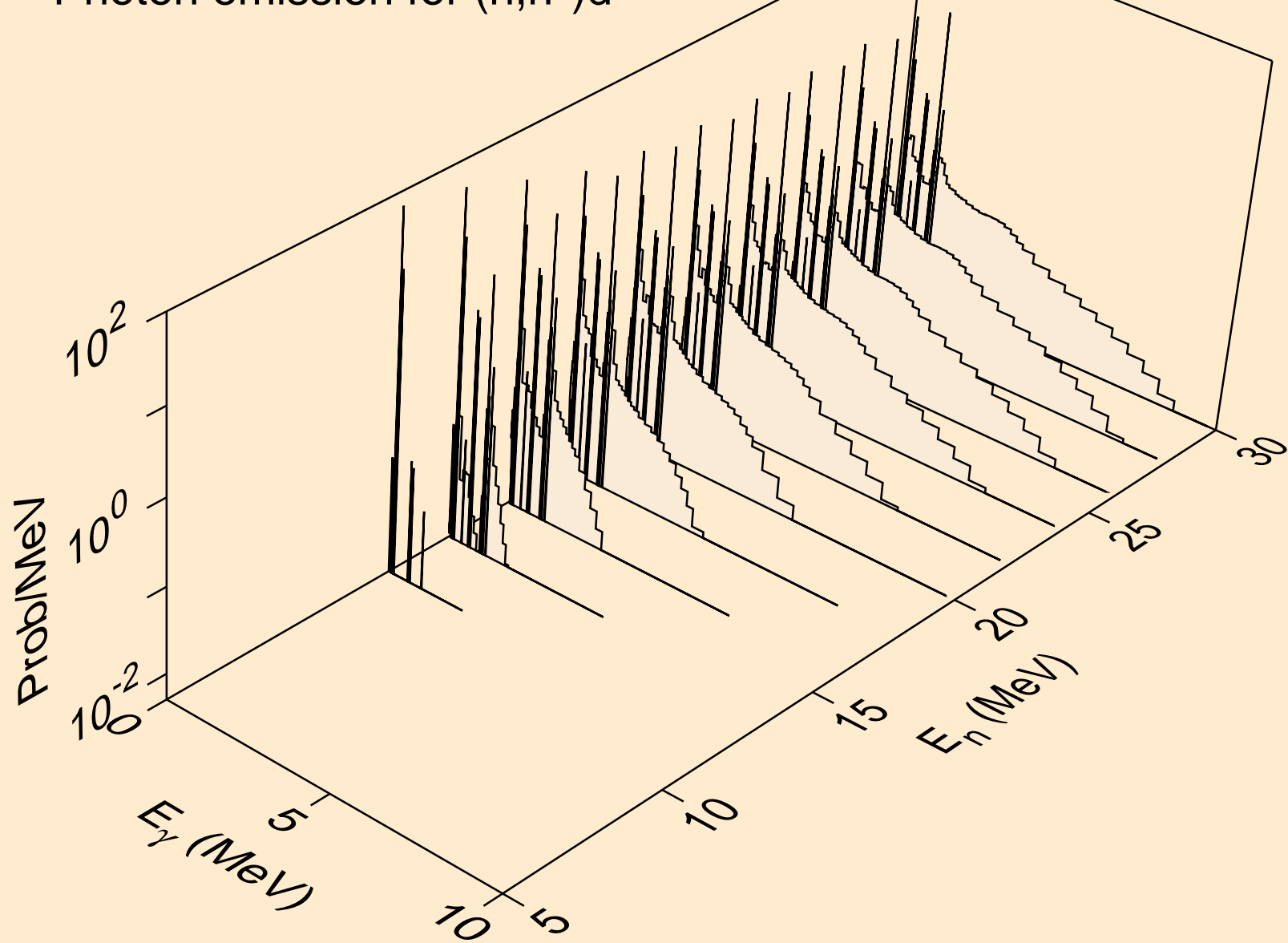

V050 DEUTERON ACER TENDL-2023 LIBRARY; T=0.K
Photon emission for (n,n*)t

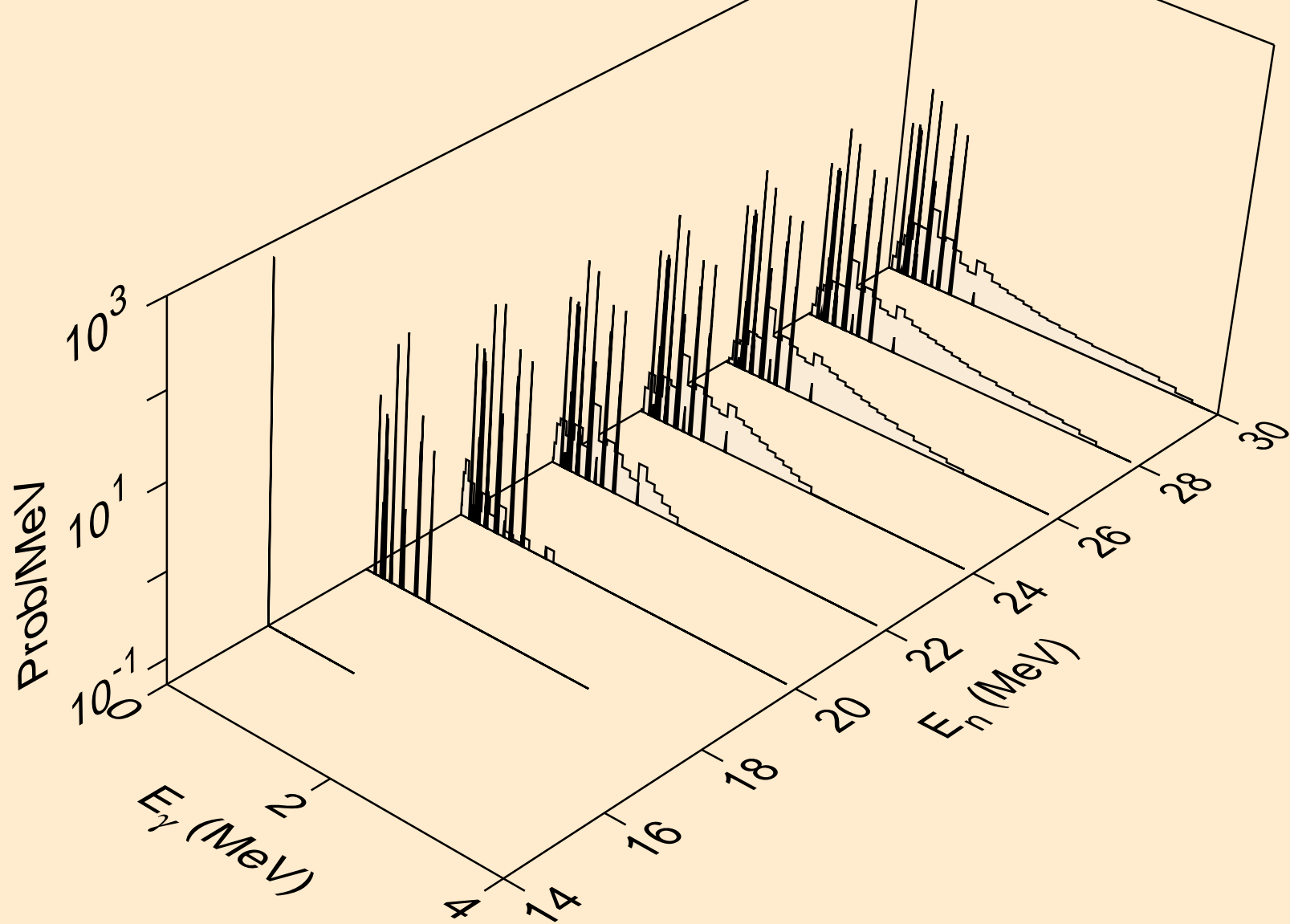

V050 DEUTERON ACER TENDL-2023 LIBRARY; T=0.K
Photon emission for (n,n*)he3

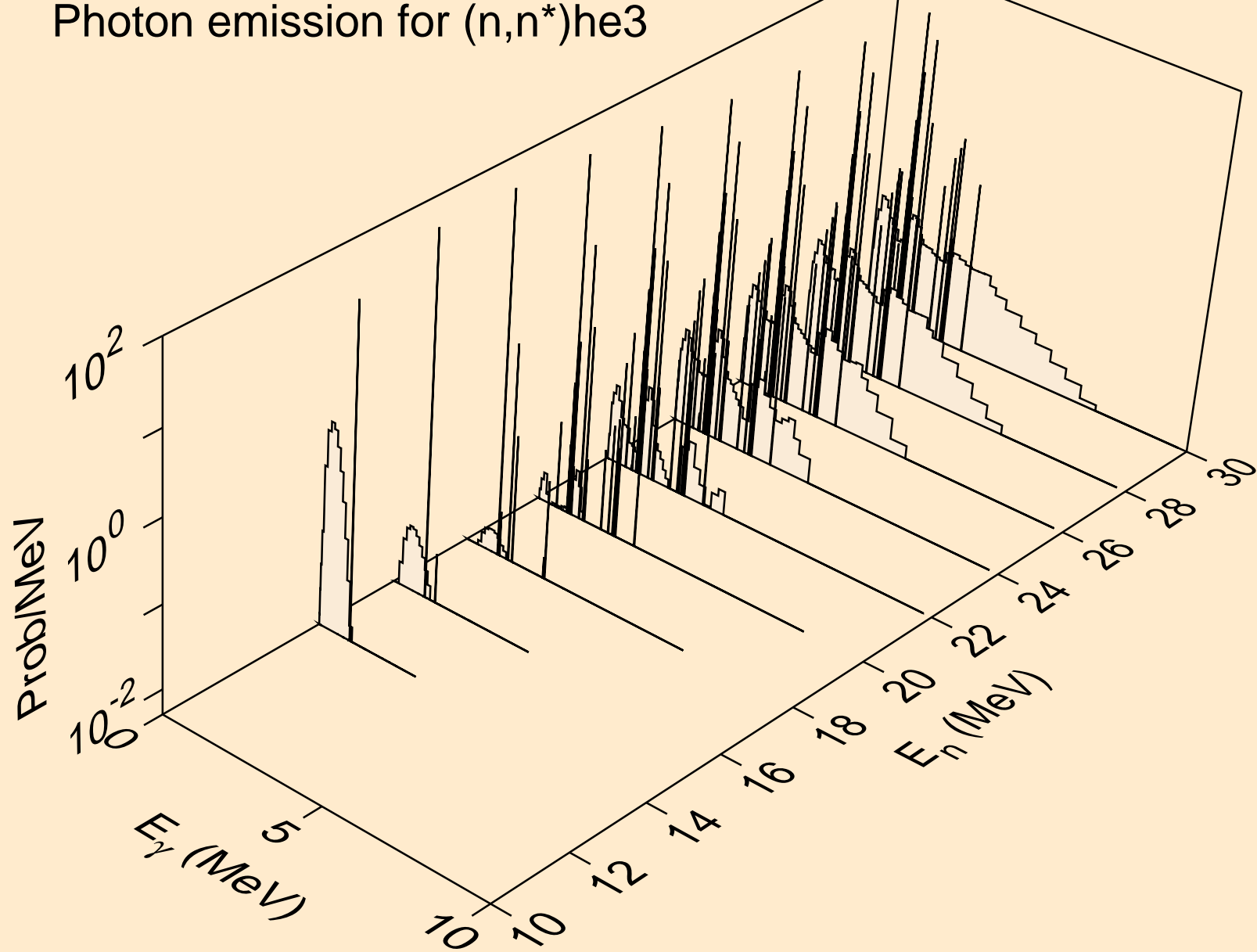

V050 DEUTERON ACER TENDL-2023 LIBRARY; T=0.K
Photon emission for (n,4n)

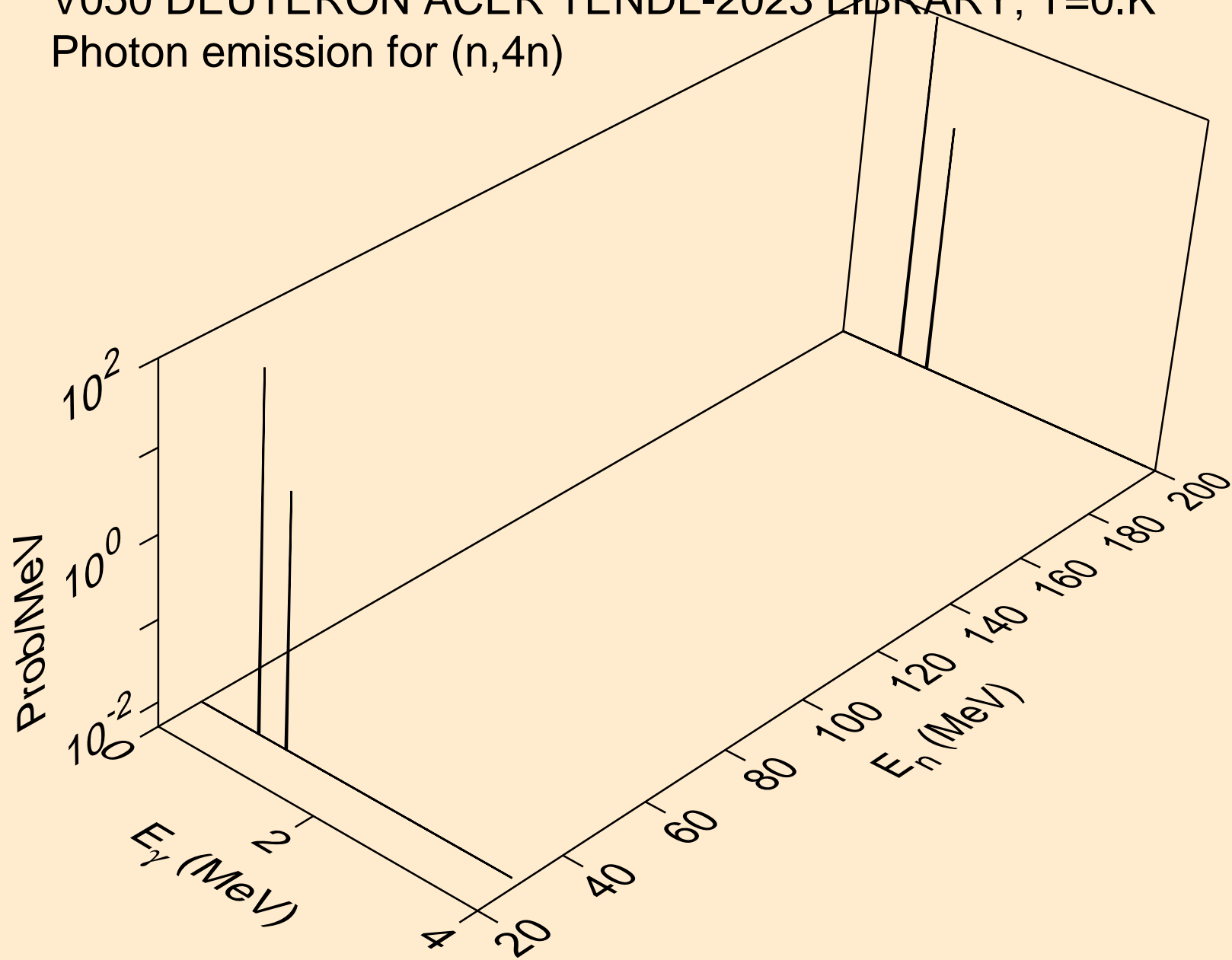

V050 DEUTERON ACER TENDL-2023 LIBRARY; T=0.K
Photon emission for (n,2np)

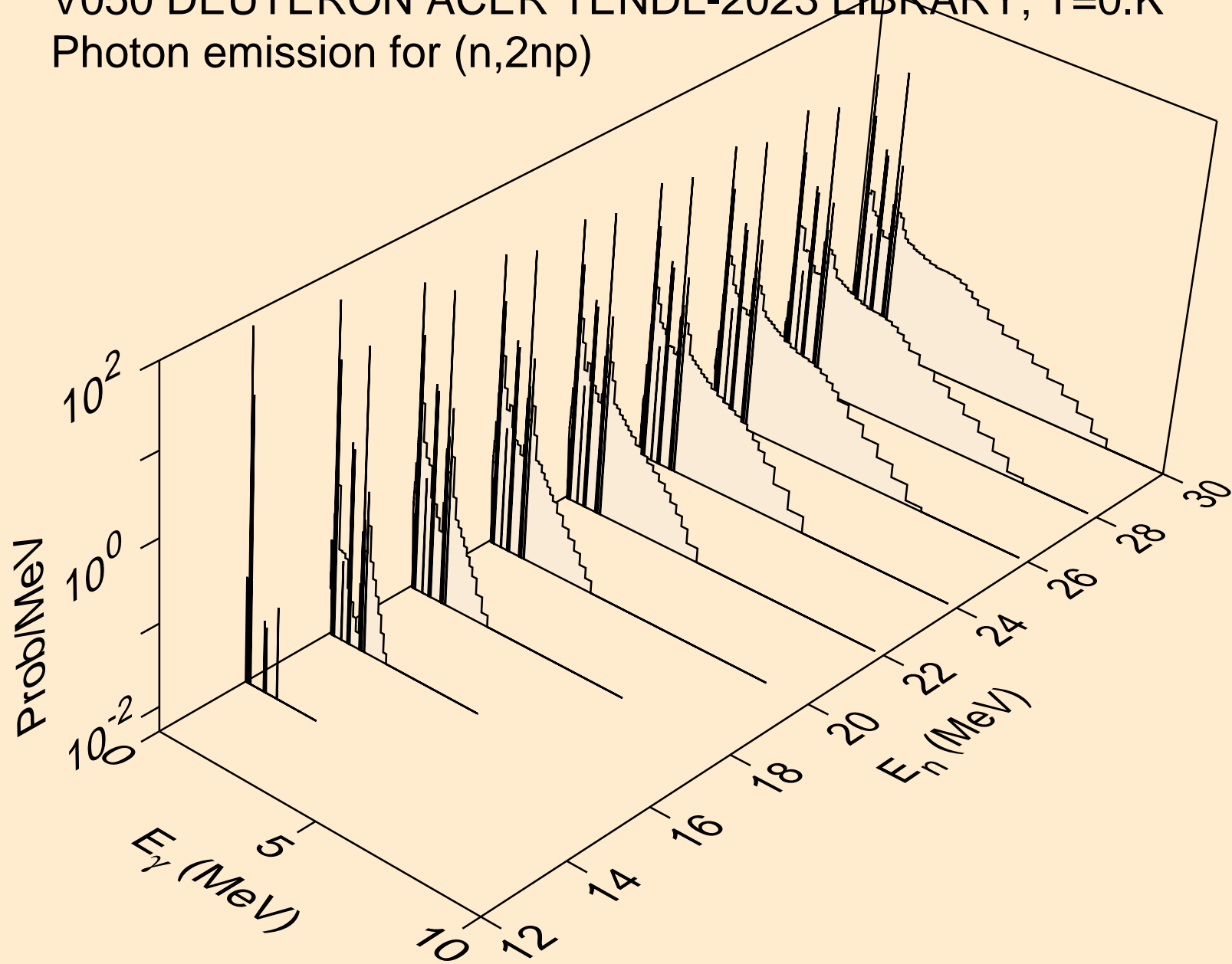

V050 DEUTERON ACER TENDL-2023 LIBRARY; T=0.K
Photon emission for (n,3np)

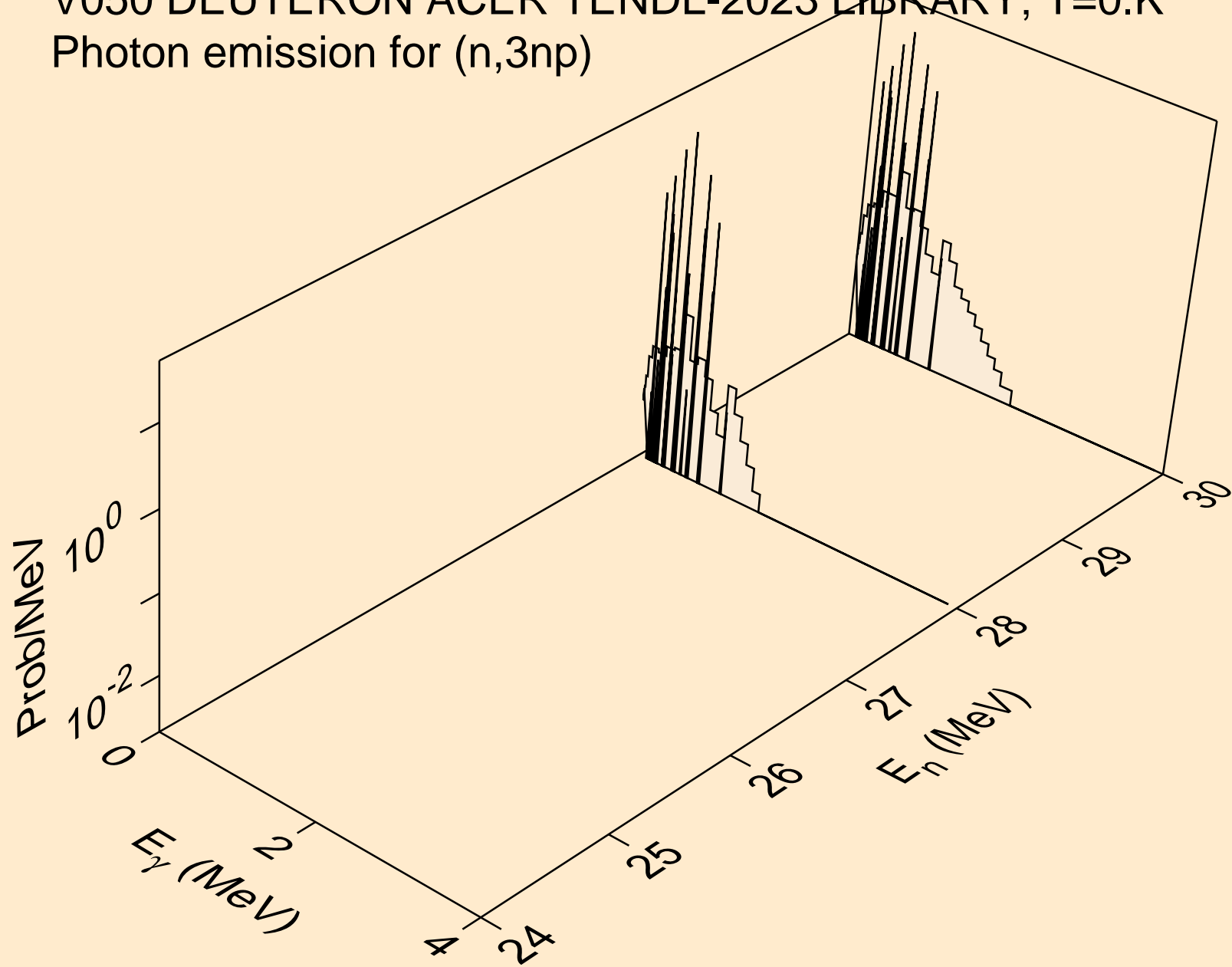

V050 DEUTERON ACER TENDL-2023 LIBRARY; T=0.K
Photon emission for (n,n2p)

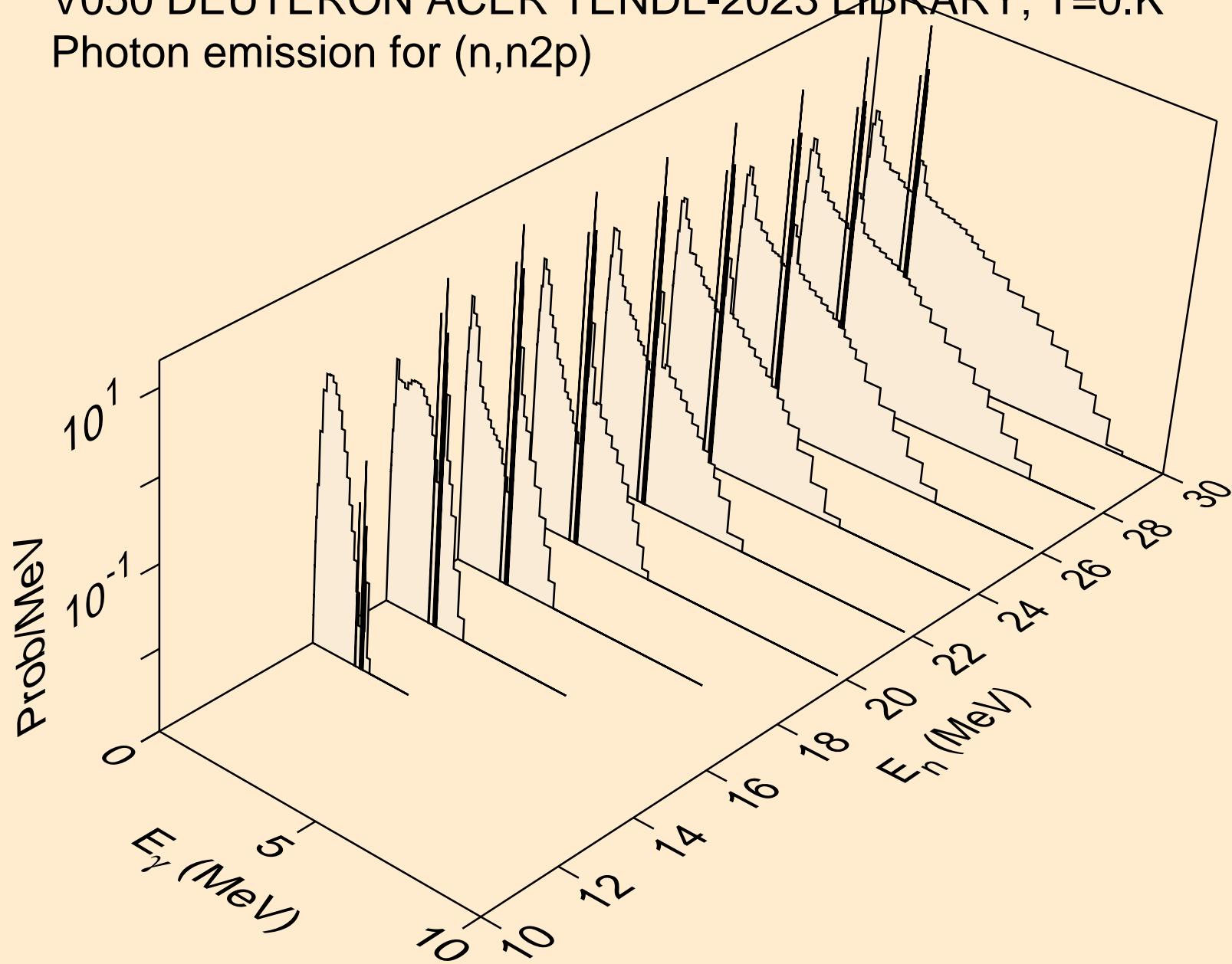

V050 DEUTERON ACER TENDL-2023 LIBRARY; T=0.K
Photon emission for (n,npa)

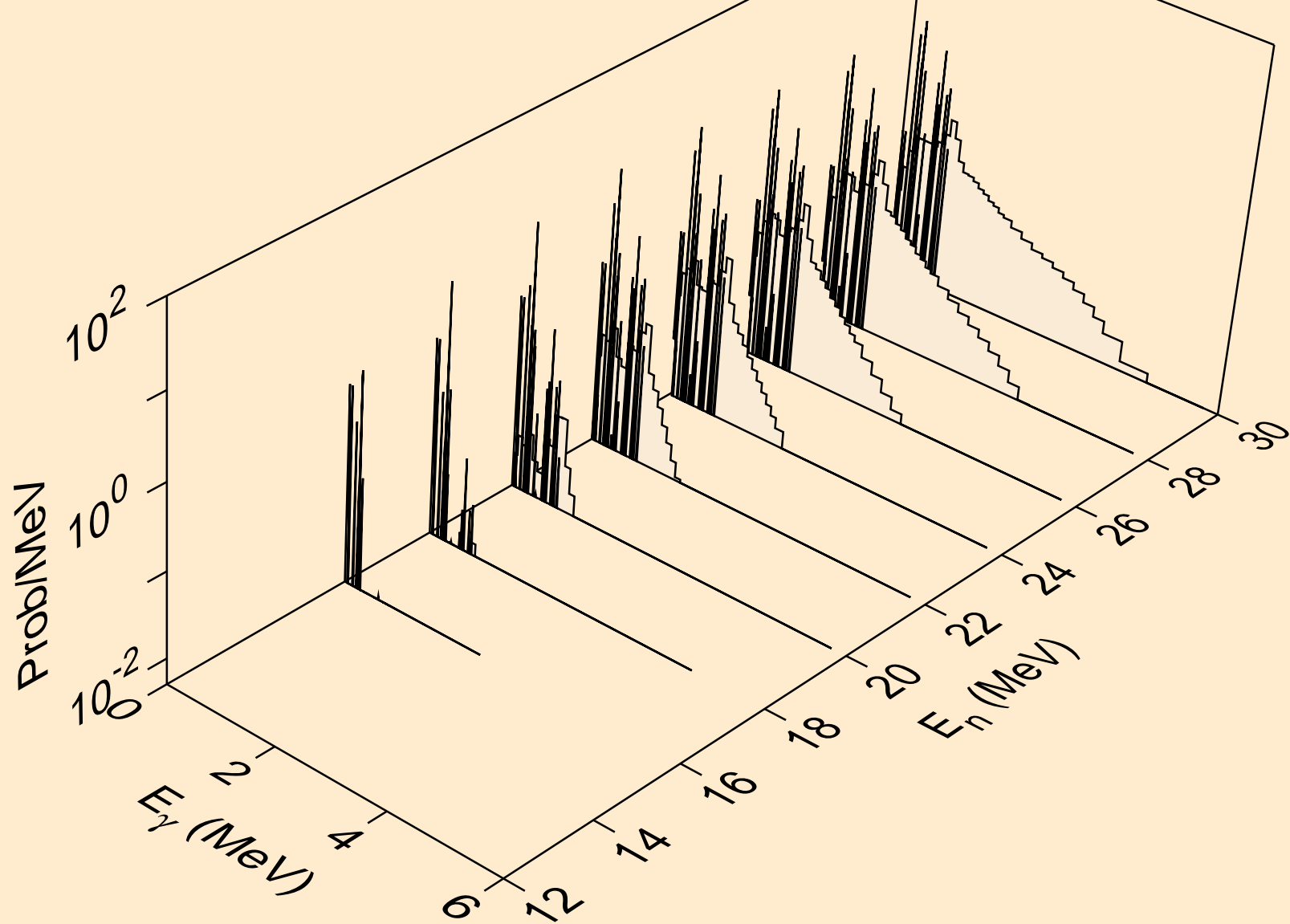

V050 DEUTERON ACER TENDL-2023 LIBRARY; T=0.K
Photon emission for (n,gma)

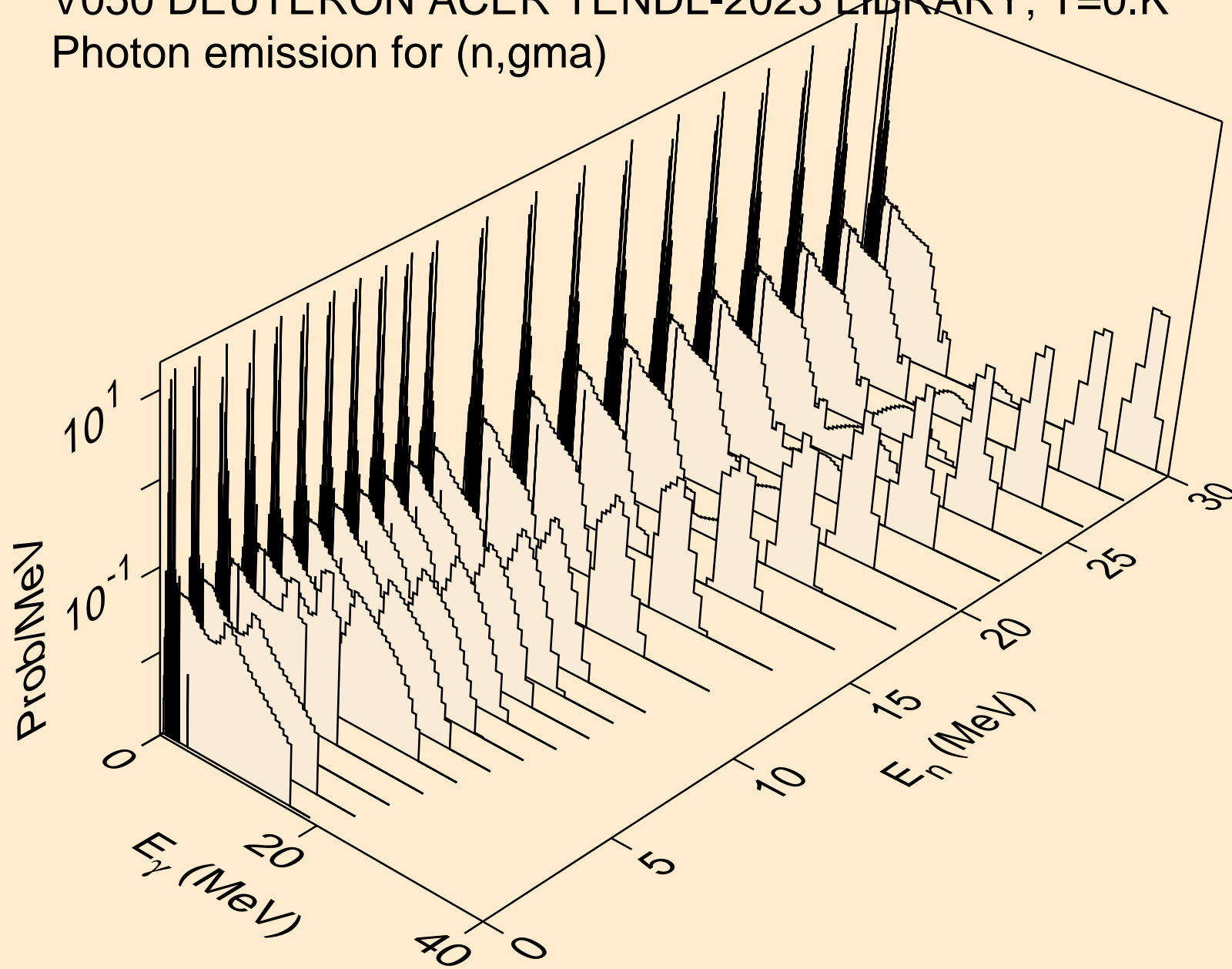

V050 DEUTERON ACER TENDL-2023 LIBRARY; T=0.K
Photon emission for (n,p)

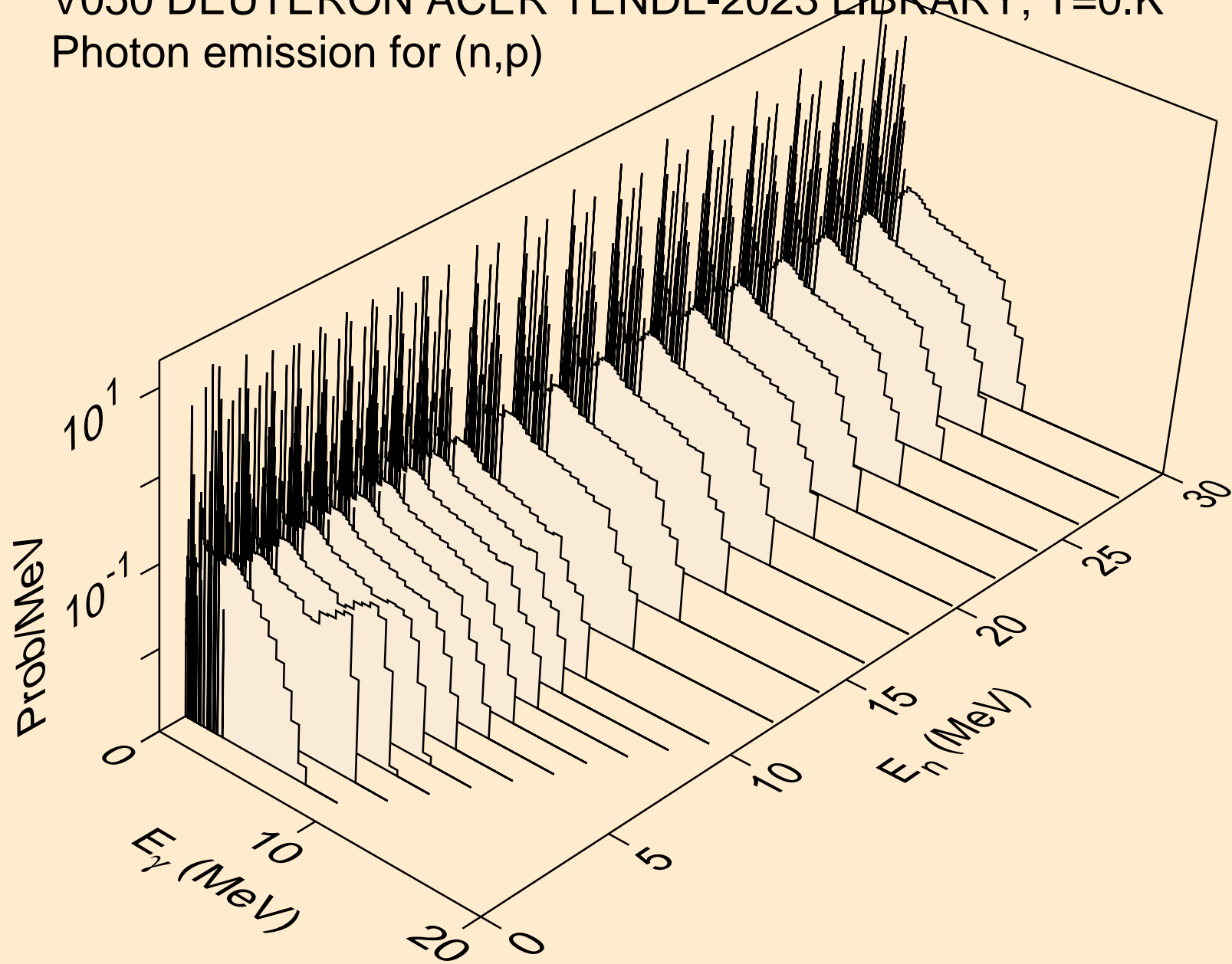

V050 DEUTERON ACER TENDL-2023 LIBRARY; T=0.K
Photon emission for inelastic

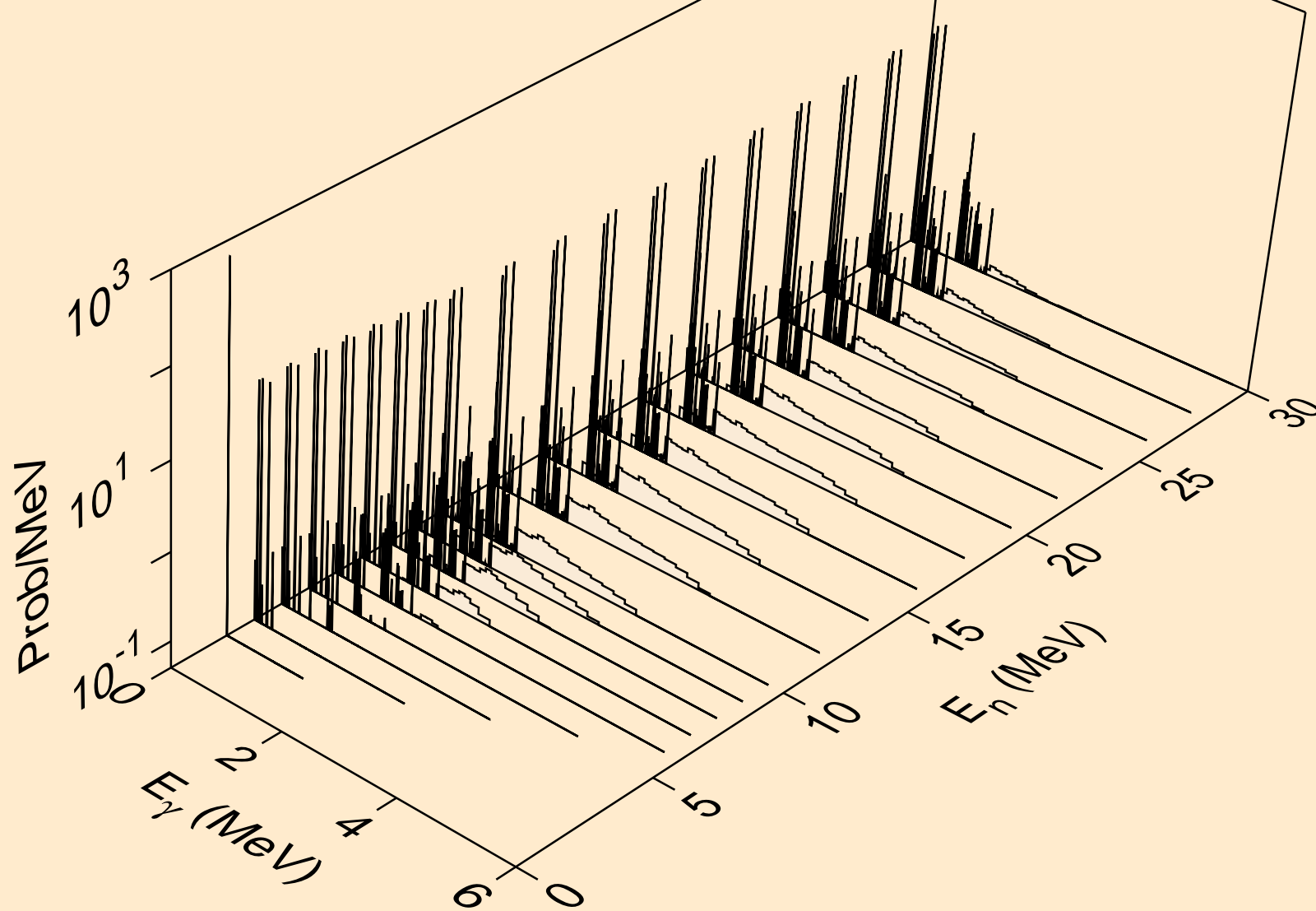

V050 DEUTERON ACER TENDL-2023 LIBRARY; T=0.K
Photon emission for (n,t)

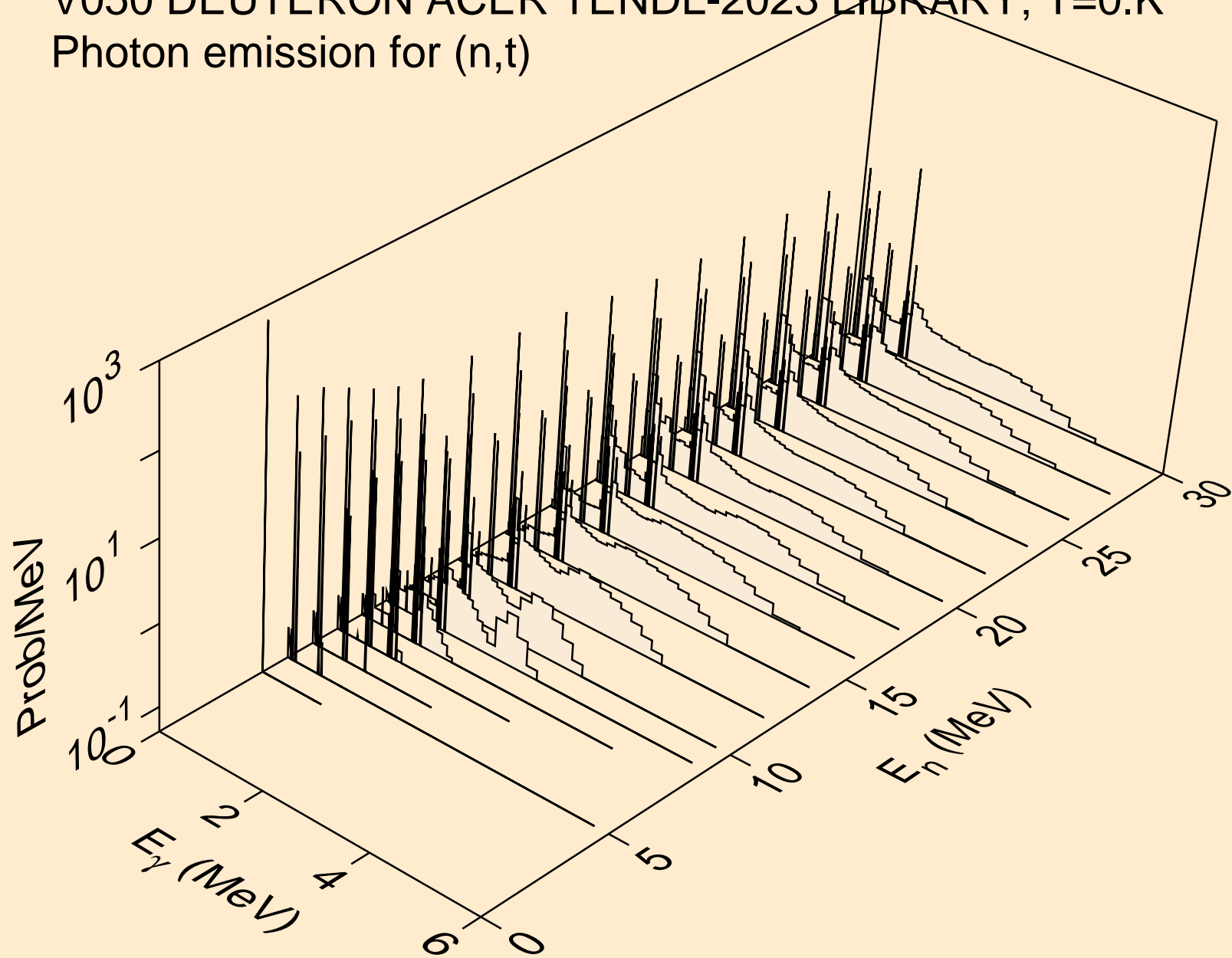

V050 DEUTERON ACER TENDL-2023 LIBRARY; T=0.K
Photon emission for (n,he3)

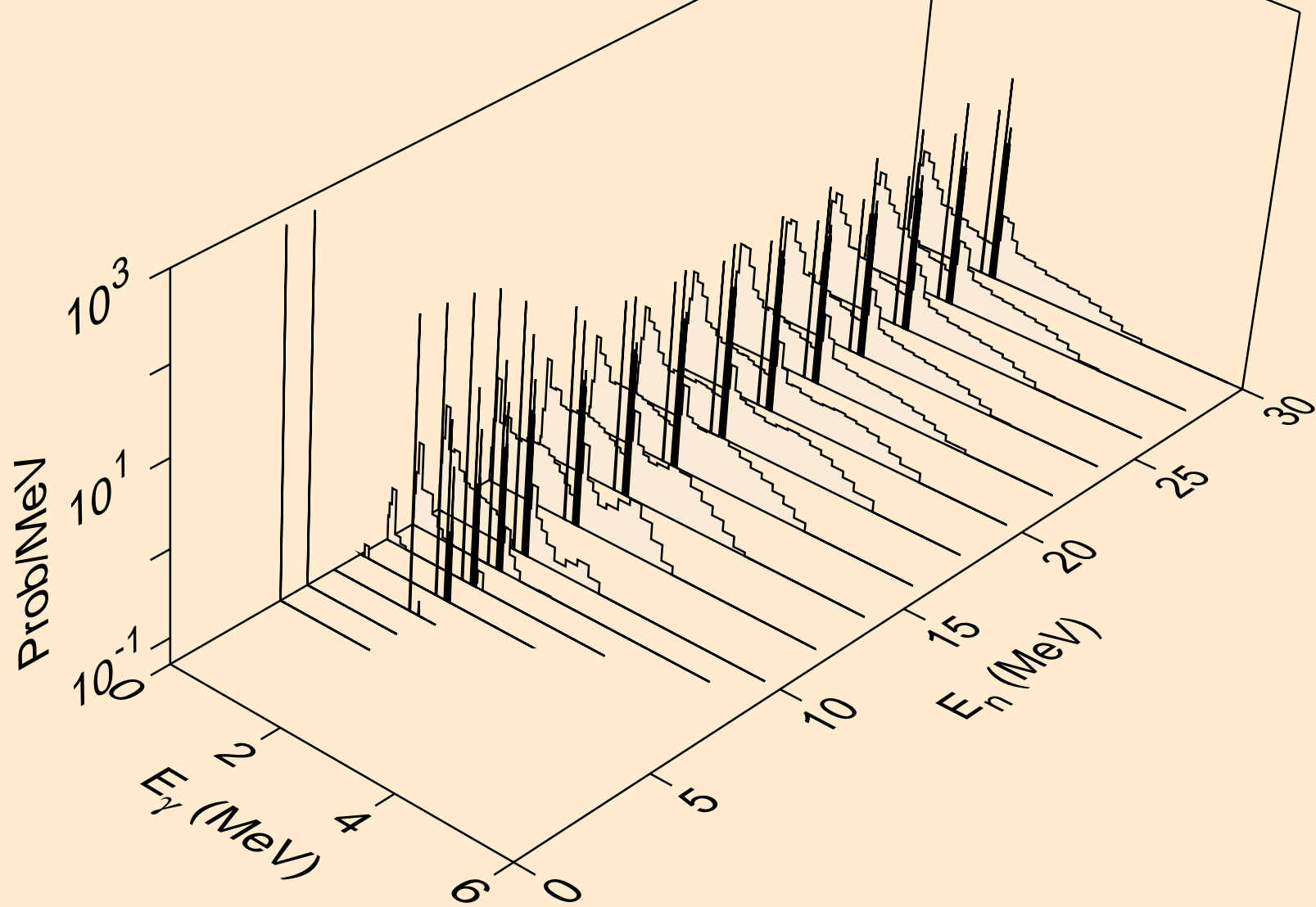

V050 DEUTERON ACER TENDL-2023 LIBRARY; T=0.K
Photon emission for (n,a)

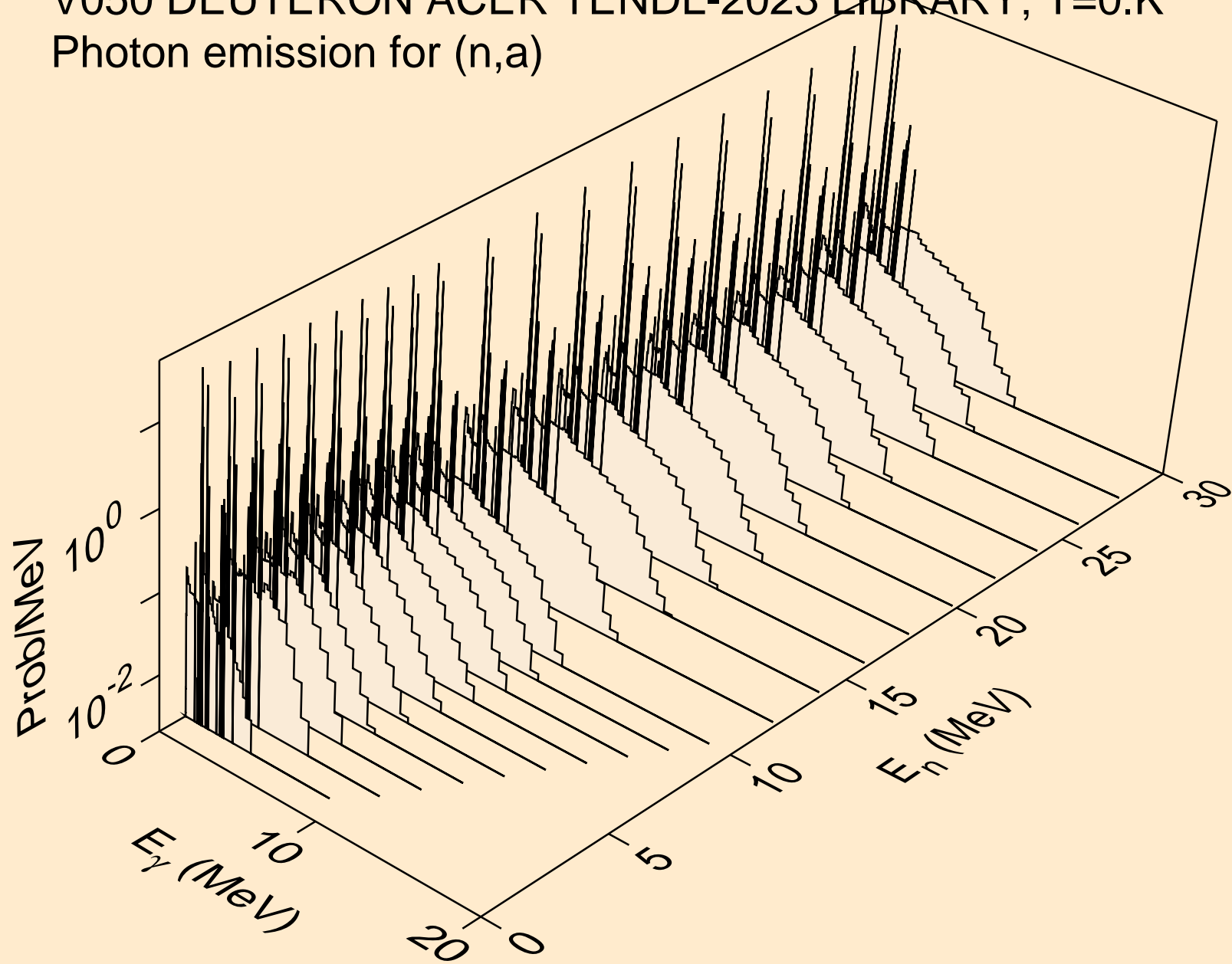

V050 DEUTERON ACER TENDL-2023 LIBRARY; T=0.K
Photon emission for (n,2a)

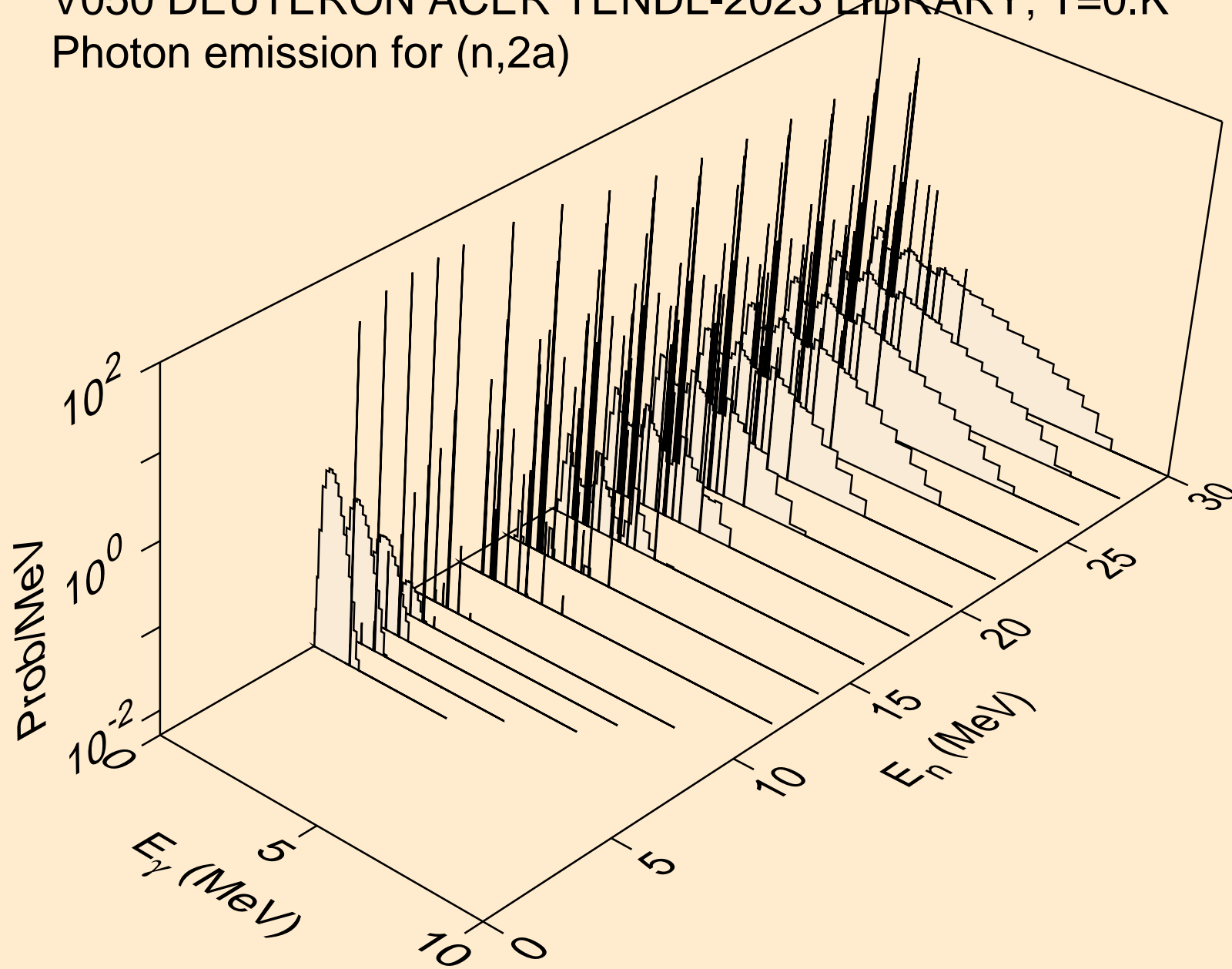

V050 DEUTERON ACER TENDL-2023 LIBRARY; T=0.K
Photon emission for (n,3a)

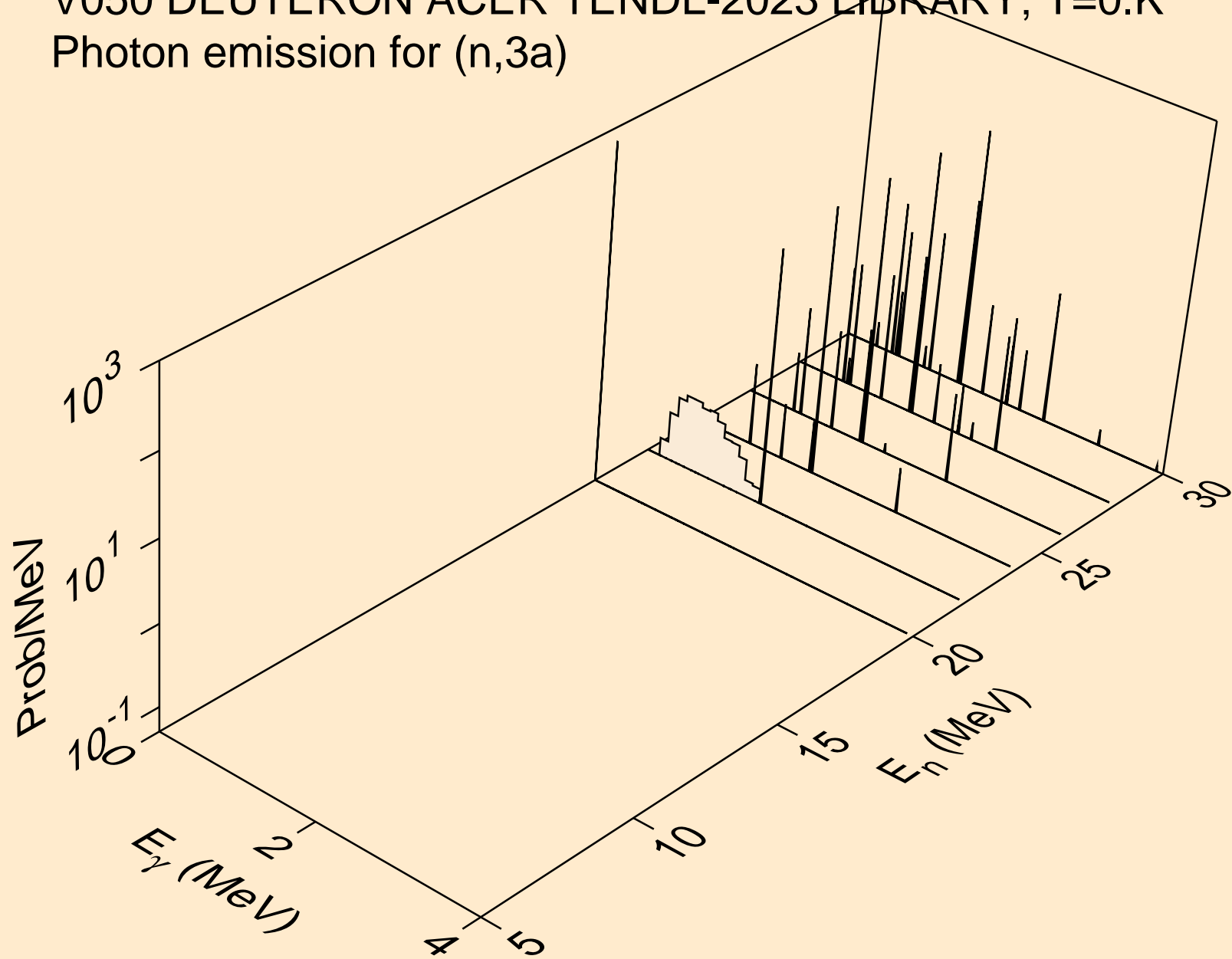

V050 DEUTERON ACER TENDL-2023 LIBRARY; T=0.K
Photon emission for (n,2p)

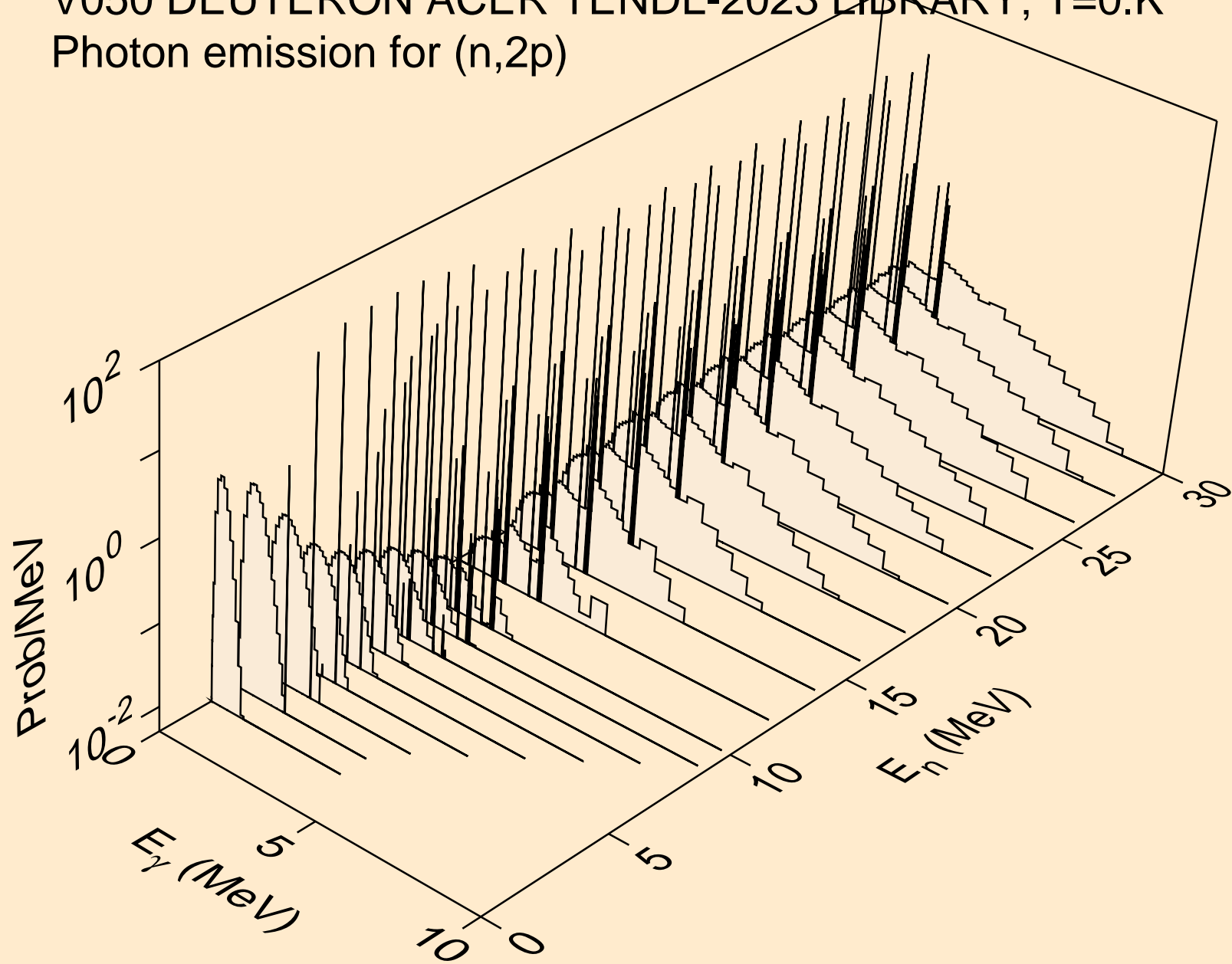

V050 DEUTERON ACER TENDL-2023 LIBRARY; T=0.K
Photon emission for (n,p)

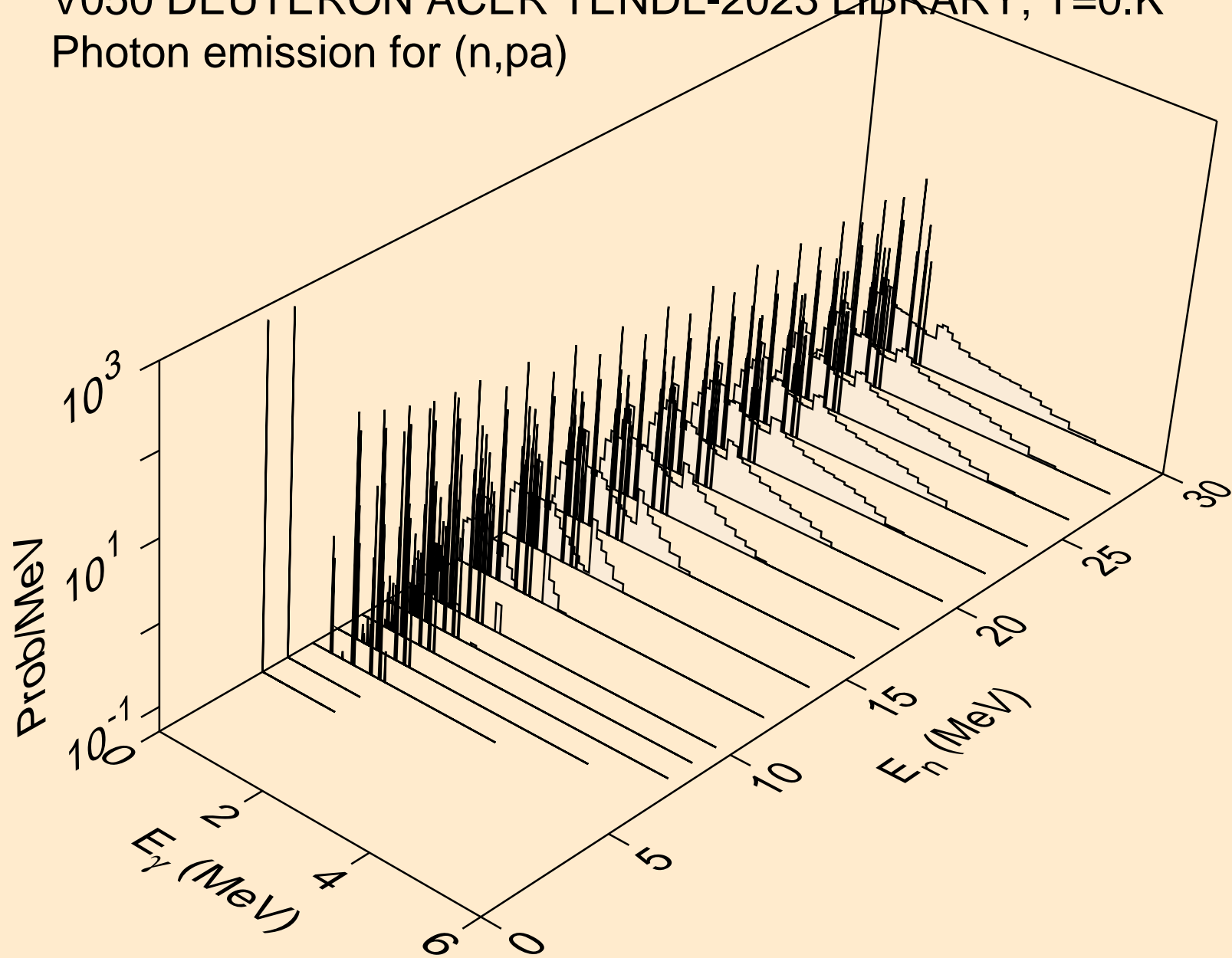

V050 DEUTERON ACER TENDL-2023 LIBRARY; T=0.K
Photon emission for (n,pd)

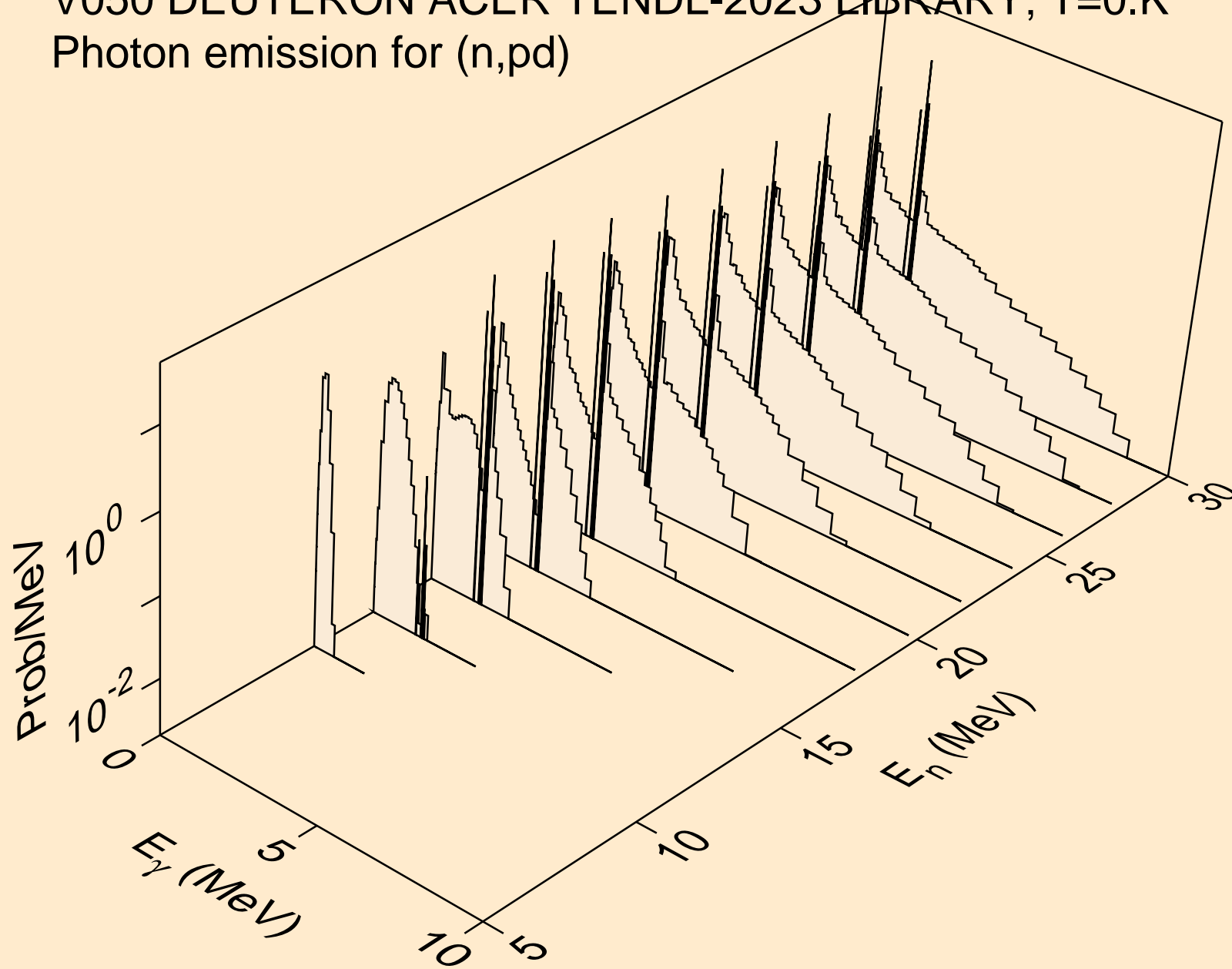

V050 DEUTERON ACER TENDL-2023 LIBRARY; T=0.K
Photon emission for (n,pt)

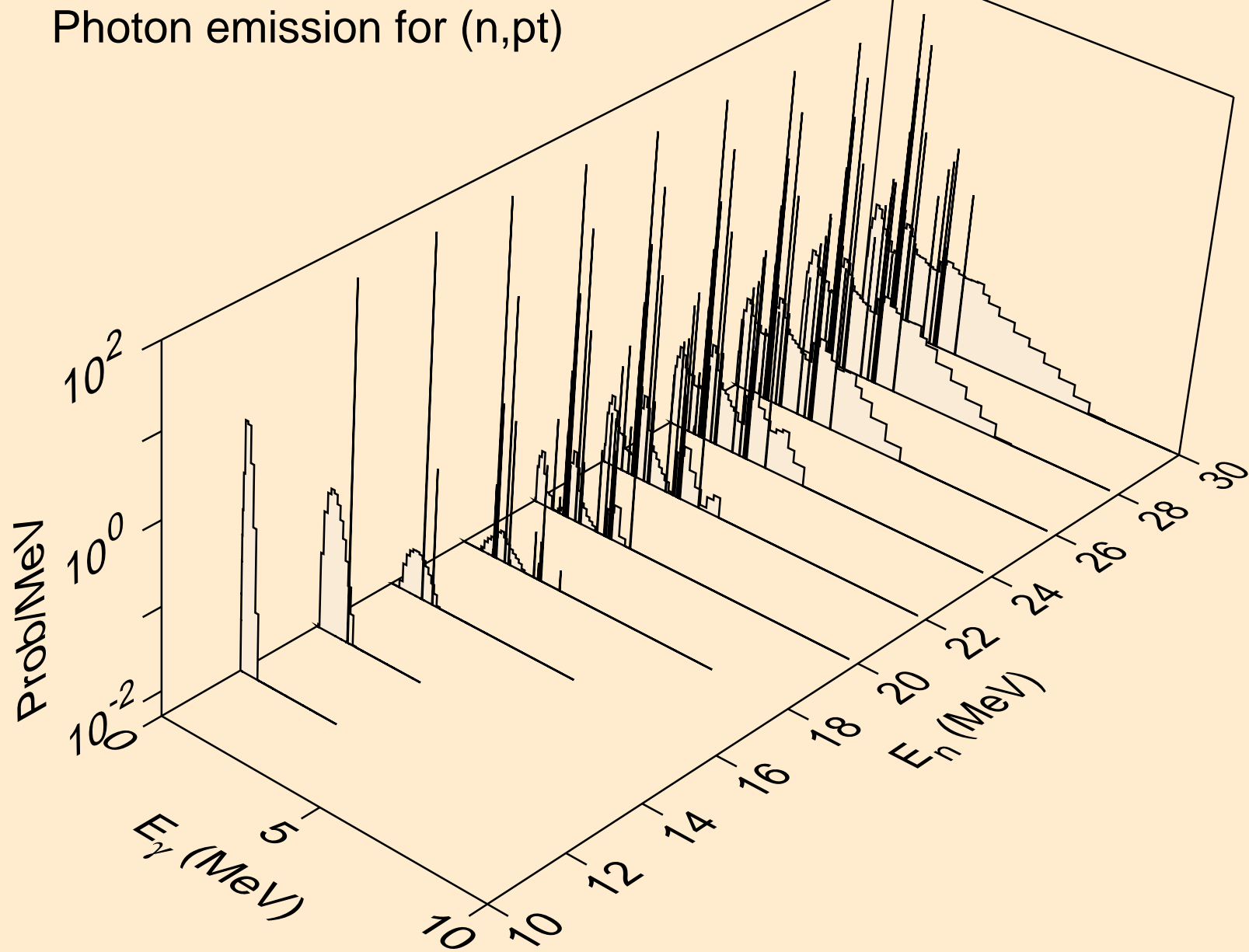

V050 DEUTERON ACER TENDL-2023 LIBRARY; T=0.K
Photon emission for (n,da)

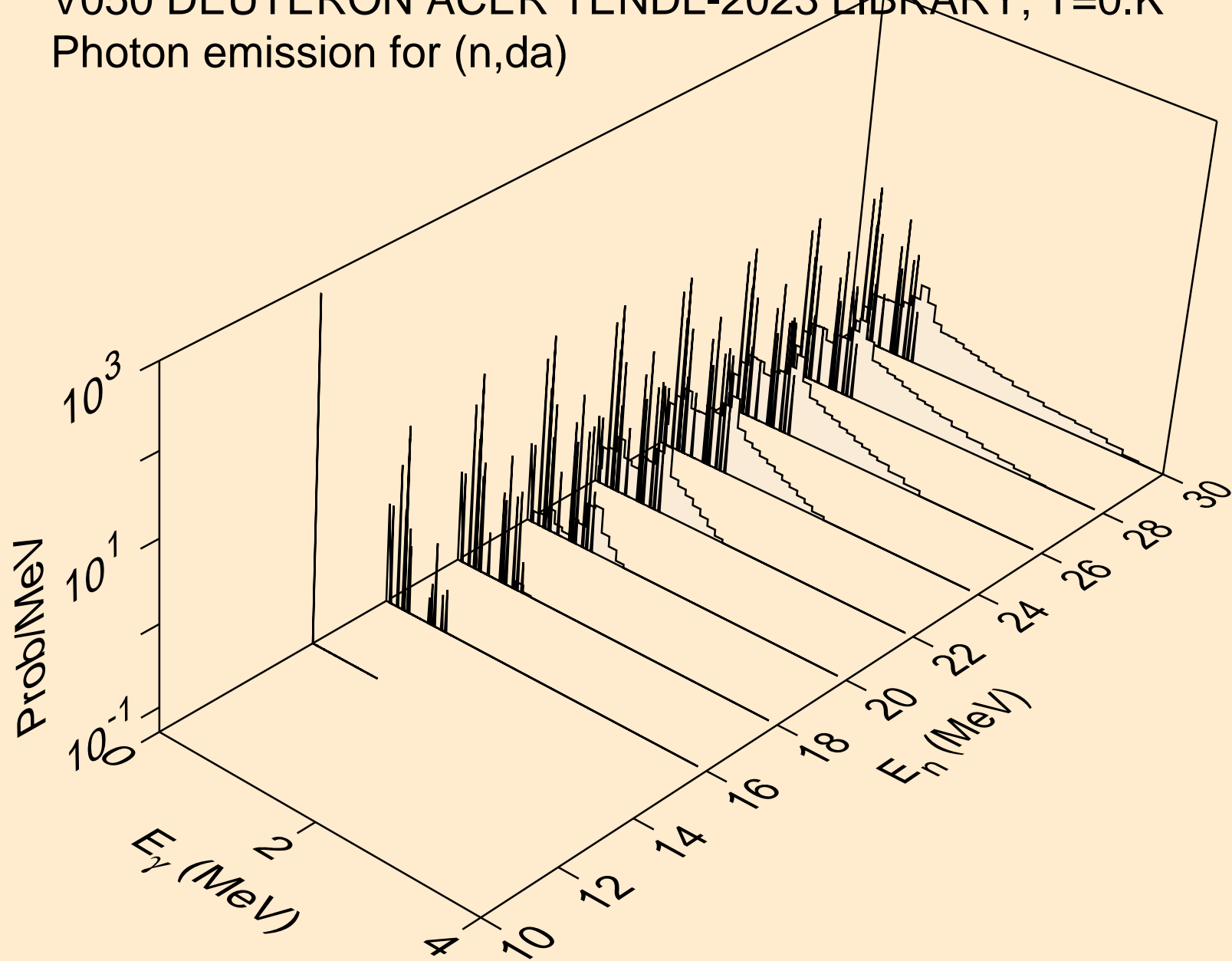

V050 DEUTERON ACER TENDL-2023 LIBRARY; T=0.K
Particle heating contributions

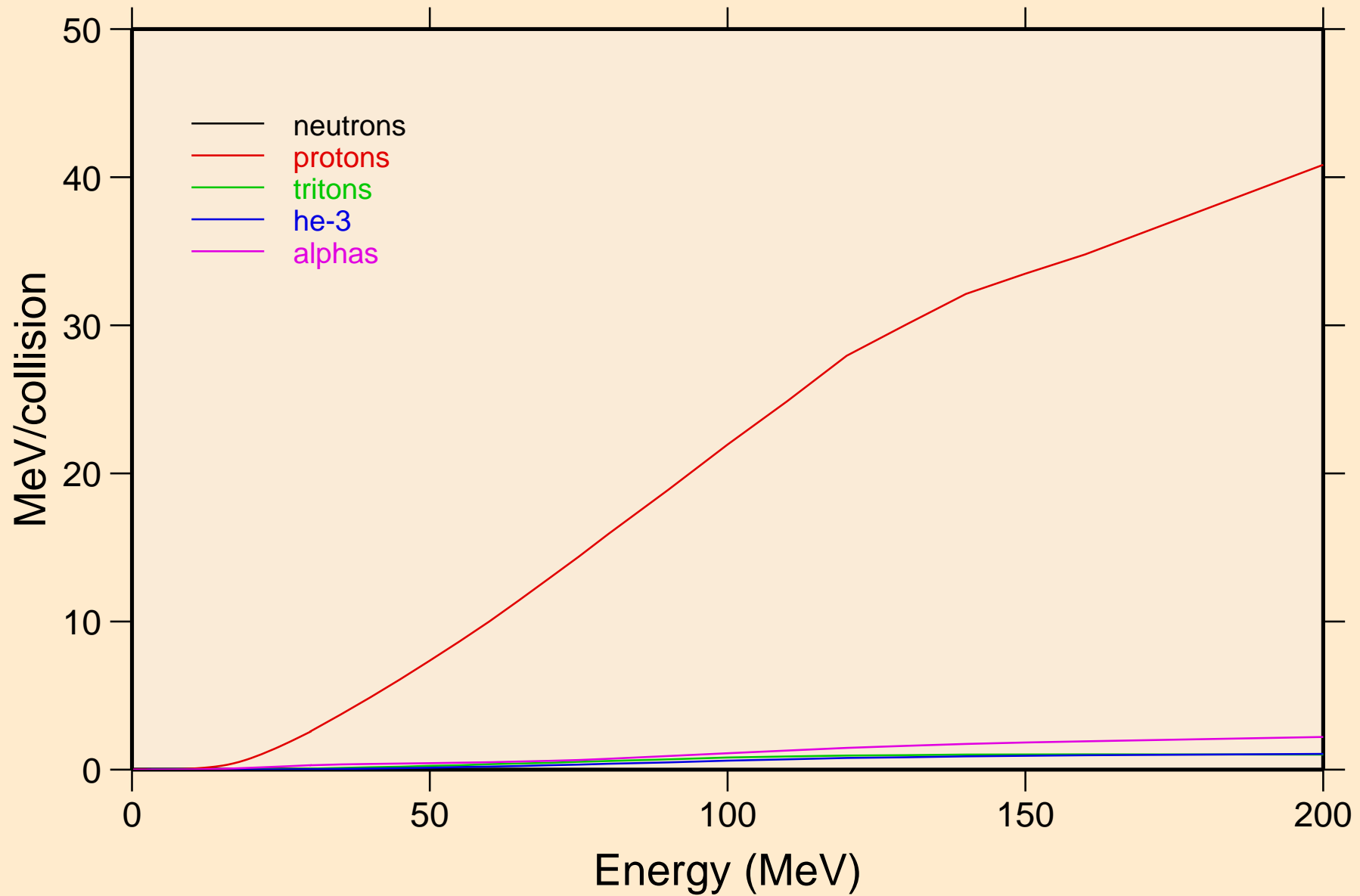

V050 DEUTERON ACER TENDL-2023 LIBRARY; T=0.K
Recoil Heating

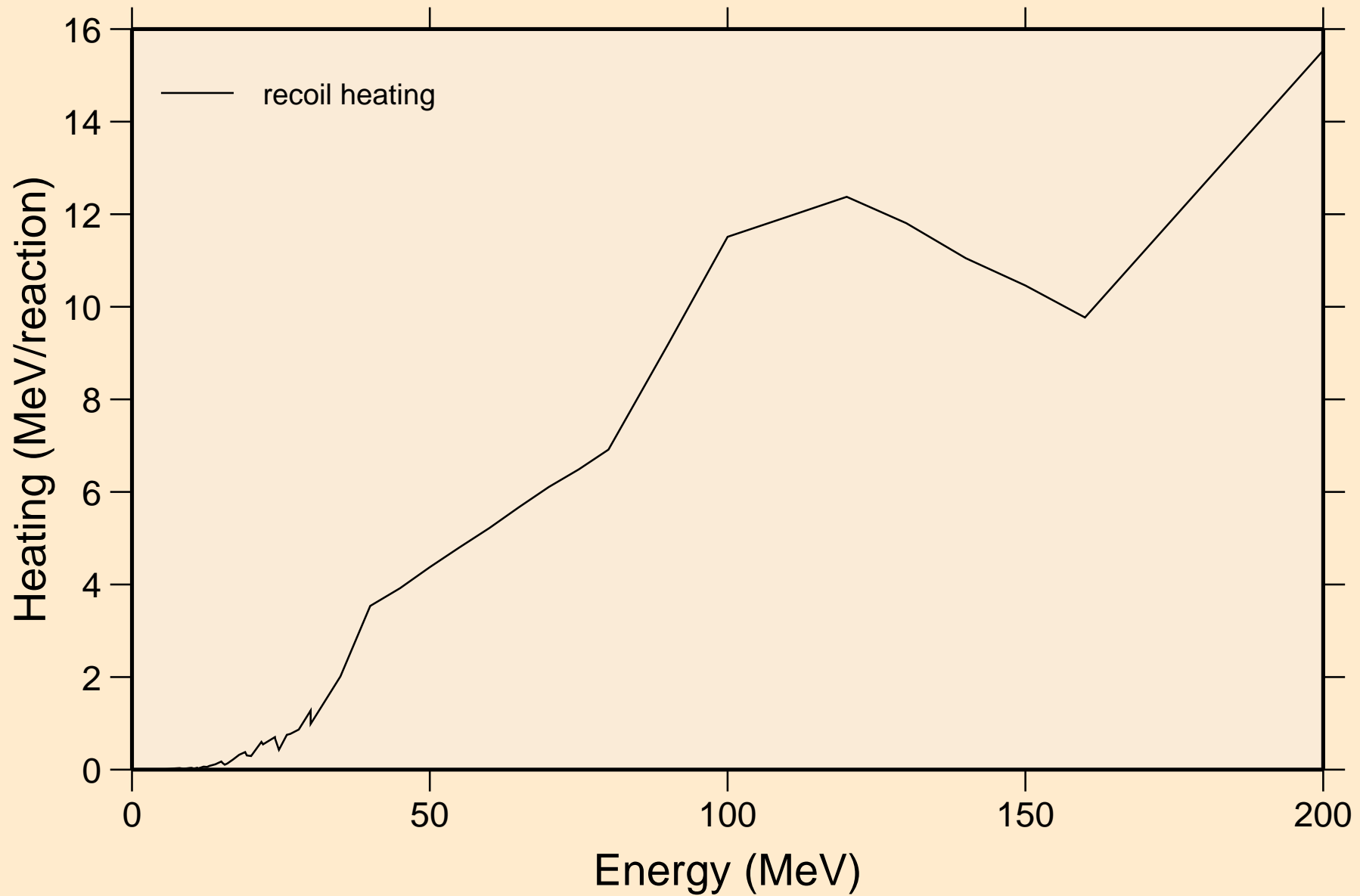

V050 DEUTERON ACER TENDL-2023 LIBRARY; T=0.K
Particle production cross sections

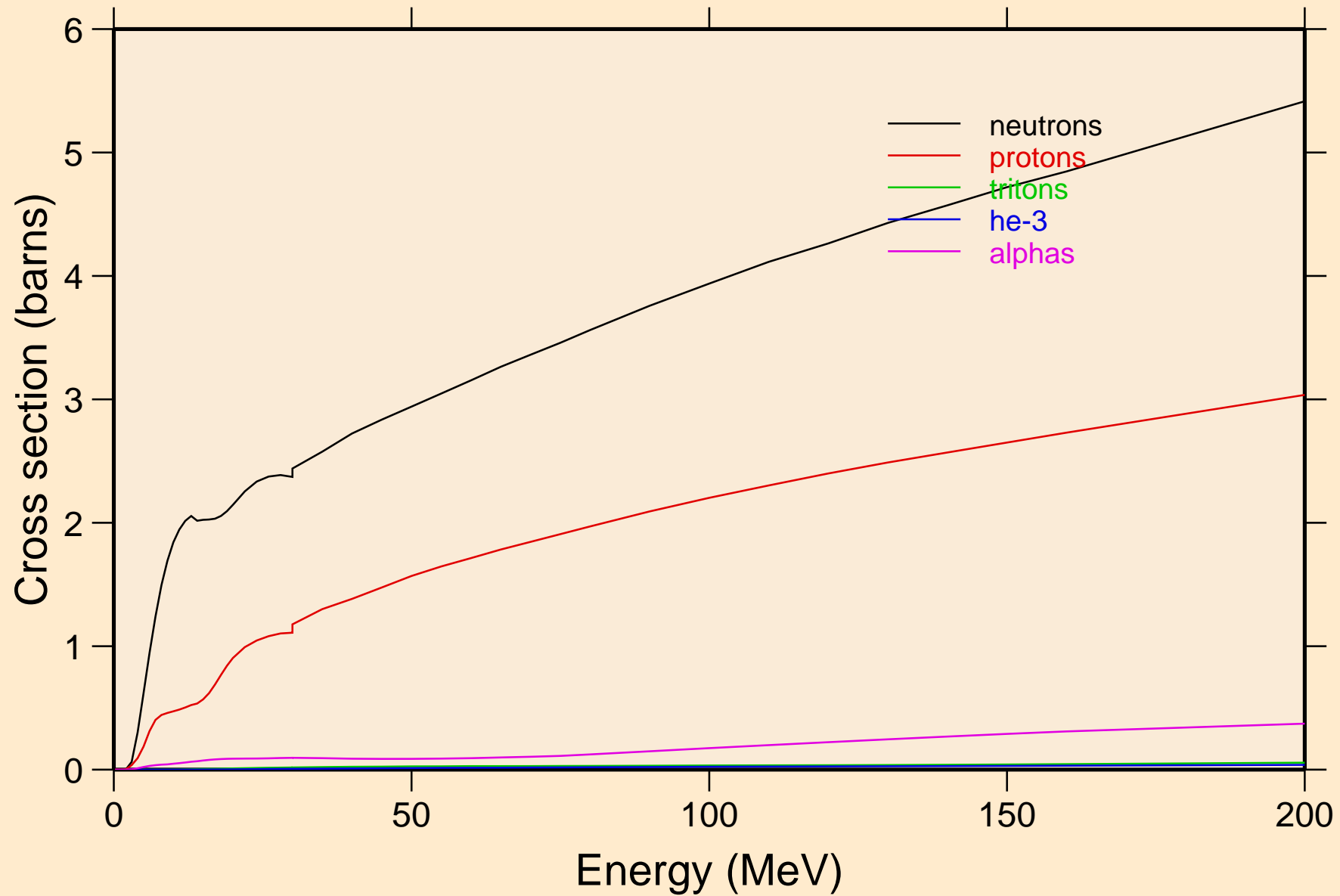

V050 DEUTERON ACER TENDL-2023 LIBRARY; T=0.K
neutrons from (d,n)

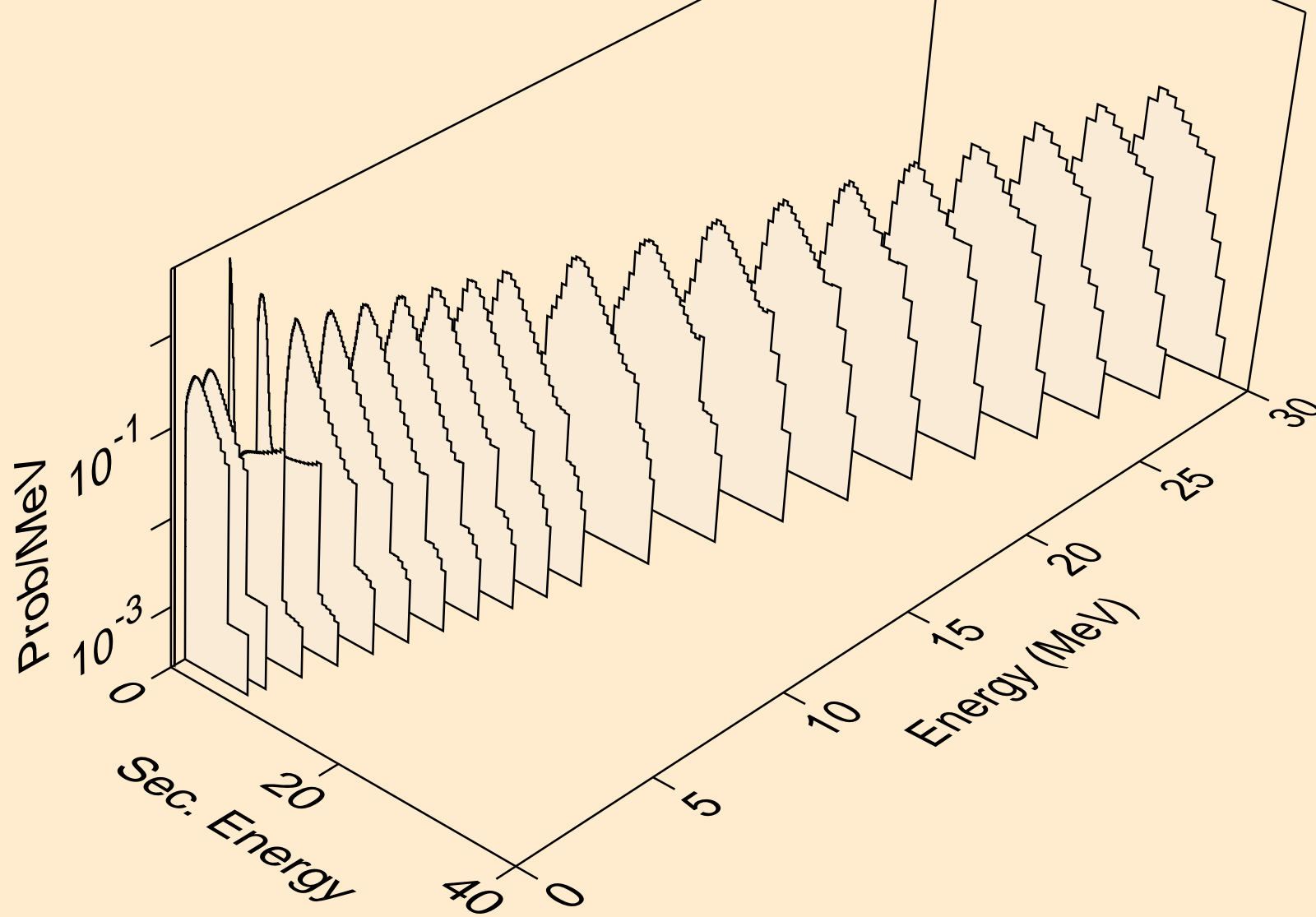

V050 DEUTERON ACER TENDL-2023 LIBRARY; T=0.K
neutrons from (d,x)

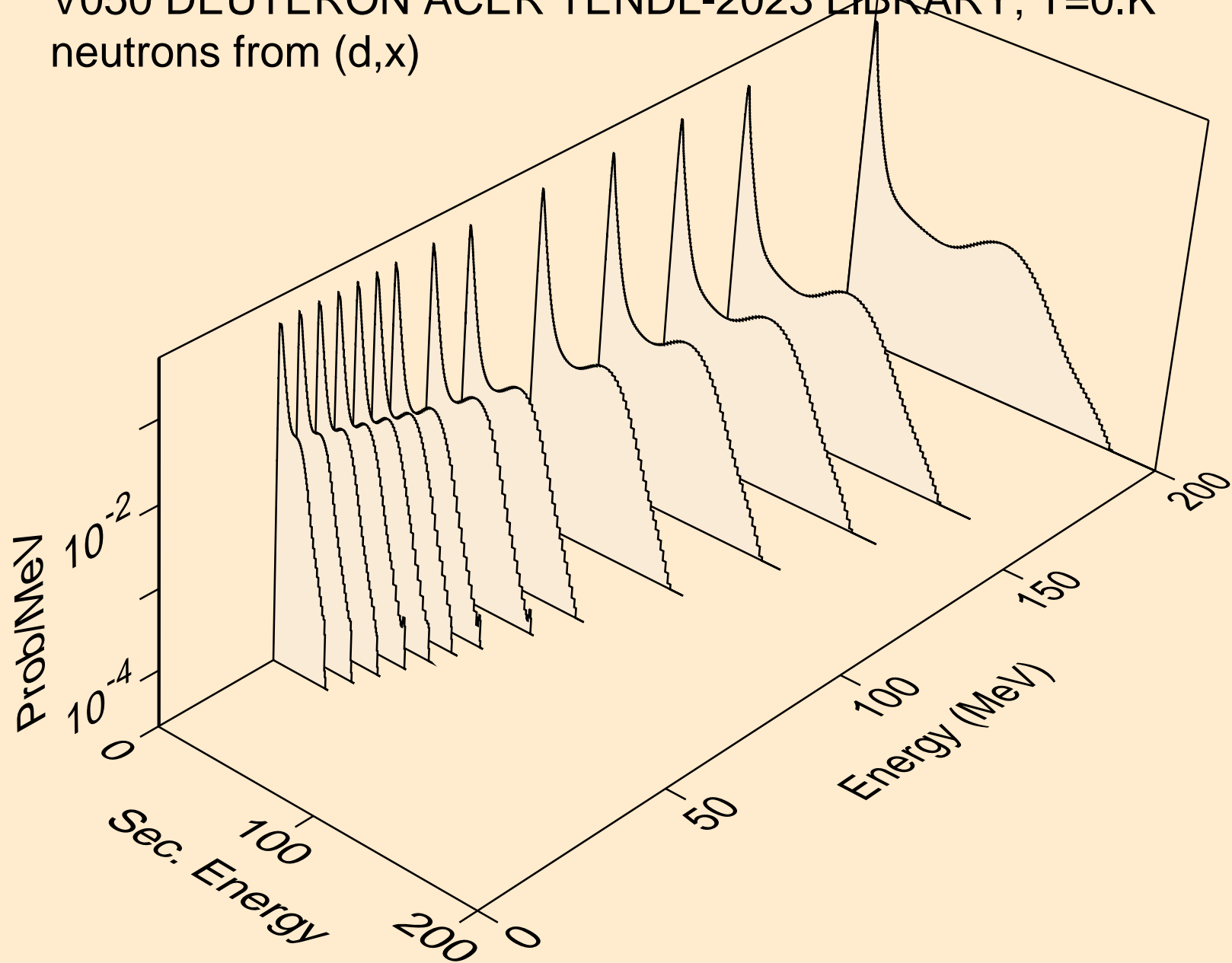

V050 DEUTERON ACER TENDL-2023 LIBRARY; T=0.K
neutrons from (d,2nd)

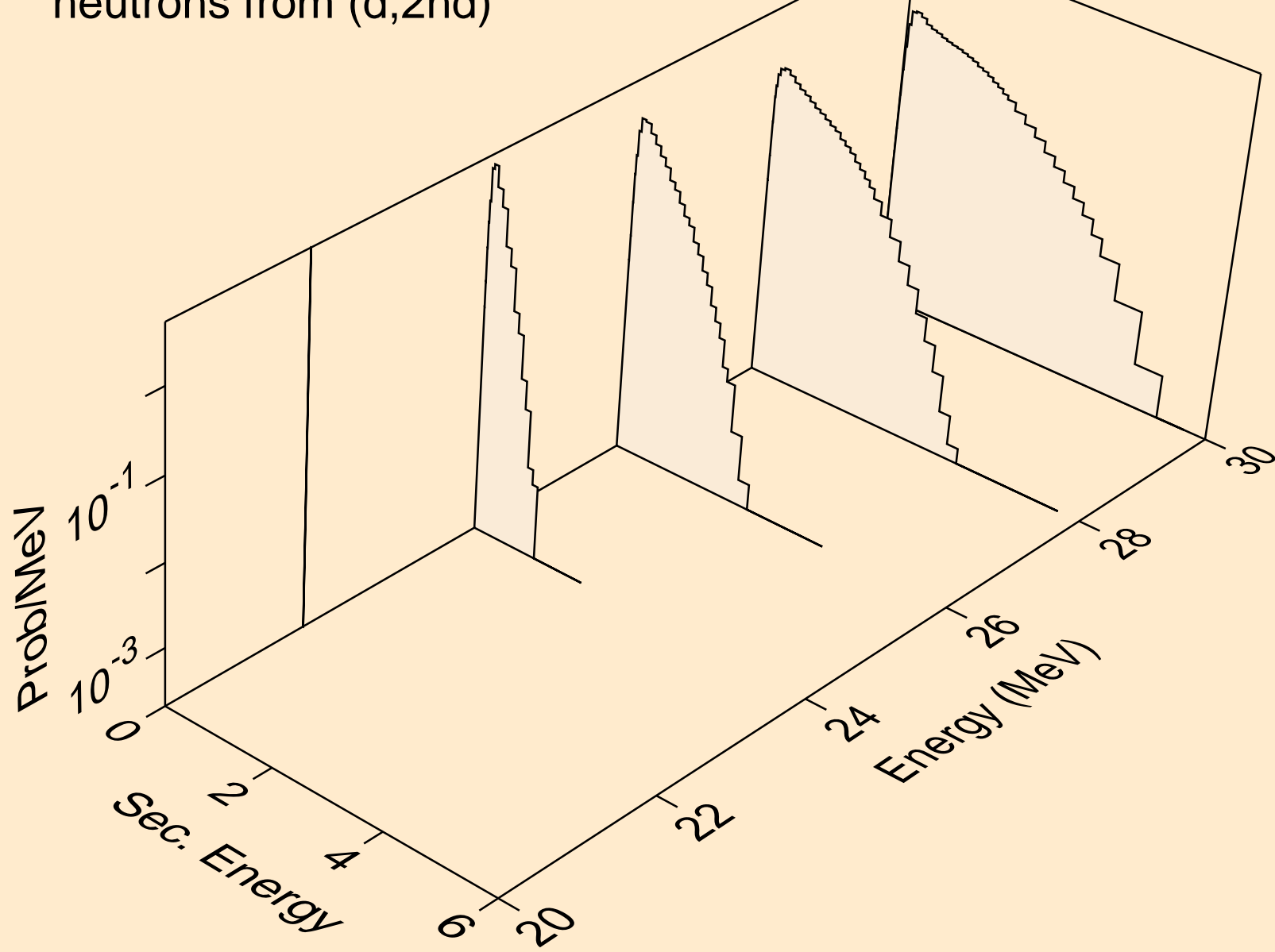

V050 DEUTERON ACER TENDL-2023 LIBRARY; T=0.K
neutrons from (d,2n)

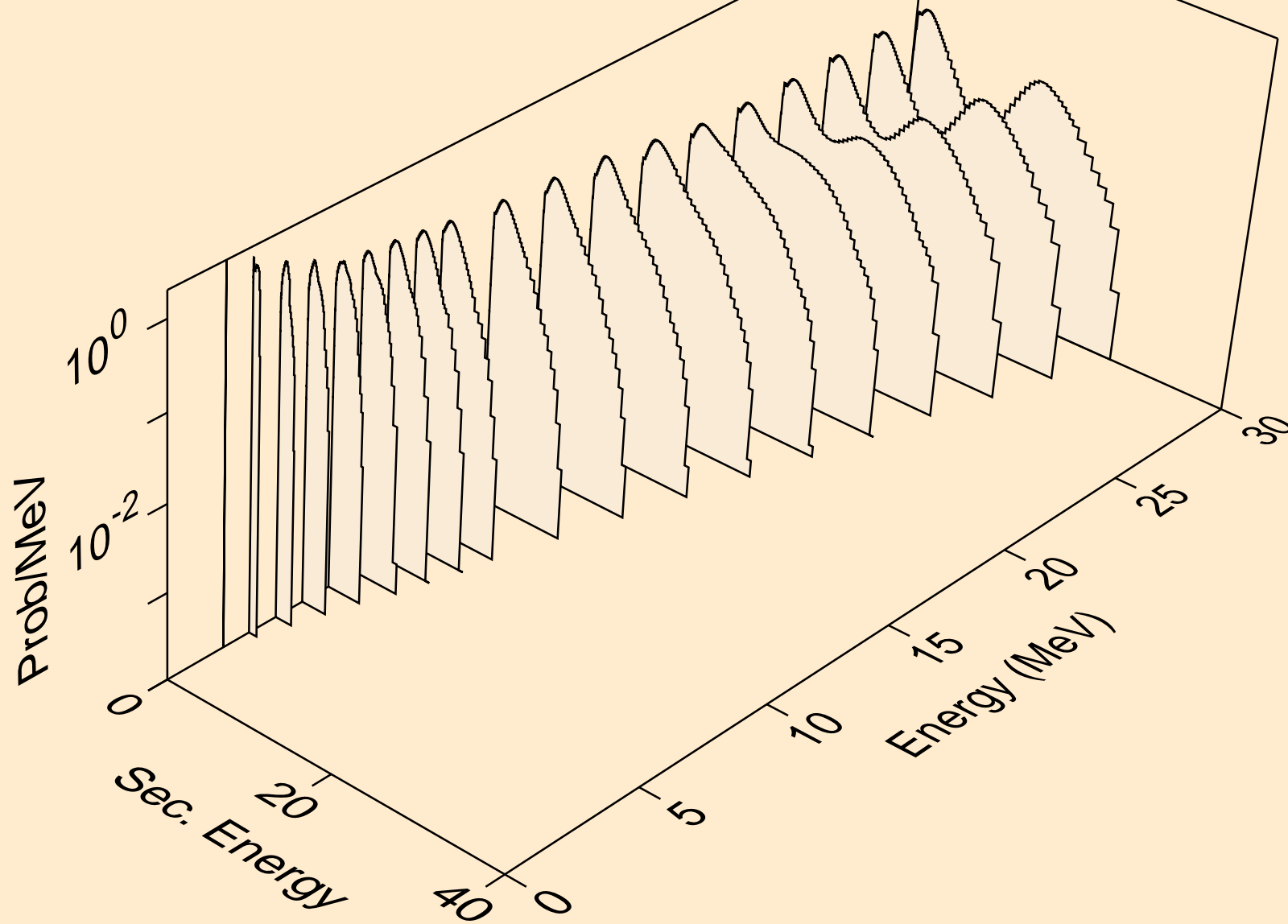

V050 DEUTERON ACER TENDL-2023 LIBRARY; T=0.K
neutrons from (d,3n)

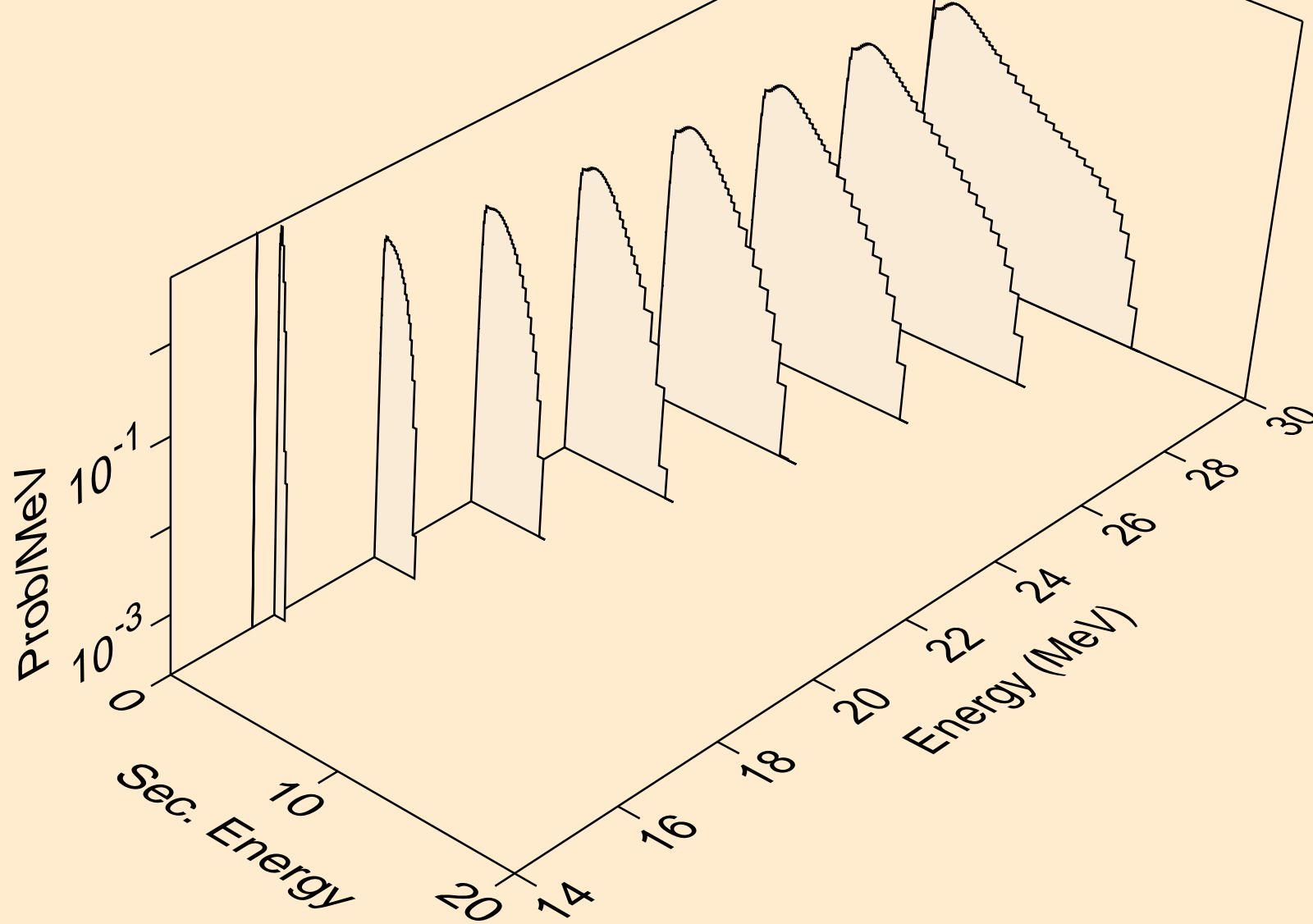

V050 DEUTERON ACER TENDL-2023 LIBRARY; T=0.K
neutrons from (d,n*)a

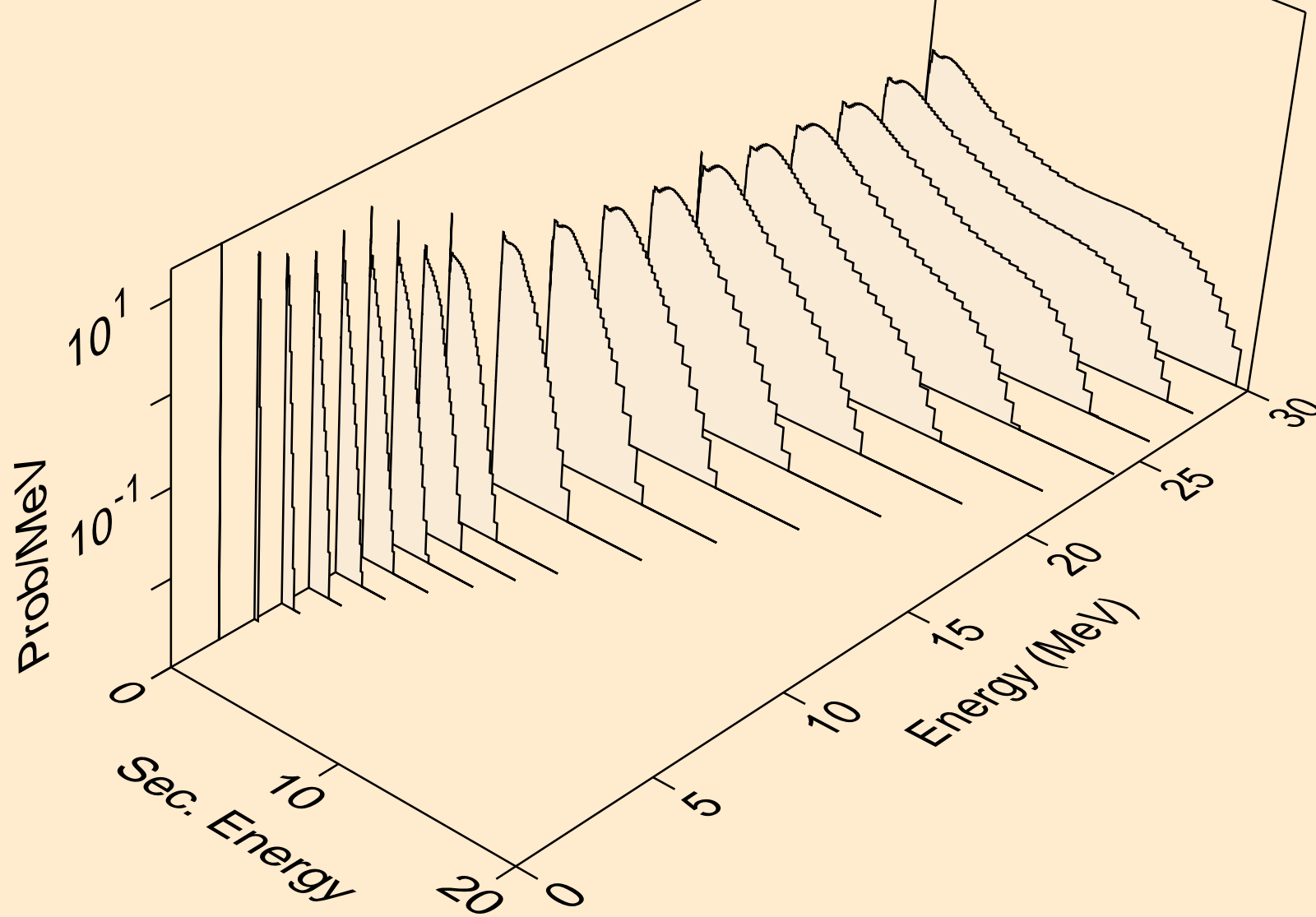

V050 DEUTERON ACER TENDL-2023 LIBRARY; T=0.K
neutrons from (d,2n)a

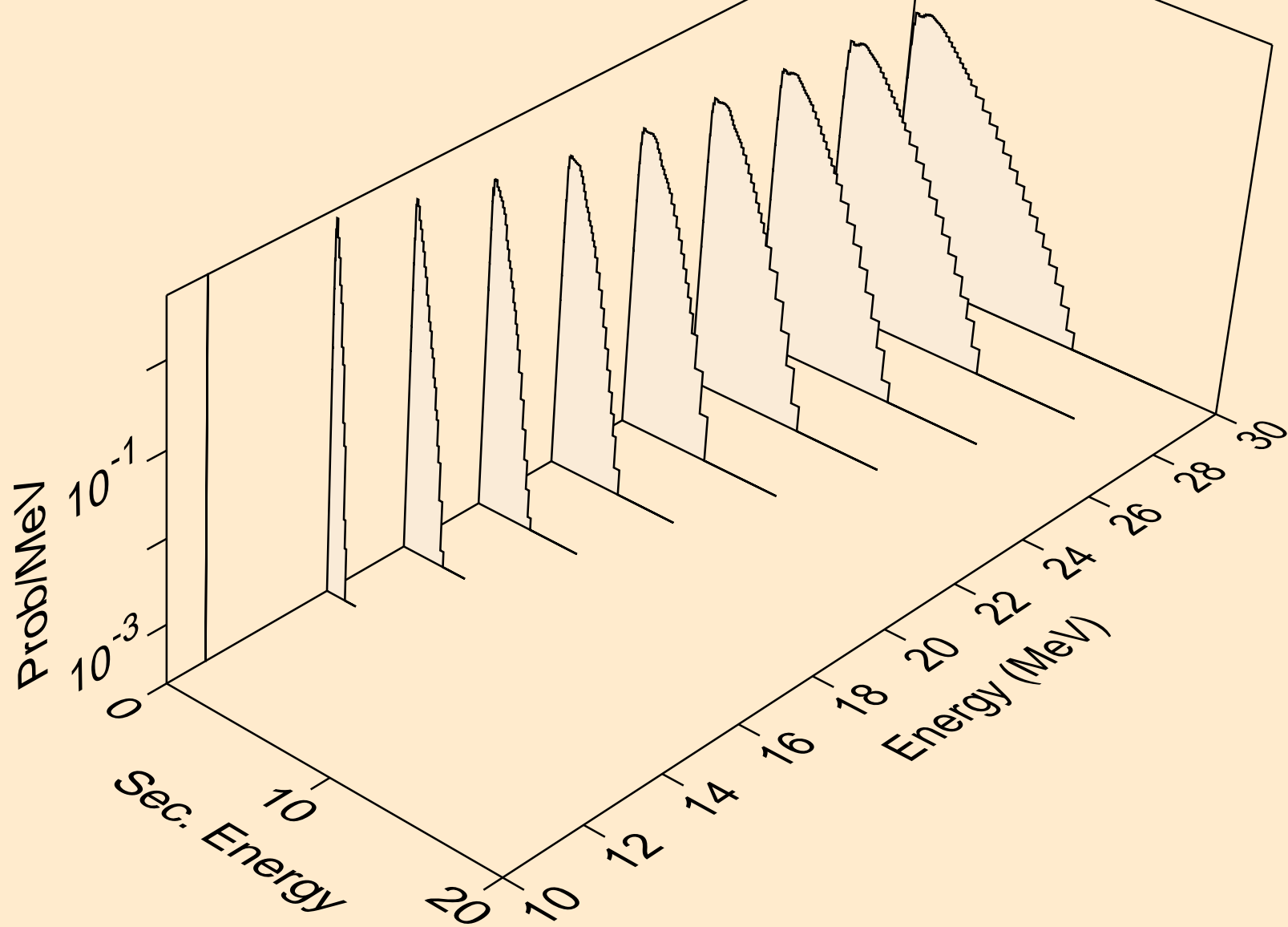

V050 DEUTERON ACER TENDL-2023 LIBRARY; T=0.K
neutrons from (d,3n)a

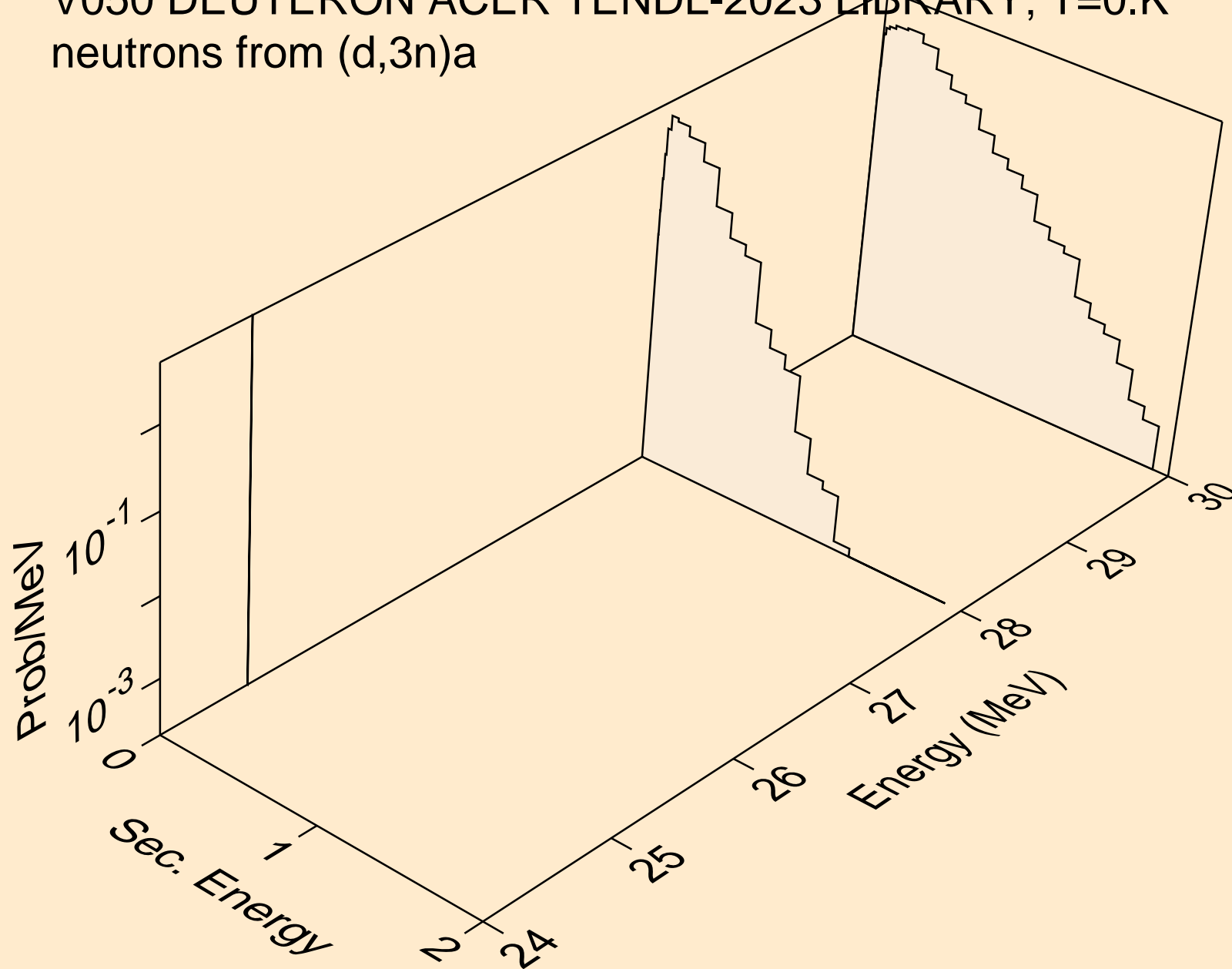

V050 DEUTERON ACER TENDL-2023 LIBRARY; T=0.K
neutrons from (d,n*)p

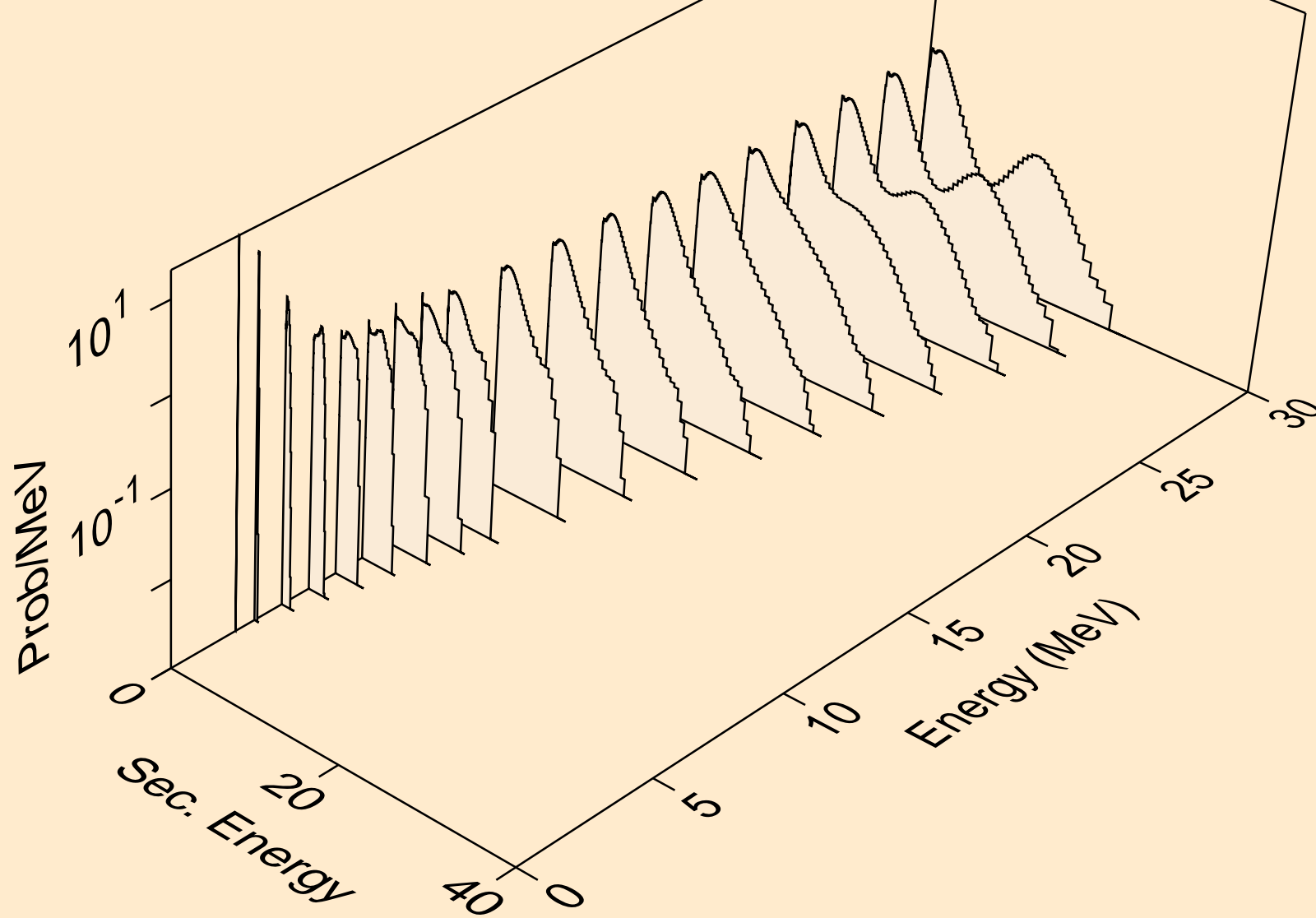

V050 DEUTERON ACER TENDL-2023 LIBRARY; T=0.K
neutrons from (d,n*)2a

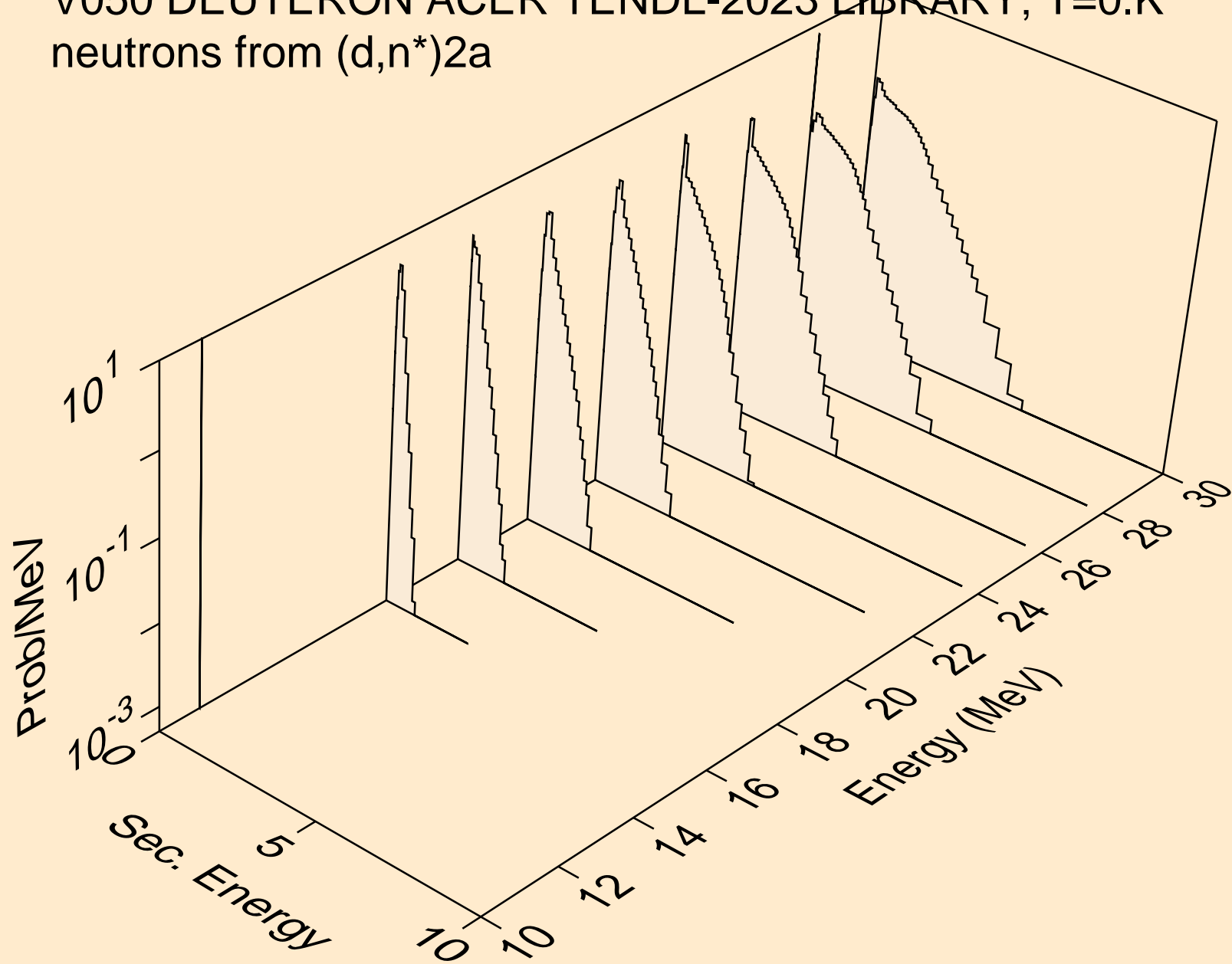

V050 DEUTERON ACER TENDL-2023 LIBRARY; T=0.K
neutrons from (d,2n)2a

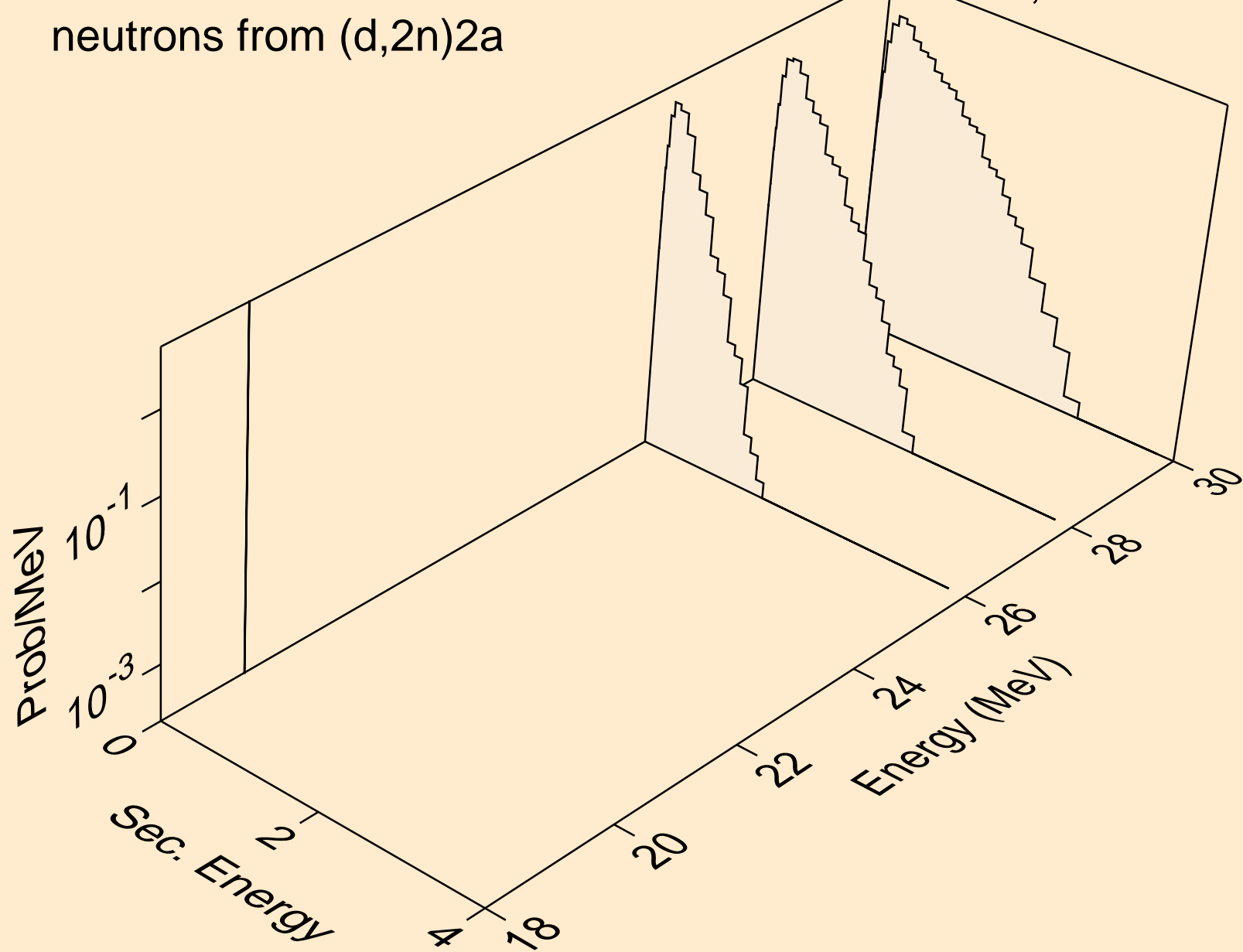

V050 DEUTERON ACER TENDL-2023 LIBRARY; T=0.K
neutrons from (d,n*)d

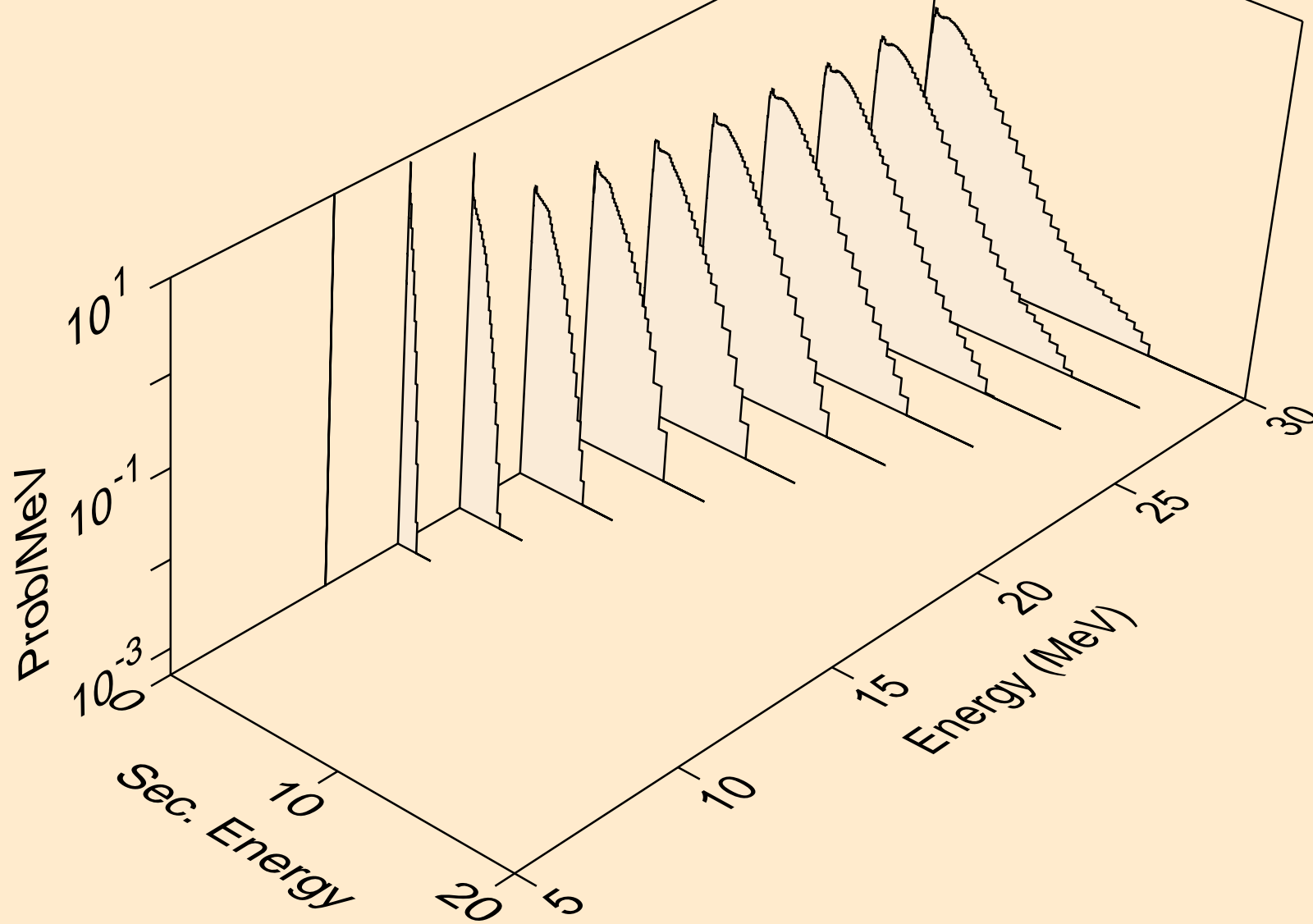

V050 DEUTERON ACER TENDL-2023 LIBRARY; T=0.K
neutrons from (d,n*)t

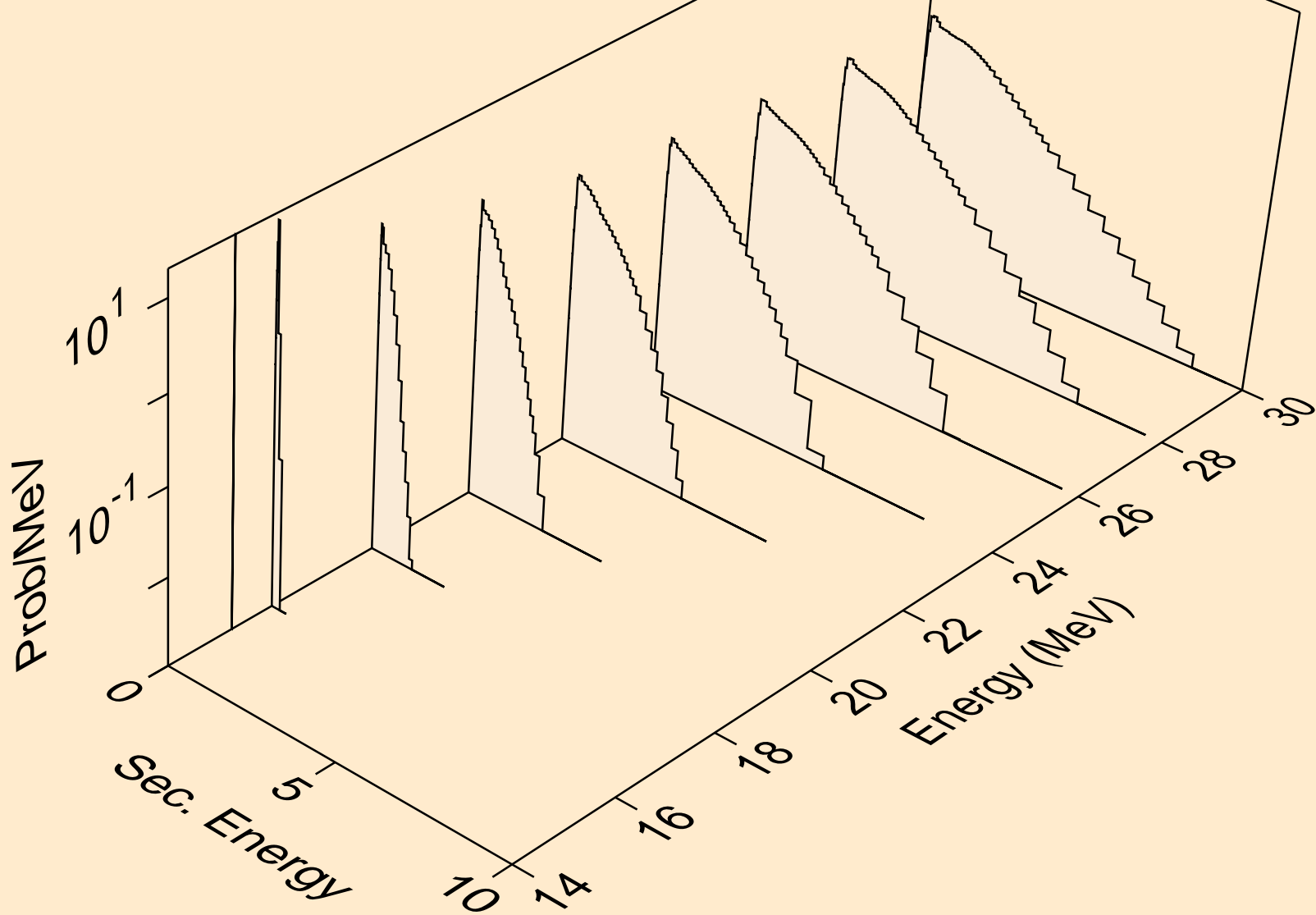

V050 DEUTERON ACER TENDL-2023 LIBRARY; T=0.K
neutrons from (d,n*)he3

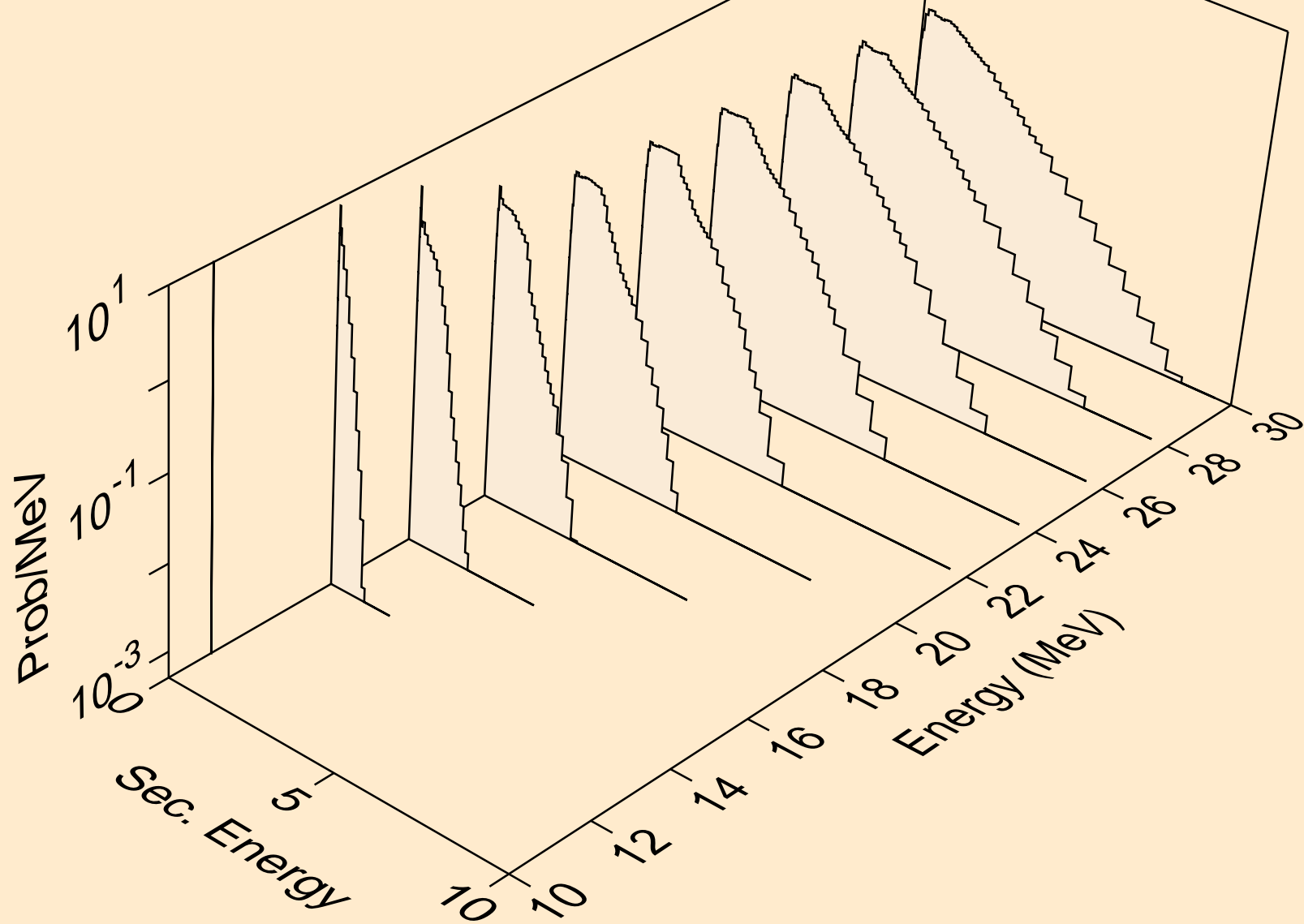

V050 DEUTERON ACER TENDL-2023 LIBRARY; T=0.K
neutrons from (d,4n)

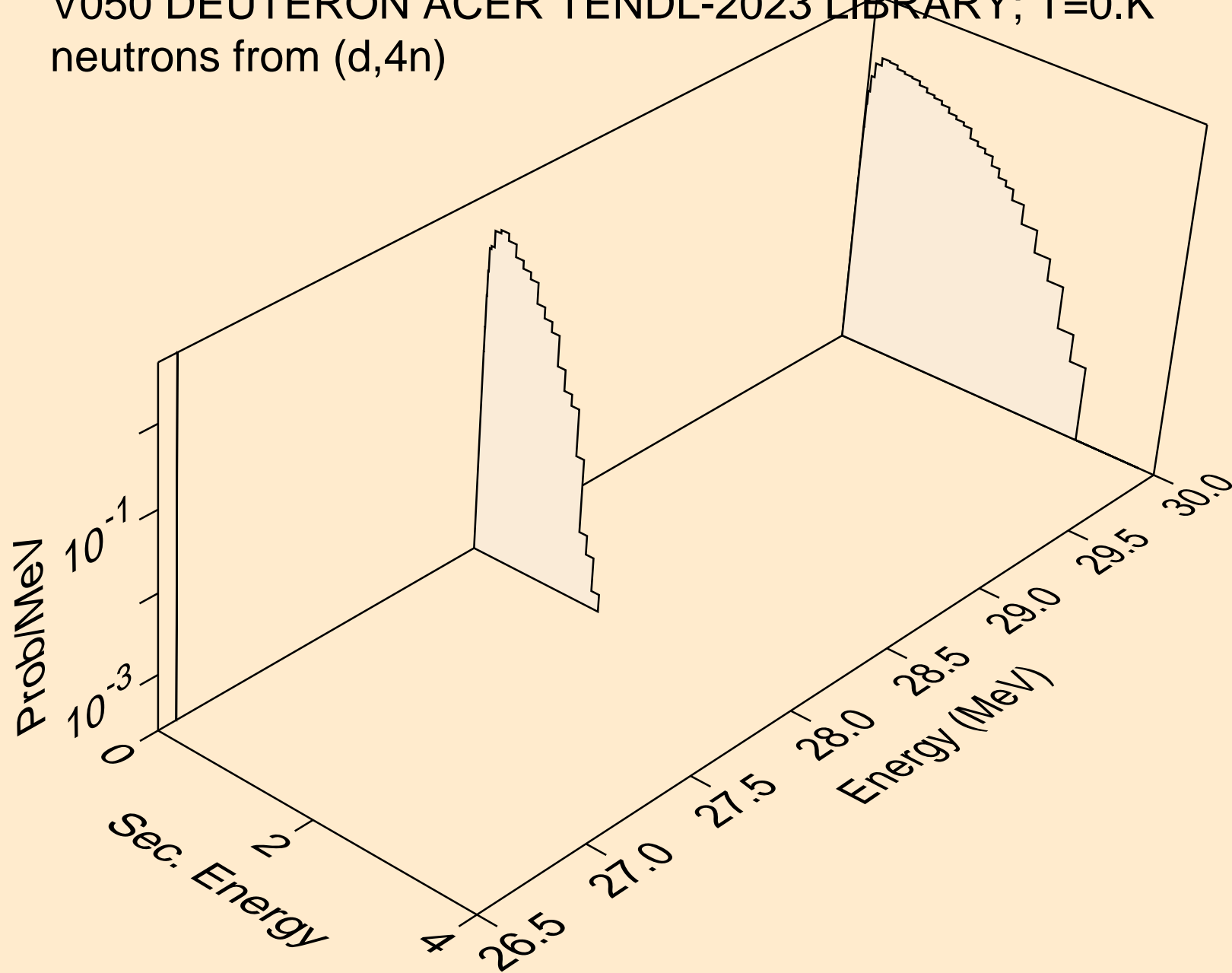

V050 DEUTERON ACER TENDL-2023 LIBRARY; T=0.K
neutrons from (d,2np)

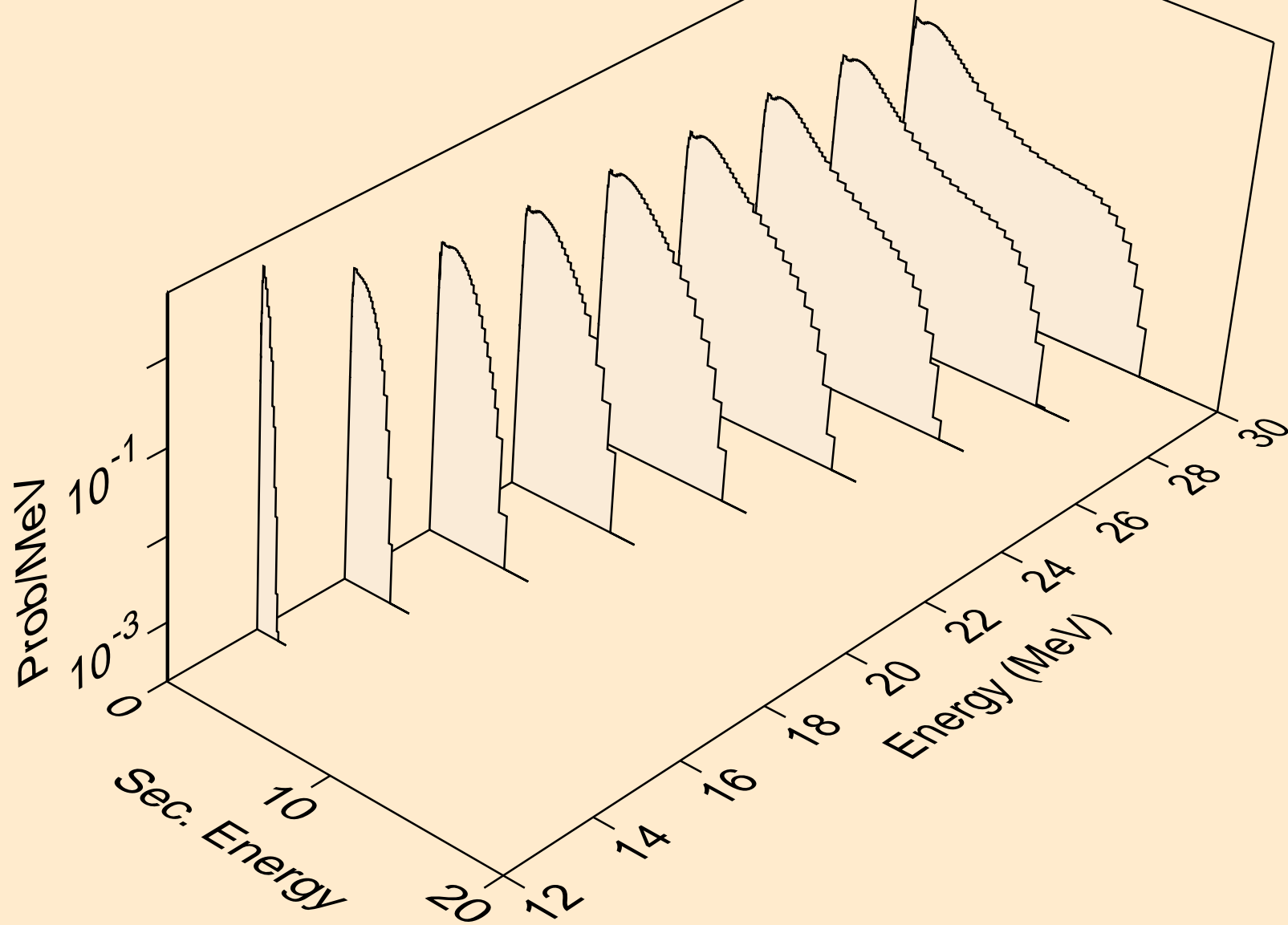

V050 DEUTERON ACER TENDL-2023 LIBRARY; T=0.K
neutrons from (d,3np)

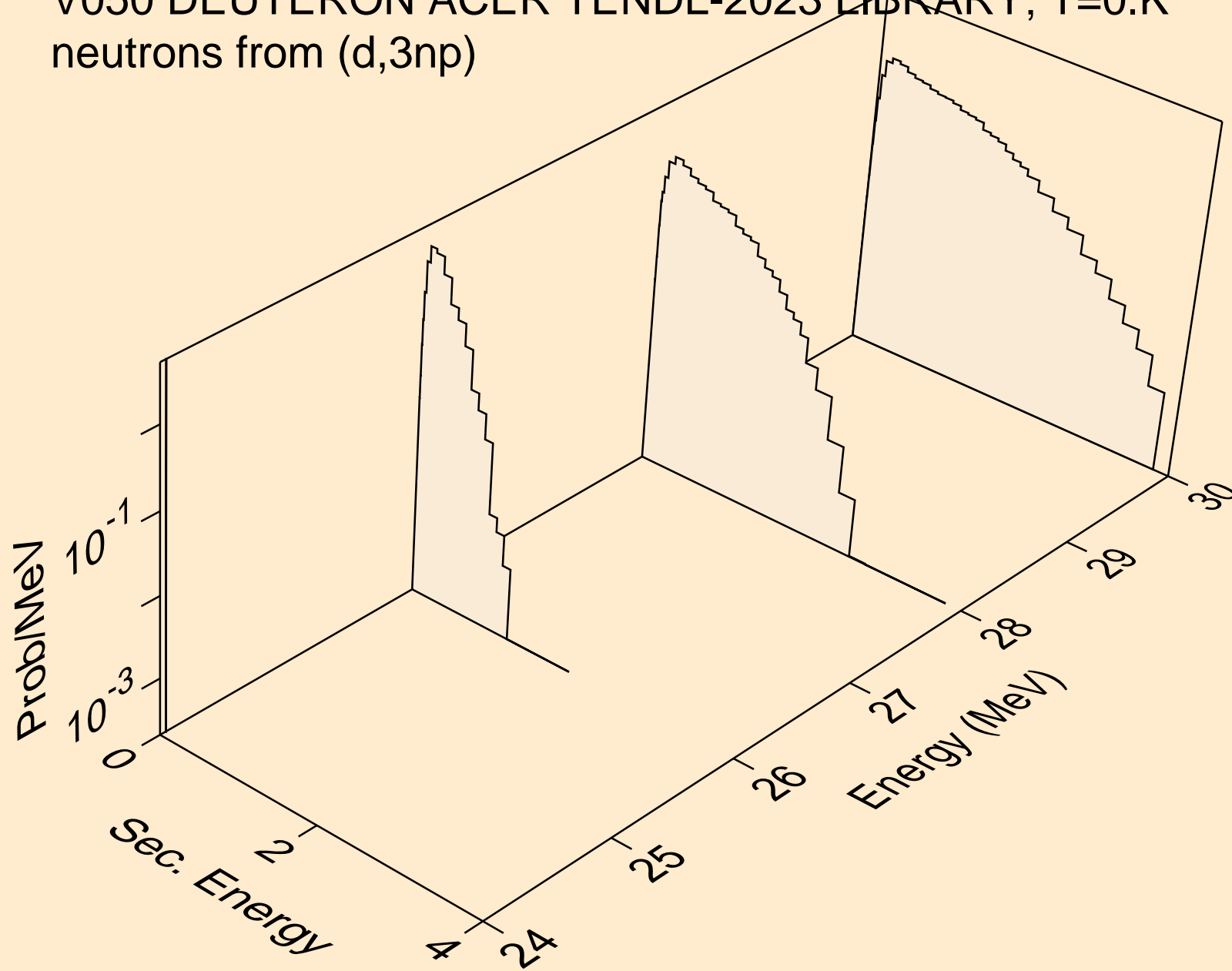

V050 DEUTERON ACER TENDL-2023 LIBRARY; T=0.K
neutrons from (d,n2p)

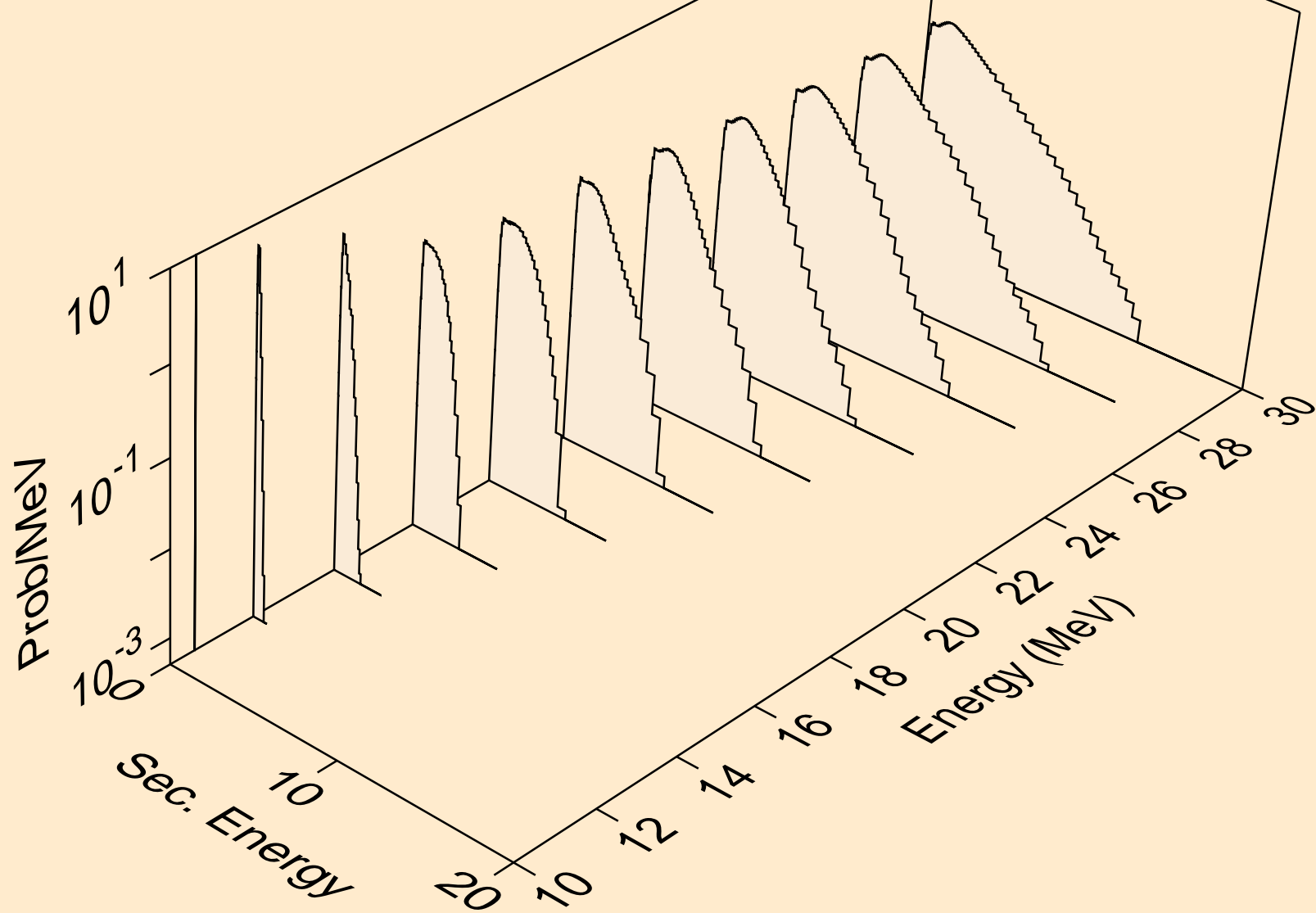

V050 DEUTERON ACER TENDL-2023 LIBRARY; T=0.K
neutrons from (d,npa)

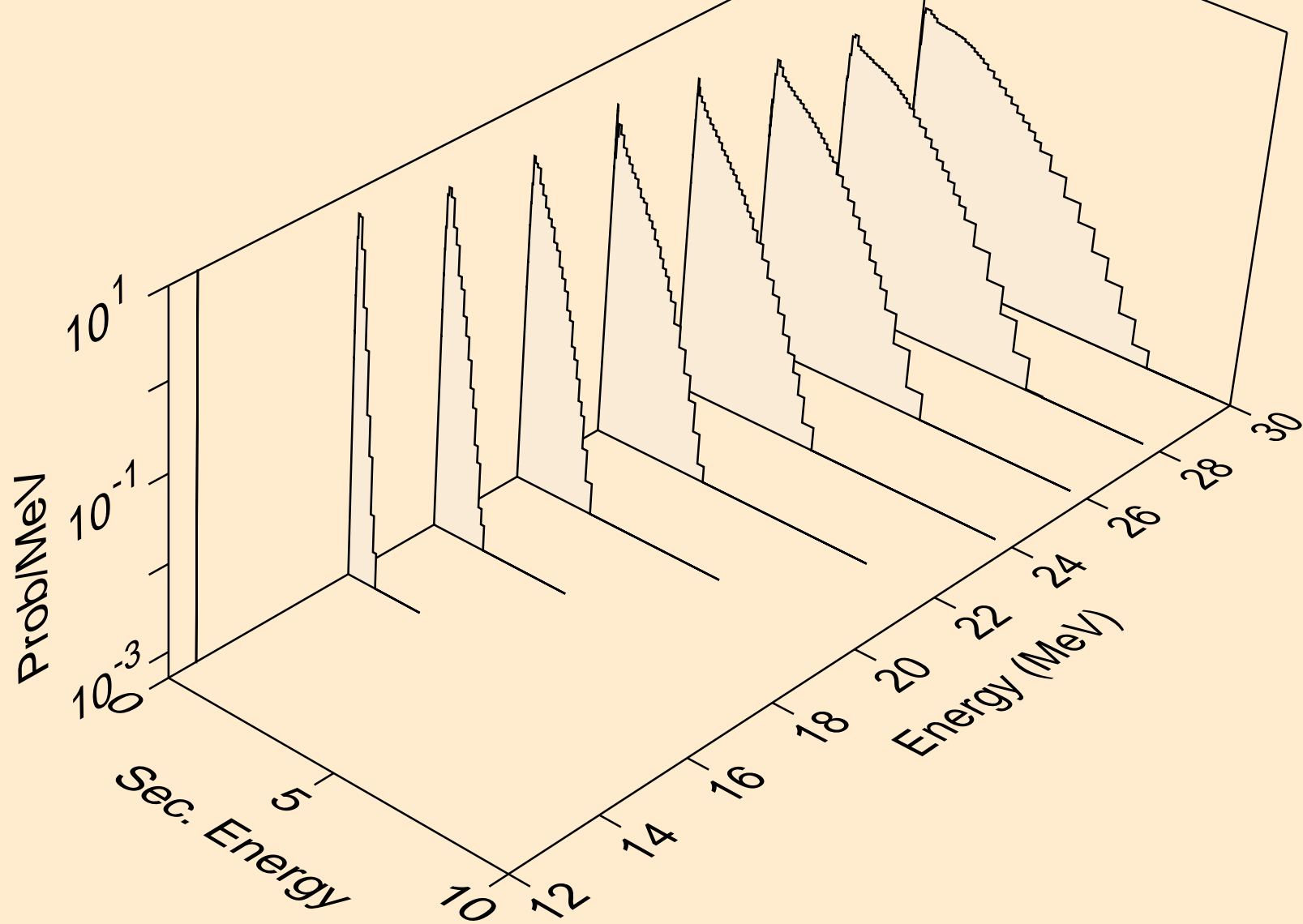

V050 DEUTERON ACER TENDL-2023 LIBRARY; T=0.K
protons from (d,x)

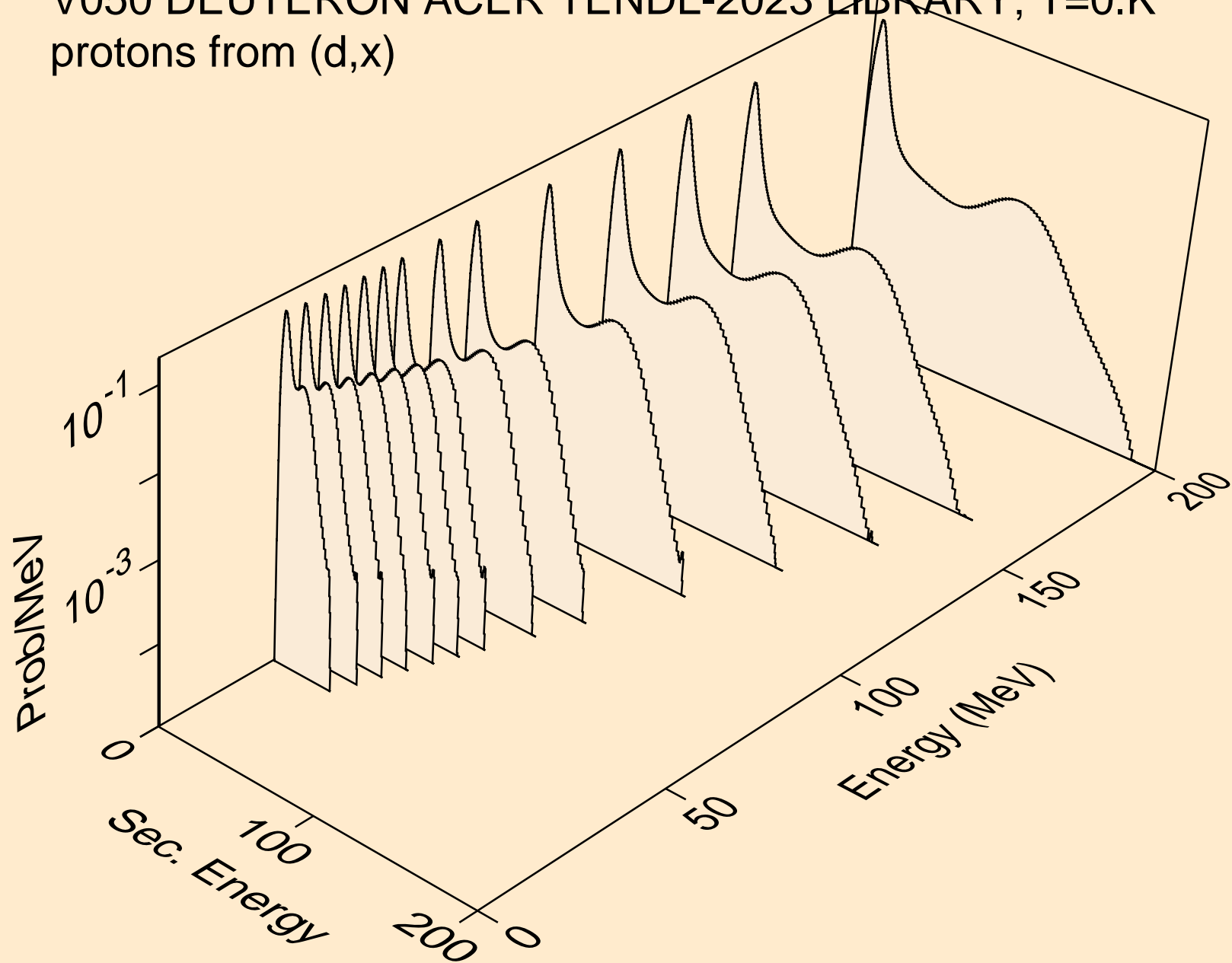

V050 DEUTERON ACER TENDL-2023 LIBRARY; T=0.K
protons from (d,n*)p

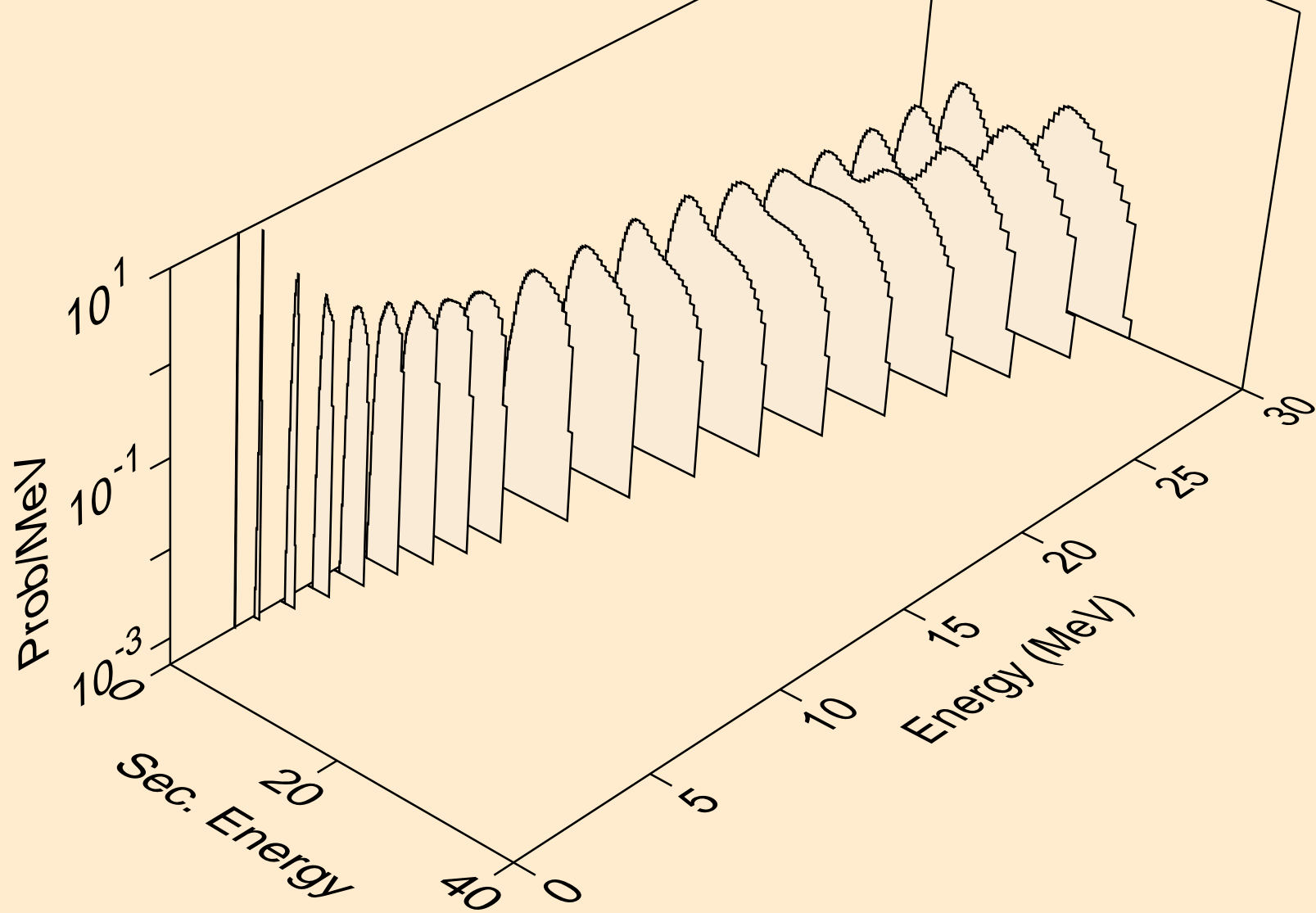

V050 DEUTERON ACER TENDL-2023 LIBRARY; T=0.K
protons from (d,2np)

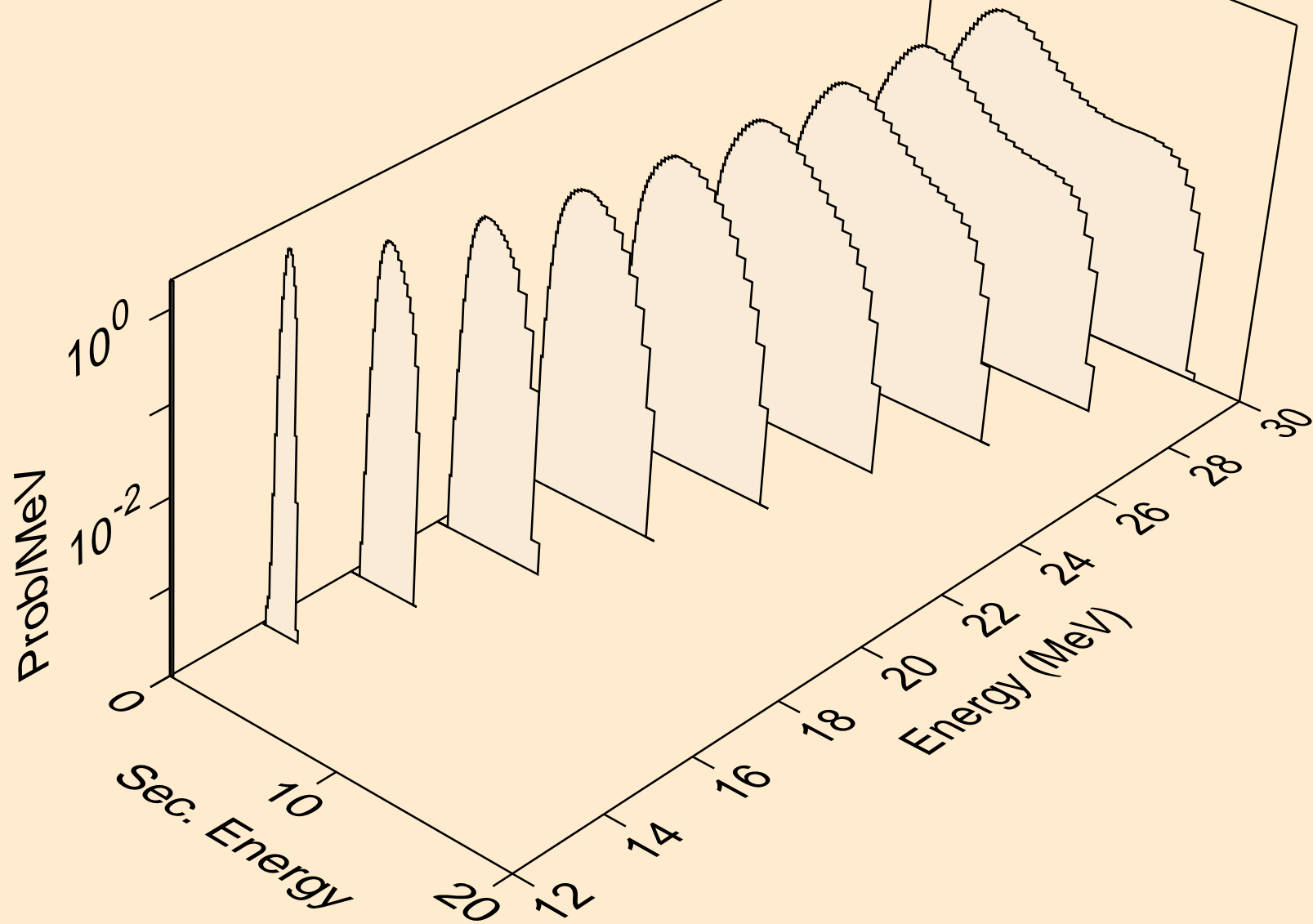

V050 DEUTERON ACER TENDL-2023 LIBRARY; T=0.K
protons from (d,3np)

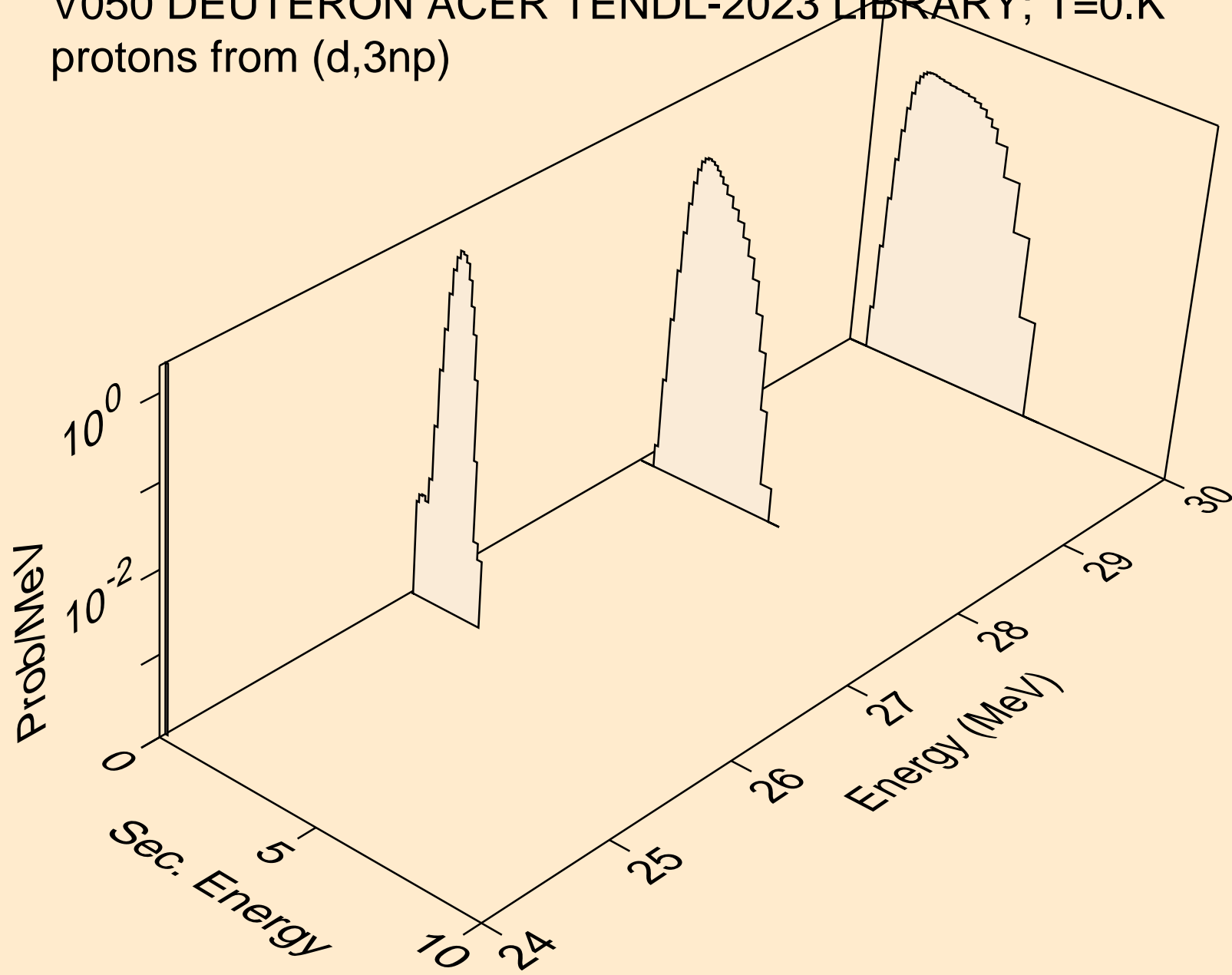

V050 DEUTERON ACER TENDL-2023 LIBRARY; T=0.K
protons from (d,n2p)

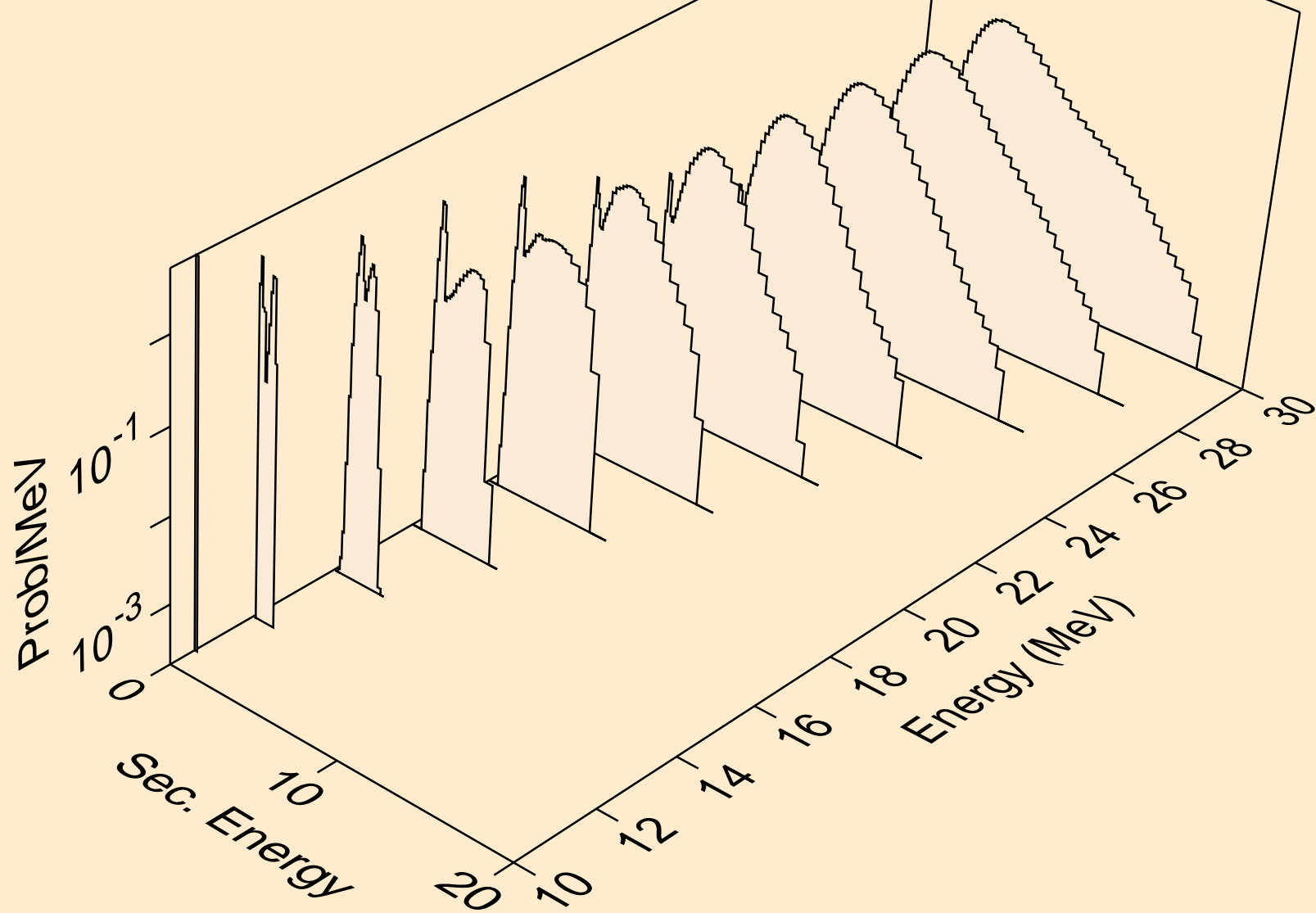

V050 DEUTERON ACER TENDL-2023 LIBRARY; T=0.K
protons from (d,npa)

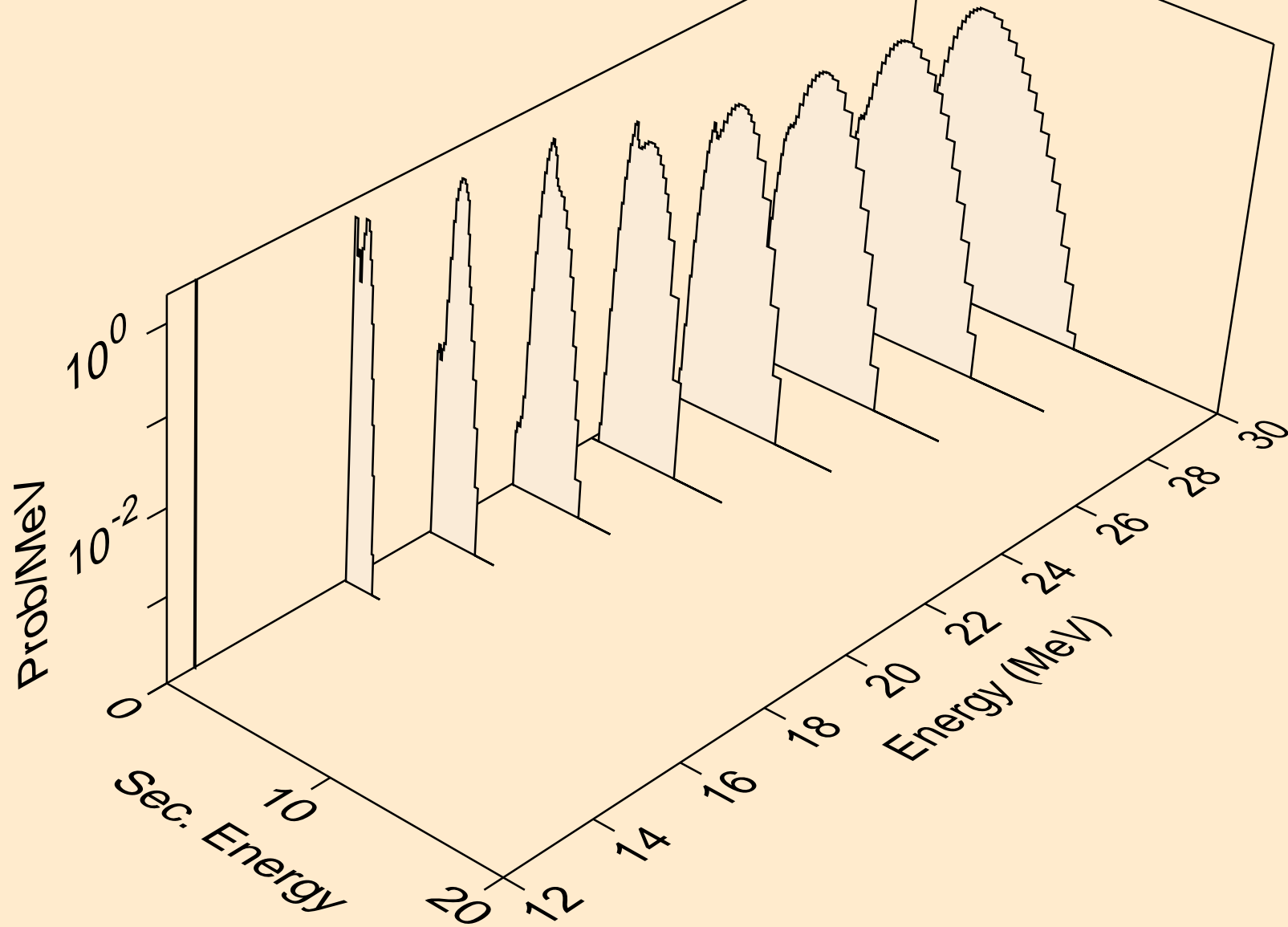

V050 DEUTERON ACER TENDL-2023 LIBRARY; T=0.K
protons from (d,p)

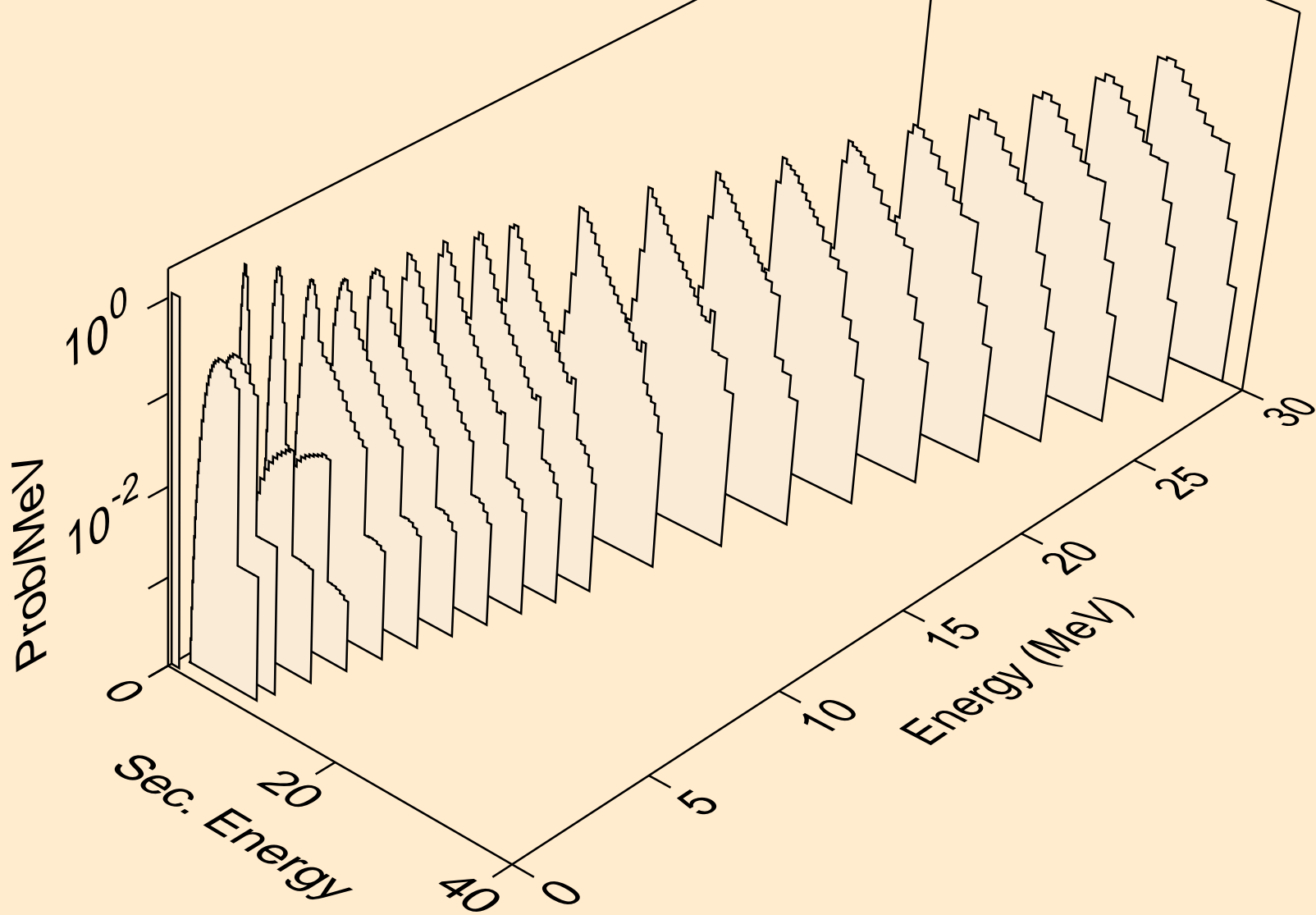

V050 DEUTERON ACER TENDL-2023 LIBRARY; T=0.K
protons from (d,2p)

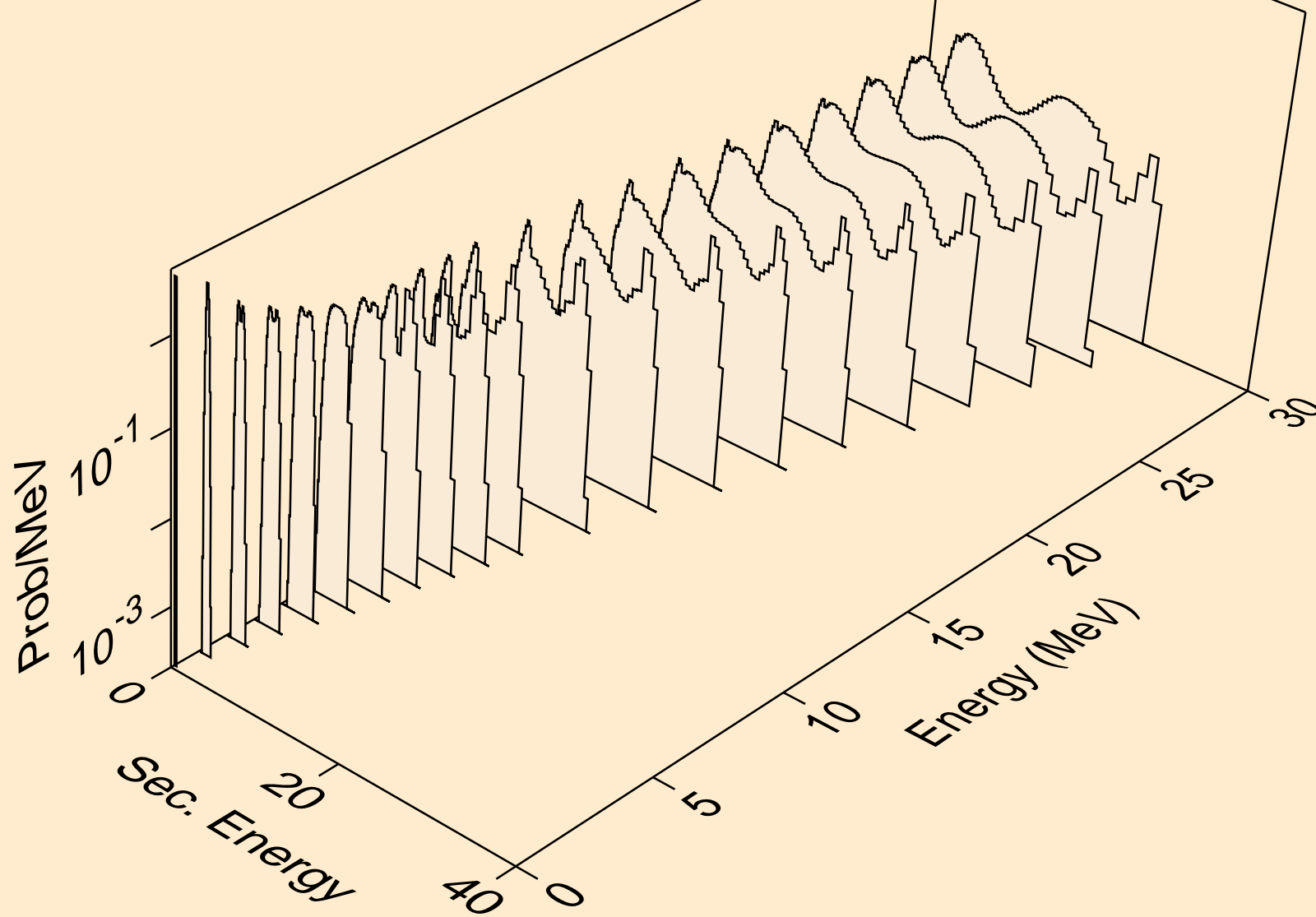

V050 DEUTERON ACER TENDL-2023 LIBRARY; T=0.K
protons from (d,pa)

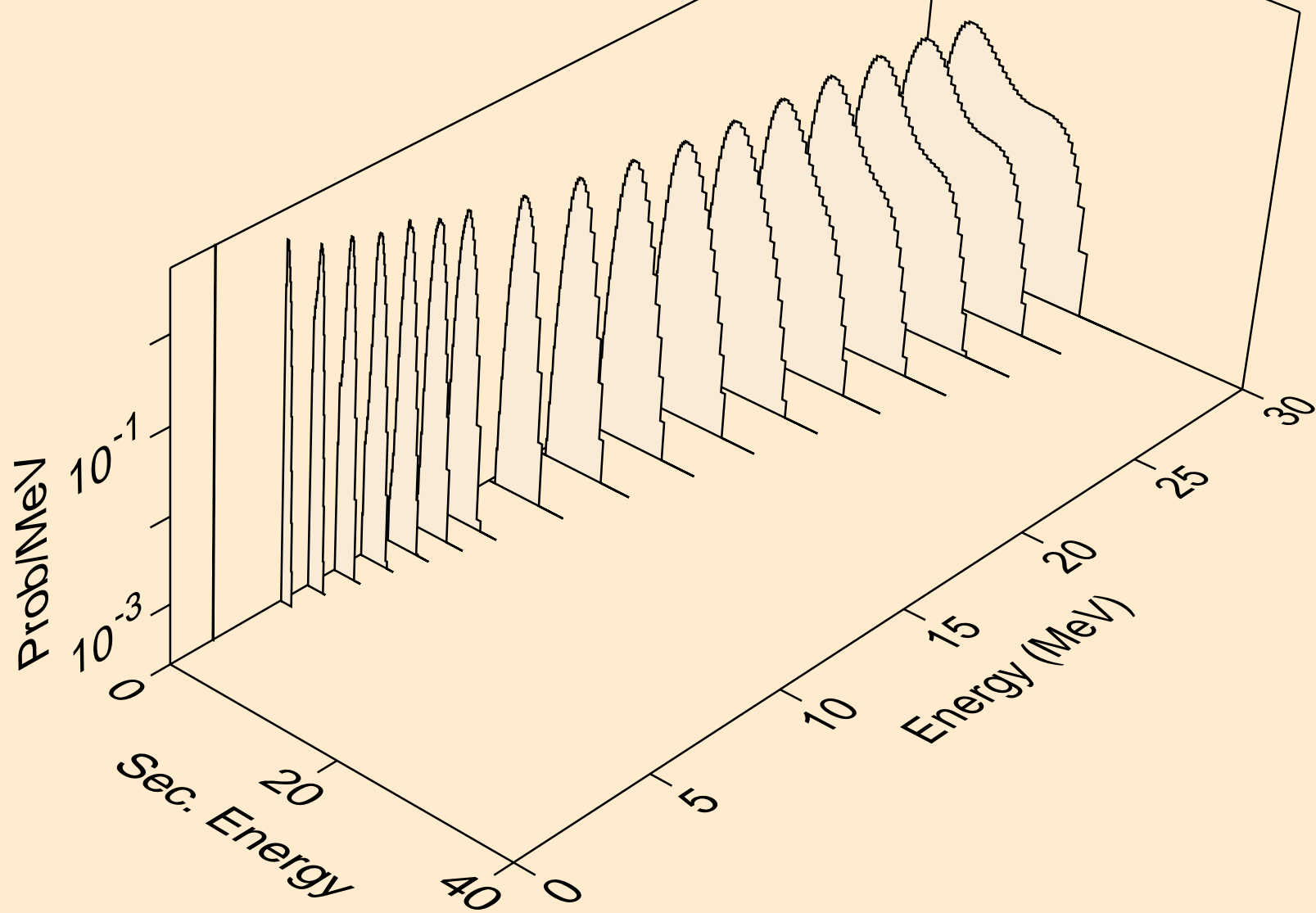

V050 DEUTERON ACER TENDL-2023 LIBRARY; T=0.K
protons from (d,pd)

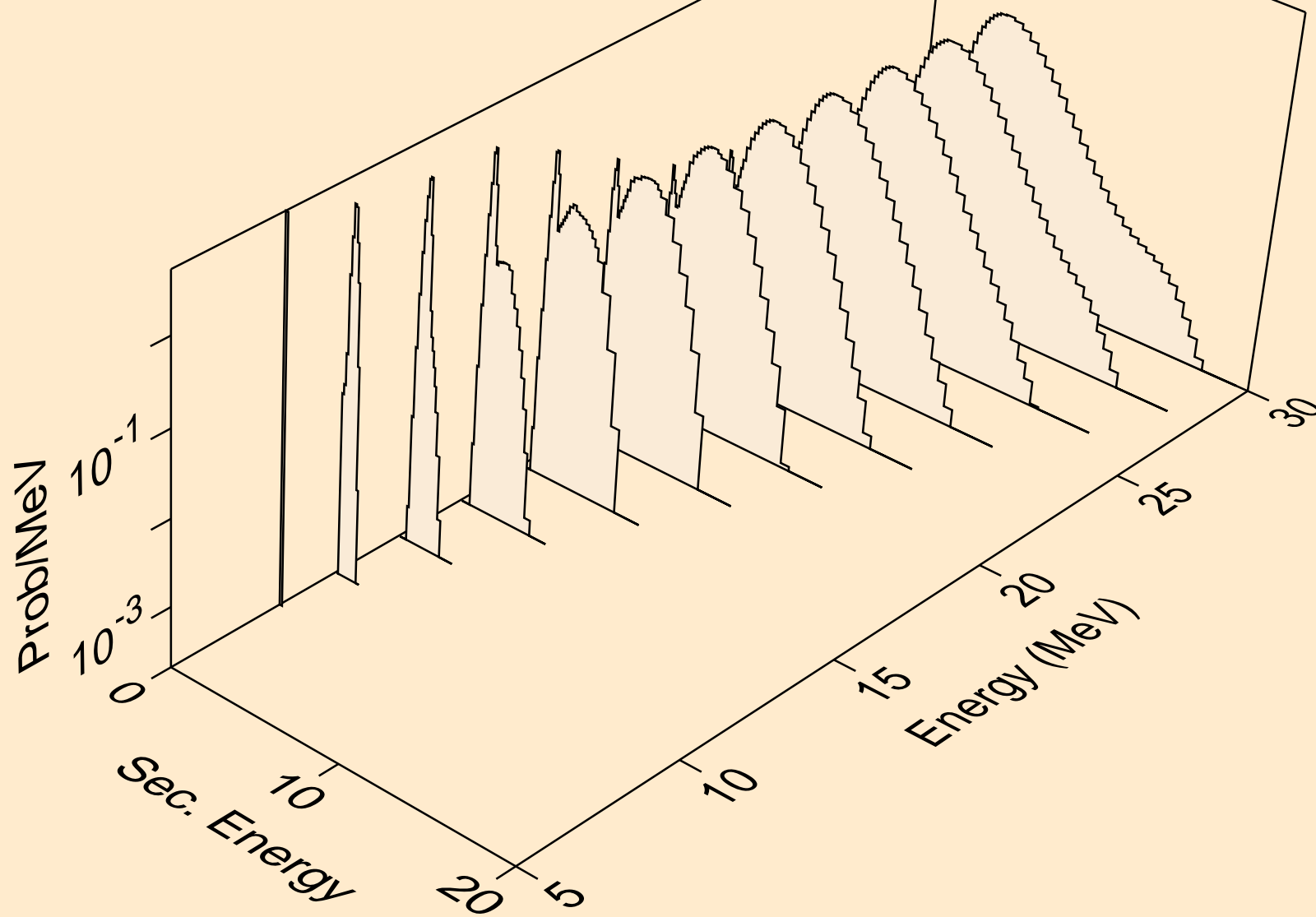

V050 DEUTERON ACER TENDL-2023 LIBRARY; T=0.K
protons from (d,pt)

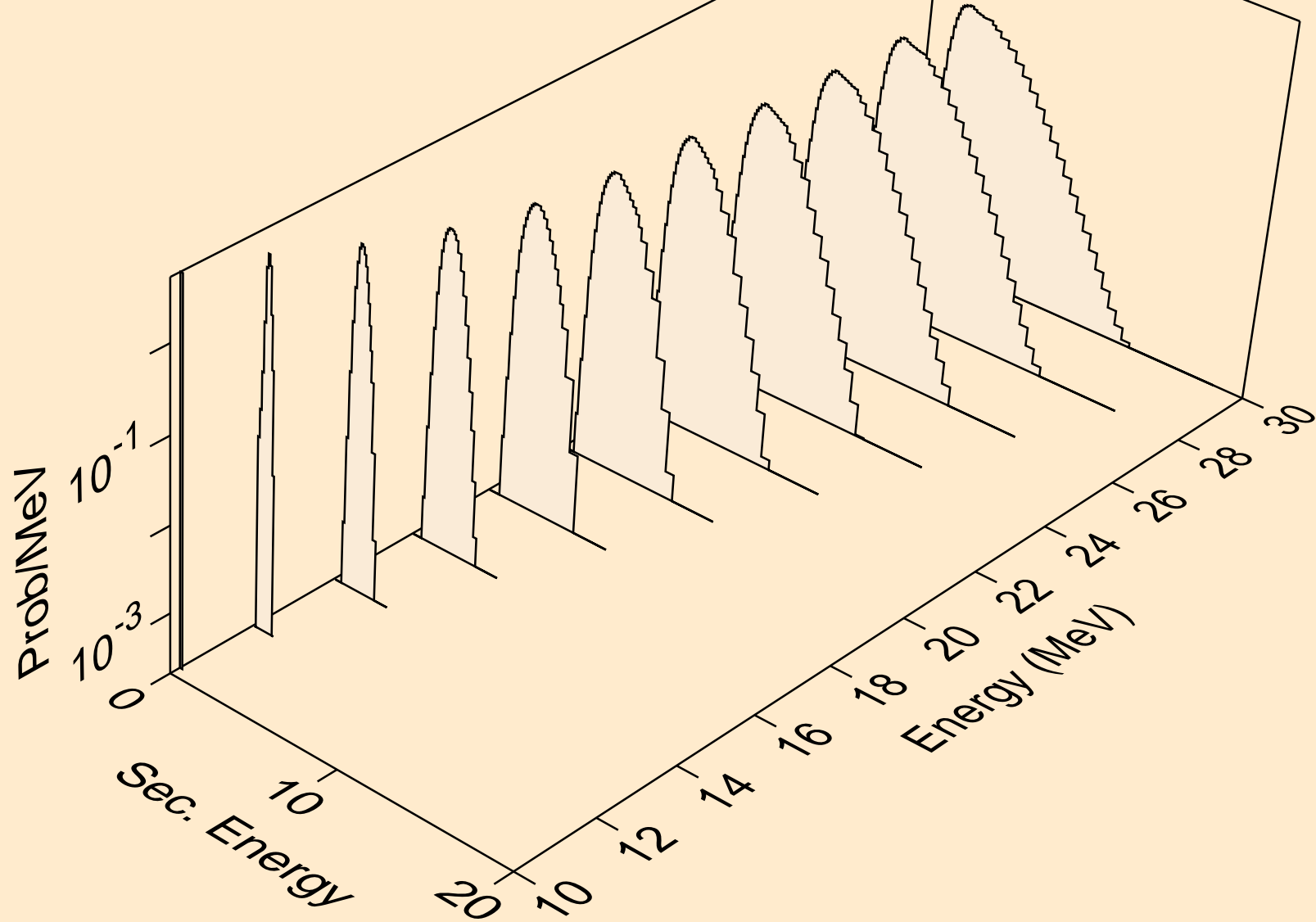

V050 DEUTERON ACER TENDL-2023 LIBRARY; T=0.K
tritons from (d,x)

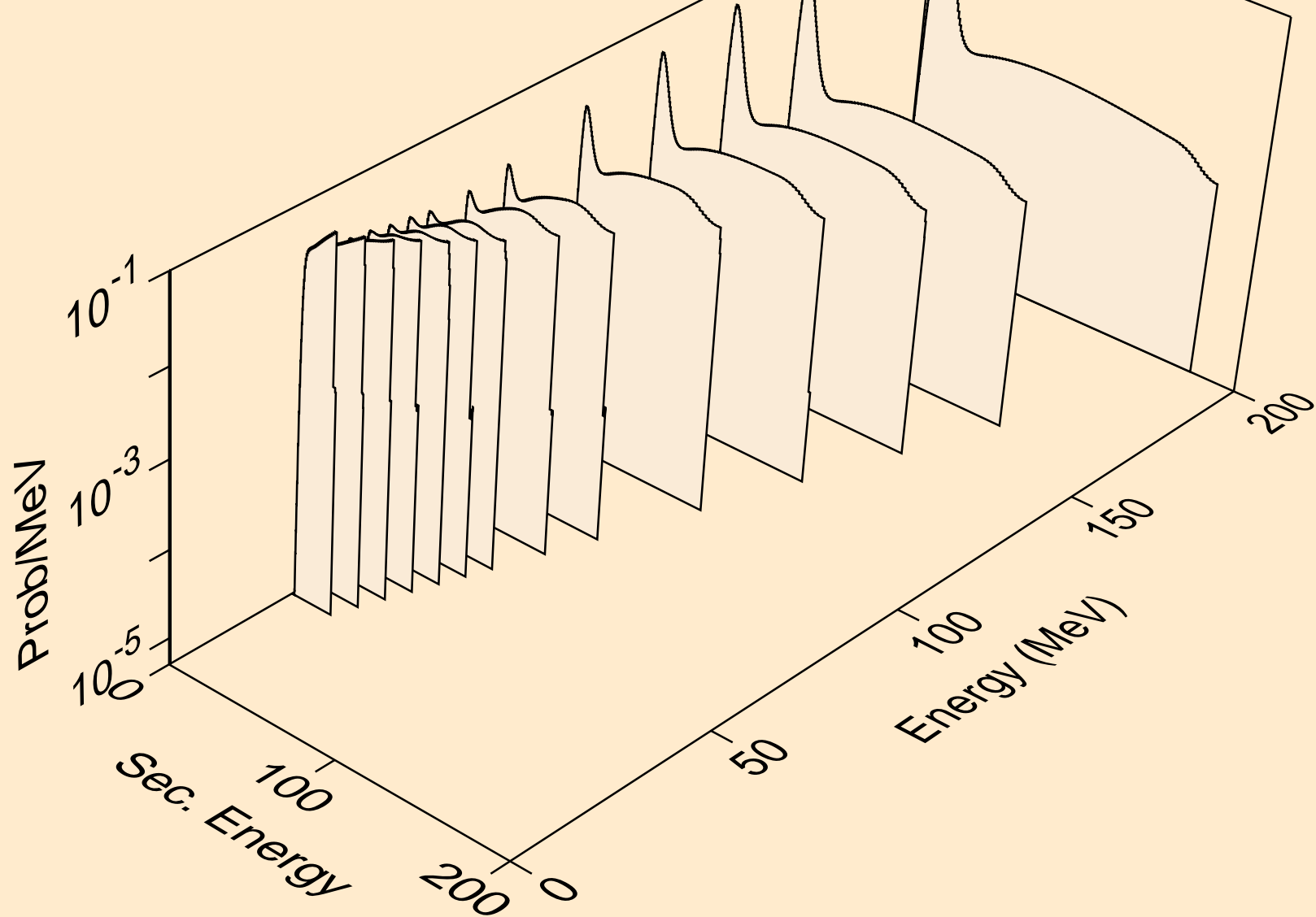

V050 DEUTERON ACER TENDL-2023 LIBRARY; T=0.K
tritons from (d,n*)t

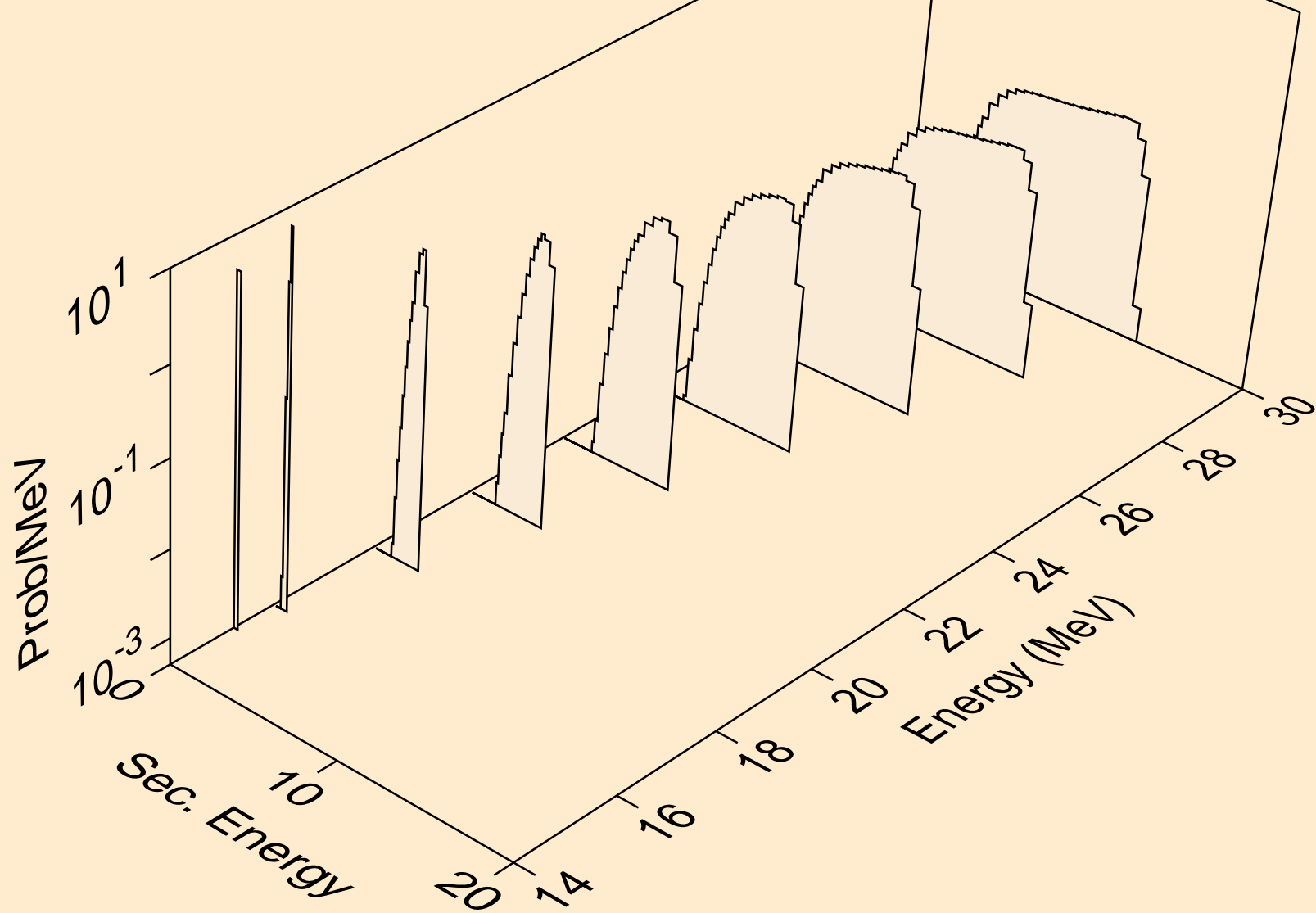

V050 DEUTERON ACER TENDL-2023 LIBRARY; T=0.K
tritons from (d,t)

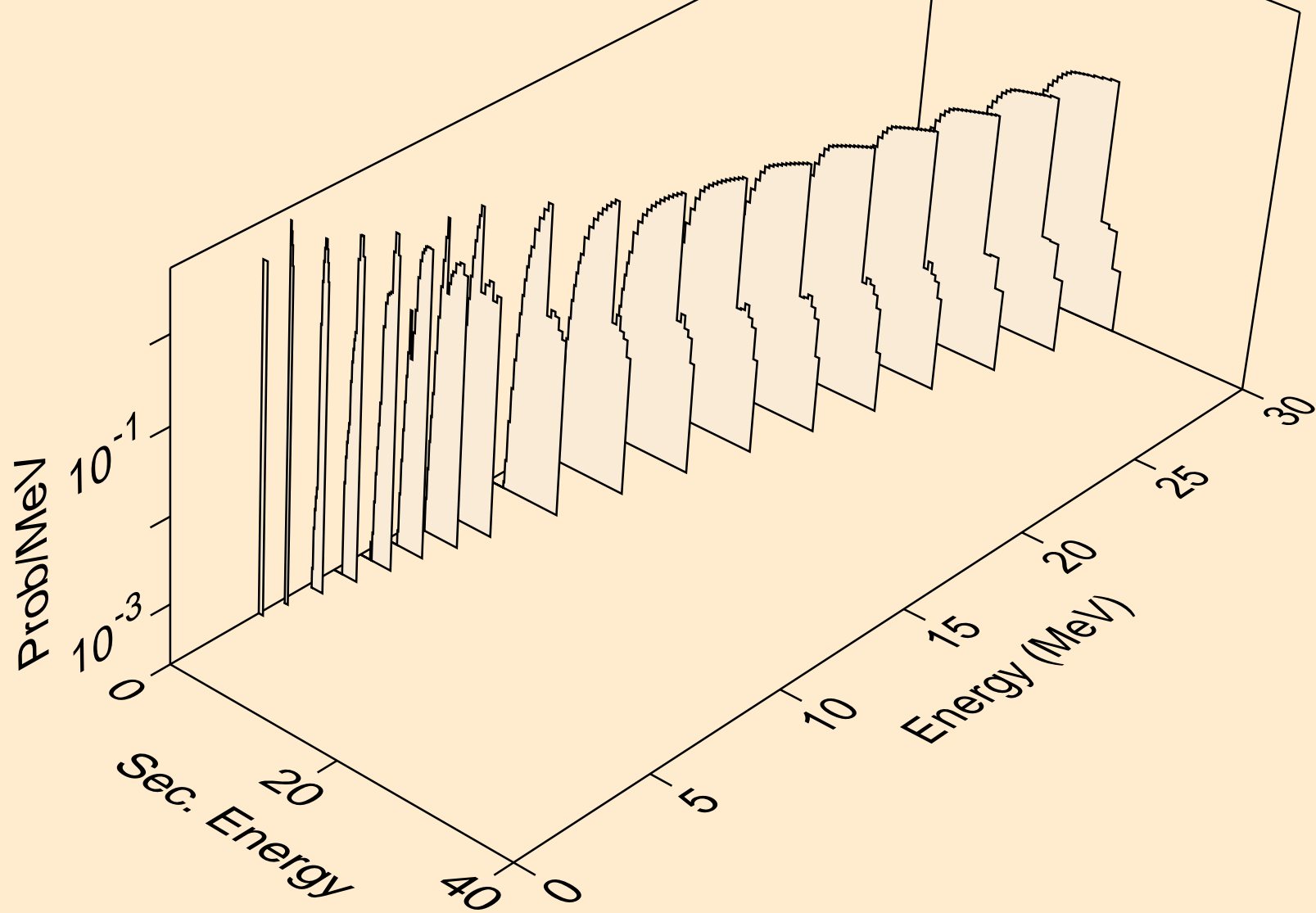

V050 DEUTERON ACER TENDL-2023 LIBRARY; T=0.K
tritons from (d,pt)

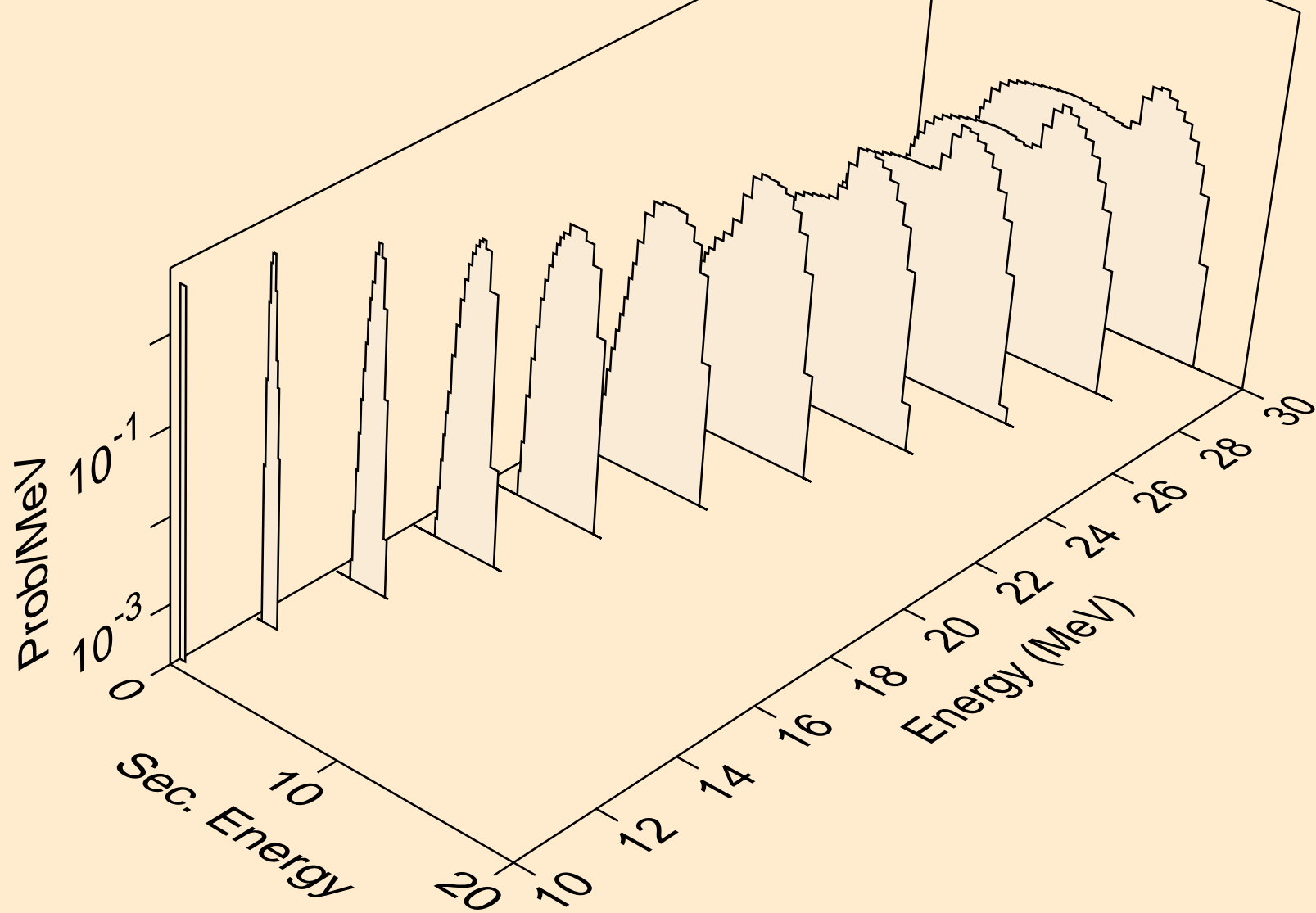

V050 DEUTERON ACER TENDL-2023 LIBRARY; T=0.K
he3s from (d,x)

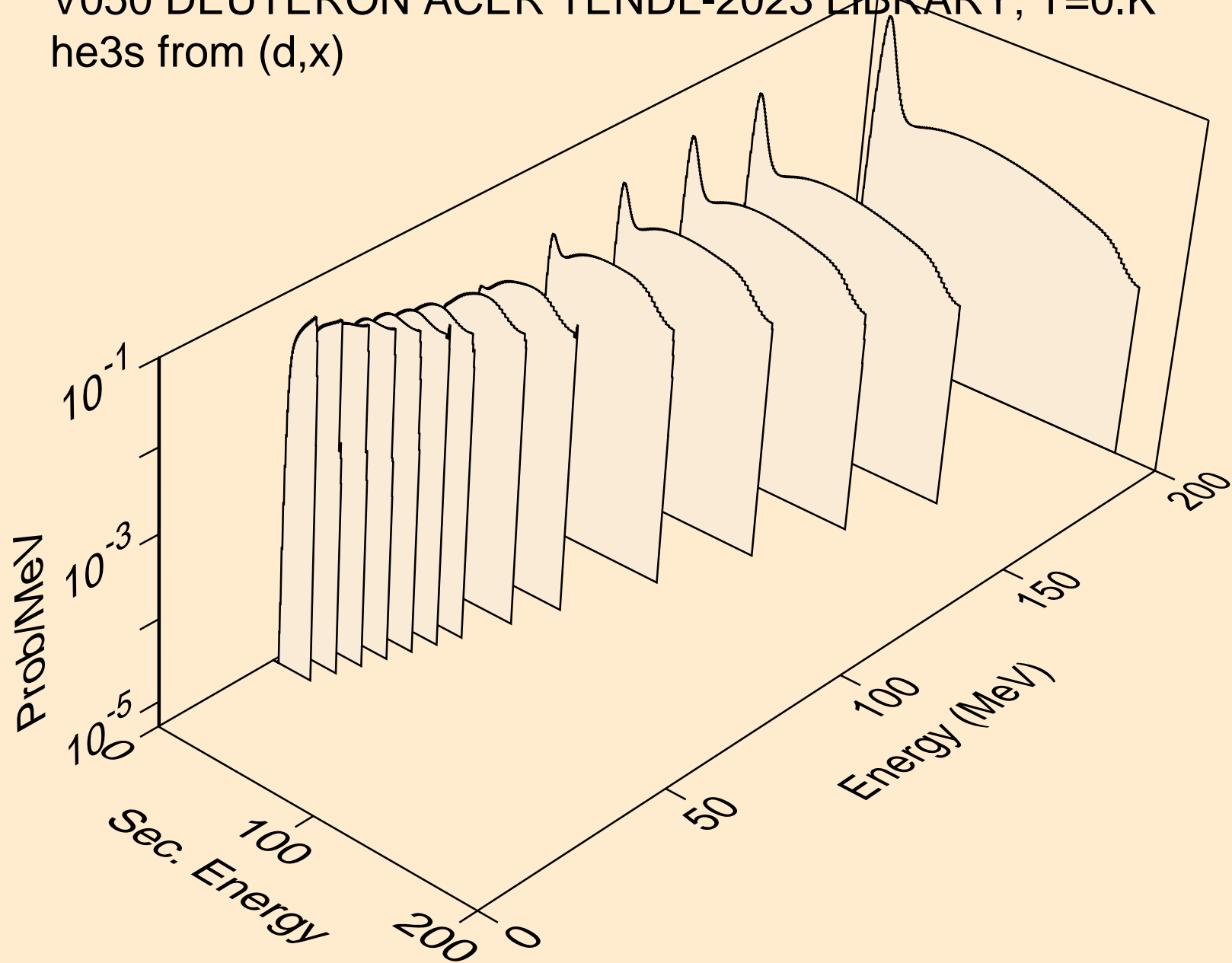

V050 DEUTERON ACER TENDL-2023 LIBRARY; T=0.K
he3s from (d,n*)he3

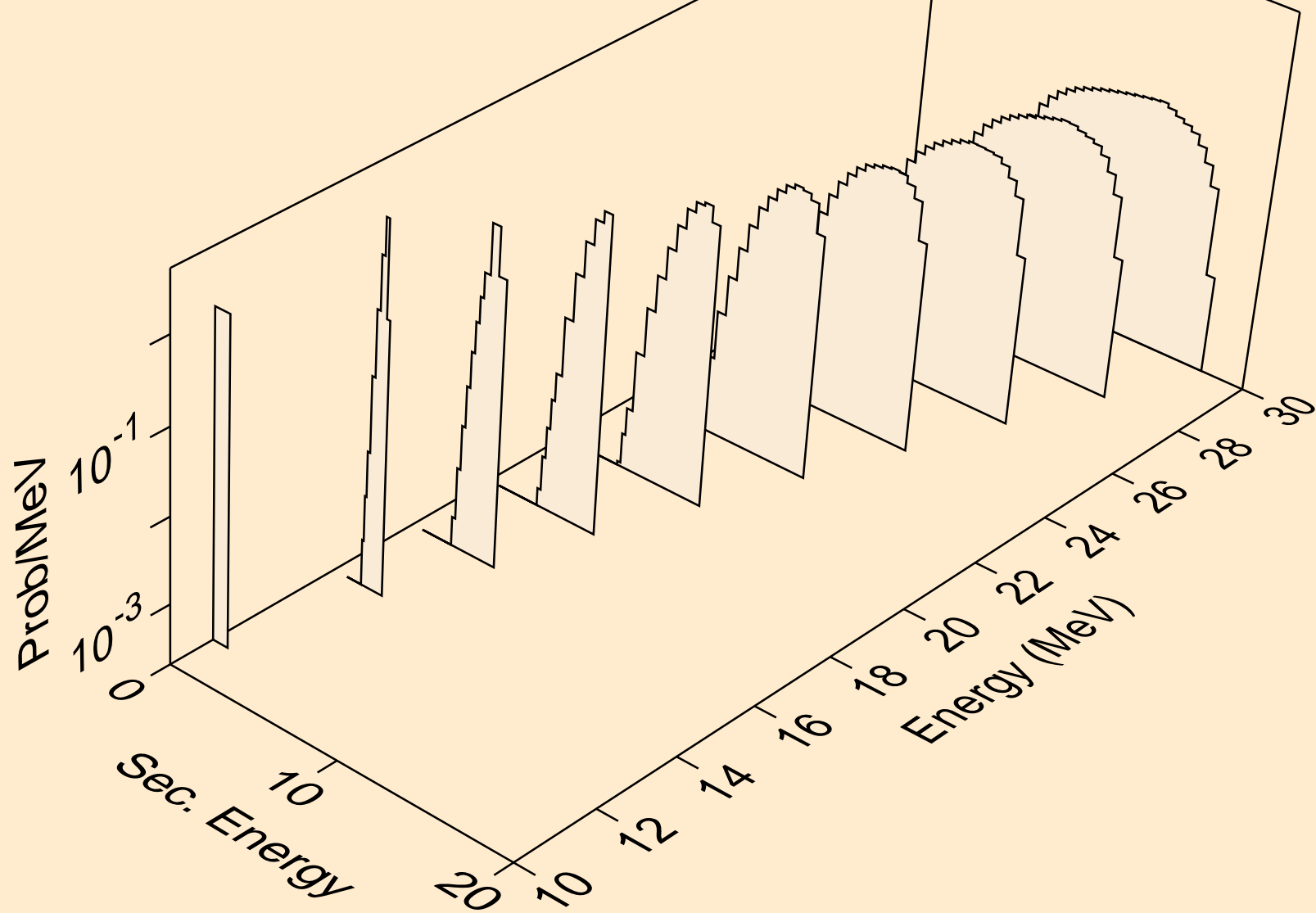

V050 DEUTERON ACER TENDL-2023 LIBRARY; T=0.K
he3s from (d,he3)

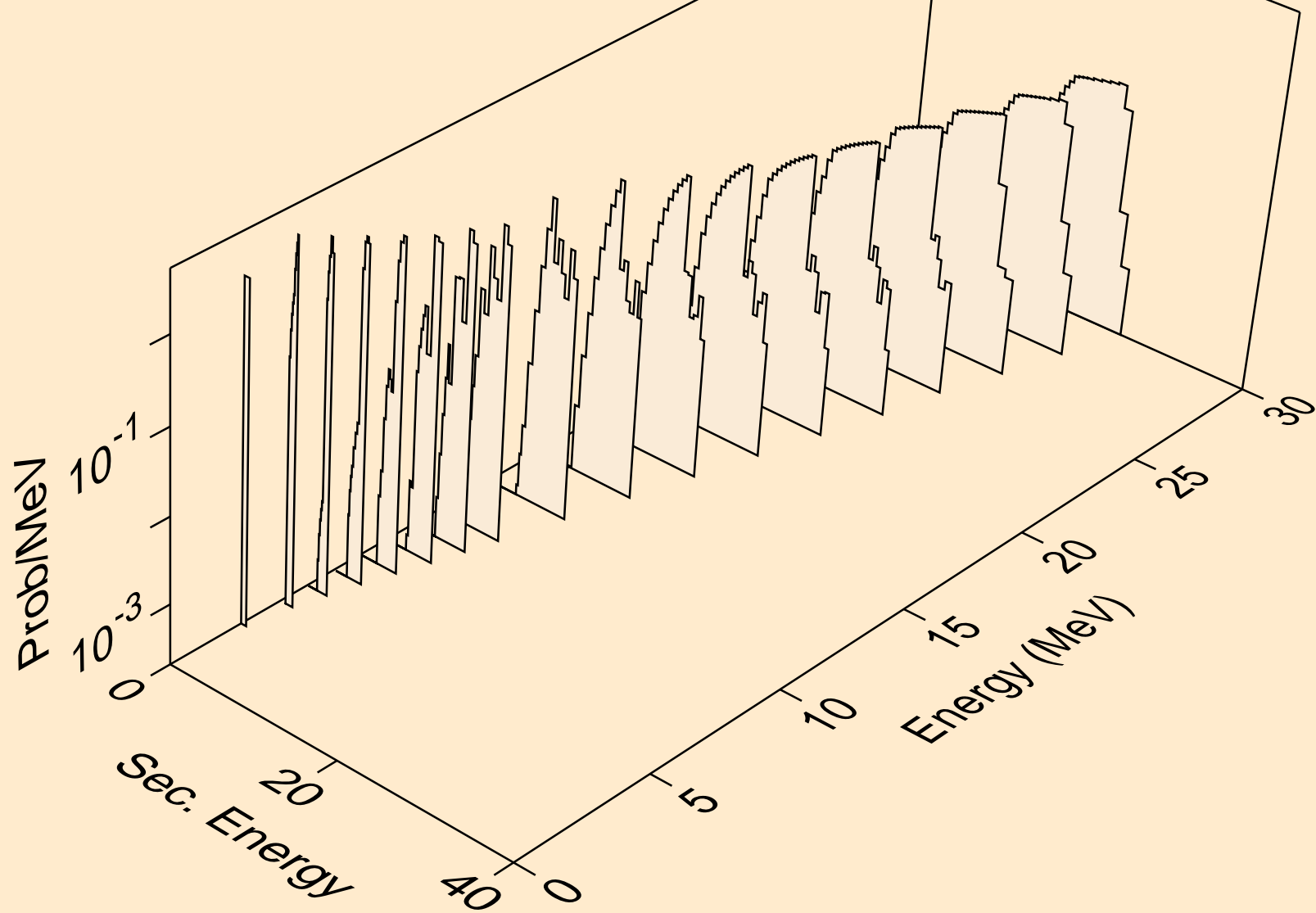

V050 DEUTERON ACER TENDL-2023 LIBRARY; T=0.K
alphas from (d,x)

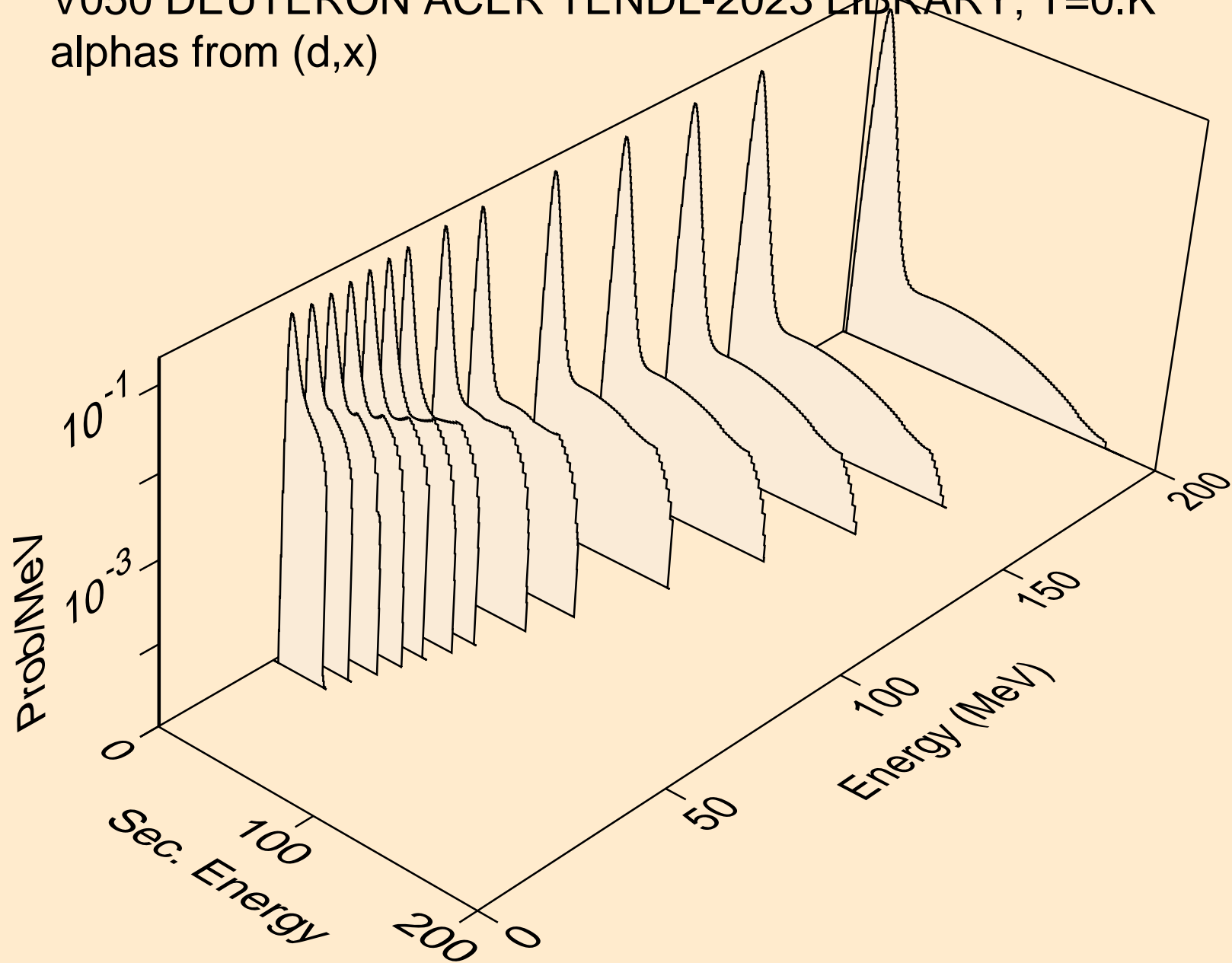

V050 DEUTERON ACER TENDL-2023 LIBRARY; T=0.K
alphas from (d,n*)a

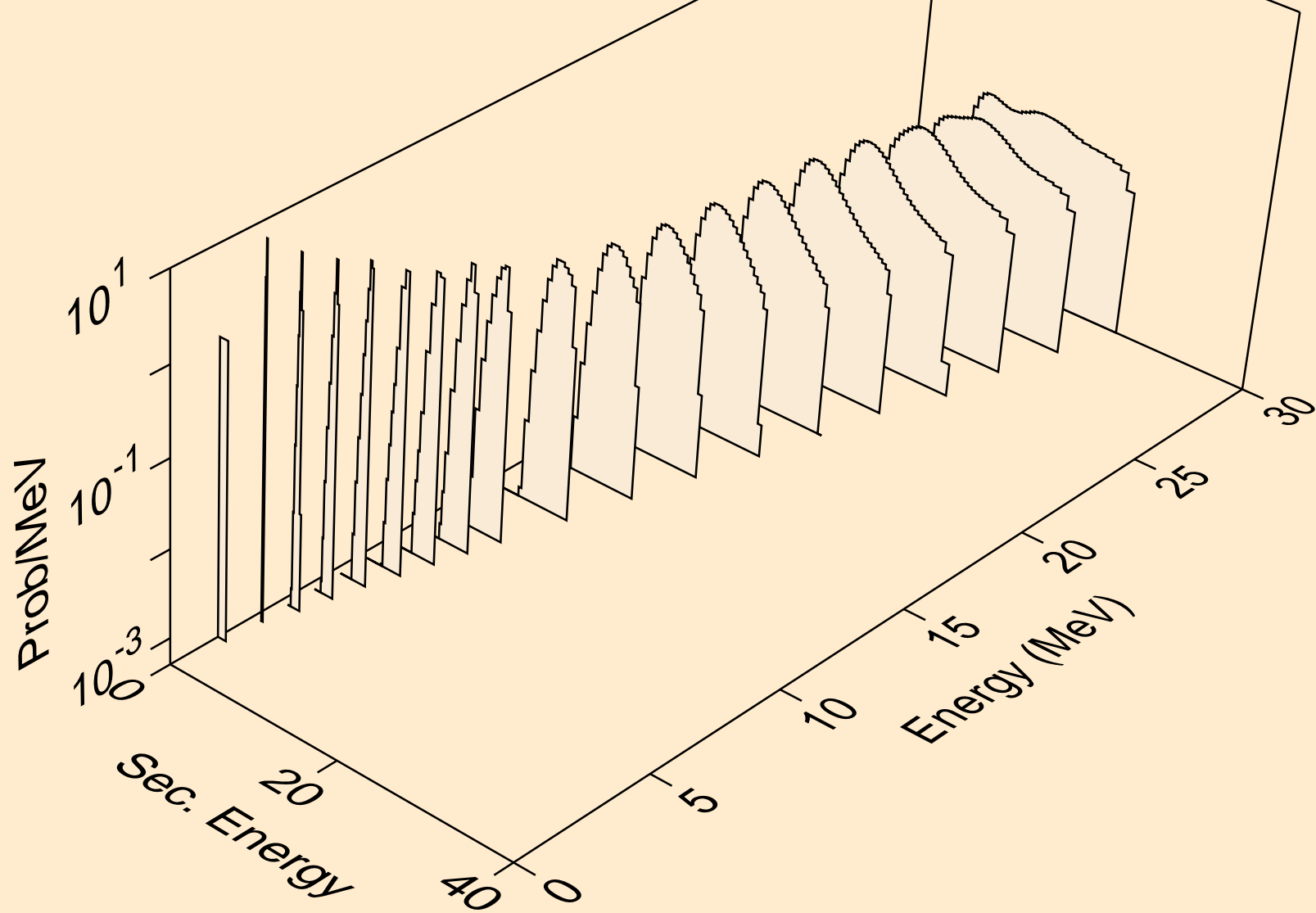

V050 DEUTERON ACER TENDL-2023 LIBRARY; T=0.K
alphas from (d,2n)a

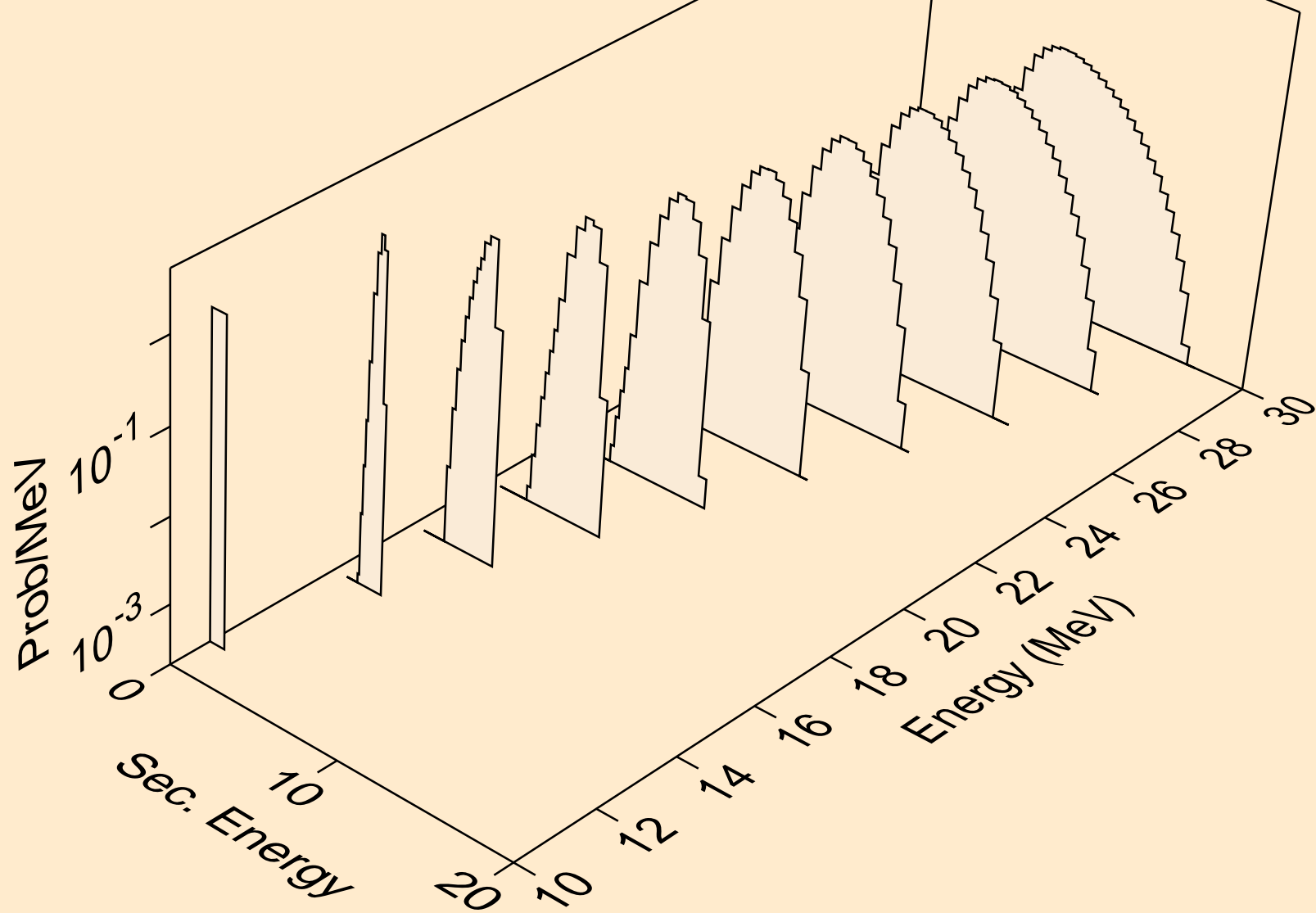

V050 DEUTERON ACER TENDL-2023 LIBRARY; T=0.K
alphas from (d,3n)a

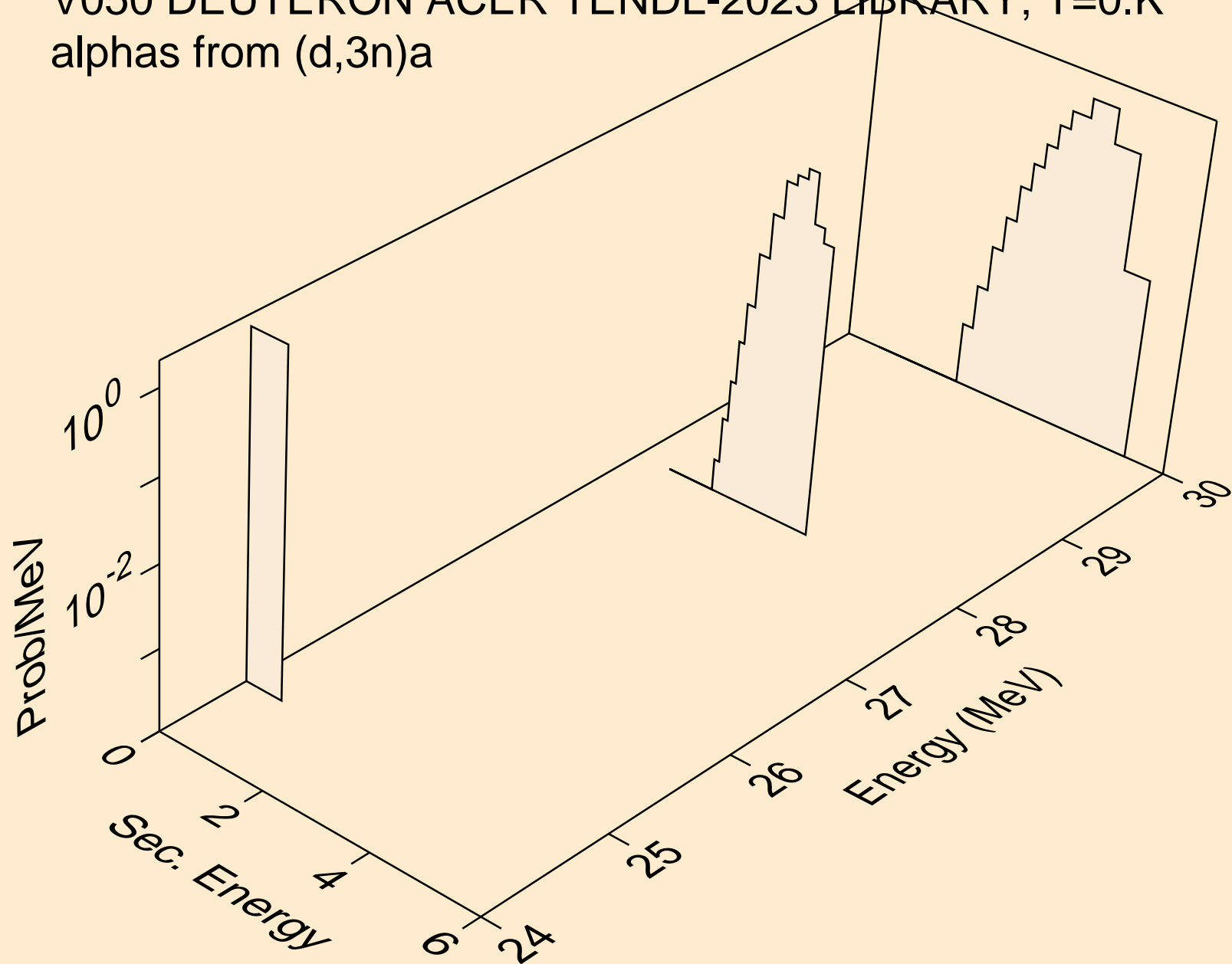

V050 DEUTERON ACER TENDL-2023 LIBRARY; T=0.K
alphas from (d,n*)2a

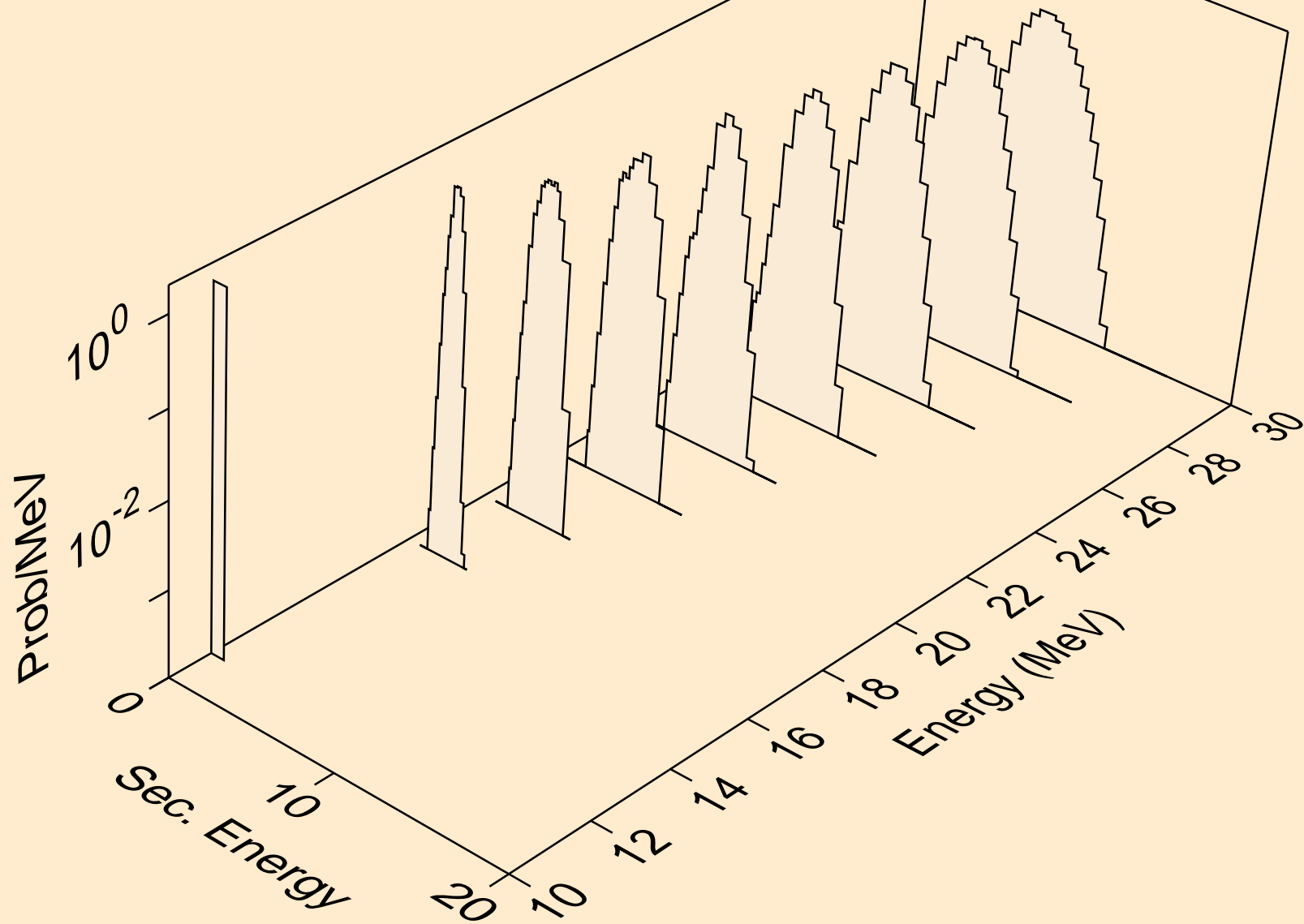

V050 DEUTERON ACER TENDL-2023 LIBRARY; T=0.K
alphas from (d,2n)2a

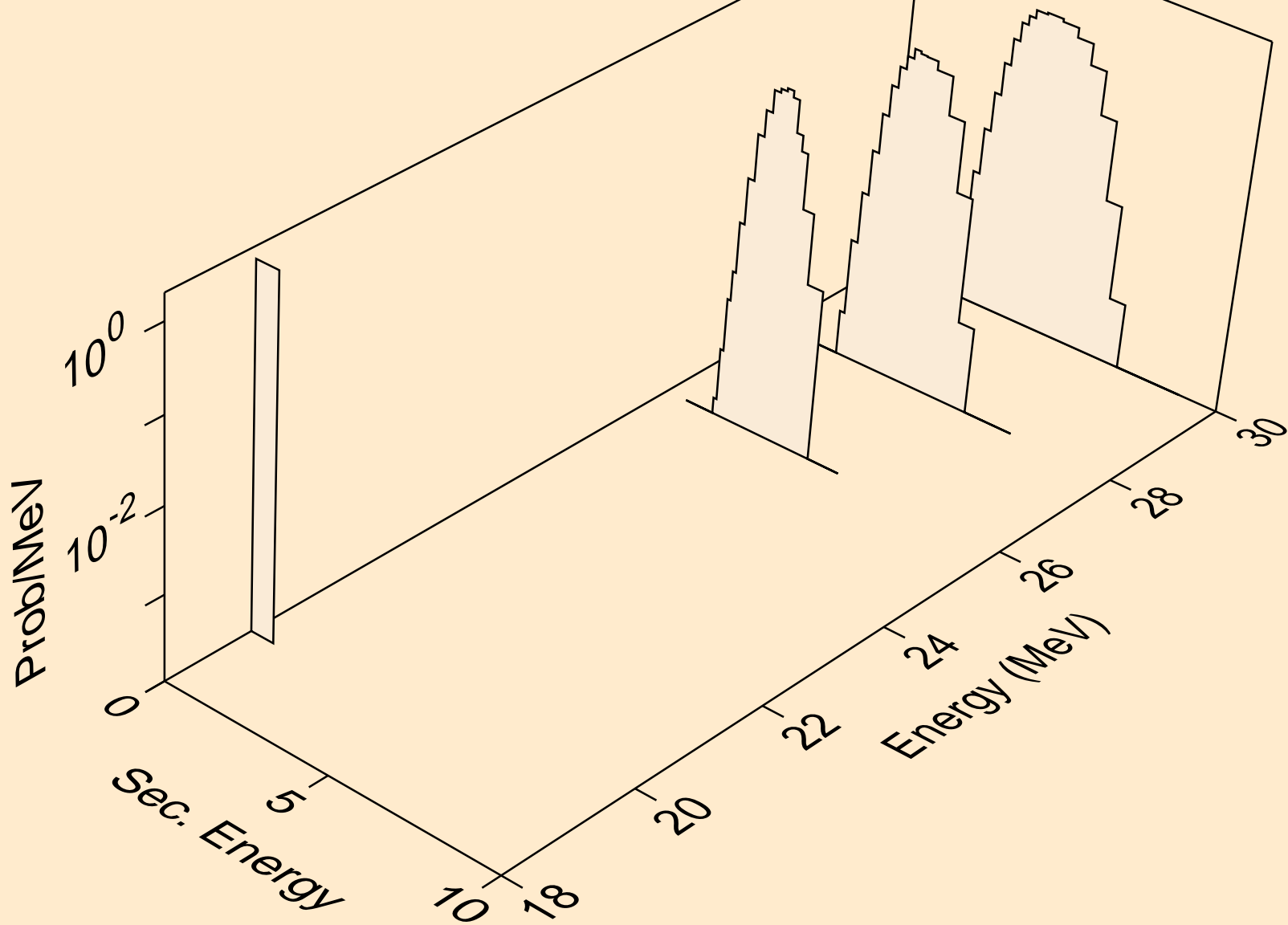

V050 DEUTERON ACER TENDL-2023 LIBRARY; T=0.K
alphas from (d,npa)

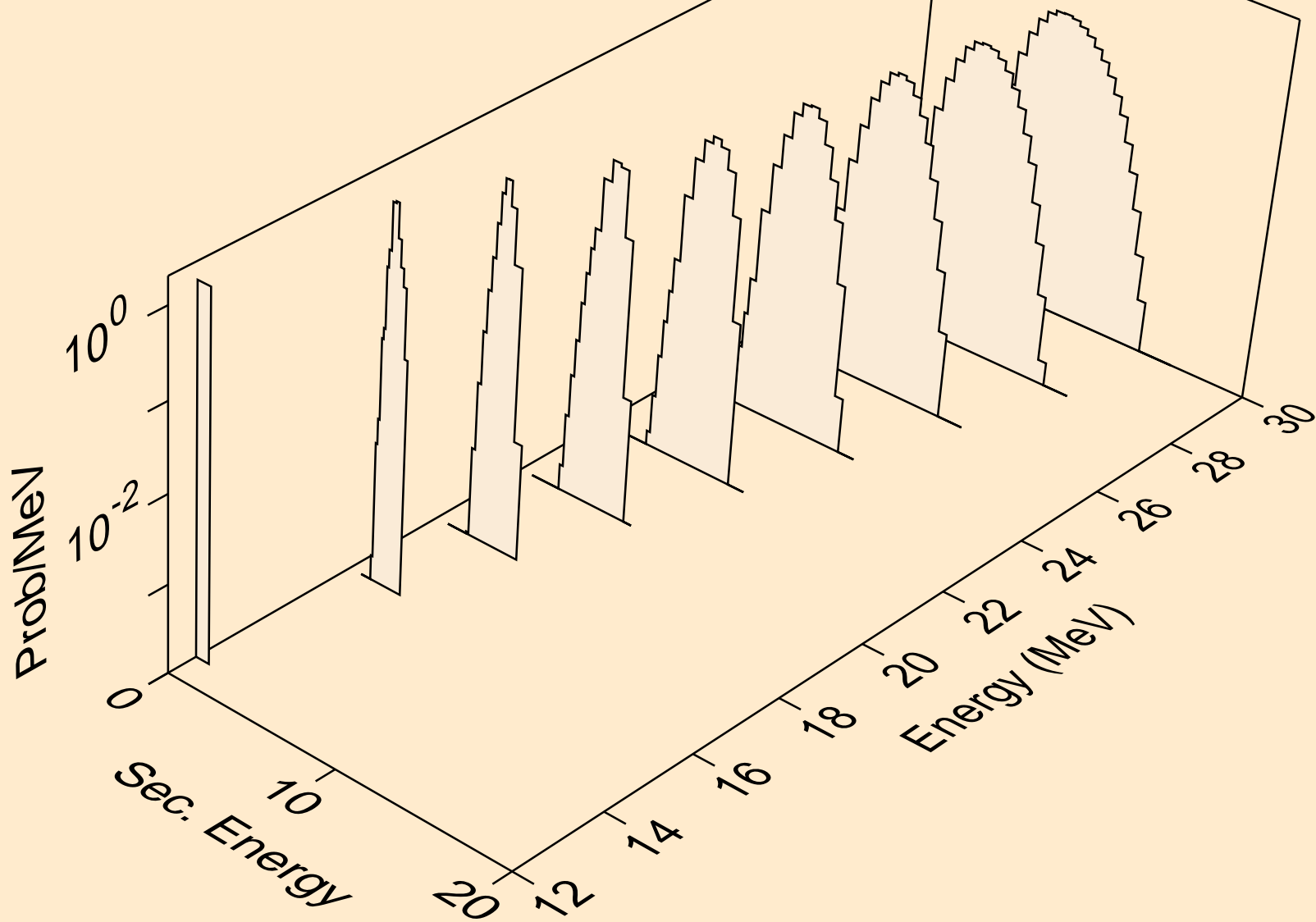

V050 DEUTERON ACER TENDL-2023 LIBRARY; T=0.K
alphas from (d,a)

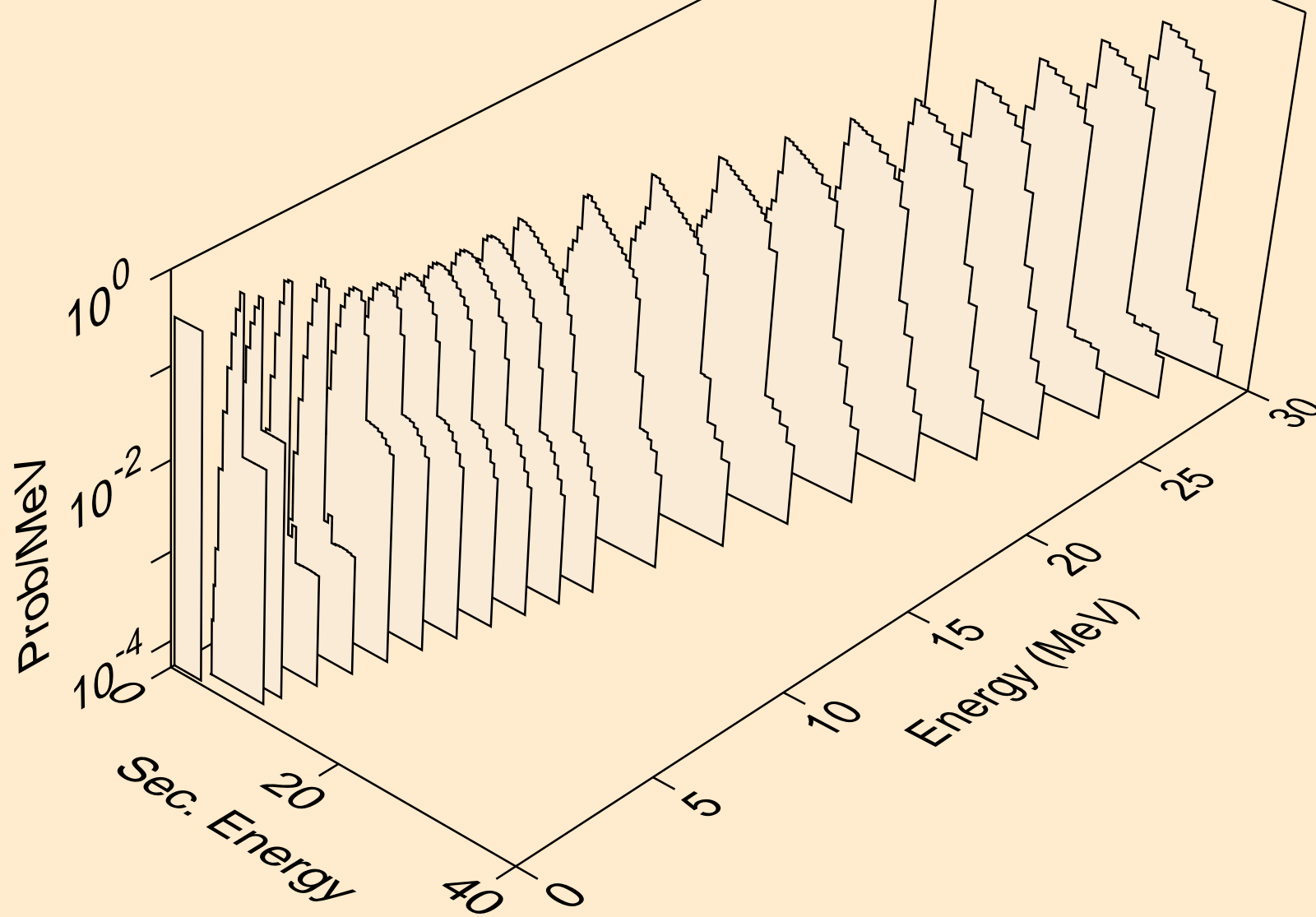

V050 DEUTERON ACER TENDL-2023 LIBRARY; T=0.K
alphas from (d,2a)

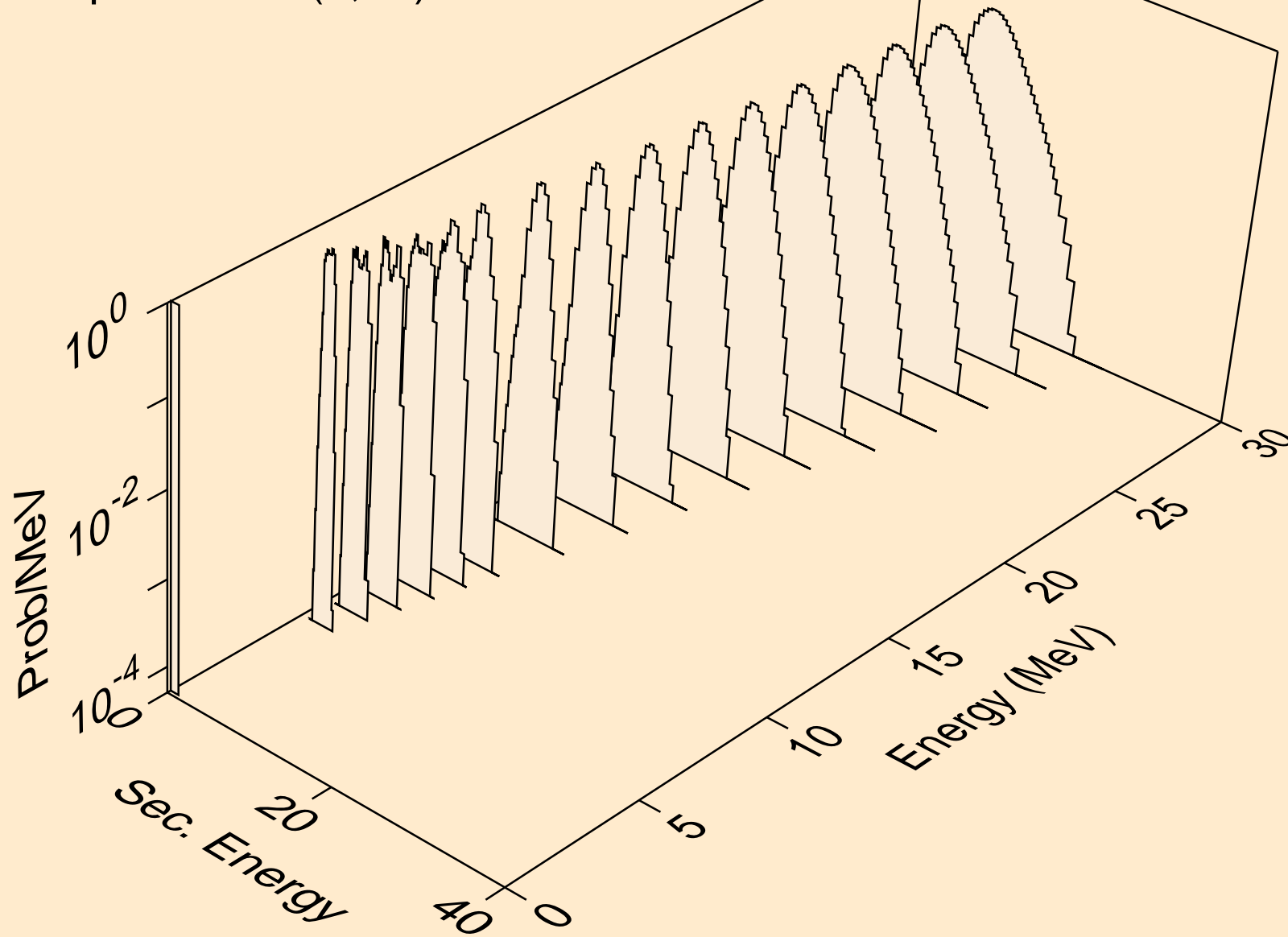

V050 DEUTERON ACER TENDL-2023 LIBRARY; T=0.K
alphas from (d,3a)

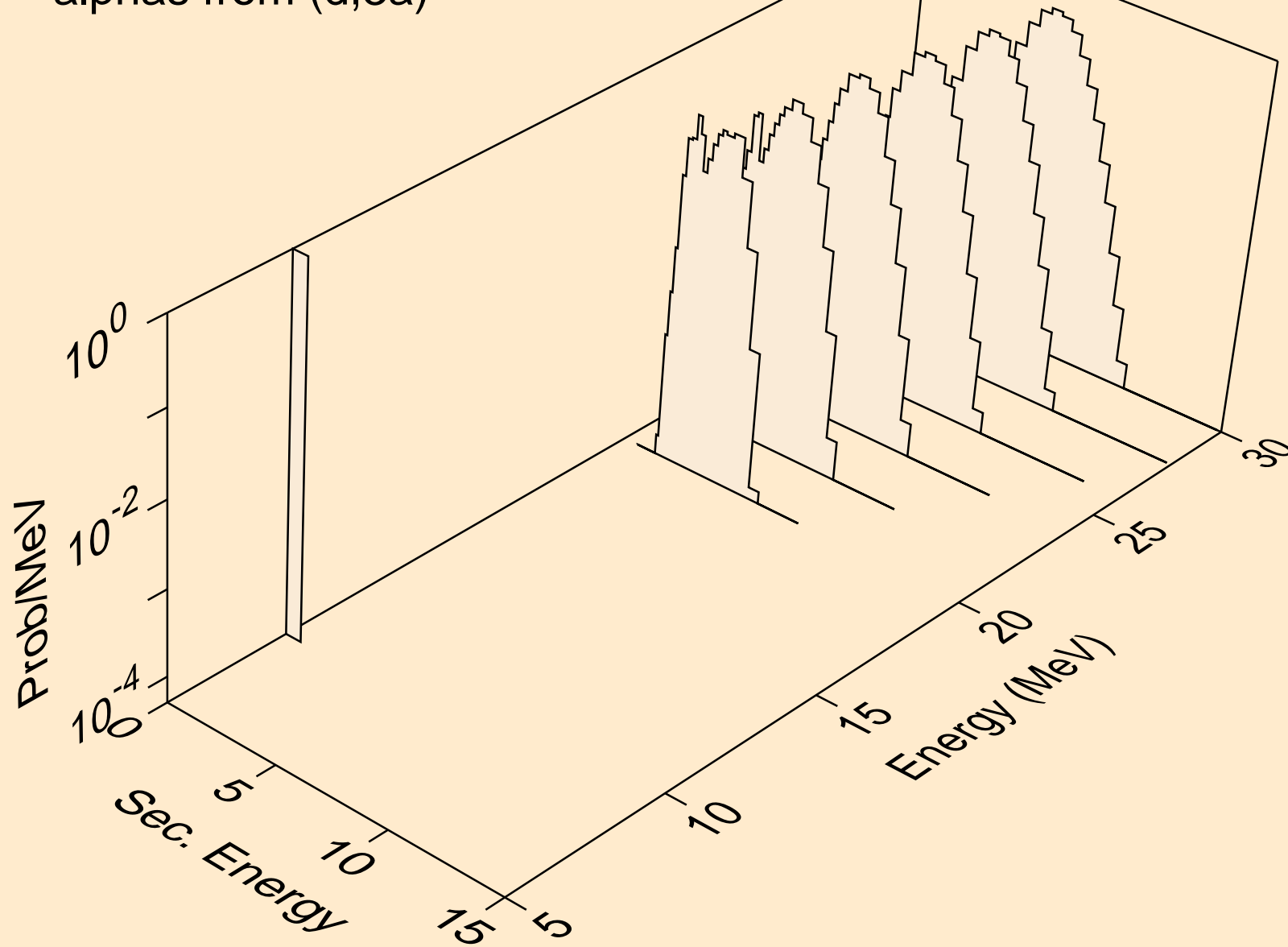

V050 DEUTERON ACER TENDL-2023 LIBRARY; T=0.K
alphas from (d,pa)

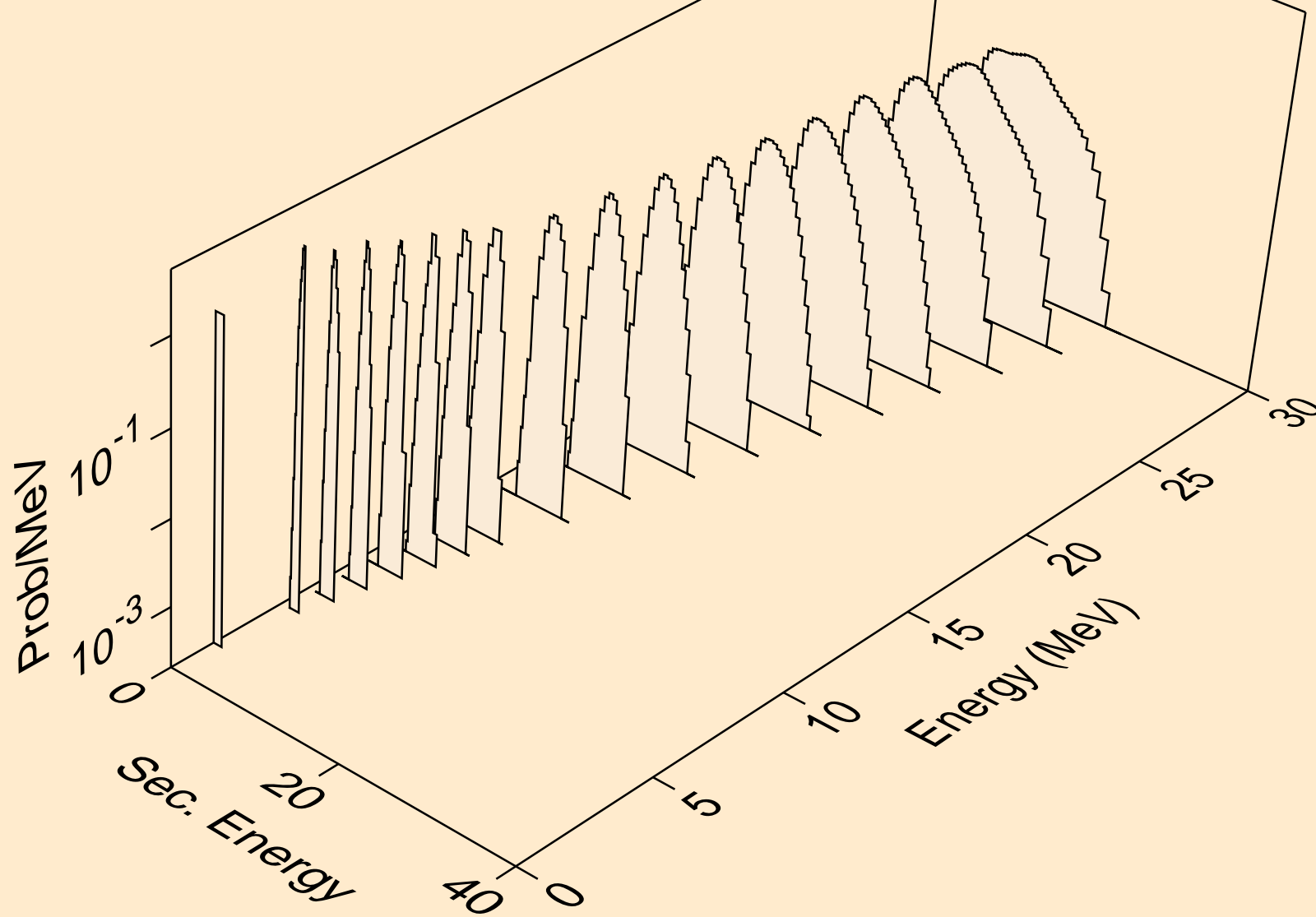

V050 DEUTERON ACER TENDL-2023 LIBRARY; T=0.K
alphas from (d,da)

