

PO204 PHOTON ACER TENDL-2023 LIBRARY; T=0.K
Principal cross sections

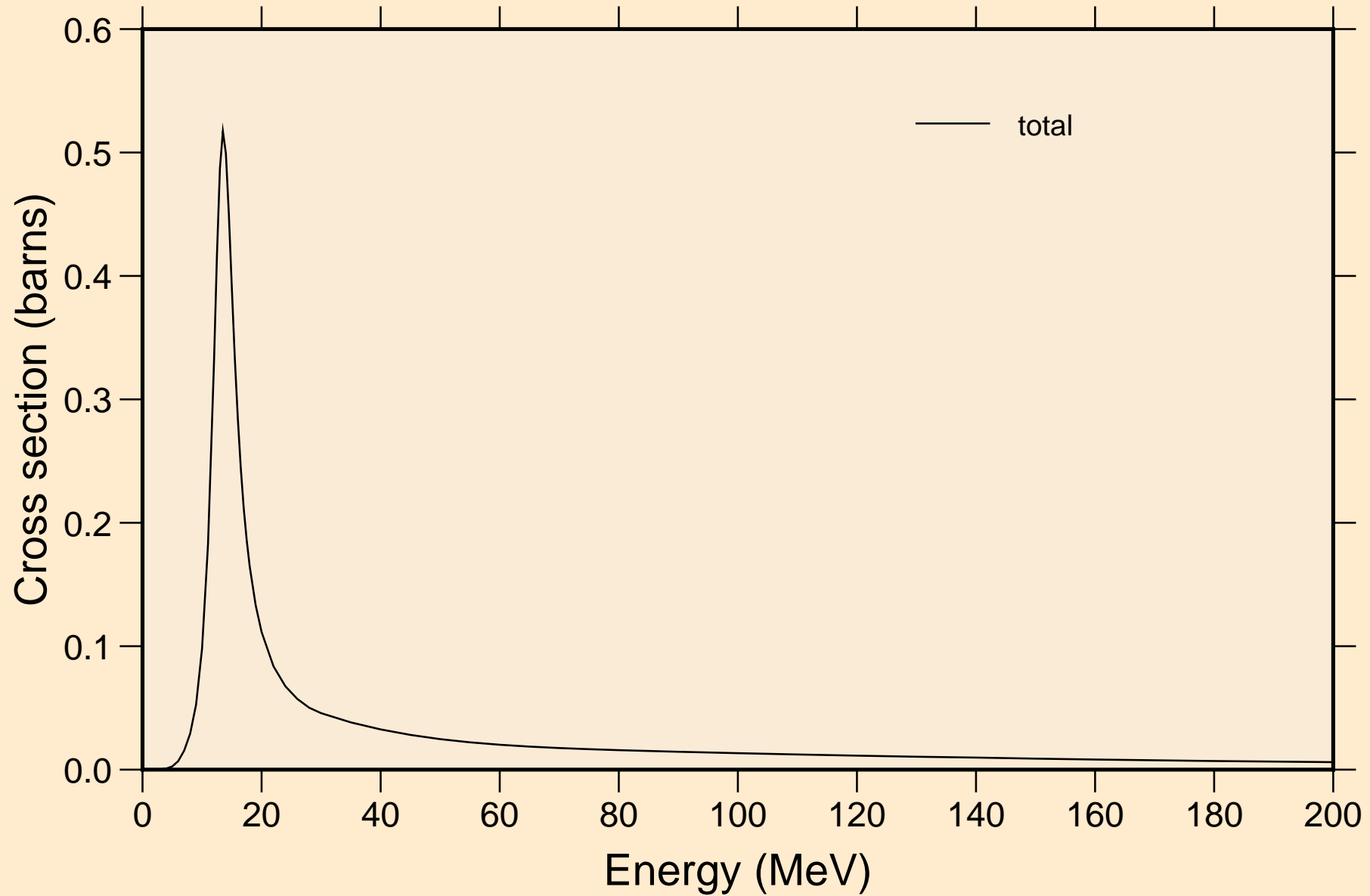

PO204 PHOTON ACER TENDL-2023 LIBRARY; T=0.K
Partial cross sections

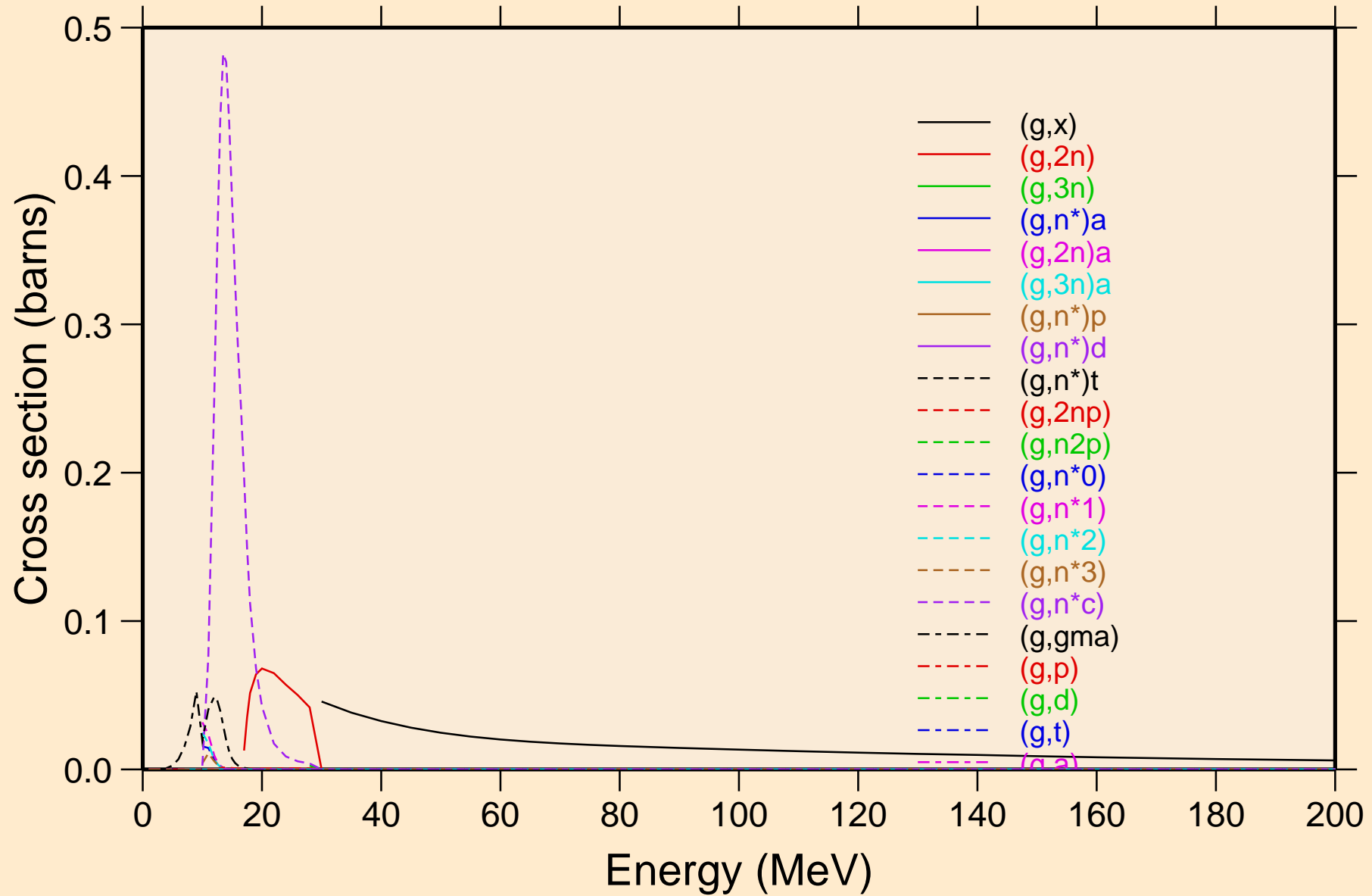

PO204 PHOTON ACER TENDL-2023 LIBRARY; T=0.K

Heating

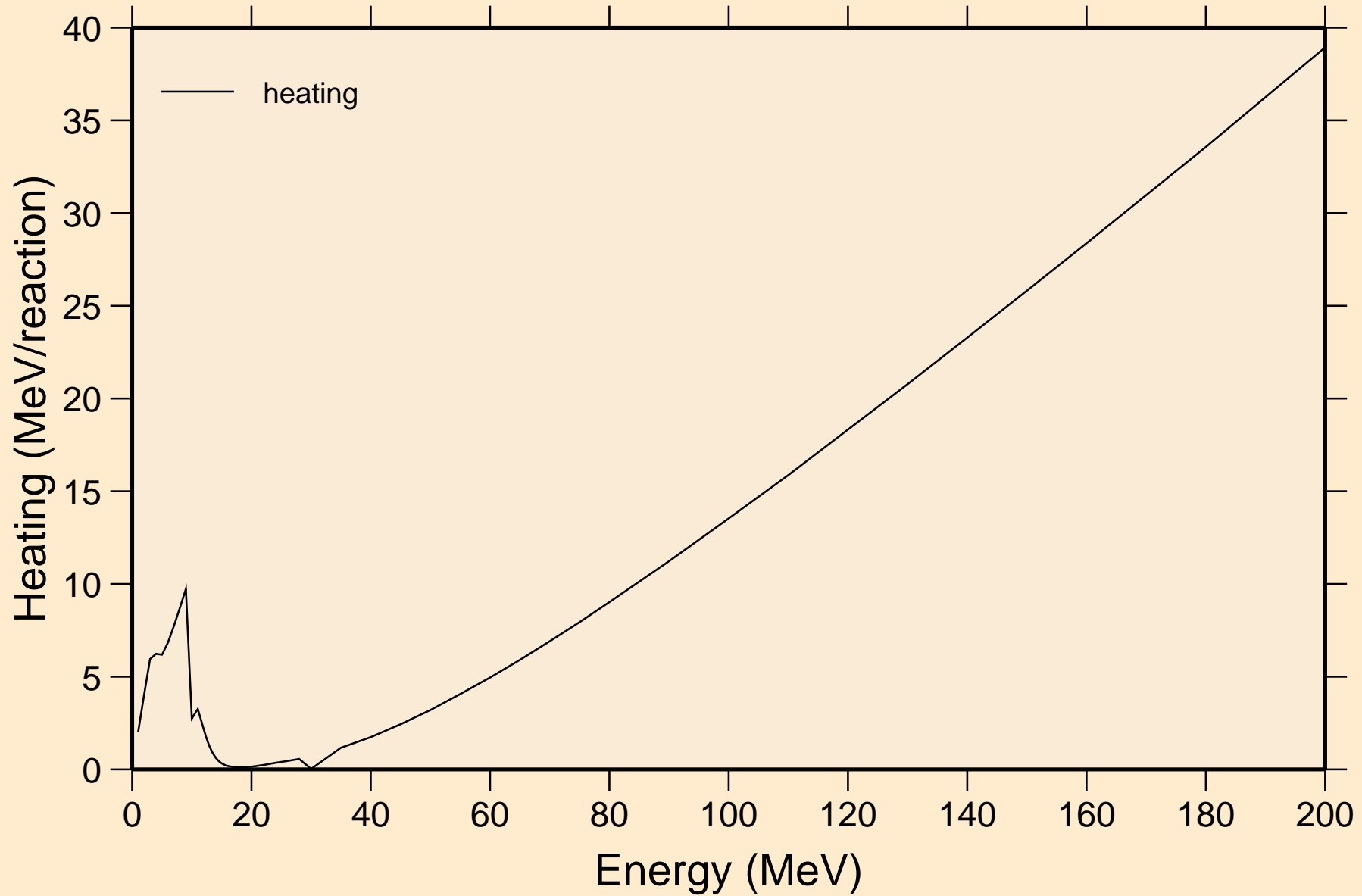

PO204 PHOTON ACER TENDL-2023 LIBRARY; T=0.K

Particle heating contributions

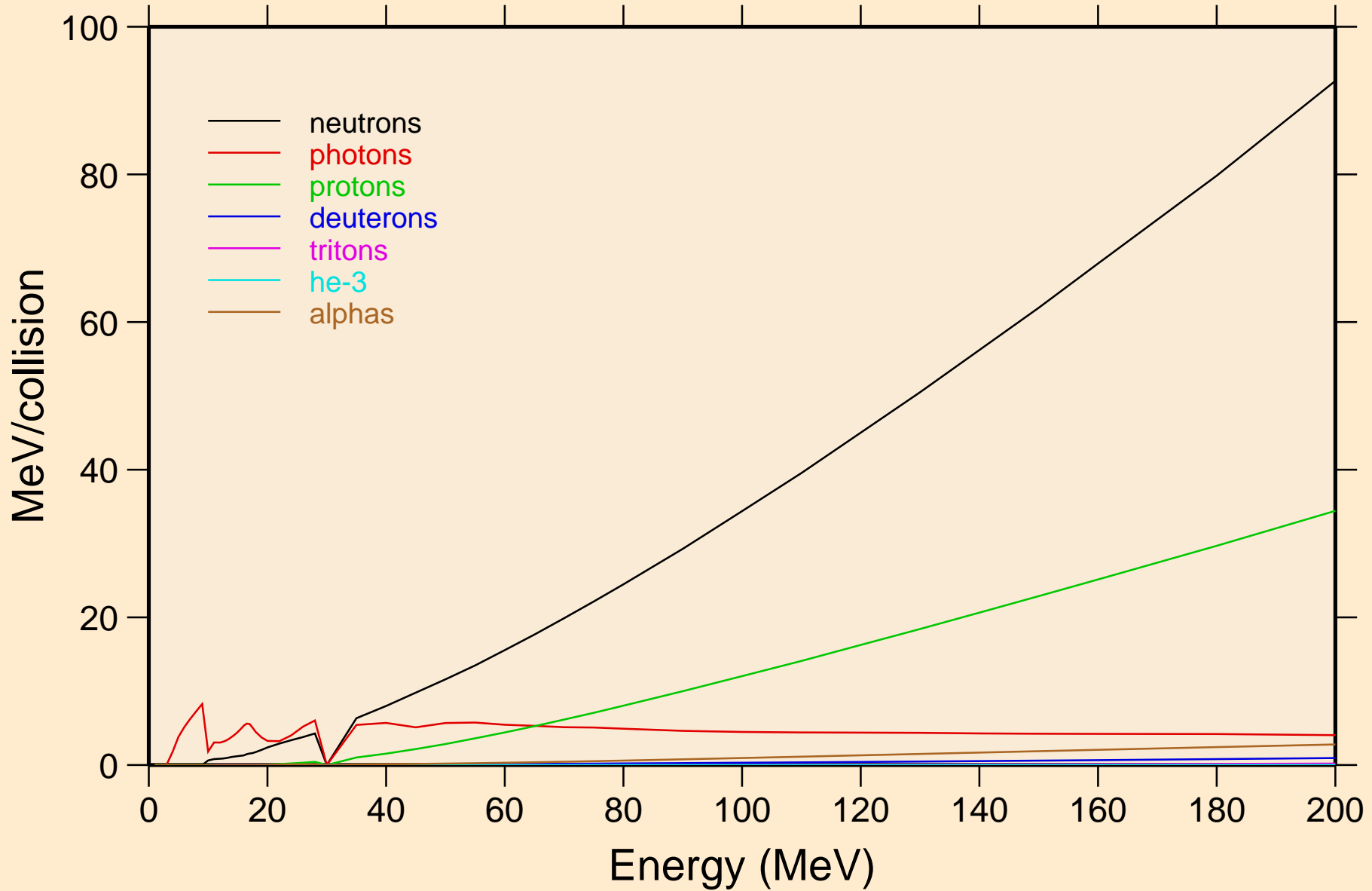

PO204 PHOTON ACER TENDL-2023 LIBRARY; T=0.K
Particle production cross sections

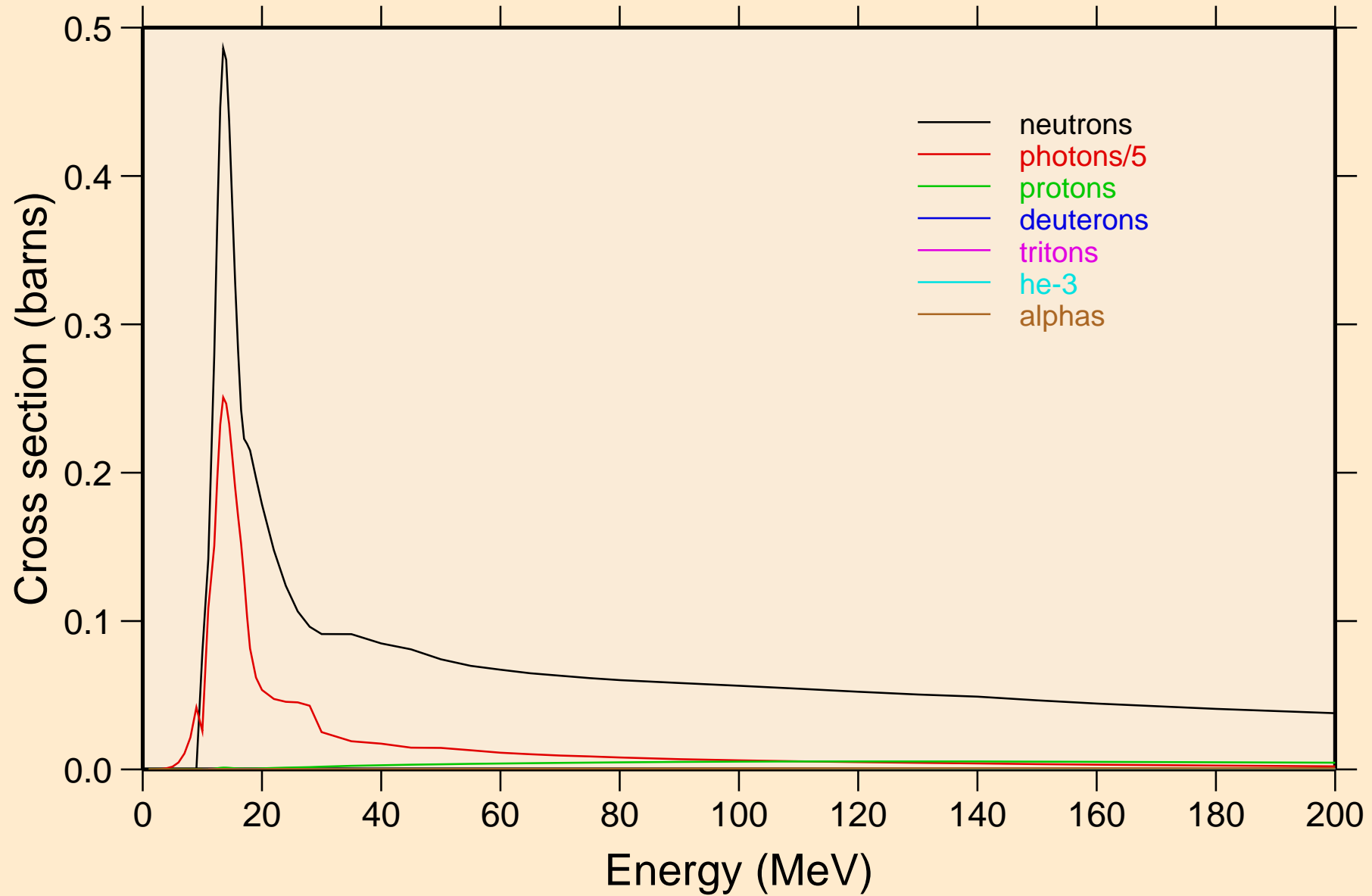

PO204 PHOTON ACER TENDL-2023 LIBRARY; T=0.K
neutrons from (g,x)

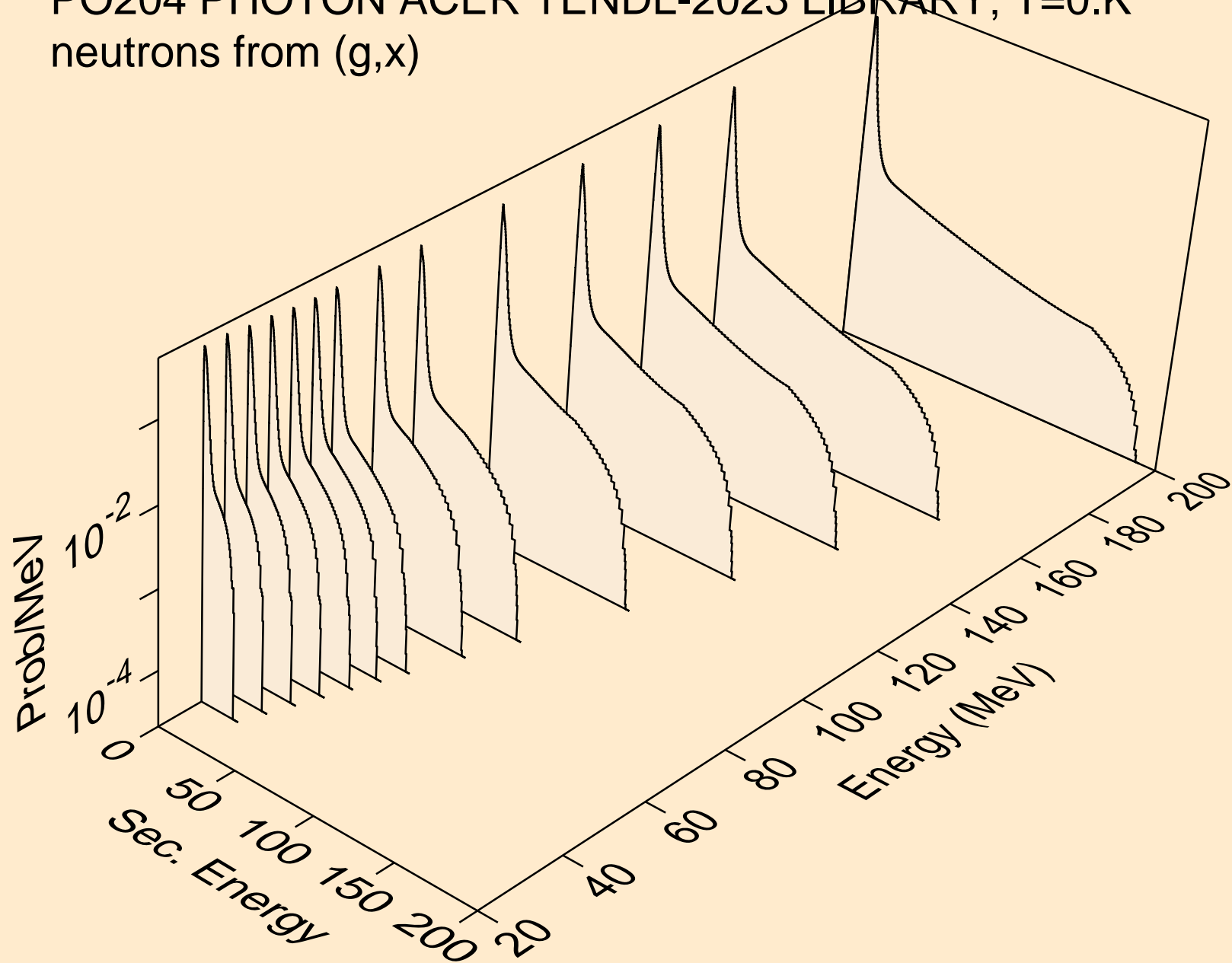

PO204 PHOTON ACER TENDL-2023 LIBRARY; T=0.K
neutrons from (g,2n)

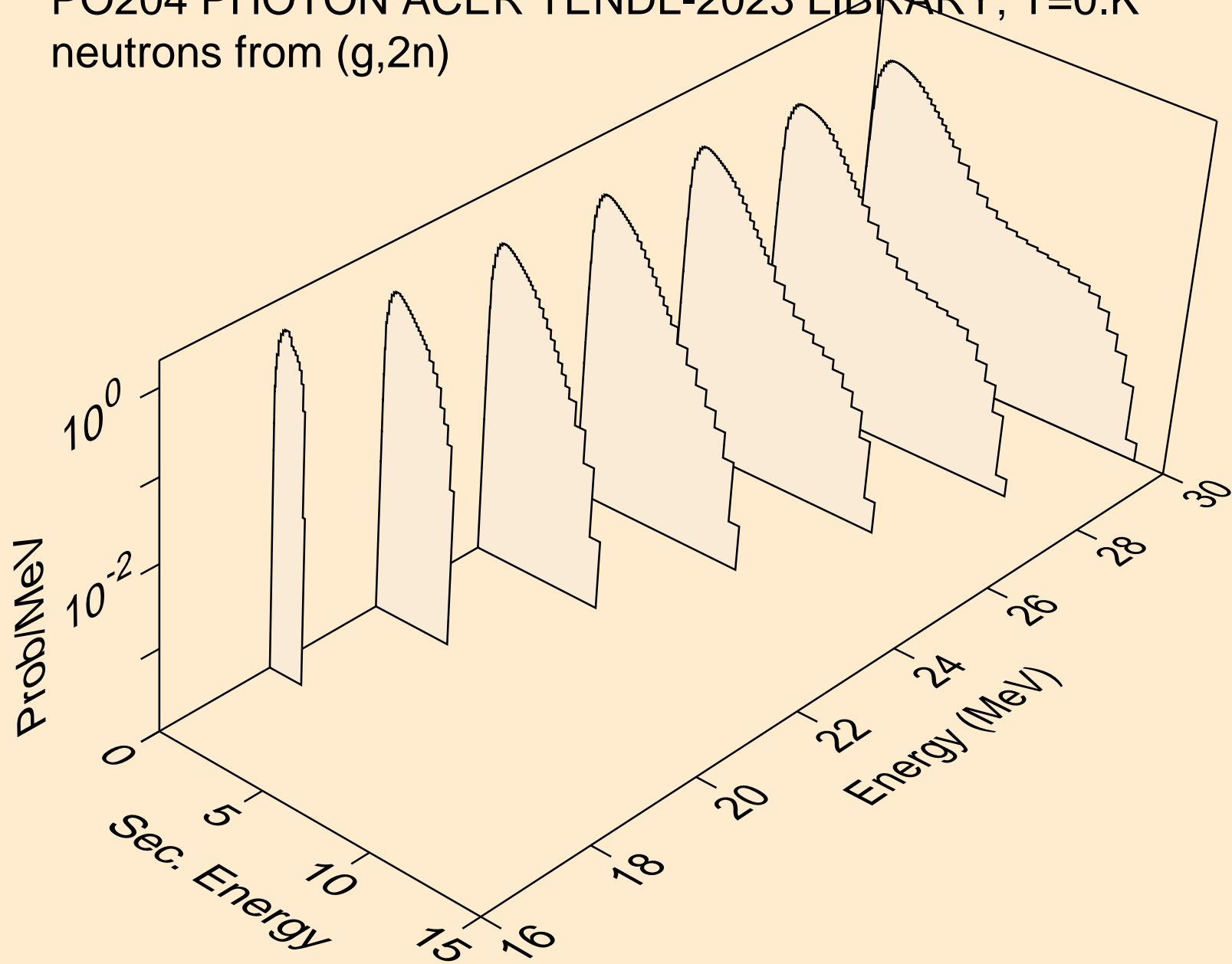

PO204 PHOTON ACER TENDL-2023 LIBRARY; T=0.K
neutrons from (g,3n)

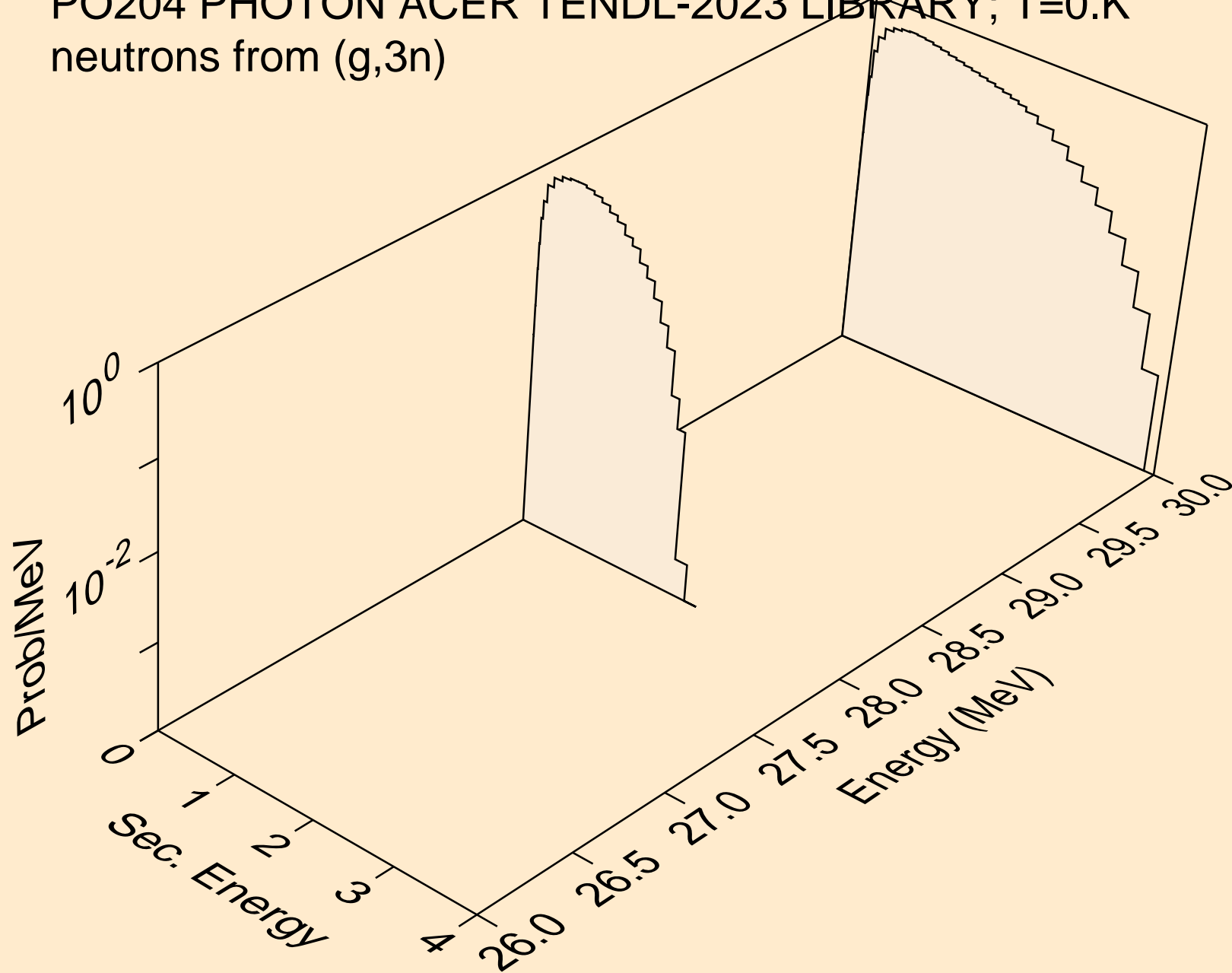

PO204 PHOTON ACER TENDL-2023 LIBRARY; T=0.K
neutrons from (g,n*)a

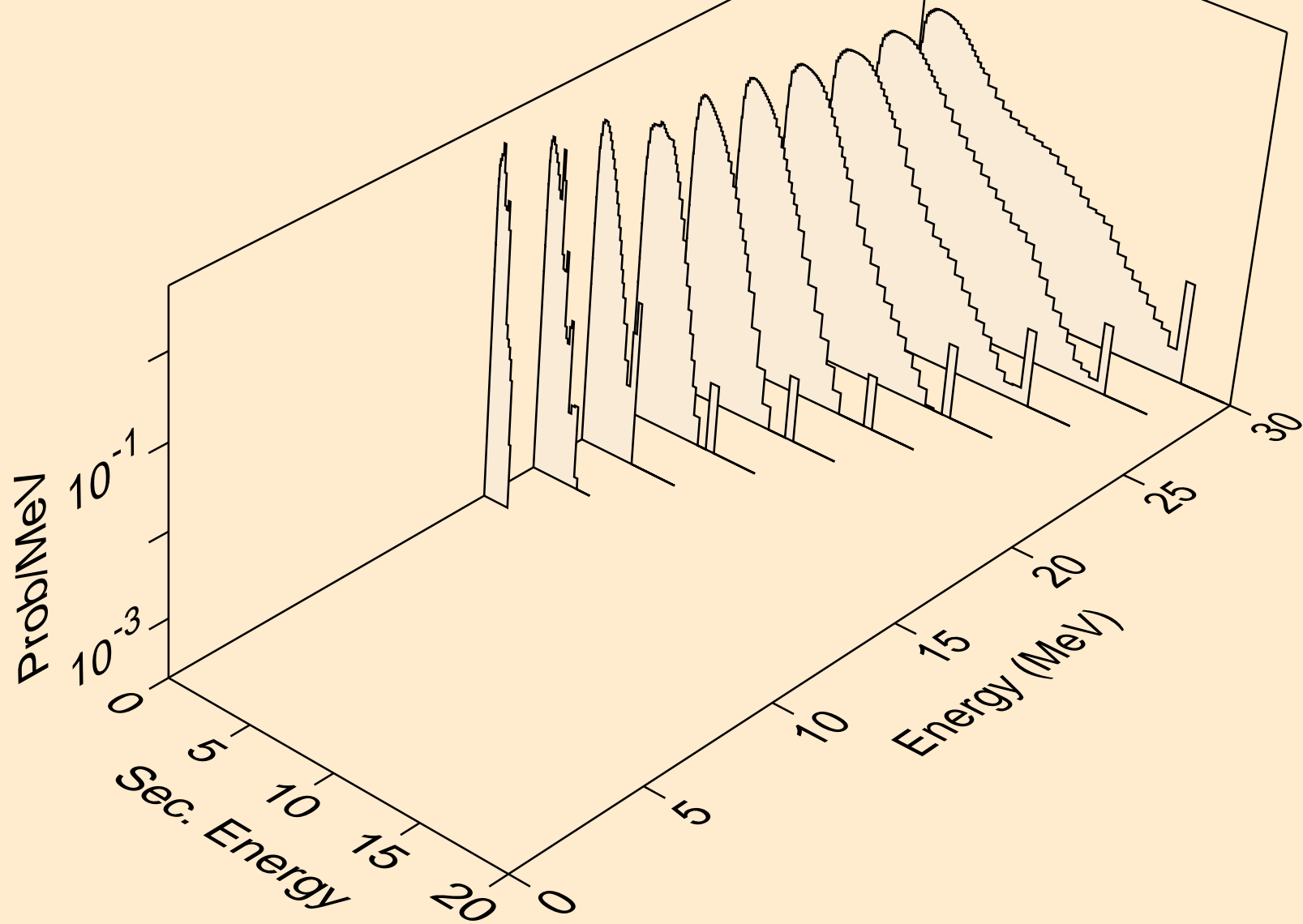

PO204 PHOTON ACER TENDL-2023 LIBRARY; T=0.K
neutrons from (g,2n)a

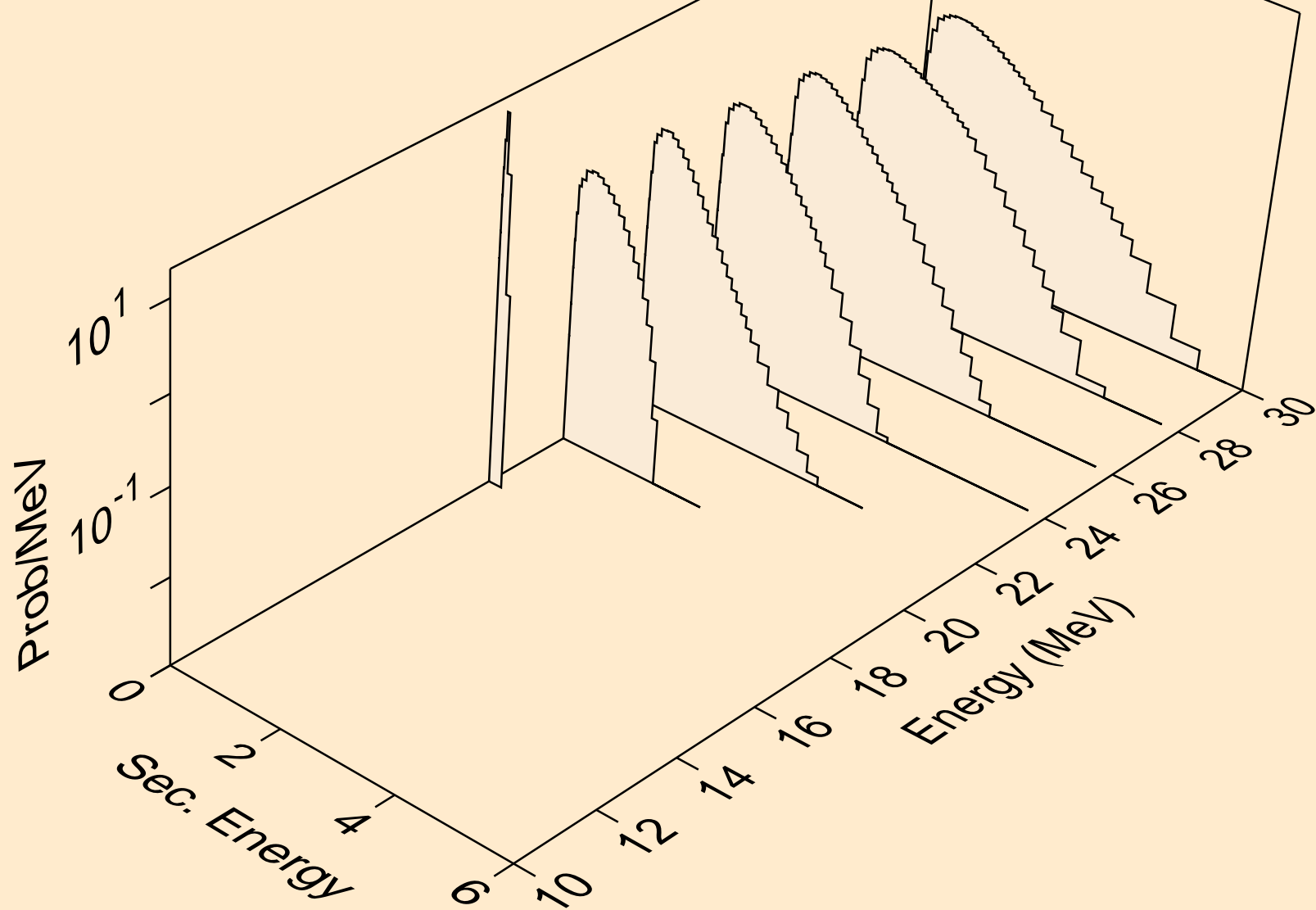

PO204 PHOTON ACER TENDL-2023 LIBRARY; T=0.K
neutrons from (g,3n)a

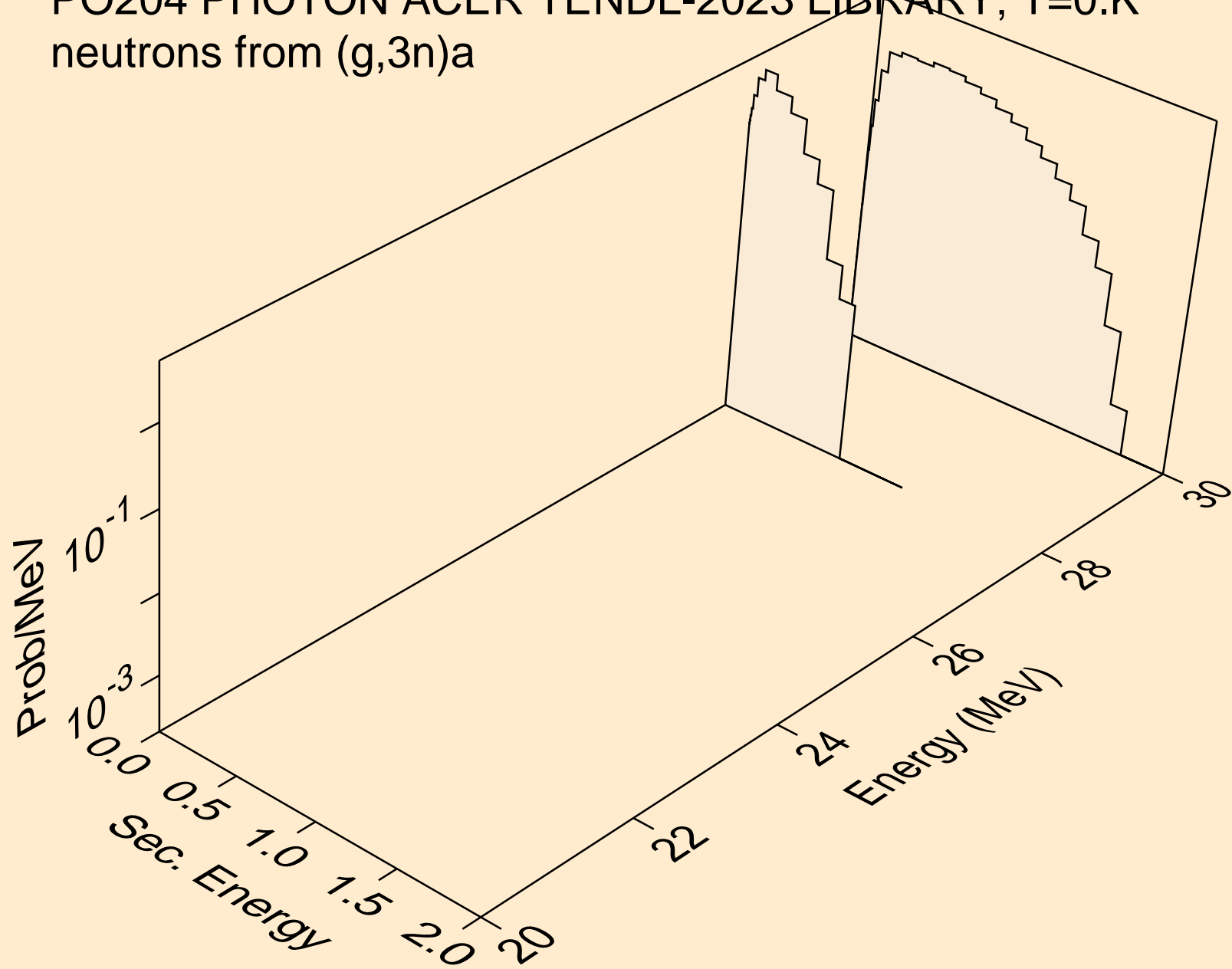

PO204 PHOTON ACER TENDL-2023 LIBRARY; T=0.K
neutrons from (g,n*)p

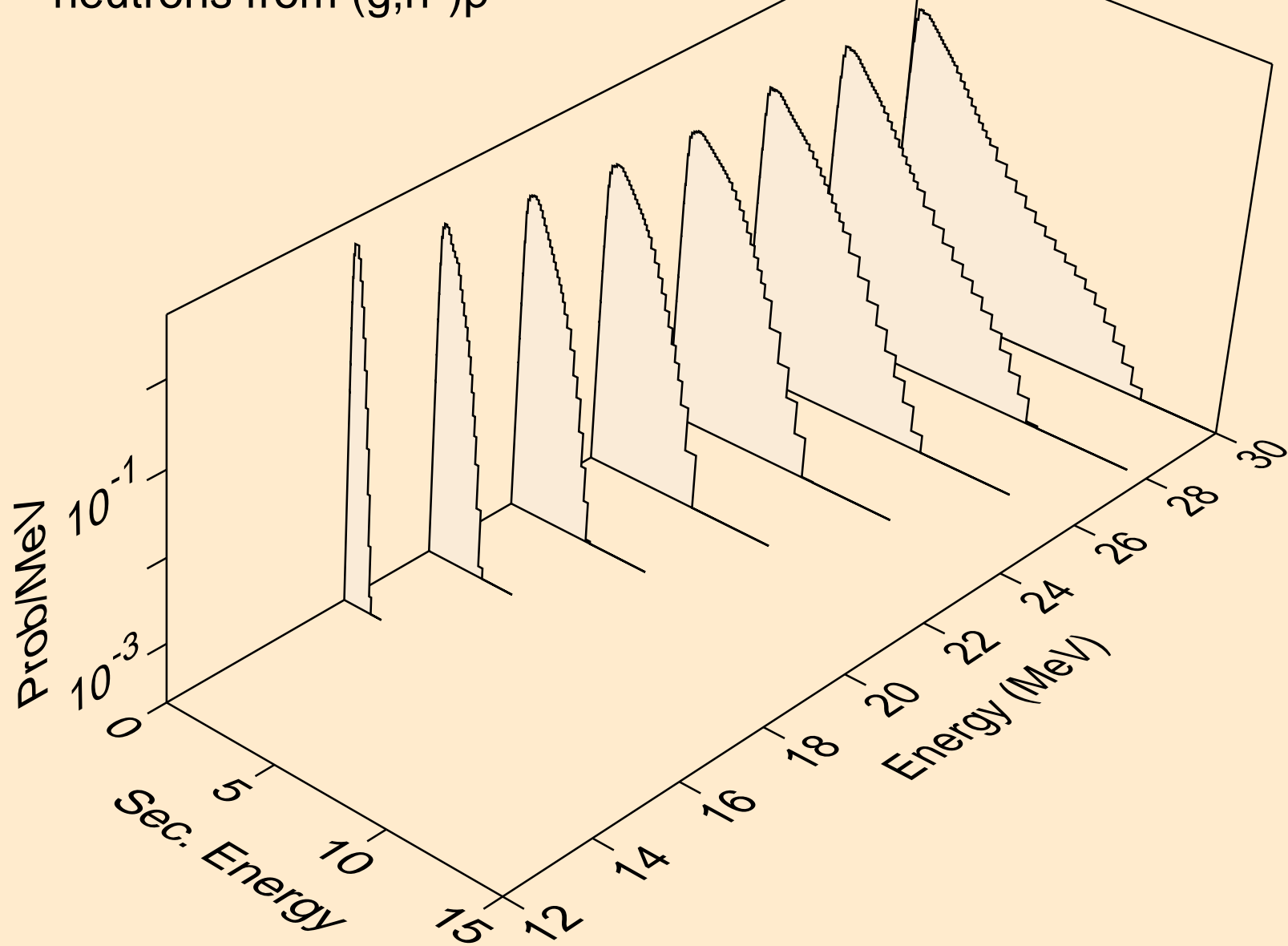

PO204 PHOTON ACER TENDL-2023 LIBRARY; T=0.K
neutrons from (g,n*)d

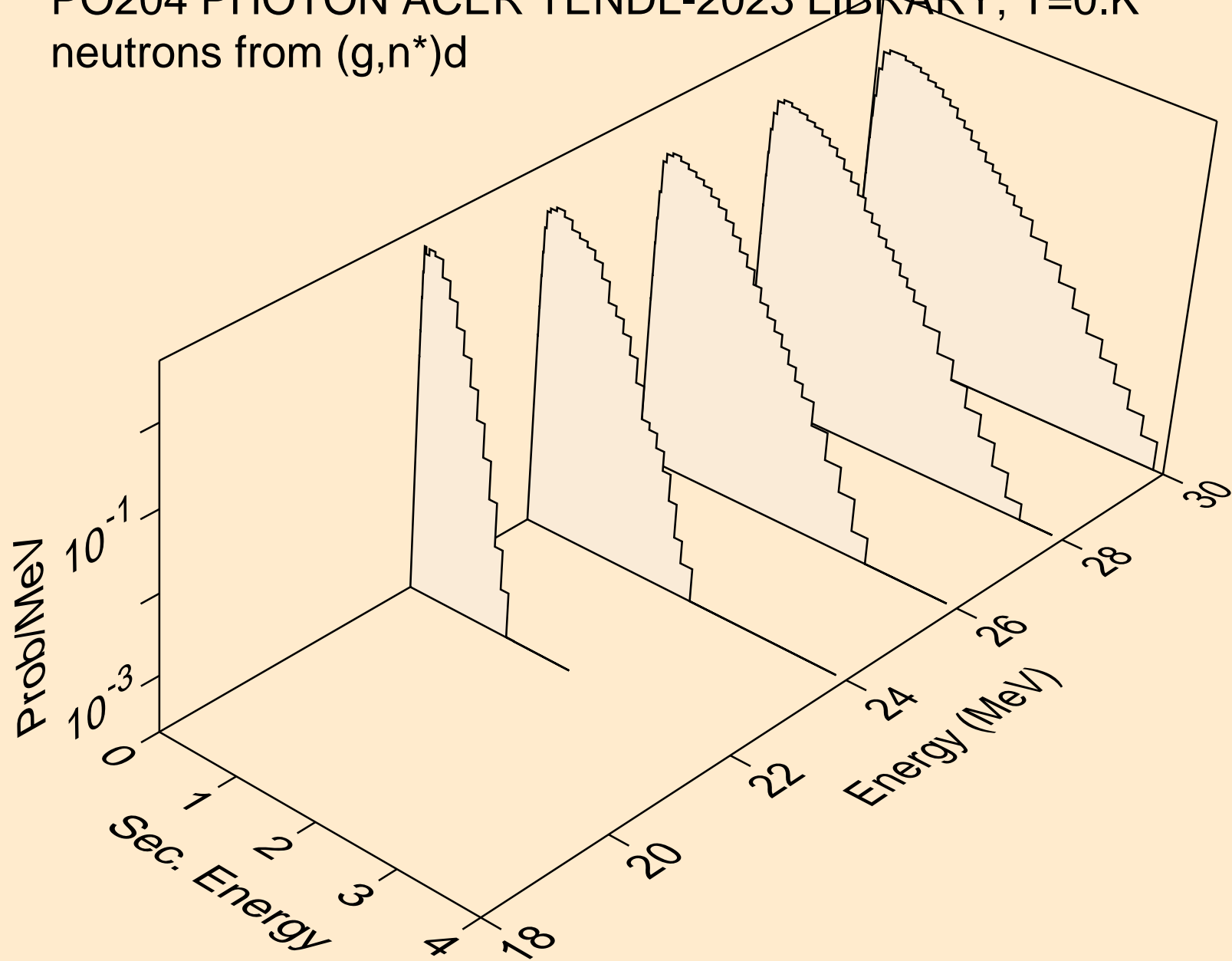

PO204 PHOTON ACER TENDL-2023 LIBRARY; T=0.K
neutrons from (g,n*)t

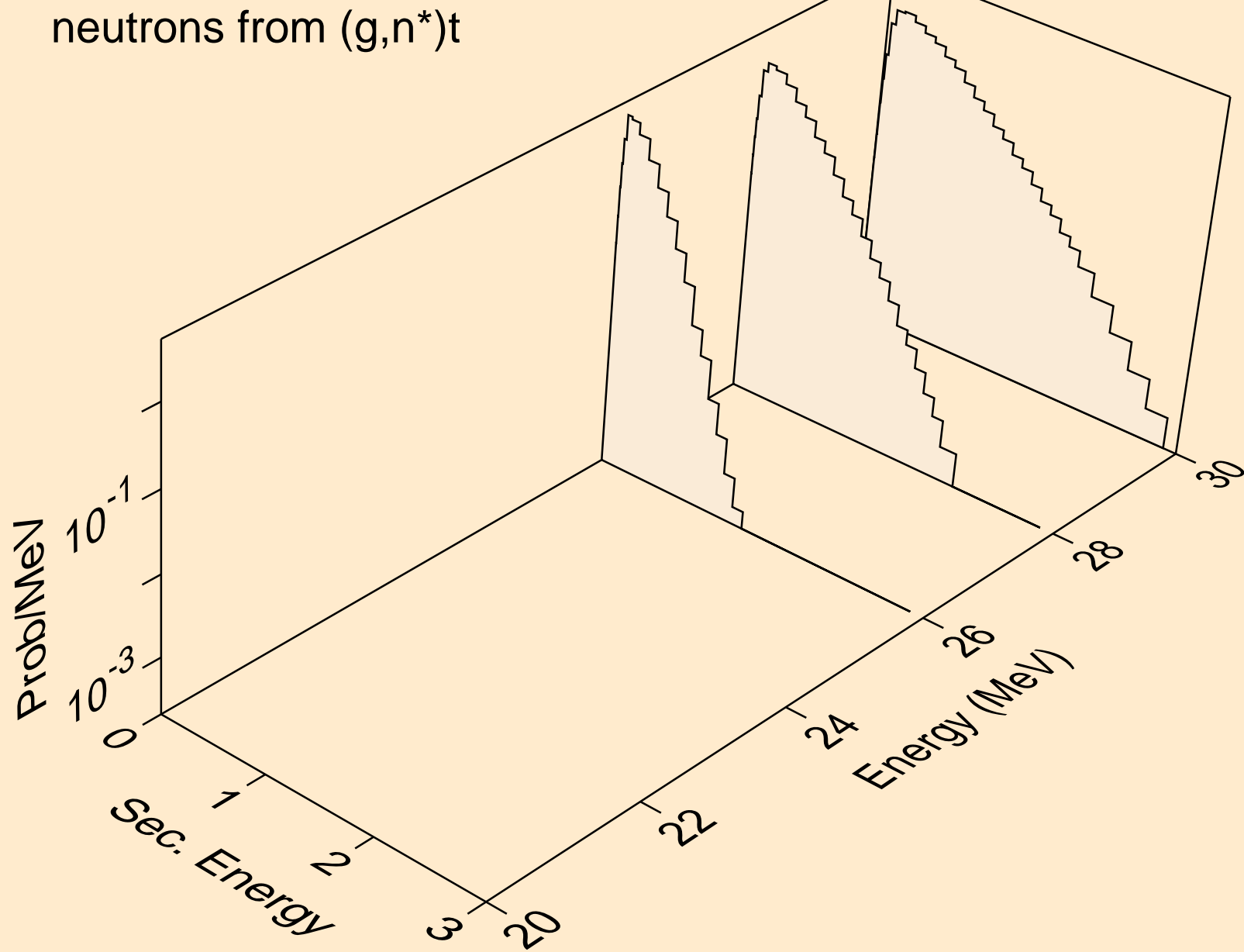

PO204 PHOTON ACER TENDL-2023 LIBRARY; T=0.K
neutrons from (g,2np)

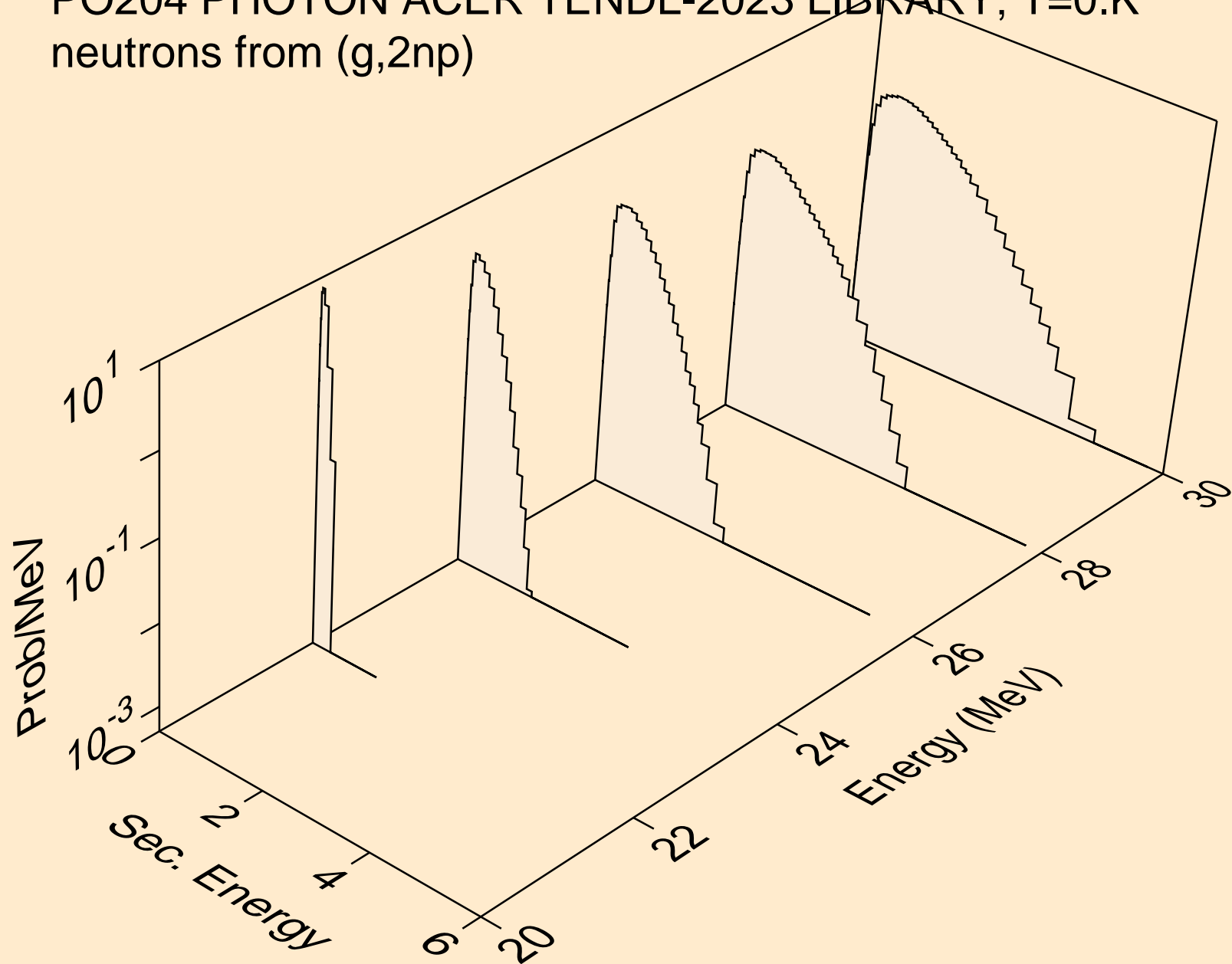

PO204 PHOTON ACER TENDL-2023 LIBRARY; T=0.K
neutrons from (g,n2p)

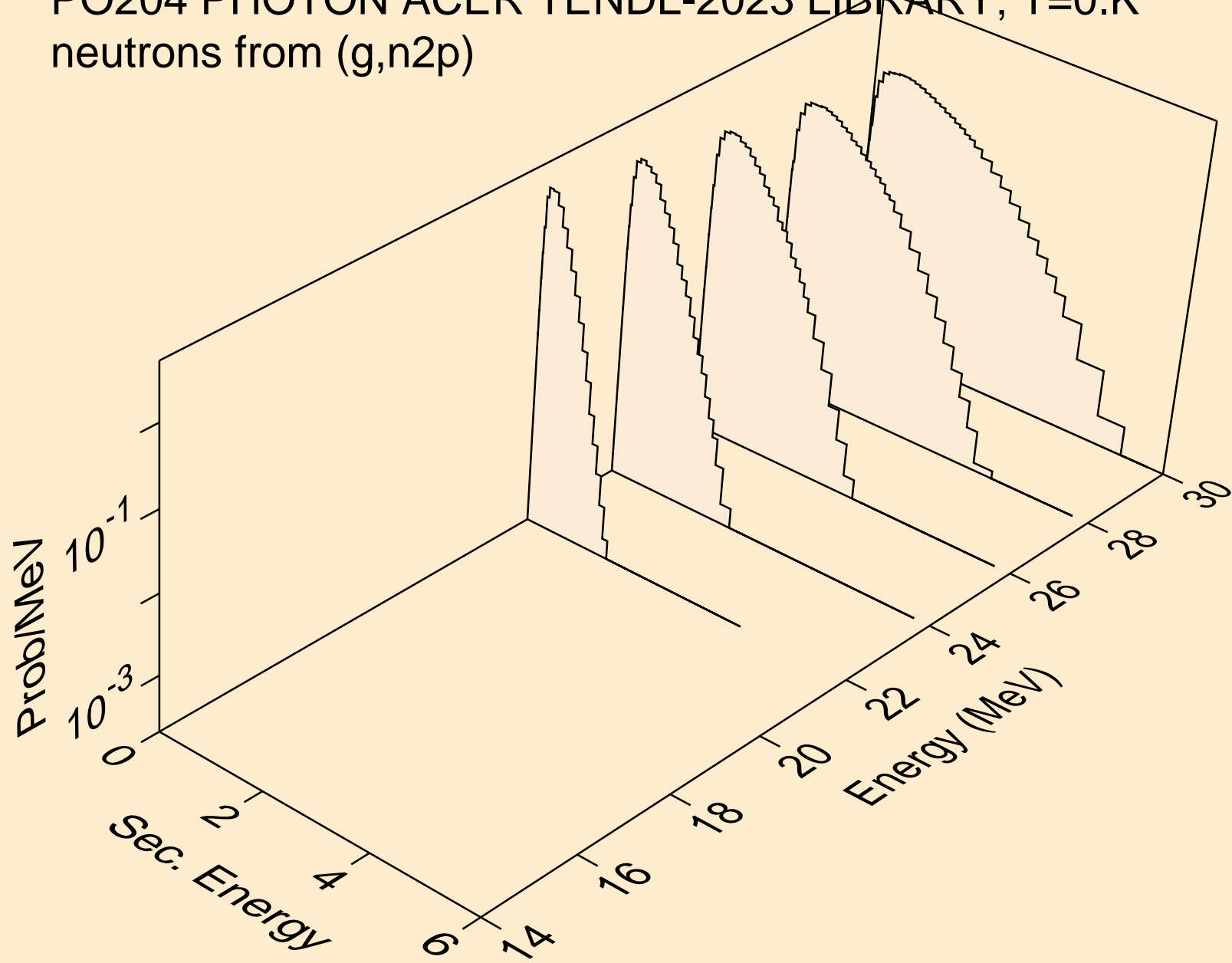

PO204 PHOTON ACER TENDL-2023 LIBRARY; T=0.K
angular distribution for (g,n*0) neutron

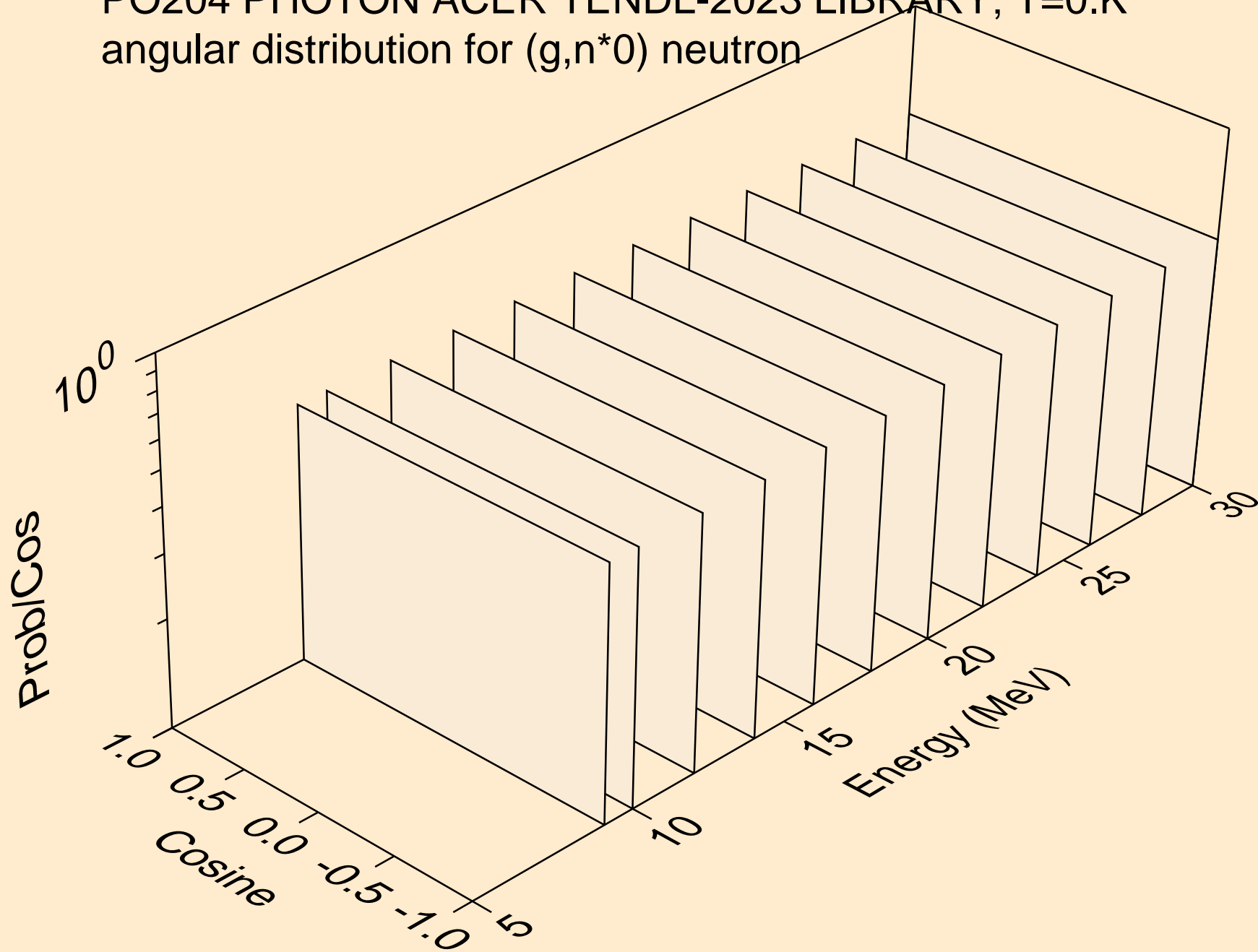

PO204 PHOTON ACER TENDL-2023 LIBRARY; T=0.K
angular distribution for (g,n*1) neutron

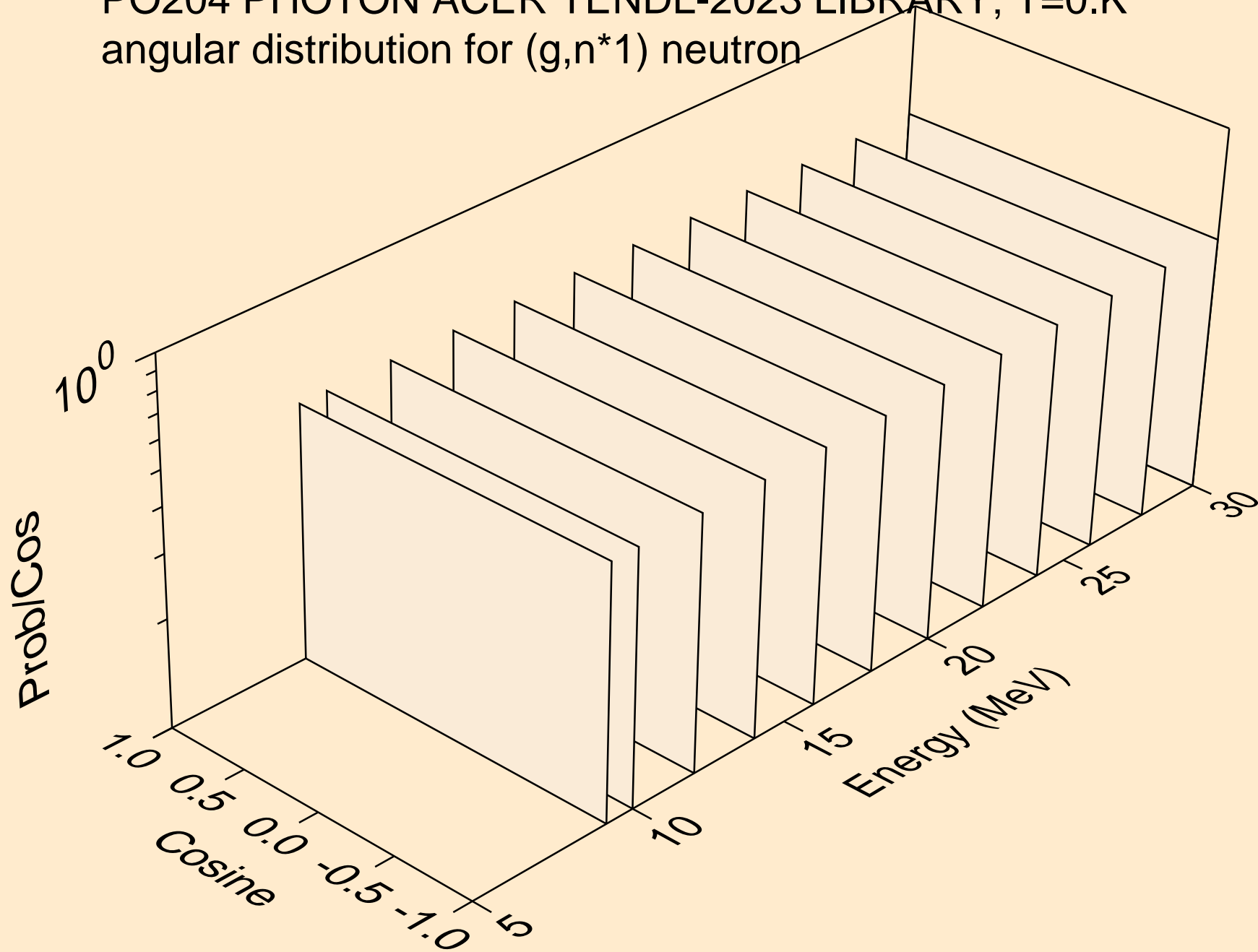

PO204 PHOTON ACER TENDL-2023 LIBRARY; T=0.K
angular distribution for (g,n*2) neutron

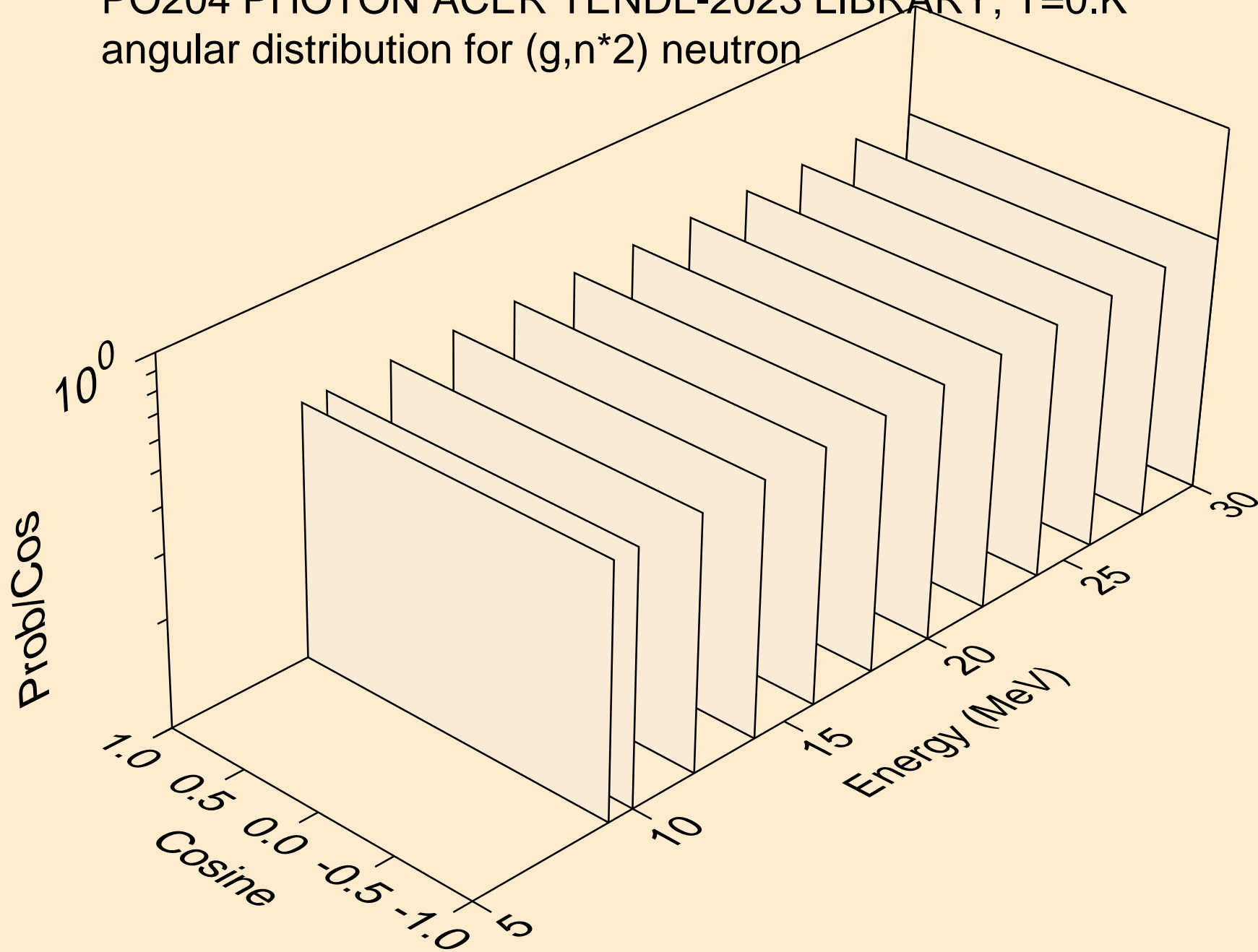

PO204 PHOTON ACER TENDL-2023 LIBRARY; T=0.K
angular distribution for (g,n*3) neutron

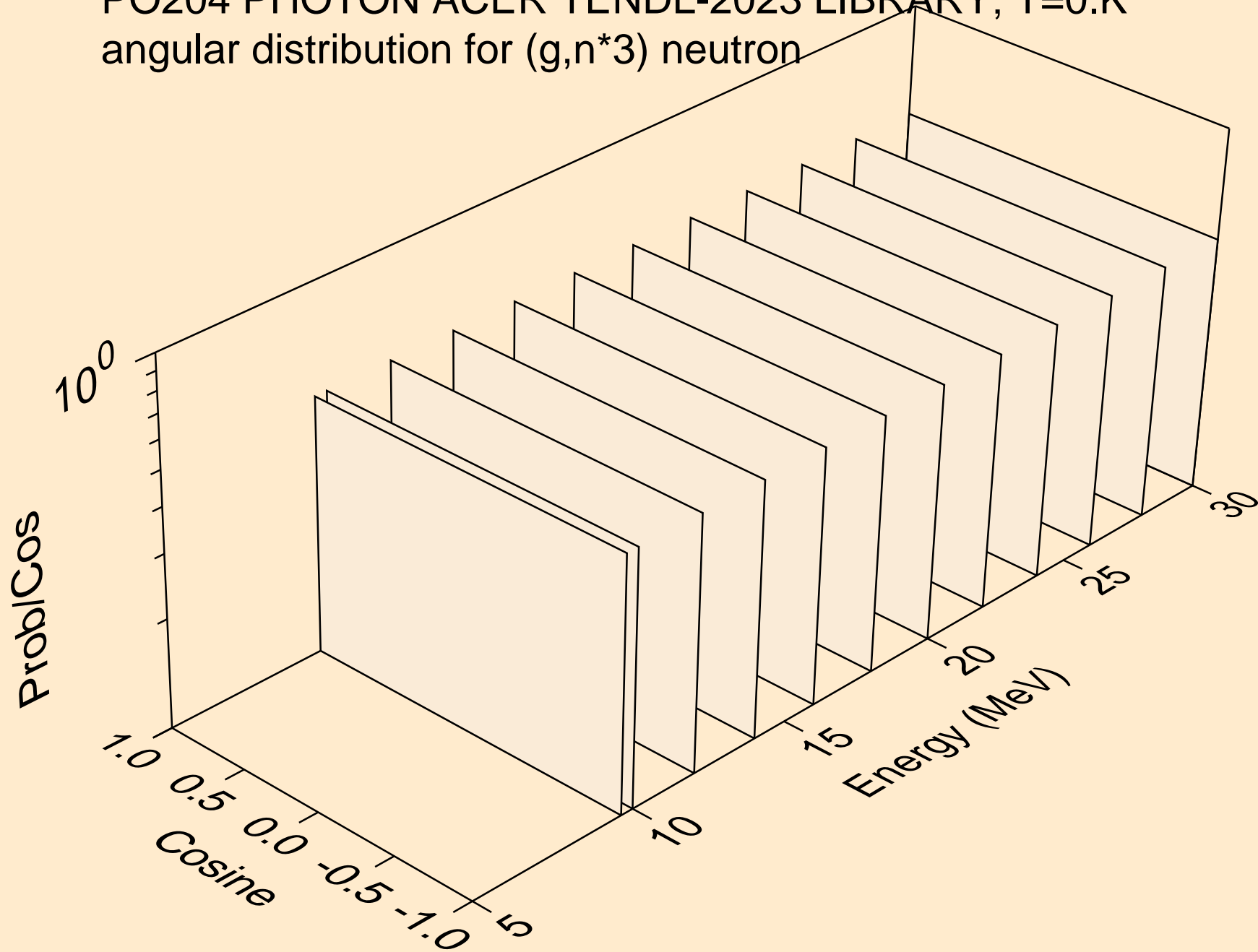

PO204 PHOTON ACER TENDL-2023 LIBRARY; T=0.K
neutrons from (g,n*c)

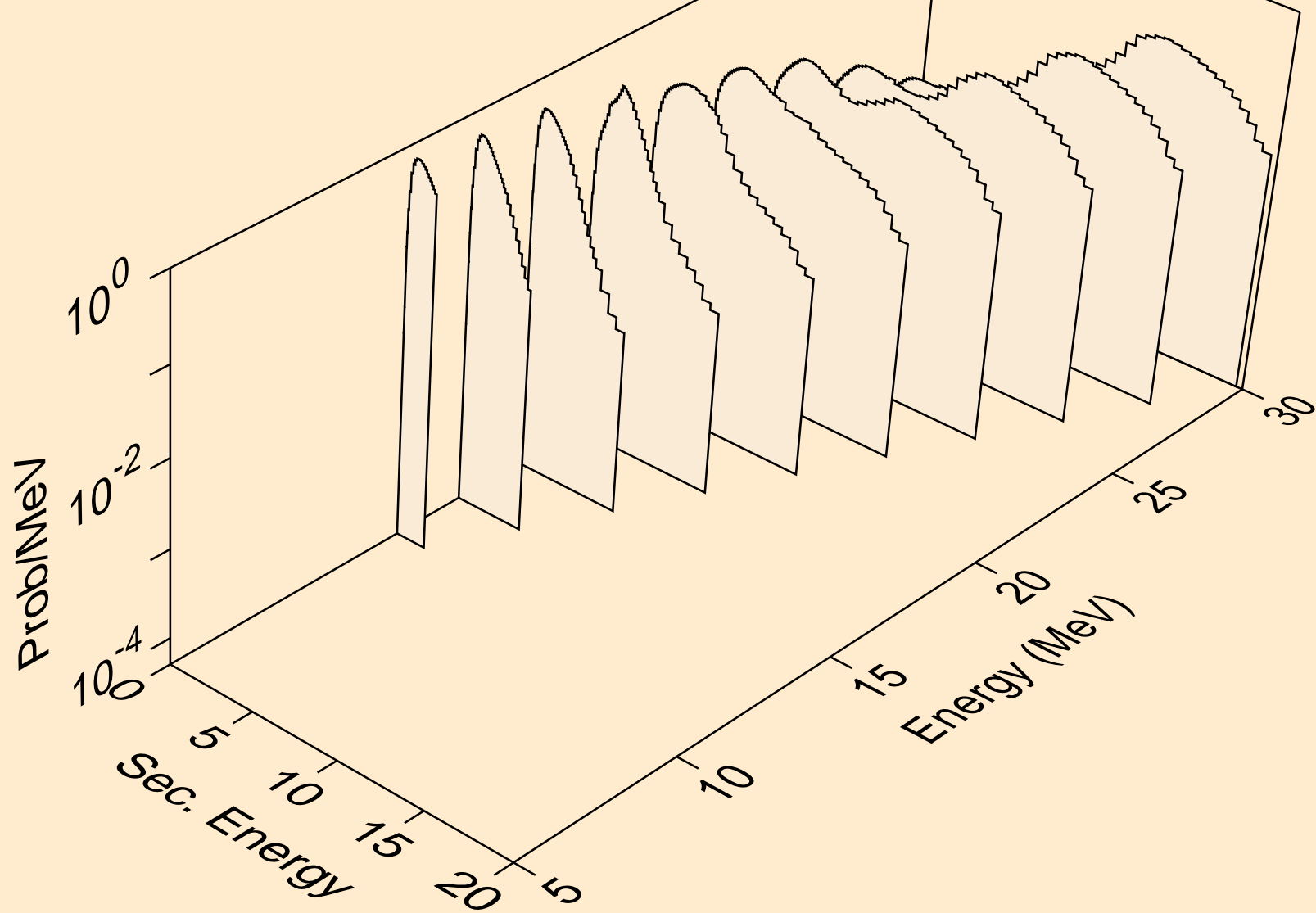

PO204 PHOTON ACER TENDL-2023 LIBRARY; T=0.K
photons from (g,x)

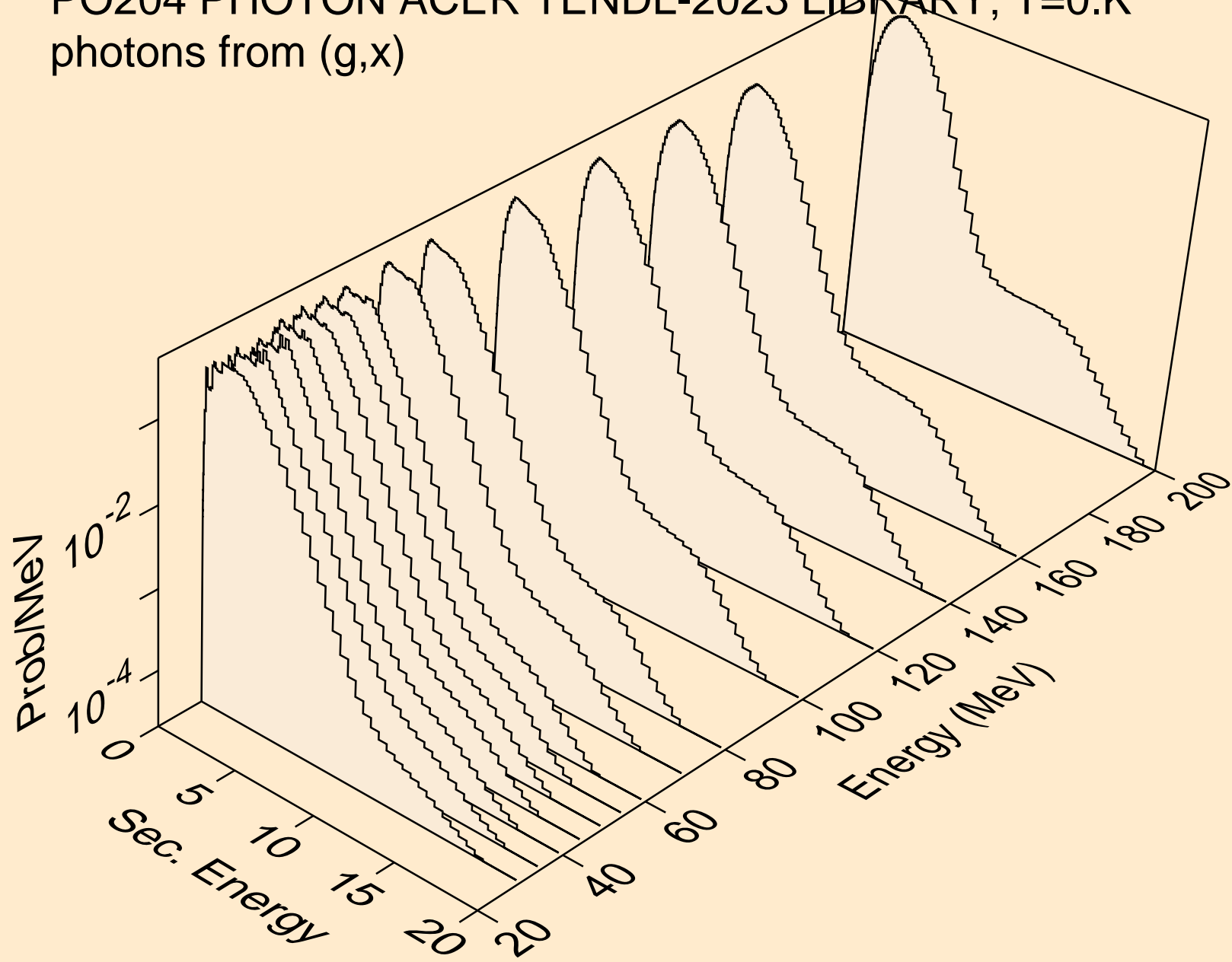

PO204 PHOTON ACER TENDL-2023 LIBRARY; T=0.K
photons from (g,2n)

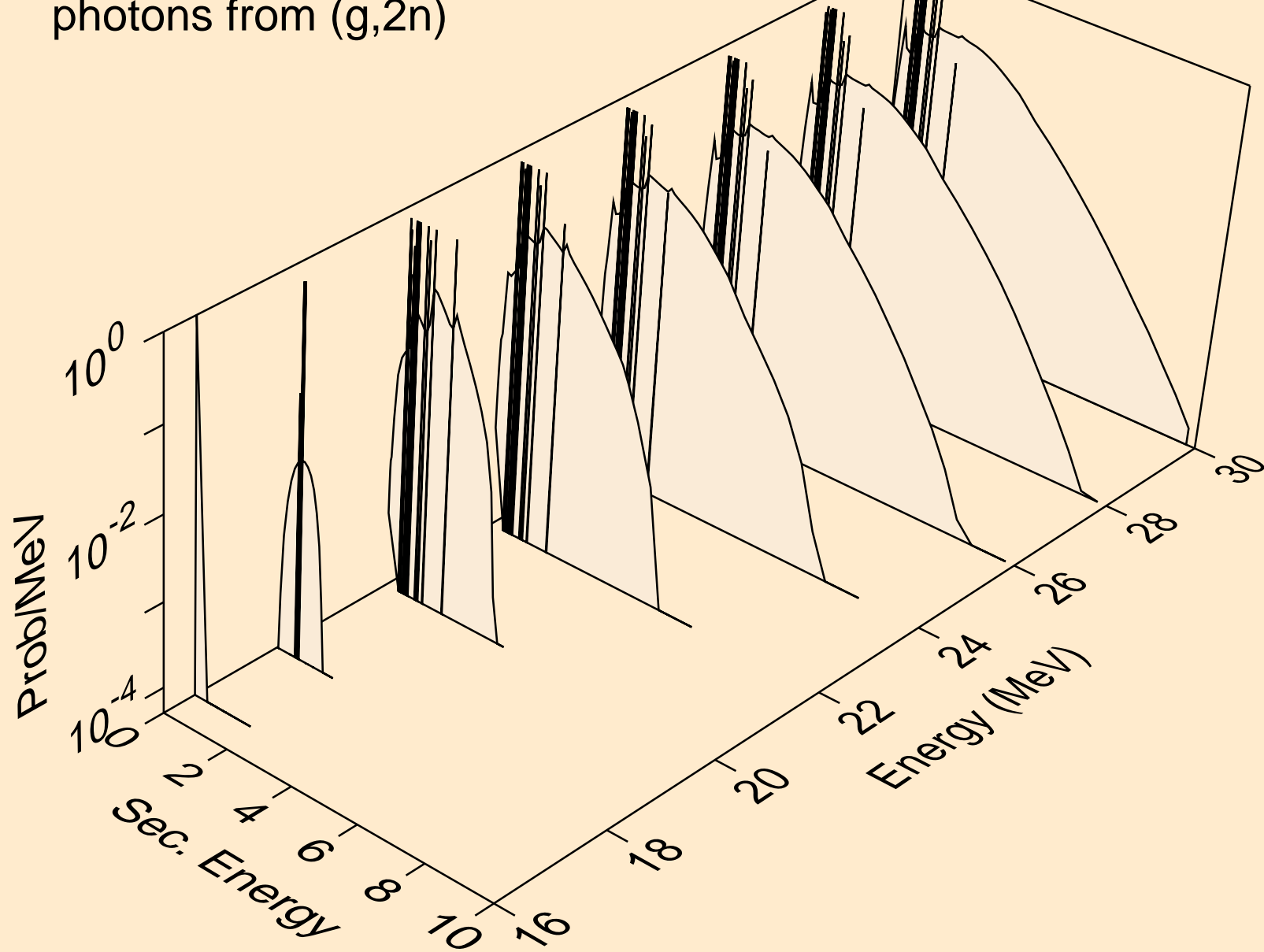

PO204 PHOTON ACER TENDL-2023 LIBRARY; T=0.K
photons from (g,3n)

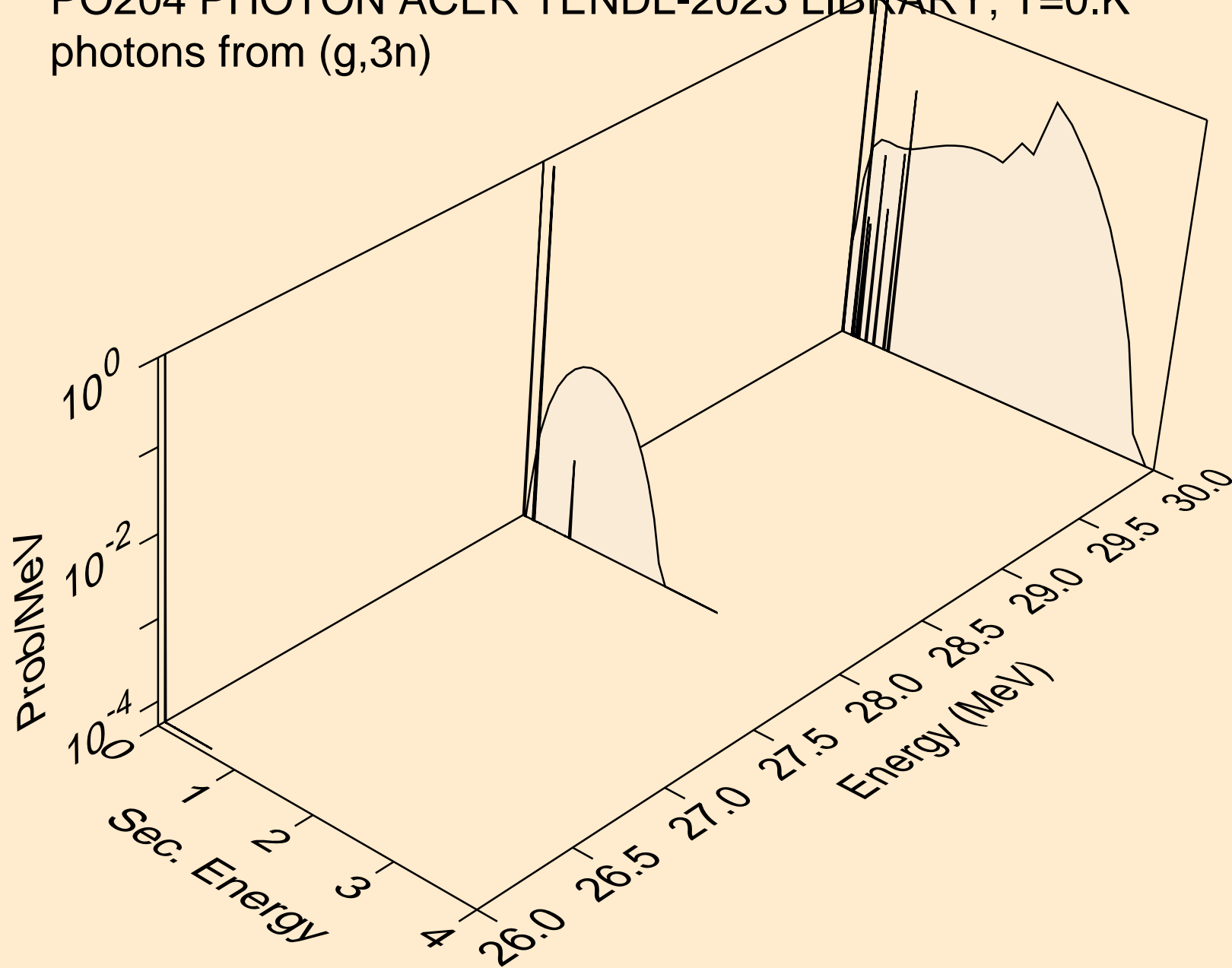

PO204 PHOTON ACER TENDL-2023 LIBRARY; T=0.K
photons from (g,n*)a

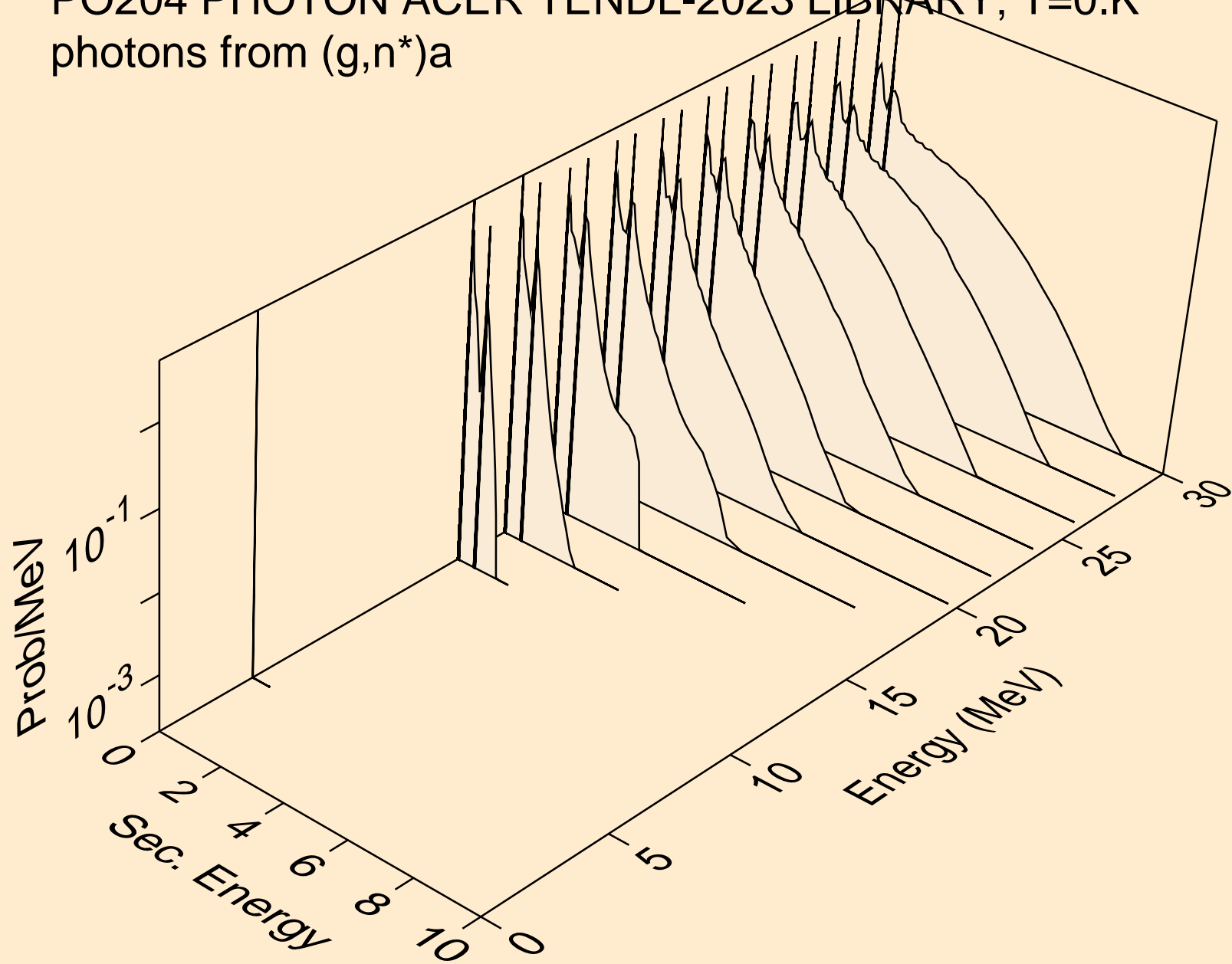

PO204 PHOTON ACER TENDL-2023 LIBRARY; T=0.K
photons from (g,2n)a

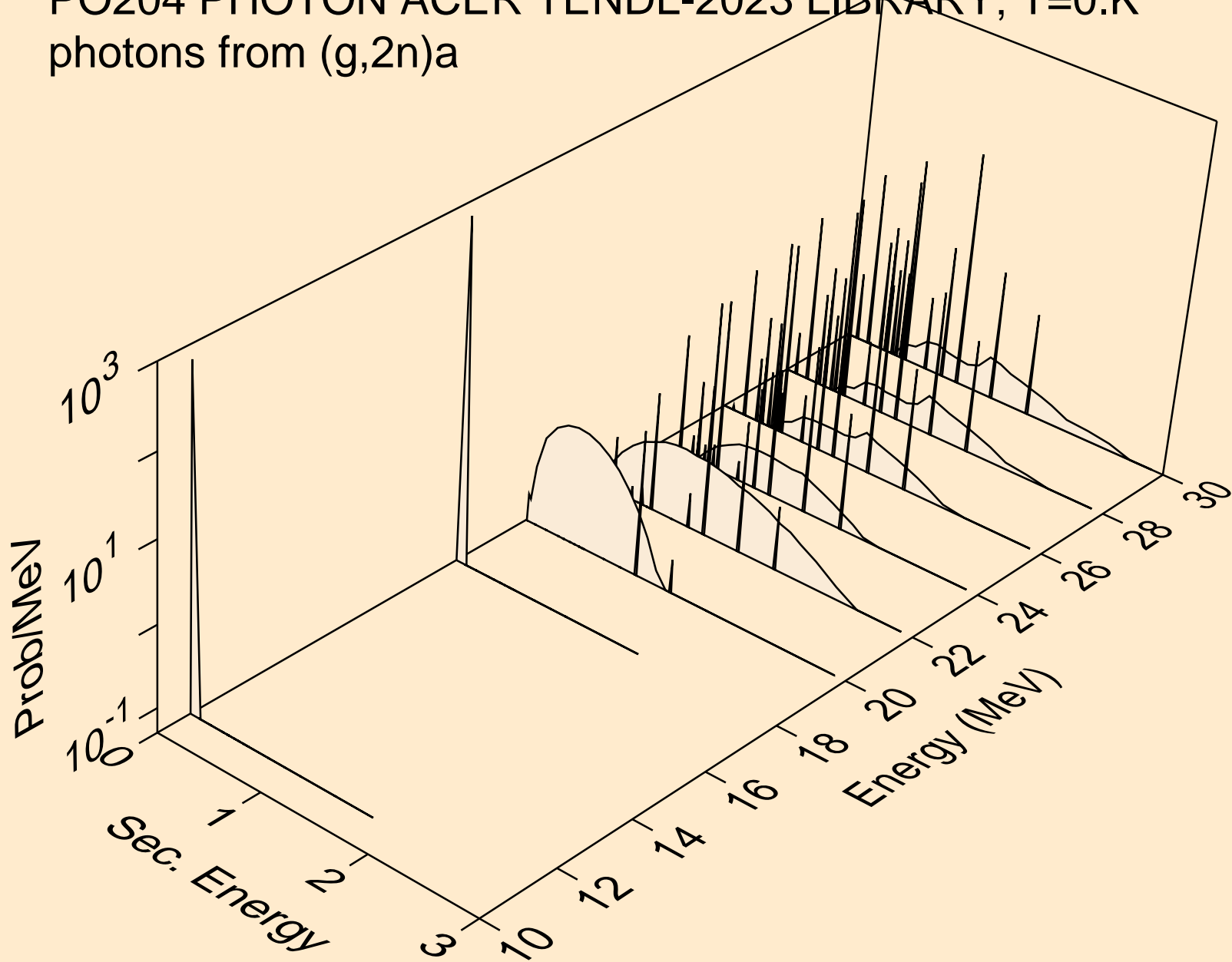

PO204 PHOTON ACER TENDL-2023 LIBRARY; T=0.K
photons from (g,3n)a

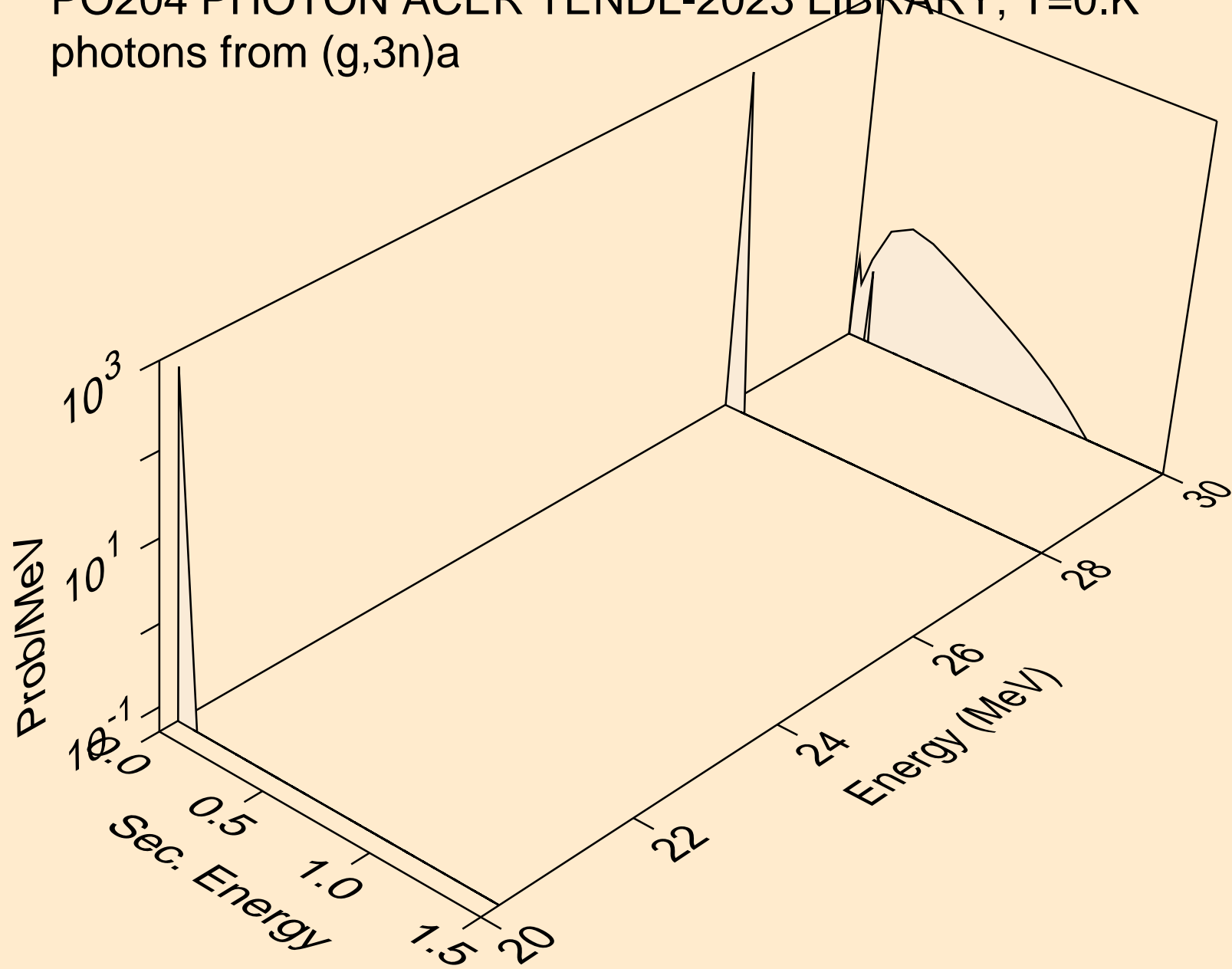

PO204 PHOTON ACER TENDL-2023 LIBRARY; T=0.K
photons from (g,n*)p

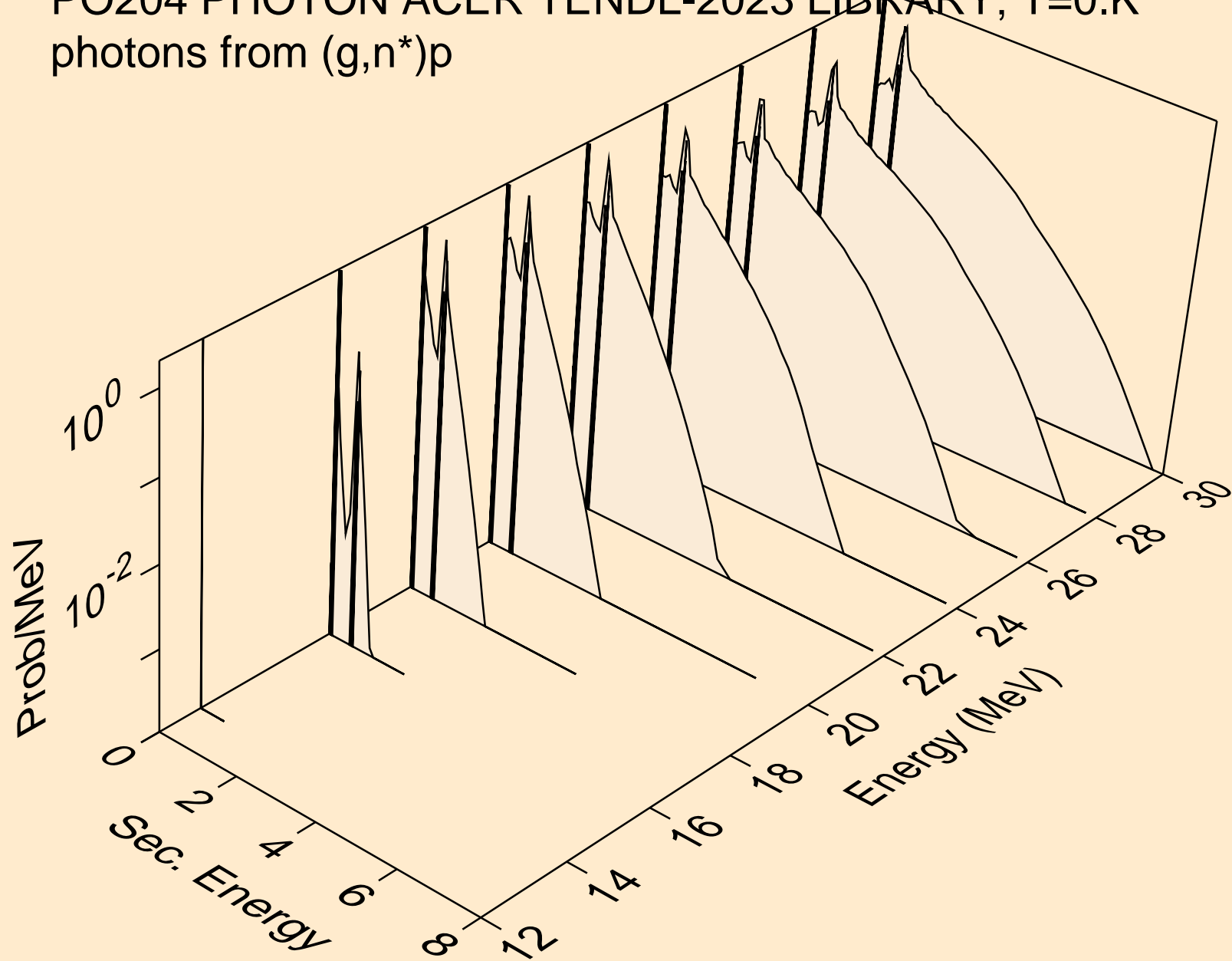

PO204 PHOTON ACER TENDL-2023 LIBRARY; T=0.K
photons from (g,n*)d

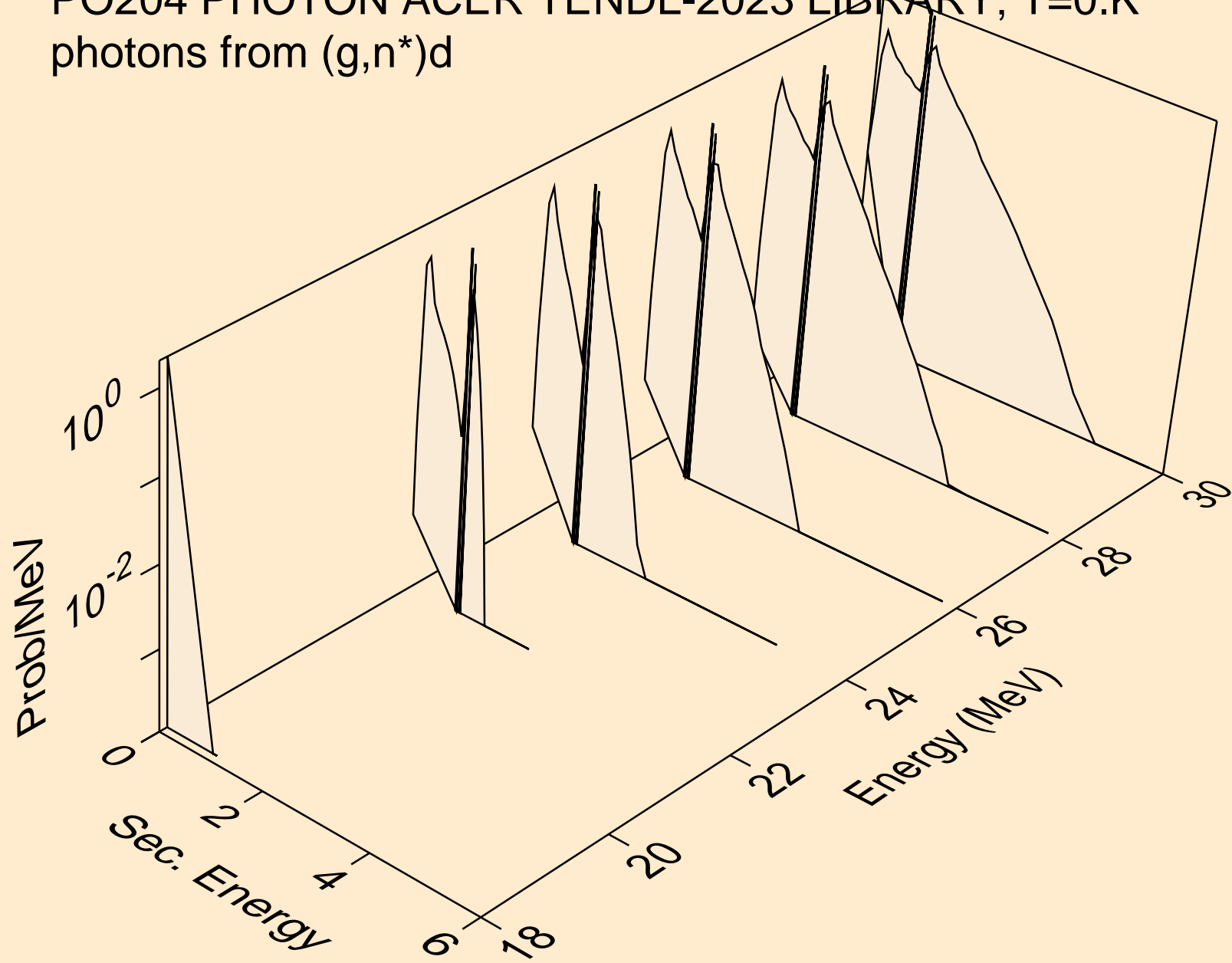

PO204 PHOTON ACER TENDL-2023 LIBRARY; T=0.K
photons from (g,n*)t

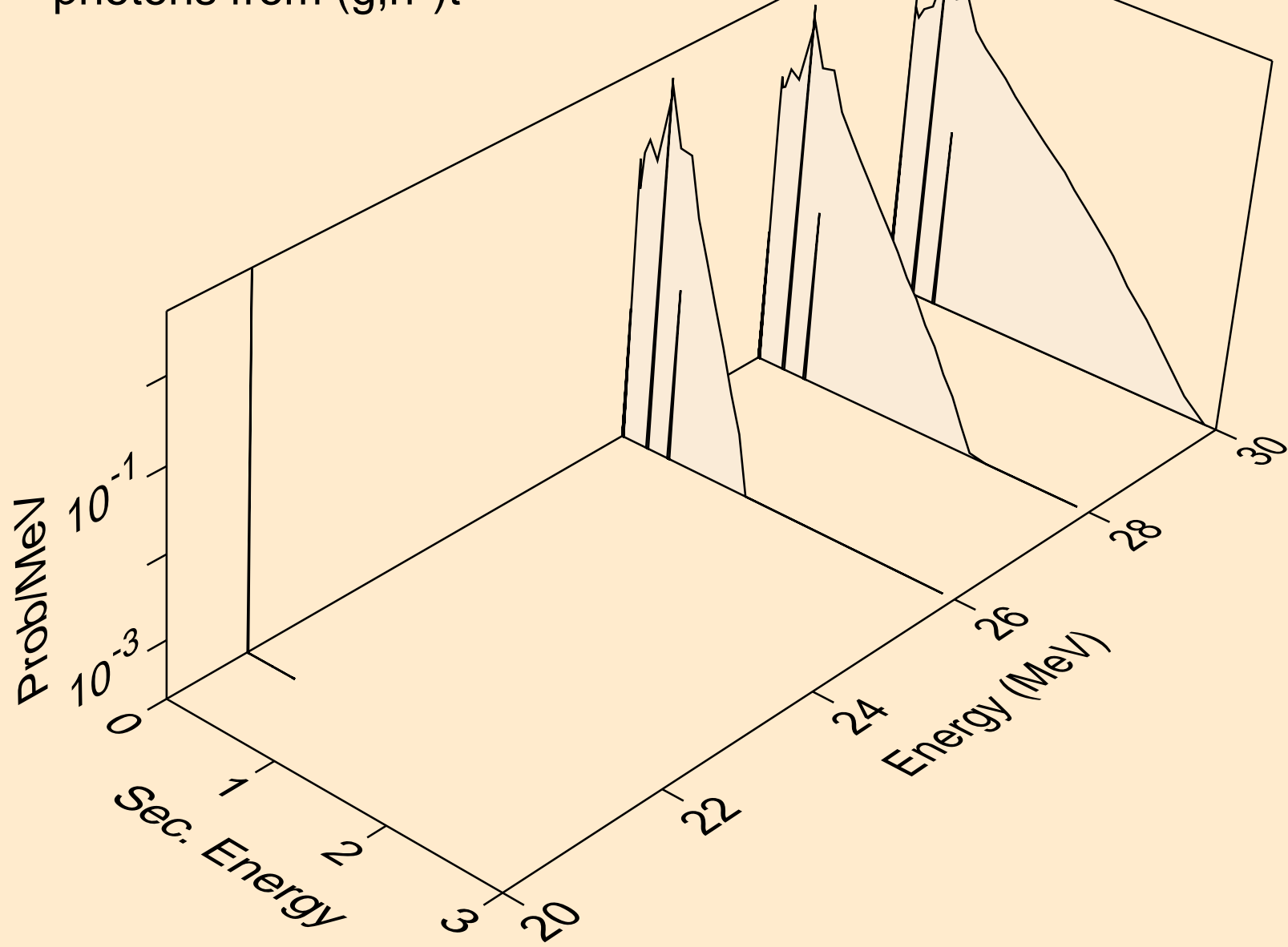

PO204 PHOTON ACER TENDL-2023 LIBRARY; T=0.K
photons from (g,2np)

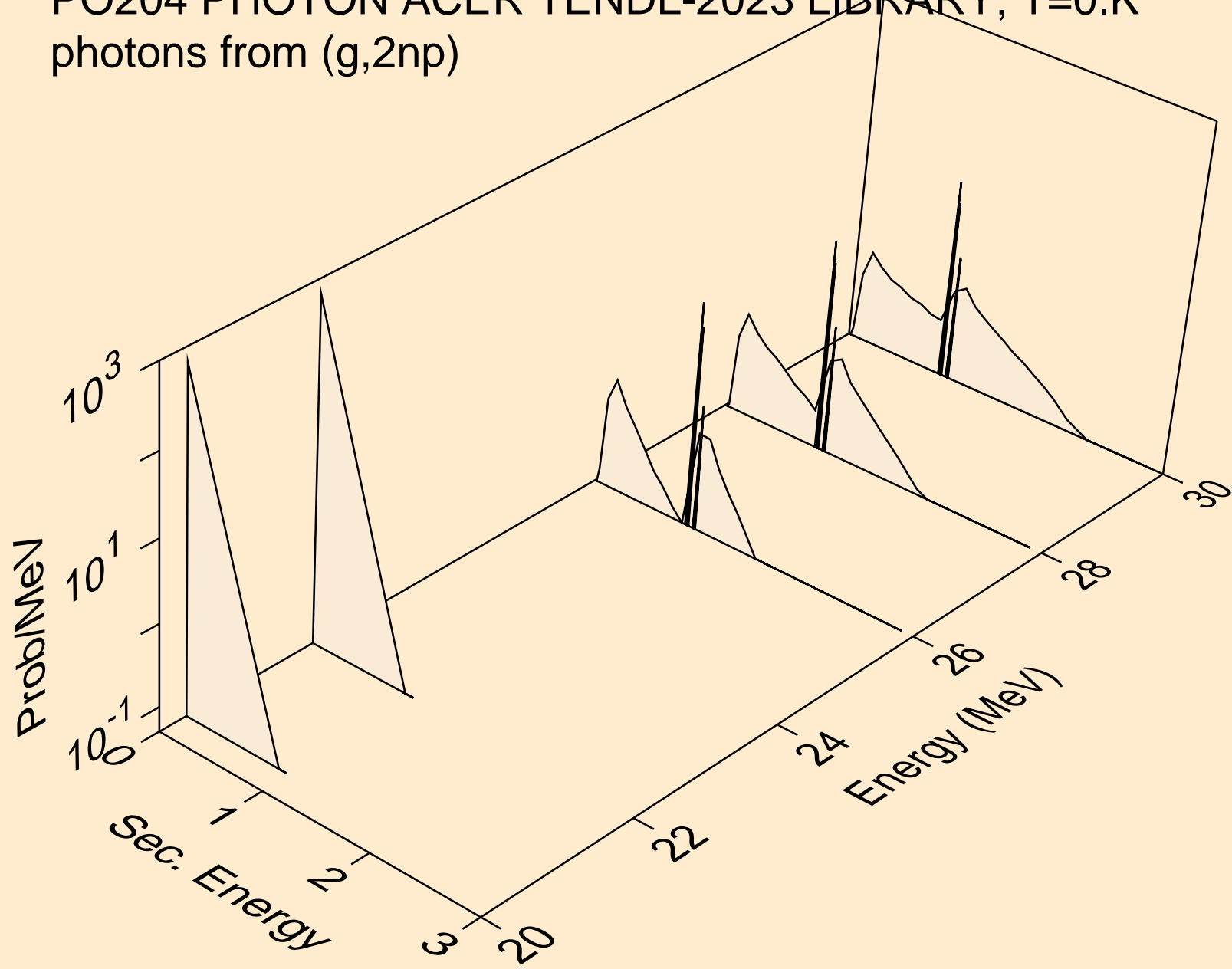

PO204 PHOTON ACER TENDL-2023 LIBRARY; T=0.K
photons from (g,n2p)

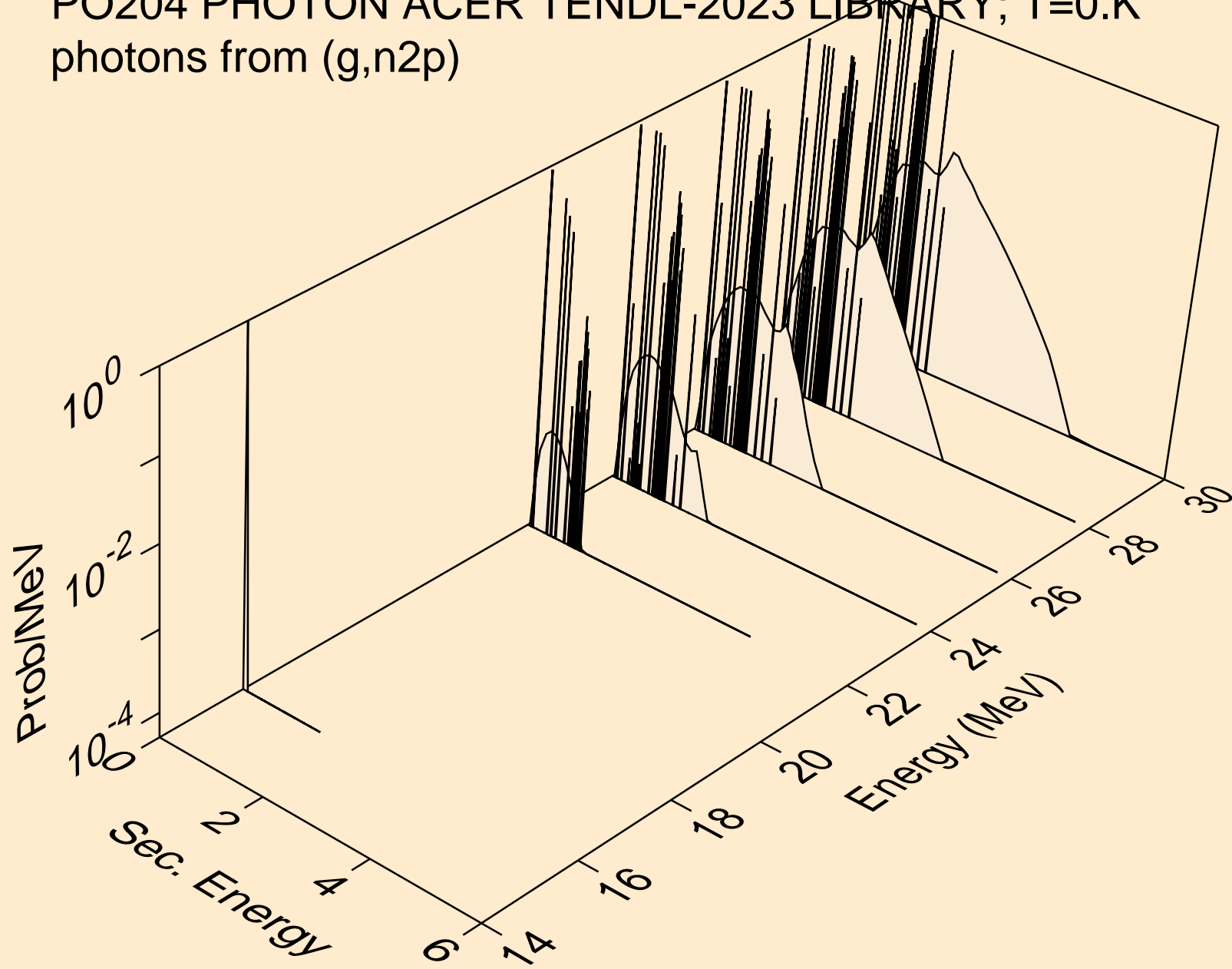

PO204 PHOTON ACER TENDL-2023 LIBRARY; T=0.K
photons from (g,n*c)

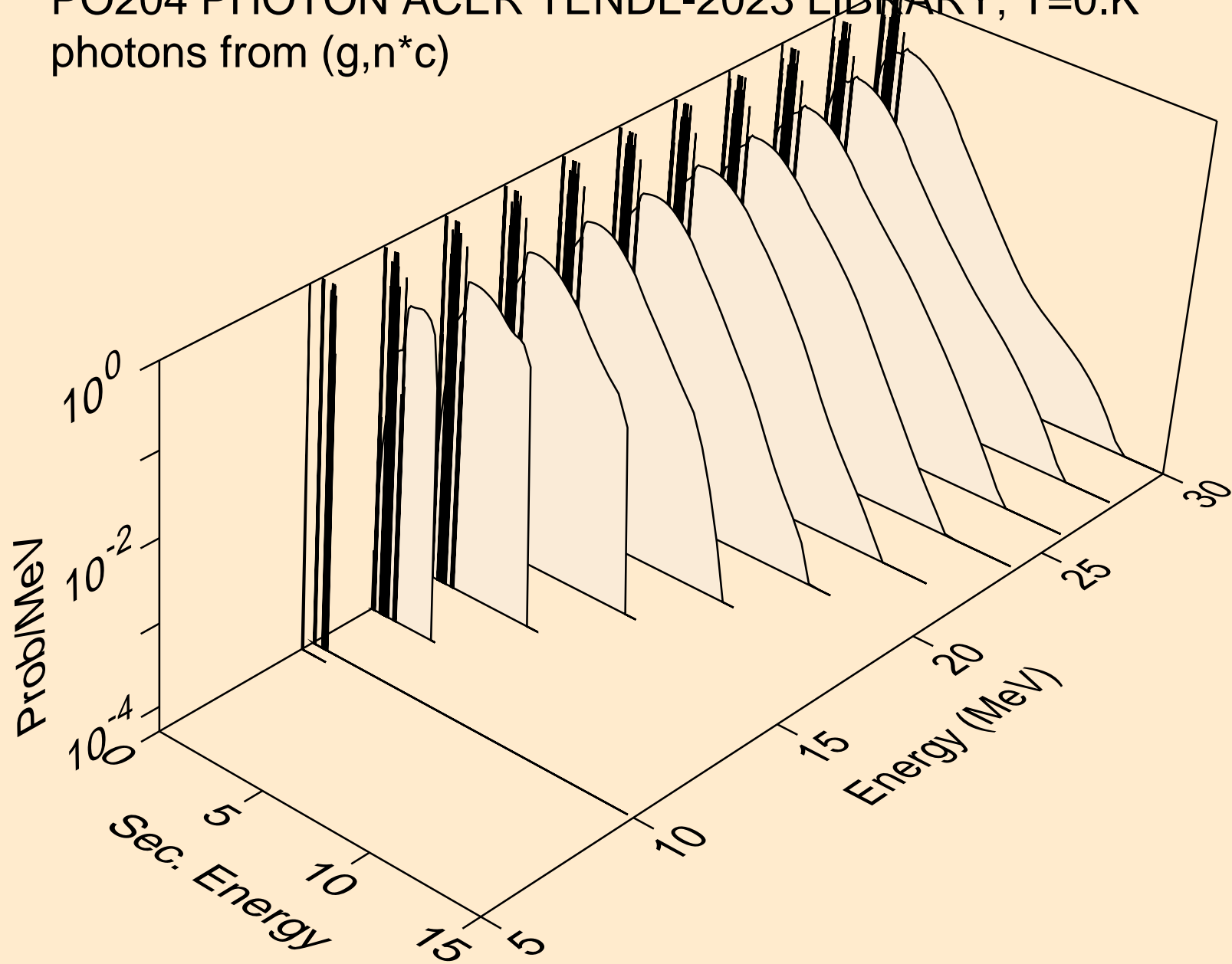

PO204 PHOTON ACER TENDL-2023 LIBRARY; T=0.K
photons from (g,gma)

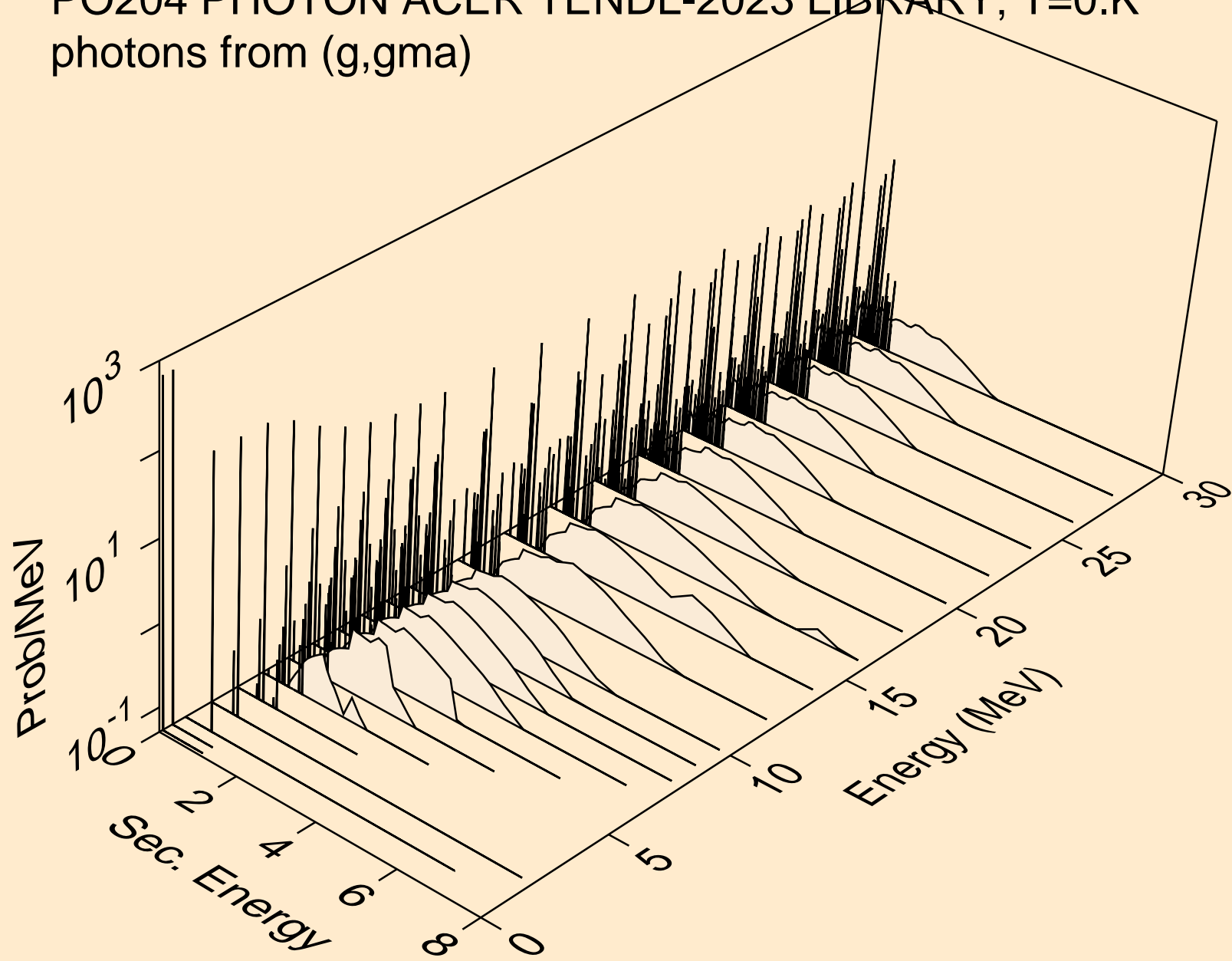

PO204 PHOTON ACER TENDL-2023 LIBRARY; T=0.K
photons from (g,p)

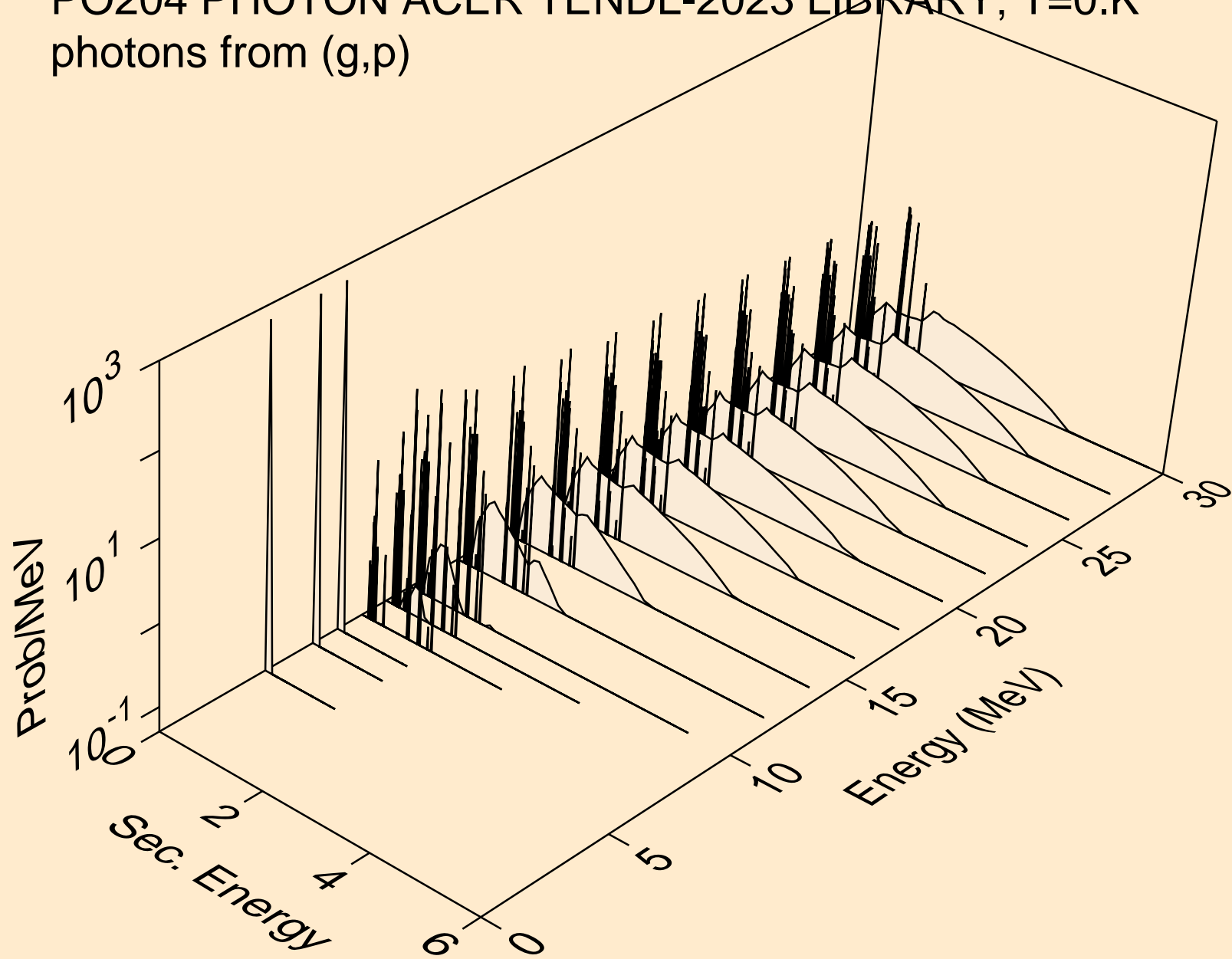

PO204 PHOTON ACER TENDL-2023 LIBRARY; T=0.K
photons from (g,d)

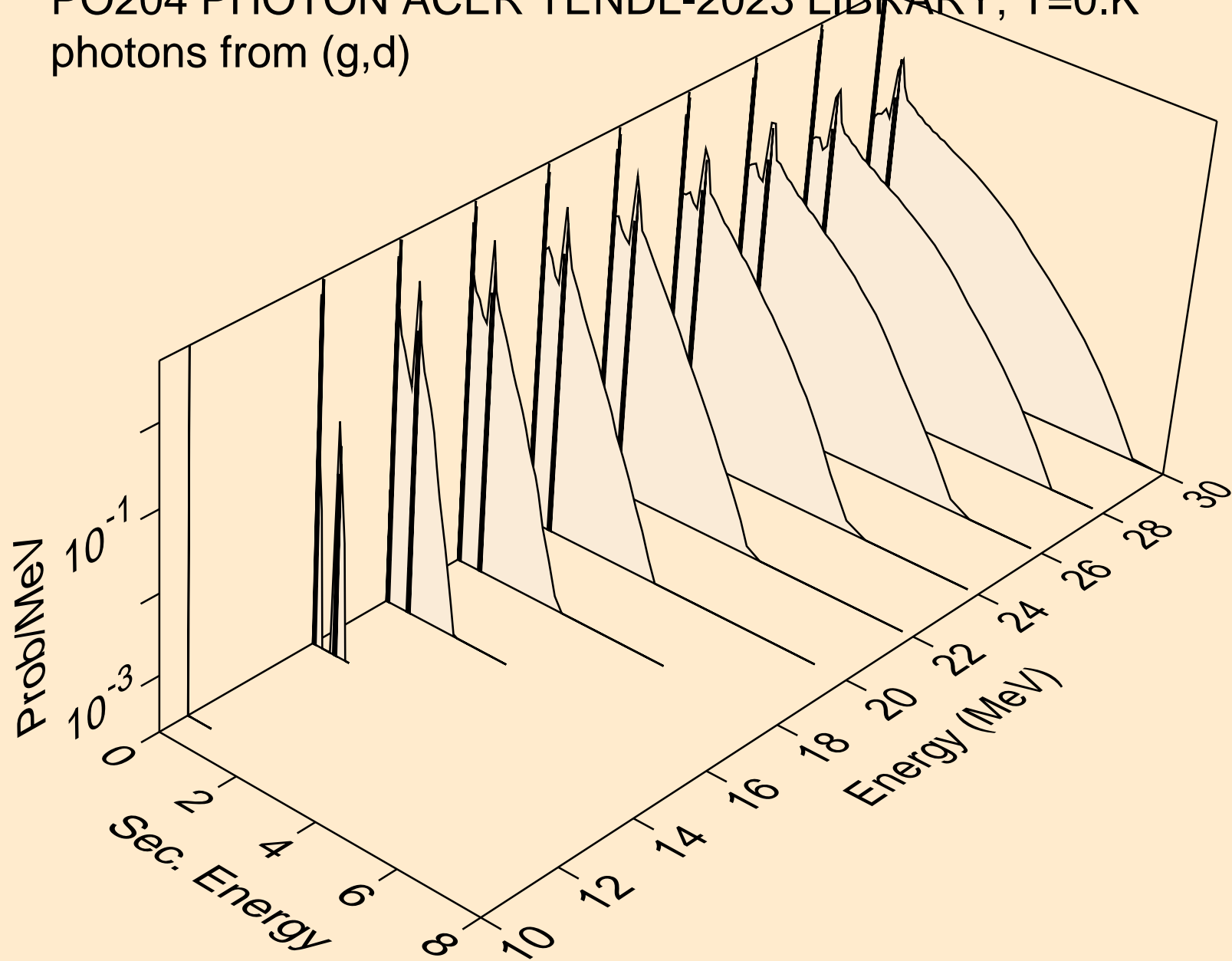

PO204 PHOTON ACER TENDL-2023 LIBRARY; T=0.K
photons from (g,t)

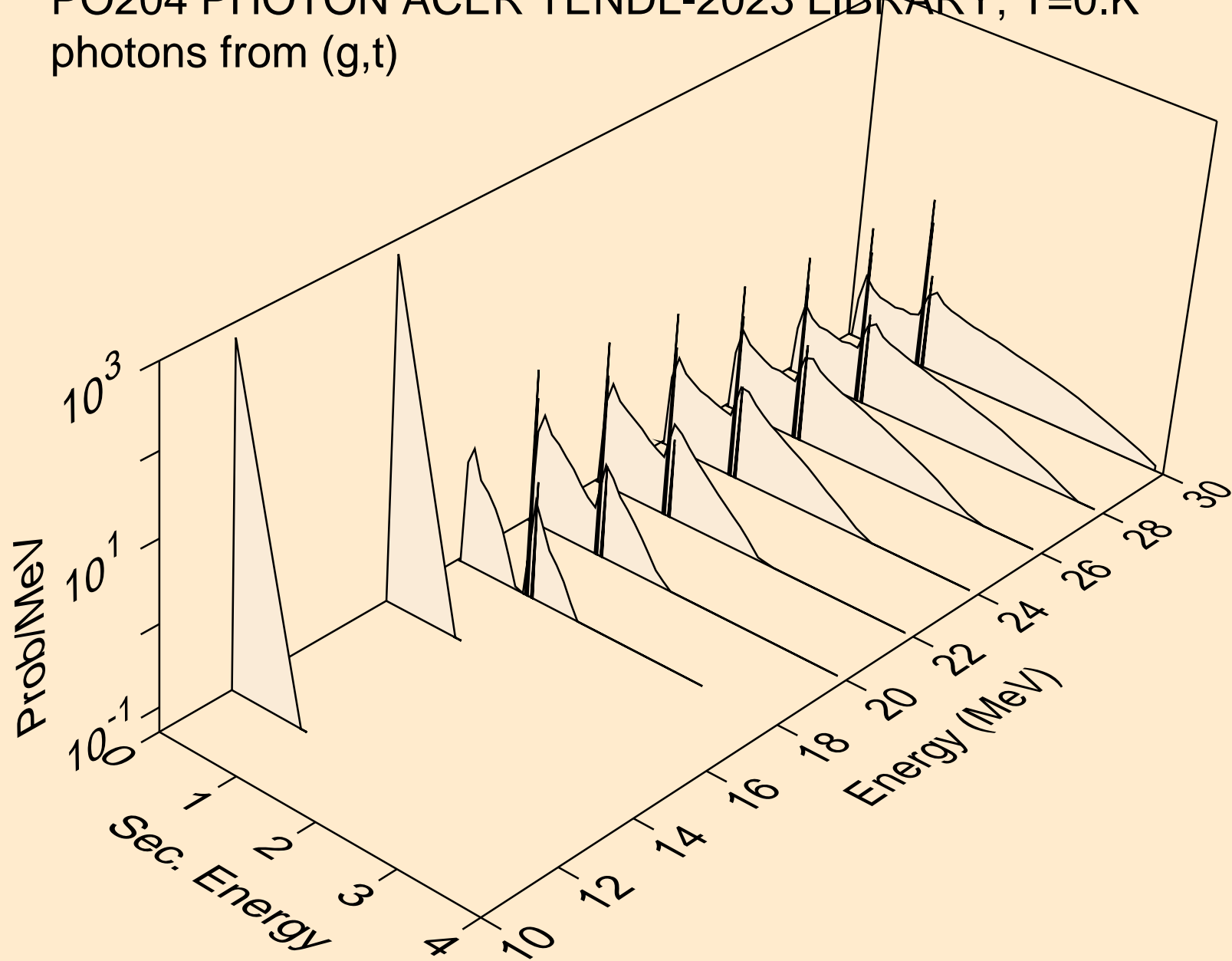

PO204 PHOTON ACER TENDL-2023 LIBRARY; T=0.K
photons from (g,a)

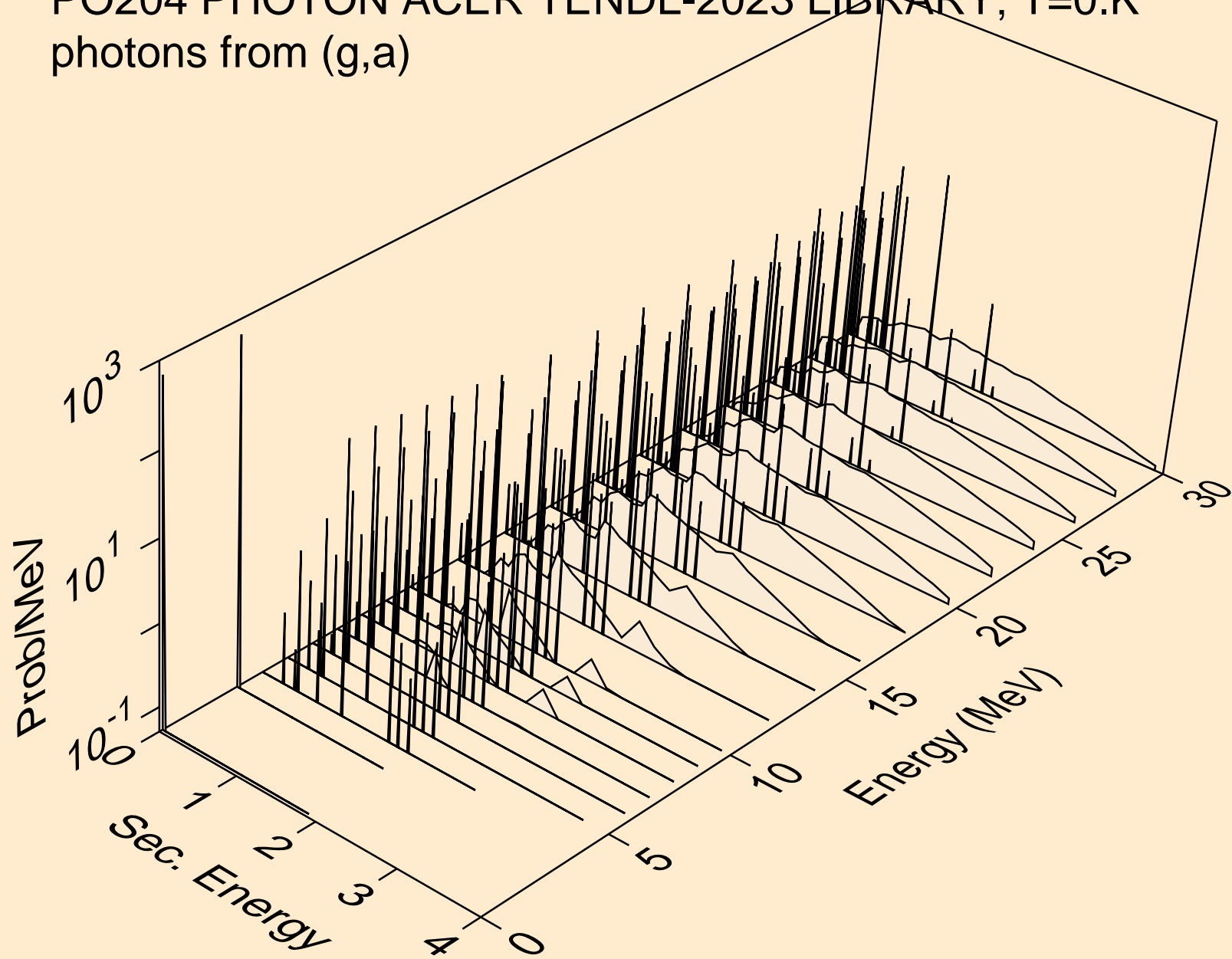

PO204 PHOTON ACER TENDL-2023 LIBRARY; T=0.K
photons from (g,2p)

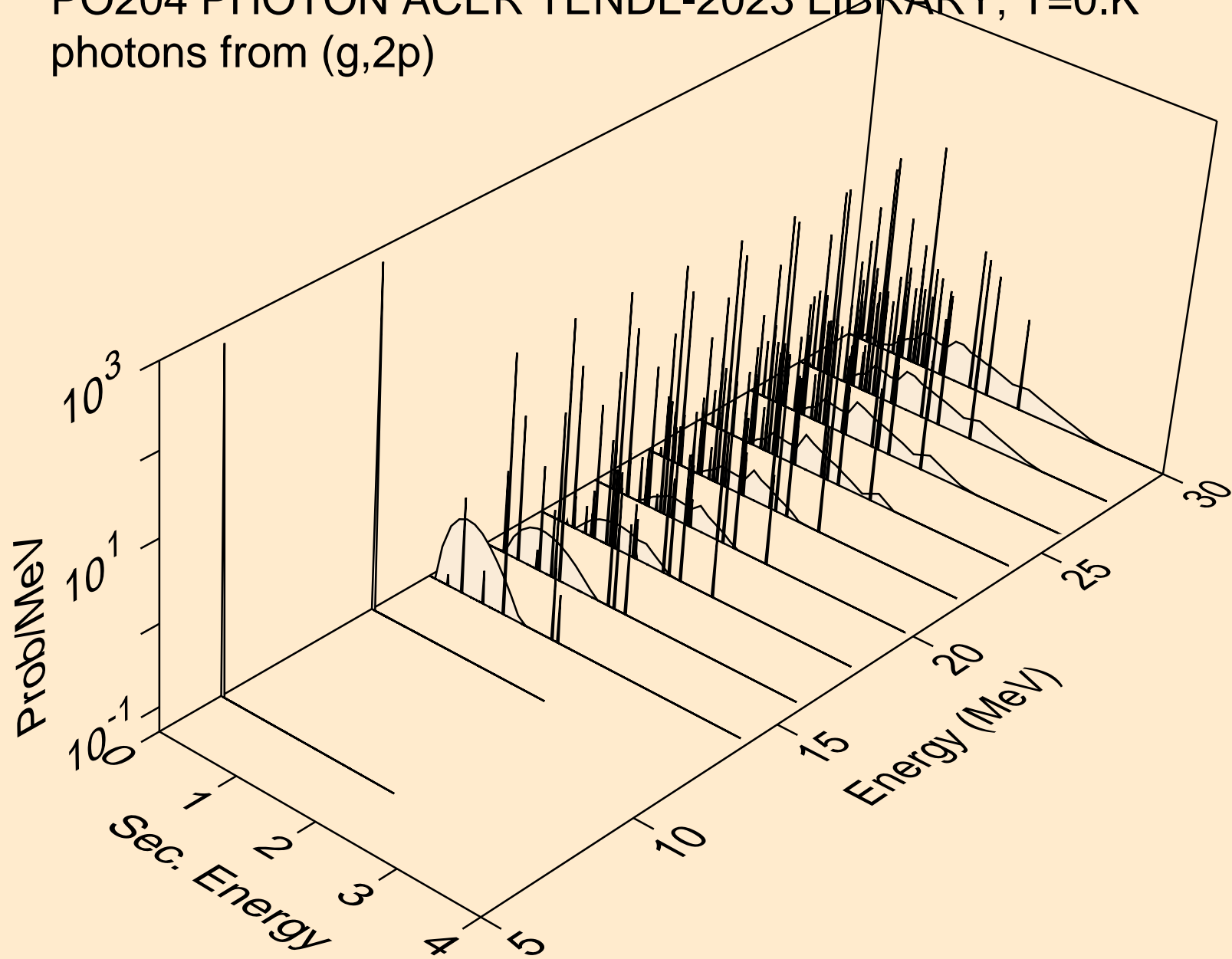

PO204 PHOTON ACER TENDL-2023 LIBRARY; T=0.K
photons from (g,pa)

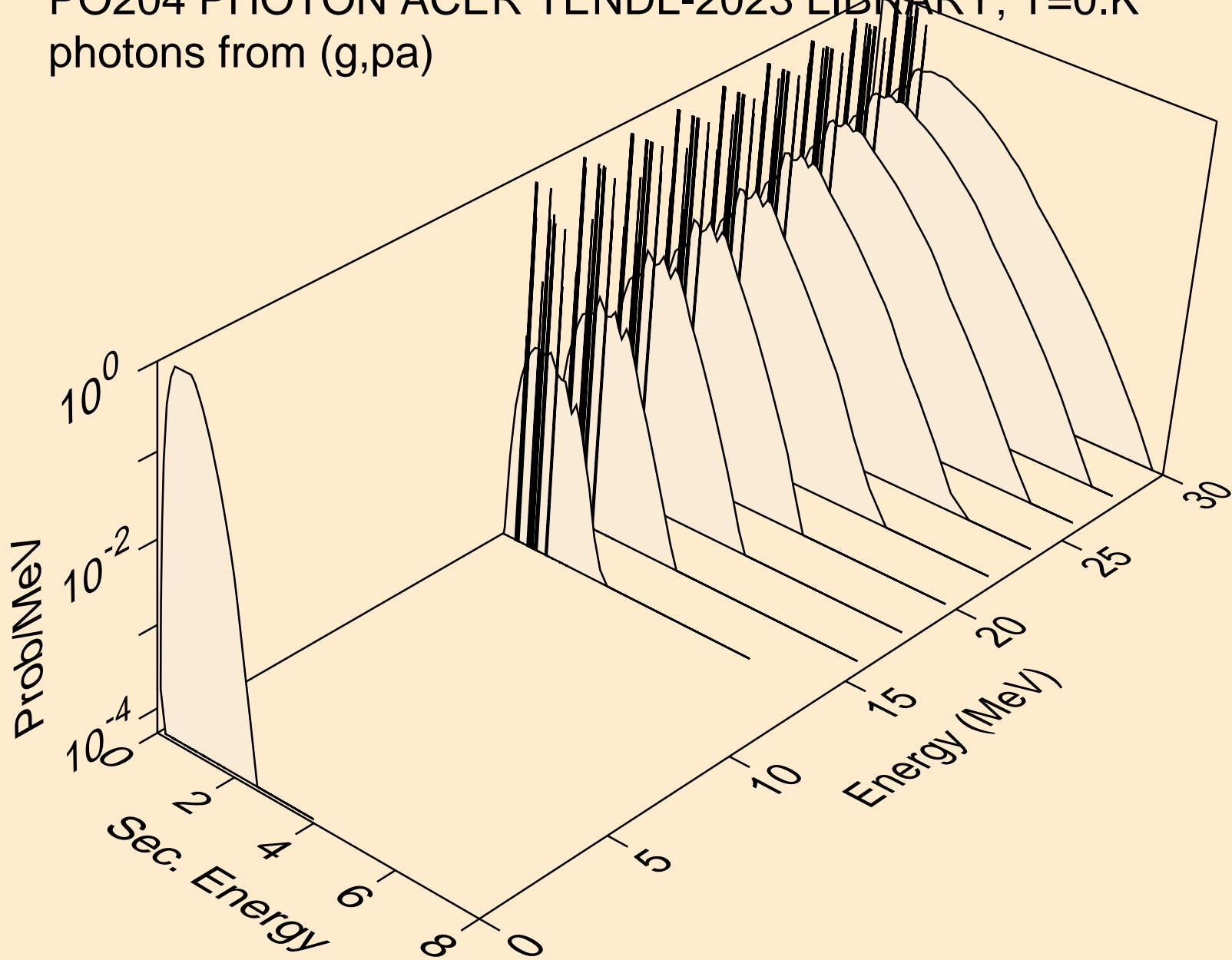

PO204 PHOTON ACER TENDL-2023 LIBRARY; T=0.K
photons from (g,pd)

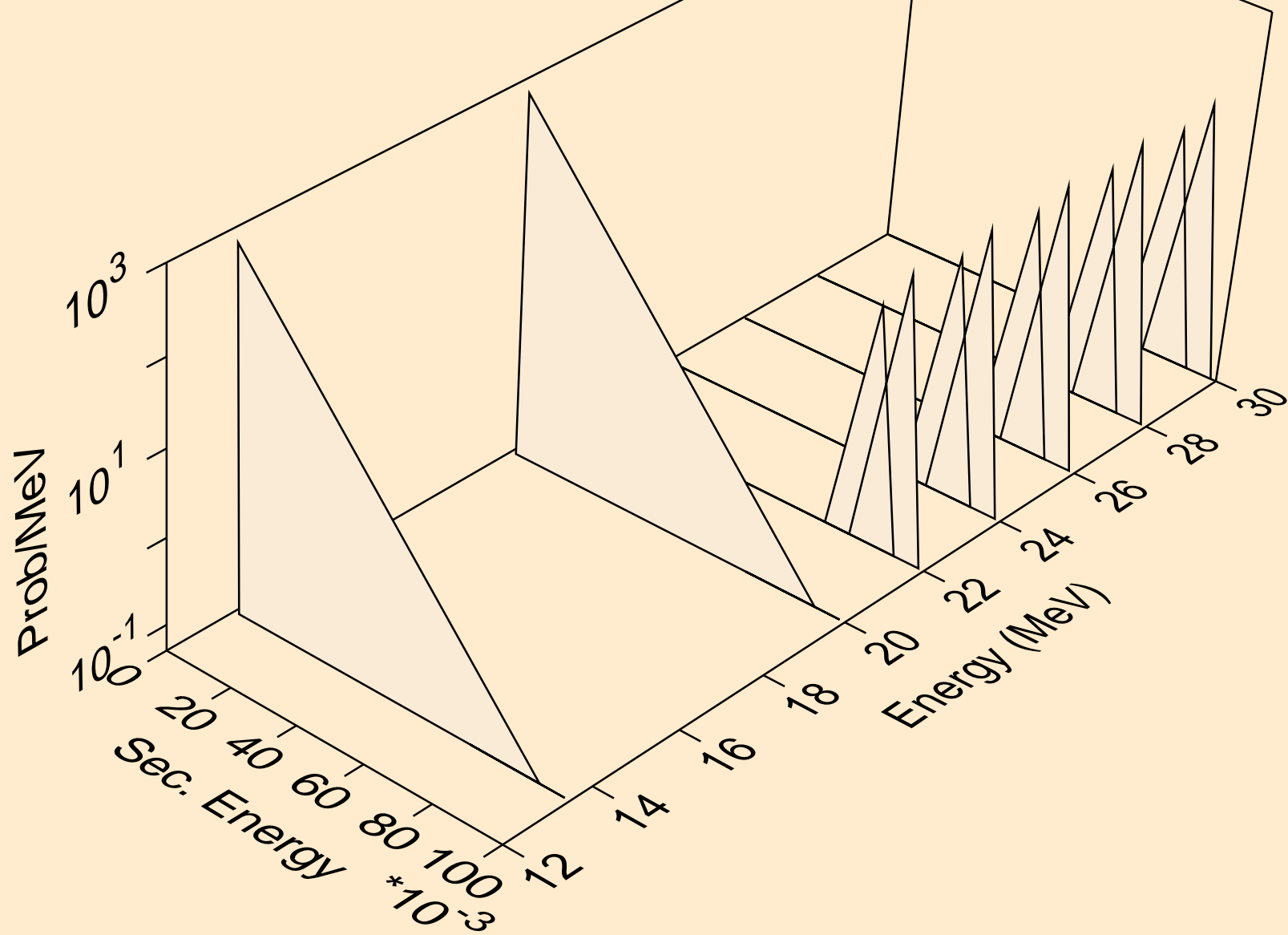

PO204 PHOTON ACER TENDL-2023 LIBRARY; T=0.K
protons from (g,x)

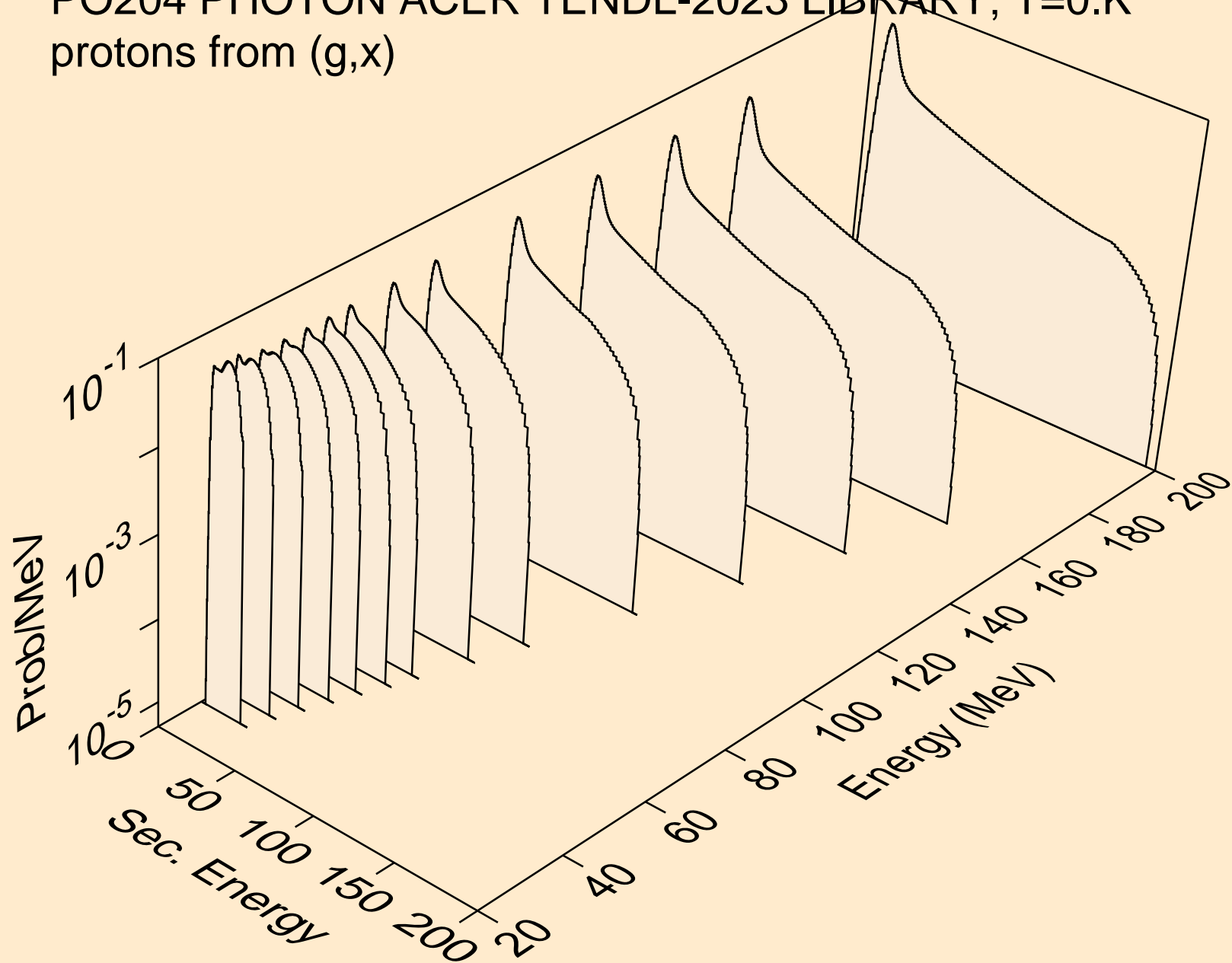

PO204 PHOTON ACER TENDL-2023 LIBRARY; T=0.K
protons from (g,n*)p

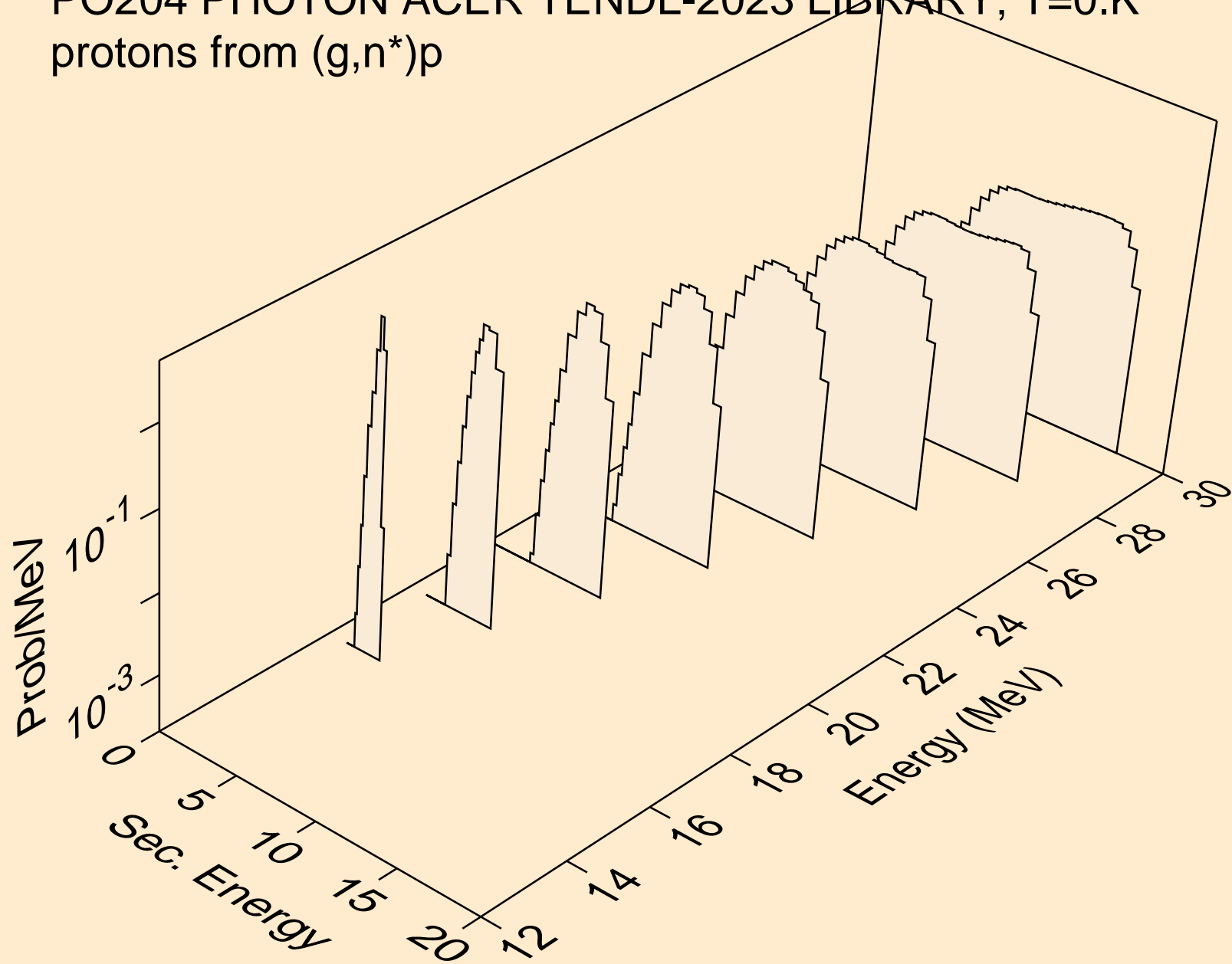

PO204 PHOTON ACER TENDL-2023 LIBRARY; T=0.K
protons from (g,2np)

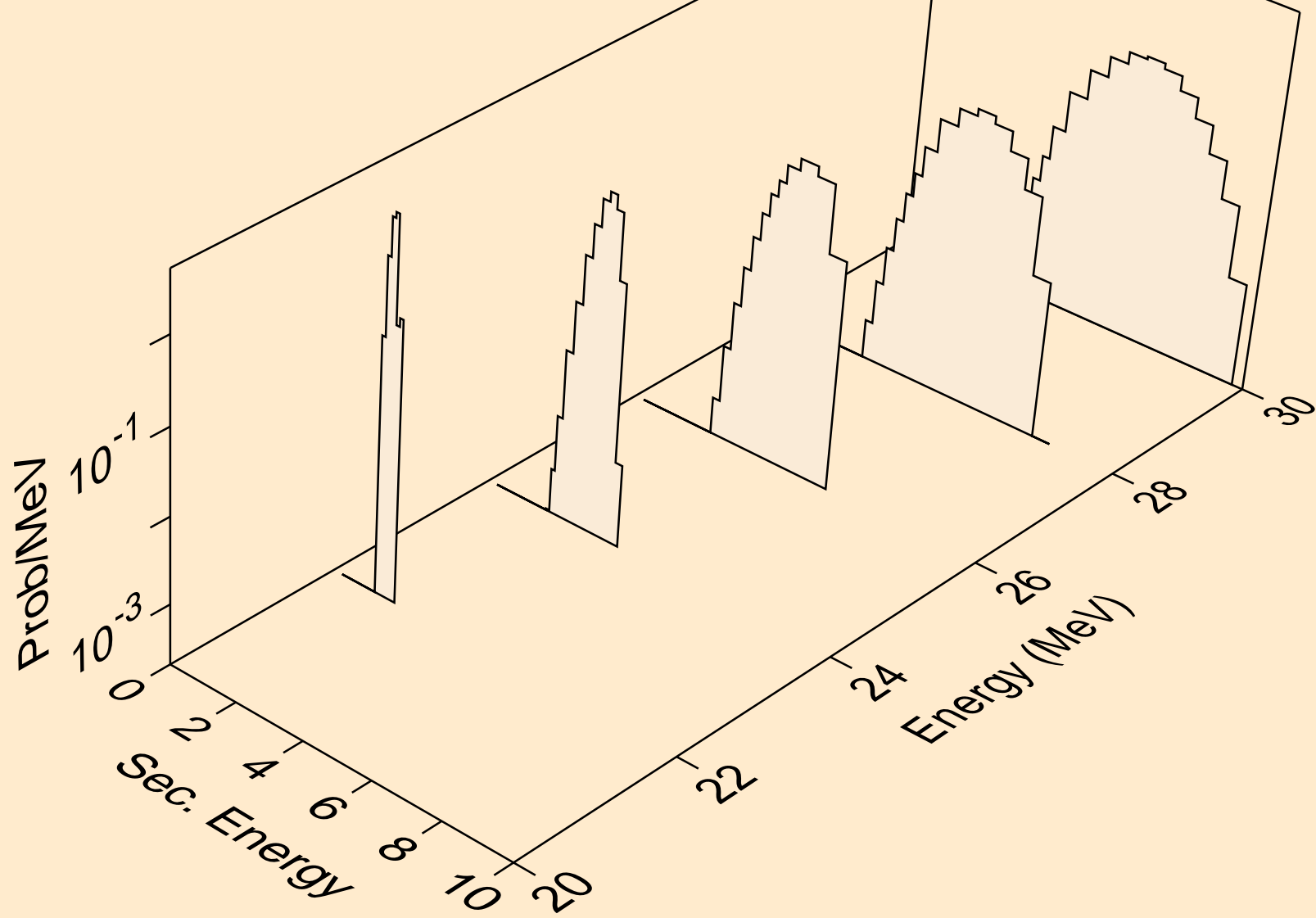

PO204 PHOTON ACER TENDL-2023 LIBRARY; T=0.K
protons from (g,n2p)

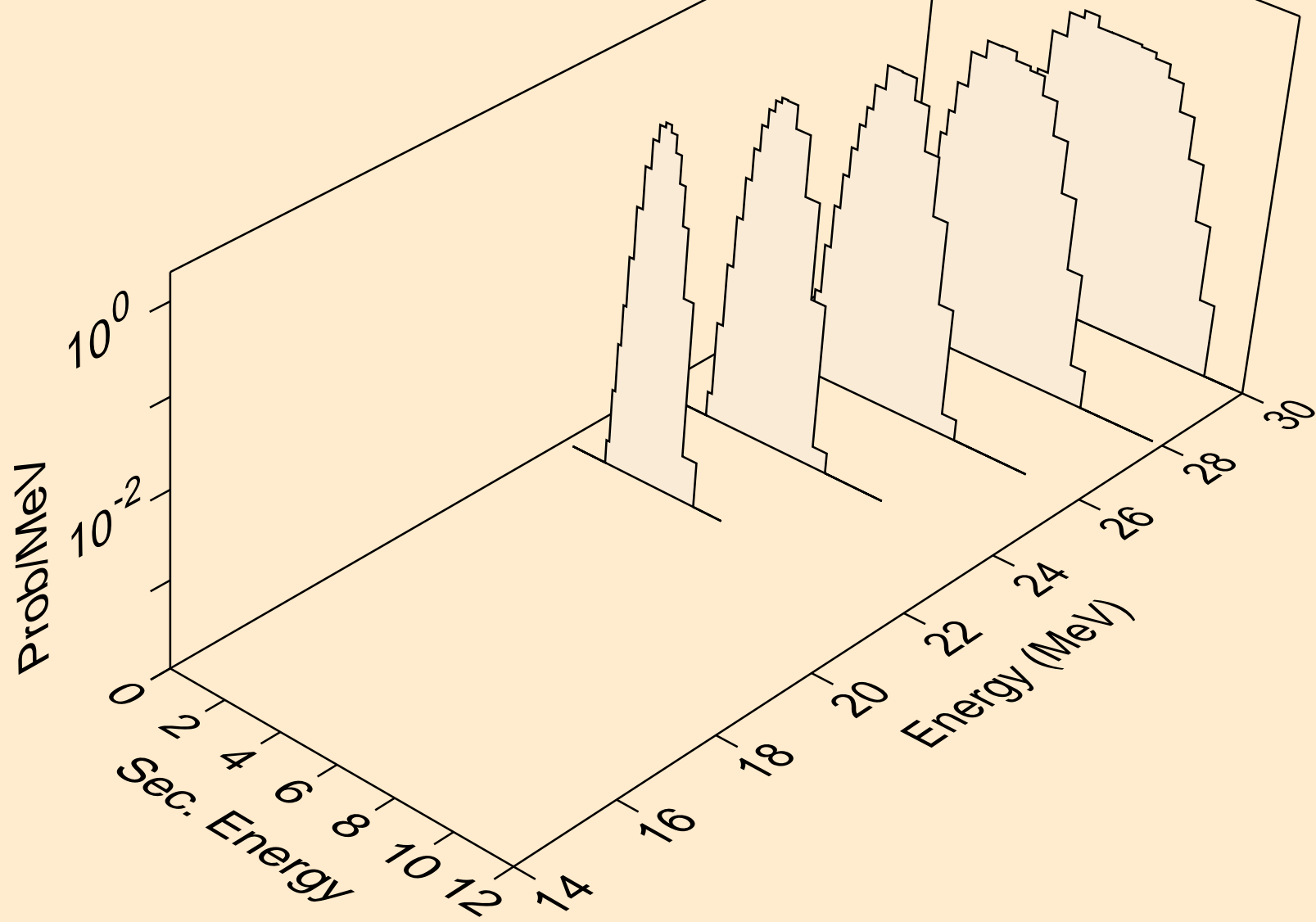

PO204 PHOTON ACER TENDL-2023 LIBRARY; T=0.K
protons from (g,p)

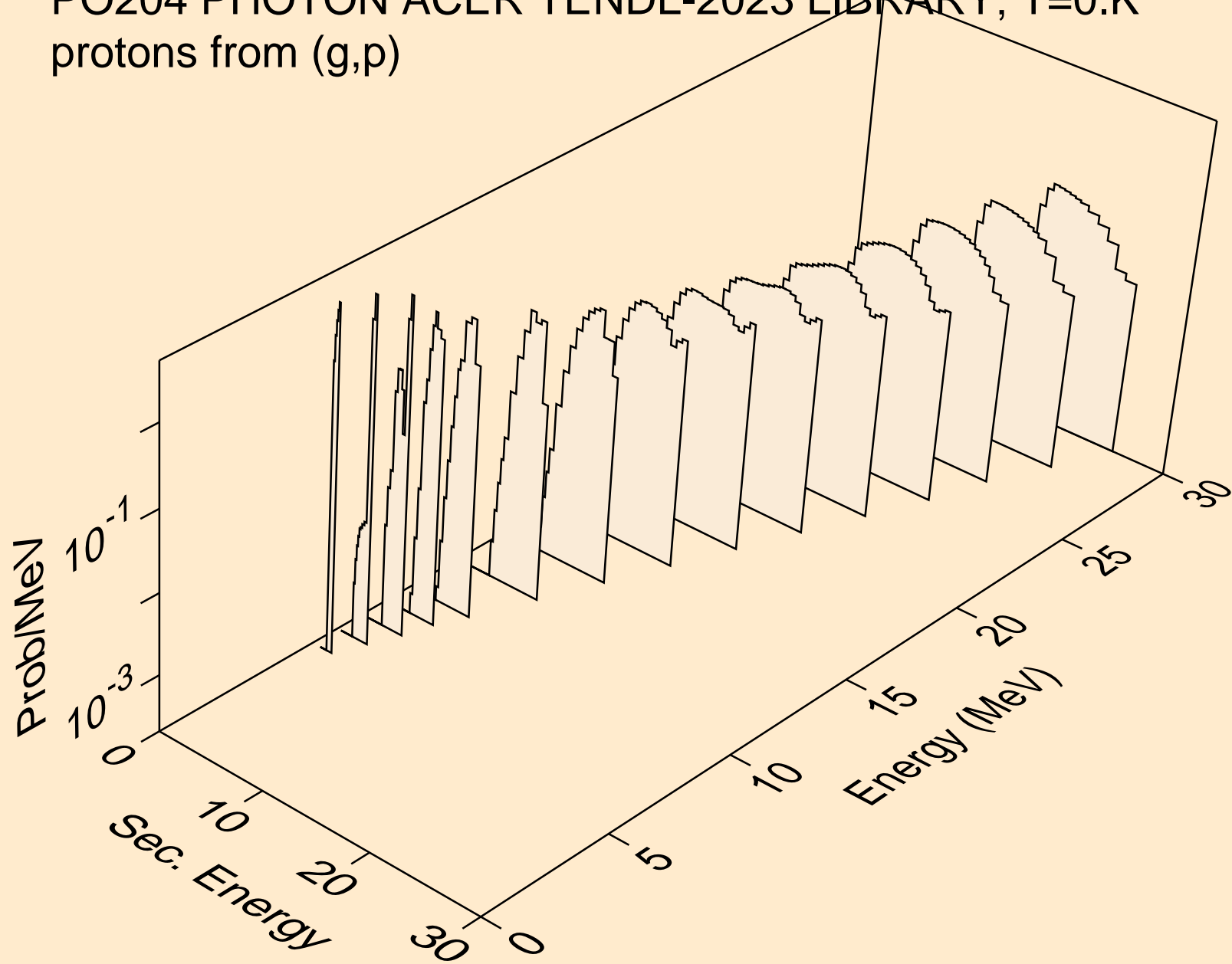

PO204 PHOTON ACER TENDL-2023 LIBRARY; T=0.K
protons from (g,2p)

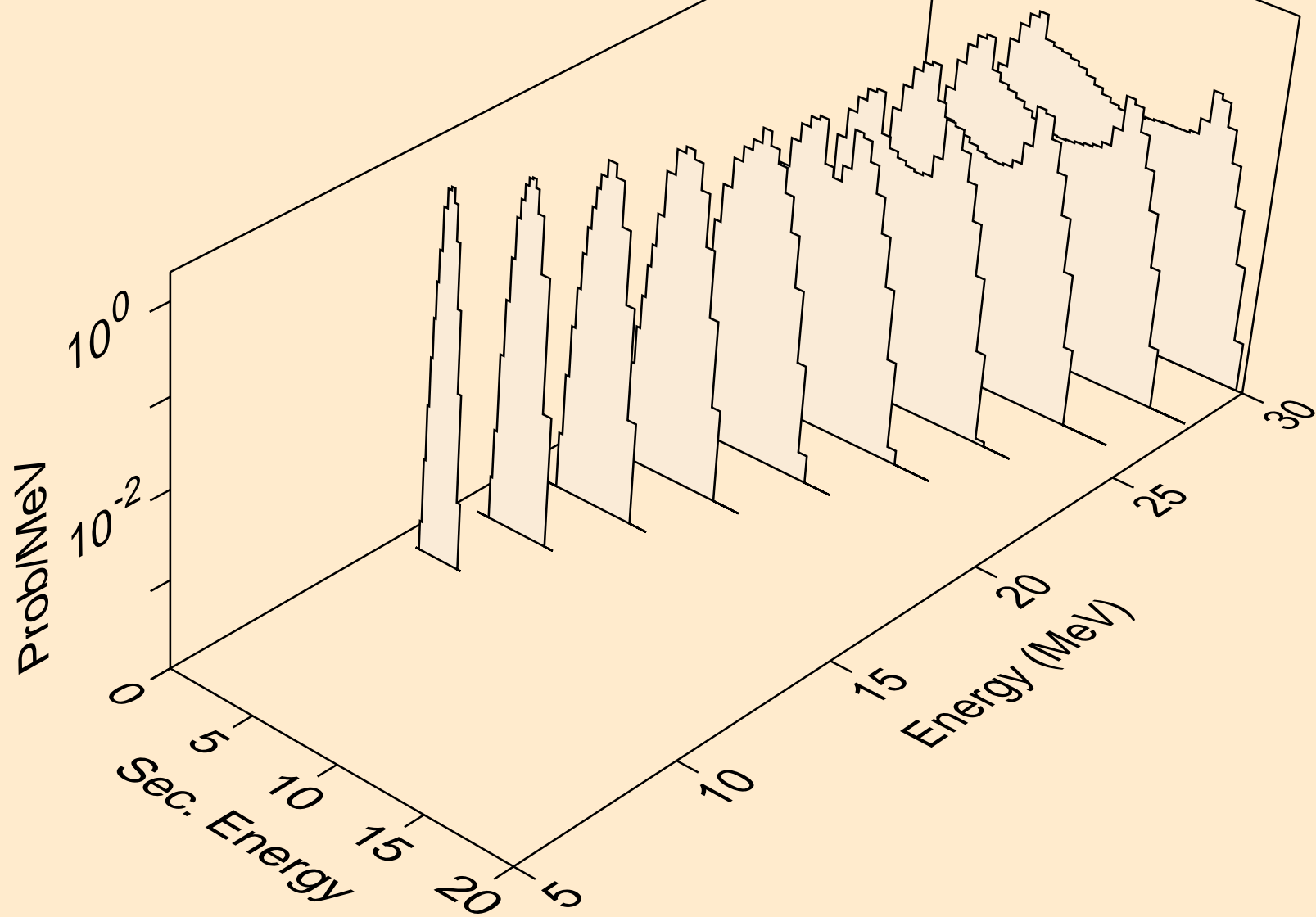

PO204 PHOTON ACER TENDL-2023 LIBRARY; T=0.K
protons from (g,pa)

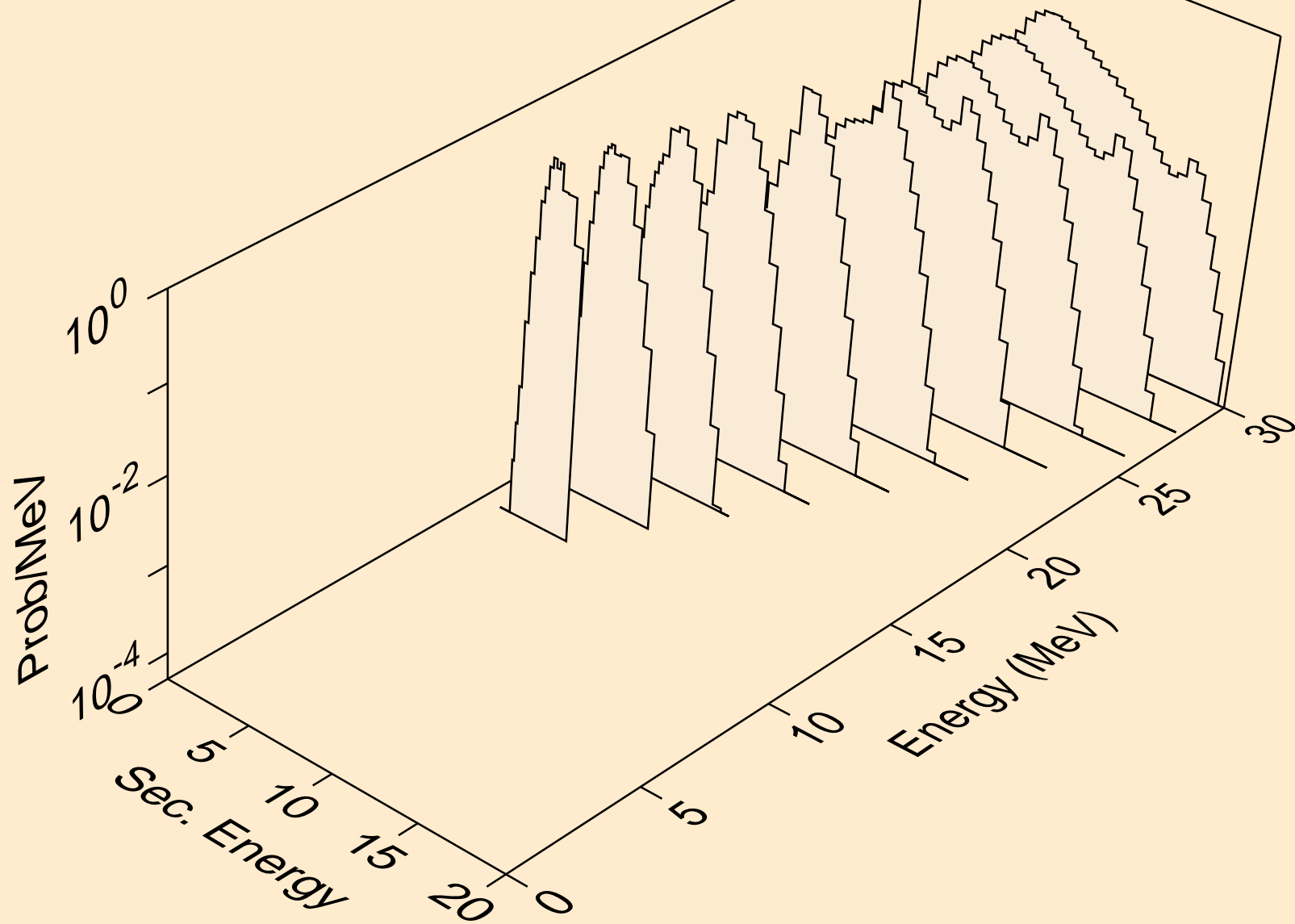

PO204 PHOTON ACER TENDL-2023 LIBRARY; T=0.K
protons from (g,pd)

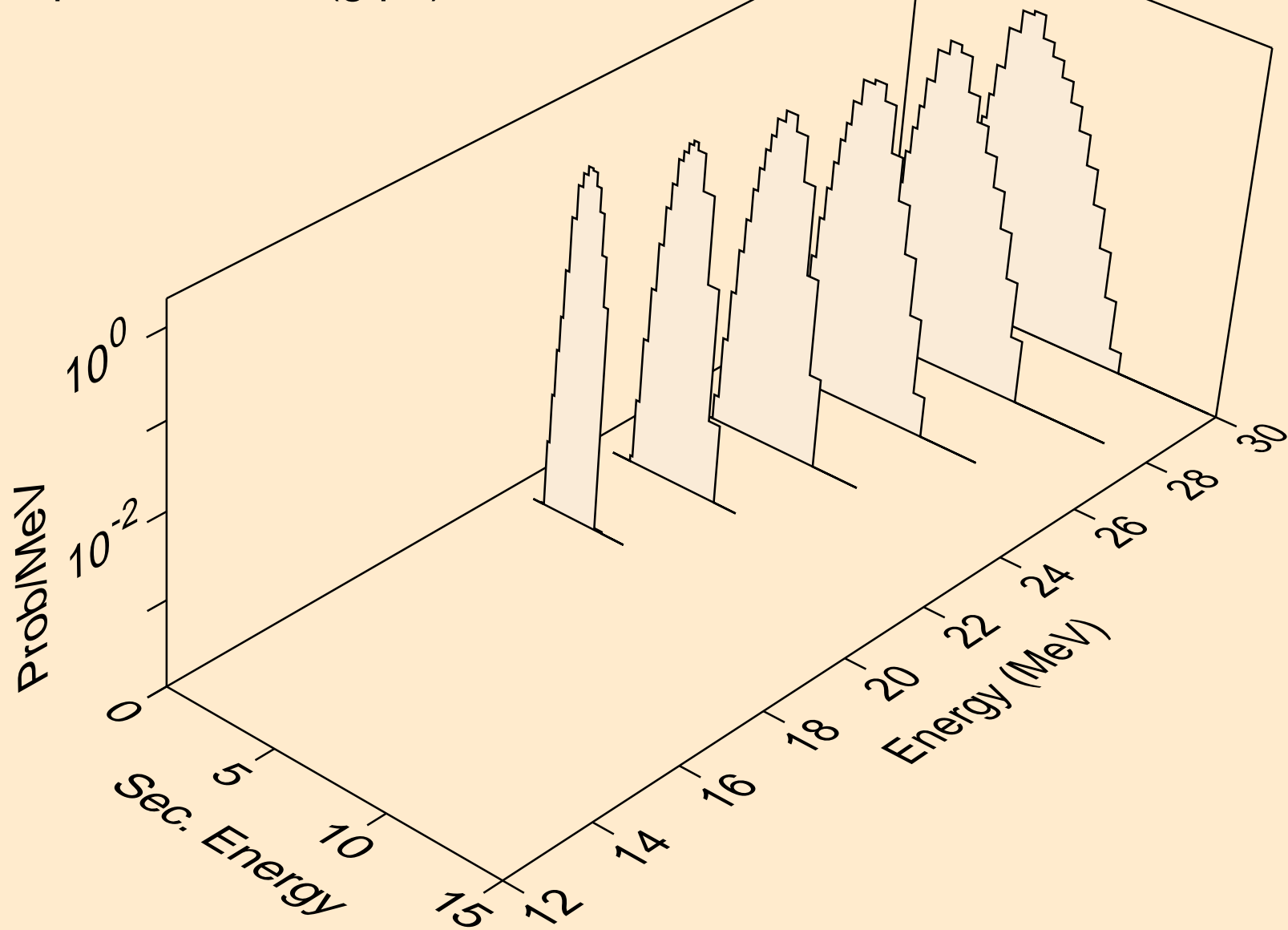

PO204 PHOTON ACER TENDL-2023 LIBRARY; T=0.K
deuterons from (g,x)

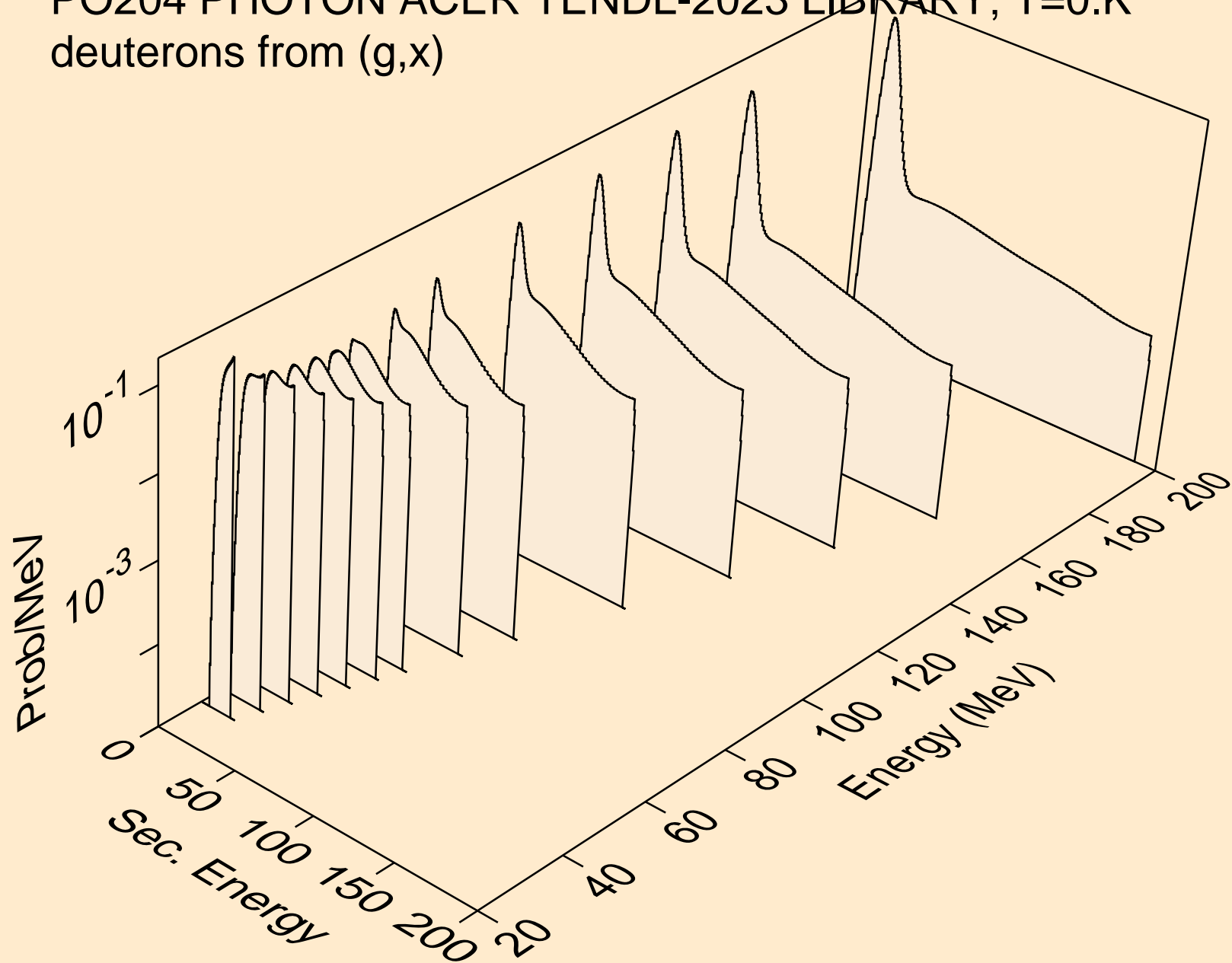

PO204 PHOTON ACER TENDL-2023 LIBRARY; T=0.K
deuterons from (g,n*)d

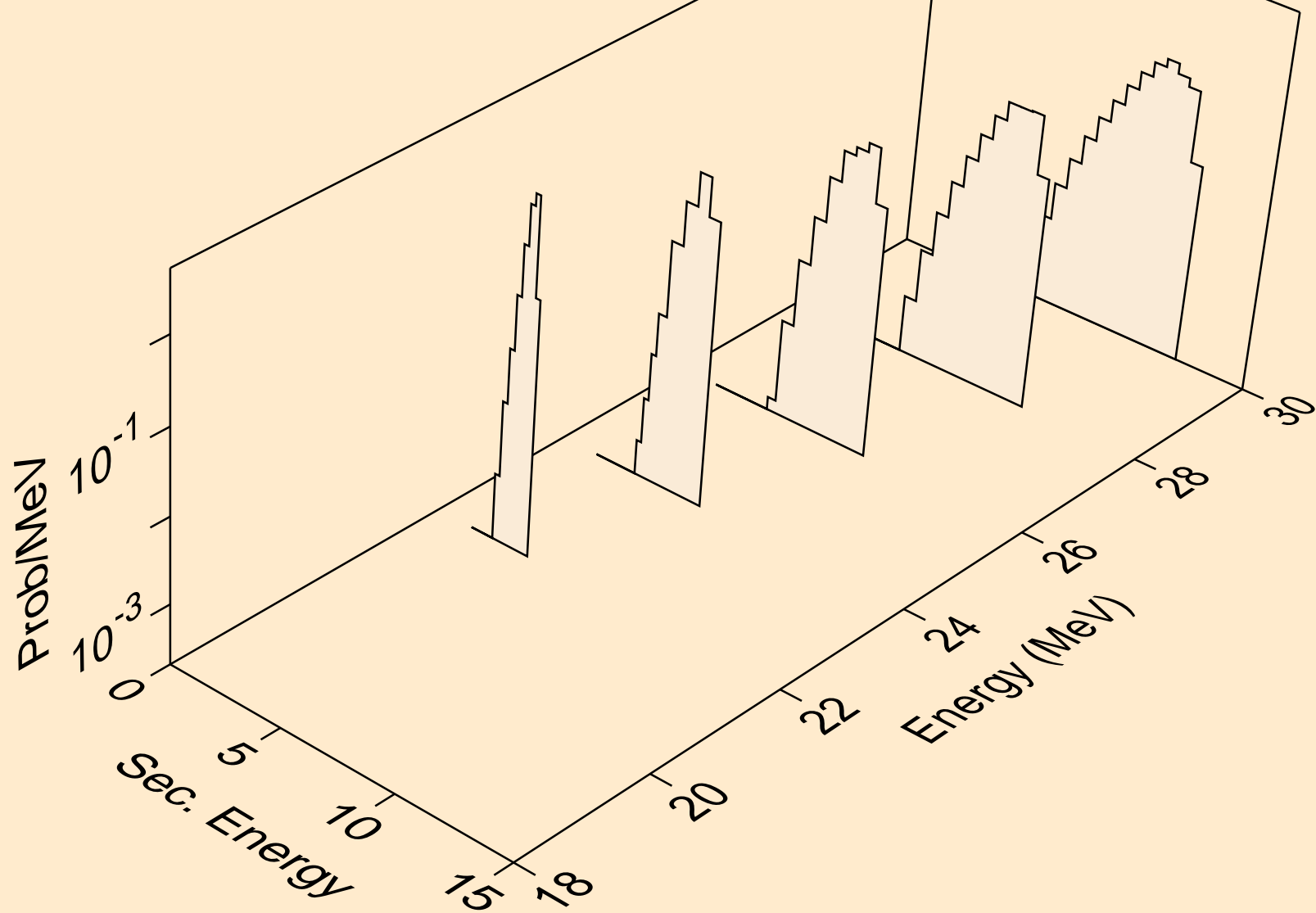

PO204 PHOTON ACER TENDL-2023 LIBRARY; T=0.K
deuterons from (g,d)

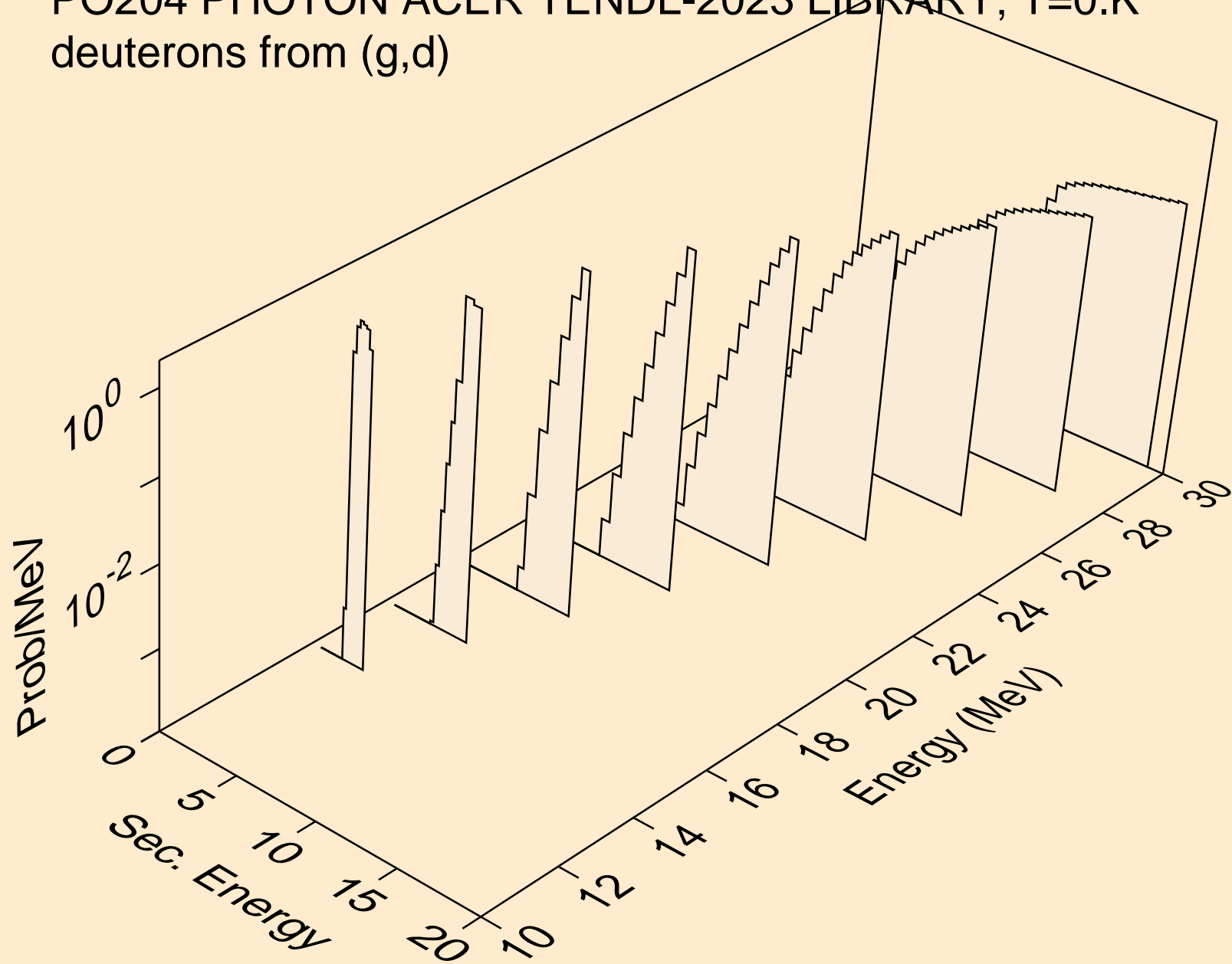

PO204 PHOTON ACER TENDL-2023 LIBRARY; T=0.K
deuterons from (g,pd)

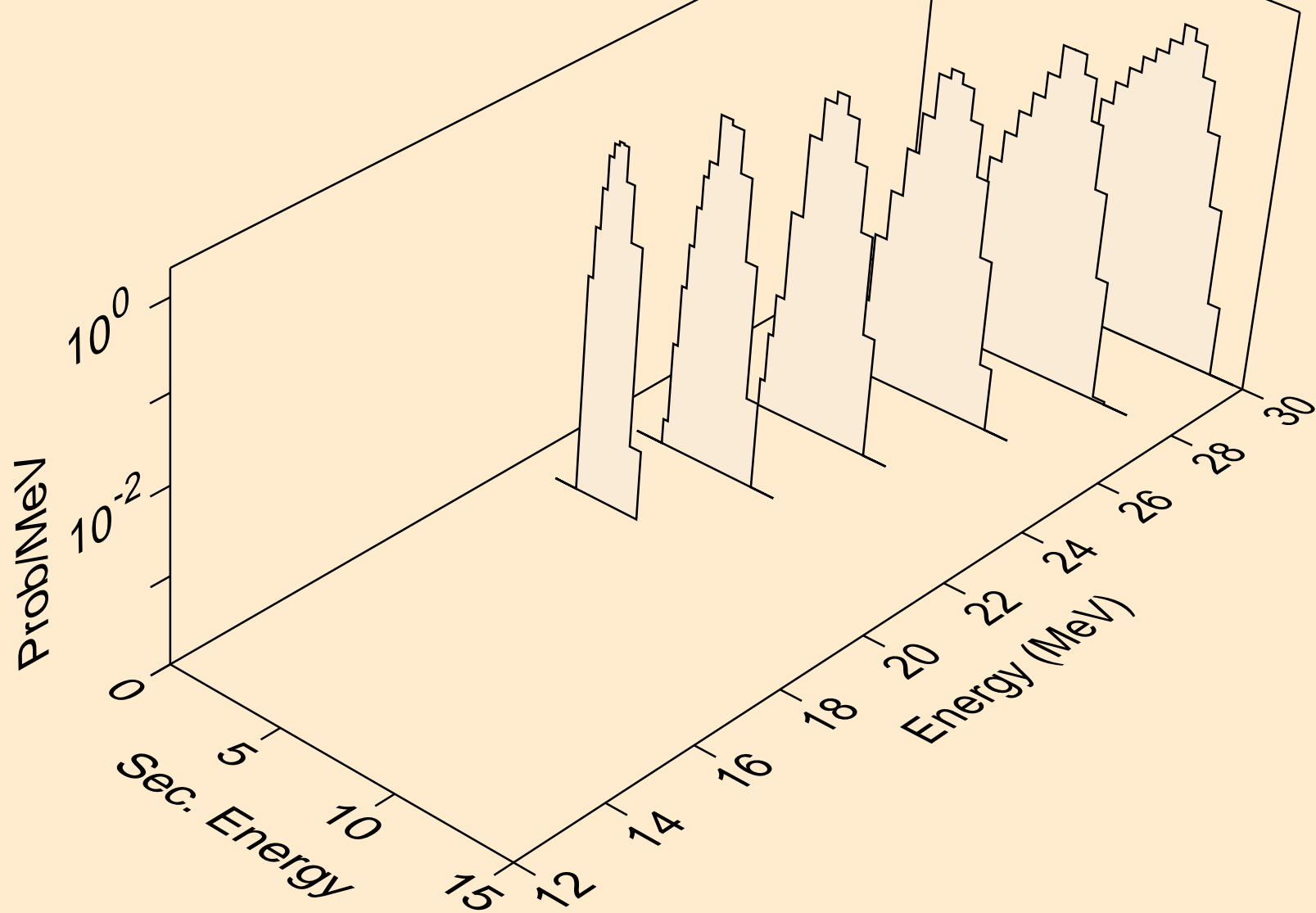

PO204 PHOTON ACER TENDL-2023 LIBRARY; T=0.K
tritons from (g,x)

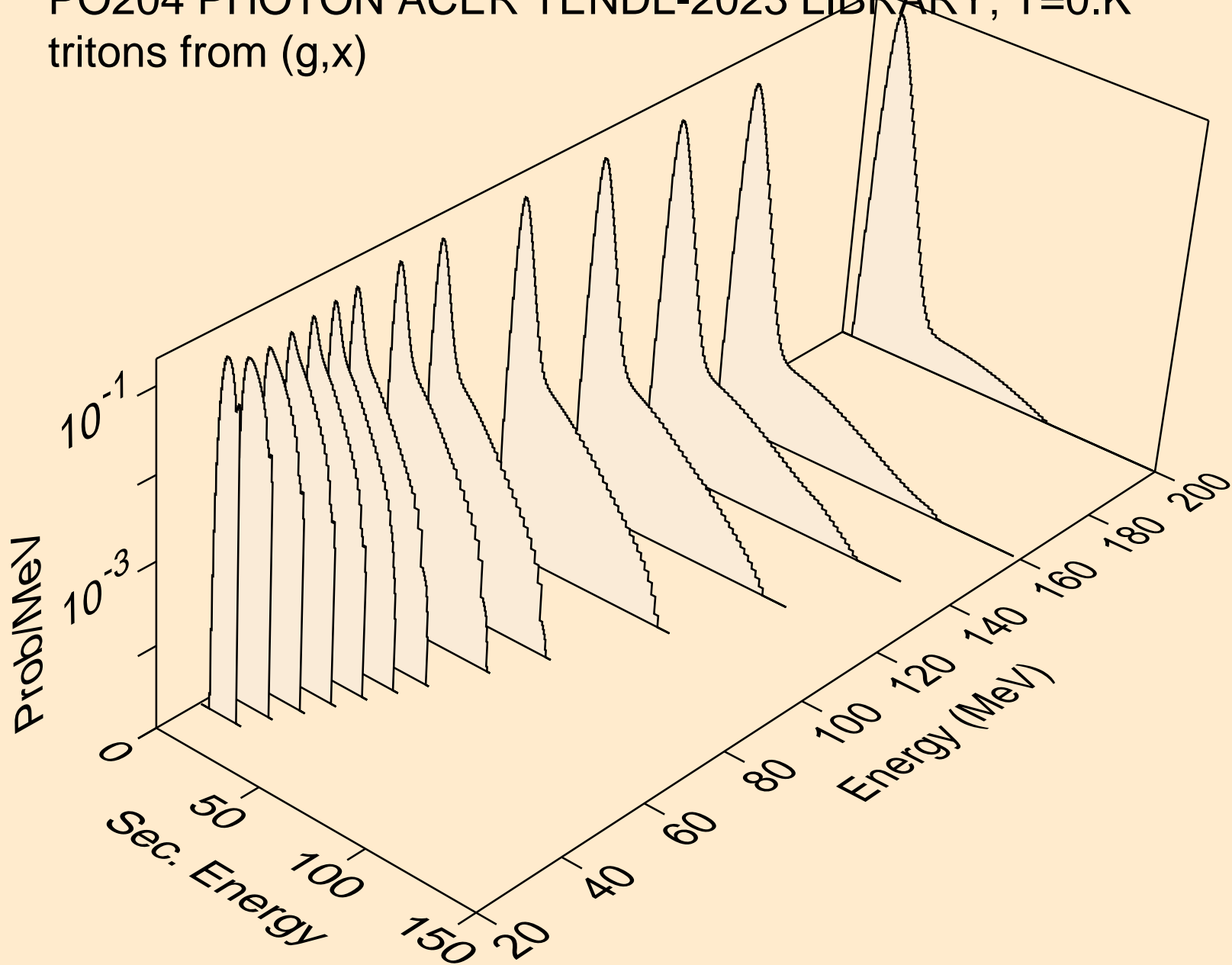

PO204 PHOTON ACER TENDL-2023 LIBRARY; T=0.K
tritons from (g,n*)t

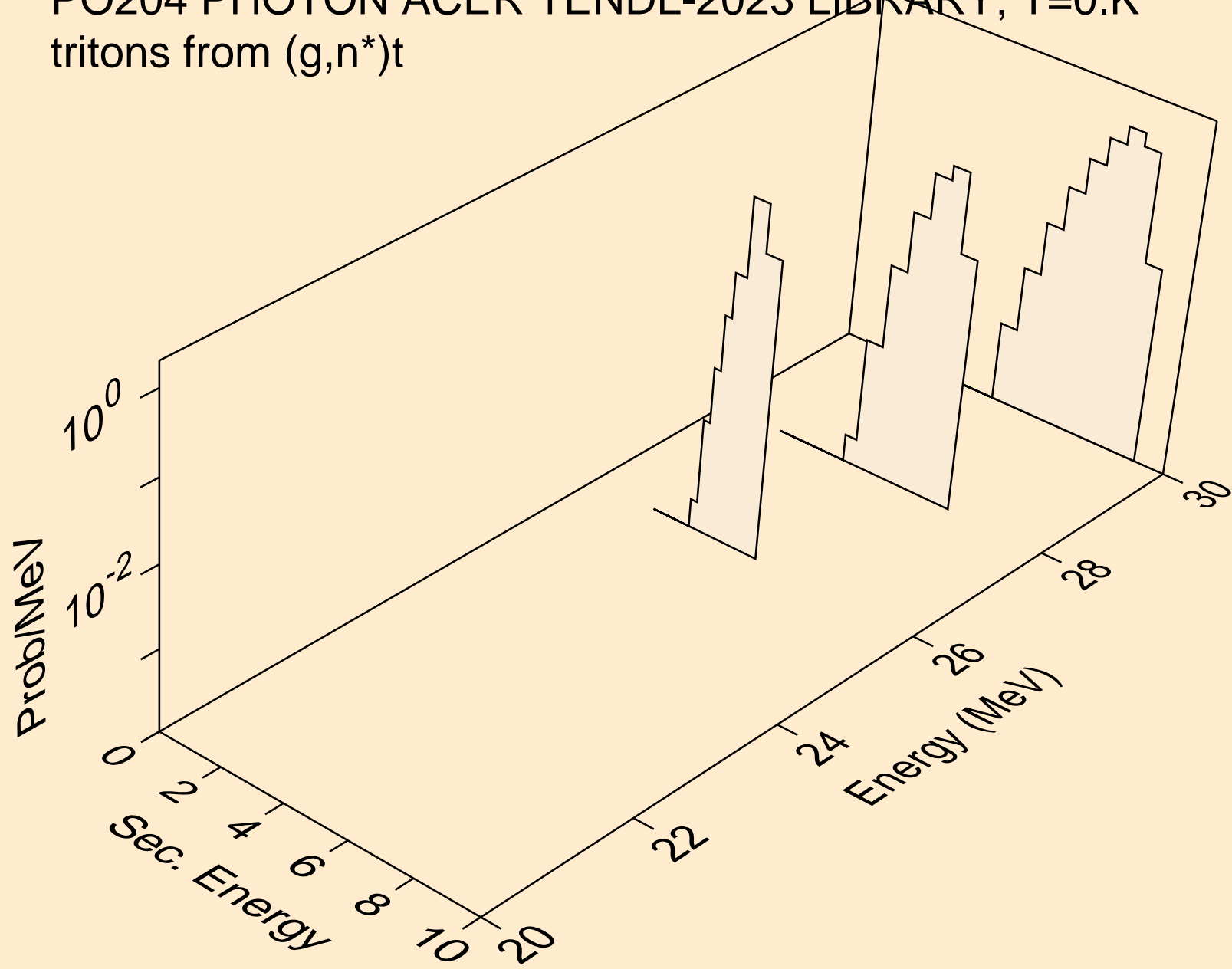

PO204 PHOTON ACER TENDL-2023 LIBRARY; T=0.K
tritons from (g,t)

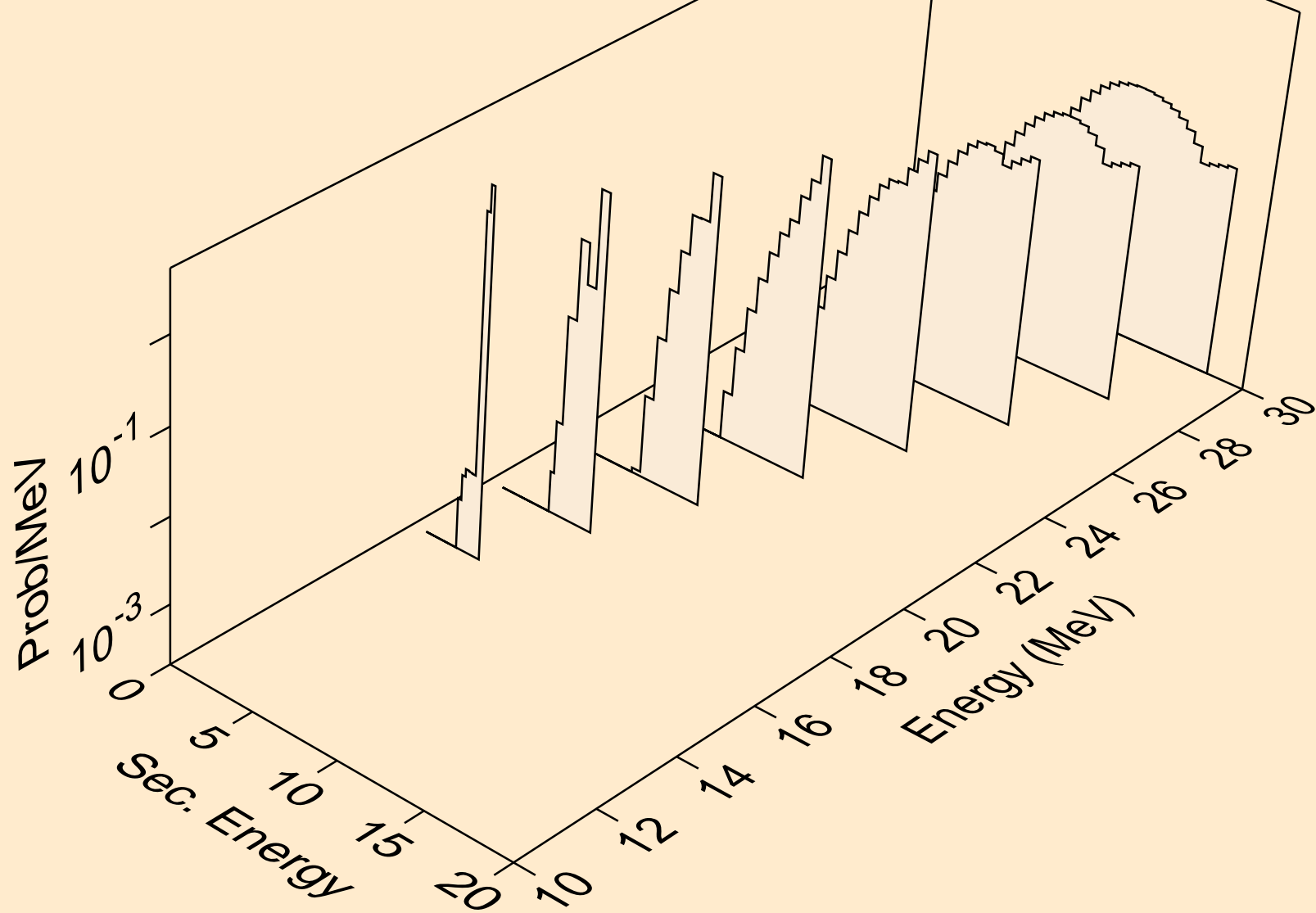

PO204 PHOTON ACER TENDL-2023 LIBRARY; T=0.K
he3s from (g,x)

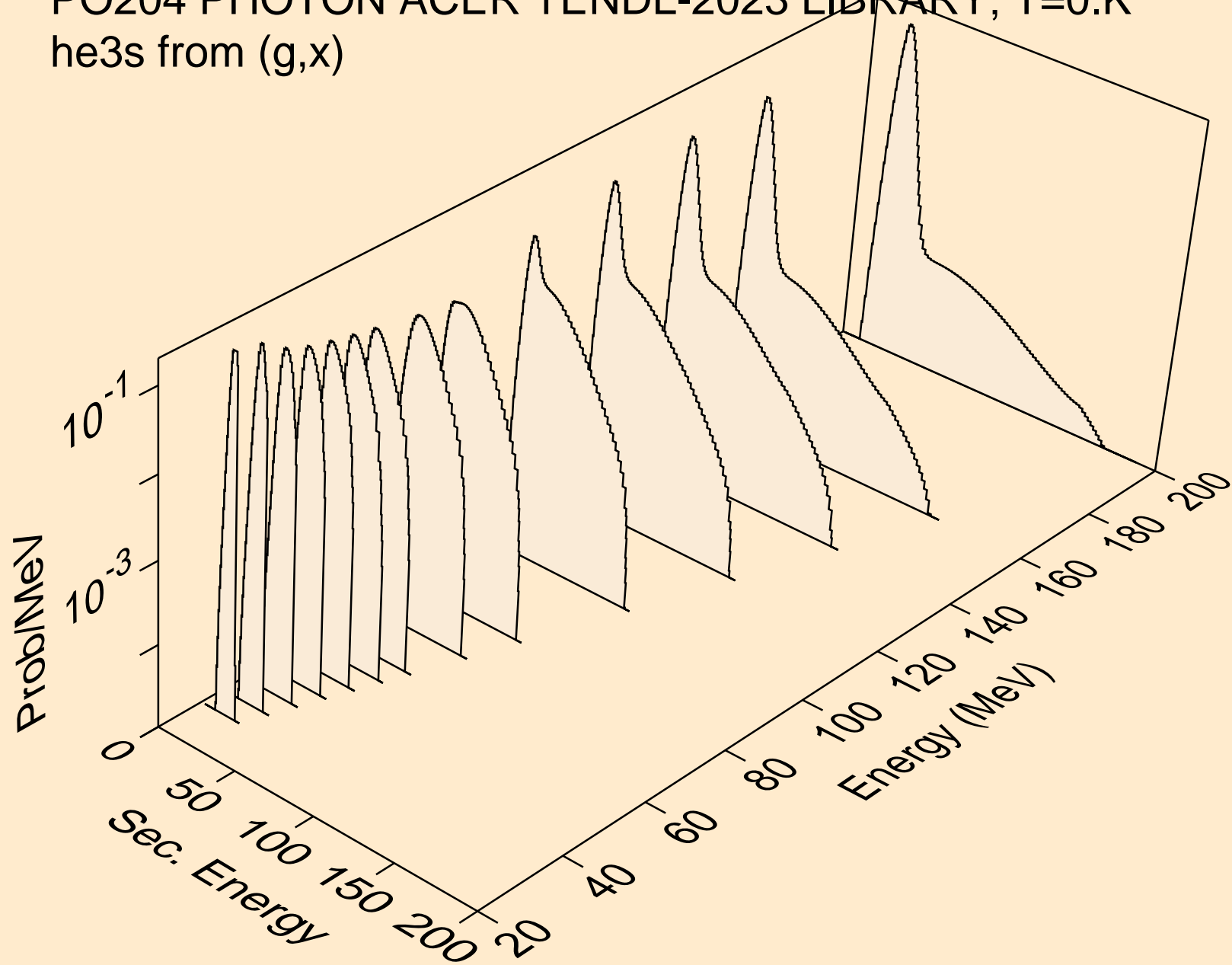

PO204 PHOTON ACER TENDL-2023 LIBRARY; T=0.K
alphas from (g,x)

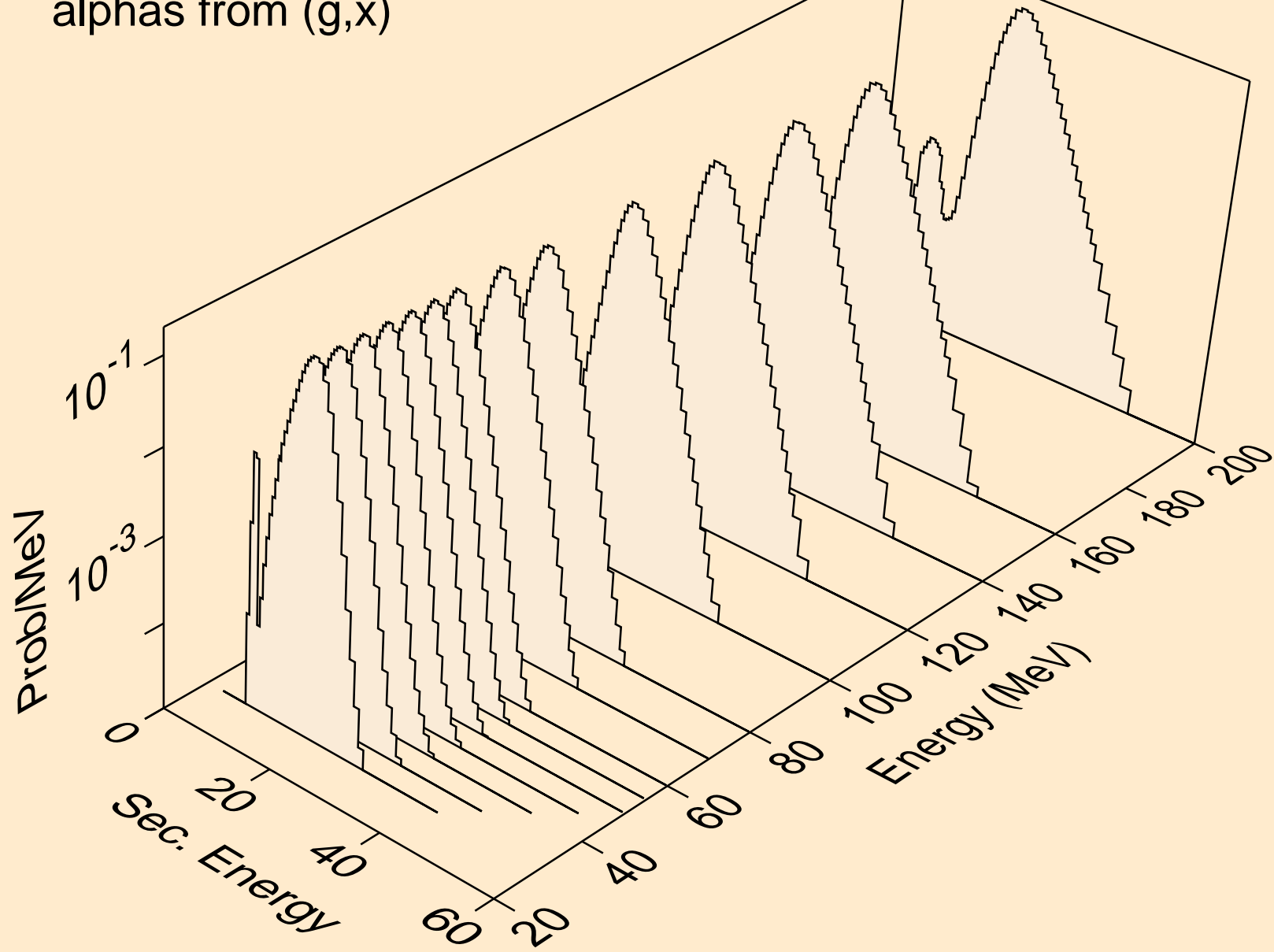

PO204 PHOTON ACER TENDL-2023 LIBRARY; T=0.K
alphas from (g,n*)a

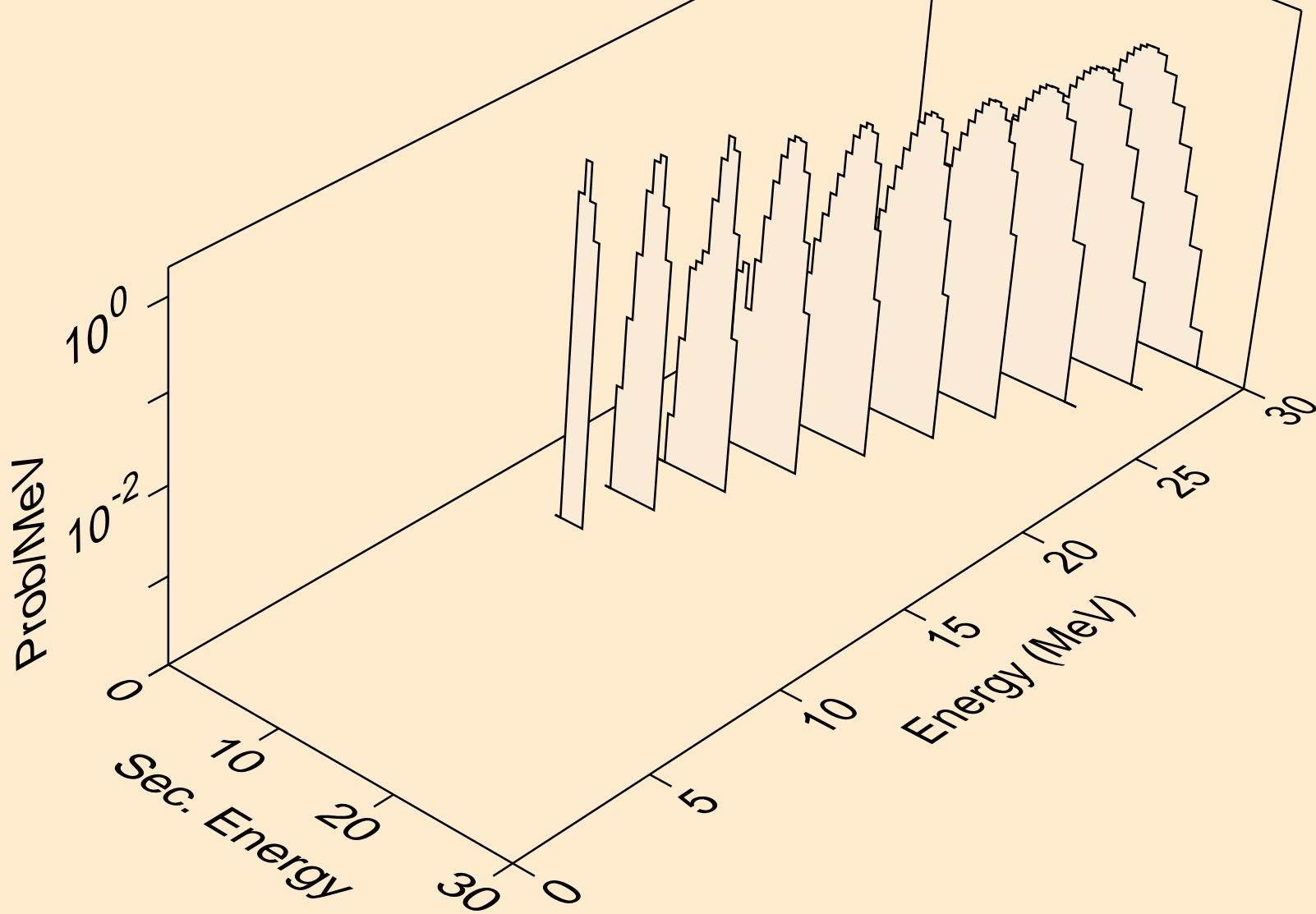

PO204 PHOTON ACER TENDL-2023 LIBRARY; T=0.K
alphas from (g,2n)a

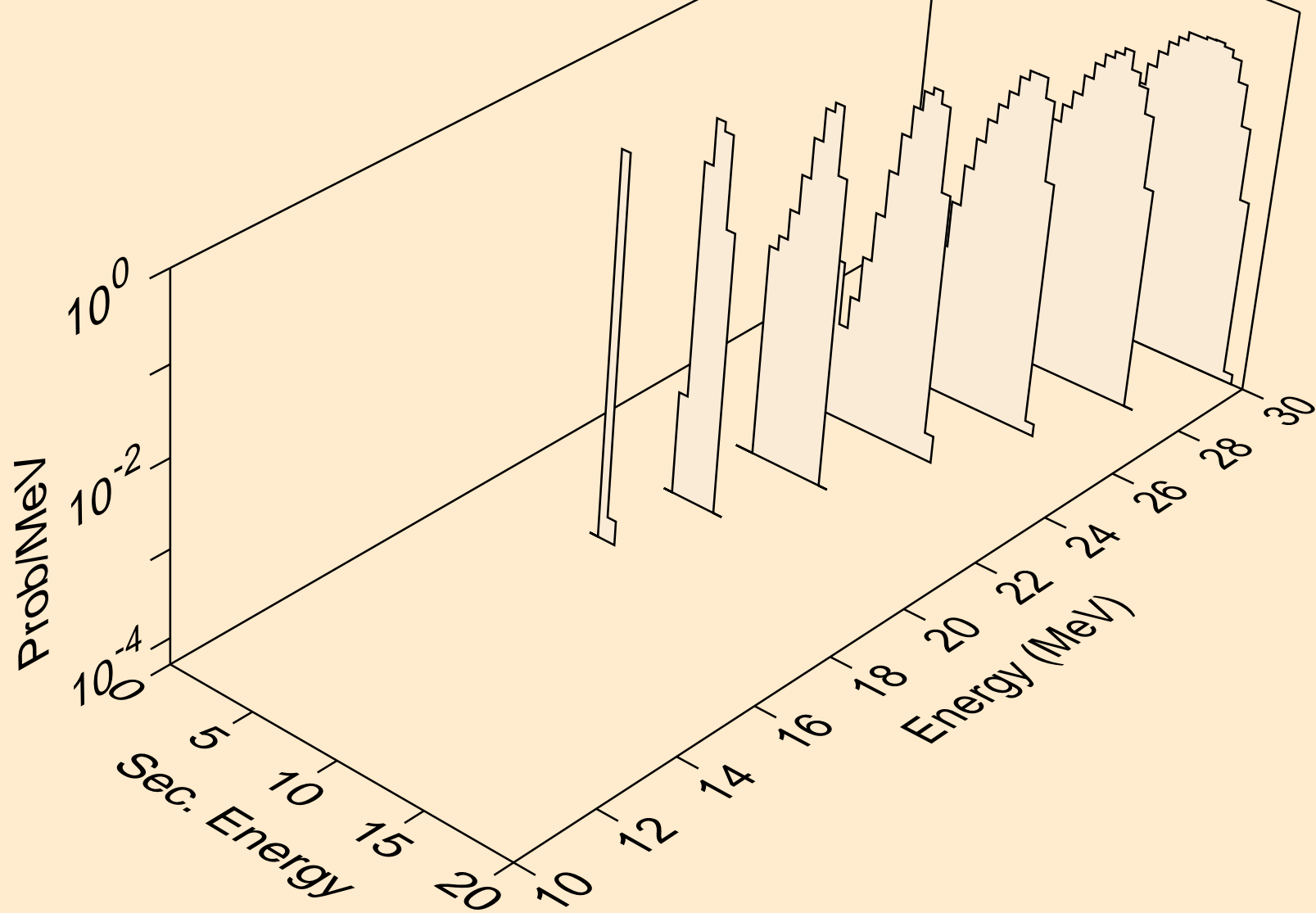

PO204 PHOTON ACER TENDL-2023 LIBRARY; T=0.K
alphas from (g,3n)a

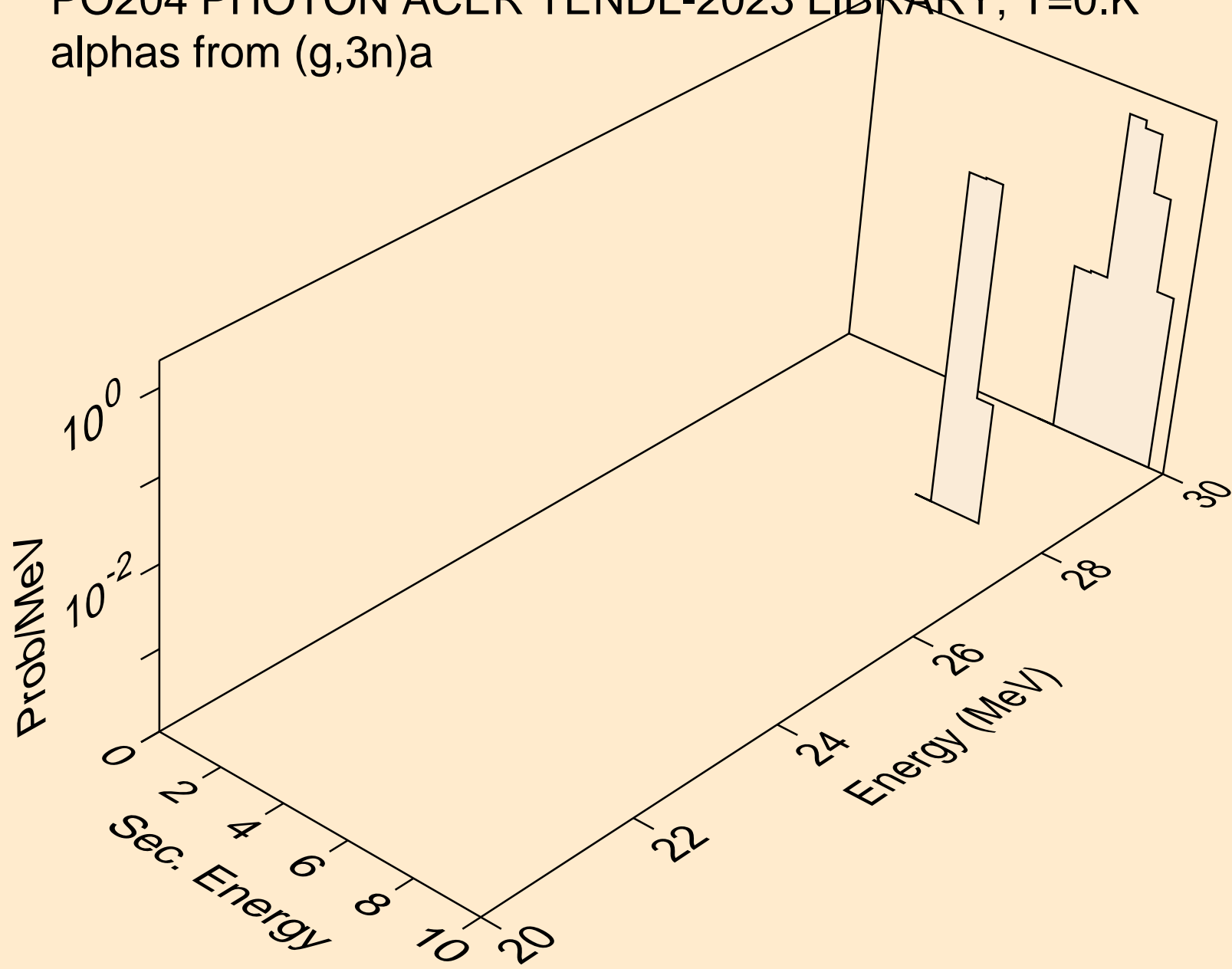

PO204 PHOTON ACER TENDL-2023 LIBRARY; T=0.K
alphas from (g,a)

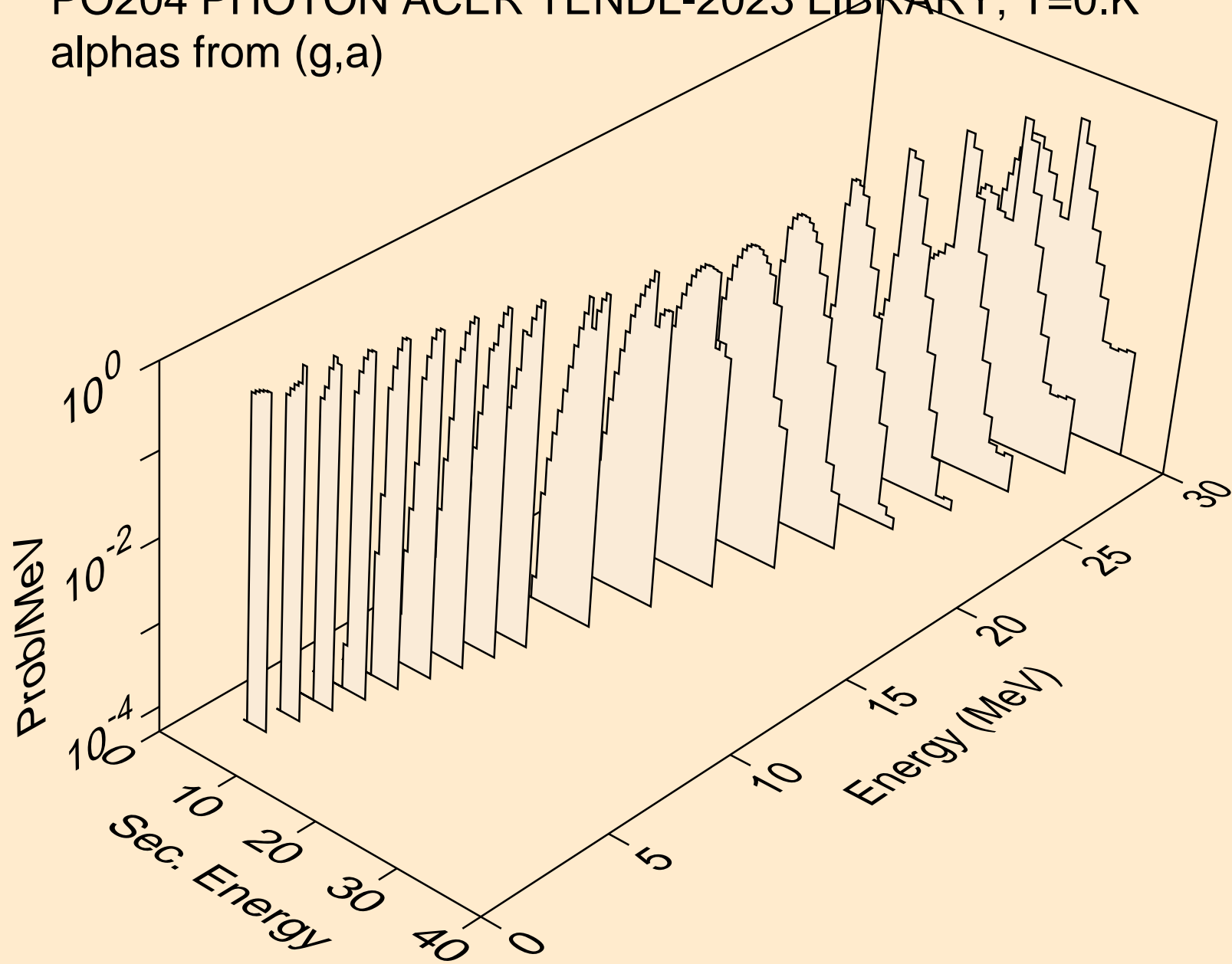

PO204 PHOTON ACER TENDL-2023 LIBRARY; T=0.K
alphas from (g,pa)

