

AT198M HELION ACER TENDL-2023 LIBRARY; T=0.K  
Principal cross sections

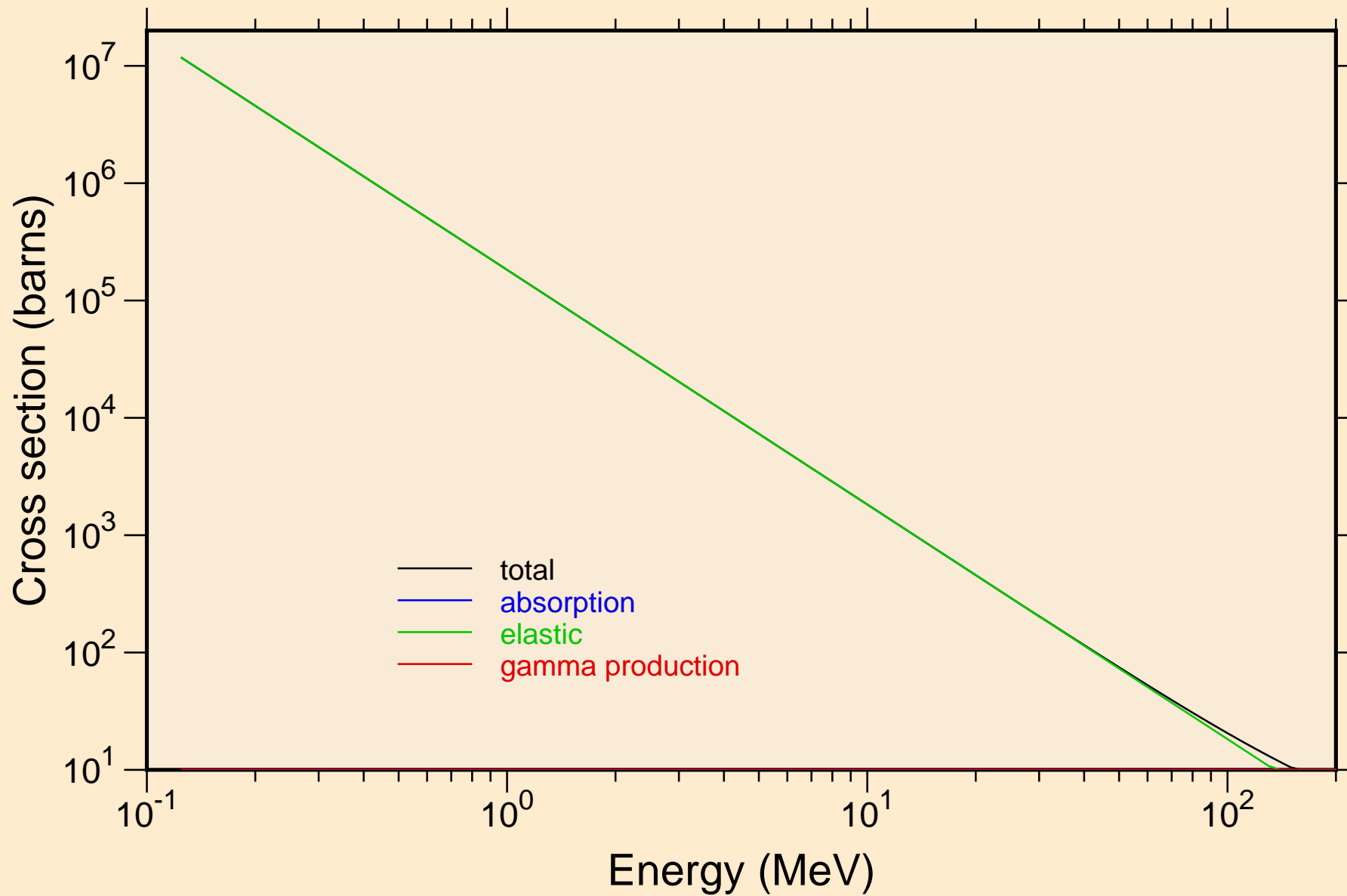

AT198M HELION ACER TENDL-2023 LIBRARY; T=0.K

Heating

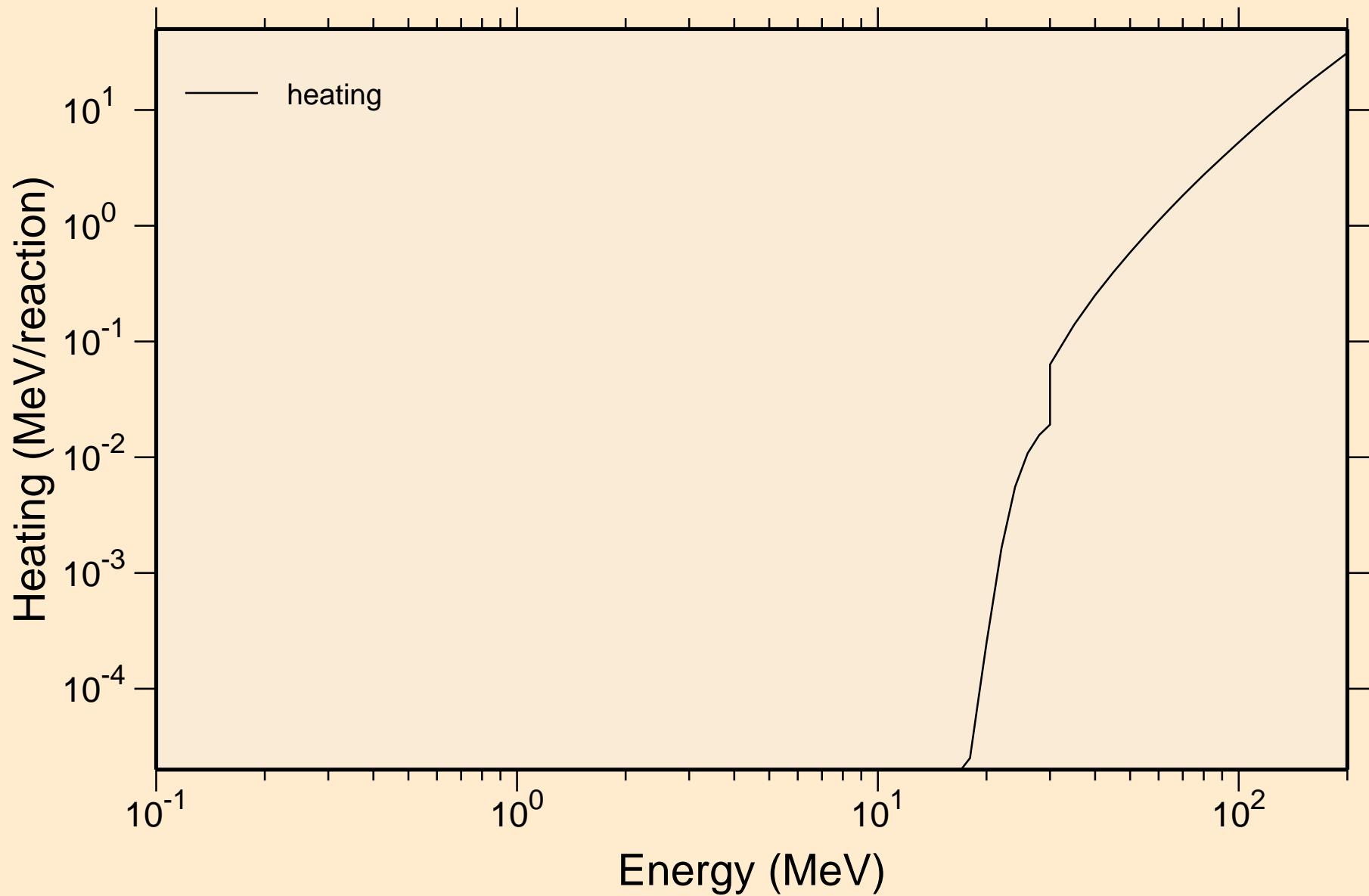

# AT198M HELION ACER TENDL-2023 LIBRARY; T=0.K

## Principal cross sections

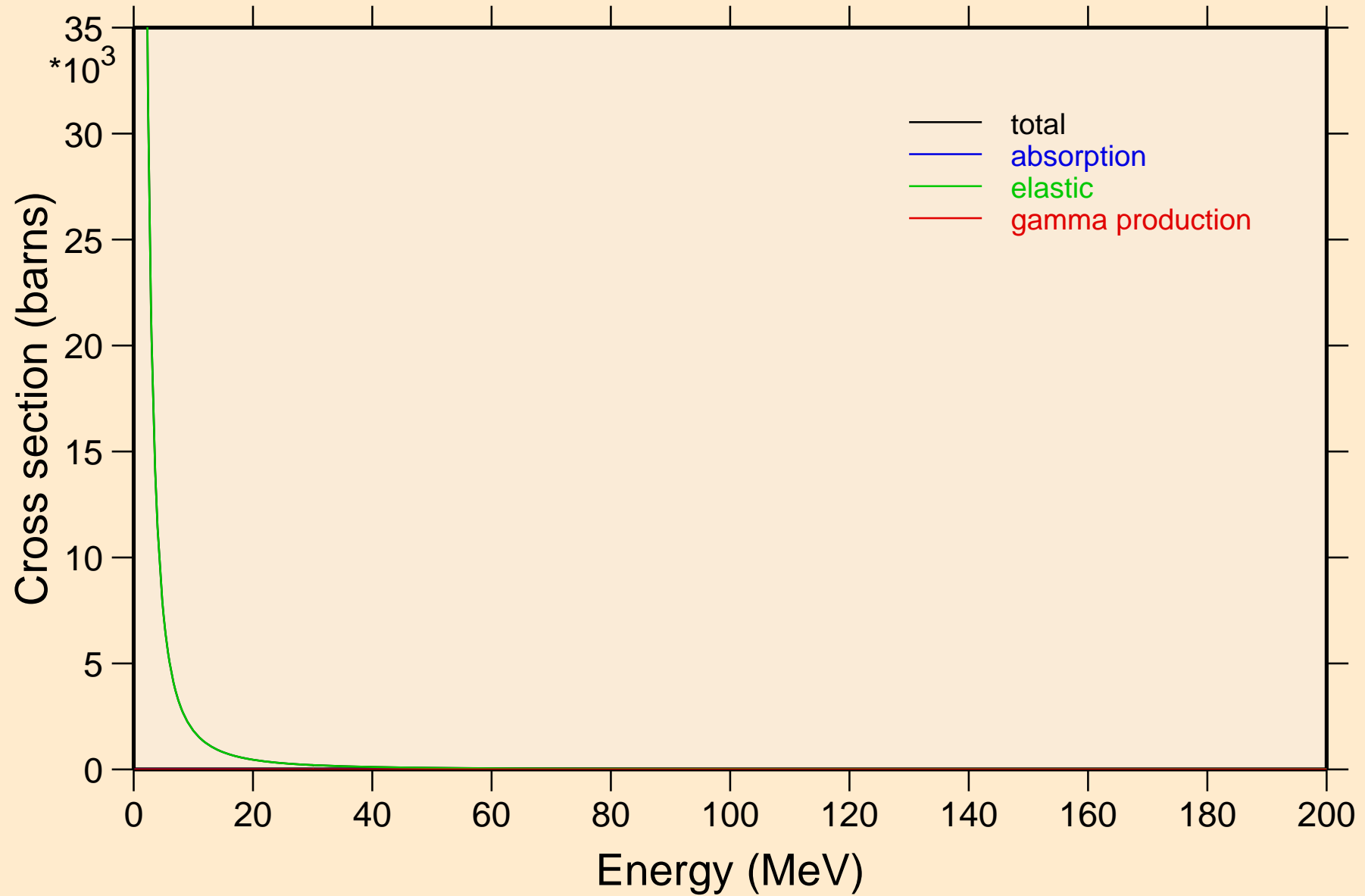

AT198M HELION ACER TENDL-2023 LIBRARY; T=0.K

Heating

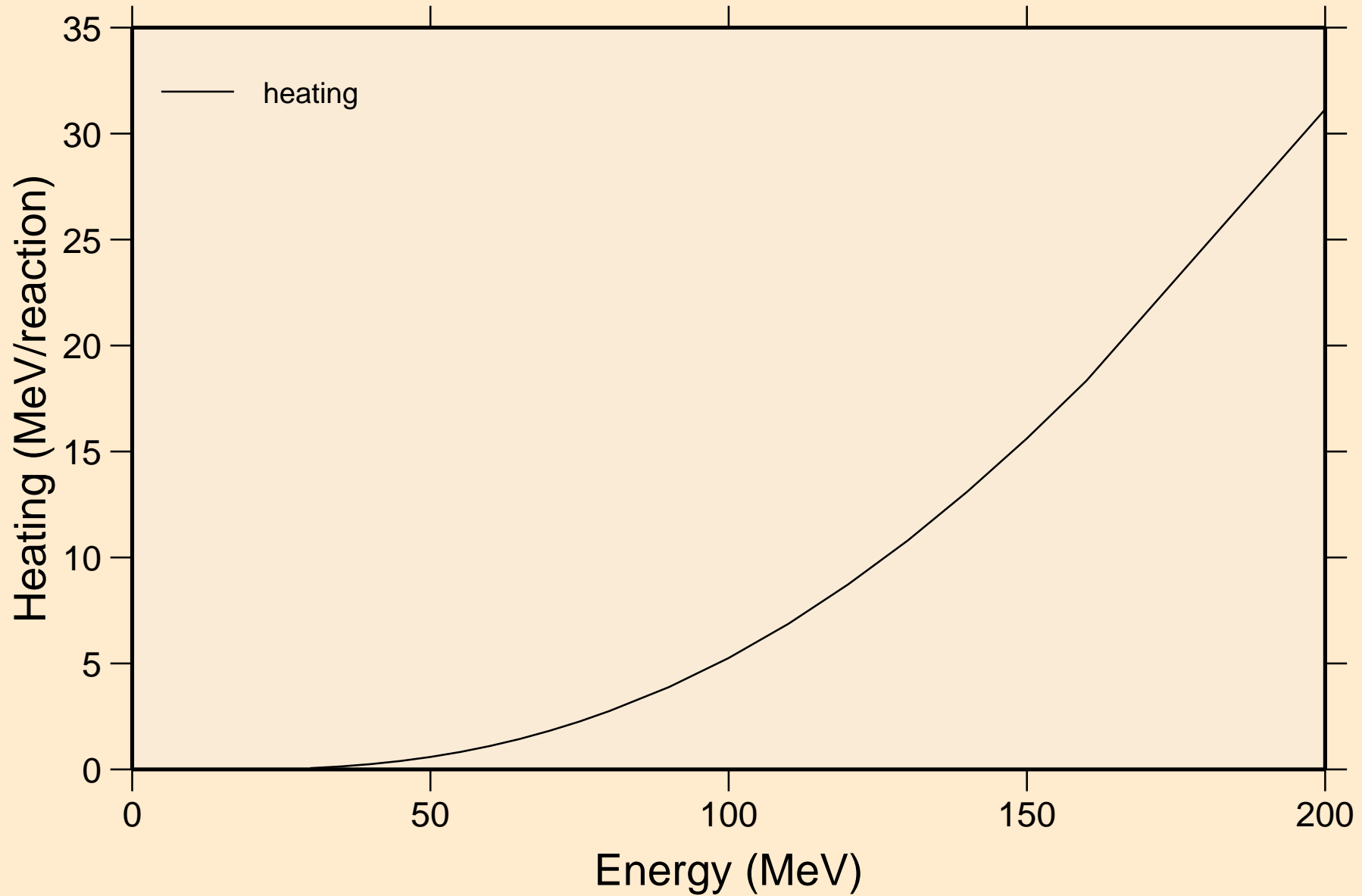

AT198M HELION ACER TENDL-2023 LIBRARY; T=0.K  
Threshold reactions

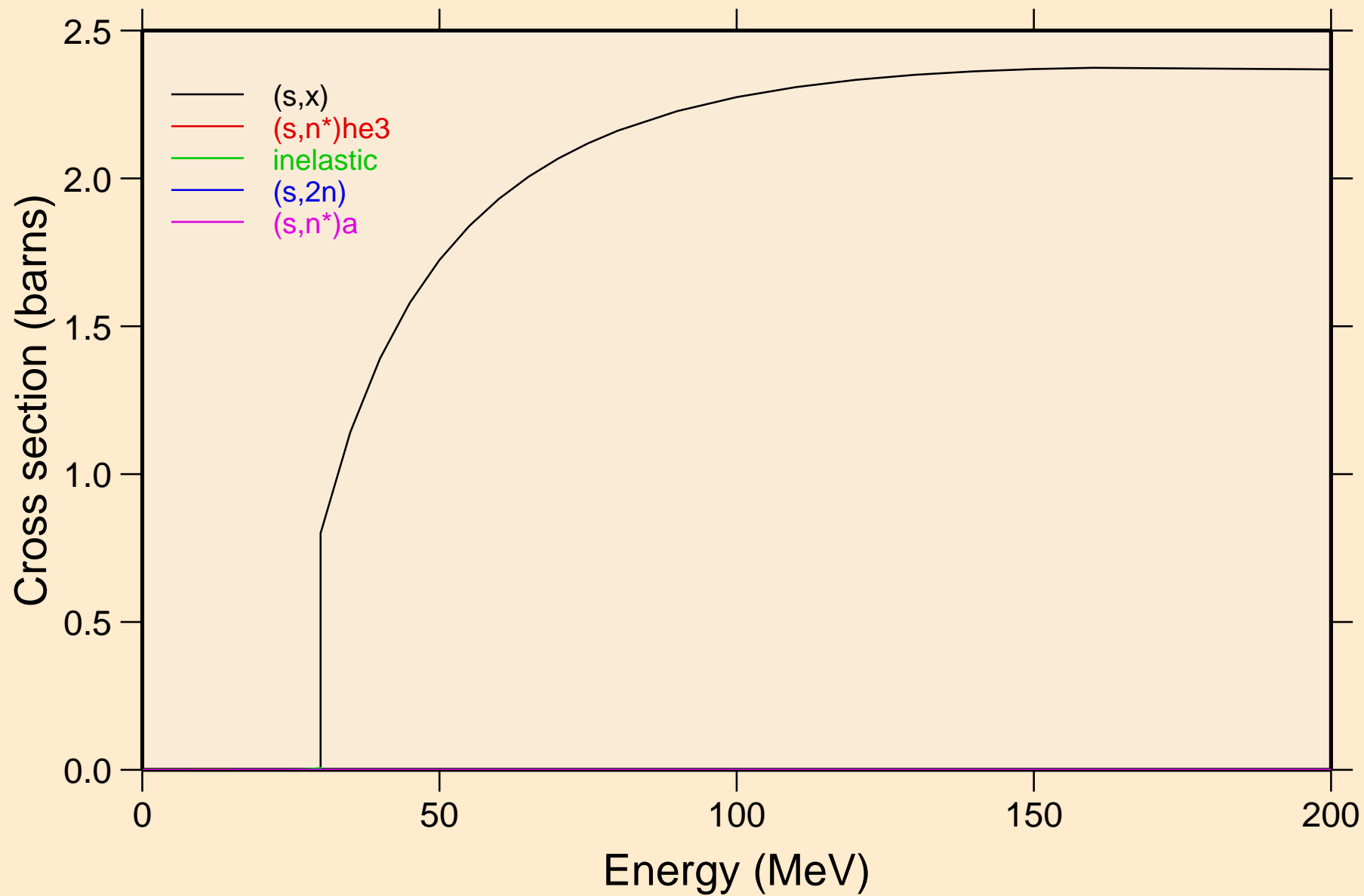

AT198M HELION ACER TENDL-2023 LIBRARY; T=0.K  
Threshold reactions

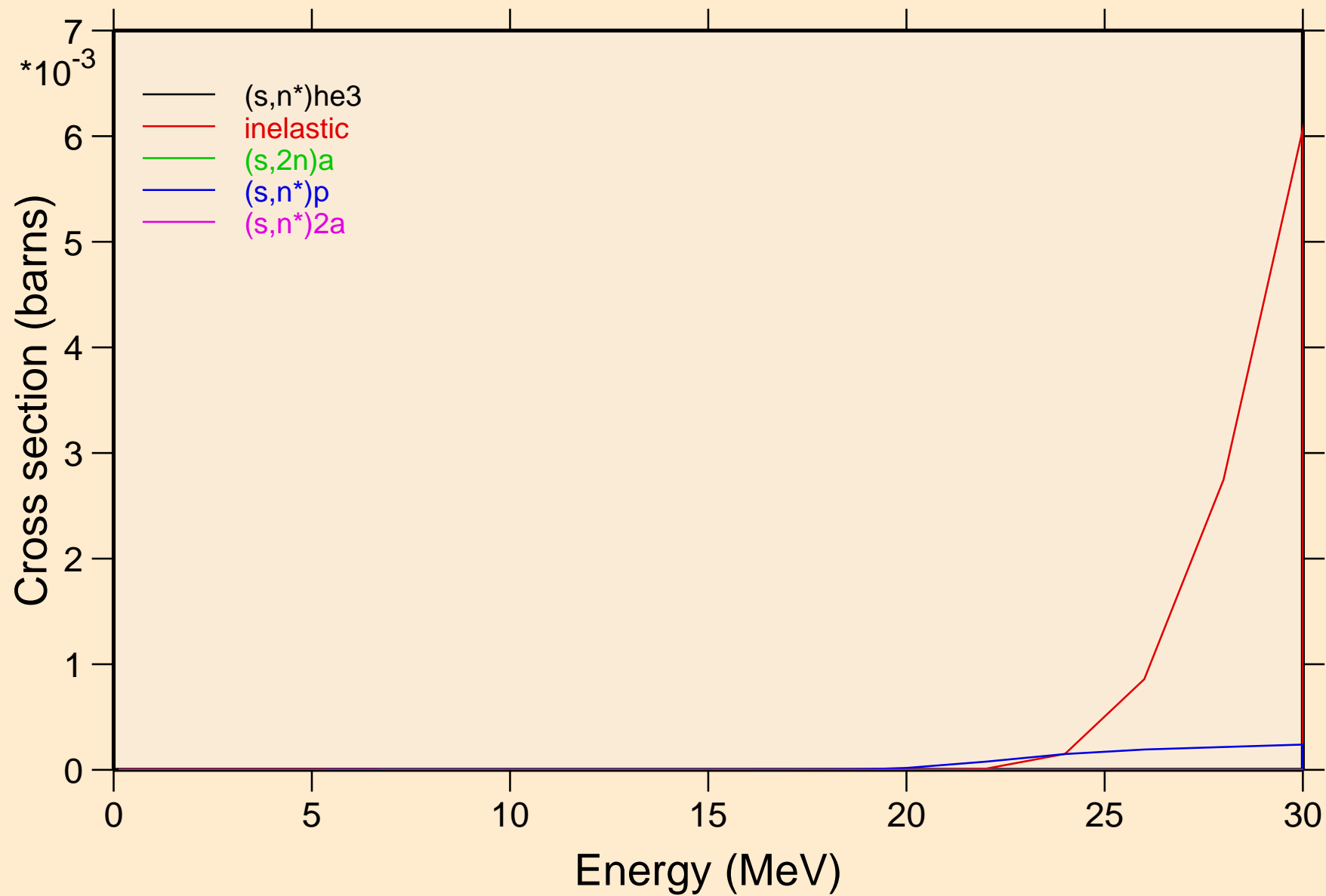

AT198M HELION ACER TENDL-2023 LIBRARY; T=0.K  
Threshold reactions

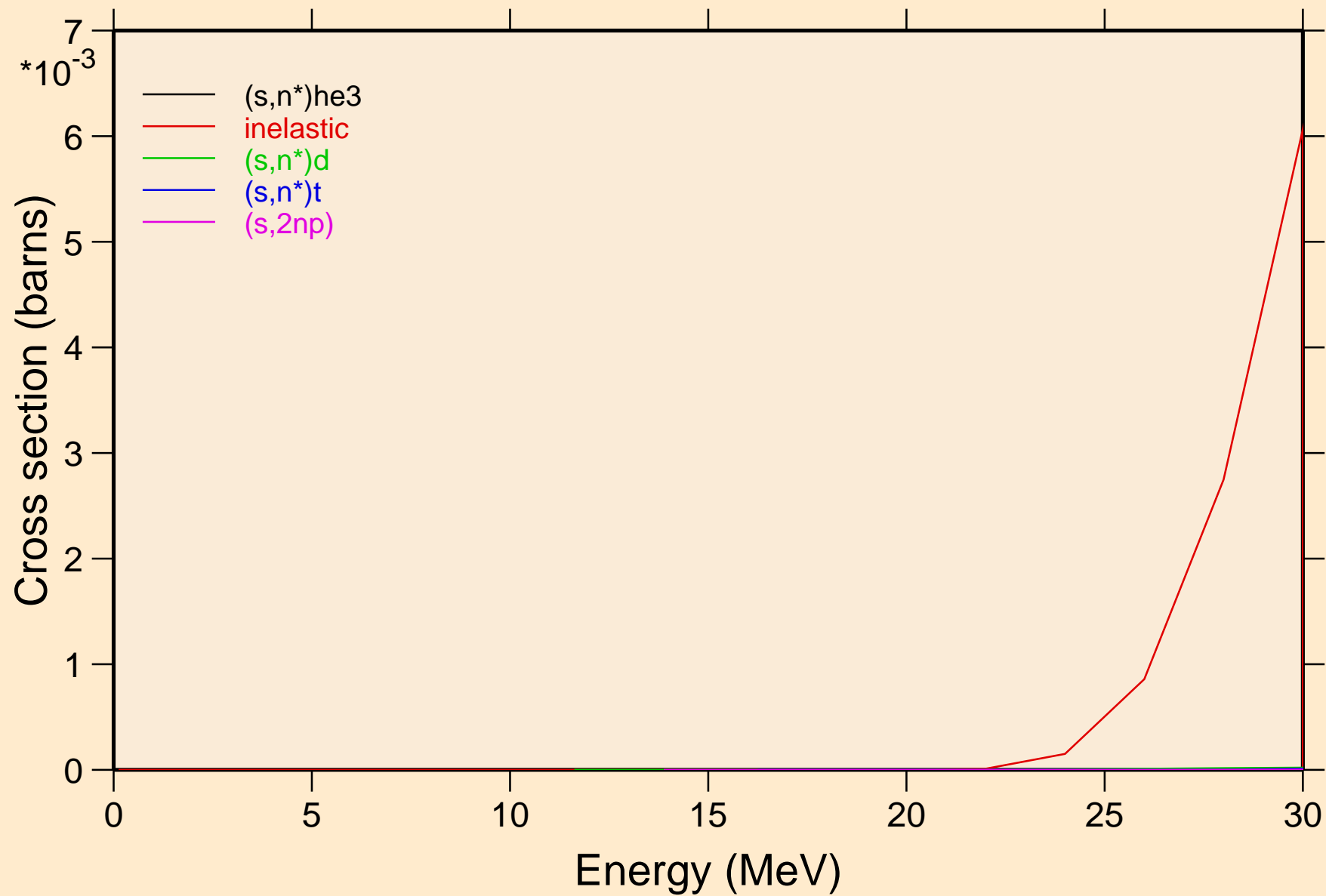

AT198M HELION ACER TENDL-2023 LIBRARY; T=0.K  
Threshold reactions

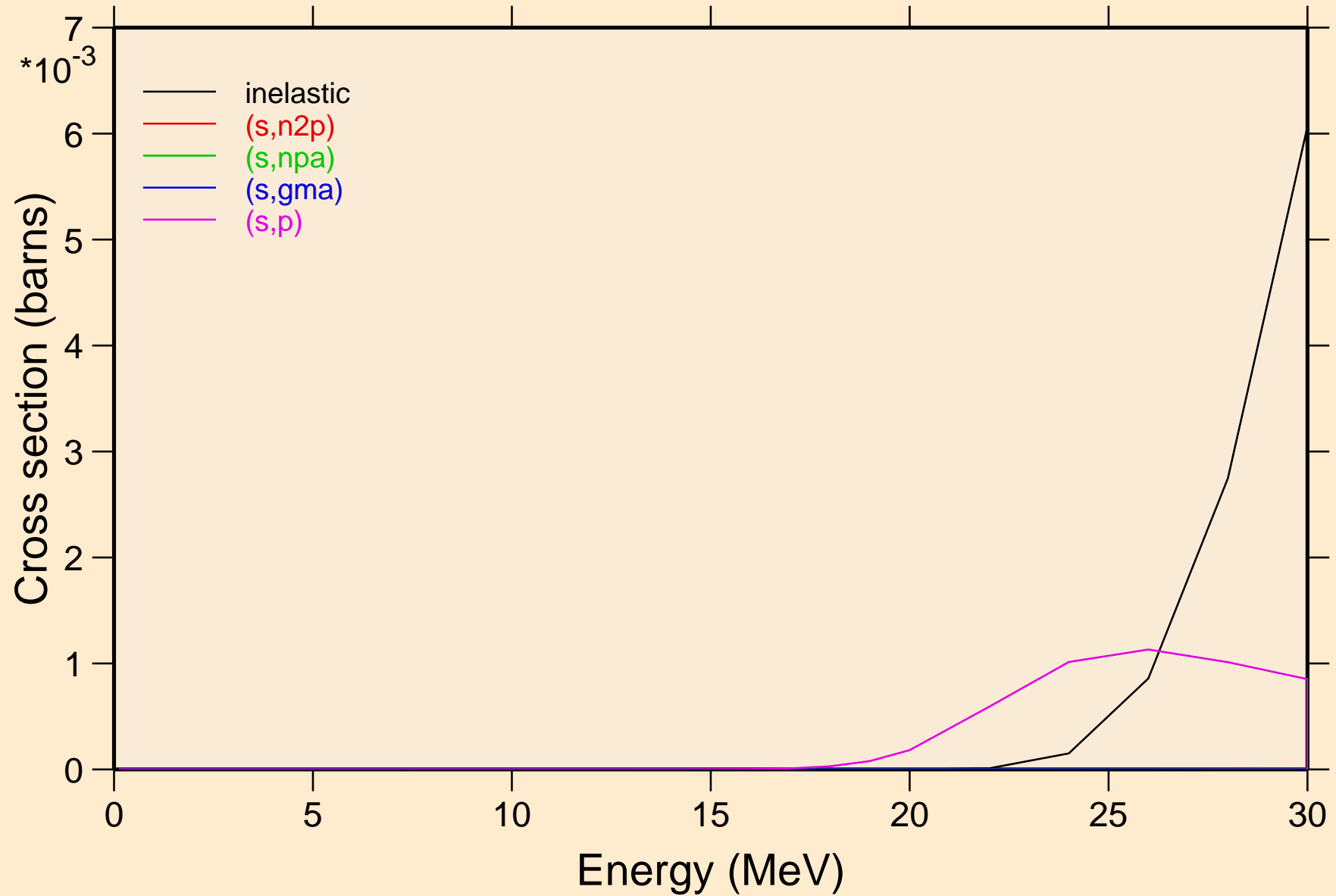

AT198M HELION ACER TENDL-2023 LIBRARY; T=0.K  
Threshold reactions

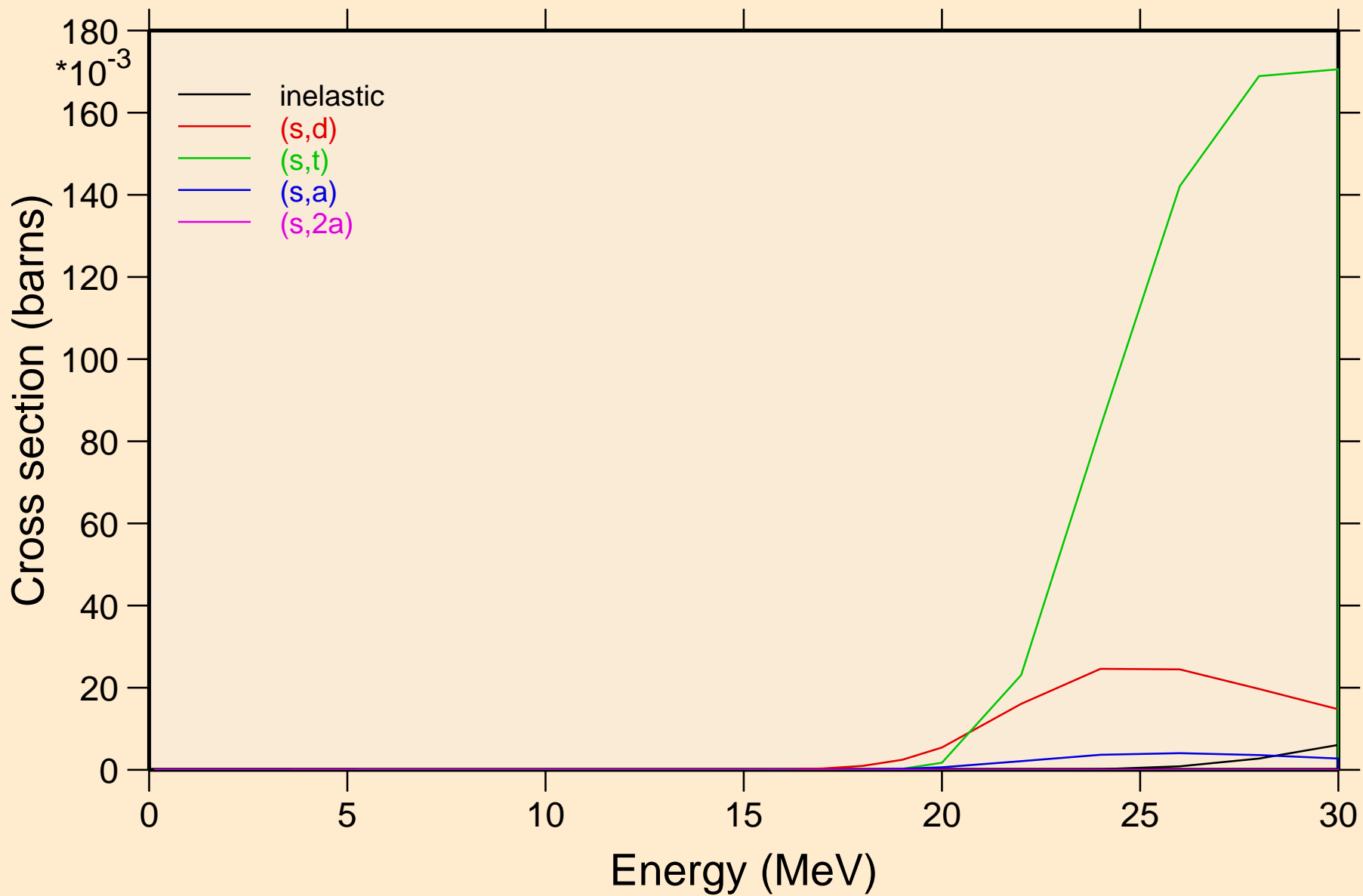

AT198M HELION ACER TENDL-2023 LIBRARY; T=0.K  
Threshold reactions

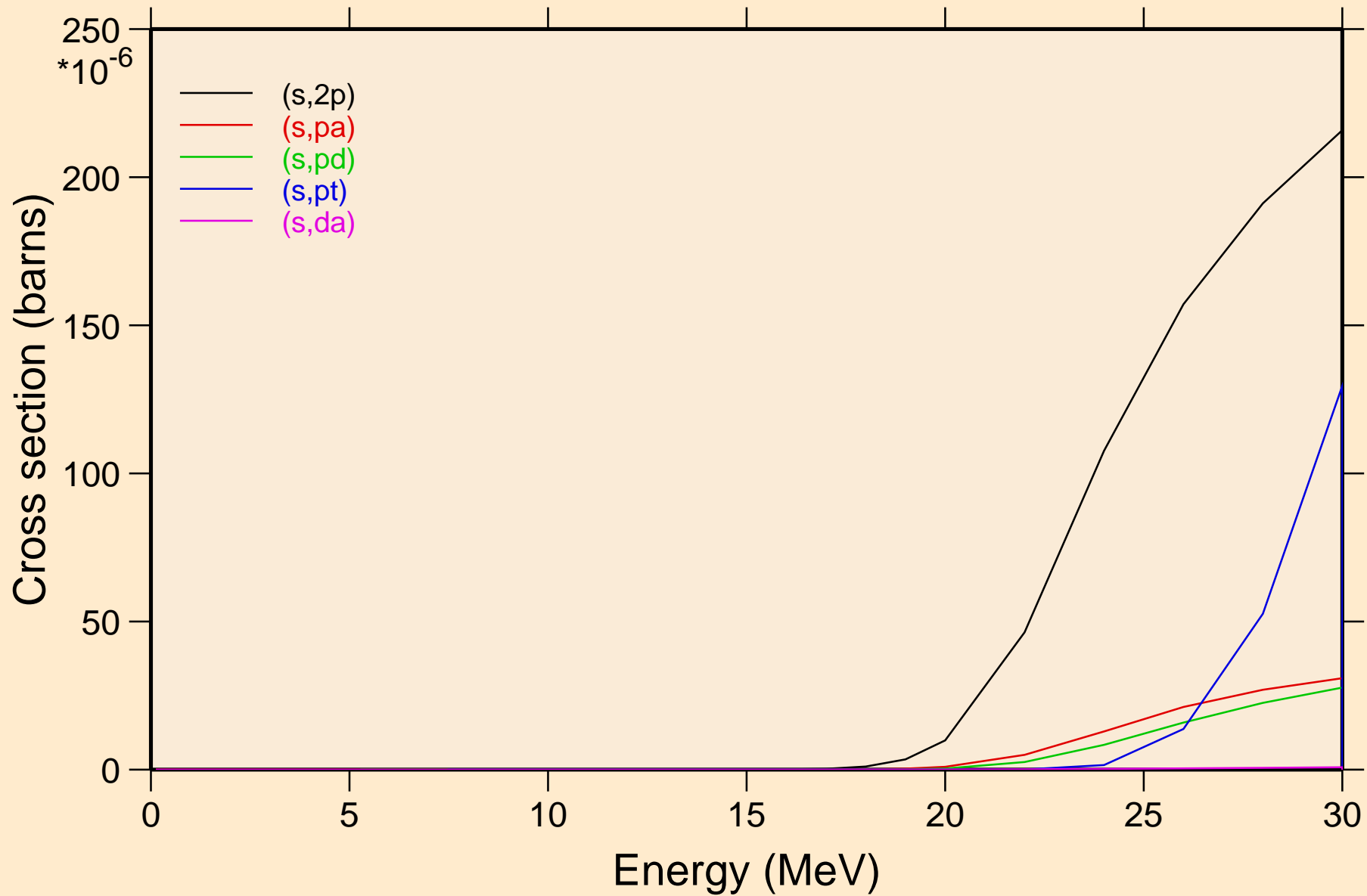

AT198M HELION ACER TENDL-2023 LIBRARY; T=0.K  
angular distribution for elastic

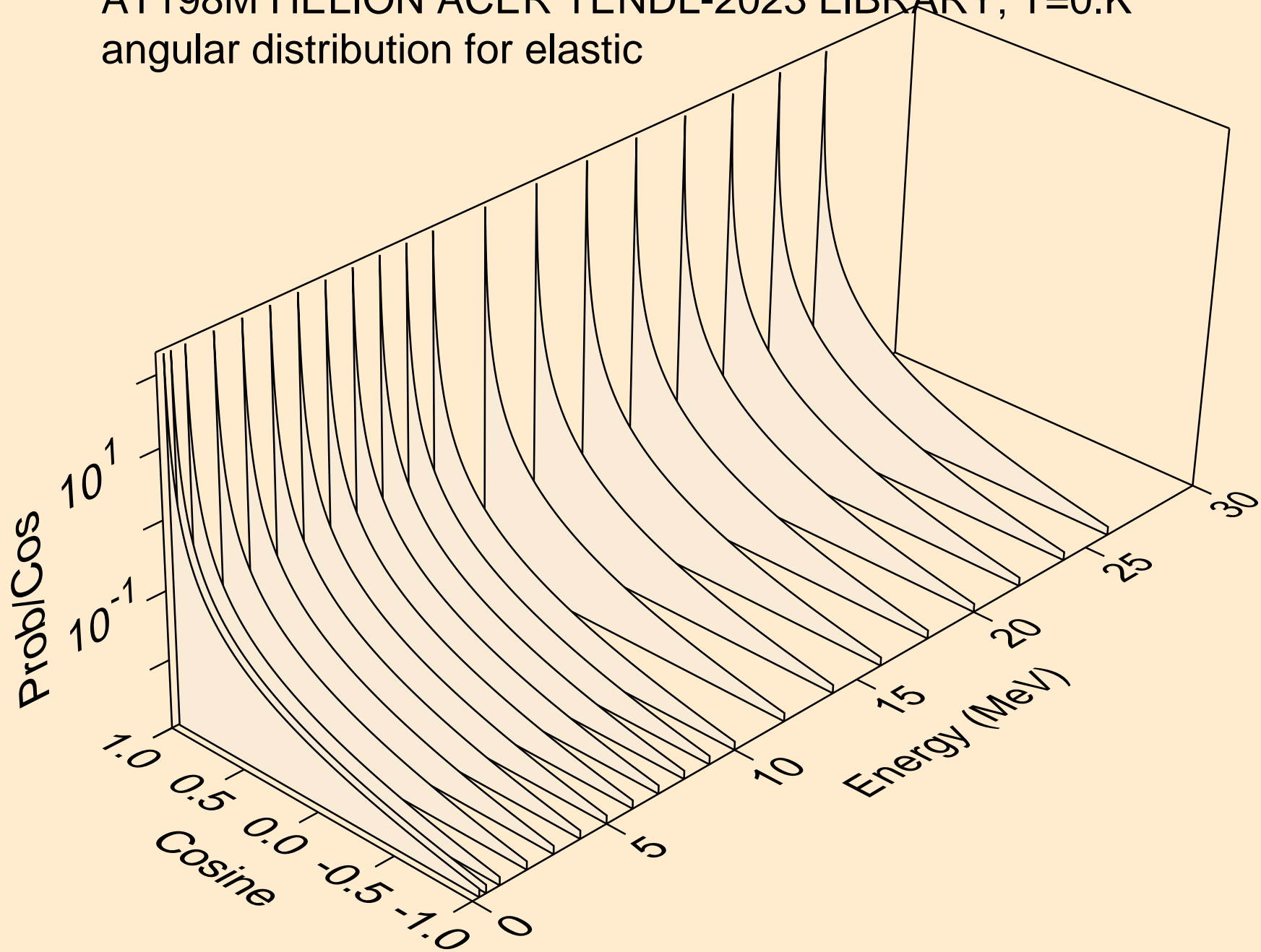

AT198M HELION ACER TENDL-2023 LIBRARY; T=0.K  
He-3 emission for (s,x)

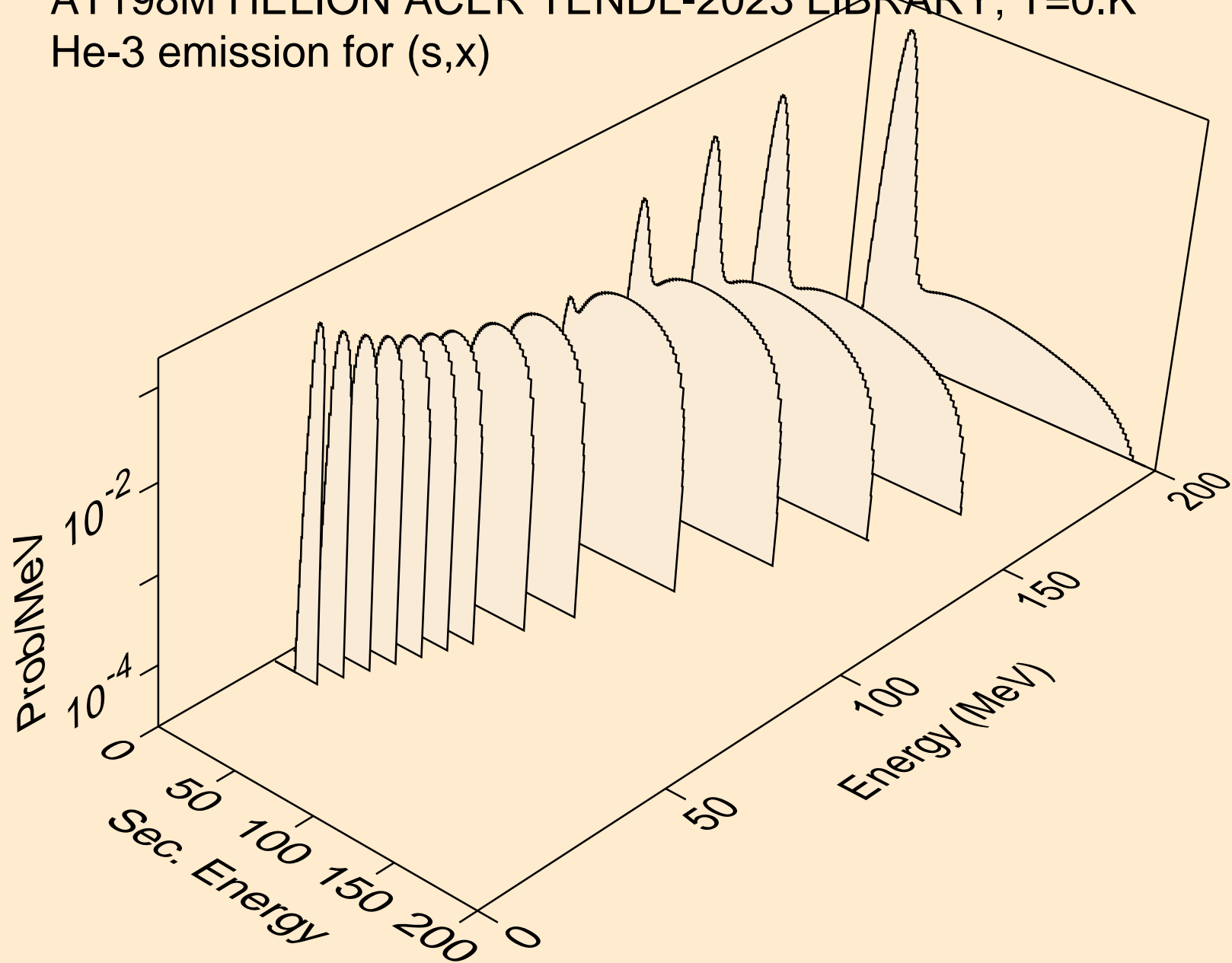

AT198M HELION ACER TENDL-2023 LIBRARY; T=0.K  
He-3 emission for (s,n\*)he3

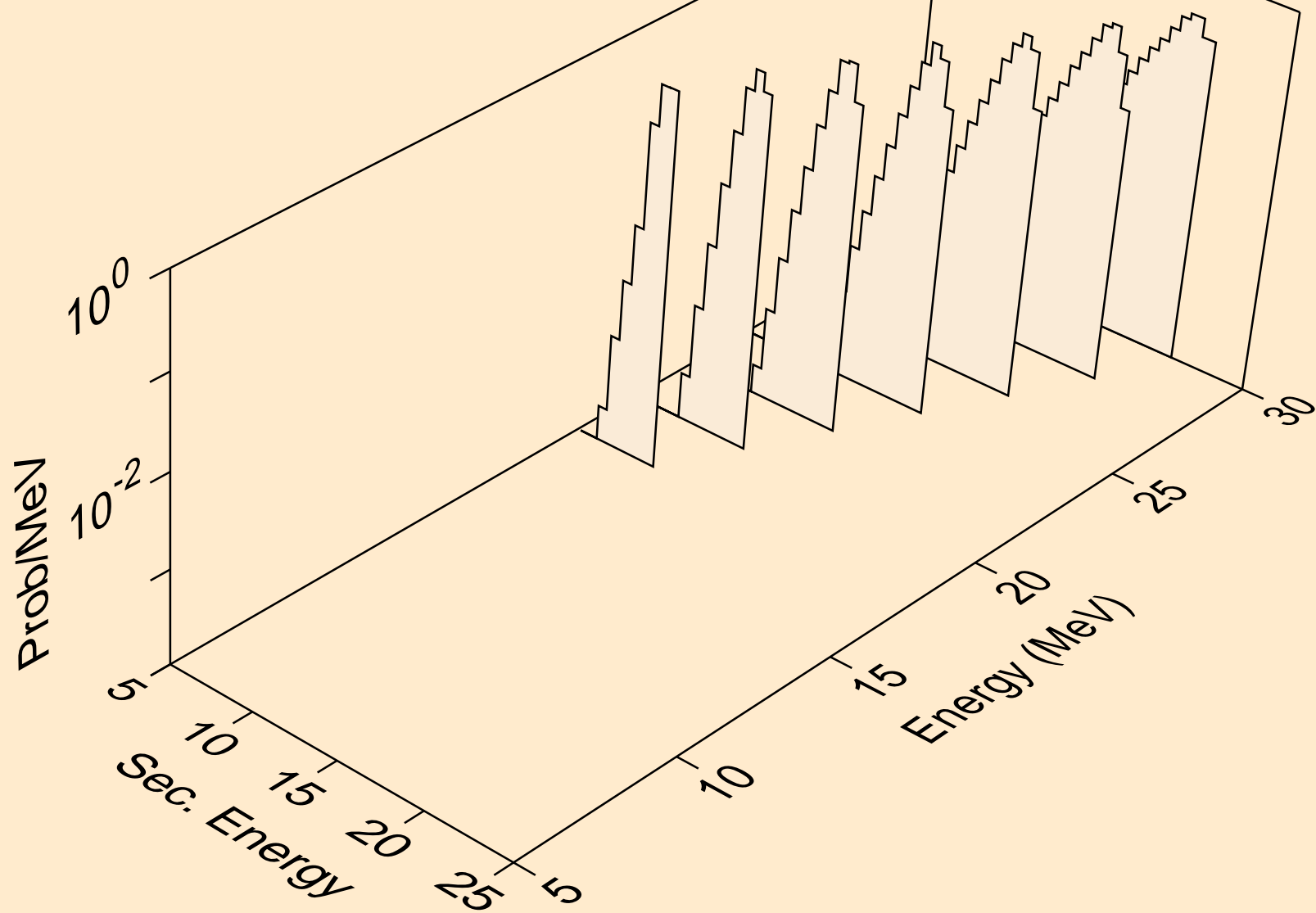

AT198M HELION ACER TENDL-2023 LIBRARY; T=0.K  
He-3 emission for inelastic

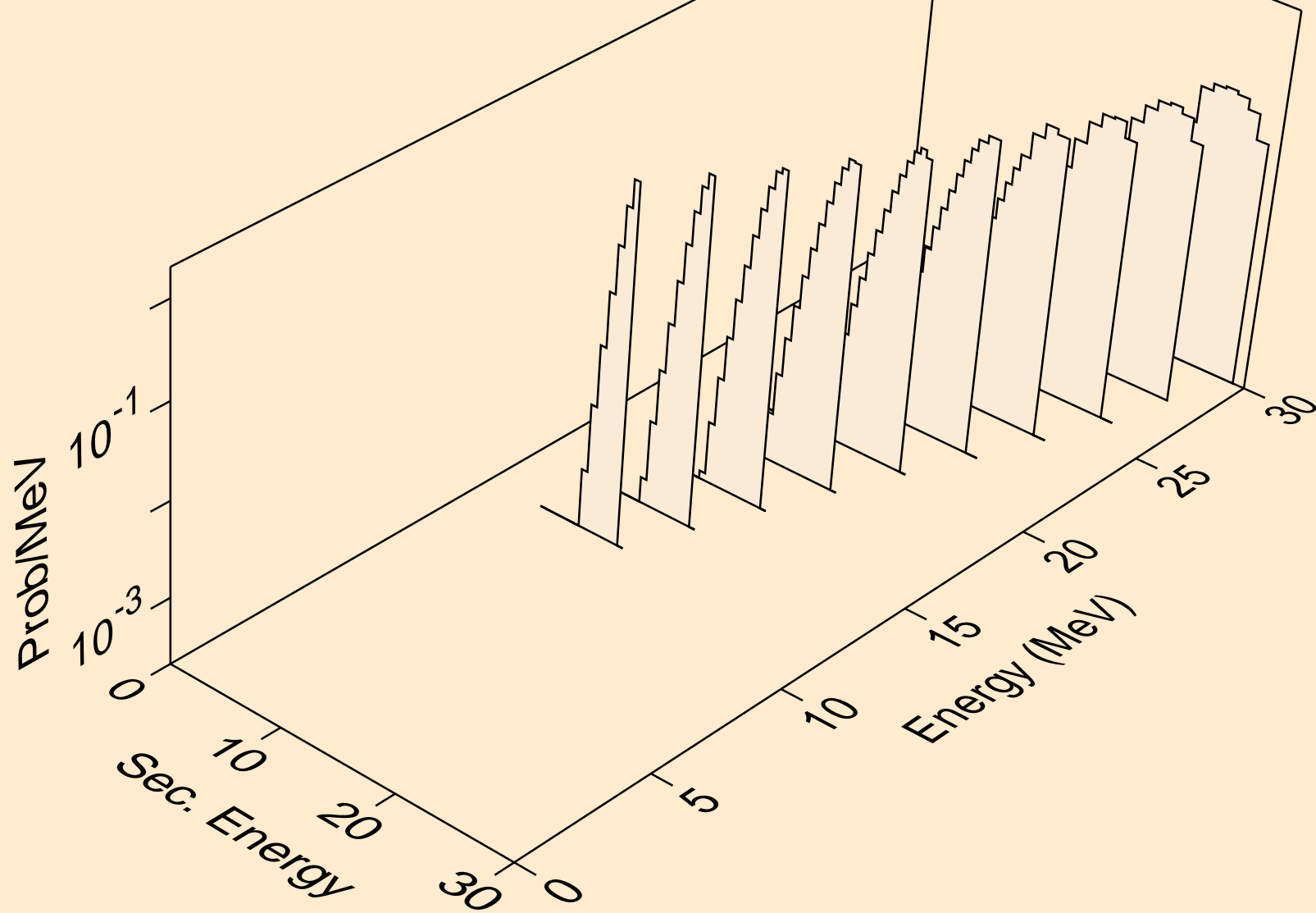

AT198M HELION ACER TENDL-2023 LIBRARY; T=0.K  
Photon emission for (z,n)

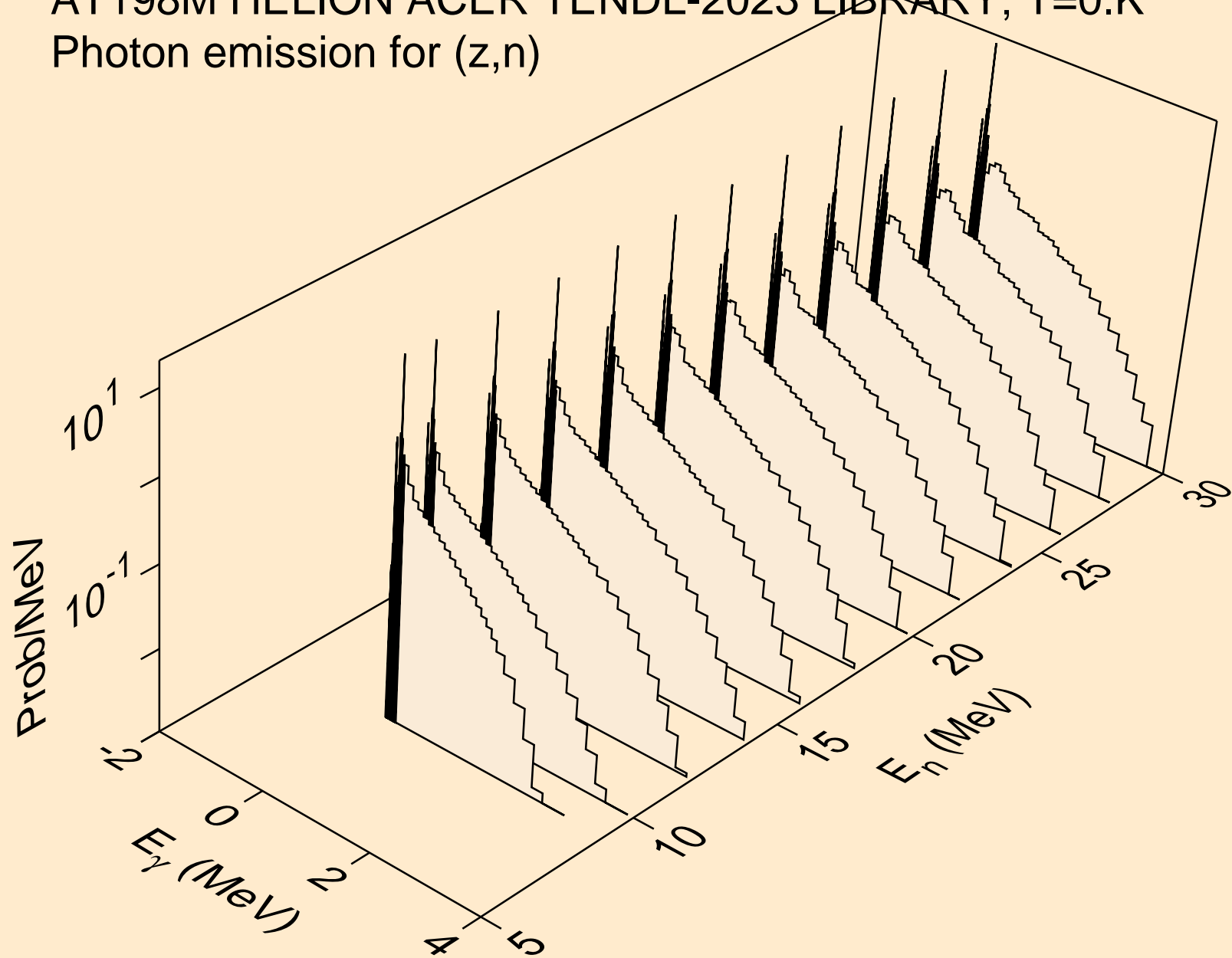

AT198M HELION ACER TENDL-2023 LIBRARY; T=0.K  
Photon emission for (z,x)

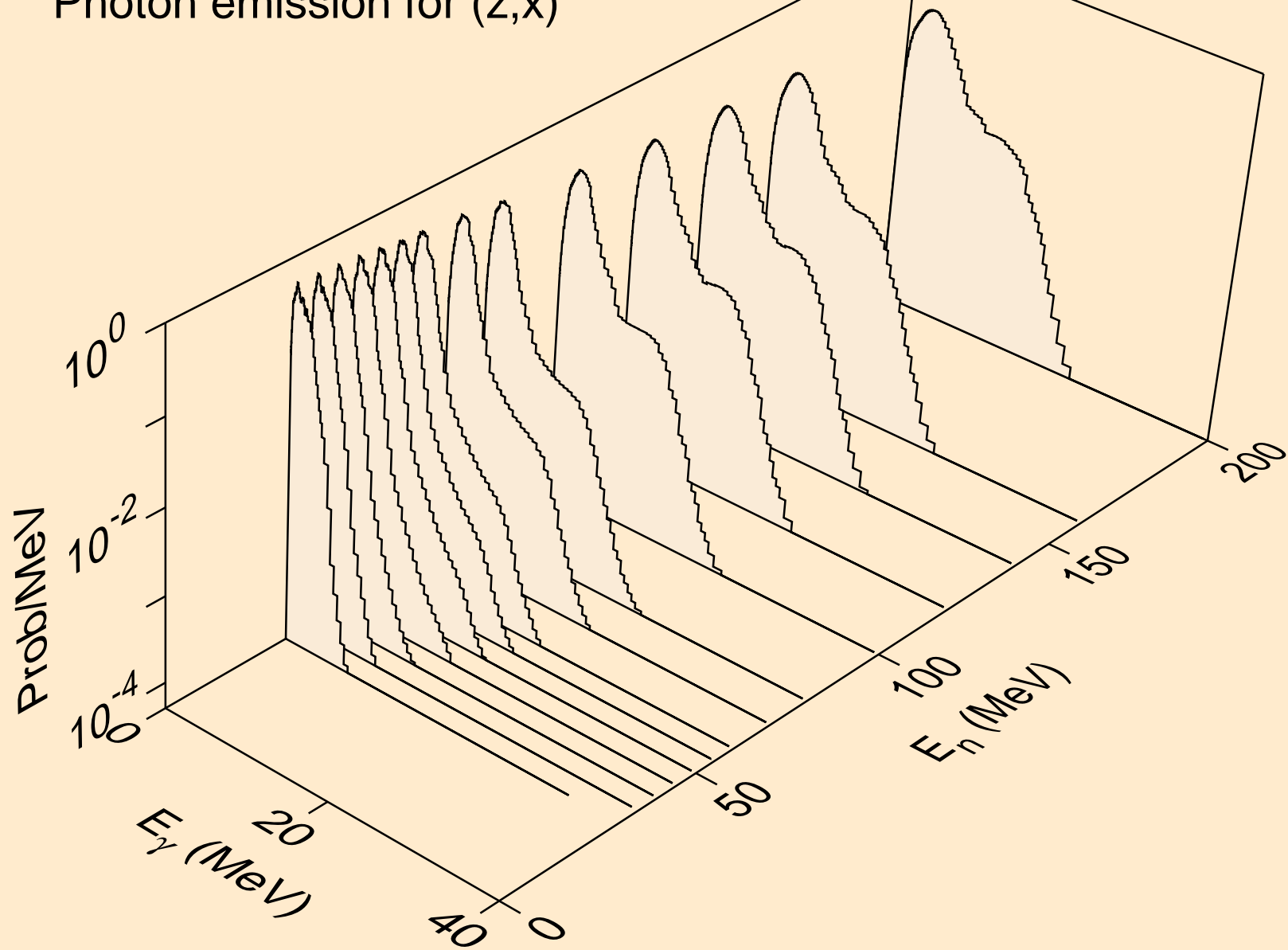

AT198M HELION ACER TENDL-2023 LIBRARY; T=0.K  
Photon emission for (n,2n)

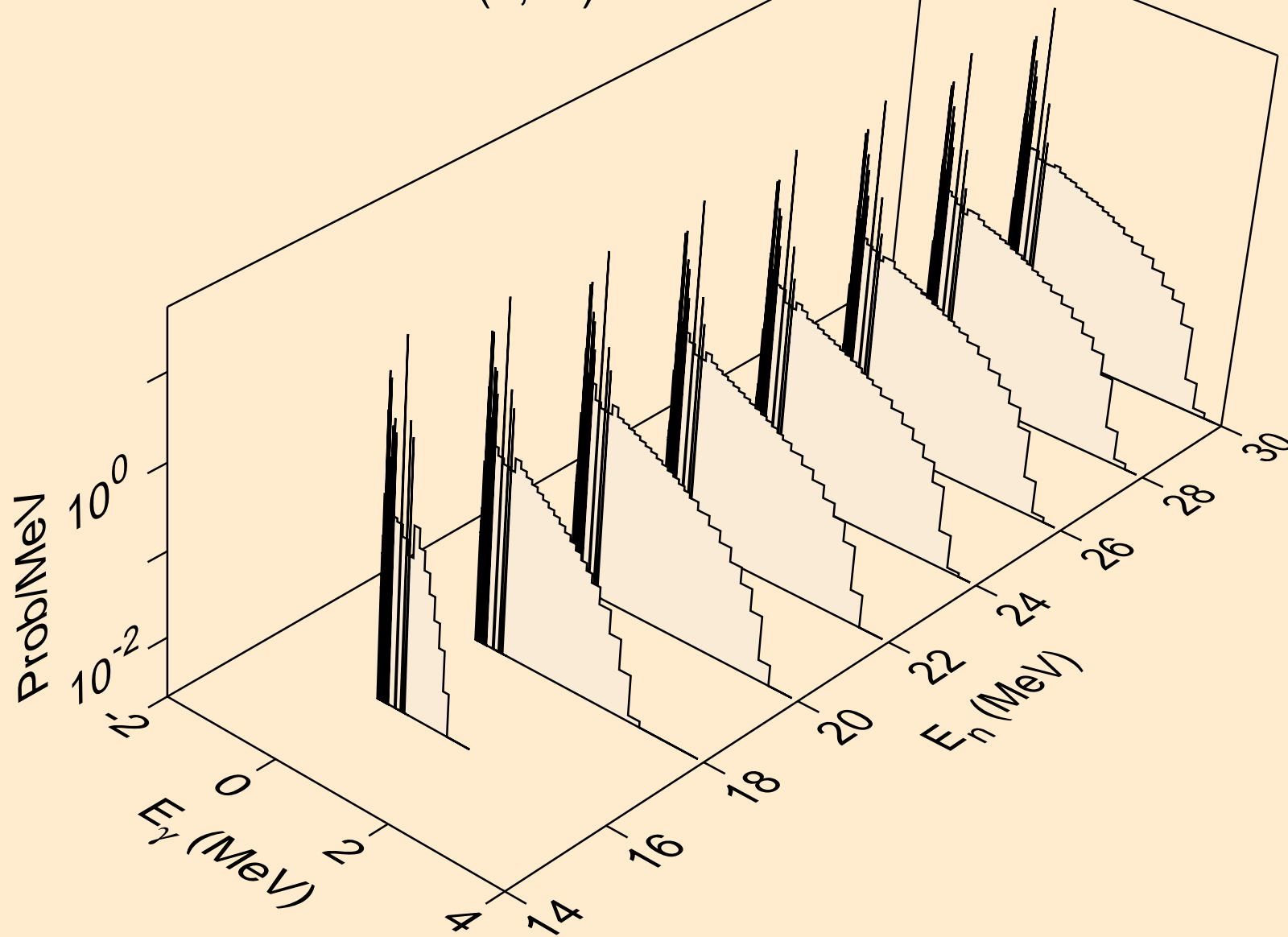

AT198M HELION ACER TENDL-2023 LIBRARY; T=0.K  
Photon emission for (n,n\*)a

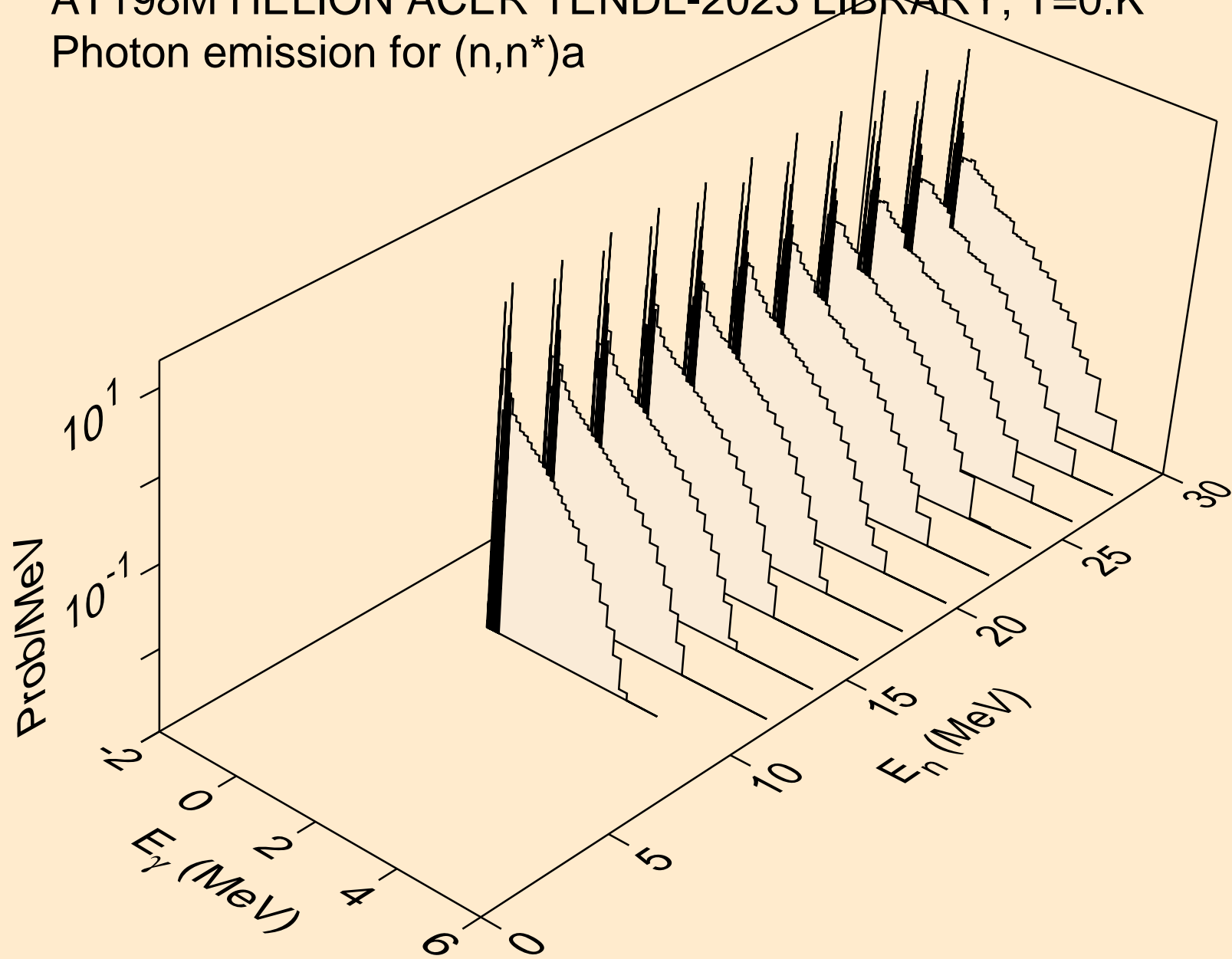

AT198M HELION ACER TENDL-2023 LIBRARY; T=0.K  
Photon emission for (n,2n)a

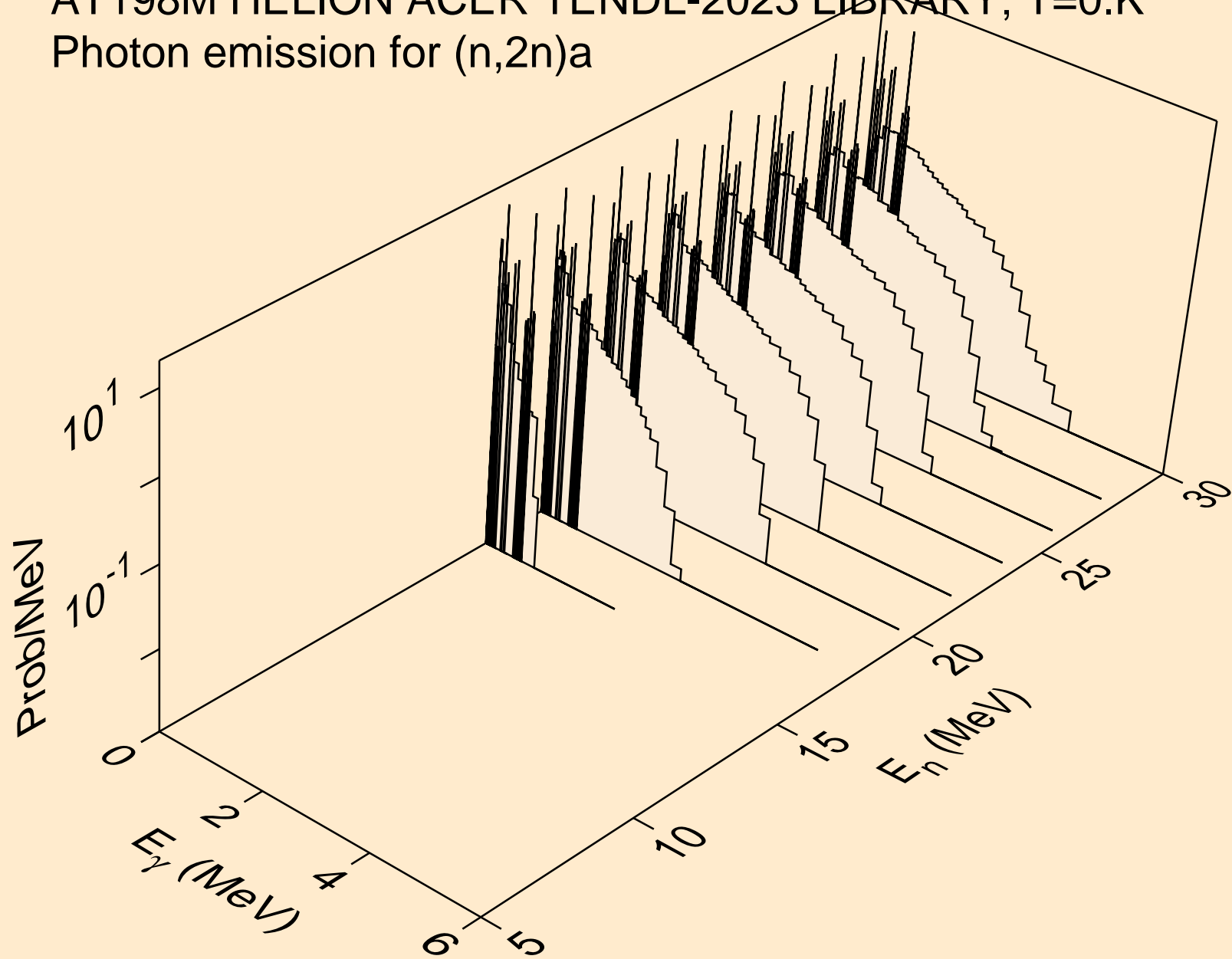

AT198M HELION ACER TENDL-2023 LIBRARY; T=0.K  
Photon emission for (n,n\*)p

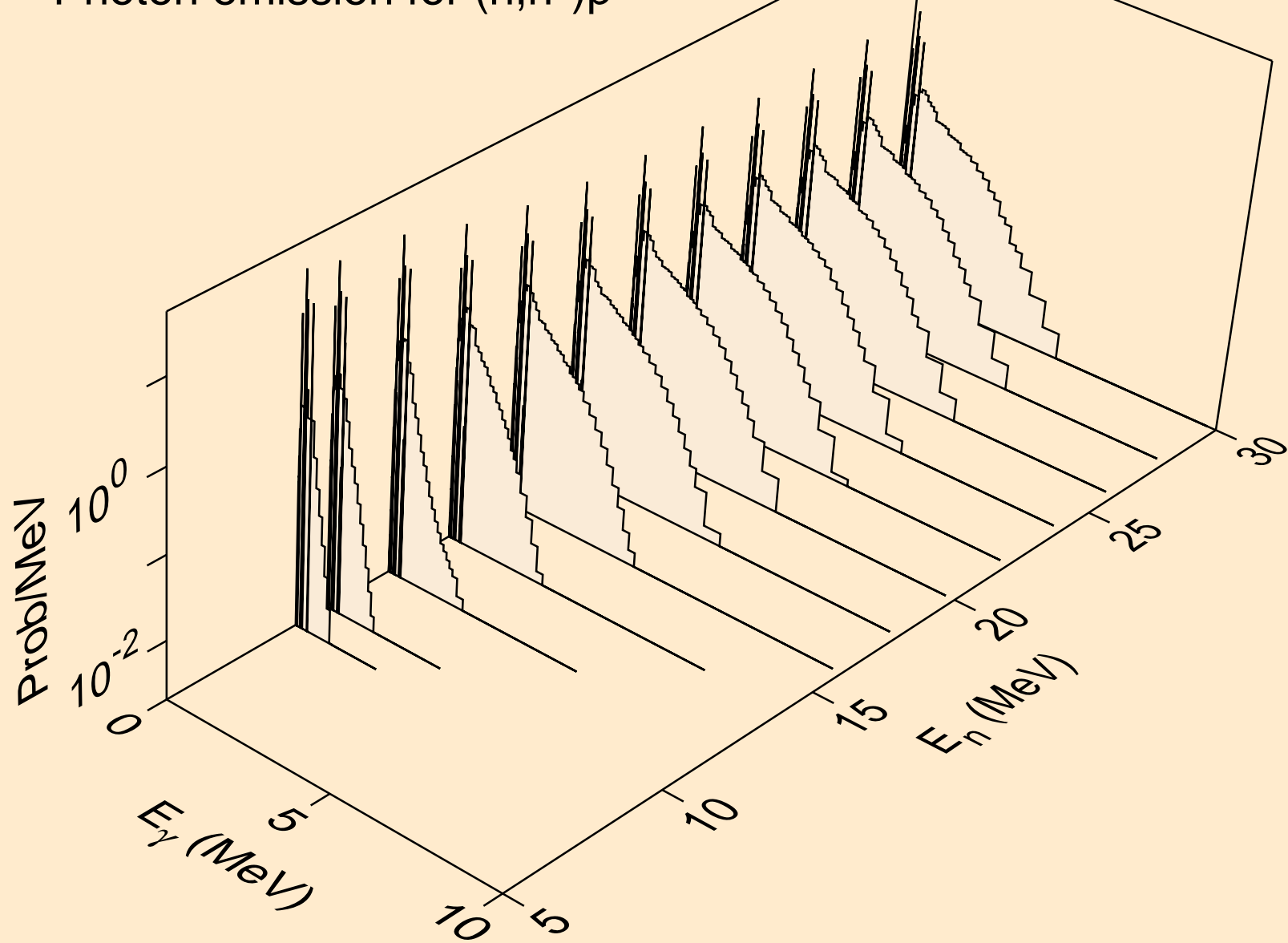

AT198M HELION ACER TENDL-2023 LIBRARY; T=0.K  
Photon emission for (n,n\*)2a

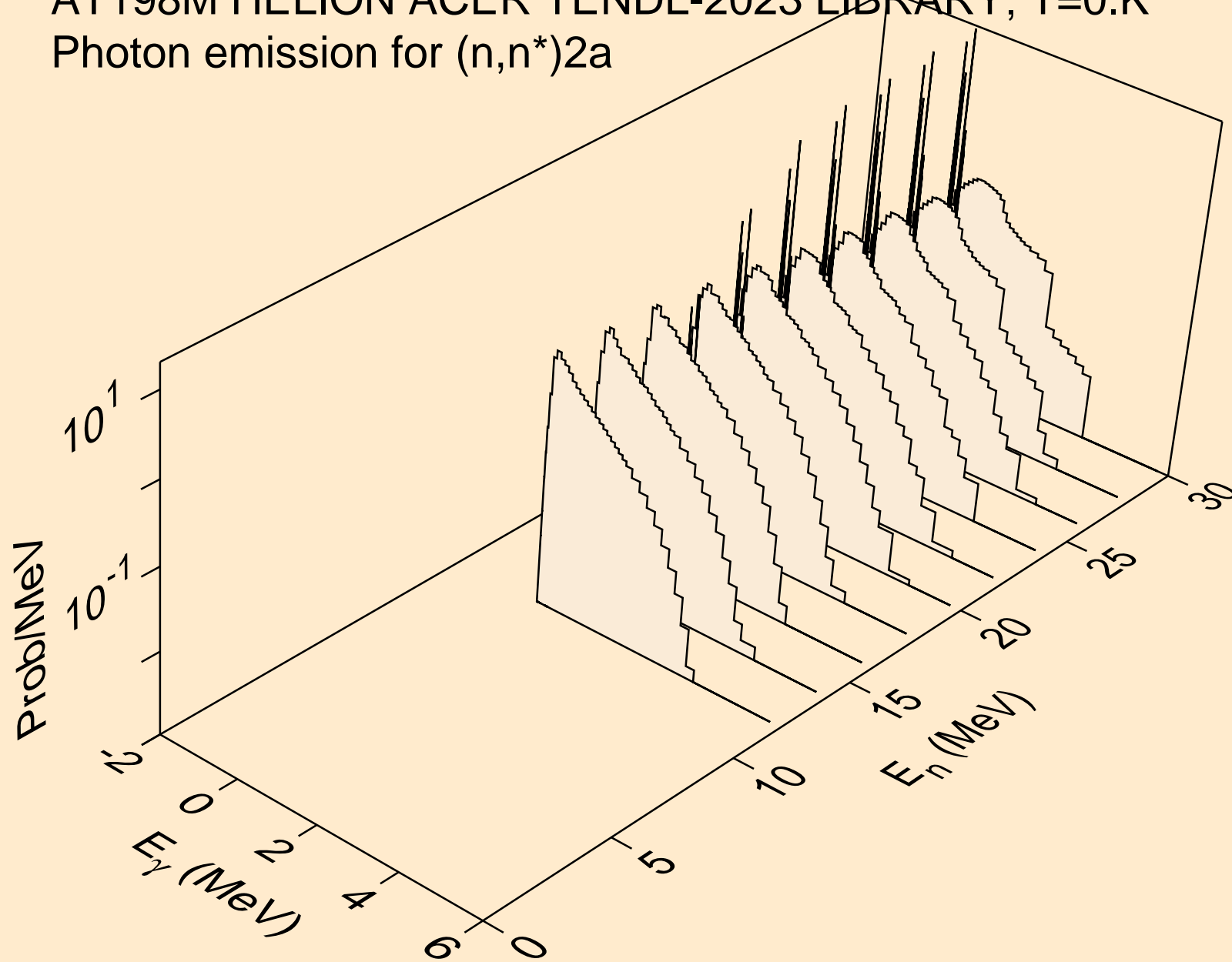

AT198M HELION ACER TENDL-2023 LIBRARY; T=0.K  
Photon emission for (n,n\*)d

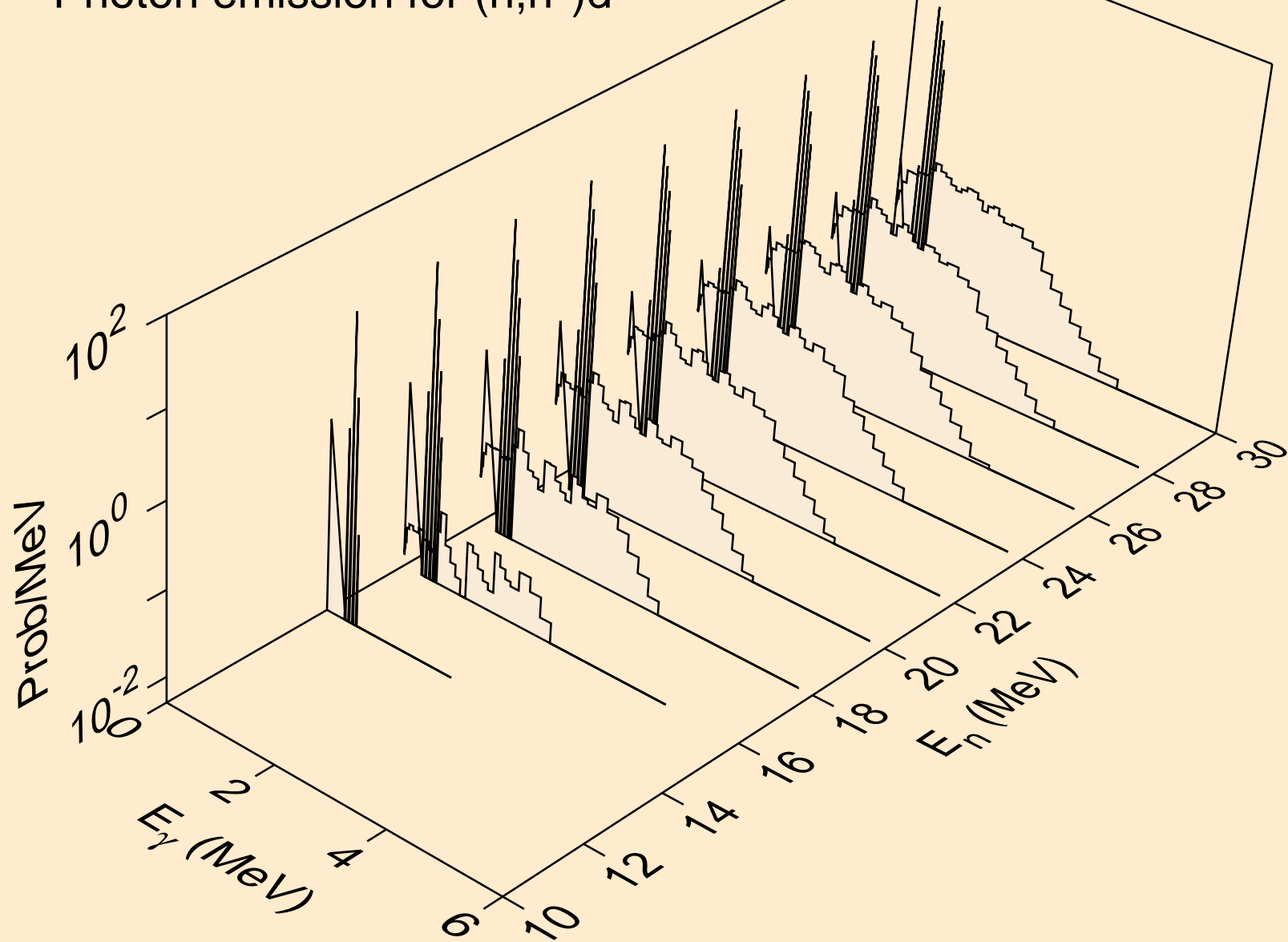

AT198M HELION ACER TENDL-2023 LIBRARY; T=0.K  
Photon emission for (n,n\*)t

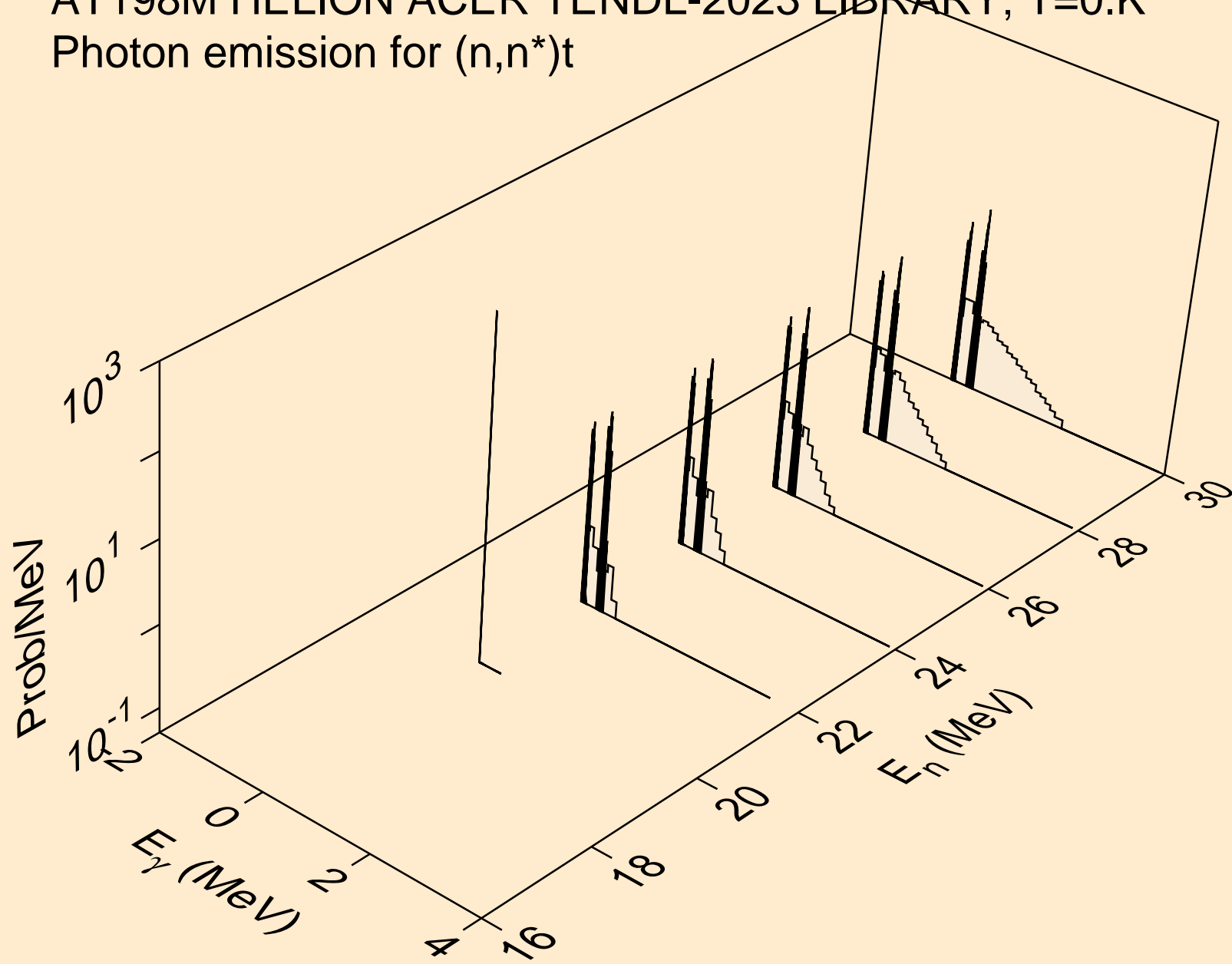

AT198M HELION ACER TENDL-2023 LIBRARY; T=0.K  
Photon emission for (n,n\*)he3

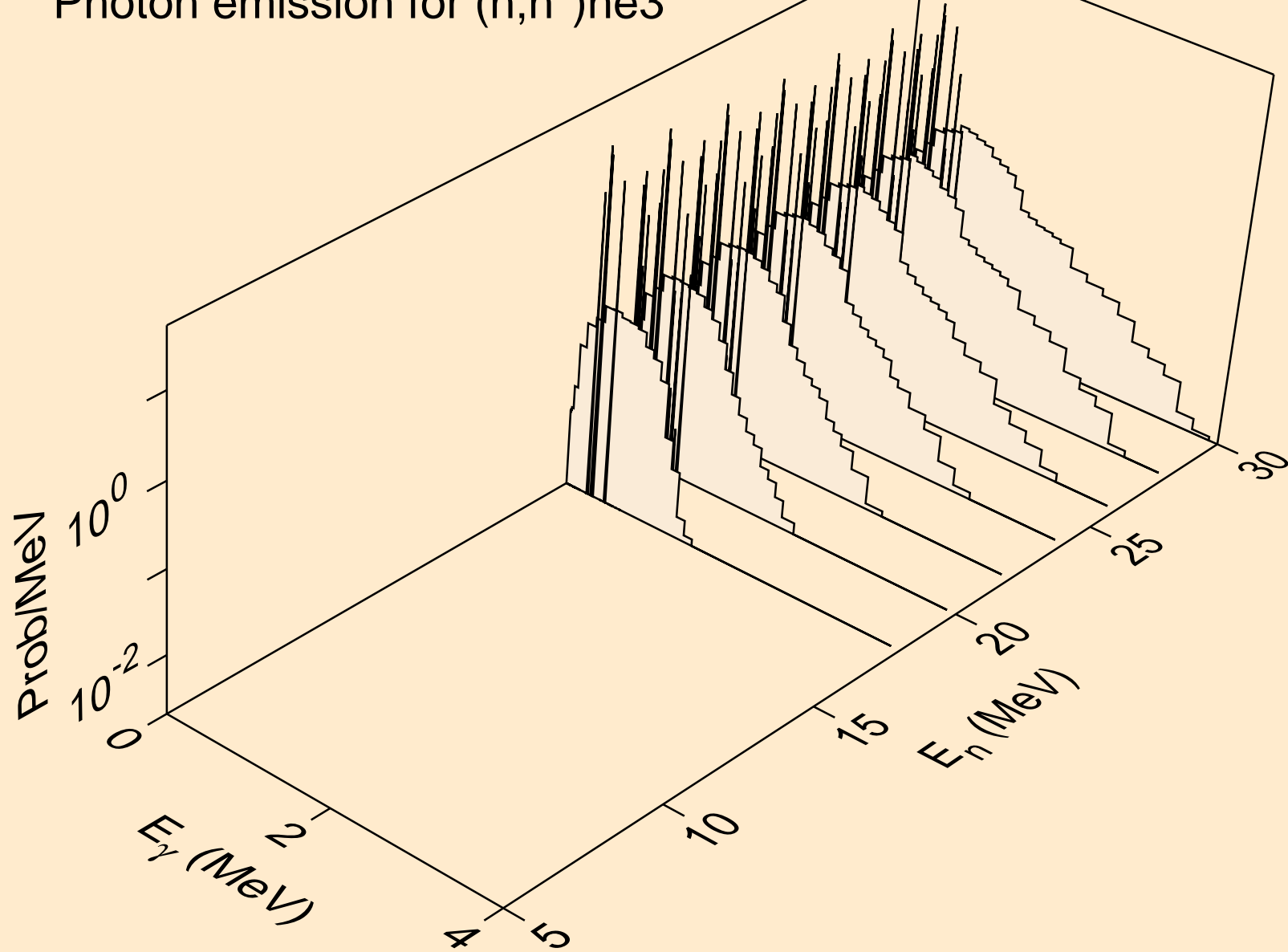

AT198M HELION ACER TENDL-2023 LIBRARY; T=0.K  
Photon emission for (n,2np)

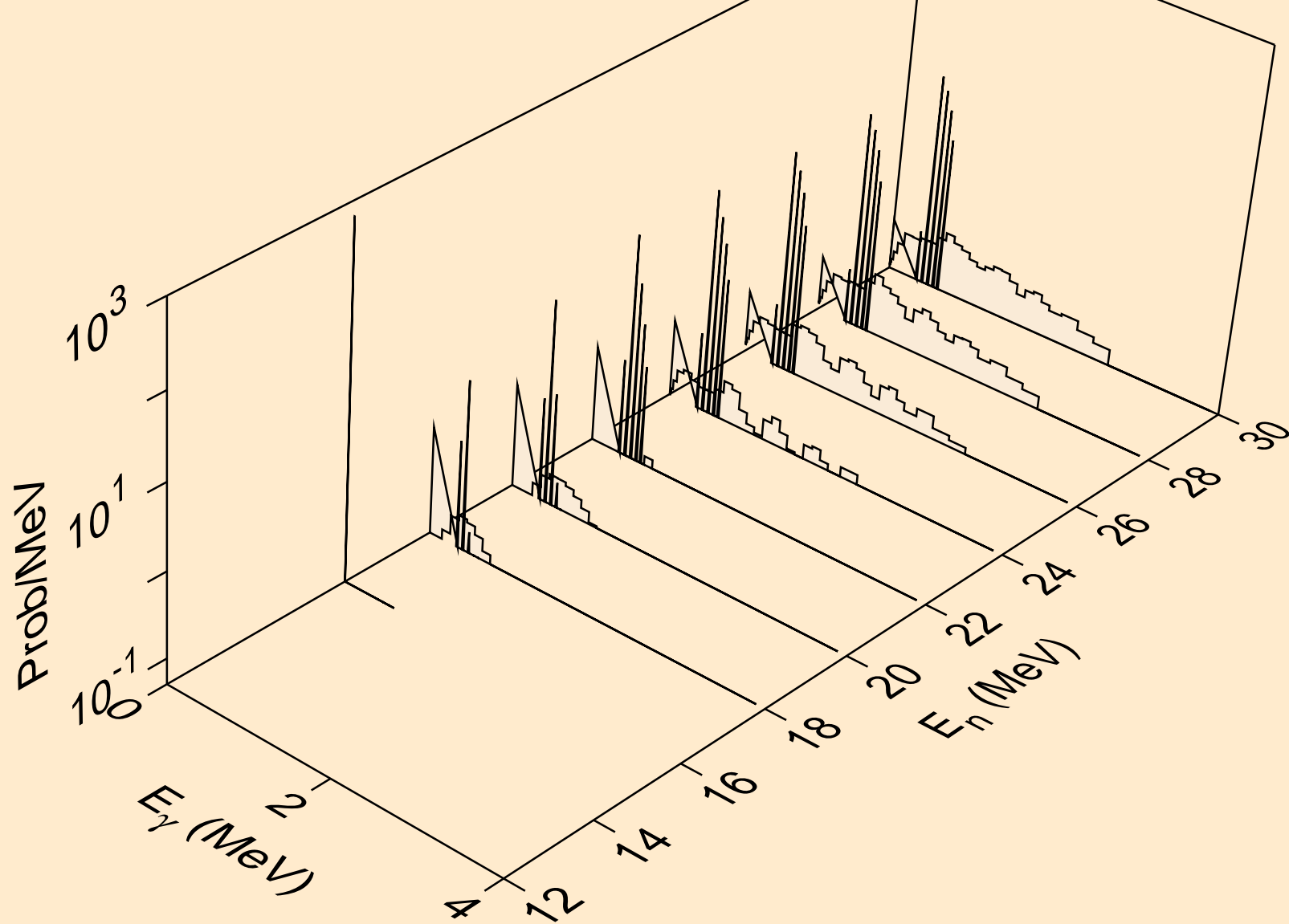

AT198M HELION ACER TENDL-2023 LIBRARY; T=0.K  
Photon emission for (n,n2p)

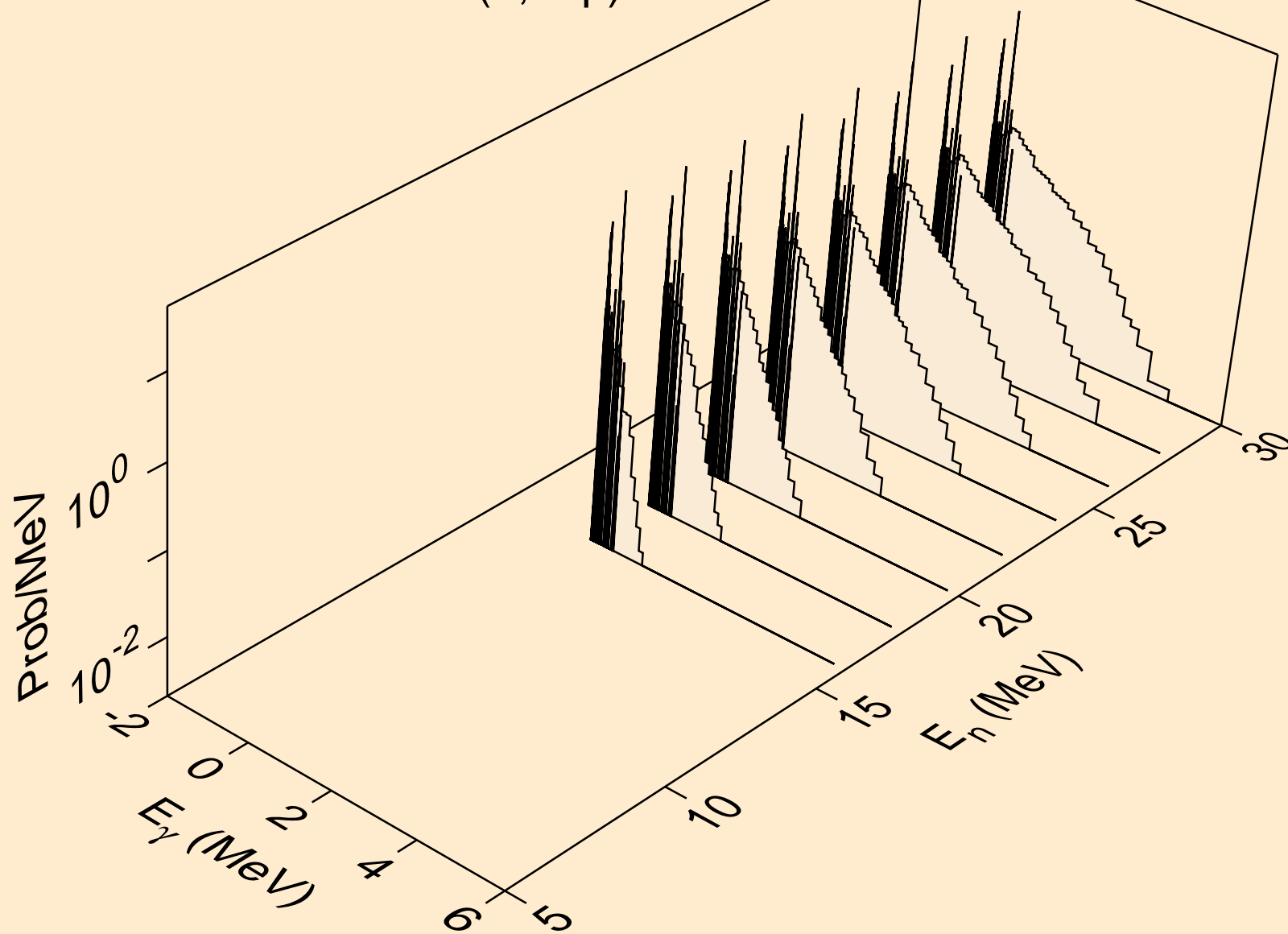

AT198M HELION ACER TENDL-2023 LIBRARY; T=0.K  
Photon emission for (n,npa)

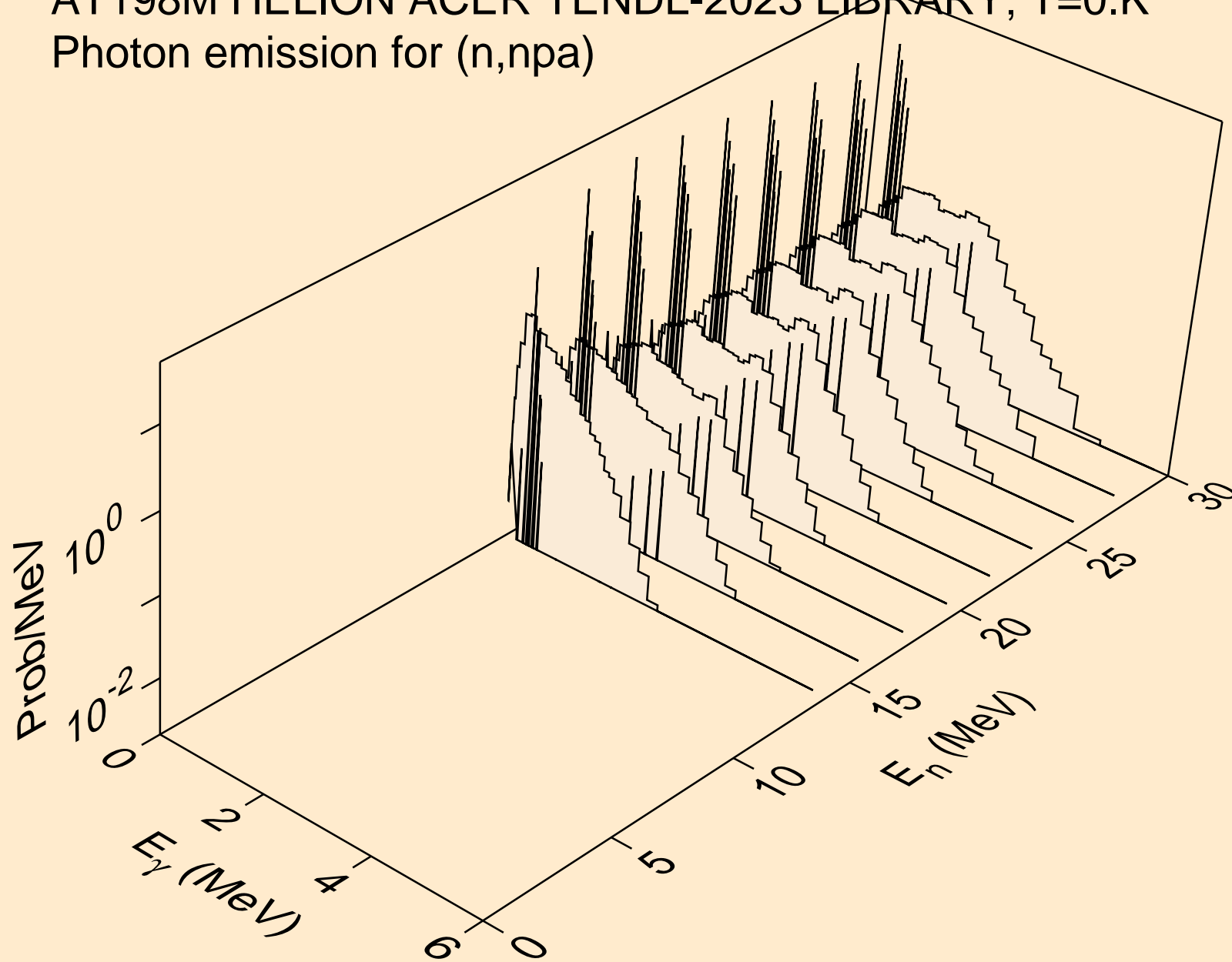

AT198M HELION ACER TENDL-2023 LIBRARY; T=0.K  
Photon emission for (n,gma)

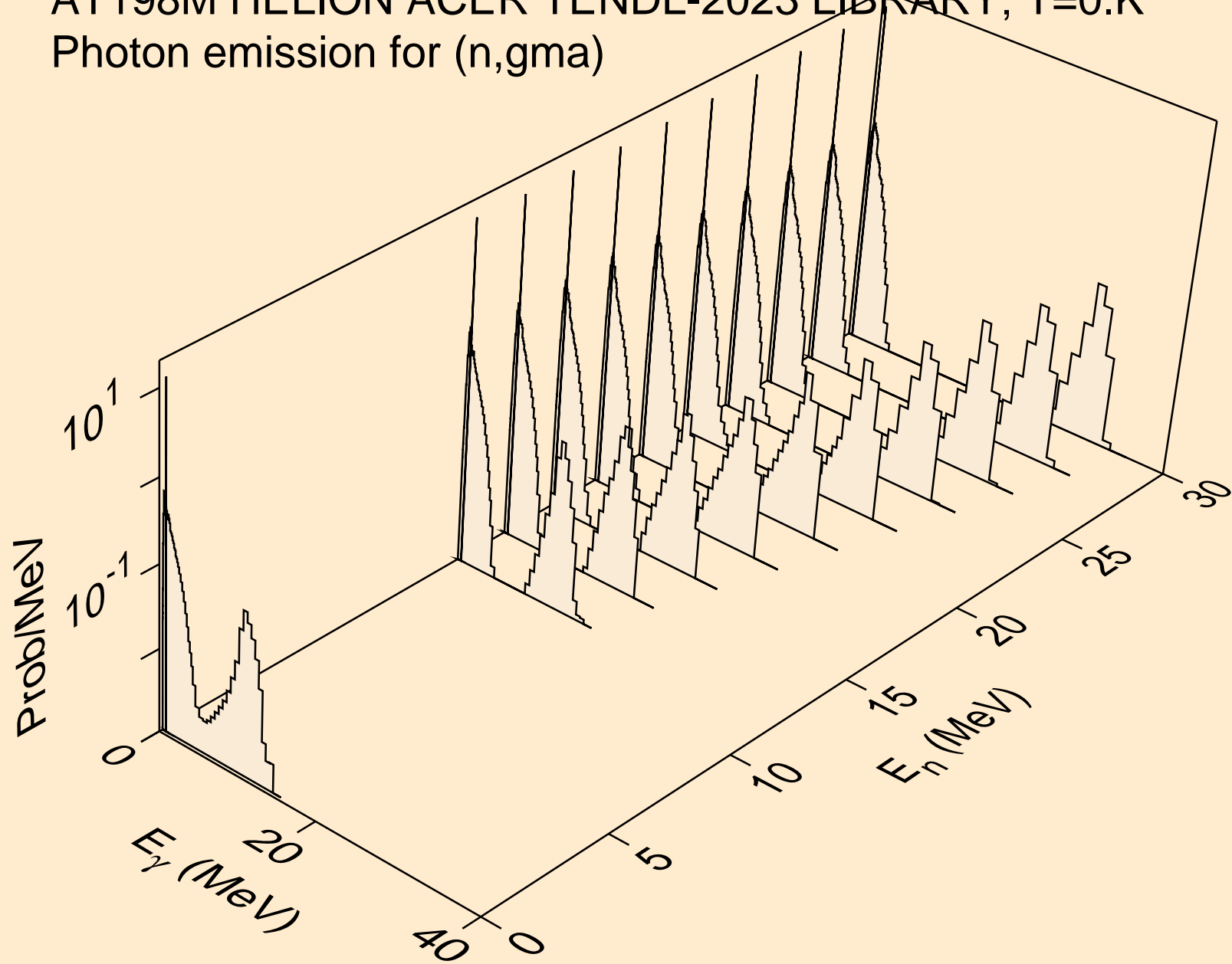

AT198M HELION ACER TENDL-2023 LIBRARY; T=0.K  
Photon emission for (n,p)

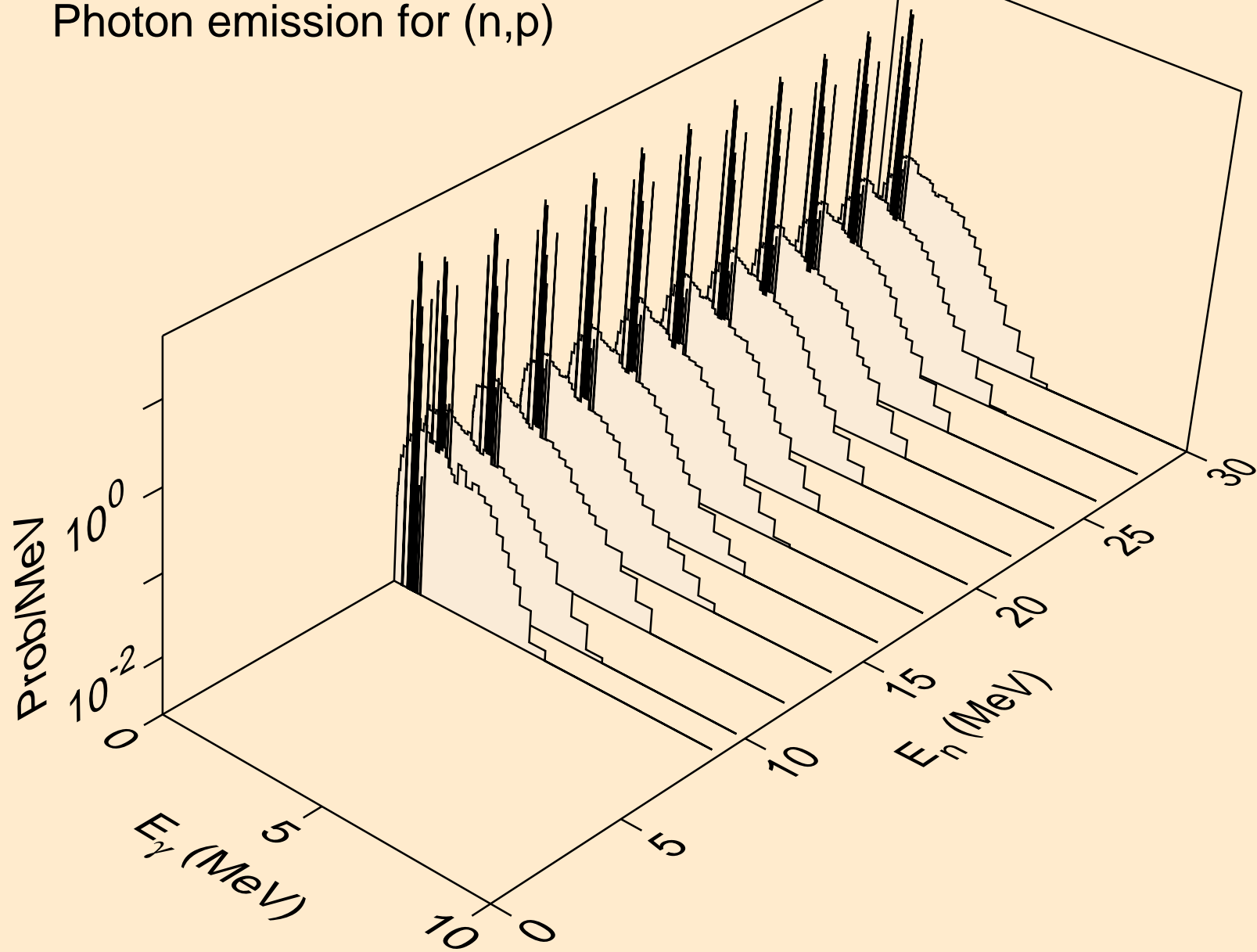

AT198M HELION ACER TENDL-2023 LIBRARY; T=0.K  
Photon emission for (n,d)

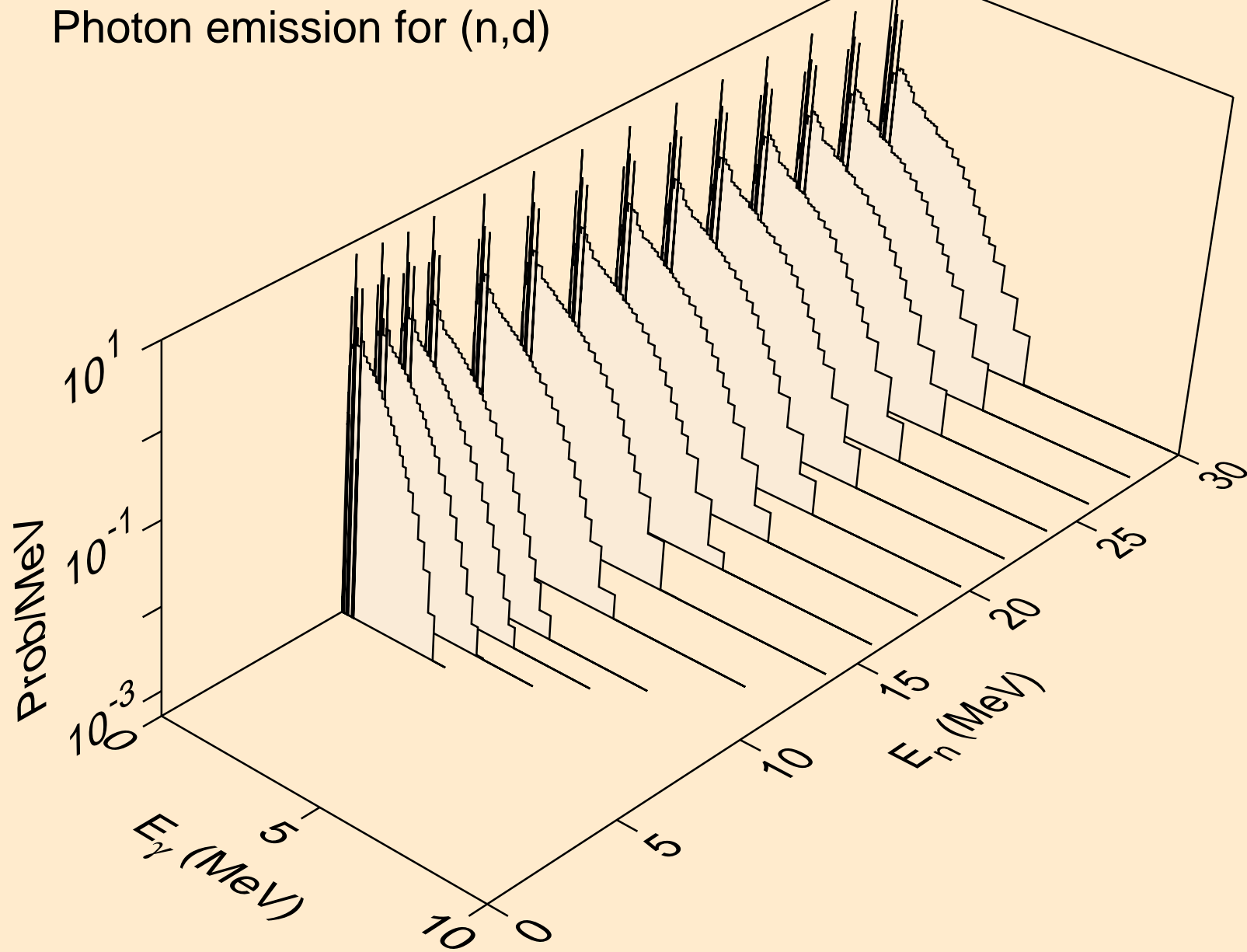

AT198M HELION ACER TENDL-2023 LIBRARY; T=0.K  
Photon emission for (n,t)

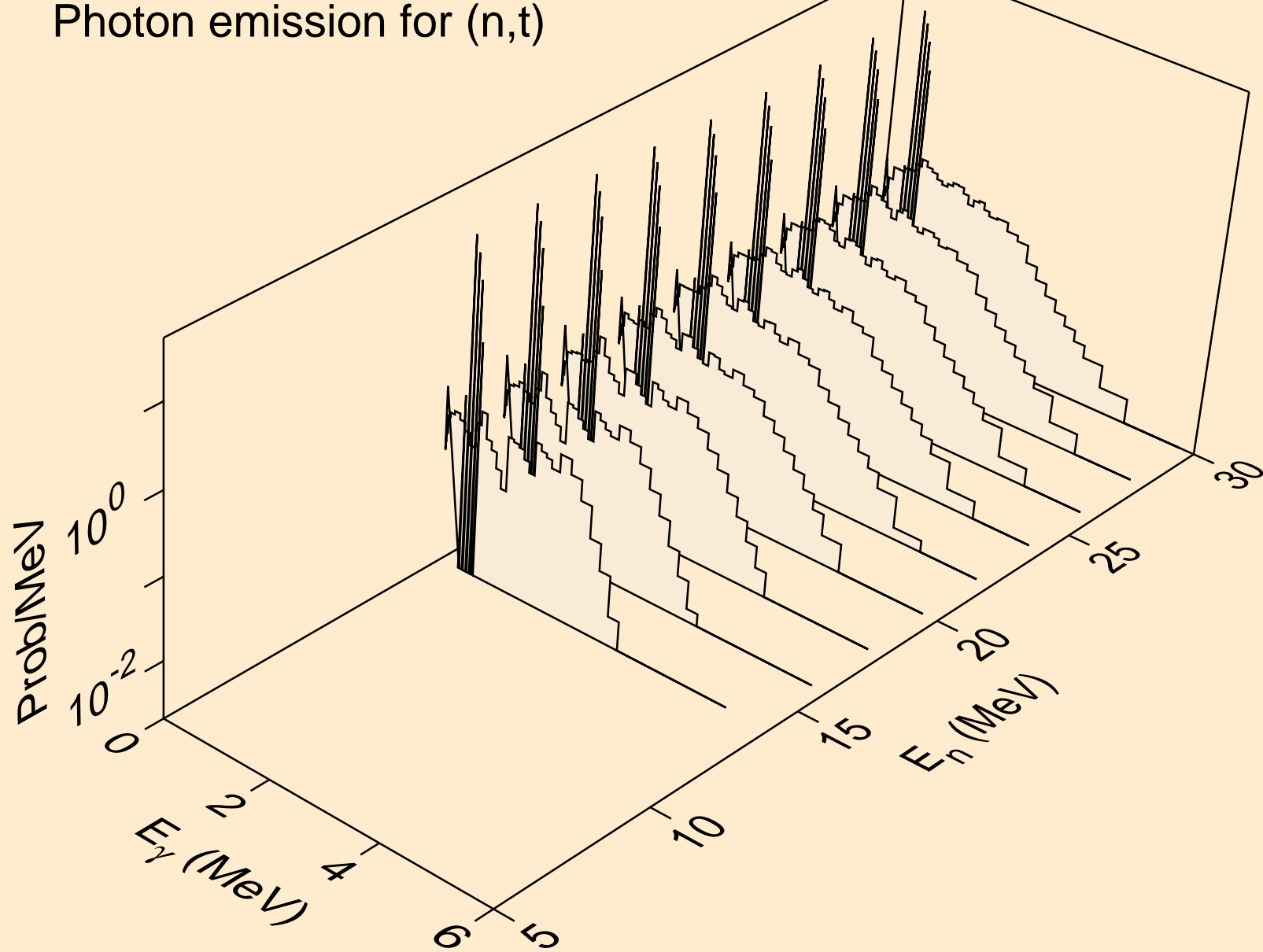

AT198M HELION ACER TENDL-2023 LIBRARY; T=0.K  
Photon emission for inelastic

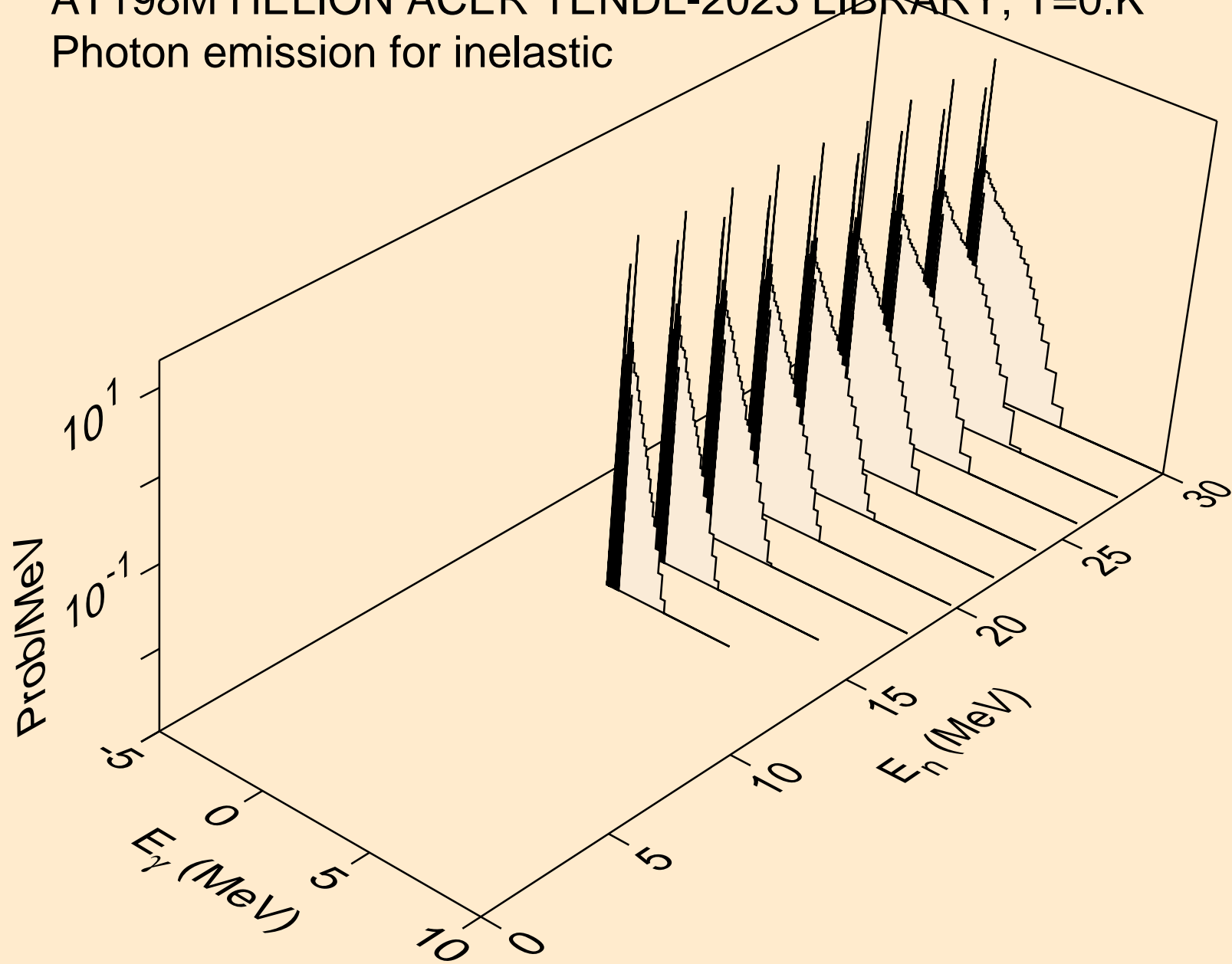

AT198M HELION ACER TENDL-2023 LIBRARY; T=0.K  
Photon emission for (n,a)

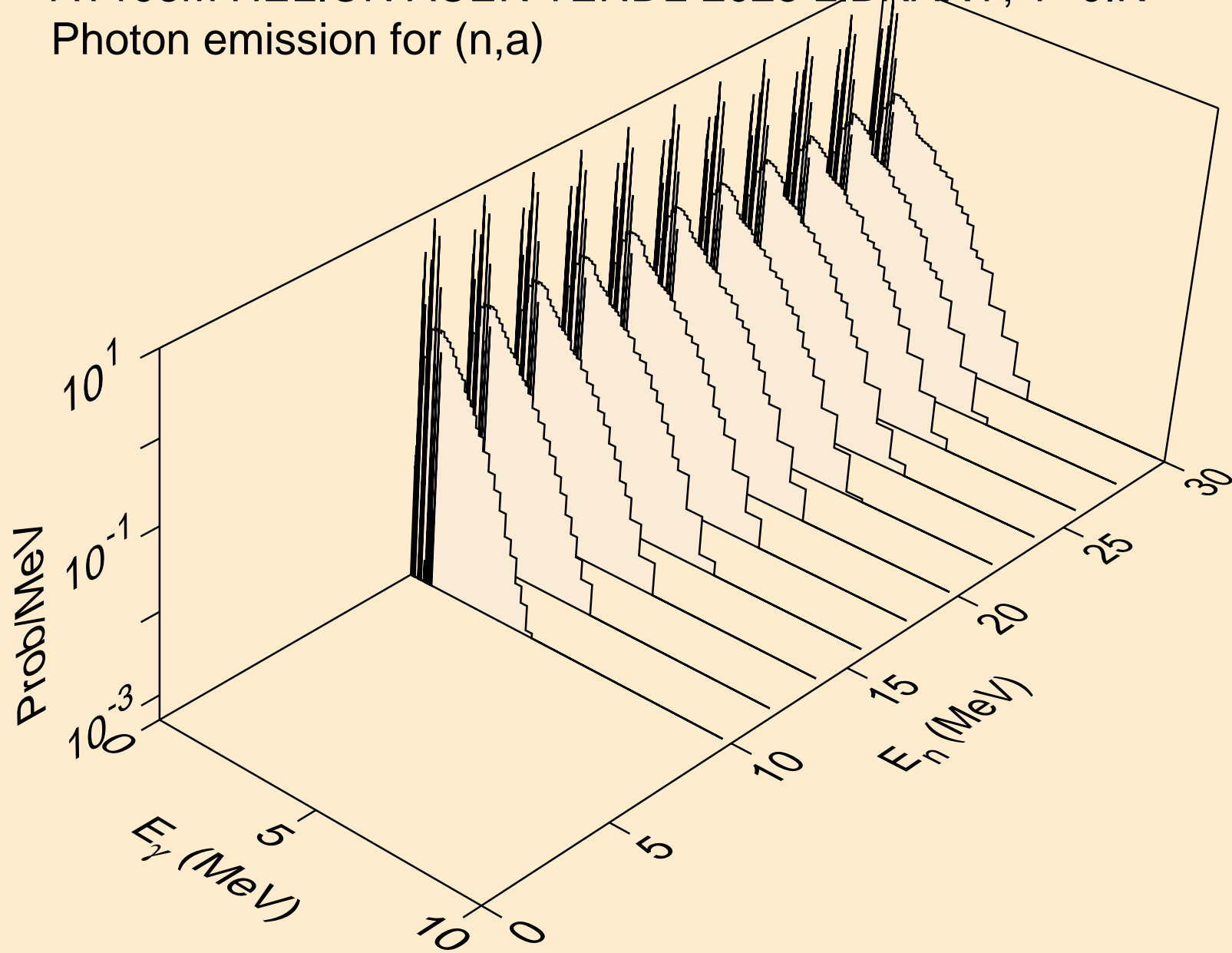

AT198M HELION ACER TENDL-2023 LIBRARY; T=0.K  
Photon emission for (n,2a)

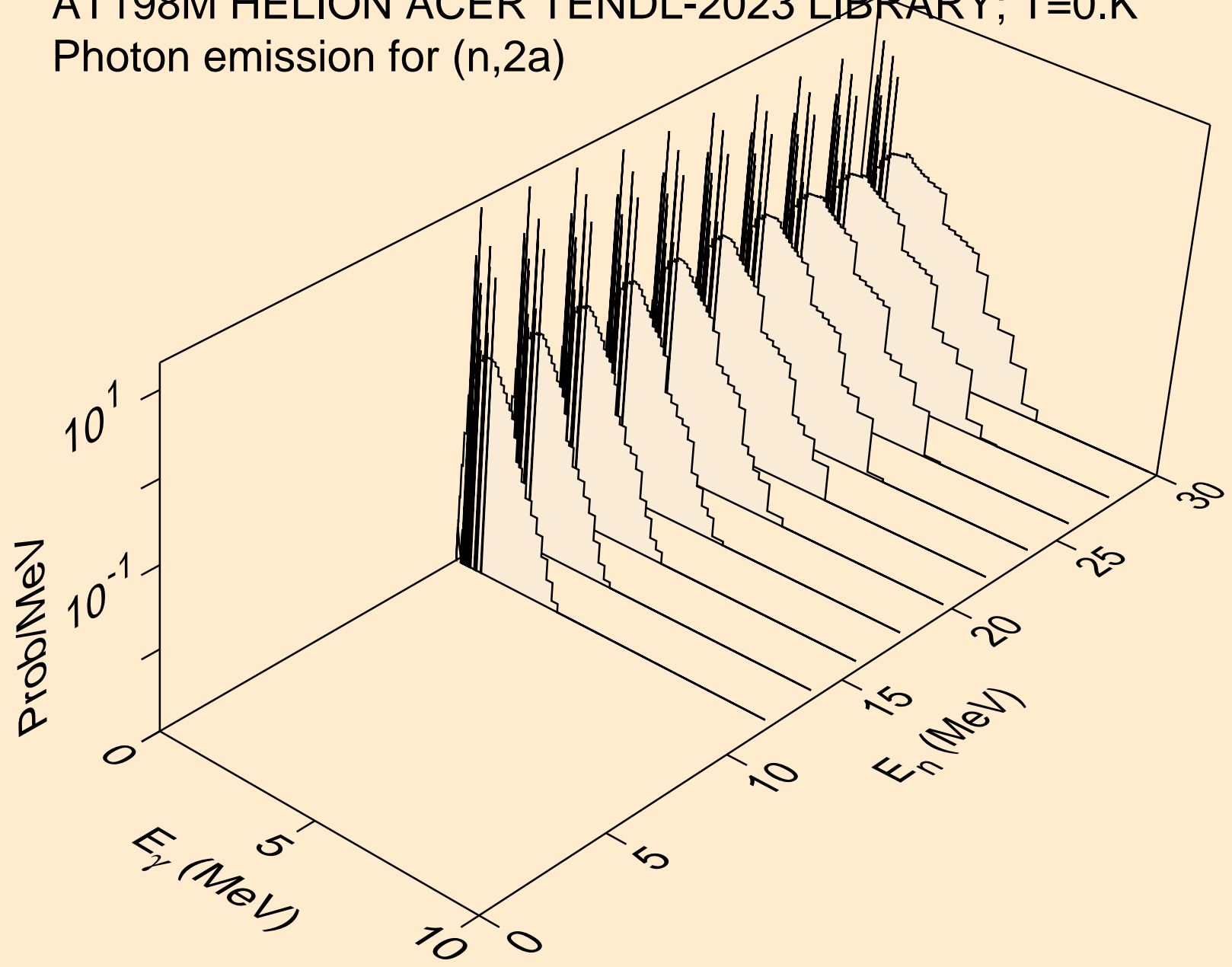

AT198M HELION ACER TENDL-2023 LIBRARY; T=0.K  
Photon emission for (n,2p)

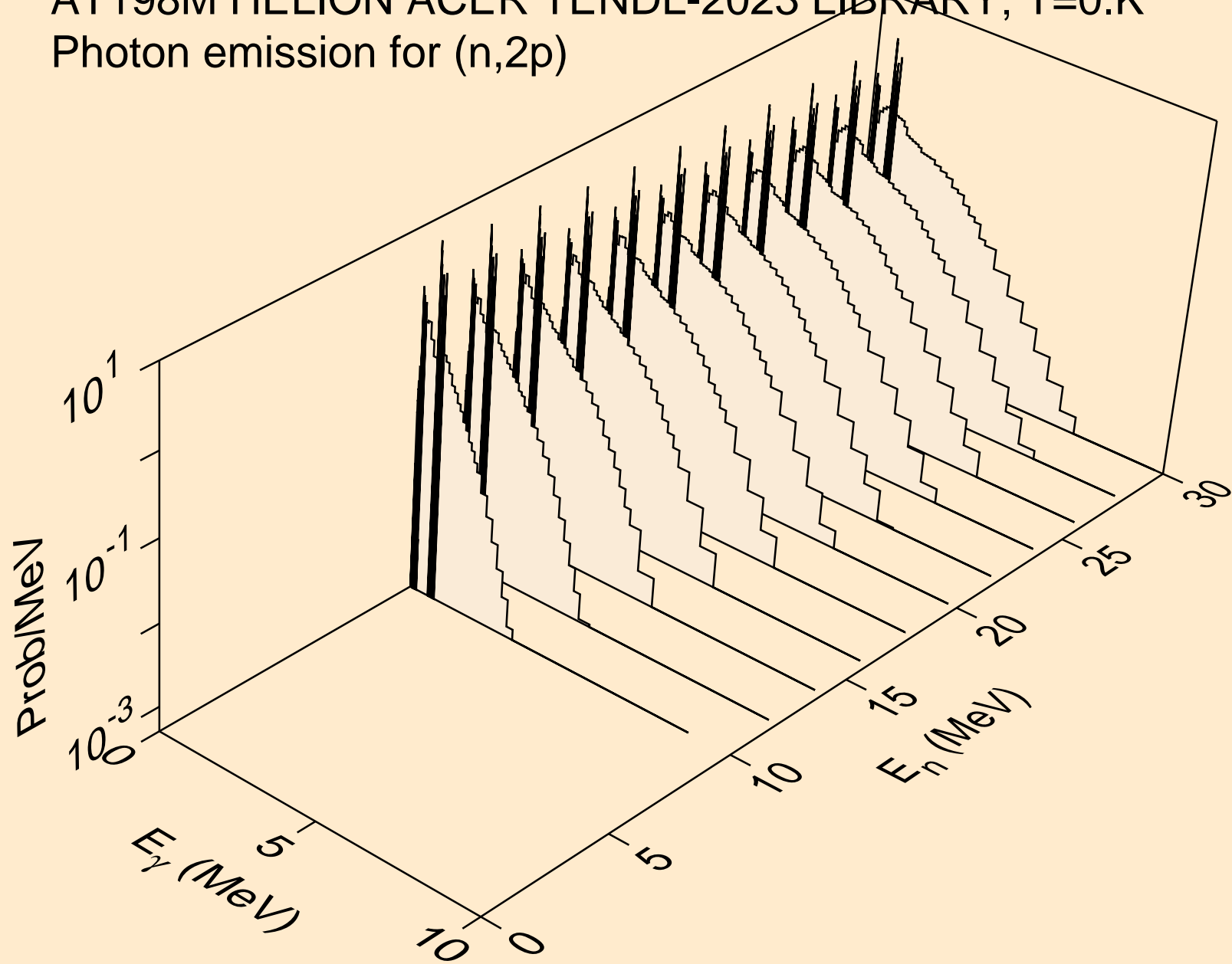

AT198M HELION ACER TENDL-2023 LIBRARY; T=0.K  
Photon emission for (n,pa)

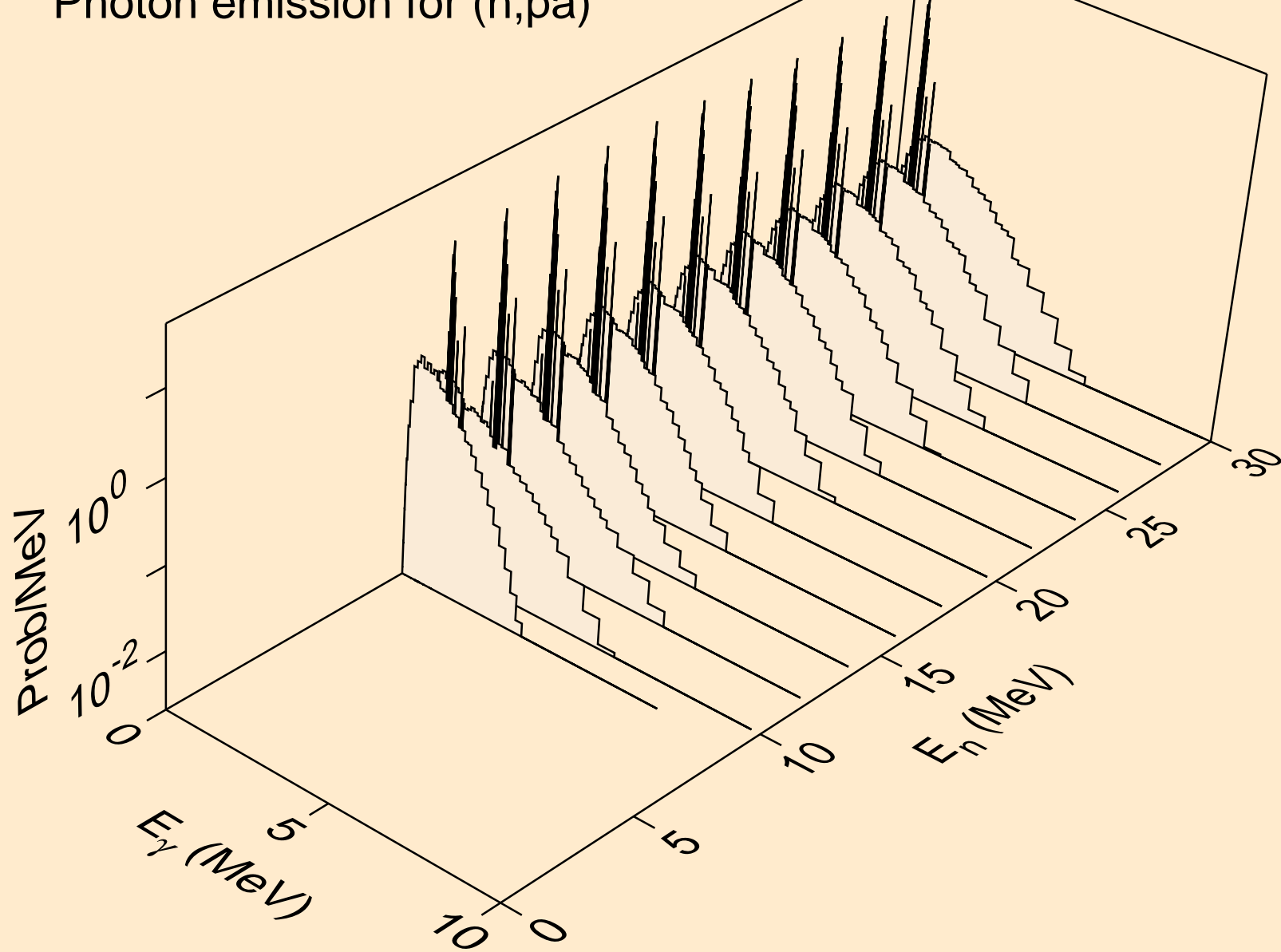

AT198M HELION ACER TENDL-2023 LIBRARY; T=0.K  
Photon emission for (n,pd)

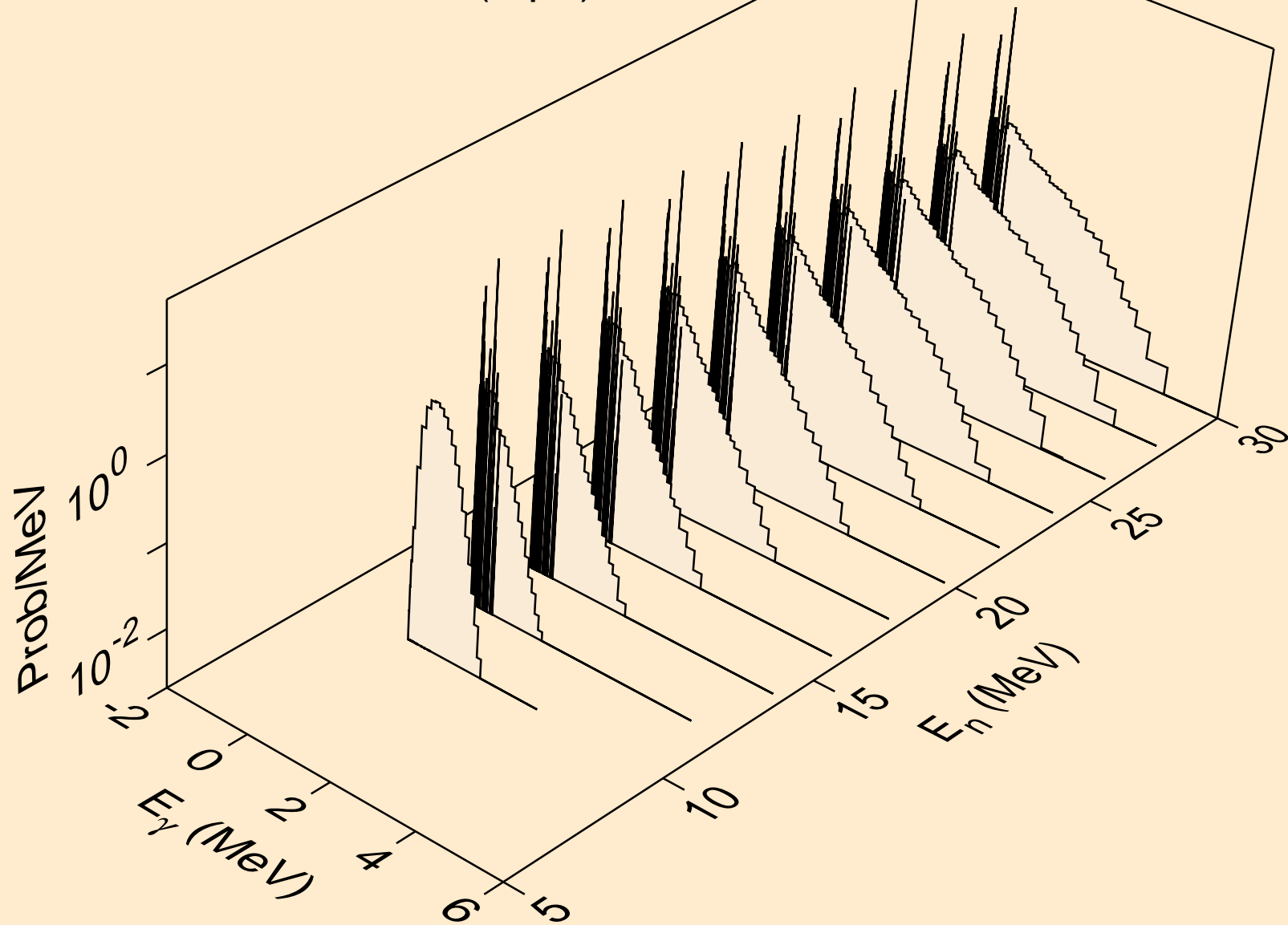

AT198M HELION ACER TENDL-2023 LIBRARY; T=0.K  
Photon emission for (n,pt)

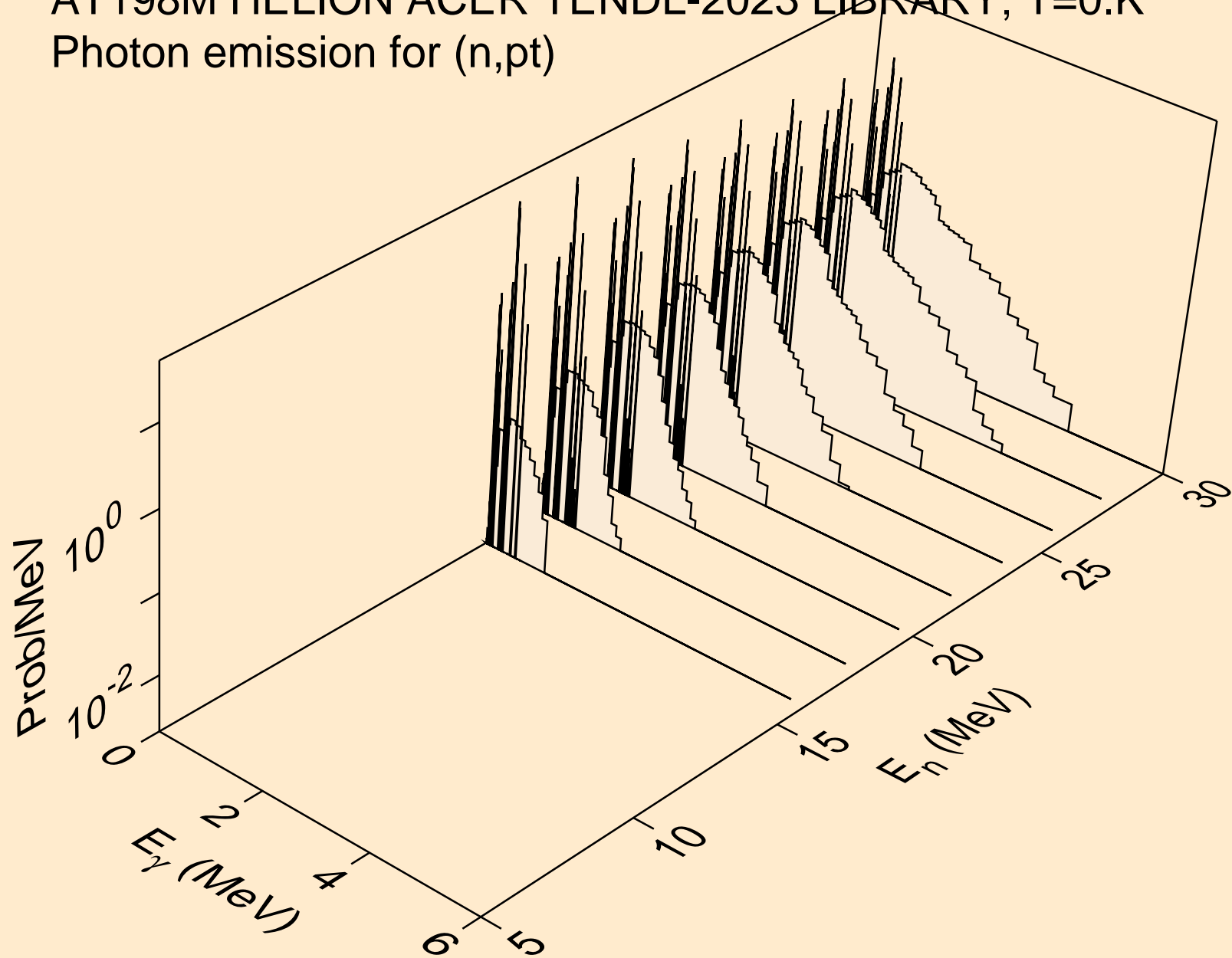

AT198M HELION ACER TENDL-2023 LIBRARY; T=0.K  
Photon emission for (n,da)

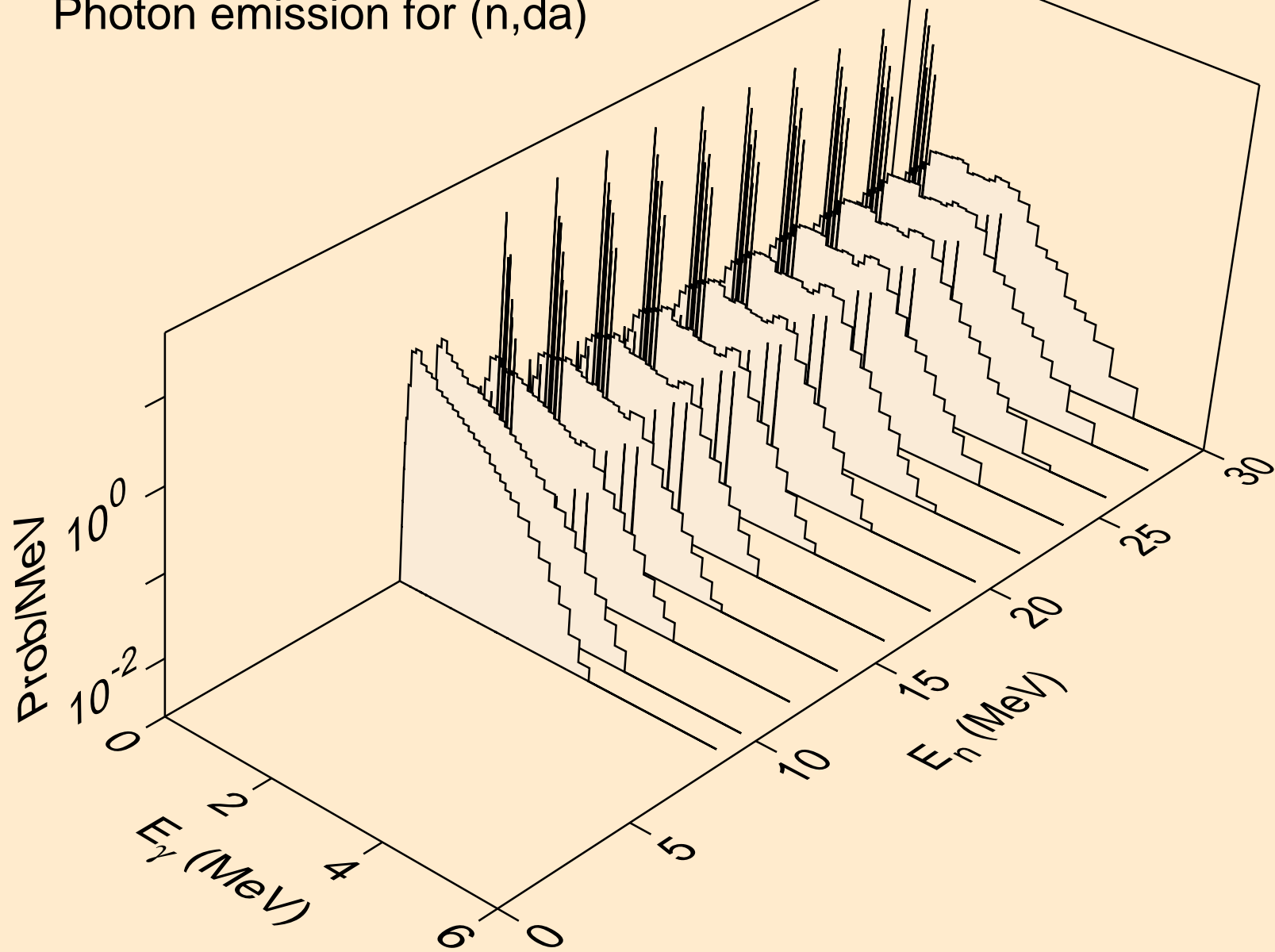

# AT198M HELION ACER TENDL-2023 LIBRARY; T=0.K

## Particle heating contributions

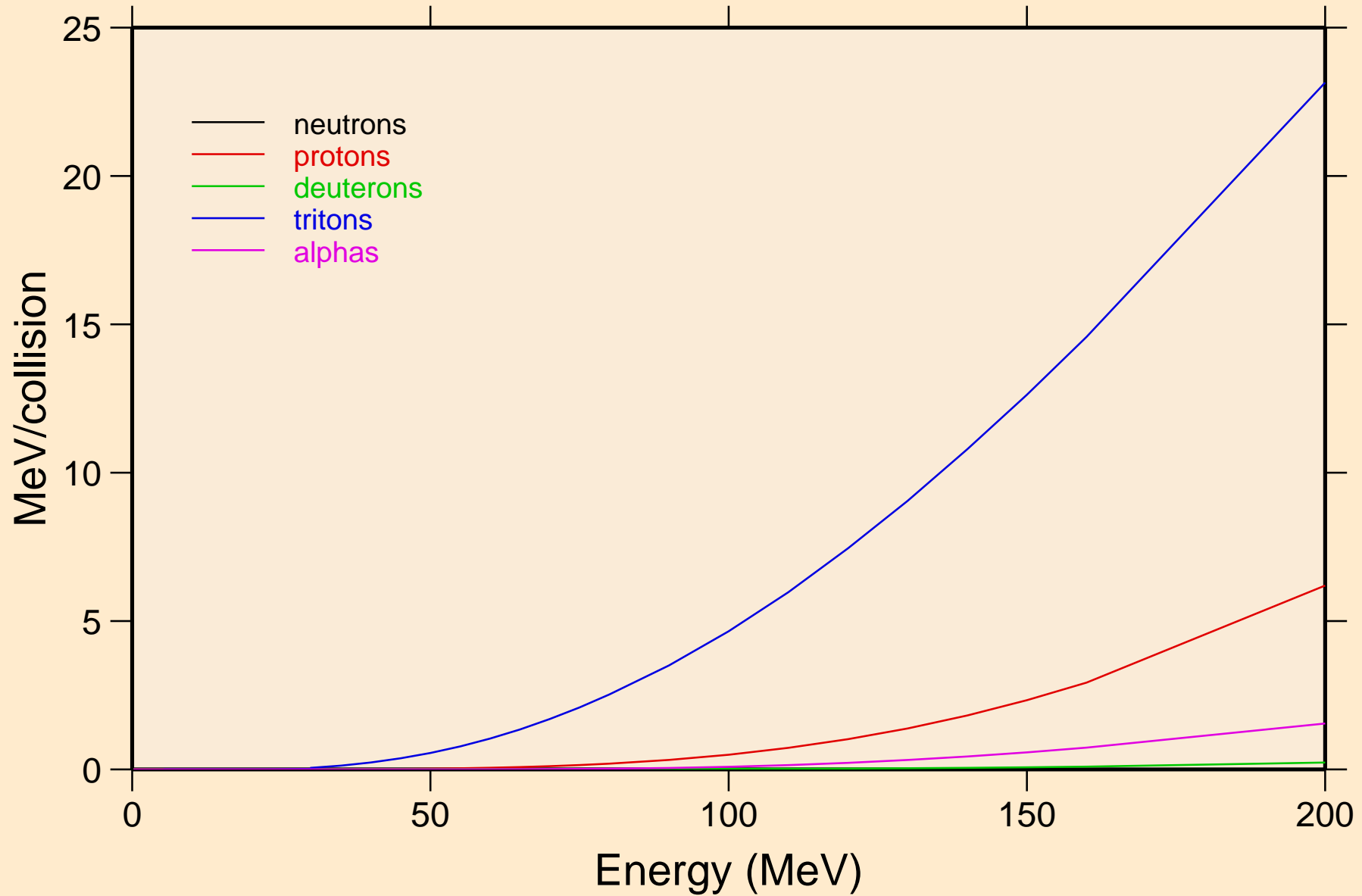

AT198M HELION ACER TENDL-2023 LIBRARY; T=0.K  
Recoil Heating

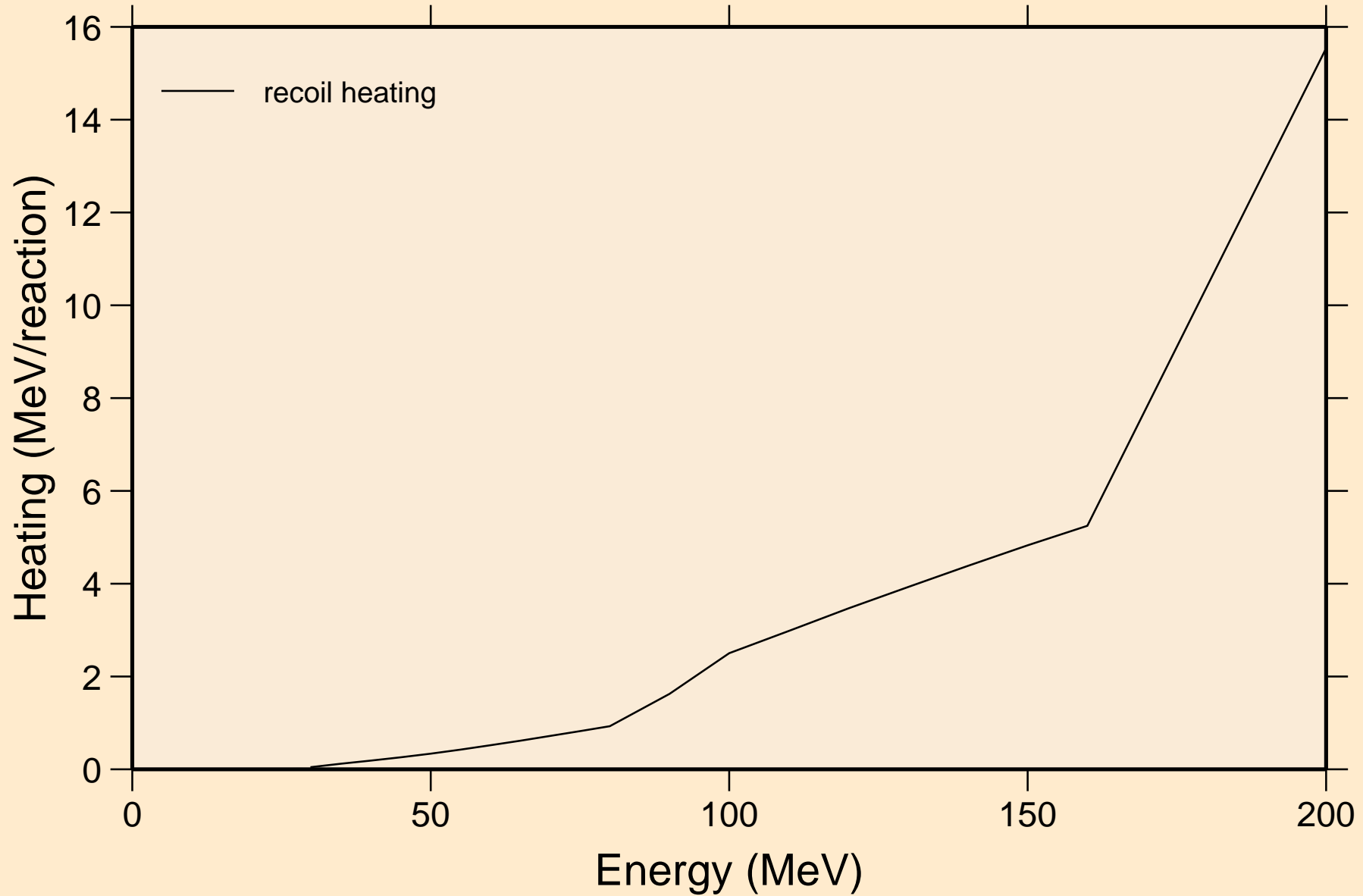

AT198M HELION ACER TENDL-2023 LIBRARY; T=0.K  
Particle production cross sections

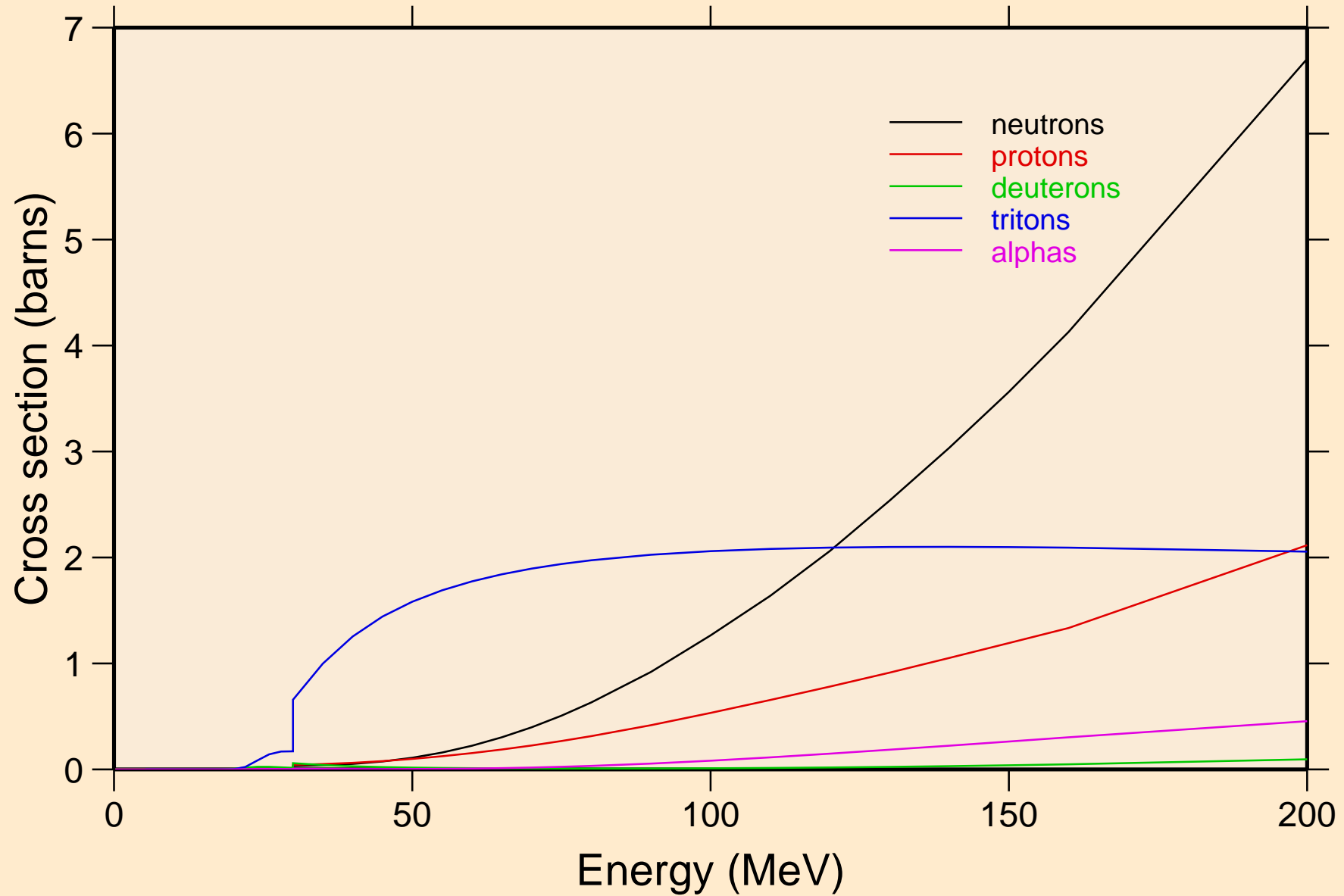

AT198M HELION ACER TENDL-2023 LIBRARY; T=0.K  
neutrons from (s,n)

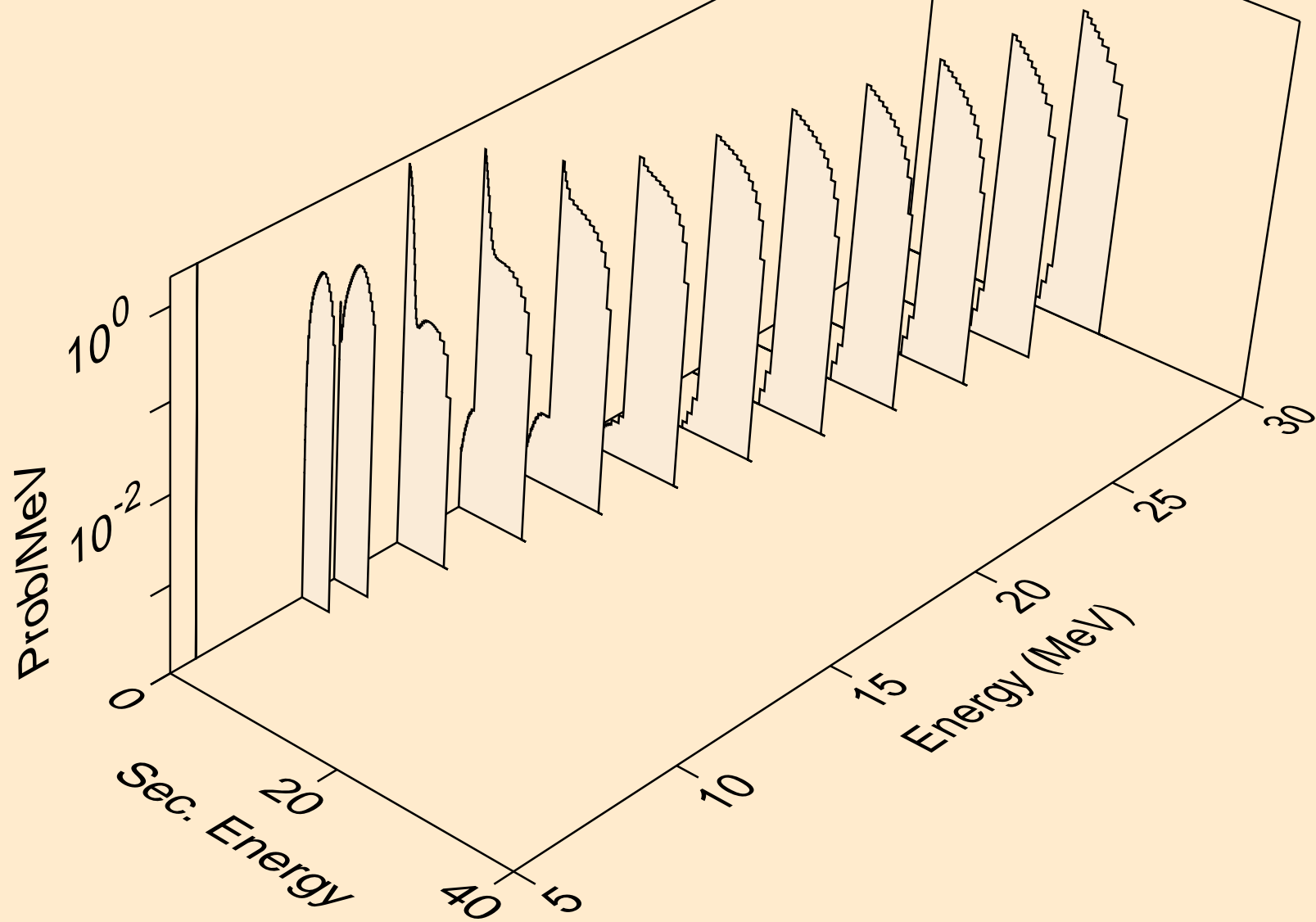

AT198M HELION ACER TENDL-2023 LIBRARY; T=0.K  
neutrons from (s,x)

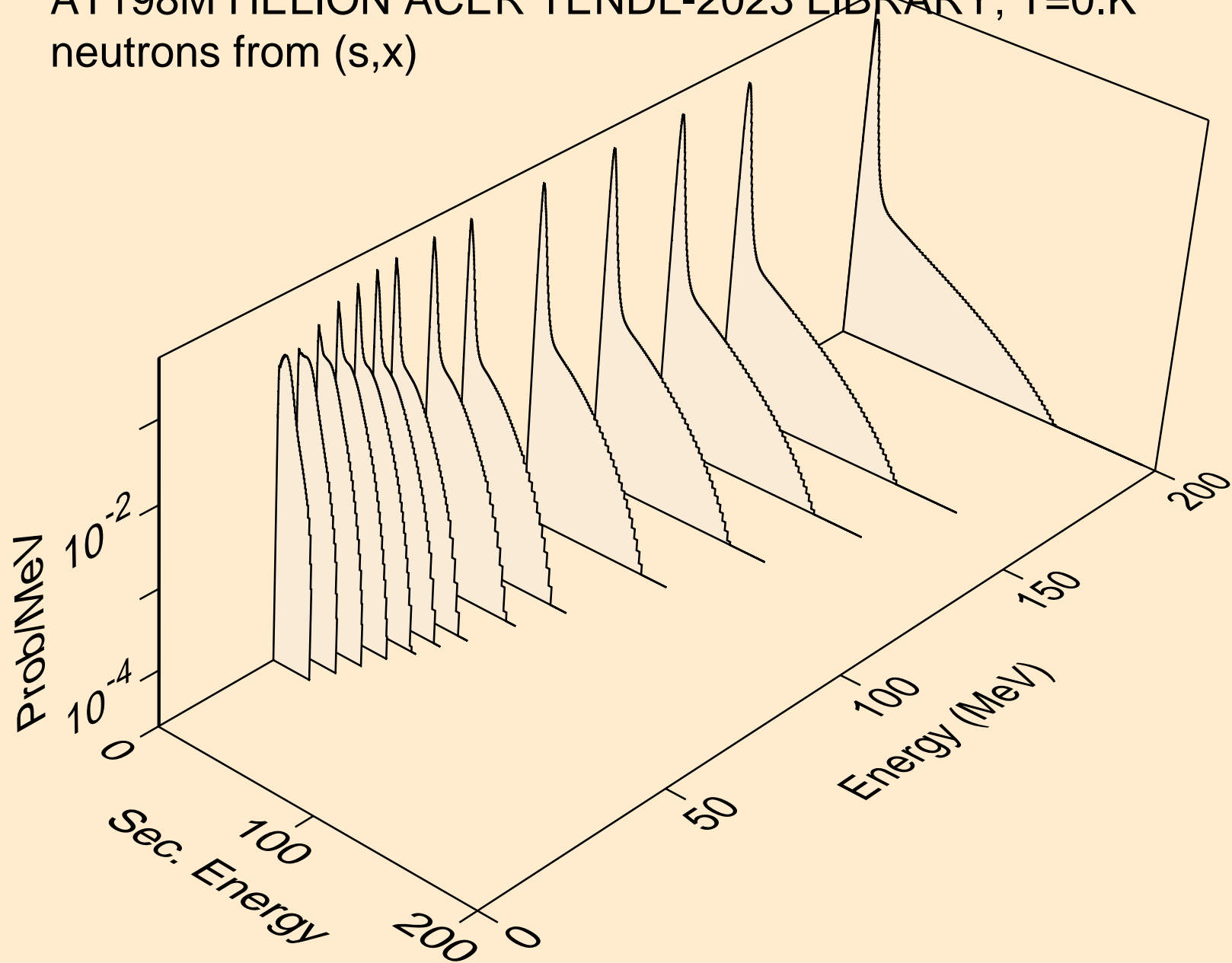

AT198M HELION ACER TENDL-2023 LIBRARY; T=0.K  
neutrons from (s,2n)

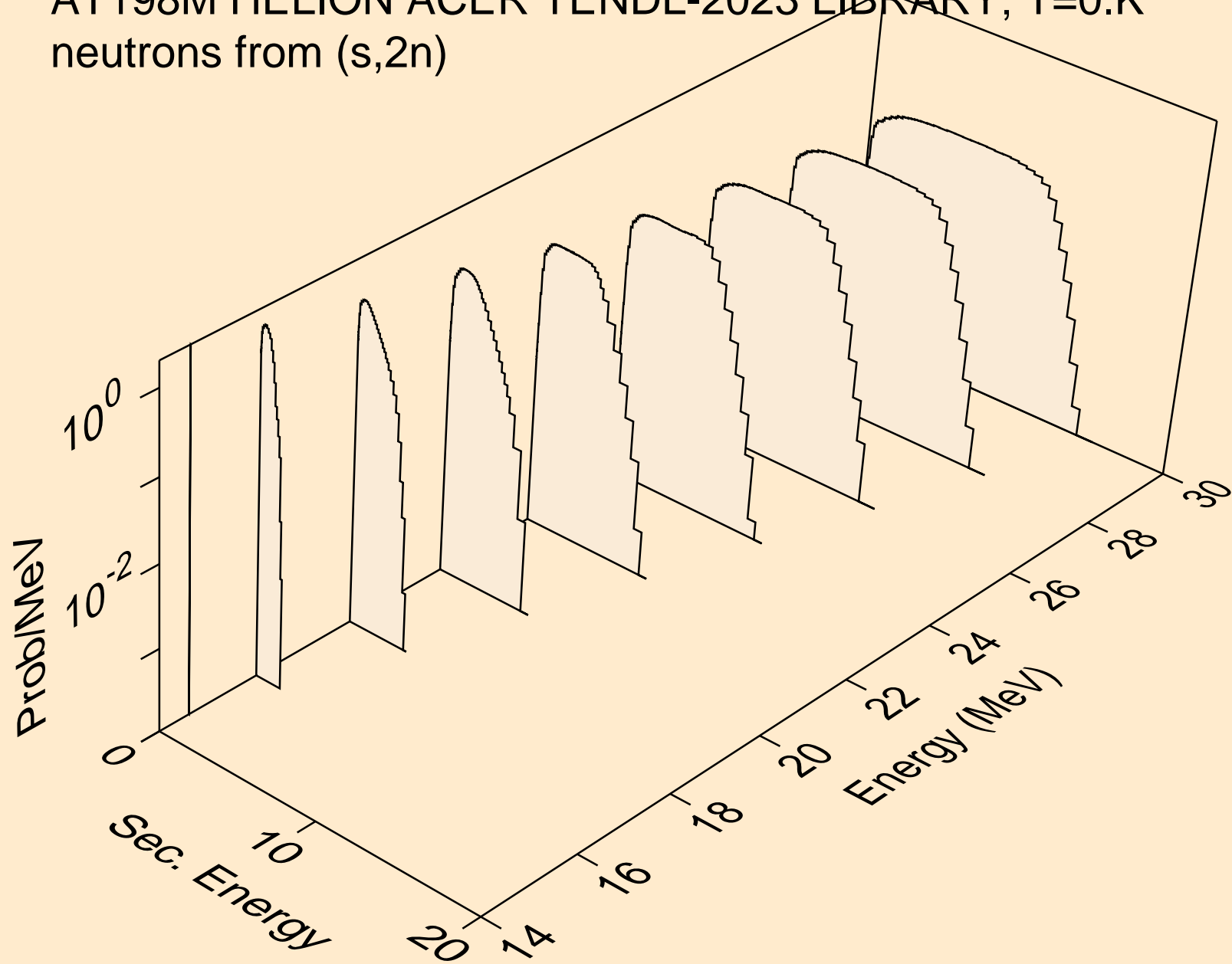

AT198M HELION ACER TENDL-2023 LIBRARY; T=0.K  
neutrons from (s,n\*)a

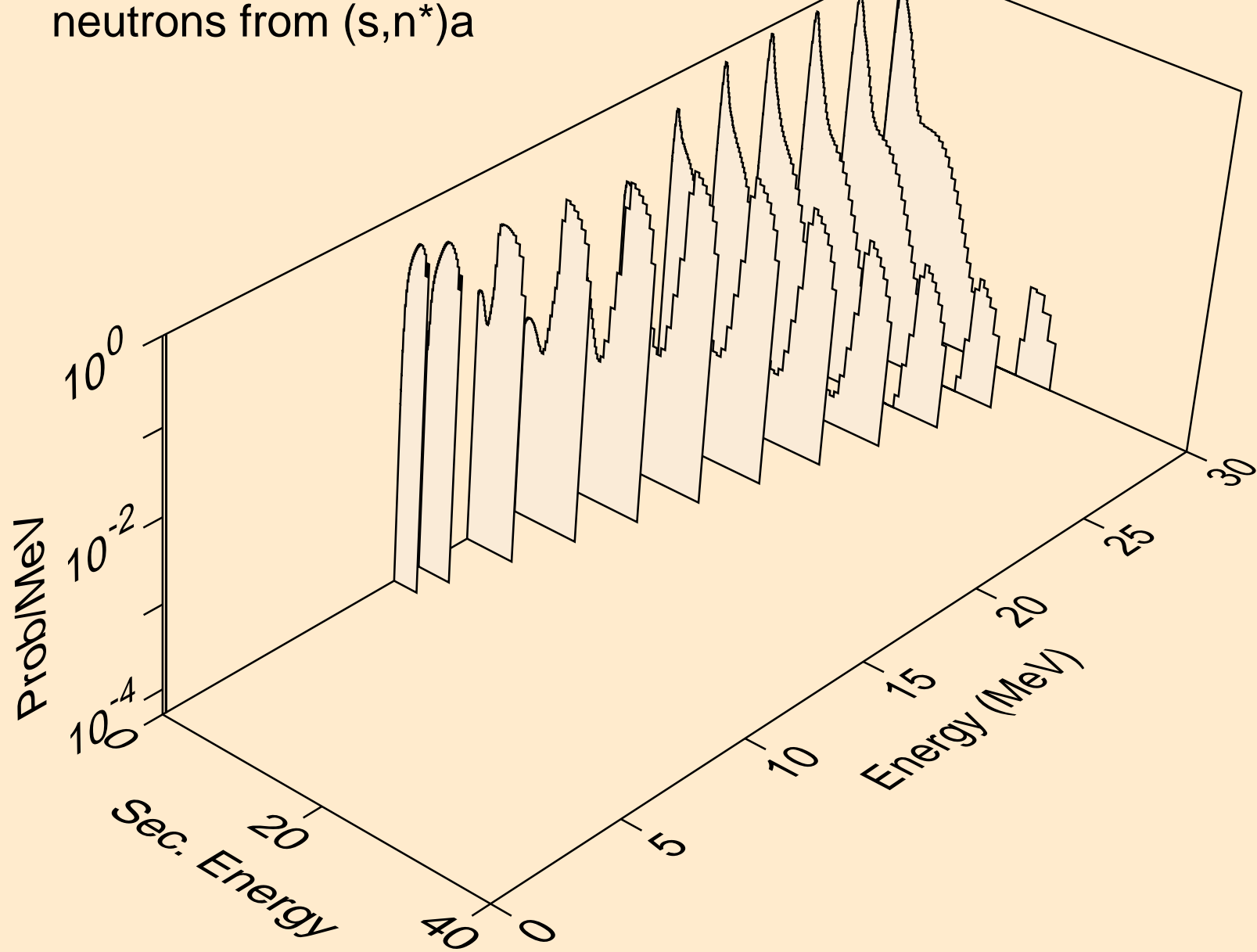

AT198M HELION ACER TENDL-2023 LIBRARY; T=0.K  
neutrons from (s,2n)a

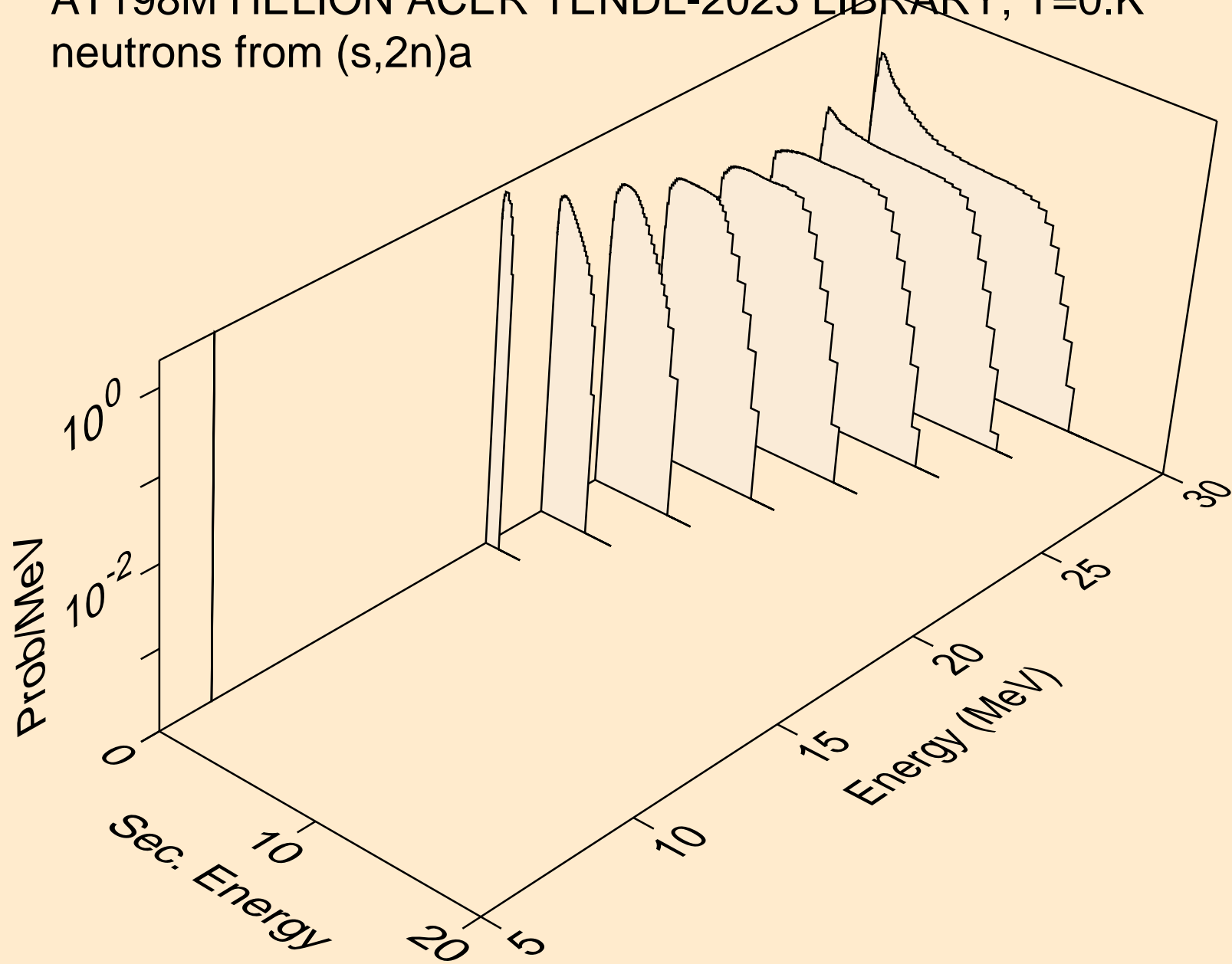

AT198M HELION ACER TENDL-2023 LIBRARY; T=0.K  
neutrons from (s,n\*)p

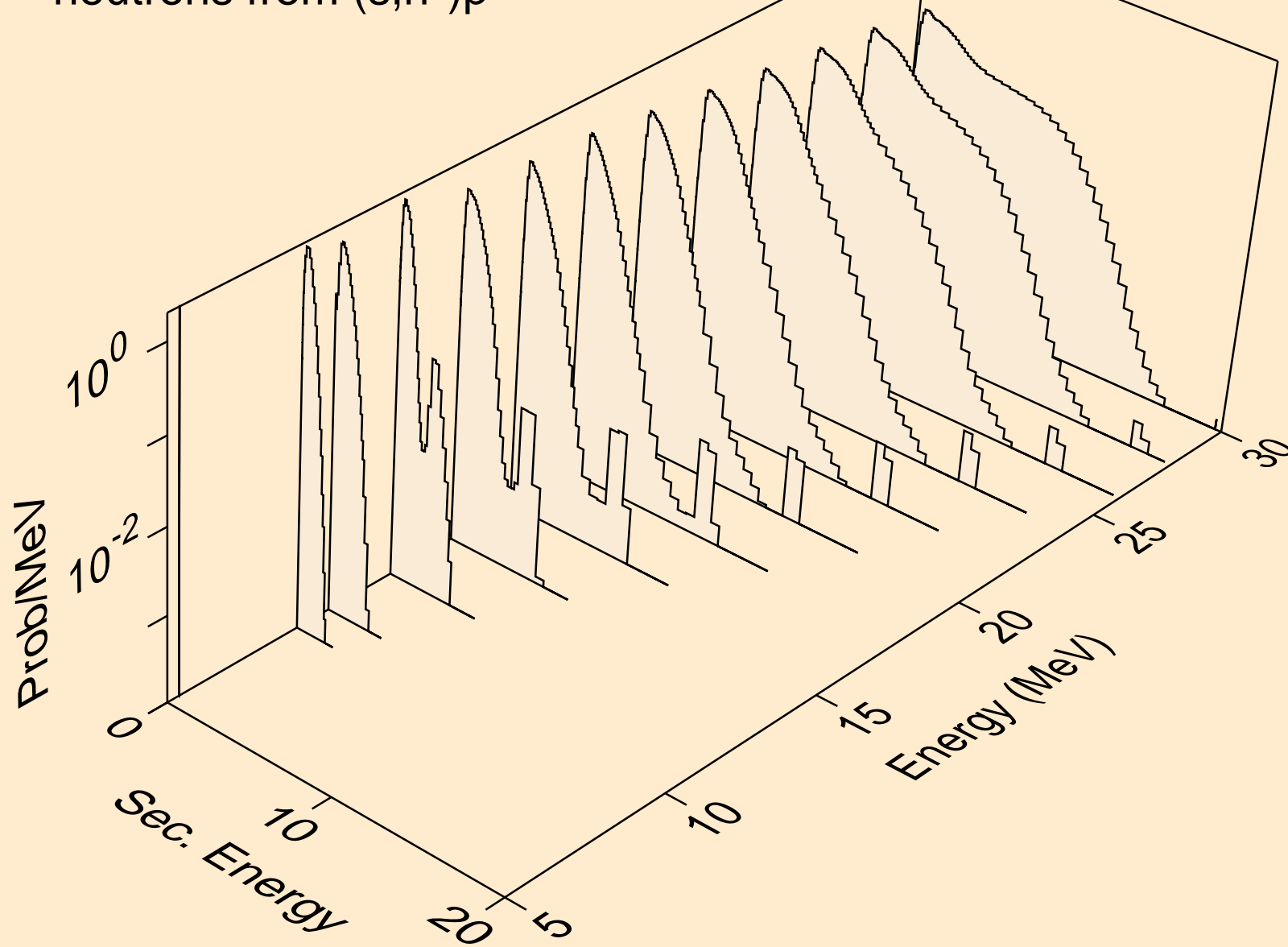

AT198M HELION ACER TENDL-2023 LIBRARY; T=0.K  
neutrons from (s,n\*)2a

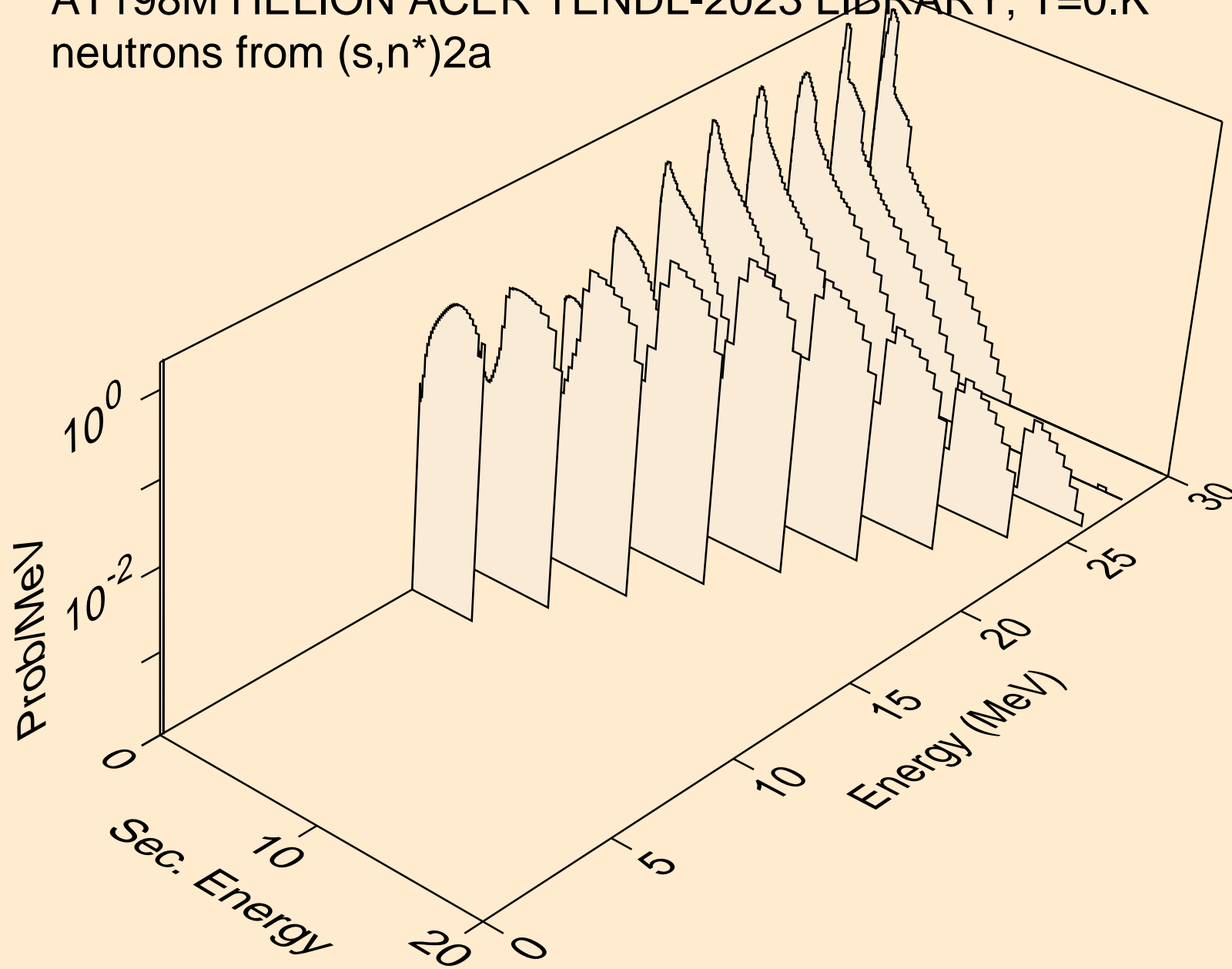

AT198M HELION ACER TENDL-2023 LIBRARY; T=0.K  
neutrons from (s,n\*)d

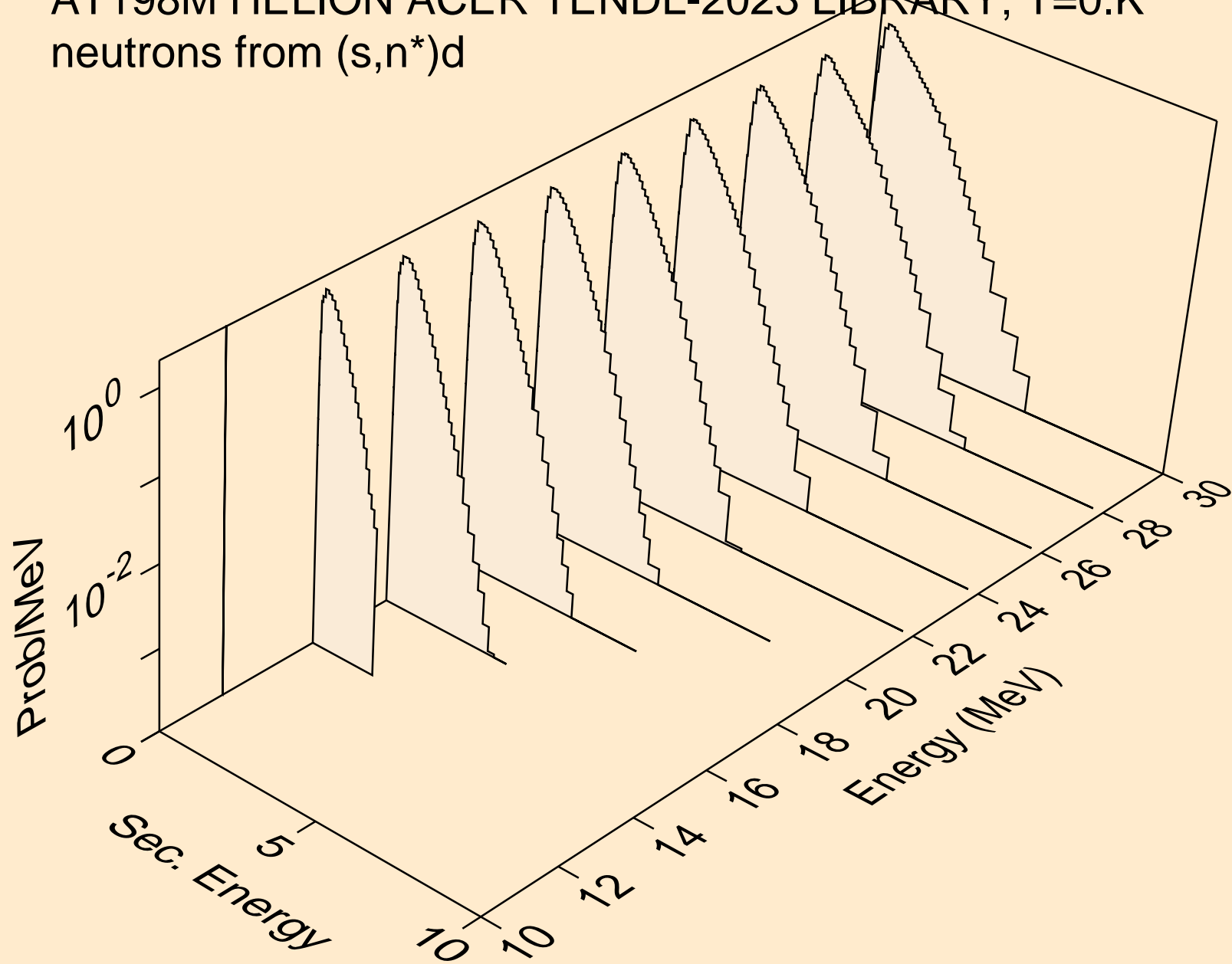

AT198M HELION ACER TENDL-2023 LIBRARY; T=0.K  
neutrons from (s,n\*)t

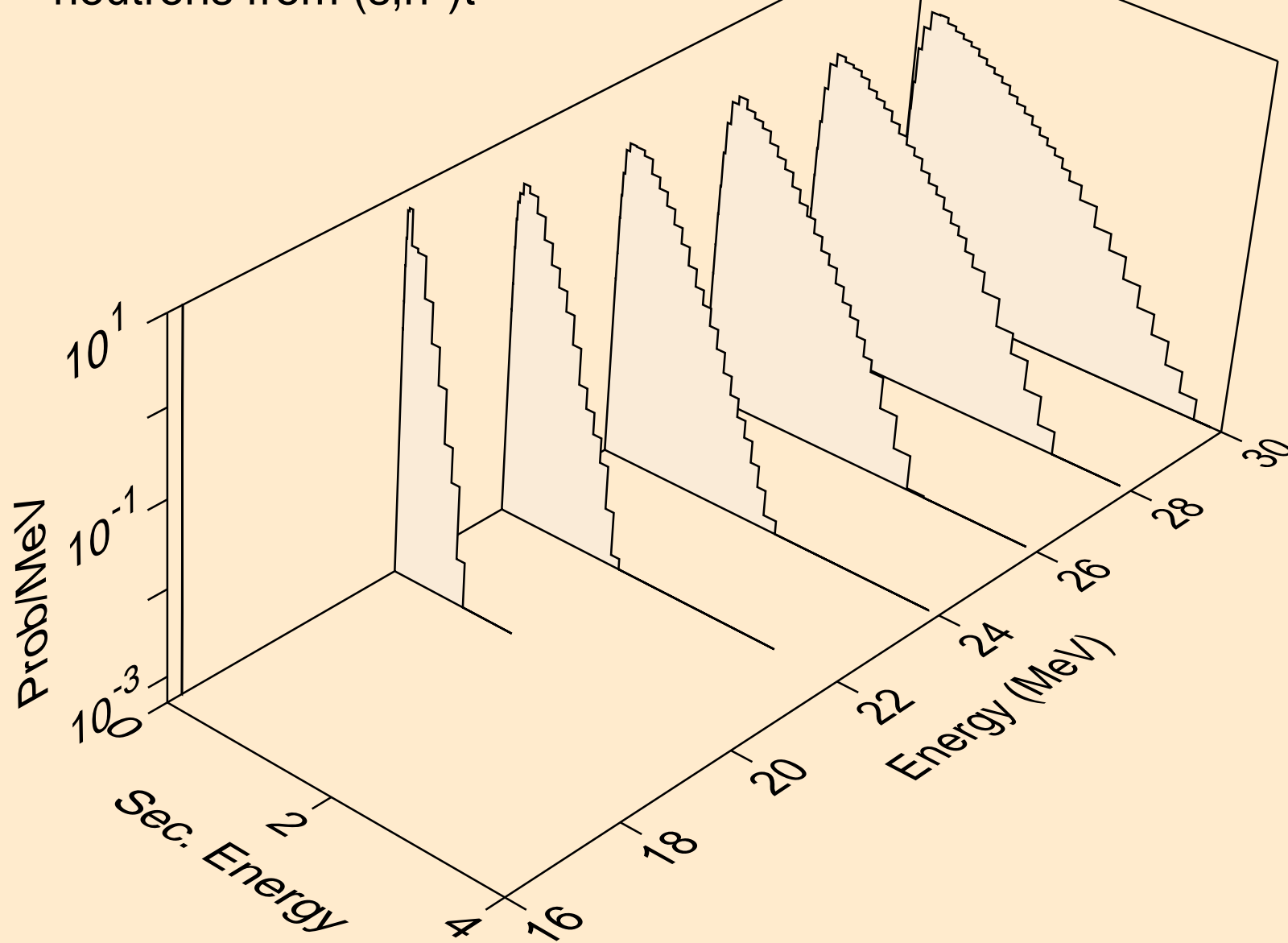

AT198M HELION ACER TENDL-2023 LIBRARY; T=0.K  
neutrons from (s,n\*)he3

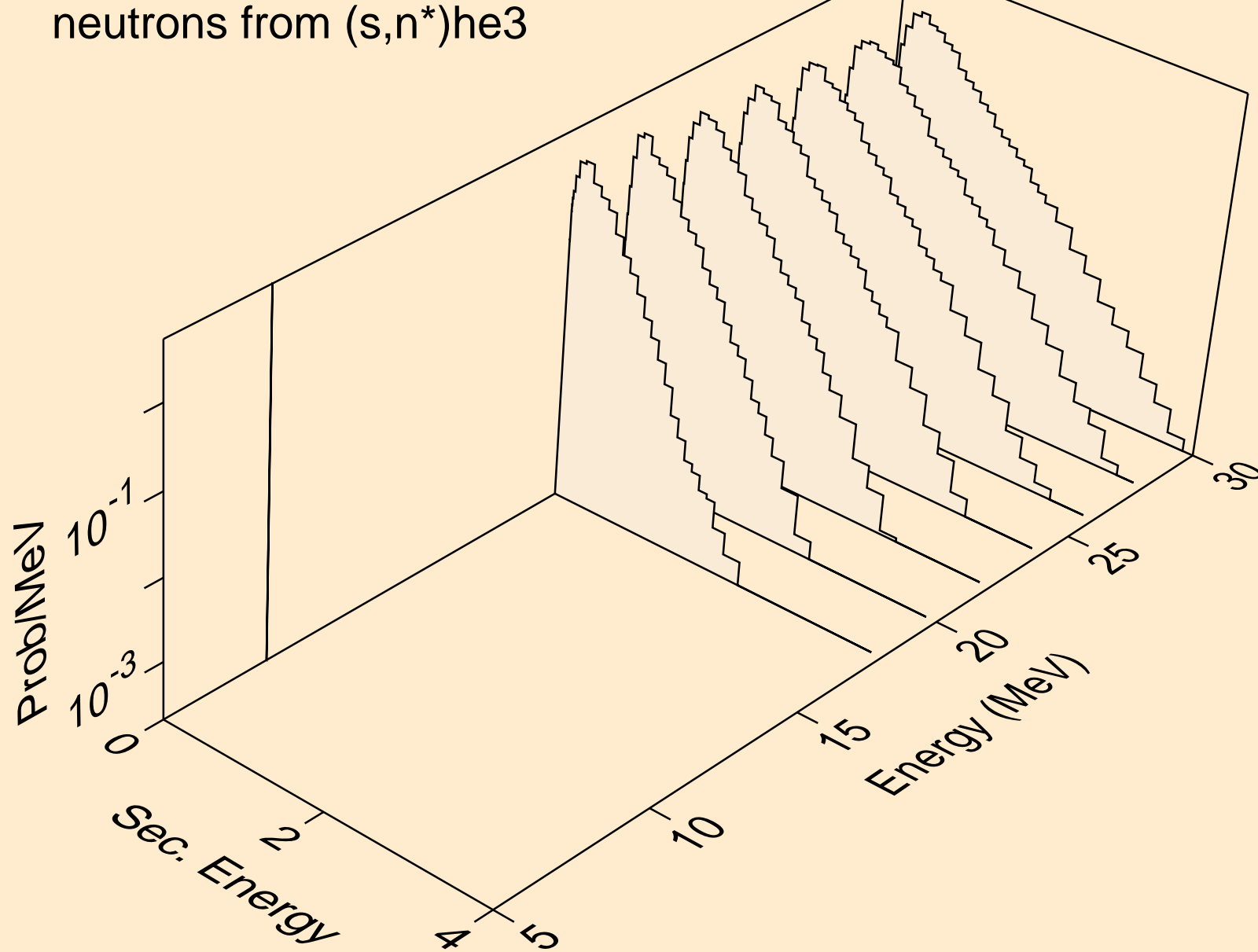

AT198M HELION ACER TENDL-2023 LIBRARY; T=0.K  
neutrons from (s,2np)

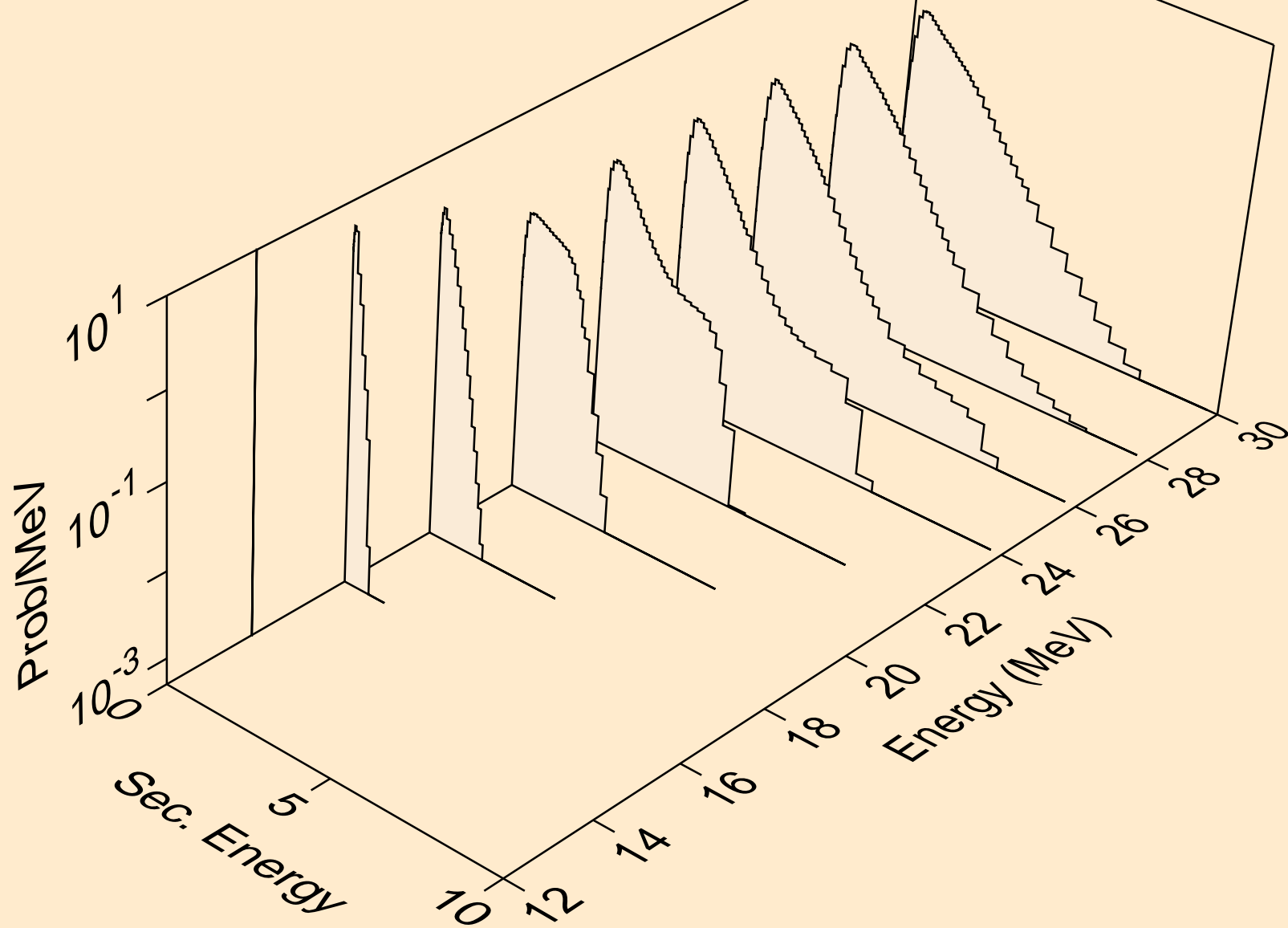

AT198M HELION ACER TENDL-2023 LIBRARY; T=0.K  
neutrons from (s,n2p)

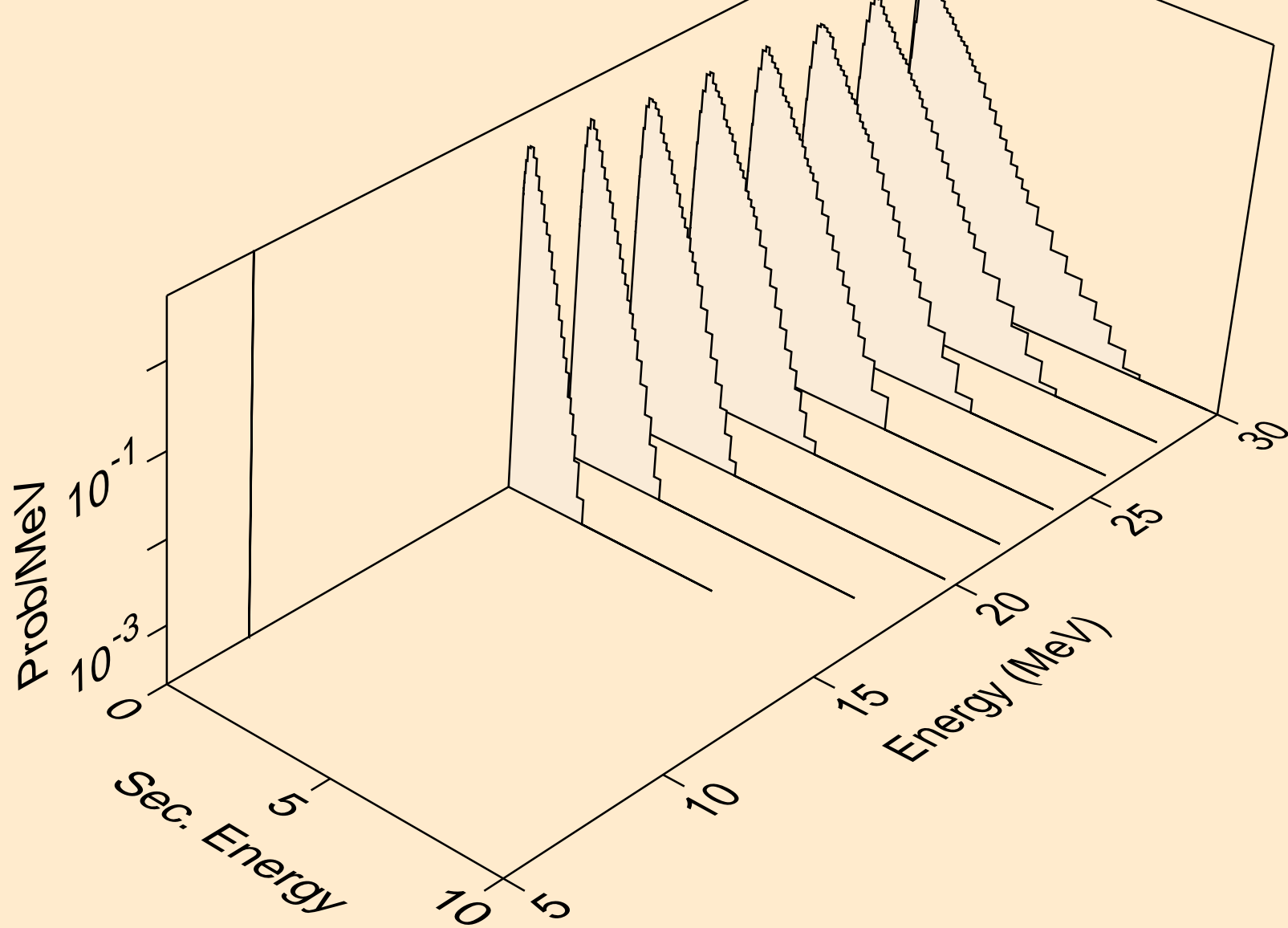

AT198M HELION ACER TENDL-2023 LIBRARY; T=0.K  
neutrons from (s,npa)

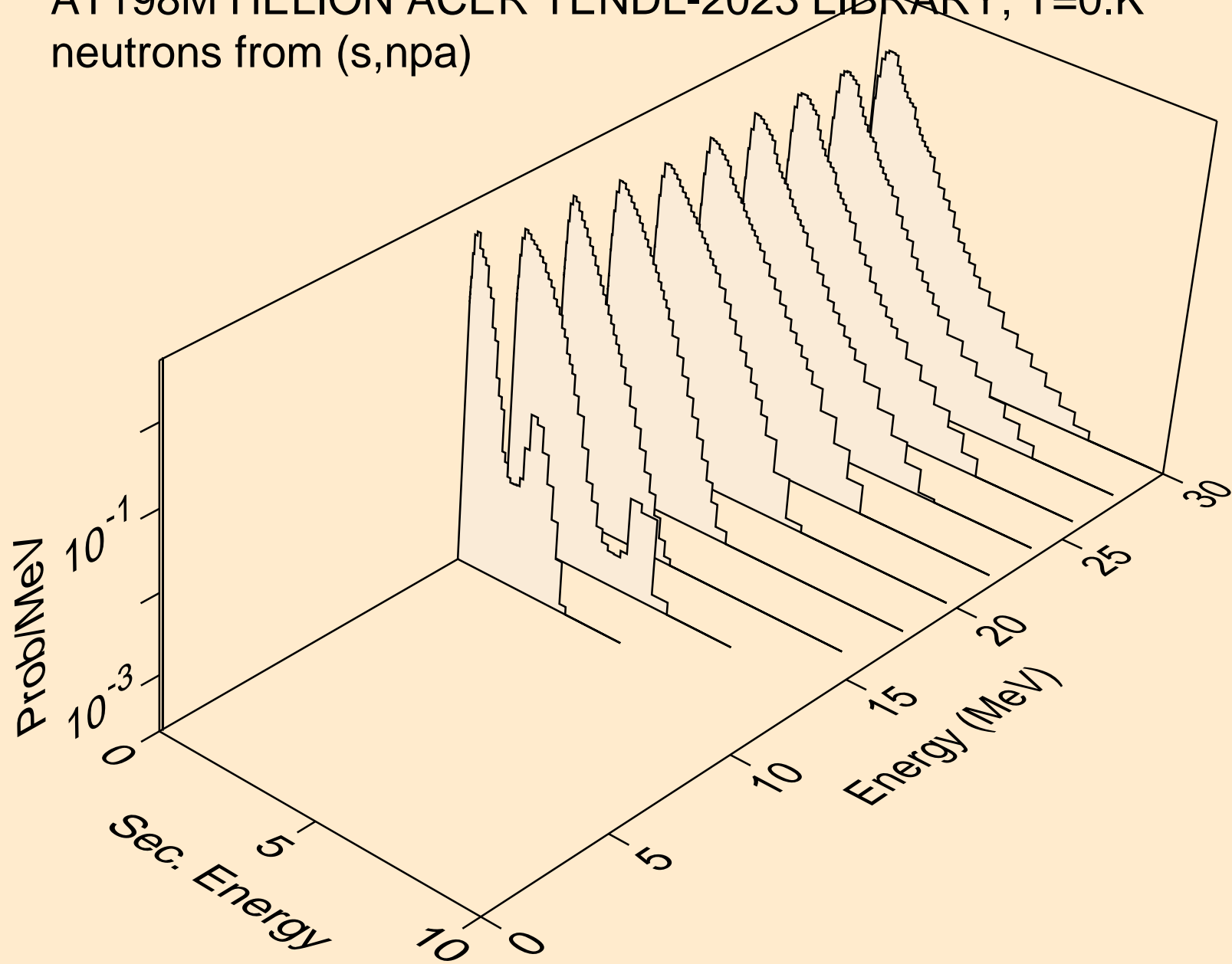

AT198M HELION ACER TENDL-2023 LIBRARY; T=0.K  
protons from (s,x)

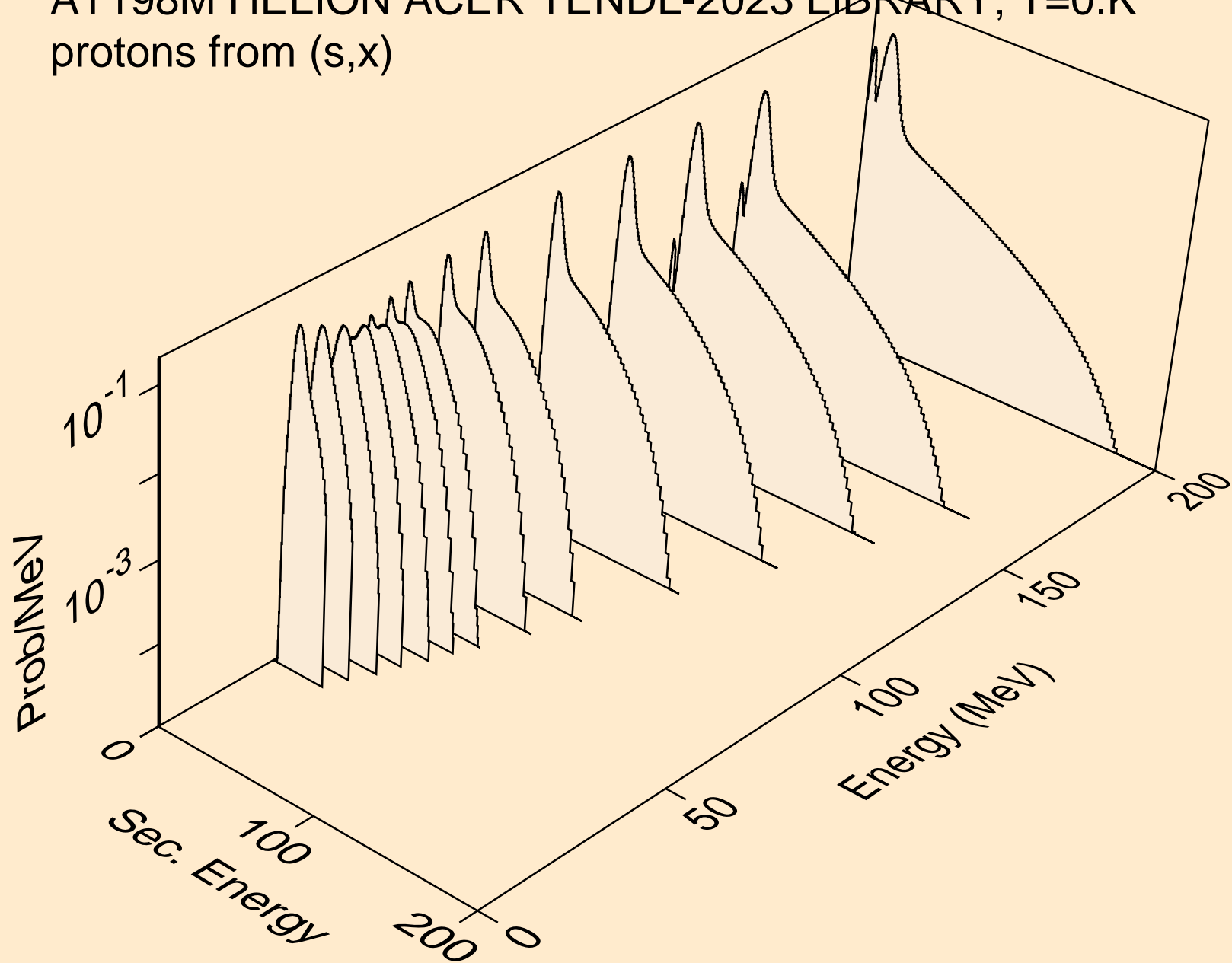

AT198M HELION ACER TENDL-2023 LIBRARY; T=0.K  
protons from (s,n\*)p

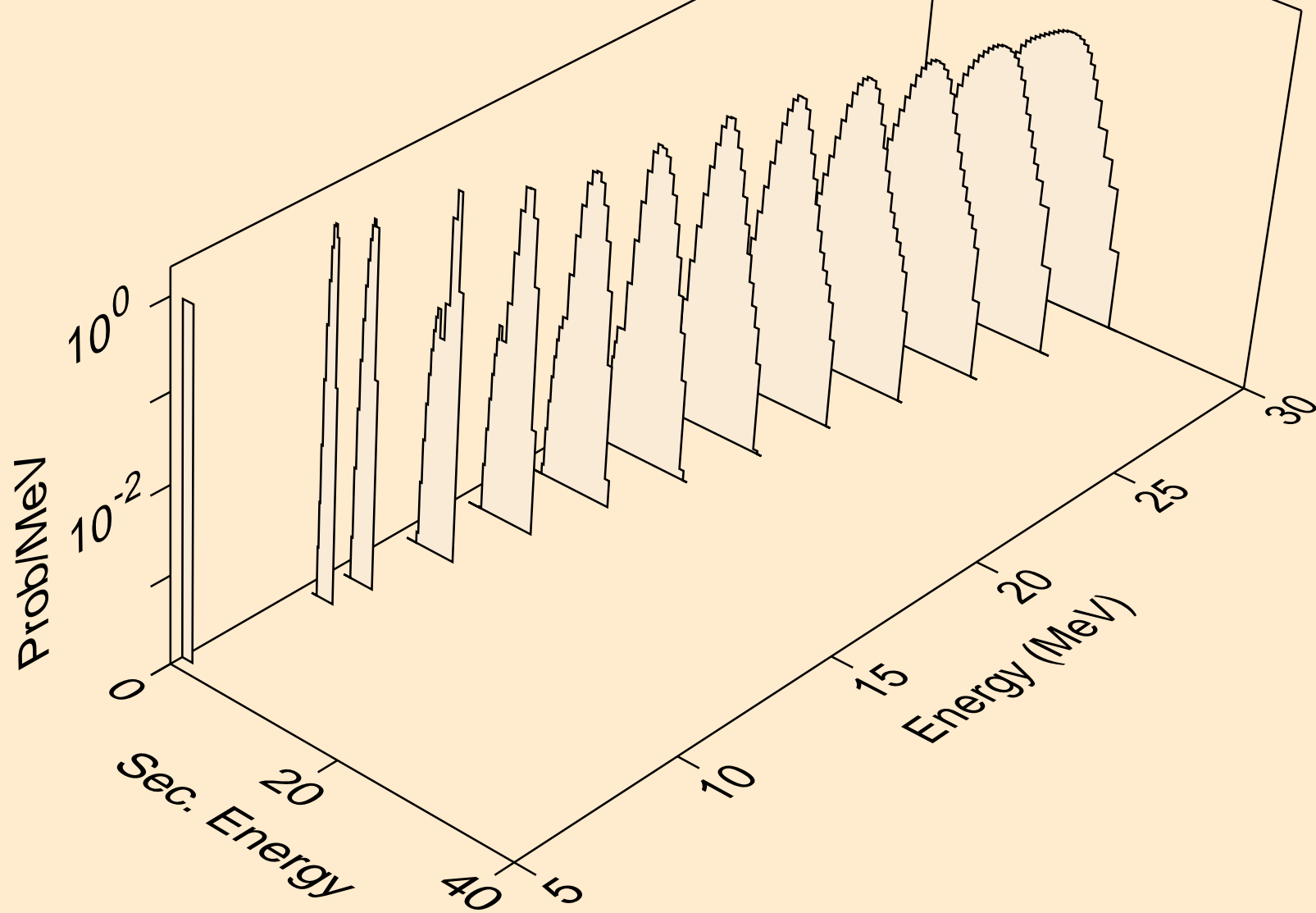

AT198M HELION ACER TENDL-2023 LIBRARY; T=0.K  
protons from (s,2np)

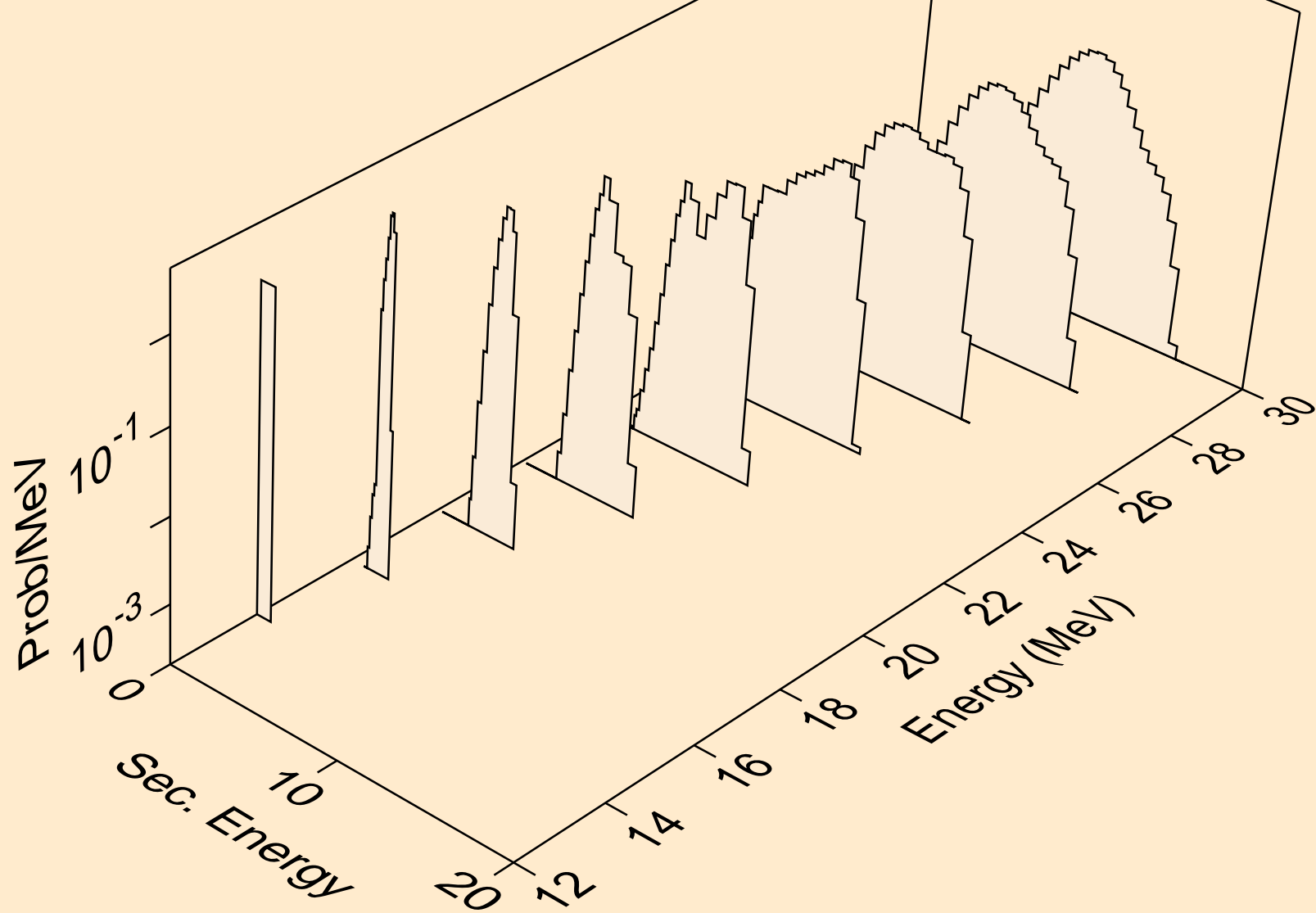

AT198M HELION ACER TENDL-2023 LIBRARY; T=0.K  
protons from (s,n2p)

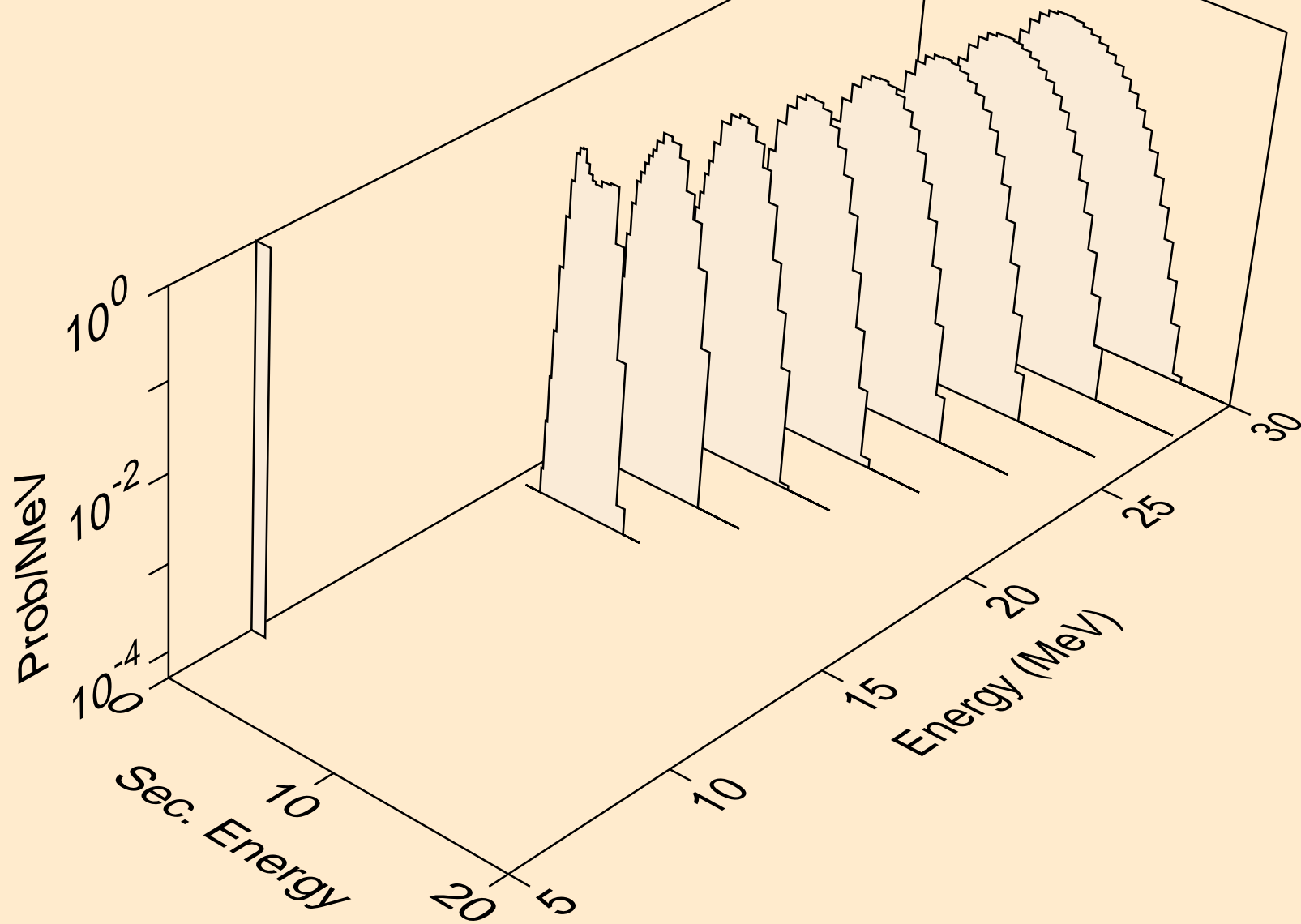

AT198M HELION ACER TENDL-2023 LIBRARY; T=0.K  
protons from (s,npa)

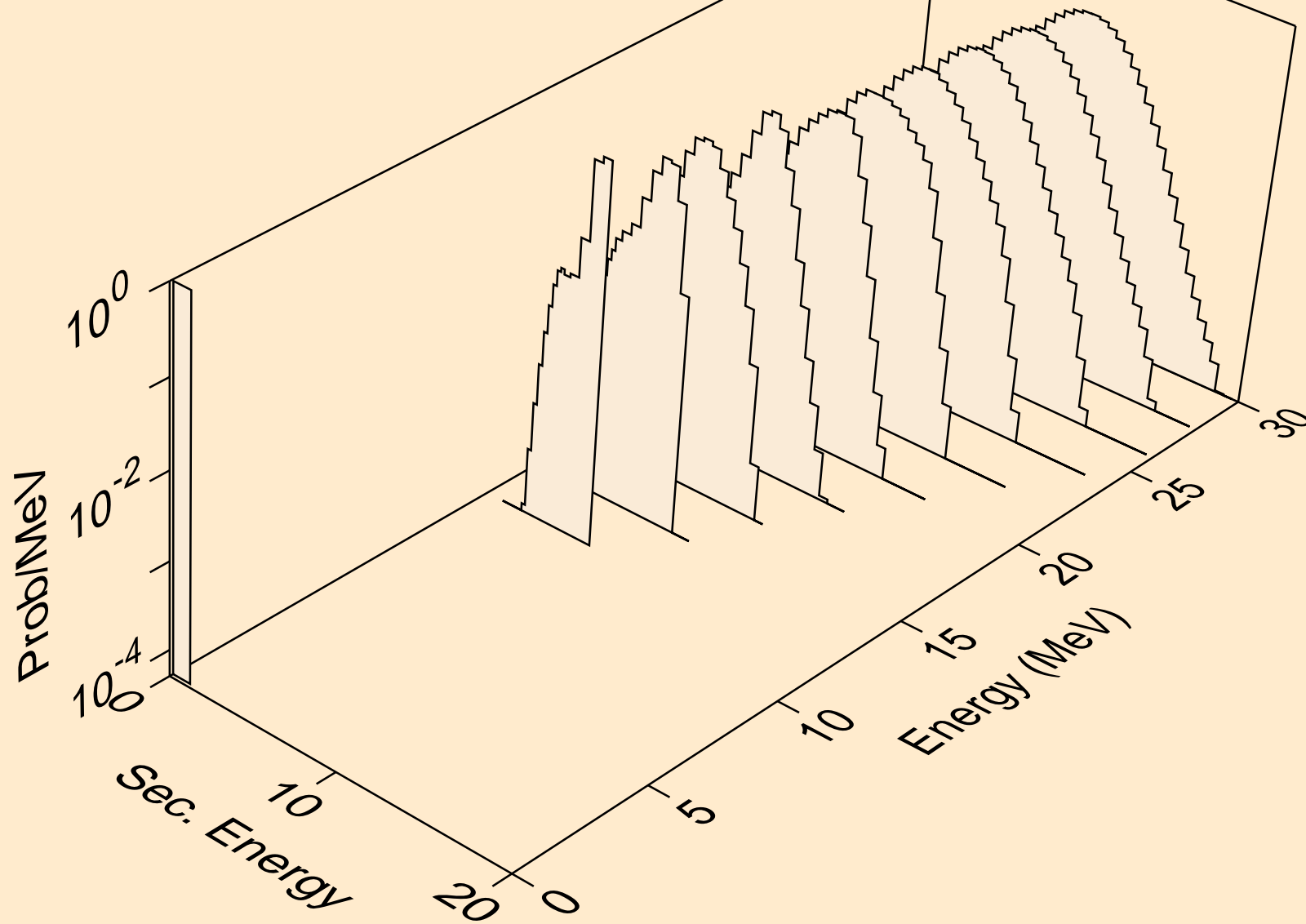

AT198M HELION ACER TENDL-2023 LIBRARY; T=0.K  
protons from (s,p)

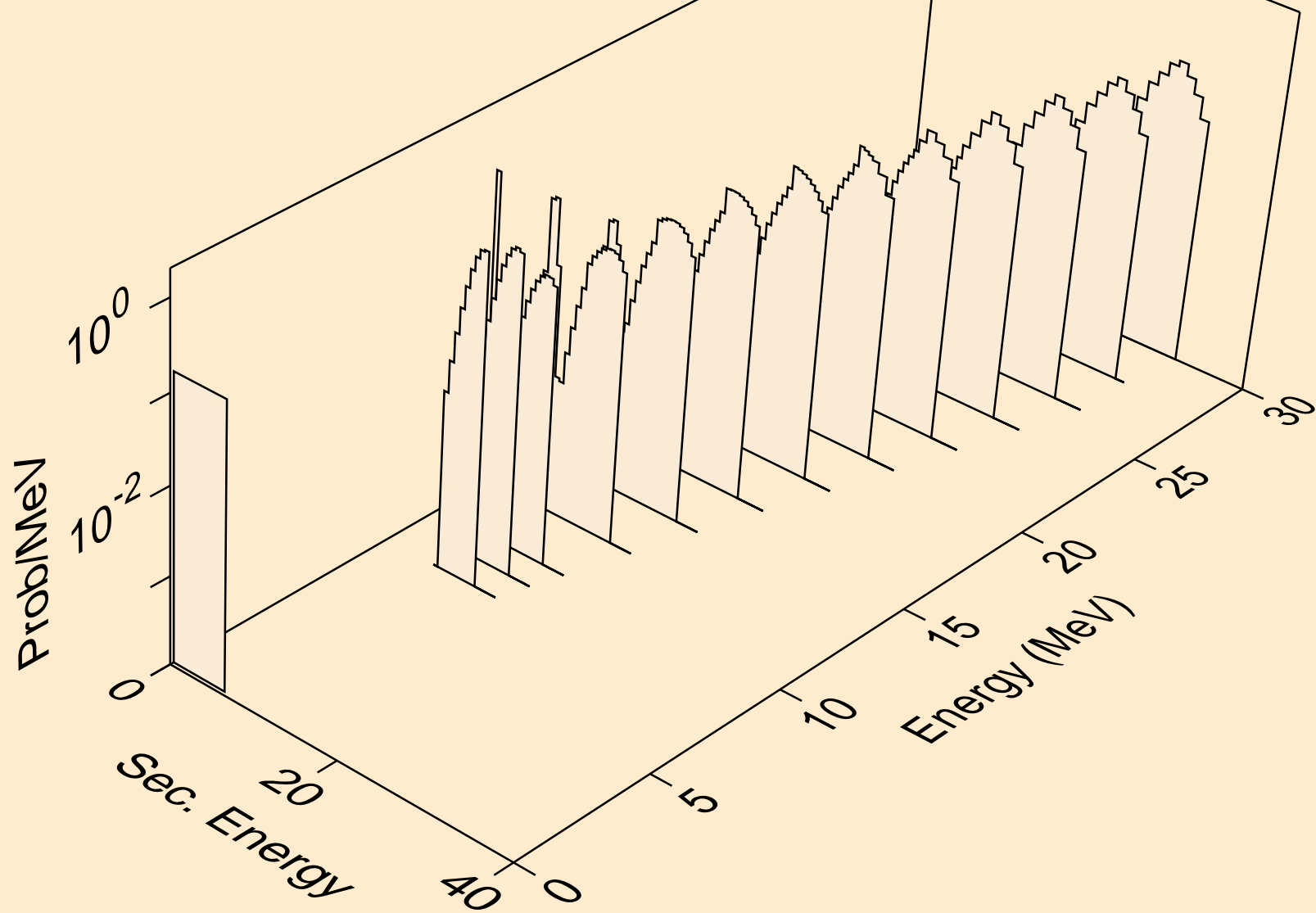

AT198M HELION ACER TENDL-2023 LIBRARY; T=0.K  
protons from (s,2p)

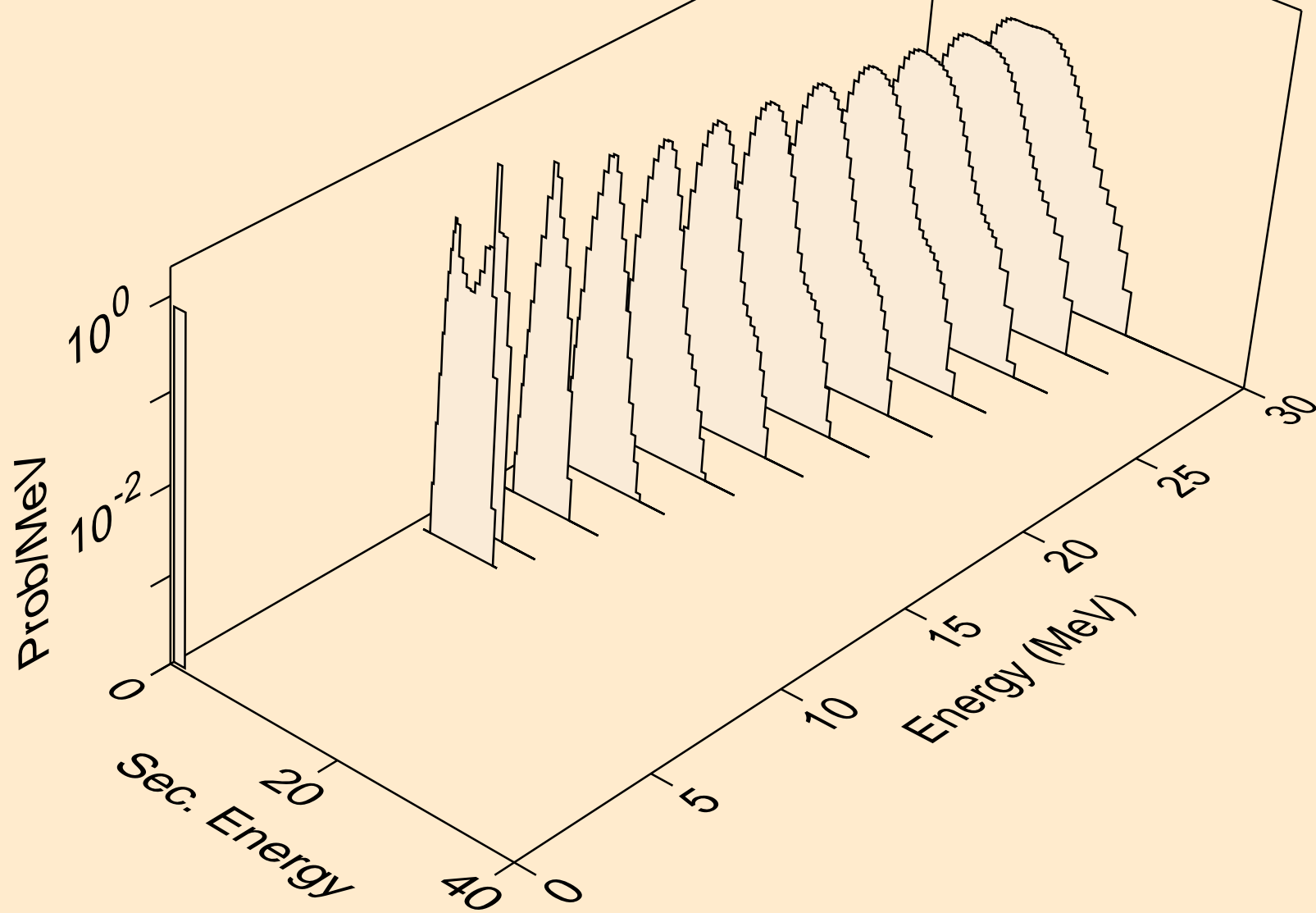

AT198M HELION ACER TENDL-2023 LIBRARY; T=0.K  
protons from (s,pa)

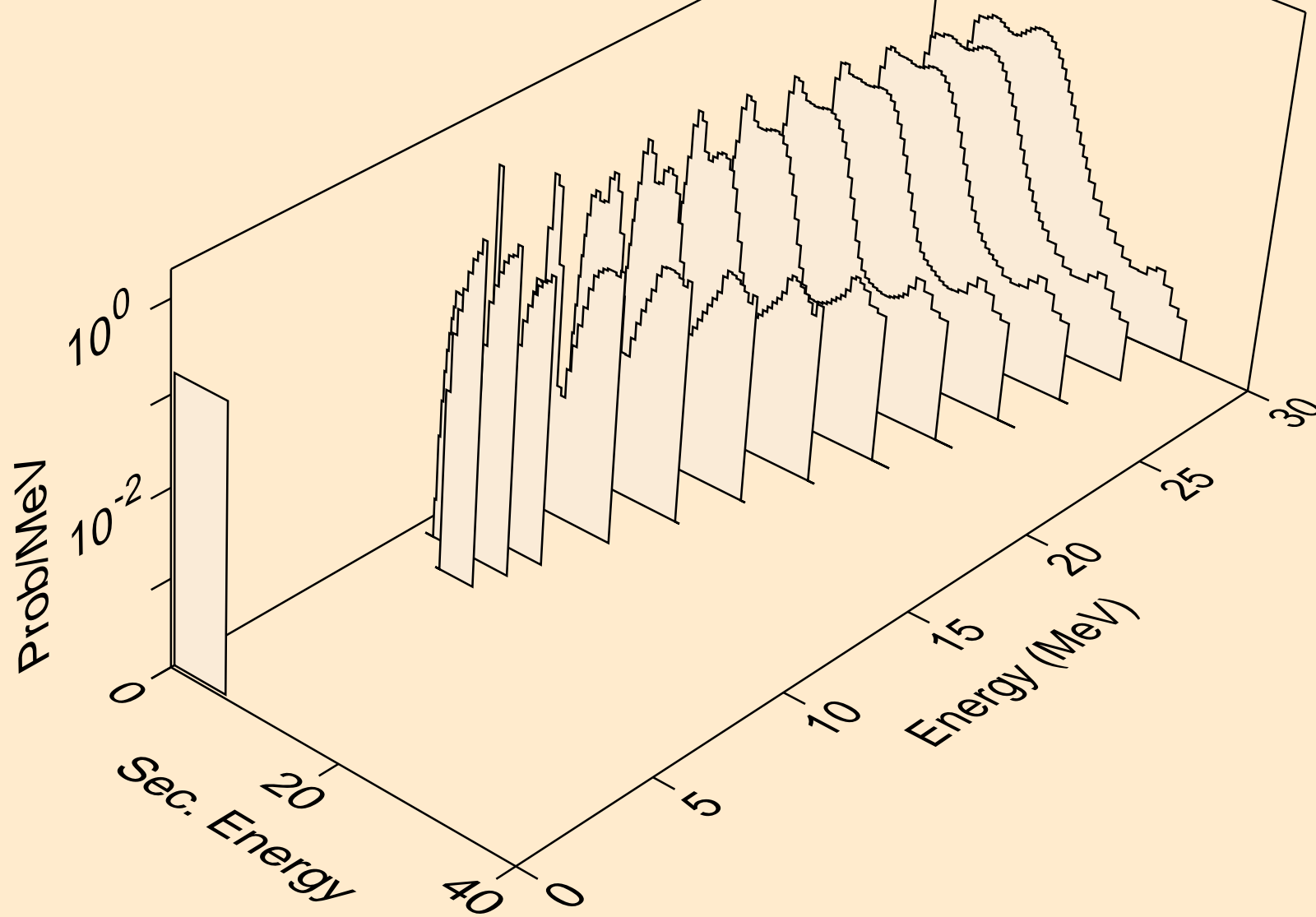

AT198M HELION ACER TENDL-2023 LIBRARY; T=0.K  
protons from (s,pd)

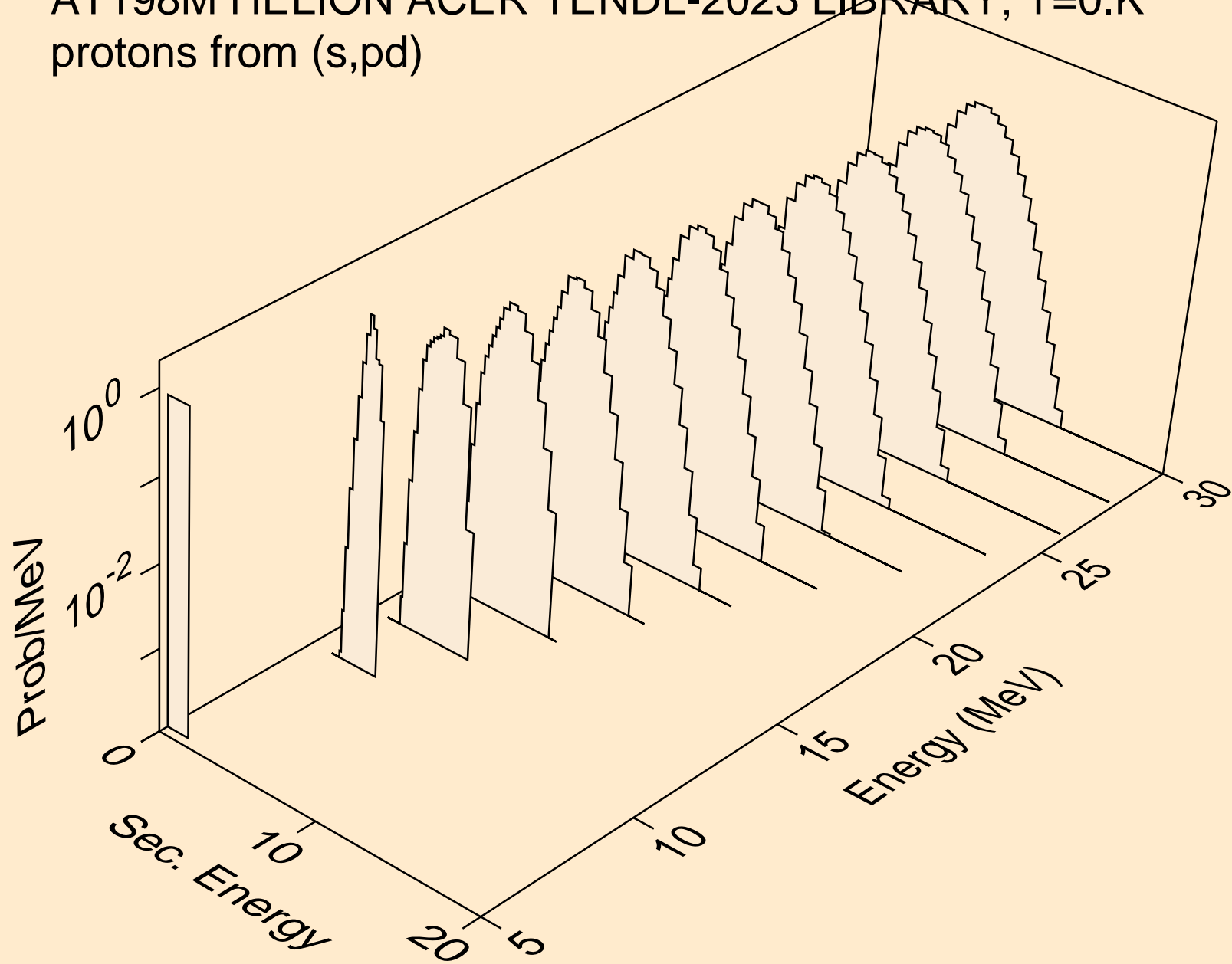

AT198M HELION ACER TENDL-2023 LIBRARY; T=0.K  
protons from (s,pt)

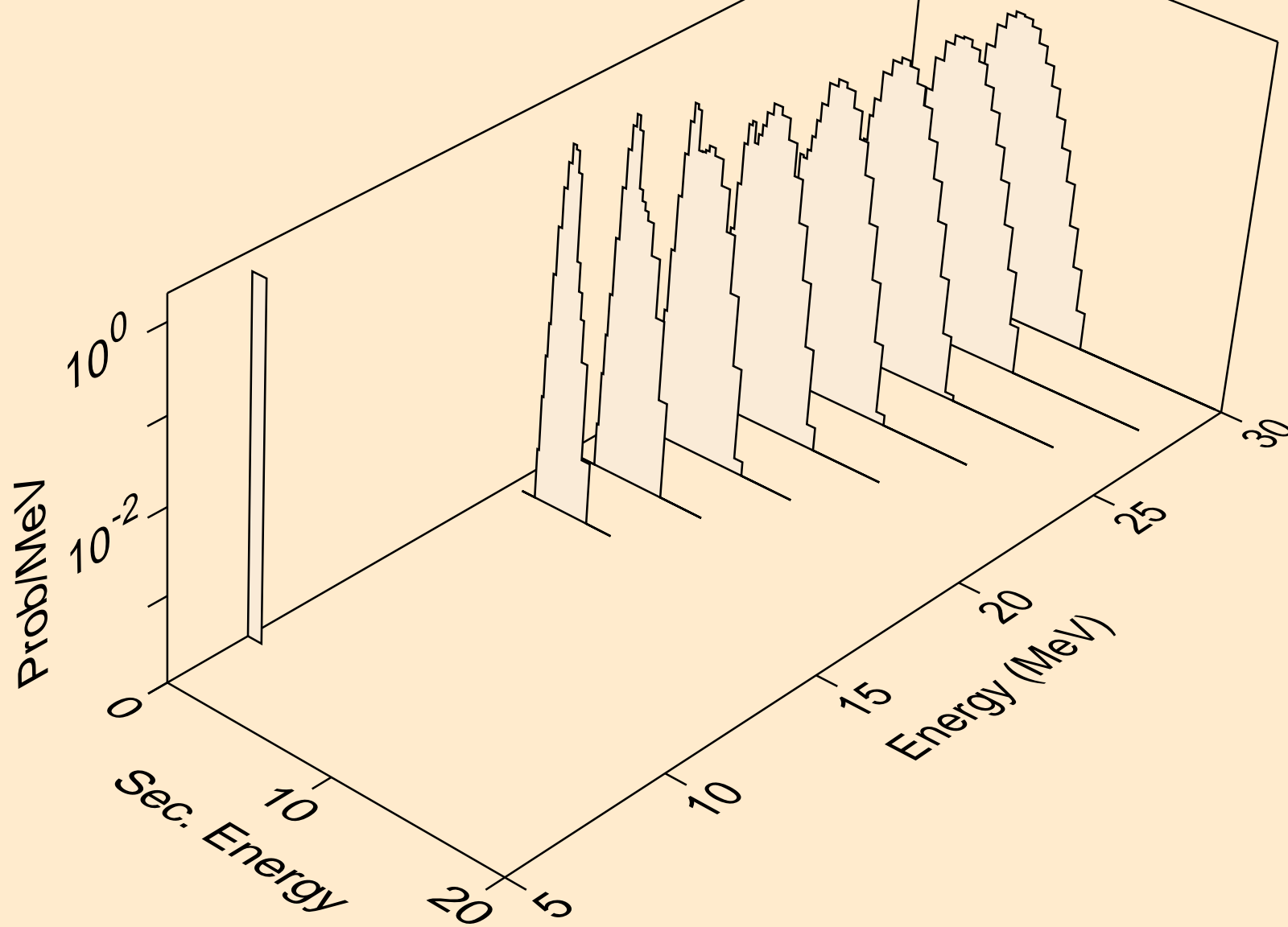

AT198M HELION ACER TENDL-2023 LIBRARY; T=0.K  
deuterons from (s,x)

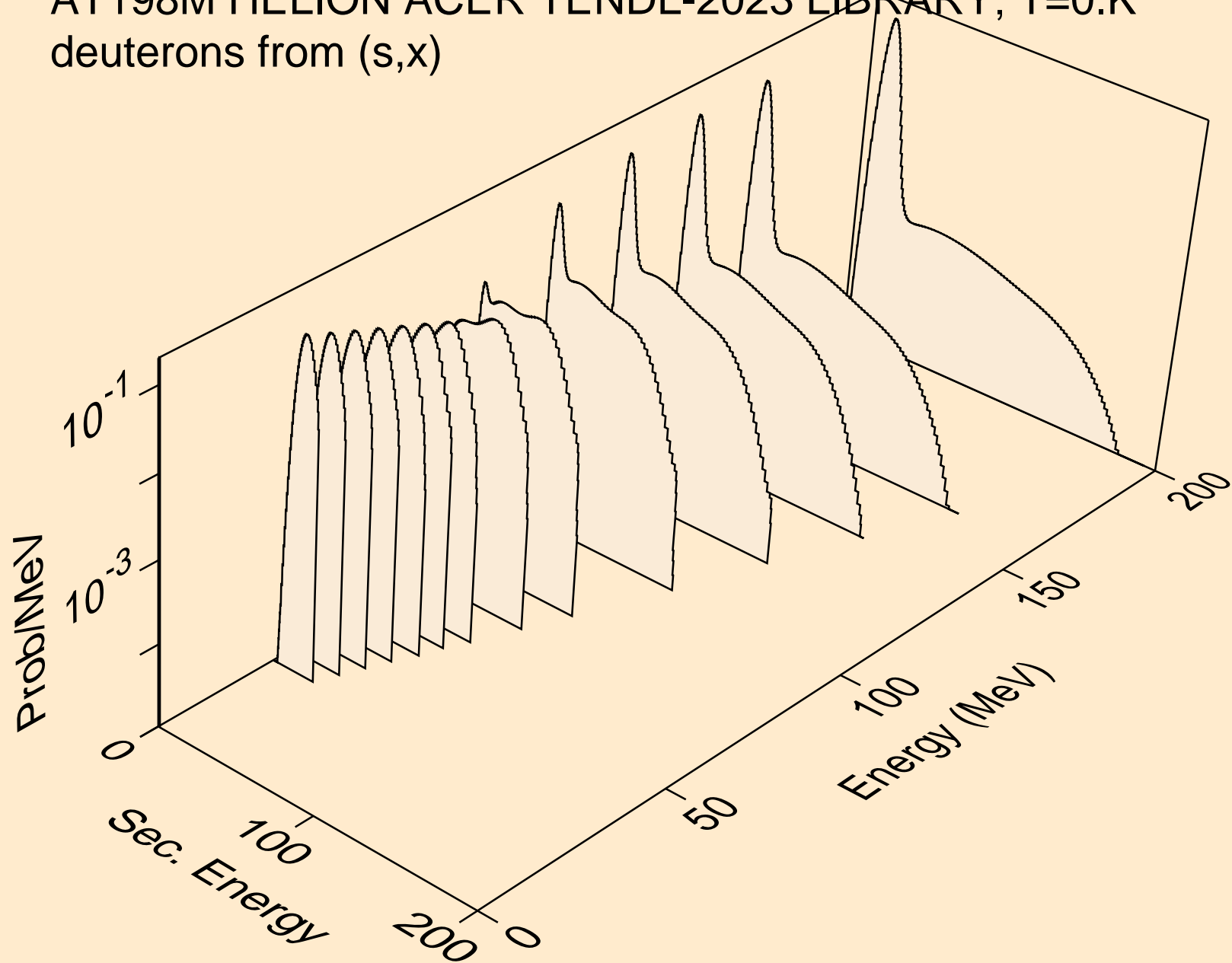

AT198M HELION ACER TENDL-2023 LIBRARY; T=0.K  
deuterons from (s,n\*)d

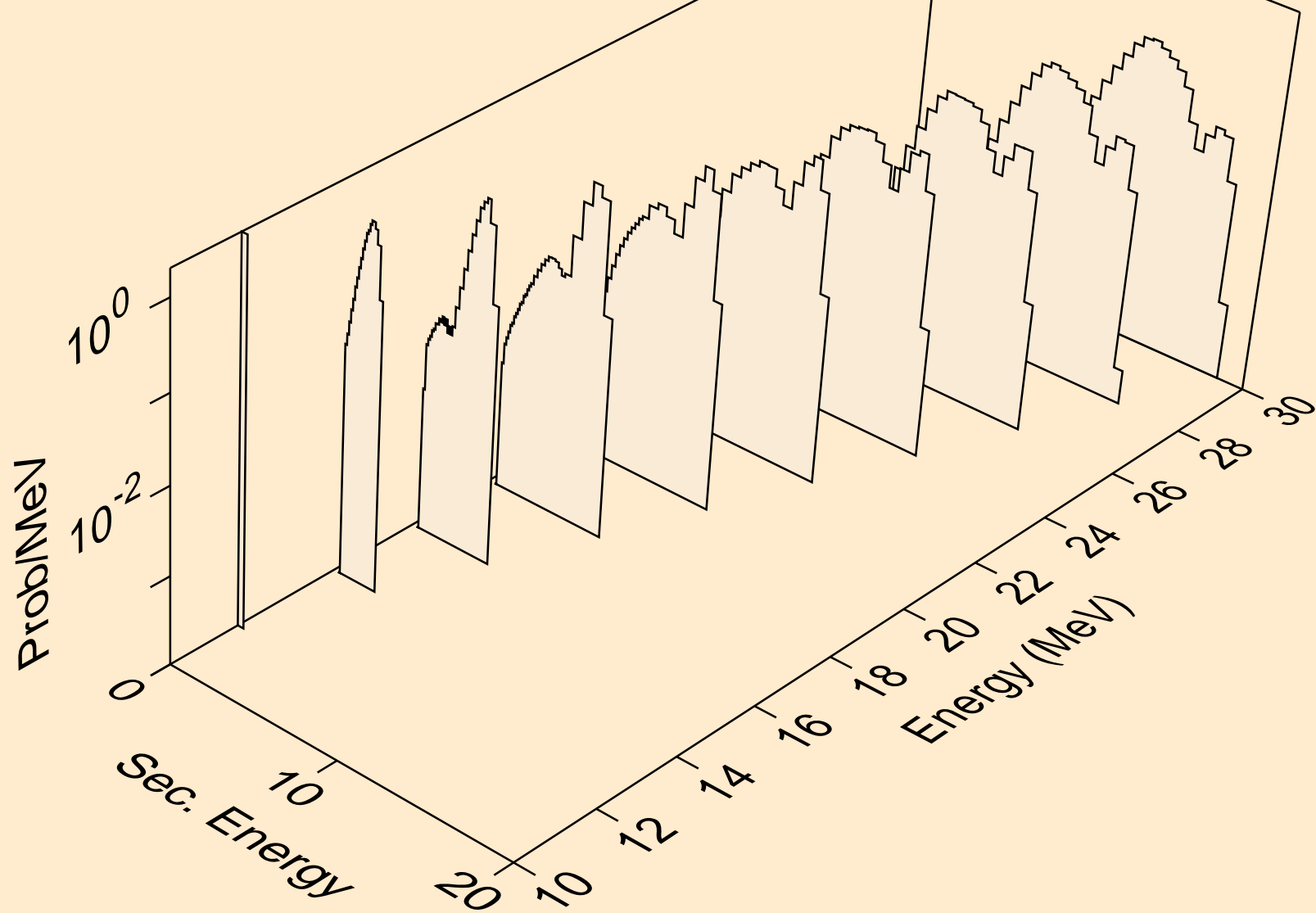

AT198M HELION ACER TENDL-2023 LIBRARY; T=0.K  
deuterons from (s,d)

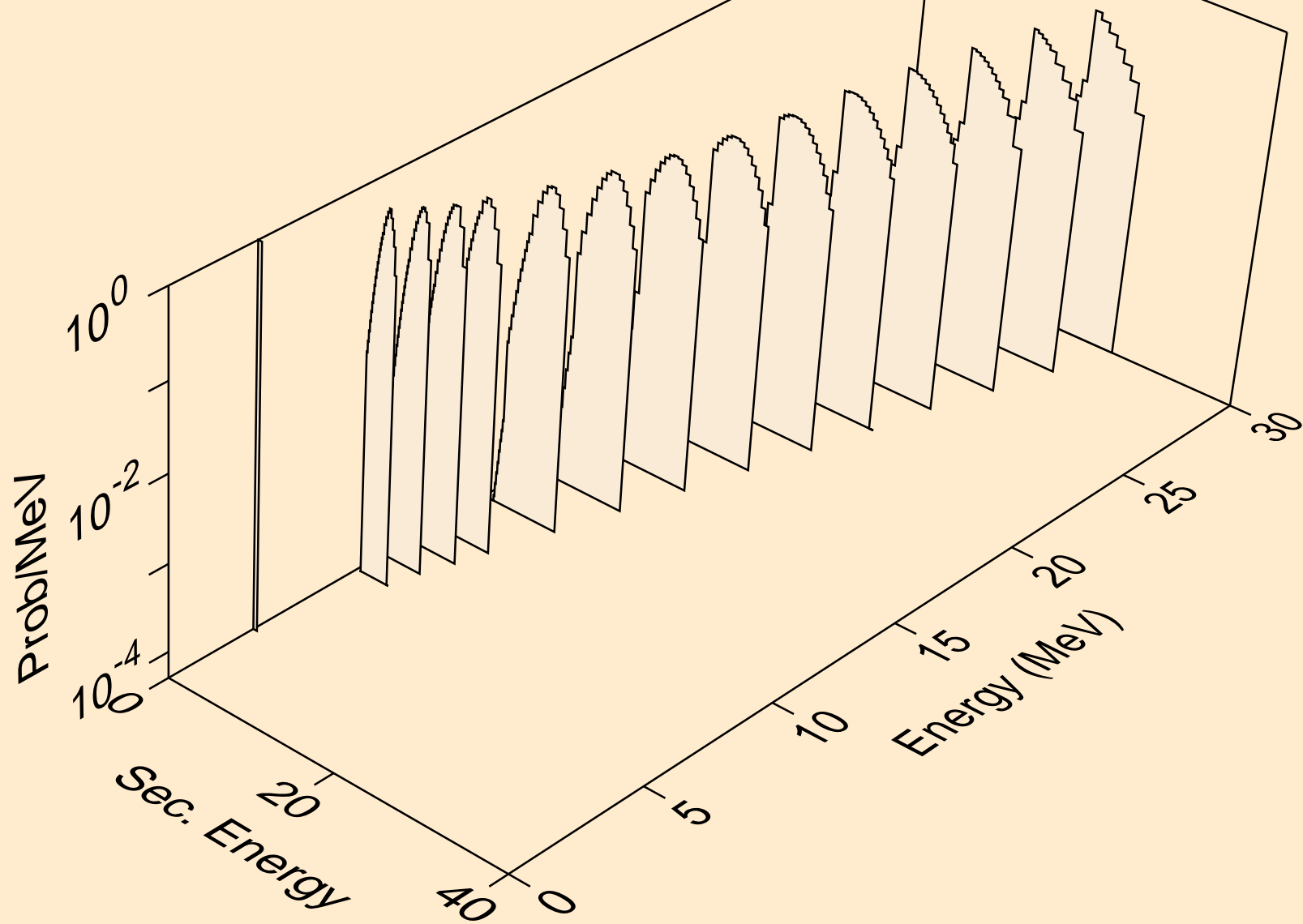

AT198M HELION ACER TENDL-2023 LIBRARY; T=0.K  
deuterons from (s,pd)

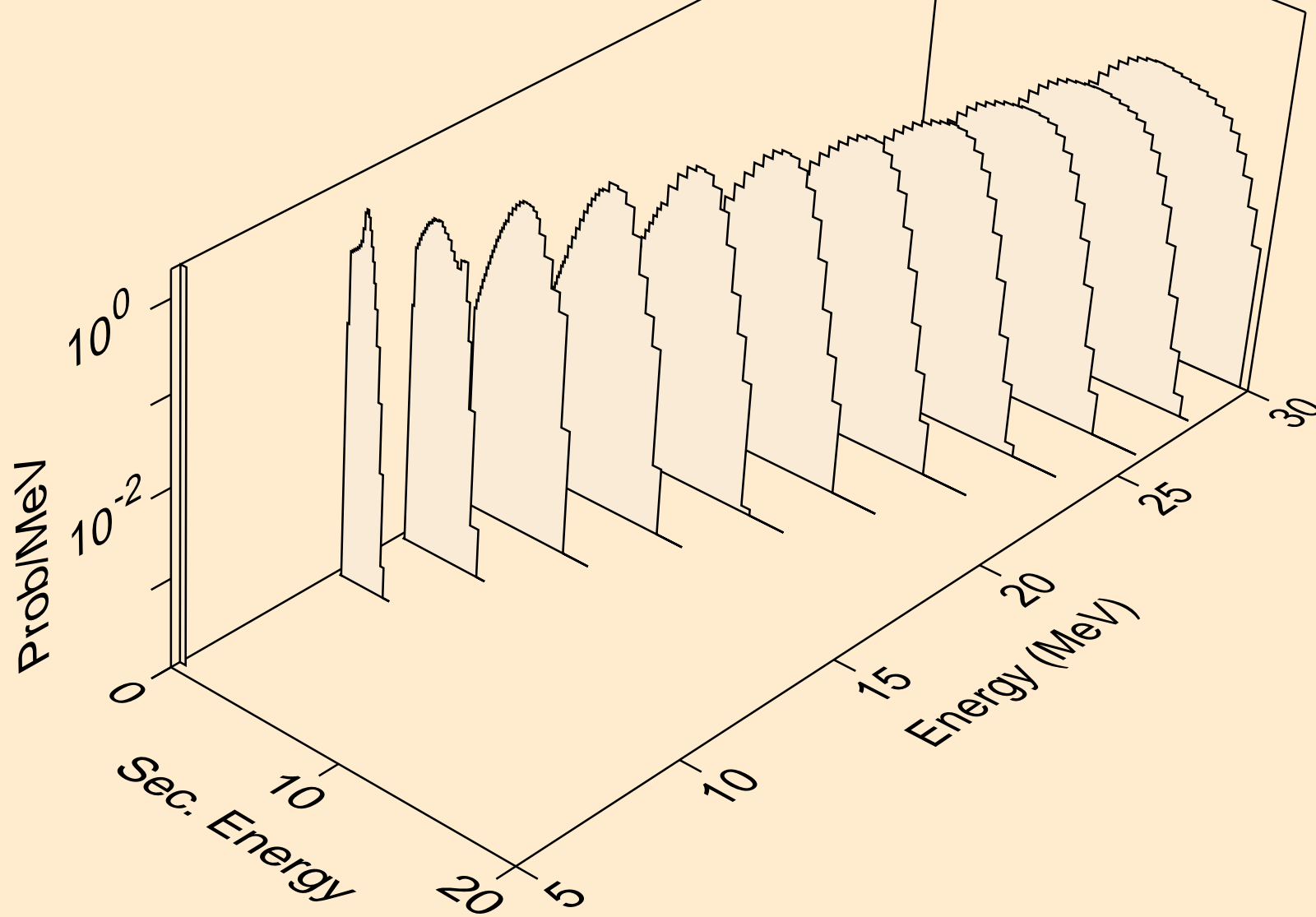

AT198M HELION ACER TENDL-2023 LIBRARY; T=0.K  
deuterons from (s,da)

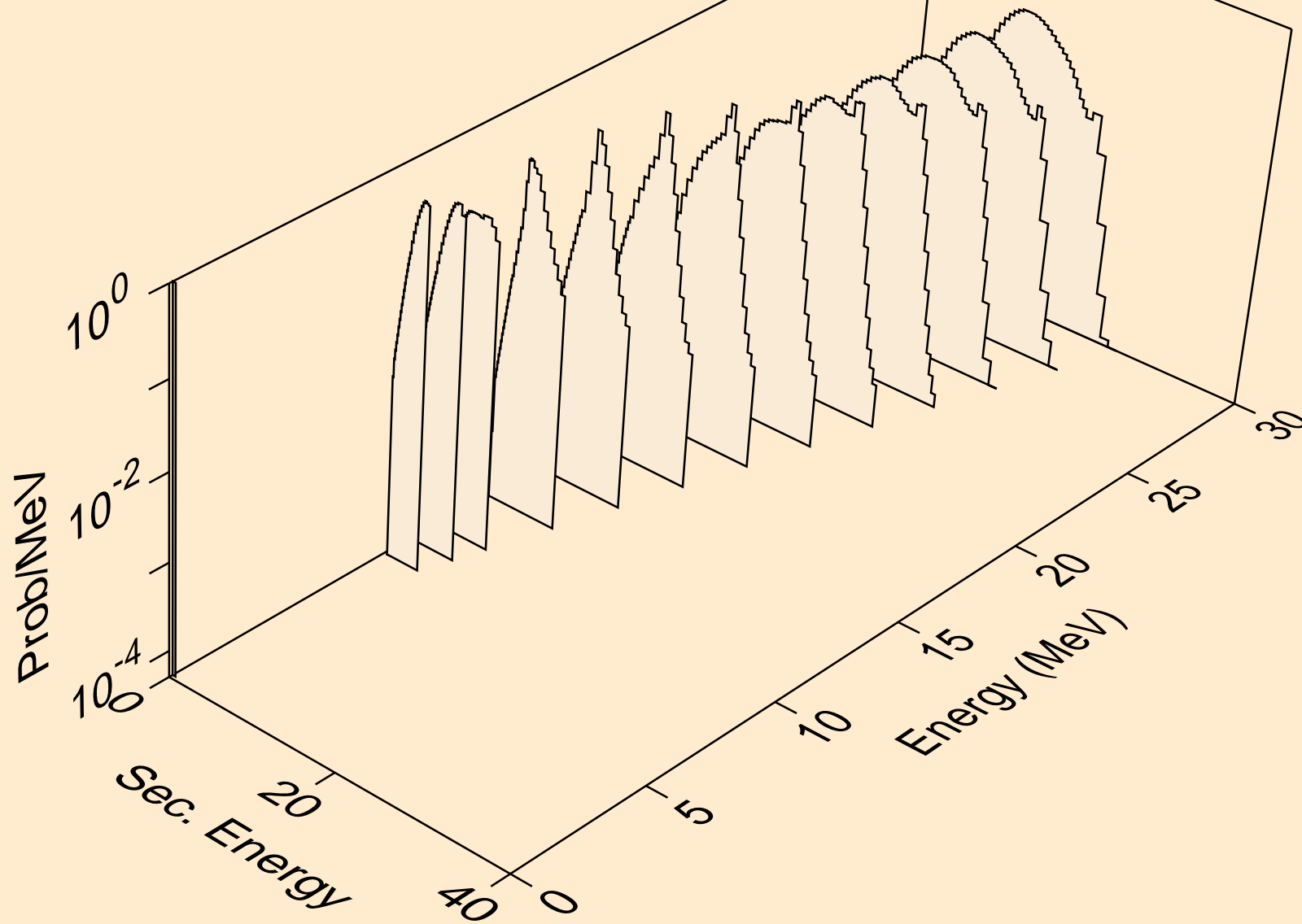

AT198M HELION ACER TENDL-2023 LIBRARY; T=0.K  
tritons from (s,x)

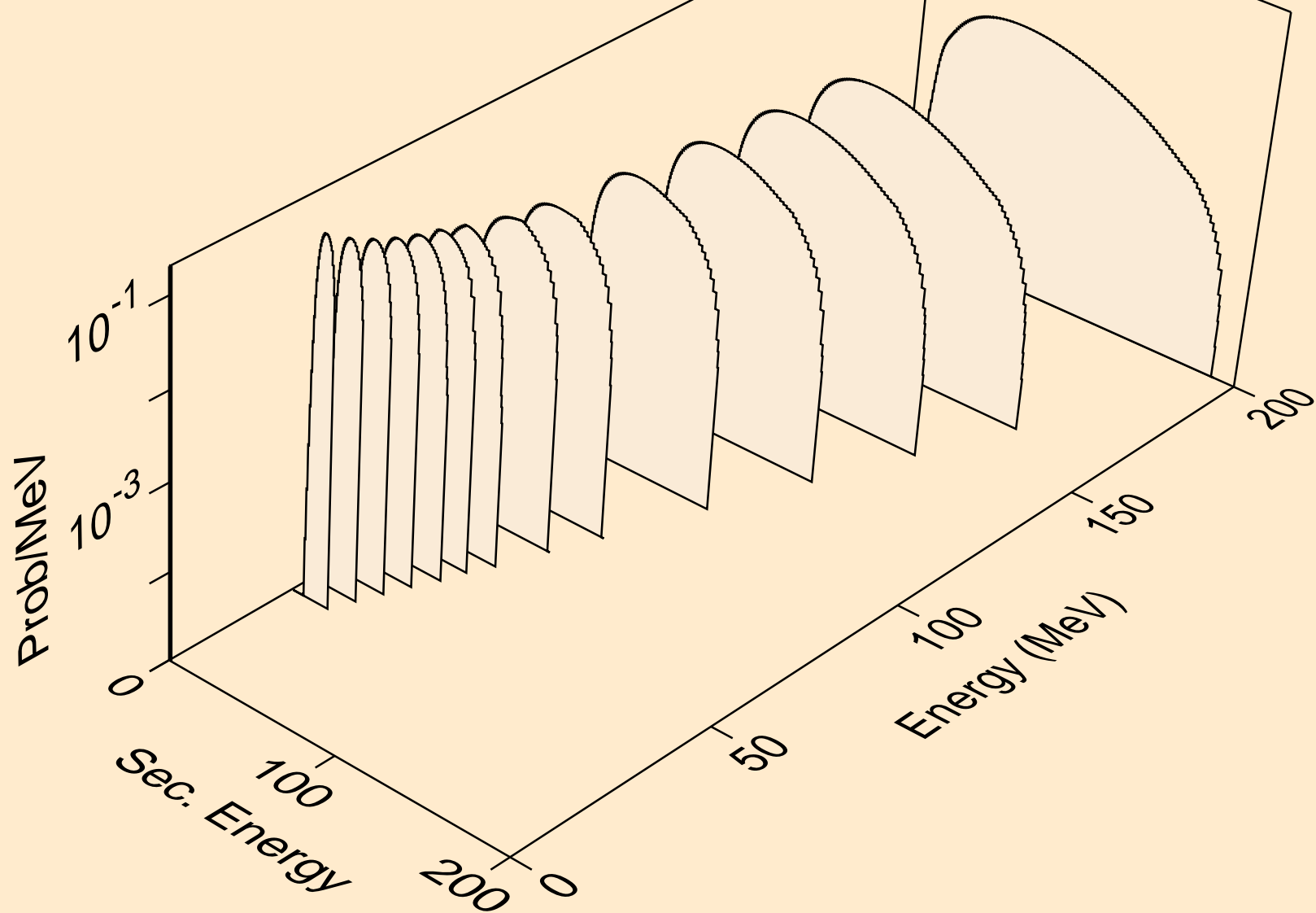

AT198M HELION ACER TENDL-2023 LIBRARY; T=0.K  
tritons from (s,n\*)t

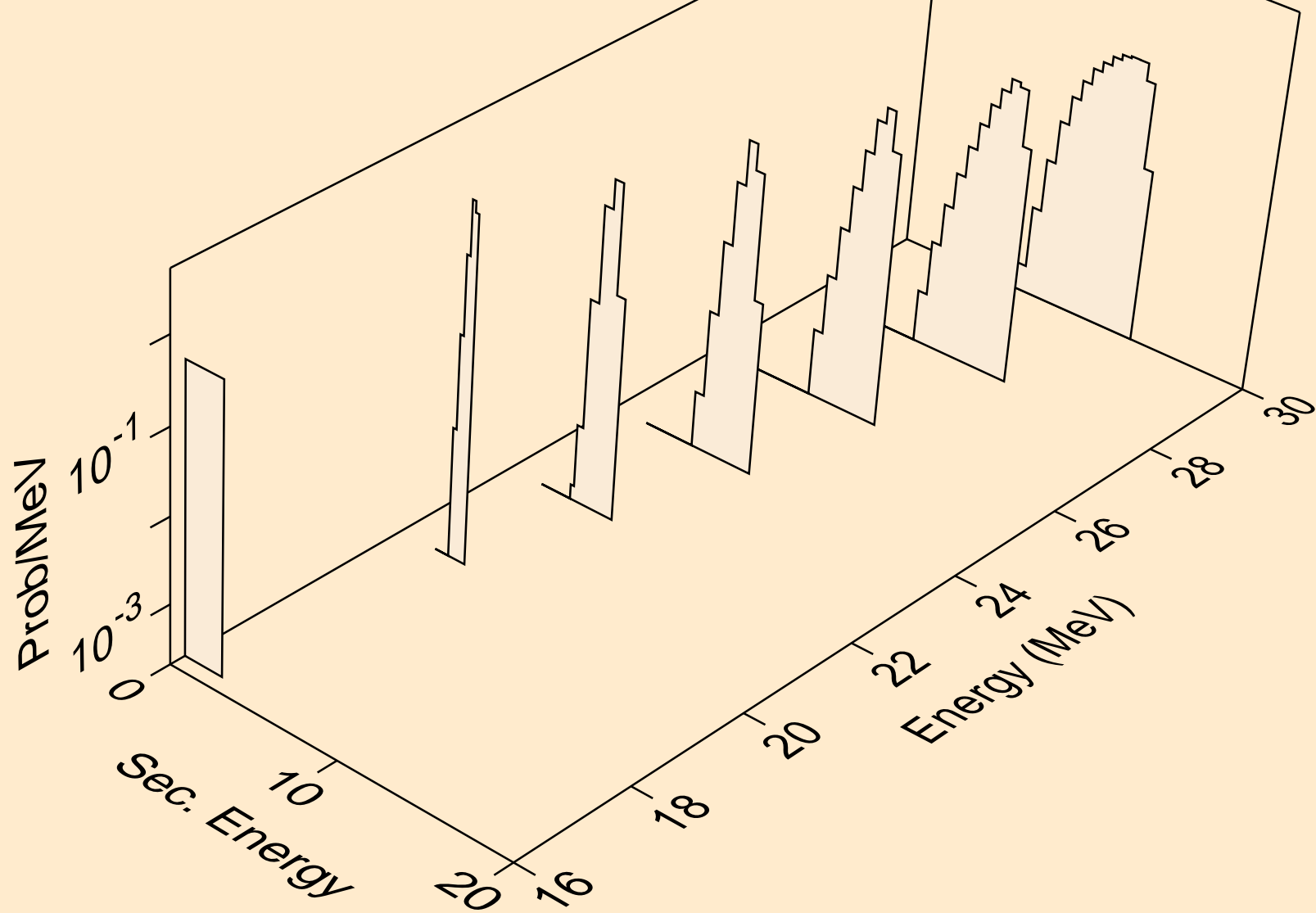

AT198M HELION ACER TENDL-2023 LIBRARY; T=0.K  
tritons from (s,t)

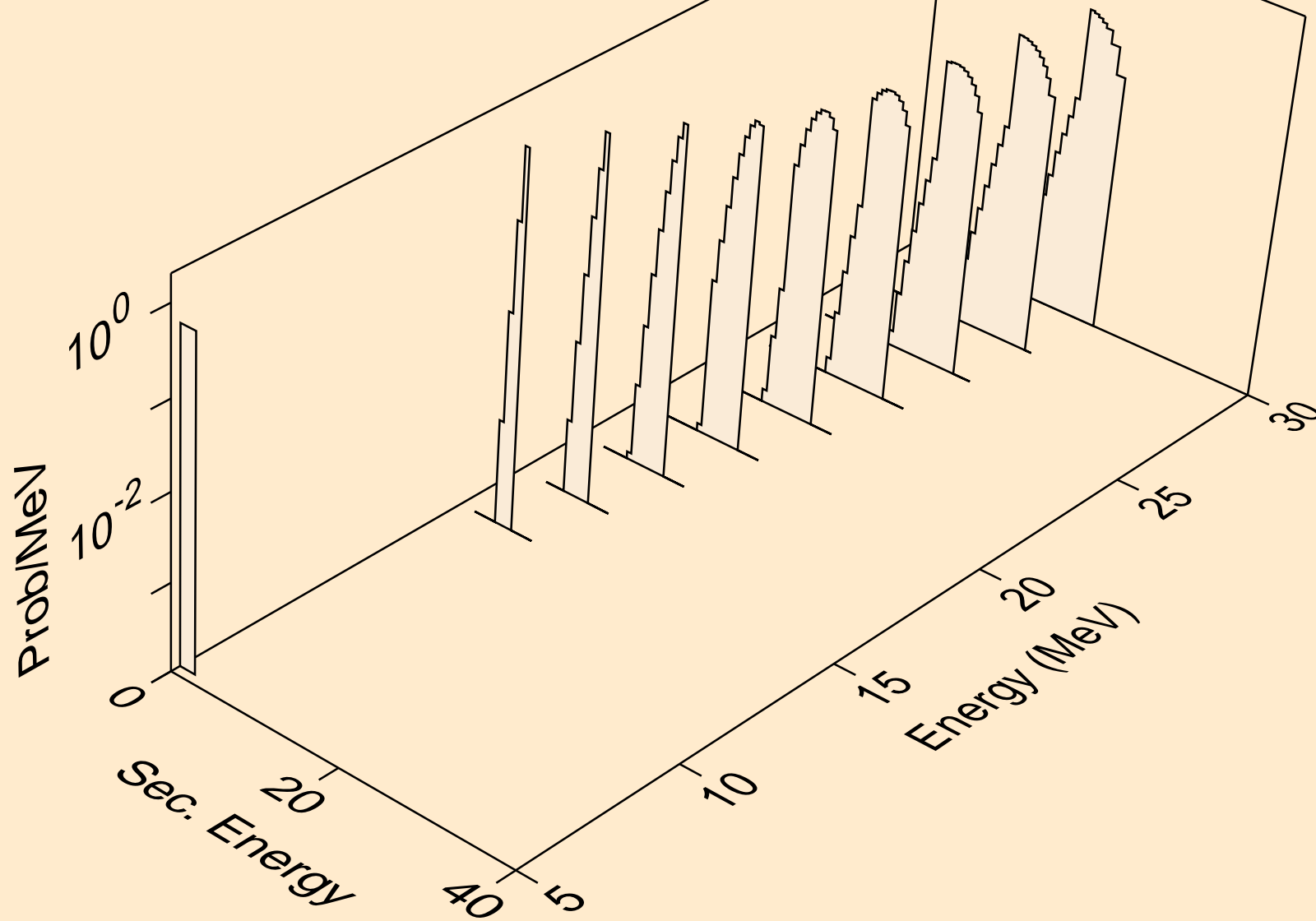

AT198M HELION ACER TENDL-2023 LIBRARY; T=0.K  
tritons from (s,pt)

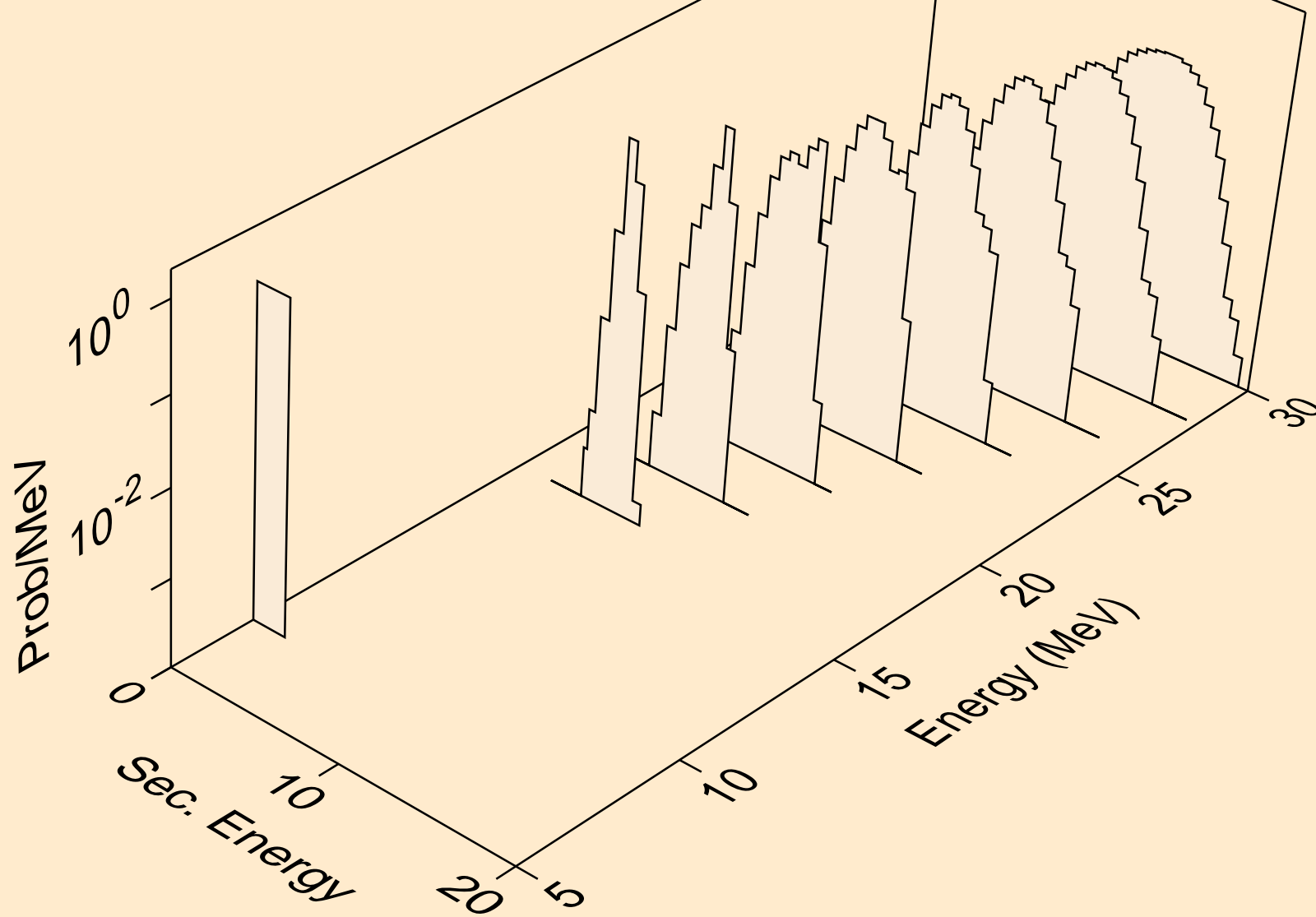

AT198M HELION ACER TENDL-2023 LIBRARY; T=0.K  
alphas from (s,x)

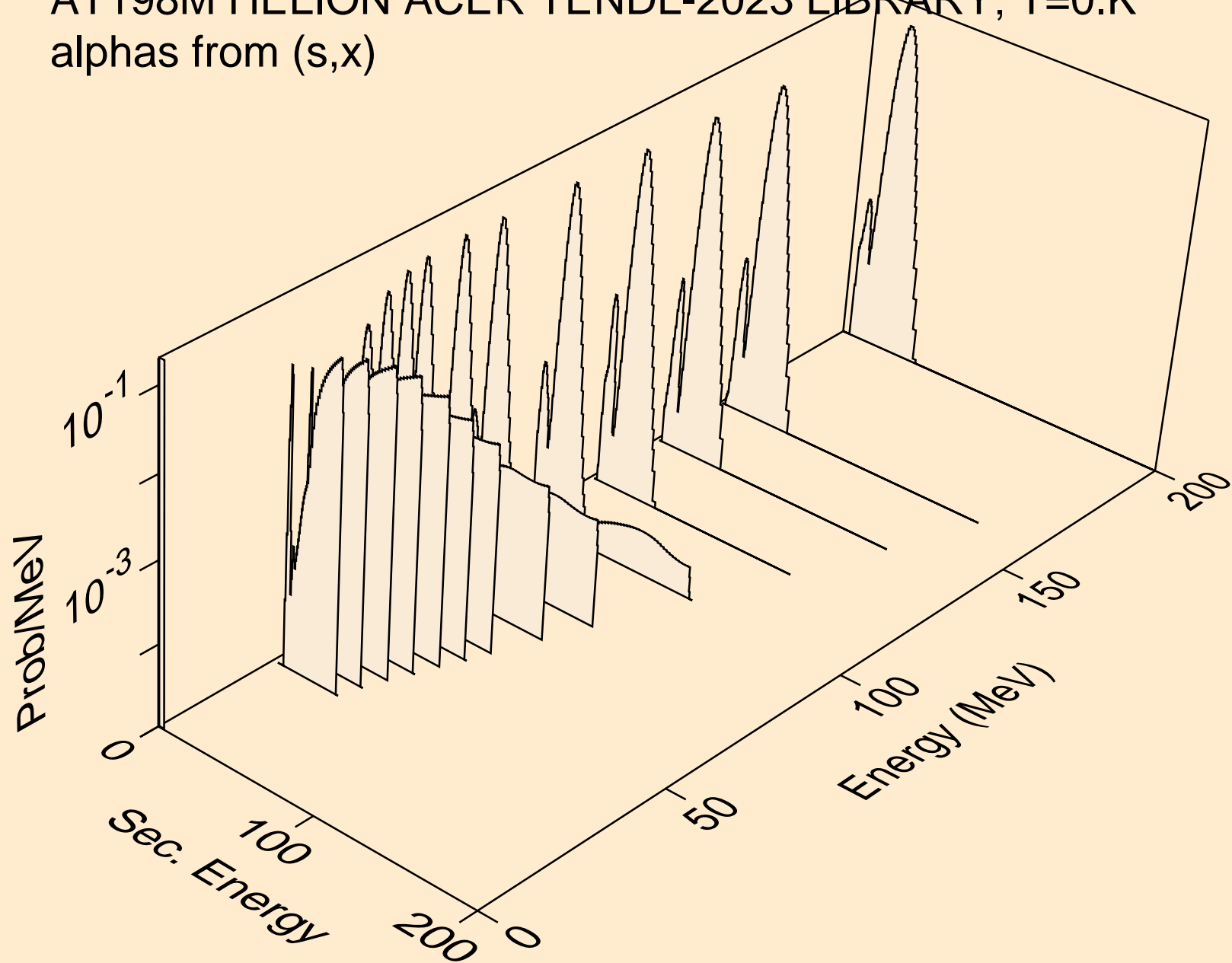

AT198M HELION ACER TENDL-2023 LIBRARY; T=0.K  
alphas from (s,n\*)a

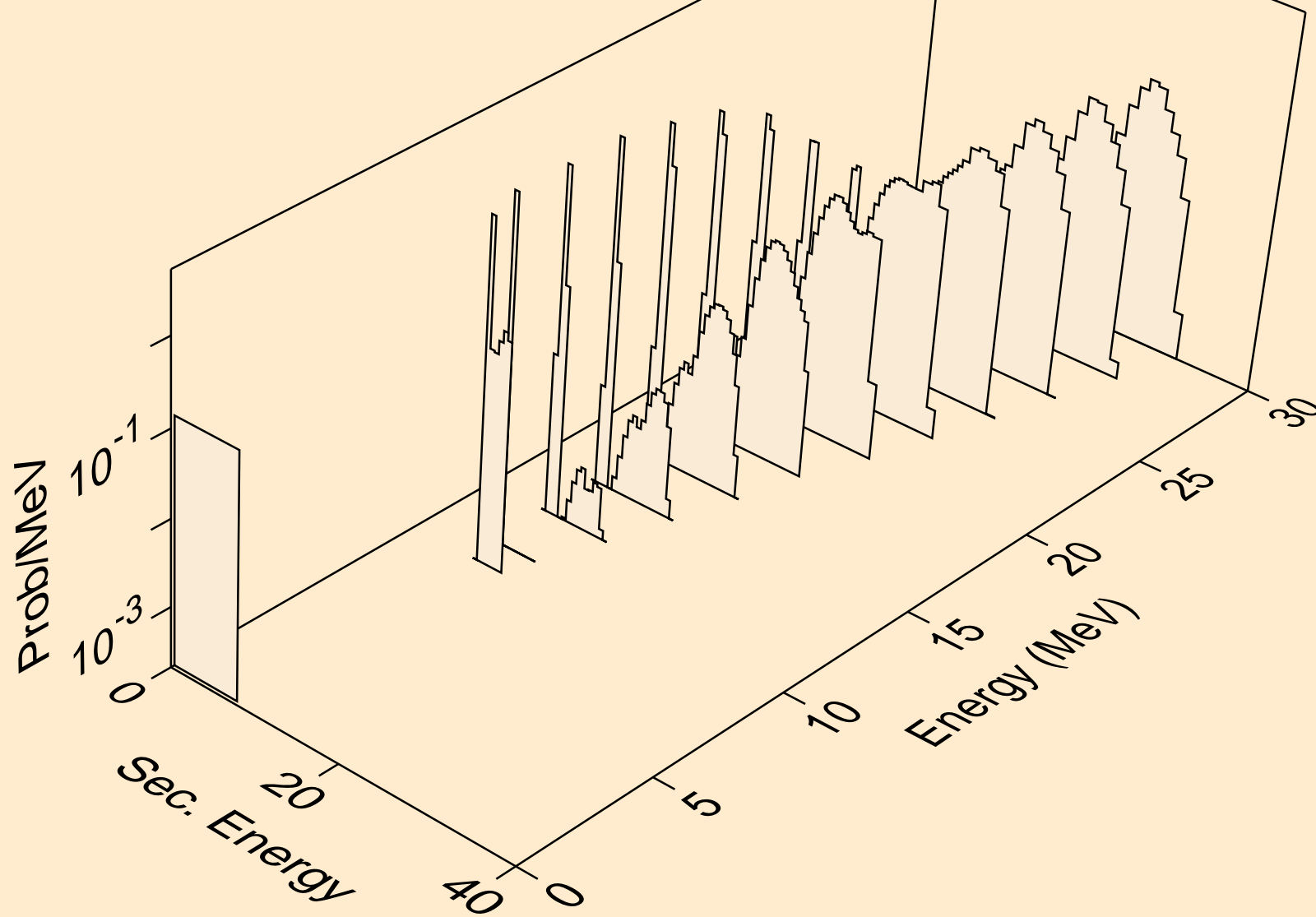

AT198M HELION ACER TENDL-2023 LIBRARY; T=0.K  
alphas from (s,2n)a

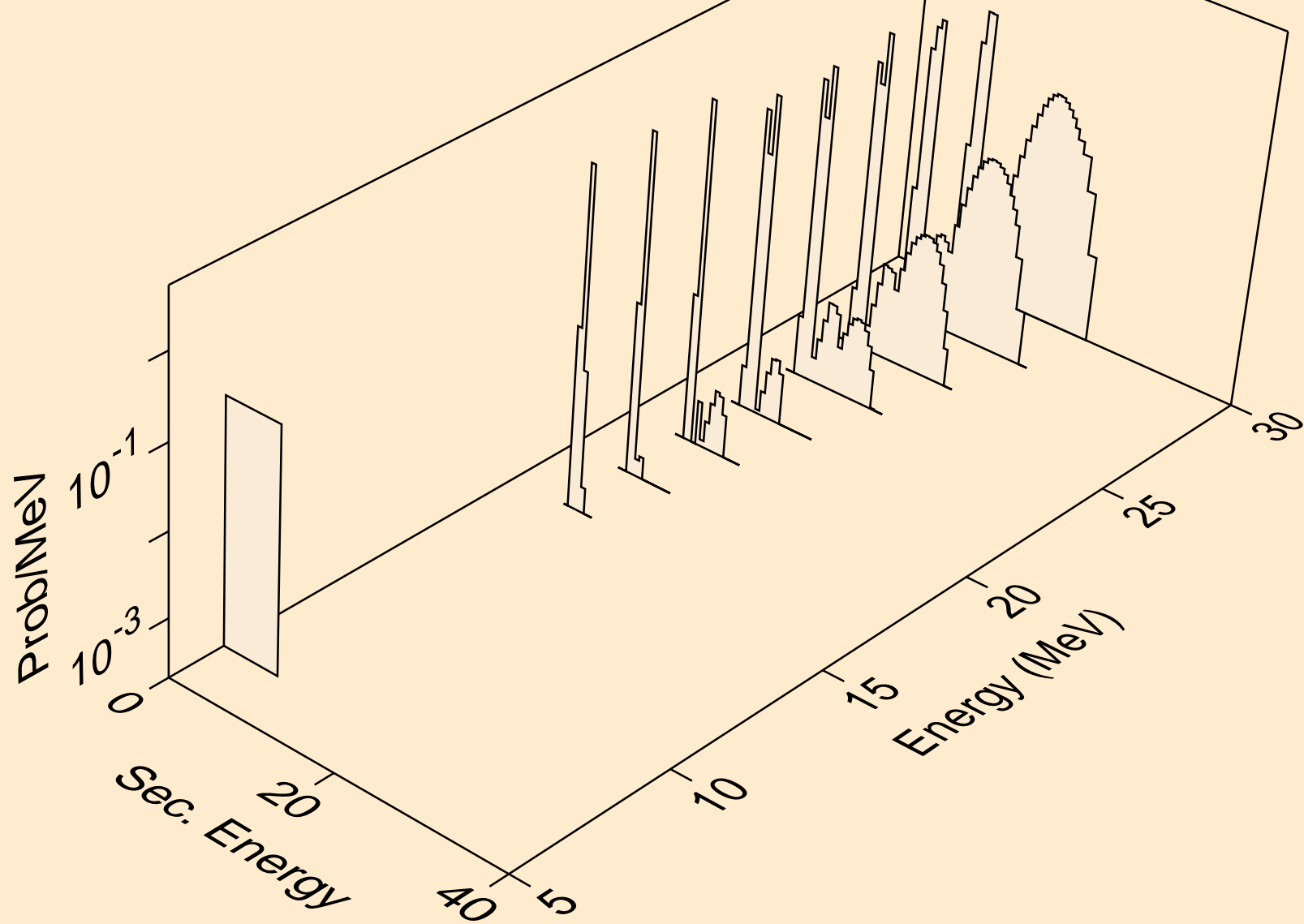

AT198M HELION ACER TENDL-2023 LIBRARY; T=0.K  
alphas from (s,n\*)2a

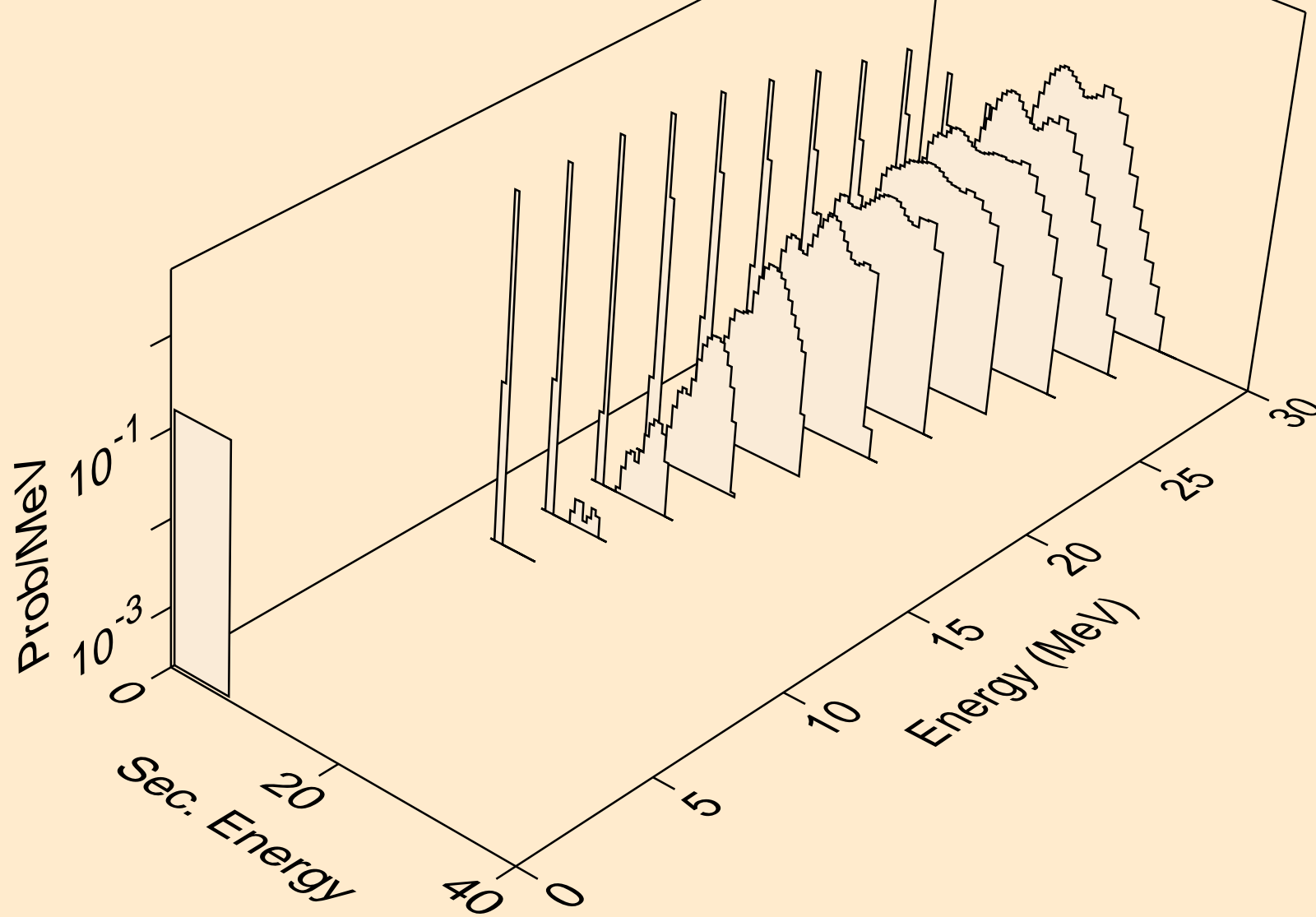

AT198M HELION ACER TENDL-2023 LIBRARY; T=0.K  
alphas from (s,npa)

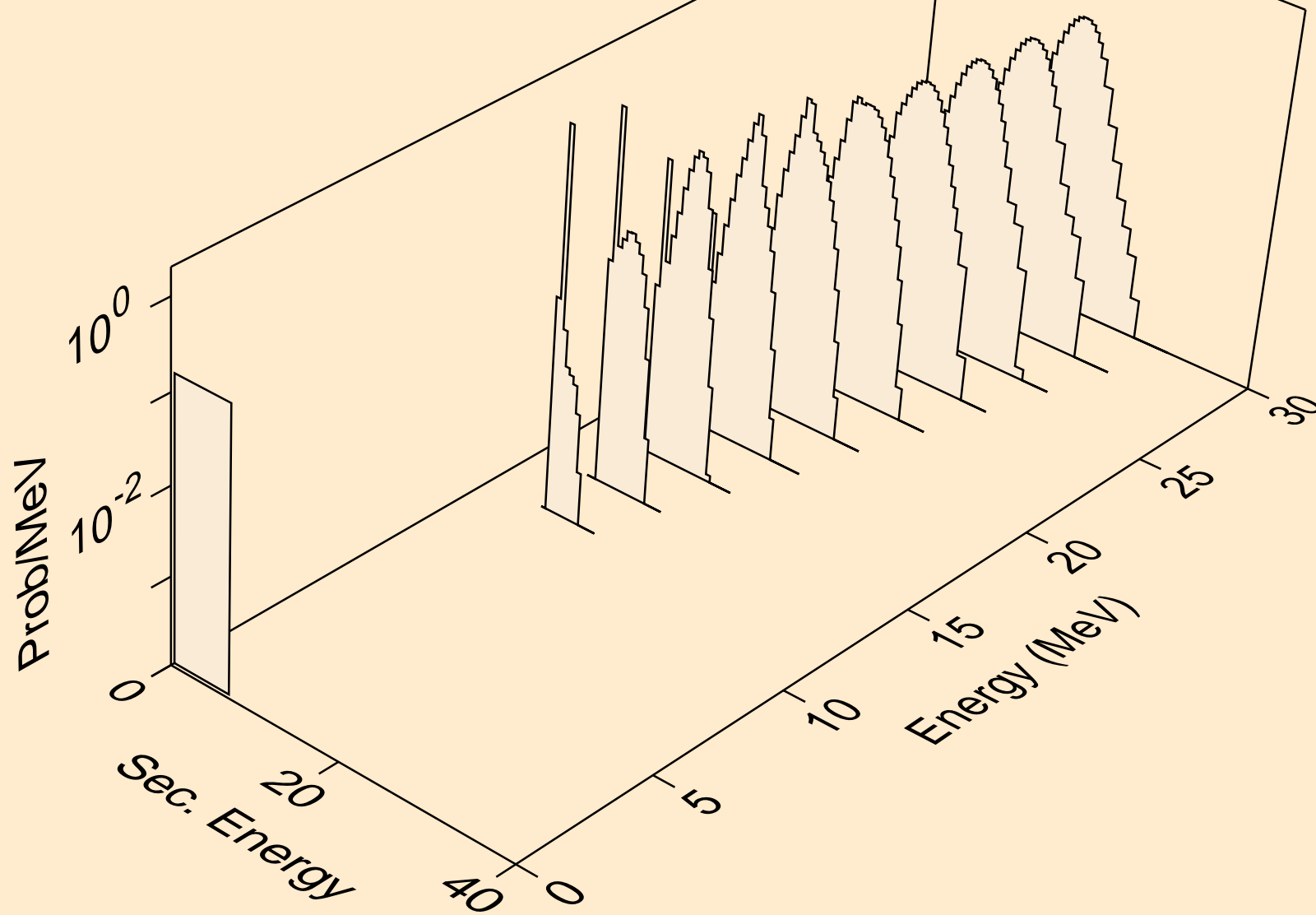

AT198M HELION ACER TENDL-2023 LIBRARY; T=0.K  
alphas from (s,a)

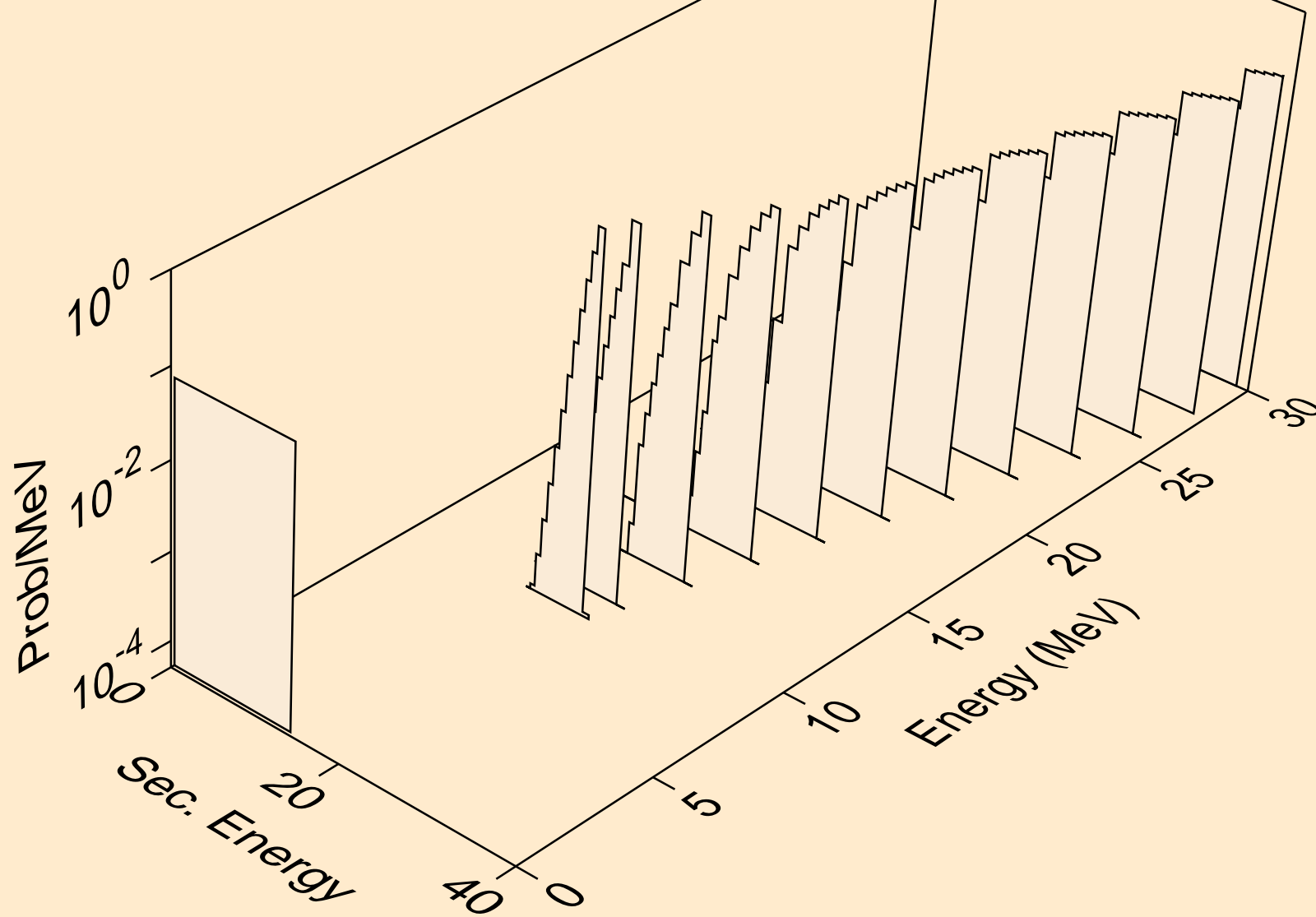

AT198M HELION ACER TENDL-2023 LIBRARY; T=0.K  
alphas from (s,2a)

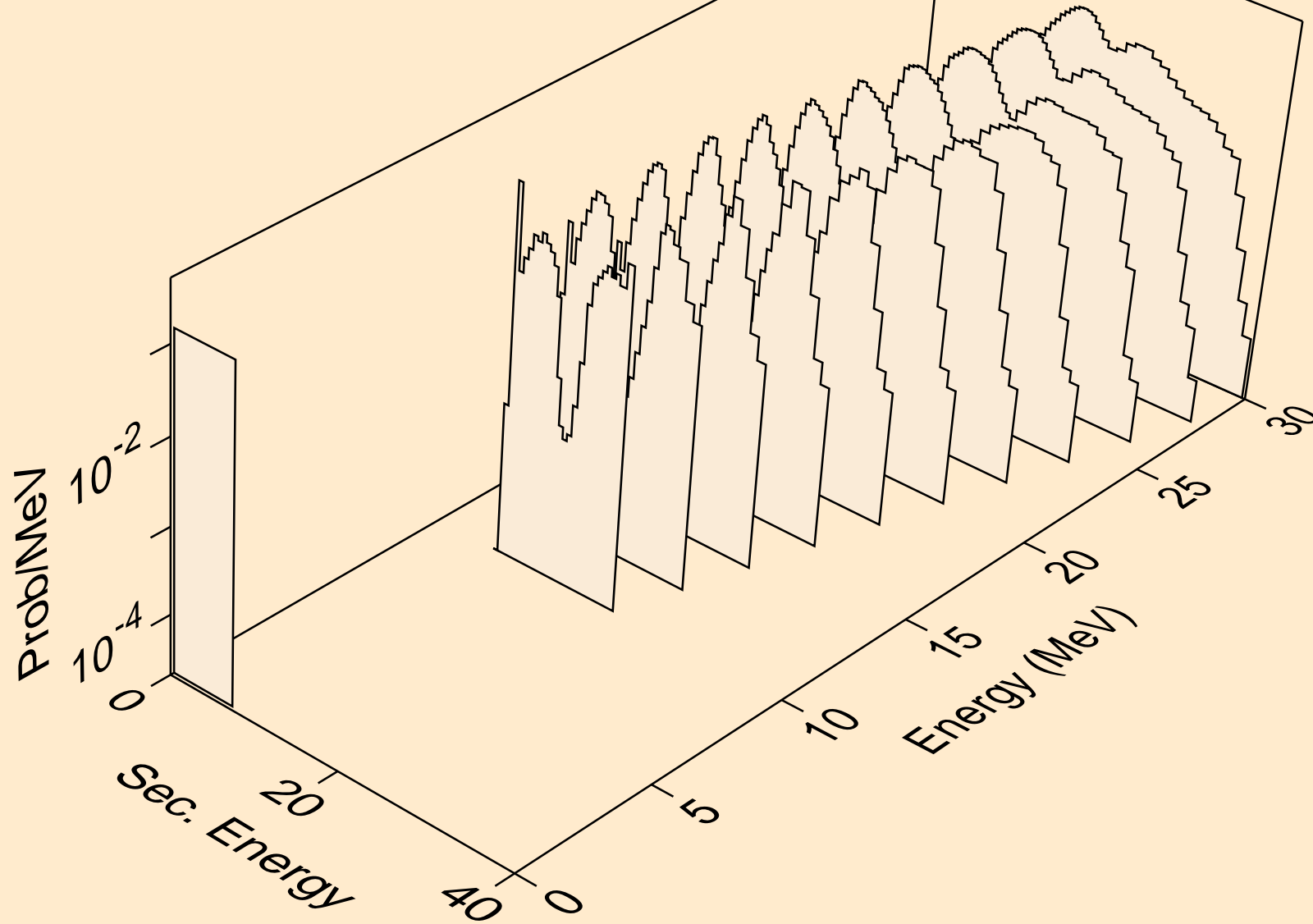

AT198M HELION ACER TENDL-2023 LIBRARY; T=0.K  
alphas from (s,pa)

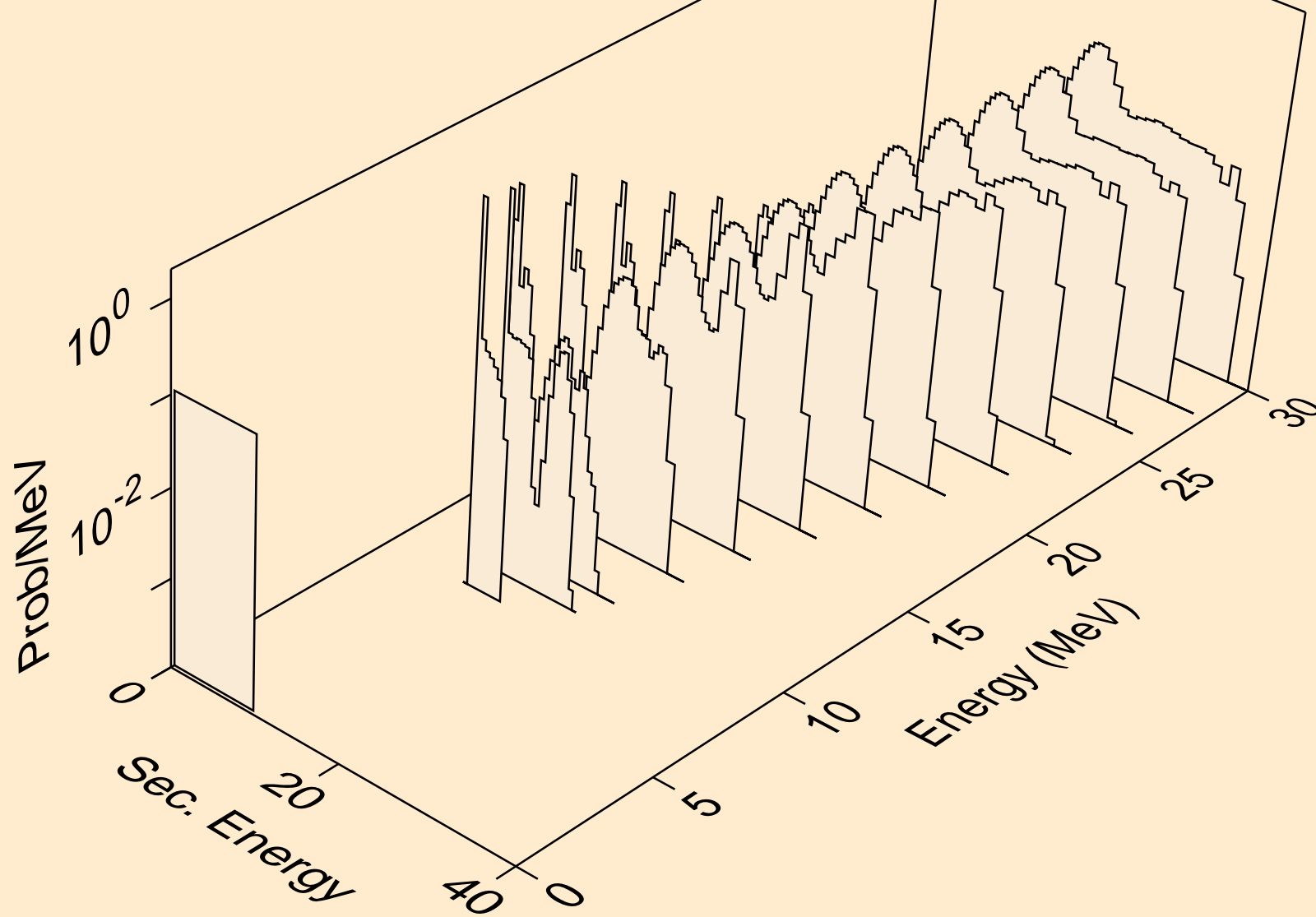

AT198M HELION ACER TENDL-2023 LIBRARY; T=0.K  
alphas from (s,da)

