

CF253 HELION ACER TENDL-2023 LIBRARY; T=0.K
Principal cross sections

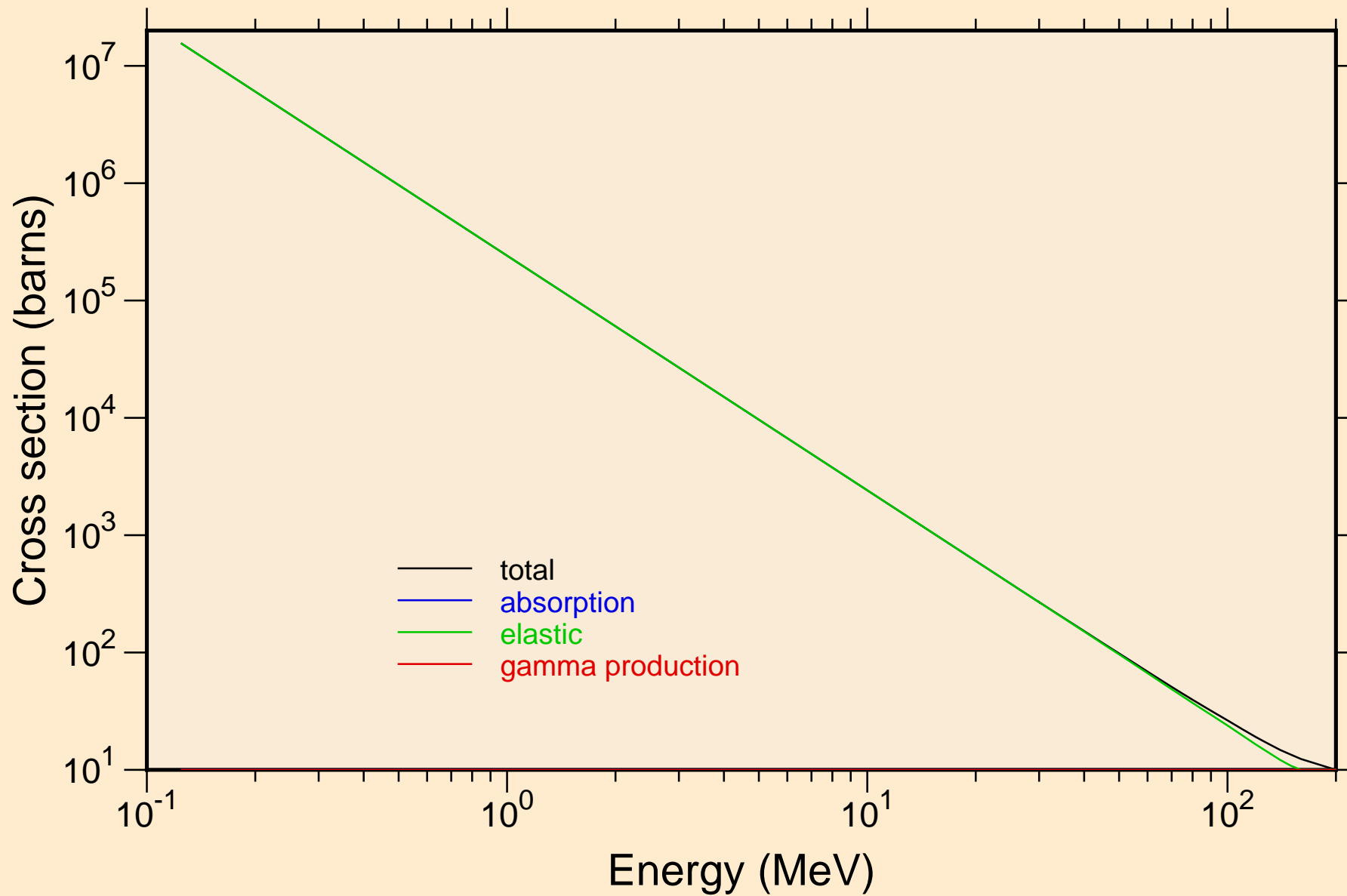

CF253 HELION ACER TENDL-2023 LIBRARY; T=0.K

Heating

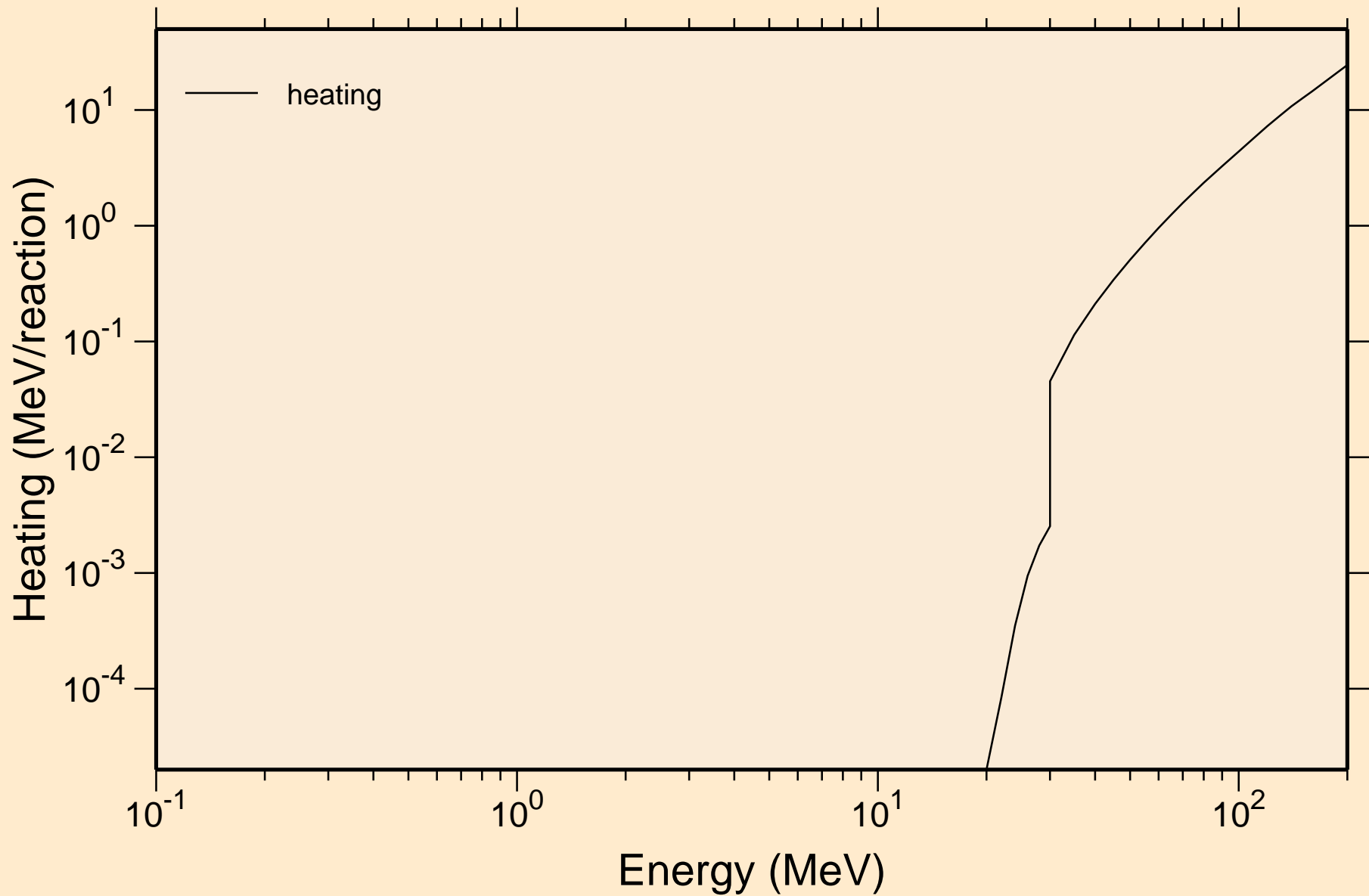

CF253 HELION ACER TENDL-2023 LIBRARY; T=0.K

Principal cross sections

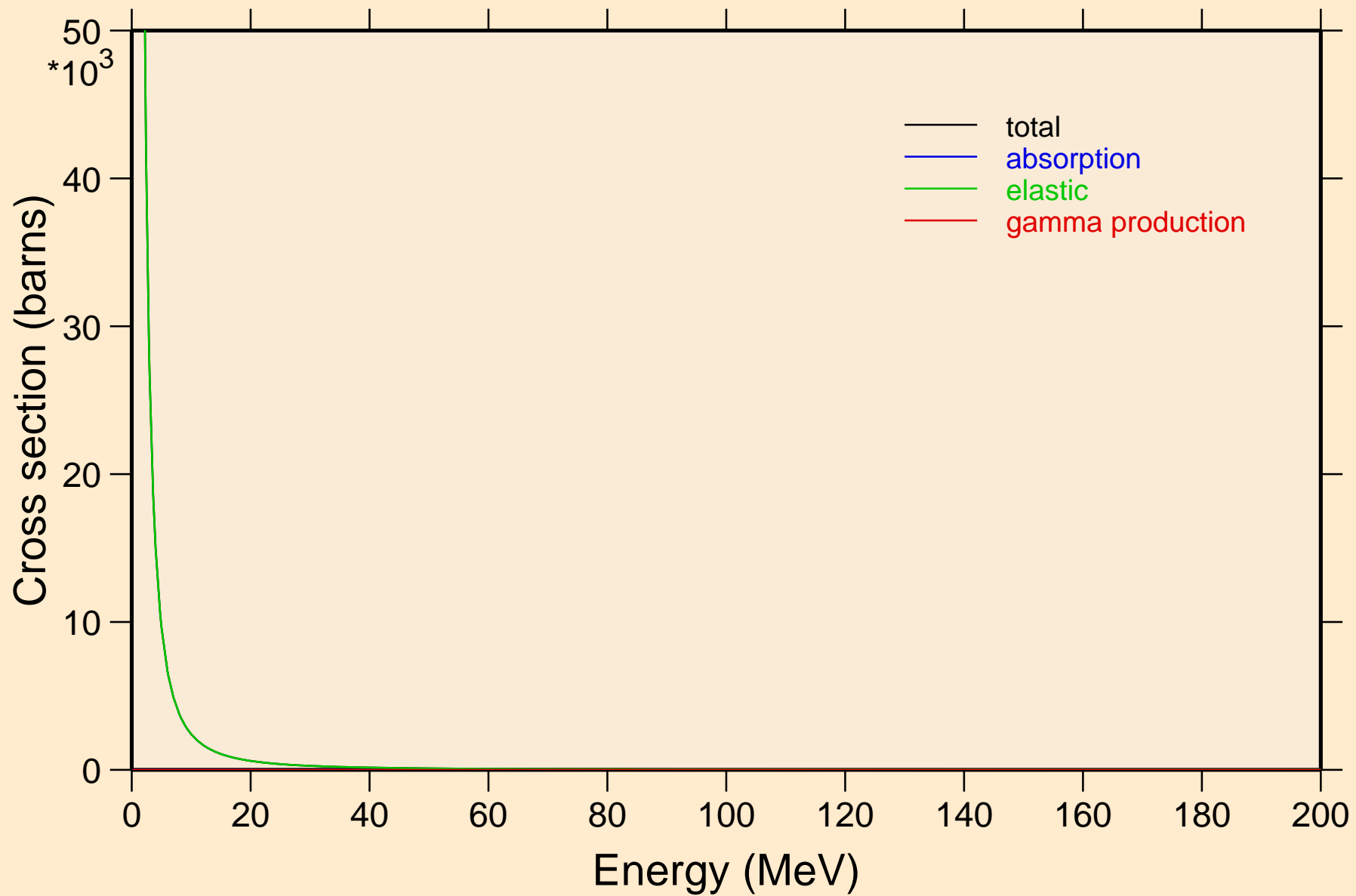

CF253 HELION ACER TENDL-2023 LIBRARY; T=0.K

Heating

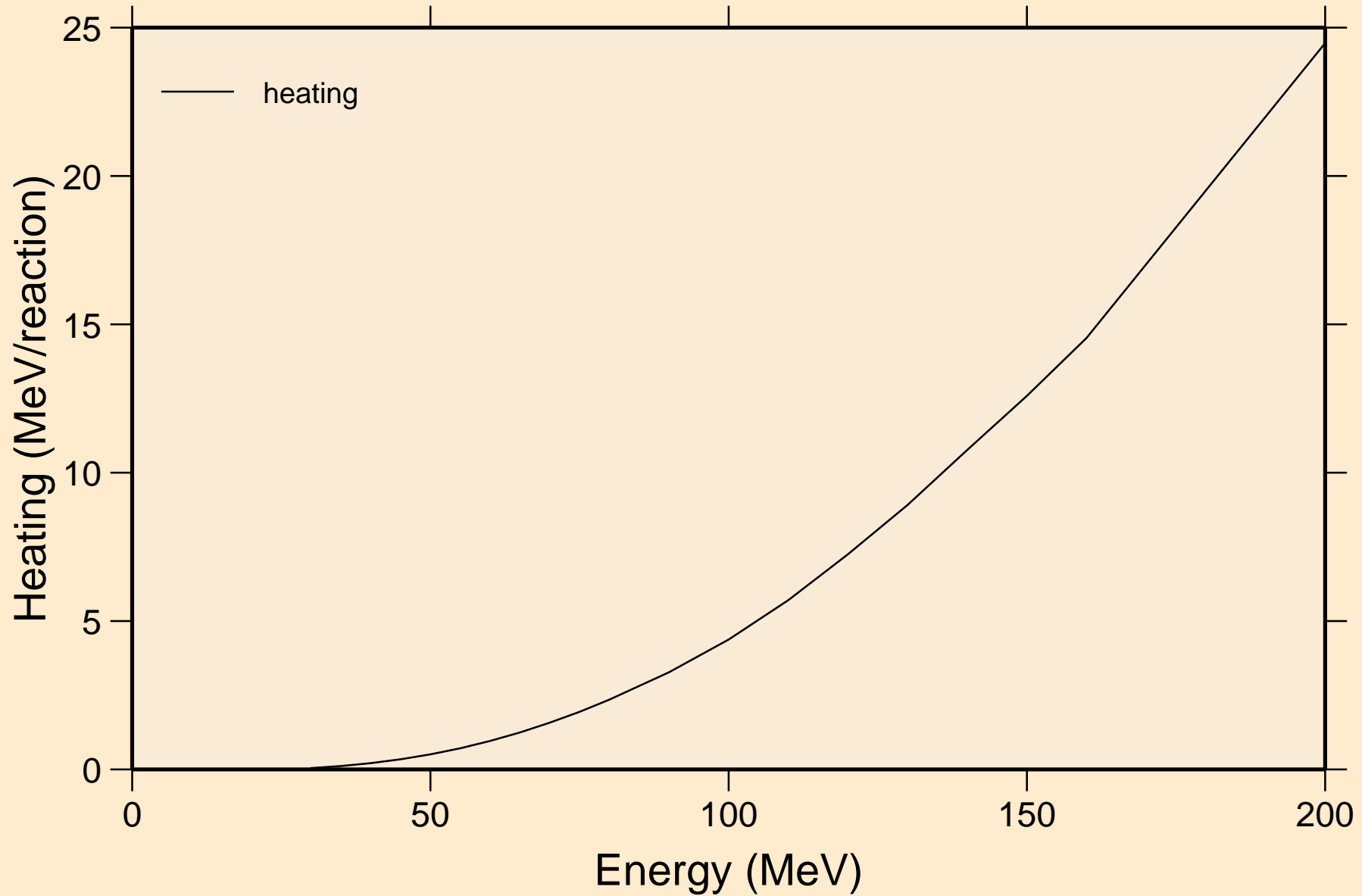

CF253 HELION ACER TENDL-2023 LIBRARY; T=0.K
Threshold reactions

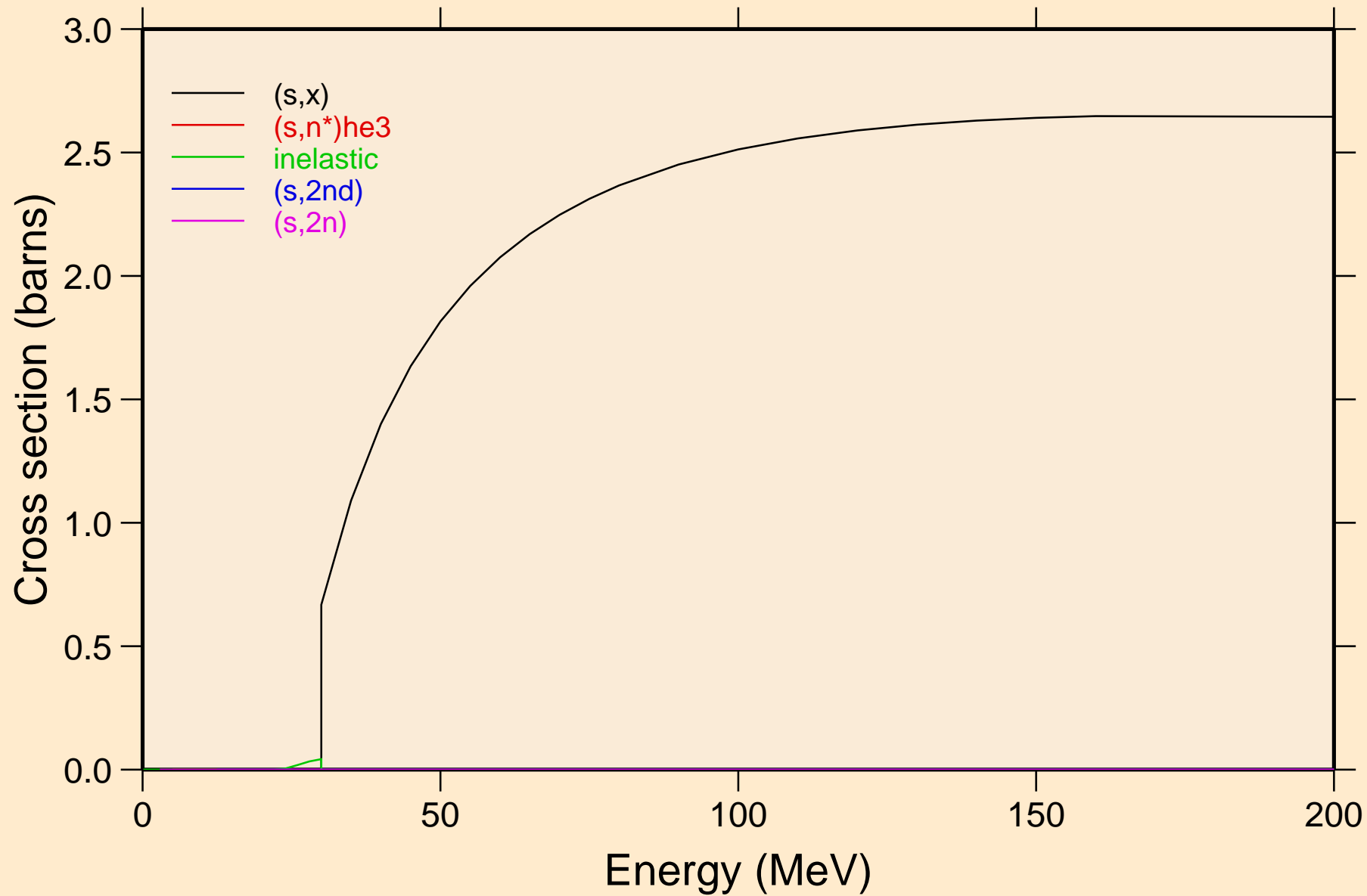

CF253 HELION ACER TENDL-2023 LIBRARY; T=0.K
Threshold reactions

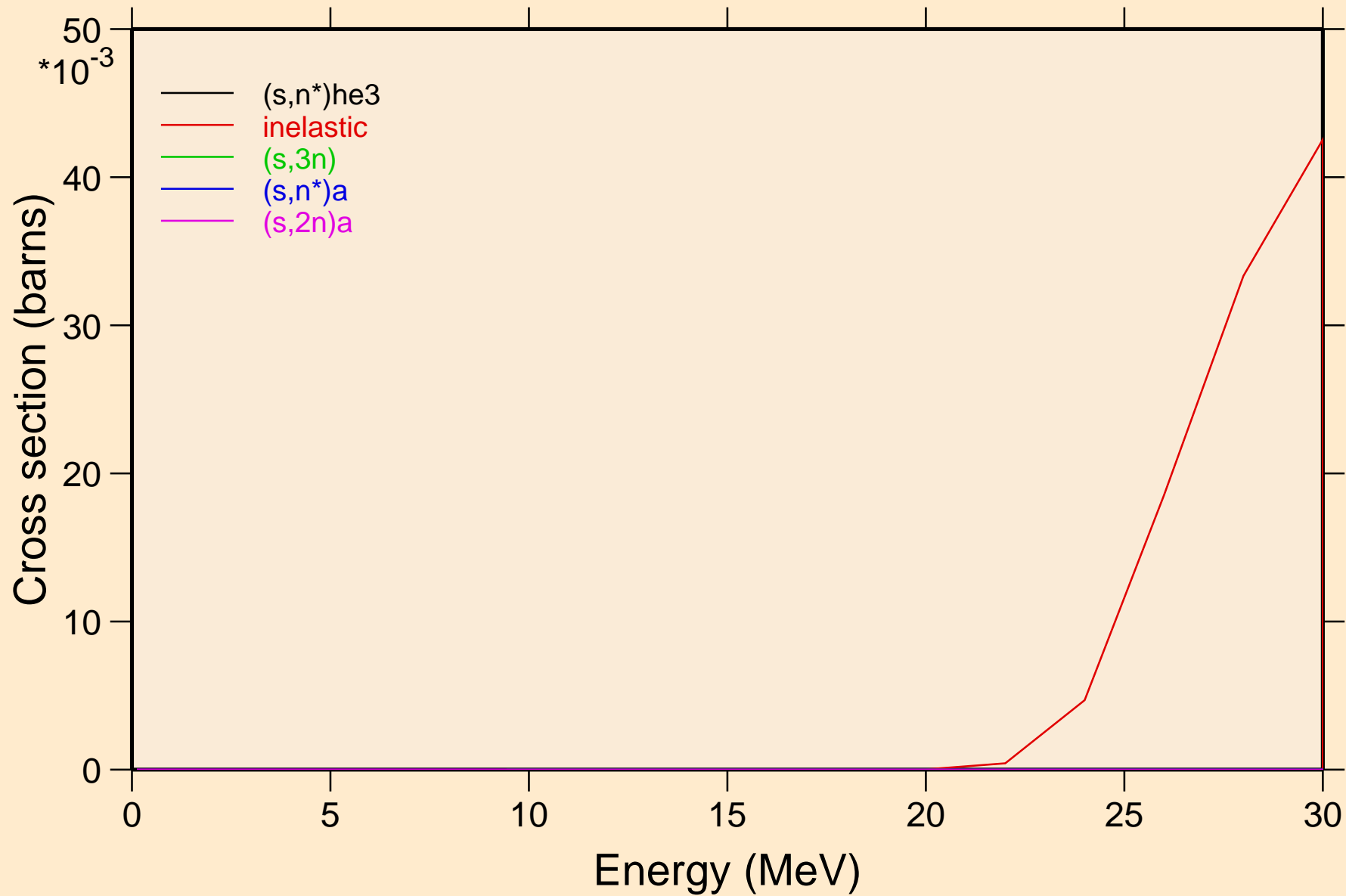

CF253 HELION ACER TENDL-2023 LIBRARY; T=0.K
Threshold reactions

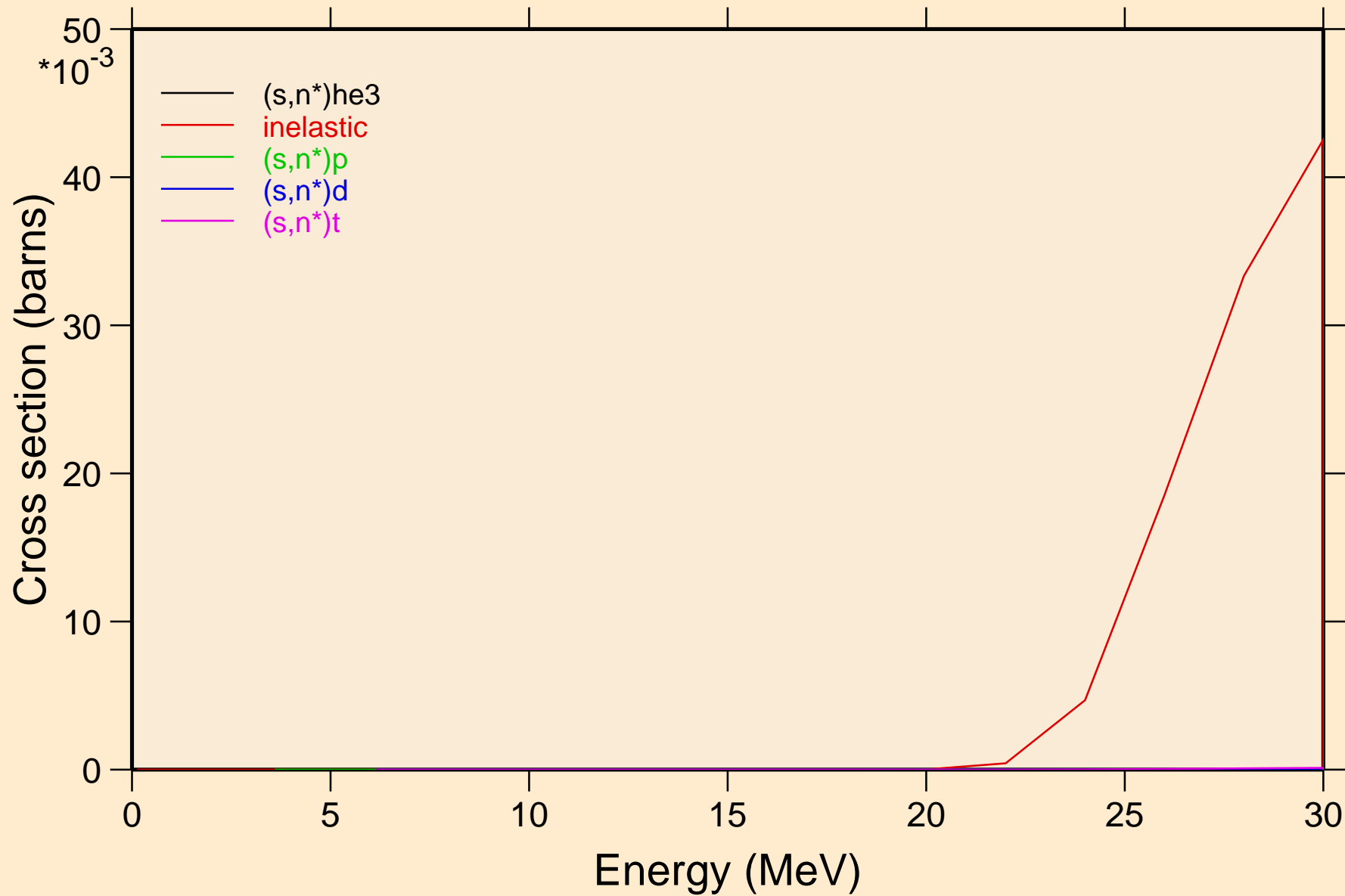

CF253 HELION ACER TENDL-2023 LIBRARY; T=0.K
Threshold reactions

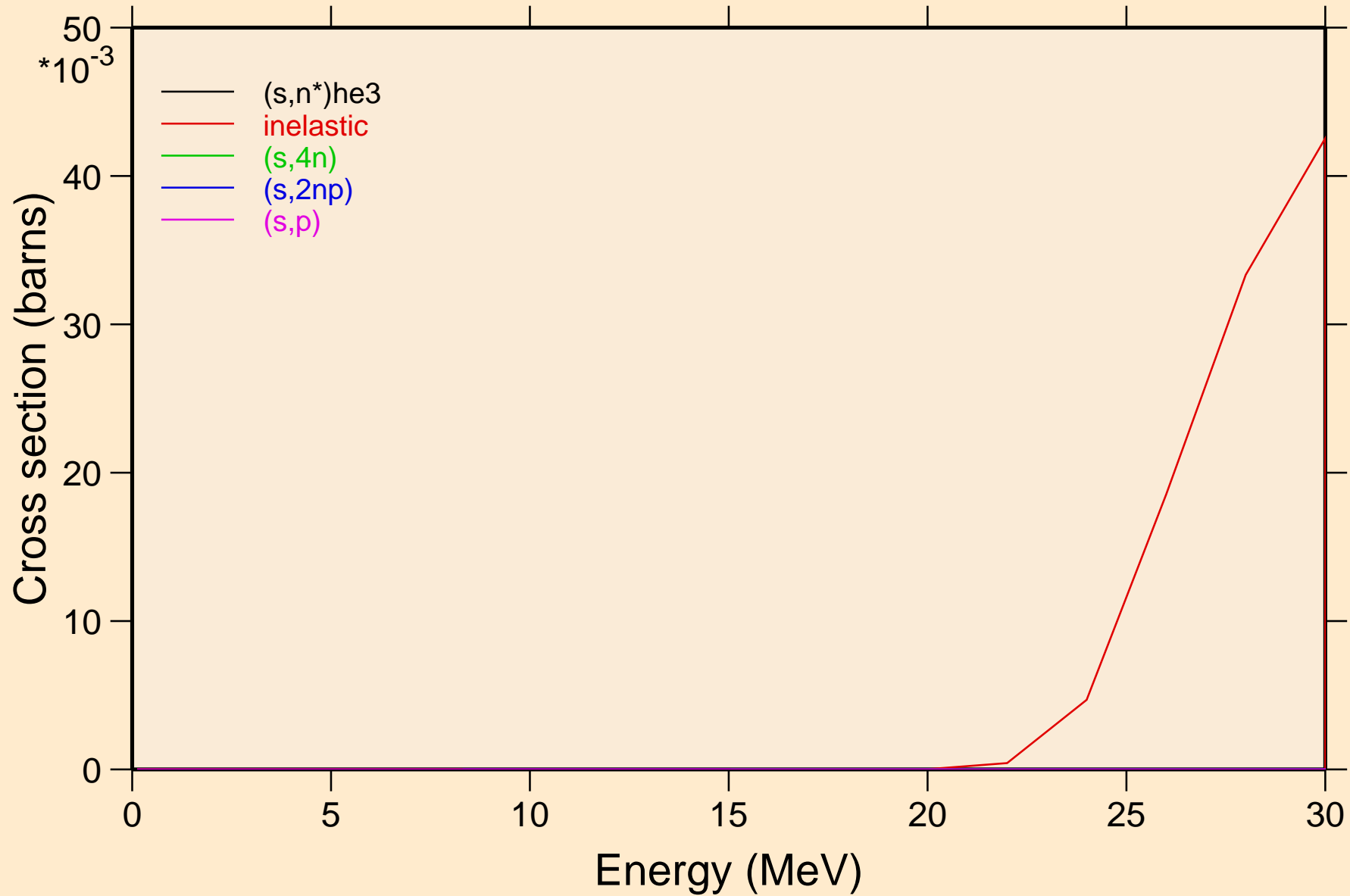

CF253 HELION ACER TENDL-2023 LIBRARY; T=0.K
Threshold reactions

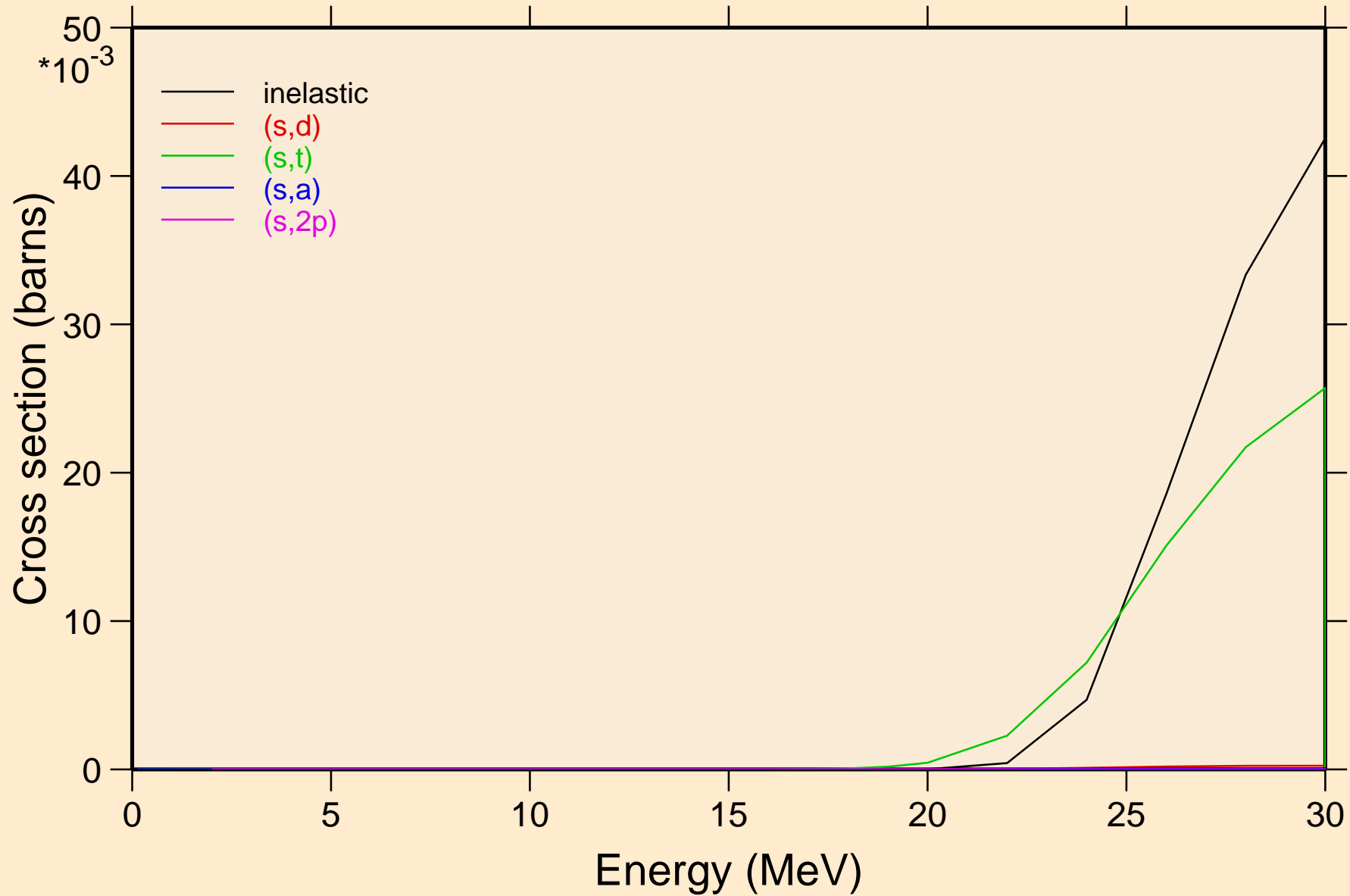

CF253 HELION ACER TENDL-2023 LIBRARY; T=0.K
angular distribution for elastic

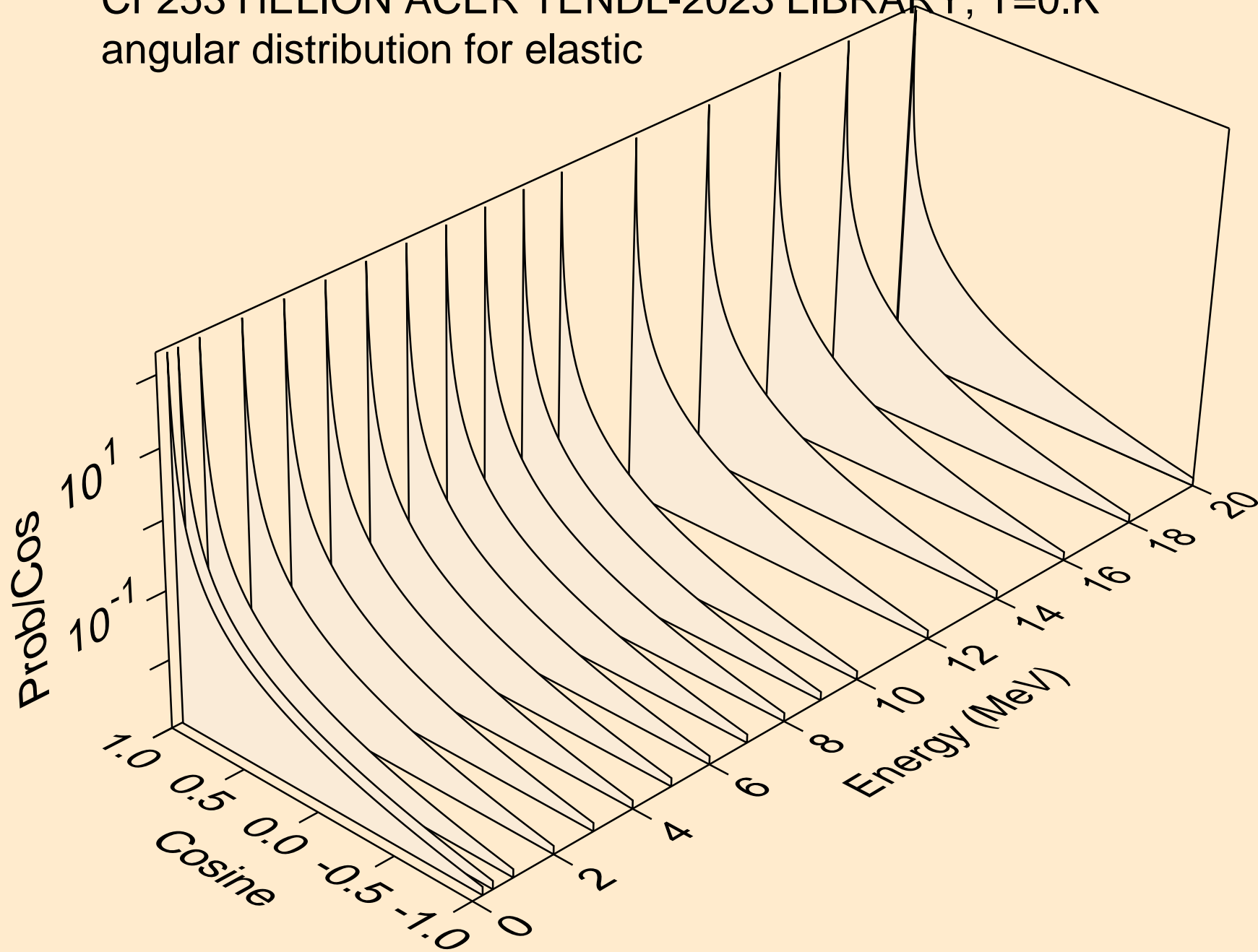

CF253 HELION ACER TENDL-2023 LIBRARY; T=0.K
angular distribution for elastic

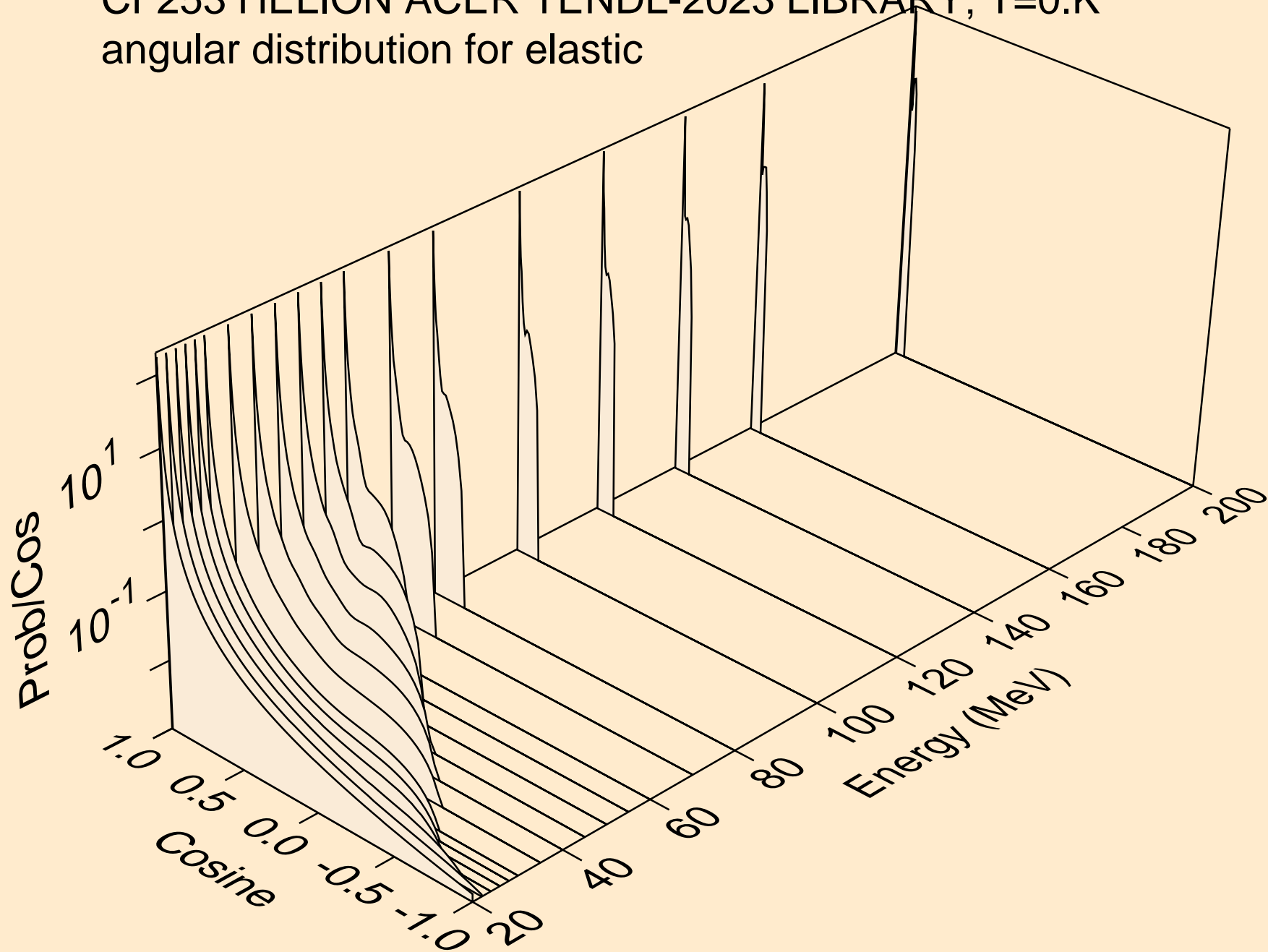

CF253 HELION ACER TENDL-2023 LIBRARY; T=0.K
He-3 emission for (s,x)

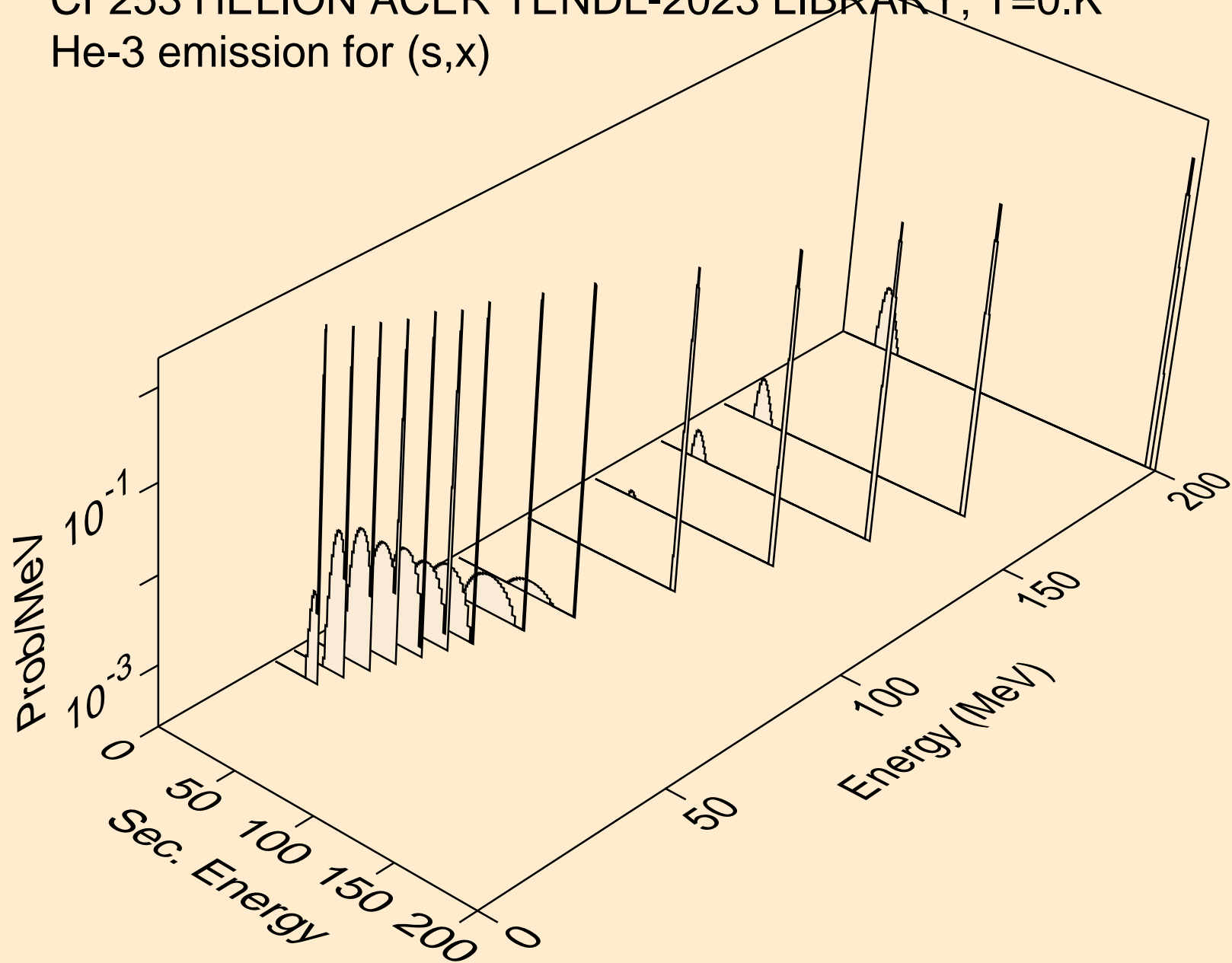

CF253 HELION ACER TENDL-2023 LIBRARY; T=0.K
He-3 emission for (s,n*)he3

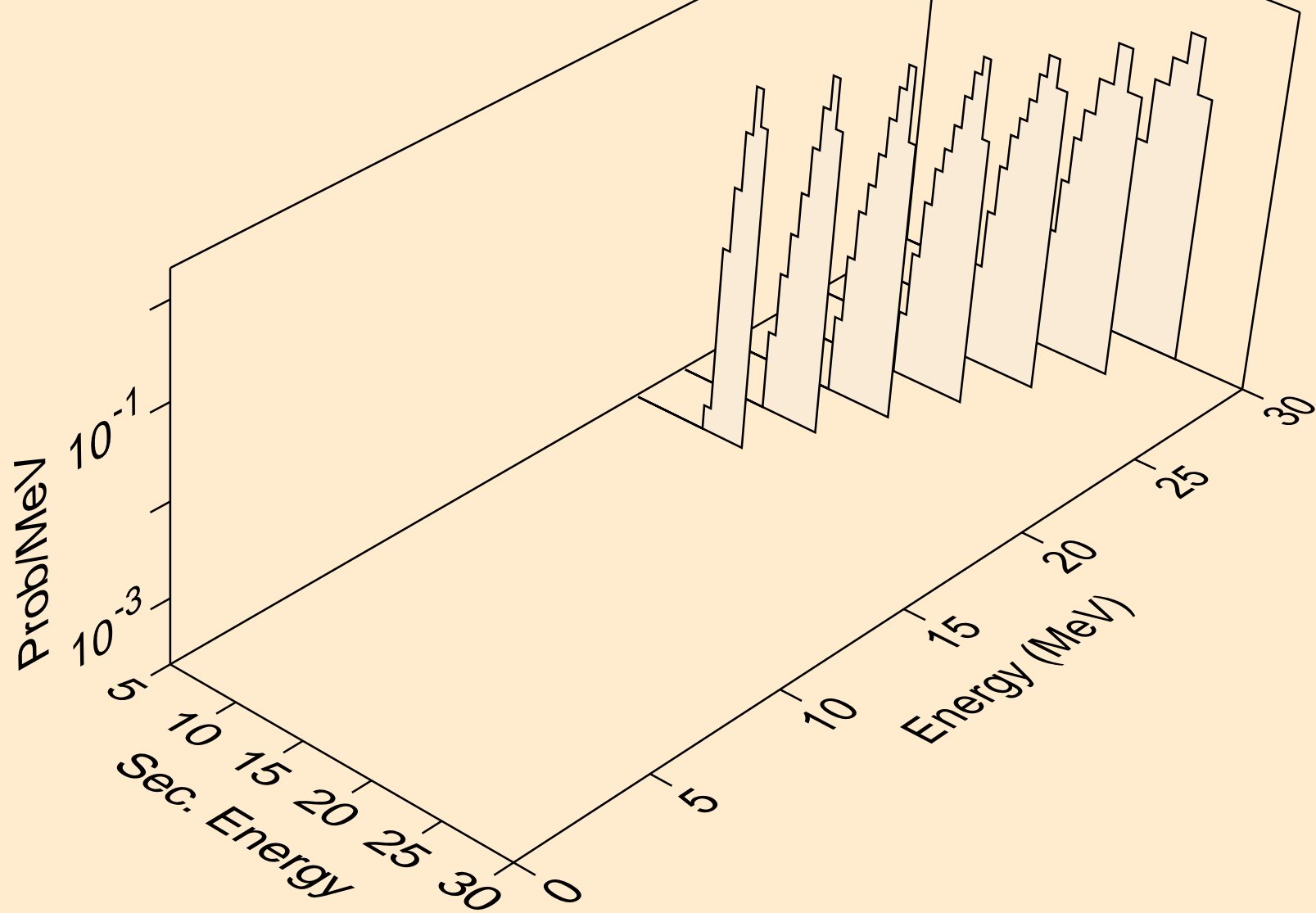

CF253 HELION ACER TENDL-2023 LIBRARY; T=0.K
He-3 emission for inelastic

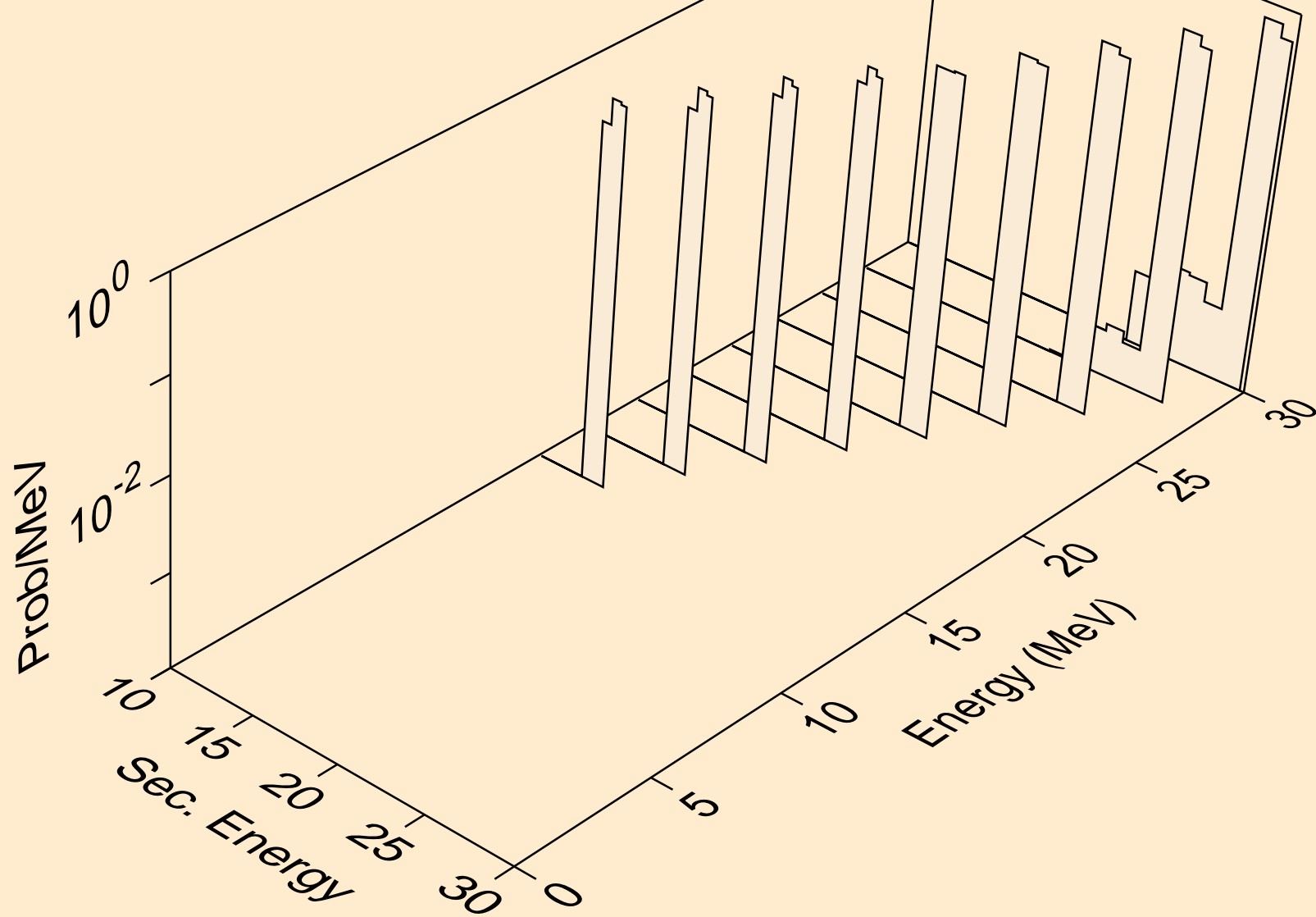

CF253 HELION ACER TENDL-2023 LIBRARY; T=0.K
Photon emission for (z,n)

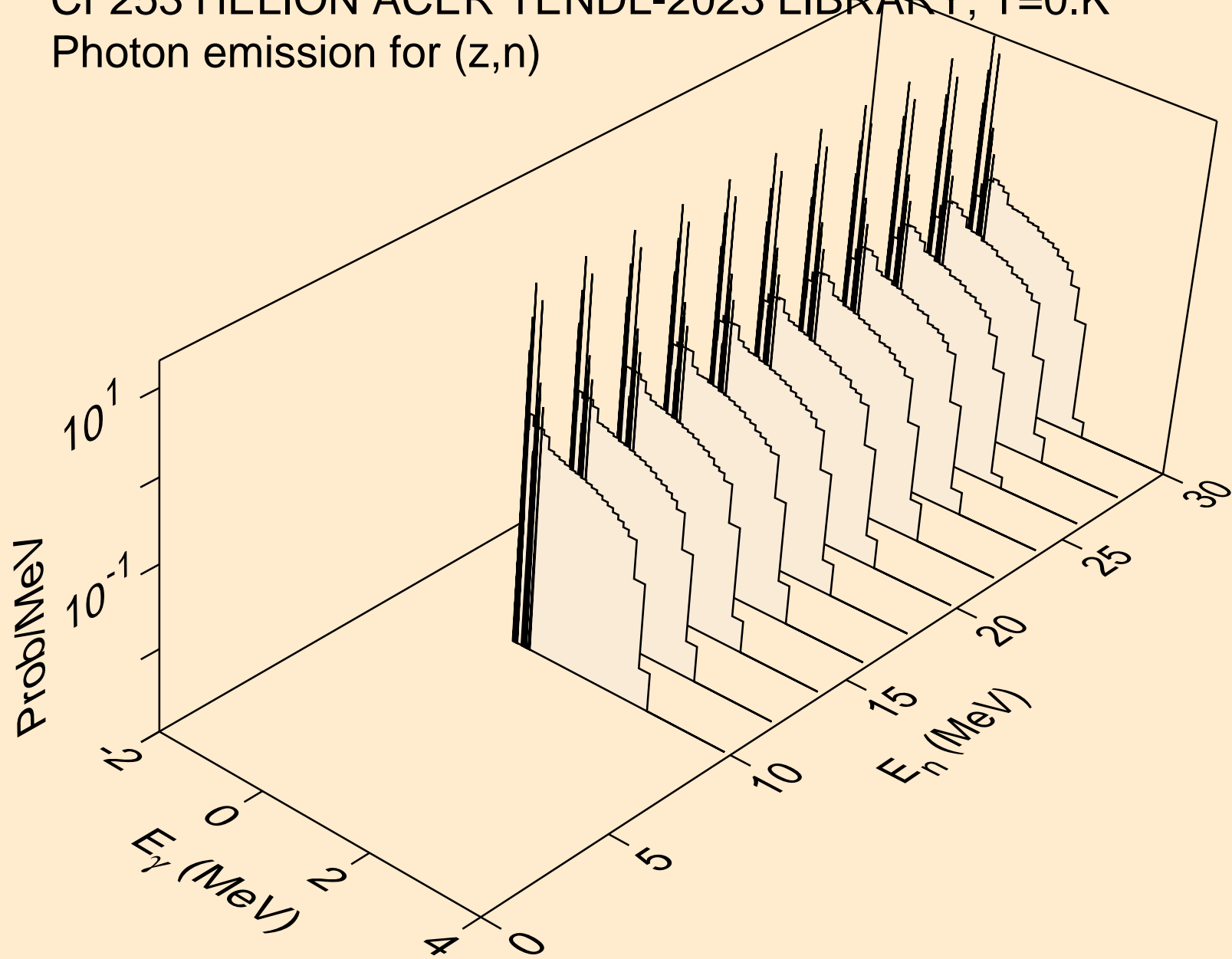

CF253 HELION ACER TENDL-2023 LIBRARY; T=0.K
Photon emission for (z,x)

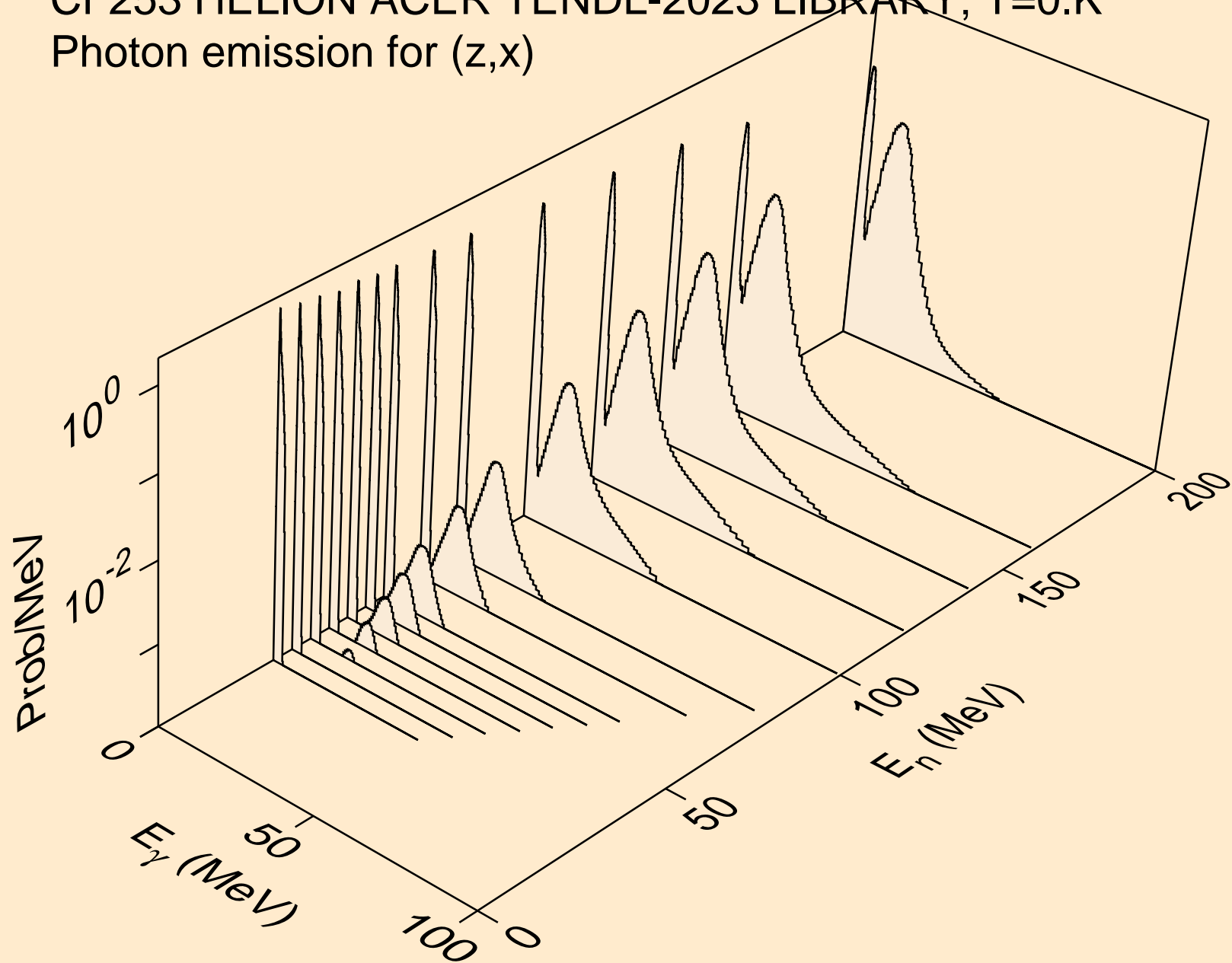

CF253 HELION ACER TENDL-2023 LIBRARY; T=0.K
Photon emission for (n,2nd)

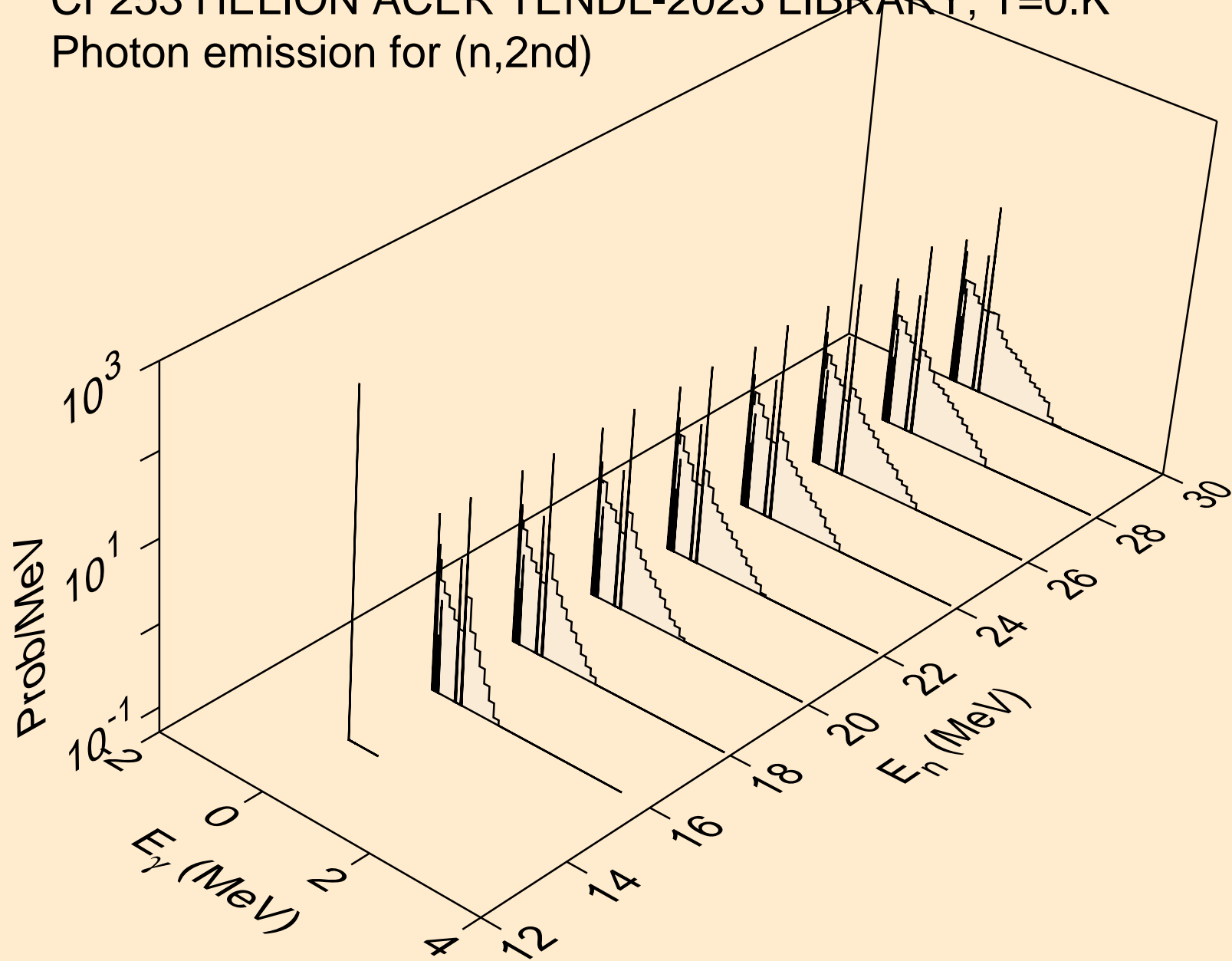

CF253 HELION ACER TENDL-2023 LIBRARY; T=0.K
Photon emission for (n,2n)

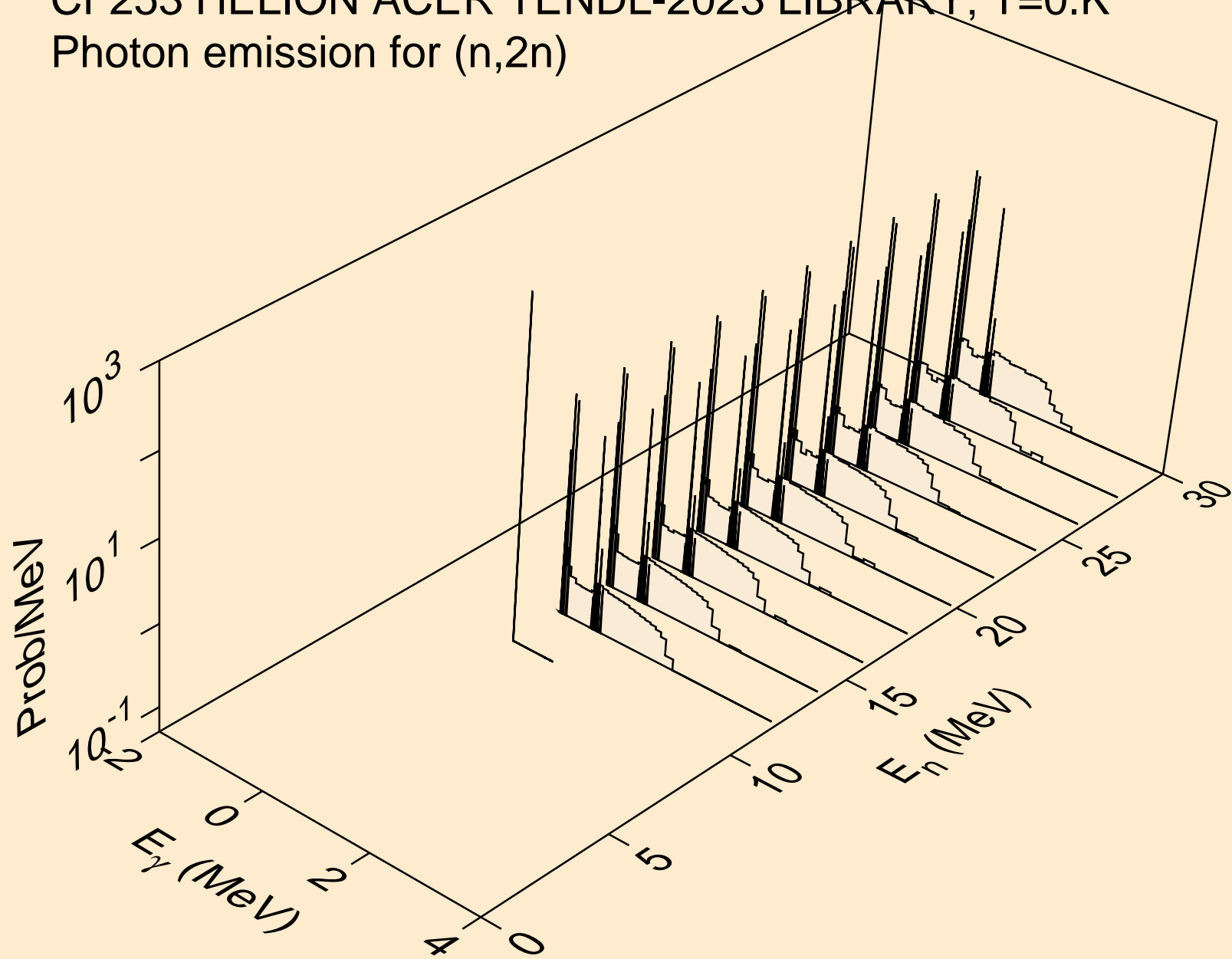

CF253 HELION ACER TENDL-2023 LIBRARY; T=0.K
Photon emission for (n,3n)

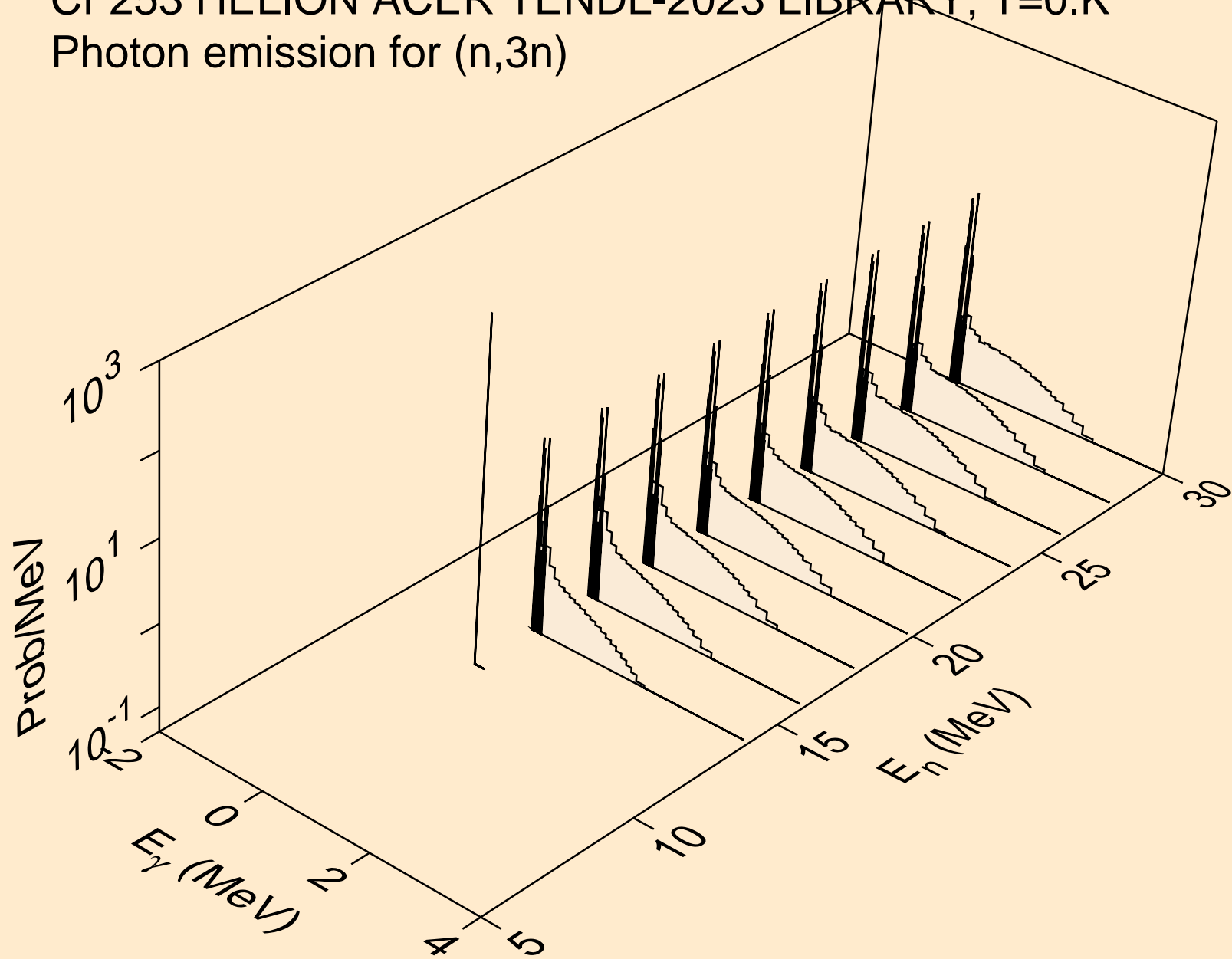

CF253 HELION ACER TENDL-2023 LIBRARY; T=0.K
Photon emission for (n,n*)a

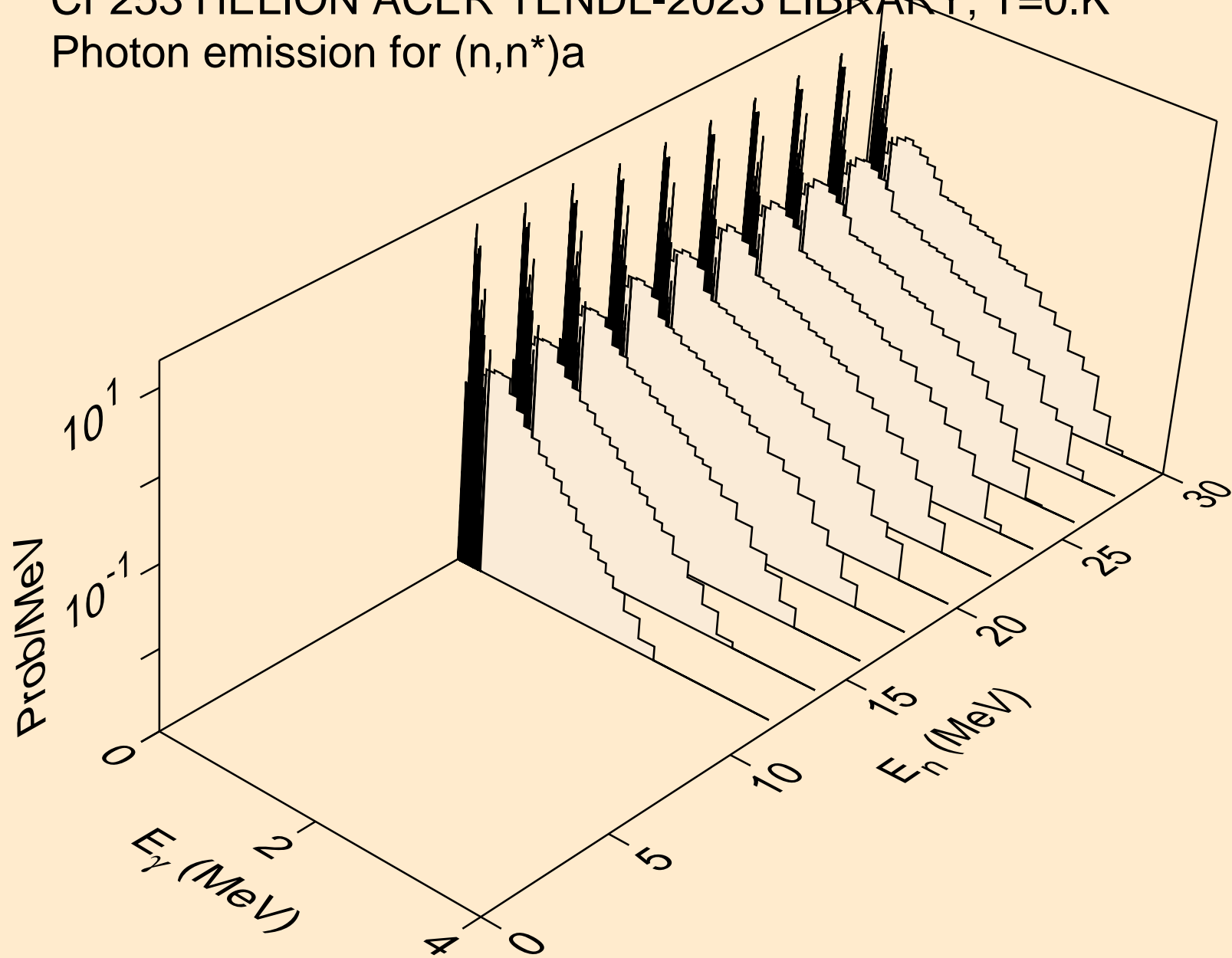

CF253 HELION ACER TENDL-2023 LIBRARY; T=0.K
Photon emission for (n,2n)a

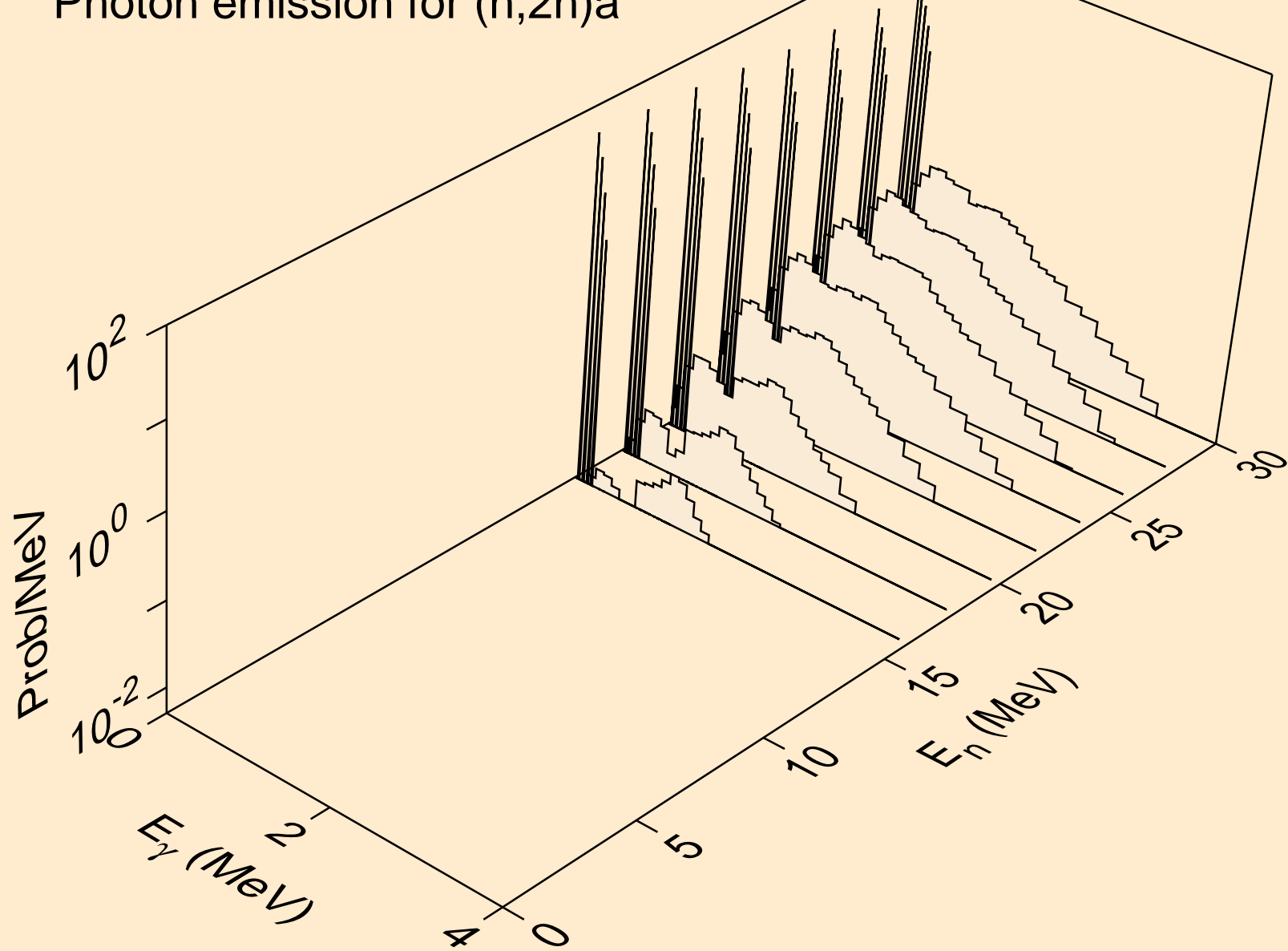

CF253 HELION ACER TENDL-2023 LIBRARY; T=0.K
Photon emission for (n,n*)p

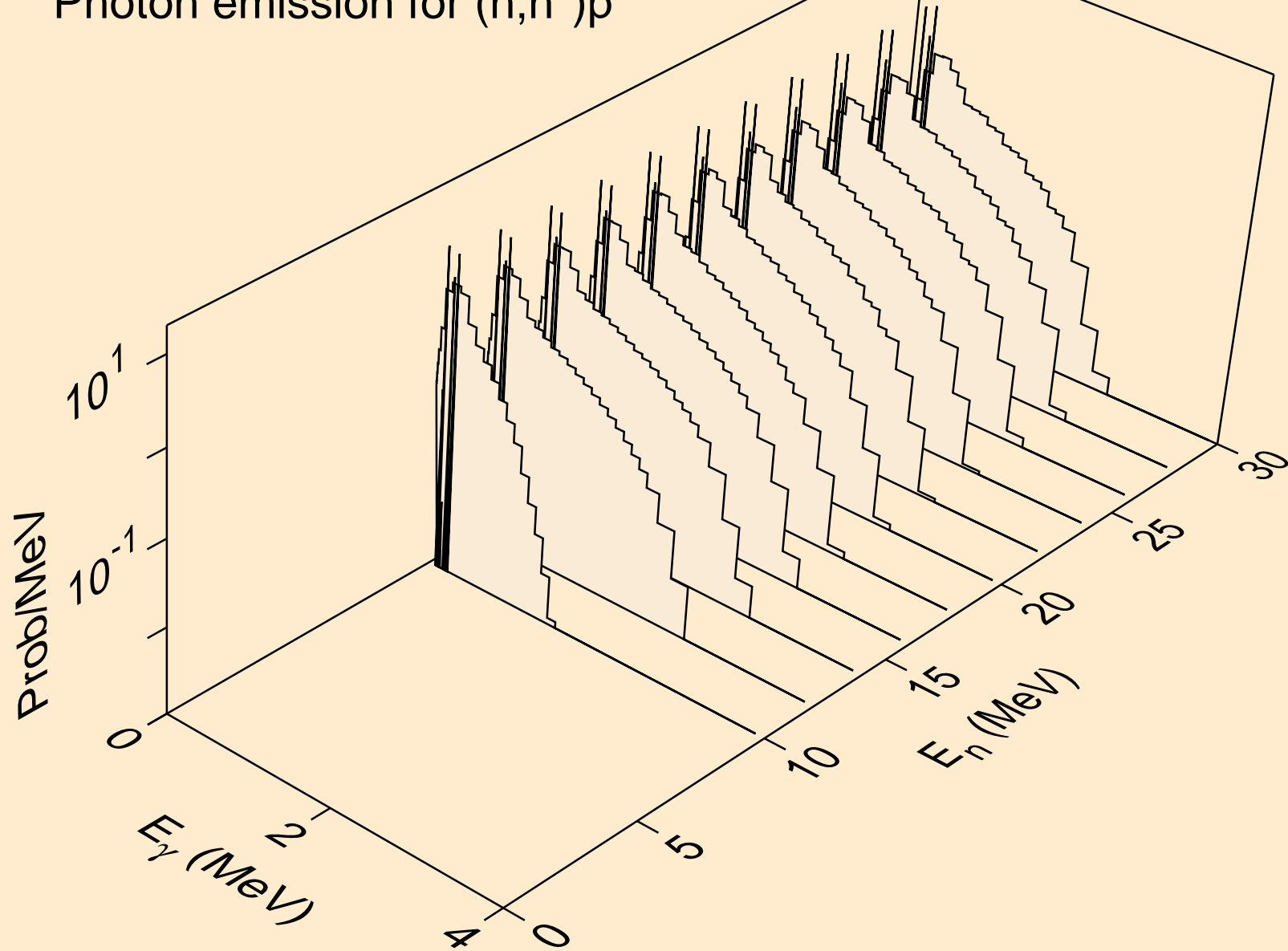

CF253 HELION ACER TENDL-2023 LIBRARY; T=0.K
Photon emission for (n,n*)d

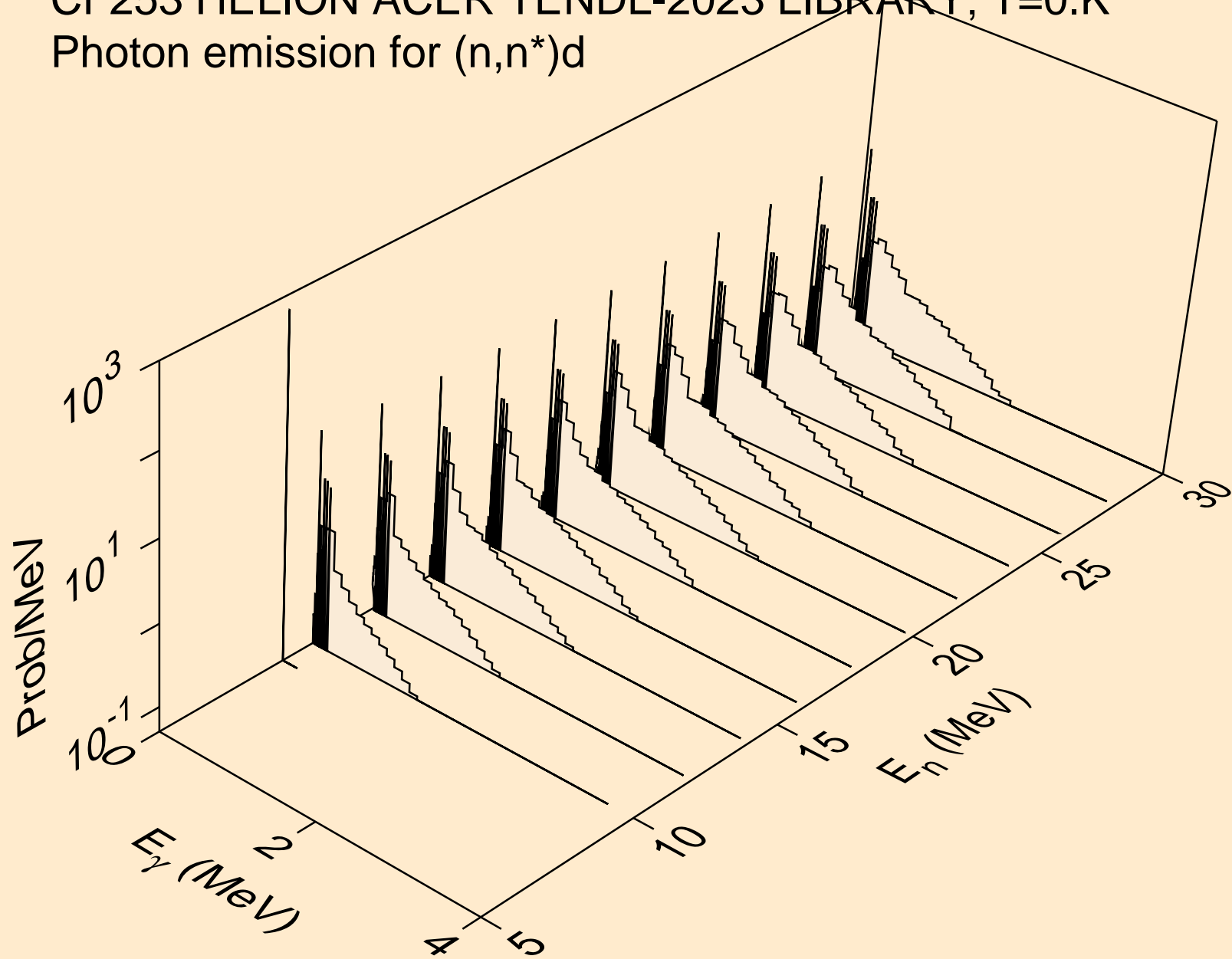

CF253 HELION ACER TENDL-2023 LIBRARY; T=0.K
Photon emission for (n,n*)t

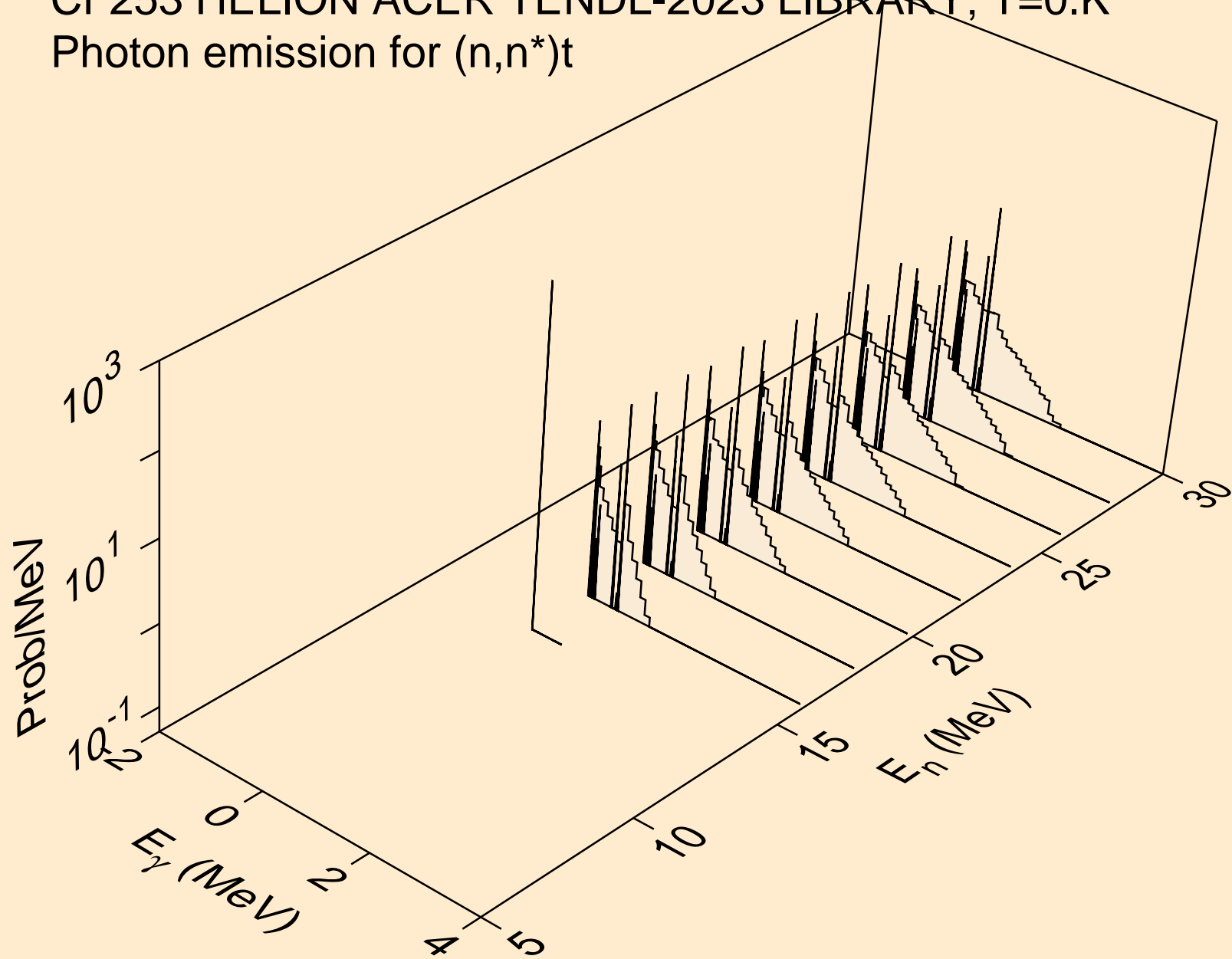

CF253 HELION ACER TENDL-2023 LIBRARY; T=0.K
Photon emission for (n,n*)he3

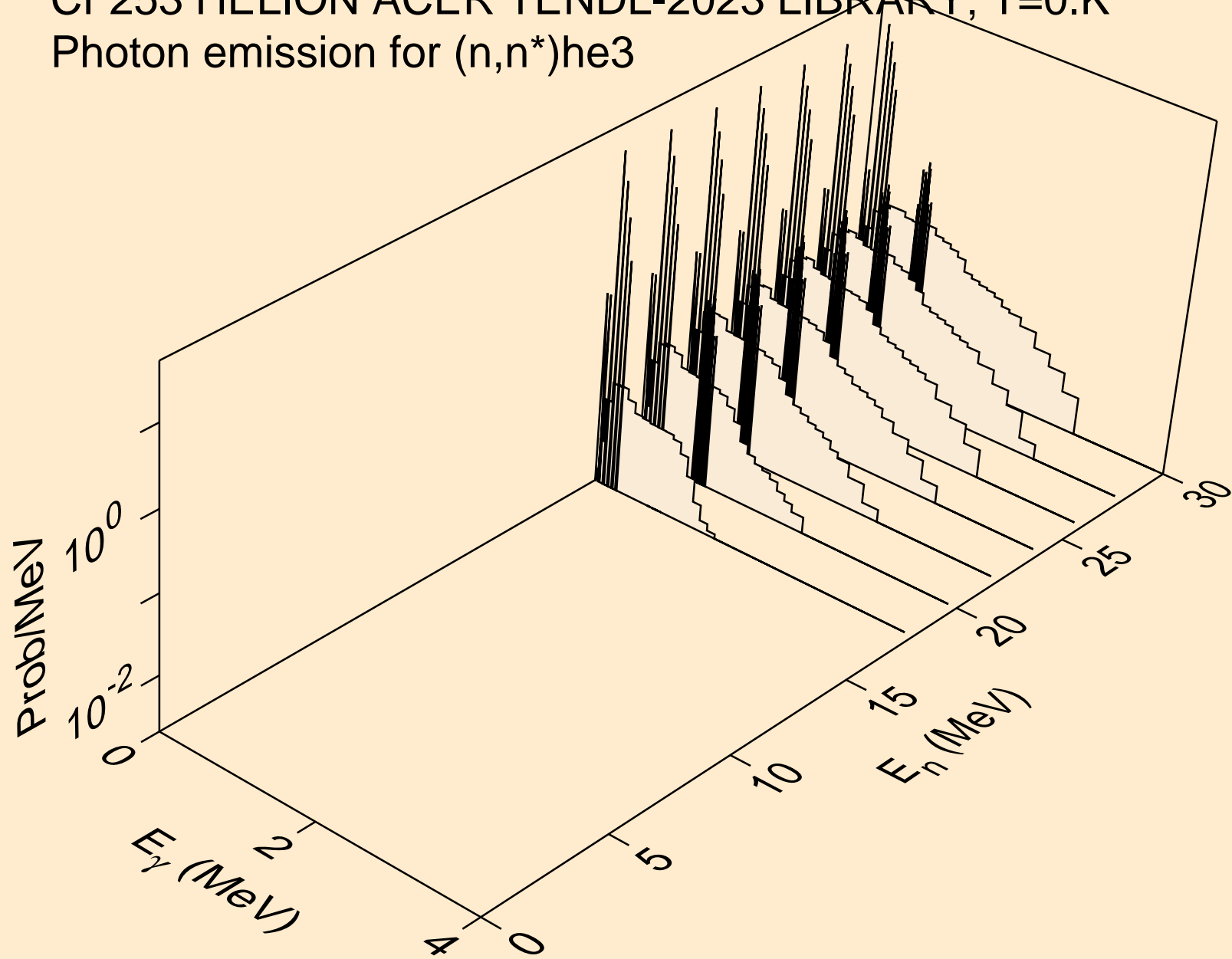

CF253 HELION ACER TENDL-2023 LIBRARY; T=0.K
Photon emission for (n,4n)

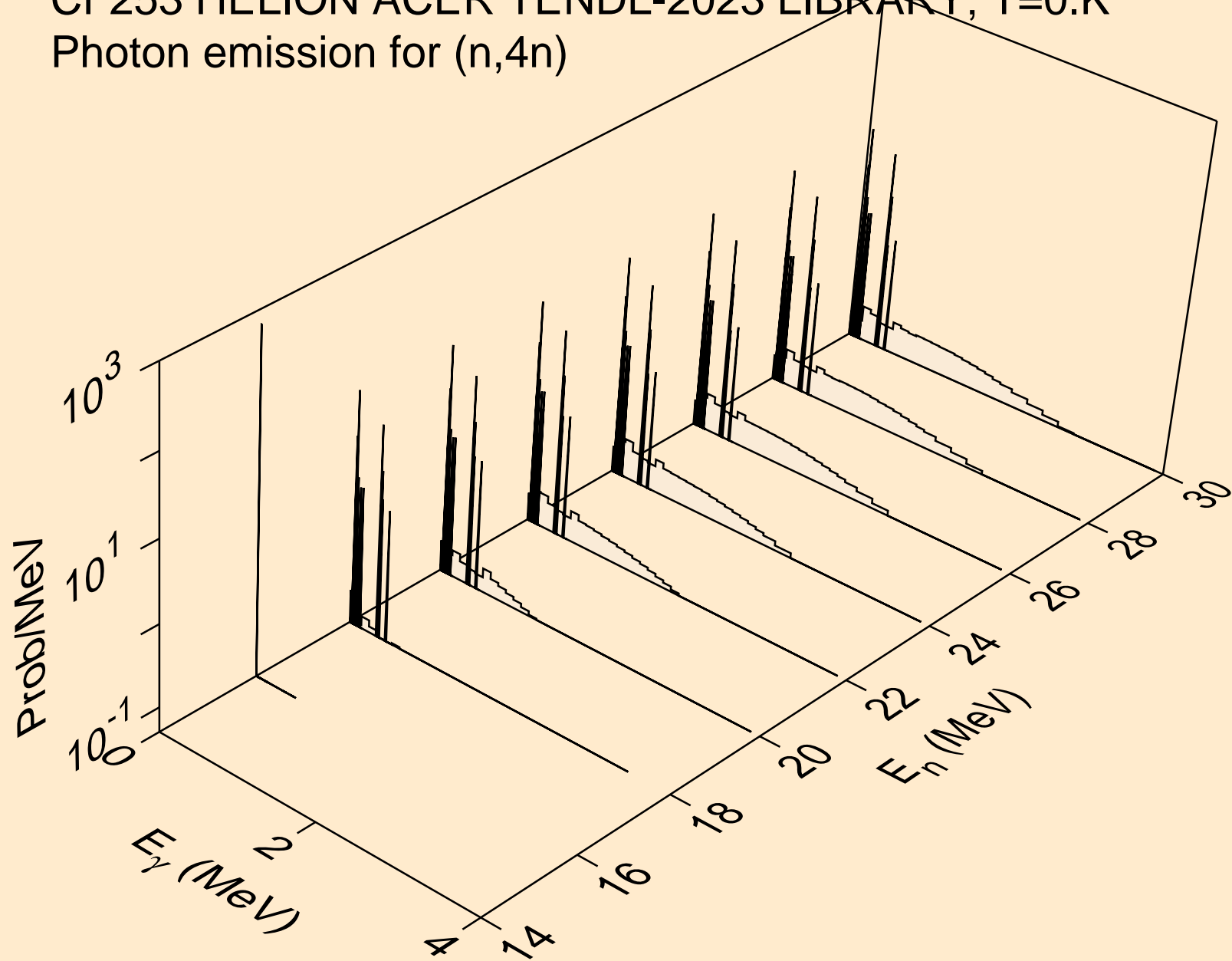

CF253 HELION ACER TENDL-2023 LIBRARY; T=0.K
Photon emission for (n,2np)

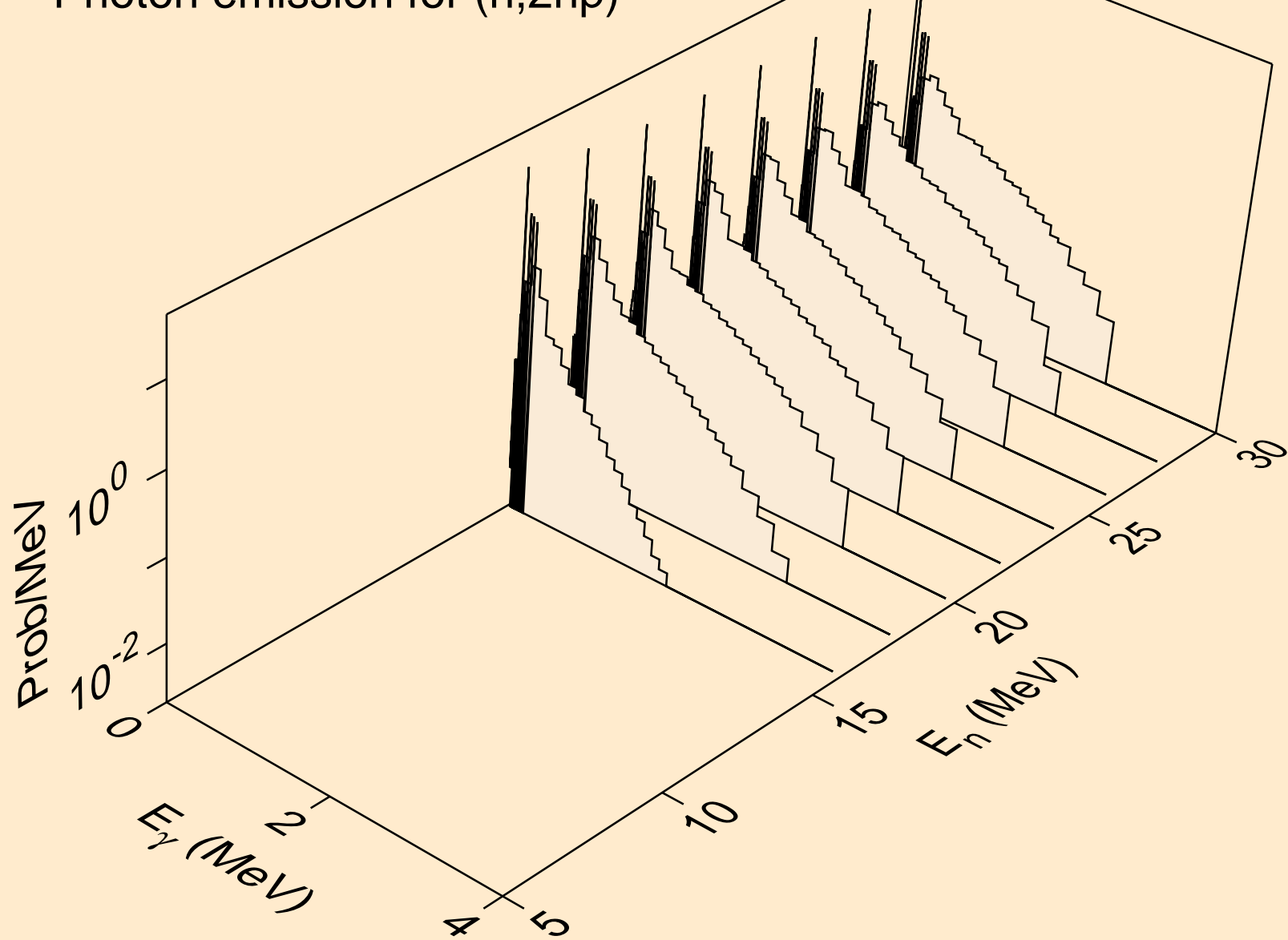

CF253 HELION ACER TENDL-2023 LIBRARY; T=0.K
Photon emission for (n,p)

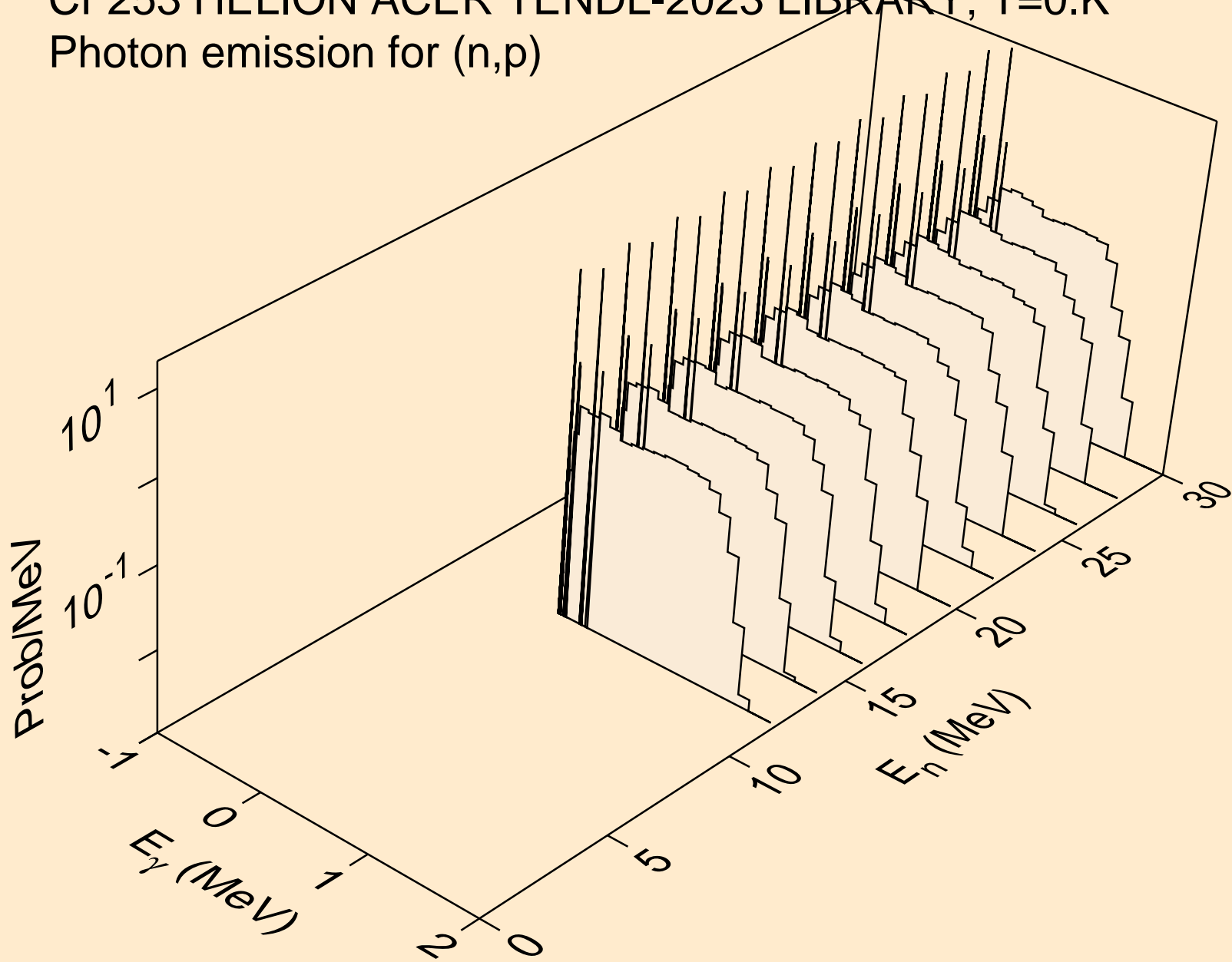

CF253 HELION ACER TENDL-2023 LIBRARY; T=0.K
Photon emission for (n,d)

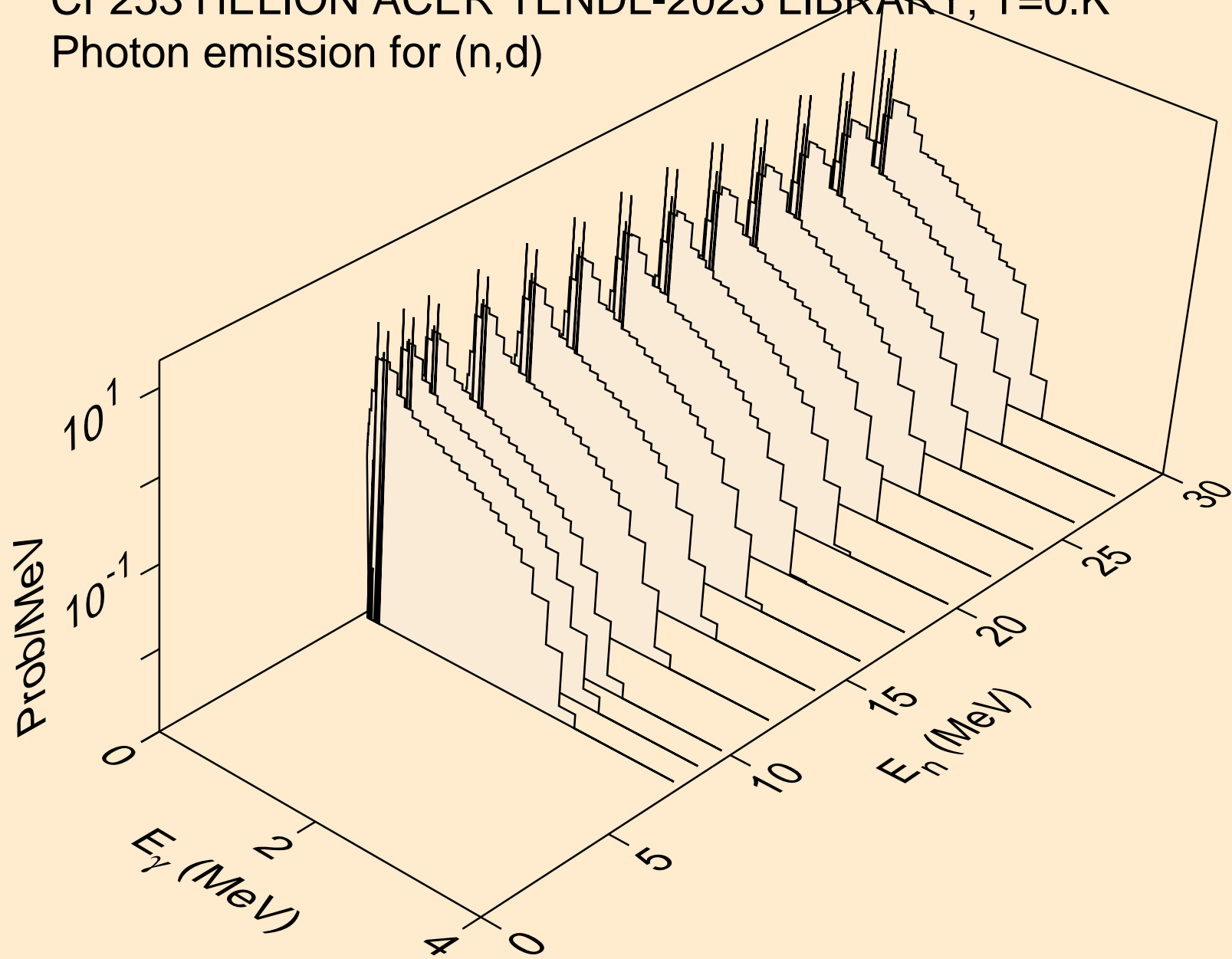

CF253 HELION ACER TENDL-2023 LIBRARY; T=0.K
Photon emission for (n,t)

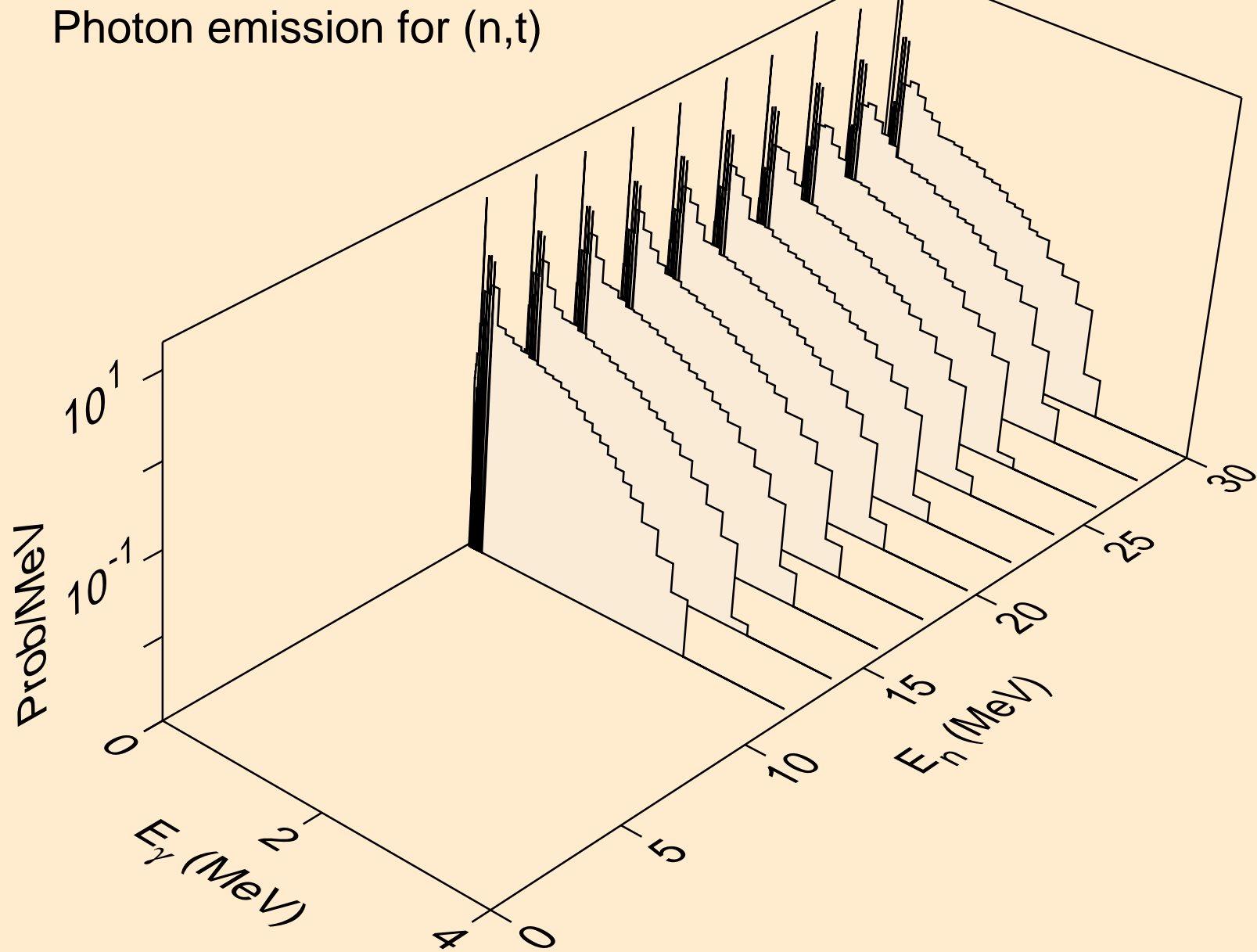

CF253 HELION ACER TENDL-2023 LIBRARY; T=0.K
Photon emission for inelastic

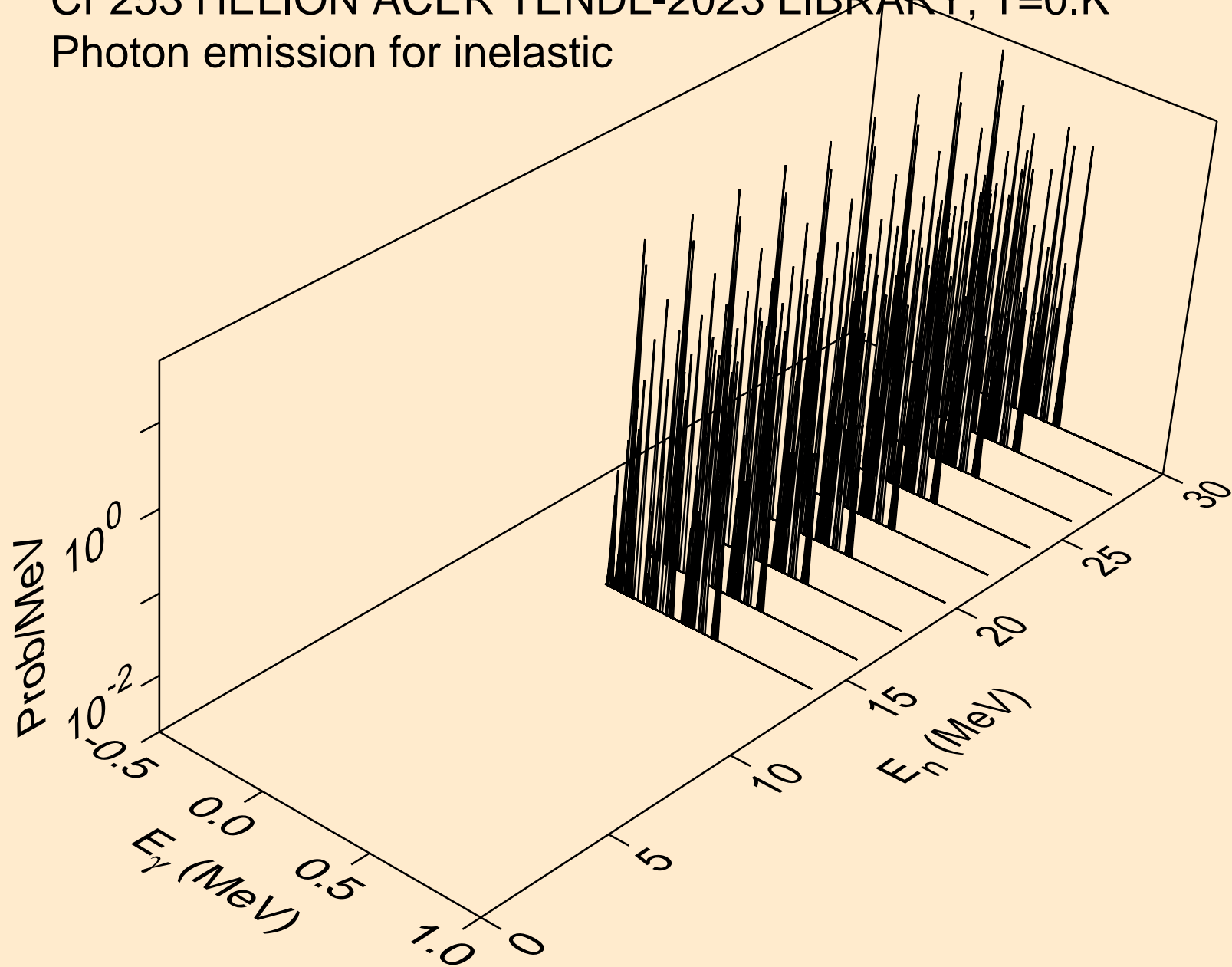

CF253 HELION ACER TENDL-2023 LIBRARY; T=0.K
Photon emission for (n,a)

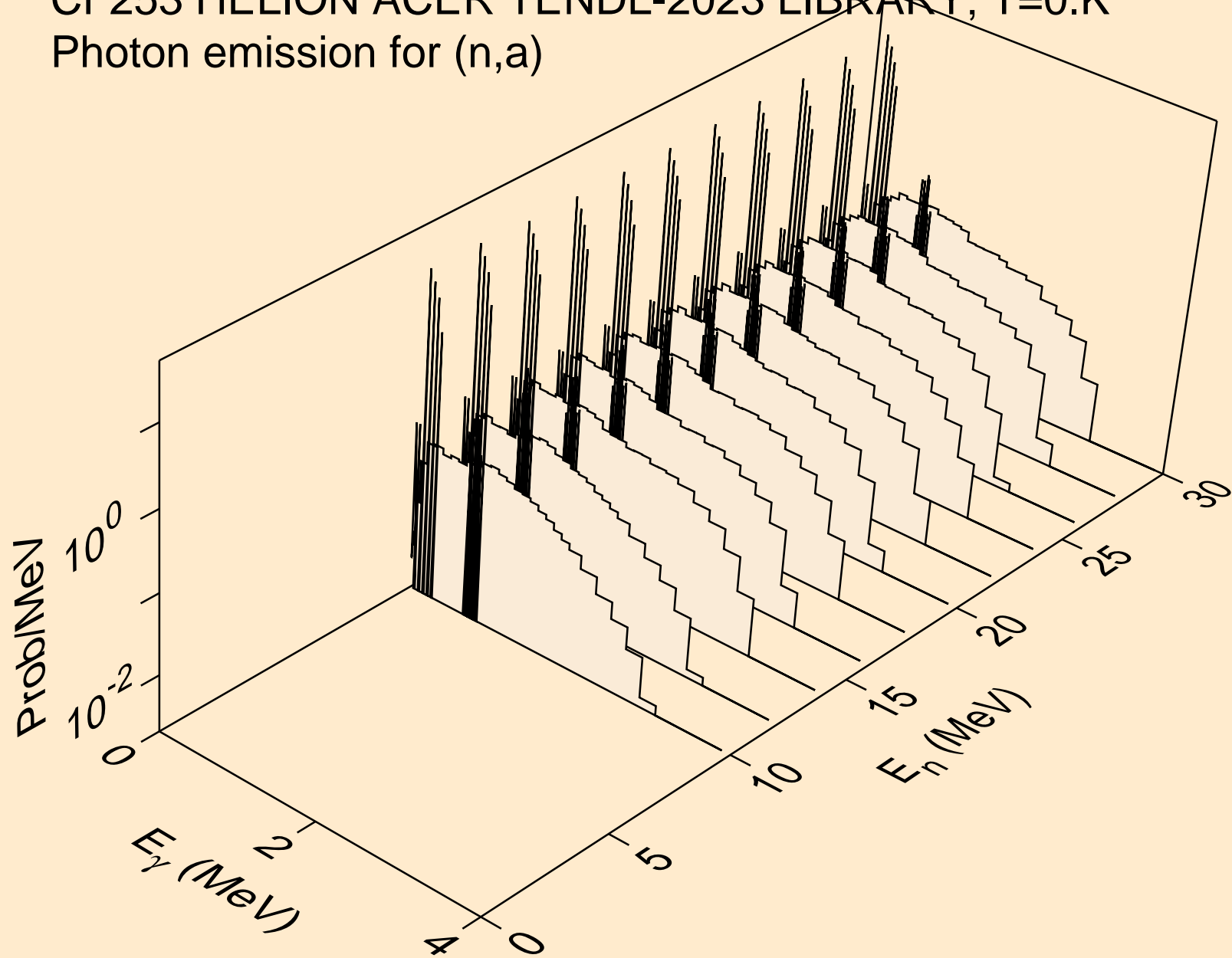

CF253 HELION ACER TENDL-2023 LIBRARY; T=0.K
Photon emission for (n,2p)

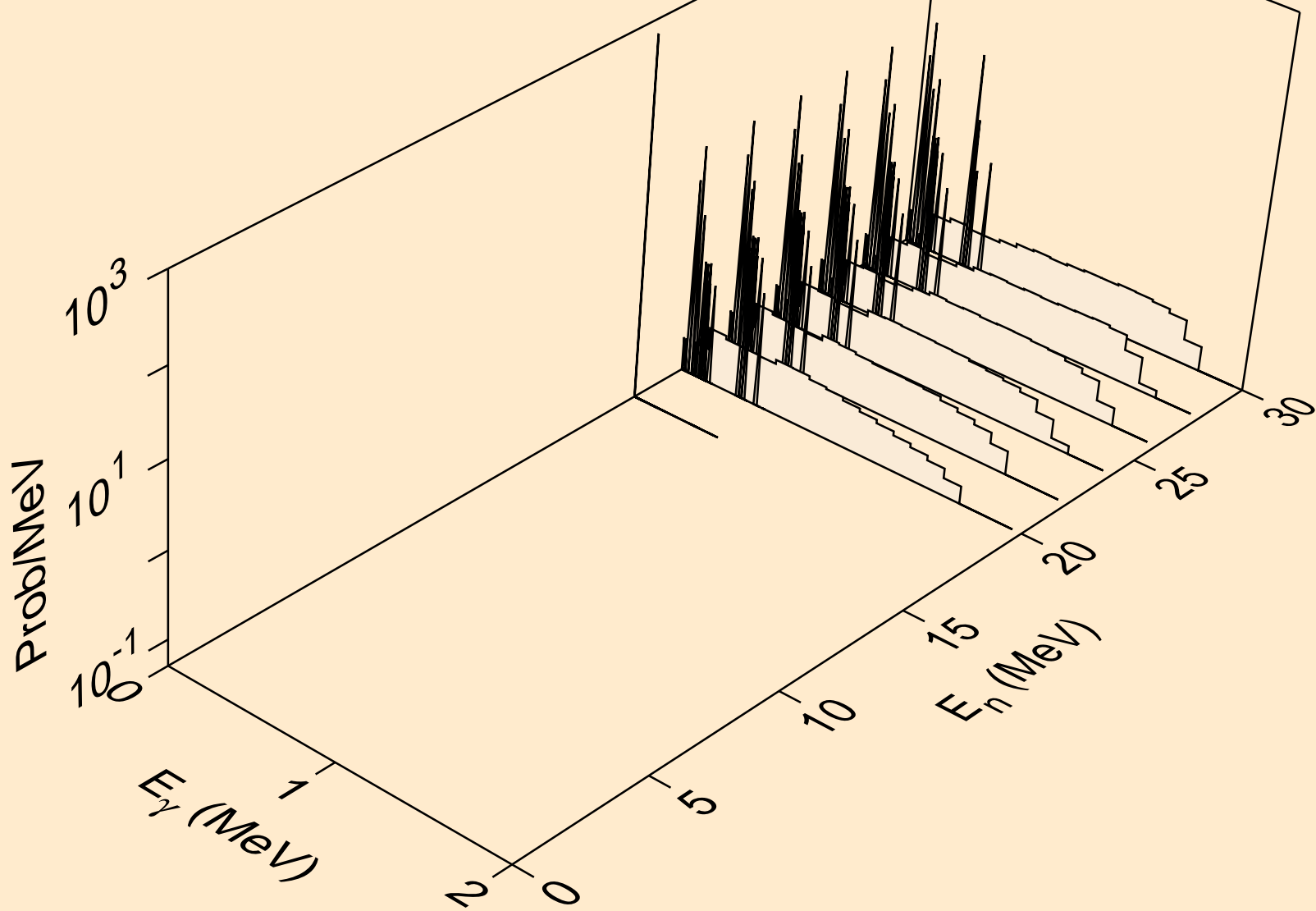

CF253 HELION ACER TENDL-2023 LIBRARY; T=0.K
Particle heating contributions

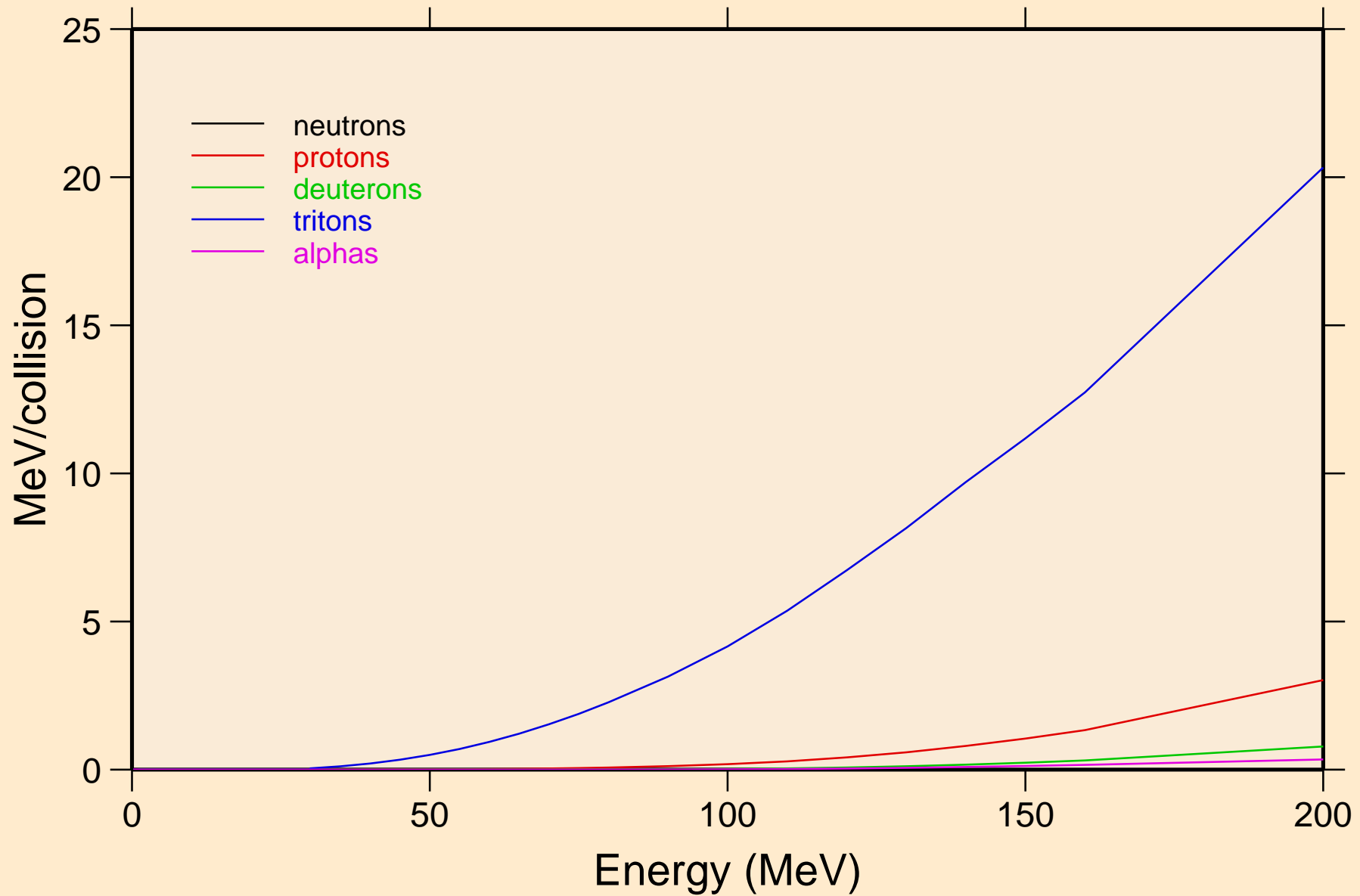

CF253 HELION ACER TENDL-2023 LIBRARY; T=0.K
Recoil Heating

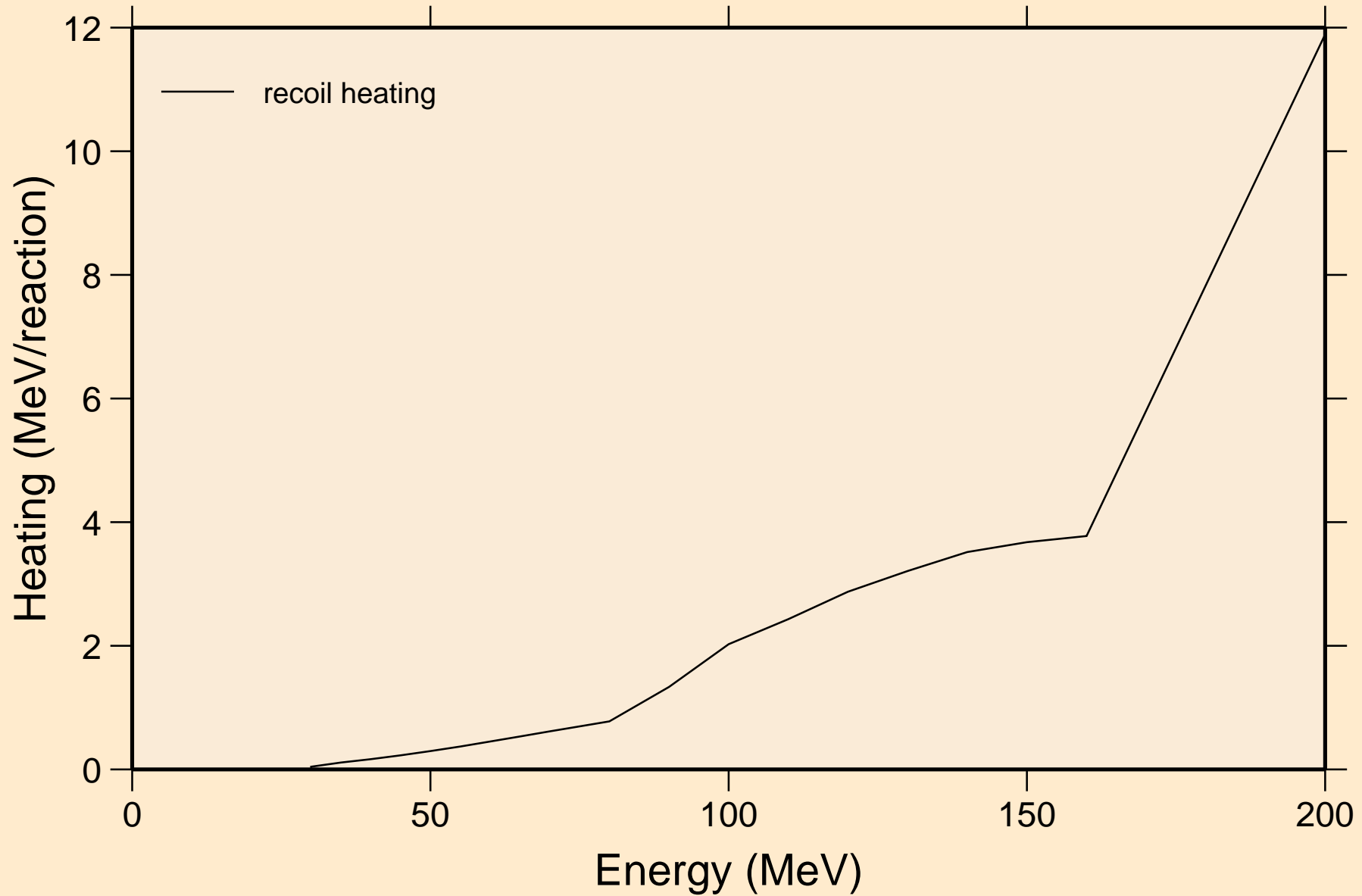

CF253 HELION ACER TENDL-2023 LIBRARY; T=0.K
Particle production cross sections

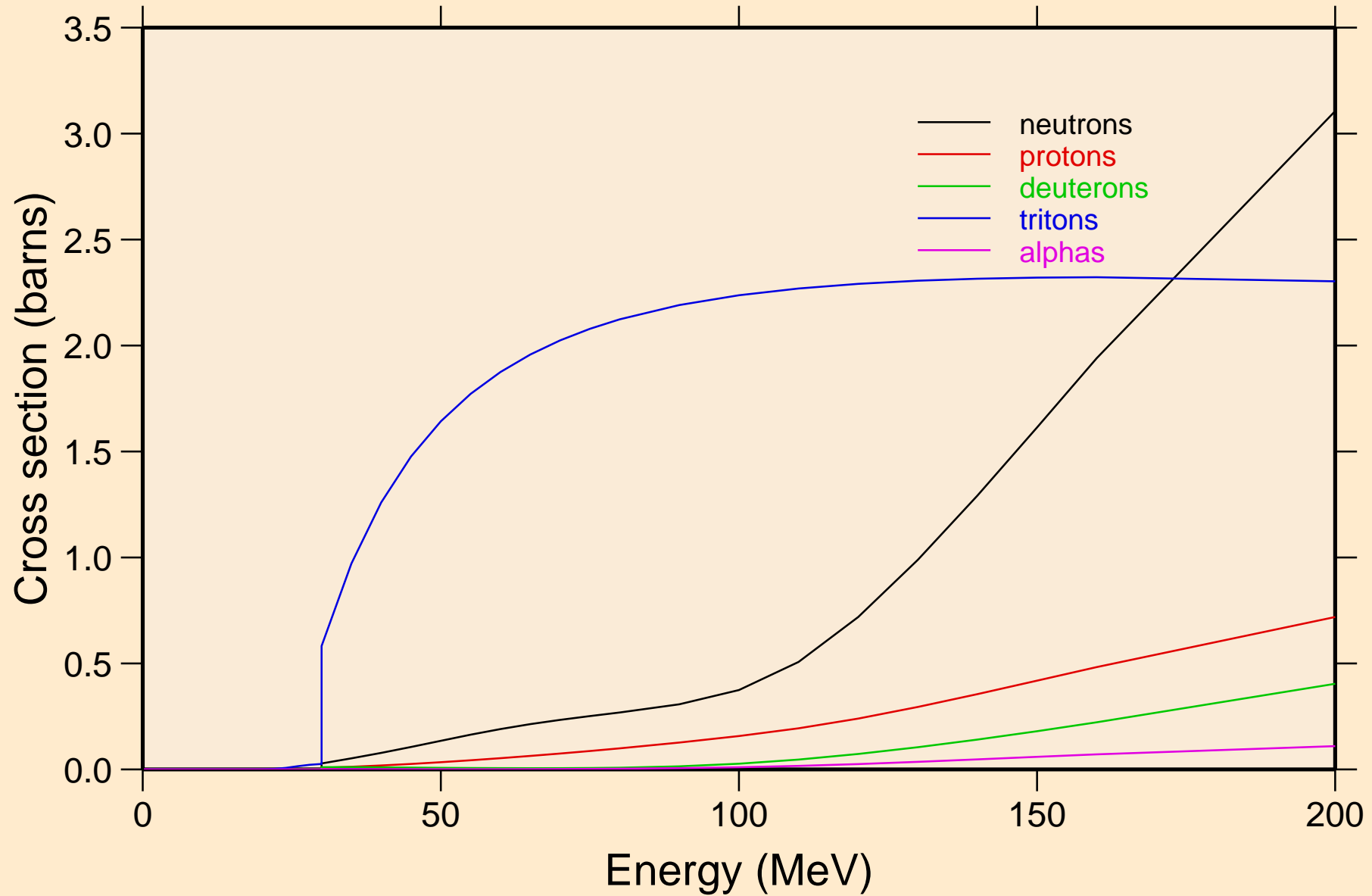

CF253 HELION ACER TENDL-2023 LIBRARY; T=0.K
neutrons from (s,n)

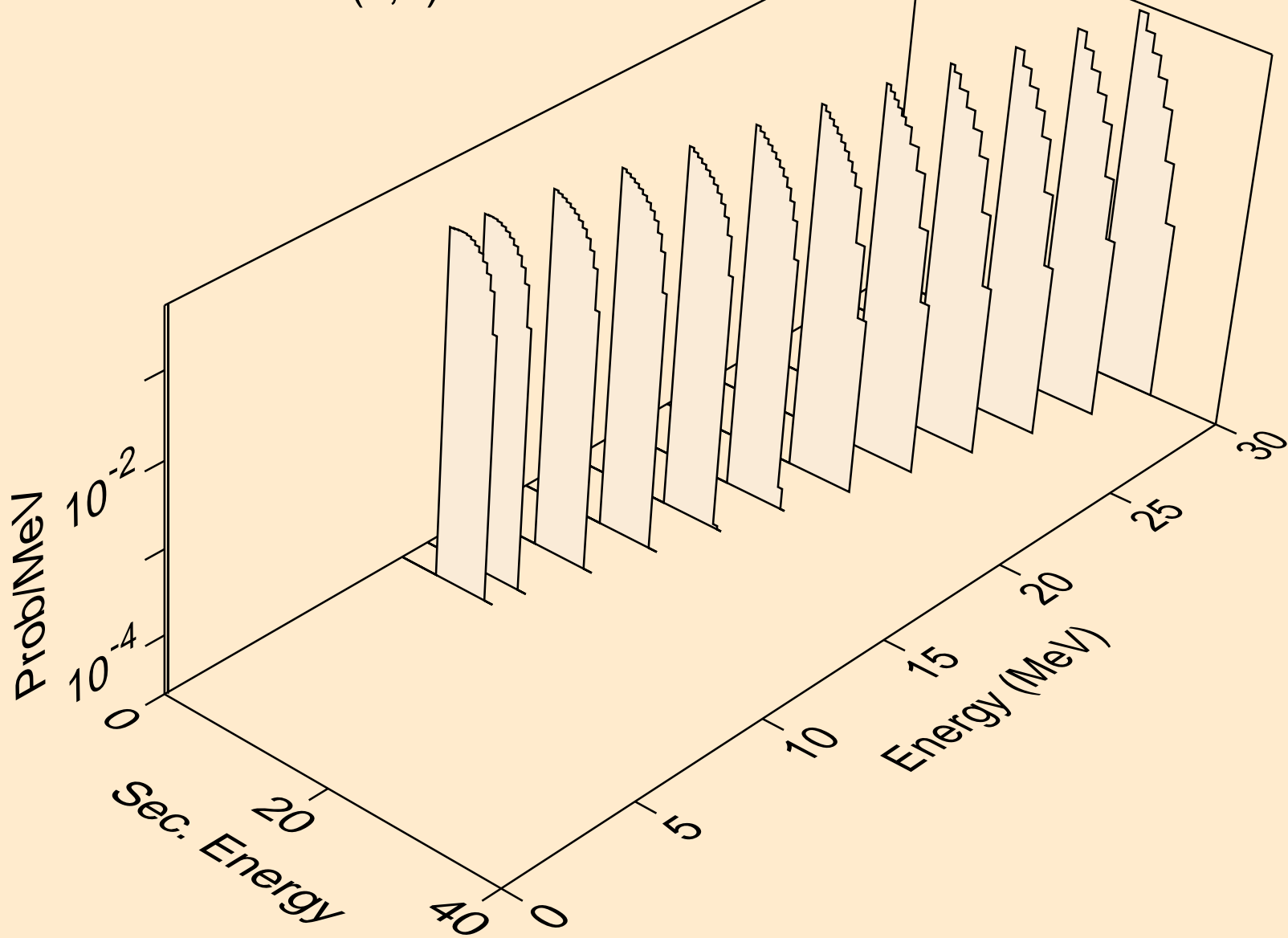

CF253 HELION ACER TENDL-2023 LIBRARY; T=0.K
neutrons from (s,x)

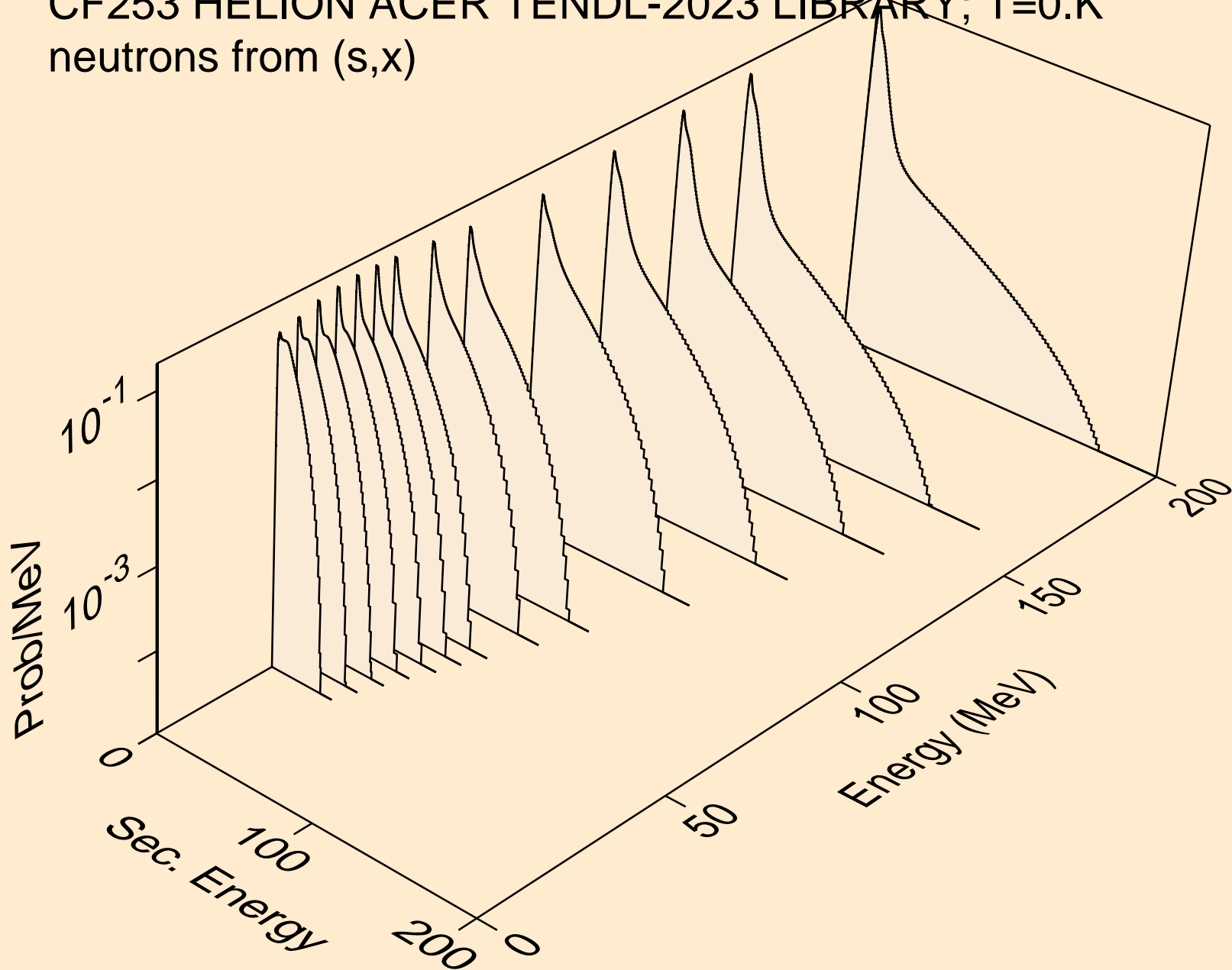

CF253 HELION ACER TENDL-2023 LIBRARY; T=0.K
neutrons from (s,2nd)

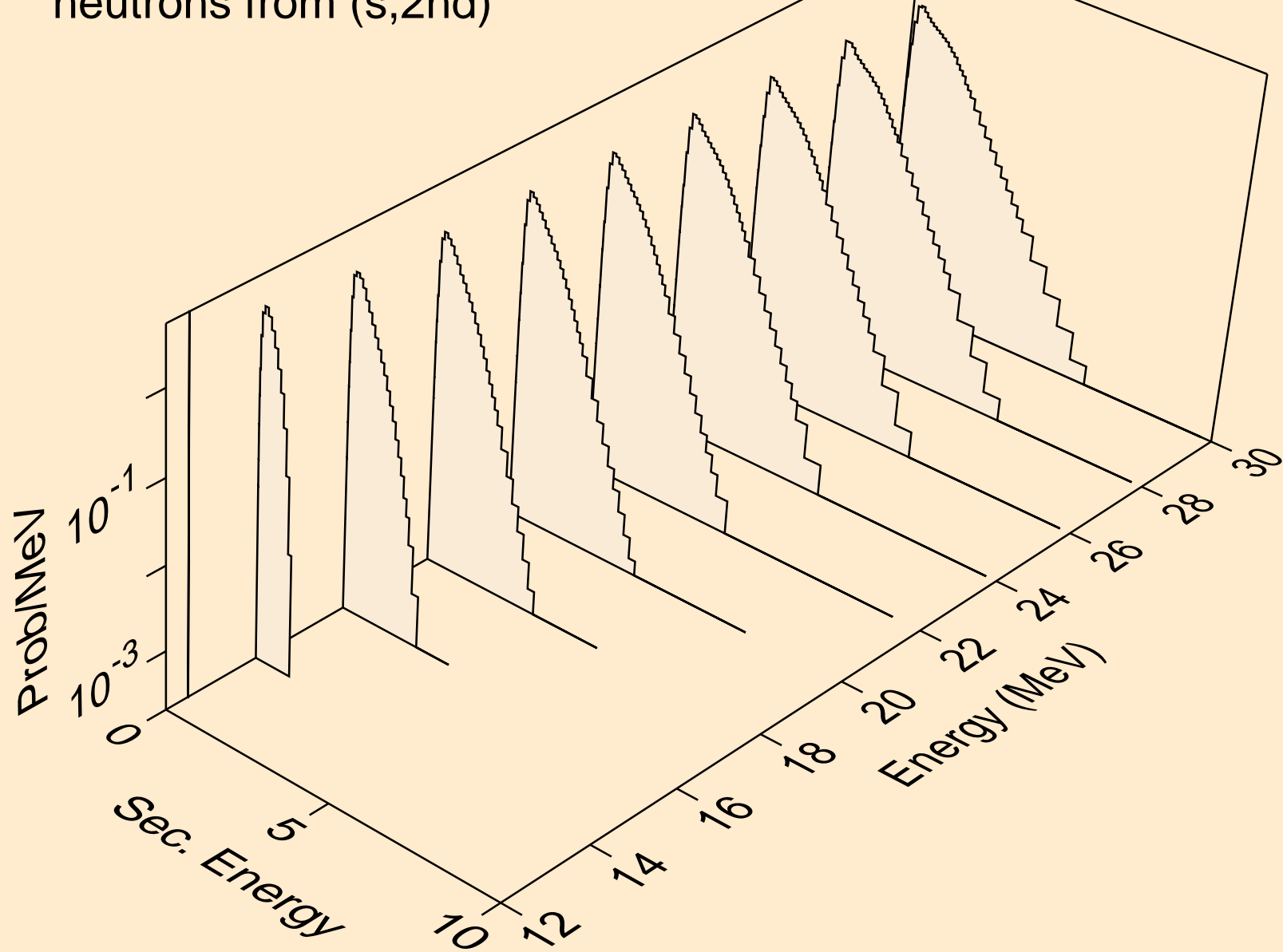

CF253 HELION ACER TENDL-2023 LIBRARY; T=0.K
neutrons from (s,2n)

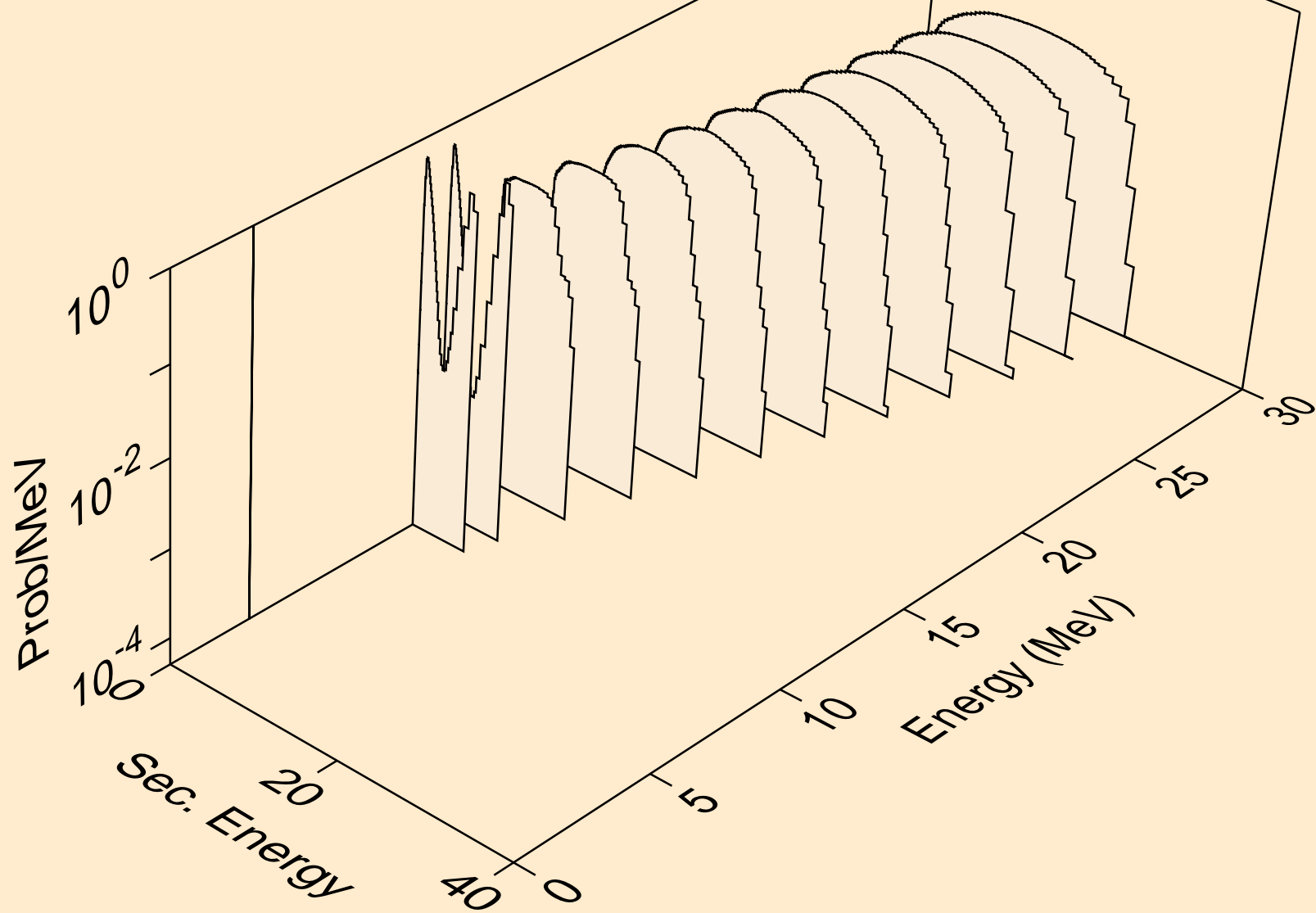

CF253 HELION ACER TENDL-2023 LIBRARY; T=0.K
neutrons from (s,3n)

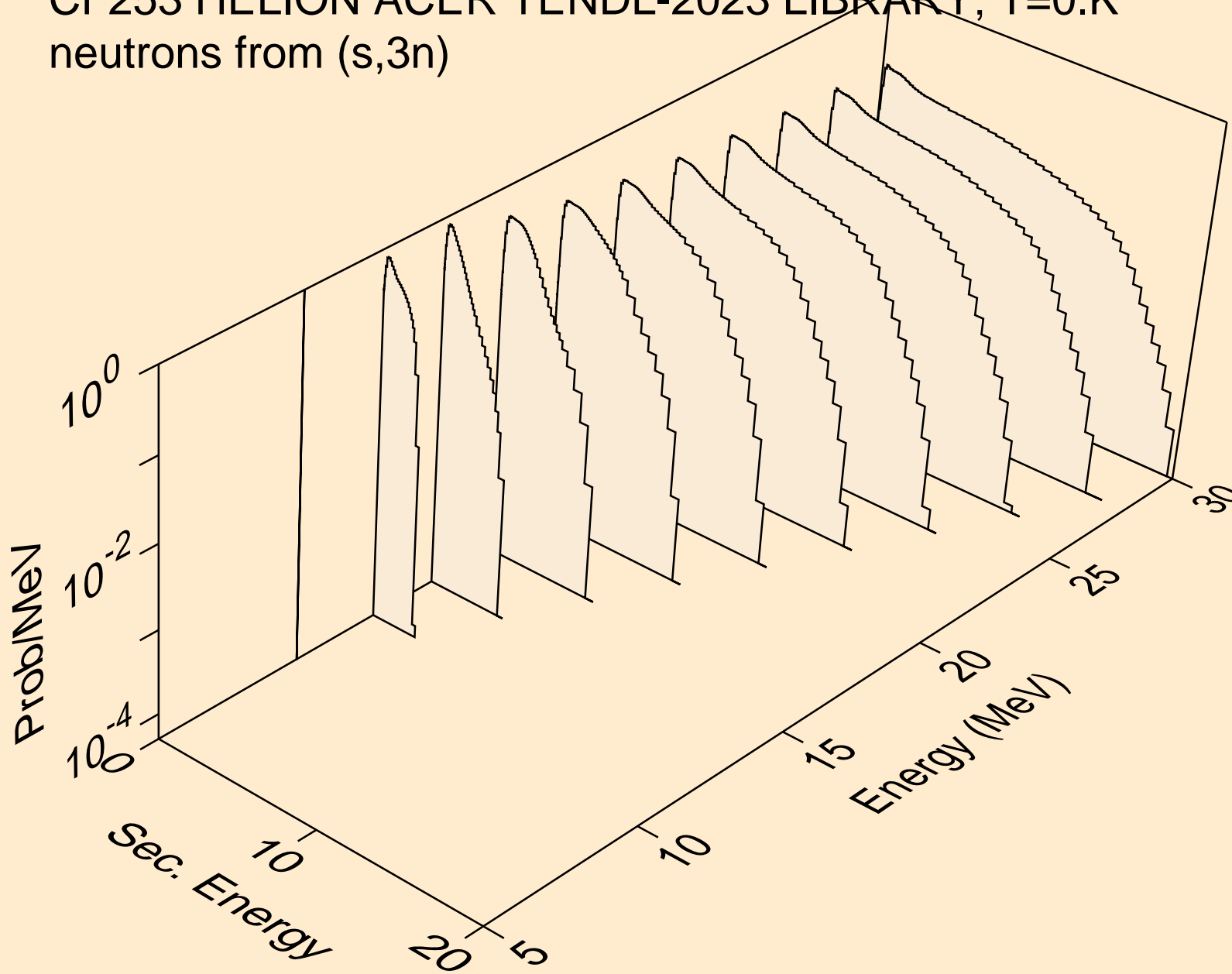

CF253 HELION ACER TENDL-2023 LIBRARY; T=0.K
neutrons from (s,n*)a

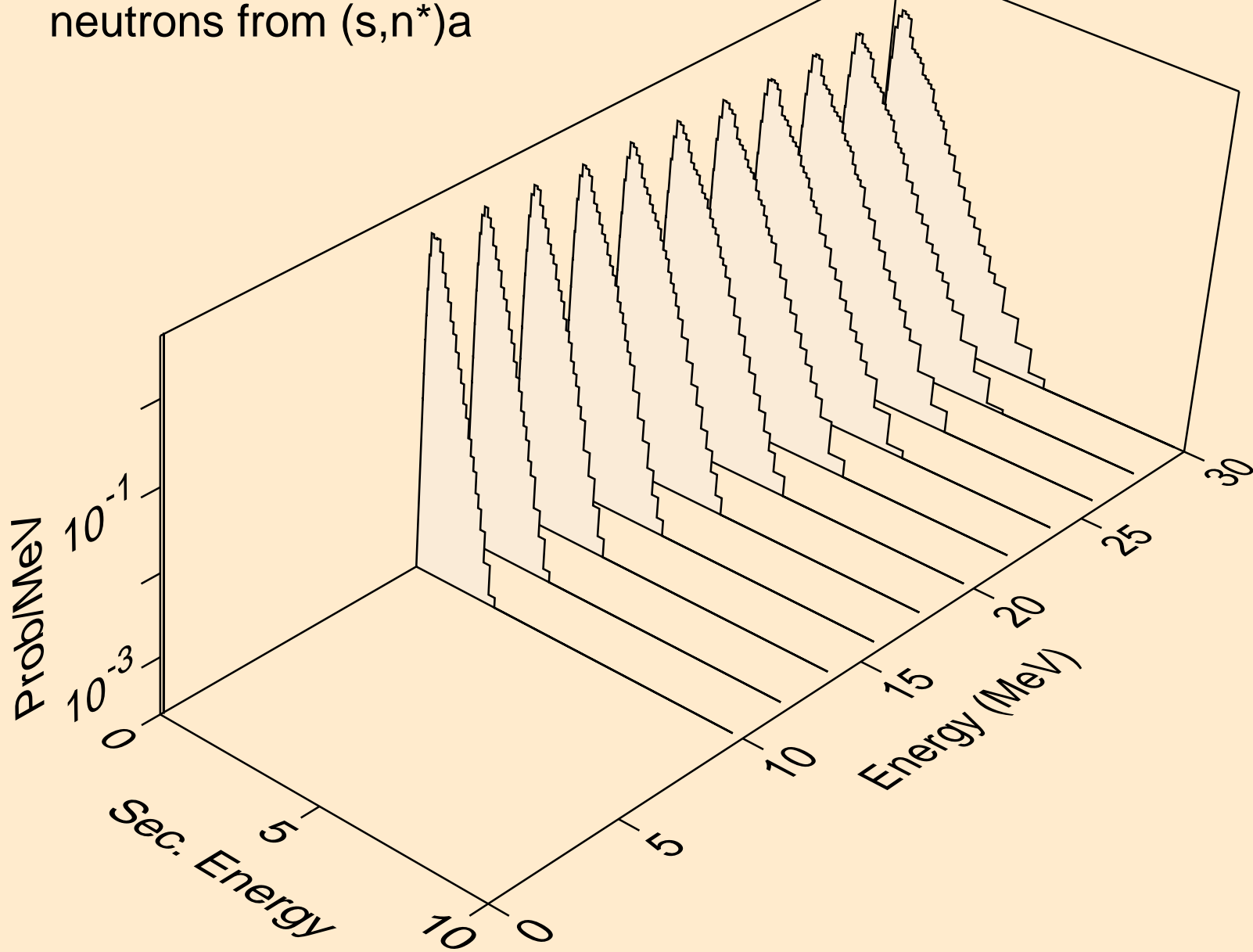

CF253 HELION ACER TENDL-2023 LIBRARY; T=0.K
neutrons from (s,2n)a

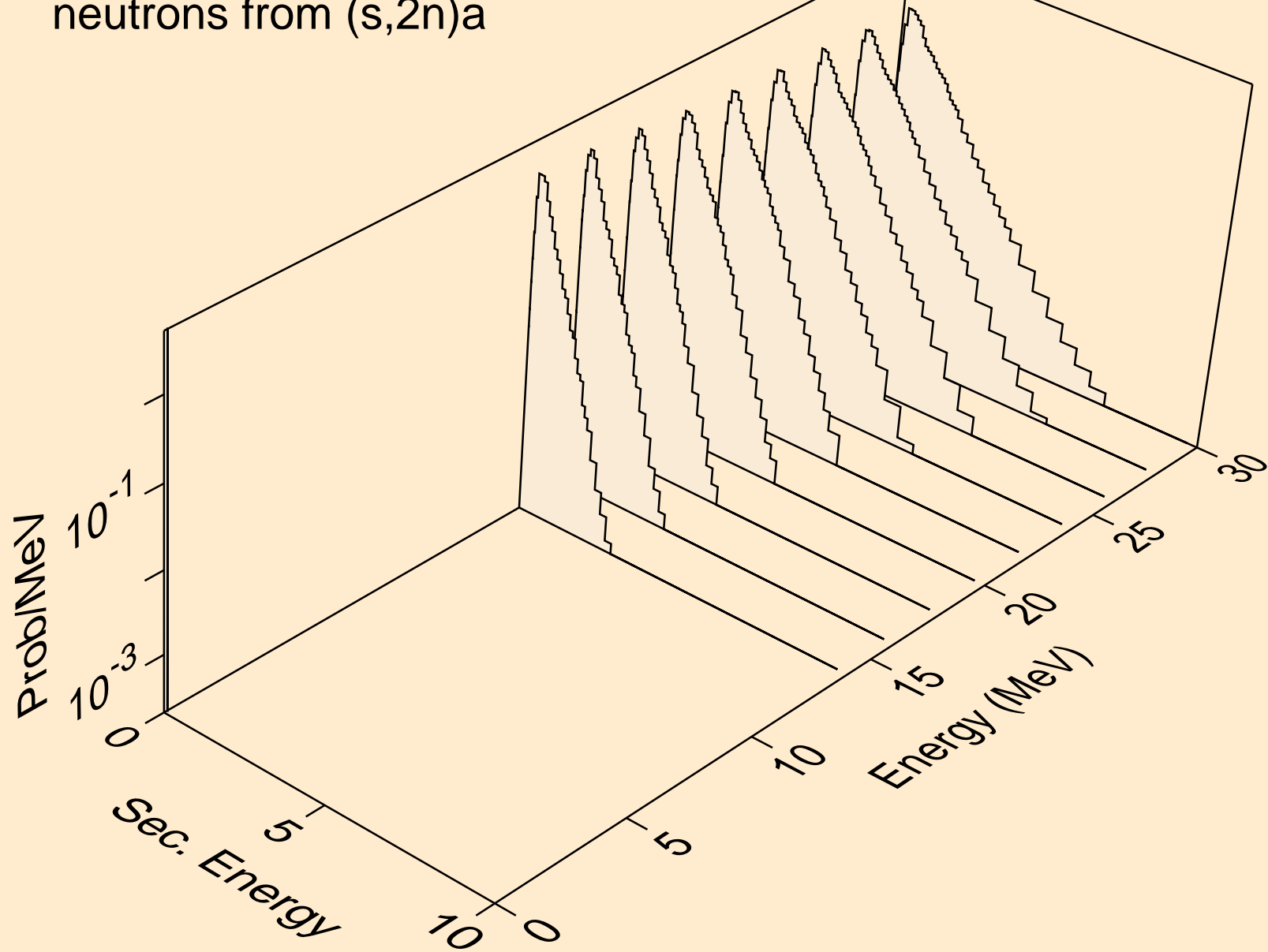

CF253 HELION ACER TENDL-2023 LIBRARY; T=0.K
neutrons from (s,n*)p

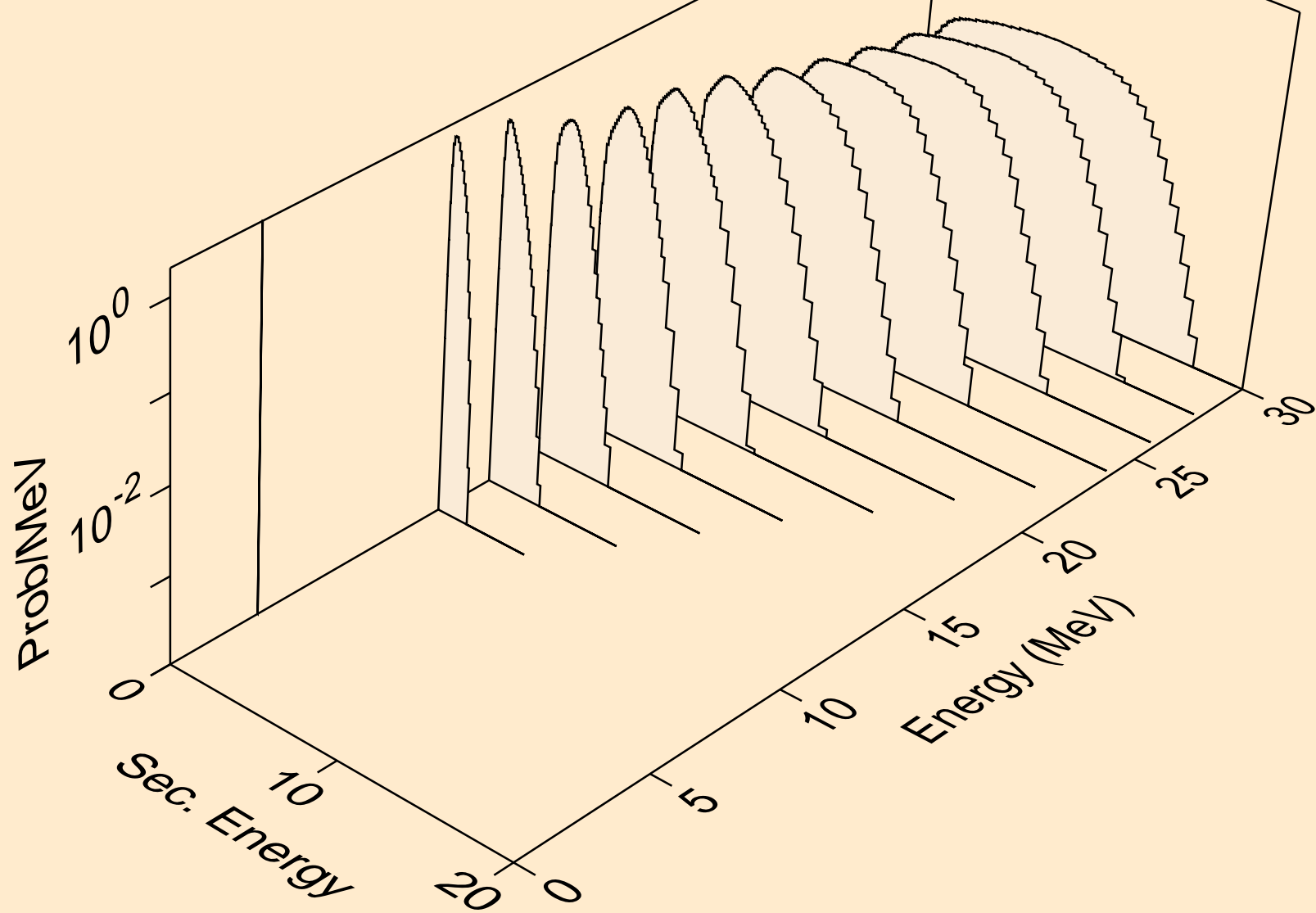

CF253 HELION ACER TENDL-2023 LIBRARY; T=0.K
neutrons from (s,n*)d

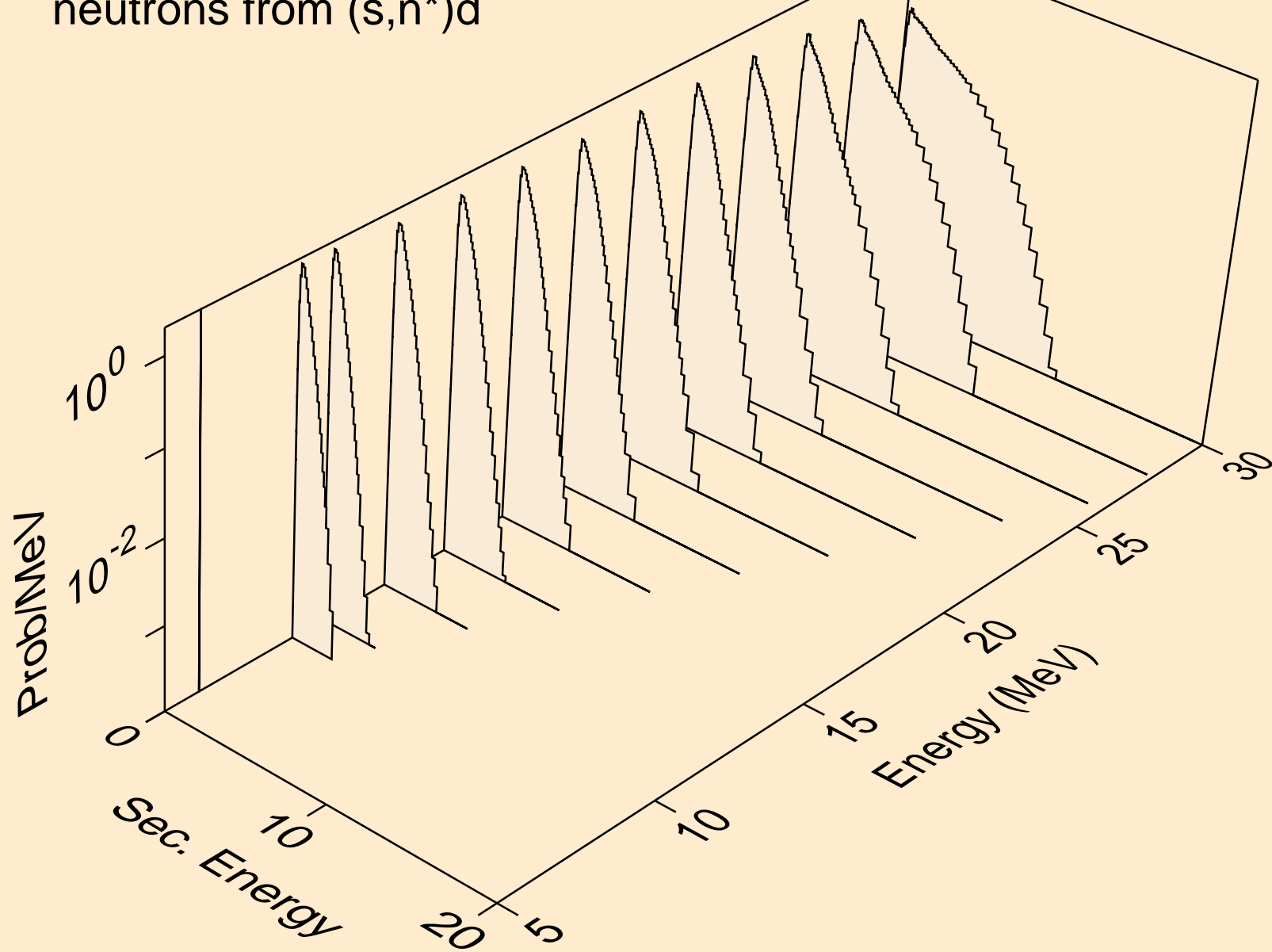

CF253 HELION ACER TENDL-2023 LIBRARY; T=0.K
neutrons from (s,n*)t

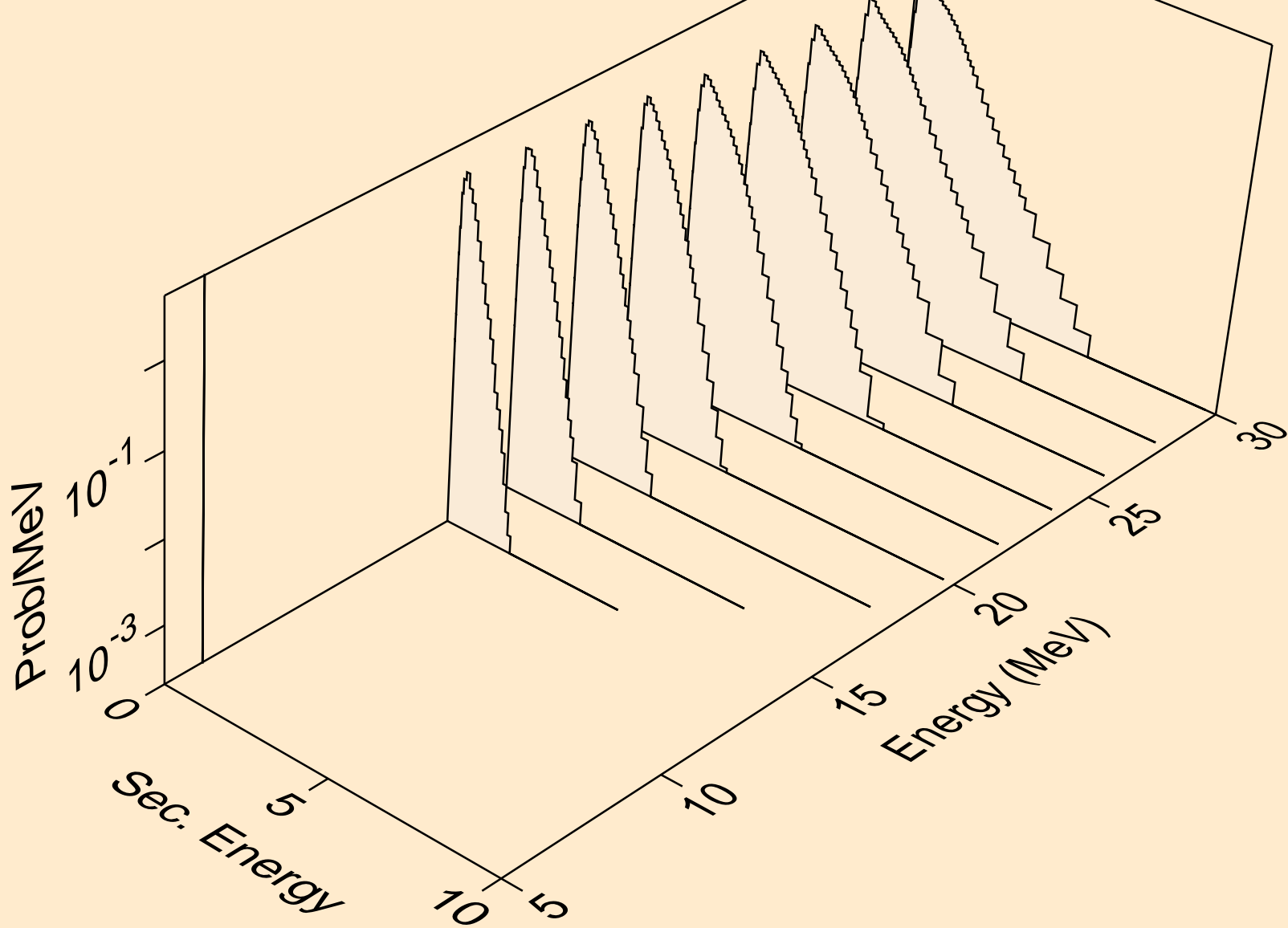

CF253 HELION ACER TENDL-2023 LIBRARY; T=0.K
neutrons from (s,n*)he3

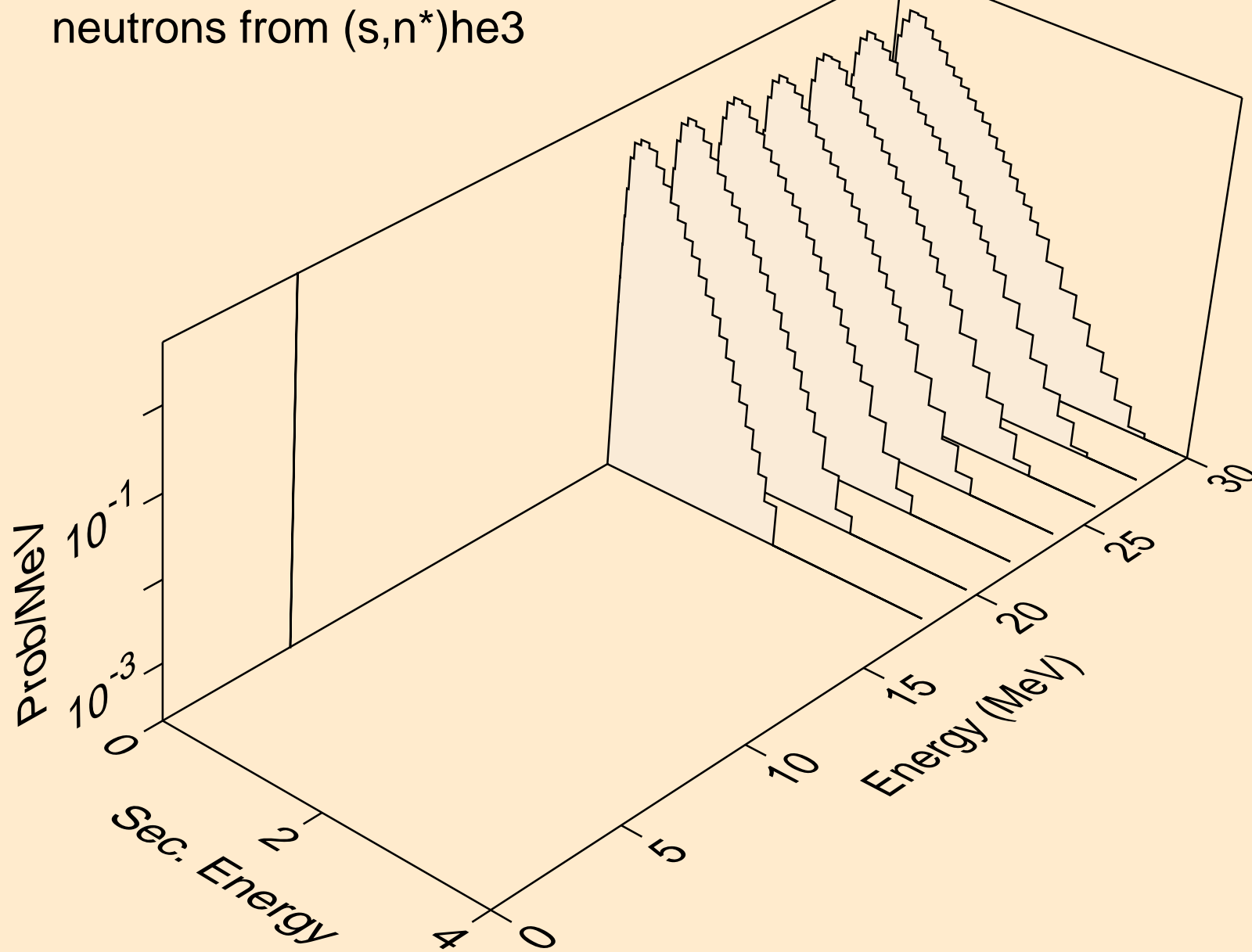

CF253 HELION ACER TENDL-2023 LIBRARY; T=0.K
neutrons from (s,4n)

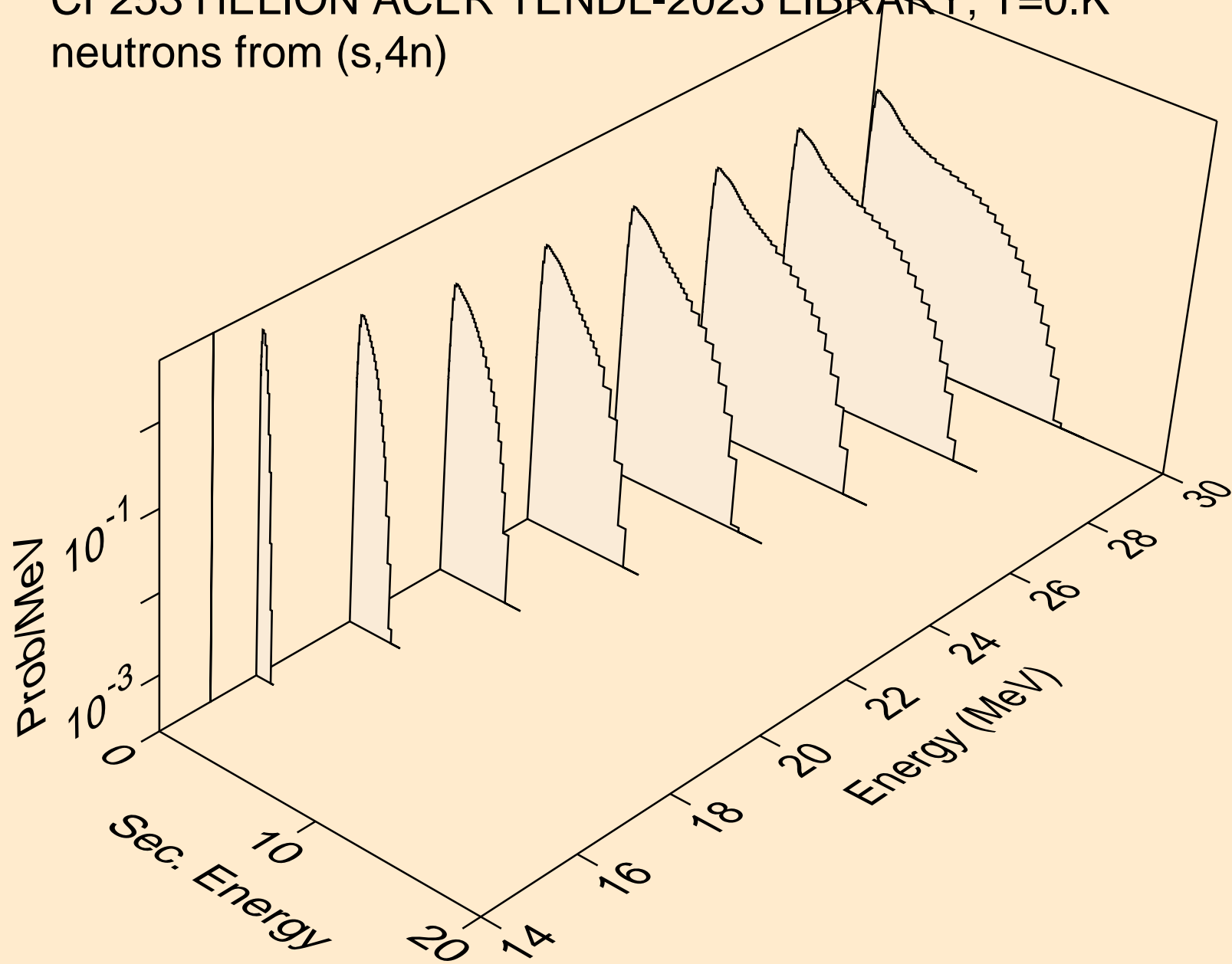

CF253 HELION ACER TENDL-2023 LIBRARY; T=0.K
neutrons from (s,2np)

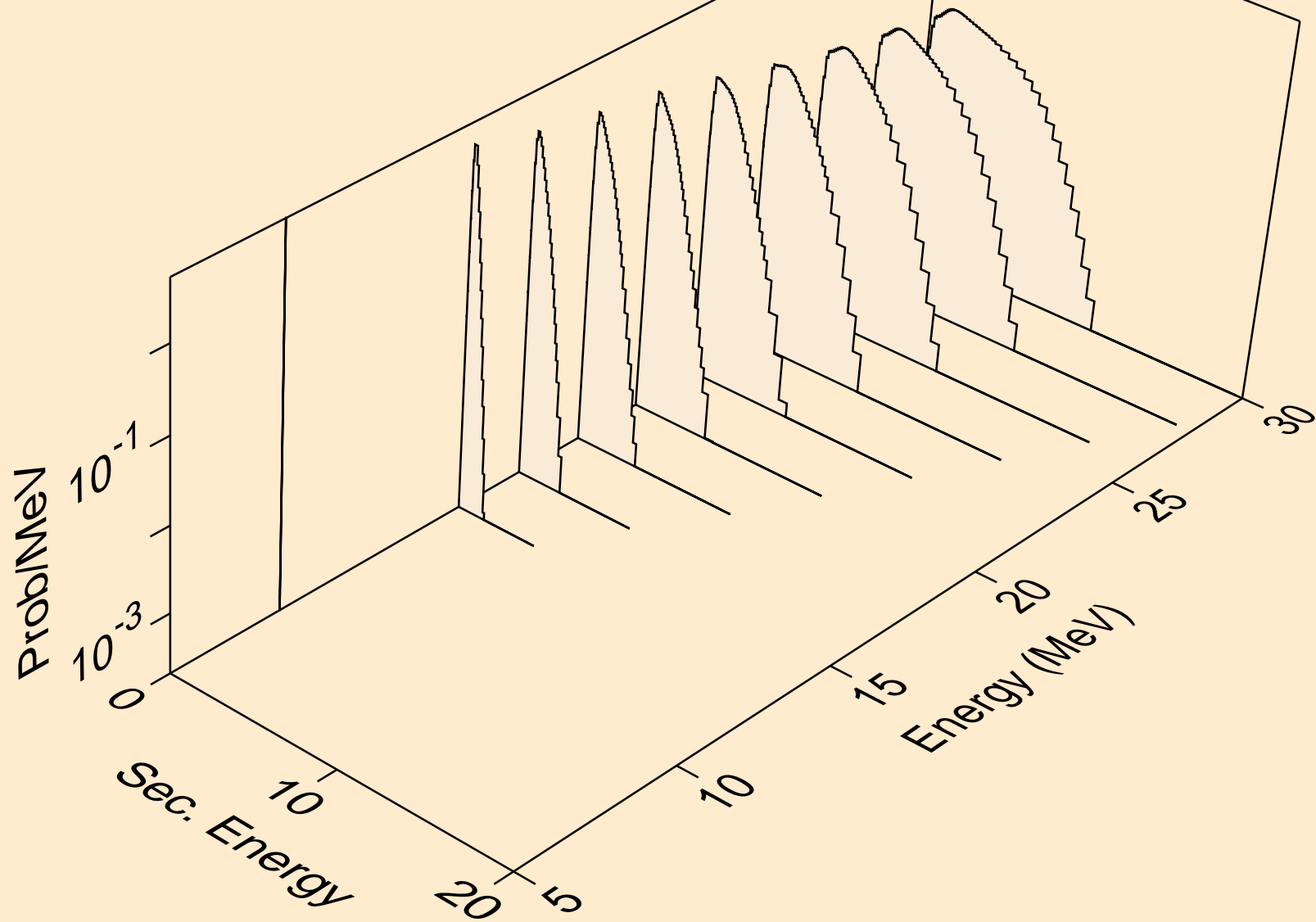

CF253 HELION ACER TENDL-2023 LIBRARY; T=0.K
protons from (s,x)

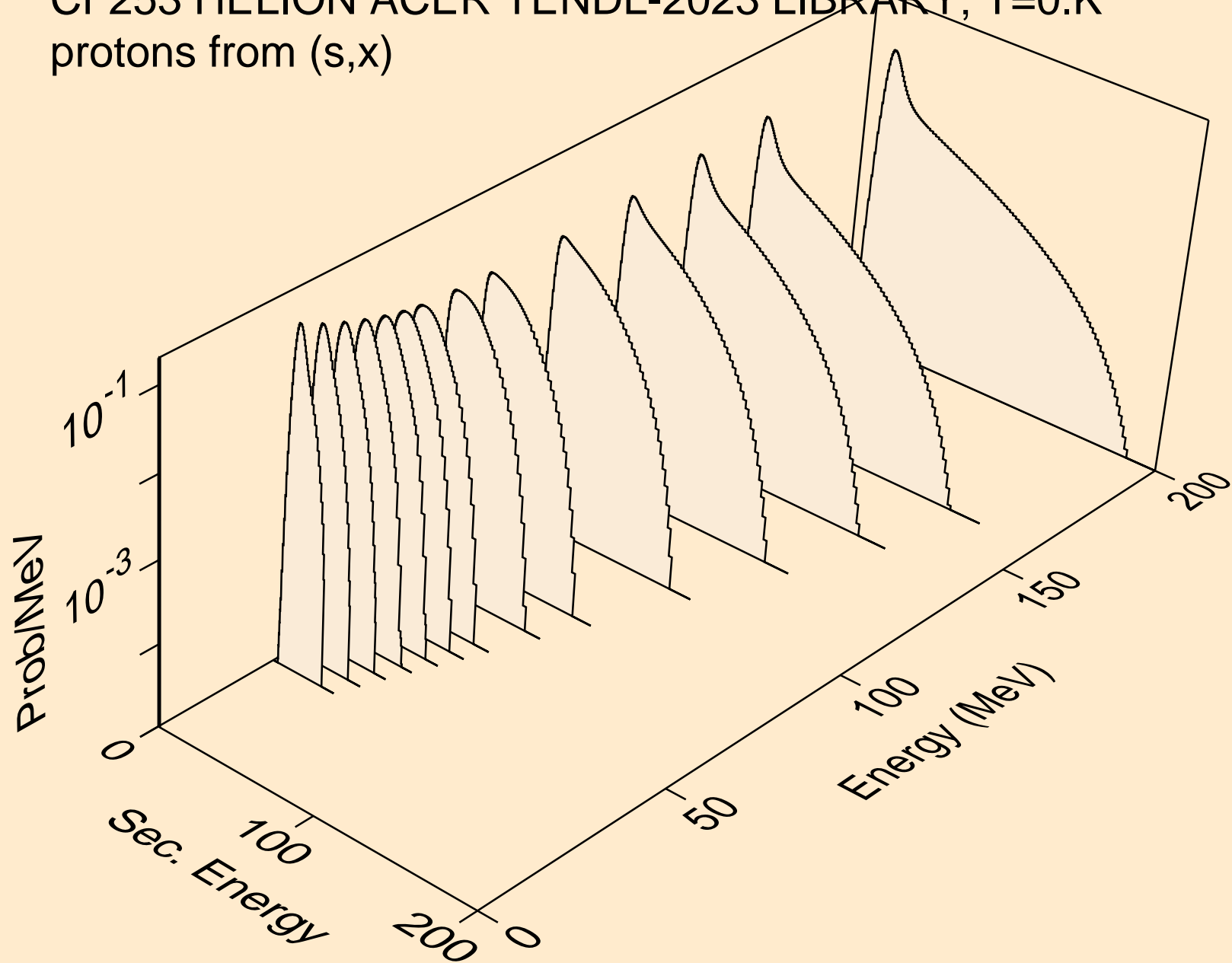

CF253 HELION ACER TENDL-2023 LIBRARY; T=0.K
protons from (s,n*)p

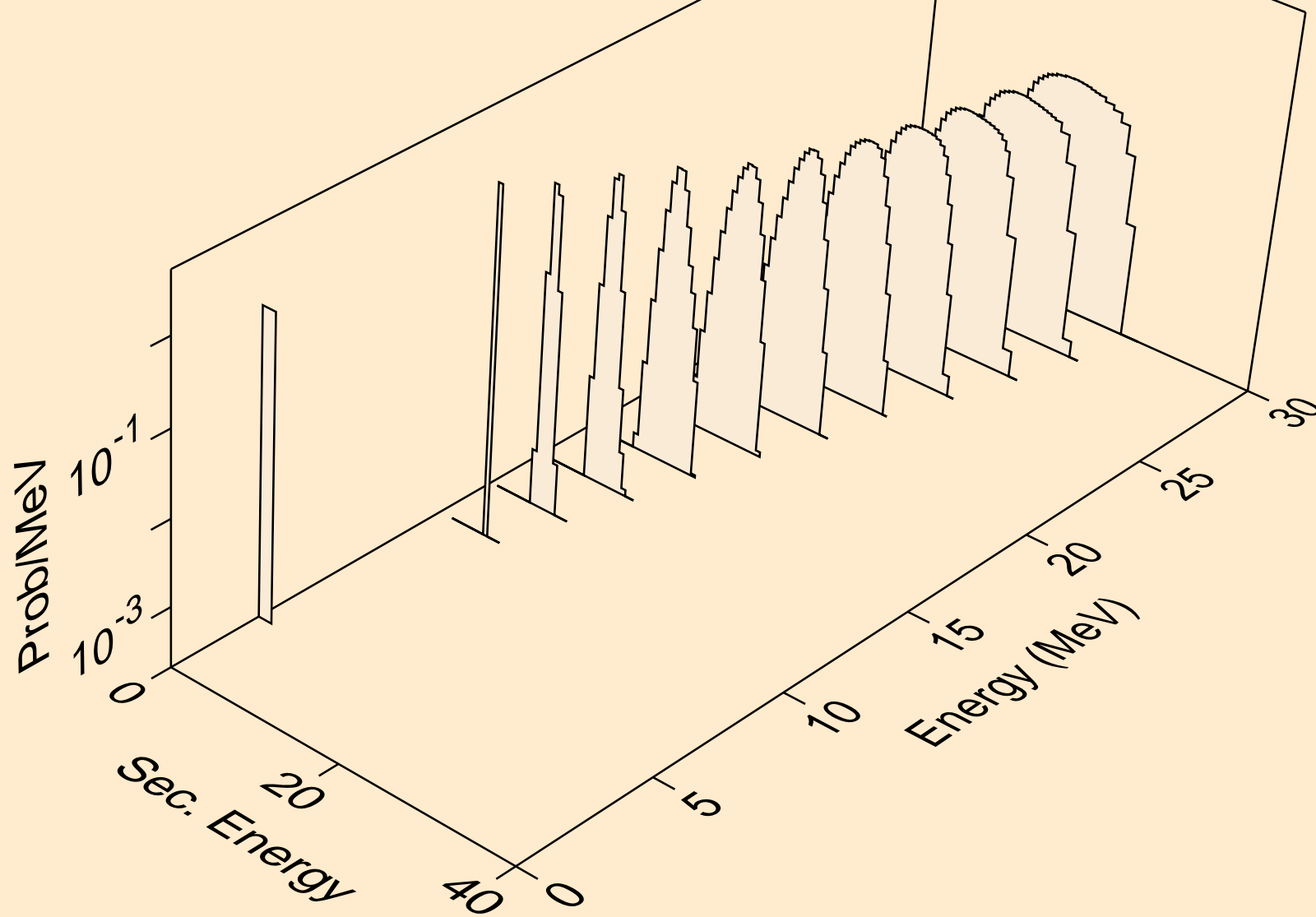

CF253 HELION ACER TENDL-2023 LIBRARY; T=0.K
protons from (s,2np)

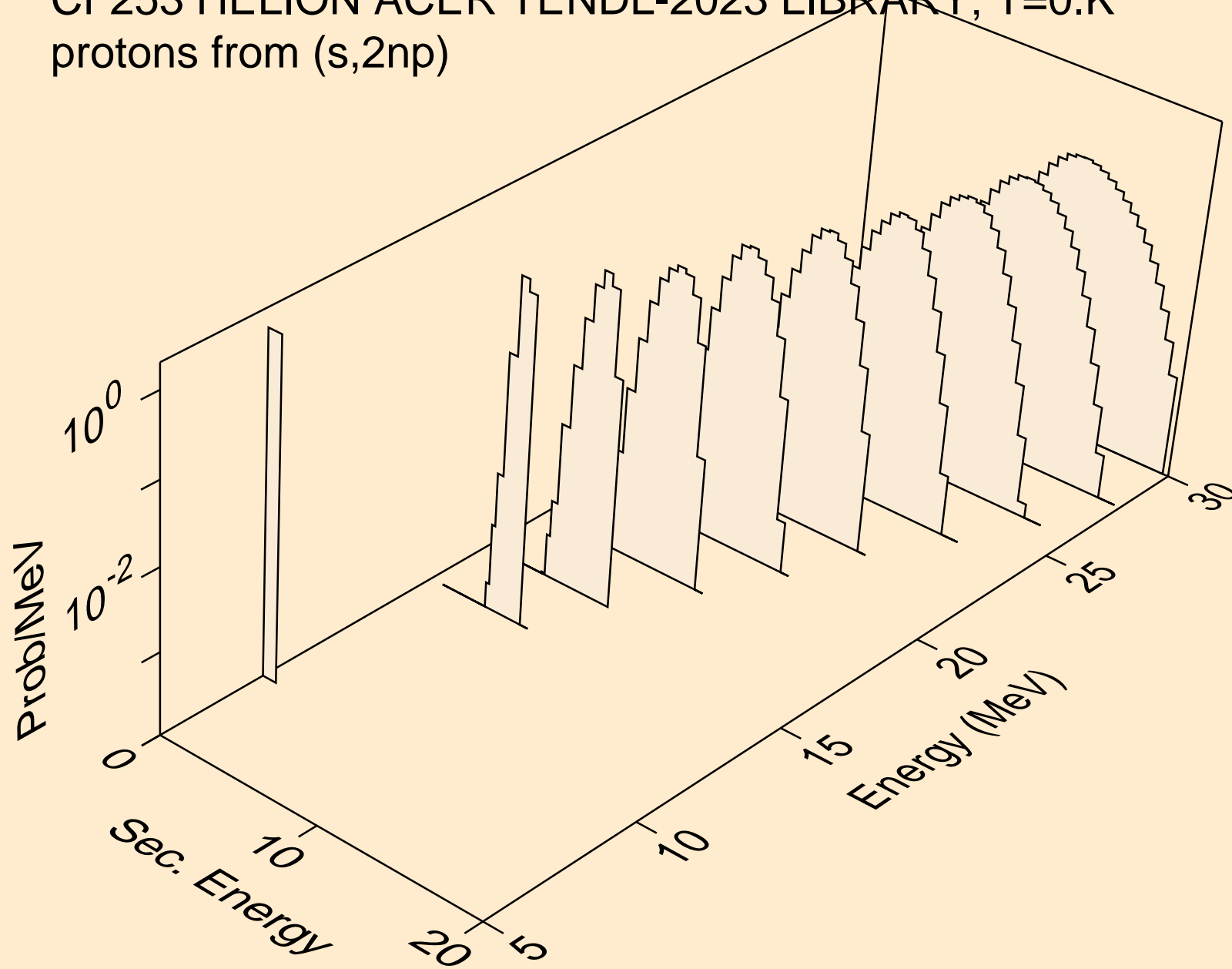

CF253 HELION ACER TENDL-2023 LIBRARY; T=0.K
protons from (s,p)

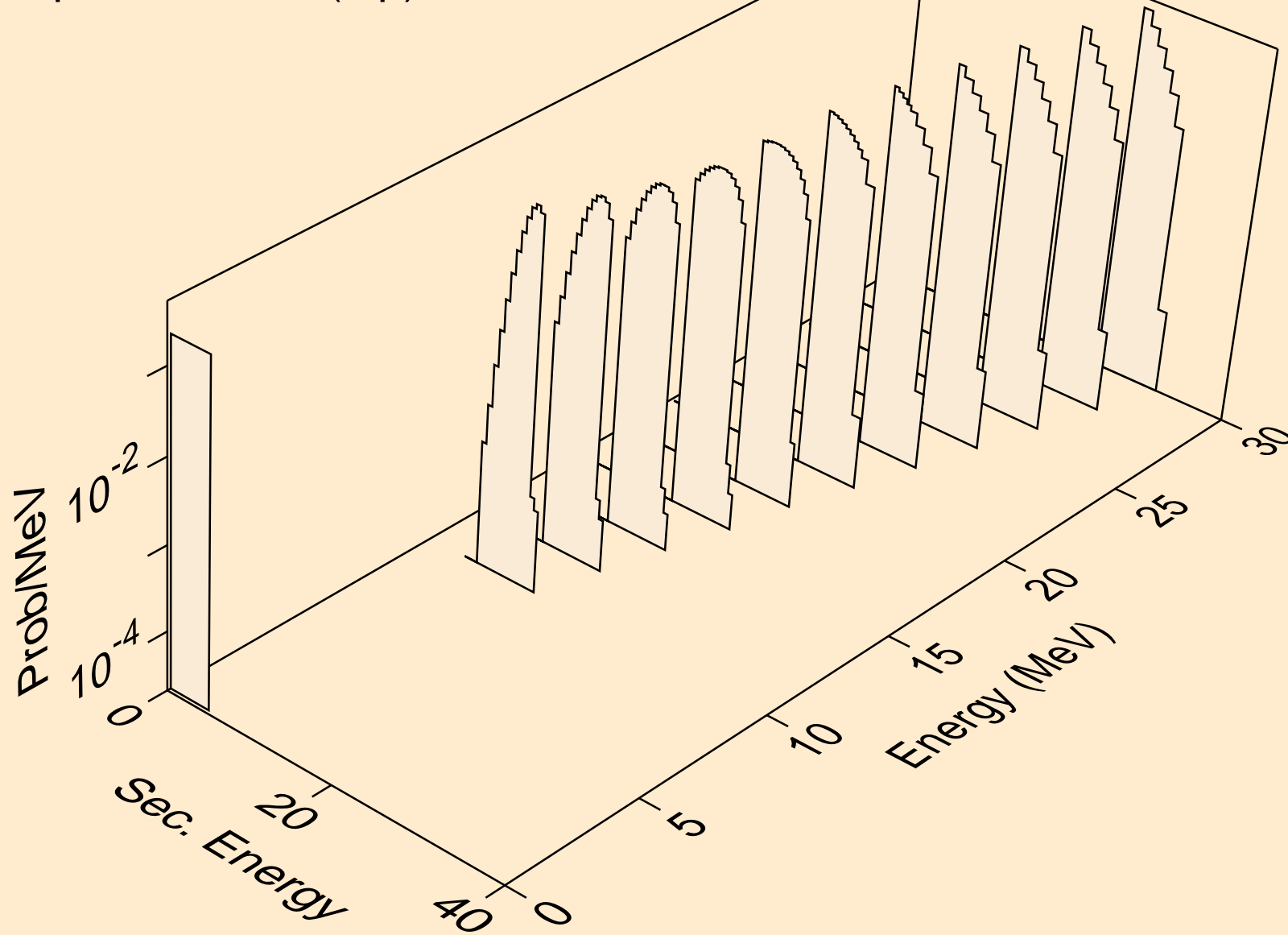

CF253 HELION ACER TENDL-2023 LIBRARY; T=0.K
protons from (s,2p)

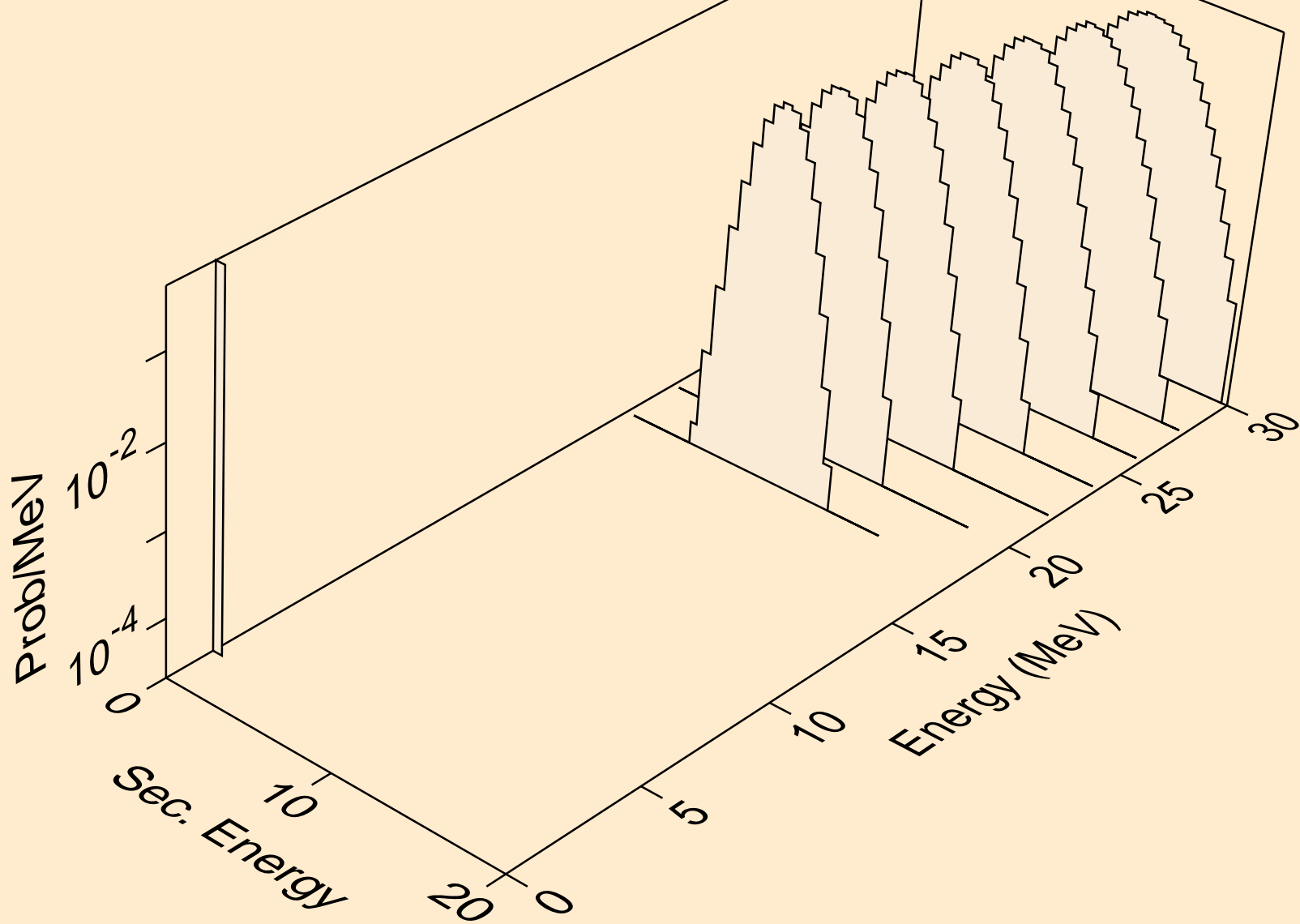

CF253 HELION ACER TENDL-2023 LIBRARY; T=0.K
deuterons from (s,x)

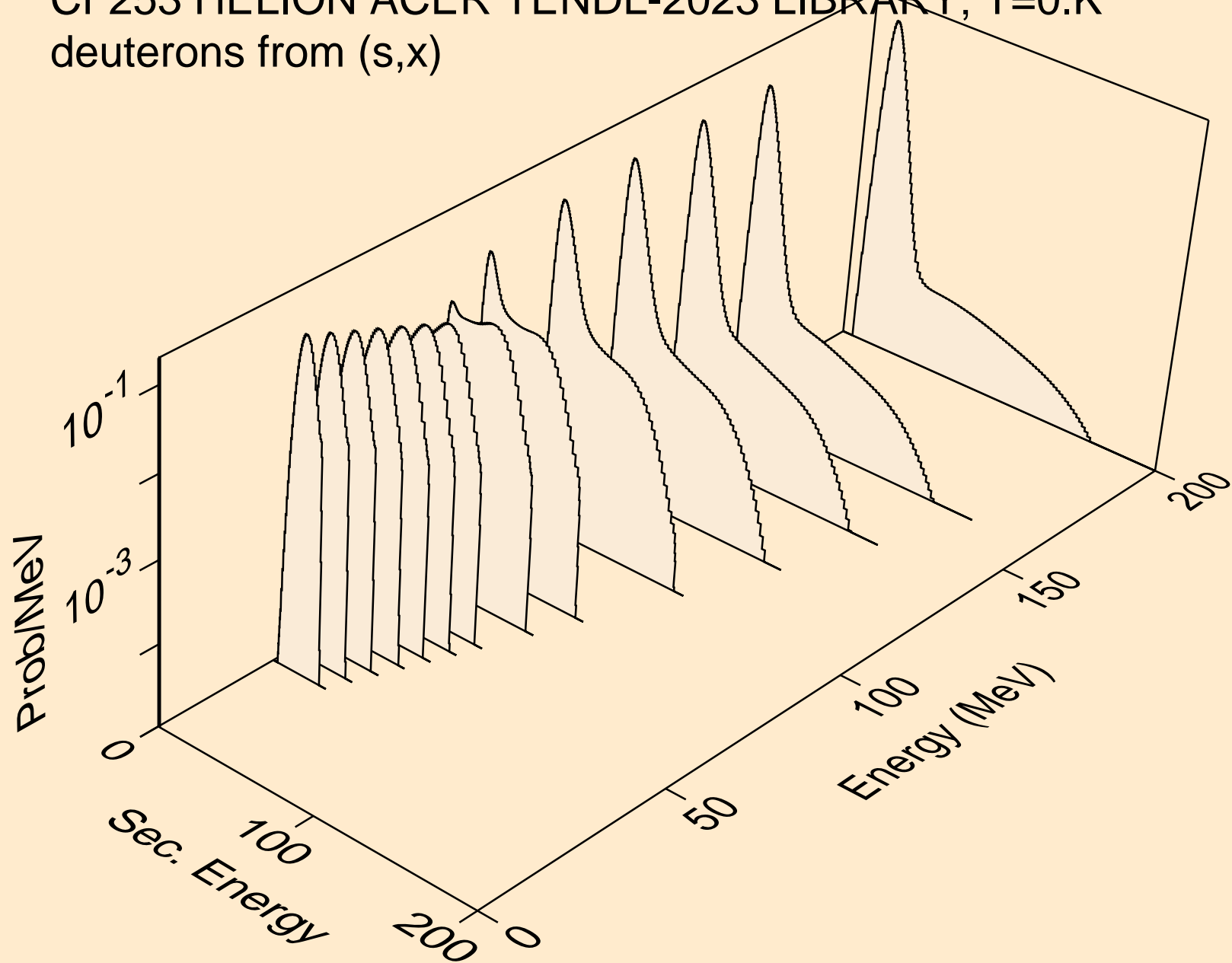

CF253 HELION ACER TENDL-2023 LIBRARY; T=0.K
deuterons from (s,2nd)

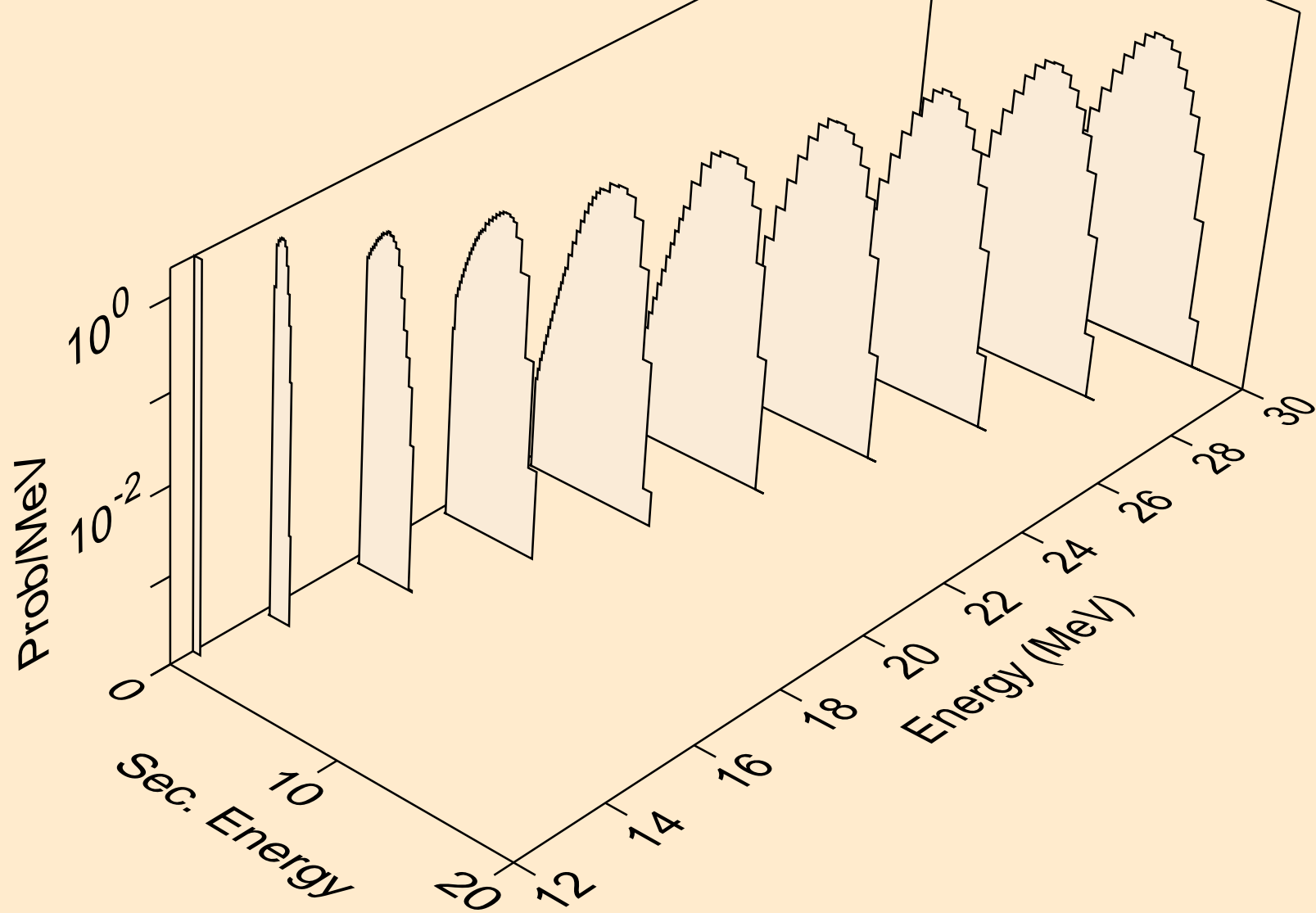

CF253 HELION ACER TENDL-2023 LIBRARY; T=0.K
deuterons from (s,n*)d

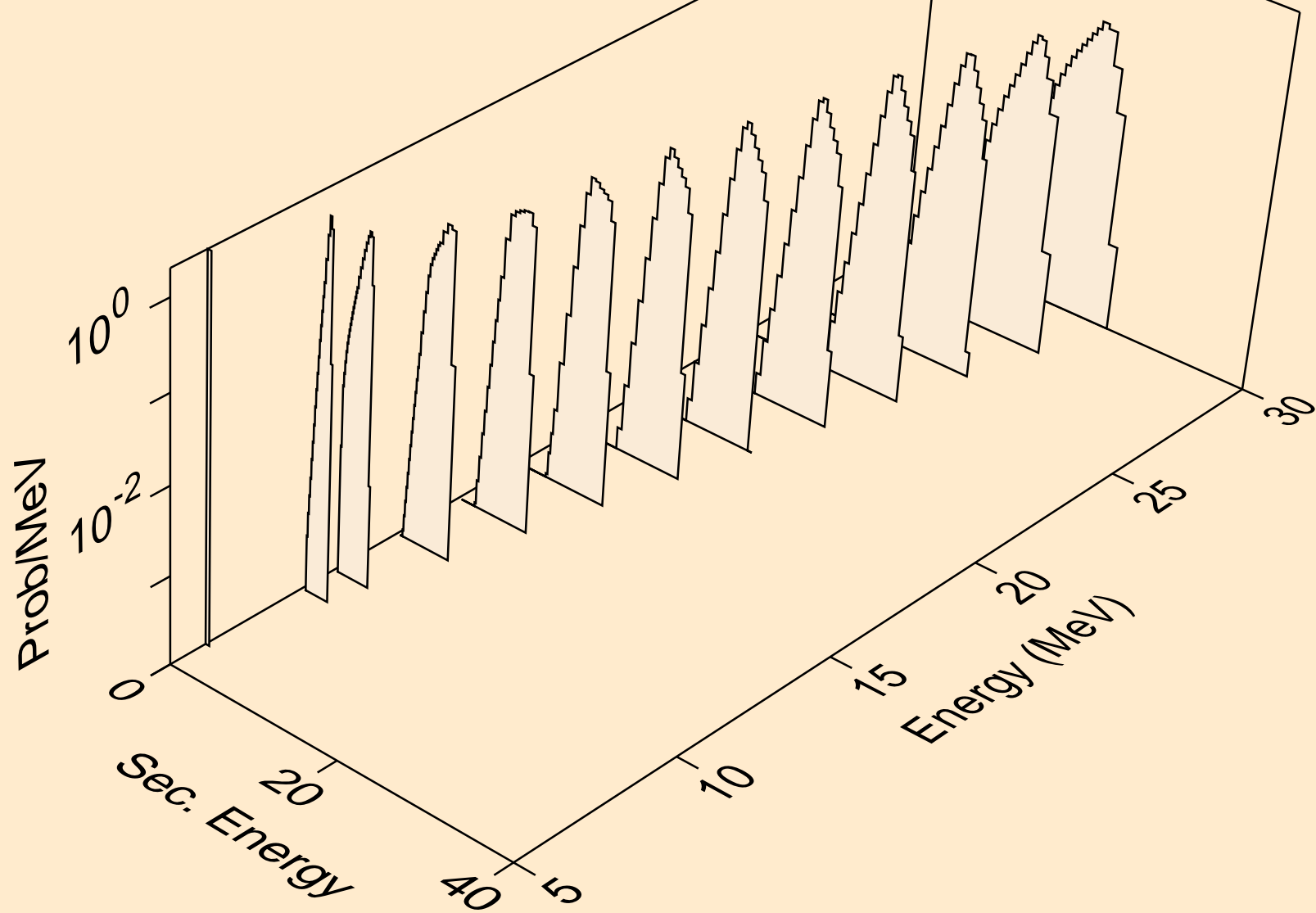

CF253 HELION ACER TENDL-2023 LIBRARY; T=0.K
deuterons from (s,d)

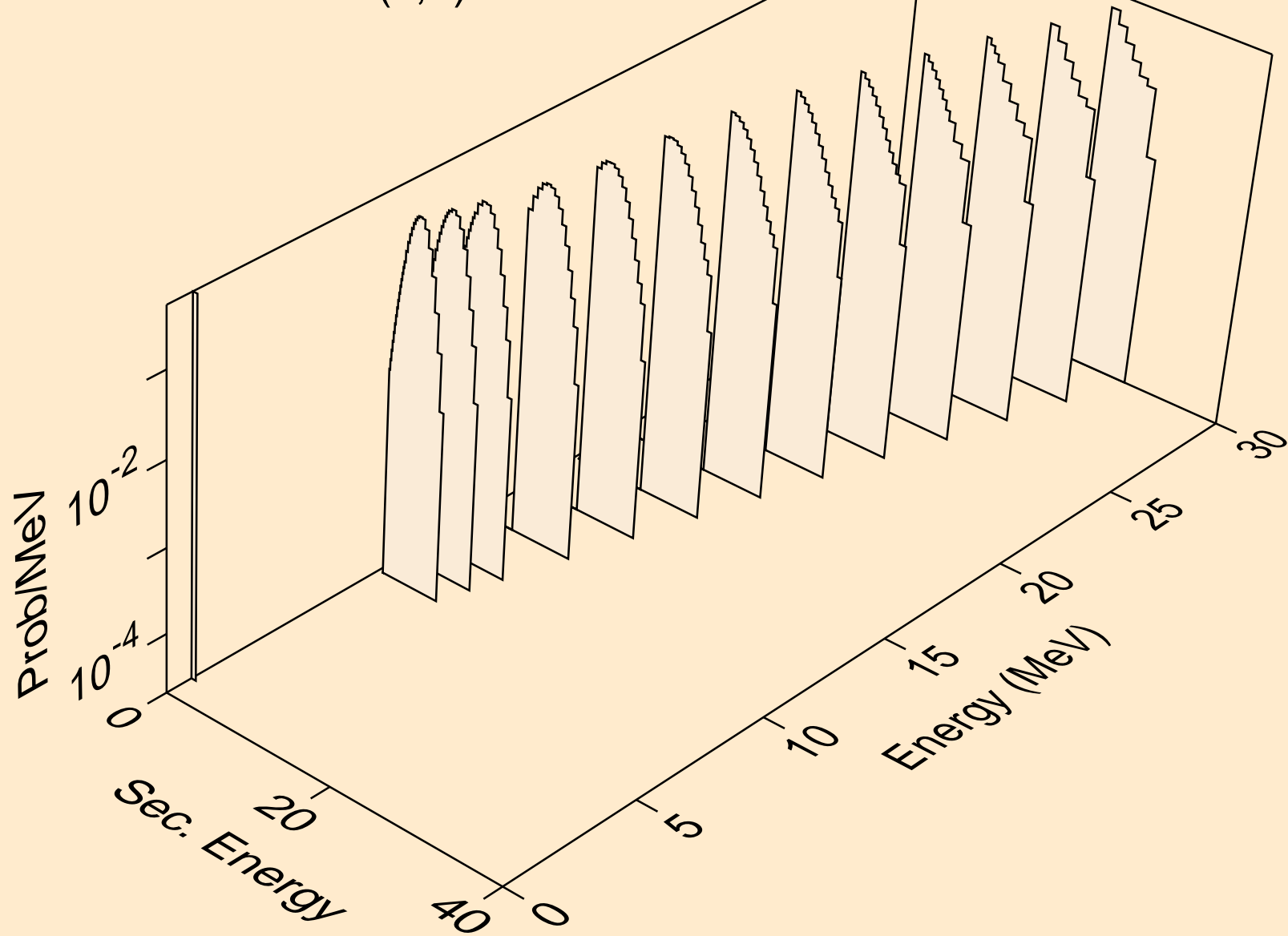

CF253 HELION ACER TENDL-2023 LIBRARY; T=0.K
tritons from (s,x)

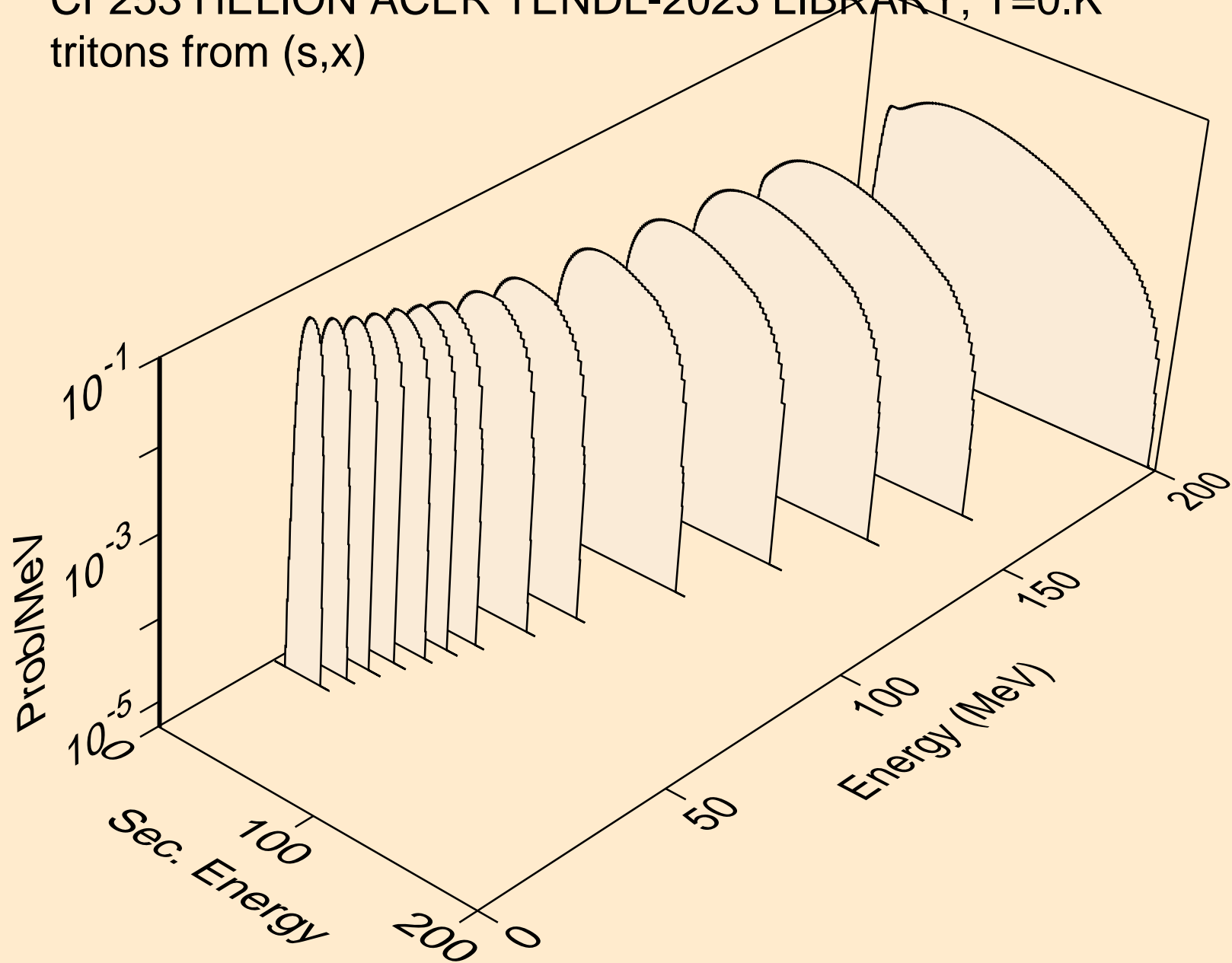

CF253 HELION ACER TENDL-2023 LIBRARY; T=0.K
tritons from (s,n*)t

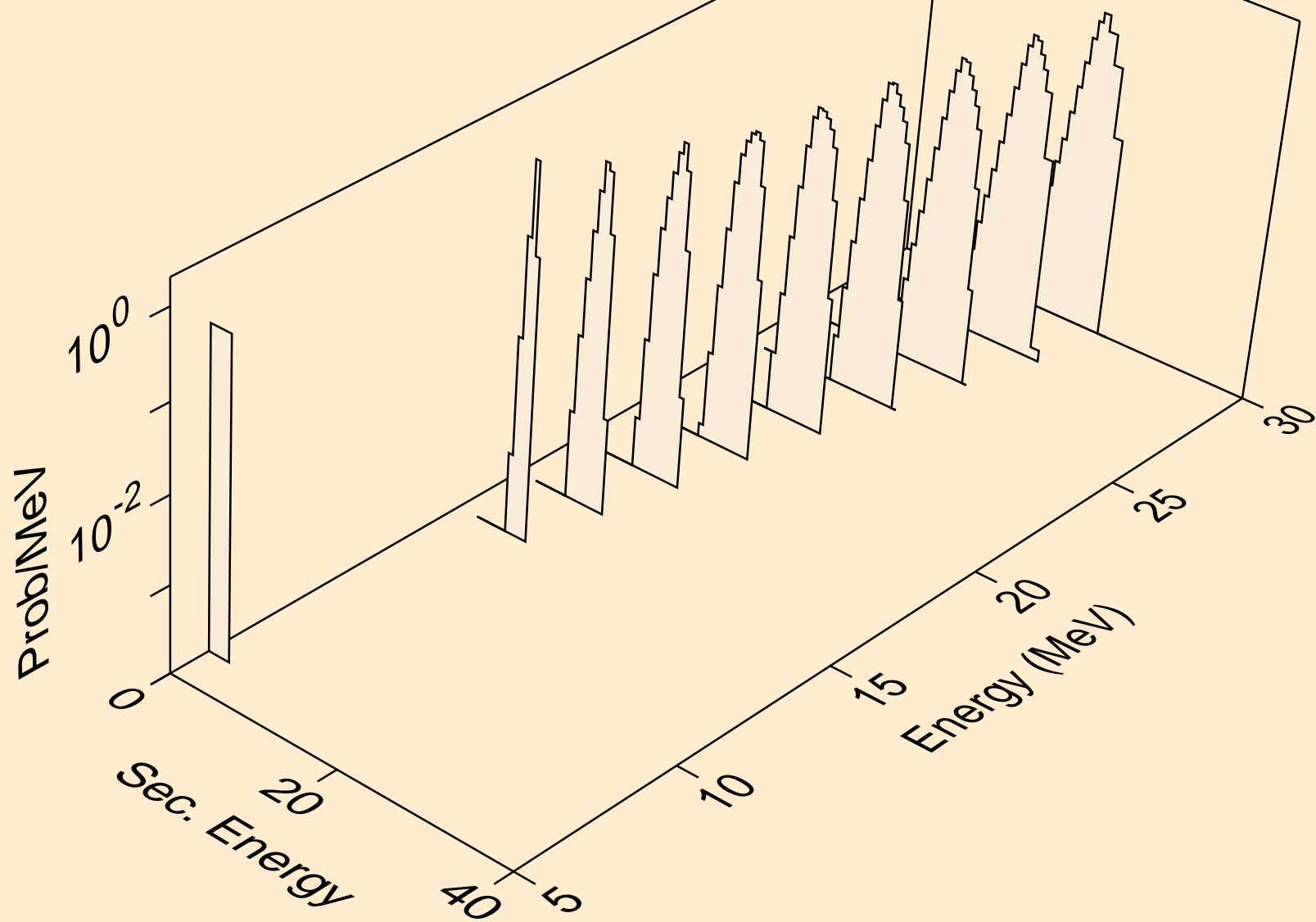

CF253 HELION ACER TENDL-2023 LIBRARY; T=0.K
tritons from (s,t)

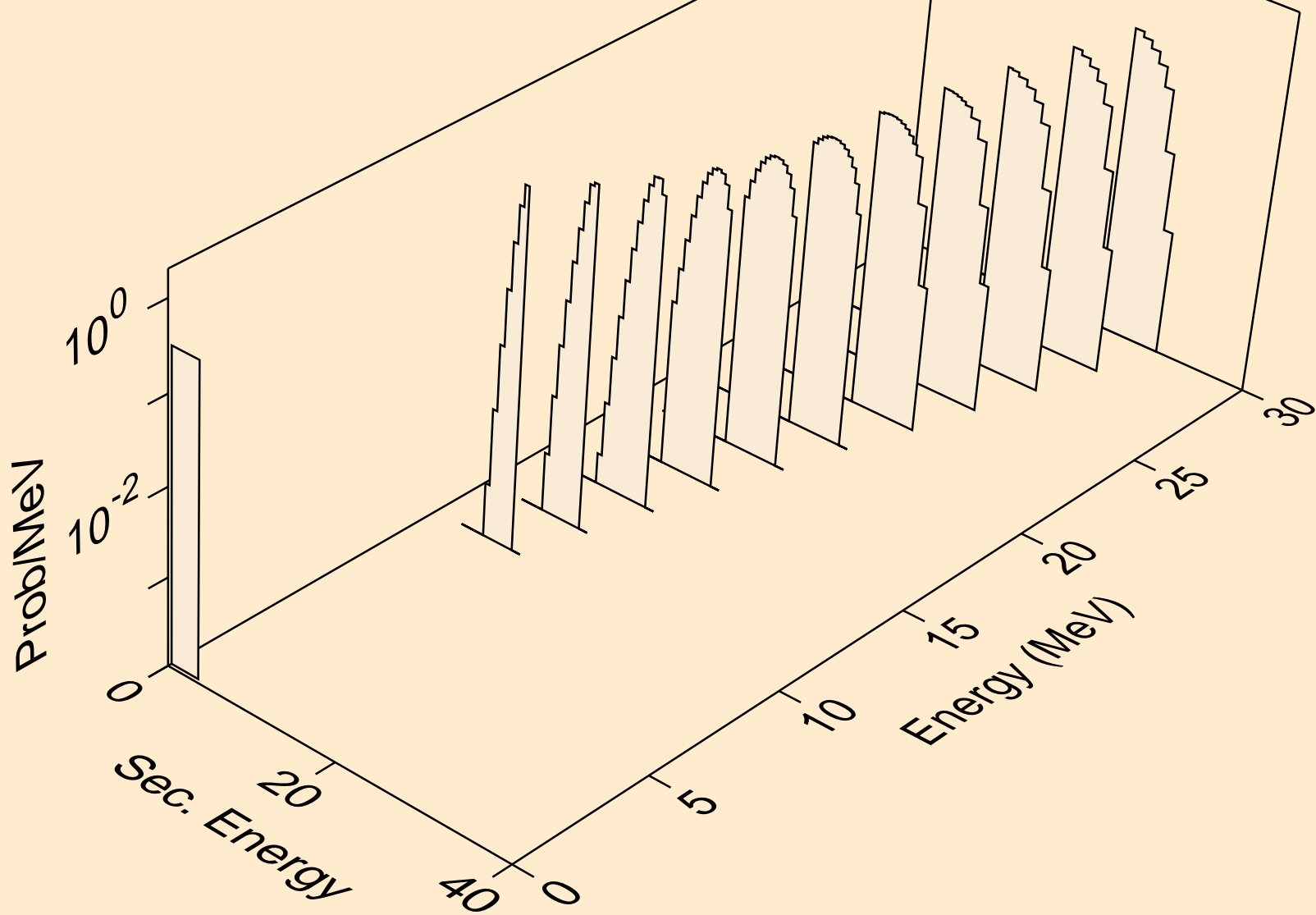

CF253 HELION ACER TENDL-2023 LIBRARY; T=0.K
alphas from (s,x)

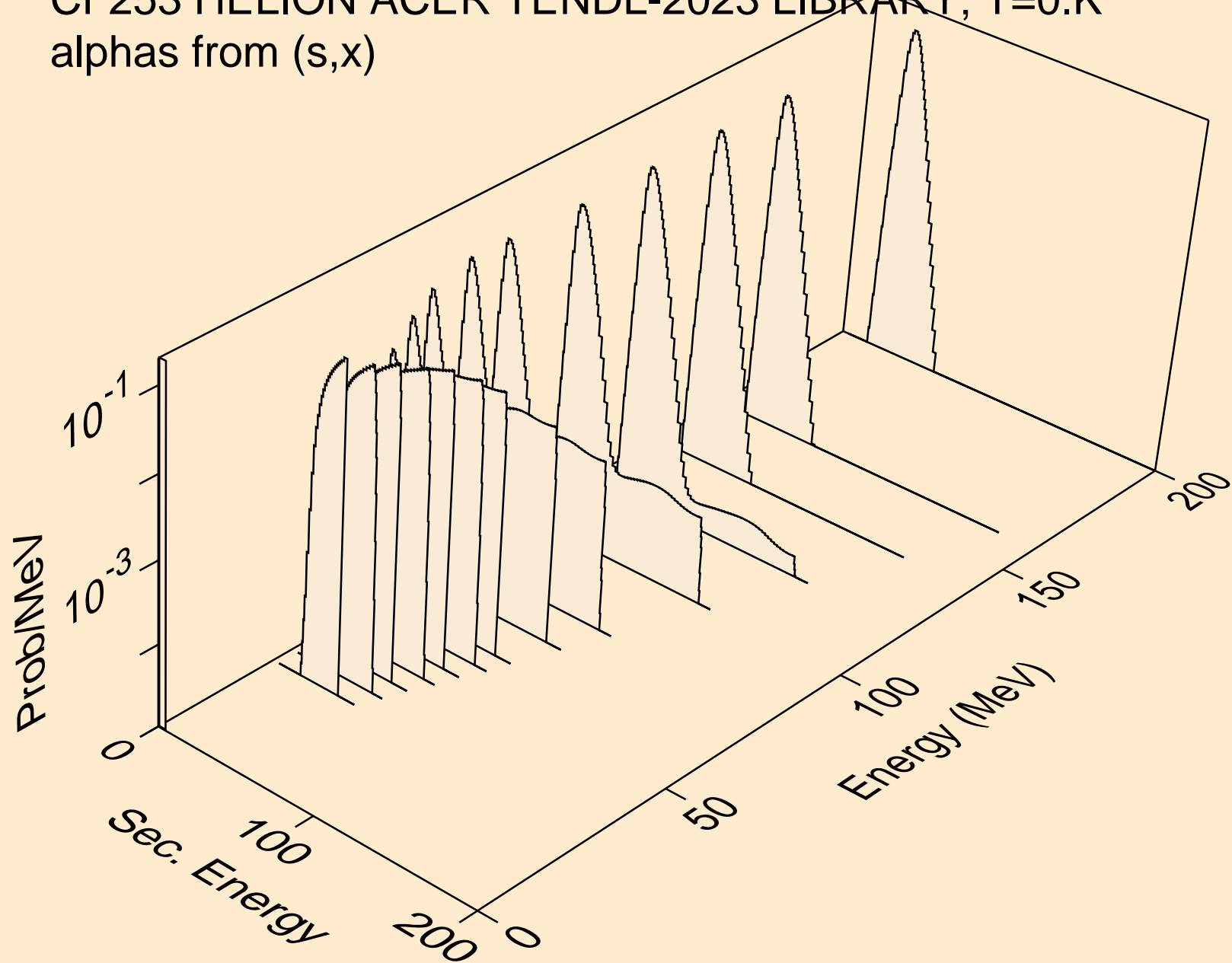

CF253 HELION ACER TENDL-2023 LIBRARY; T=0.K
alphas from (s,n*)a

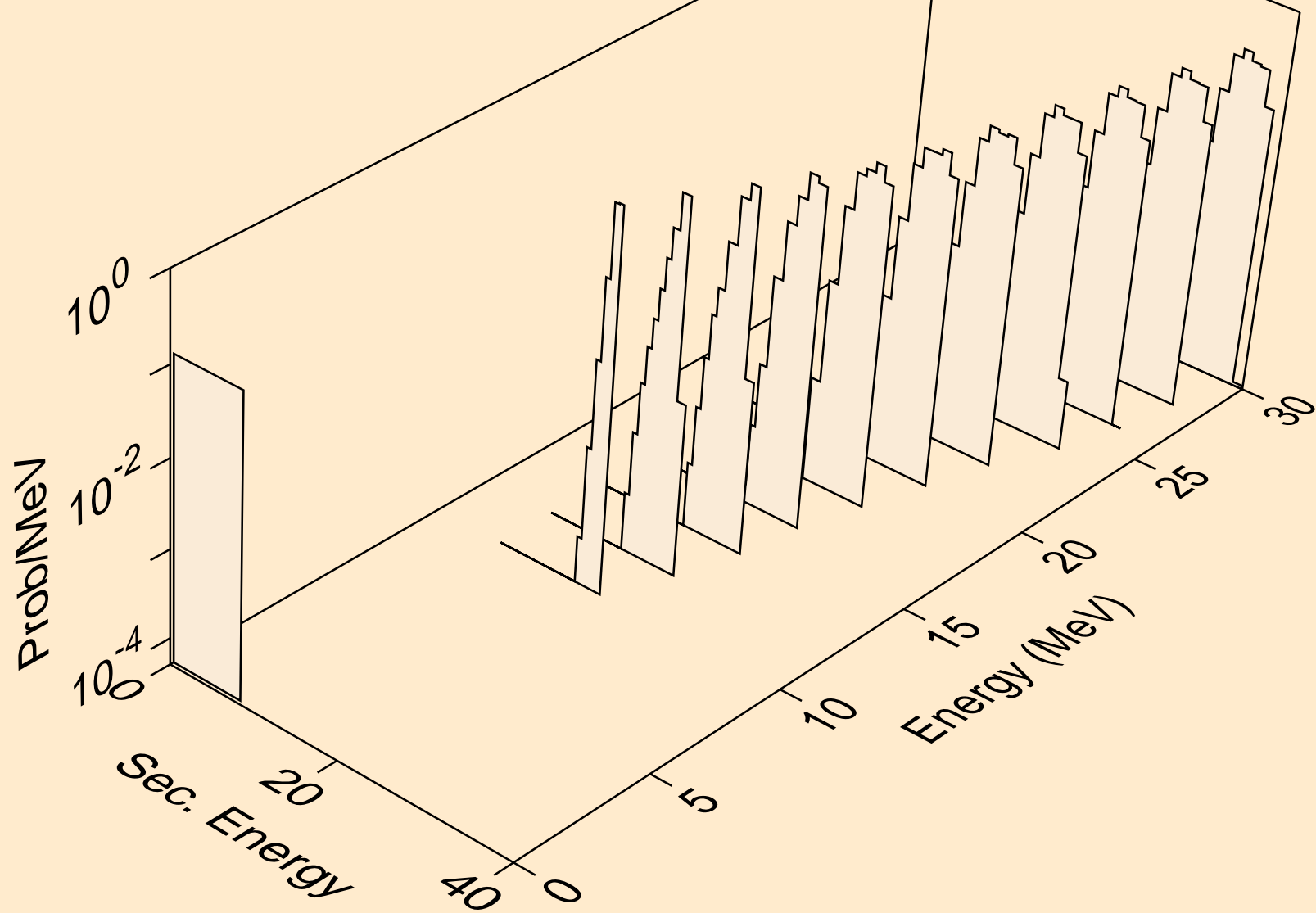

CF253 HELION ACER TENDL-2023 LIBRARY; T=0.K
alphas from (s,2n)a

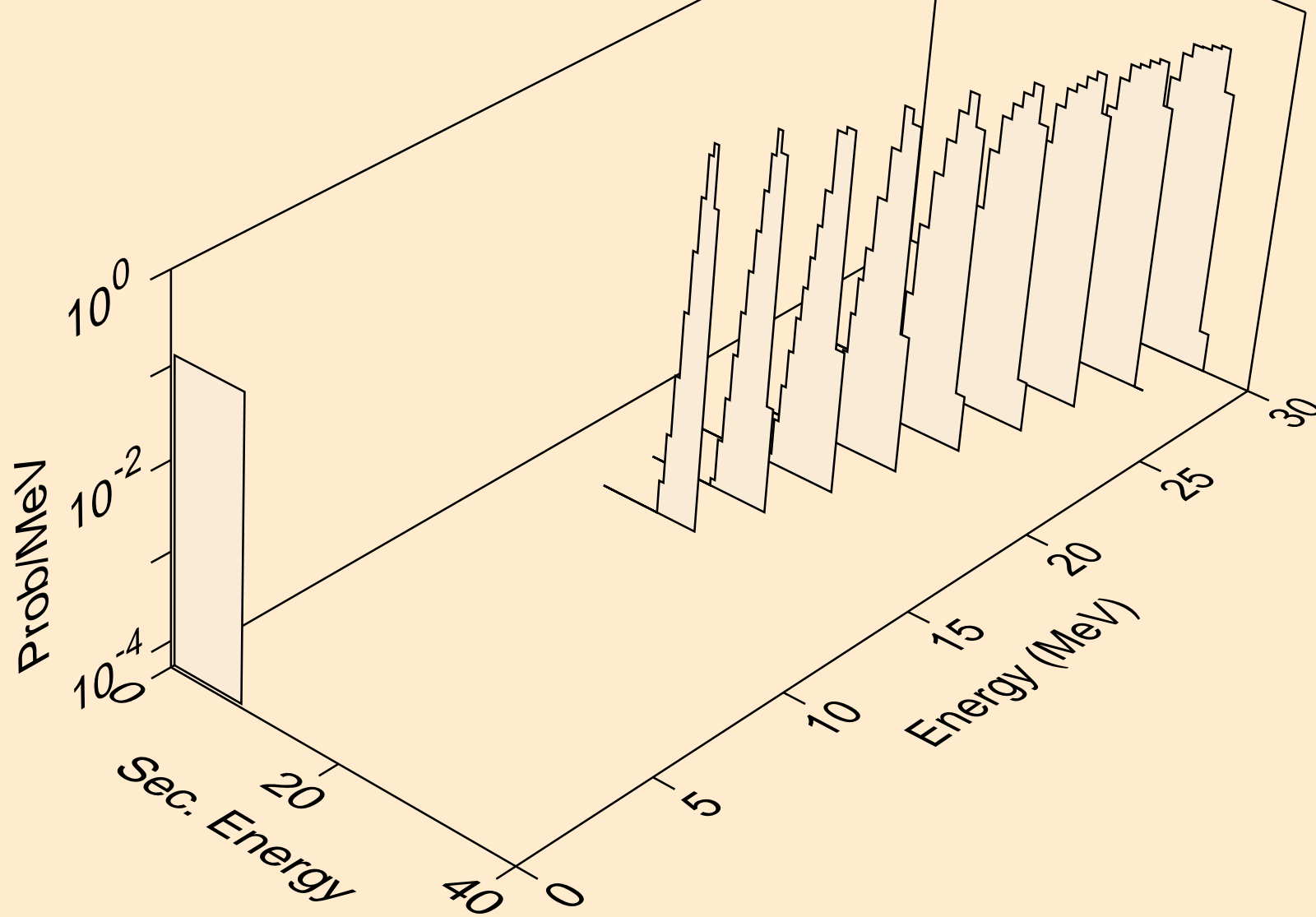

CF253 HELION ACER TENDL-2023 LIBRARY; T=0.K
alphas from (s,a)

