

CS119M HELION ACER TENDL-2023 LIBRARY; T=0.K  
Principal cross sections

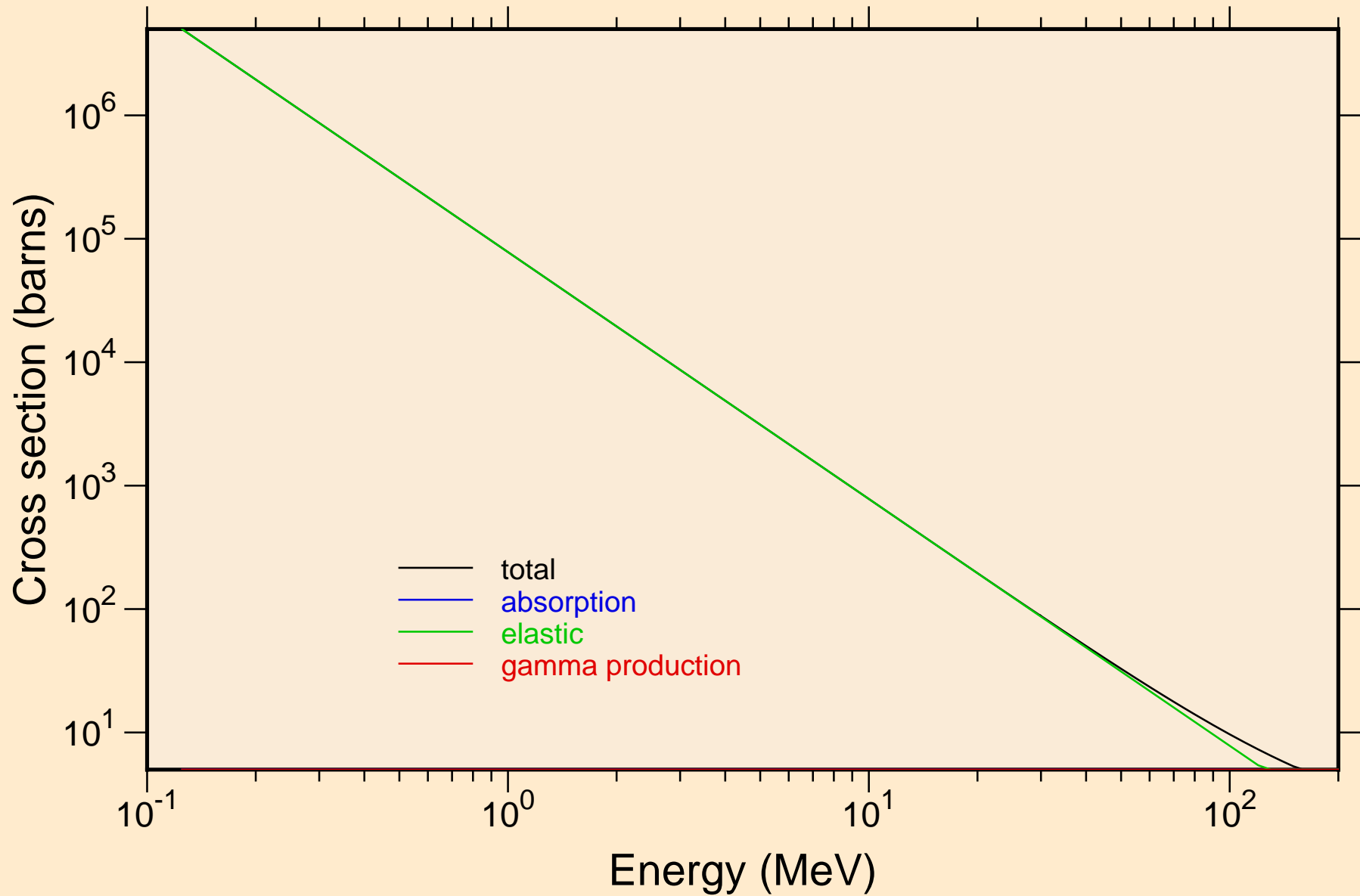

# CS119M HELION ACER TENDL-2023 LIBRARY; T=0.K

## Heating

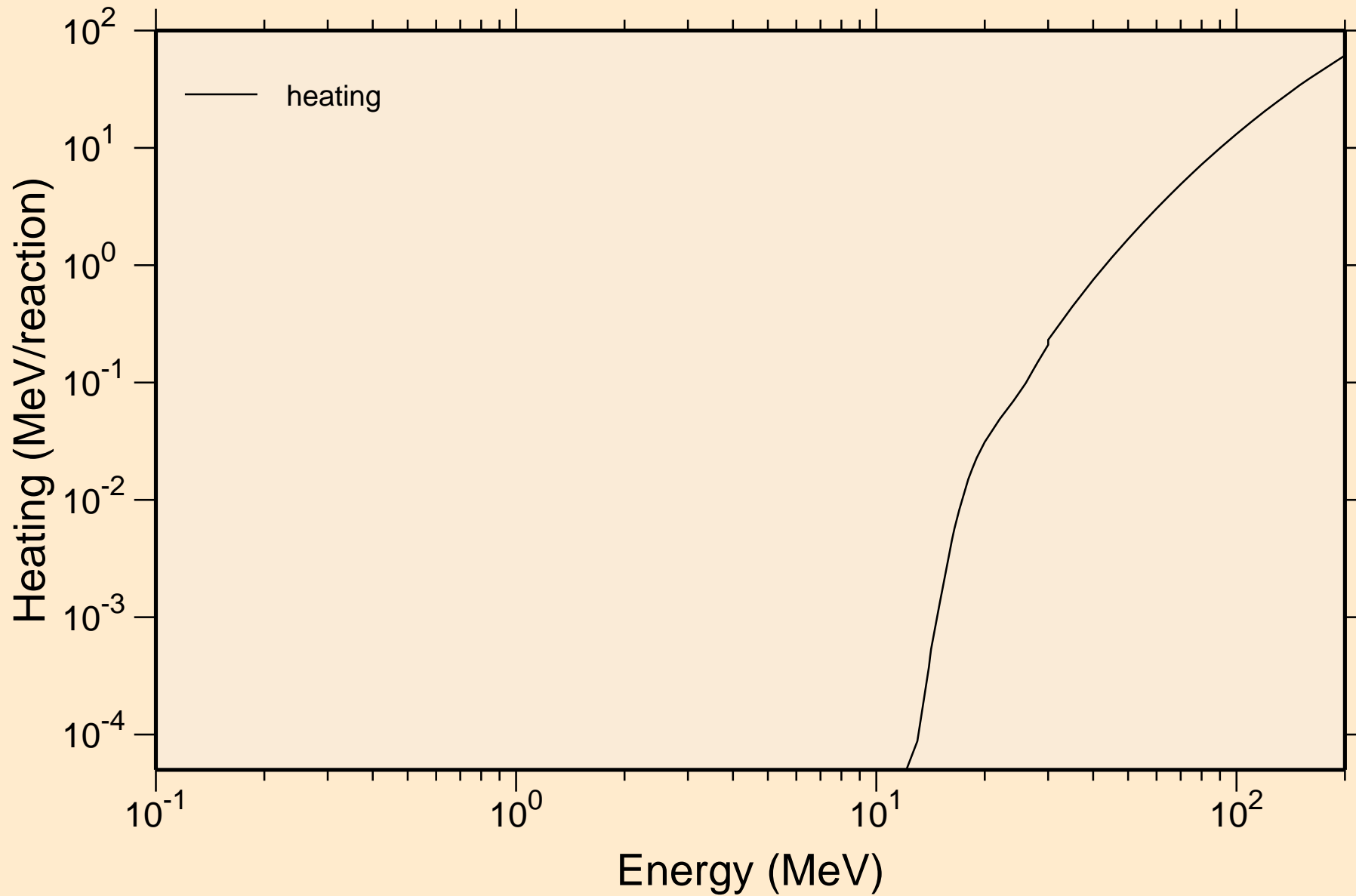

# CS119M HELION ACER TENDL-2023 LIBRARY; T=0.K

## Principal cross sections

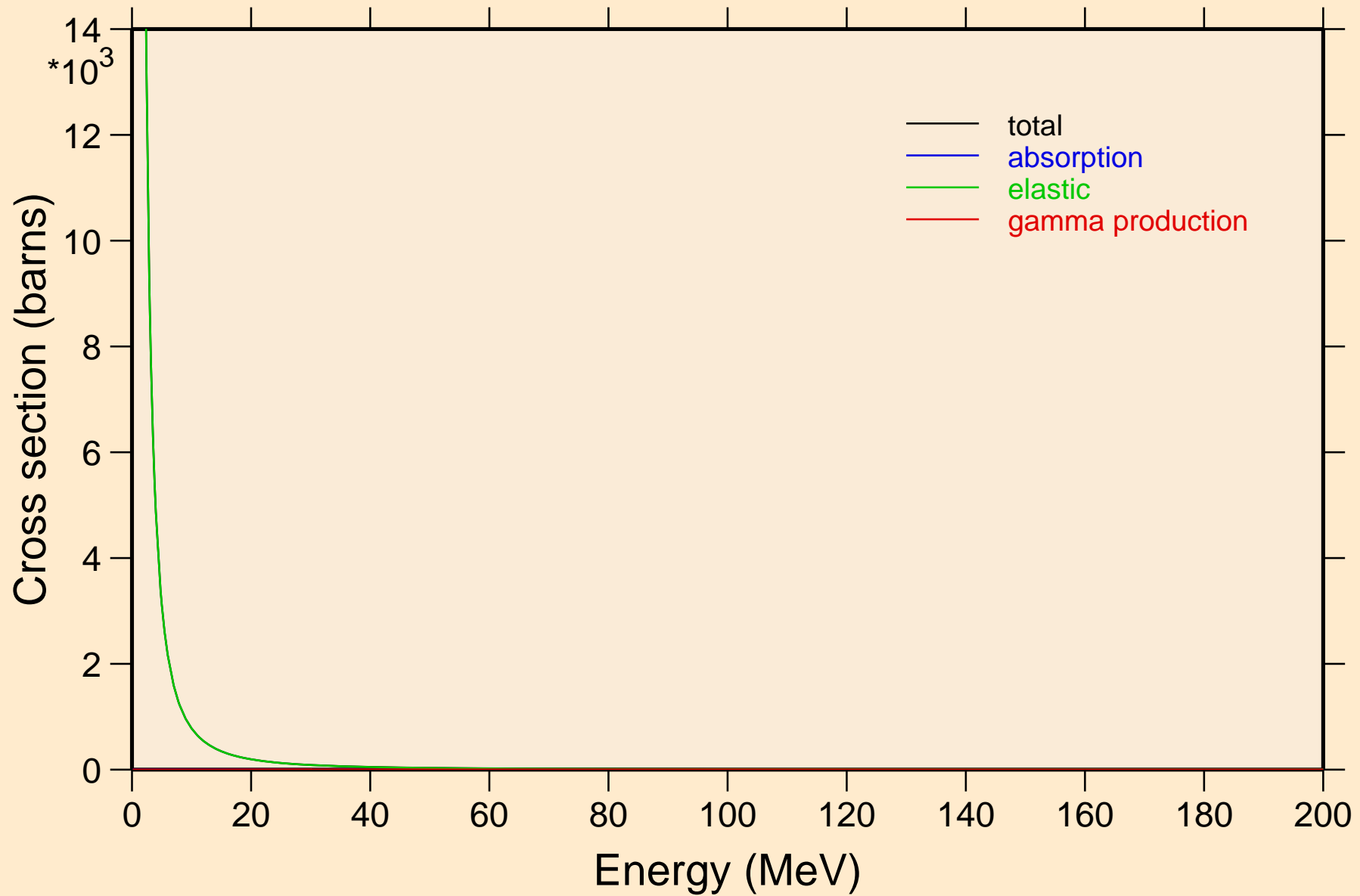

# CS119M HELION ACER TENDL-2023 LIBRARY; T=0.K

## Heating

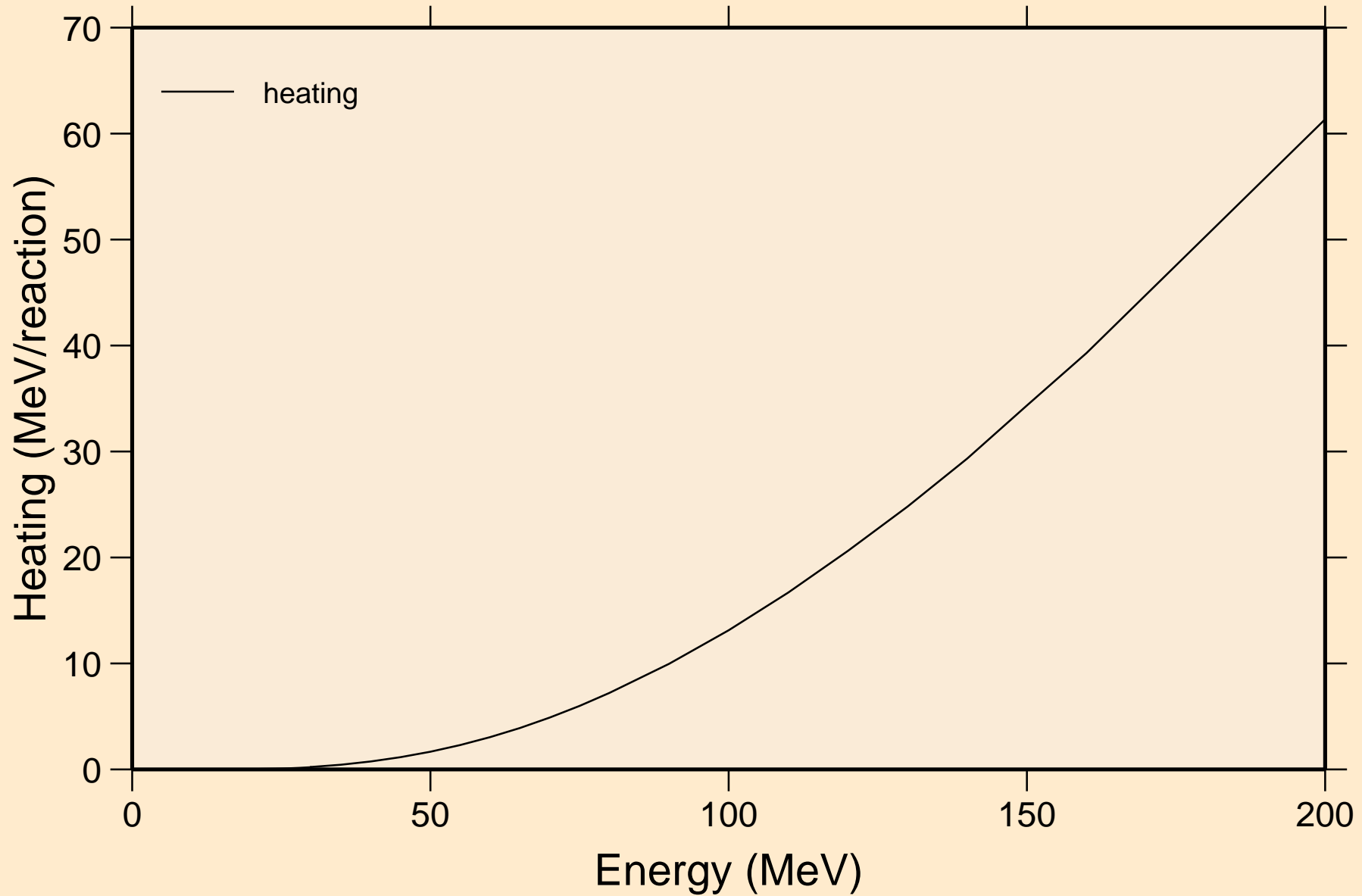

# CS119M HELION ACER TENDL-2023 LIBRARY; T=0.K

## Threshold reactions

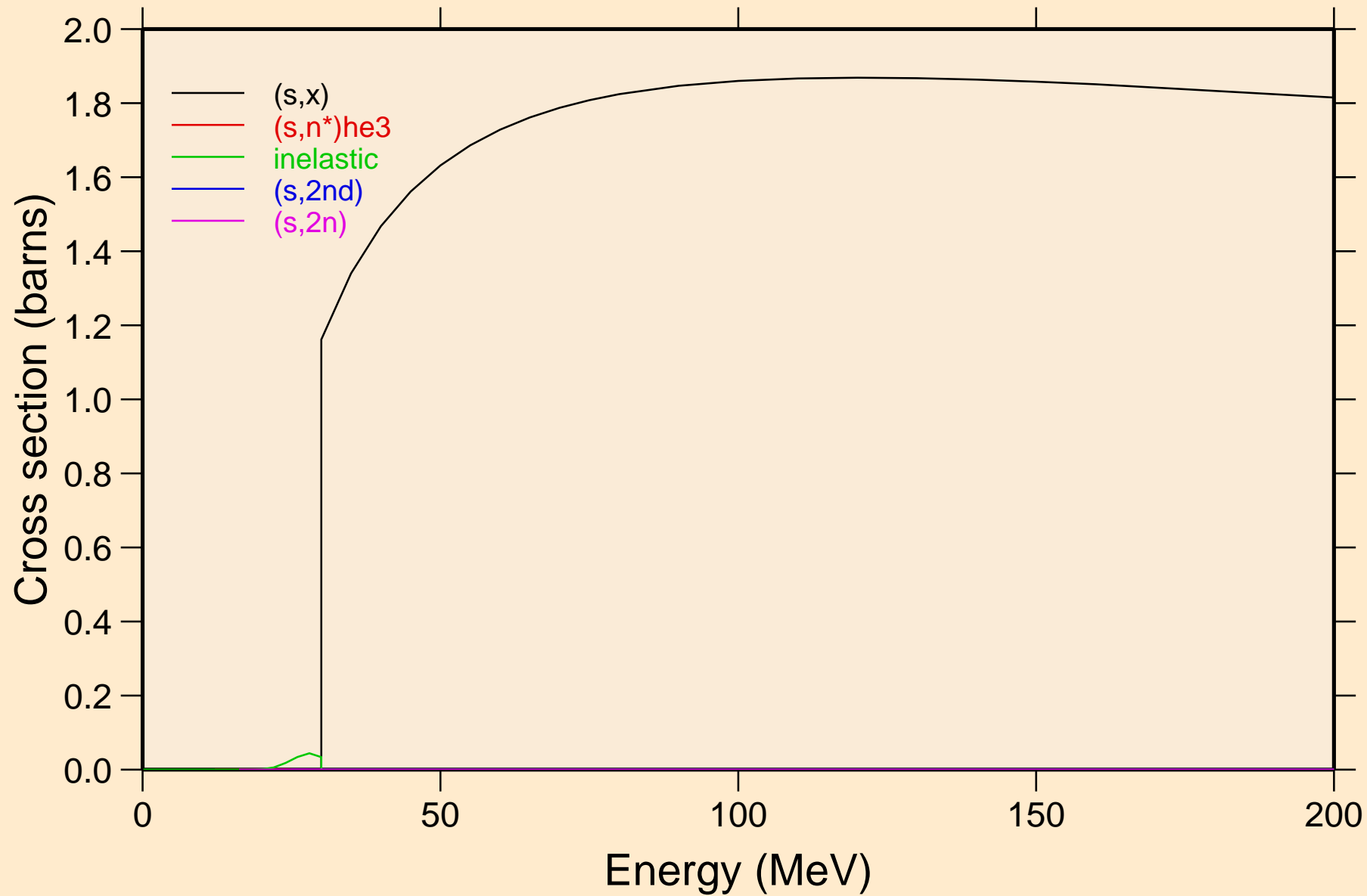

# CS119M HELION ACER TENDL-2023 LIBRARY; T=0.K

## Threshold reactions

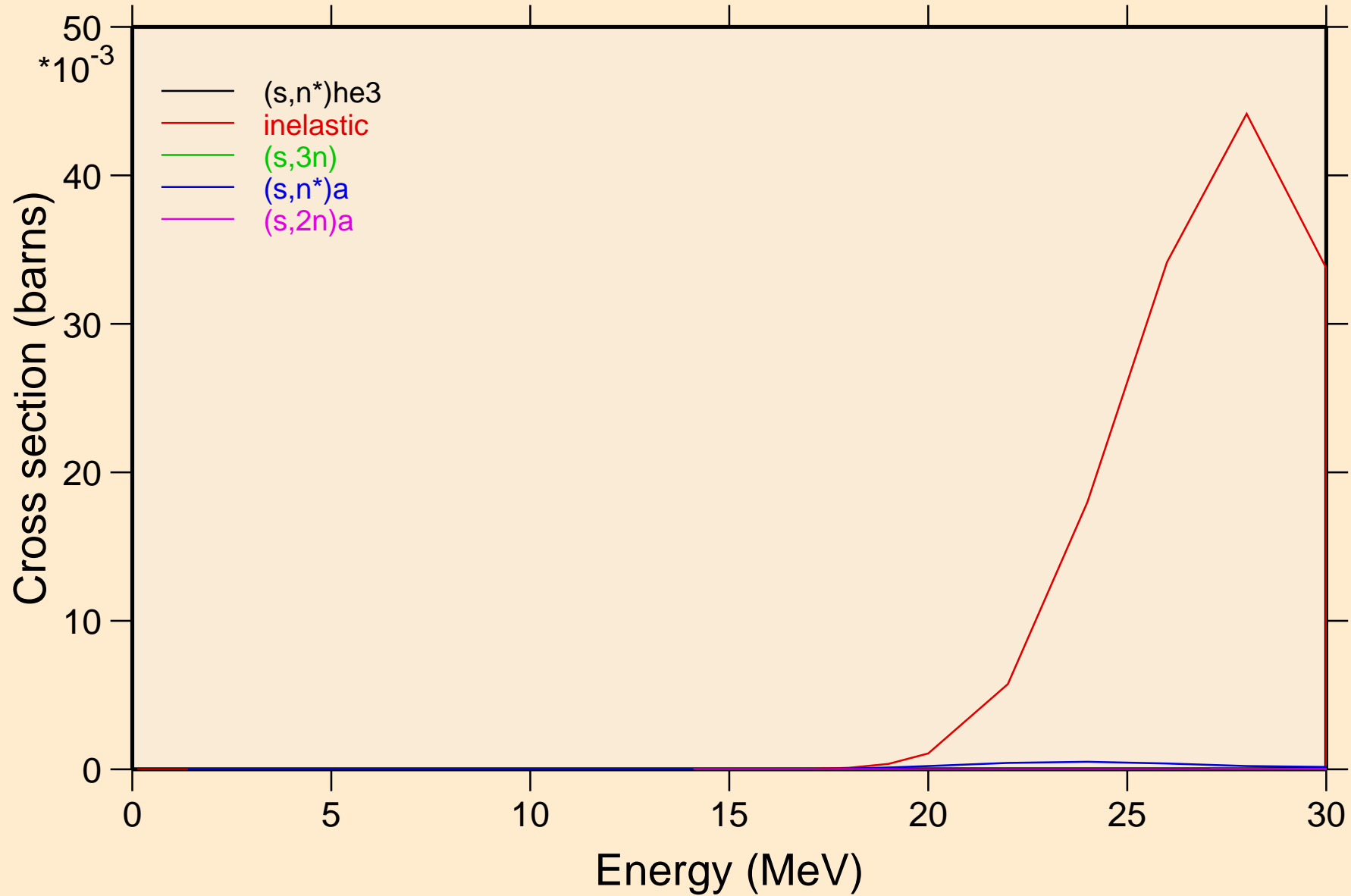

CS119M HELION ACER TENDL-2023 LIBRARY; T=0.K  
Threshold reactions

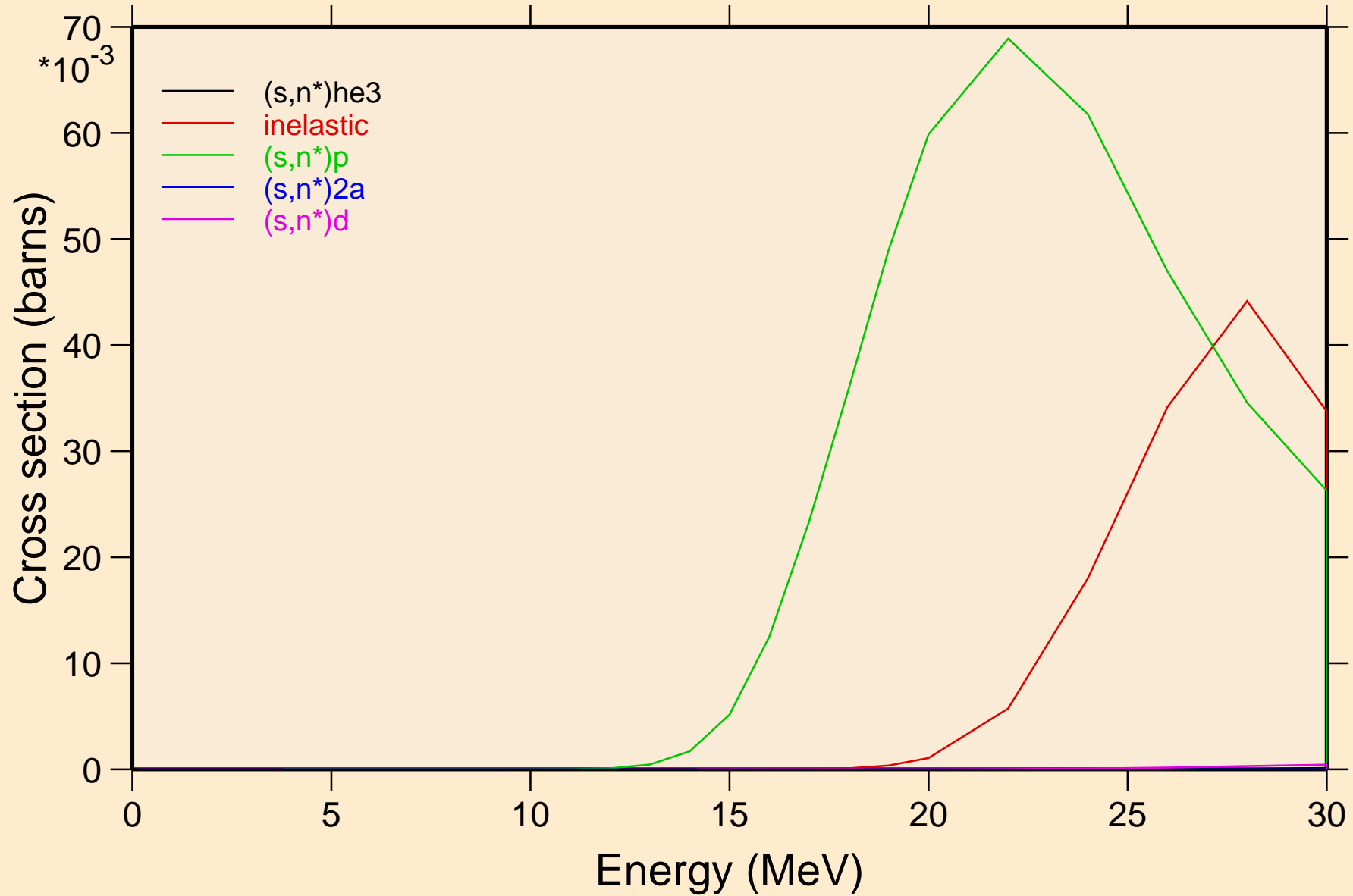

# CS119M HELION ACER TENDL-2023 LIBRARY; T=0.K

## Threshold reactions

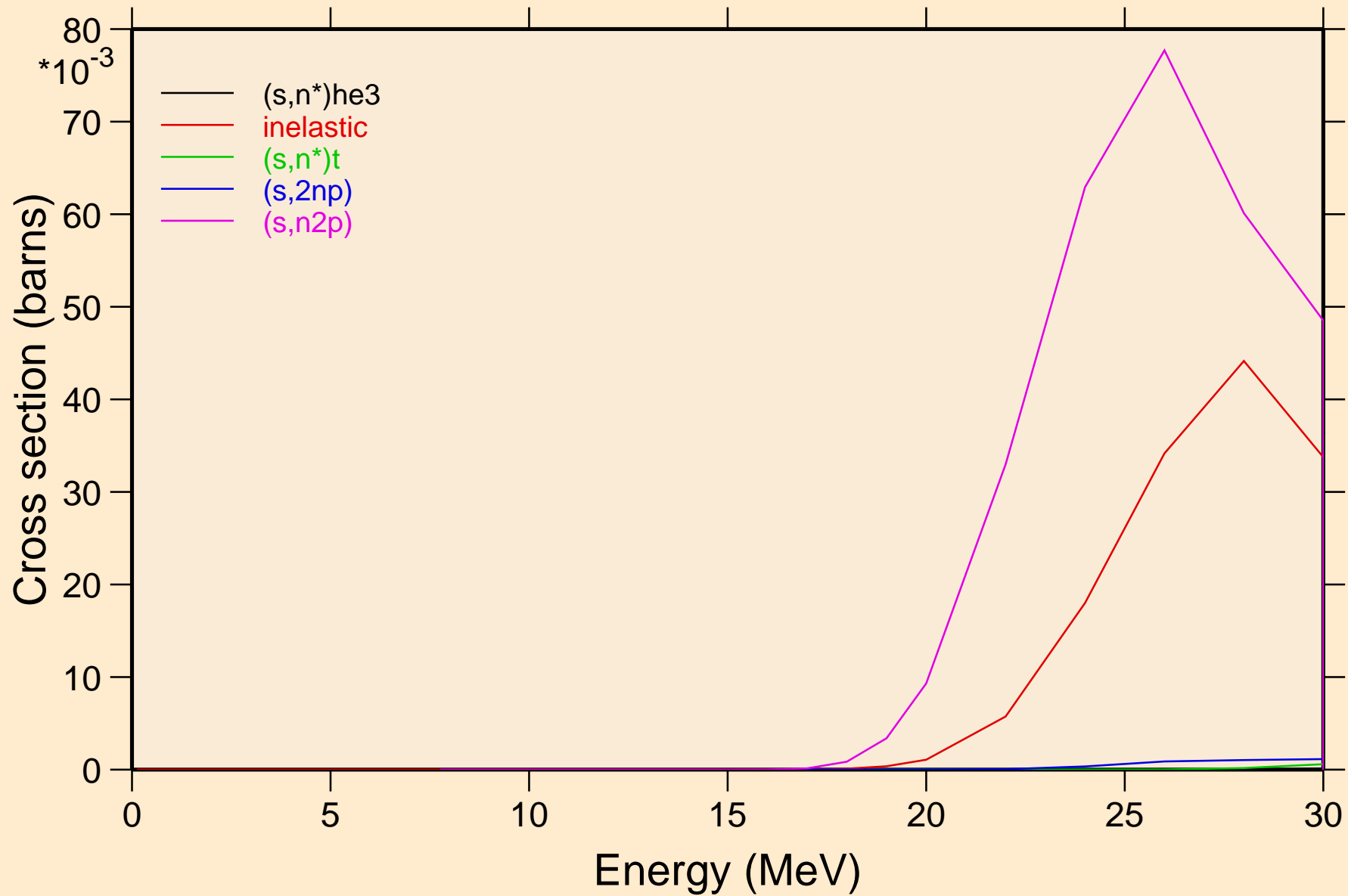

# CS119M HELION ACER TENDL-2023 LIBRARY; T=0.K

## Threshold reactions

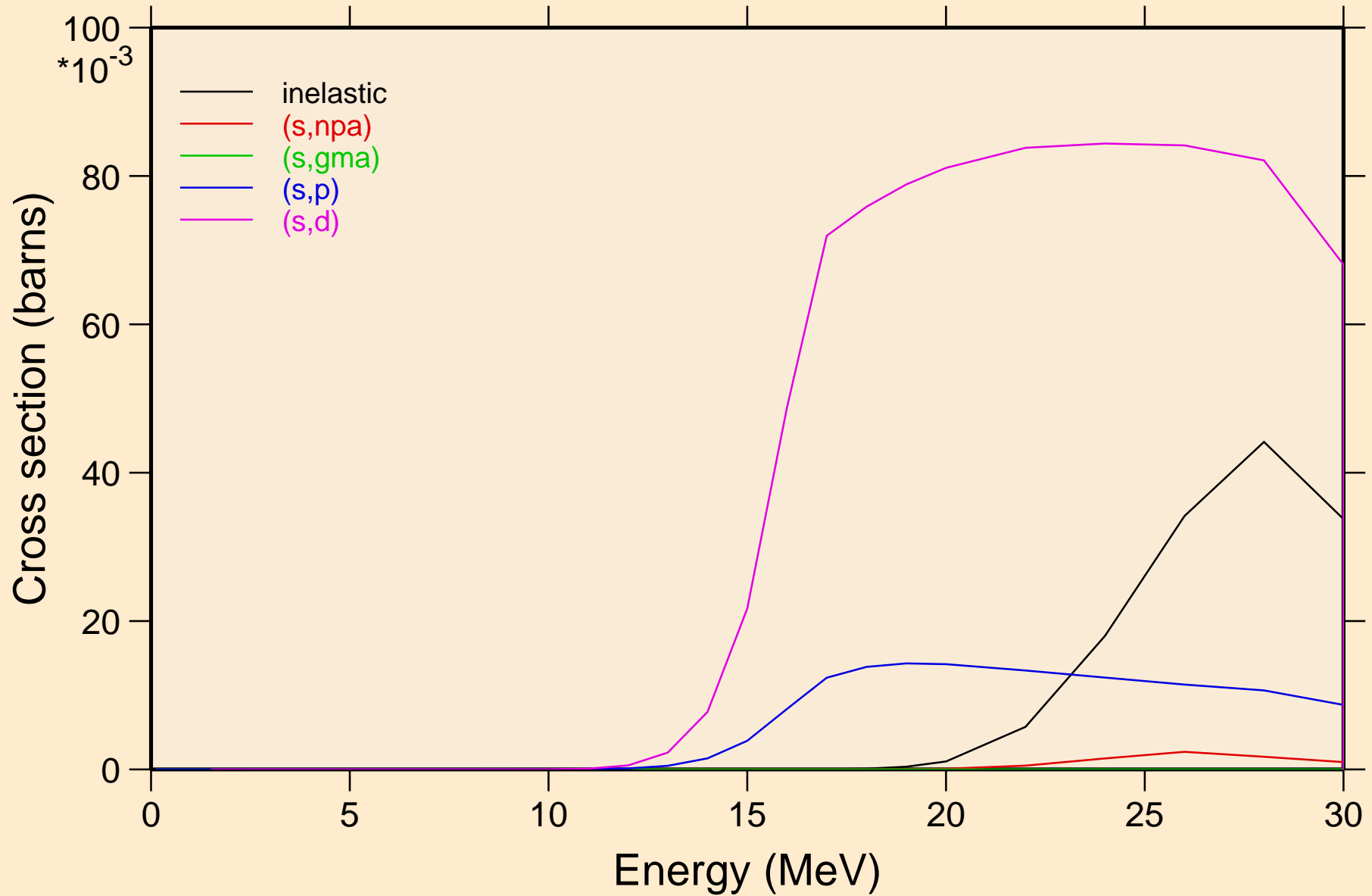

# CS119M HELION ACER TENDL-2023 LIBRARY; T=0.K

## Threshold reactions

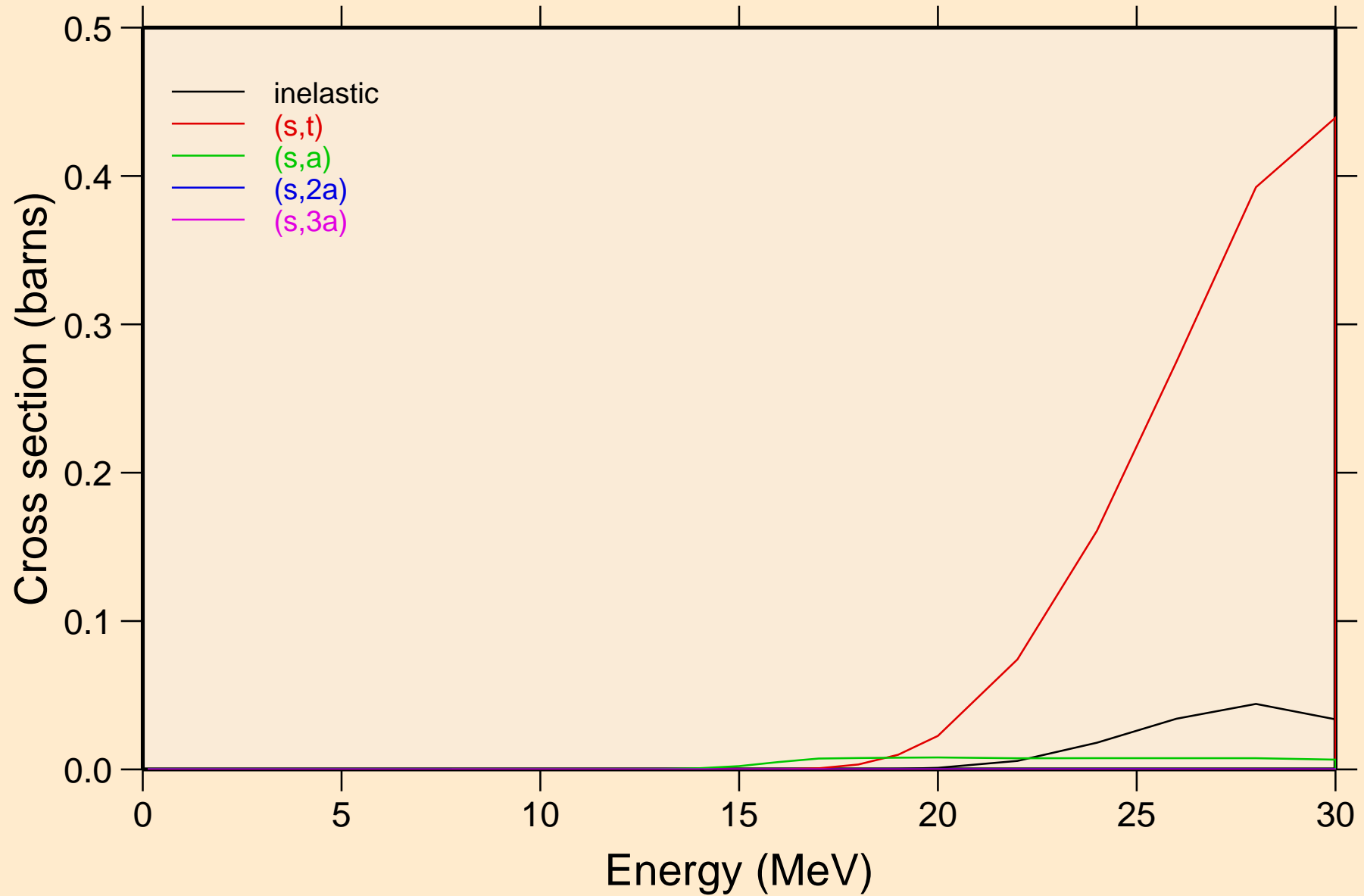

# CS119M HELION ACER TENDL-2023 LIBRARY; T=0.K

## Threshold reactions

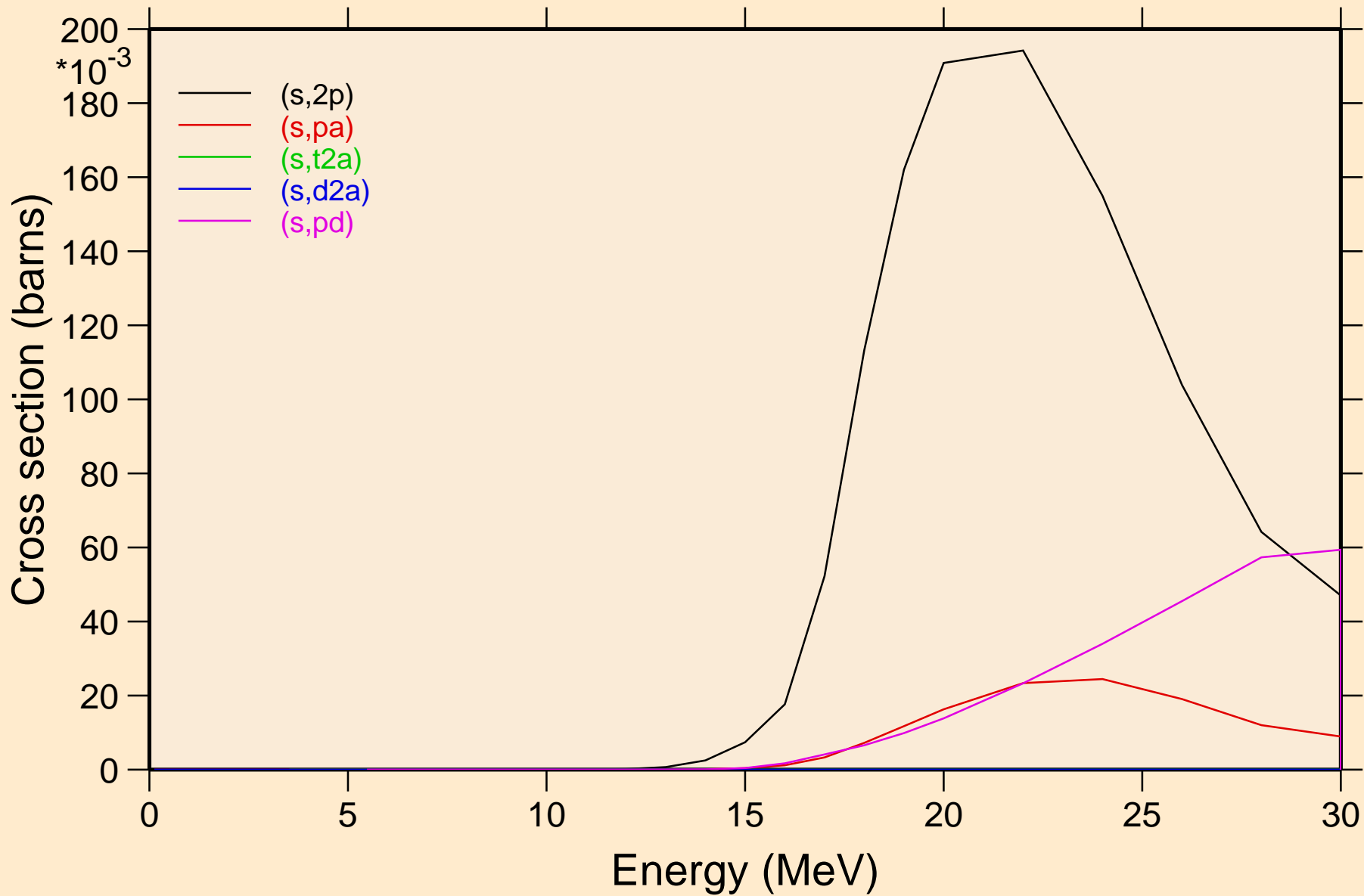

CS119M HELION ACER TENDL-2023 LIBRARY; T=0.K  
Threshold reactions

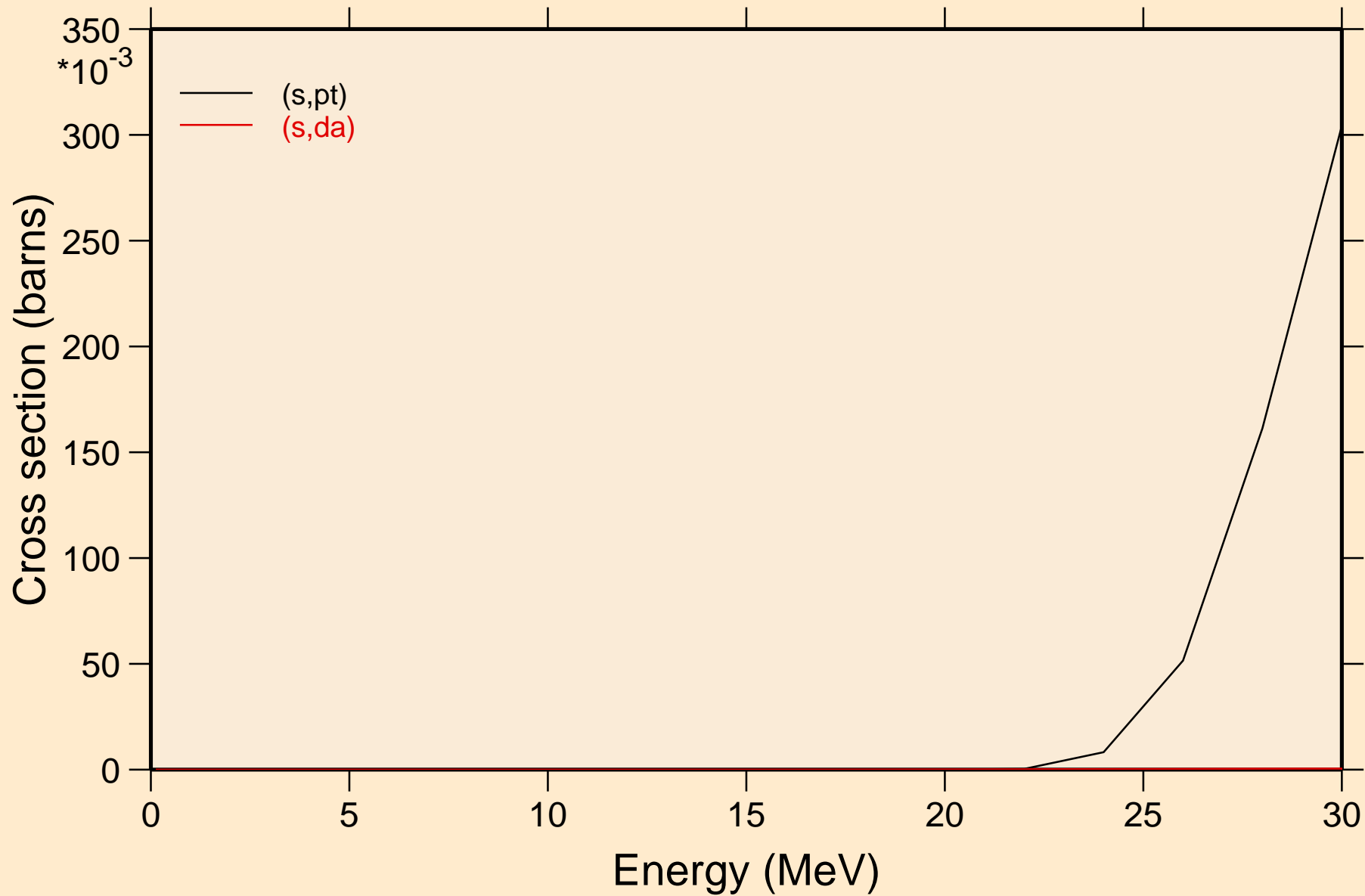

CS119M HELION ACER TENDL-2023 LIBRARY; T=0.K  
angular distribution for elastic

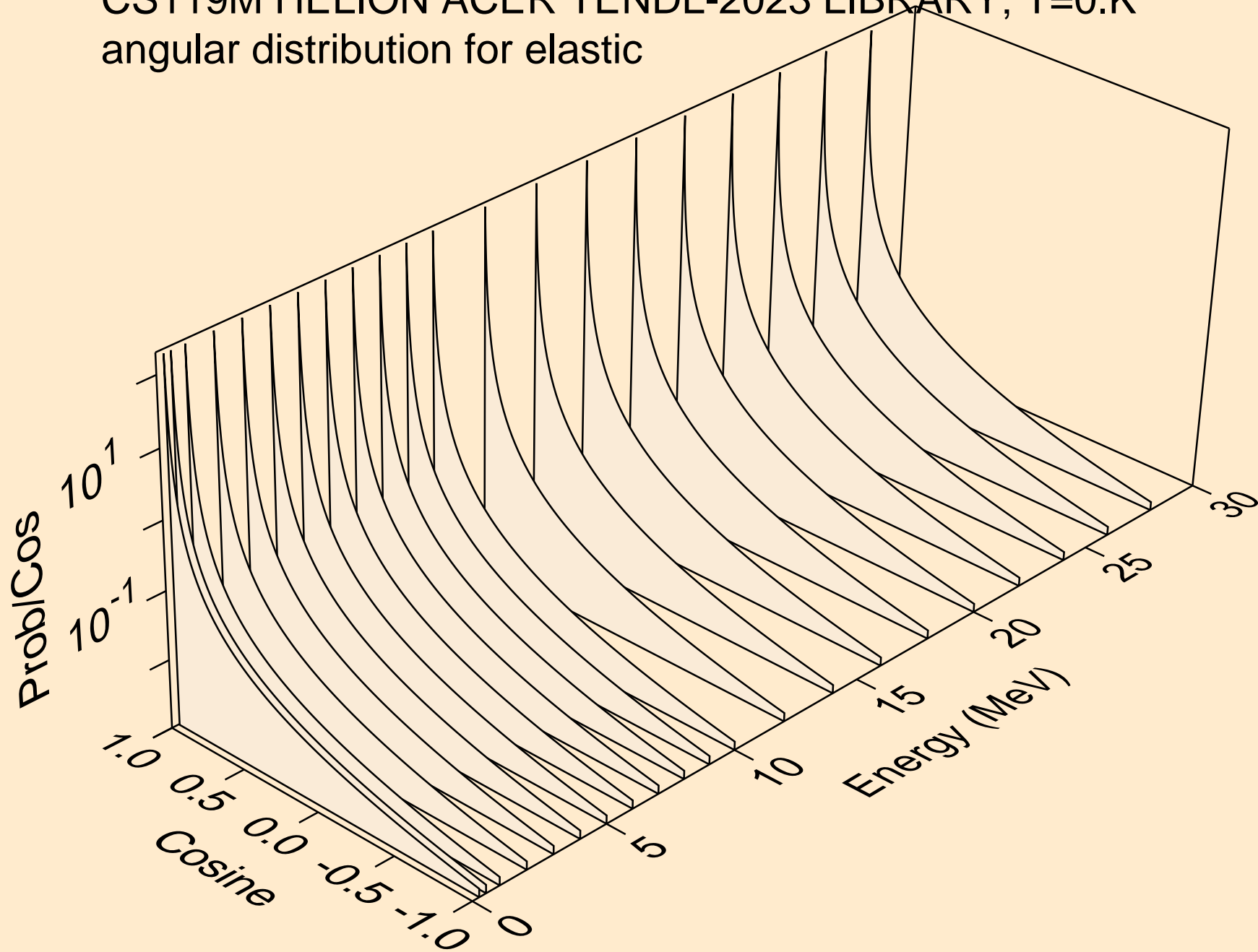

CS119M HELION ACER TENDL-2023 LIBRARY; T=0.K  
He-3 emission for (s,x)

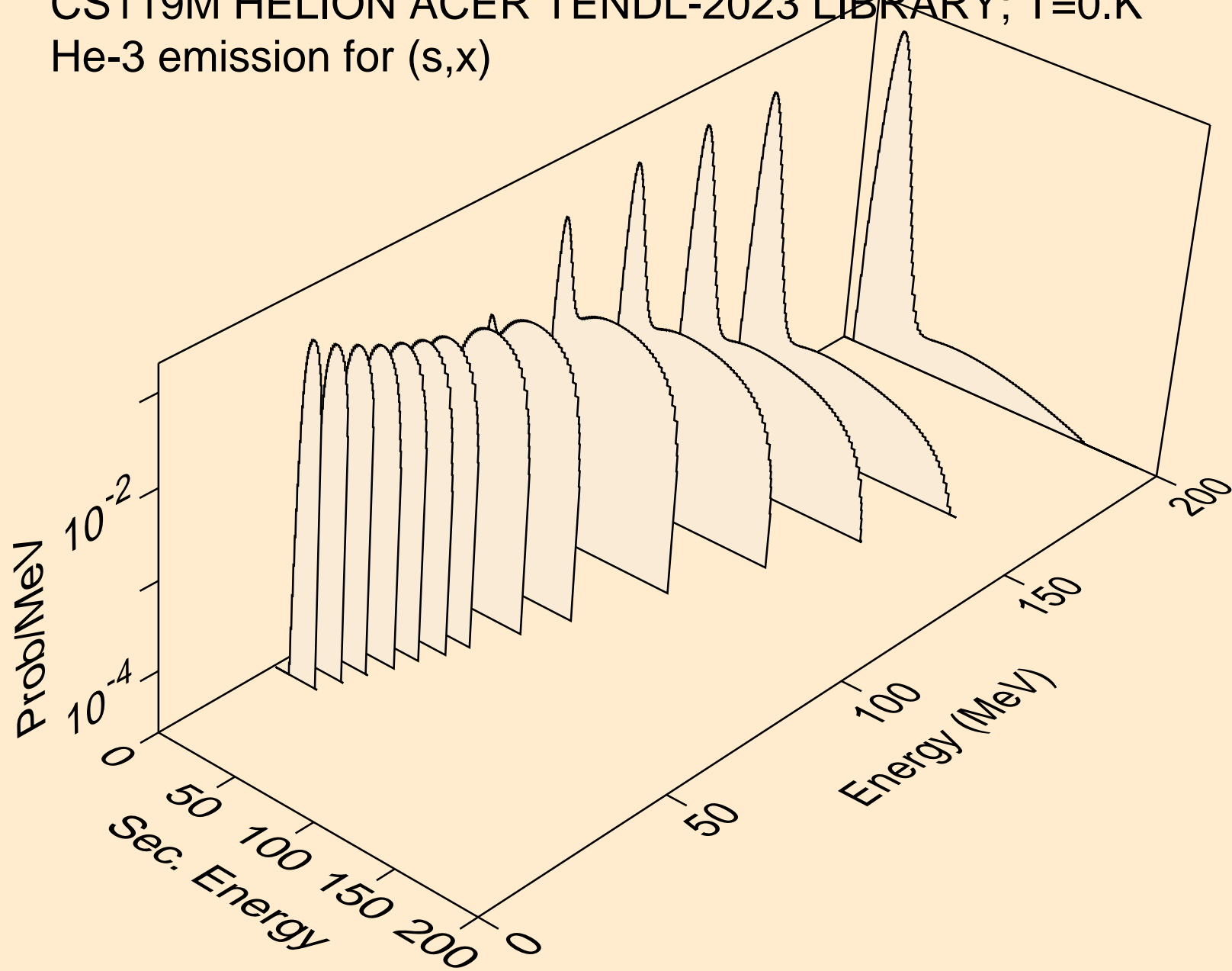

CS119M HELION ACER TENDL-2023 LIBRARY; T=0.K  
He-3 emission for (s,n\*)he3

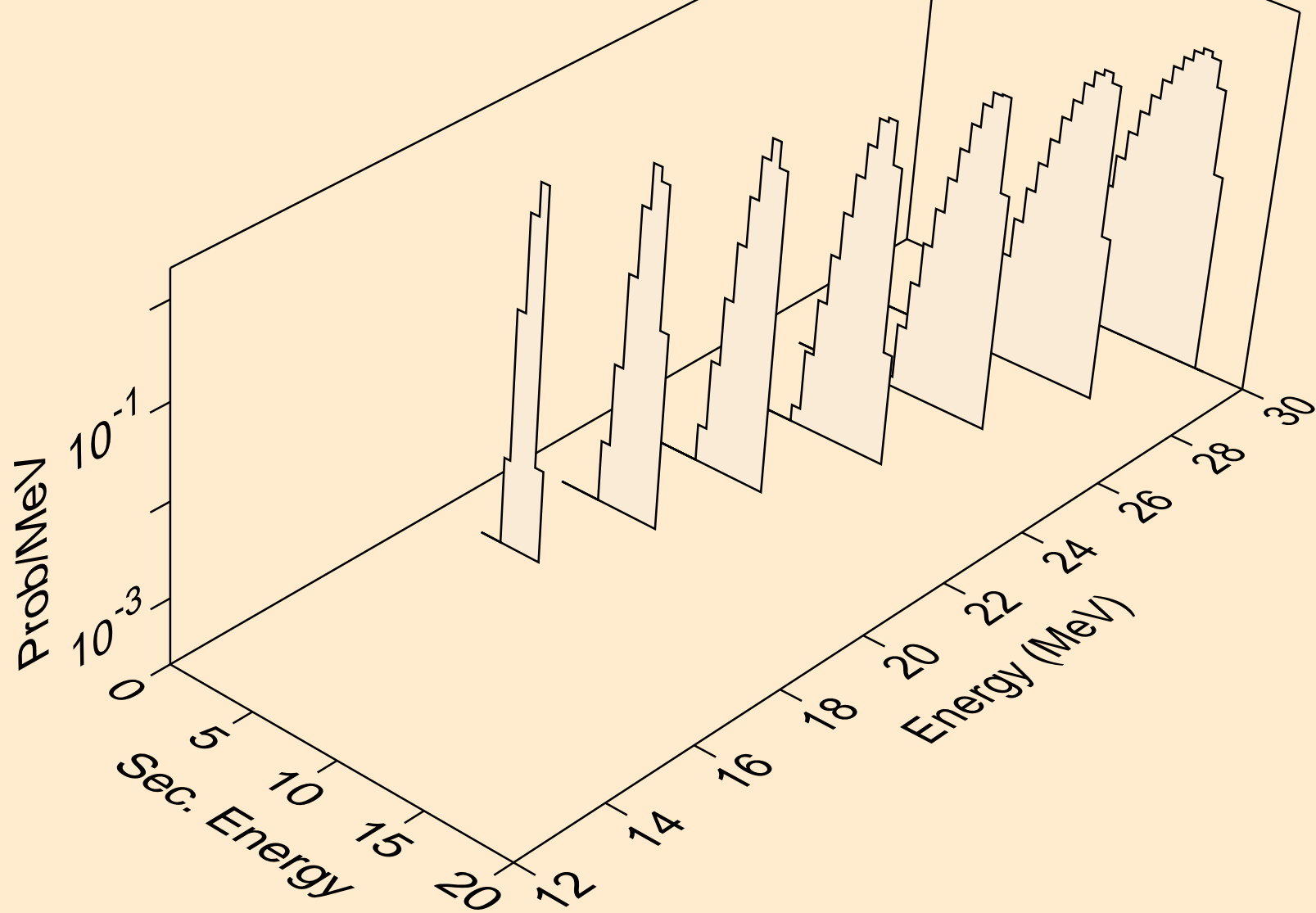

CS119M HELION ACER TENDL-2023 LIBRARY; T=0.K  
He-3 emission for inelastic

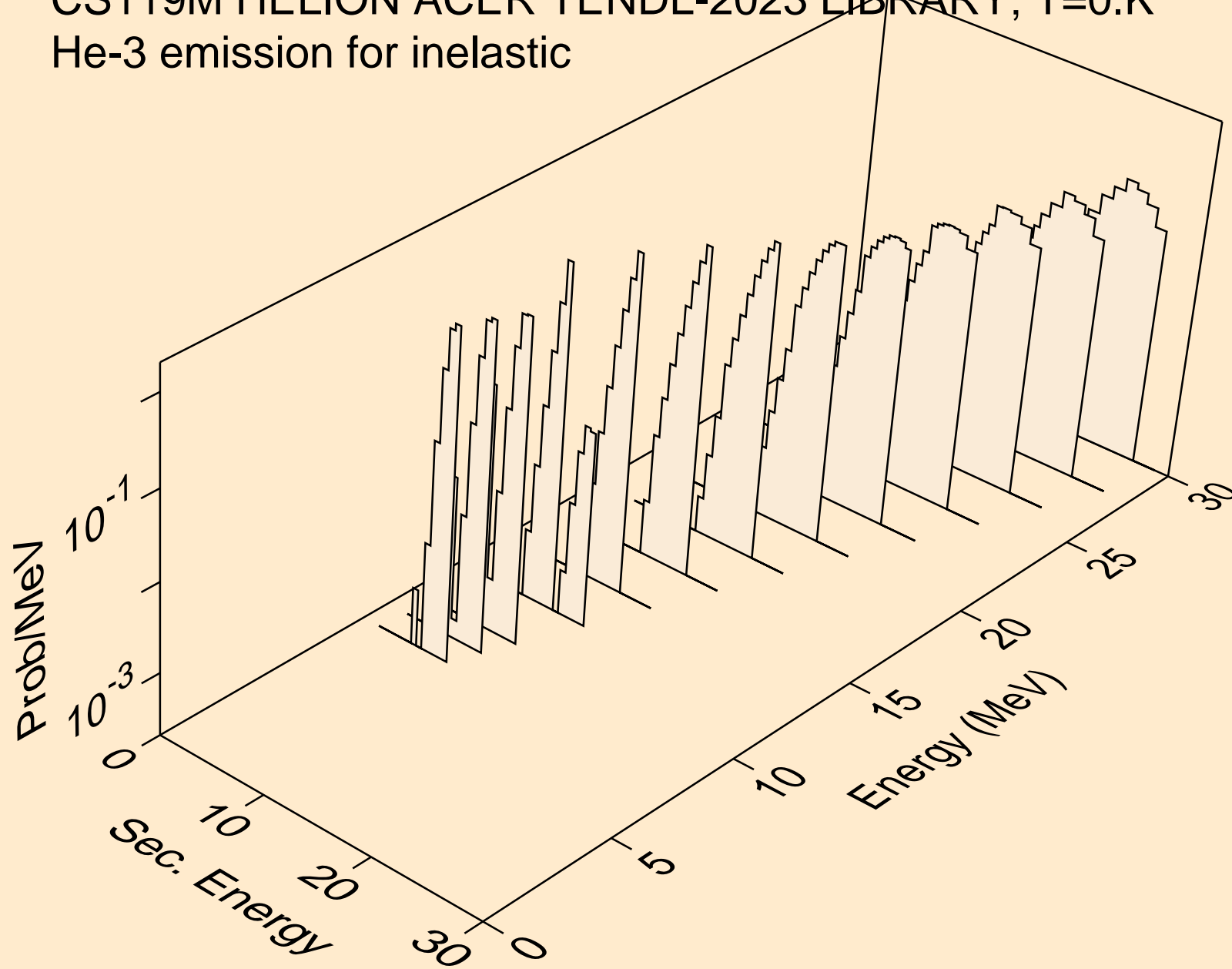

CS119M HELION ACER TENDL-2023 LIBRARY; T=0.K  
Photon emission for (z,n)

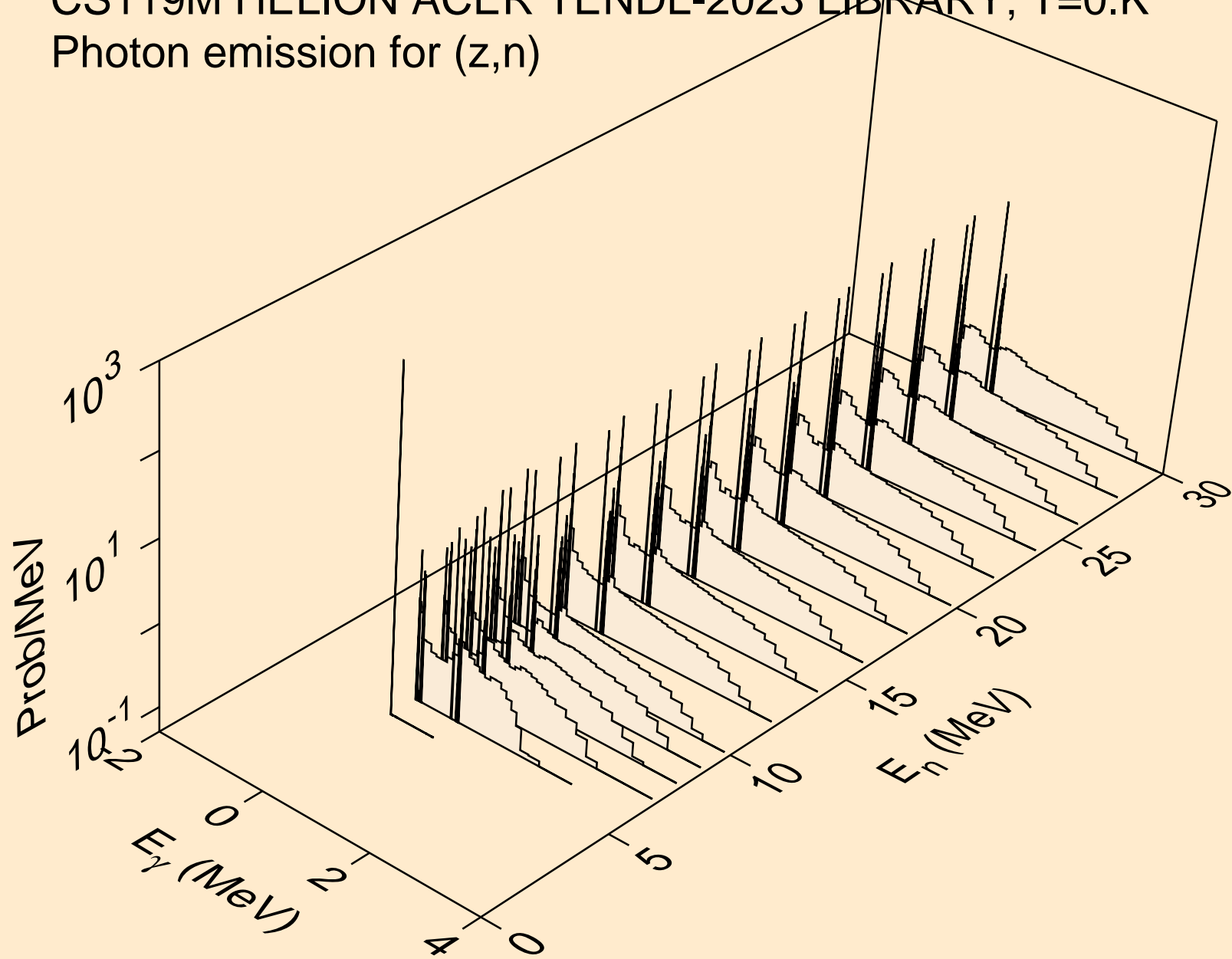

CS119M HELION ACER TENDL-2023 LIBRARY; T=0.K  
Photon emission for (z,x)

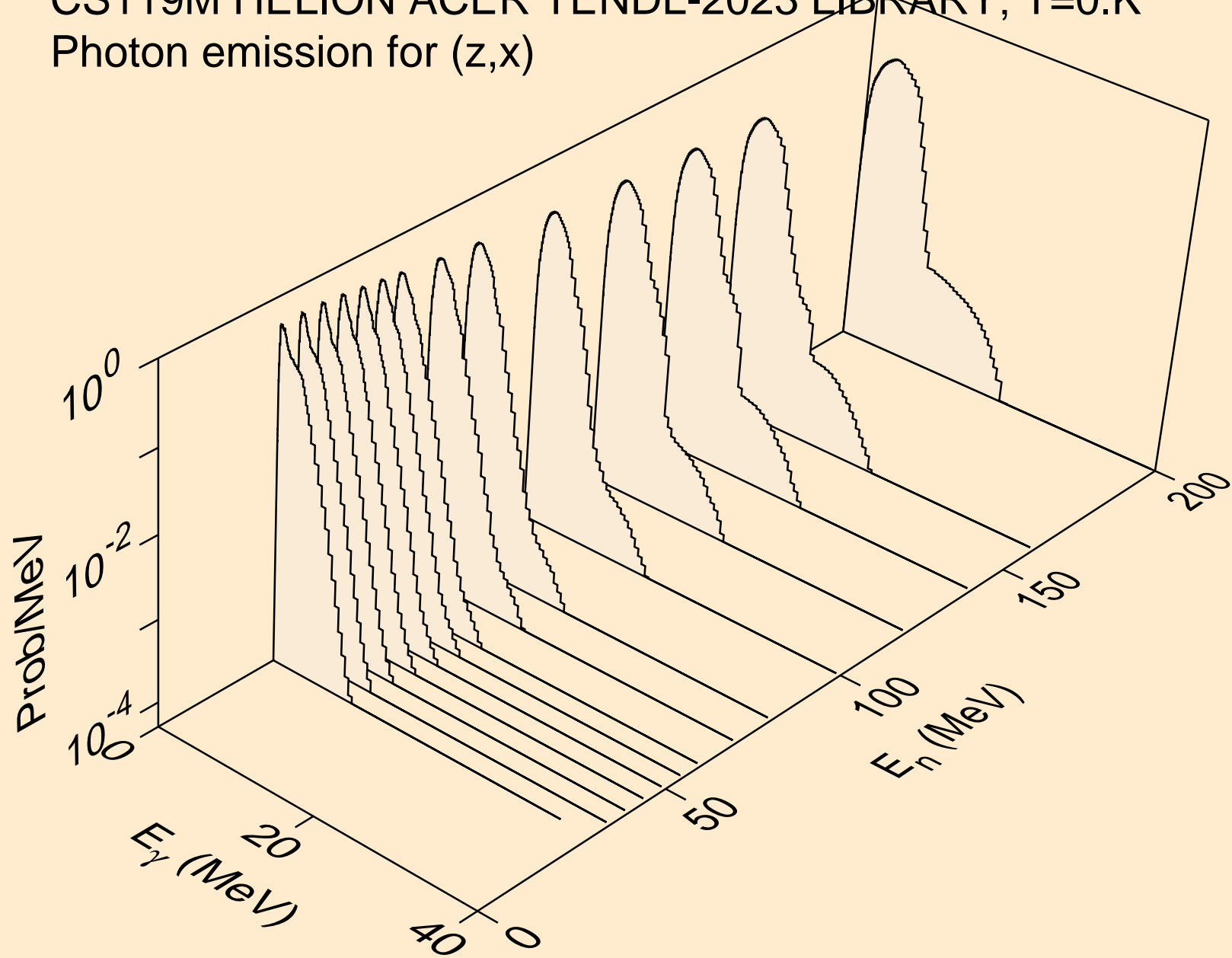

CS119M HELION ACER TENDL-2023 LIBRARY; T=0.K  
Photon emission for (n,2nd)

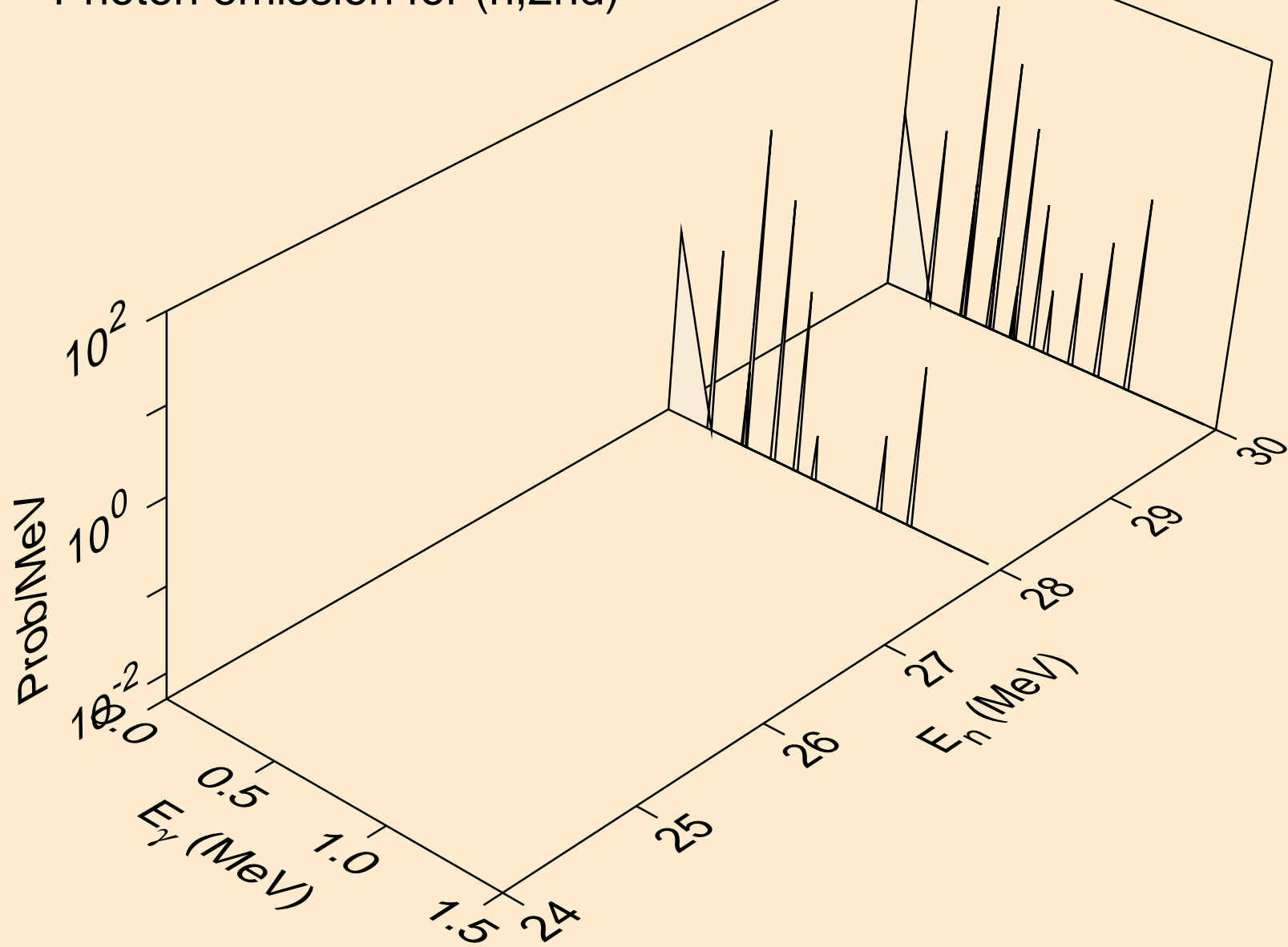

CS119M HELION ACER TENDL-2023 LIBRARY; T=0.K  
Photon emission for (n,2n)

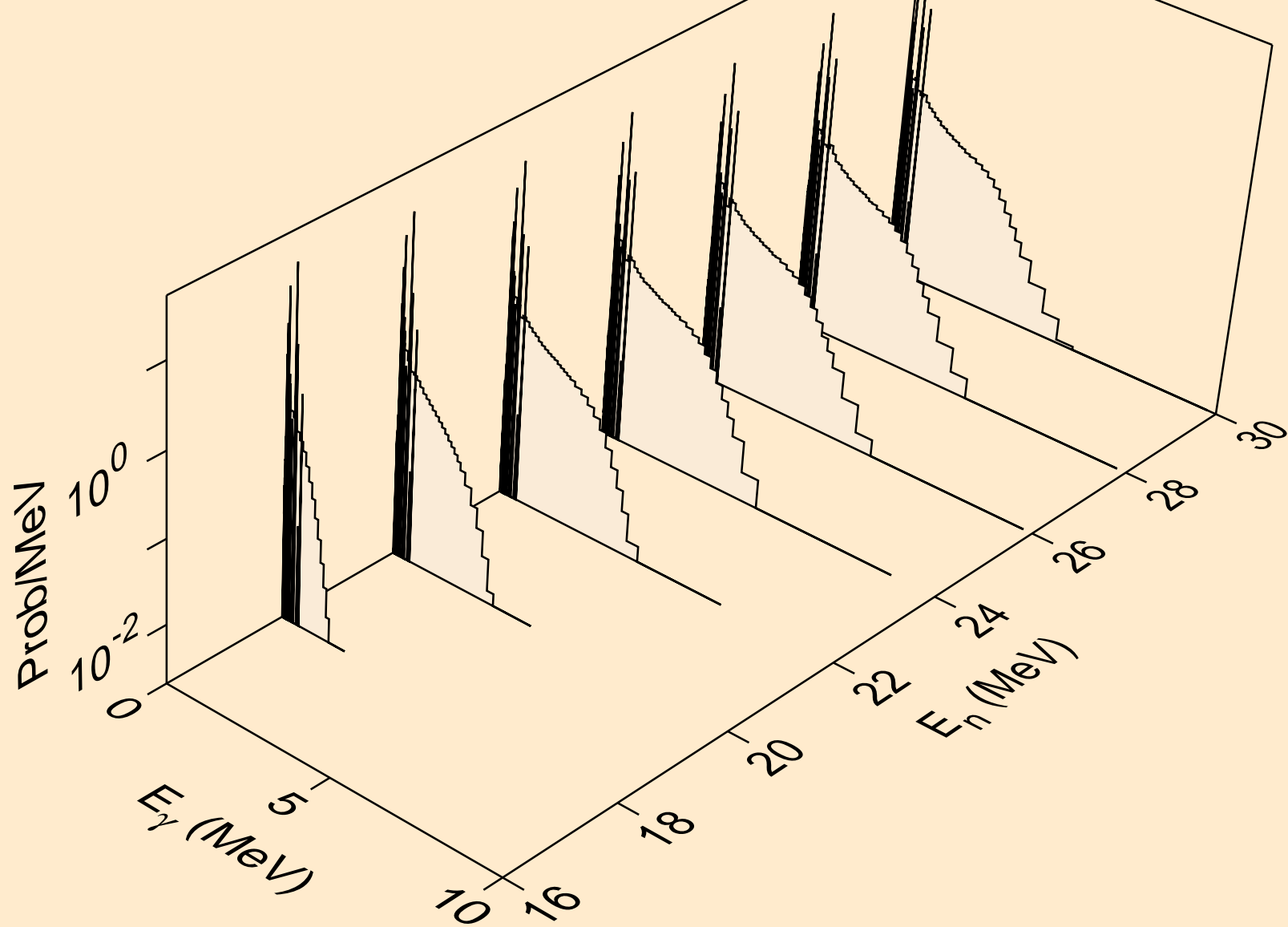

CS119M HELION ACER TENDL-2023 LIBRARY; T=0.K  
Photon emission for (n,3n)

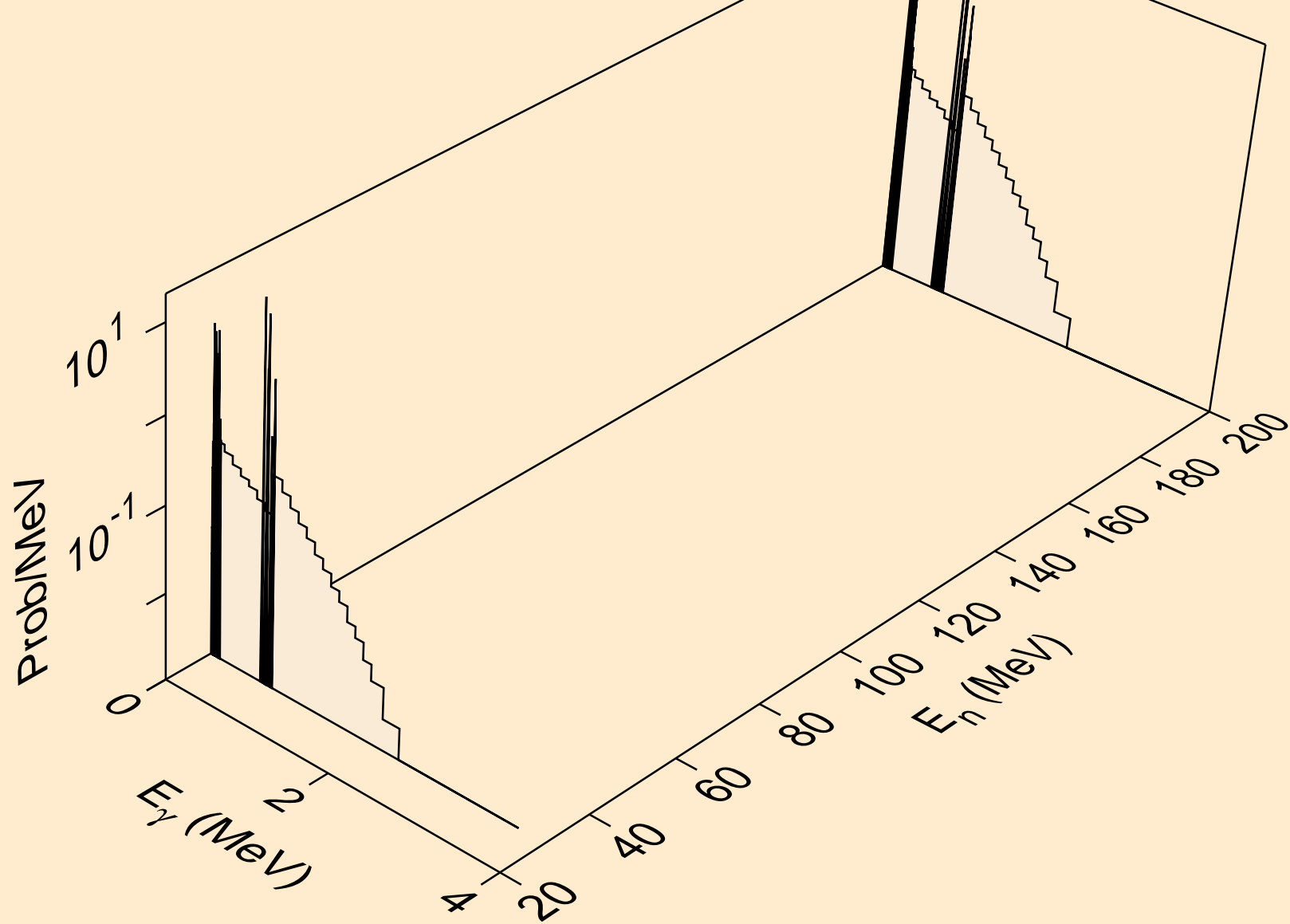

CS119M HELION ACER TENDL-2023 LIBRARY; T=0.K  
Photon emission for (n,n\*)a

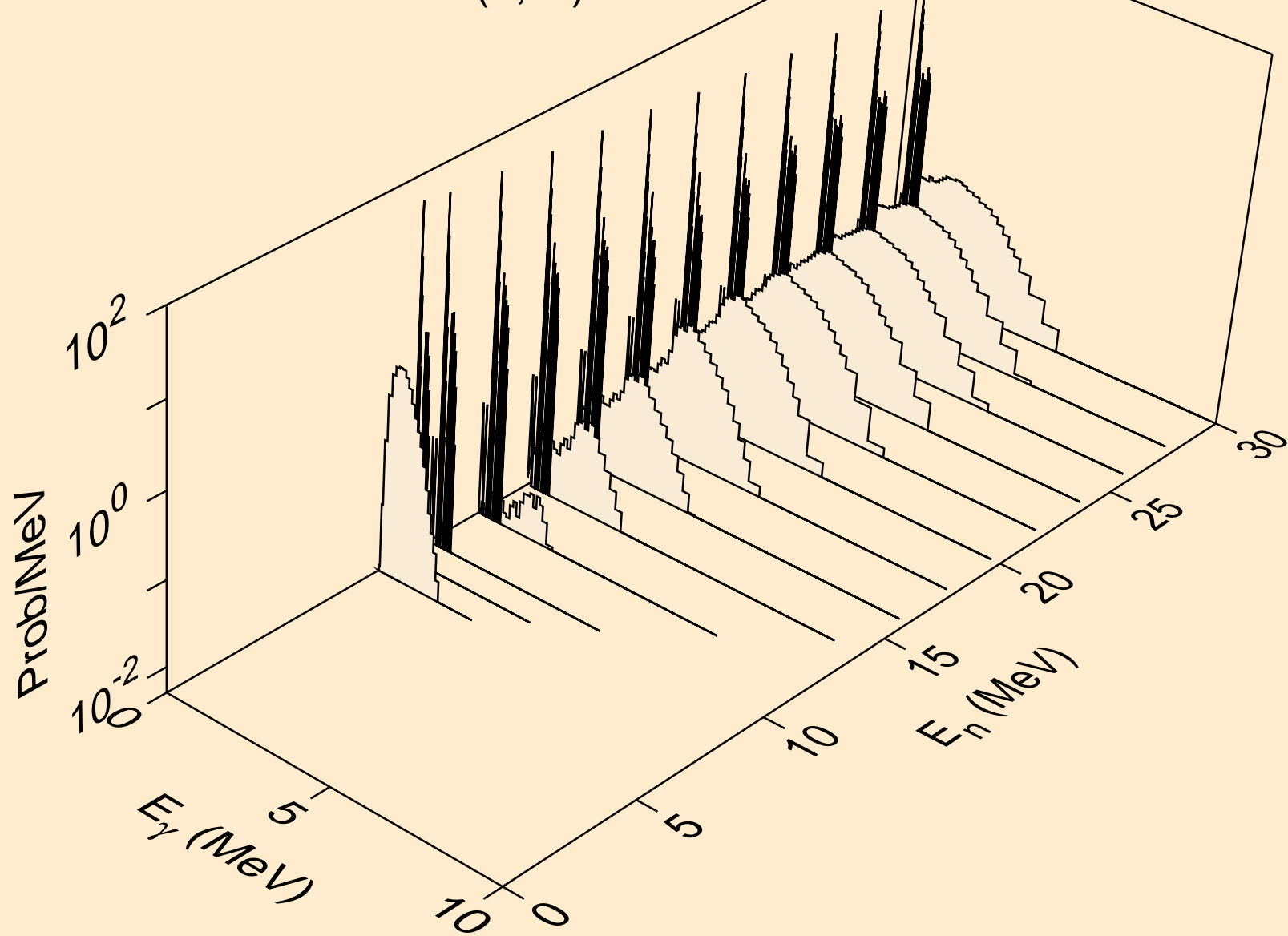

CS119M HELION ACER TENDL-2023 LIBRARY; T=0.K  
Photon emission for (n,2n)a

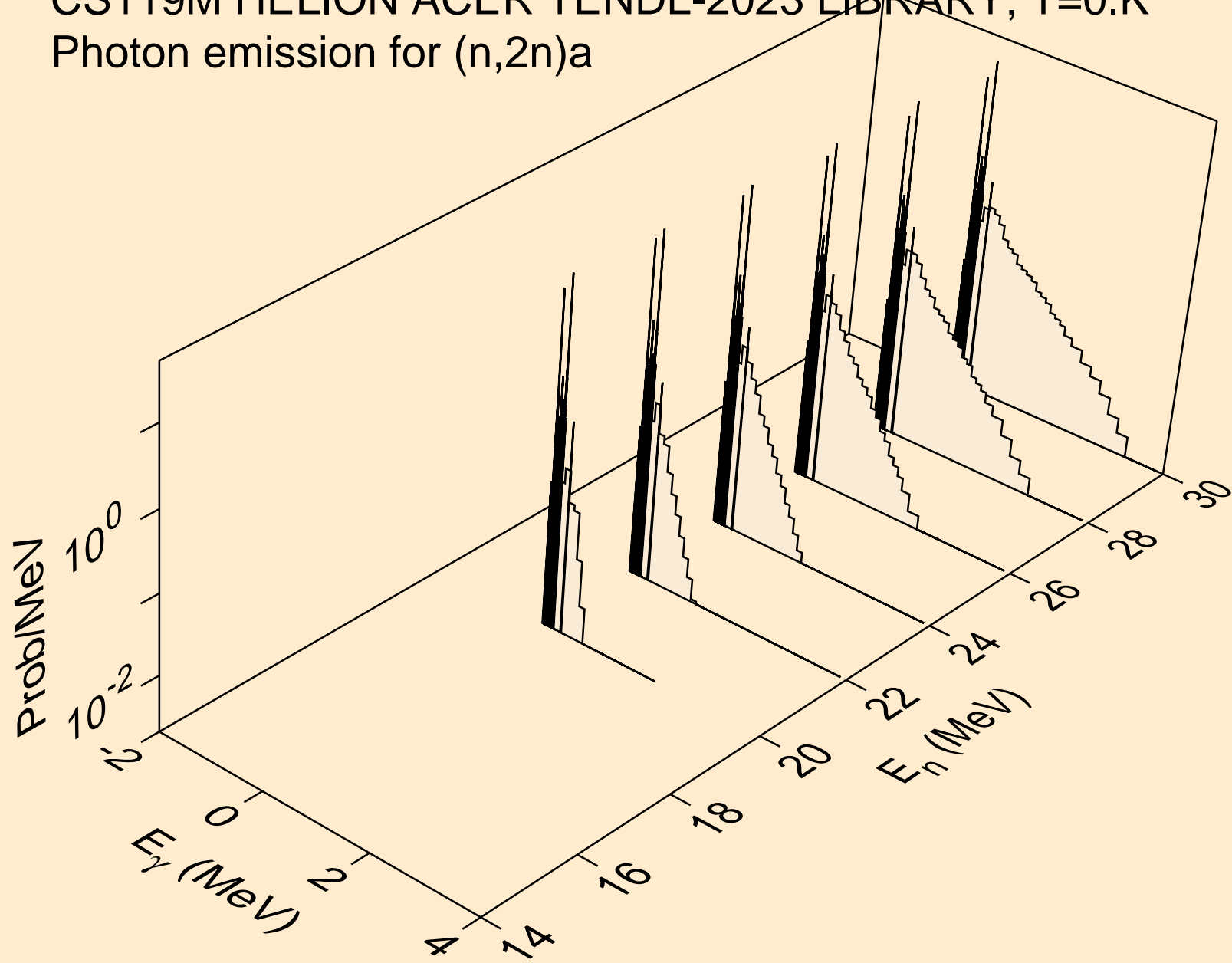

CS119M HELION ACER TENDL-2023 LIBRARY; T=0.K  
Photon emission for (n,n\*)p

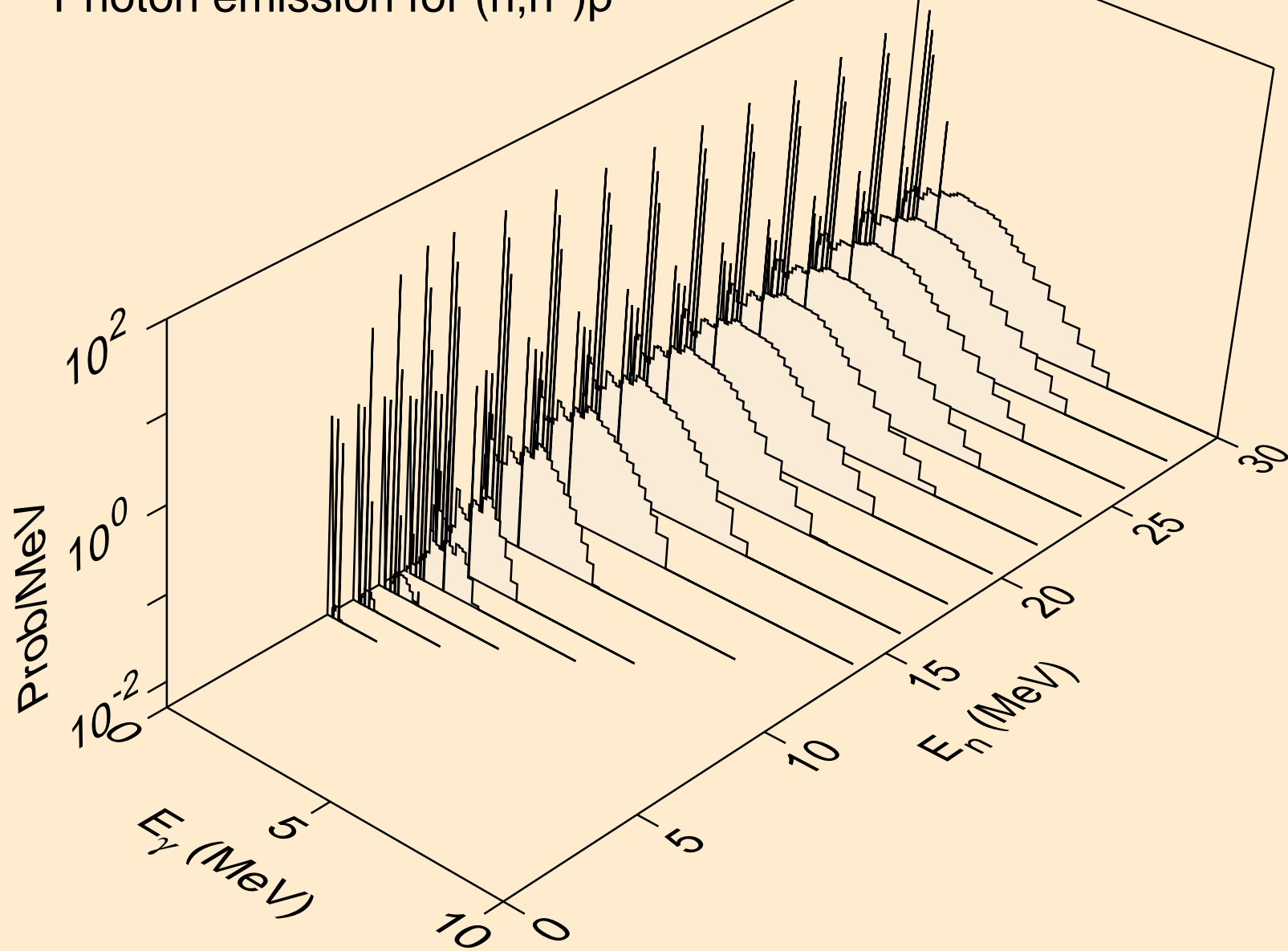

CS119M HELION ACER TENDL-2023 LIBRARY; T=0.K  
Photon emission for (n,n\*)2a

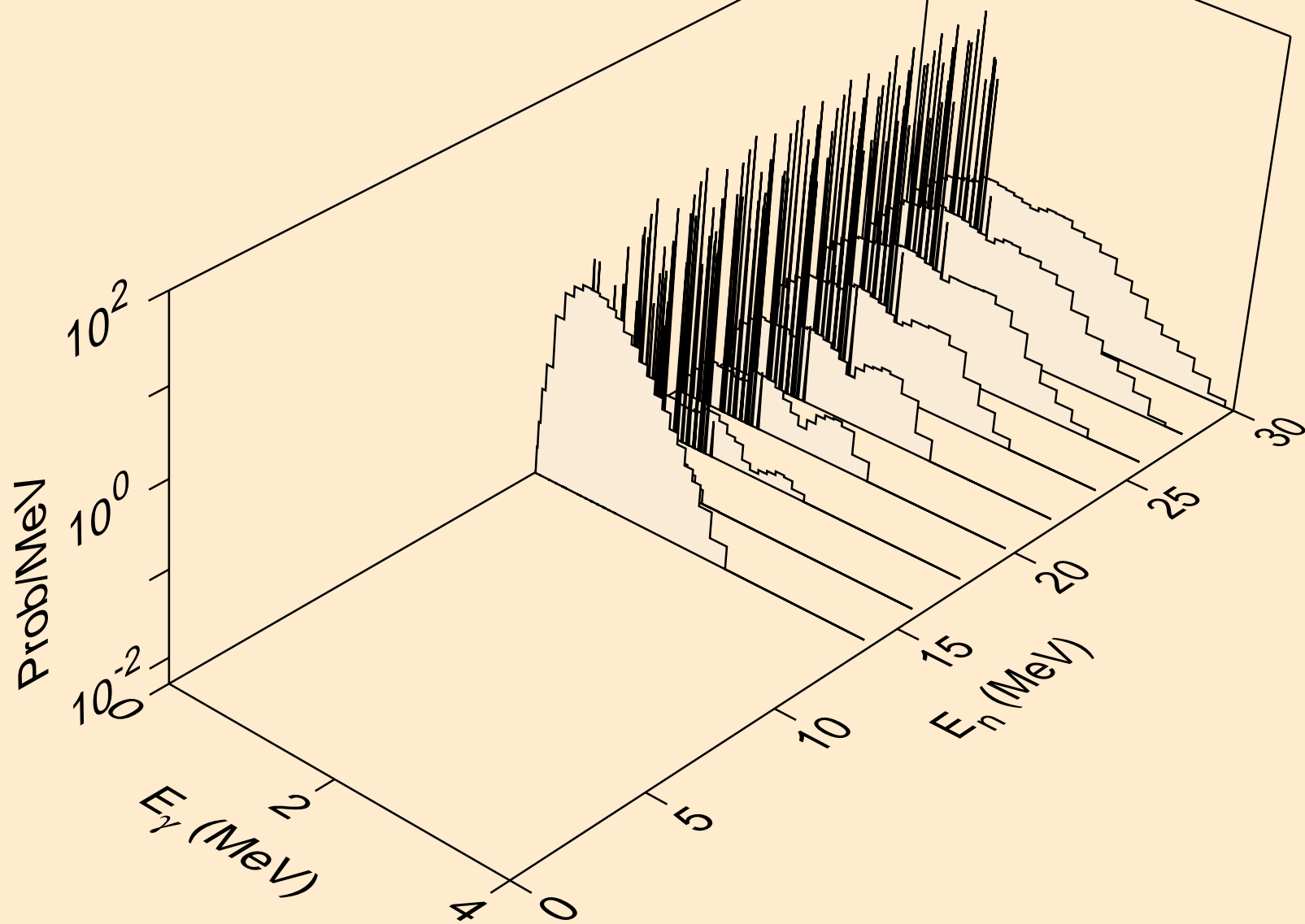

CS119M HELION ACER TENDL-2023 LIBRARY; T=0.K  
Photon emission for (n,n\*)d

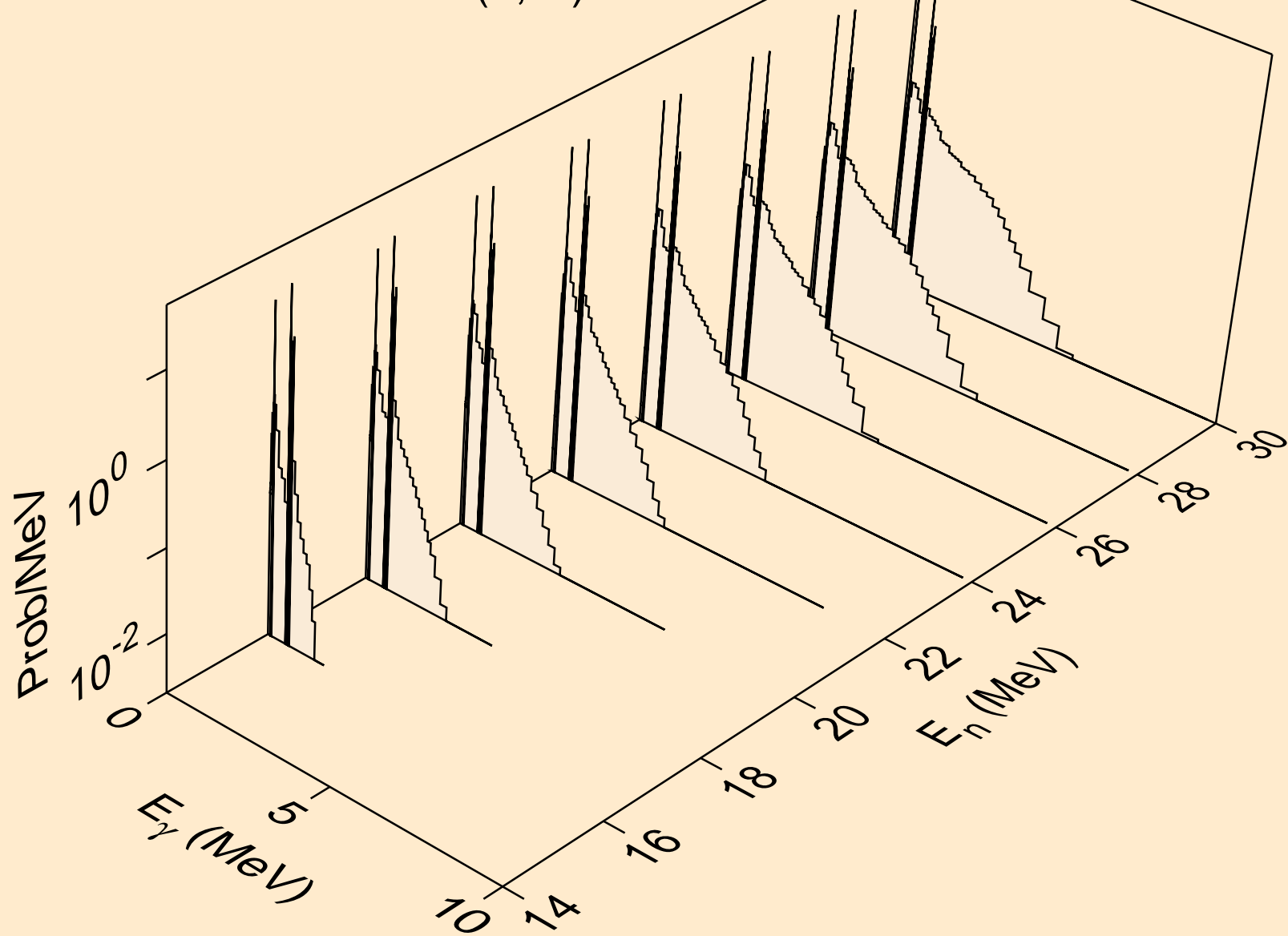

CS119M HELION ACER TENDL-2023 LIBRARY; T=0.K  
Photon emission for (n,n\*)t

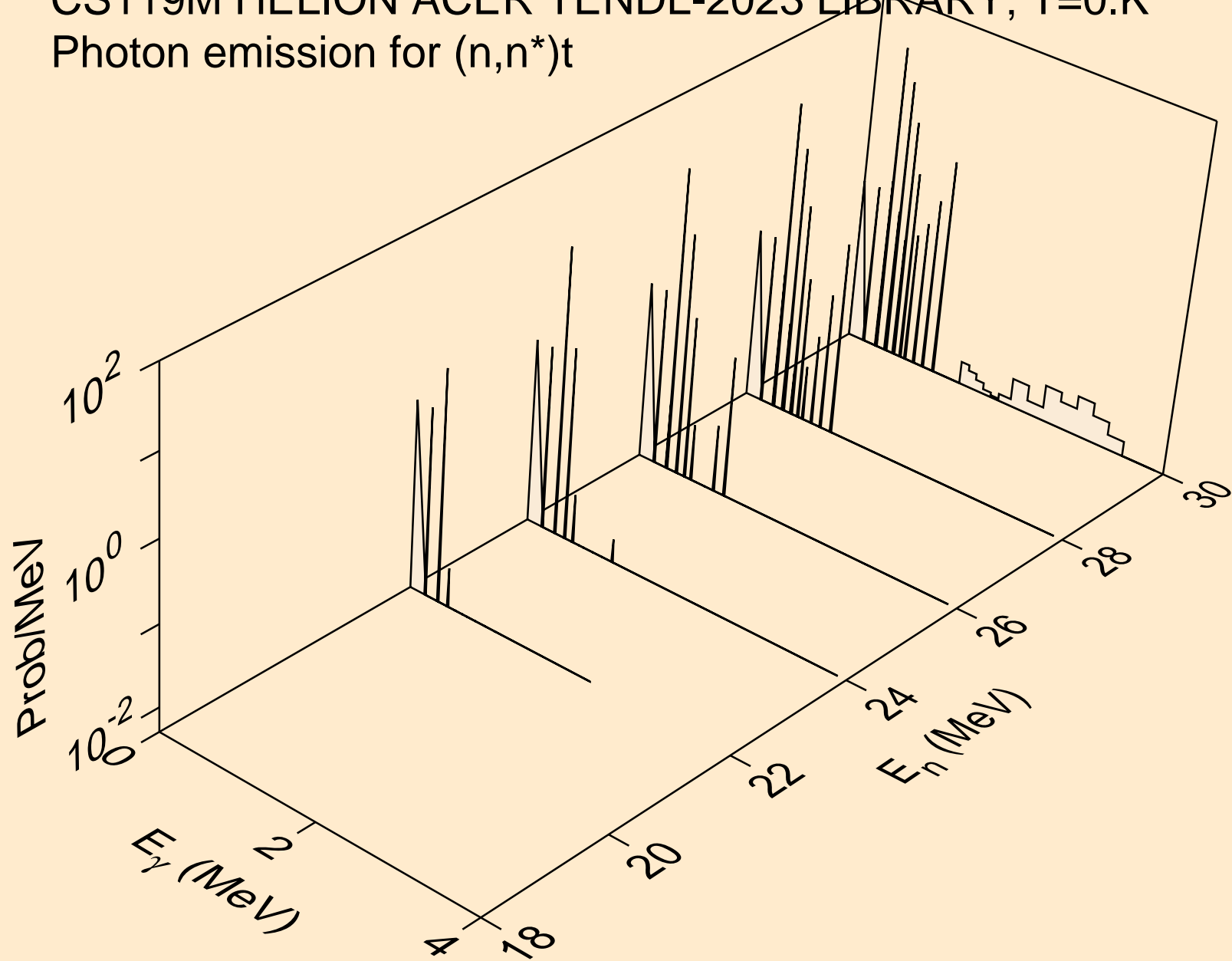

CS119M HELION ACER TENDL-2023 LIBRARY; T=0.K  
Photon emission for (n,n\*)he3

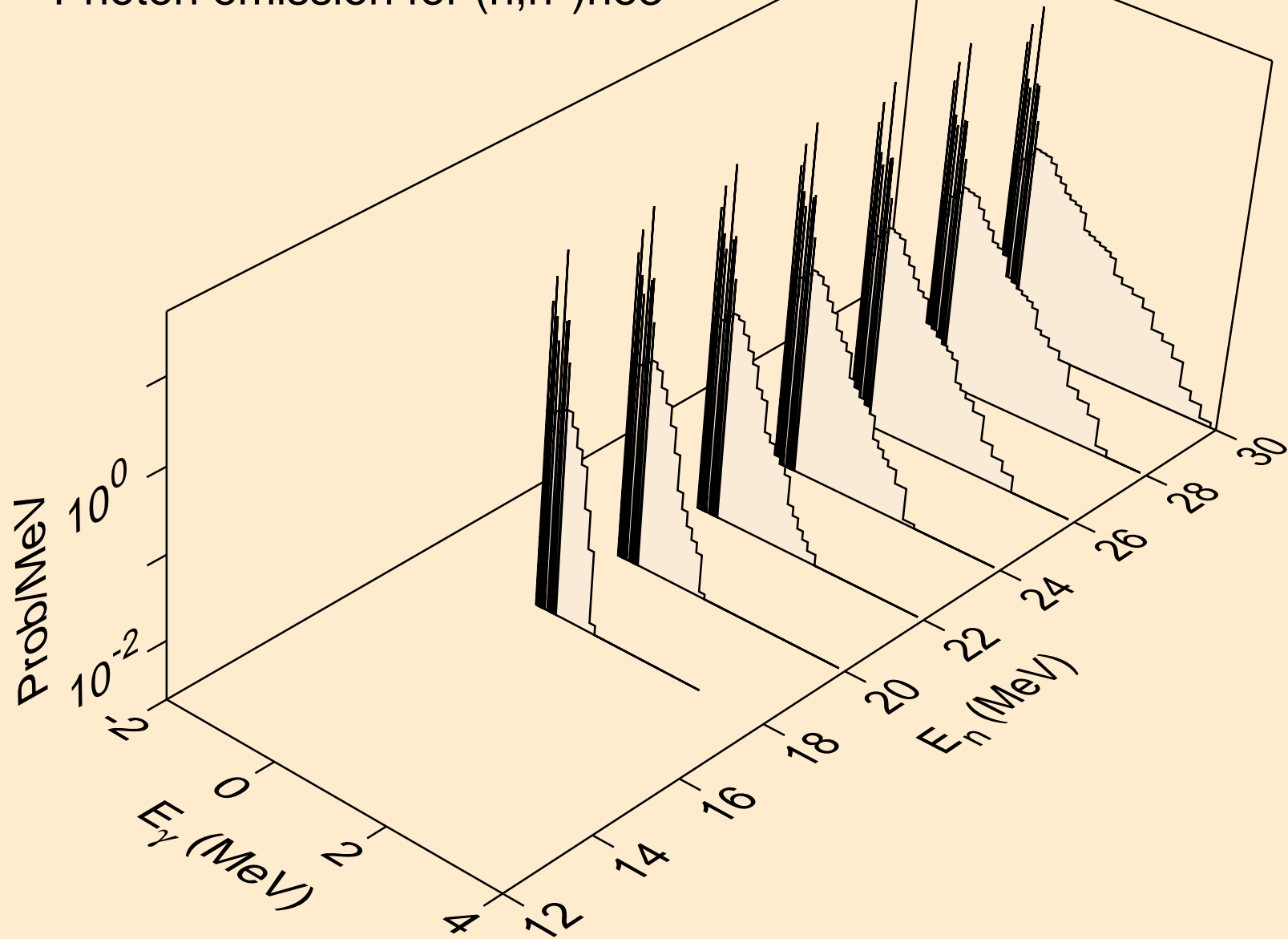

CS119M HELION ACER TENDL-2023 LIBRARY; T=0.K  
Photon emission for (n,2np)

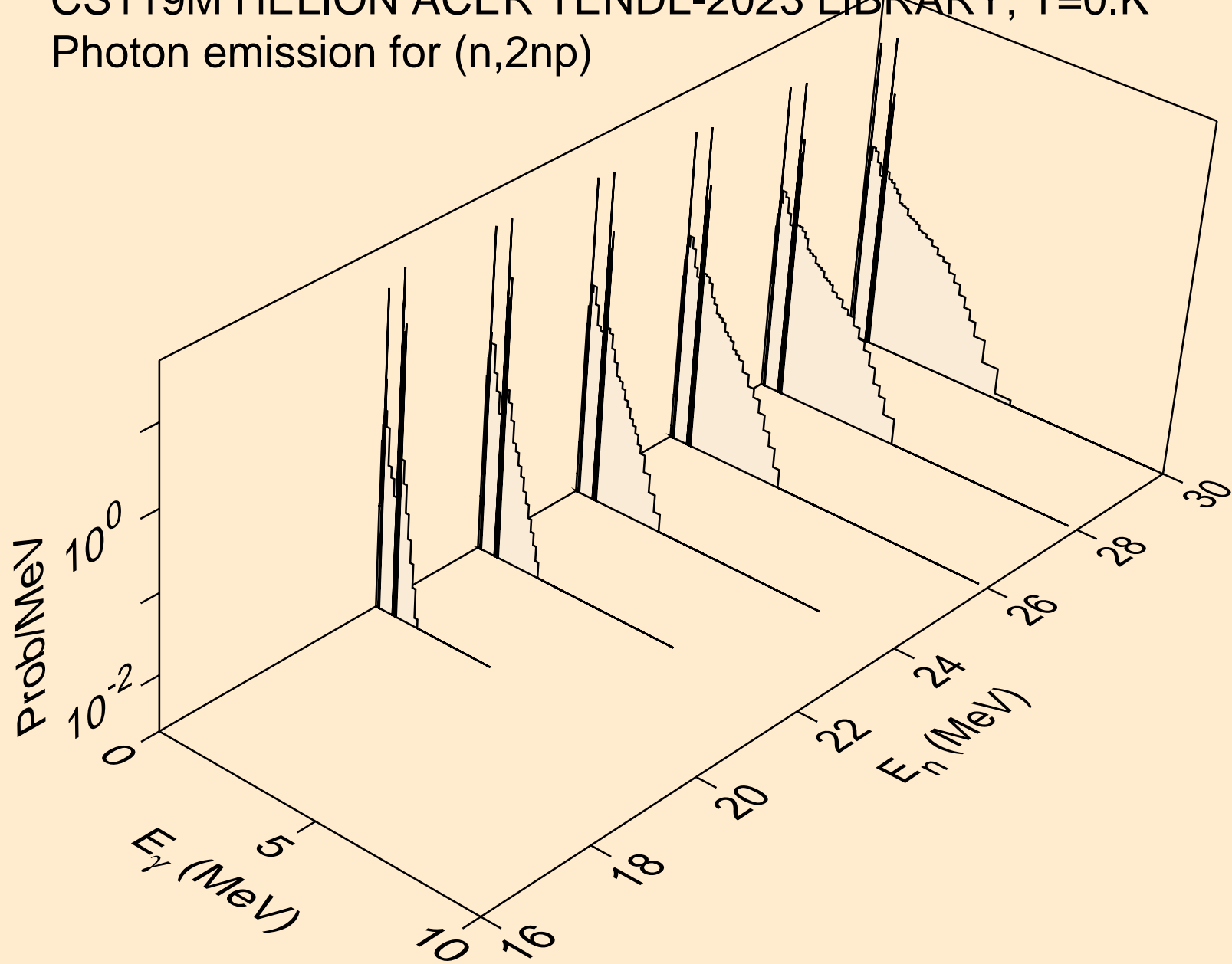

CS119M HELION ACER TENDL-2023 LIBRARY; T=0.K  
Photon emission for (n,n2p)

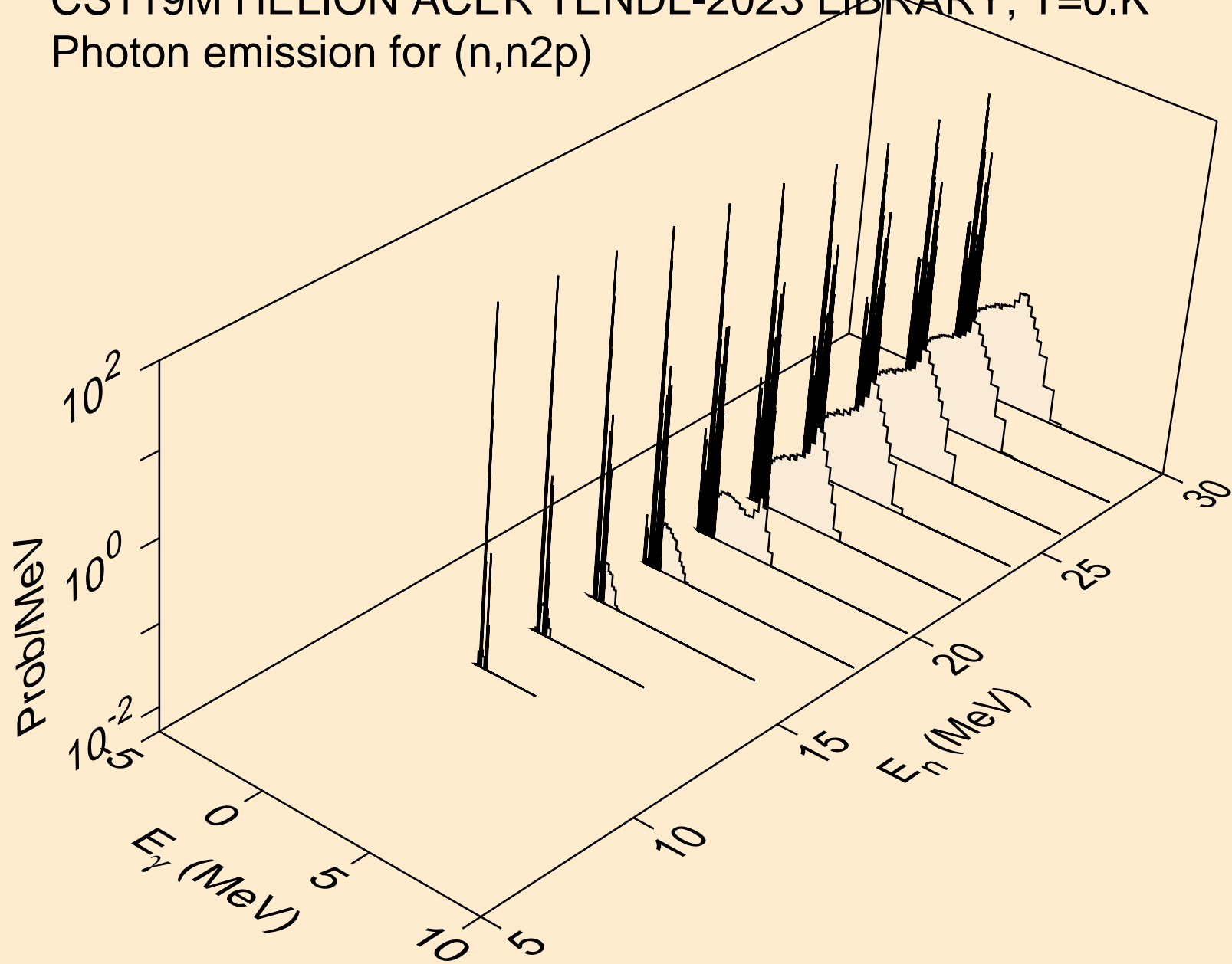

CS119M HELION ACER TENDL-2023 LIBRARY; T=0.K  
Photon emission for (n,npa)

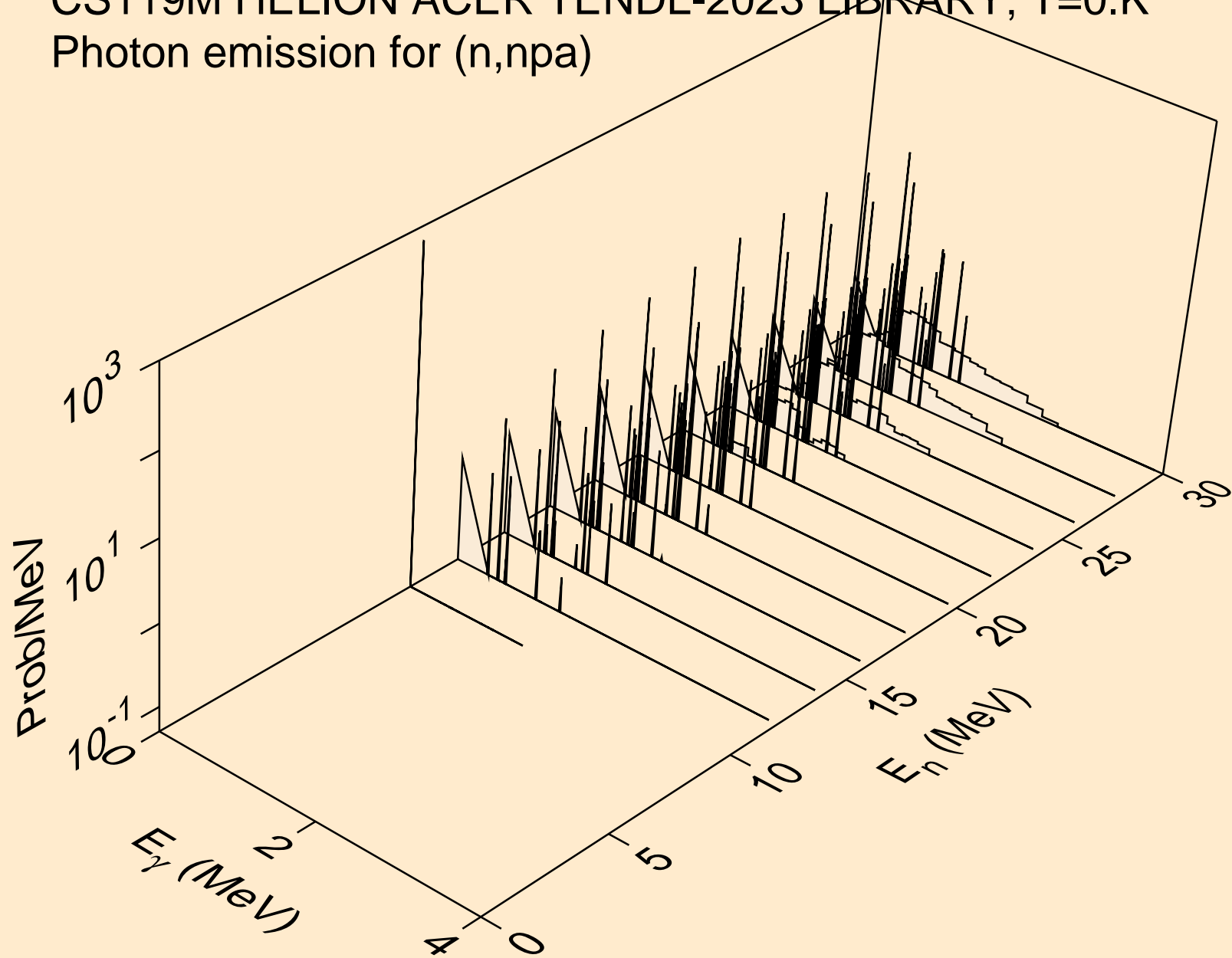

CS119M HELION ACER TENDL-2023 LIBRARY; T=0.K  
Photon emission for (n,gma)

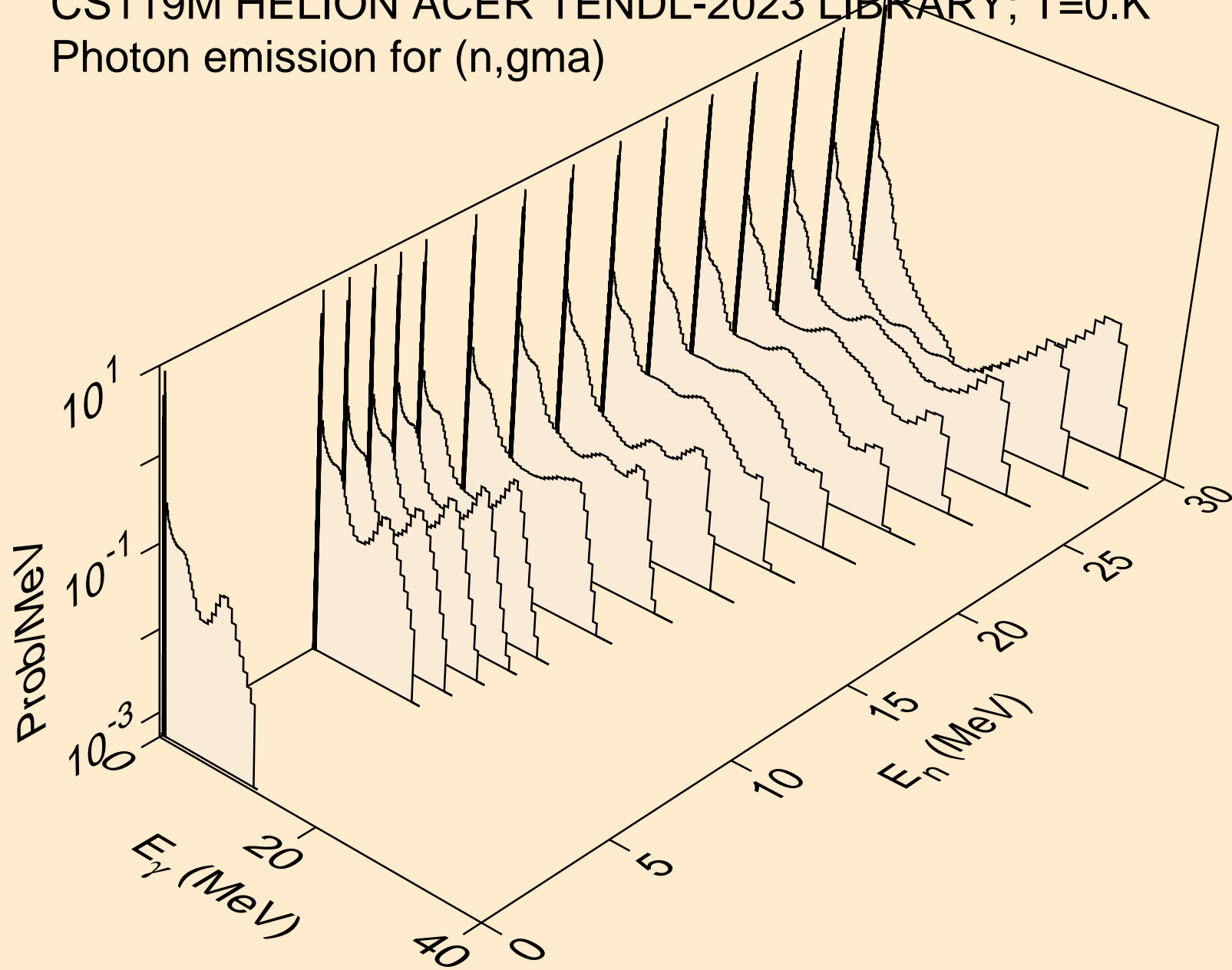

CS119M HELION ACER TENDL-2023 LIBRARY; T=0.K  
Photon emission for (n,p)

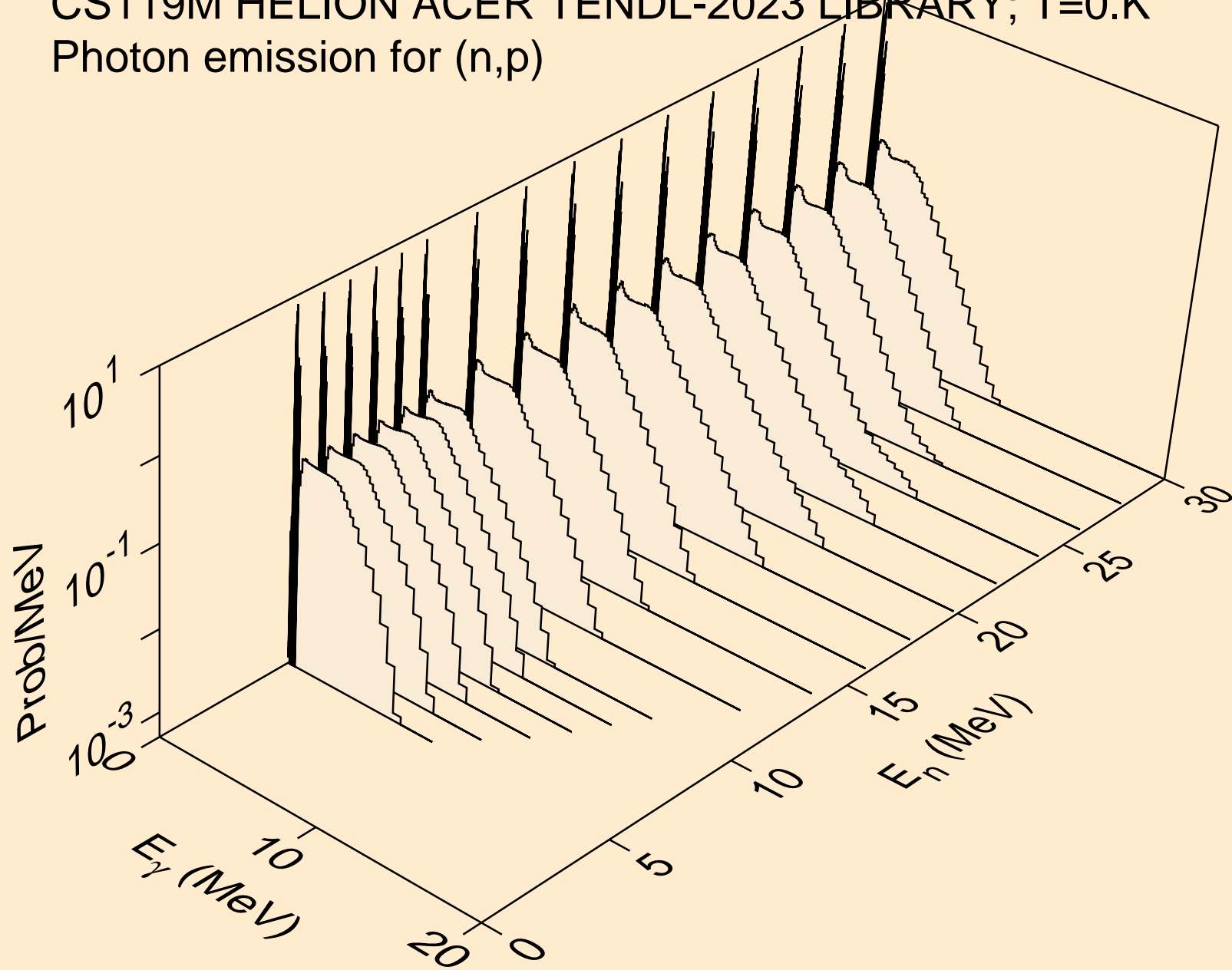

CS119M HELION ACER TENDL-2023 LIBRARY; T=0.K  
Photon emission for (n,d)

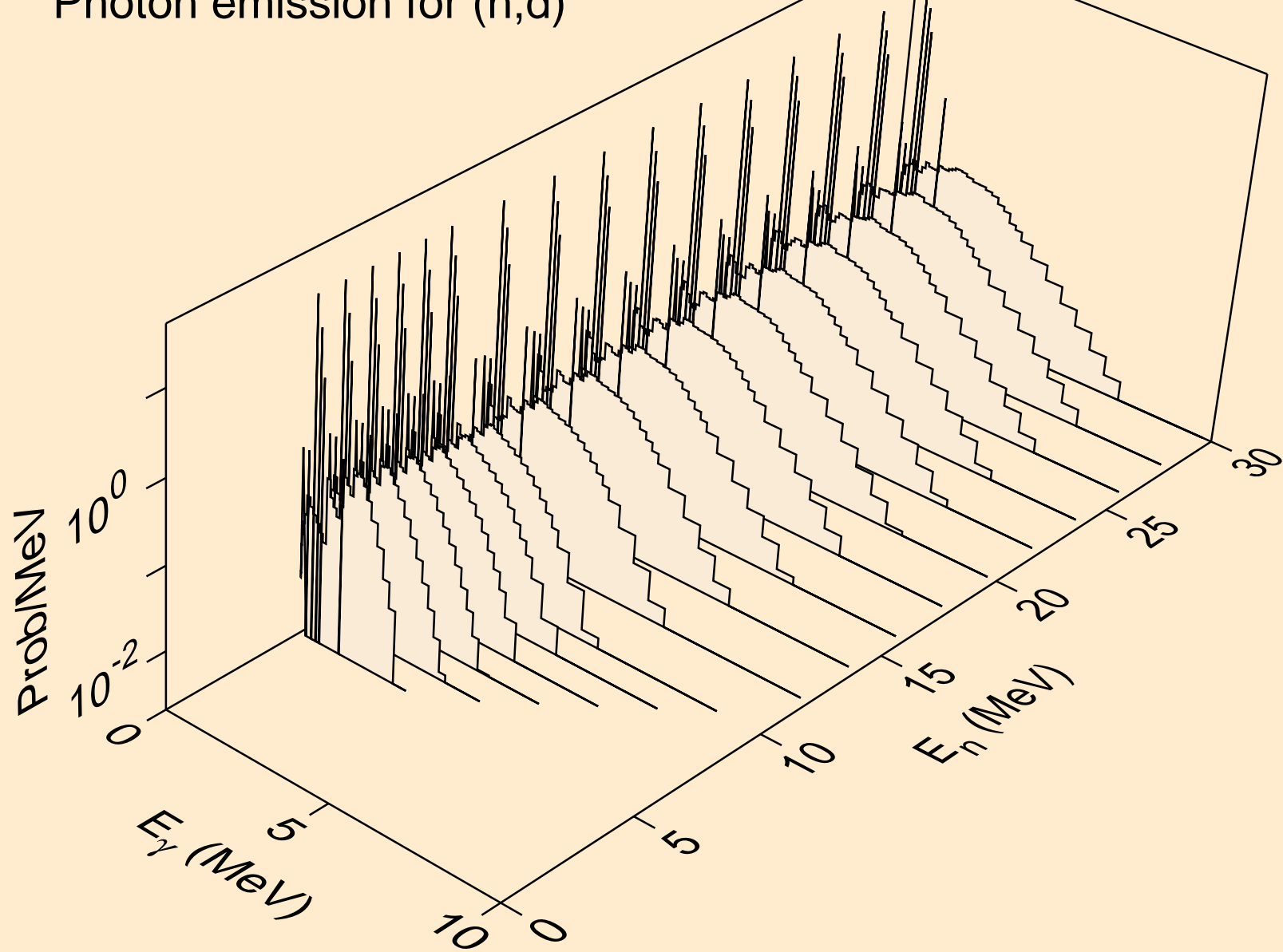

CS119M HELION ACER TENDL-2023 LIBRARY; T=0.K  
Photon emission for (n,t)

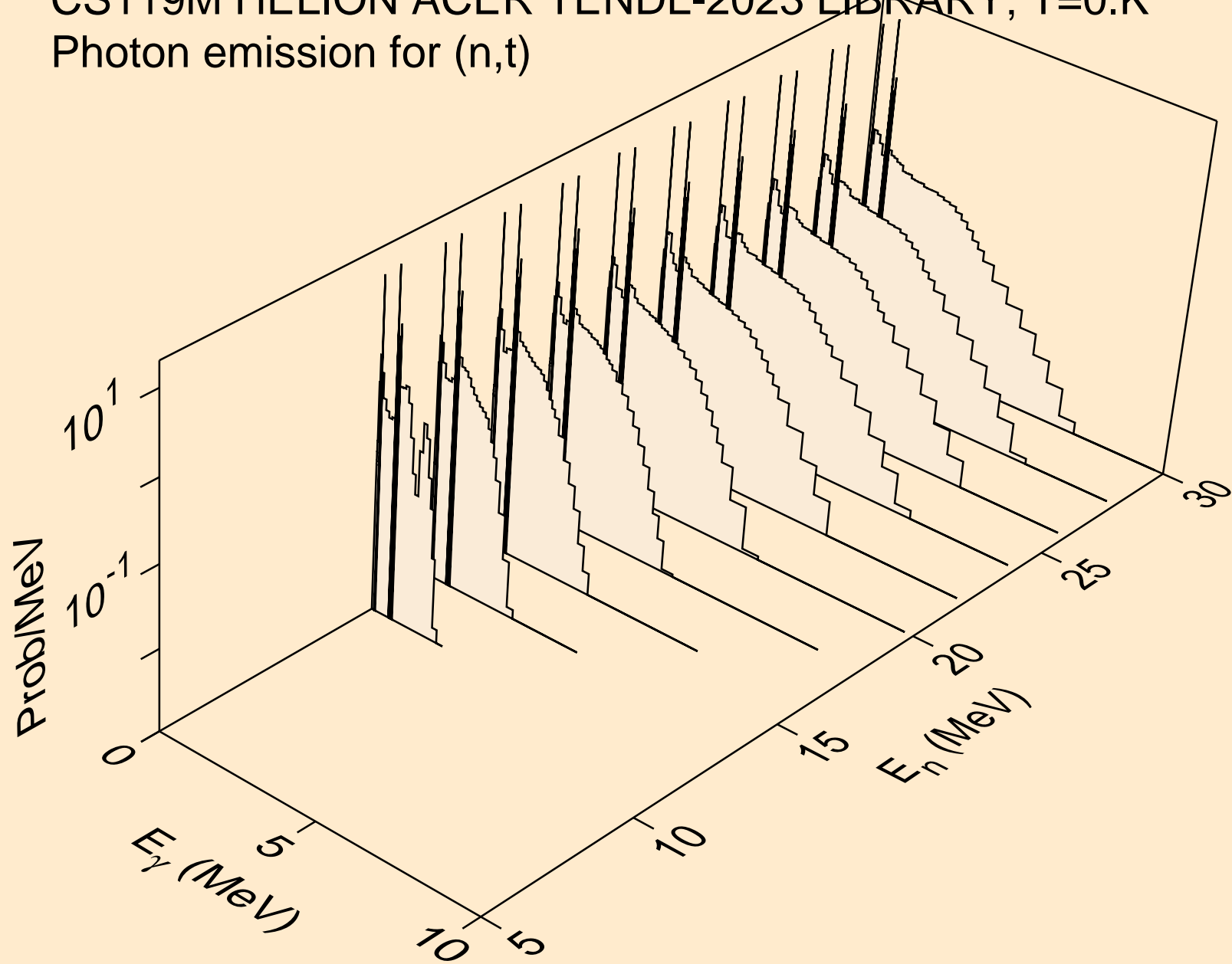

CS119M HELION ACER TENDL-2023 LIBRARY; T=0.K  
Photon emission for inelastic

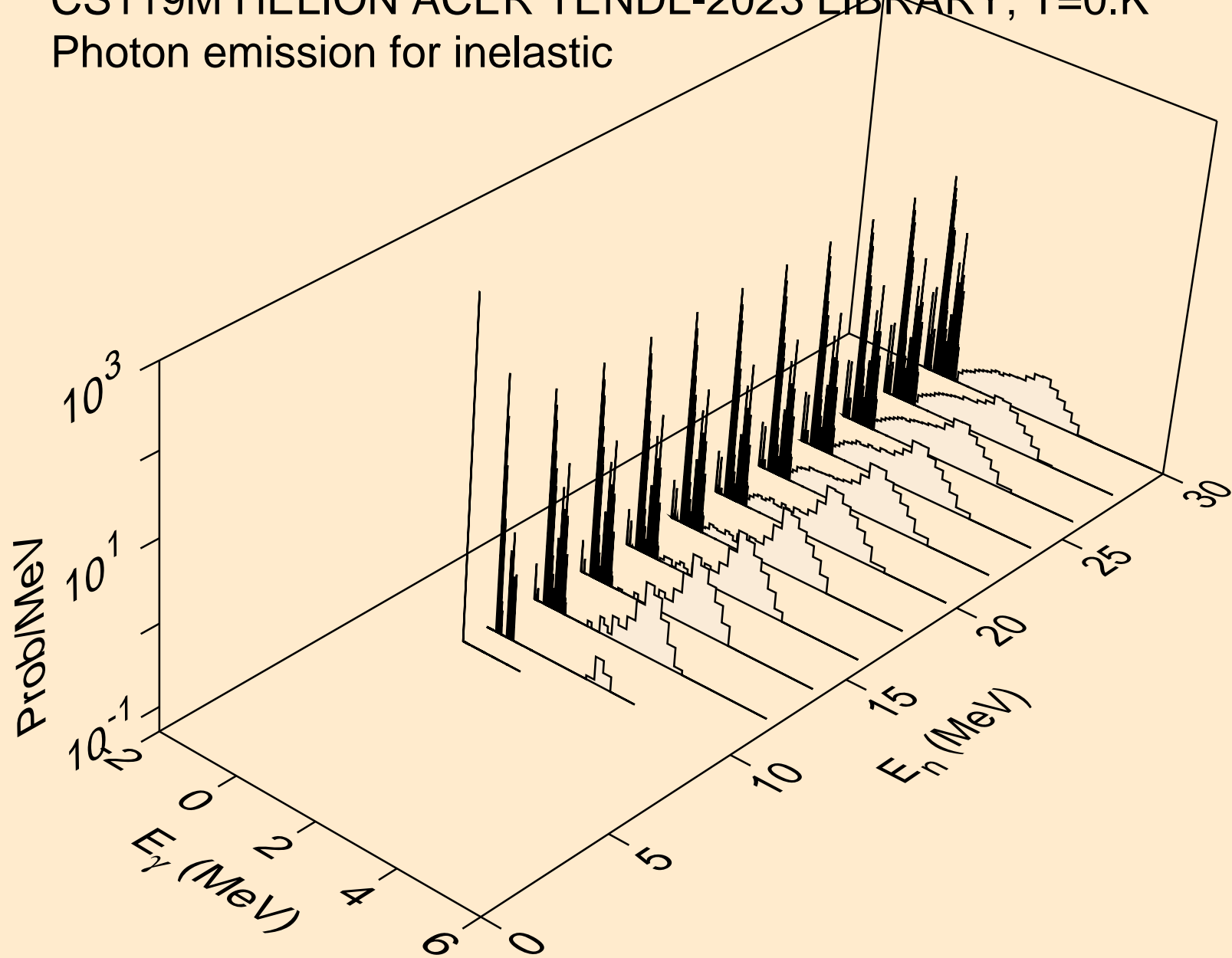

CS119M HELION ACER TENDL-2023 LIBRARY; T=0.K  
Photon emission for (n,a)

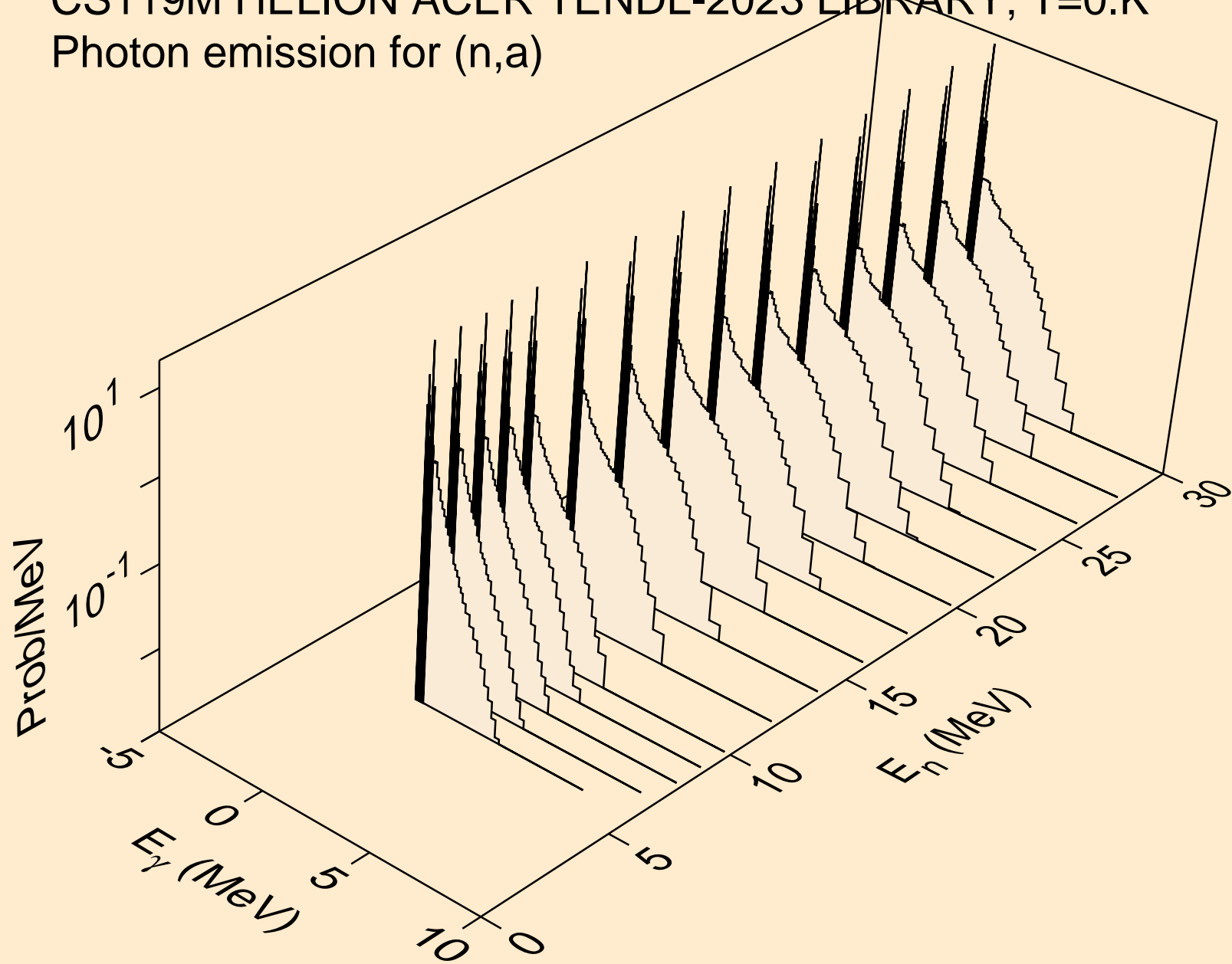

CS119M HELION ACER TENDL-2023 LIBRARY; T=0.K  
Photon emission for (n,2a)

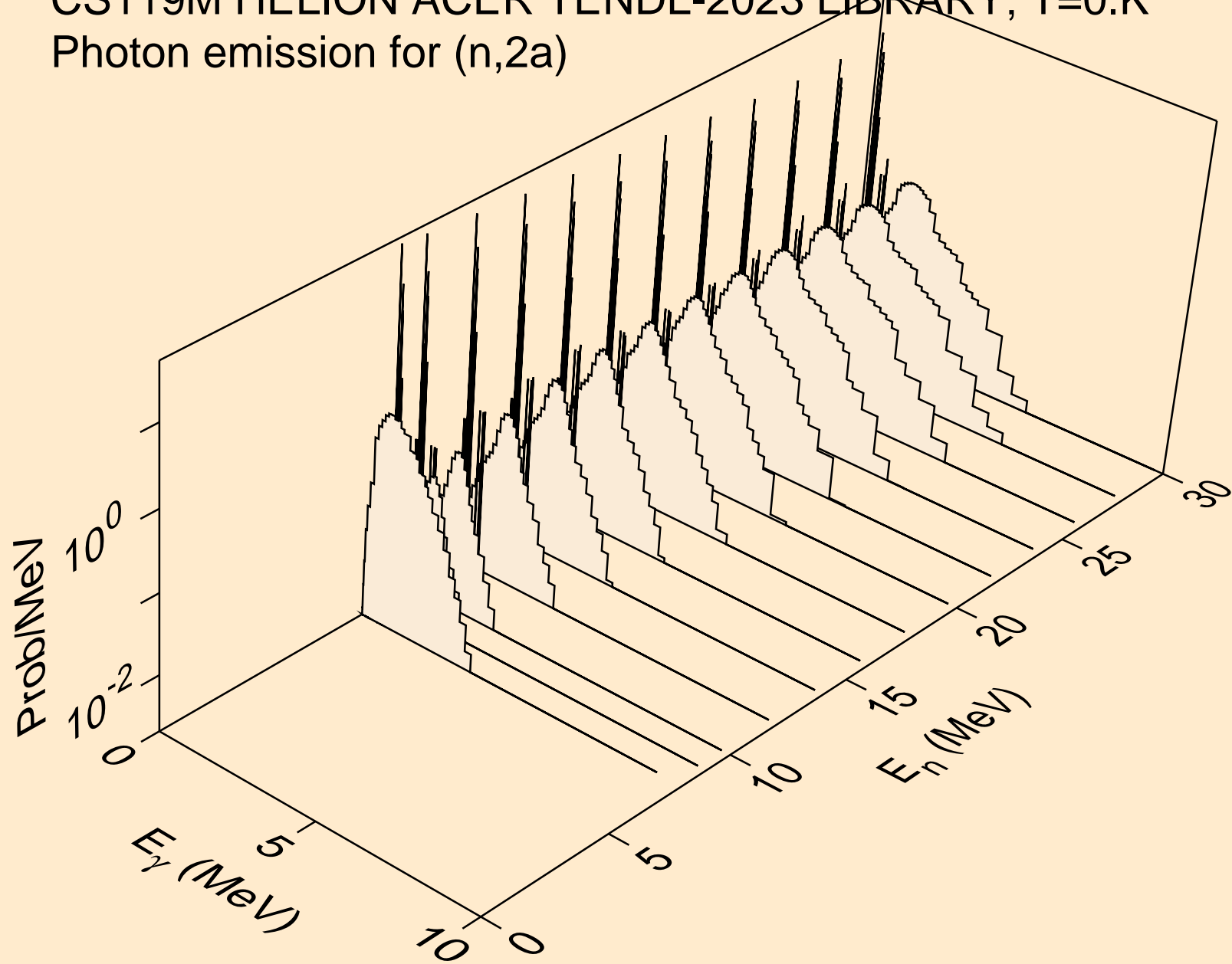

CS119M HELION ACER TENDL-2023 LIBRARY; T=0.K  
Photon emission for (n,3a)

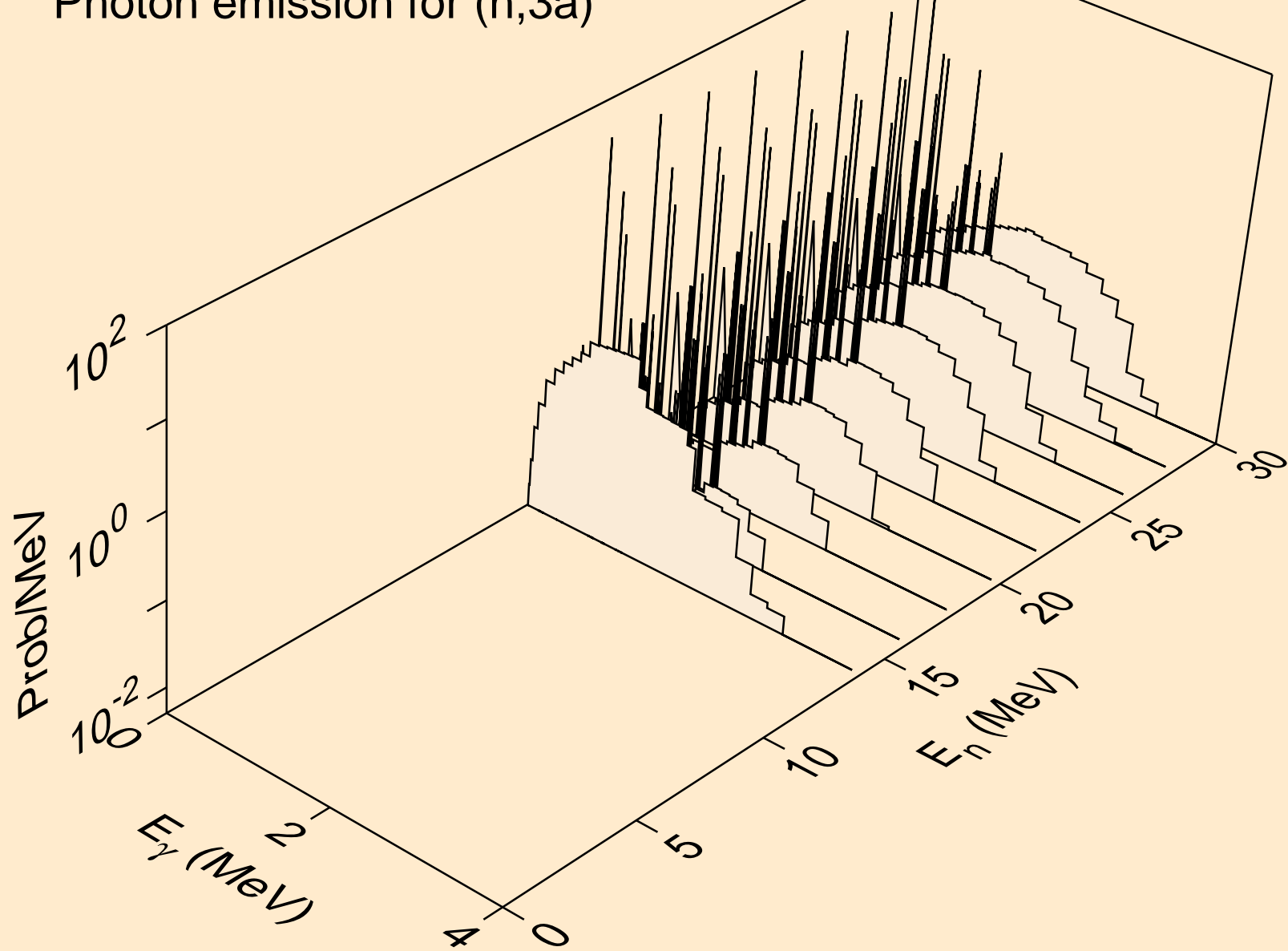

CS119M HELION ACER TENDL-2023 LIBRARY; T=0.K  
Photon emission for (n,2p)

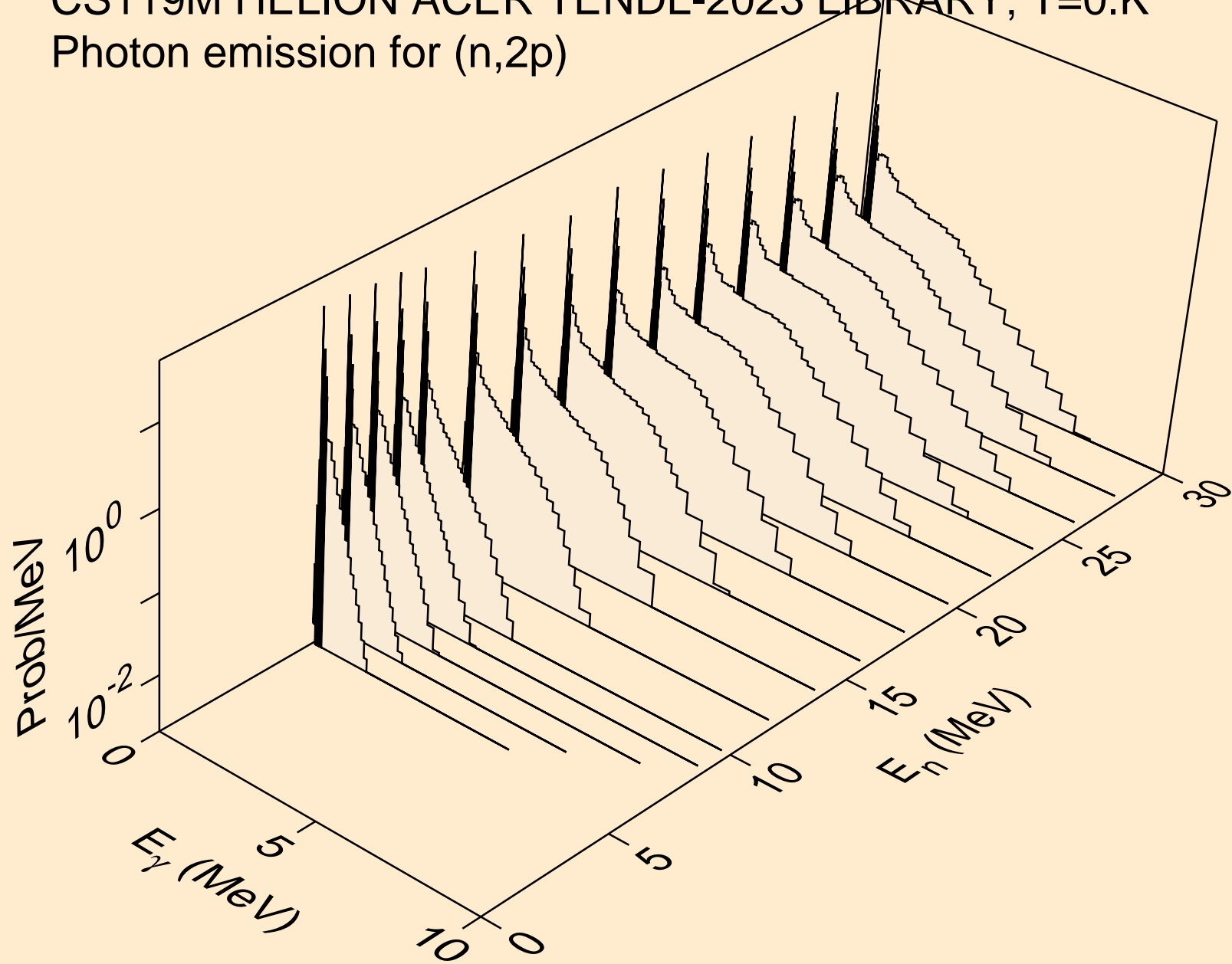

CS119M HELION ACER TENDL-2023 LIBRARY; T=0.K  
Photon emission for (n,pa)

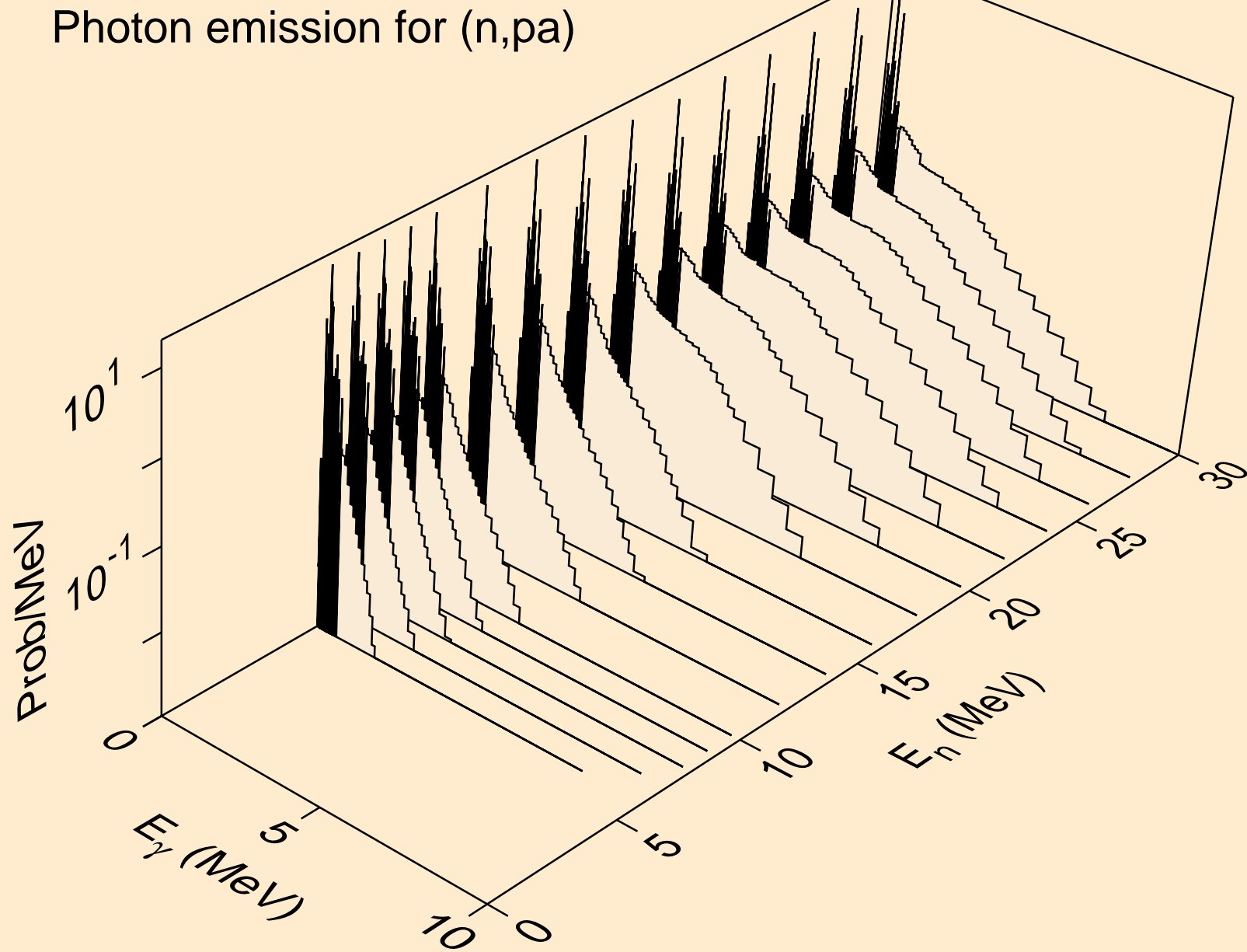

CS119M HELION ACER TENDL-2023 LIBRARY; T=0.K  
Photon emission for (n,t2a)

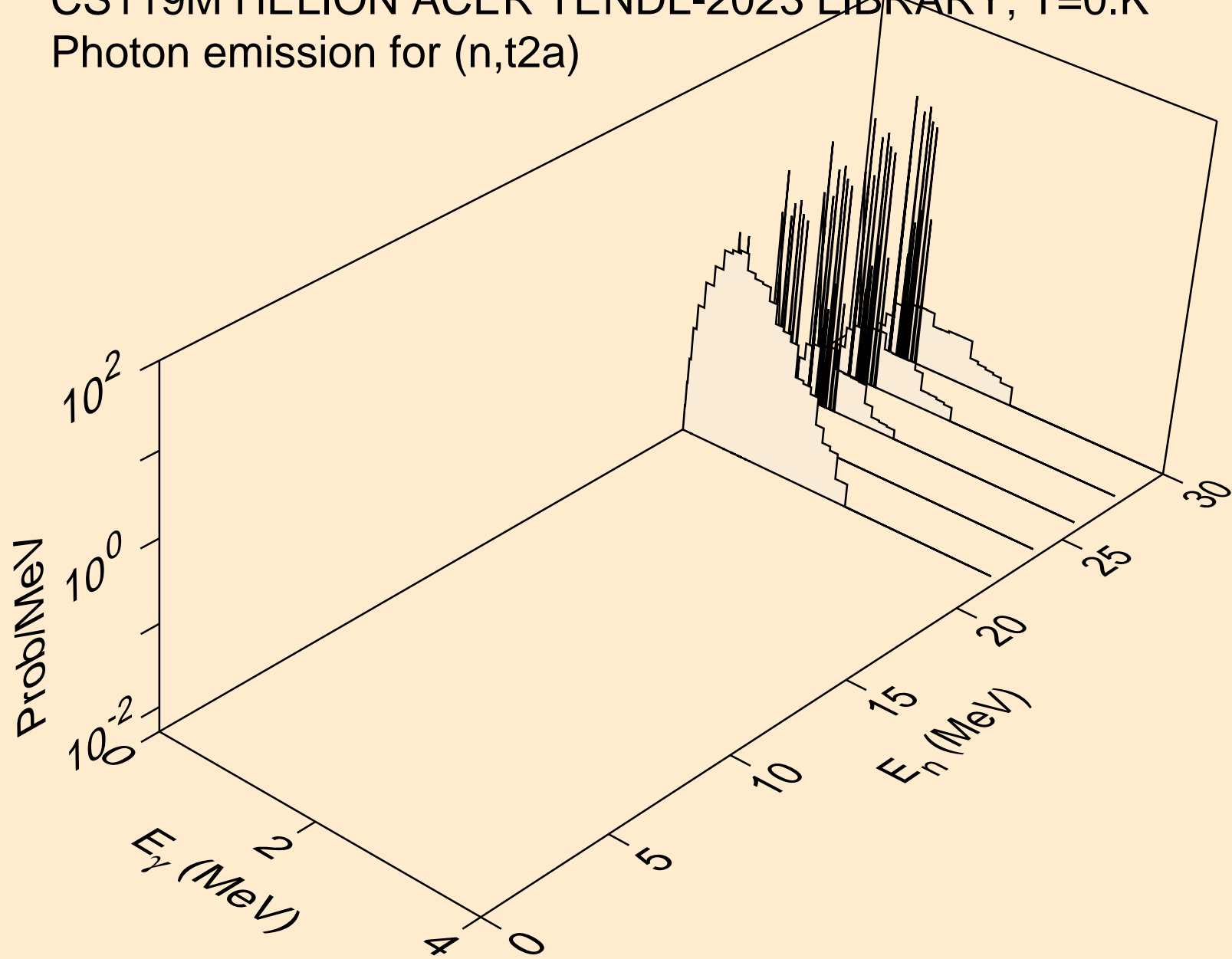

CS119M HELION ACER TENDL-2023 LIBRARY; T=0.K  
Photon emission for (n,d2a)

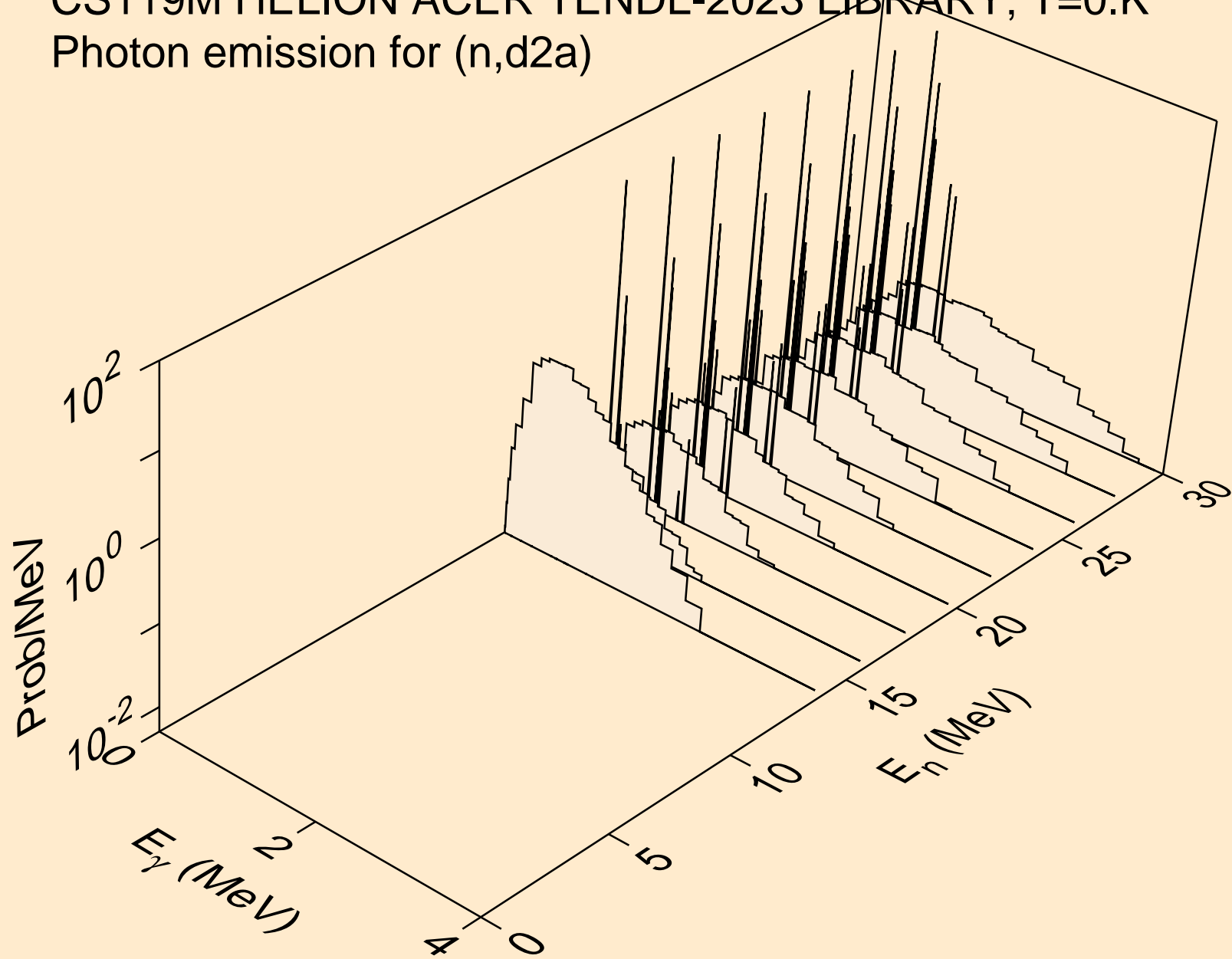

CS119M HELION ACER TENDL-2023 LIBRARY; T=0.K  
Photon emission for (n,pd)

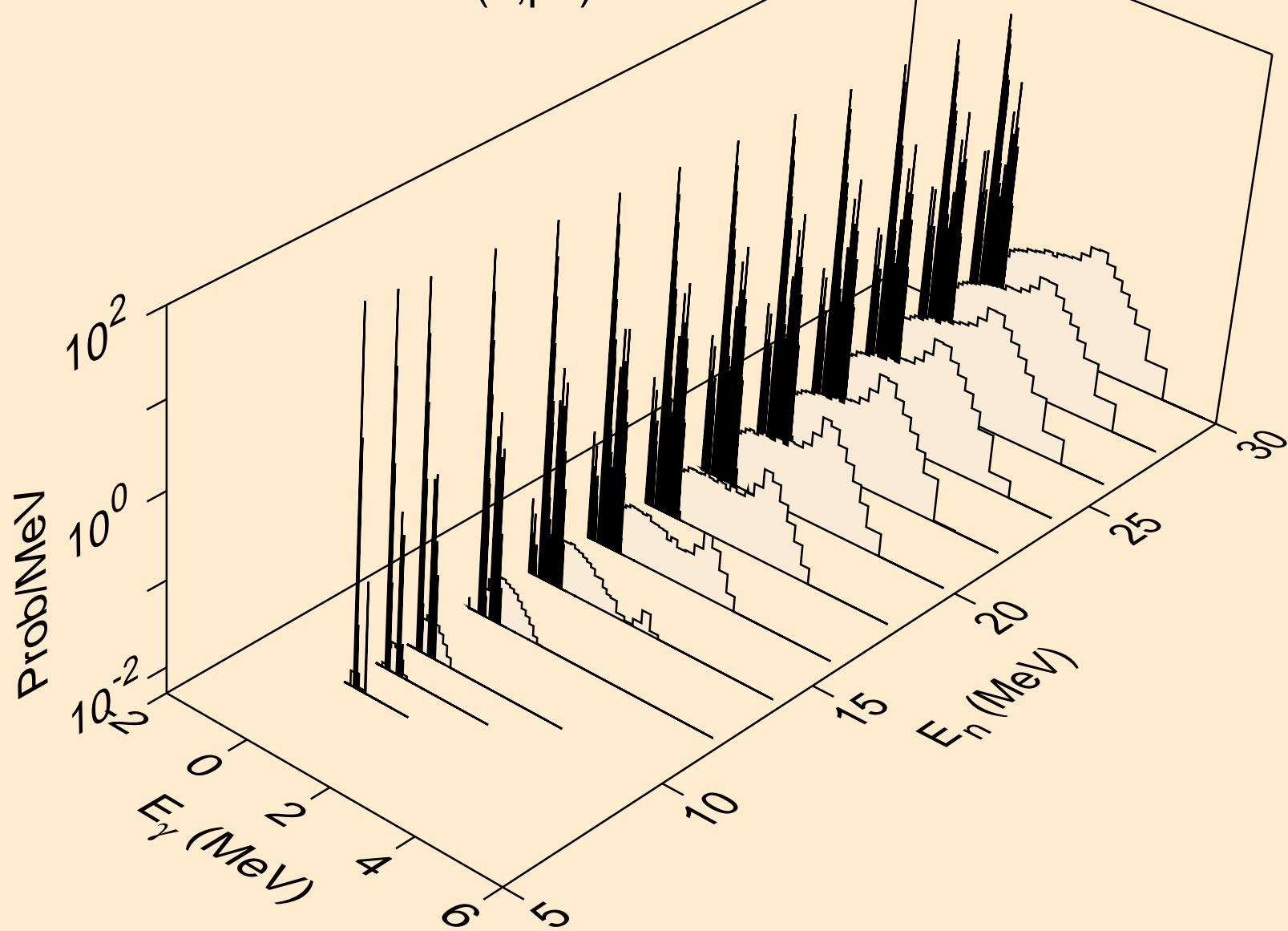

CS119M HELION ACER TENDL-2023 LIBRARY; T=0.K  
Photon emission for (n,pt)

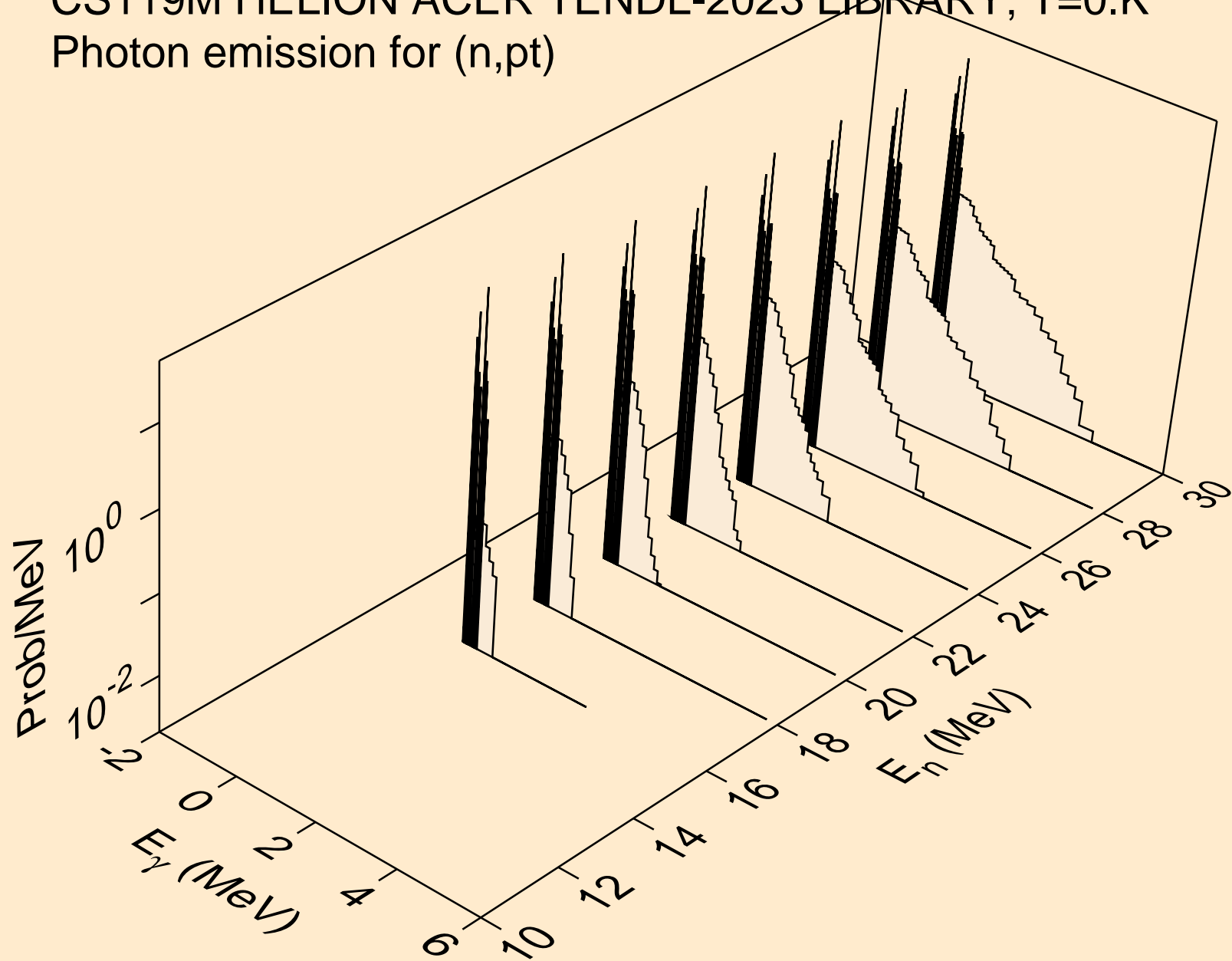

CS119M HELION ACER TENDL-2023 LIBRARY; T=0.K  
Photon emission for (n,da)

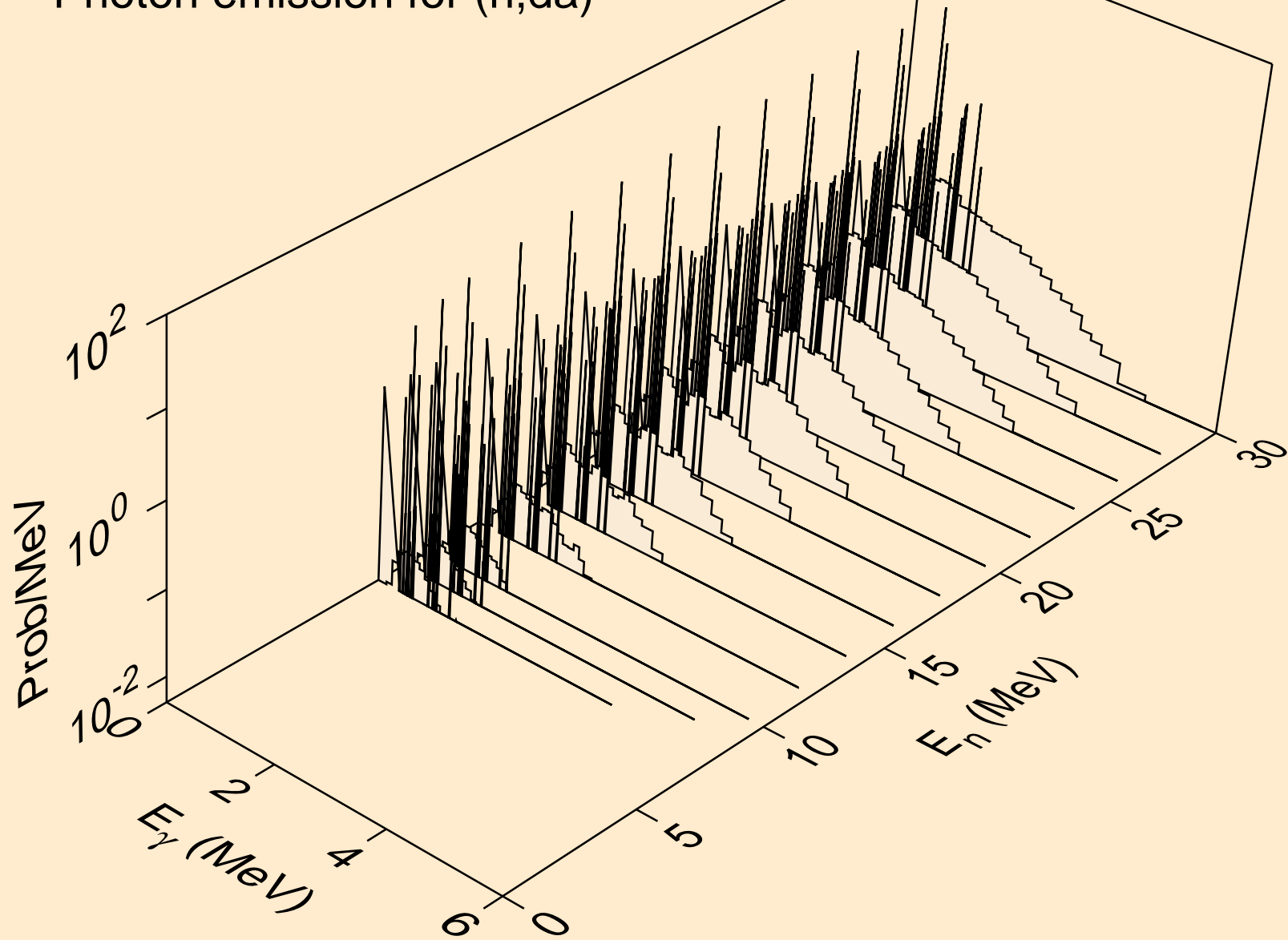

# CS119M HELION ACER TENDL-2023 LIBRARY; T=0.K

## Particle heating contributions

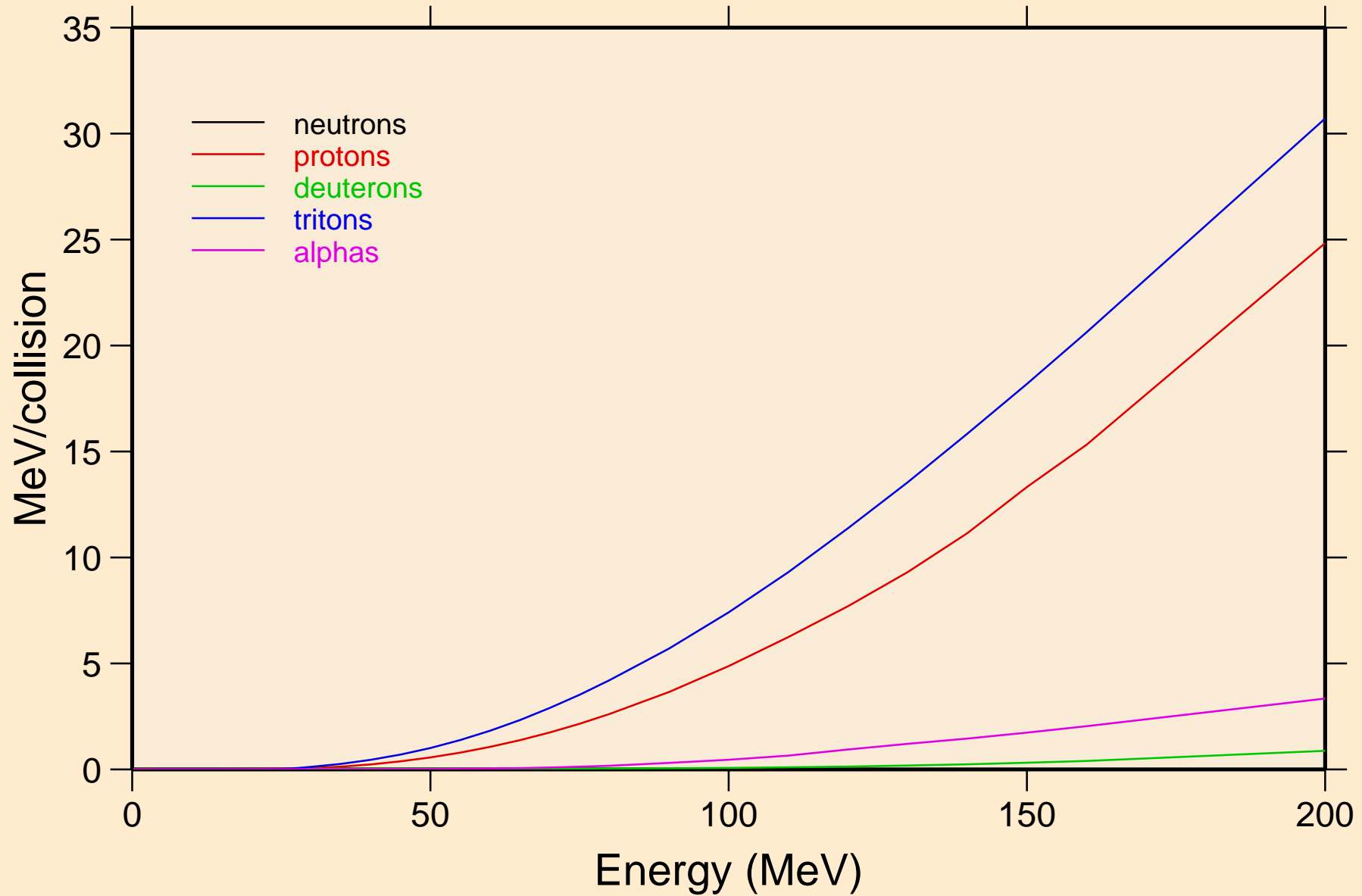

# CS119M HELION ACER TENDL-2023 LIBRARY; T=0.K

## Recoil Heating

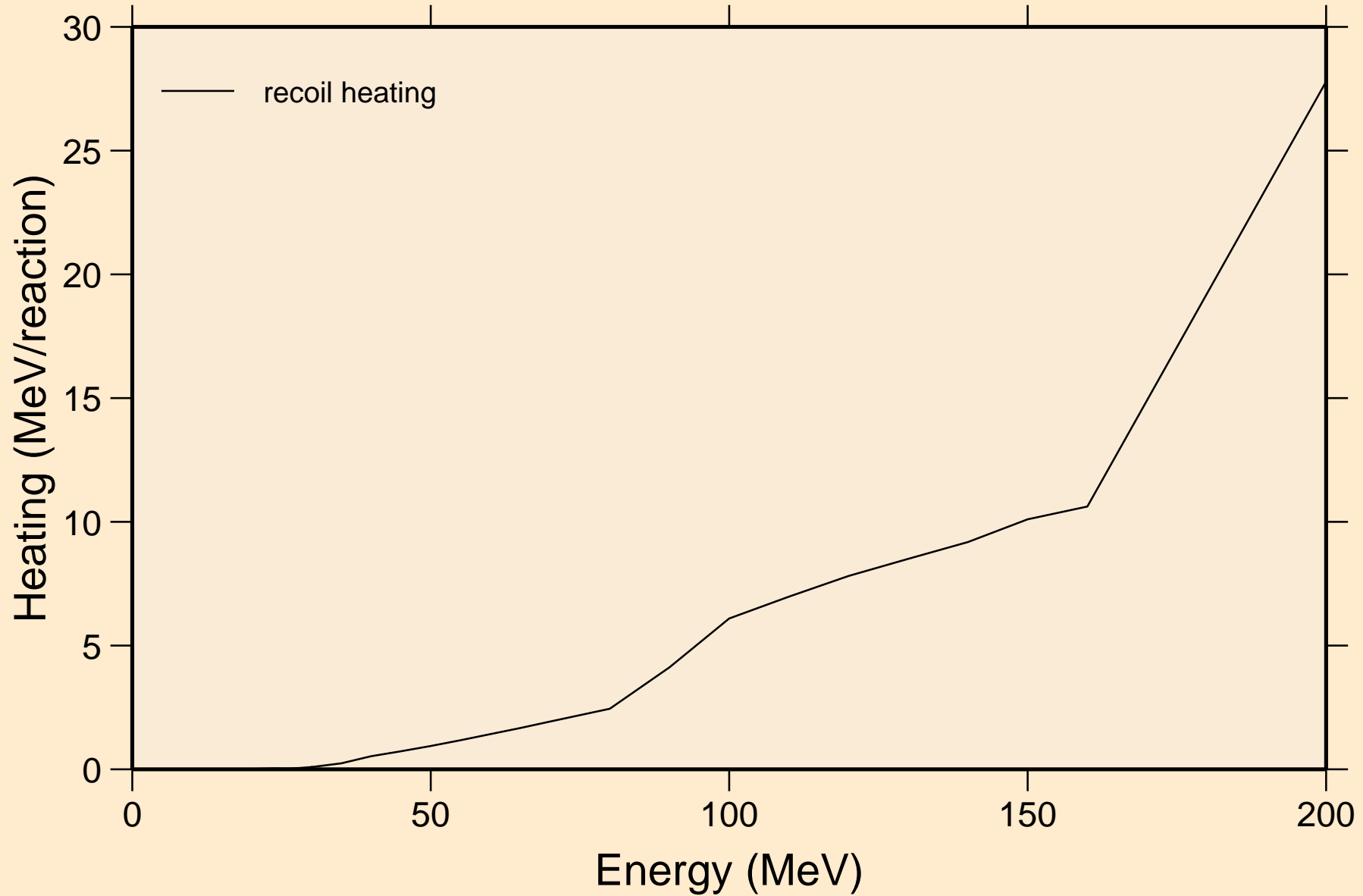

CS119M HELION ACER TENDL-2023 LIBRARY; T=0.K  
Particle production cross sections

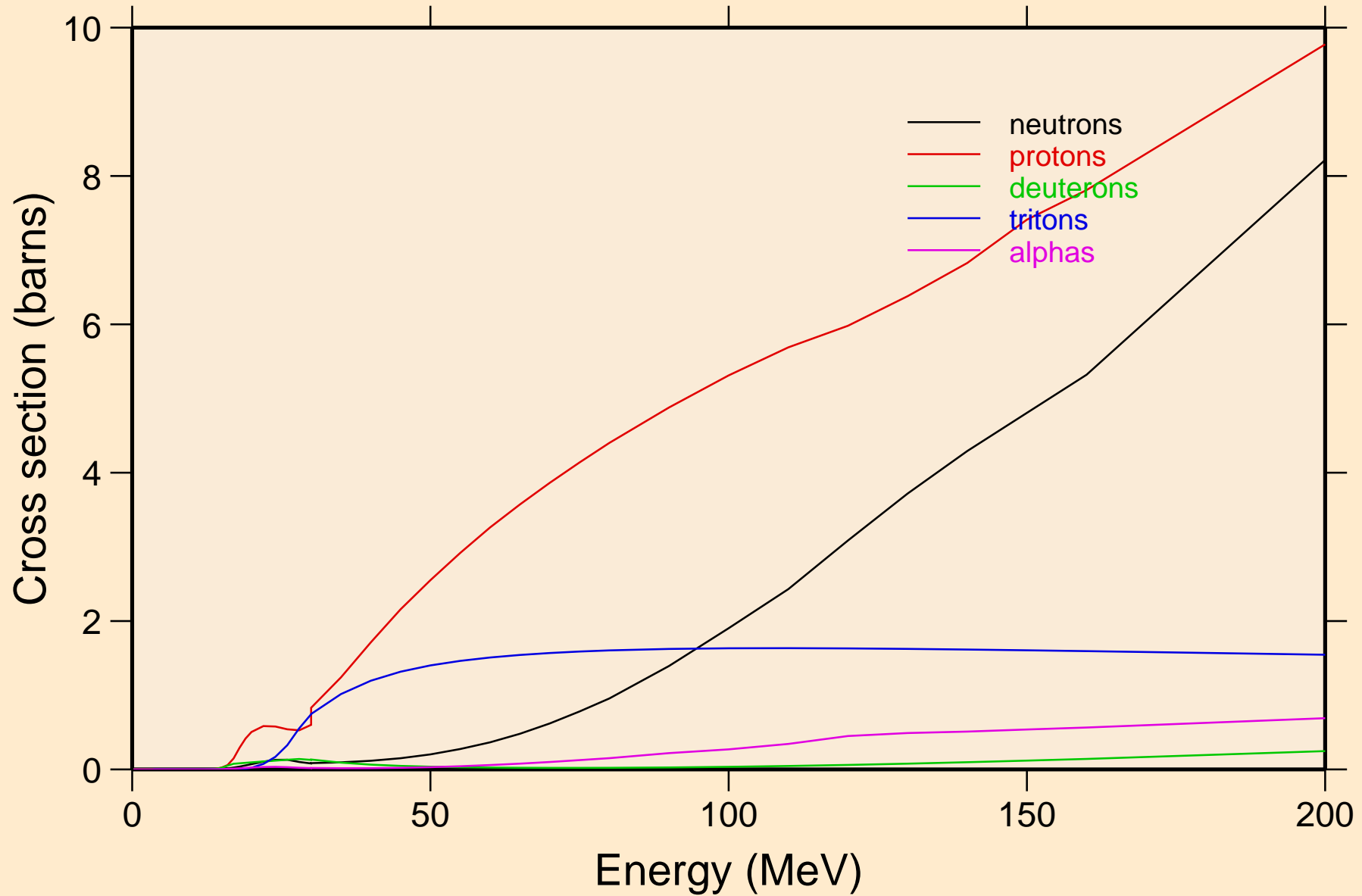

CS119M HELION ACER TENDL-2023 LIBRARY; T=0.K  
neutrons from (s,n)

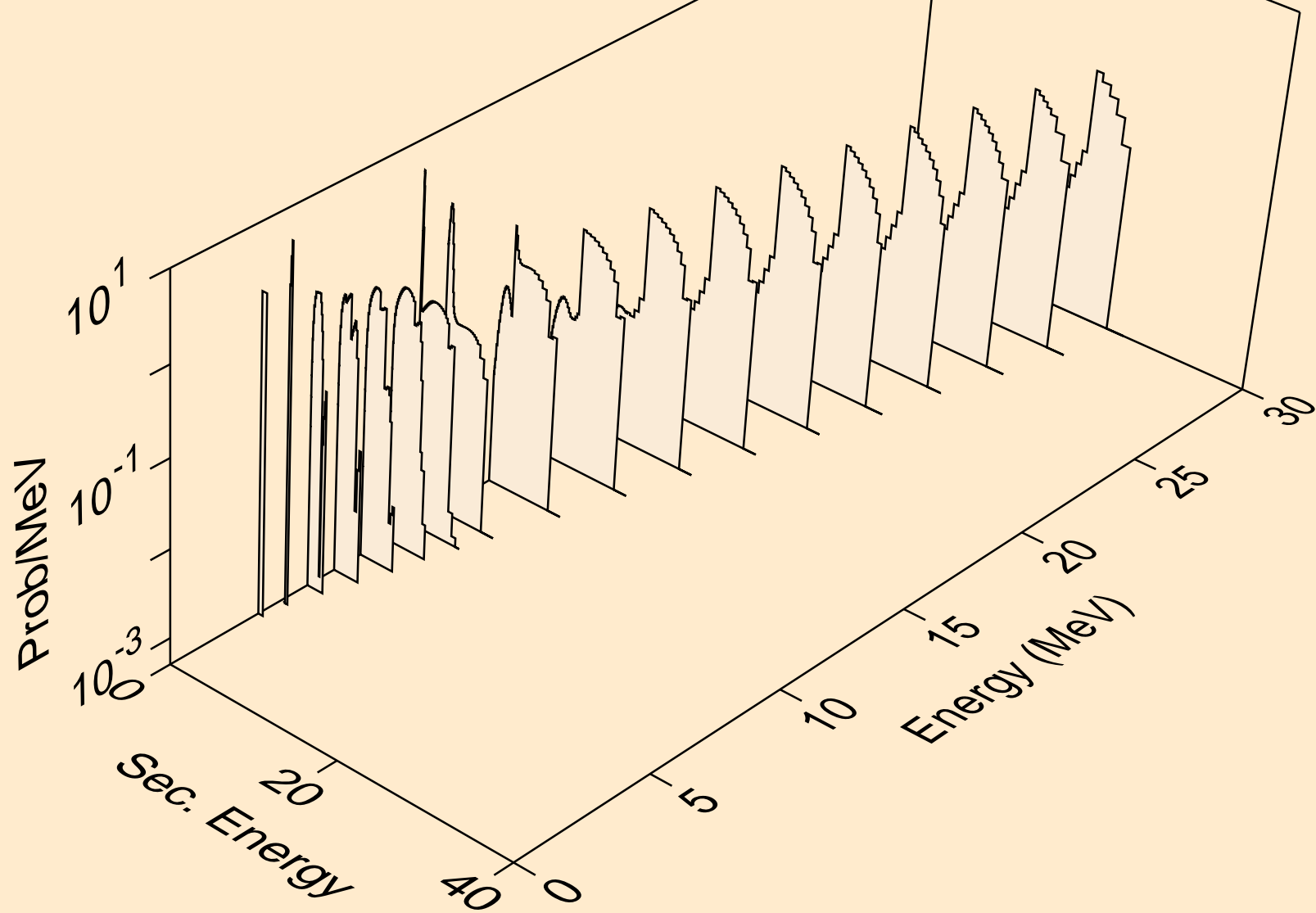

CS119M HELION ACER TENDL-2023 LIBRARY; T=0.K  
neutrons from (s,x)

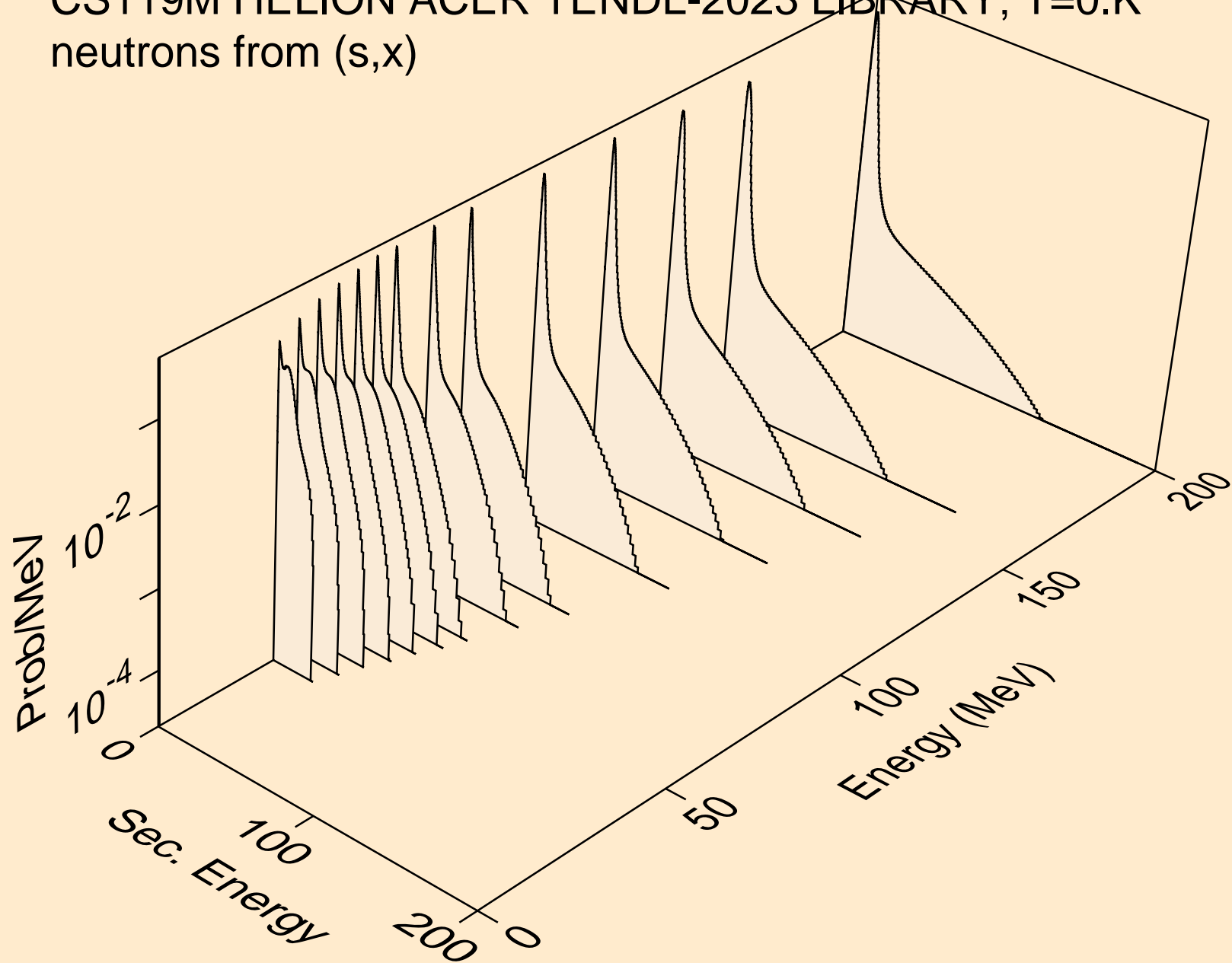

CS119M HELION ACER TENDL-2023 LIBRARY; T=0.K  
neutrons from (s,2nd)

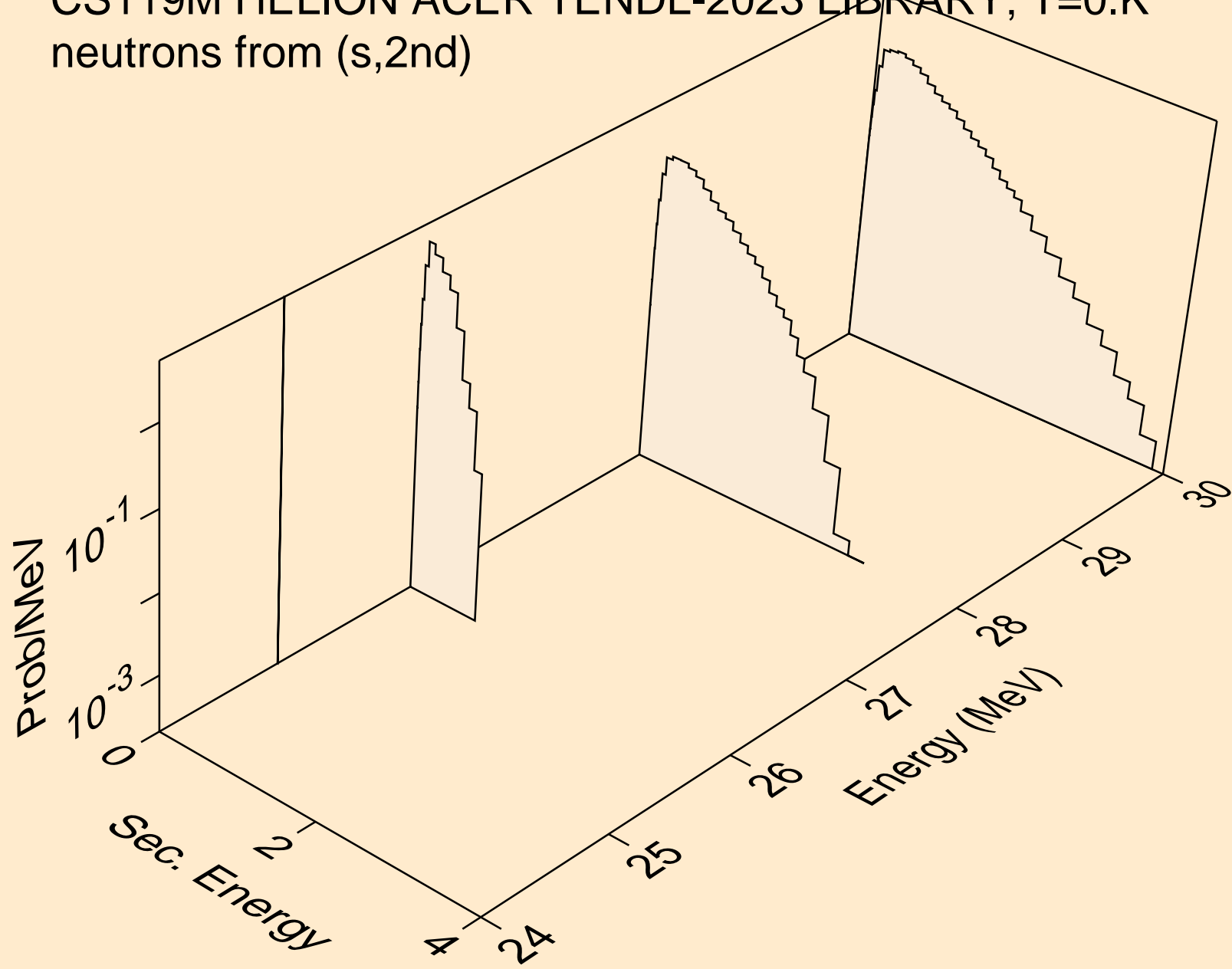

CS119M HELION ACER TENDL-2023 LIBRARY; T=0.K  
neutrons from (s,2n)

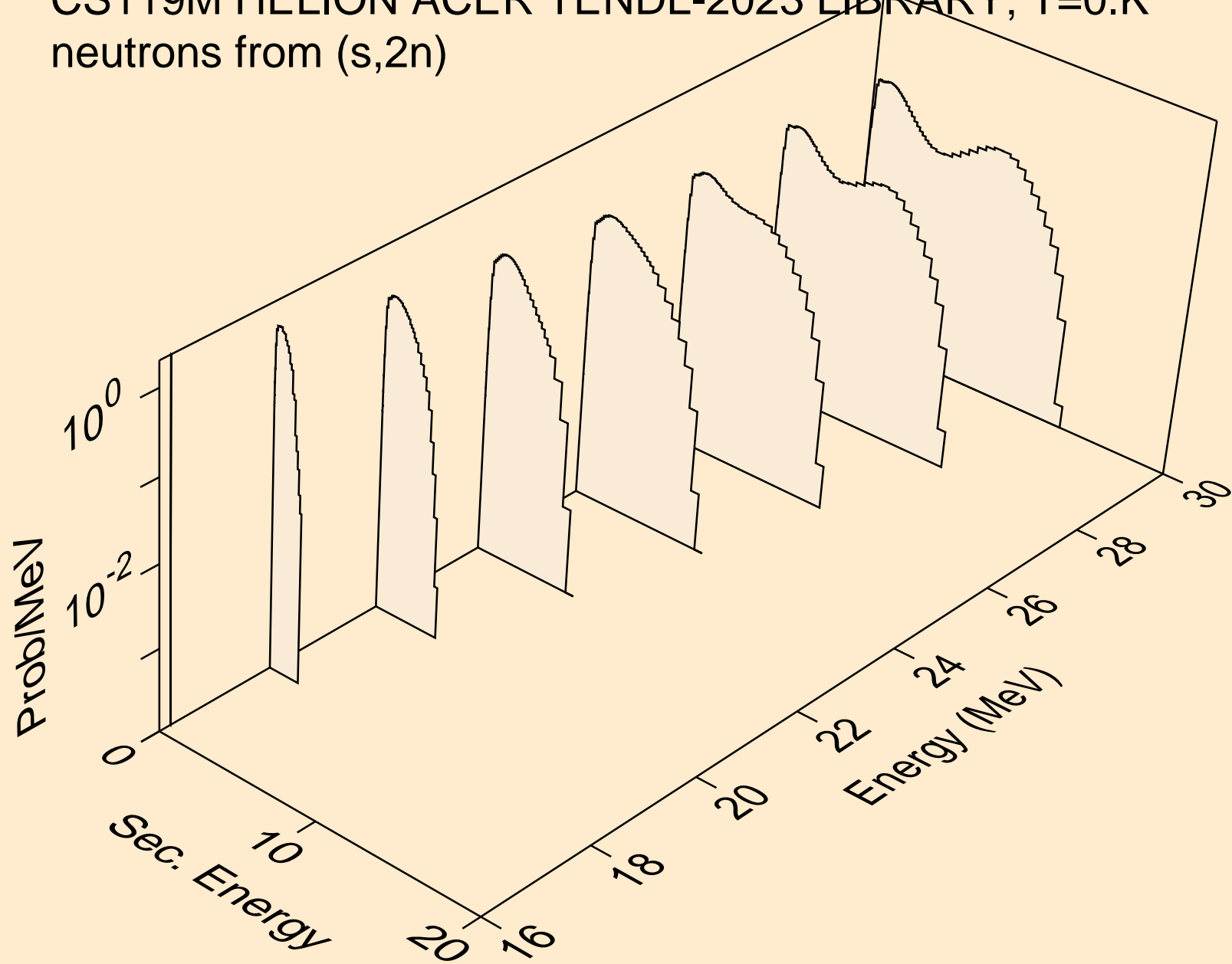

CS119M HELION ACER TENDL-2023 LIBRARY; T=0.K  
neutrons from (s,3n)

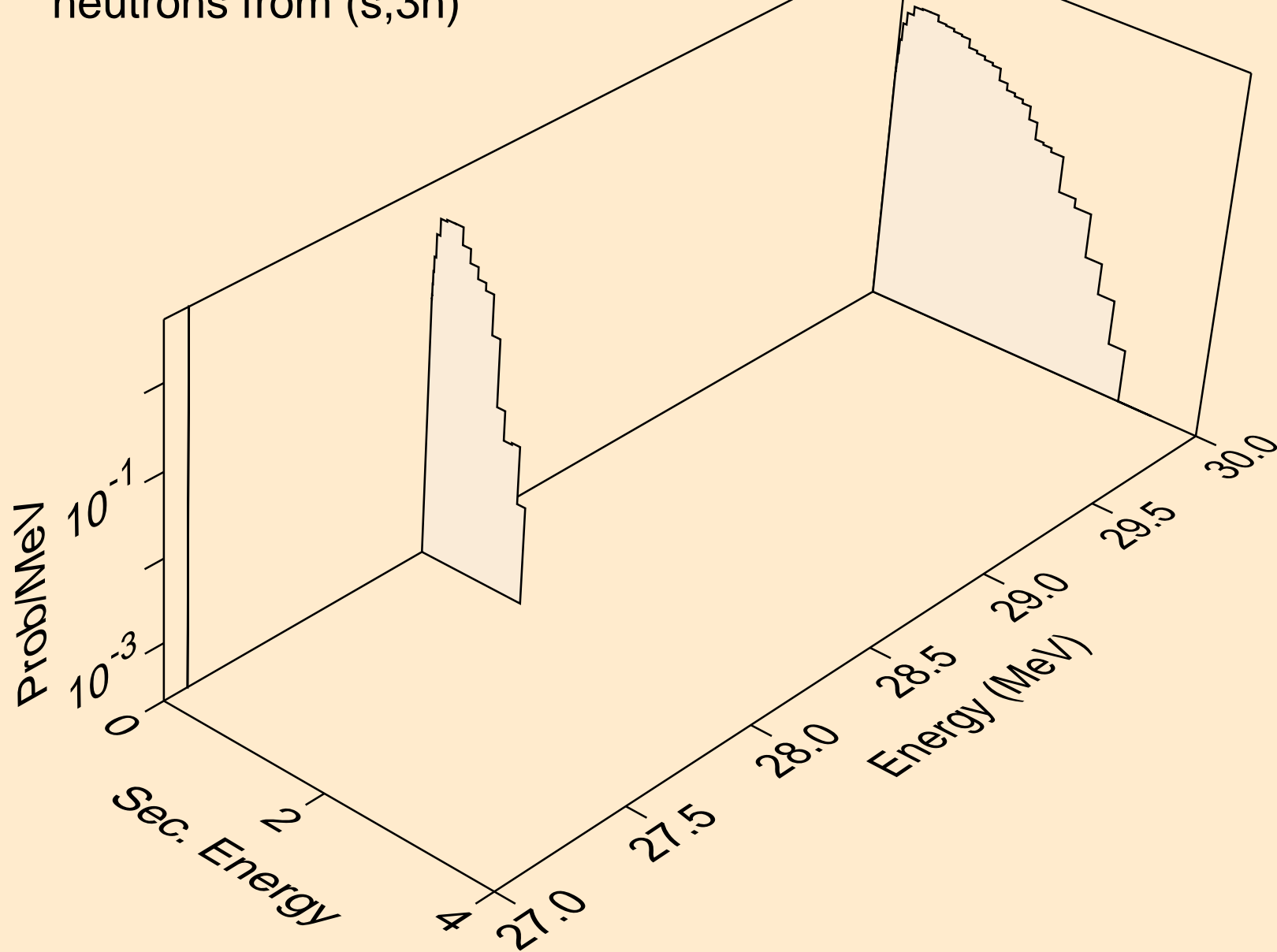

CS119M HELION ACER TENDL-2023 LIBRARY; T=0.K  
neutrons from (s,n\*)a

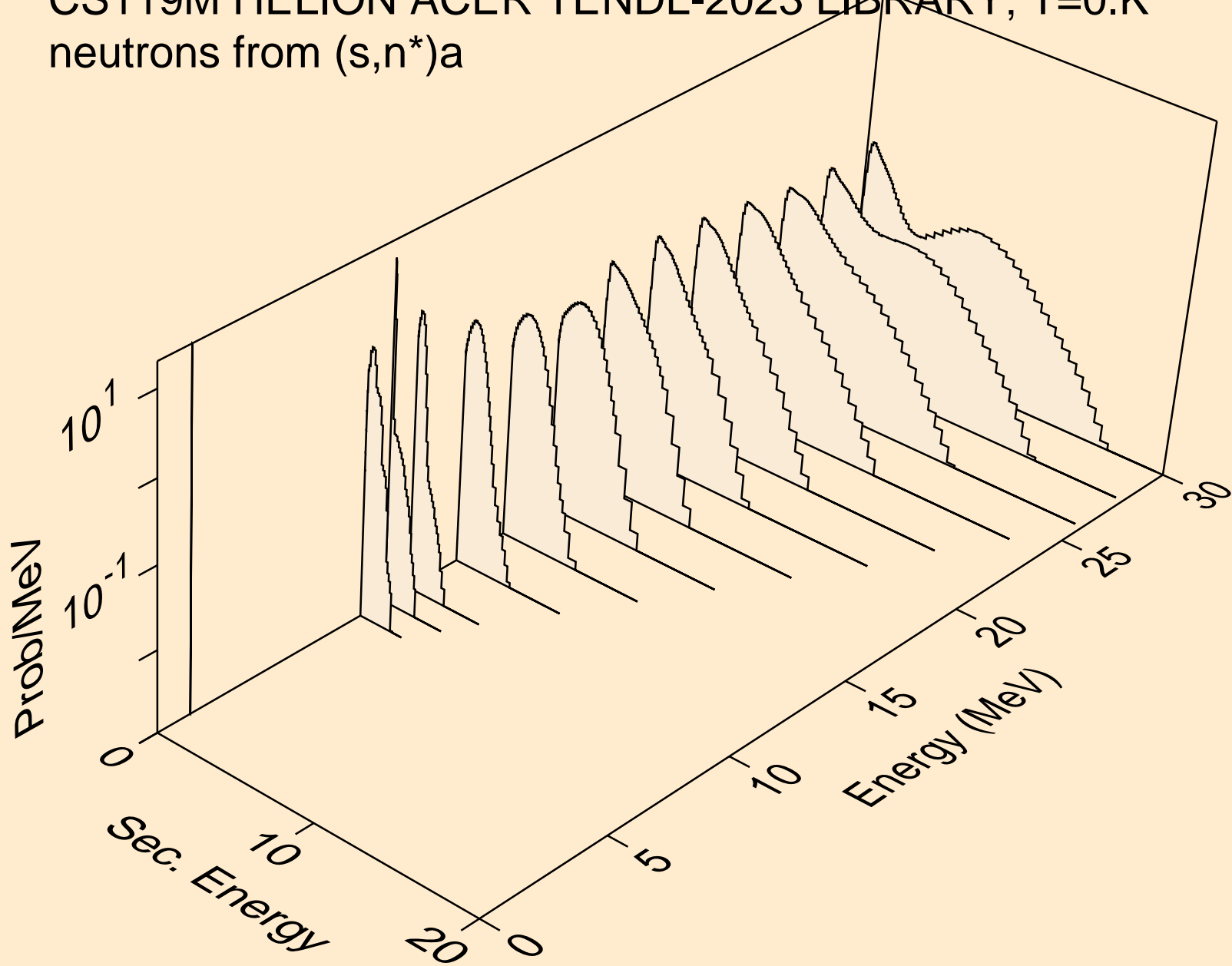

CS119M HELION ACER TENDL-2023 LIBRARY; T=0.K  
neutrons from (s,2n)a

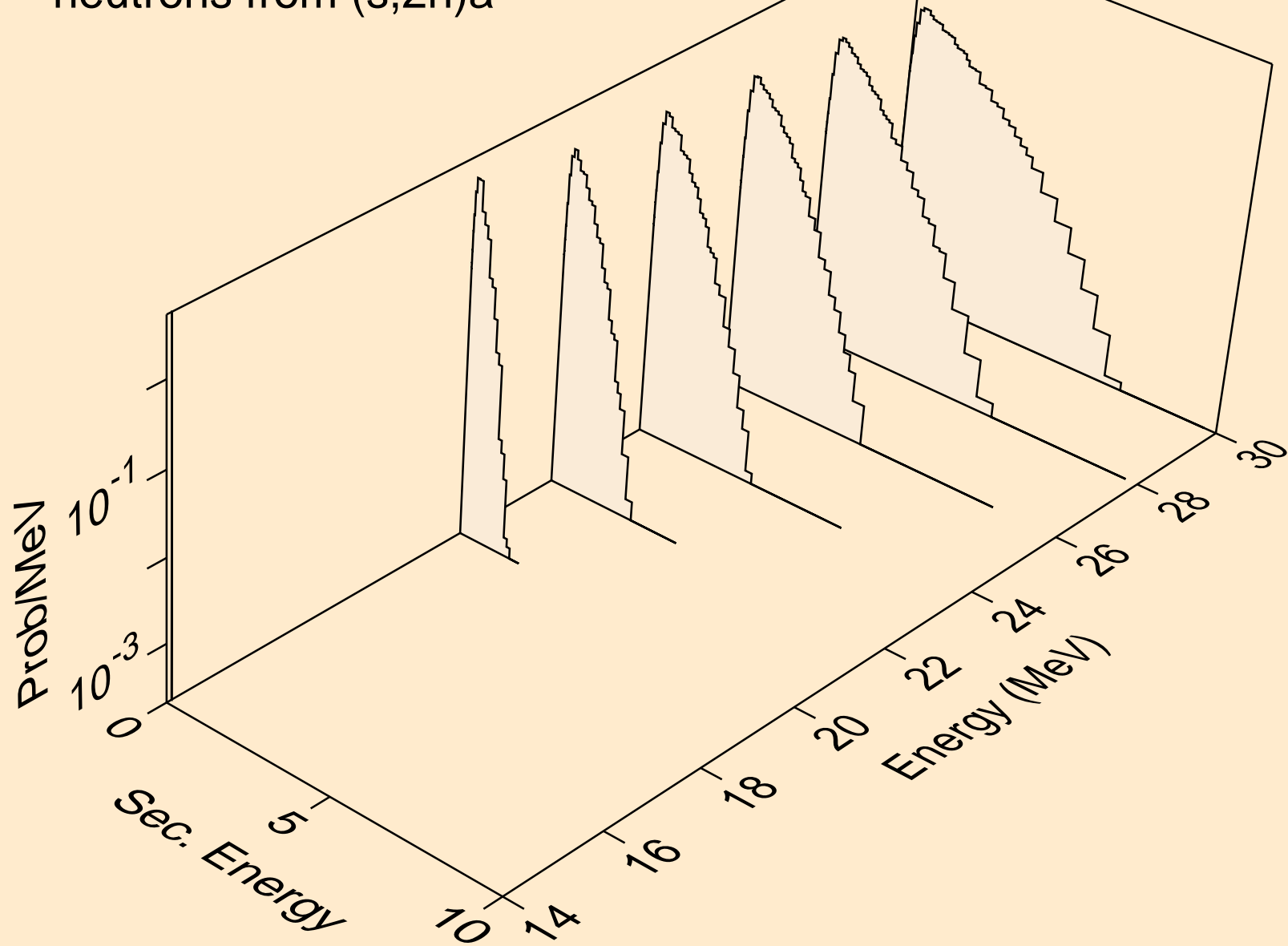

CS119M HELION ACER TENDL-2023 LIBRARY; T=0.K  
neutrons from (s,n\*)p

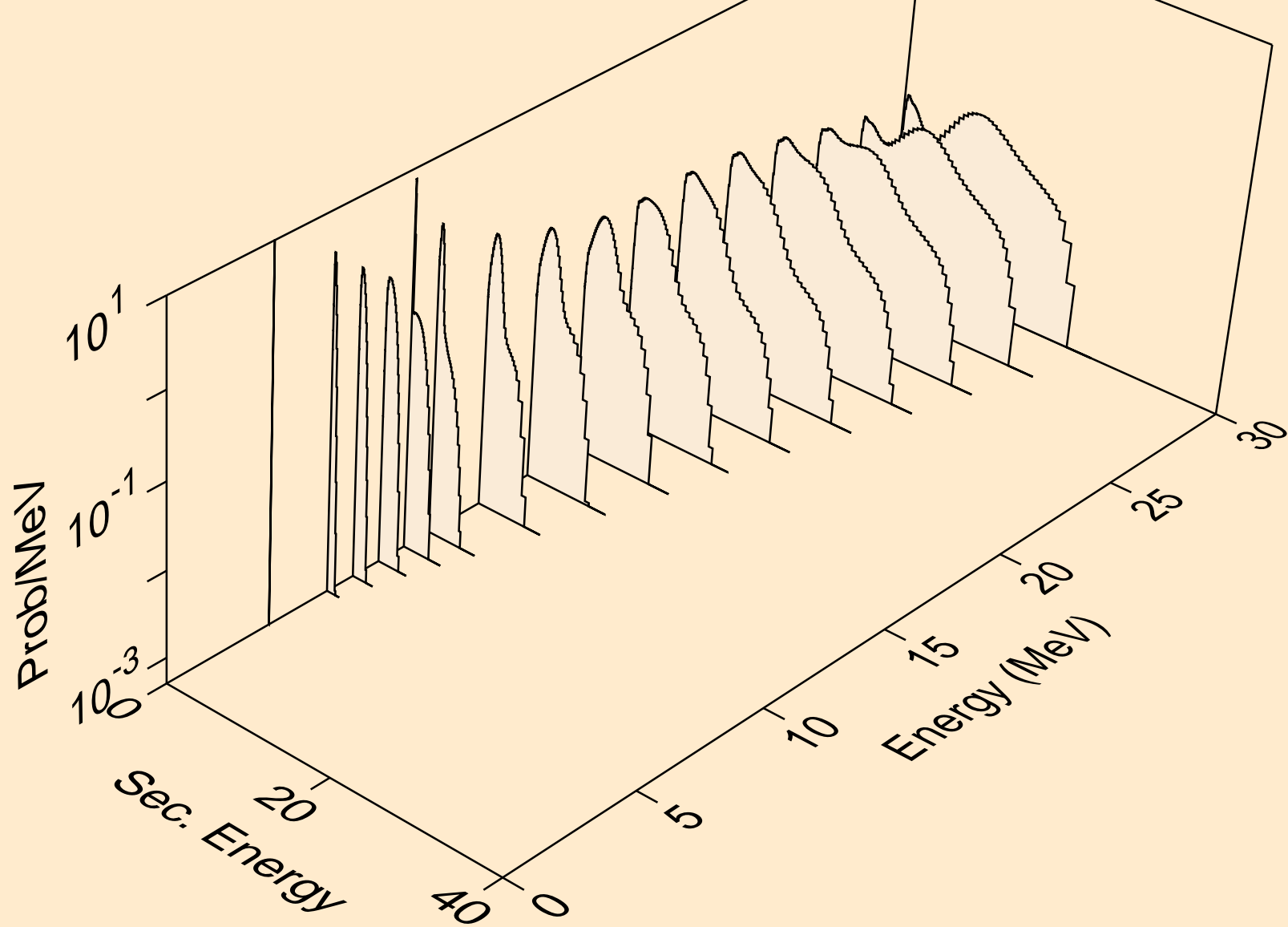

CS119M HELION ACER TENDL-2023 LIBRARY; T=0.K  
neutrons from (s,n\*)2a

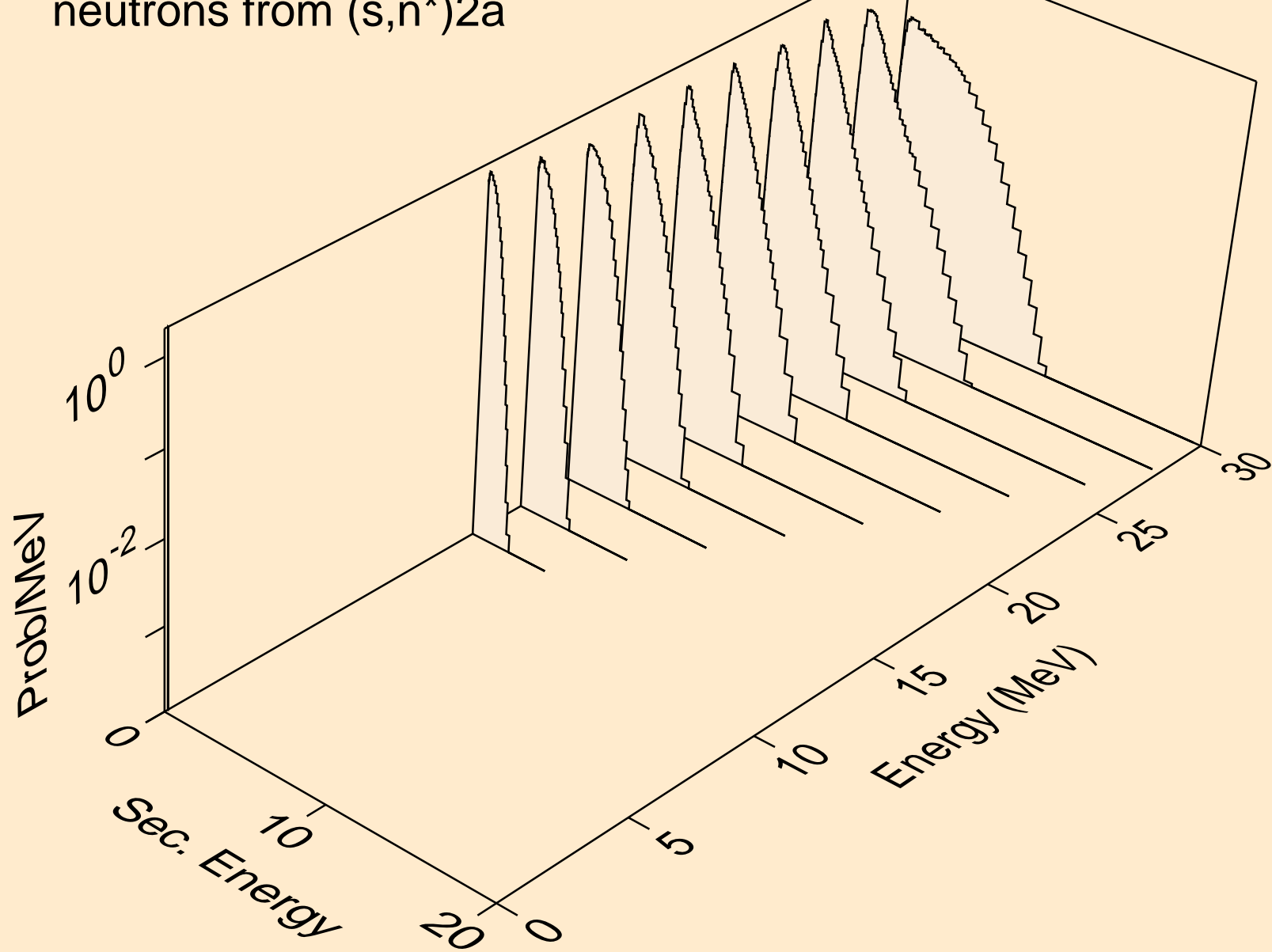

CS119M HELION ACER TENDL-2023 LIBRARY; T=0.K  
neutrons from (s,n\*)d

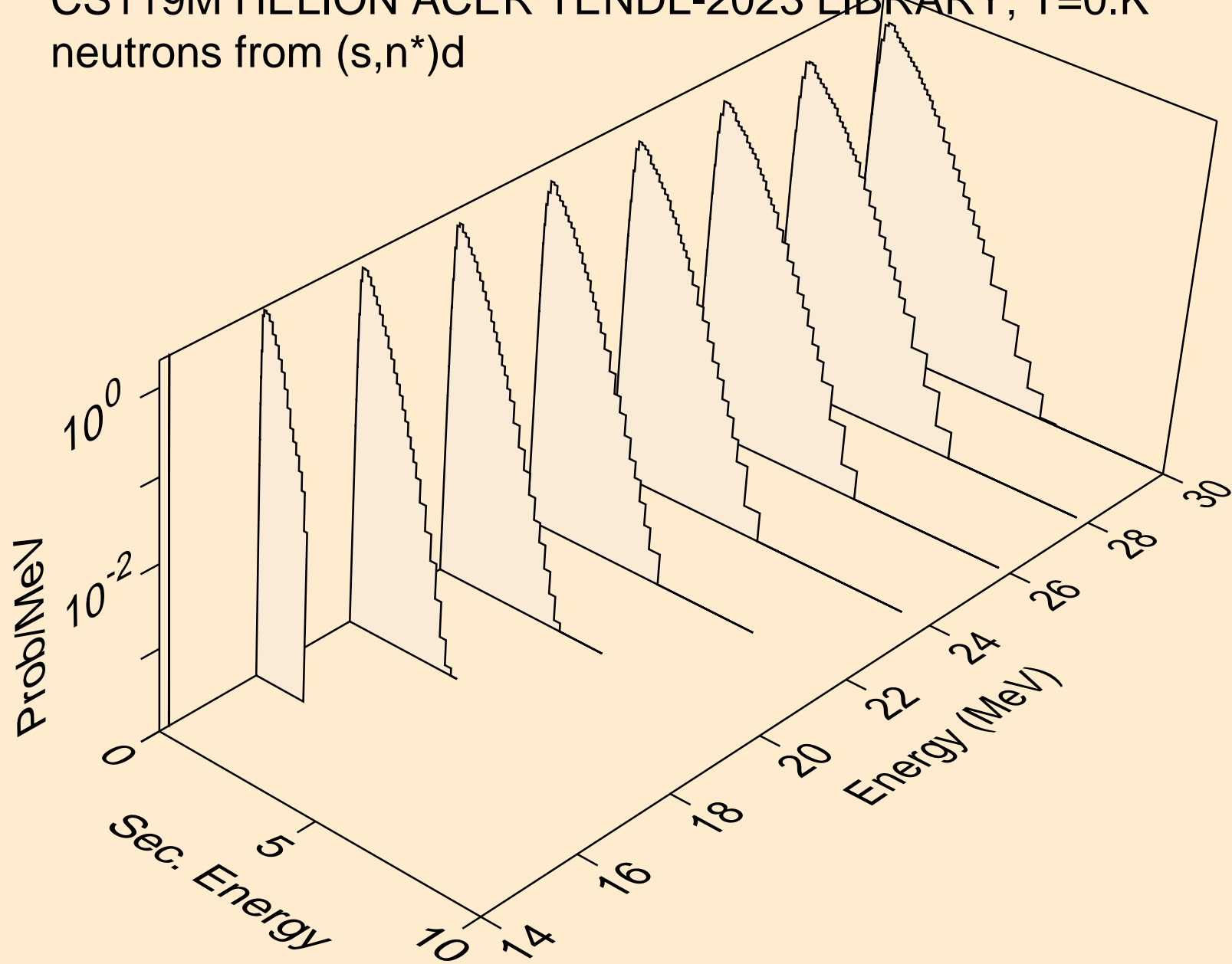

CS119M HELION ACER TENDL-2023 LIBRARY; T=0.K  
neutrons from (s,n\*)t

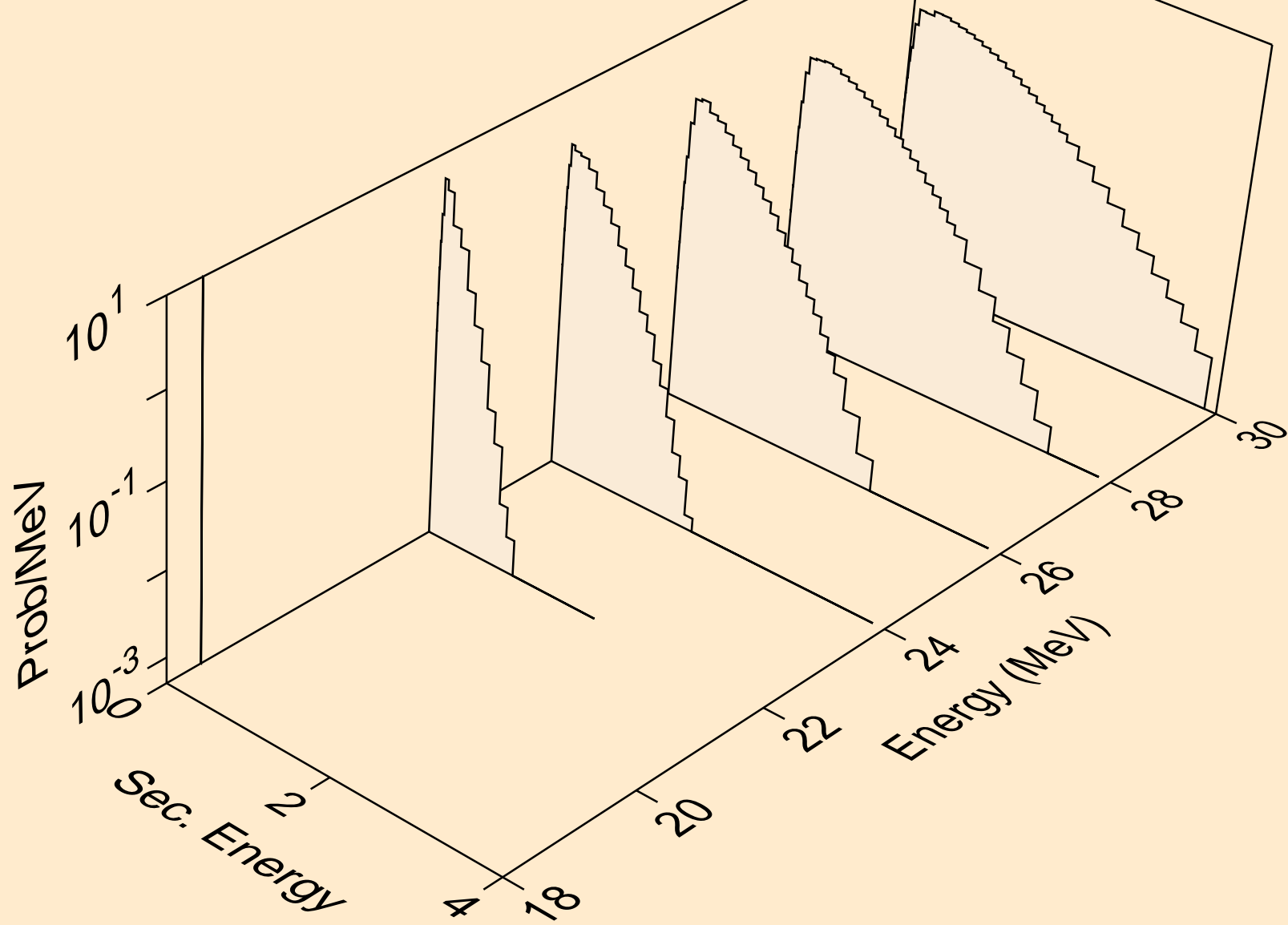

CS119M HELION ACER TENDL-2023 LIBRARY; T=0.K  
neutrons from (s,n\*)he3

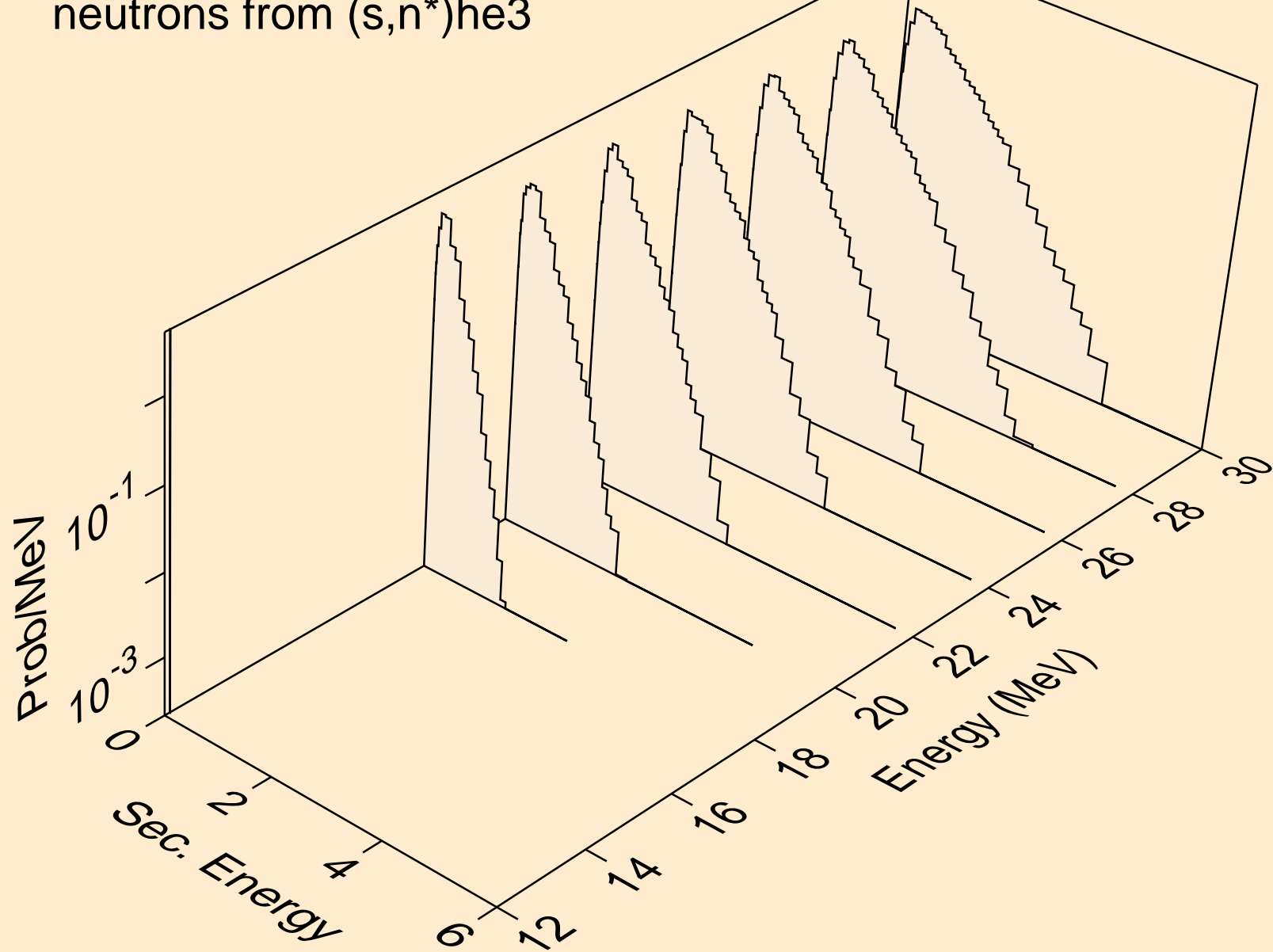

CS119M HELION ACER TENDL-2023 LIBRARY; T=0.K  
neutrons from (s,2np)

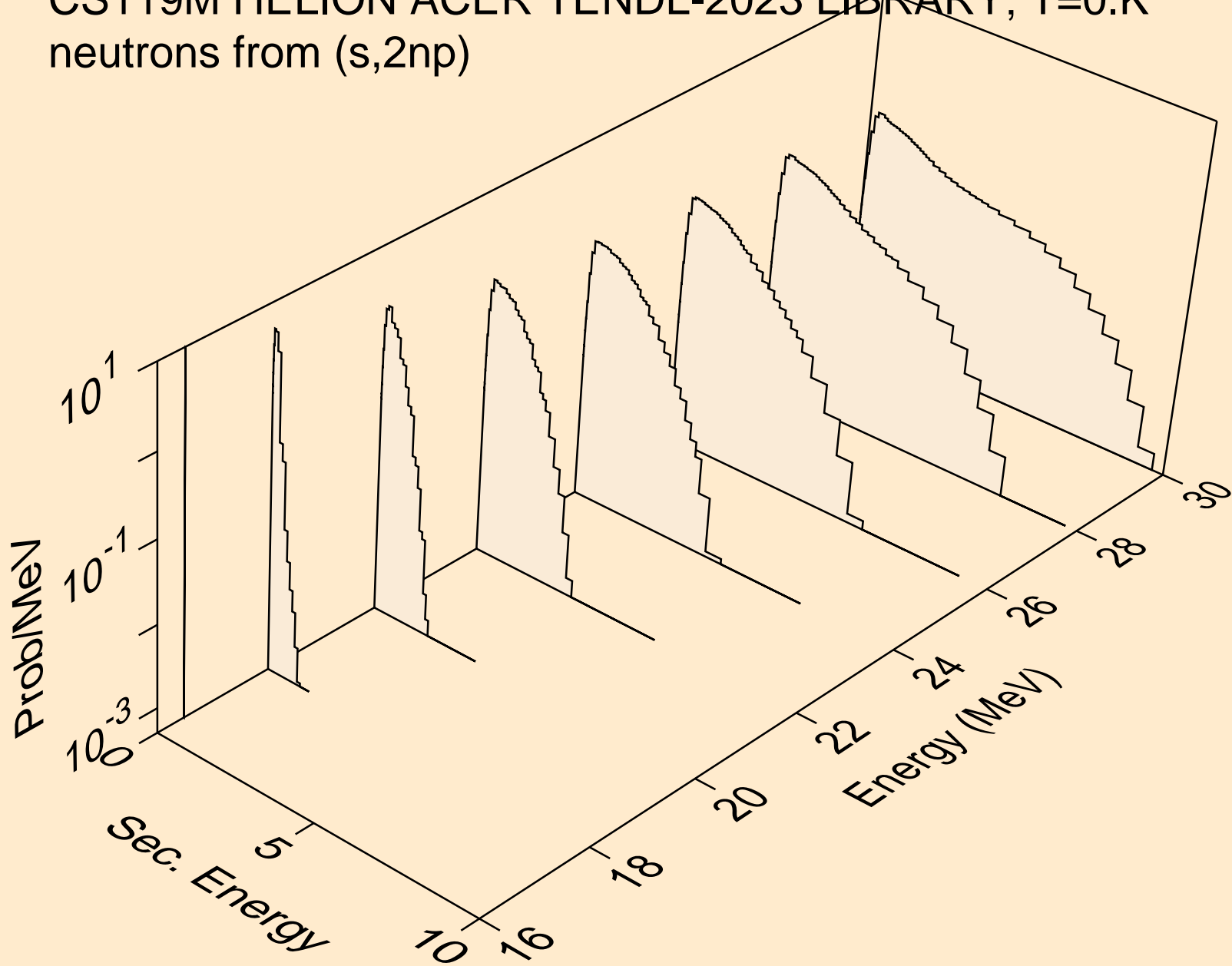

CS119M HELION ACER TENDL-2023 LIBRARY; T=0.K  
neutrons from (s,n2p)

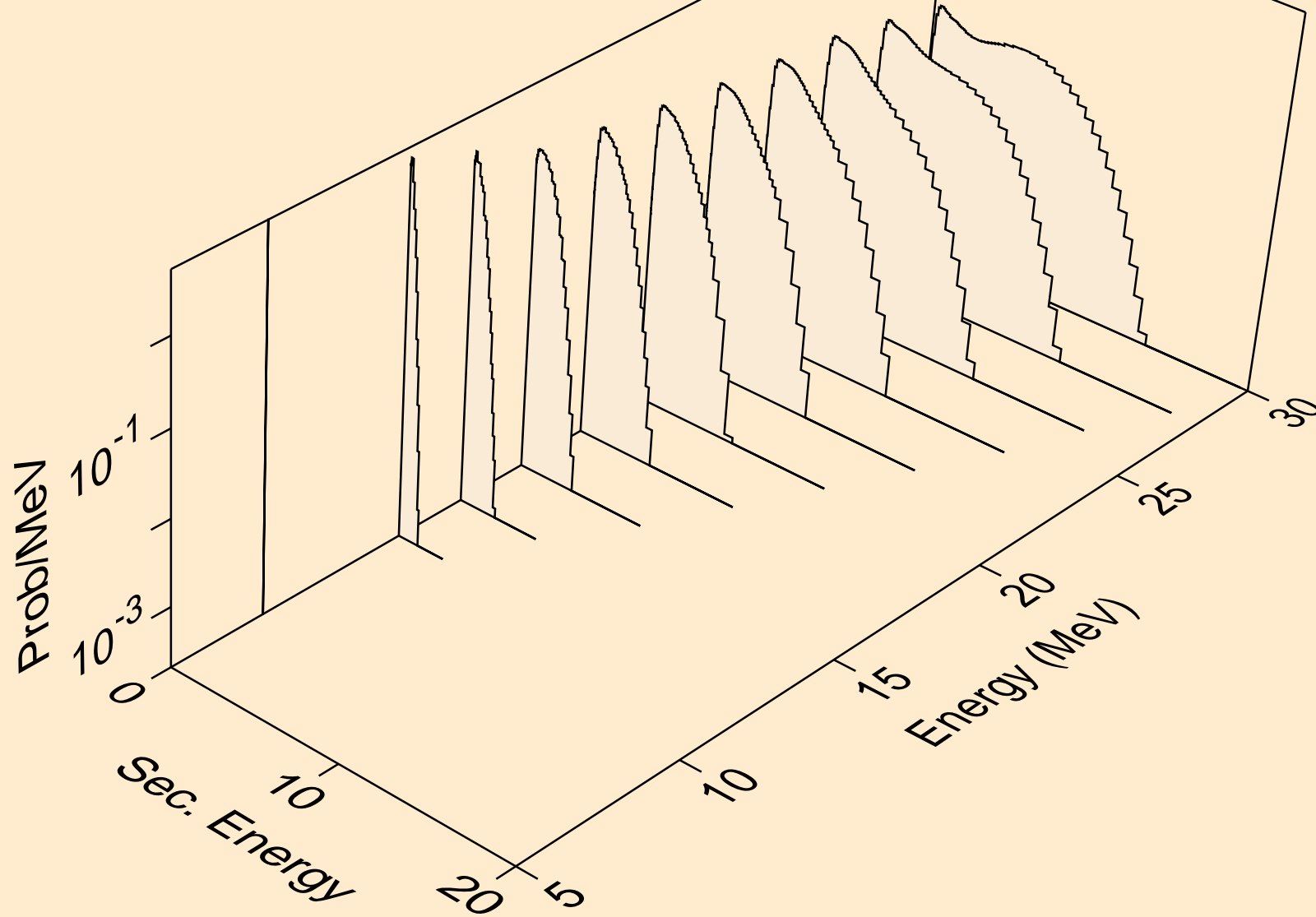

CS119M HELION ACER TENDL-2023 LIBRARY; T=0.K  
neutrons from (s,npa)

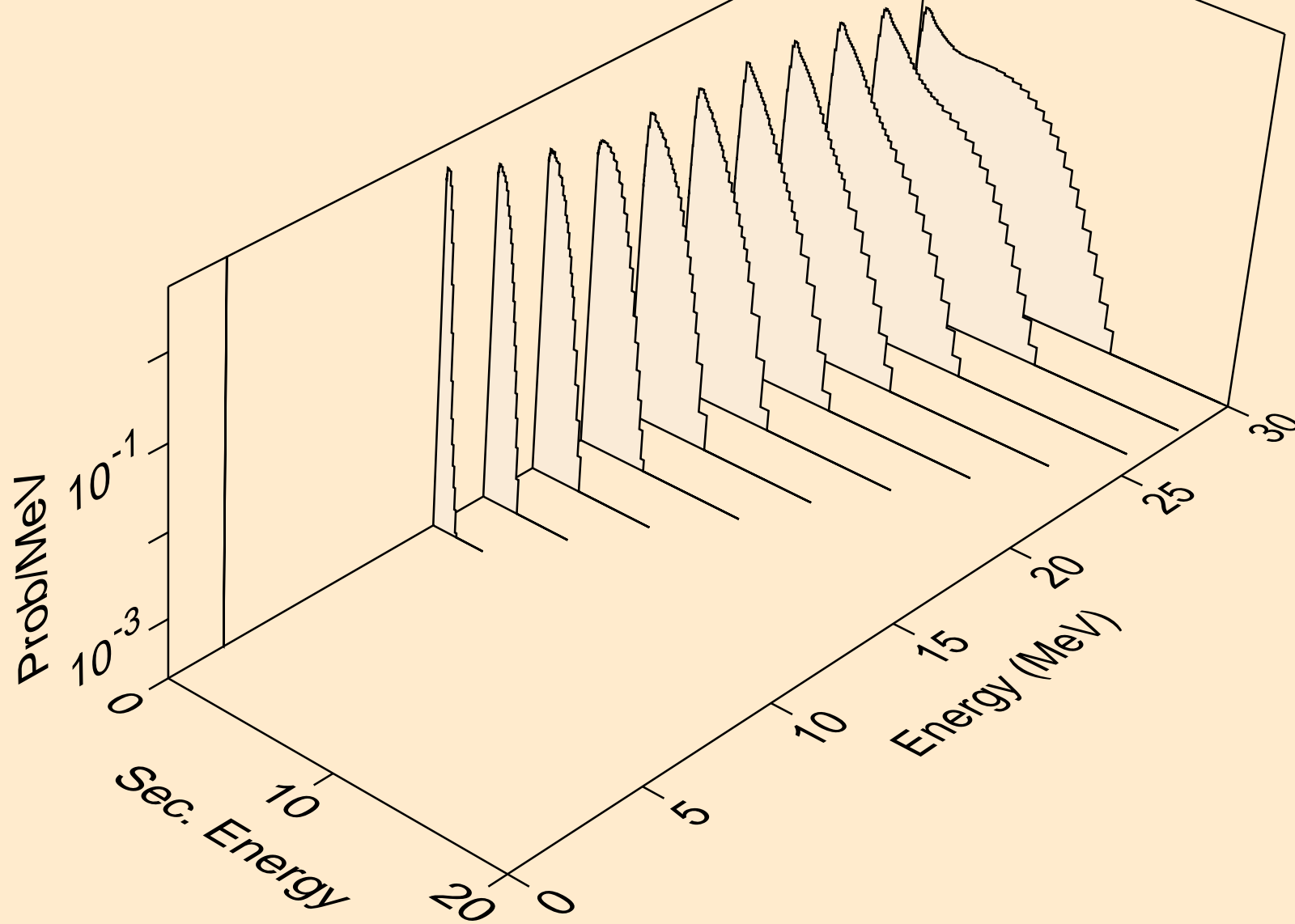

CS119M HELION ACER TENDL-2023 LIBRARY; T=0.K  
protons from (s,x)

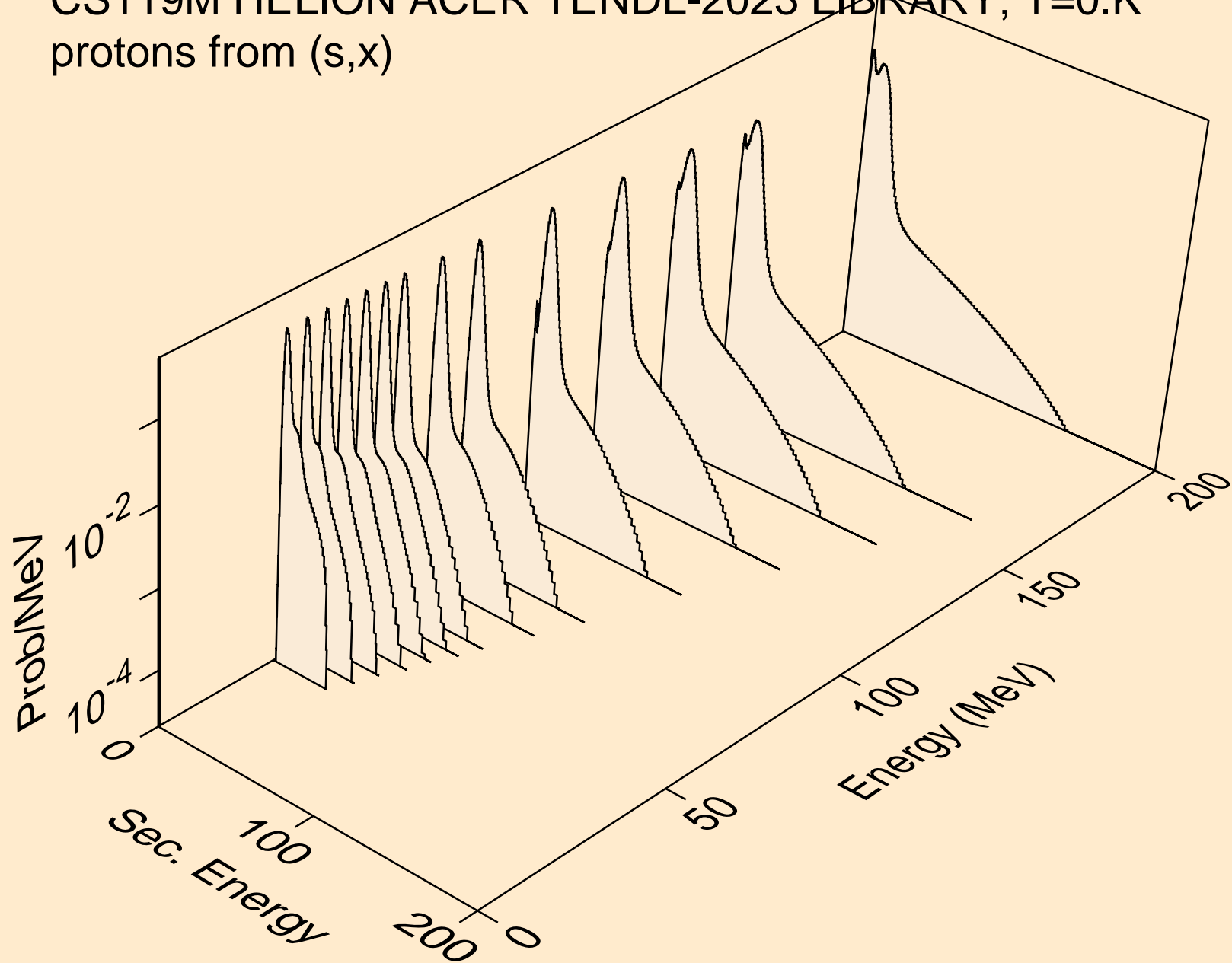

CS119M HELION ACER TENDL-2023 LIBRARY; T=0.K  
protons from (s,n\*)p

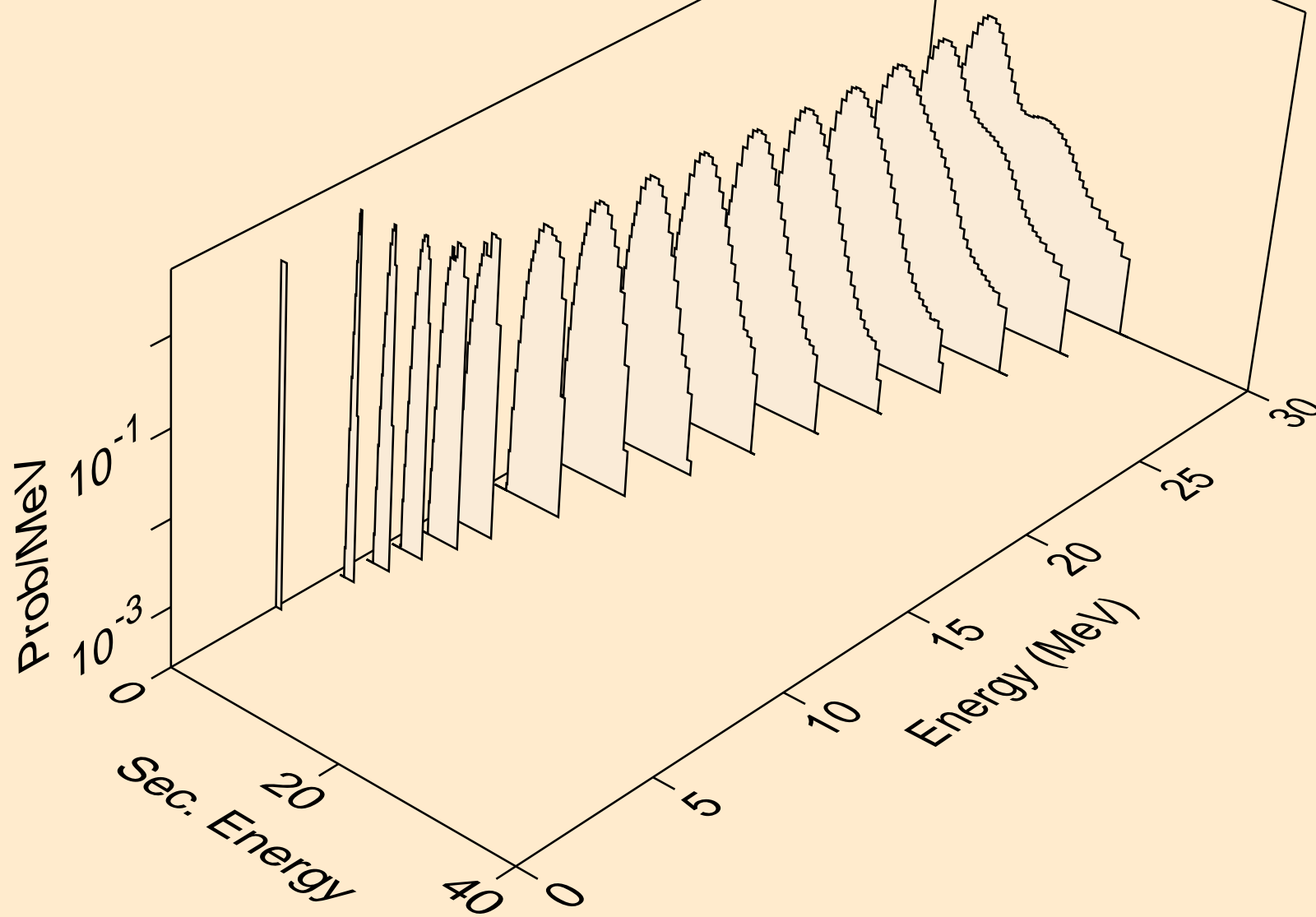

CS119M HELION ACER TENDL-2023 LIBRARY; T=0.K  
protons from (s,2np)

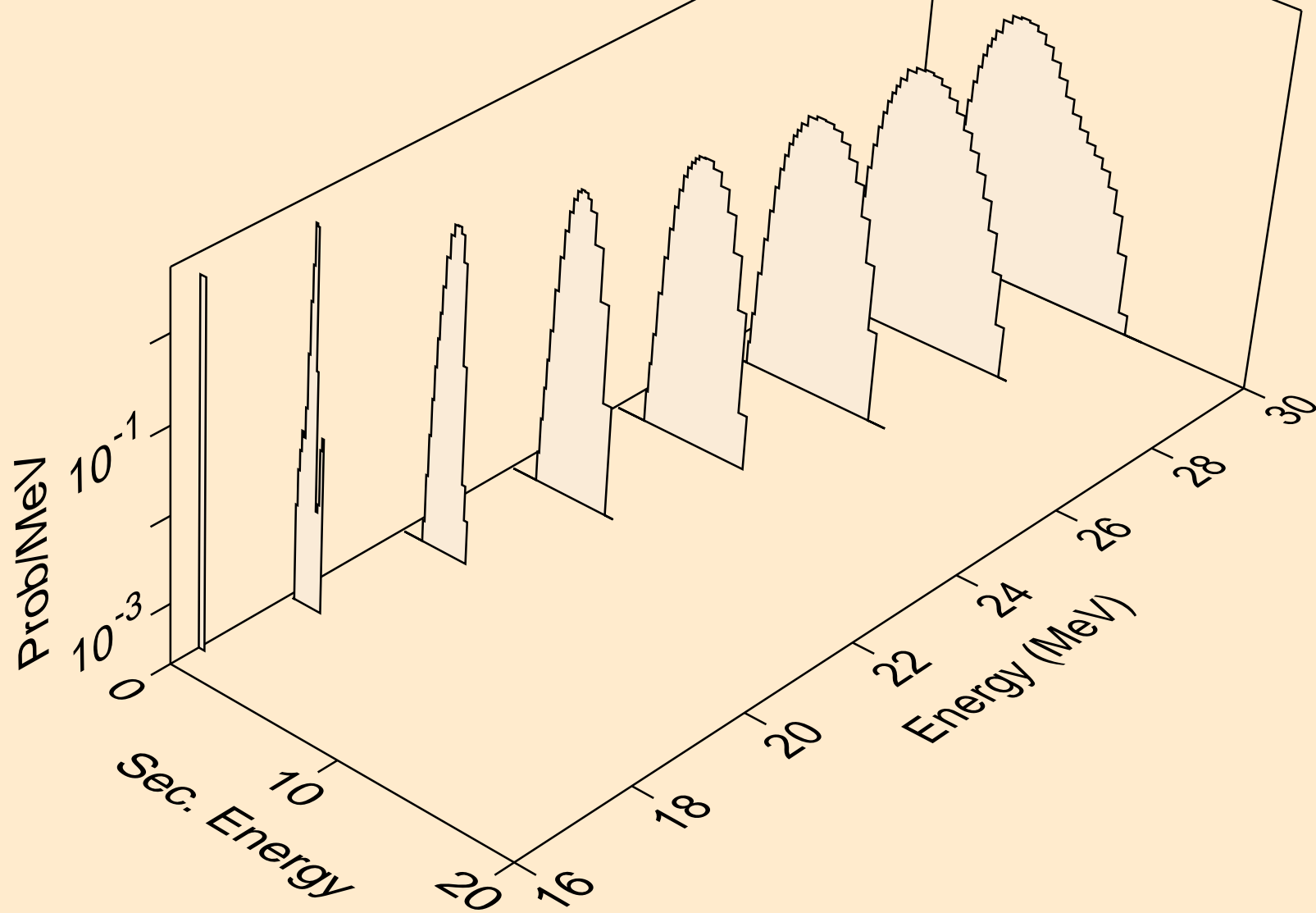

CS119M HELION ACER TENDL-2023 LIBRARY; T=0.K  
protons from (s,n2p)

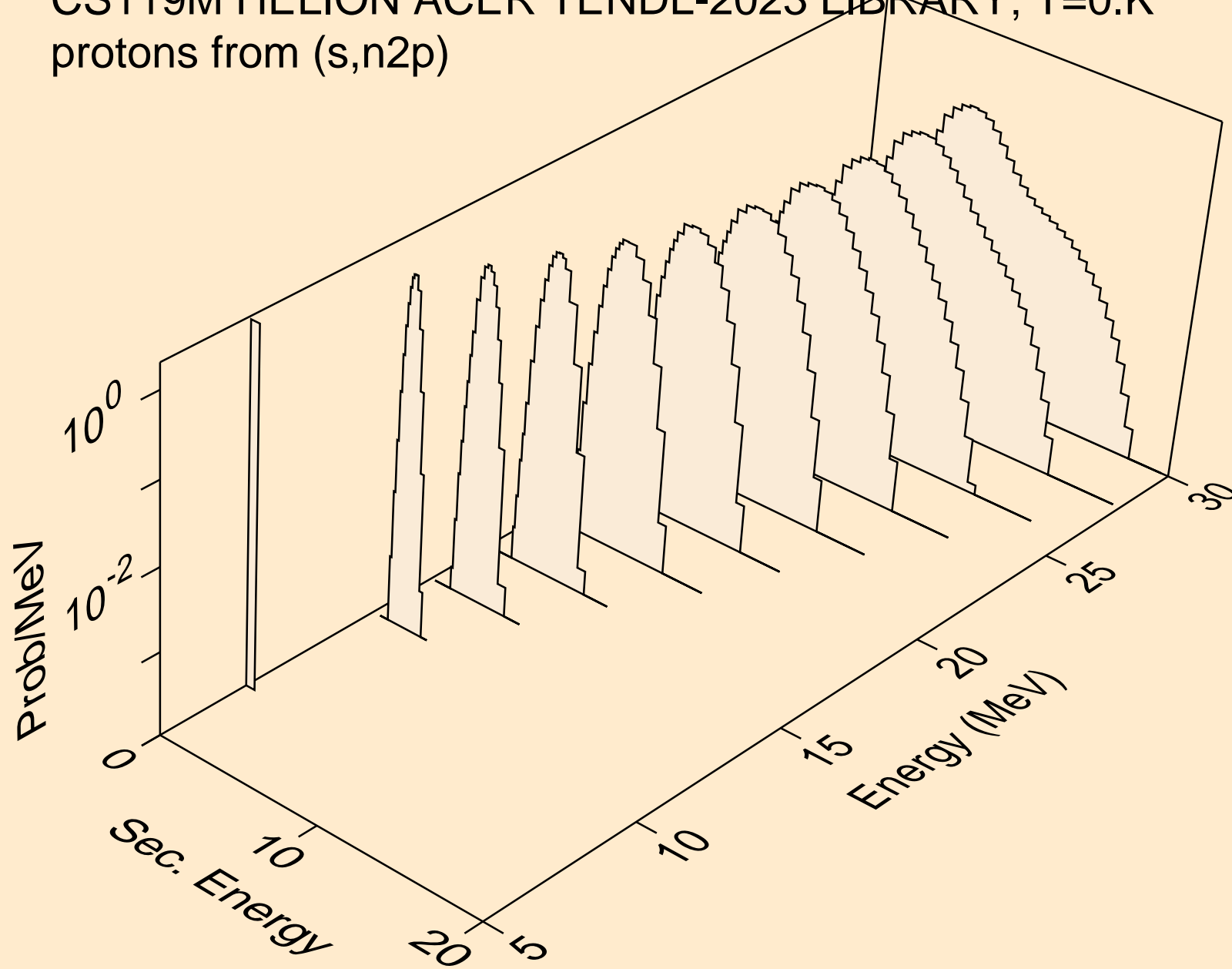

CS119M HELION ACER TENDL-2023 LIBRARY; T=0.K  
protons from (s,npa)

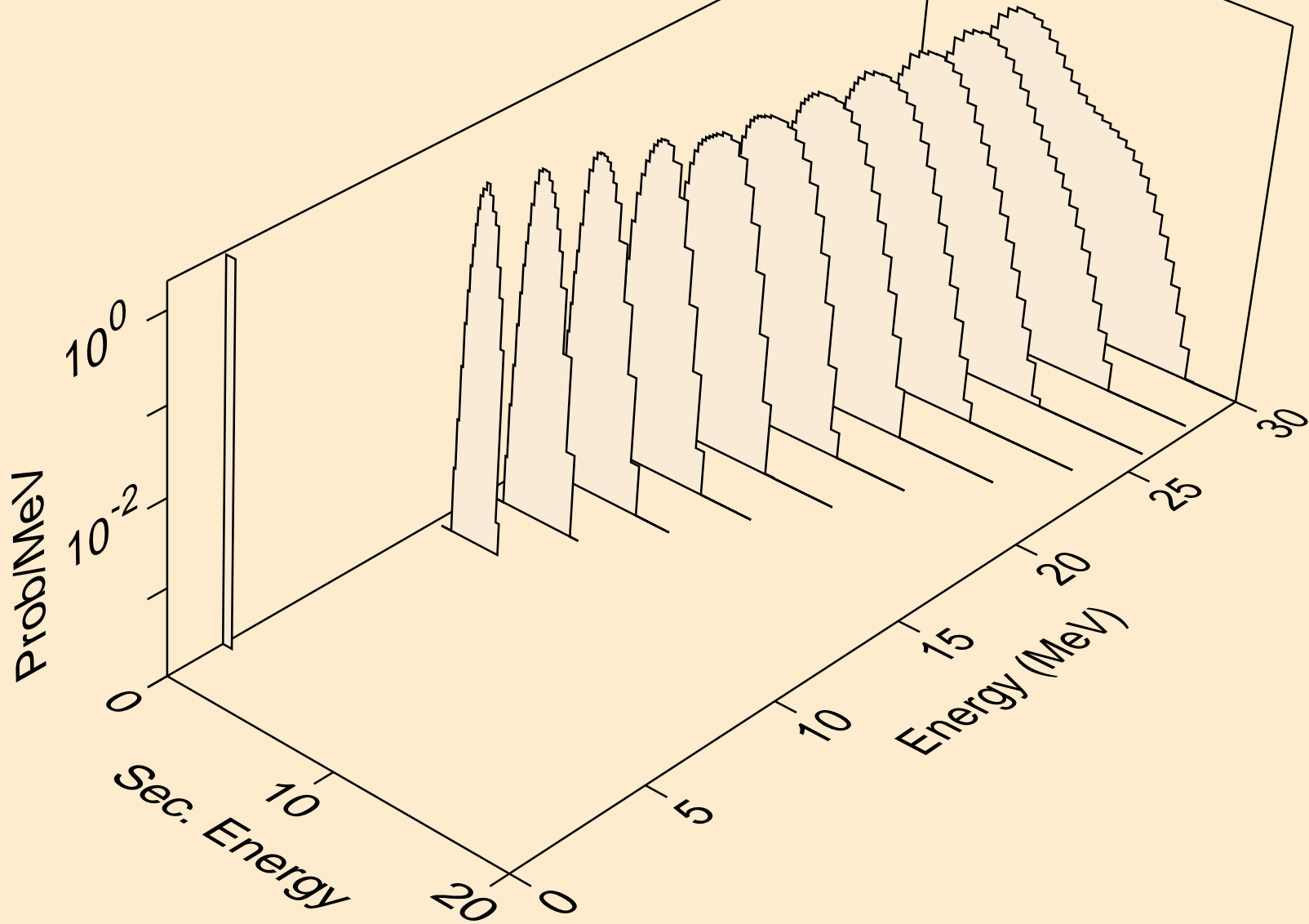

CS119M HELION ACER TENDL-2023 LIBRARY; T=0.K  
protons from (s,p)

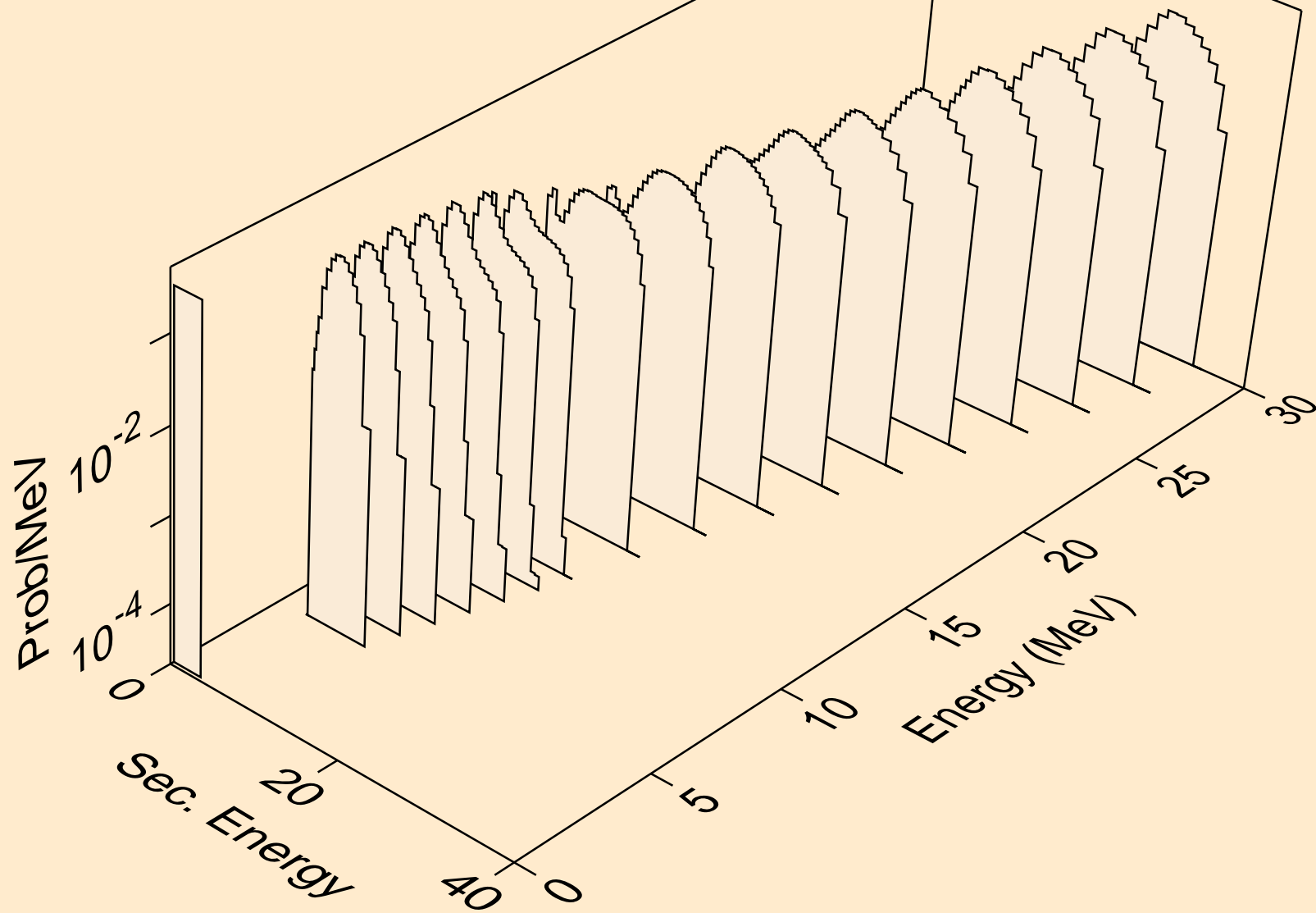

CS119M HELION ACER TENDL-2023 LIBRARY; T=0.K  
protons from (s,2p)

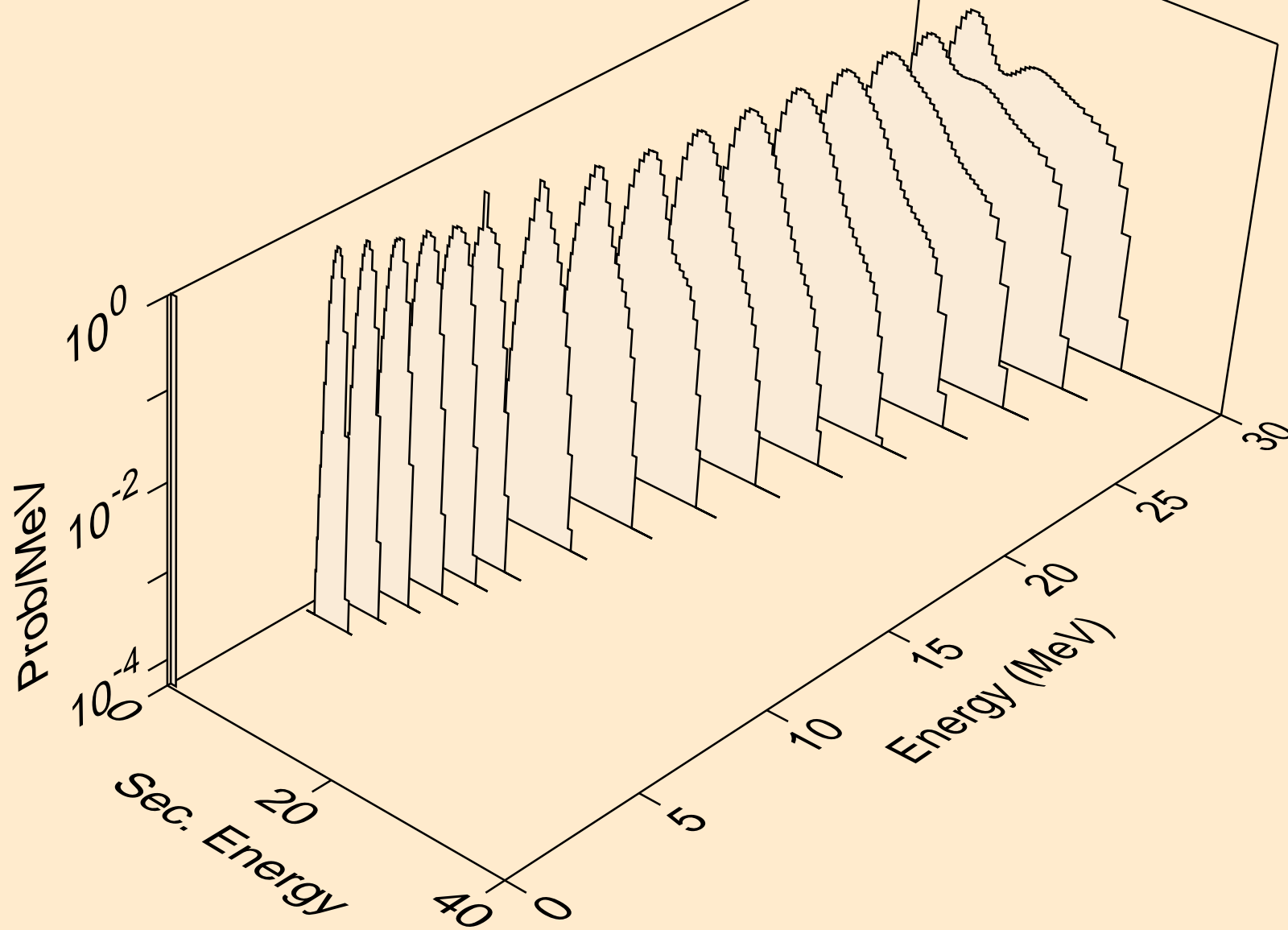

CS119M HELION ACER TENDL-2023 LIBRARY; T=0.K  
protons from (s,pa)

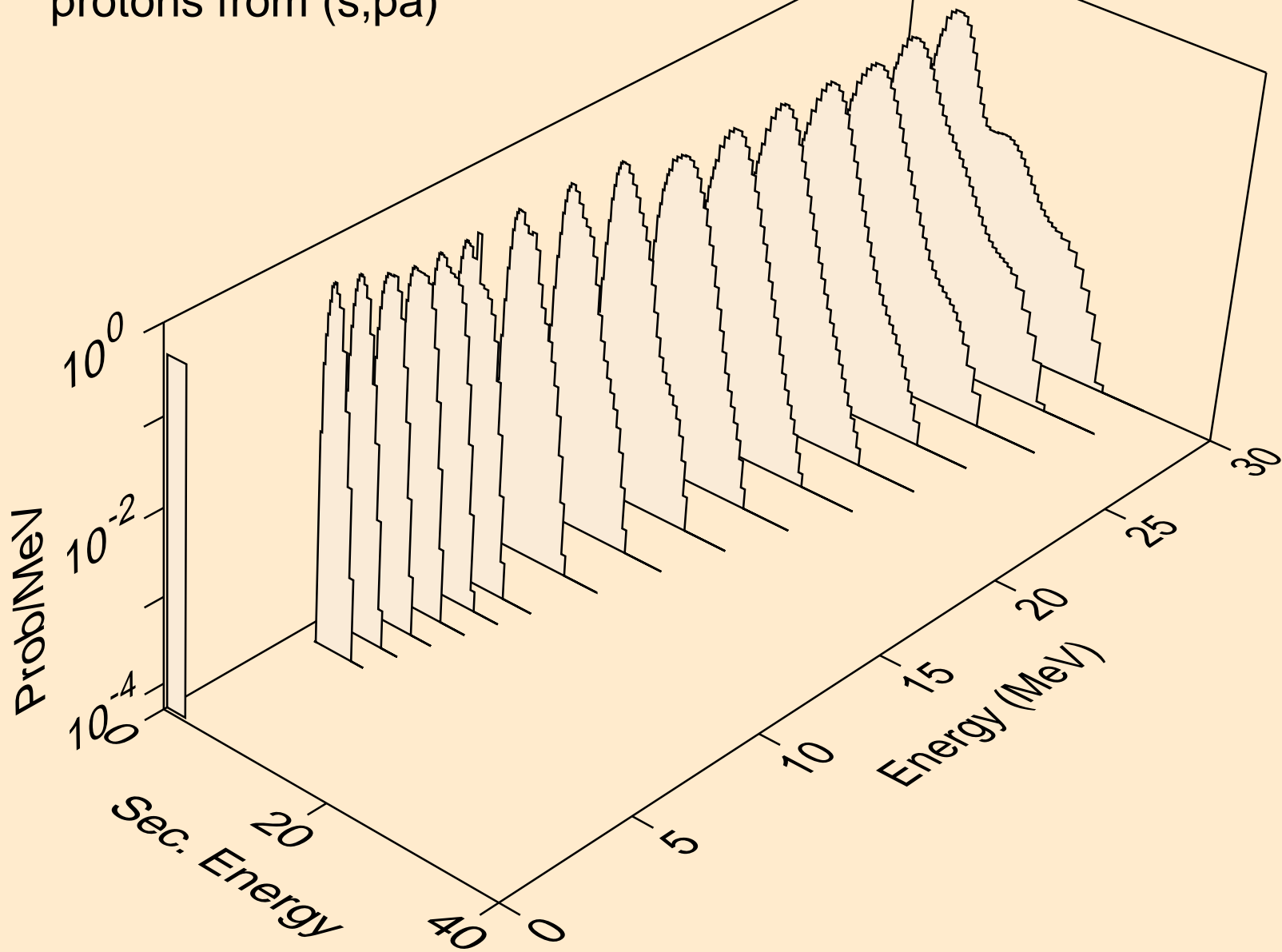

CS119M HELION ACER TENDL-2023 LIBRARY; T=0.K  
protons from (s,pd)

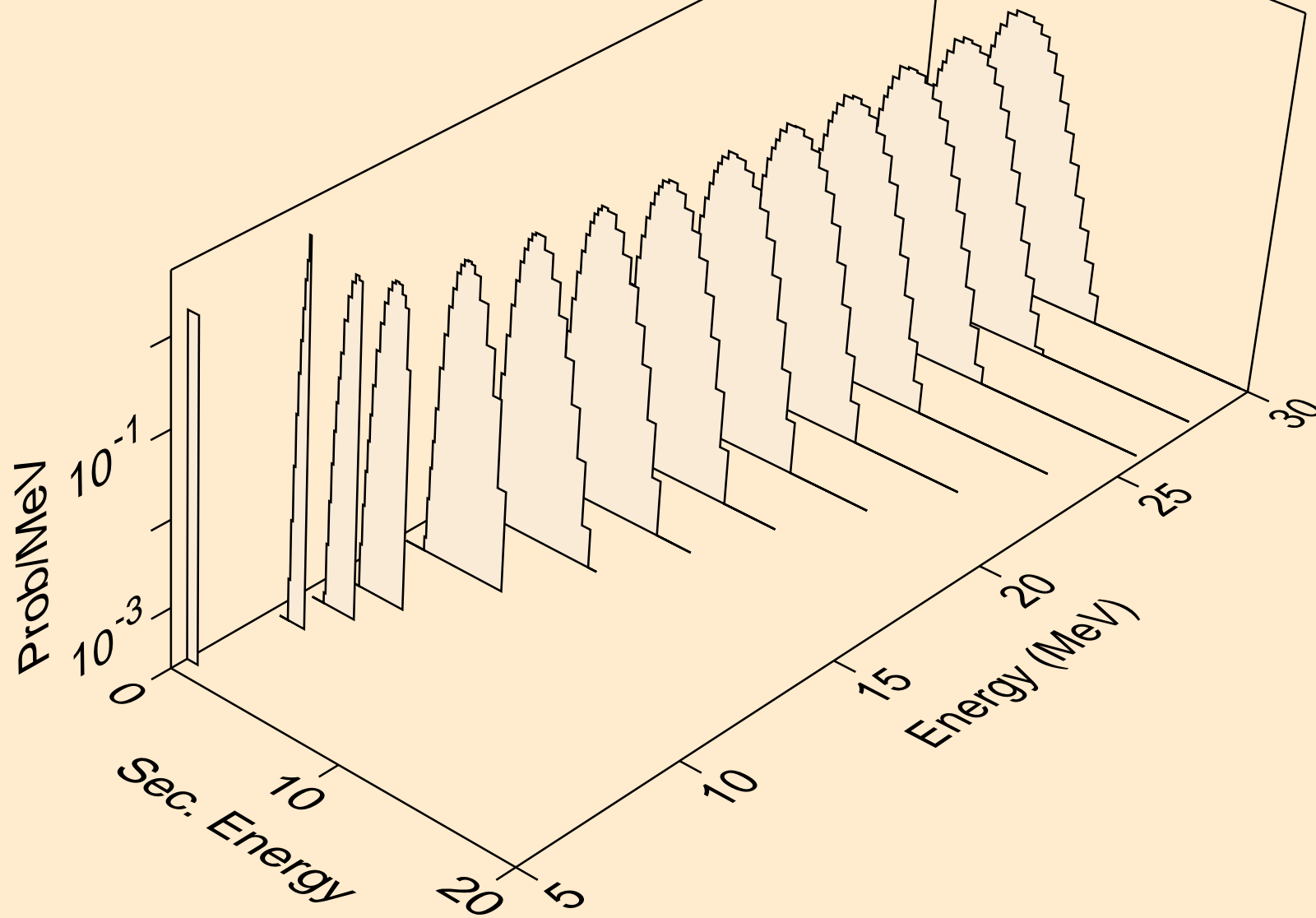

CS119M HELION ACER TENDL-2023 LIBRARY; T=0.K  
protons from (s,pt)

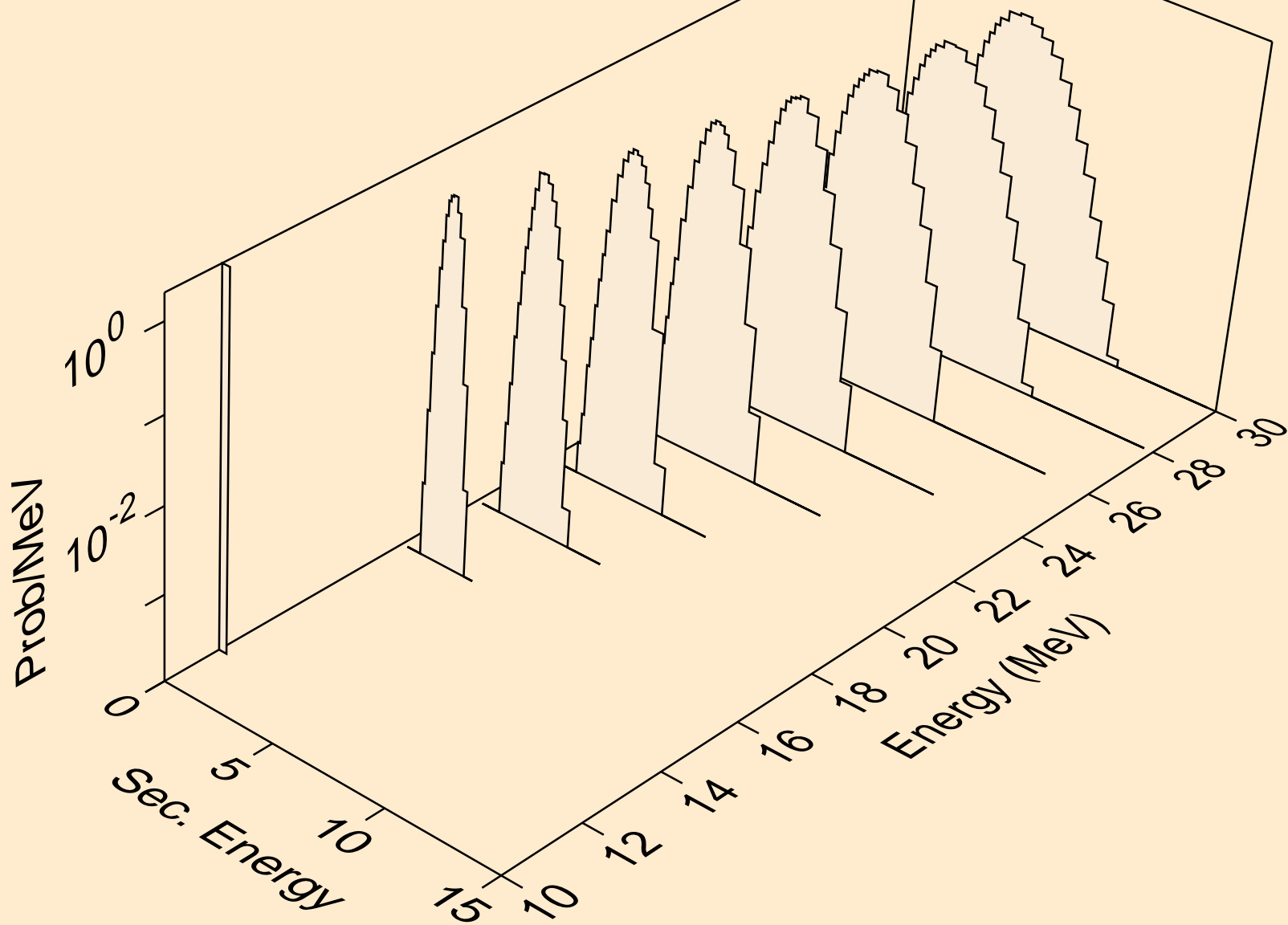

CS119M HELION ACER TENDL-2023 LIBRARY; T=0.K  
deuterons from (s,x)

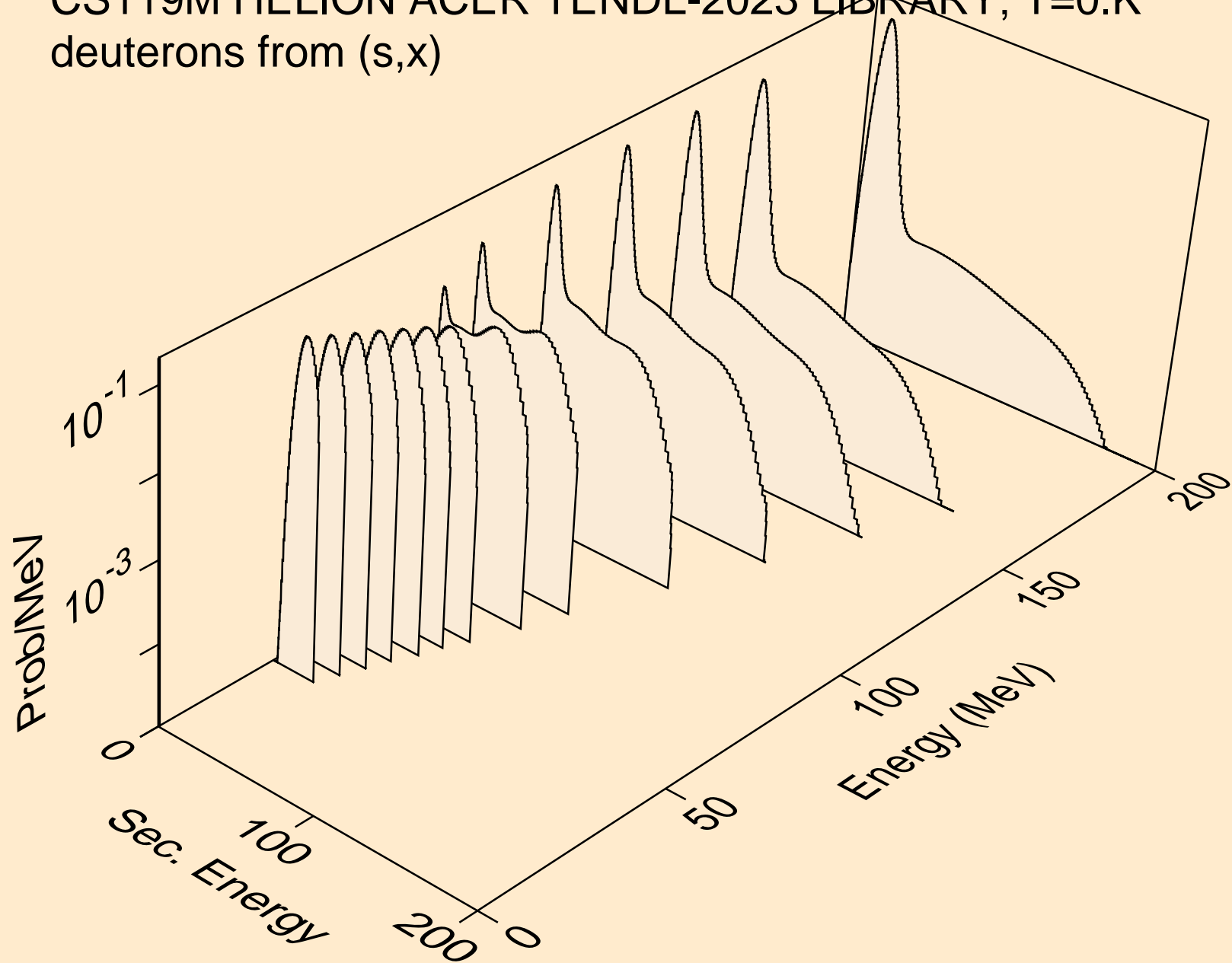

CS119M HELION ACER TENDL-2023 LIBRARY; T=0.K  
deuterons from (s,2nd)

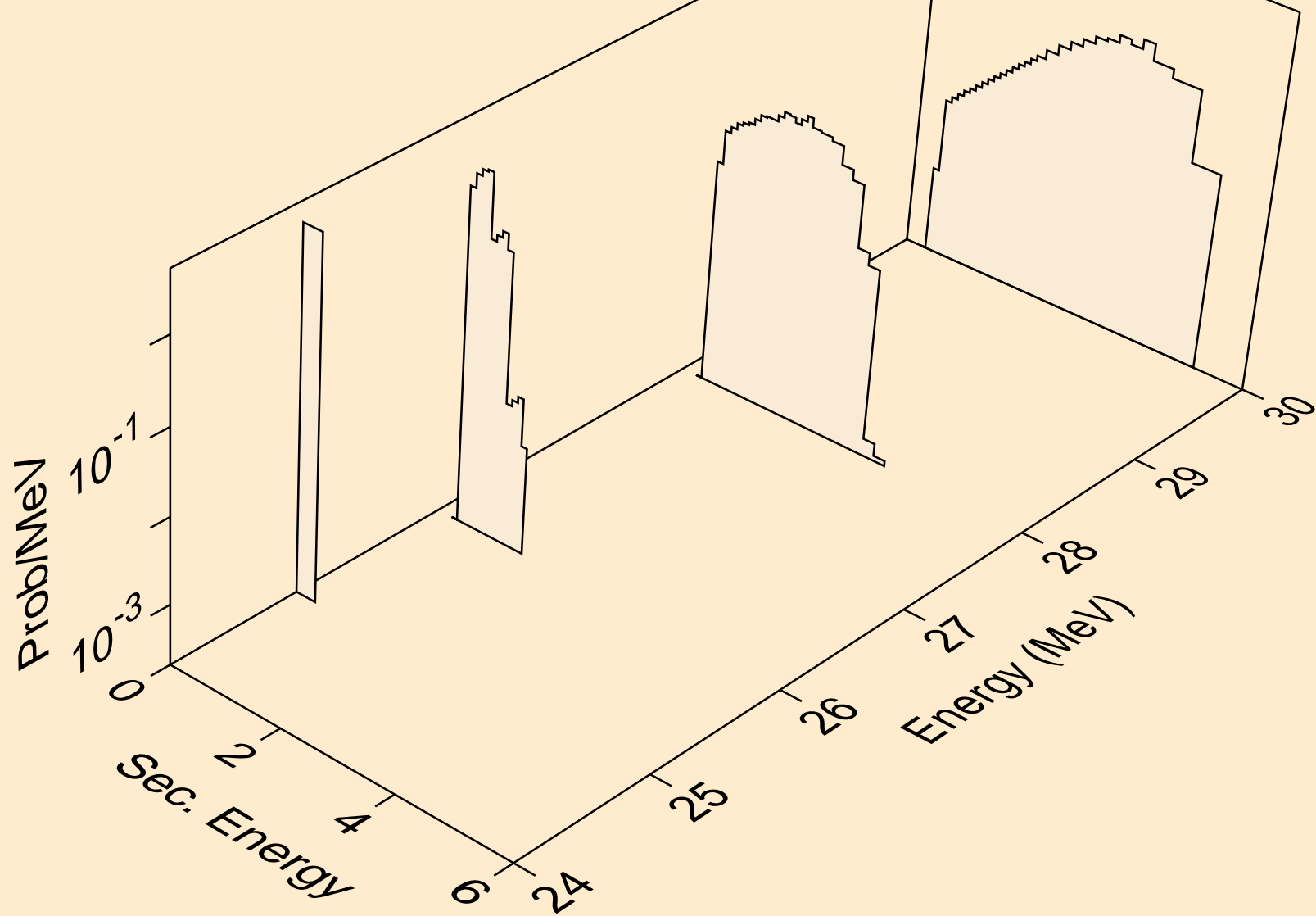

CS119M HELION ACER TENDL-2023 LIBRARY; T=0.K  
deuterons from (s,n\*)d

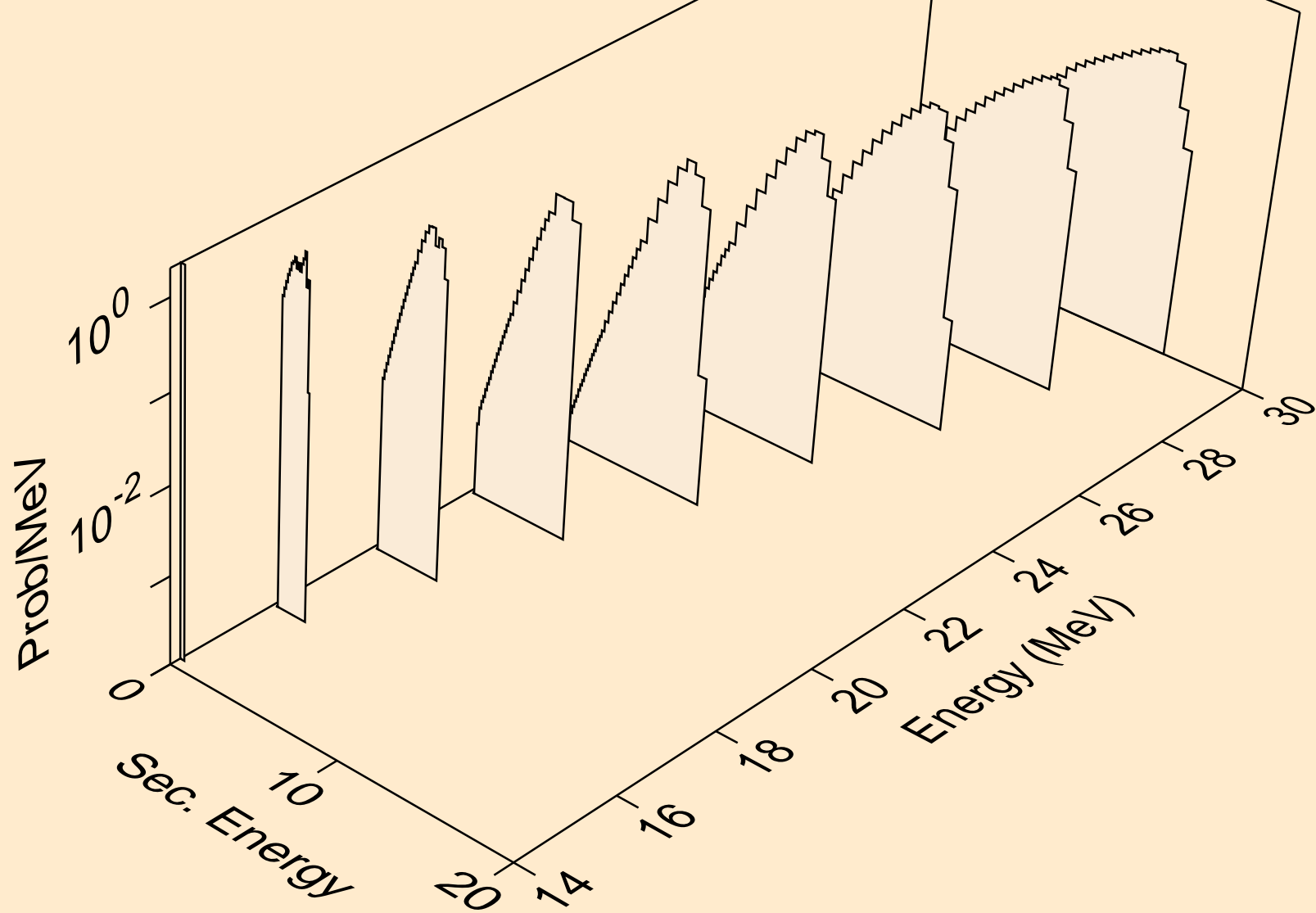

CS119M HELION ACER TENDL-2023 LIBRARY; T=0.K  
deuterons from (s,d)

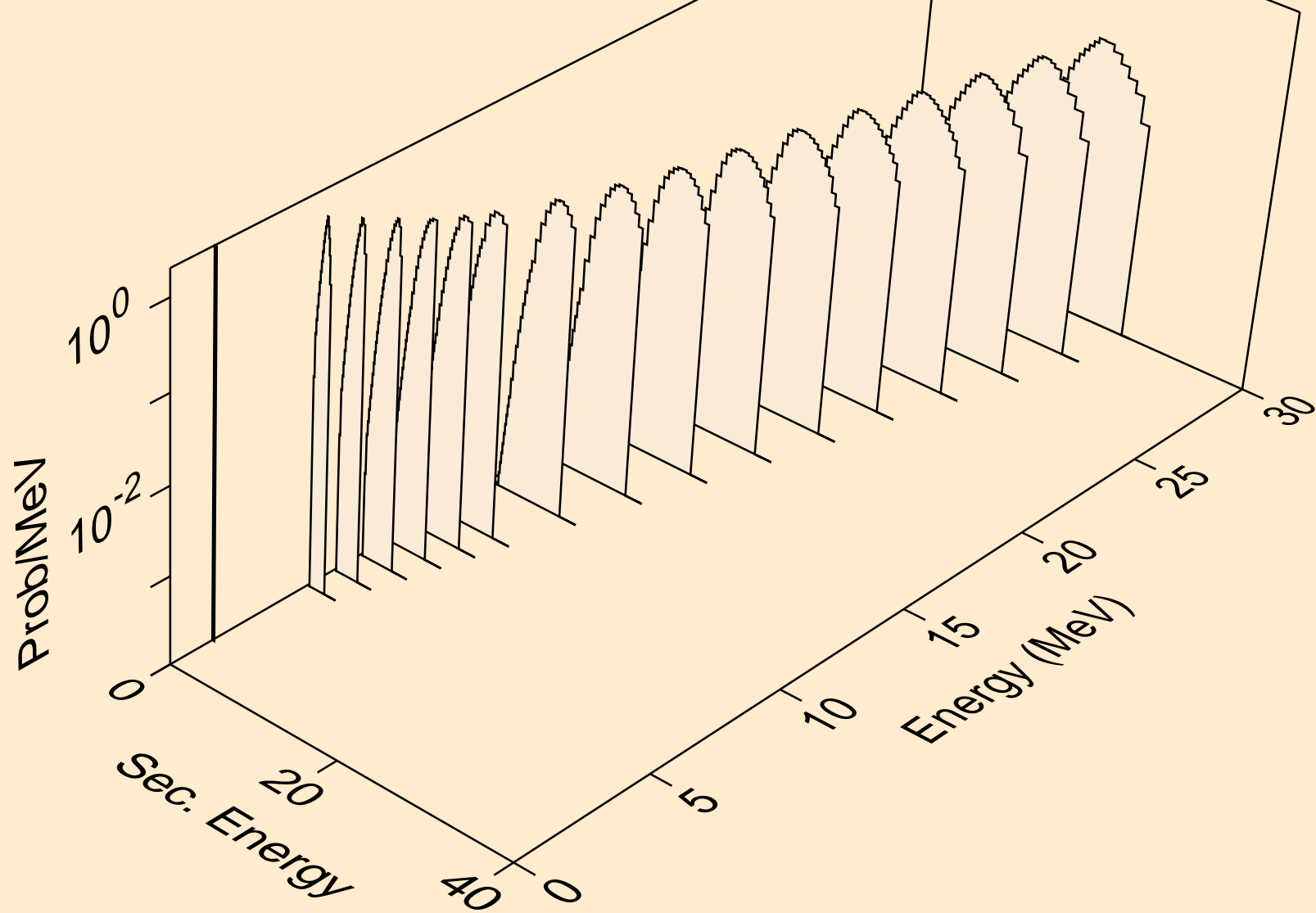

CS119M HELION ACER TENDL-2023 LIBRARY; T=0.K  
deuterons from (s,d2a)

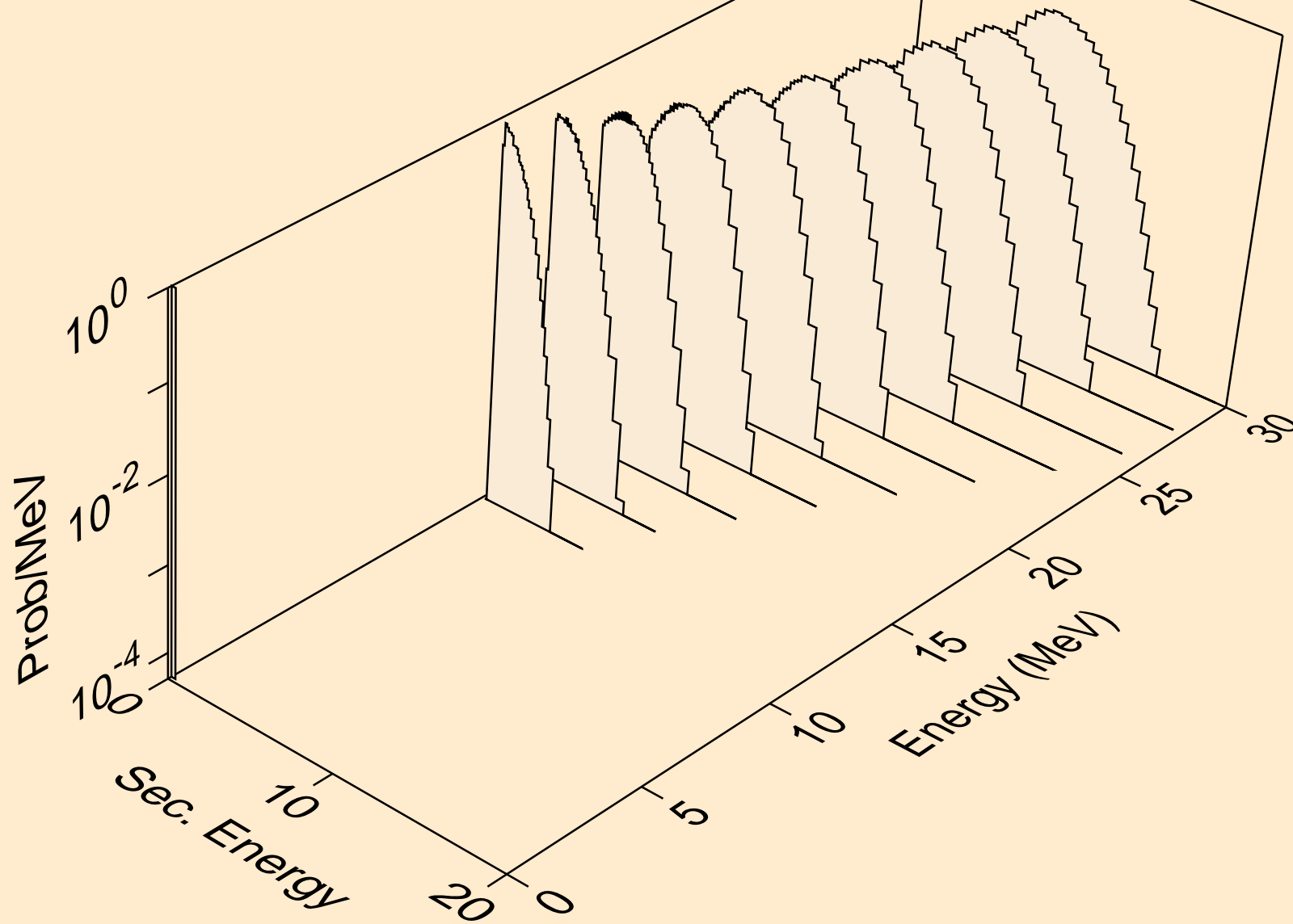

CS119M HELION ACER TENDL-2023 LIBRARY; T=0.K  
deuterons from (s,pd)

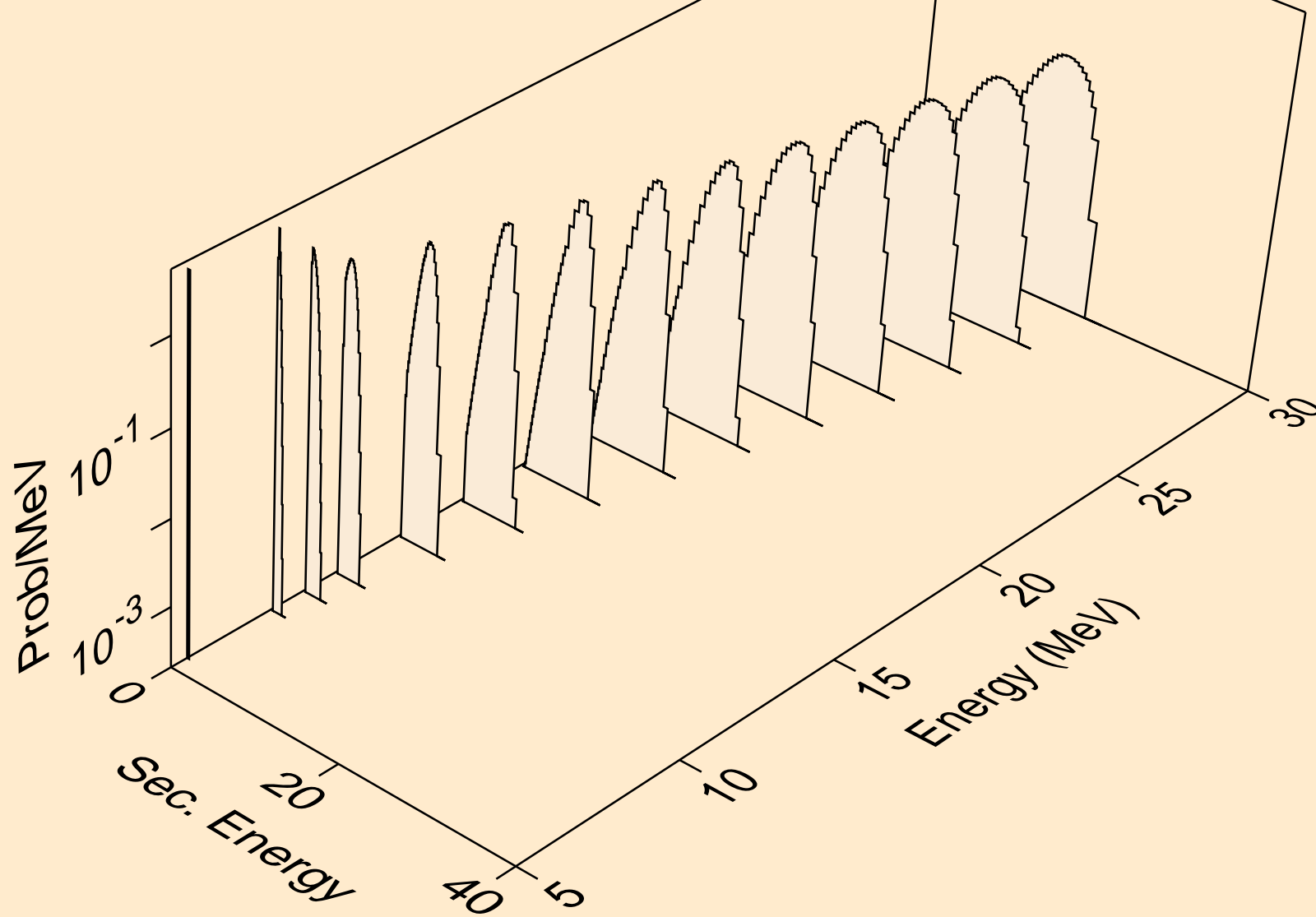

CS119M HELION ACER TENDL-2023 LIBRARY; T=0.K  
deuterons from (s,da)

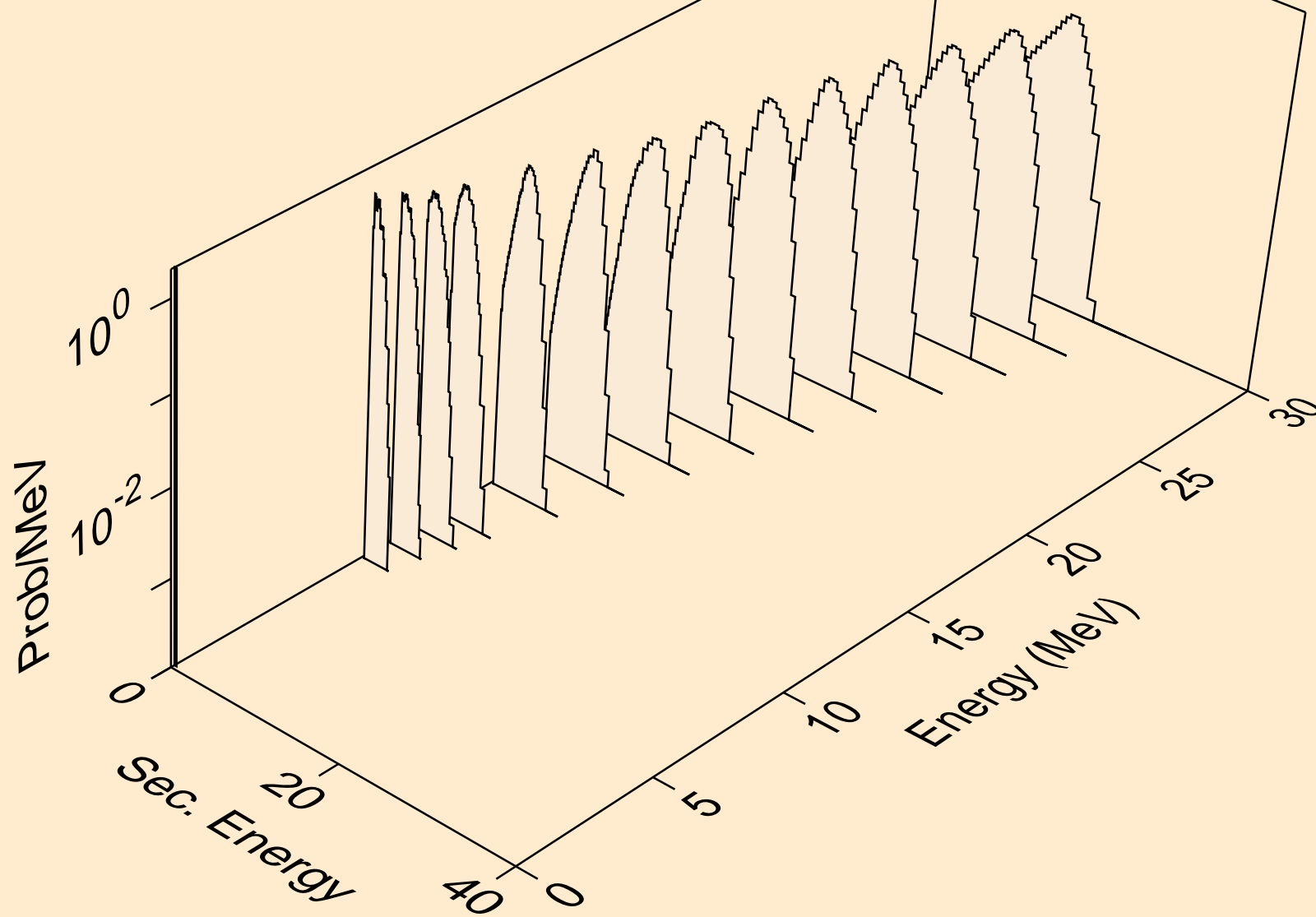

CS119M HELION ACER TENDL-2023 LIBRARY; T=0.K  
tritons from (s,x)

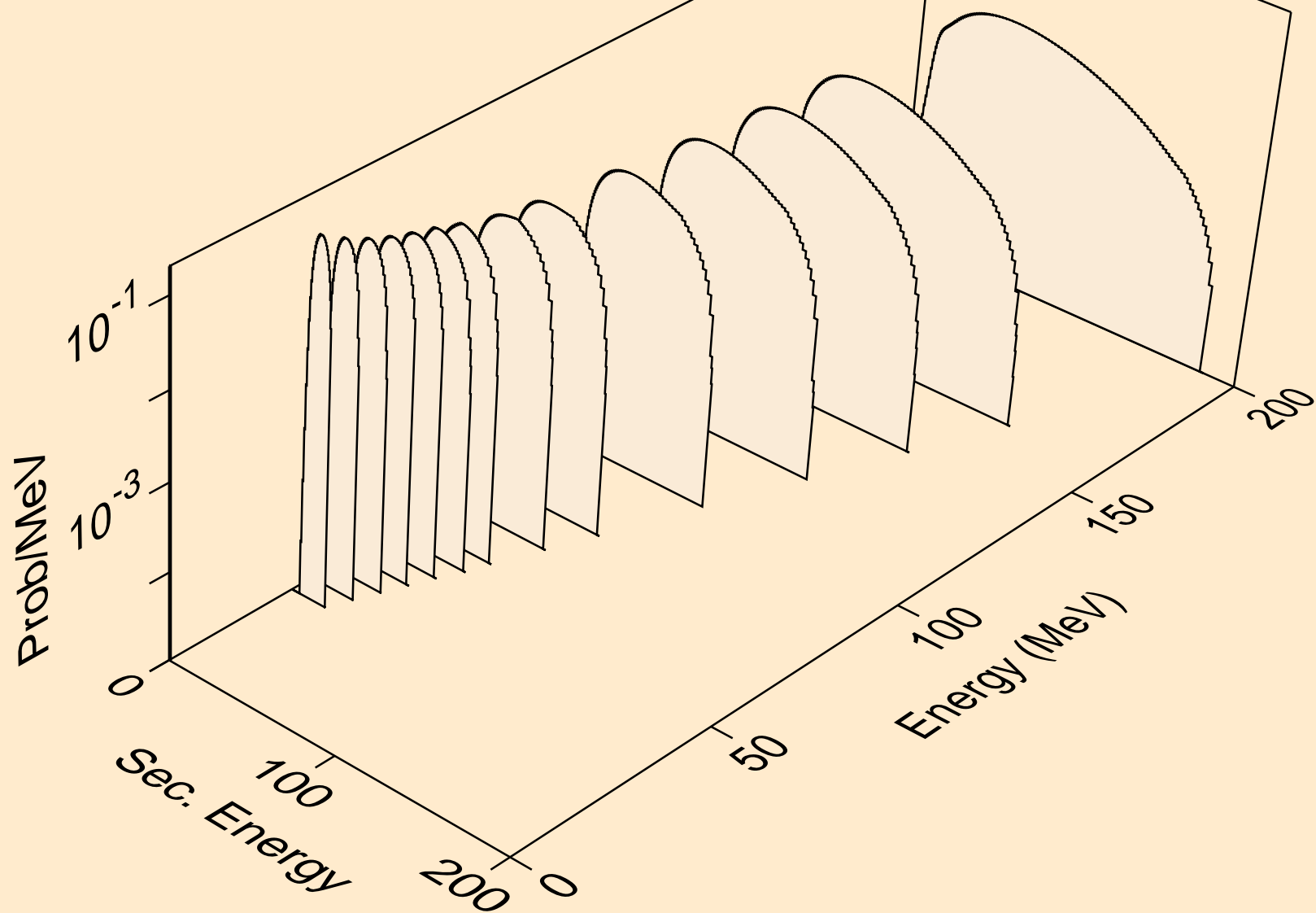

CS119M HELION ACER TENDL-2023 LIBRARY; T=0.K  
tritons from (s,n\*)t

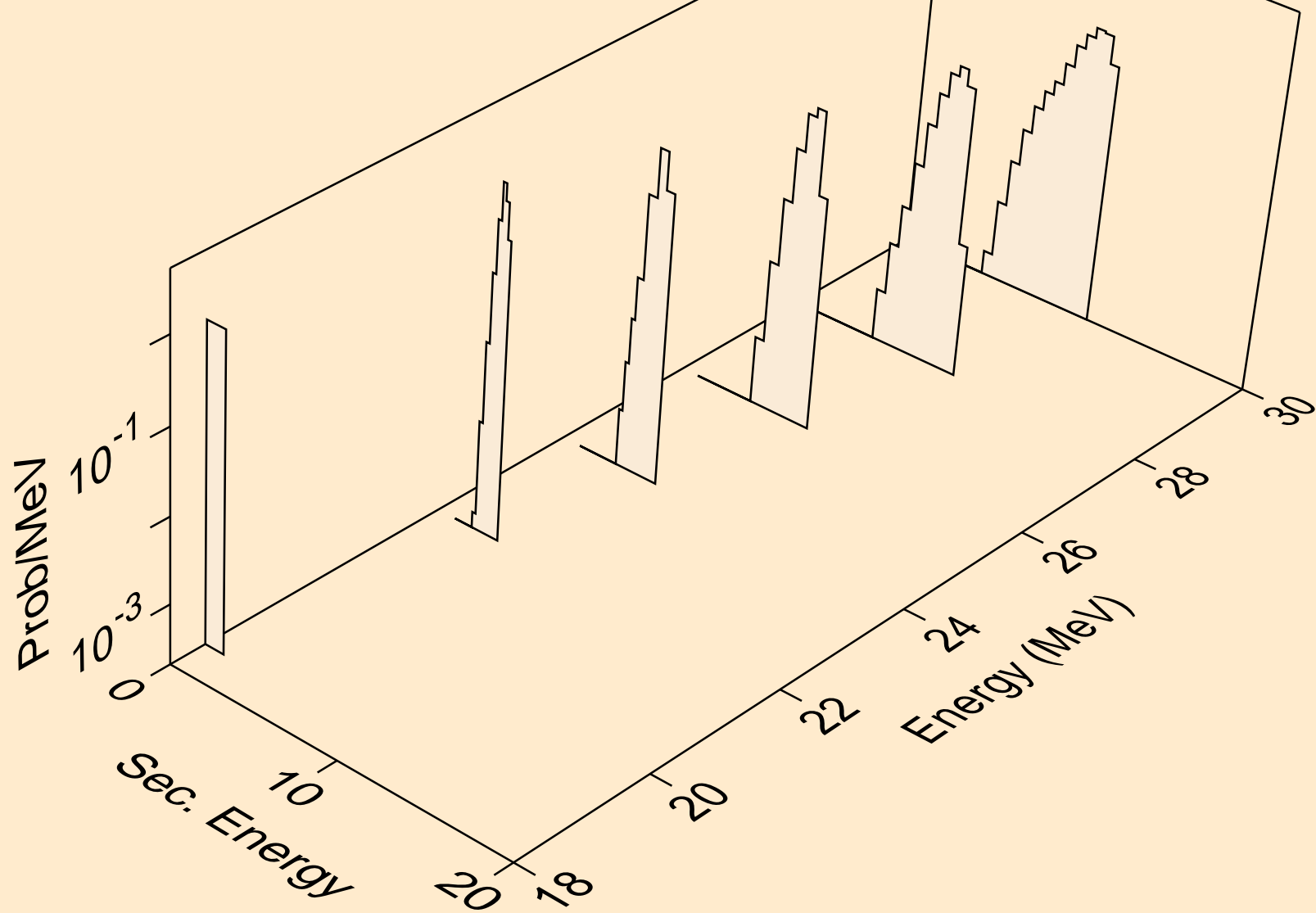

CS119M HELION ACER TENDL-2023 LIBRARY; T=0.K  
tritons from (s,t)

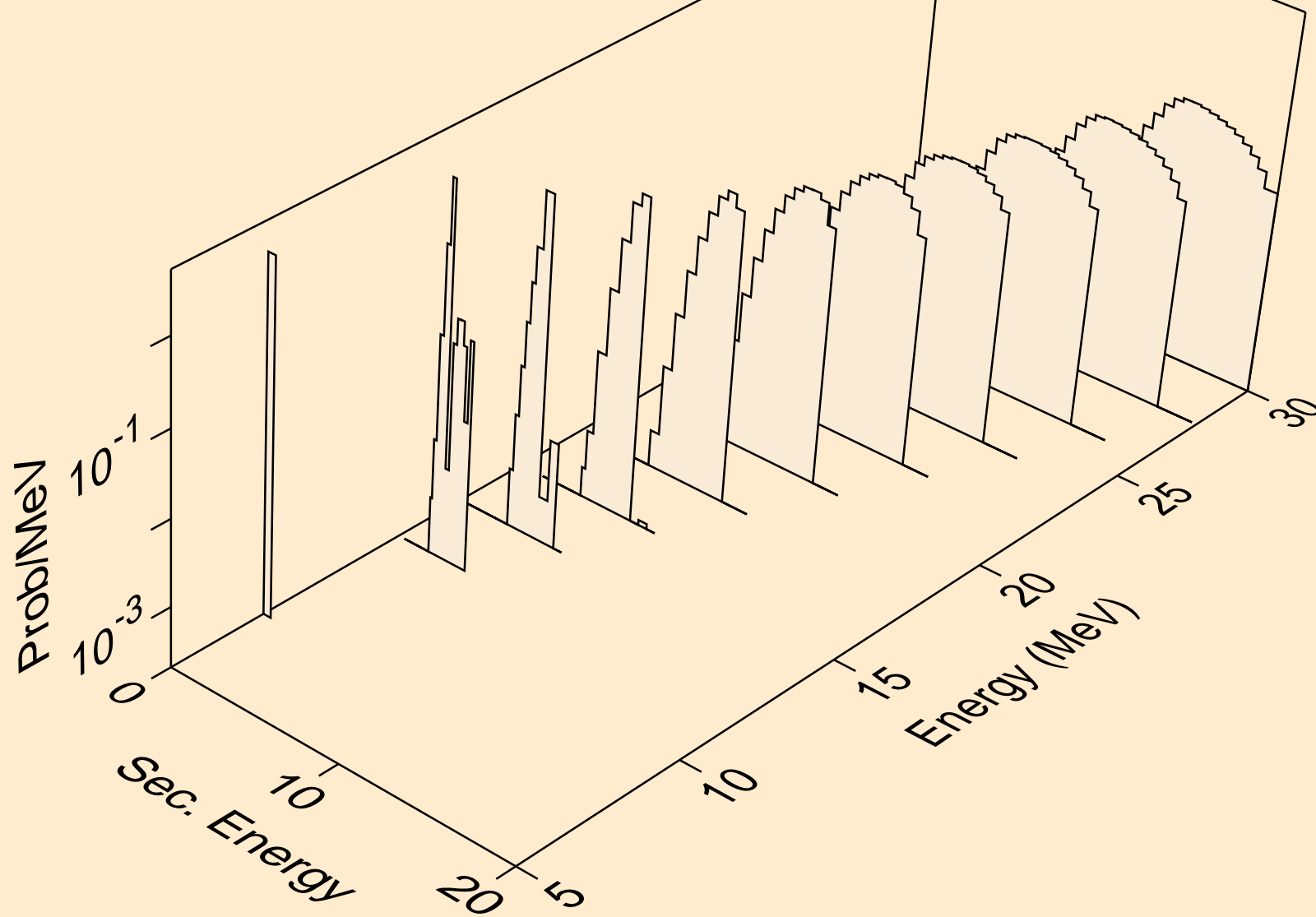

CS119M HELION ACER TENDL-2023 LIBRARY; T=0.K  
tritons from (s,t2a)

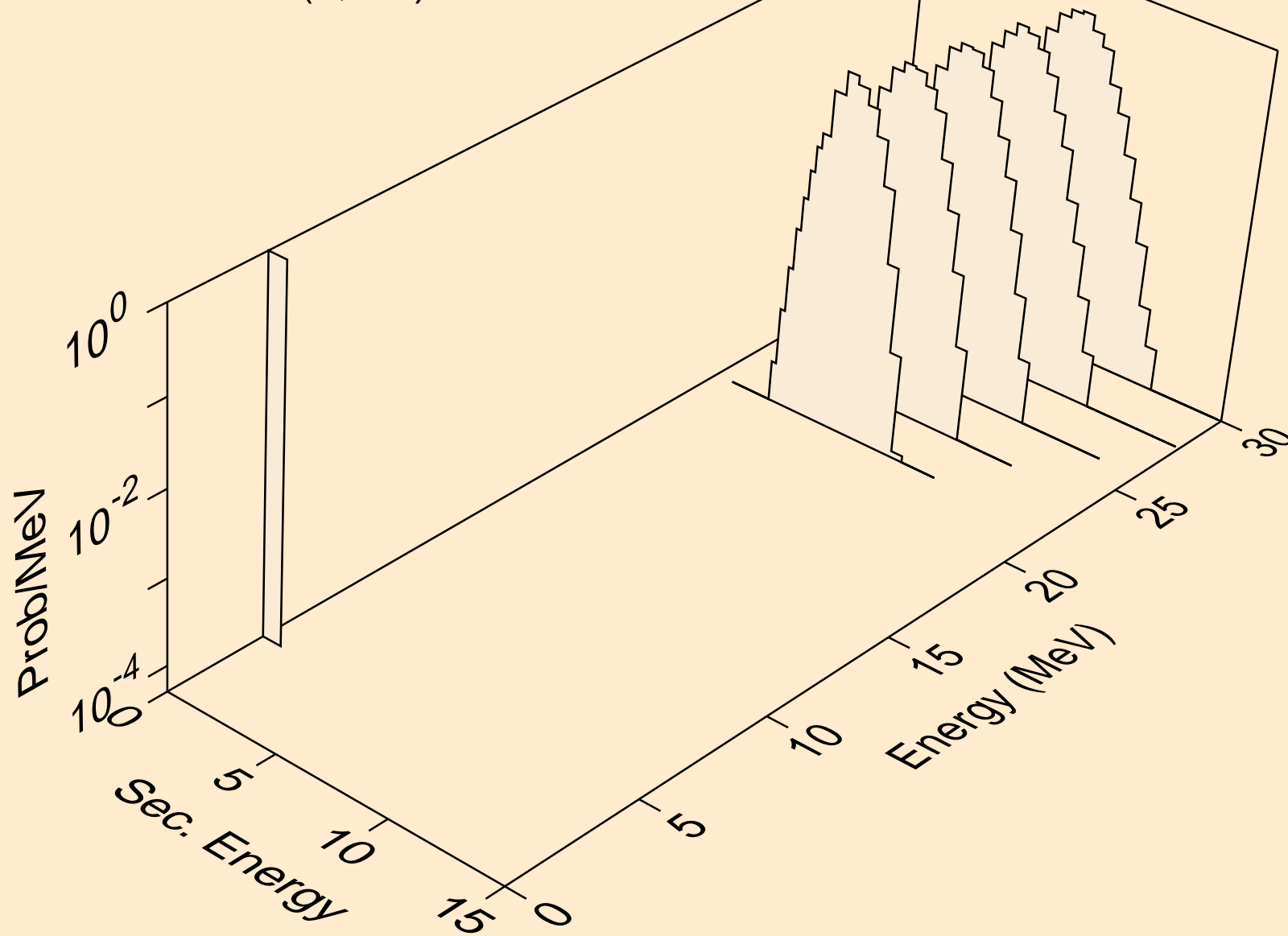

CS119M HELION ACER TENDL-2023 LIBRARY; T=0.K  
tritons from (s,pt)

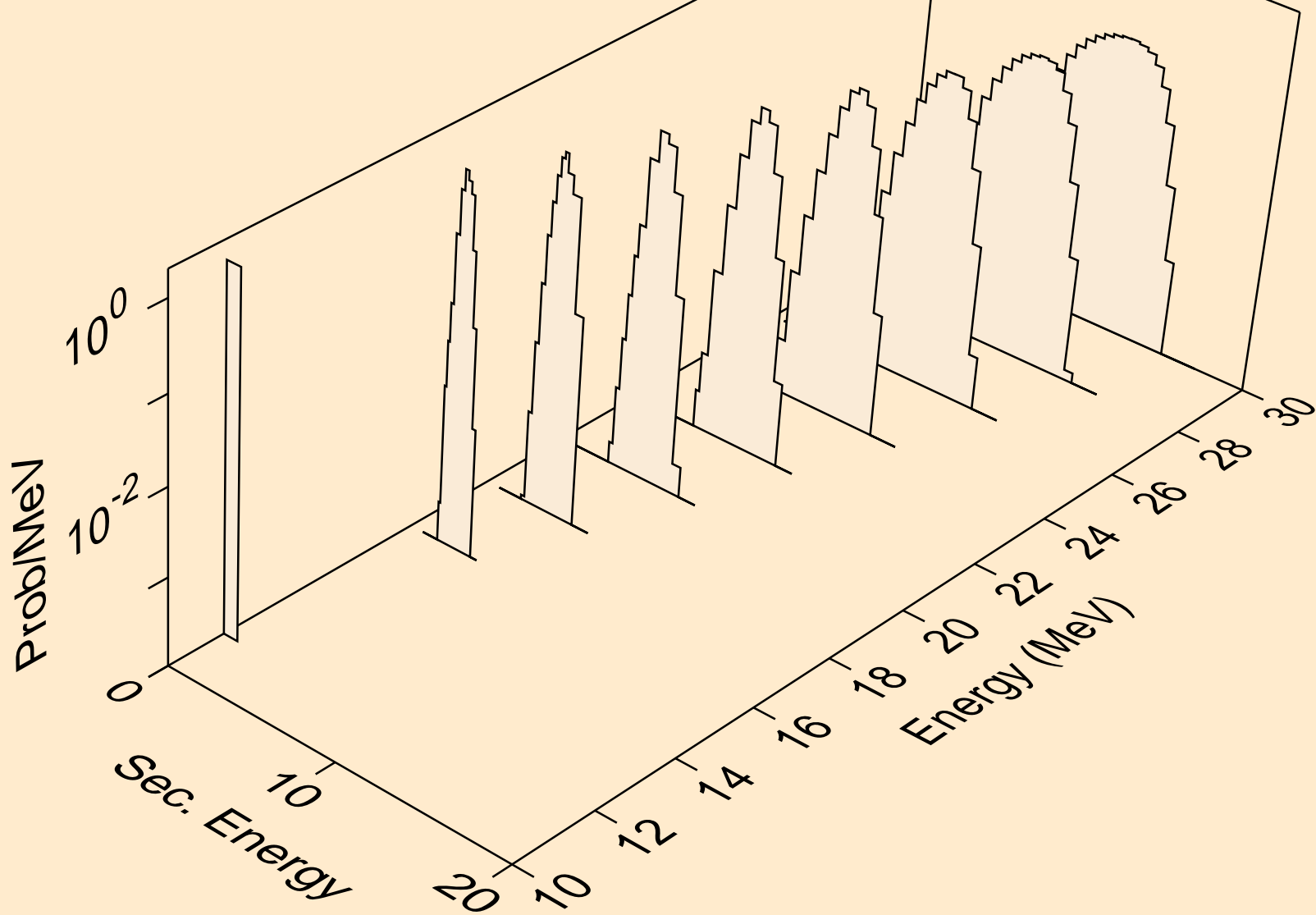

CS119M HELION ACER TENDL-2023 LIBRARY; T=0.K  
alphas from (s,x)

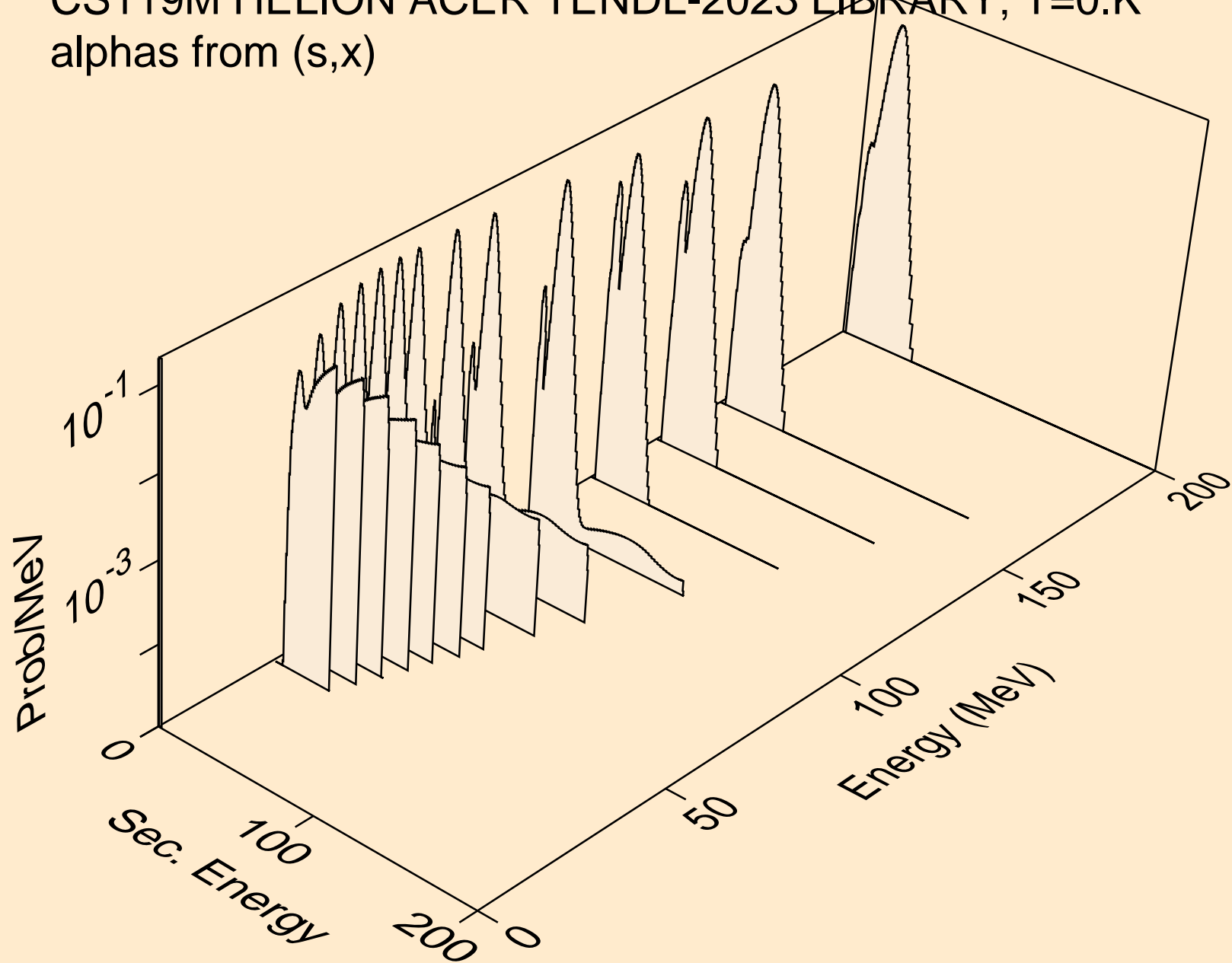

CS119M HELION ACER TENDL-2023 LIBRARY; T=0.K  
alphas from (s,n\*)a

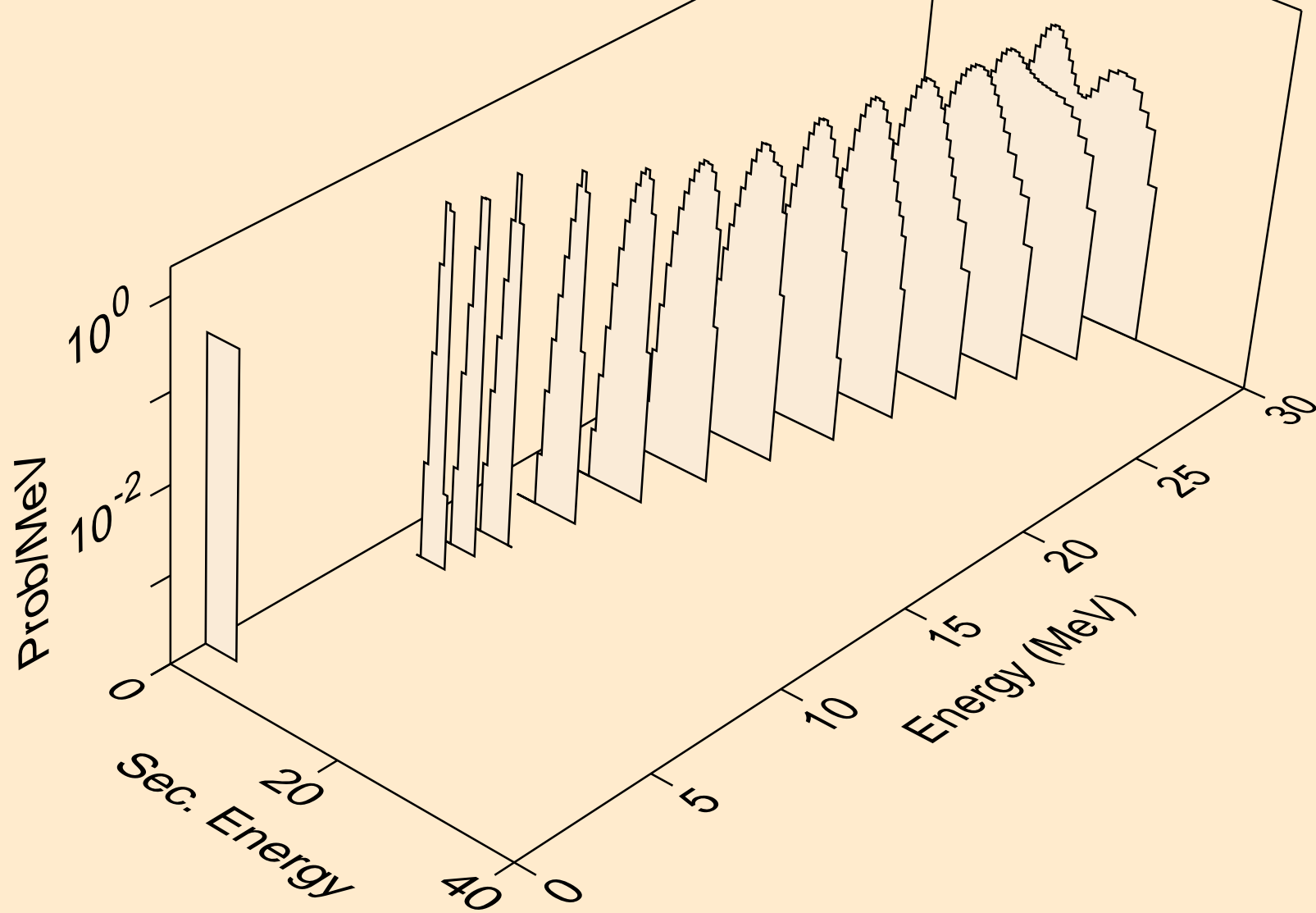

CS119M HELION ACER TENDL-2023 LIBRARY; T=0.K  
alphas from (s,2n)a

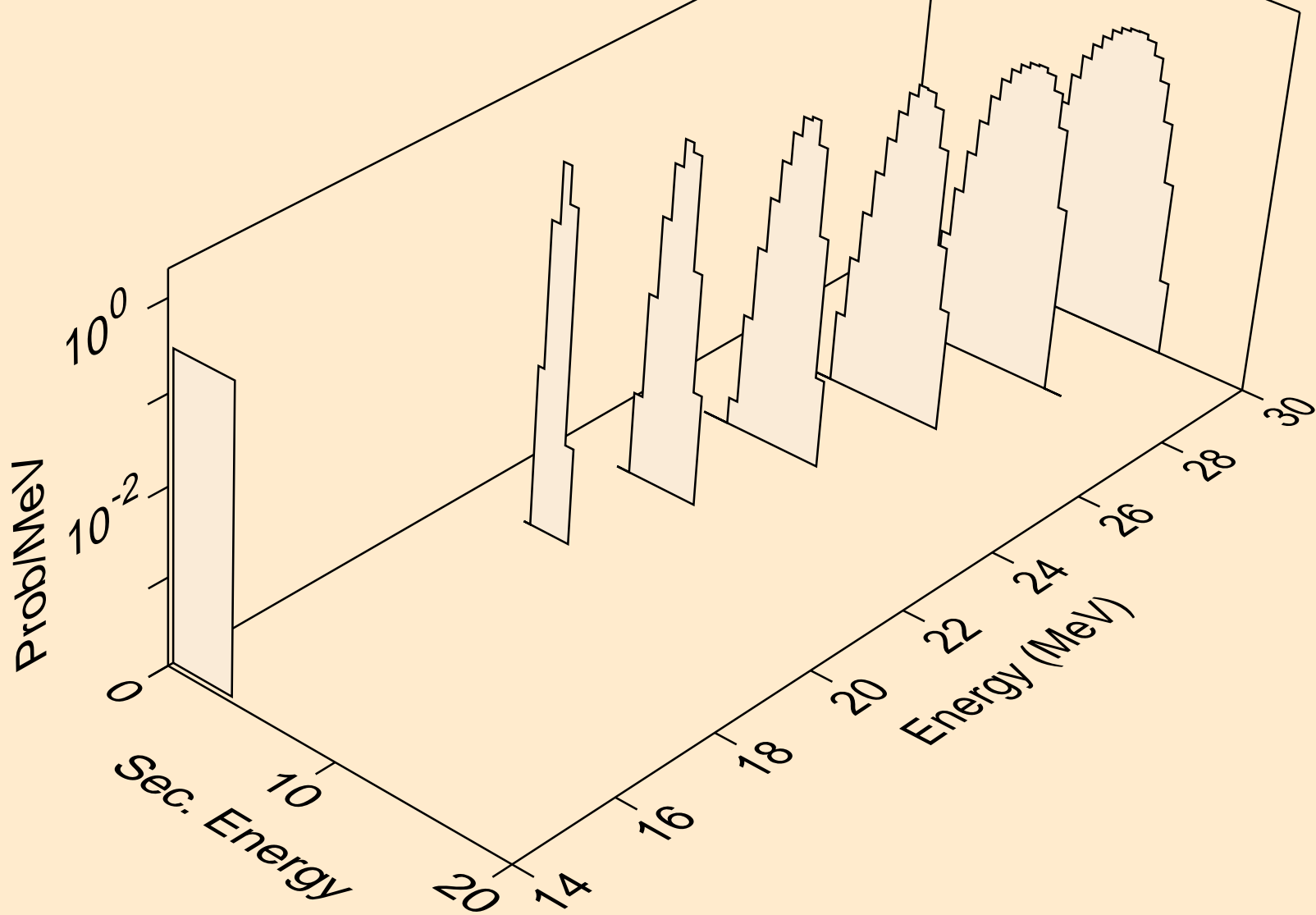

CS119M HELION ACER TENDL-2023 LIBRARY; T=0.K  
alphas from (s,n\*)2a

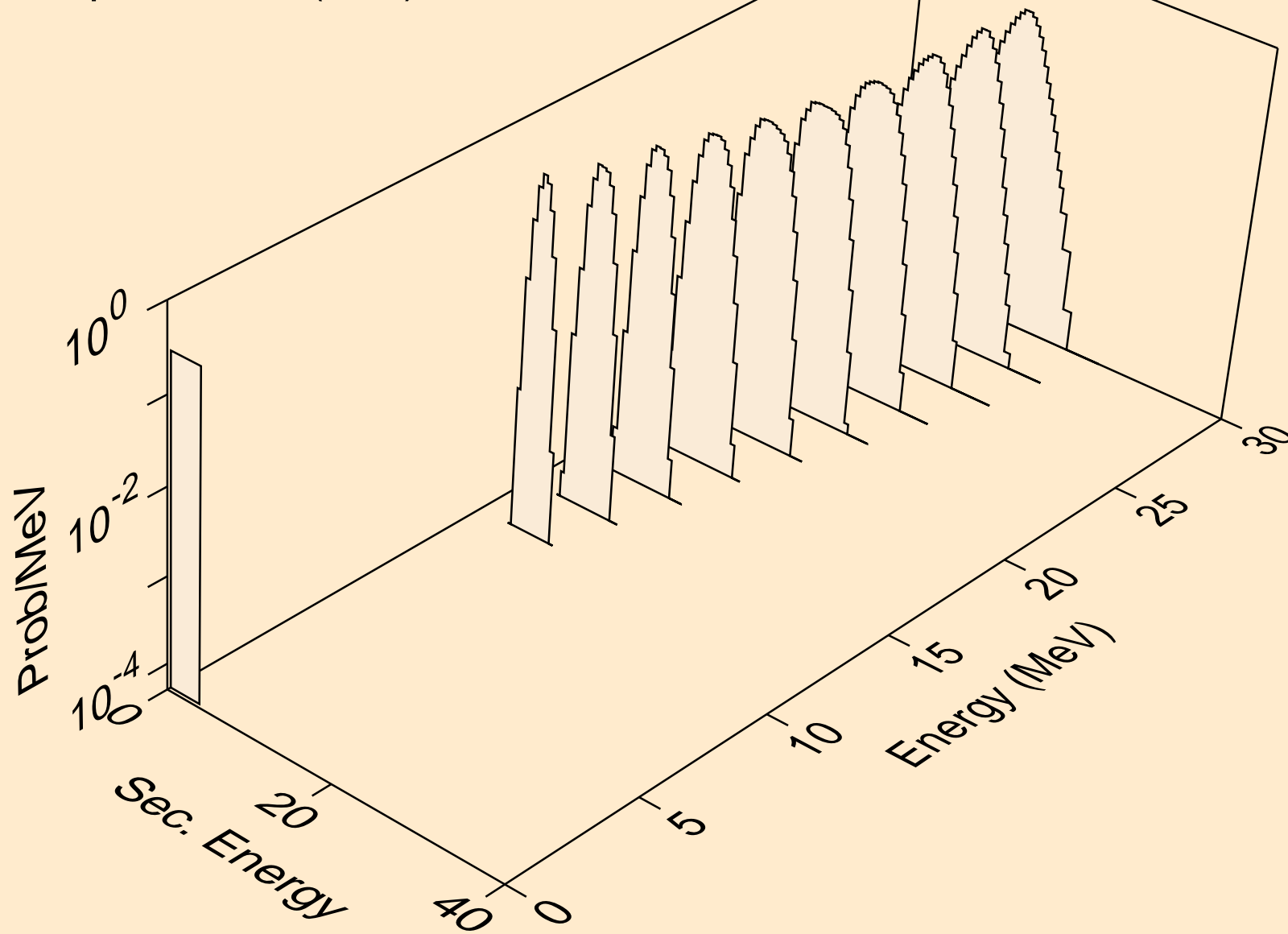

CS119M HELION ACER TENDL-2023 LIBRARY; T=0.K  
alphas from (s,npa)

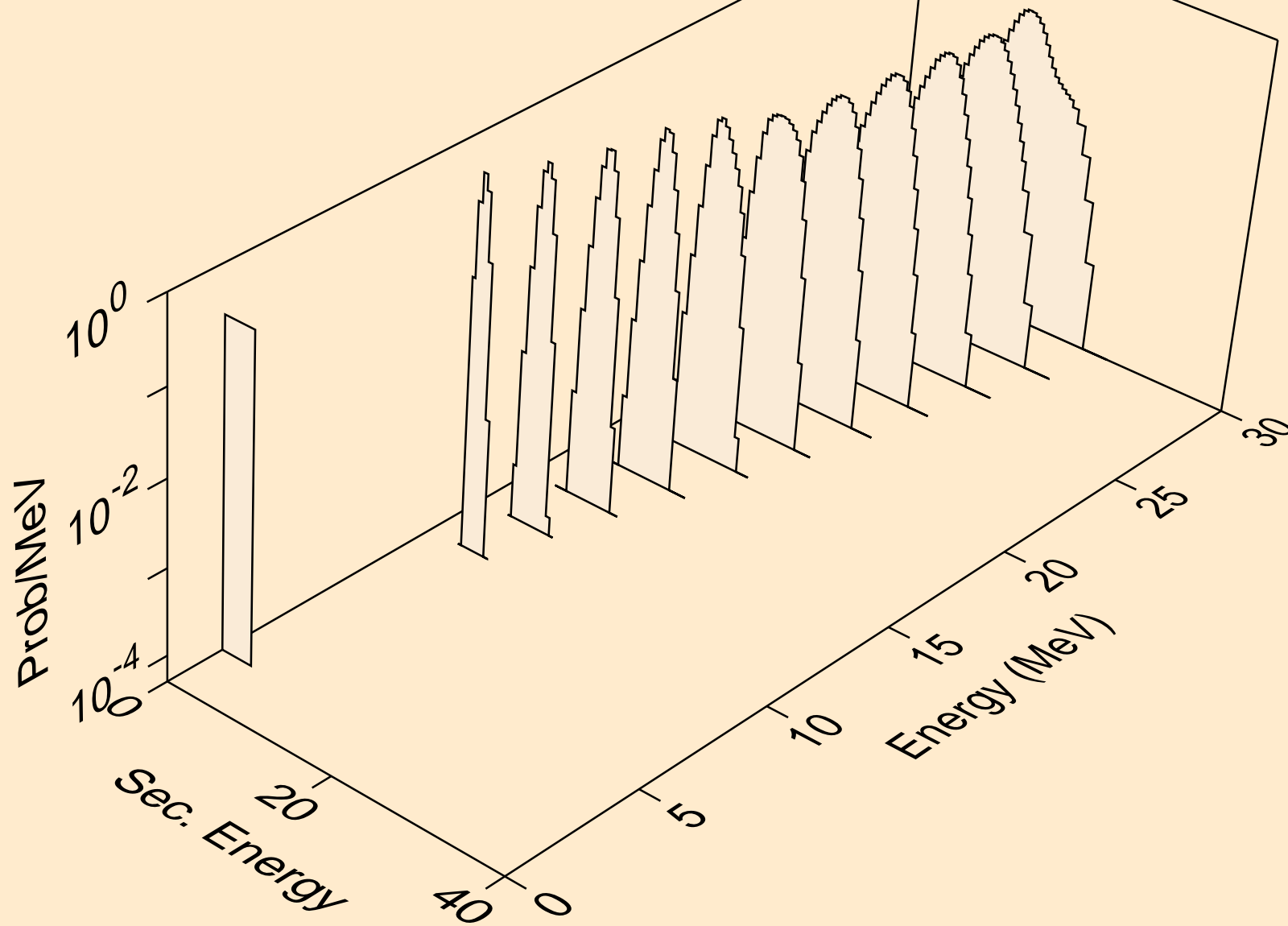

CS119M HELION ACER TENDL-2023 LIBRARY; T=0.K  
alphas from (s,a)

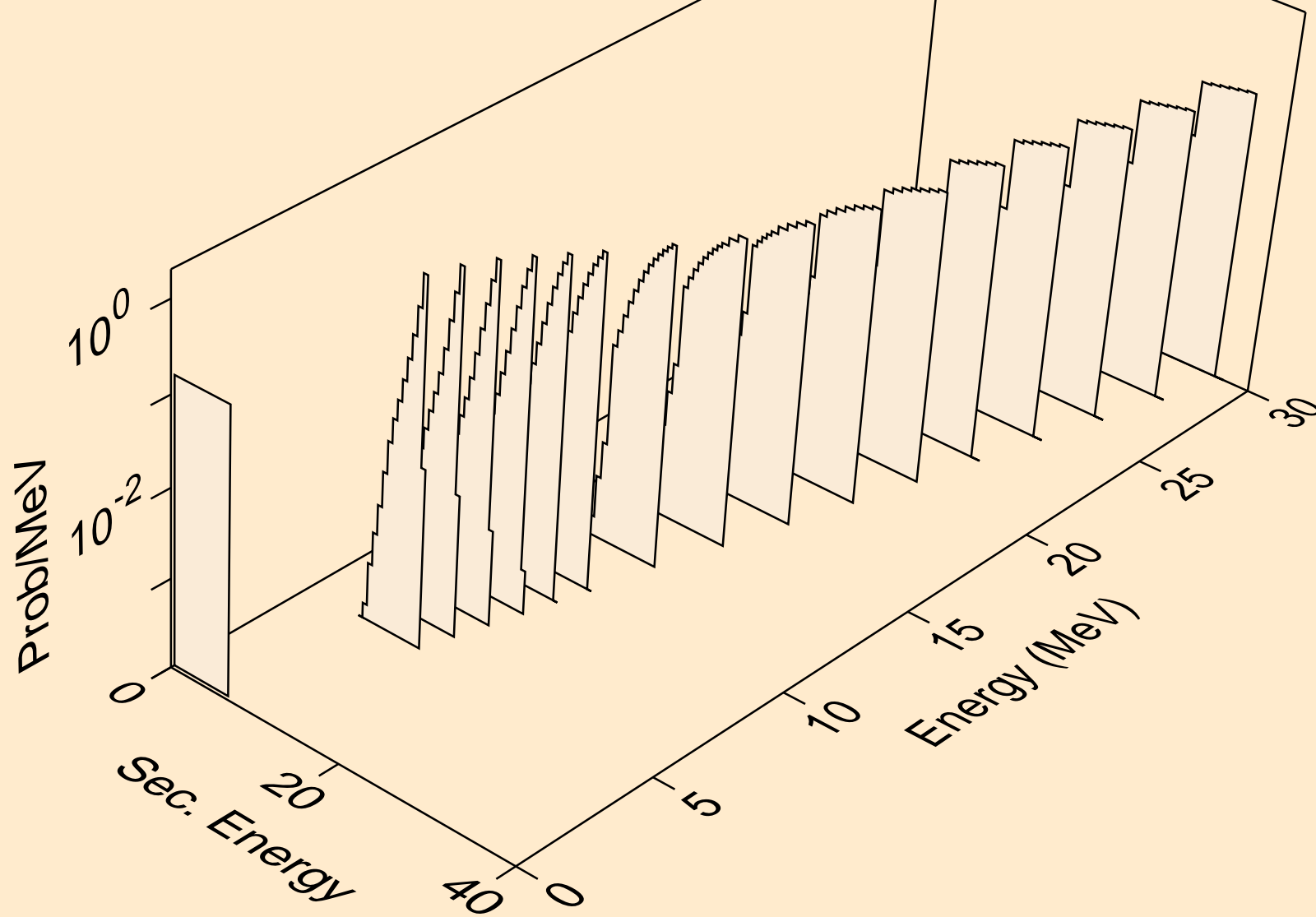

CS119M HELION ACER TENDL-2023 LIBRARY; T=0.K  
alphas from (s,2a)

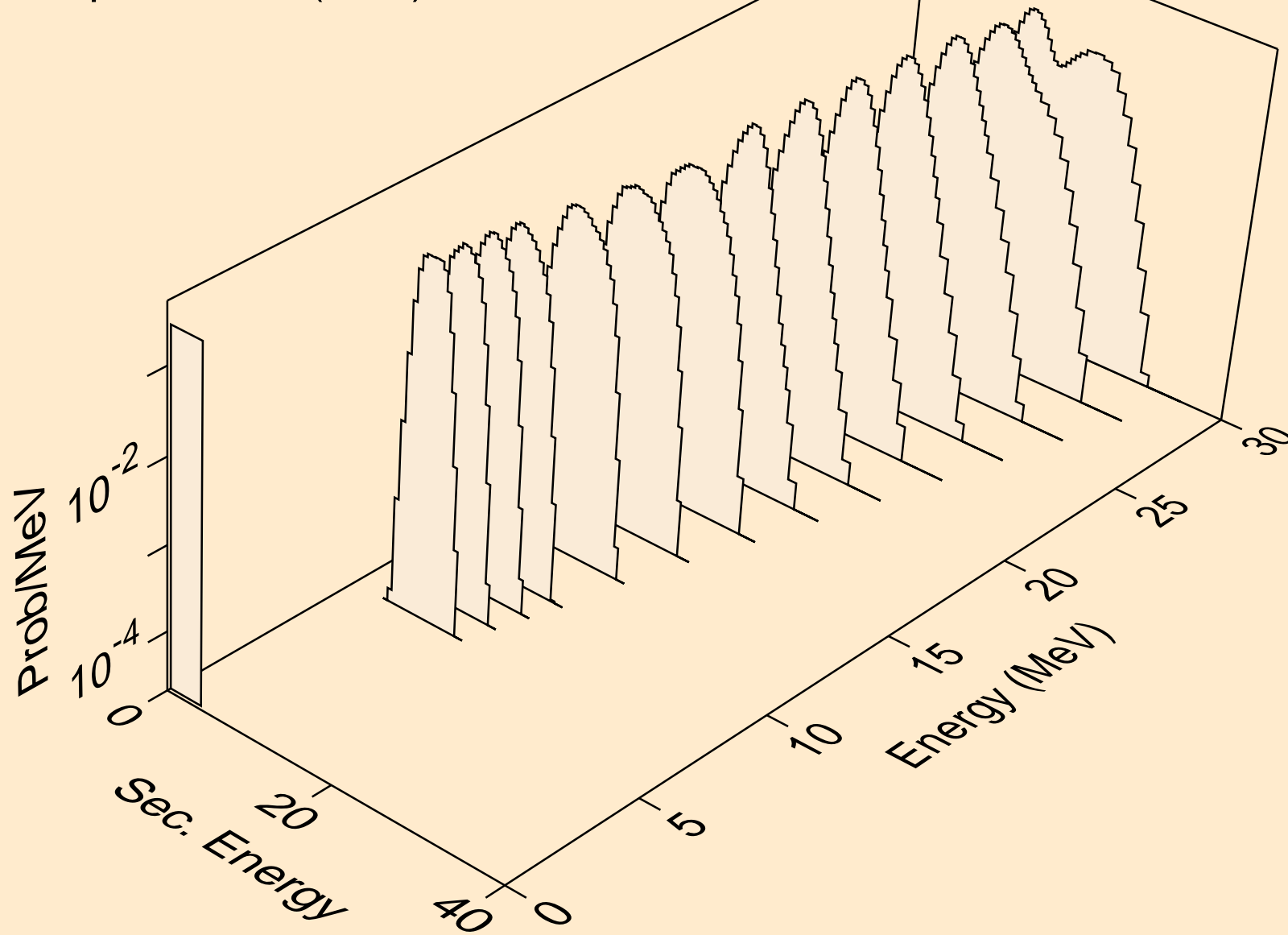

CS119M HELION ACER TENDL-2023 LIBRARY; T=0.K  
alphas from (s,3a)

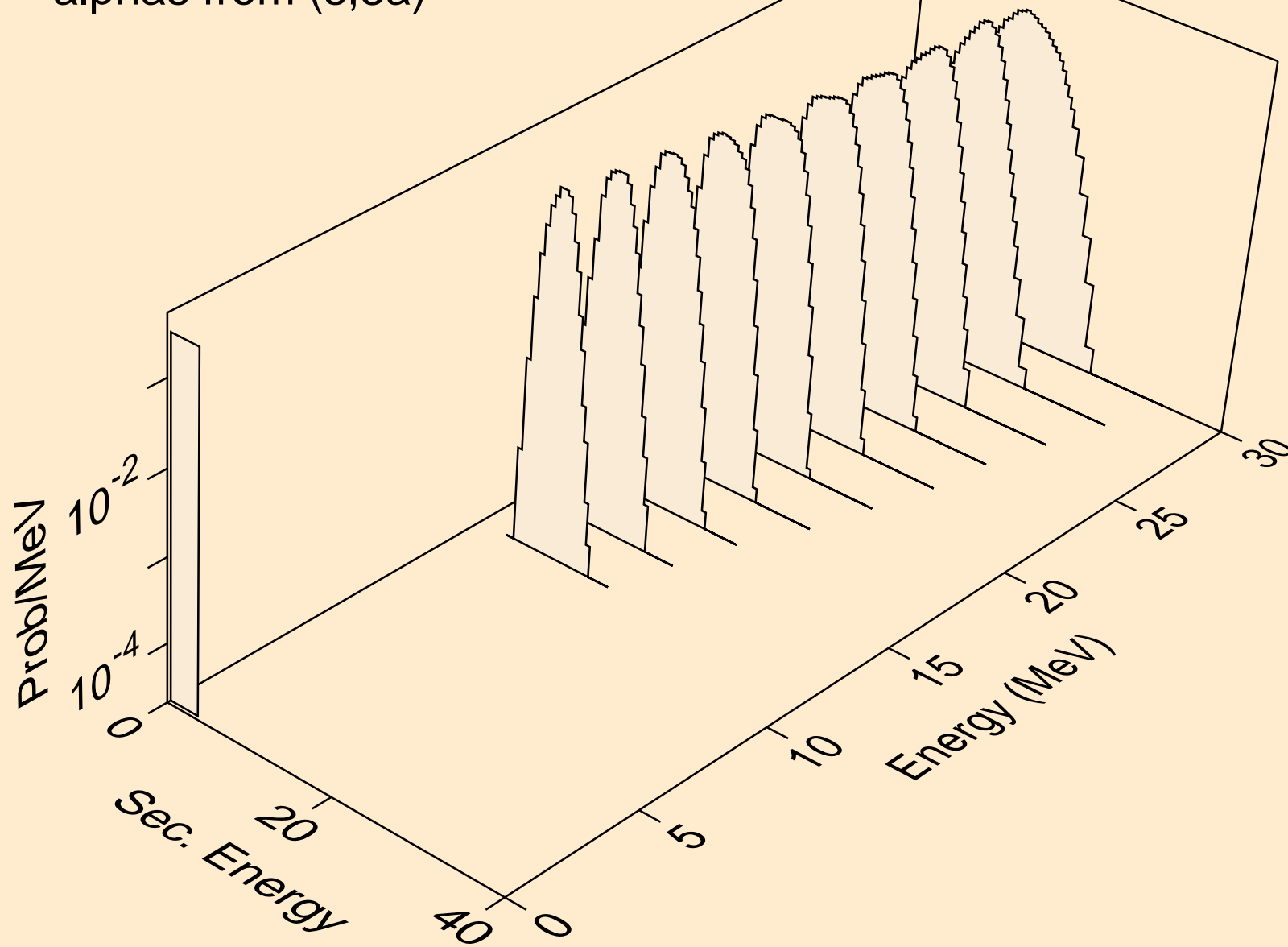

CS119M HELION ACER TENDL-2023 LIBRARY; T=0.K  
alphas from (s,pa)

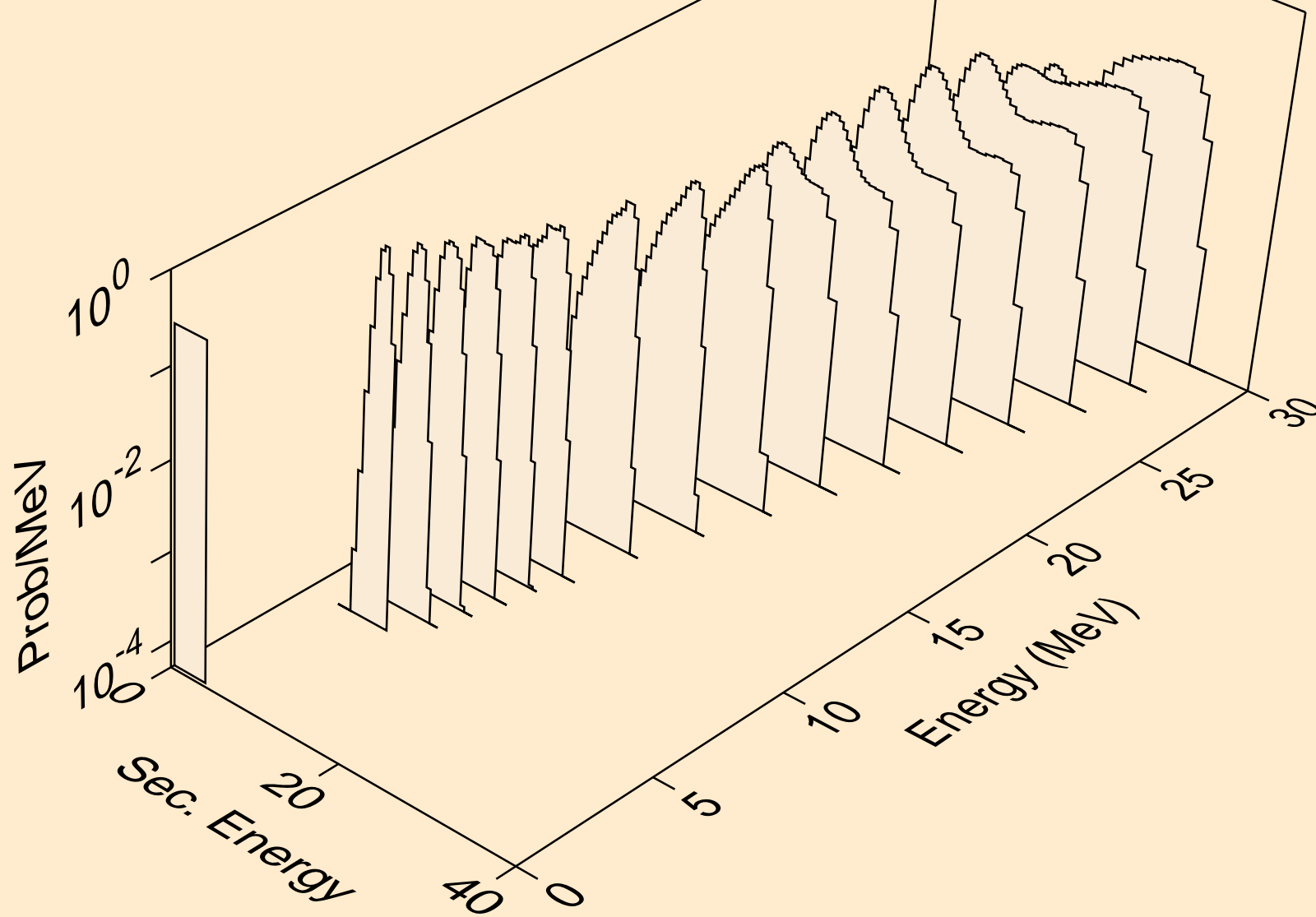

CS119M HELION ACER TENDL-2023 LIBRARY; T=0.K  
alphas from (s,t2a)

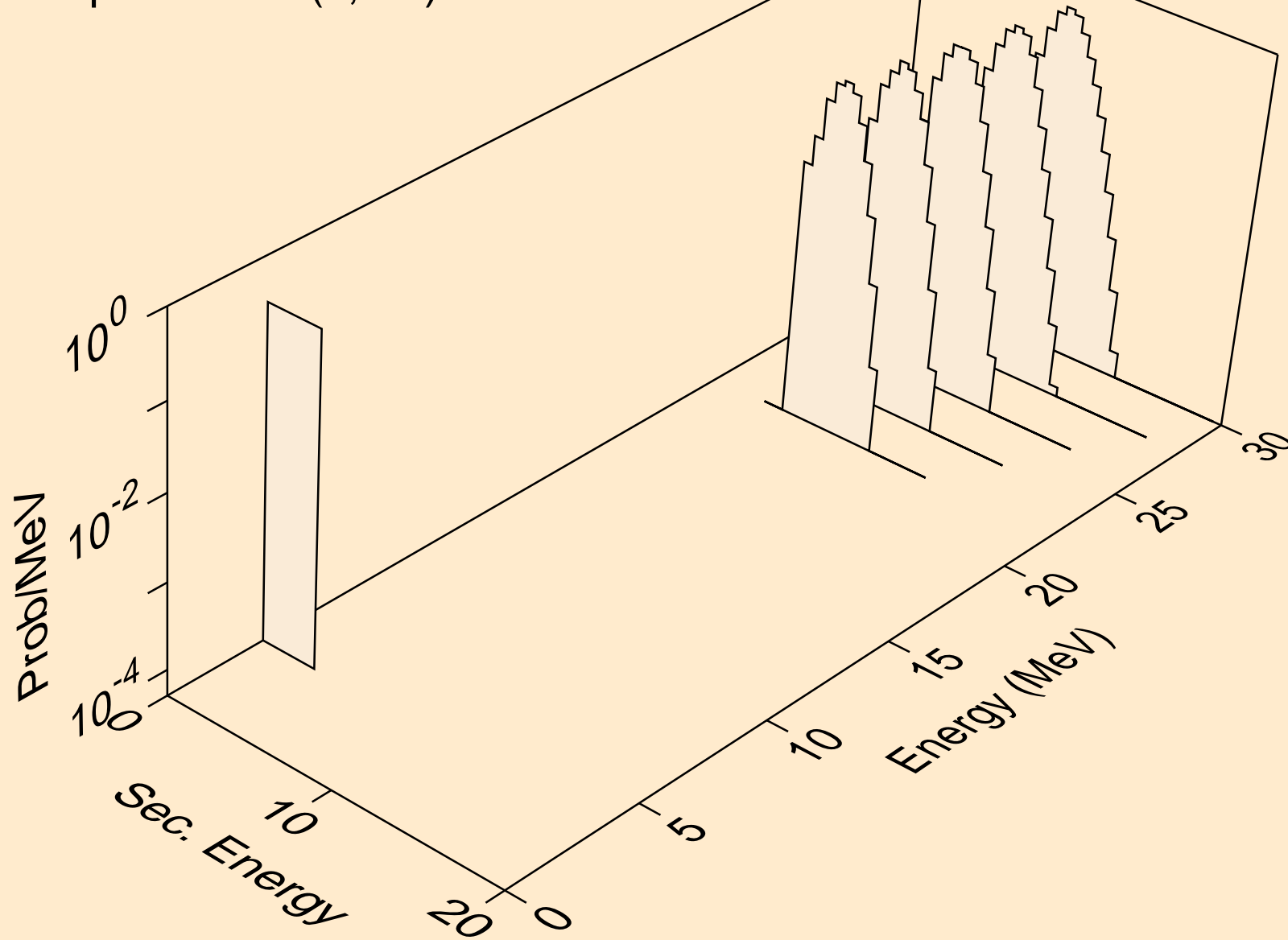

CS119M HELION ACER TENDL-2023 LIBRARY; T=0.K  
alphas from (s,d2a)

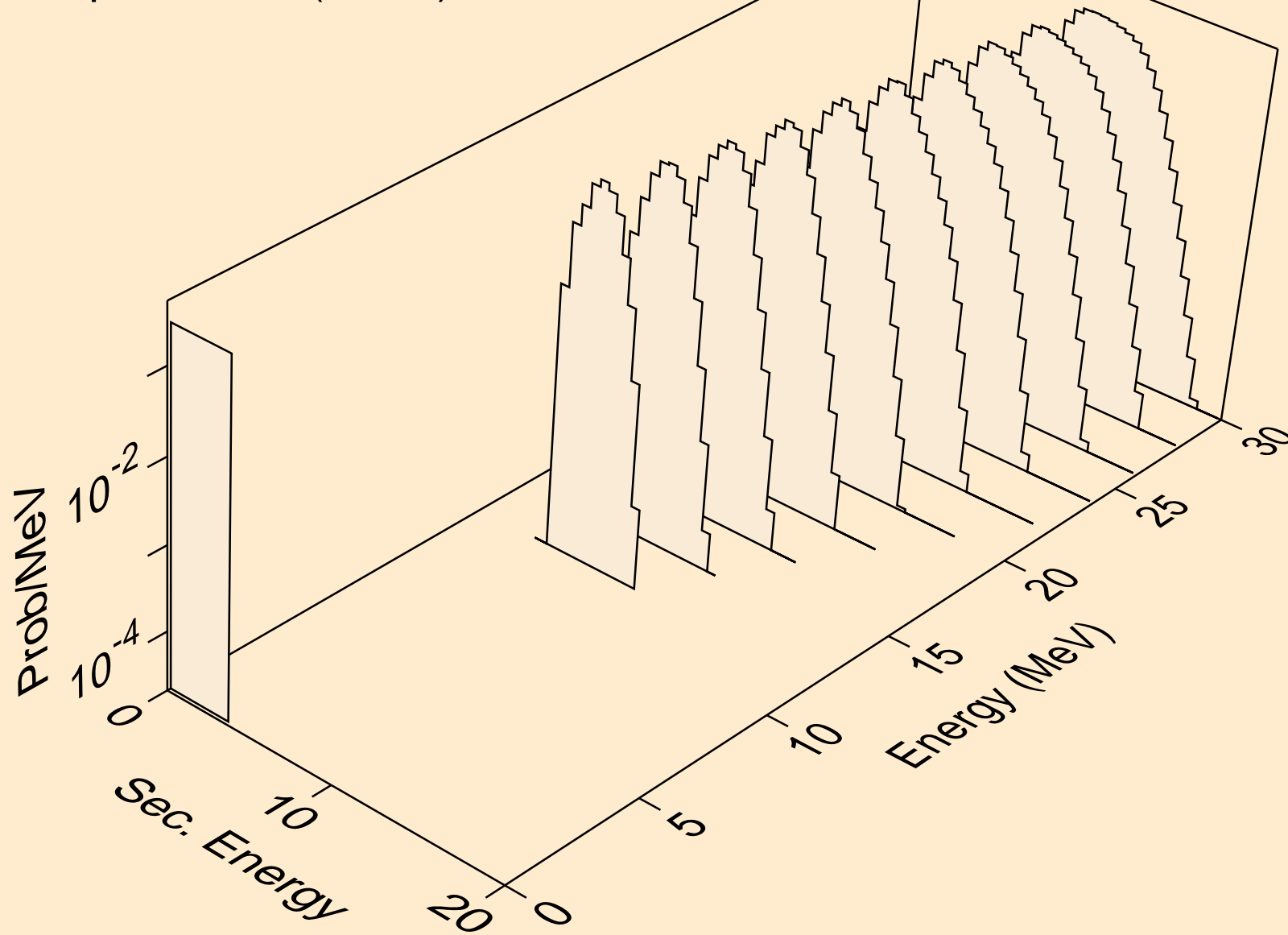

CS119M HELION ACER TENDL-2023 LIBRARY; T=0.K  
alphas from (s,da)

