

FM247M HELION ACER TENDL-2023 LIBRARY; T=0.K
Principal cross sections

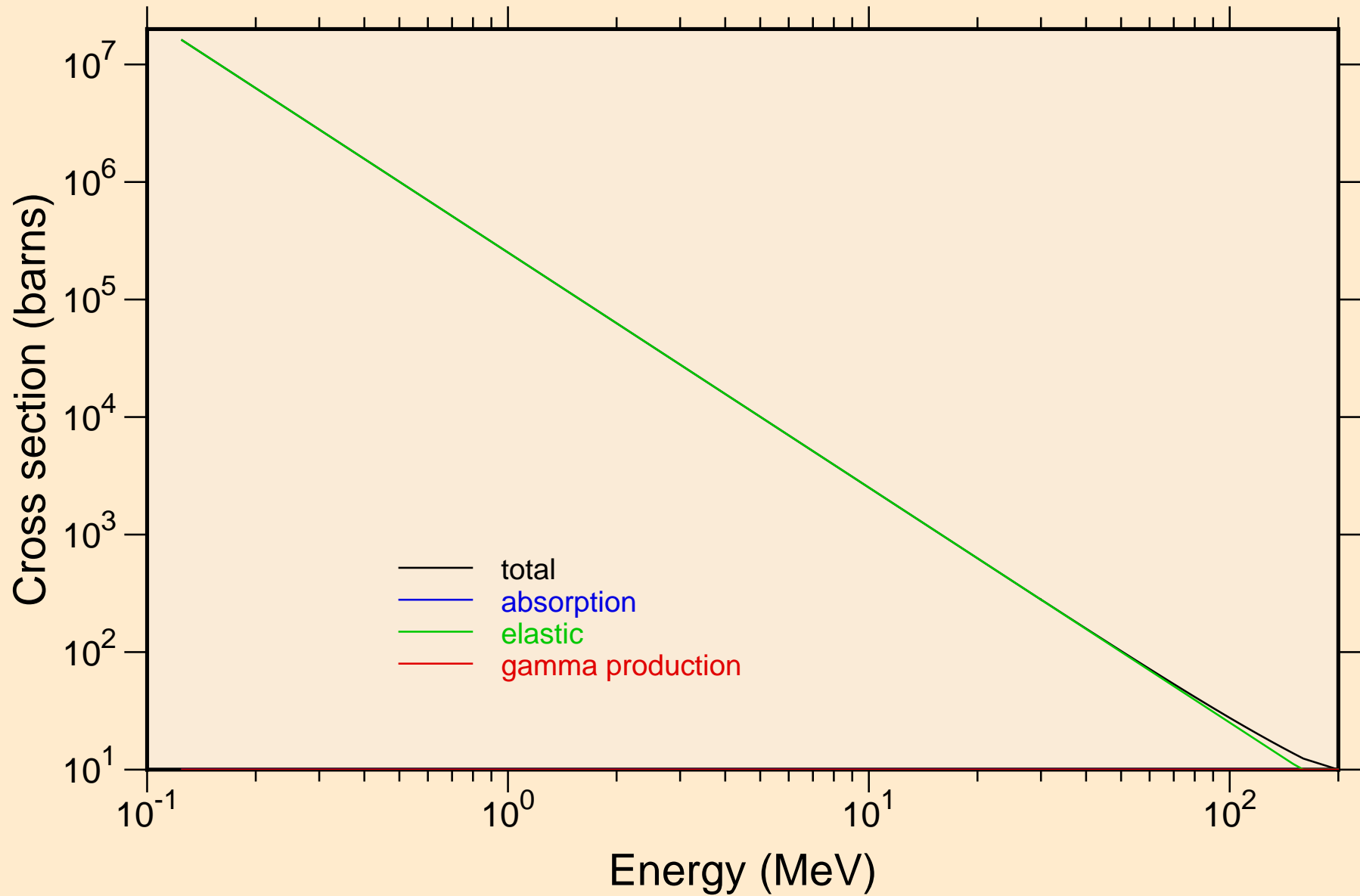

FM247M HELION ACER TENDL-2023 LIBRARY; T=0.K
Heating

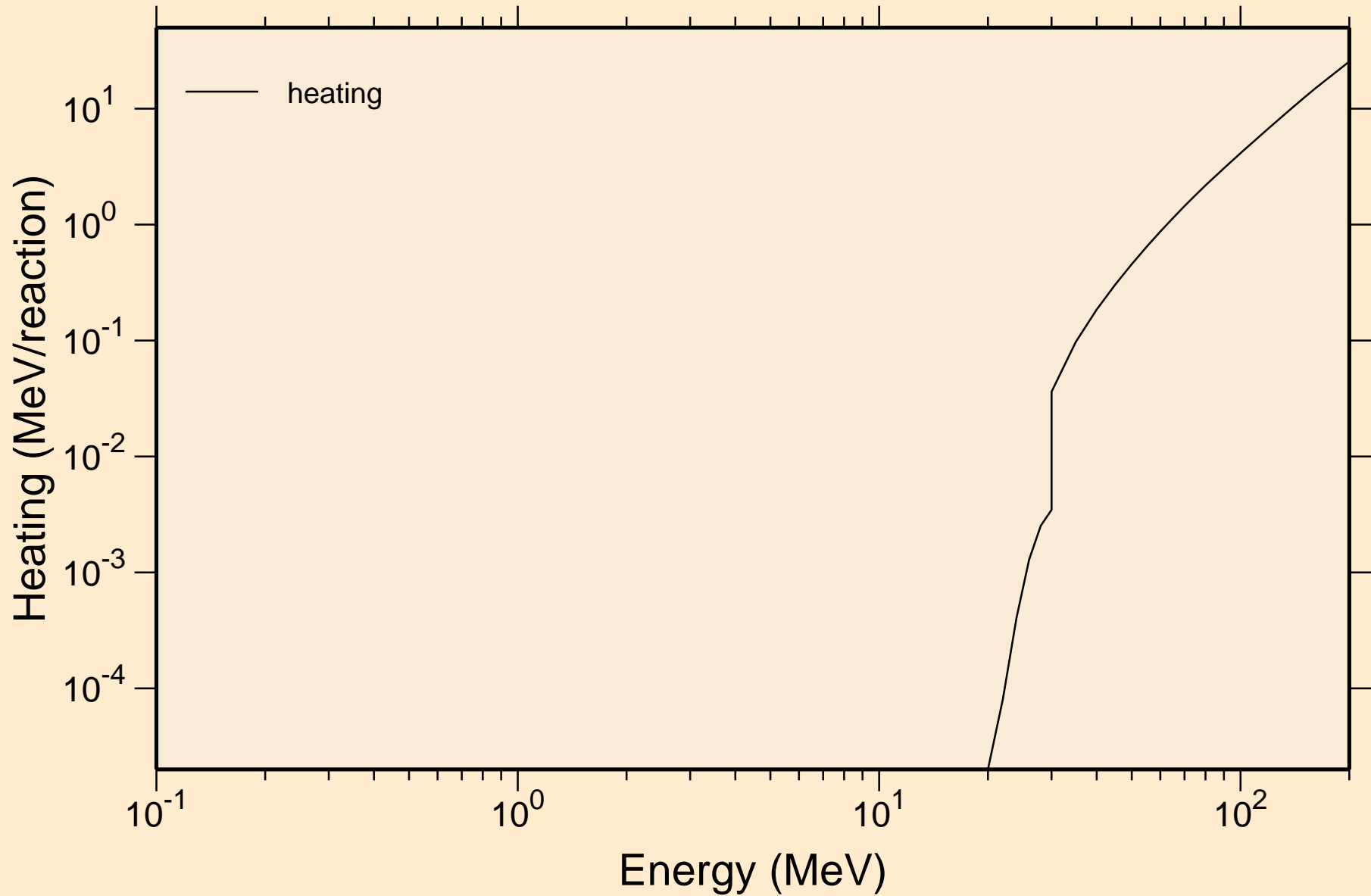

FM247M HELION ACER TENDL-2023 LIBRARY; T=0.K

Principal cross sections

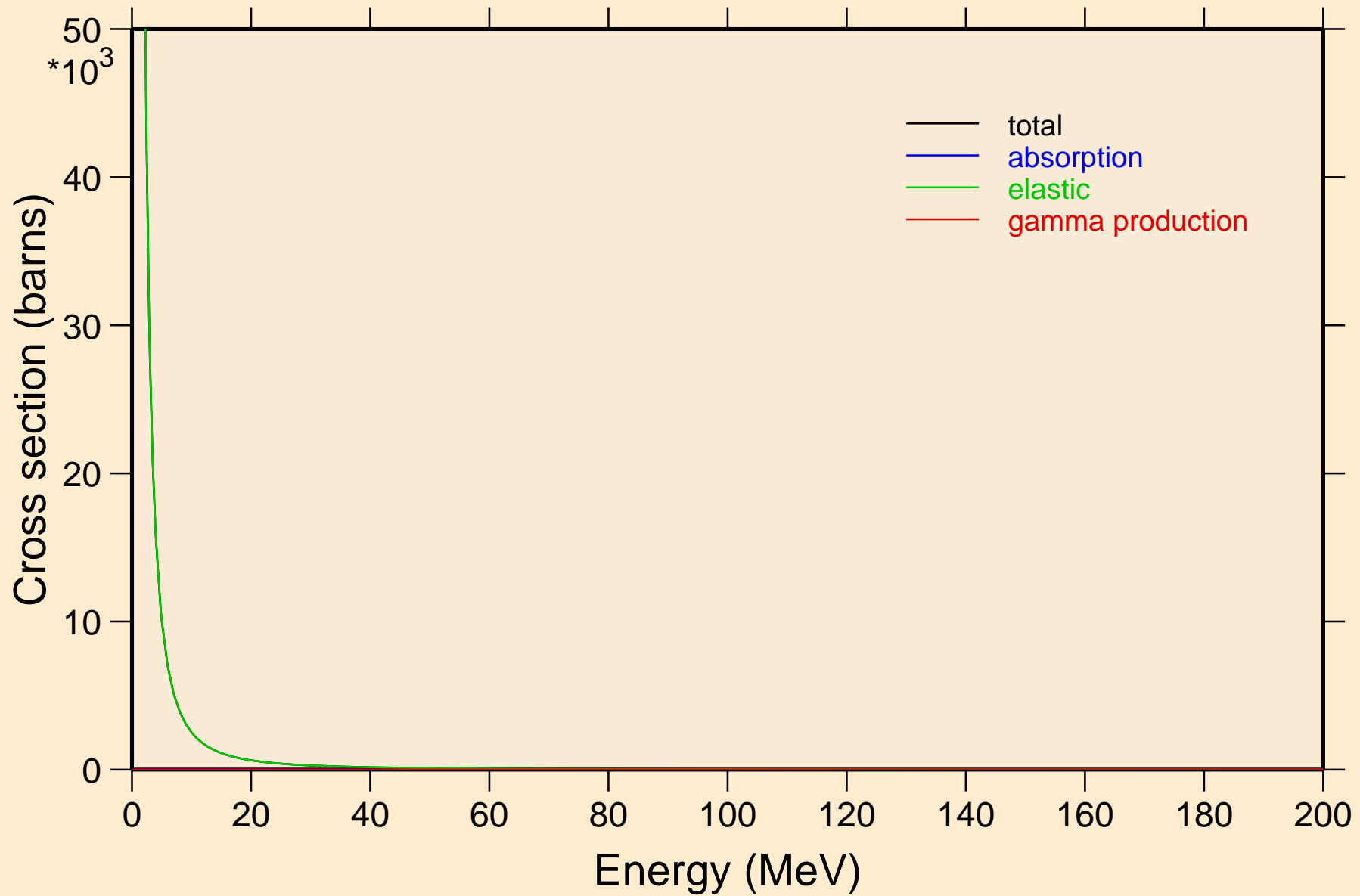

FM247M HELION ACER TENDL-2023 LIBRARY; T=0.K

Heating

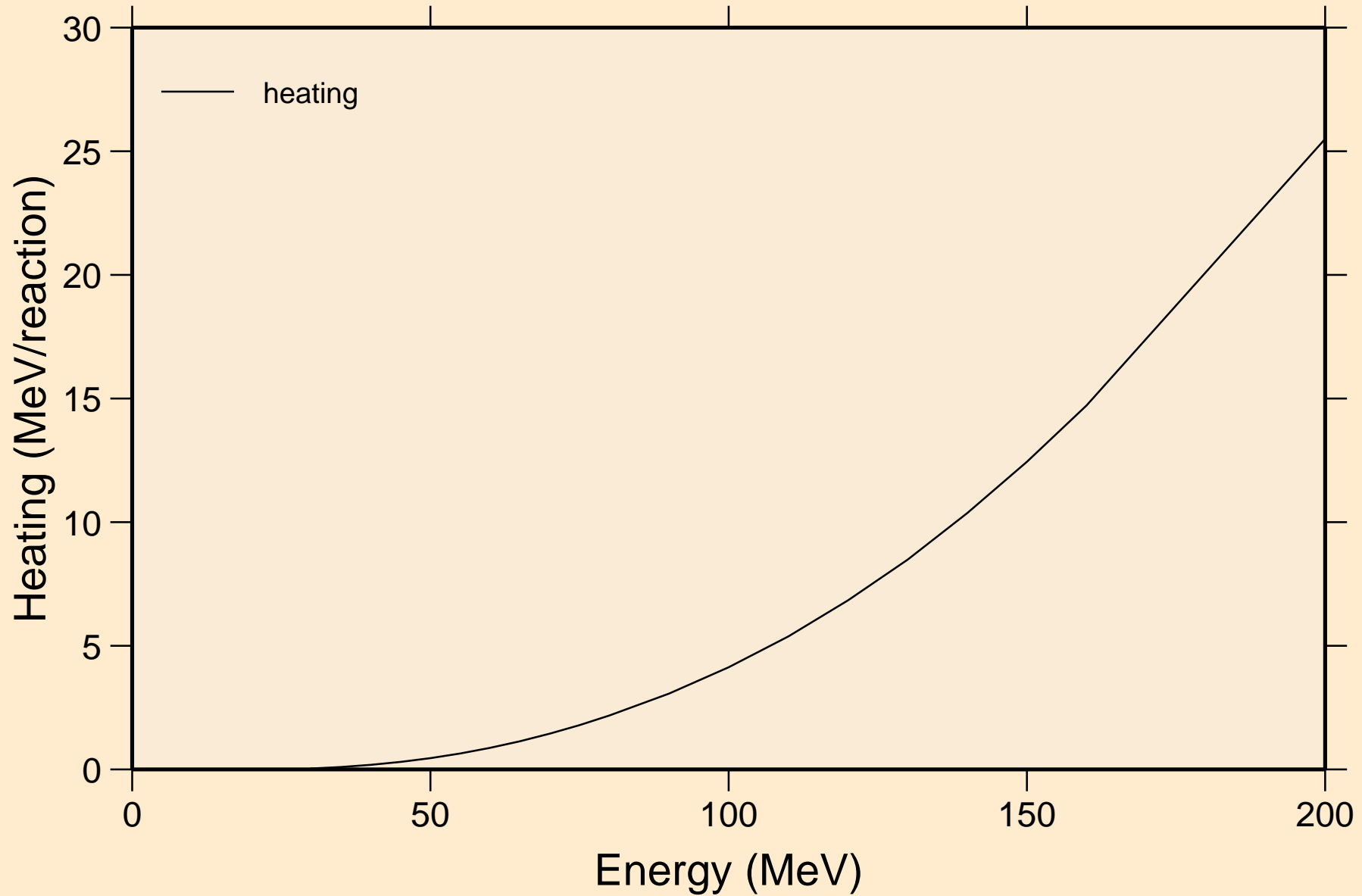

FM247M HELION ACER TENDL-2023 LIBRARY; T=0.K
Threshold reactions

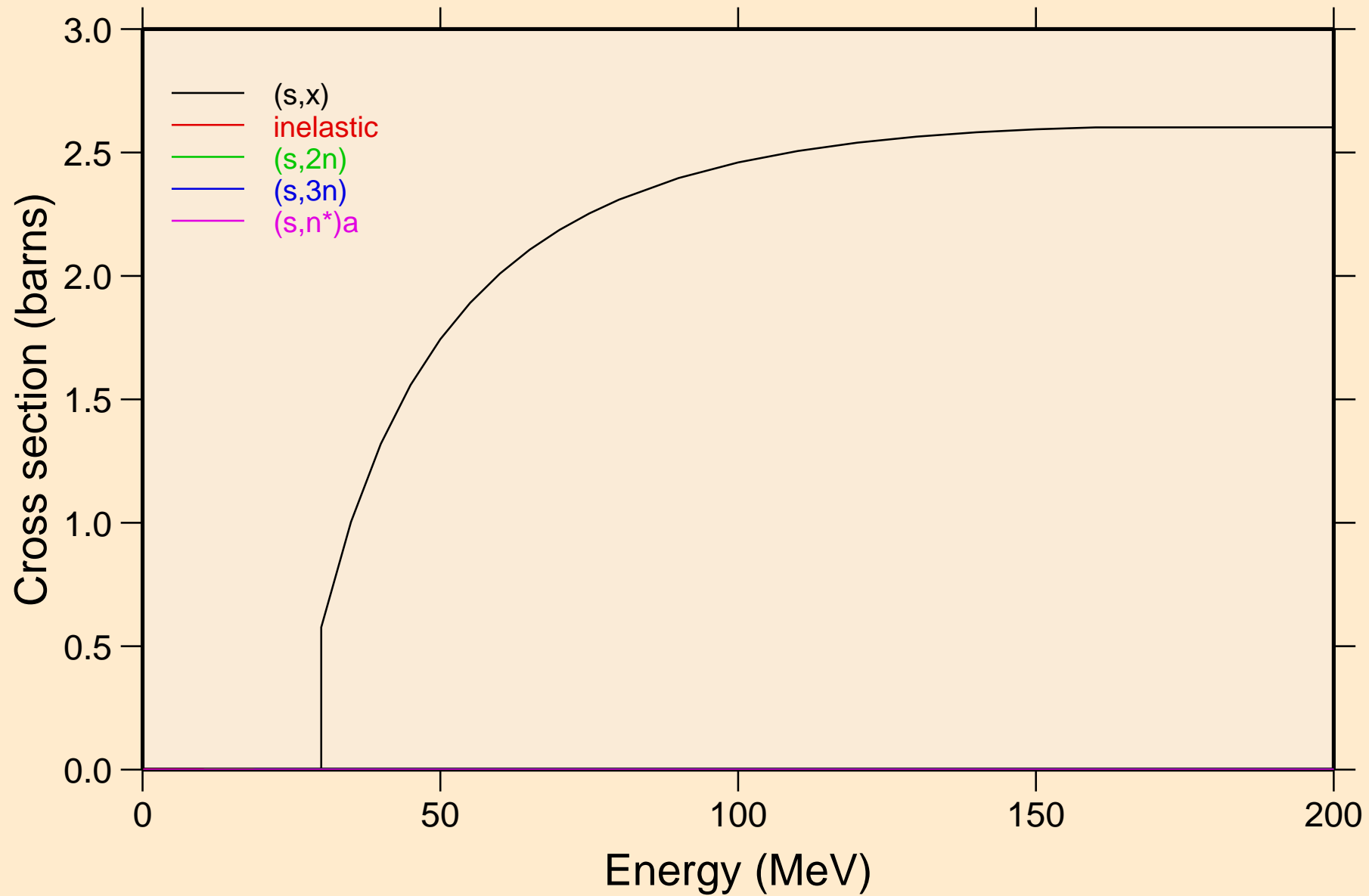

FM247M HELION ACER TENDL-2023 LIBRARY; T=0.K
Threshold reactions

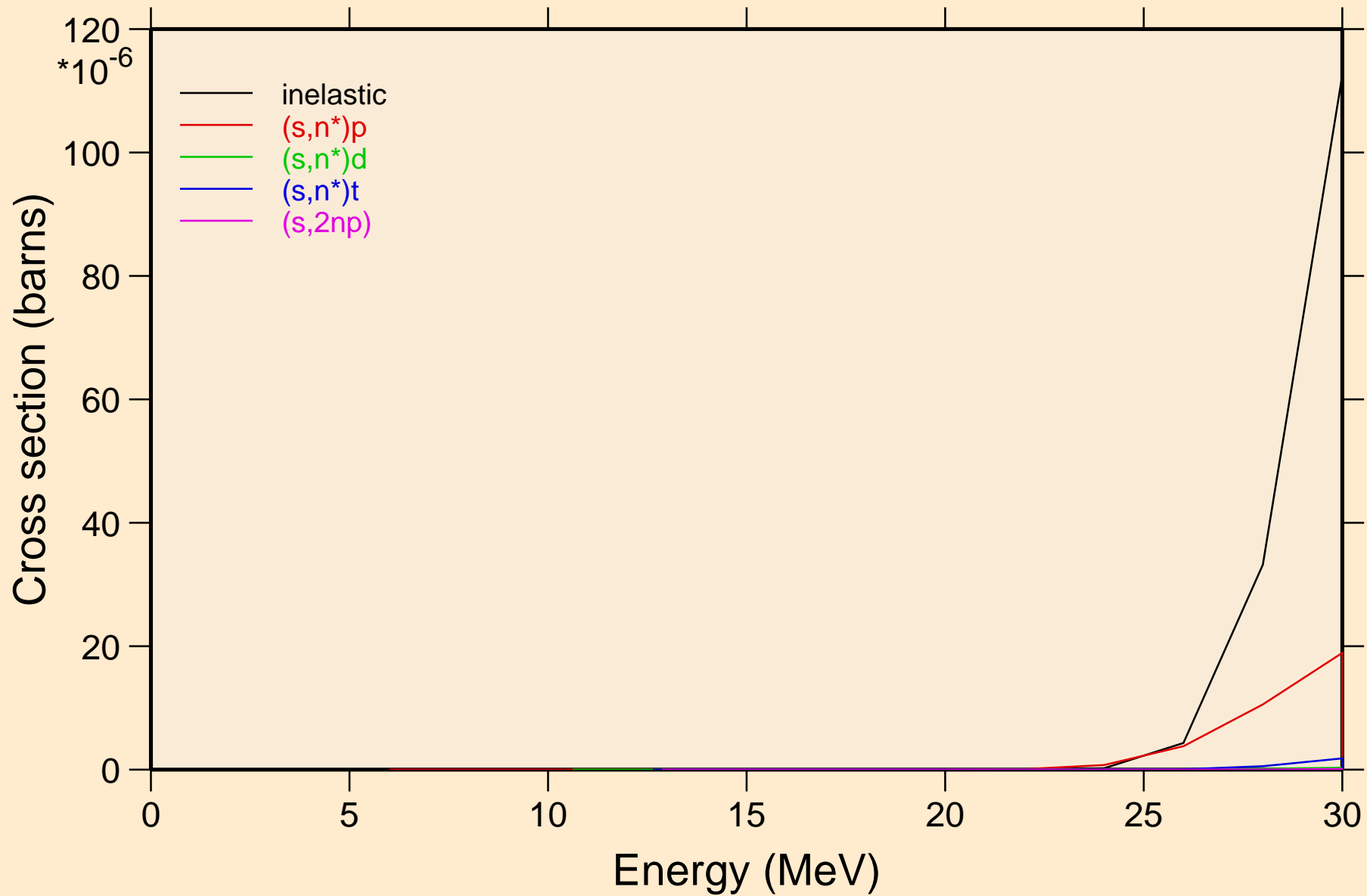

FM247M HELION ACER TENDL-2023 LIBRARY; T=0.K
Threshold reactions

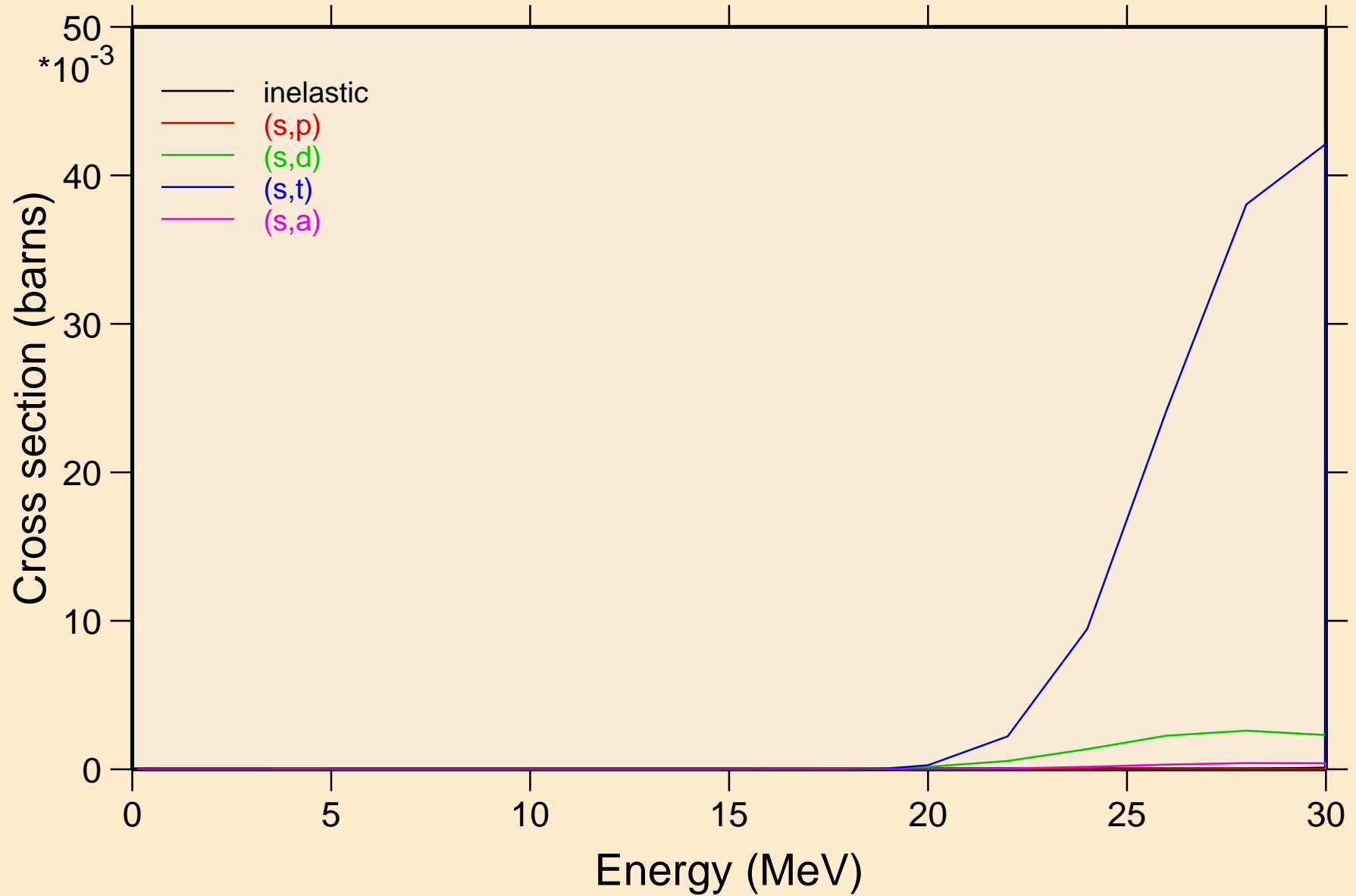

FM247M HELION ACER TENDL-2023 LIBRARY; T=0.K
Threshold reactions

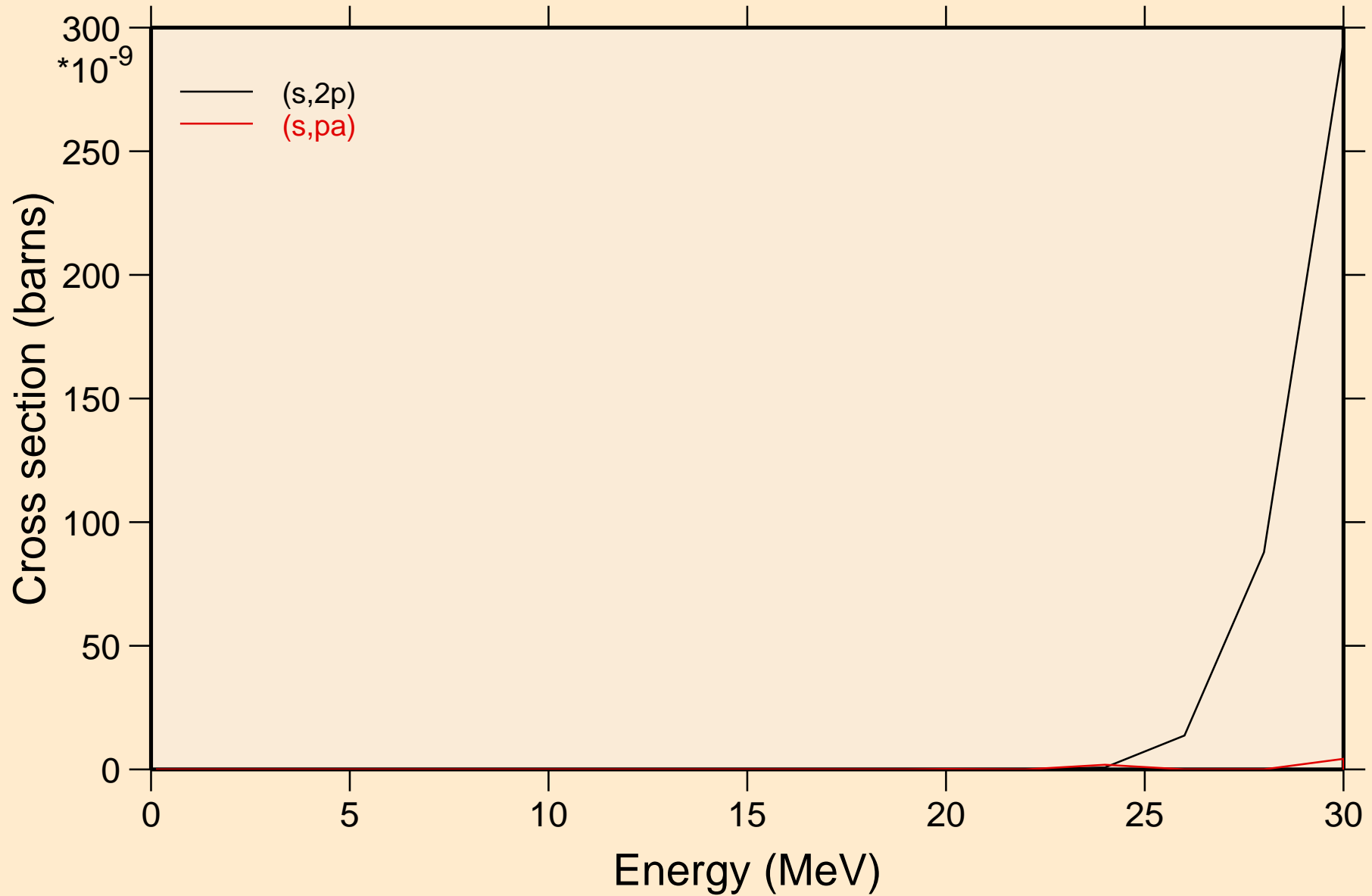

FM247M HELION ACER TENDL-2023 LIBRARY; T=0.K
angular distribution for elastic

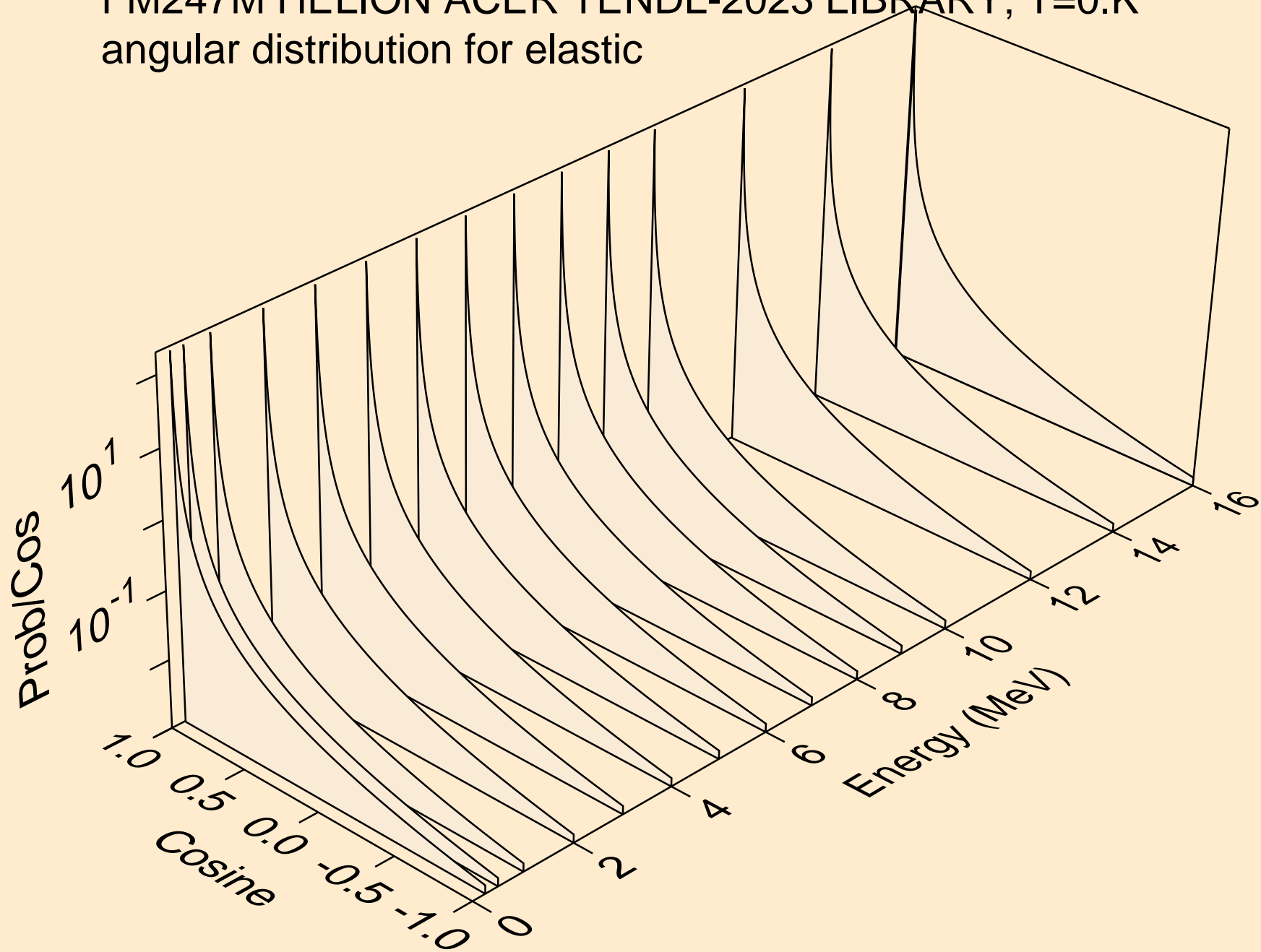

FM247M HELION ACER TENDL-2023 LIBRARY; T=0.K
He-3 emission for (s,x)

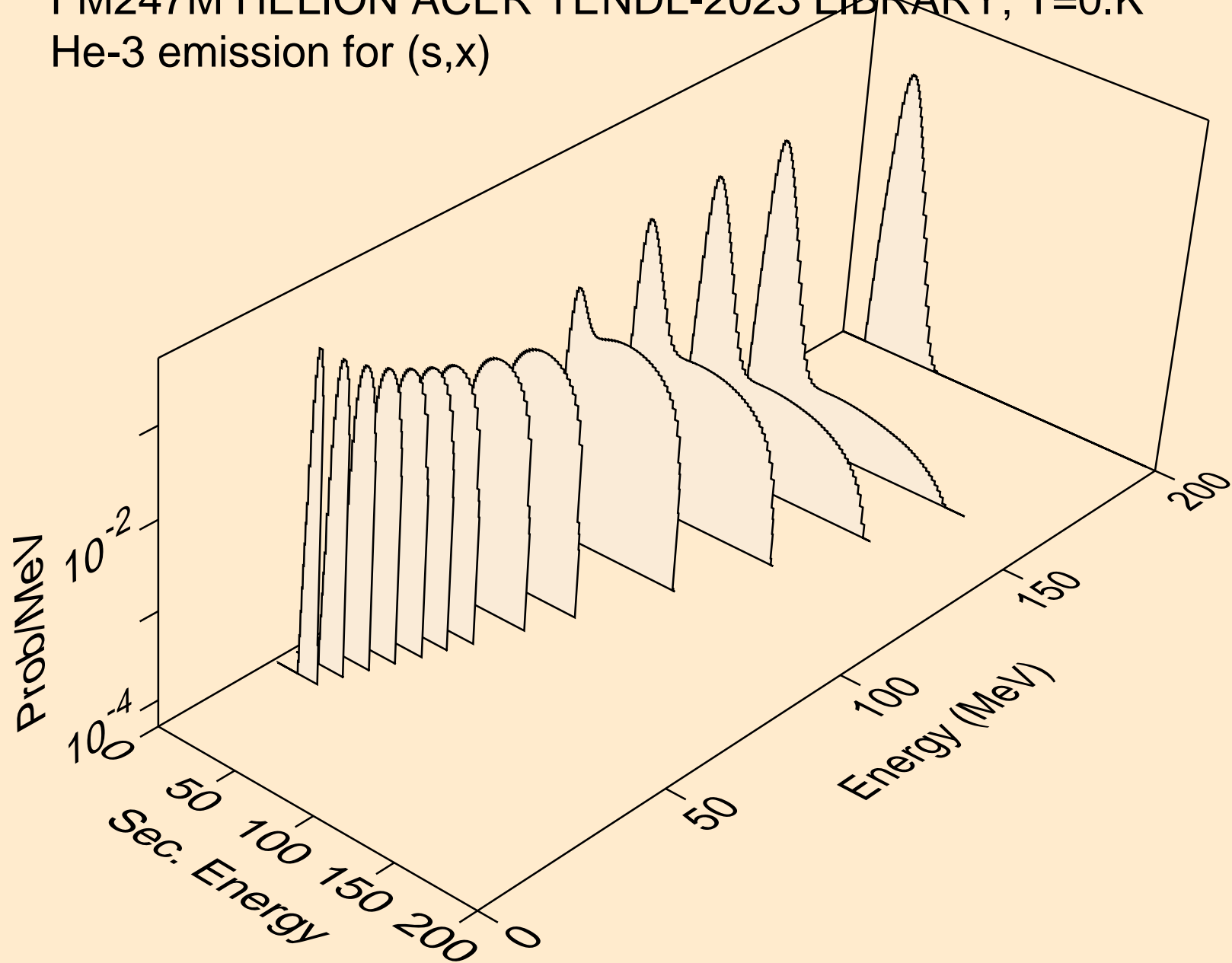

FM247M HELION ACER TENDL-2023 LIBRARY; T=0.K
He-3 emission for inelastic

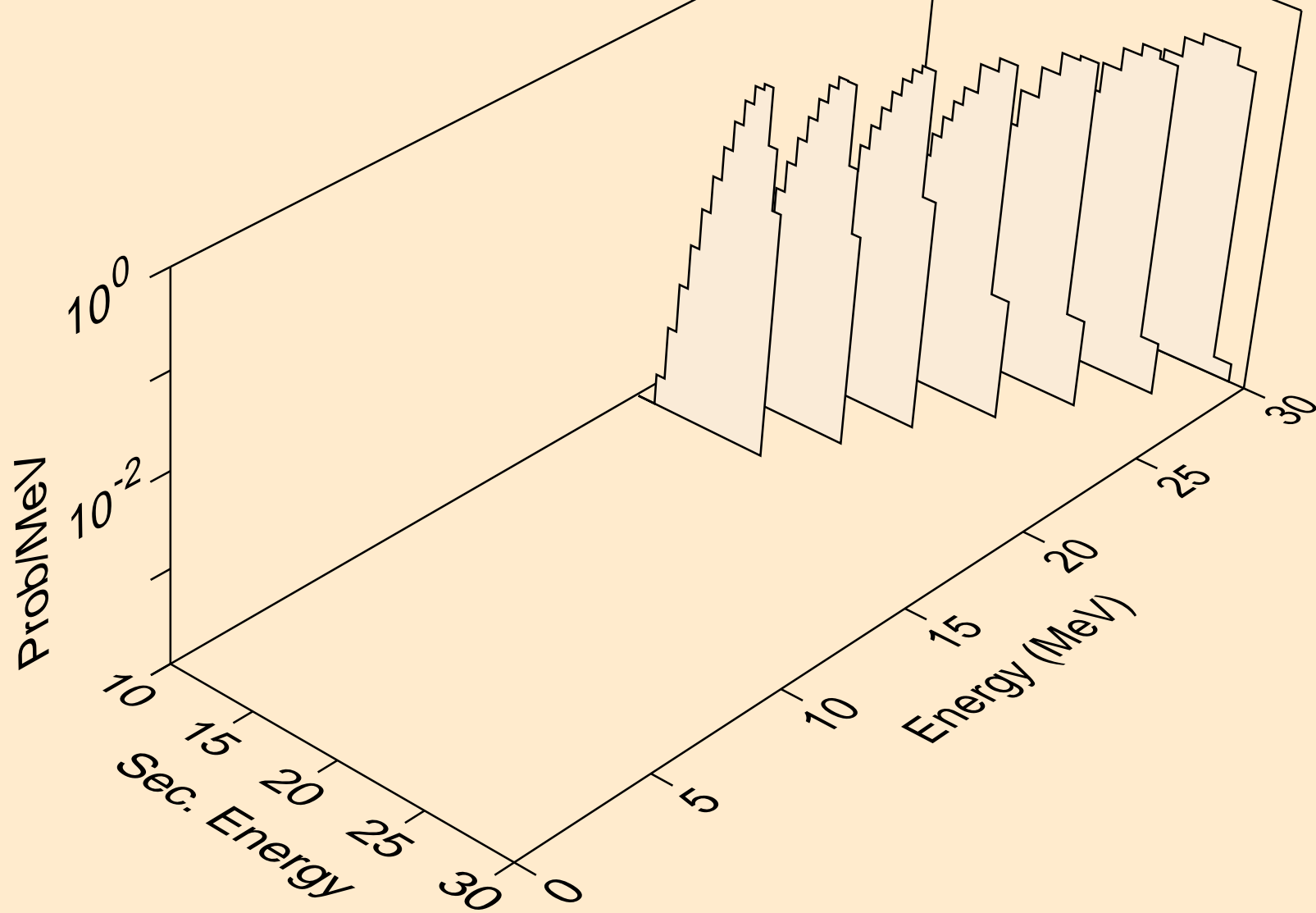

FM247M HELION ACER TENDL-2023 LIBRARY; T=0.K
Photon emission for (z,n)

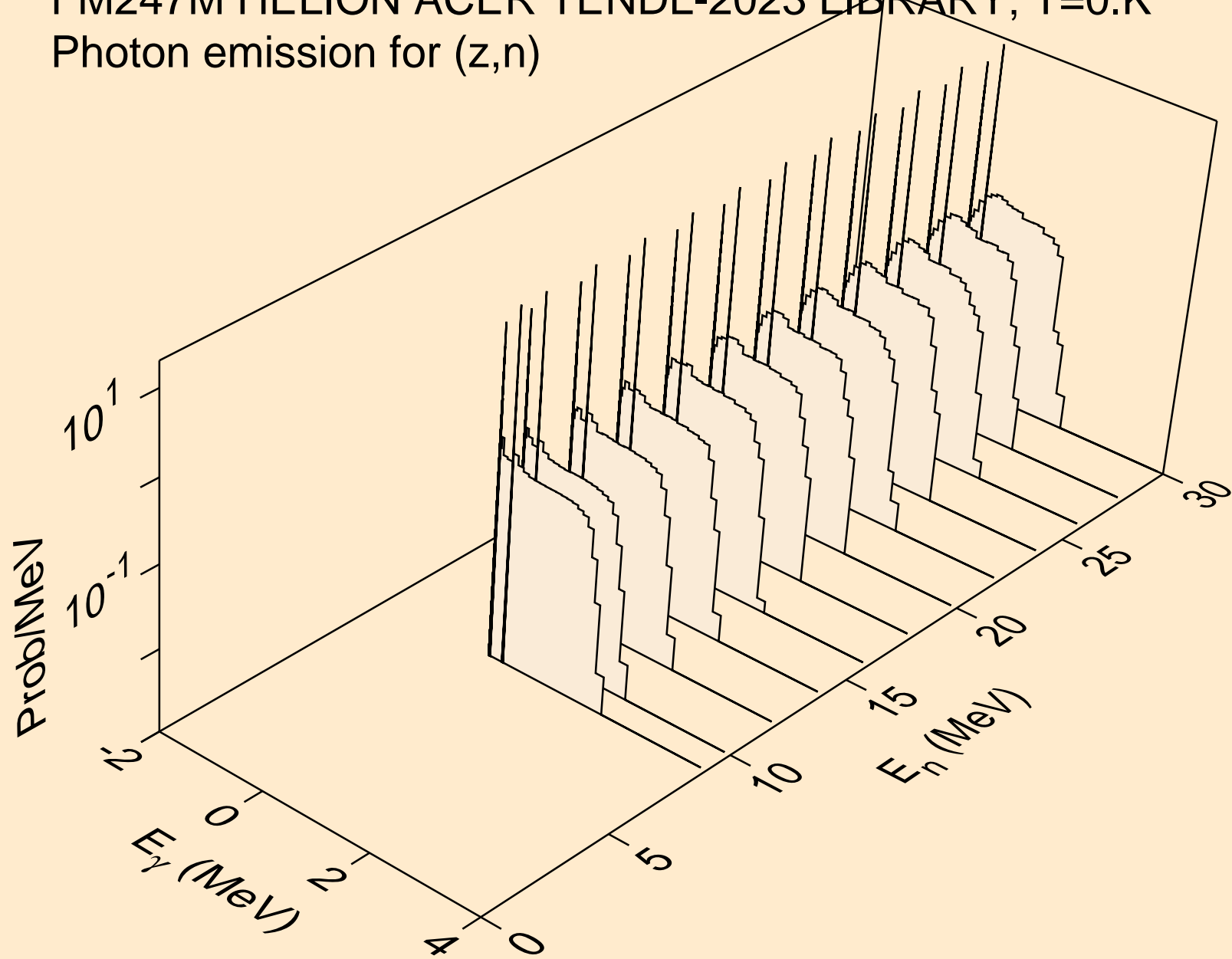

FM247M HELION ACER TENDL-2023 LIBRARY; T=0.K
Photon emission for (z,x)

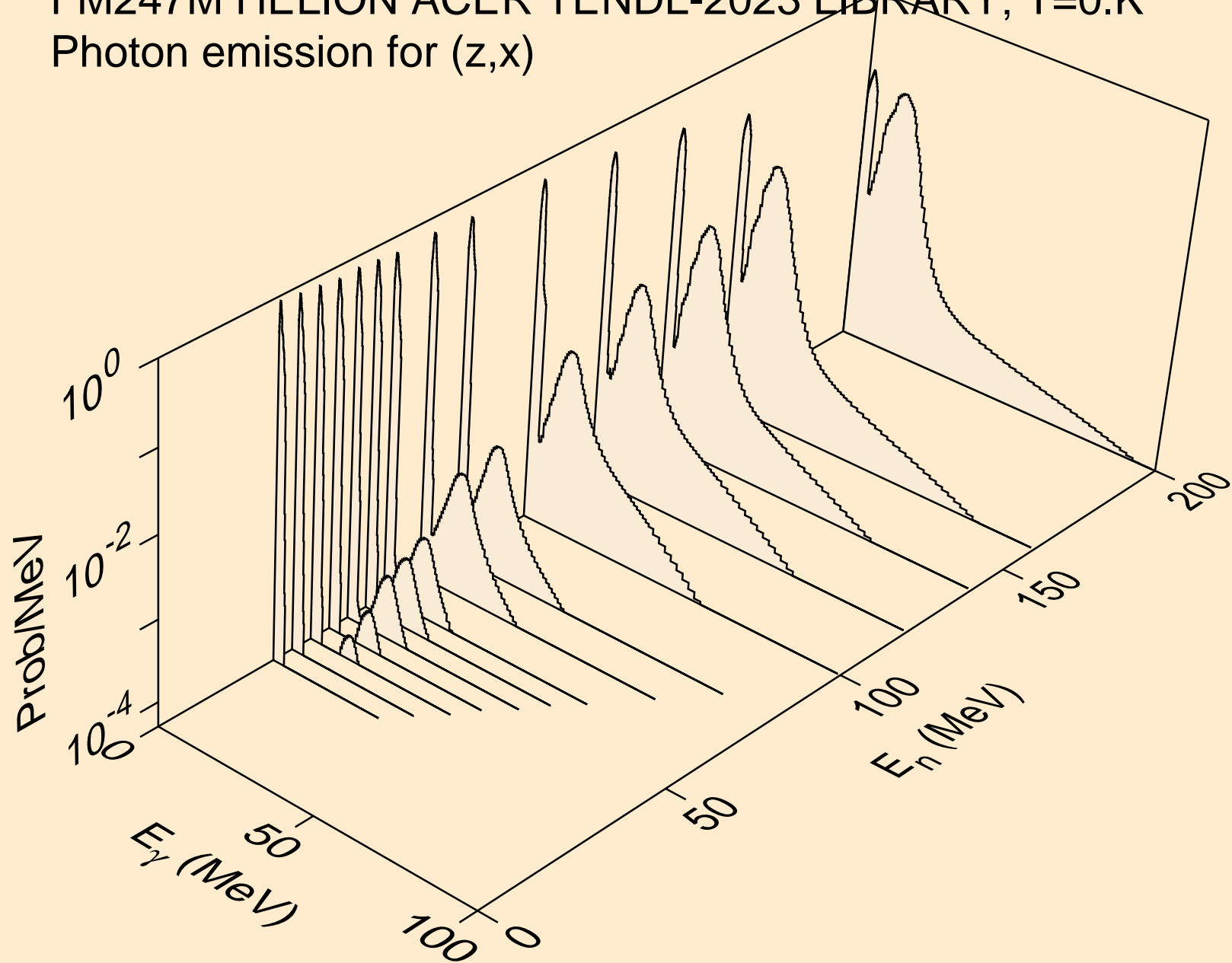

FM247M HELION ACER TENDL-2023 LIBRARY; T=0.K
Photon emission for (n,2n)

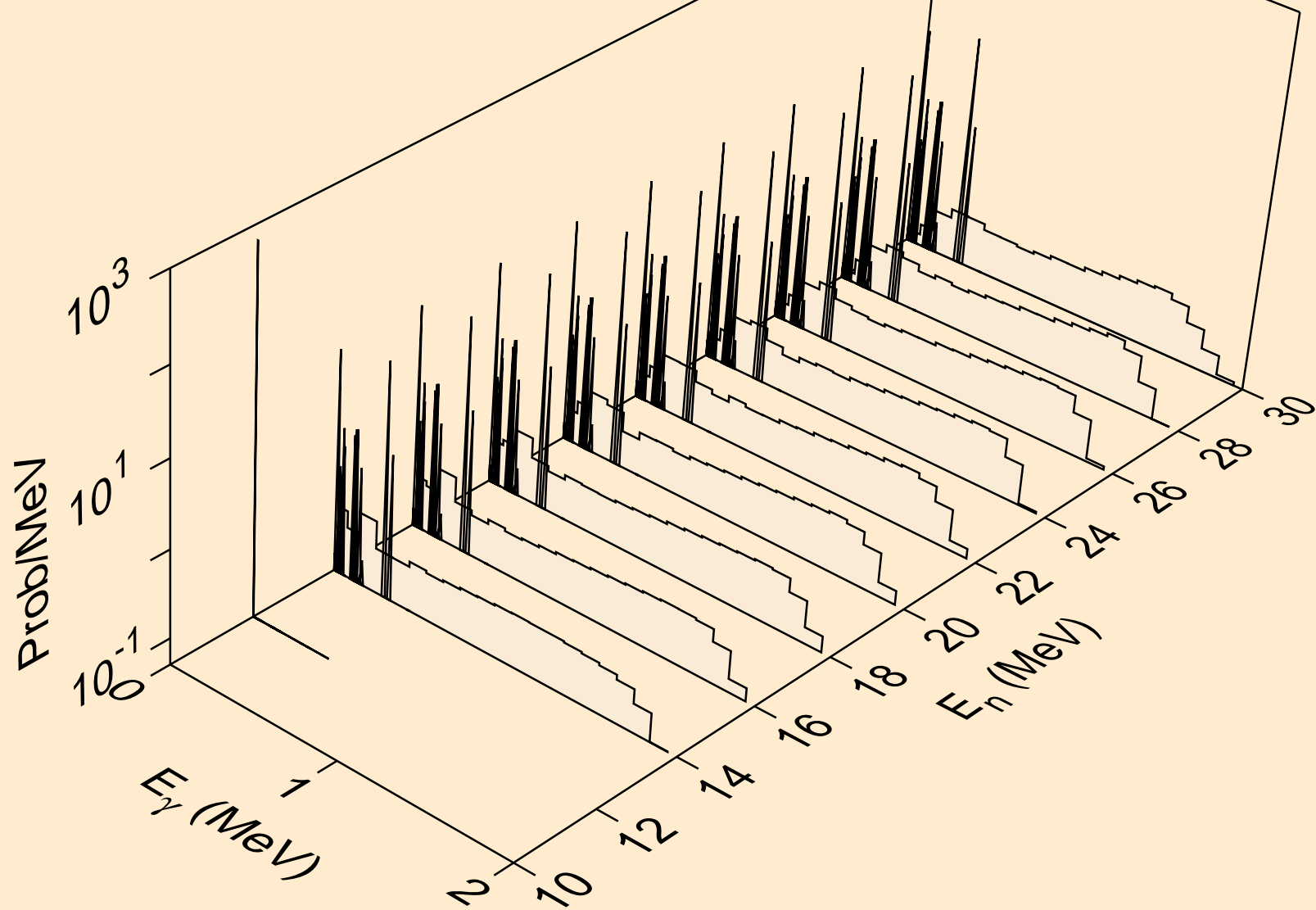

FM247M HELION ACER TENDL-2023 LIBRARY; T=0.K
Photon emission for (n,3n)

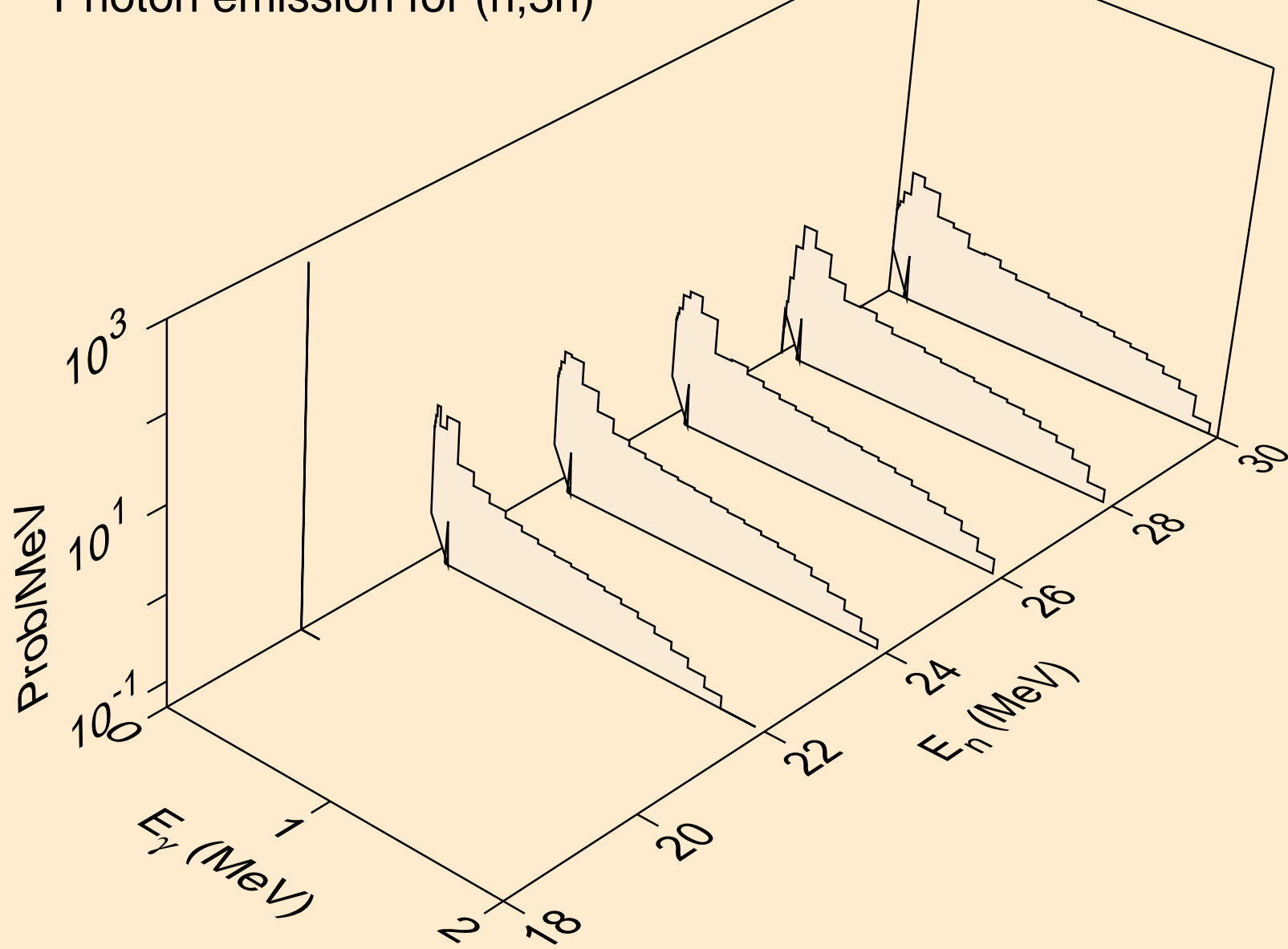

FM247M HELION ACER TENDL-2023 LIBRARY; T=0.K
Photon emission for (n,n*)a

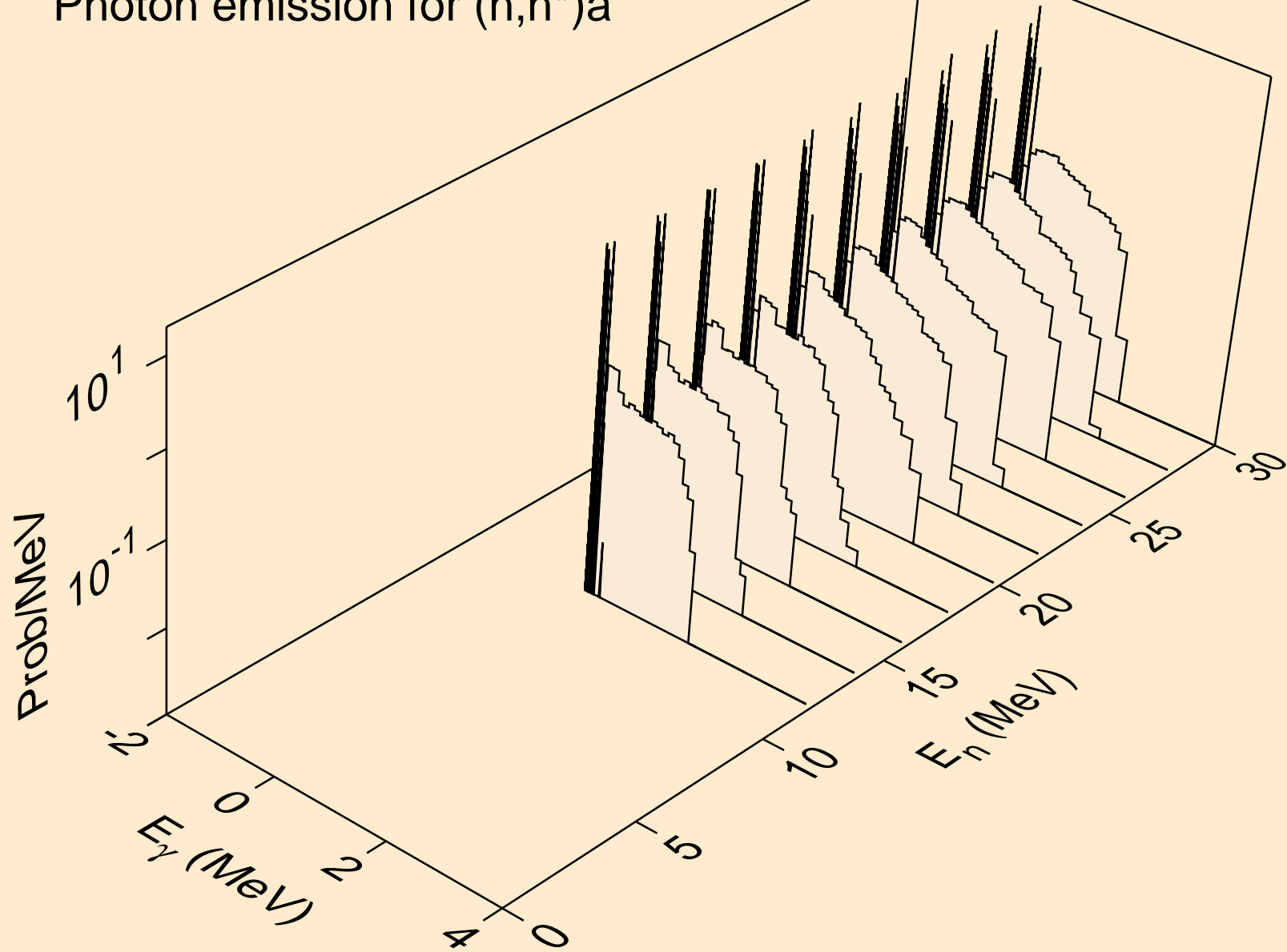

FM247M HELION ACER TENDL-2023 LIBRARY; T=0.K
Photon emission for (n,n*)p

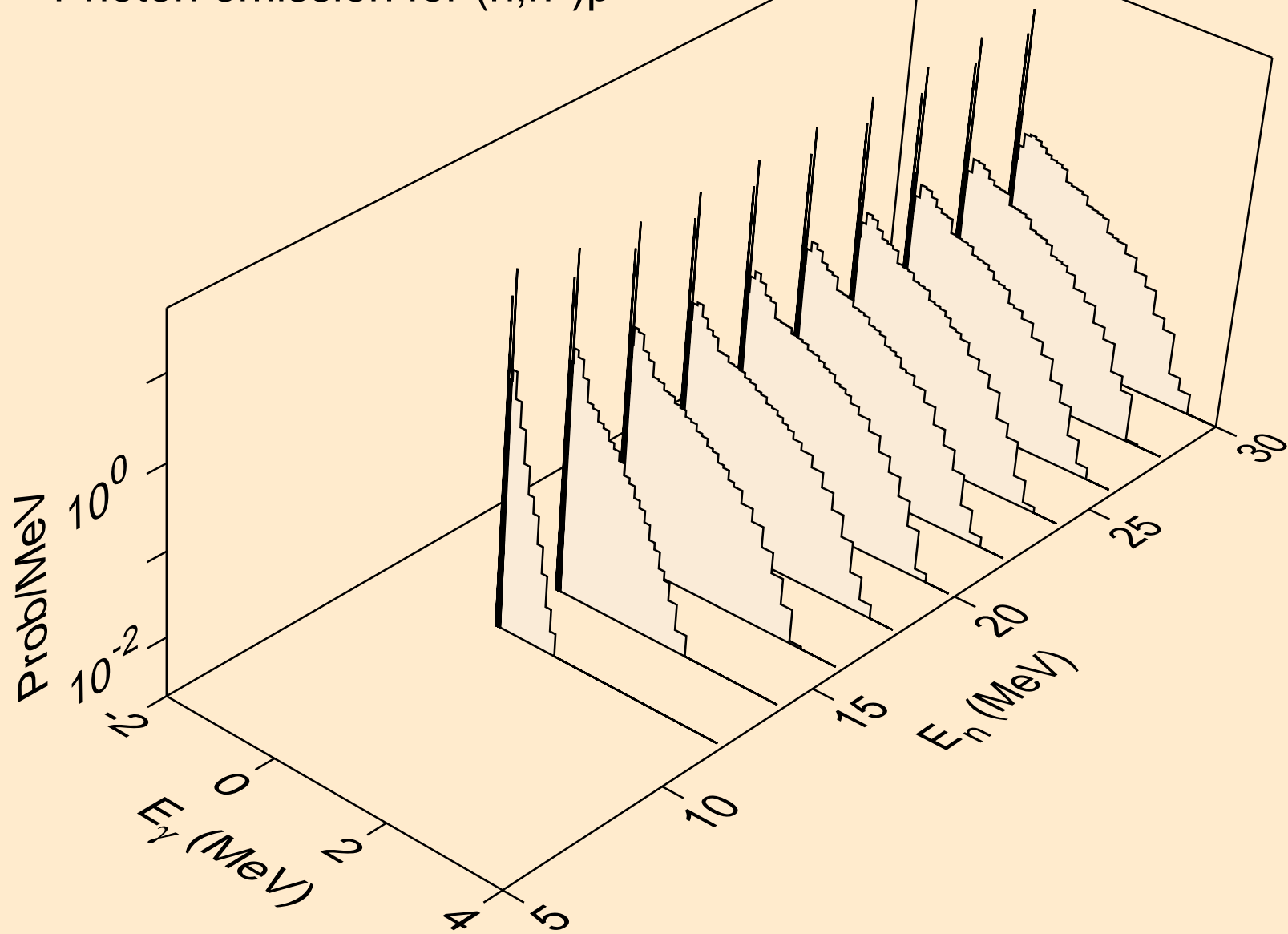

FM247M HELION ACER TENDL-2023 LIBRARY; T=0.K
Photon emission for (n,n*)d

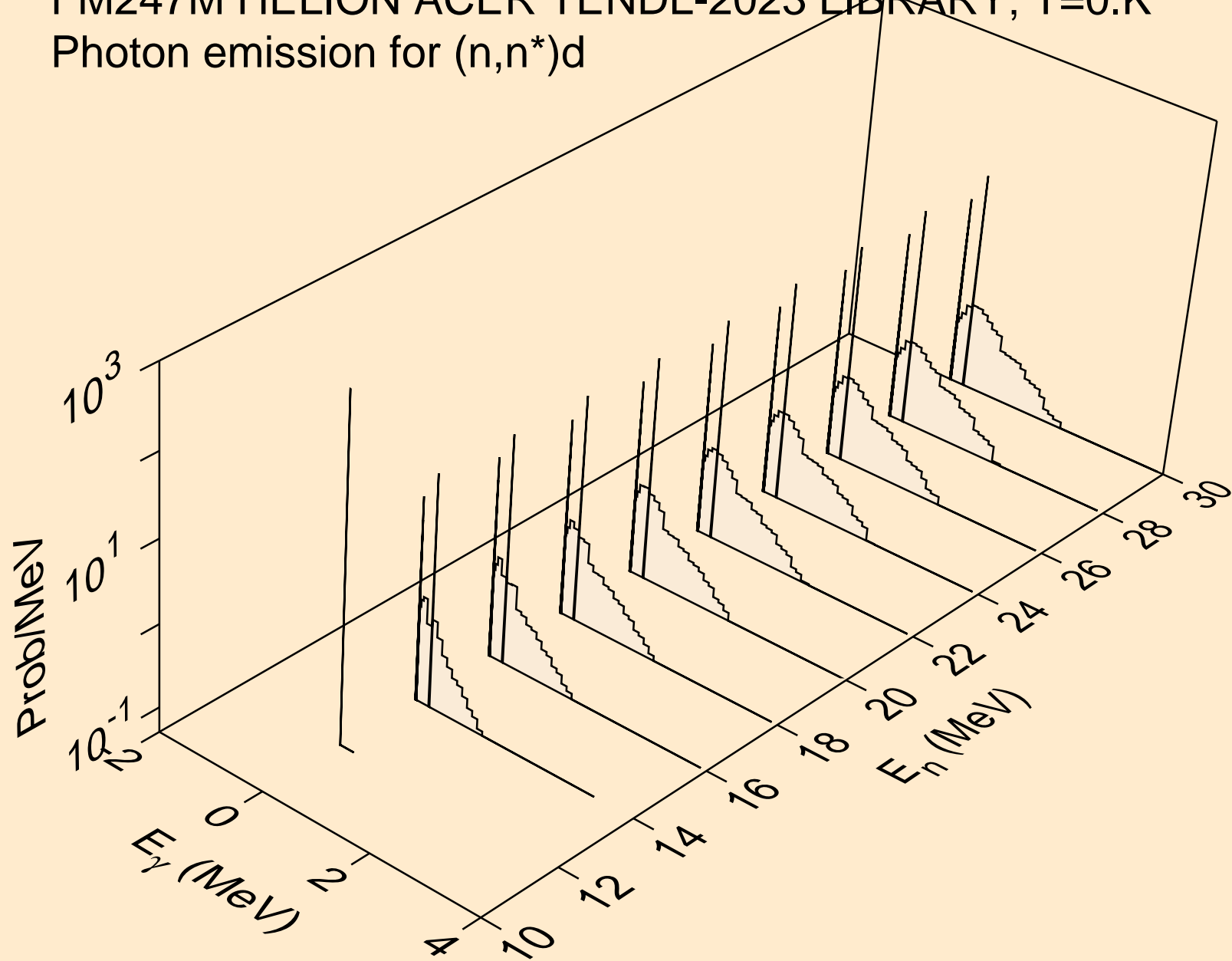

FM247M HELION ACER TENDL-2023 LIBRARY; T=0.K
Photon emission for (n,n*)t

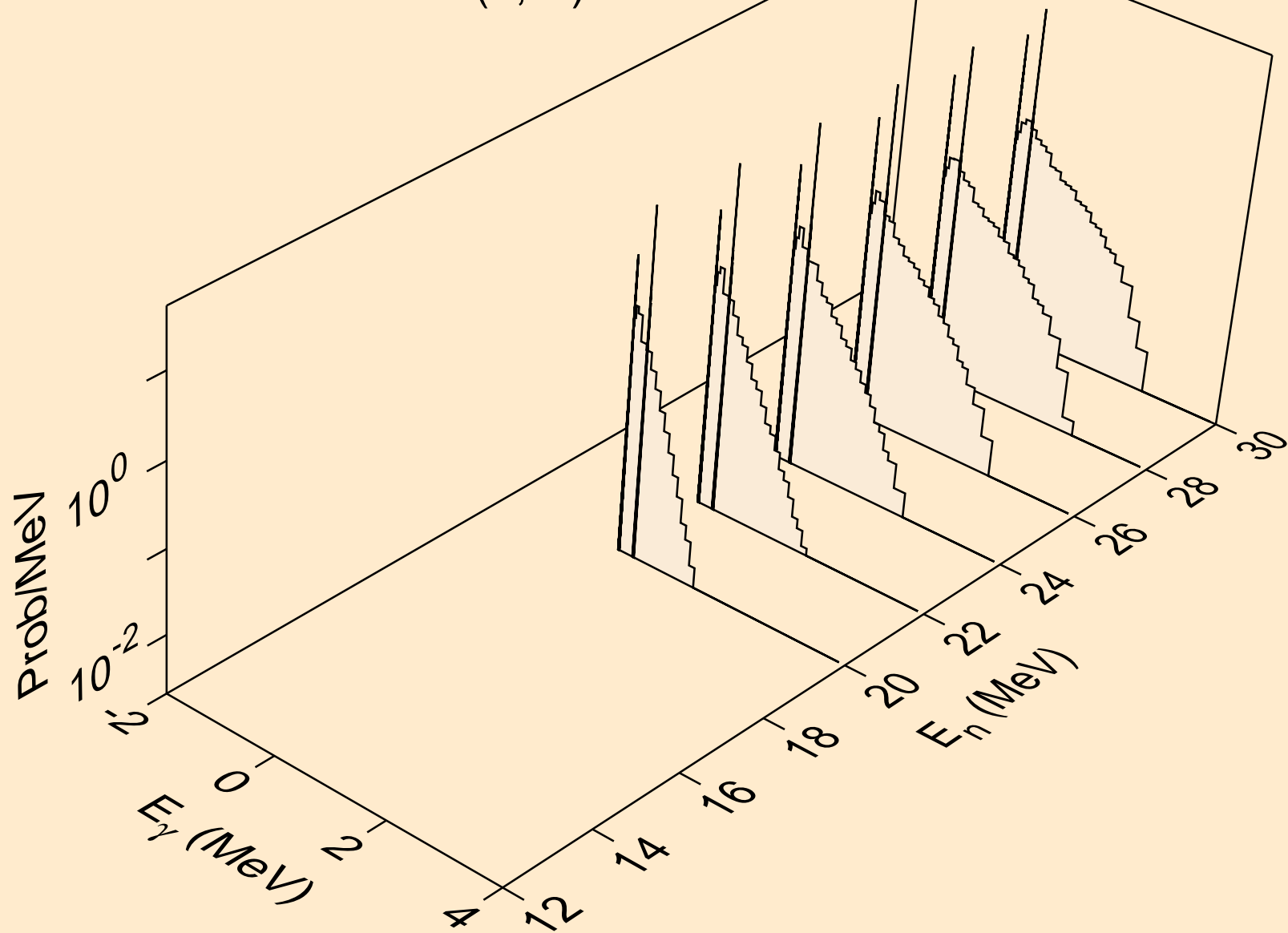

FM247M HELION ACER TENDL-2023 LIBRARY; T=0.K
Photon emission for (n,2np)

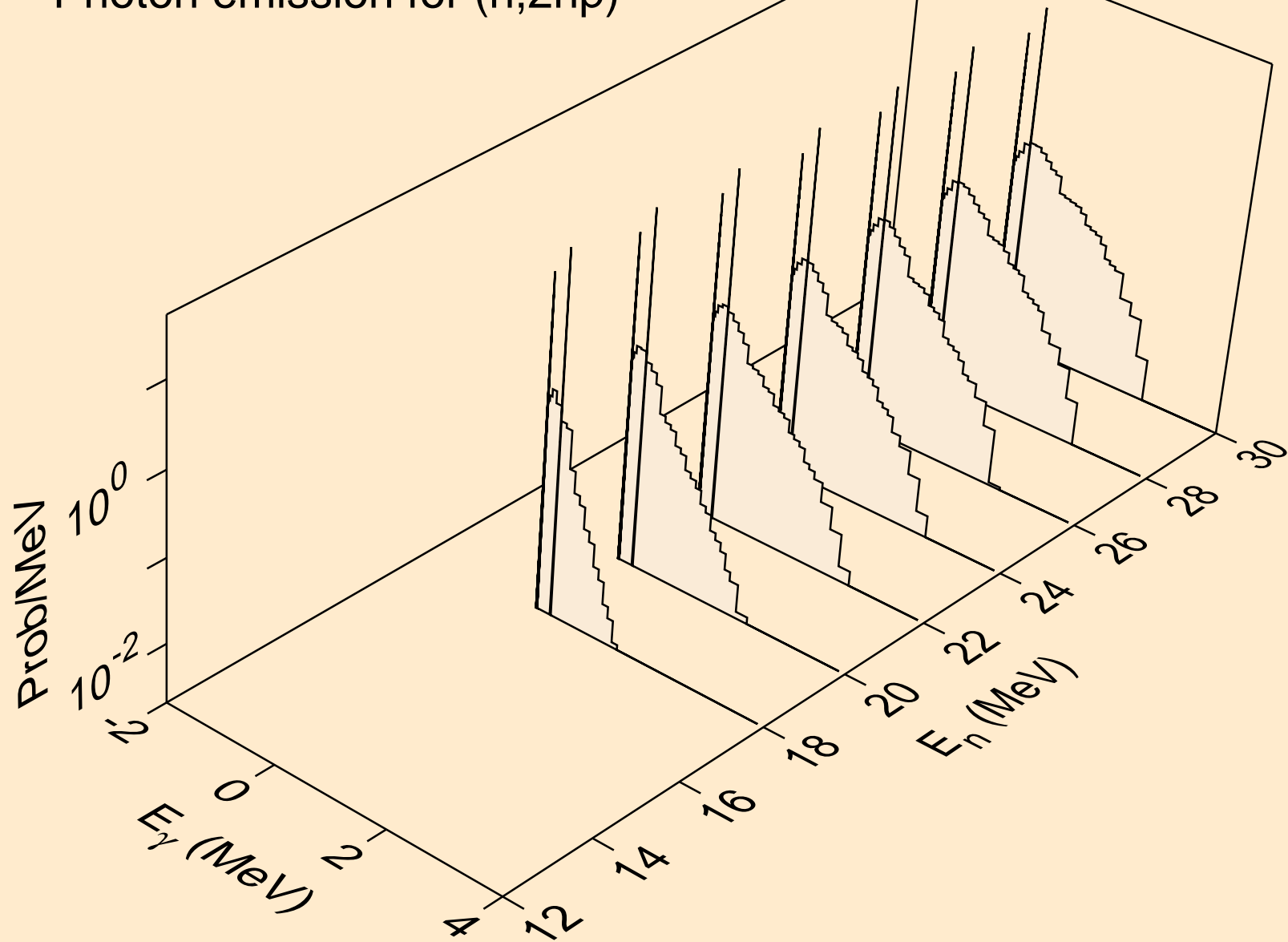

FM247M HELION ACER TENDL-2023 LIBRARY; T=0.K
Photon emission for (n,p)

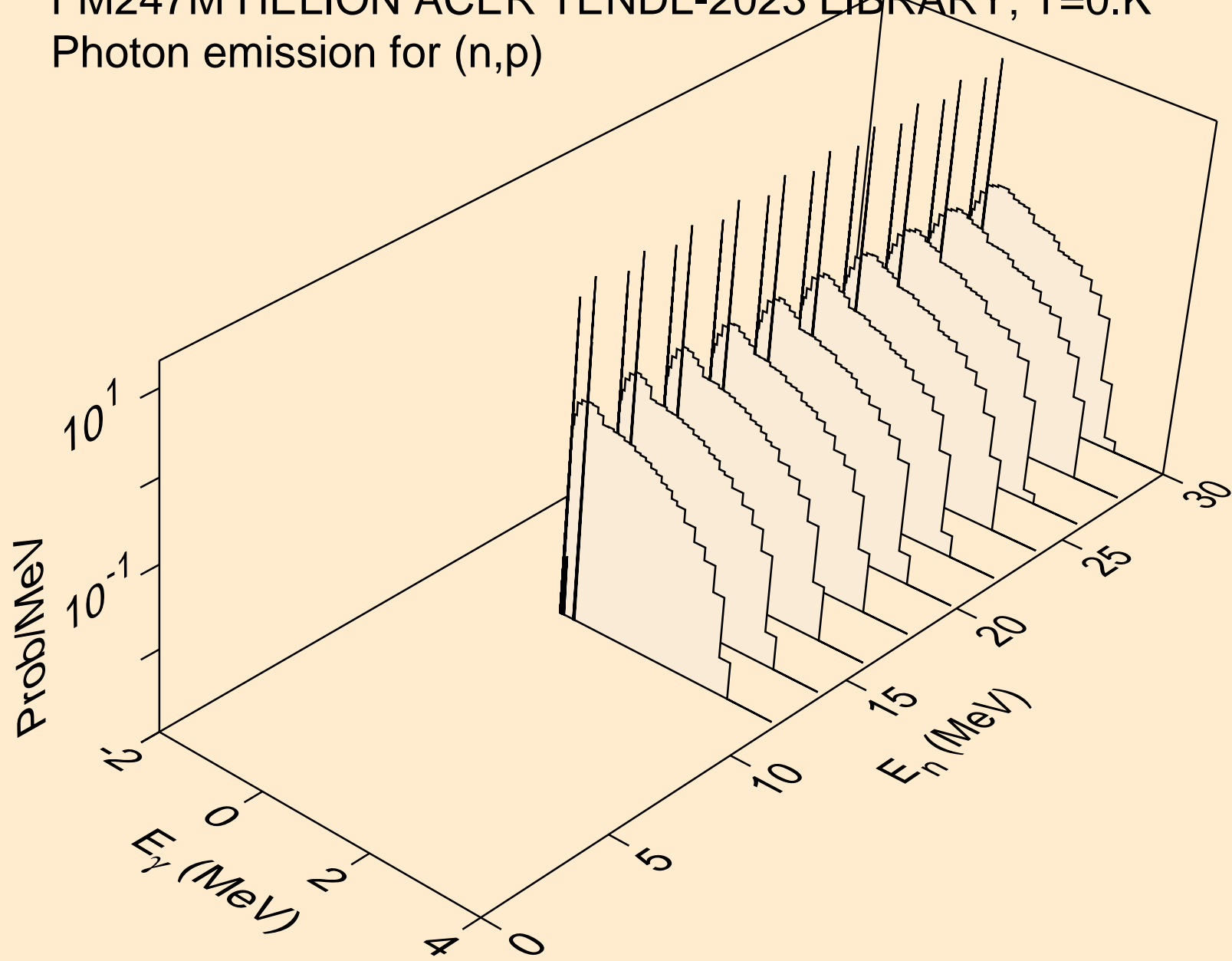

FM247M HELION ACER TENDL-2023 LIBRARY; T=0.K
Photon emission for (n,d)

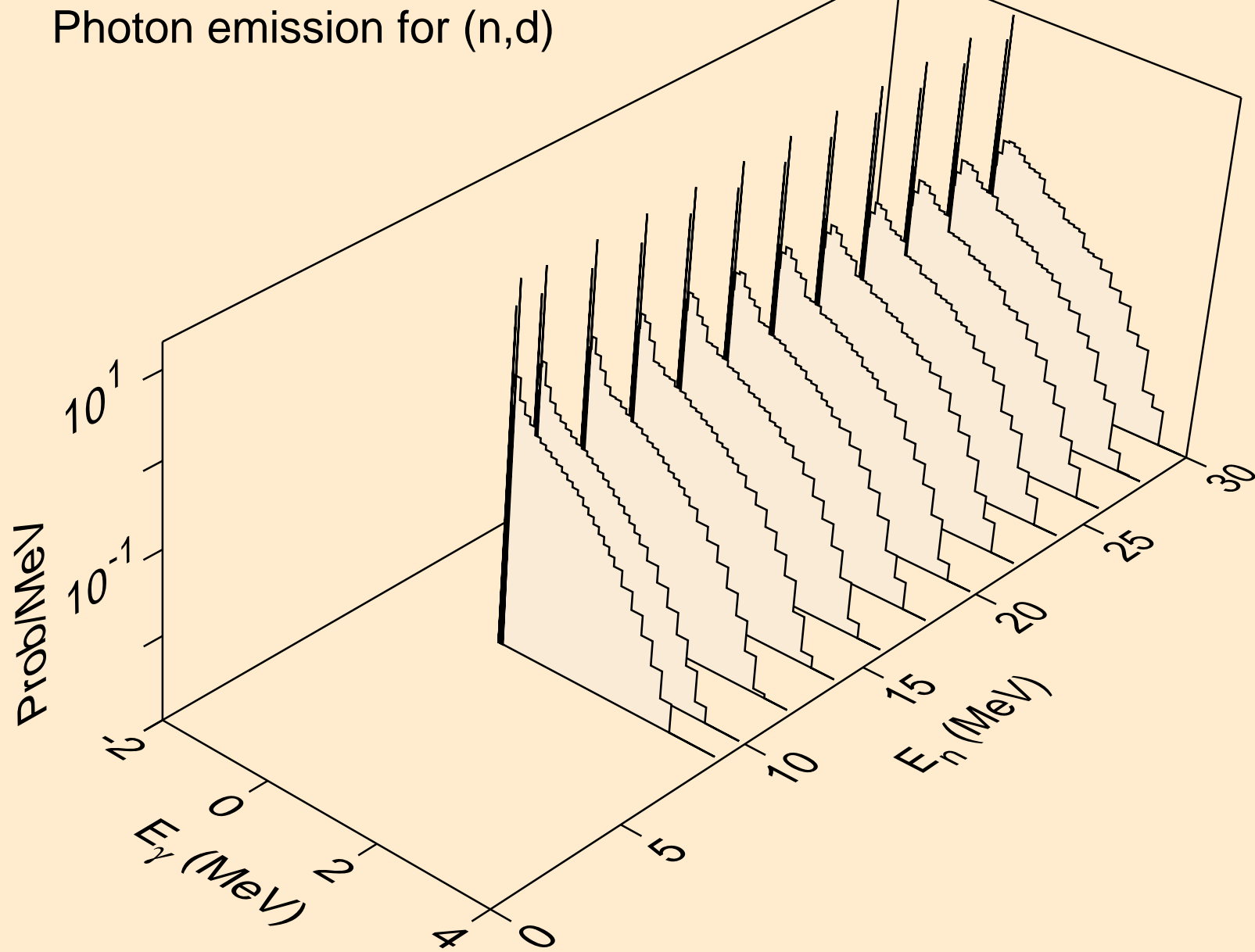

FM247M HELION ACER TENDL-2023 LIBRARY; T=0.K
Photon emission for (n,t)

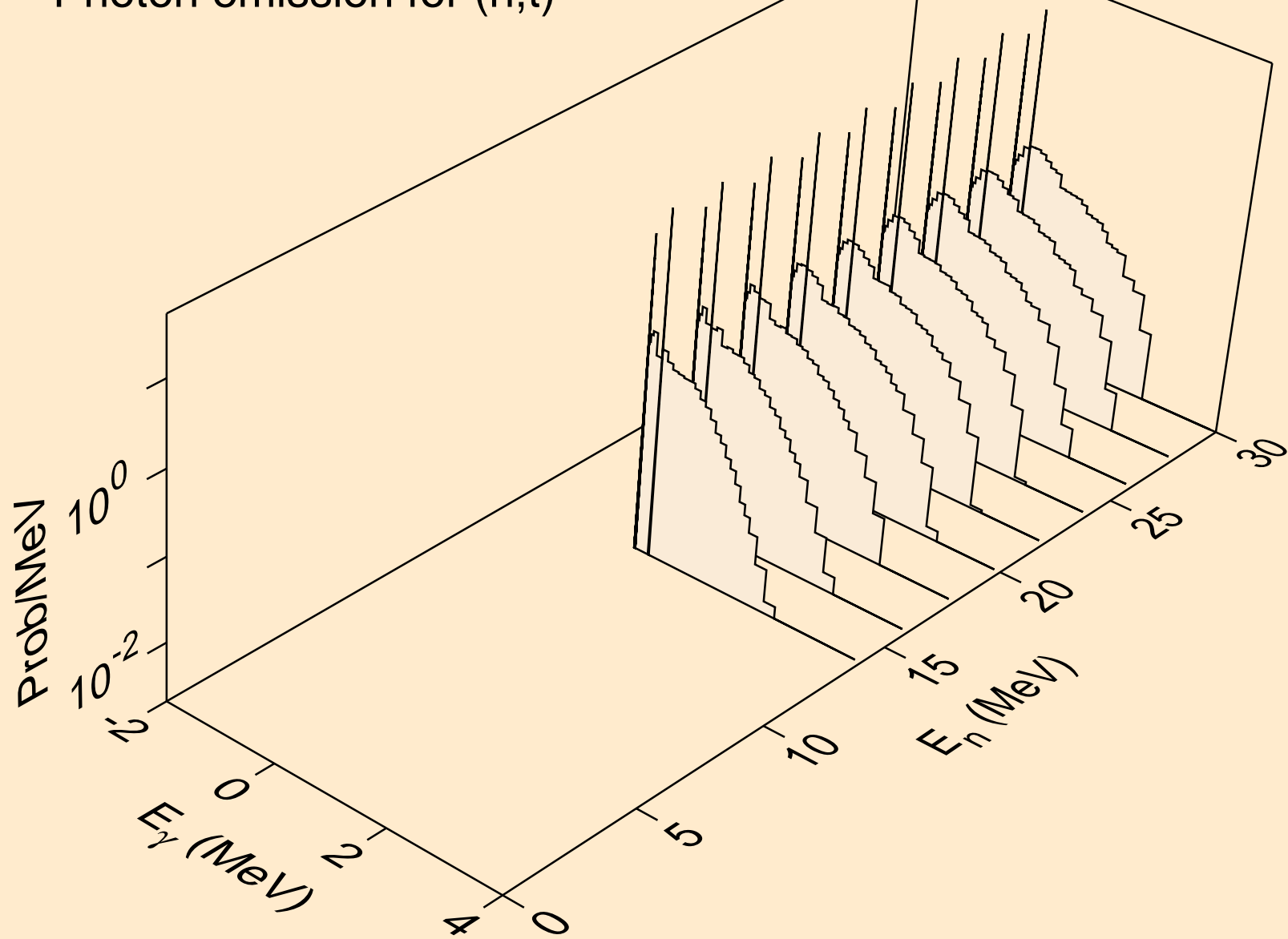

FM247M HELION ACER TENDL-2023 LIBRARY; T=0.K
Photon emission for inelastic

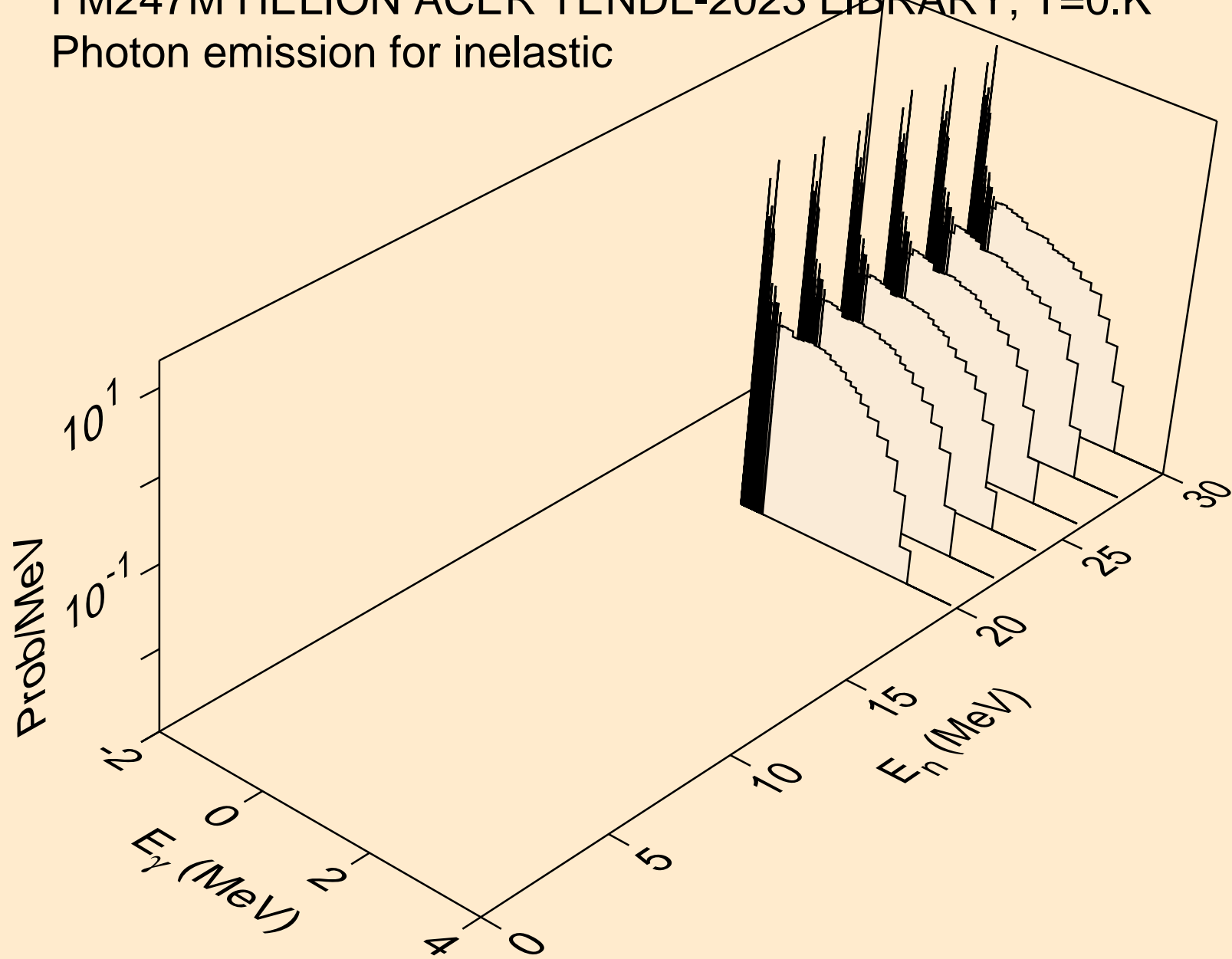

FM247M HELION ACER TENDL-2023 LIBRARY; T=0.K
Photon emission for (n,a)

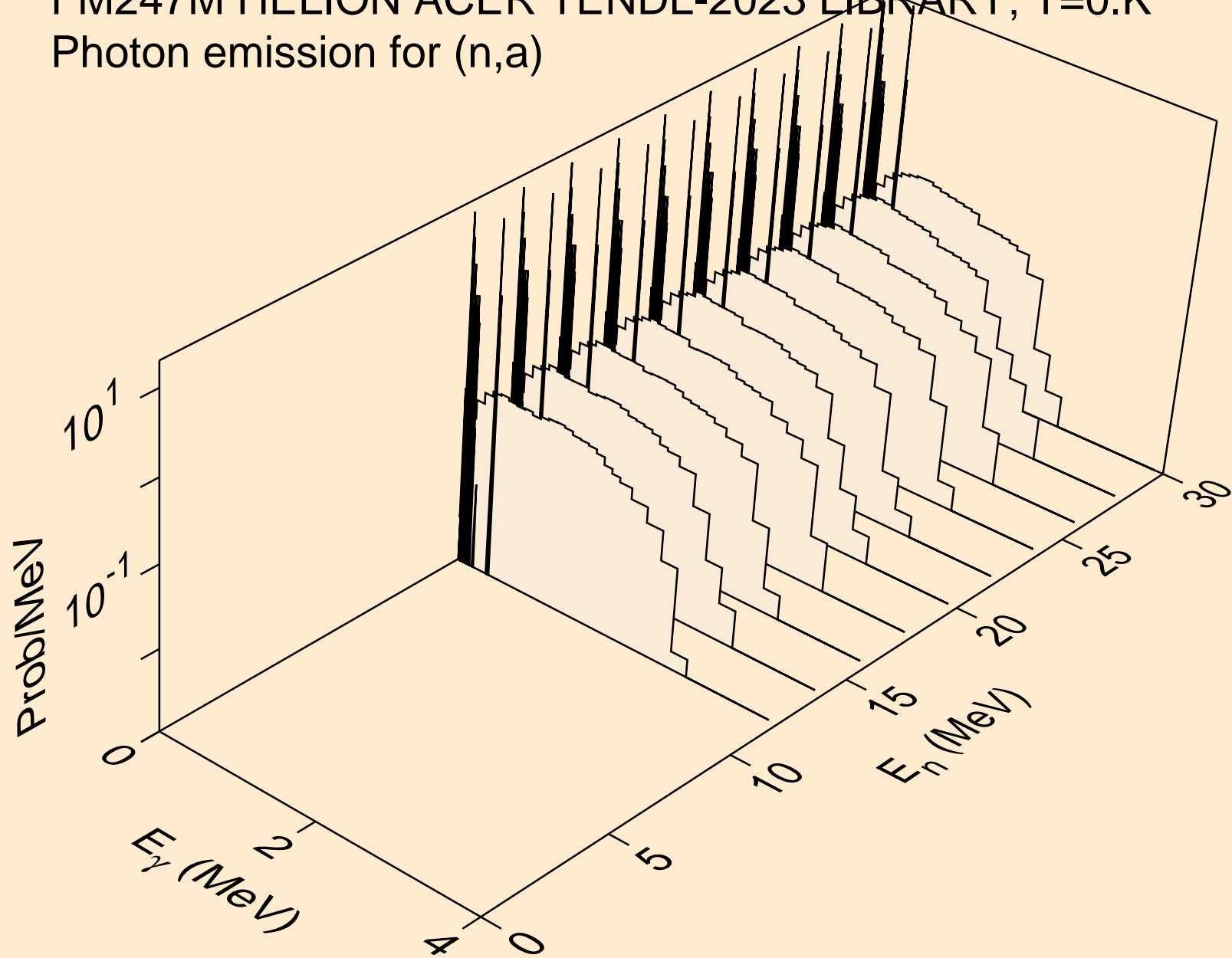

FM247M HELION ACER TENDL-2023 LIBRARY; T=0.K
Photon emission for (n,2p)

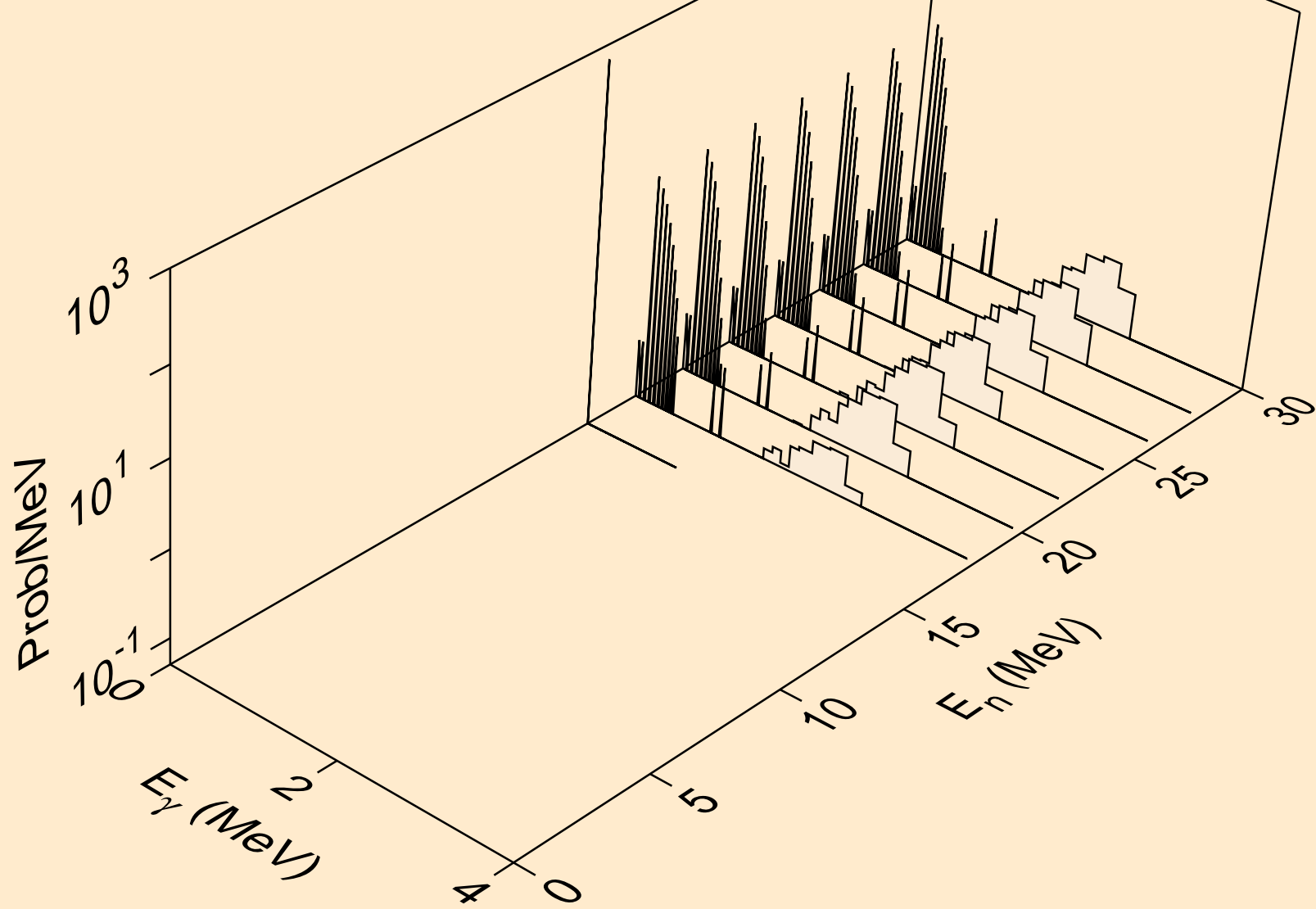

FM247M HELION ACER TENDL-2023 LIBRARY; T=0.K
Photon emission for (n,pa)

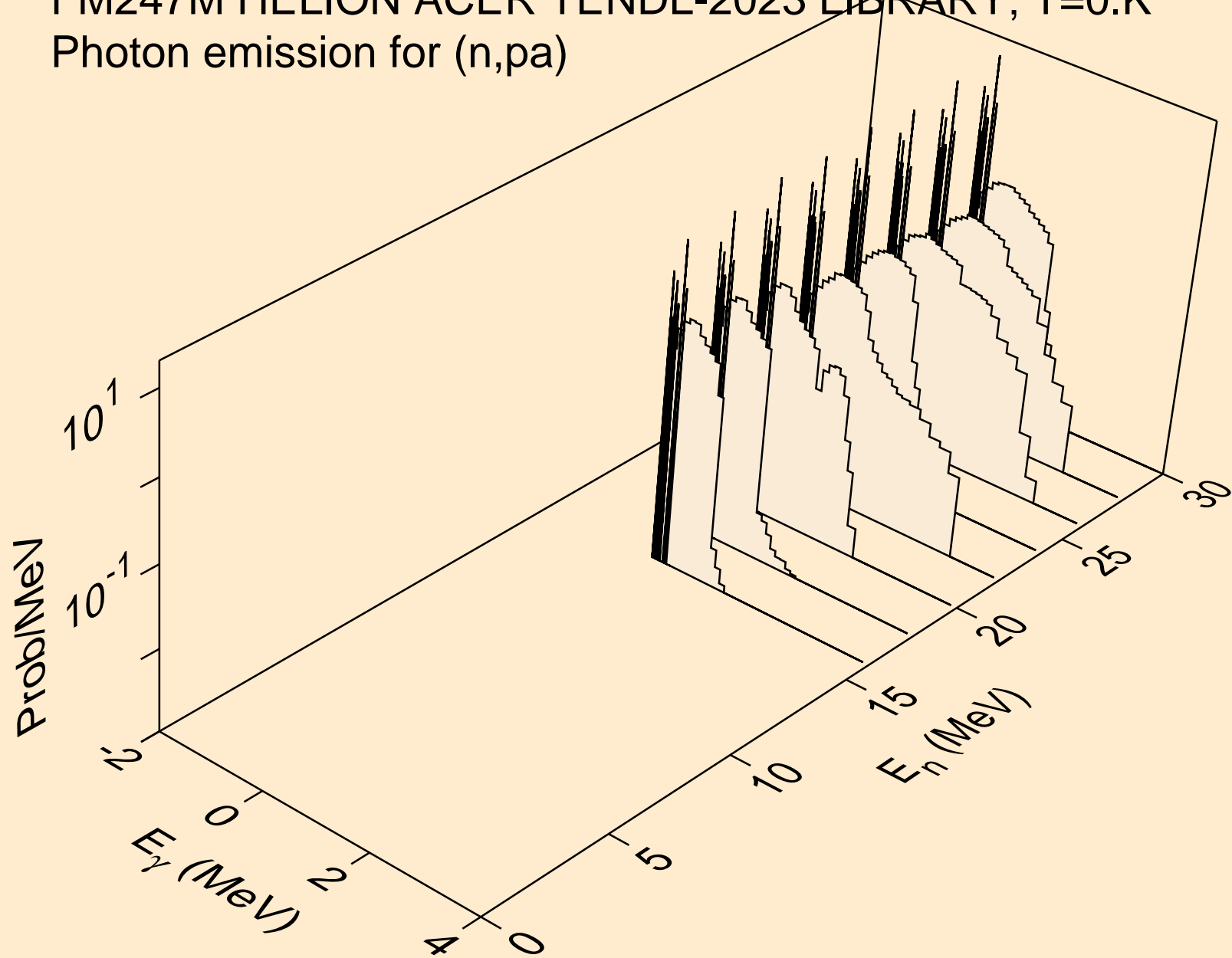

FM247M HELION ACER TENDL-2023 LIBRARY; T=0.K
Particle heating contributions

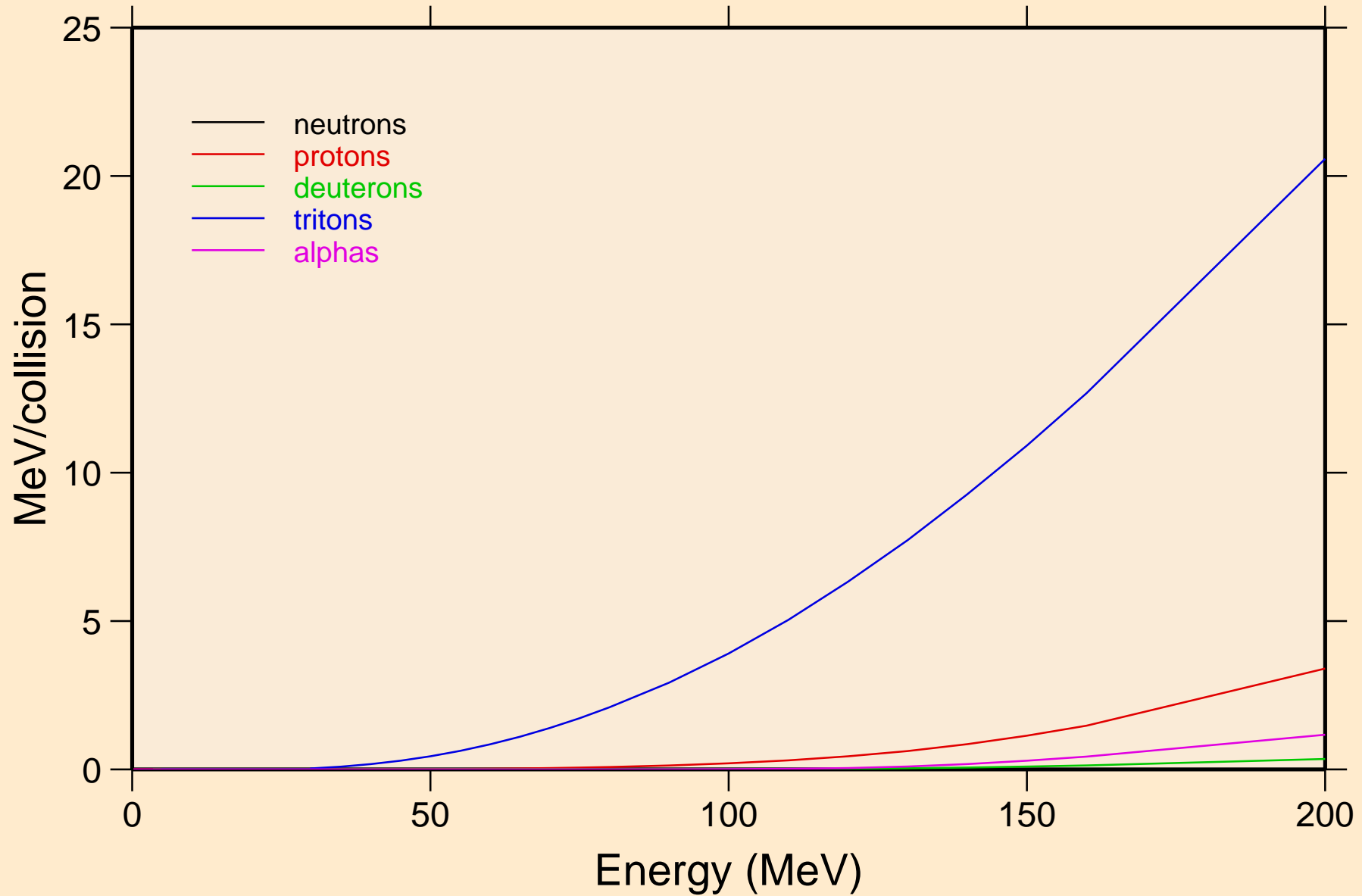

FM247M HELION ACER TENDL-2023 LIBRARY; T=0.K
Recoil Heating

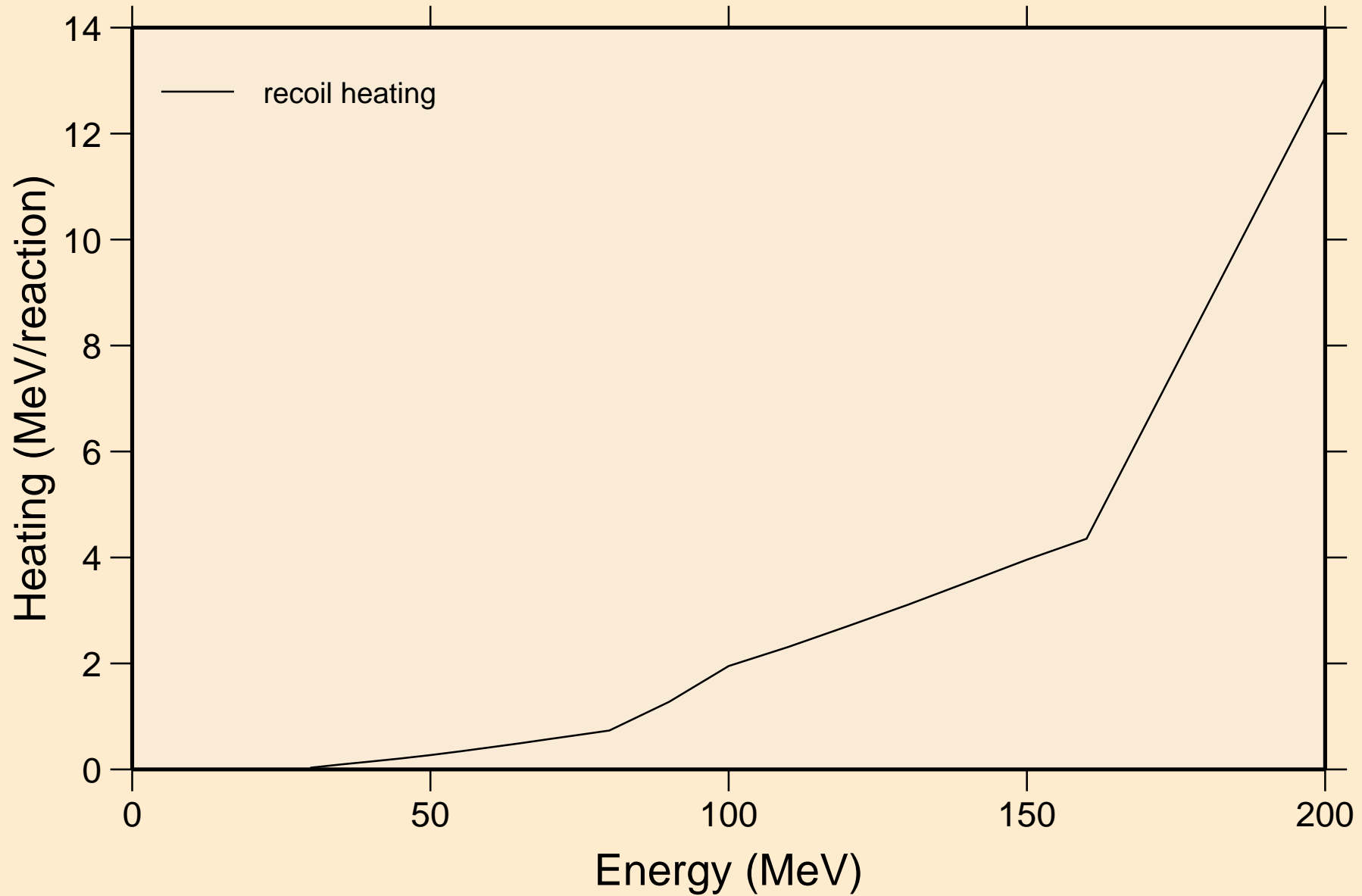

FM247M HELION ACER TENDL-2023 LIBRARY; T=0.K

Particle production cross sections

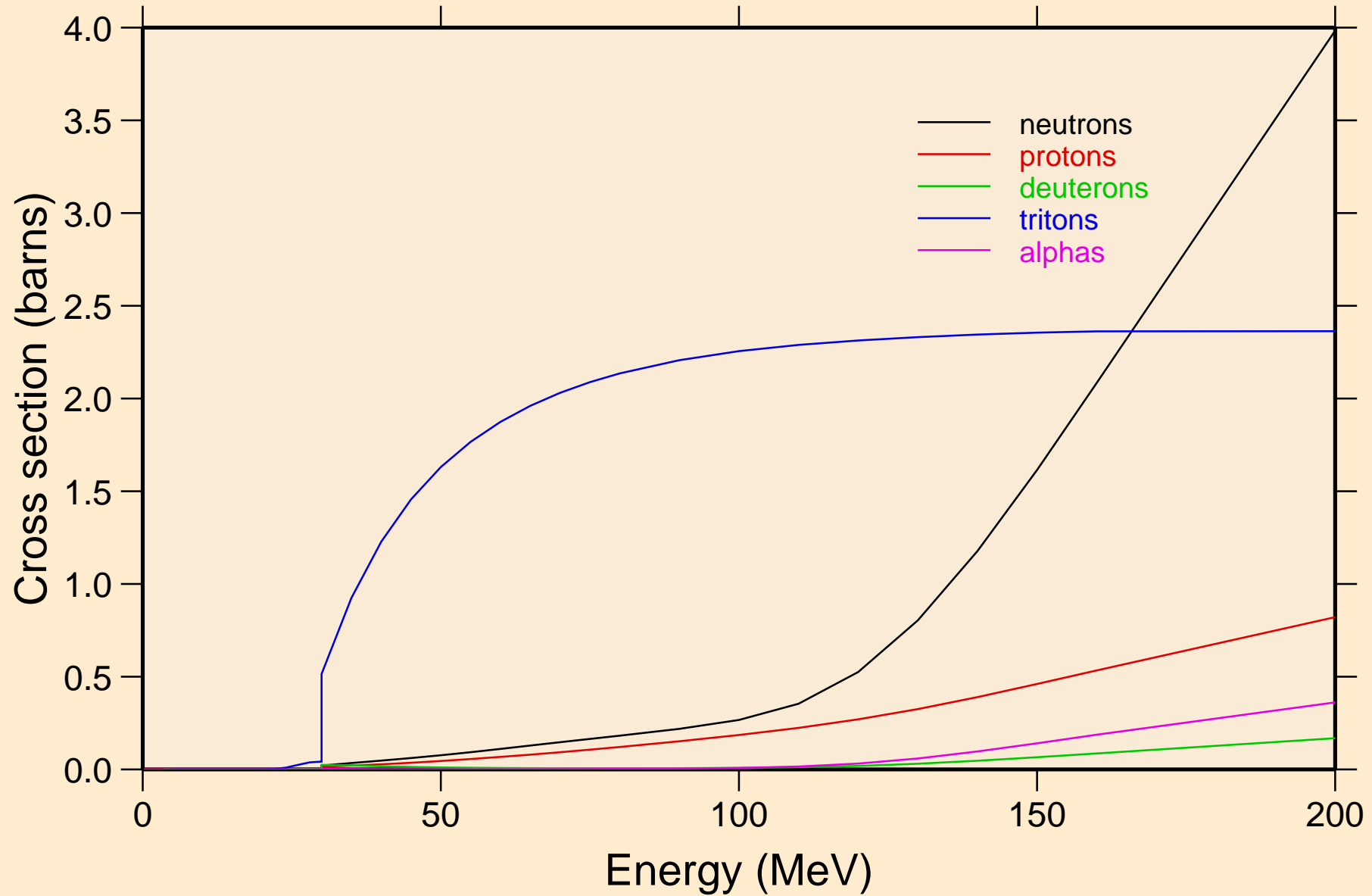

FM247M HELION ACER TENDL-2023 LIBRARY; T=0.K
neutrons from (s,n)

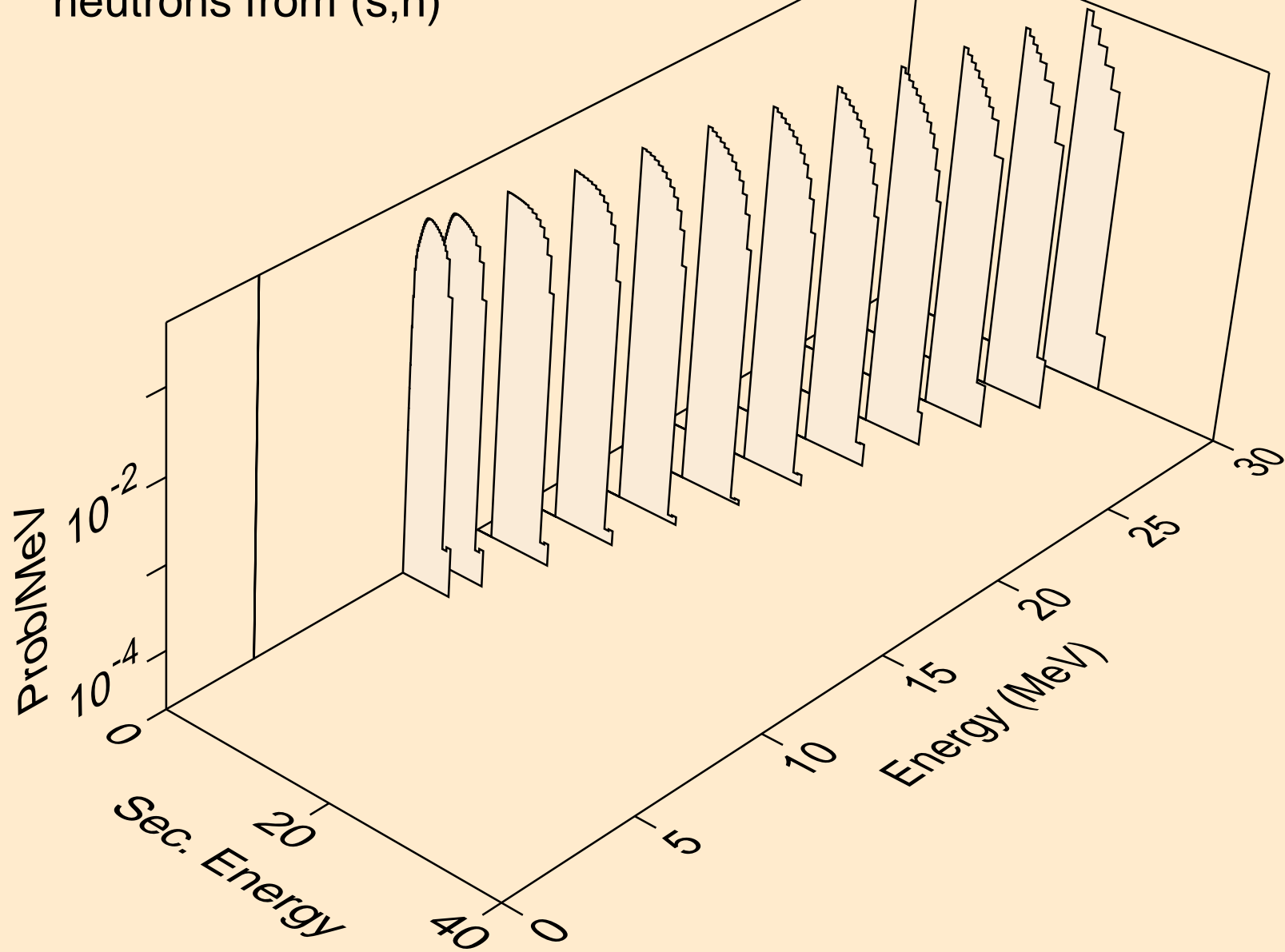

FM247M HELION ACER TENDL-2023 LIBRARY; T=0.K
neutrons from (s,x)

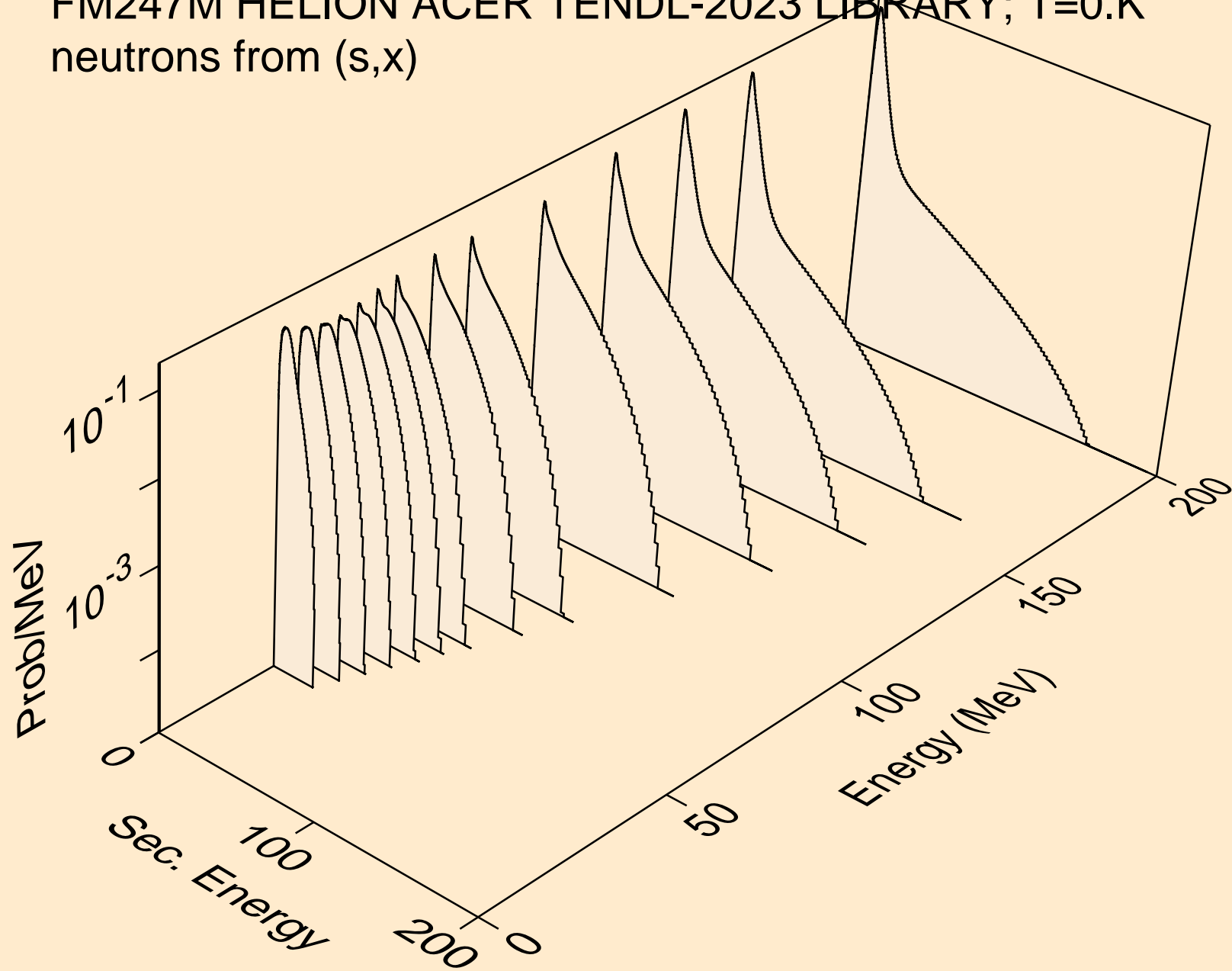

FM247M HELION ACER TENDL-2023 LIBRARY; T=0.K
neutrons from (s,2n)

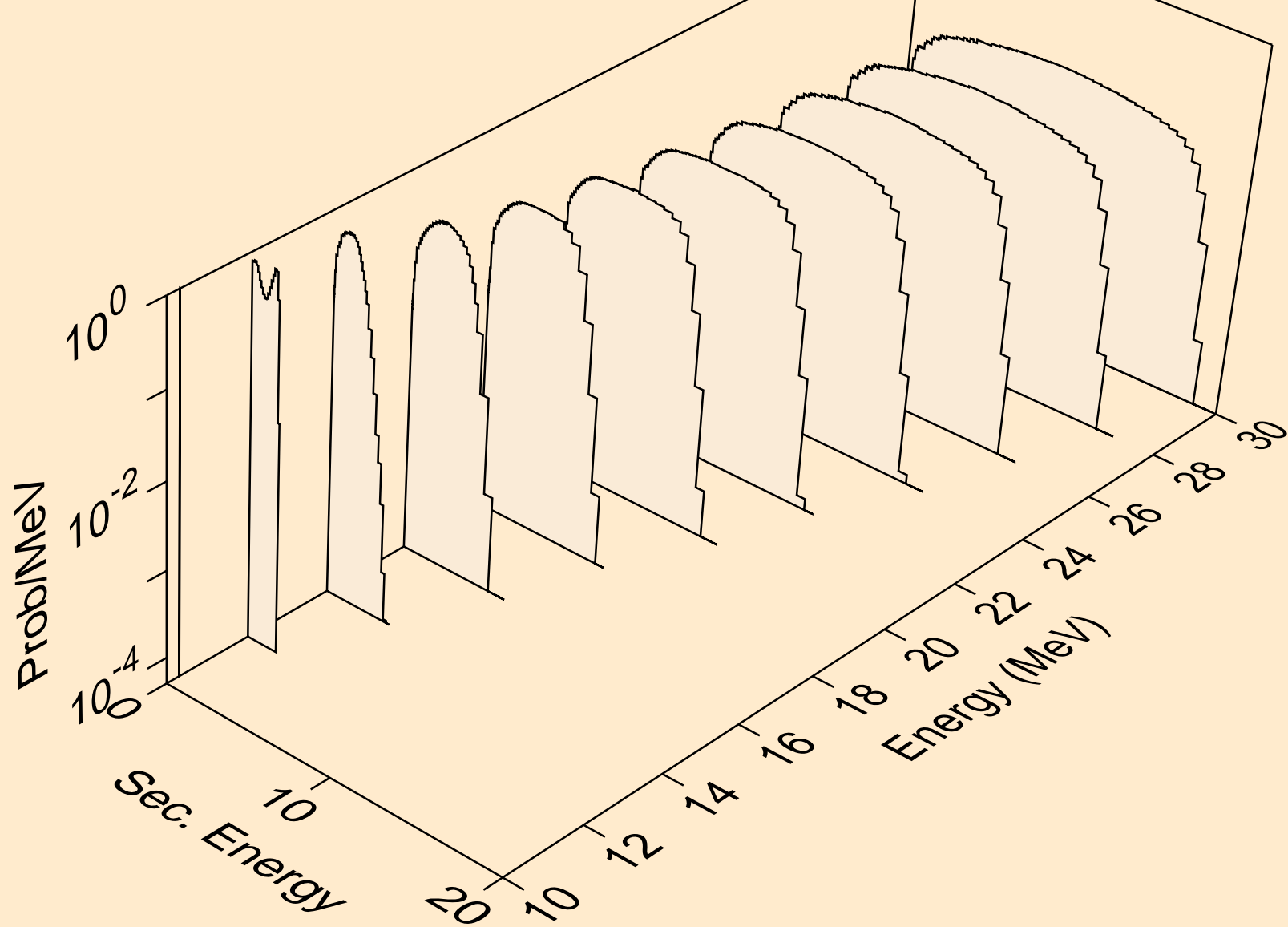

FM247M HELION ACER TENDL-2023 LIBRARY; T=0.K
neutrons from (s,3n)

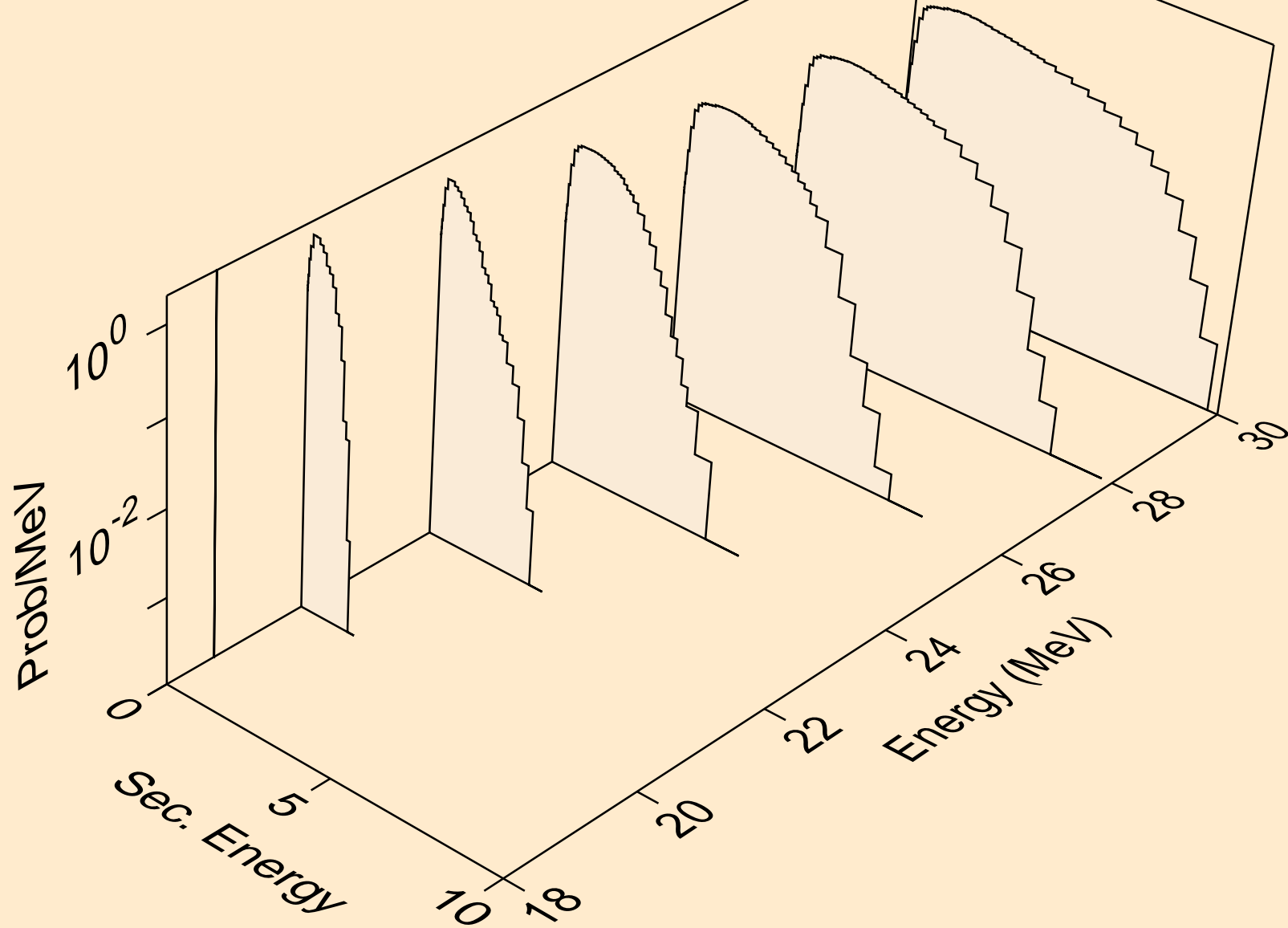

FM247M HELION ACER TENDL-2023 LIBRARY; T=0.K
neutrons from (s,n*)a

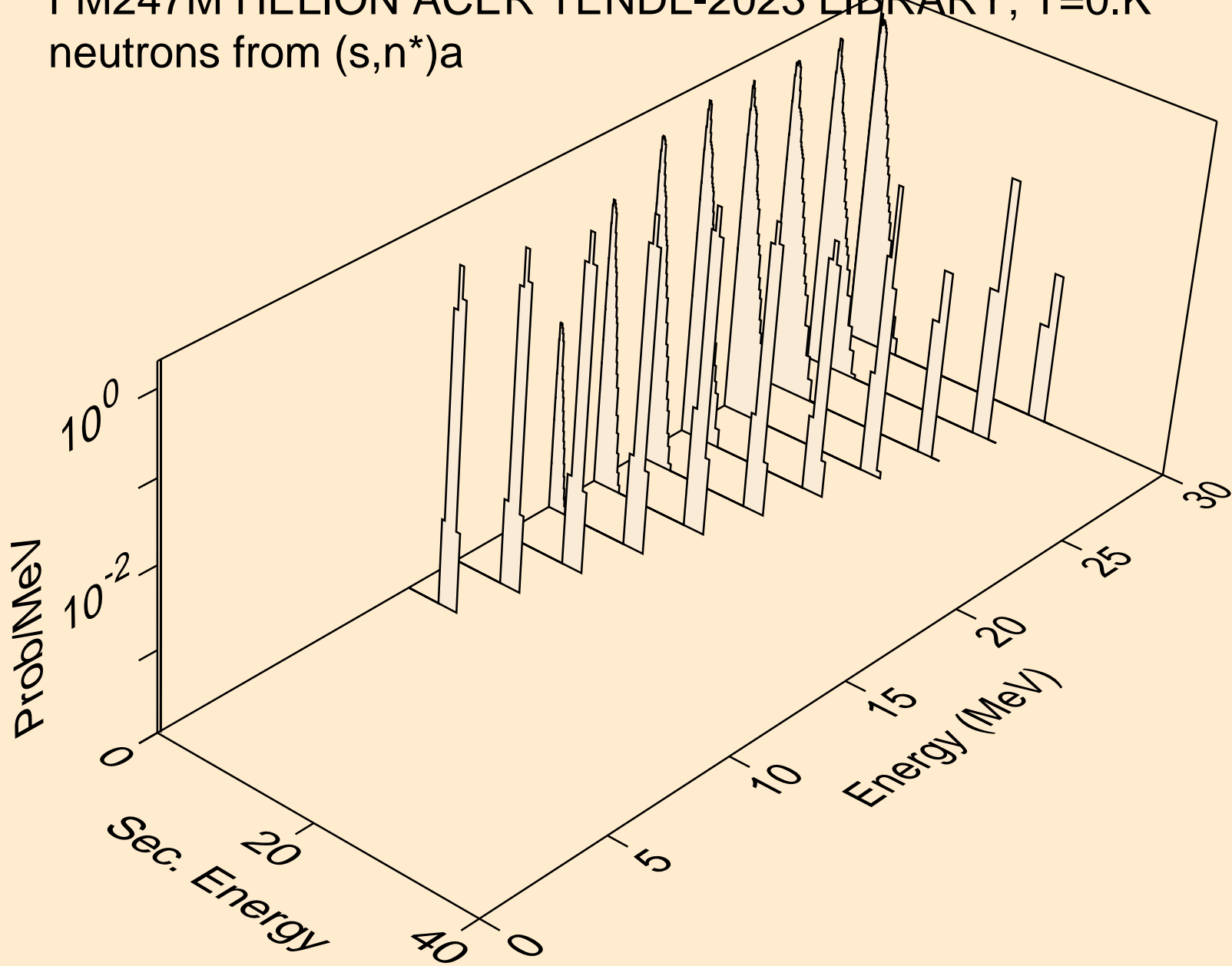

FM247M HELION ACER TENDL-2023 LIBRARY; T=0.K
neutrons from (s,n*)p

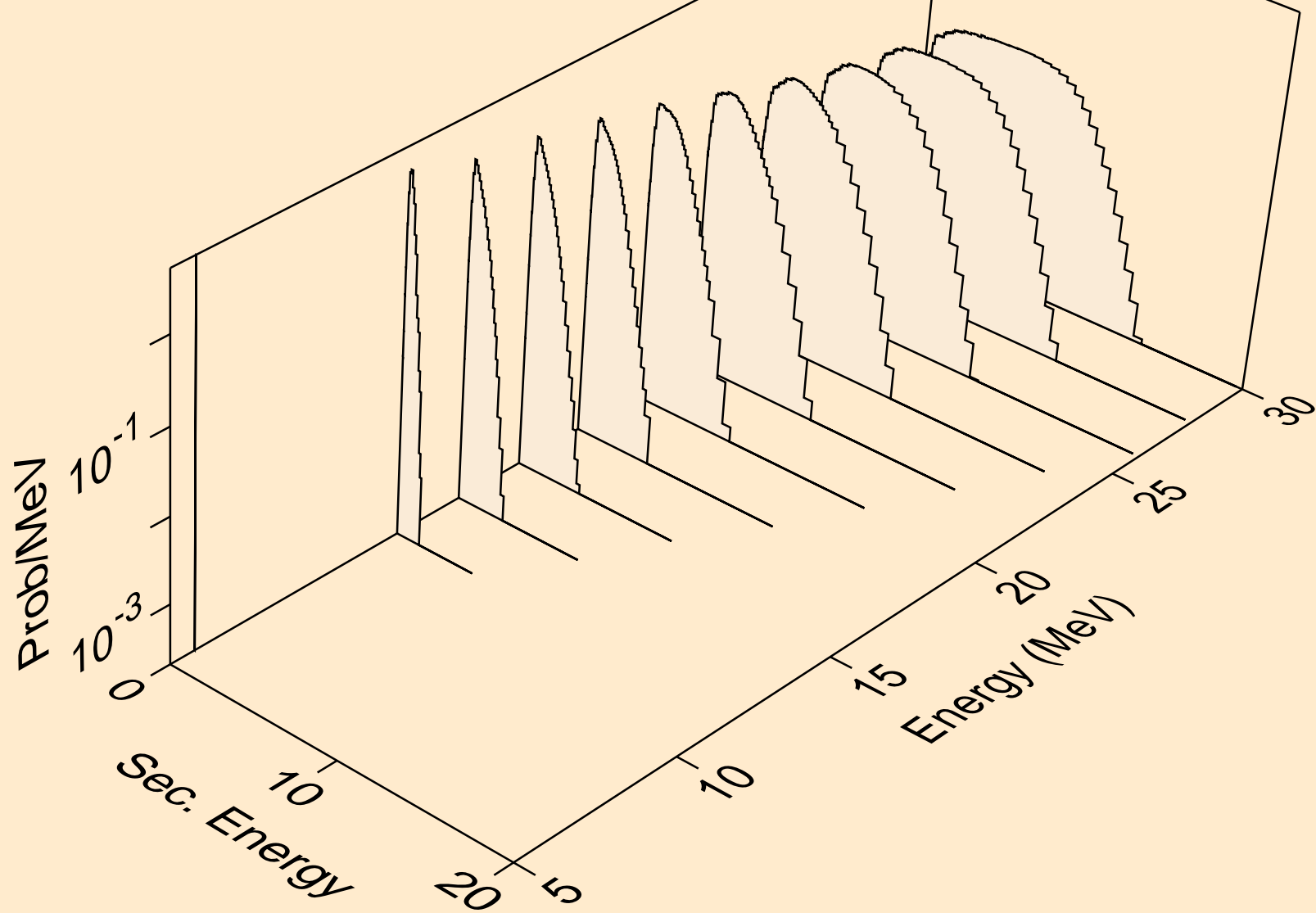

FM247M HELION ACER TENDL-2023 LIBRARY; T=0.K
neutrons from (s,n*)d

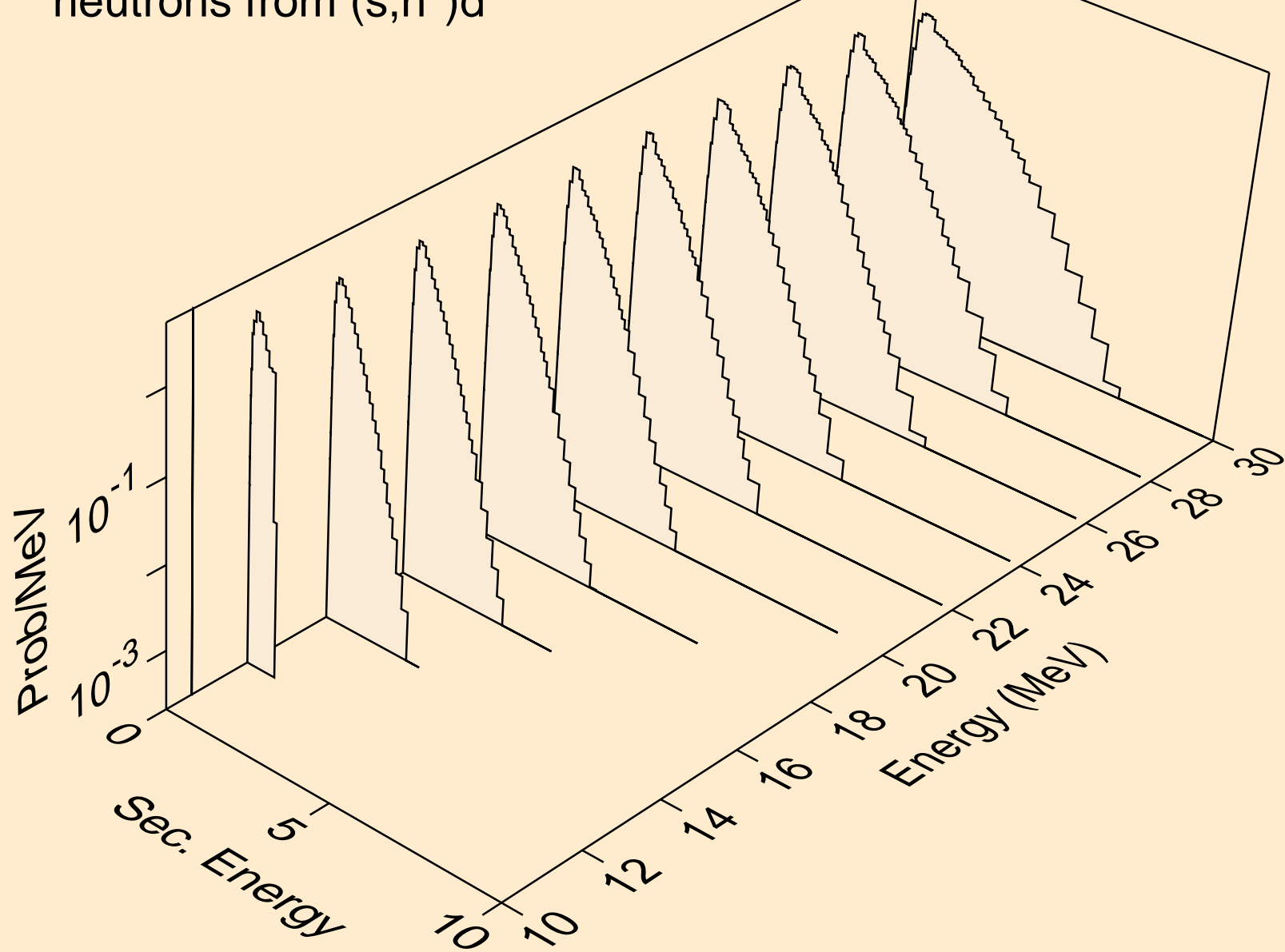

FM247M HELION ACER TENDL-2023 LIBRARY; T=0.K
neutrons from (s,n*)t

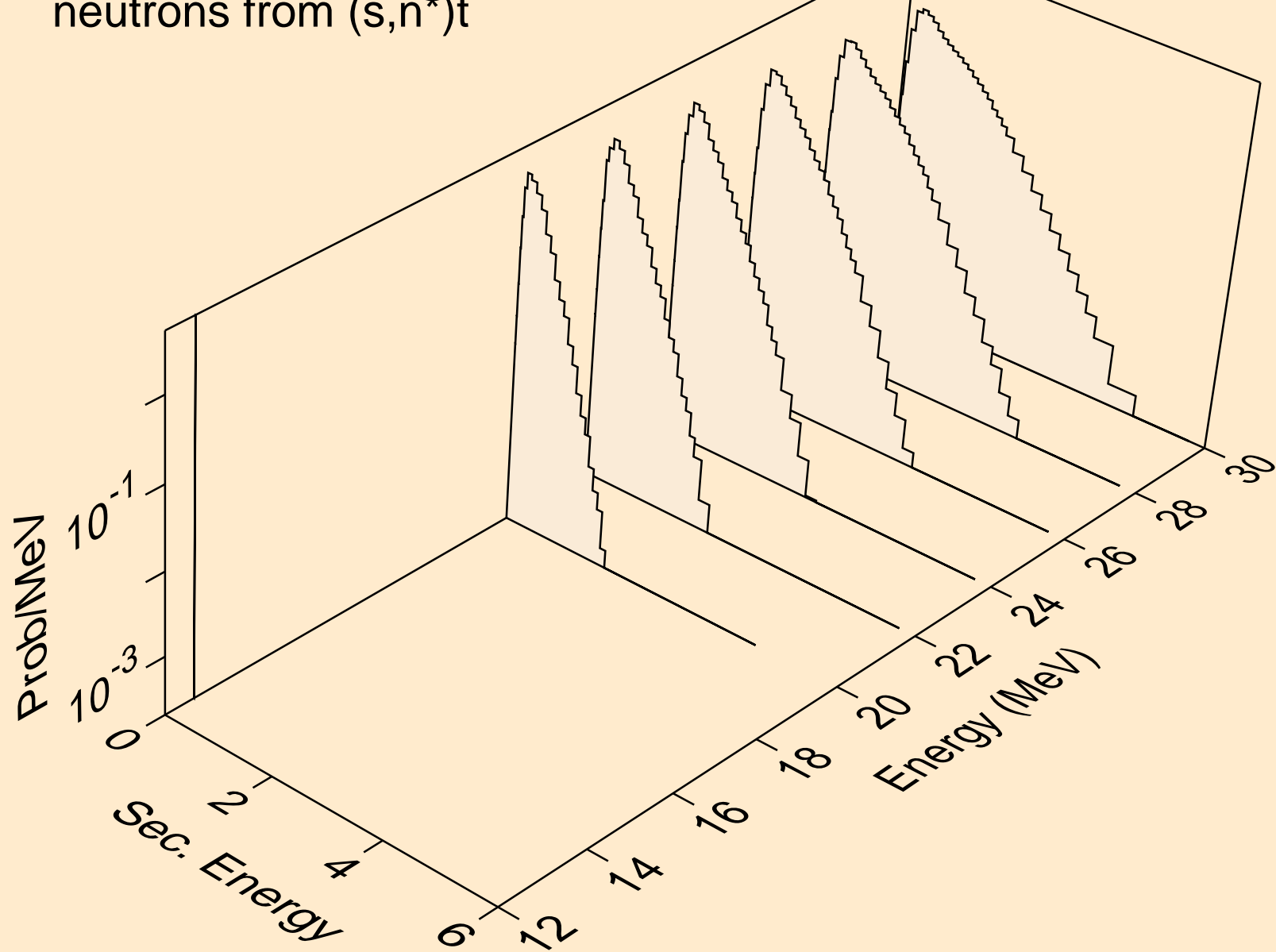

FM247M HELION ACER TENDL-2023 LIBRARY; T=0.K
neutrons from (s,2np)

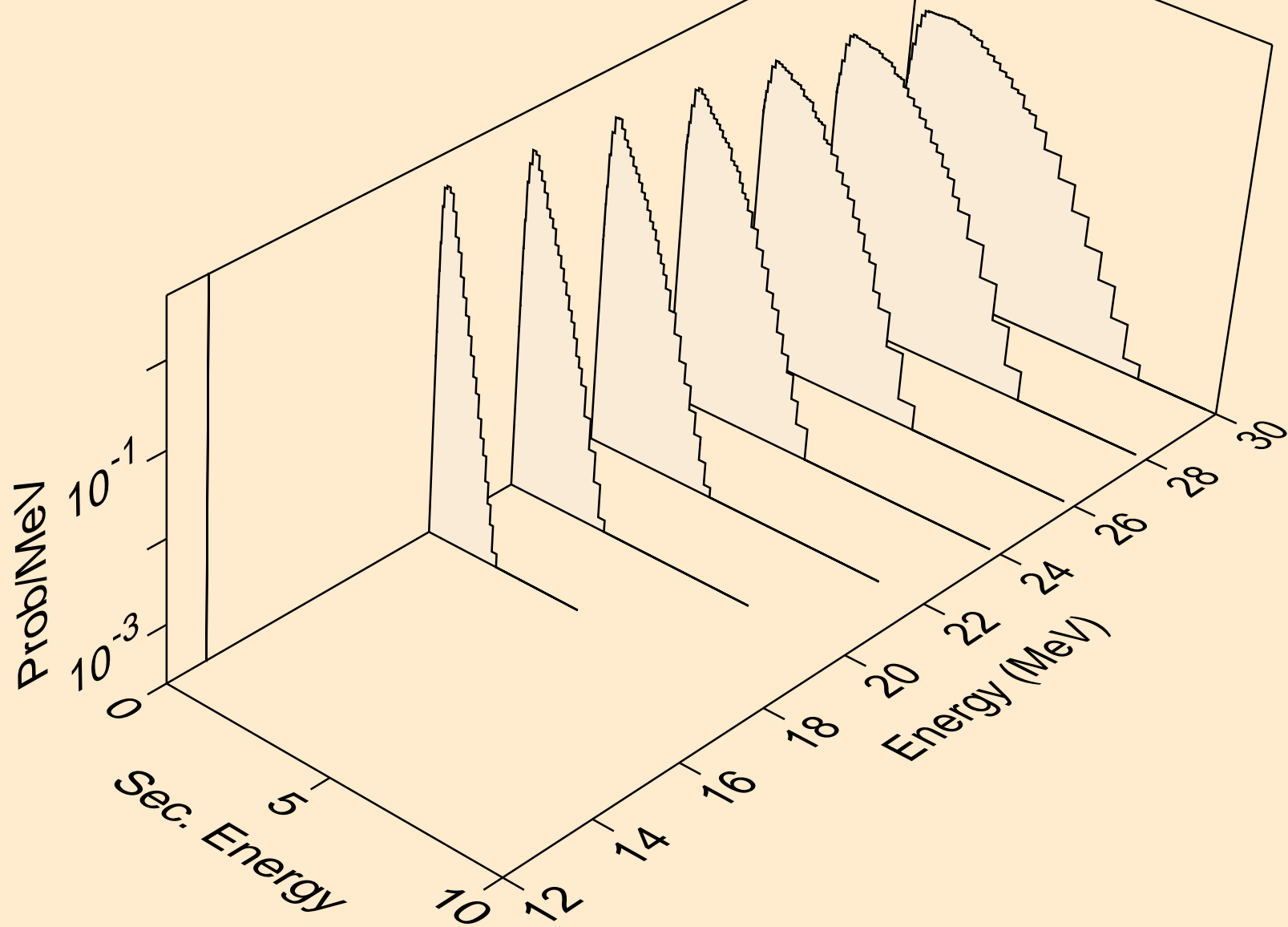

FM247M HELION ACER TENDL-2023 LIBRARY; T=0.K
protons from (s,x)

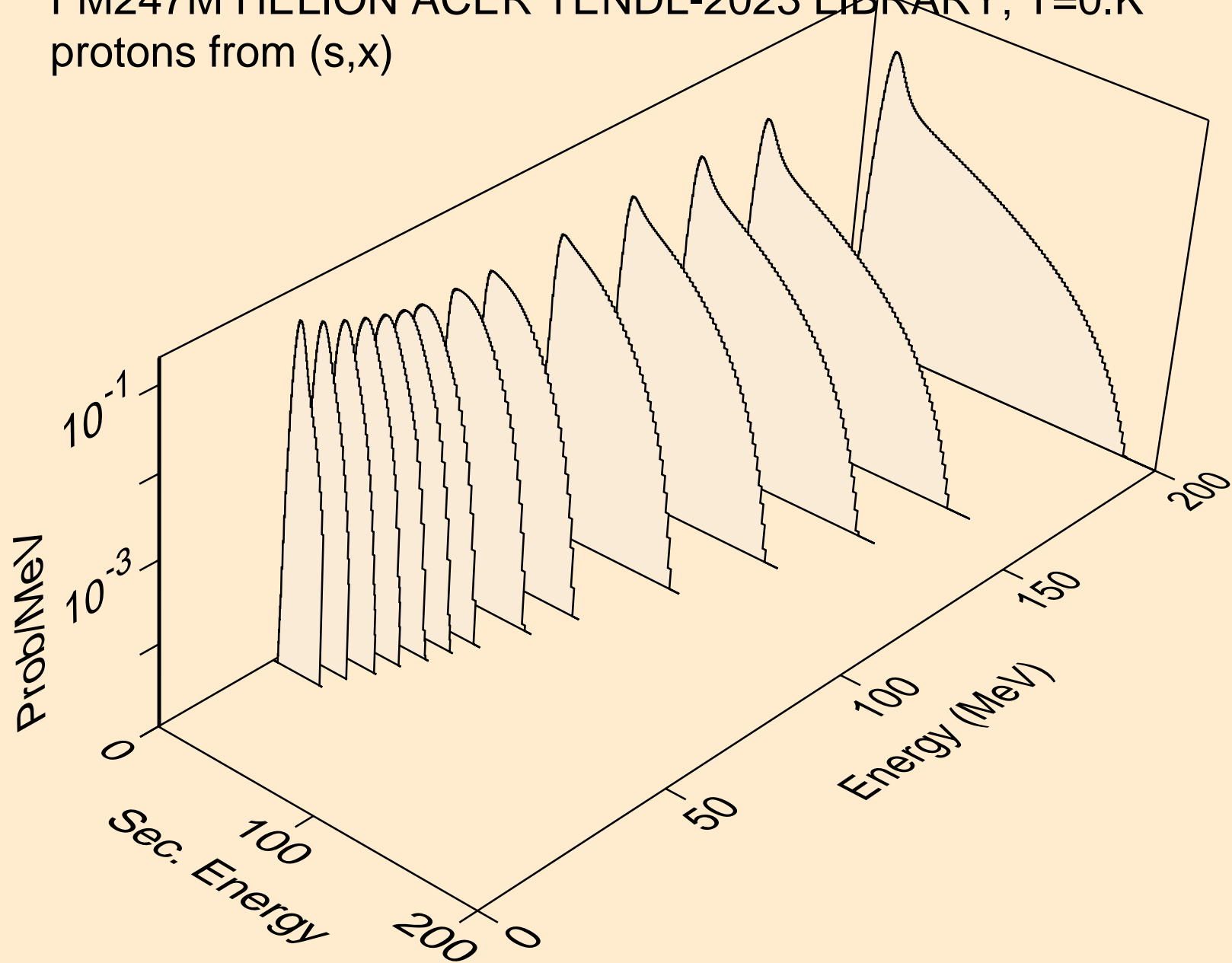

FM247M HELION ACER TENDL-2023 LIBRARY; T=0.K
protons from (s,n*)p

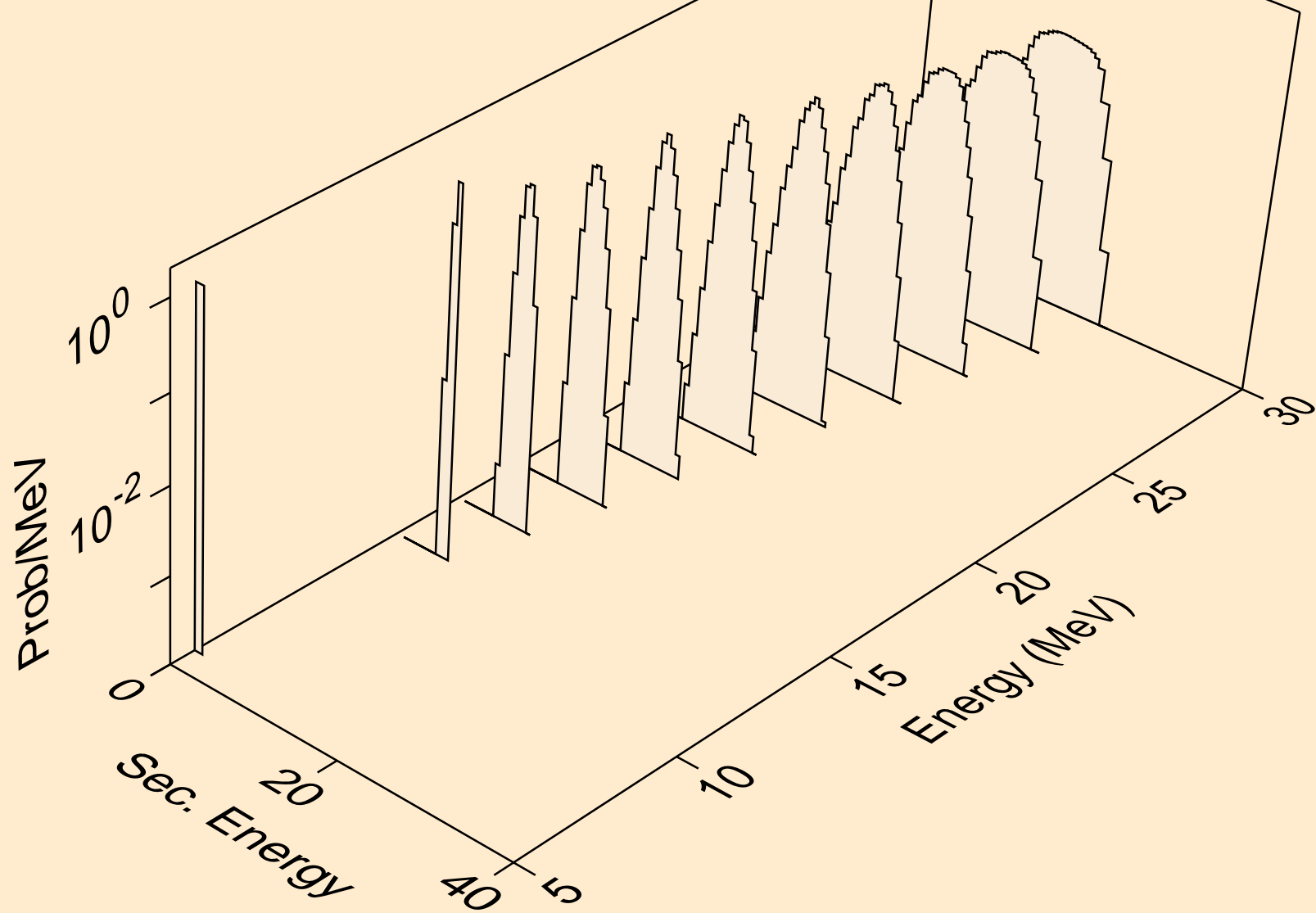

FM247M HELION ACER TENDL-2023 LIBRARY; T=0.K
protons from (s,2np)

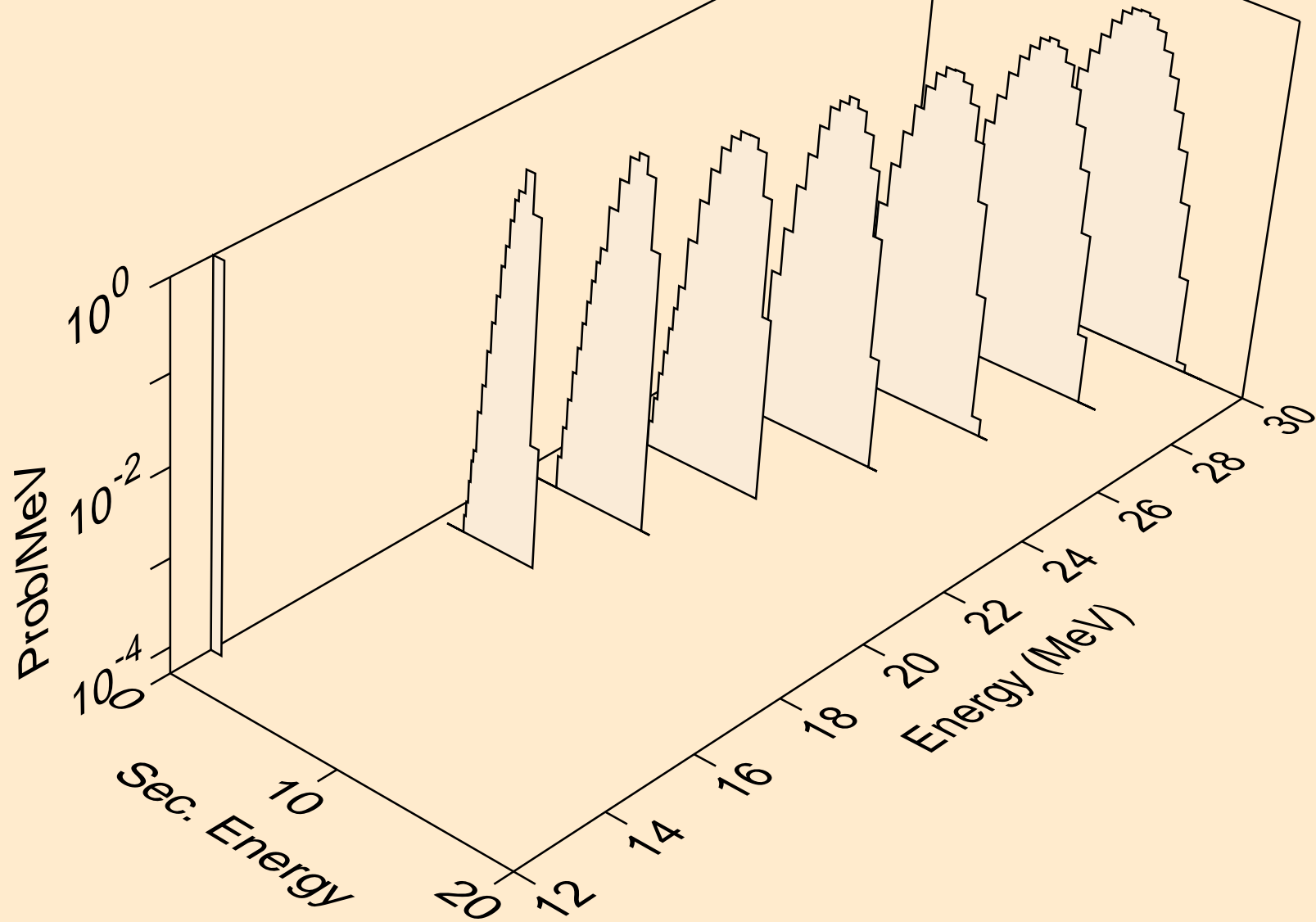

FM247M HELION ACER TENDL-2023 LIBRARY; T=0.K
protons from (s,p)

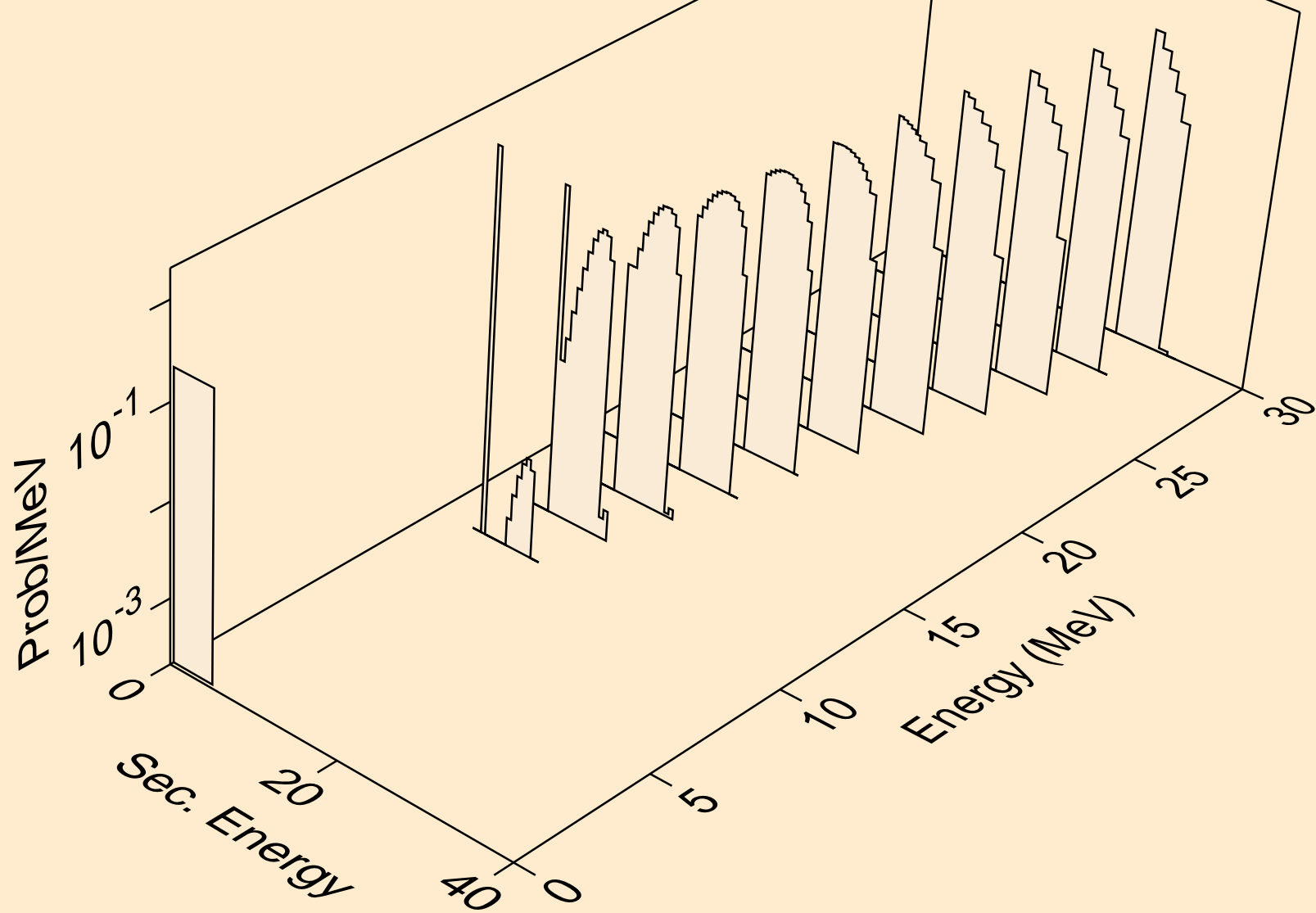

FM247M HELION ACER TENDL-2023 LIBRARY; T=0.K
protons from (s,2p)

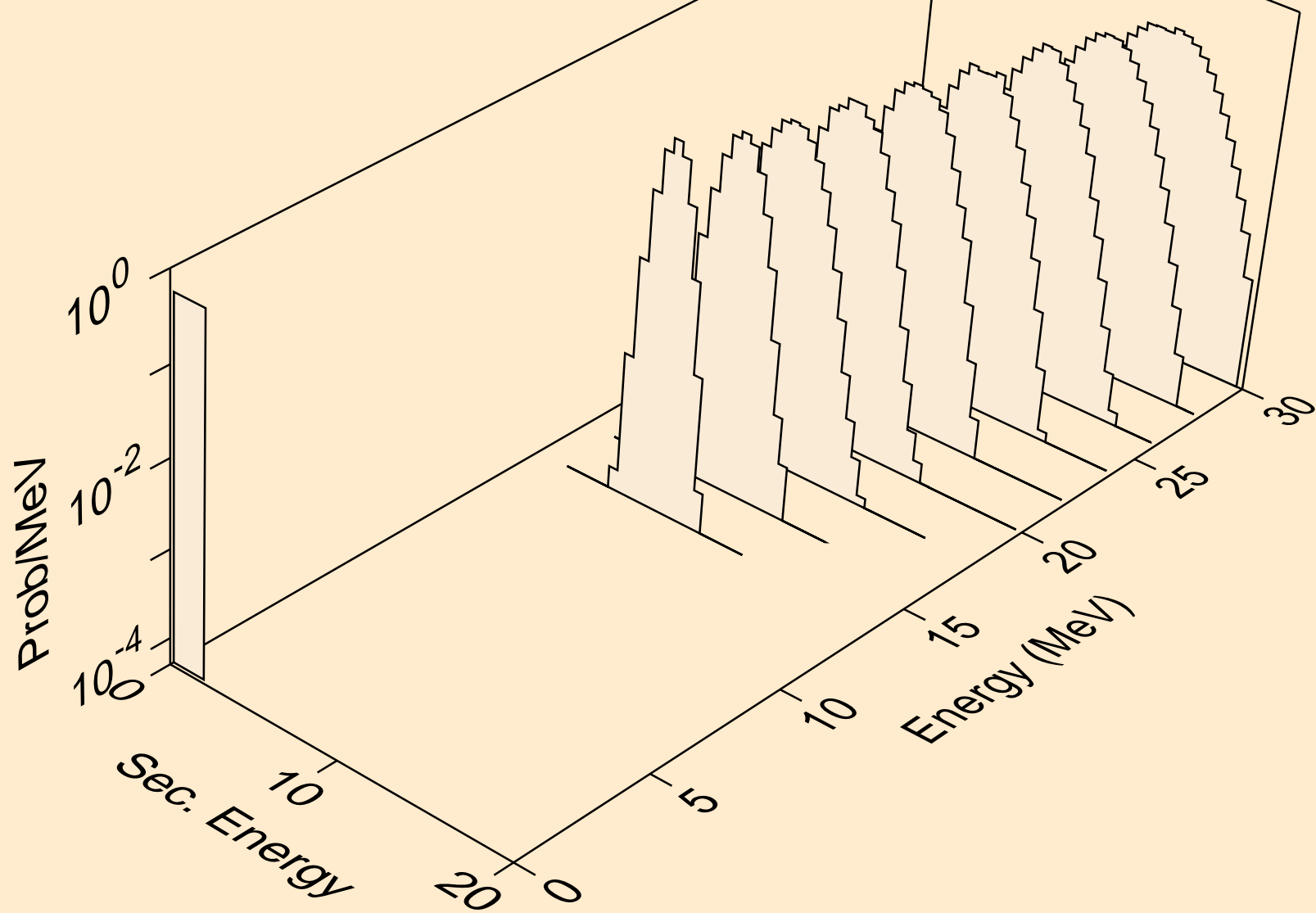

FM247M HELION ACER TENDL-2023 LIBRARY; T=0.K
protons from (s,pa)

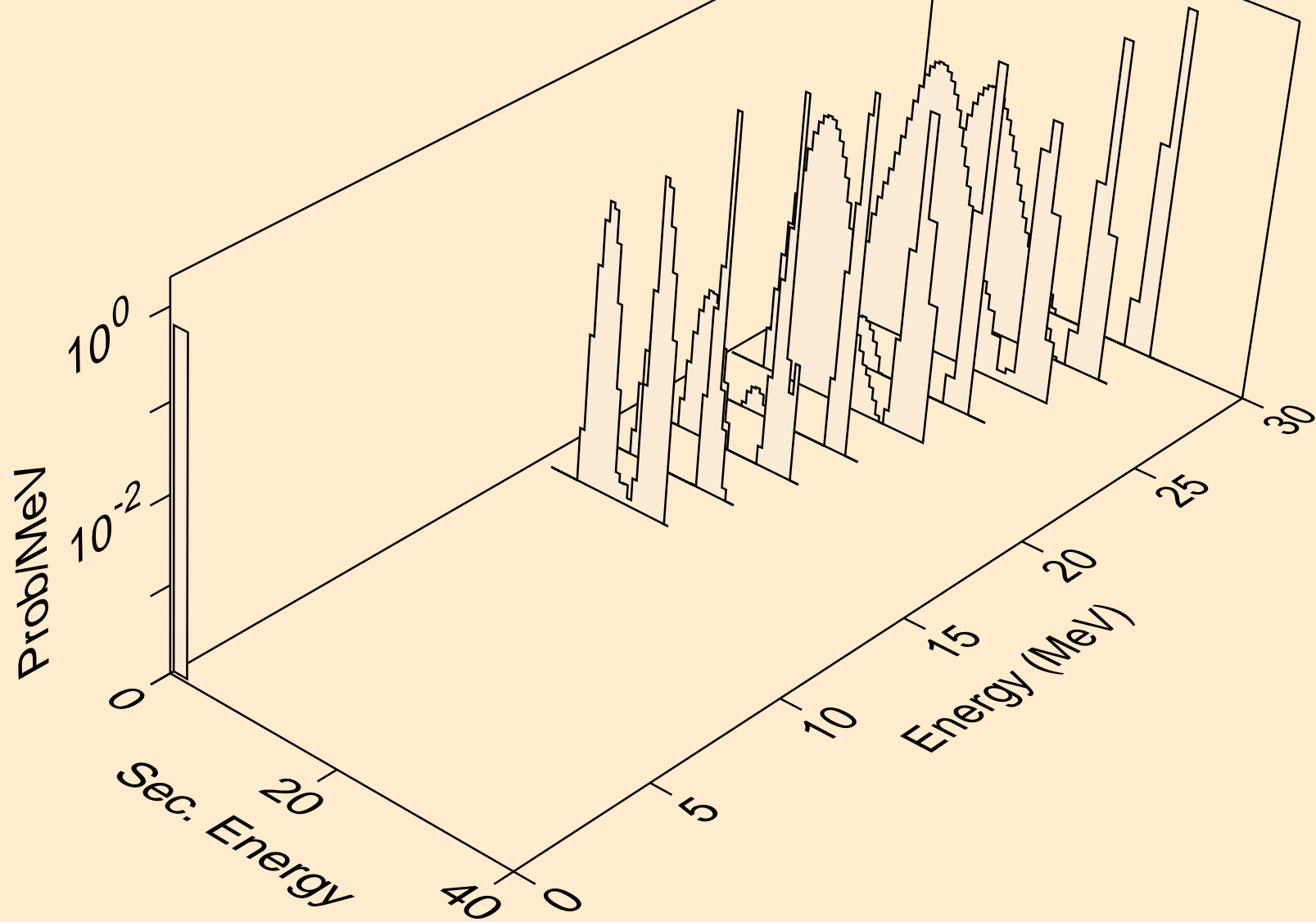

FM247M HELION ACER TENDL-2023 LIBRARY; T=0.K
deuterons from (s,x)

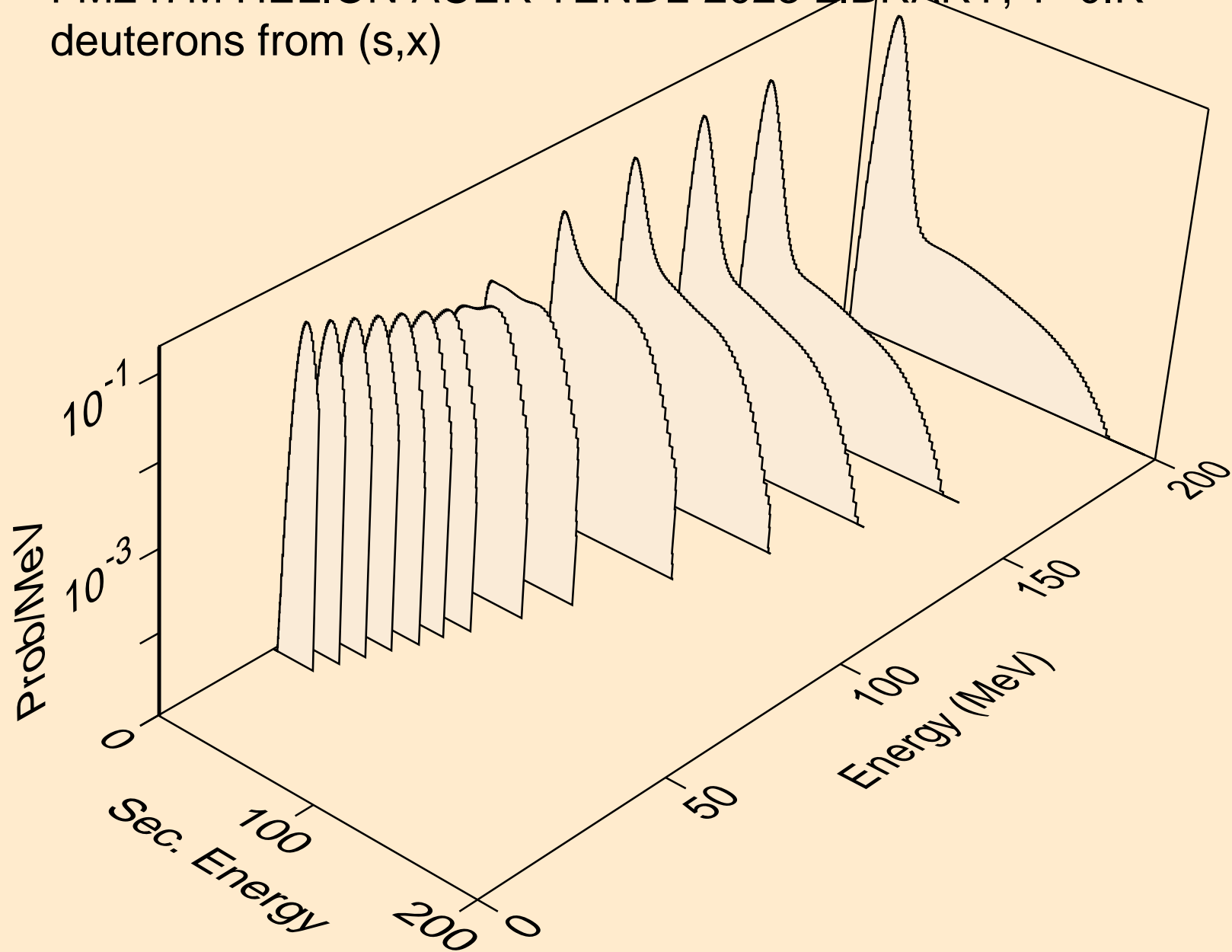

FM247M HELION ACER TENDL-2023 LIBRARY; T=0.K
deuterons from (s,n*)d

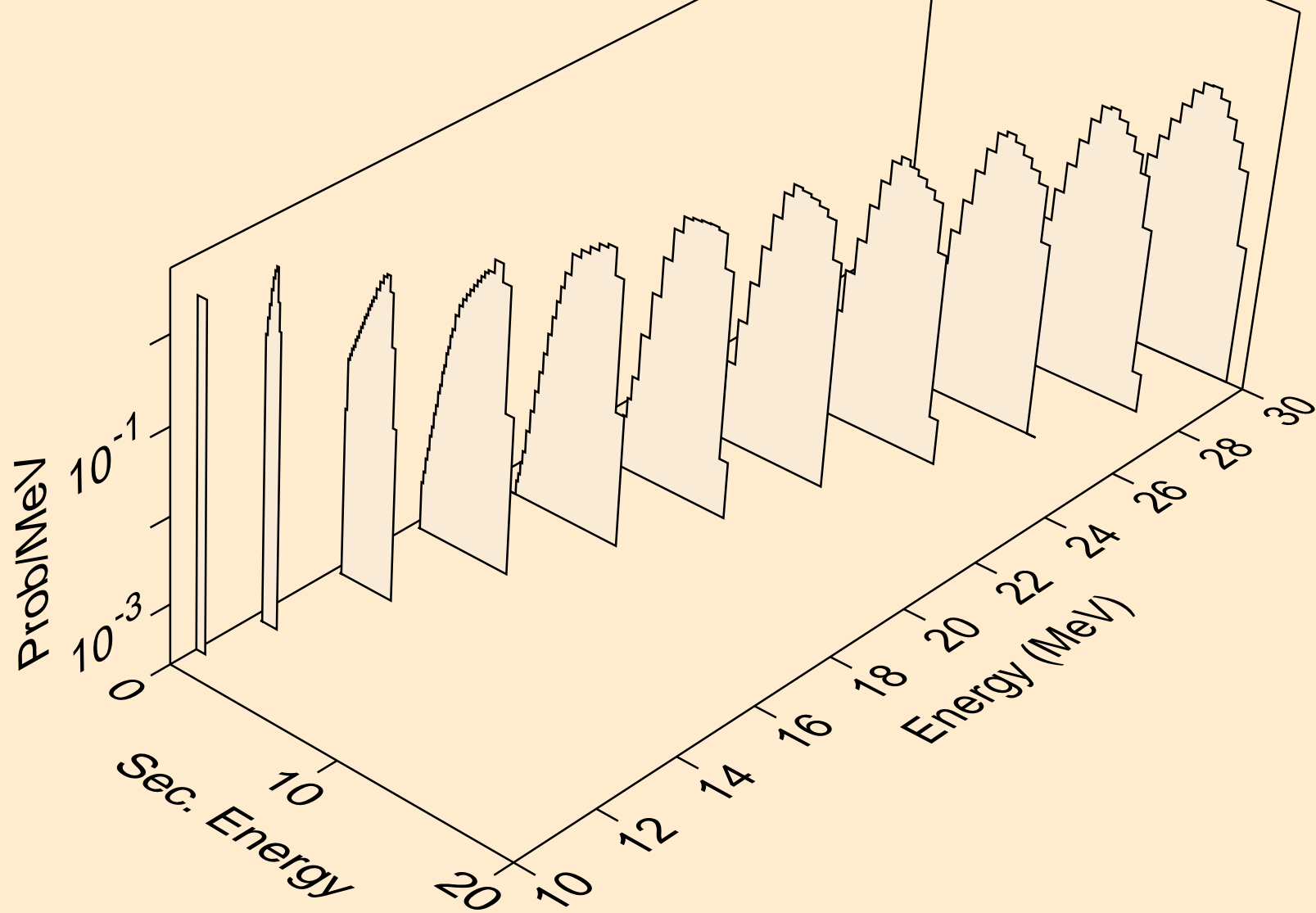

FM247M HELION ACER TENDL-2023 LIBRARY; T=0.K
deuterons from (s,d)

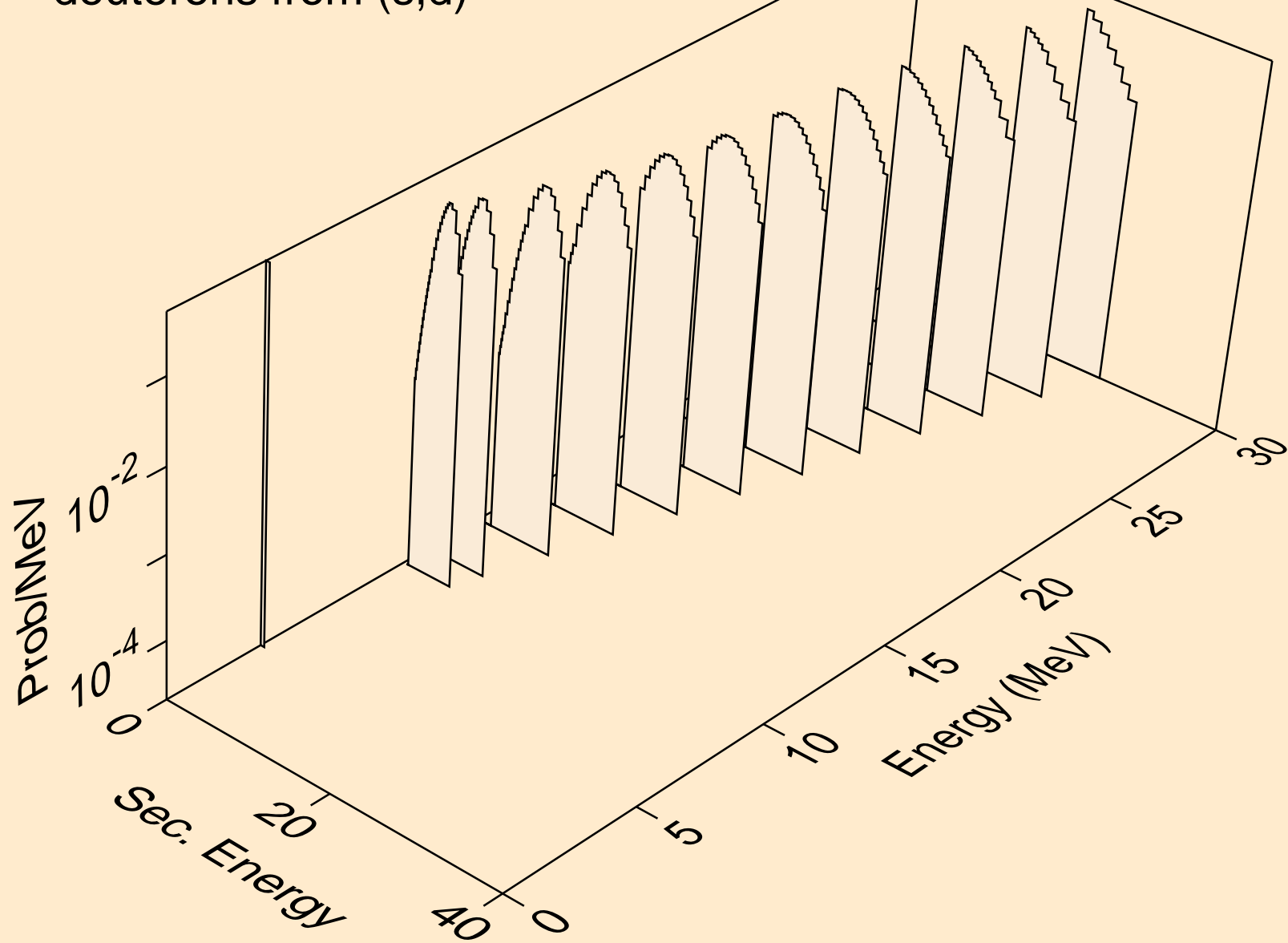

FM247M HELION ACER TENDL-2023 LIBRARY; T=0.K
tritons from (s,x)

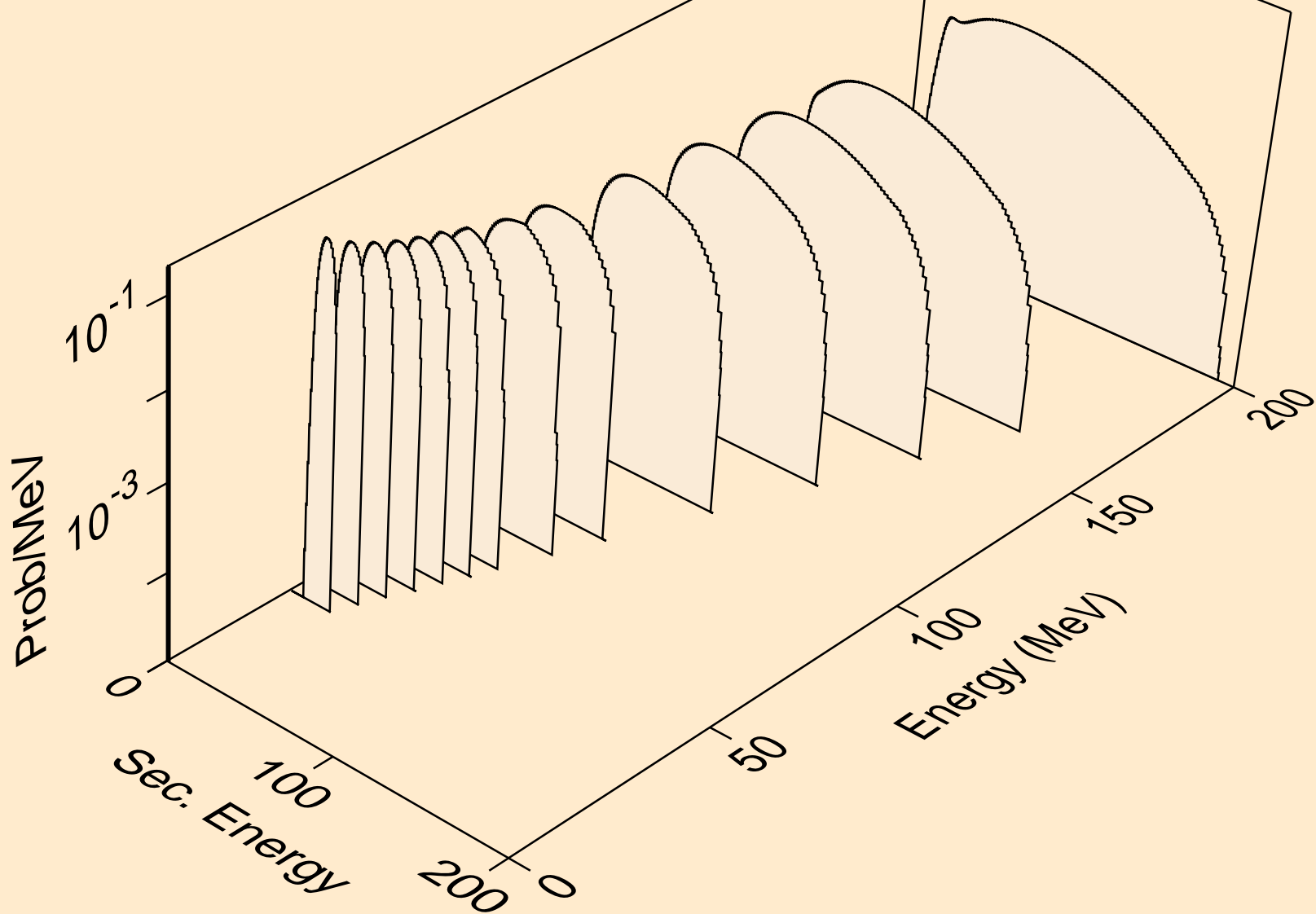

FM247M HELION ACER TENDL-2023 LIBRARY; T=0.K
tritons from (s,n*)t

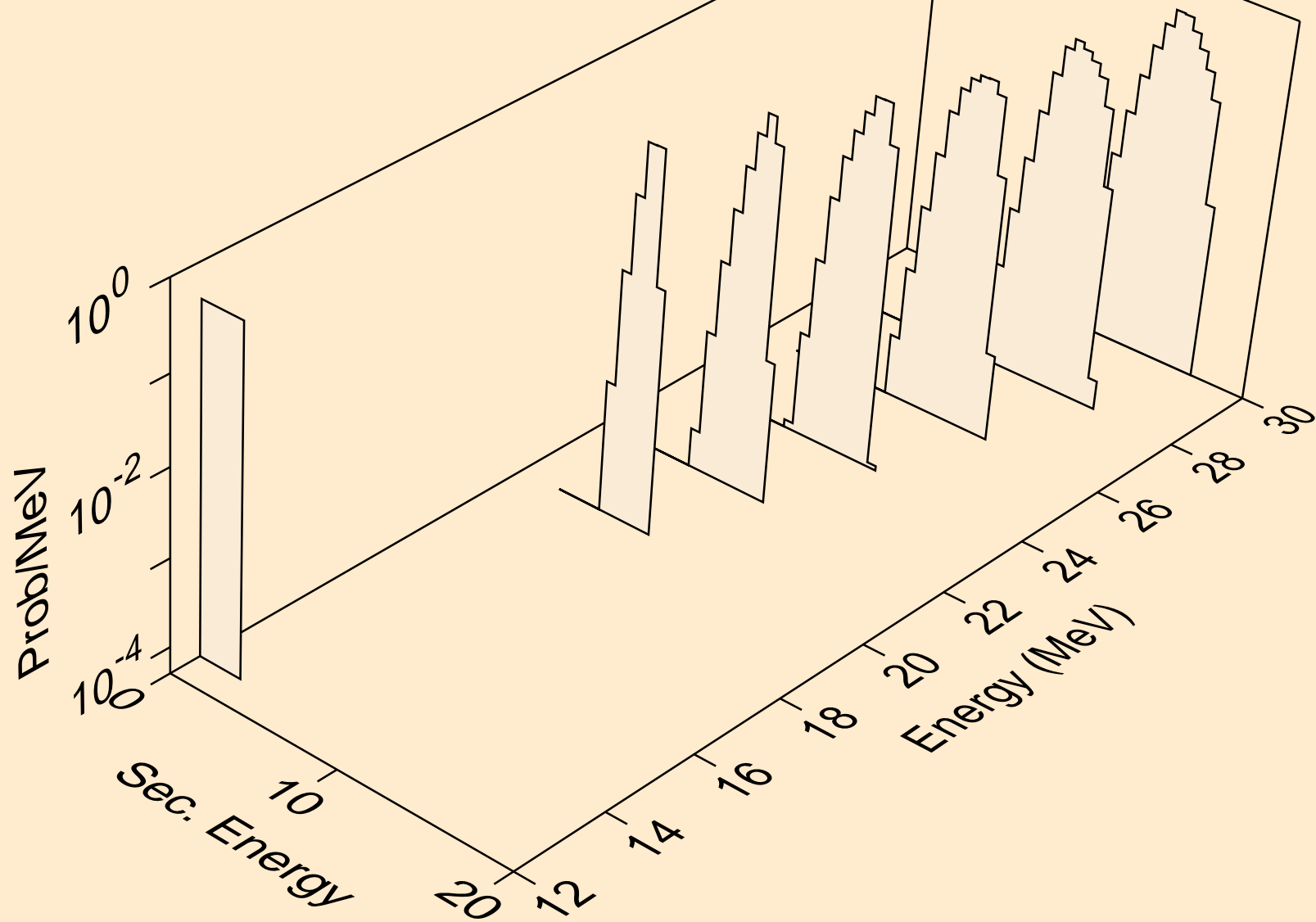

FM247M HELION ACER TENDL-2023 LIBRARY; T=0.K
tritons from (s,t)

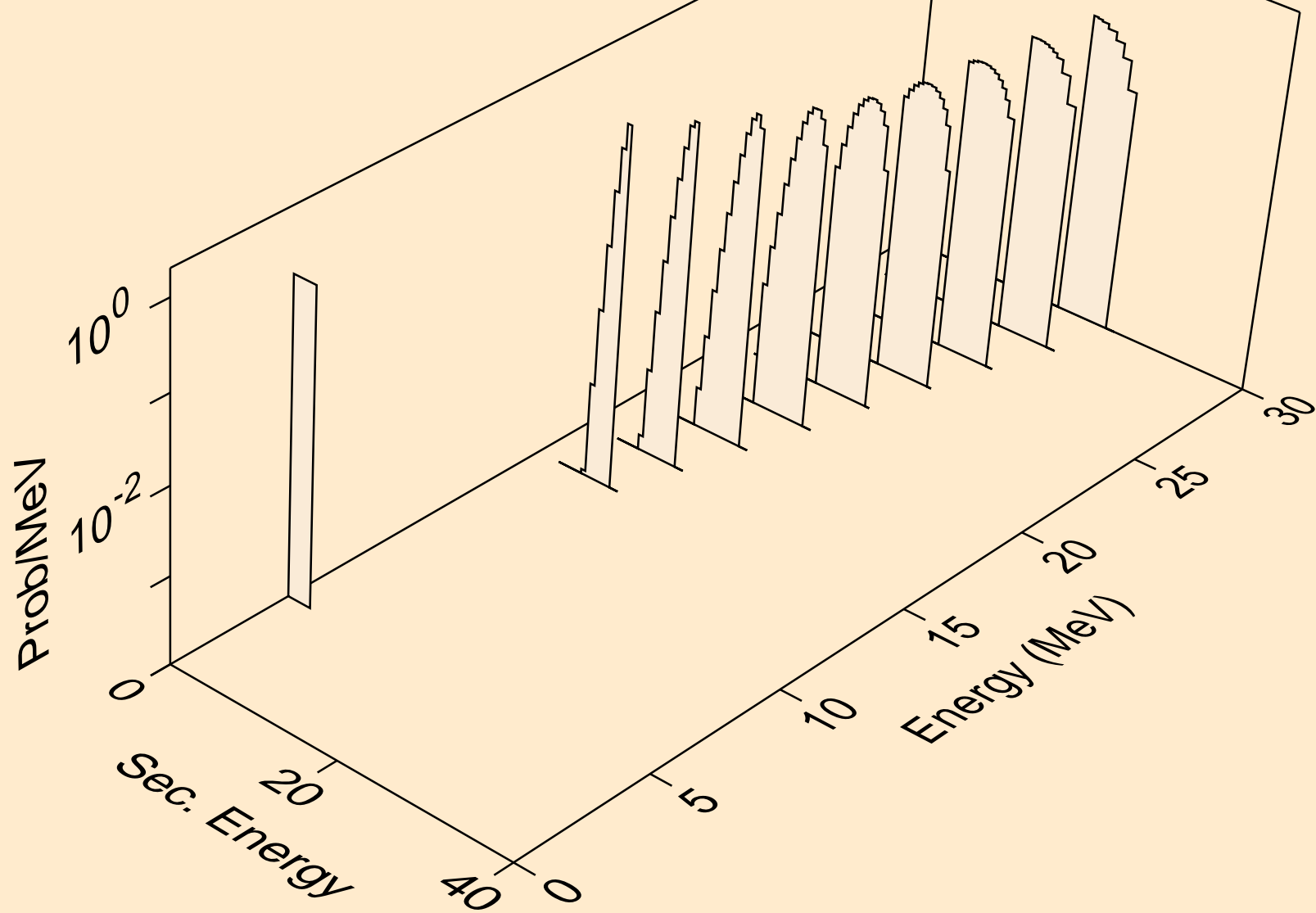

FM247M HELION ACER TENDL-2023 LIBRARY; T=0.K
alphas from (s,x)

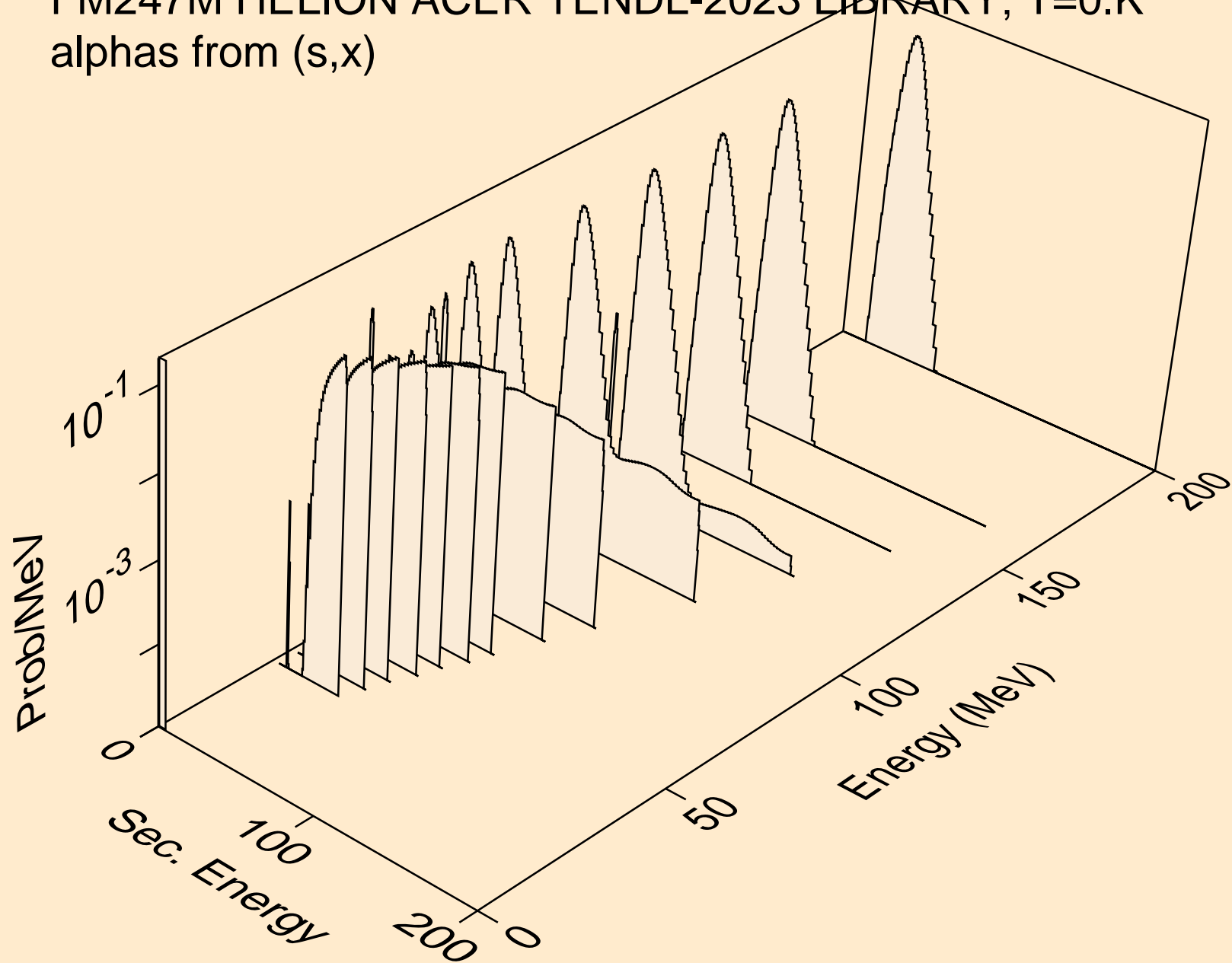

FM247M HELION ACER TENDL-2023 LIBRARY; T=0.K
alphas from (s,n*)a

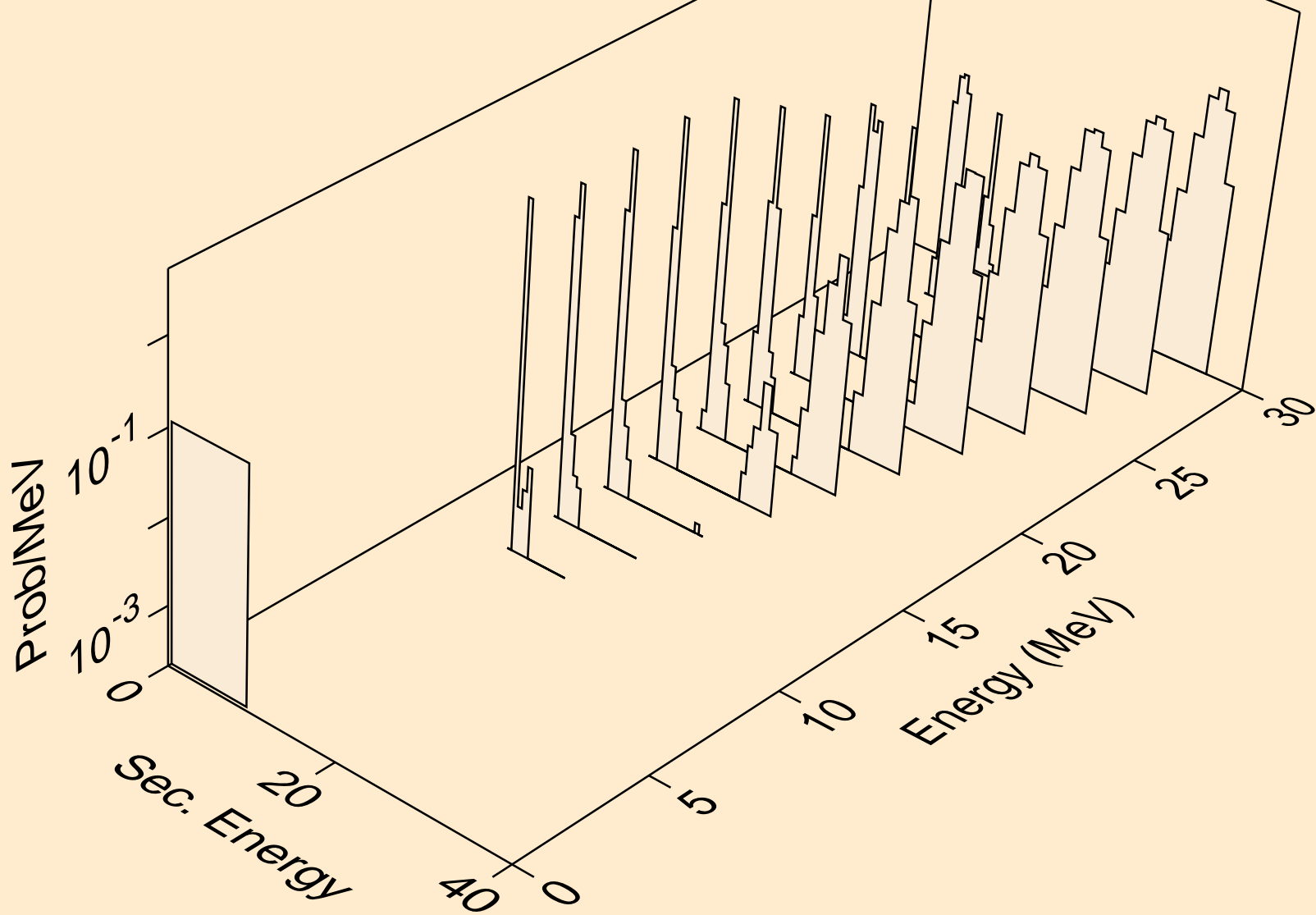

FM247M HELION ACER TENDL-2023 LIBRARY; T=0.K
alphas from (s,a)

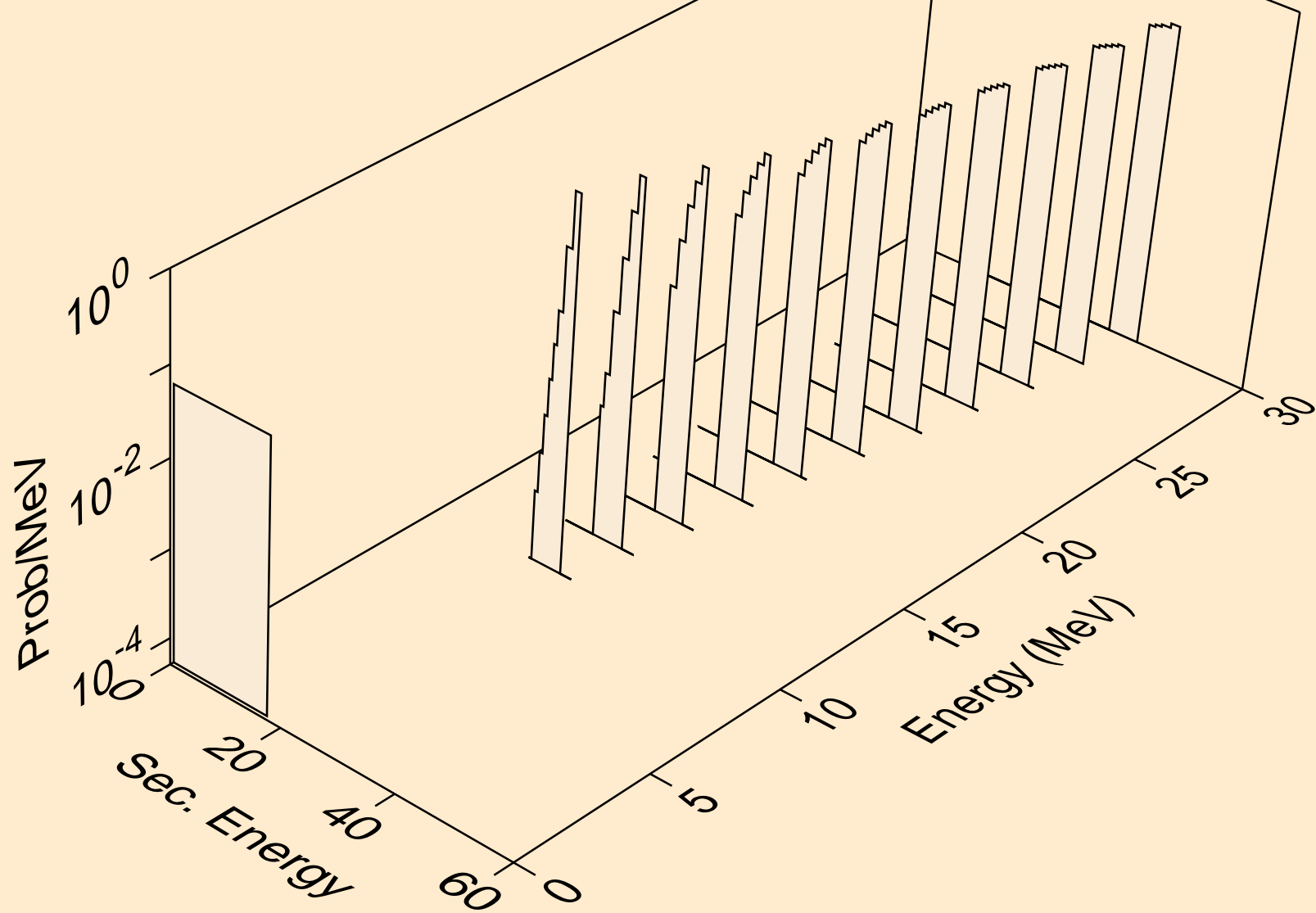

FM247M HELION ACER TENDL-2023 LIBRARY; T=0.K
alphas from (s,pa)

