

# HG194 HELION ACER TENDL-2023 LIBRARY; T=0.K

## Principal cross sections

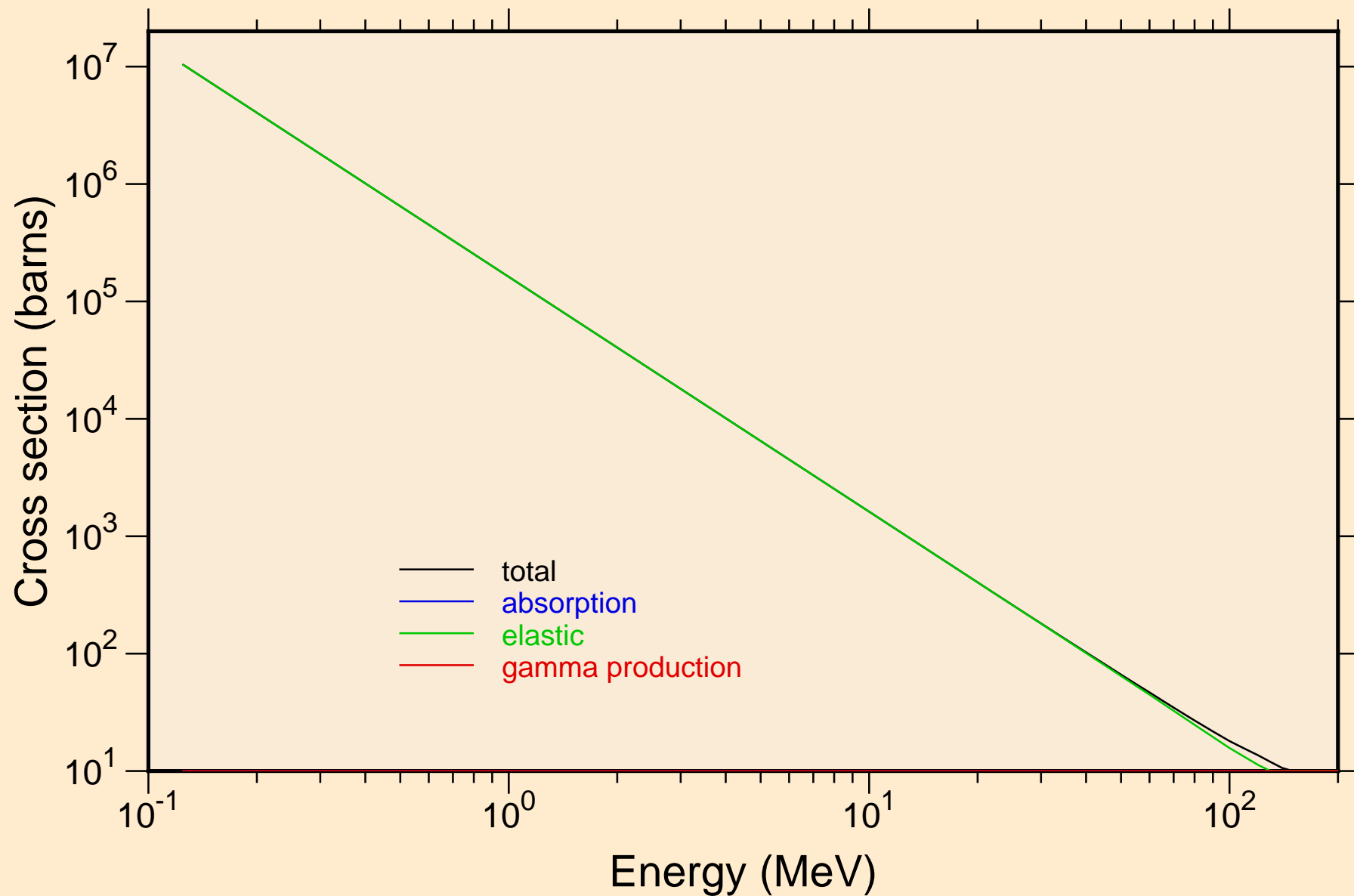

HG194 HELION ACER TENDL-2023 LIBRARY; T=0.K  
Heating

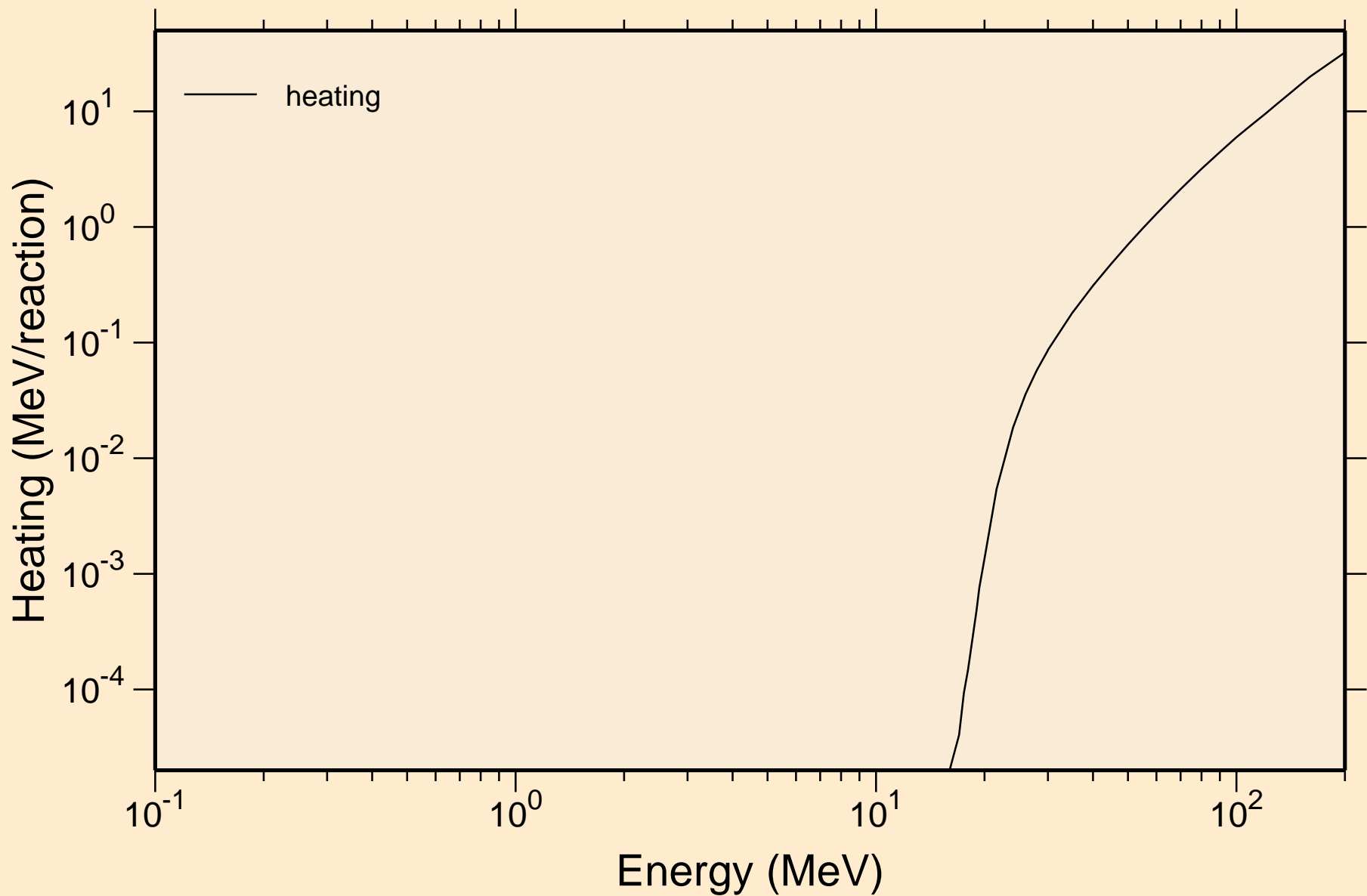

# HG194 HELION ACER TENDL-2023 LIBRARY; T=0.K

## Principal cross sections

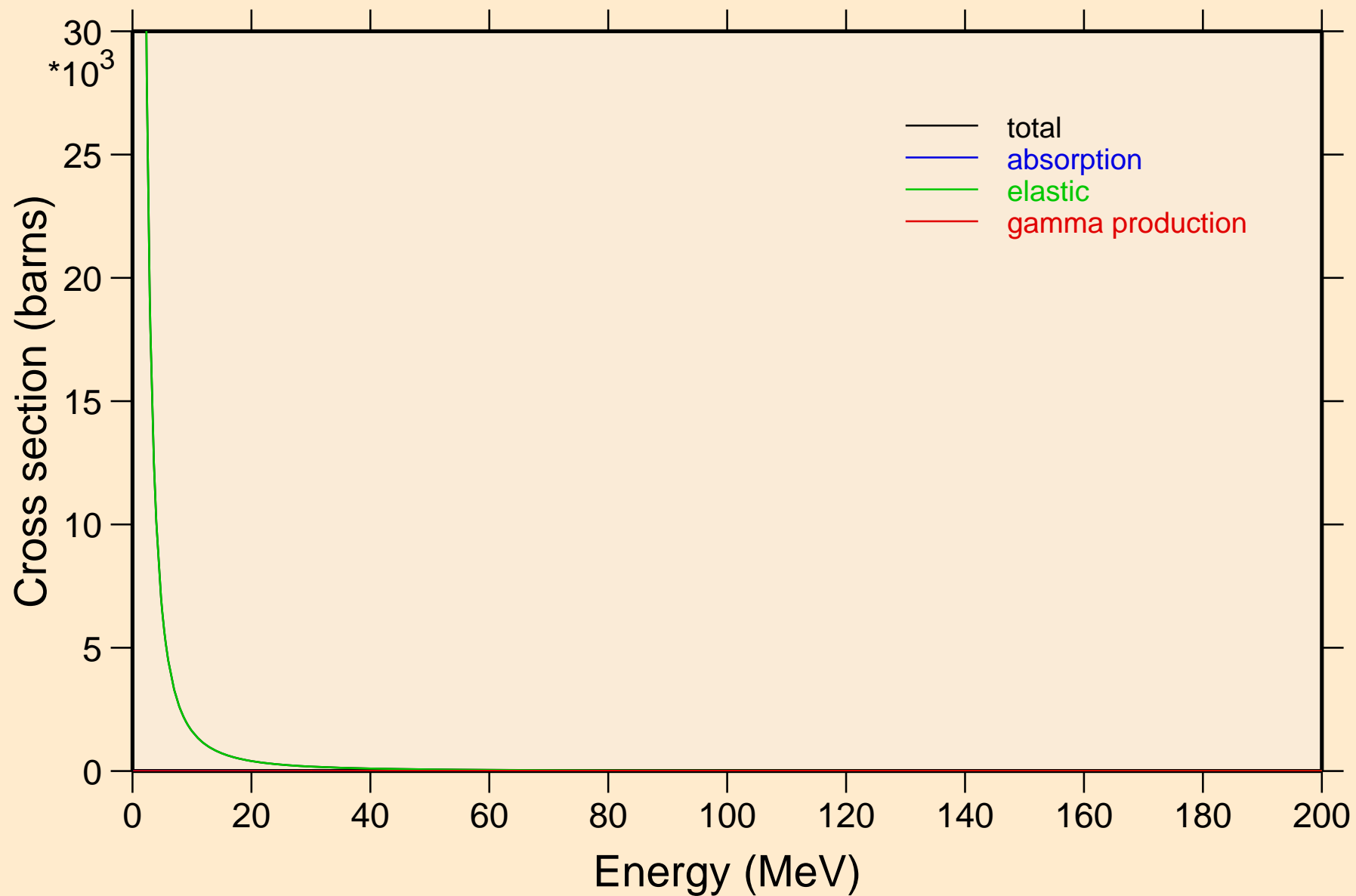

HG194 HELION ACER TENDL-2023 LIBRARY; T=0.K  
Heating

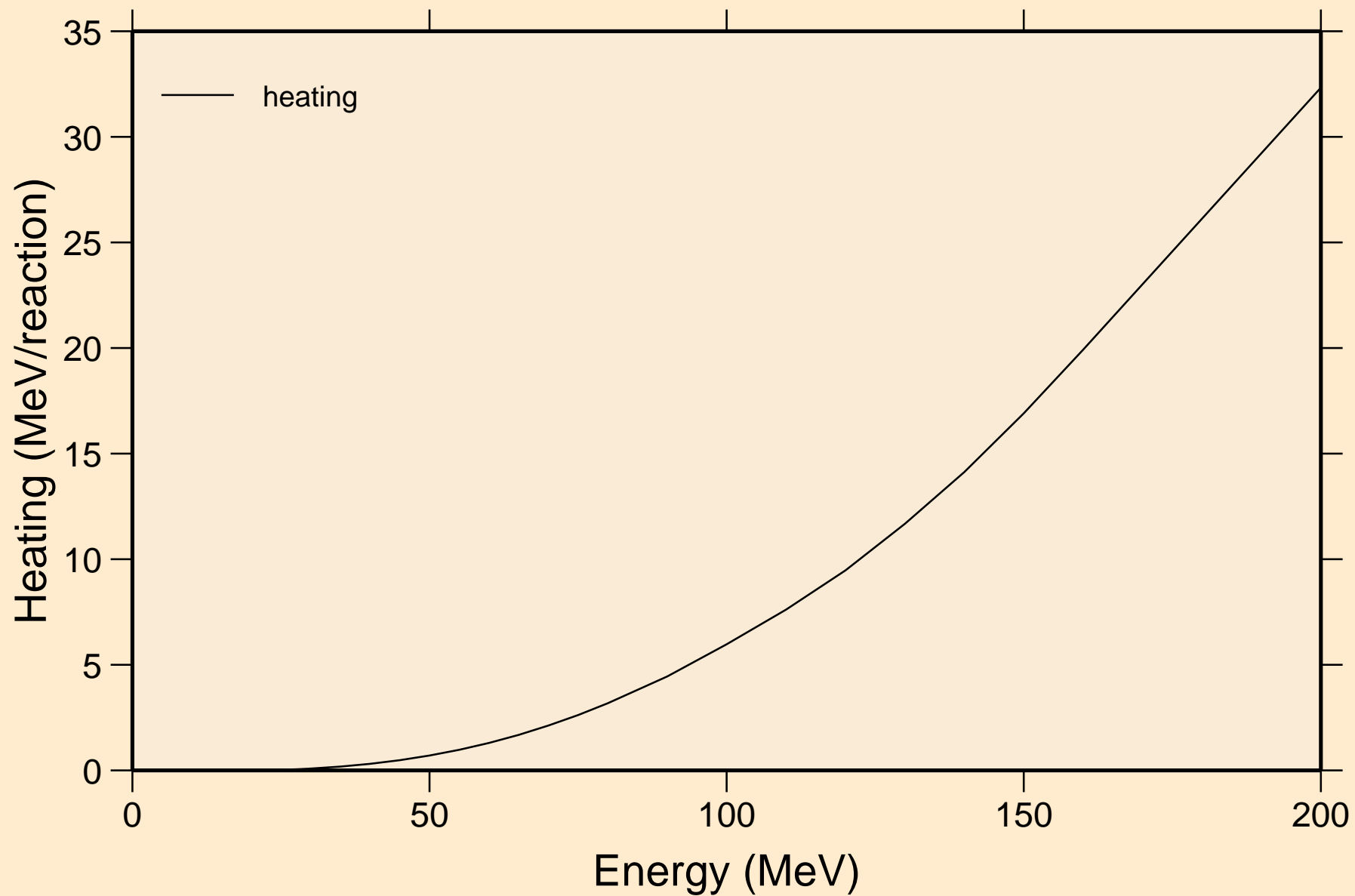

HG194 HELION ACER TENDL-2023 LIBRARY; T=0.K  
Threshold reactions

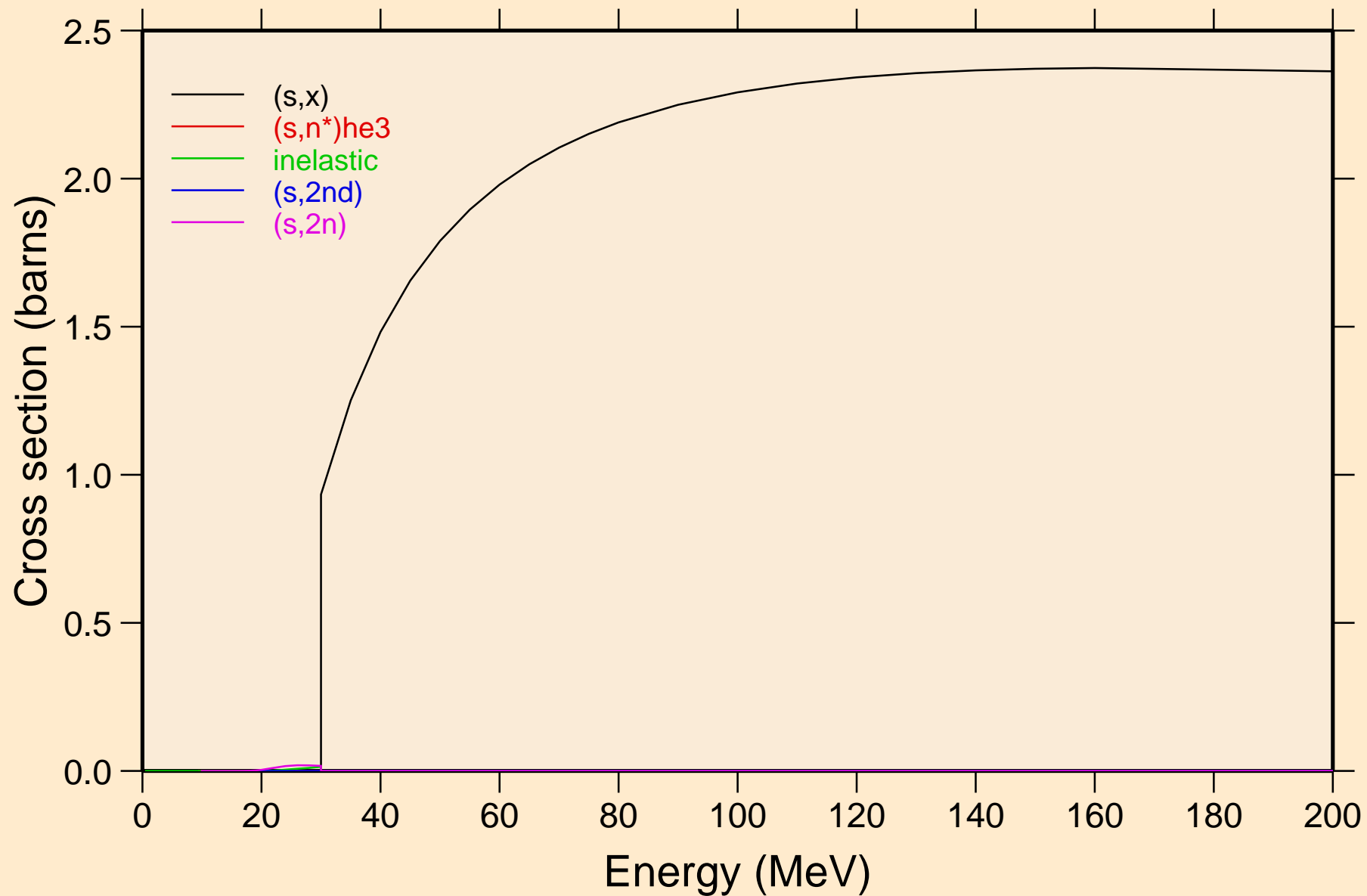

HG194 HELION ACER TENDL-2023 LIBRARY; T=0.K  
Threshold reactions

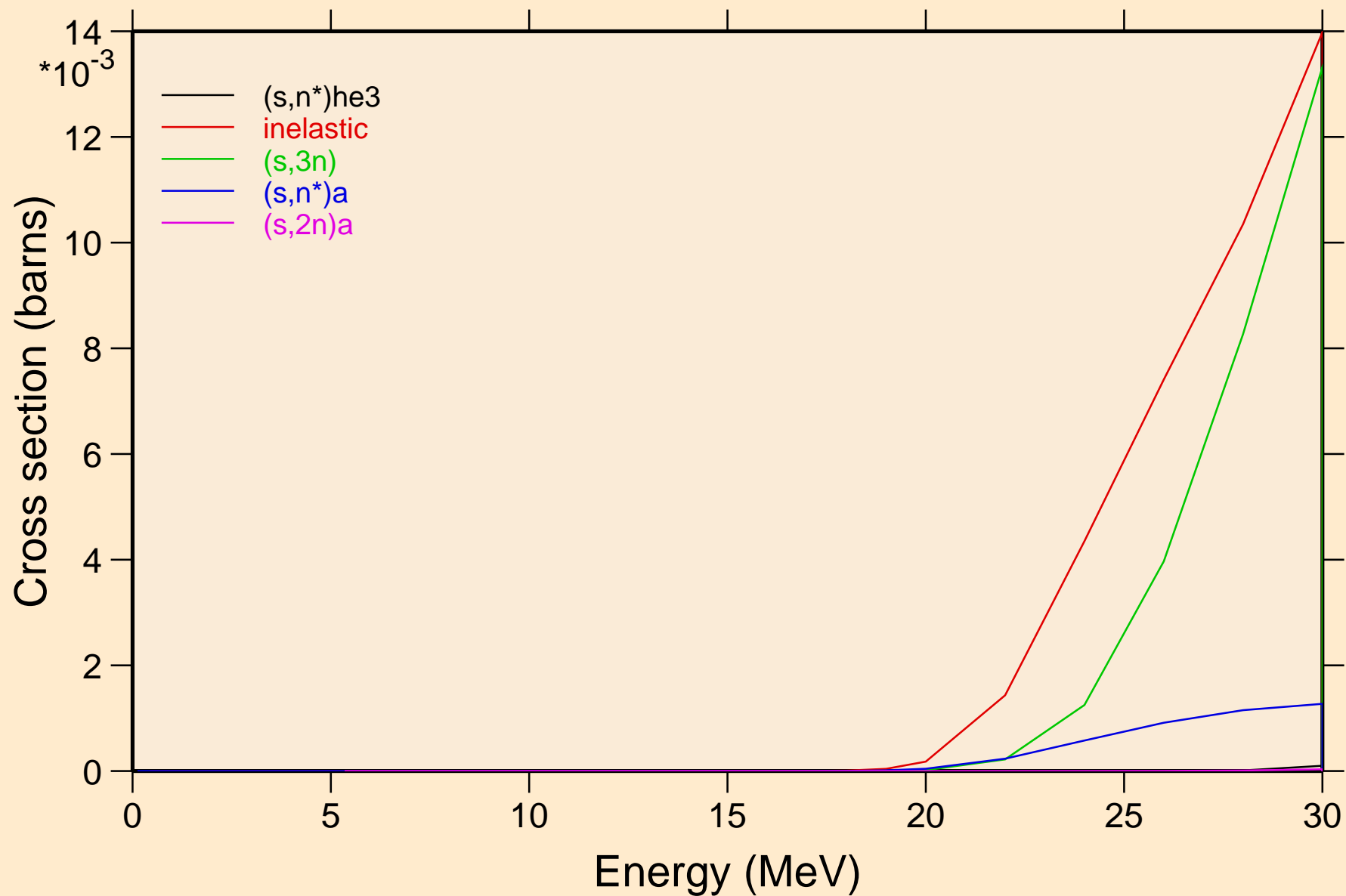

HG194 HELION ACER TENDL-2023 LIBRARY; T=0.K  
Threshold reactions

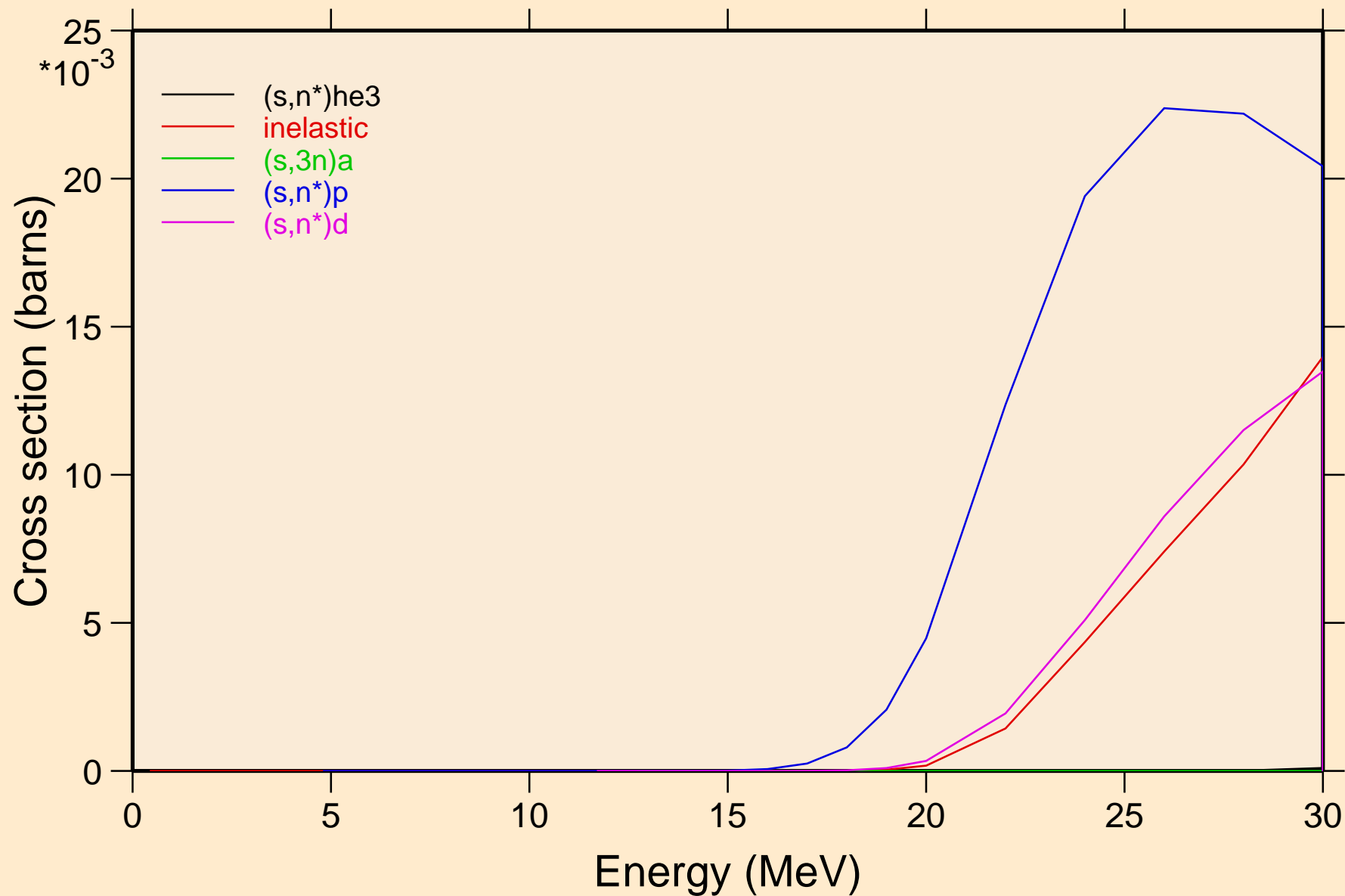

# HG194 HELION ACER TENDL-2023 LIBRARY; T=0.K

## Threshold reactions

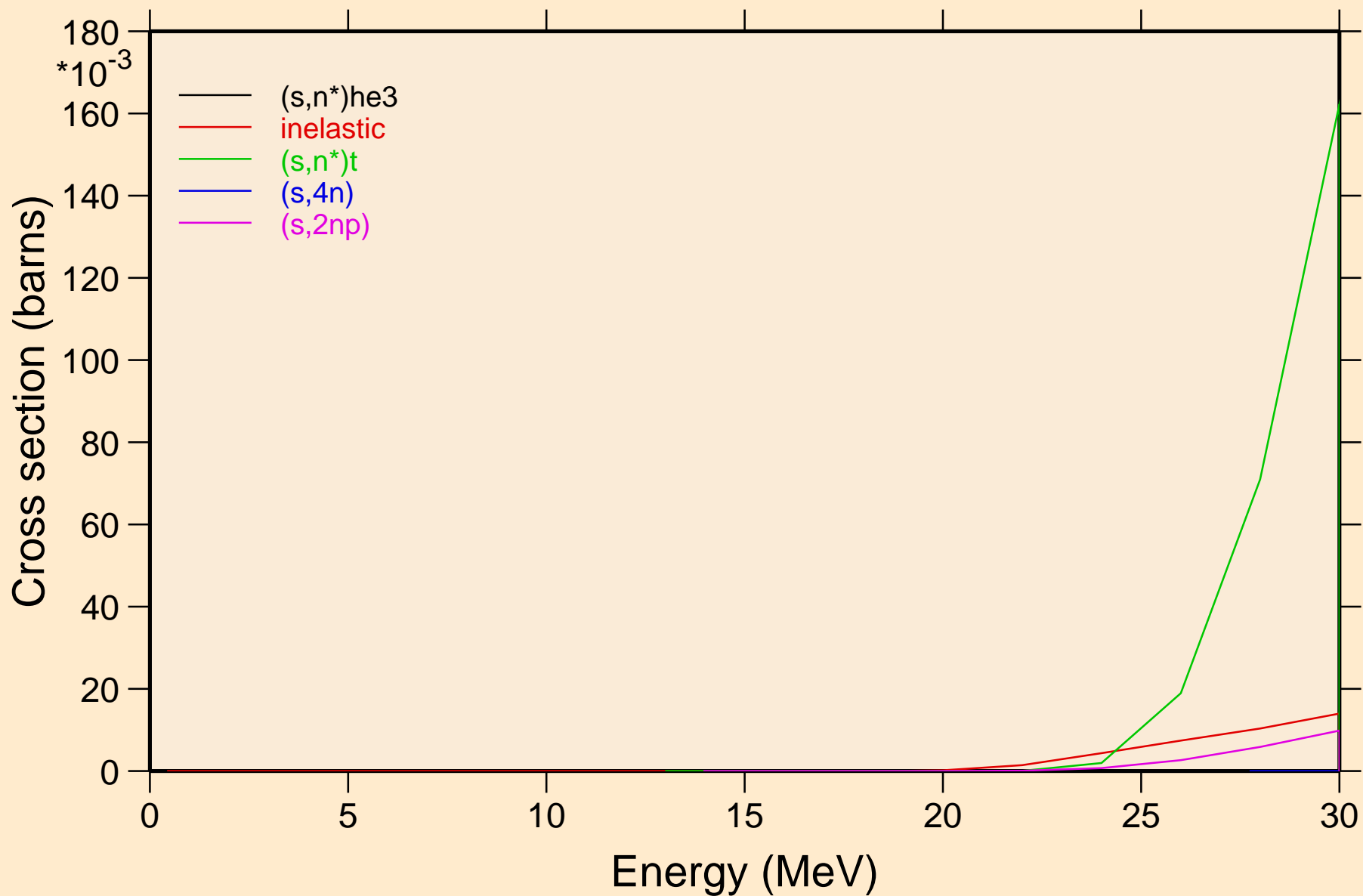

HG194 HELION ACER TENDL-2023 LIBRARY; T=0.K  
Threshold reactions

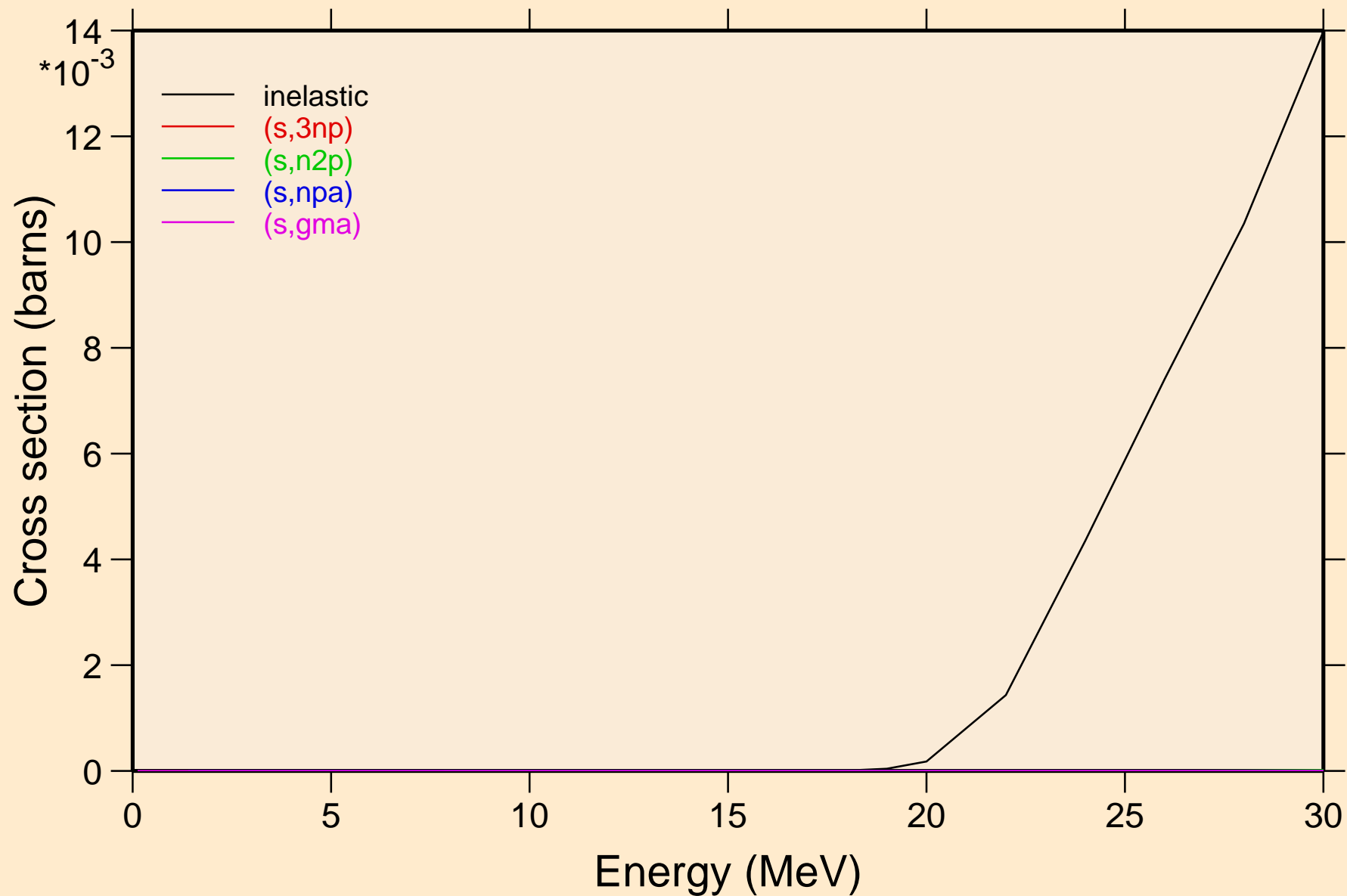

# HG194 HELION ACER TENDL-2023 LIBRARY; T=0.K

## Threshold reactions

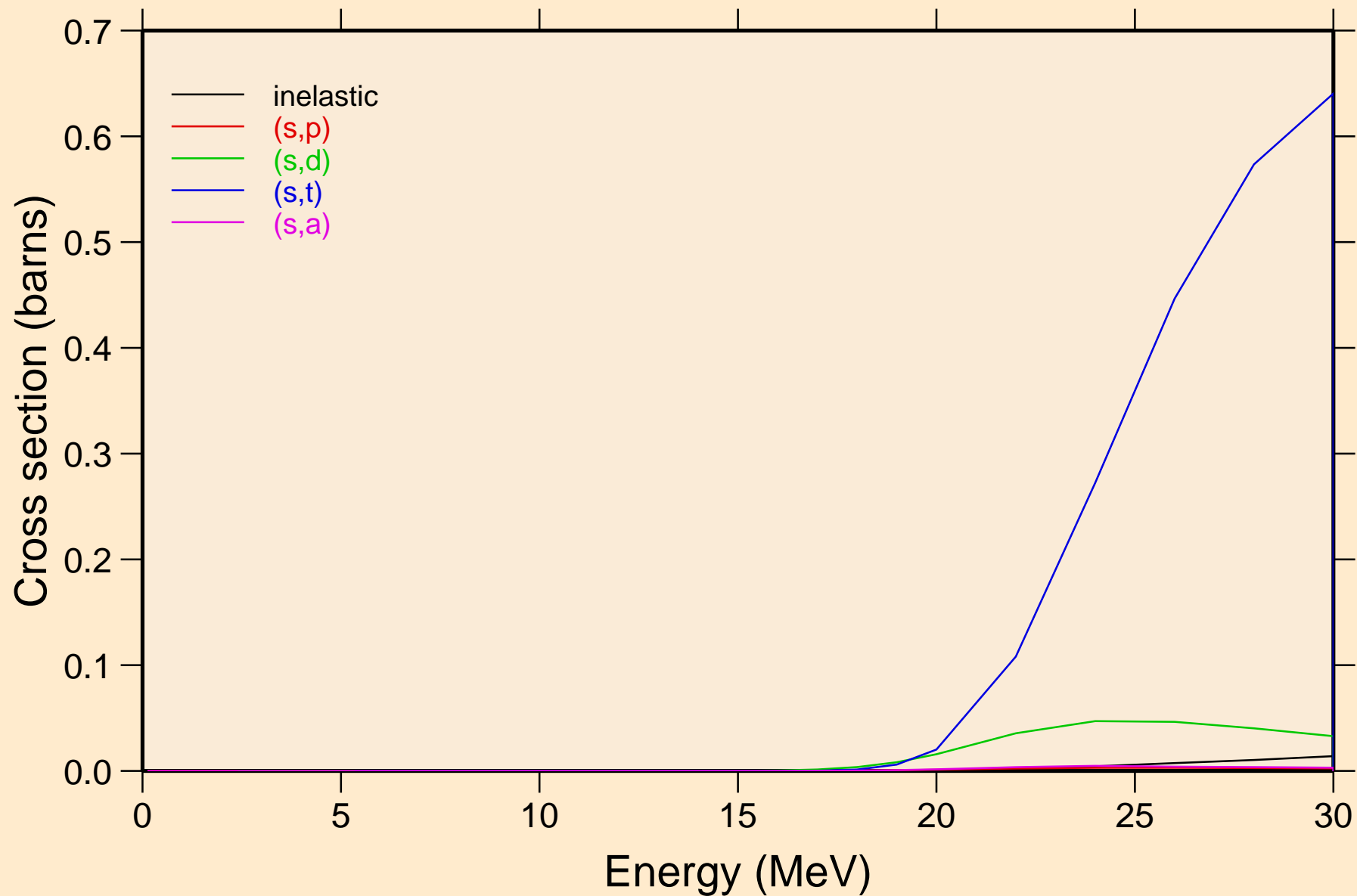

# HG194 HELION ACER TENDL-2023 LIBRARY; T=0.K

## Threshold reactions

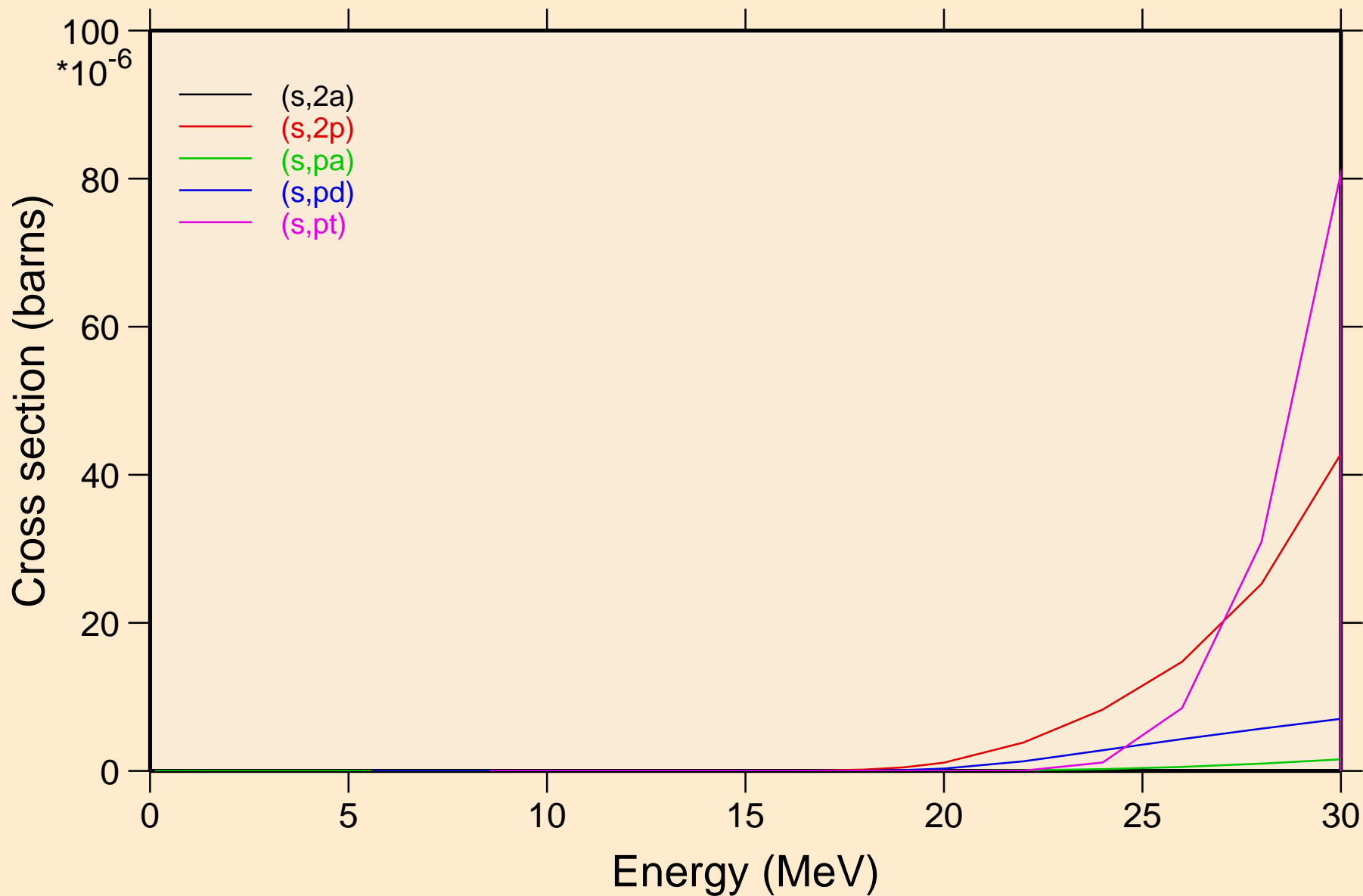

HG194 HELION ACER TENDL-2023 LIBRARY; T=0.K  
Threshold reactions

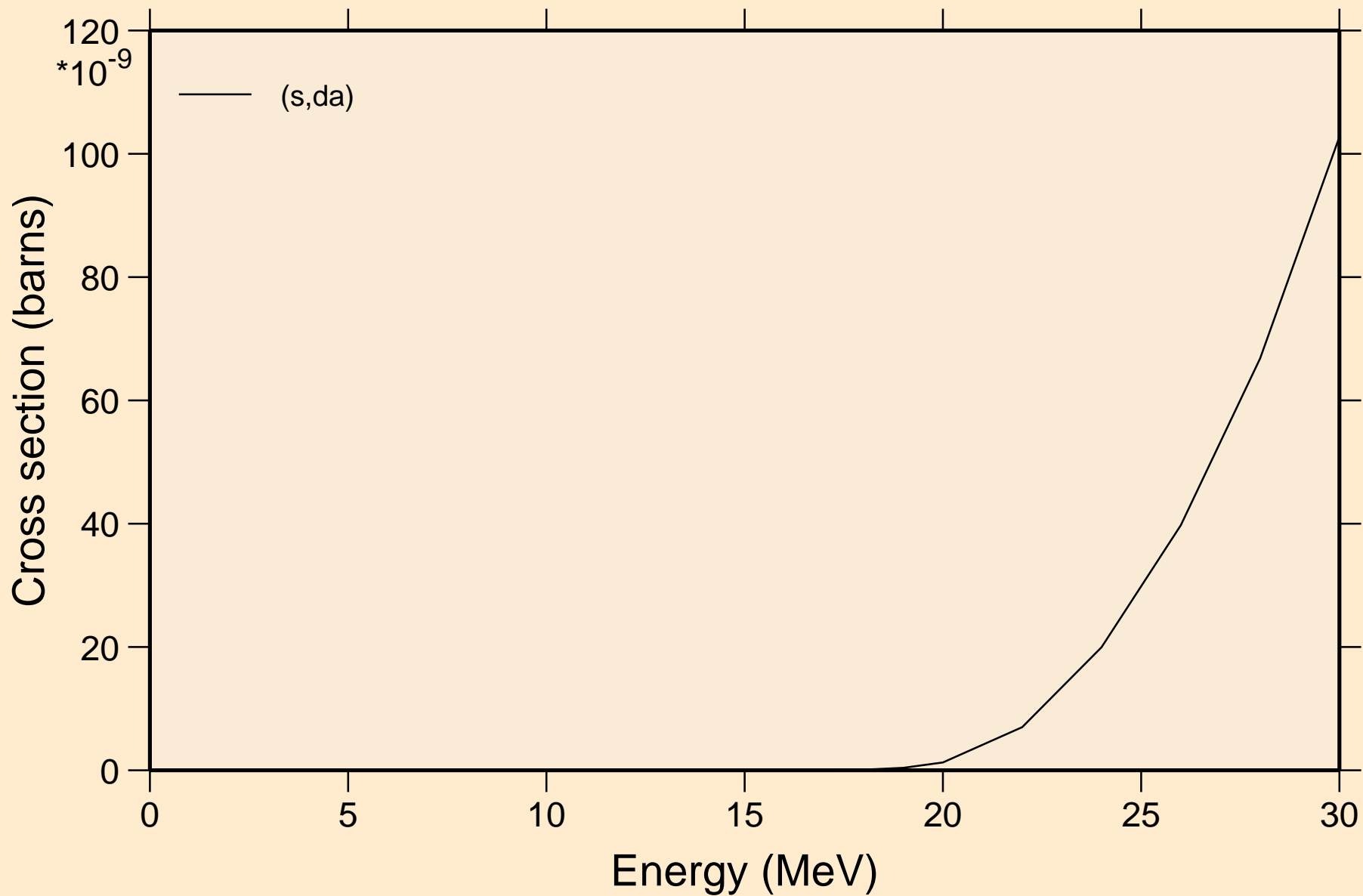

HG194 HELION ACER TENDL-2023 LIBRARY; T=0.K  
angular distribution for elastic

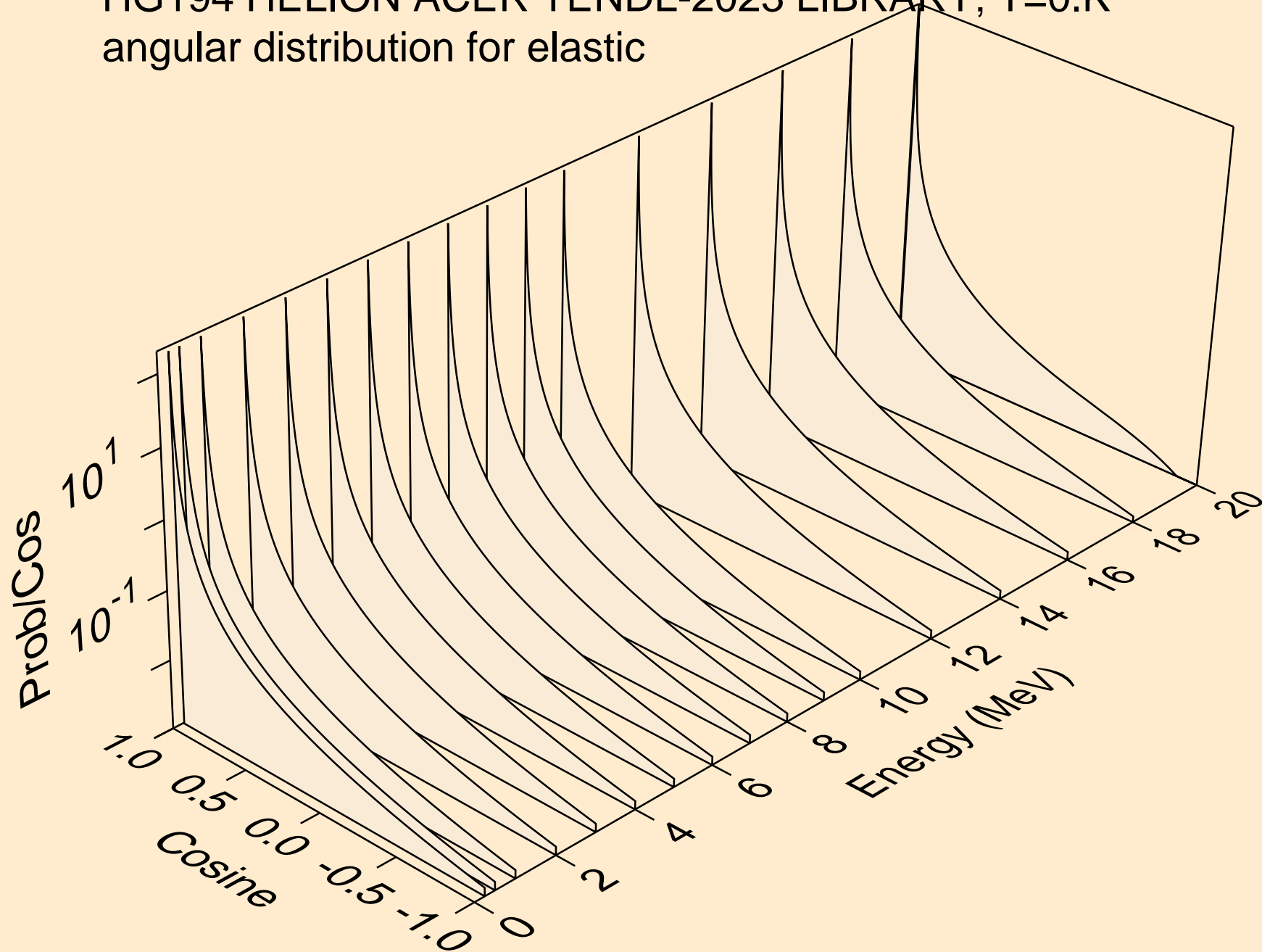

HG194 HELION ACER TENDL-2023 LIBRARY; T=0.K  
angular distribution for elastic

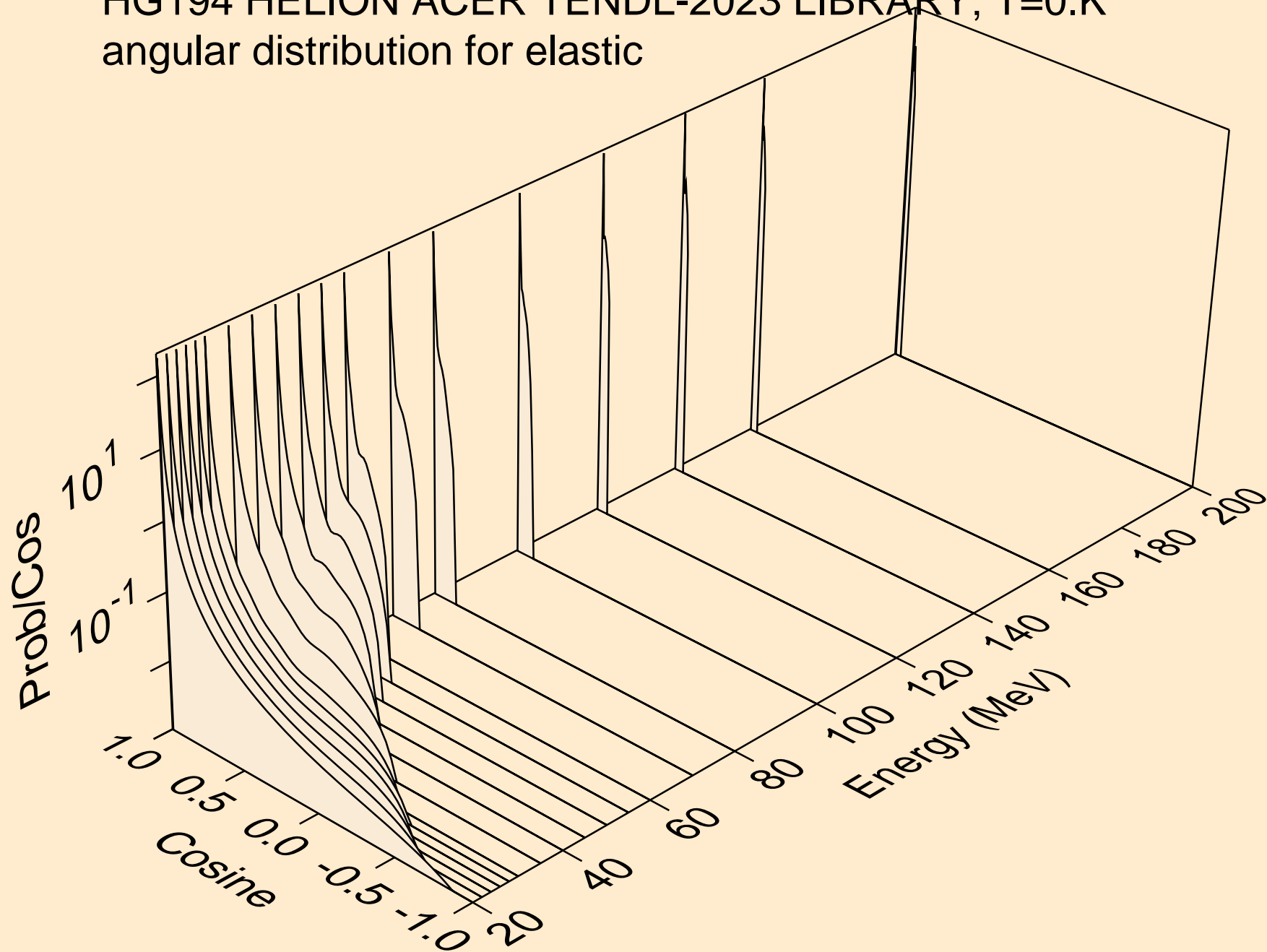

HG194 HELION ACER TENDL-2023 LIBRARY; T=0.K  
He-3 emission for (s,x)

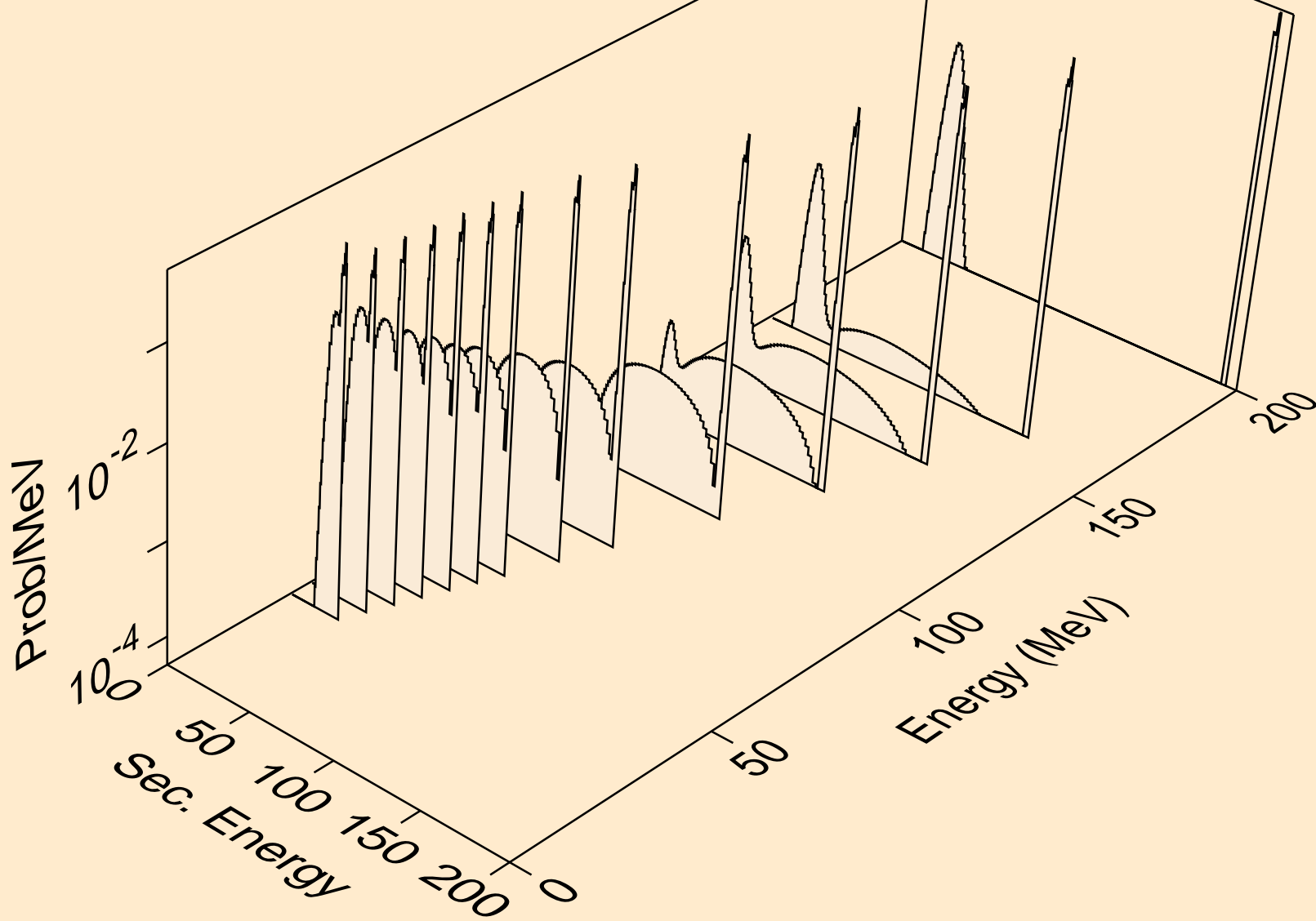

HG194 HELION ACER TENDL-2023 LIBRARY; T=0.K  
He-3 emission for (s,n\*)he3

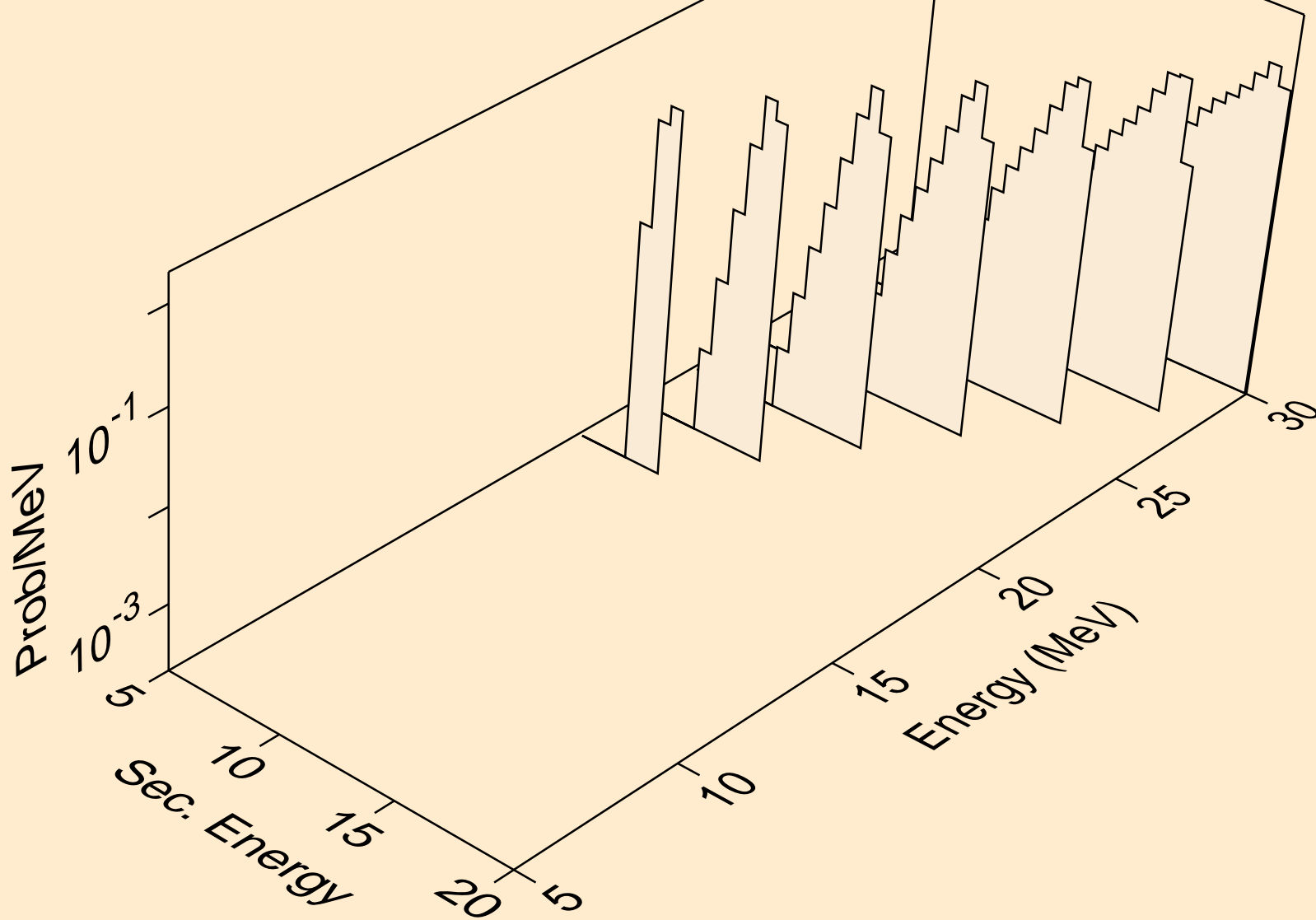

HG194 HELION ACER TENDL-2023 LIBRARY; T=0.K  
He-3 emission for inelastic

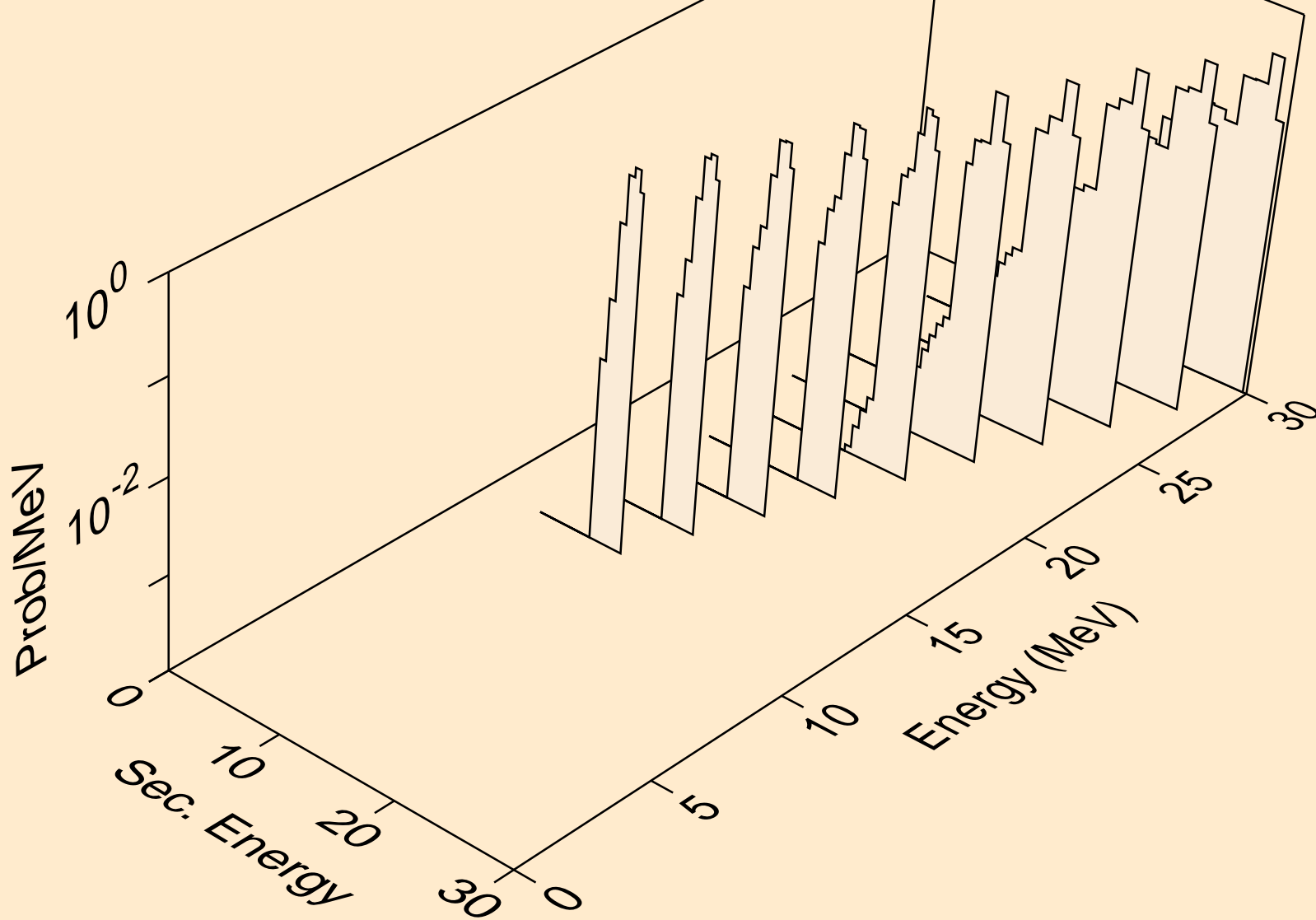

HG194 HELION ACER TENDL-2023 LIBRARY; T=0.K  
Photon emission for (z,n)

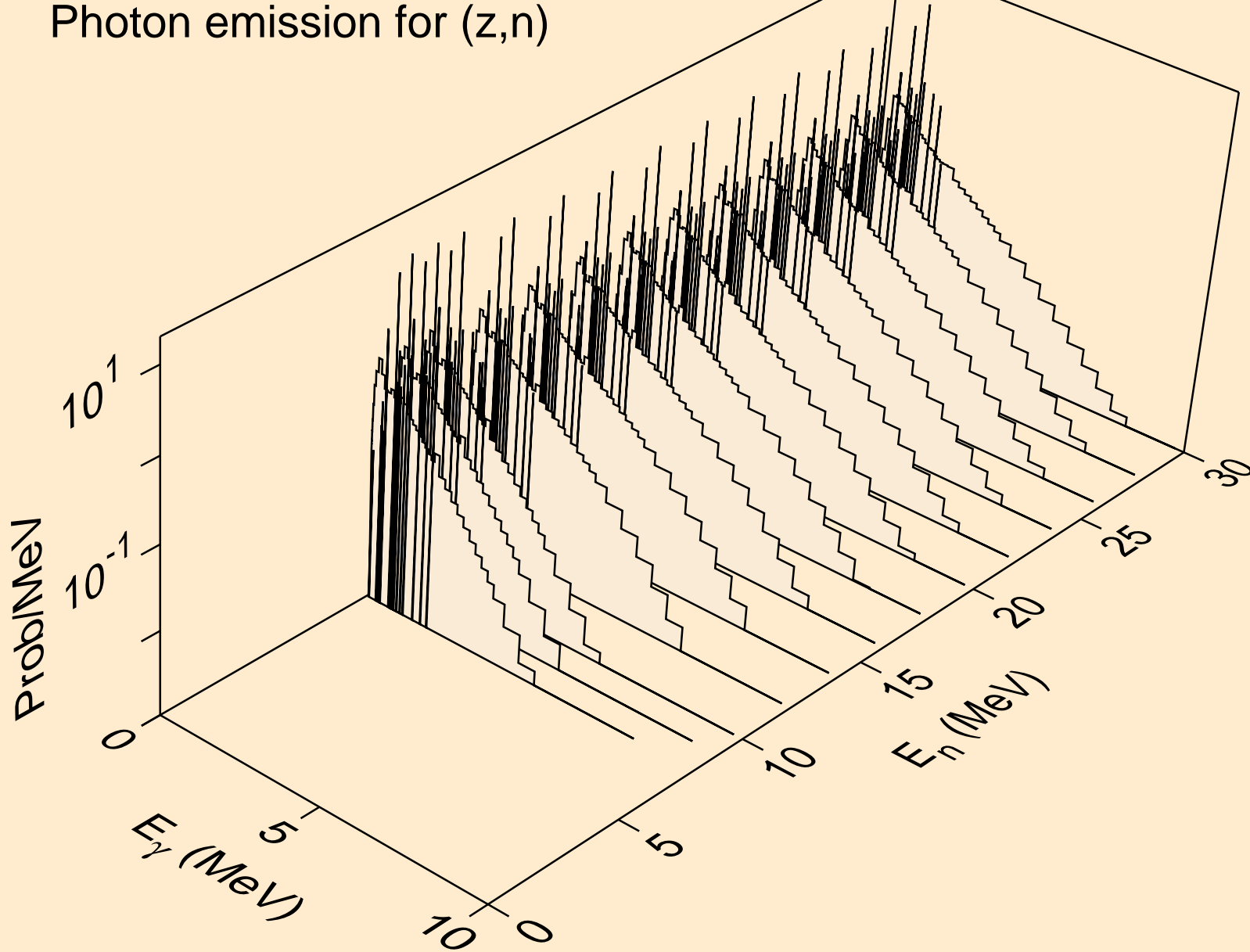

HG194 HELION ACER TENDL-2023 LIBRARY; T=0.K  
Photon emission for (z,x)

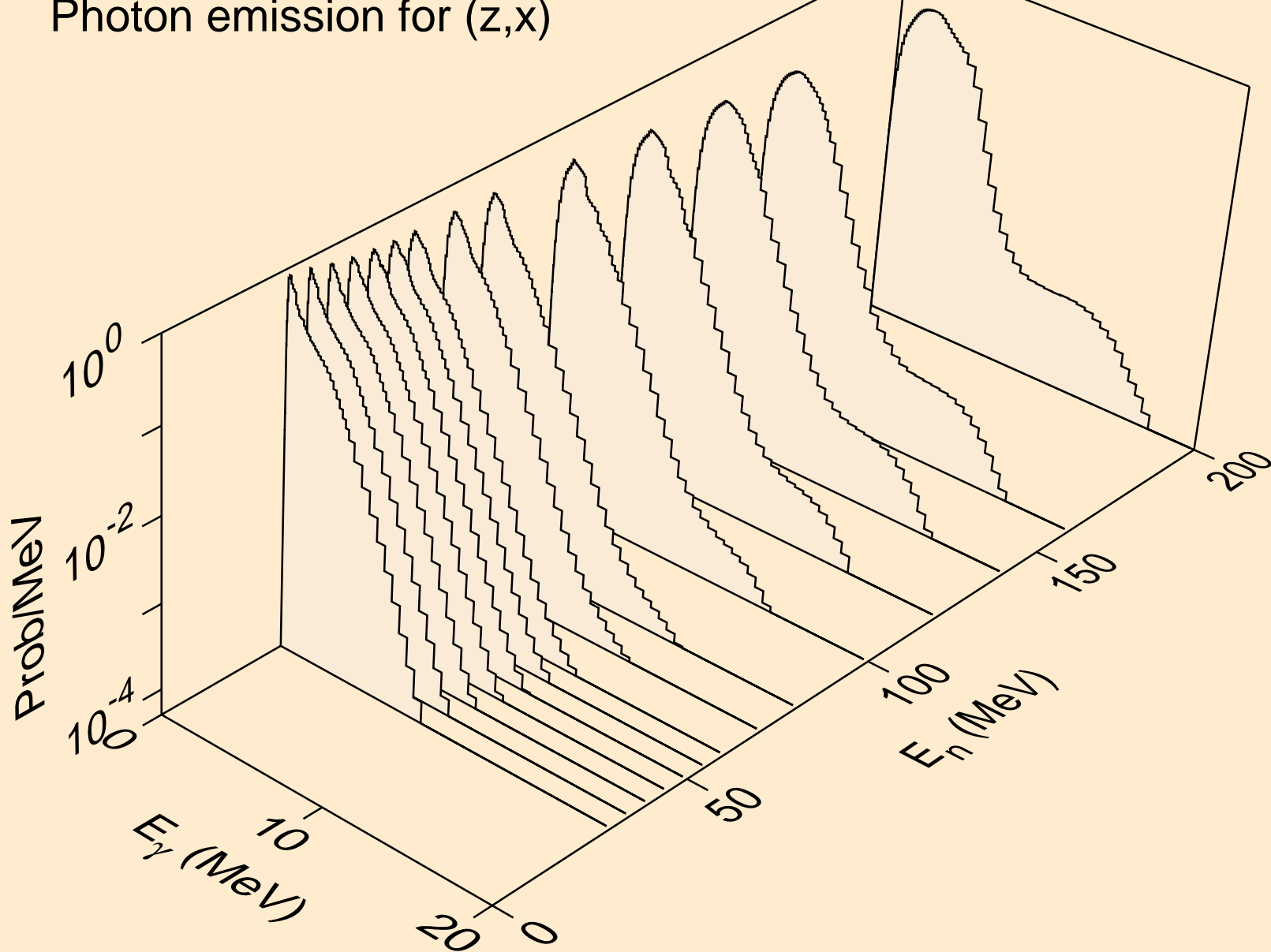

HG194 HELION ACER TENDL-2023 LIBRARY; T=0.K  
Photon emission for (n,2nd)

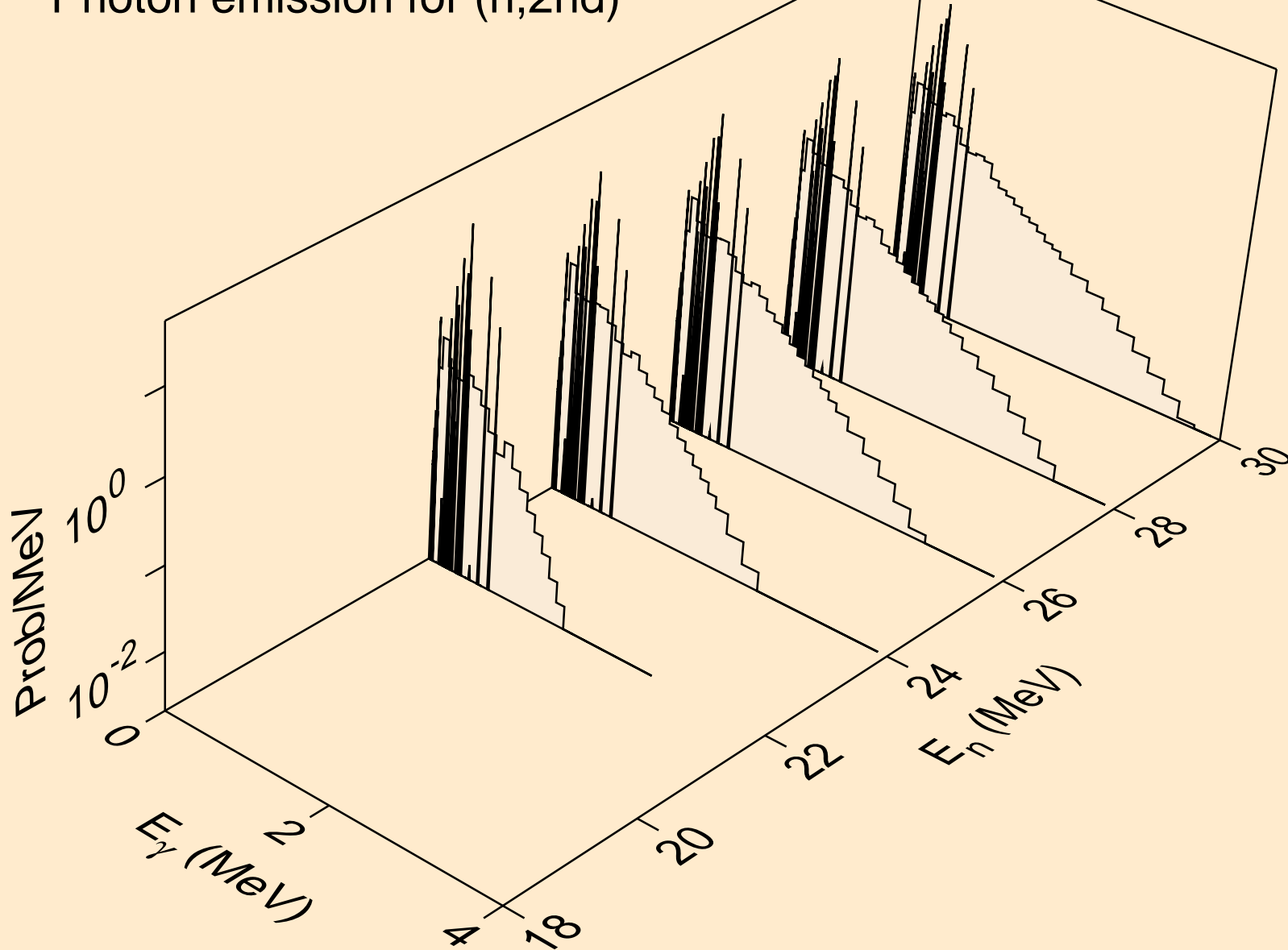

HG194 HELION ACER TENDL-2023 LIBRARY; T=0.K  
Photon emission for (n,2n)

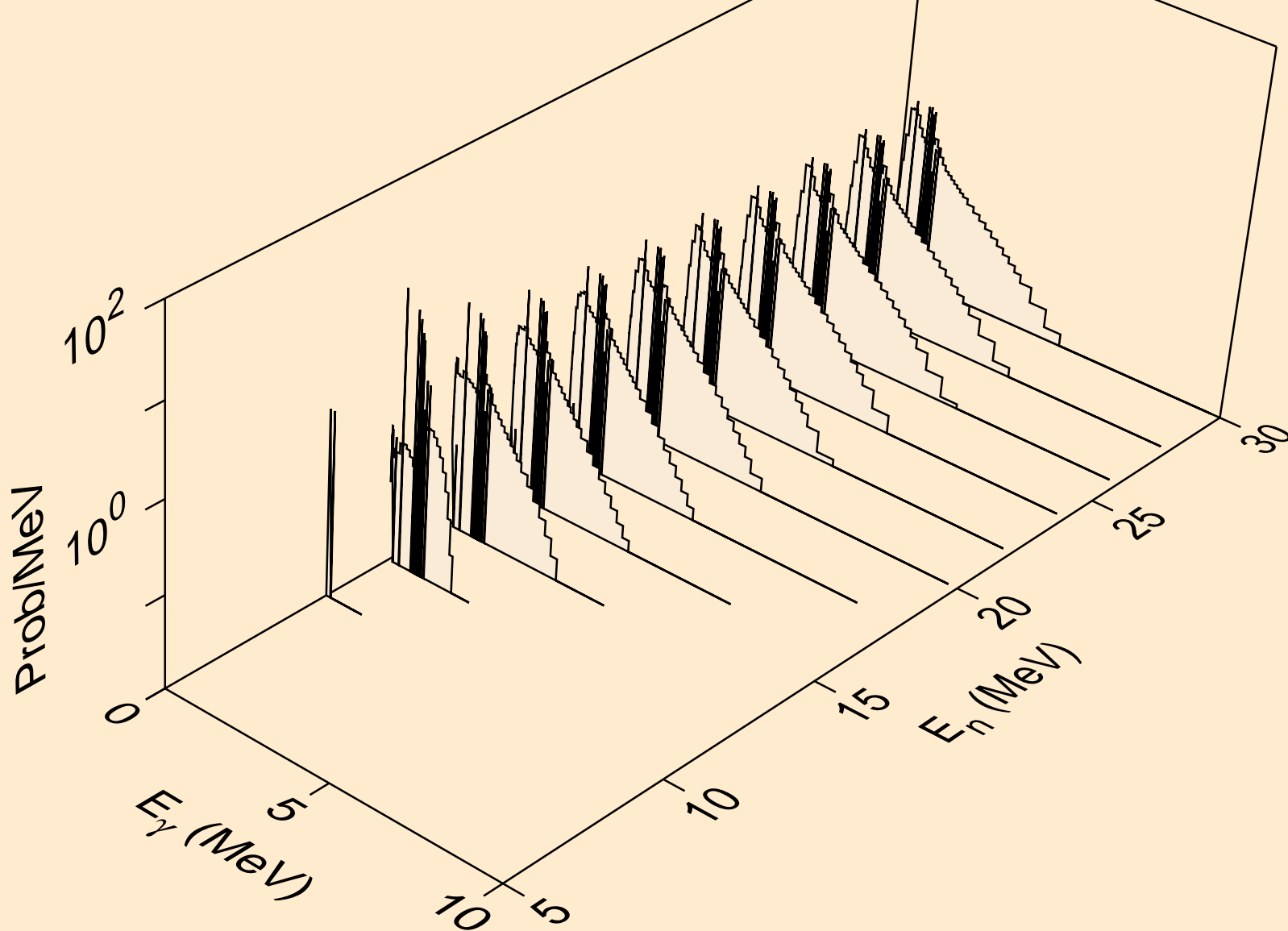

HG194 HELION ACER TENDL-2023 LIBRARY; T=0.K  
Photon emission for (n,3n)

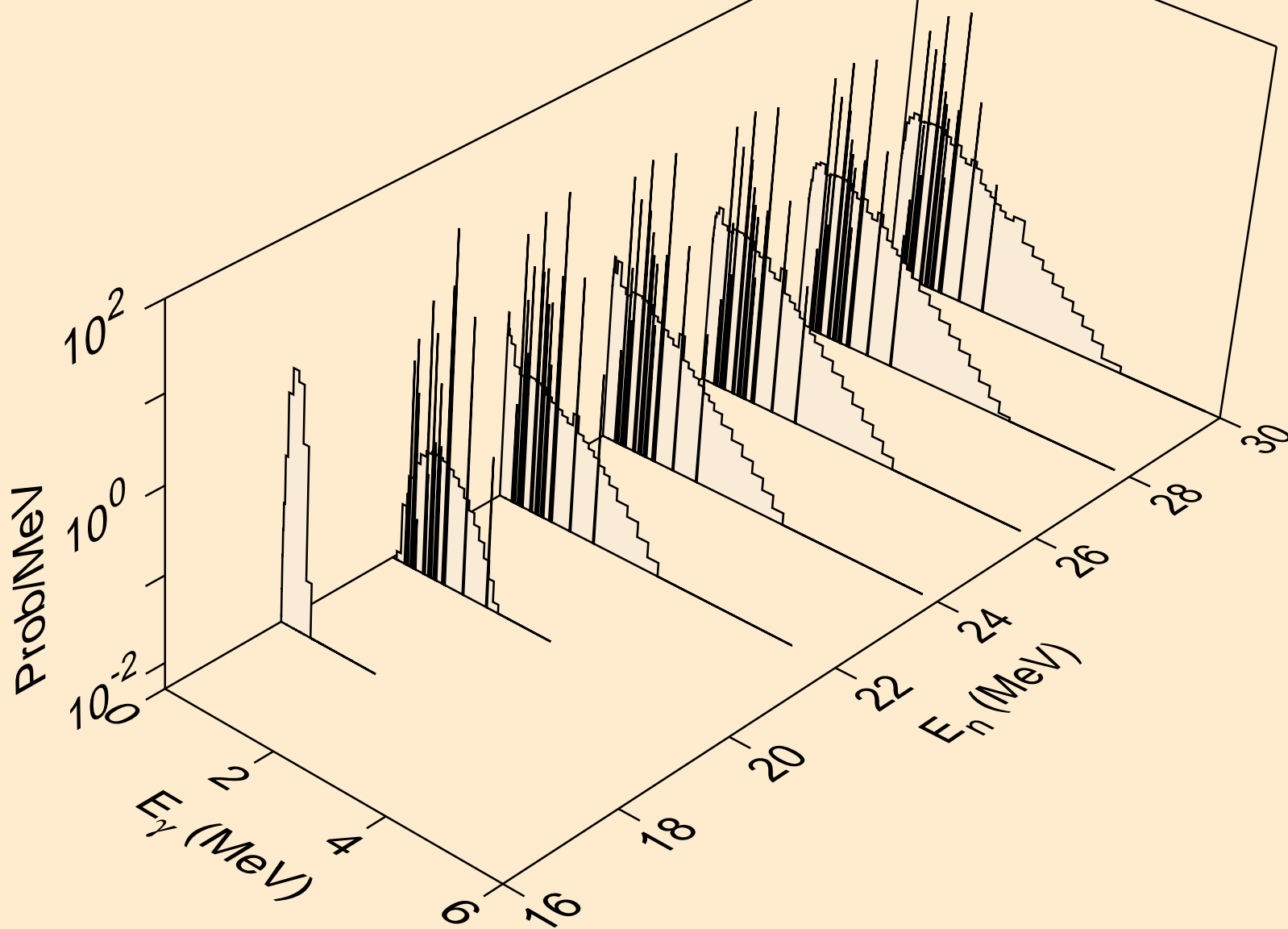

HG194 HELION ACER TENDL-2023 LIBRARY; T=0.K  
Photon emission for (n,n\*)a

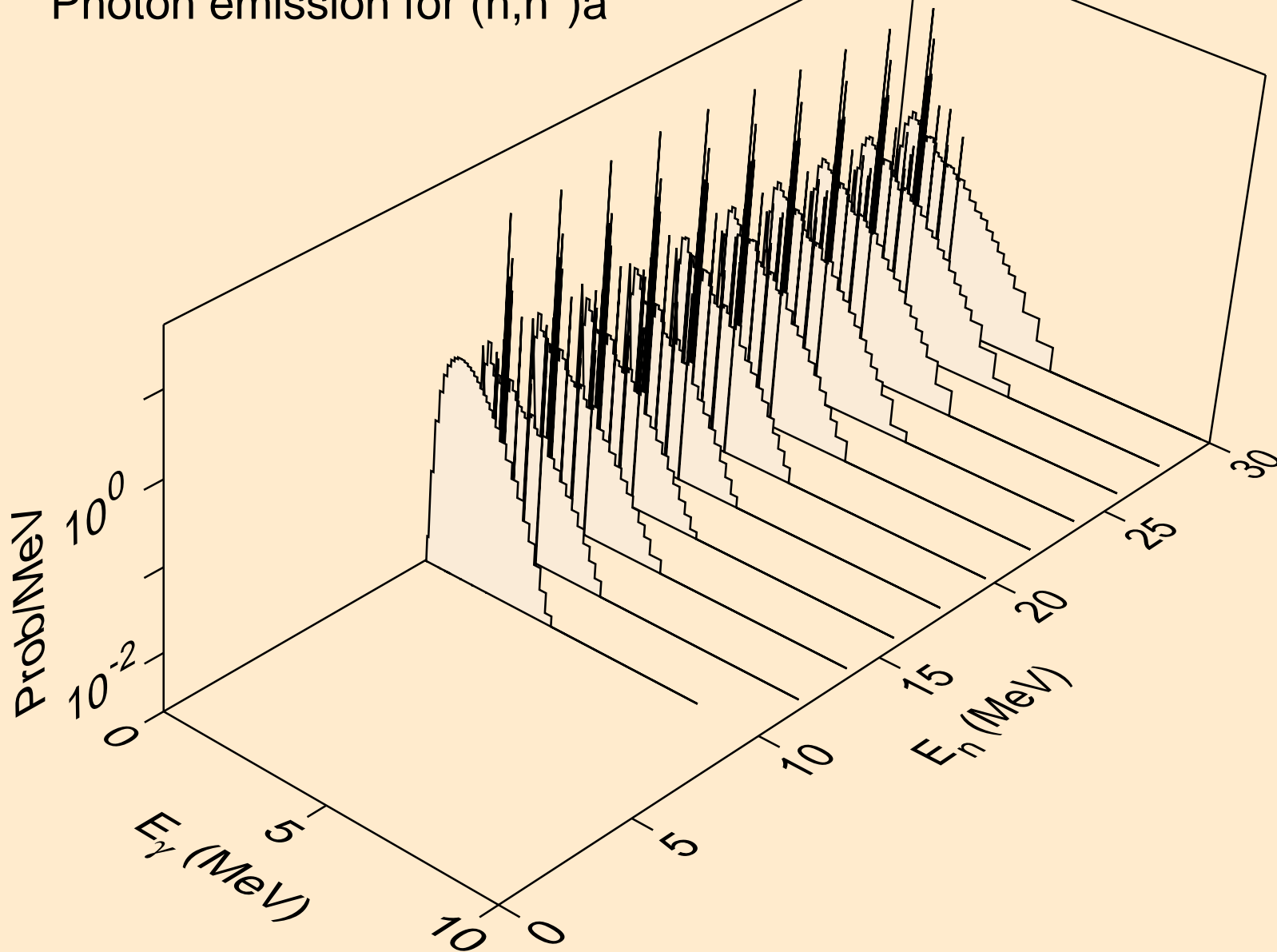

HG194 HELION ACER TENDL-2023 LIBRARY; T=0.K  
Photon emission for (n,2n)a

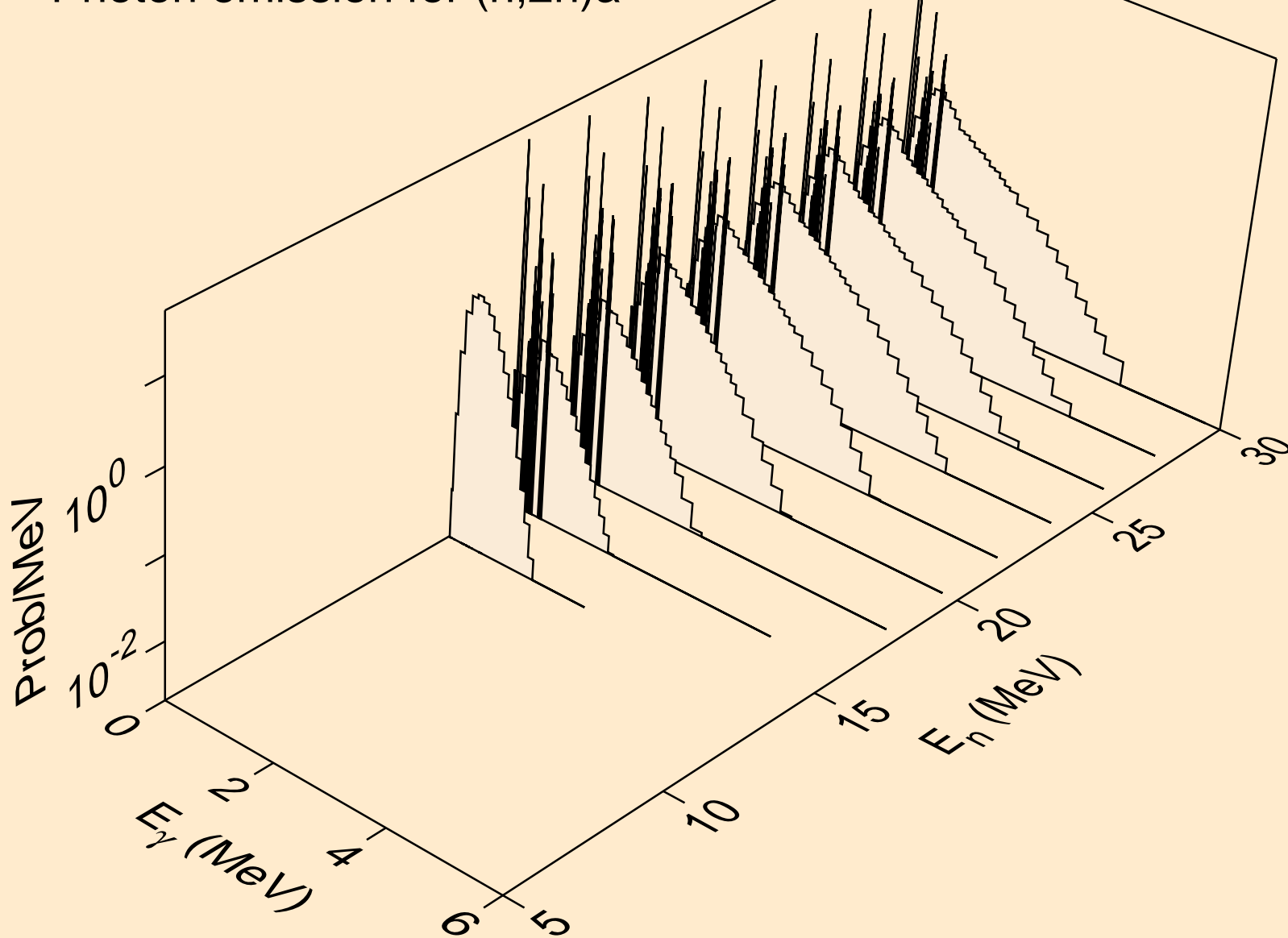

HG194 HELION ACER TENDL-2023 LIBRARY; T=0.K  
Photon emission for (n,3n)a

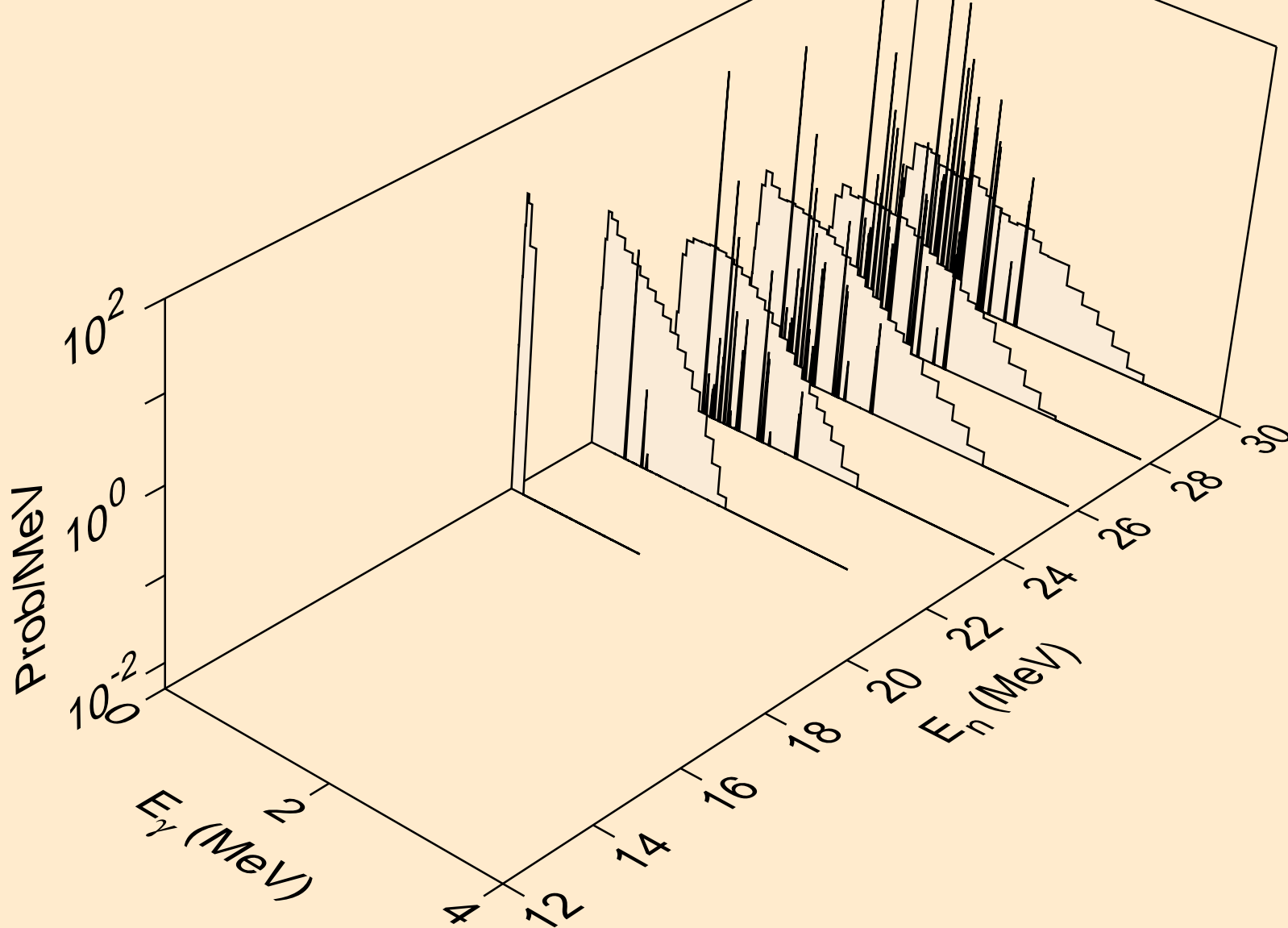

HG194 HELION ACER TENDL-2023 LIBRARY; T=0.K  
Photon emission for (n,n\*)p

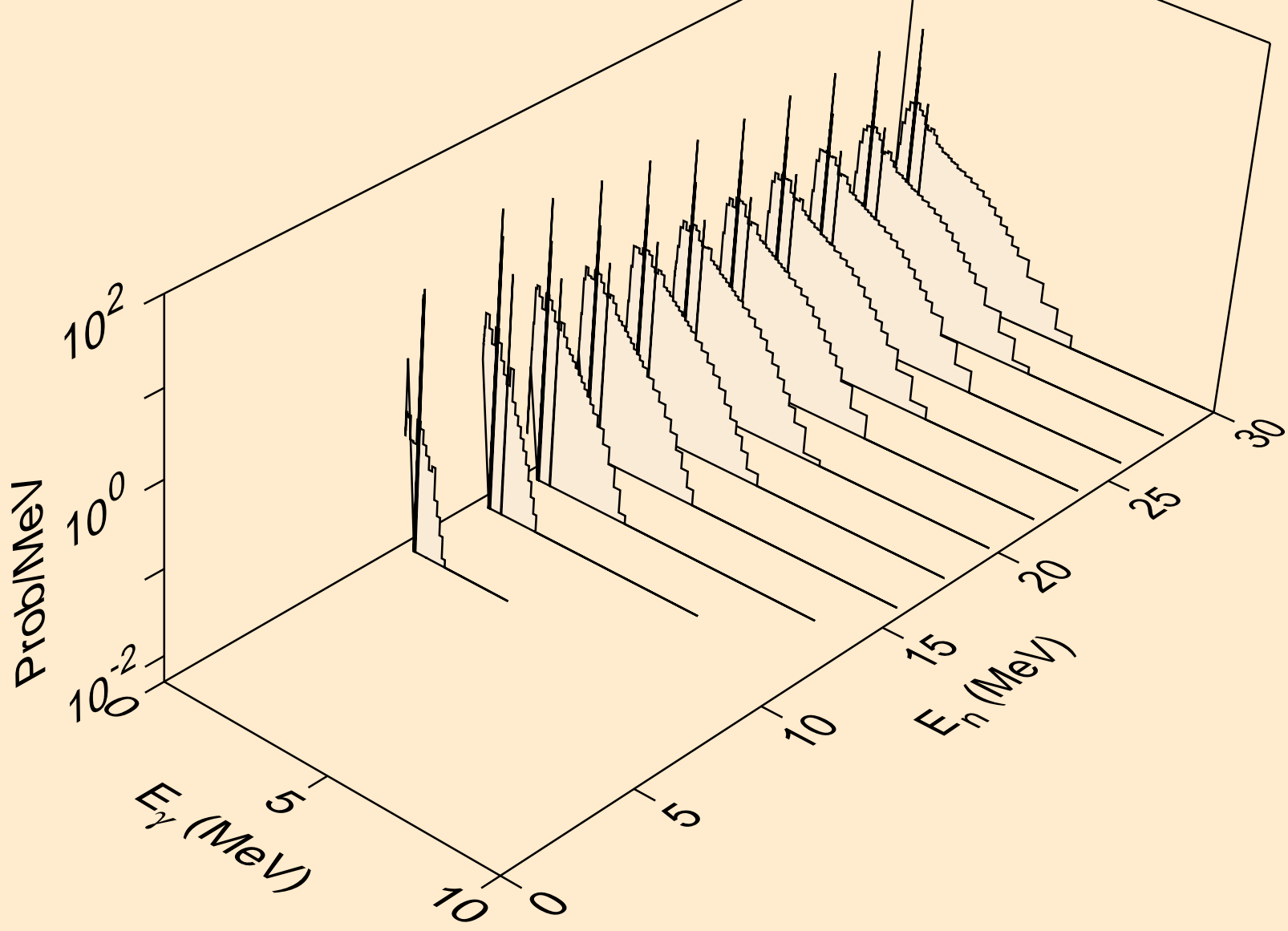

HG194 HELION ACER TENDL-2023 LIBRARY; T=0.K  
Photon emission for (n,n\*)d

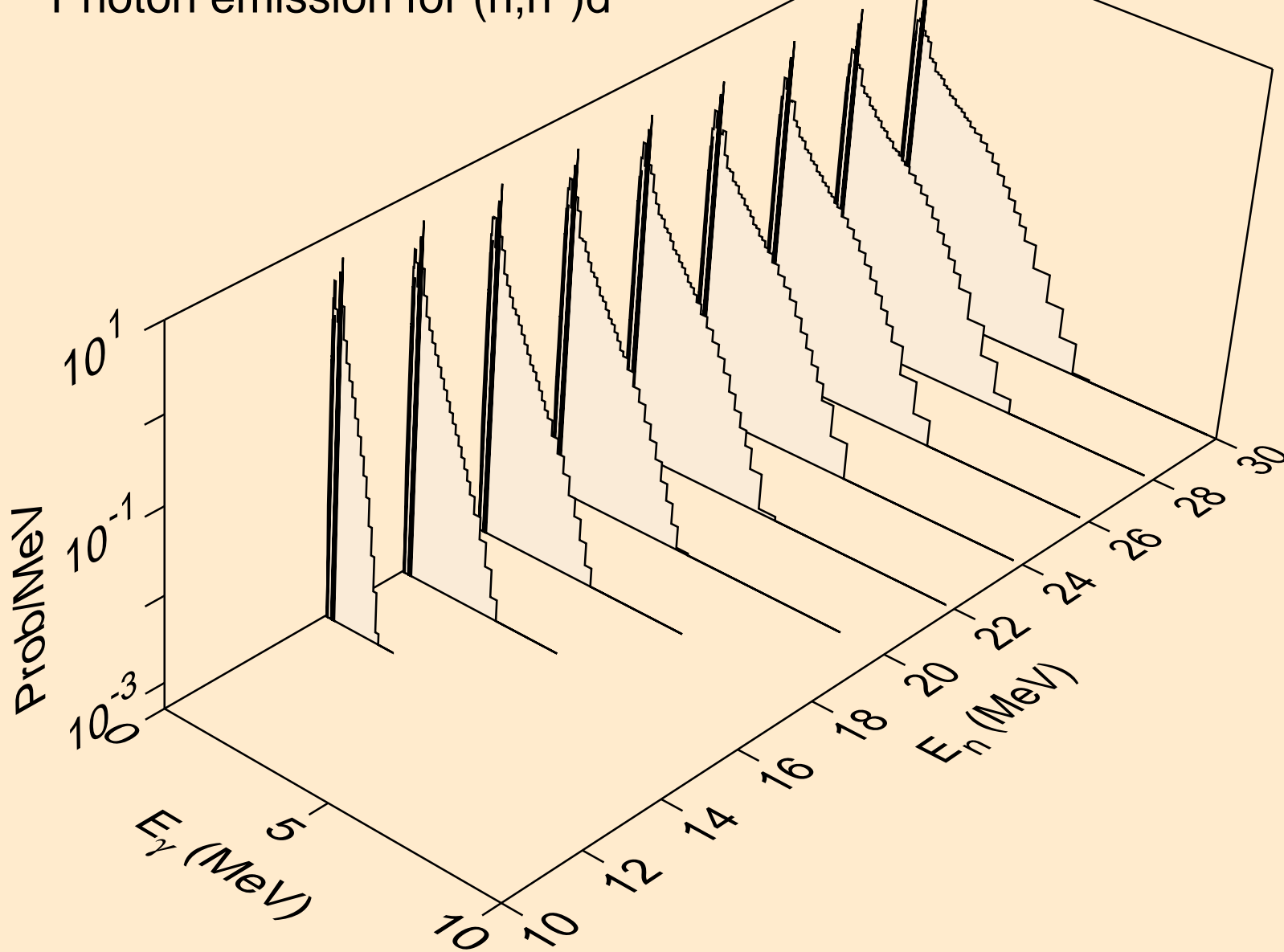

HG194 HELION ACER TENDL-2023 LIBRARY; T=0.K  
Photon emission for (n,n\*)t

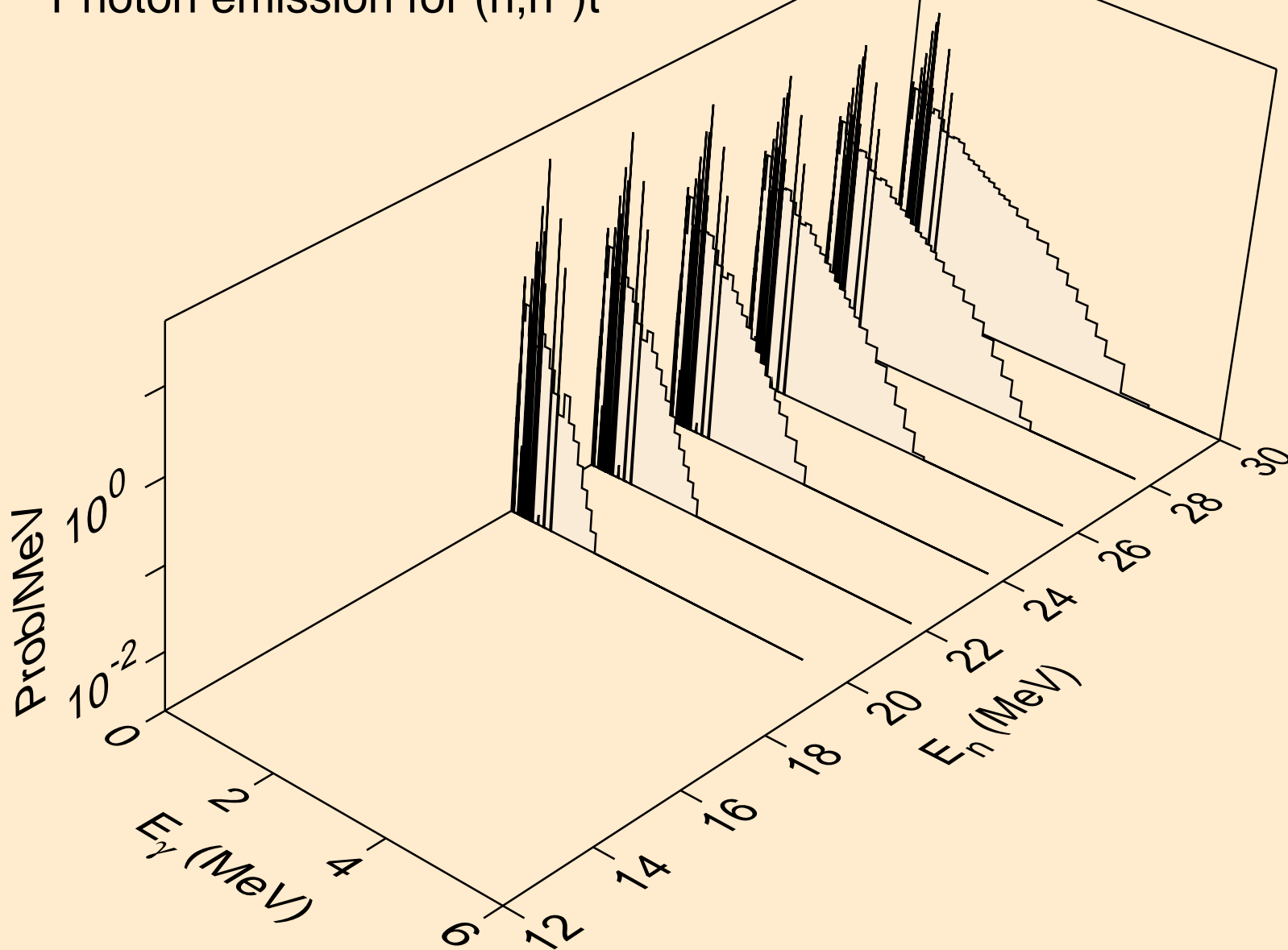

HG194 HELION ACER TENDL-2023 LIBRARY; T=0.K  
Photon emission for (n,n\*)he3

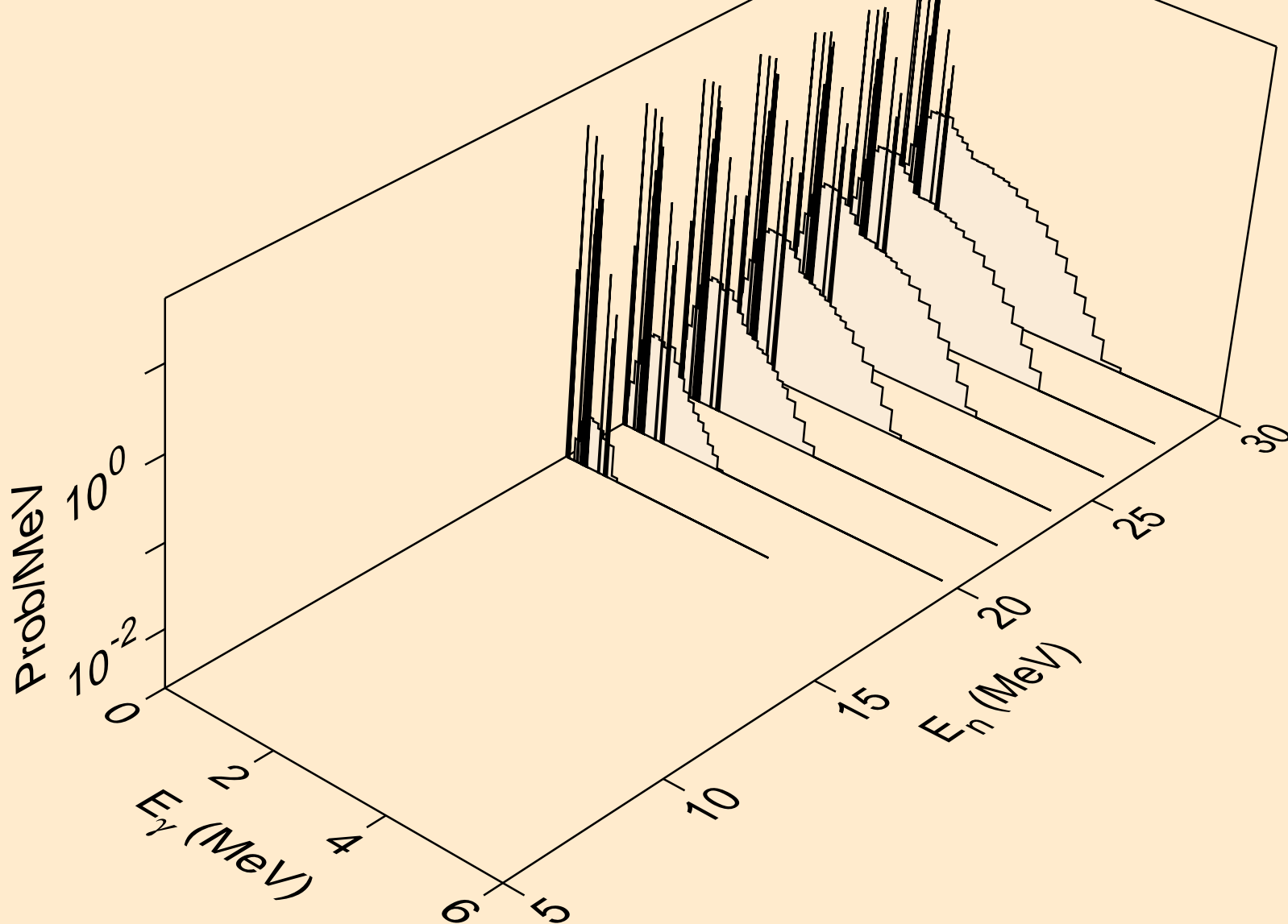

HG194 HELION ACER TENDL-2023 LIBRARY; T=0.K  
Photon emission for (n,4n)

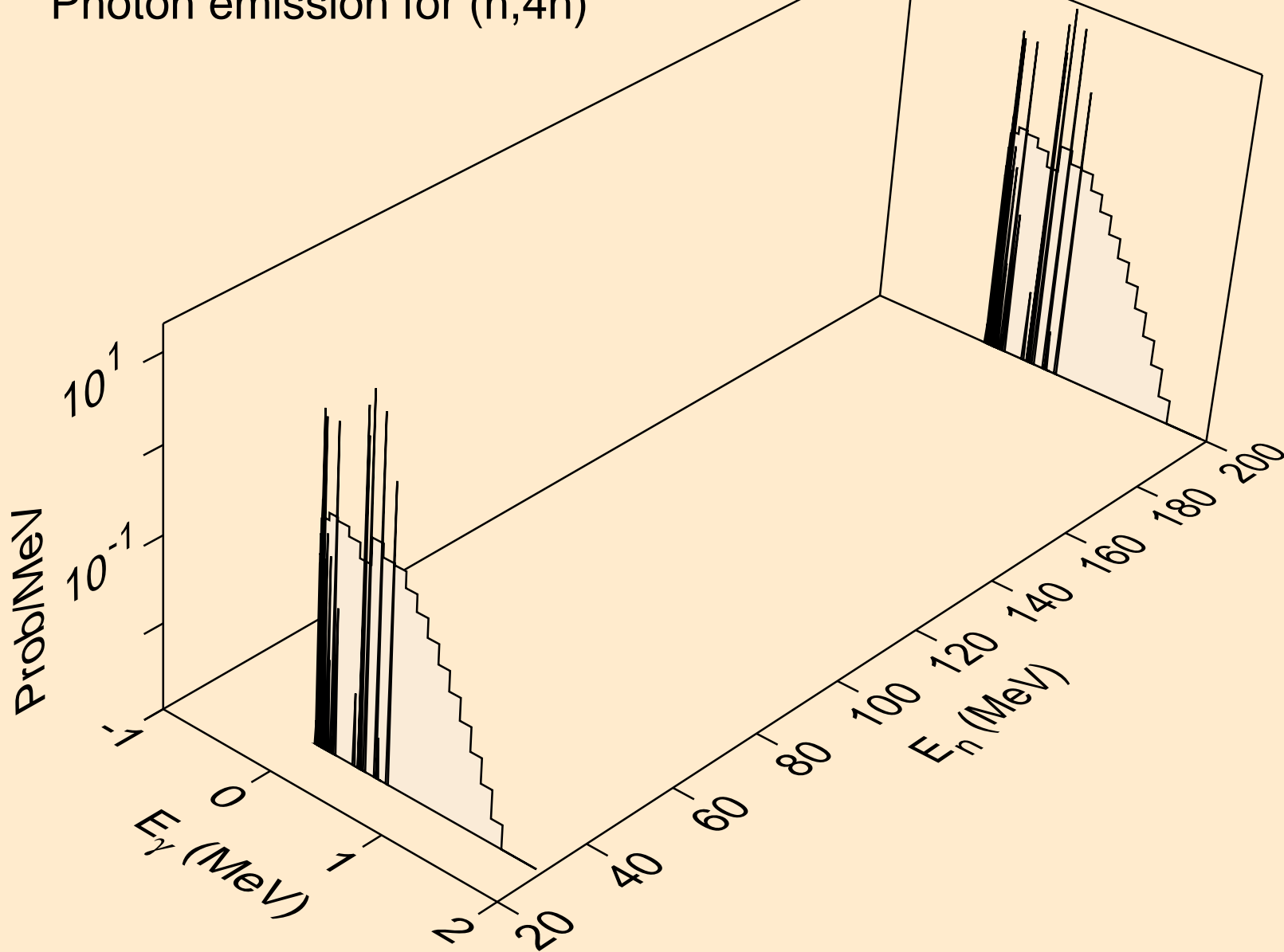

HG194 HELION ACER TENDL-2023 LIBRARY; T=0.K  
Photon emission for (n,2np)

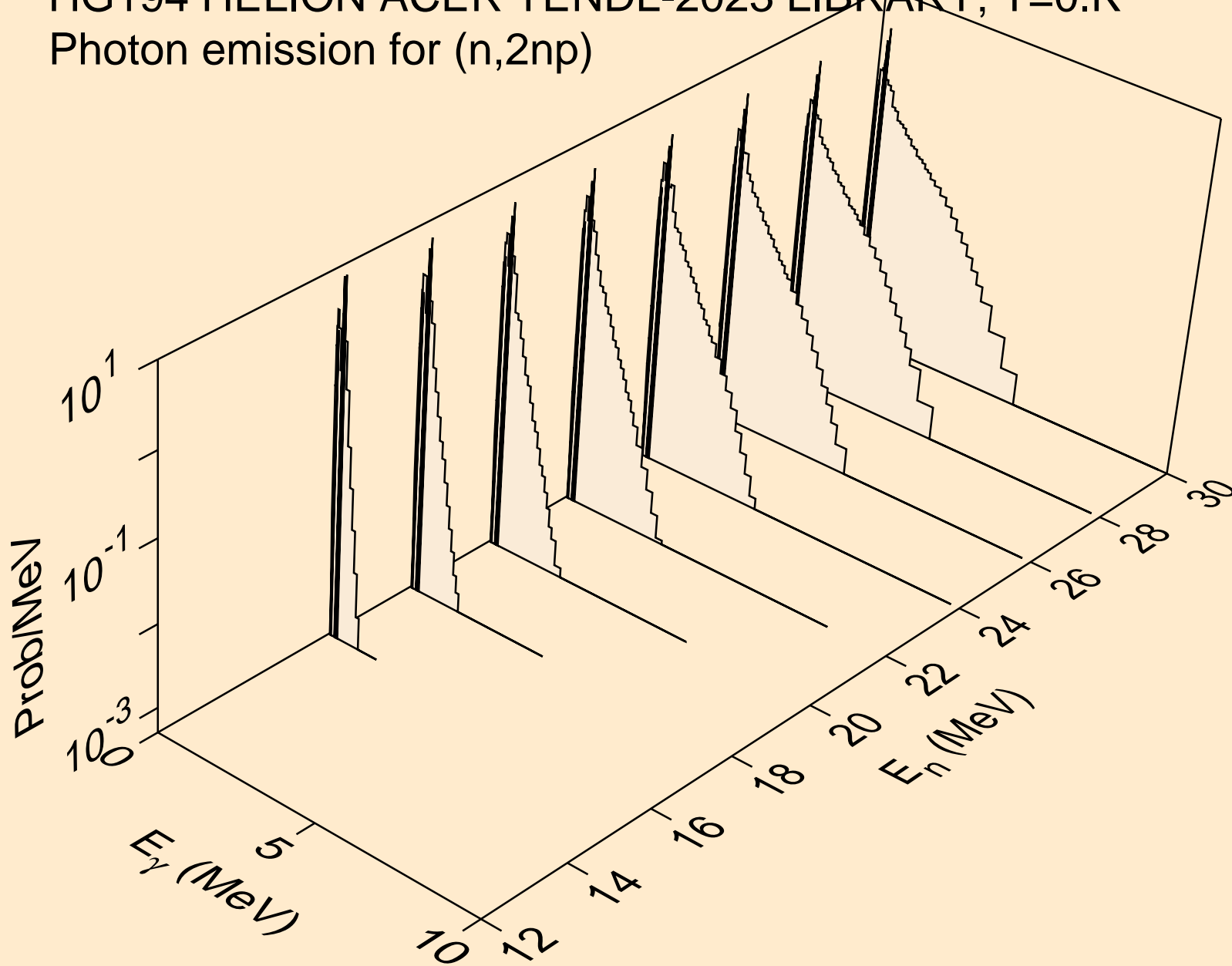

HG194 HELION ACER TENDL-2023 LIBRARY; T=0.K  
Photon emission for (n,3np)

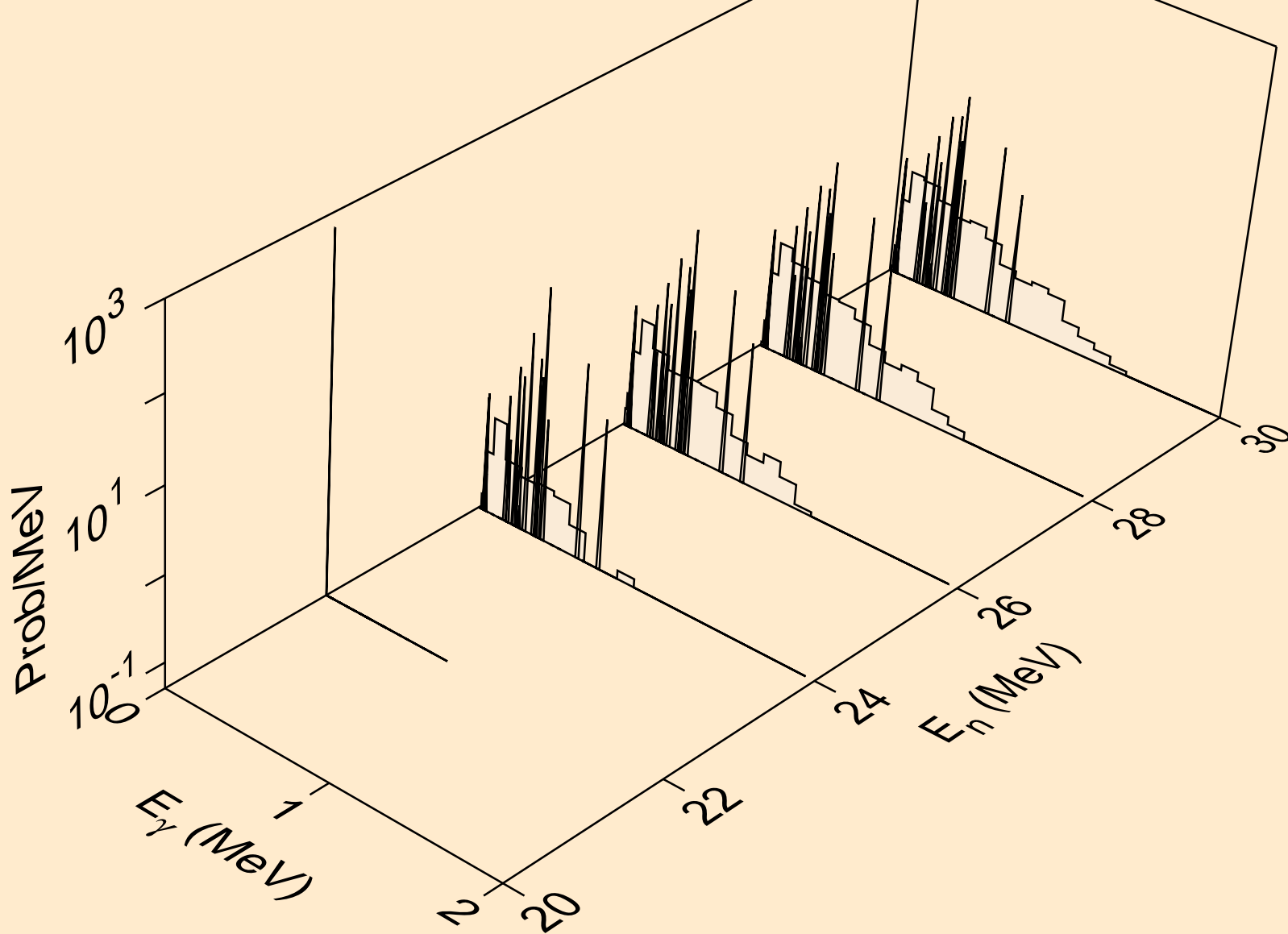

HG194 HELION ACER TENDL-2023 LIBRARY; T=0.K  
Photon emission for (n,n2p)

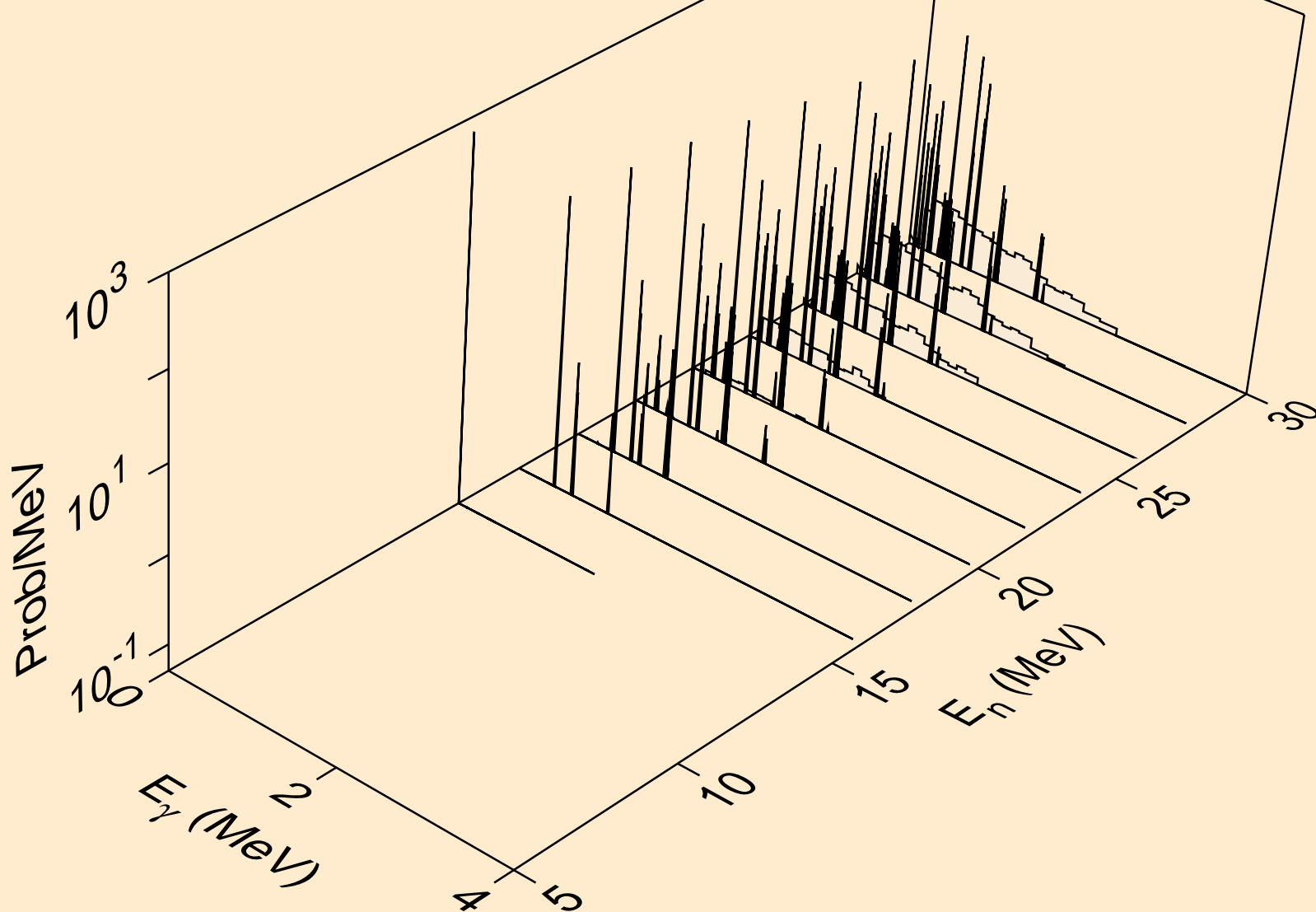

HG194 HELION ACER TENDL-2023 LIBRARY; T=0.K  
Photon emission for (n,npa)

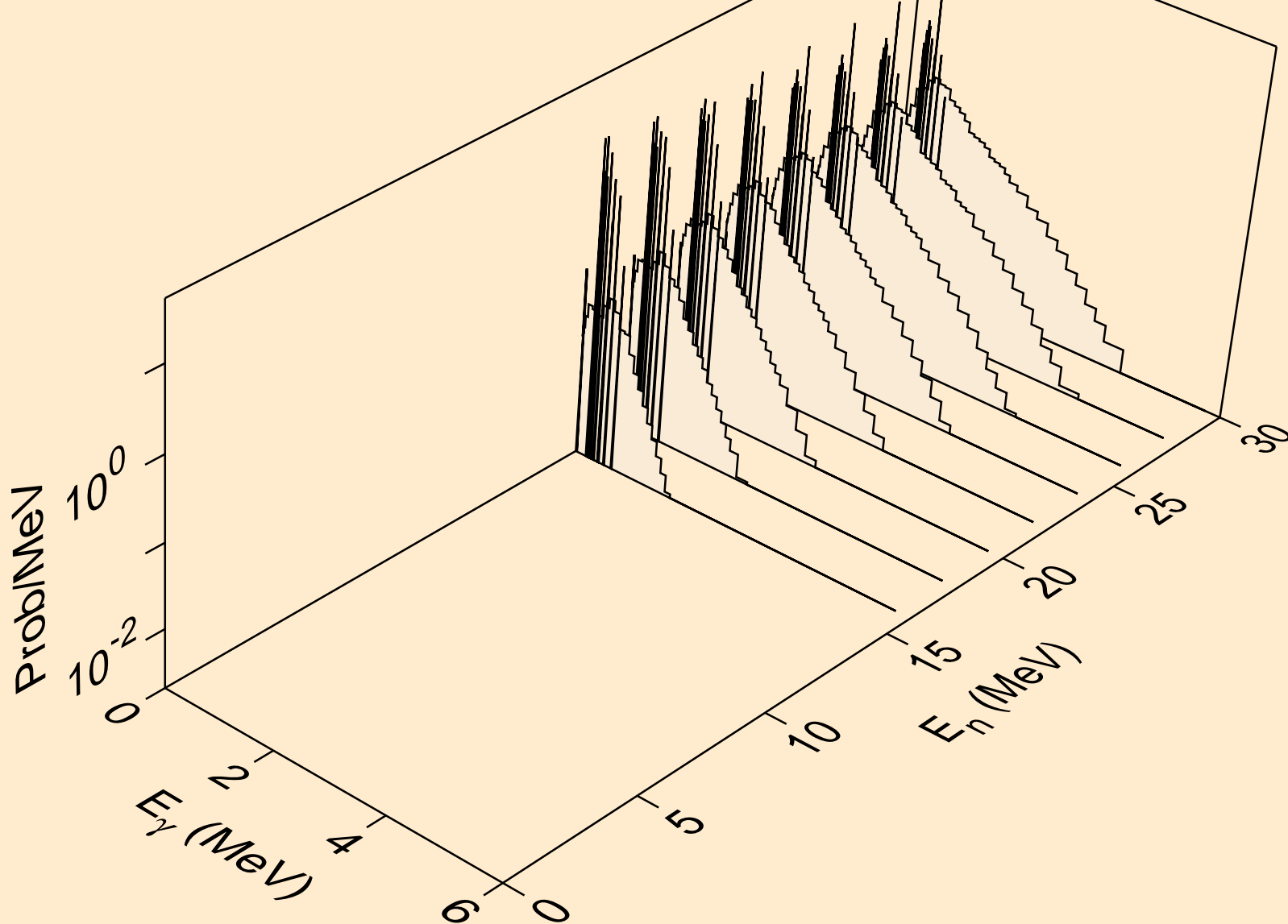

HG194 HELION ACER TENDL-2023 LIBRARY; T=0.K  
Photon emission for (n,gma)

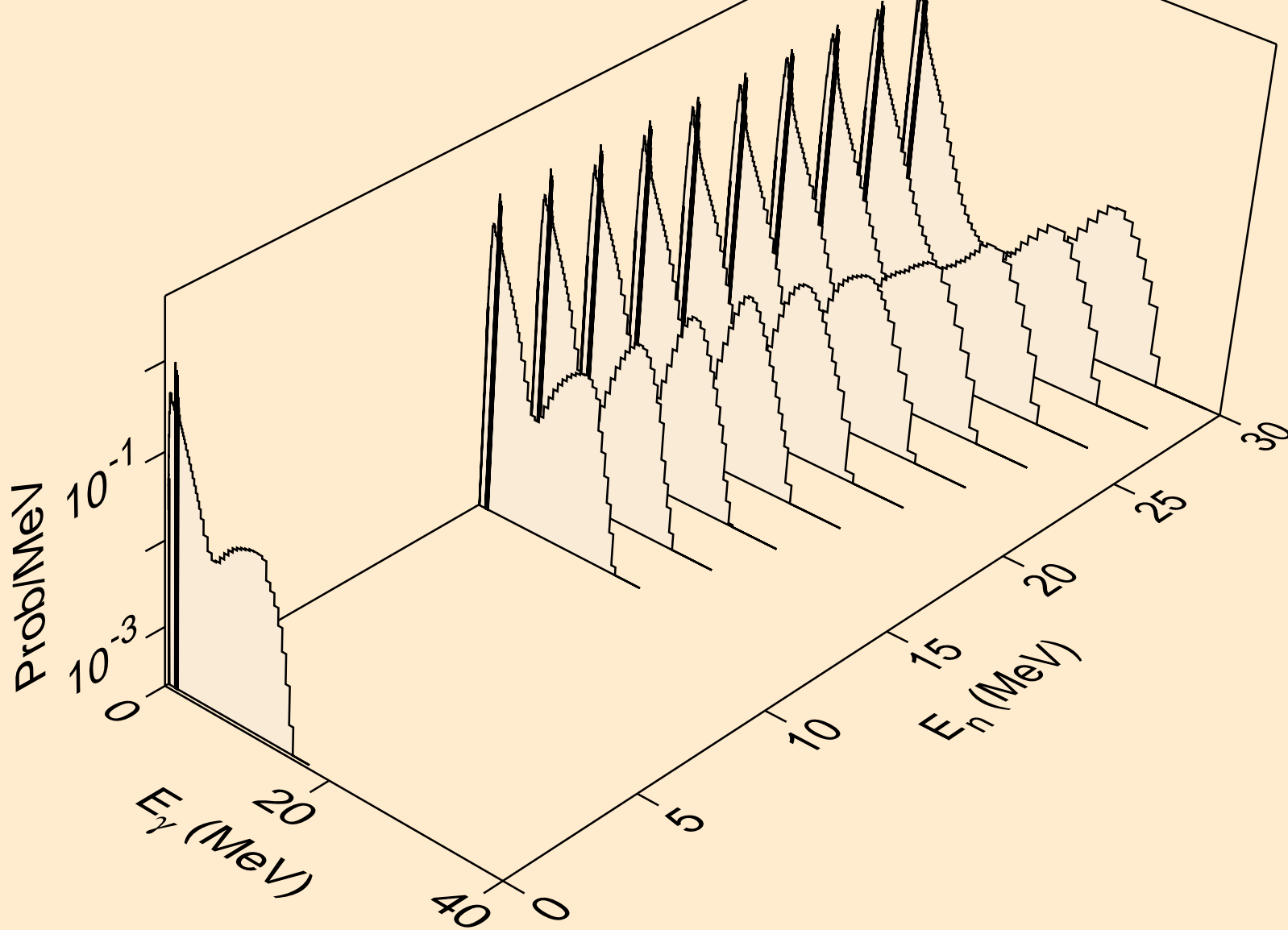

HG194 HELION ACER TENDL-2023 LIBRARY; T=0.K  
Photon emission for (n,p)

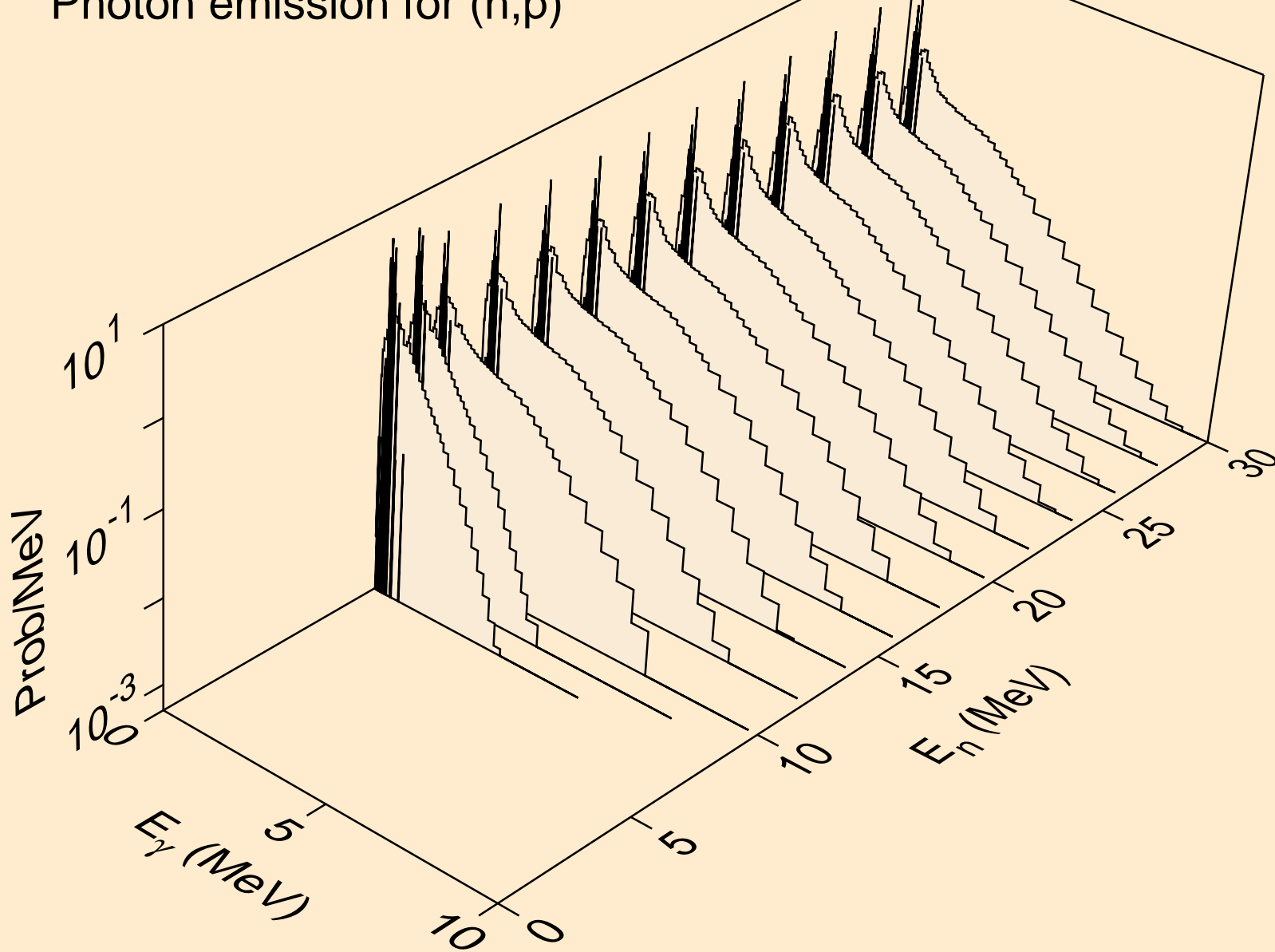

HG194 HELION ACER TENDL-2023 LIBRARY; T=0.K  
Photon emission for (n,d)

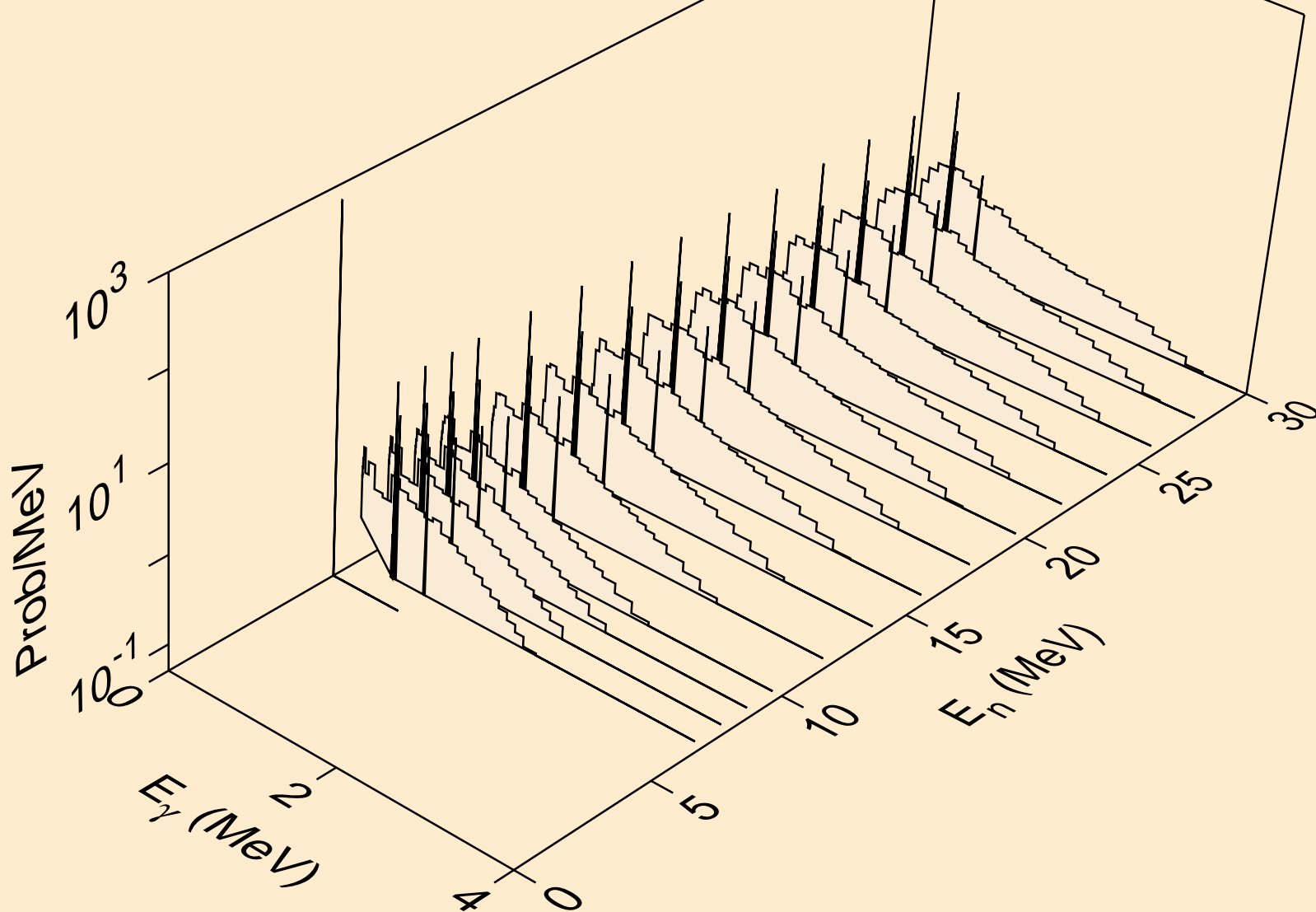

HG194 HELION ACER TENDL-2023 LIBRARY; T=0.K  
Photon emission for (n,t)

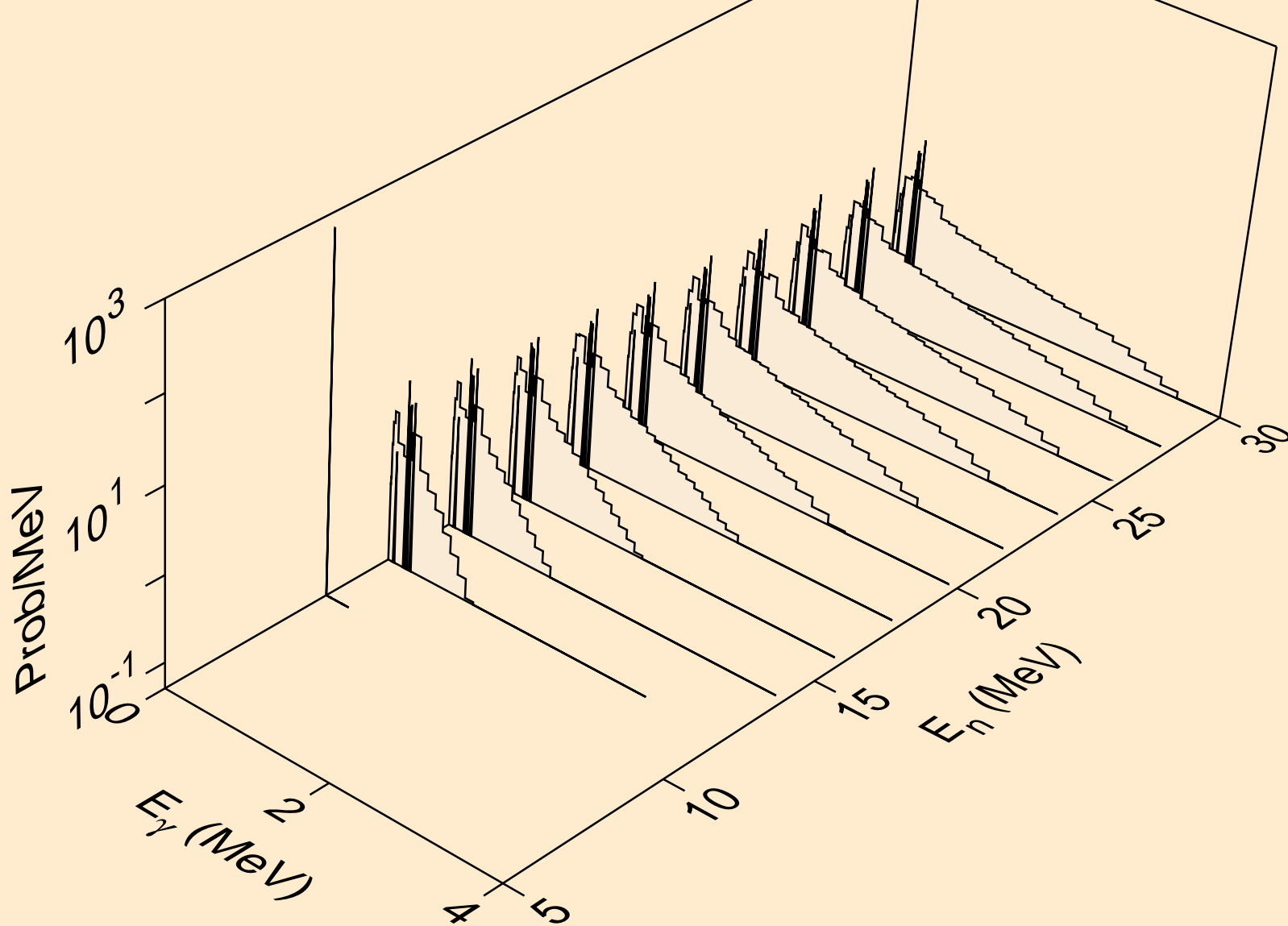

HG194 HELION ACER TENDL-2023 LIBRARY; T=0.K  
Photon emission for inelastic

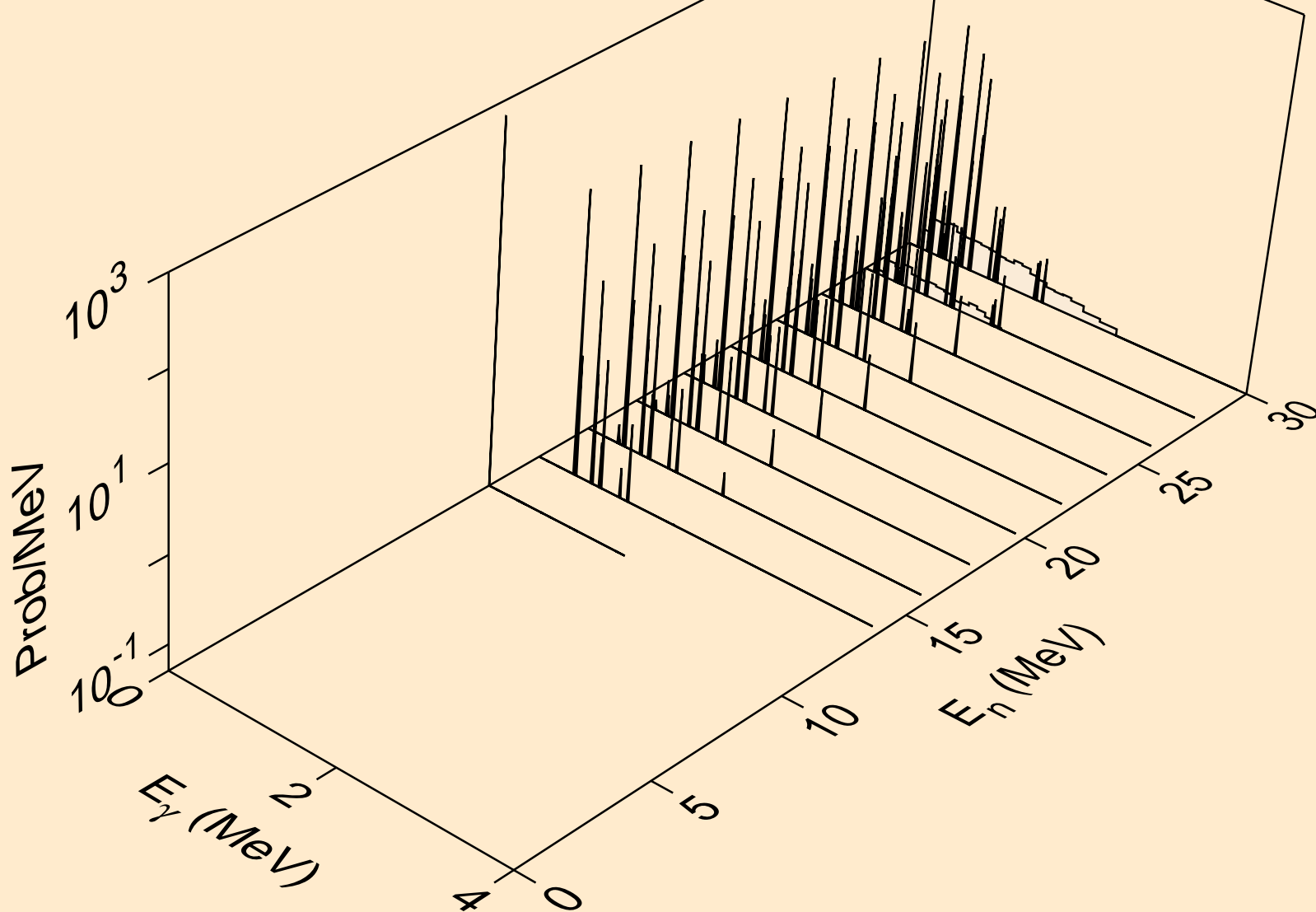

HG194 HELION ACER TENDL-2023 LIBRARY; T=0.K  
Photon emission for (n,a)

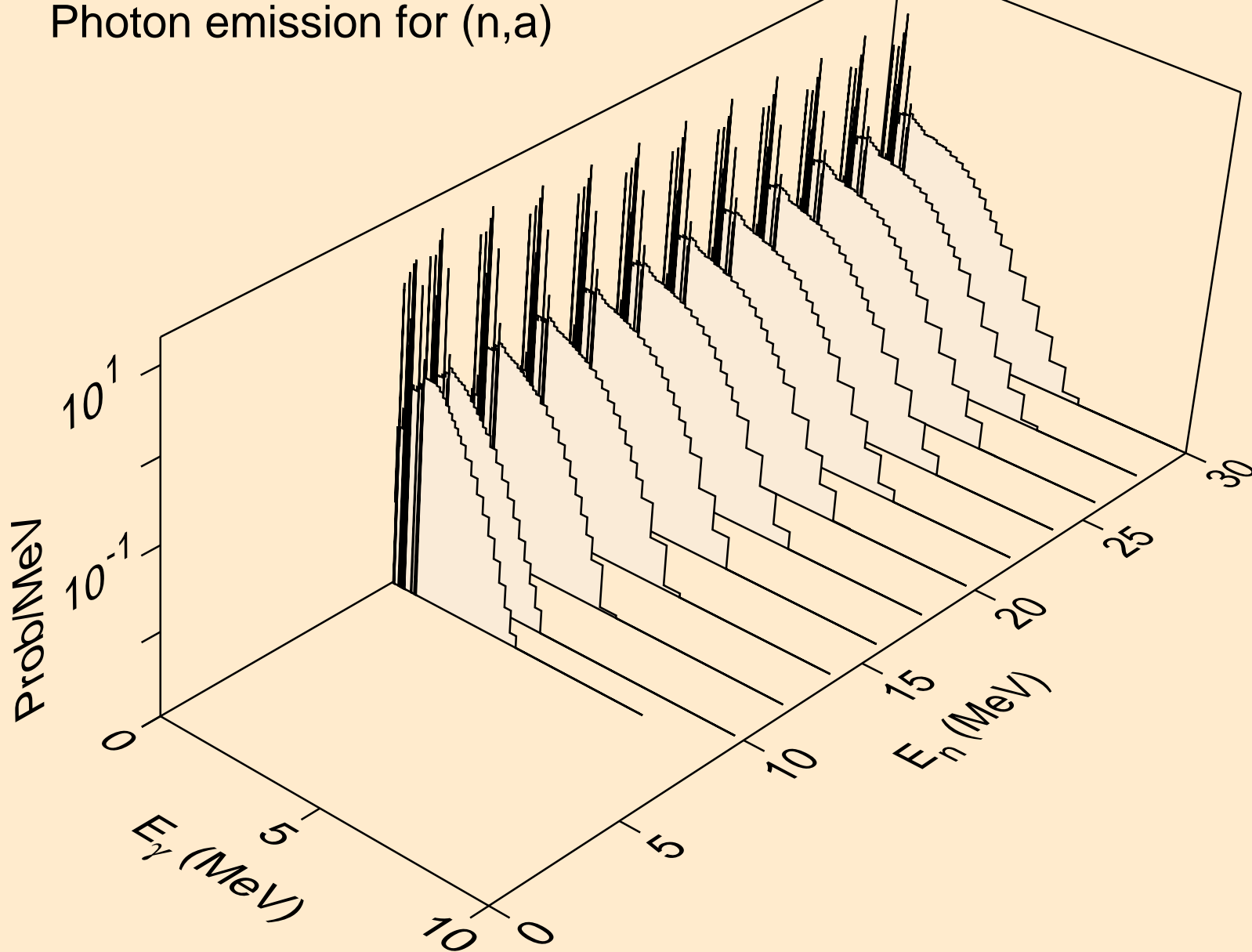

HG194 HELION ACER TENDL-2023 LIBRARY; T=0.K  
Photon emission for (n,2a)

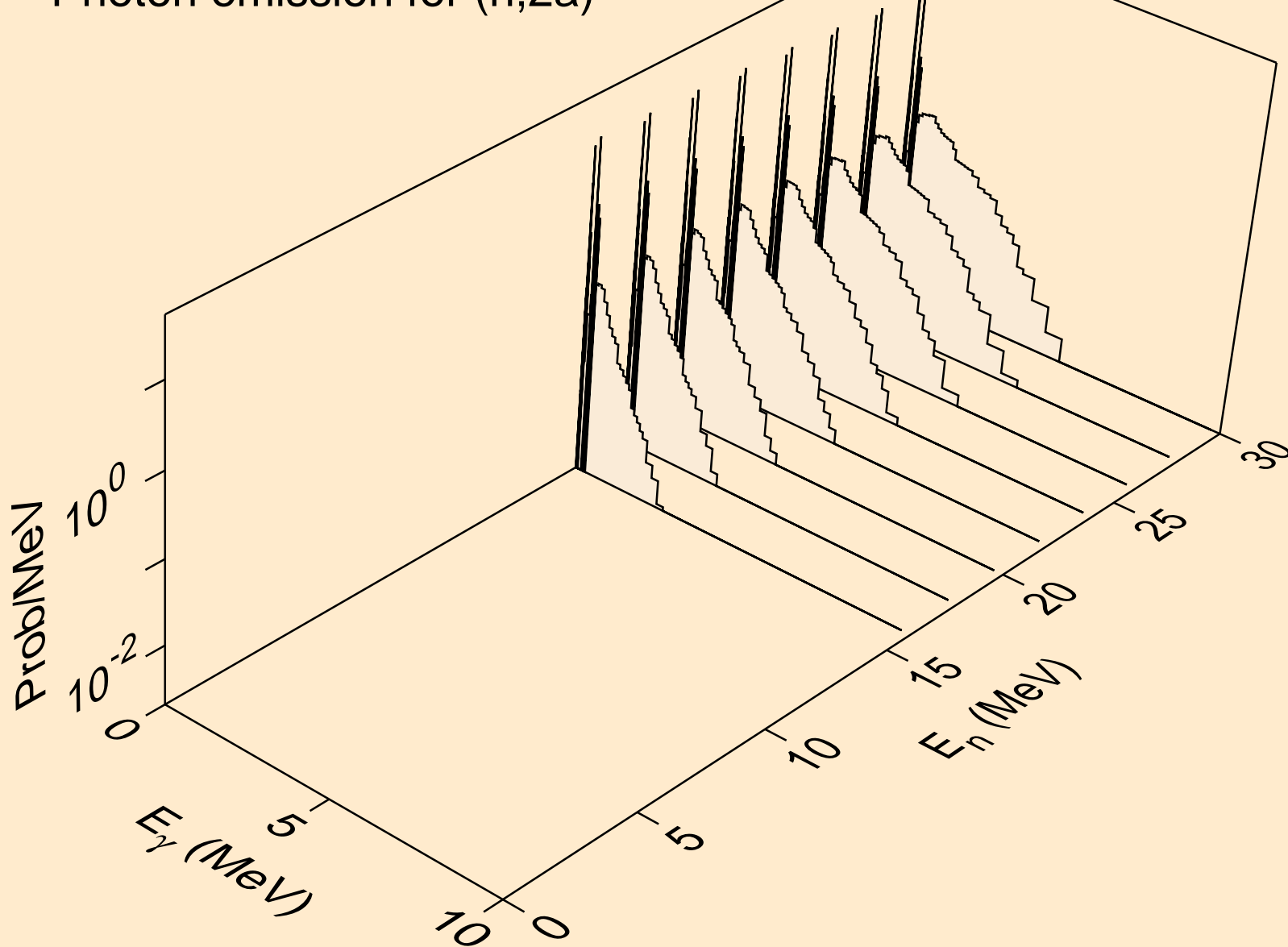

HG194 HELION ACER TENDL-2023 LIBRARY; T=0.K  
Photon emission for (n,2p)

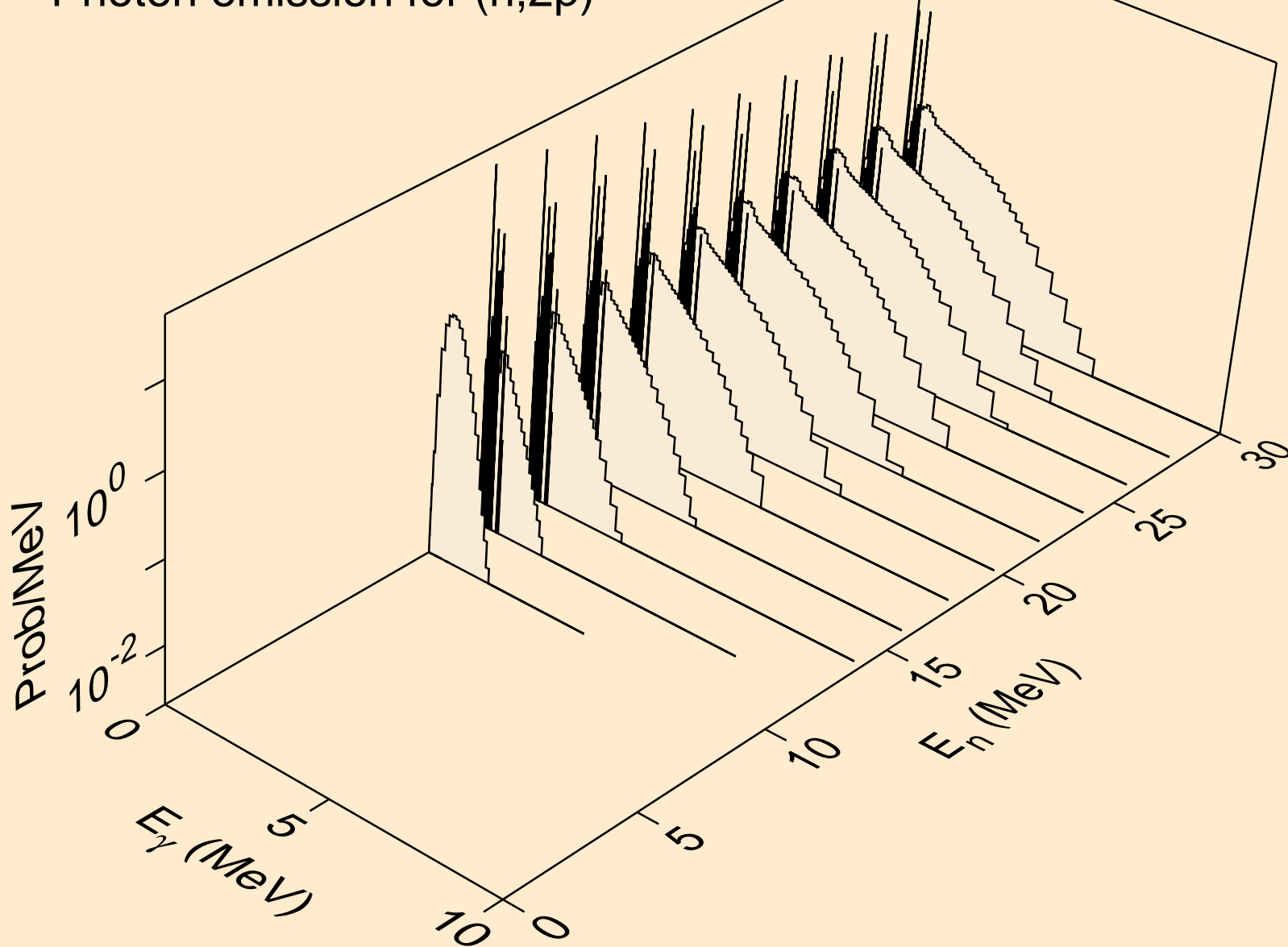

HG194 HELION ACER TENDL-2023 LIBRARY; T=0.K  
Photon emission for (n,pa)

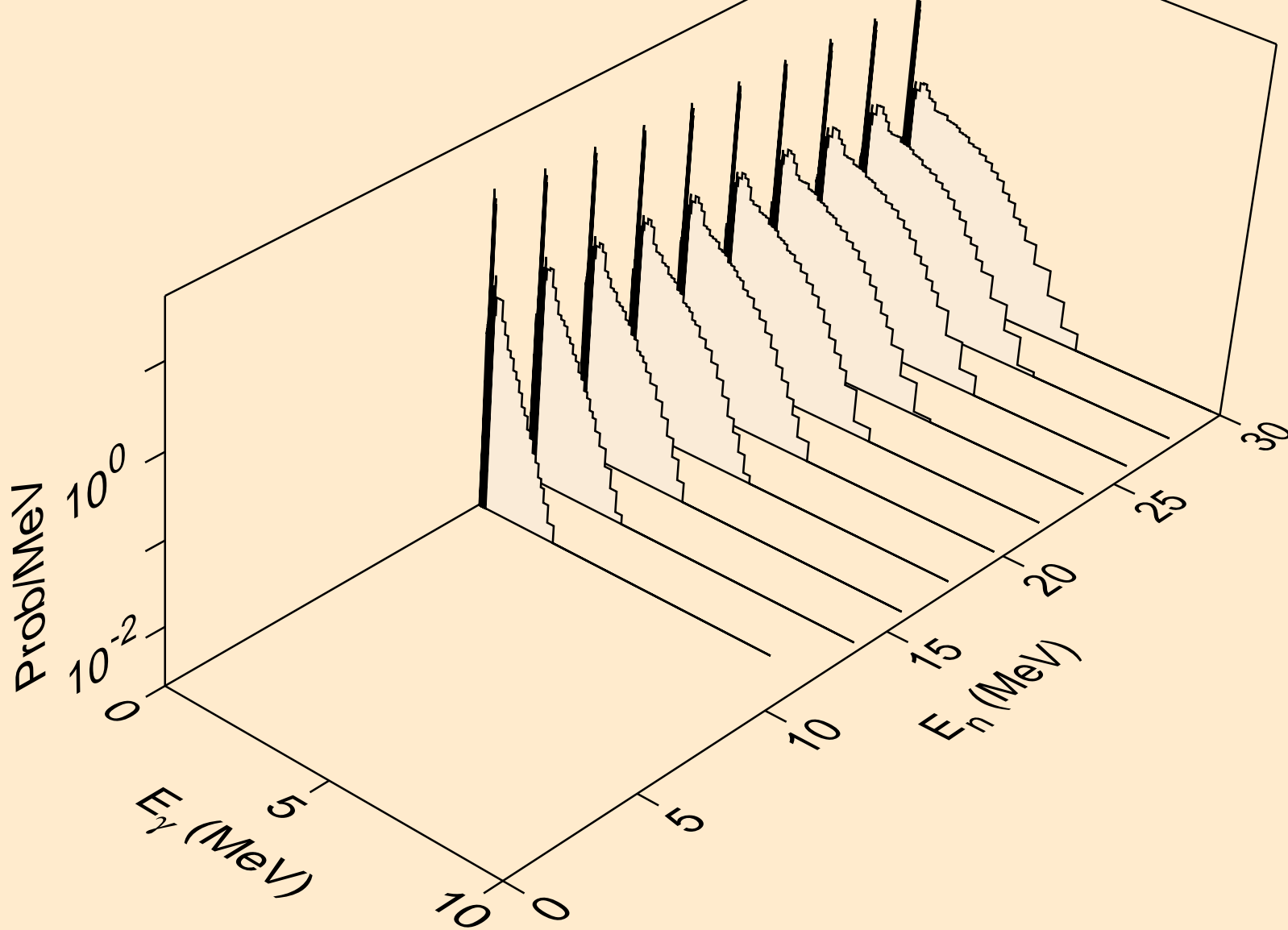

HG194 HELION ACER TENDL-2023 LIBRARY; T=0.K  
Photon emission for (n,pd)

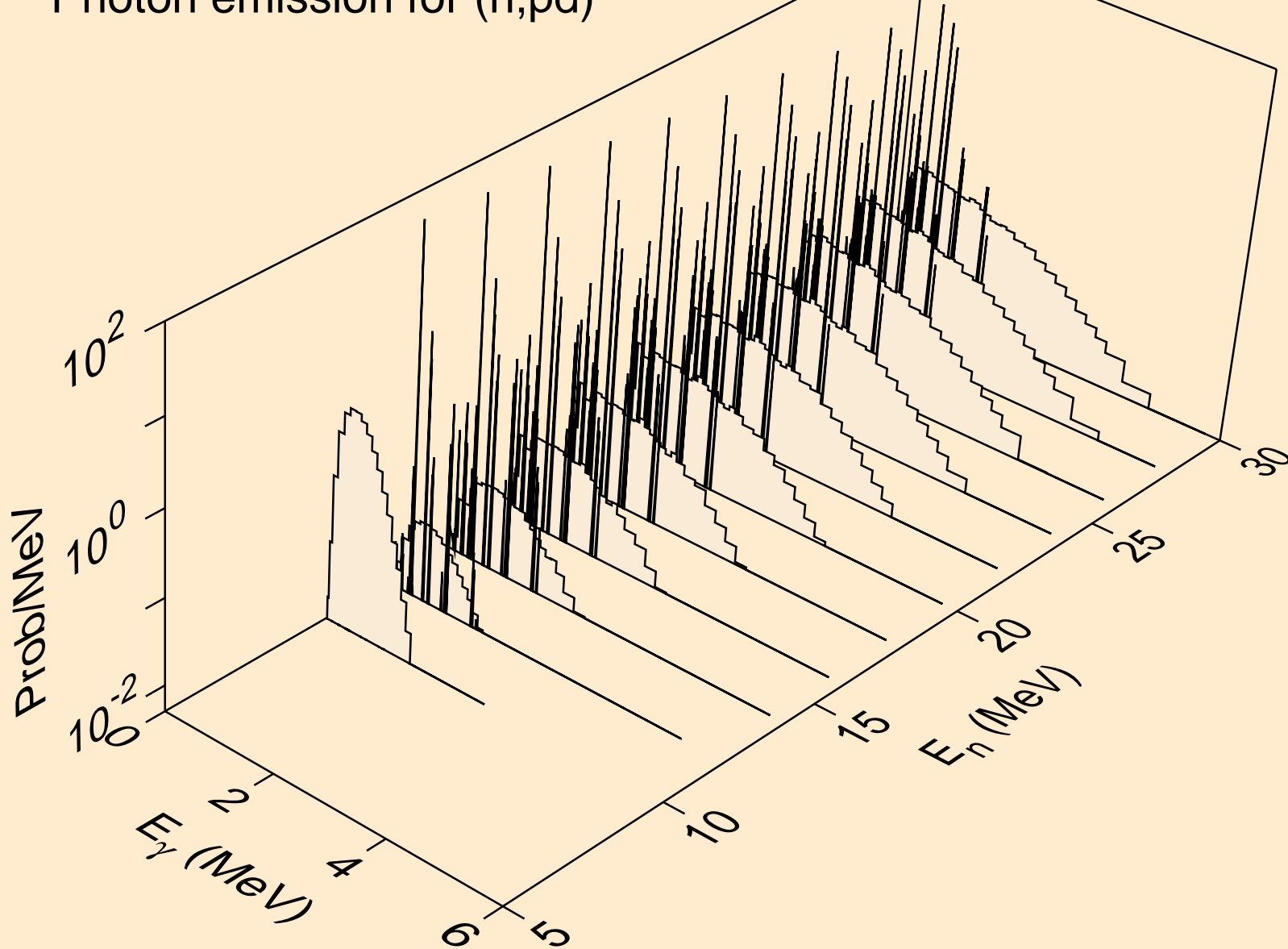

HG194 HELION ACER TENDL-2023 LIBRARY; T=0.K  
Photon emission for (n,pt)

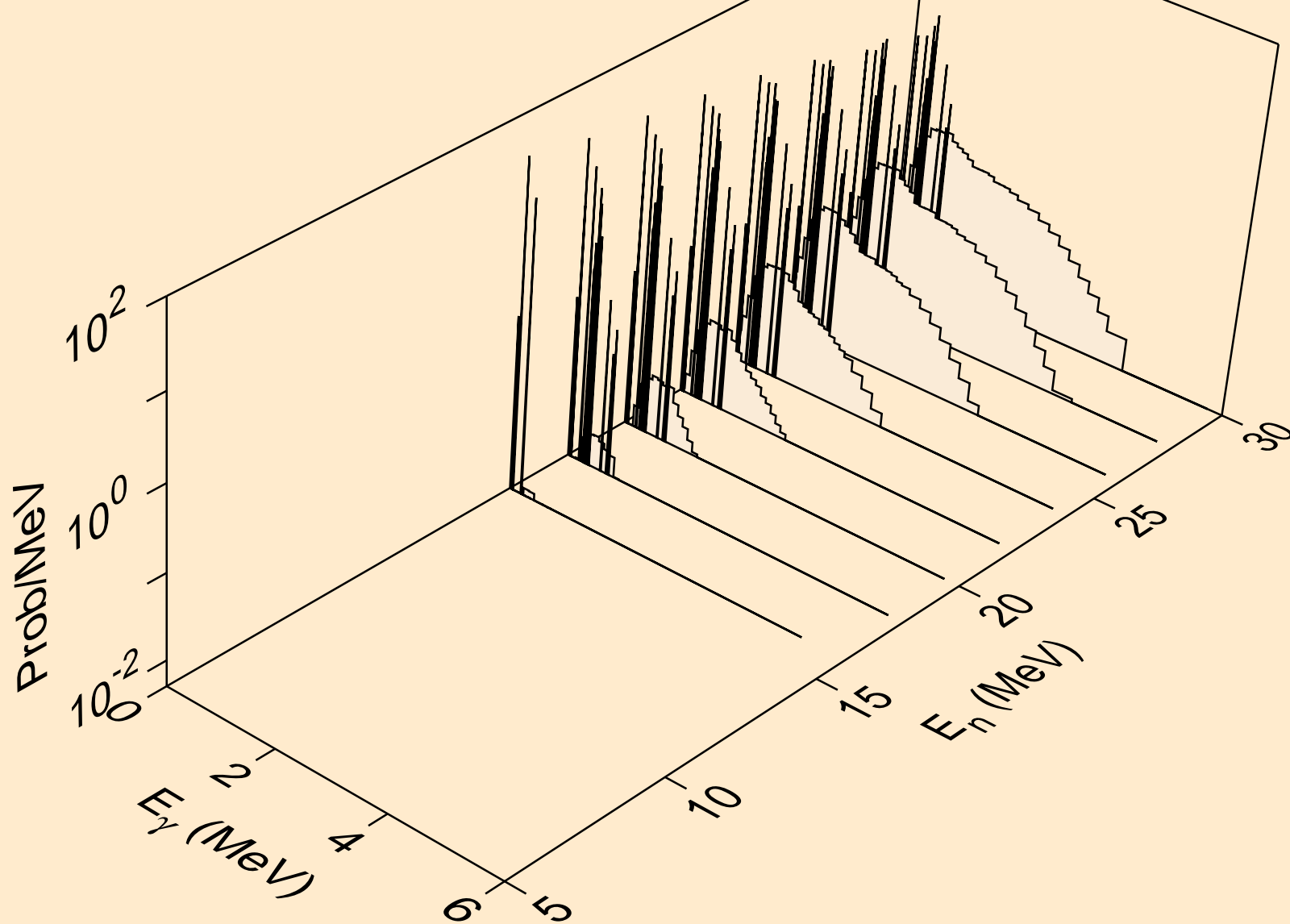

HG194 HELION ACER TENDL-2023 LIBRARY; T=0.K  
Photon emission for (n,da)

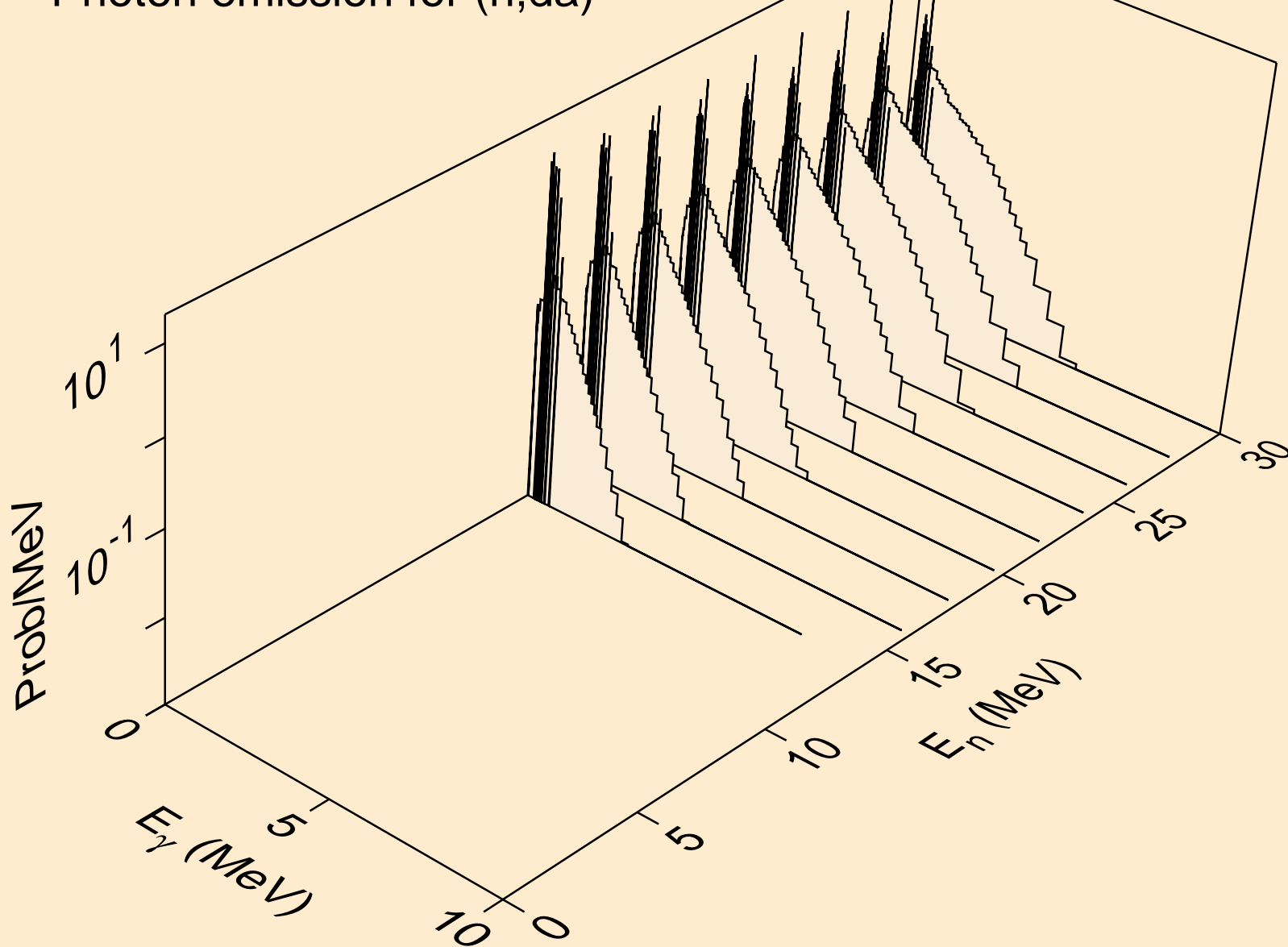

# HG194 HELION ACER TENDL-2023 LIBRARY; T=0.K

## Particle heating contributions

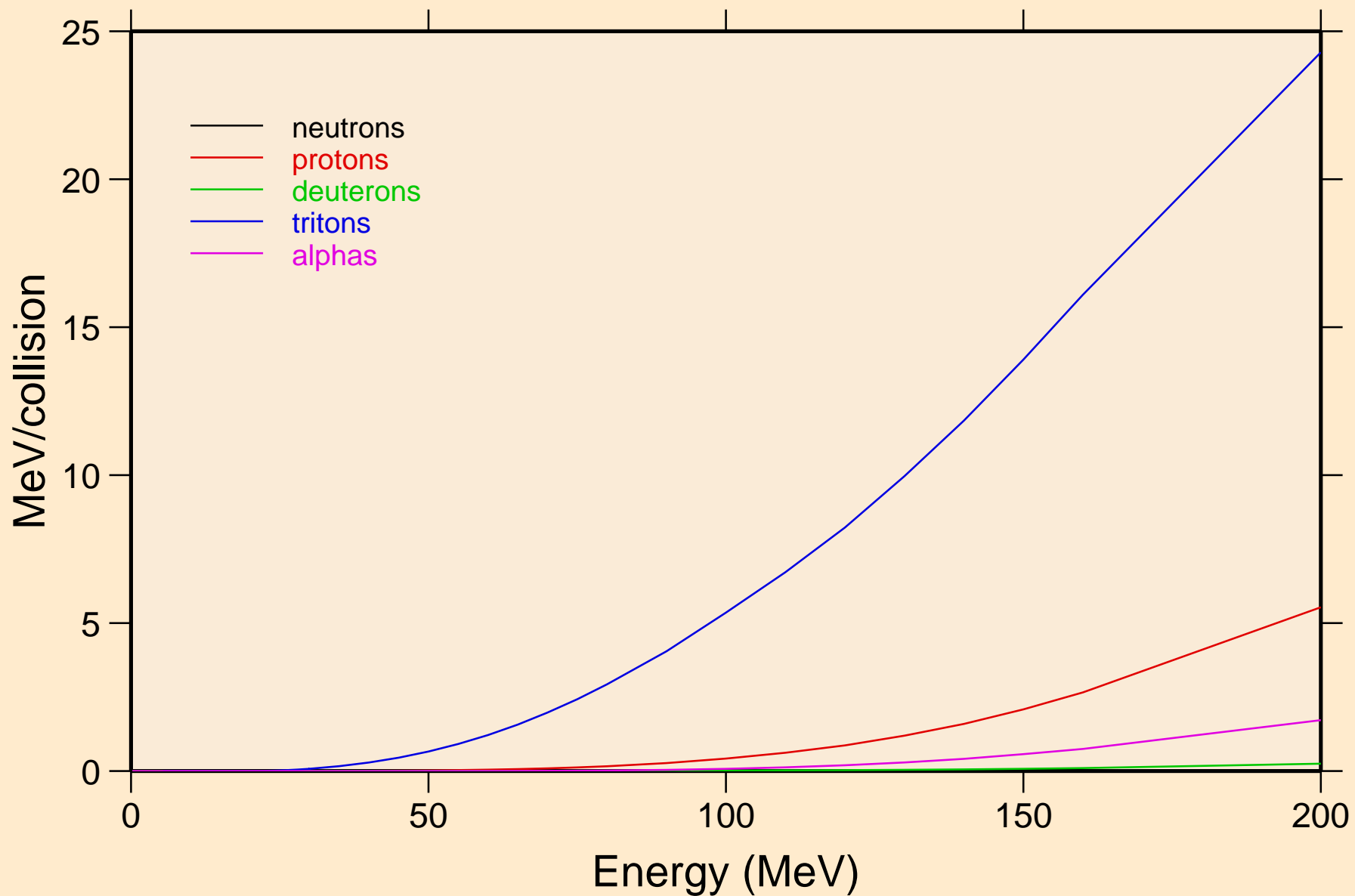

HG194 HELION ACER TENDL-2023 LIBRARY; T=0.K  
Recoil Heating

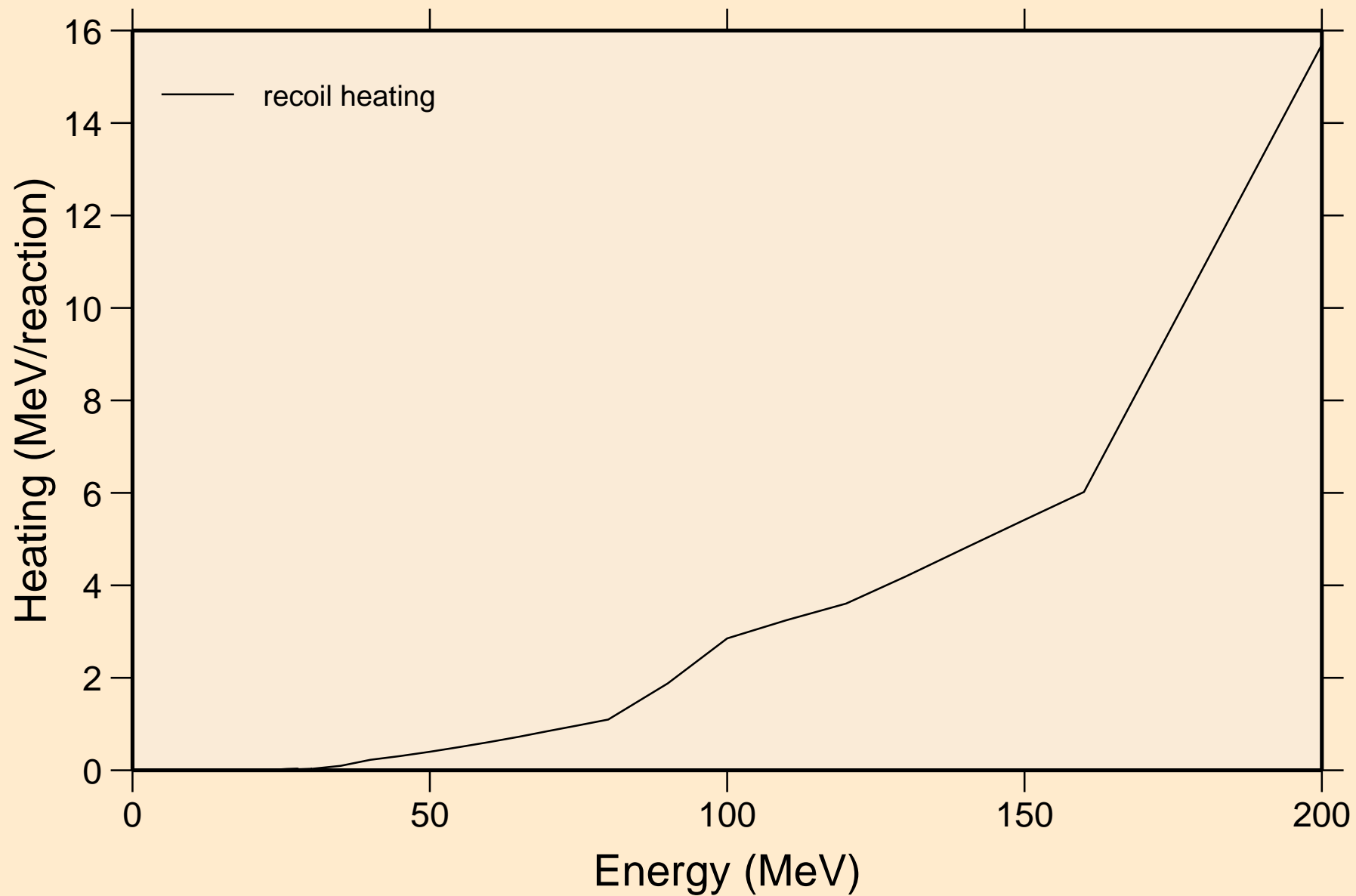

HG194 HELION ACER TENDL-2023 LIBRARY; T=0.K  
Particle production cross sections

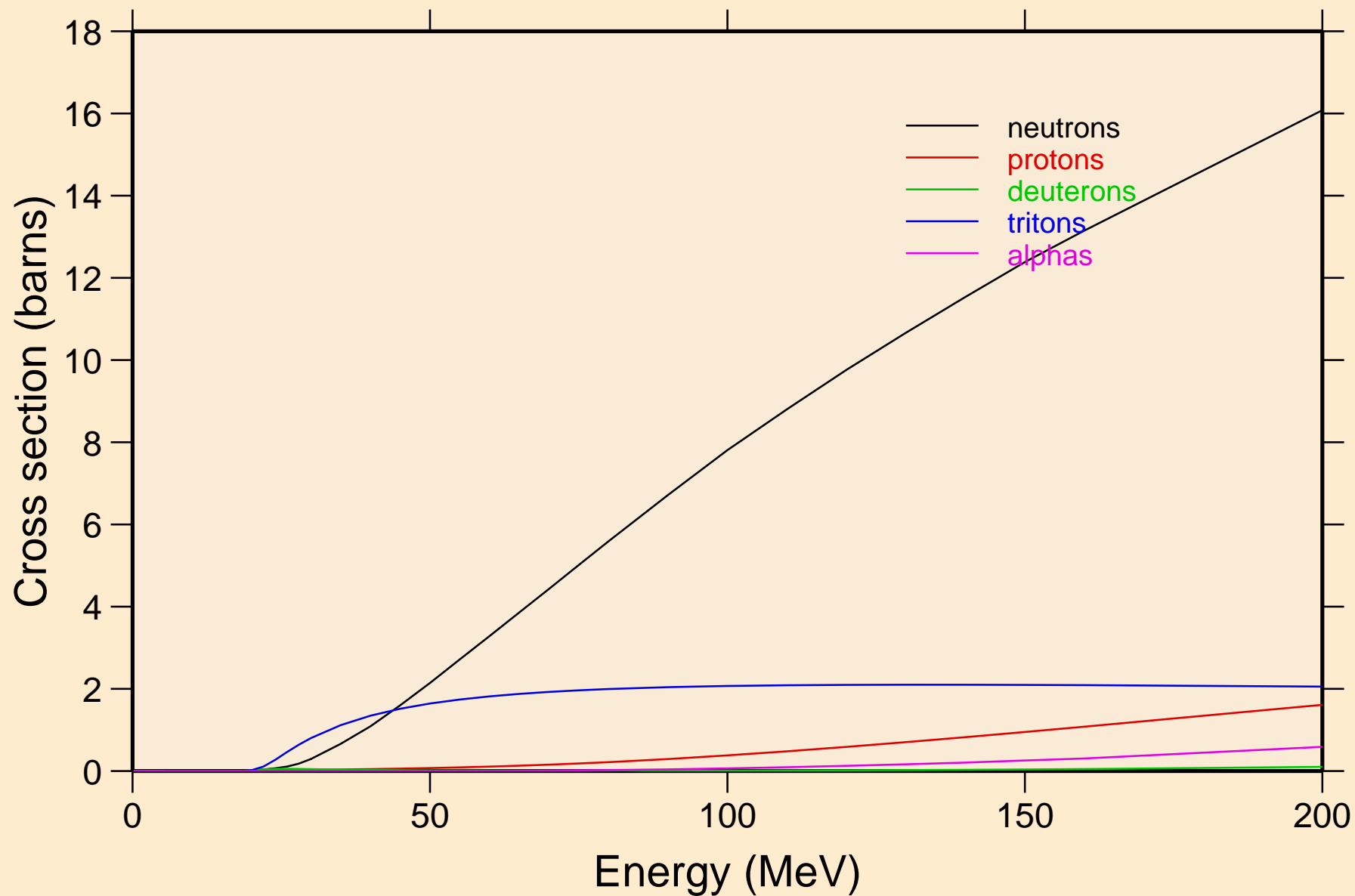

HG194 HELION ACER TENDL-2023 LIBRARY; T=0.K  
neutrons from (s,n)

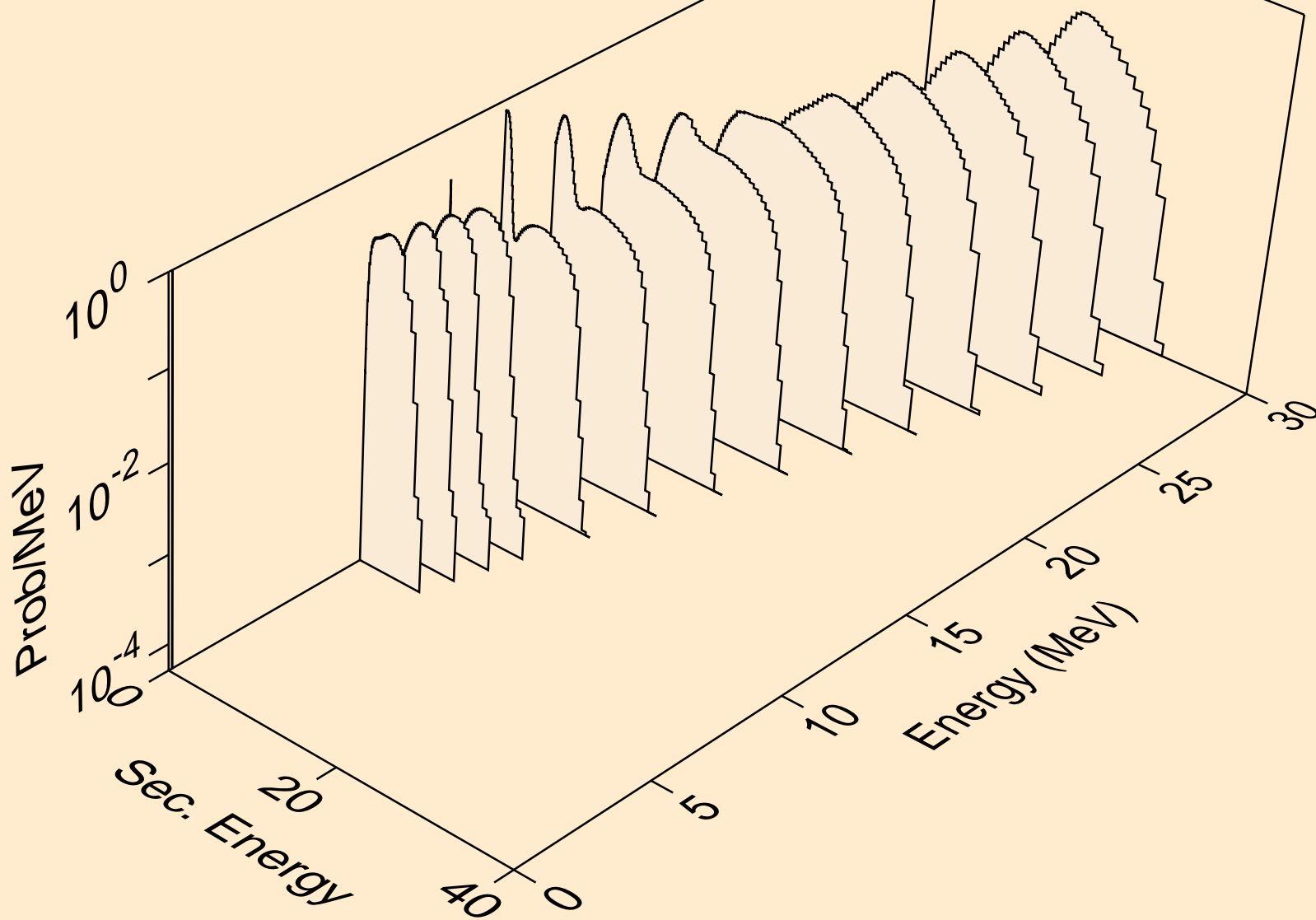

HG194 HELION ACER TENDL-2023 LIBRARY; T=0.K  
neutrons from (s,x)

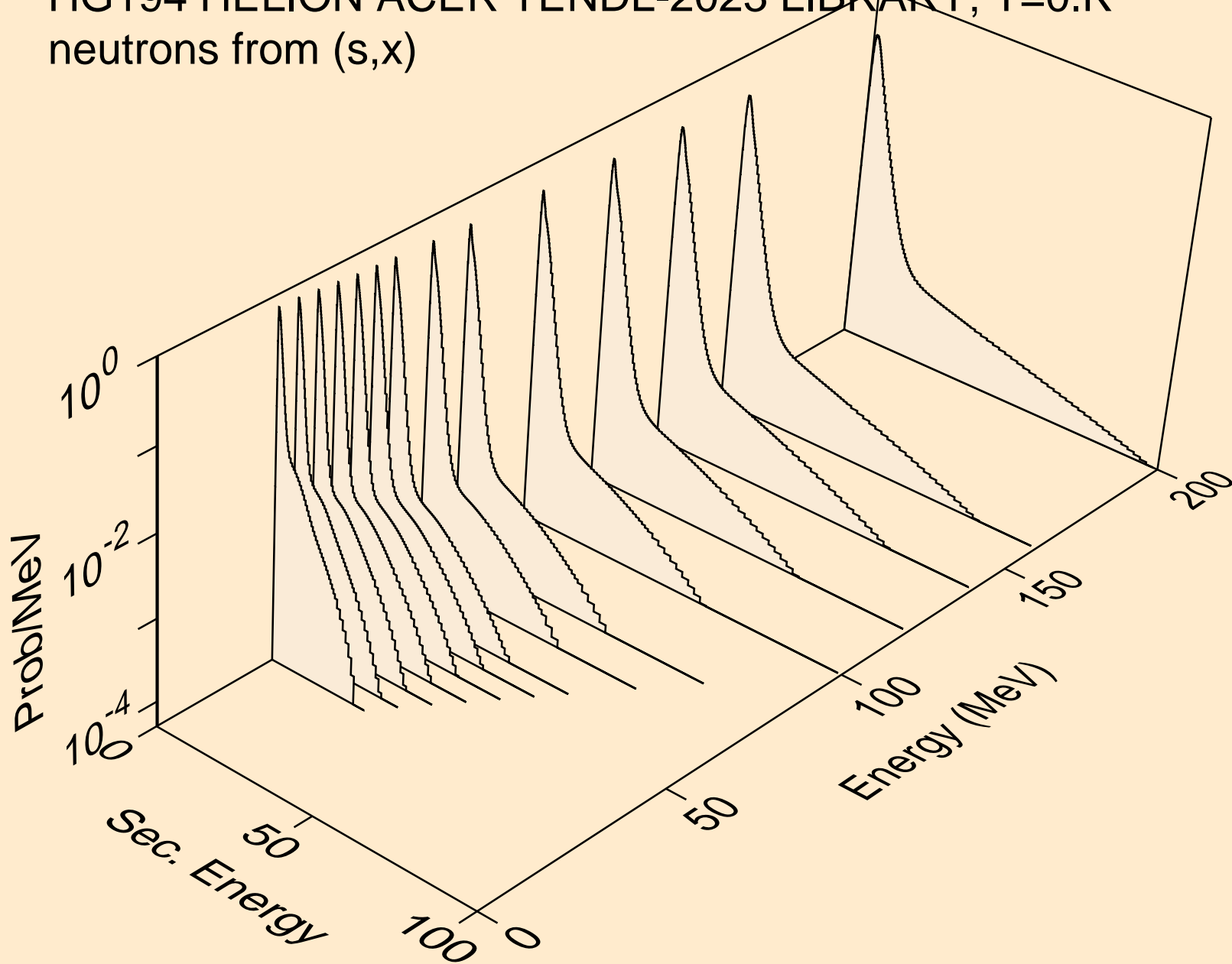

HG194 HELION ACER TENDL-2023 LIBRARY; T=0.K  
neutrons from (s,2nd)

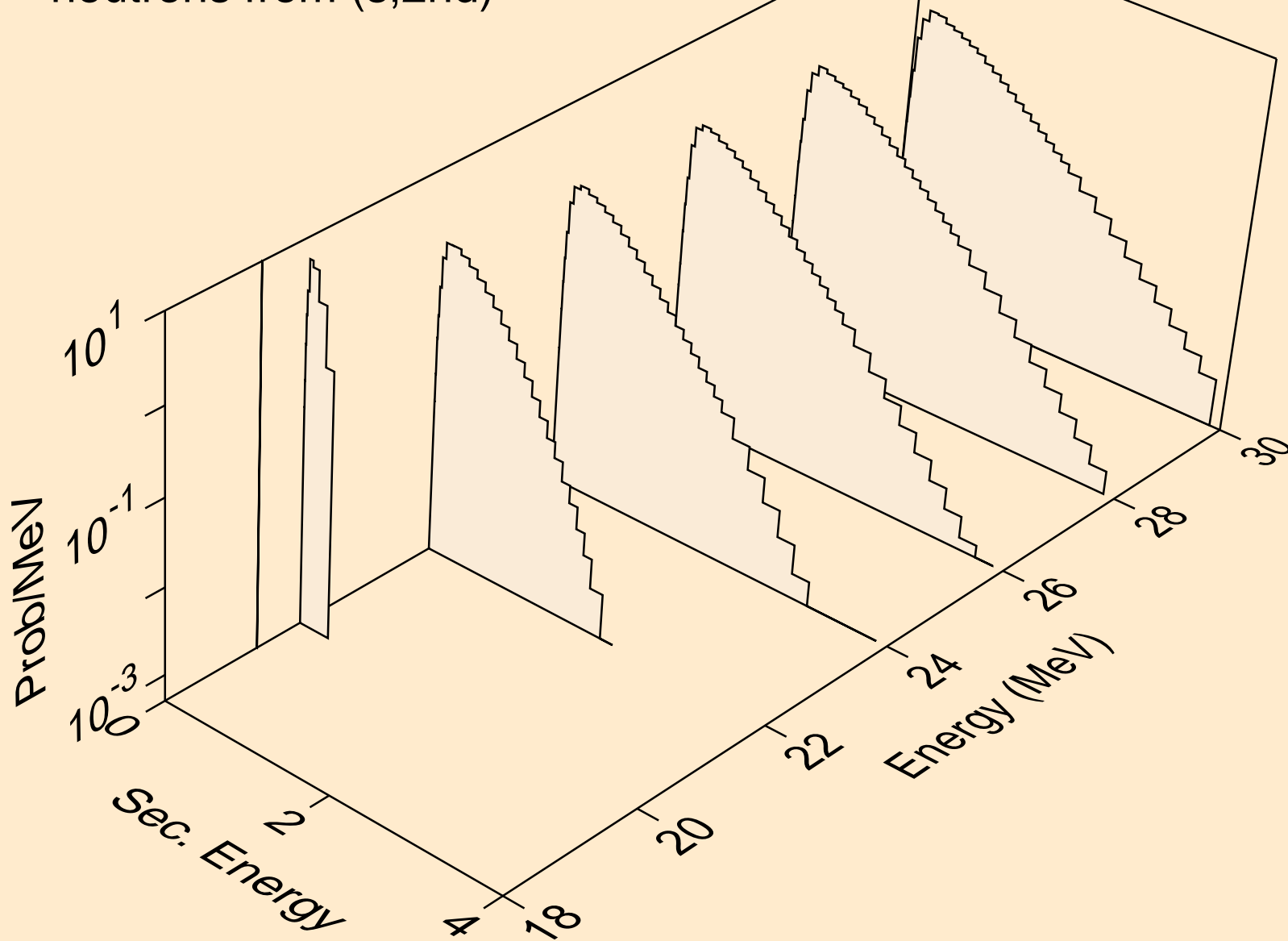

HG194 HELION ACER TENDL-2023 LIBRARY; T=0.K  
neutrons from (s,2n)

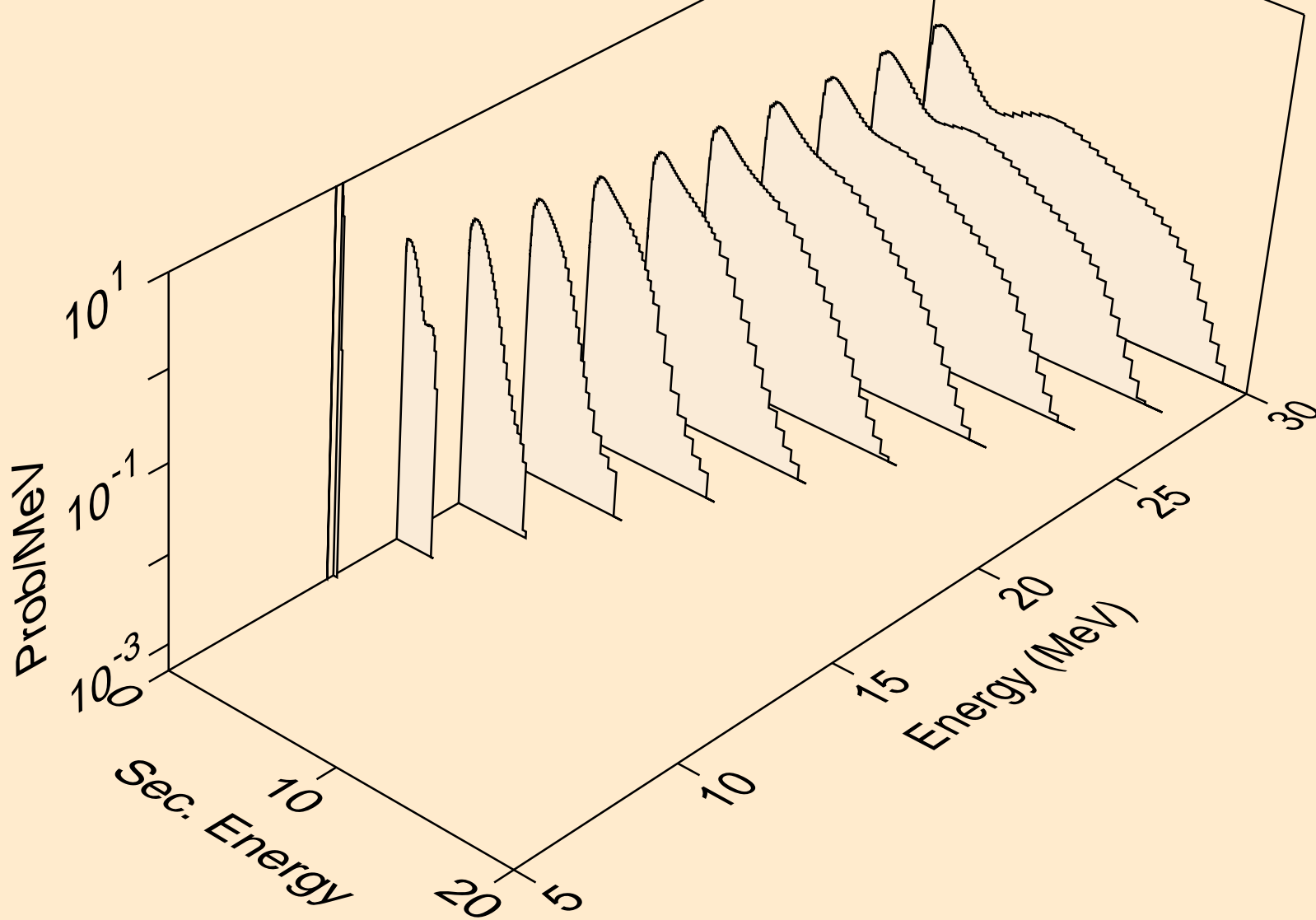

HG194 HELION ACER TENDL-2023 LIBRARY; T=0.K  
neutrons from (s,3n)

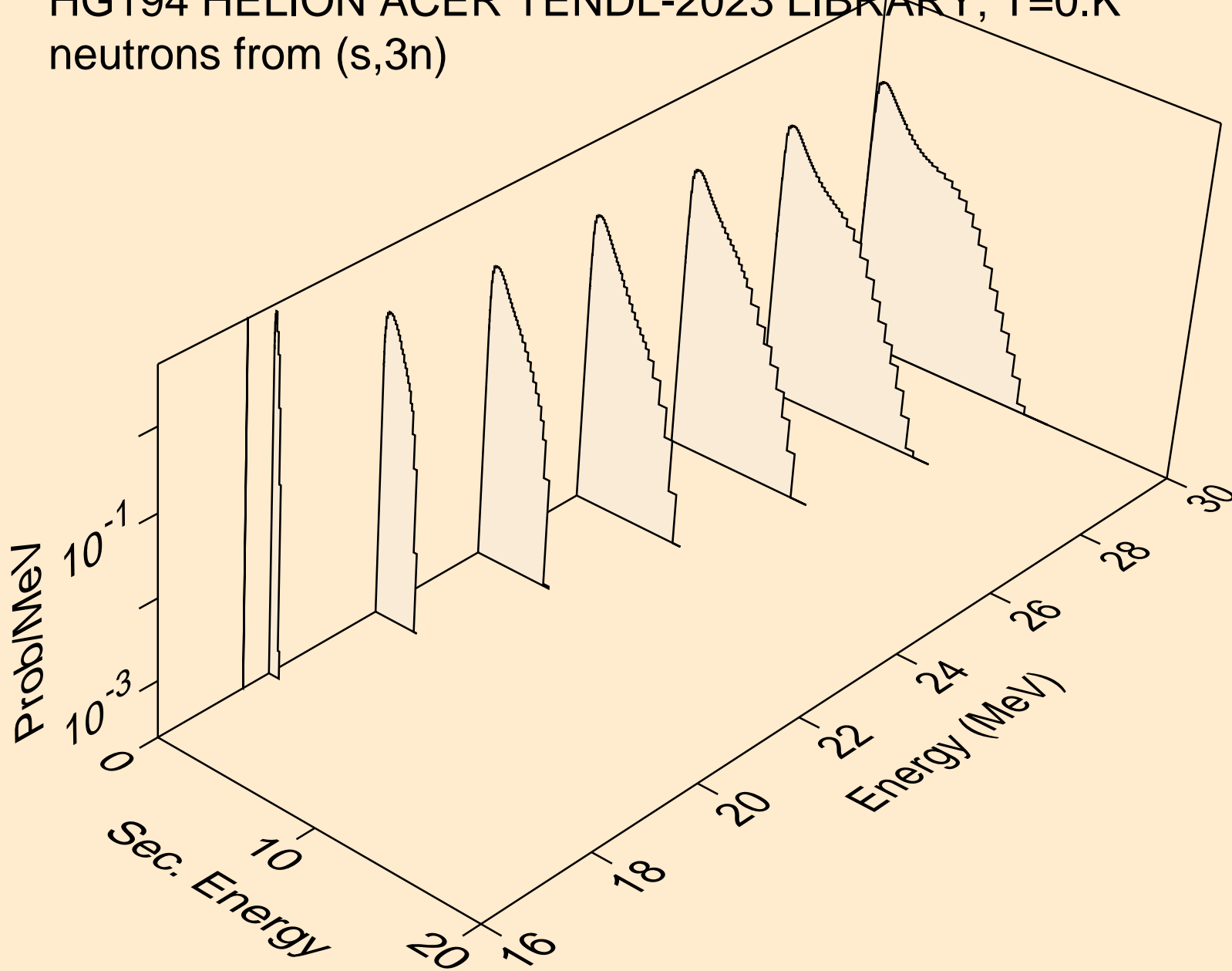

HG194 HELION ACER TENDL-2023 LIBRARY; T=0.K  
neutrons from (s,n\*)a

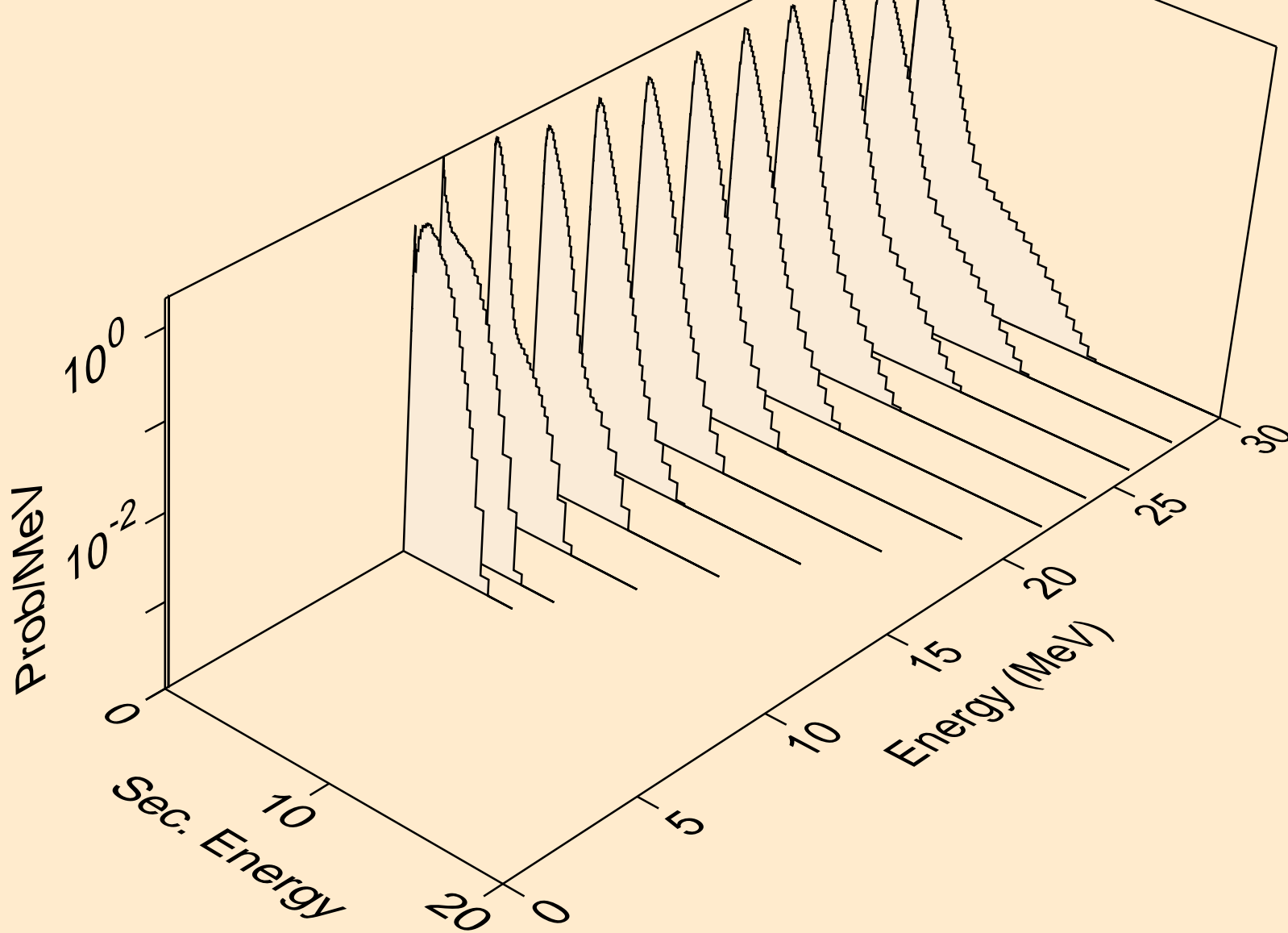

HG194 HELION ACER TENDL-2023 LIBRARY; T=0.K  
neutrons from (s,2n)a

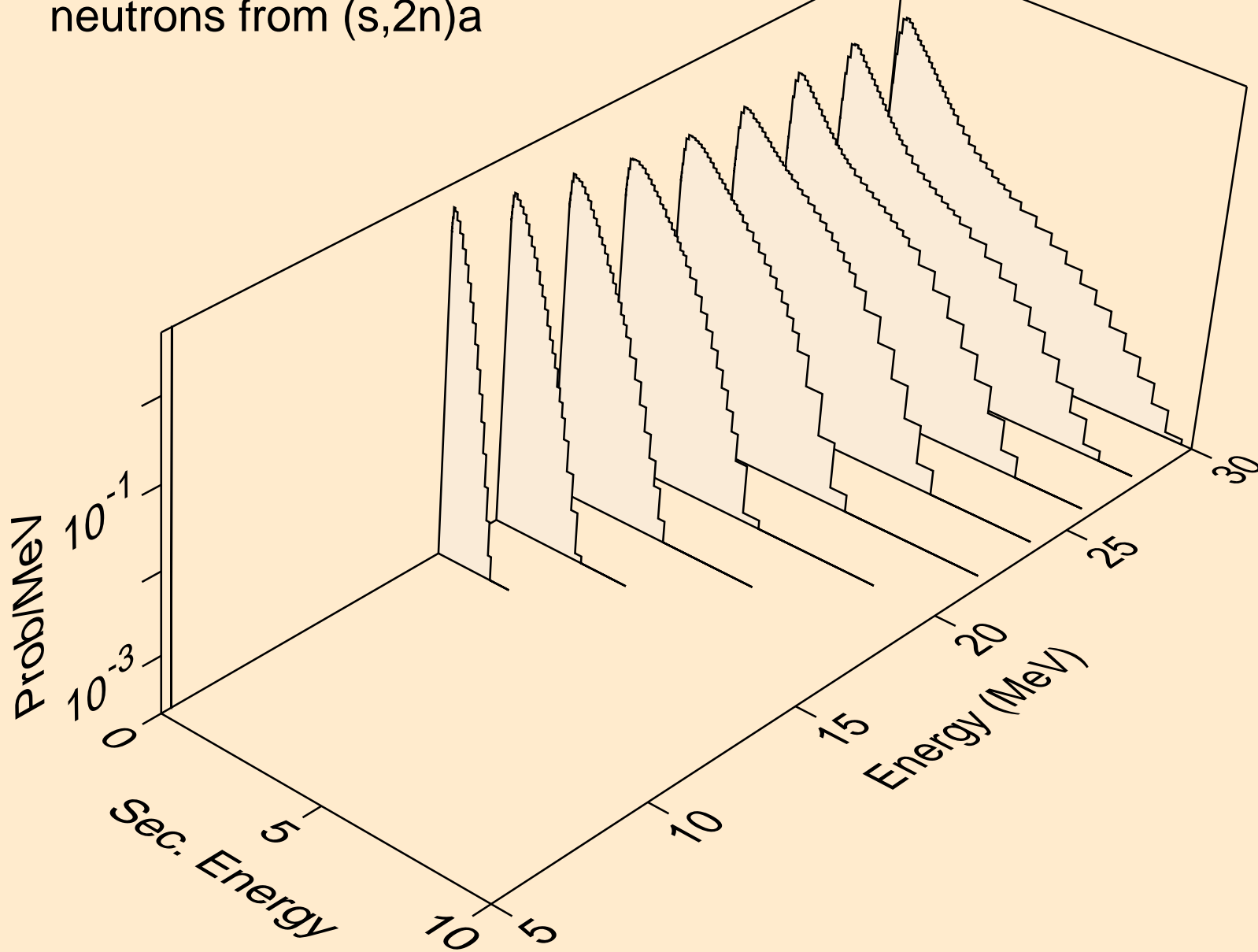

HG194 HELION ACER TENDL-2023 LIBRARY; T=0.K  
neutrons from (s,3n)a

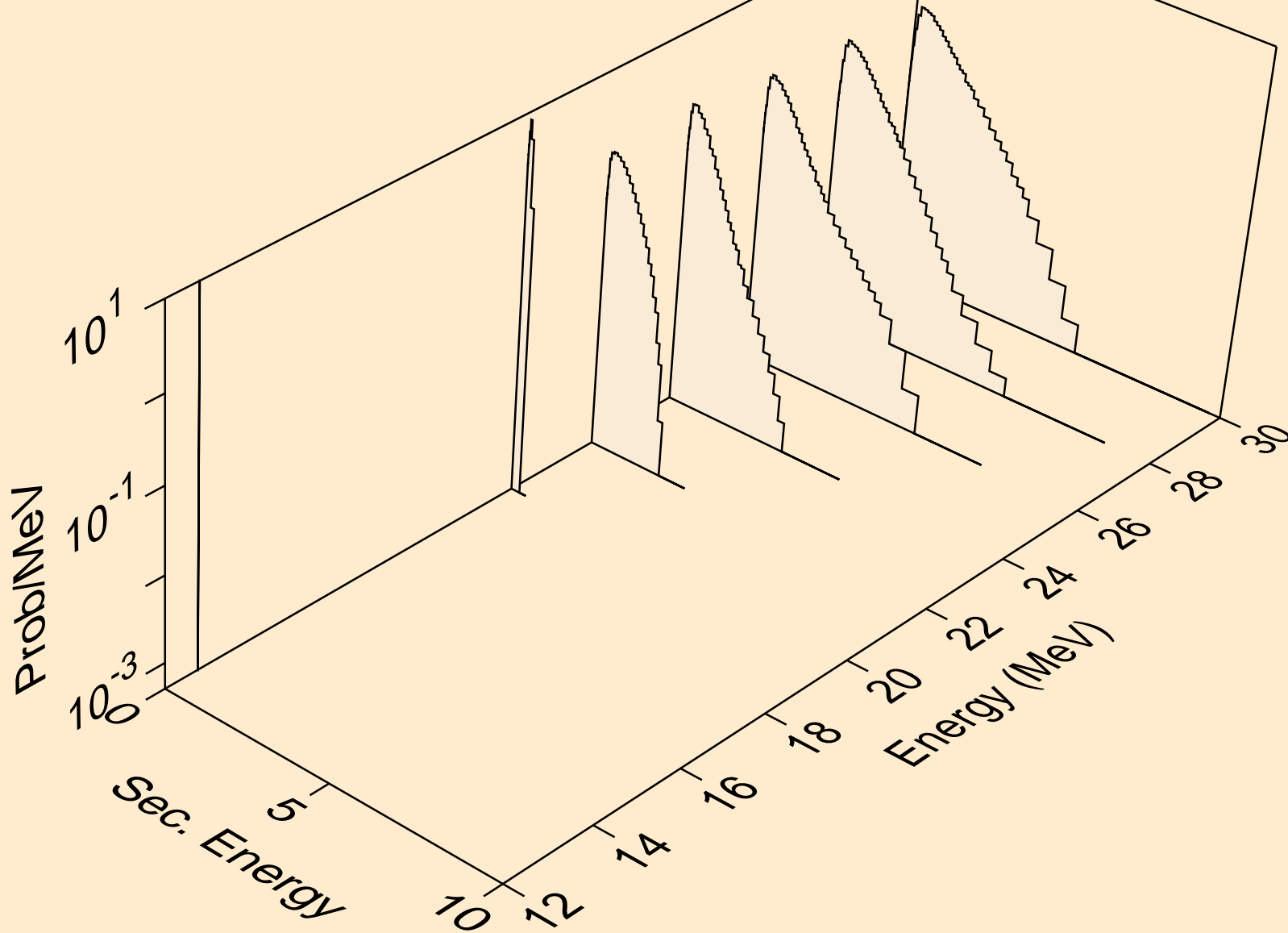

HG194 HELION ACER TENDL-2023 LIBRARY; T=0.K  
neutrons from (s,n\*)p

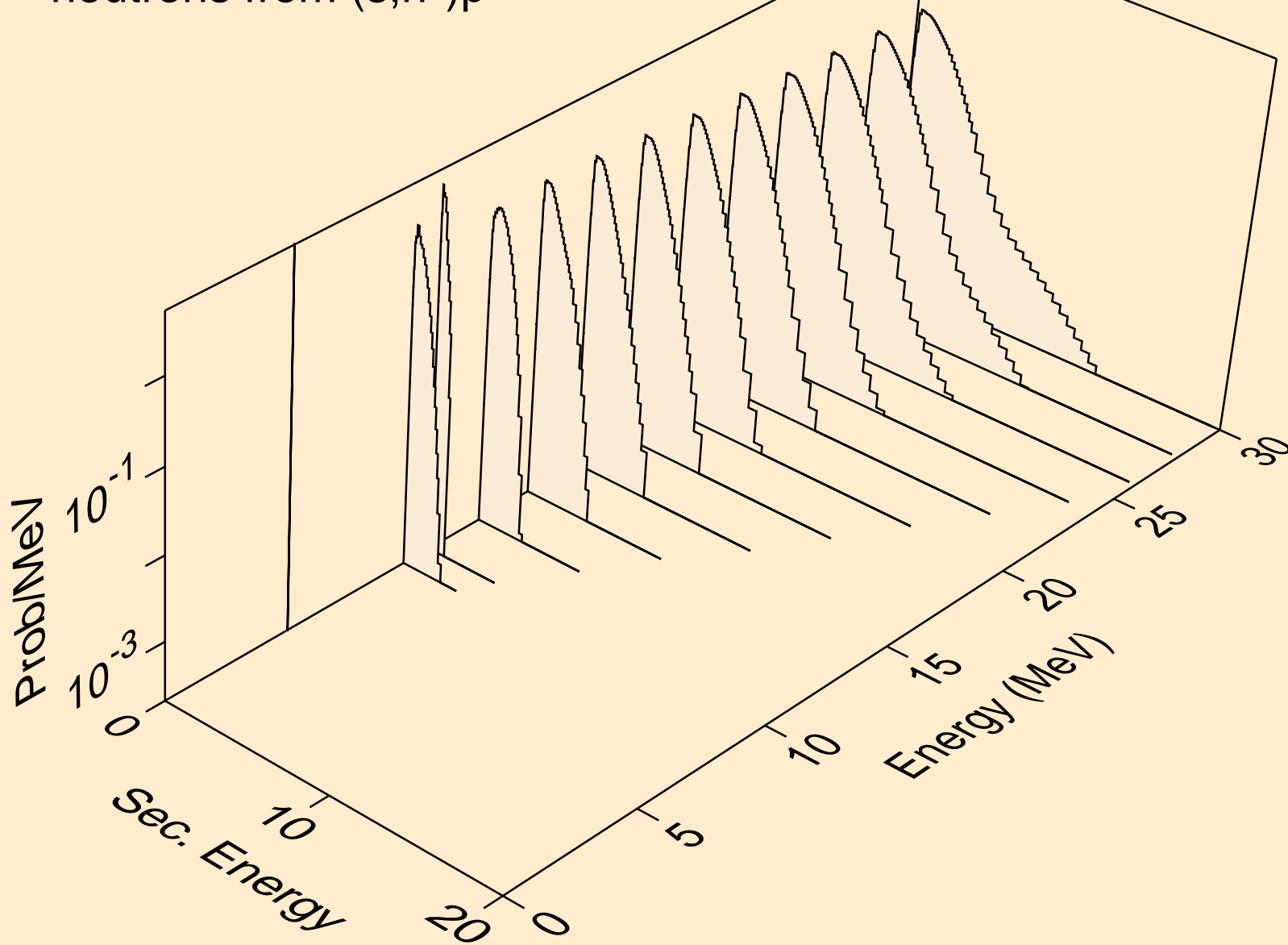

HG194 HELION ACER TENDL-2023 LIBRARY; T=0.K  
neutrons from (s,n\*)d

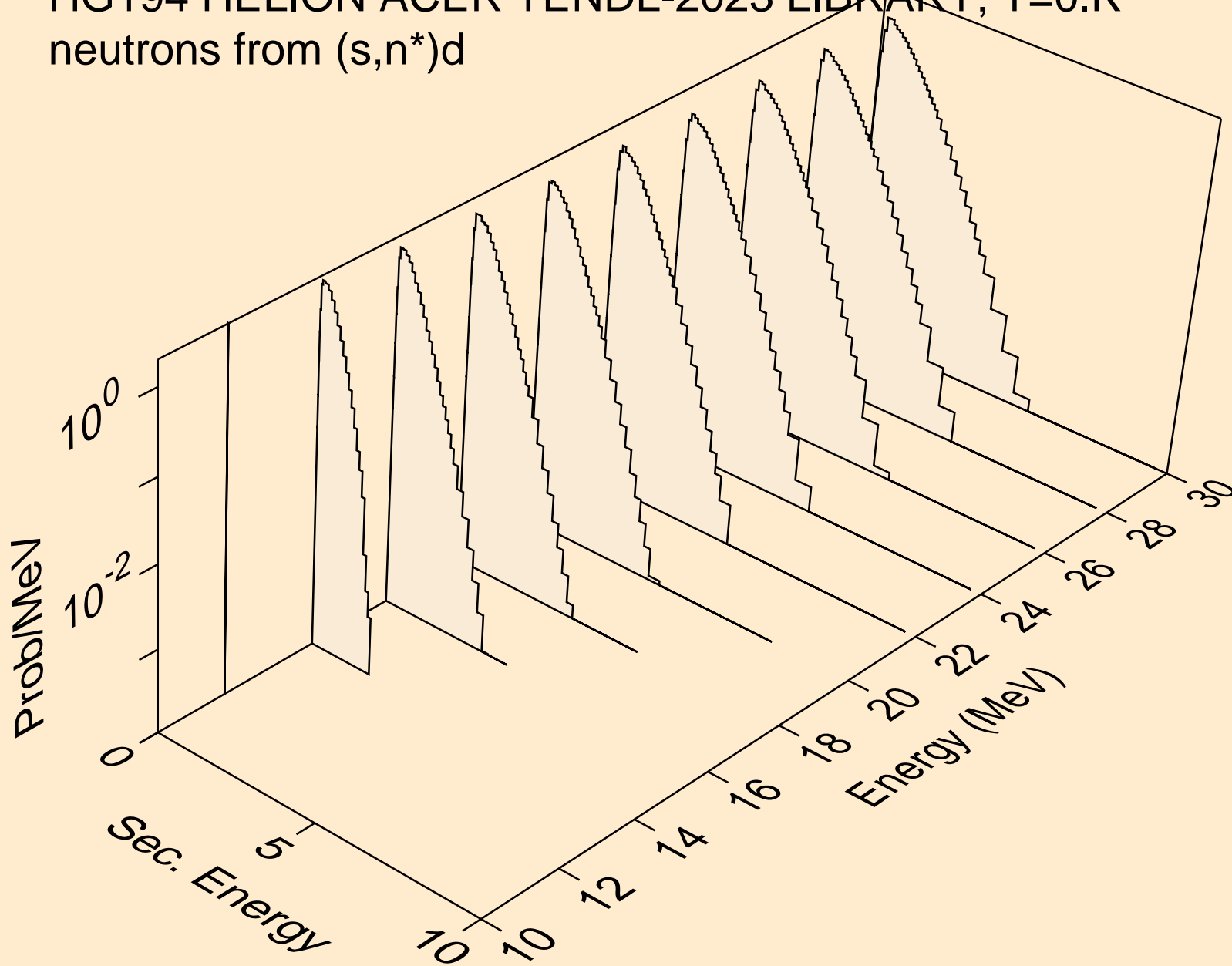

HG194 HELION ACER TENDL-2023 LIBRARY; T=0.K  
neutrons from (s,n\*)t

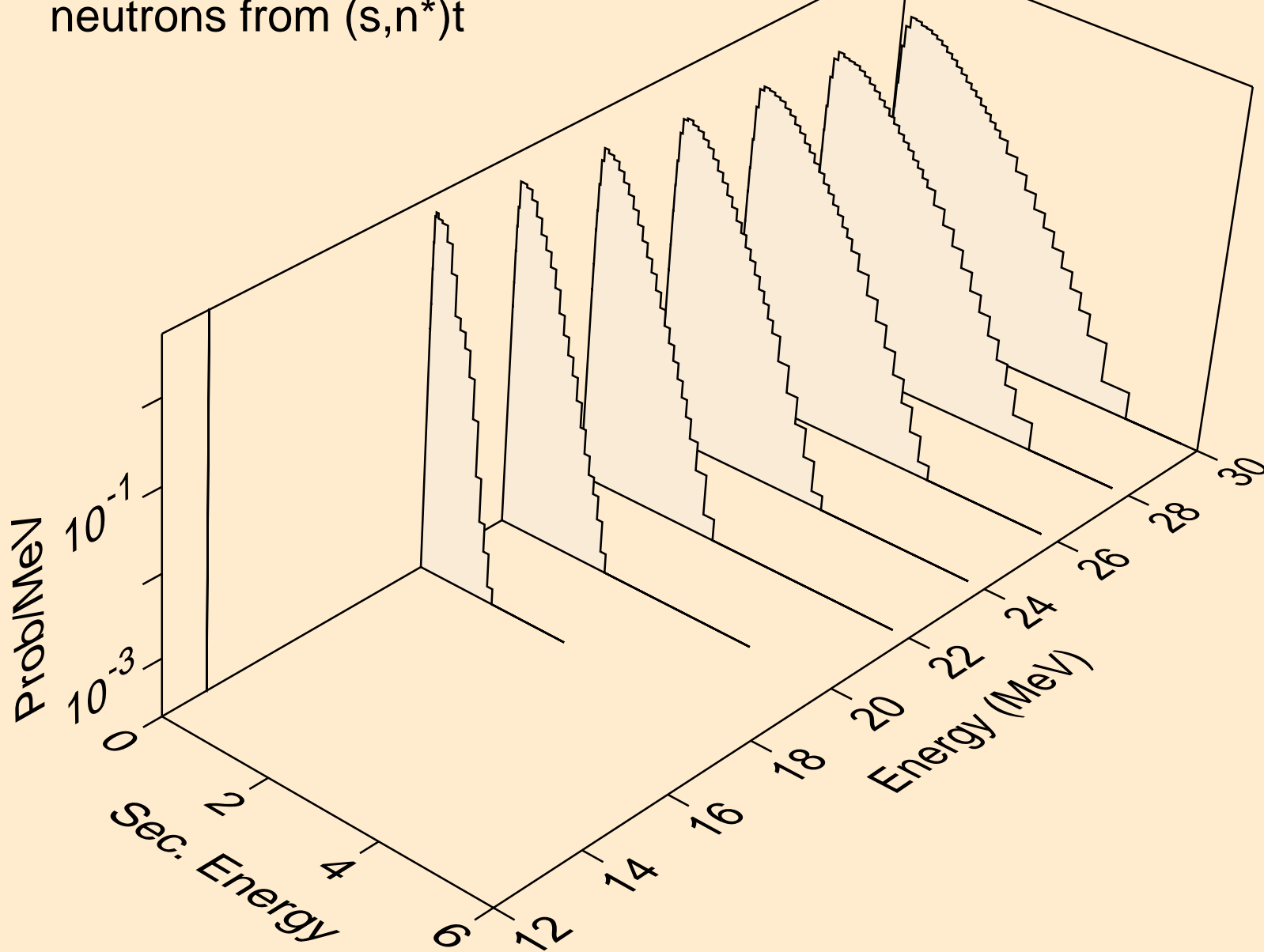

HG194 HELION ACER TENDL-2023 LIBRARY; T=0.K  
neutrons from (s,n\*)he3

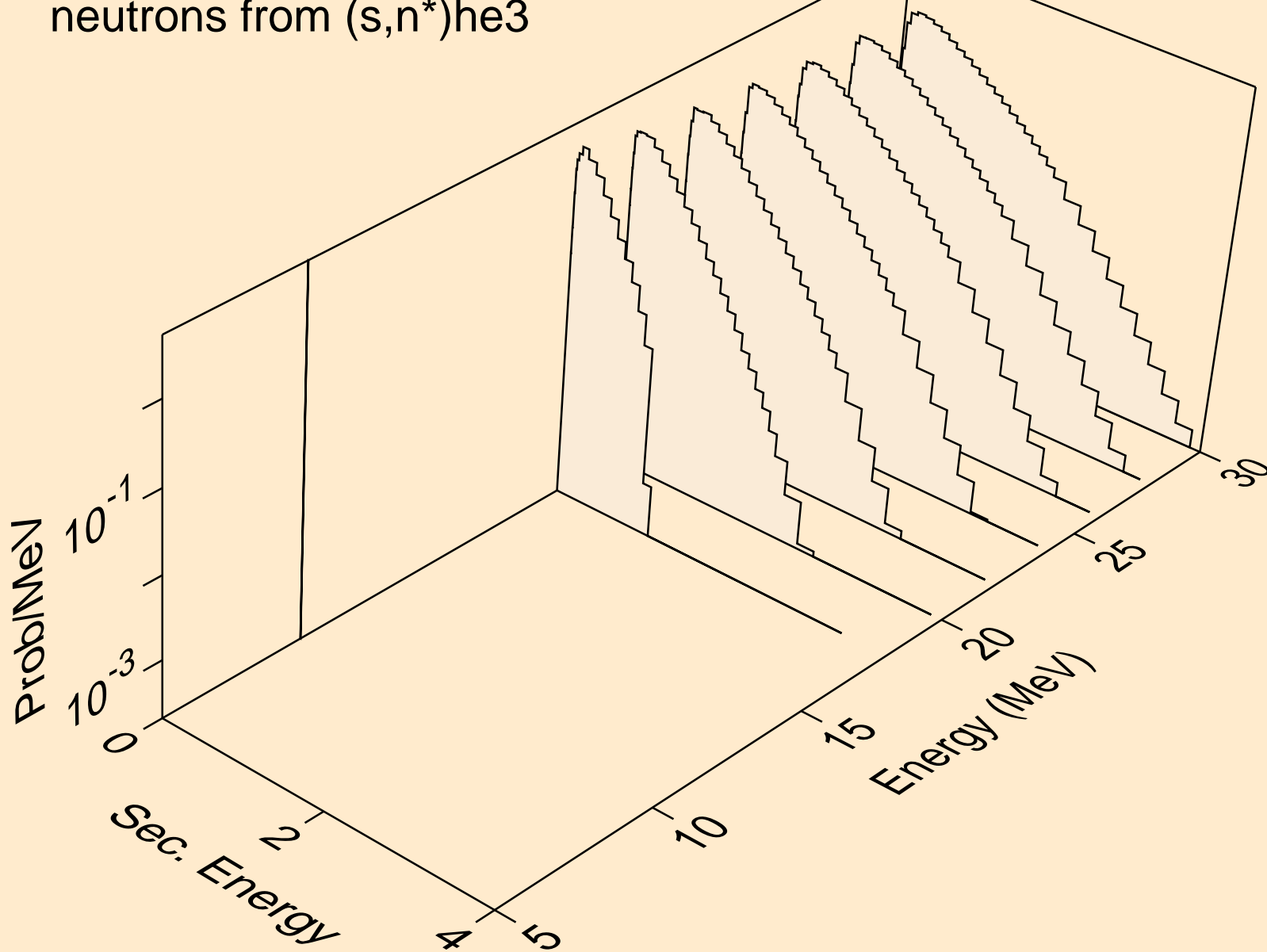

HG194 HELION ACER TENDL-2023 LIBRARY; T=0.K  
neutrons from (s,4n)

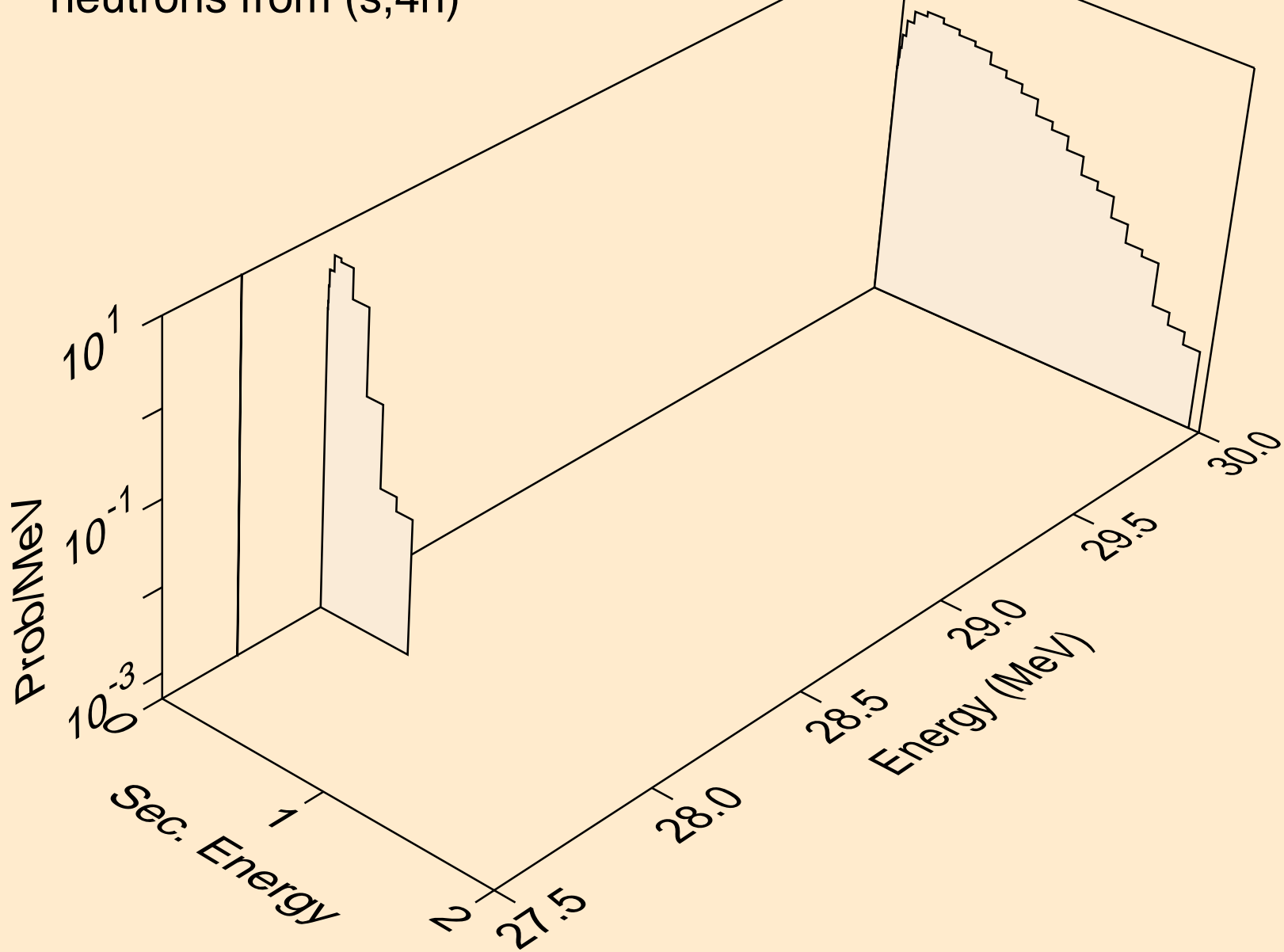

HG194 HELION ACER TENDL-2023 LIBRARY; T=0.K  
neutrons from (s,2np)

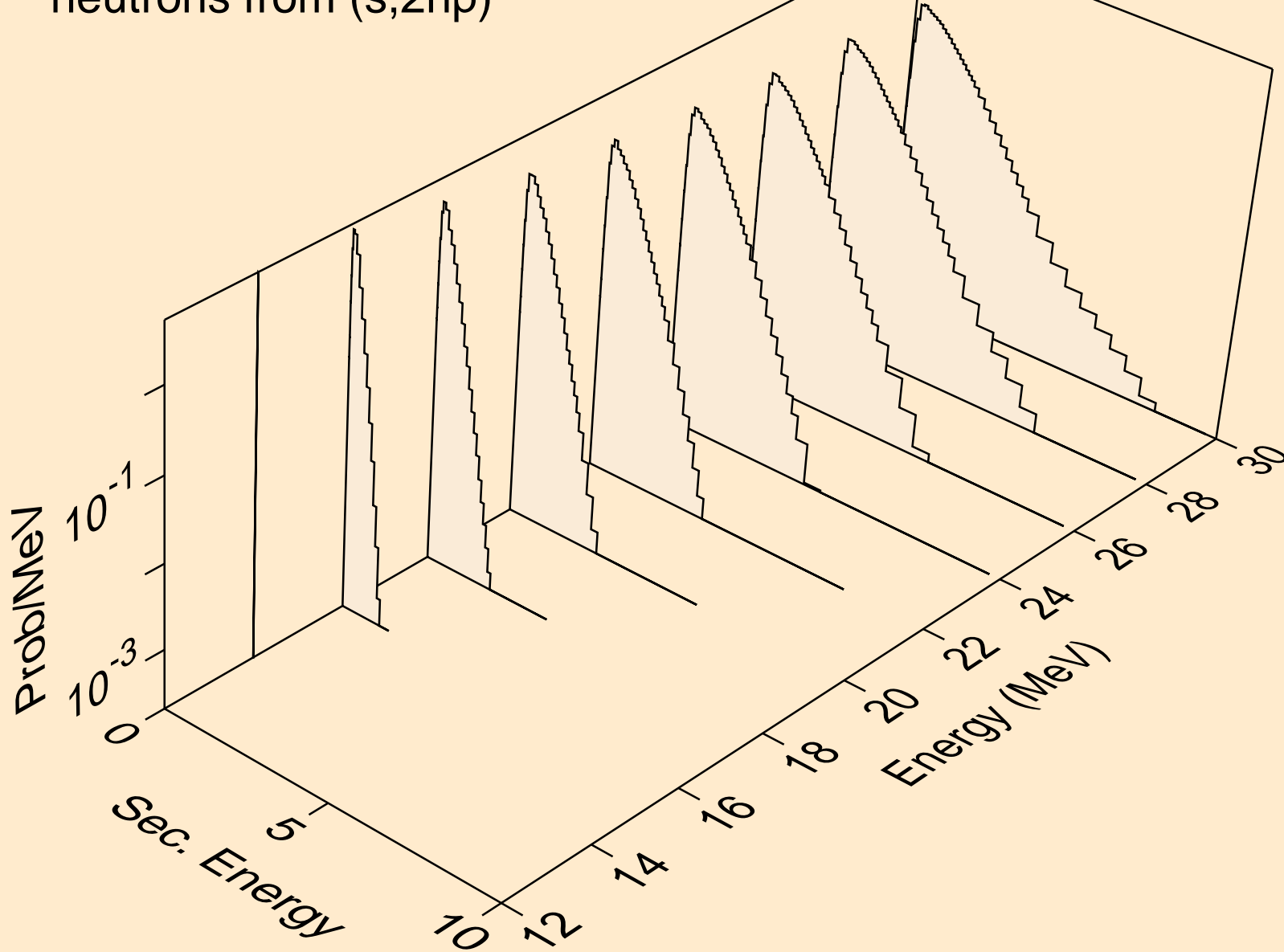

HG194 HELION ACER TENDL-2023 LIBRARY; T=0.K  
neutrons from (s,3np)

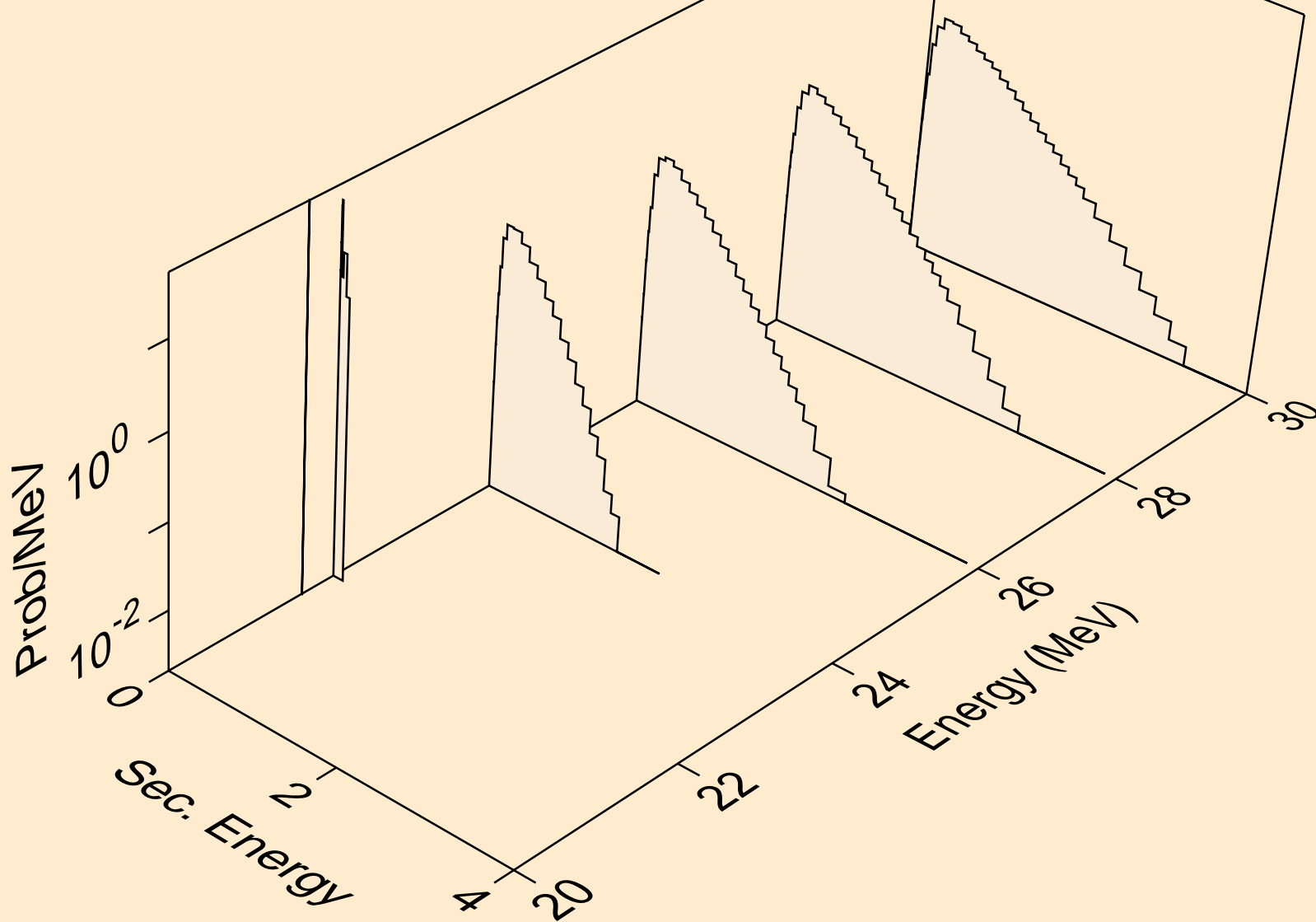

HG194 HELION ACER TENDL-2023 LIBRARY; T=0.K  
neutrons from (s,n2p)

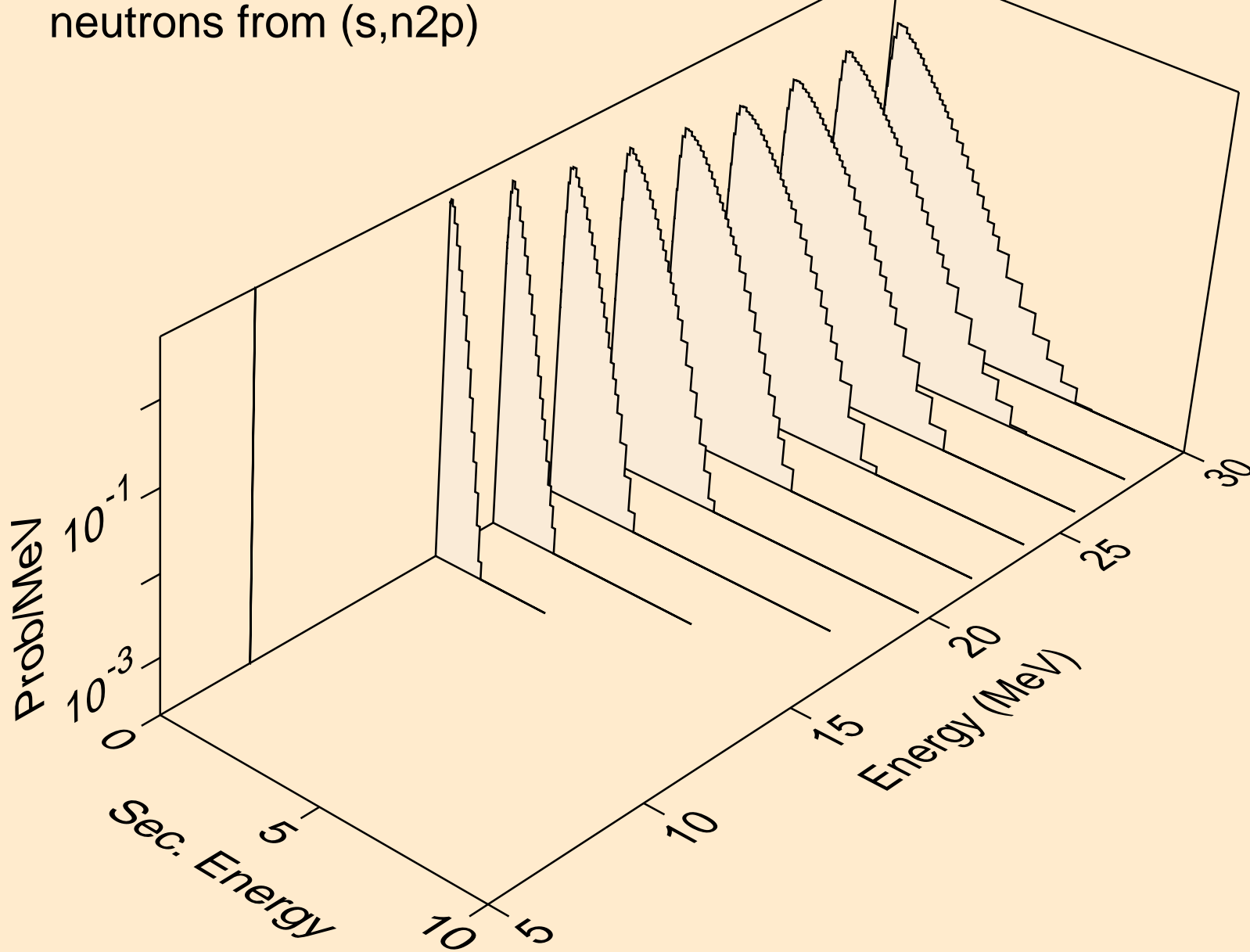

HG194 HELION ACER TENDL-2023 LIBRARY; T=0.K  
neutrons from (s,npa)

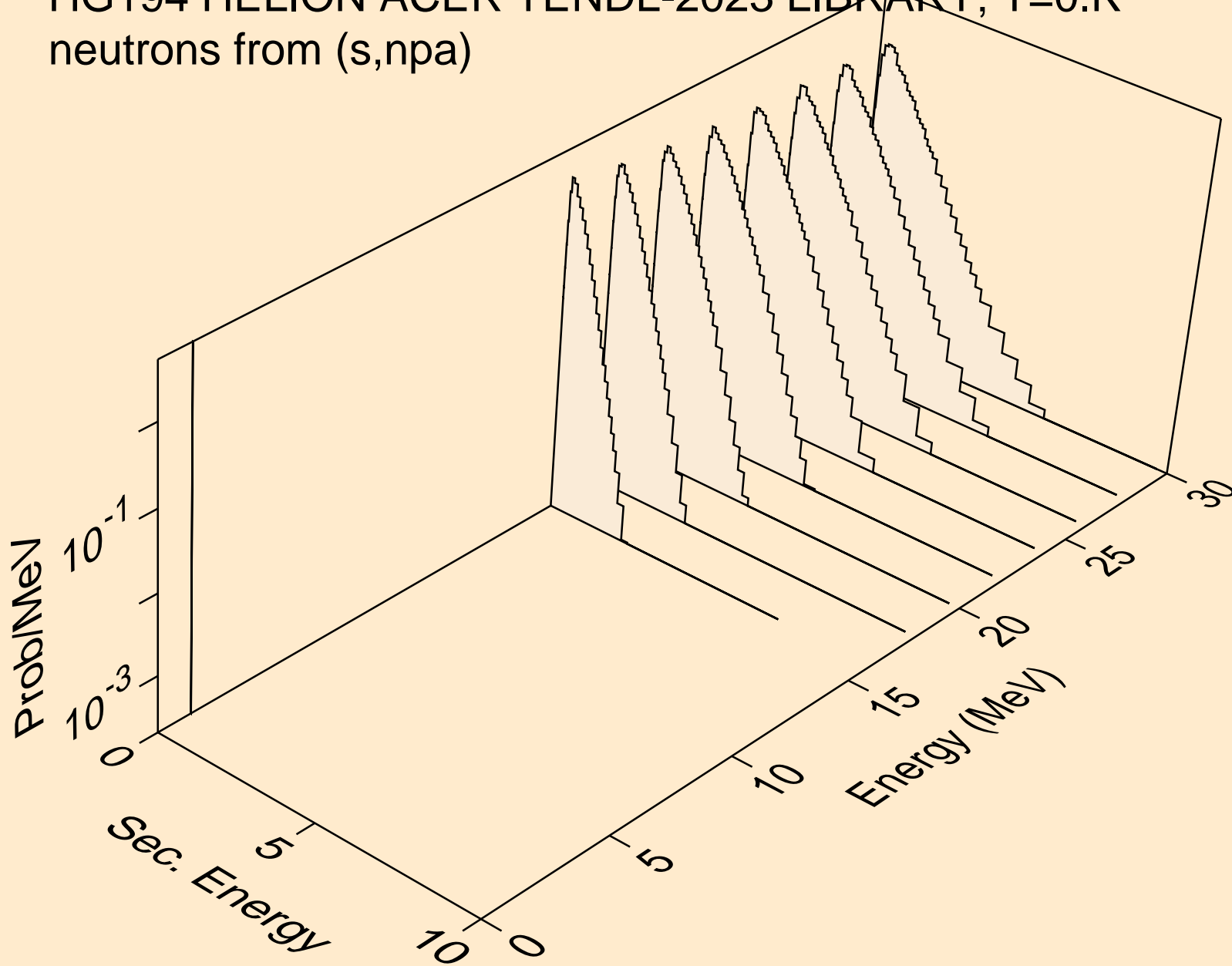

HG194 HELION ACER TENDL-2023 LIBRARY; T=0.K  
protons from (s,x)

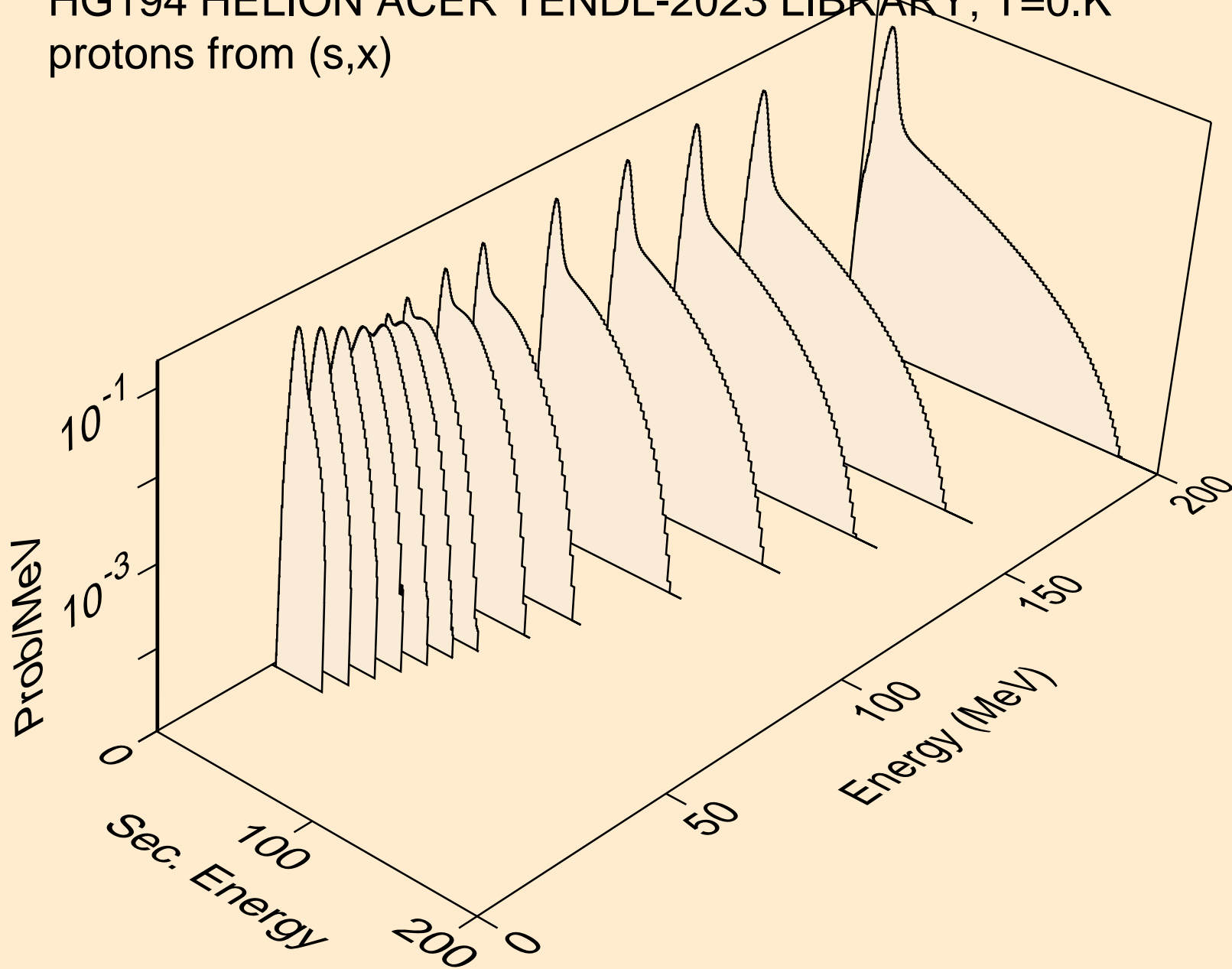

HG194 HELION ACER TENDL-2023 LIBRARY; T=0.K  
protons from (s,n\*)p

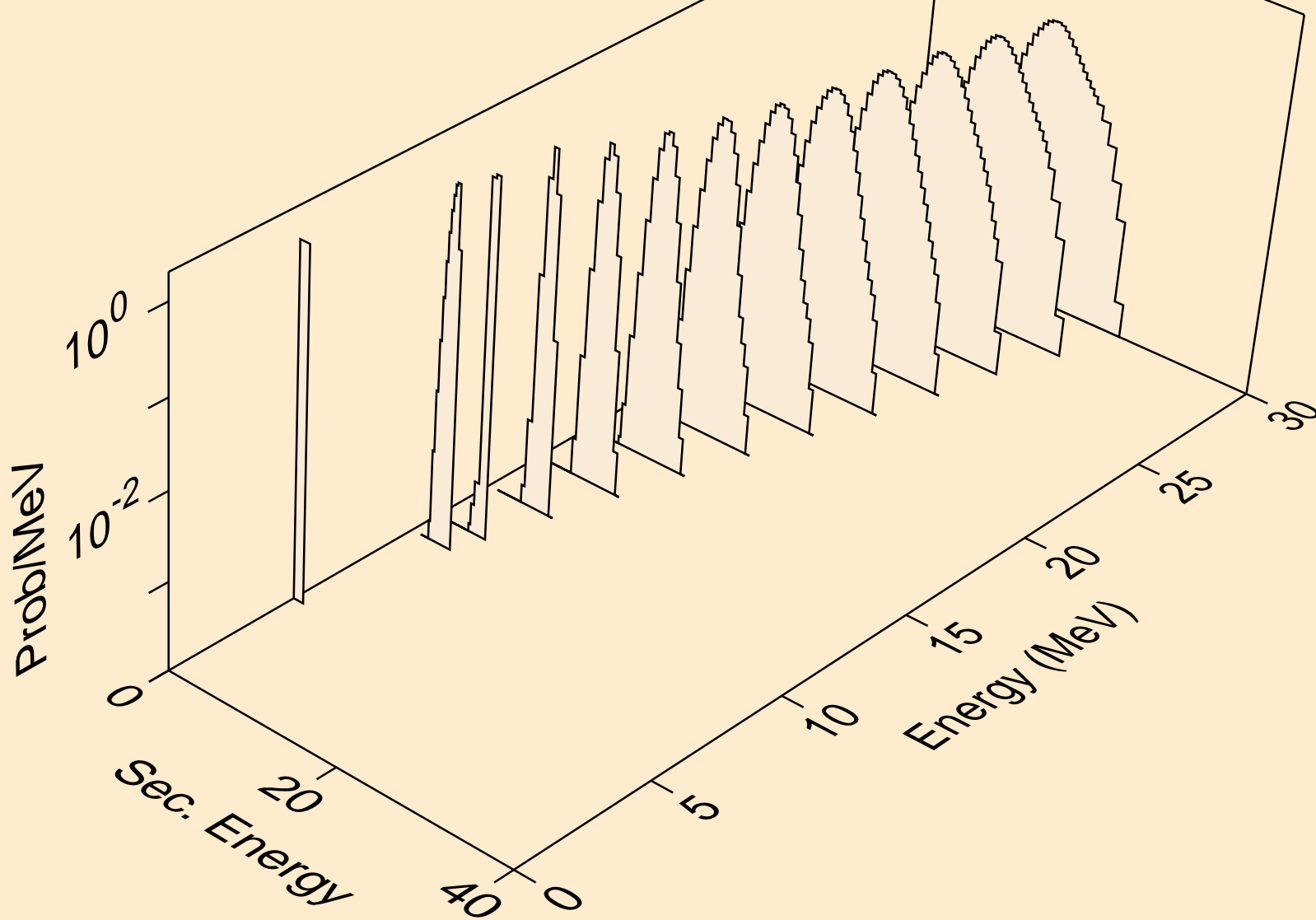

HG194 HELION ACER TENDL-2023 LIBRARY; T=0.K  
protons from (s,2np)

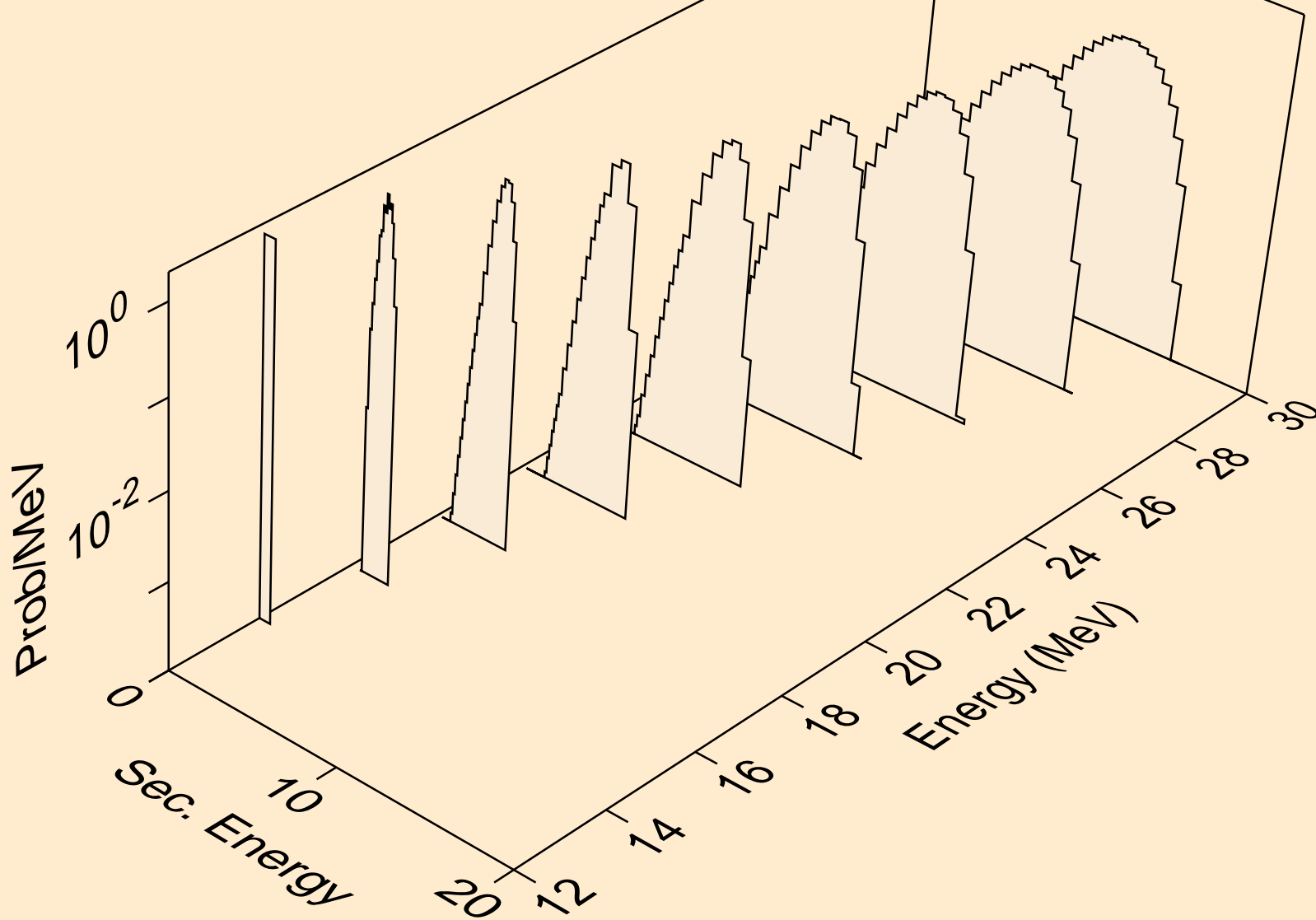

HG194 HELION ACER TENDL-2023 LIBRARY; T=0.K  
protons from (s,3np)

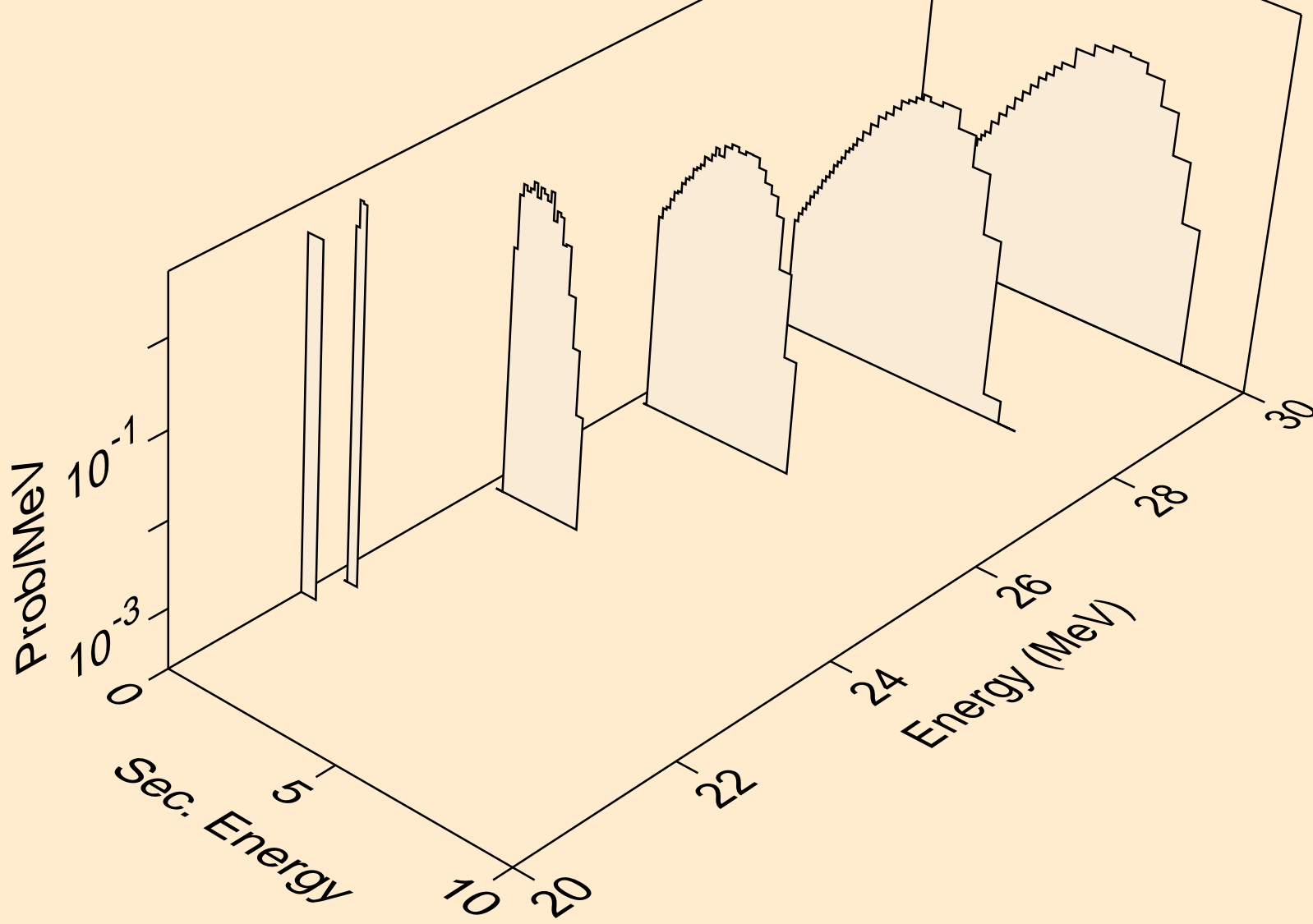

HG194 HELION ACER TENDL-2023 LIBRARY; T=0.K  
protons from (s,n2p)

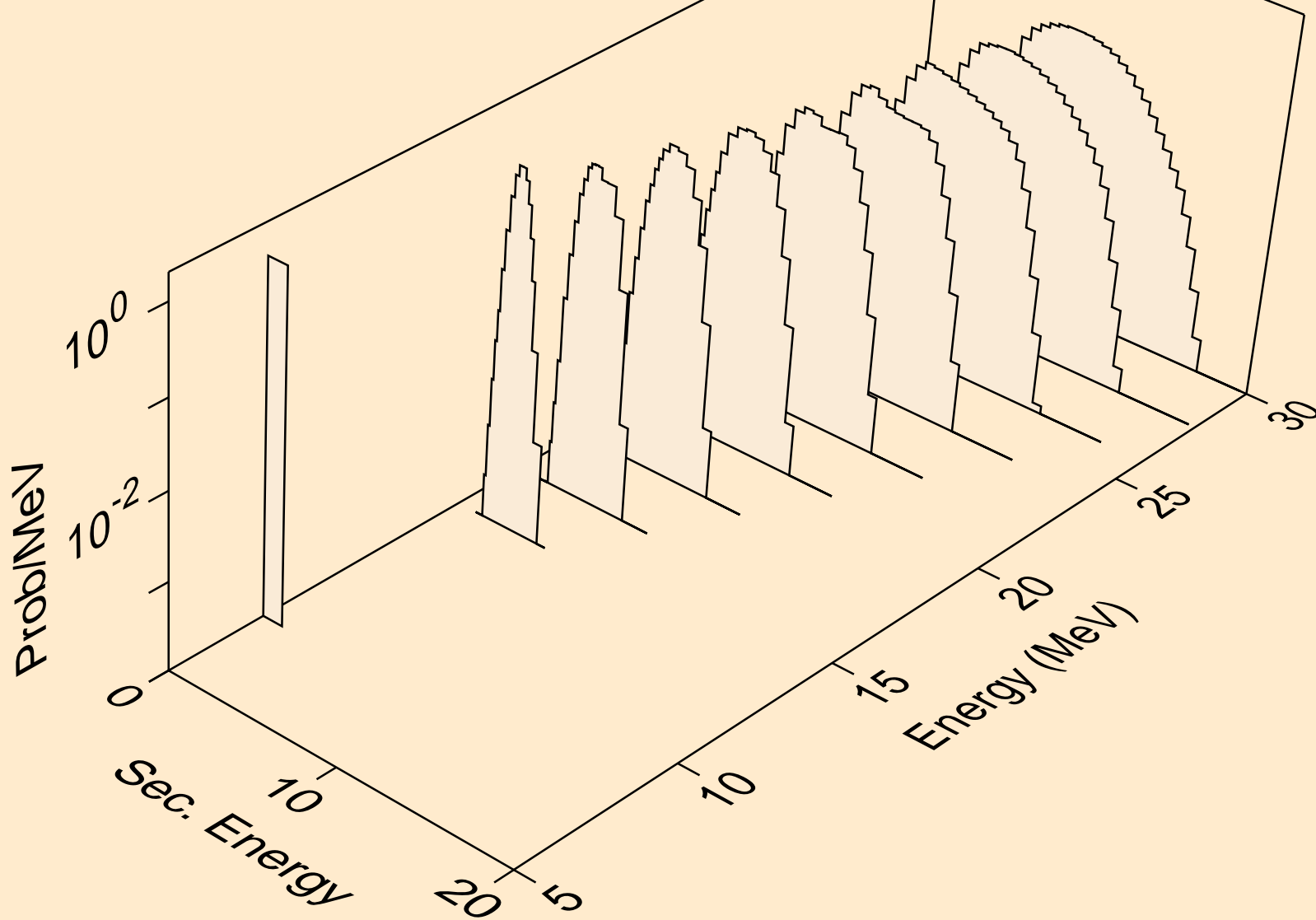

HG194 HELION ACER TENDL-2023 LIBRARY; T=0.K  
protons from (s,npa)

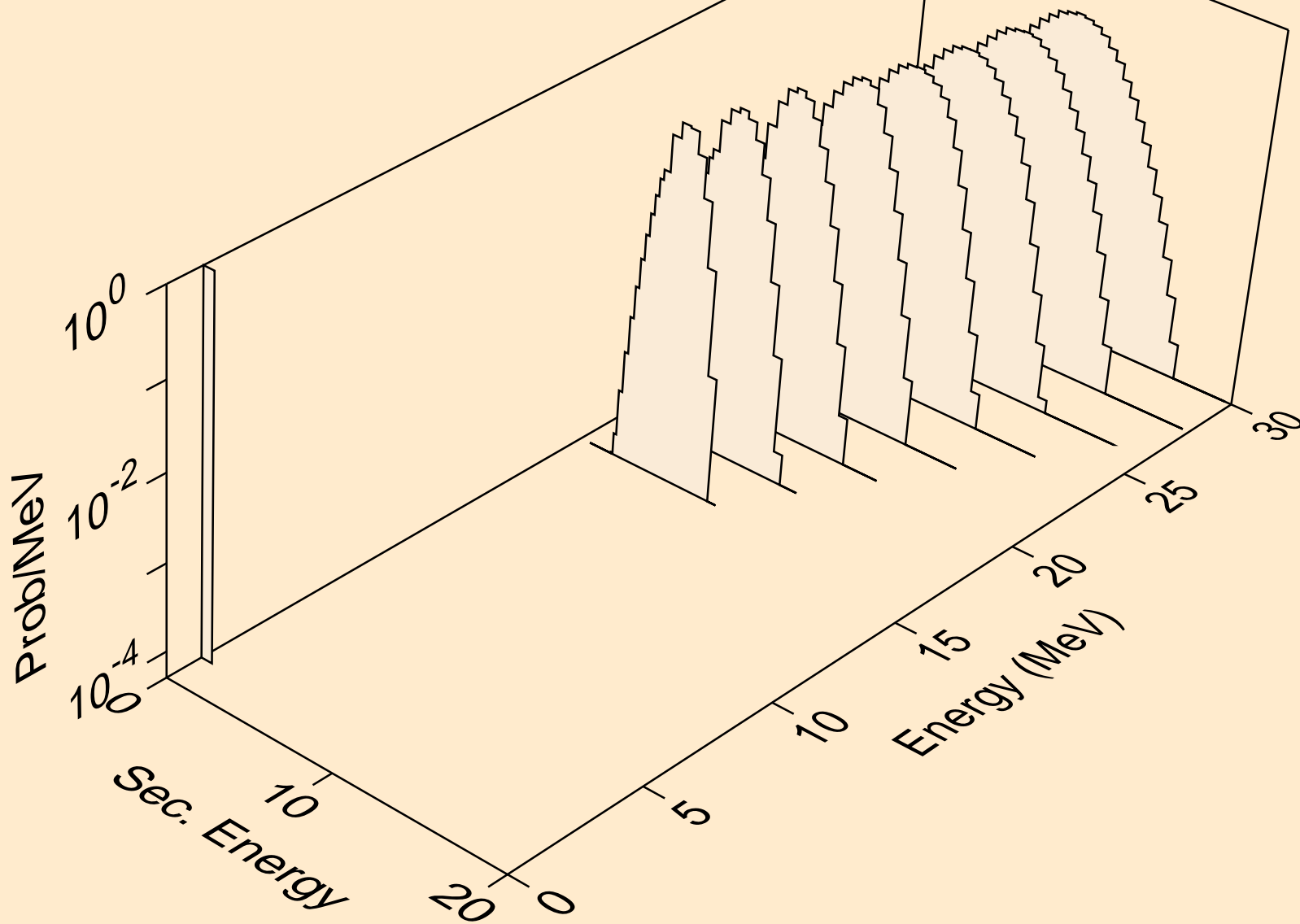

HG194 HELION ACER TENDL-2023 LIBRARY; T=0.K  
protons from (s,p)

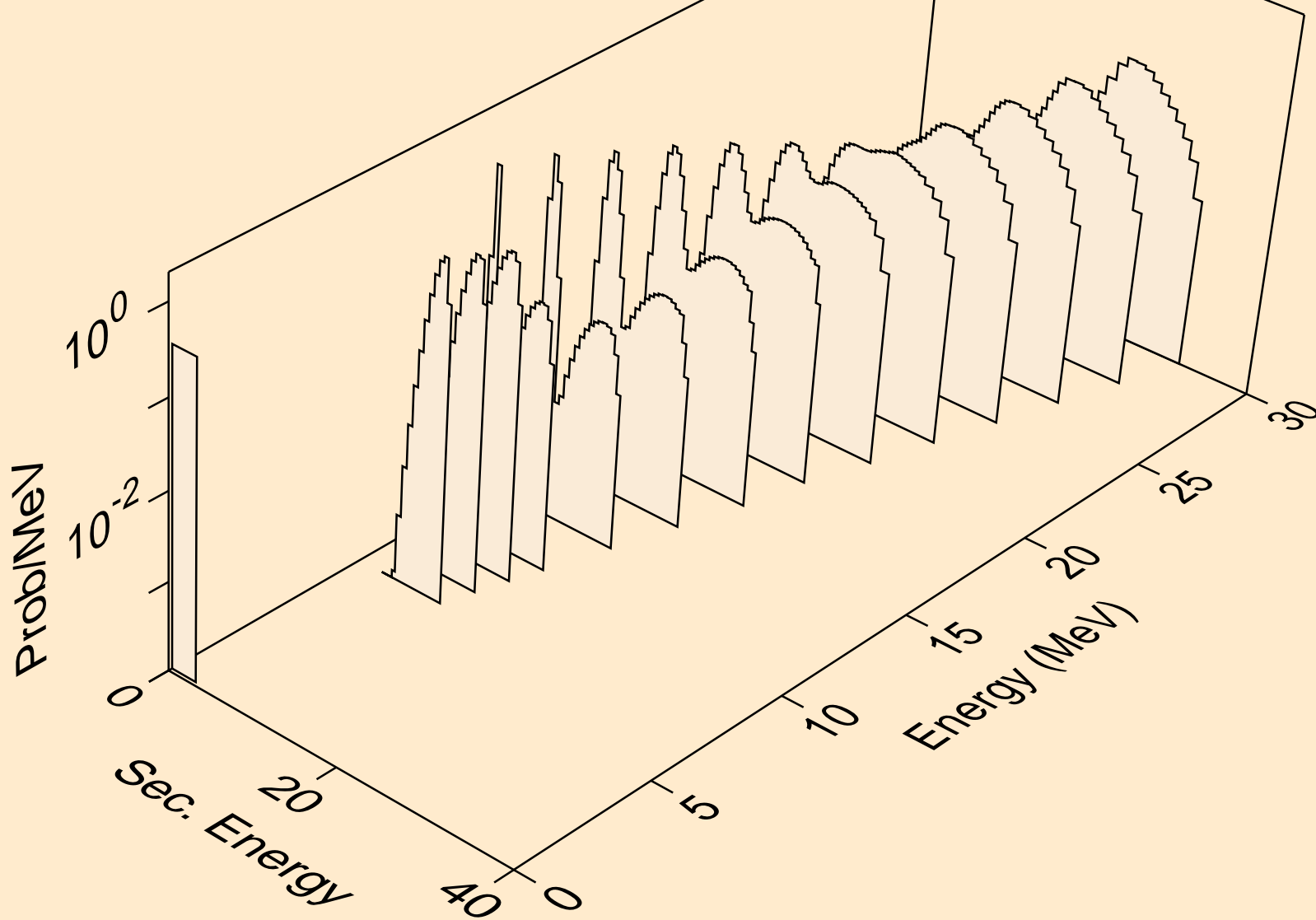

HG194 HELION ACER TENDL-2023 LIBRARY; T=0.K  
protons from (s,2p)

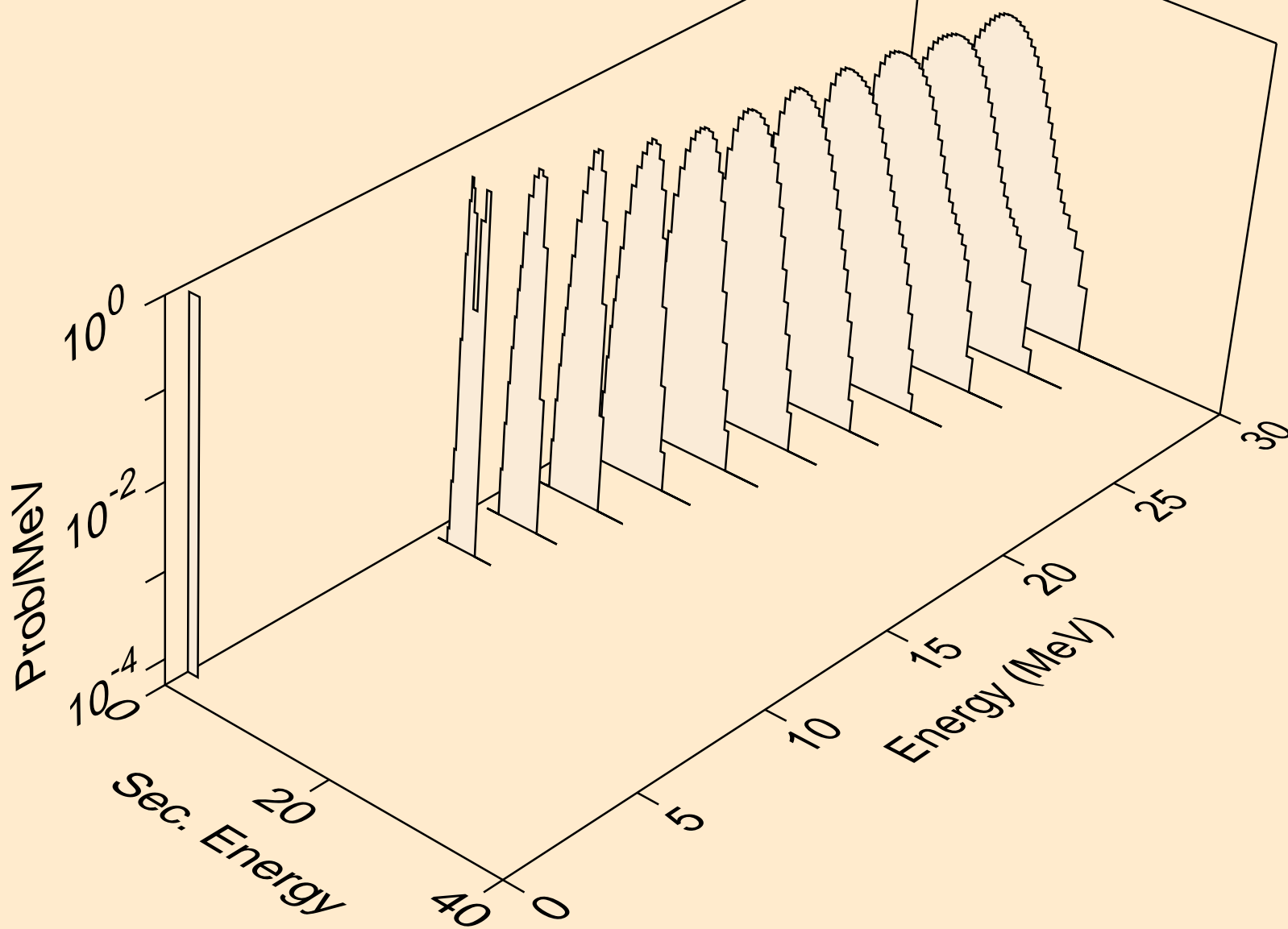

HG194 HELION ACER TENDL-2023 LIBRARY; T=0.K  
protons from (s,pa)

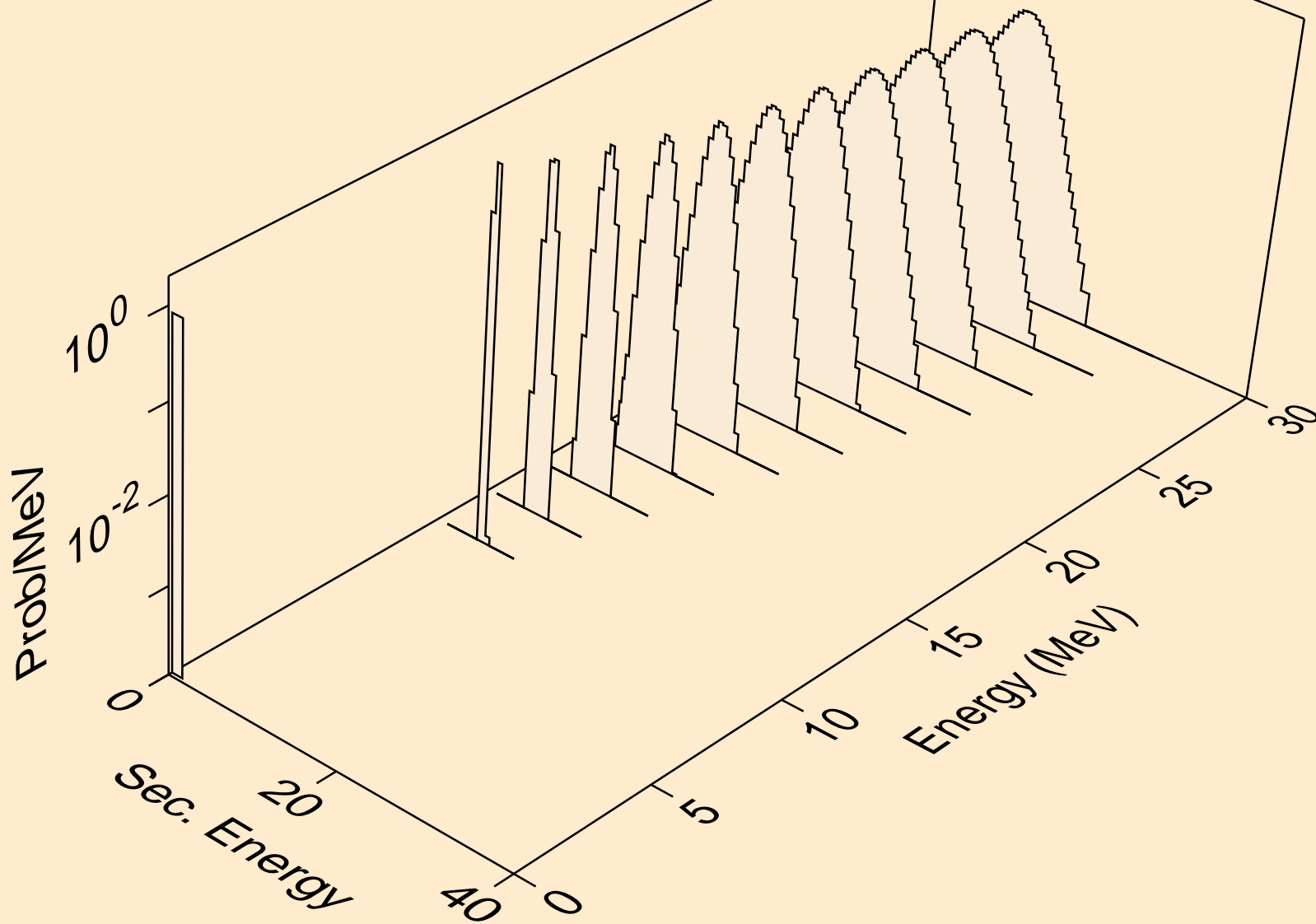

HG194 HELION ACER TENDL-2023 LIBRARY; T=0.K  
protons from (s,pd)

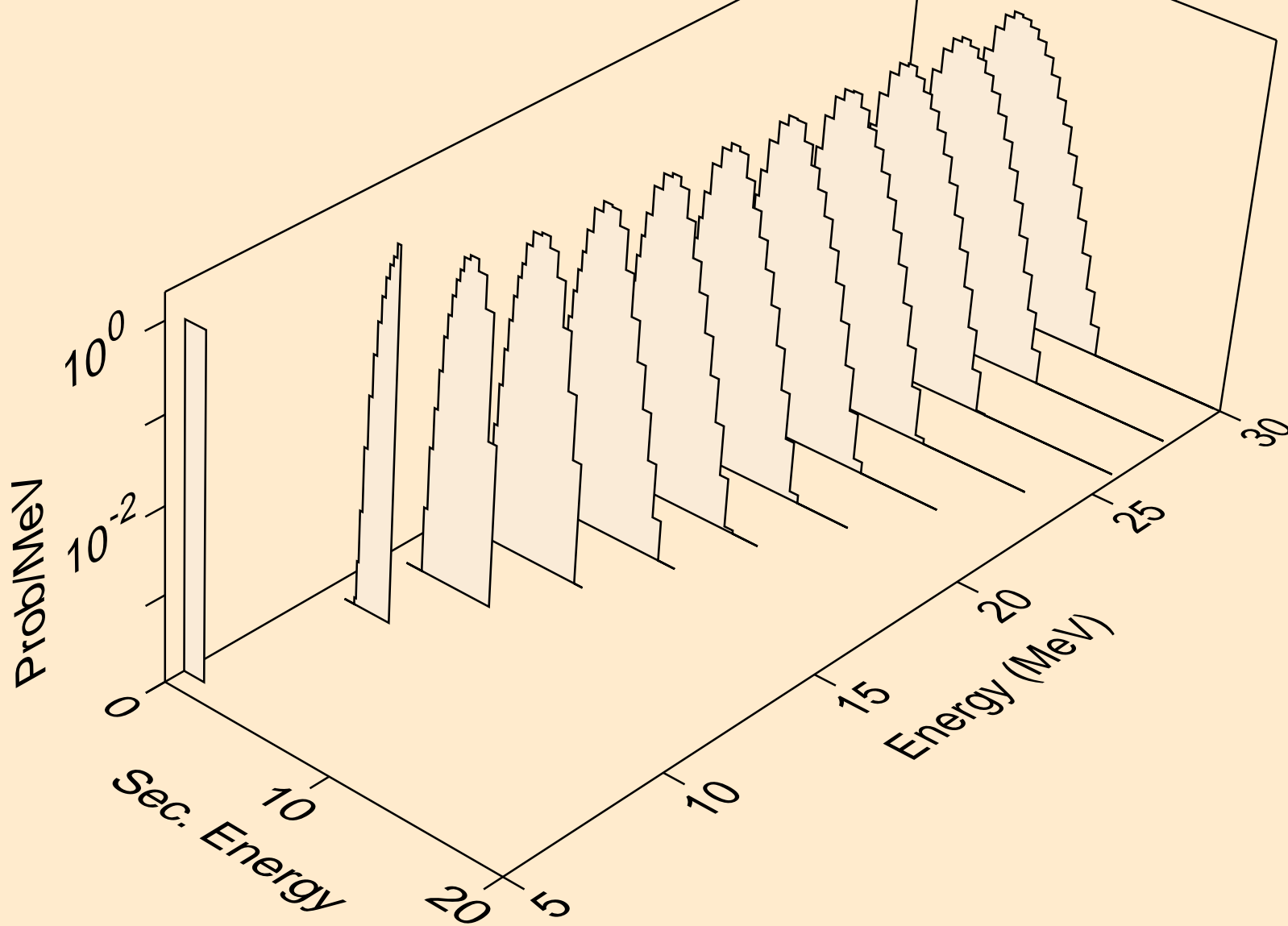

HG194 HELION ACER TENDL-2023 LIBRARY; T=0.K  
protons from (s,pt)

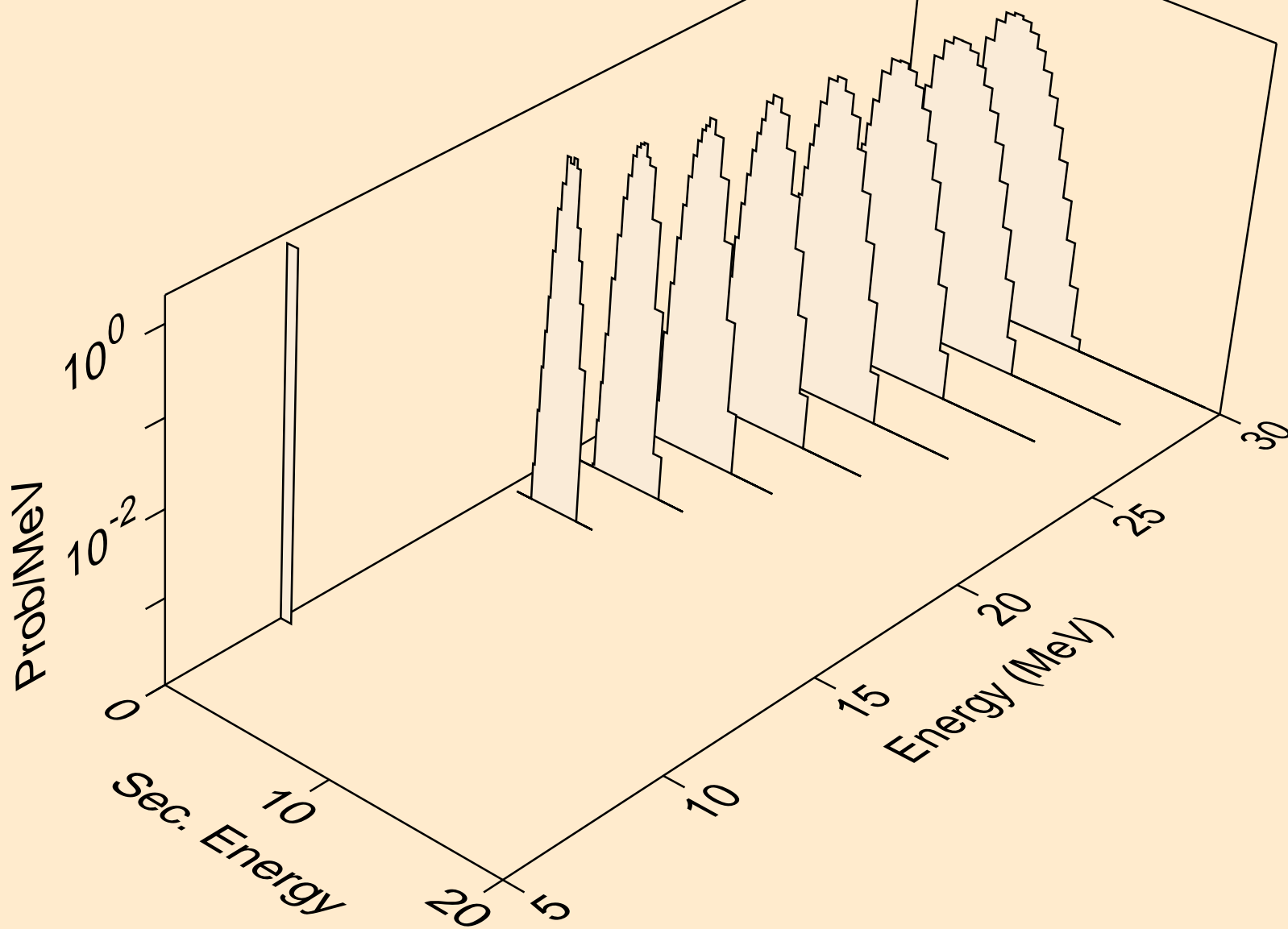

HG194 HELION ACER TENDL-2023 LIBRARY; T=0.K  
deuterons from (s,x)

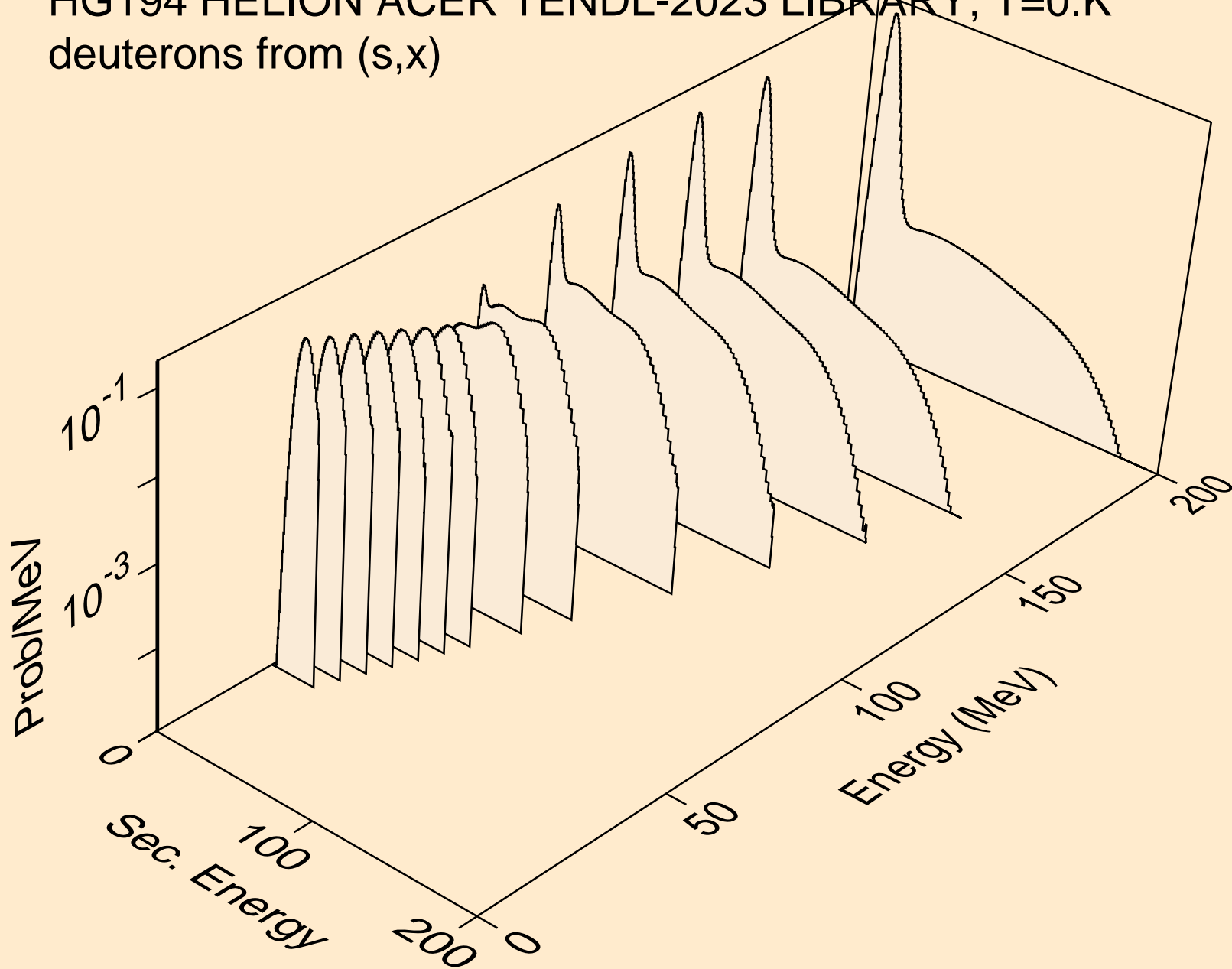

HG194 HELION ACER TENDL-2023 LIBRARY; T=0.K  
deuterons from (s,2nd)

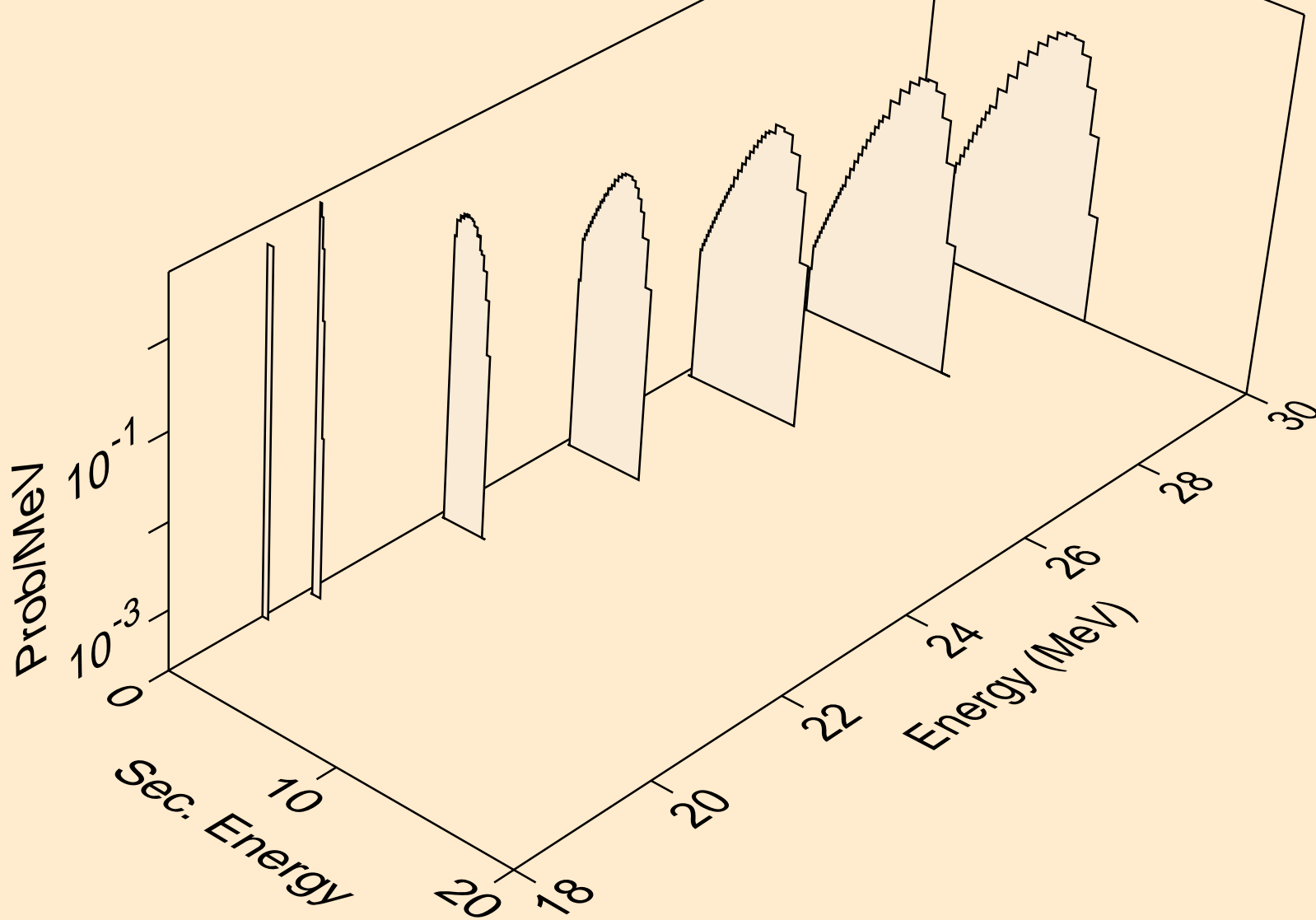

HG194 HELION ACER TENDL-2023 LIBRARY; T=0.K  
deuterons from (s,n\*)d

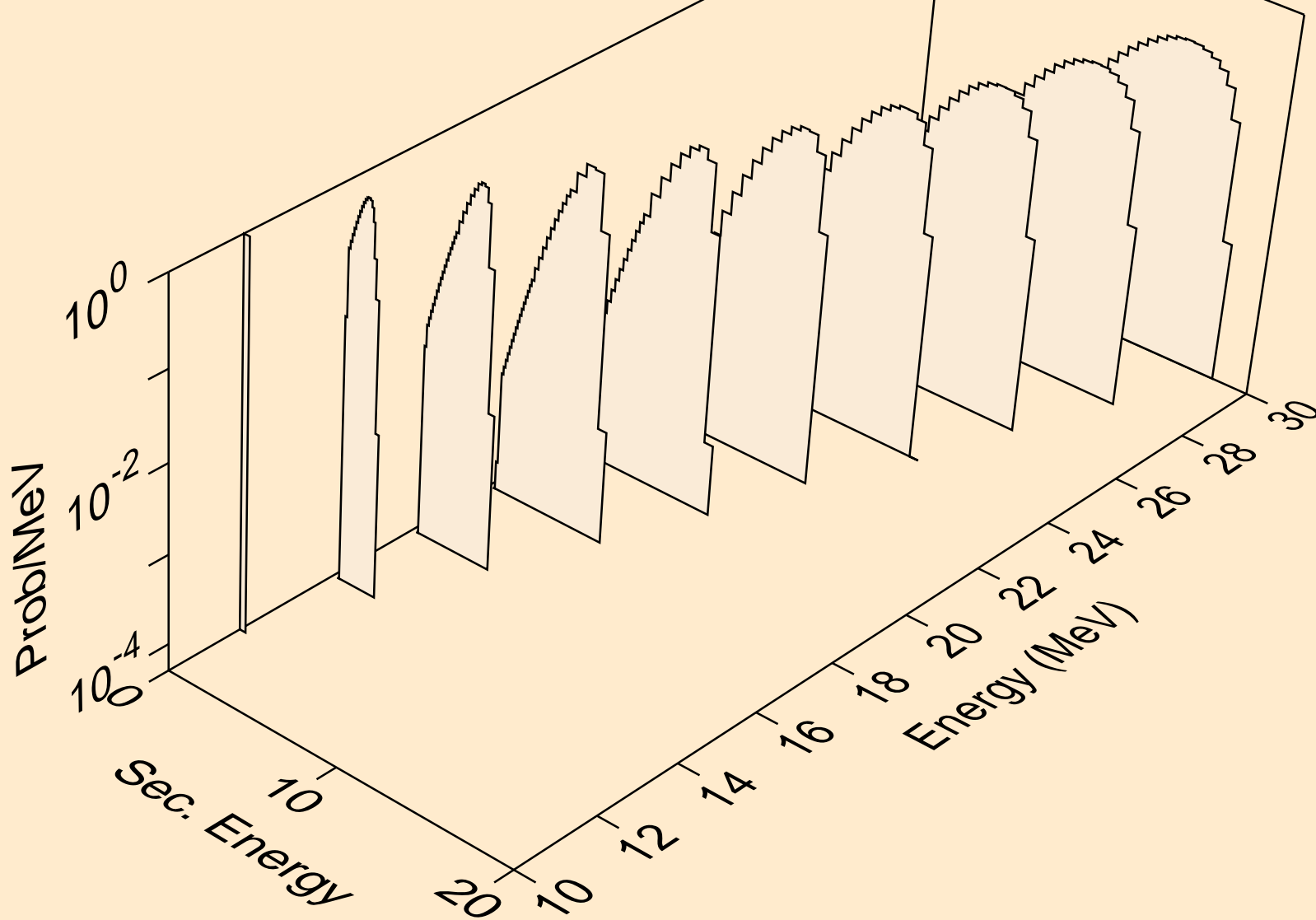

HG194 HELION ACER TENDL-2023 LIBRARY; T=0.K  
deuterons from (s,d)

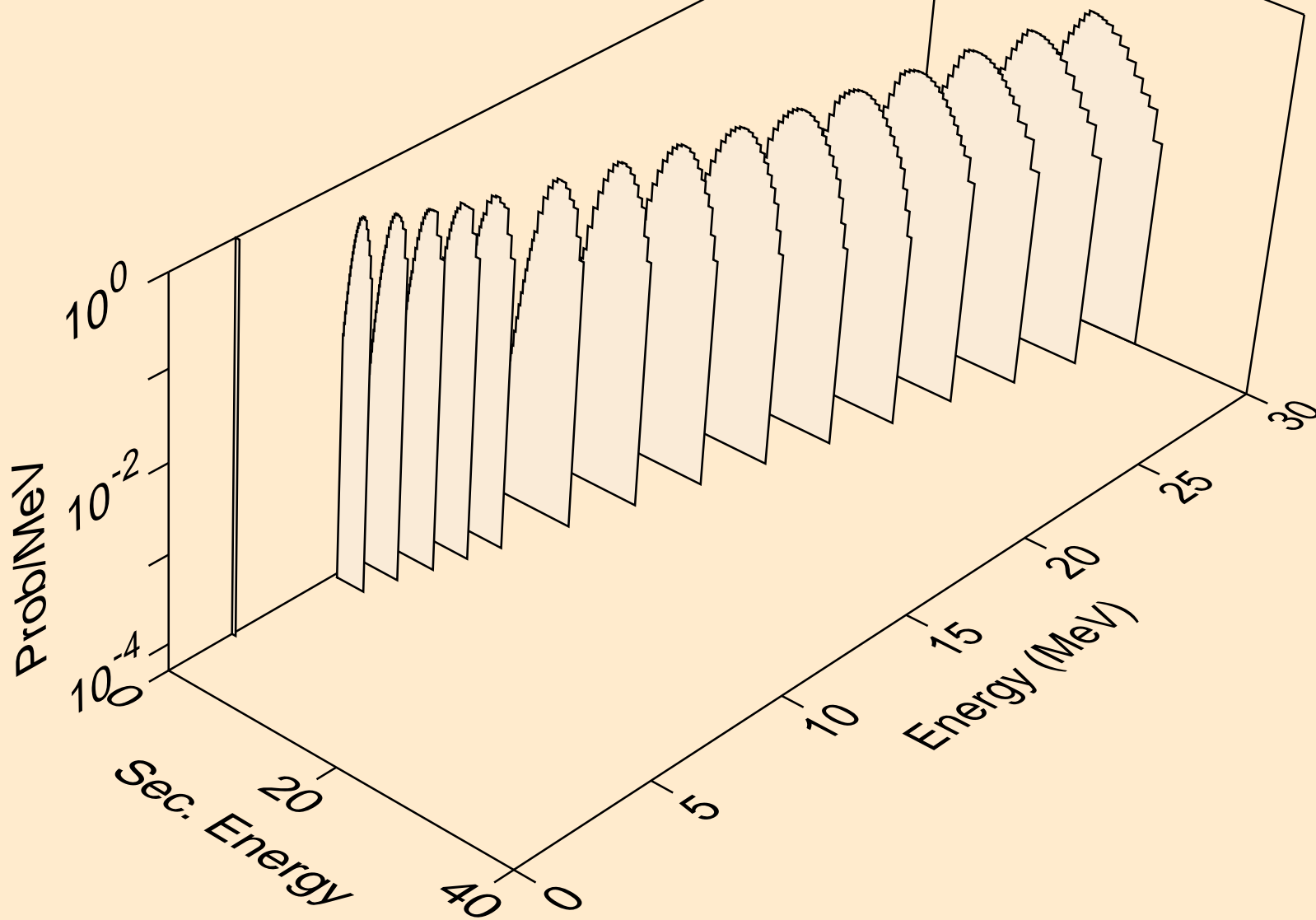

HG194 HELION ACER TENDL-2023 LIBRARY; T=0.K  
deuterons from (s,pd)

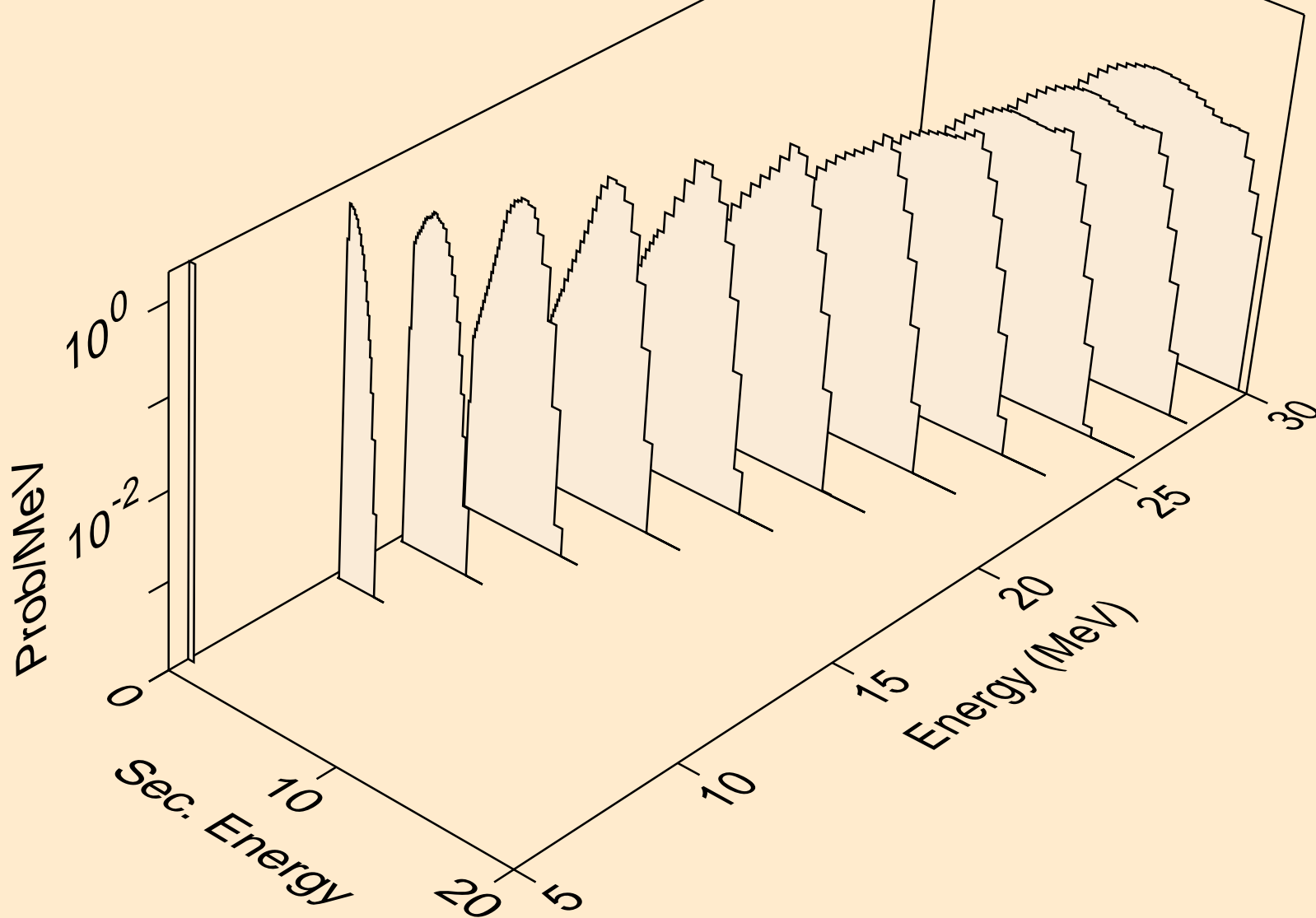

HG194 HELION ACER TENDL-2023 LIBRARY; T=0.K  
deuterons from (s,da)

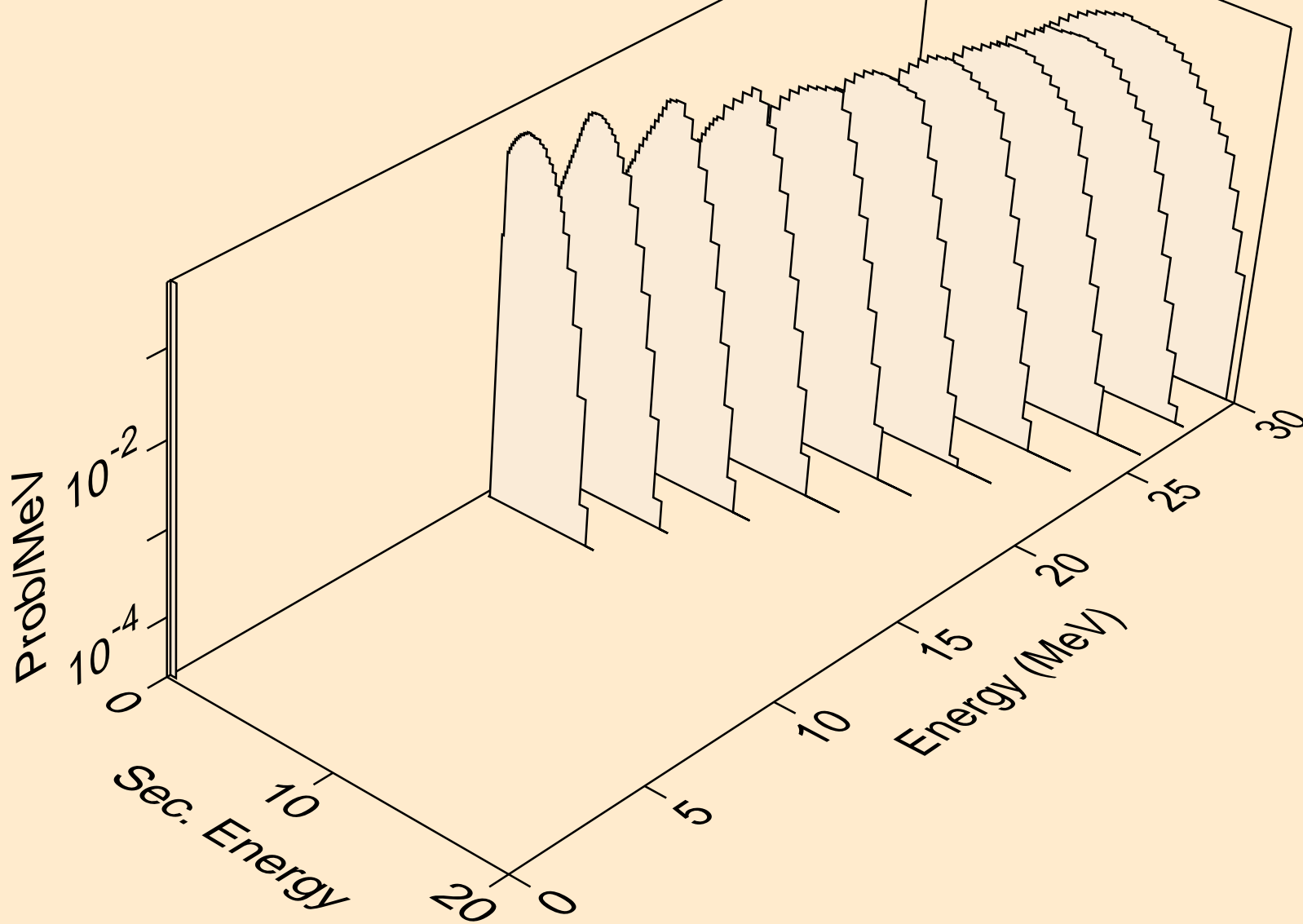

HG194 HELION ACER TENDL-2023 LIBRARY; T=0.K  
tritons from (s,x)

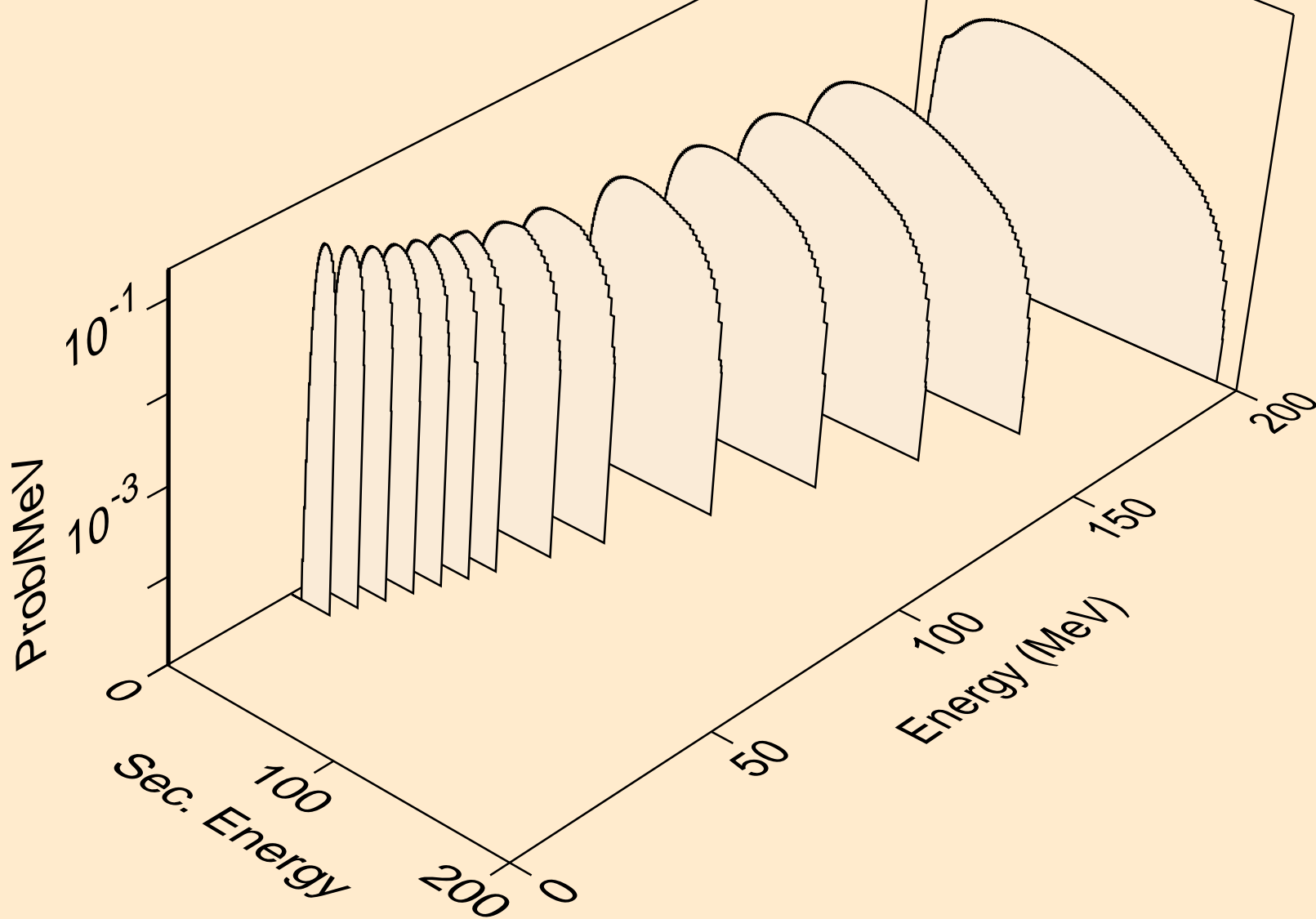

HG194 HELION ACER TENDL-2023 LIBRARY; T=0.K  
tritons from (s,n\*)t

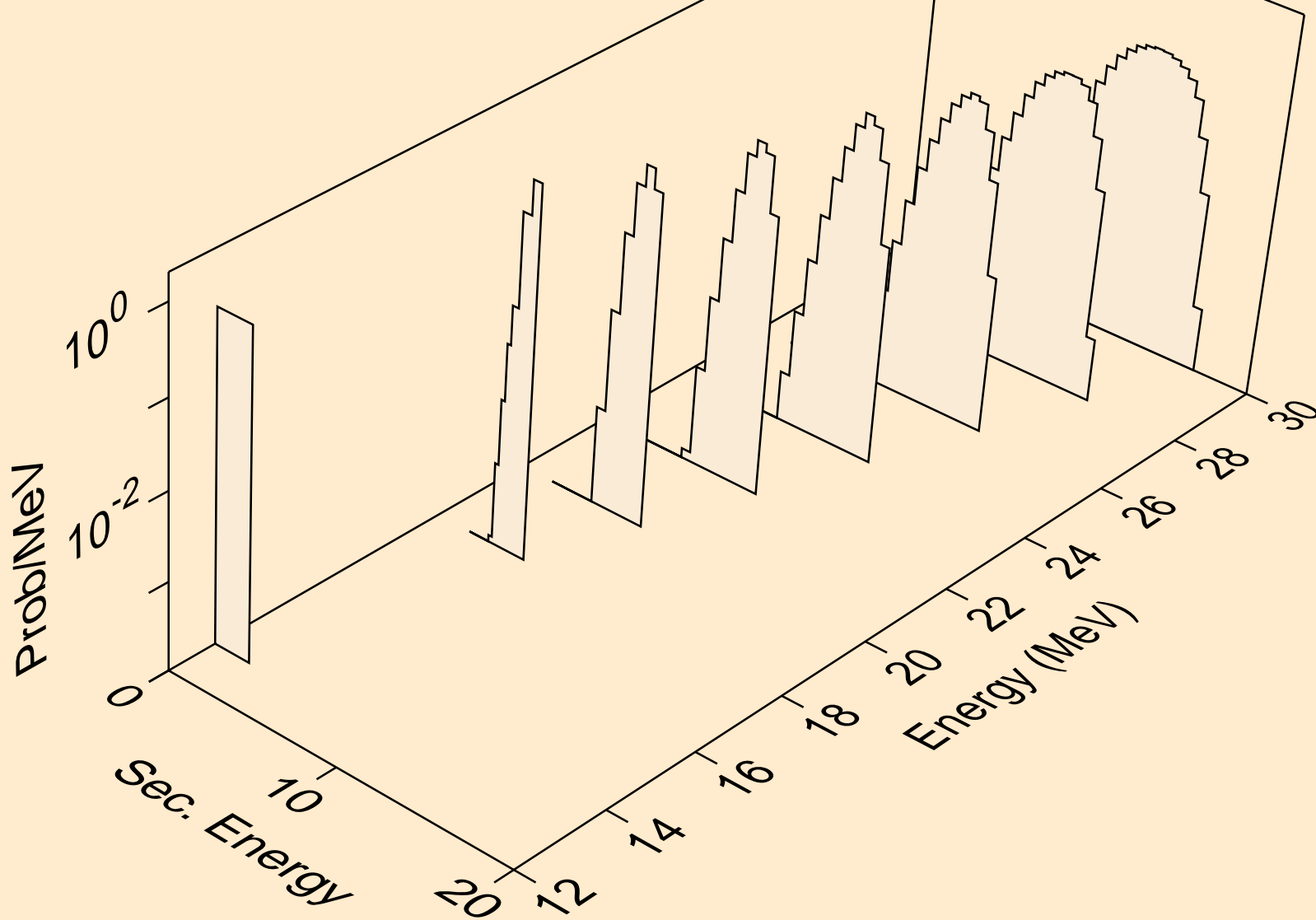

HG194 HELION ACER TENDL-2023 LIBRARY; T=0.K  
tritons from (s,t)

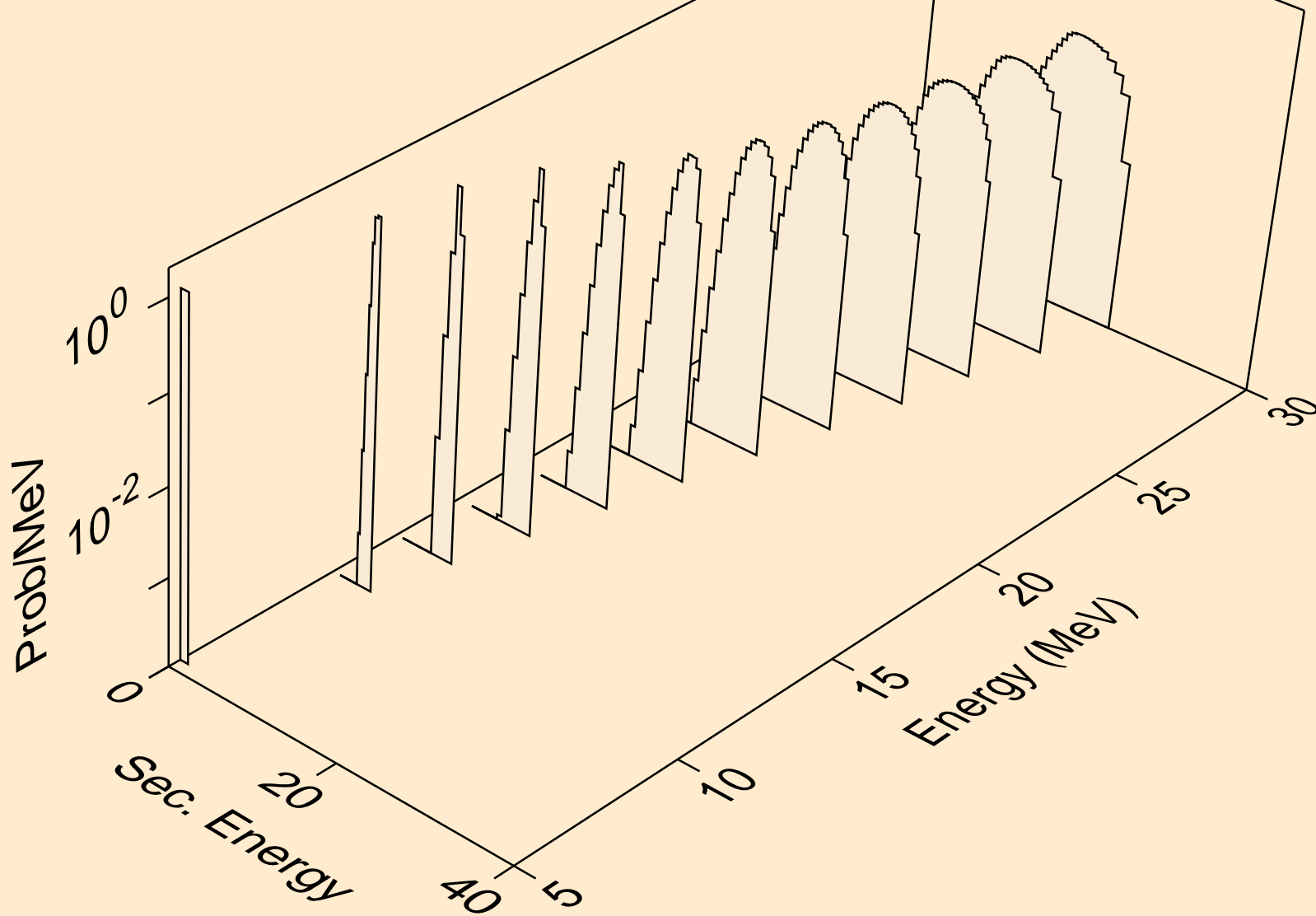

HG194 HELION ACER TENDL-2023 LIBRARY; T=0.K  
tritons from (s,pt)

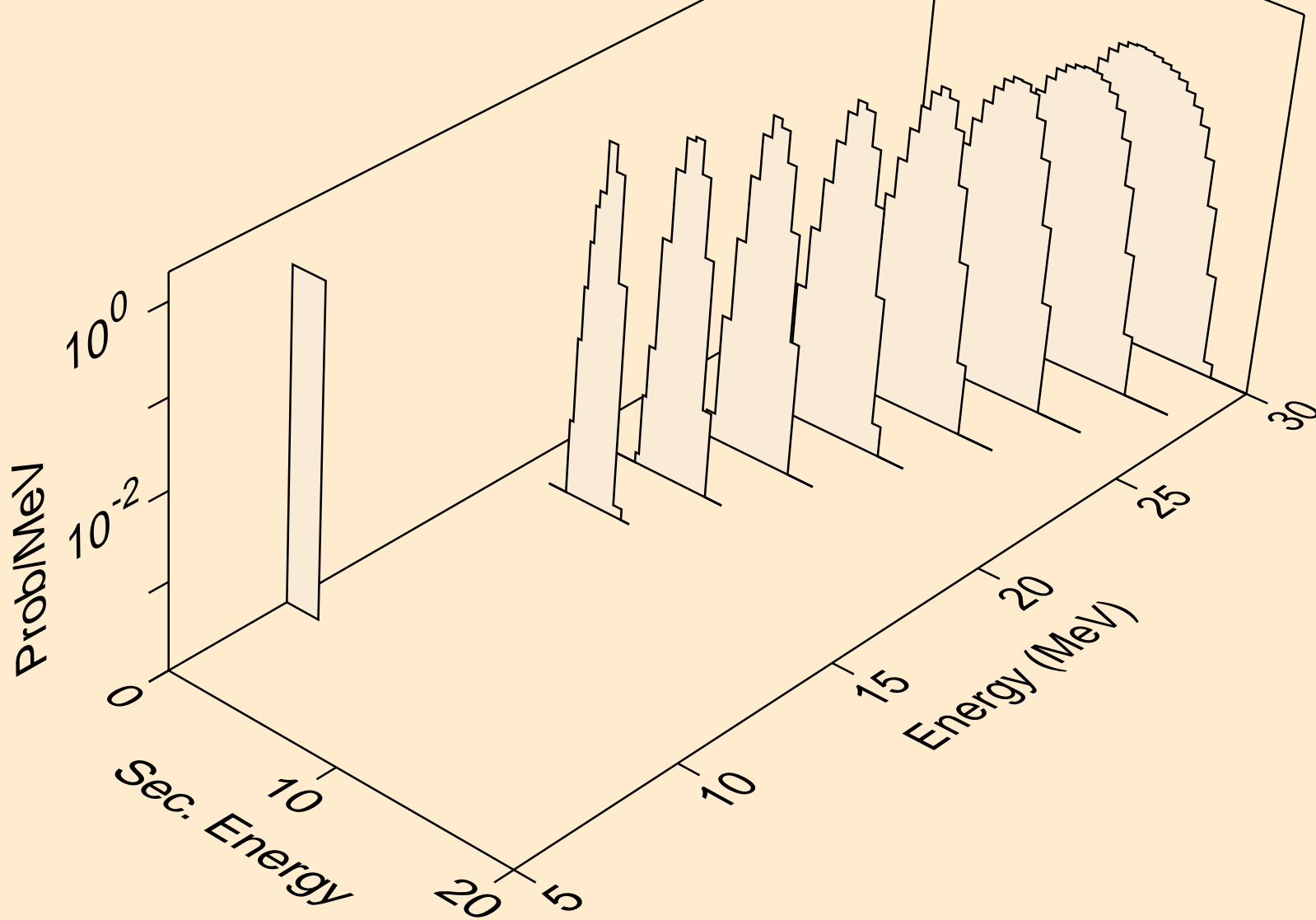

HG194 HELION ACER TENDL-2023 LIBRARY; T=0.K  
alphas from (s,x)

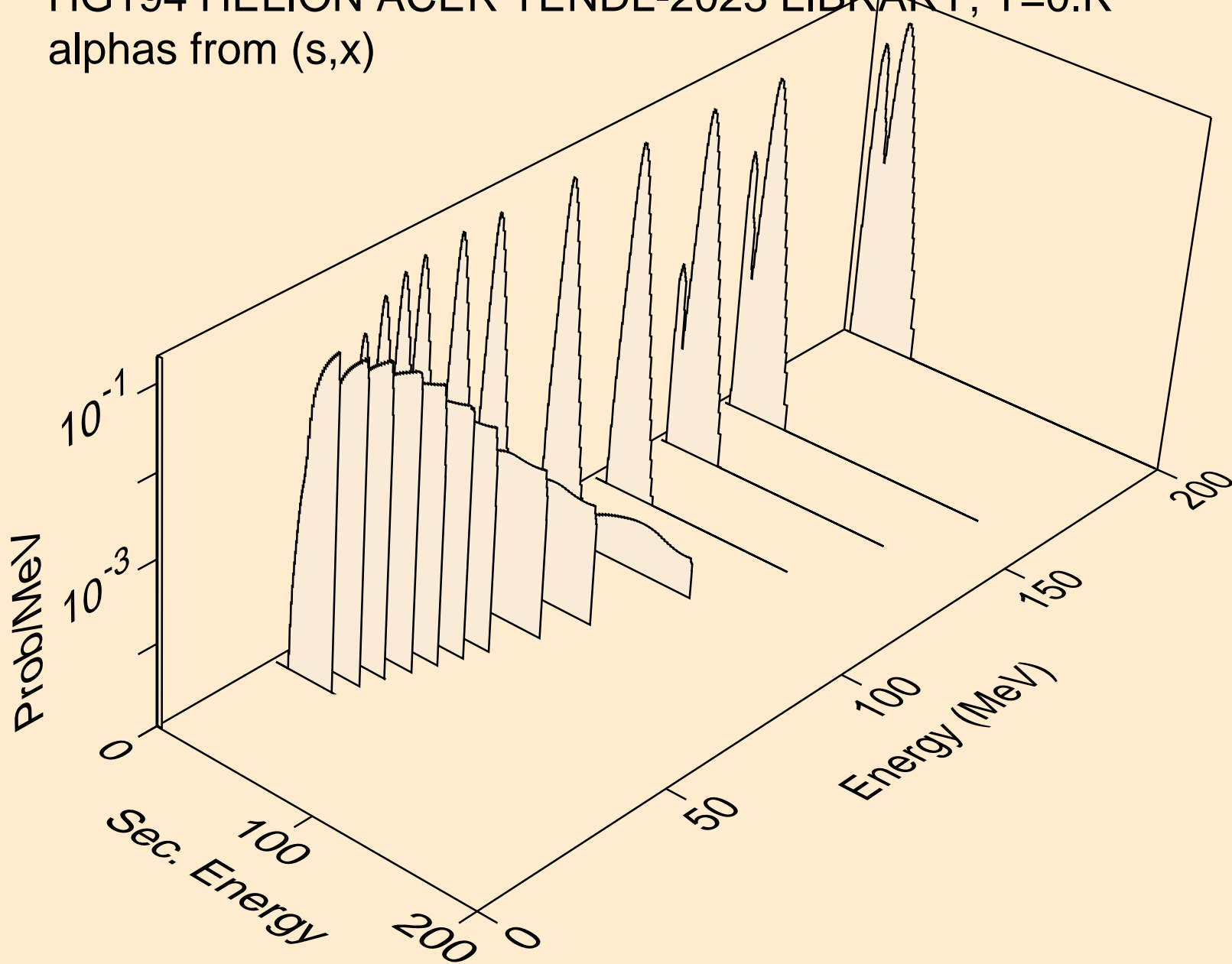

HG194 HELION ACER TENDL-2023 LIBRARY; T=0.K  
alphas from (s,n\*)a

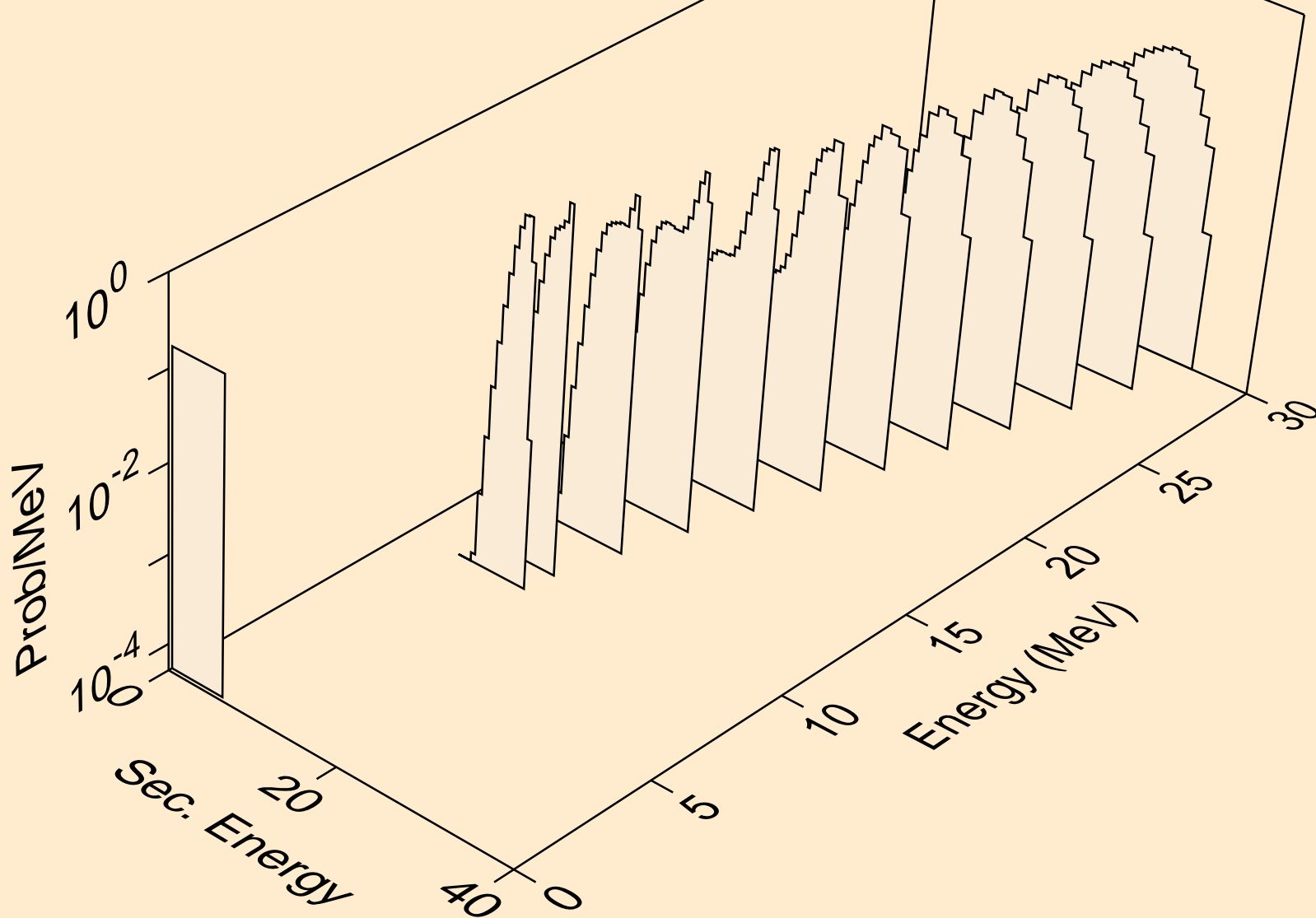

HG194 HELION ACER TENDL-2023 LIBRARY; T=0.K  
alphas from (s,2n)a

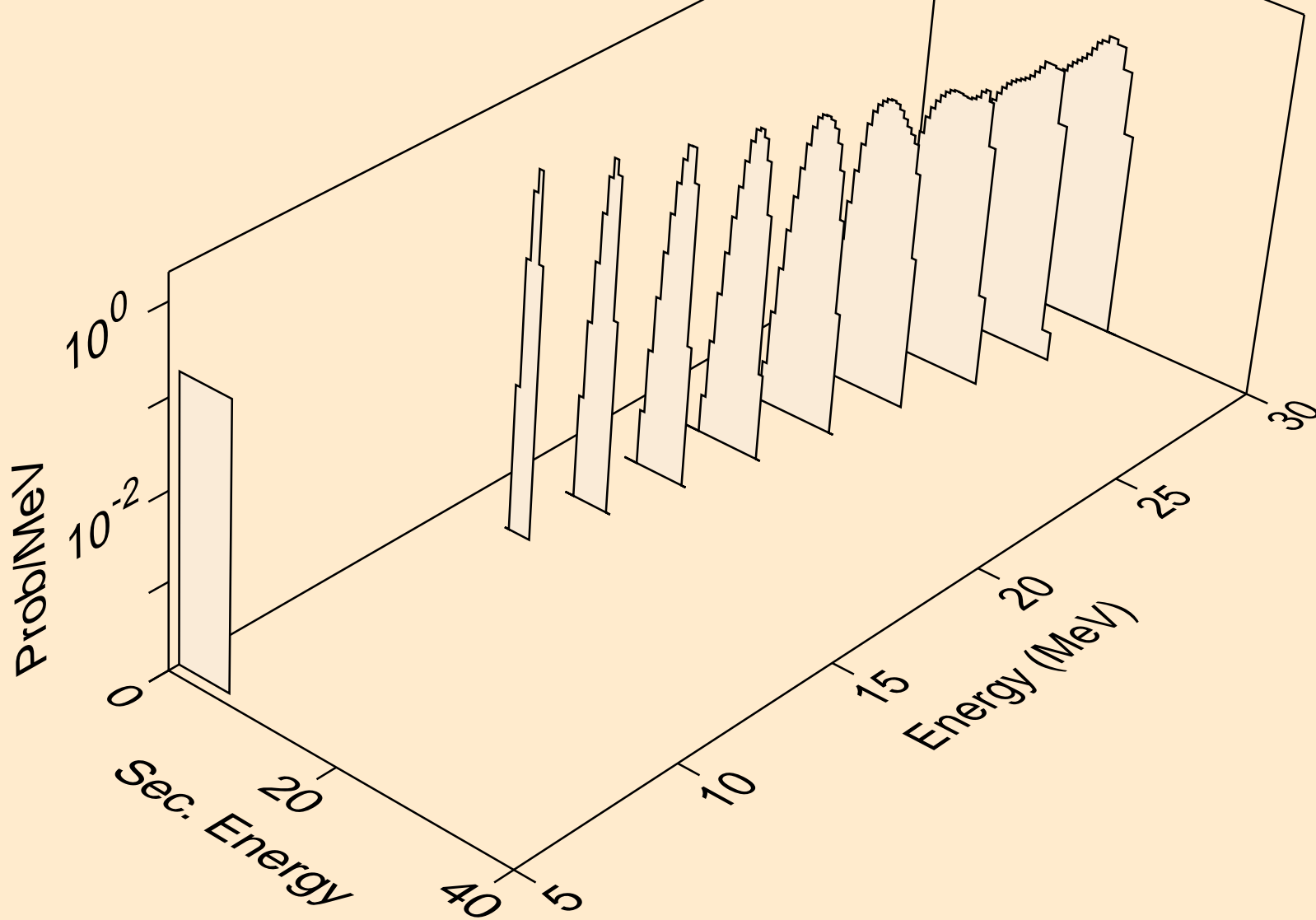

HG194 HELION ACER TENDL-2023 LIBRARY; T=0.K  
alphas from (s,3n)a

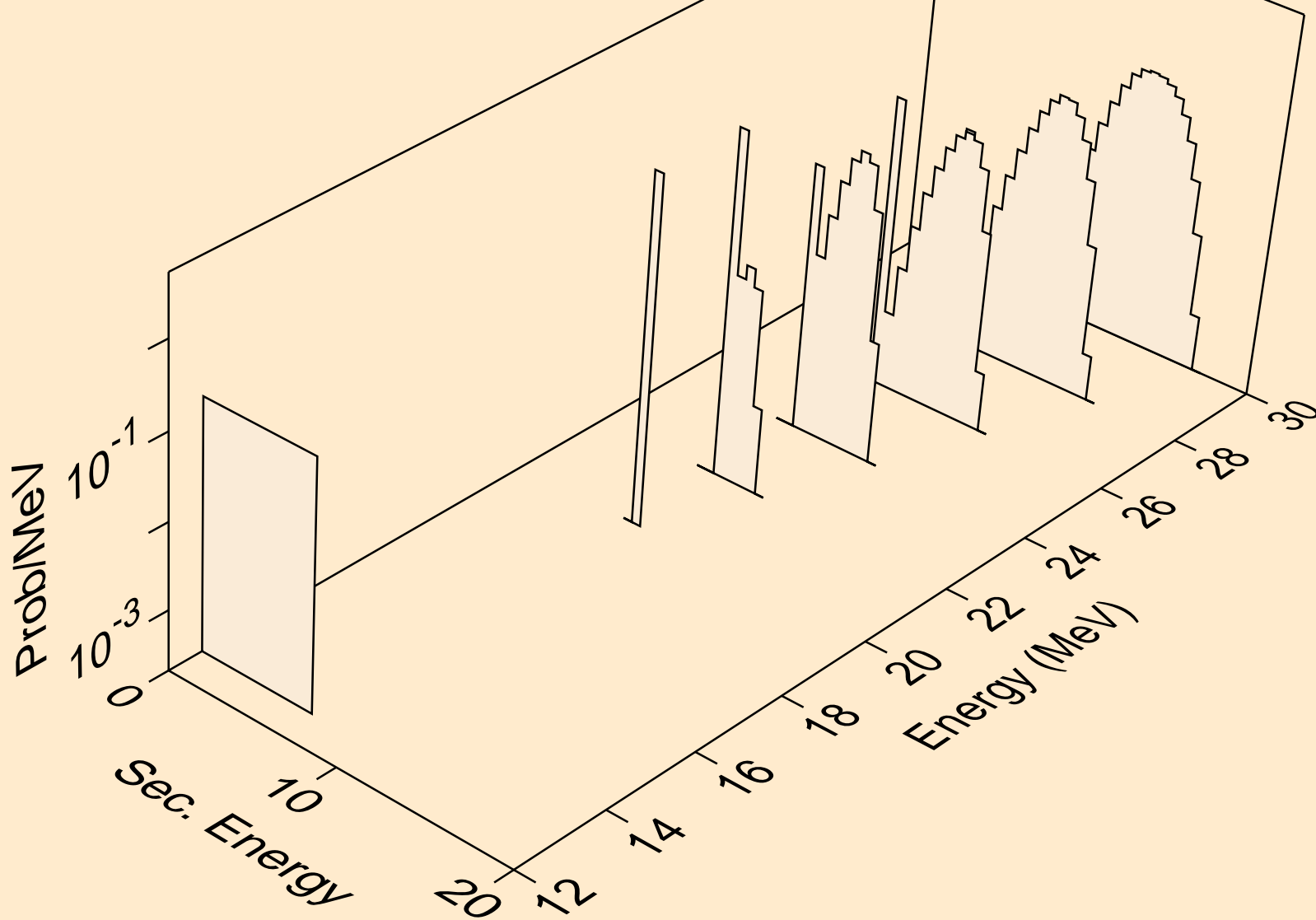

HG194 HELION ACER TENDL-2023 LIBRARY; T=0.K  
alphas from (s,npa)

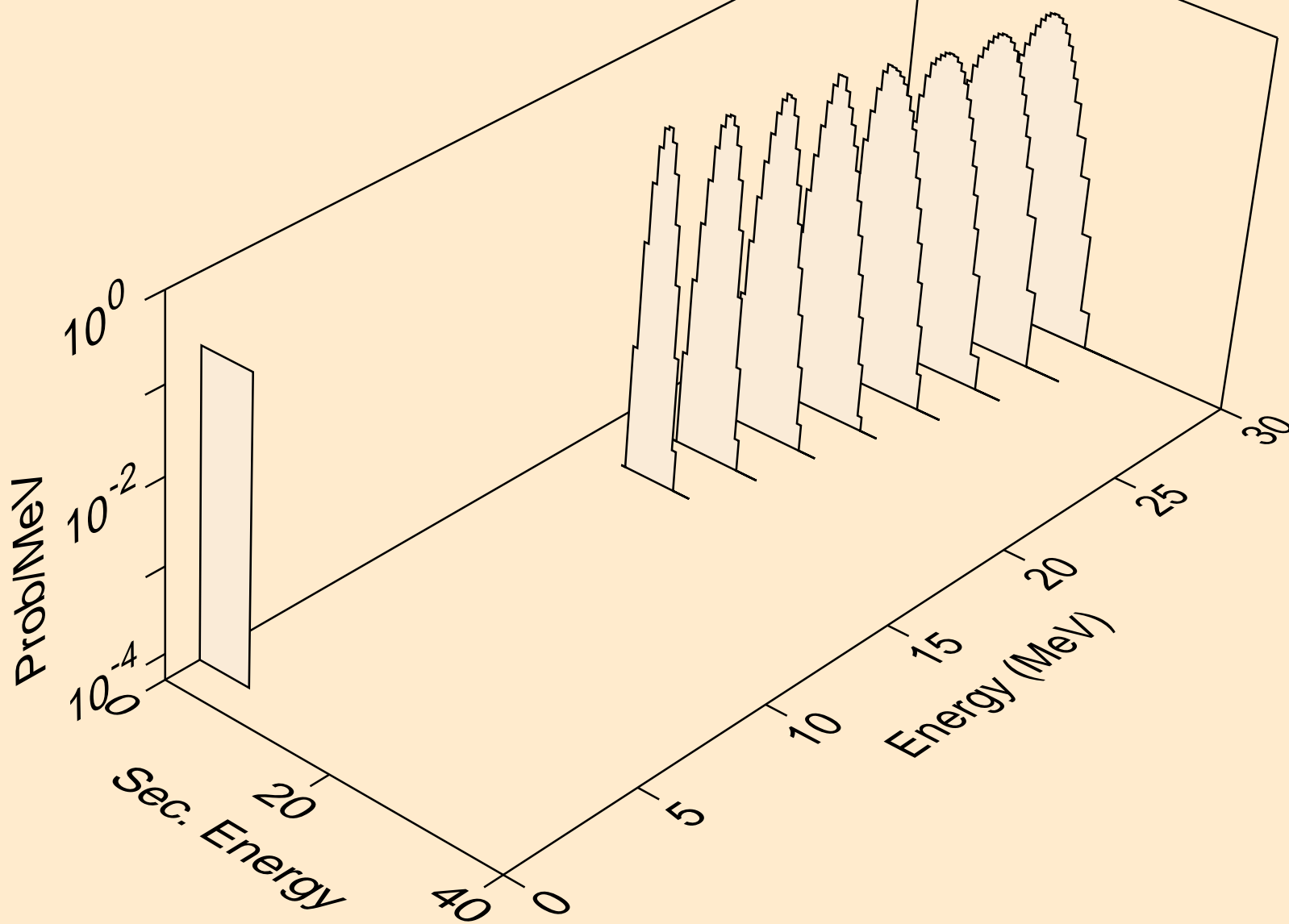

HG194 HELION ACER TENDL-2023 LIBRARY; T=0.K  
alphas from (s,a)

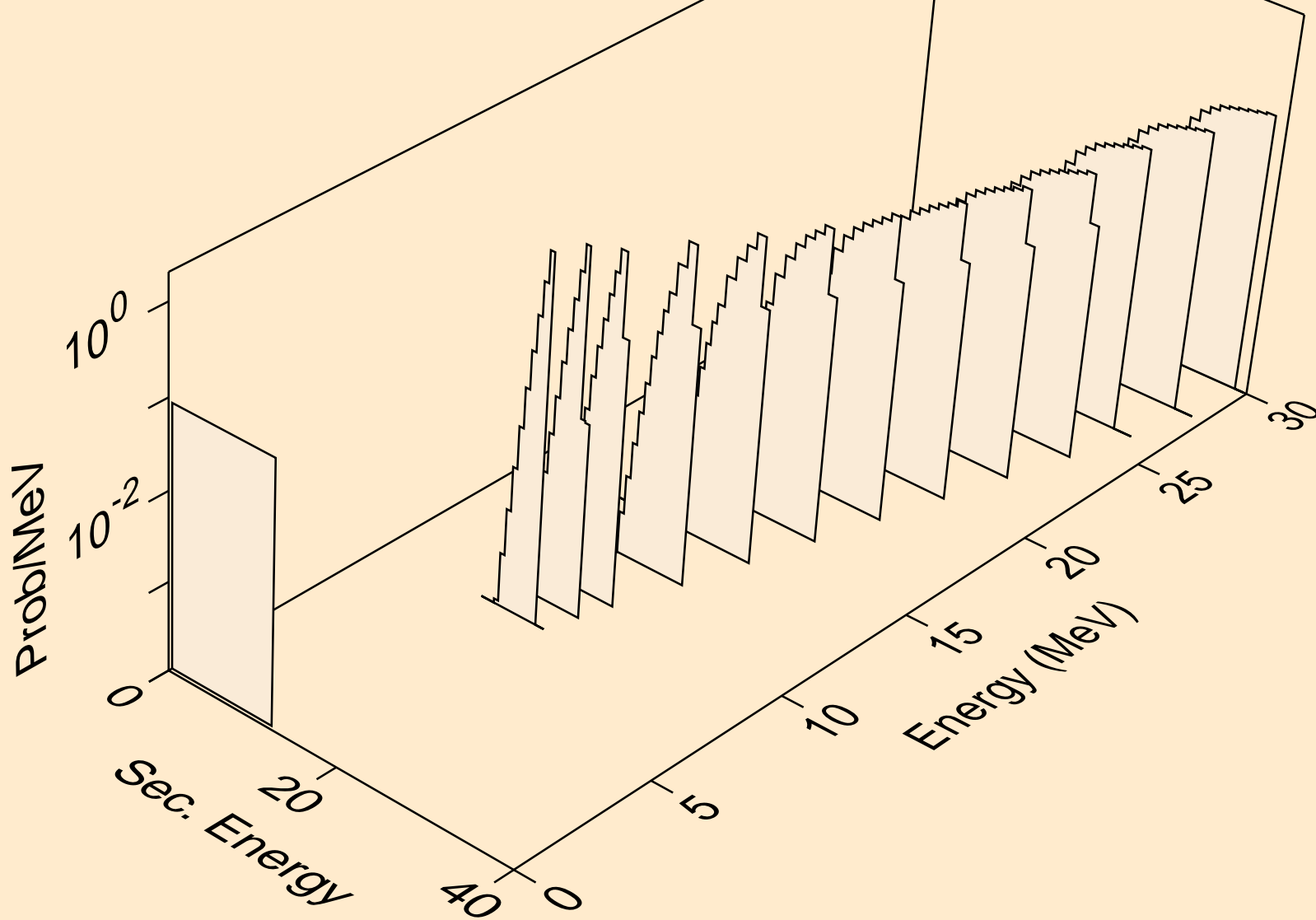

HG194 HELION ACER TENDL-2023 LIBRARY; T=0.K  
alphas from (s,2a)

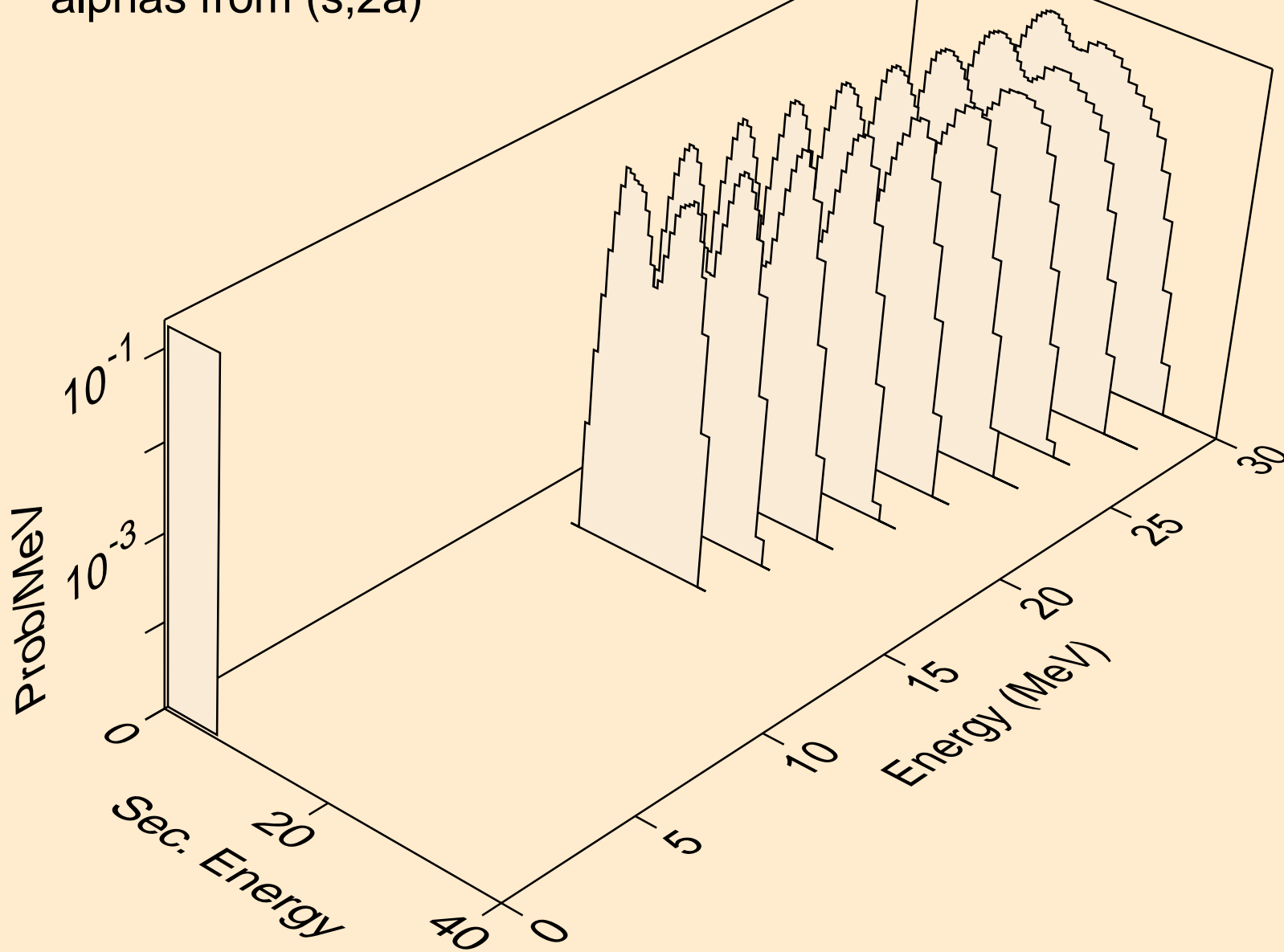

HG194 HELION ACER TENDL-2023 LIBRARY; T=0.K  
alphas from (s,pa)

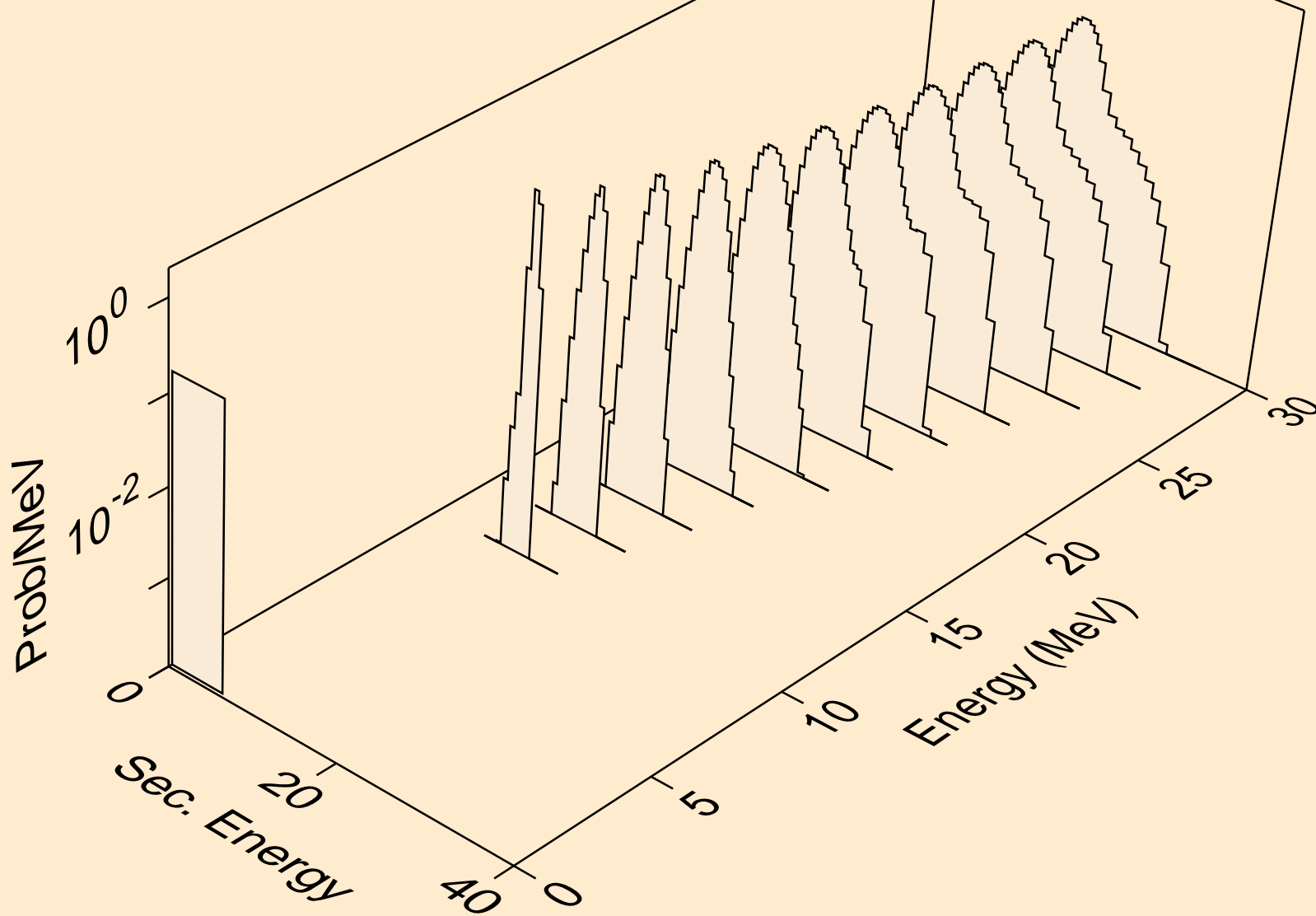

HG194 HELION ACER TENDL-2023 LIBRARY; T=0.K  
alphas from (s,da)

