

IR200 HELION ACER TENDL-2023 LIBRARY; T=0.K  
Principal cross sections

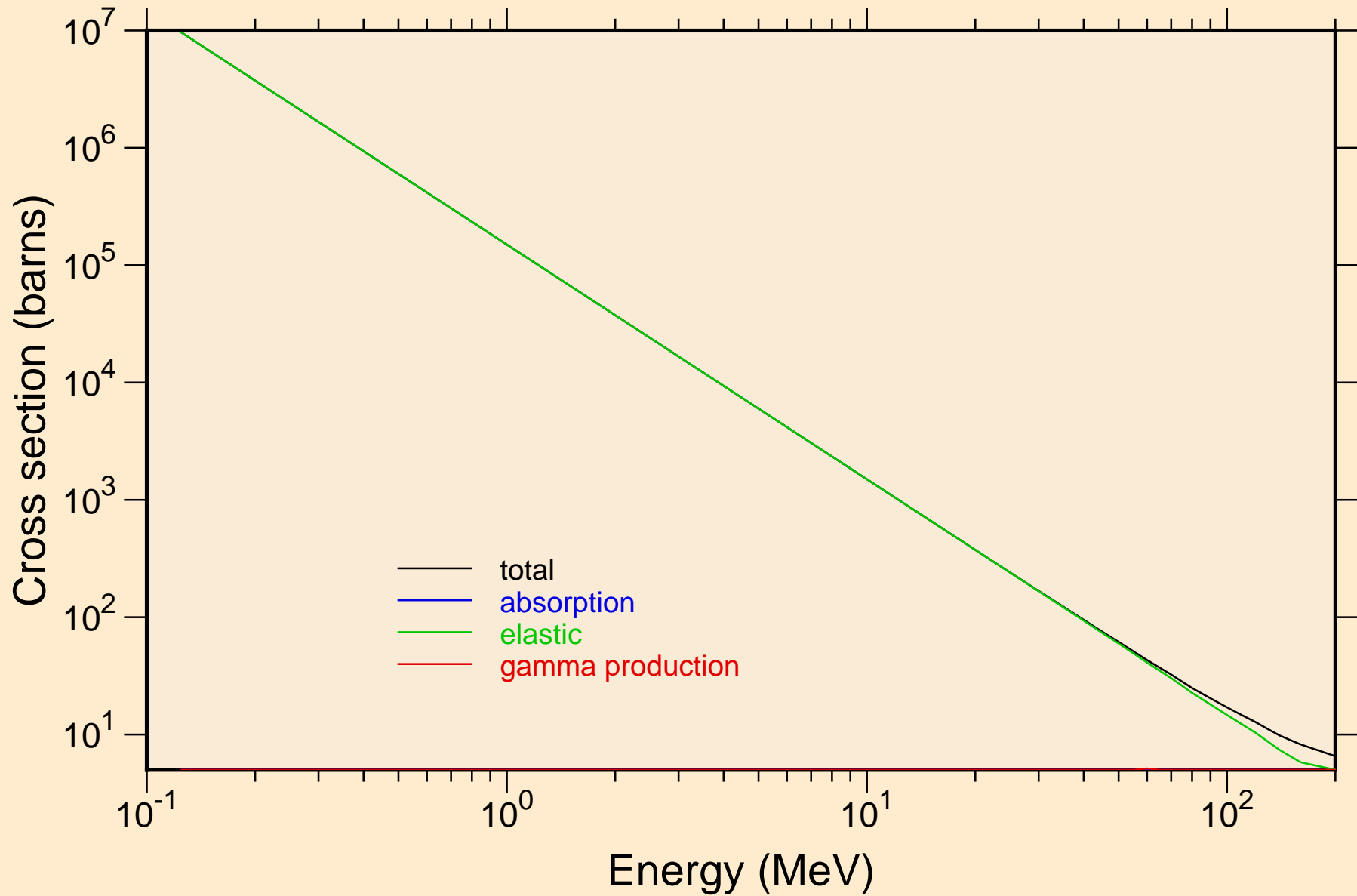

IR200 HELION ACER TENDL-2023 LIBRARY; T=0.K

Heating

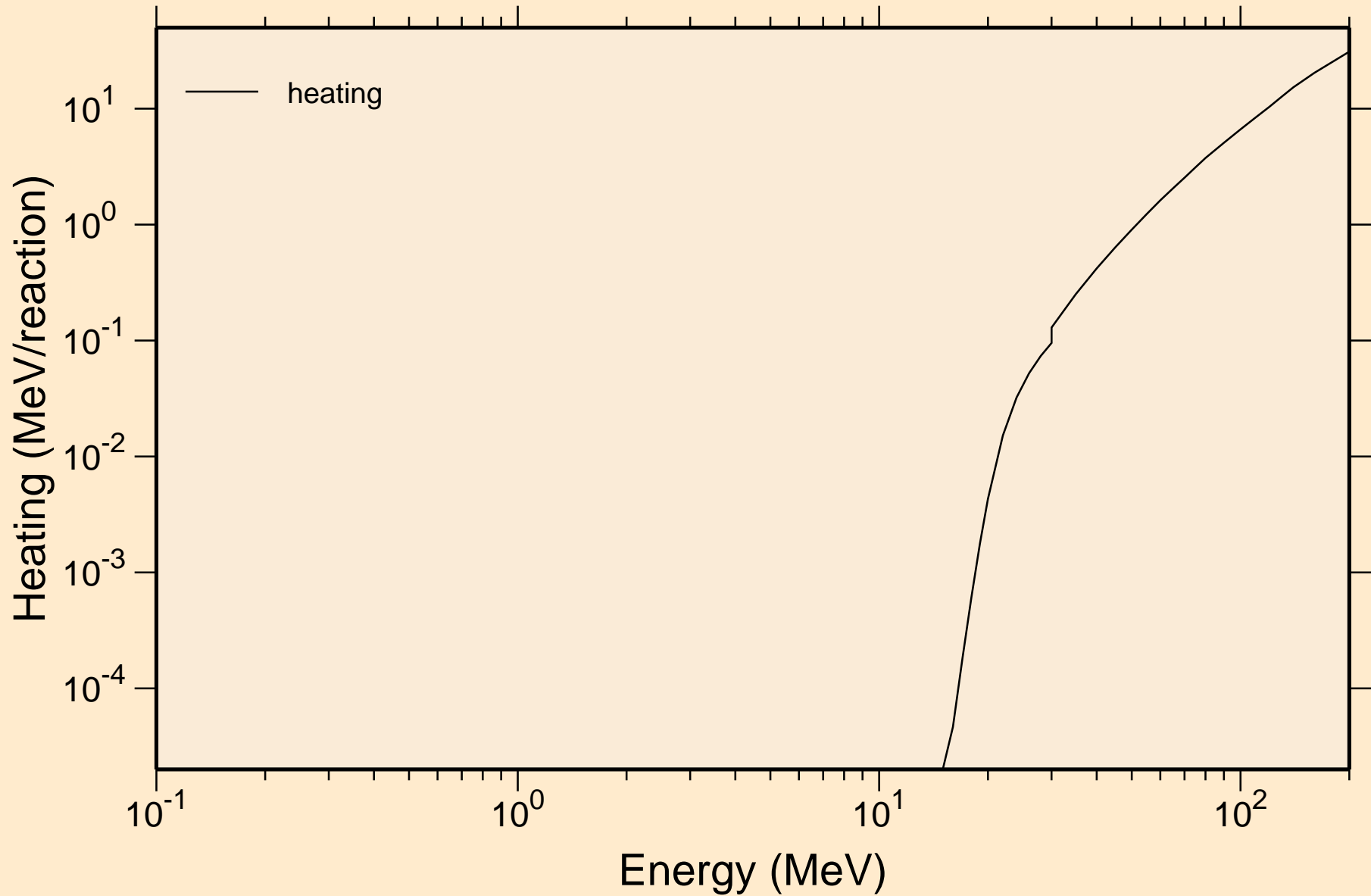

# IR200 HELION ACER TENDL-2023 LIBRARY; T=0.K

## Principal cross sections

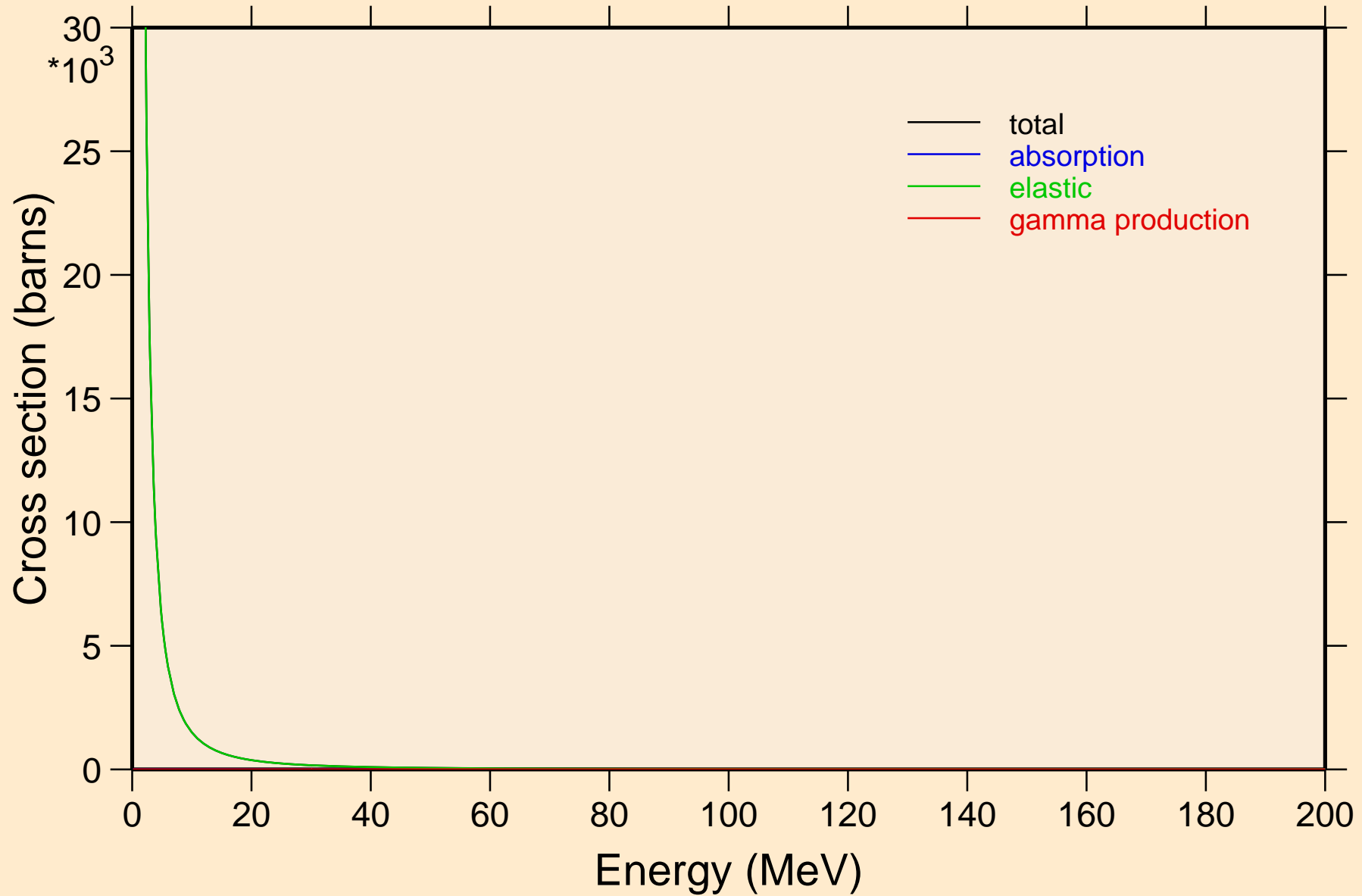

IR200 HELION ACER TENDL-2023 LIBRARY; T=0.K

Heating

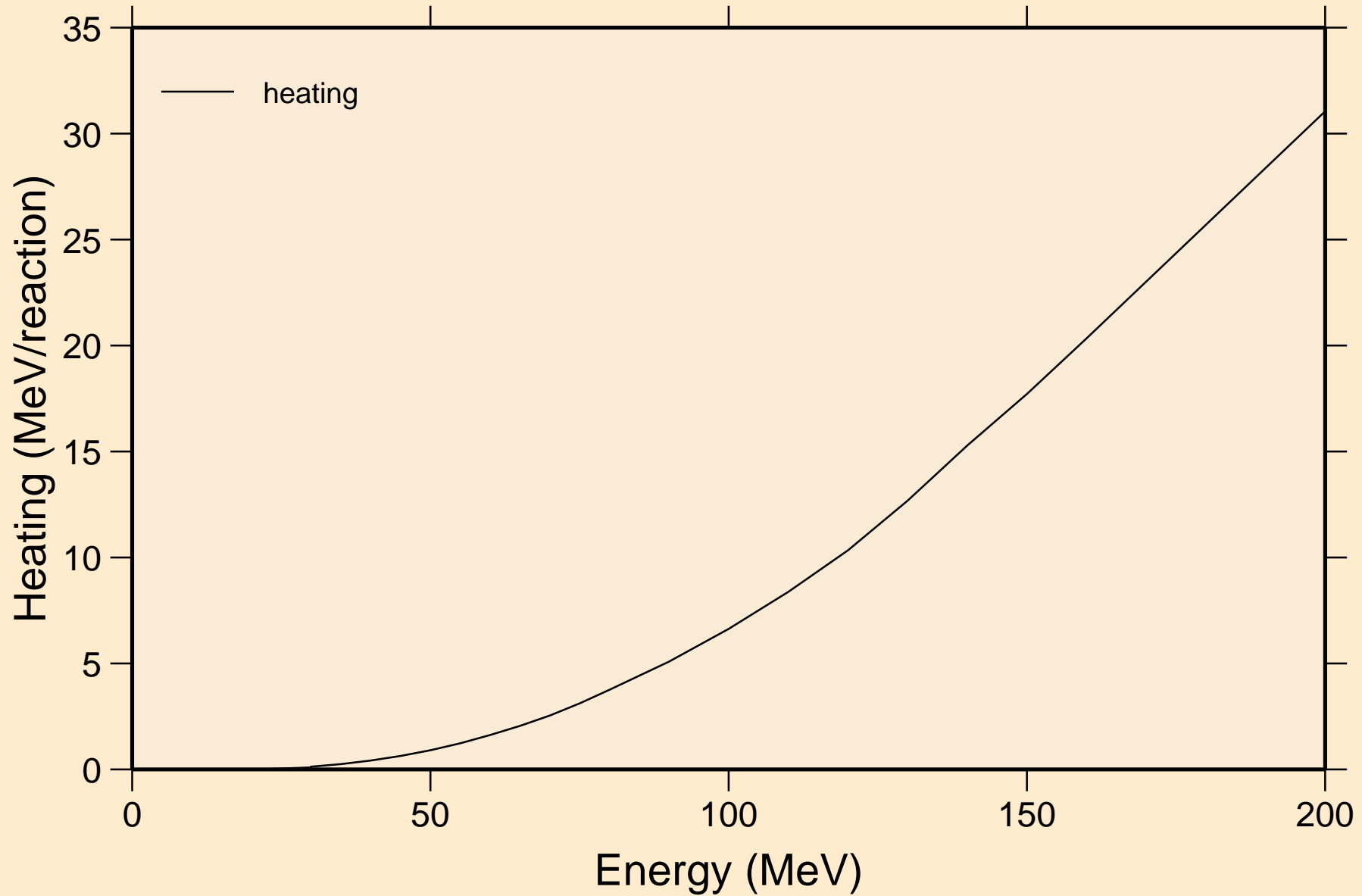

IR200 HELION ACER TENDL-2023 LIBRARY; T=0.K  
Threshold reactions

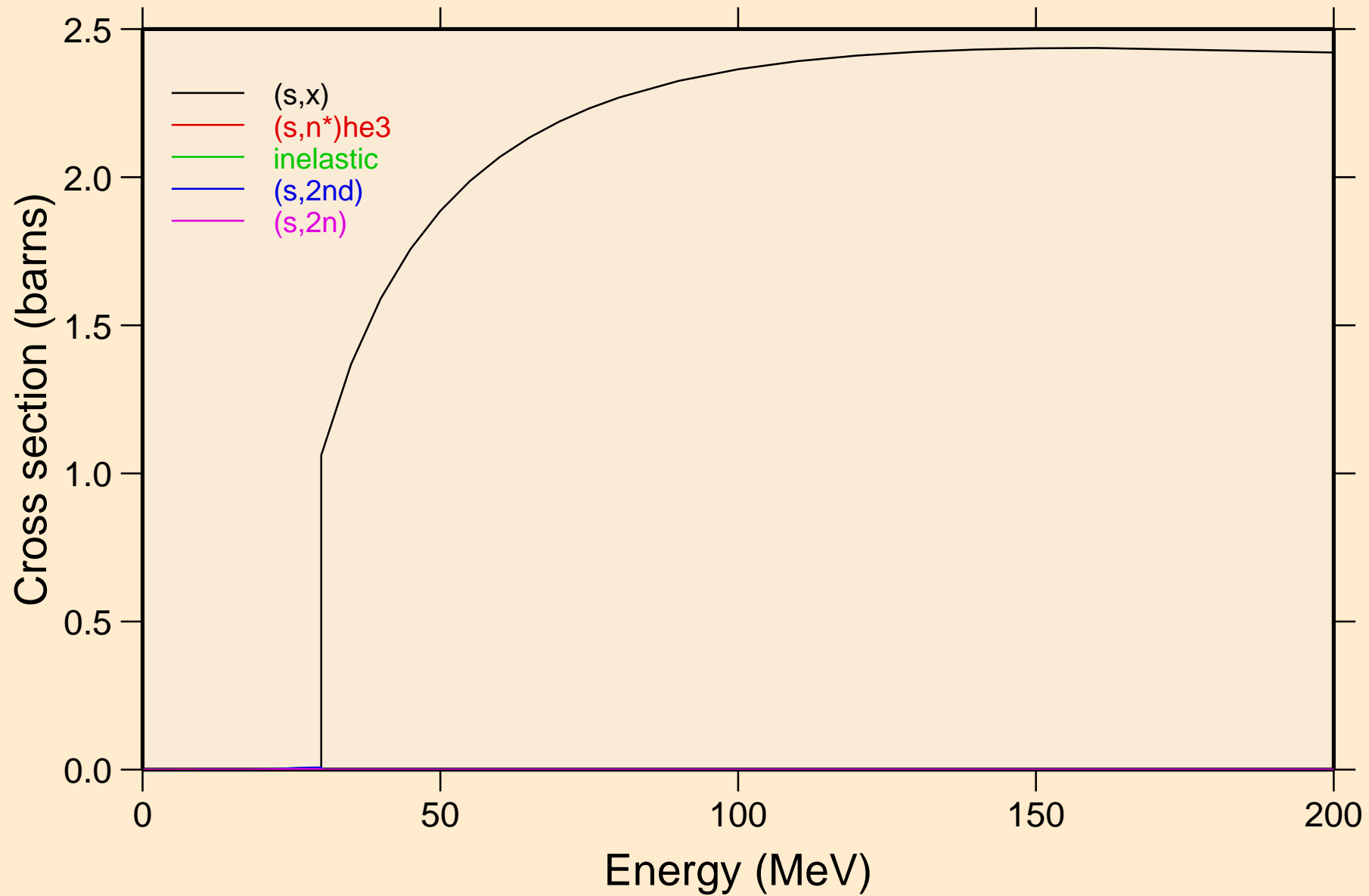

IR200 HELION ACER TENDL-2023 LIBRARY; T=0.K  
Threshold reactions

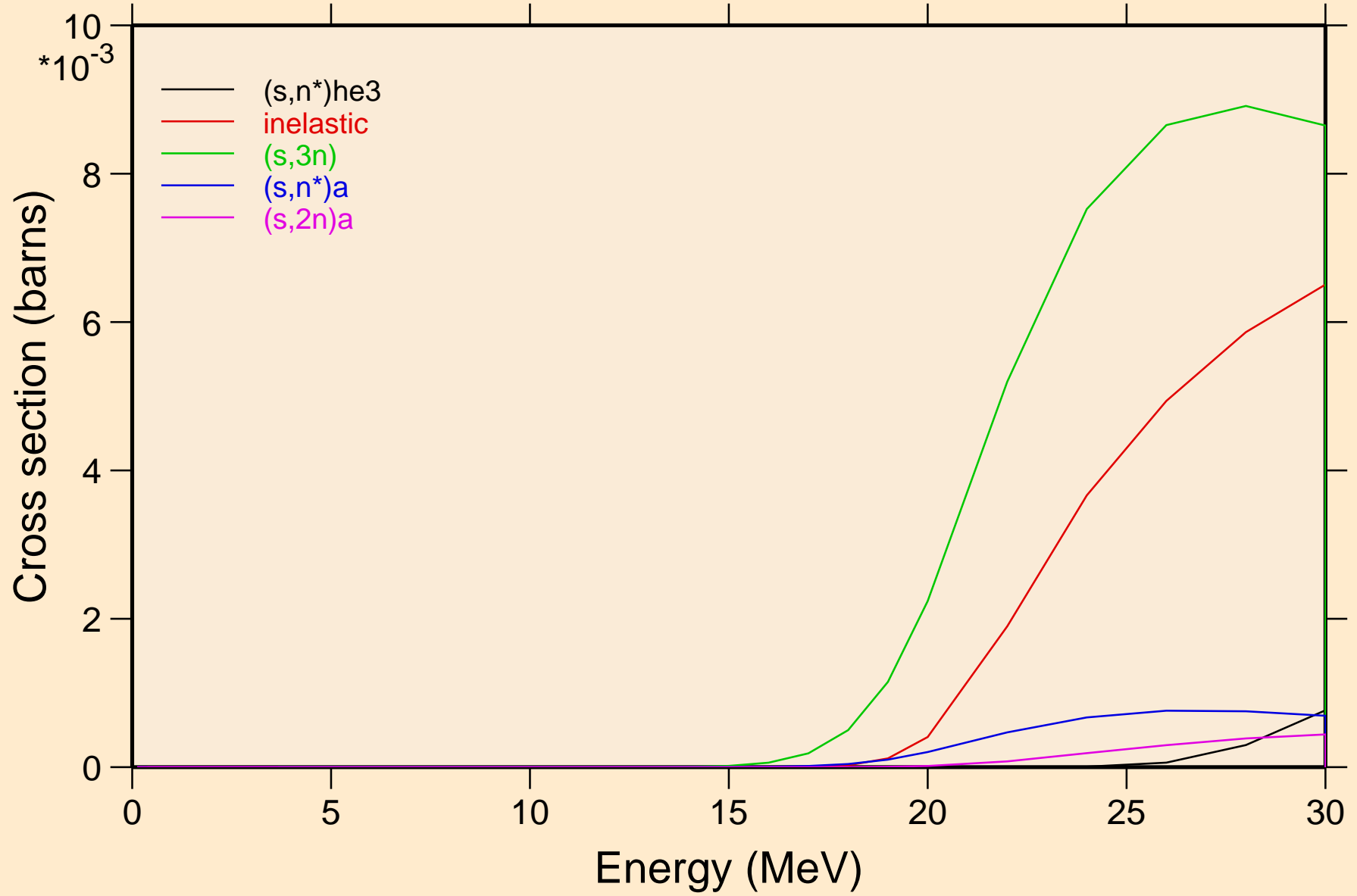

IR200 HELION ACER TENDL-2023 LIBRARY; T=0.K  
Threshold reactions

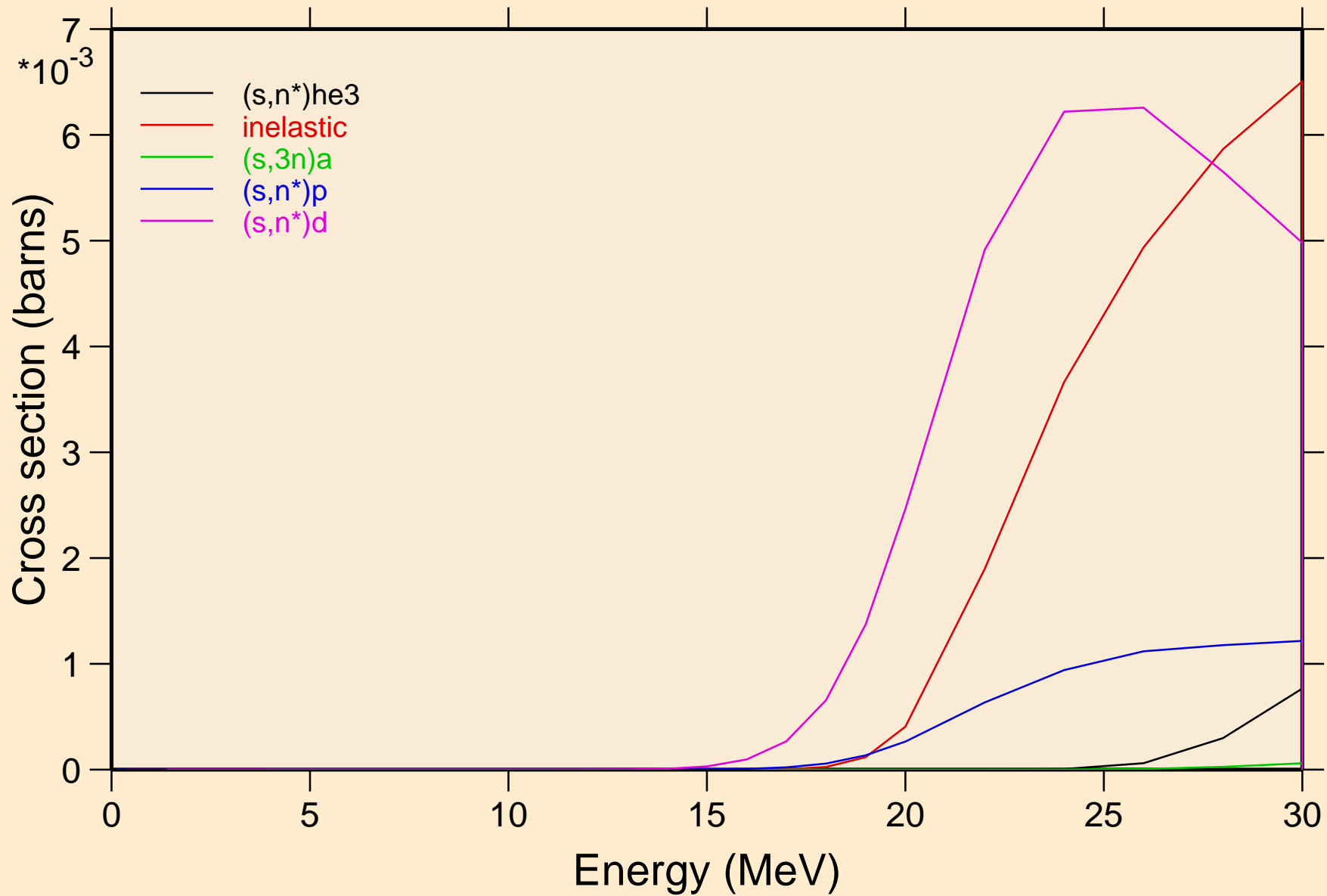

IR200 HELION ACER TENDL-2023 LIBRARY; T=0.K  
Threshold reactions



IR200 HELION ACER TENDL-2023 LIBRARY; T=0.K  
Threshold reactions

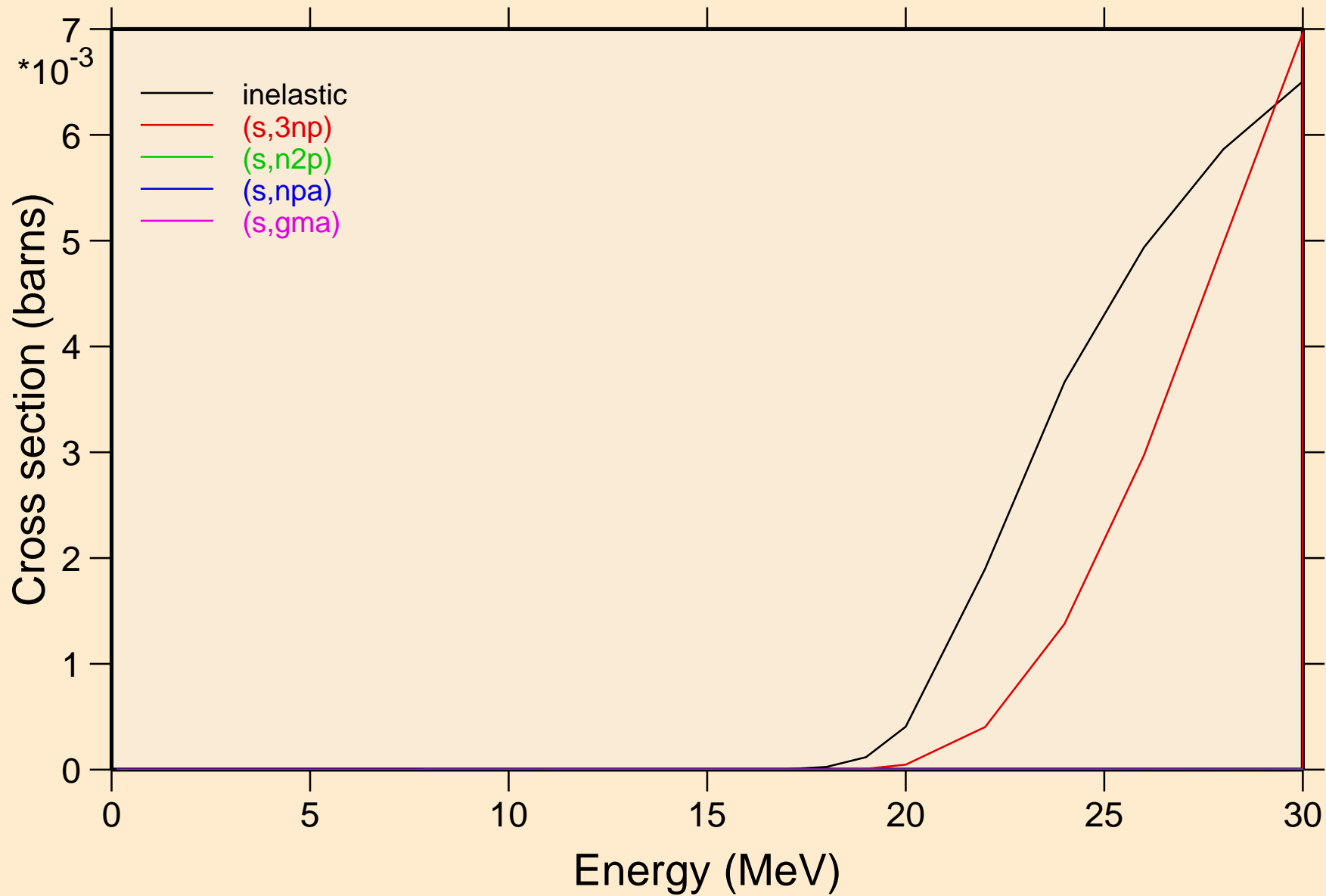

IR200 HELION ACER TENDL-2023 LIBRARY; T=0.K  
Threshold reactions

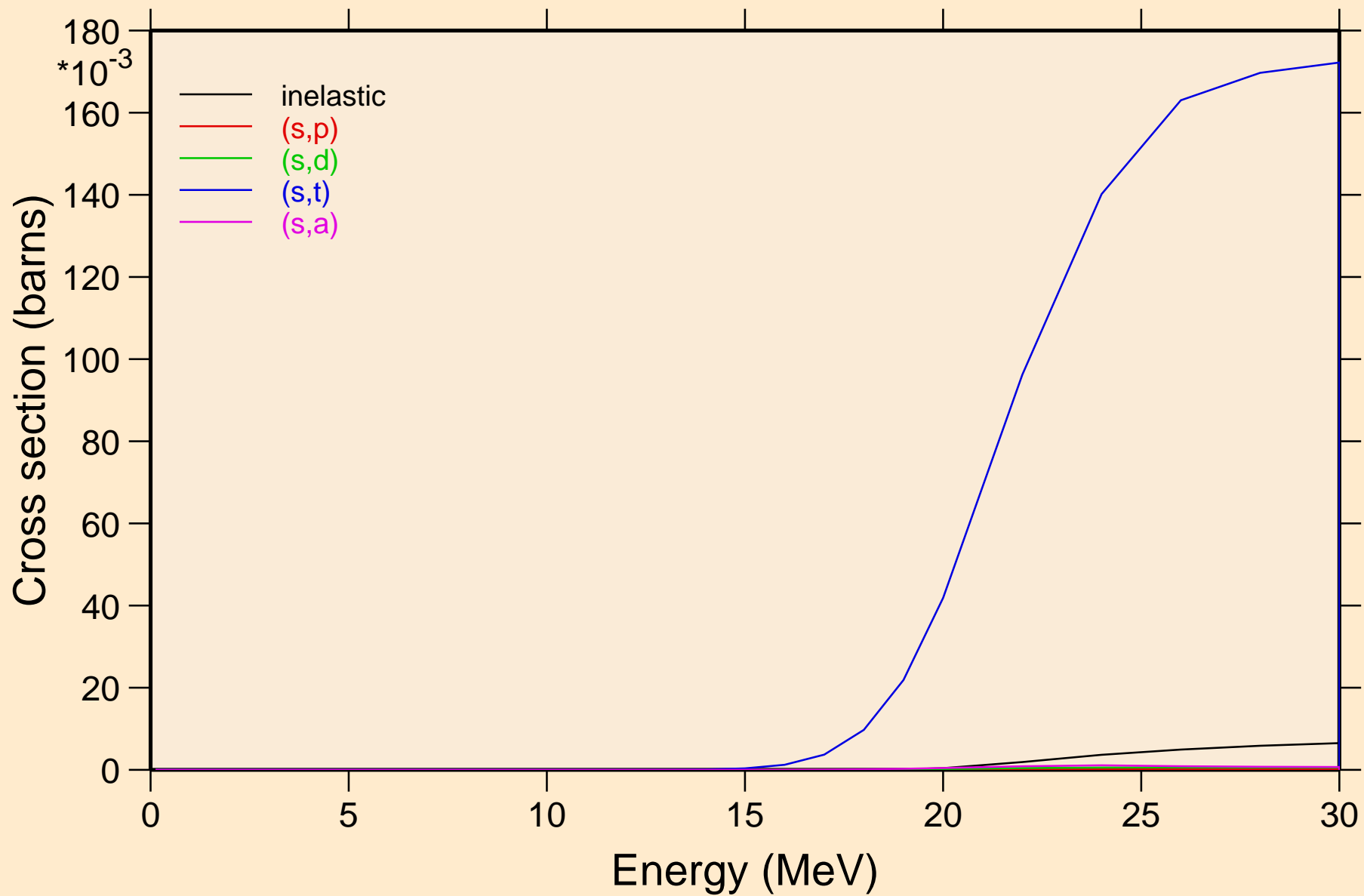

IR200 HELION ACER TENDL-2023 LIBRARY; T=0.K  
Threshold reactions

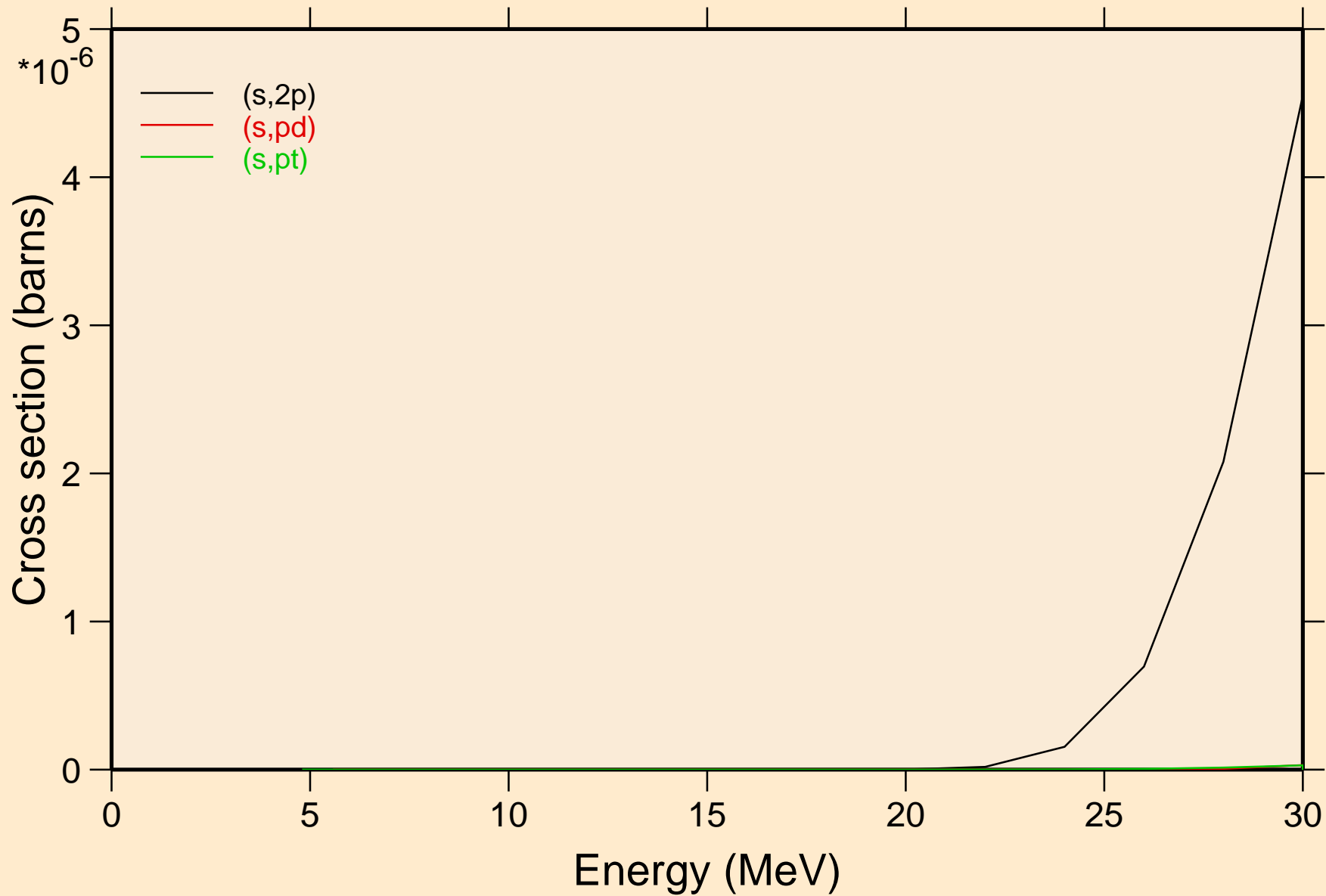

IR200 HELION ACER TENDL-2023 LIBRARY; T=0.K  
angular distribution for elastic

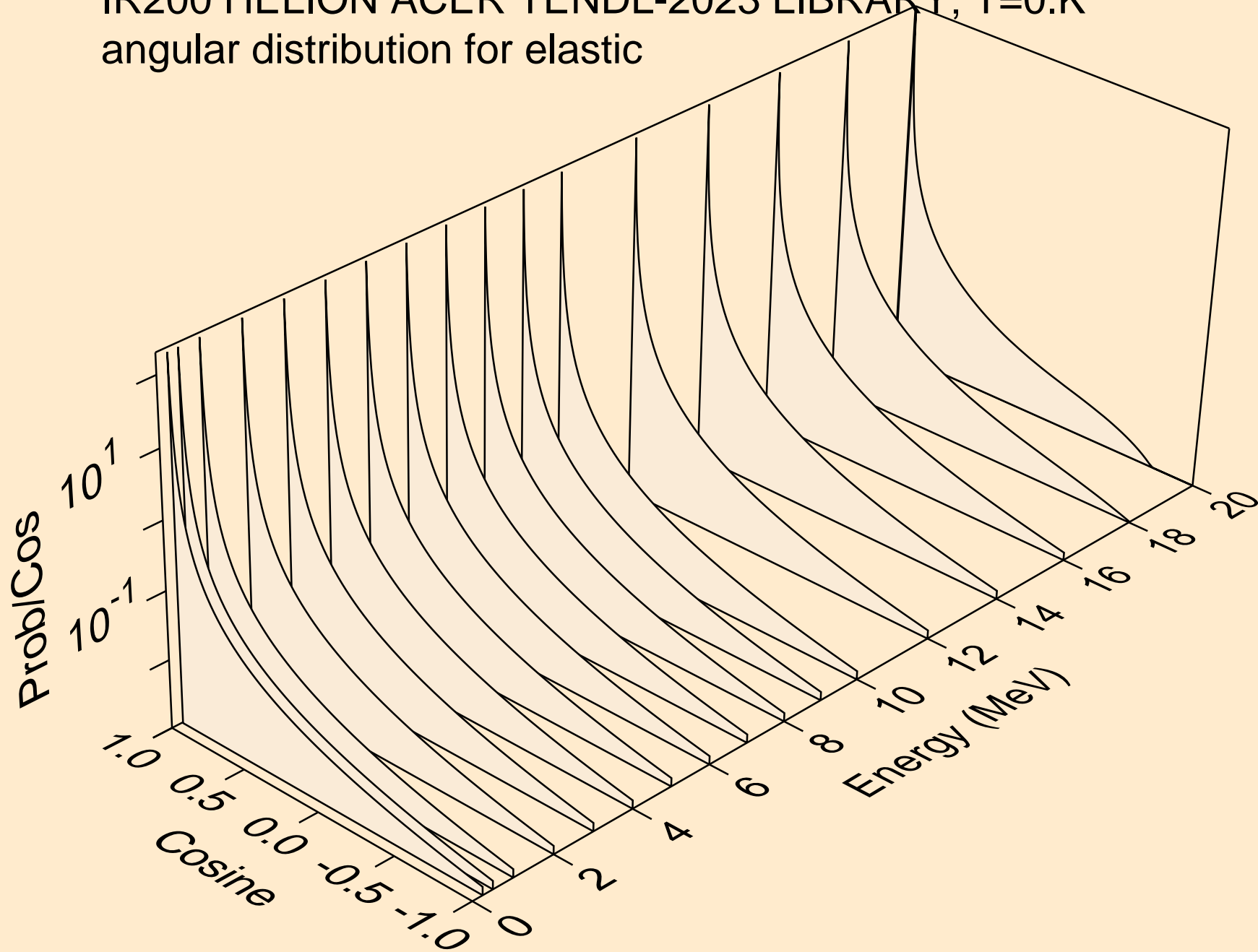

IR200 HELION ACER TENDL-2023 LIBRARY; T=0.K  
angular distribution for elastic

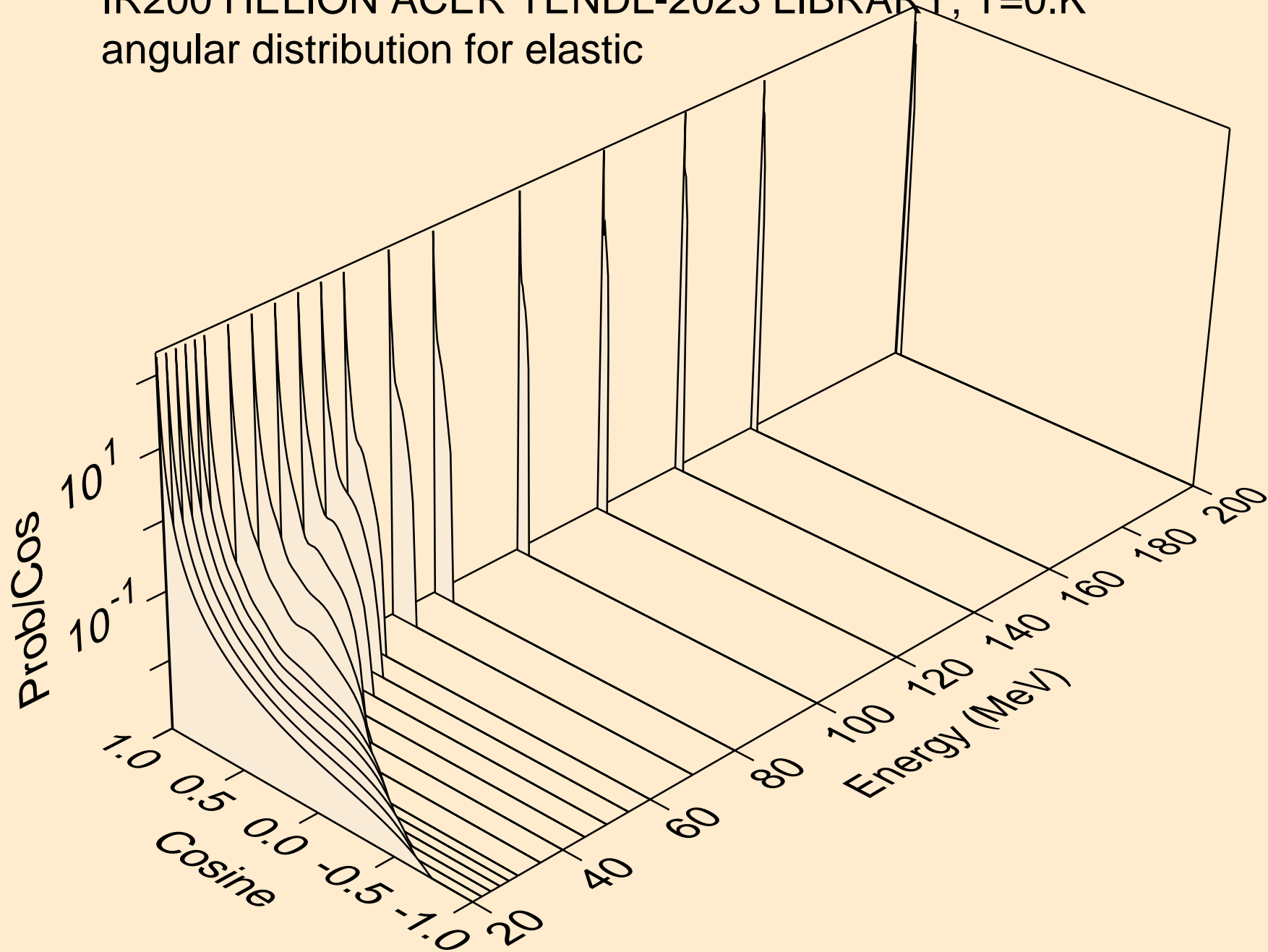

IR200 HELION ACER TENDL-2023 LIBRARY; T=0.K  
He-3 emission for (s,x)

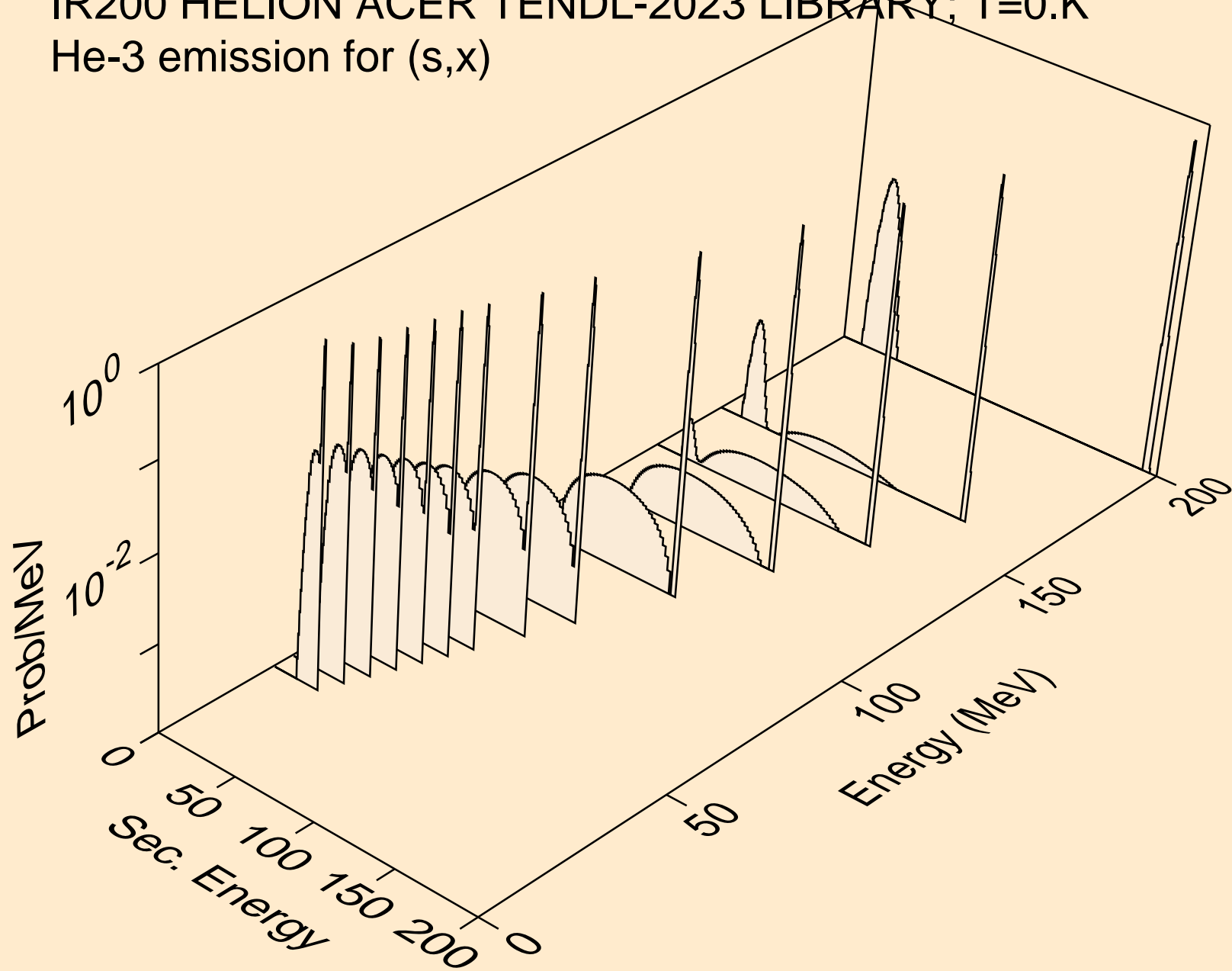

IR200 HELION ACER TENDL-2023 LIBRARY; T=0.K  
He-3 emission for (s,n\*)he3

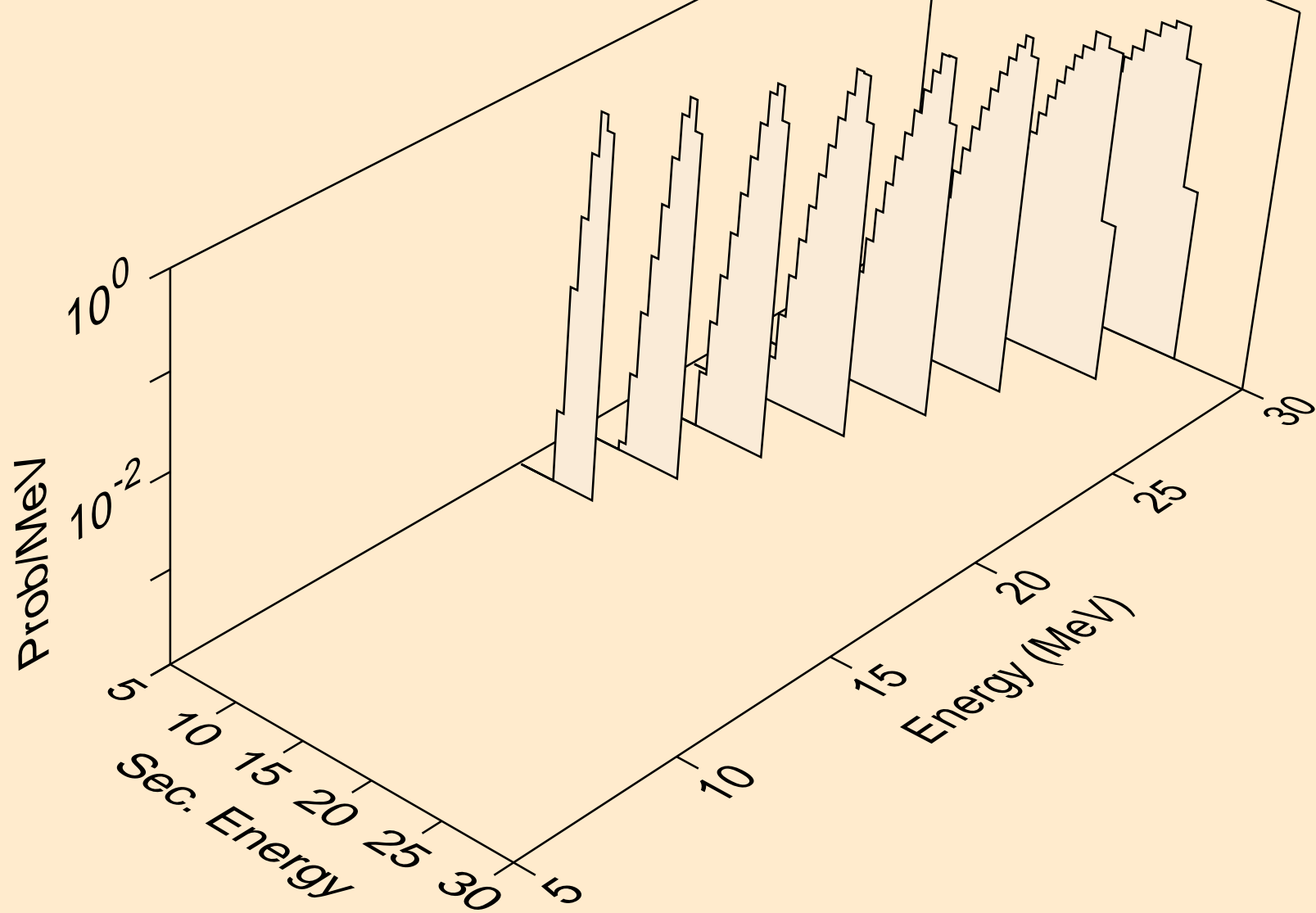

IR200 HELION ACER TENDL-2023 LIBRARY; T=0.K  
He-3 emission for inelastic

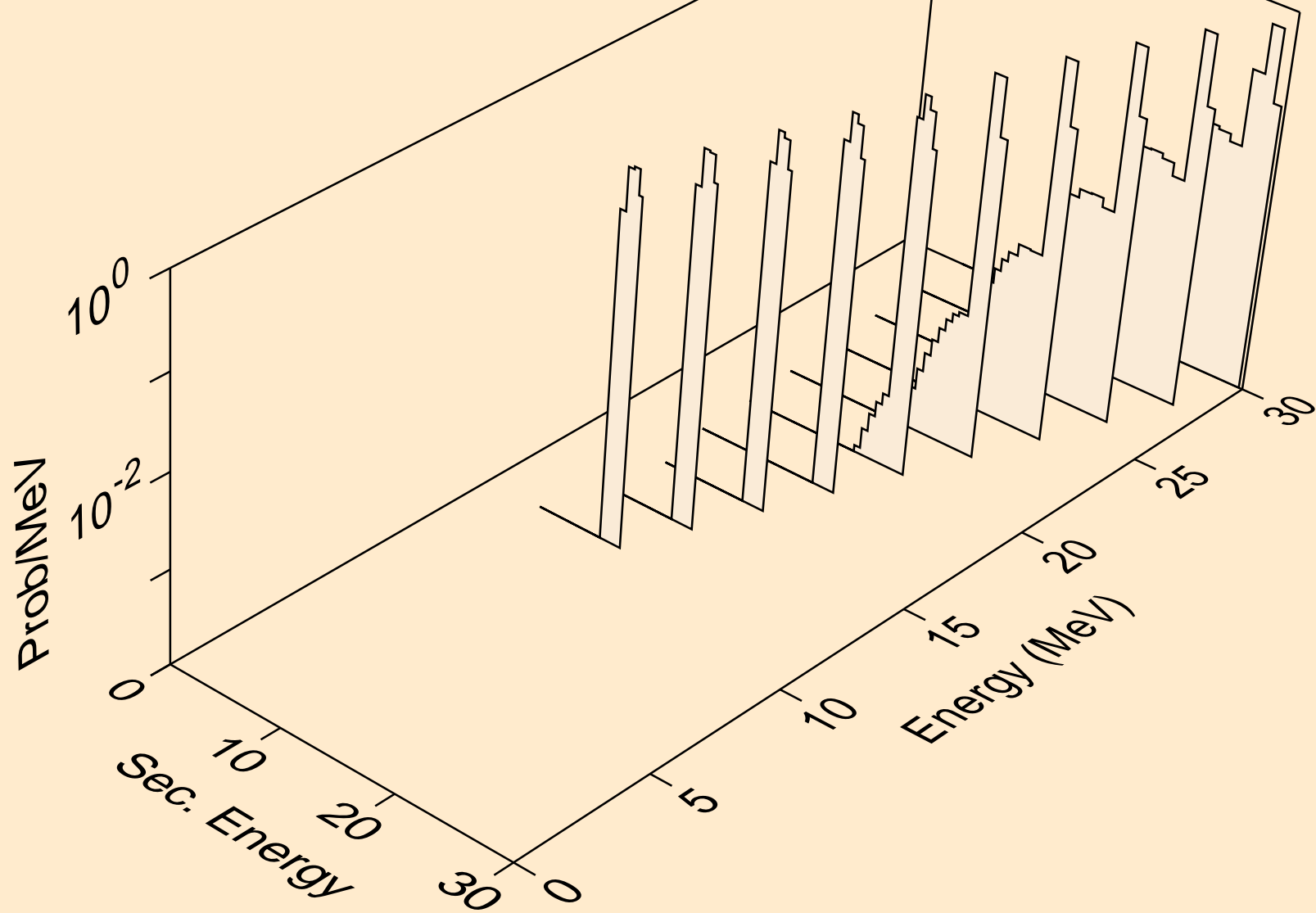

IR200 HELION ACER TENDL-2023 LIBRARY; T=0.K  
Photon emission for (z,n)

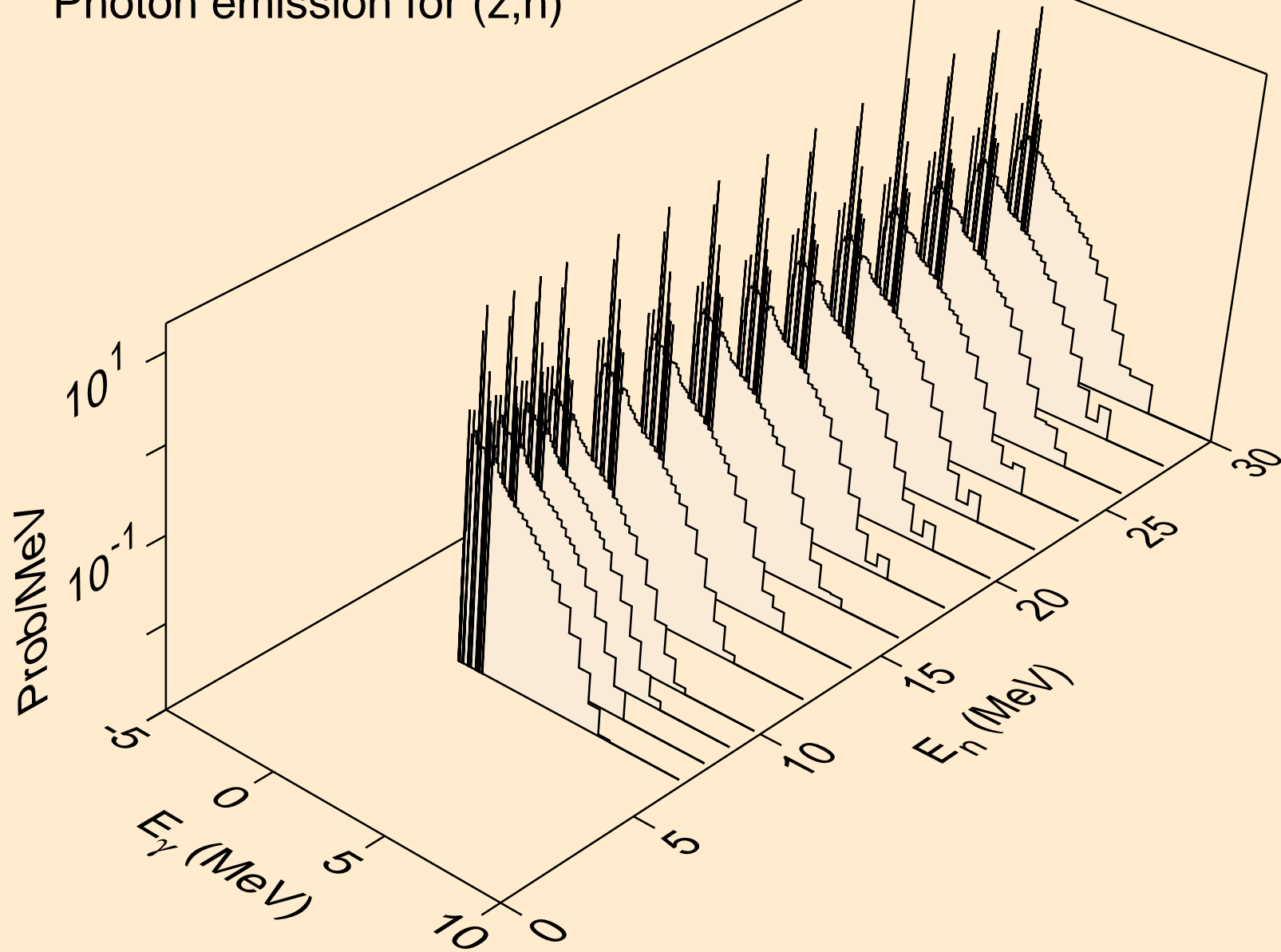

IR200 HELION ACER TENDL-2023 LIBRARY; T=0.K  
Photon emission for (z,x)

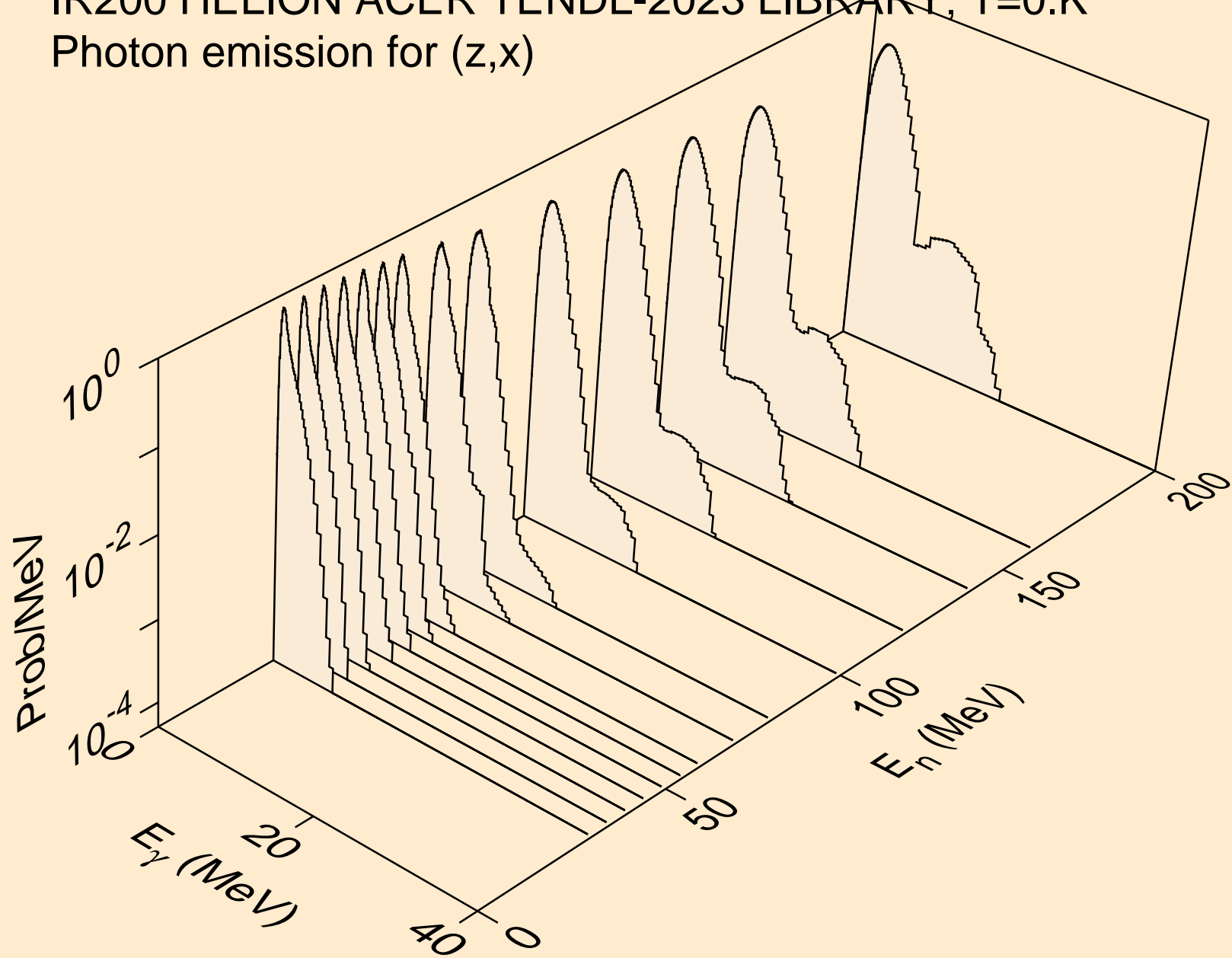

IR200 HELION ACER TENDL-2023 LIBRARY; T=0.K  
Photon emission for (n,2nd)

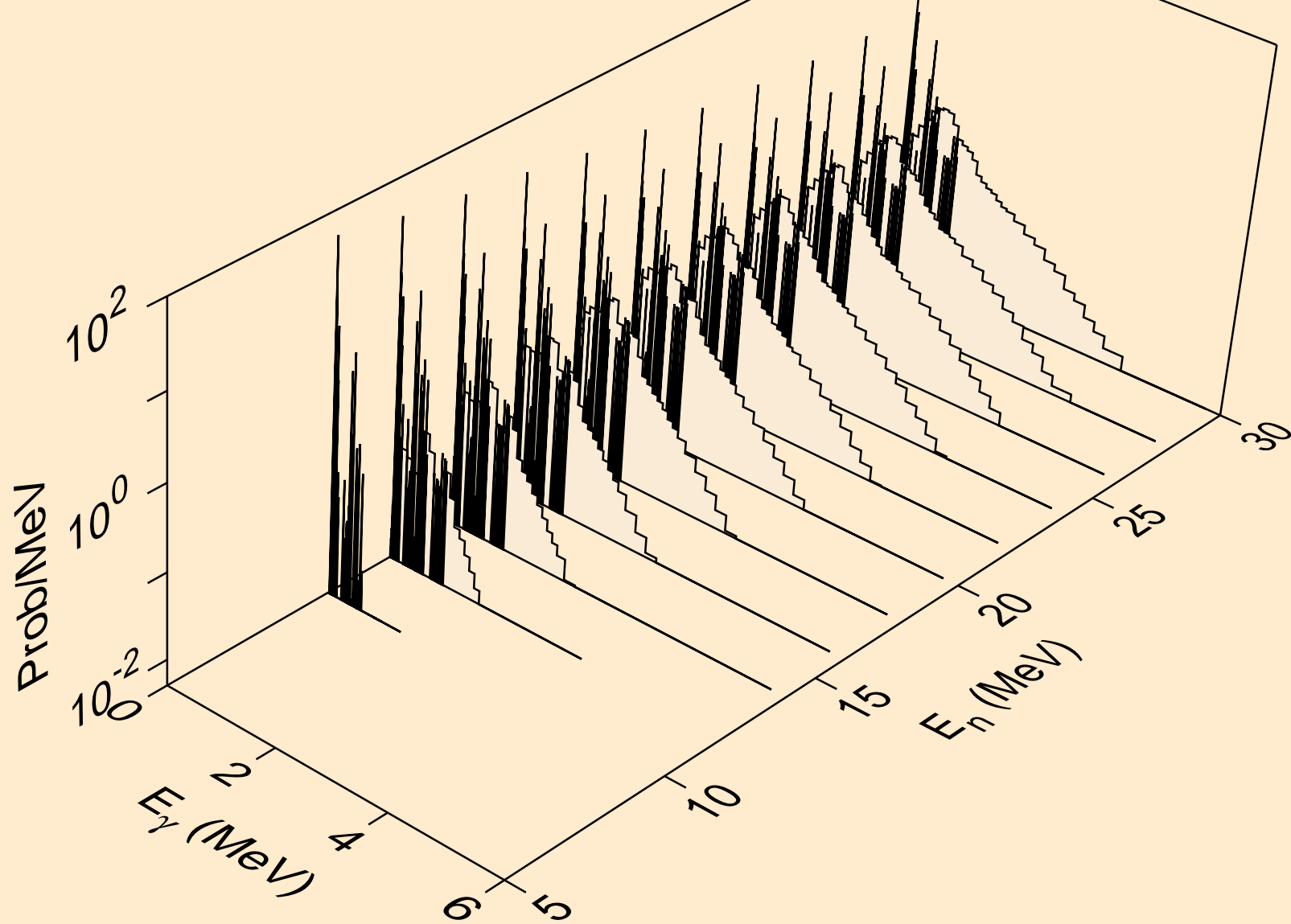

IR200 HELION ACER TENDL-2023 LIBRARY; T=0.K  
Photon emission for (n,2n)

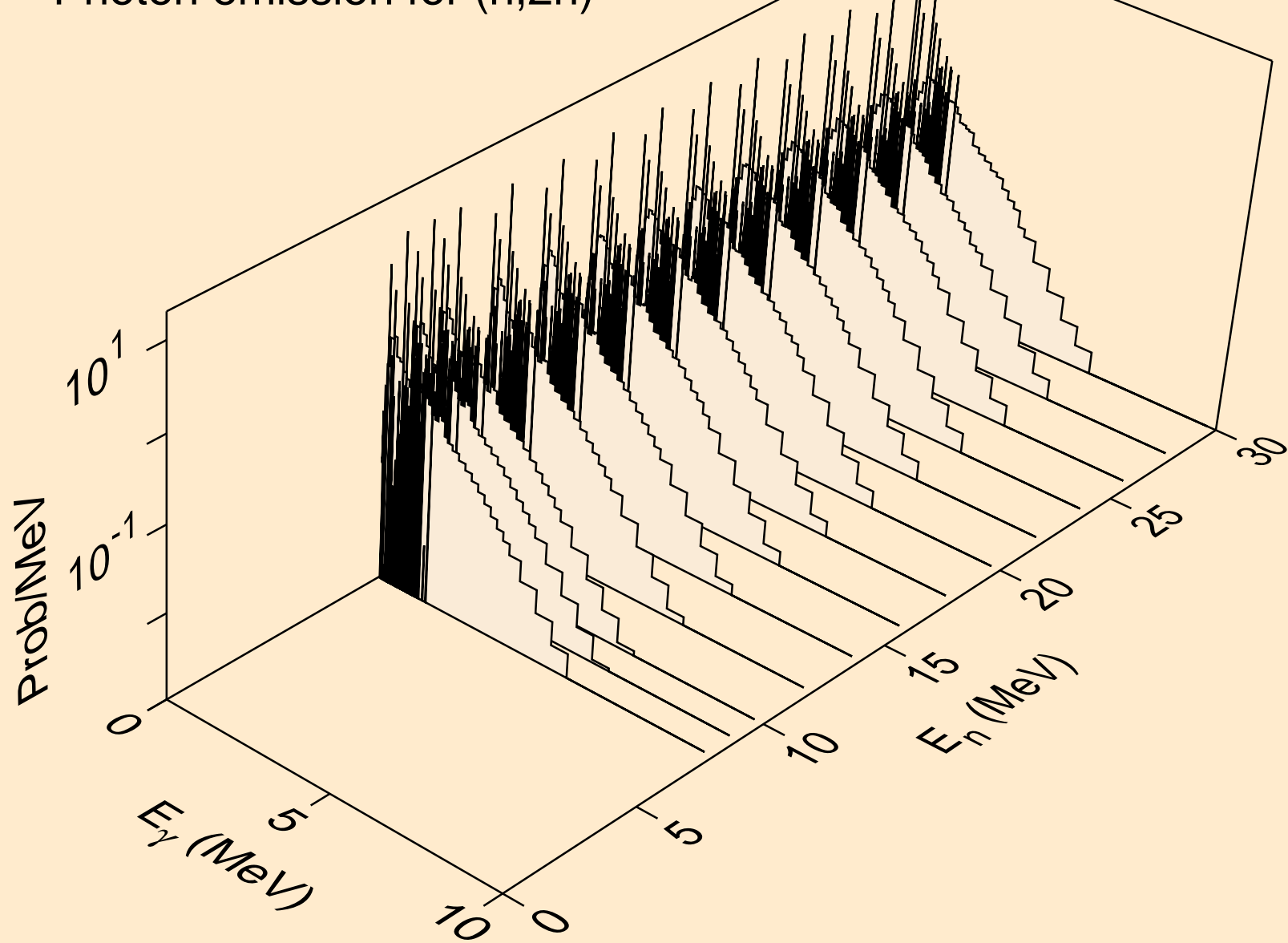

IR200 HELION ACER TENDL-2023 LIBRARY; T=0.K  
Photon emission for (n,3n)

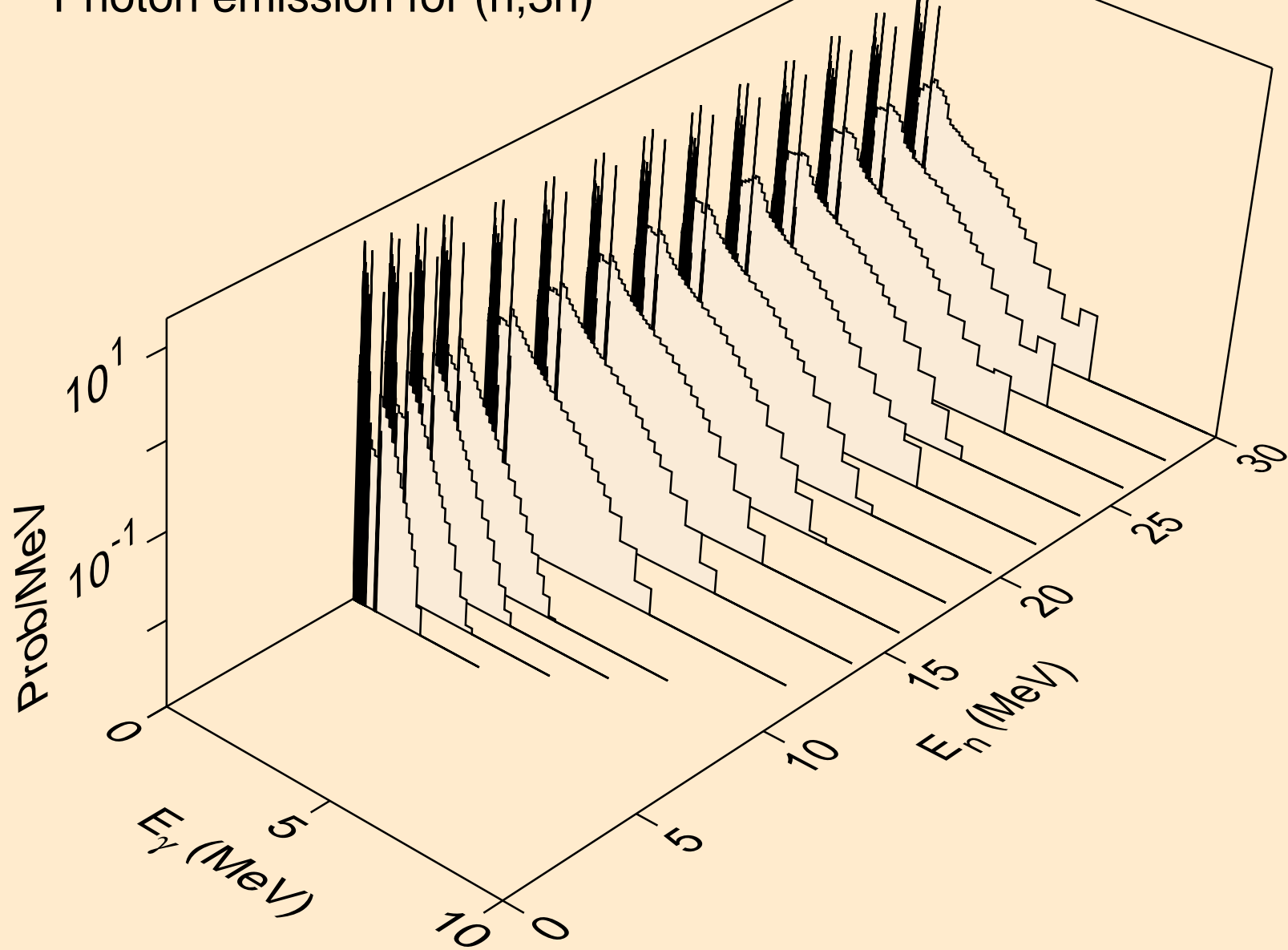

IR200 HELION ACER TENDL-2023 LIBRARY; T=0.K  
Photon emission for (n,n\*)a

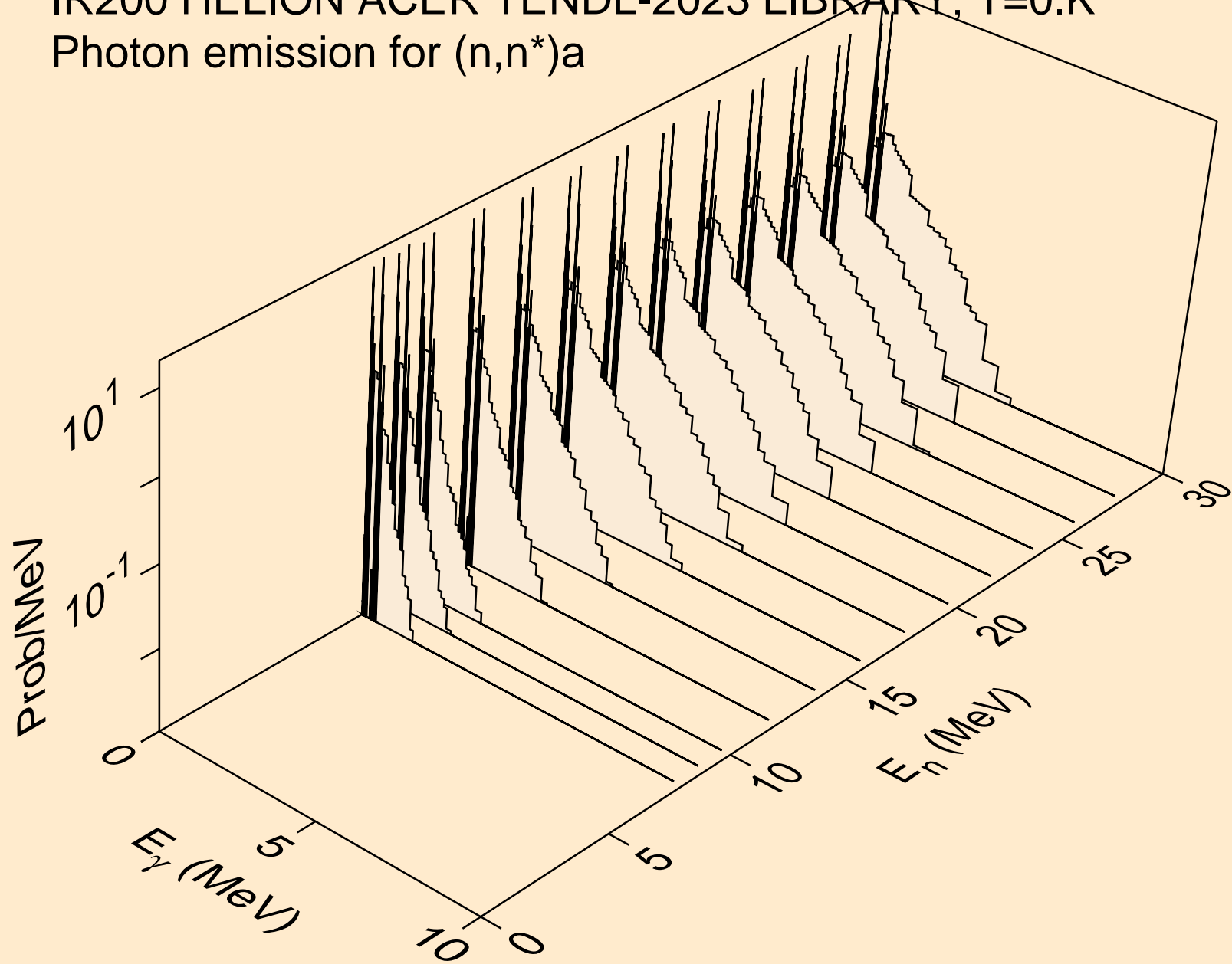

IR200 HELION ACER TENDL-2023 LIBRARY; T=0.K  
Photon emission for (n,2n)a

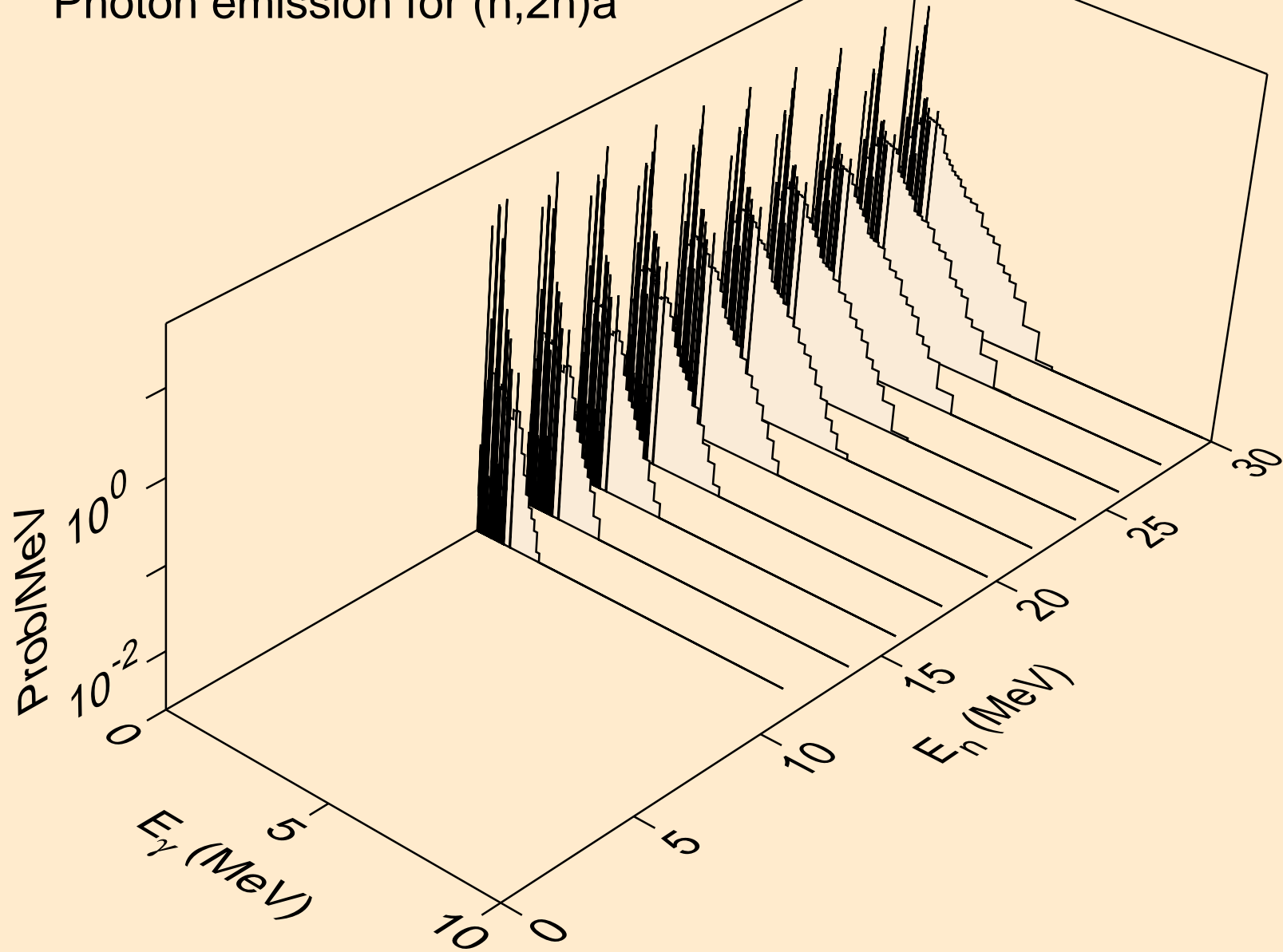

IR200 HELION ACER TENDL-2023 LIBRARY; T=0.K  
Photon emission for (n,3n)a

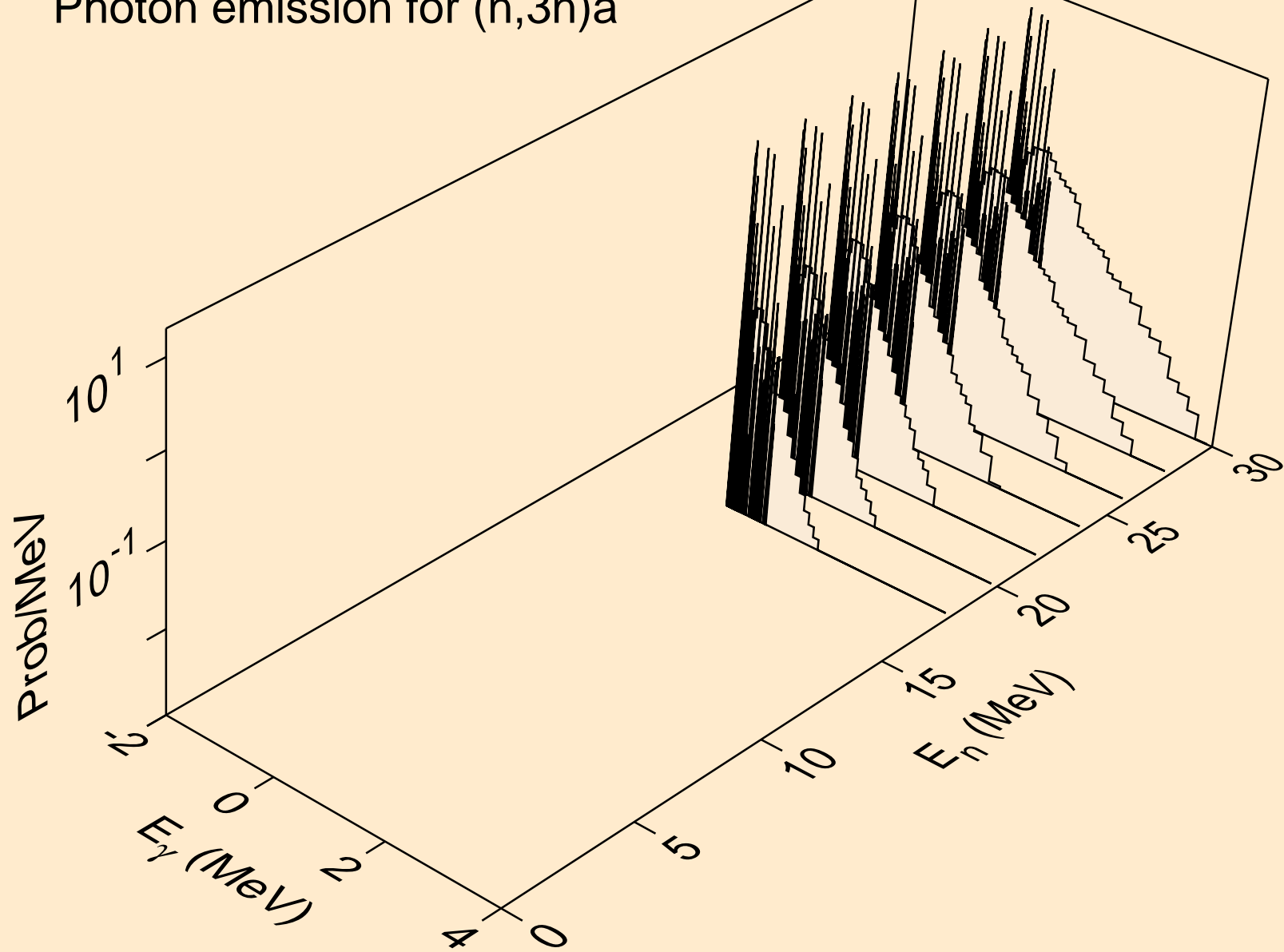

IR200 HELION ACER TENDL-2023 LIBRARY; T=0.K  
Photon emission for (n,n\*)p

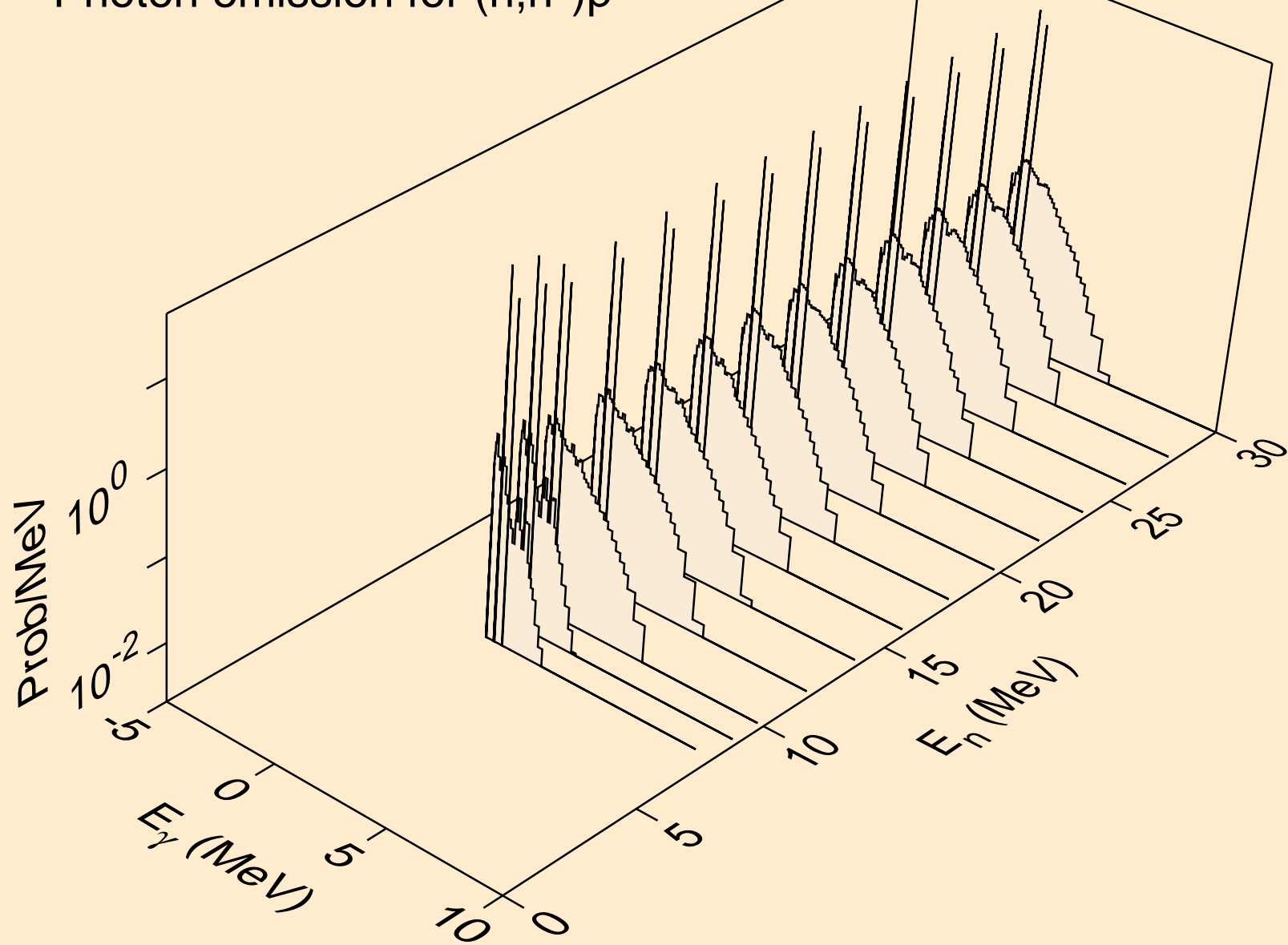

IR200 HELION ACER TENDL-2023 LIBRARY; T=0.K  
Photon emission for (n,n\*)d

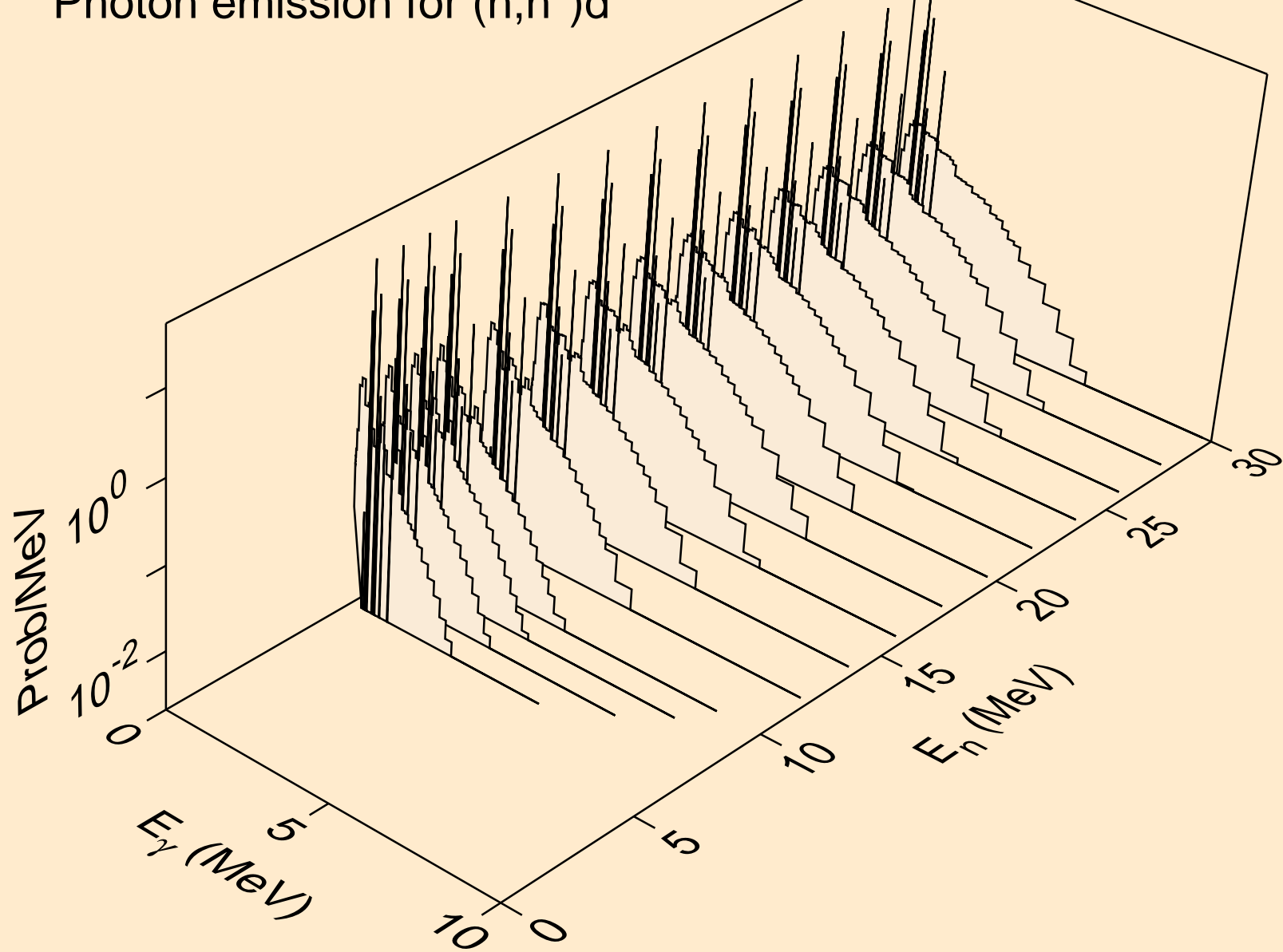

IR200 HELION ACER TENDL-2023 LIBRARY; T=0.K  
Photon emission for (n,n\*)t

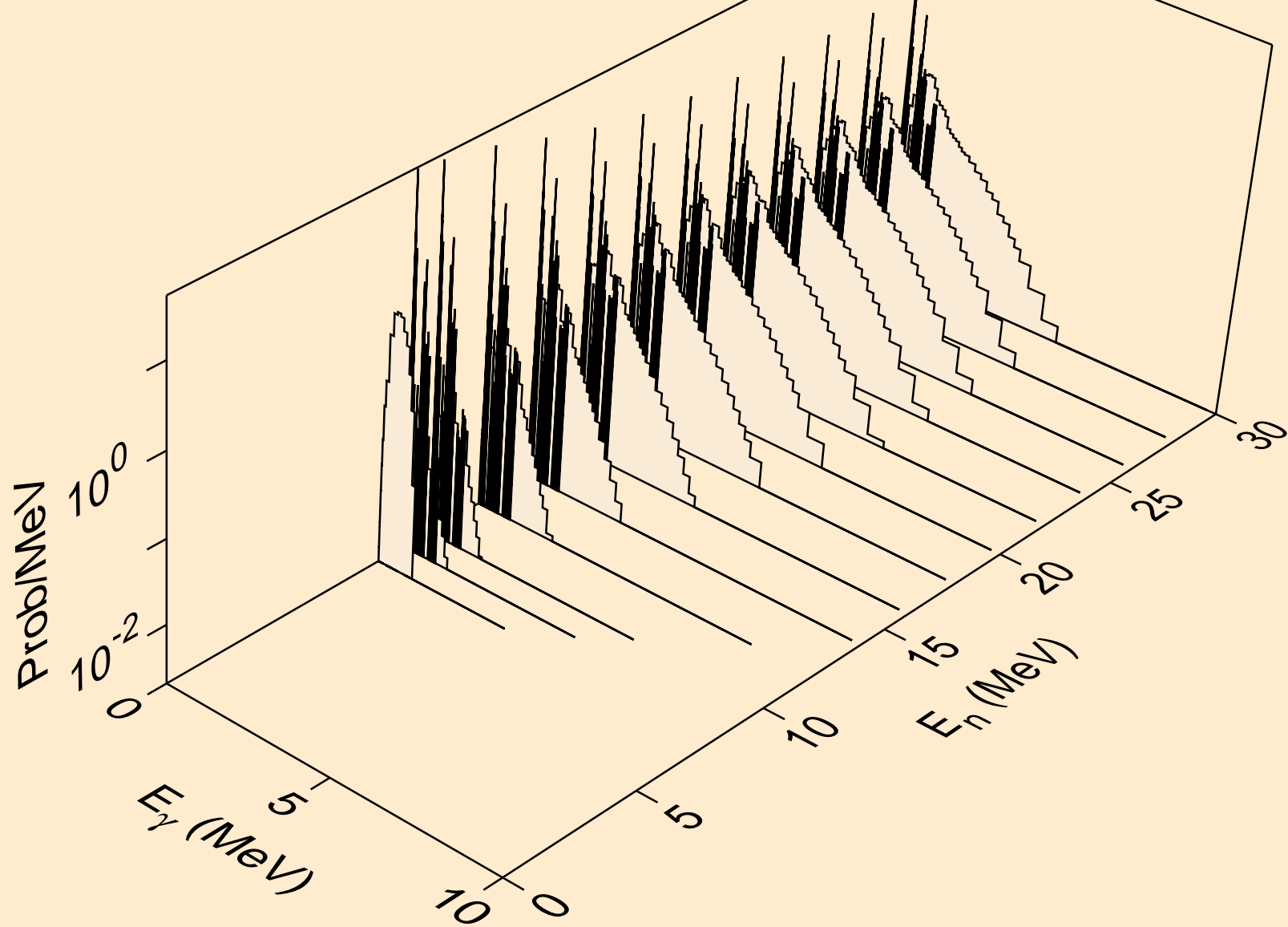

IR200 HELION ACER TENDL-2023 LIBRARY; T=0.K  
Photon emission for (n,n\*)he3

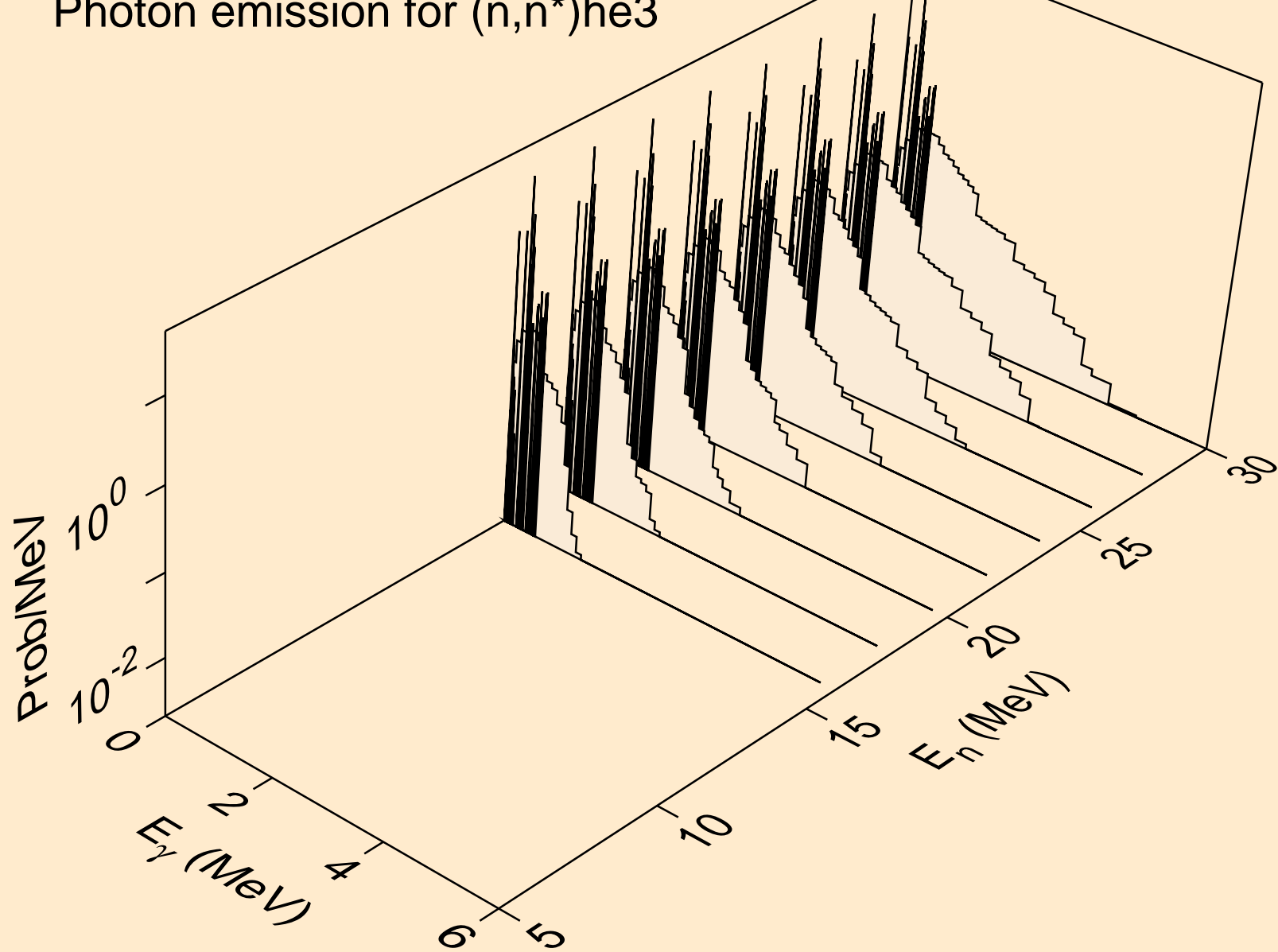

IR200 HELION ACER TENDL-2023 LIBRARY; T=0.K  
Photon emission for (n,4n)

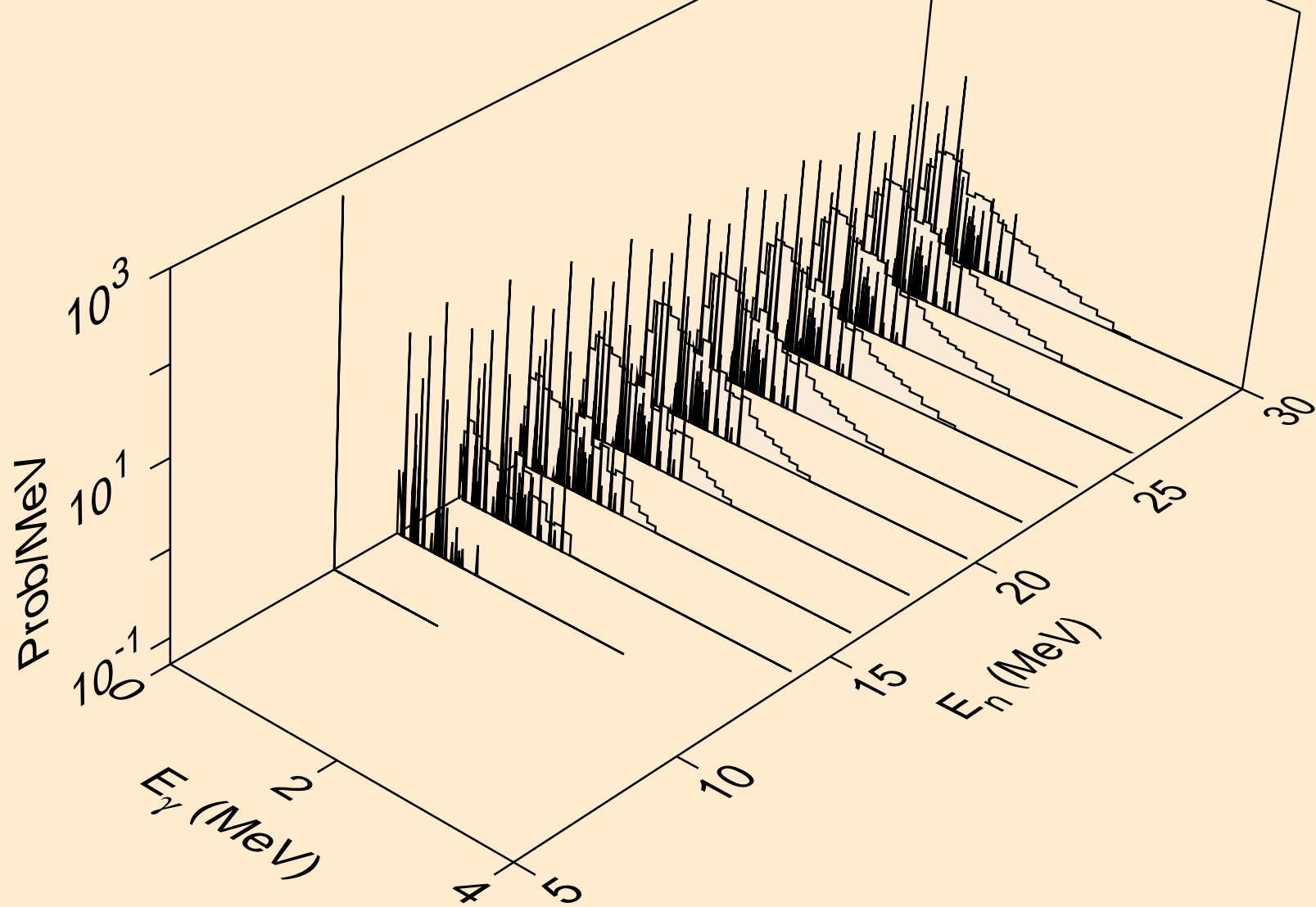

IR200 HELION ACER TENDL-2023 LIBRARY; T=0.K  
Photon emission for (n,2np)

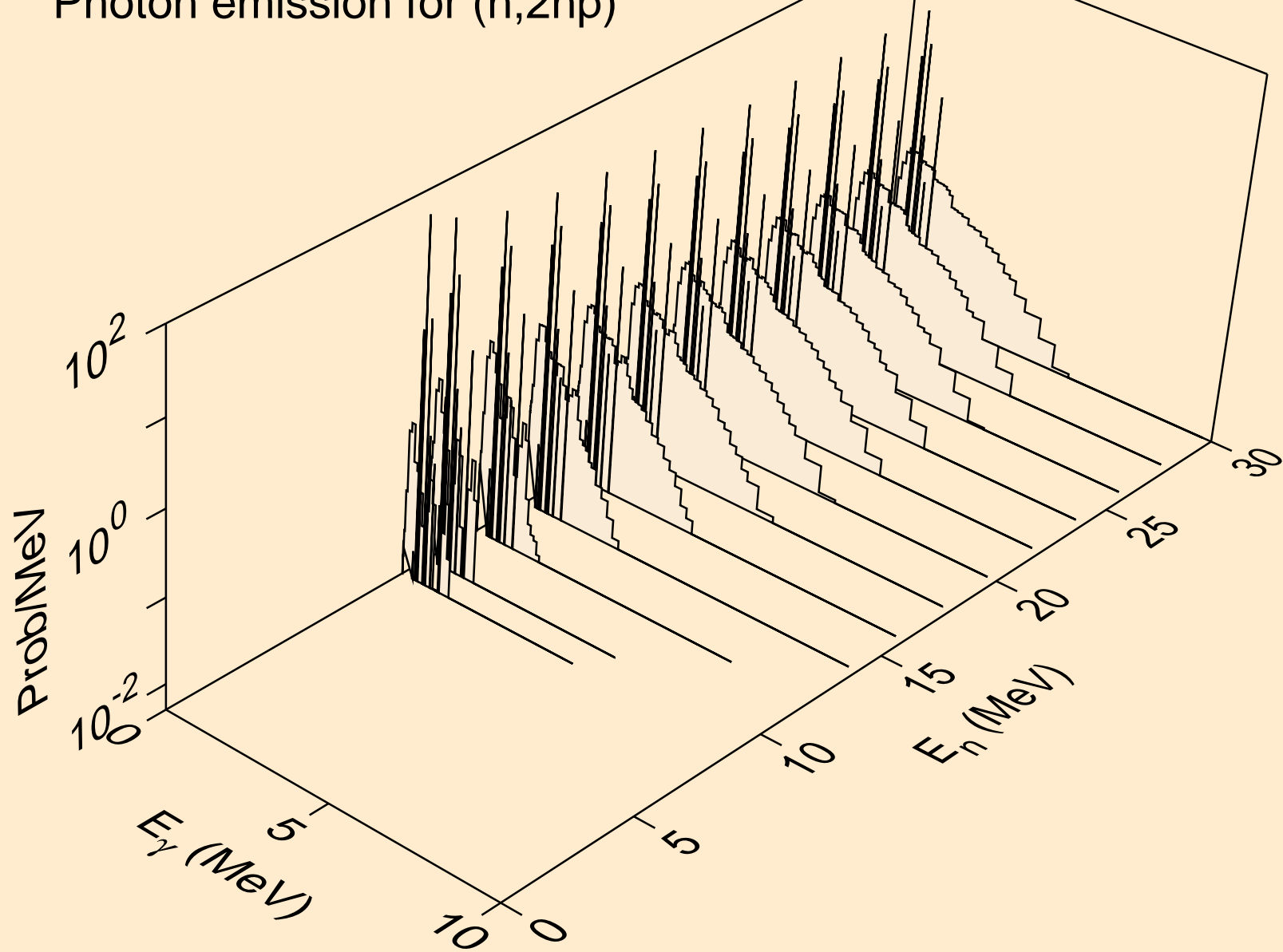

IR200 HELION ACER TENDL-2023 LIBRARY; T=0.K  
Photon emission for (n,3np)

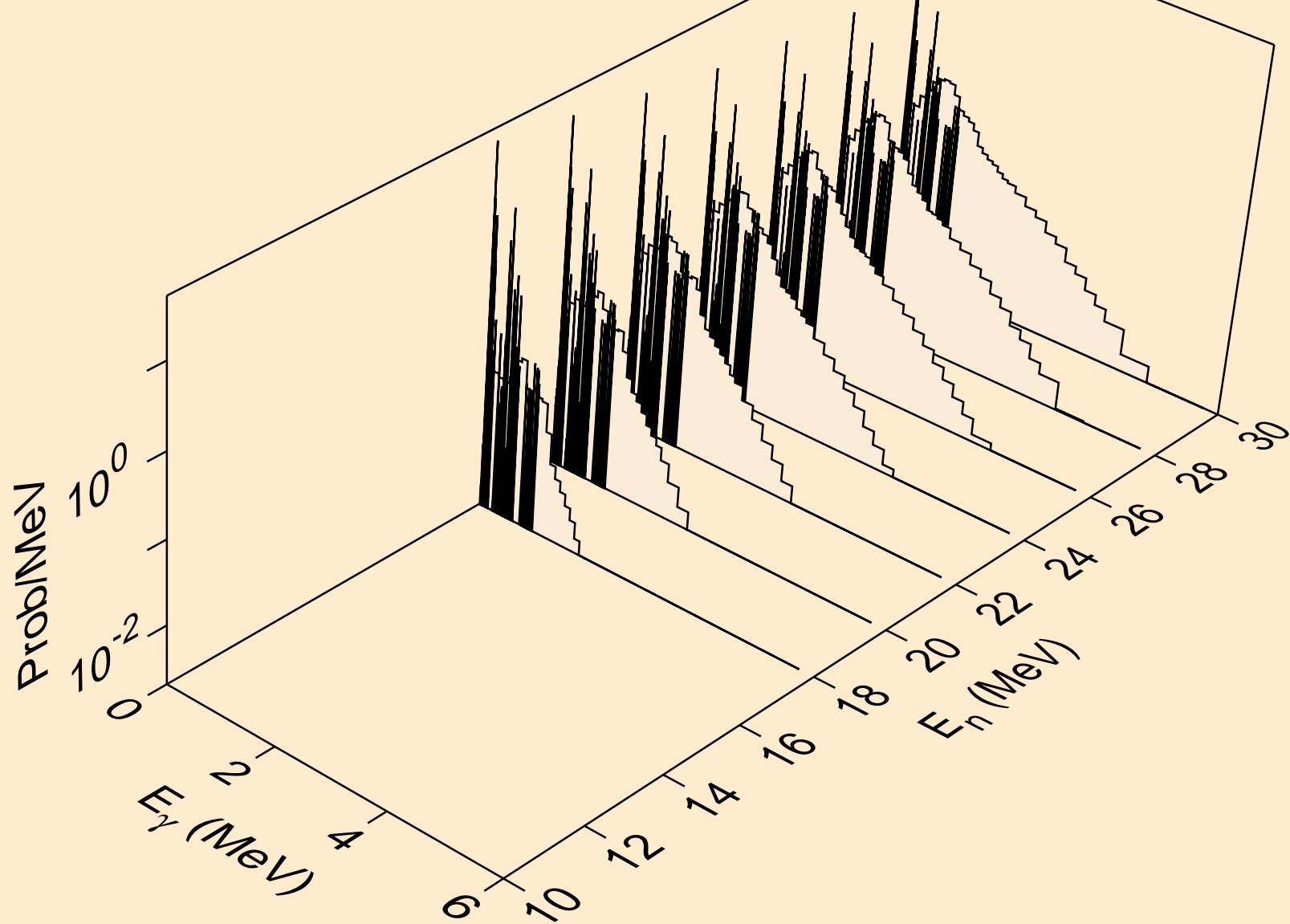

IR200 HELION ACER TENDL-2023 LIBRARY; T=0.K  
Photon emission for (n,n2p)

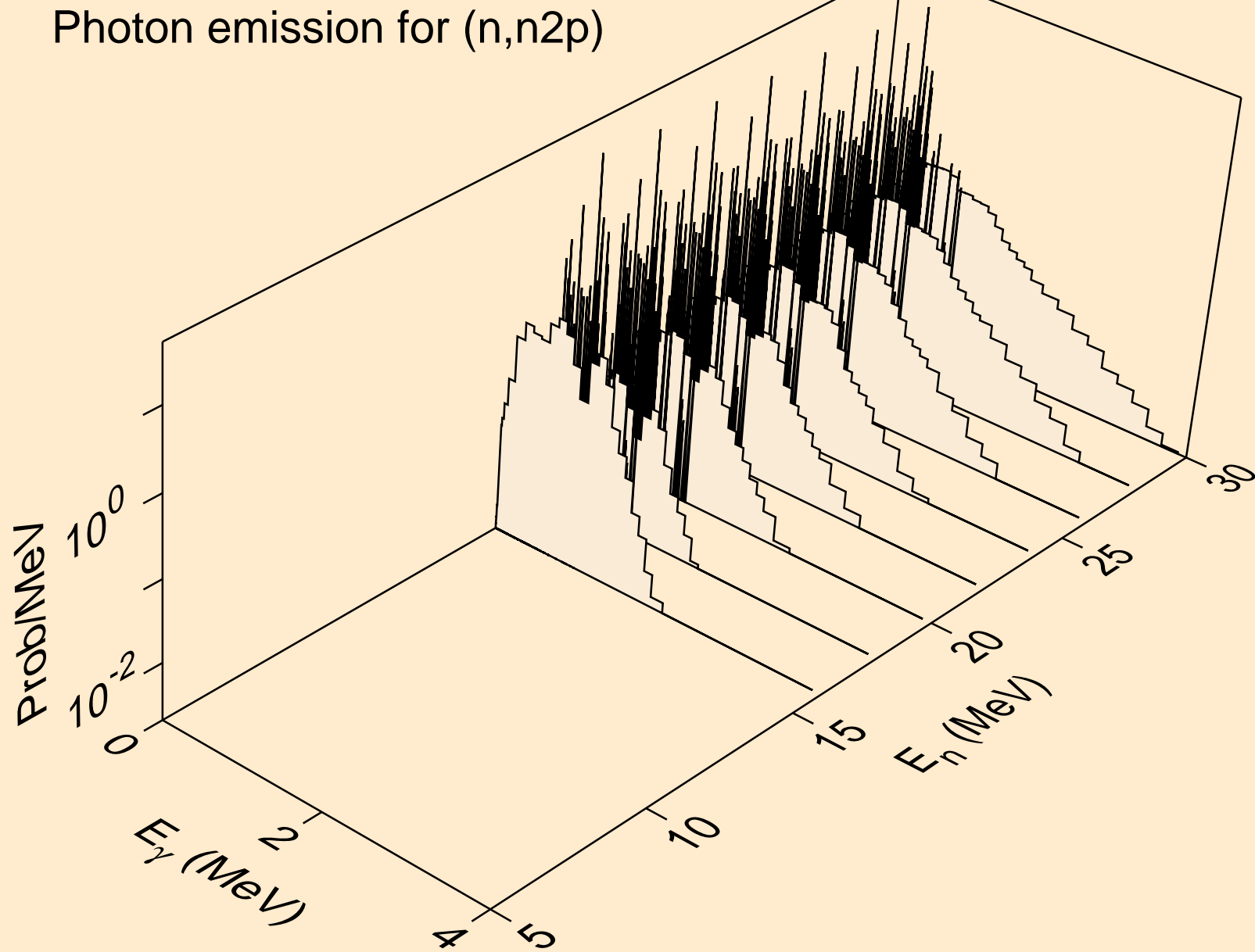

IR200 HELION ACER TENDL-2023 LIBRARY; T=0.K  
Photon emission for (n,npa)

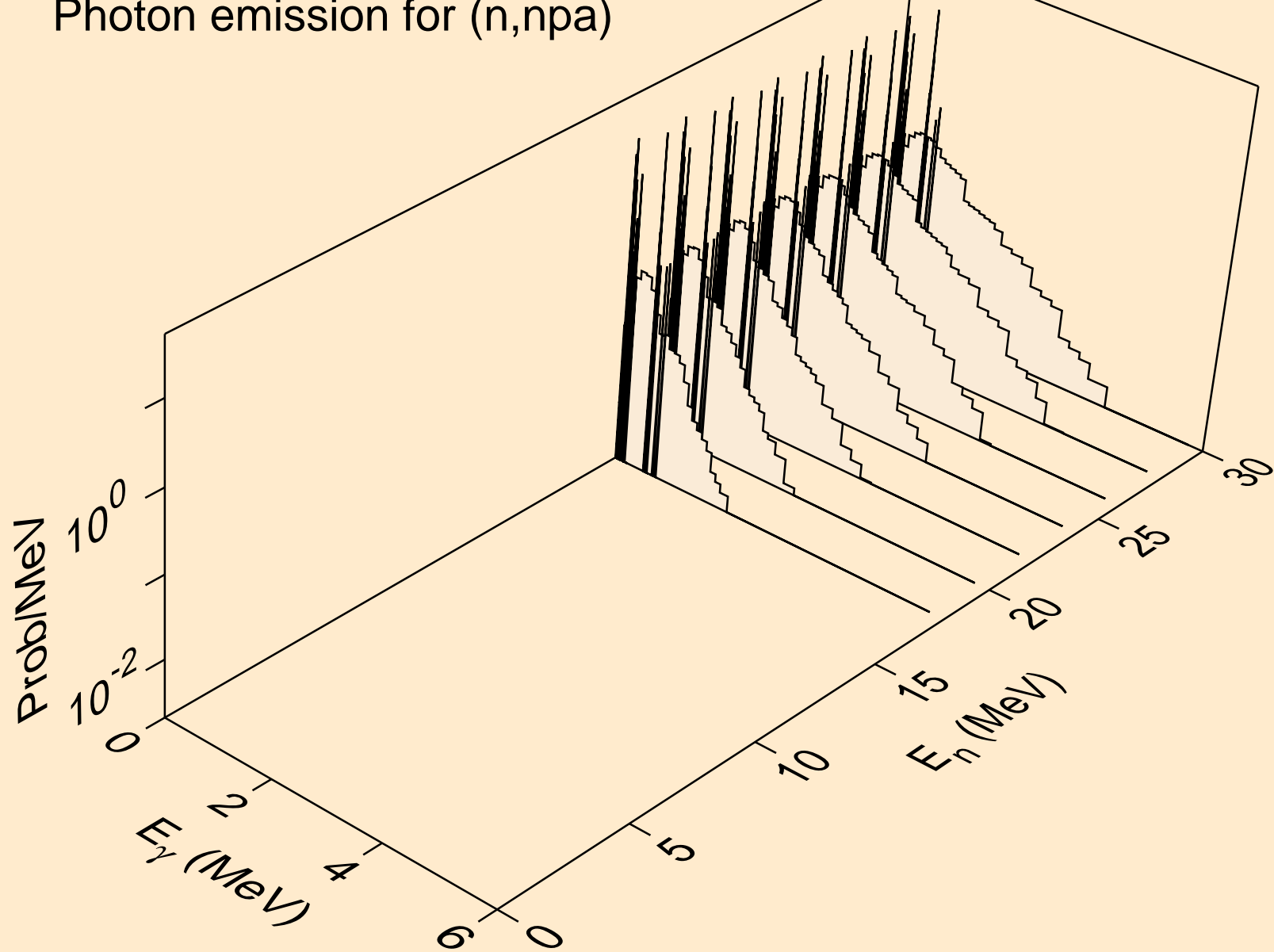

IR200 HELION ACER TENDL-2023 LIBRARY; T=0.K  
Photon emission for (n,gma)

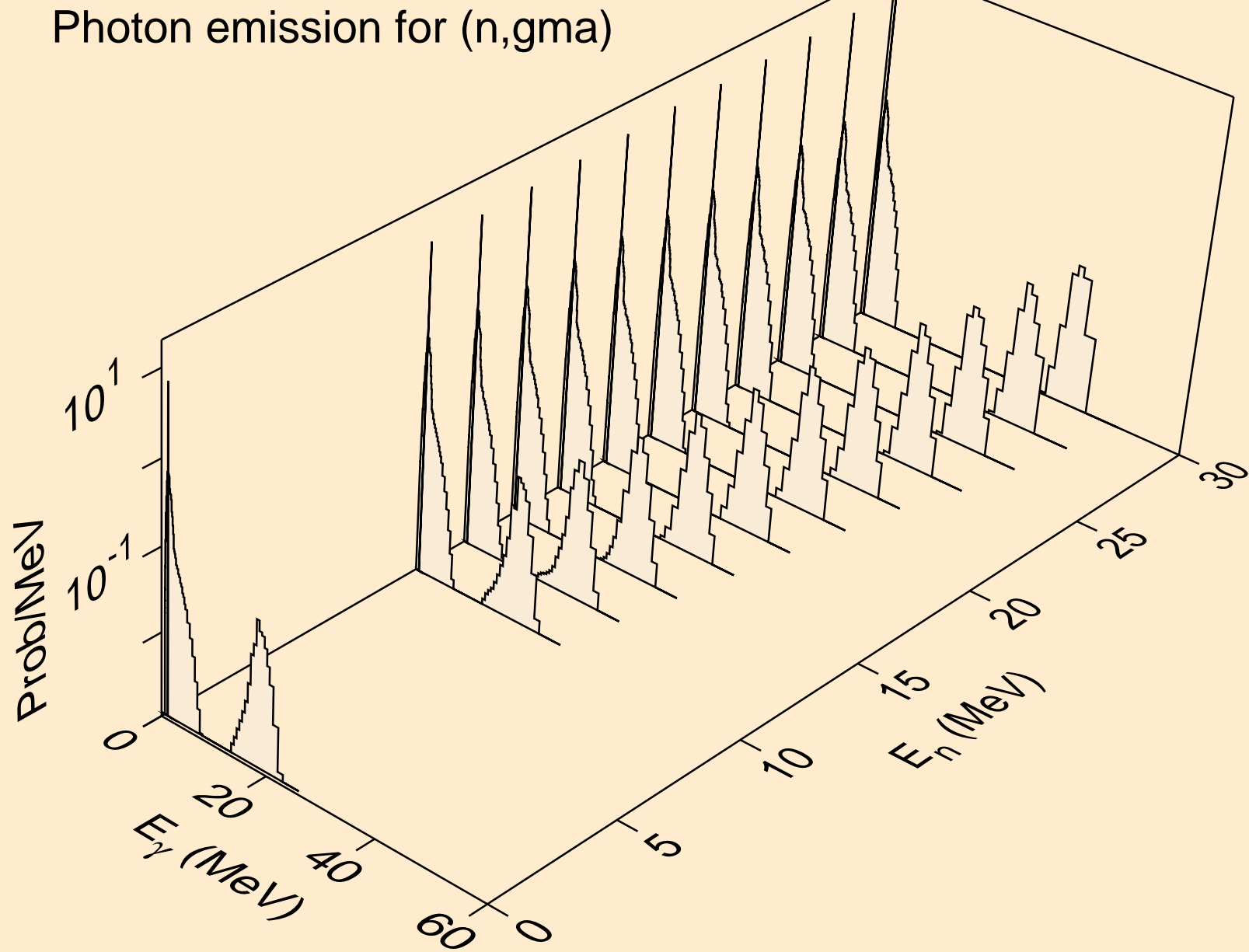

IR200 HELION ACER TENDL-2023 LIBRARY; T=0.K  
Photon emission for (n,p)

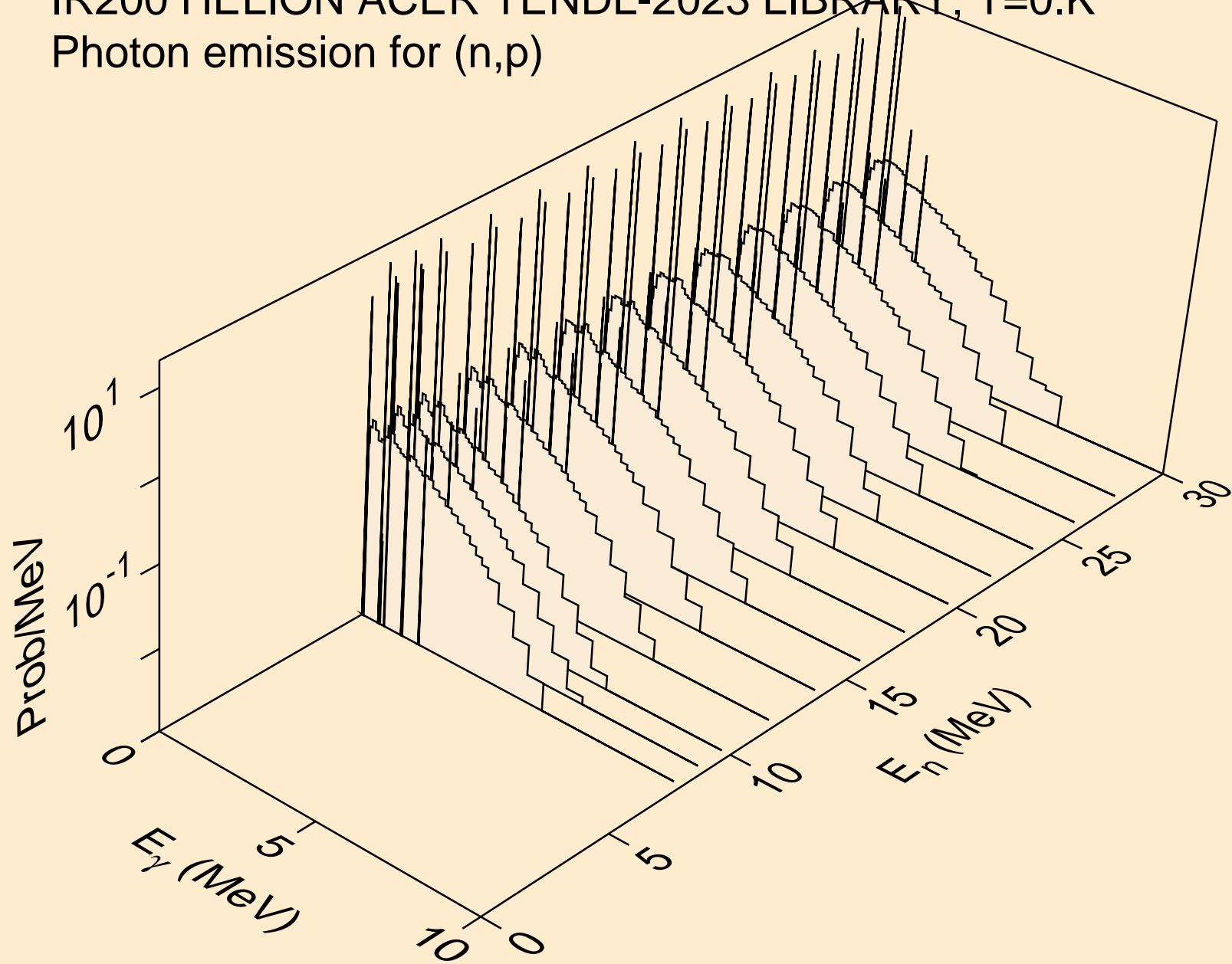

IR200 HELION ACER TENDL-2023 LIBRARY; T=0.K  
Photon emission for (n,d)

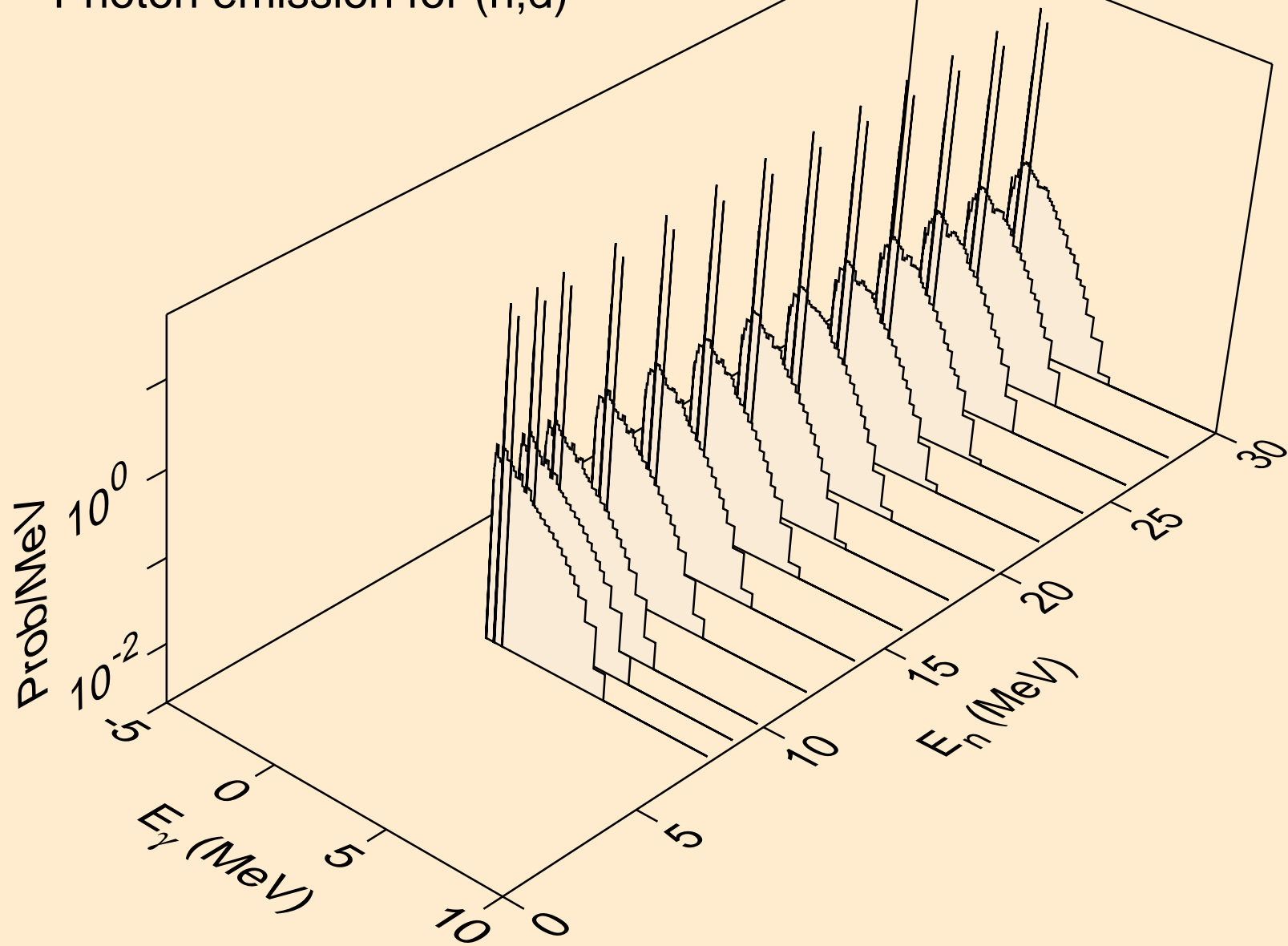

IR200 HELION ACER TENDL-2023 LIBRARY; T=0.K  
Photon emission for (n,t)

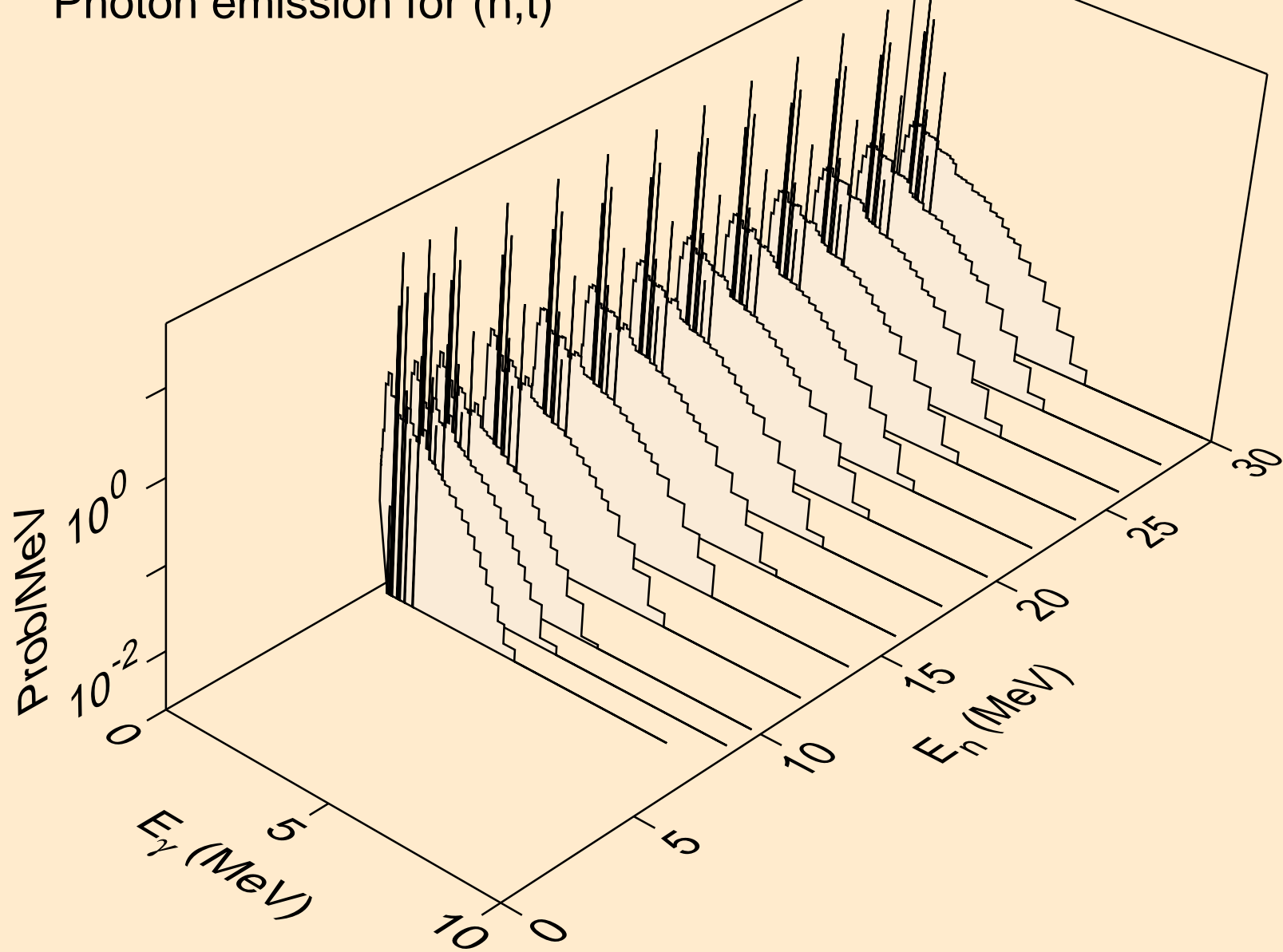

IR200 HELION ACER TENDL-2023 LIBRARY; T=0.K  
Photon emission for inelastic

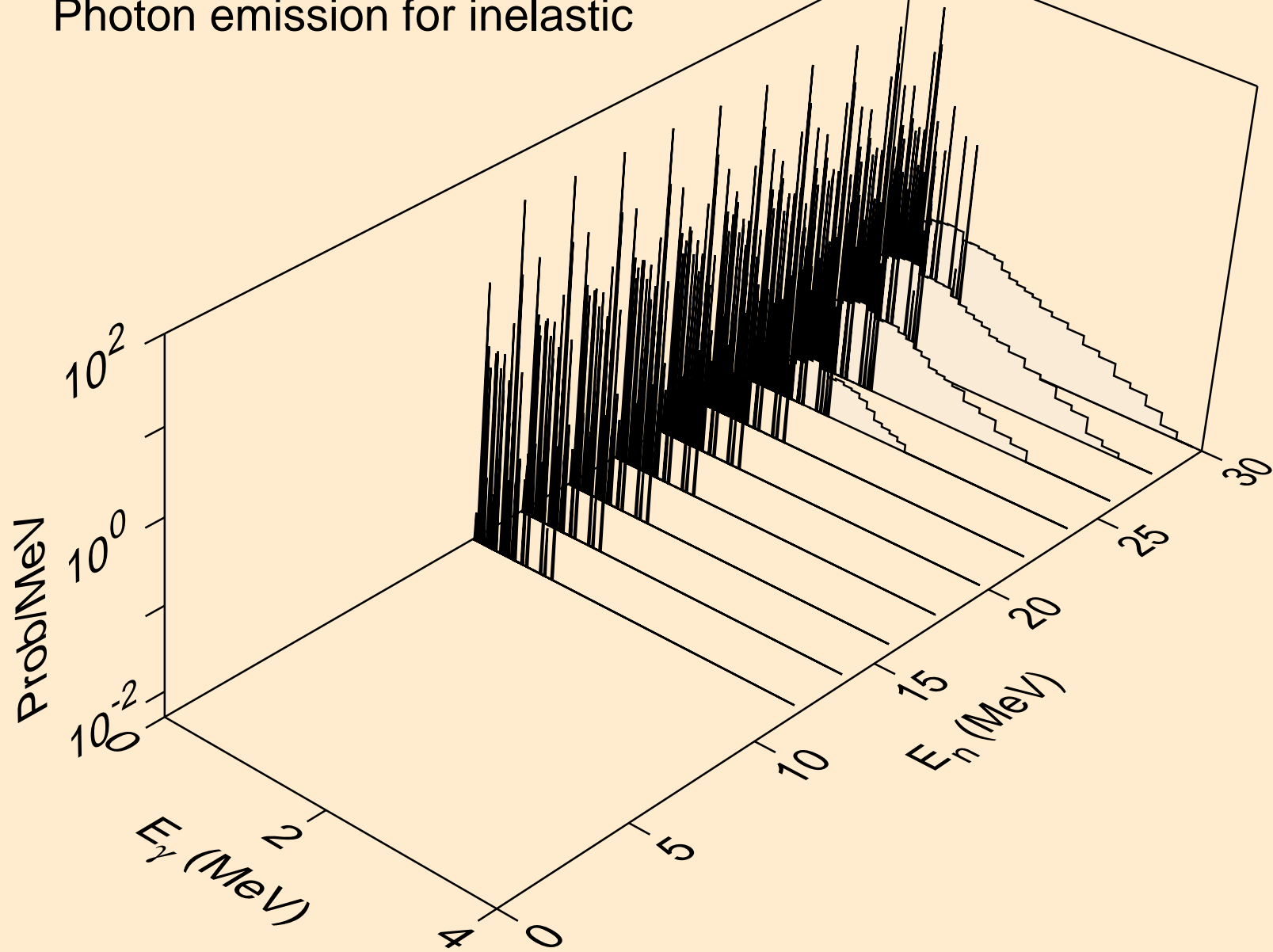

IR200 HELION ACER TENDL-2023 LIBRARY; T=0.K  
Photon emission for (n,a)

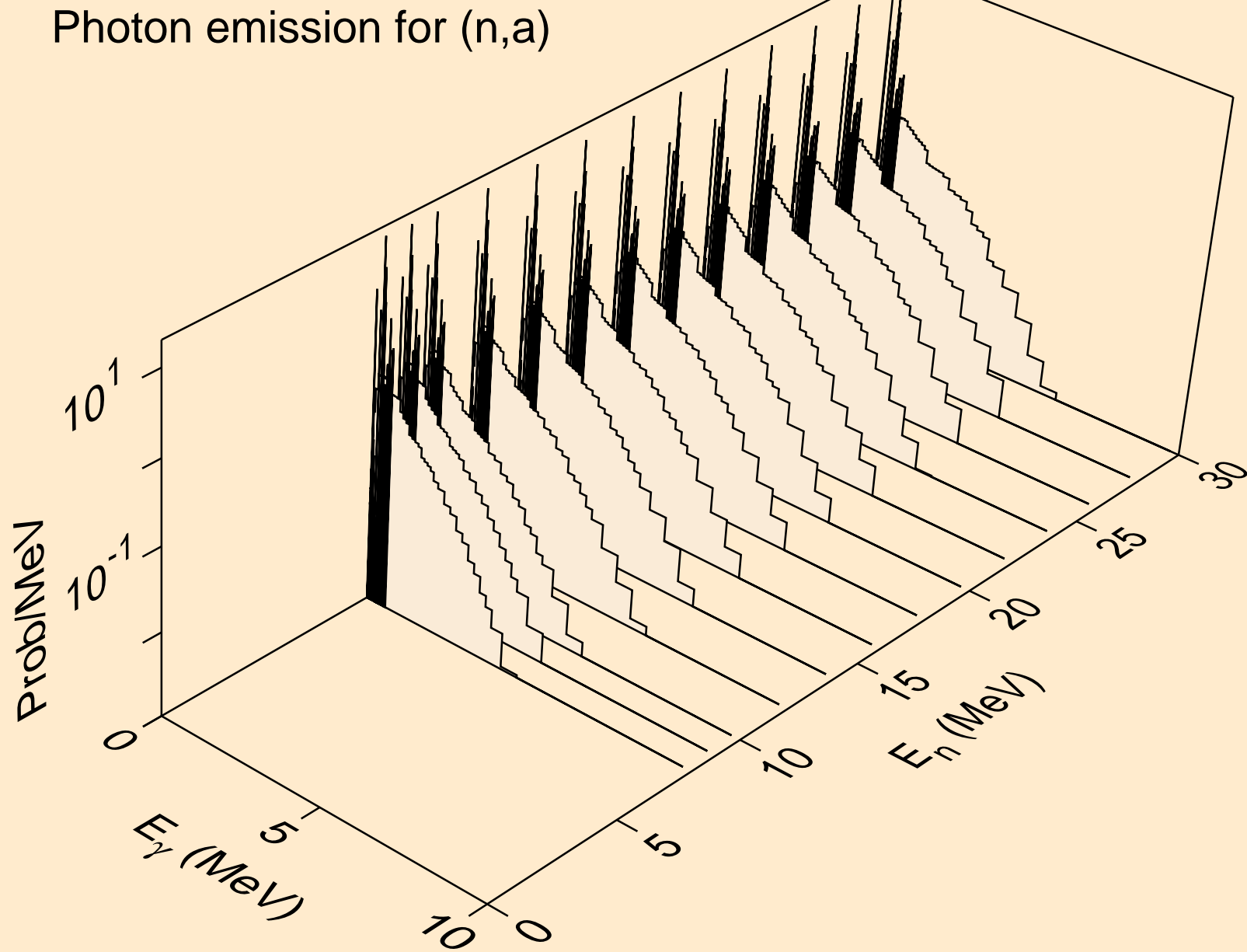

IR200 HELION ACER TENDL-2023 LIBRARY; T=0.K  
Photon emission for (n,2p)

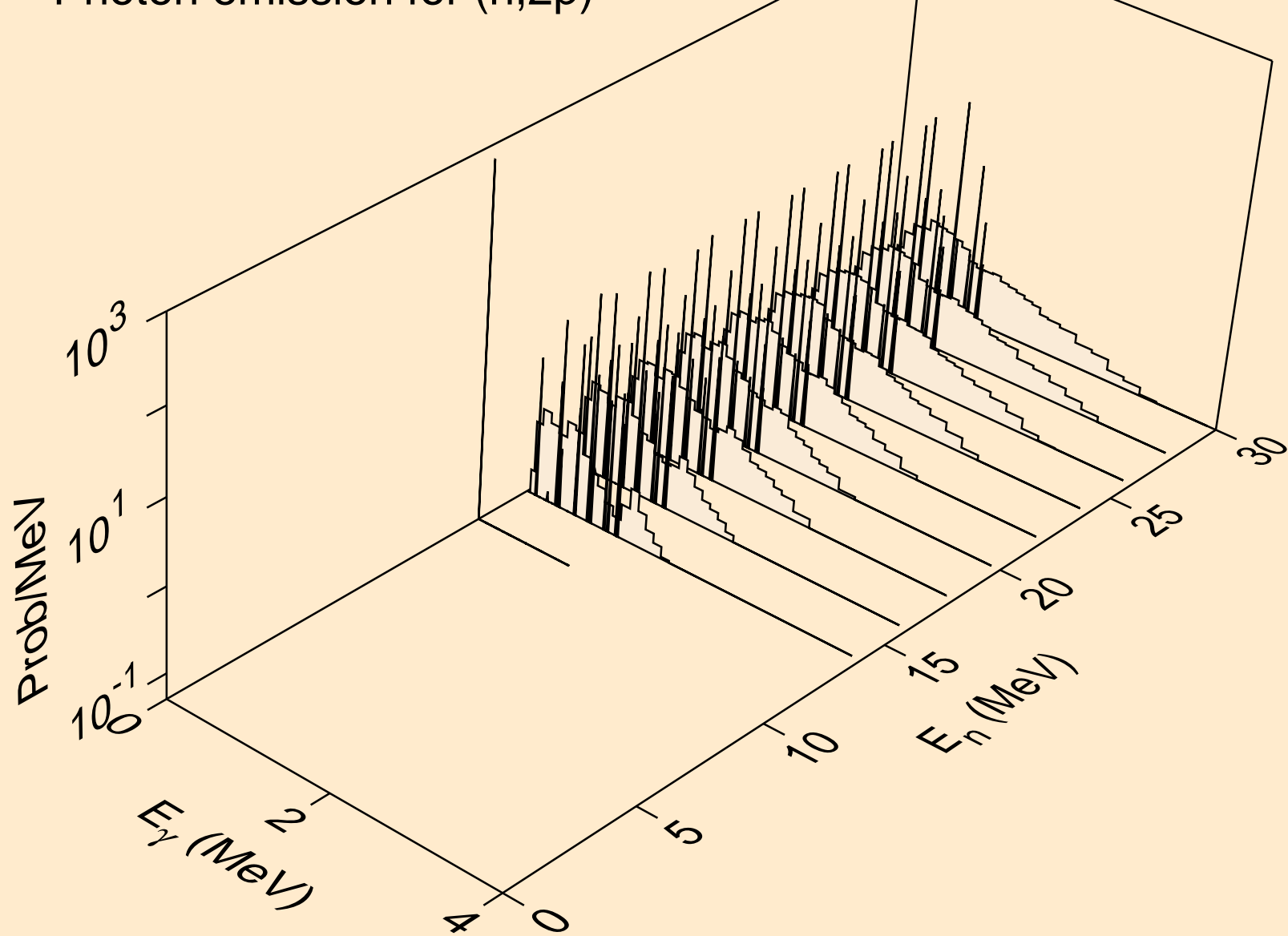

IR200 HELION ACER TENDL-2023 LIBRARY; T=0.K  
Photon emission for (n,pd)

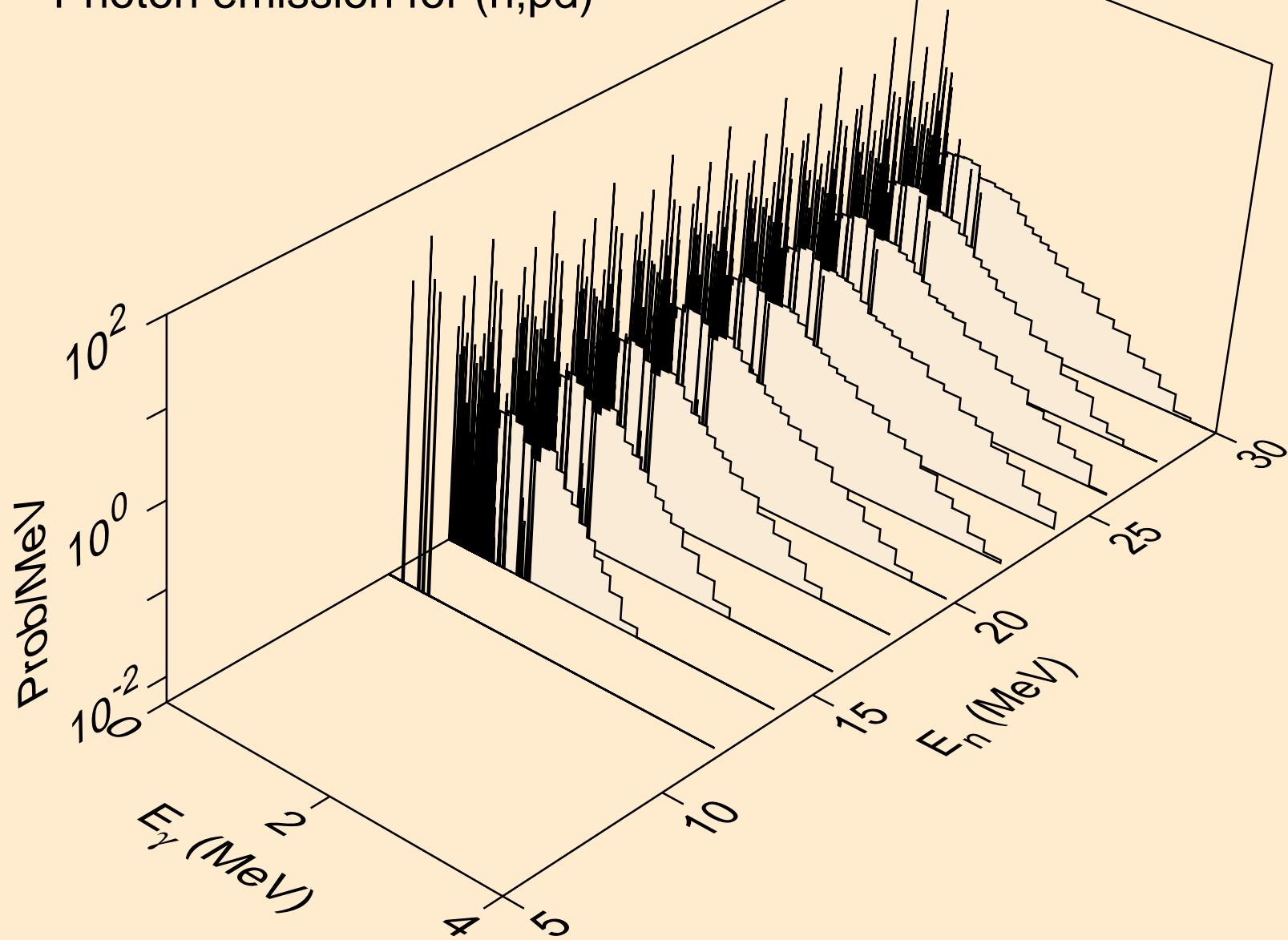

IR200 HELION ACER TENDL-2023 LIBRARY; T=0.K  
Photon emission for (n,pt)

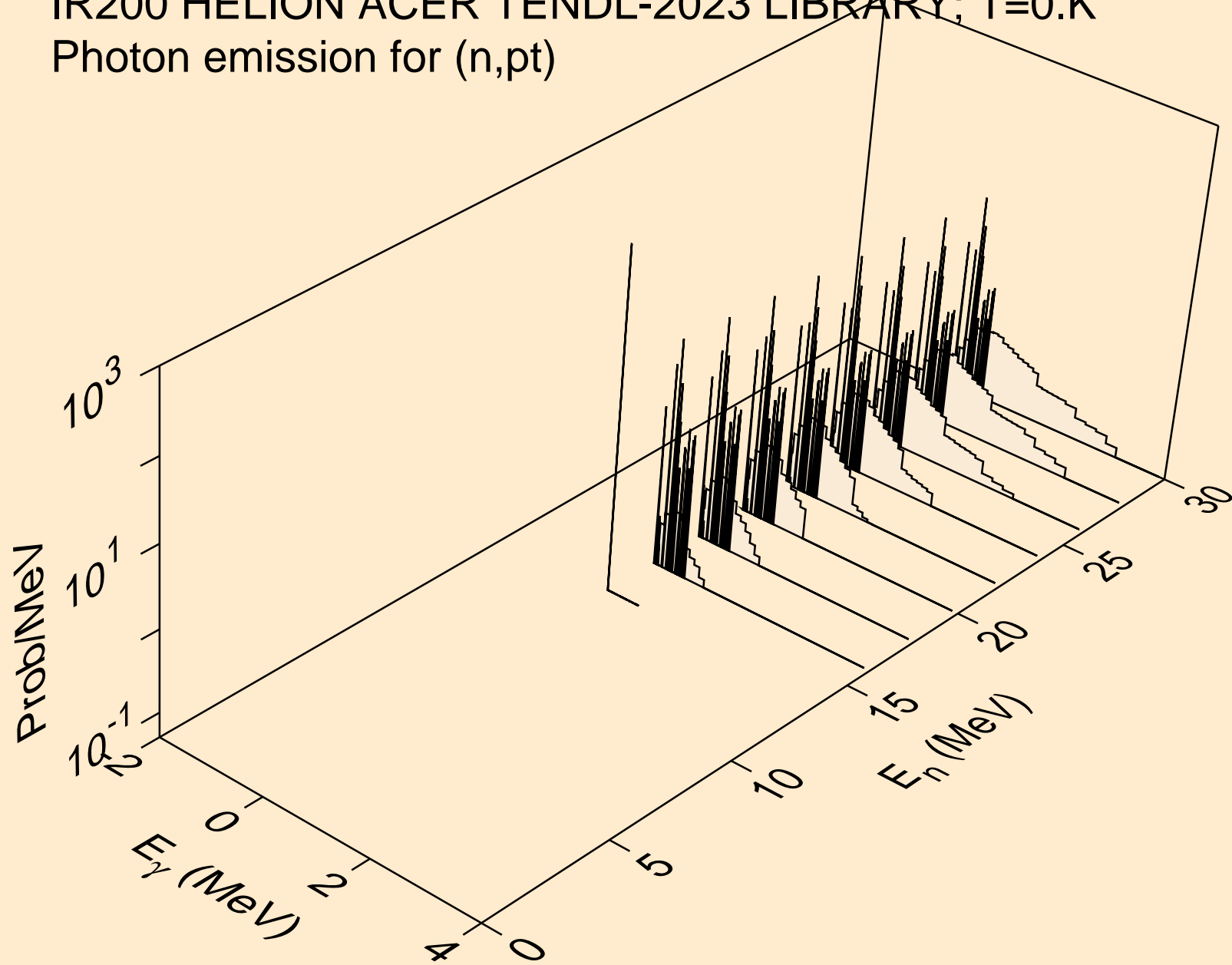

IR200 HELION ACER TENDL-2023 LIBRARY; T=0.K  
Particle heating contributions

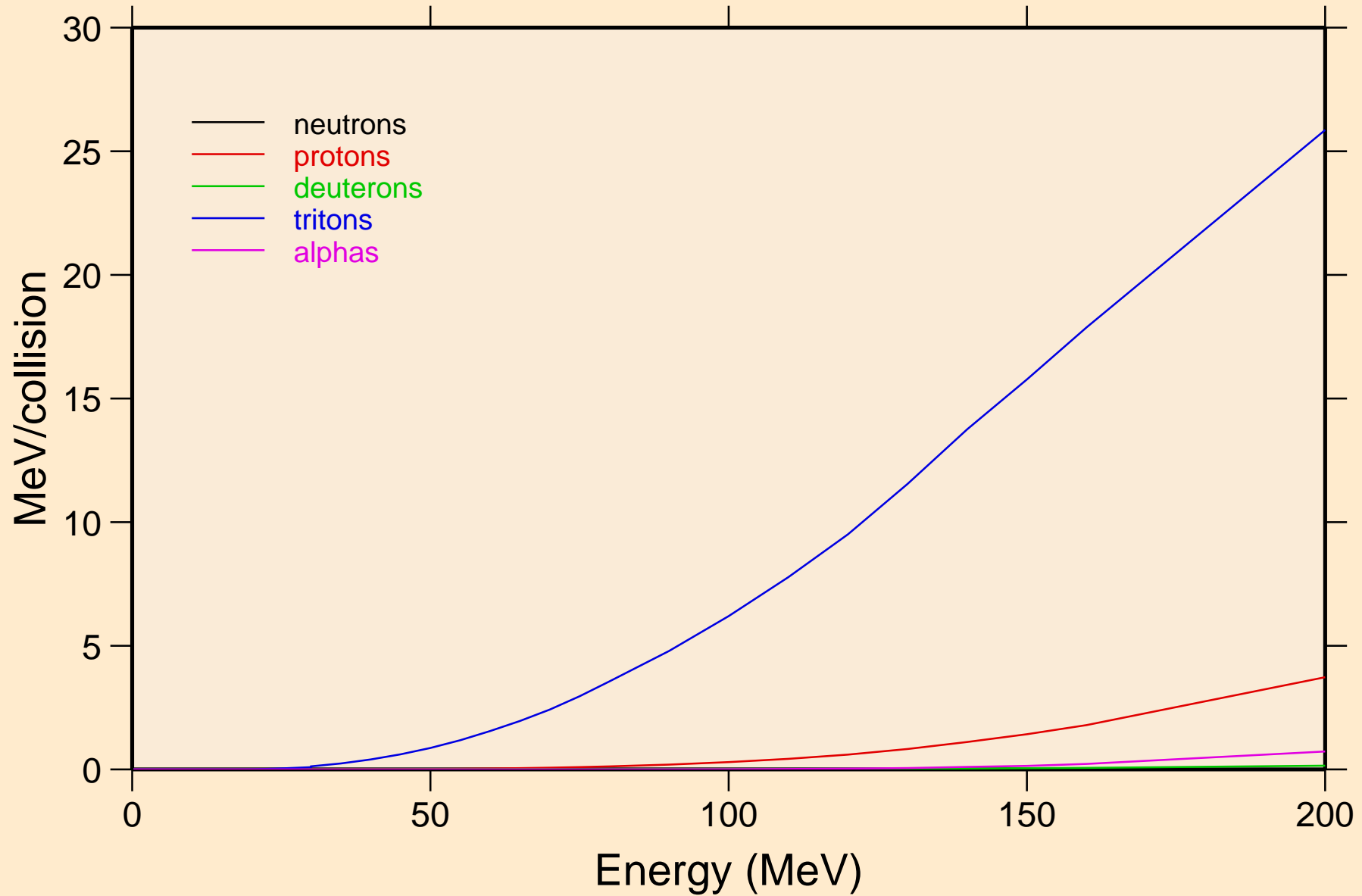

IR200 HELION ACER TENDL-2023 LIBRARY; T=0.K  
Recoil Heating

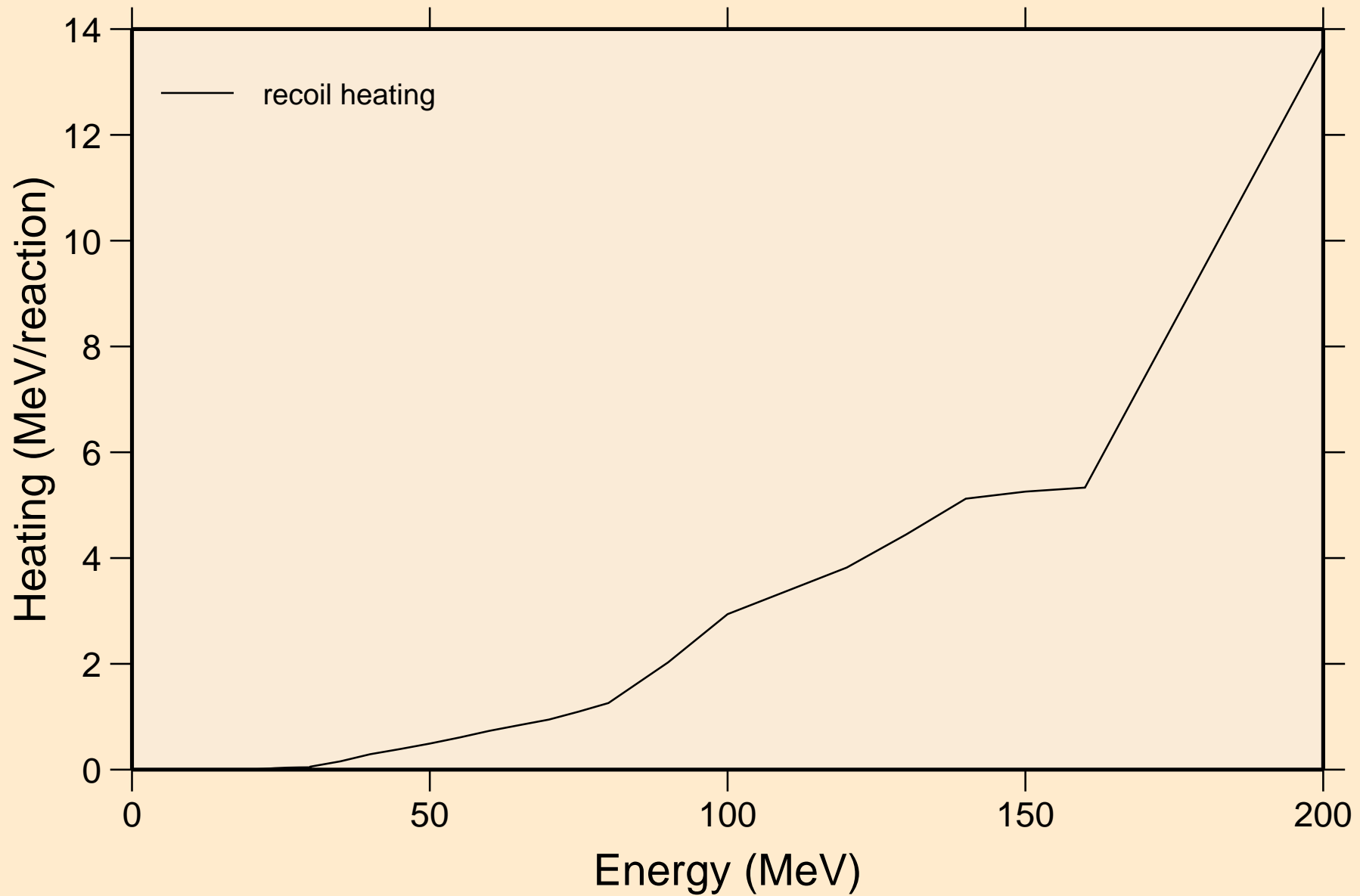

IR200 HELION ACER TENDL-2023 LIBRARY; T=0.K  
Particle production cross sections

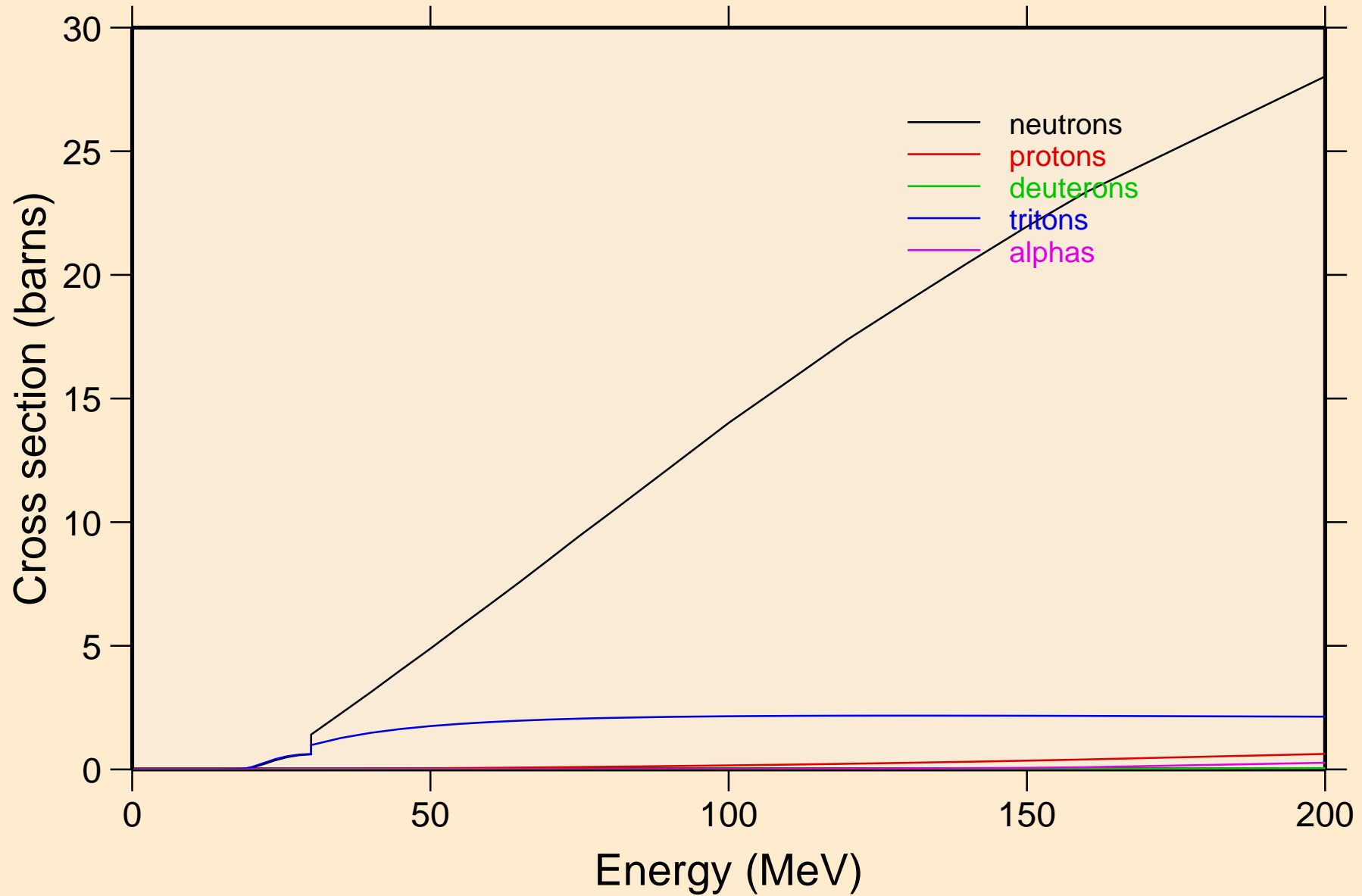

IR200 HELION ACER TENDL-2023 LIBRARY; T=0.K  
neutrons from (s,n)

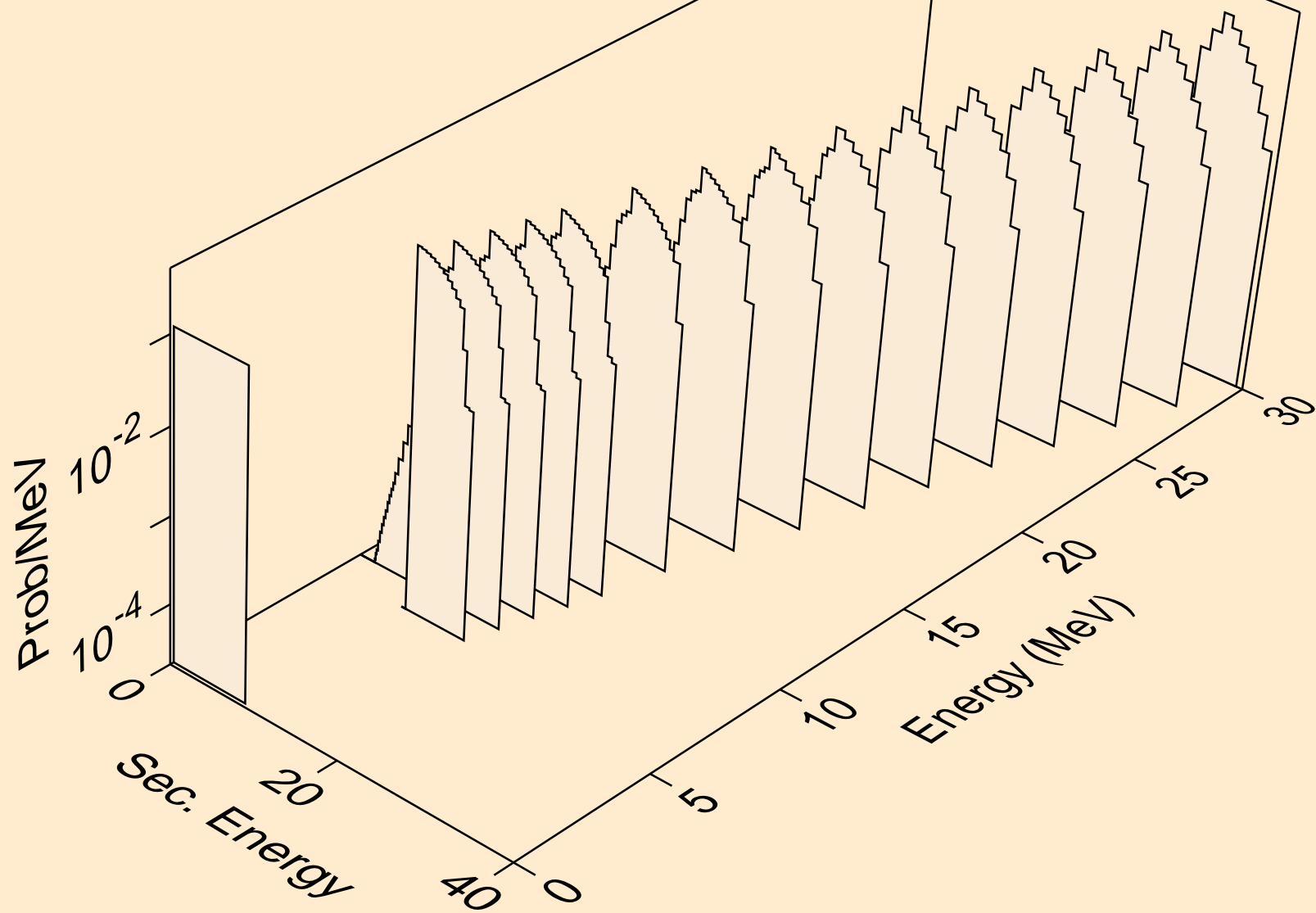

IR200 HELION ACER TENDL-2023 LIBRARY; T=0.K  
neutrons from (s,x)

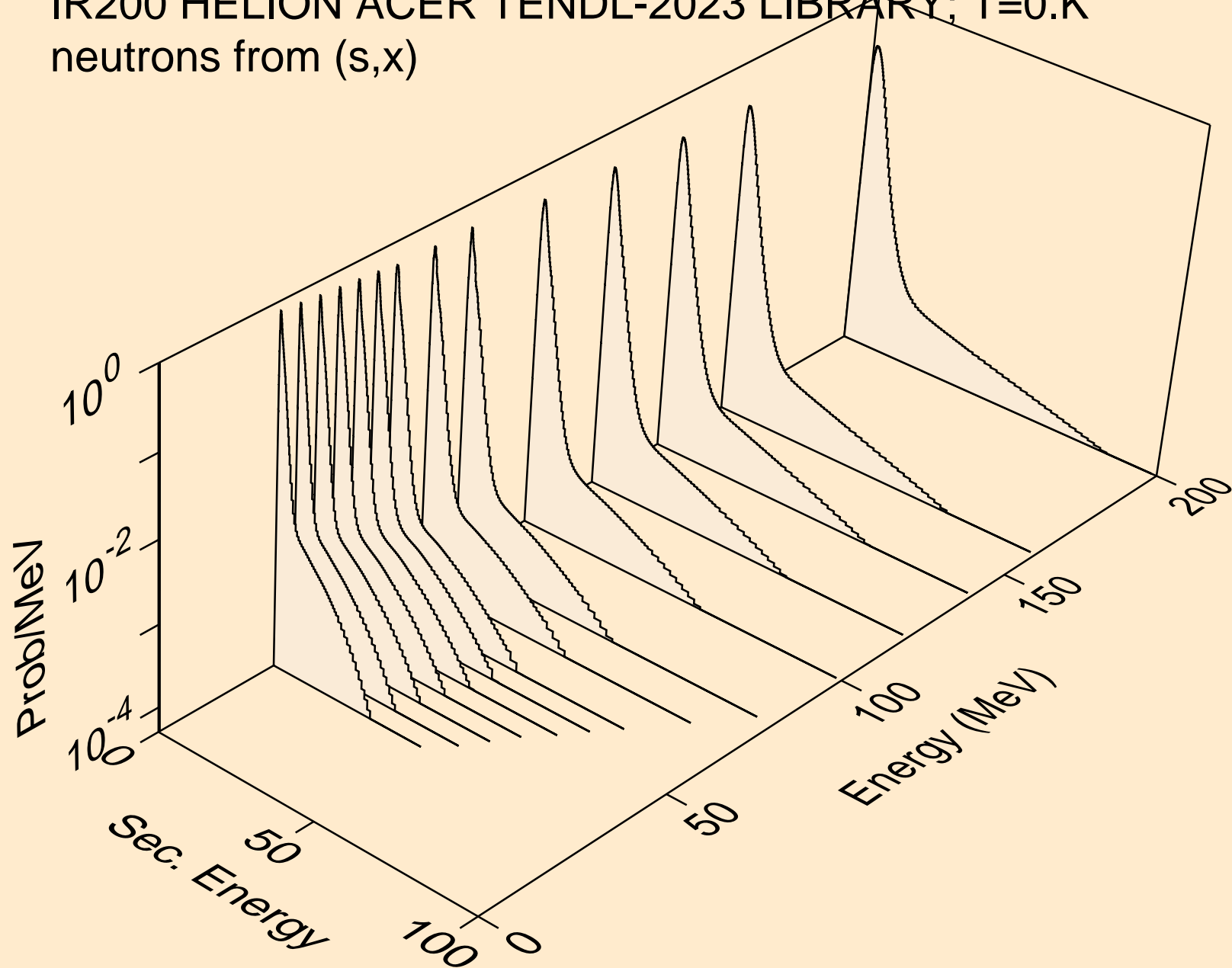

IR200 HELION ACER TENDL-2023 LIBRARY; T=0.K  
neutrons from (s,2nd)

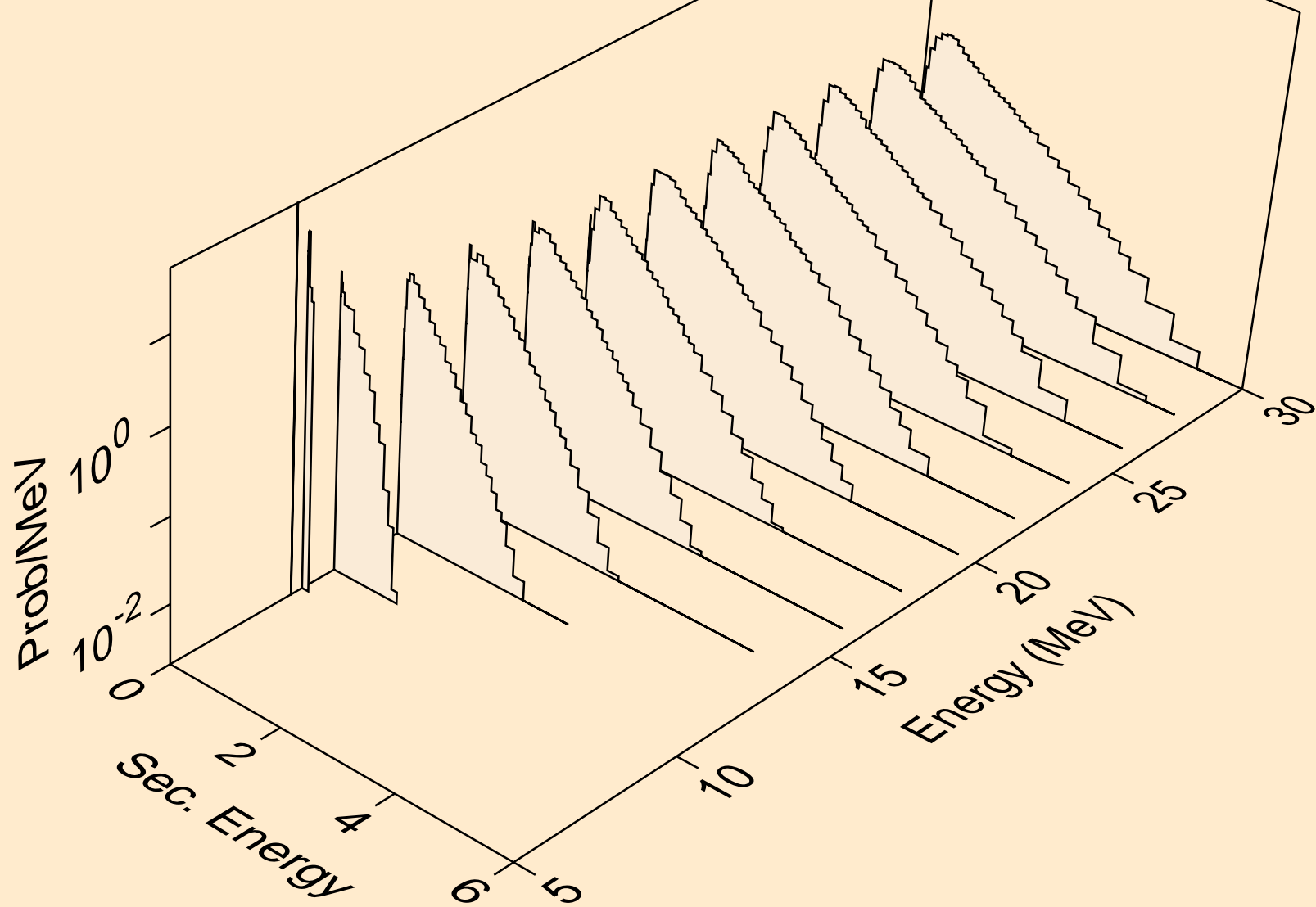

IR200 HELION ACER TENDL-2023 LIBRARY; T=0.K  
neutrons from (s,2n)

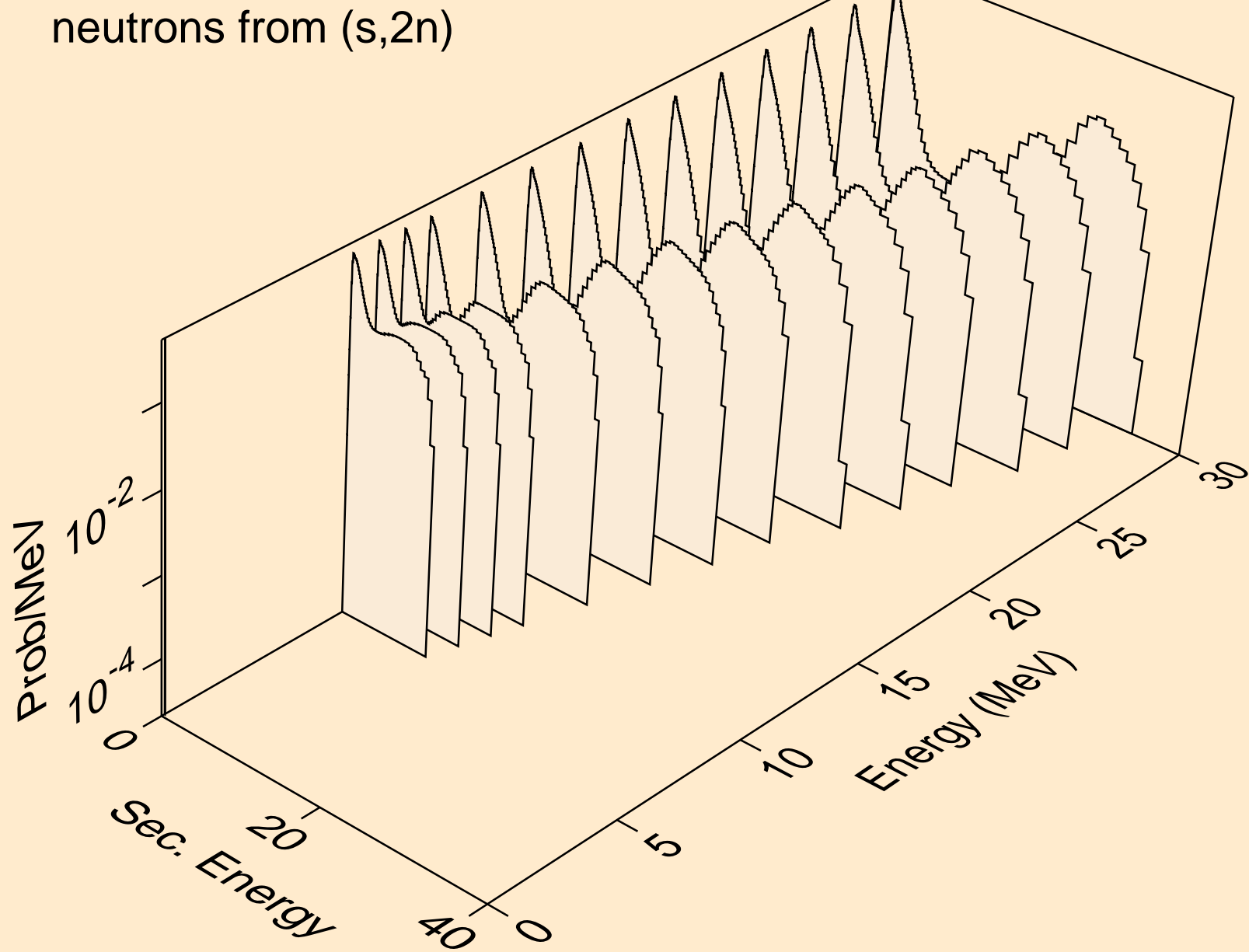

IR200 HELION ACER TENDL-2023 LIBRARY; T=0.K  
neutrons from (s,3n)

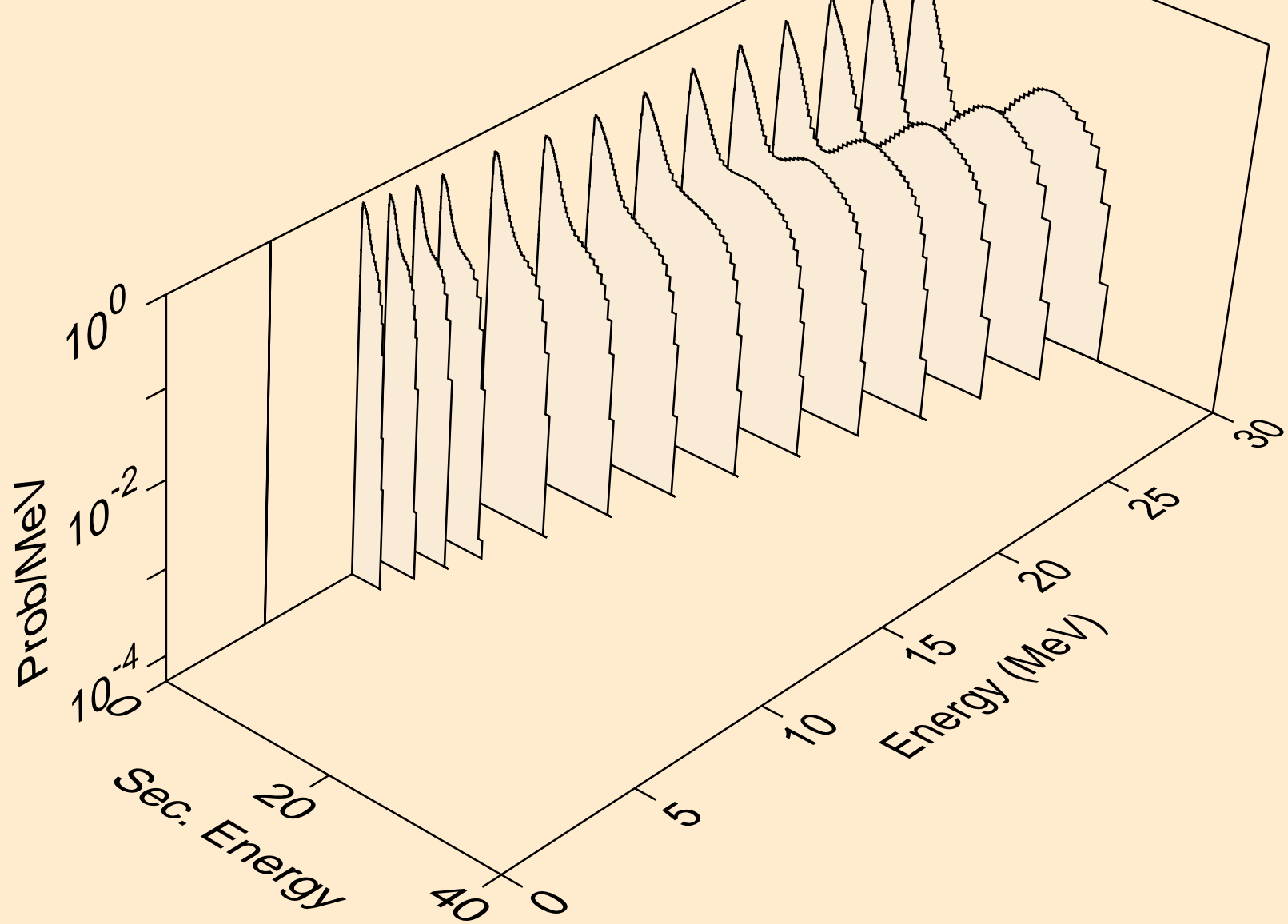

IR200 HELION ACER TENDL-2023 LIBRARY; T=0.K  
neutrons from (s,n\*)a

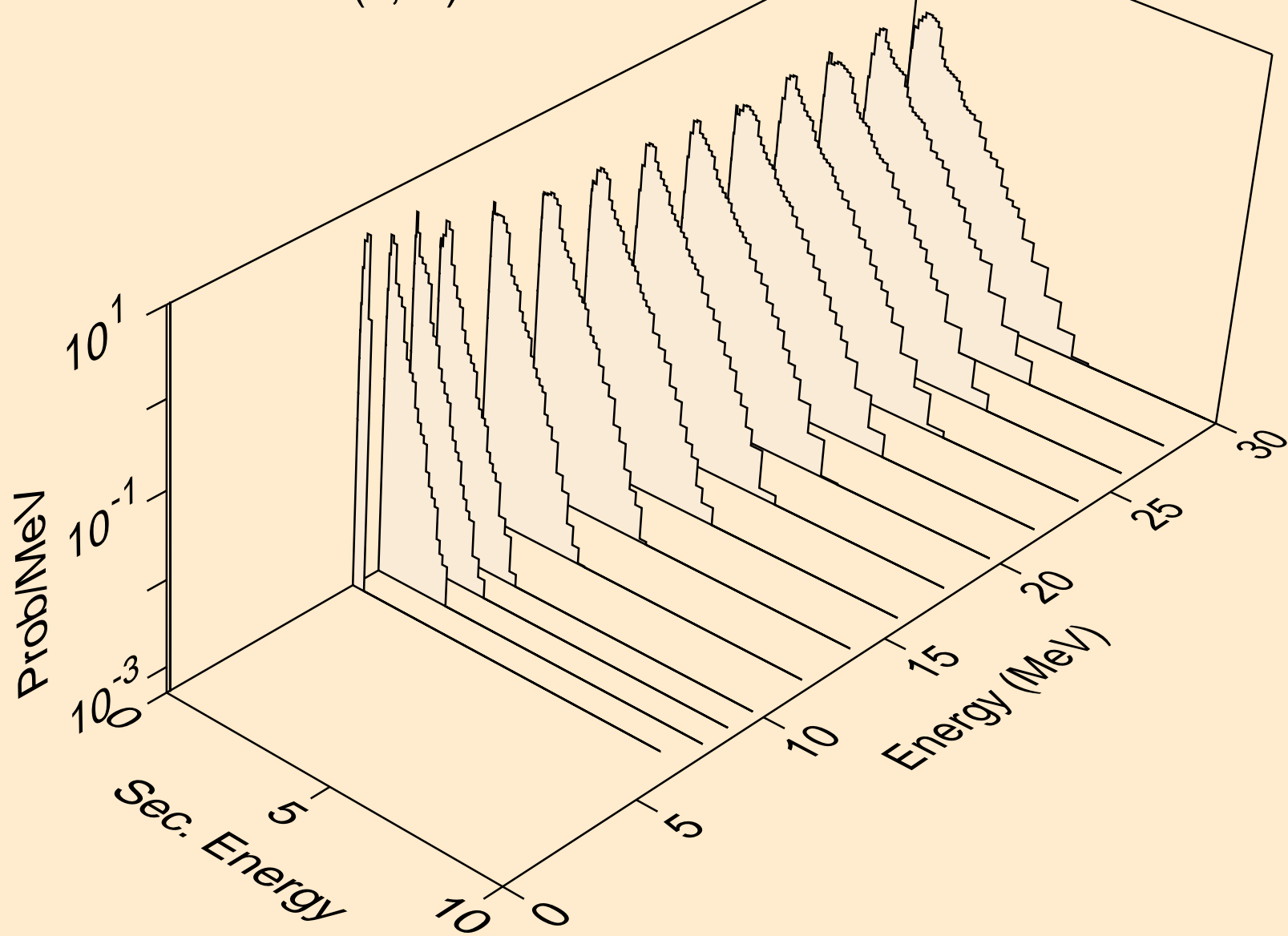

IR200 HELION ACER TENDL-2023 LIBRARY; T=0.K  
neutrons from (s,2n)a

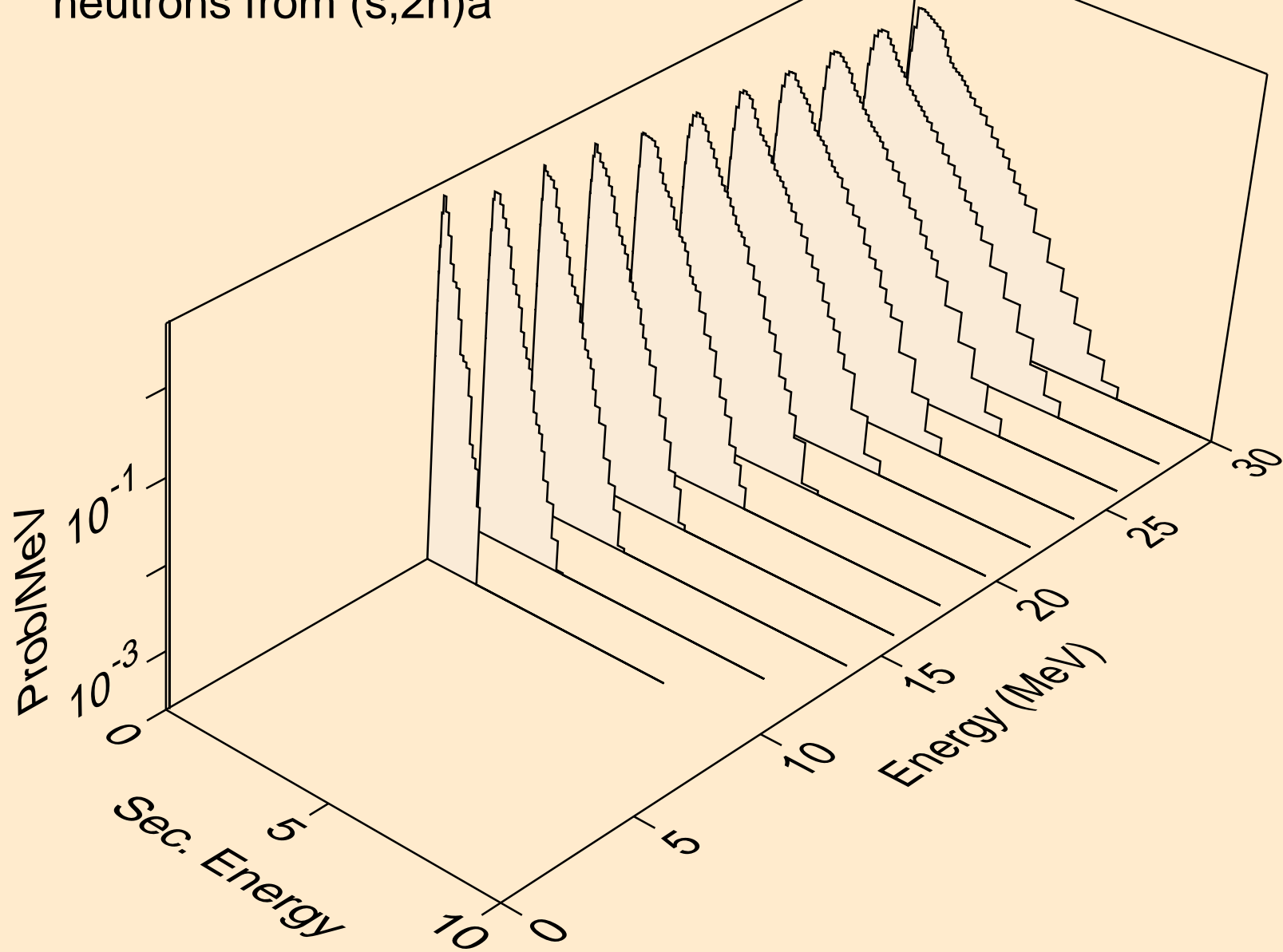

IR200 HELION ACER TENDL-2023 LIBRARY; T=0.K  
neutrons from (s,3n)a

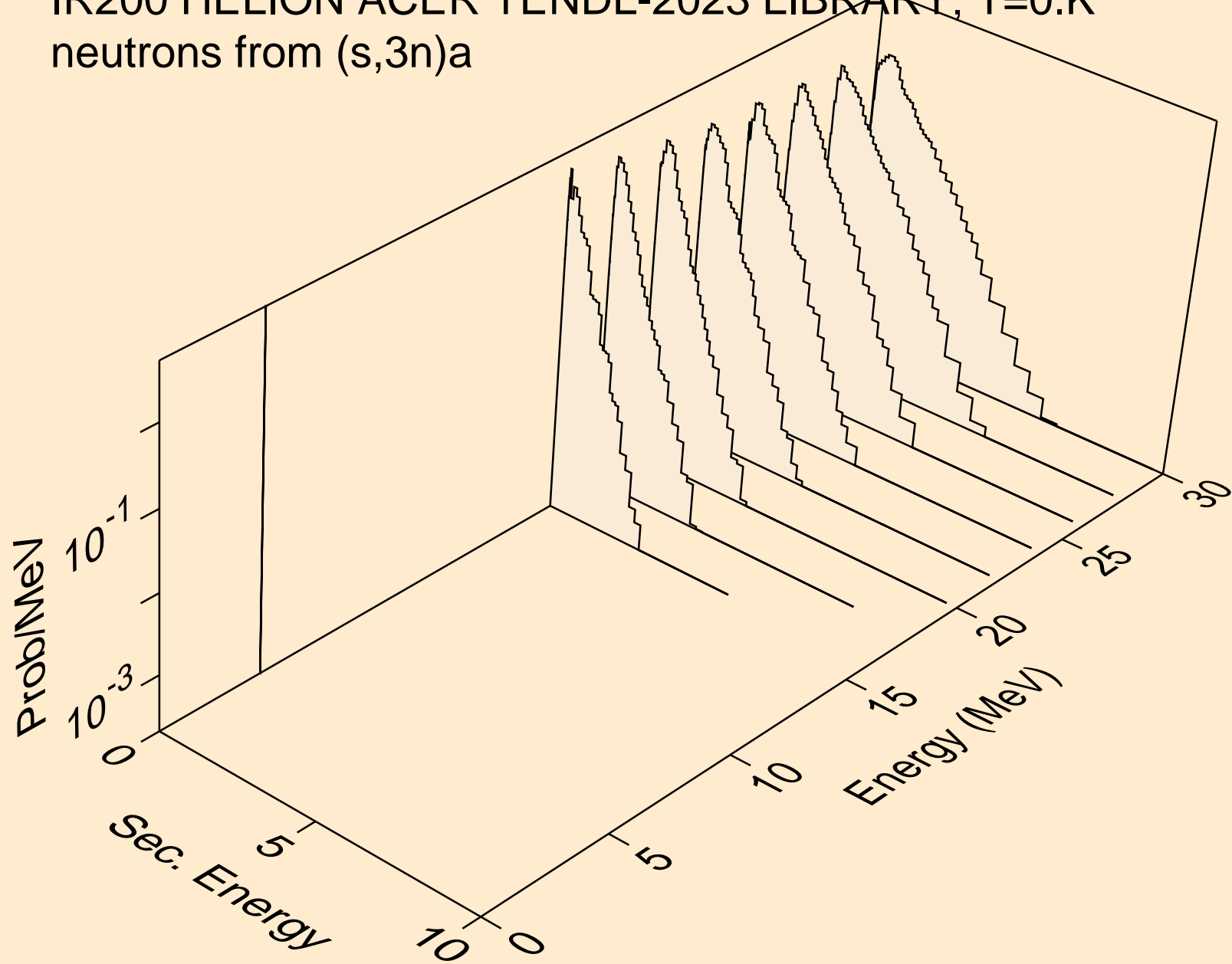

IR200 HELION ACER TENDL-2023 LIBRARY; T=0.K  
neutrons from (s,n\*)p

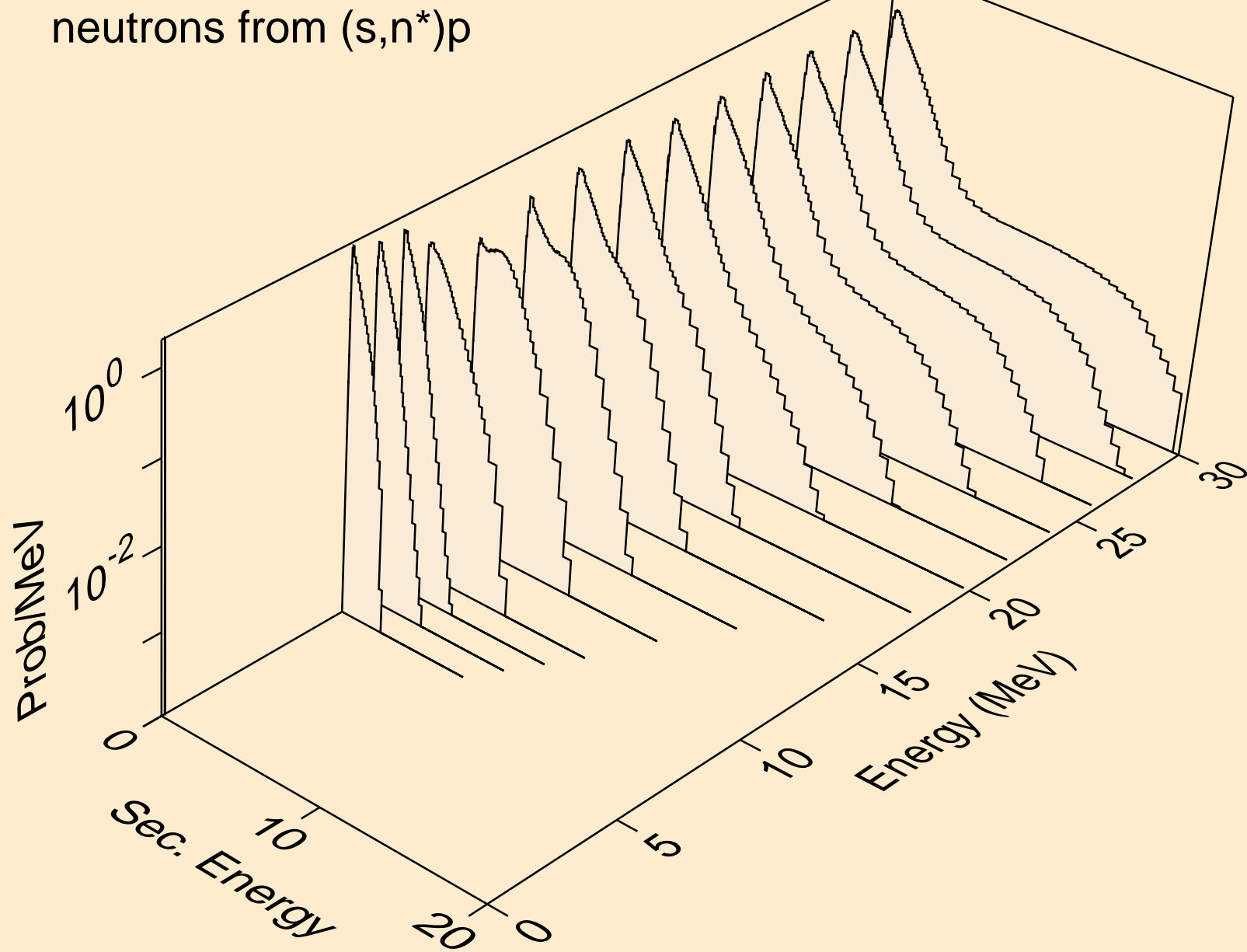

IR200 HELION ACER TENDL-2023 LIBRARY; T=0.K  
neutrons from (s,n\*)d

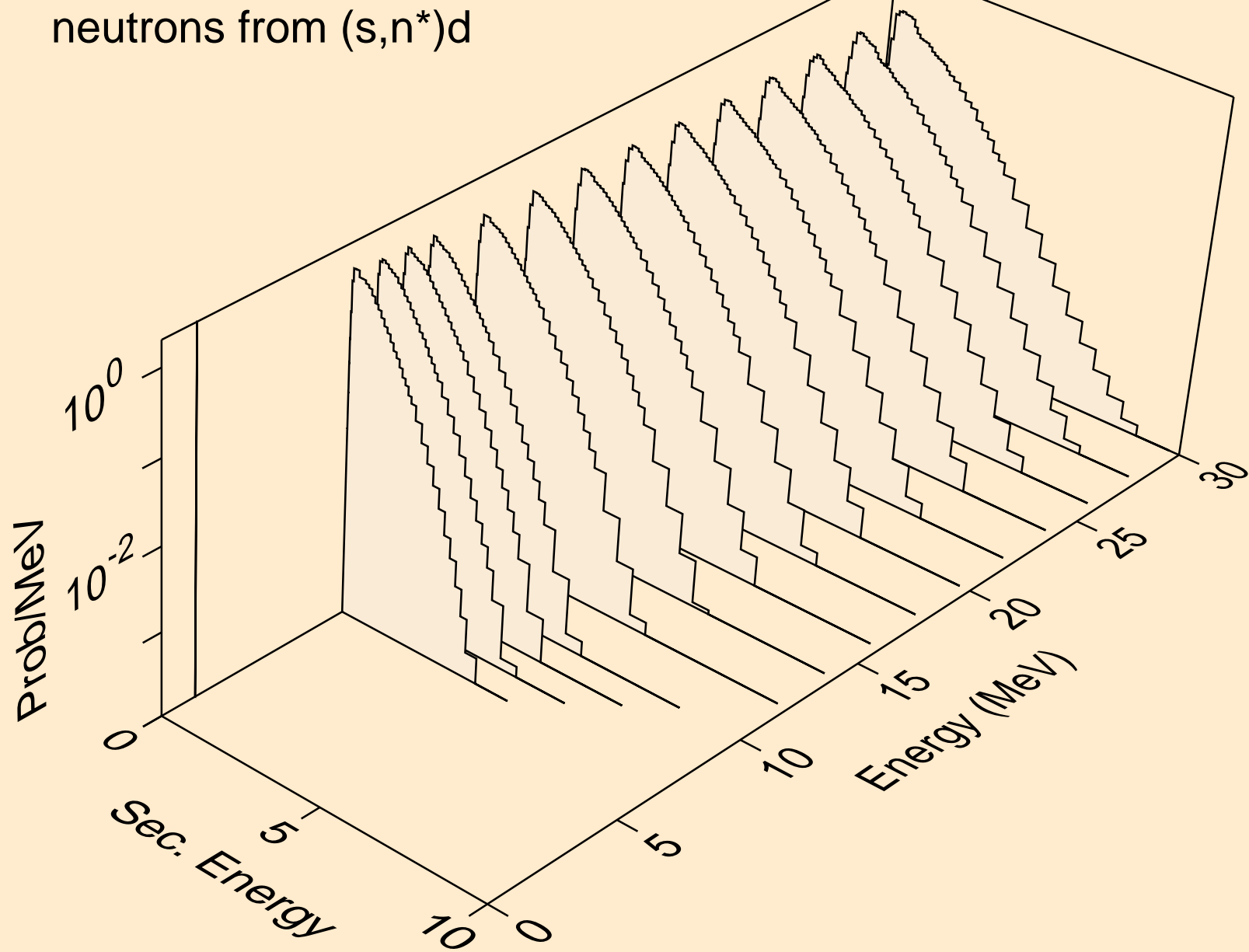

IR200 HELION ACER TENDL-2023 LIBRARY; T=0.K  
neutrons from (s,n\*)t

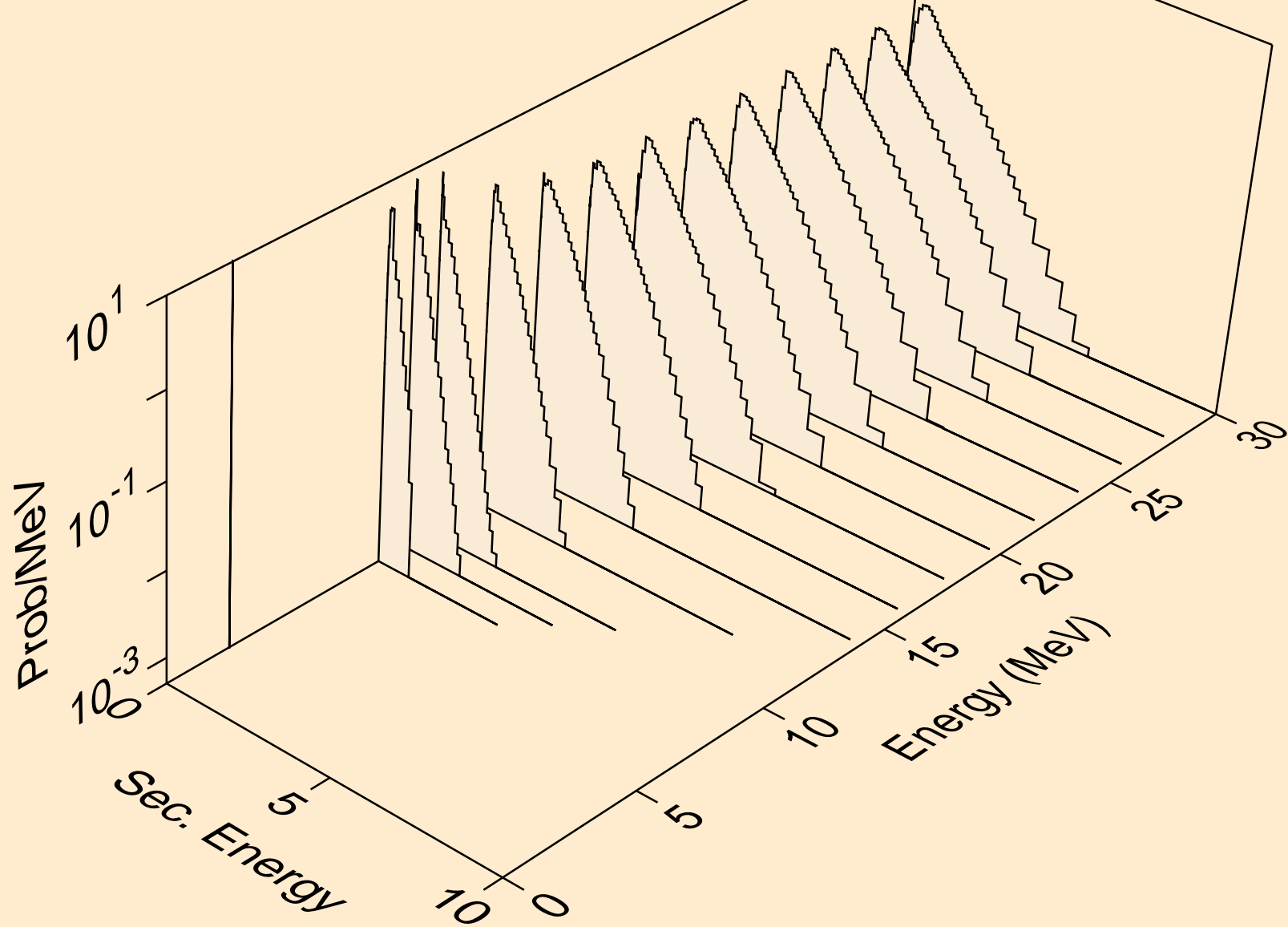

IR200 HELION ACER TENDL-2023 LIBRARY; T=0.K  
neutrons from (s,n\*)he3

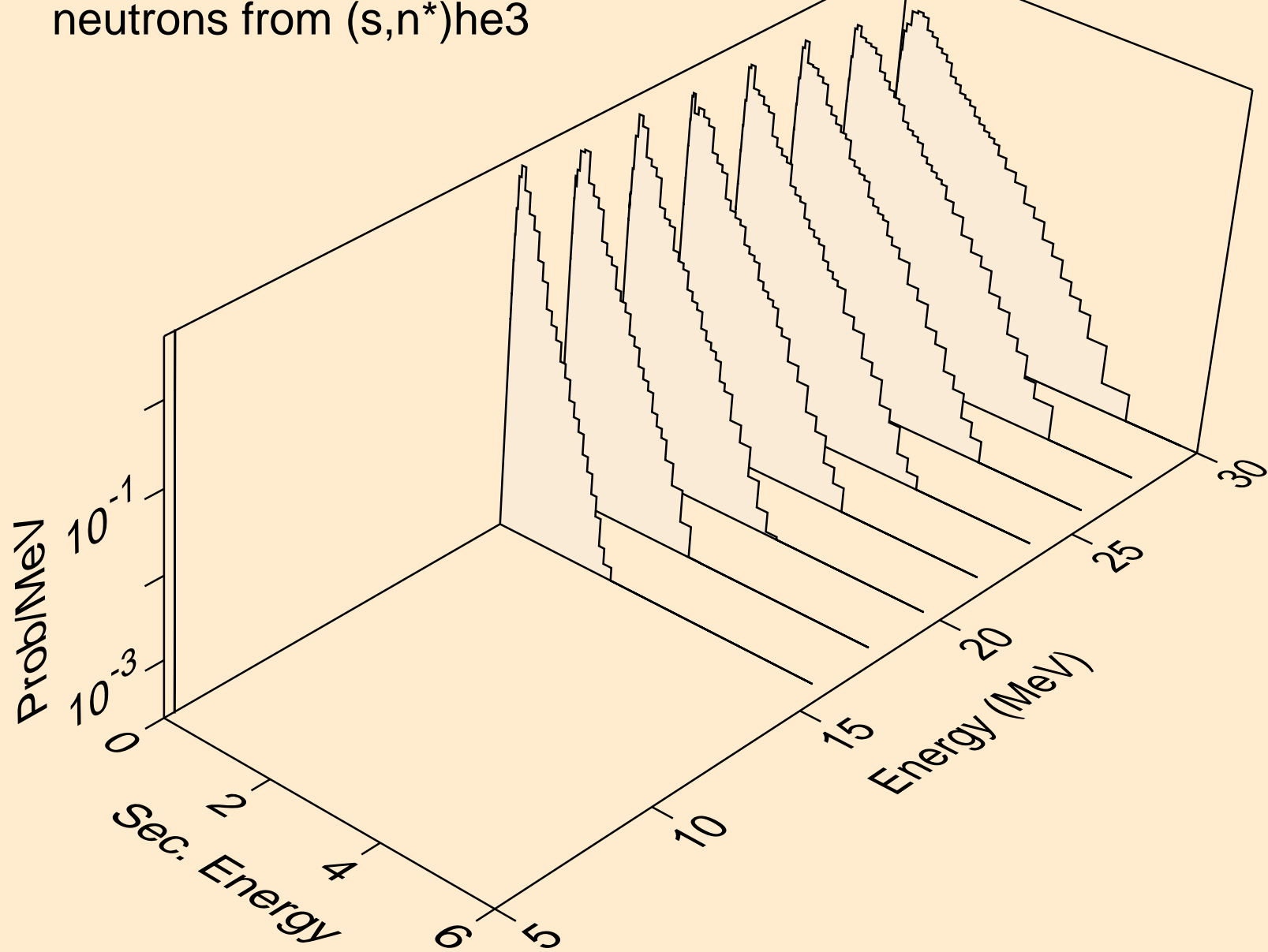

IR200 HELION ACER TENDL-2023 LIBRARY; T=0.K  
neutrons from (s,4n)

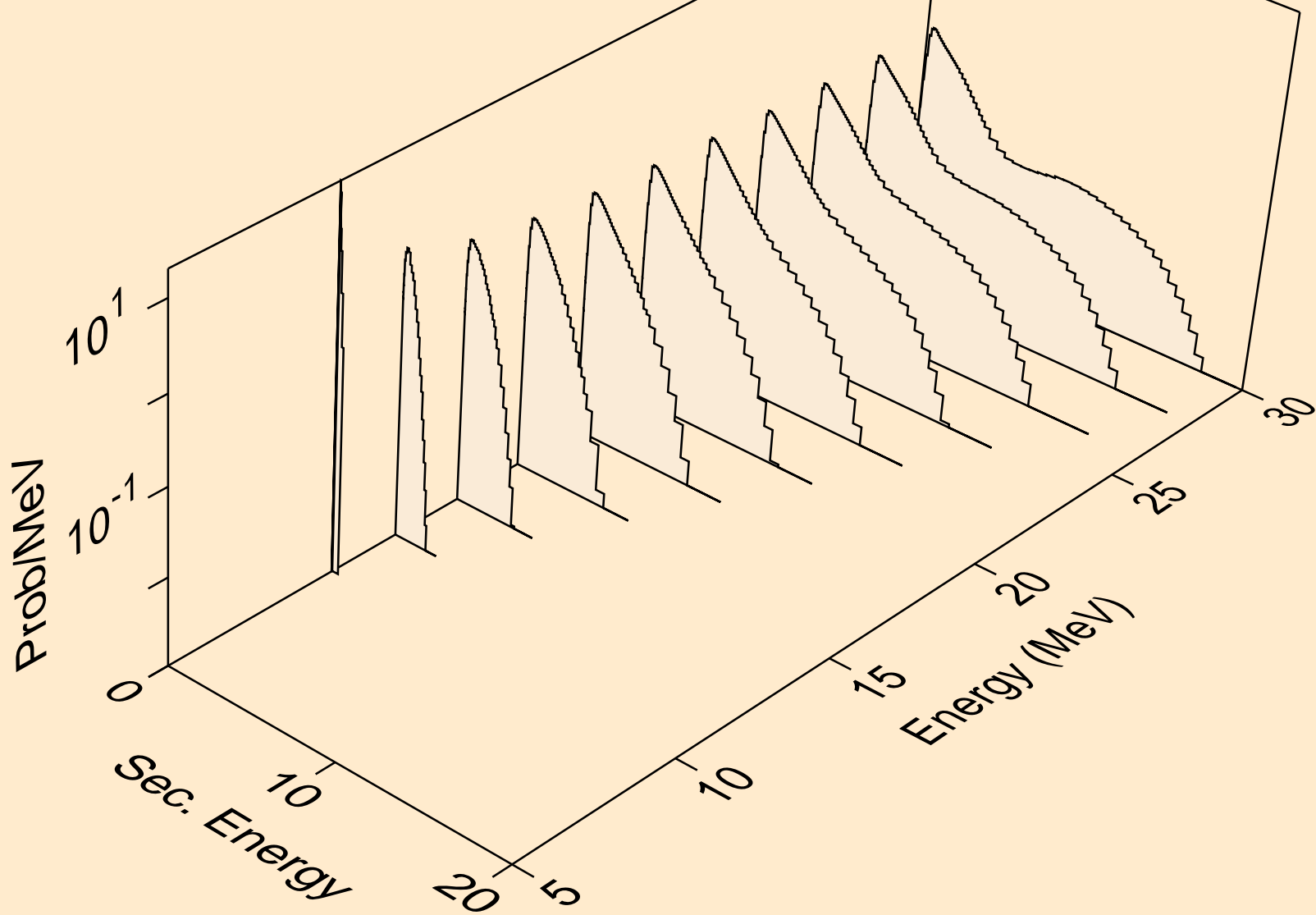

IR200 HELION ACER TENDL-2023 LIBRARY; T=0.K  
neutrons from (s,2np)

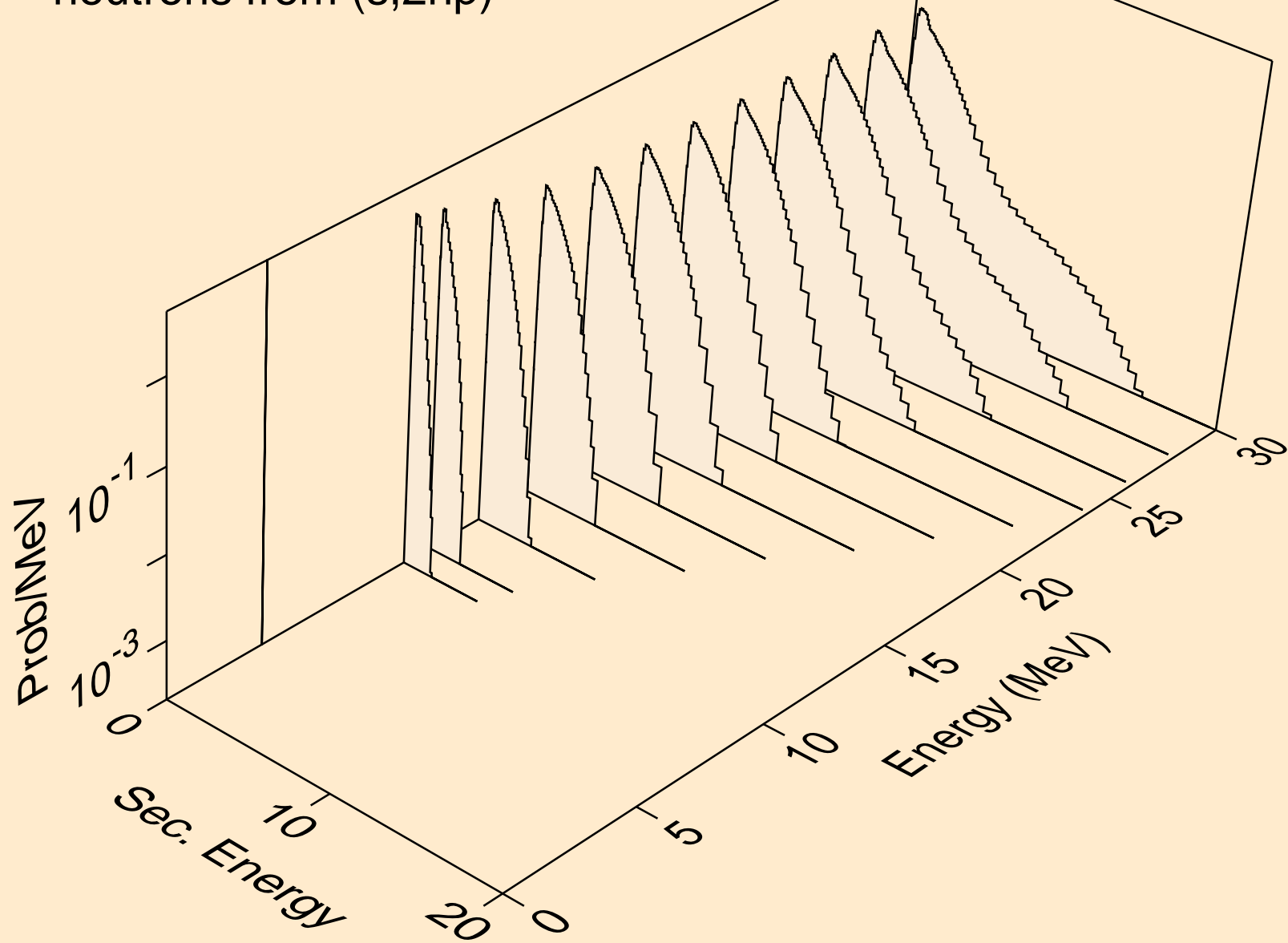

IR200 HELION ACER TENDL-2023 LIBRARY; T=0.K  
neutrons from (s,3np)

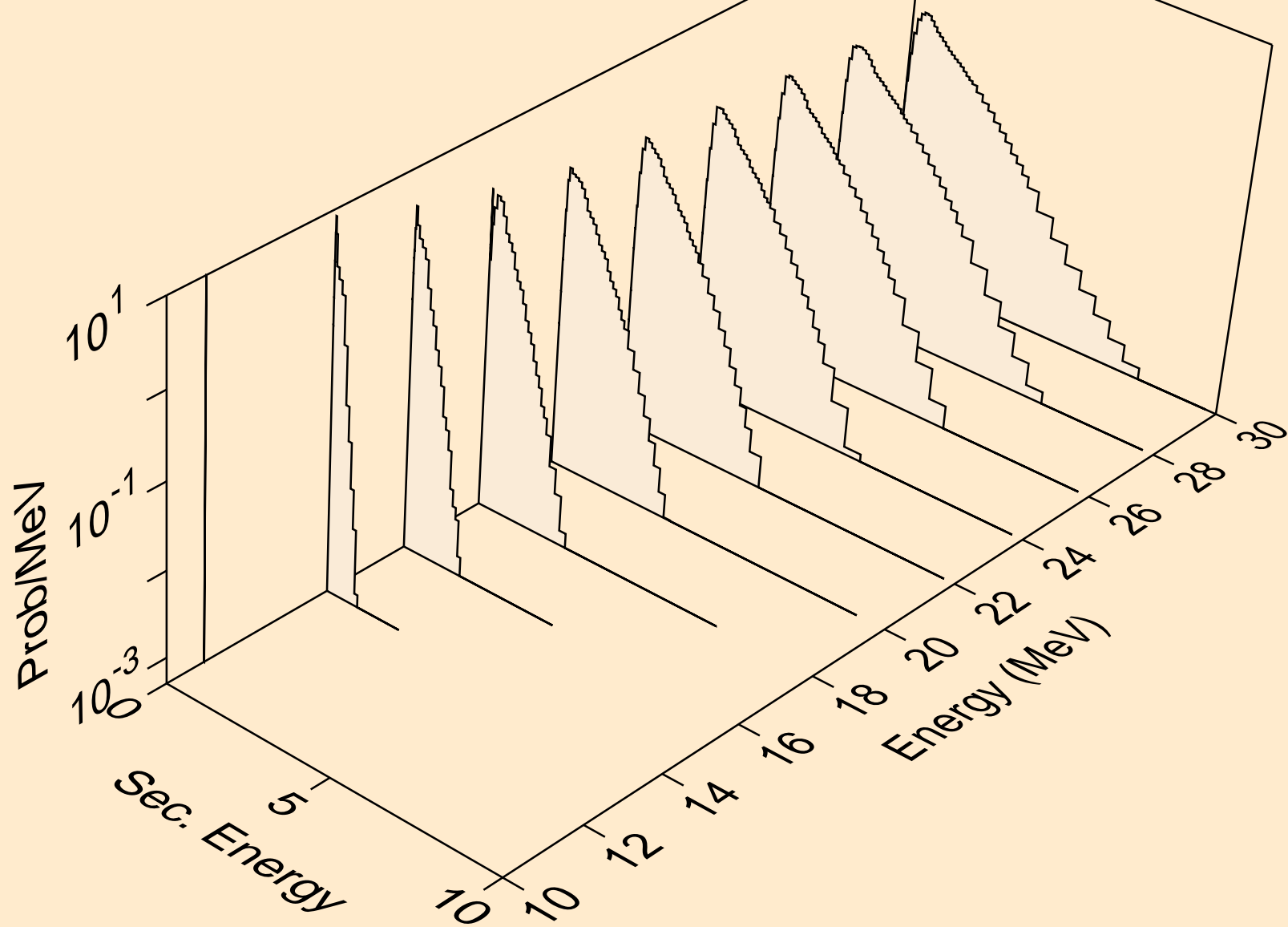

IR200 HELION ACER TENDL-2023 LIBRARY; T=0.K  
neutrons from (s,n2p)

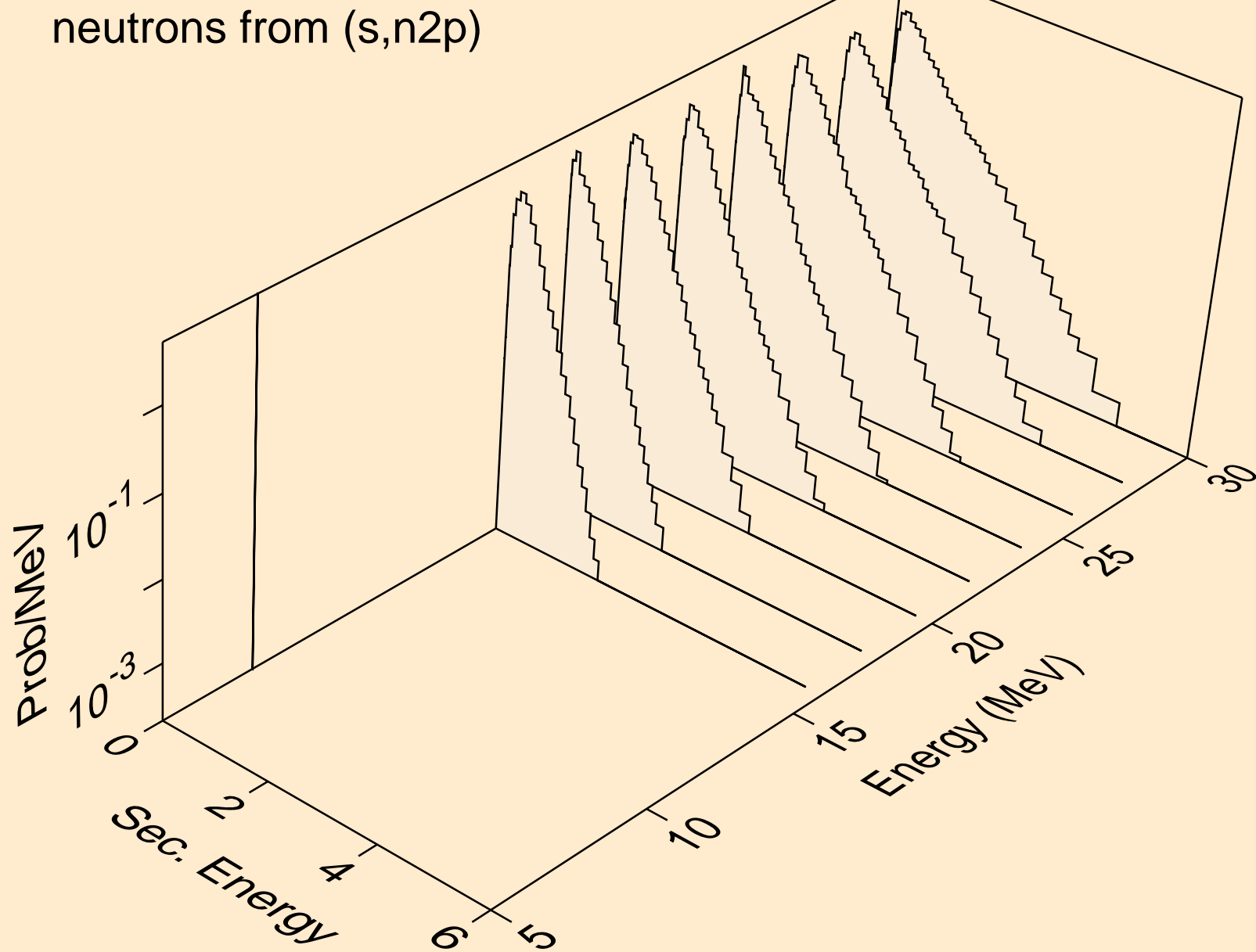

IR200 HELION ACER TENDL-2023 LIBRARY; T=0.K  
neutrons from (s,npa)

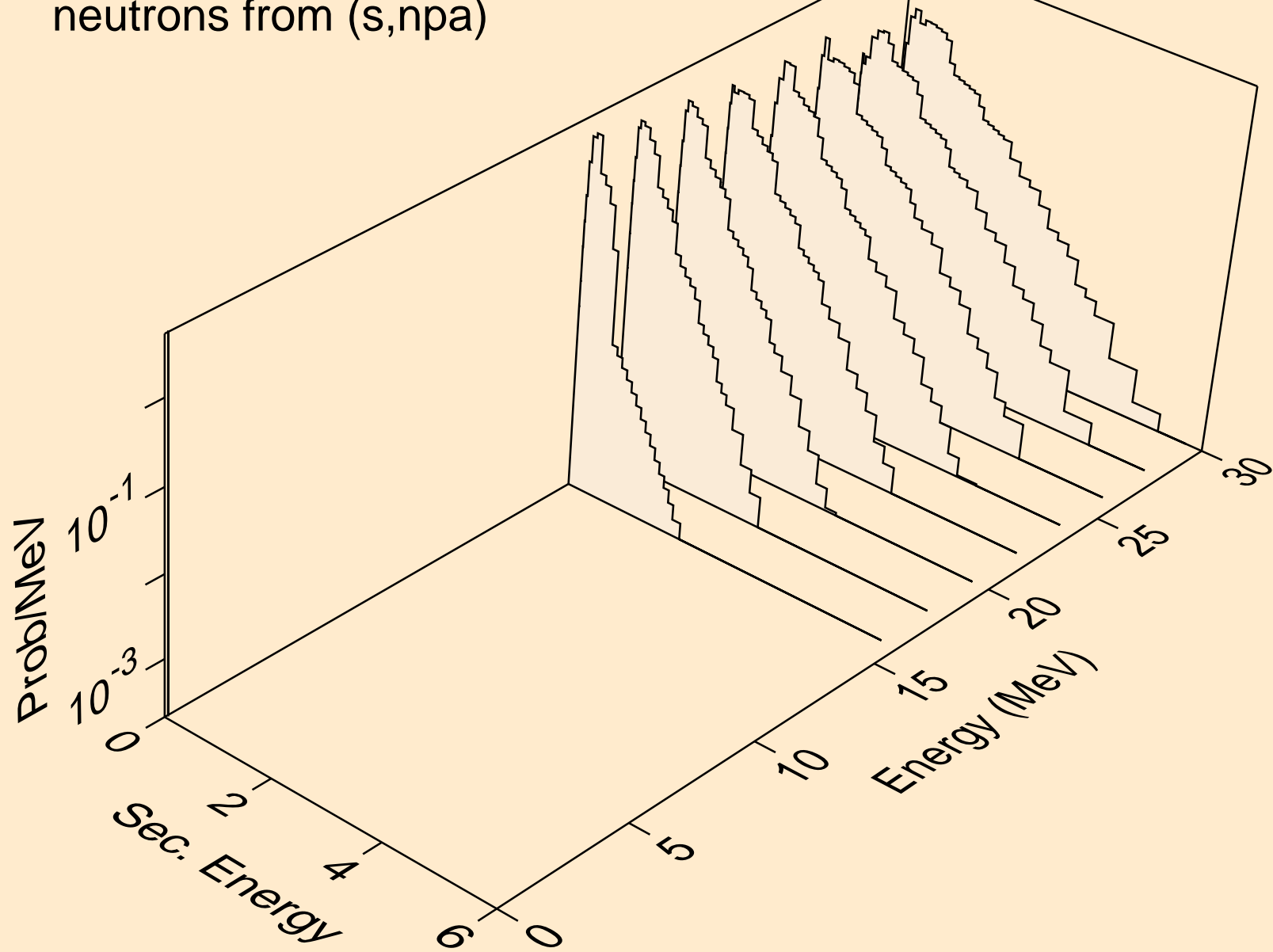

IR200 HELION ACER TENDL-2023 LIBRARY; T=0.K  
protons from (s,x)

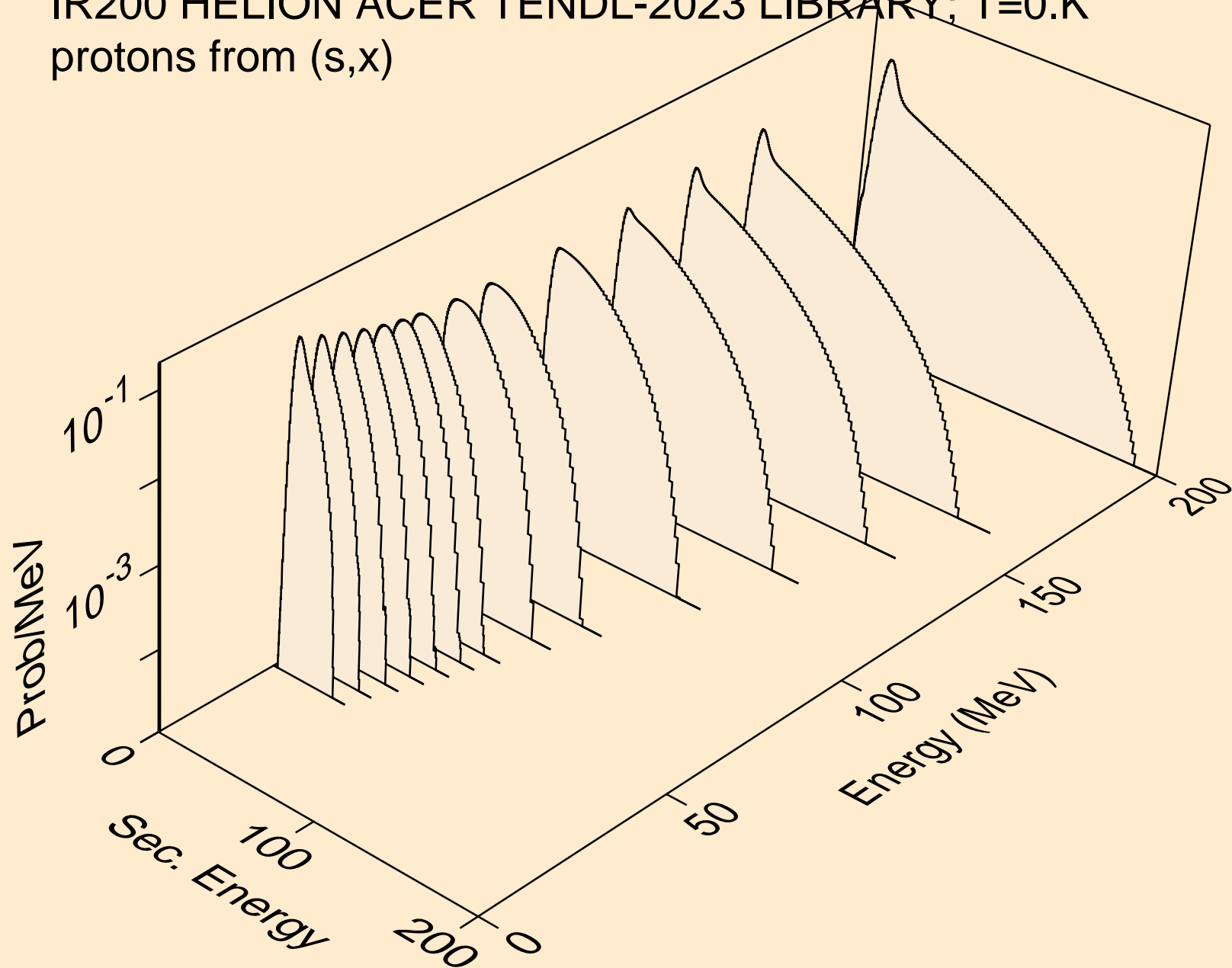

IR200 HELION ACER TENDL-2023 LIBRARY; T=0.K  
protons from (s,n\*)p

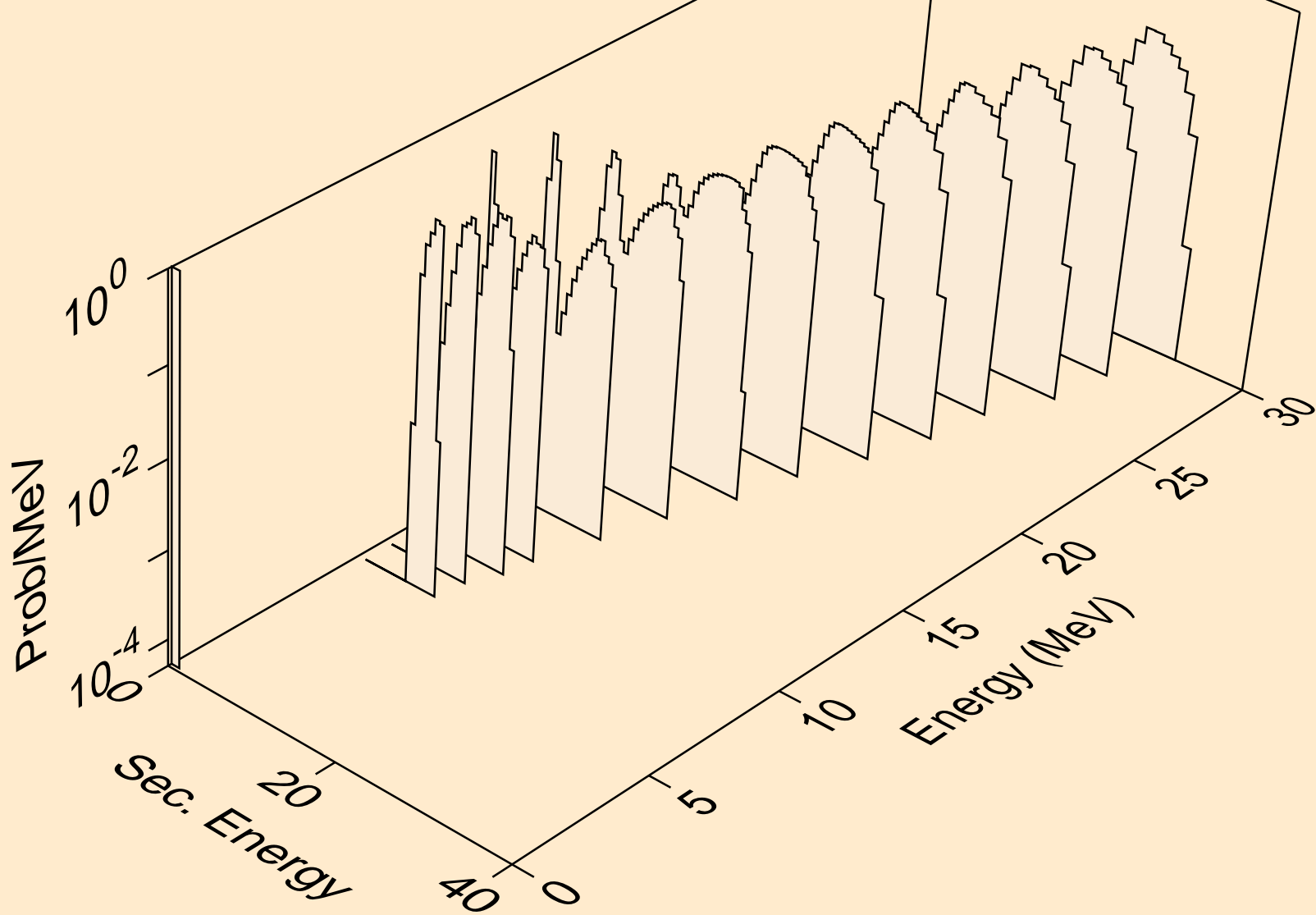

IR200 HELION ACER TENDL-2023 LIBRARY; T=0.K  
protons from (s,2np)

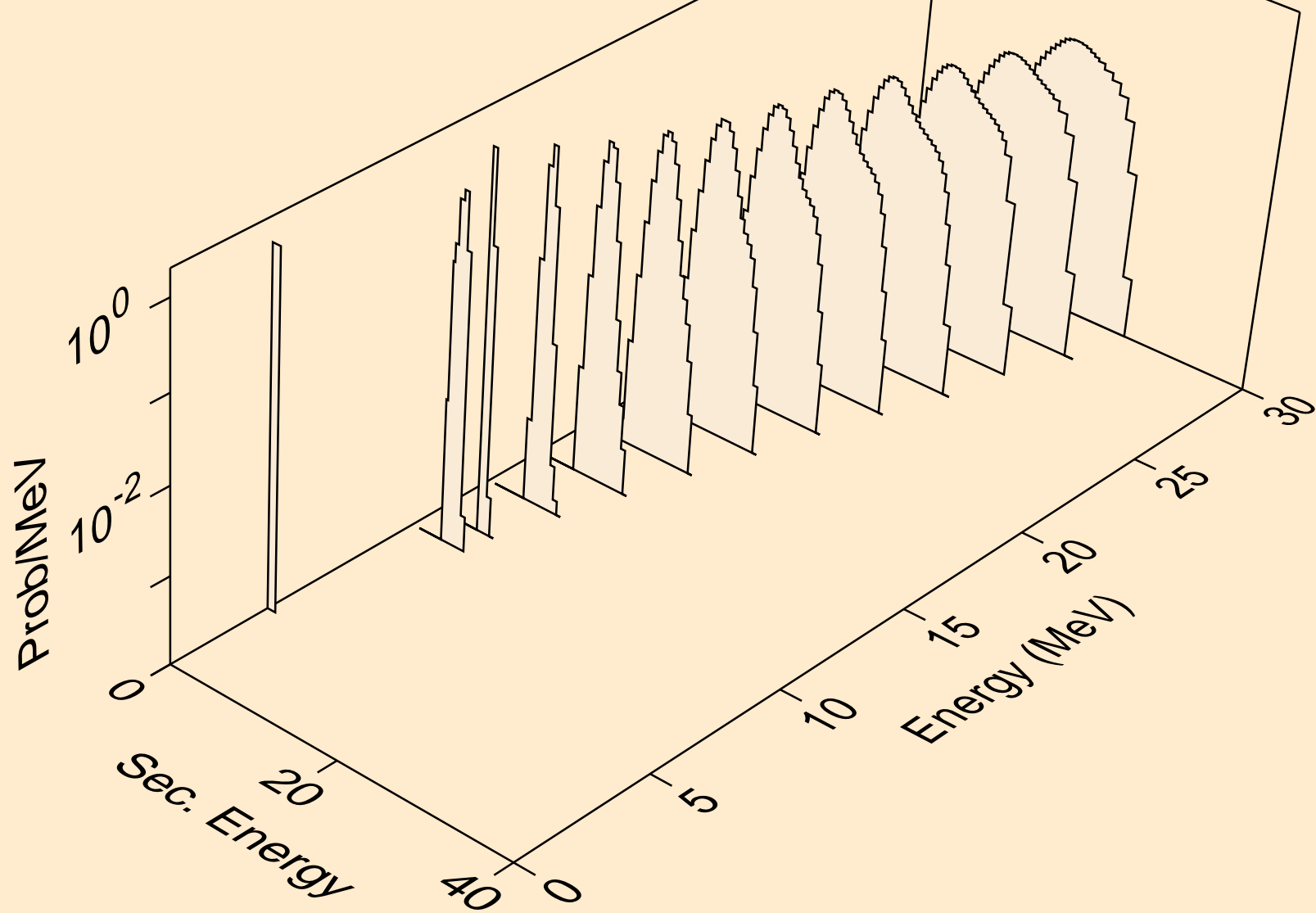

IR200 HELION ACER TENDL-2023 LIBRARY; T=0.K  
protons from (s,3np)

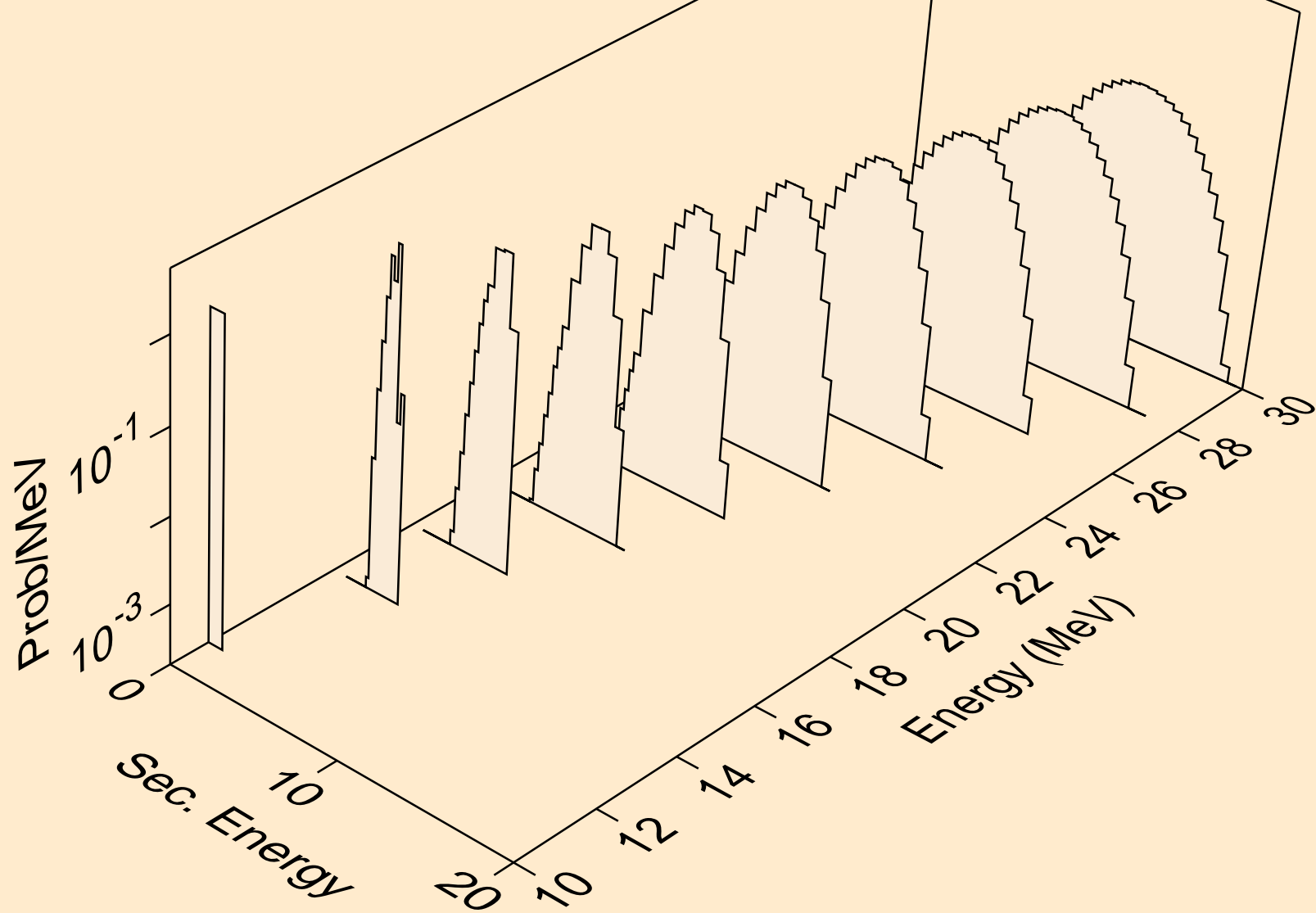

IR200 HELION ACER TENDL-2023 LIBRARY; T=0.K  
protons from (s,n2p)

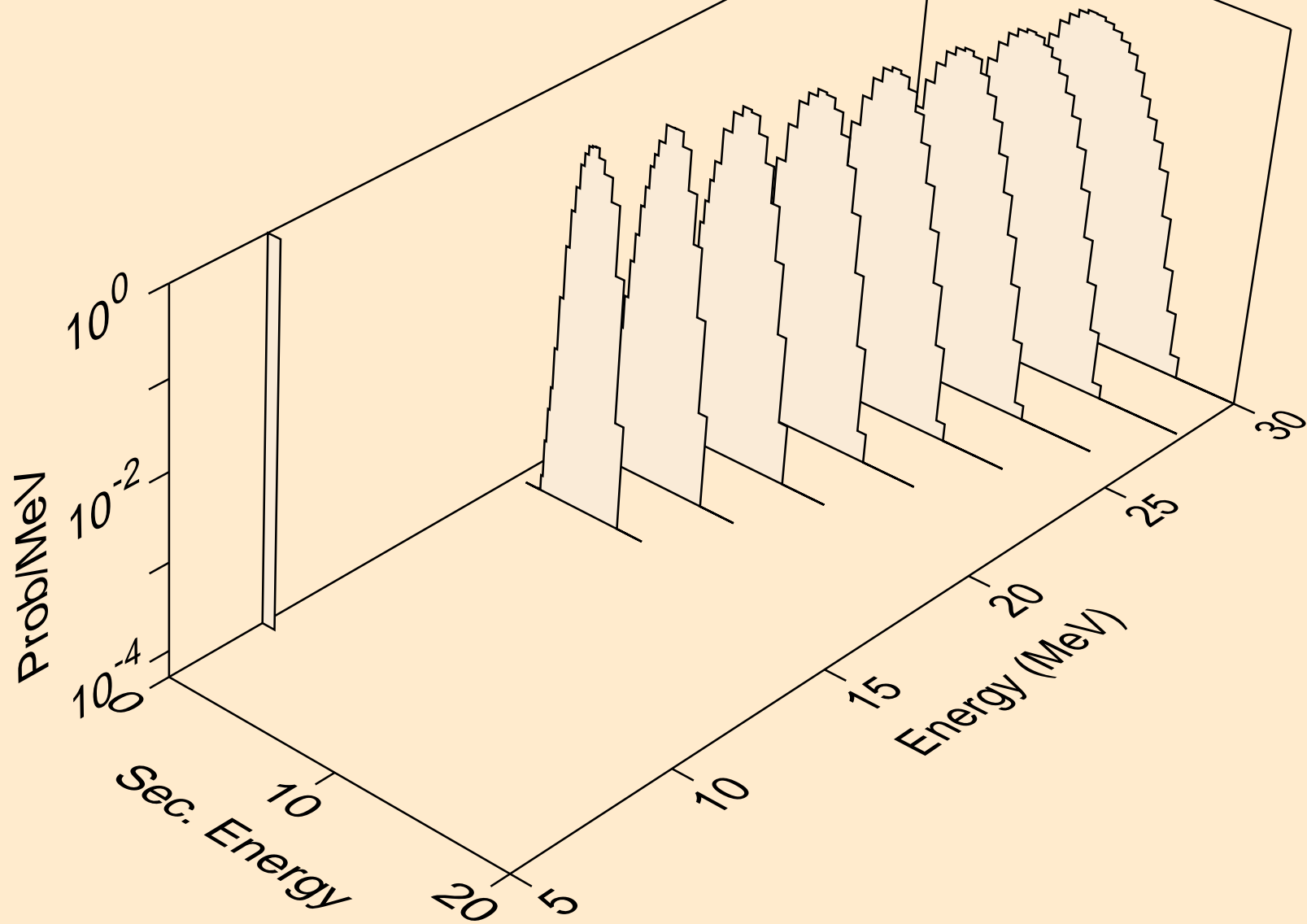

IR200 HELION ACER TENDL-2023 LIBRARY; T=0.K  
protons from (s,npa)

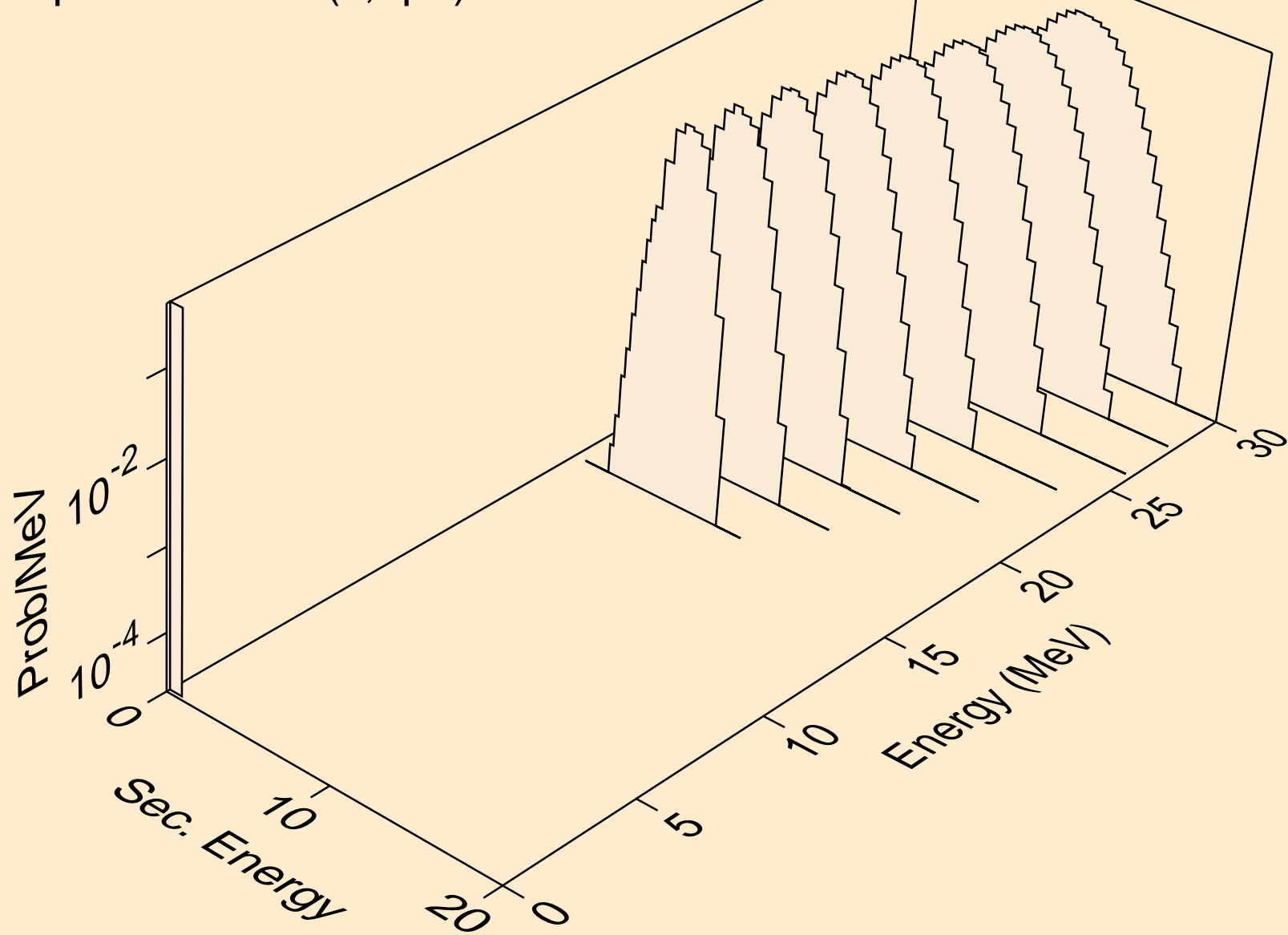

IR200 HELION ACER TENDL-2023 LIBRARY; T=0.K  
protons from (s,p)

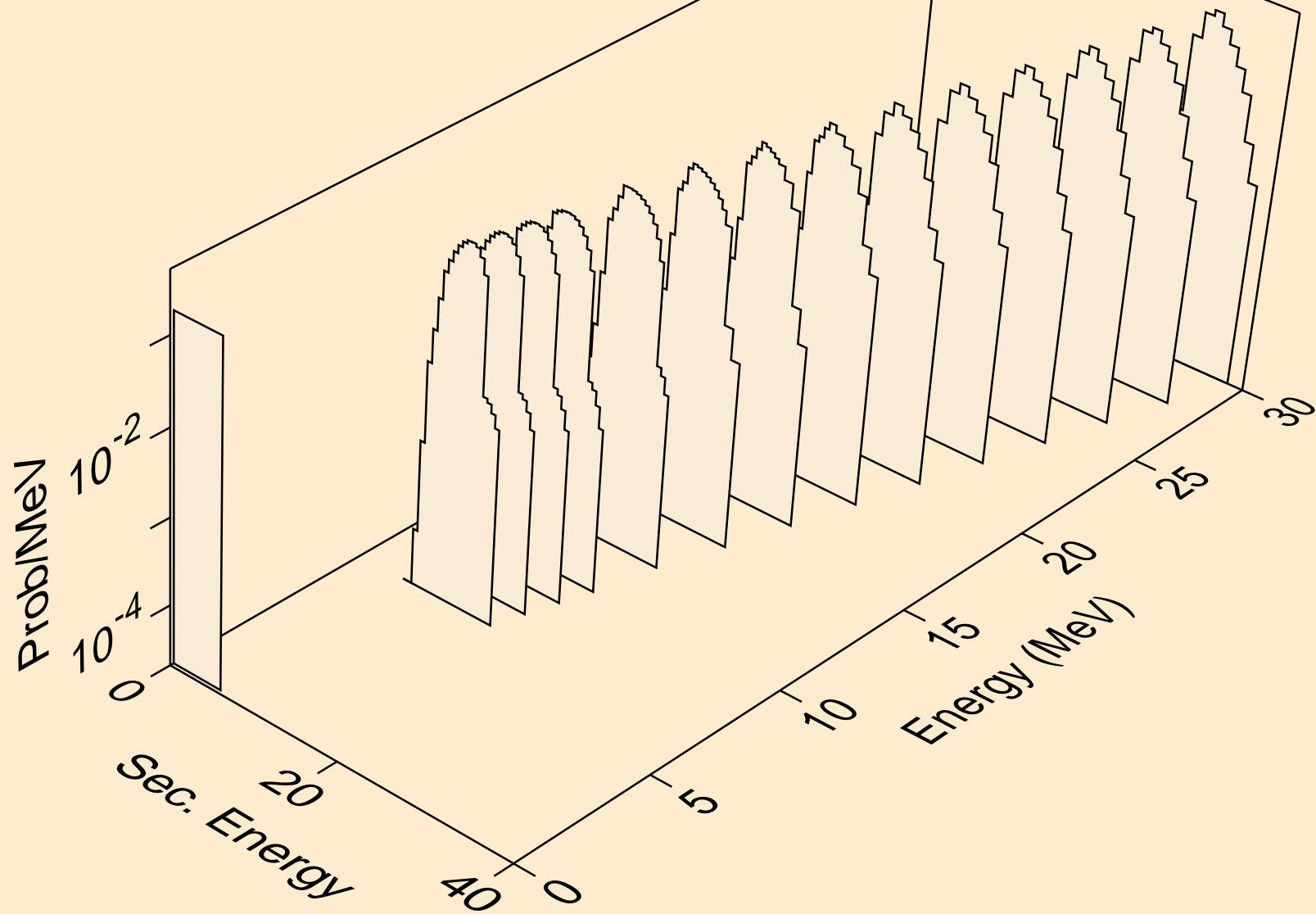

IR200 HELION ACER TENDL-2023 LIBRARY; T=0.K  
protons from (s,2p)

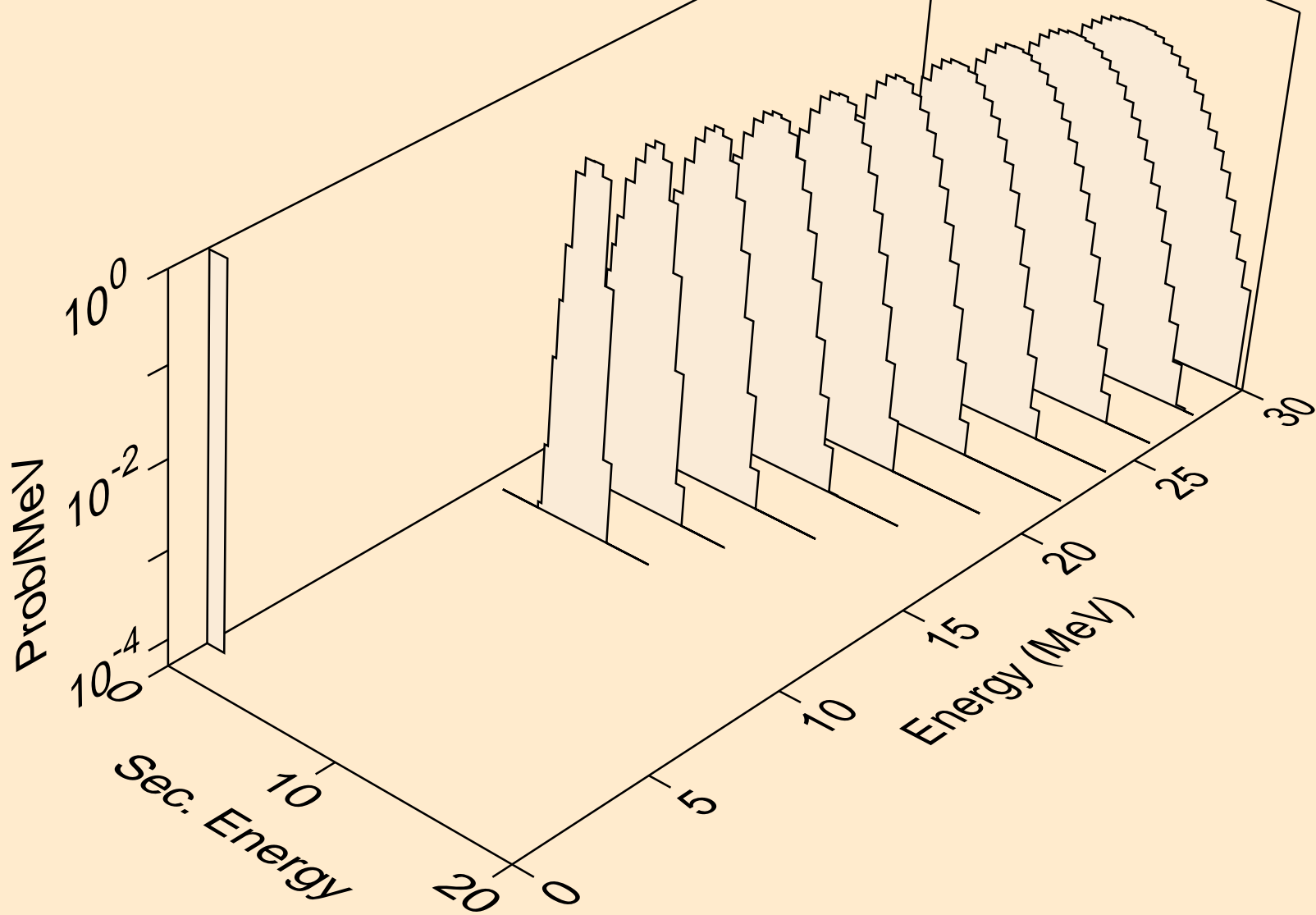

IR200 HELION ACER TENDL-2023 LIBRARY; T=0.K  
protons from (s,pd)

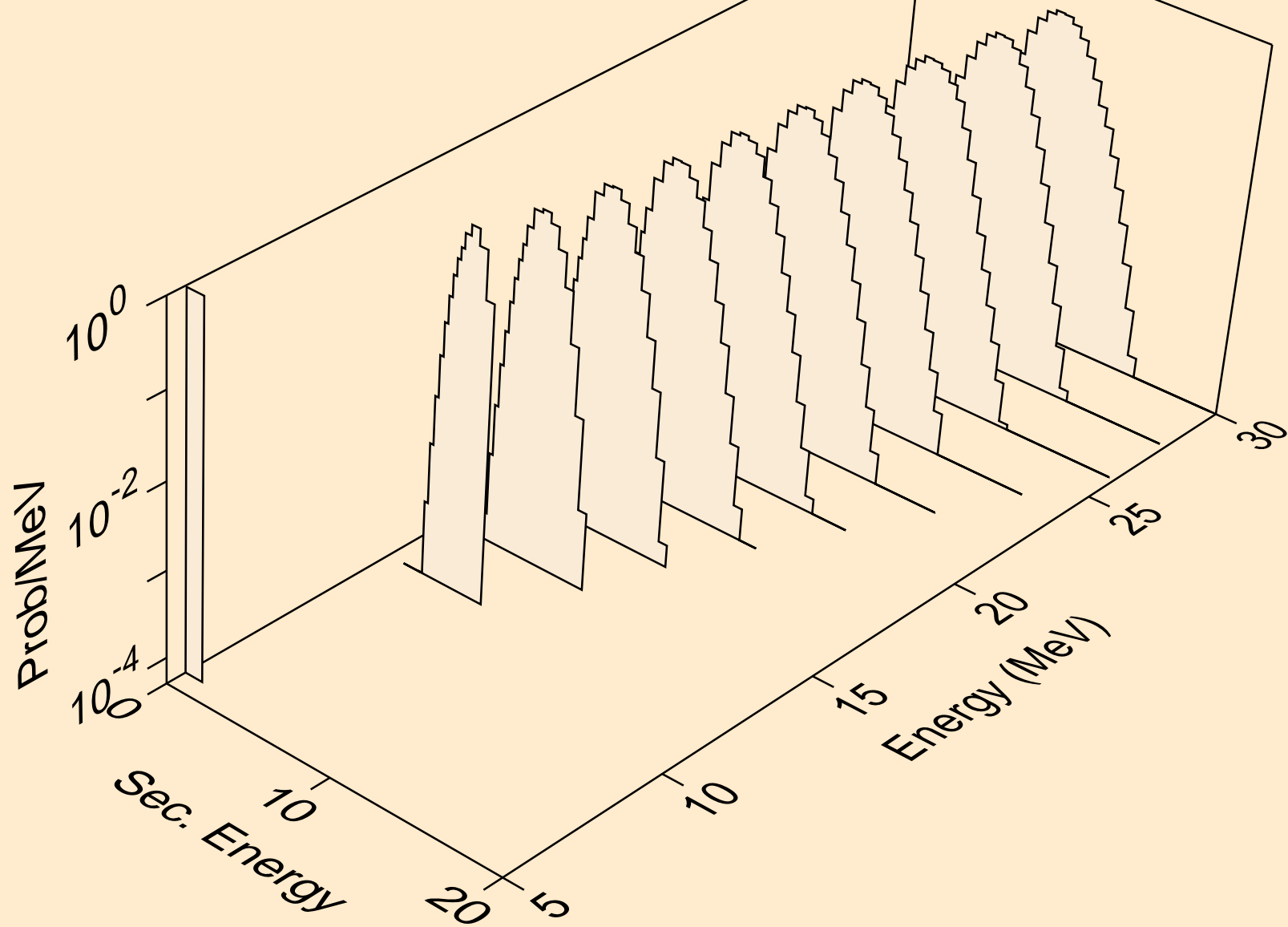

IR200 HELION ACER TENDL-2023 LIBRARY; T=0.K  
protons from (s,pt)

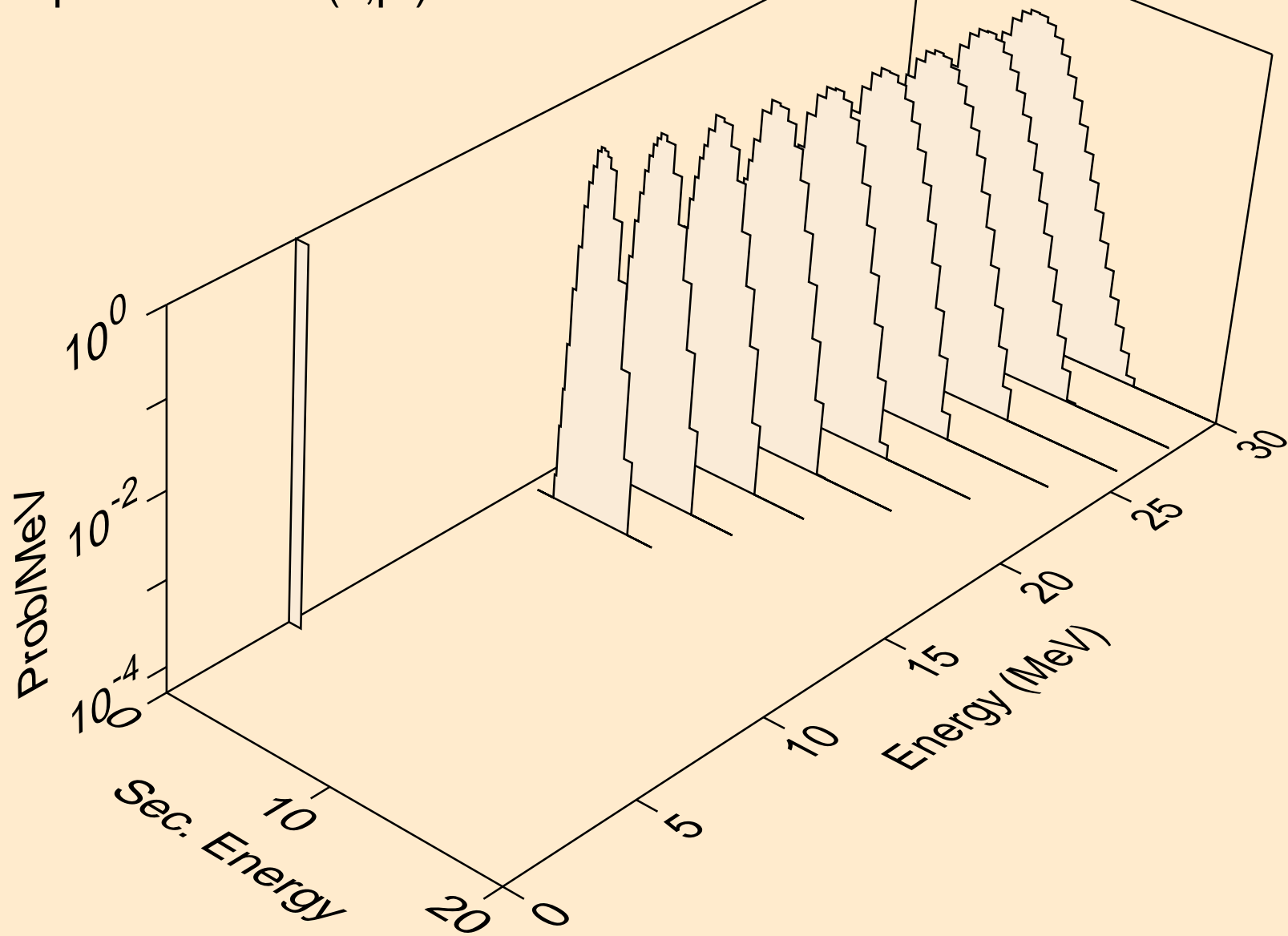

IR200 HELION ACER TENDL-2023 LIBRARY; T=0.K  
deuterons from (s,x)

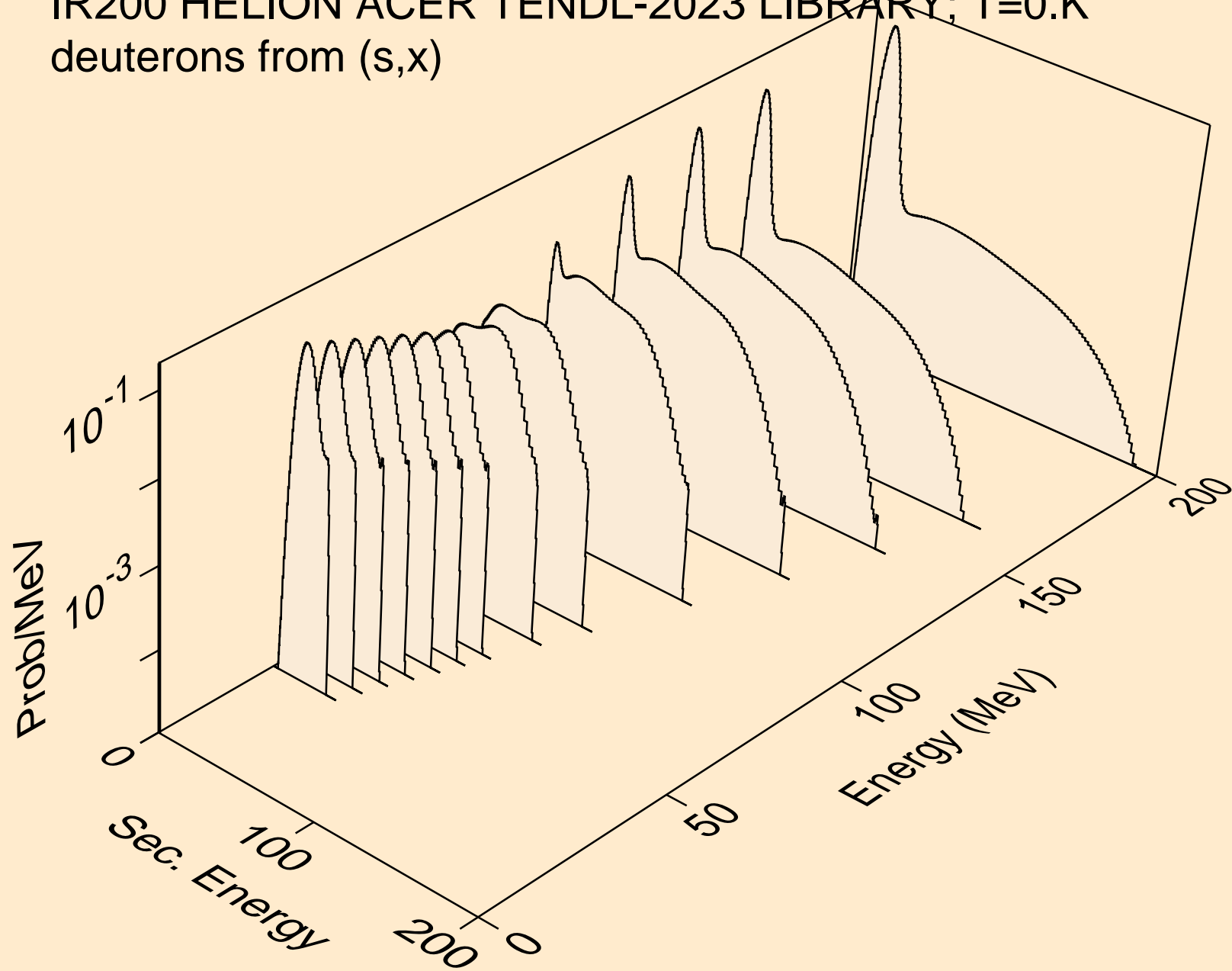

IR200 HELION ACER TENDL-2023 LIBRARY; T=0.K  
deuterons from (s,2nd)

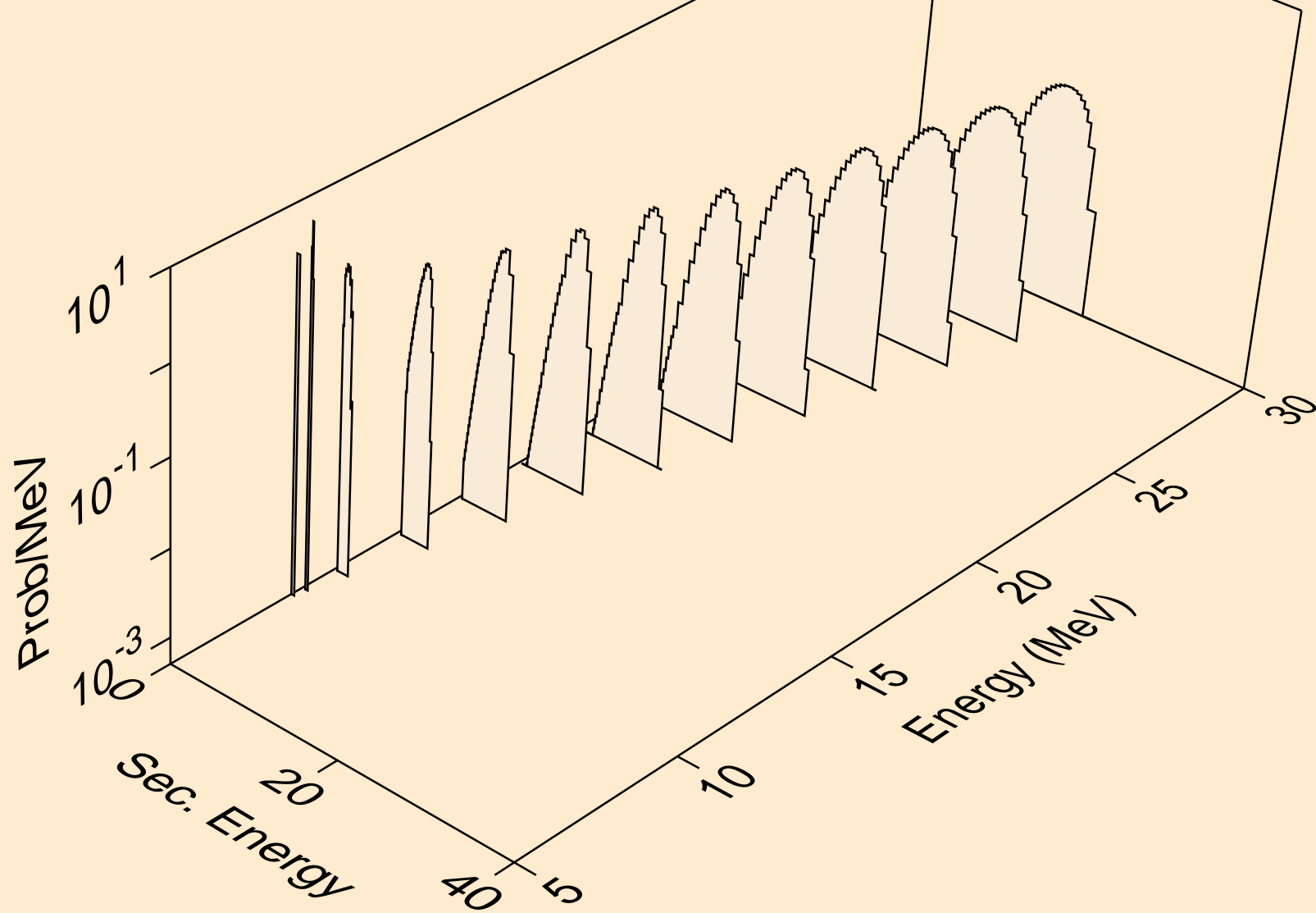

IR200 HELION ACER TENDL-2023 LIBRARY; T=0.K  
deuterons from (s,n\*)d

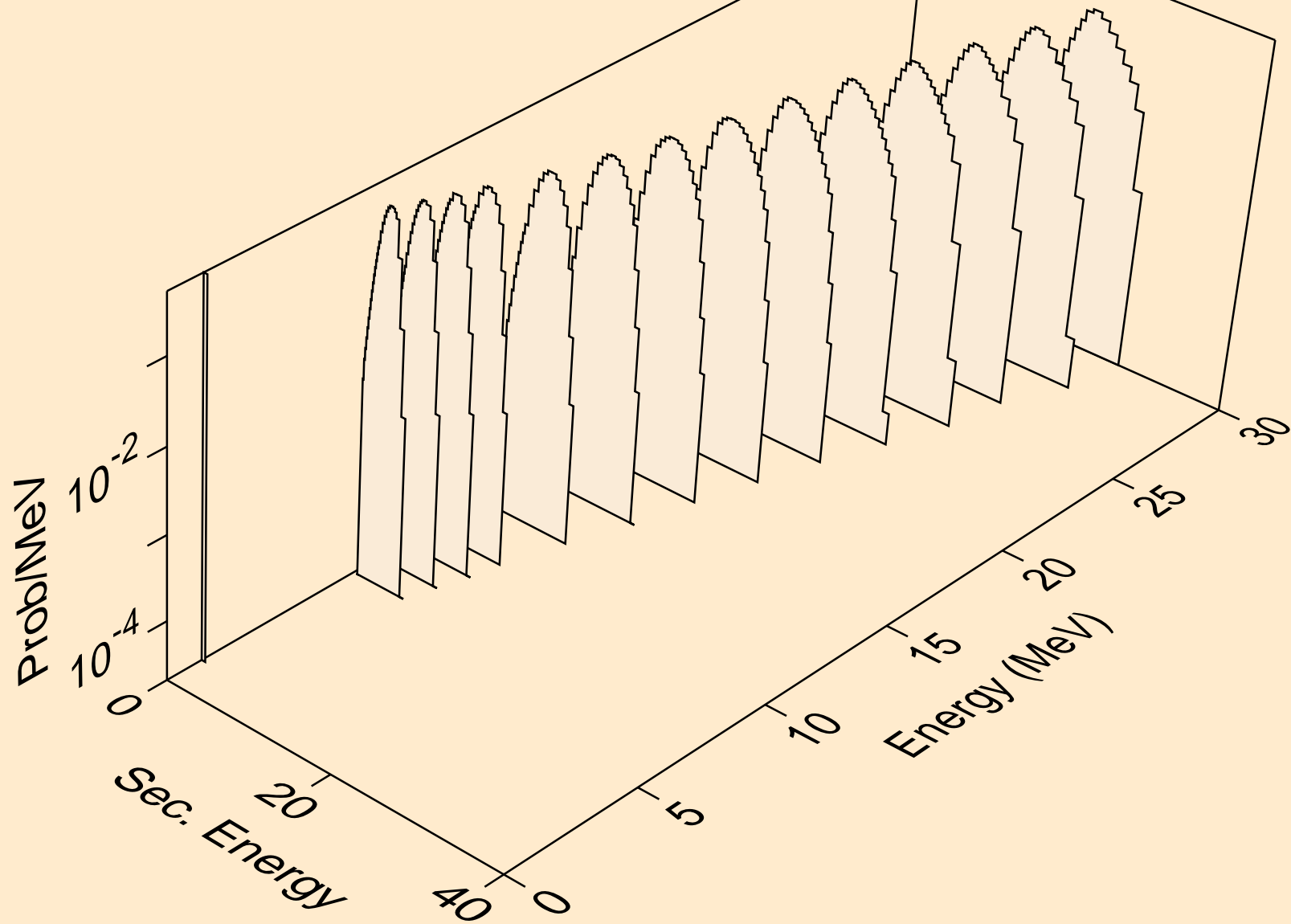

IR200 HELION ACER TENDL-2023 LIBRARY; T=0.K  
deuterons from (s,d)

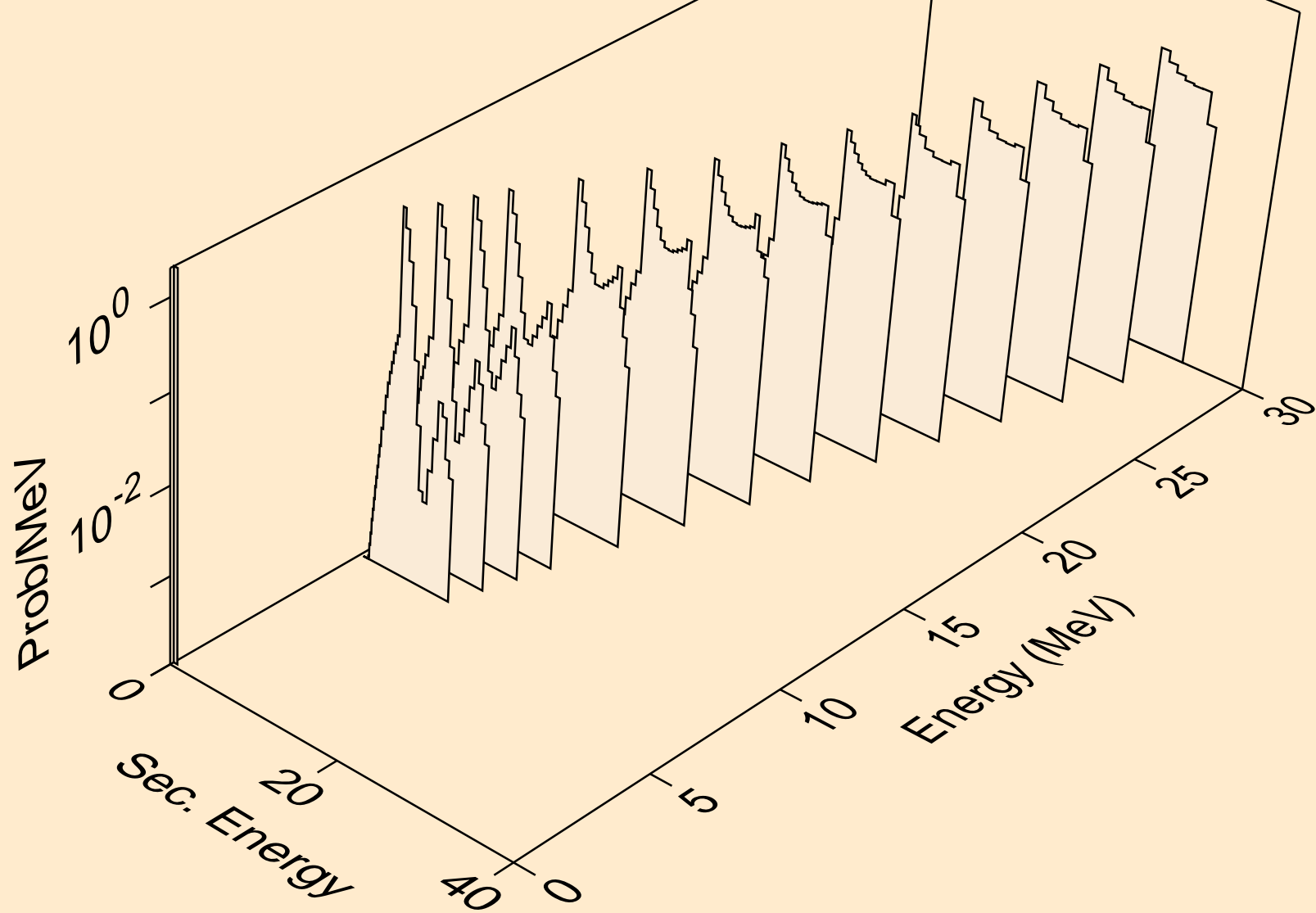

IR200 HELION ACER TENDL-2023 LIBRARY; T=0.K  
deuterons from (s,pd)

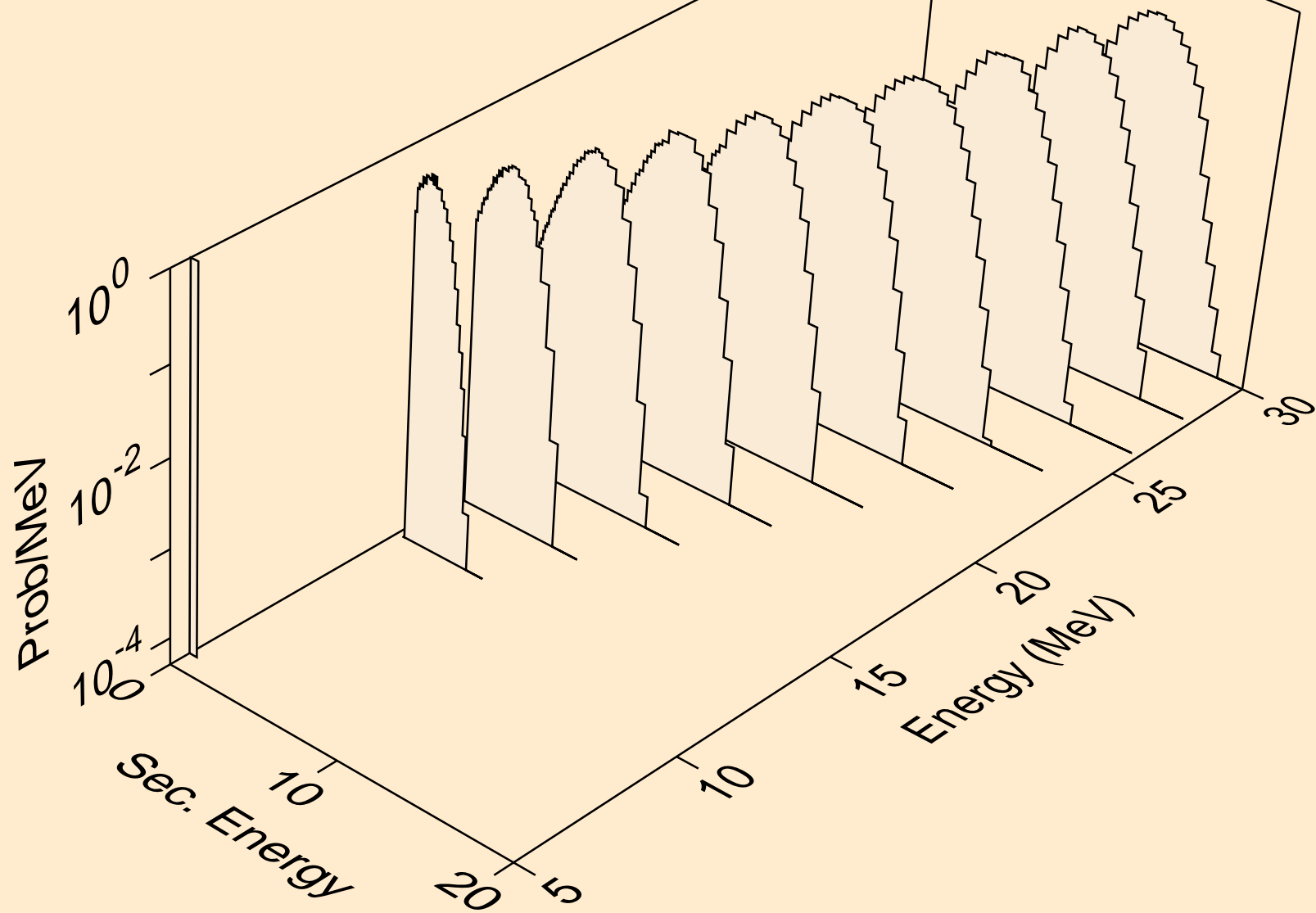

IR200 HELION ACER TENDL-2023 LIBRARY; T=0.K  
tritons from (s,x)

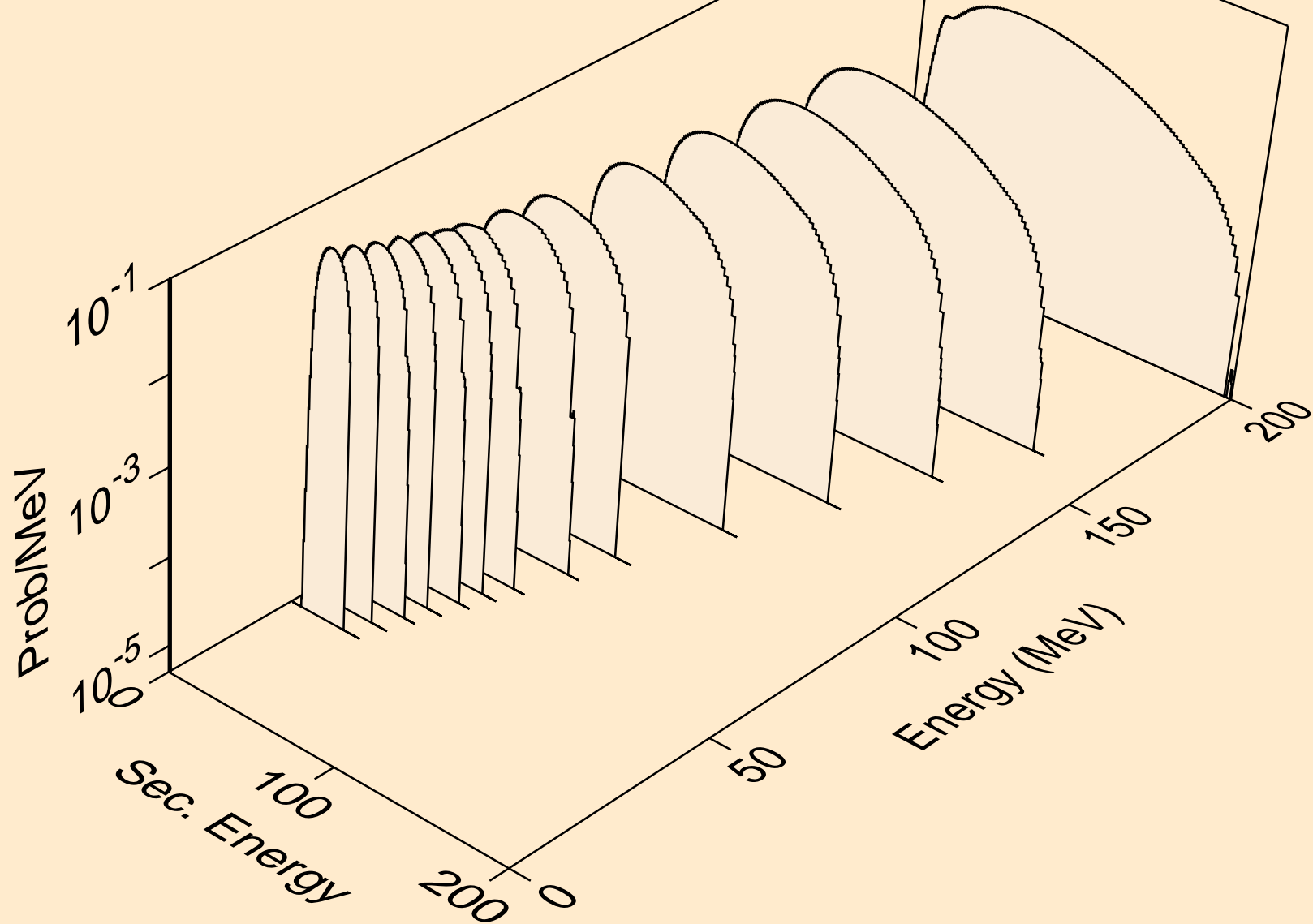

IR200 HELION ACER TENDL-2023 LIBRARY; T=0.K  
tritons from (s,n\*)t

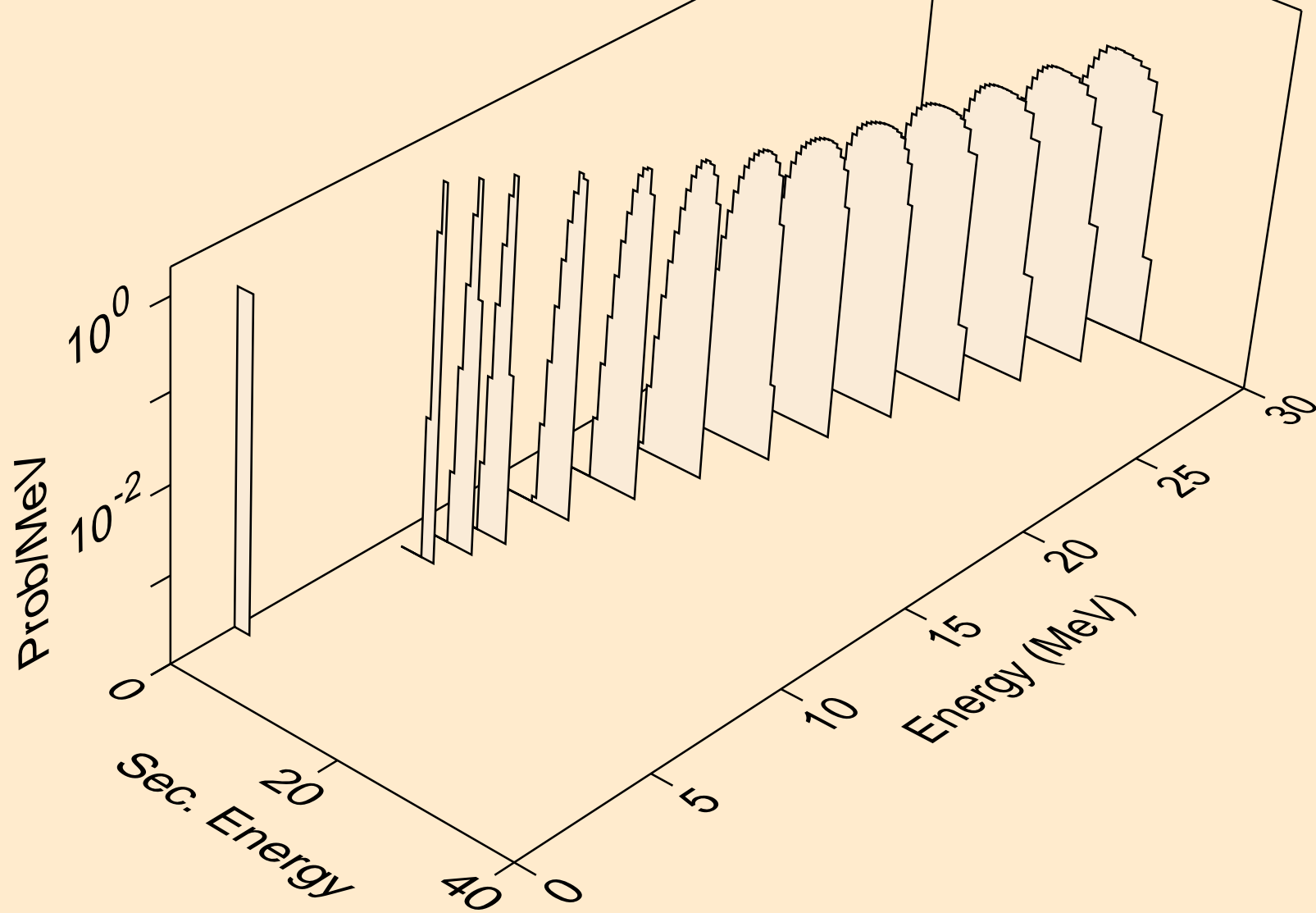

IR200 HELION ACER TENDL-2023 LIBRARY; T=0.K  
tritons from (s,t)

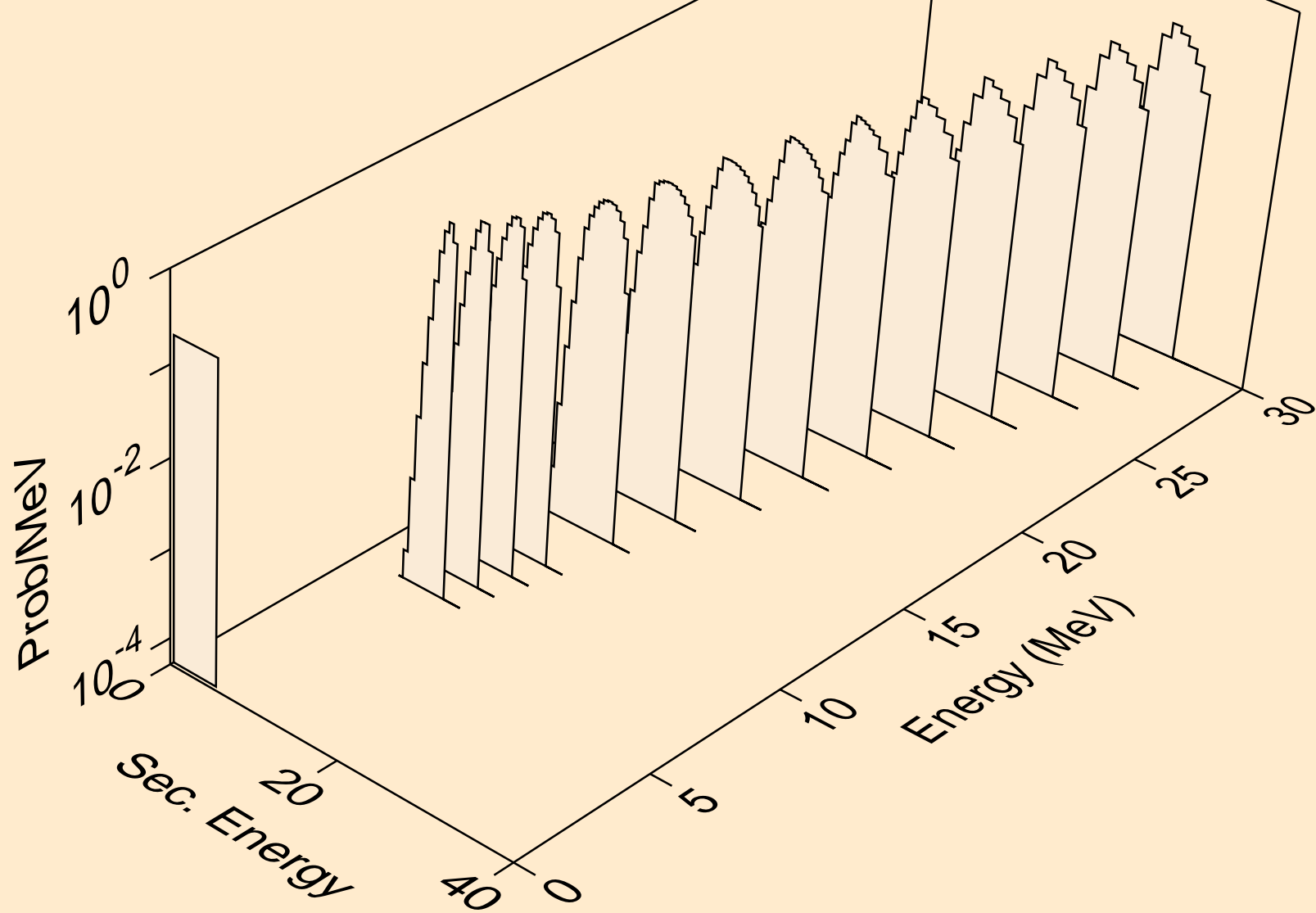

IR200 HELION ACER TENDL-2023 LIBRARY; T=0.K  
tritons from (s,pt)

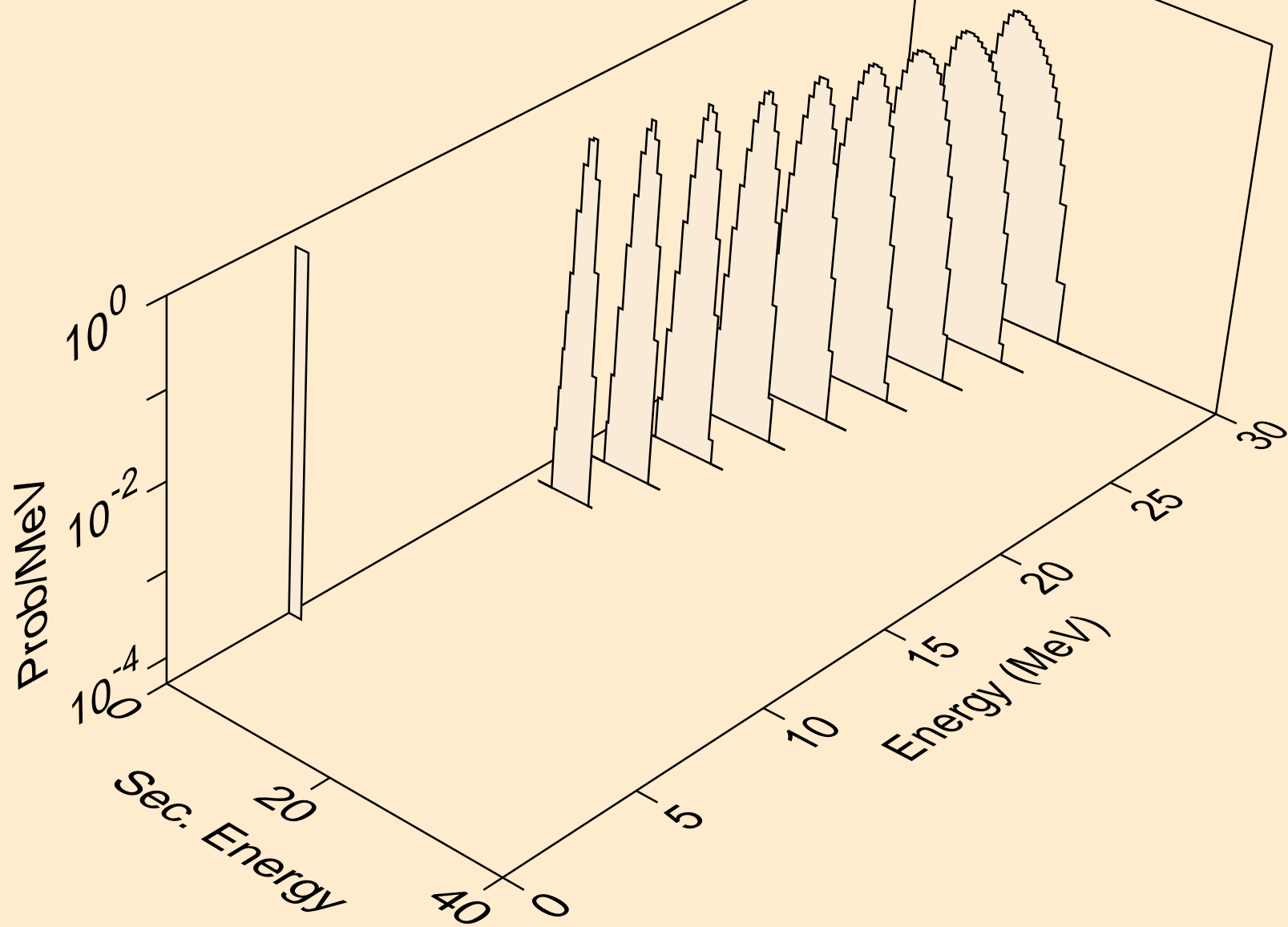

IR200 HELION ACER TENDL-2023 LIBRARY; T=0.K  
alphas from (s,x)

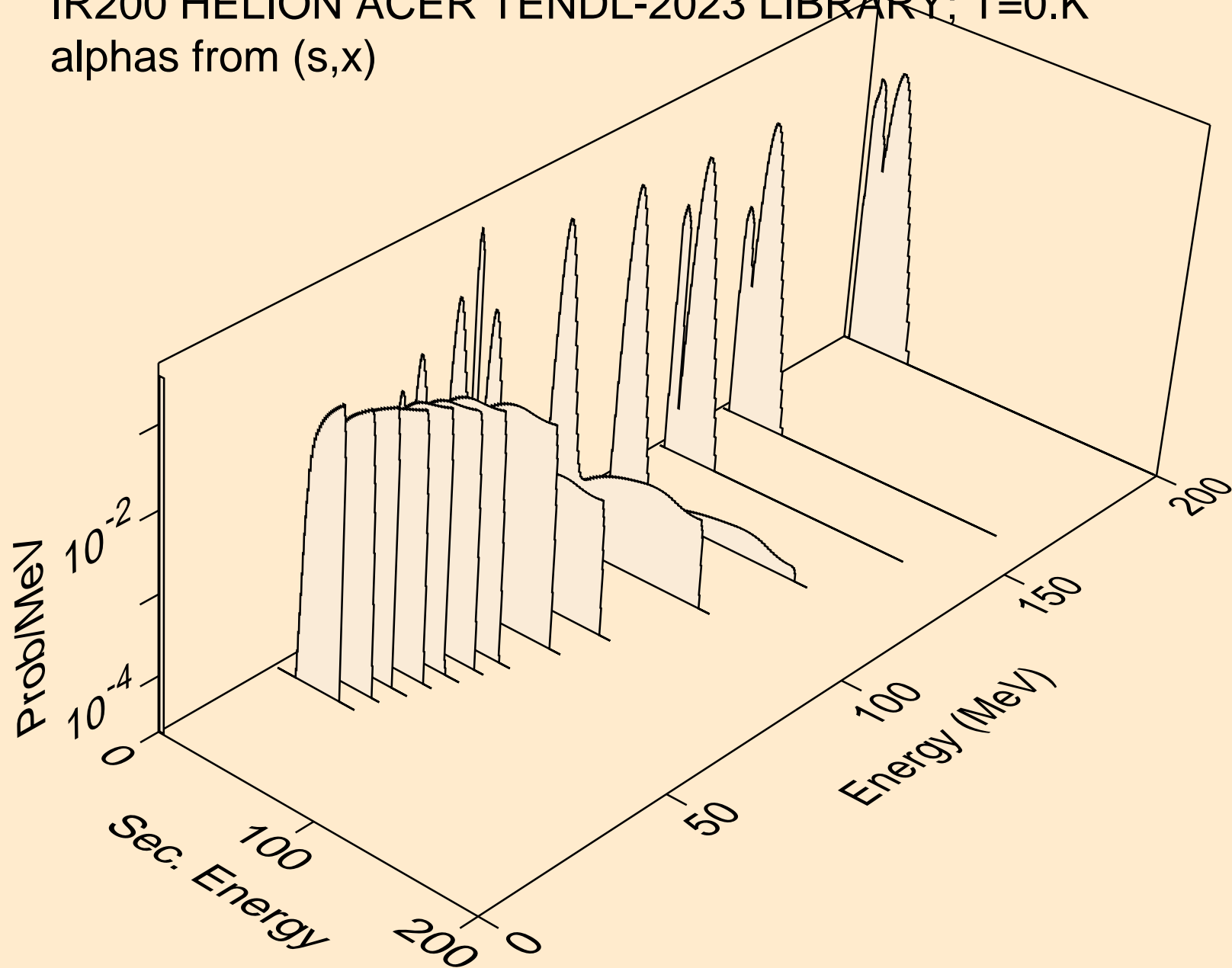

IR200 HELION ACER TENDL-2023 LIBRARY; T=0.K  
alphas from (s,n\*)a

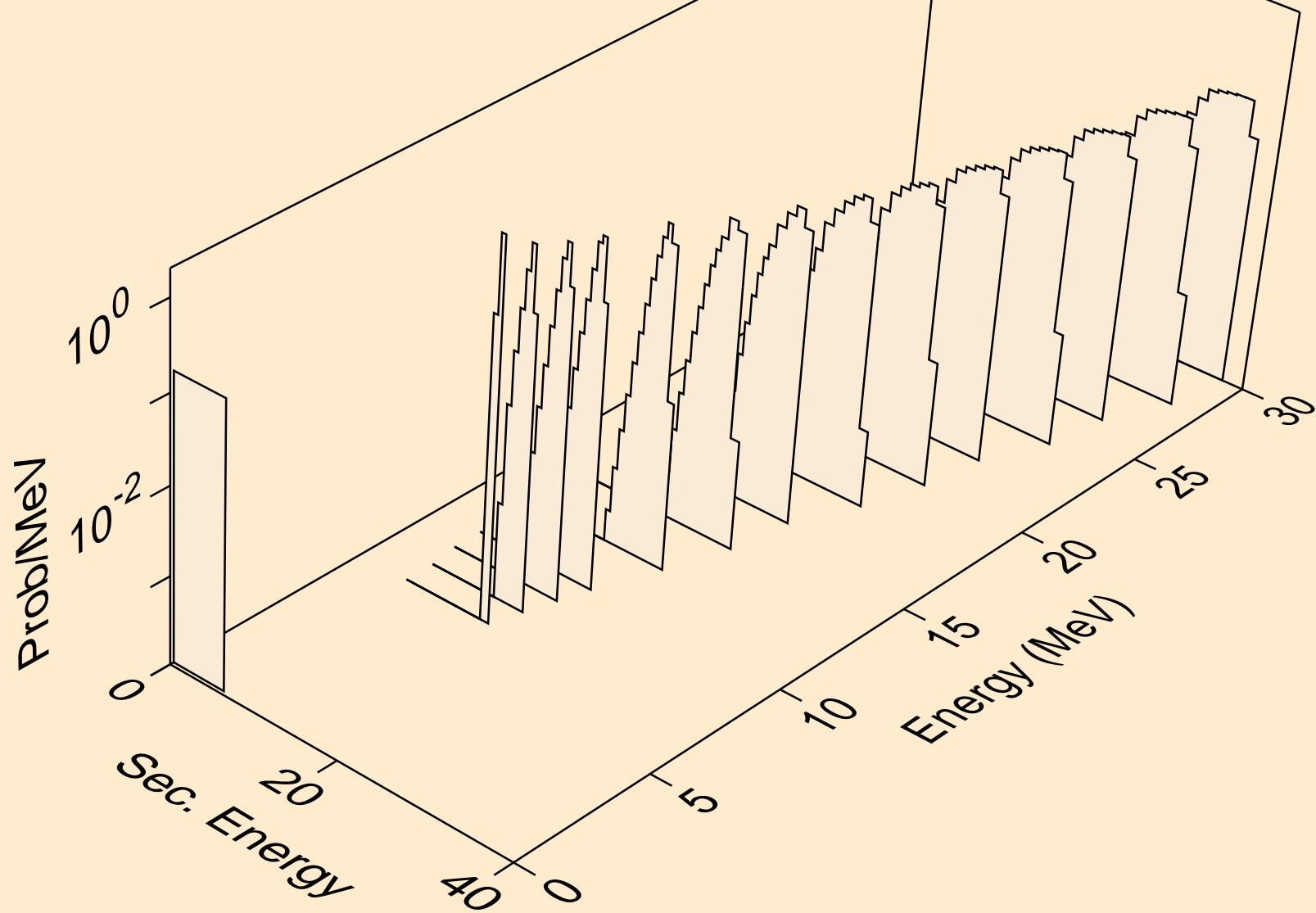

IR200 HELION ACER TENDL-2023 LIBRARY; T=0.K  
alphas from (s,2n)a

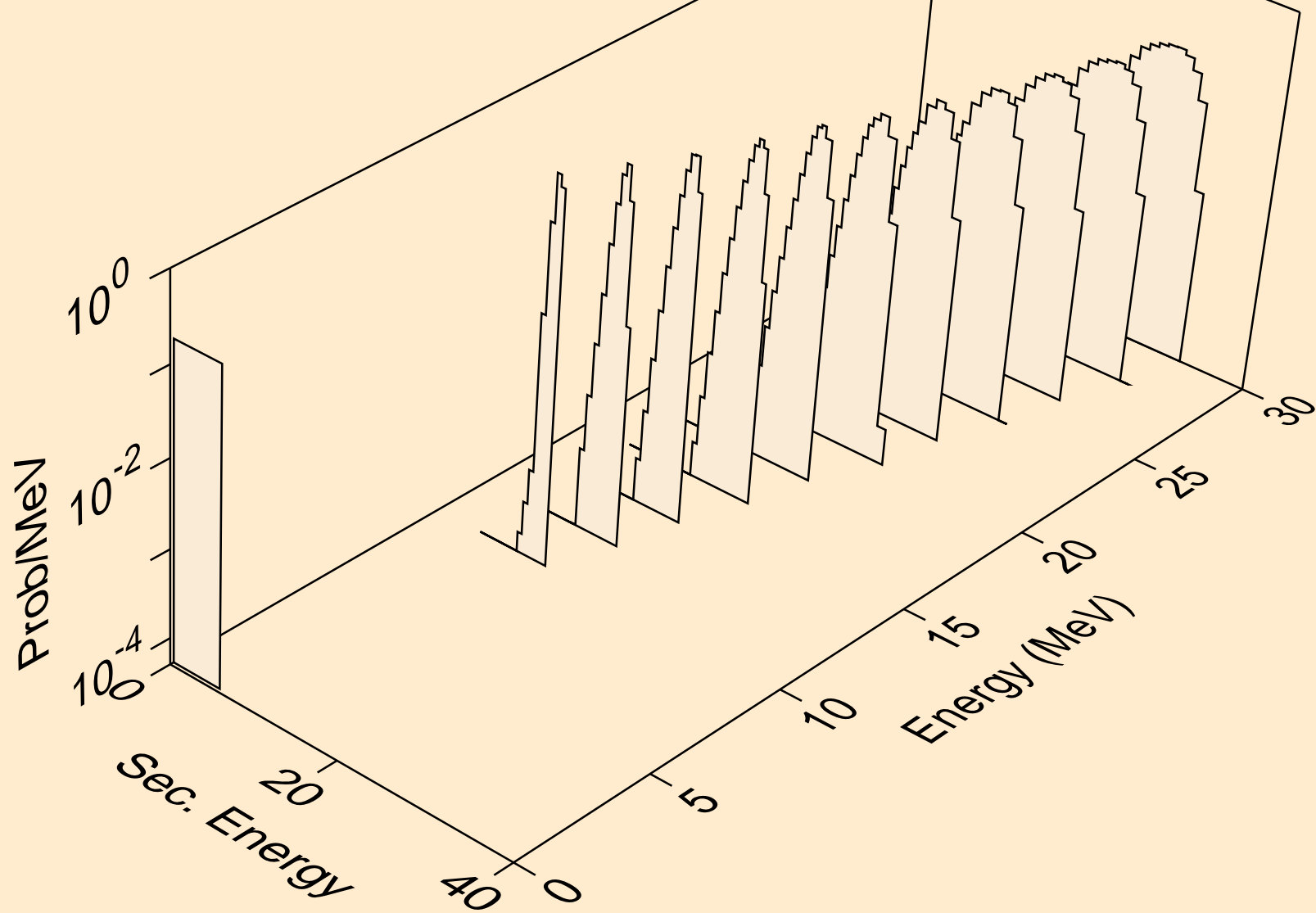

IR200 HELION ACER TENDL-2023 LIBRARY; T=0.K  
alphas from (s,3n)a

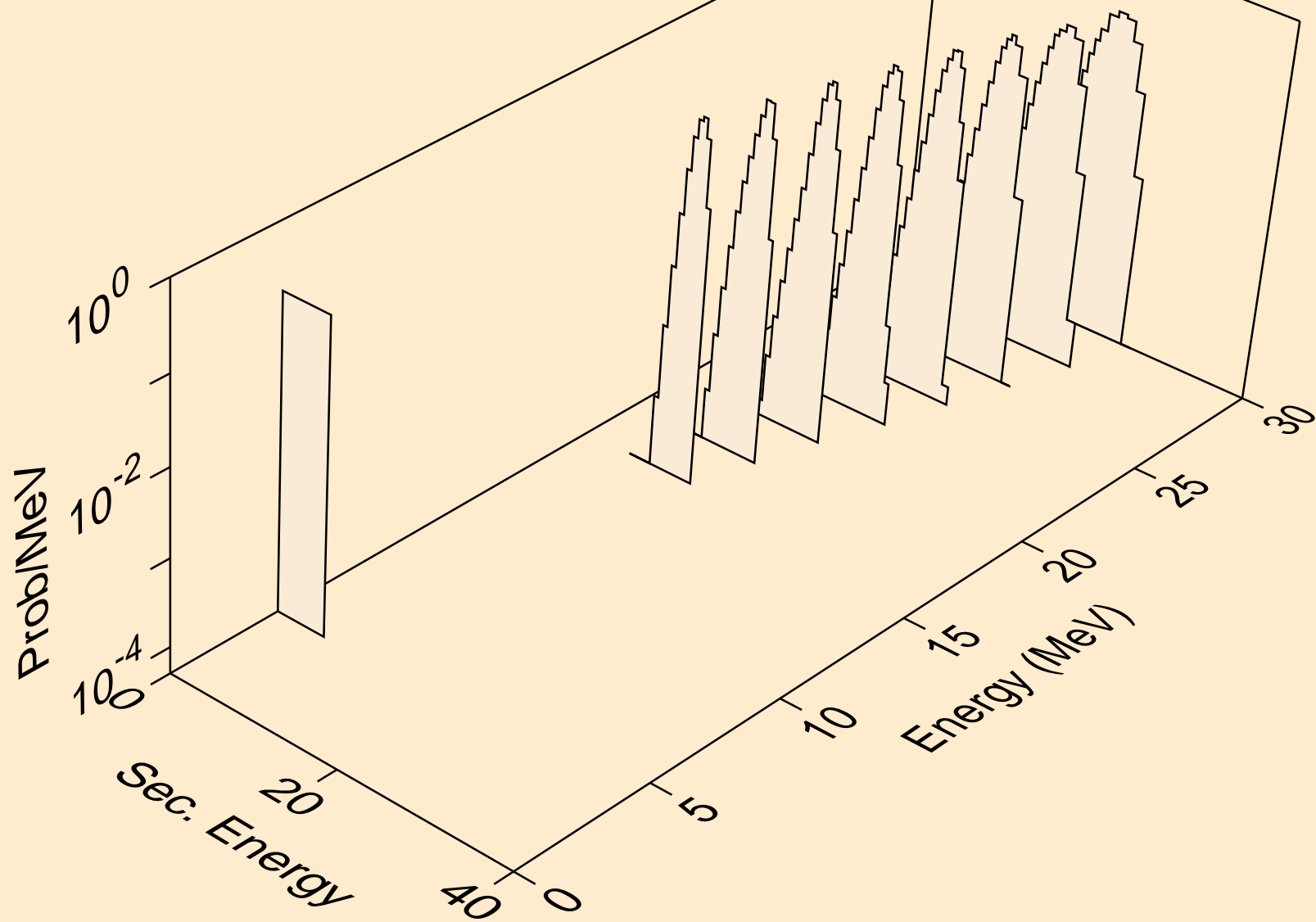

IR200 HELION ACER TENDL-2023 LIBRARY; T=0.K  
alphas from (s,npa)

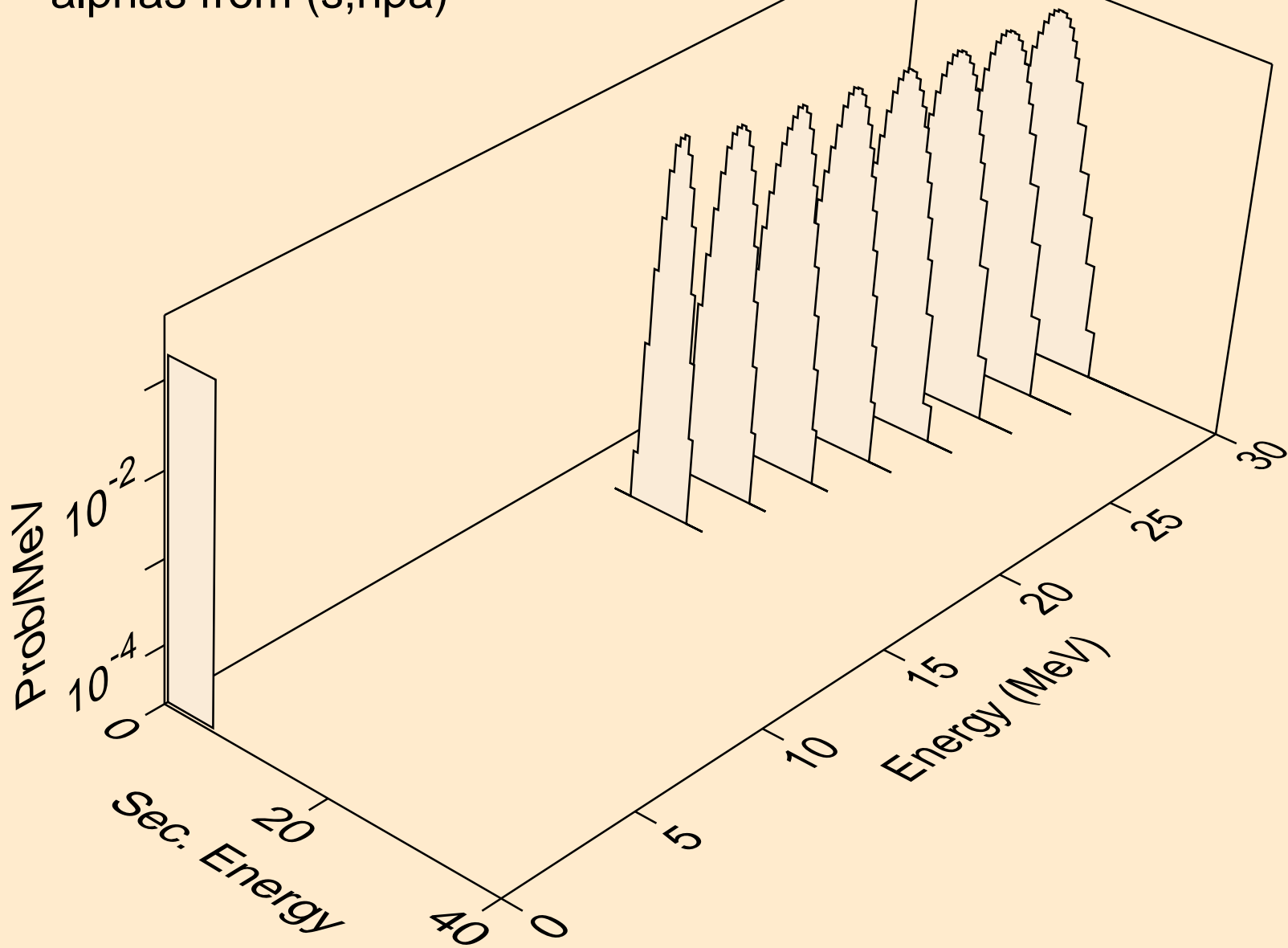

IR200 HELION ACER TENDL-2023 LIBRARY; T=0.K  
alphas from (s,a)

