

MD246M HELION ACER TENDL-2023 LIBRARY; T=0.K  
Principal cross sections

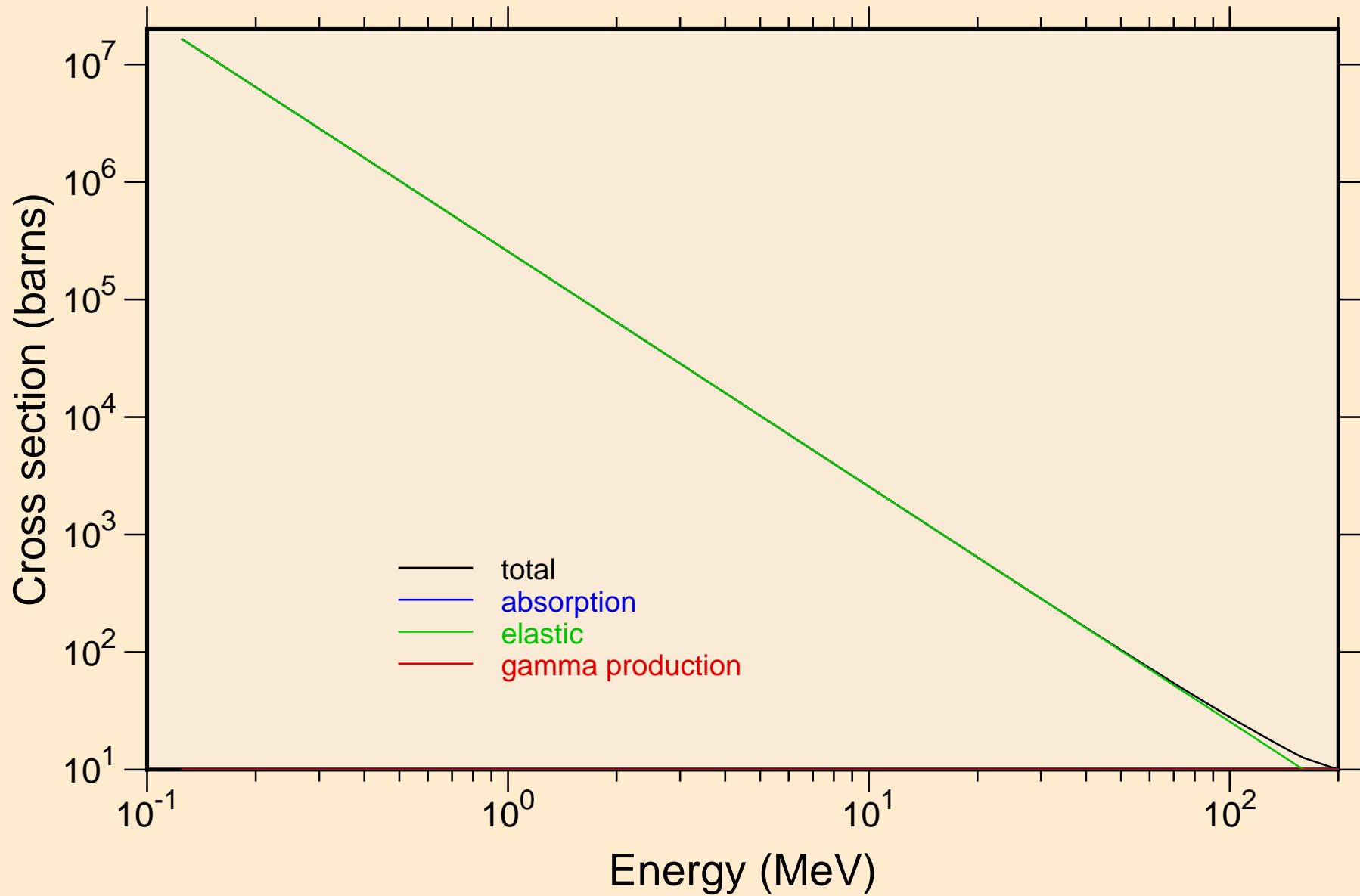

# MD246M HELION ACER TENDL-2023 LIBRARY; T=0.K

## Heating

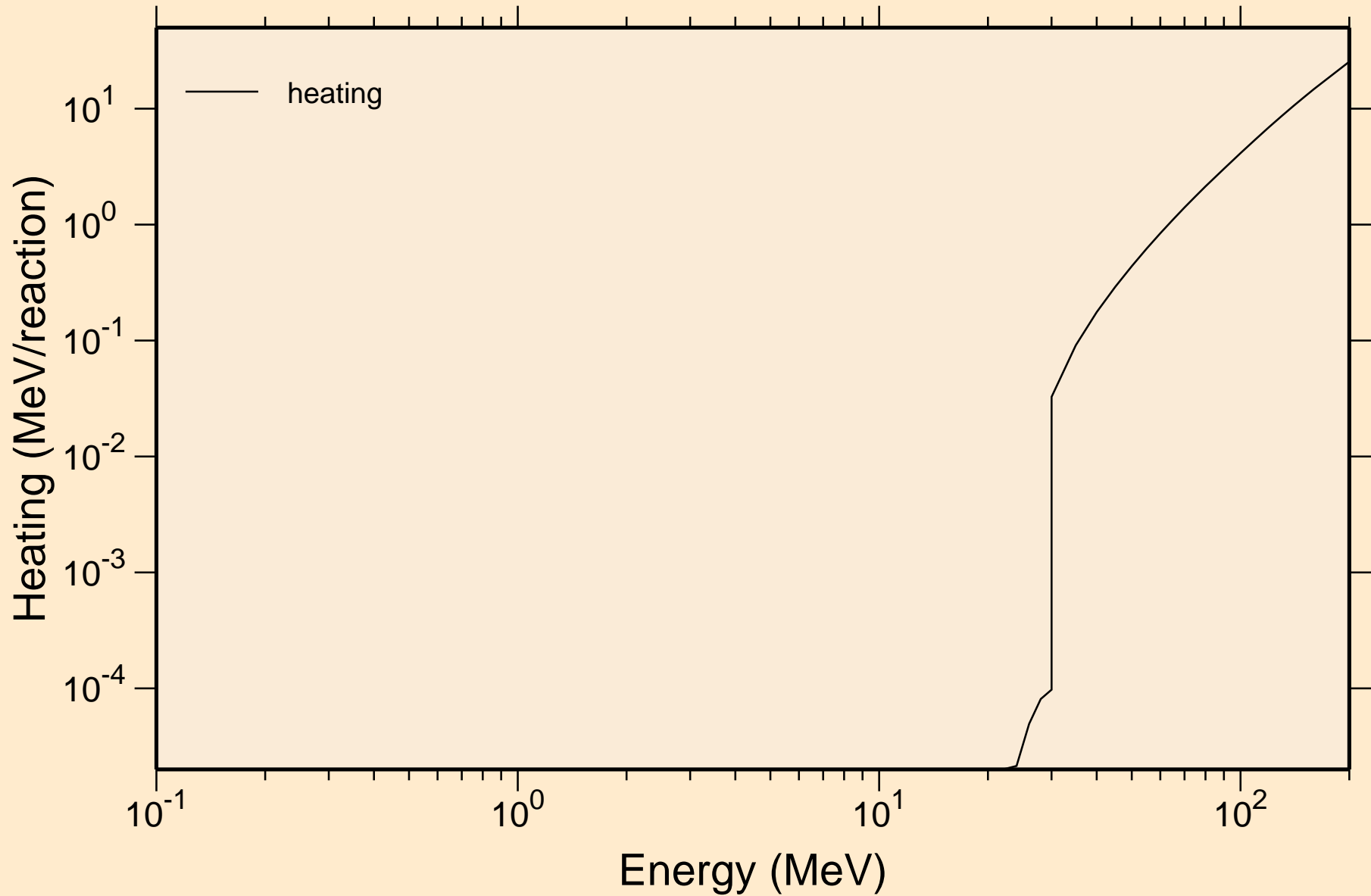

# MD246M HELION ACER TENDL-2023 LIBRARY; T=0.K

## Principal cross sections

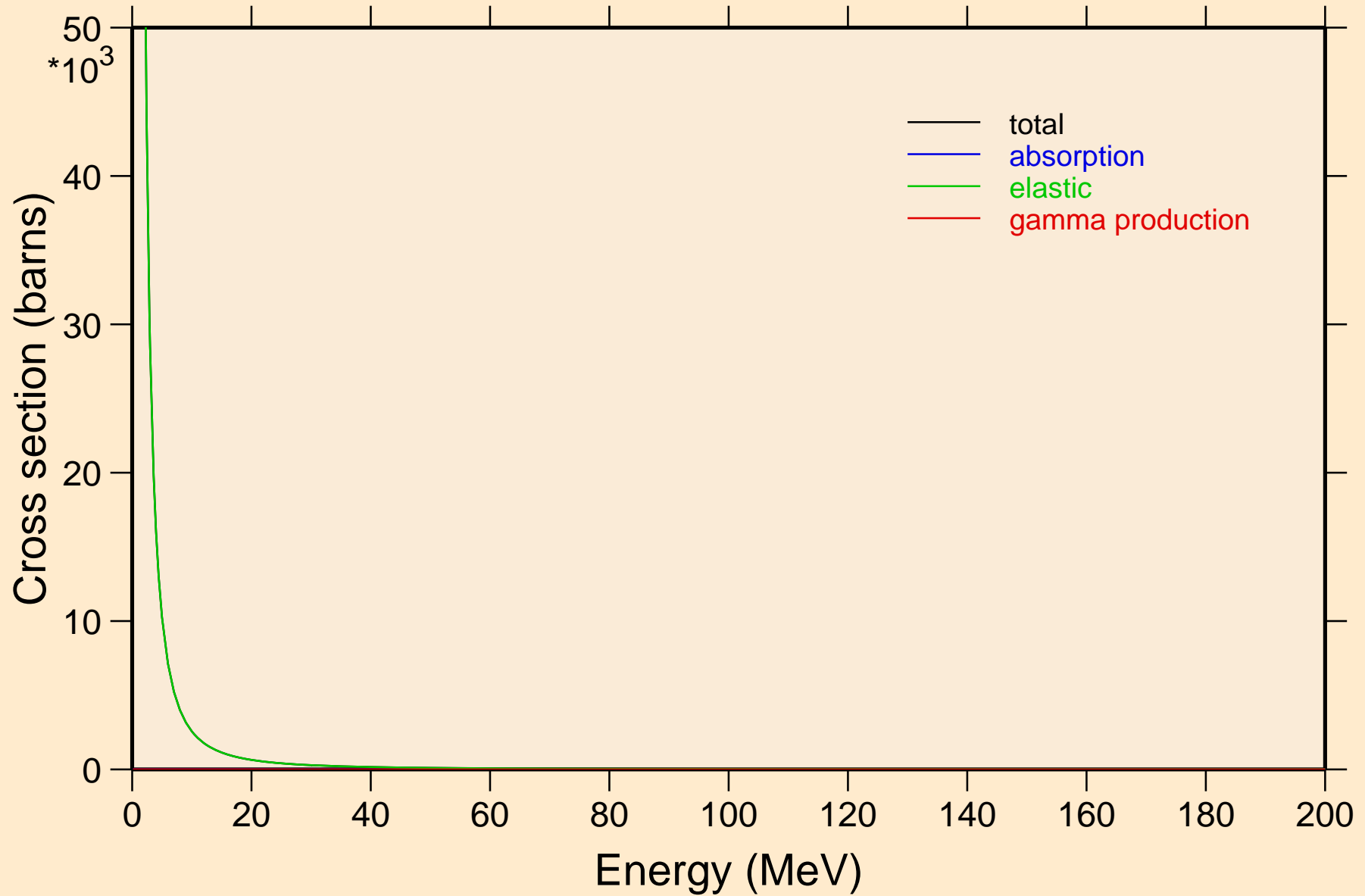

MD246M HELION ACER TENDL-2023 LIBRARY; T=0.K

Heating

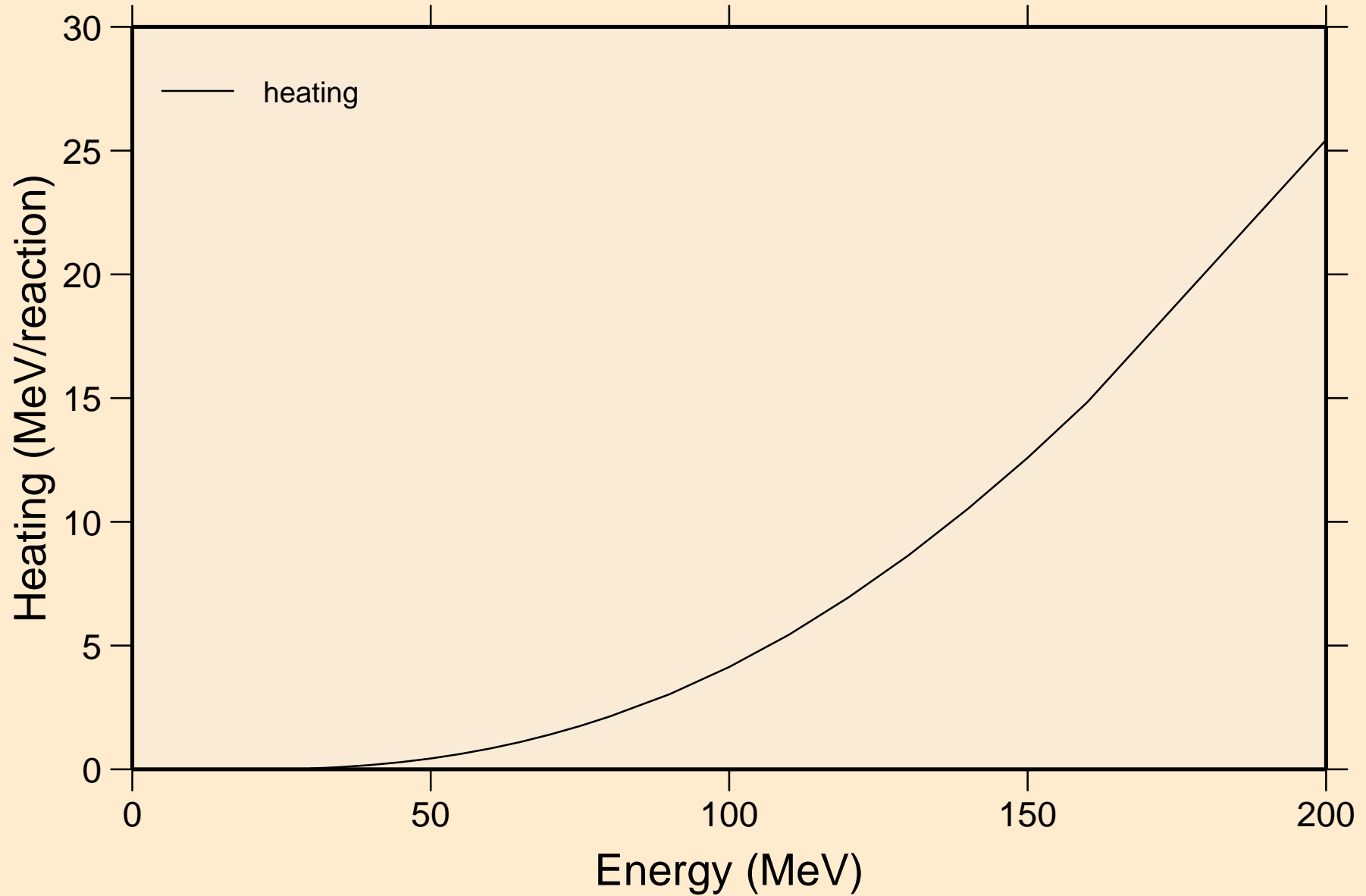

MD246M HELION ACER TENDL-2023 LIBRARY; T=0.K  
Threshold reactions

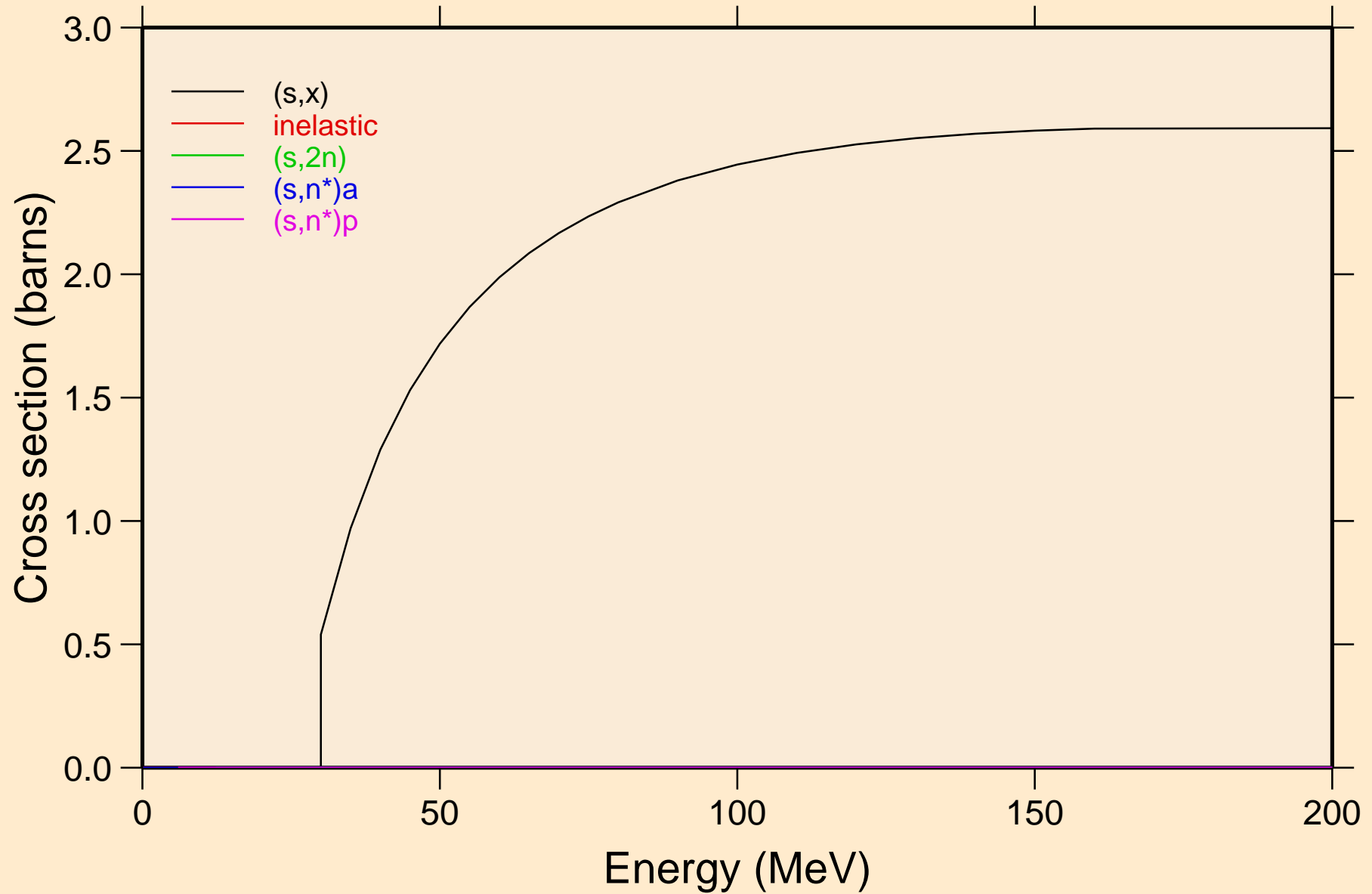

MD246M HELION ACER TENDL-2023 LIBRARY; T=0.K  
Threshold reactions

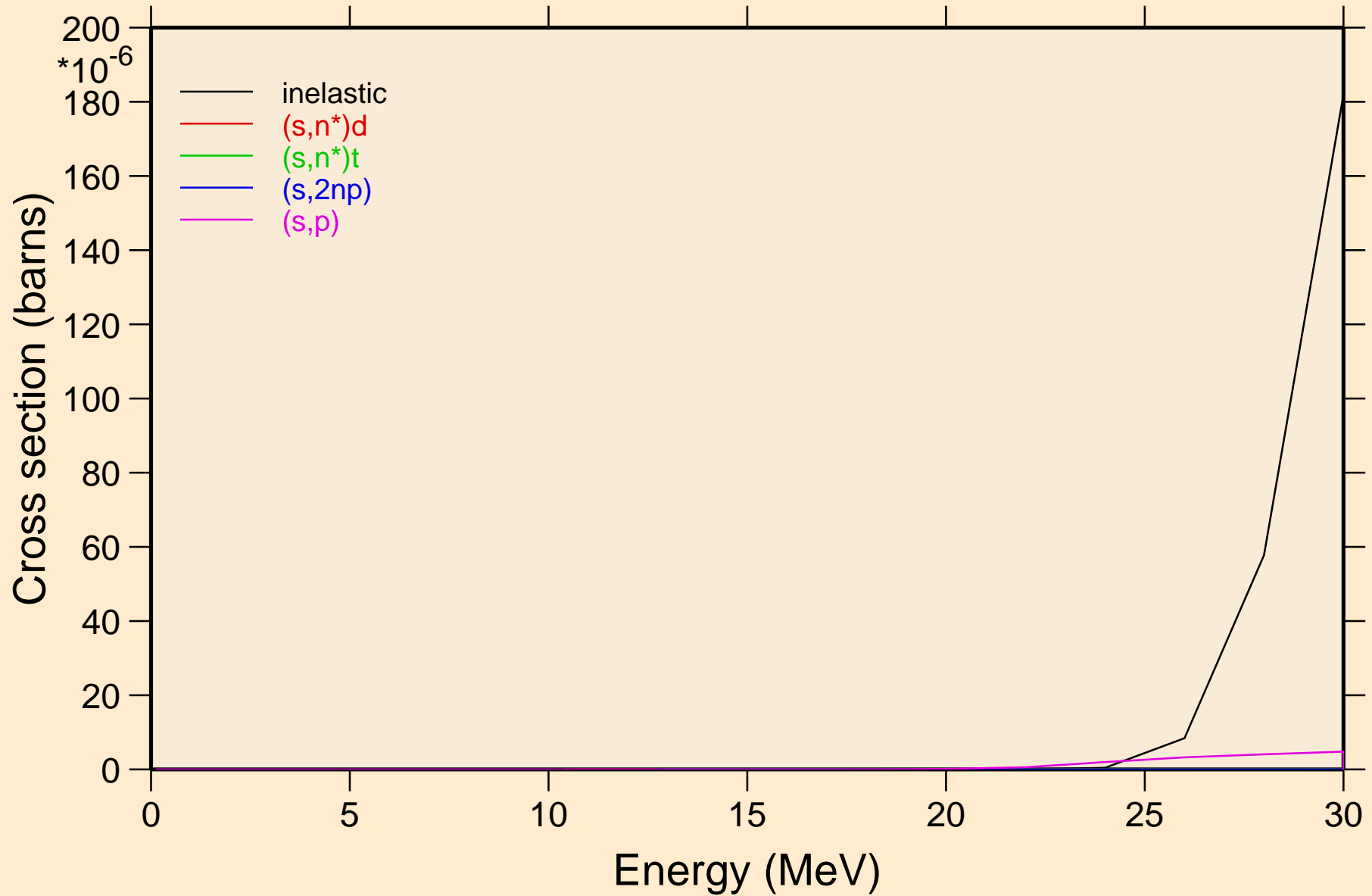

MD246M HELION ACER TENDL-2023 LIBRARY; T=0.K  
Threshold reactions

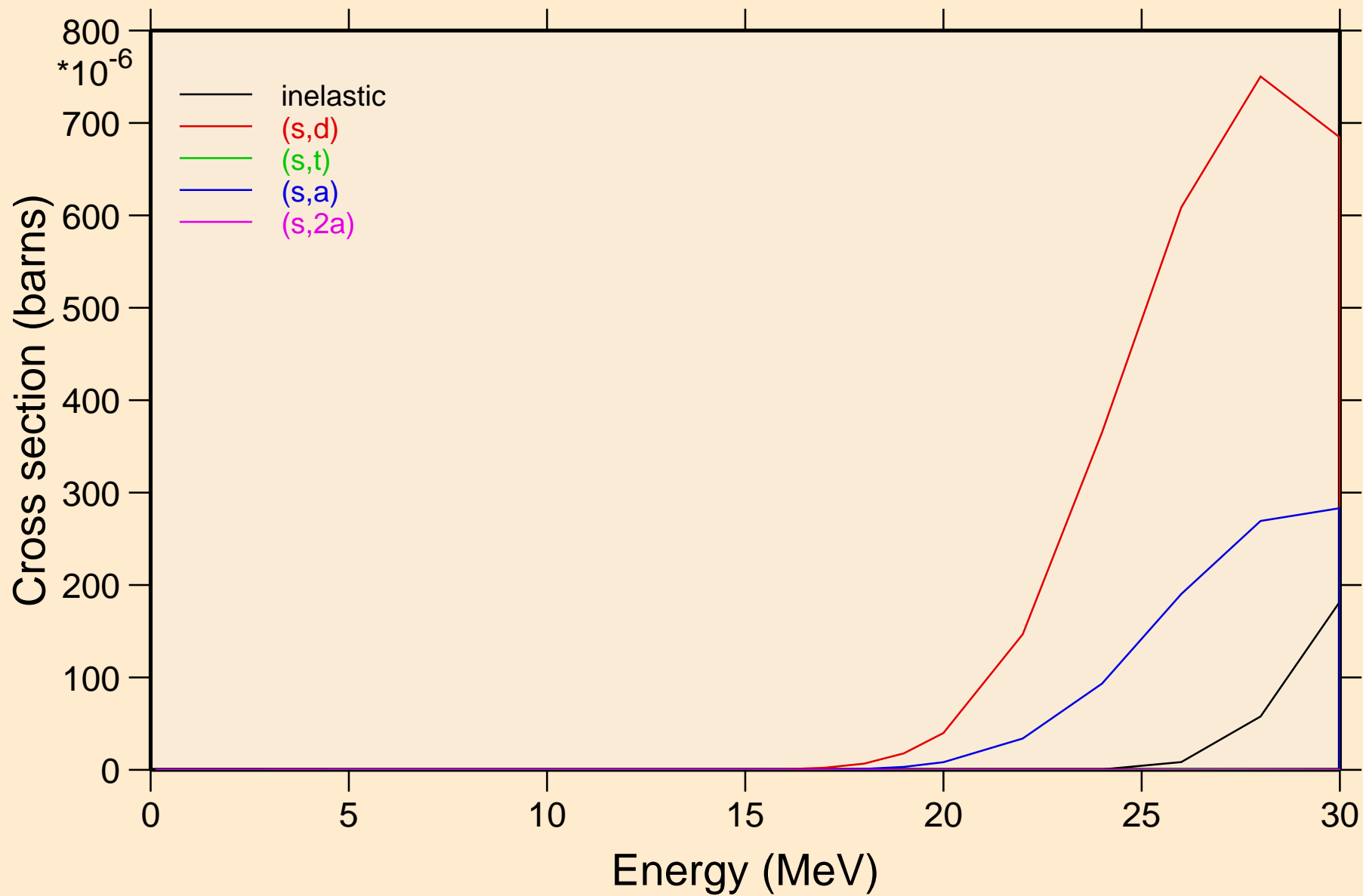

MD246M HELION ACER TENDL-2023 LIBRARY; T=0.K  
Threshold reactions

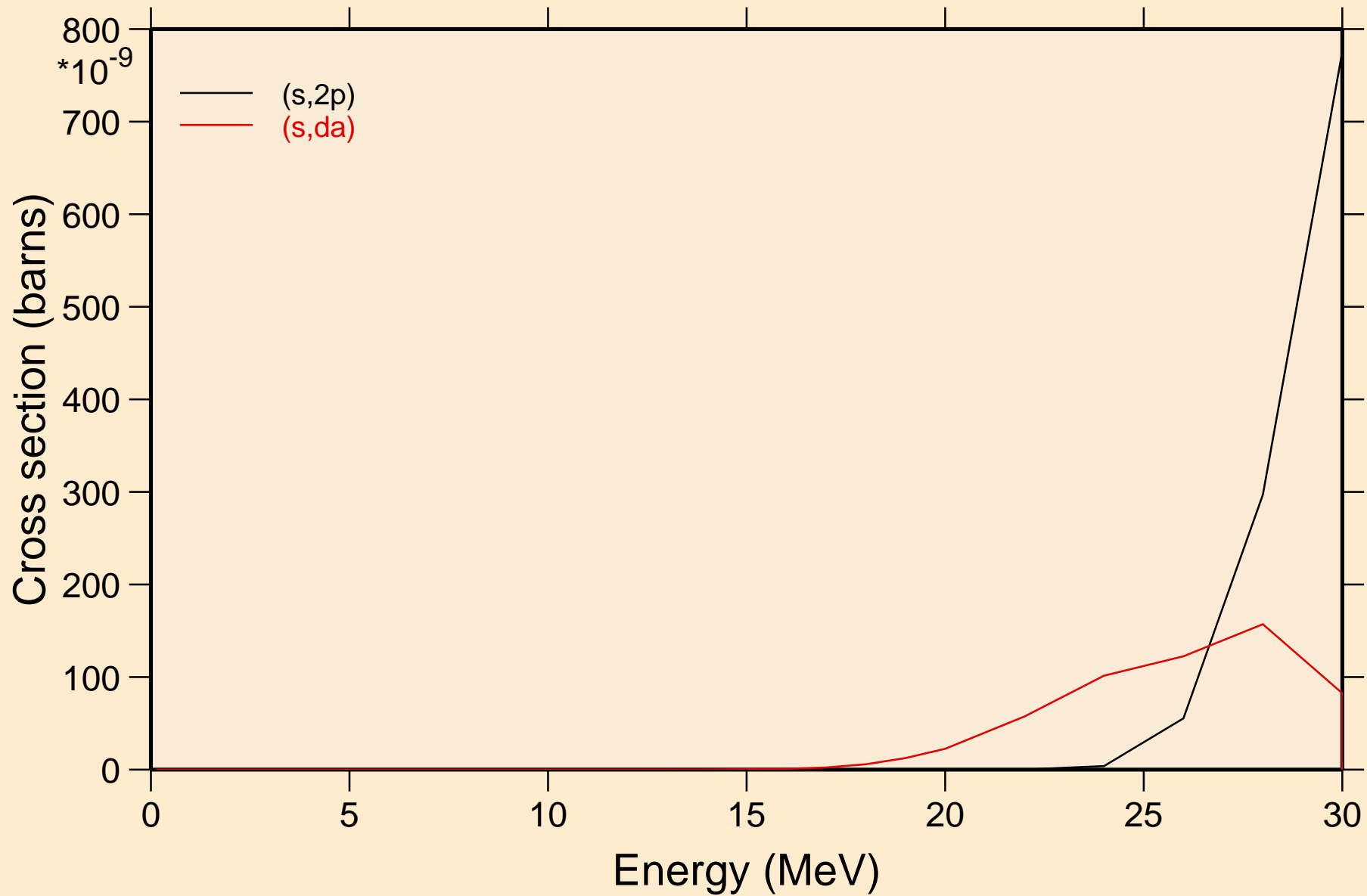

MD246M HELION ACER TENDL-2023 LIBRARY; T=0.K  
angular distribution for elastic

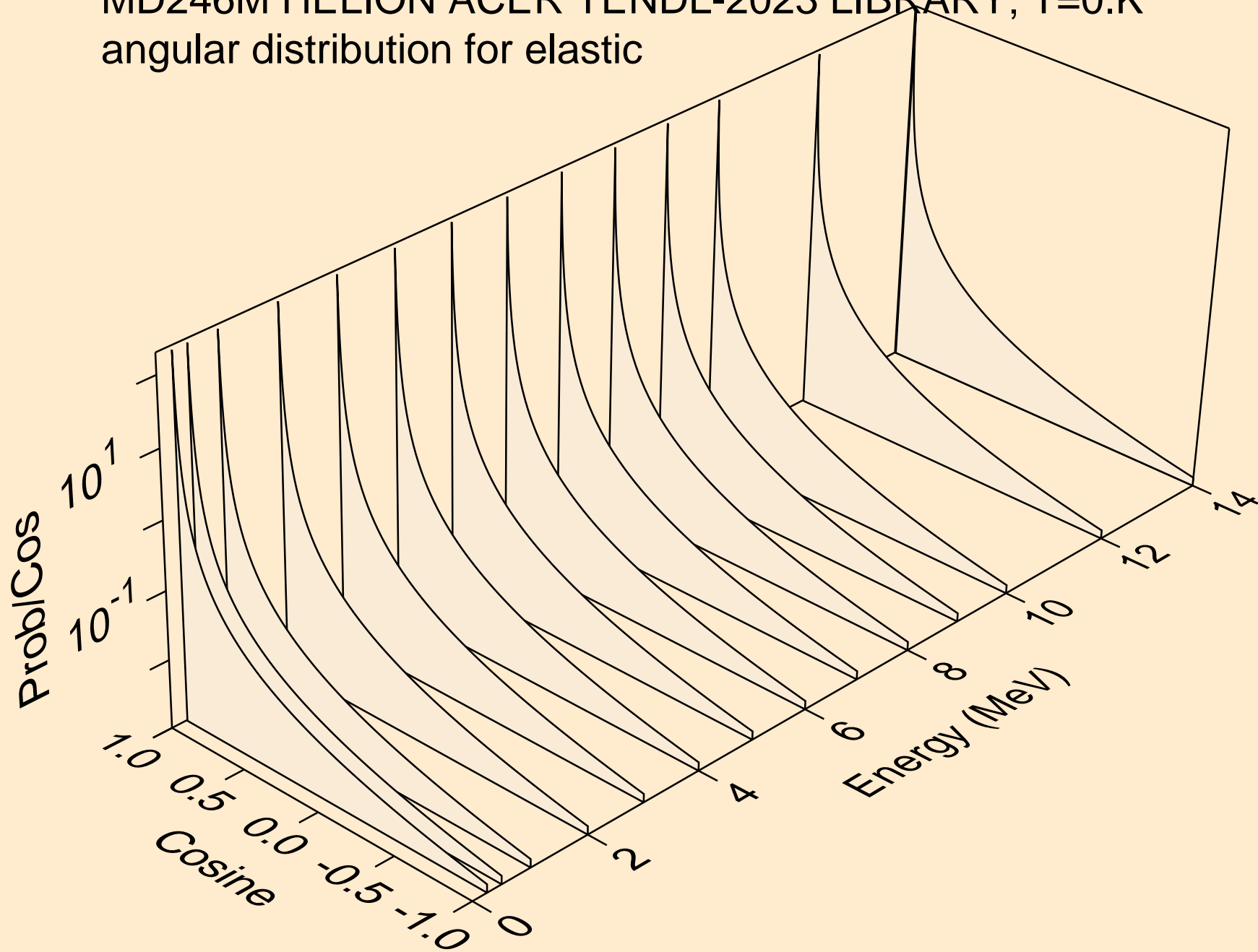

MD246M HELION ACER TENDL-2023 LIBRARY; T=0.K  
He-3 emission for (s,x)

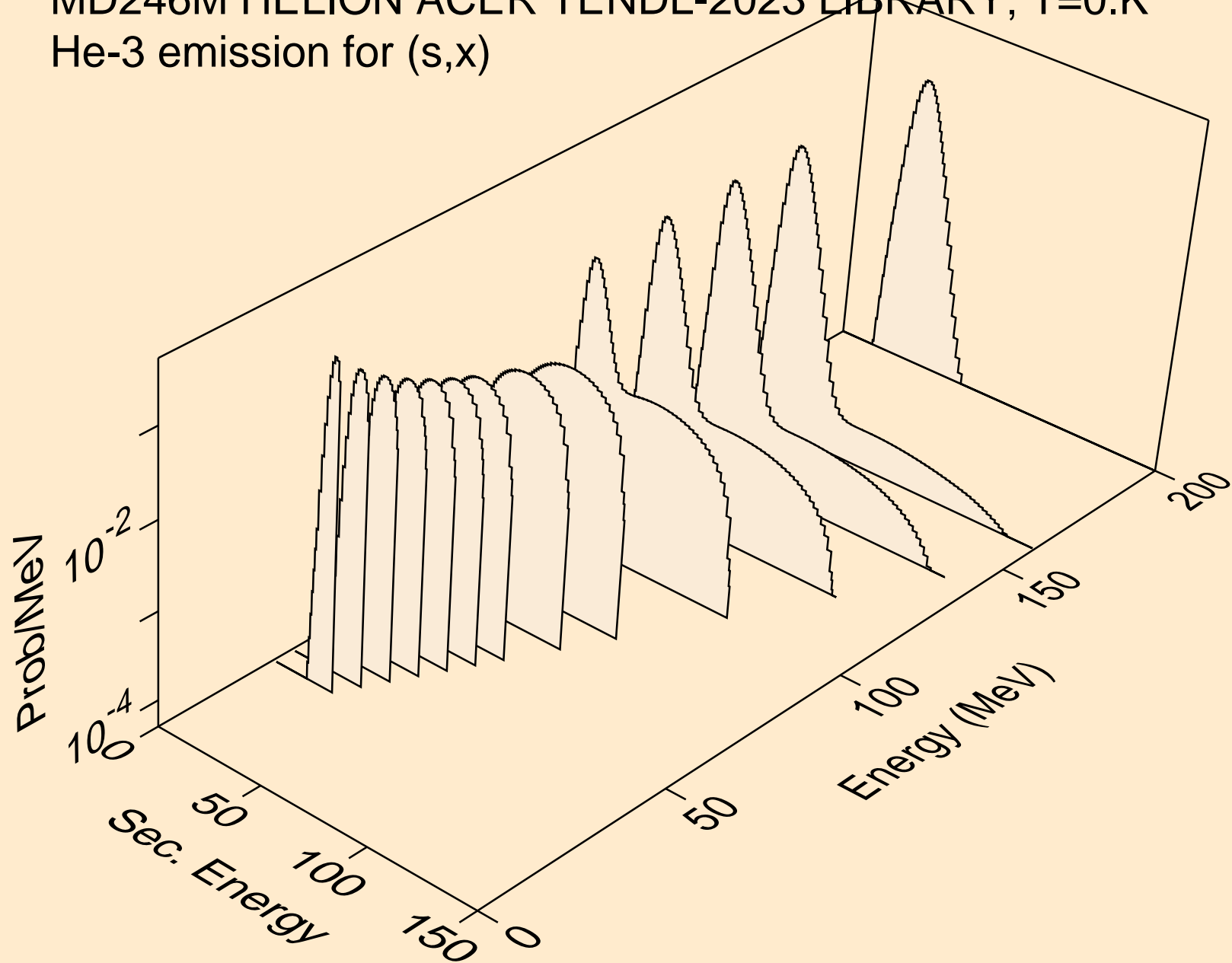

MD246M HELION ACER TENDL-2023 LIBRARY; T=0.K  
He-3 emission for inelastic

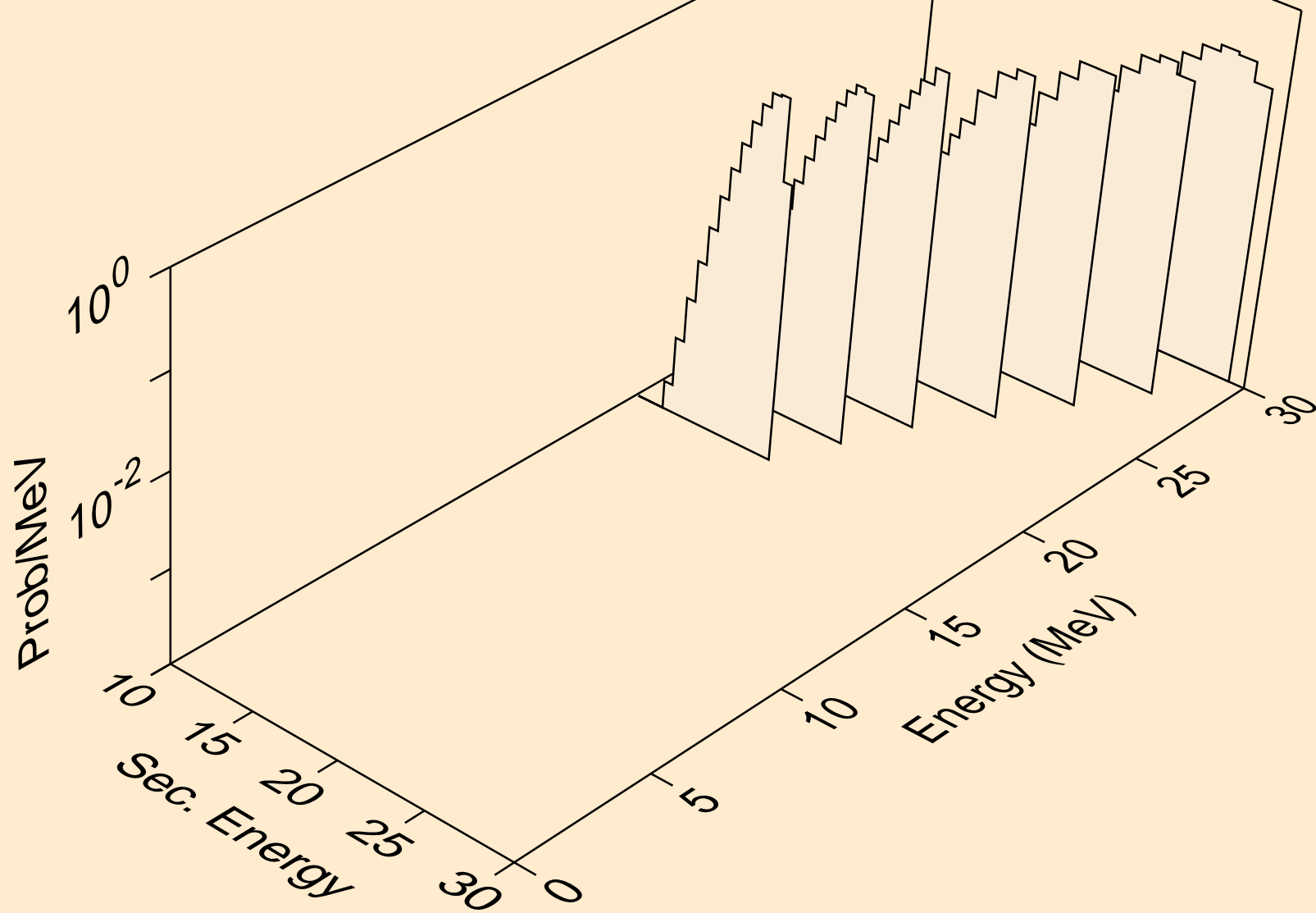

MD246M HELION ACER TENDL-2023 LIBRARY; T=0.K  
Photon emission for (z,n)

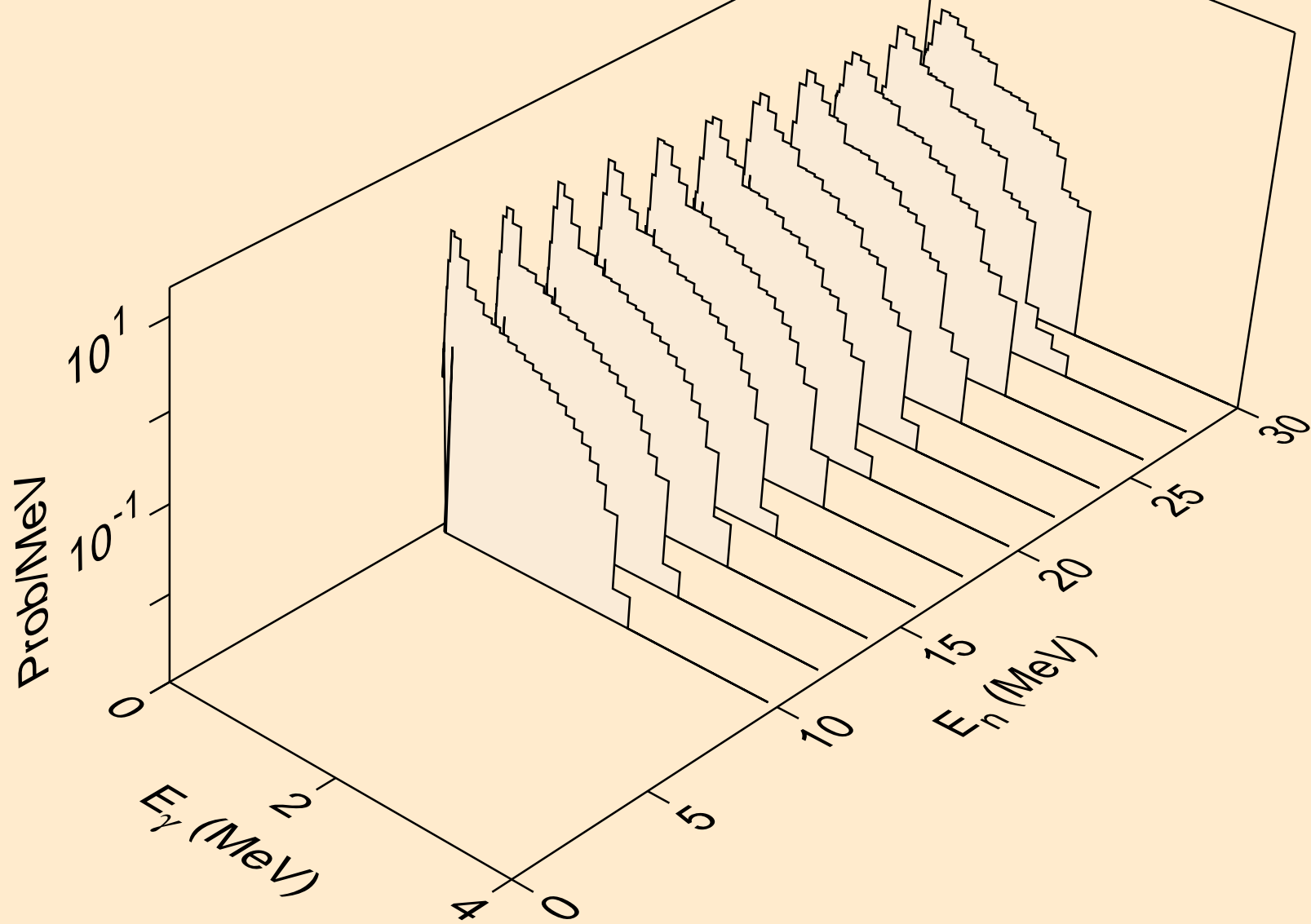

MD246M HELION ACER TENDL-2023 LIBRARY; T=0.K  
Photon emission for (z,x)

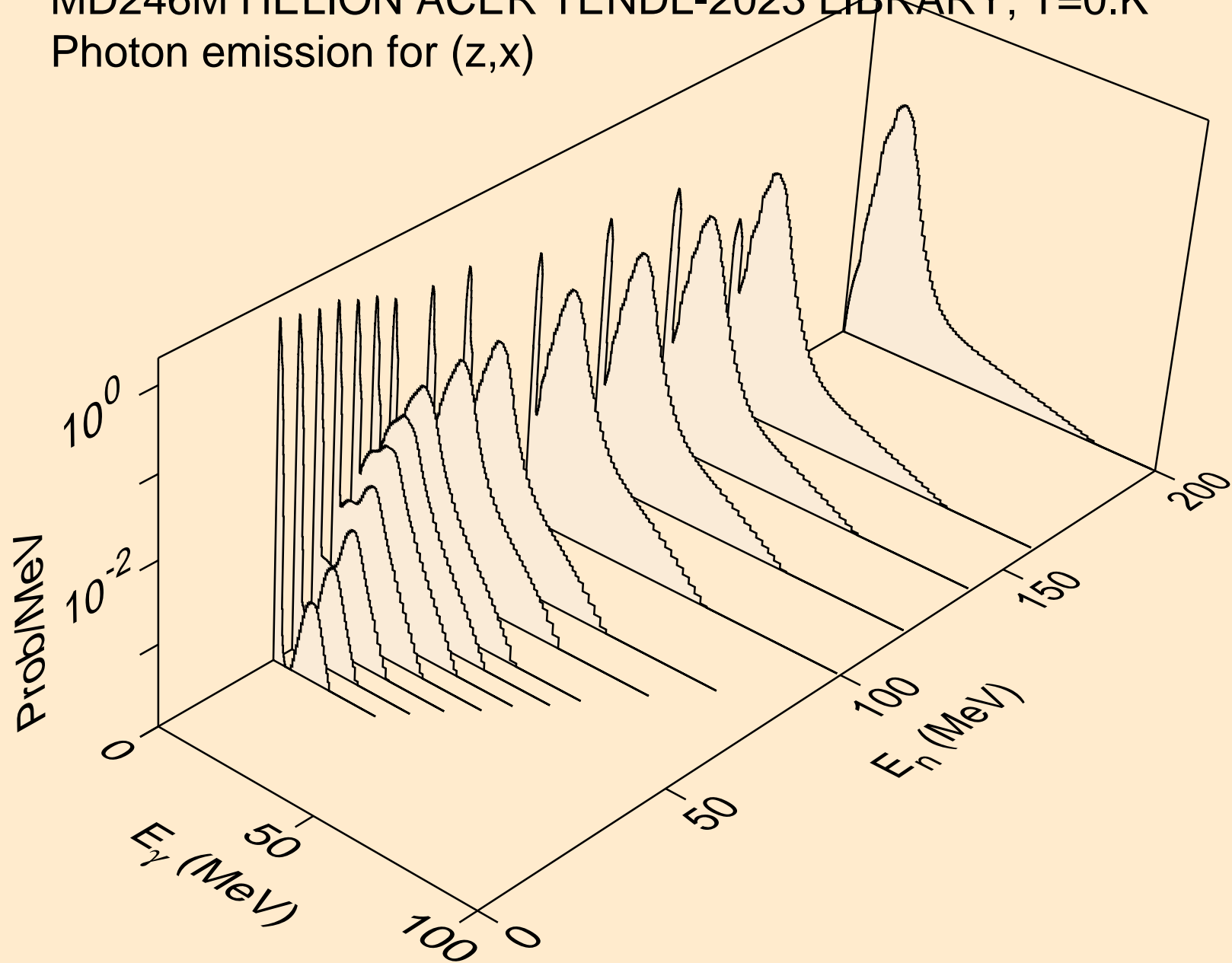

MD246M HELION ACER TENDL-2023 LIBRARY; T=0.K  
Photon emission for (n,2n)

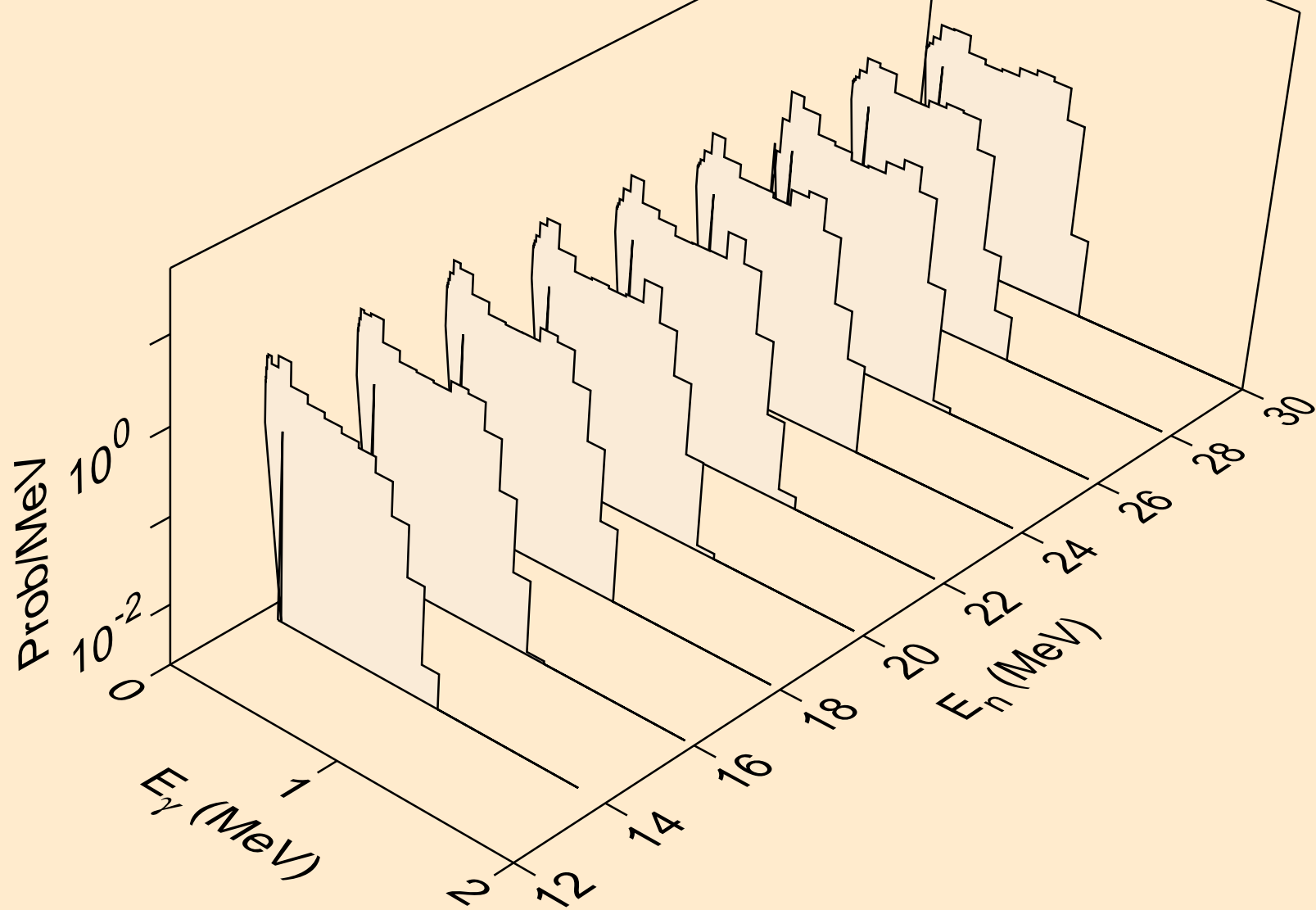

MD246M HELION ACER TENDL-2023 LIBRARY; T=0.K  
Photon emission for (n,n\*)a

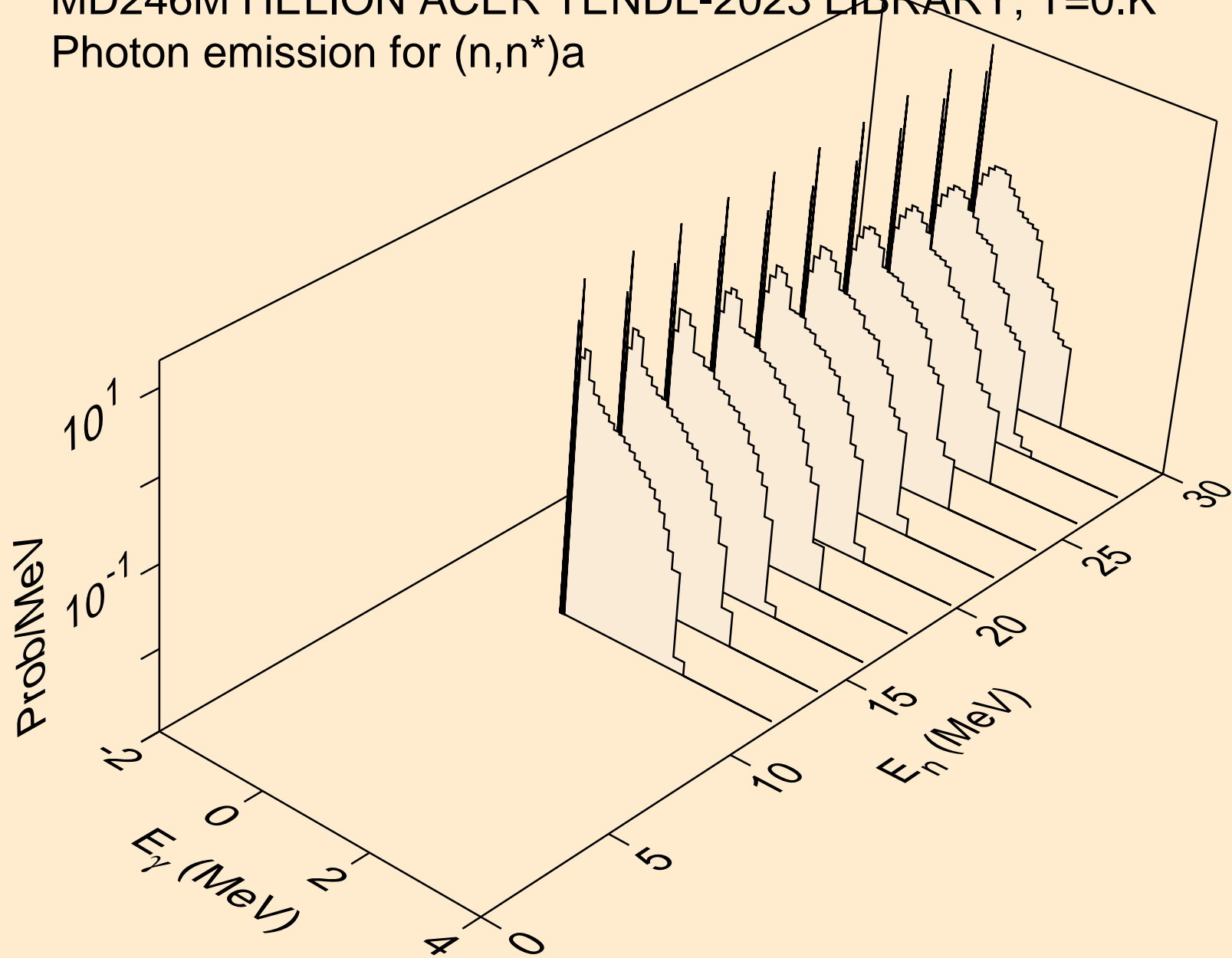

MD246M HELION ACER TENDL-2023 LIBRARY; T=0.K  
Photon emission for (n,n\*)p

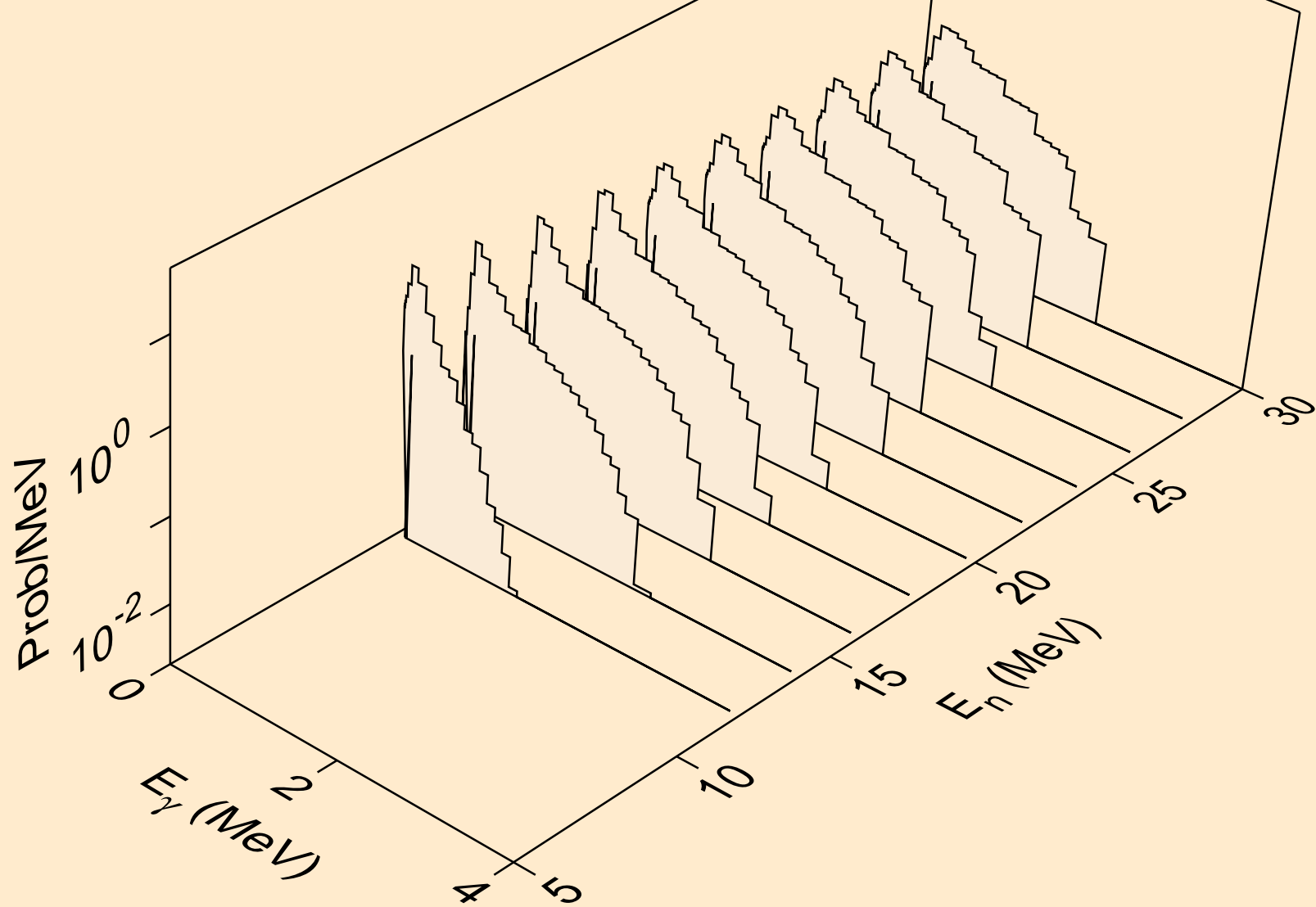

MD246M HELION ACER TENDL-2023 LIBRARY; T=0.K  
Photon emission for (n,n\*)d

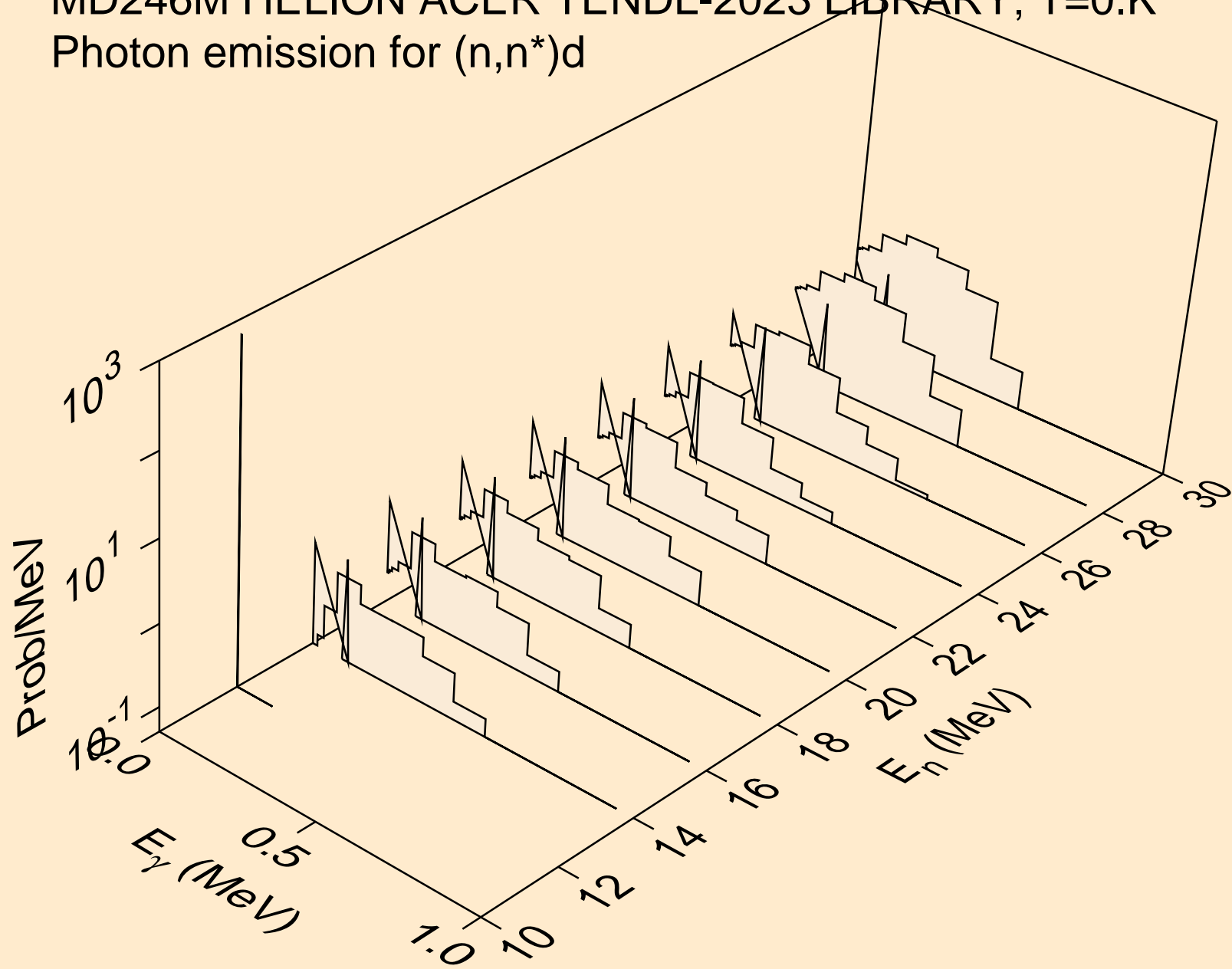

MD246M HELION ACER TENDL-2023 LIBRARY; T=0.K  
Photon emission for (n,n\*)t

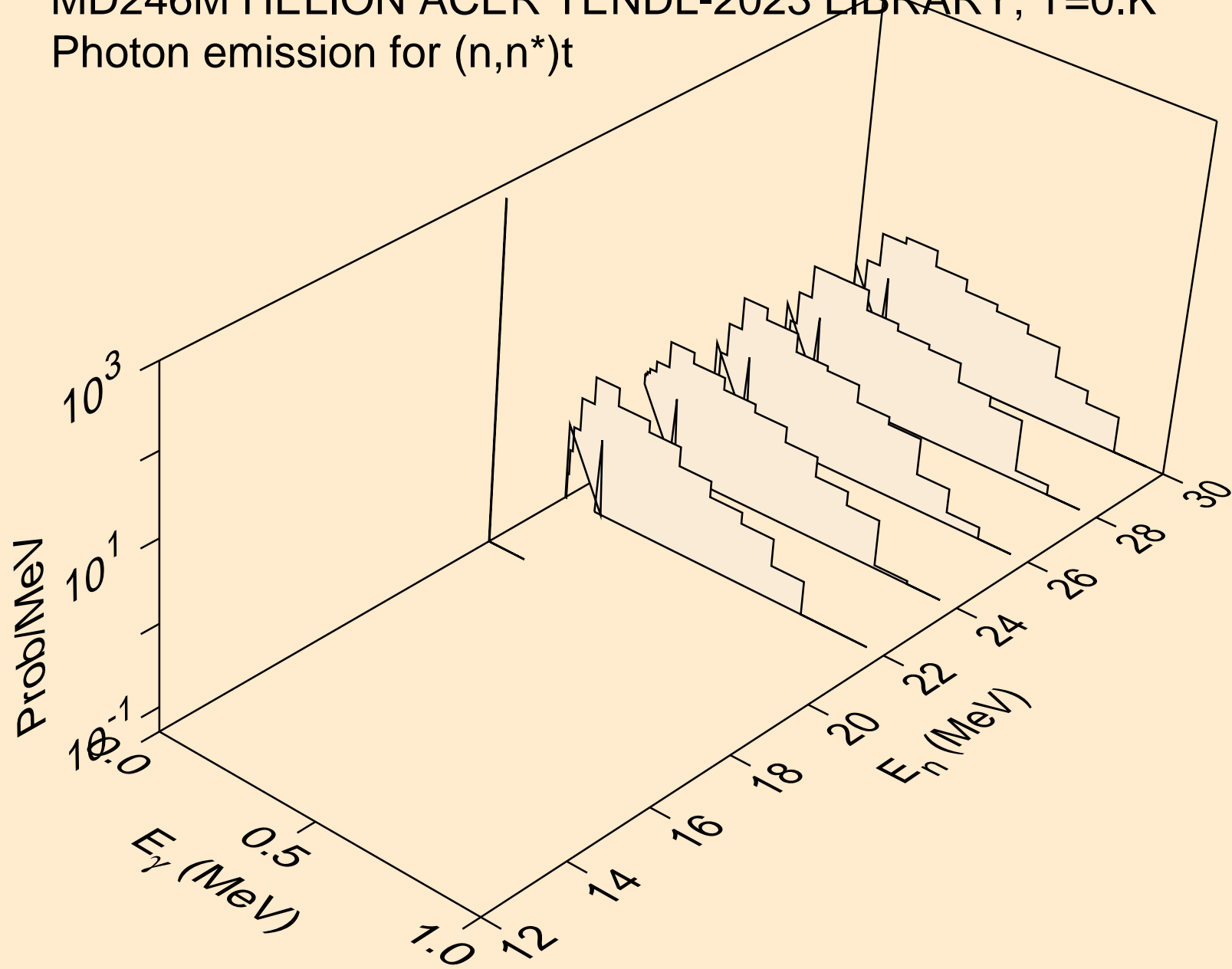

MD246M HELION ACER TENDL-2023 LIBRARY; T=0.K  
Photon emission for (n,2np)

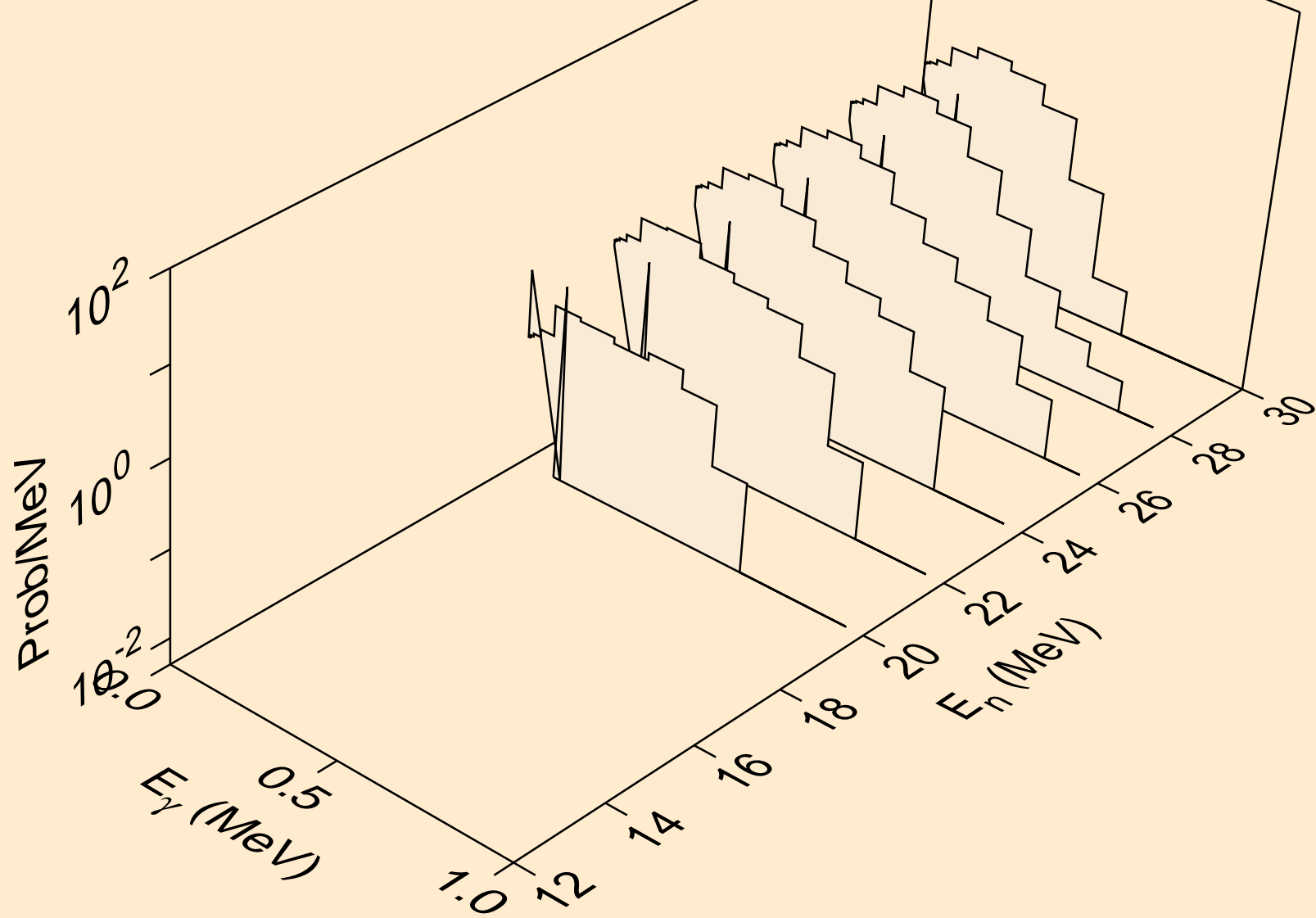

MD246M HELION ACER TENDL-2023 LIBRARY; T=0.K  
Photon emission for (n,p)

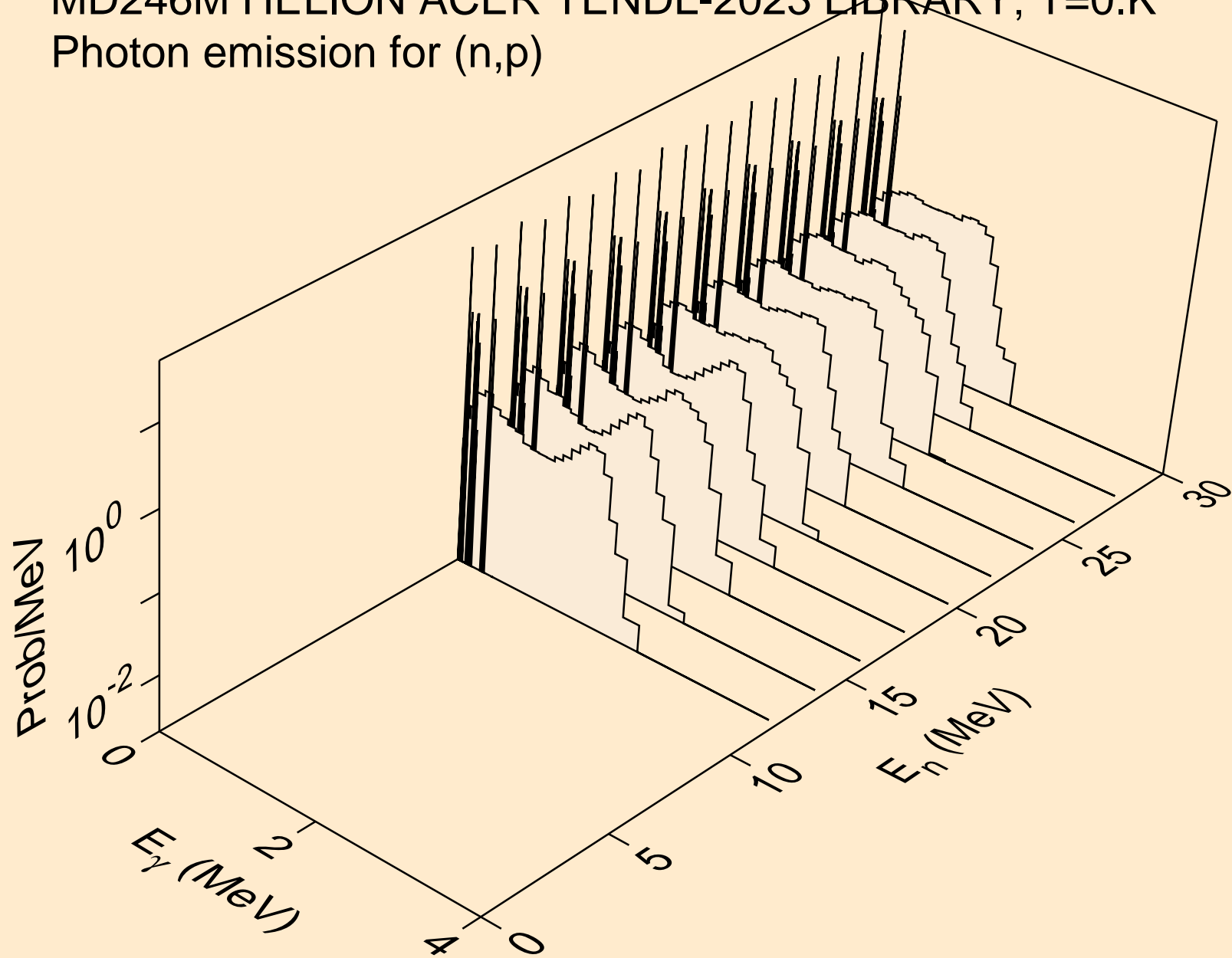

MD246M HELION ACER TENDL-2023 LIBRARY; T=0.K  
Photon emission for (n,d)

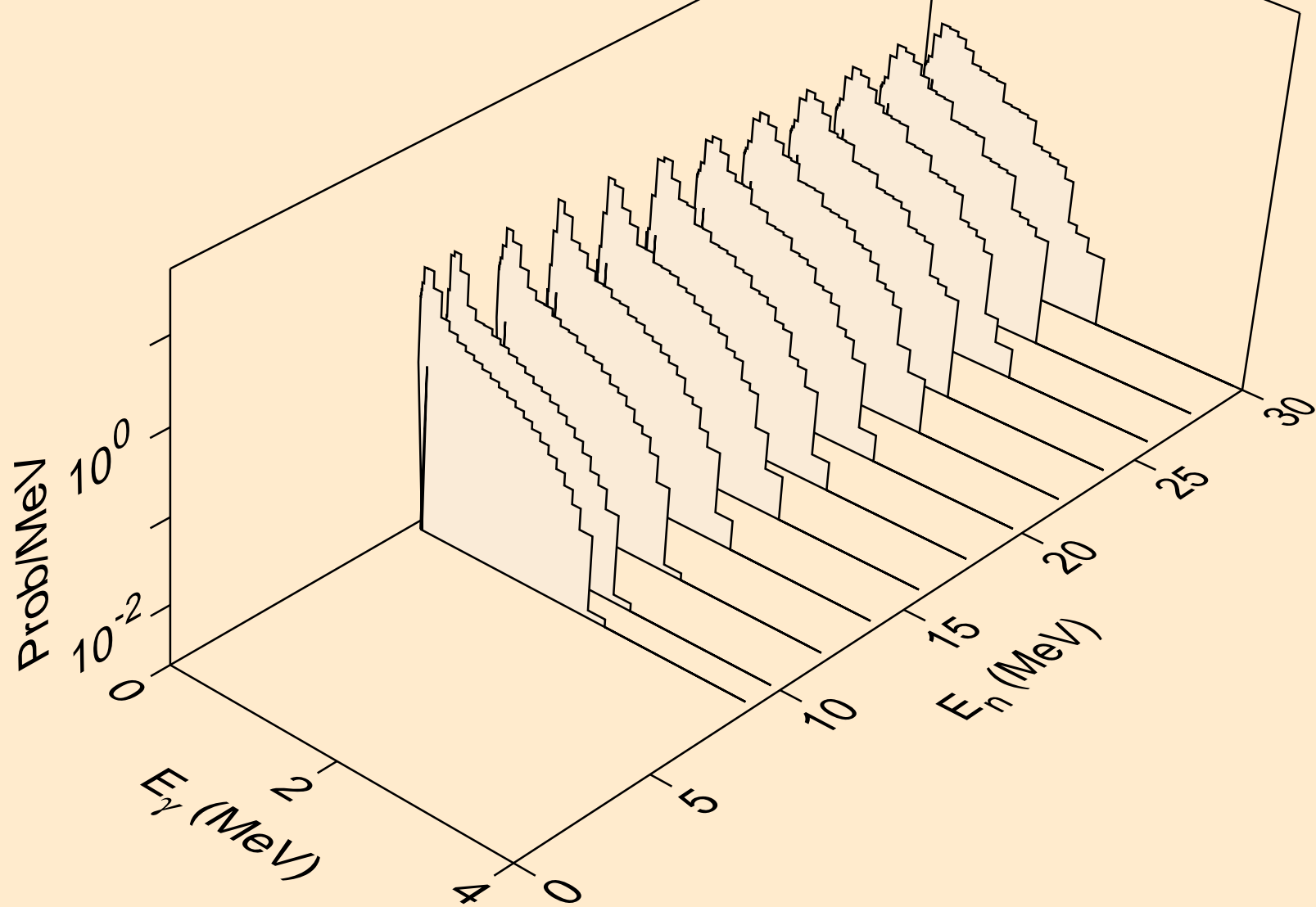

MD246M HELION ACER TENDL-2023 LIBRARY; T=0.K  
Photon emission for (n,t)

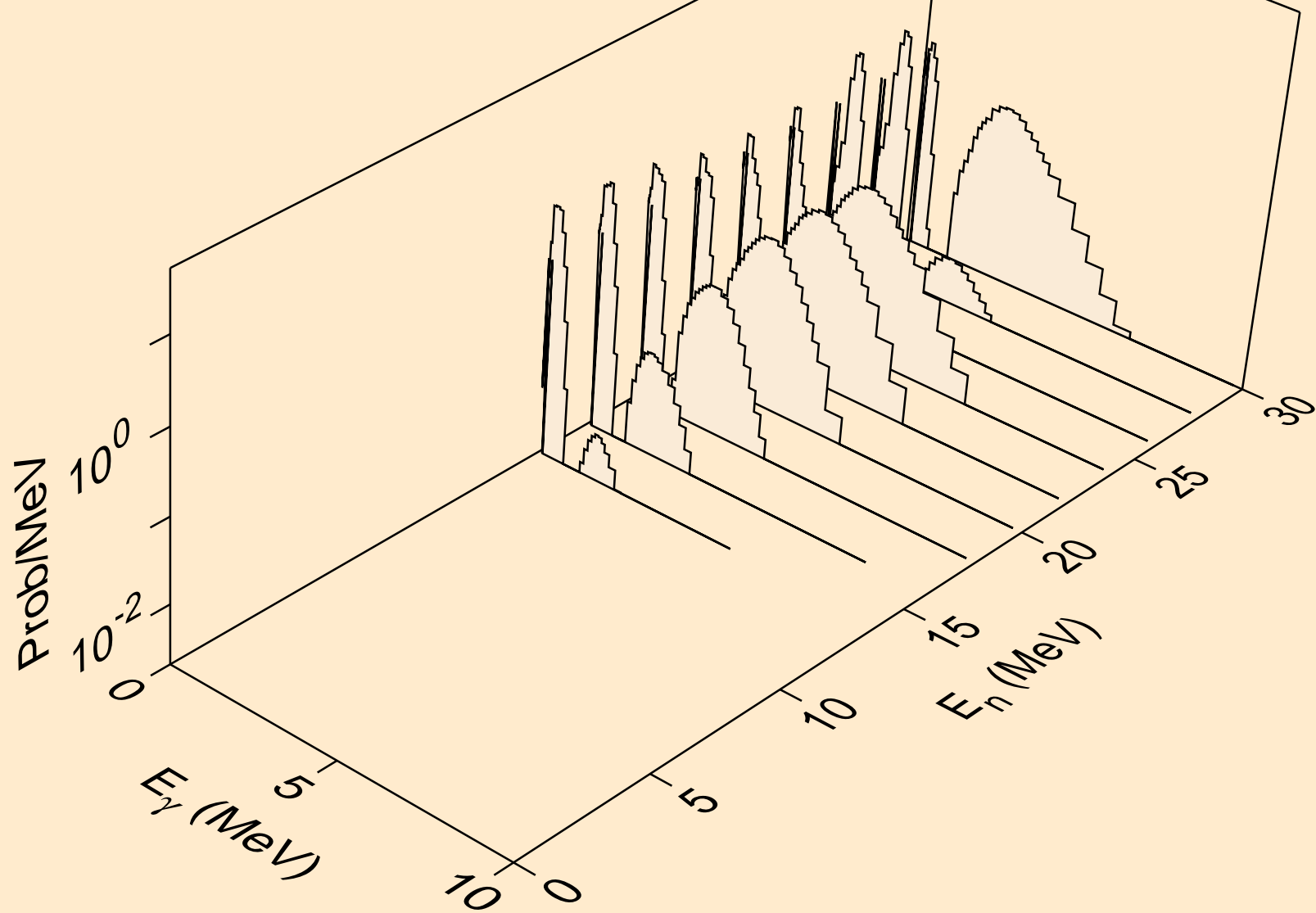

MD246M HELION ACER TENDL-2023 LIBRARY; T=0.K  
Photon emission for inelastic

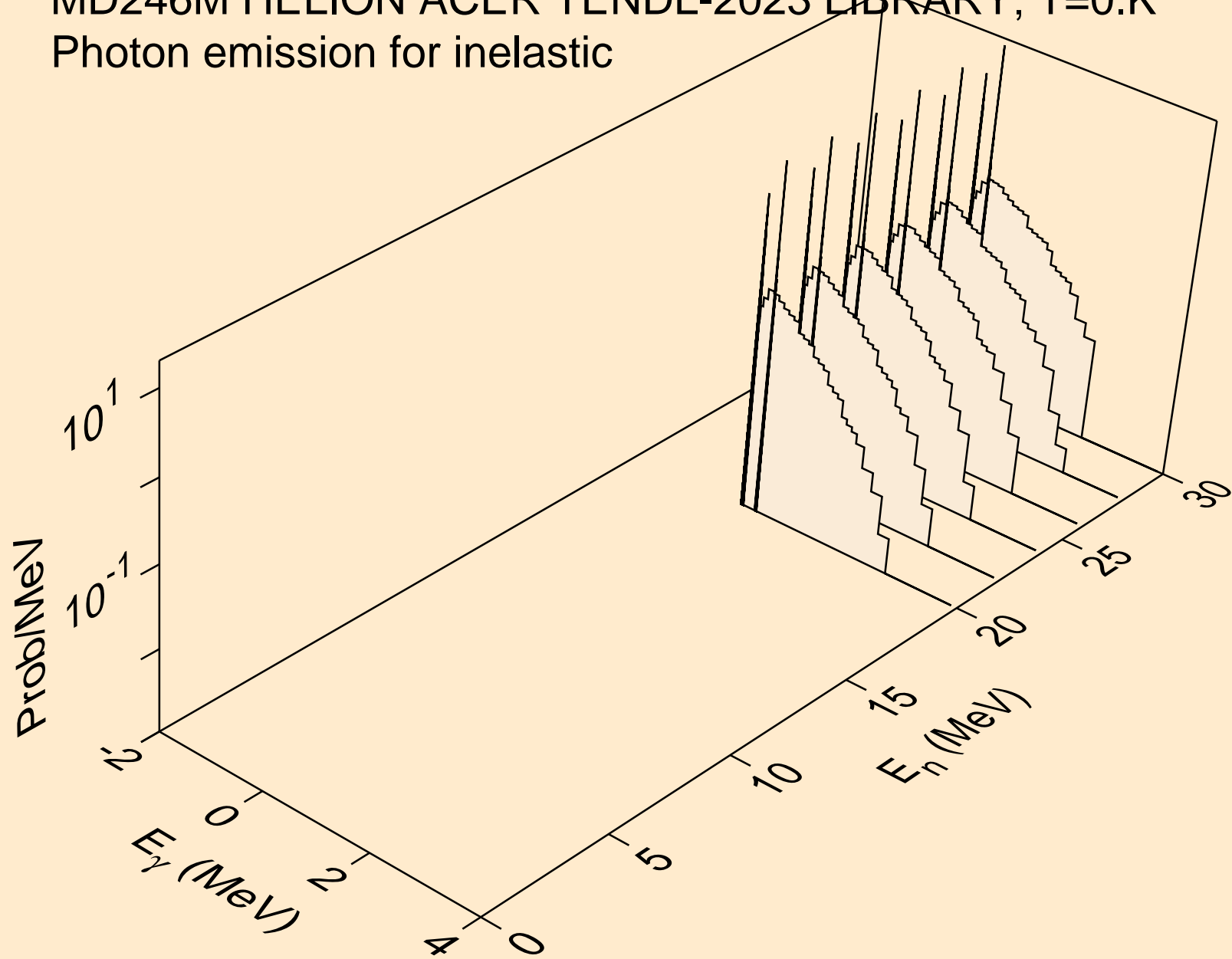

MD246M HELION ACER TENDL-2023 LIBRARY; T=0.K  
Photon emission for (n,a)

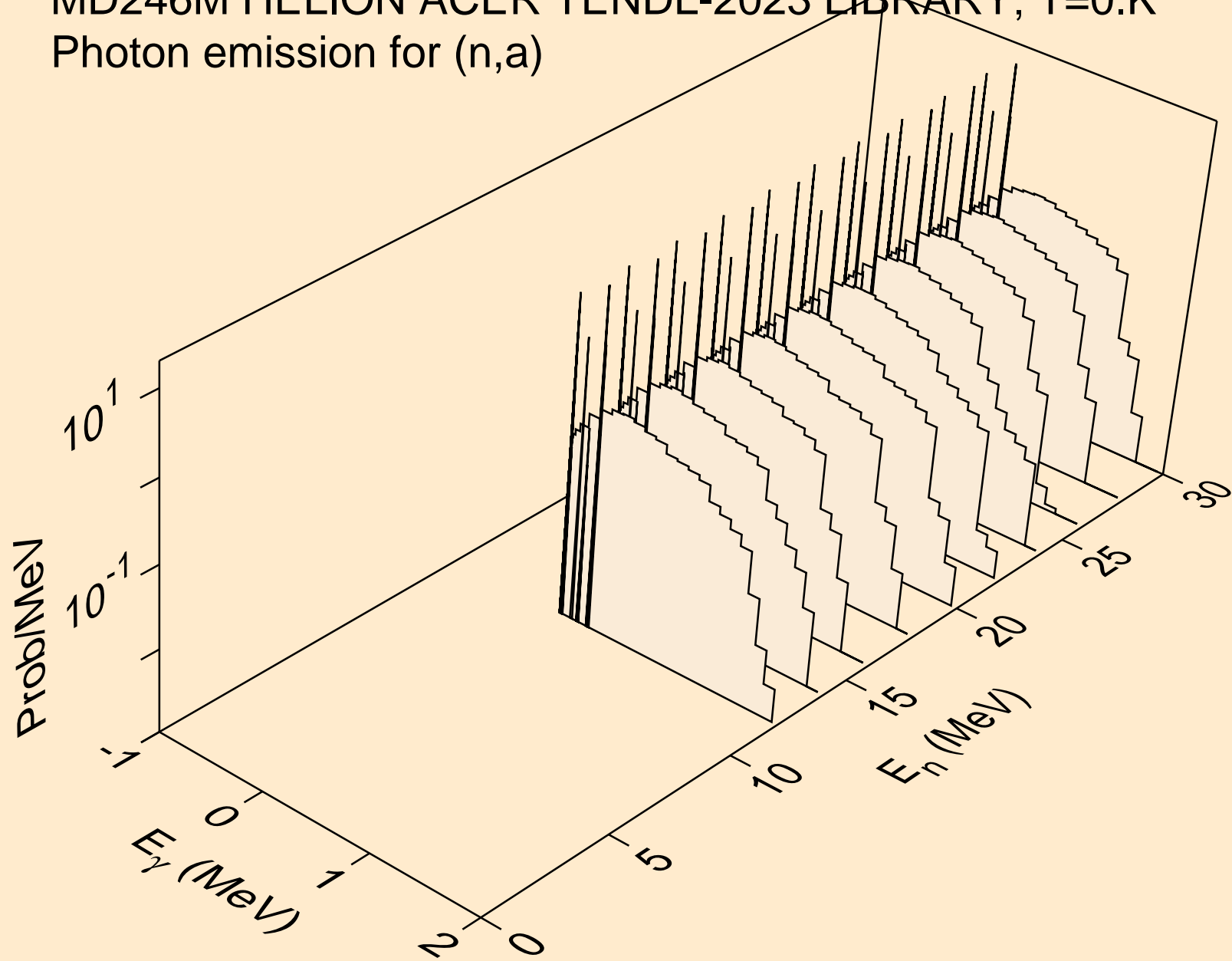

MD246M HELION ACER TENDL-2023 LIBRARY; T=0.K  
Photon emission for (n,2a)

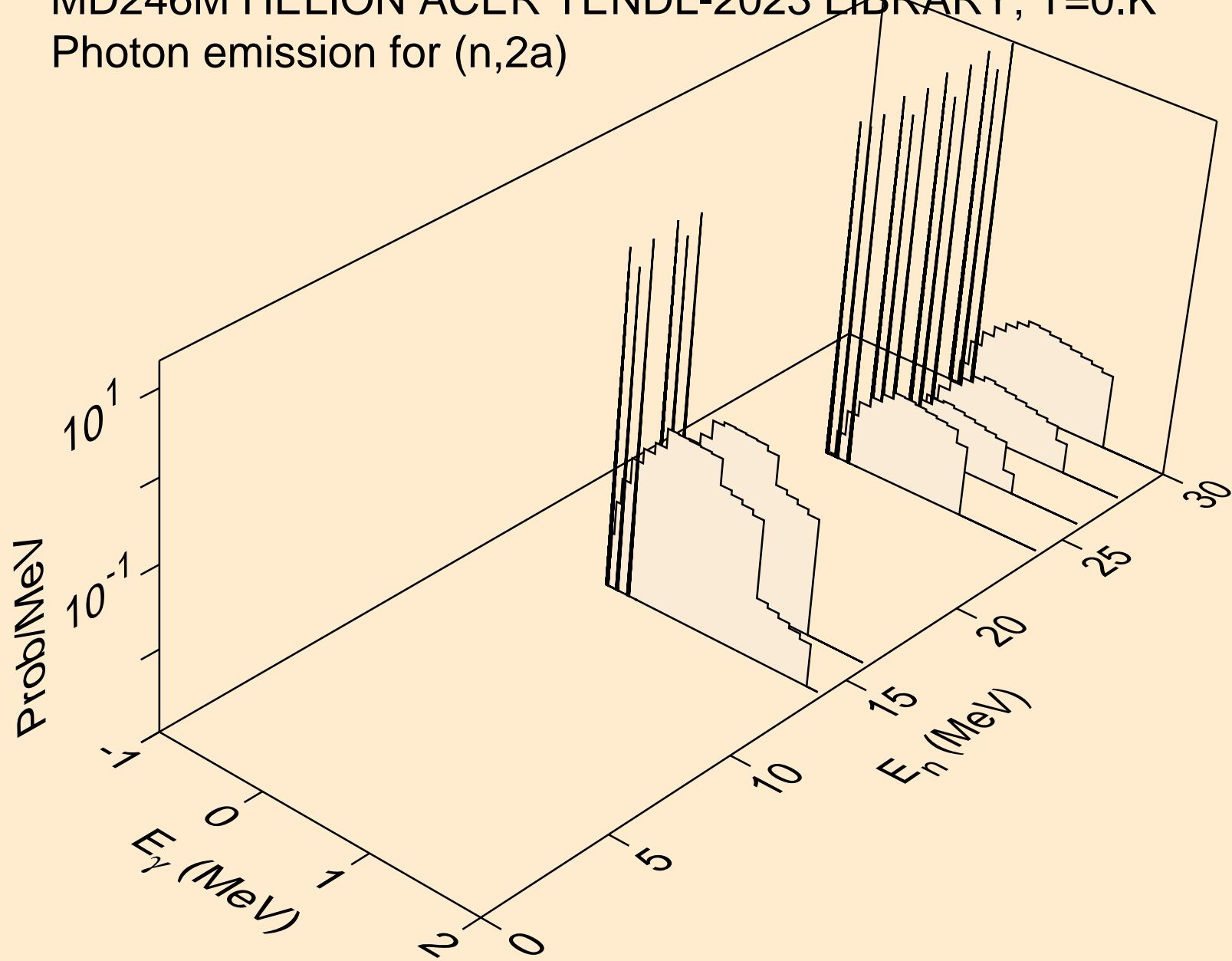

MD246M HELION ACER TENDL-2023 LIBRARY; T=0.K  
Photon emission for (n,2p)

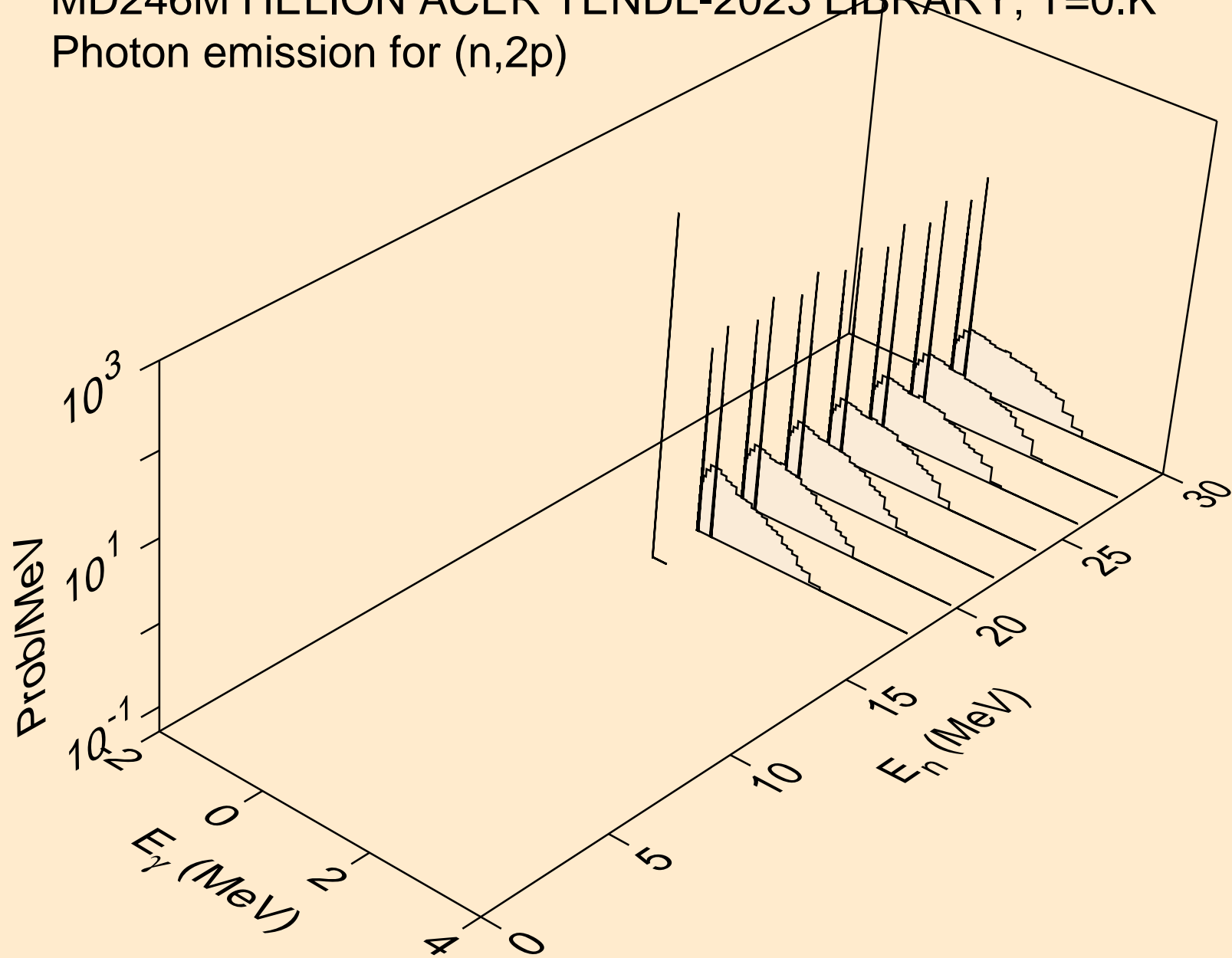

MD246M HELION ACER TENDL-2023 LIBRARY; T=0.K  
Photon emission for (n,da)

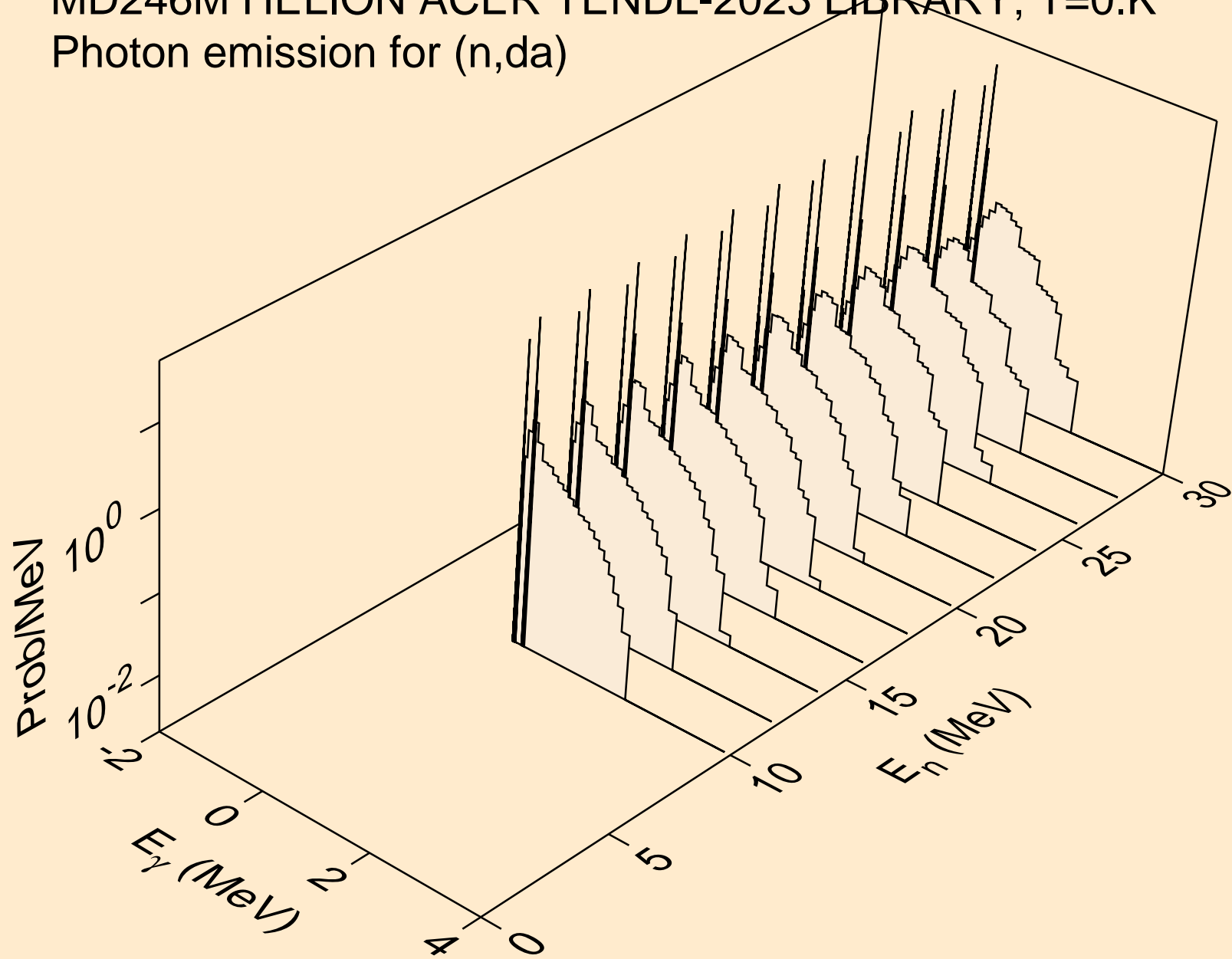

MD246M HELION ACER TENDL-2023 LIBRARY; T=0.K  
Particle heating contributions

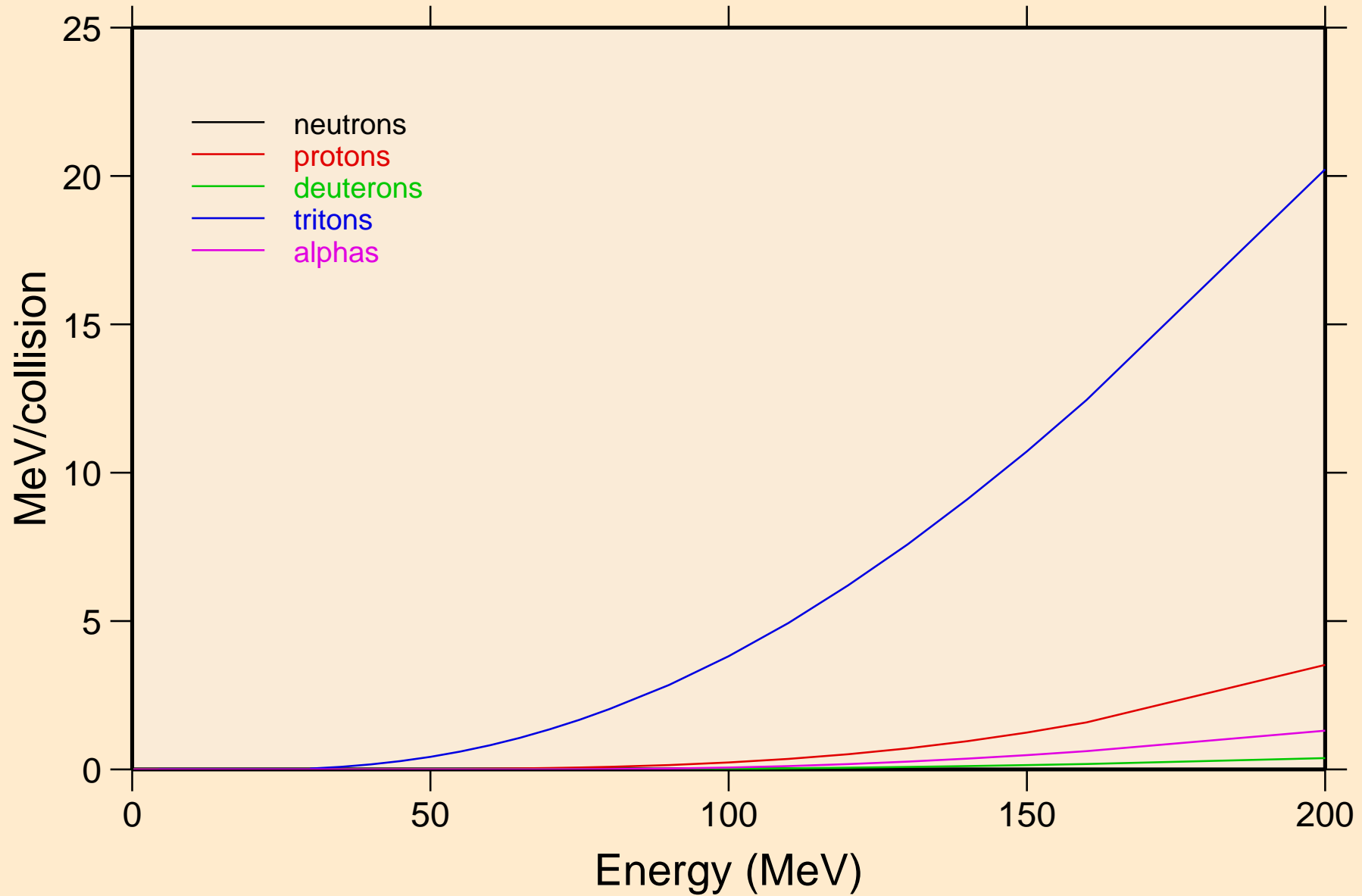

MD246M HELION ACER TENDL-2023 LIBRARY; T=0.K  
Recoil Heating

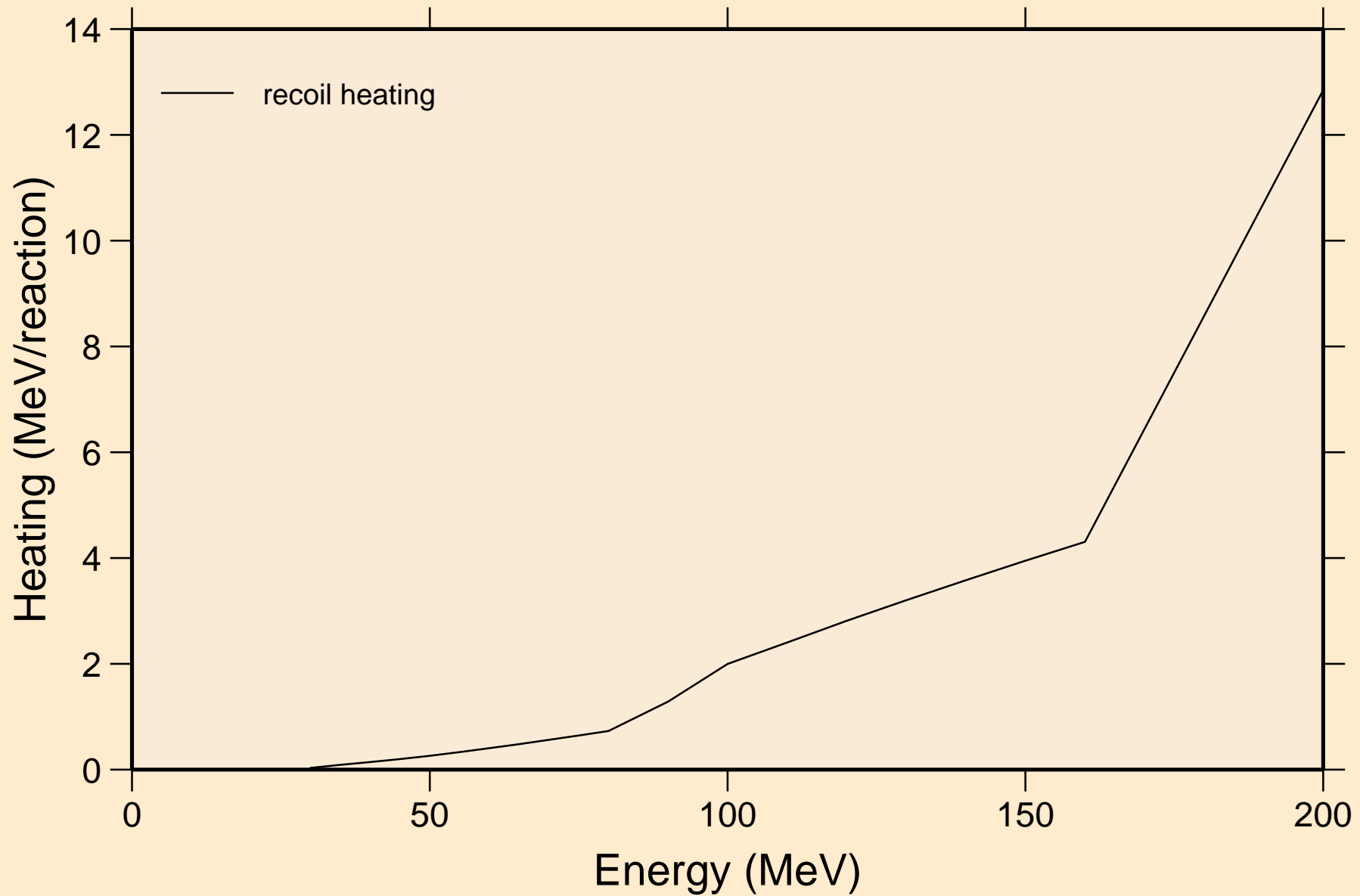

# MD246M HELION ACER TENDL-2023 LIBRARY; T=0.K

## Particle production cross sections

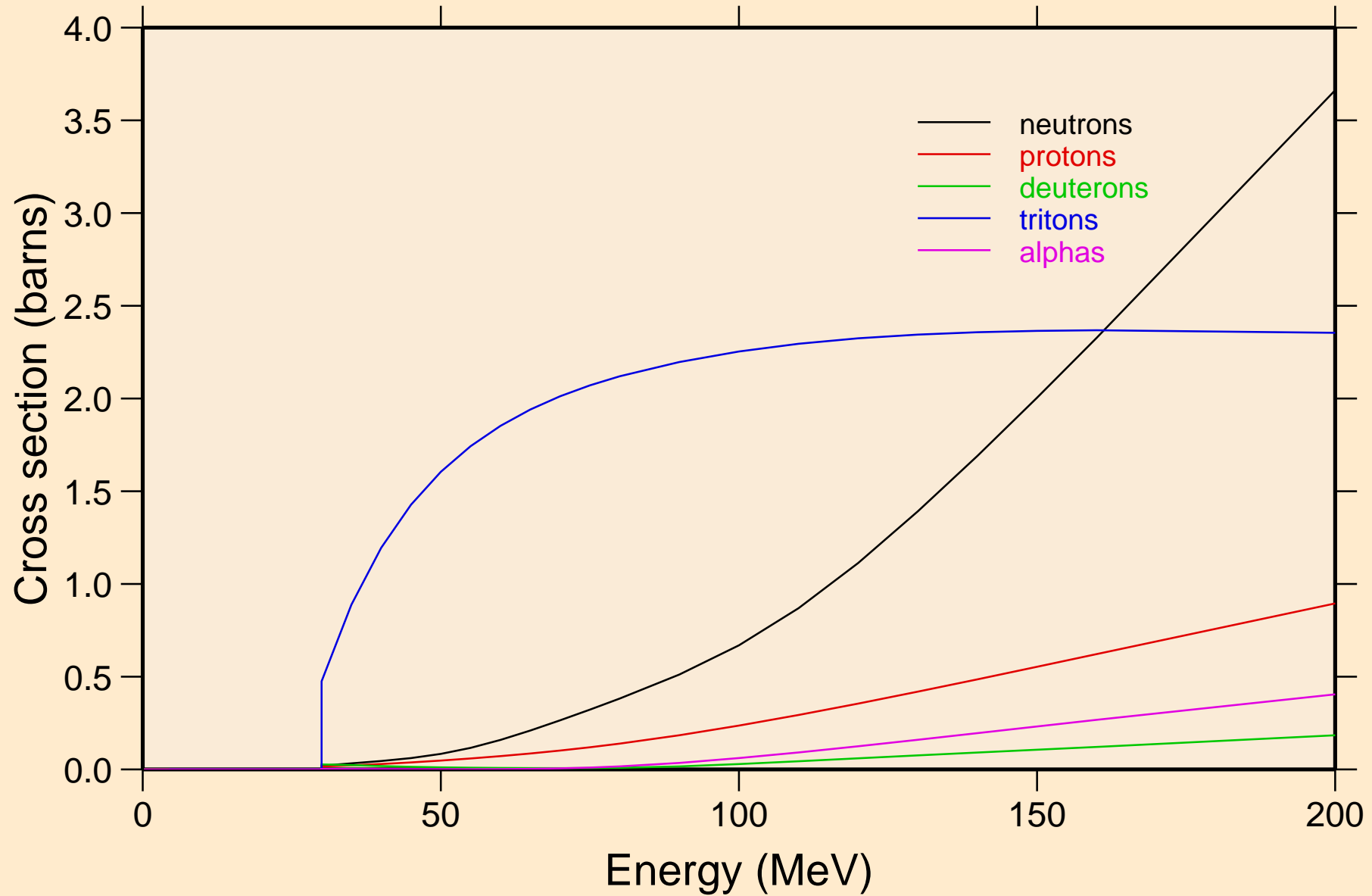

MD246M HELION ACER TENDL-2023 LIBRARY; T=0.K  
neutrons from (s,n)

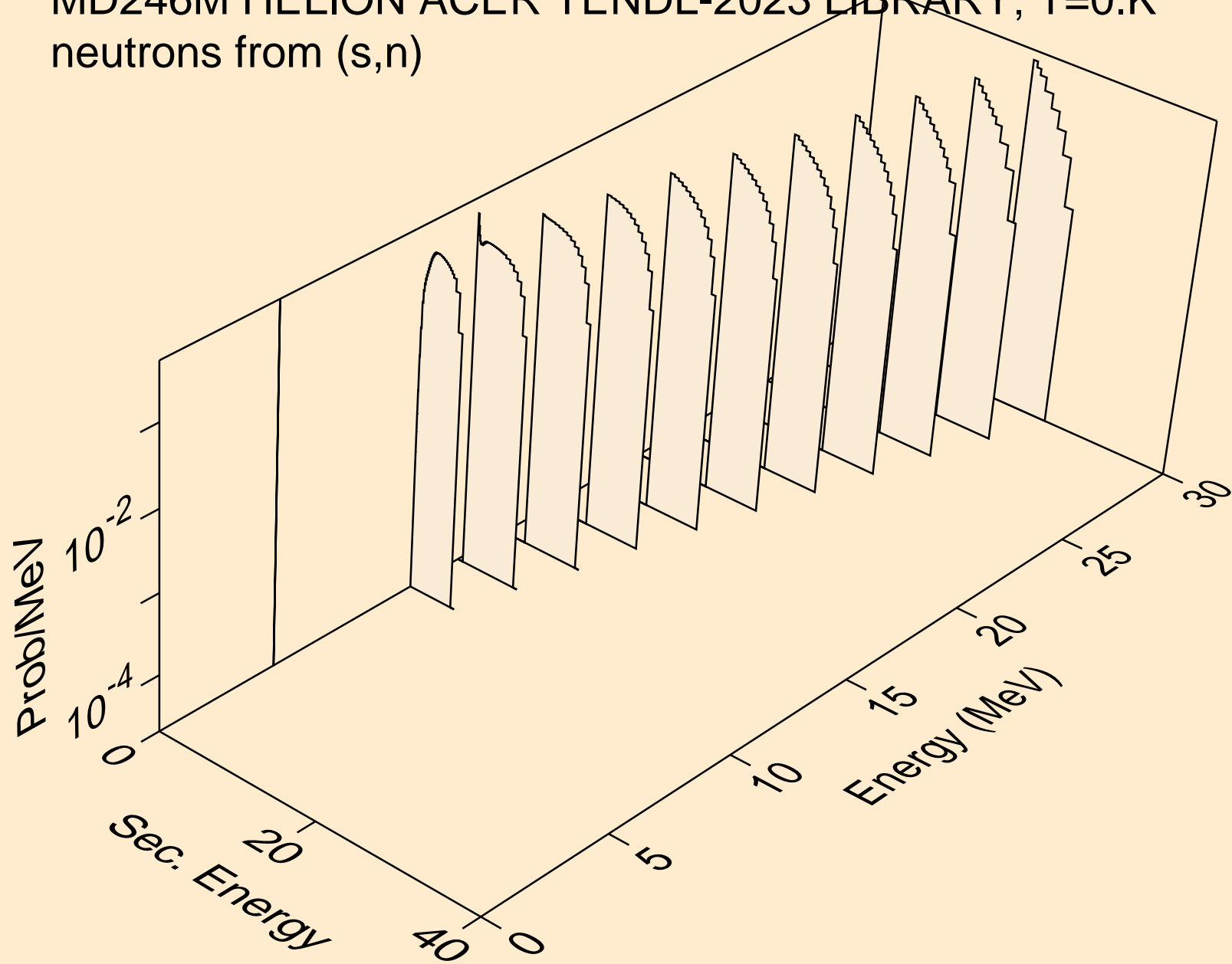

MD246M HELION ACER TENDL-2023 LIBRARY; T=0.K  
neutrons from (s,x)

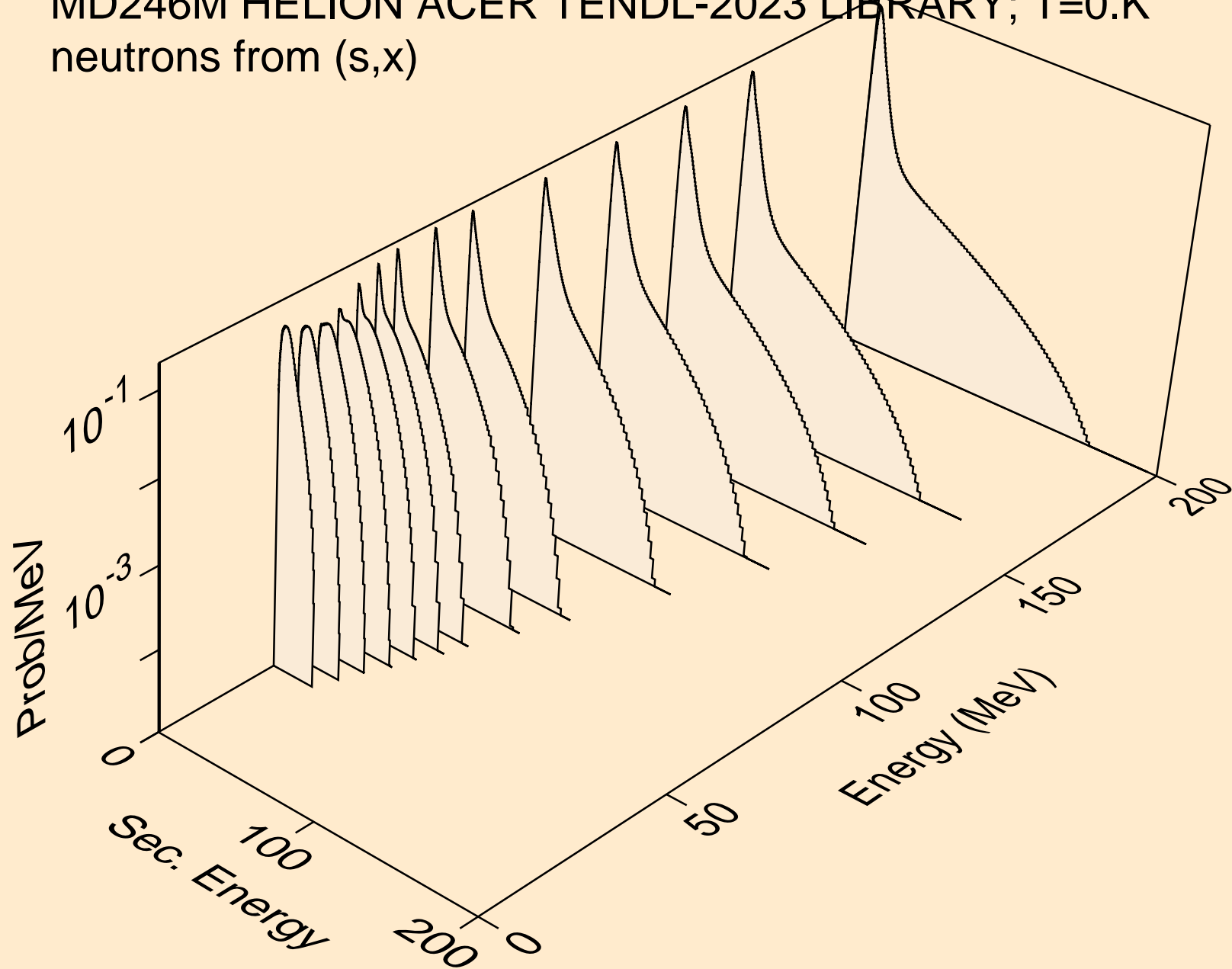

MD246M HELION ACER TENDL-2023 LIBRARY; T=0.K  
neutrons from (s,2n)

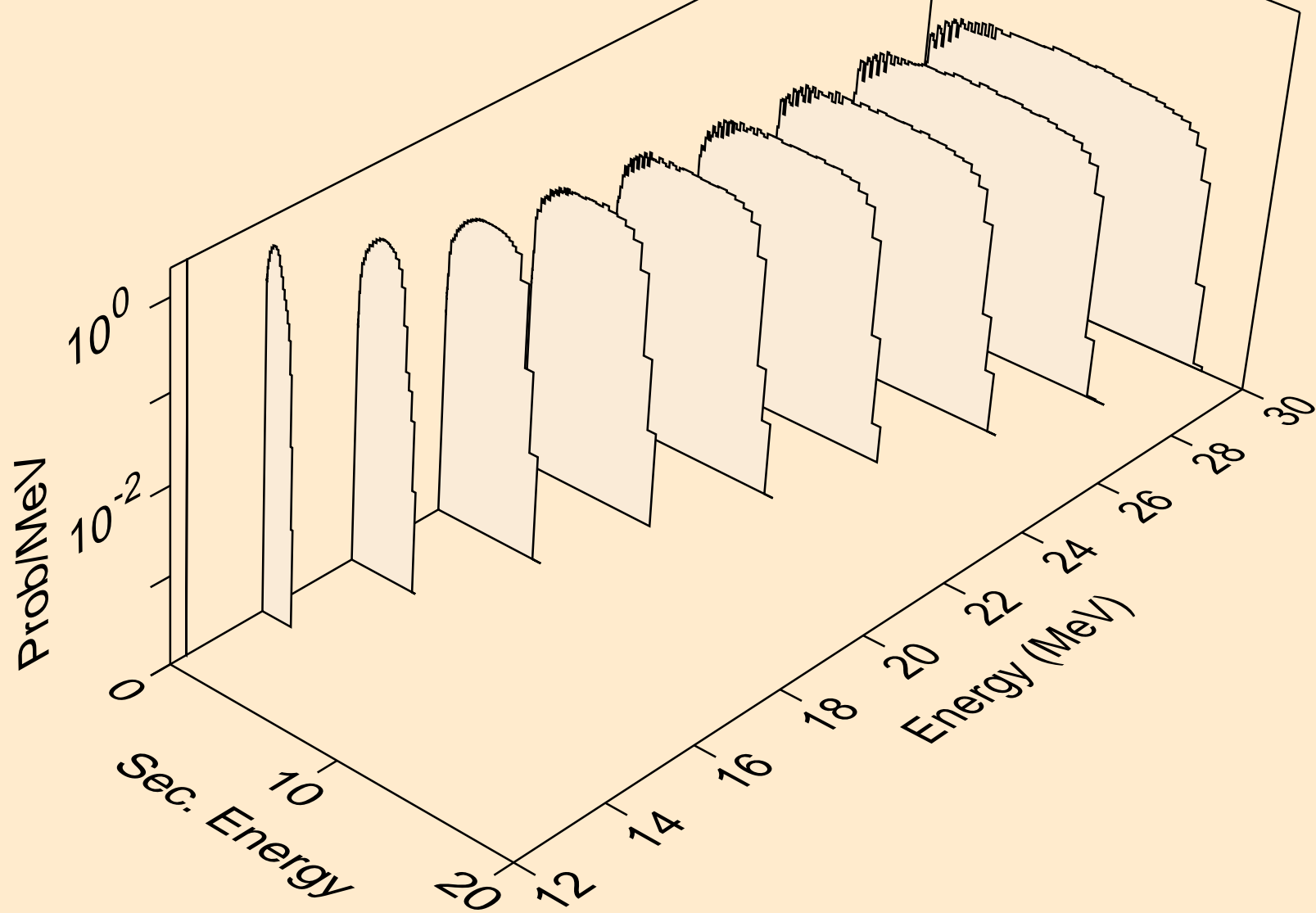

MD246M HELION ACER TENDL-2023 LIBRARY; T=0.K  
neutrons from (s,n\*)a

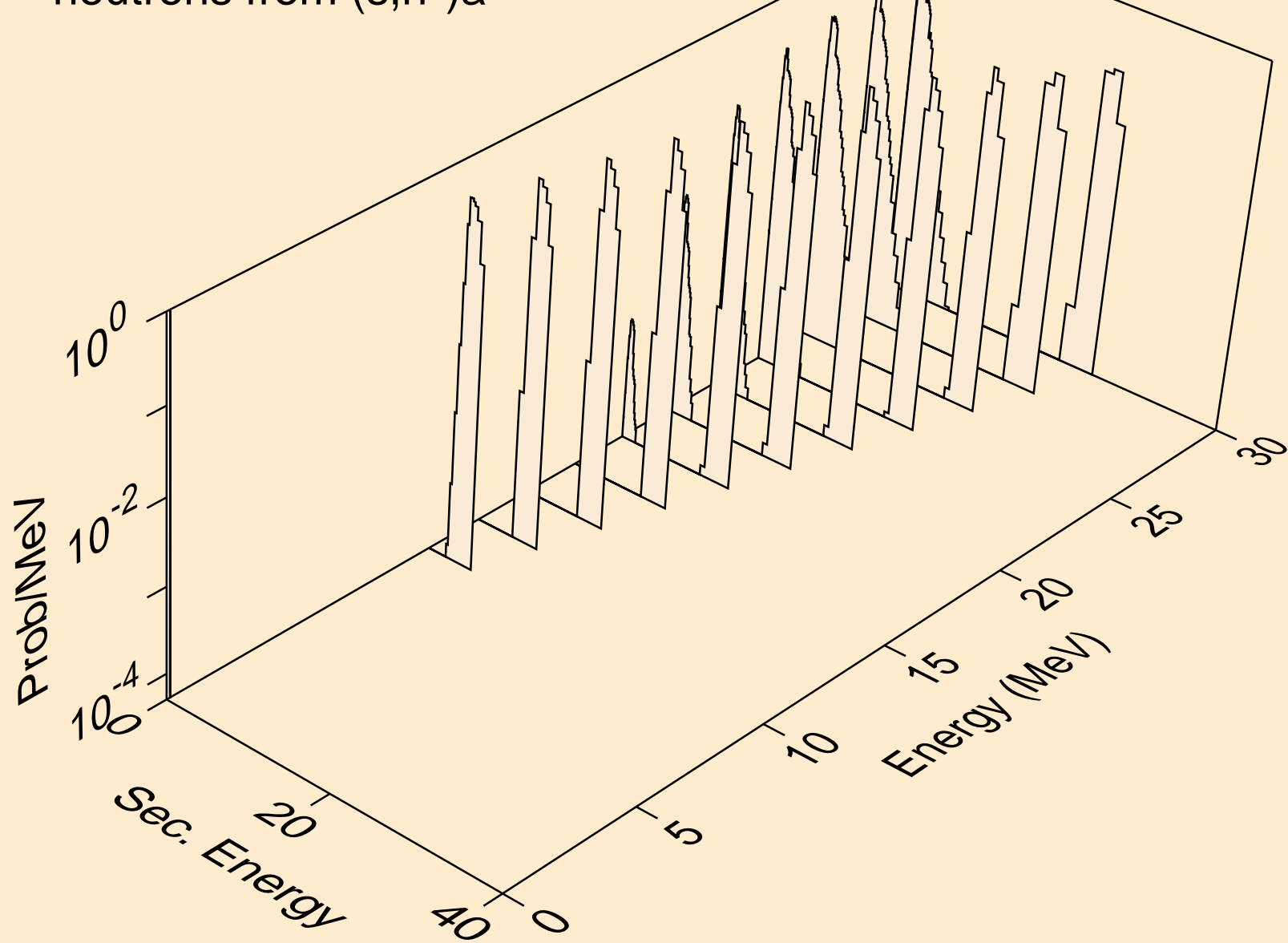

MD246M HELION ACER TENDL-2023 LIBRARY; T=0.K  
neutrons from (s,n\*)p

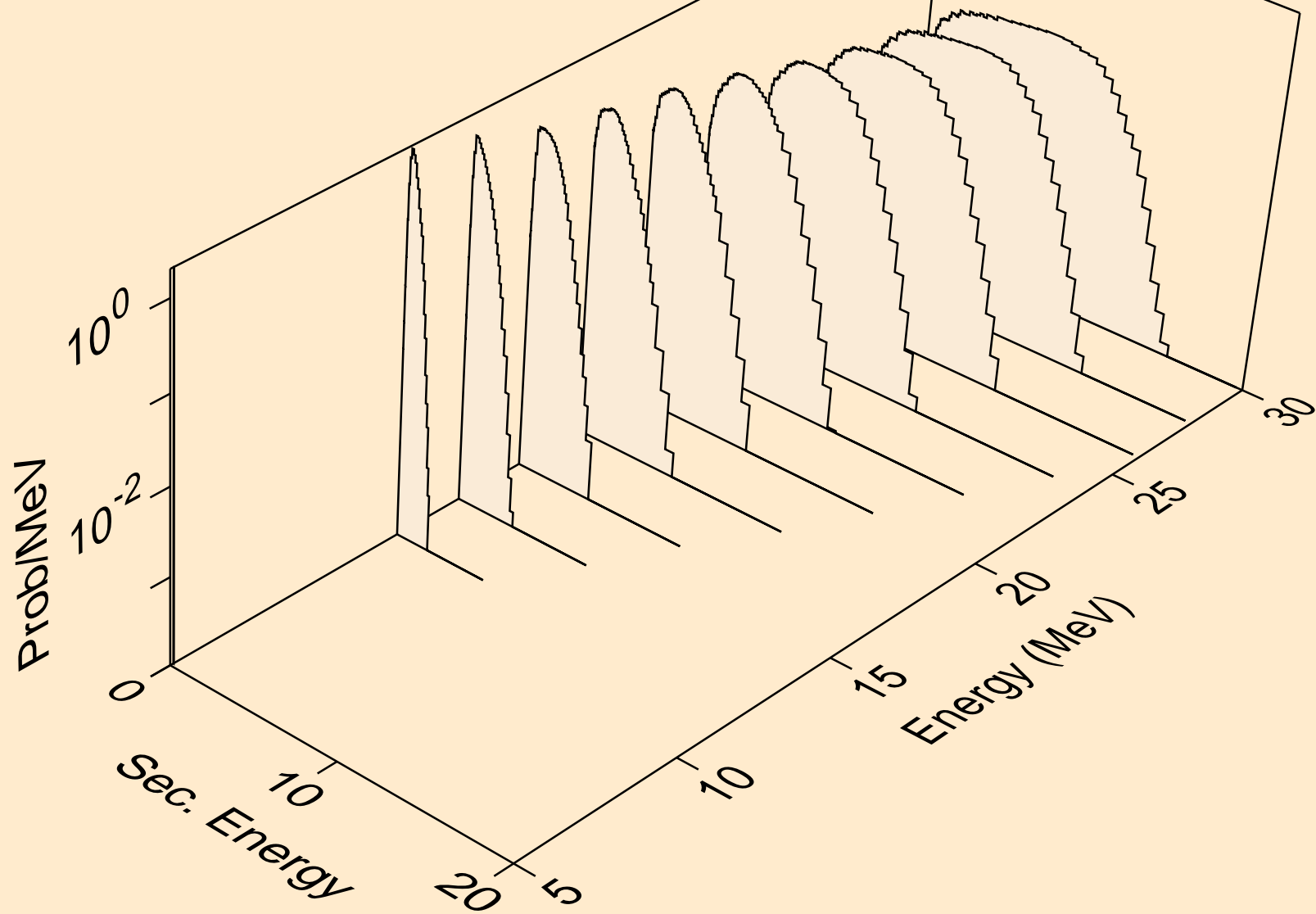

MD246M HELION ACER TENDL-2023 LIBRARY; T=0.K  
neutrons from (s,n\*)d

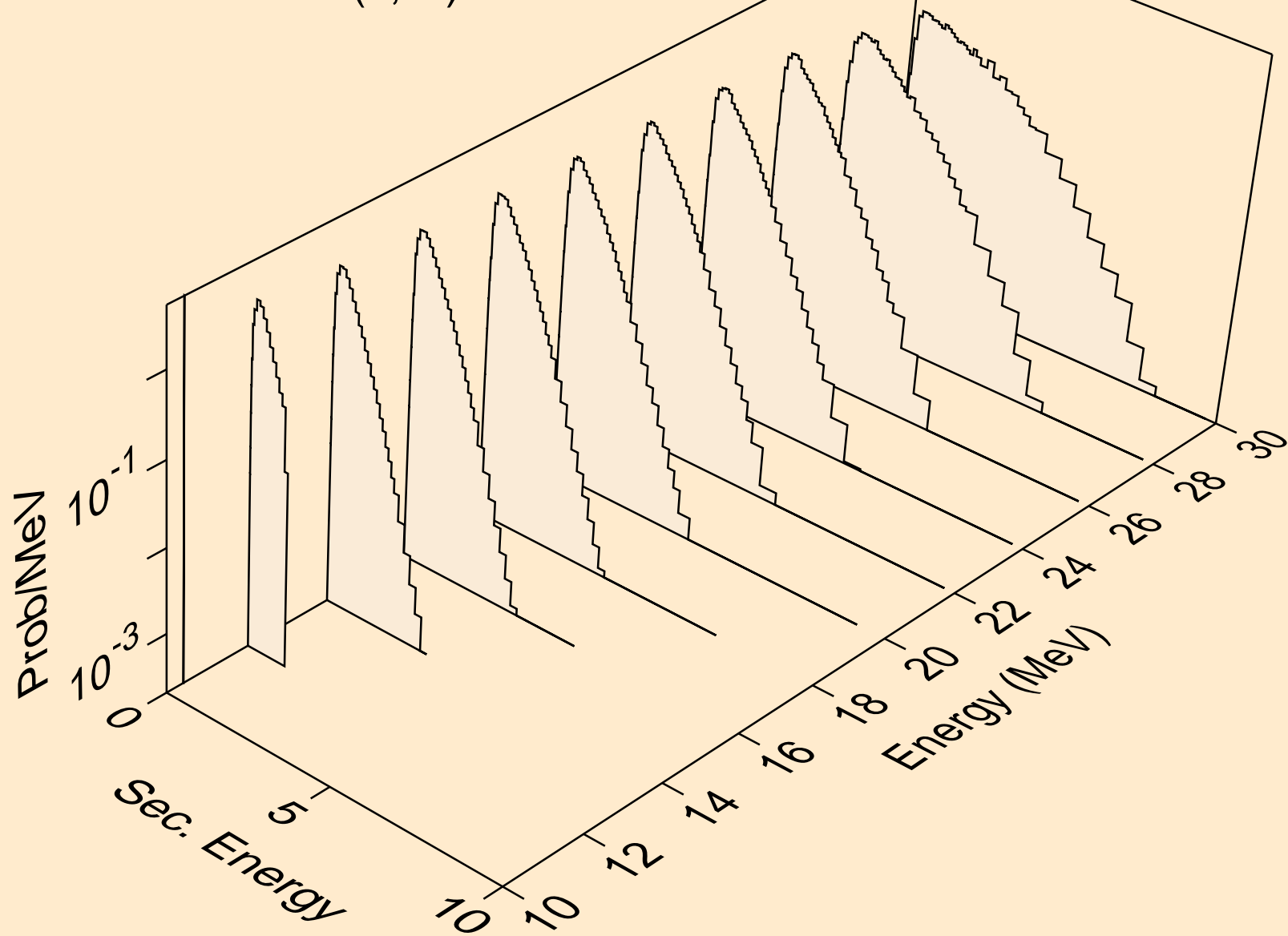

MD246M HELION ACER TENDL-2023 LIBRARY; T=0.K  
neutrons from (s,n\*)t

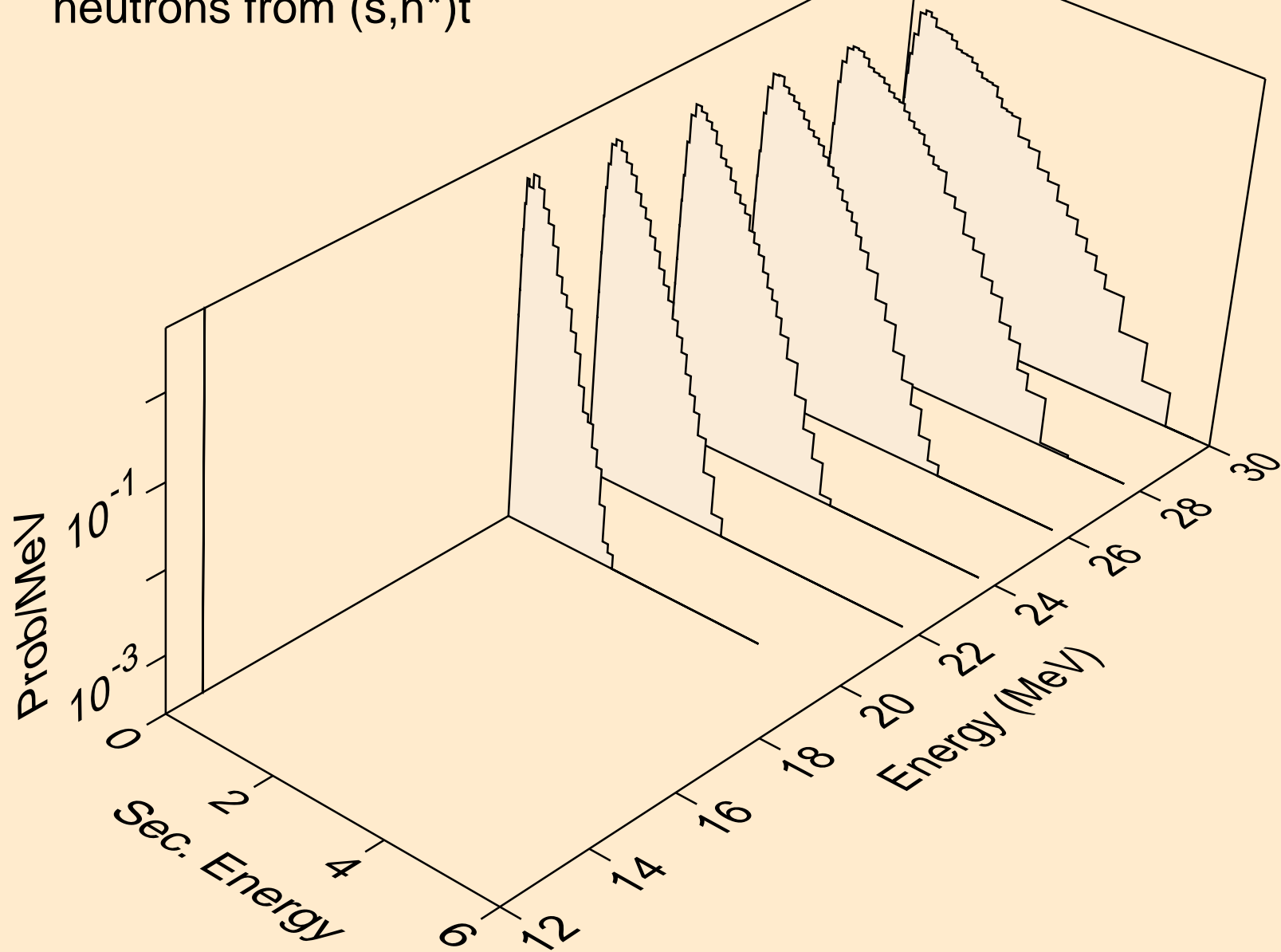

MD246M HELION ACER TENDL-2023 LIBRARY; T=0.K  
neutrons from (s,2np)

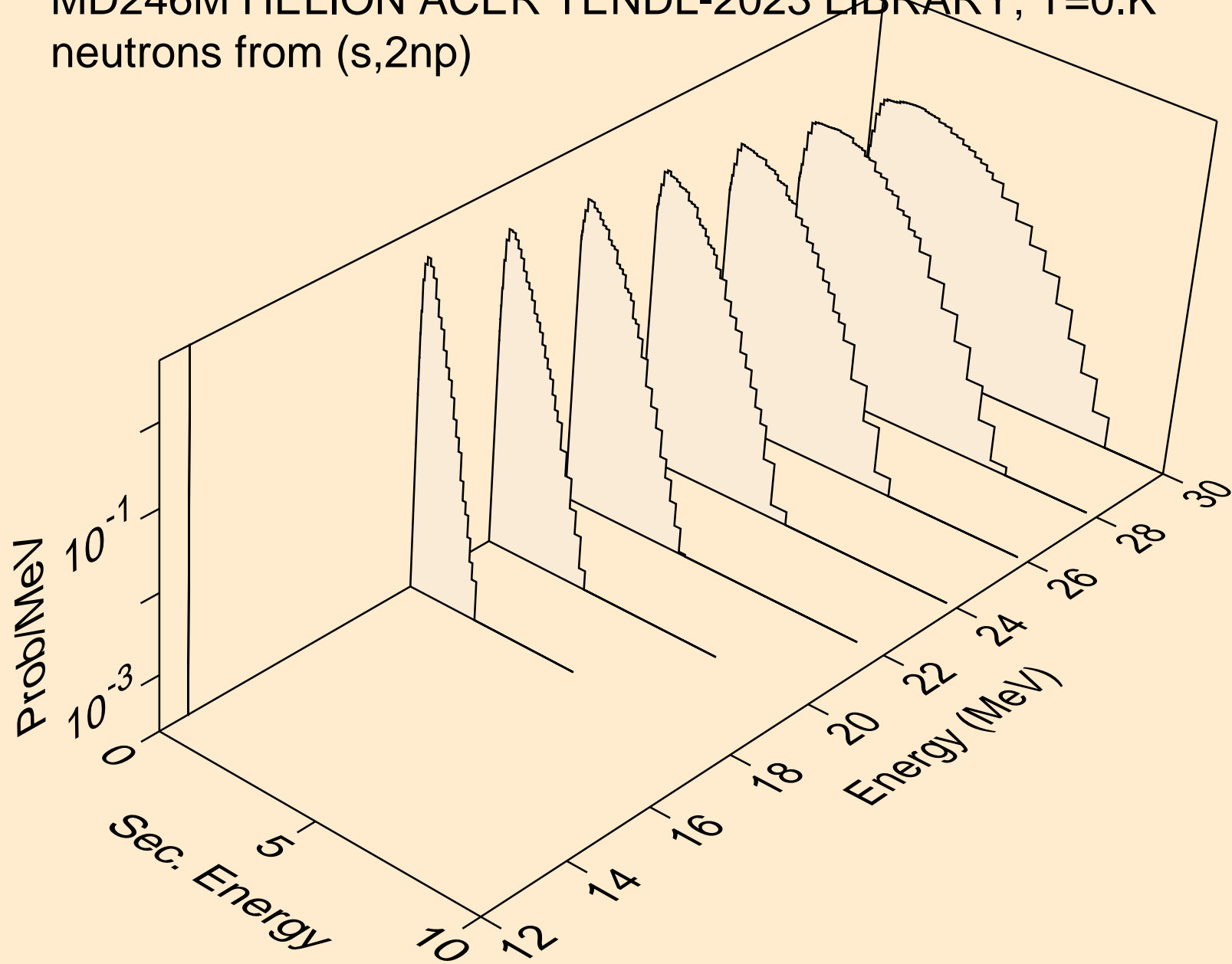

MD246M HELION ACER TENDL-2023 LIBRARY; T=0.K  
protons from (s,x)

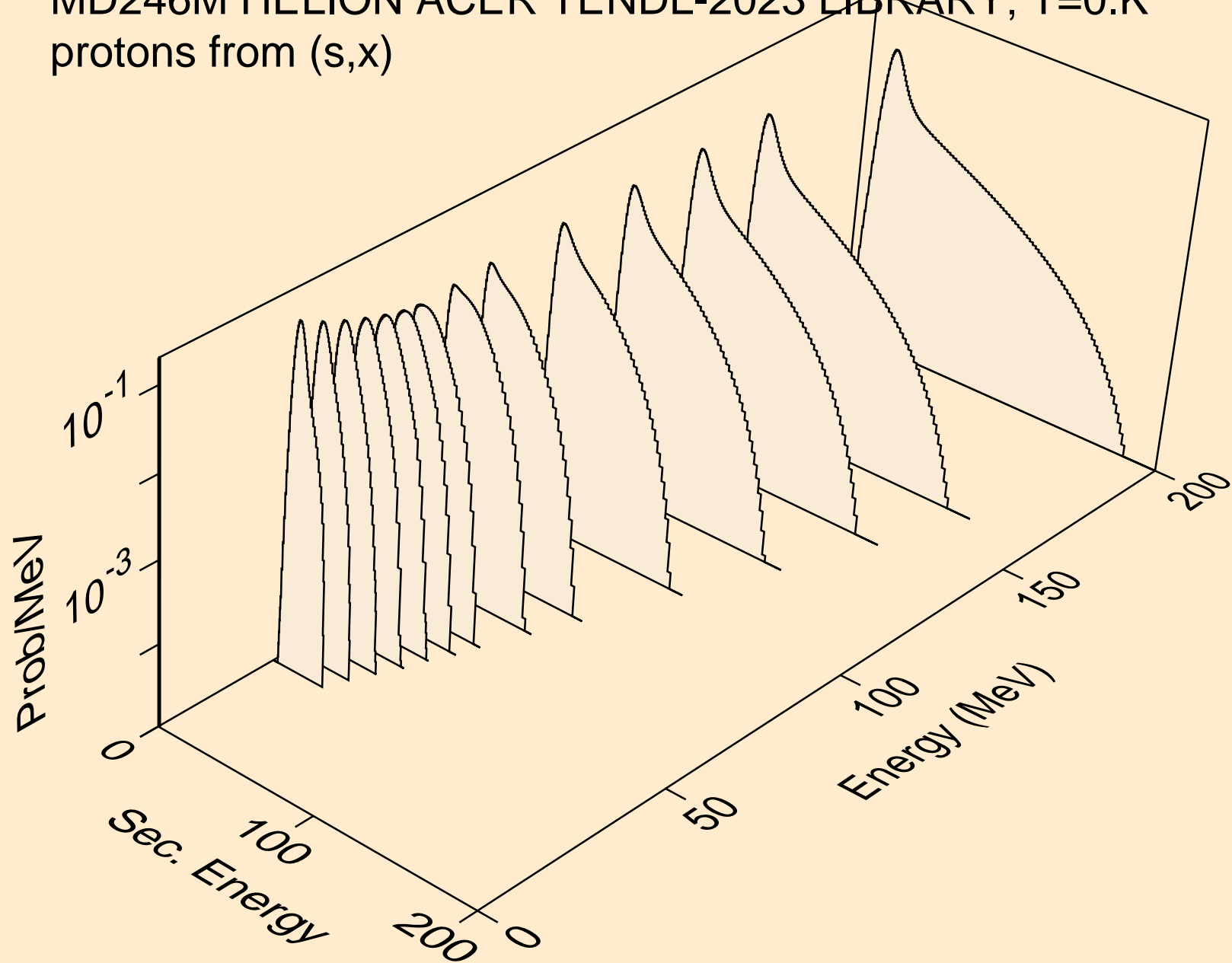

MD246M HELION ACER TENDL-2023 LIBRARY; T=0.K  
protons from (s,n\*)p

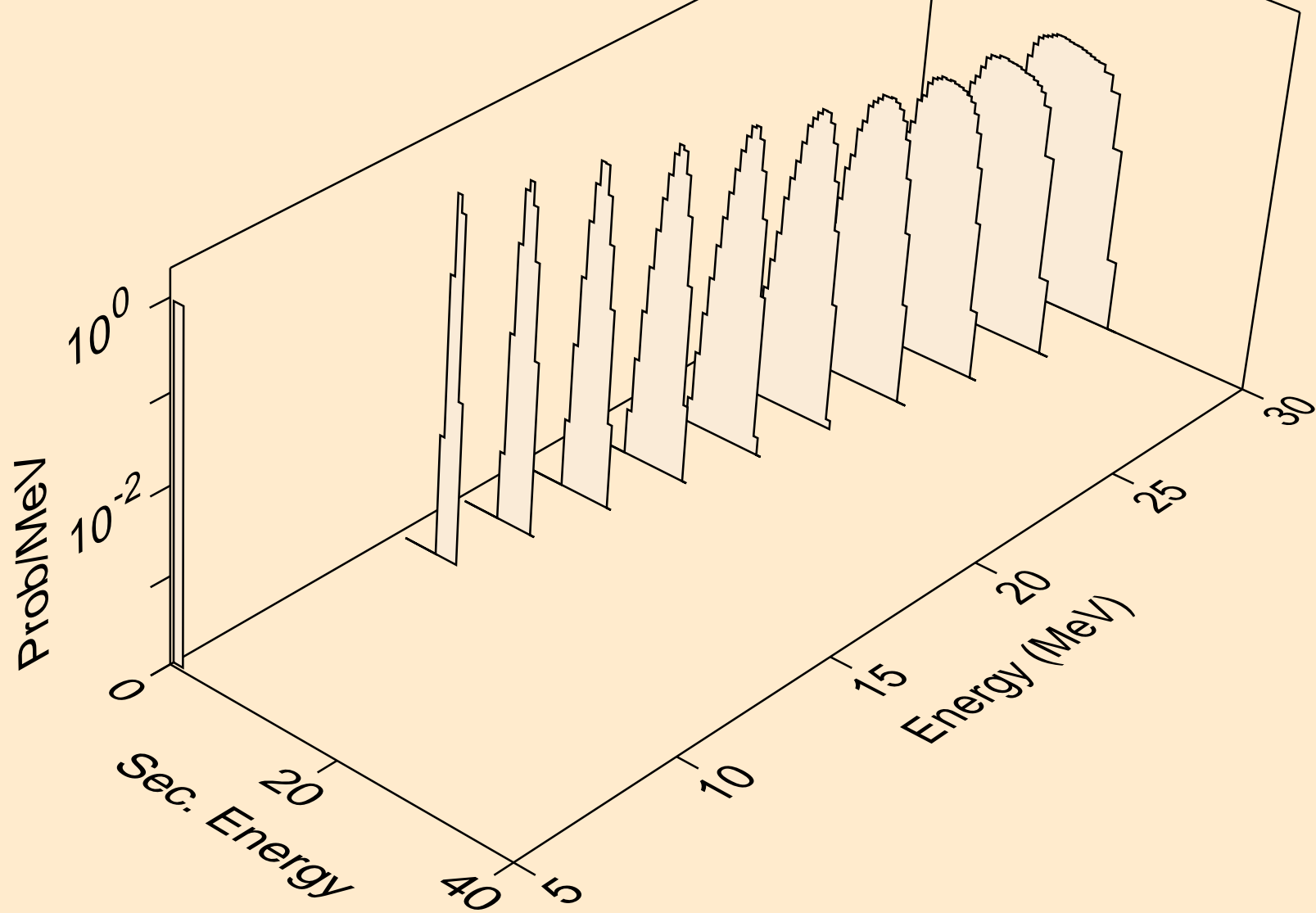

MD246M HELION ACER TENDL-2023 LIBRARY; T=0.K  
protons from (s,2np)

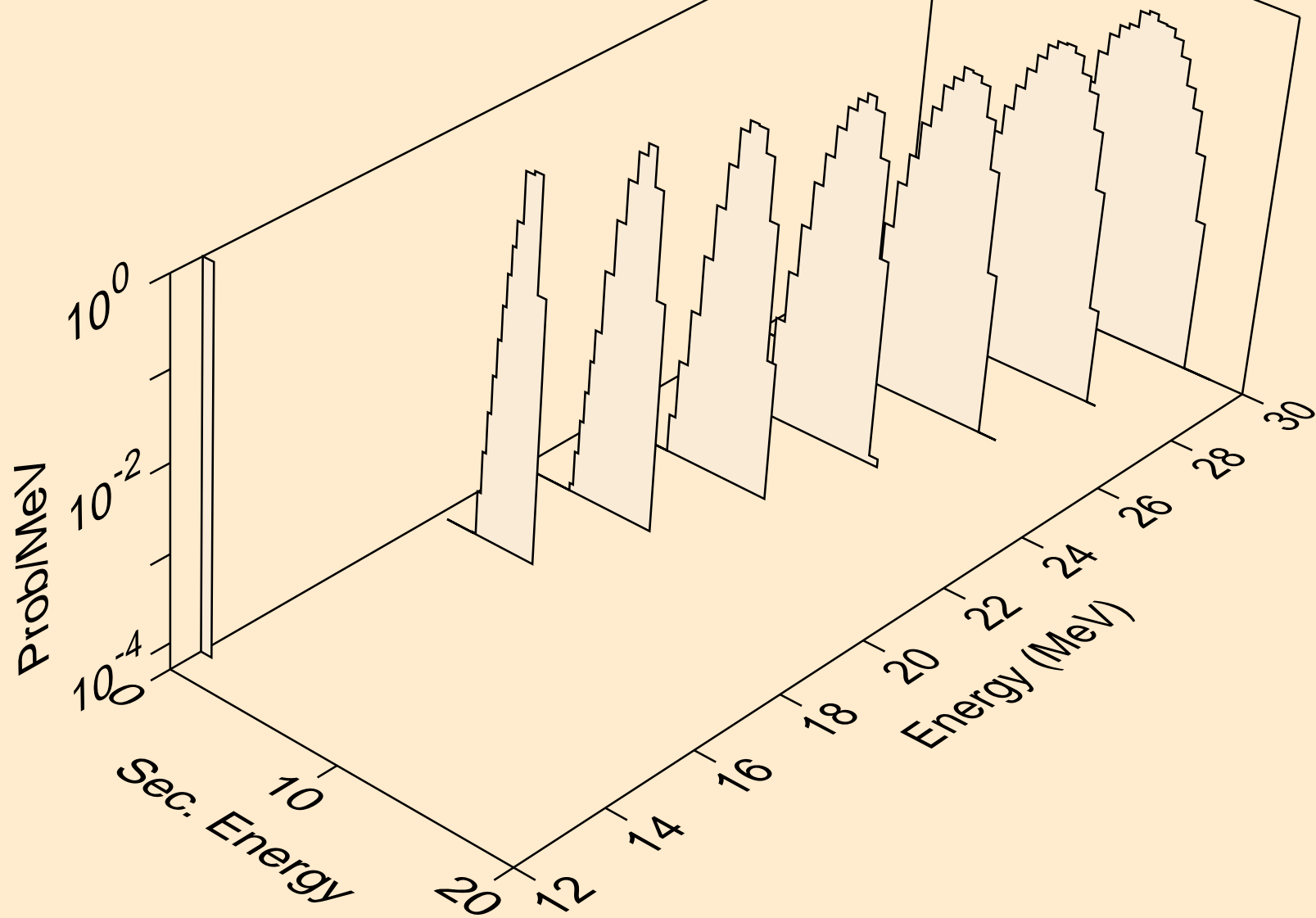

MD246M HELION ACER TENDL-2023 LIBRARY; T=0.K  
protons from (s,p)

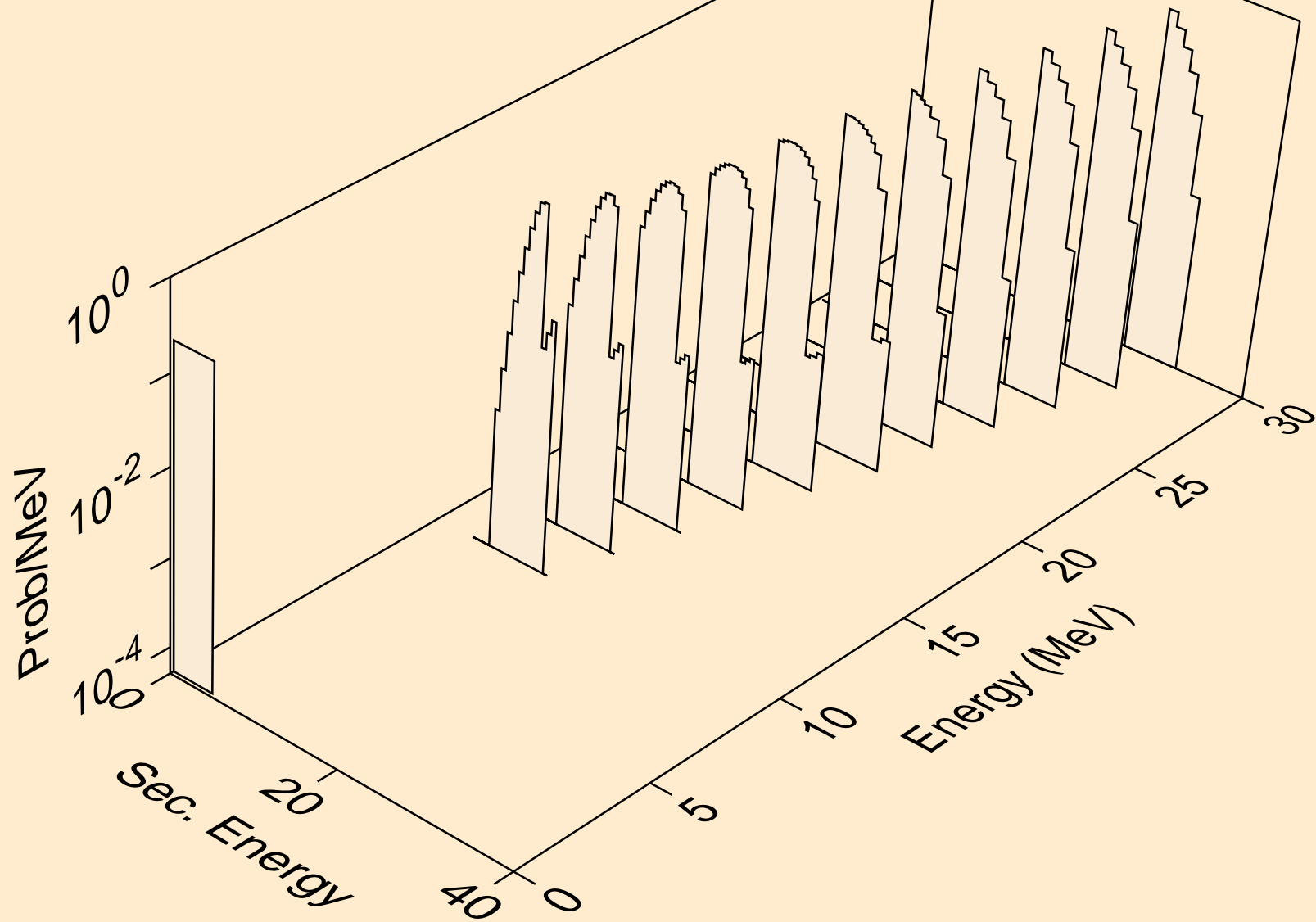

MD246M HELION ACER TENDL-2023 LIBRARY; T=0.K  
protons from (s,2p)

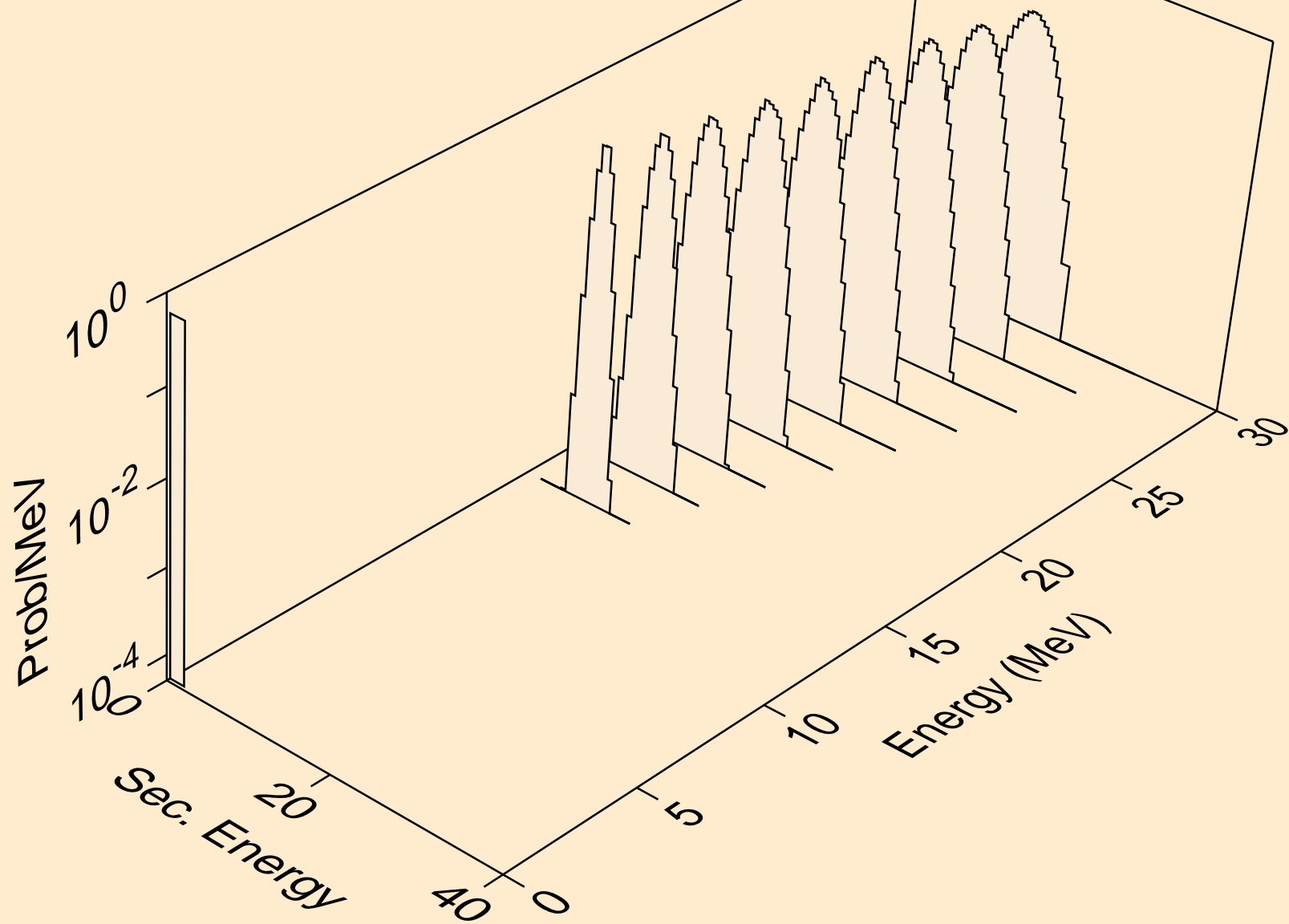

MD246M HELION ACER TENDL-2023 LIBRARY; T=0.K  
deuterons from (s,x)

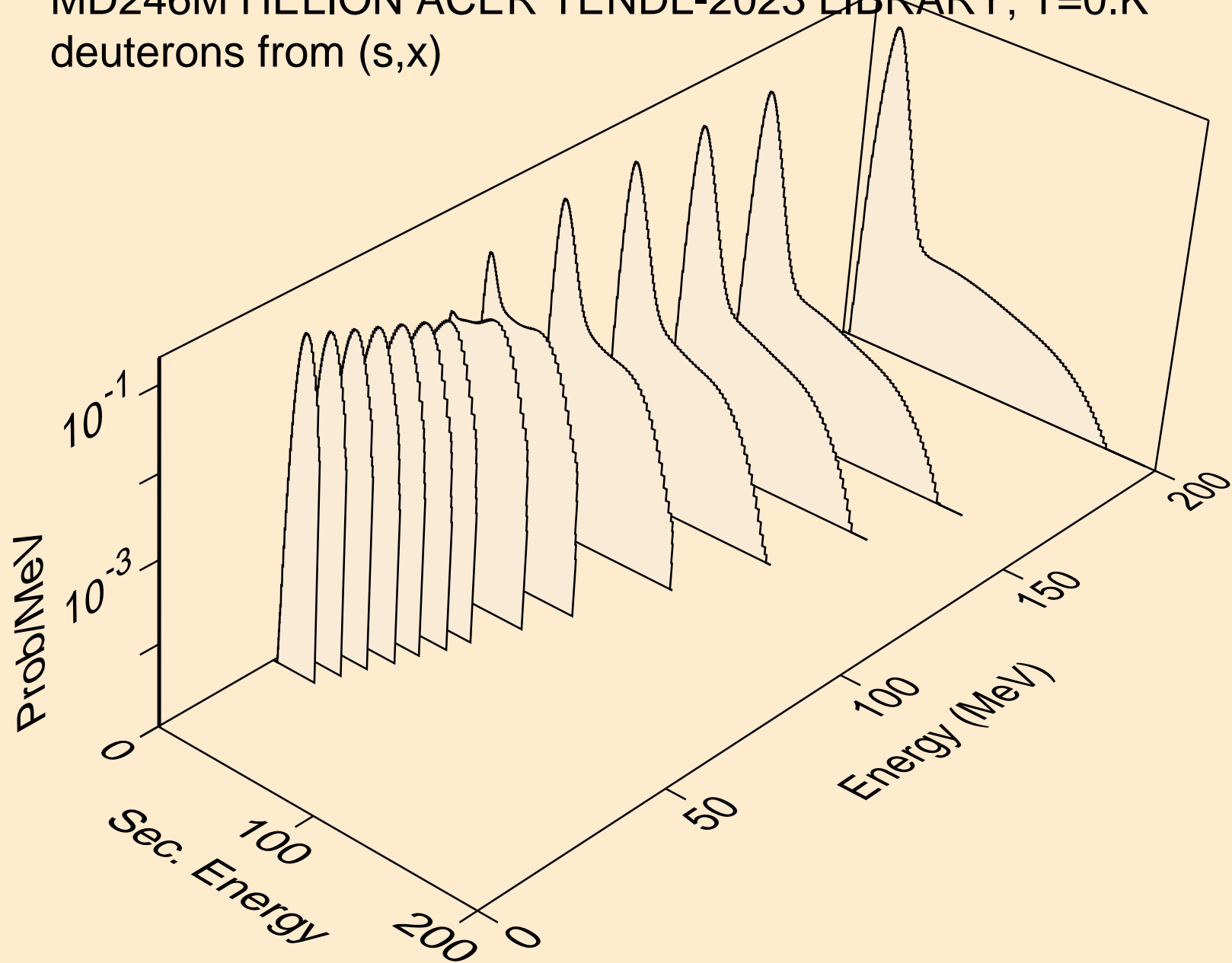

MD246M HELION ACER TENDL-2023 LIBRARY; T=0.K  
deuterons from (s,n\*)d

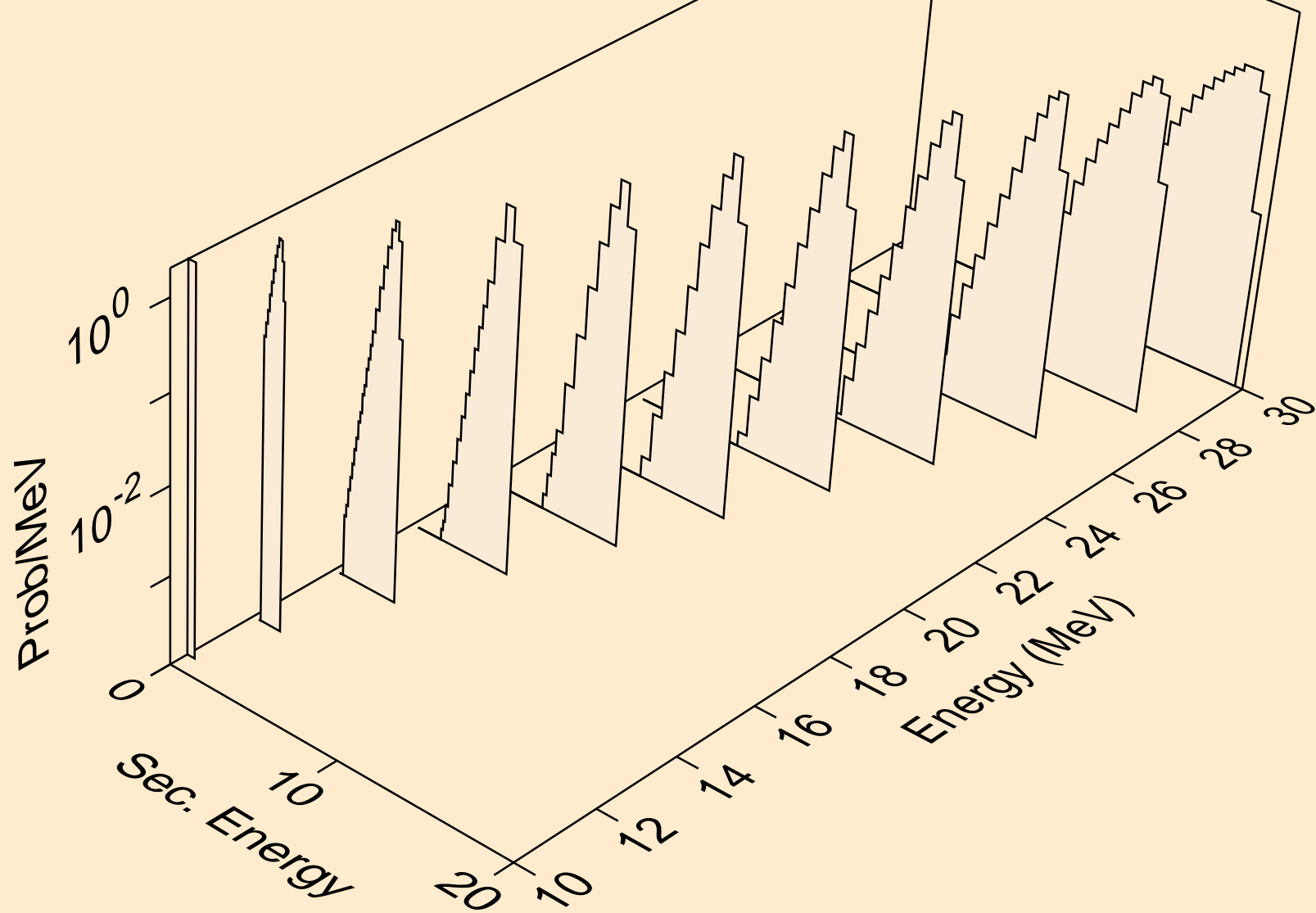

MD246M HELION ACER TENDL-2023 LIBRARY; T=0.K  
deuterons from (s,d)

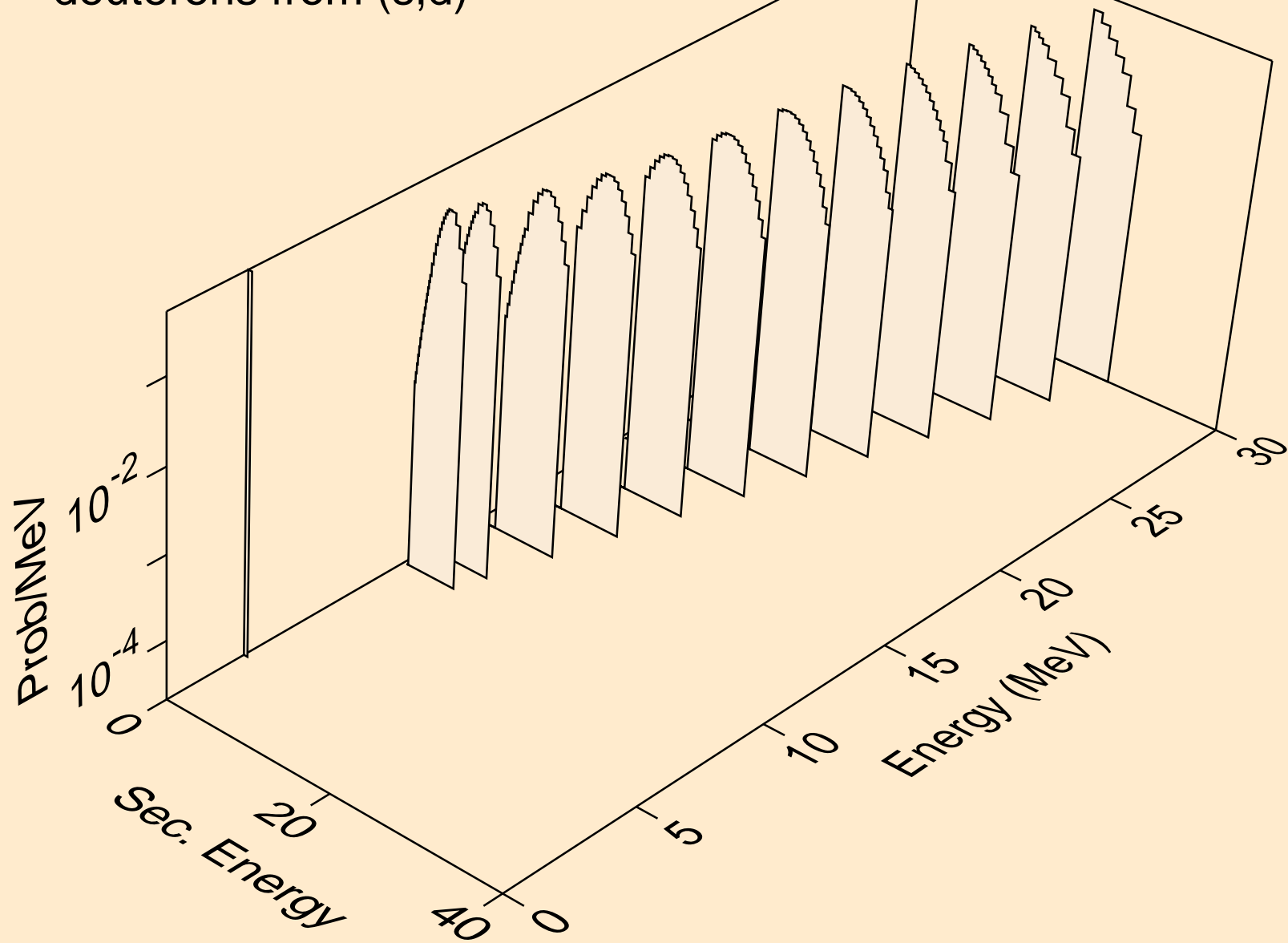

MD246M HELION ACER TENDL-2023 LIBRARY; T=0.K  
deuterons from (s,da)

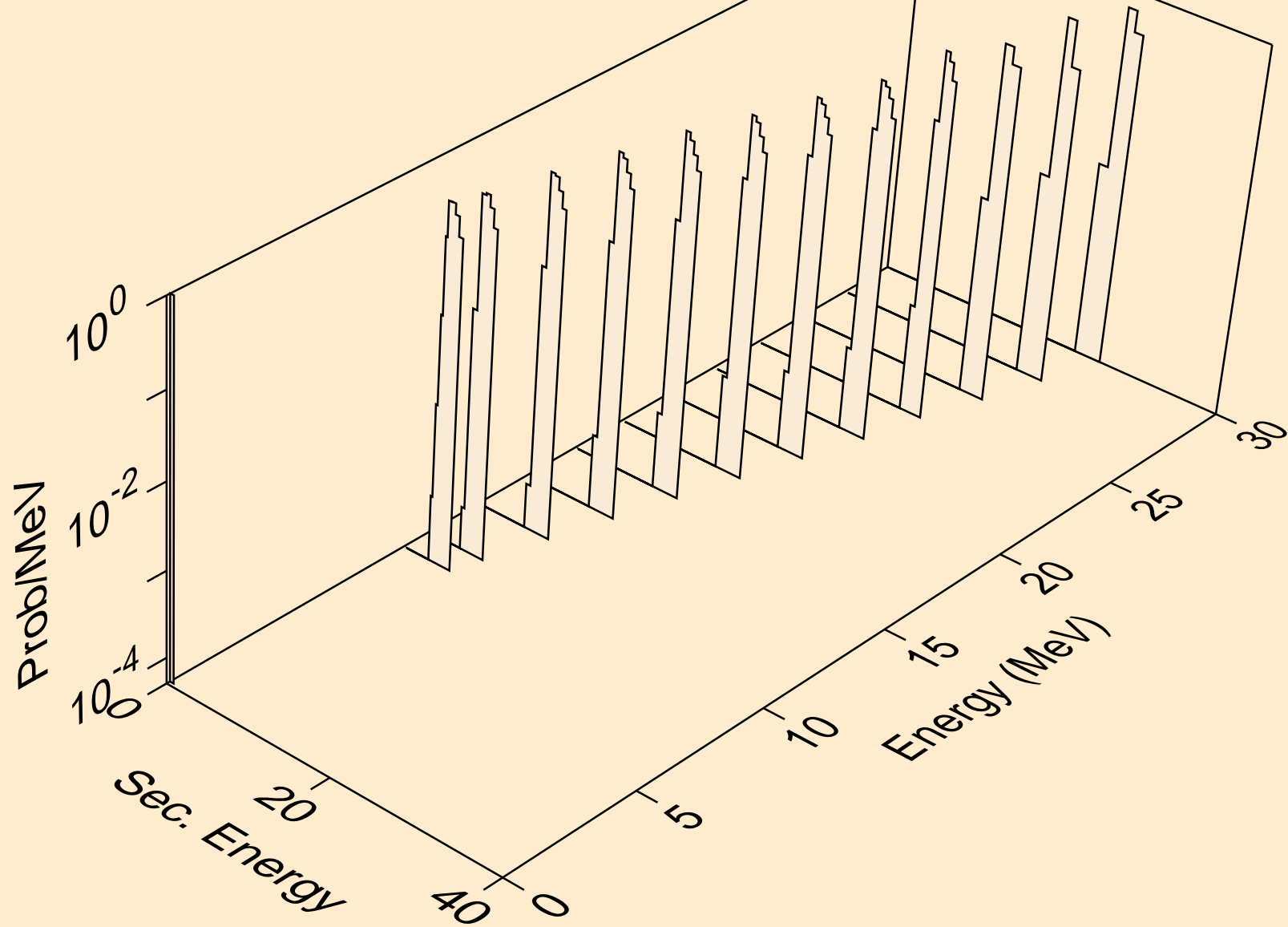

MD246M HELION ACER TENDL-2023 LIBRARY; T=0.K  
tritons from (s,x)

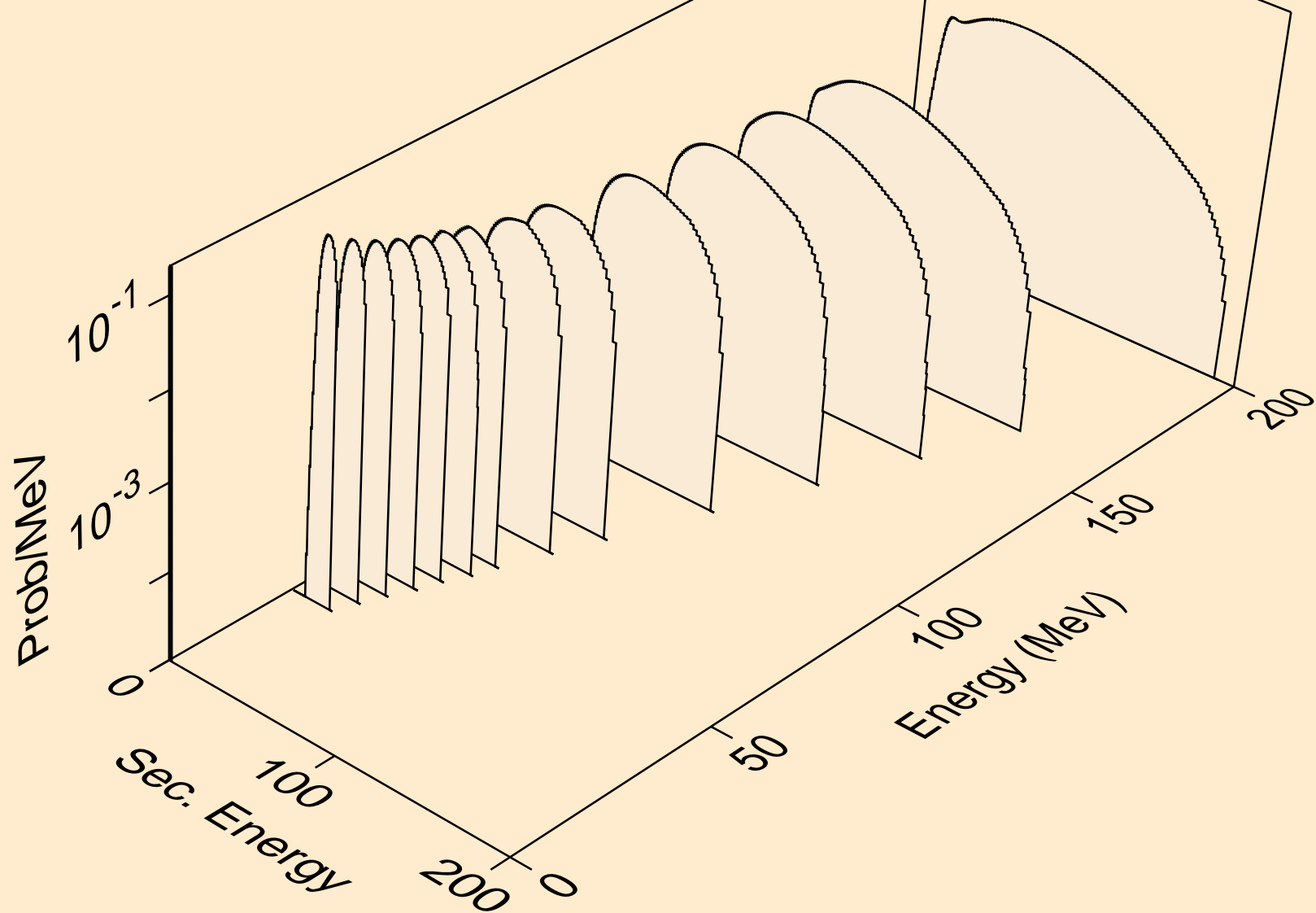

MD246M HELION ACER TENDL-2023 LIBRARY; T=0.K  
tritons from (s,n\*)t

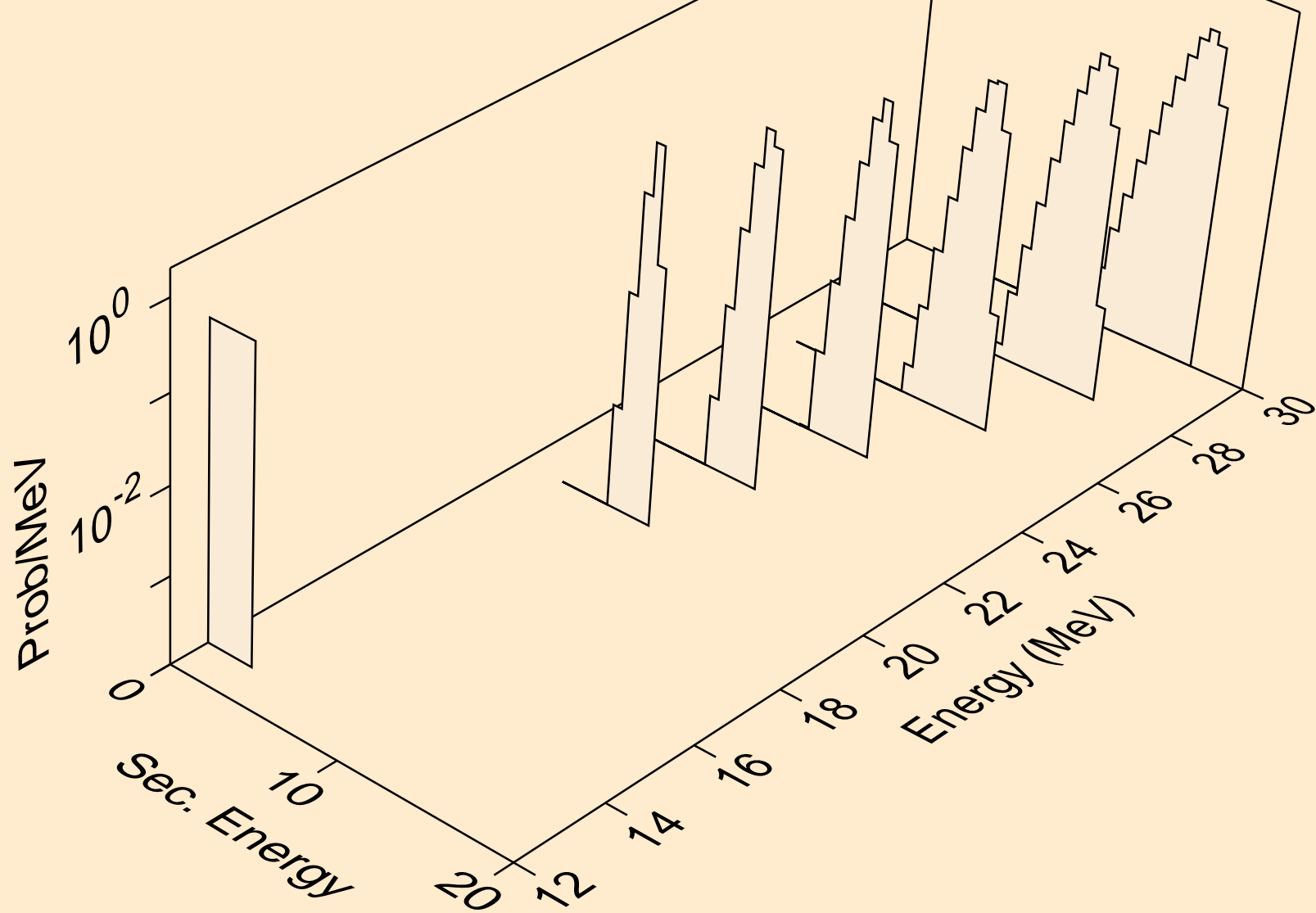

MD246M HELION ACER TENDL-2023 LIBRARY; T=0.K  
tritons from (s,t)

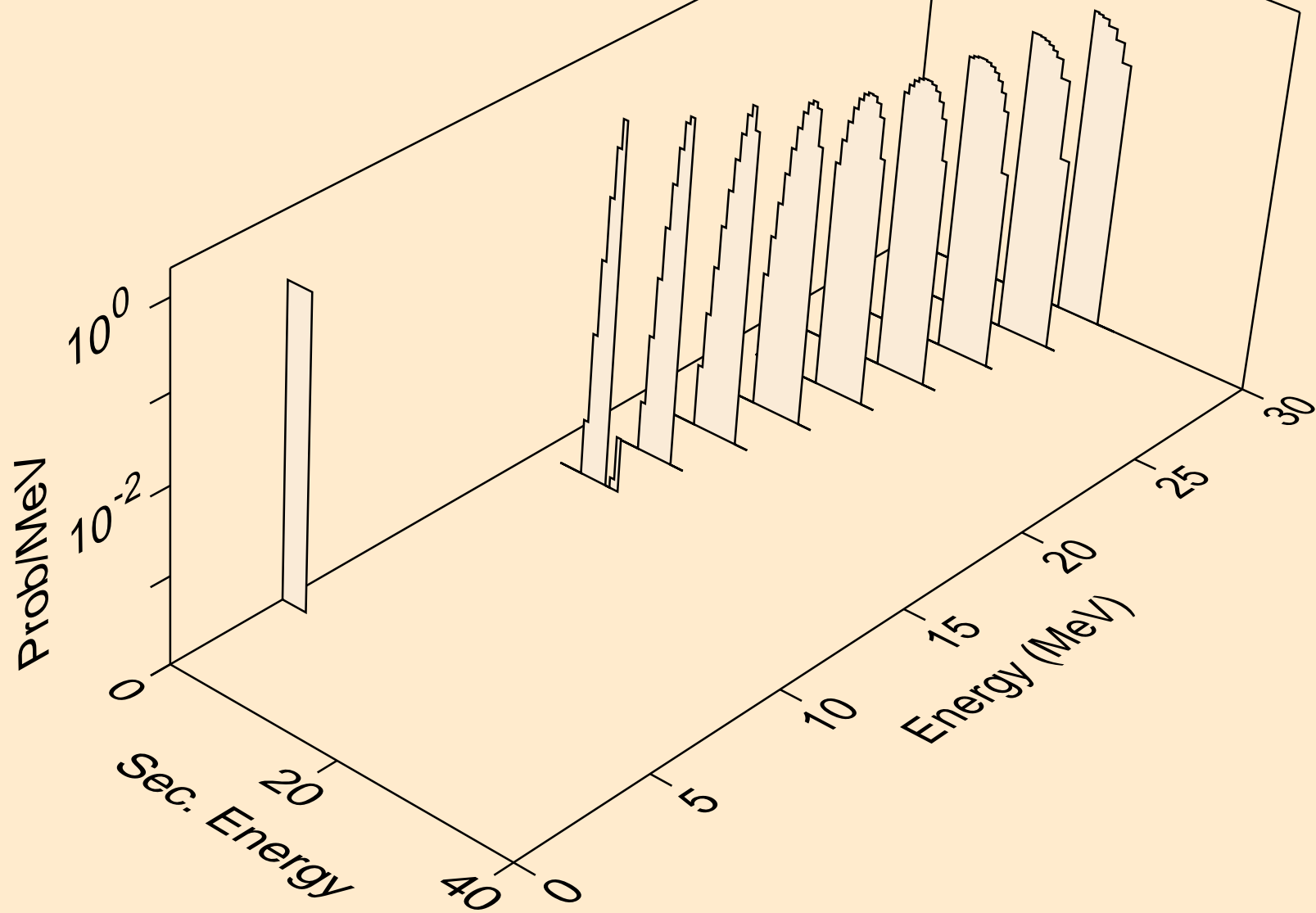

MD246M HELION ACER TENDL-2023 LIBRARY; T=0.K  
alphas from (s,x)

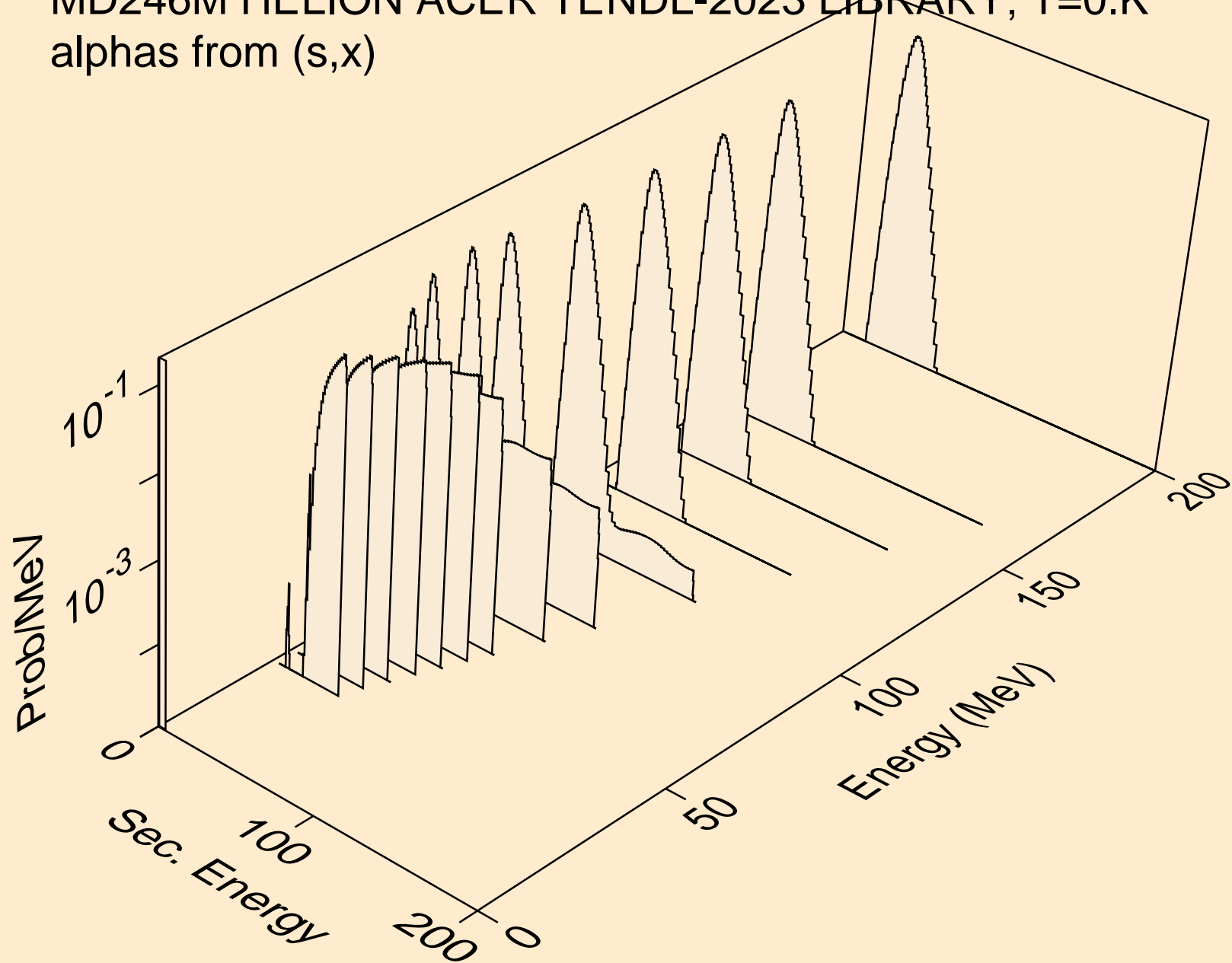

MD246M HELION ACER TENDL-2023 LIBRARY; T=0.K  
alphas from (s,n\*)a

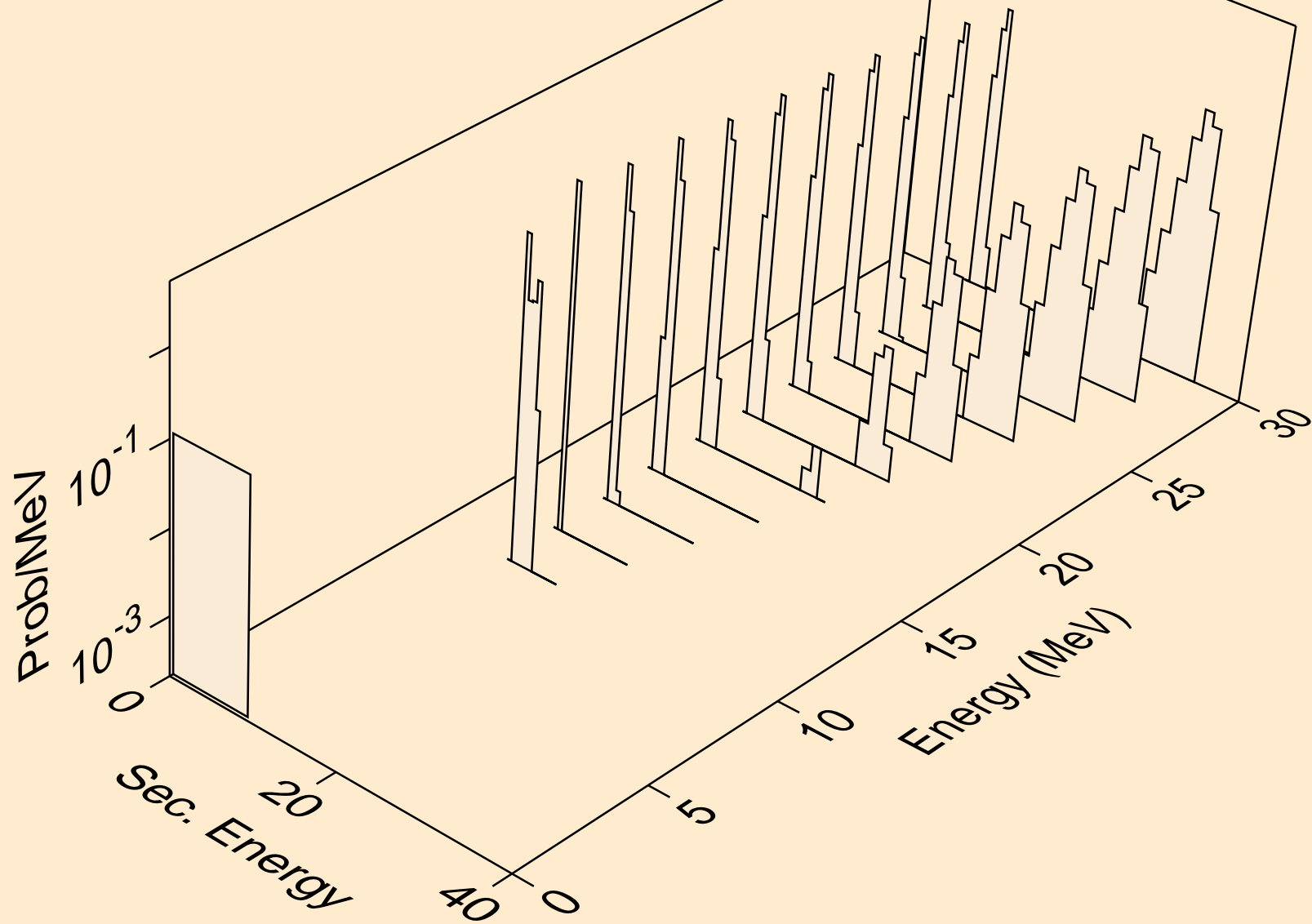

MD246M HELION ACER TENDL-2023 LIBRARY; T=0.K  
alphas from (s,a)

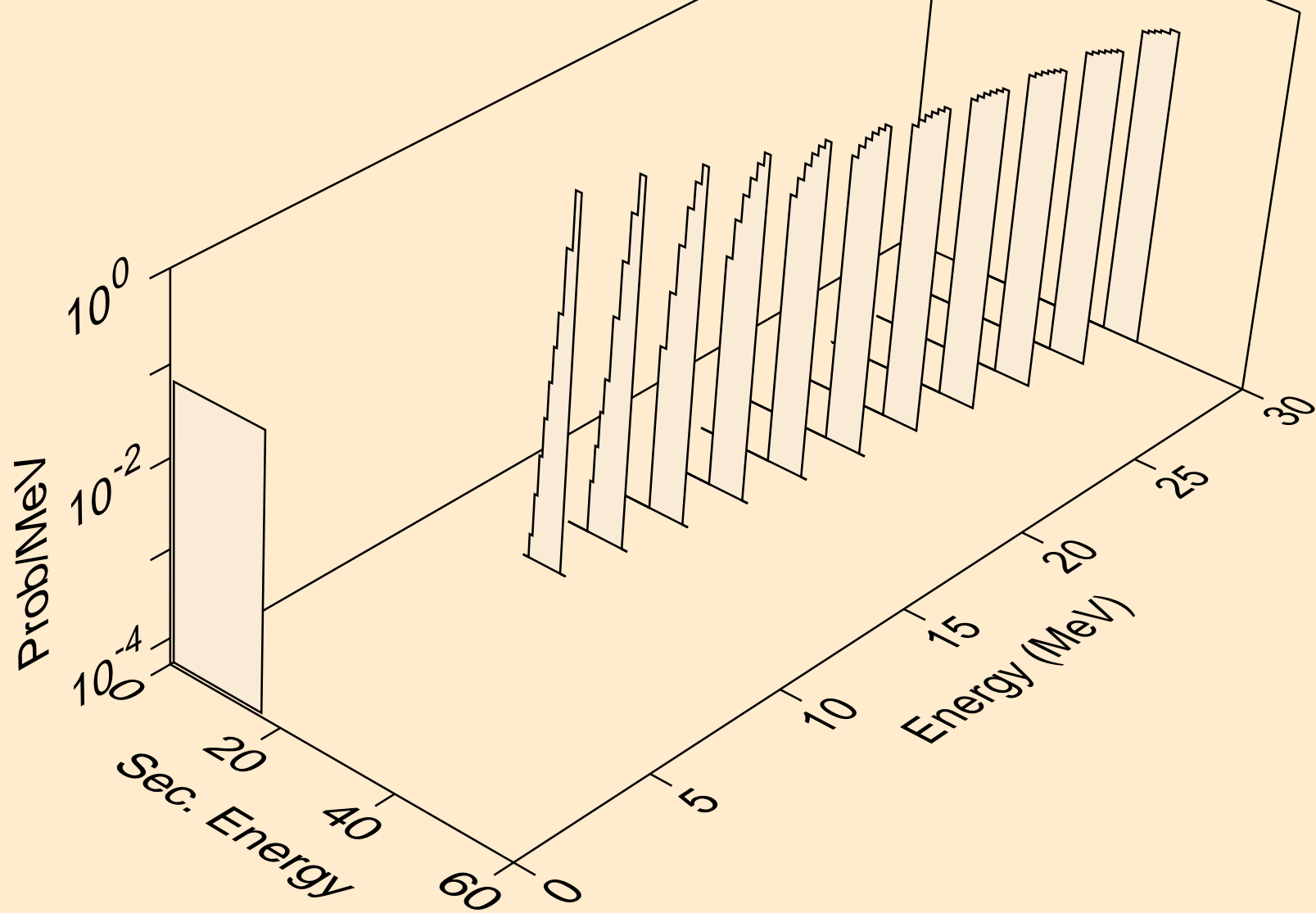

MD246M HELION ACER TENDL-2023 LIBRARY; T=0.K  
alphas from (s,2a)

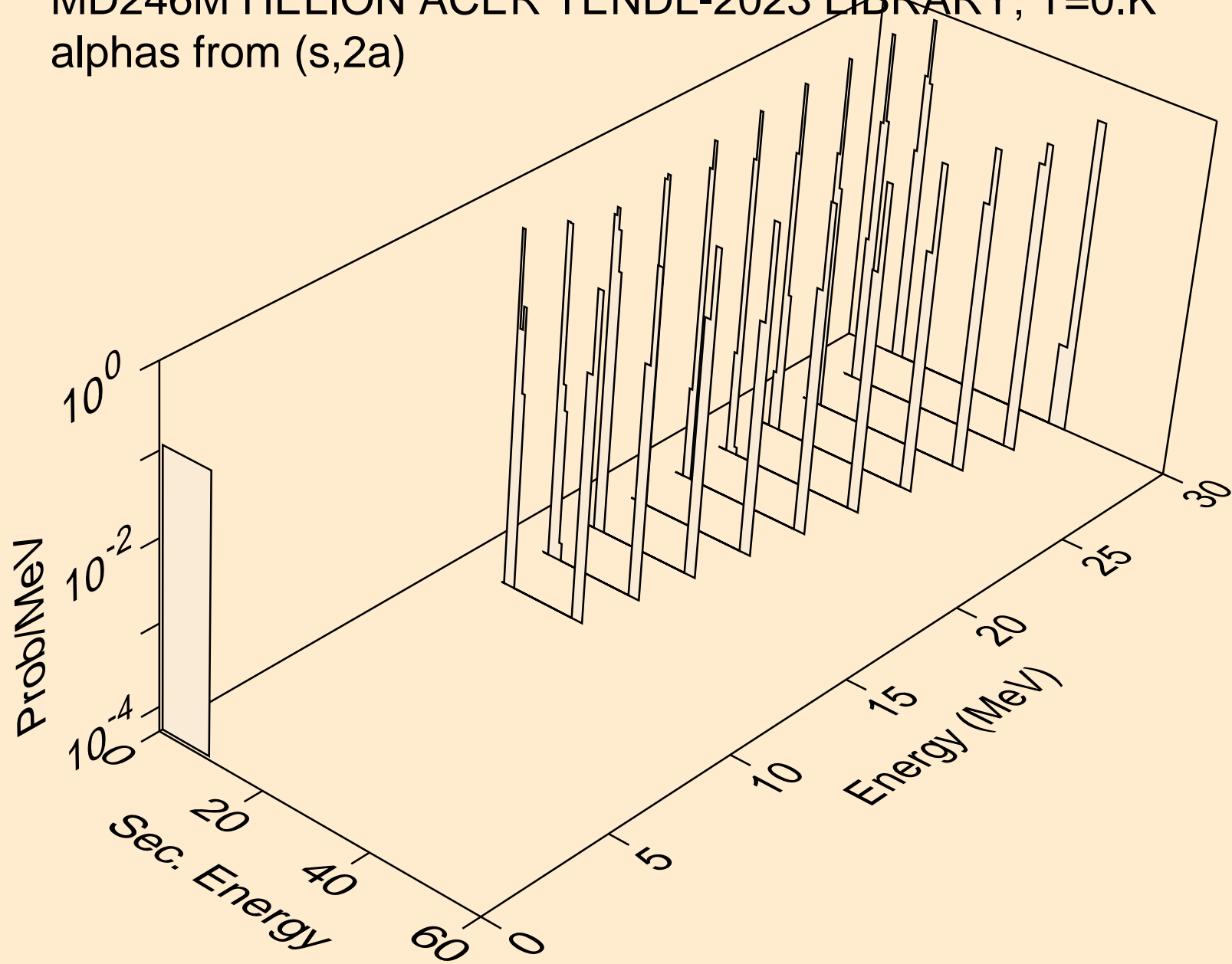

MD246M HELION ACER TENDL-2023 LIBRARY; T=0.K  
alphas from (s,da)

