

# ND151 HELION ACER TENDL-2023 LIBRARY; T=0.K

## Principal cross sections

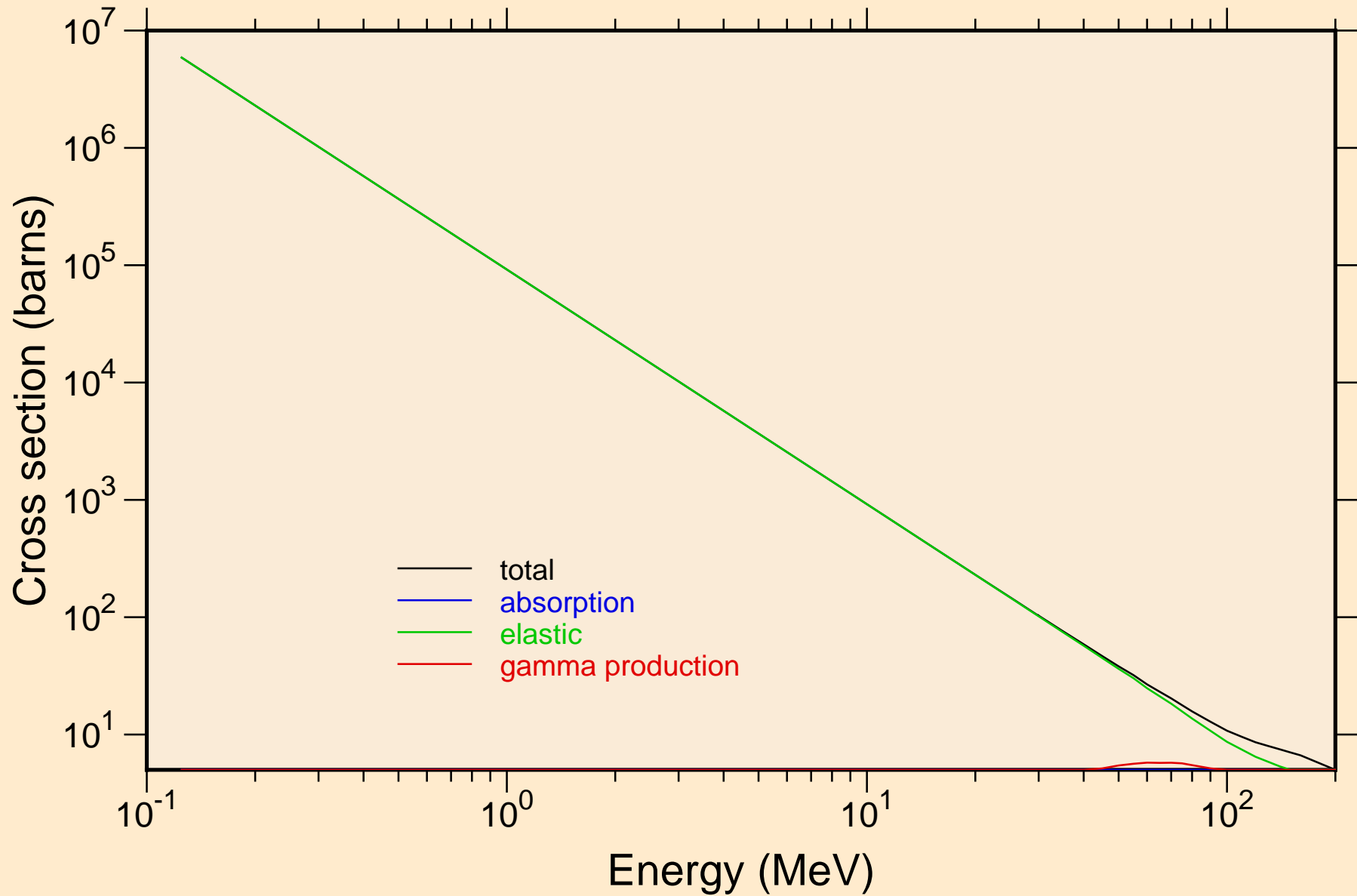

ND151 HELION ACER TENDL-2023 LIBRARY; T=0.K  
Heating

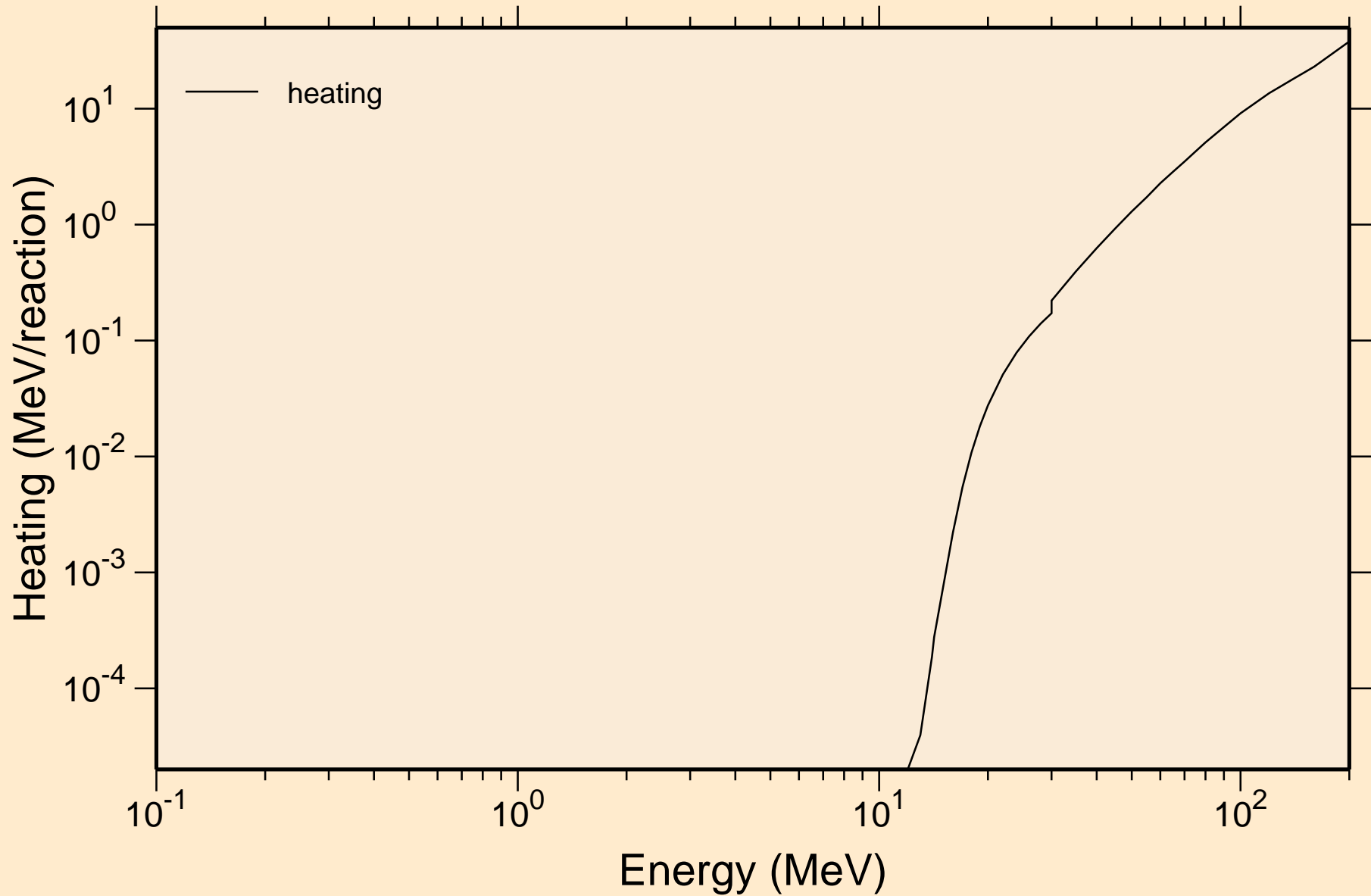

# ND151 HELION ACER TENDL-2023 LIBRARY; T=0.K

## Principal cross sections

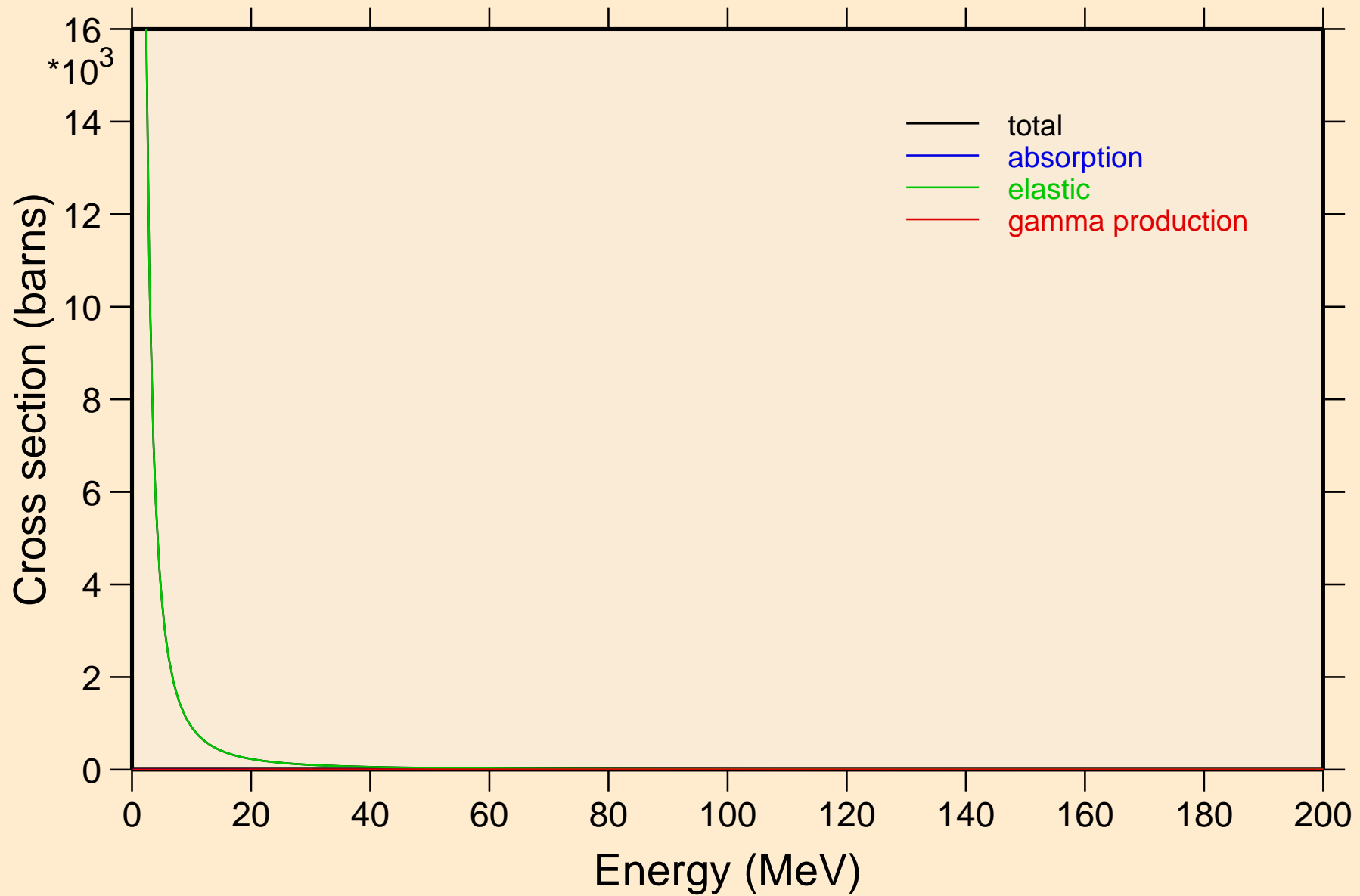

ND151 HELION ACER TENDL-2023 LIBRARY; T=0.K

Heating

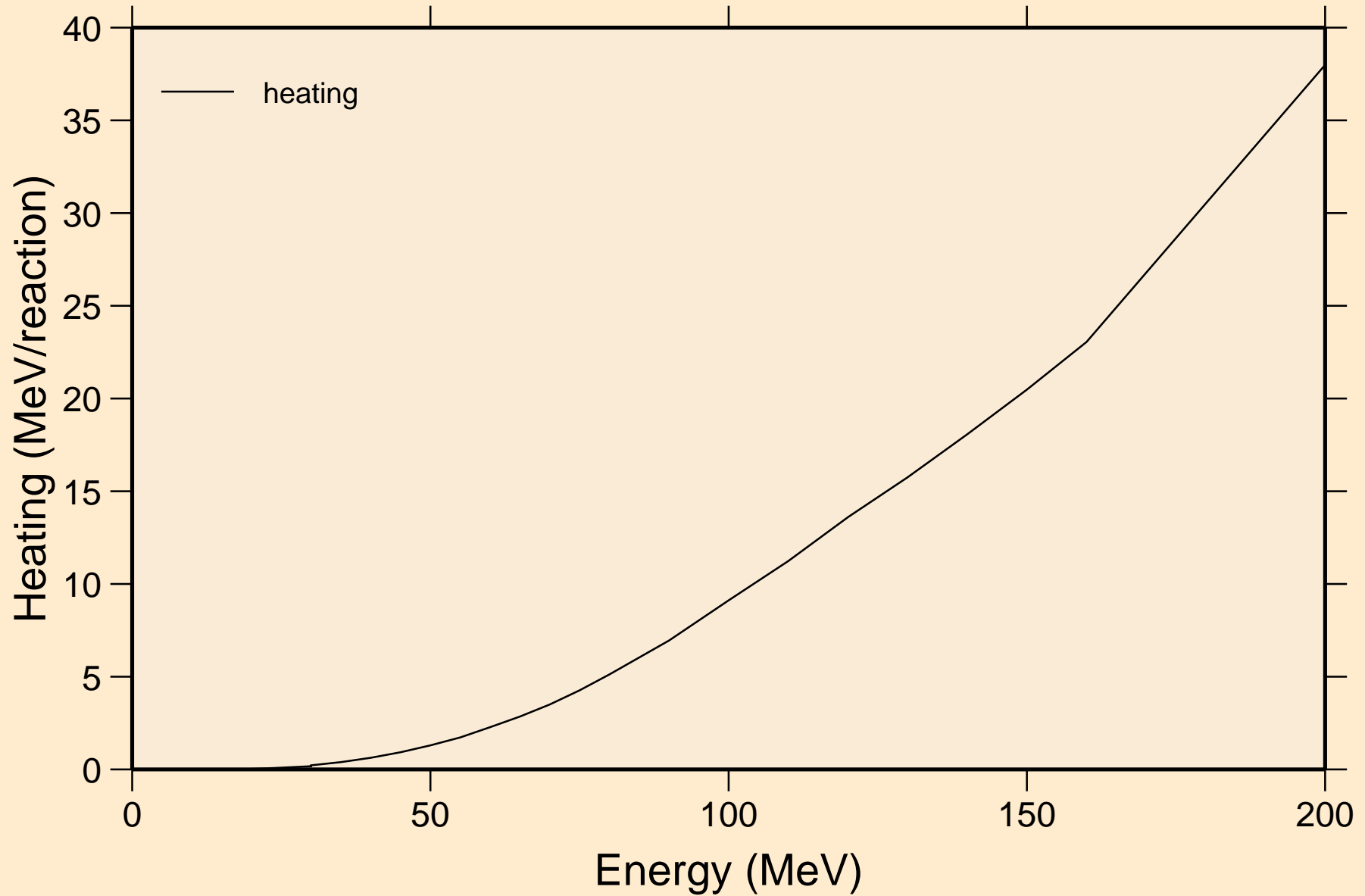

# ND151 HELION ACER TENDL-2023 LIBRARY; T=0.K

## Threshold reactions

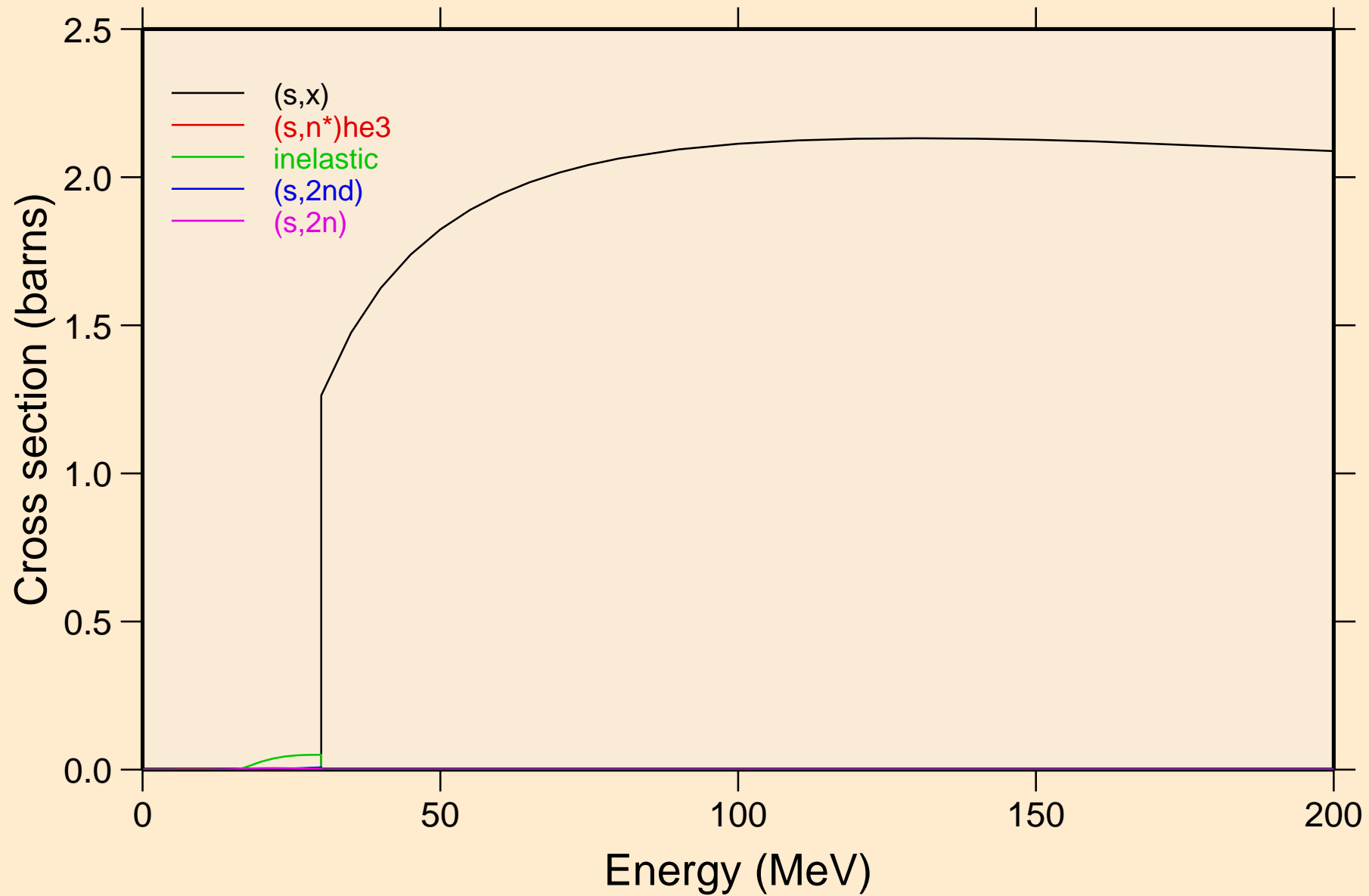

# ND151 HELION ACER TENDL-2023 LIBRARY; T=0.K

## Threshold reactions

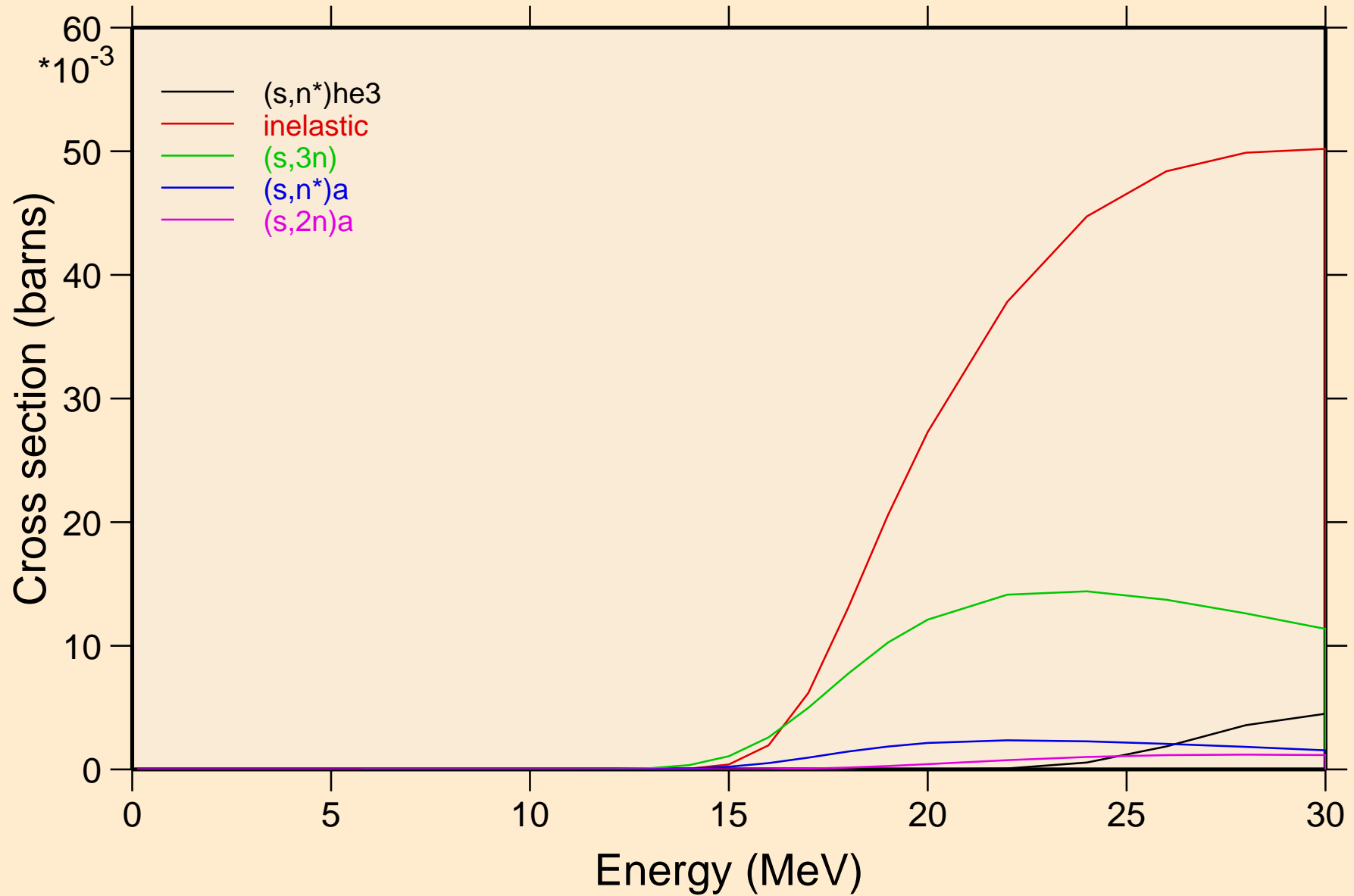

# ND151 HELION ACER TENDL-2023 LIBRARY; T=0.K

## Threshold reactions

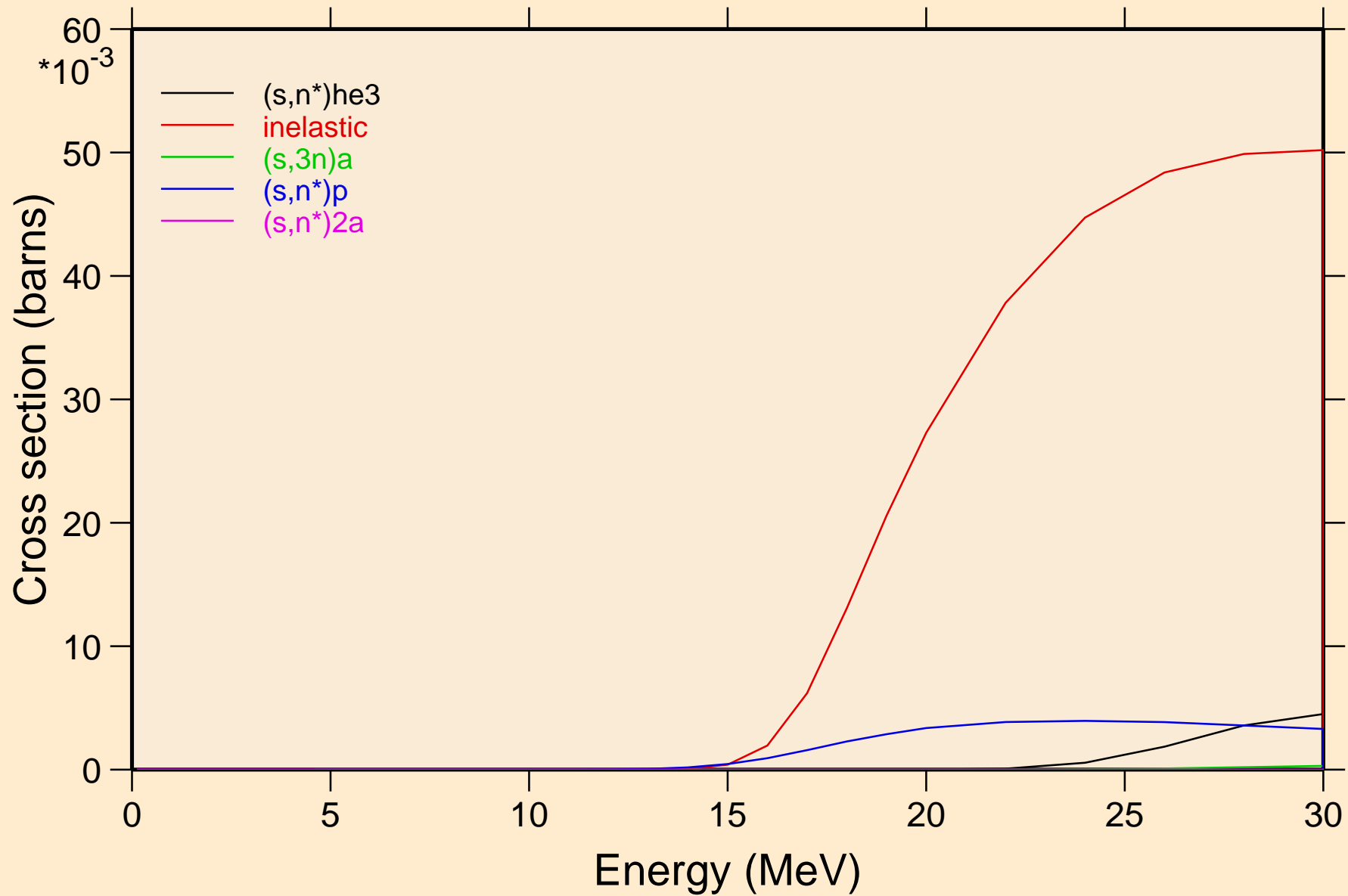

# ND151 HELION ACER TENDL-2023 LIBRARY; T=0.K

## Threshold reactions

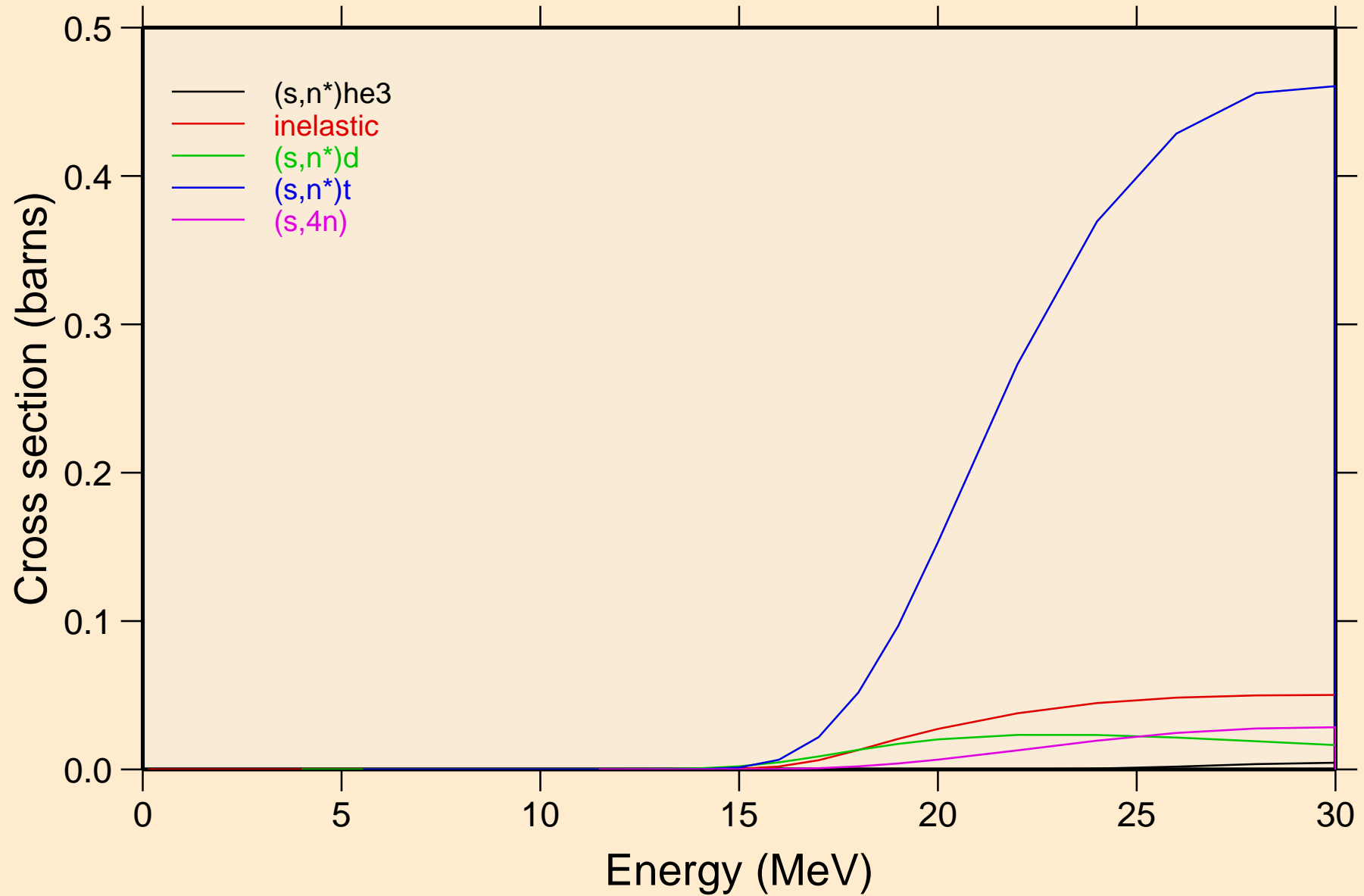

# ND151 HELION ACER TENDL-2023 LIBRARY; T=0.K

## Threshold reactions

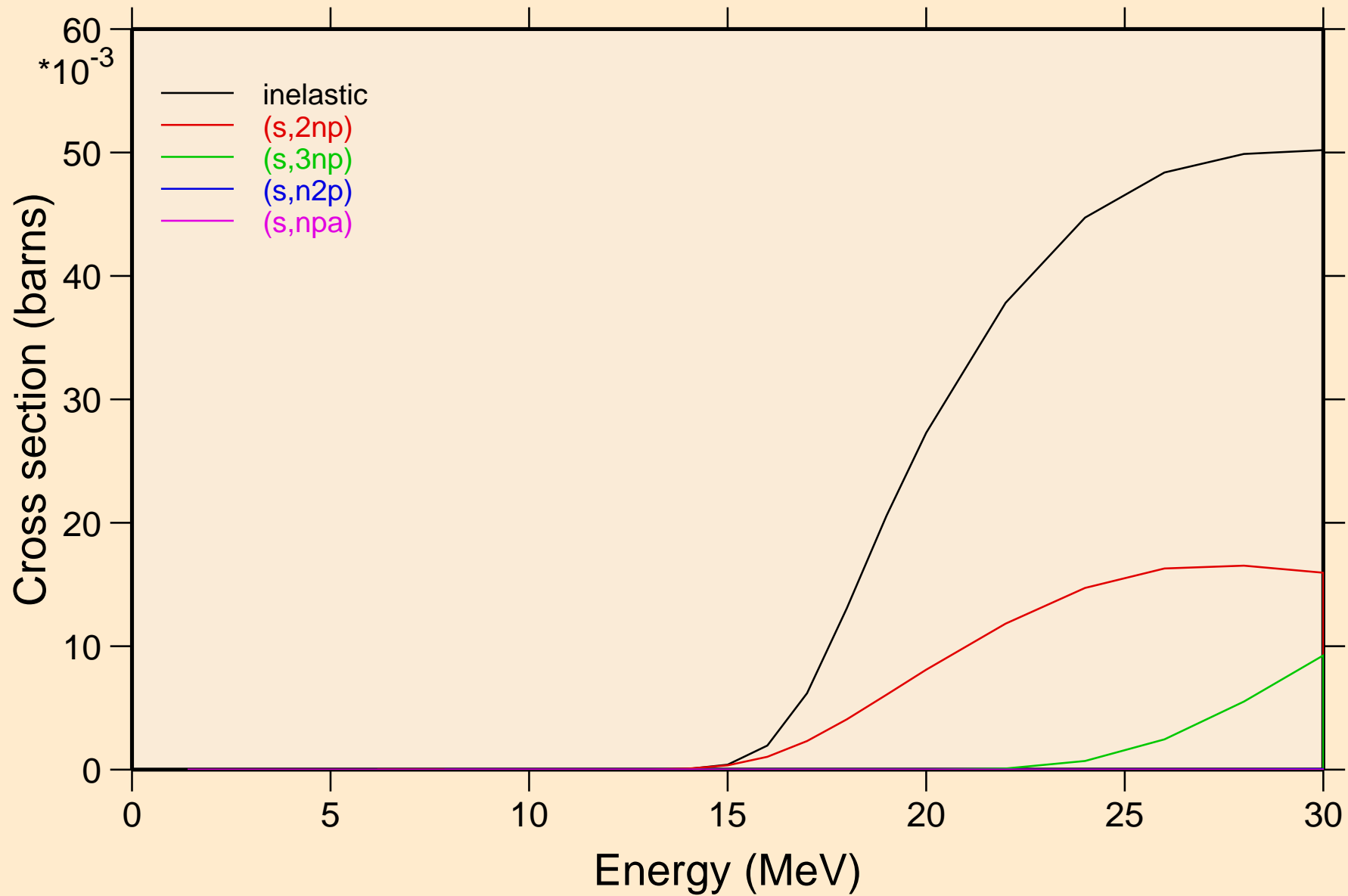

# ND151 HELION ACER TENDL-2023 LIBRARY; T=0.K

## Threshold reactions

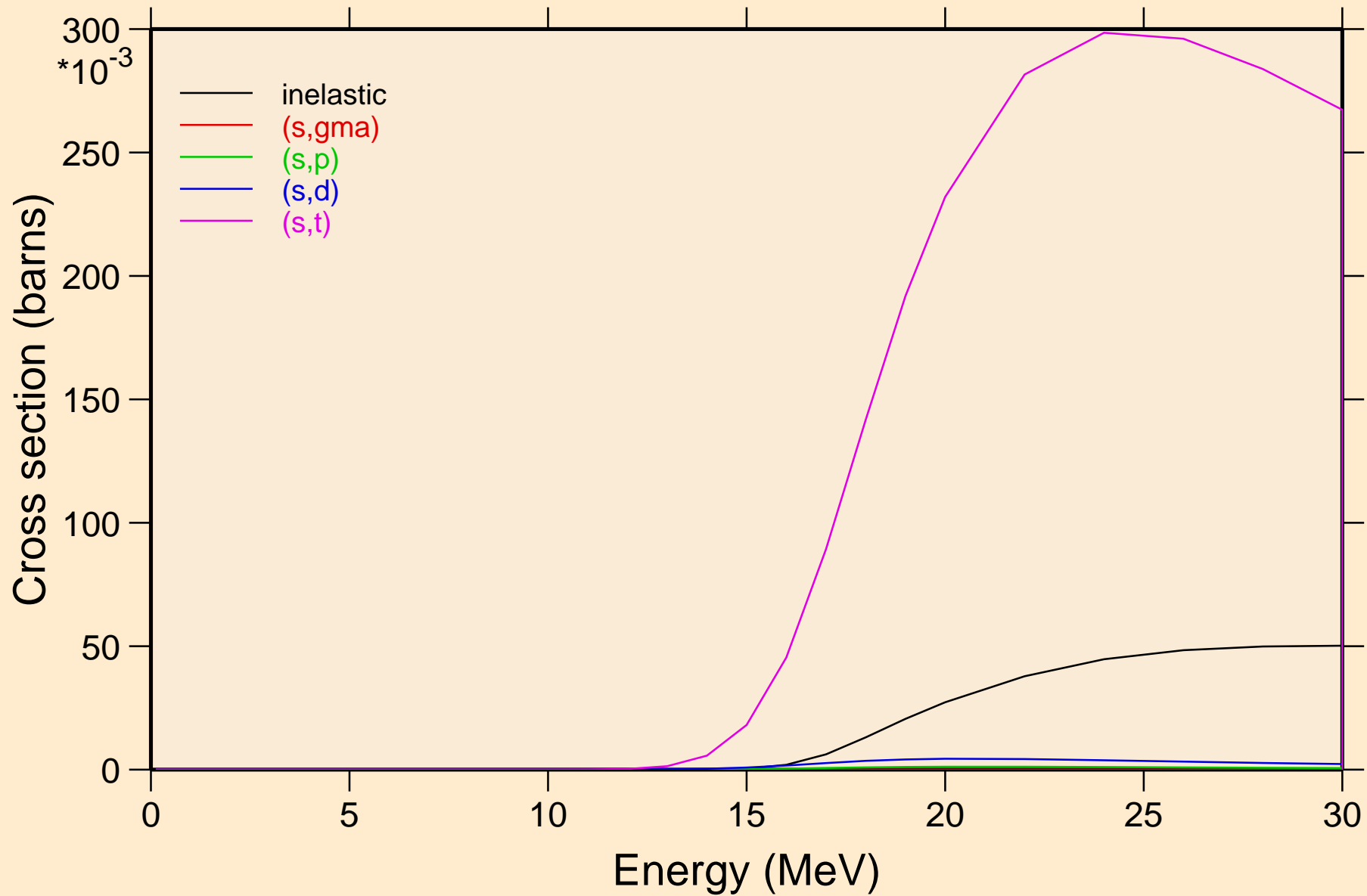

# ND151 HELION ACER TENDL-2023 LIBRARY; T=0.K

## Threshold reactions

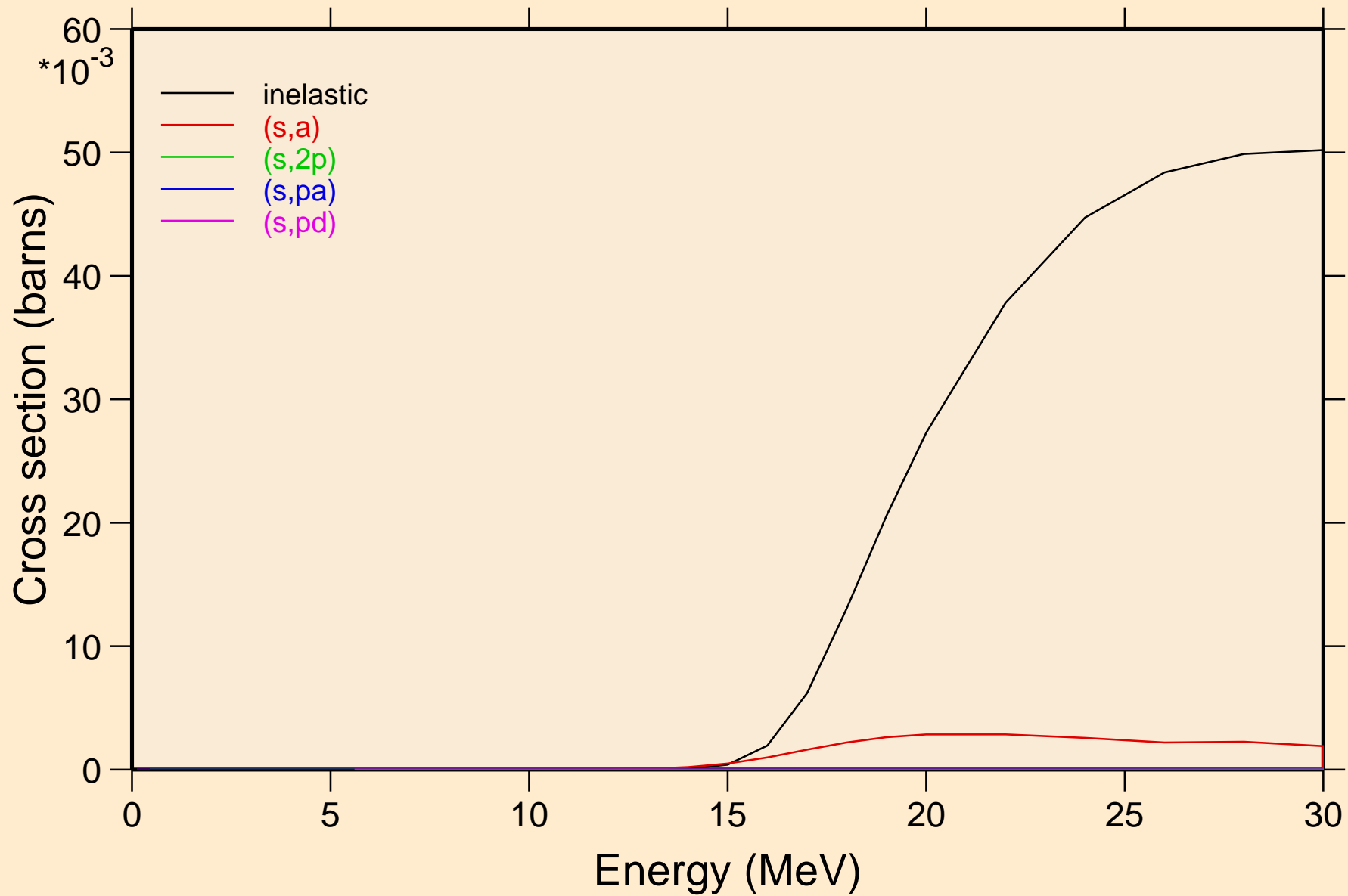

ND151 HELION ACER TENDL-2023 LIBRARY; T=0.K  
Threshold reactions

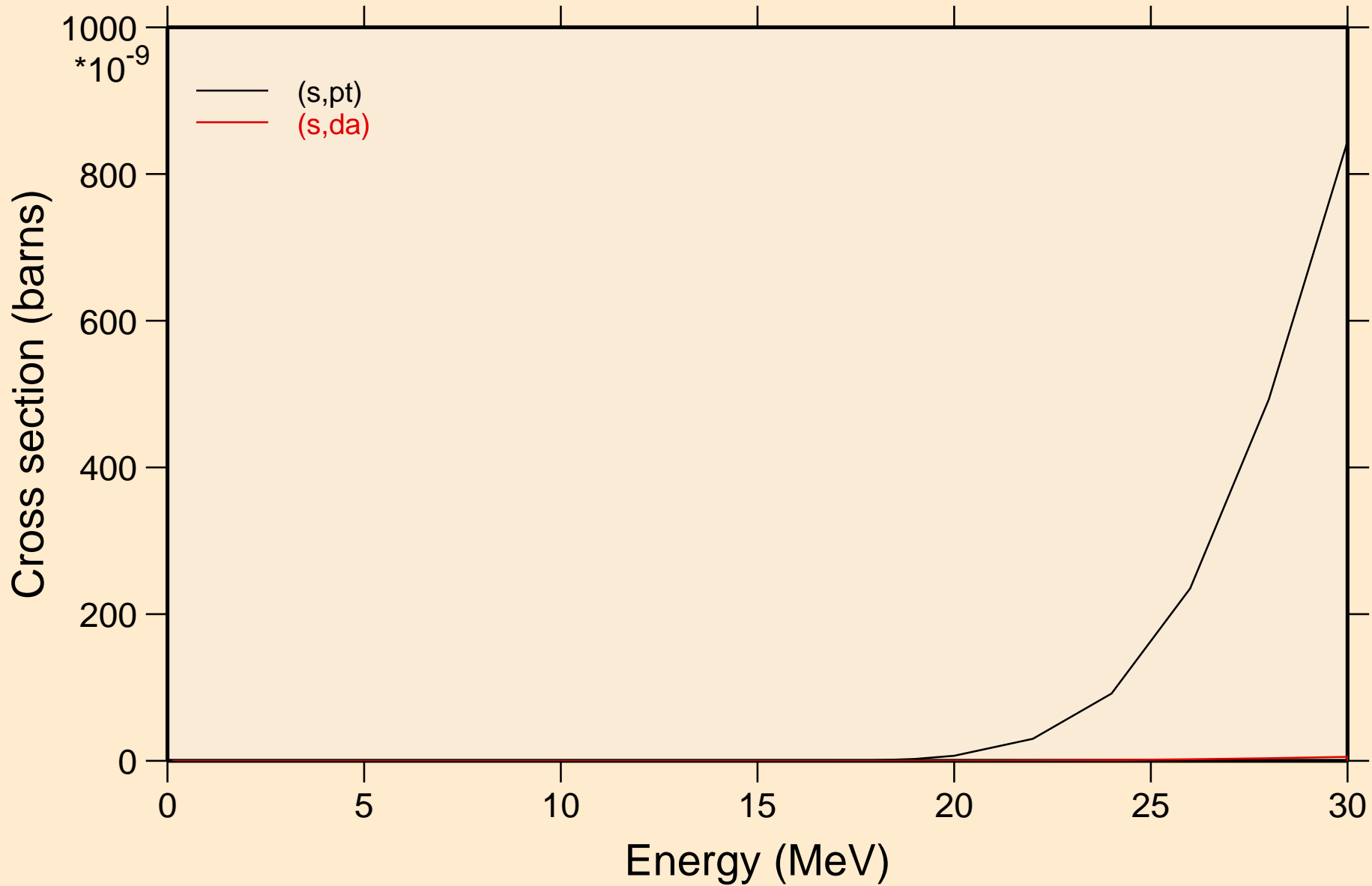

ND151 HELION ACER TENDL-2023 LIBRARY; T=0.K  
angular distribution for elastic

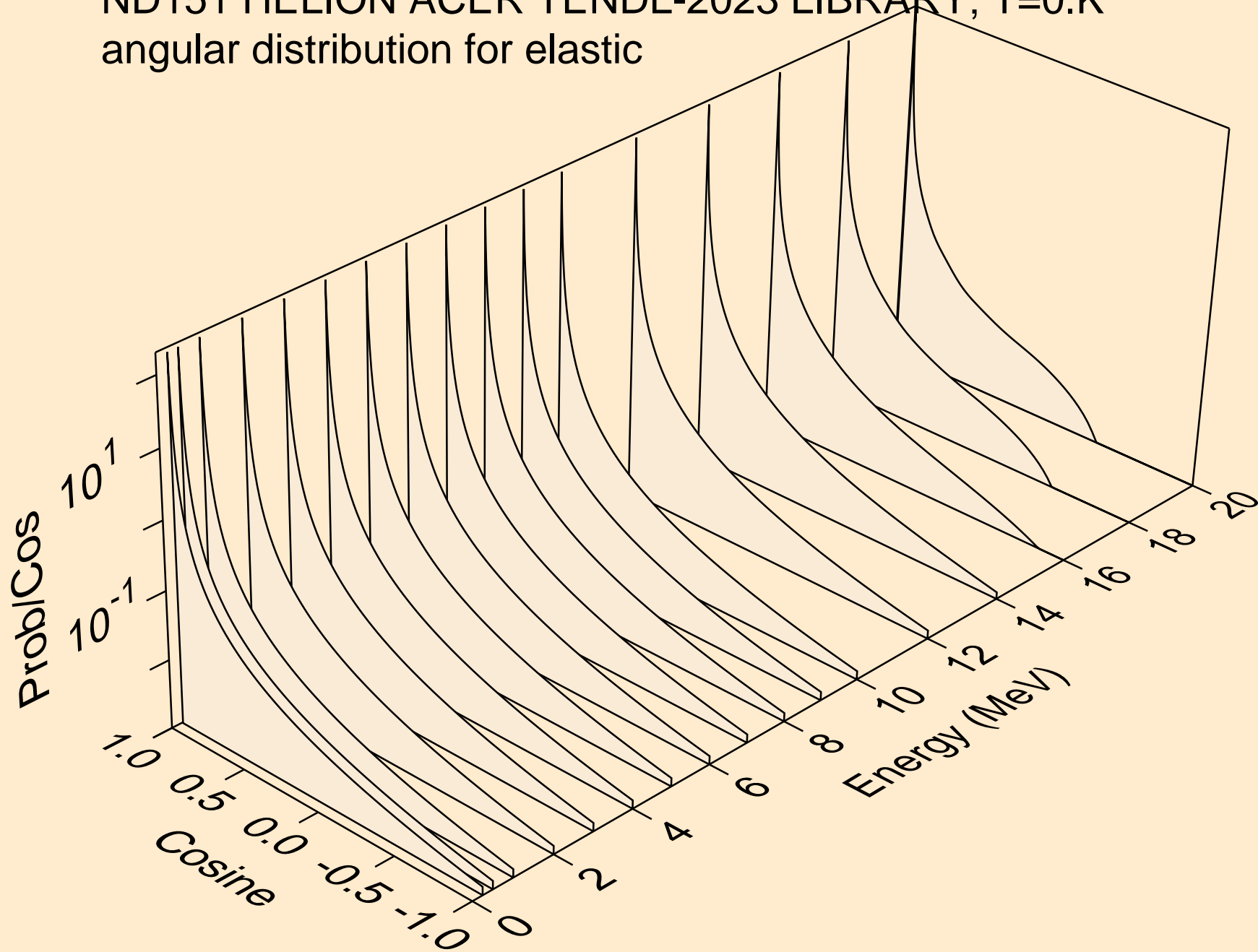

ND151 HELION ACER TENDL-2023 LIBRARY; T=0.K  
angular distribution for elastic

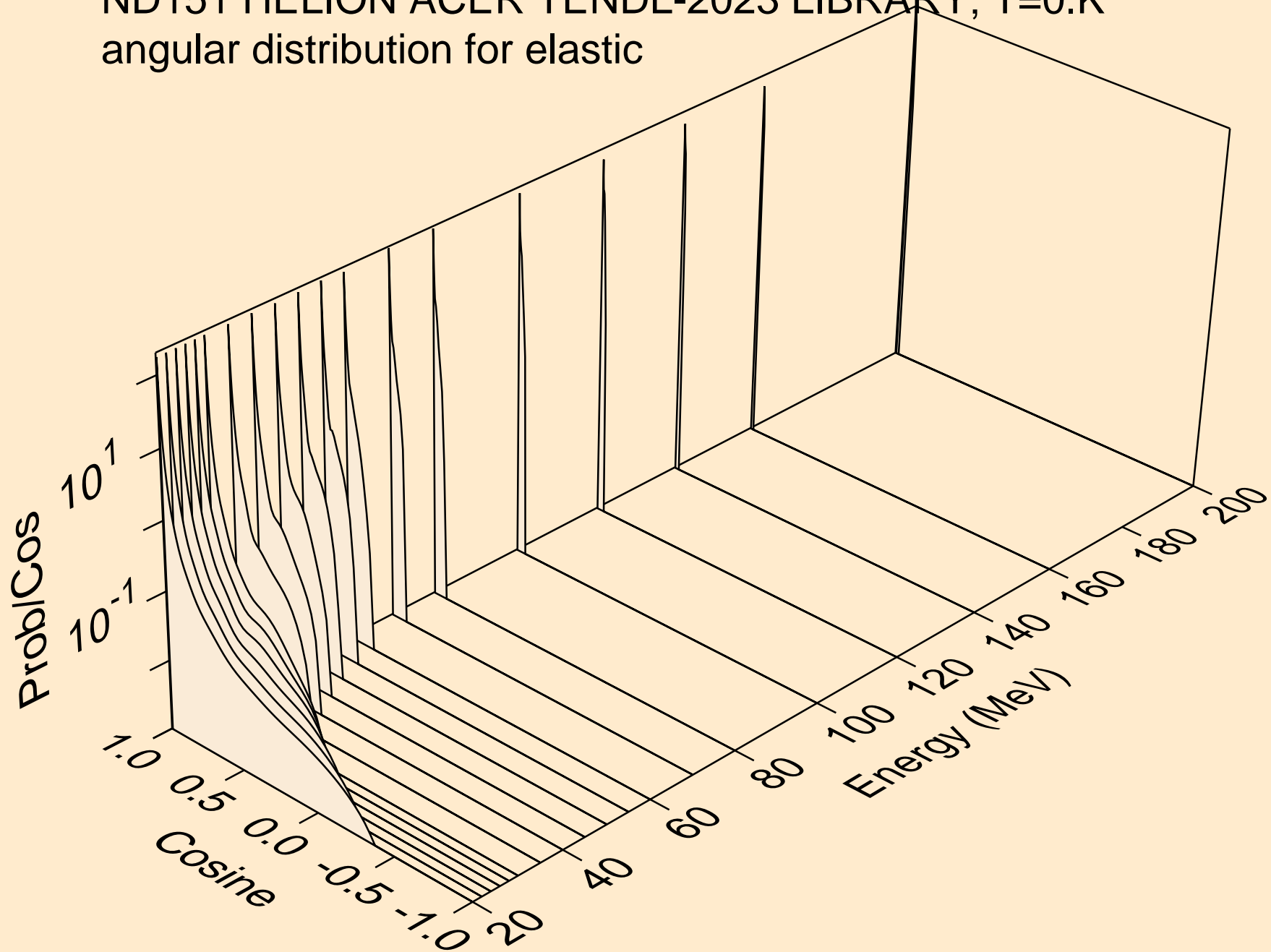

ND151 HELION ACER TENDL-2023 LIBRARY; T=0.K  
He-3 emission for (s,x)

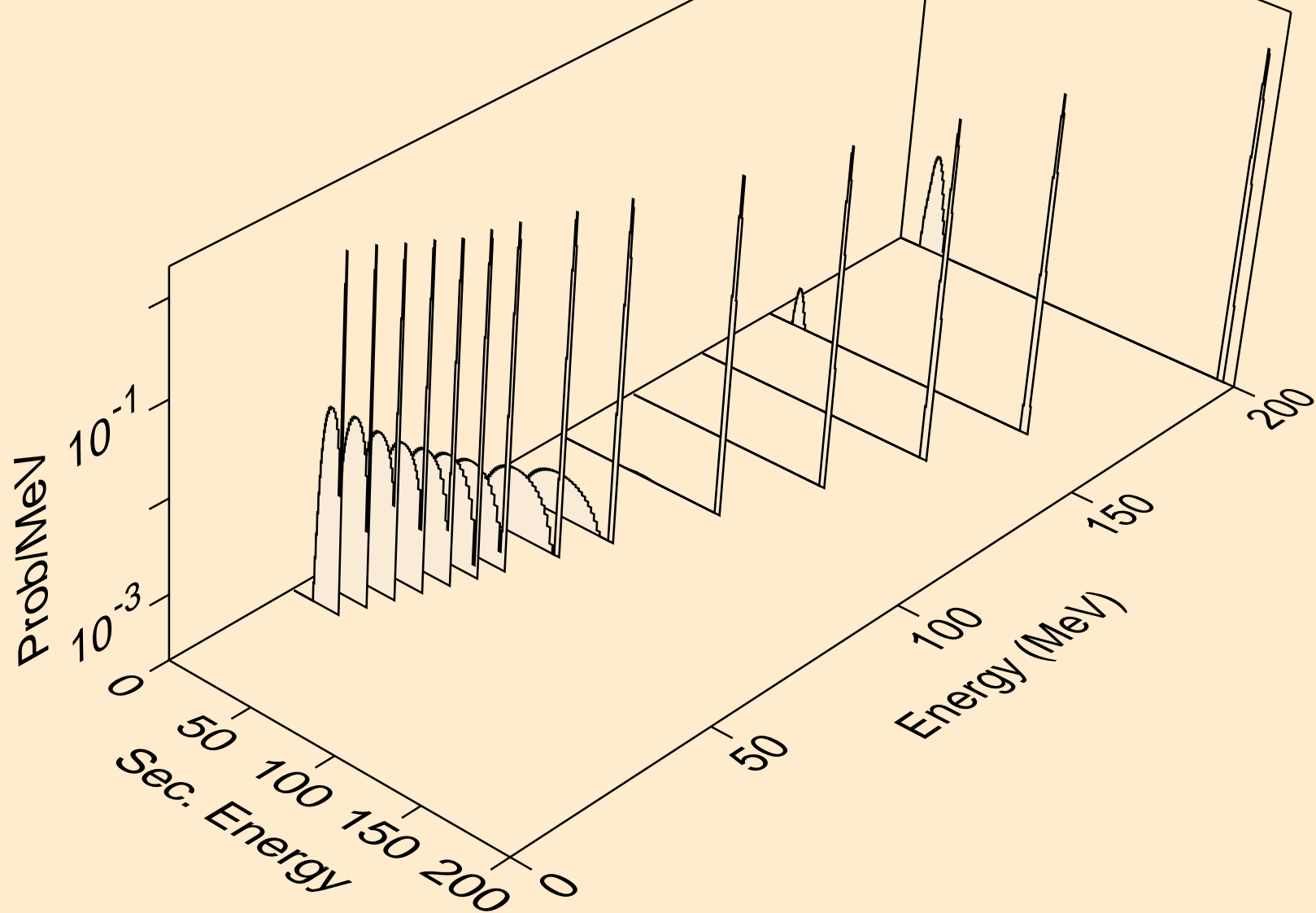

ND151 HELION ACER TENDL-2023 LIBRARY; T=0.K  
He-3 emission for (s,n\*)he3

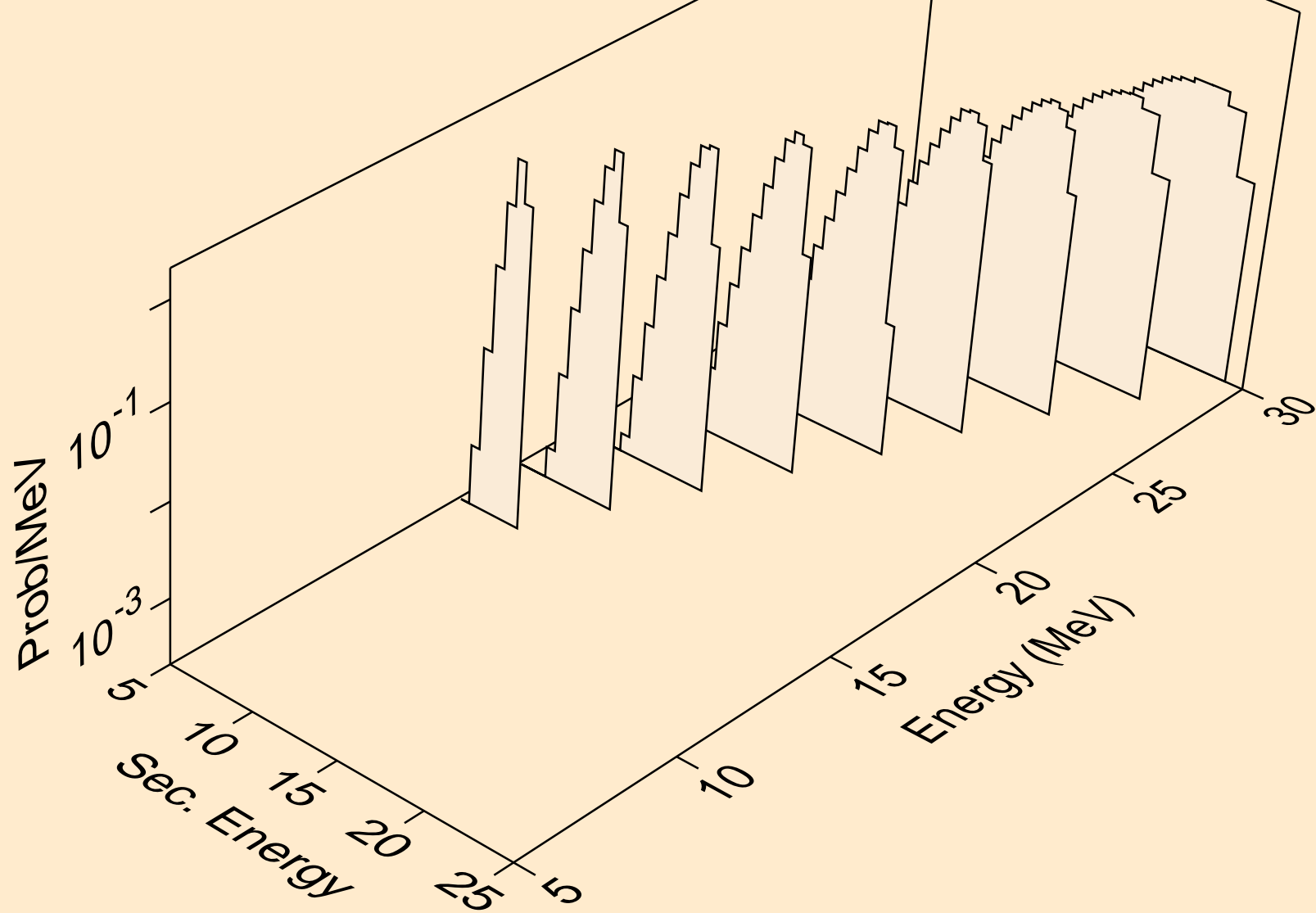

ND151 HELION ACER TENDL-2023 LIBRARY; T=0.K  
He-3 emission for inelastic

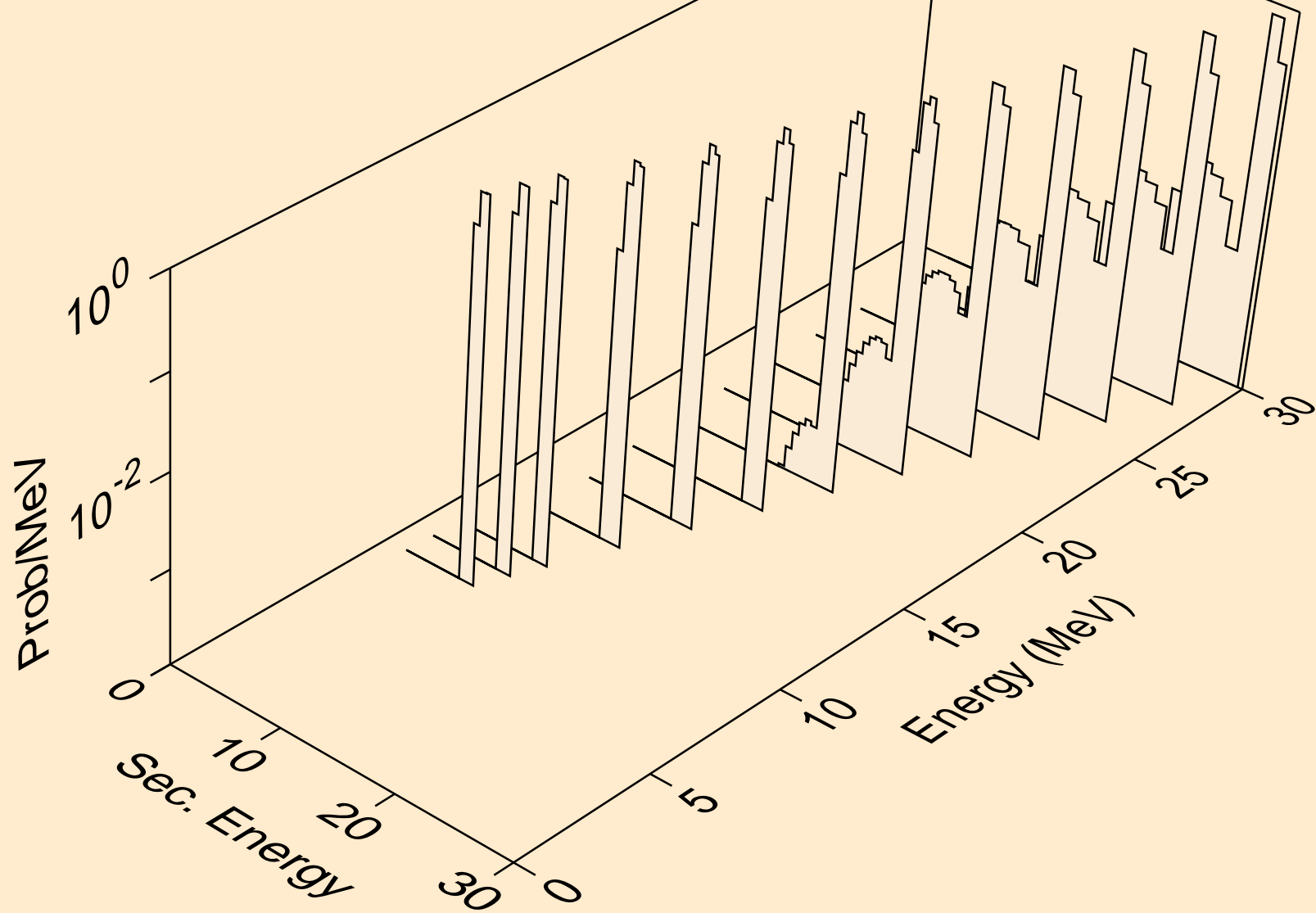

ND151 HELION ACER TENDL-2023 LIBRARY; T=0.K  
Photon emission for (z,n)

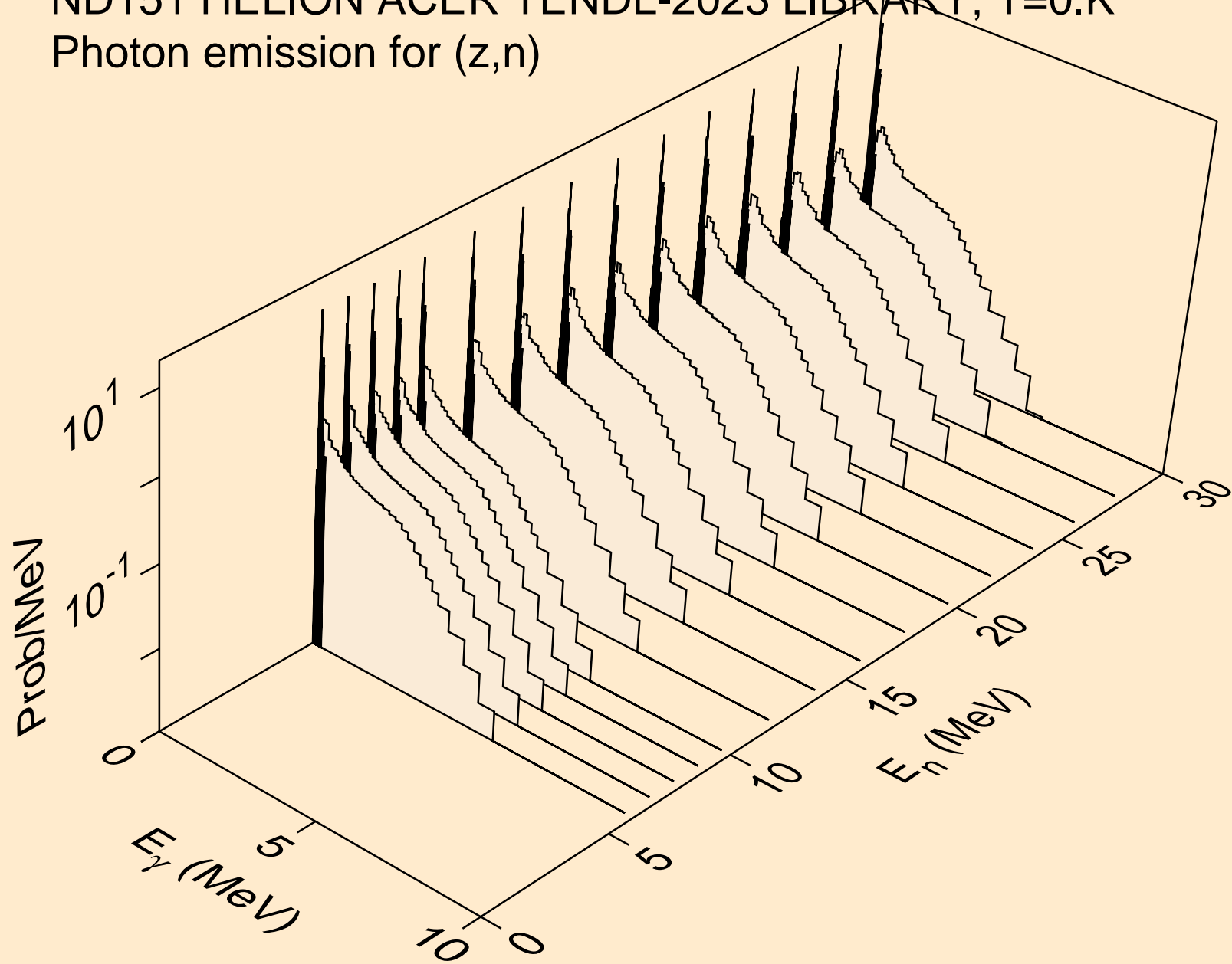

ND151 HELION ACER TENDL-2023 LIBRARY; T=0.K  
Photon emission for (z,x)

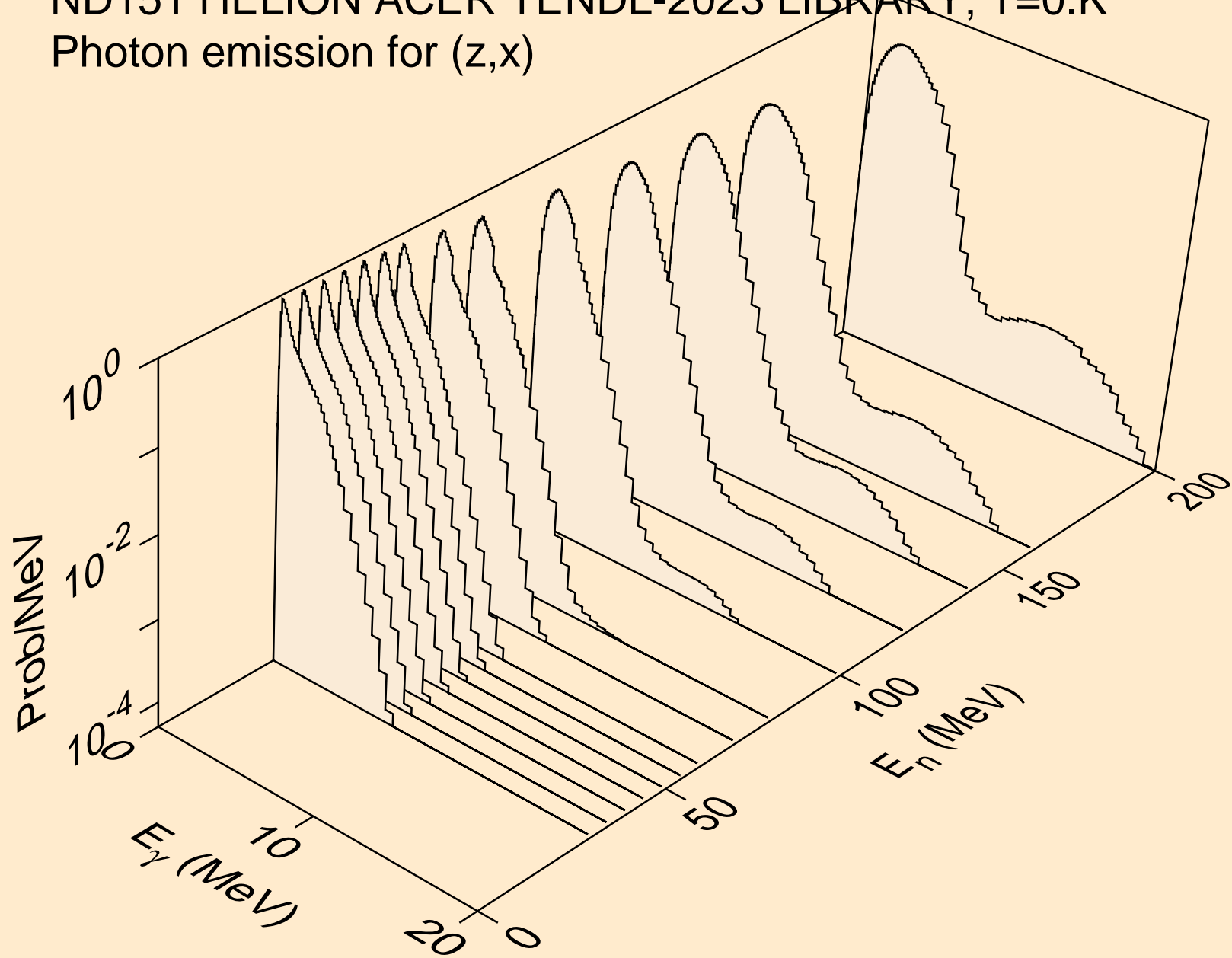

ND151 HELION ACER TENDL-2023 LIBRARY; T=0.K  
Photon emission for (n,2nd)

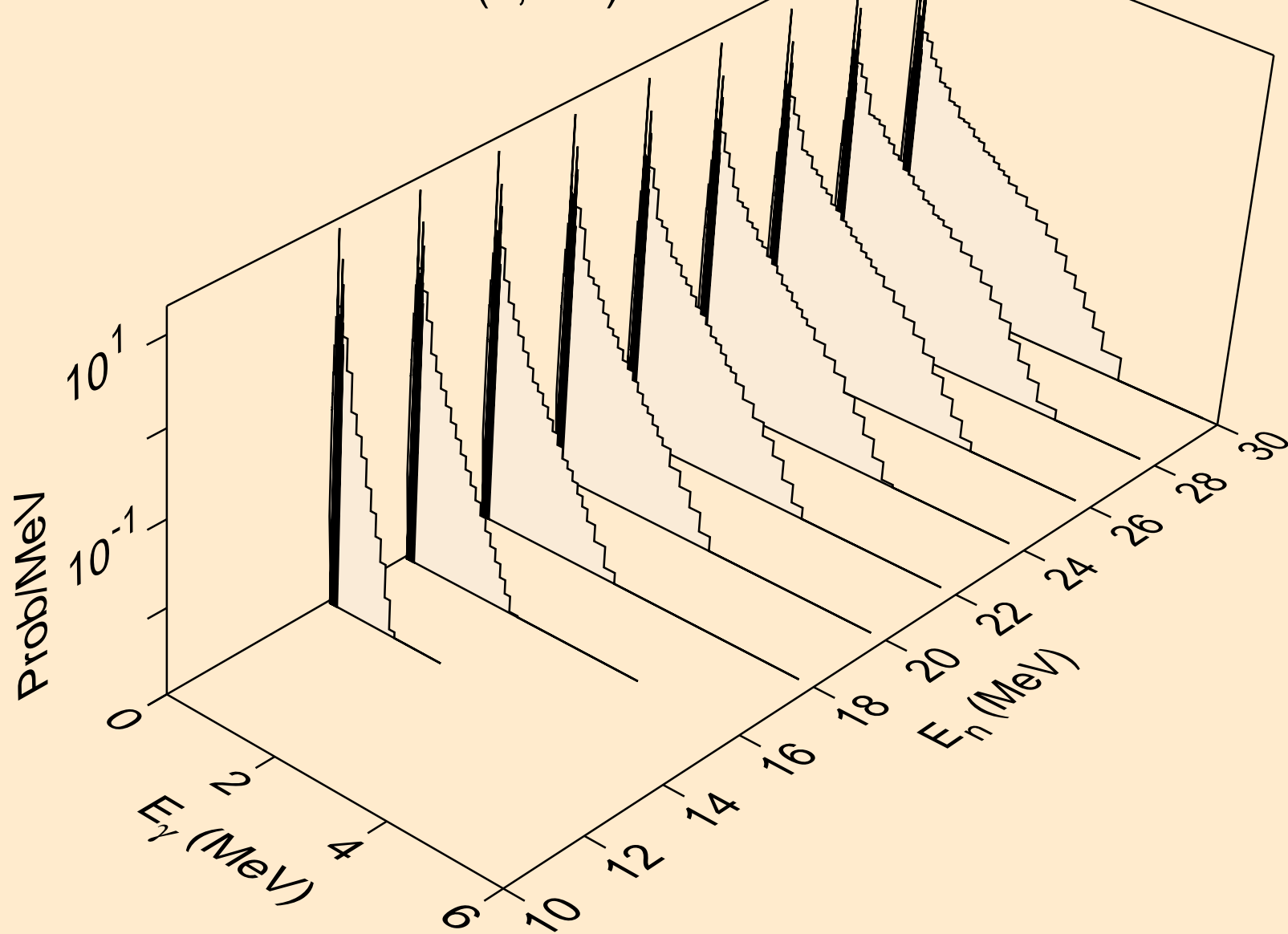

ND151 HELION ACER TENDL-2023 LIBRARY; T=0.K  
Photon emission for (n,2n)

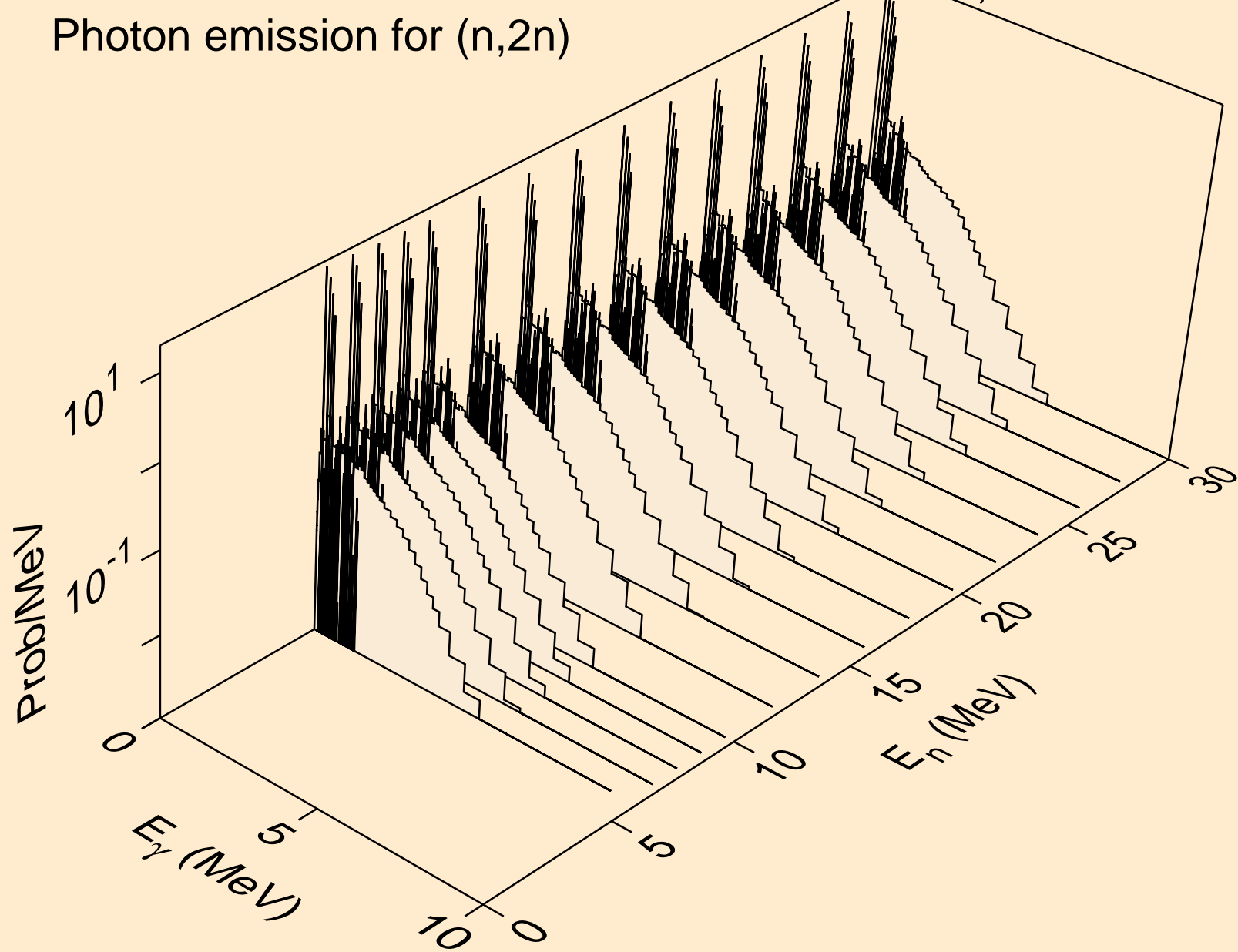

ND151 HELION ACER TENDL-2023 LIBRARY; T=0.K  
Photon emission for (n,3n)

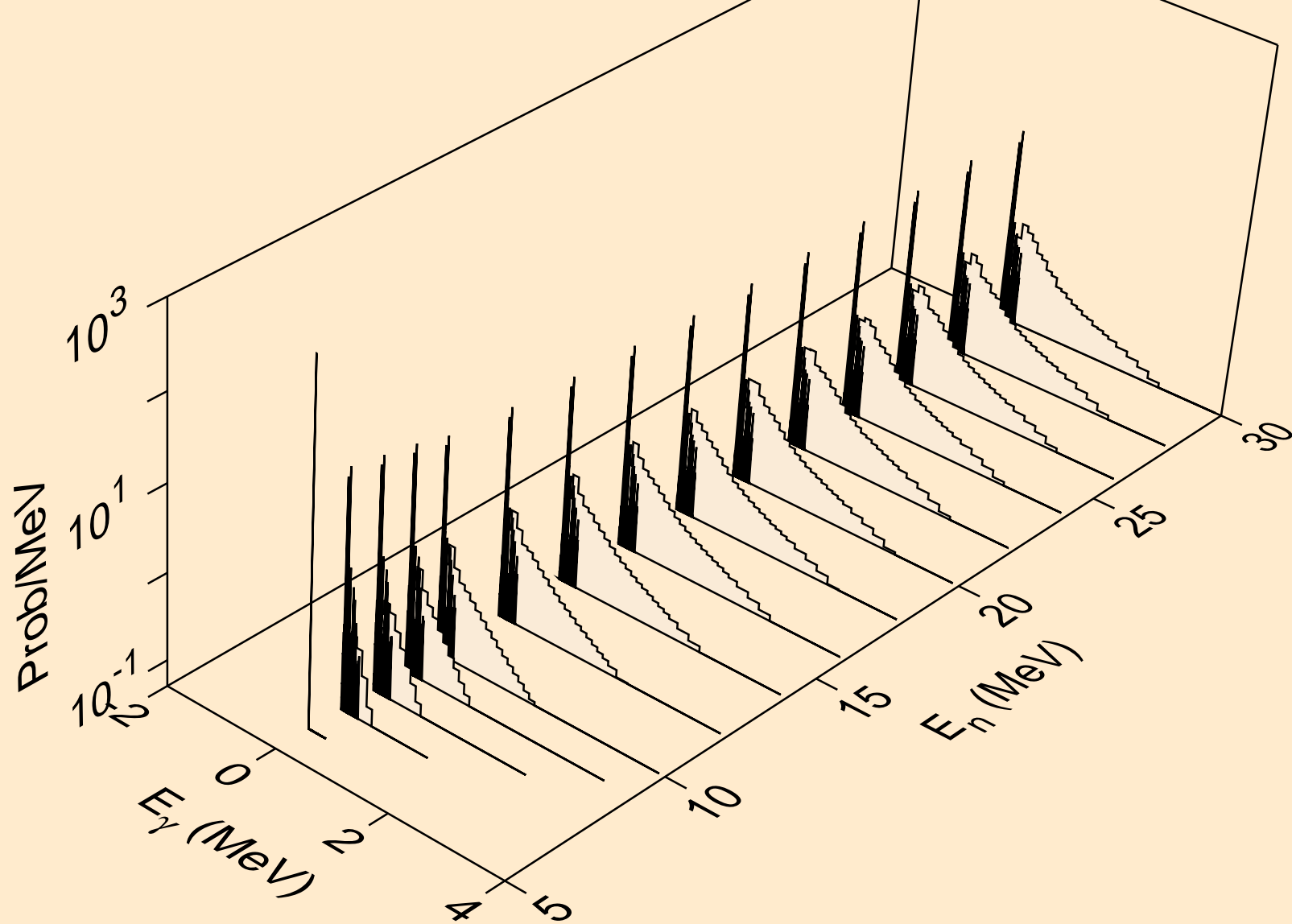

ND151 HELION ACER TENDL-2023 LIBRARY; T=0.K  
Photon emission for (n,n\*)a

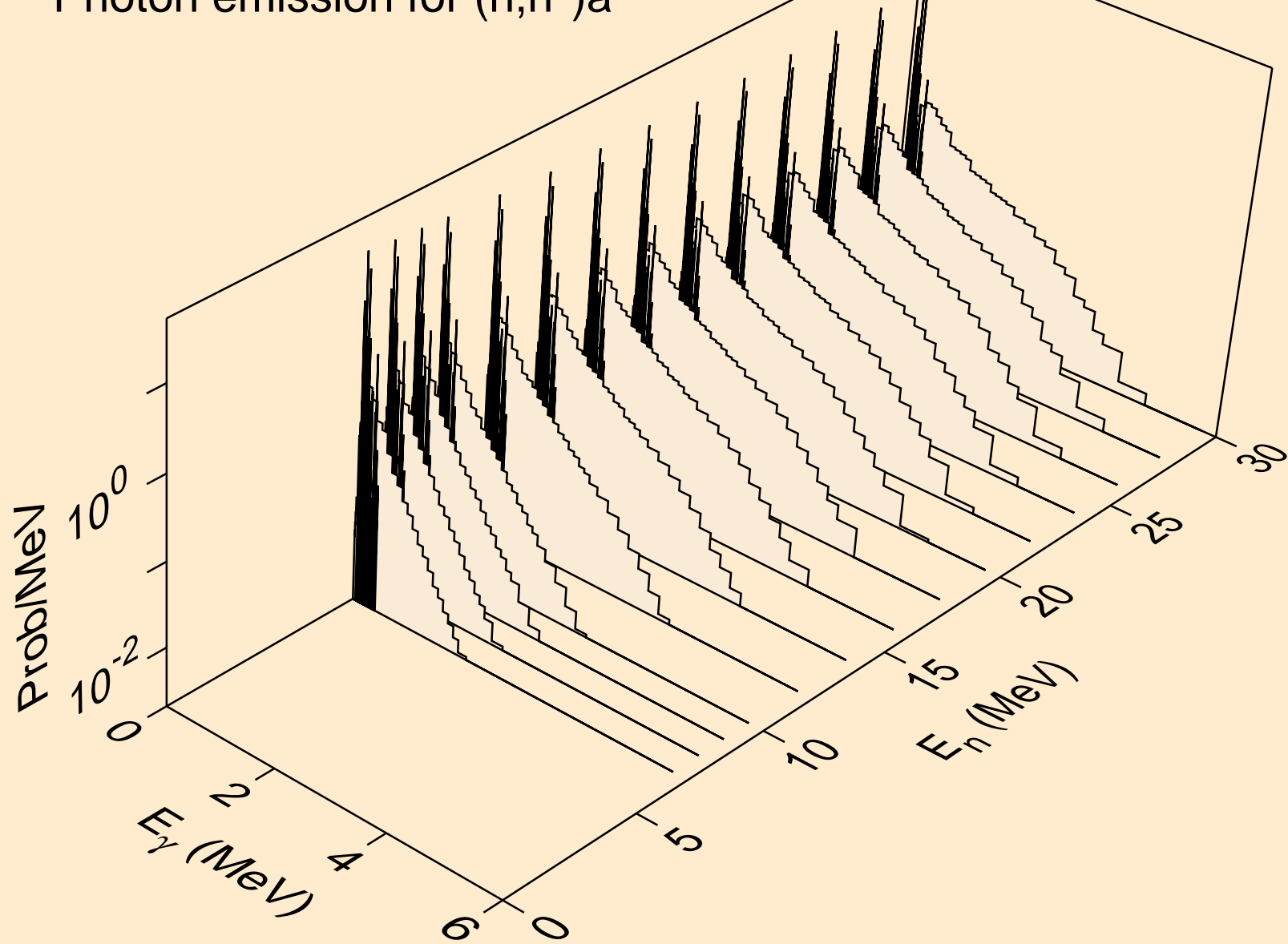

ND151 HELION ACER TENDL-2023 LIBRARY; T=0.K  
Photon emission for (n,2n)a

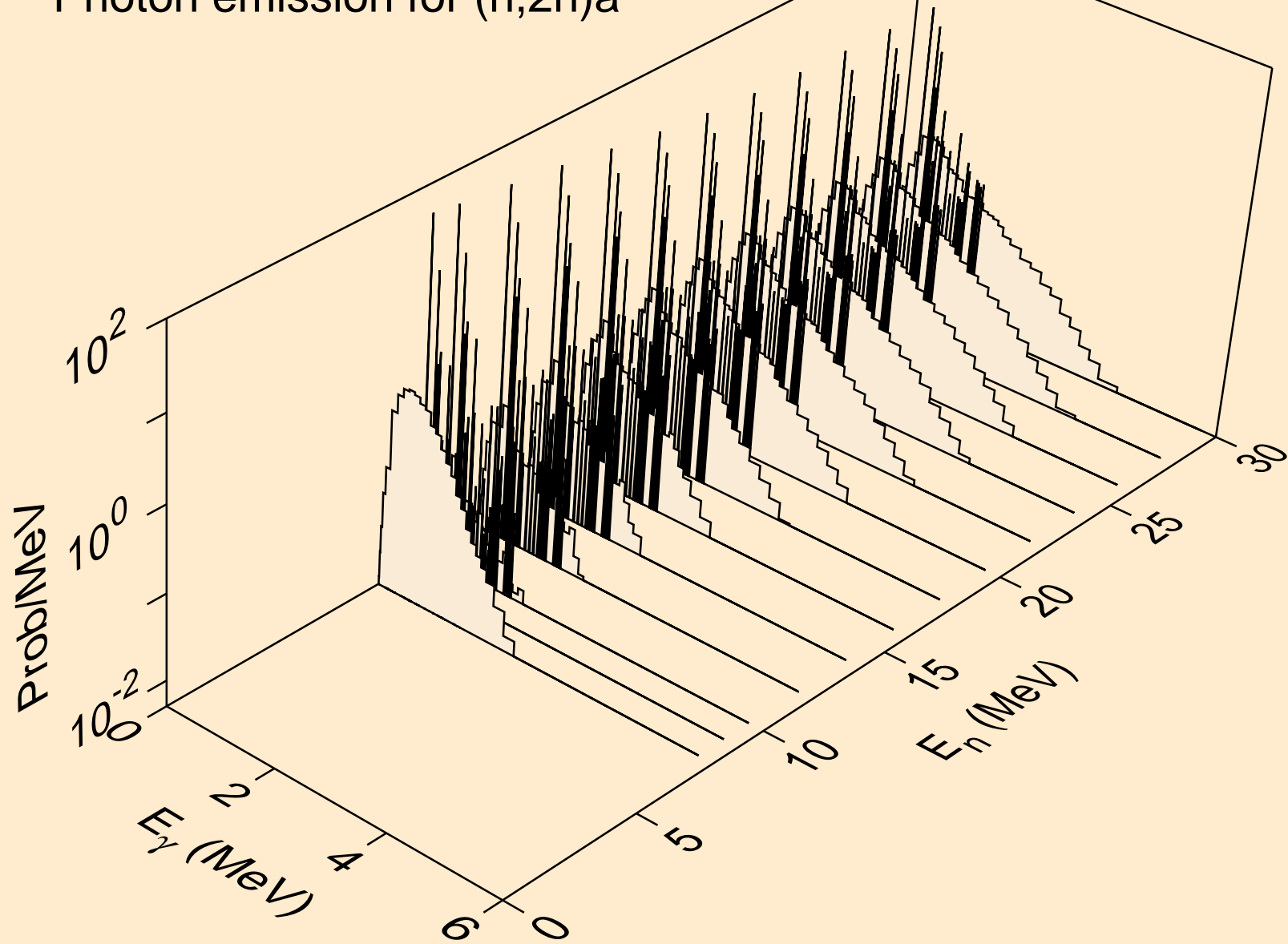

ND151 HELION ACER TENDL-2023 LIBRARY; T=0.K  
Photon emission for (n,3n)a

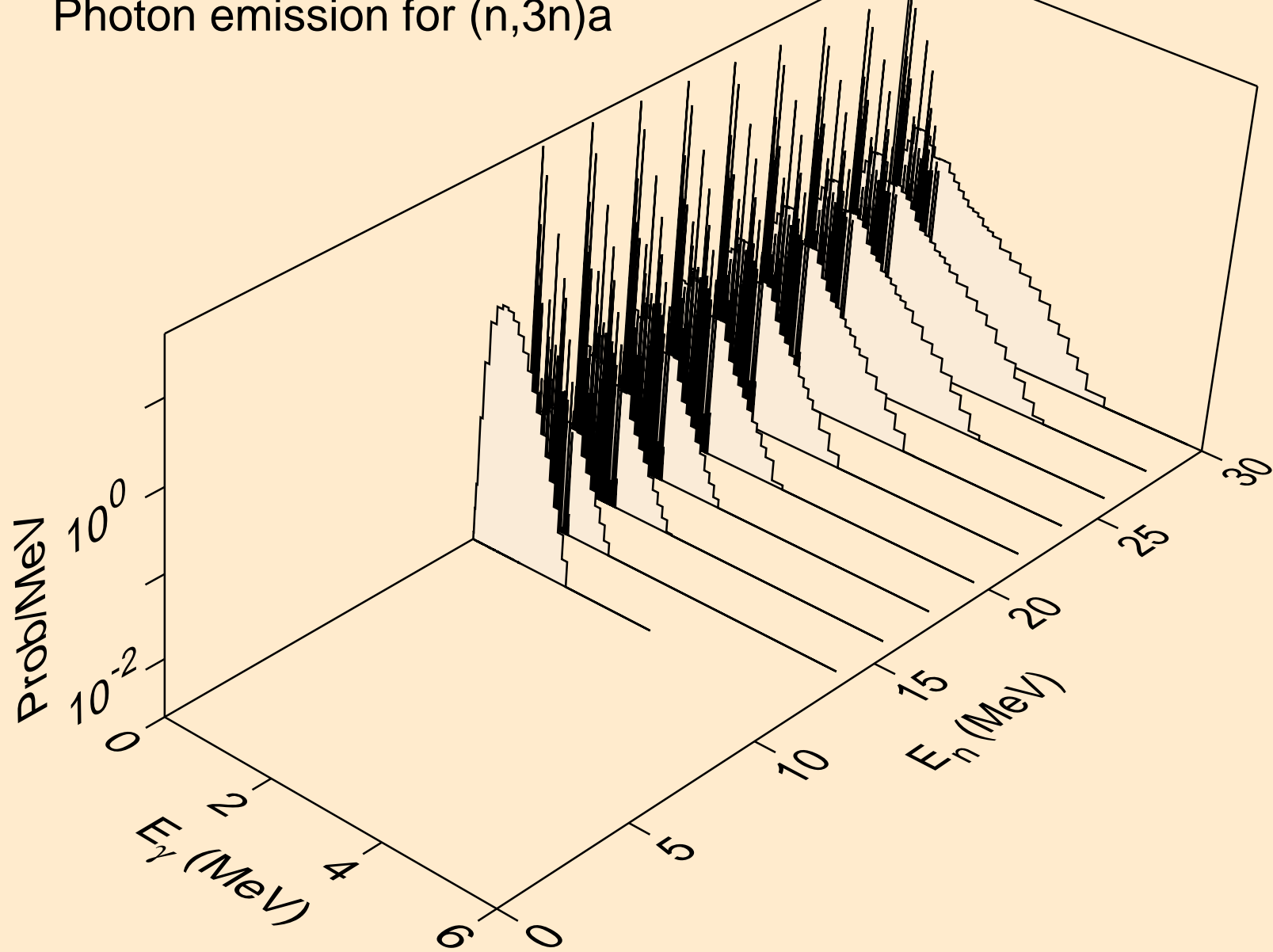

ND151 HELION ACER TENDL-2023 LIBRARY; T=0.K  
Photon emission for (n,n\*)p

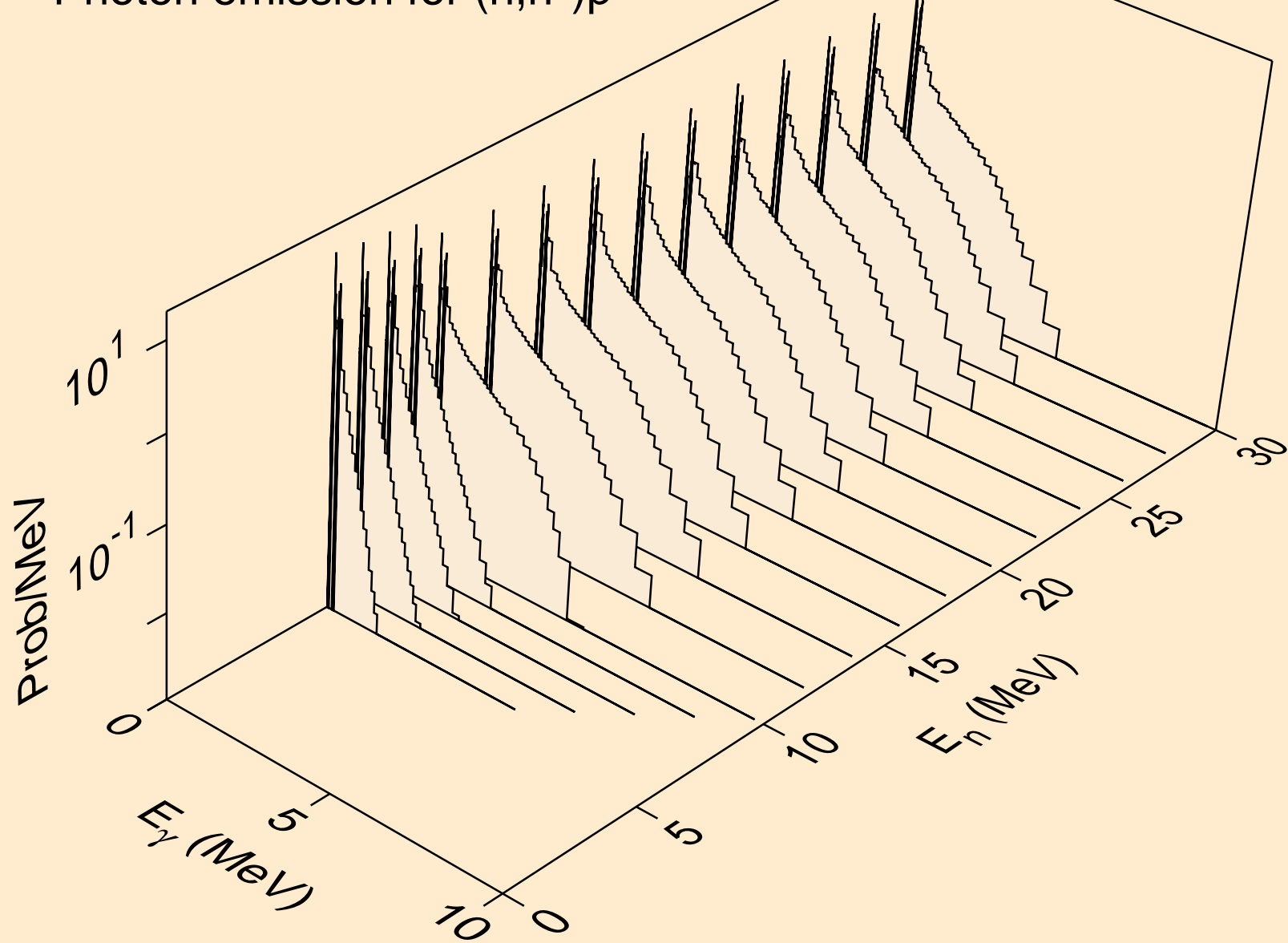

ND151 HELION ACER TENDL-2023 LIBRARY; T=0.K  
Photon emission for (n,n\*)2a

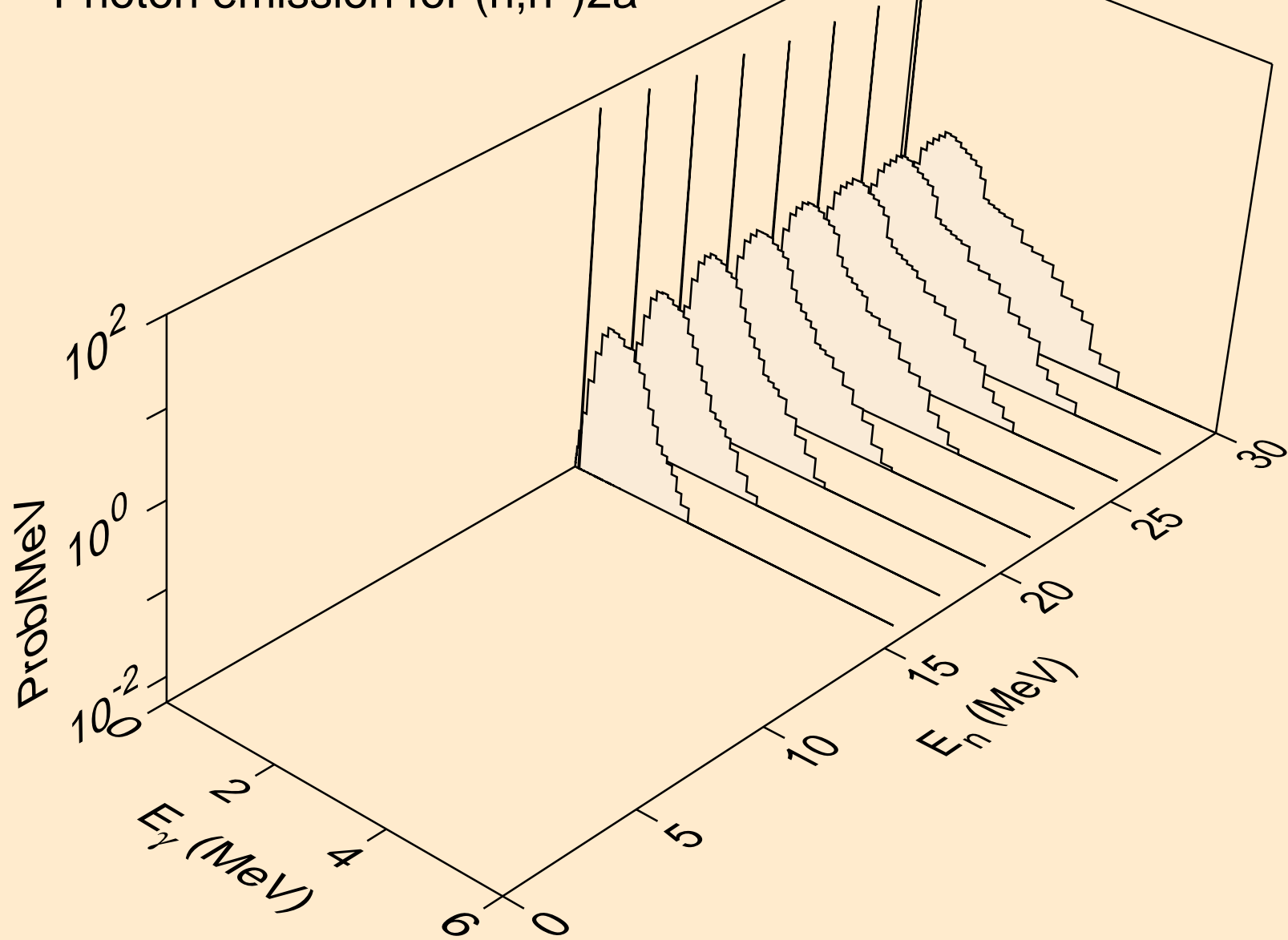

ND151 HELION ACER TENDL-2023 LIBRARY; T=0.K  
Photon emission for (n,n\*)d

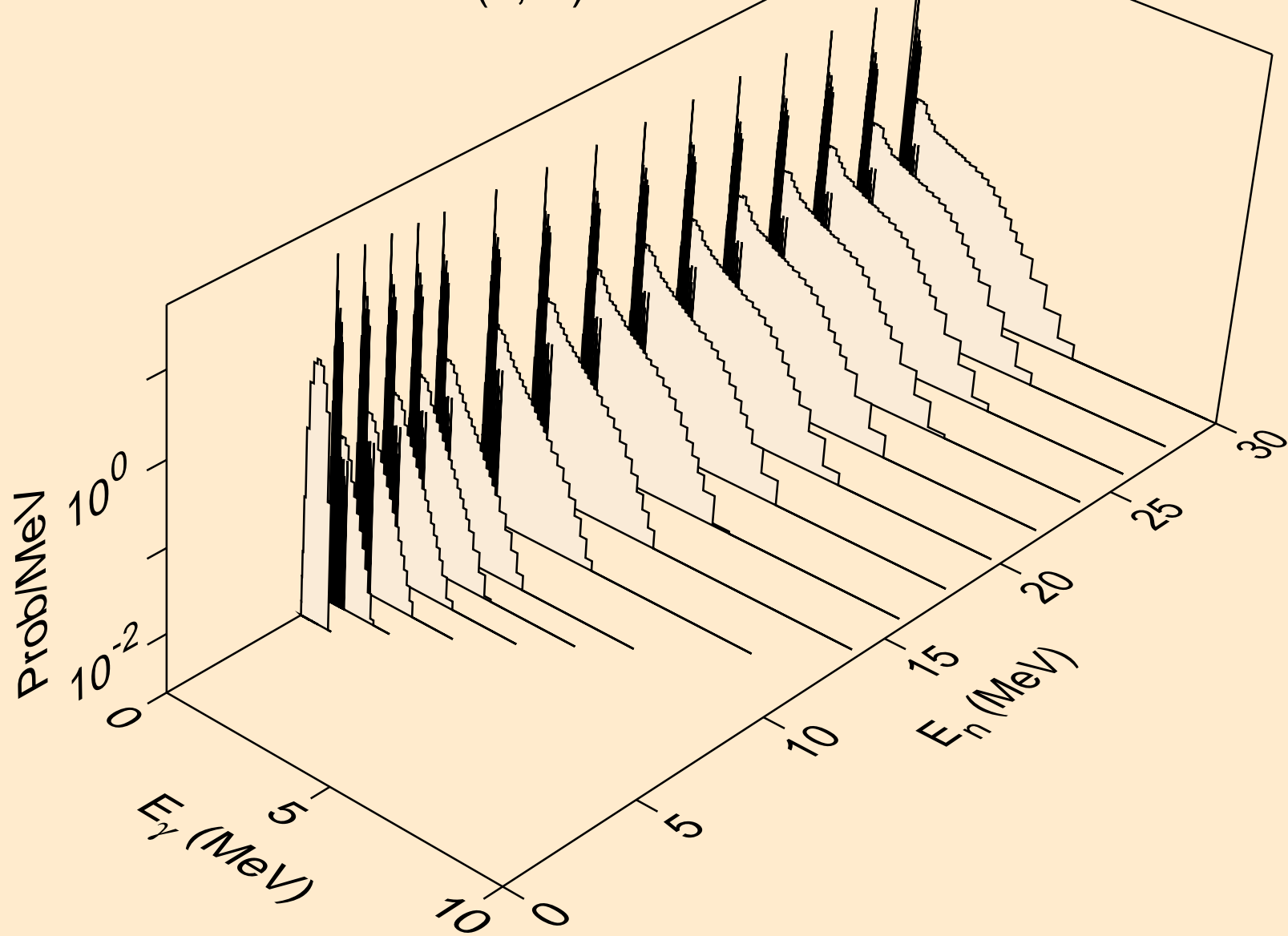

ND151 HELION ACER TENDL-2023 LIBRARY; T=0.K  
Photon emission for (n,n\*)t

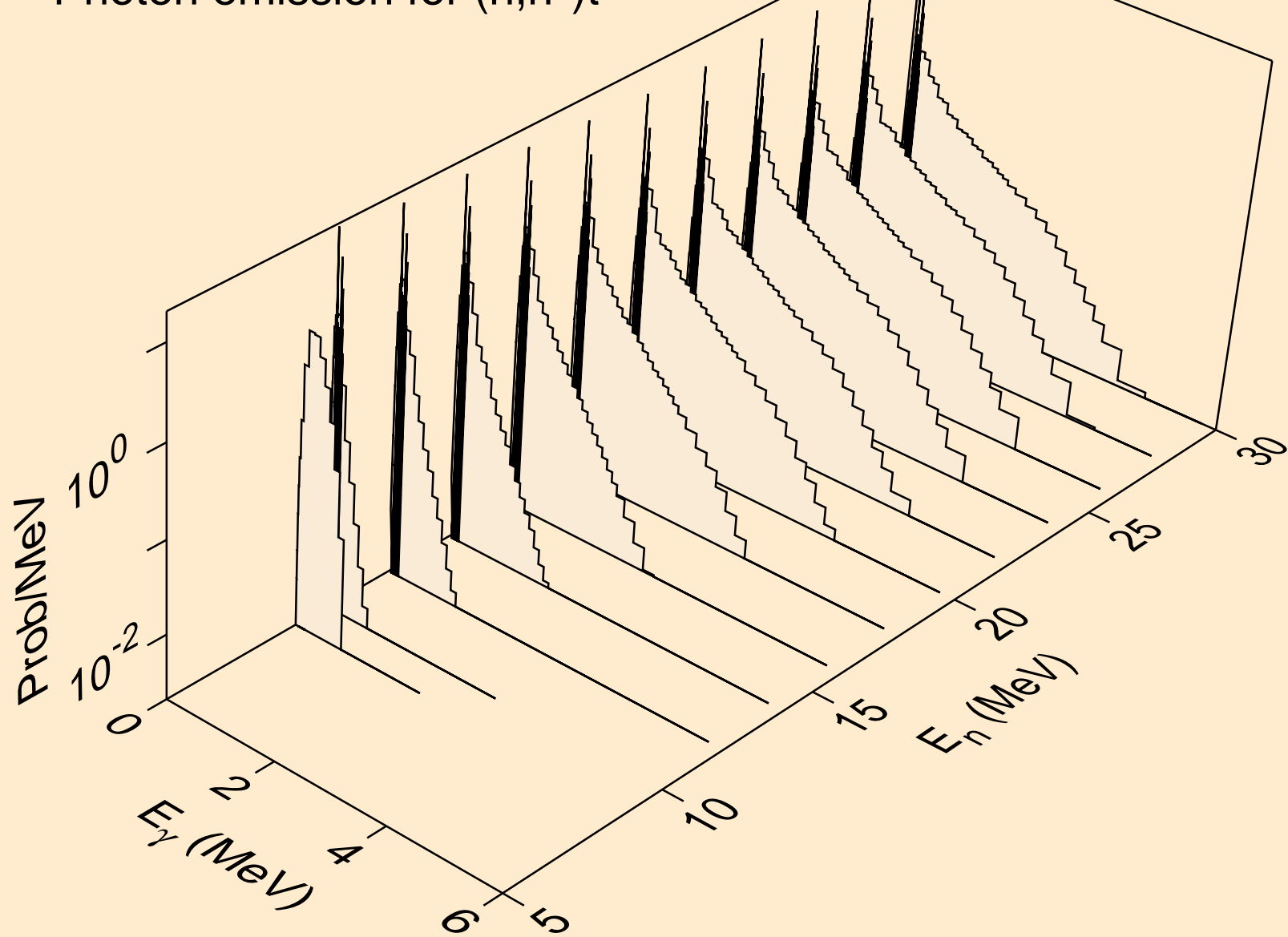

ND151 HELION ACER TENDL-2023 LIBRARY; T=0.K  
Photon emission for (n,n\*)he3

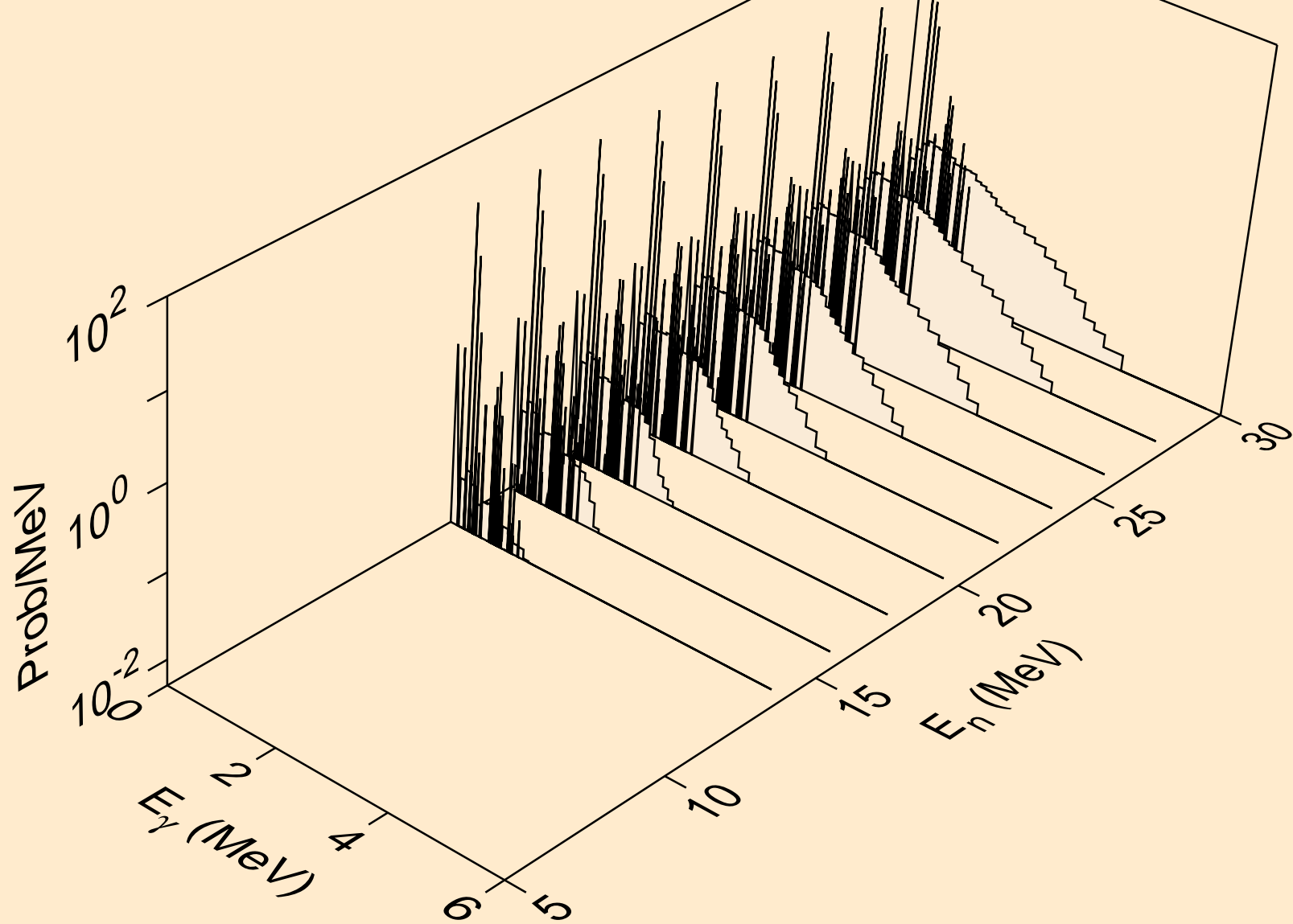

ND151 HELION ACER TENDL-2023 LIBRARY; T=0.K  
Photon emission for (n,4n)

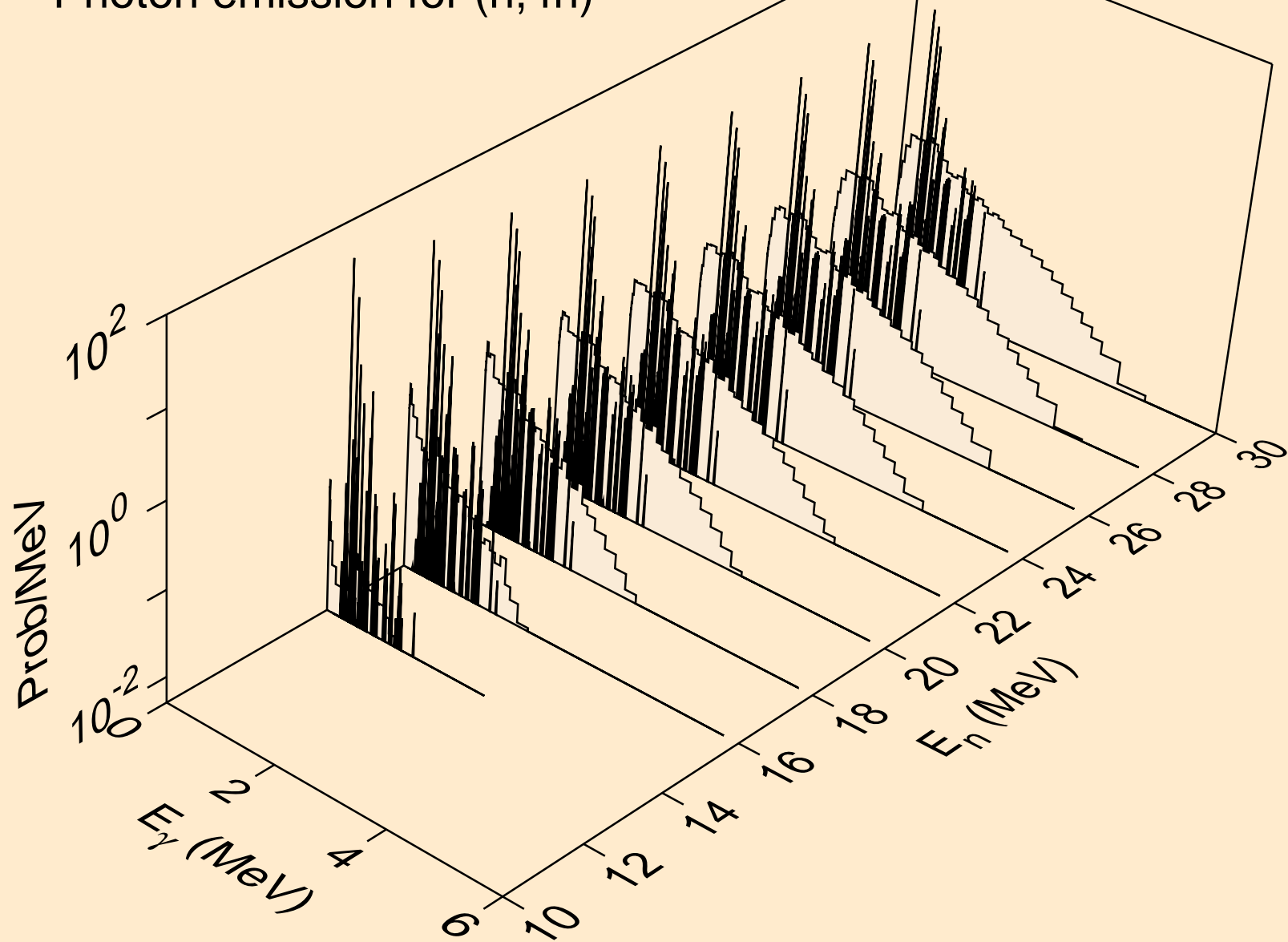

ND151 HELION ACER TENDL-2023 LIBRARY; T=0.K  
Photon emission for (n,2np)

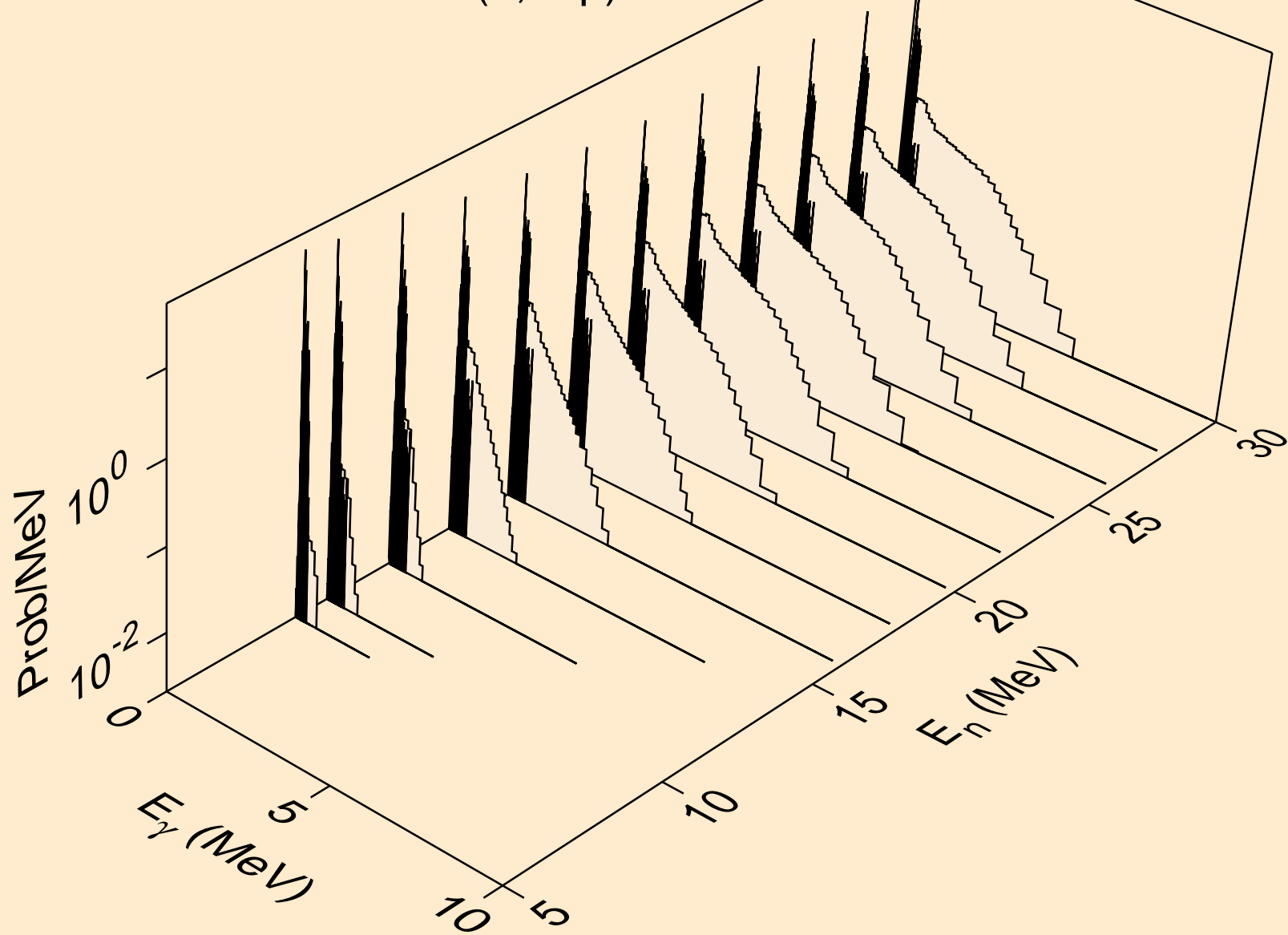

ND151 HELION ACER TENDL-2023 LIBRARY; T=0.K  
Photon emission for (n,3np)

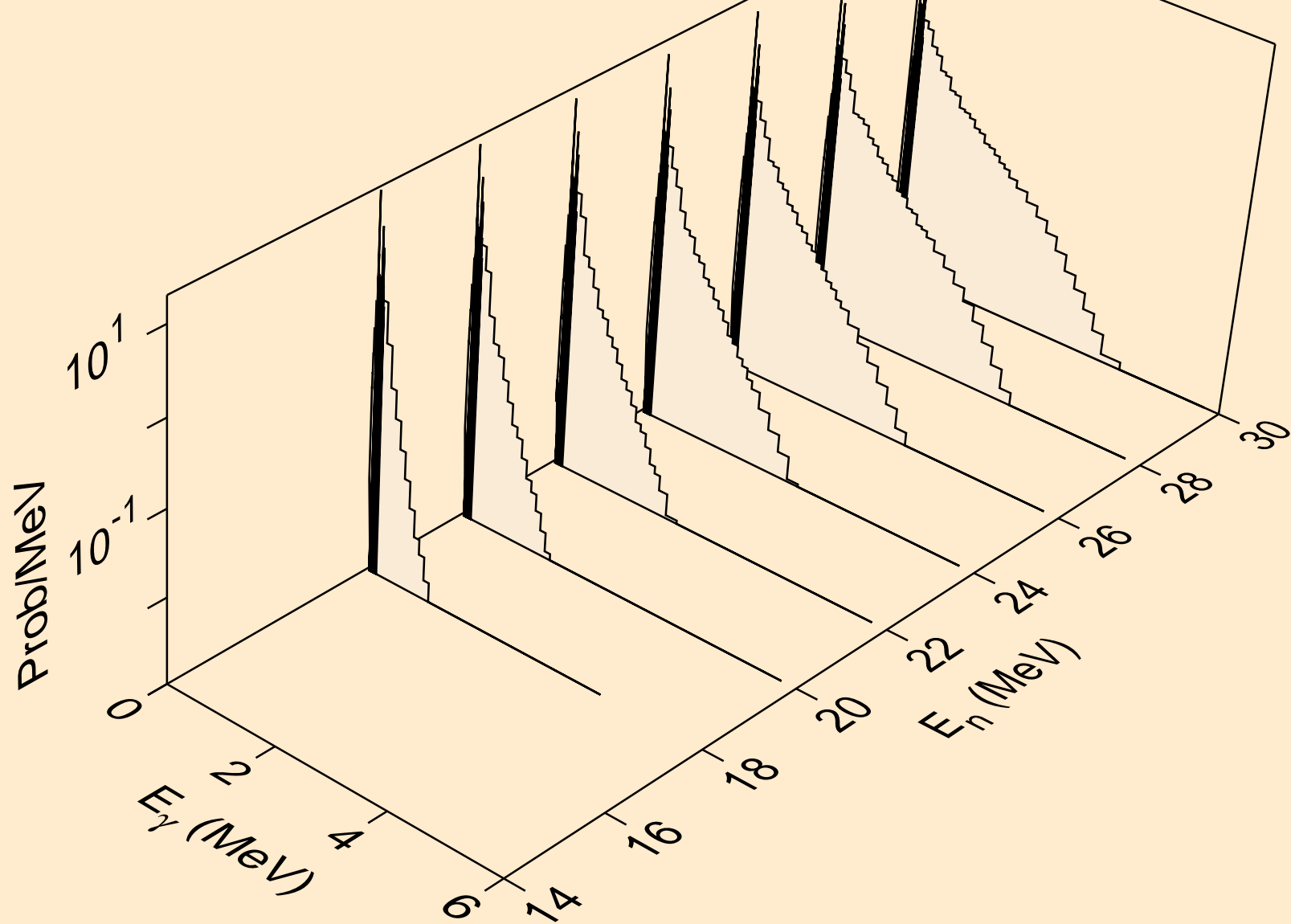

ND151 HELION ACER TENDL-2023 LIBRARY; T=0.K  
Photon emission for (n,n2p)

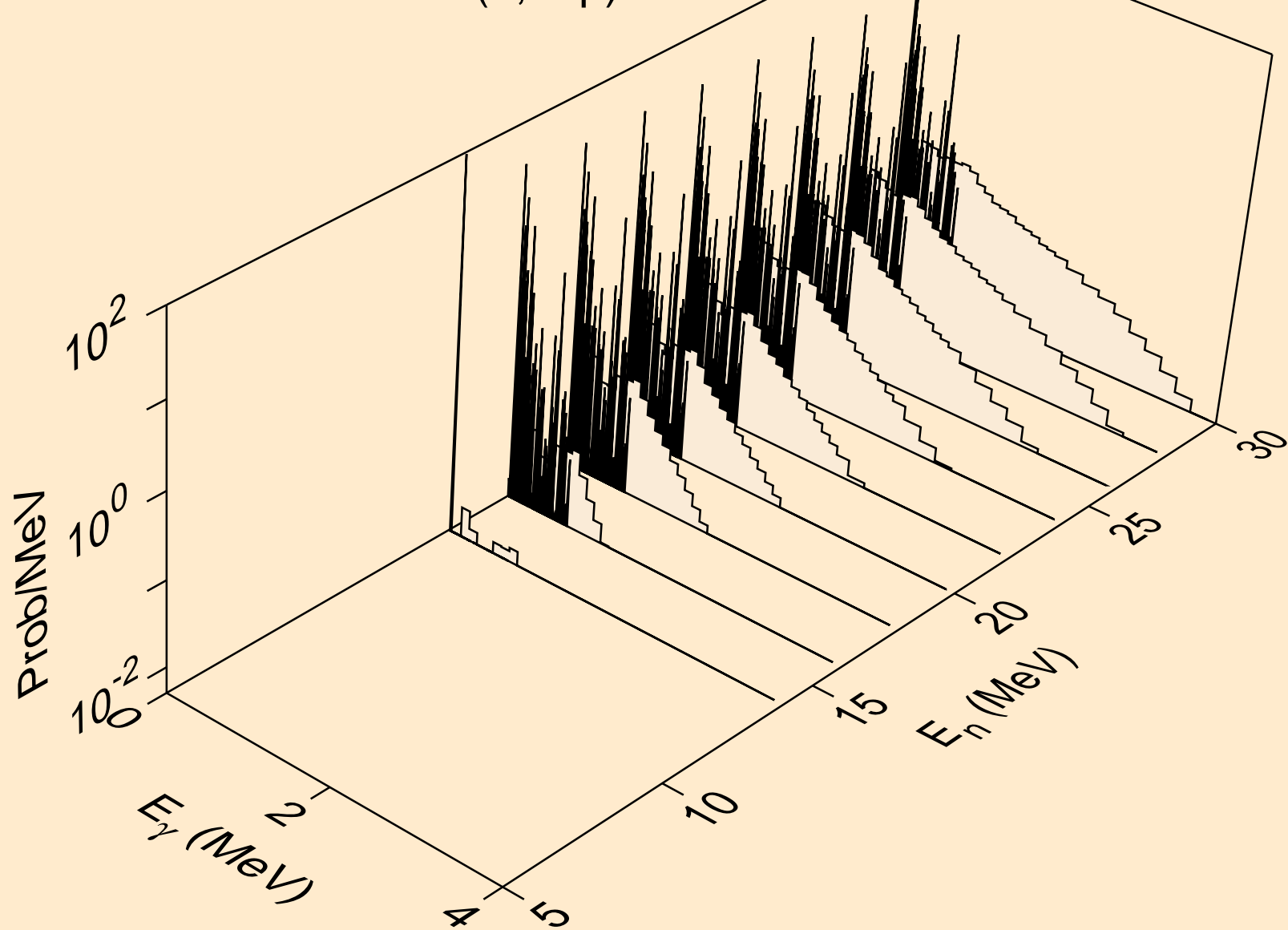

ND151 HELION ACER TENDL-2023 LIBRARY; T=0.K  
Photon emission for (n,npa)

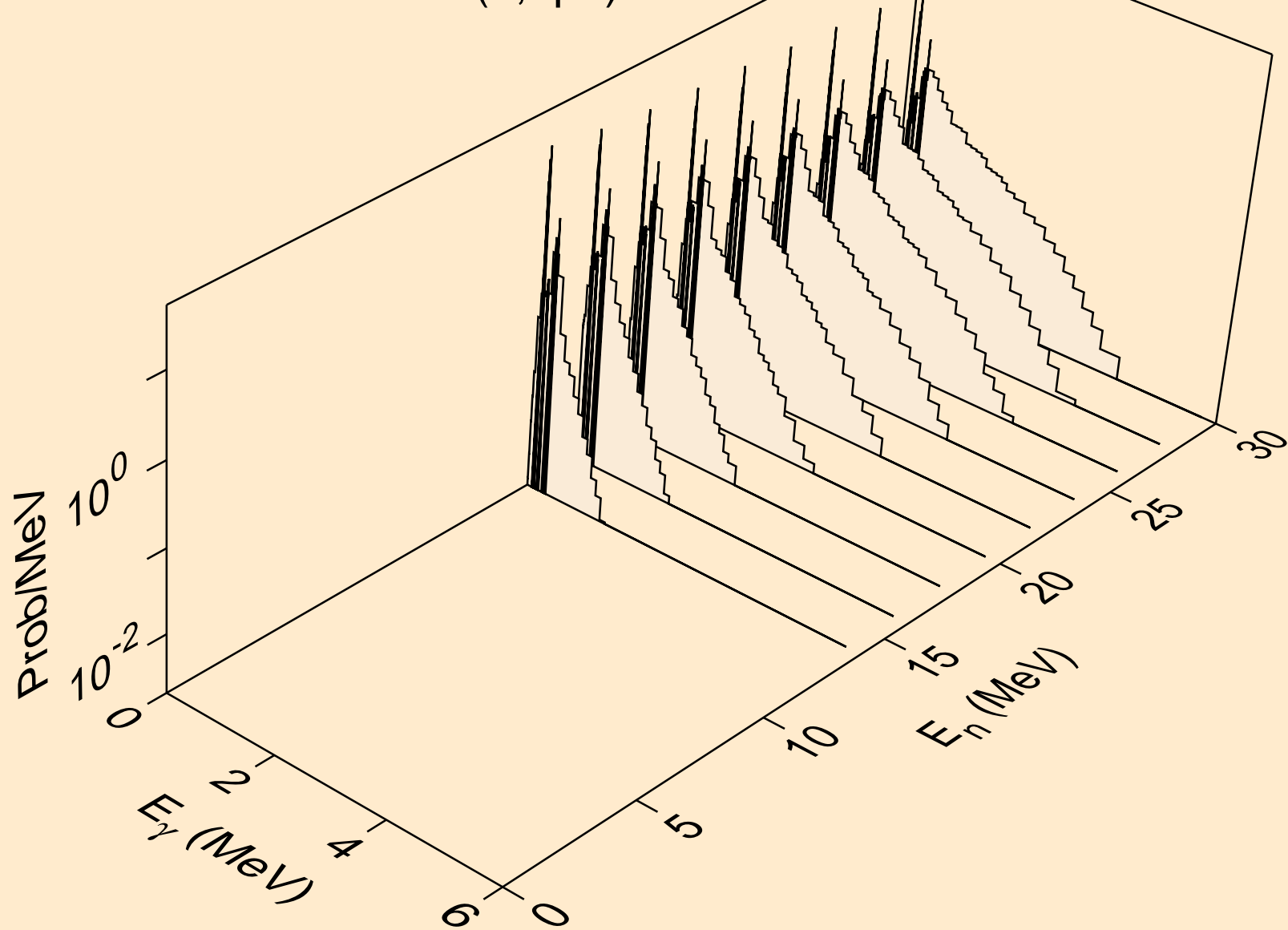

ND151 HELION ACER TENDL-2023 LIBRARY; T=0.K  
Photon emission for (n,gma)

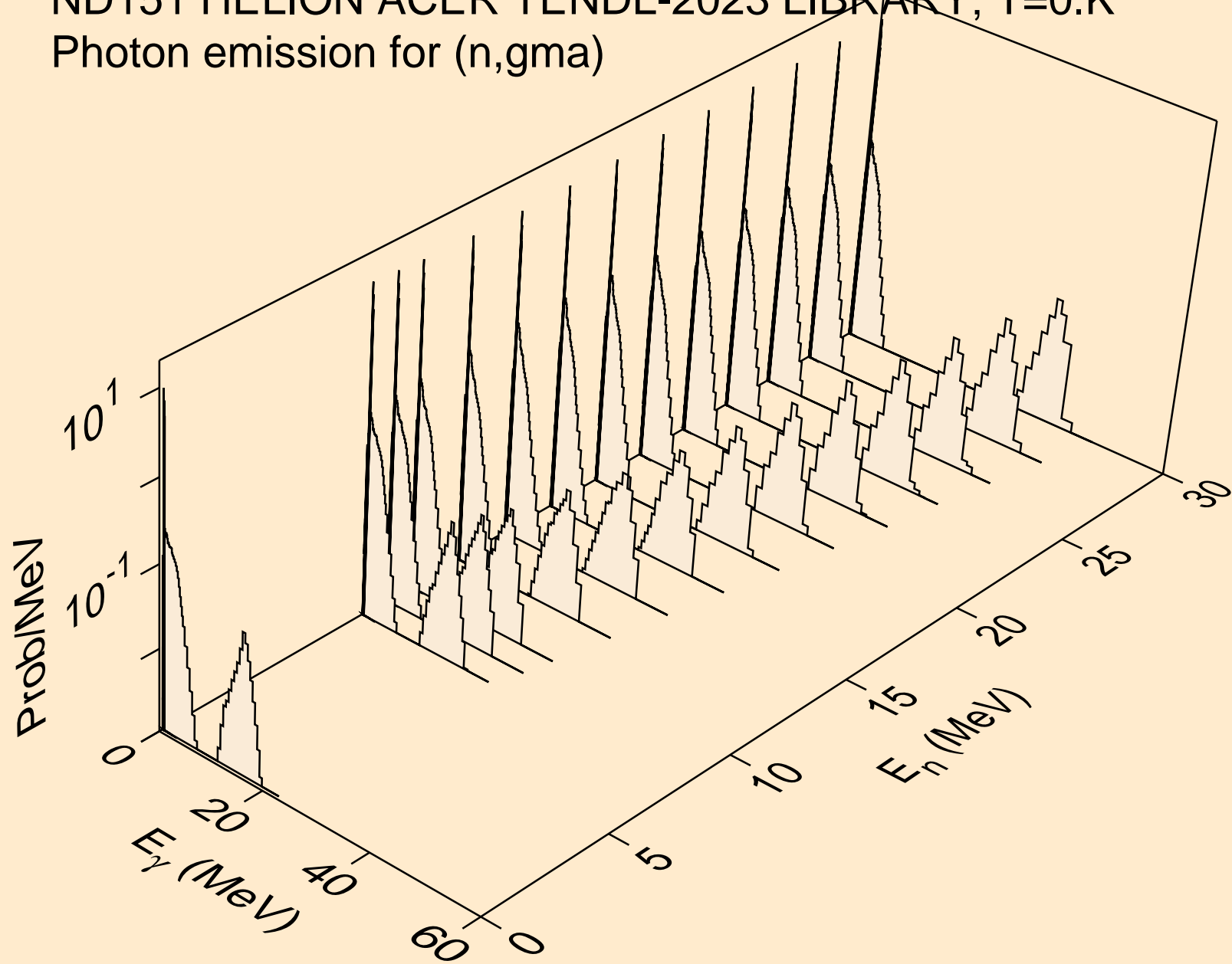

ND151 HELION ACER TENDL-2023 LIBRARY; T=0.K  
Photon emission for (n,p)

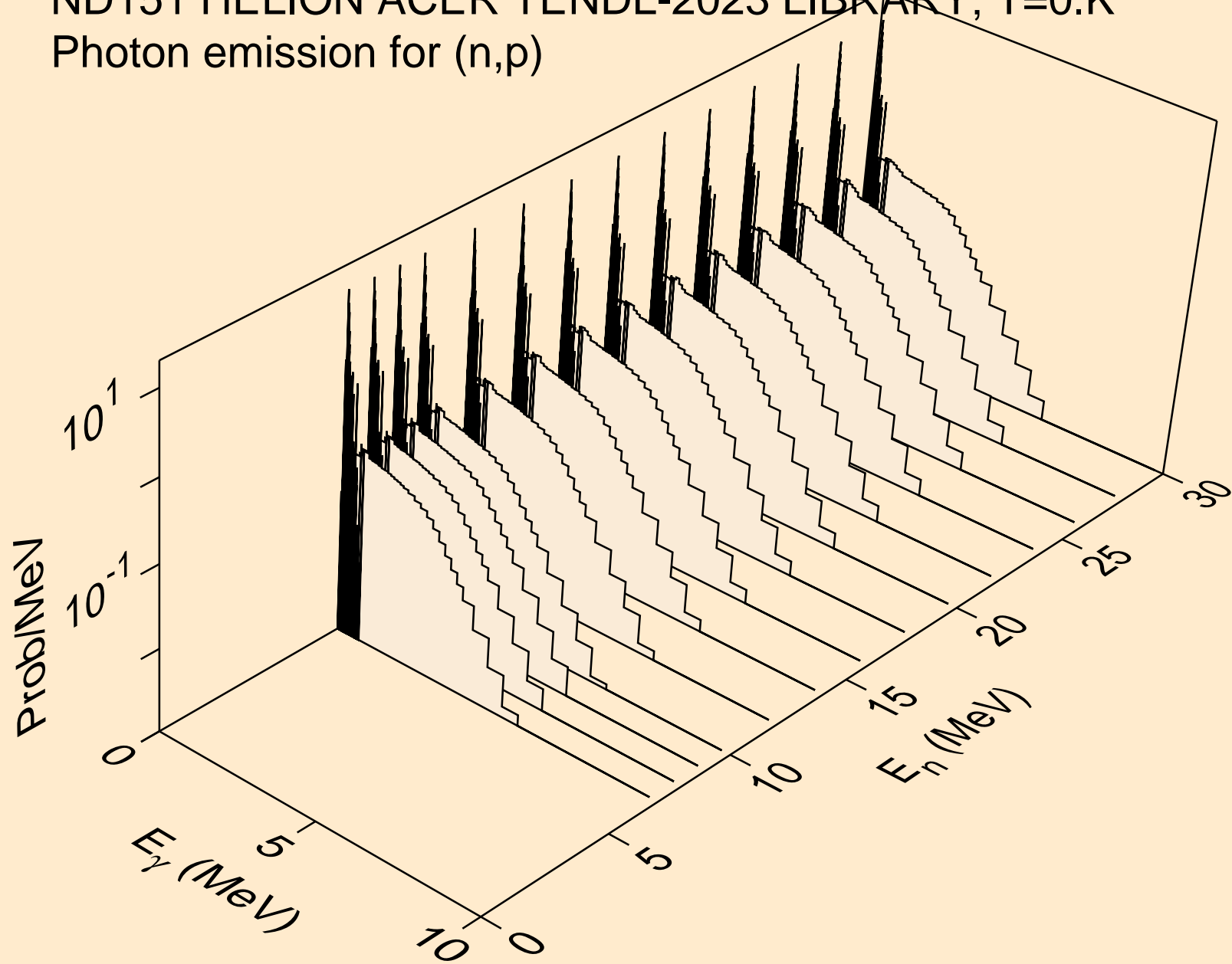

ND151 HELION ACER TENDL-2023 LIBRARY; T=0.K  
Photon emission for (n,d)

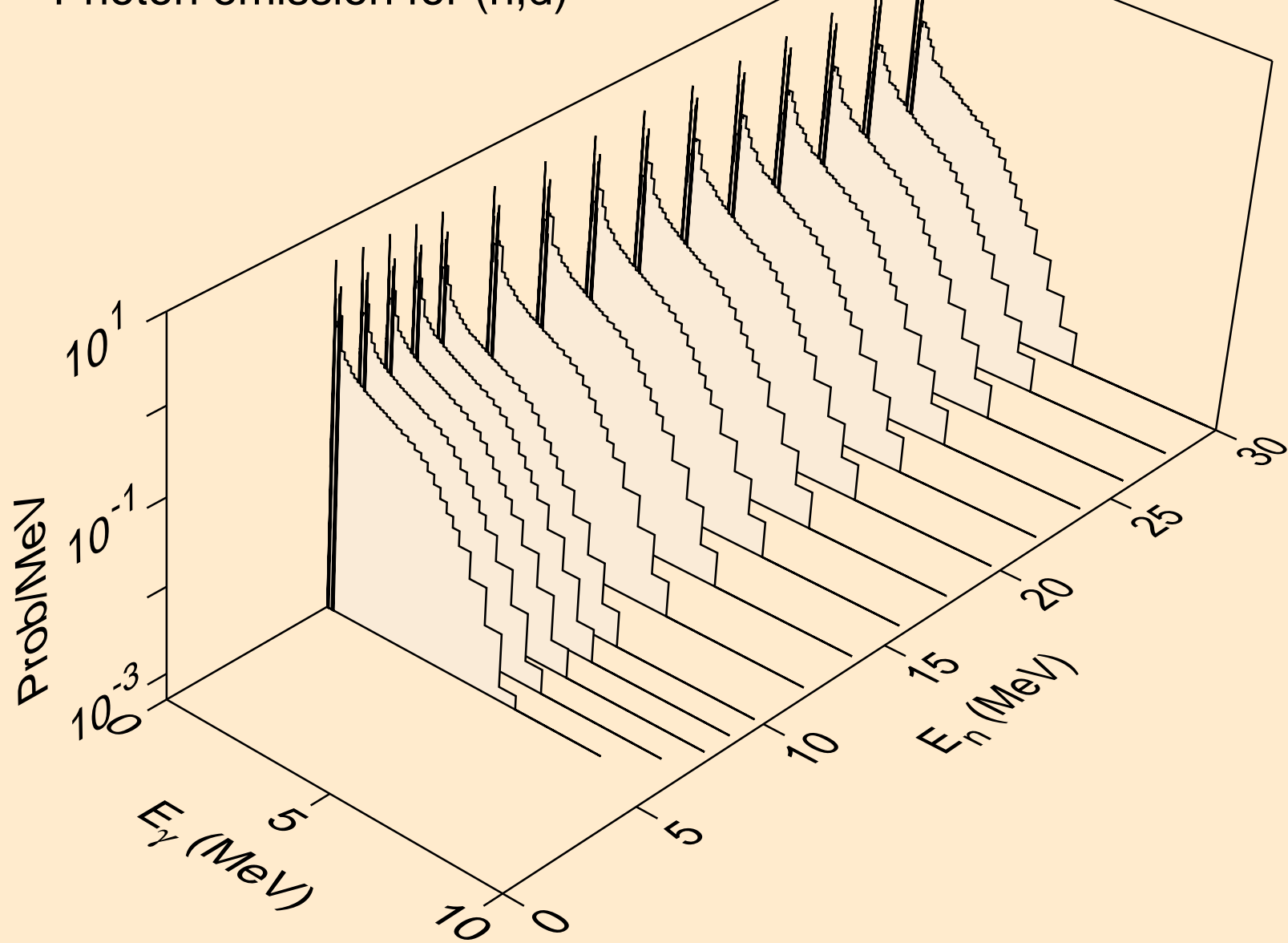

ND151 HELION ACER TENDL-2023 LIBRARY; T=0.K  
Photon emission for (n,t)

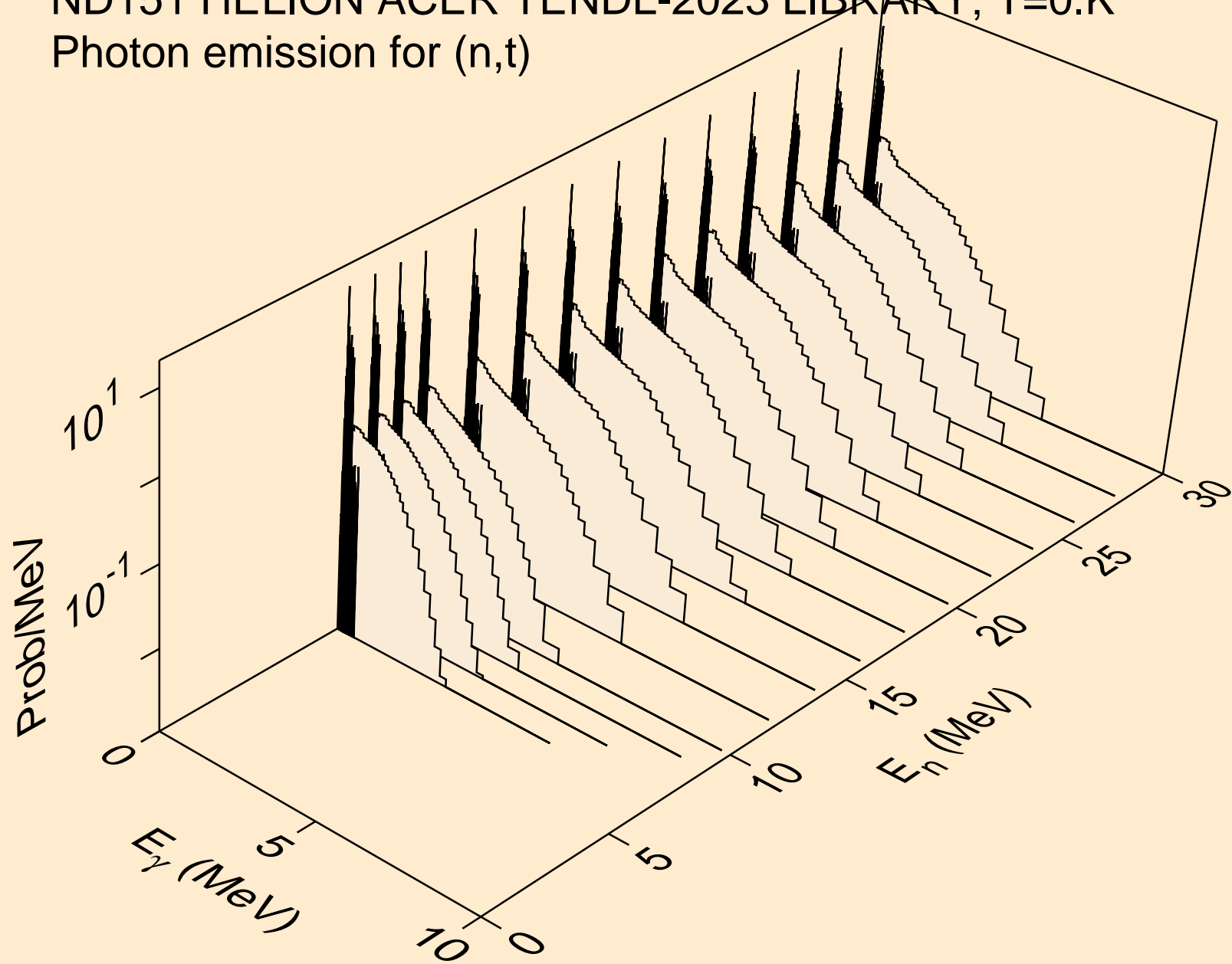

ND151 HELION ACER TENDL-2023 LIBRARY; T=0.K  
Photon emission for inelastic

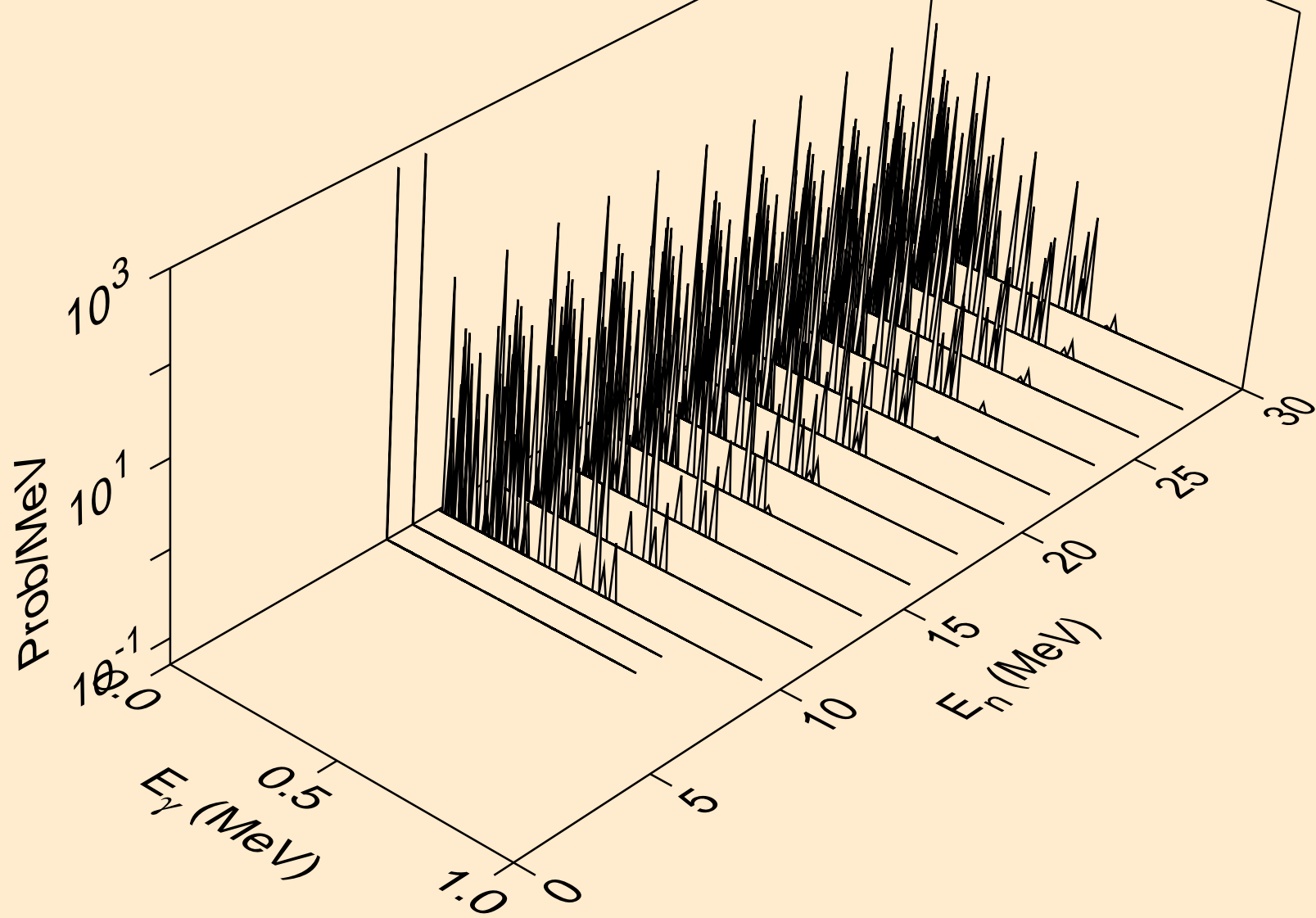

ND151 HELION ACER TENDL-2023 LIBRARY; T=0.K  
Photon emission for (n,a)

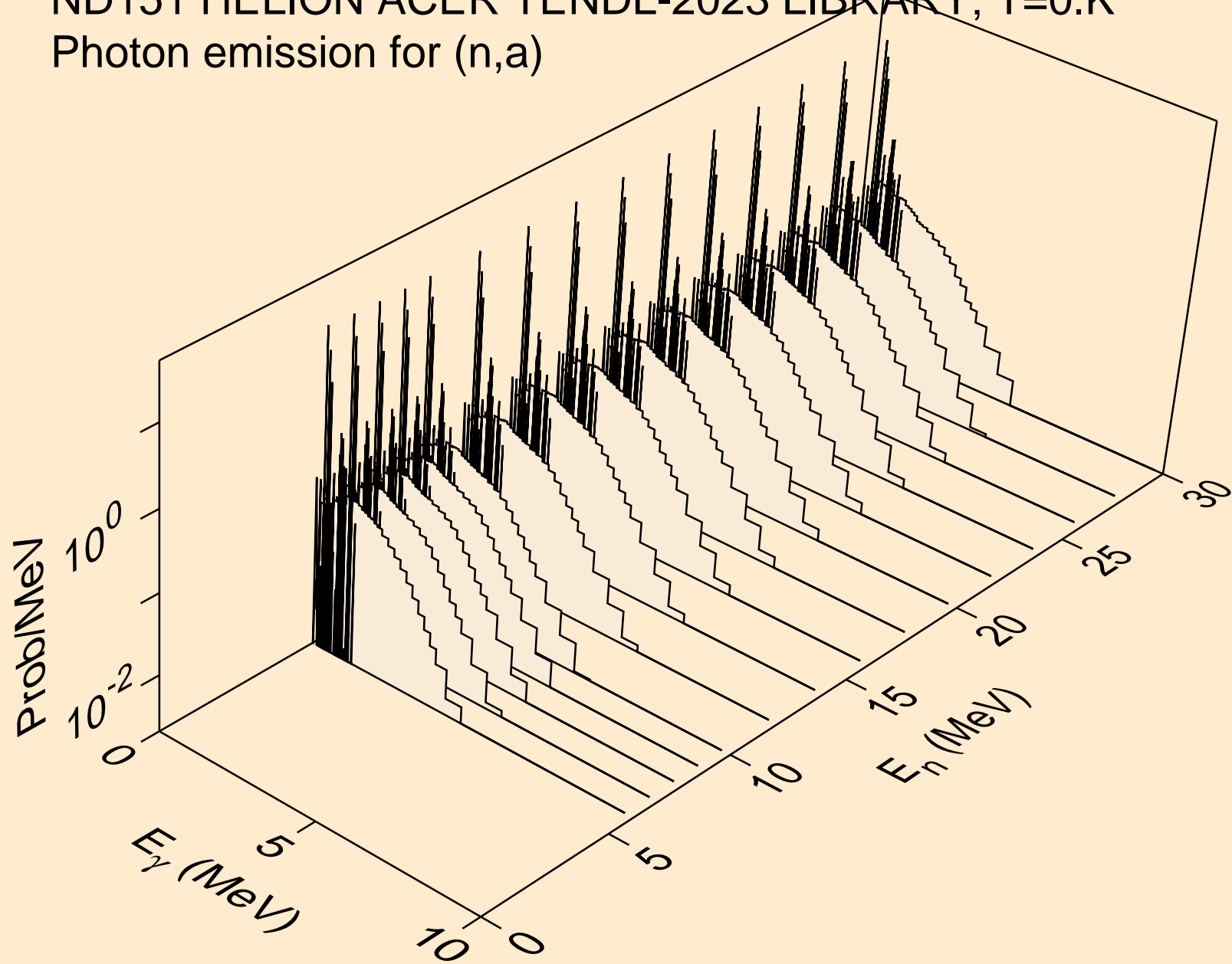

ND151 HELION ACER TENDL-2023 LIBRARY; T=0.K  
Photon emission for (n,2p)

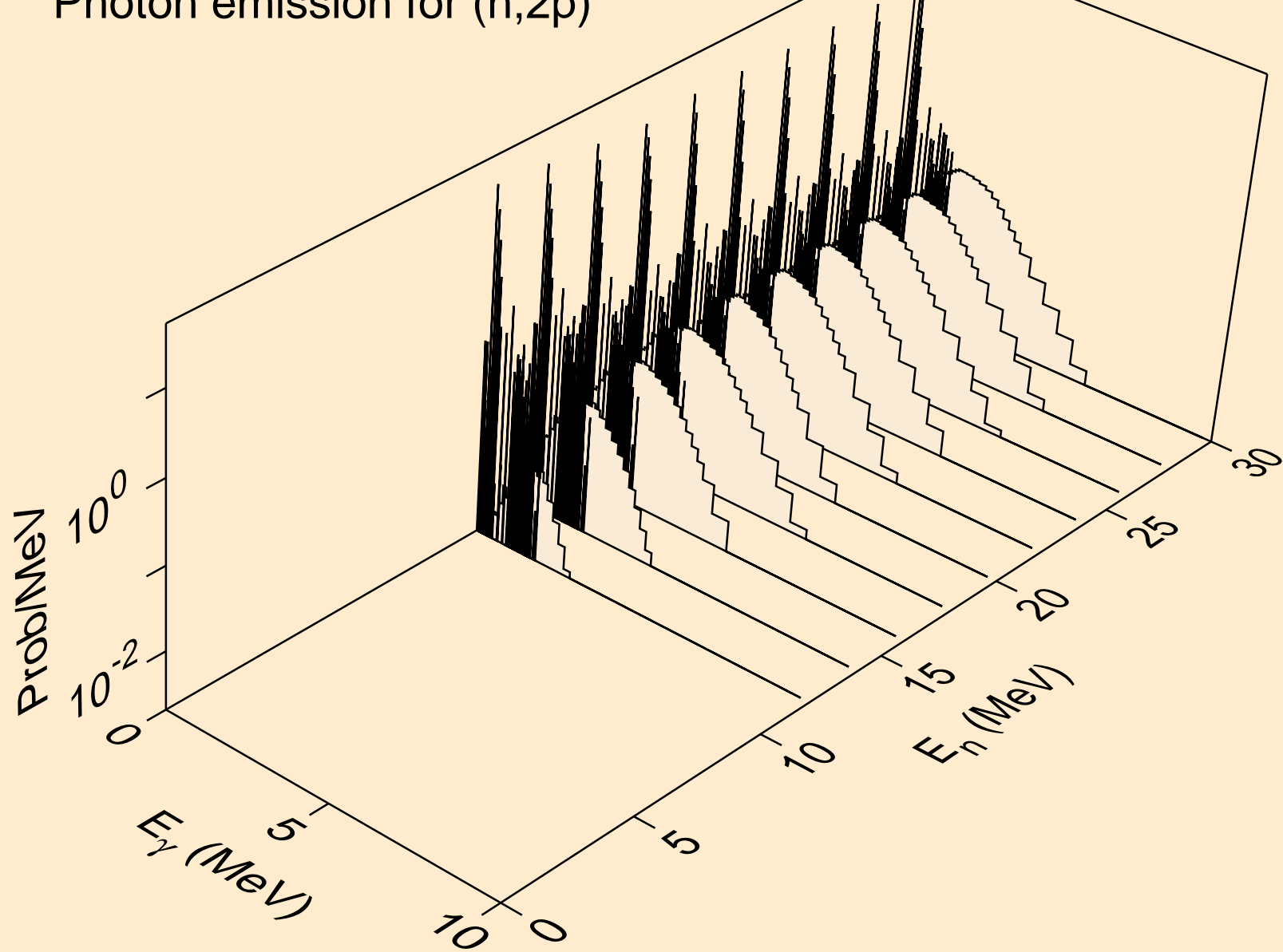

ND151 HELION ACER TENDL-2023 LIBRARY; T=0.K  
Photon emission for (n,pa)

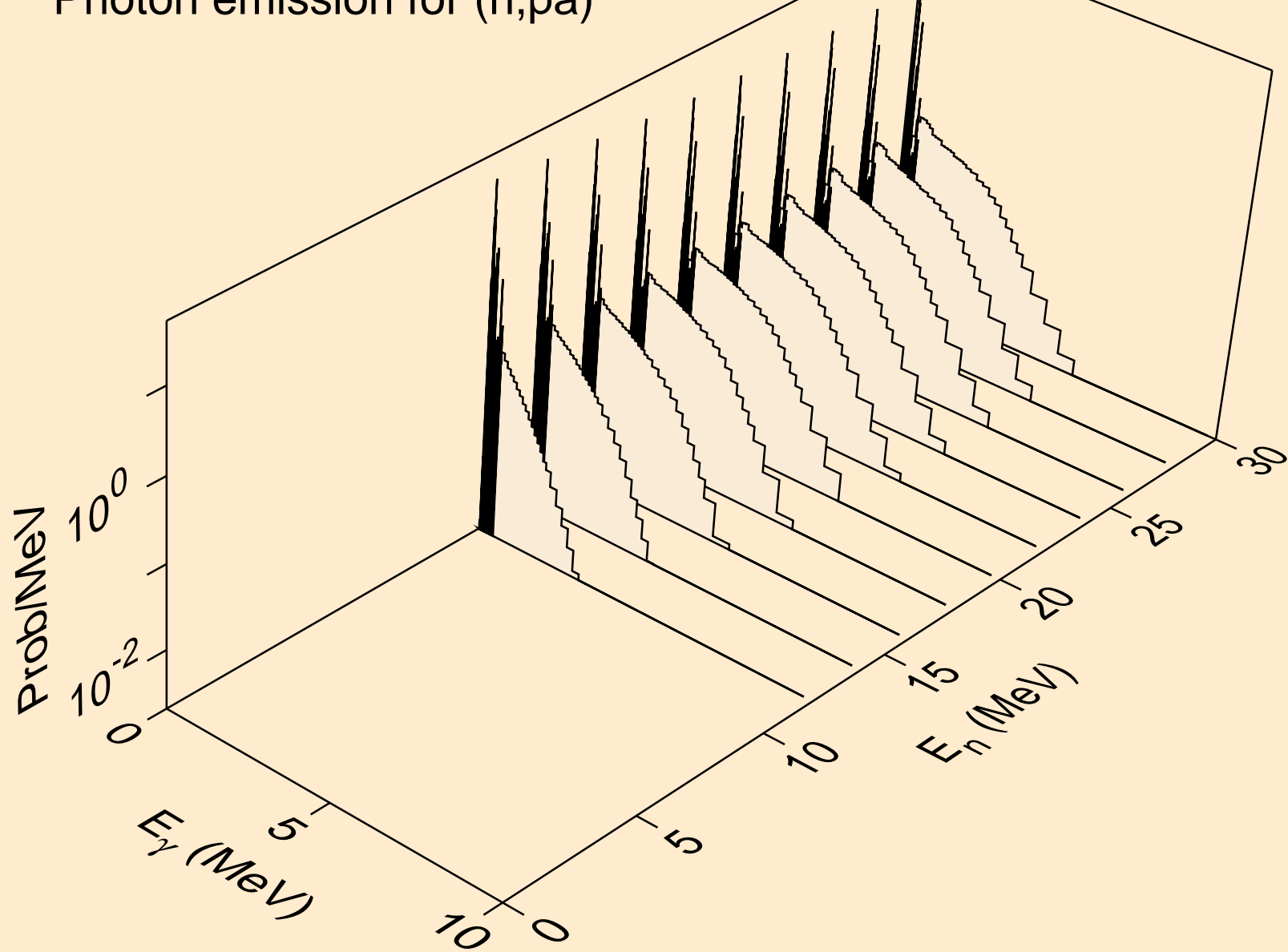

ND151 HELION ACER TENDL-2023 LIBRARY; T=0.K  
Photon emission for (n,pd)

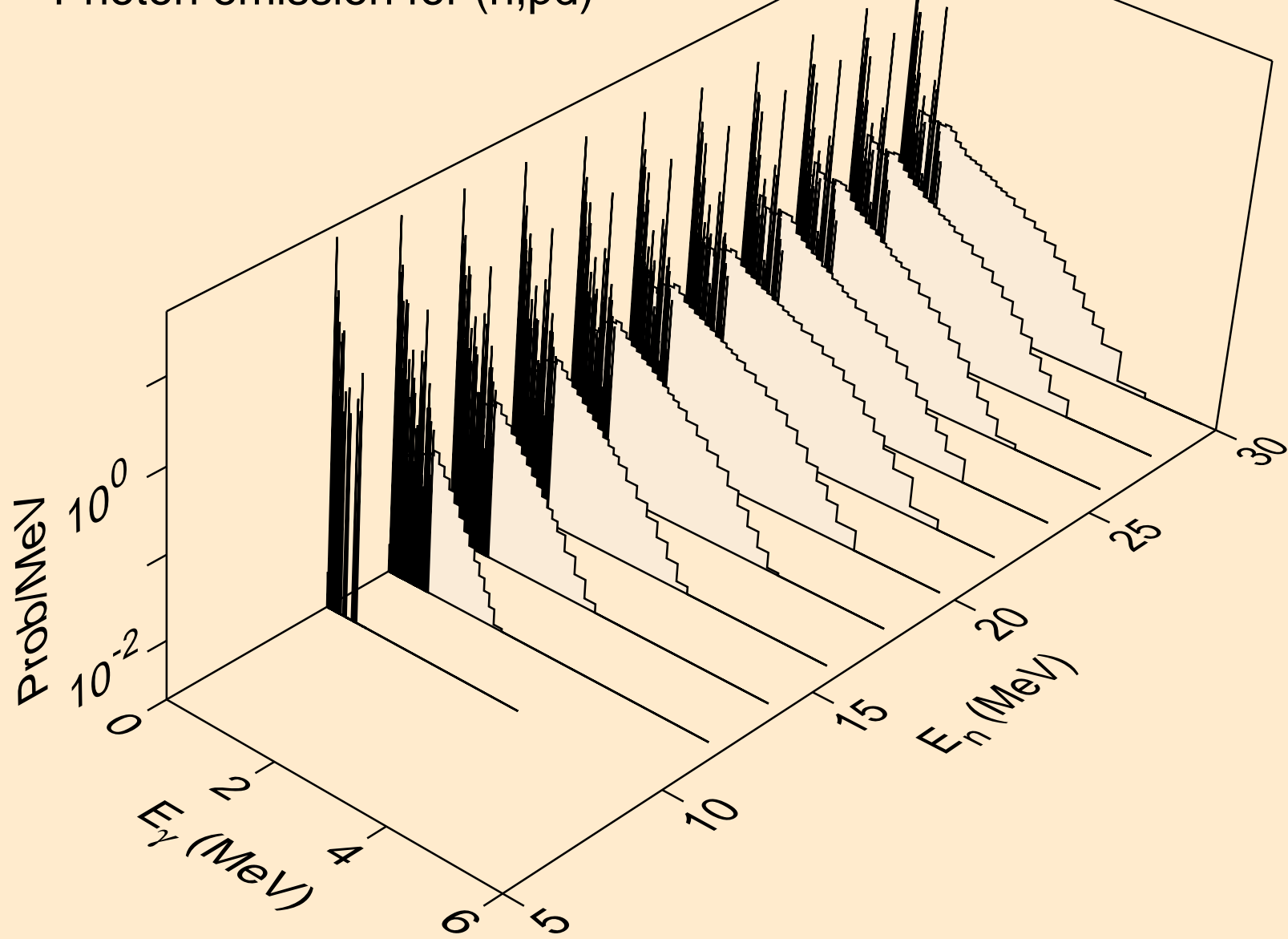

ND151 HELION ACER TENDL-2023 LIBRARY; T=0.K  
Photon emission for (n,pt)

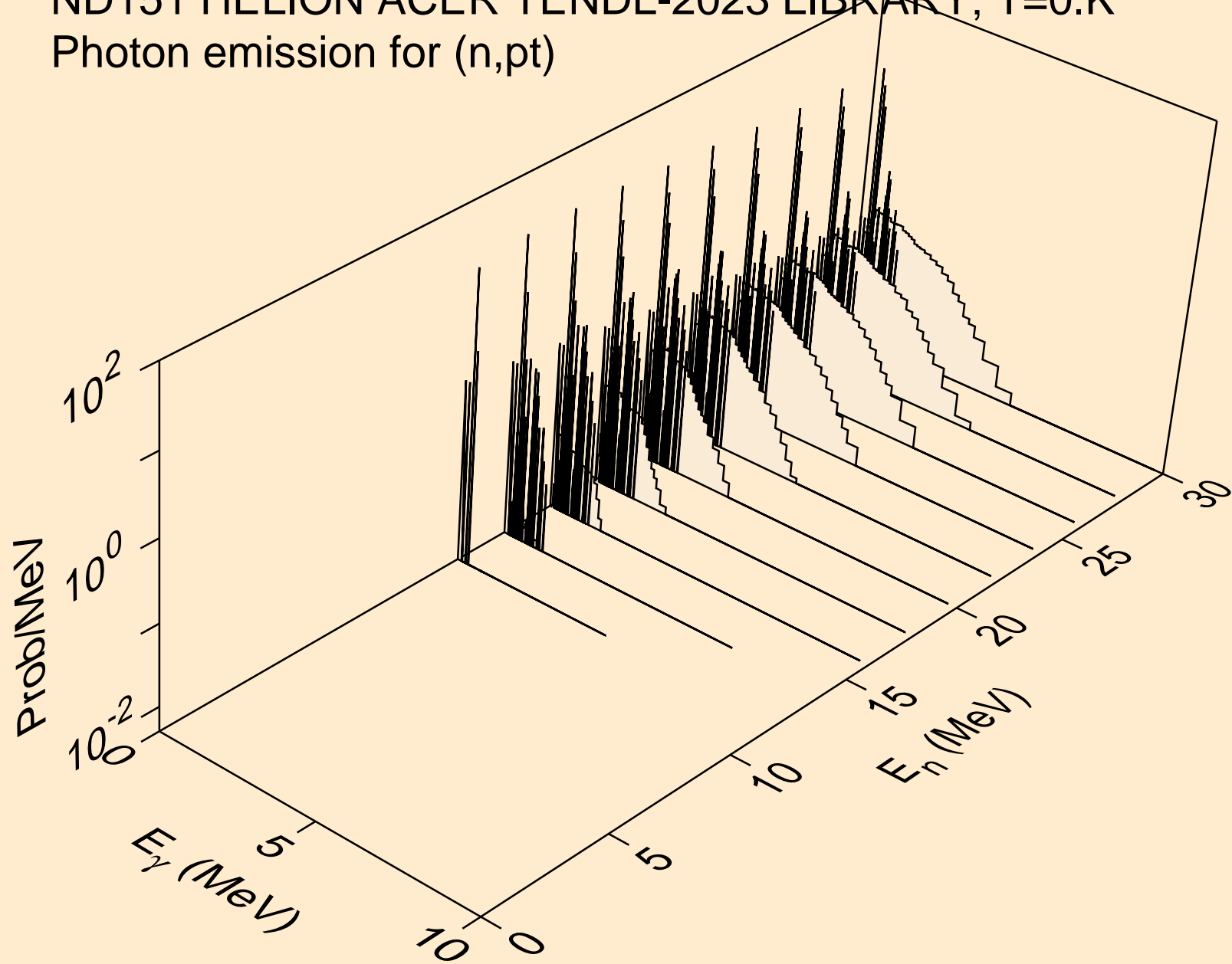

ND151 HELION ACER TENDL-2023 LIBRARY; T=0.K  
Photon emission for (n,da)

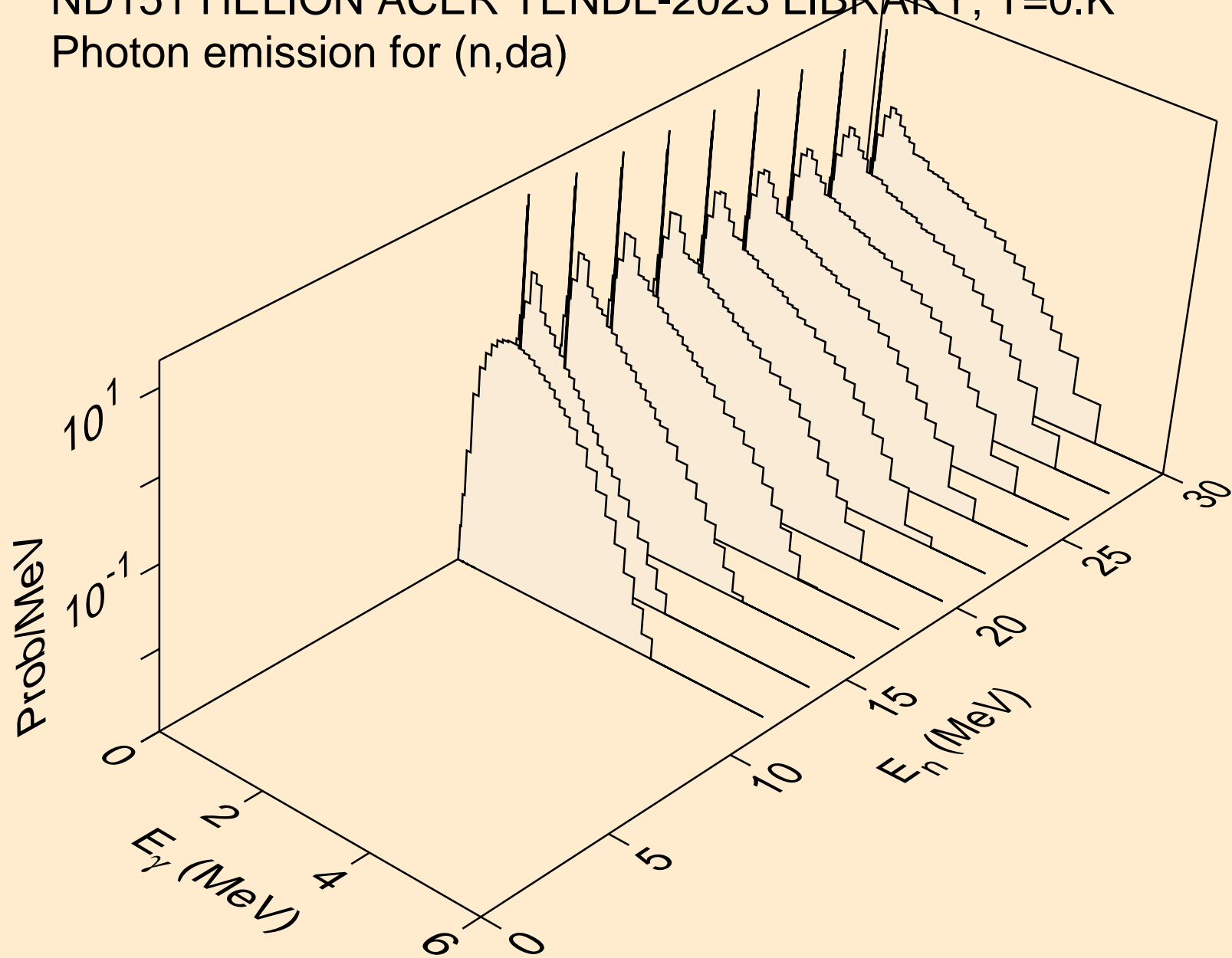

# ND151 HELION ACER TENDL-2023 LIBRARY; T=0.K

## Particle heating contributions

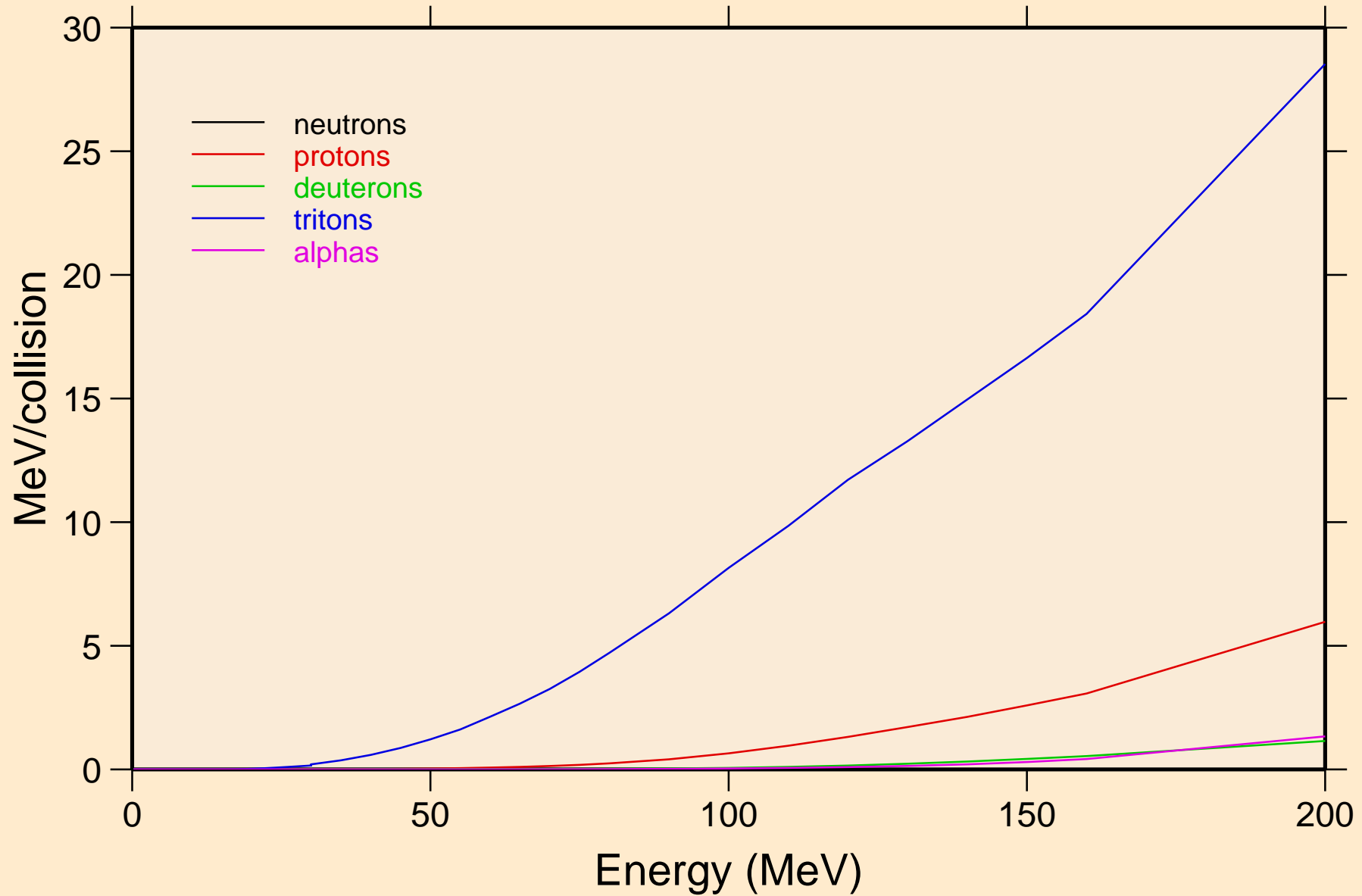

ND151 HELION ACER TENDL-2023 LIBRARY; T=0.K  
Recoil Heating

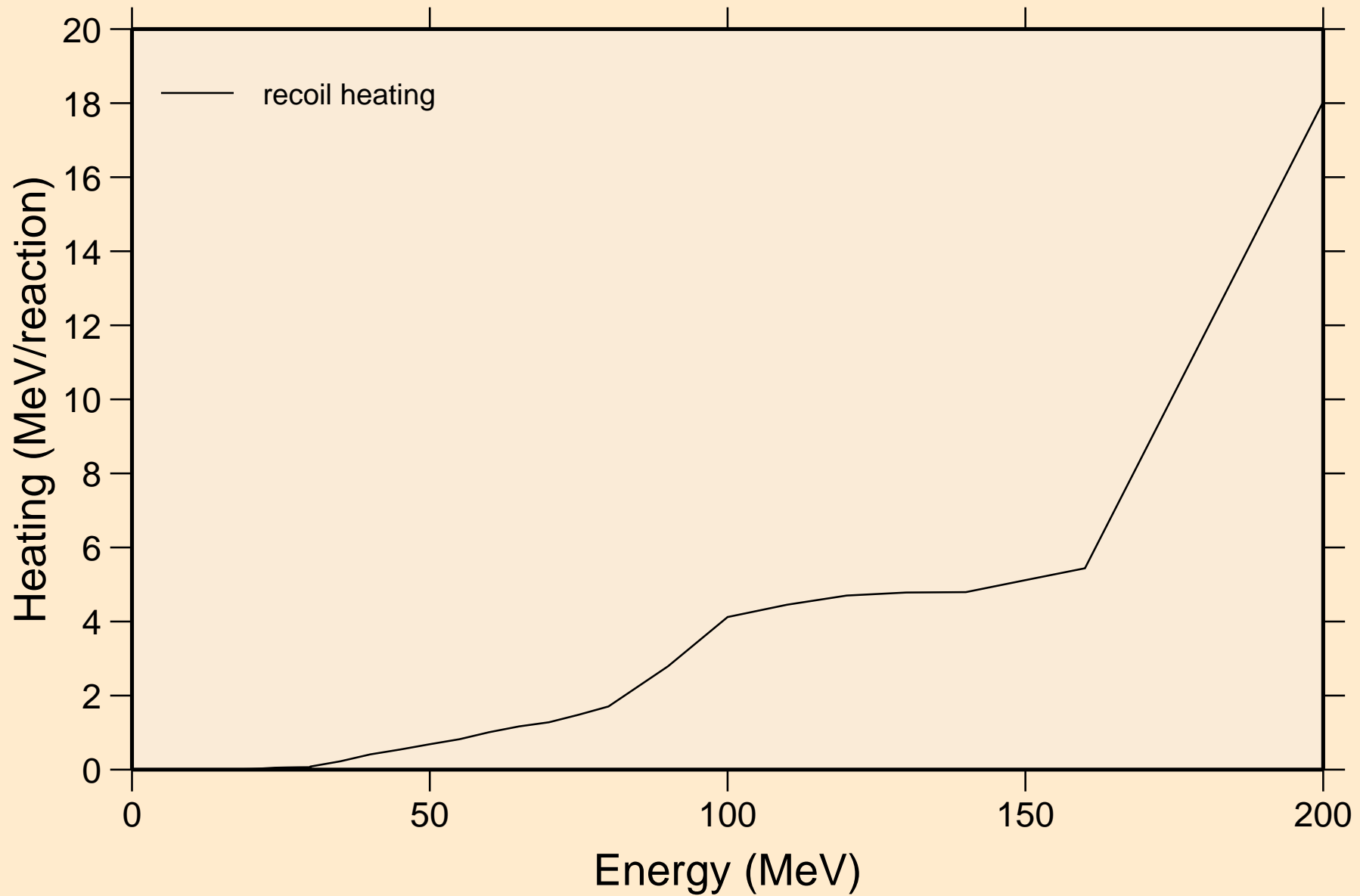

# ND151 HELION ACER TENDL-2023 LIBRARY; T=0.K

## Particle production cross sections

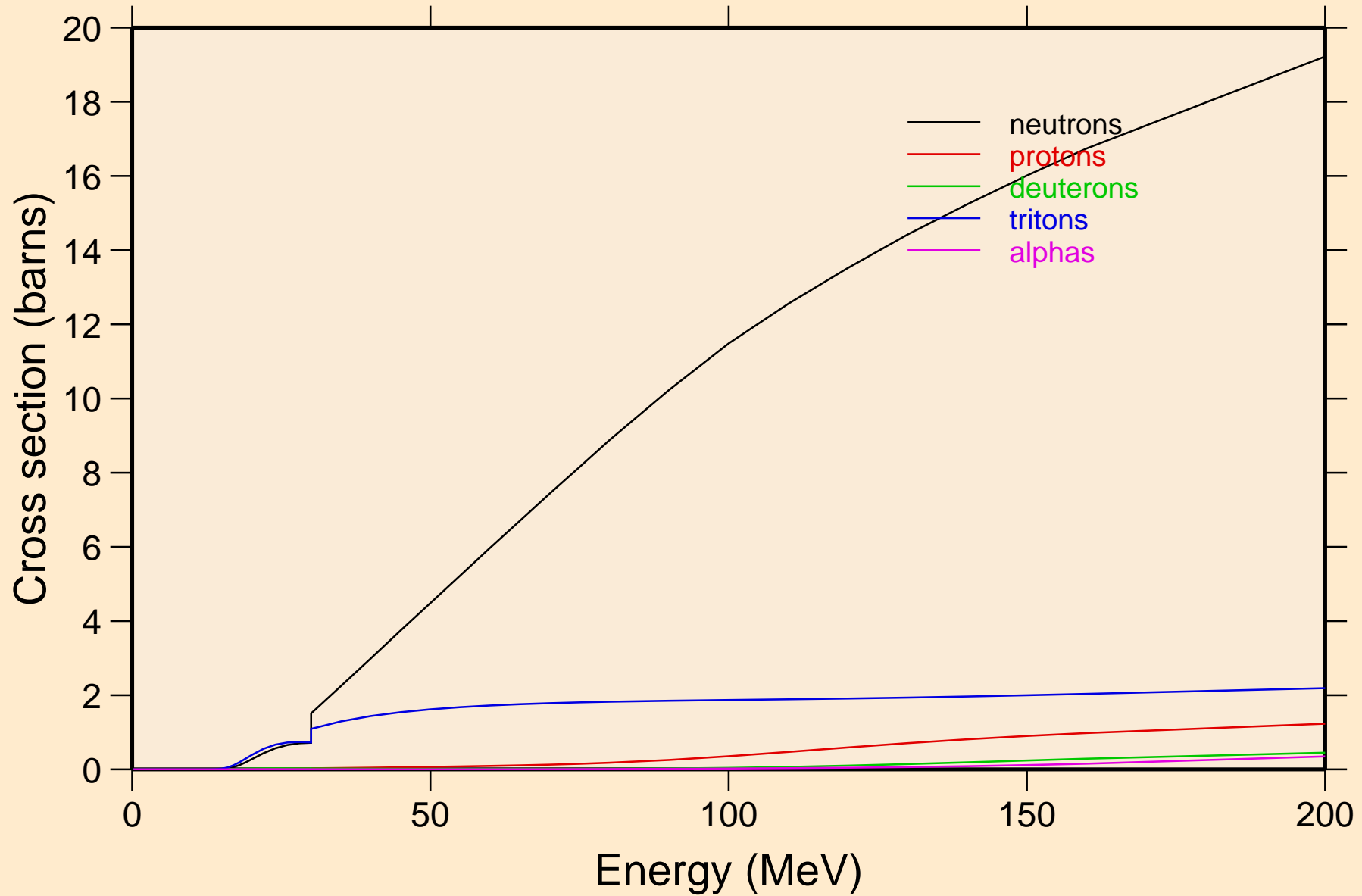

ND151 HELION ACER TENDL-2023 LIBRARY; T=0.K  
neutrons from (s,n)

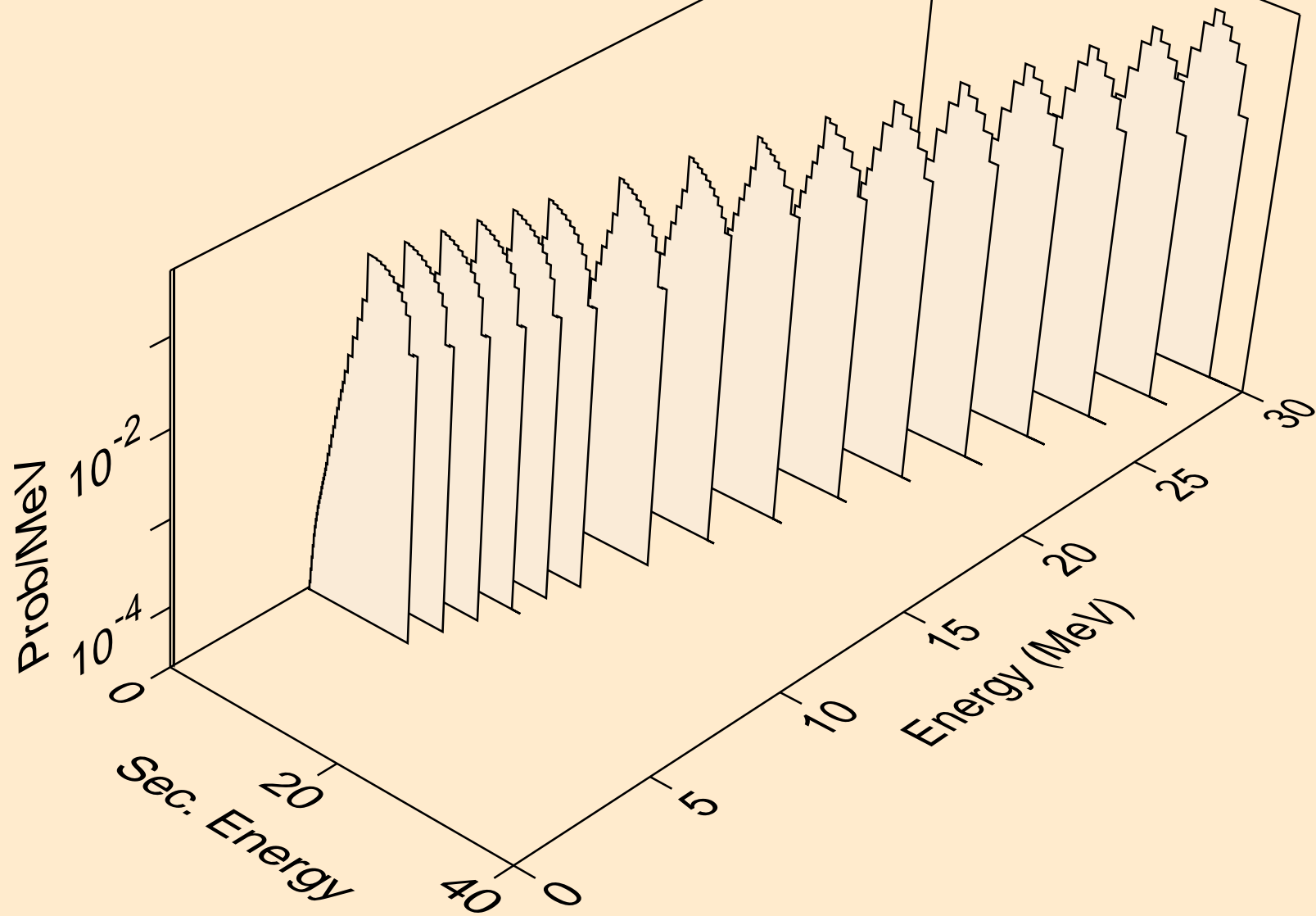

ND151 HELION ACER TENDL-2023 LIBRARY; T=0.K  
neutrons from (s,x)

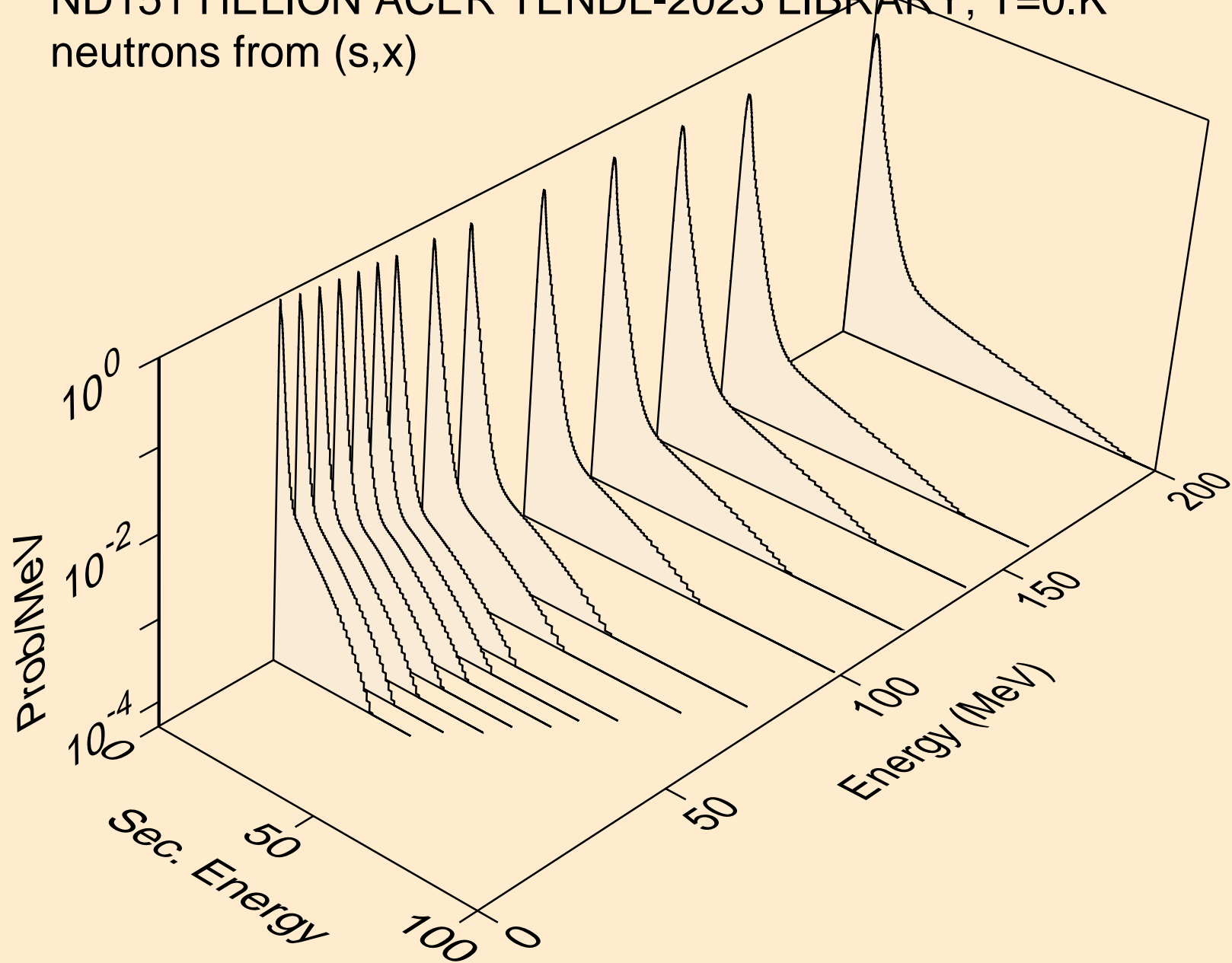

ND151 HELION ACER TENDL-2023 LIBRARY; T=0.K  
neutrons from (s,2nd)

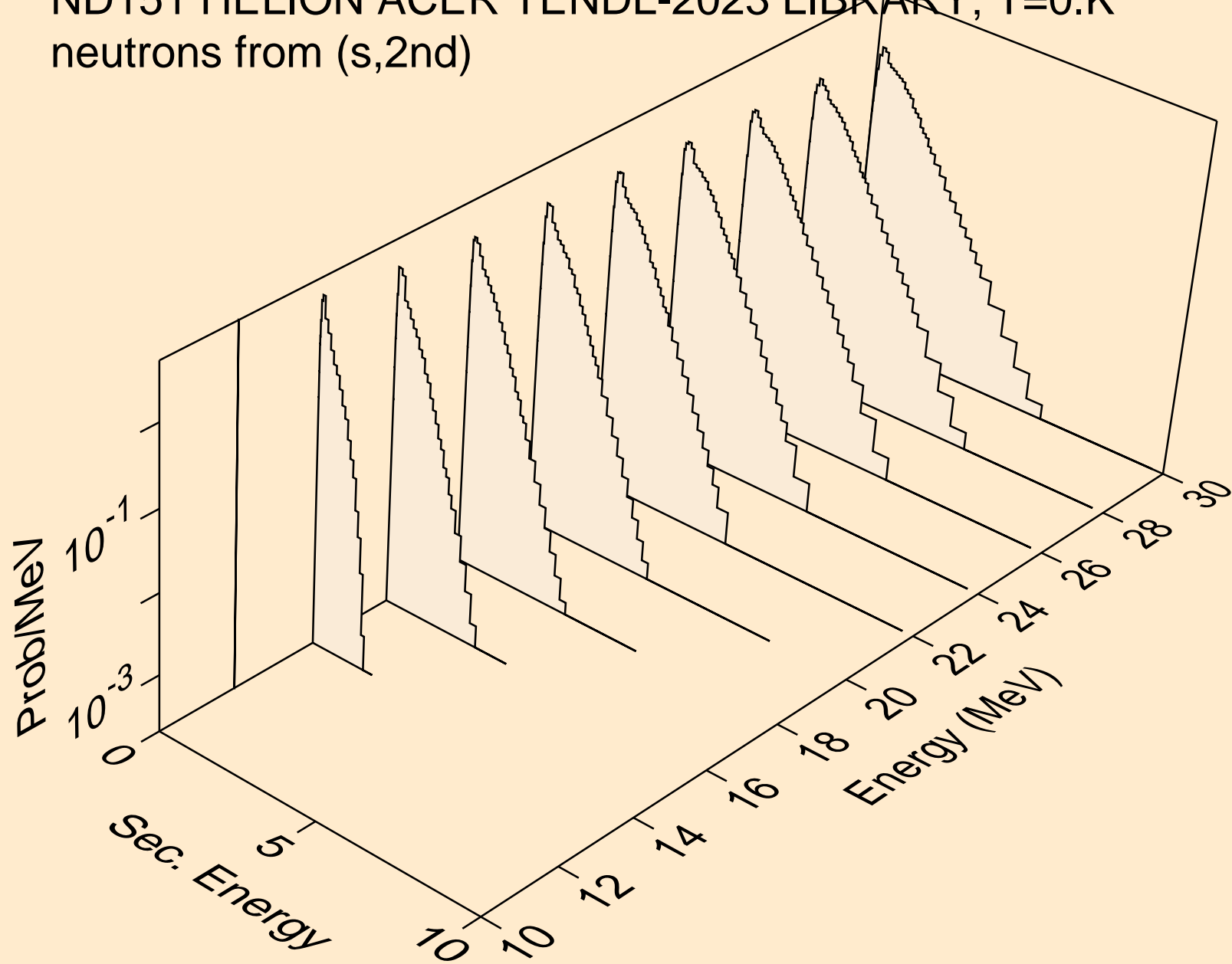

ND151 HELION ACER TENDL-2023 LIBRARY; T=0.K  
neutrons from (s,2n)

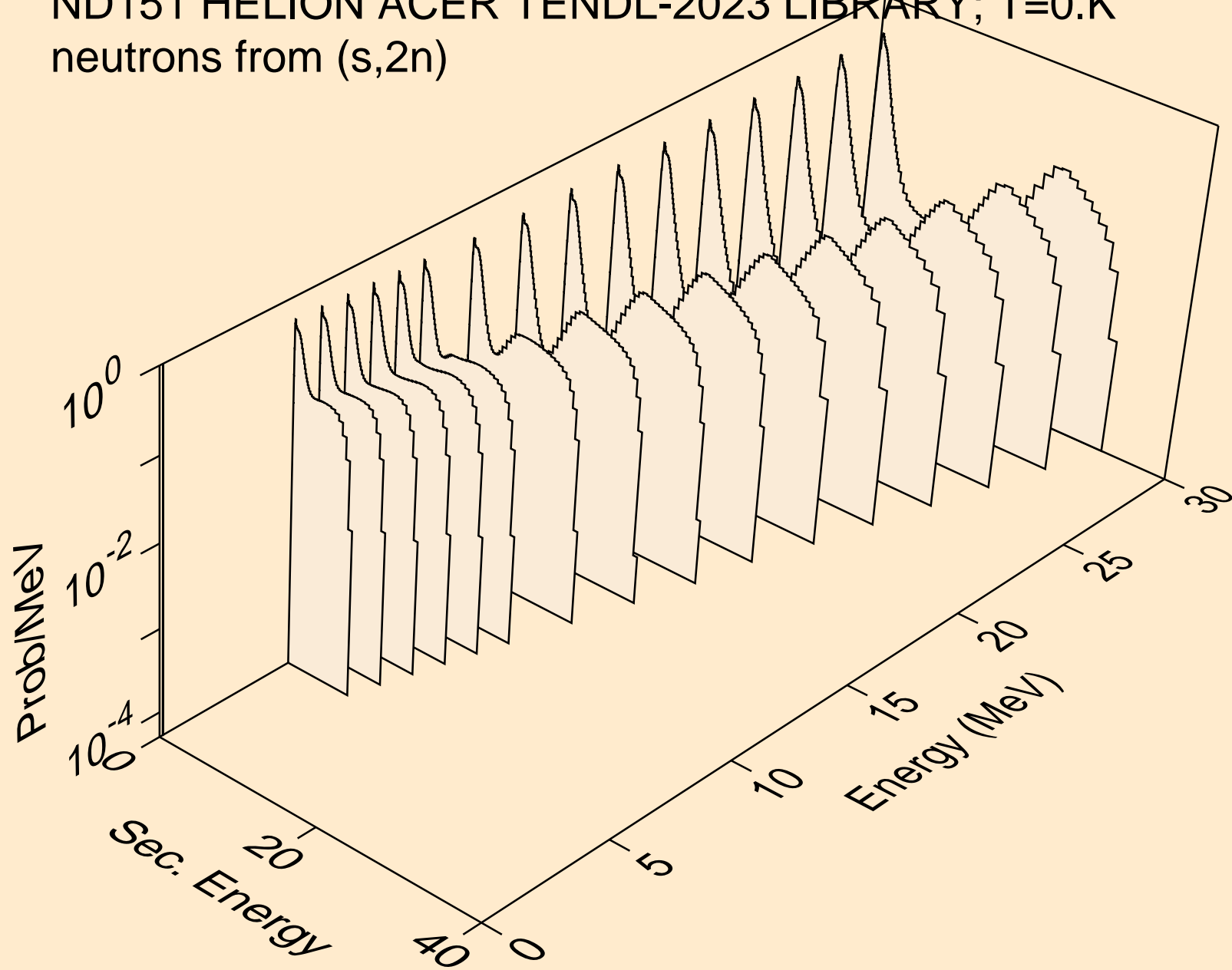

ND151 HELION ACER TENDL-2023 LIBRARY; T=0.K  
neutrons from (s,3n)

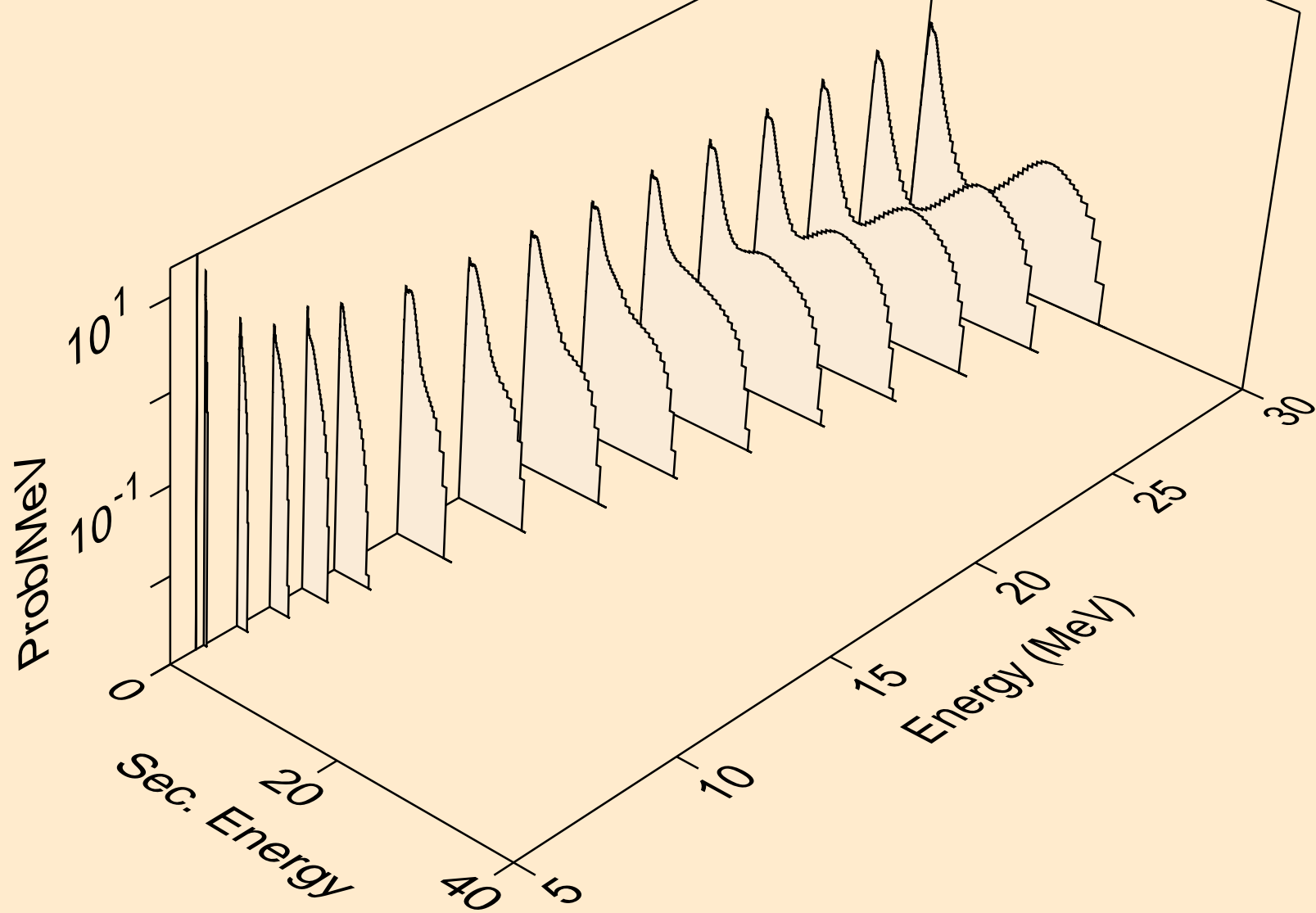

ND151 HELION ACER TENDL-2023 LIBRARY; T=0.K  
neutrons from (s,n\*)a

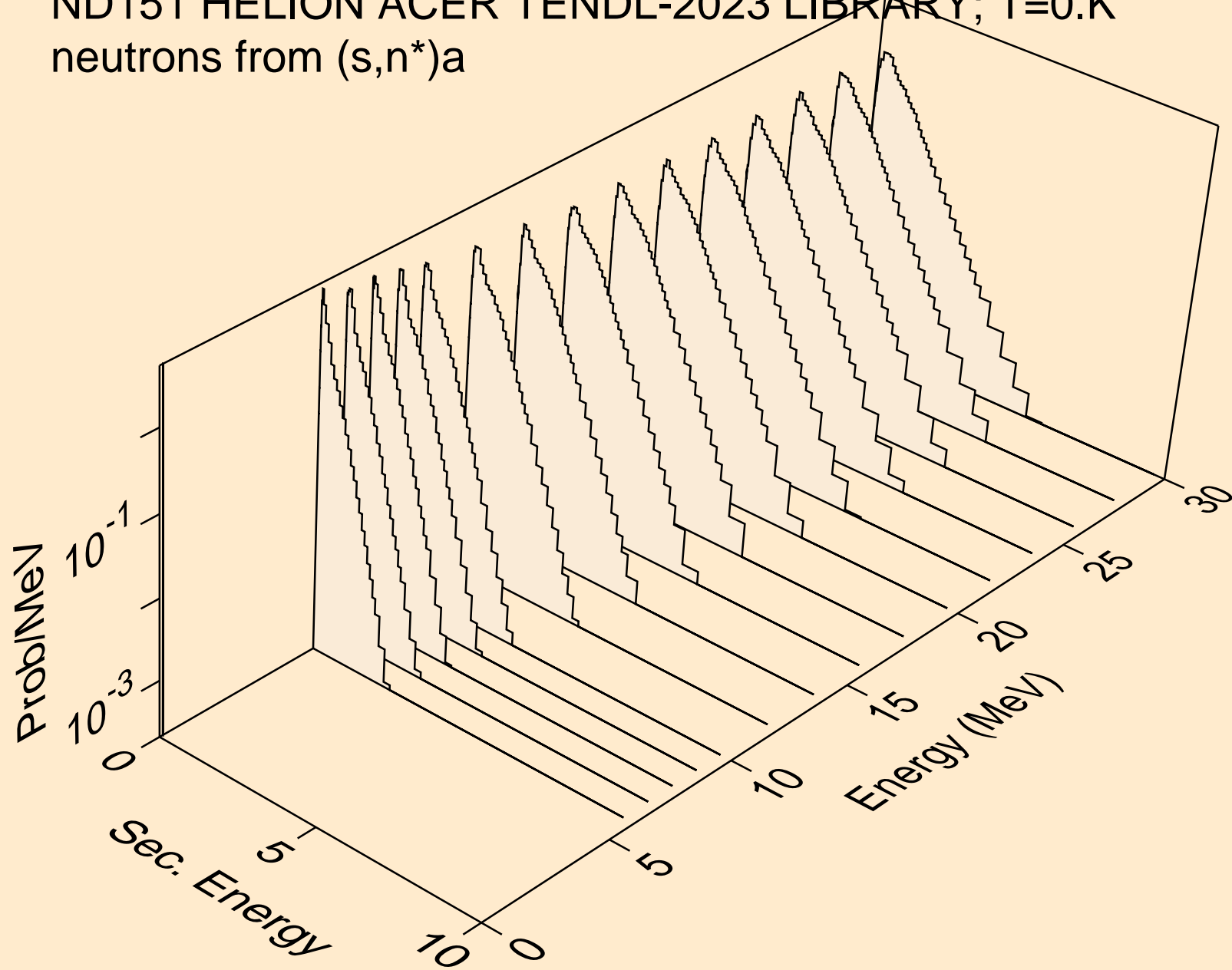

ND151 HELION ACER TENDL-2023 LIBRARY; T=0.K  
neutrons from (s,2n)a

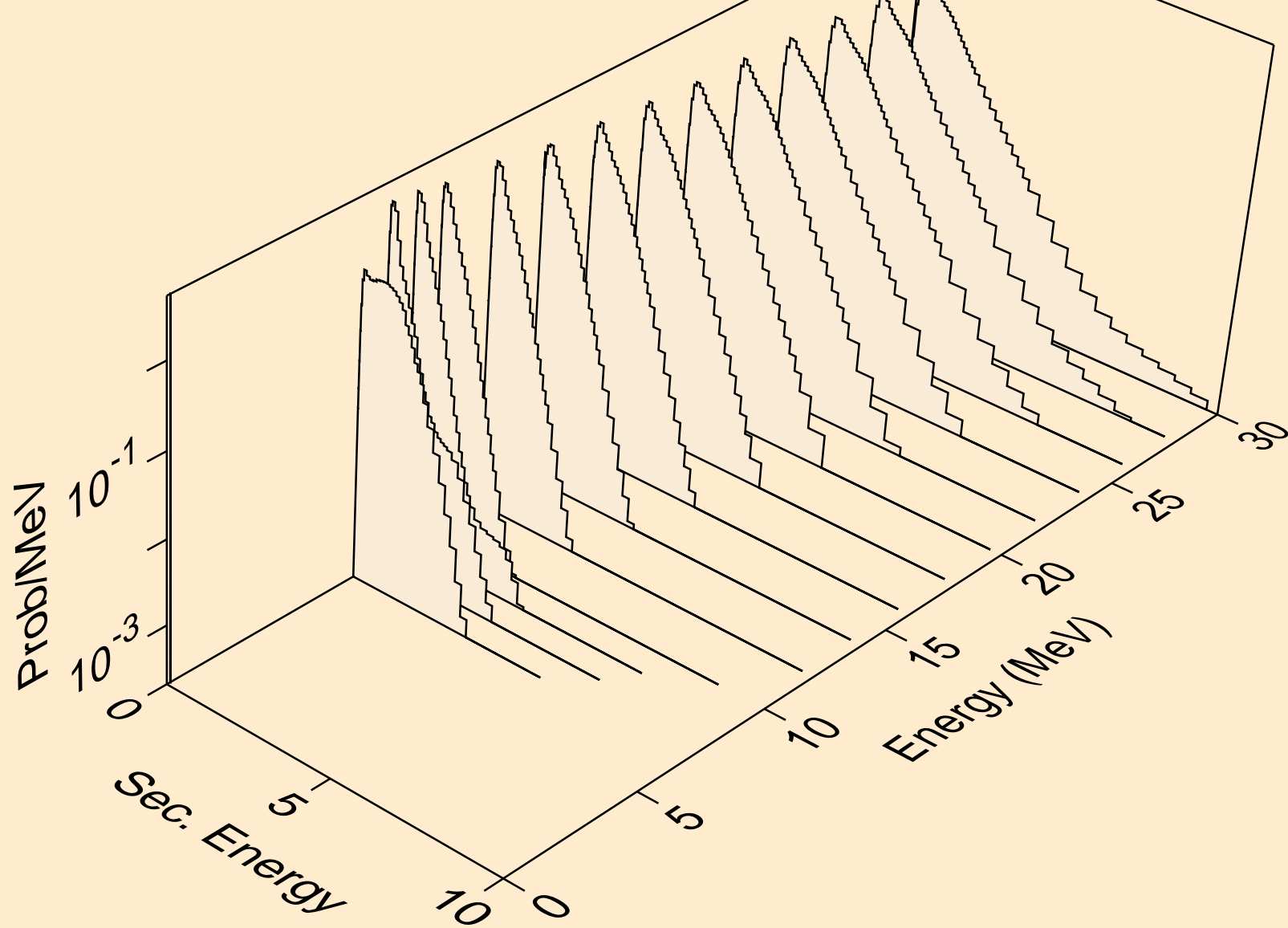

ND151 HELION ACER TENDL-2023 LIBRARY; T=0.K  
neutrons from (s,3n)a

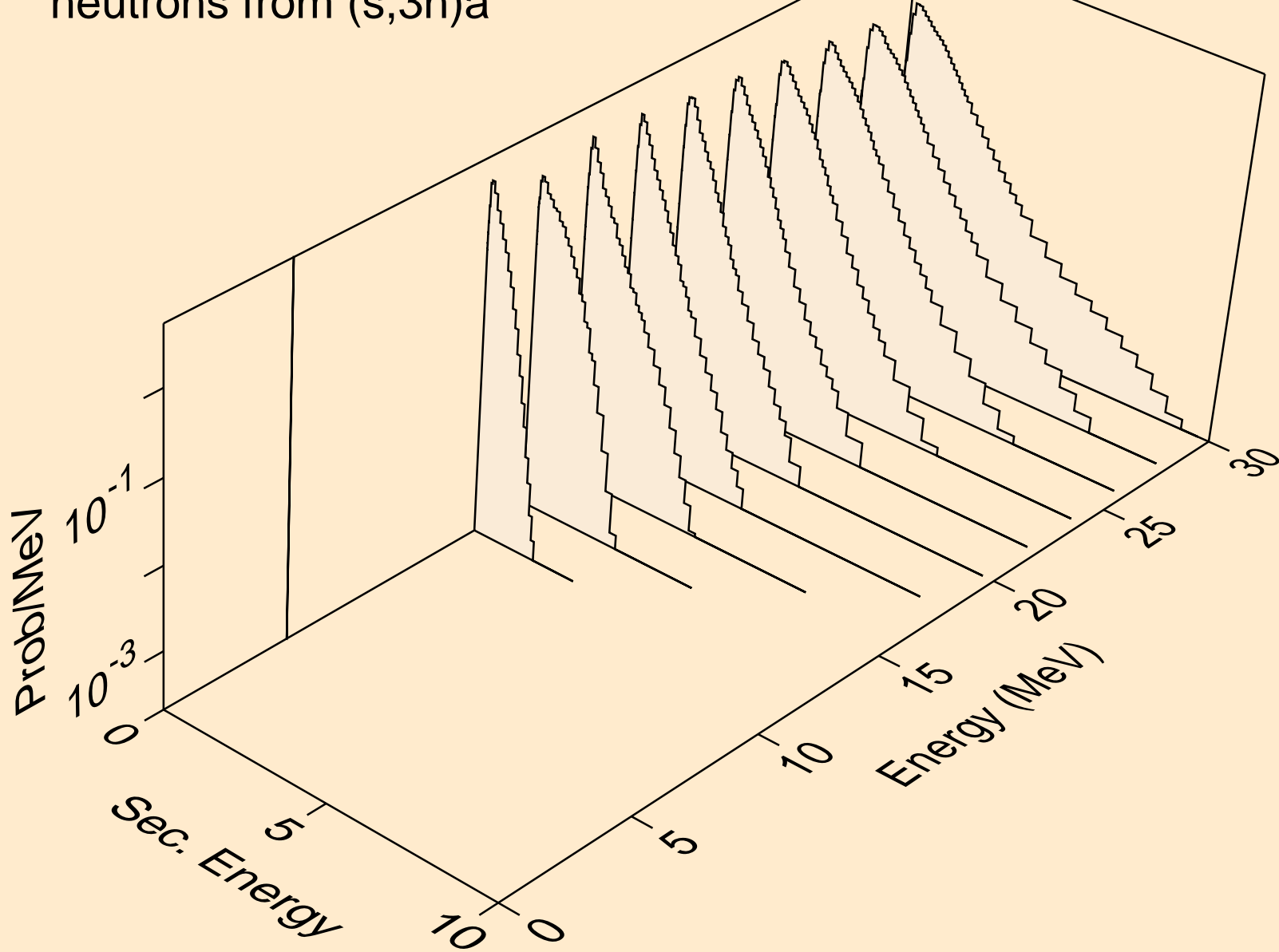

ND151 HELION ACER TENDL-2023 LIBRARY; T=0.K  
neutrons from (s,n\*)p

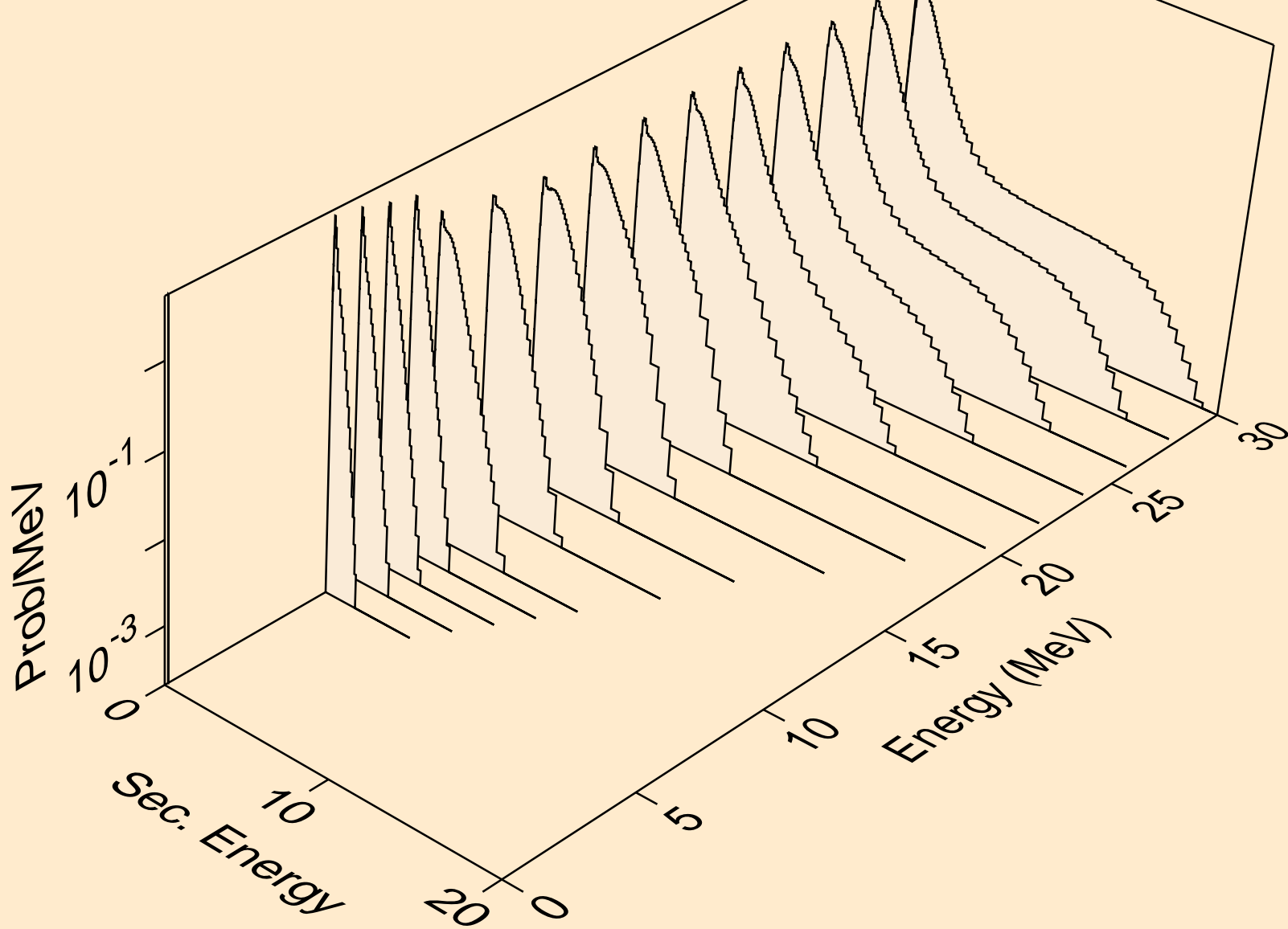

ND151 HELION ACER TENDL-2023 LIBRARY; T=0.K  
neutrons from (s,n\*)2a

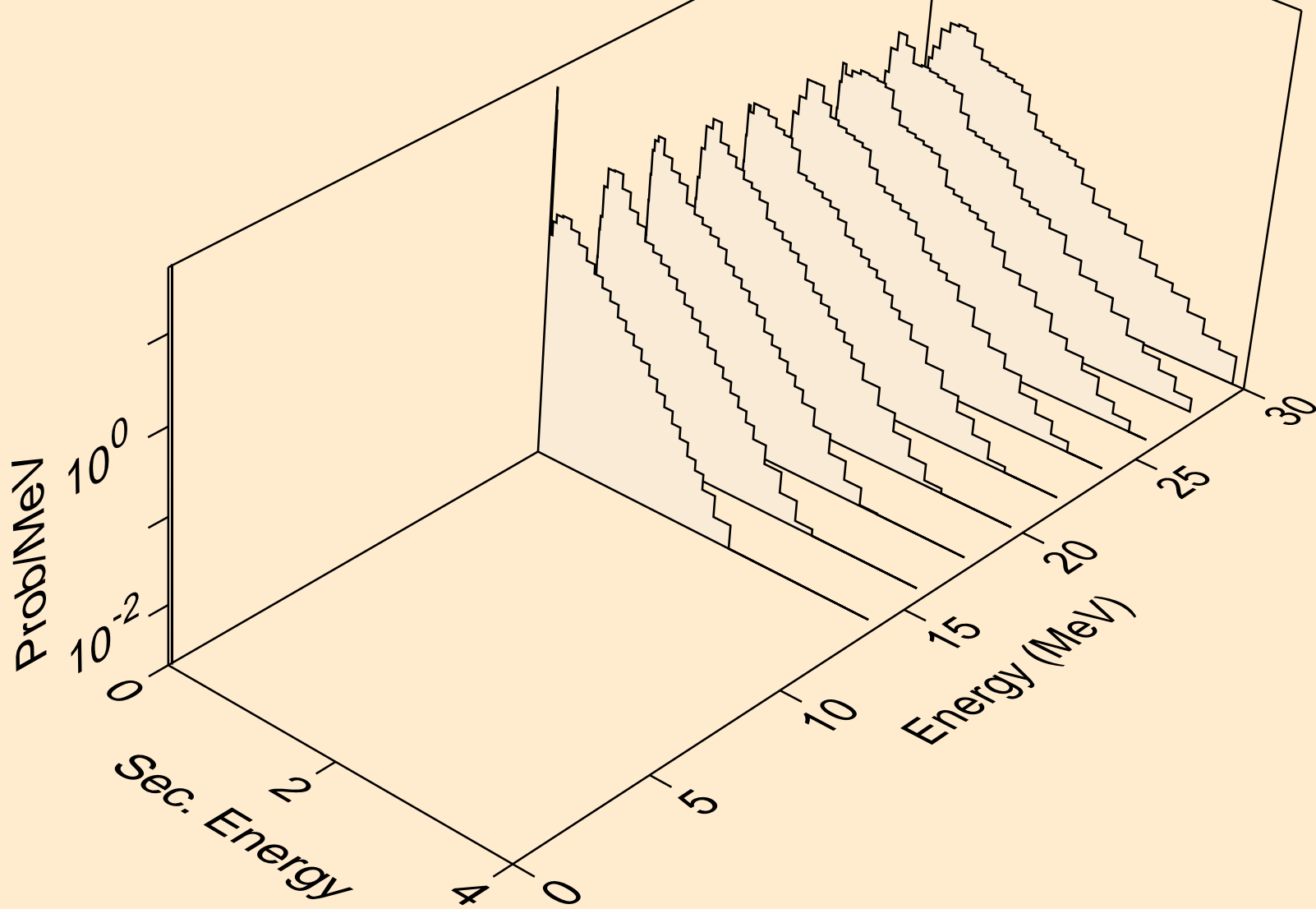

ND151 HELION ACER TENDL-2023 LIBRARY; T=0.K  
neutrons from (s,n\*)d

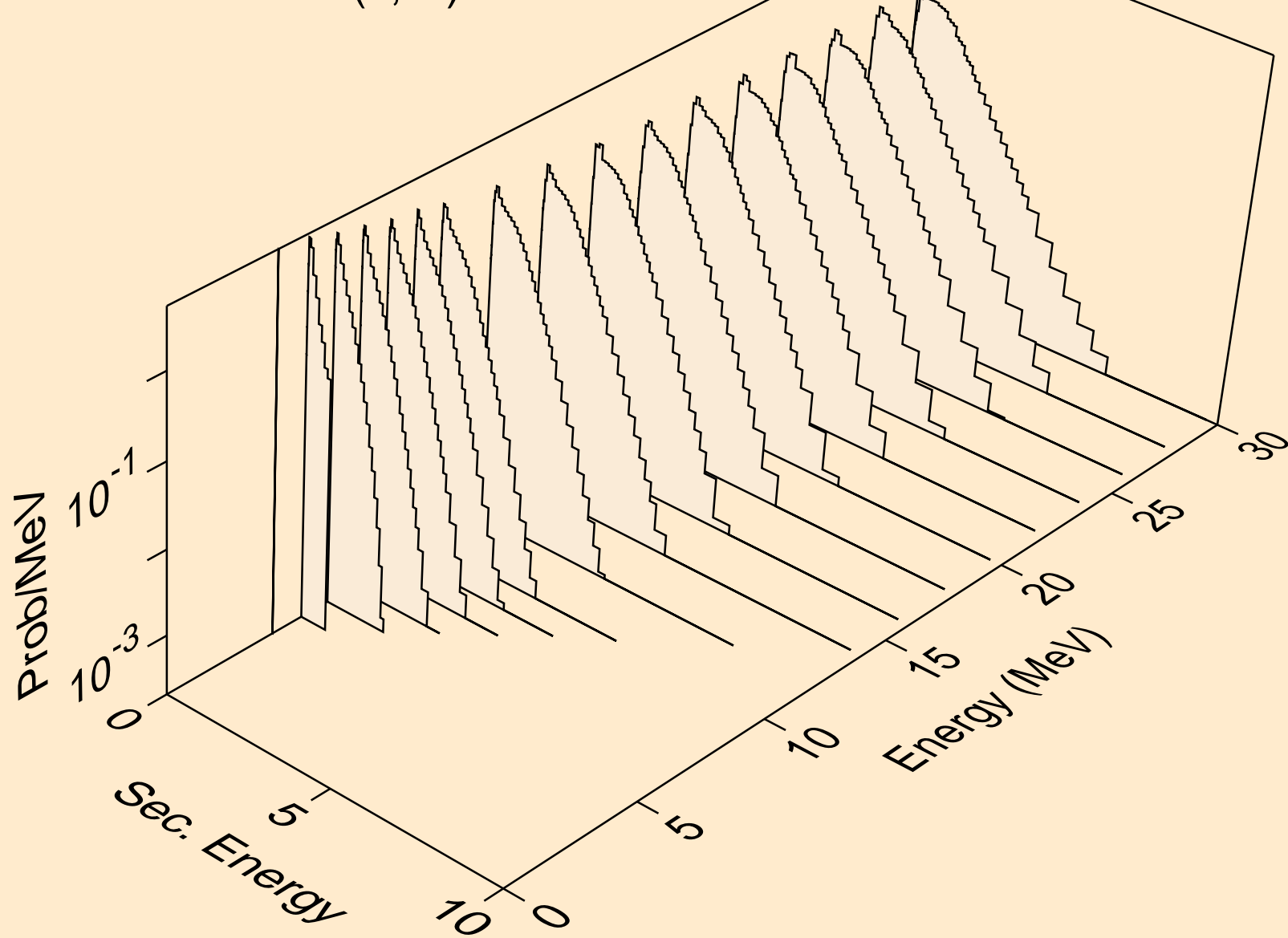

ND151 HELION ACER TENDL-2023 LIBRARY; T=0.K  
neutrons from (s,n\*)t

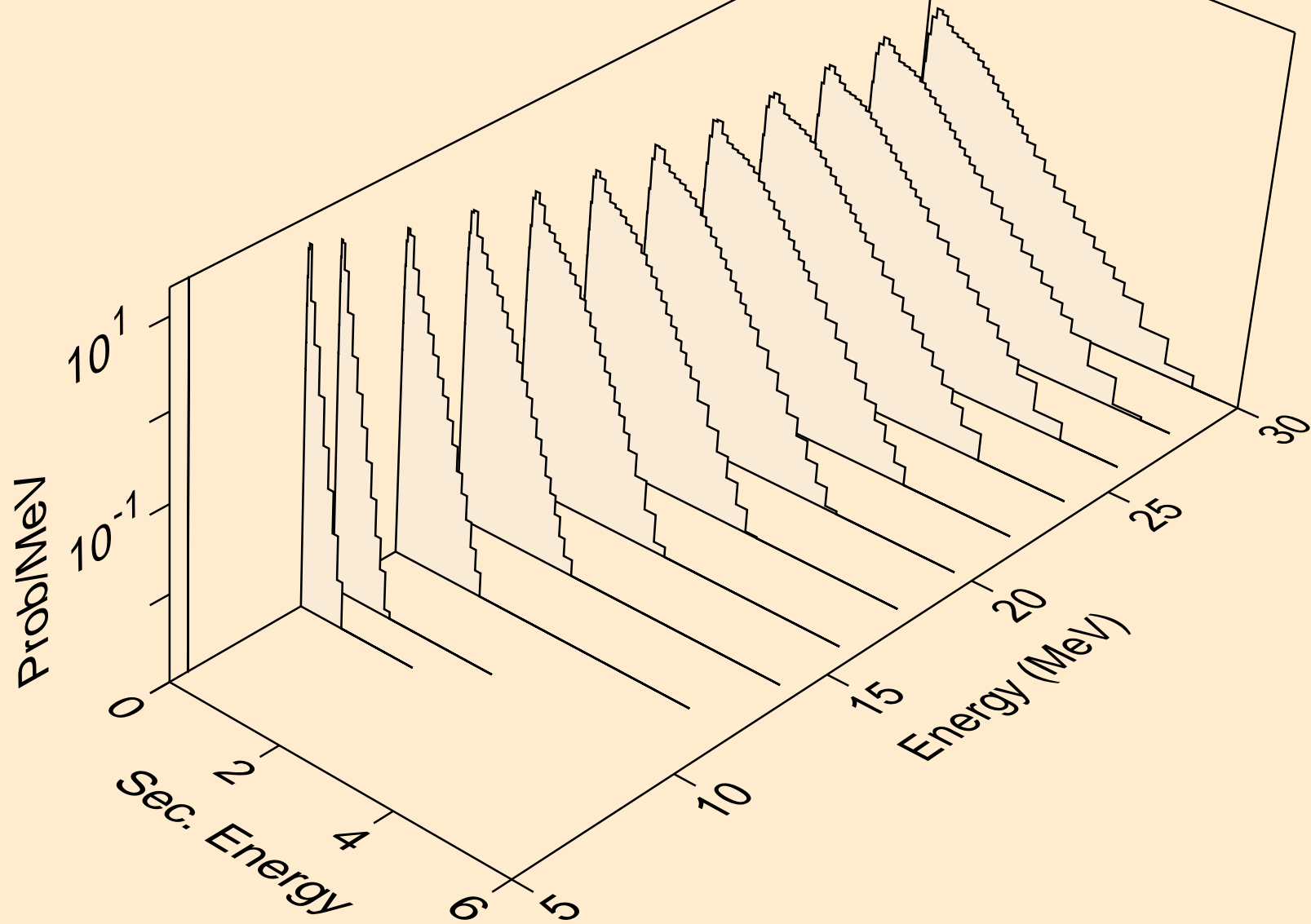

ND151 HELION ACER TENDL-2023 LIBRARY; T=0.K  
neutrons from (s,n\*)he3

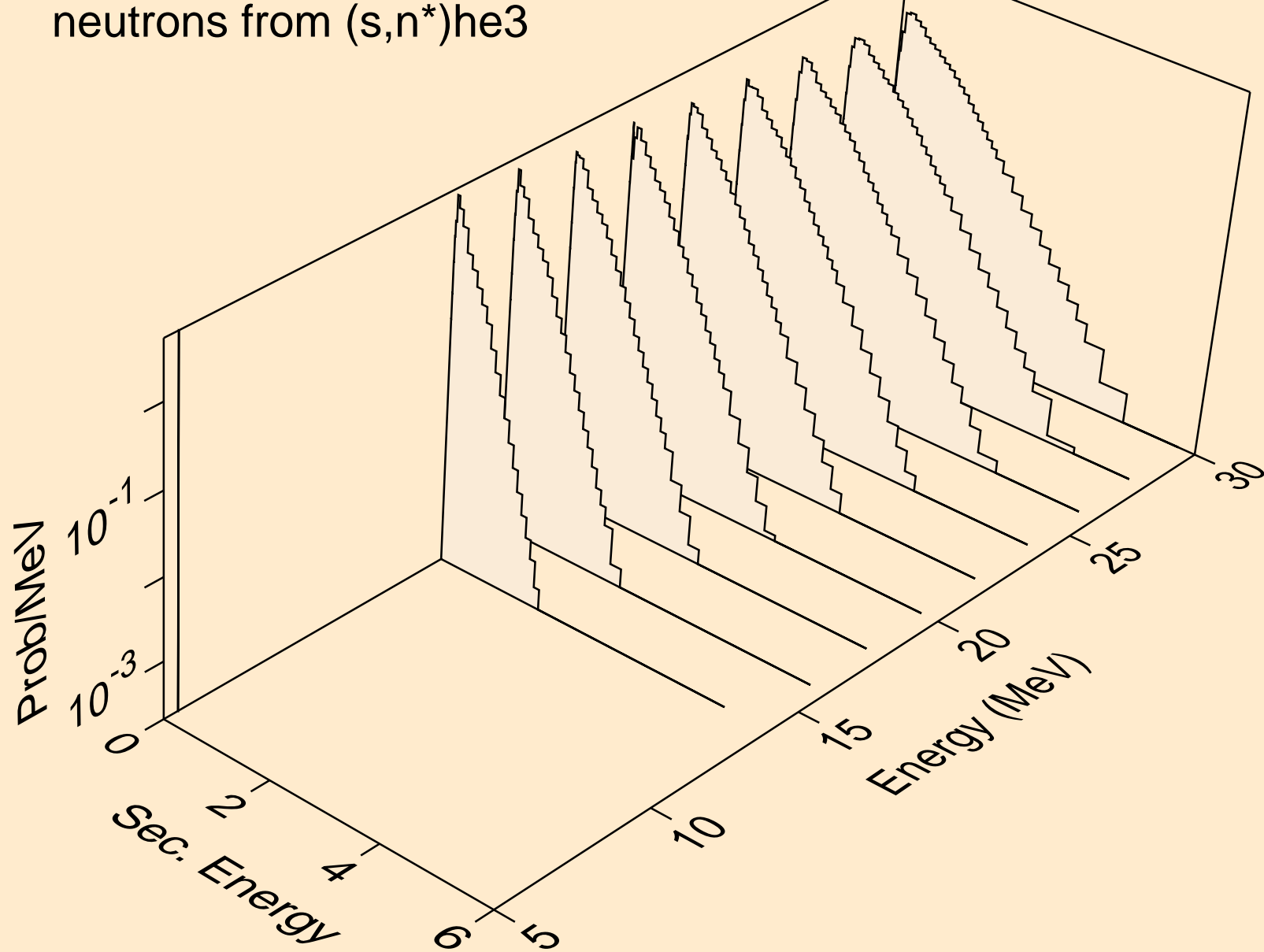

ND151 HELION ACER TENDL-2023 LIBRARY; T=0.K  
neutrons from (s,4n)

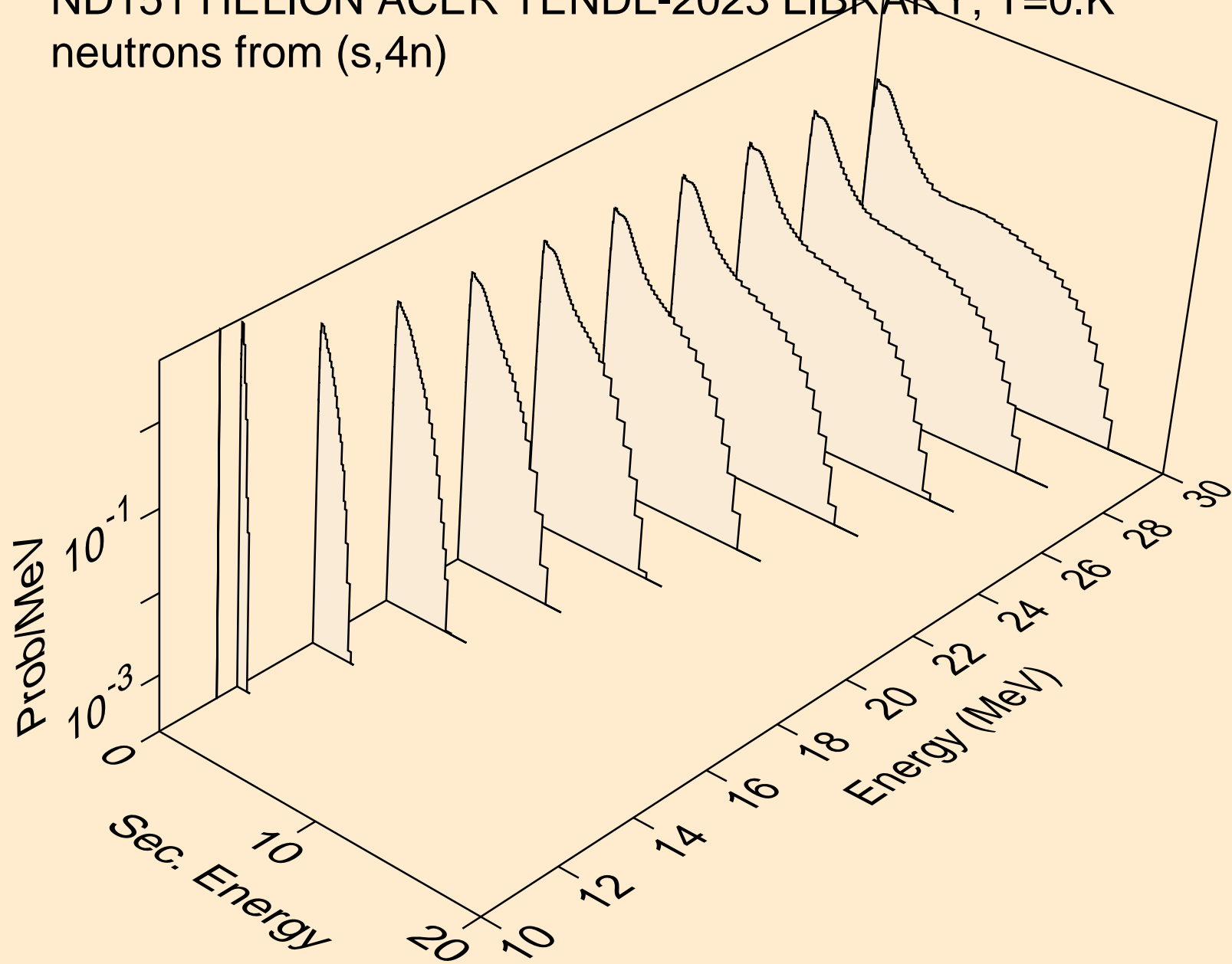

ND151 HELION ACER TENDL-2023 LIBRARY; T=0.K  
neutrons from (s,2np)

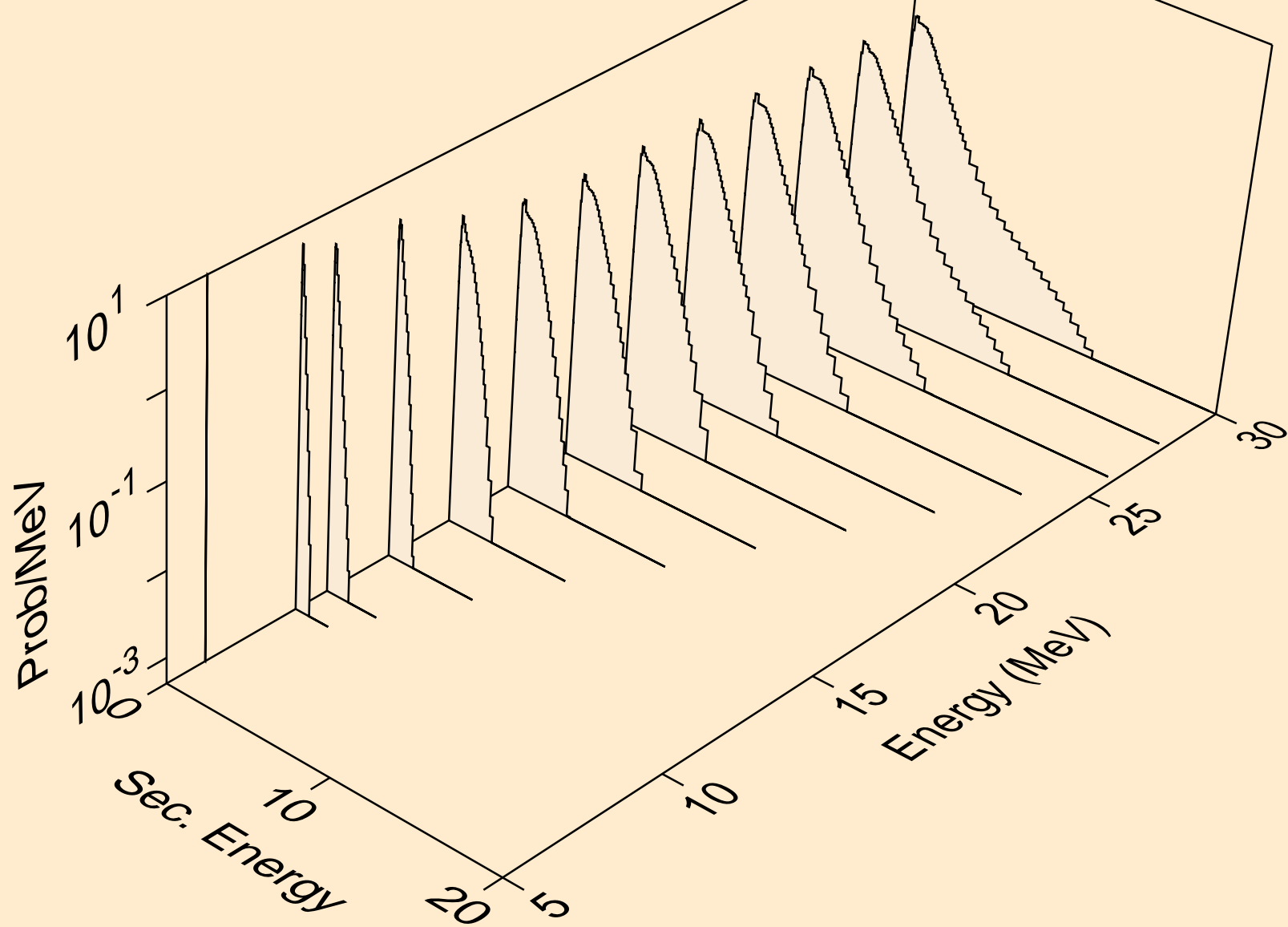

ND151 HELION ACER TENDL-2023 LIBRARY; T=0.K  
neutrons from (s,3np)

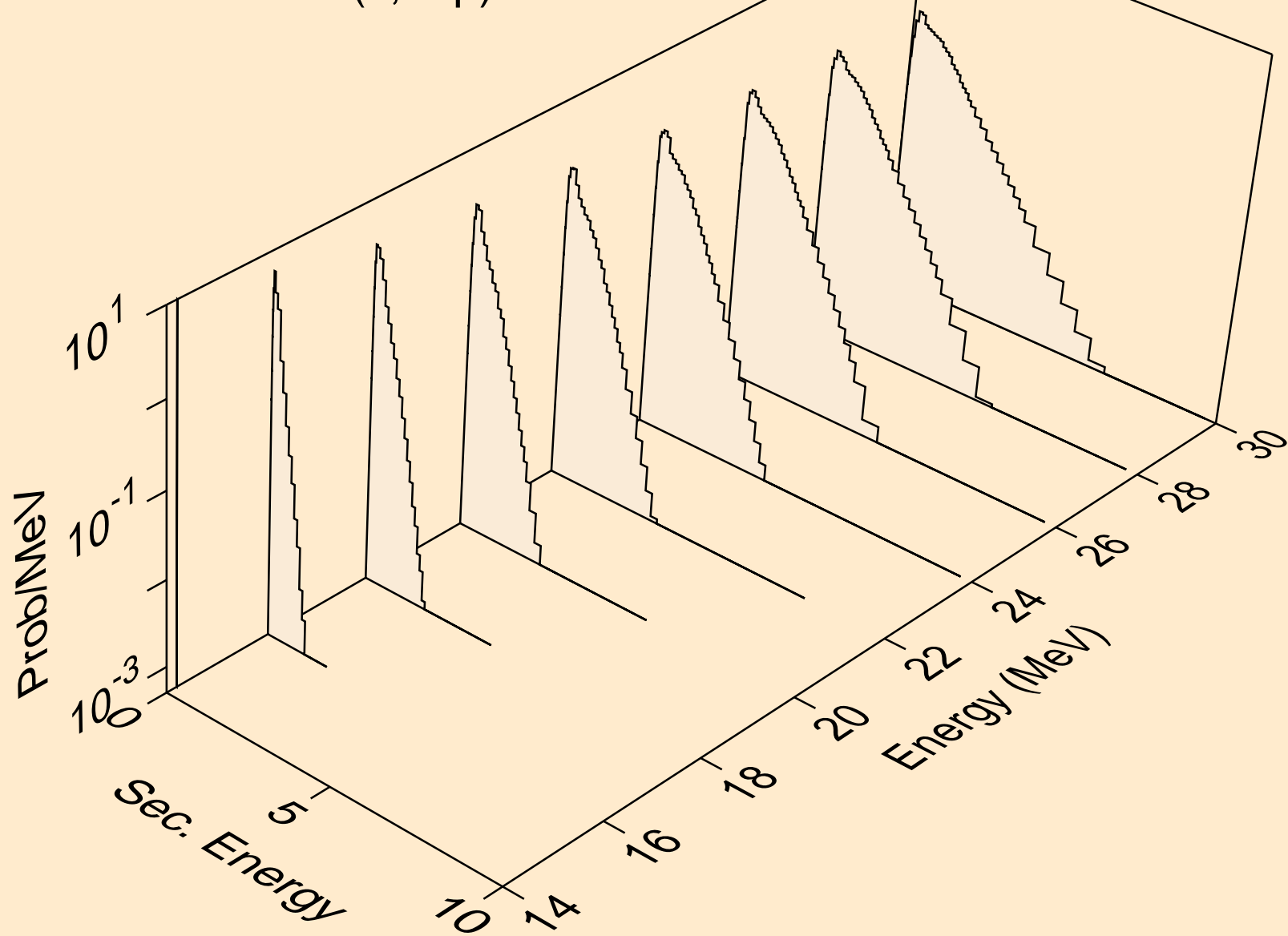

ND151 HELION ACER TENDL-2023 LIBRARY; T=0.K  
neutrons from (s,n2p)

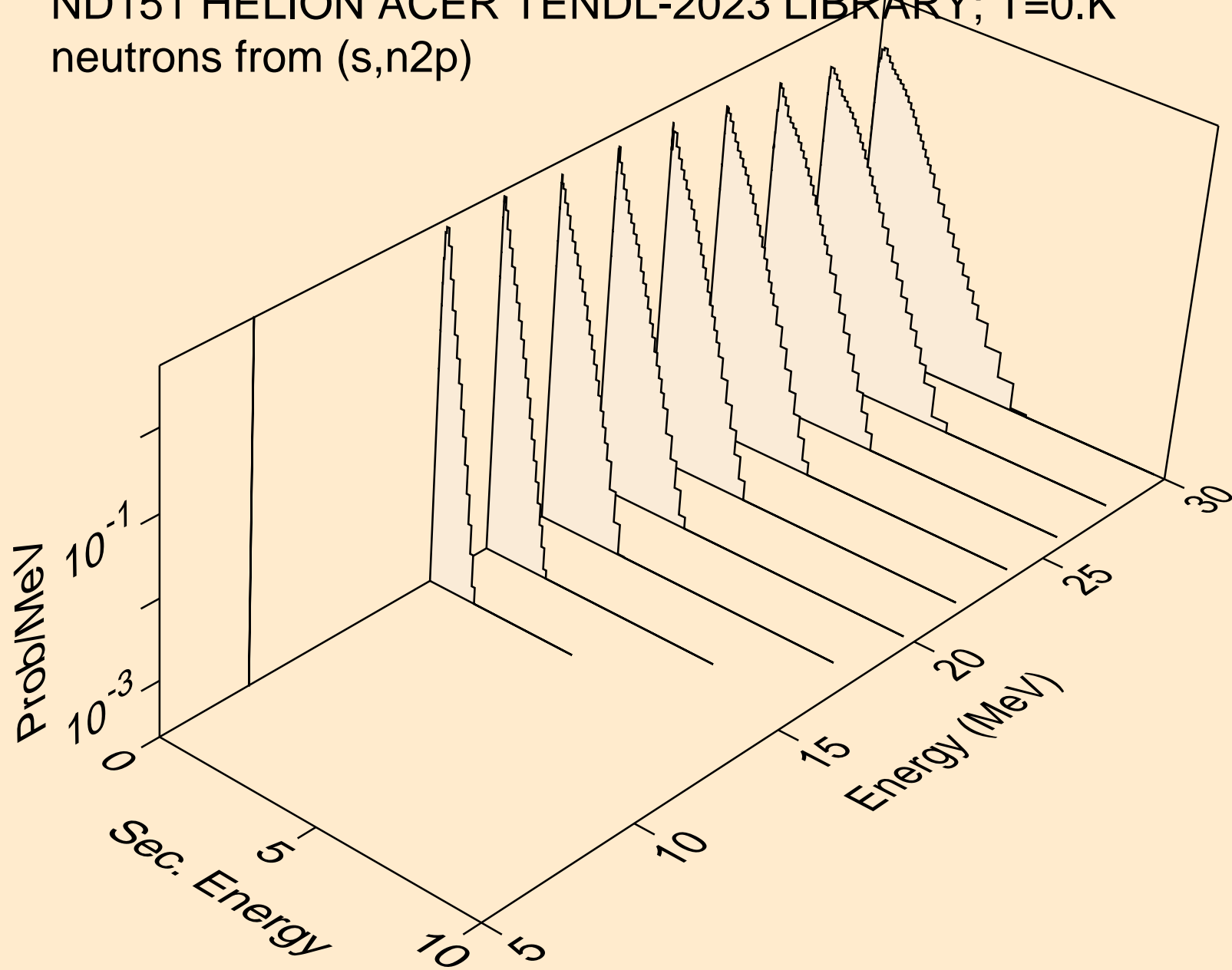

ND151 HELION ACER TENDL-2023 LIBRARY; T=0.K  
neutrons from (s,npa)

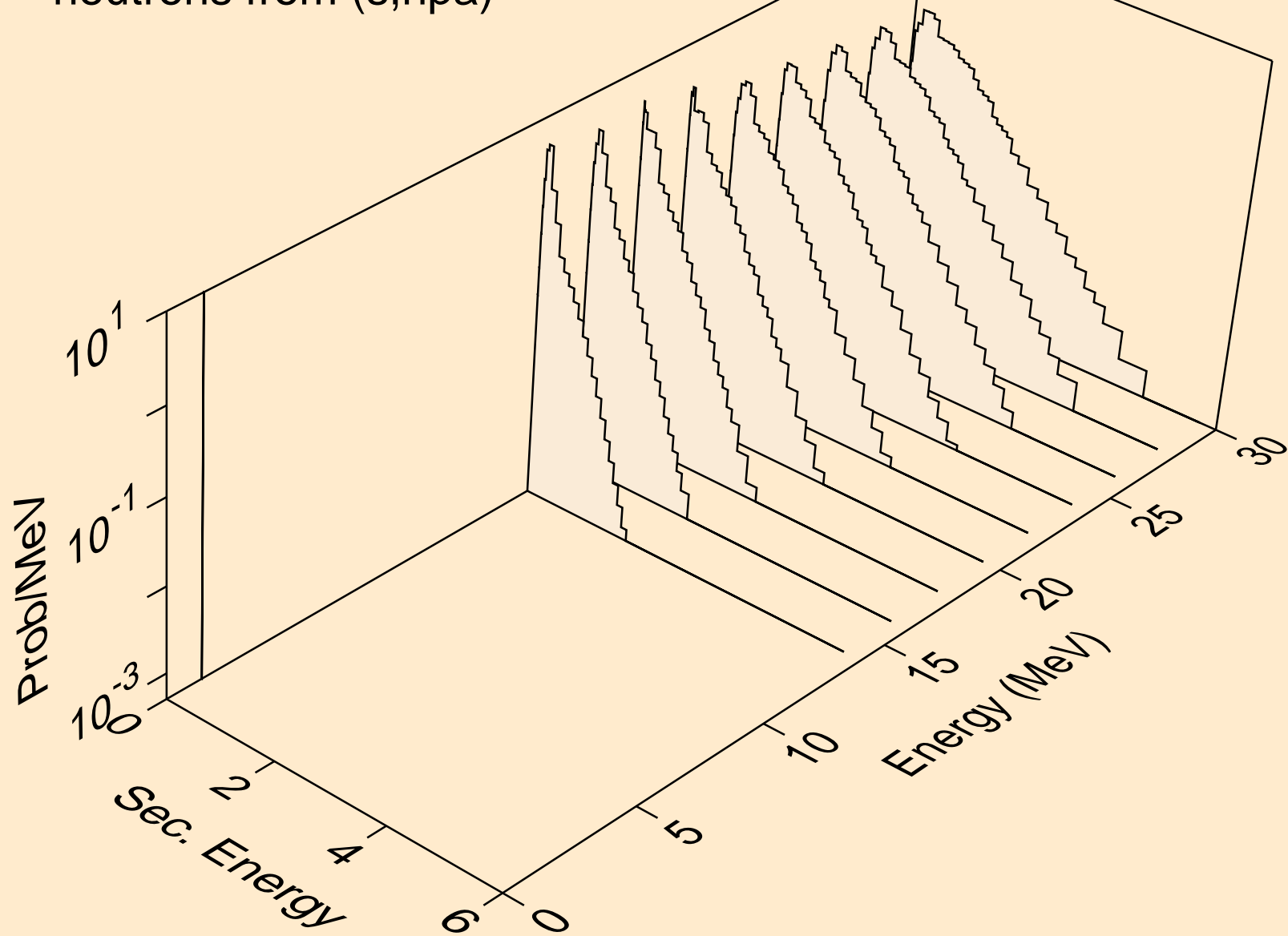

ND151 HELION ACER TENDL-2023 LIBRARY; T=0.K  
protons from (s,x)

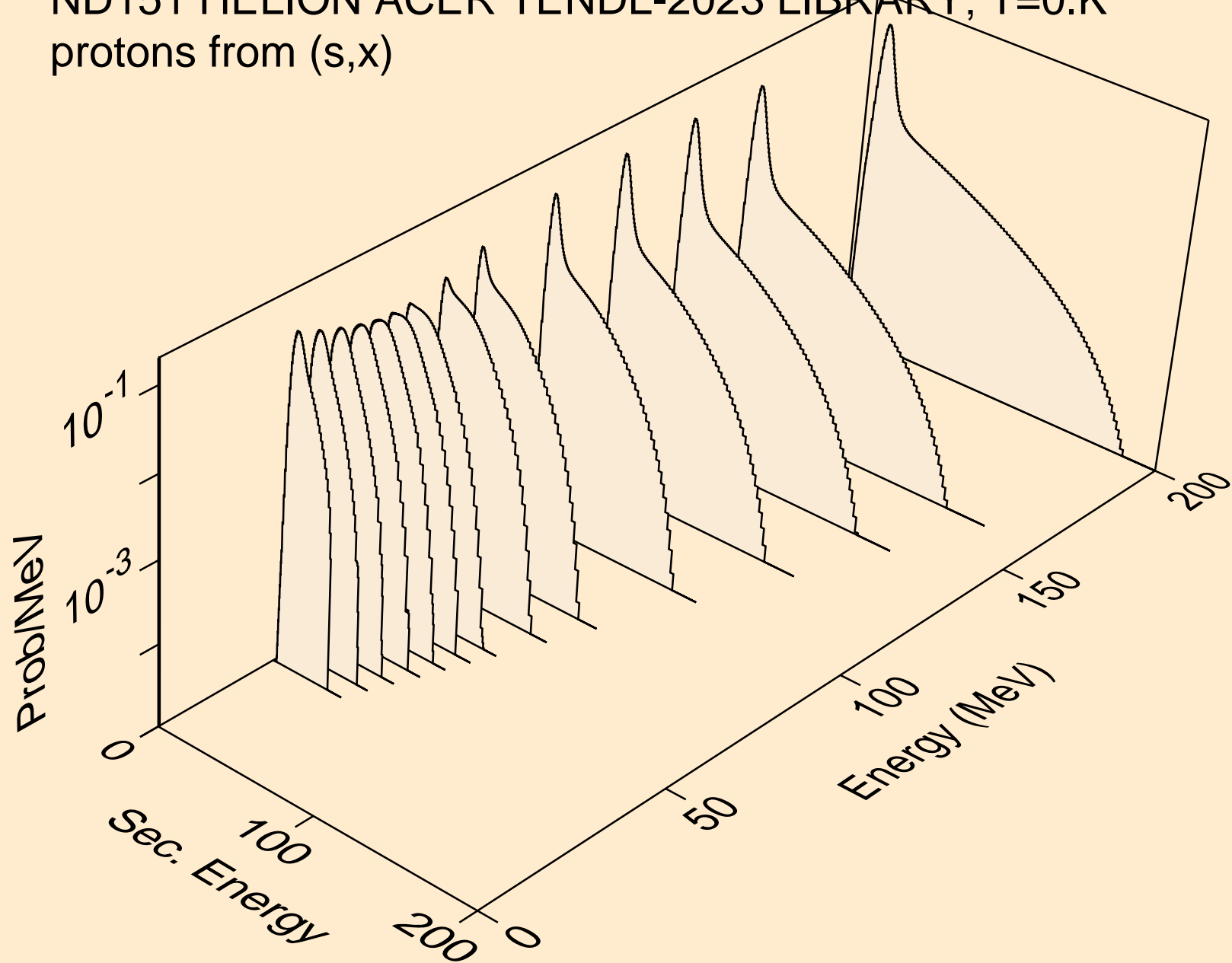

ND151 HELION ACER TENDL-2023 LIBRARY; T=0.K  
protons from (s,n\*)p

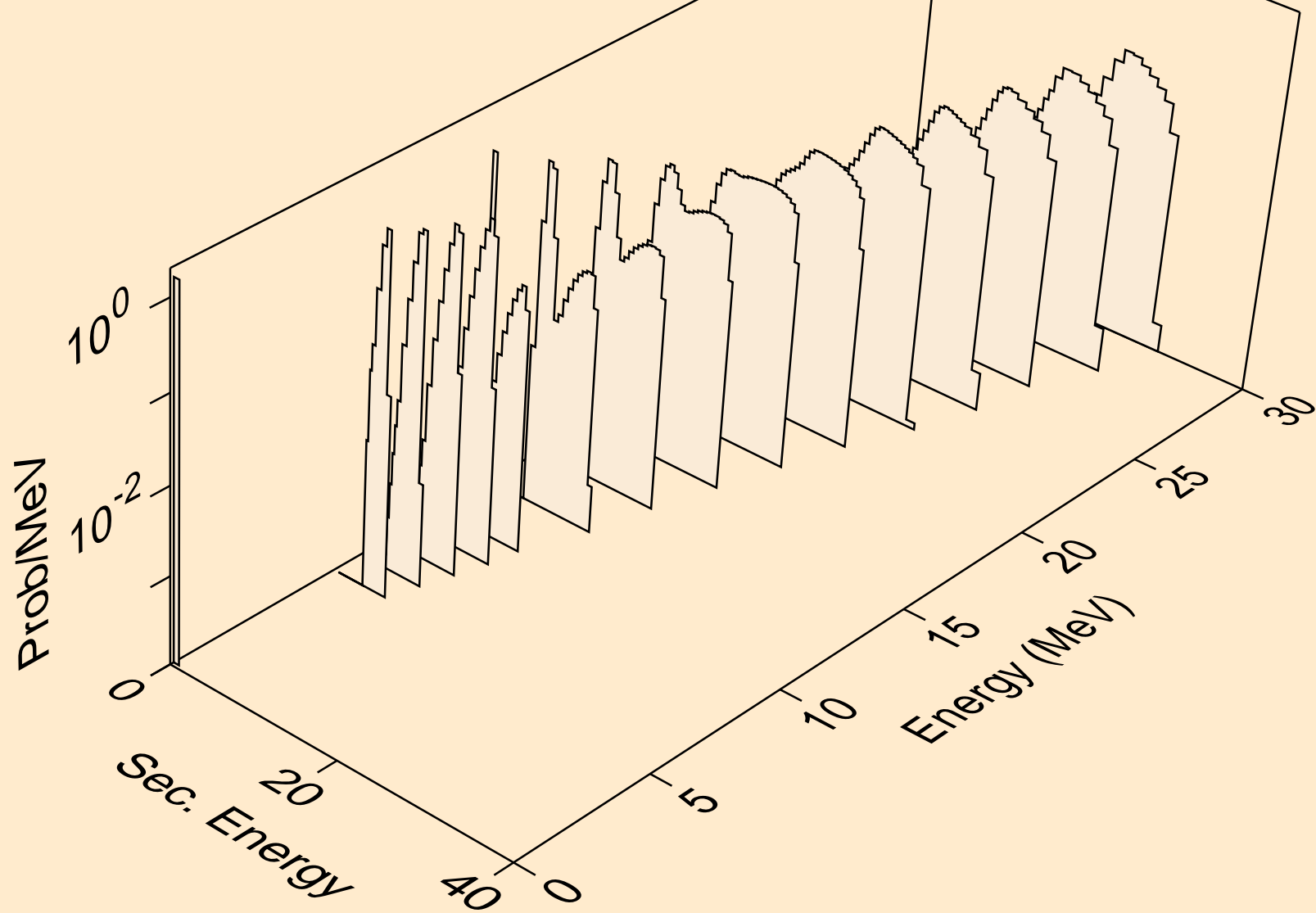

ND151 HELION ACER TENDL-2023 LIBRARY; T=0.K  
protons from (s,2np)

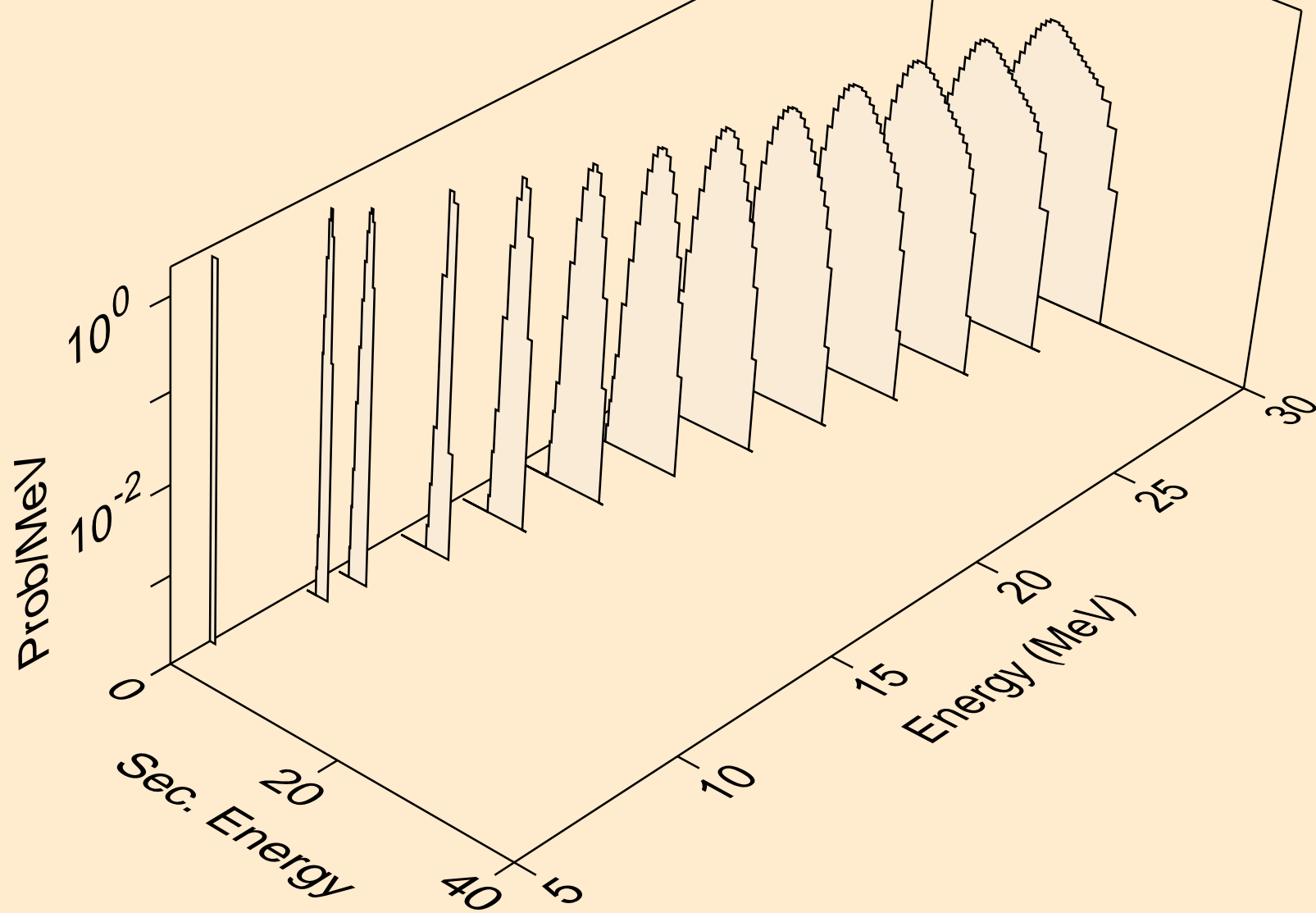

ND151 HELION ACER TENDL-2023 LIBRARY; T=0.K  
protons from (s,3np)

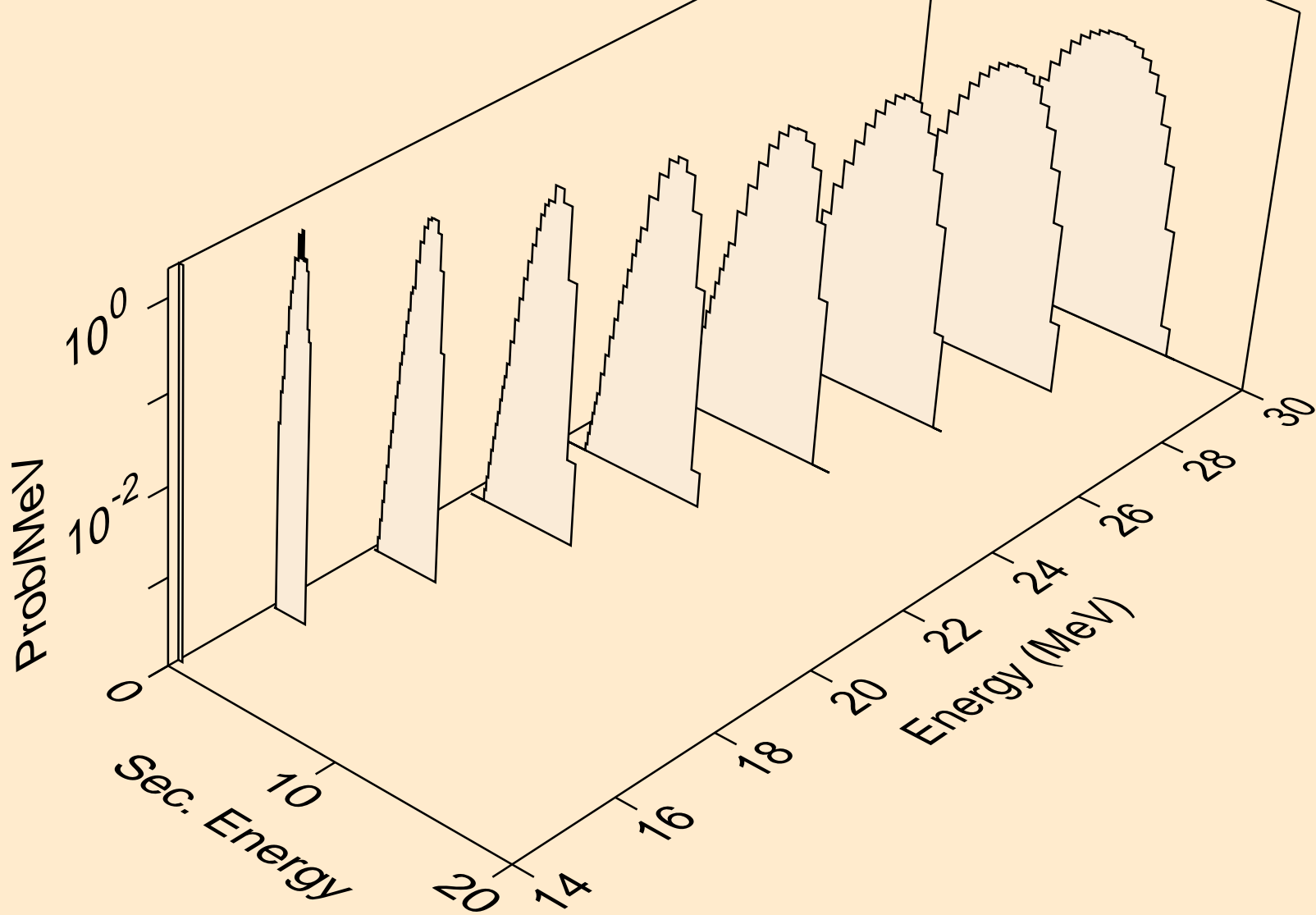

ND151 HELION ACER TENDL-2023 LIBRARY; T=0.K  
protons from (s,n2p)

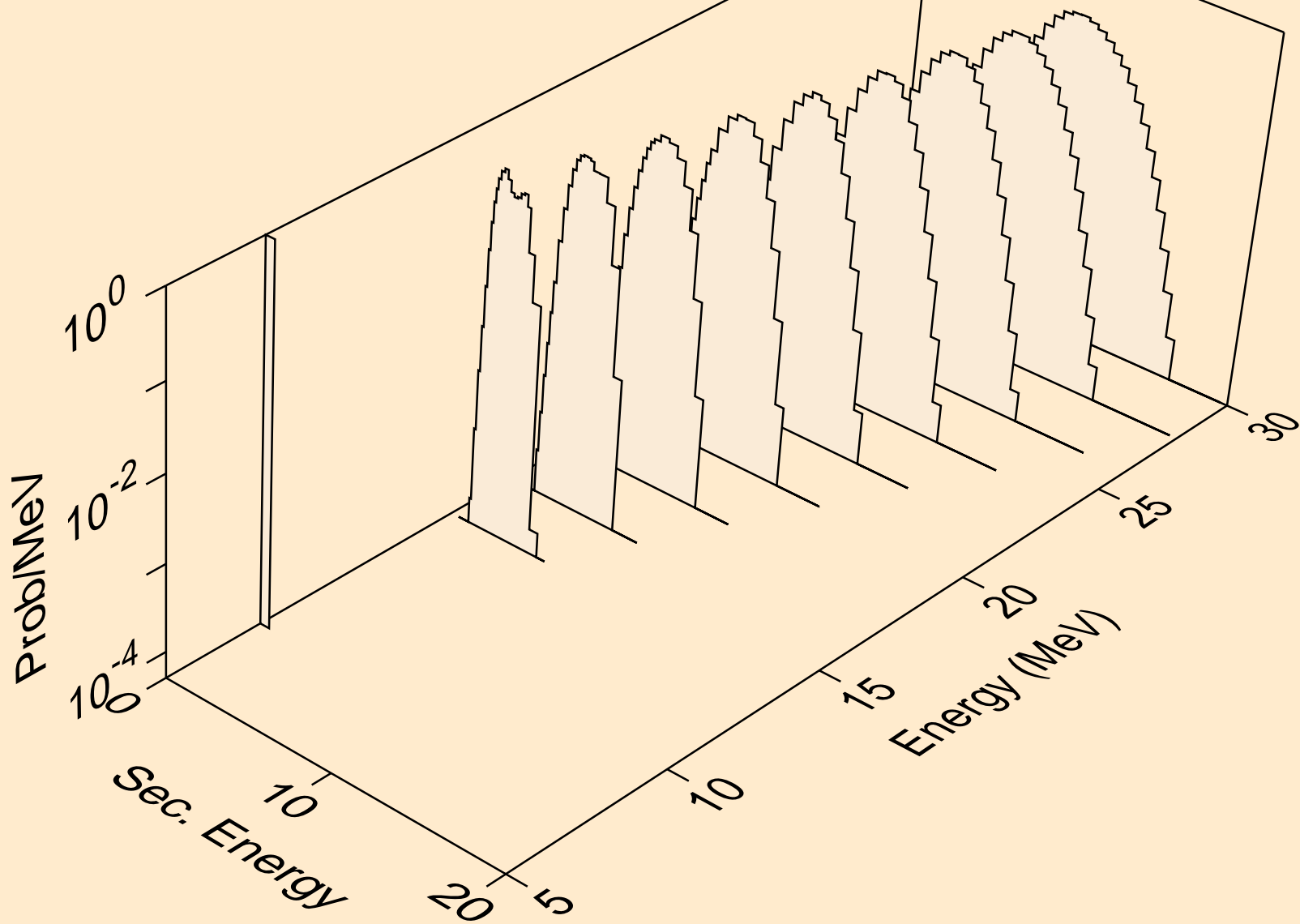

ND151 HELION ACER TENDL-2023 LIBRARY; T=0.K  
protons from (s,npa)

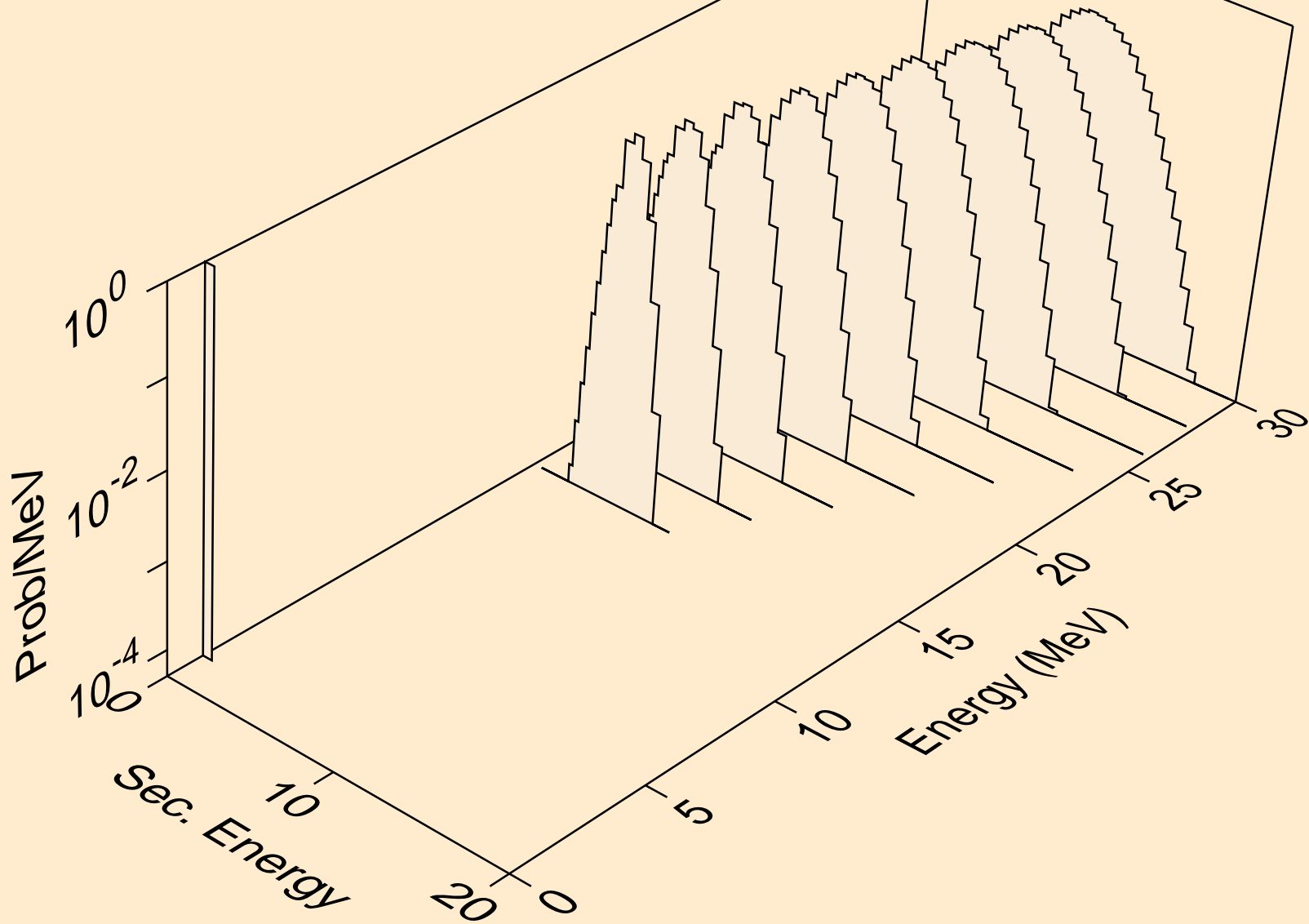

ND151 HELION ACER TENDL-2023 LIBRARY; T=0.K  
protons from (s,p)

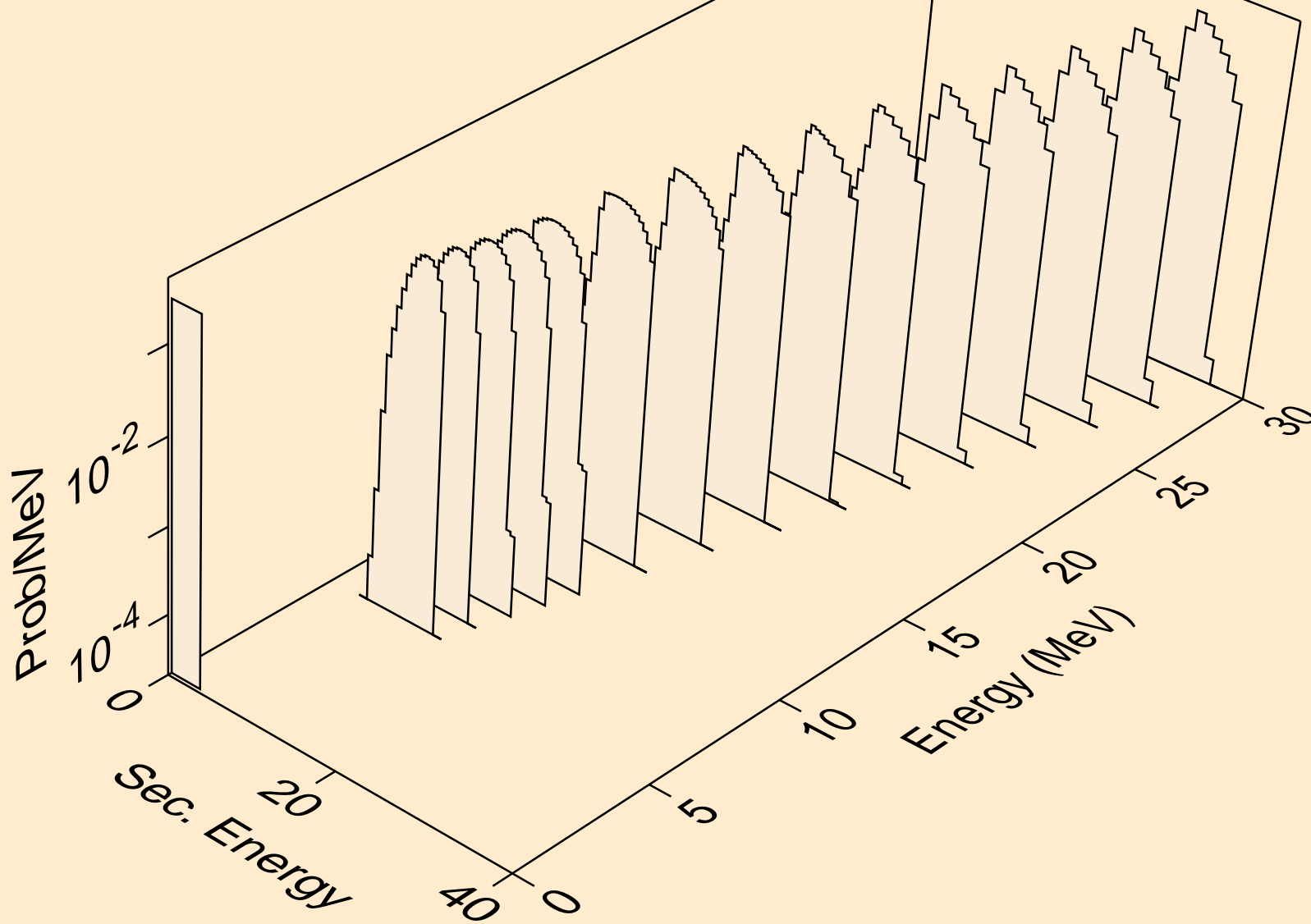

ND151 HELION ACER TENDL-2023 LIBRARY; T=0.K  
protons from (s,2p)

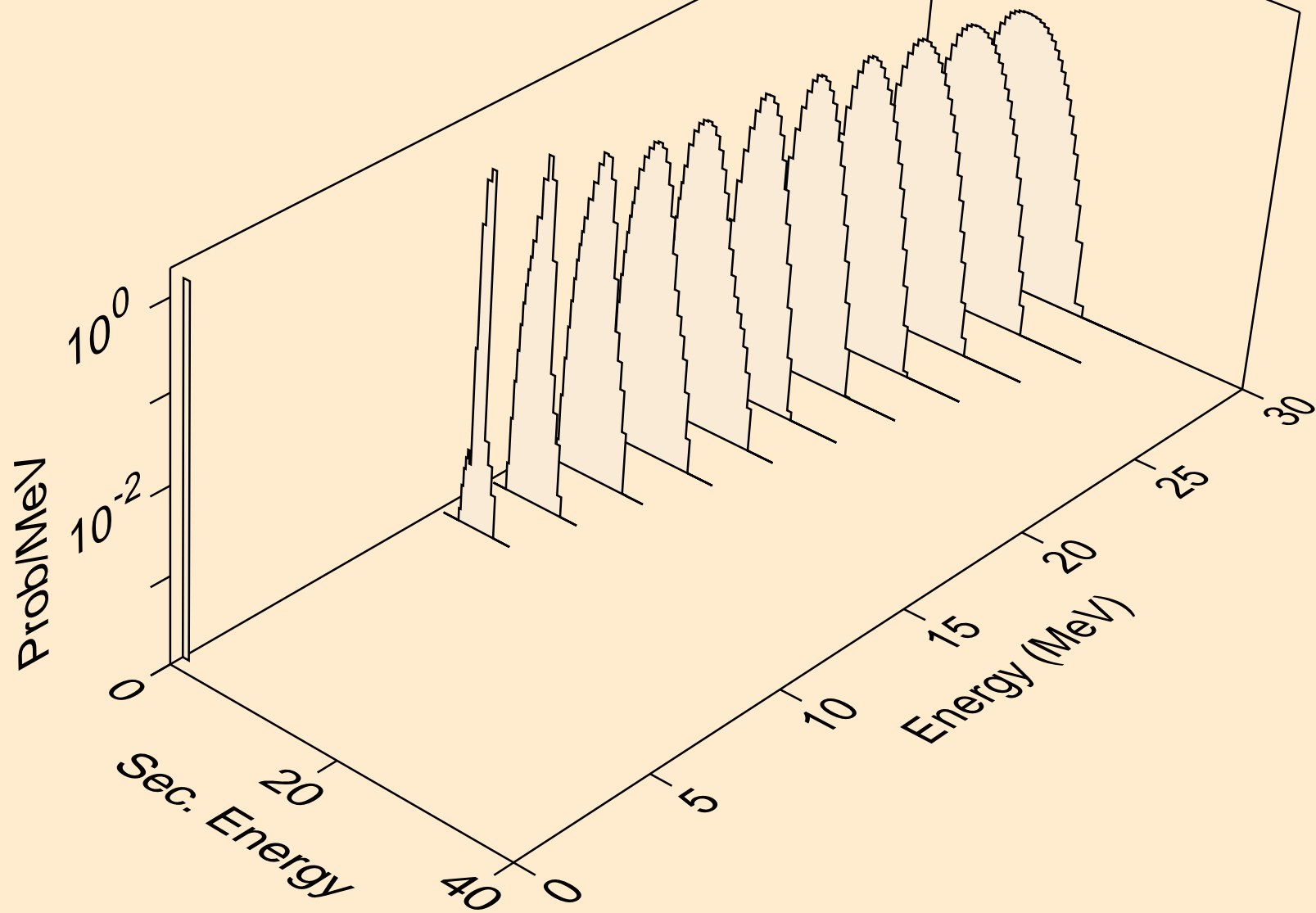

ND151 HELION ACER TENDL-2023 LIBRARY; T=0.K  
protons from (s,pa)

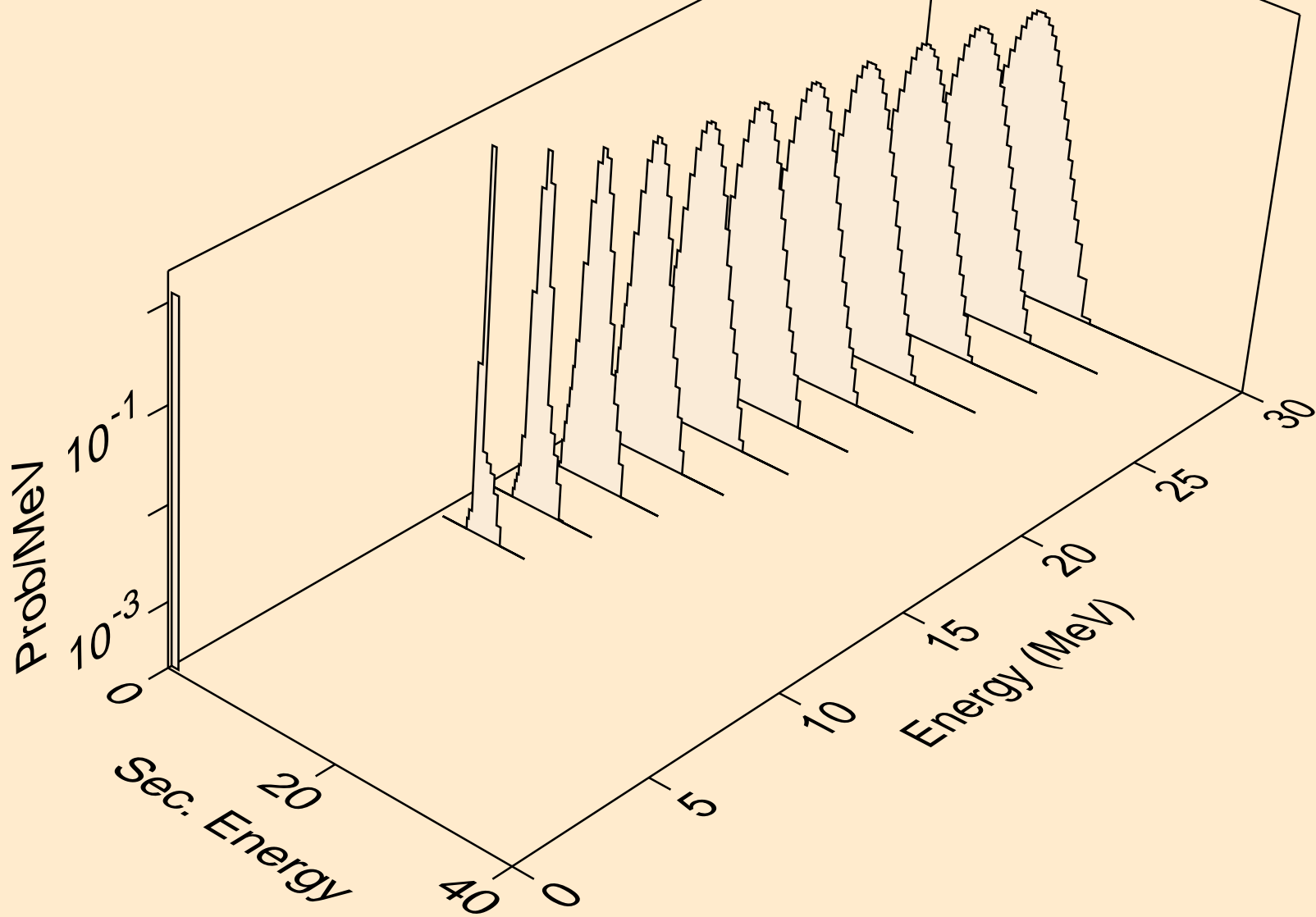

ND151 HELION ACER TENDL-2023 LIBRARY; T=0.K  
protons from (s,pd)

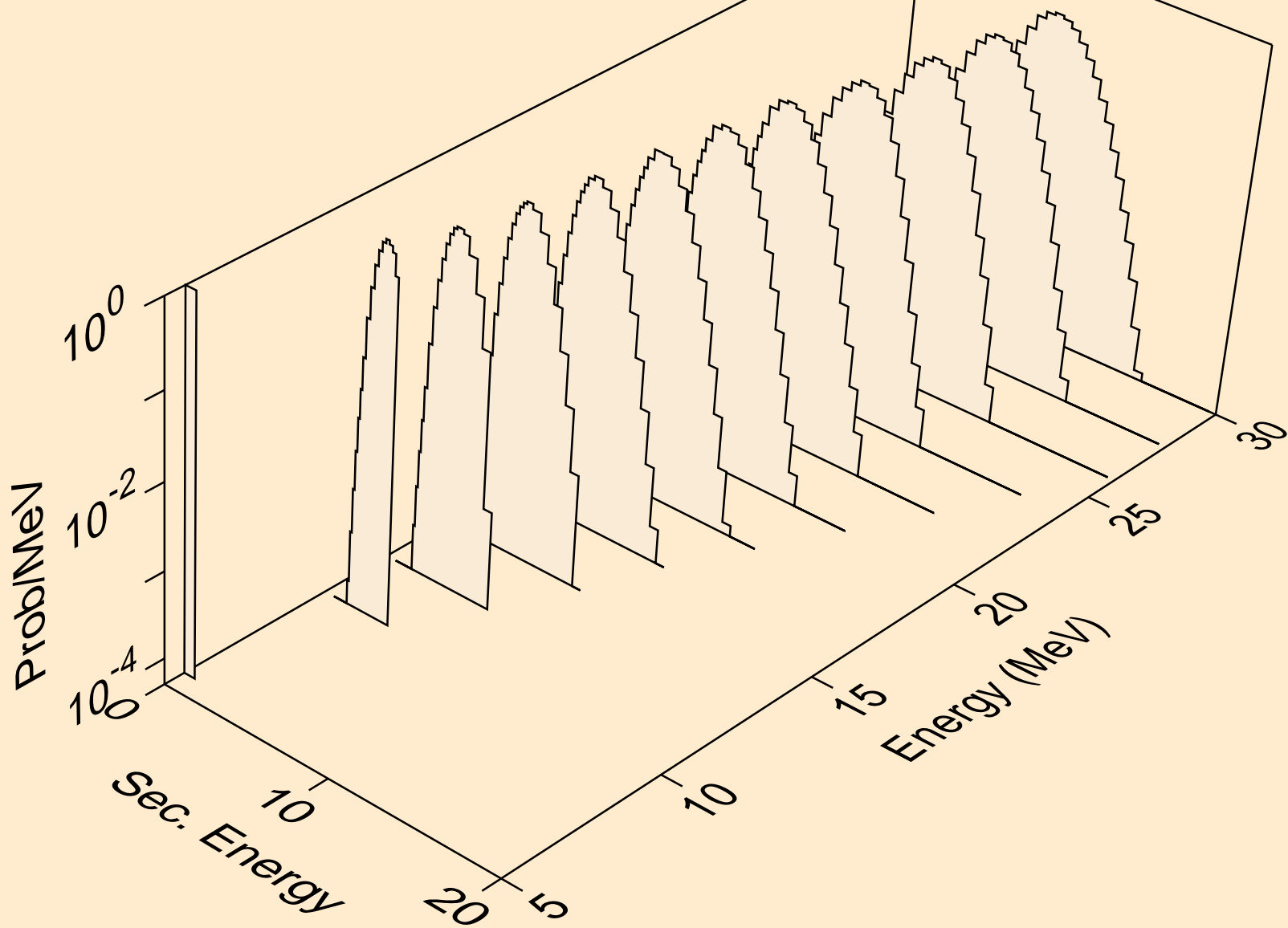

ND151 HELION ACER TENDL-2023 LIBRARY; T=0.K  
protons from (s,pt)

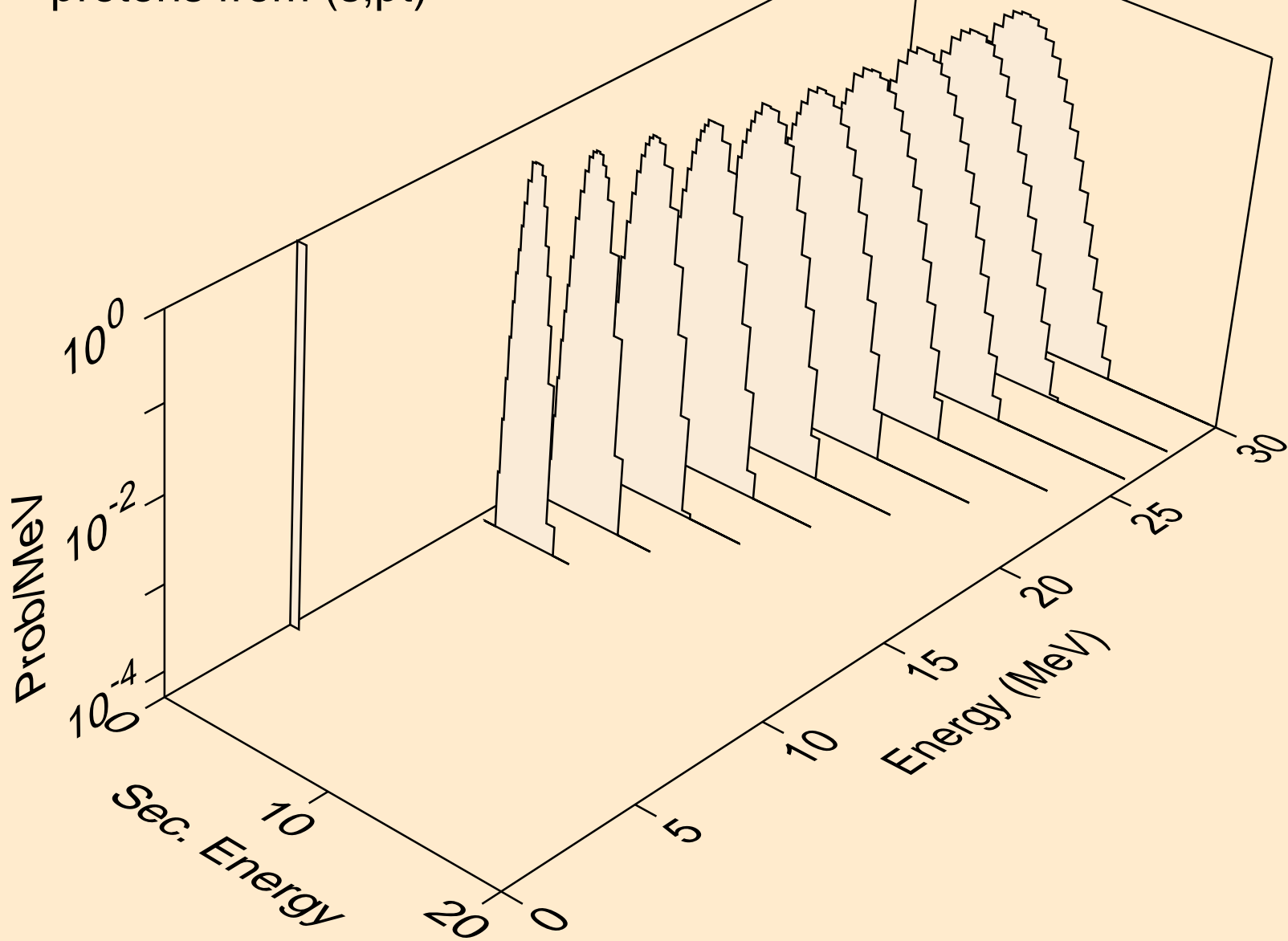

ND151 HELION ACER TENDL-2023 LIBRARY; T=0.K  
deuterons from (s,x)

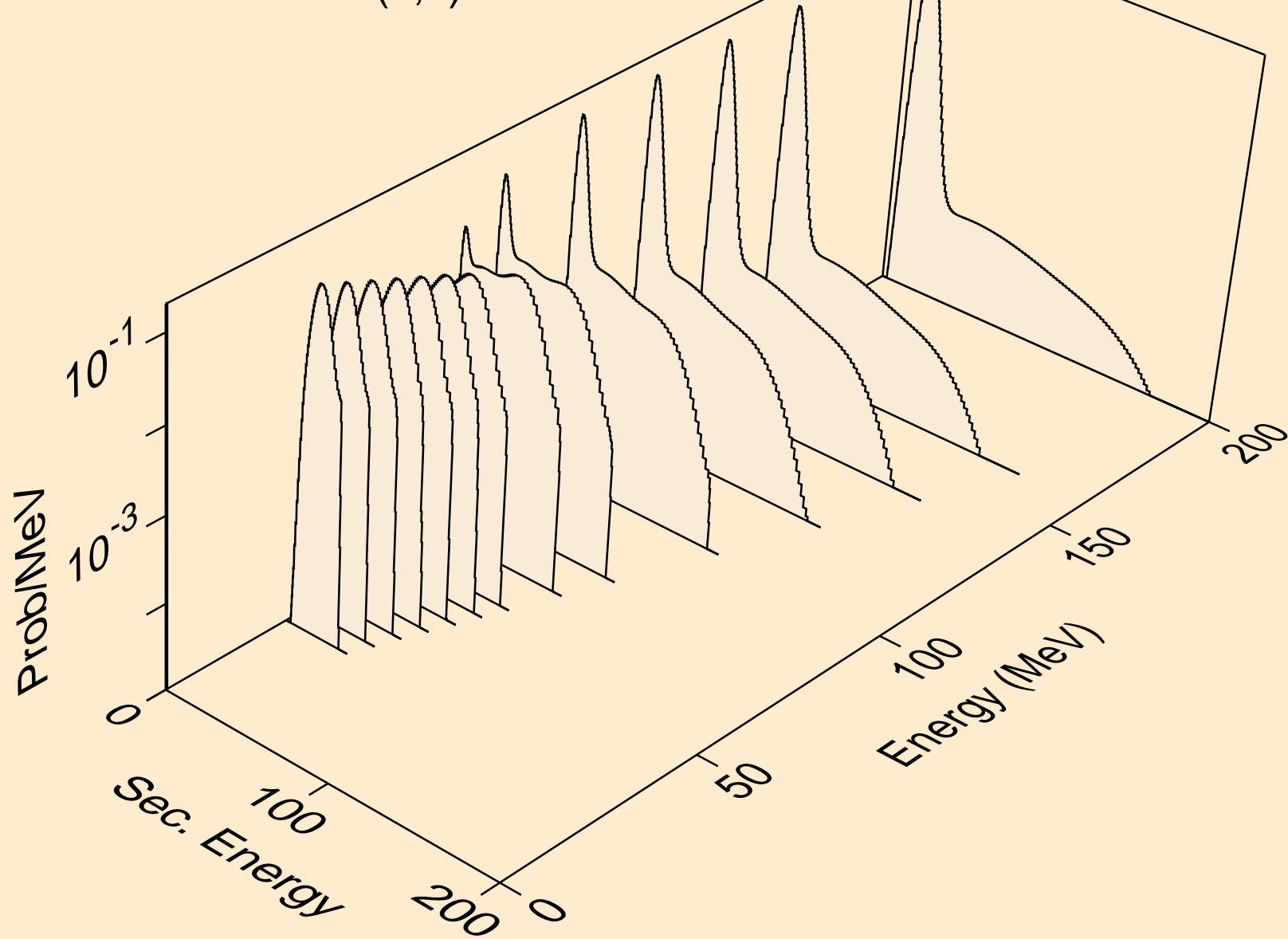

ND151 HELION ACER TENDL-2023 LIBRARY; T=0.K  
deuterons from (s,2nd)

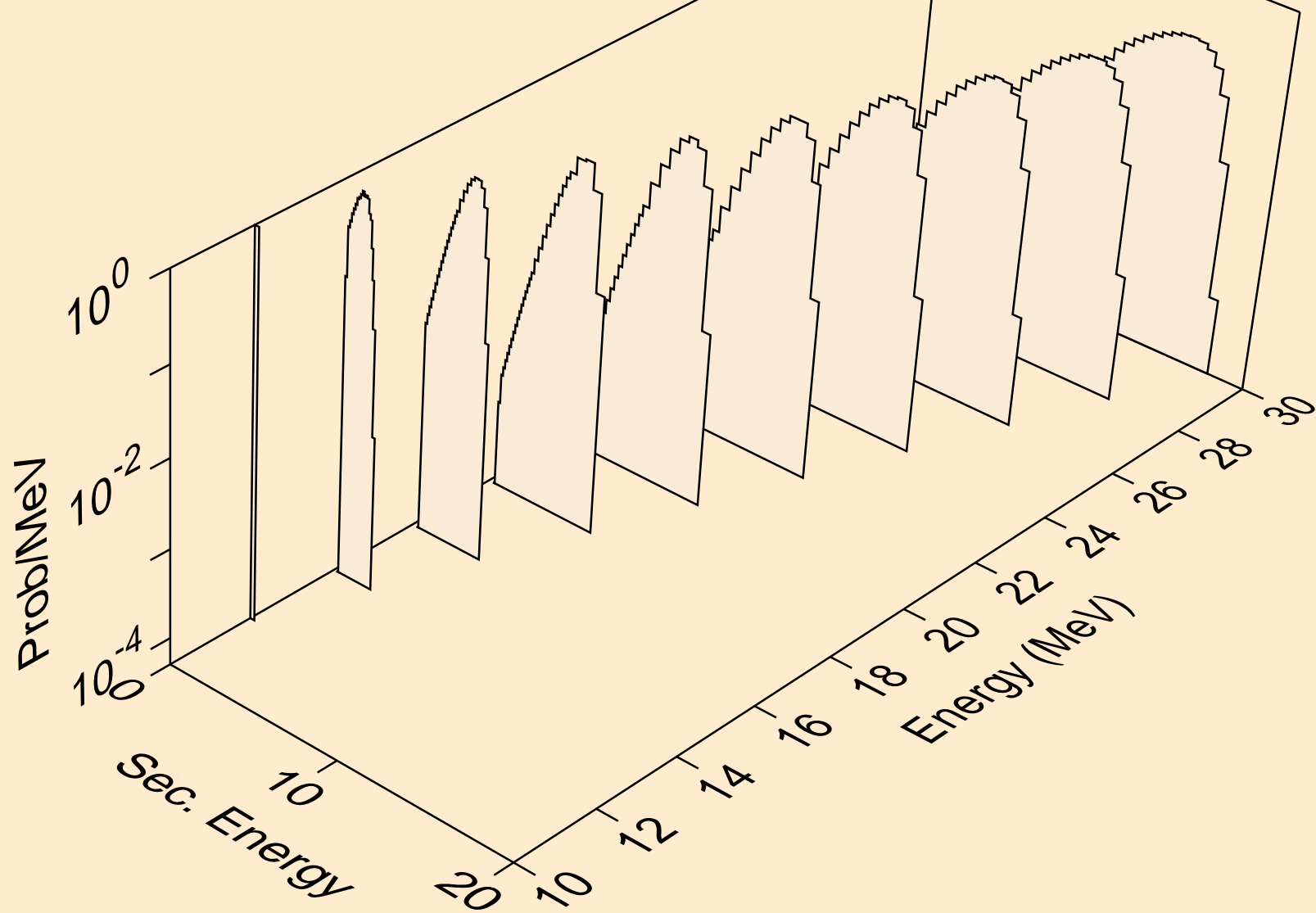

ND151 HELION ACER TENDL-2023 LIBRARY; T=0.K  
deuterons from (s,n\*)d

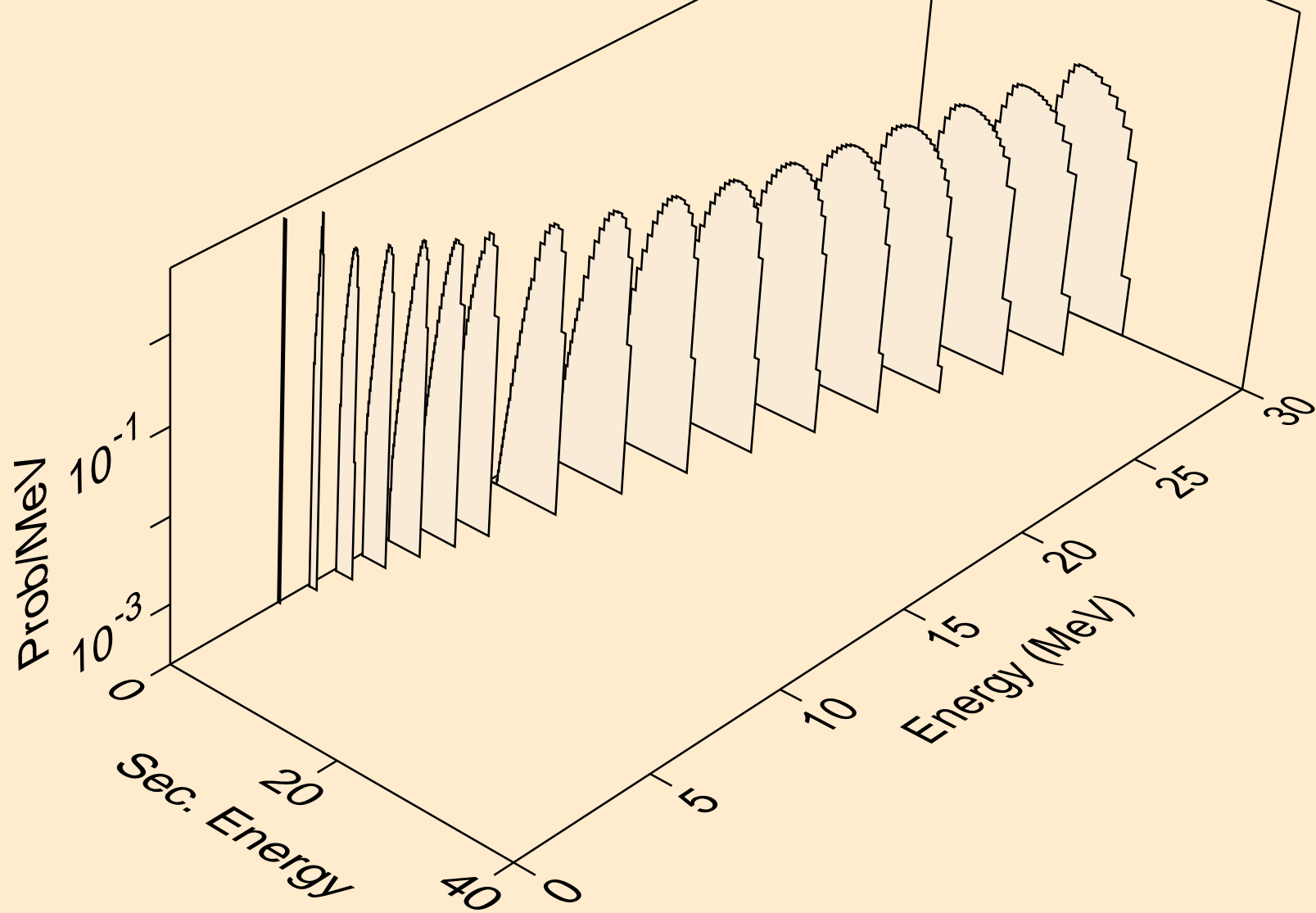

ND151 HELION ACER TENDL-2023 LIBRARY; T=0.K  
deuterons from (s,d)

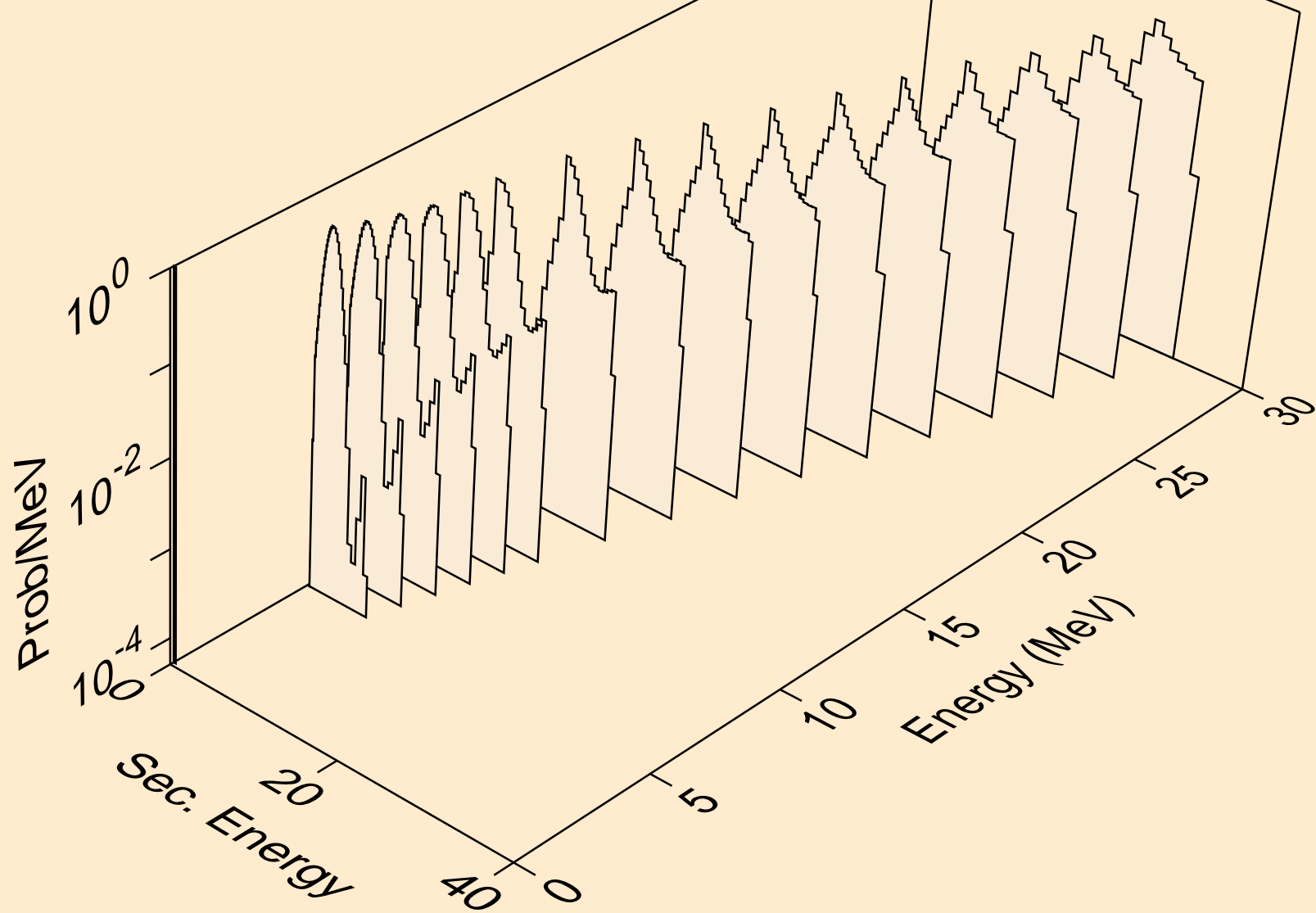

ND151 HELION ACER TENDL-2023 LIBRARY; T=0.K  
deuterons from (s,pd)

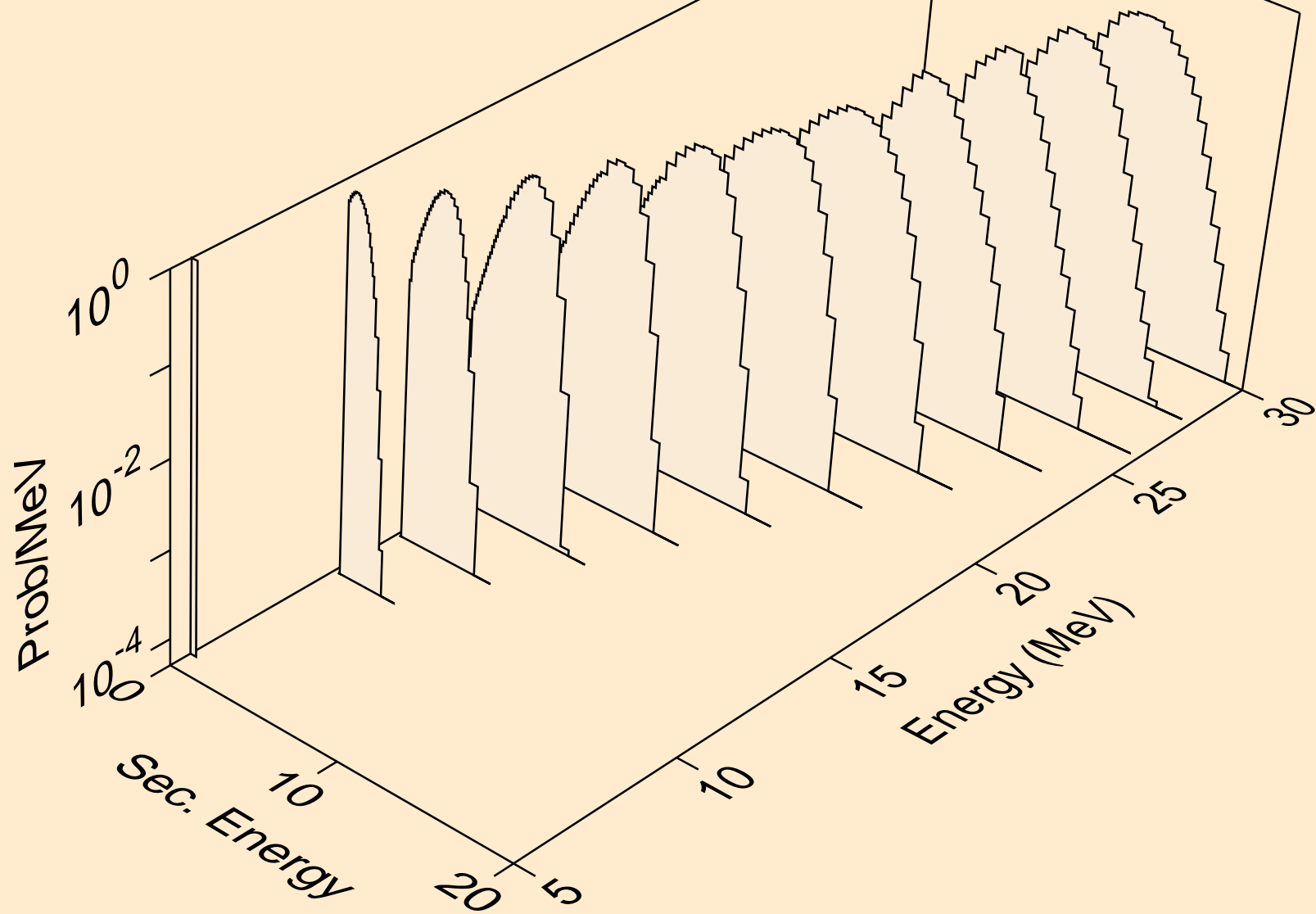

ND151 HELION ACER TENDL-2023 LIBRARY; T=0.K  
deuterons from (s,da)

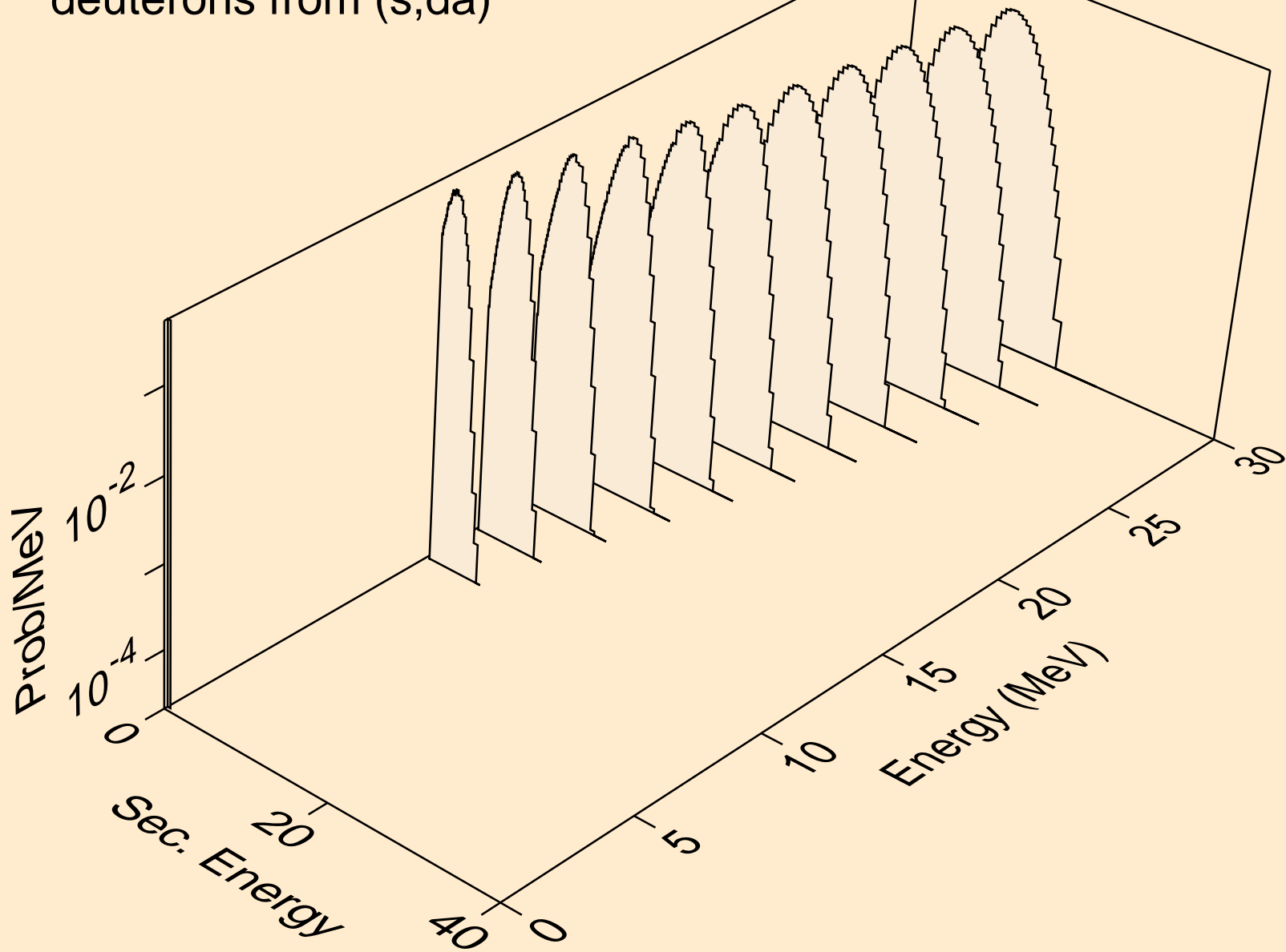

ND151 HELION ACER TENDL-2023 LIBRARY; T=0.K  
tritons from (s,x)

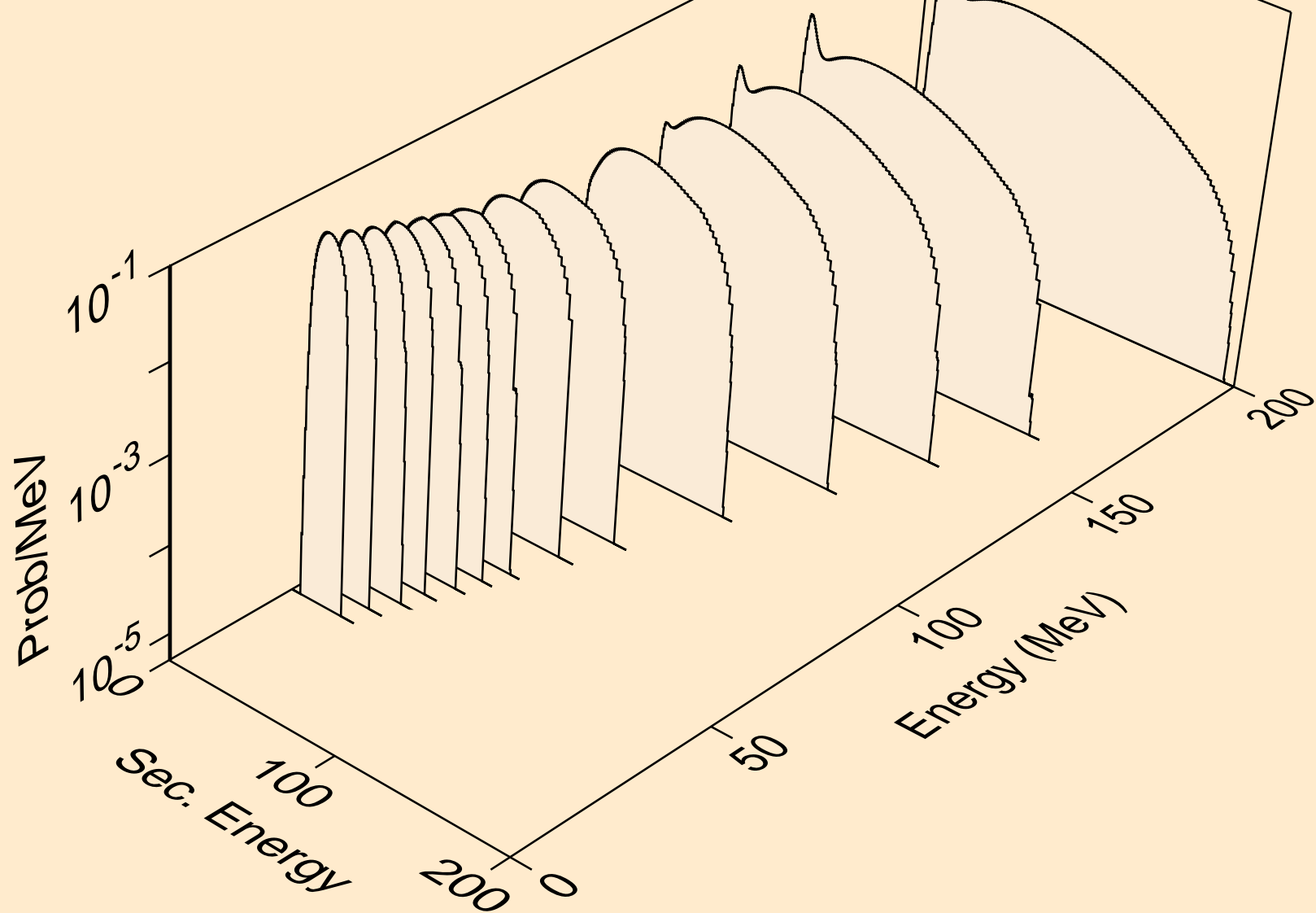

ND151 HELION ACER TENDL-2023 LIBRARY; T=0.K  
tritons from (s,n\*)t

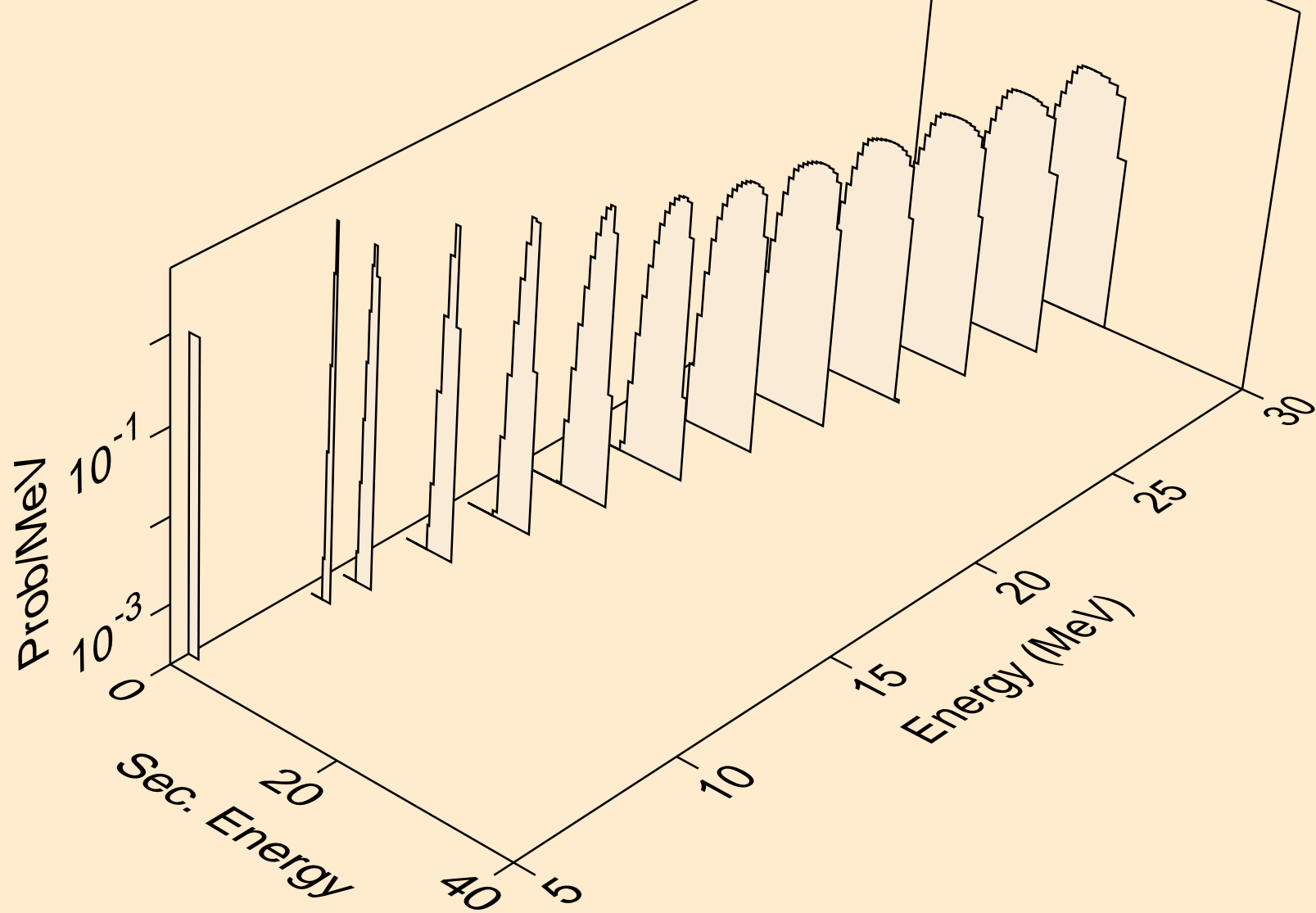

ND151 HELION ACER TENDL-2023 LIBRARY; T=0.K  
tritons from (s,t)

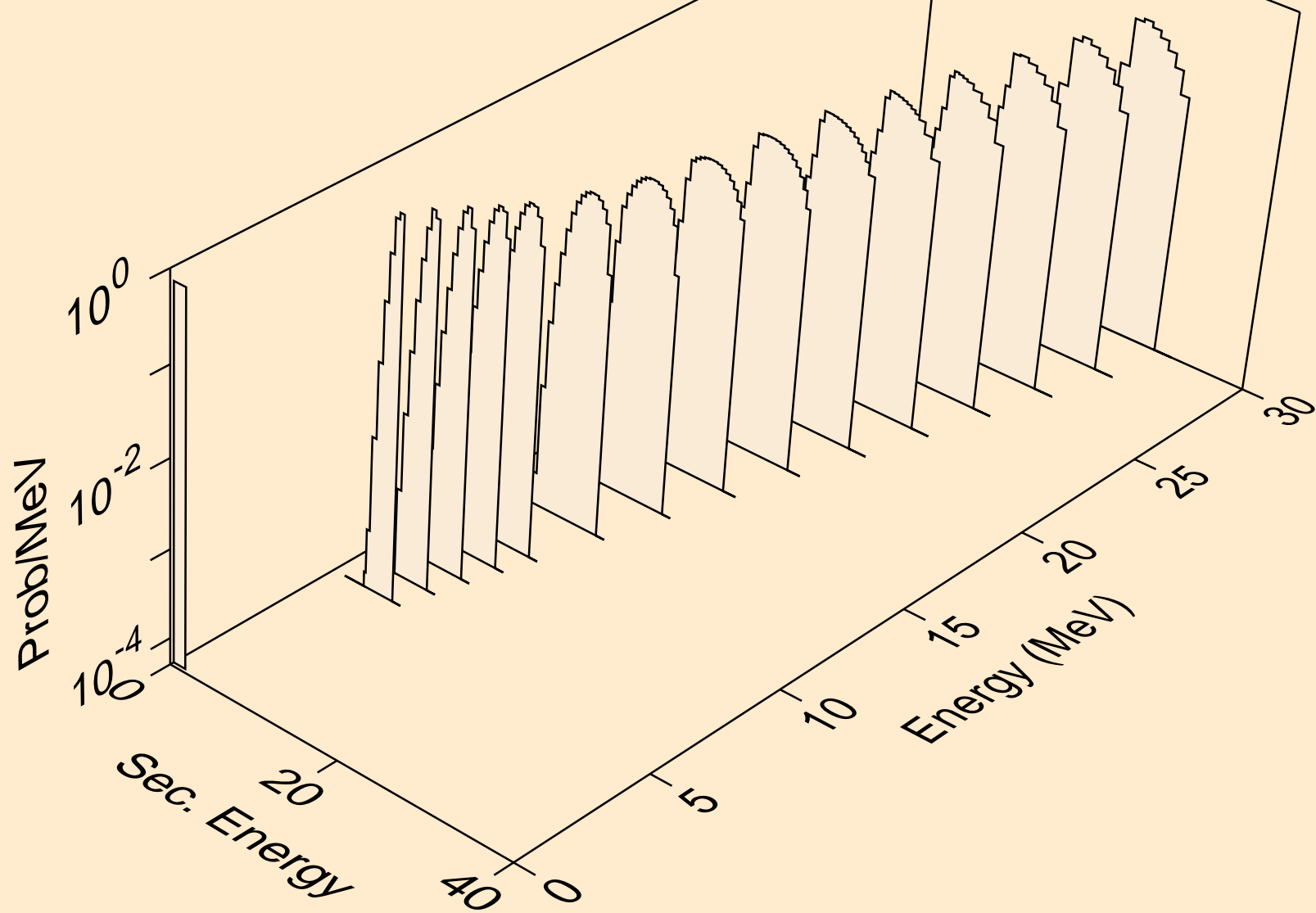

ND151 HELION ACER TENDL-2023 LIBRARY; T=0.K  
tritons from (s,pt)

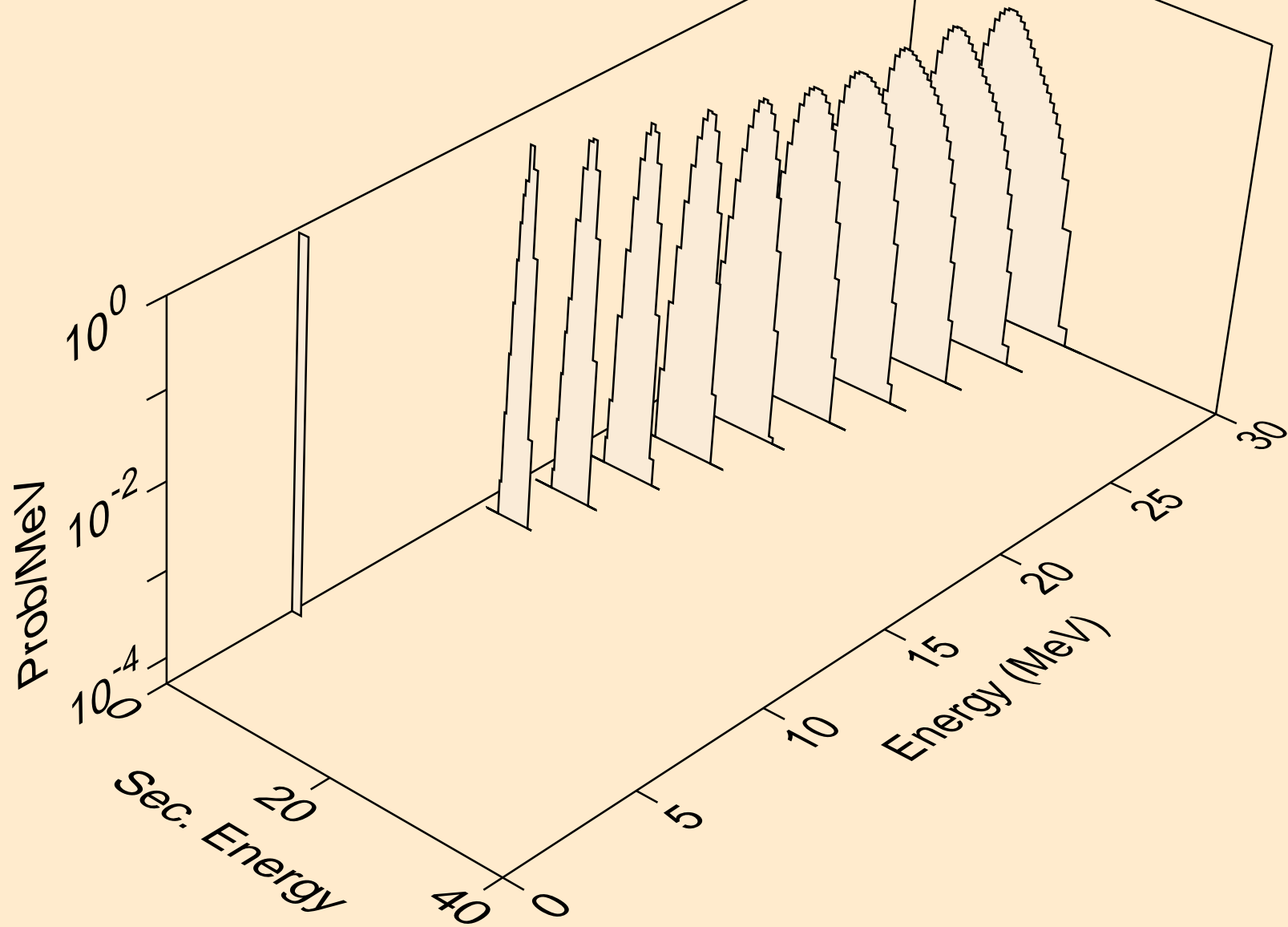

ND151 HELION ACER TENDL-2023 LIBRARY; T=0.K  
alphas from (s,x)

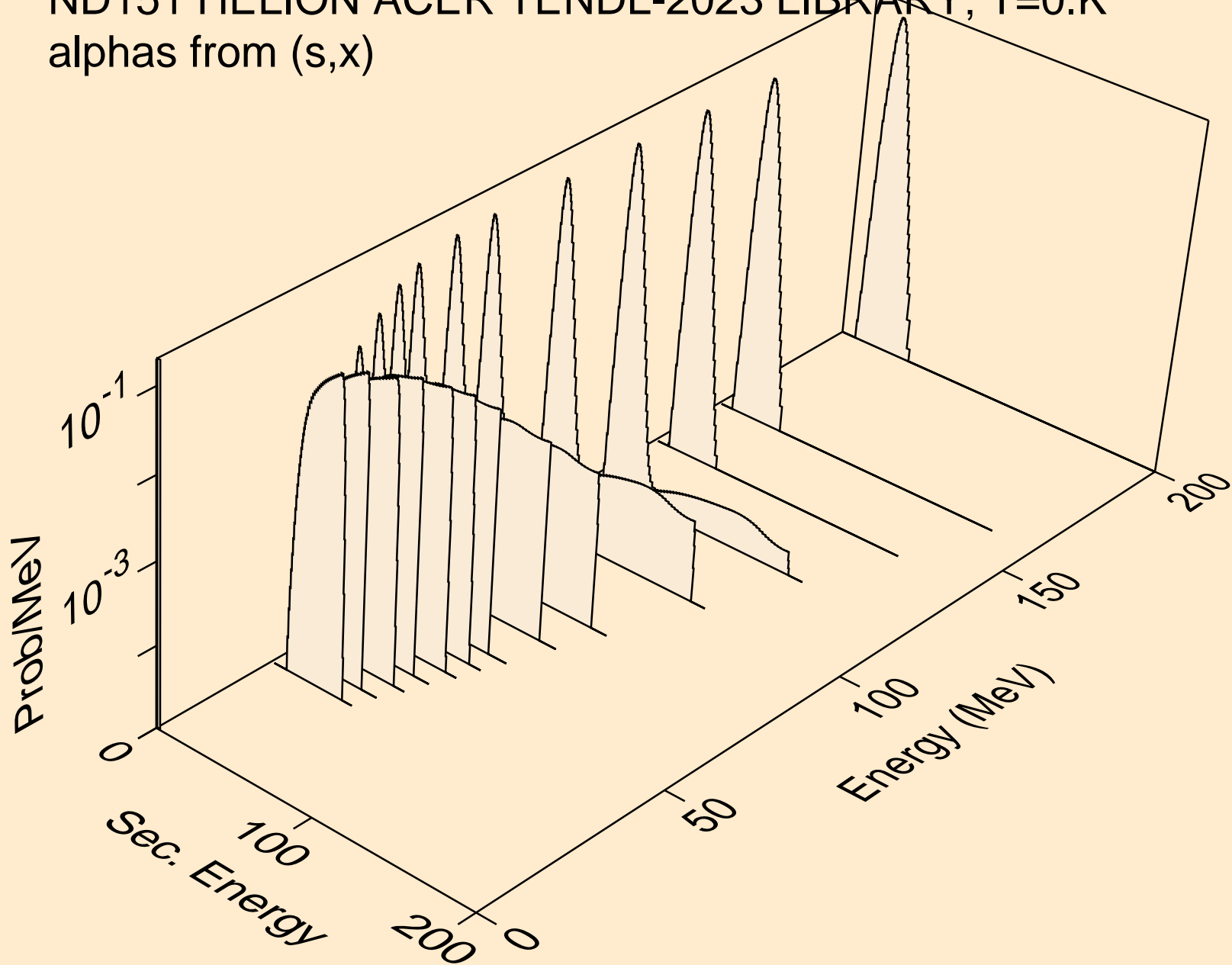

ND151 HELION ACER TENDL-2023 LIBRARY; T=0.K  
alphas from (s,n\*)a

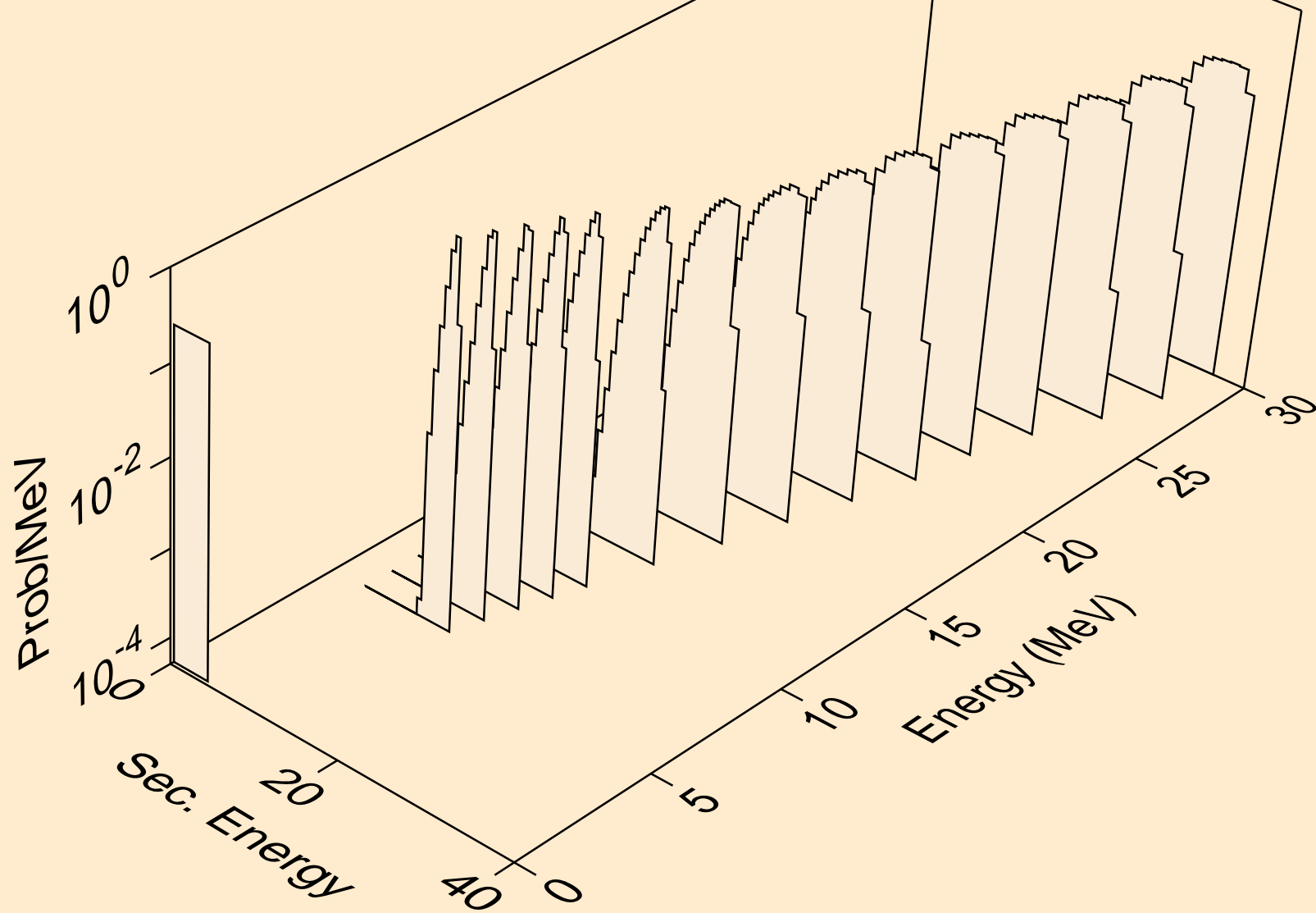

ND151 HELION ACER TENDL-2023 LIBRARY; T=0.K  
alphas from (s,2n)a

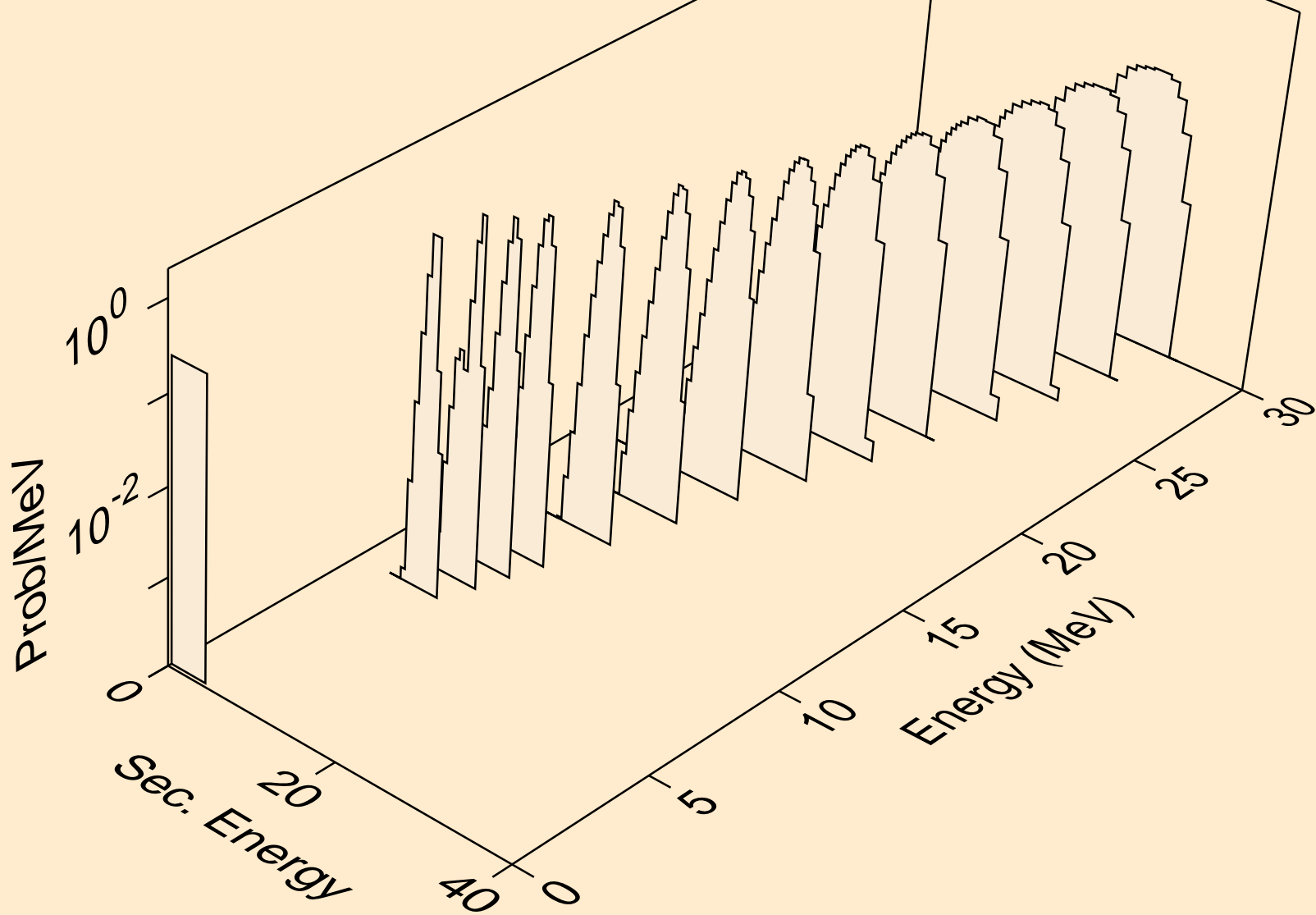

ND151 HELION ACER TENDL-2023 LIBRARY; T=0.K  
alphas from (s,3n)a

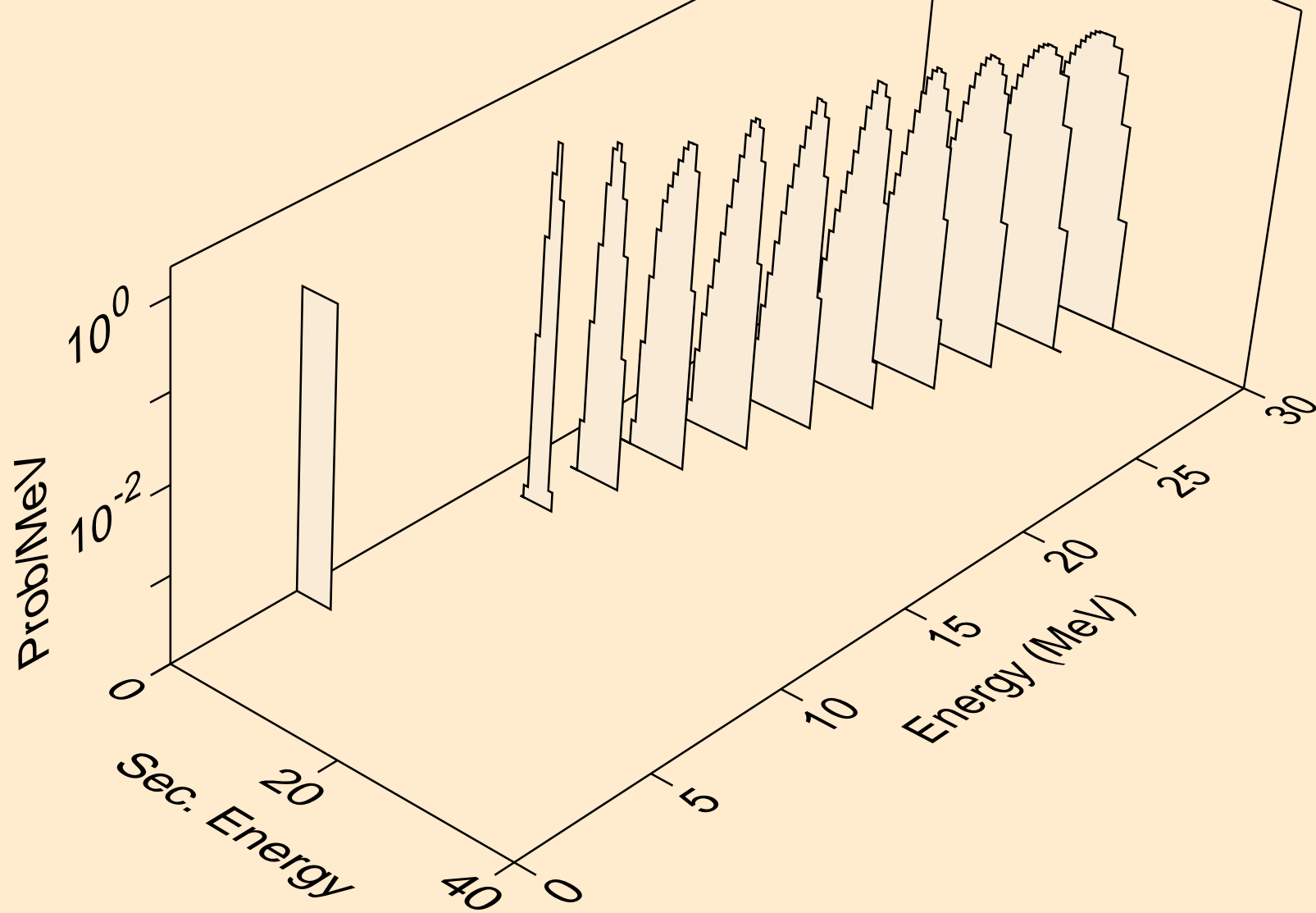

ND151 HELION ACER TENDL-2023 LIBRARY; T=0.K  
alphas from (s,n\*)2a

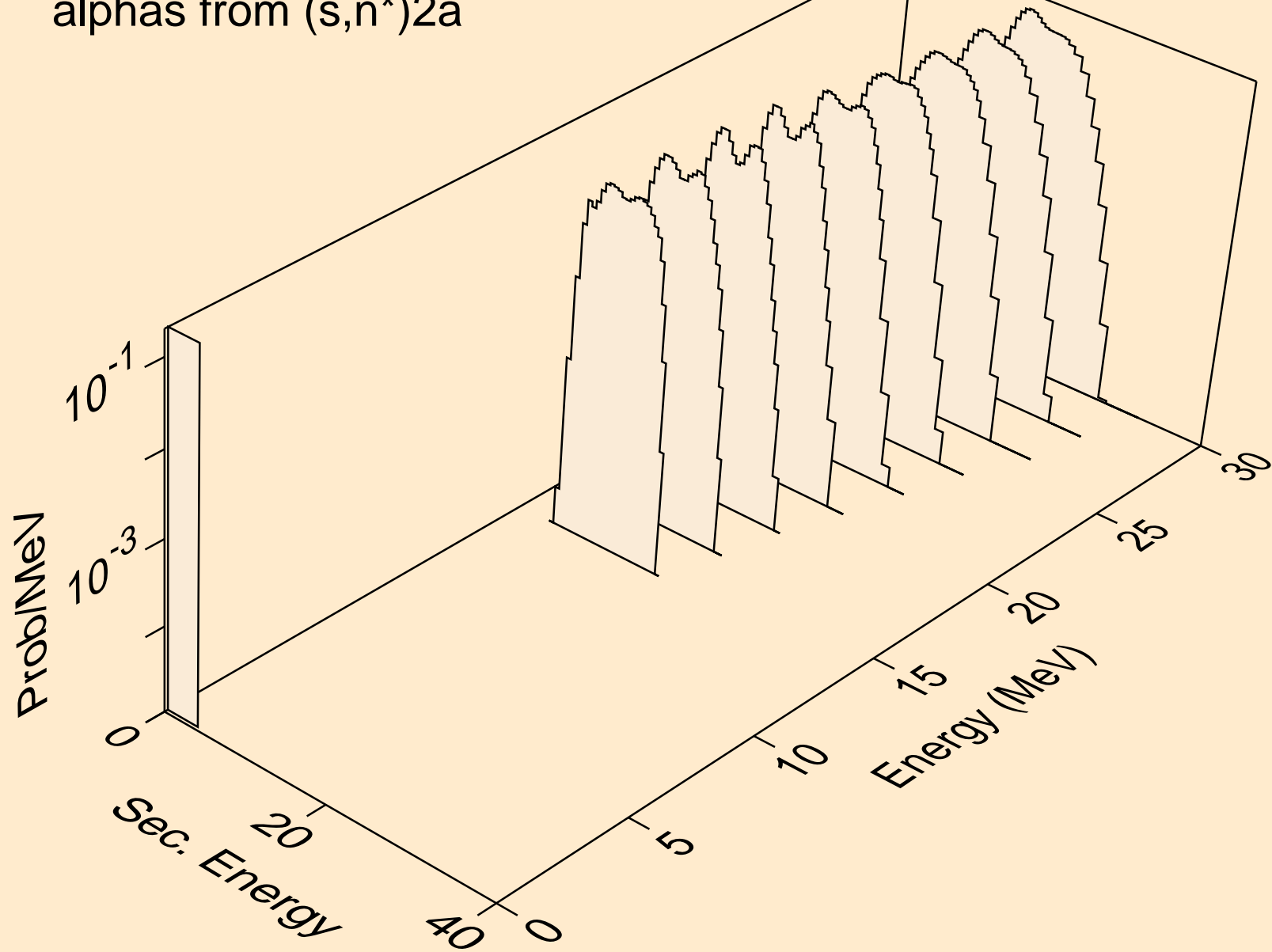

ND151 HELION ACER TENDL-2023 LIBRARY; T=0.K  
alphas from (s,npa)

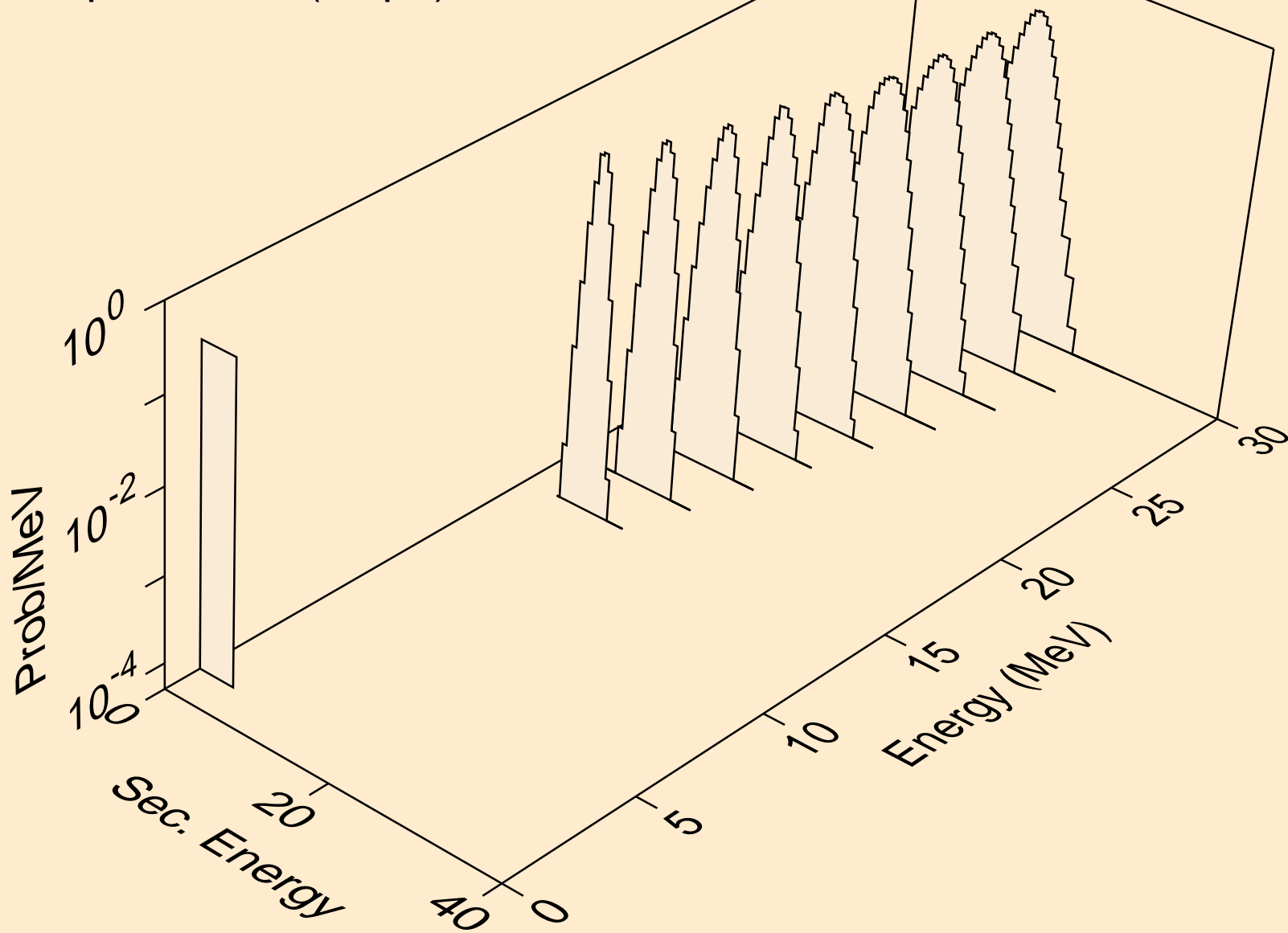

ND151 HELION ACER TENDL-2023 LIBRARY; T=0.K  
alphas from (s,a)

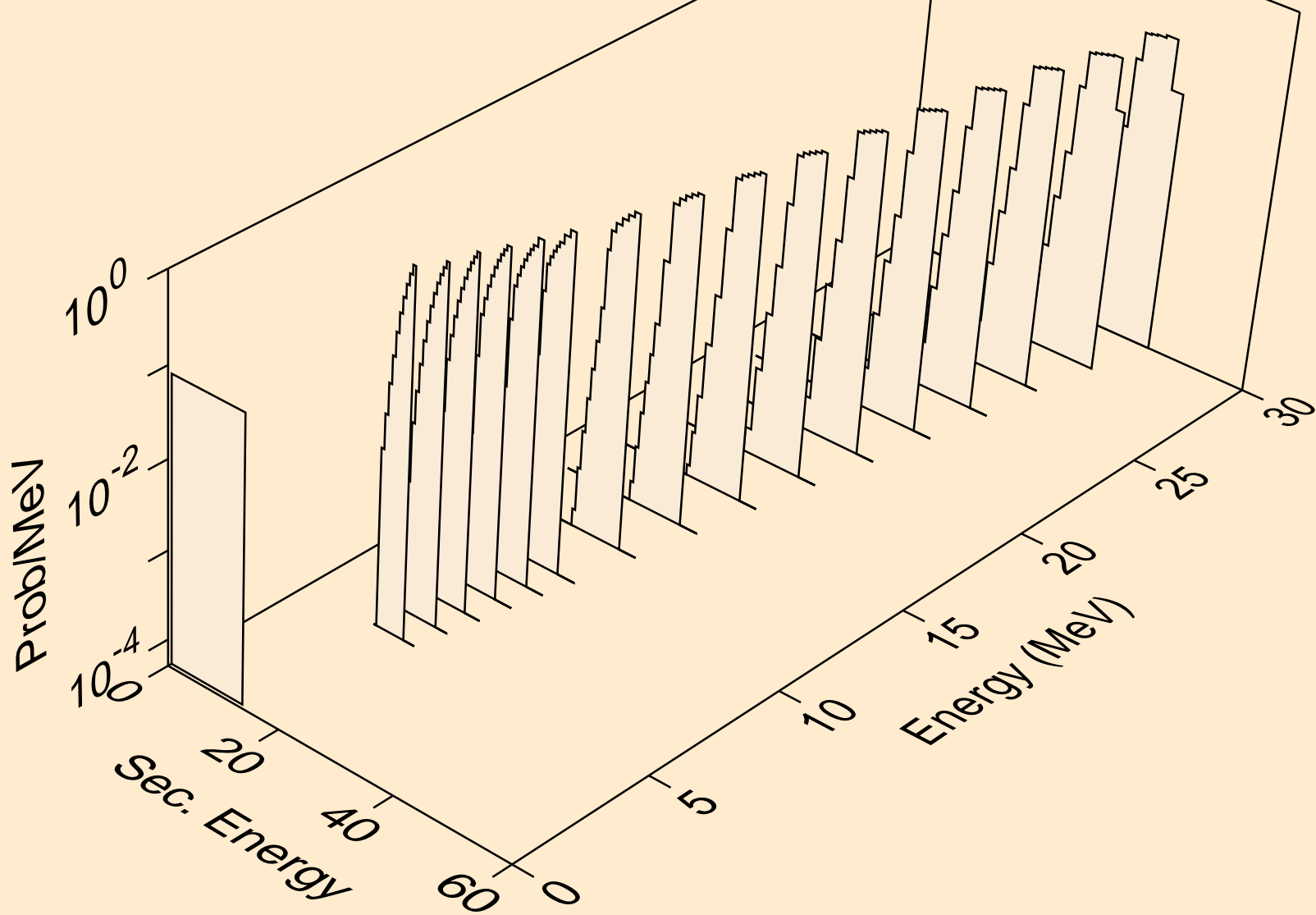

ND151 HELION ACER TENDL-2023 LIBRARY; T=0.K  
alphas from (s,pa)

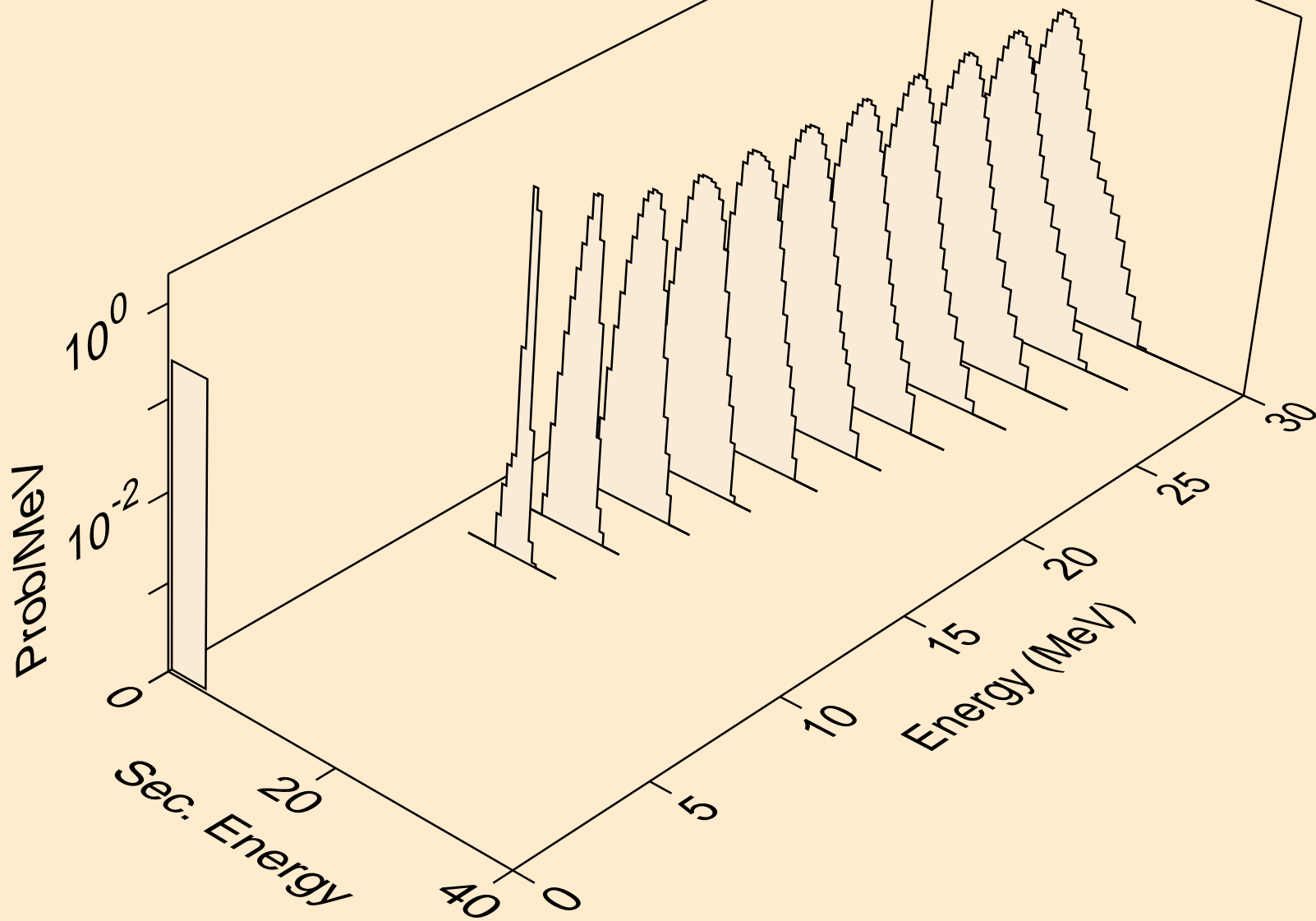

ND151 HELION ACER TENDL-2023 LIBRARY; T=0.K  
alphas from (s,da)

