

NH285 HELION ACER TENDL-2023 LIBRARY; T=0.K
Principal cross sections

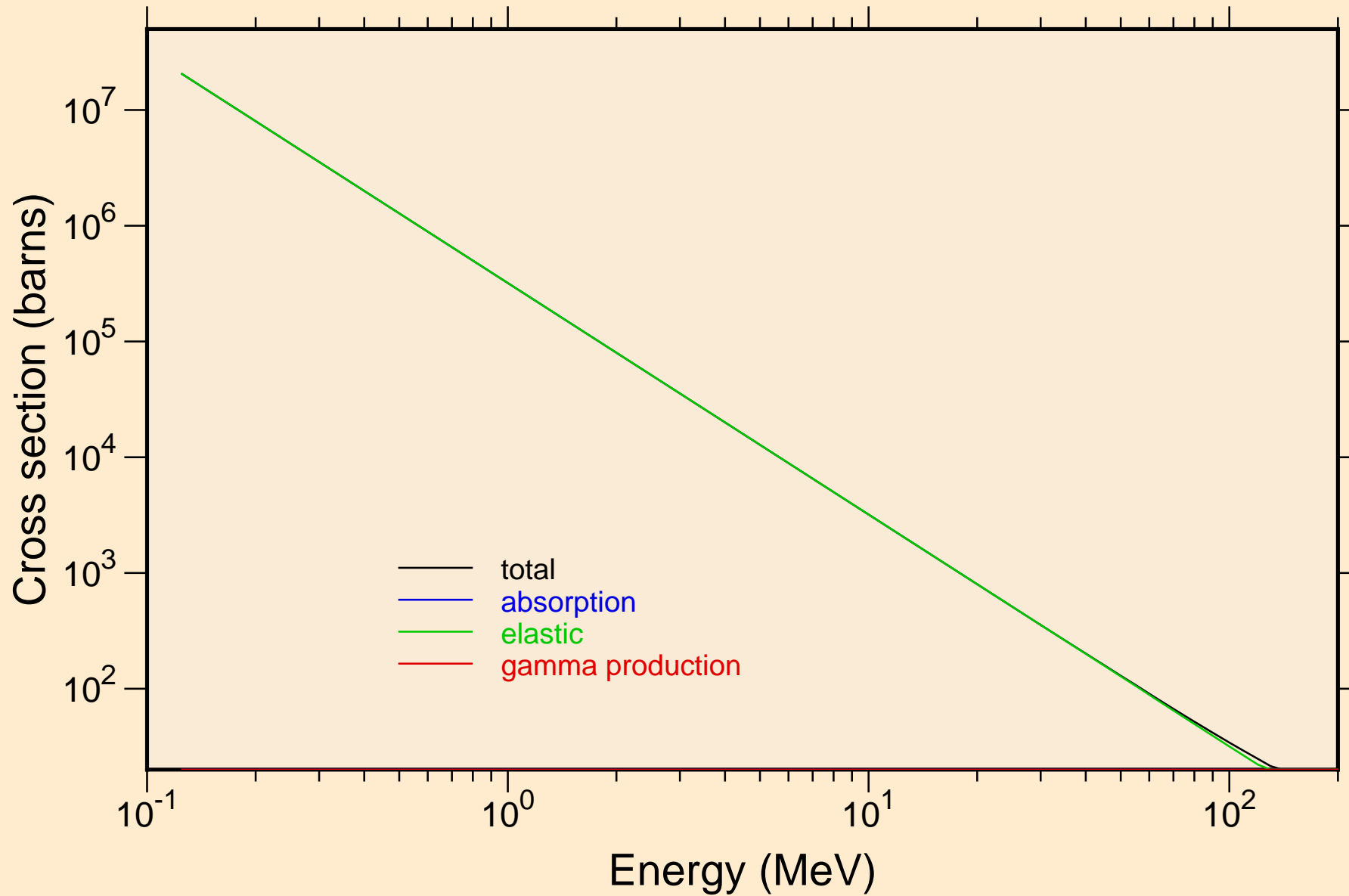

NH285 HELION ACER TENDL-2023 LIBRARY; T=0.K

Heating

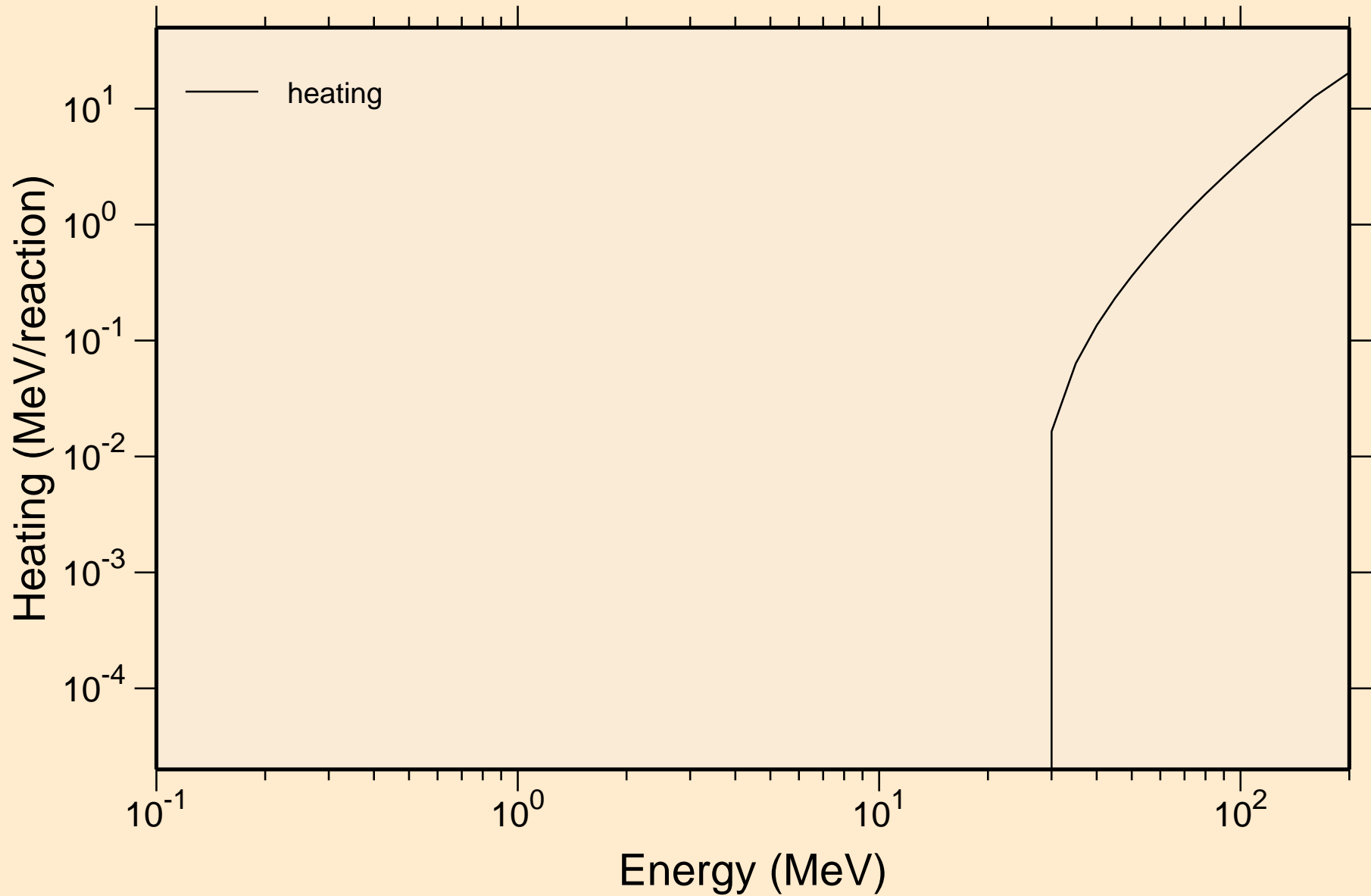

NH285 HELION ACER TENDL-2023 LIBRARY; T=0.K

Principal cross sections

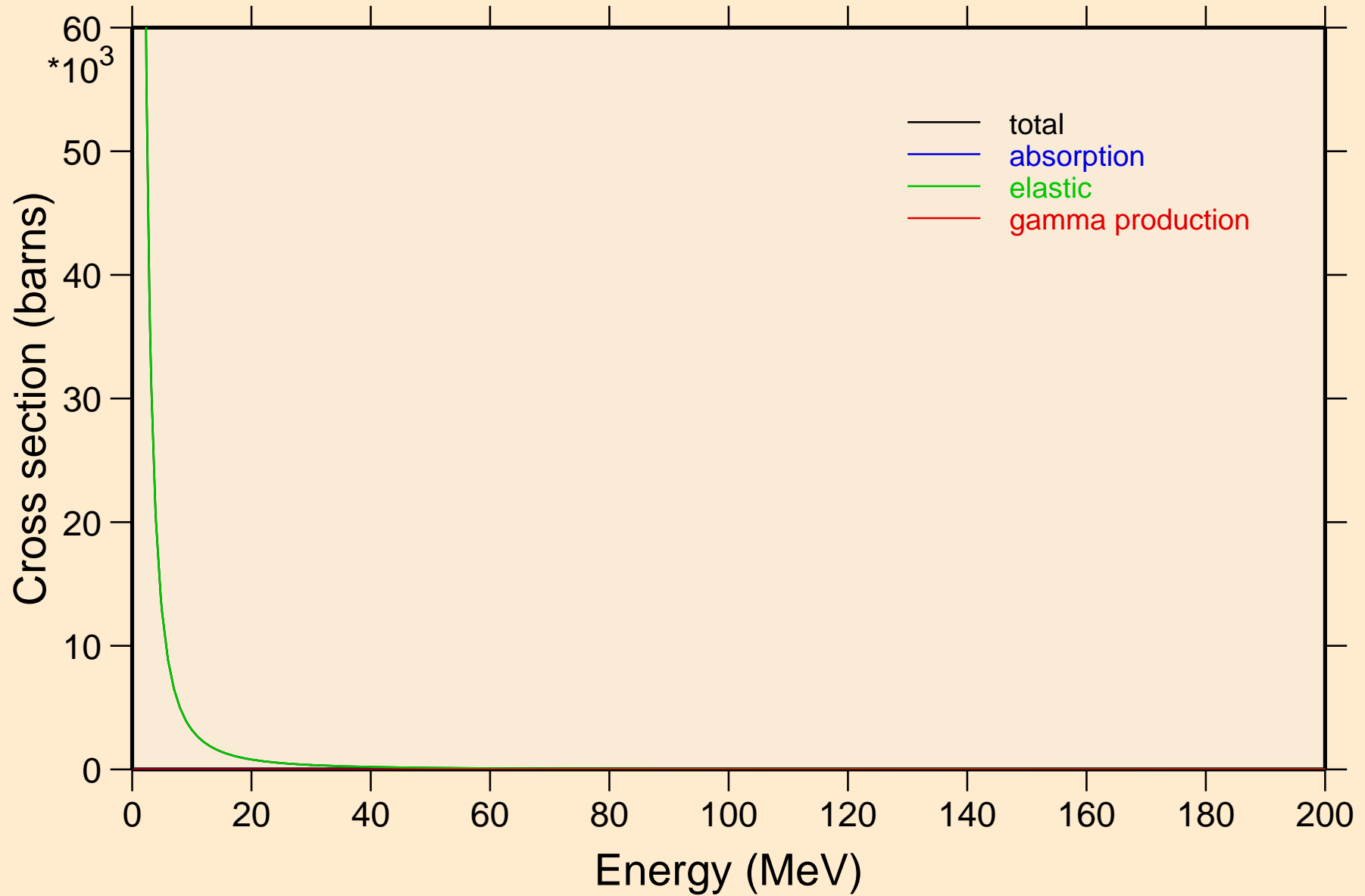

NH285 HELION ACER TENDL-2023 LIBRARY; T=0.K

Heating

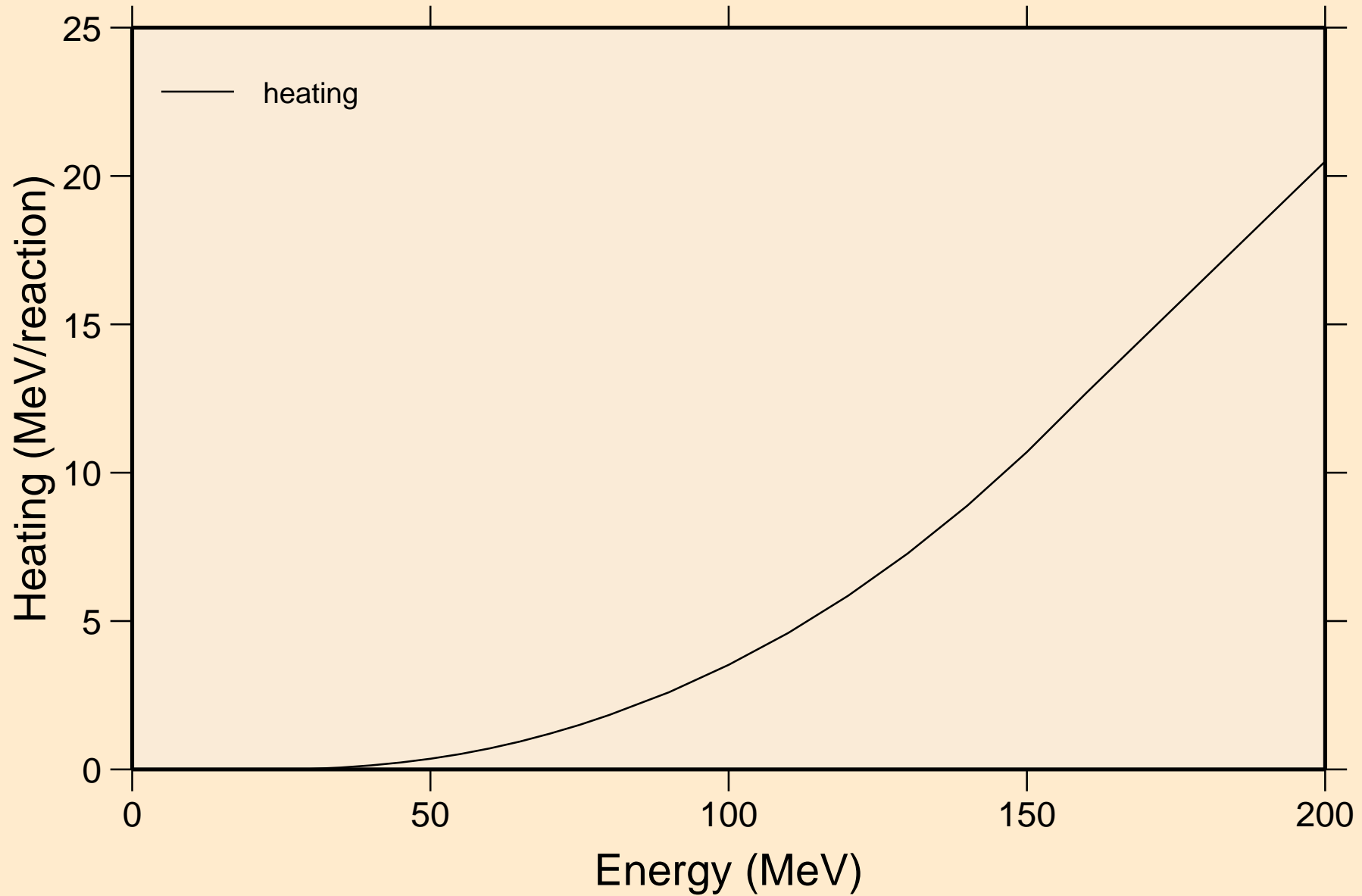

NH285 HELION ACER TENDL-2023 LIBRARY; T=0.K
Threshold reactions

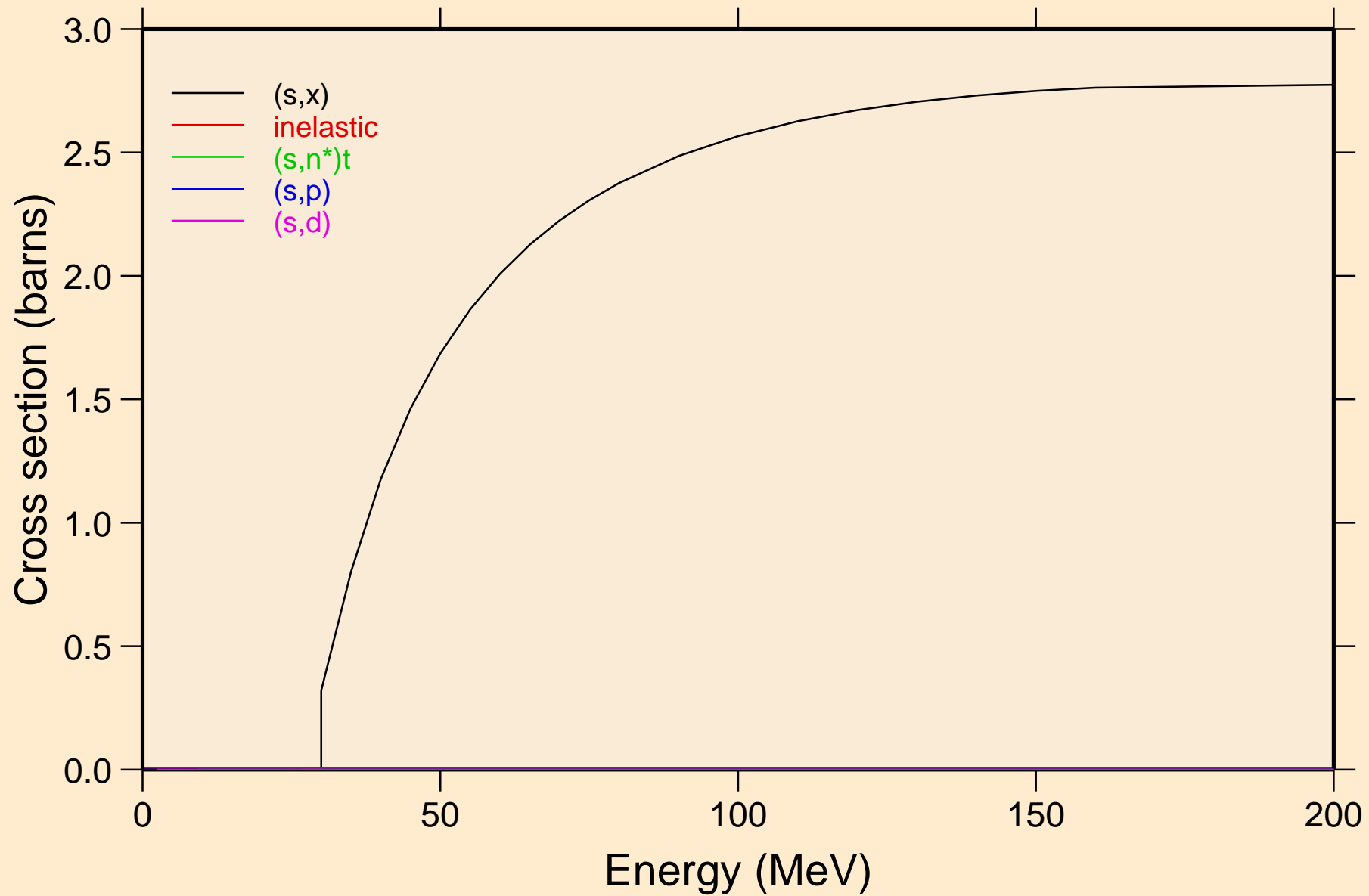

NH285 HELION ACER TENDL-2023 LIBRARY; T=0.K
Threshold reactions

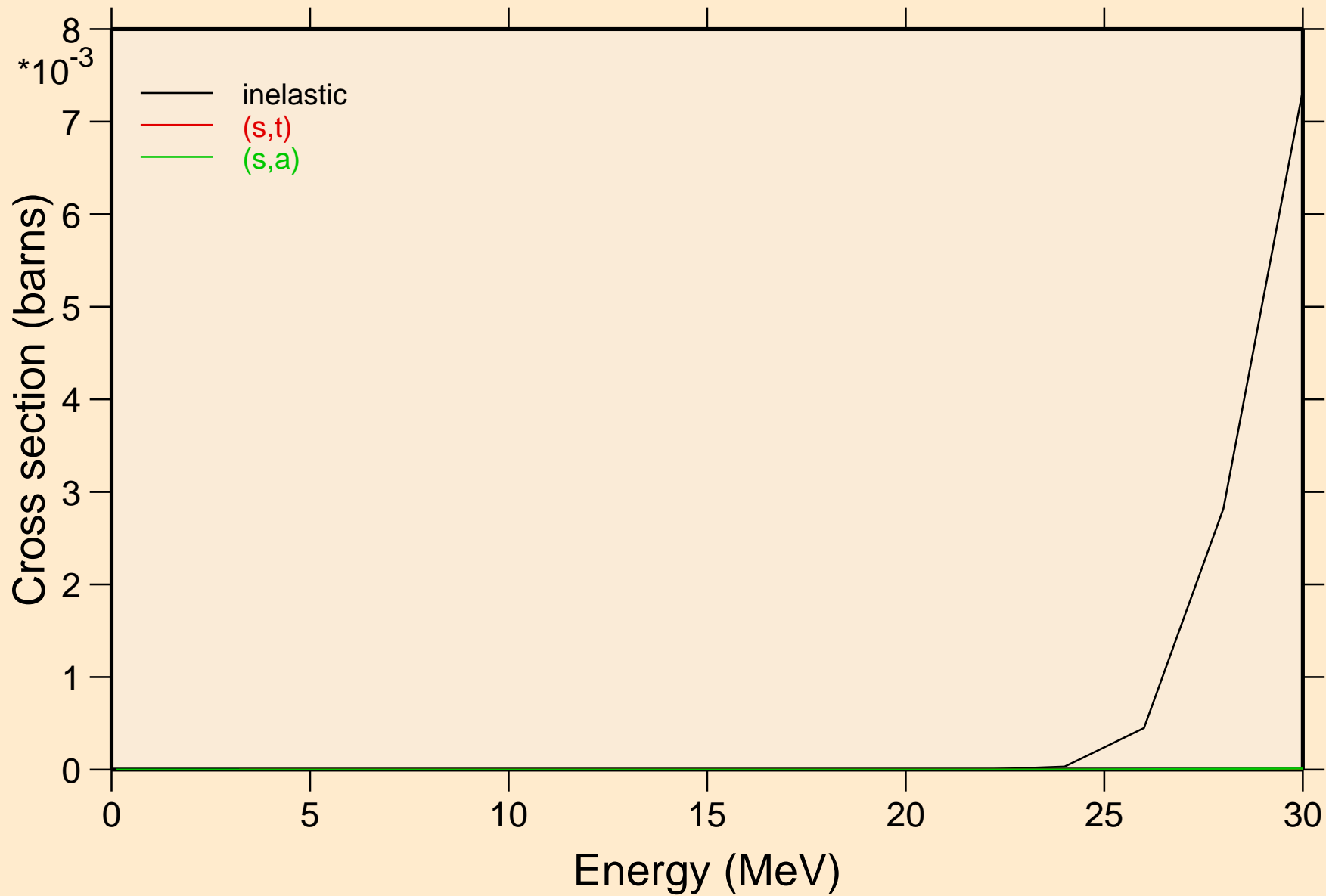

NH285 HELION ACER TENDL-2023 LIBRARY; T=0.K
angular distribution for elastic

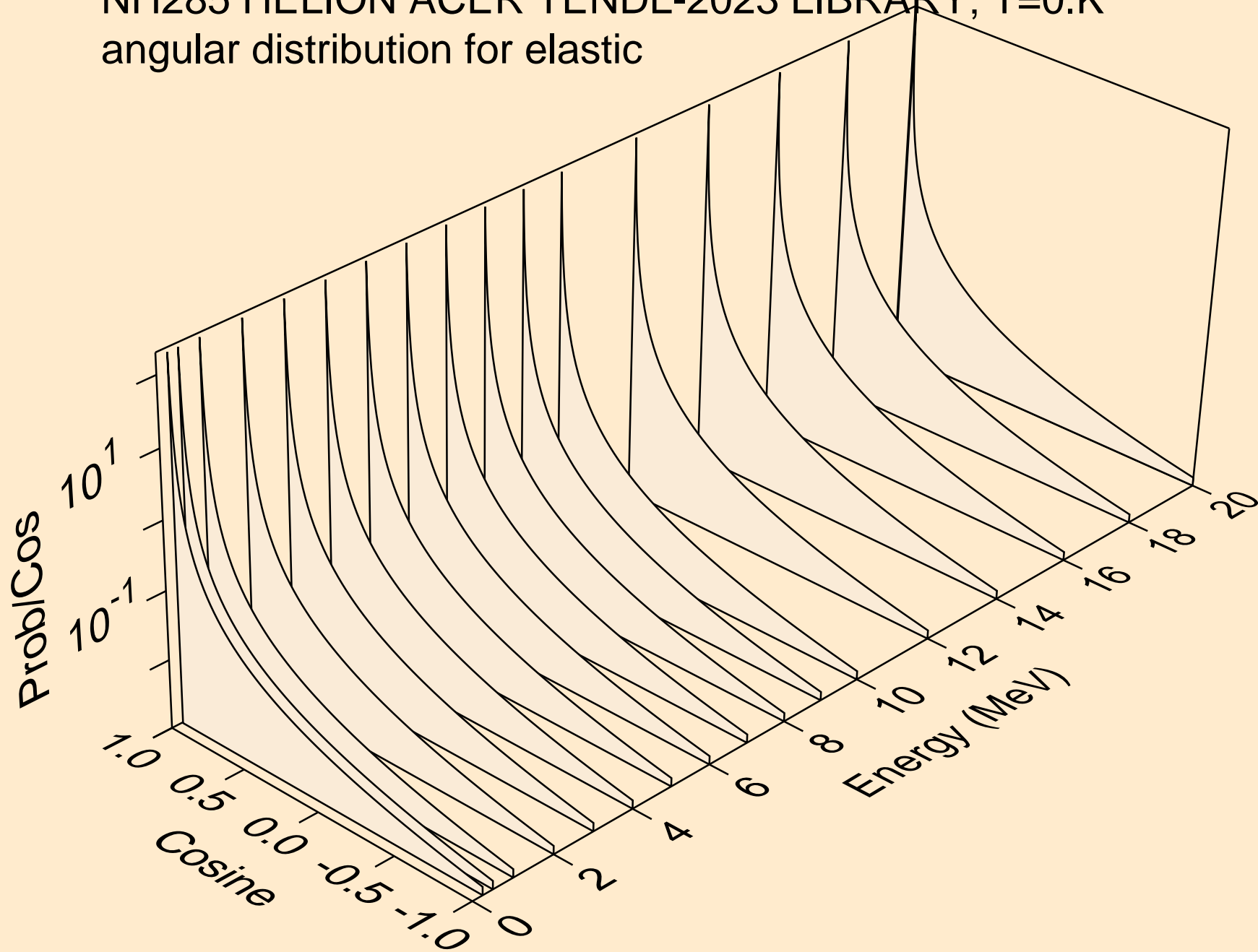

NH285 HELION ACER TENDL-2023 LIBRARY; T=0.K
angular distribution for elastic

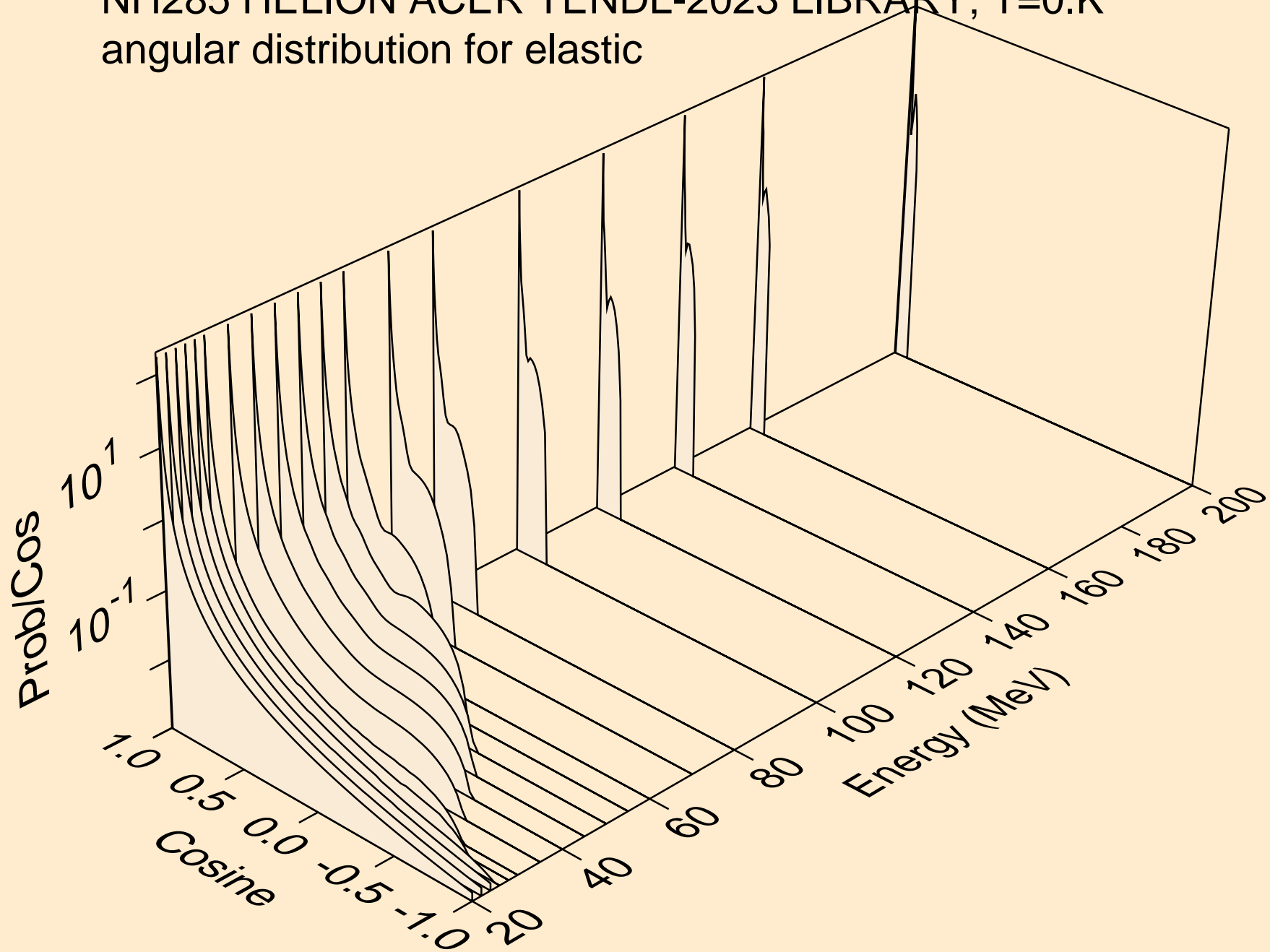

NH285 HELION ACER TENDL-2023 LIBRARY; T=0.K
He-3 emission for (s,x)

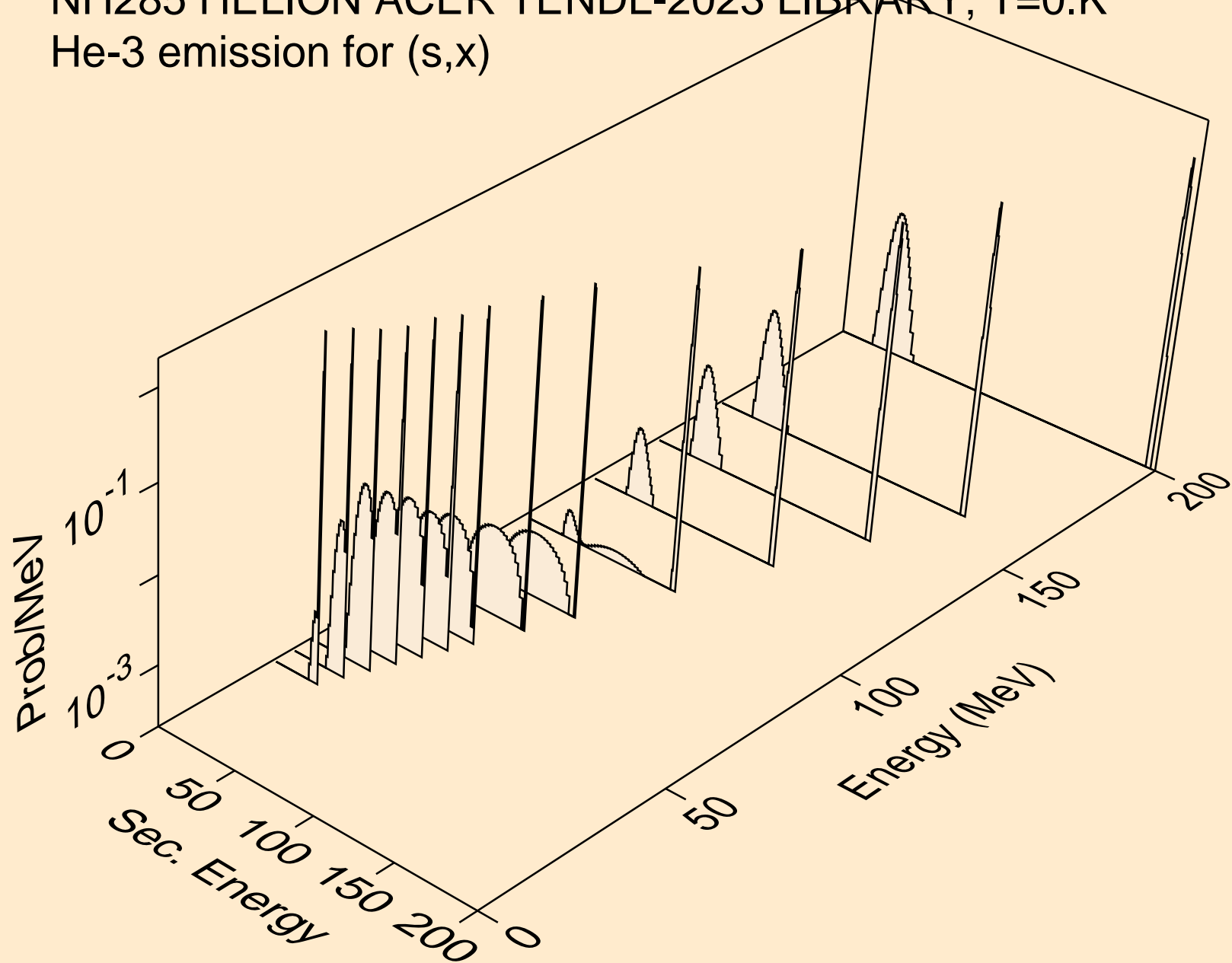

NH285 HELION ACER TENDL-2023 LIBRARY; T=0.K
He-3 emission for inelastic

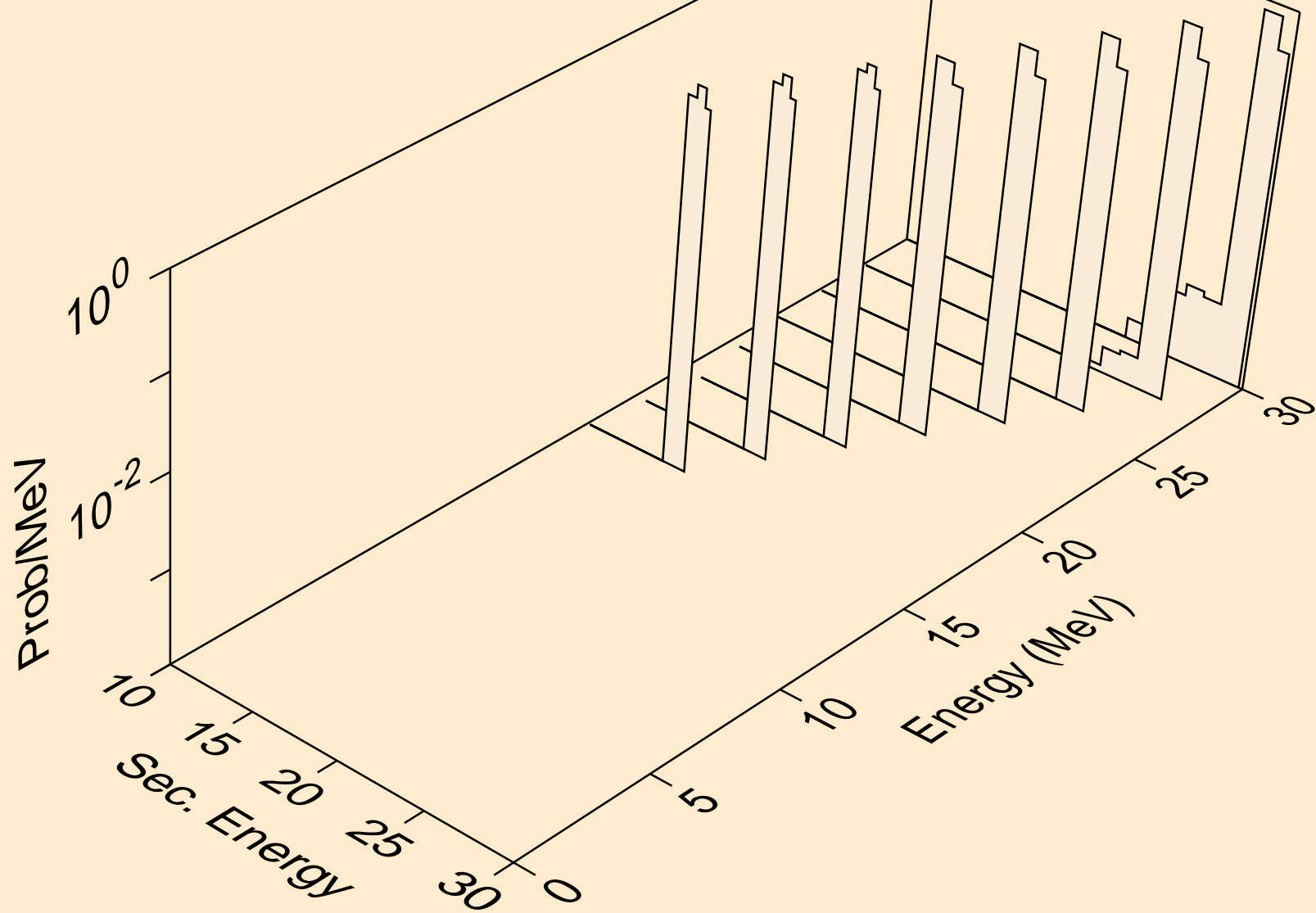

NH285 HELION ACER TENDL-2023 LIBRARY; T=0.K
Photon emission for (z,n)

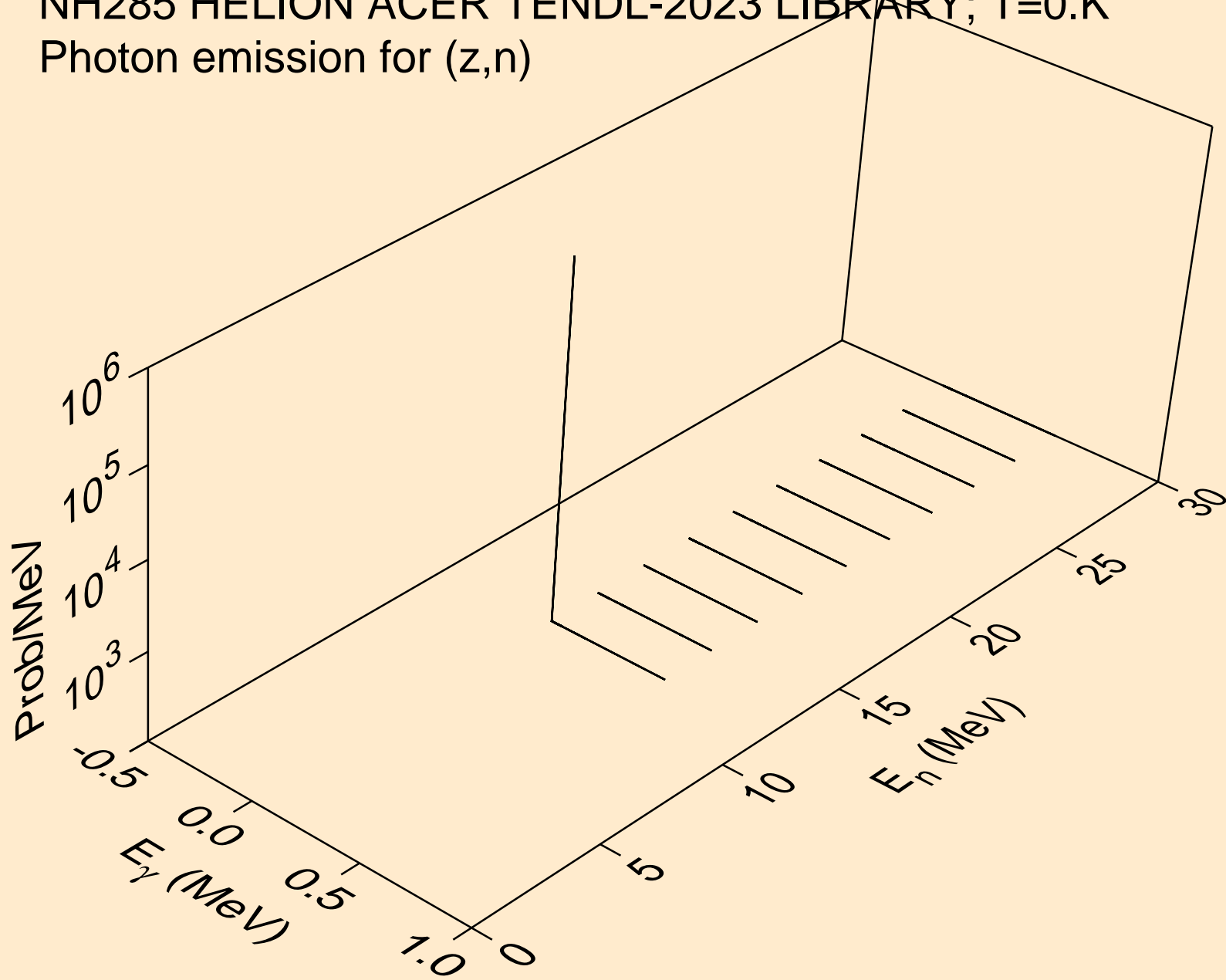

NH285 HELION ACER TENDL-2023 LIBRARY; T=0.K
Photon emission for (z,x)

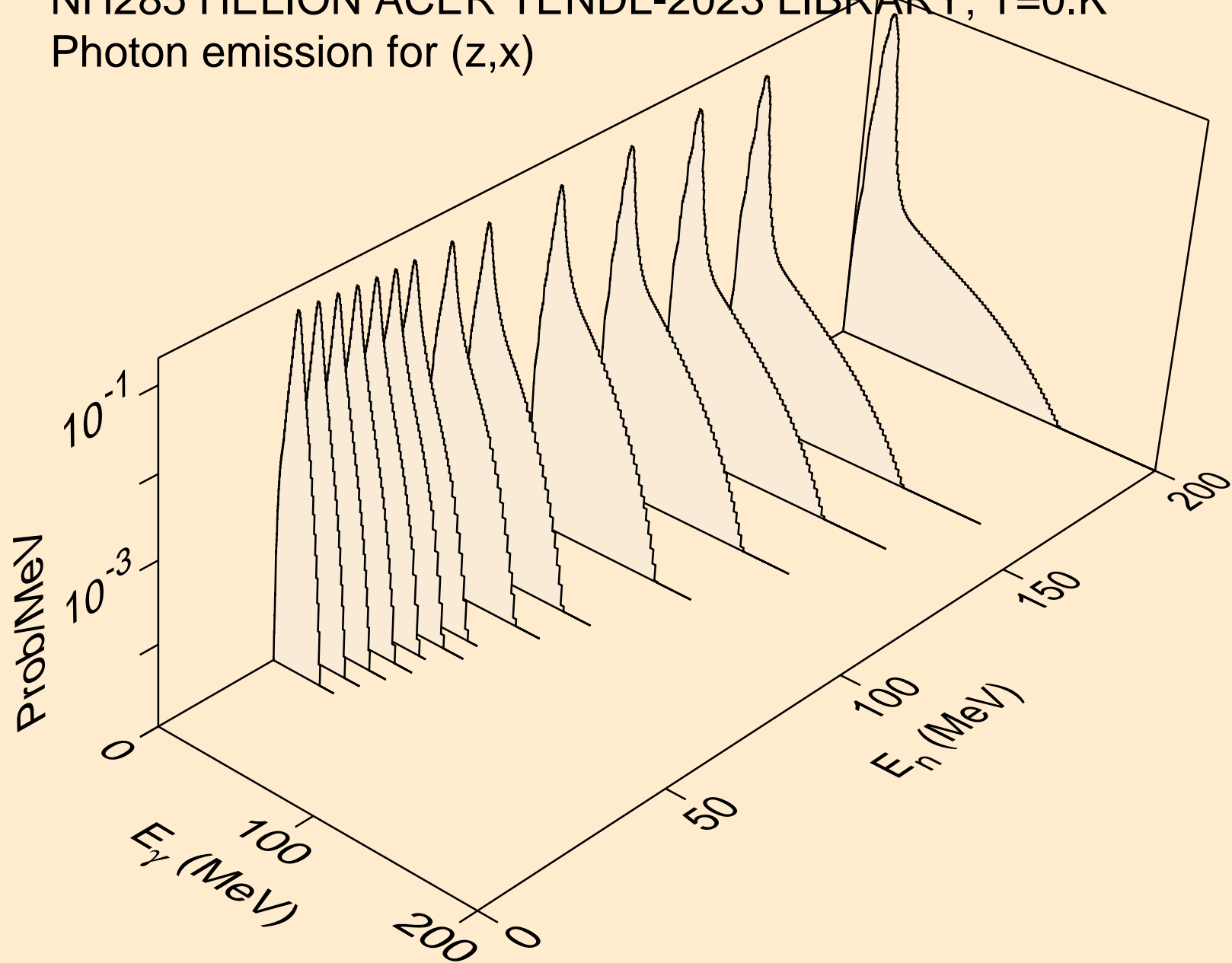

NH285 HELION ACER TENDL-2023 LIBRARY; T=0.K
Photon emission for (n,n*)t

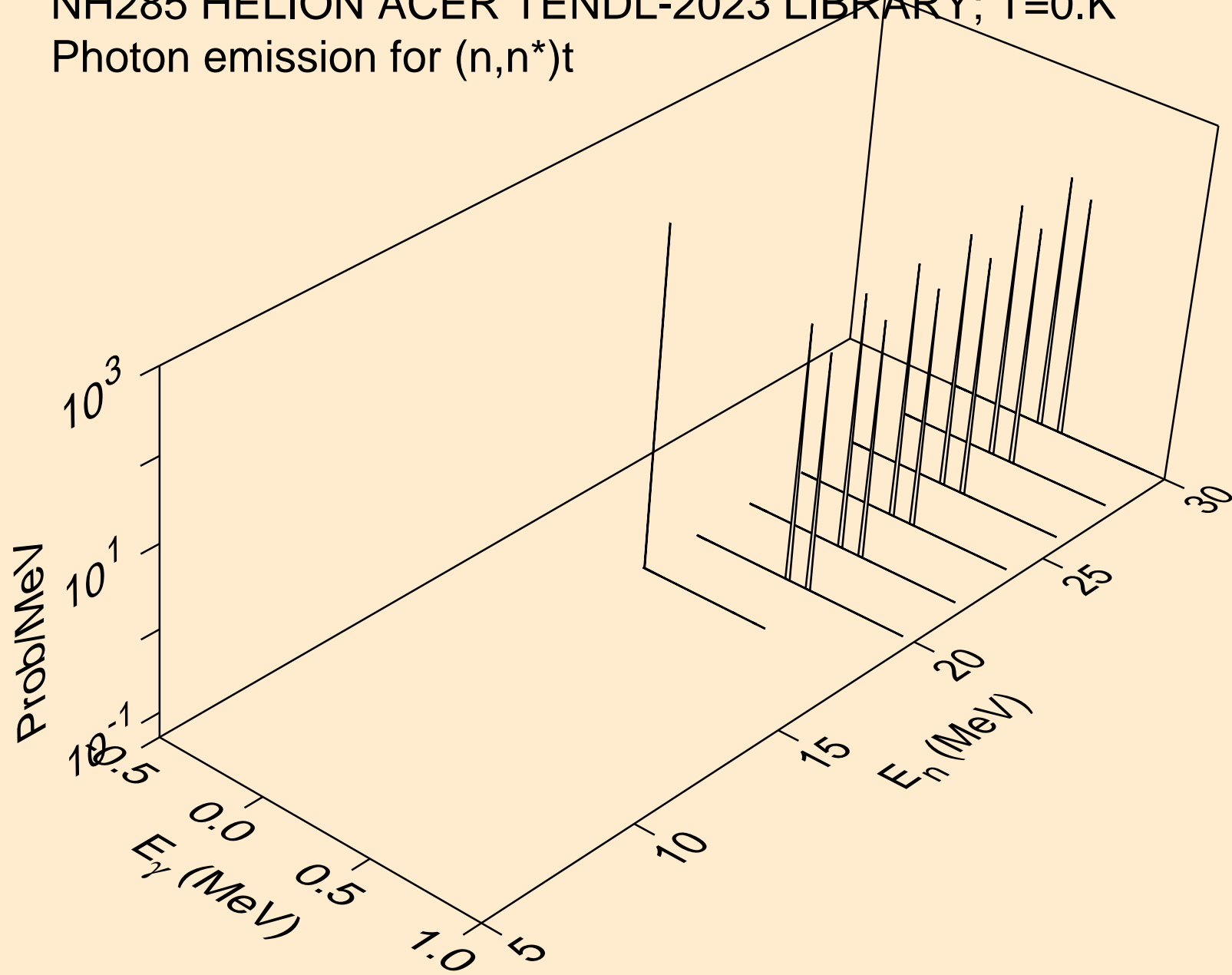

NH285 HELION ACER TENDL-2023 LIBRARY; T=0.K
Photon emission for (n,p)

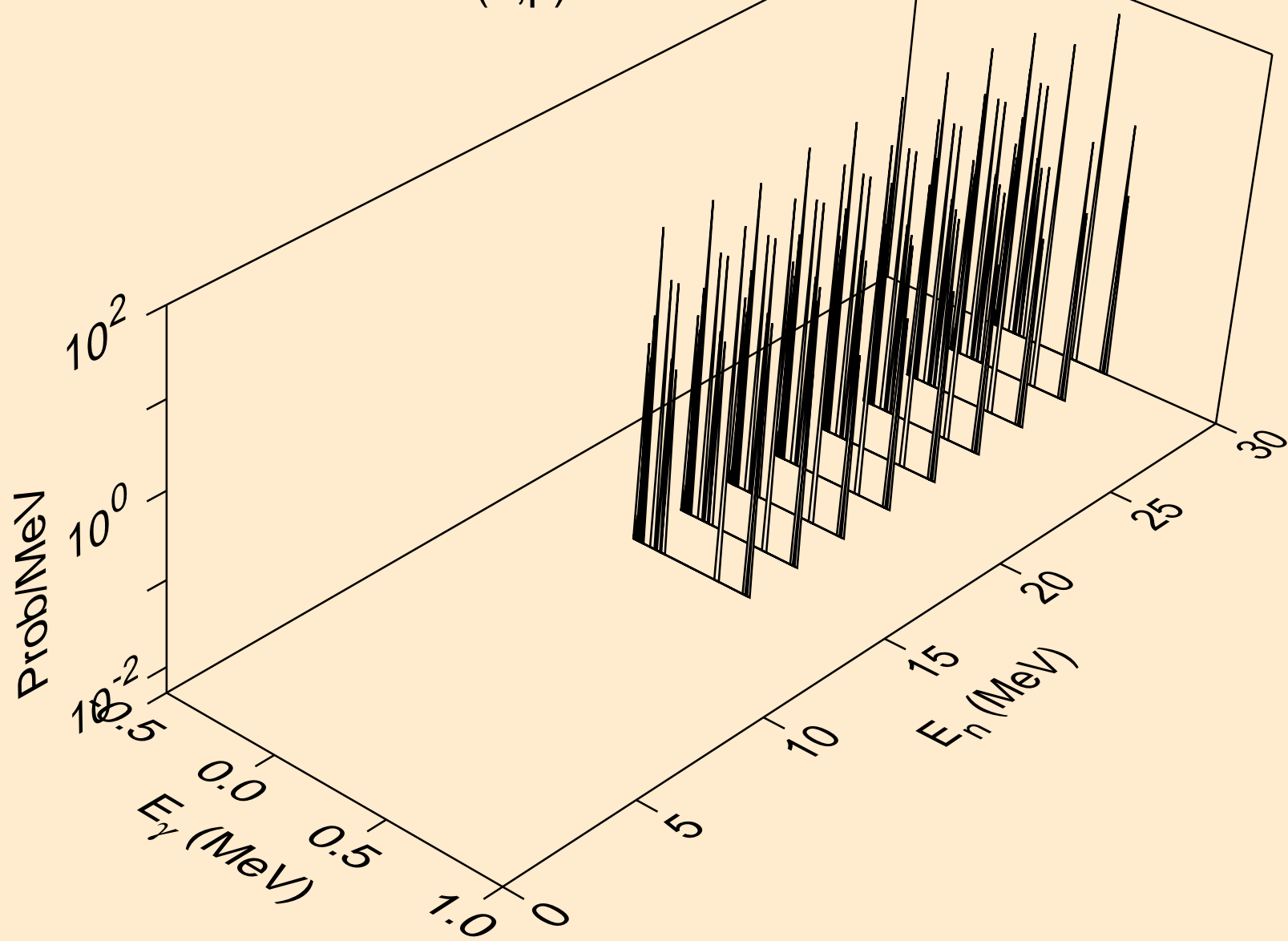

NH285 HELION ACER TENDL-2023 LIBRARY; T=0.K
Photon emission for (n,d)

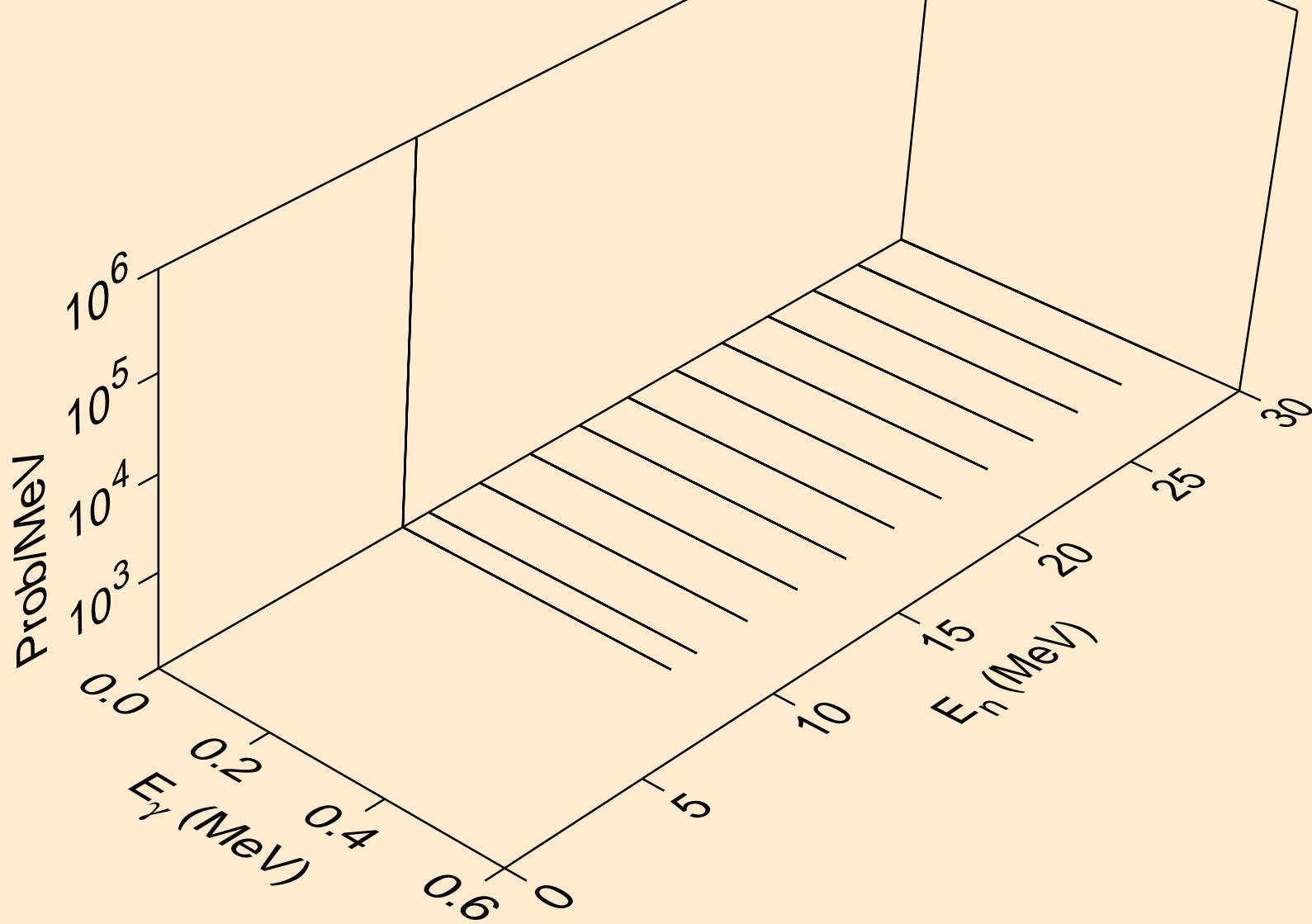

NH285 HELION ACER TENDL-2023 LIBRARY; T=0.K
Photon emission for (n,t)

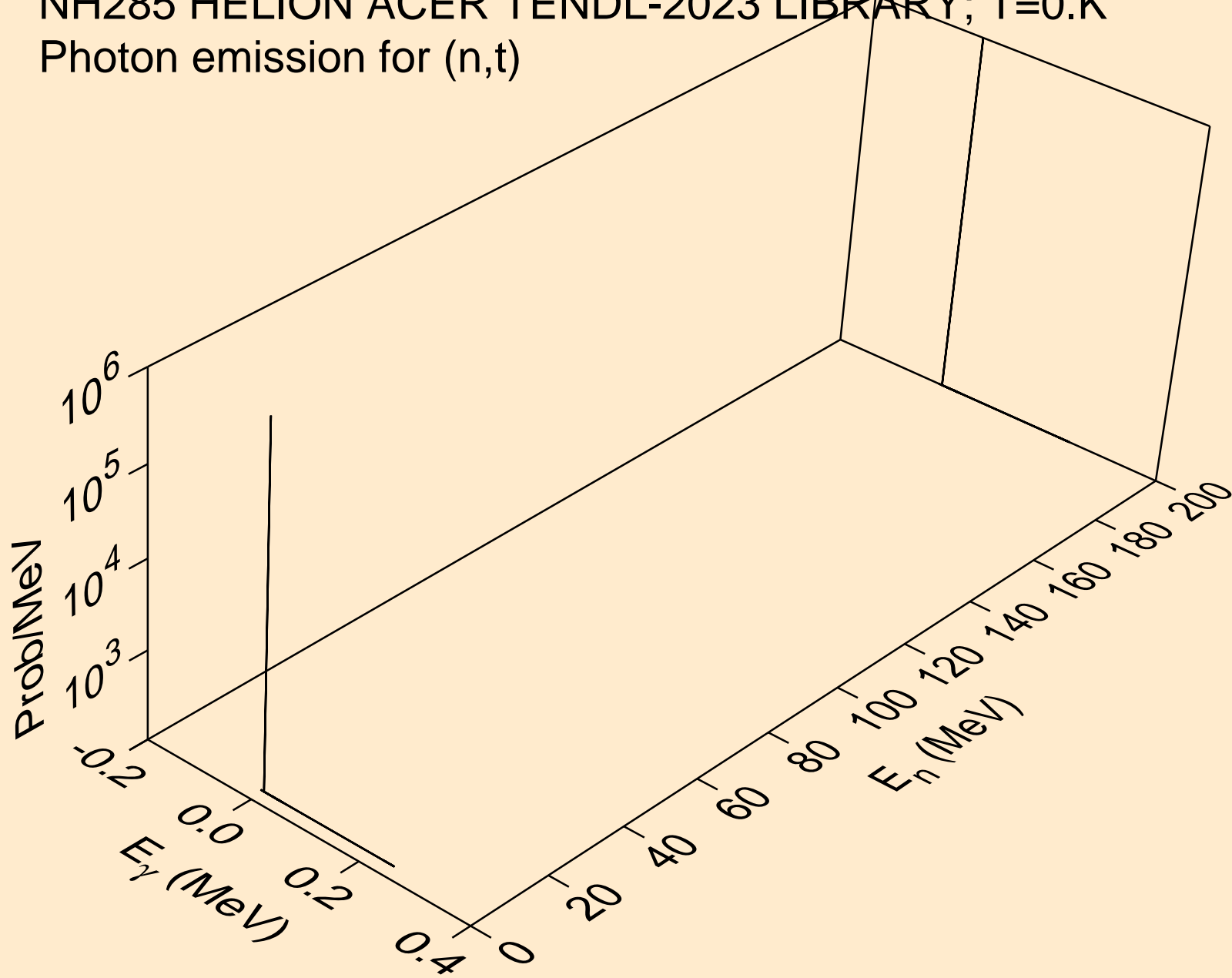

NH285 HELION ACER TENDL-2023 LIBRARY; T=0.K
Photon emission for inelastic

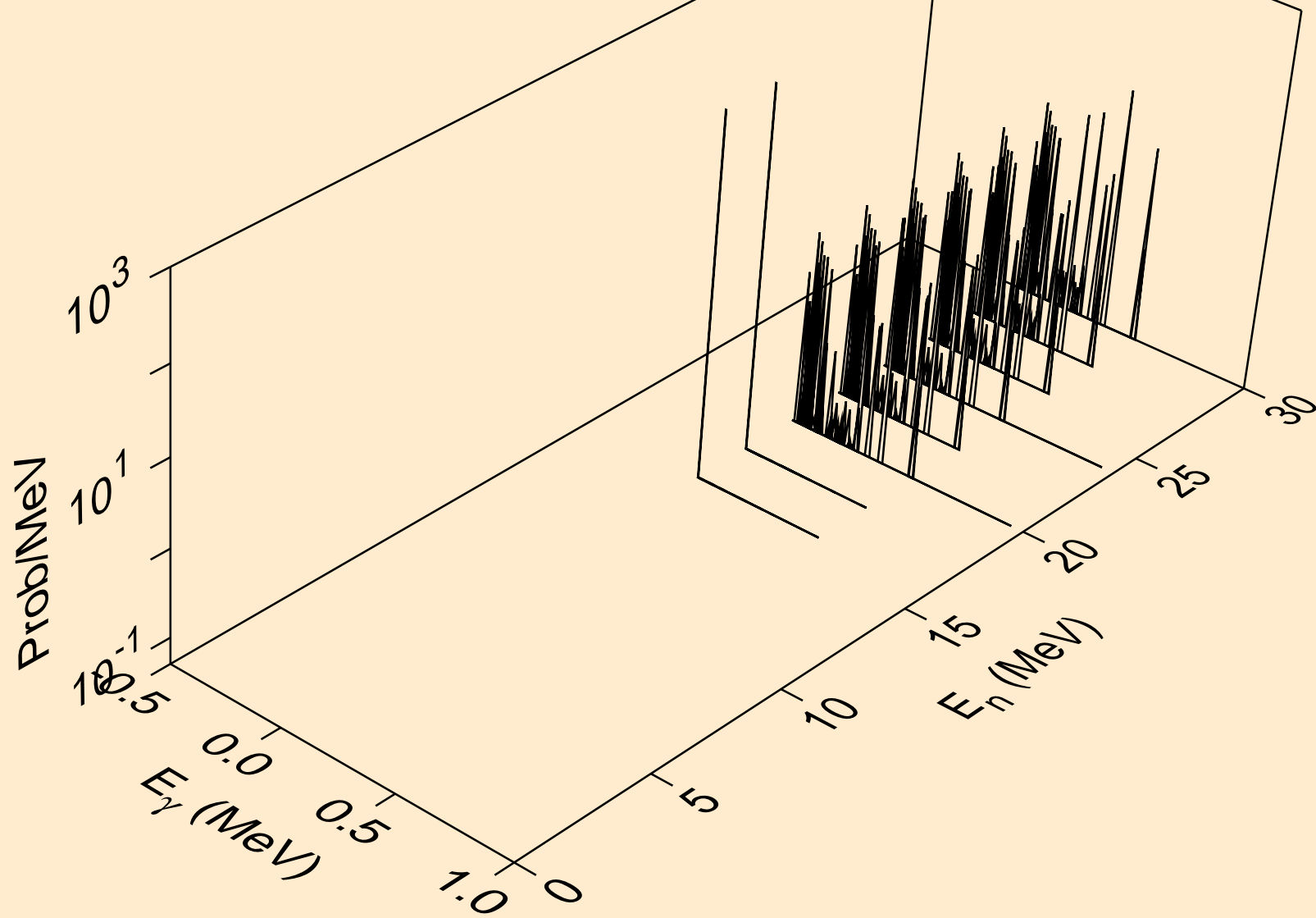

NH285 HELION ACER TENDL-2023 LIBRARY; T=0.K
Photon emission for (n,a)

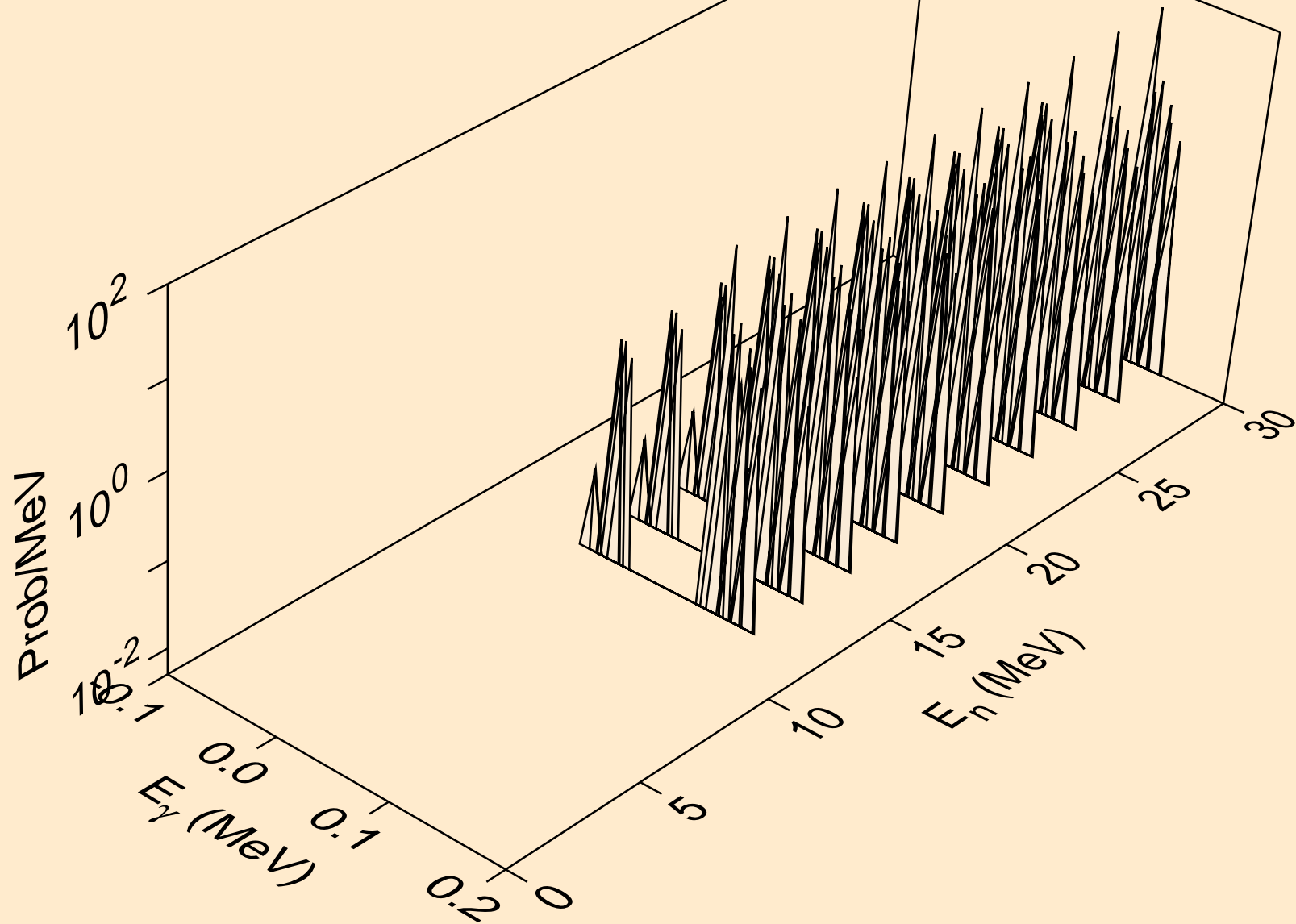

NH285 HELION ACER TENDL-2023 LIBRARY; T=0.K

Particle heating contributions

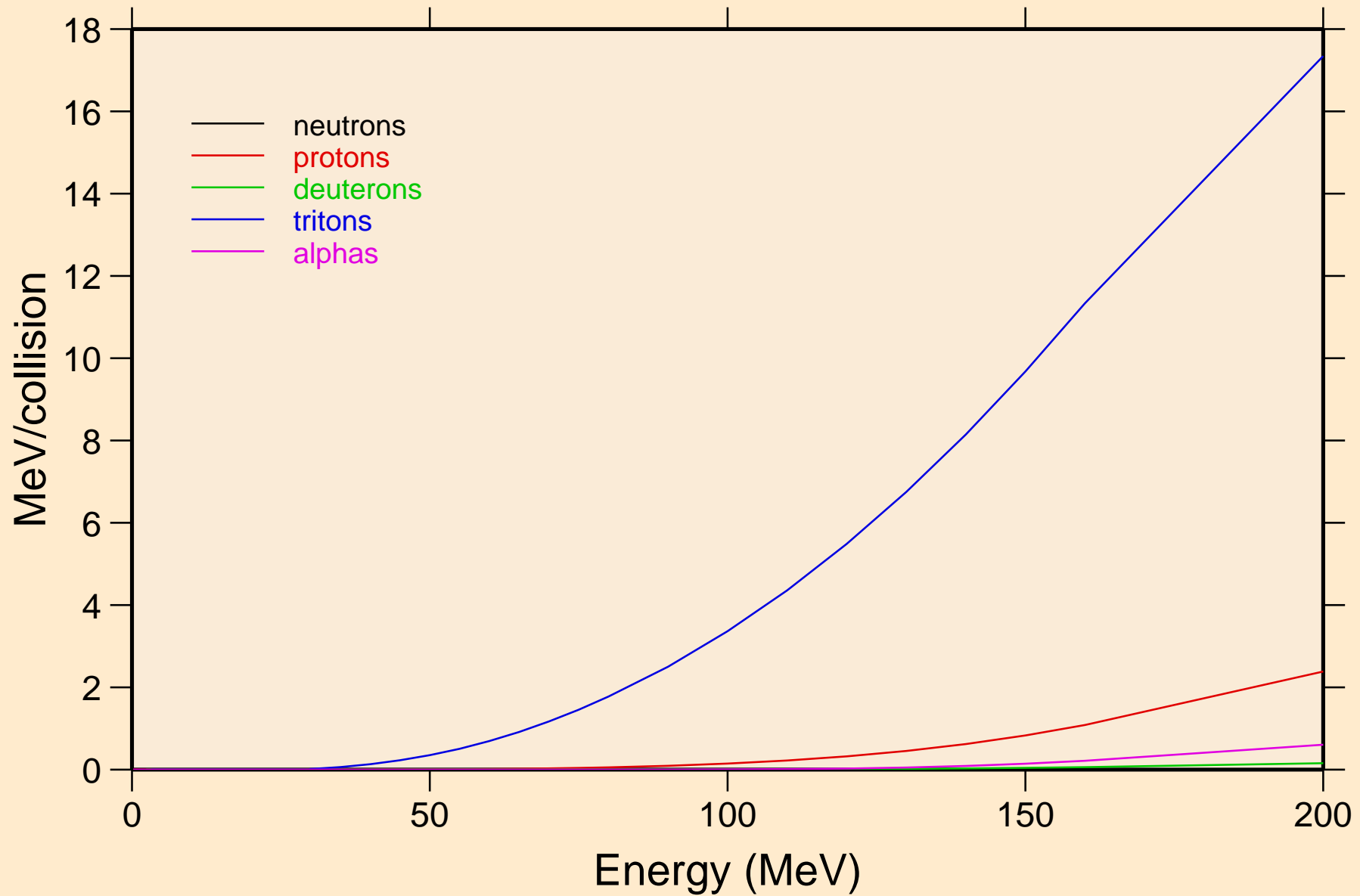

NH285 HELION ACER TENDL-2023 LIBRARY; T=0.K
Recoil Heating

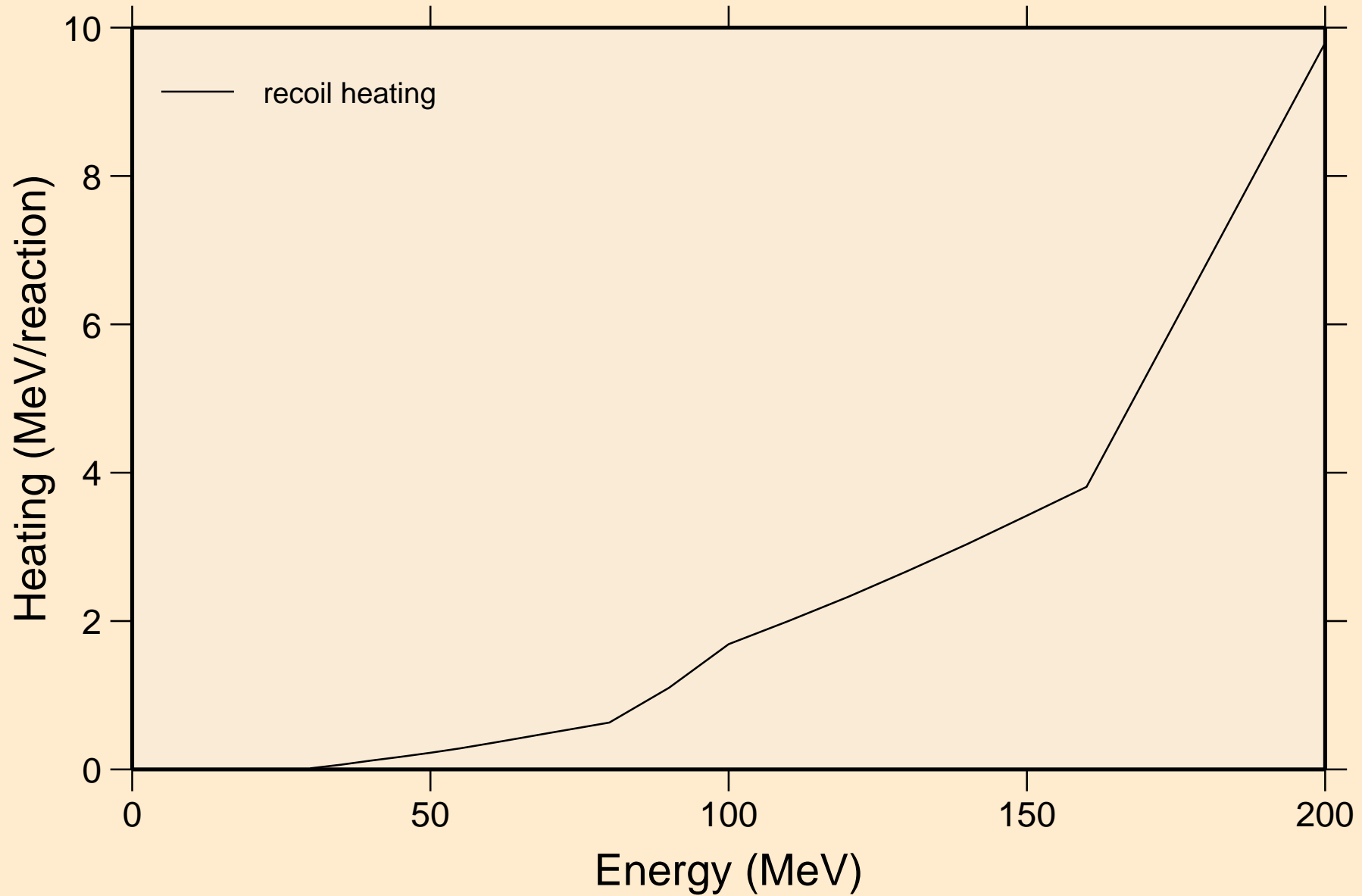

NH285 HELION ACER TENDL-2023 LIBRARY; T=0.K

Particle production cross sections

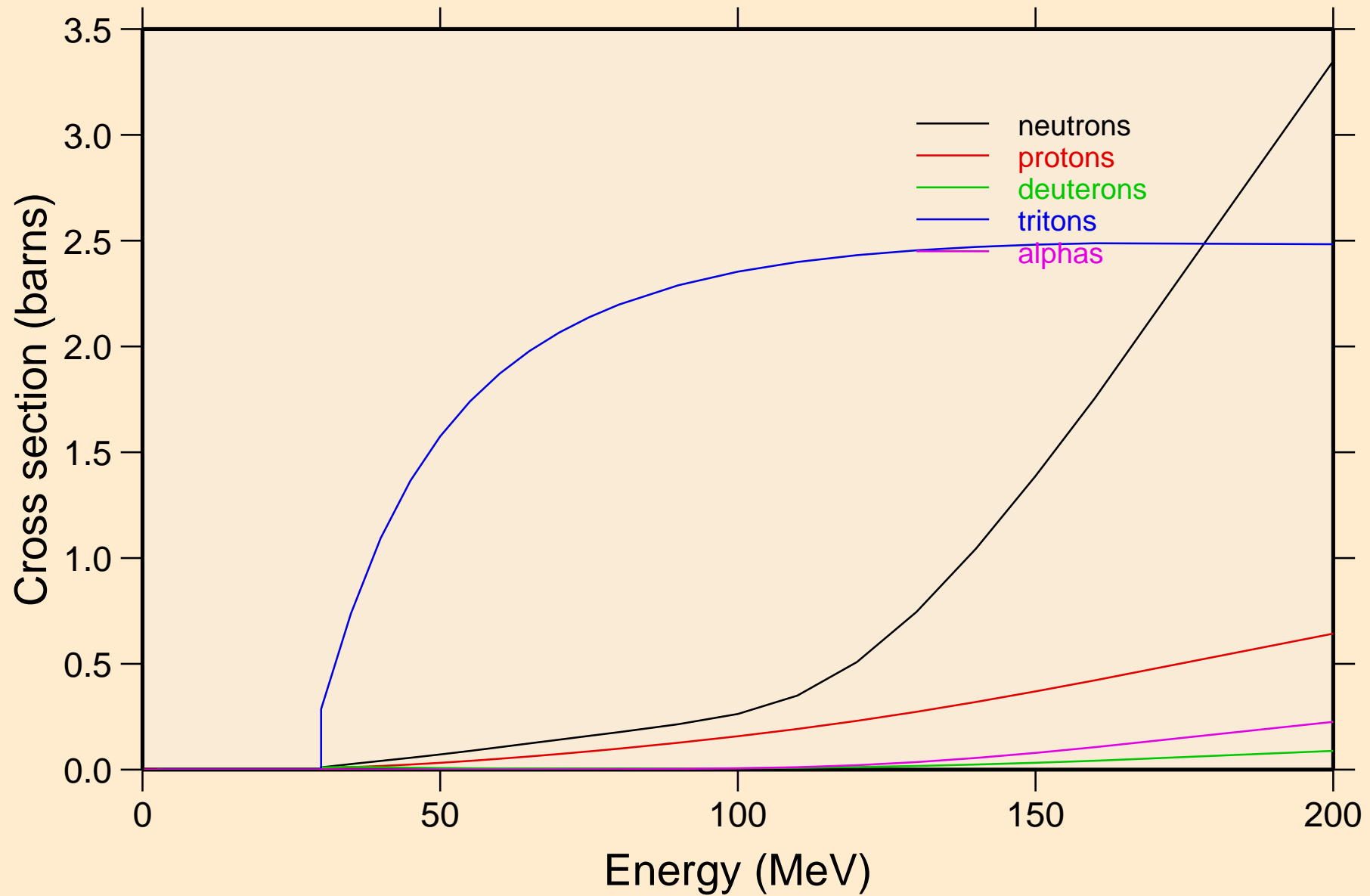

NH285 HELION ACER TENDL-2023 LIBRARY; T=0.K
neutrons from (s,n)

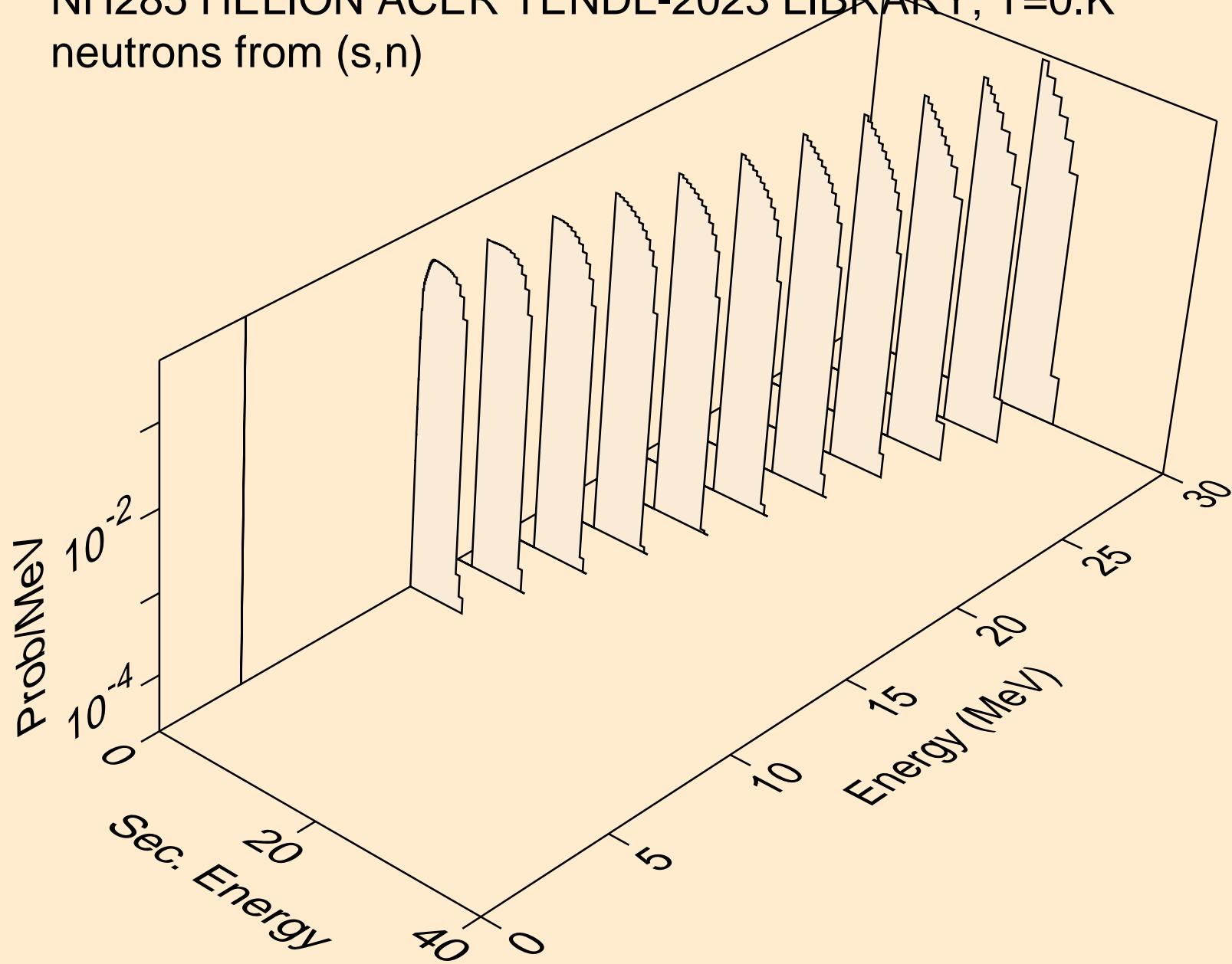

NH285 HELION ACER TENDL-2023 LIBRARY; T=0.K
neutrons from (s,x)

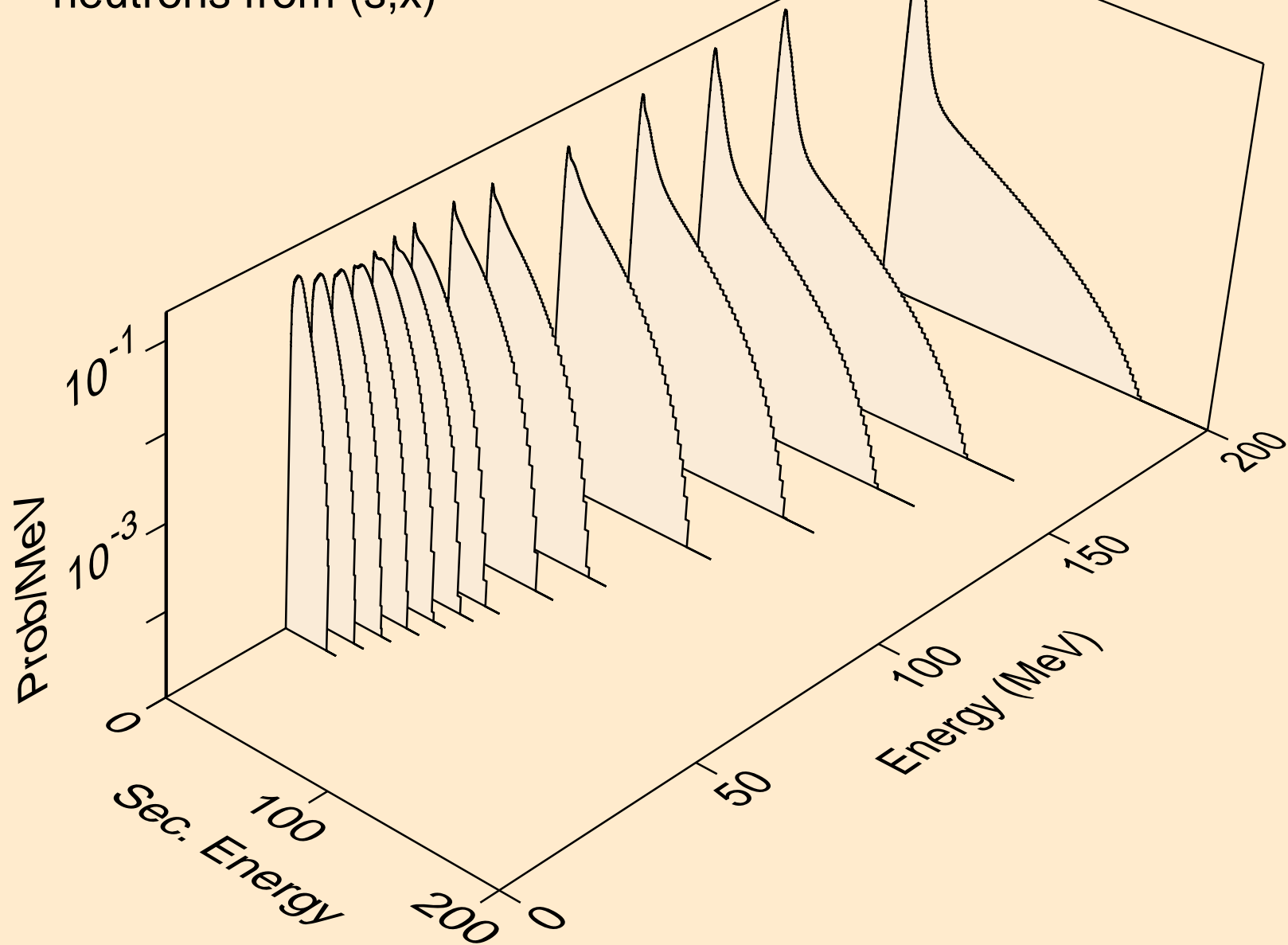

NH285 HELION ACER TENDL-2023 LIBRARY; T=0.K
neutrons from (s,n*)t

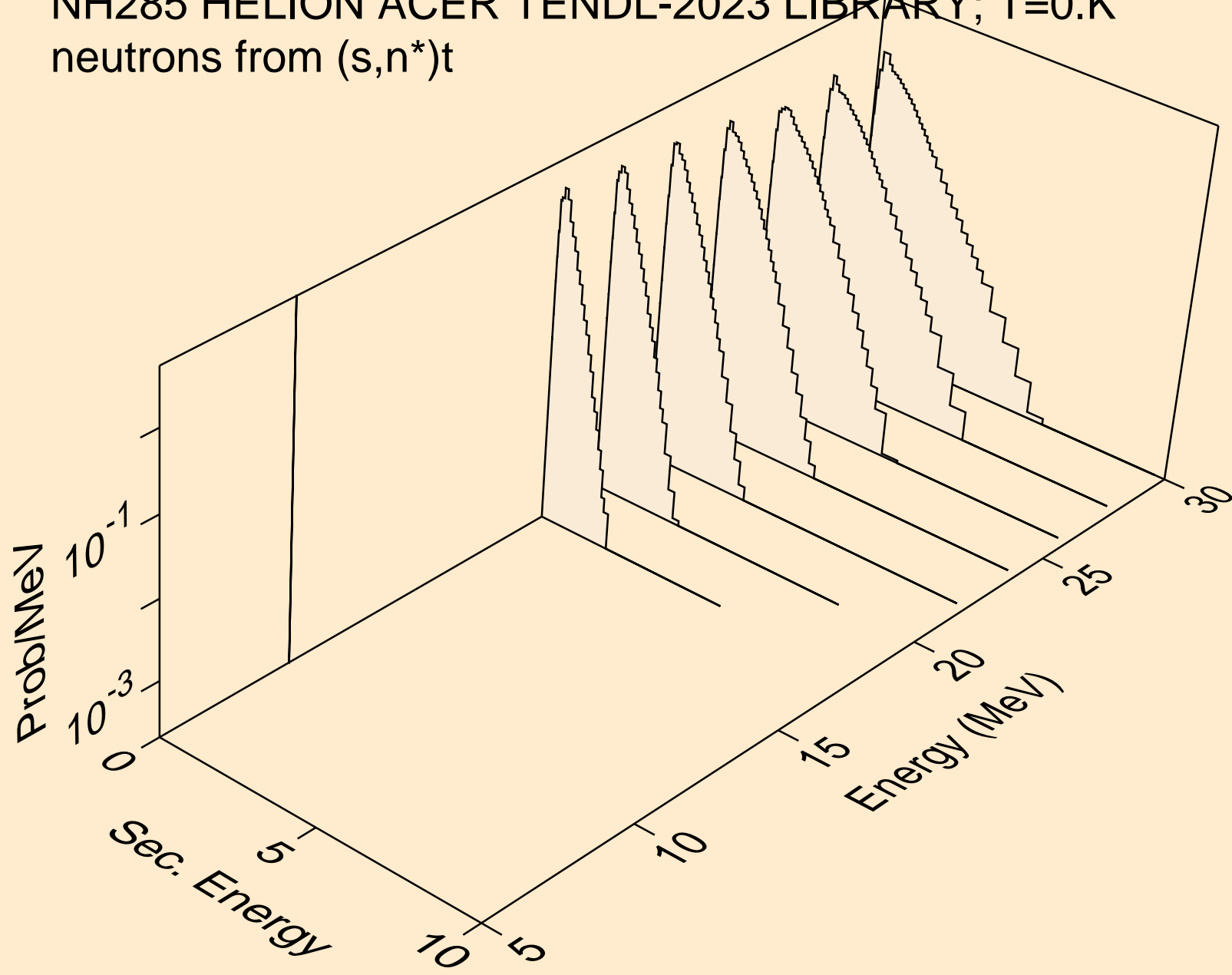

NH285 HELION ACER TENDL-2023 LIBRARY; T=0.K
protons from (s,x)

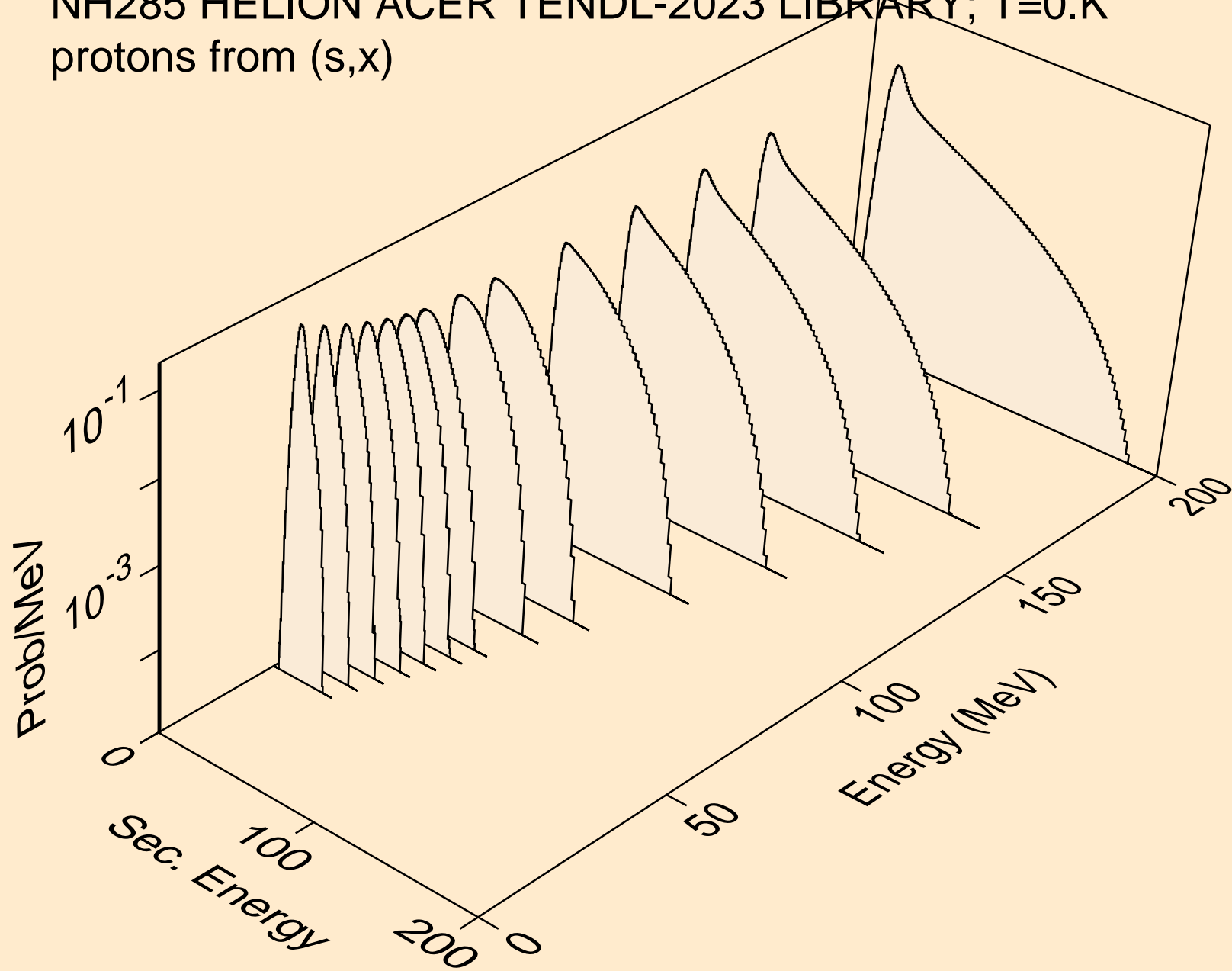

NH285 HELION ACER TENDL-2023 LIBRARY; T=0.K
protons from (s,p)

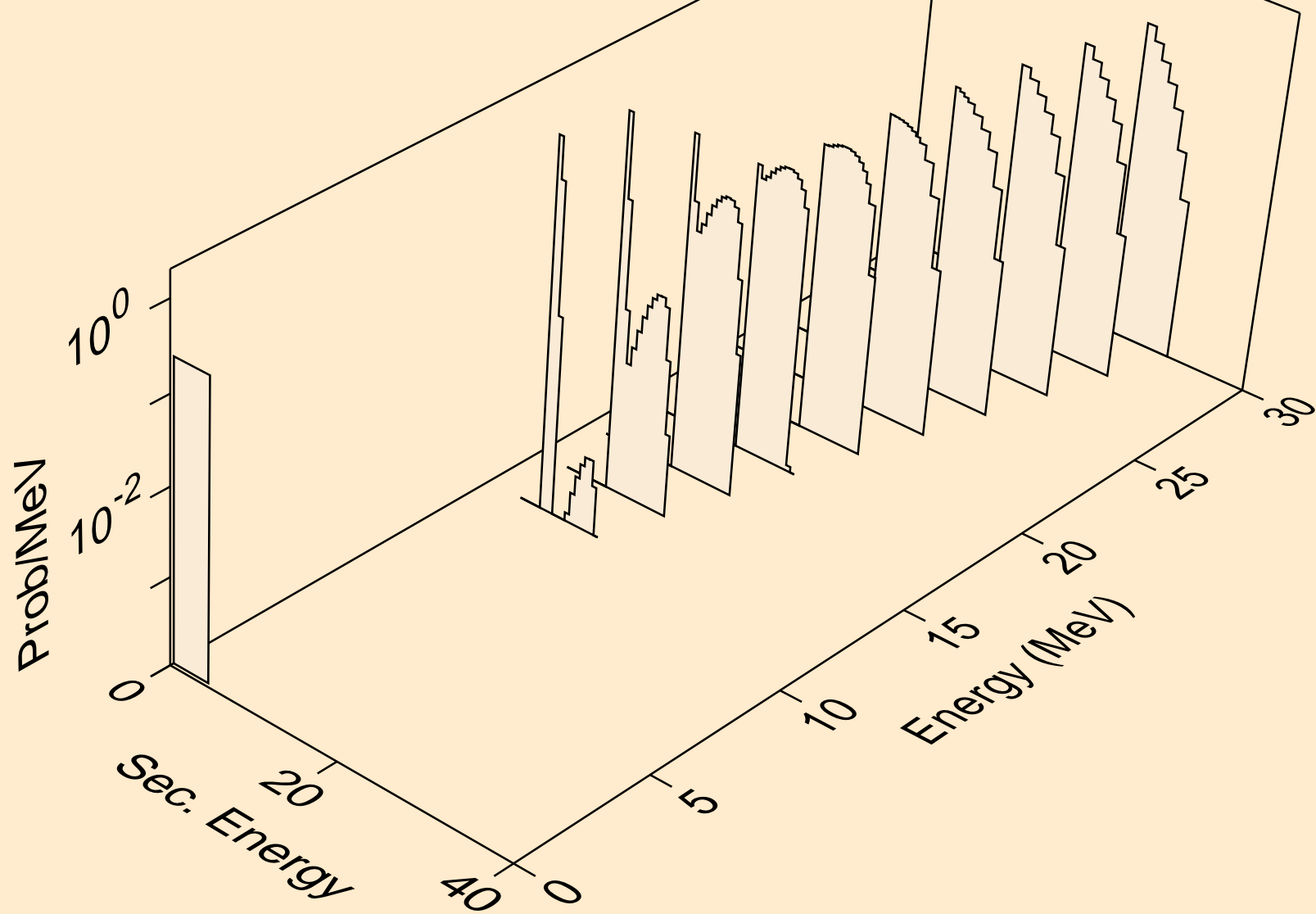

NH285 HELION ACER TENDL-2023 LIBRARY; T=0.K
deuterons from (s,x)

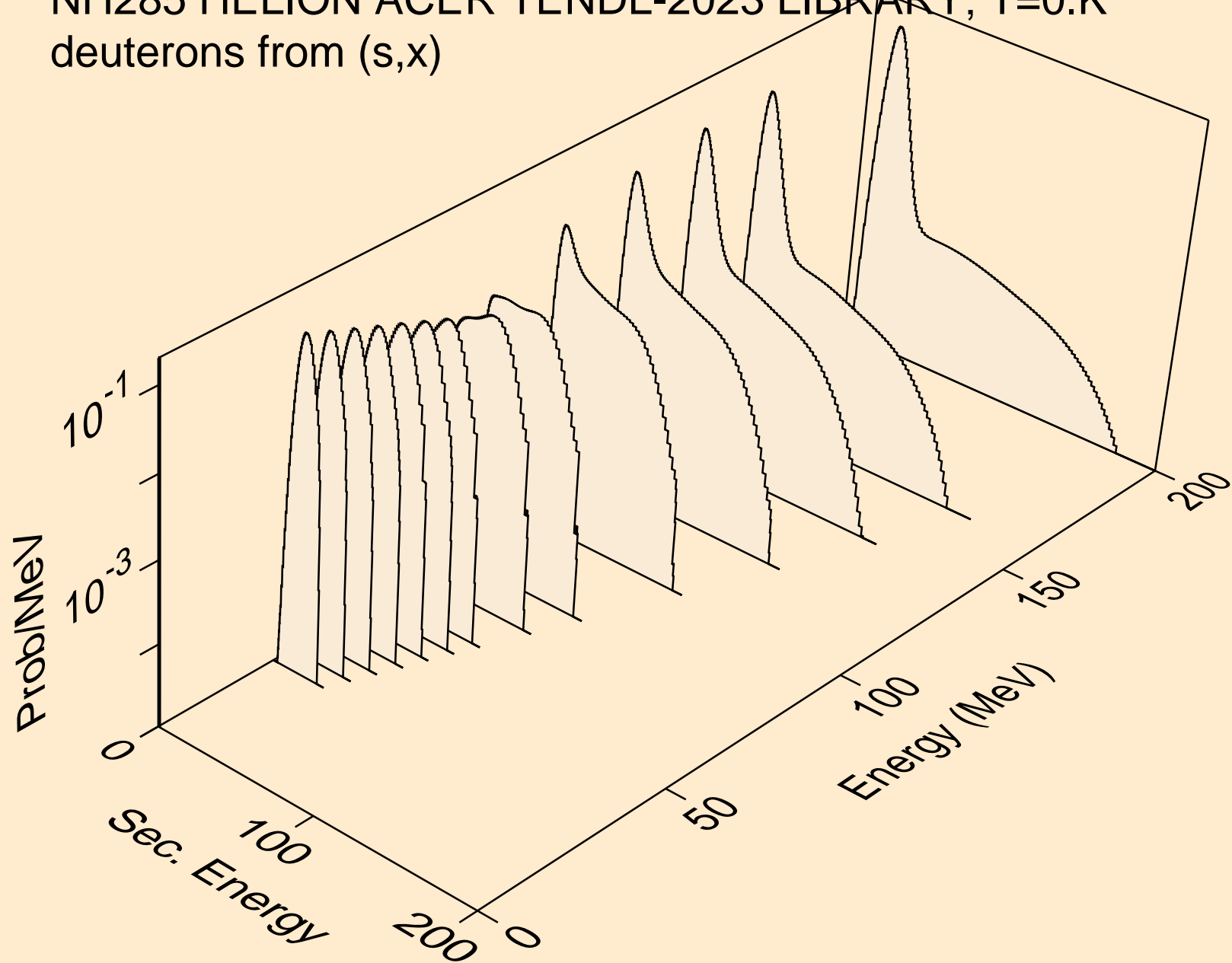

NH285 HELION ACER TENDL-2023 LIBRARY; T=0.K
deuterons from (s,d)

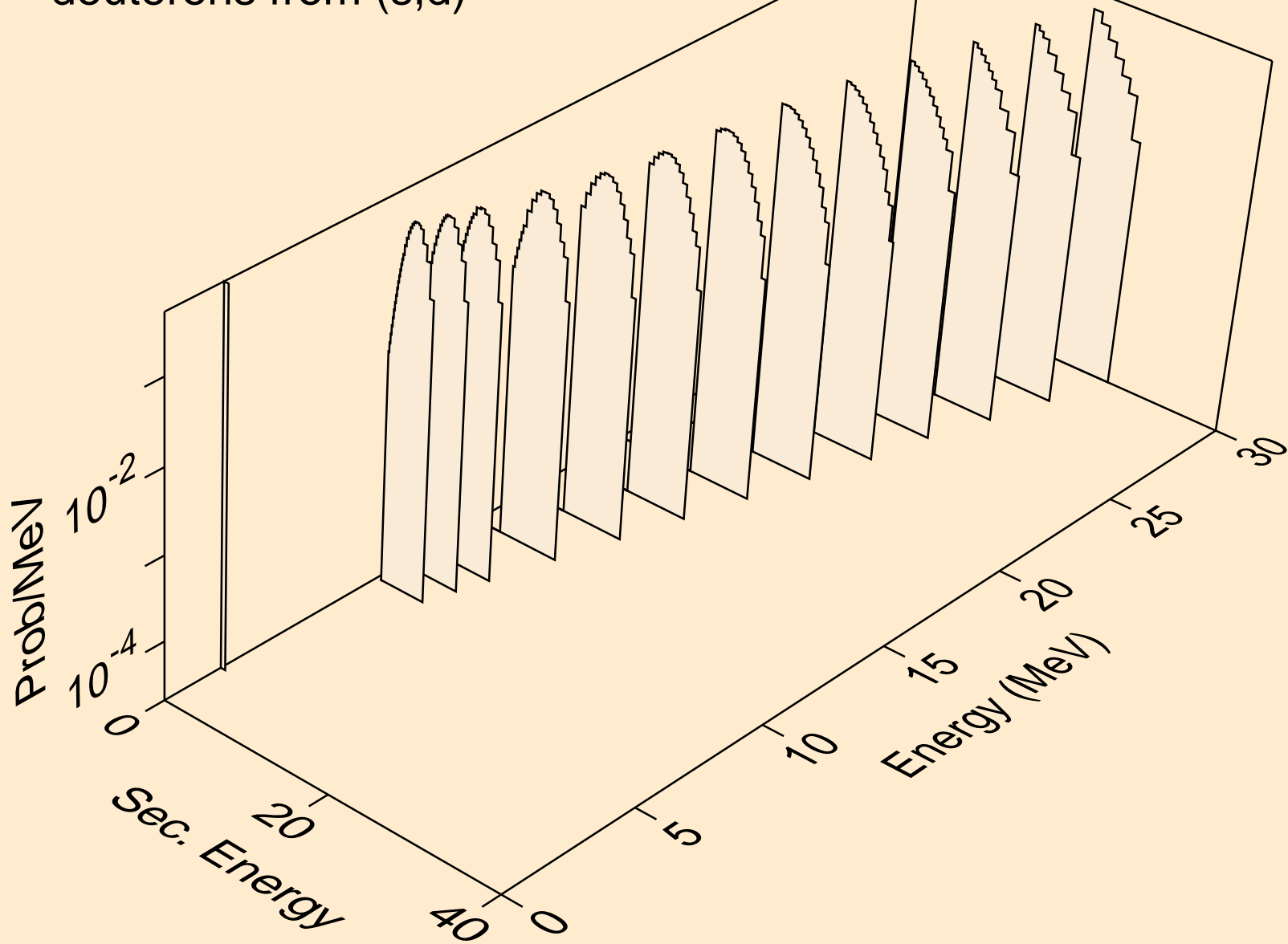

NH285 HELION ACER TENDL-2023 LIBRARY; T=0.K
tritons from (s,x)

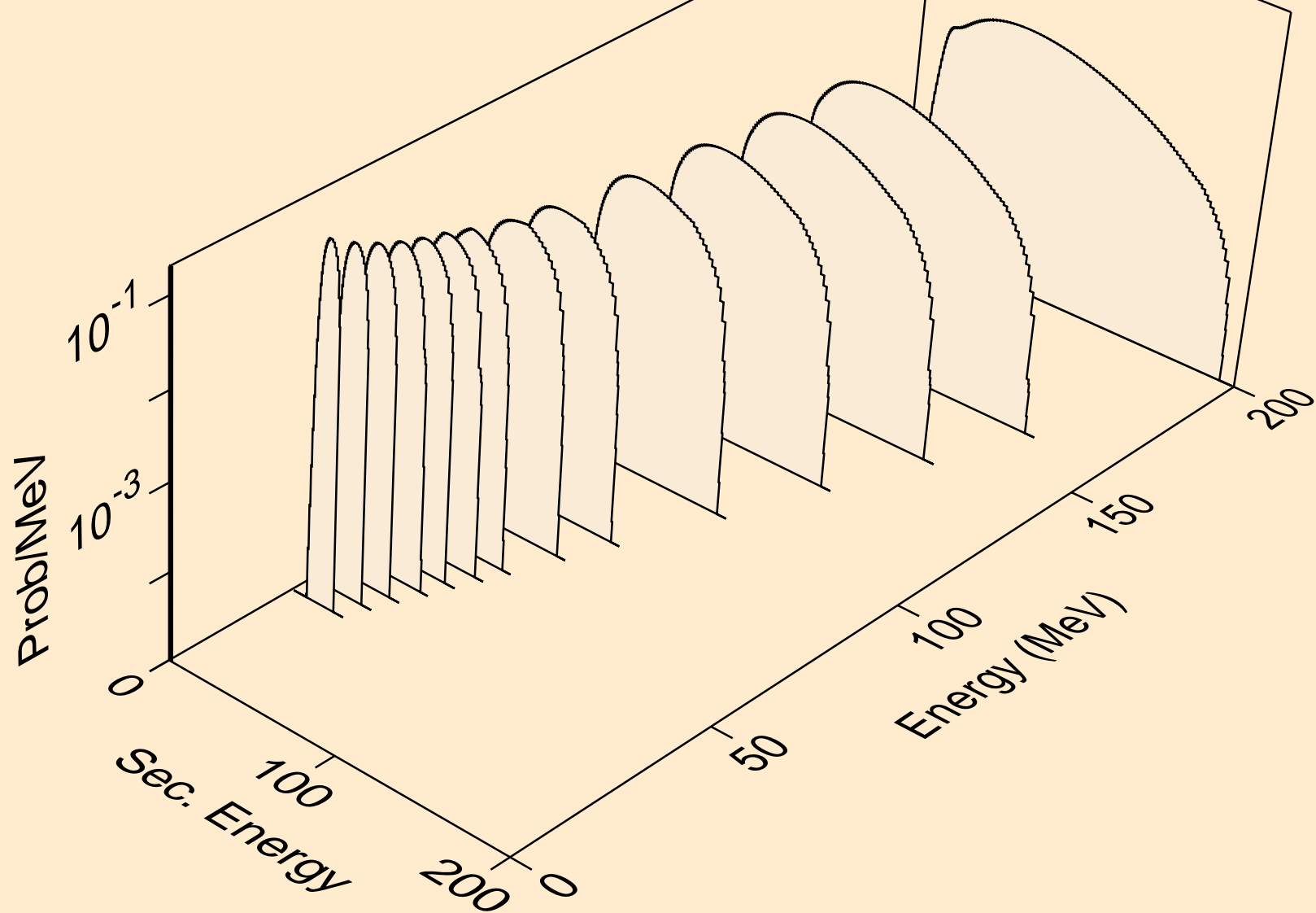

NH285 HELION ACER TENDL-2023 LIBRARY; T=0.K
tritons from (s,n*)t

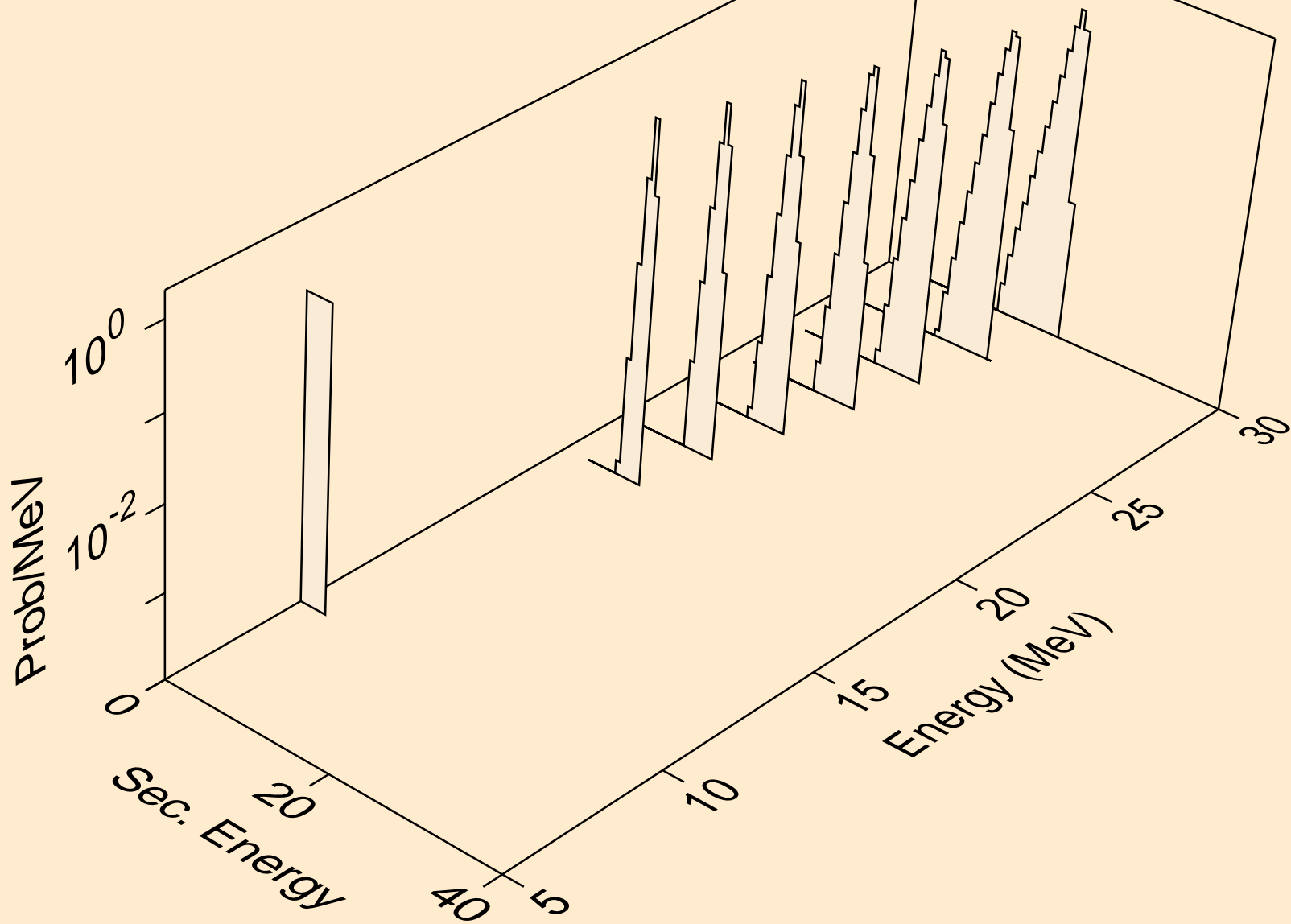

NH285 HELION ACER TENDL-2023 LIBRARY; T=0.K
tritons from (s,t)

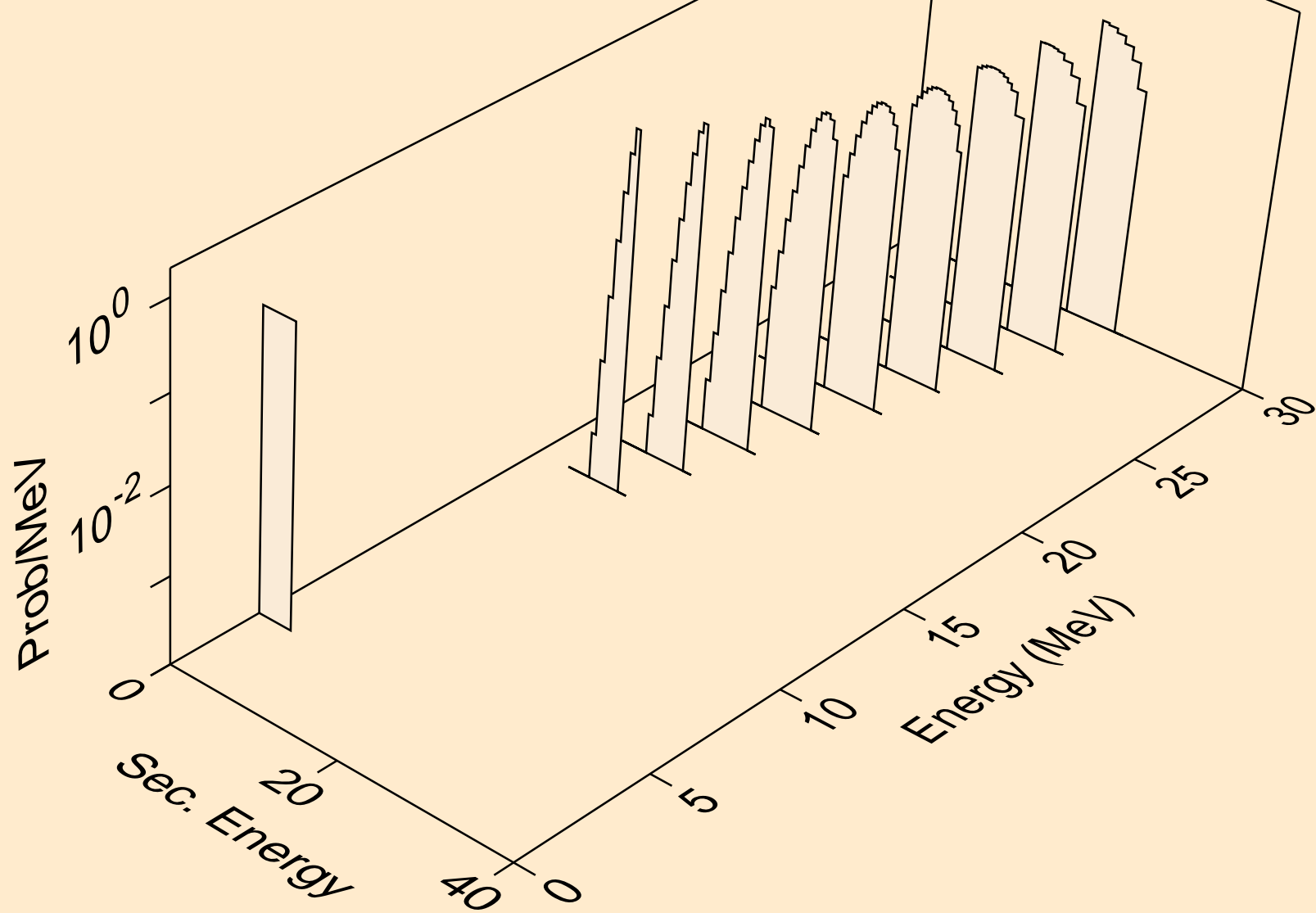

NH285 HELION ACER TENDL-2023 LIBRARY; T=0.K
alphas from (s,x)

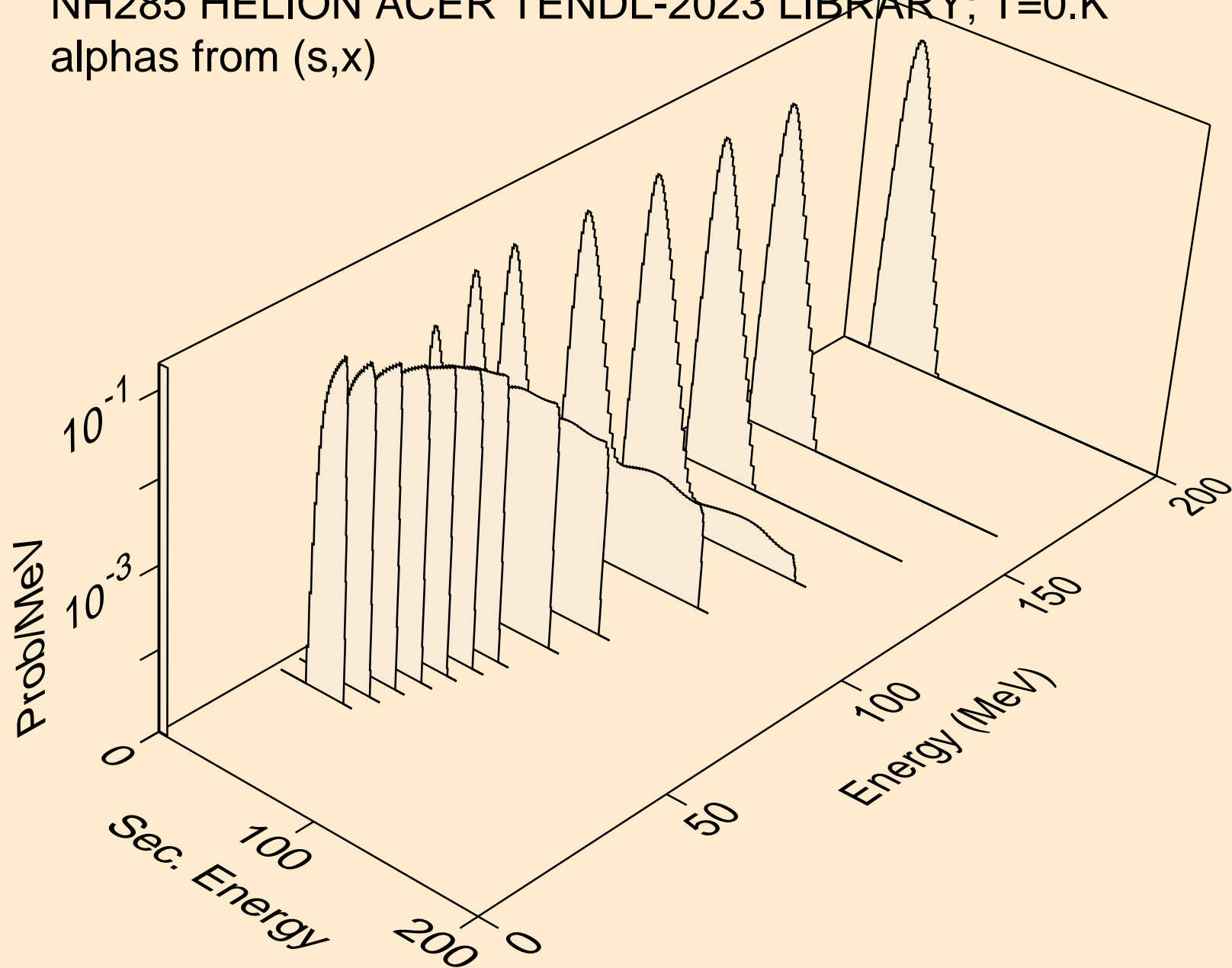

NH285 HELION ACER TENDL-2023 LIBRARY; T=0.K
alphas from (s,a)

