

SE087 HELION ACER TENDL-2023 LIBRARY; T=0.K  
Principal cross sections

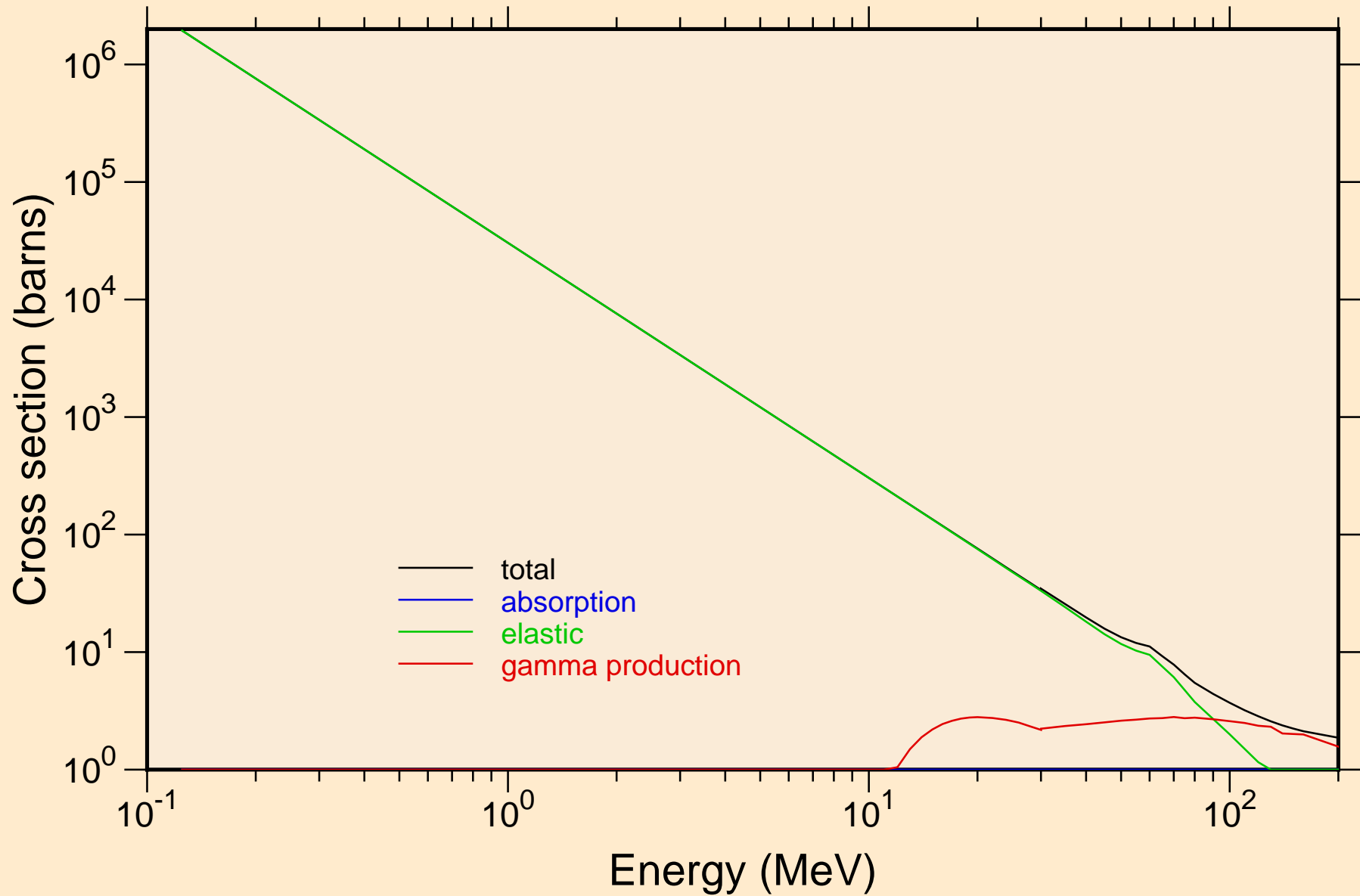

# SE087 HELION ACER TENDL-2023 LIBRARY; T=0.K

## Heating

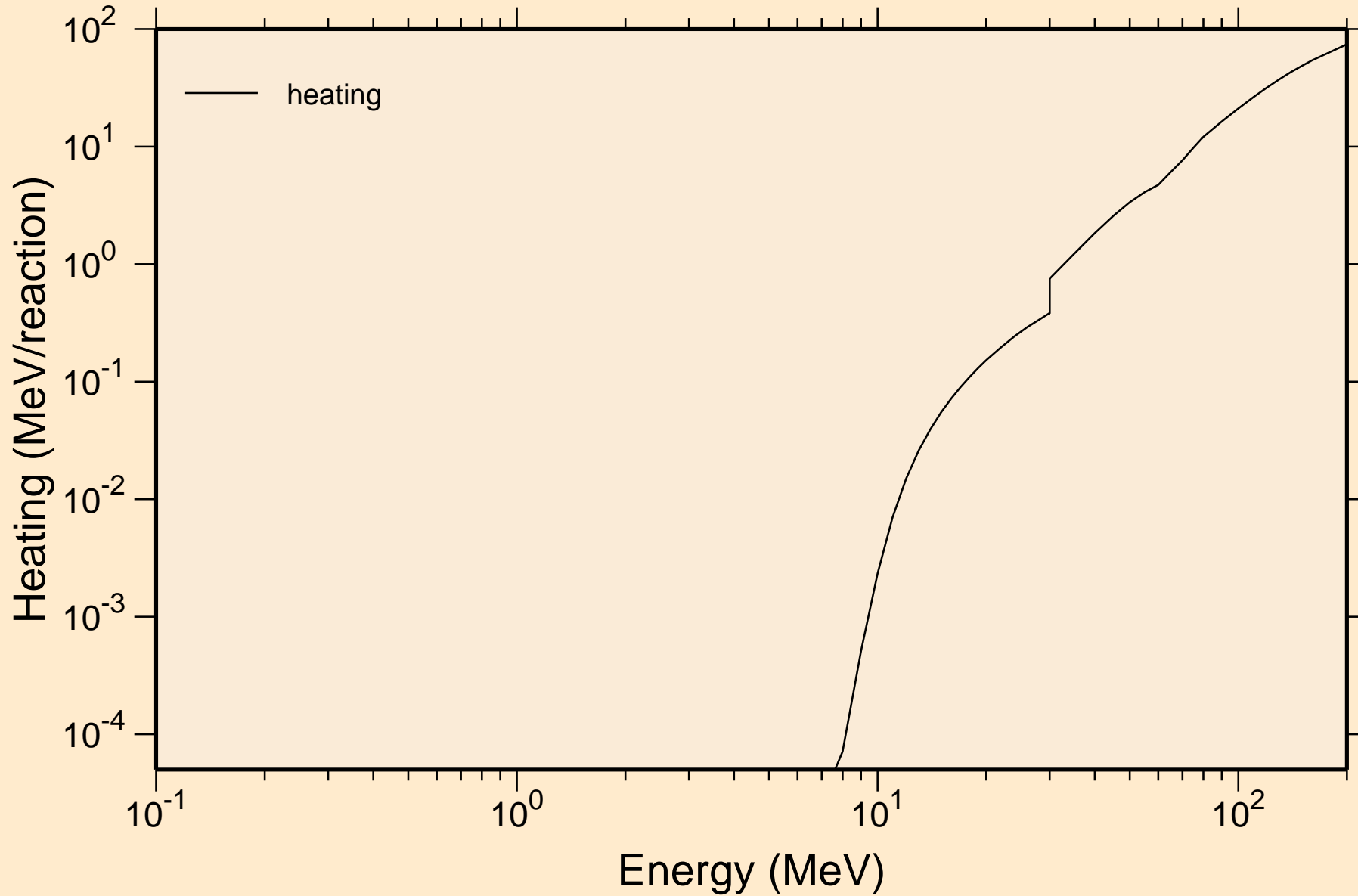

SE087 HELION ACER TENDL-2023 LIBRARY; T=0.K

Principal cross sections

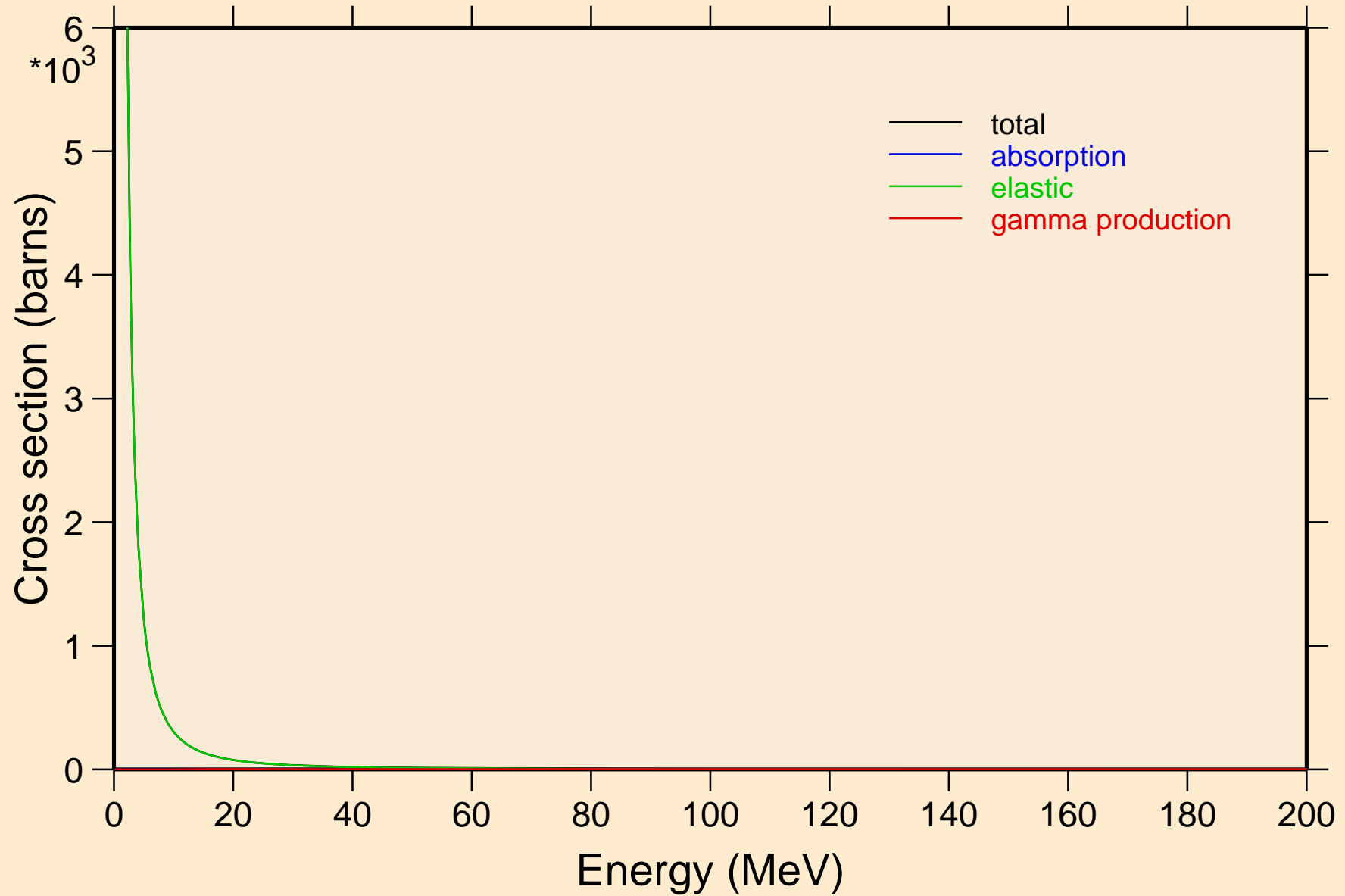

SE087 HELION ACER TENDL-2023 LIBRARY; T=0.K

Heating

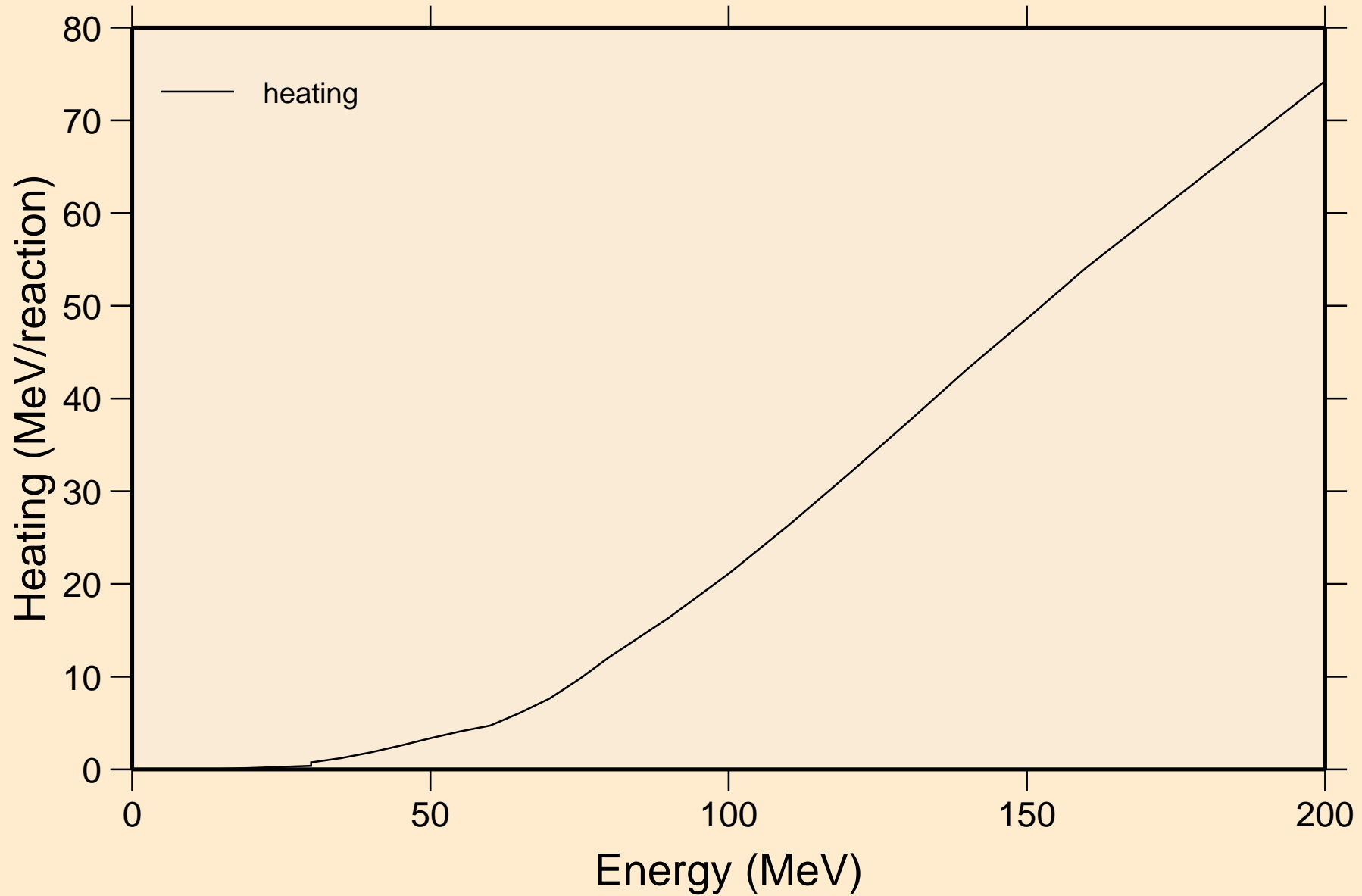

SE087 HELION ACER TENDL-2023 LIBRARY; T=0.K  
Threshold reactions

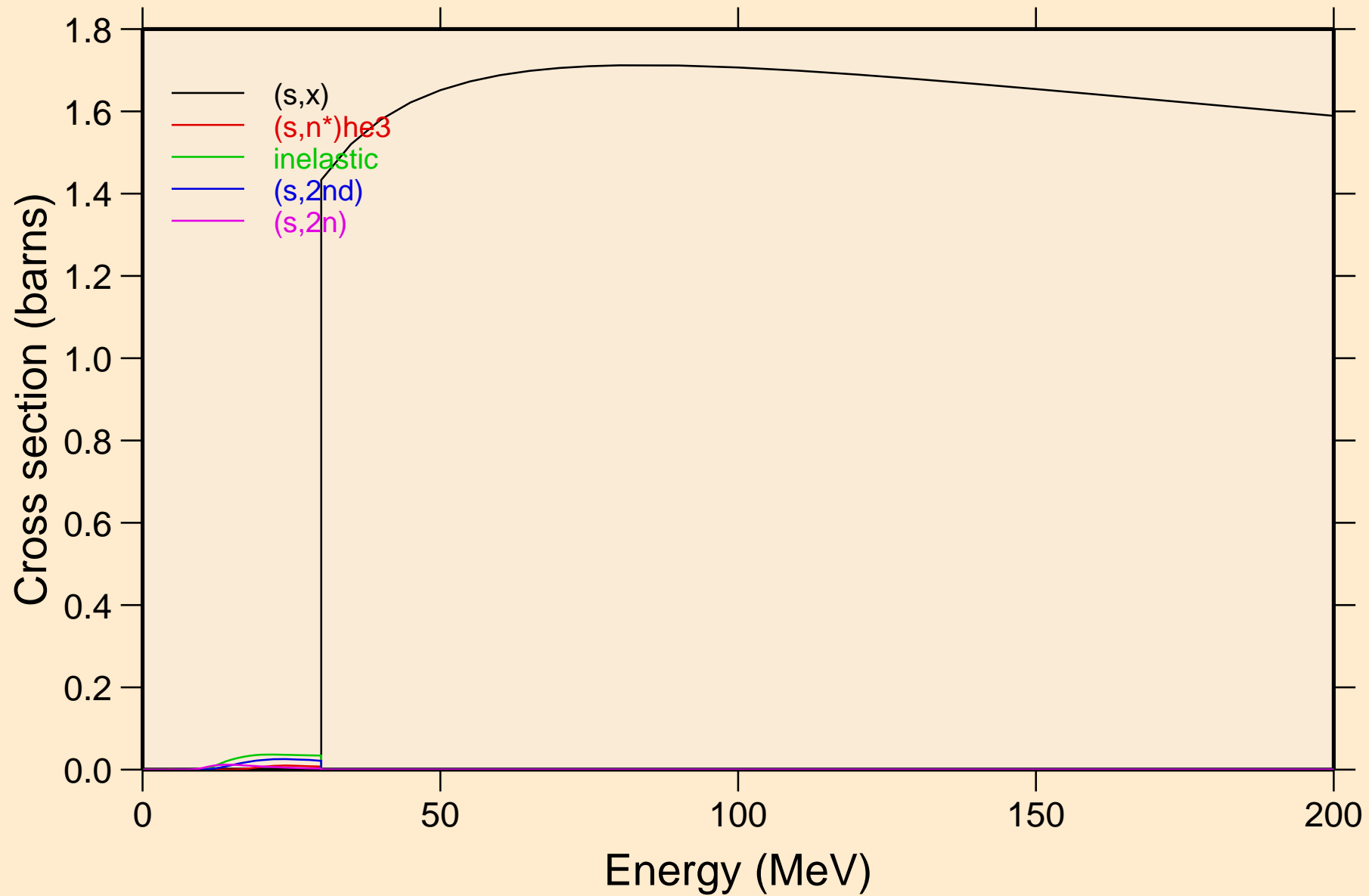

SE087 HELION ACER TENDL-2023 LIBRARY; T=0.K  
Threshold reactions

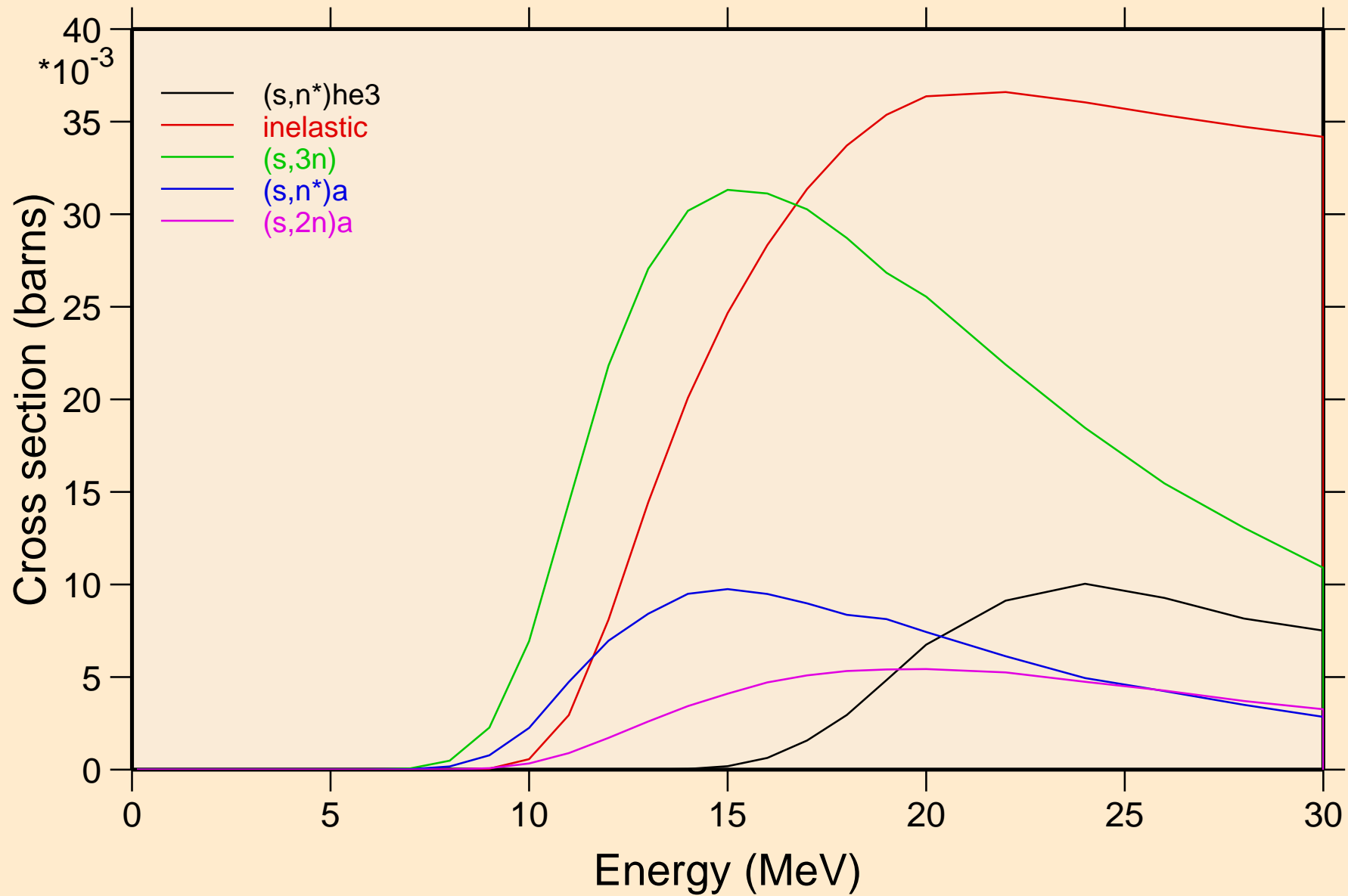

SE087 HELION ACER TENDL-2023 LIBRARY; T=0.K  
Threshold reactions

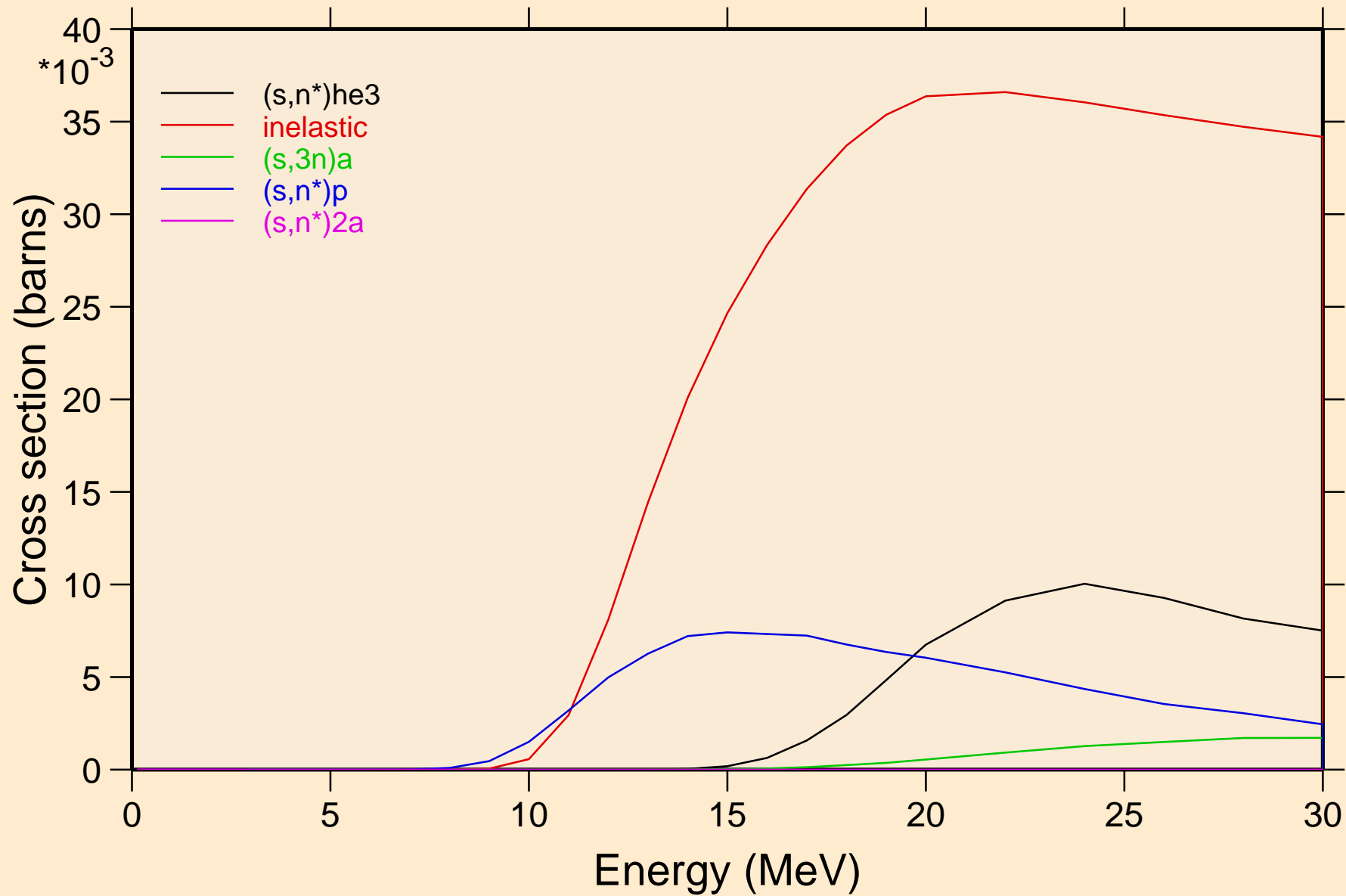

SE087 HELION ACER TENDL-2023 LIBRARY; T=0.K  
Threshold reactions

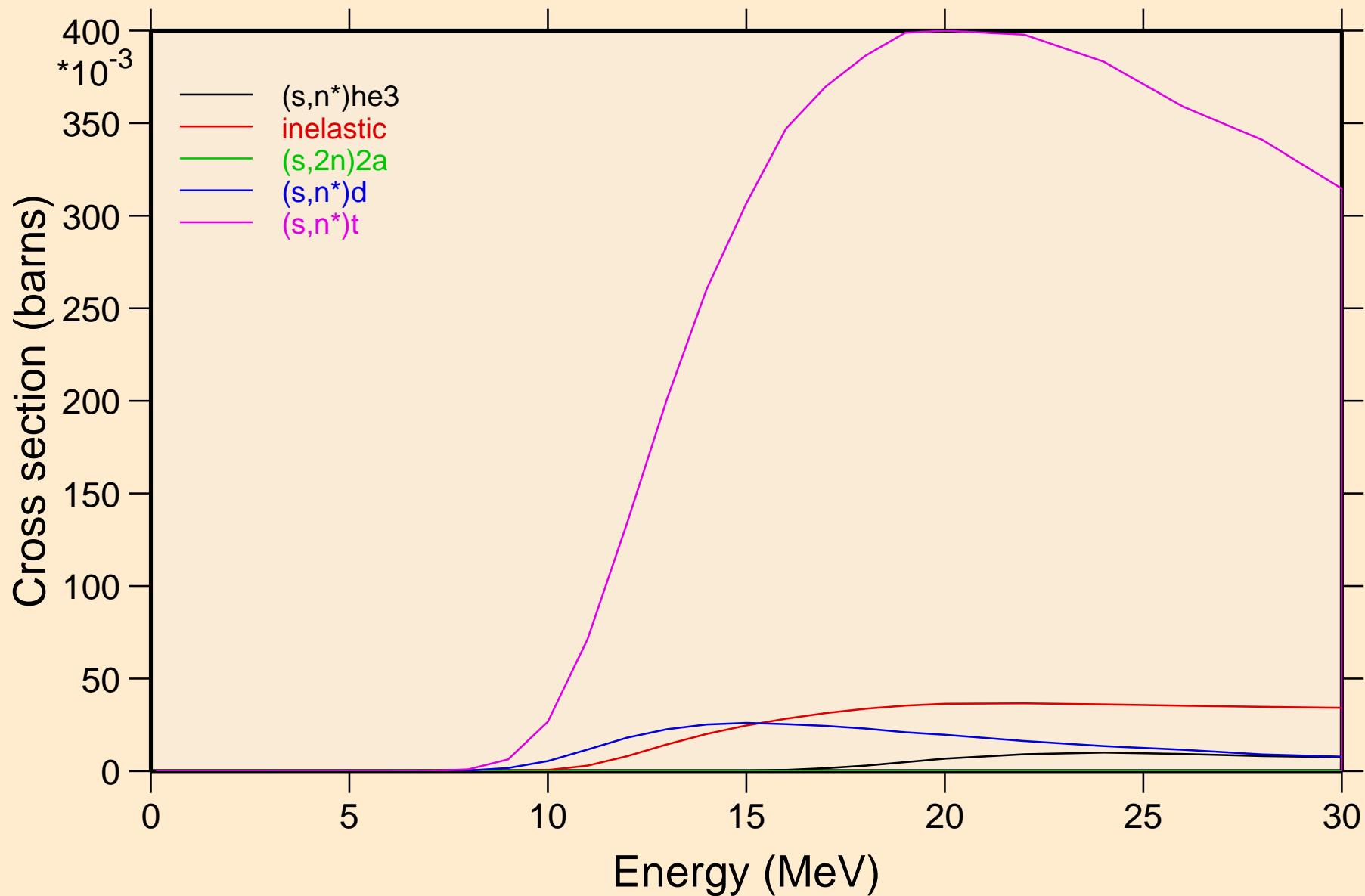

SE087 HELION ACER TENDL-2023 LIBRARY; T=0.K  
Threshold reactions

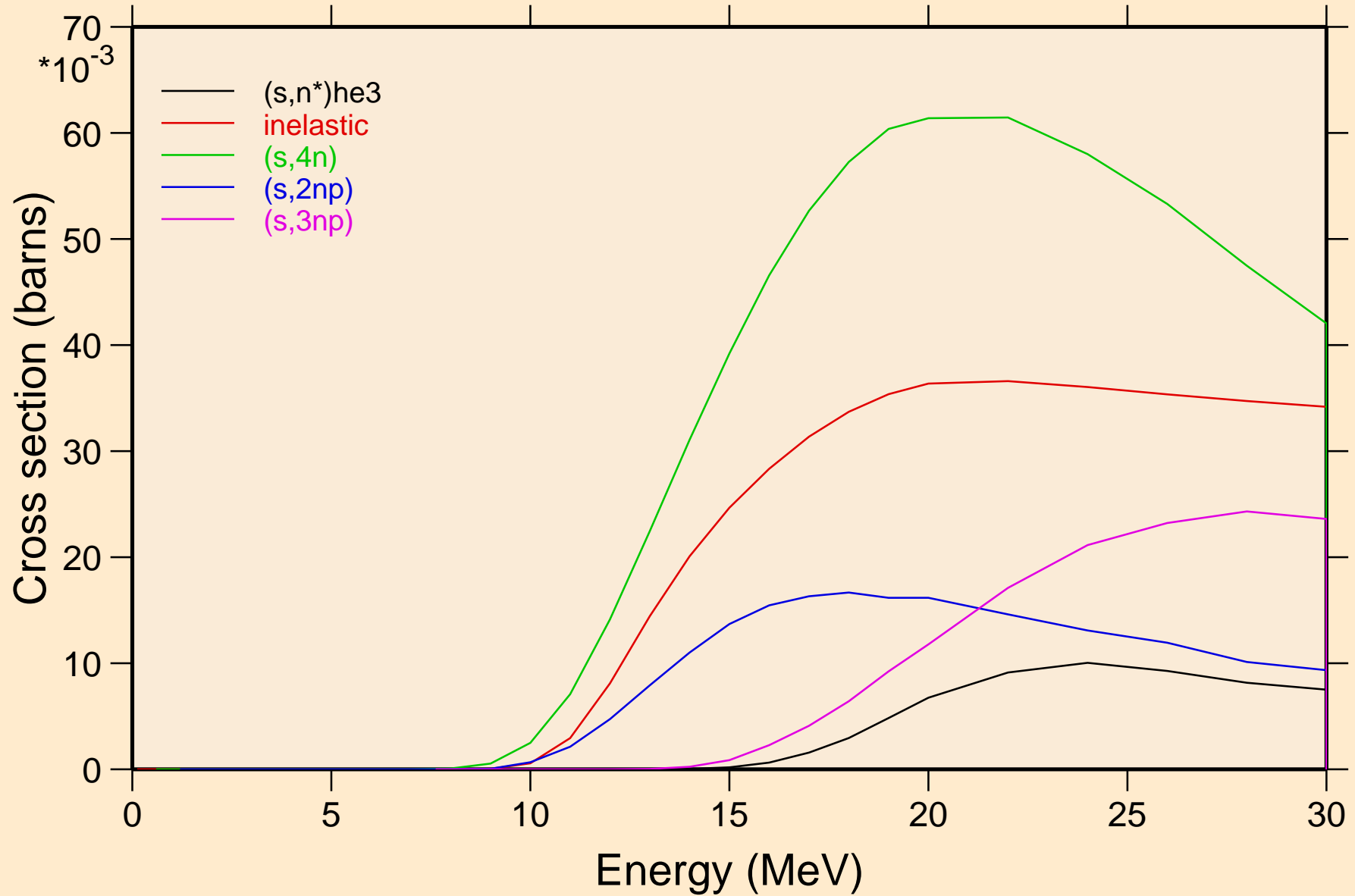

SE087 HELION ACER TENDL-2023 LIBRARY; T=0.K  
Threshold reactions

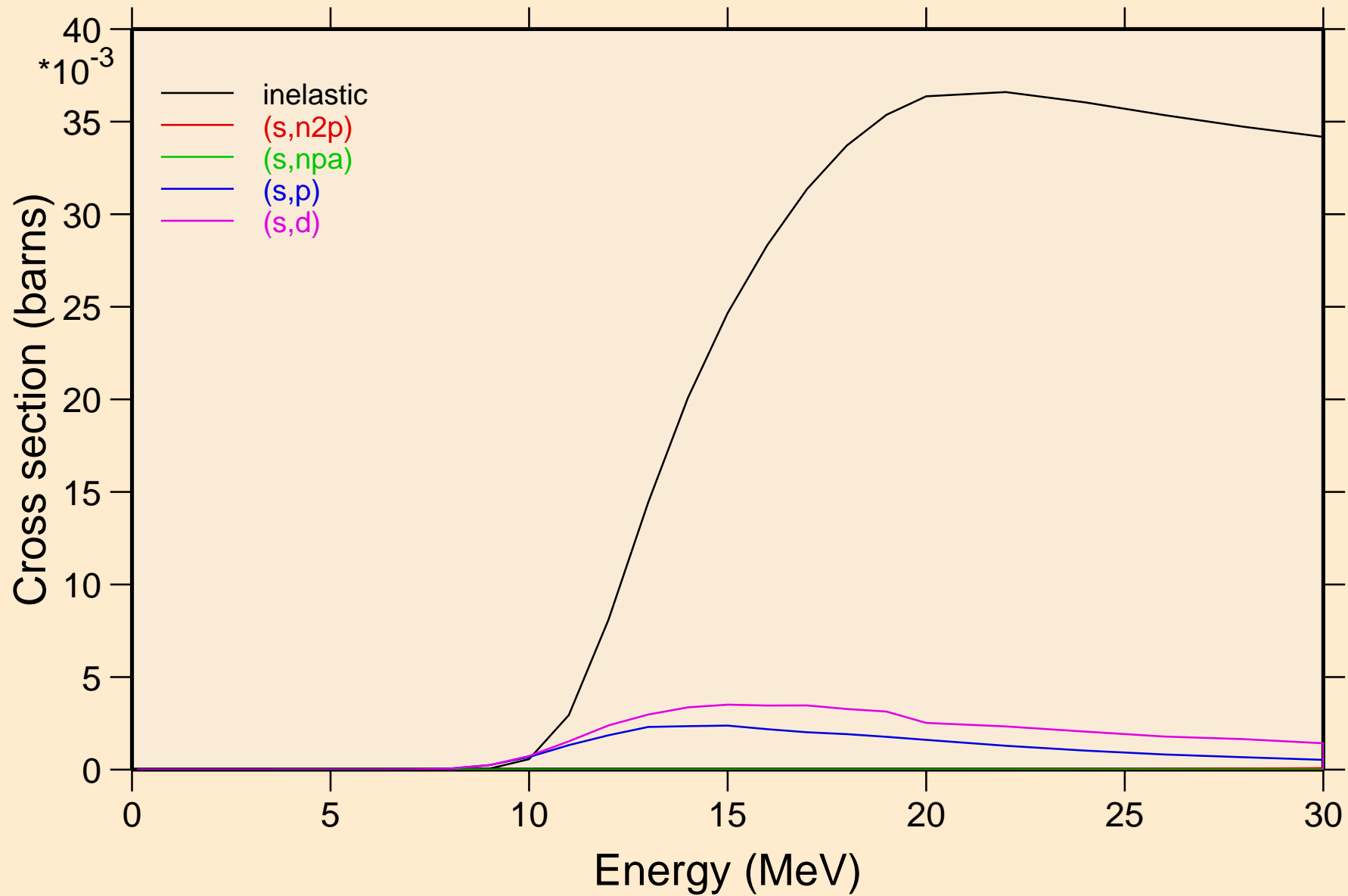

SE087 HELION ACER TENDL-2023 LIBRARY; T=0.K  
Threshold reactions

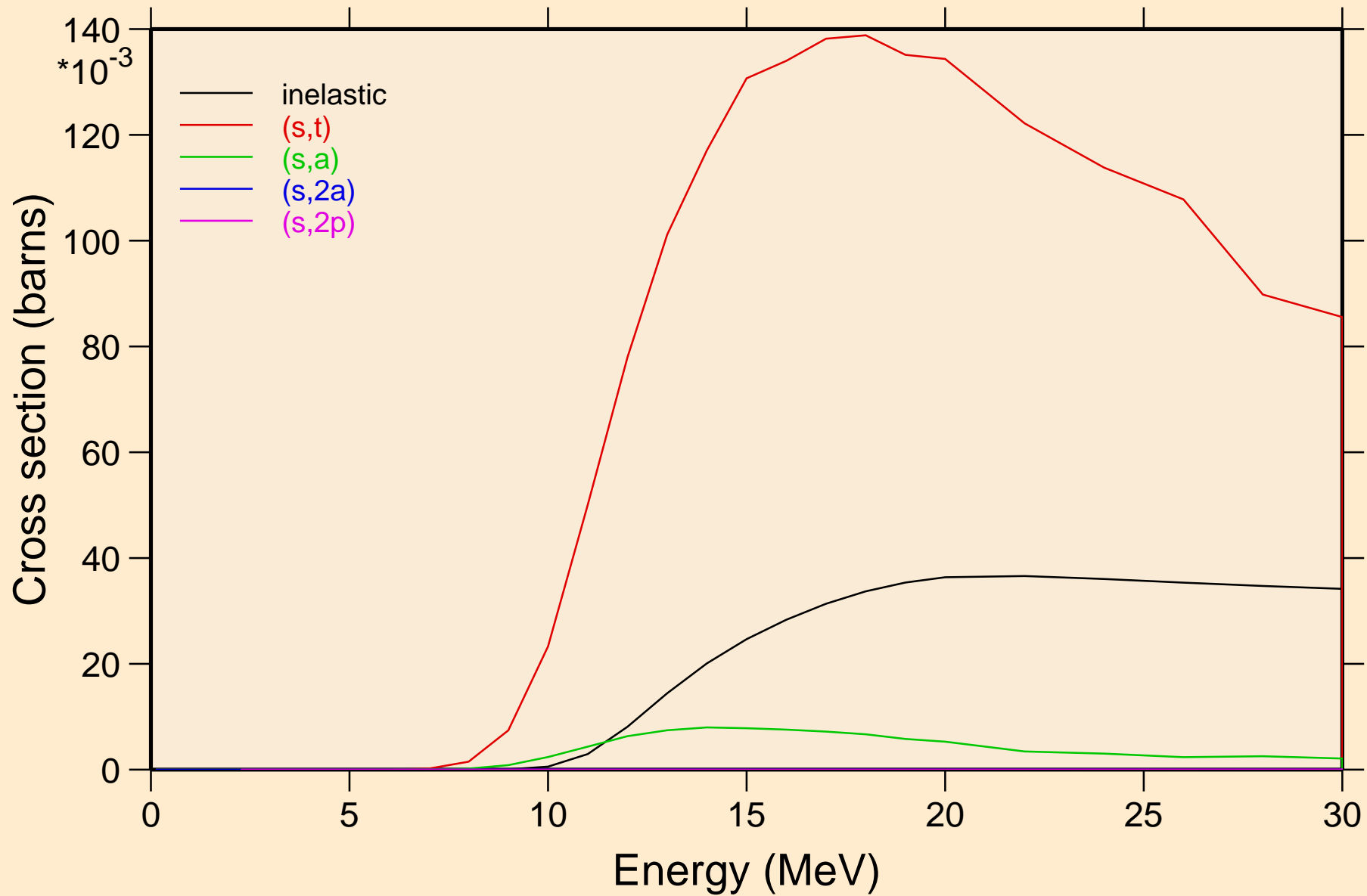

SE087 HELION ACER TENDL-2023 LIBRARY; T=0.K  
Threshold reactions

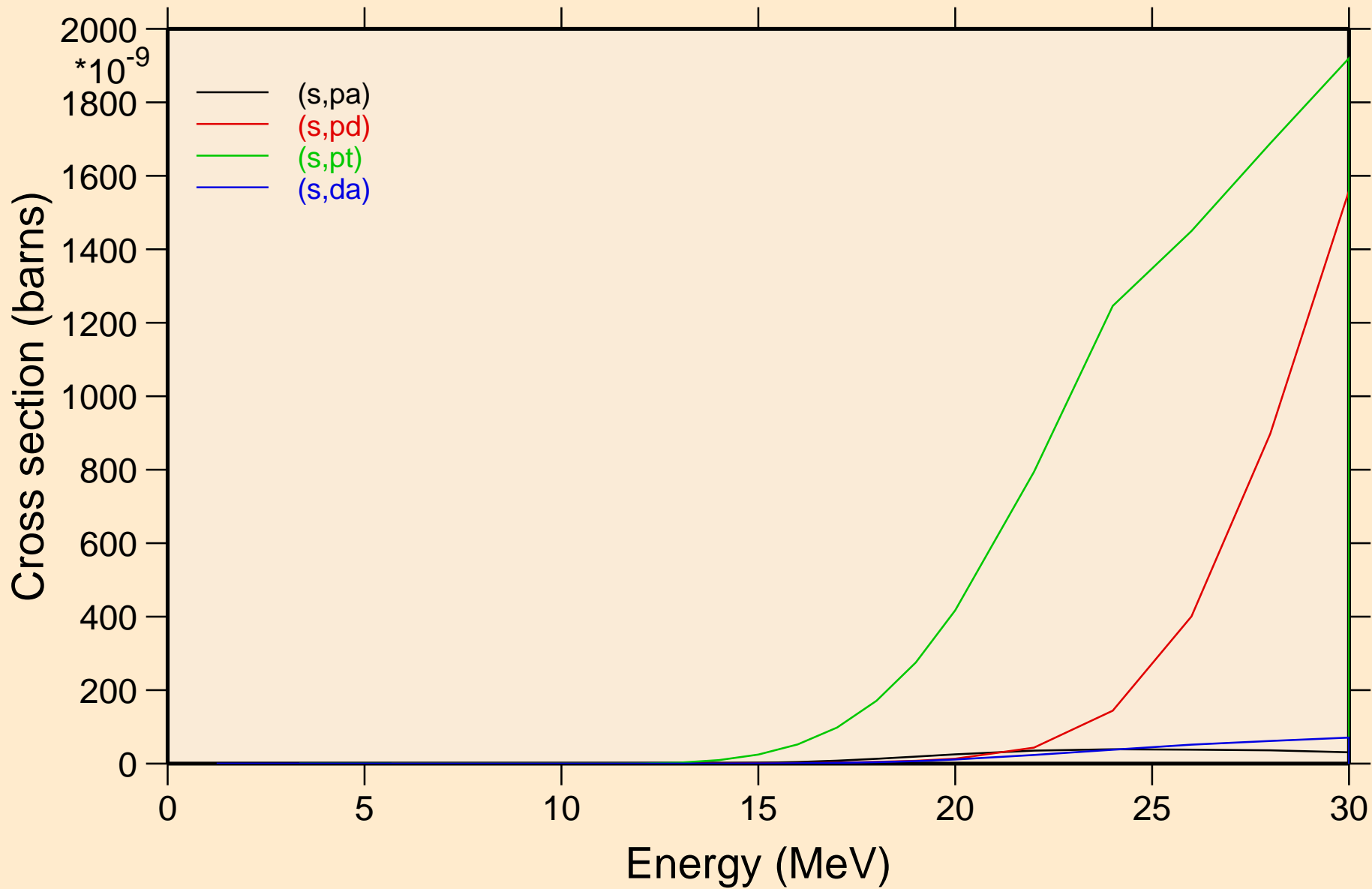

SE087 HELION ACER TENDL-2023 LIBRARY; T=0.K  
angular distribution for elastic

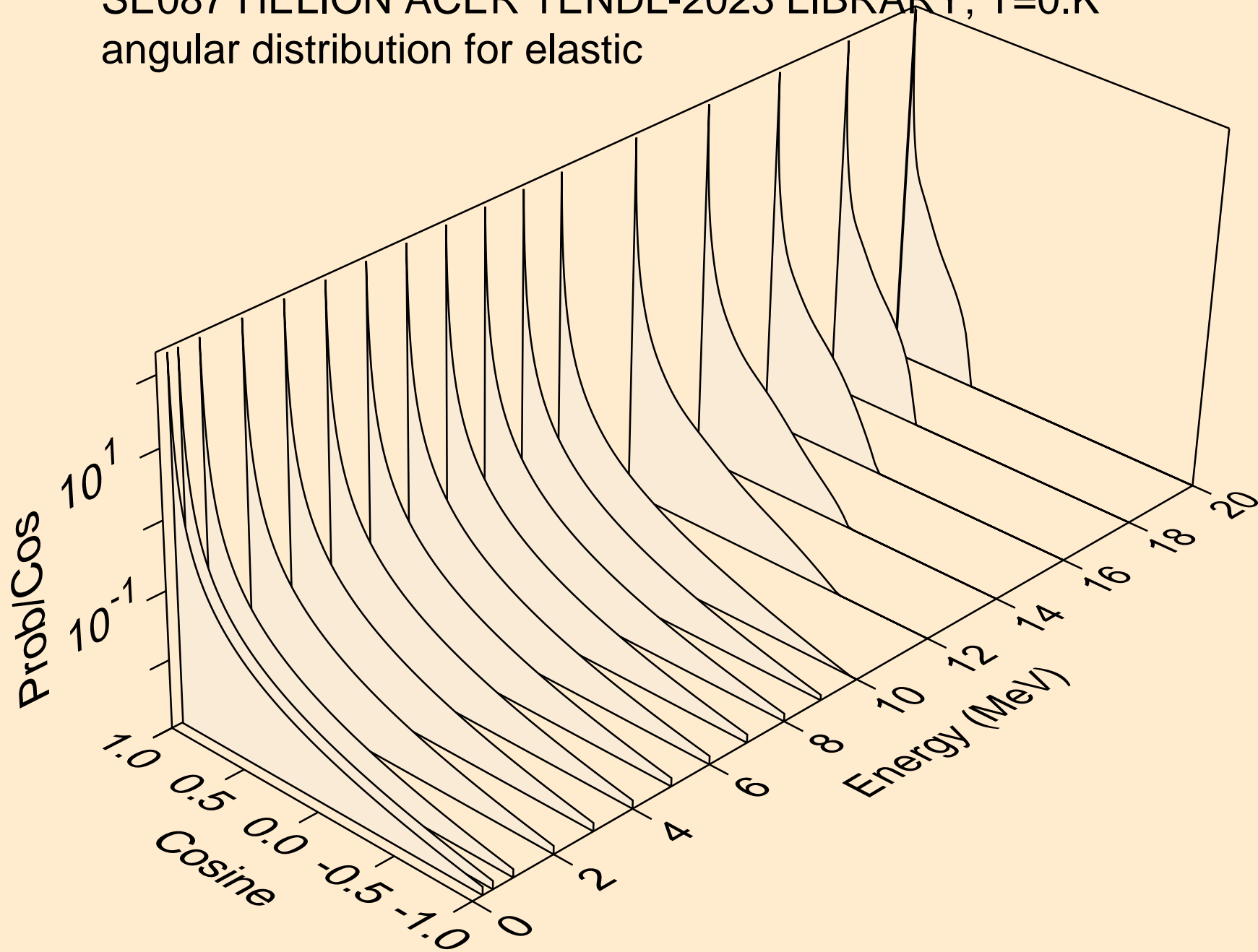

SE087 HELION ACER TENDL-2023 LIBRARY; T=0.K  
angular distribution for elastic

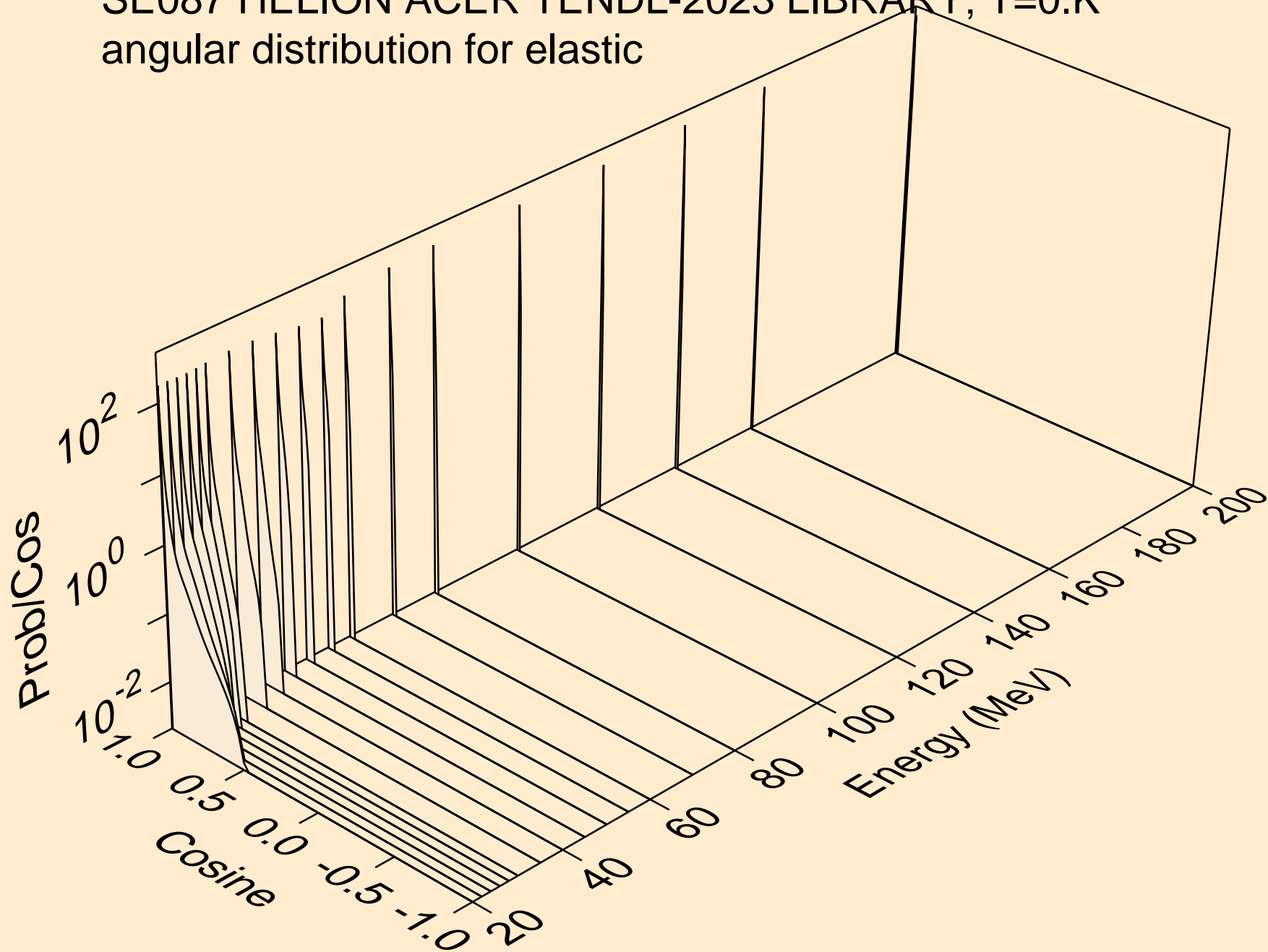

SE087 HELION ACER TENDL-2023 LIBRARY; T=0.K  
He-3 emission for (s,x)

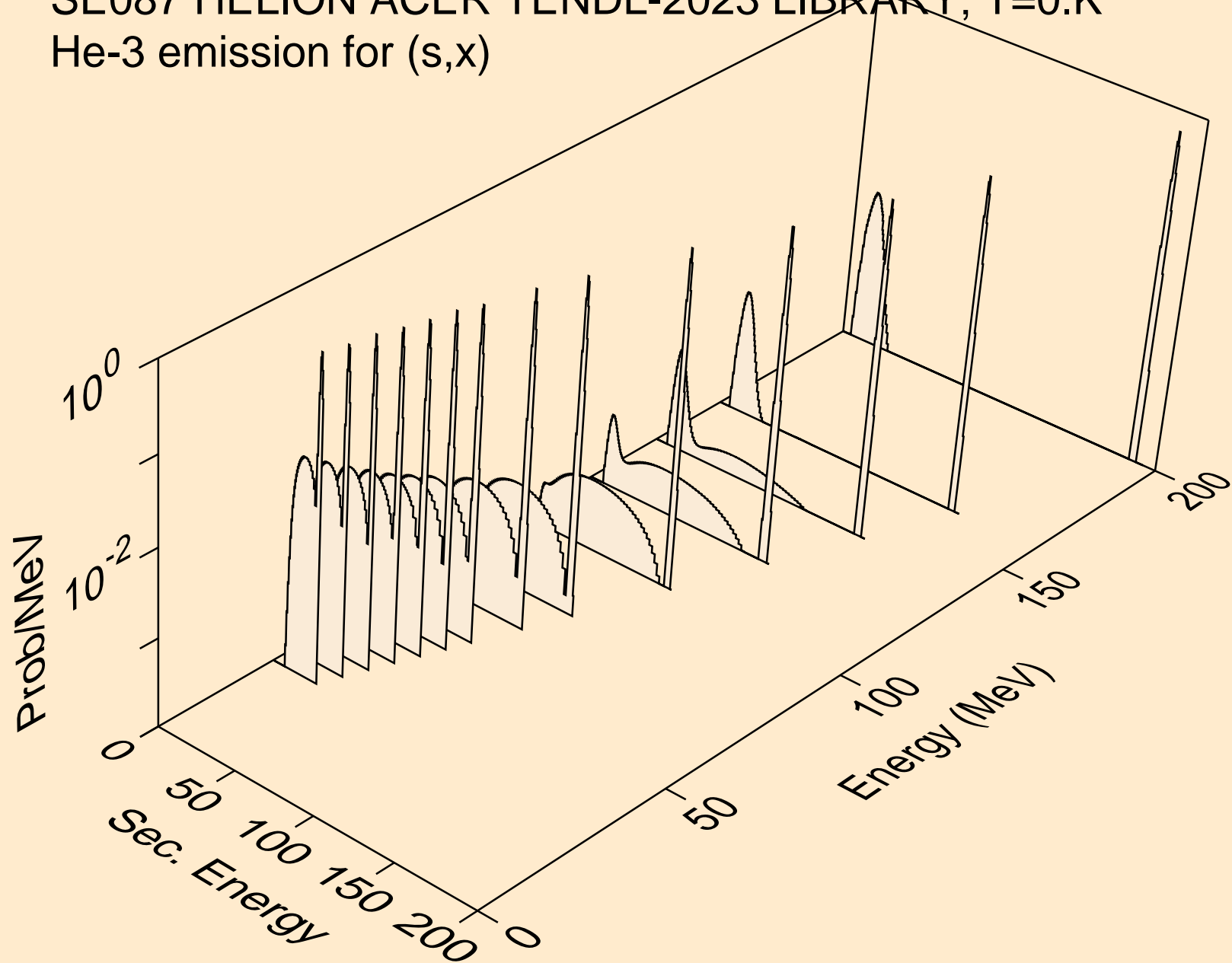

SE087 HELION ACER TENDL-2023 LIBRARY; T=0.K  
He-3 emission for (s,n\*)he3

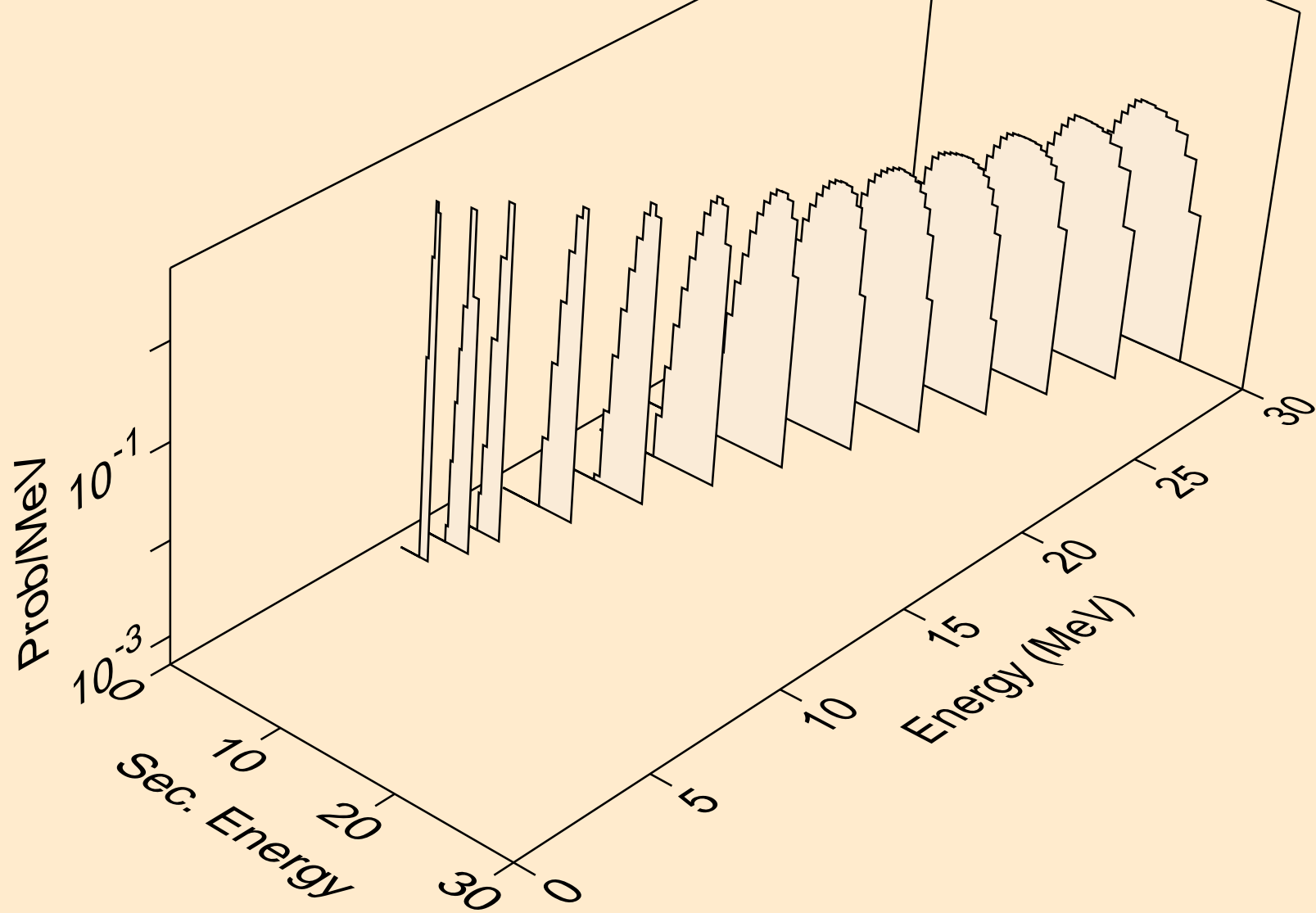

SE087 HELION ACER TENDL-2023 LIBRARY; T=0.K  
He-3 emission for inelastic

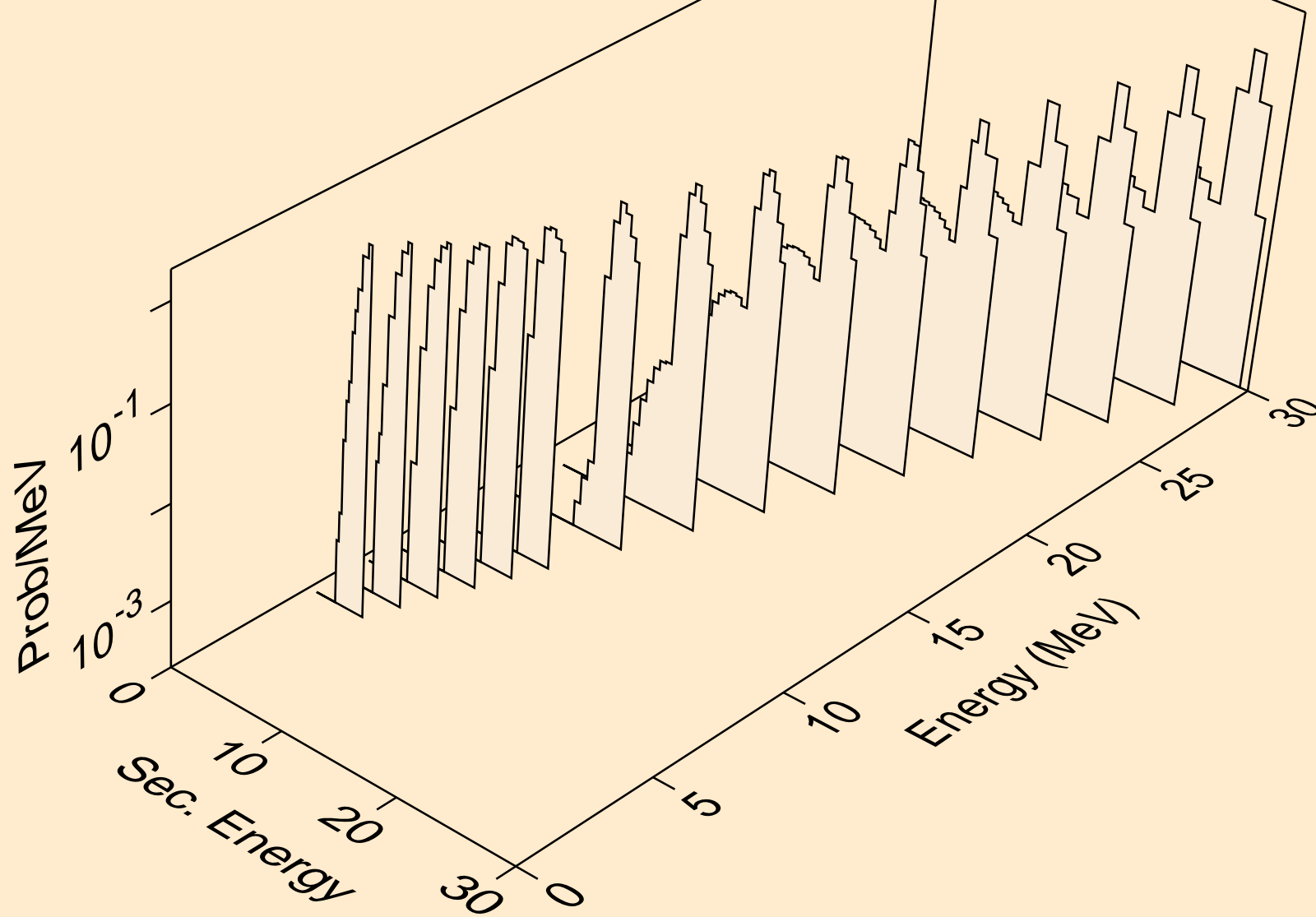

SE087 HELION ACER TENDL-2023 LIBRARY; T=0.K  
Photon emission for (z,n)

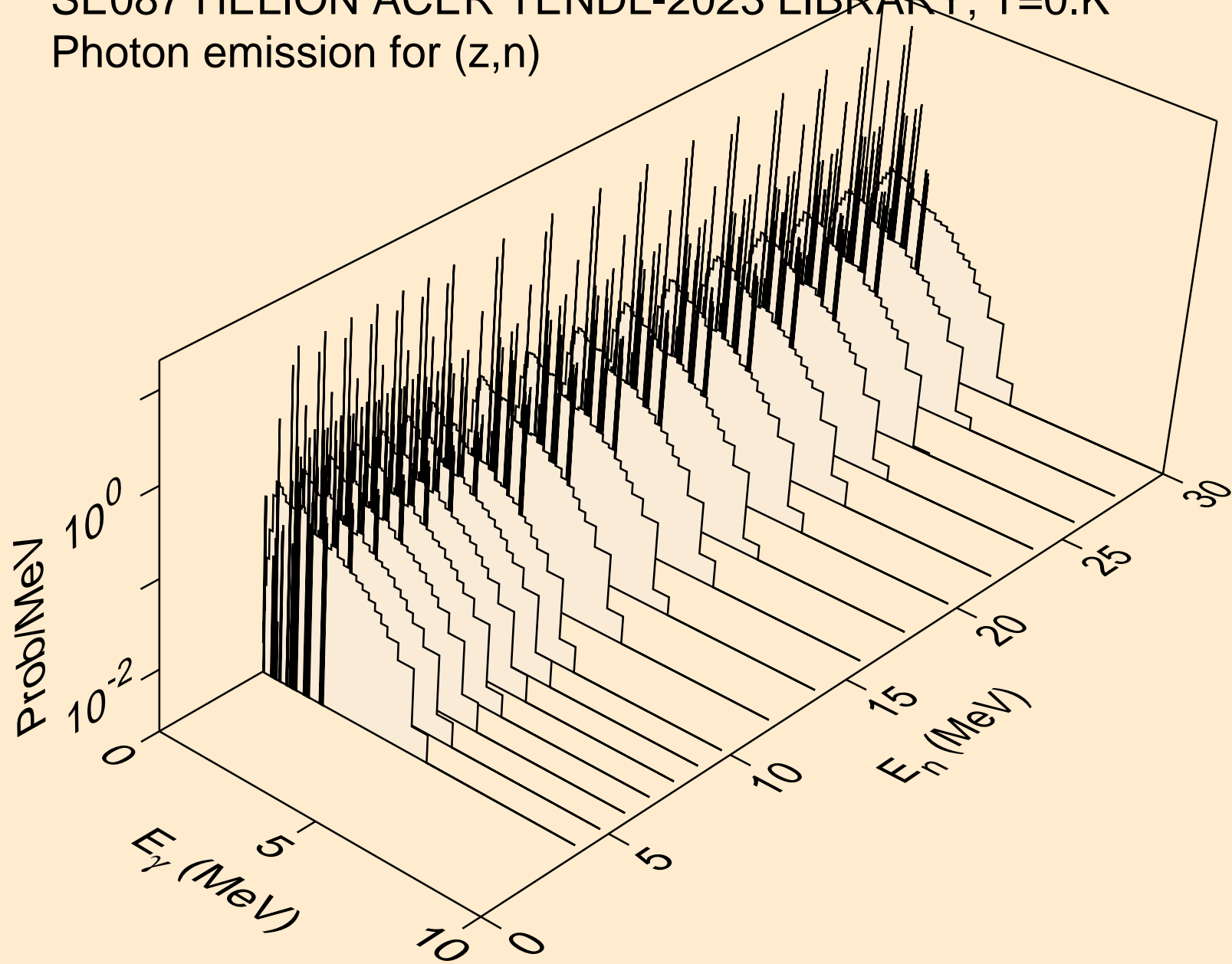

SE087 HELION ACER TENDL-2023 LIBRARY; T=0.K  
Photon emission for (z,x)

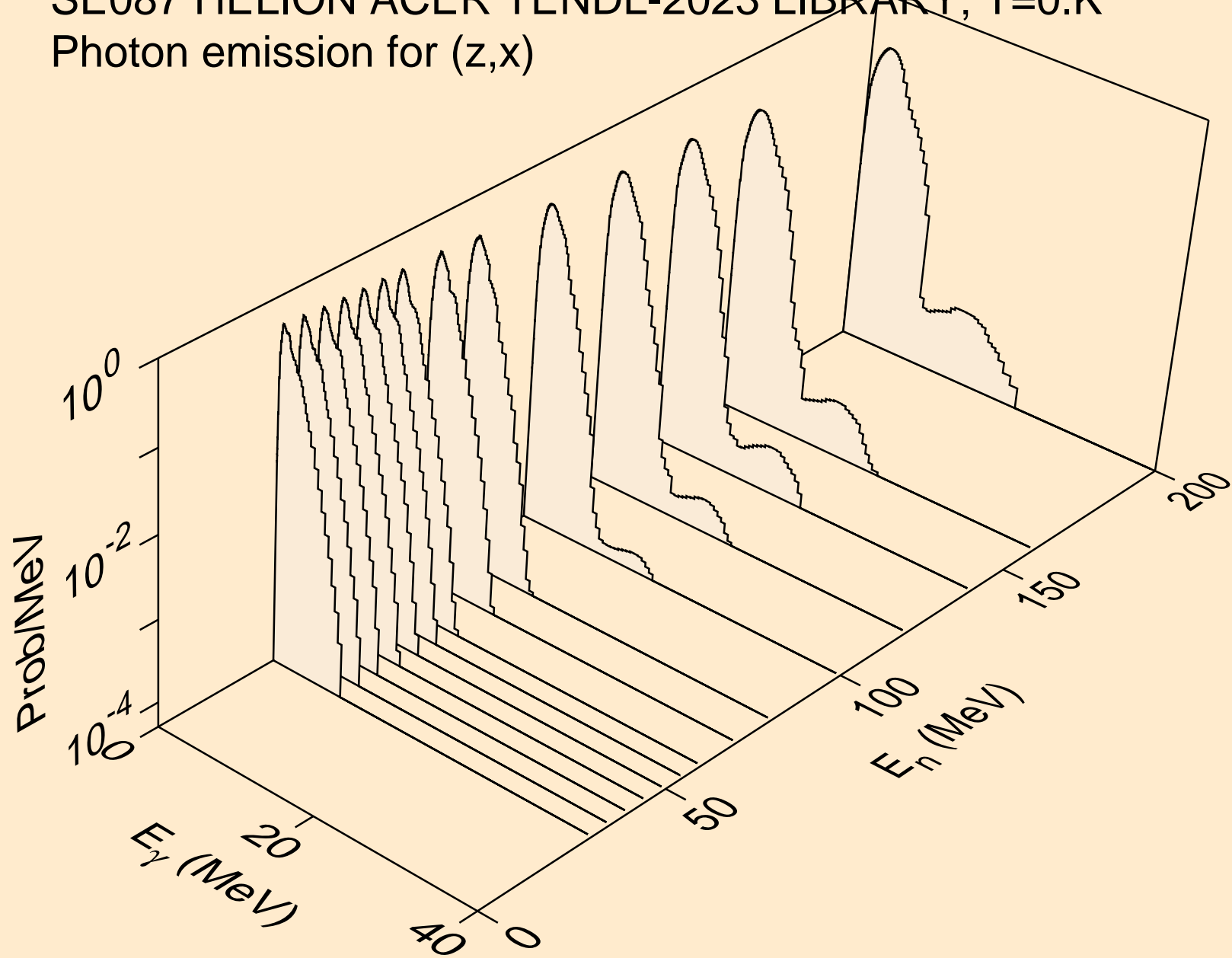

SE087 HELION ACER TENDL-2023 LIBRARY; T=0.K  
Photon emission for (n,2nd)

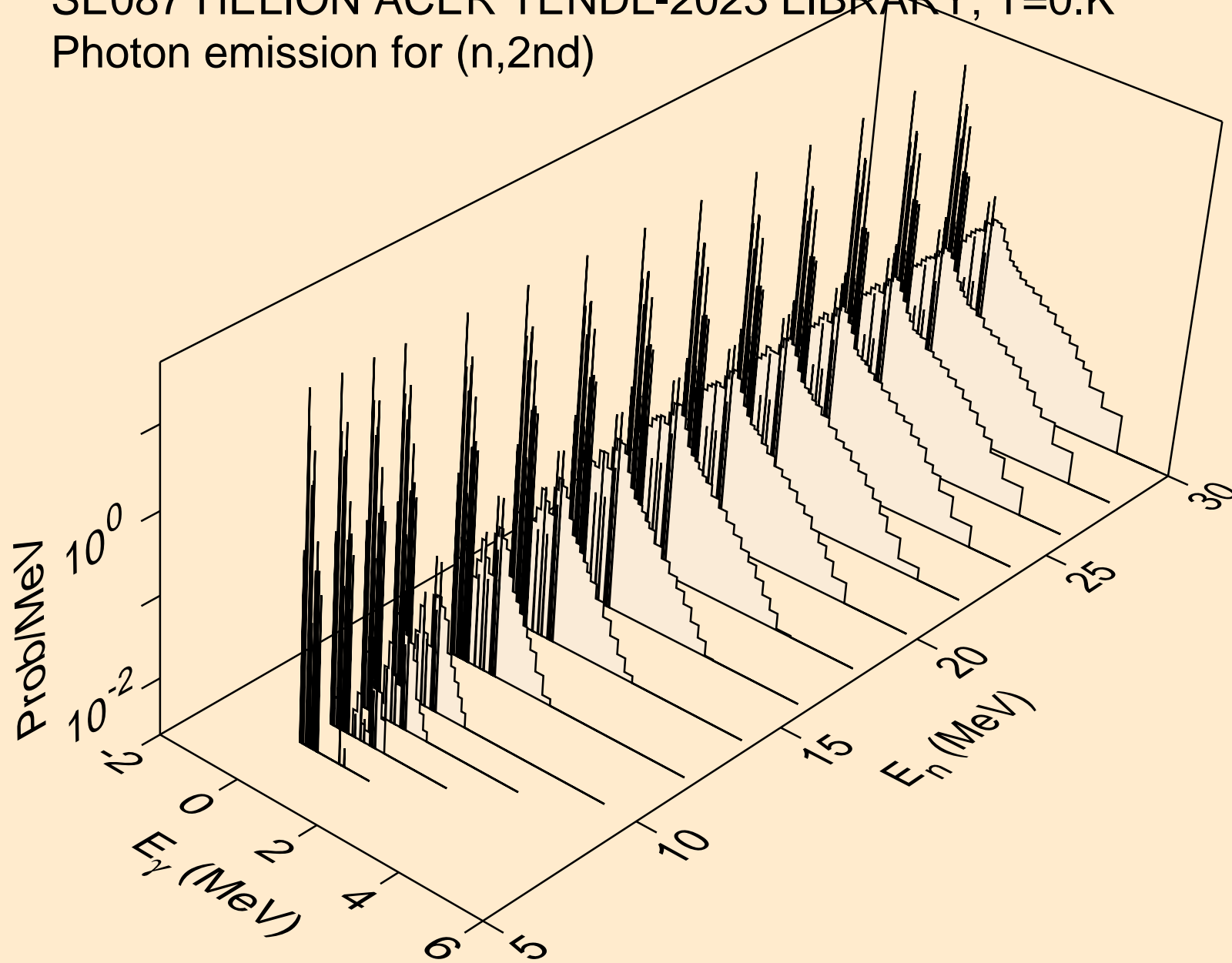

SE087 HELION ACER TENDL-2023 LIBRARY; T=0.K  
Photon emission for (n,2n)

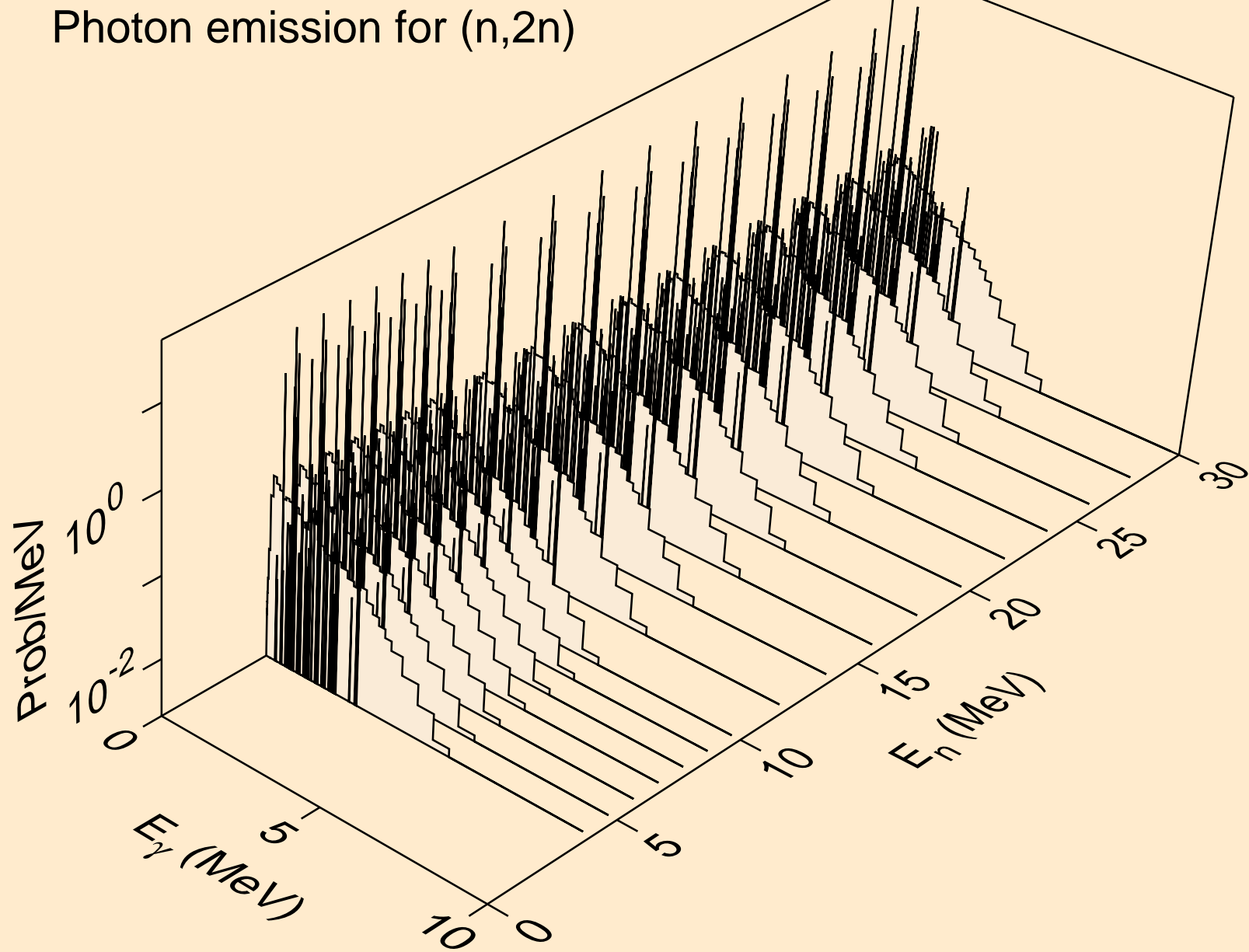

SE087 HELION ACER TENDL-2023 LIBRARY; T=0.K  
Photon emission for (n,3n)

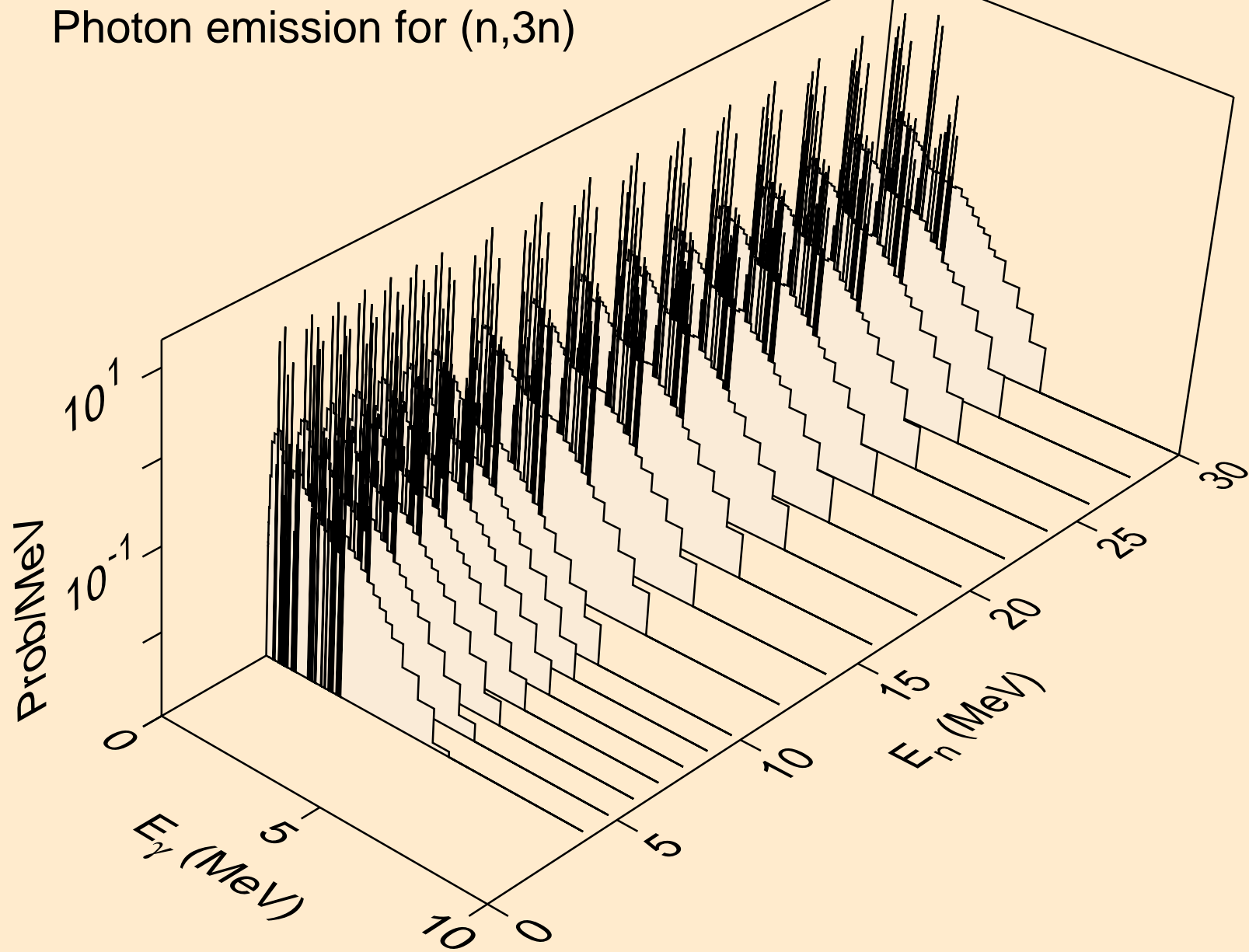

SE087 HELION ACER TENDL-2023 LIBRARY; T=0.K  
Photon emission for (n,n\*)a

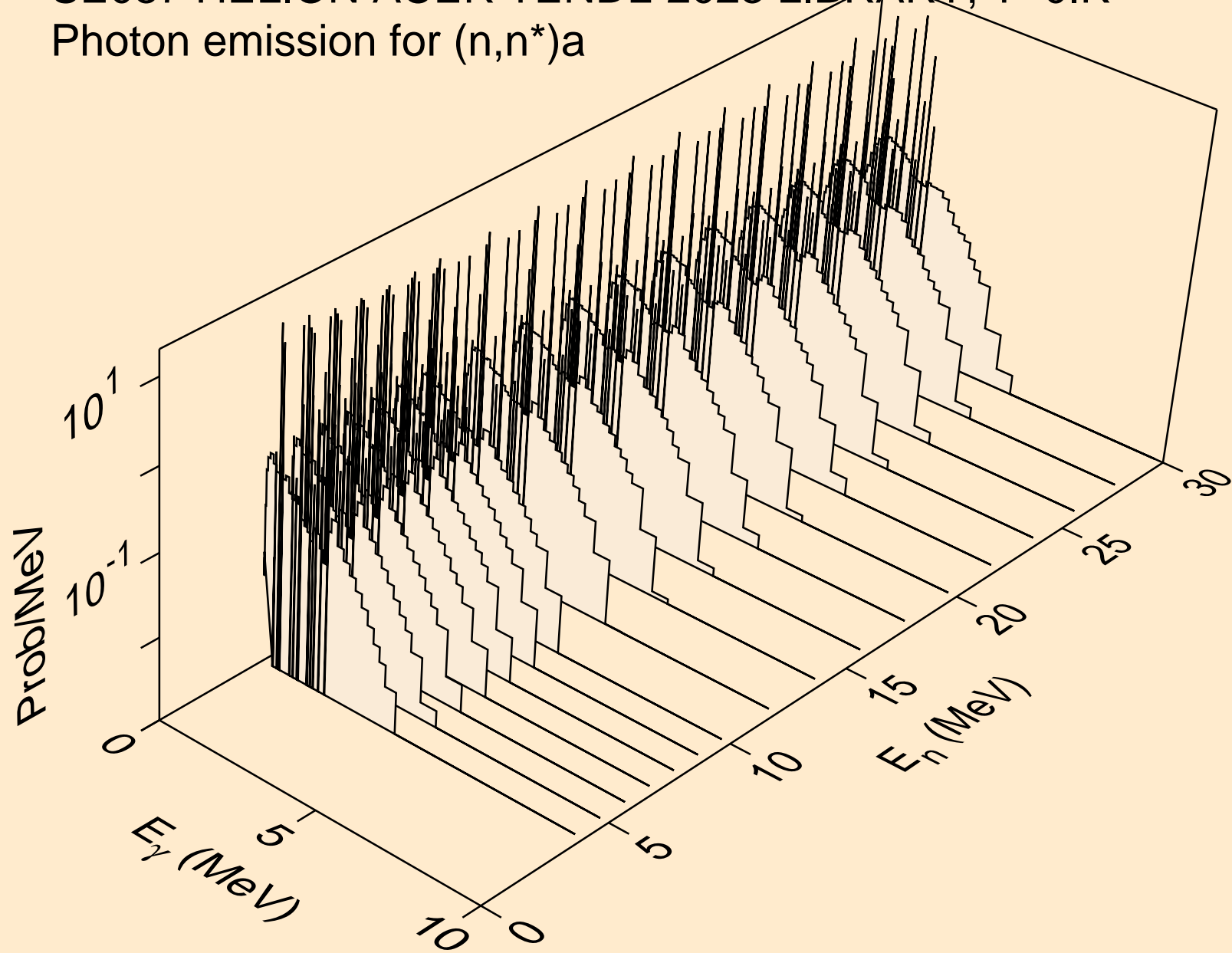

SE087 HELION ACER TENDL-2023 LIBRARY; T=0.K  
Photon emission for (n,2n)a

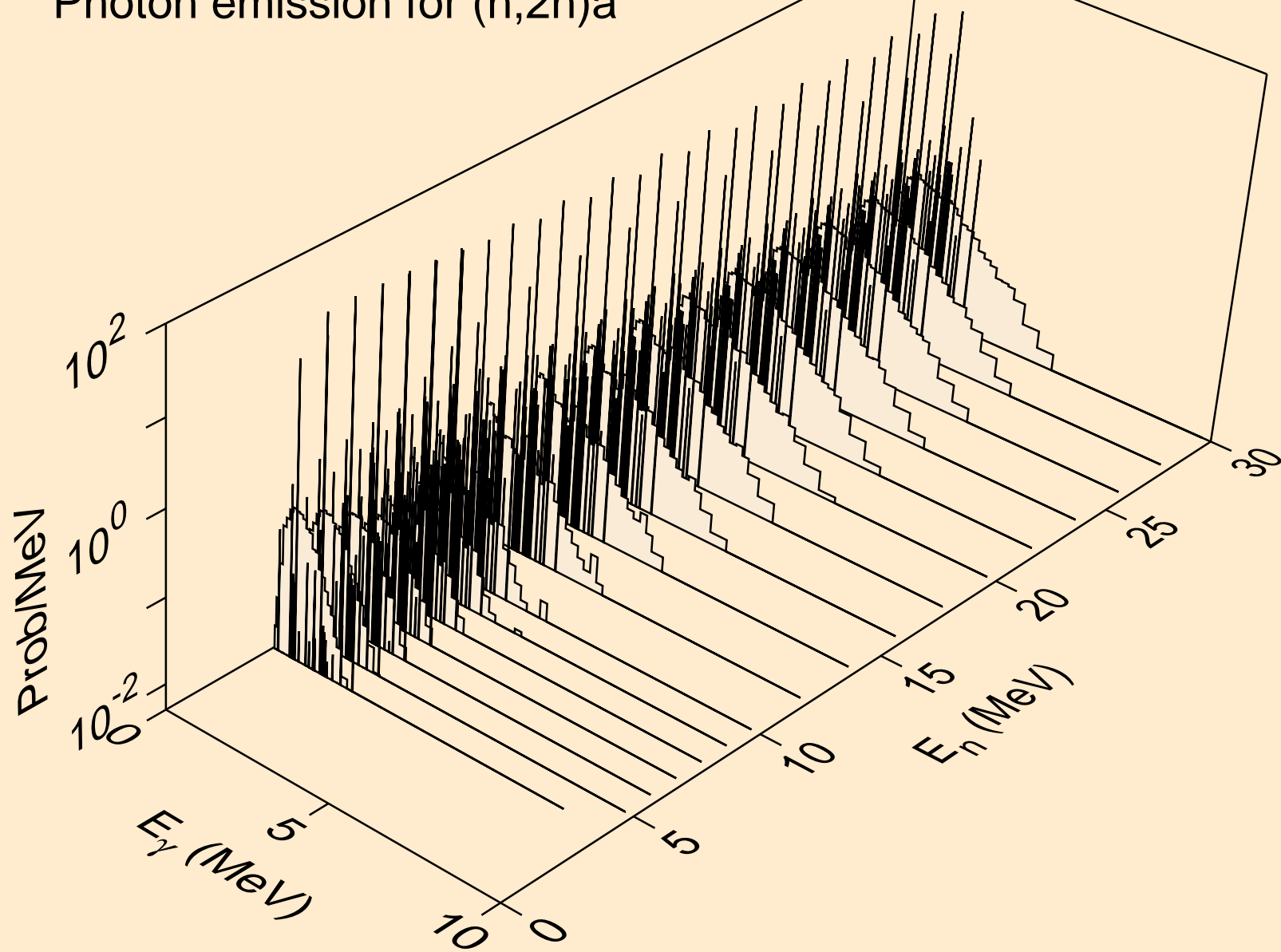

SE087 HELION ACER TENDL-2023 LIBRARY; T=0.K  
Photon emission for (n,3n)a

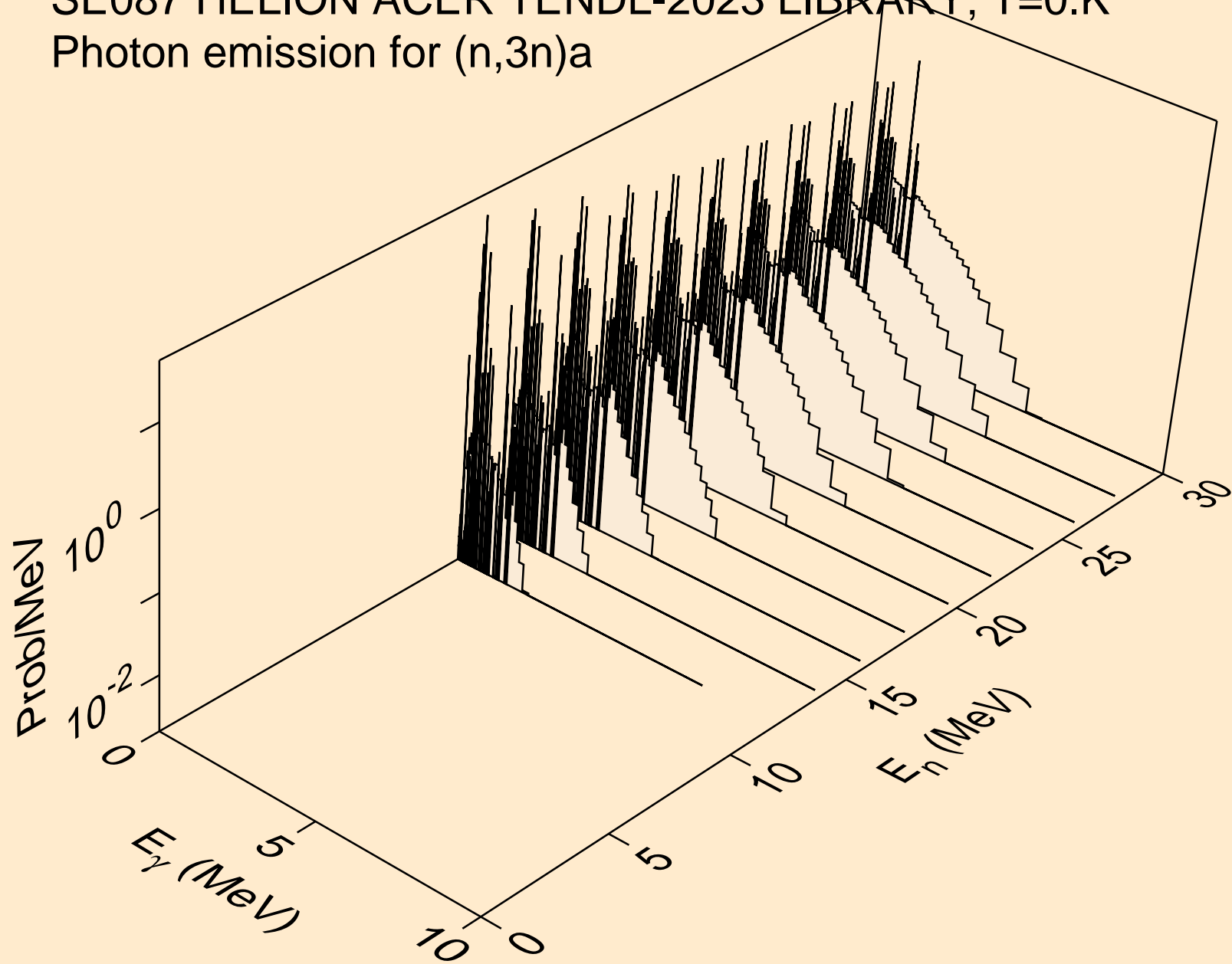

SE087 HELION ACER TENDL-2023 LIBRARY; T=0.K  
Photon emission for (n,n\*)p

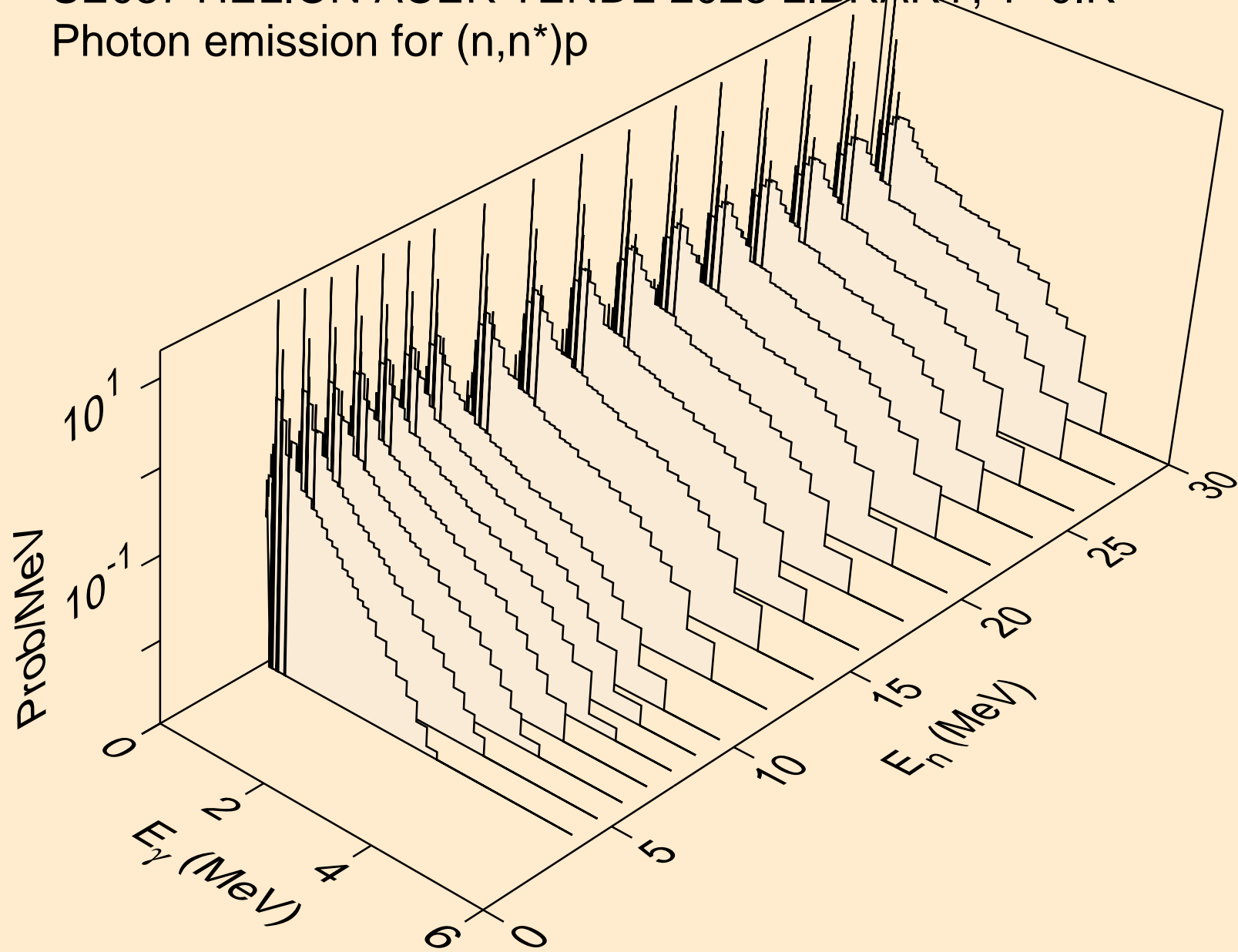

SE087 HELION ACER TENDL-2023 LIBRARY; T=0.K  
Photon emission for (n,n\*)2a

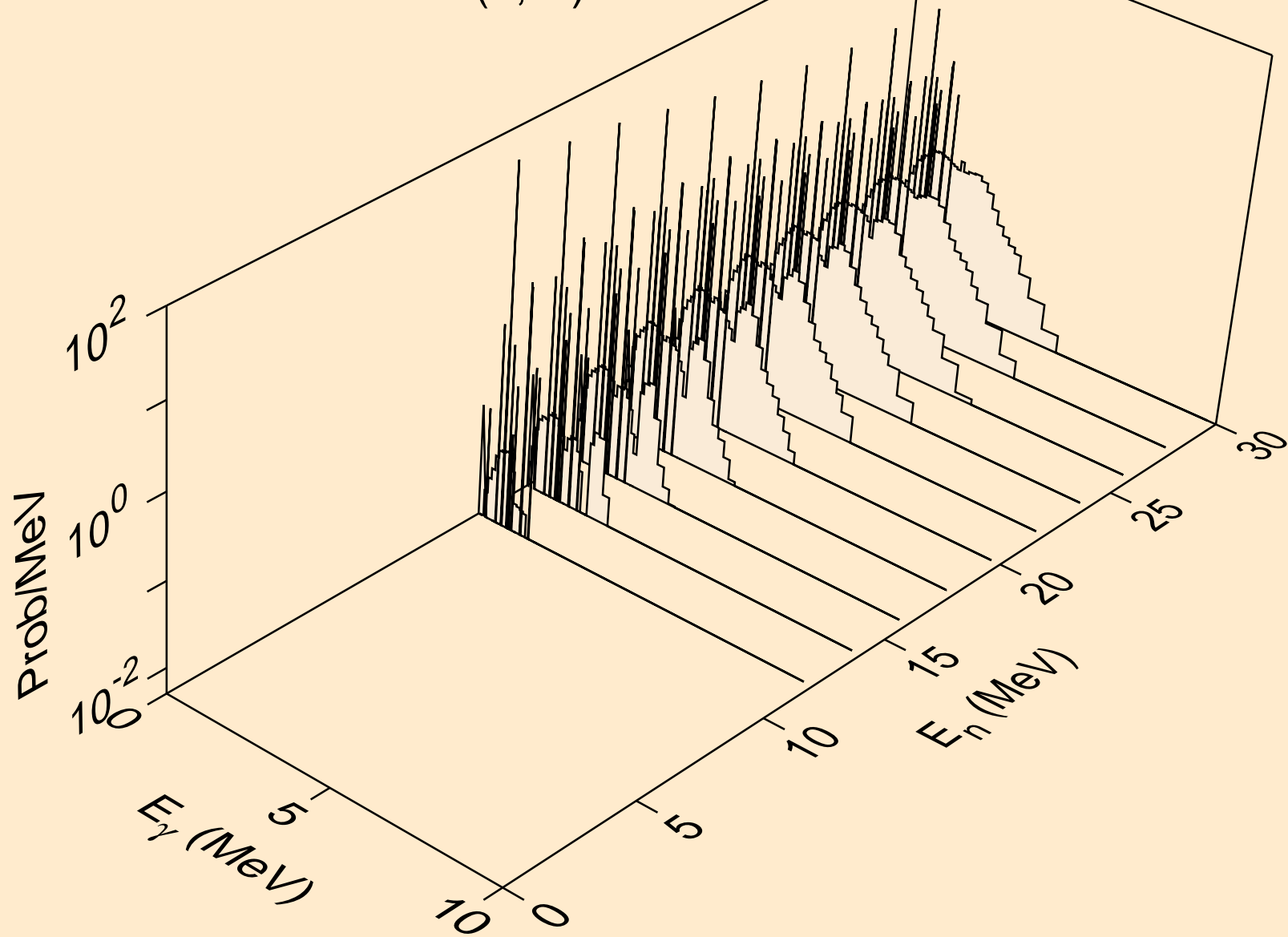

SE087 HELION ACER TENDL-2023 LIBRARY; T=0.K  
Photon emission for (n,2n)2a

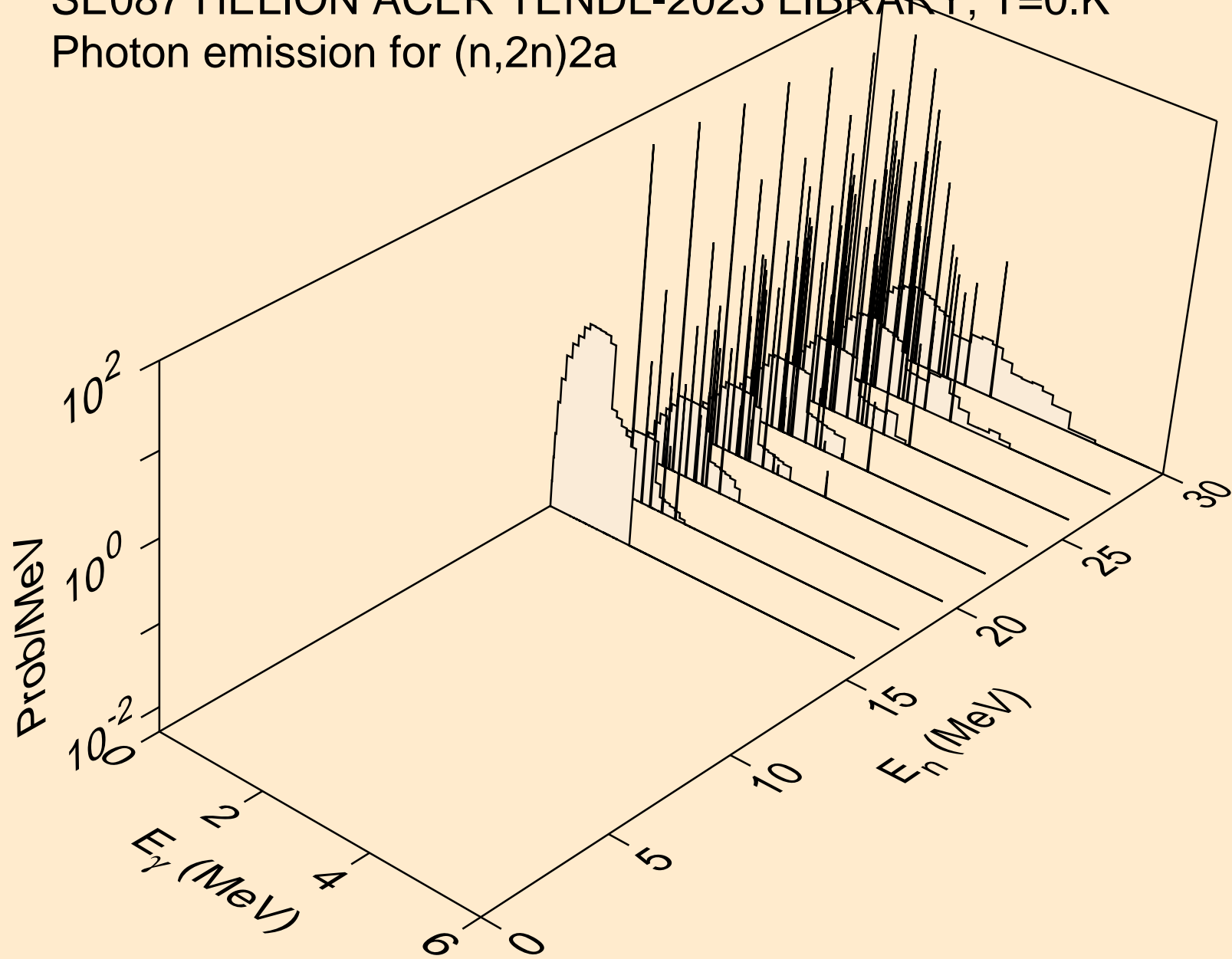

SE087 HELION ACER TENDL-2023 LIBRARY; T=0.K  
Photon emission for (n,n\*)d

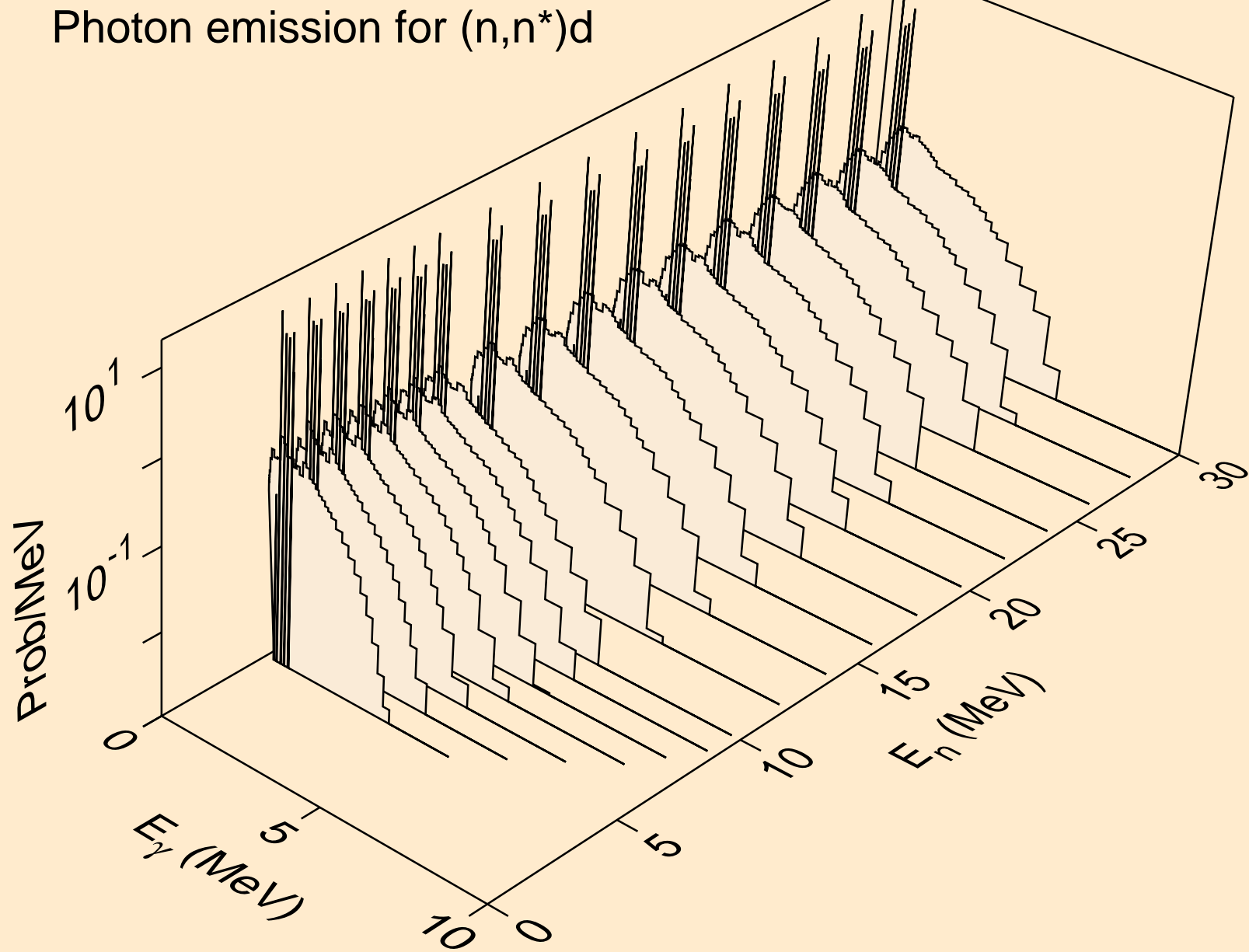

SE087 HELION ACER TENDL-2023 LIBRARY; T=0.K  
Photon emission for (n,n\*)t

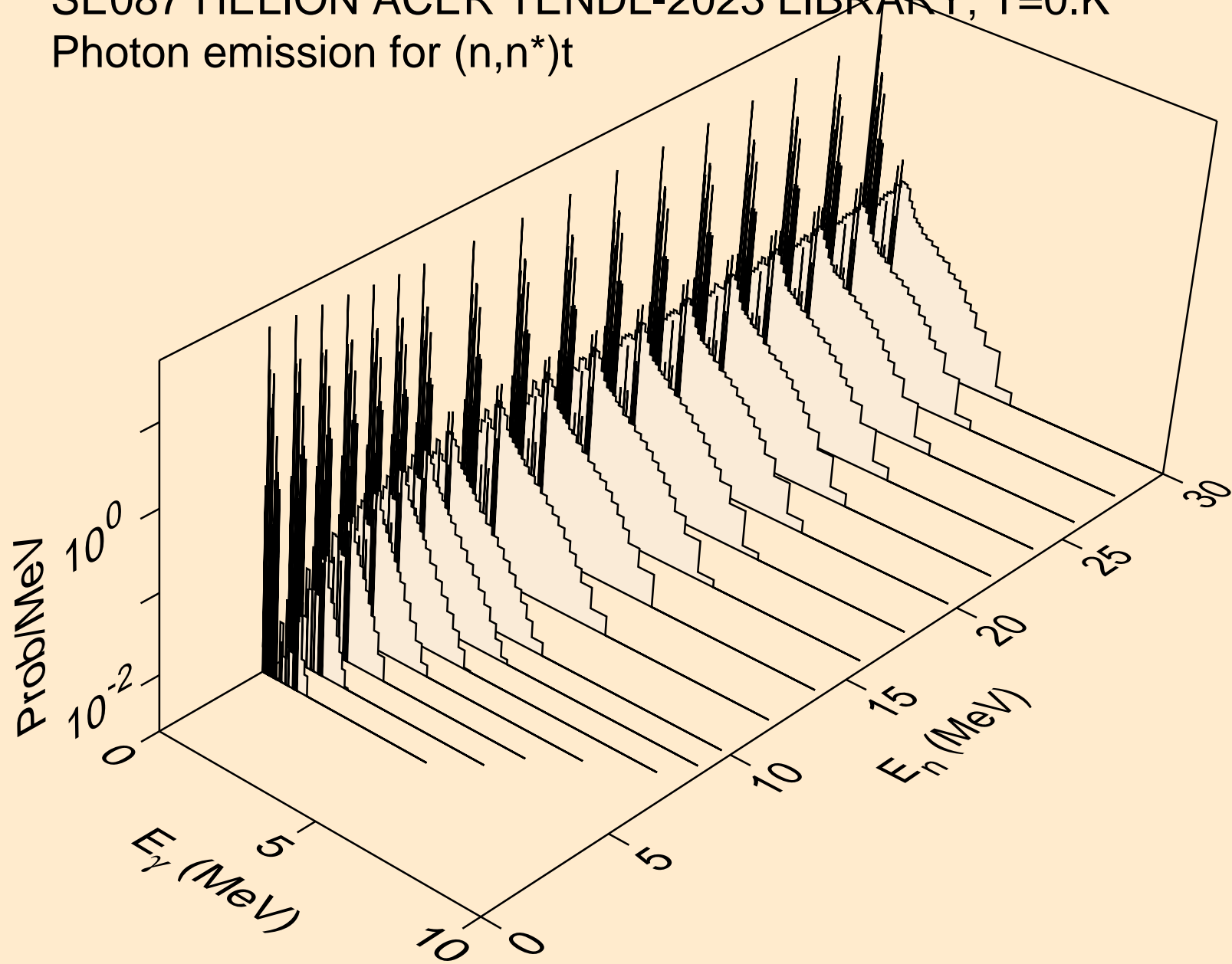

SE087 HELION ACER TENDL-2023 LIBRARY; T=0.K  
Photon emission for (n,n\*)he3

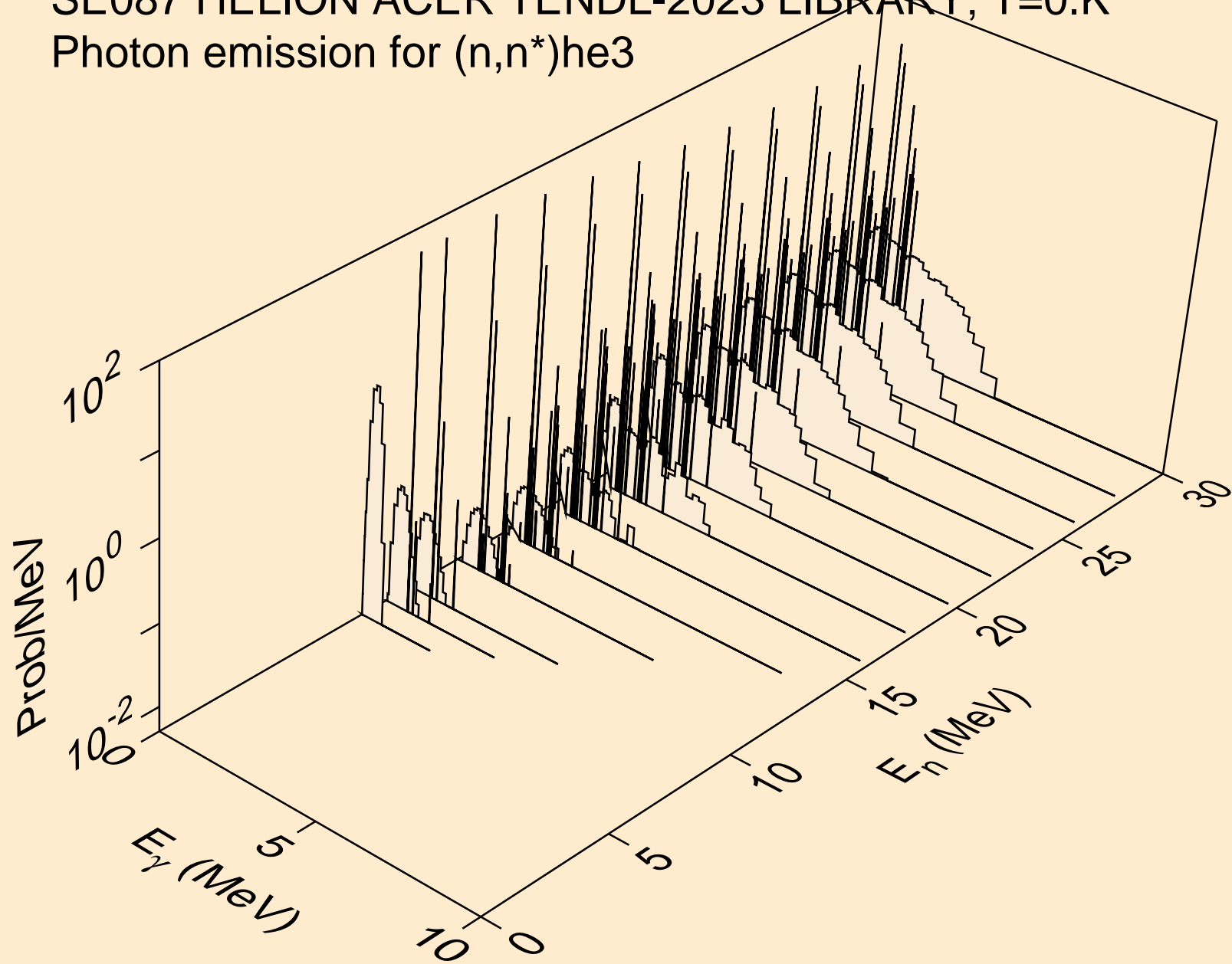

SE087 HELION ACER TENDL-2023 LIBRARY; T=0.K  
Photon emission for (n,4n)

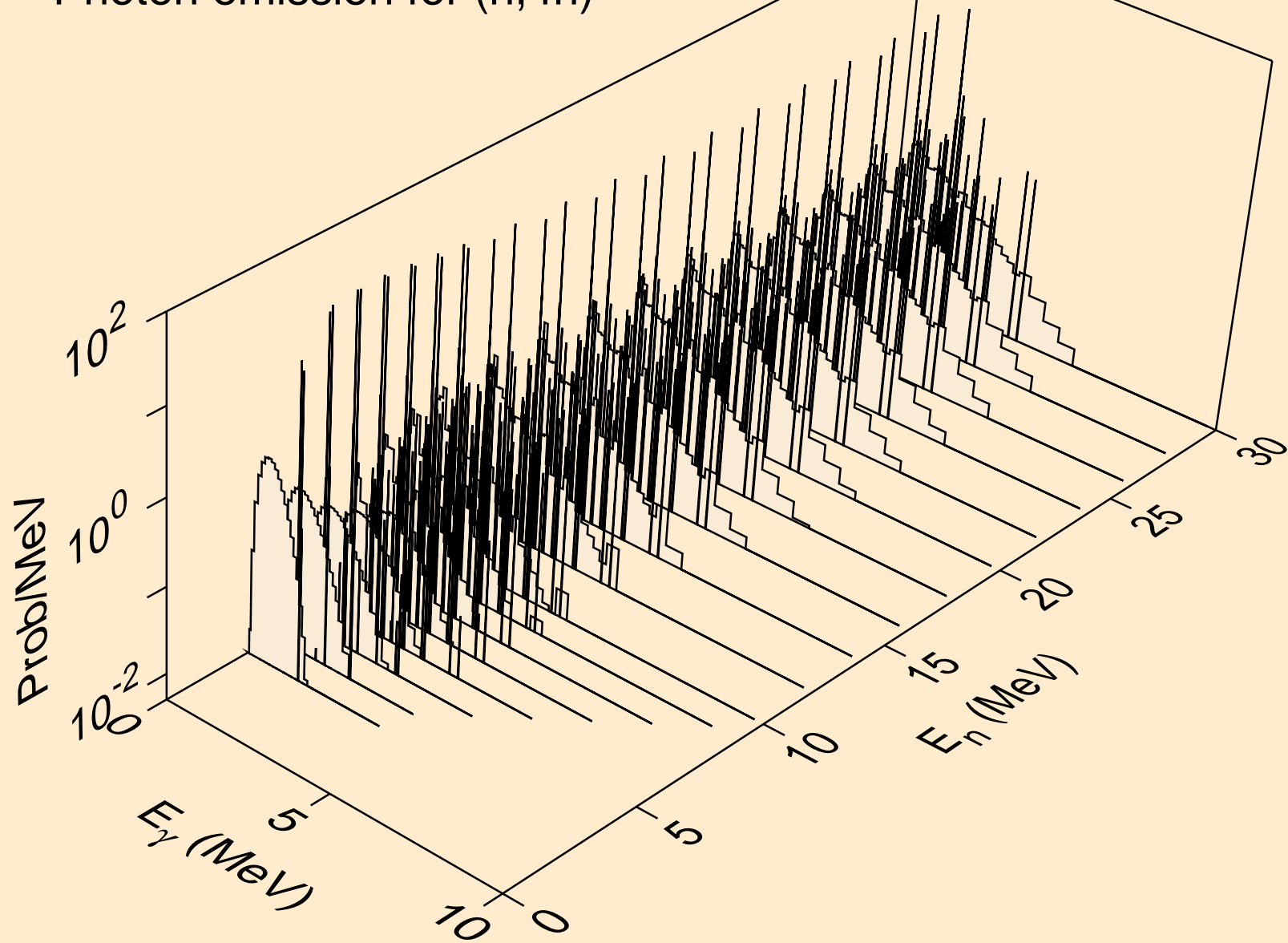

SE087 HELION ACER TENDL-2023 LIBRARY; T=0.K  
Photon emission for (n,2np)

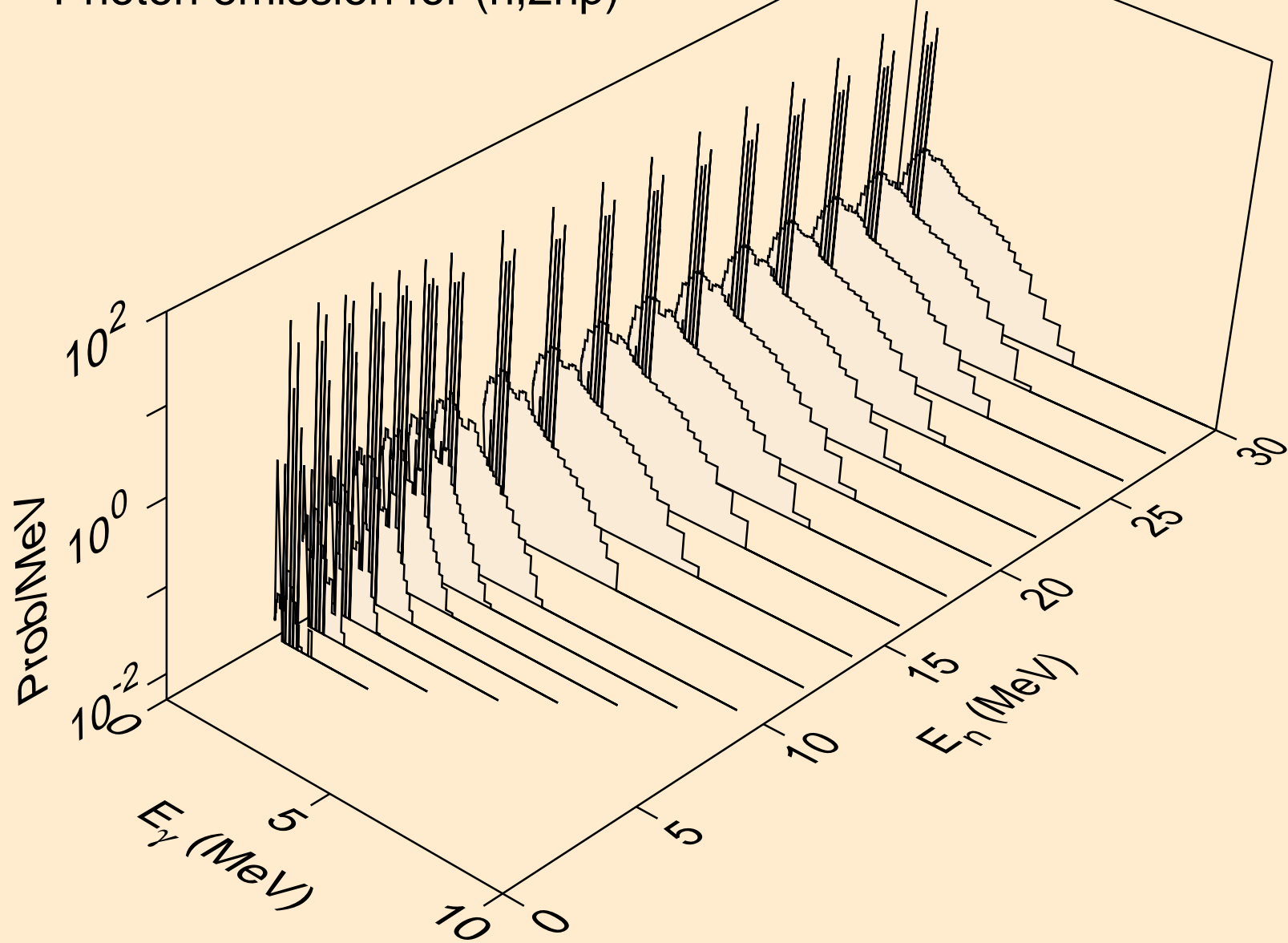

SE087 HELION ACER TENDL-2023 LIBRARY; T=0.K  
Photon emission for (n,3np)

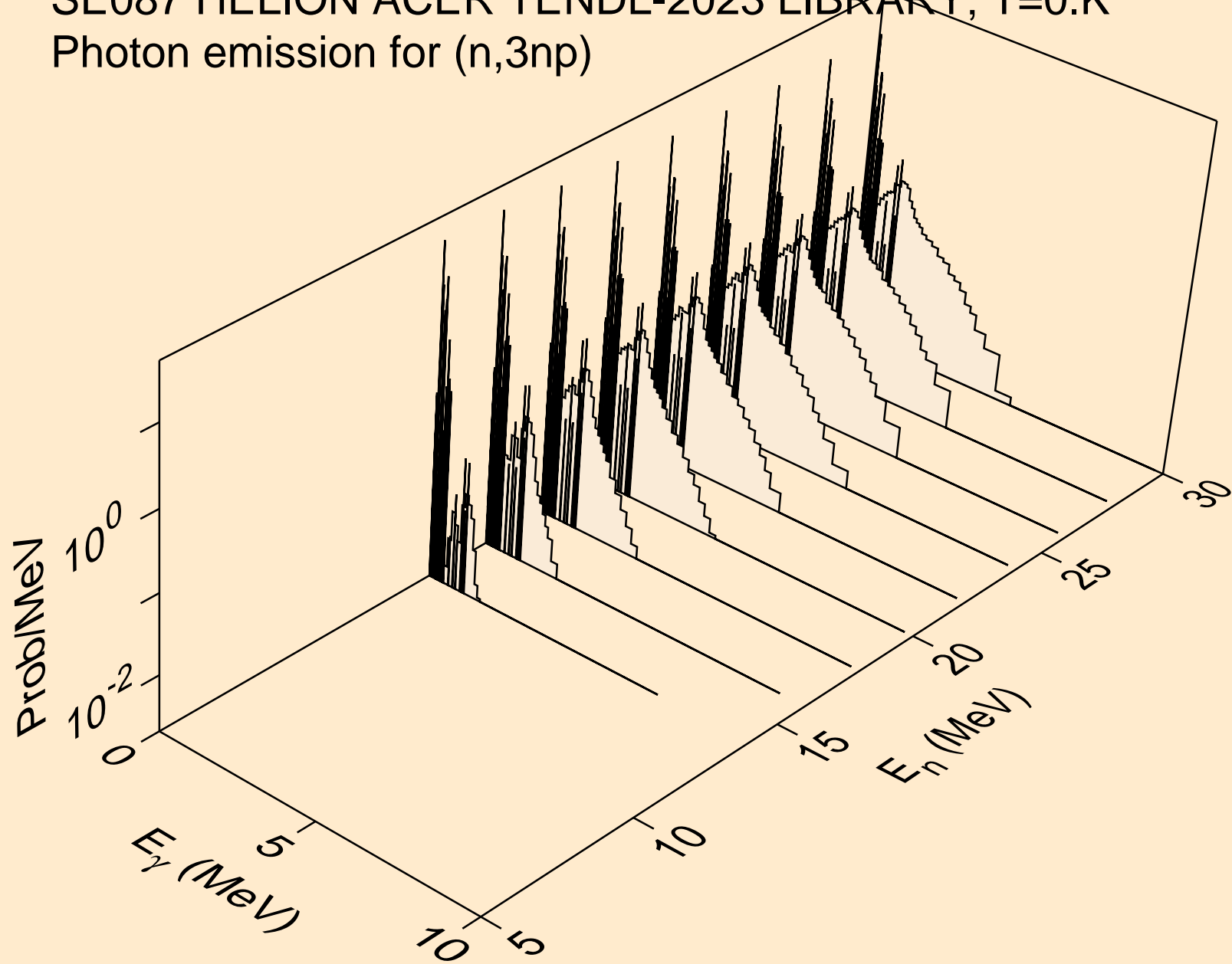

SE087 HELION ACER TENDL-2023 LIBRARY; T=0.K  
Photon emission for (n,n2p)

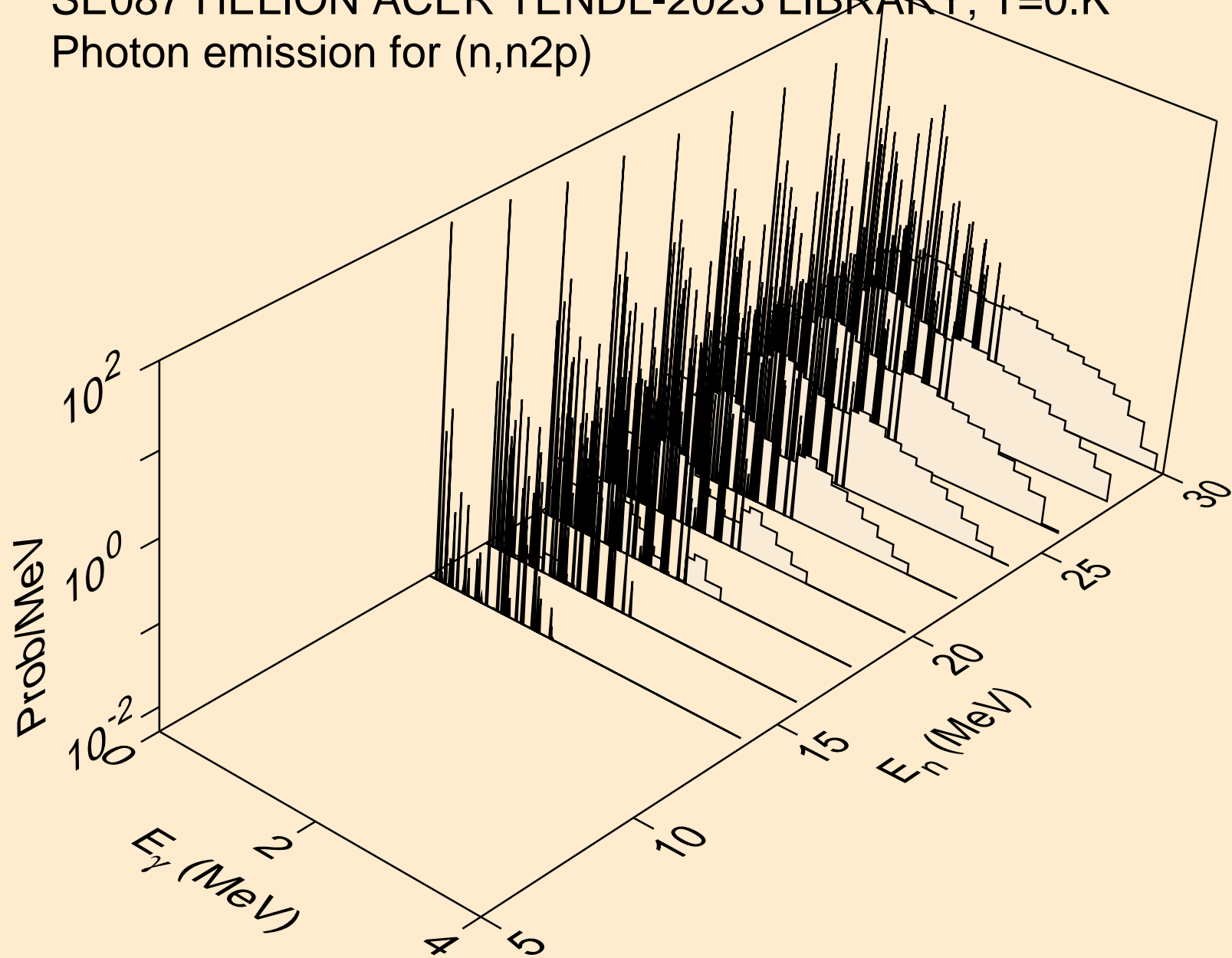

SE087 HELION ACER TENDL-2023 LIBRARY; T=0.K  
Photon emission for (n,npa)

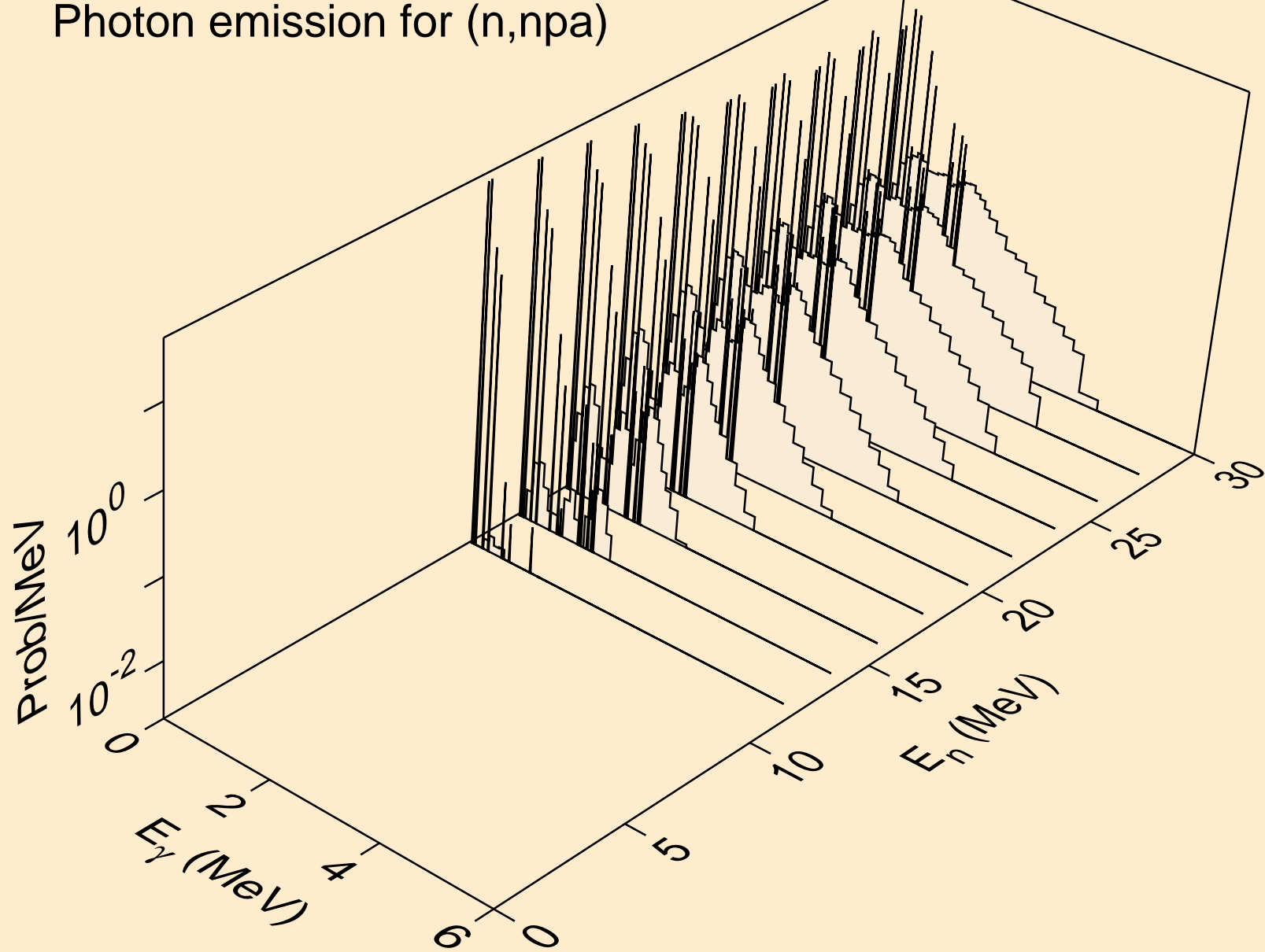

SE087 HELION ACER TENDL-2023 LIBRARY; T=0.K  
Photon emission for (n,p)

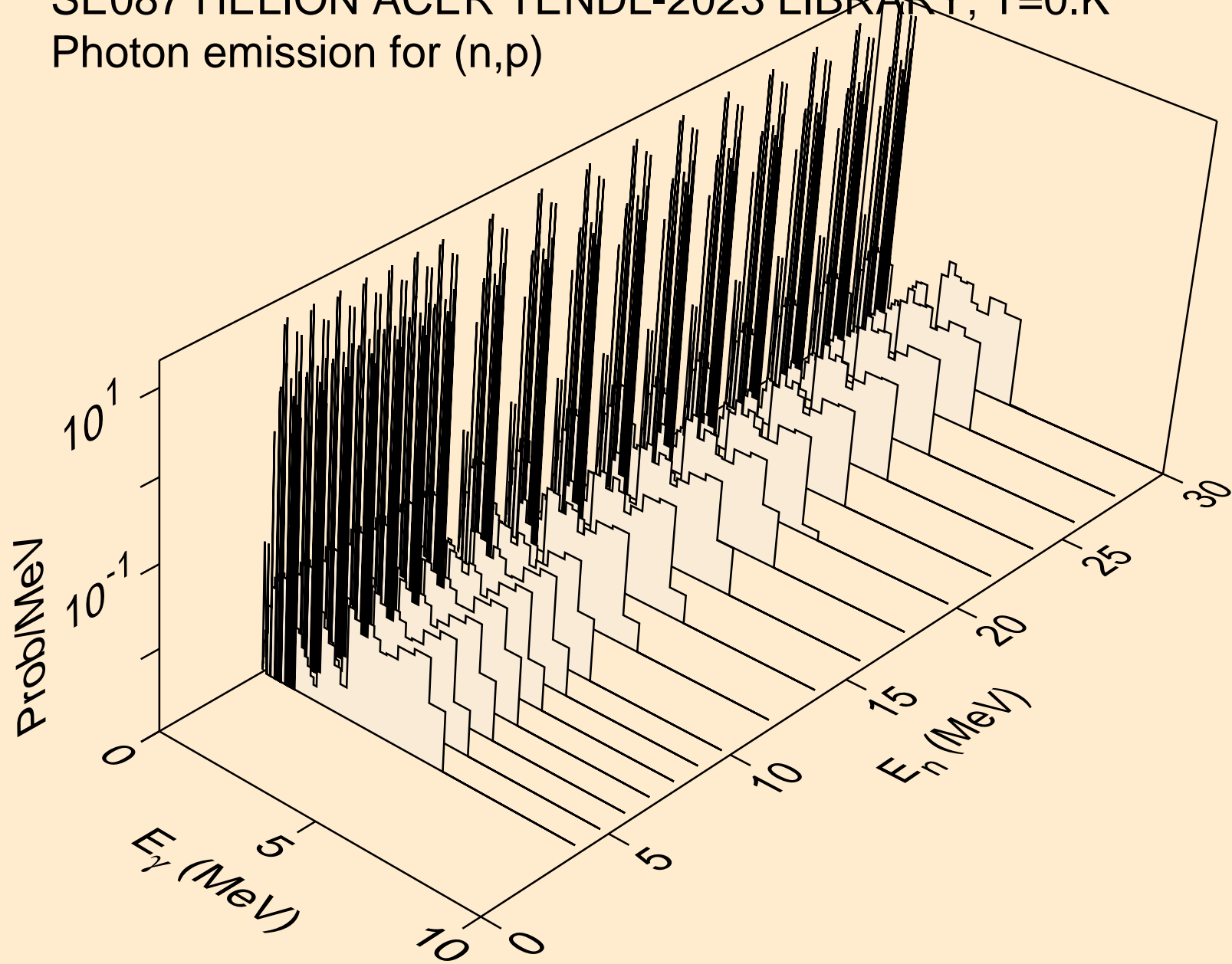

SE087 HELION ACER TENDL-2023 LIBRARY; T=0.K  
Photon emission for (n,d)

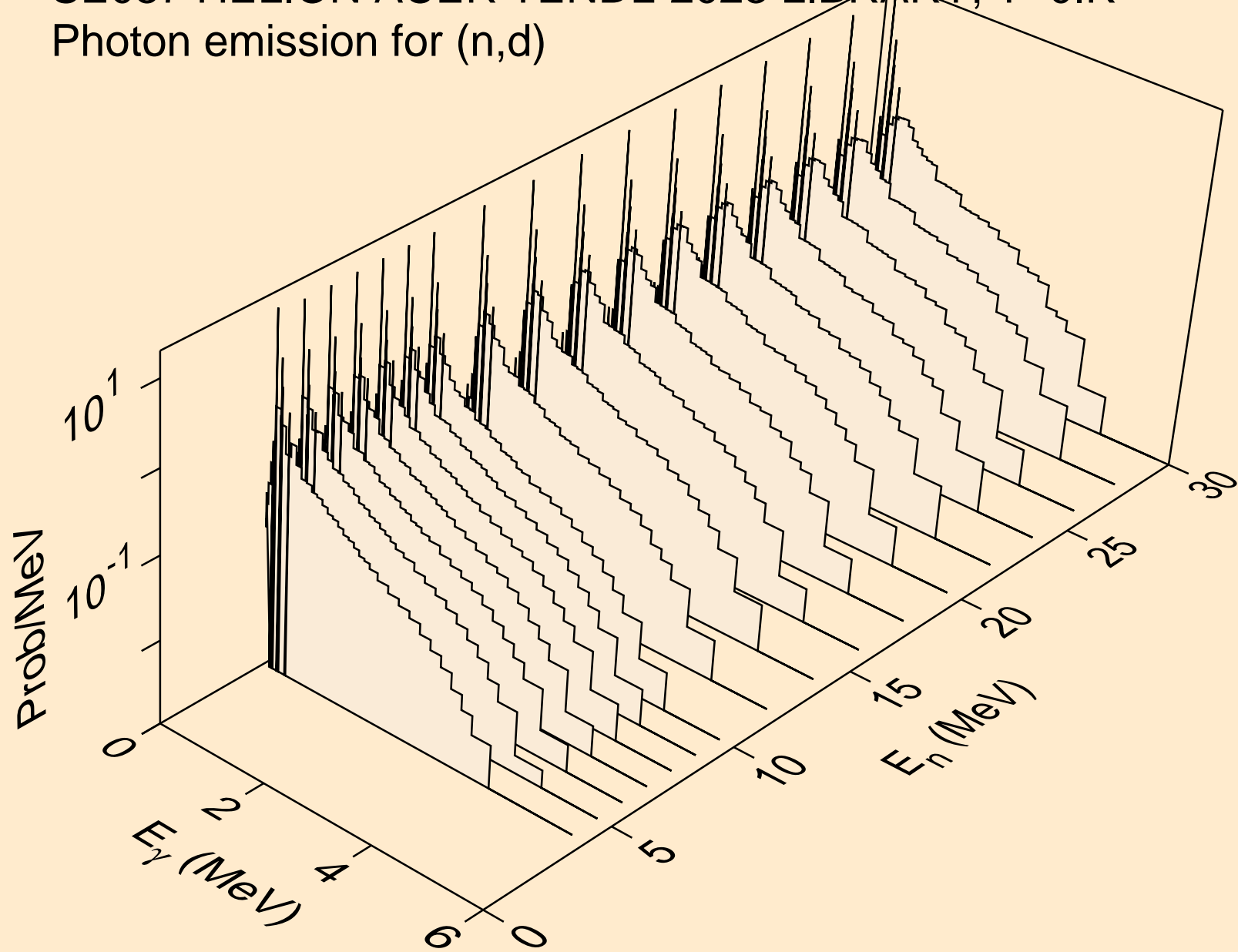

SE087 HELION ACER TENDL-2023 LIBRARY; T=0.K  
Photon emission for (n,t)

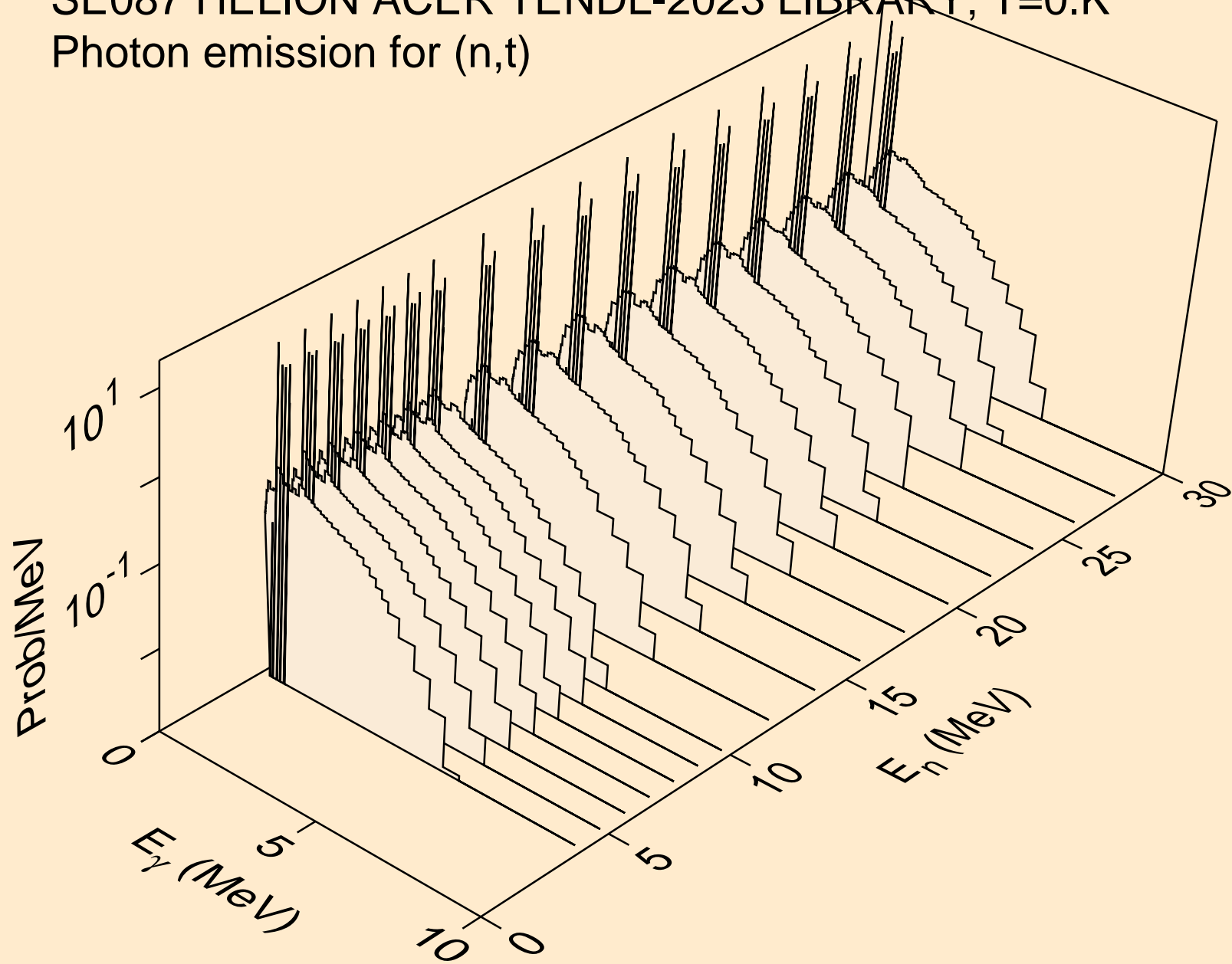

SE087 HELION ACER TENDL-2023 LIBRARY; T=0.K  
Photon emission for inelastic

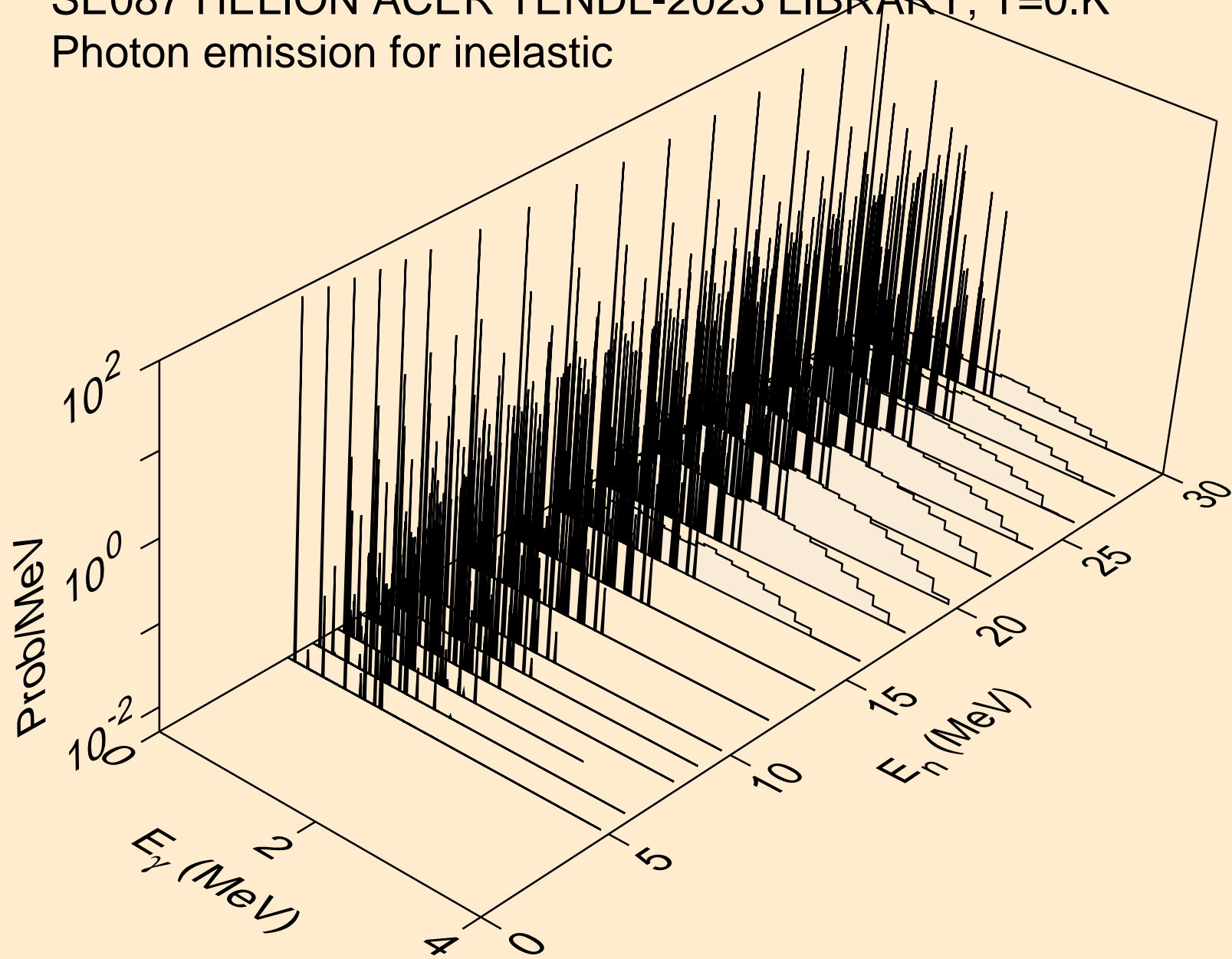

SE087 HELION ACER TENDL-2023 LIBRARY; T=0.K  
Photon emission for (n,a)

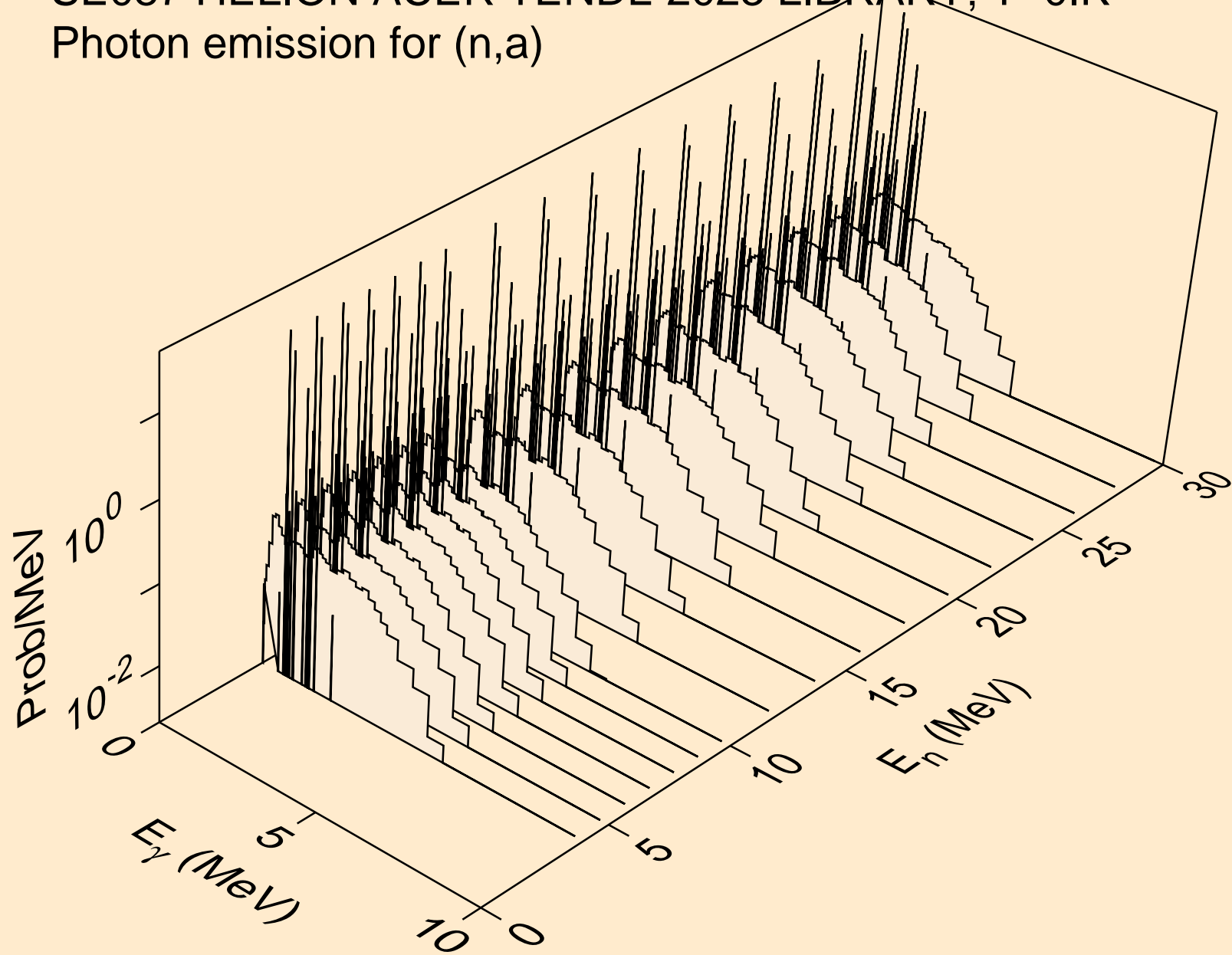

SE087 HELION ACER TENDL-2023 LIBRARY; T=0.K  
Photon emission for (n,2a)

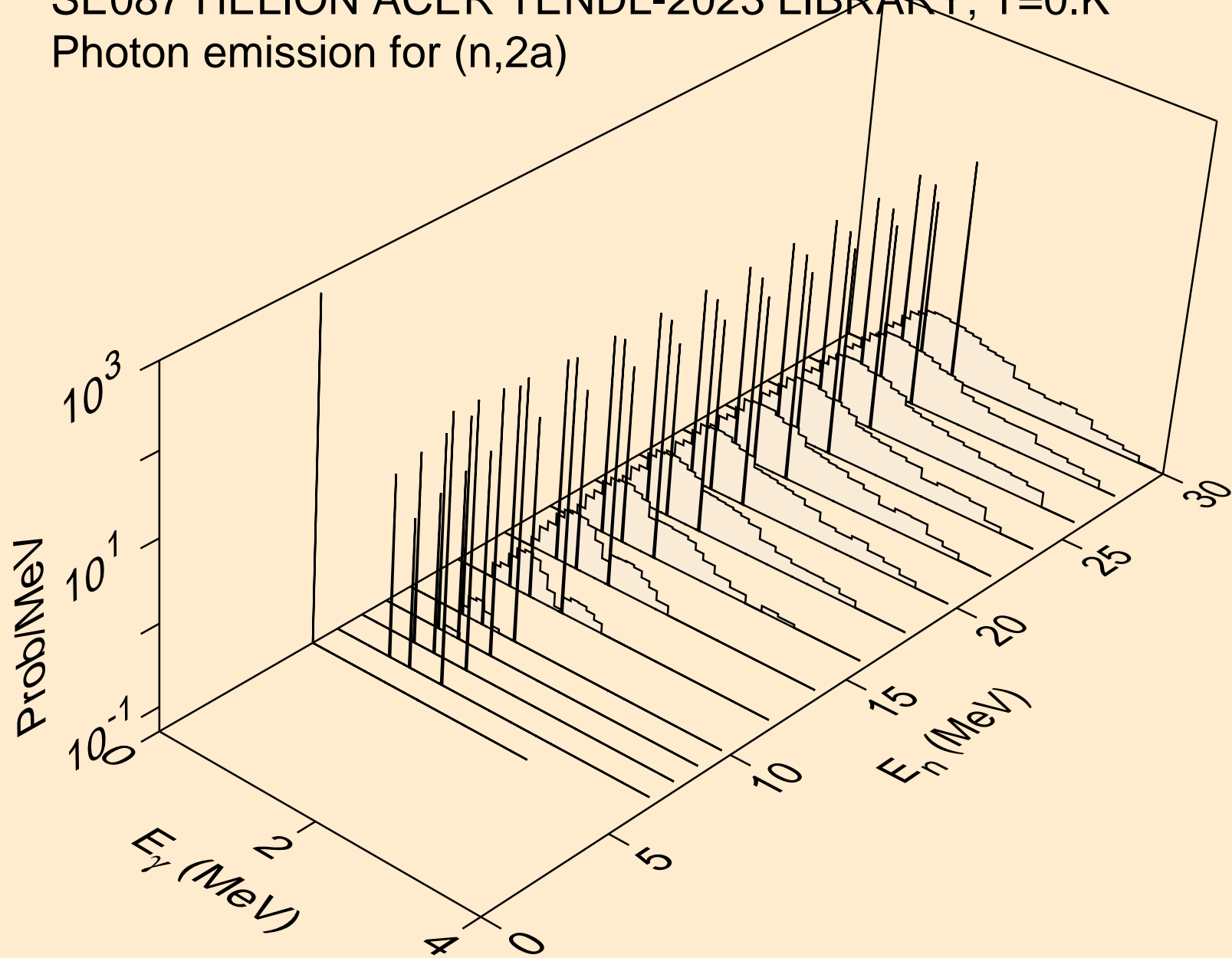

SE087 HELION ACER TENDL-2023 LIBRARY; T=0.K  
Photon emission for (n,2p)

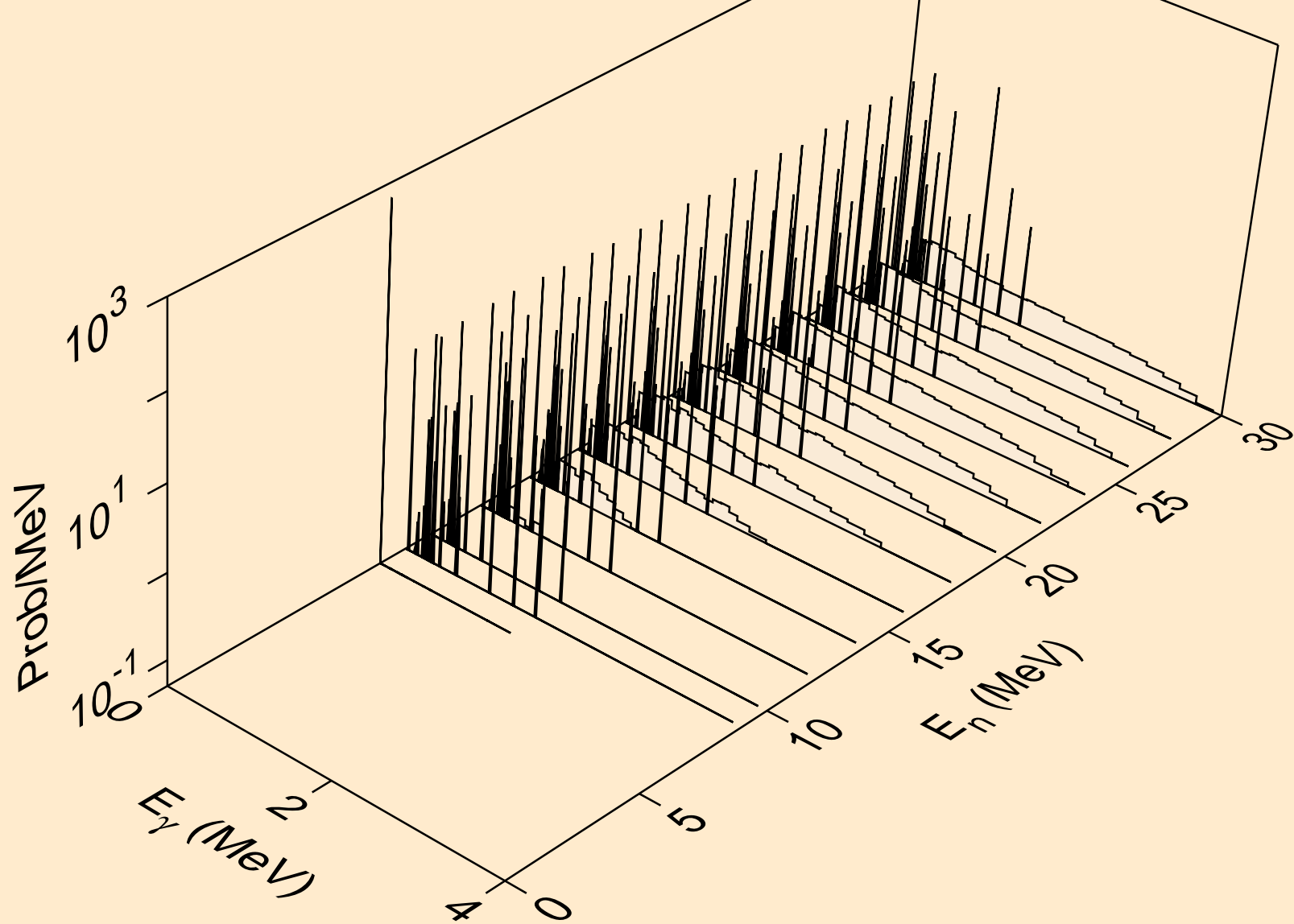

SE087 HELION ACER TENDL-2023 LIBRARY; T=0.K  
Photon emission for (n,pa)

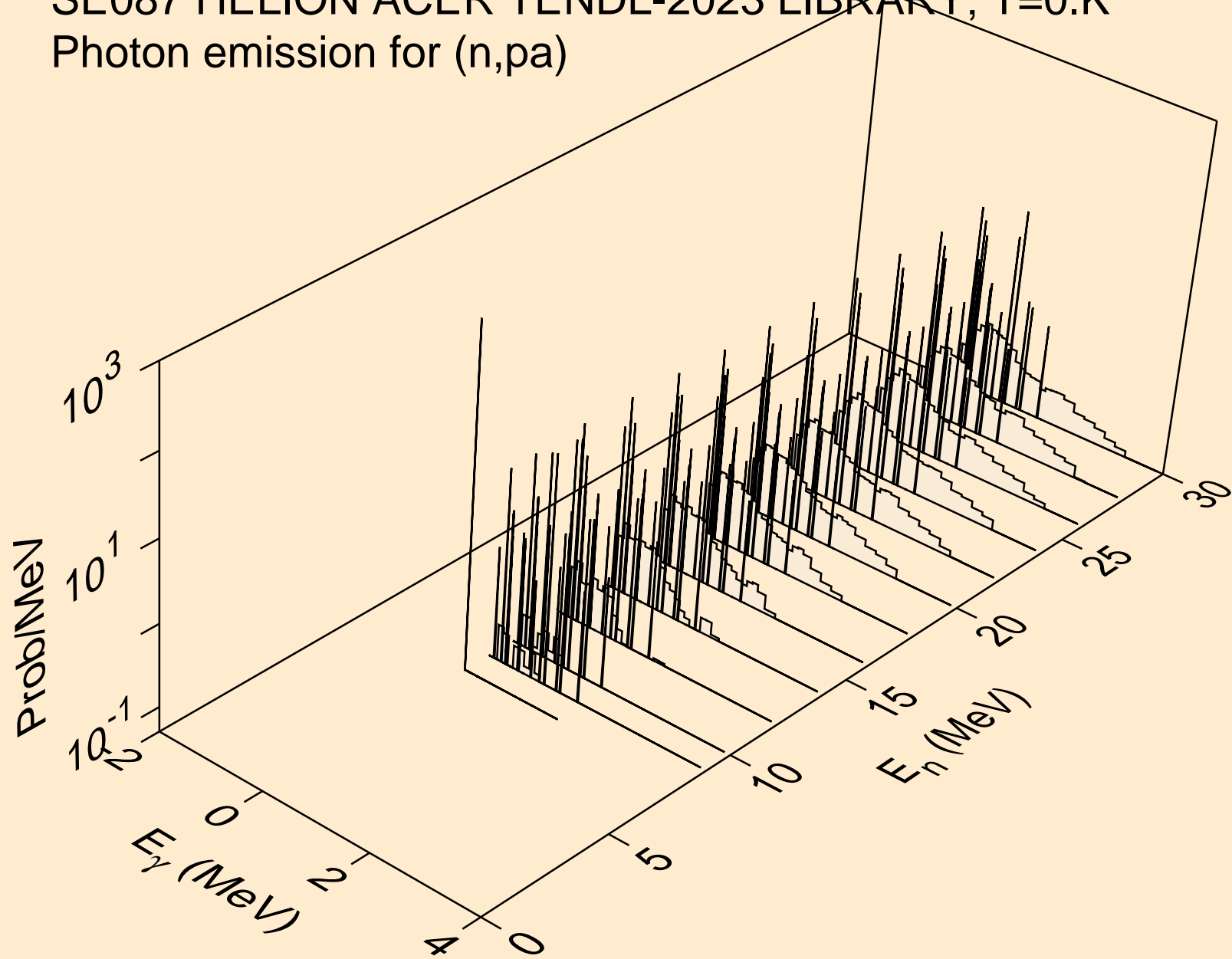

SE087 HELION ACER TENDL-2023 LIBRARY; T=0.K  
Photon emission for (n,pd)

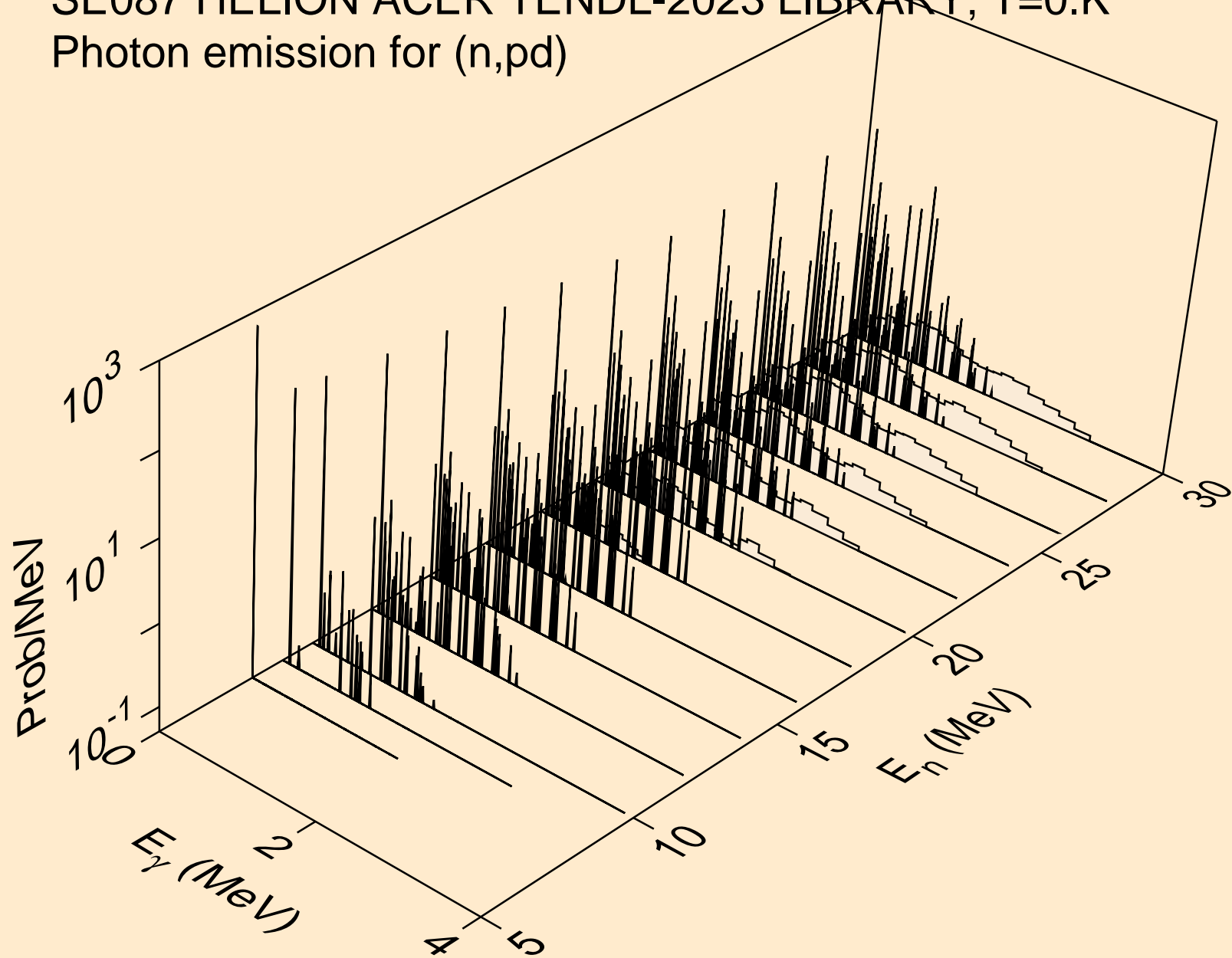

SE087 HELION ACER TENDL-2023 LIBRARY; T=0.K  
Photon emission for (n,pt)

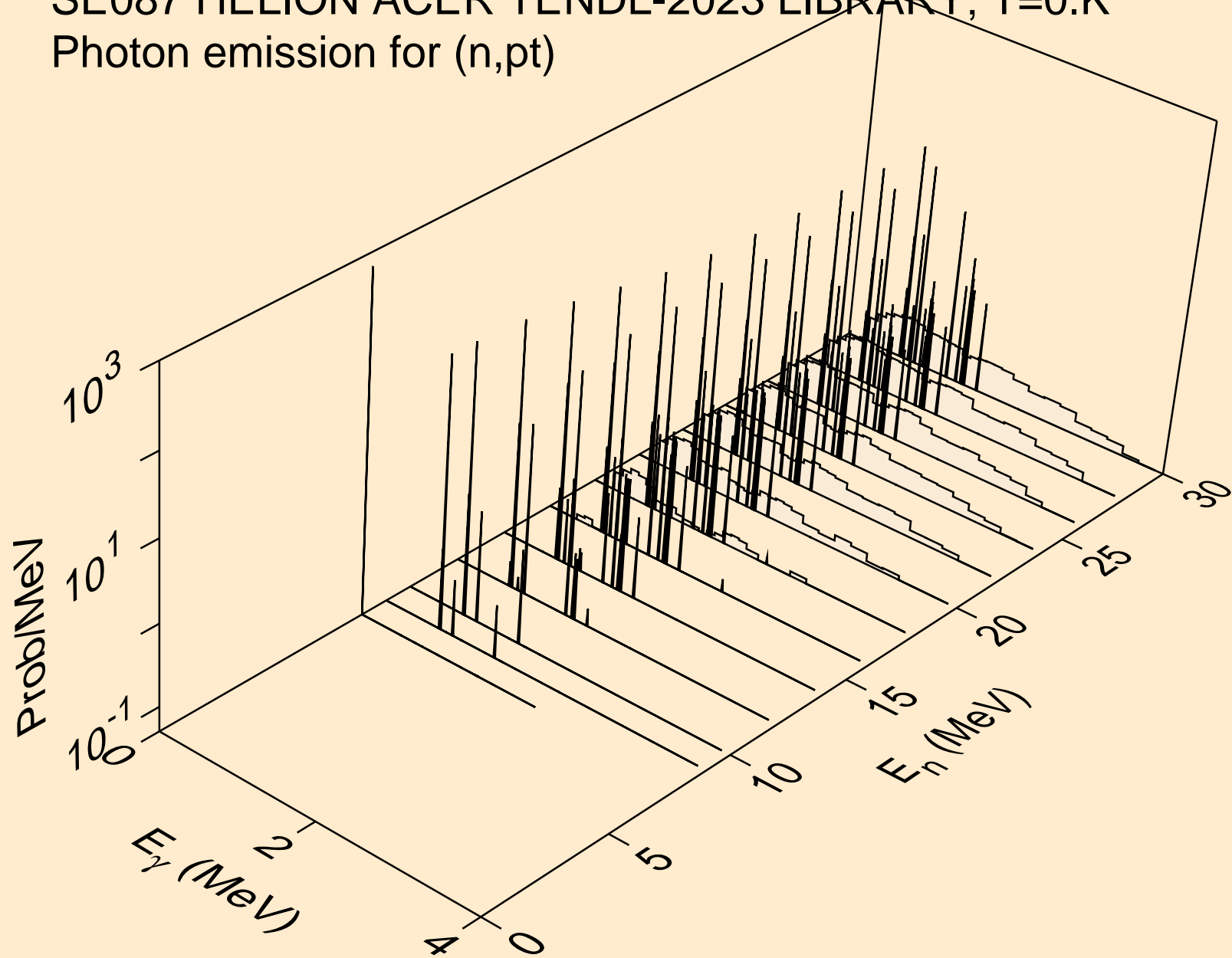

SE087 HELION ACER TENDL-2023 LIBRARY; T=0.K  
Photon emission for (n,da)

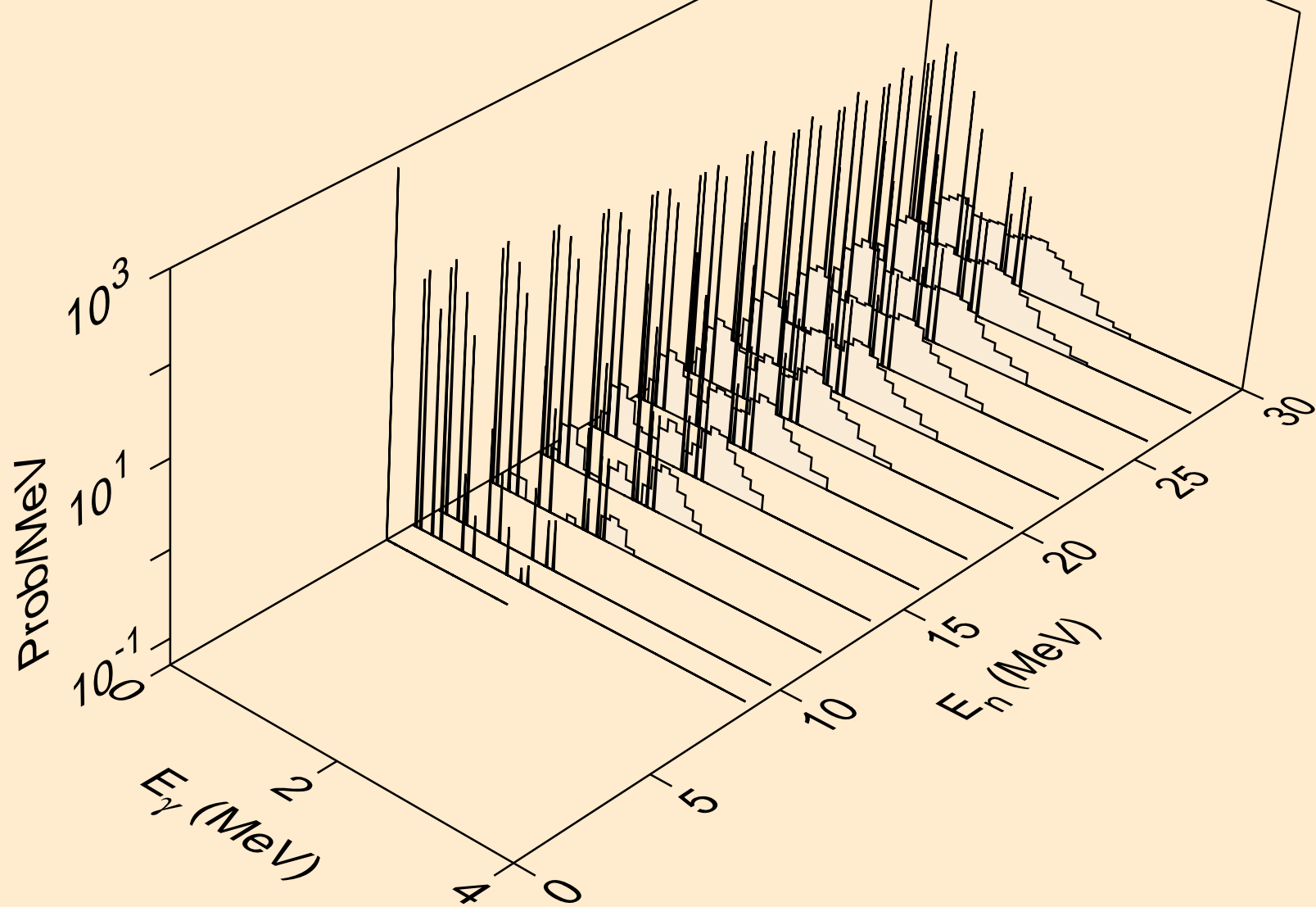

SE087 HELION ACER TENDL-2023 LIBRARY; T=0.K  
Particle heating contributions

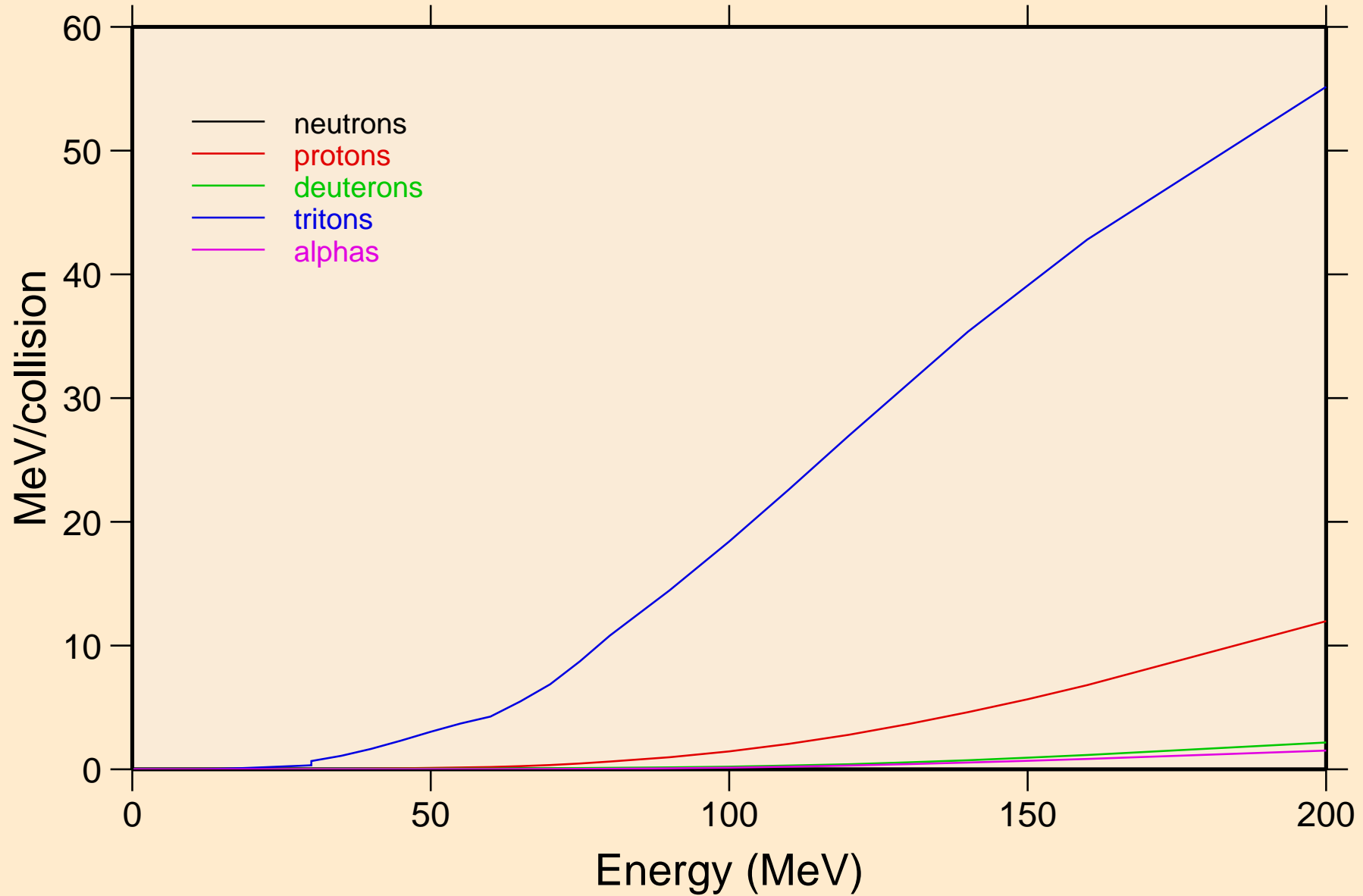

SE087 HELION ACER TENDL-2023 LIBRARY; T=0.K  
Recoil Heating

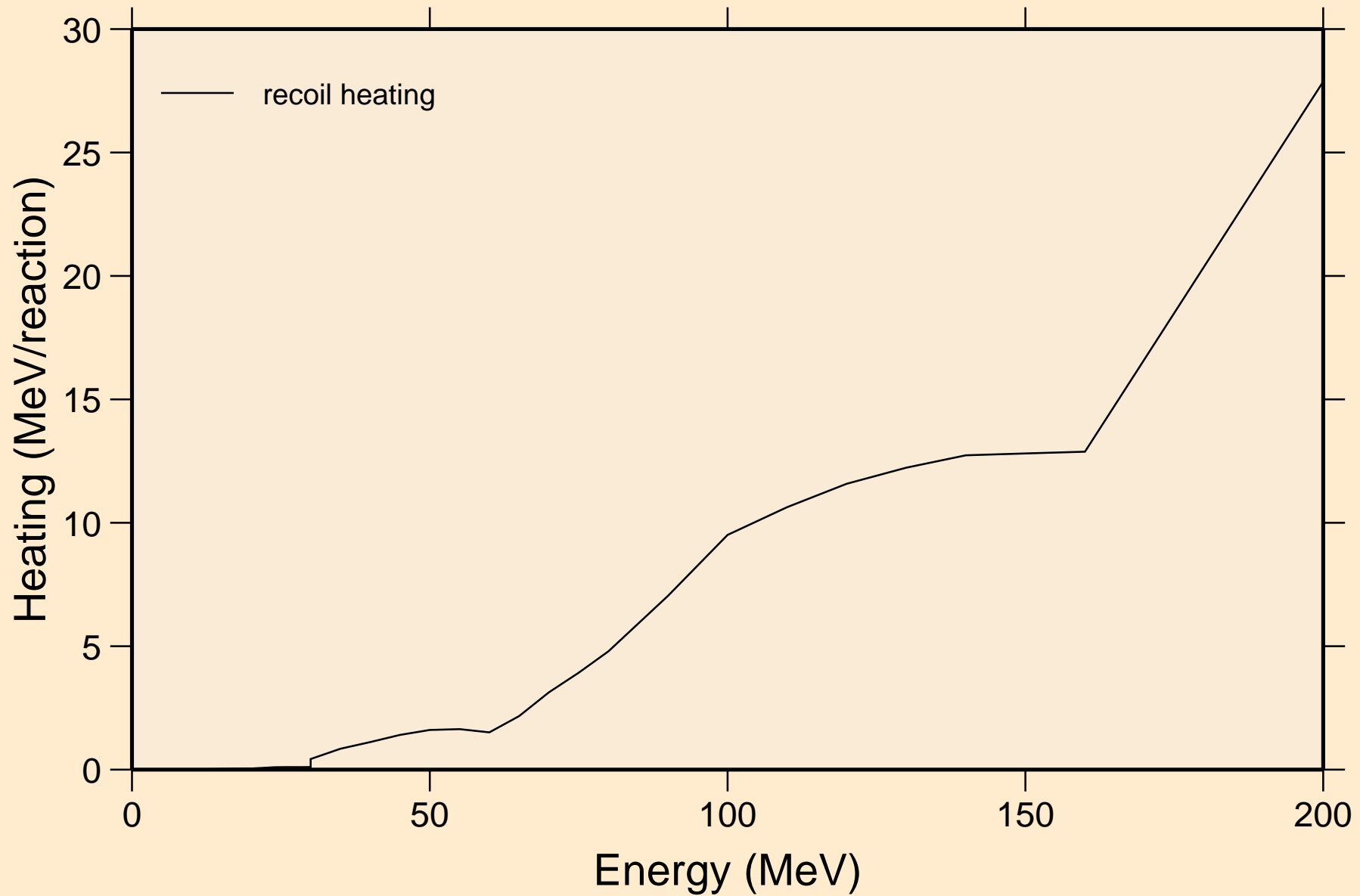

SE087 HELION ACER TENDL-2023 LIBRARY; T=0.K  
Particle production cross sections

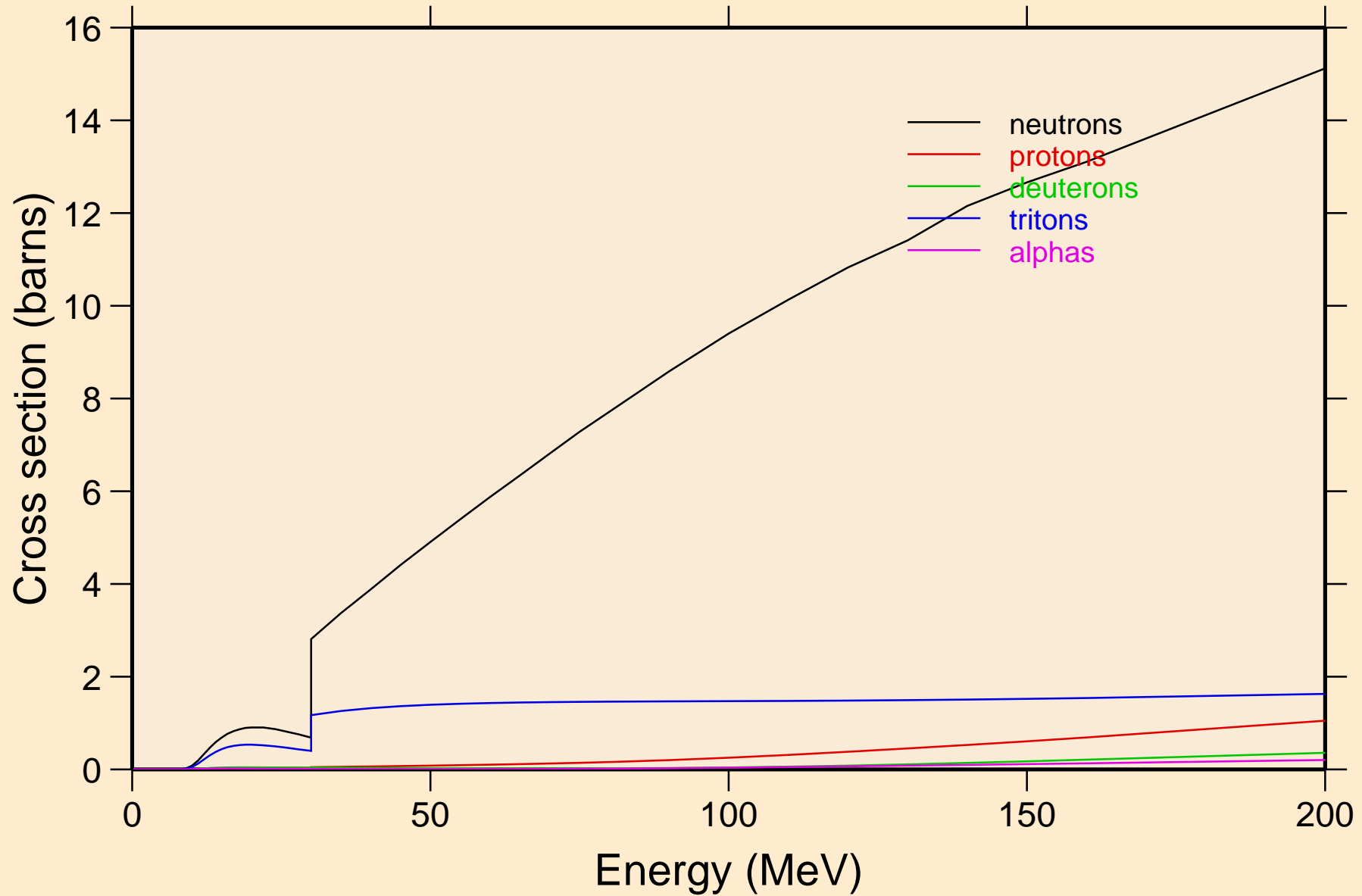

SE087 HELION ACER TENDL-2023 LIBRARY; T=0.K  
neutrons from (s,n)

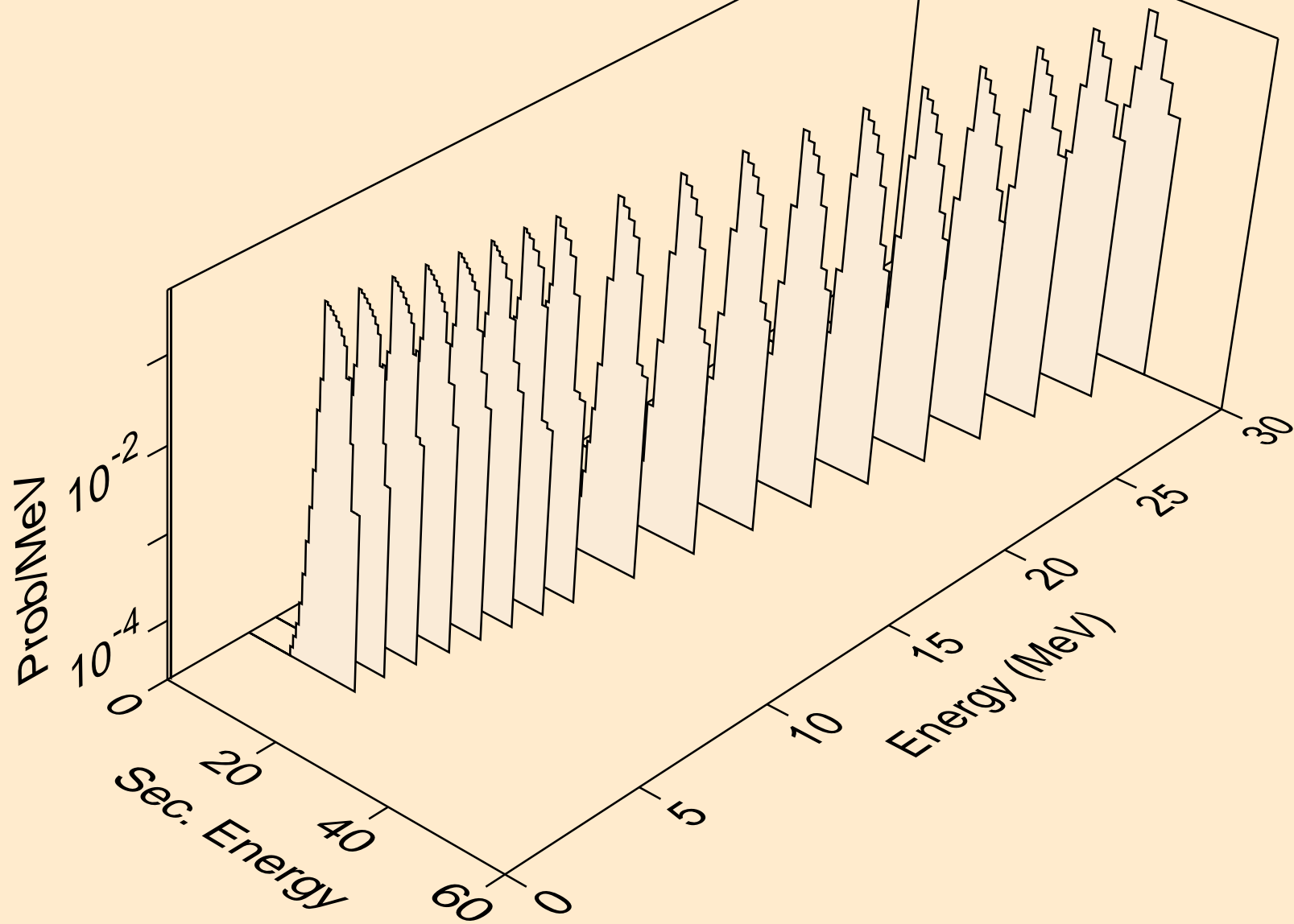

SE087 HELION ACER TENDL-2023 LIBRARY; T=0.K  
neutrons from (s,x)

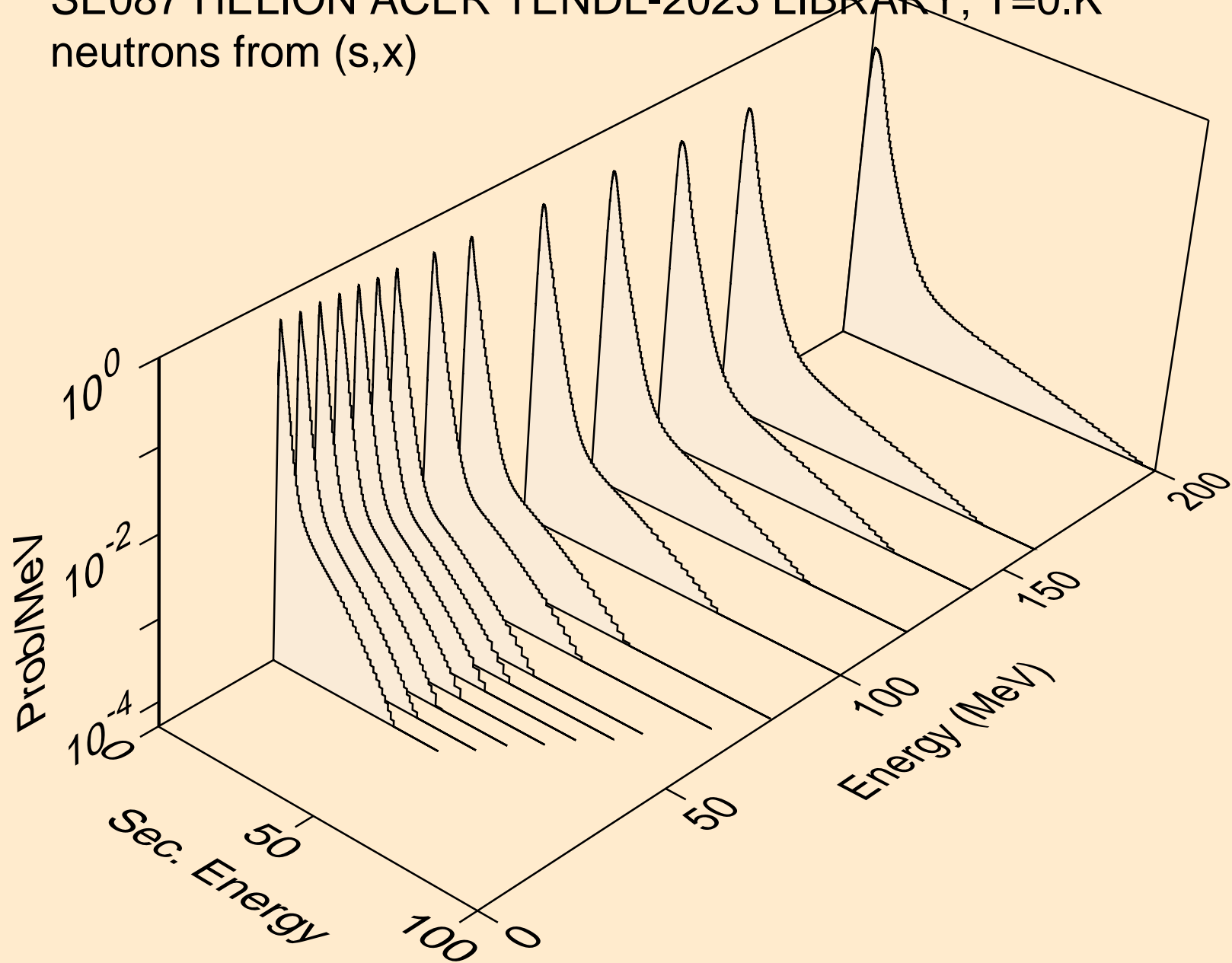

SE087 HELION ACER TENDL-2023 LIBRARY; T=0.K  
neutrons from (s,2nd)

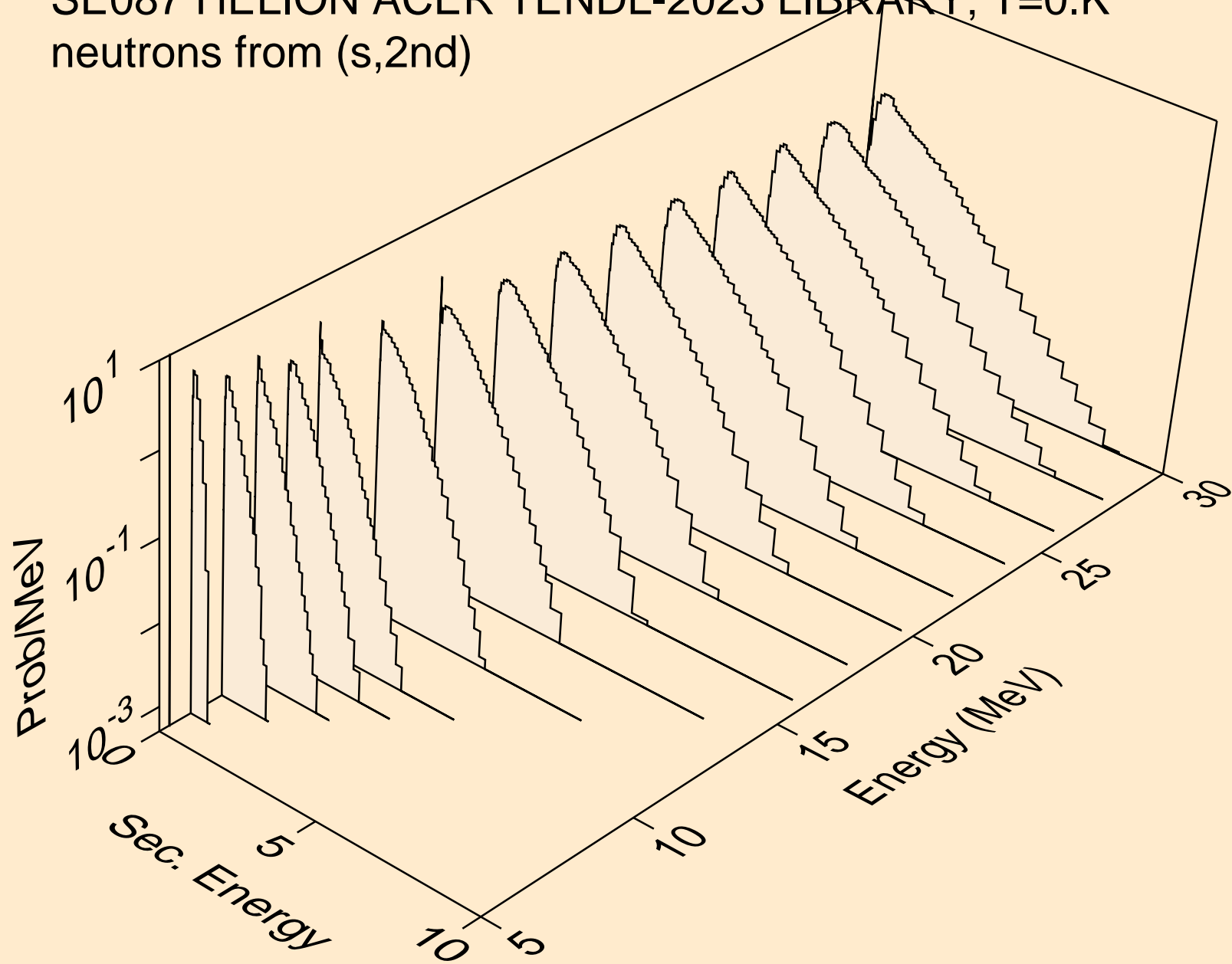

SE087 HELION ACER TENDL-2023 LIBRARY; T=0.K  
neutrons from (s,2n)

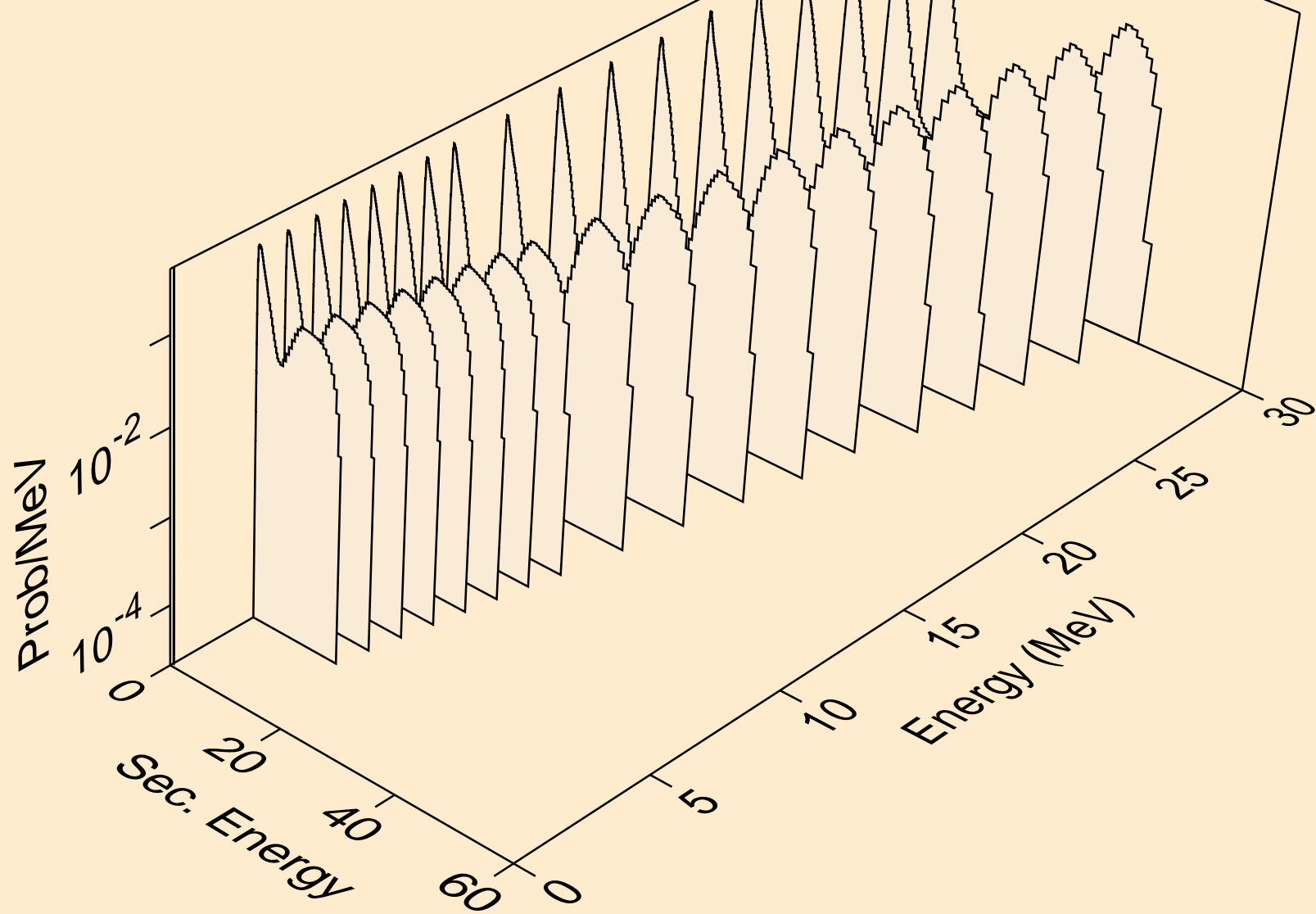

SE087 HELION ACER TENDL-2023 LIBRARY; T=0.K  
neutrons from (s,3n)

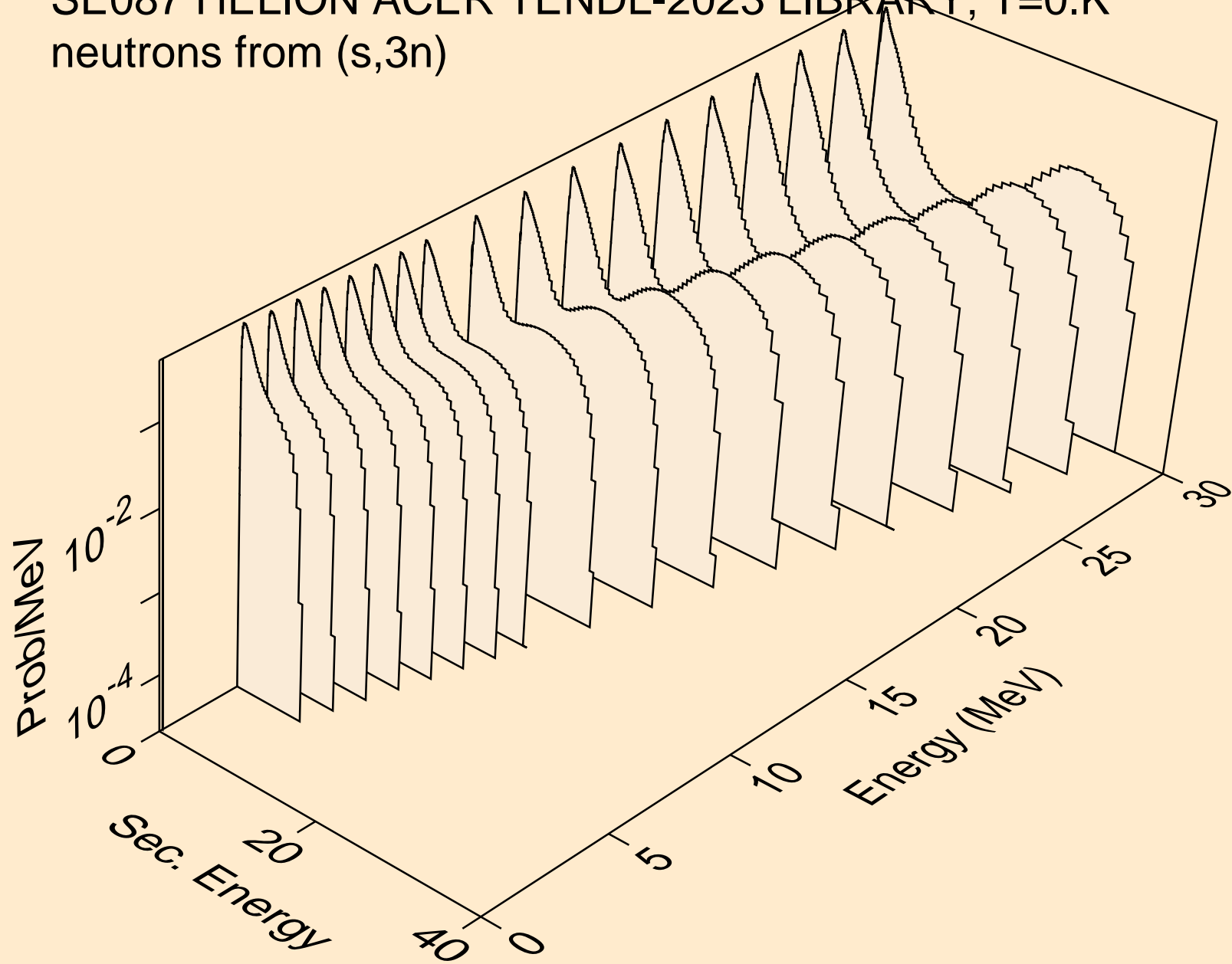

SE087 HELION ACER TENDL-2023 LIBRARY; T=0.K  
neutrons from (s,n\*)a

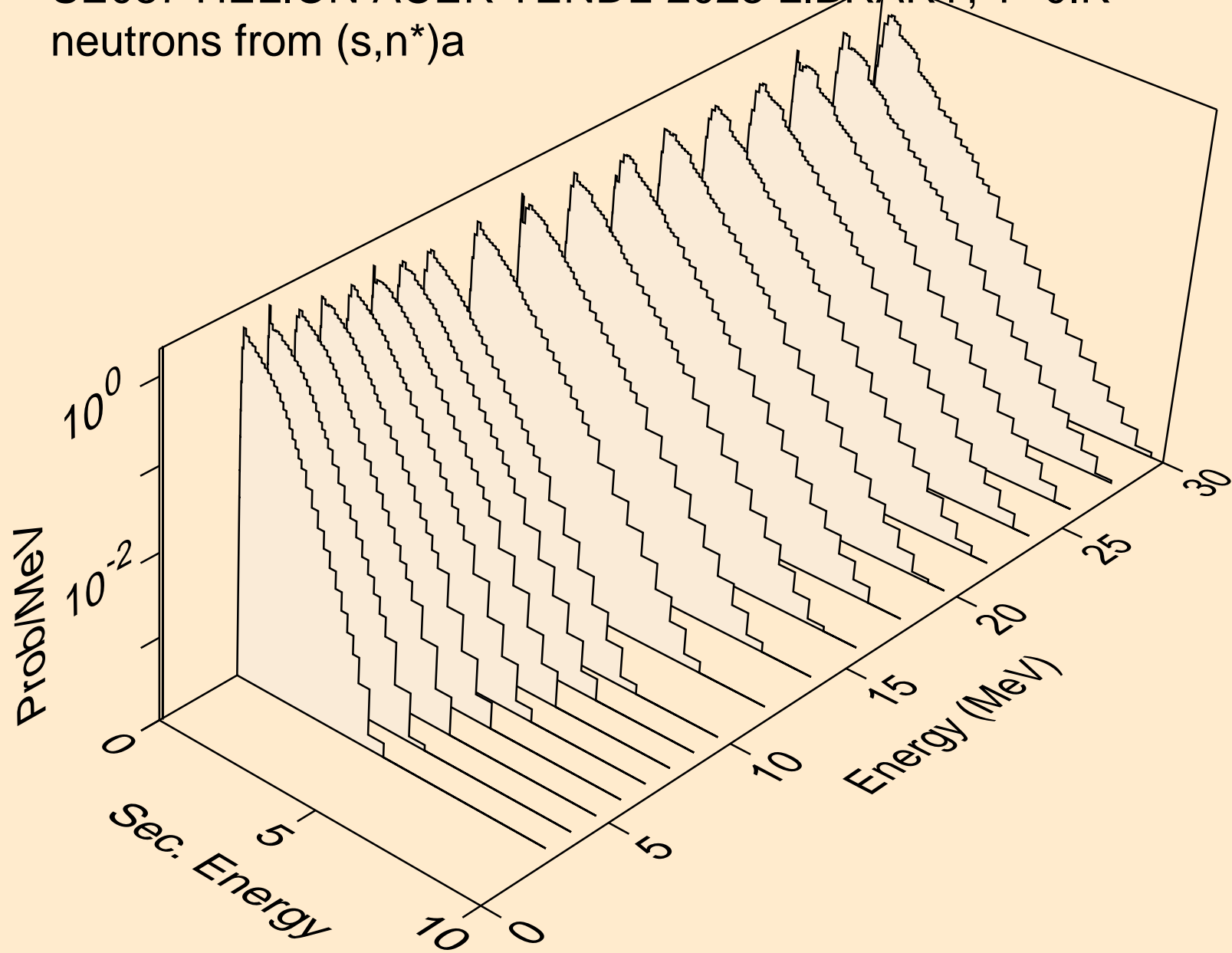

SE087 HELION ACER TENDL-2023 LIBRARY; T=0.K  
neutrons from (s,2n)a

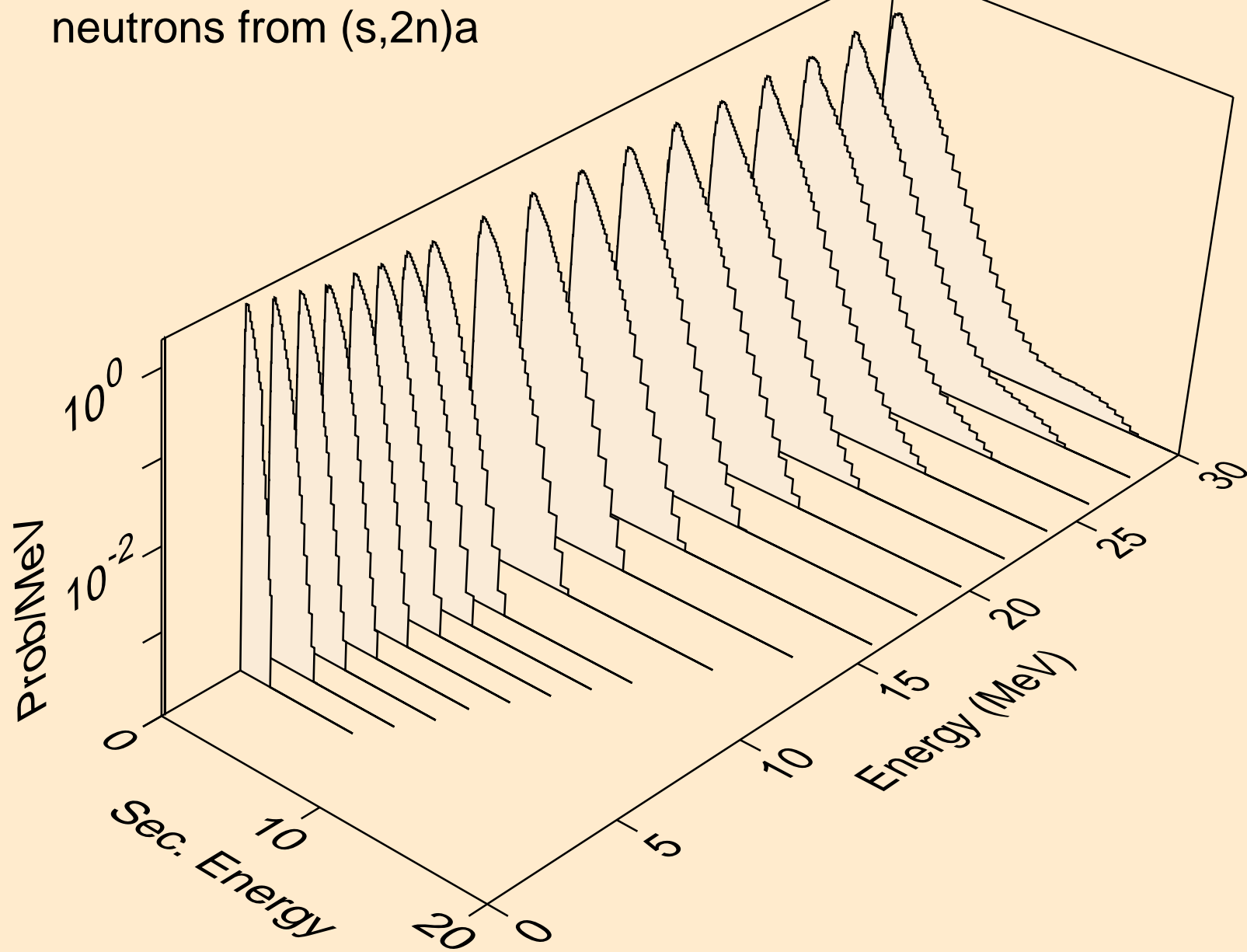

SE087 HELION ACER TENDL-2023 LIBRARY; T=0.K  
neutrons from (s,3n)a

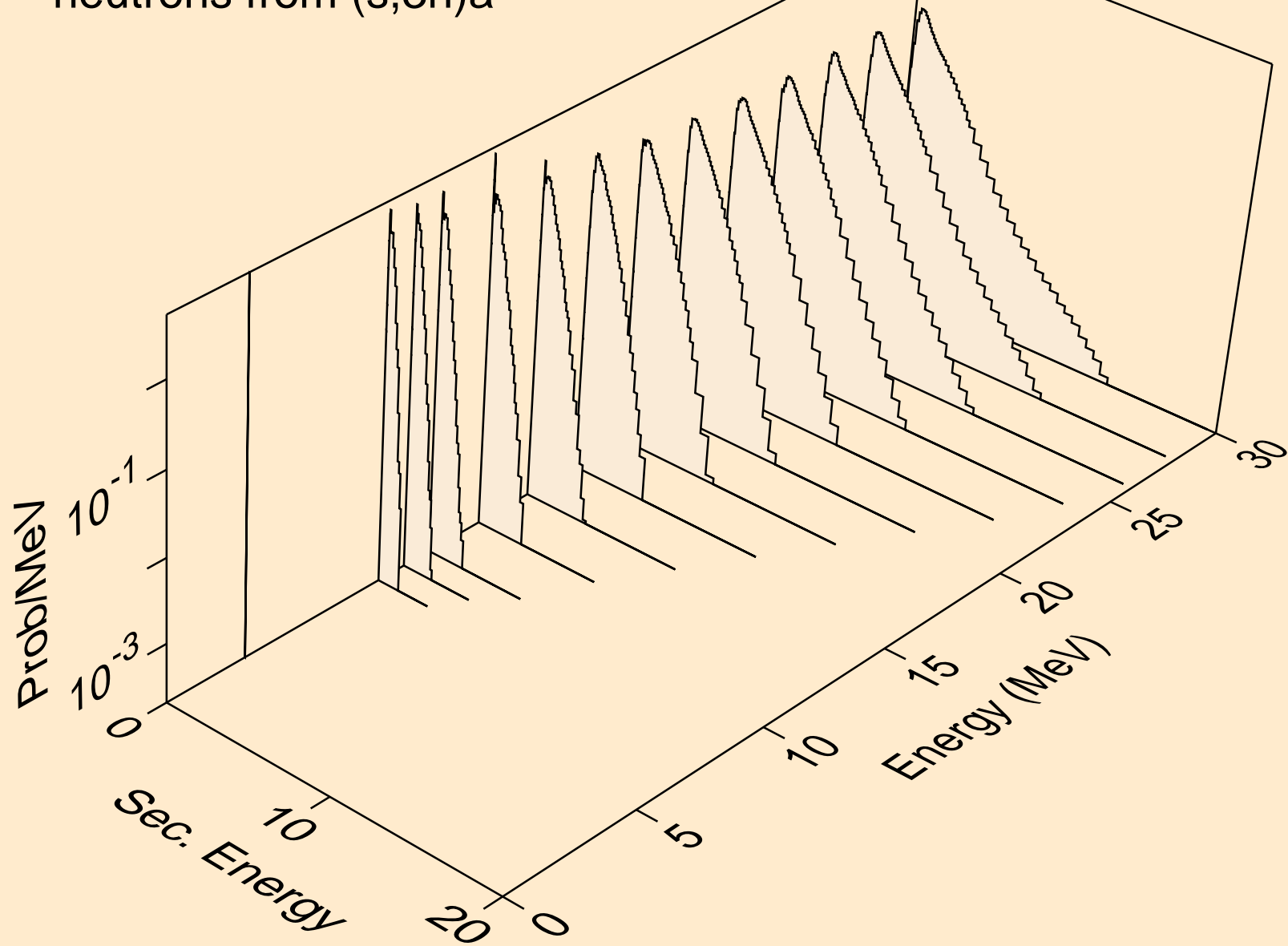

SE087 HELION ACER TENDL-2023 LIBRARY; T=0.K  
neutrons from (s,n\*)p

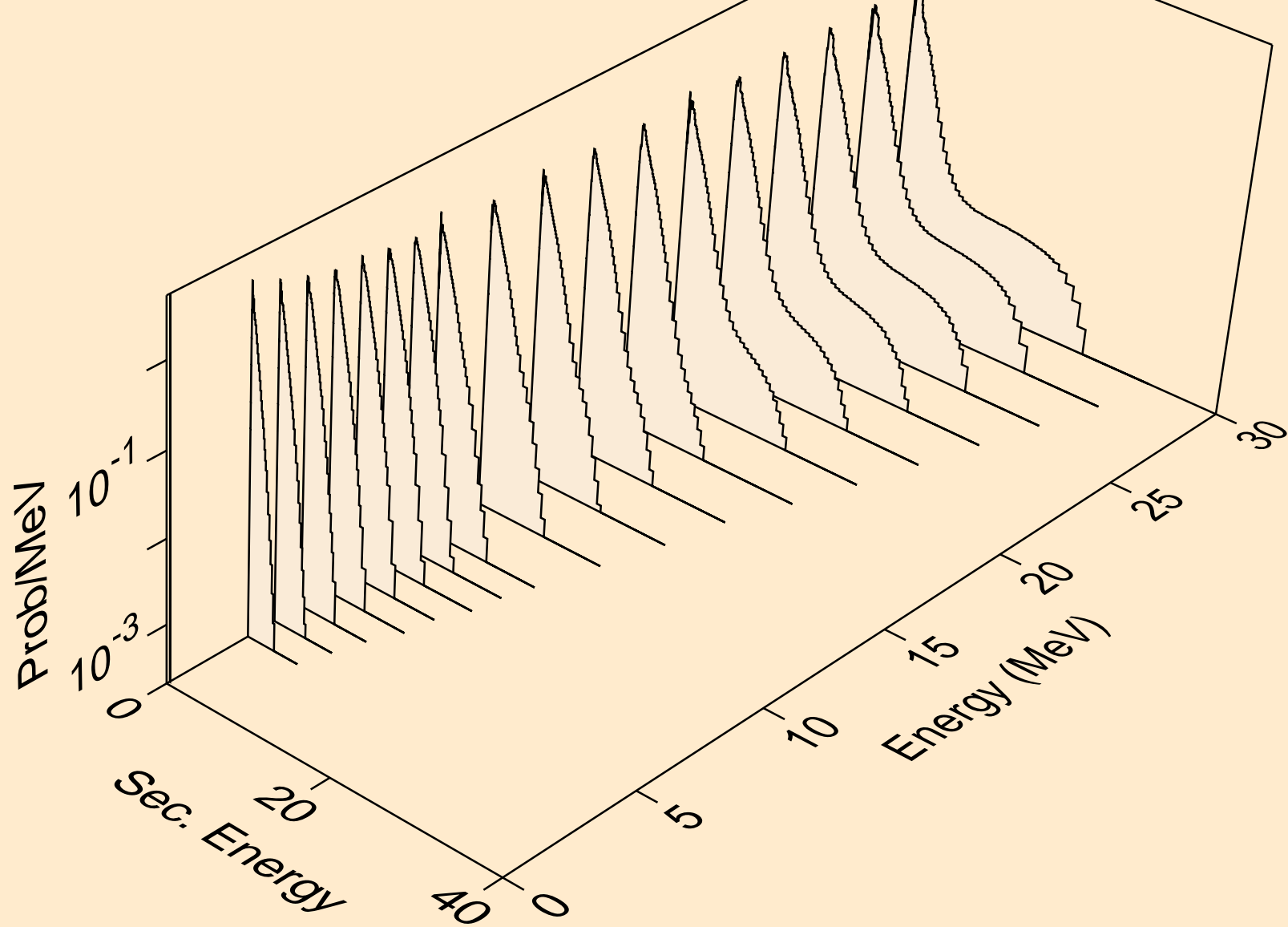

SE087 HELION ACER TENDL-2023 LIBRARY; T=0.K  
neutrons from (s,n\*)2a

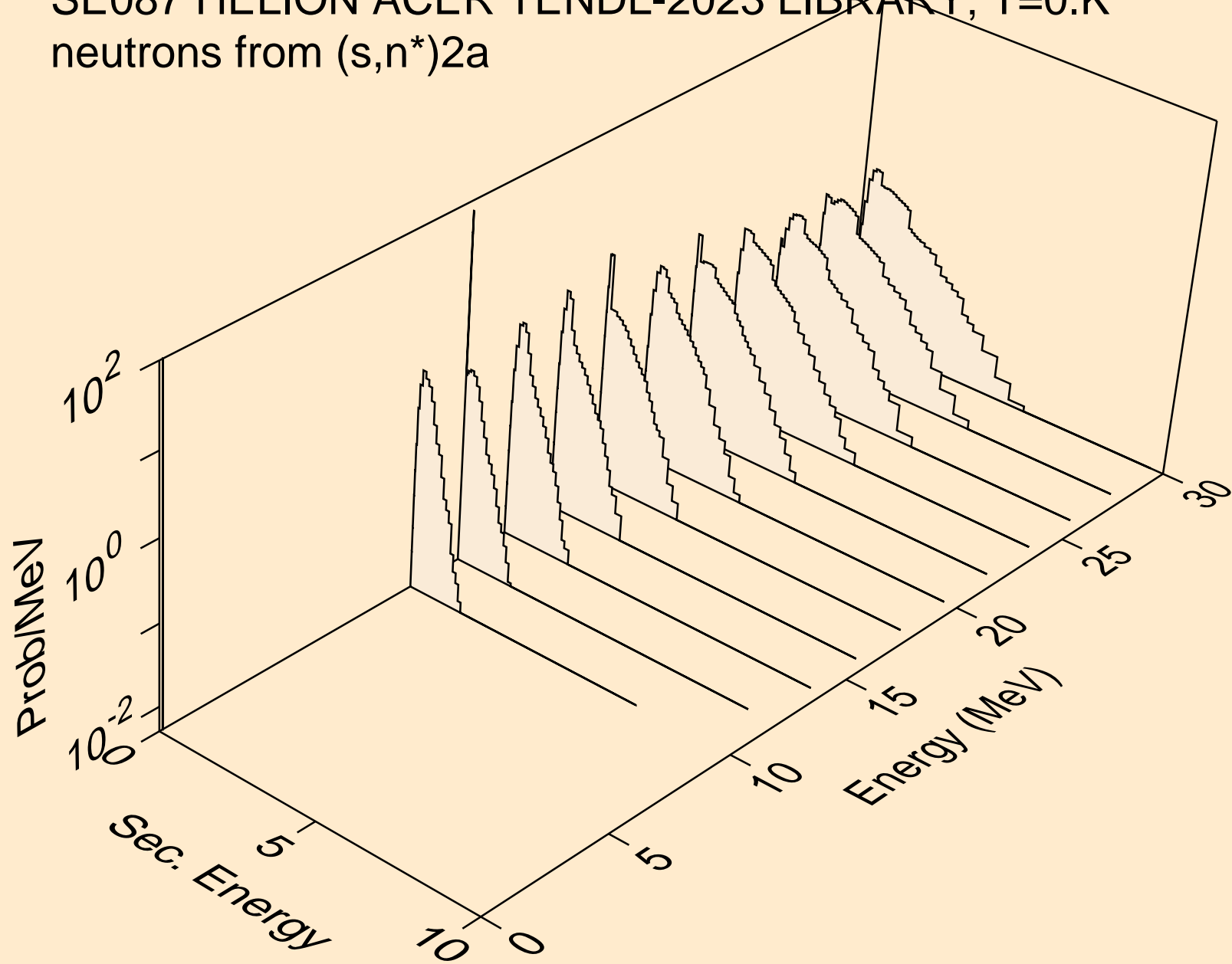

SE087 HELION ACER TENDL-2023 LIBRARY; T=0.K  
neutrons from (s,2n)2a

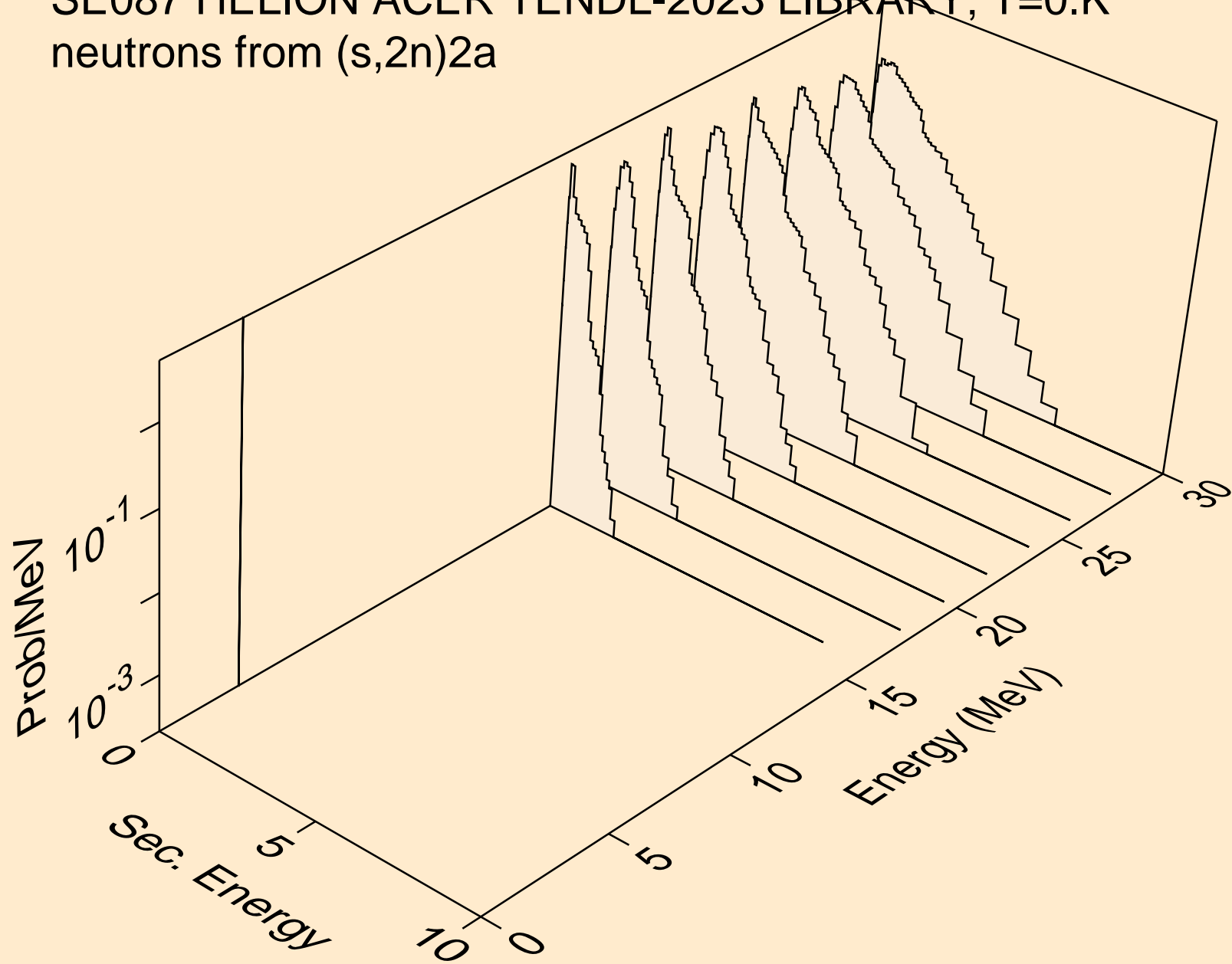

SE087 HELION ACER TENDL-2023 LIBRARY; T=0.K  
neutrons from (s,n\*)d

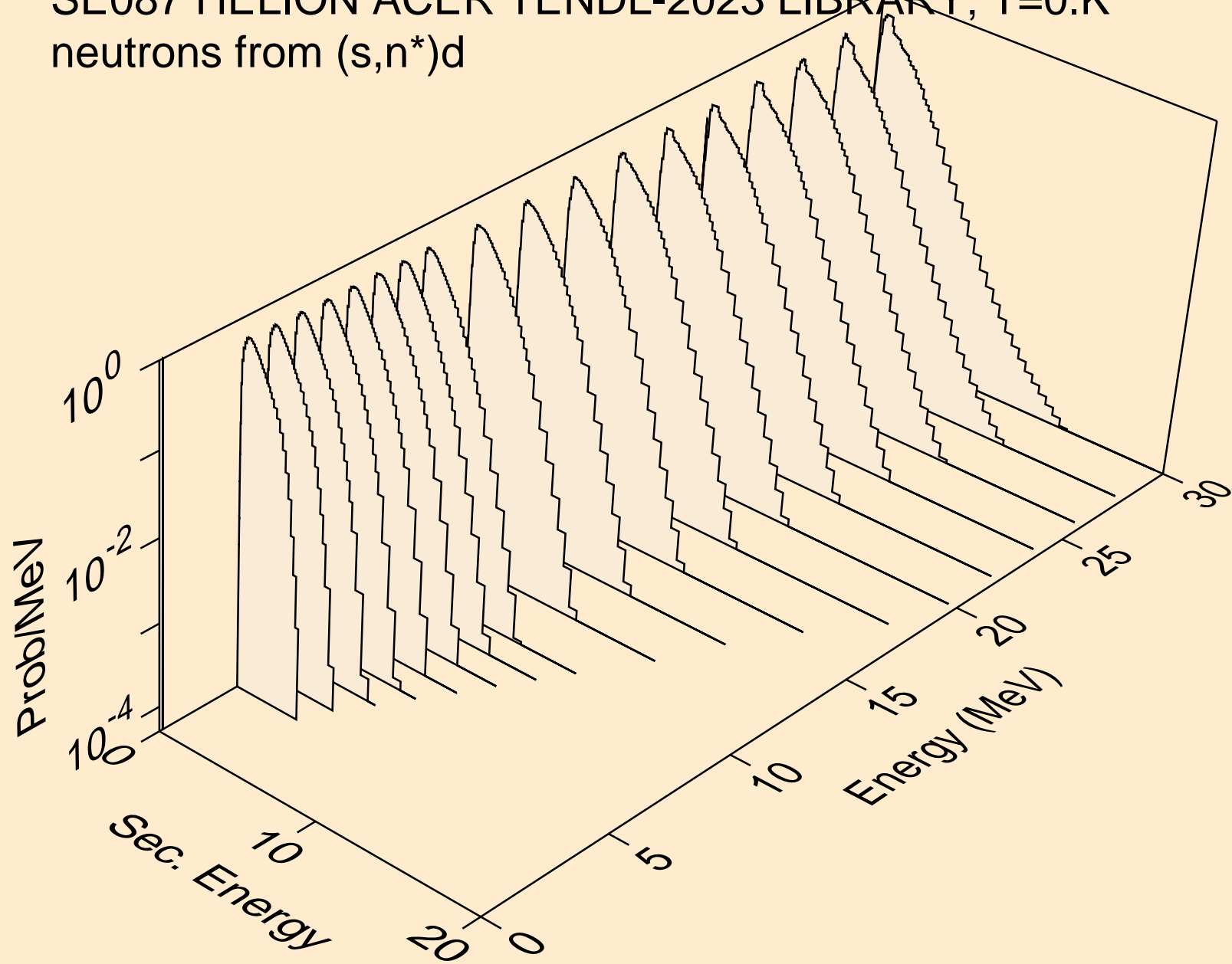

SE087 HELION ACER TENDL-2023 LIBRARY; T=0.K  
neutrons from (s,n\*)t

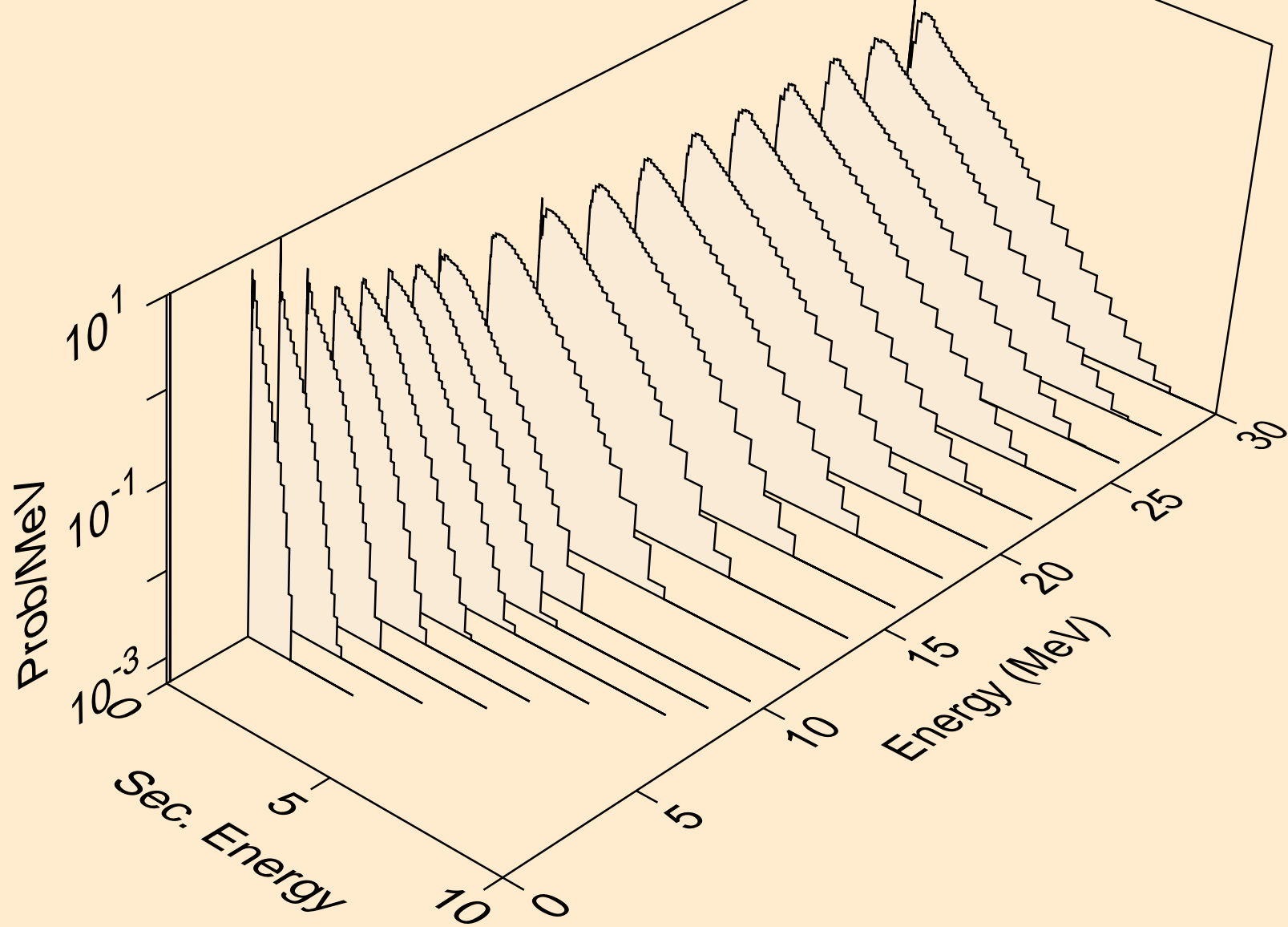

SE087 HELION ACER TENDL-2023 LIBRARY; T=0.K  
neutrons from (s,n\*)he3

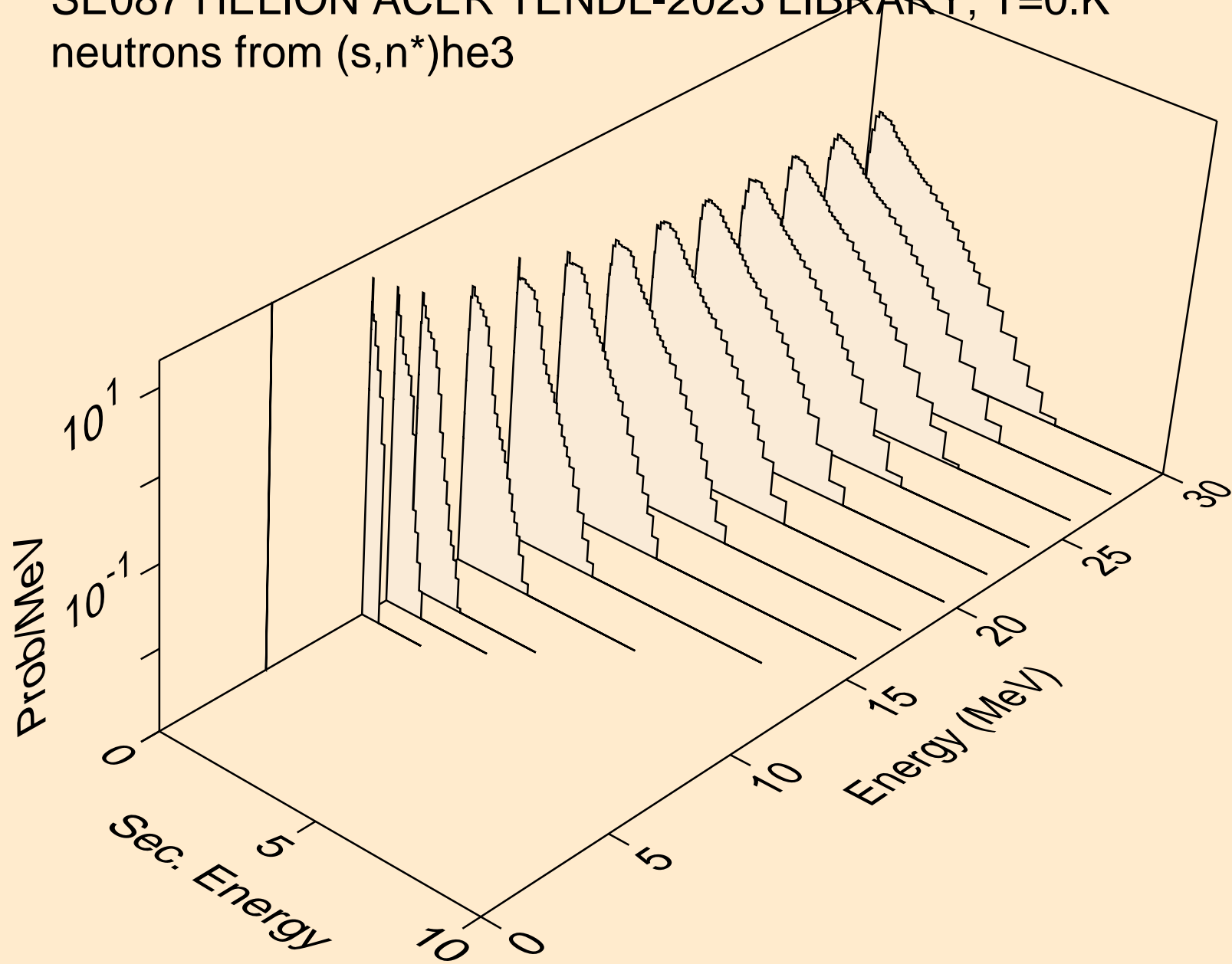

SE087 HELION ACER TENDL-2023 LIBRARY; T=0.K  
neutrons from (s,4n)

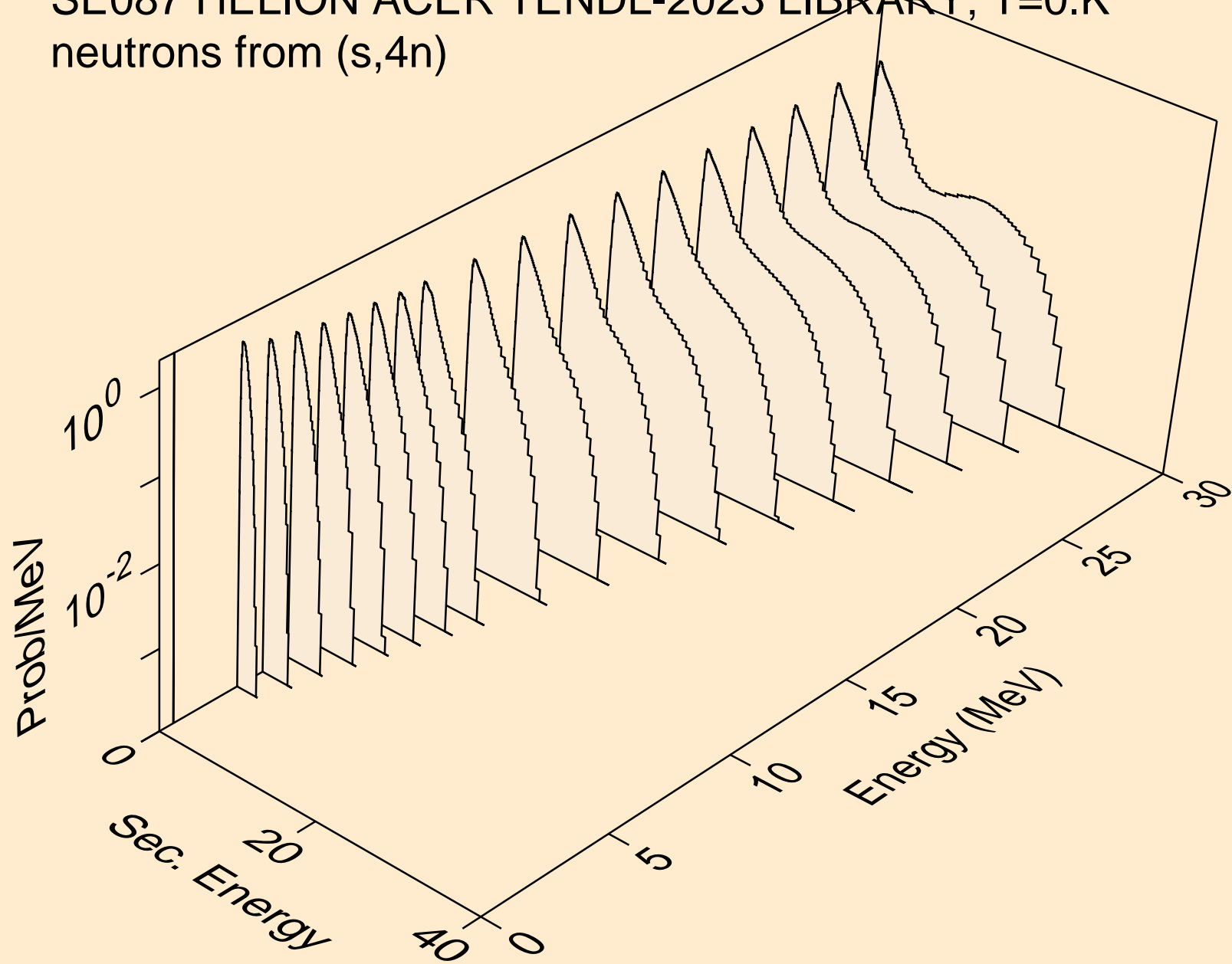

SE087 HELION ACER TENDL-2023 LIBRARY; T=0.K  
neutrons from (s,2np)

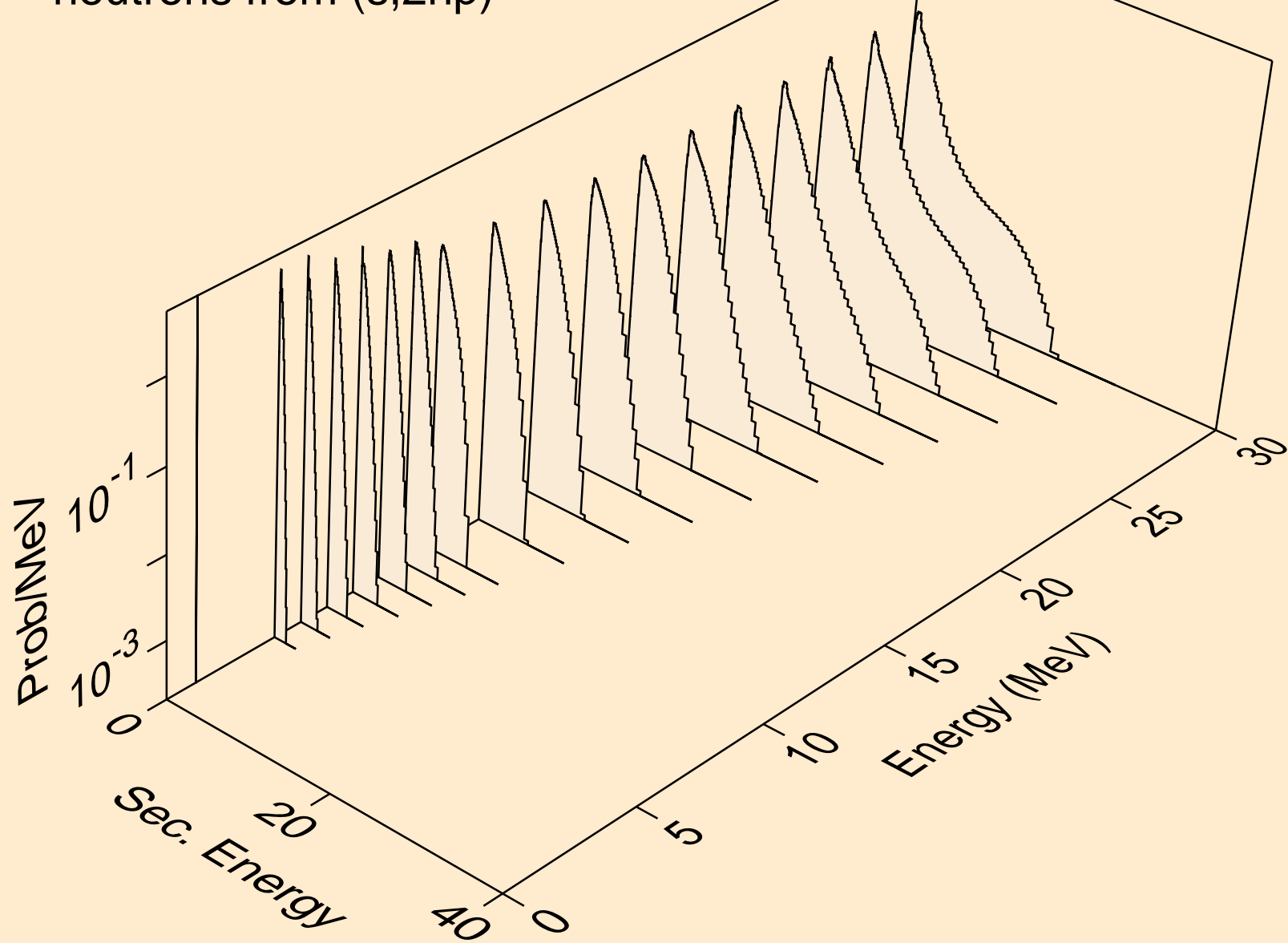

SE087 HELION ACER TENDL-2023 LIBRARY; T=0.K  
neutrons from (s,3np)

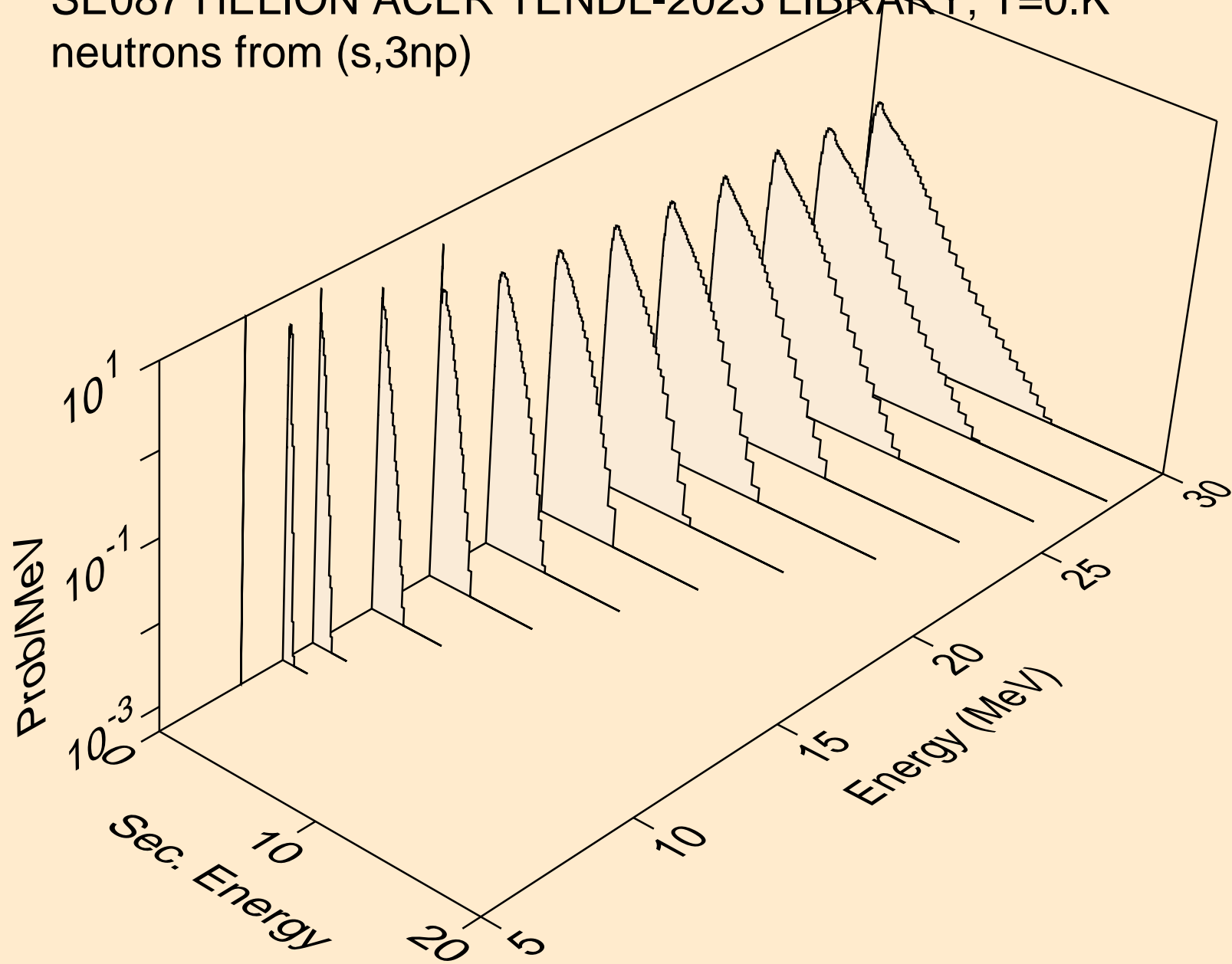

SE087 HELION ACER TENDL-2023 LIBRARY; T=0.K  
neutrons from (s,n2p)

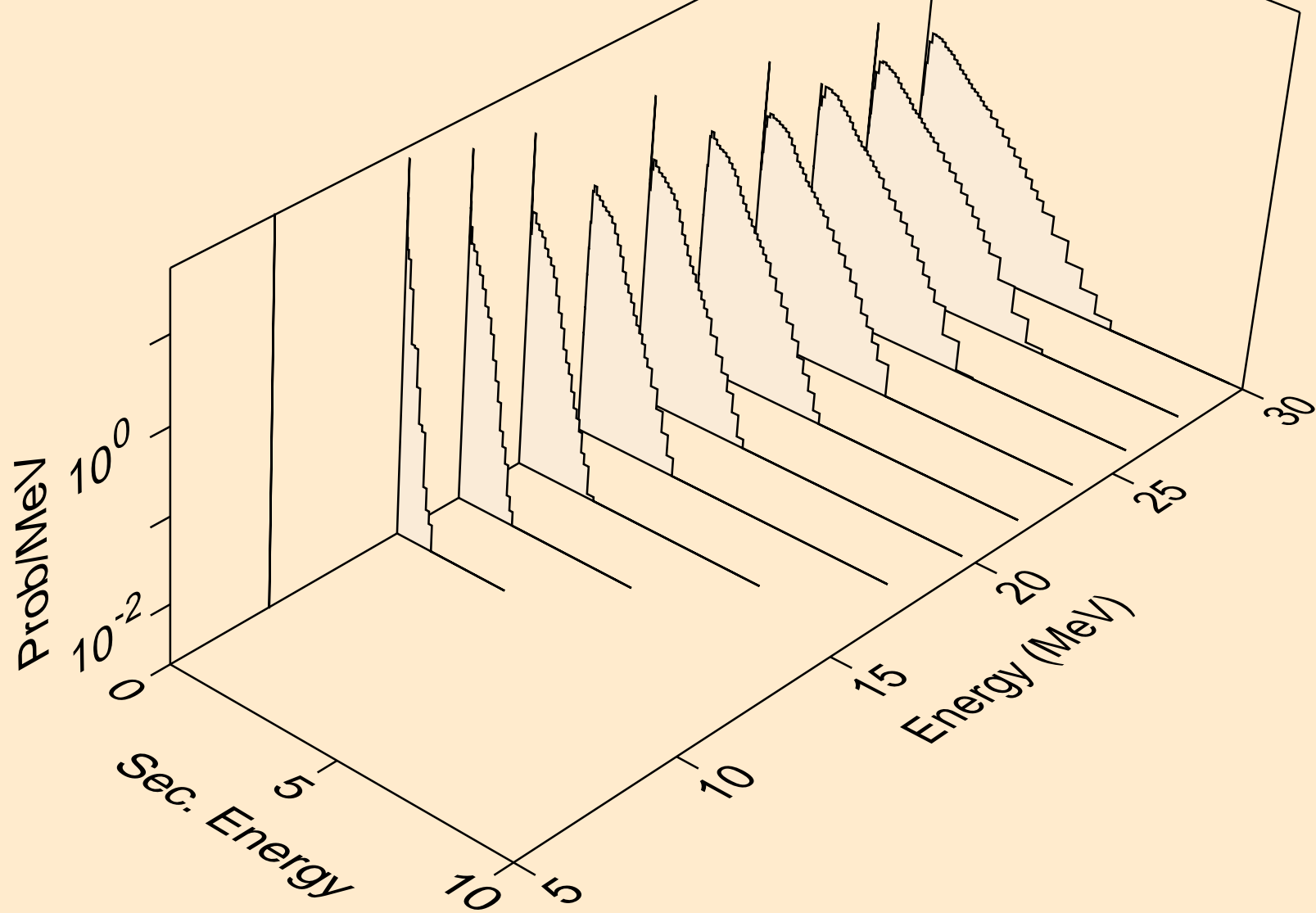

SE087 HELION ACER TENDL-2023 LIBRARY; T=0.K  
neutrons from (s,npa)

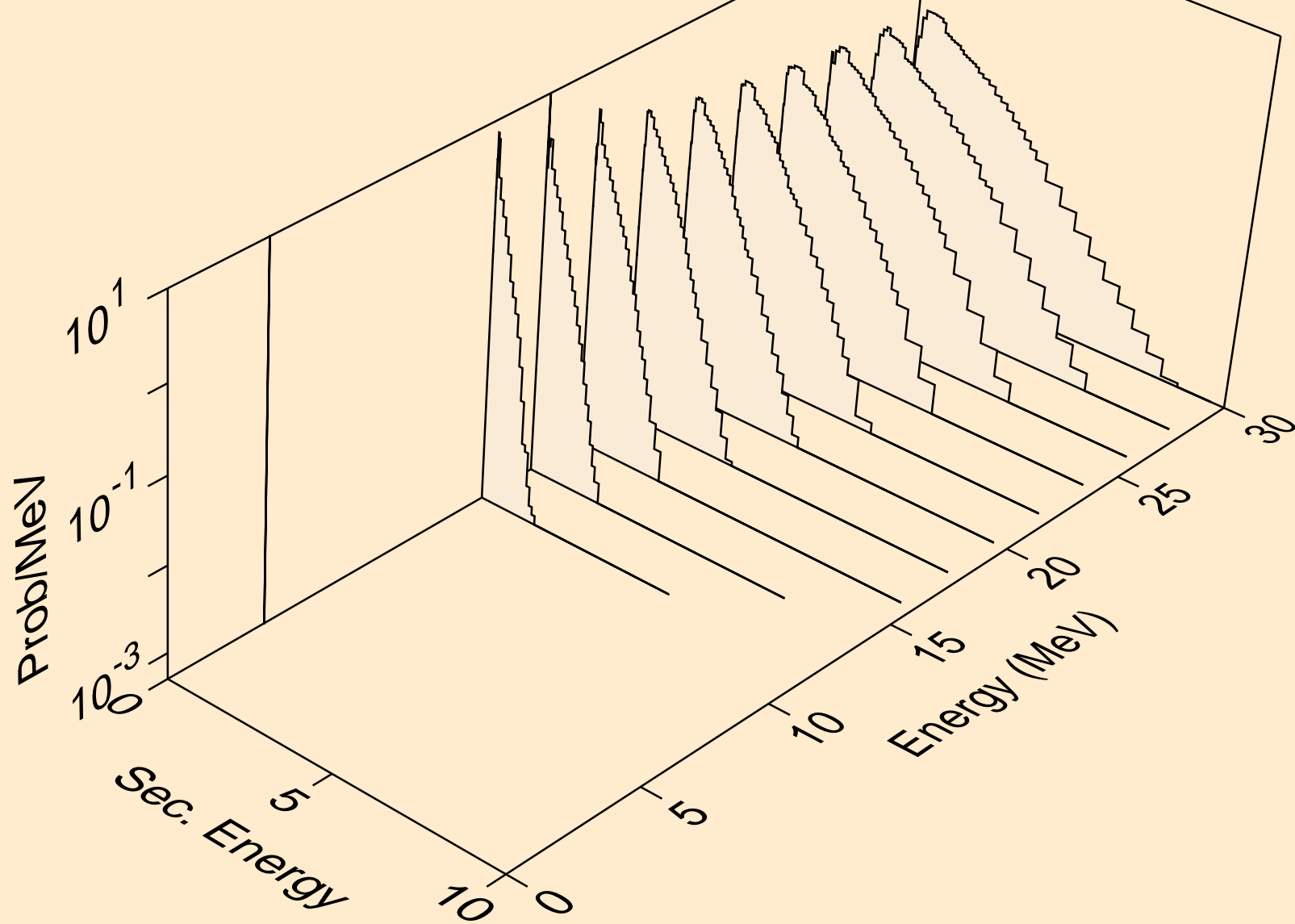

SE087 HELION ACER TENDL-2023 LIBRARY; T=0.K  
protons from (s,x)

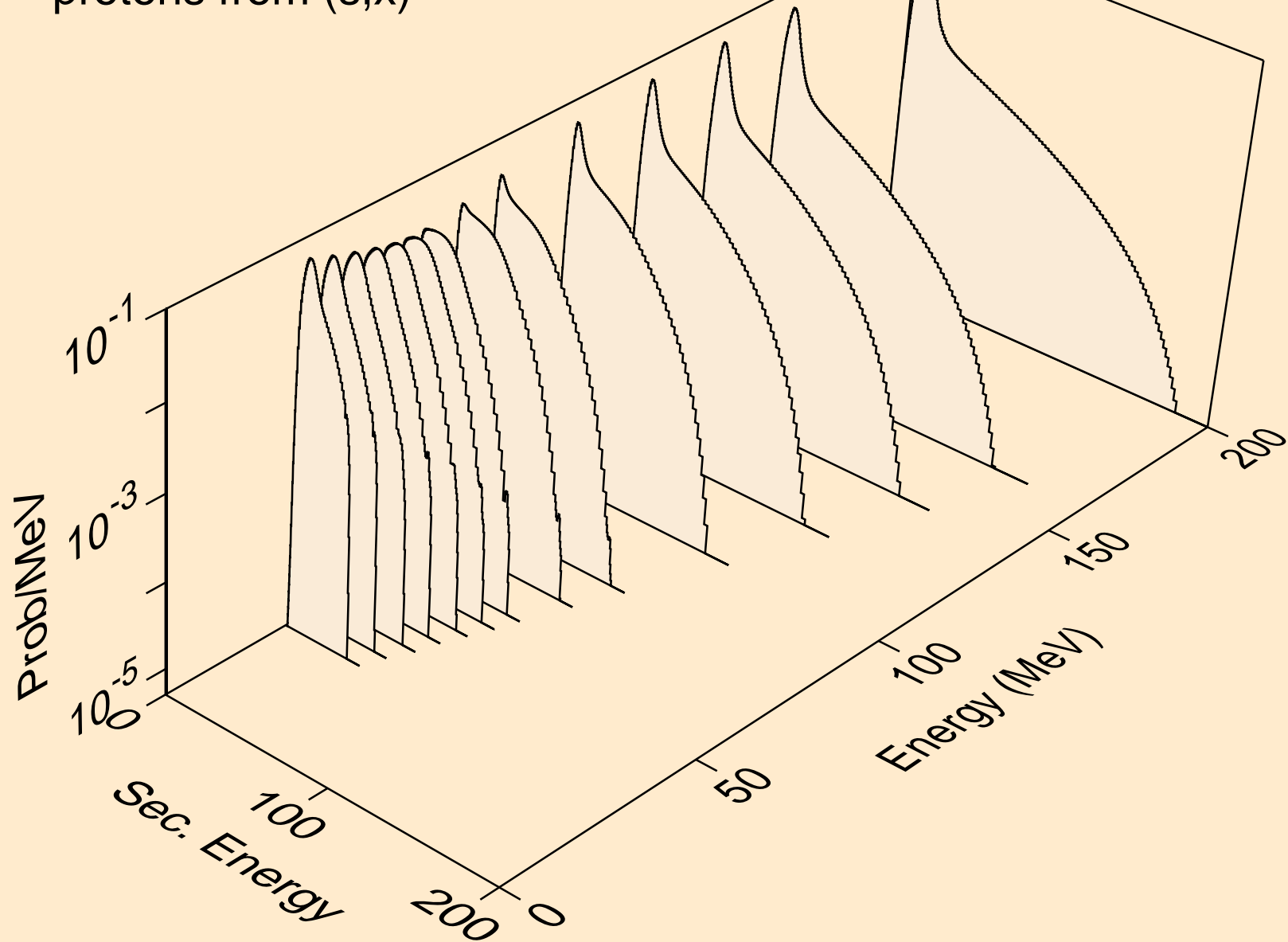

SE087 HELION ACER TENDL-2023 LIBRARY; T=0.K  
protons from (s,n\*)p

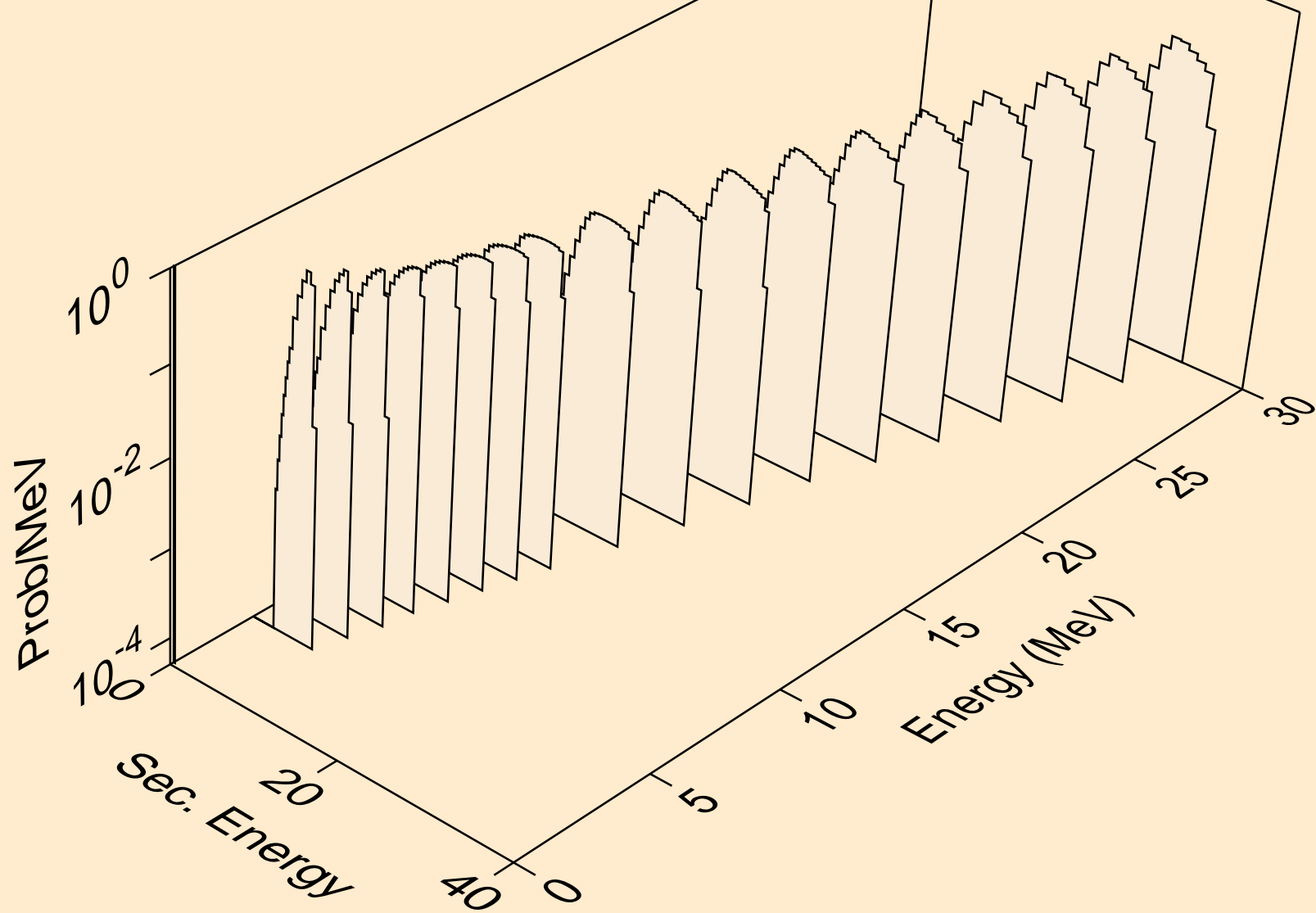

SE087 HELION ACER TENDL-2023 LIBRARY; T=0.K  
protons from (s,2np)

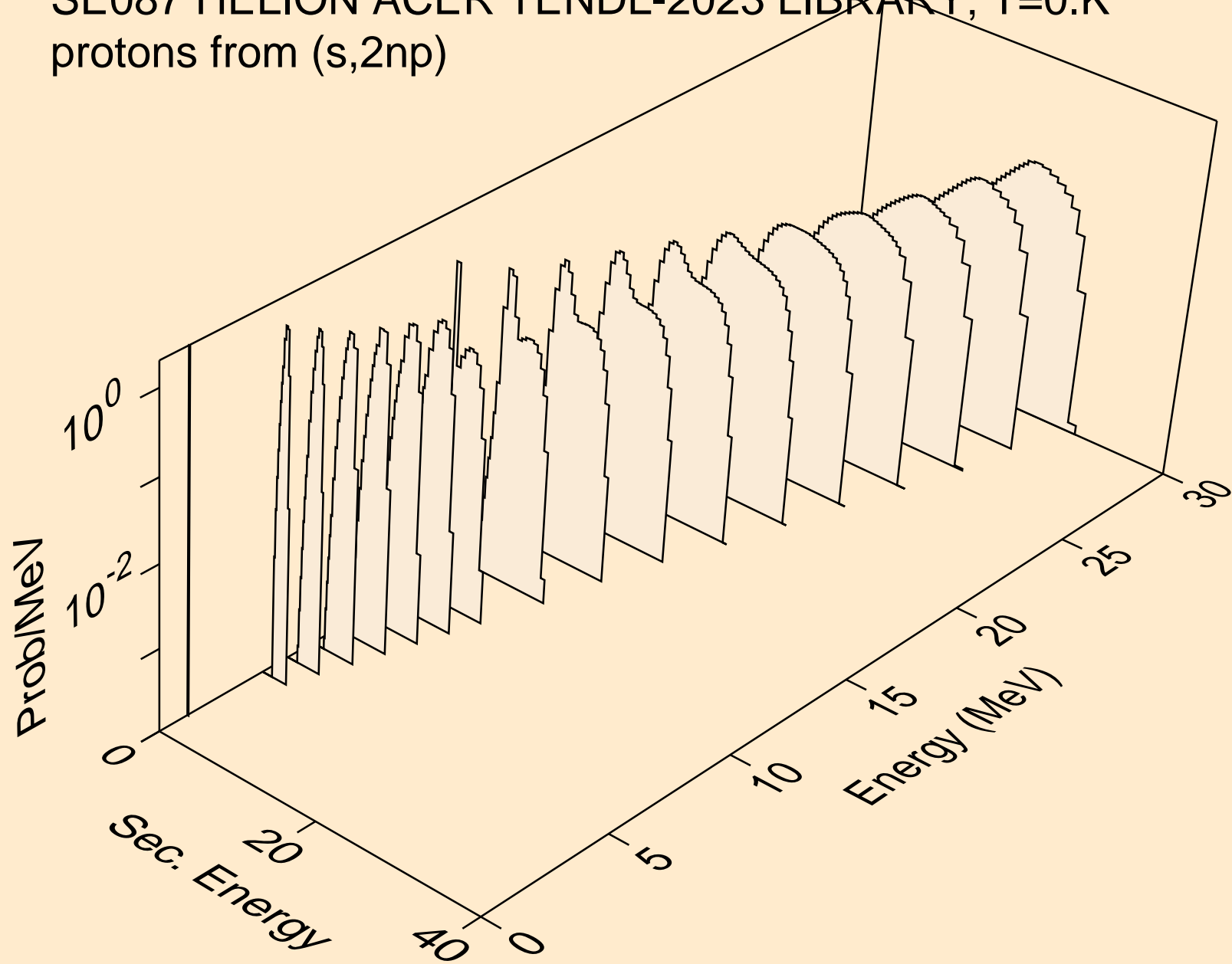

SE087 HELION ACER TENDL-2023 LIBRARY; T=0.K  
protons from (s,3np)

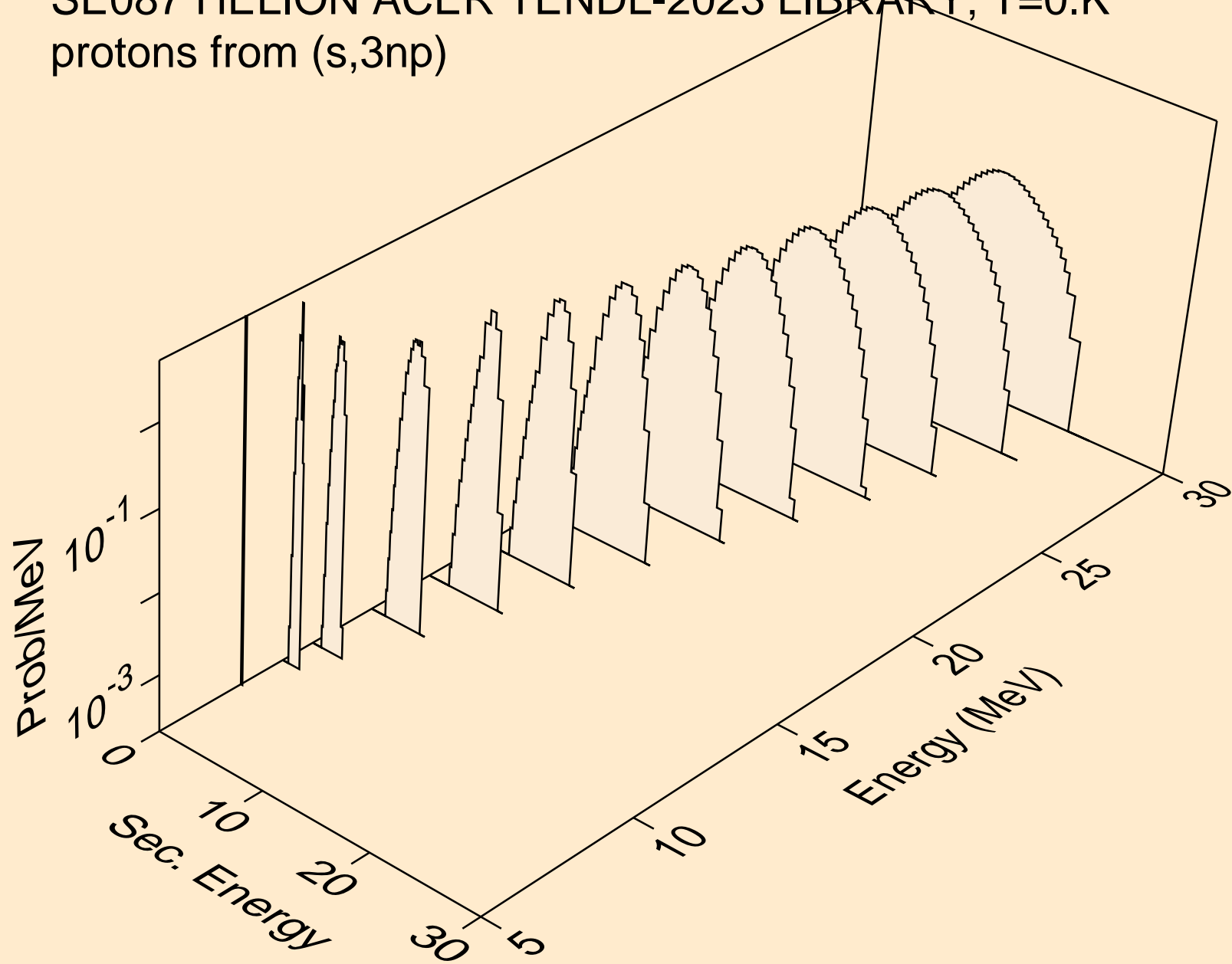

SE087 HELION ACER TENDL-2023 LIBRARY; T=0.K  
protons from (s,n2p)

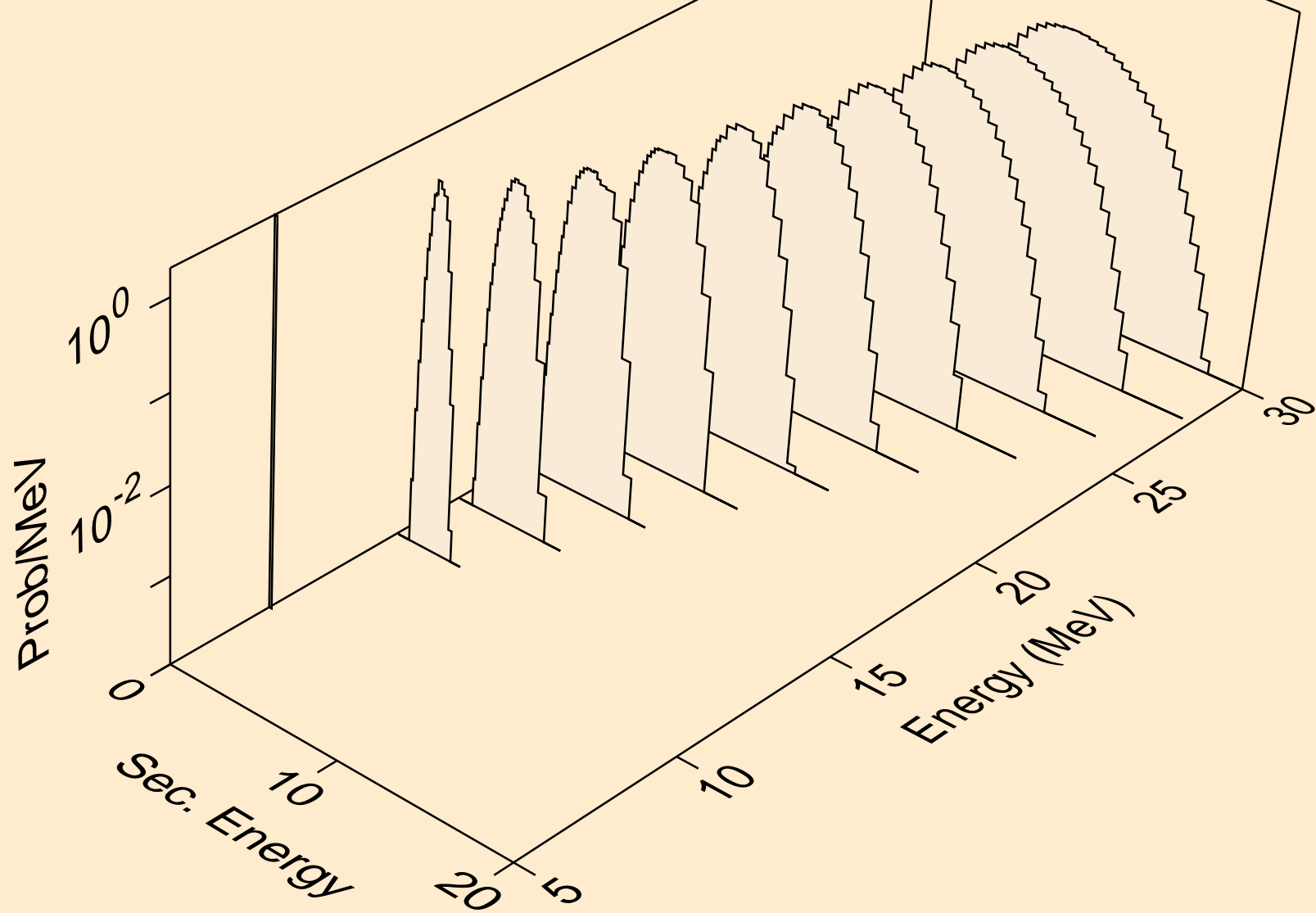

SE087 HELION ACER TENDL-2023 LIBRARY; T=0.K  
protons from (s,npa)

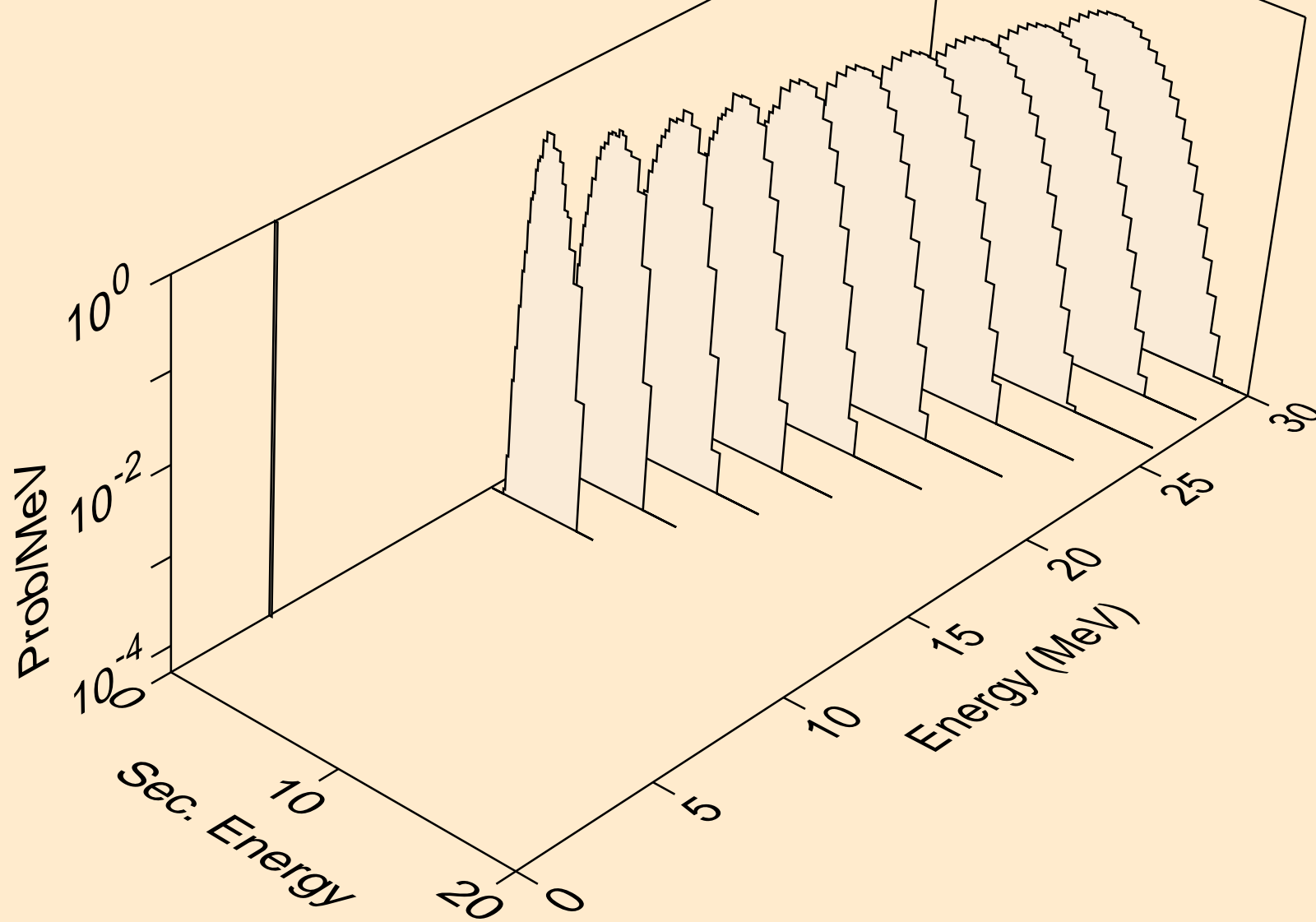

SE087 HELION ACER TENDL-2023 LIBRARY; T=0.K  
protons from (s,p)

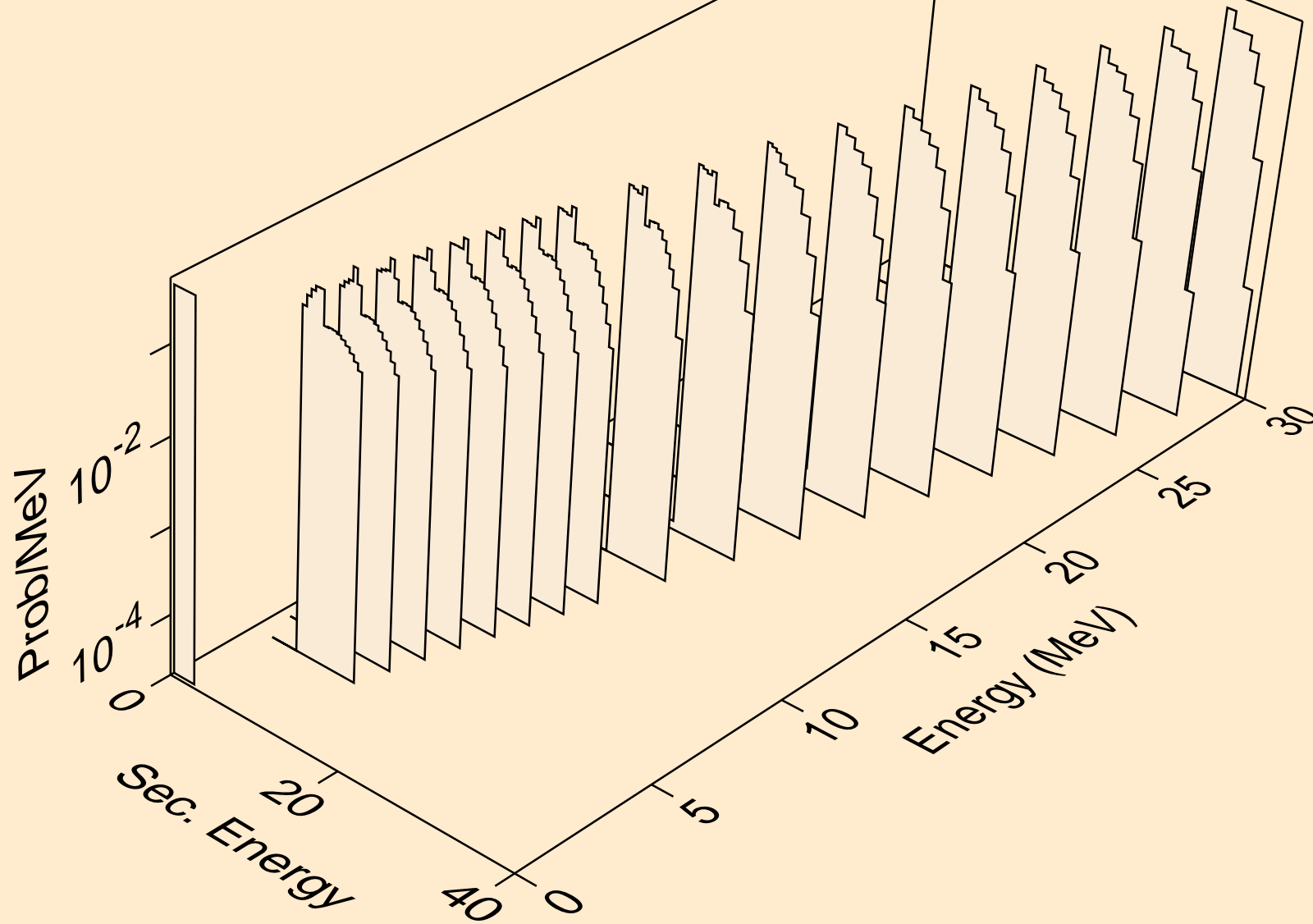

SE087 HELION ACER TENDL-2023 LIBRARY; T=0.K  
protons from (s,2p)

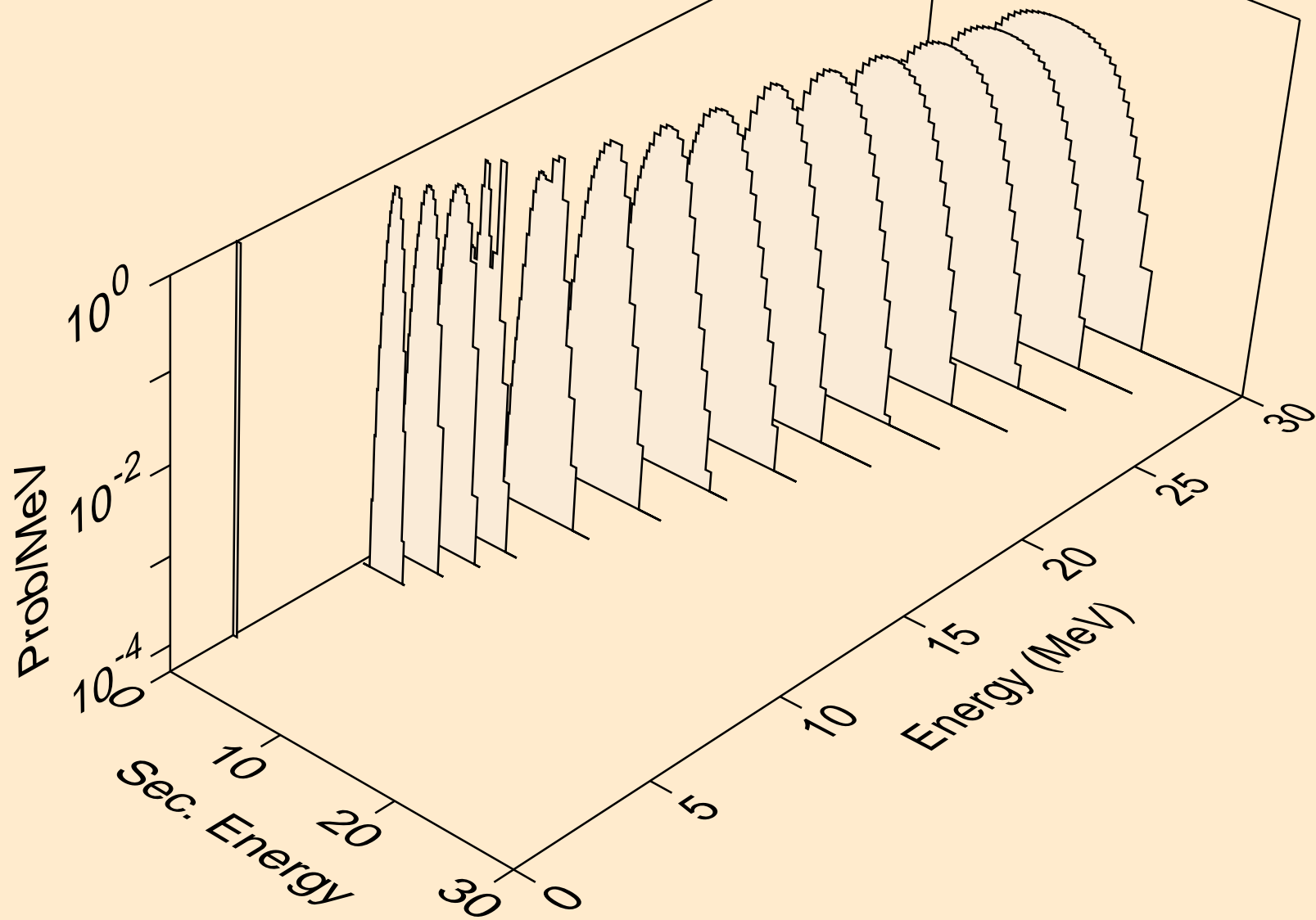

SE087 HELION ACER TENDL-2023 LIBRARY; T=0.K  
protons from (s,pa)

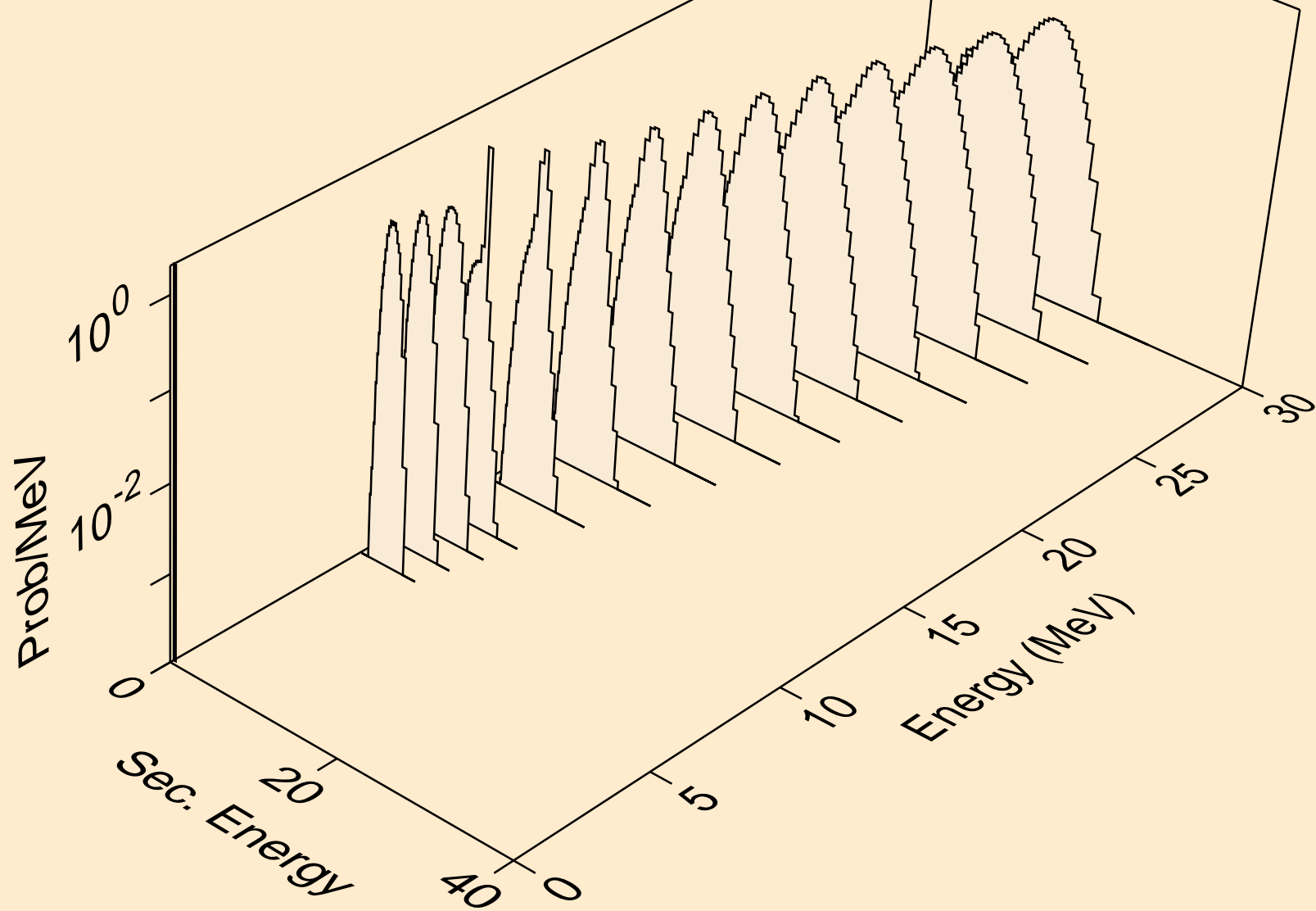

SE087 HELION ACER TENDL-2023 LIBRARY; T=0.K  
protons from (s,pd)

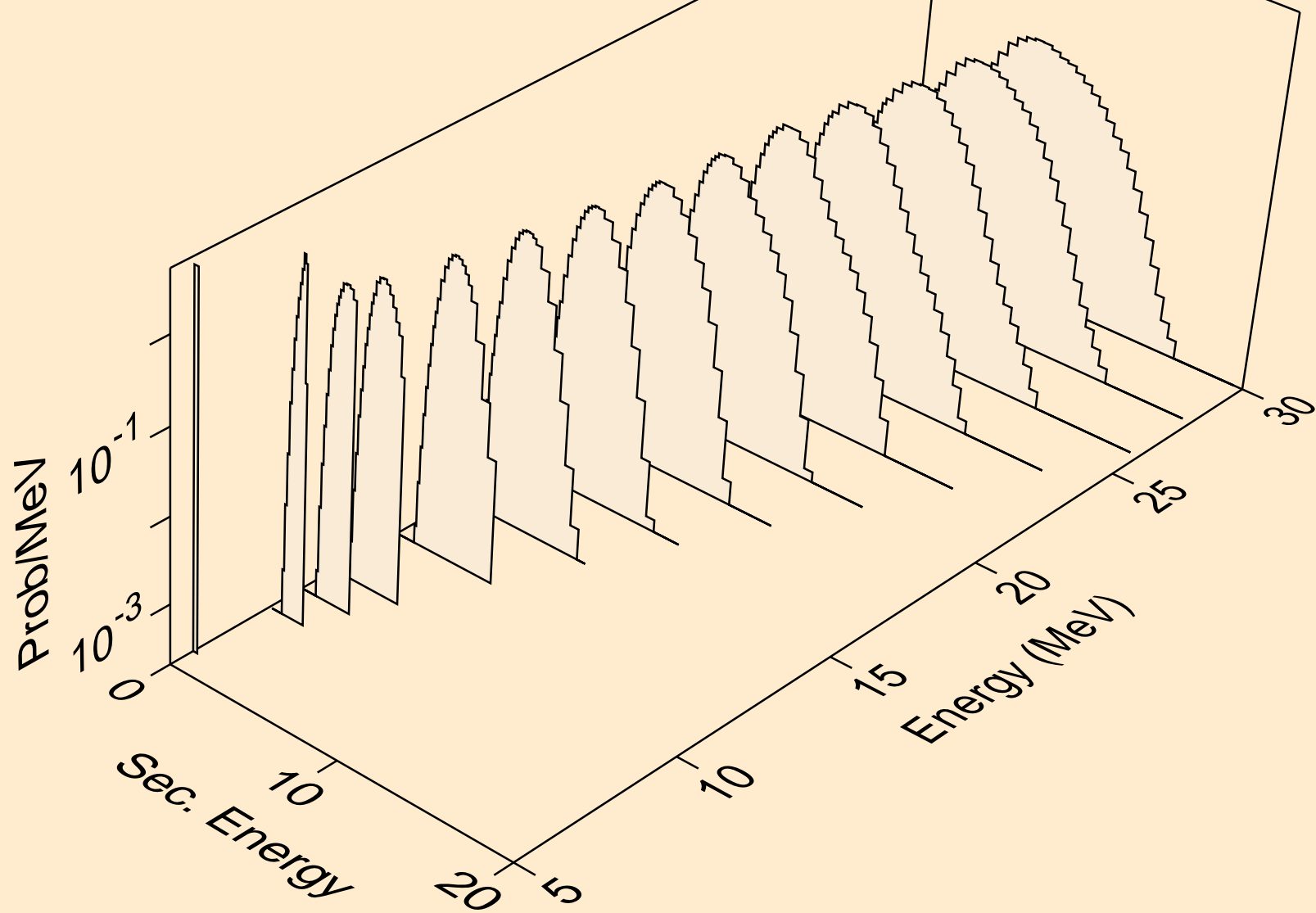

SE087 HELION ACER TENDL-2023 LIBRARY; T=0.K  
protons from (s,pt)

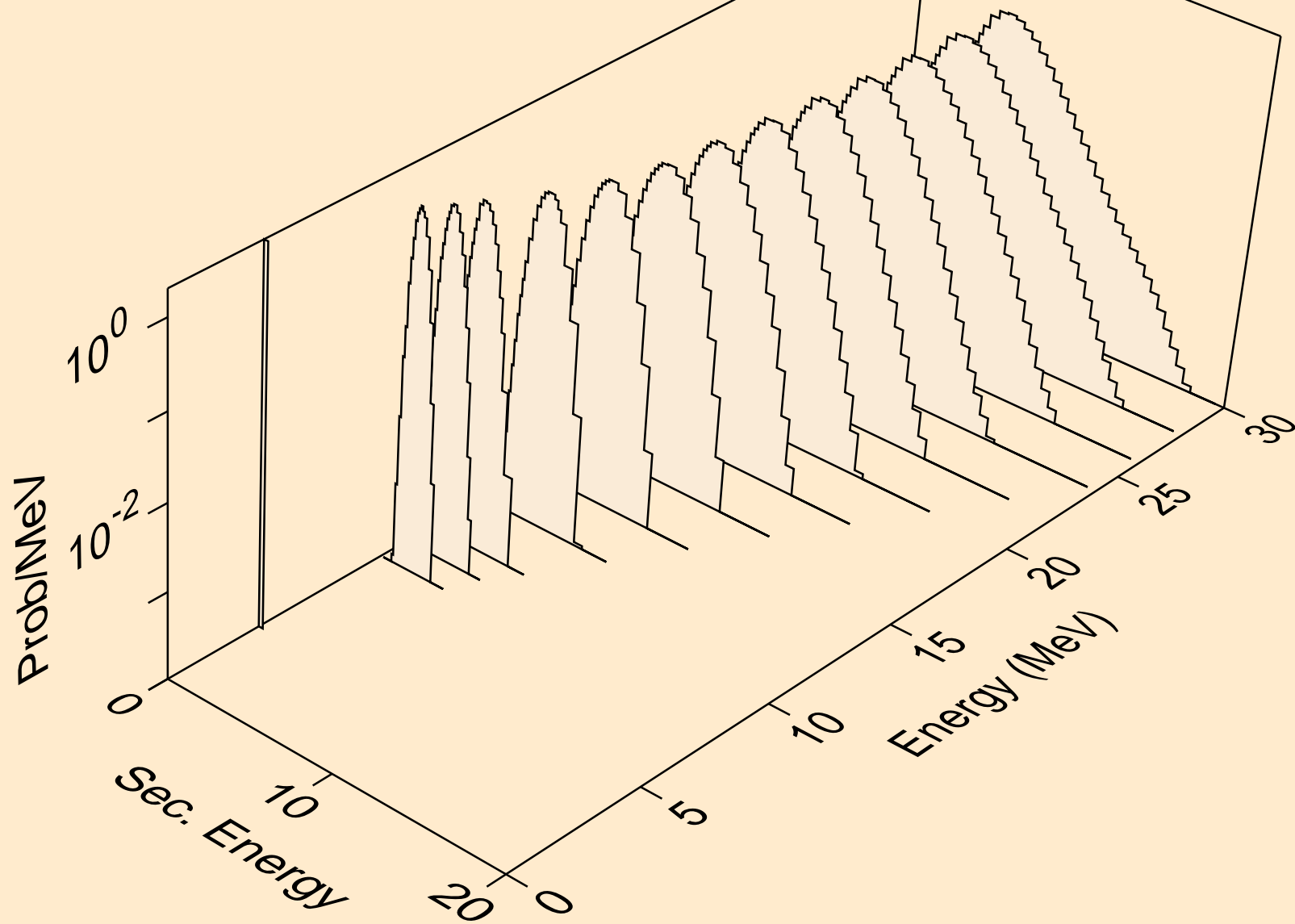

SE087 HELION ACER TENDL-2023 LIBRARY; T=0.K  
deuterons from (s,x)

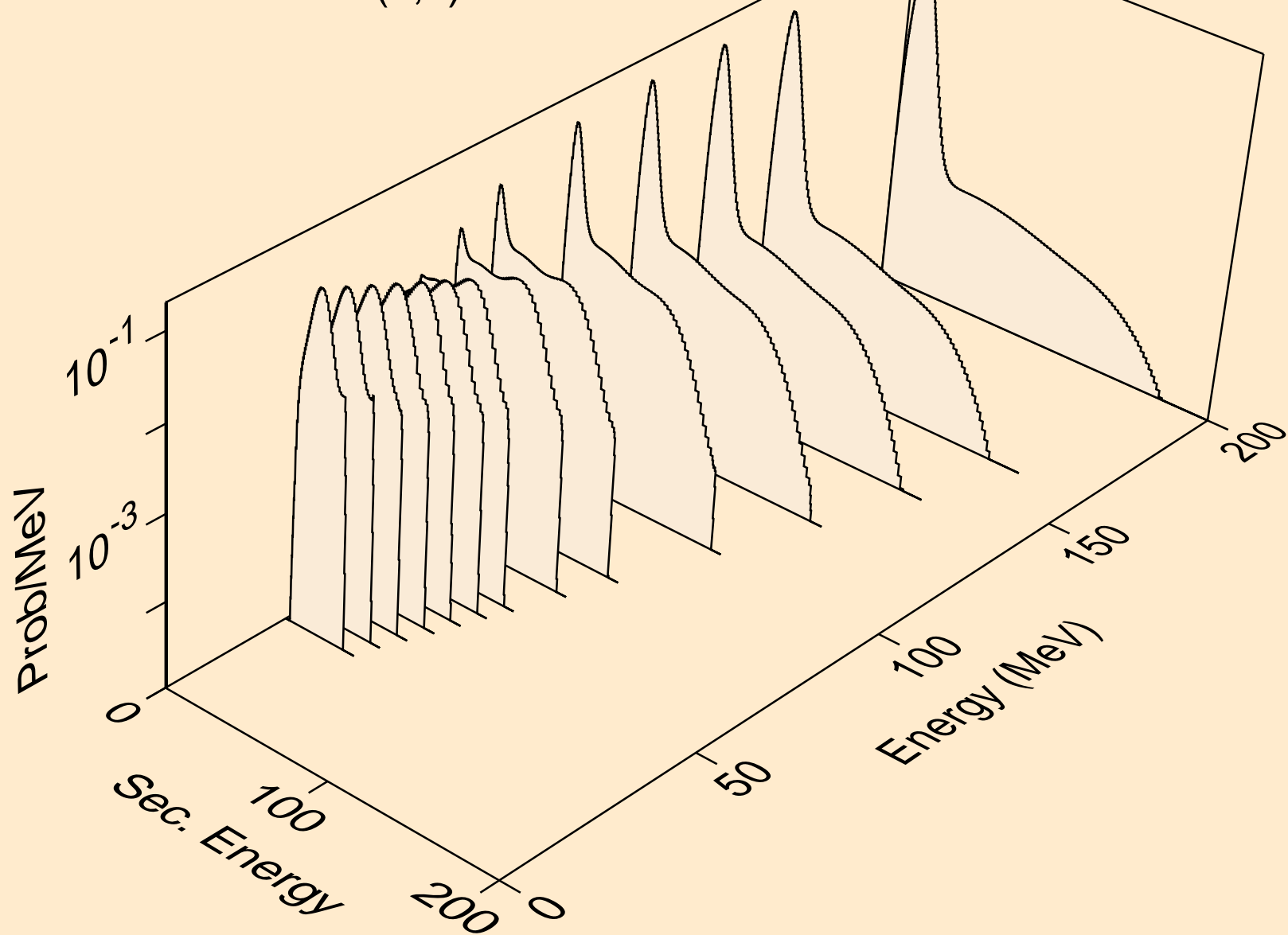

SE087 HELION ACER TENDL-2023 LIBRARY; T=0.K  
deuterons from (s,2nd)

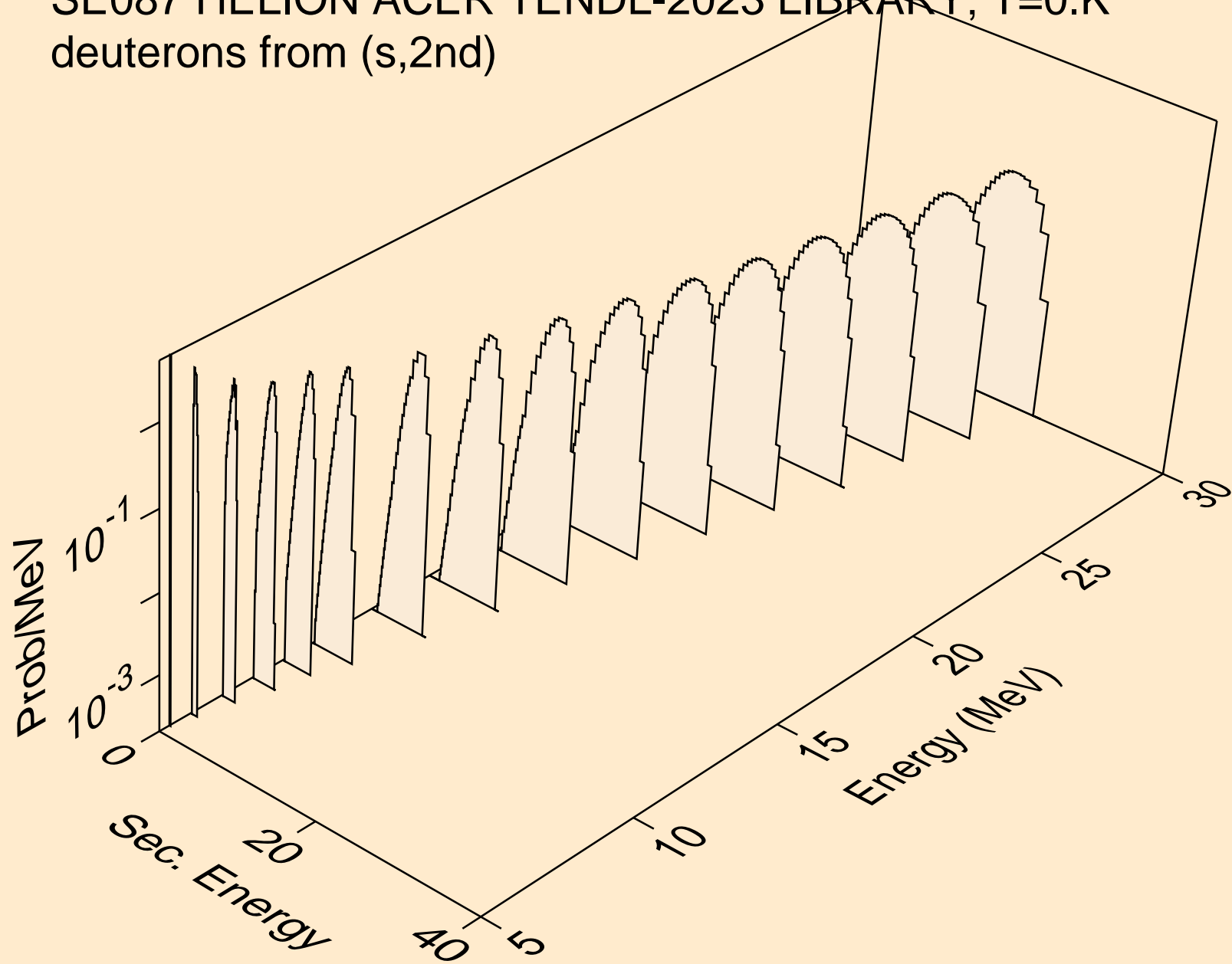

SE087 HELION ACER TENDL-2023 LIBRARY; T=0.K  
deuterons from (s,n\*)d

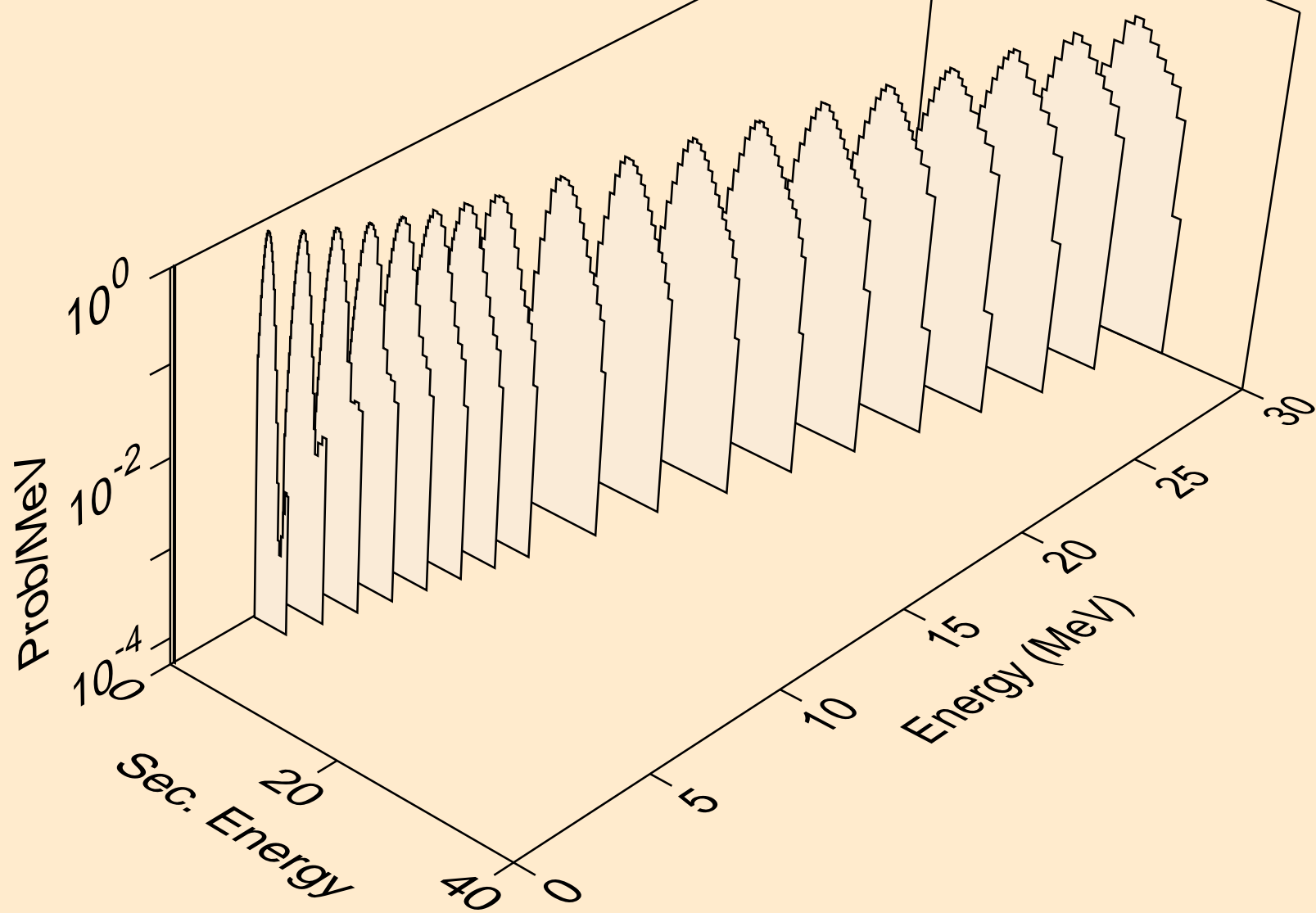

SE087 HELION ACER TENDL-2023 LIBRARY; T=0.K  
deuterons from (s,d)

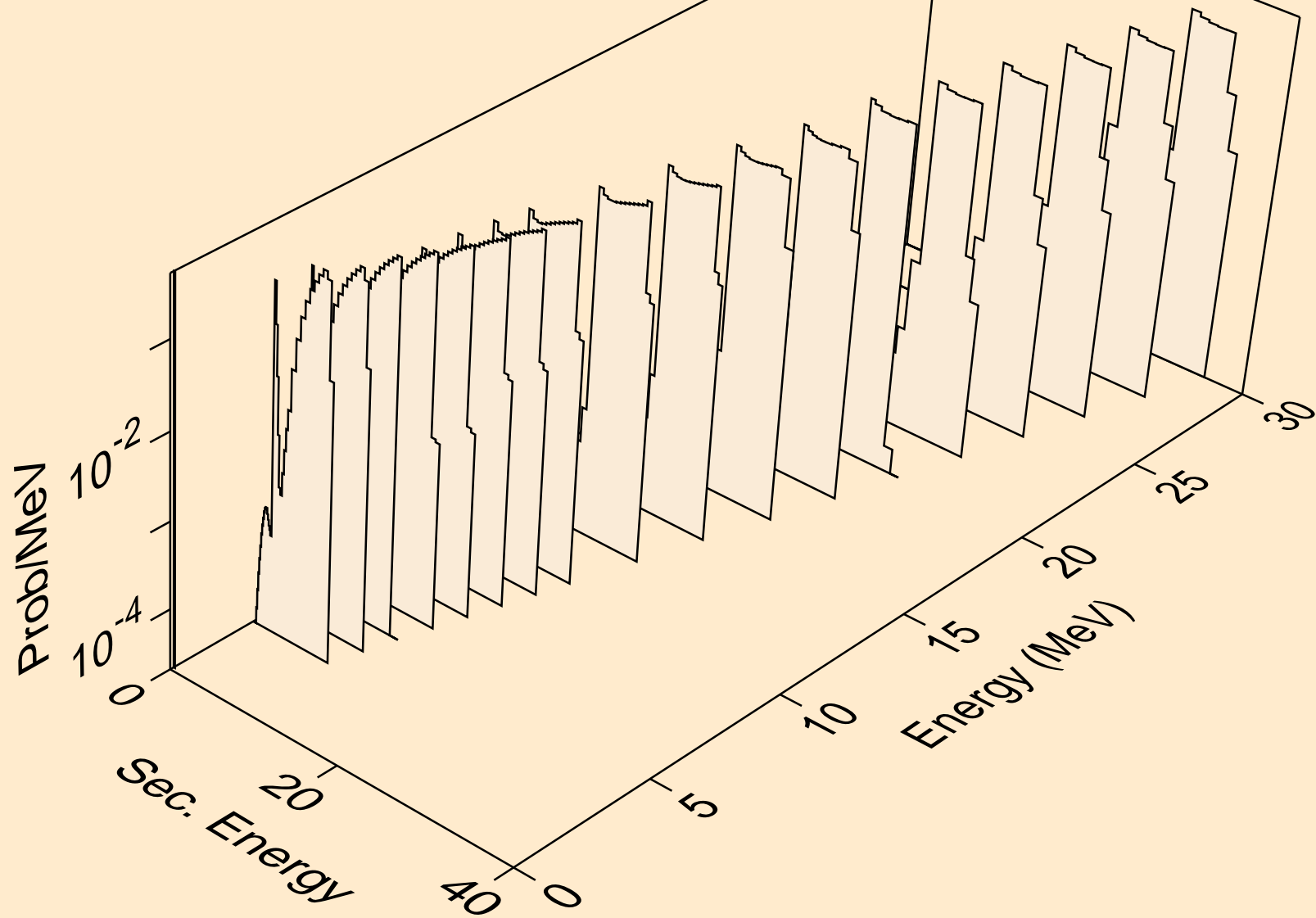

SE087 HELION ACER TENDL-2023 LIBRARY; T=0.K  
deuterons from (s,pd)

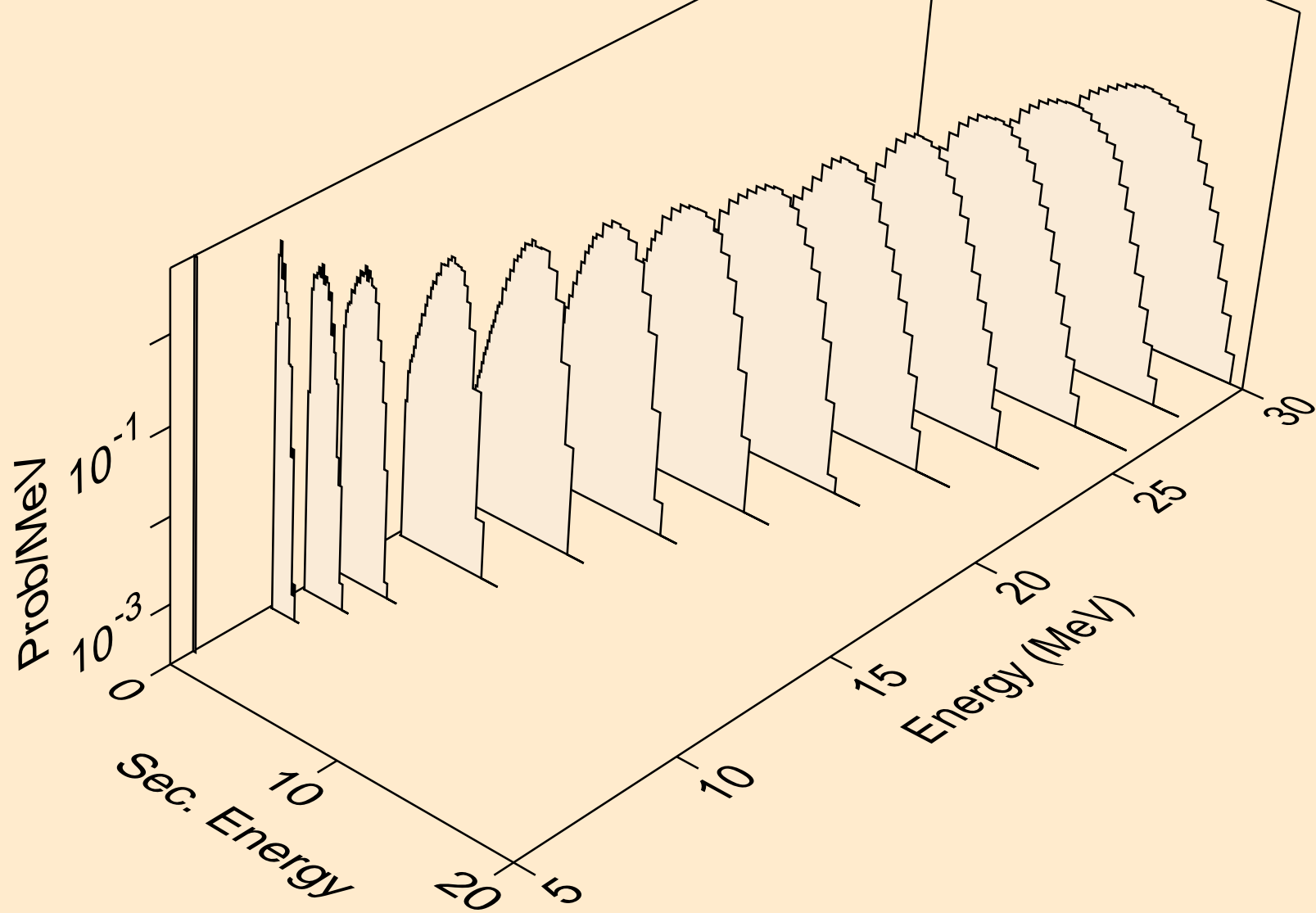

SE087 HELION ACER TENDL-2023 LIBRARY; T=0.K  
deuterons from (s,da)

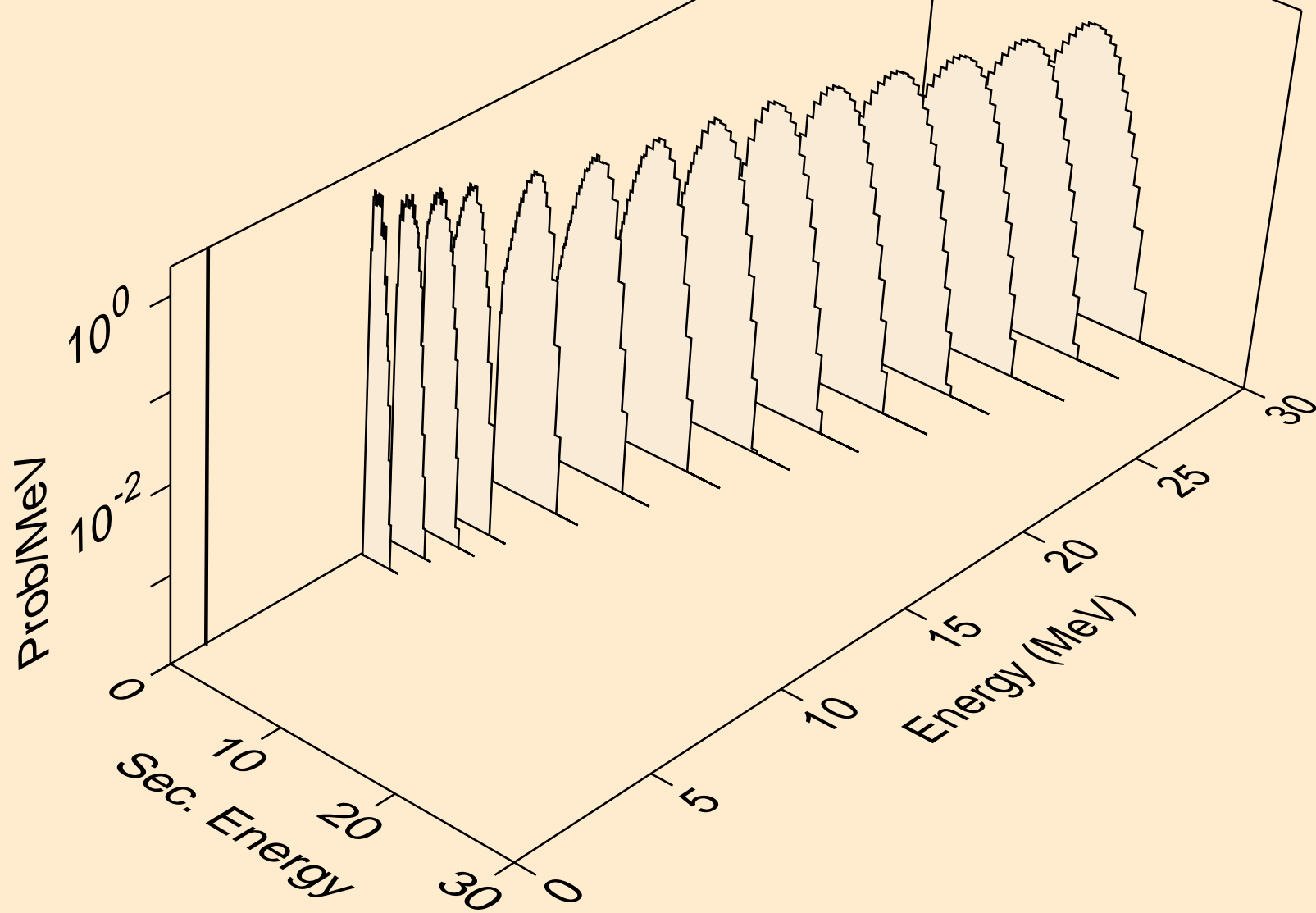

SE087 HELION ACER TENDL-2023 LIBRARY; T=0.K  
tritons from (s,x)

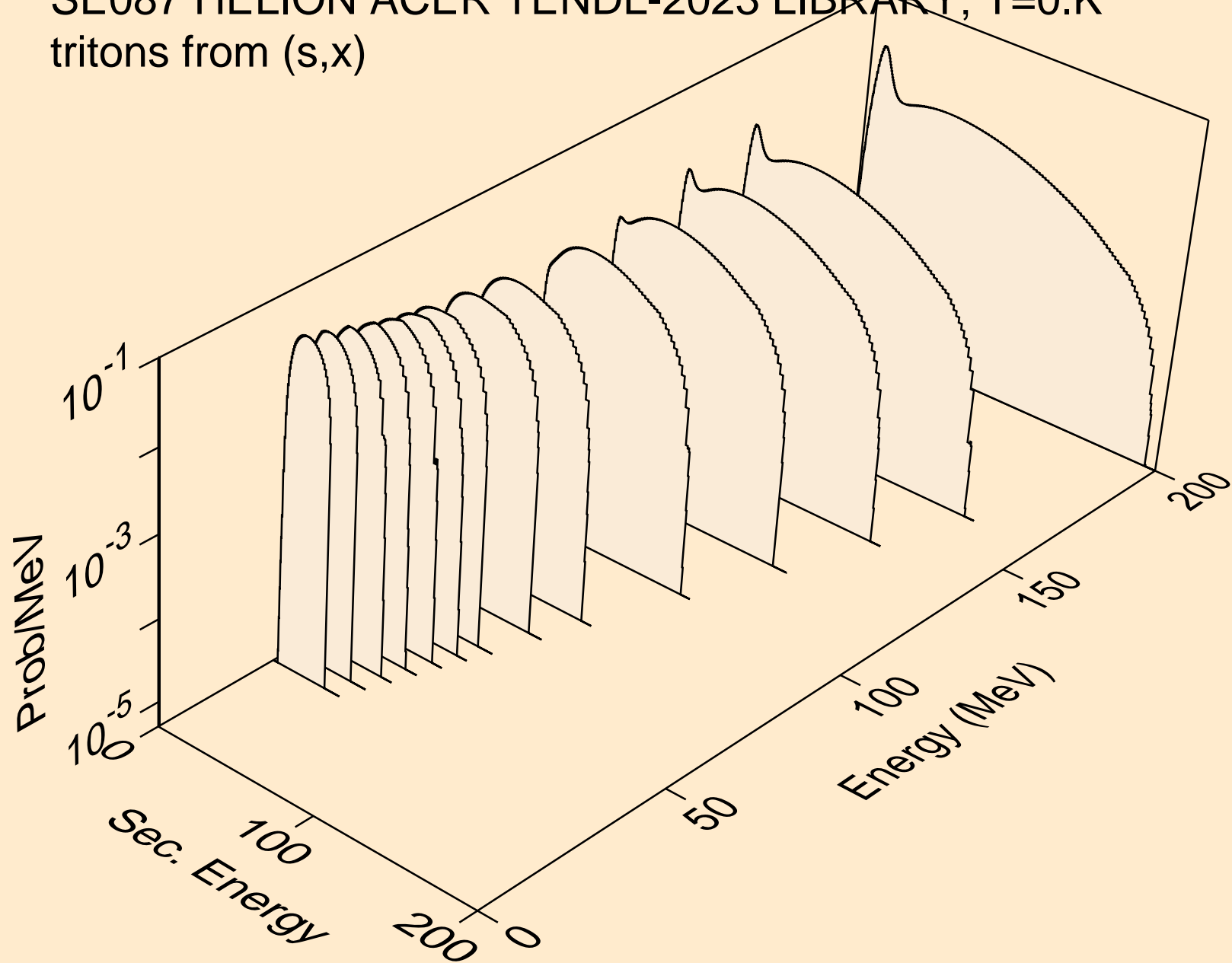

SE087 HELION ACER TENDL-2023 LIBRARY; T=0.K  
tritons from (s,n\*)t

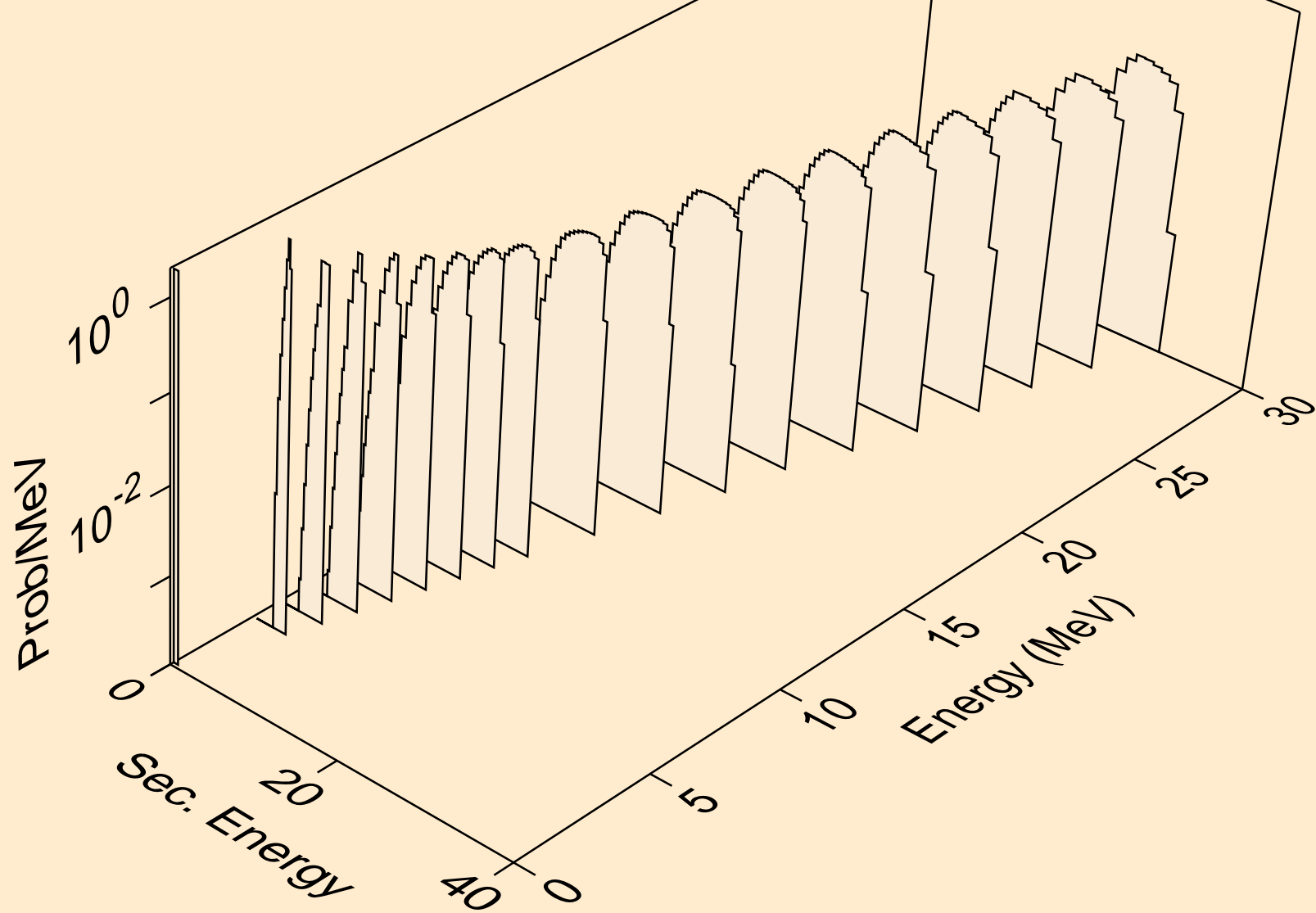

SE087 HELION ACER TENDL-2023 LIBRARY; T=0.K  
tritons from (s,t)

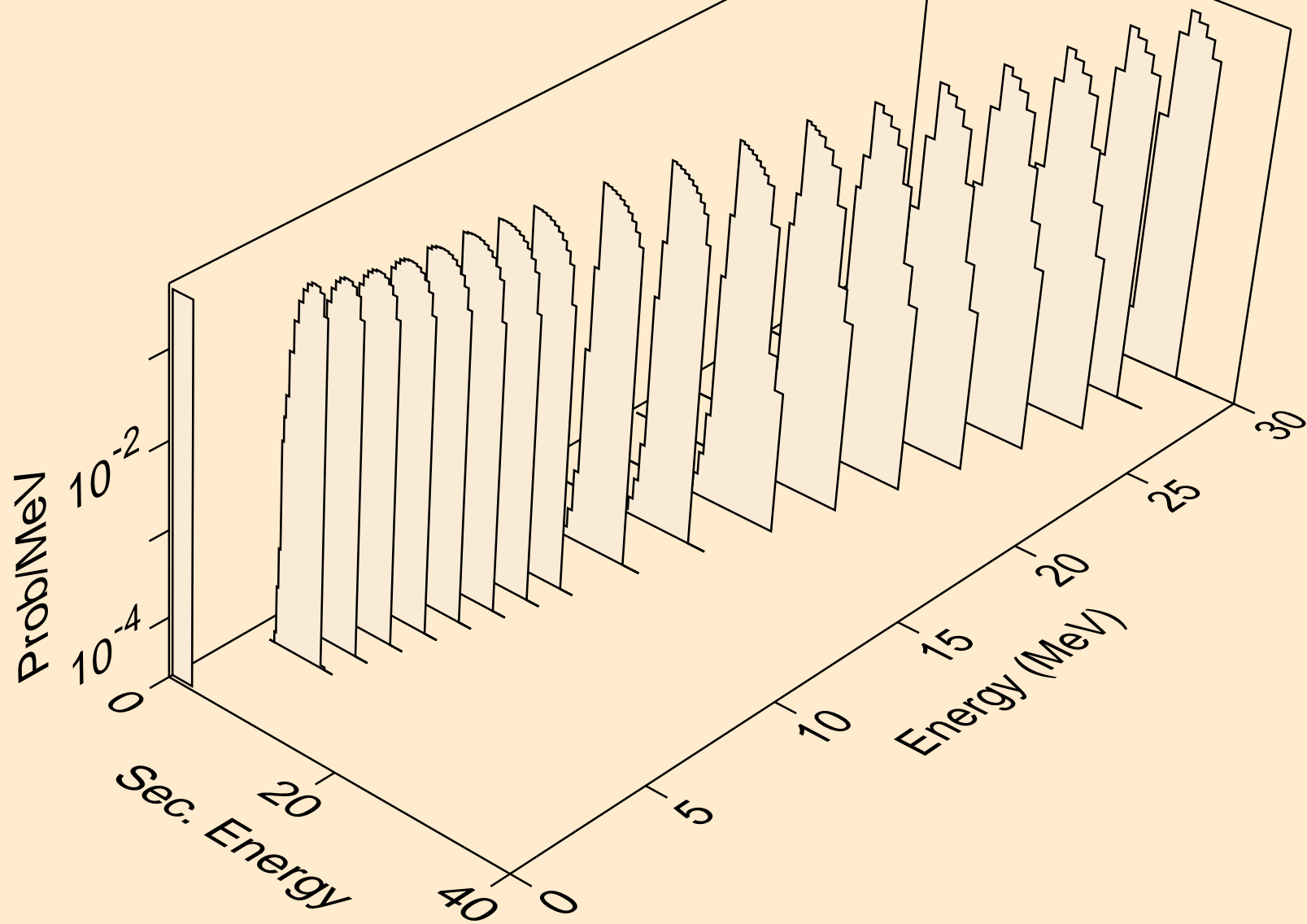

SE087 HELION ACER TENDL-2023 LIBRARY; T=0.K  
tritons from (s,pt)

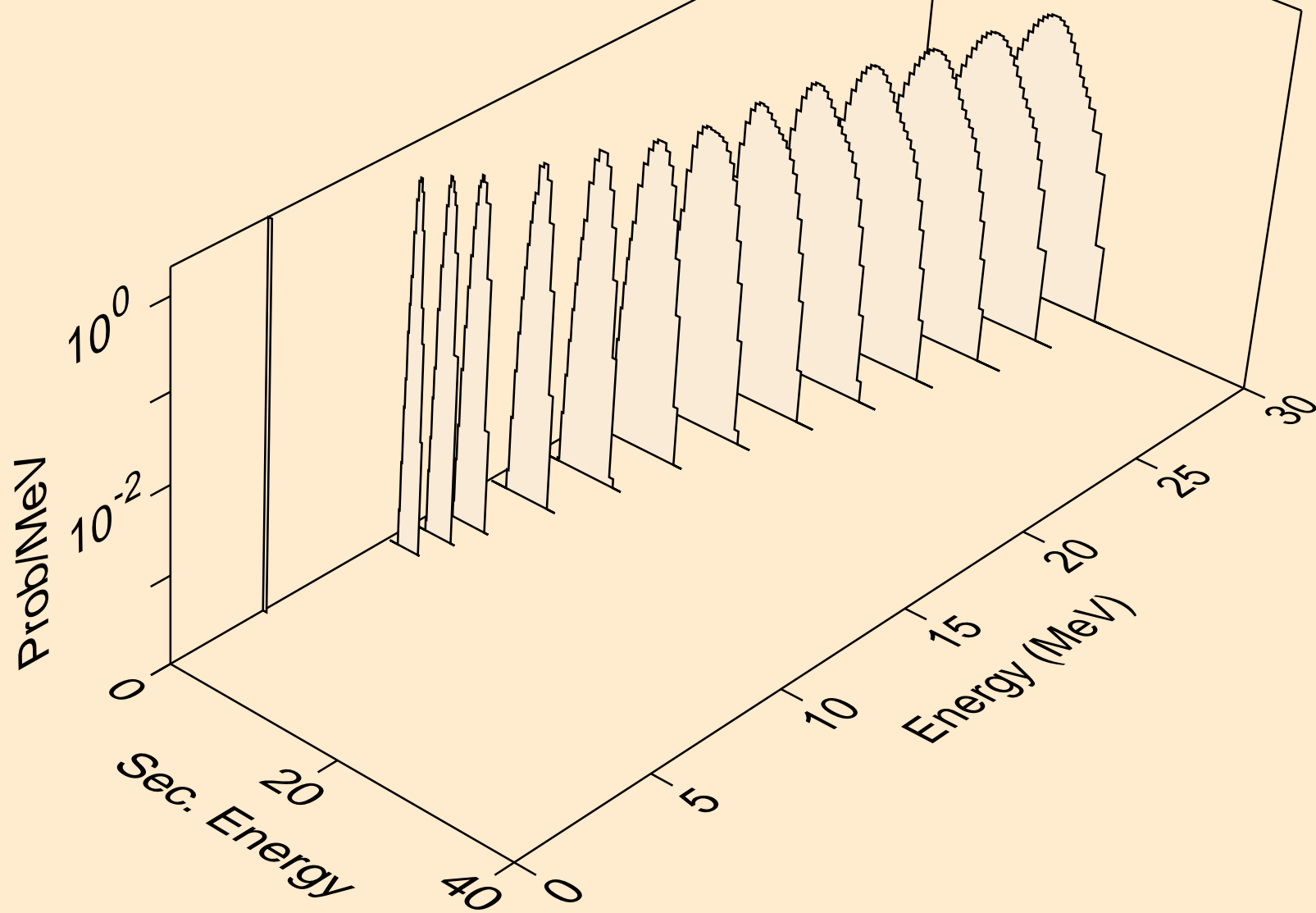

SE087 HELION ACER TENDL-2023 LIBRARY; T=0.K  
alphas from (s,x)

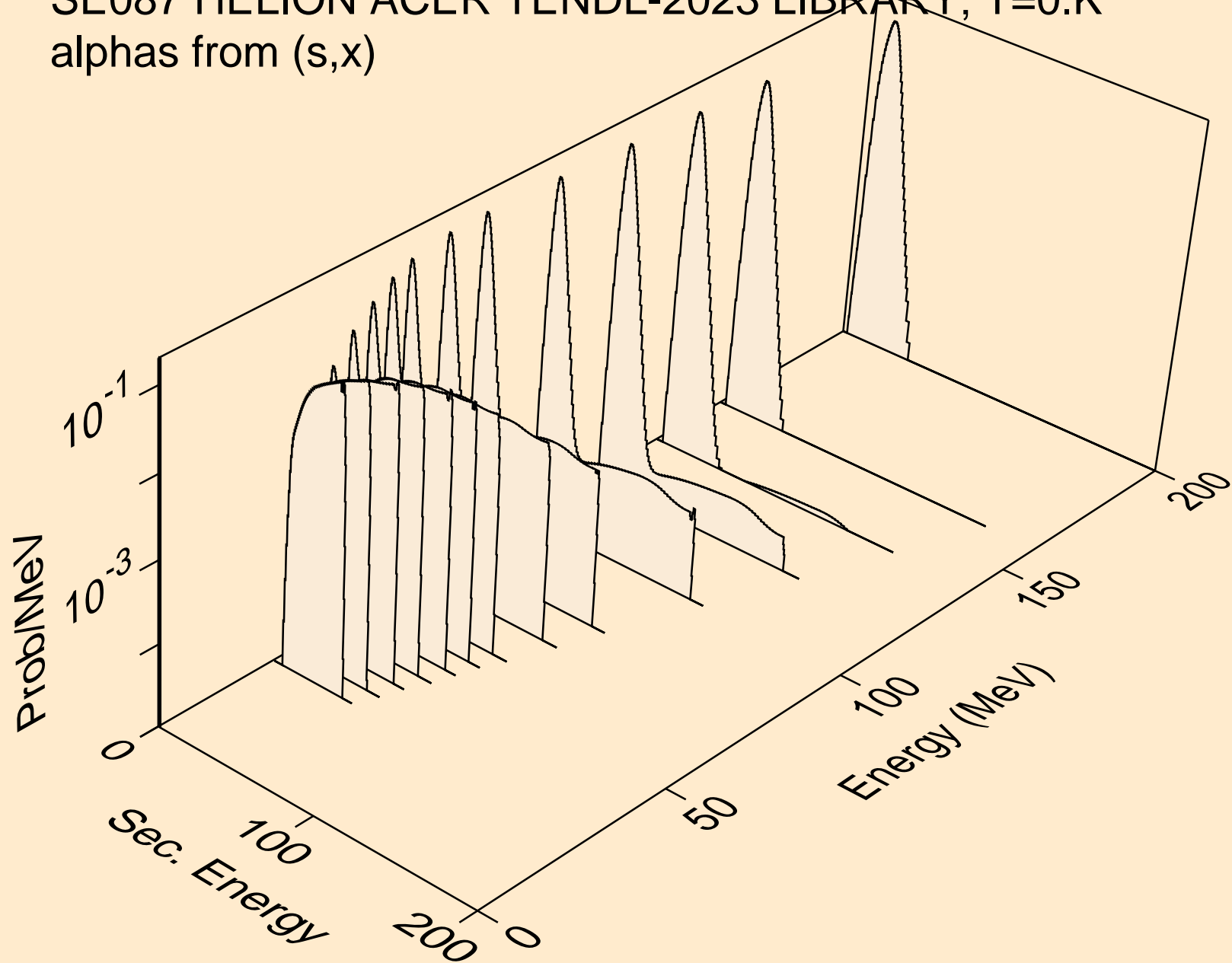

SE087 HELION ACER TENDL-2023 LIBRARY; T=0.K  
alphas from (s,n\*)a

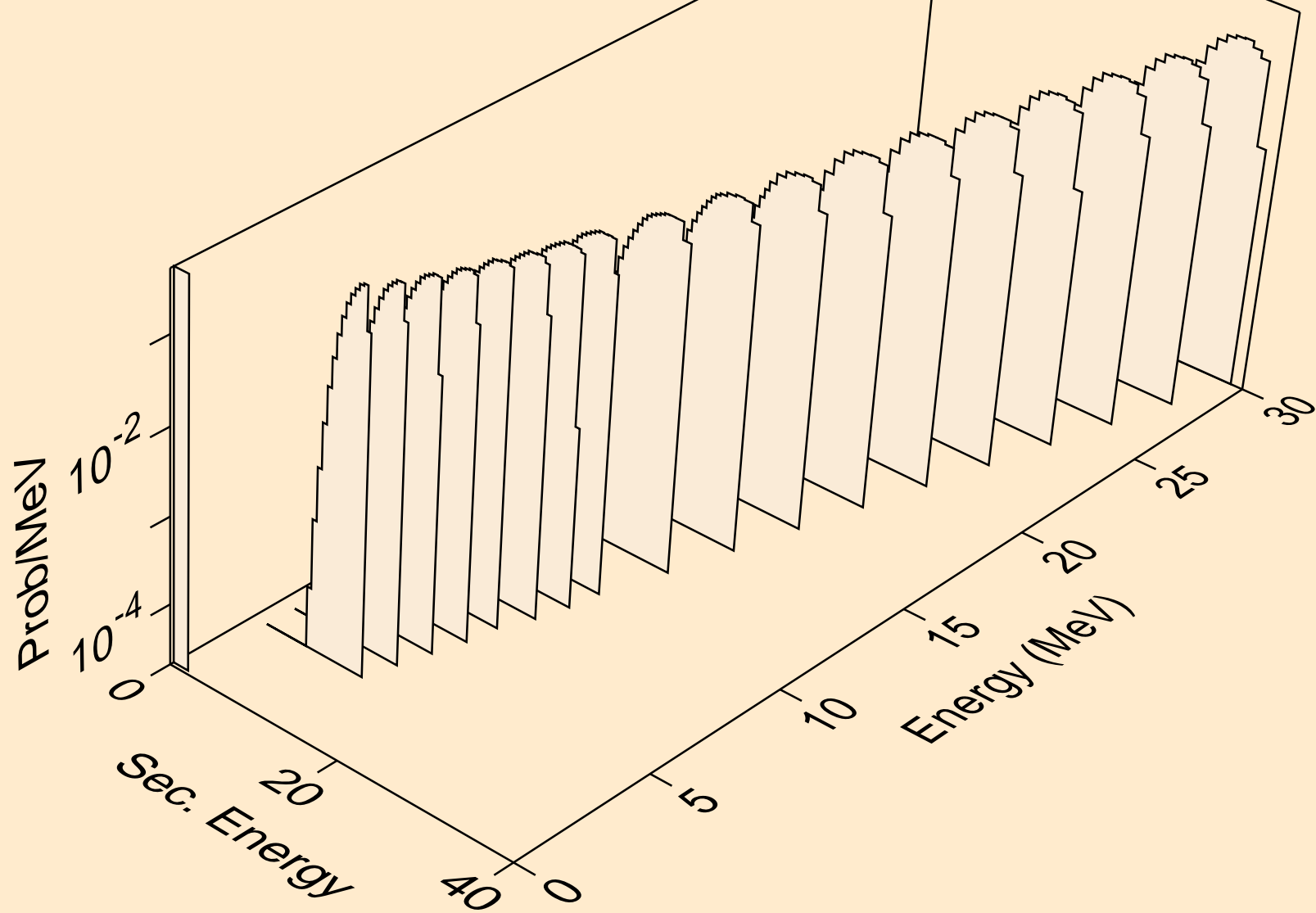

SE087 HELION ACER TENDL-2023 LIBRARY; T=0.K  
alphas from (s,2n)a

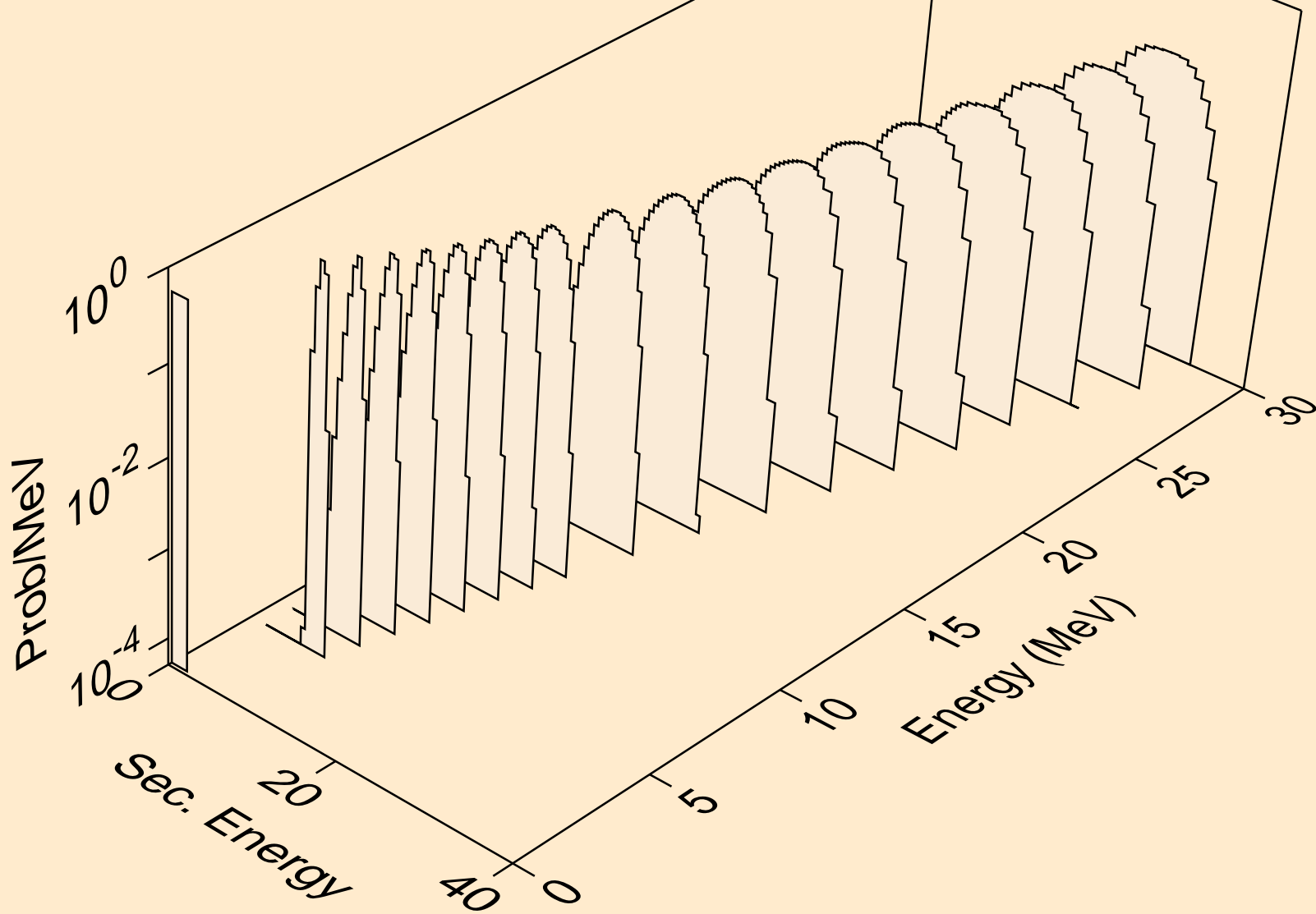

SE087 HELION ACER TENDL-2023 LIBRARY; T=0.K  
alphas from (s,3n)a

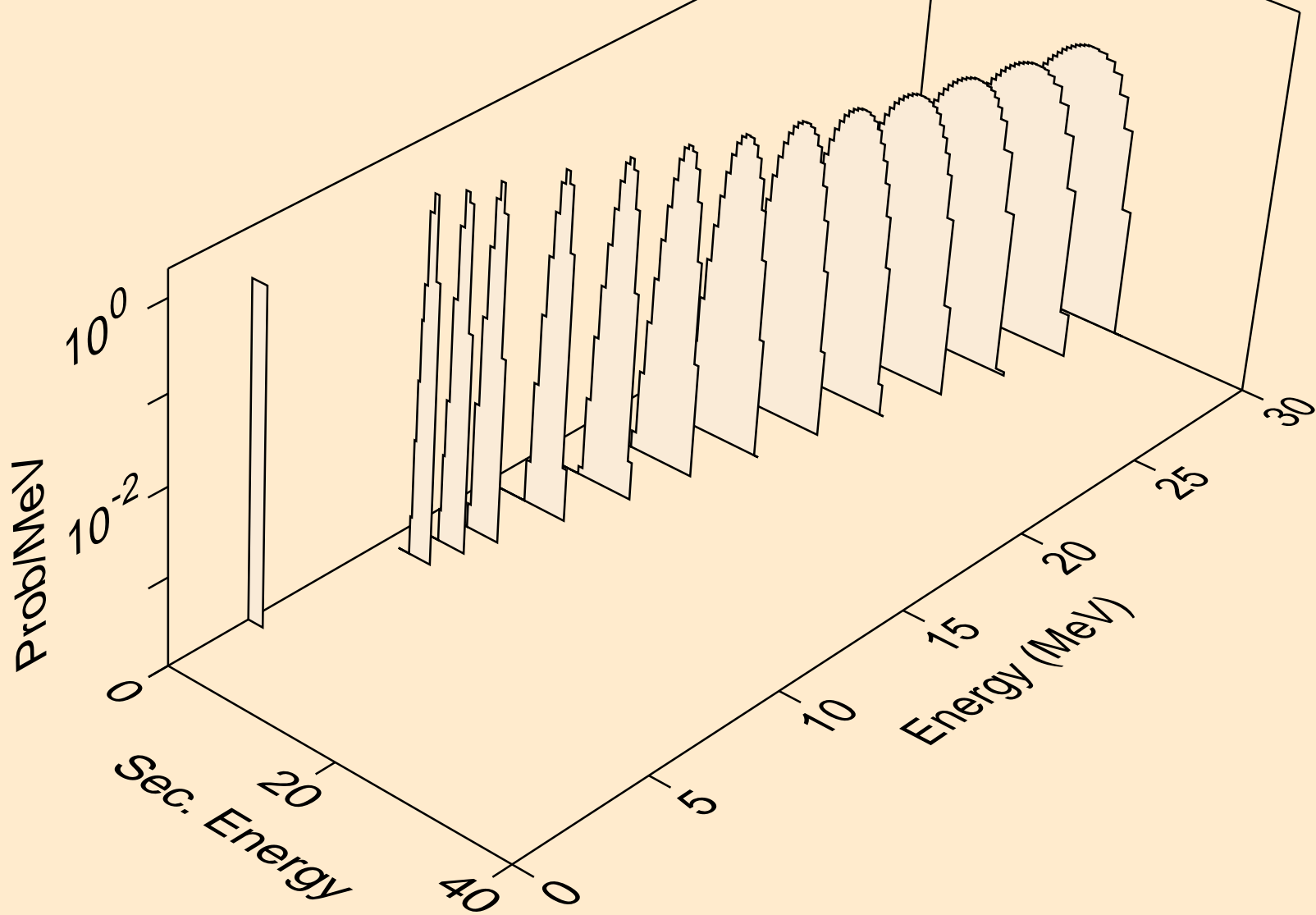

SE087 HELION ACER TENDL-2023 LIBRARY; T=0.K  
alphas from (s,n\*)2a

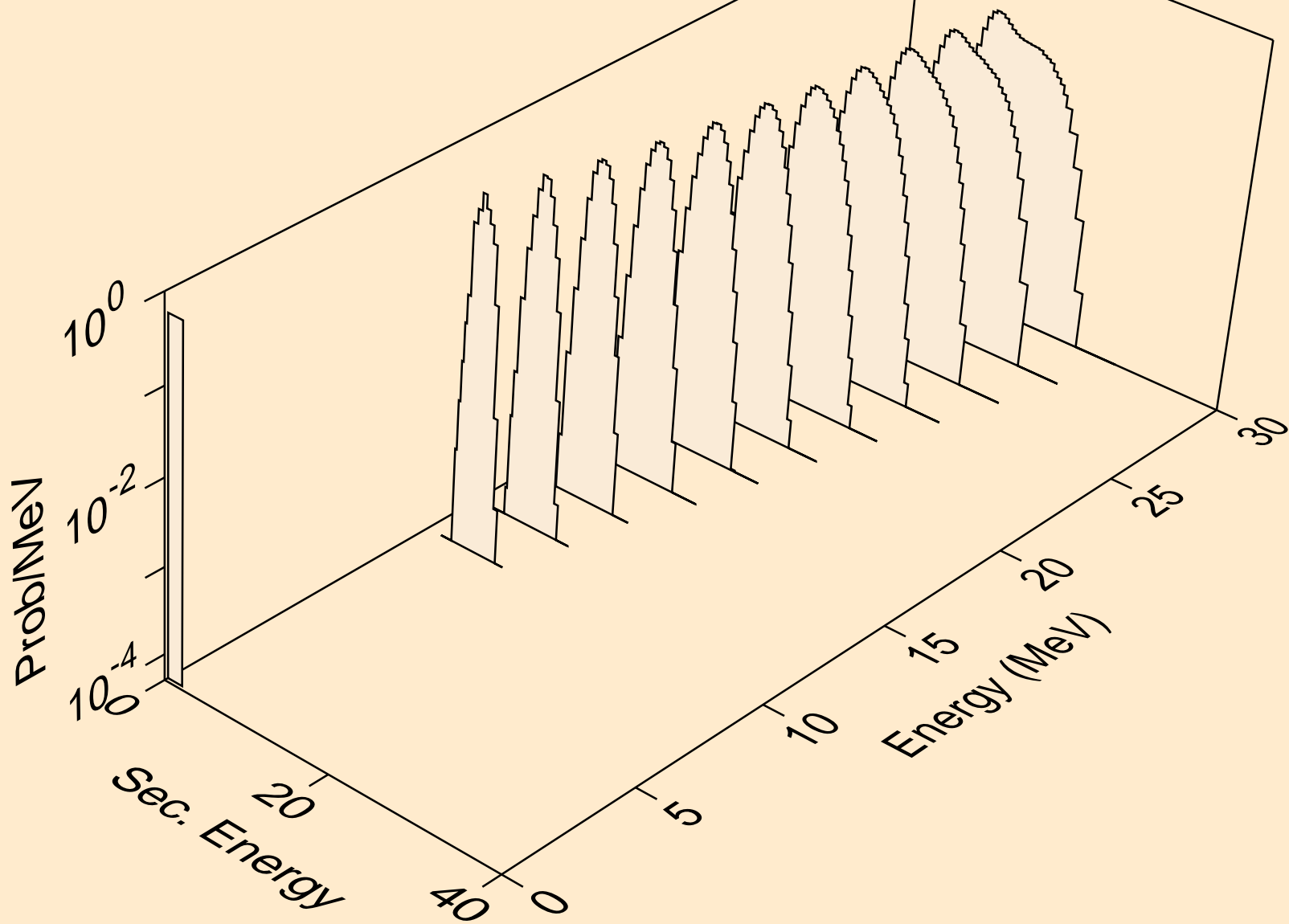

SE087 HELION ACER TENDL-2023 LIBRARY; T=0.K  
alphas from (s,2n)2a

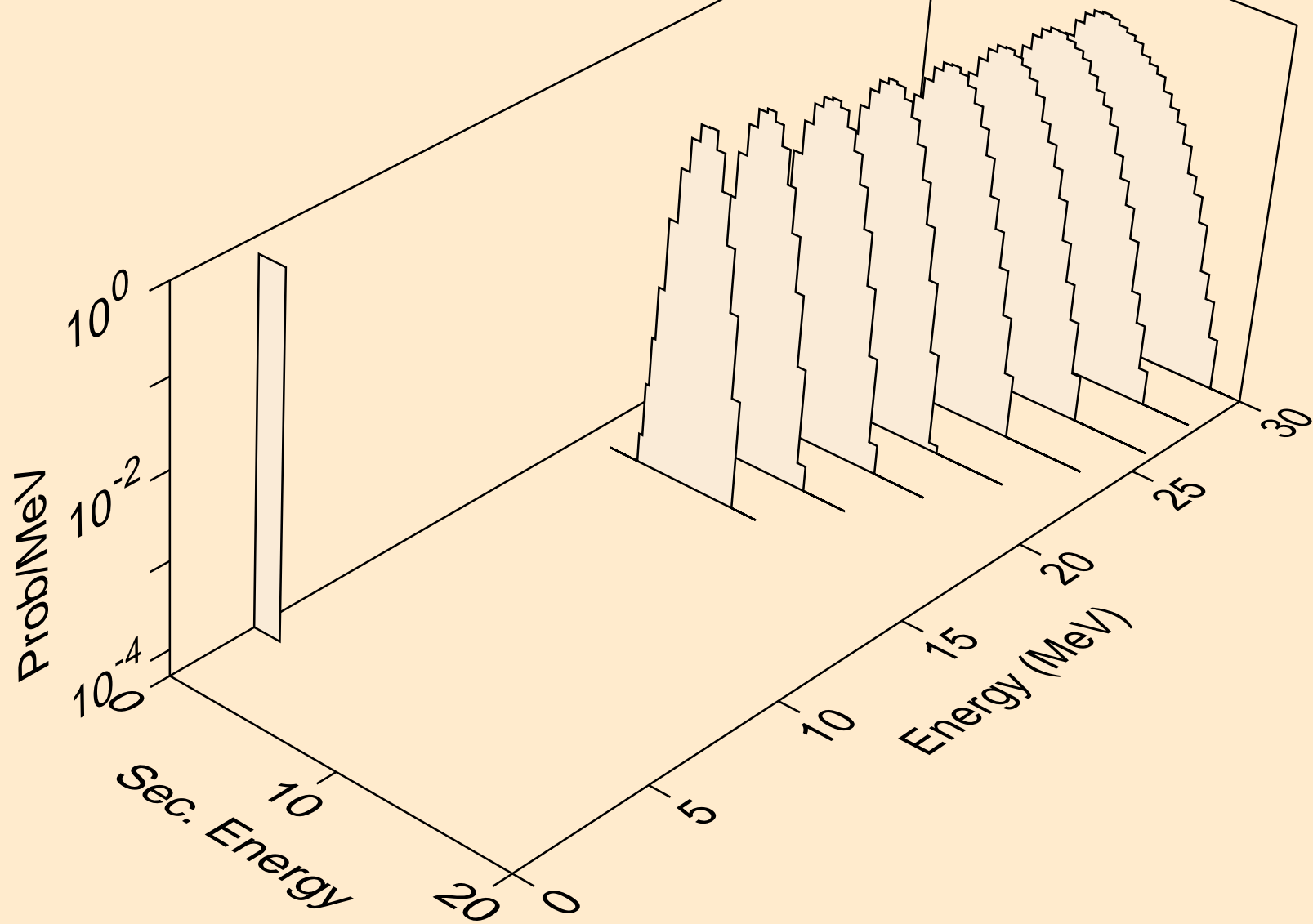

SE087 HELION ACER TENDL-2023 LIBRARY; T=0.K  
alphas from (s,npa)

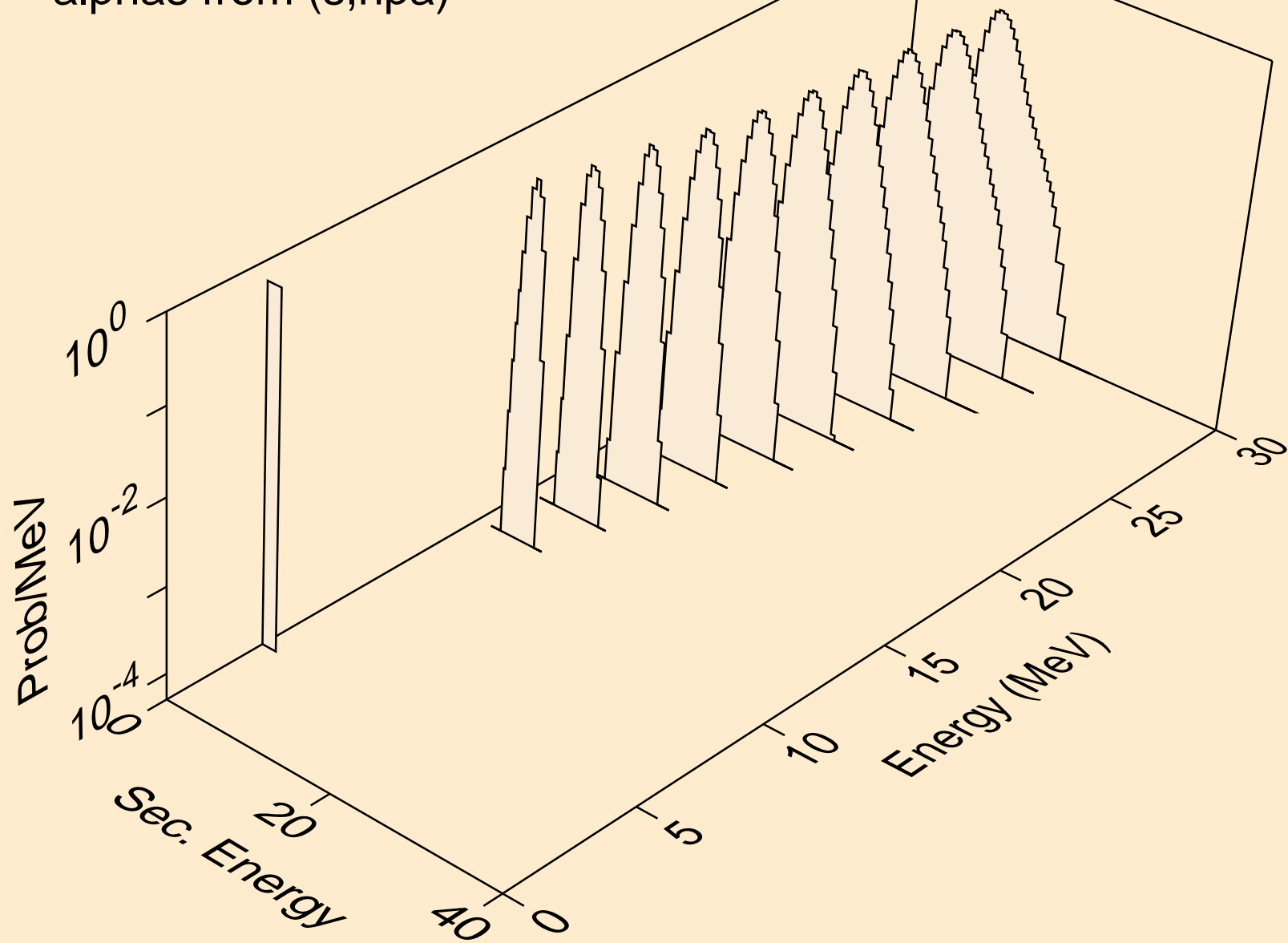

SE087 HELION ACER TENDL-2023 LIBRARY; T=0.K  
alphas from (s,a)

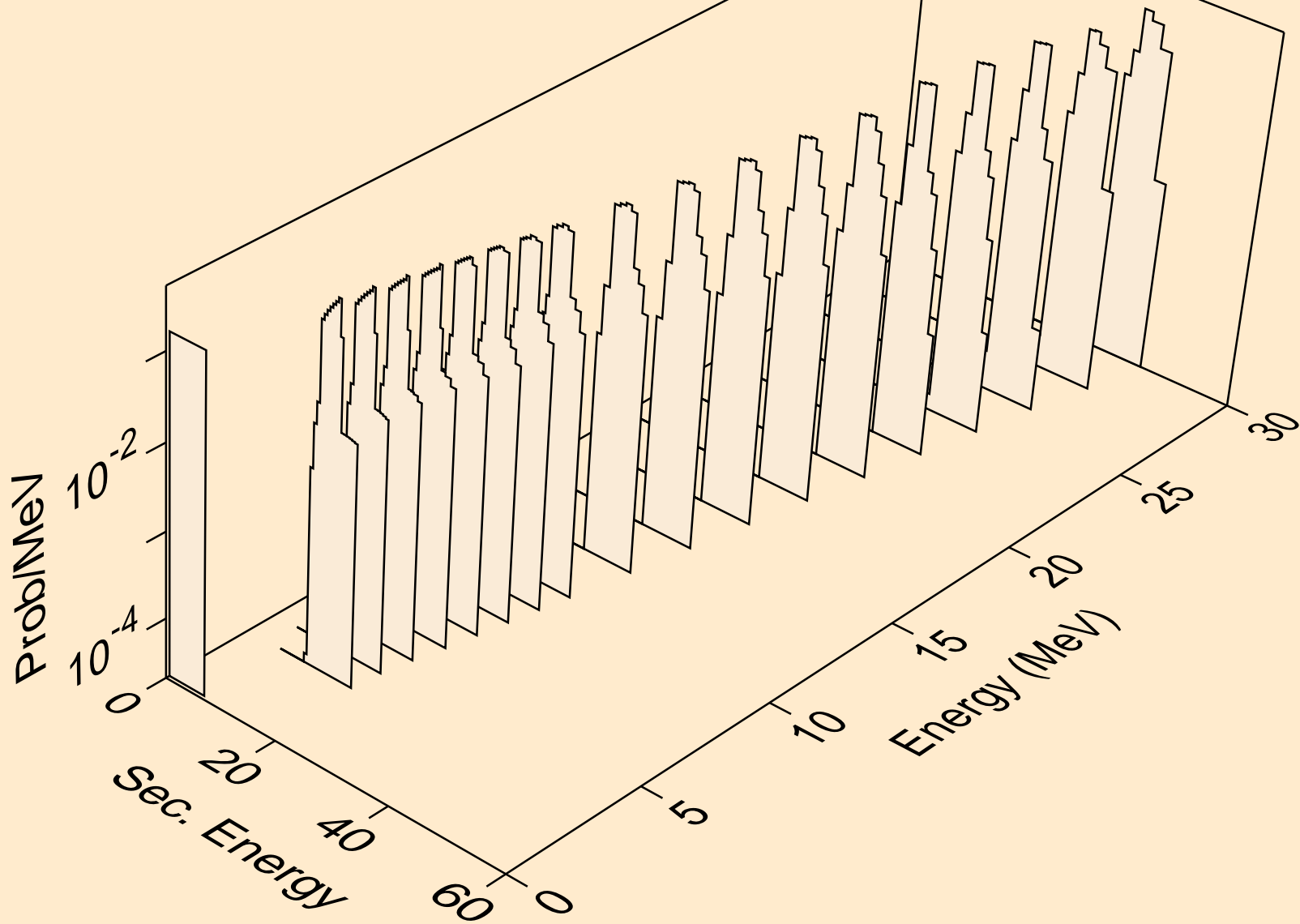

SE087 HELION ACER TENDL-2023 LIBRARY; T=0.K  
alphas from (s,2a)

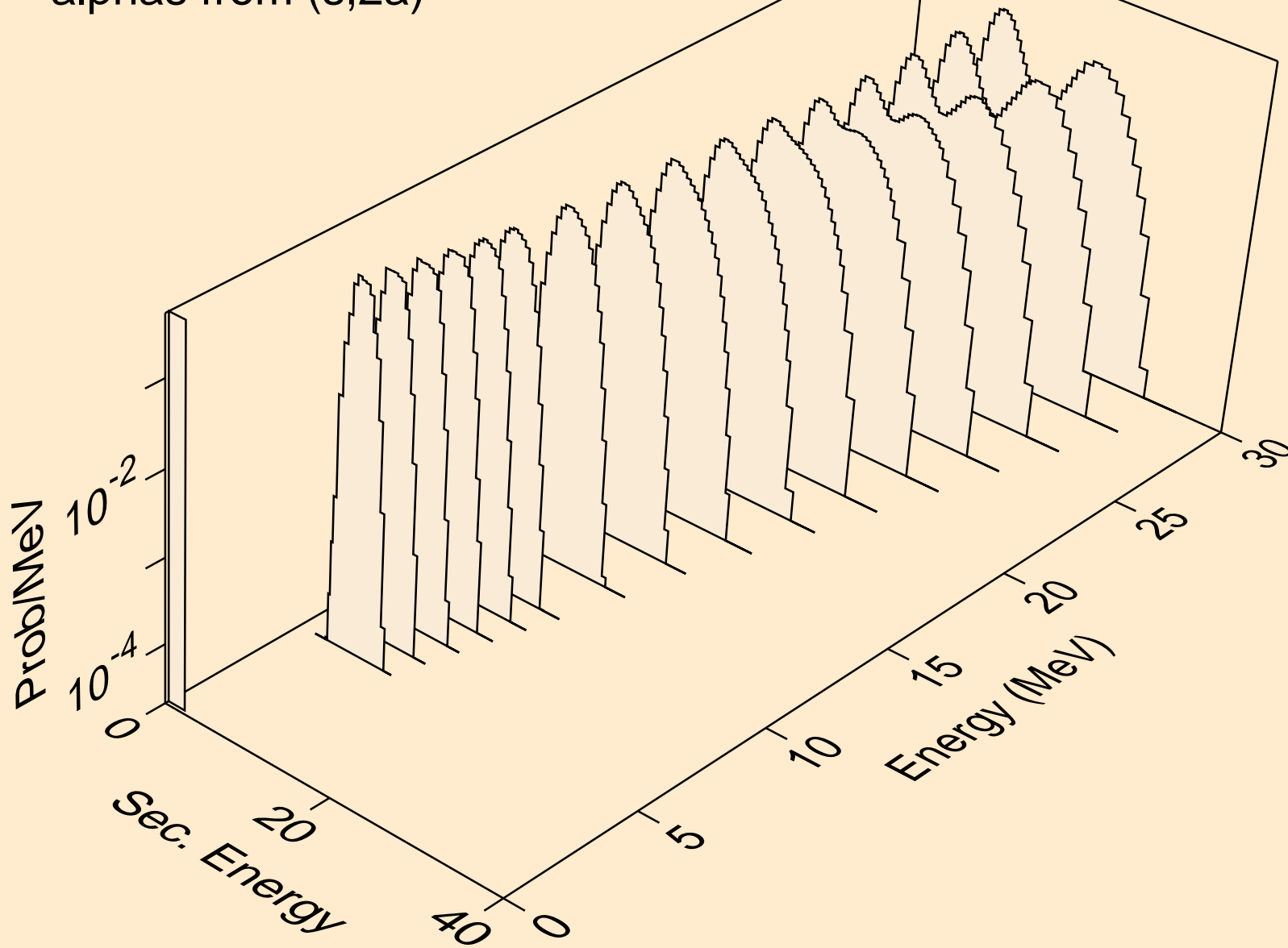

SE087 HELION ACER TENDL-2023 LIBRARY; T=0.K  
alphas from (s,pa)

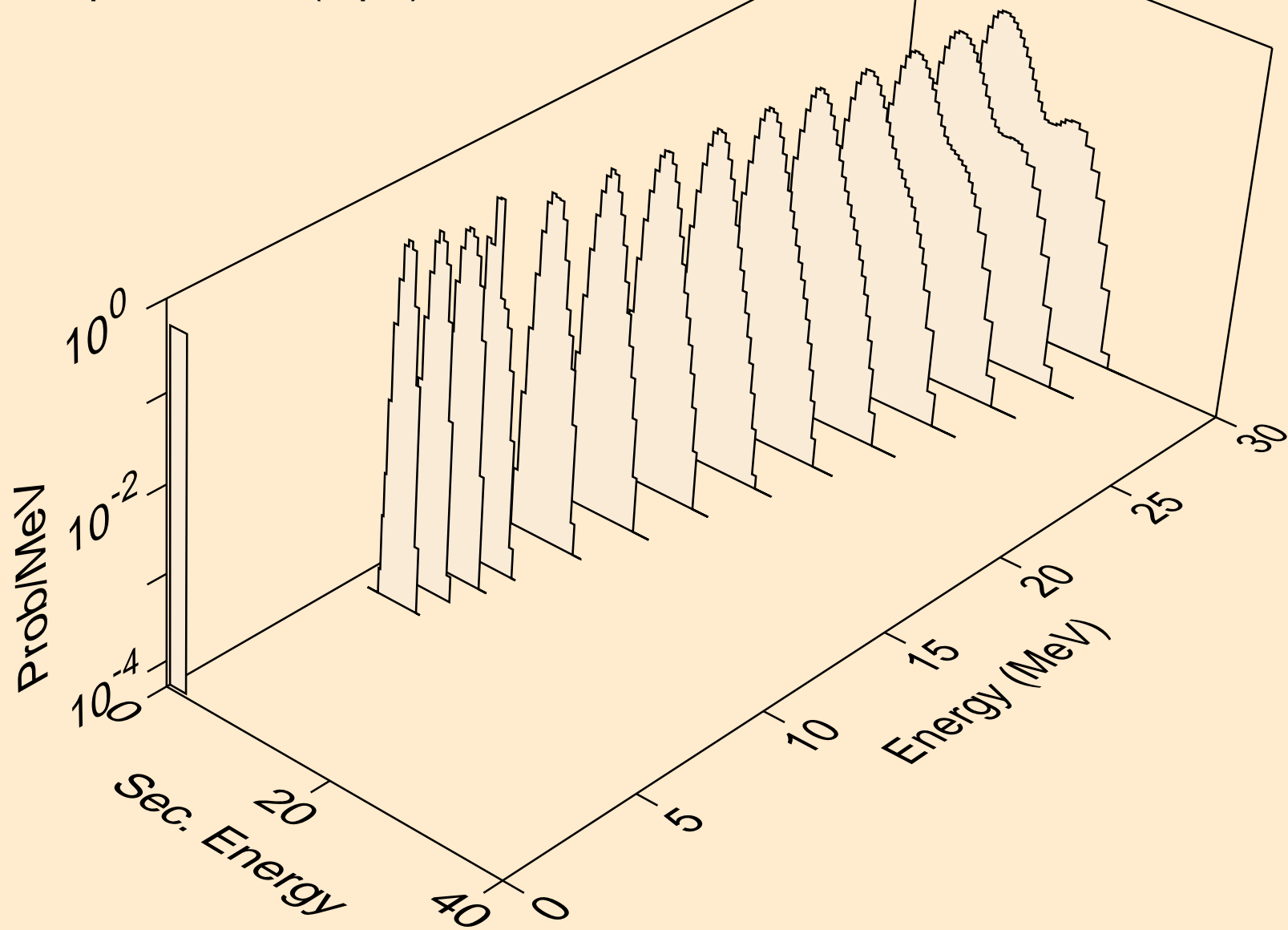

SE087 HELION ACER TENDL-2023 LIBRARY; T=0.K  
alphas from (s,da)

