

# AL027 NEUTRON ACER TENDL-2023 LIBRARY; T=0.K

## Principal cross sections

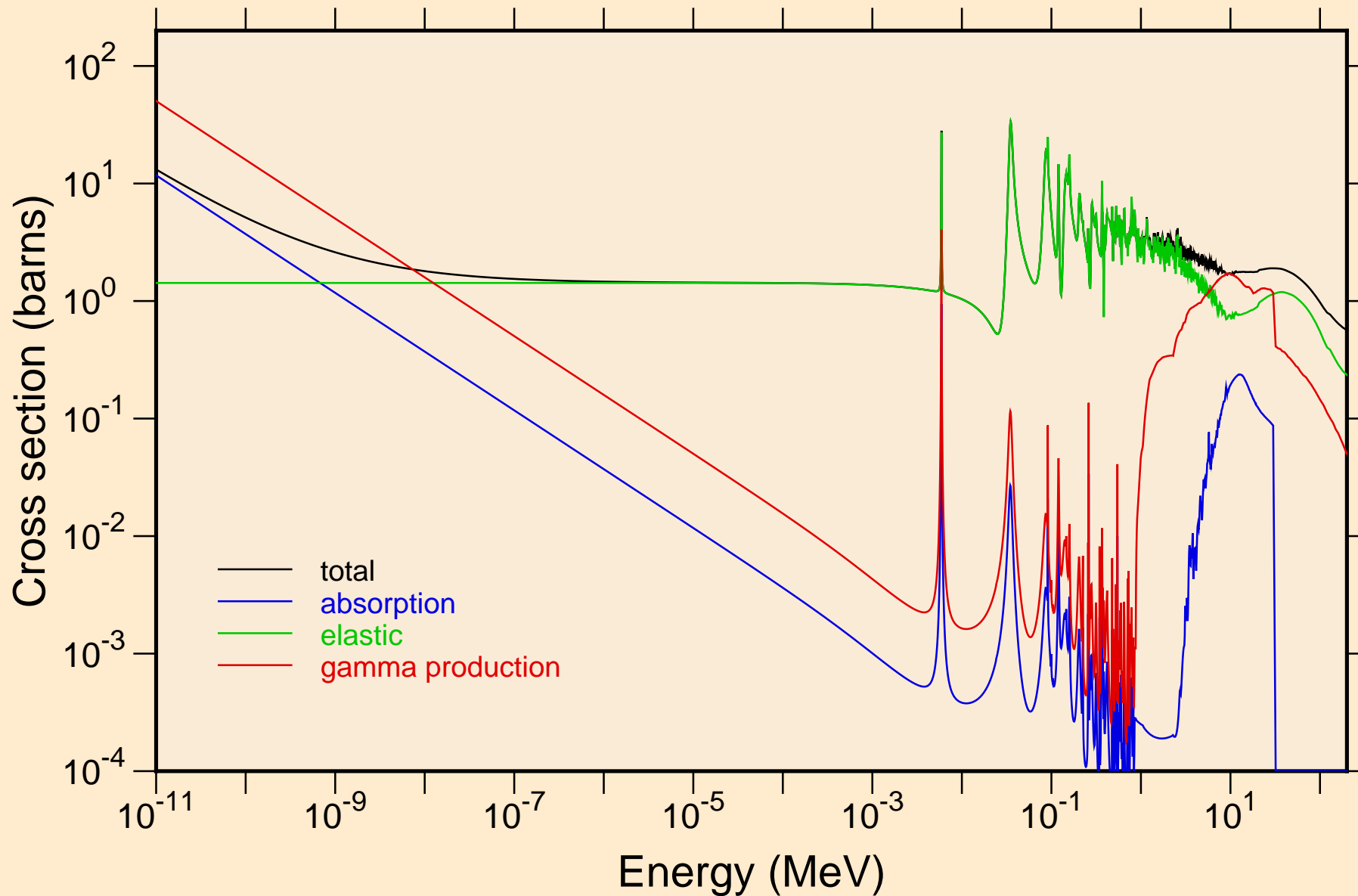

AL027 NEUTRON ACER TENDL-2023 LIBRARY; T=0.K  
resonance total cross section

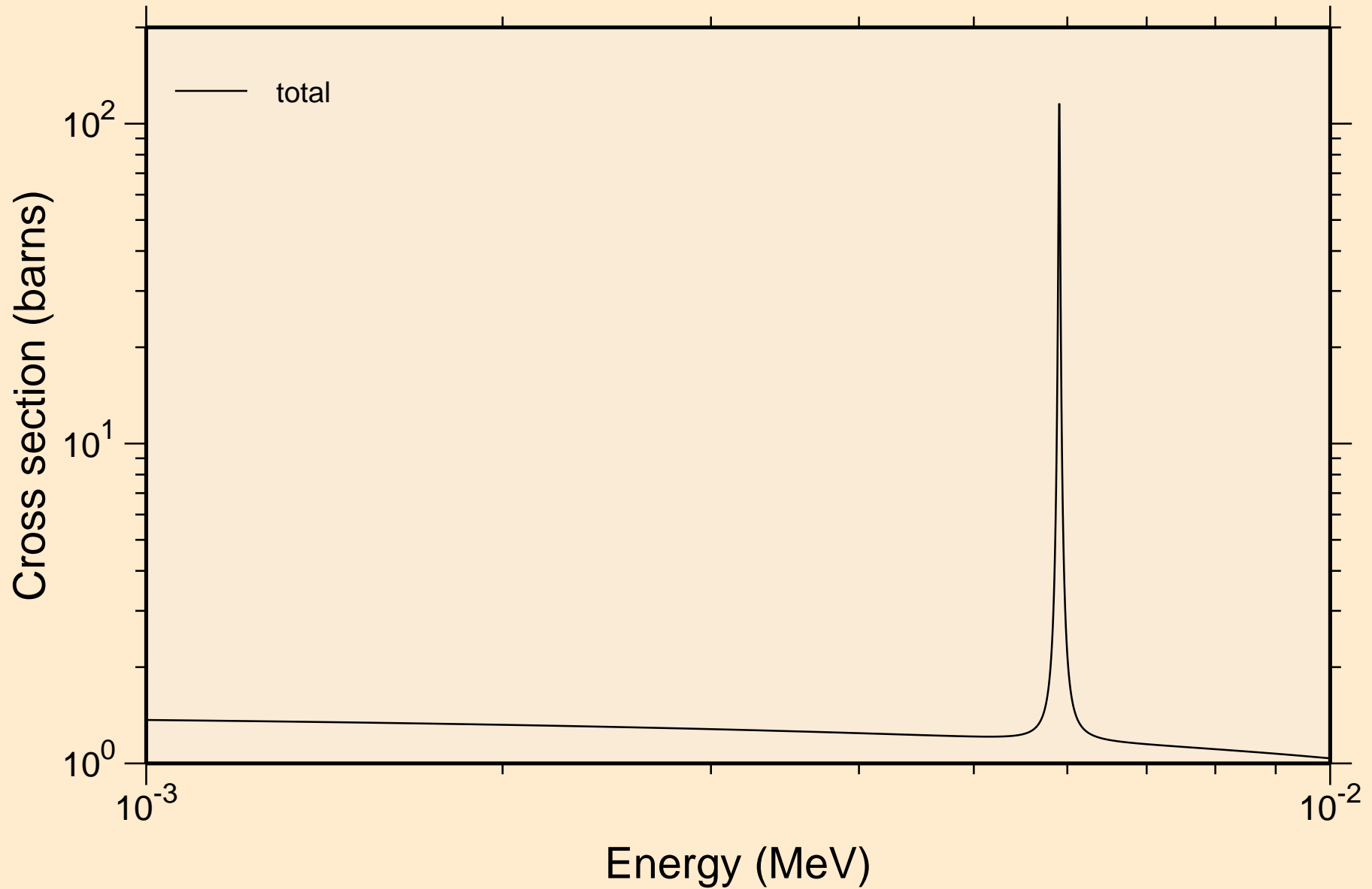

AL027 NEUTRON ACER TENDL-2023 LIBRARY; T=0.K  
resonance total cross section

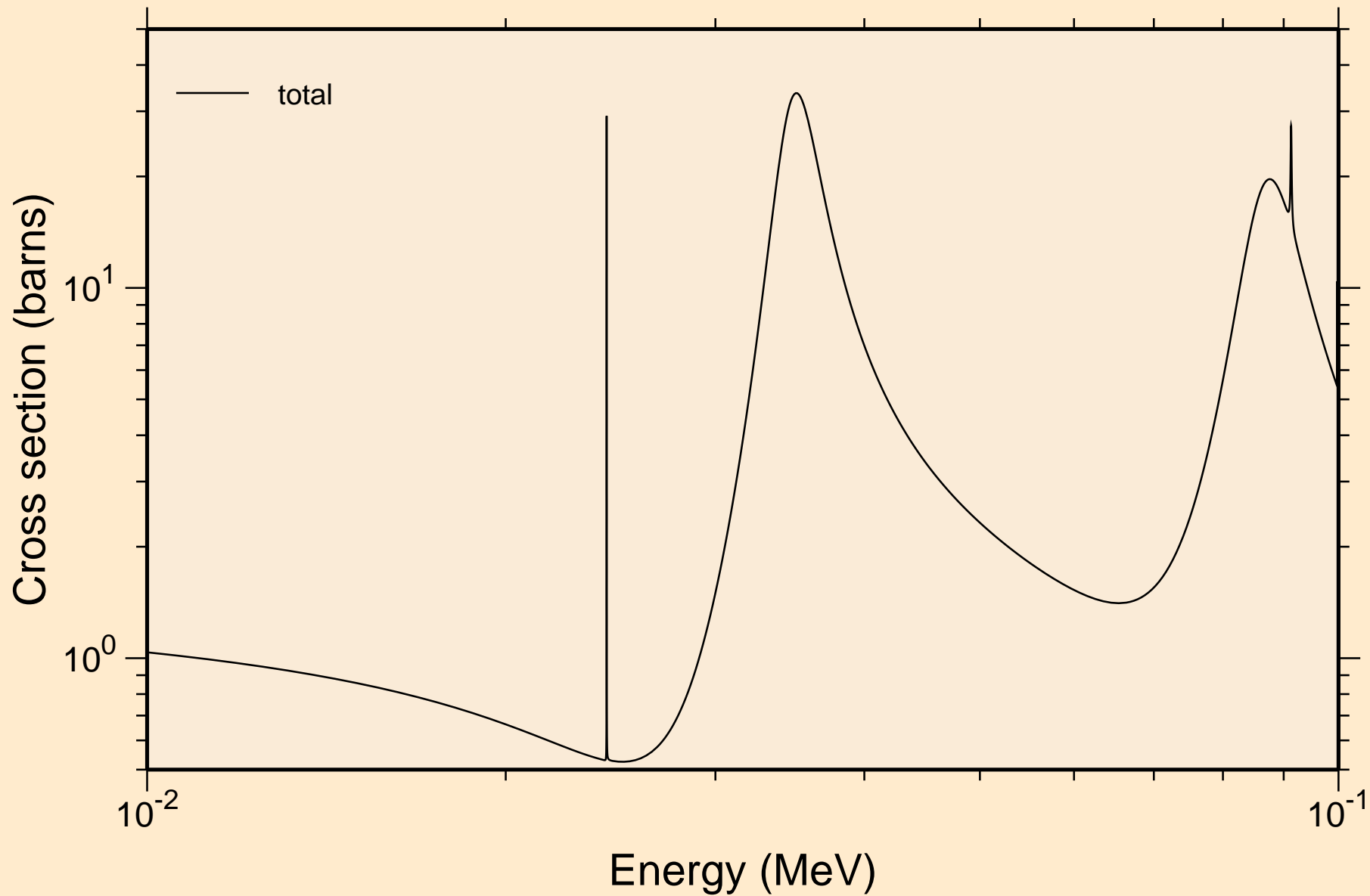

AL027 NEUTRON ACER TENDL-2023 LIBRARY; T=0.K  
resonance total cross section

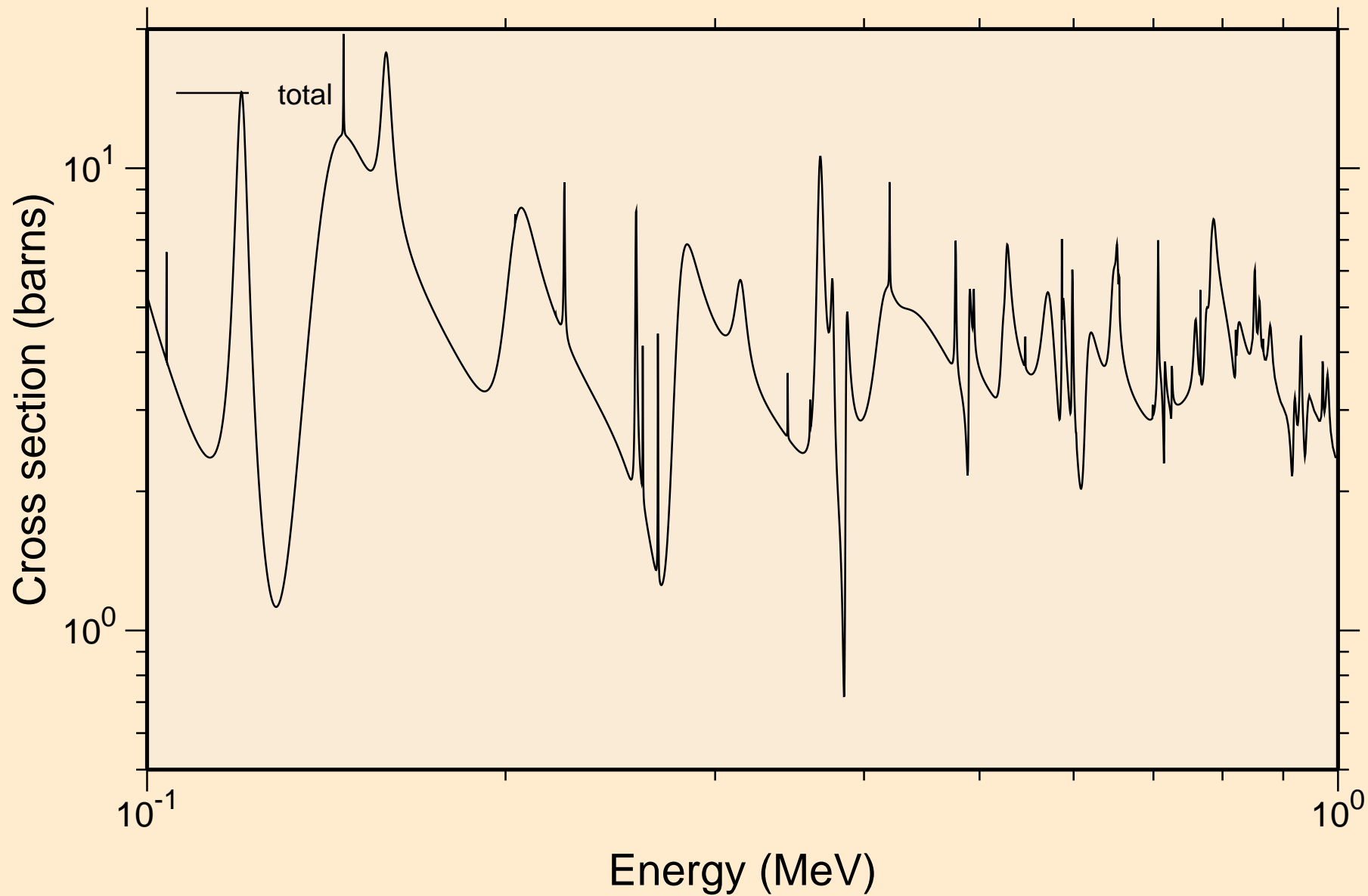

AL027 NEUTRON ACER TENDL-2023 LIBRARY; T=0.K  
resonance total cross section

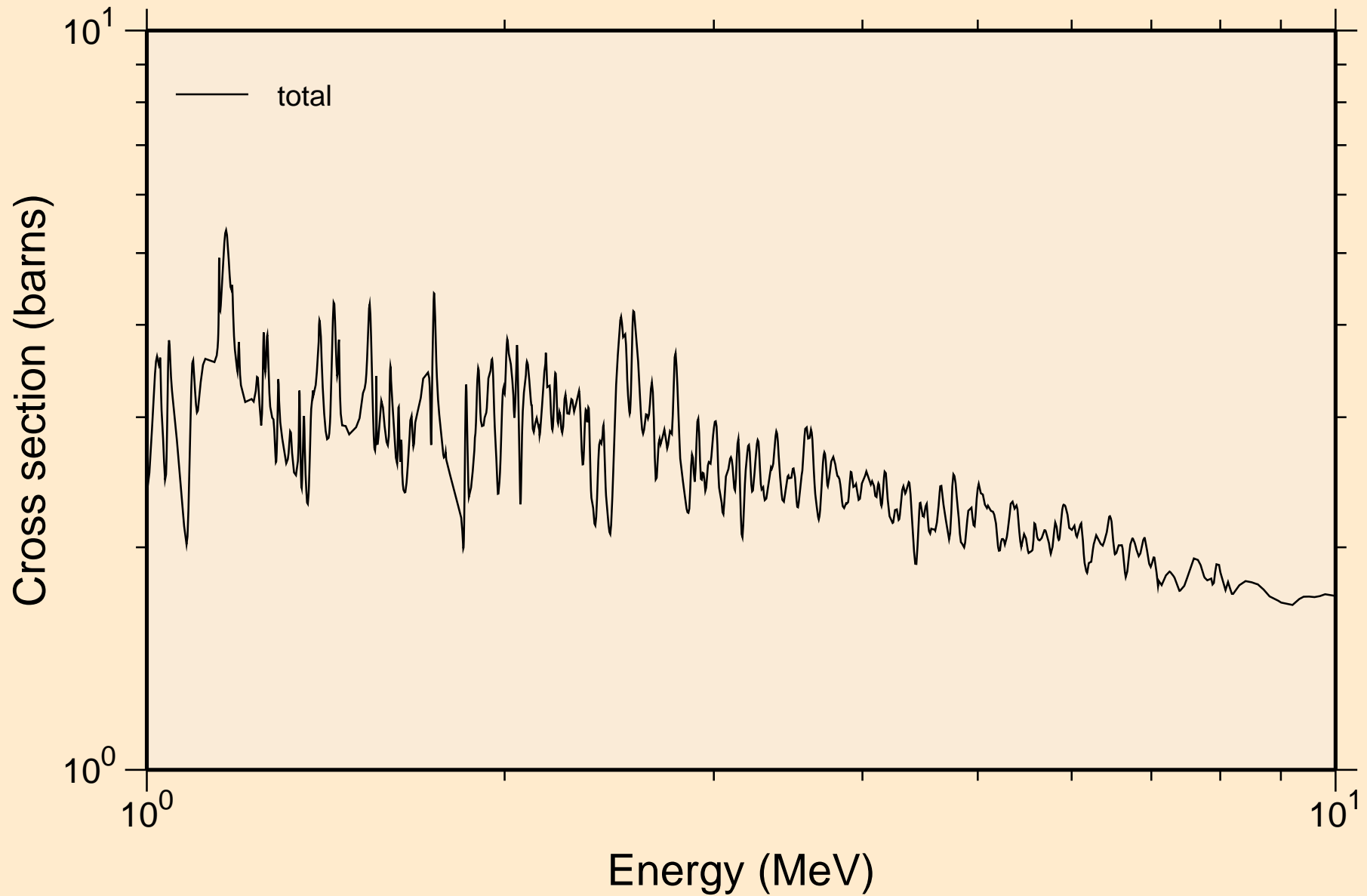

AL027 NEUTRON ACER TENDL-2023 LIBRARY; T=0.K  
resonance absorption cross sections

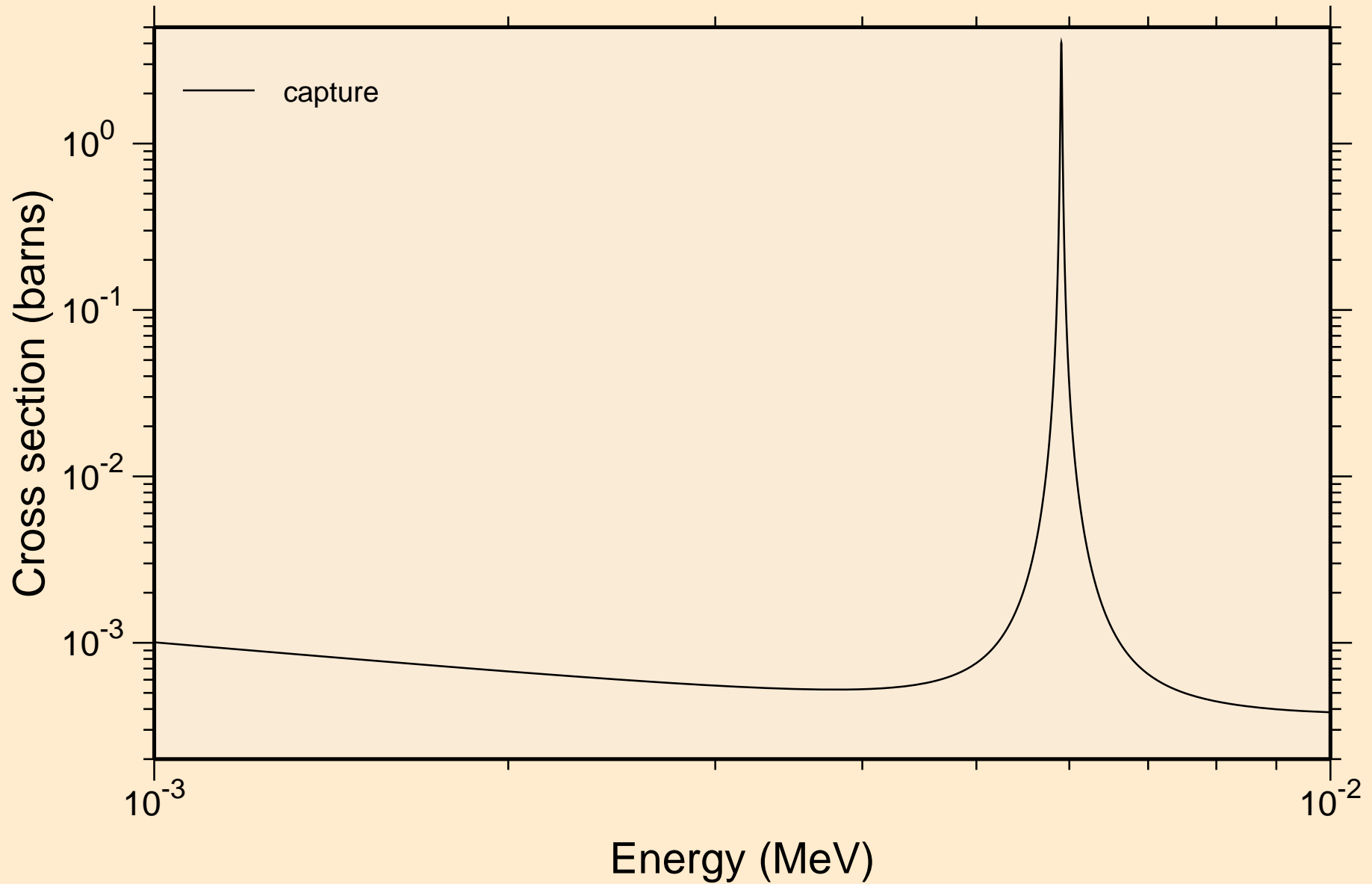

AL027 NEUTRON ACER TENDL-2023 LIBRARY; T=0.K  
resonance absorption cross sections

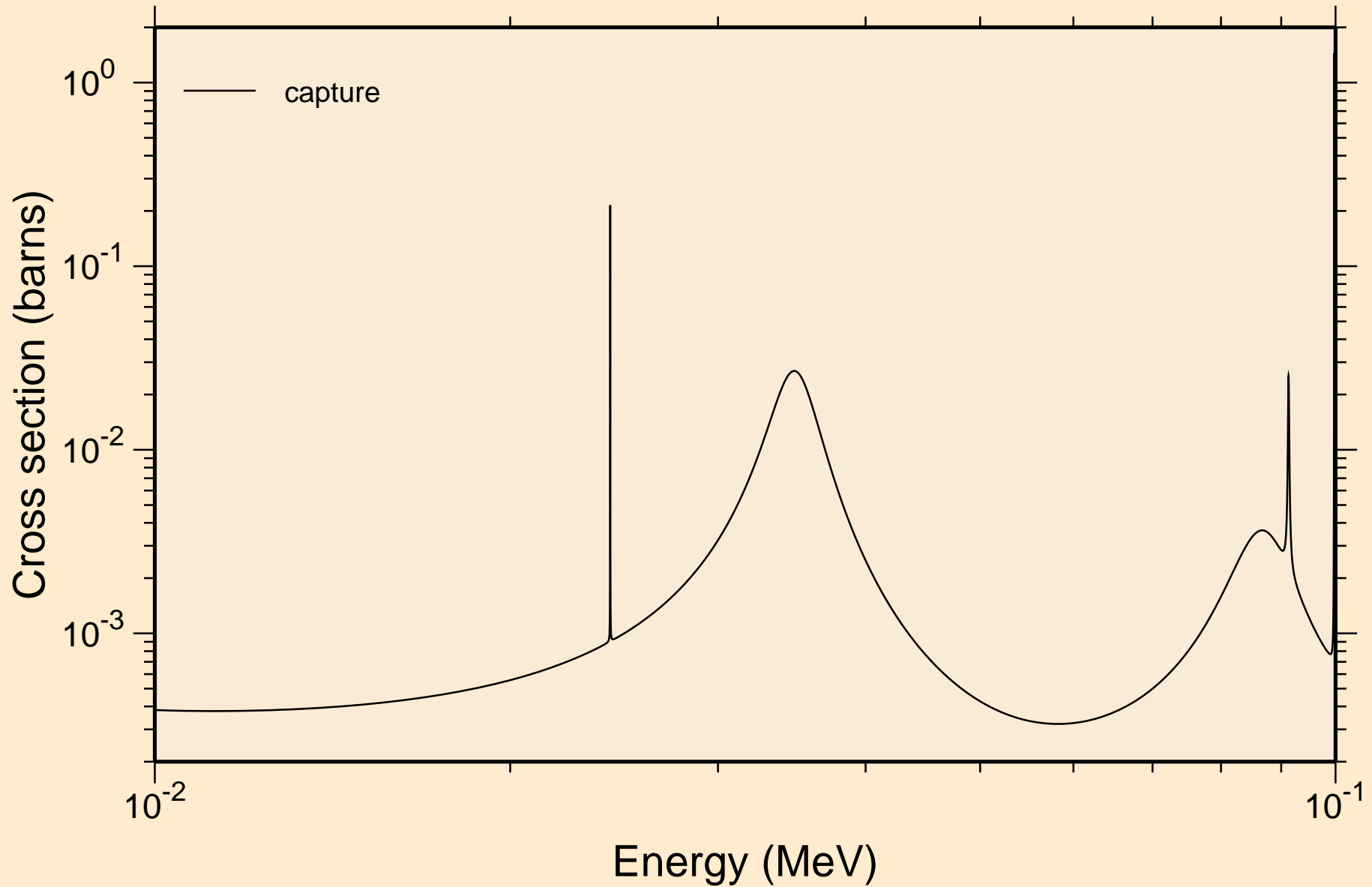

AL027 NEUTRON ACER TENDL-2023 LIBRARY; T=0.K  
resonance absorption cross sections

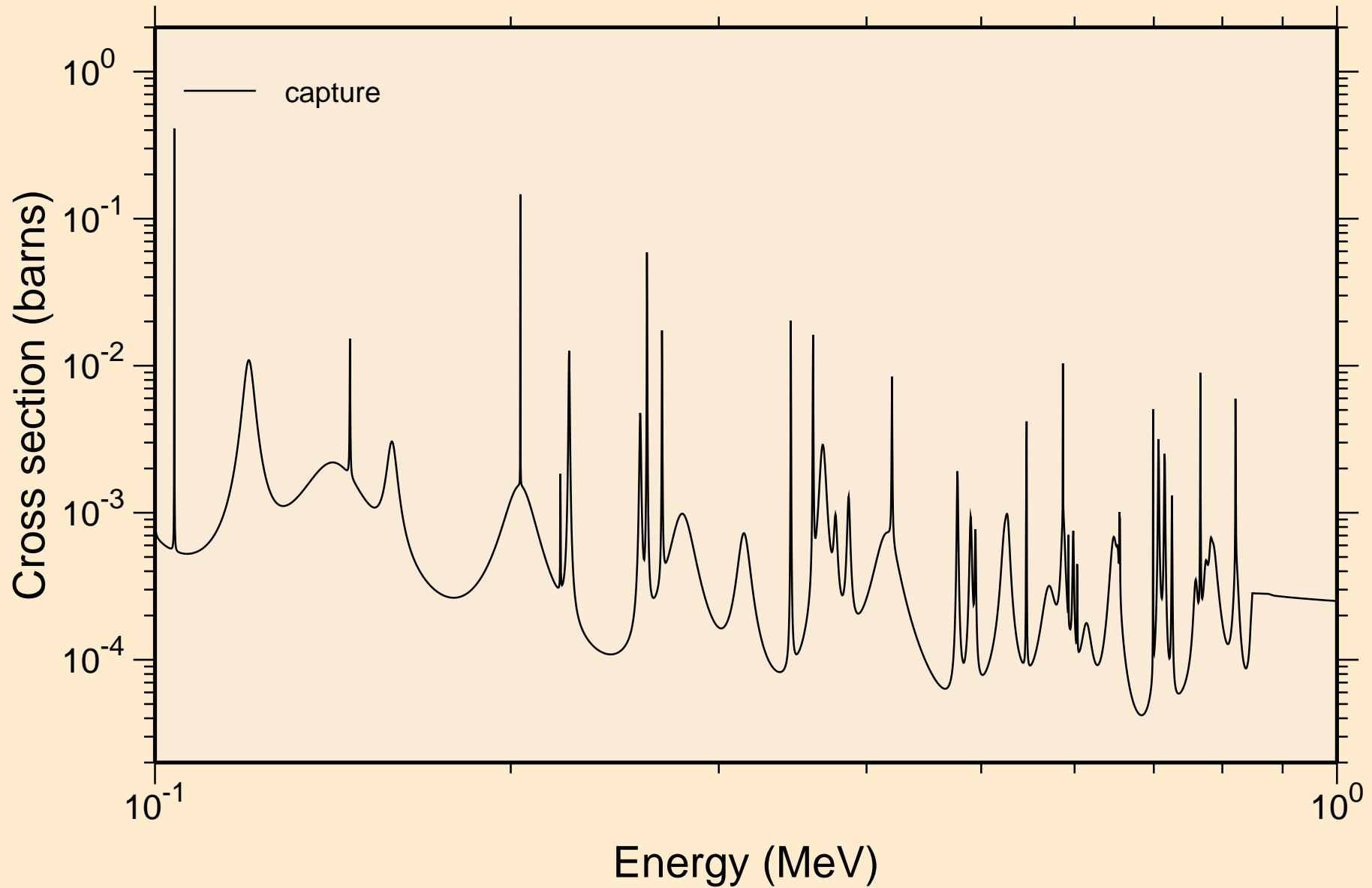

AL027 NEUTRON ACER TENDL-2023 LIBRARY; T=0.K  
resonance absorption cross sections

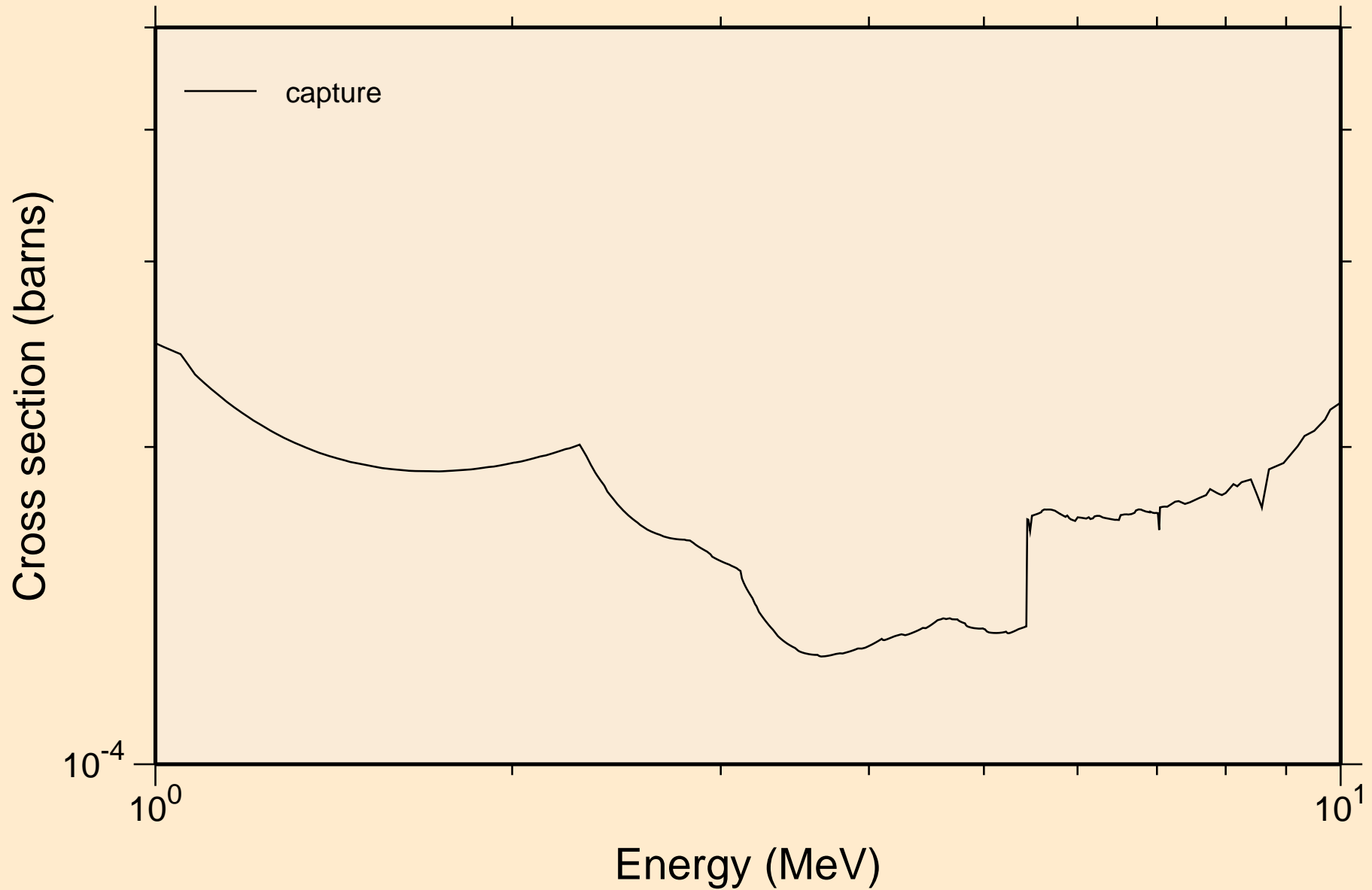

# AL027 NEUTRON ACER TENDL-2023 LIBRARY; T=0.K

## Heating

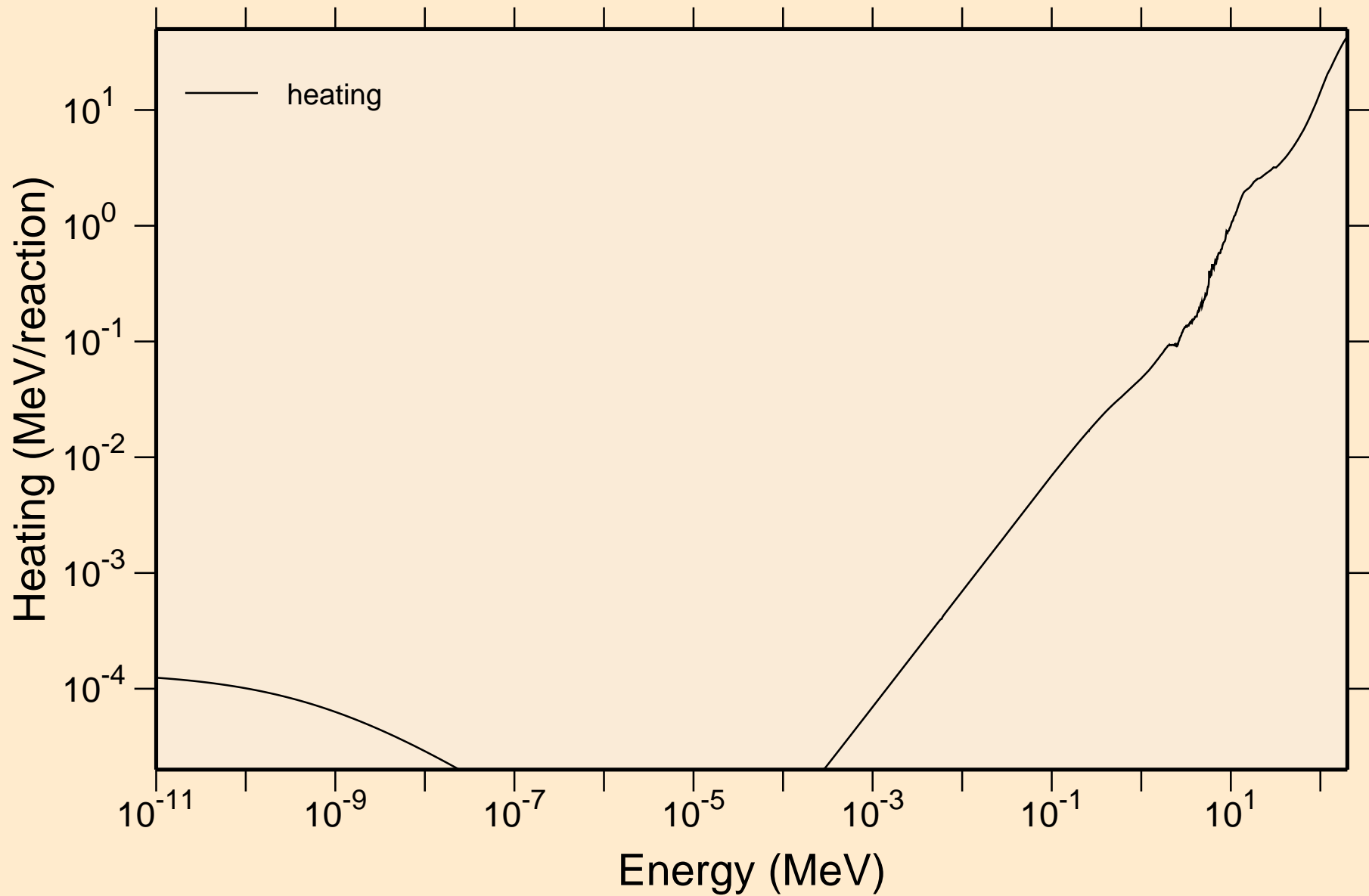

AL027 NEUTRON ACER TENDL-2023 LIBRARY; T=0.K  
Damage

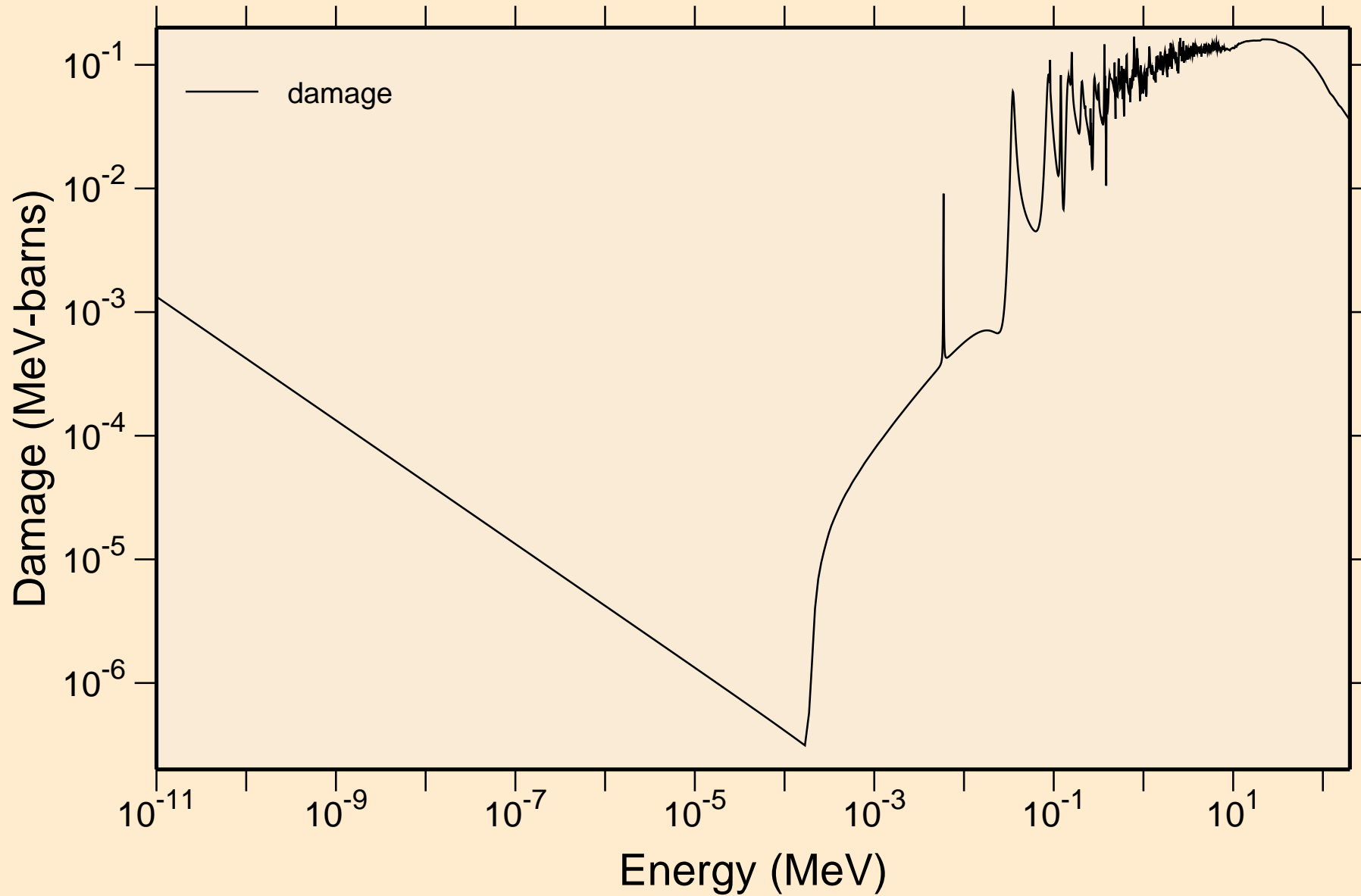

AL027 NEUTRON ACER TENDL-2023 LIBRARY; T=0.K  
Non-threshold reactions

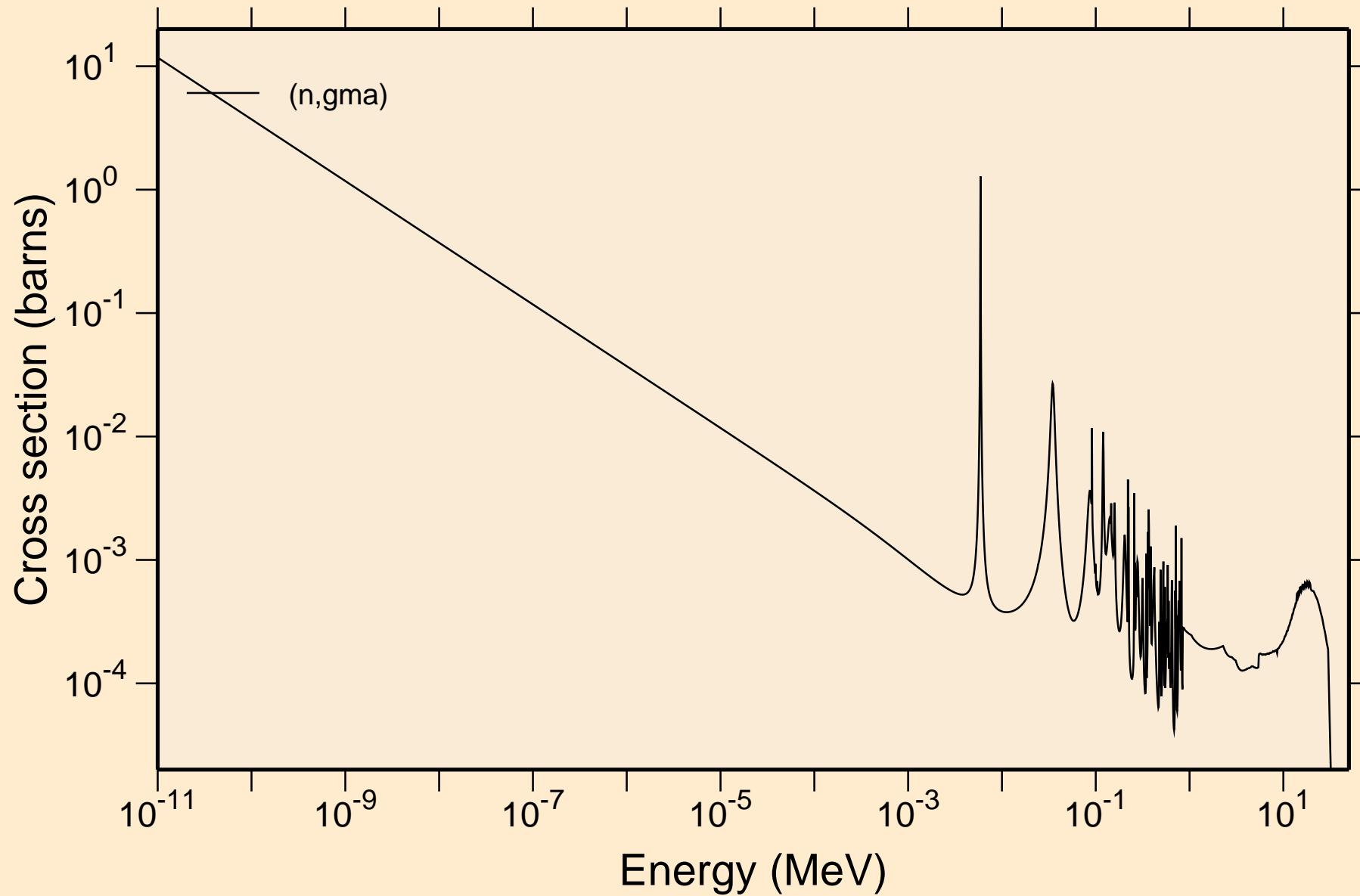

# AL027 NEUTRON ACER TENDL-2023 LIBRARY; T=0.K

## Principal cross sections

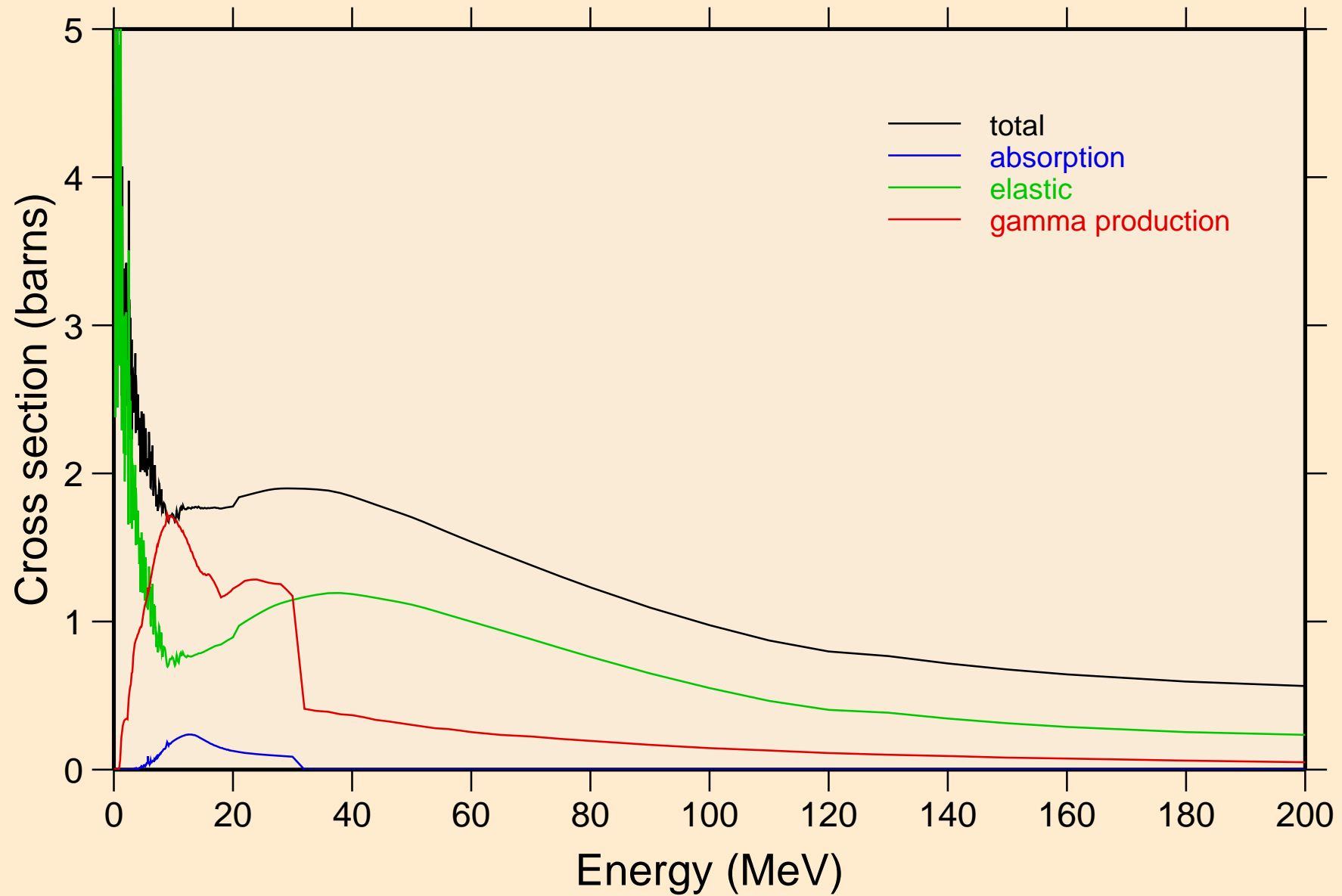

# AL027 NEUTRON ACER TENDL-2023 LIBRARY; T=0.K

## Heating

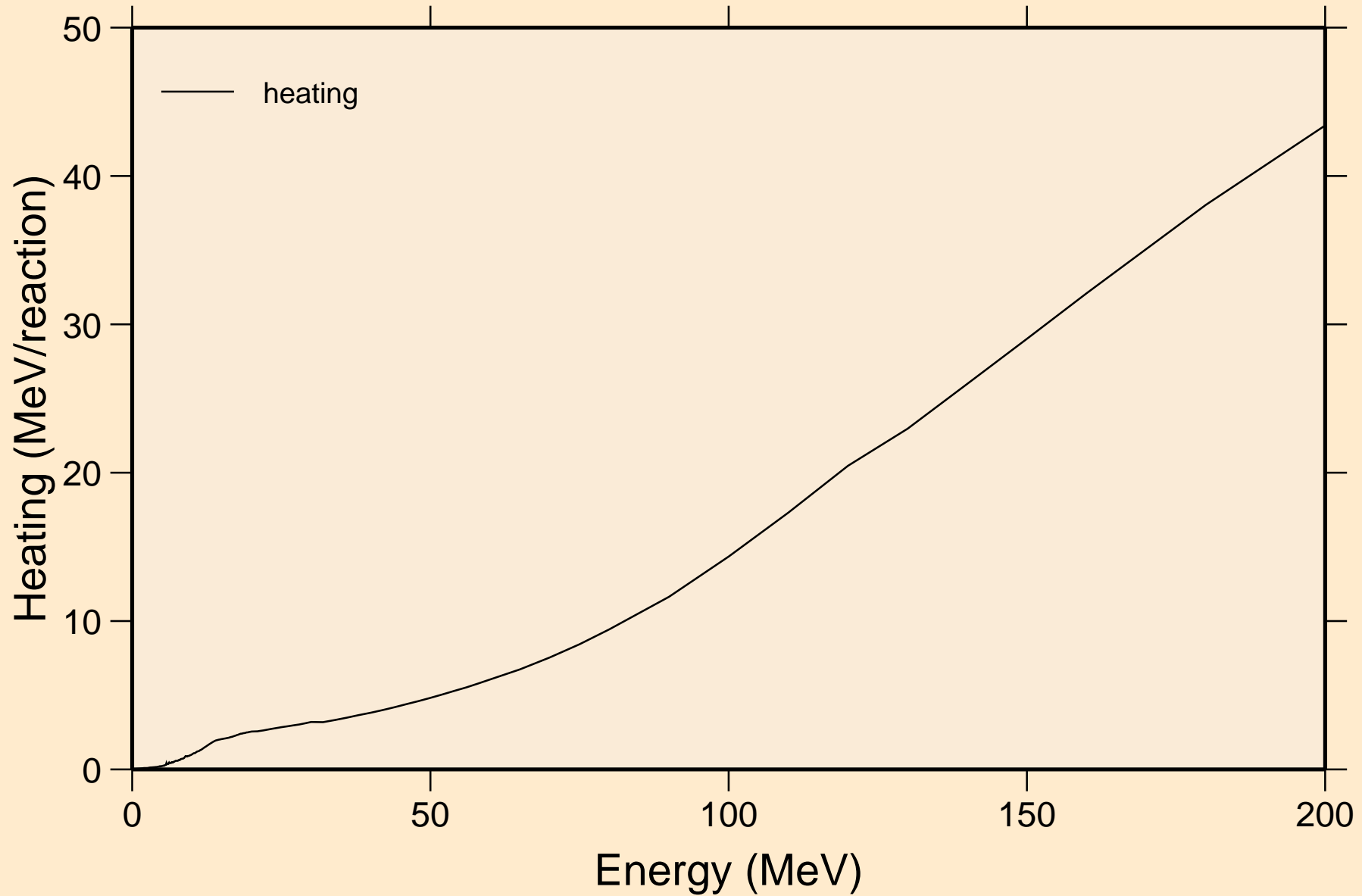

# AL027 NEUTRON ACER TENDL-2023 LIBRARY; T=0.K

## Damage

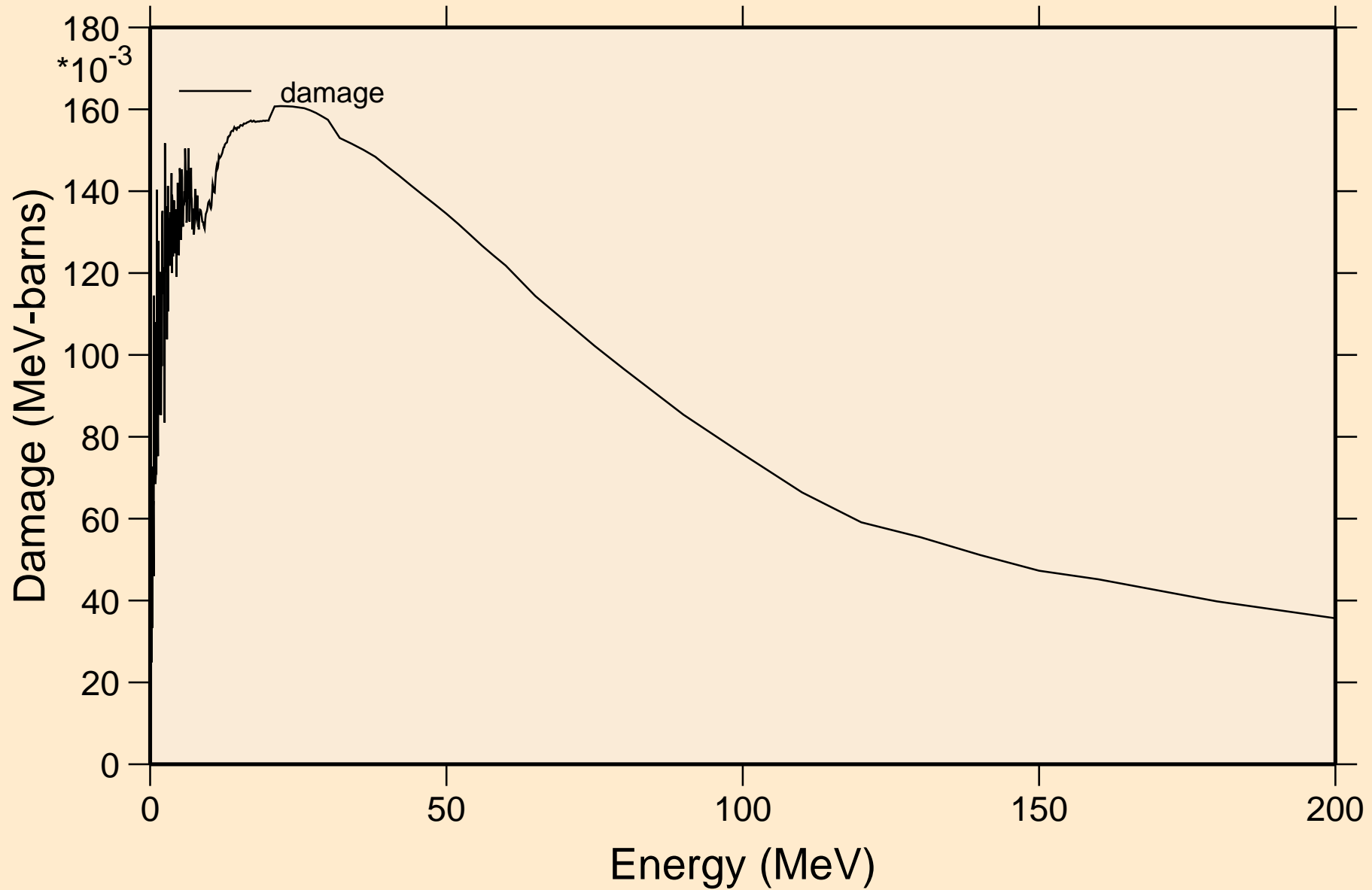

AL027 NEUTRON ACER TENDL-2023 LIBRARY; T=0.K  
Non-threshold reactions

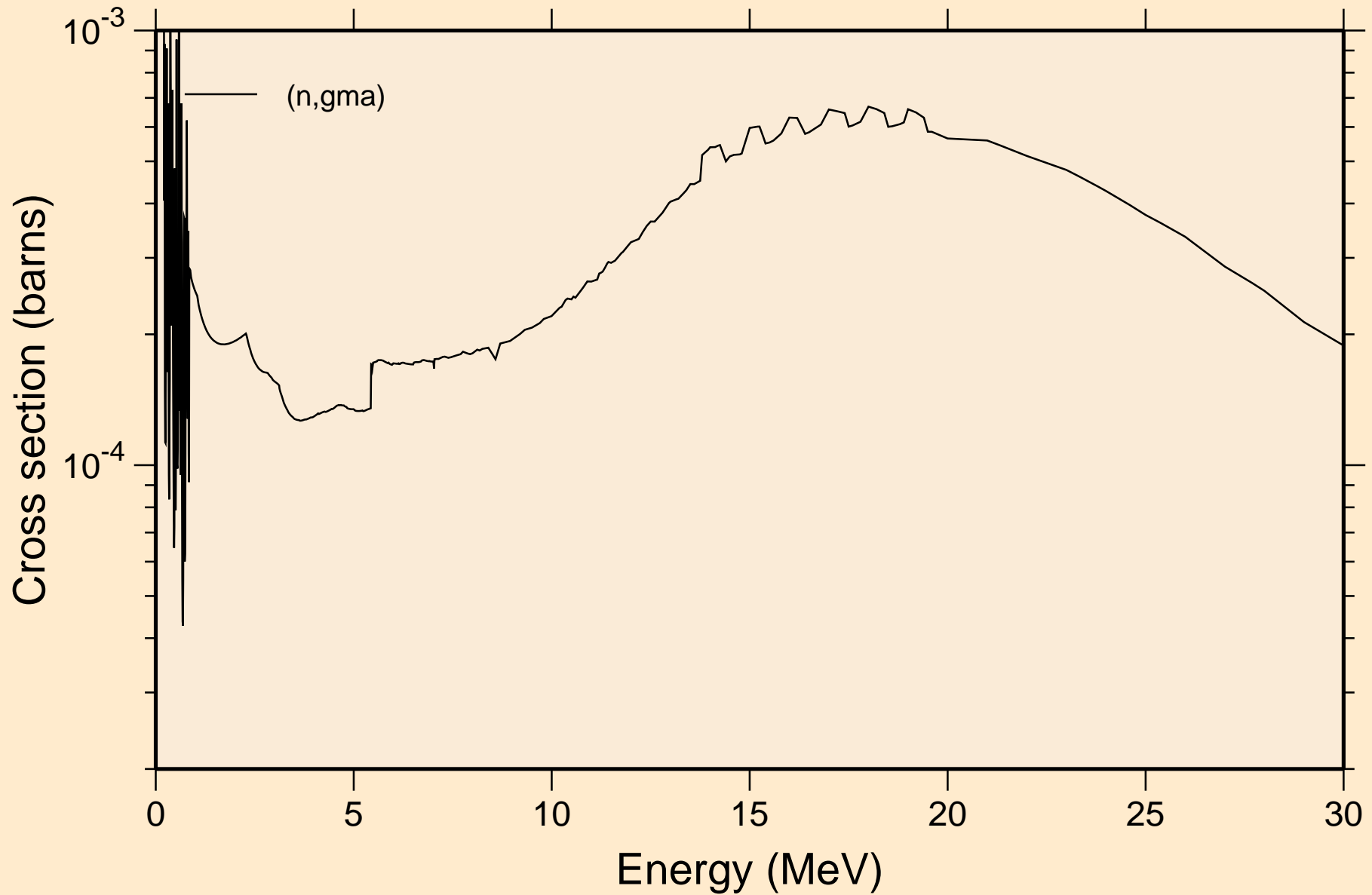

AL027 NEUTRON ACER TENDL-2023 LIBRARY; T=0.K  
Inelastic levels

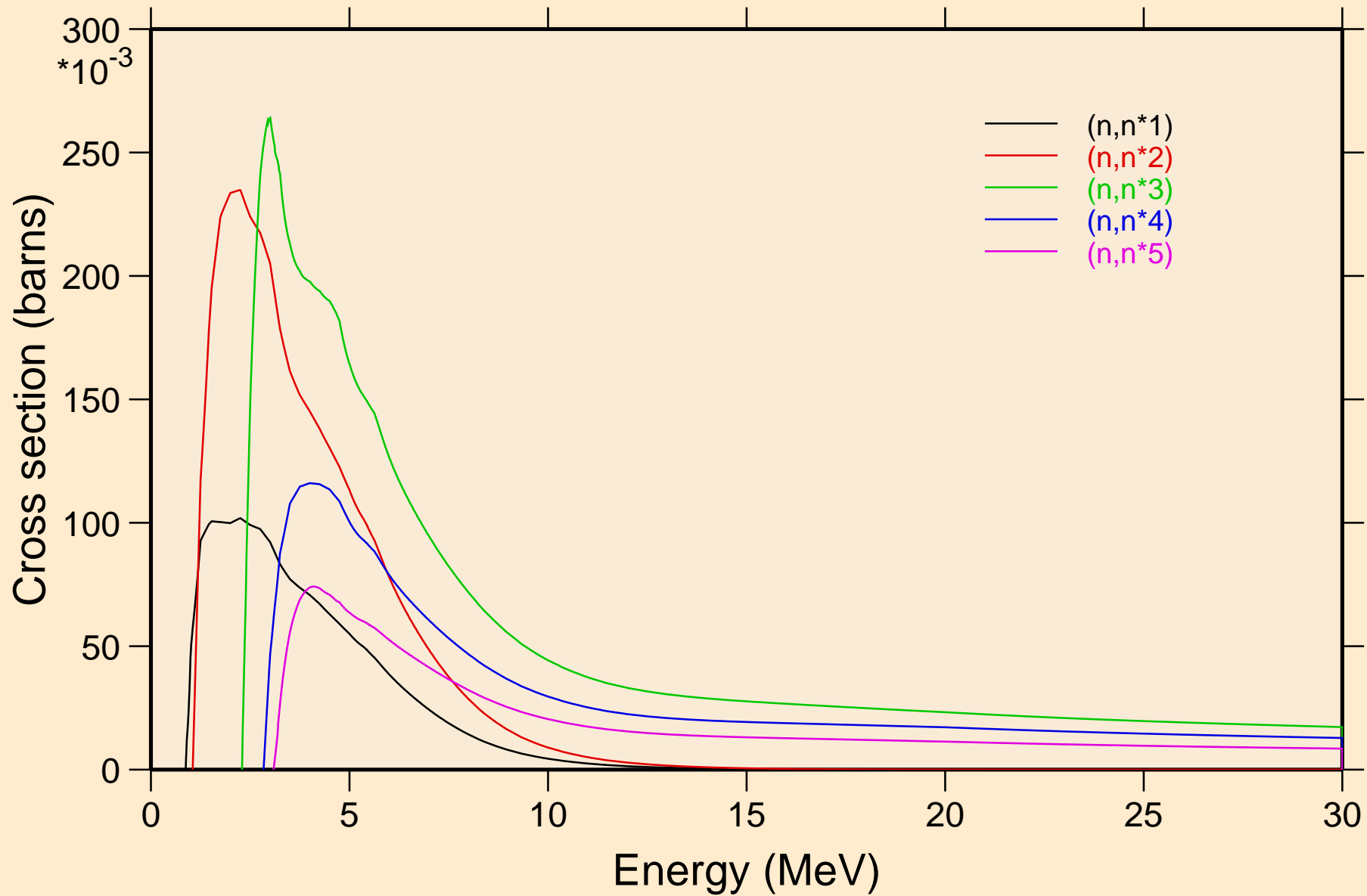

AL027 NEUTRON ACER TENDL-2023 LIBRARY; T=0.K  
Inelastic levels

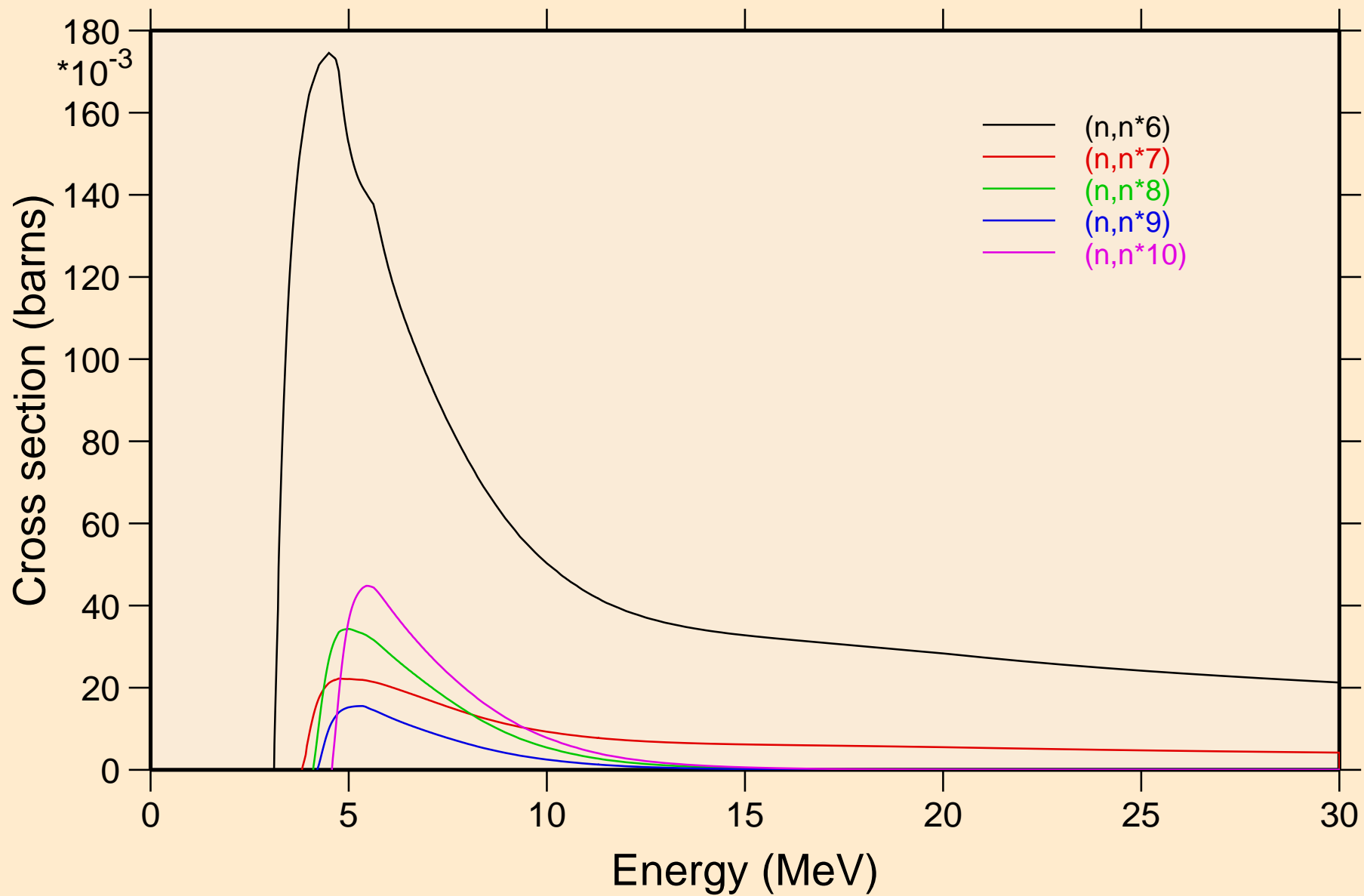

AL027 NEUTRON ACER TENDL-2023 LIBRARY; T=0.K  
Inelastic levels

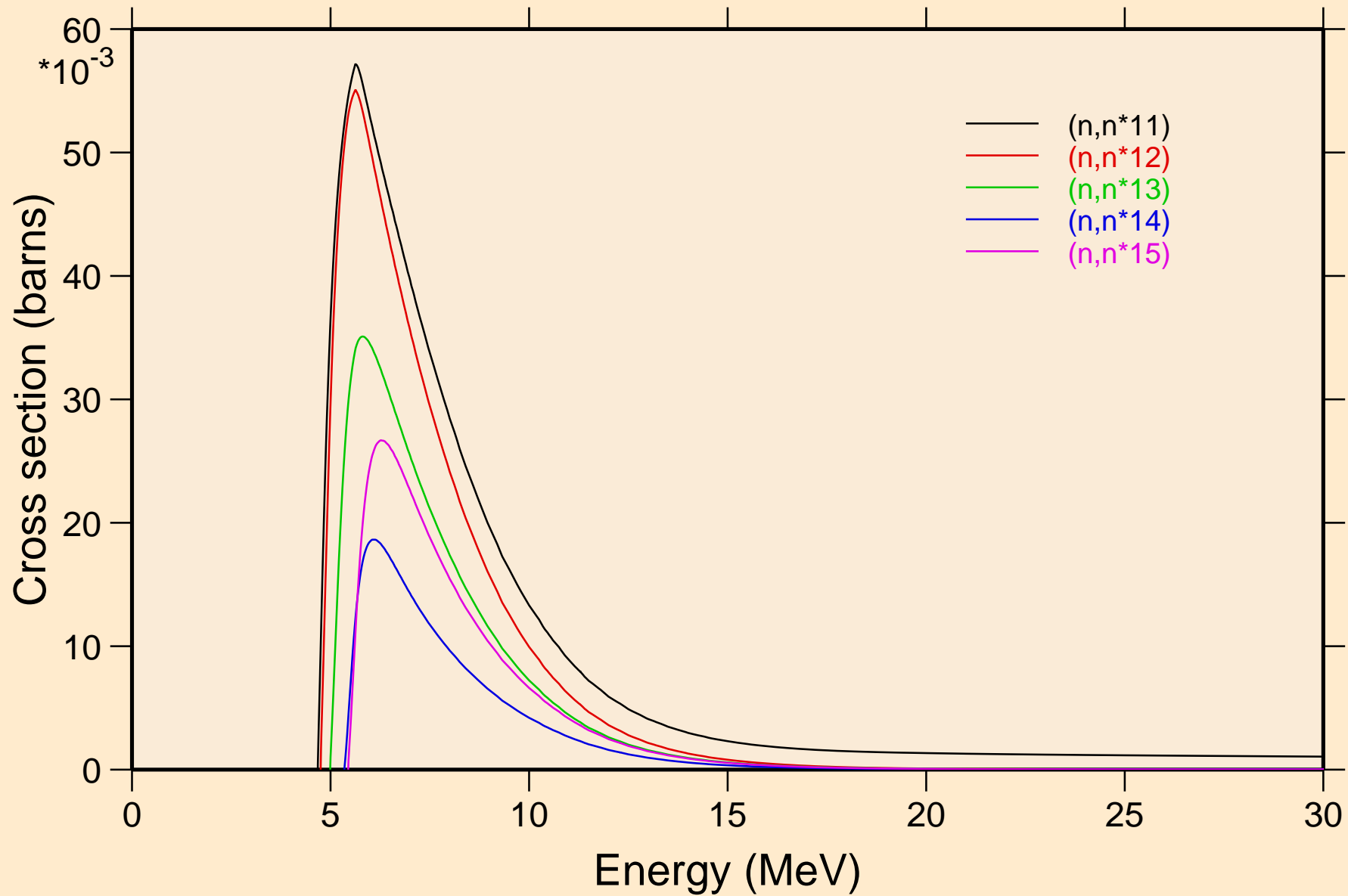

AL027 NEUTRON ACER TENDL-2023 LIBRARY; T=0.K  
Inelastic levels

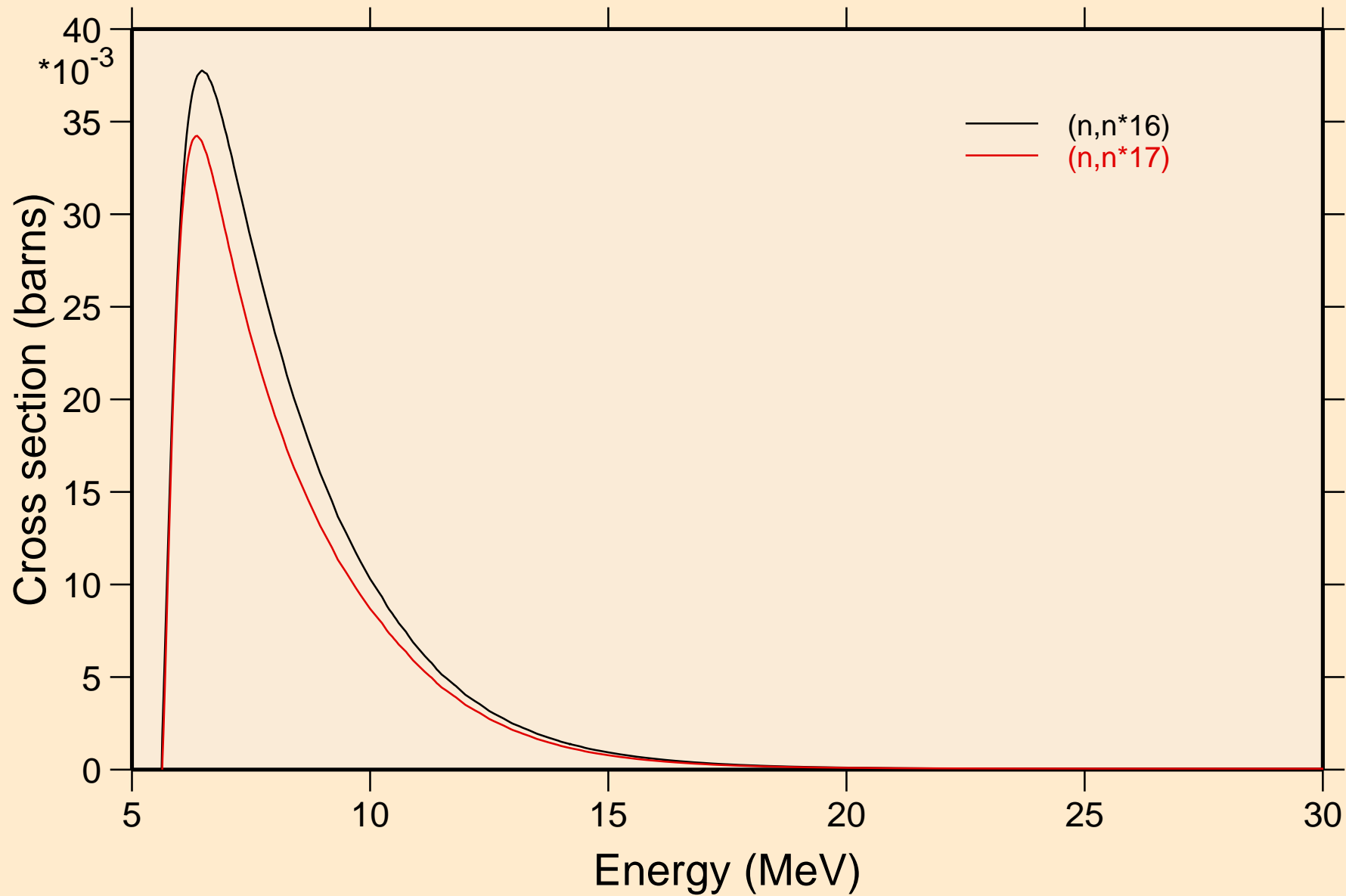

# AL027 NEUTRON ACER TENDL-2023 LIBRARY; T=0.K

## Threshold reactions

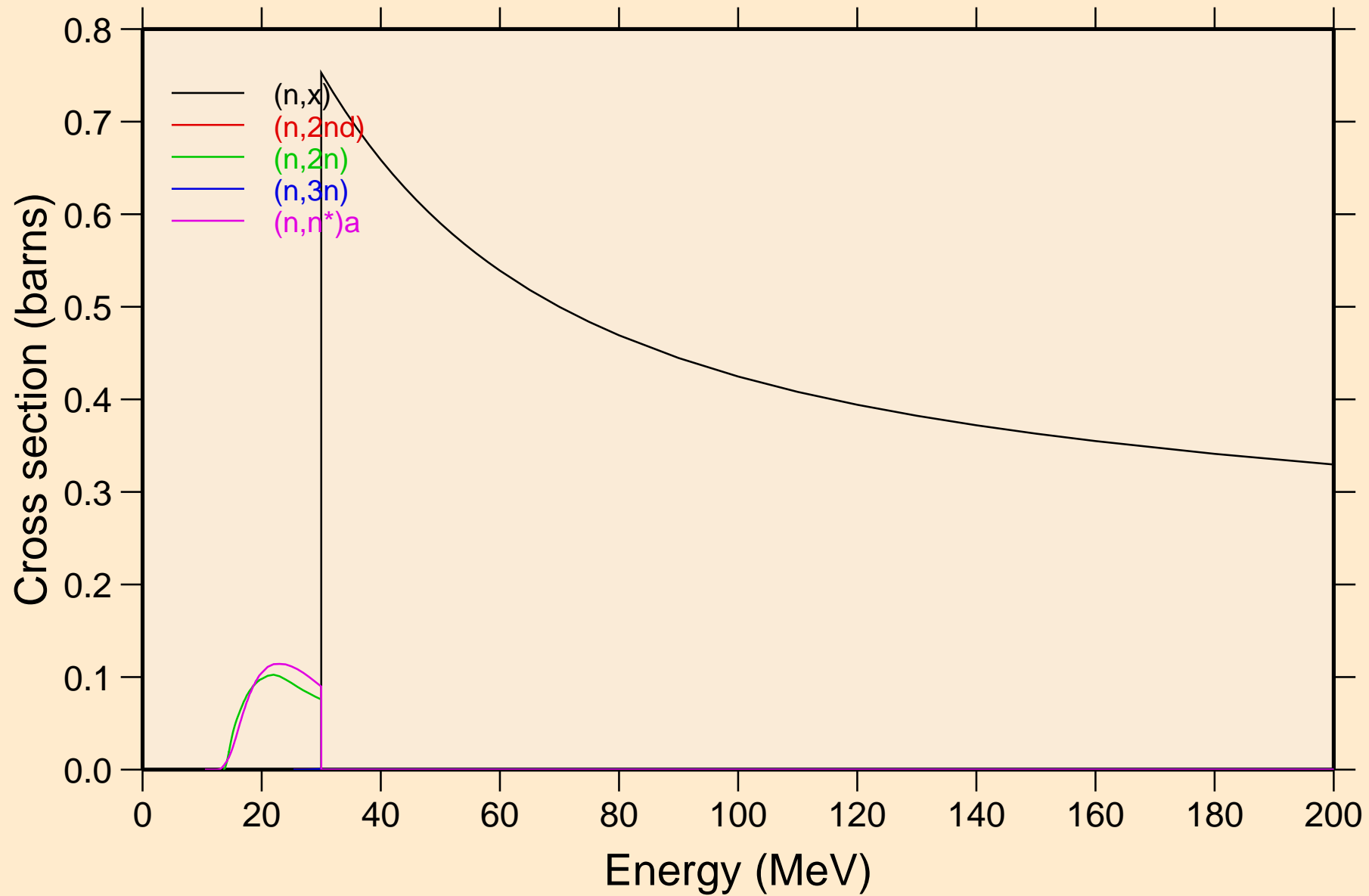

# AL027 NEUTRON ACER TENDL-2023 LIBRARY; T=0.K

## Threshold reactions

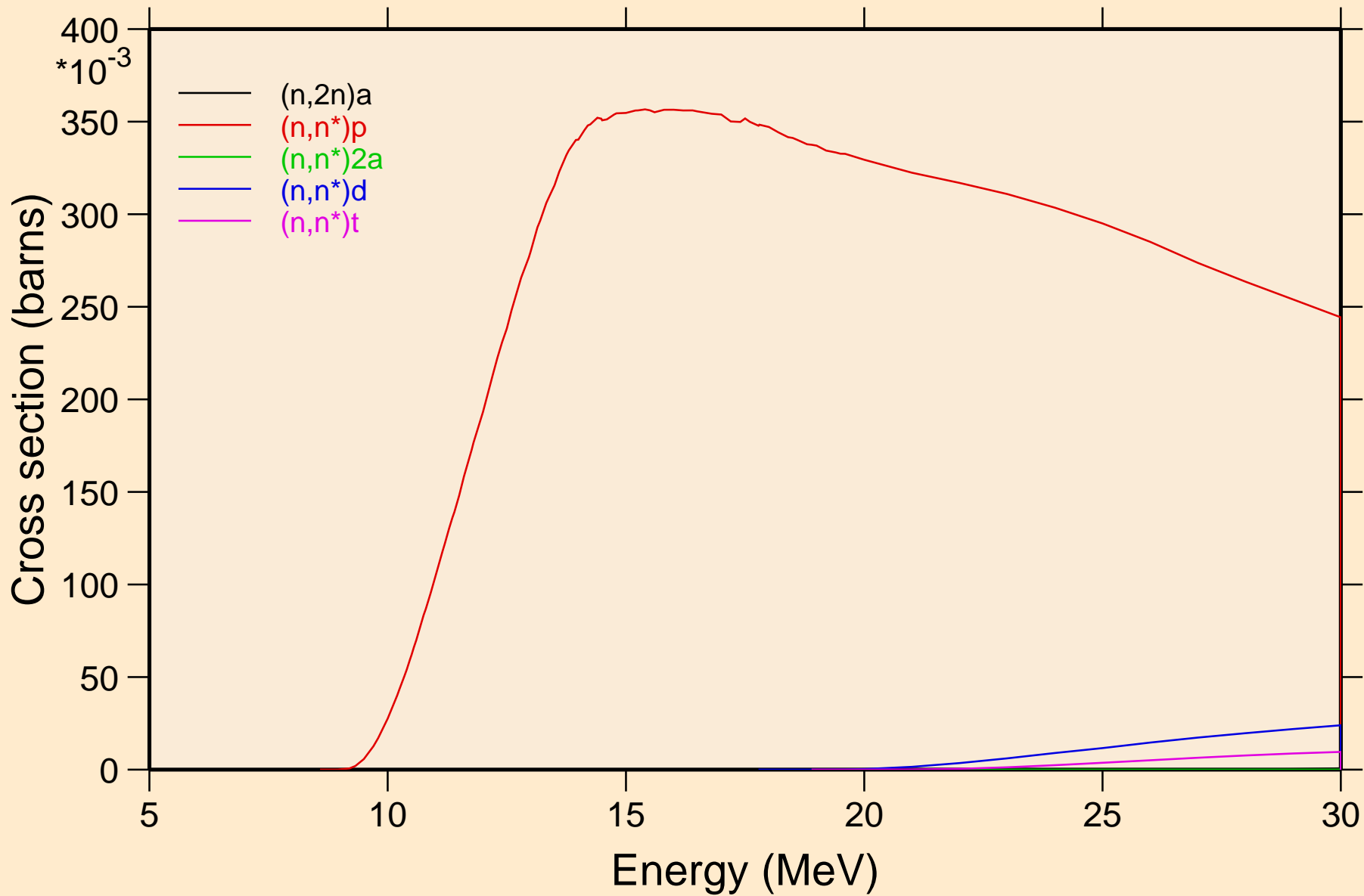

AL027 NEUTRON ACER TENDL-2023 LIBRARY; T=0.K  
Threshold reactions

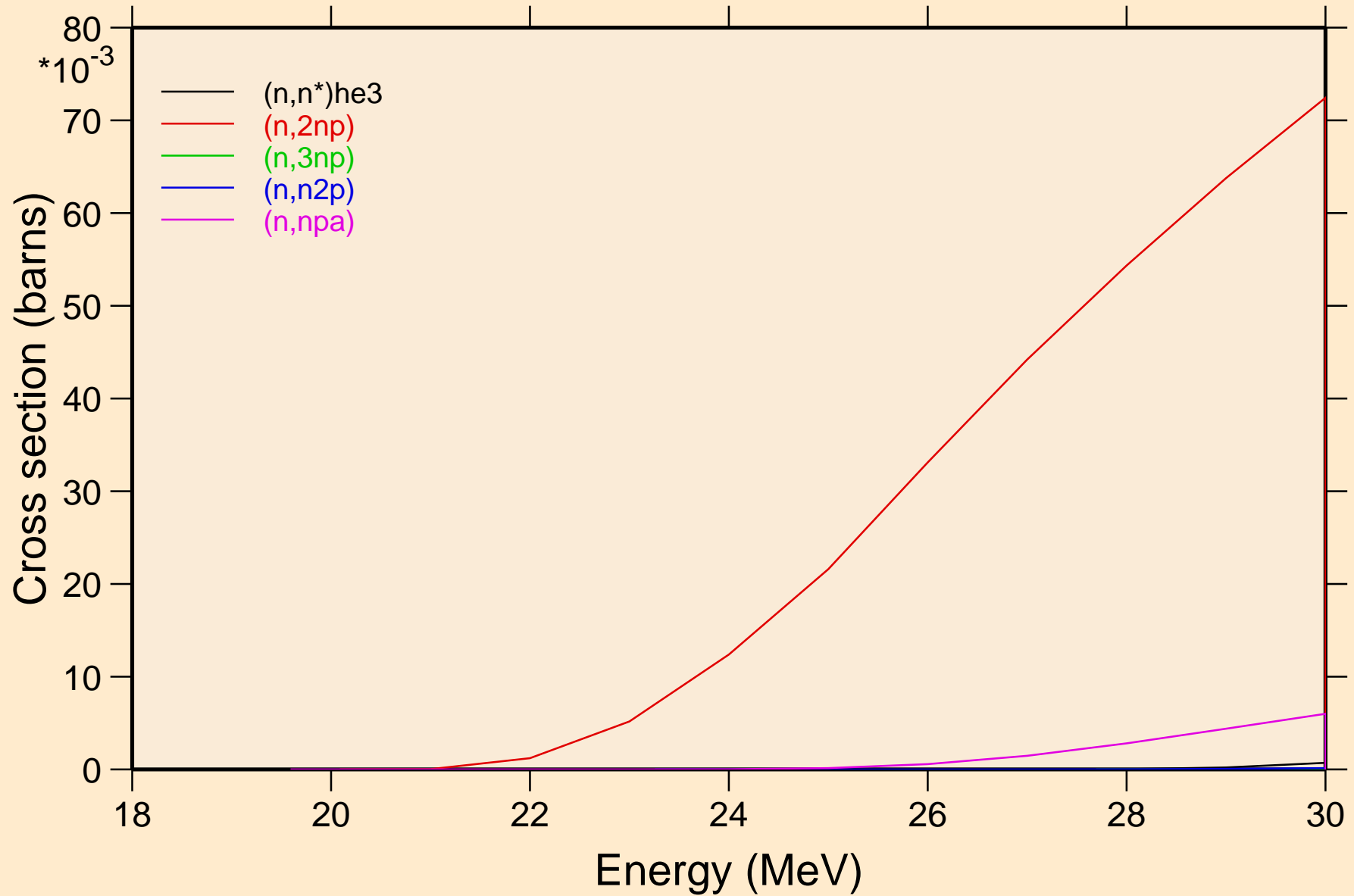

AL027 NEUTRON ACER TENDL-2023 LIBRARY; T=0.K  
Threshold reactions

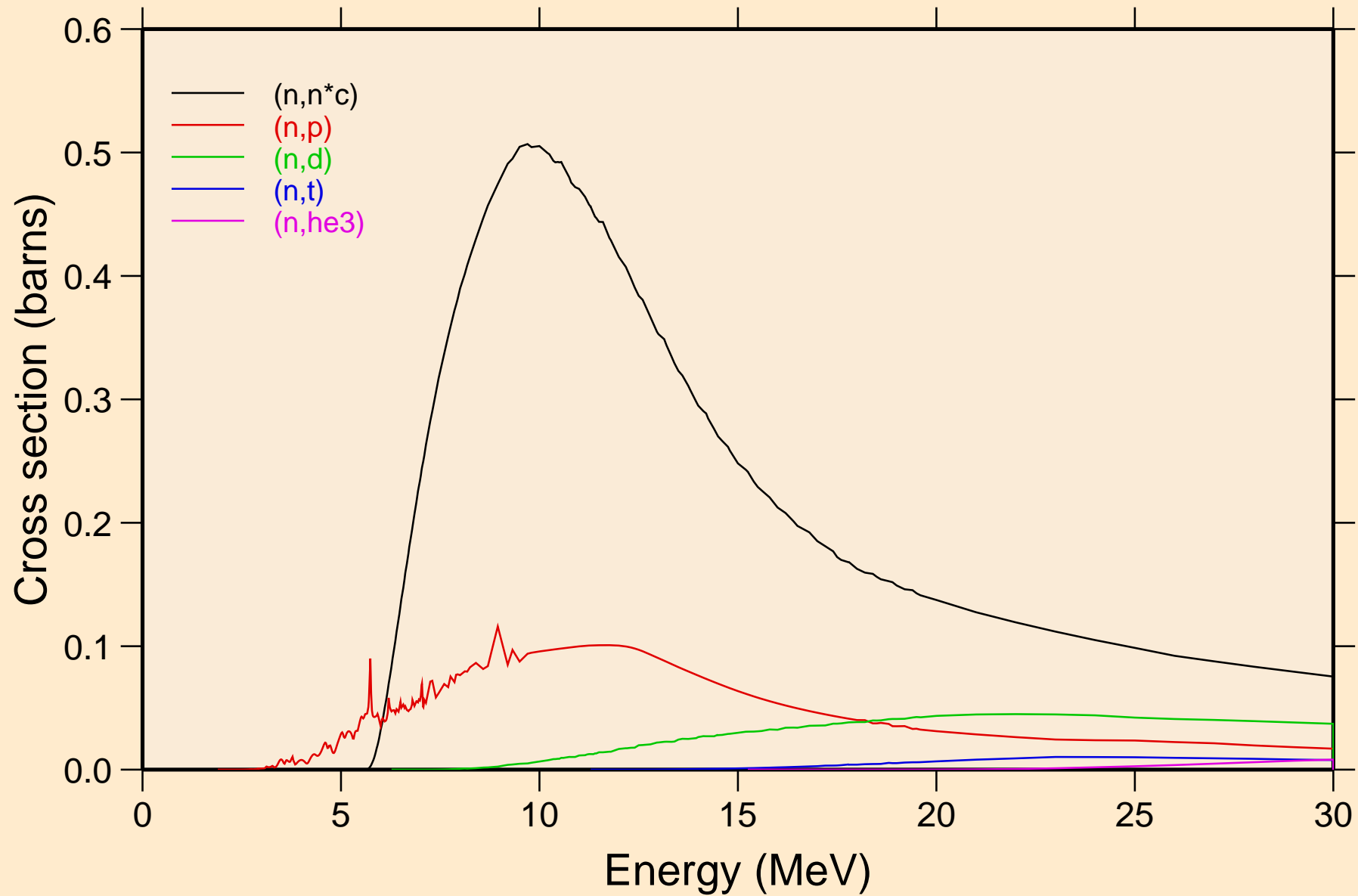

AL027 NEUTRON ACER TENDL-2023 LIBRARY; T=0.K  
Threshold reactions

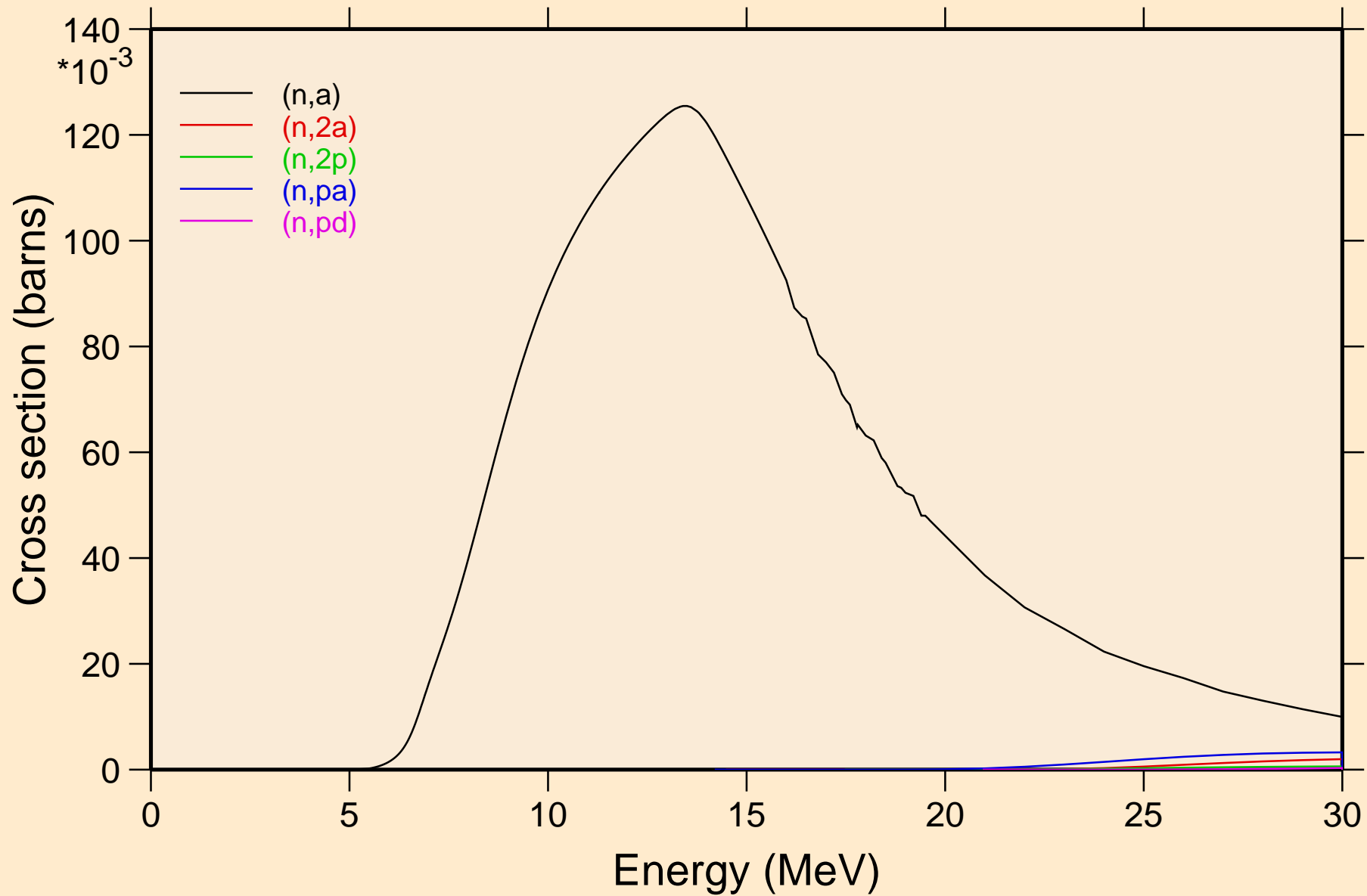

# AL027 NEUTRON ACER TENDL-2023 LIBRARY; T=0.K

## Threshold reactions

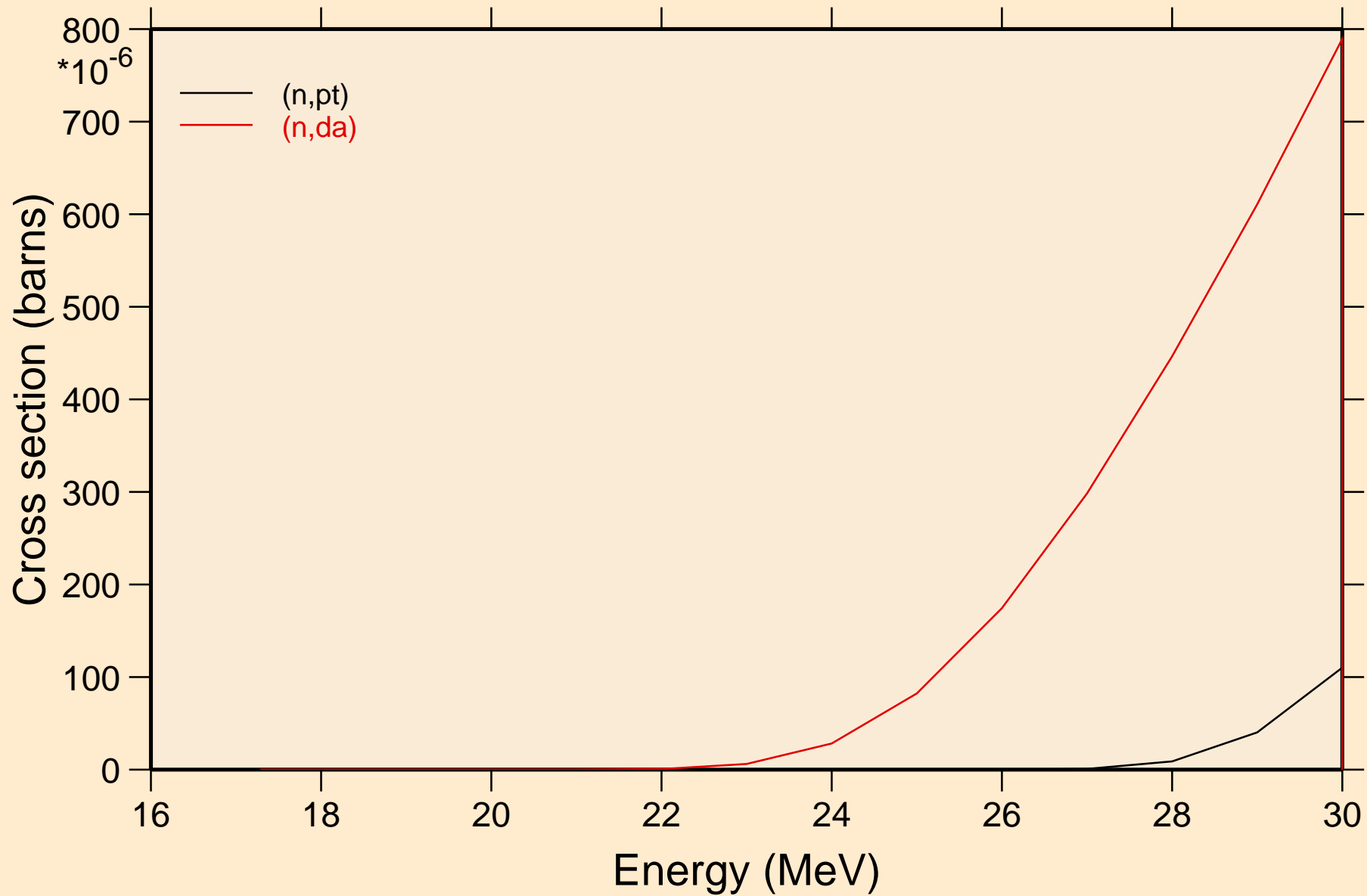

AL027 NEUTRON ACER TENDL-2023 LIBRARY; T=0.K  
Threshold reactions

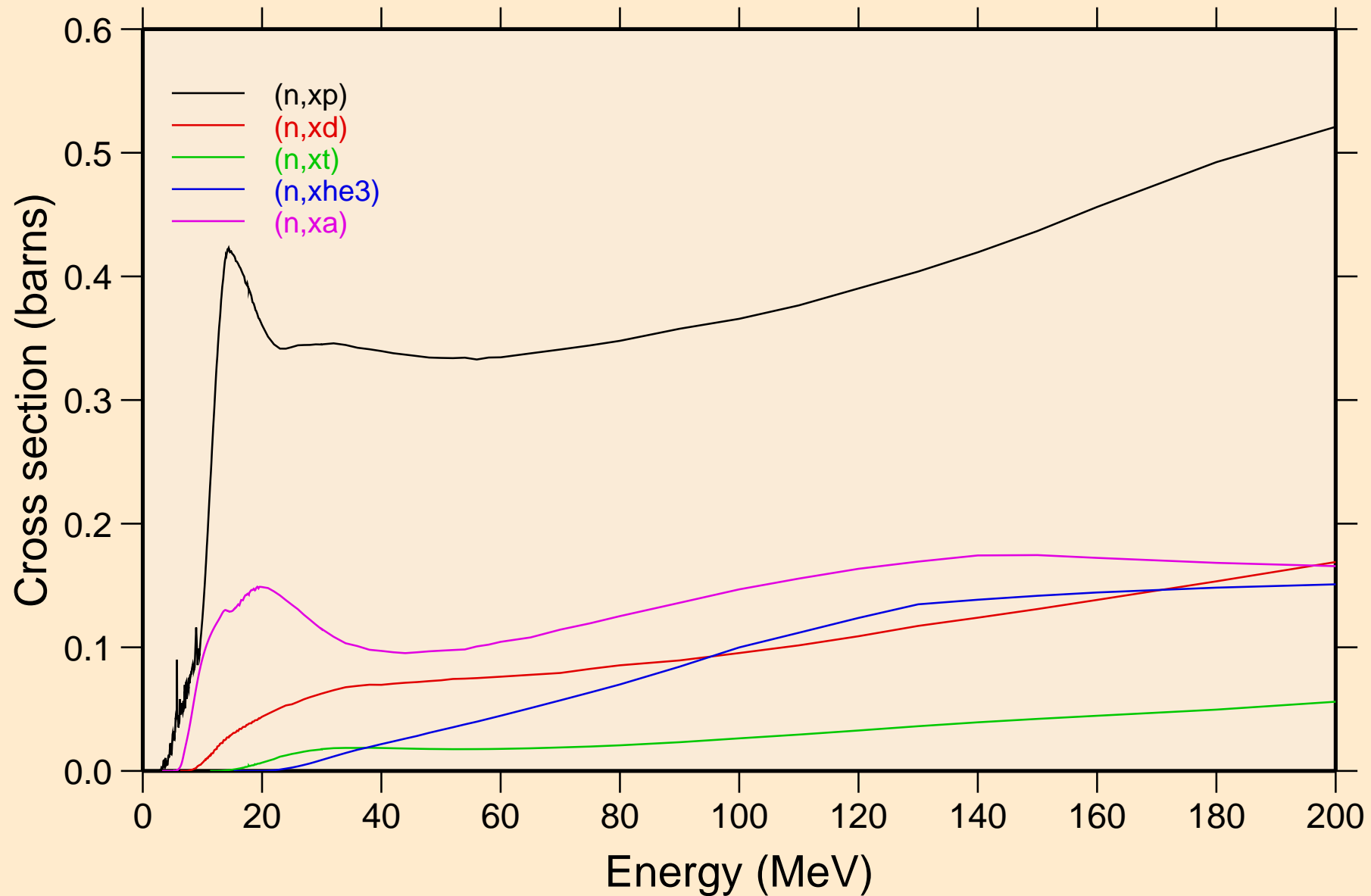

AL027 NEUTRON ACER TENDL-2023 LIBRARY; T=0.K  
angular distribution for elastic

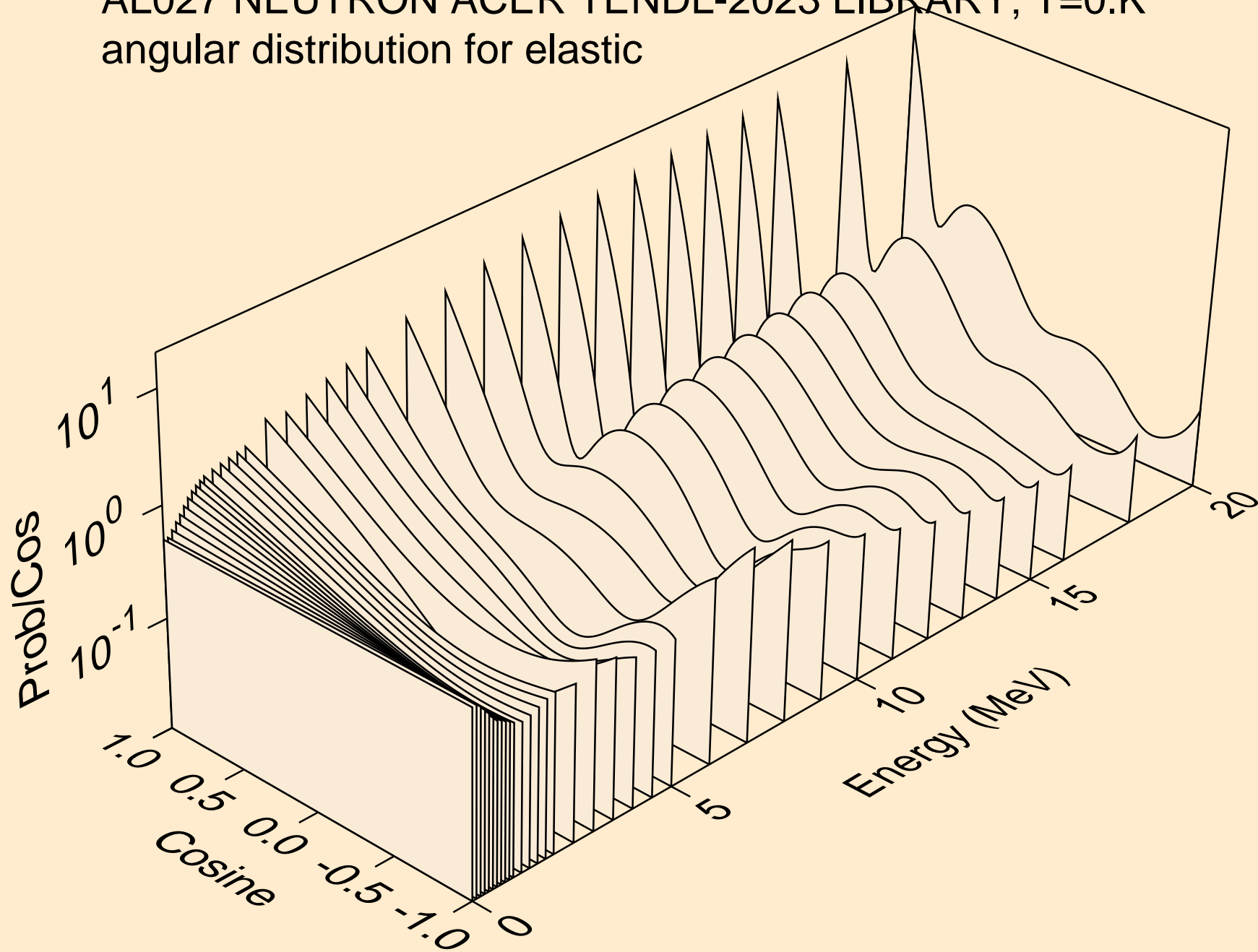

AL027 NEUTRON ACER TENDL-2023 LIBRARY; T=0.K  
angular distribution for elastic

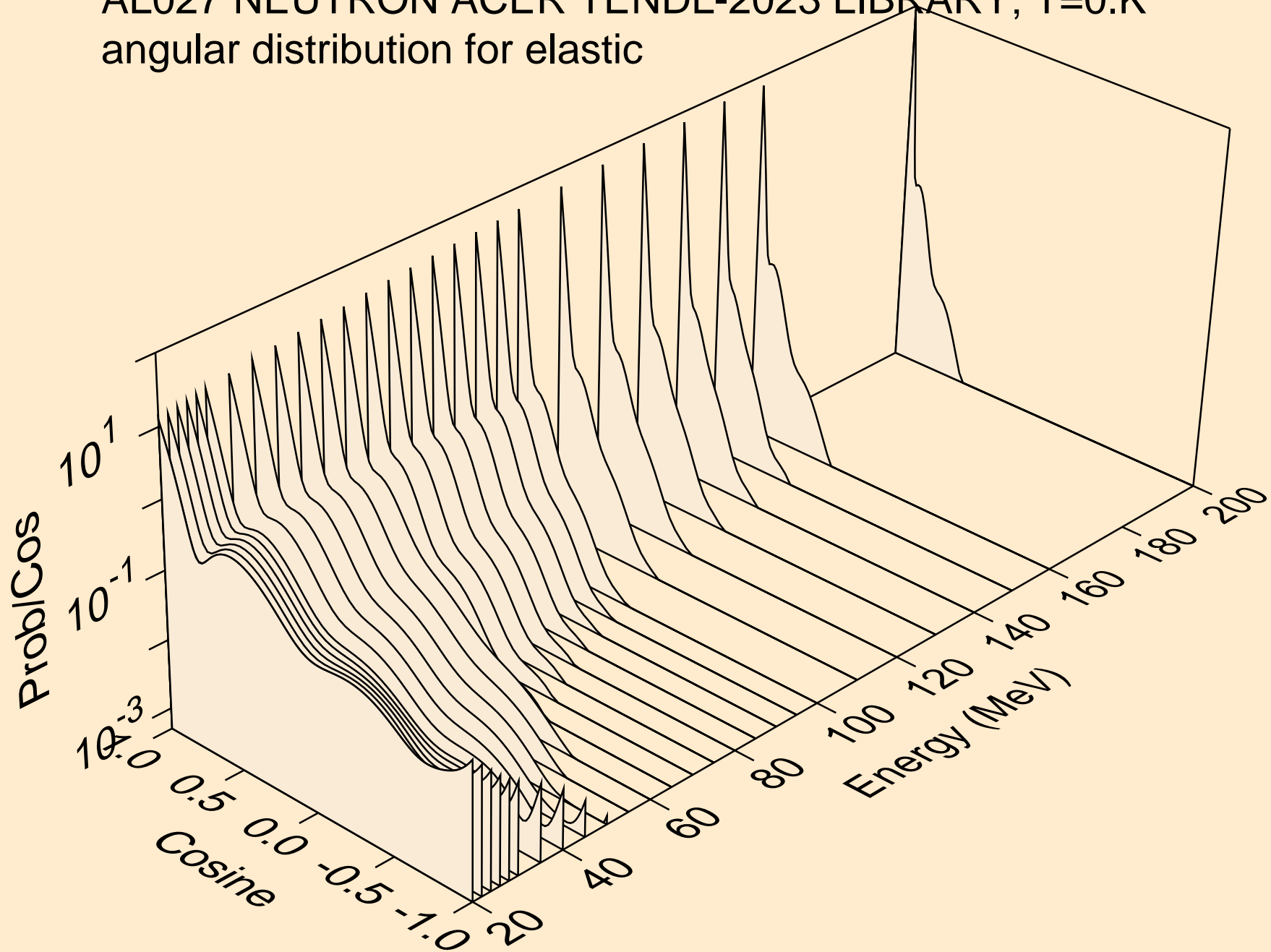

AL027 NEUTRON ACER TENDL-2023 LIBRARY; T=0.K  
angular distribution for (n,n\*1)

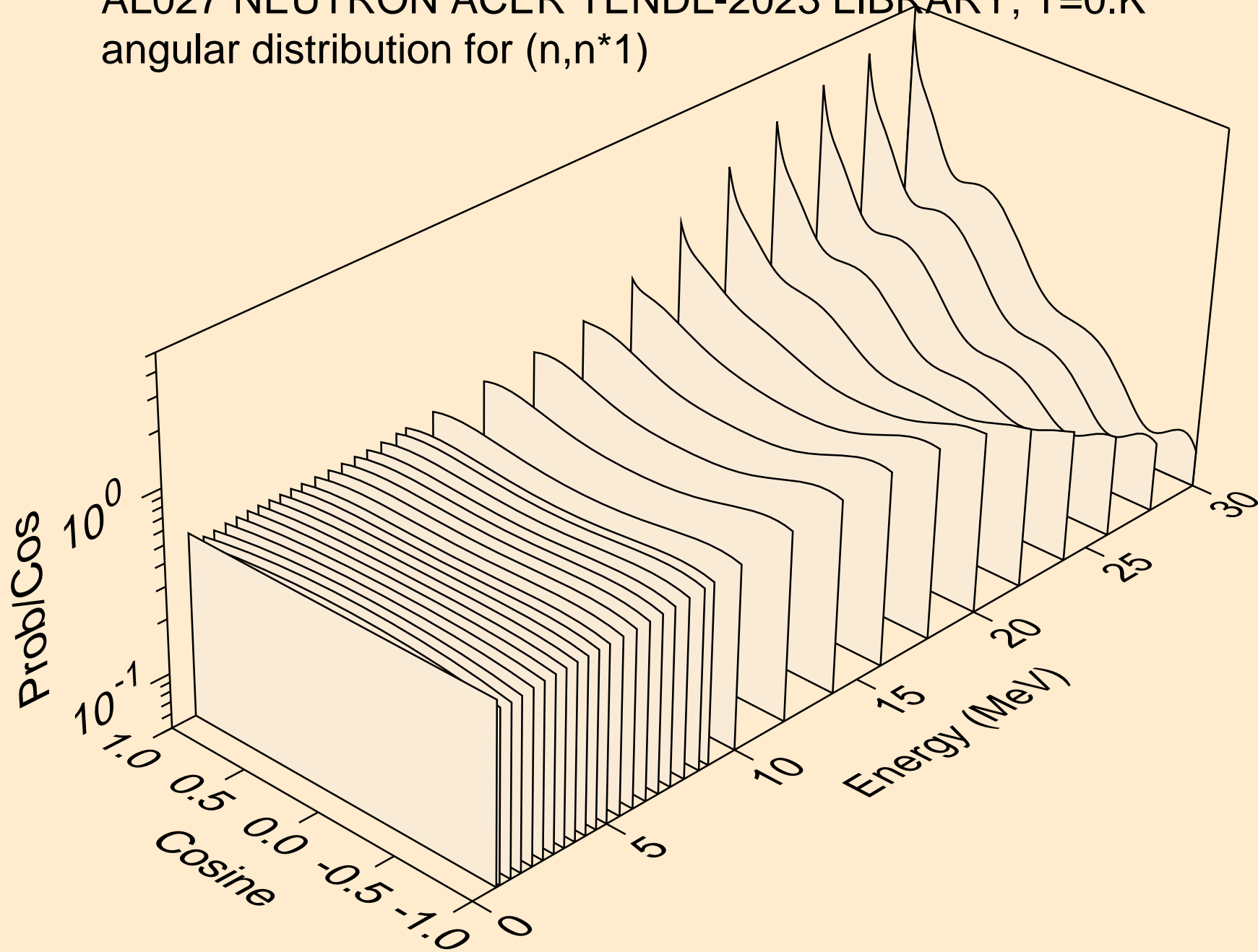

AL027 NEUTRON ACER TENDL-2023 LIBRARY; T=0.K  
angular distribution for (n,n\*2)

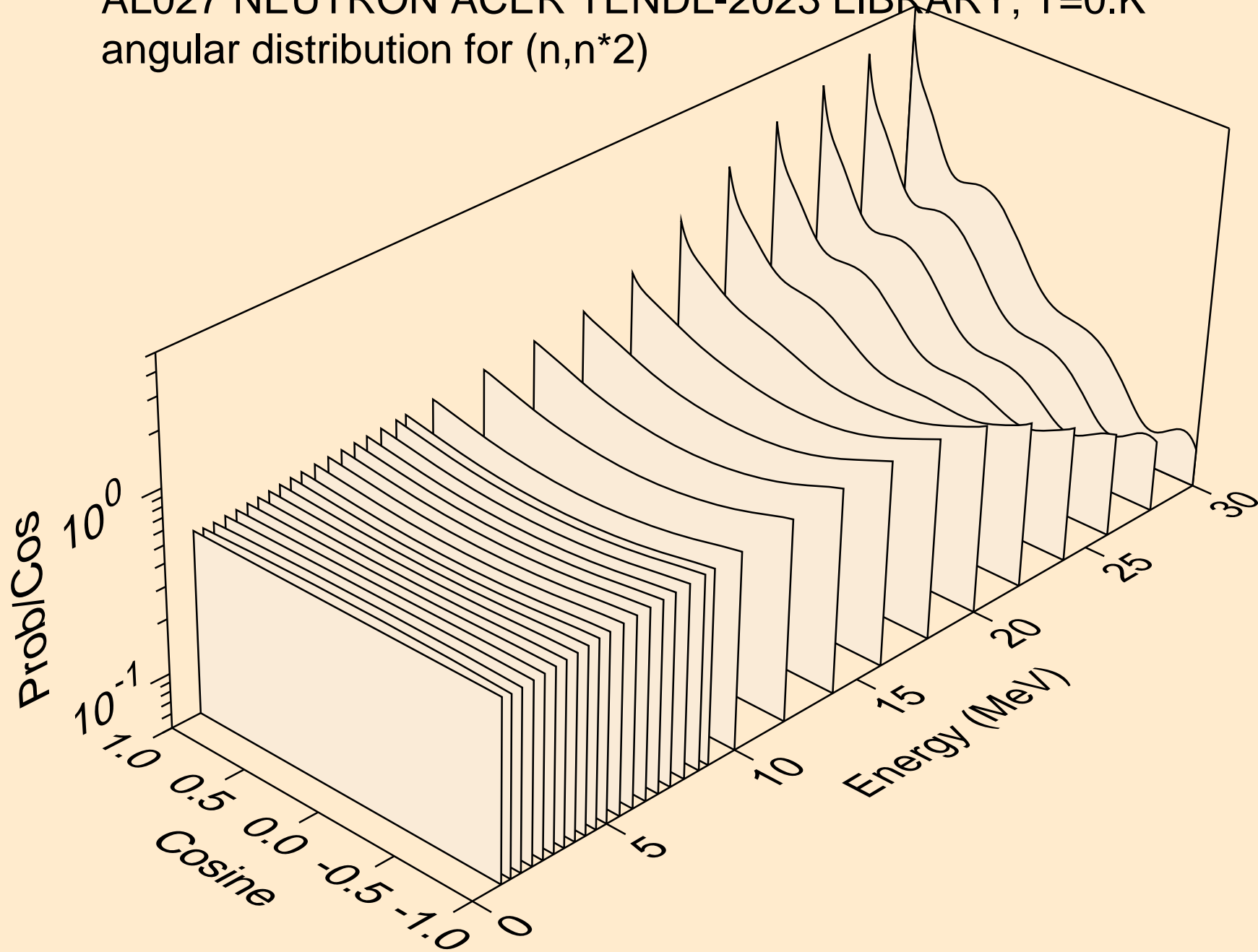

AL027 NEUTRON ACER TENDL-2023 LIBRARY; T=0.K  
angular distribution for (n,n\*3)

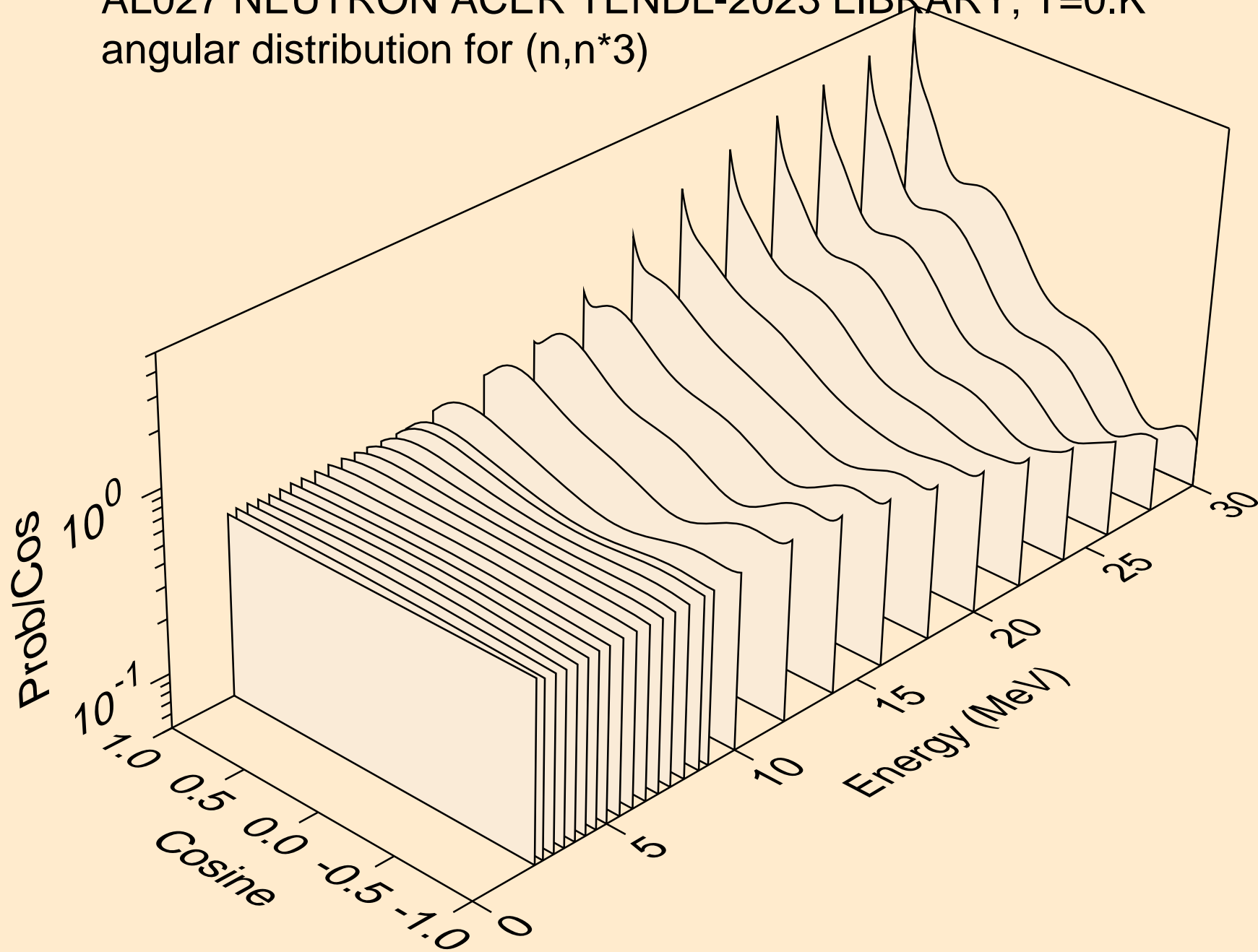

AL027 NEUTRON ACER TENDL-2023 LIBRARY; T=0.K  
angular distribution for (n,n\*4)

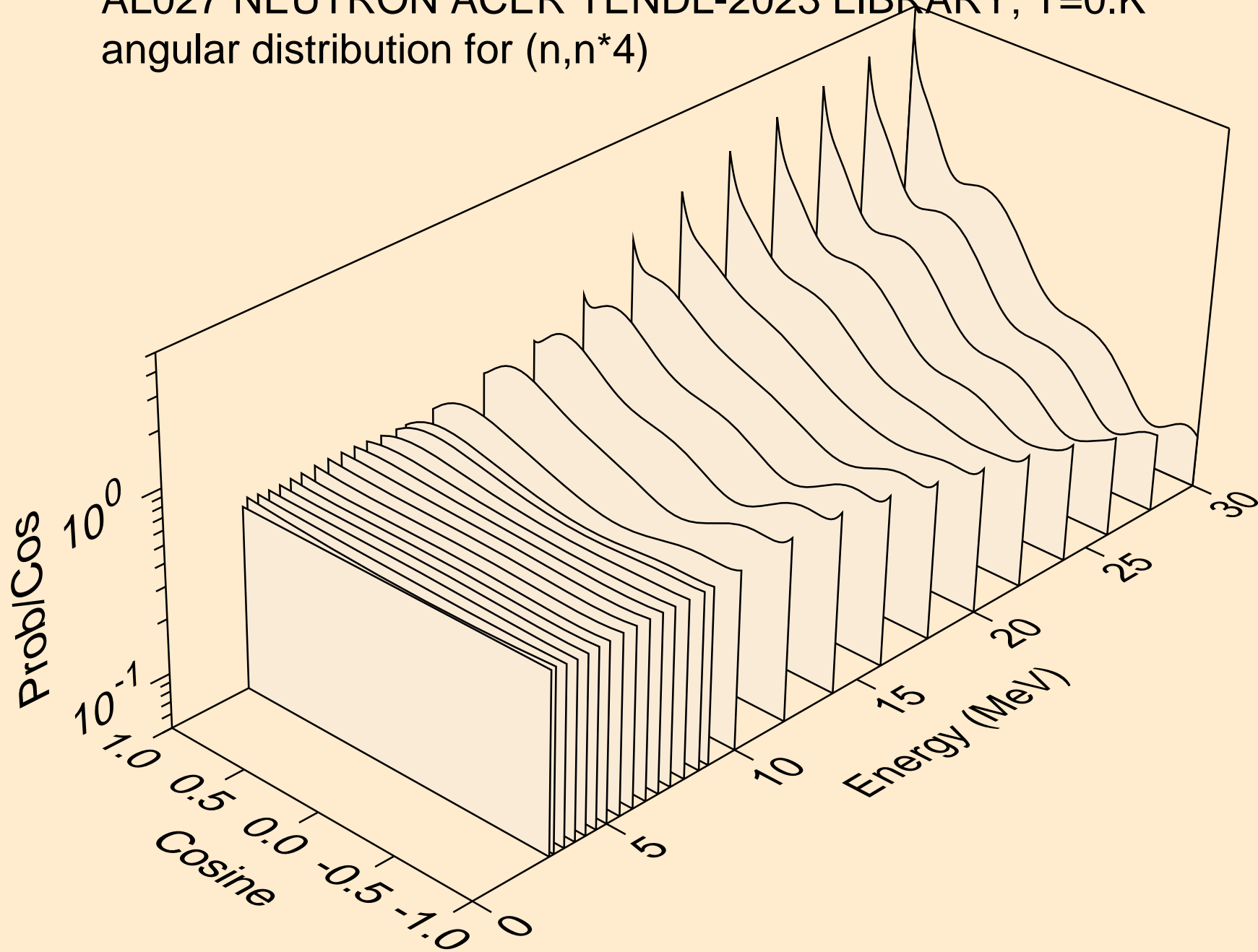

AL027 NEUTRON ACER TENDL-2023 LIBRARY; T=0.K  
angular distribution for (n,n\*5)

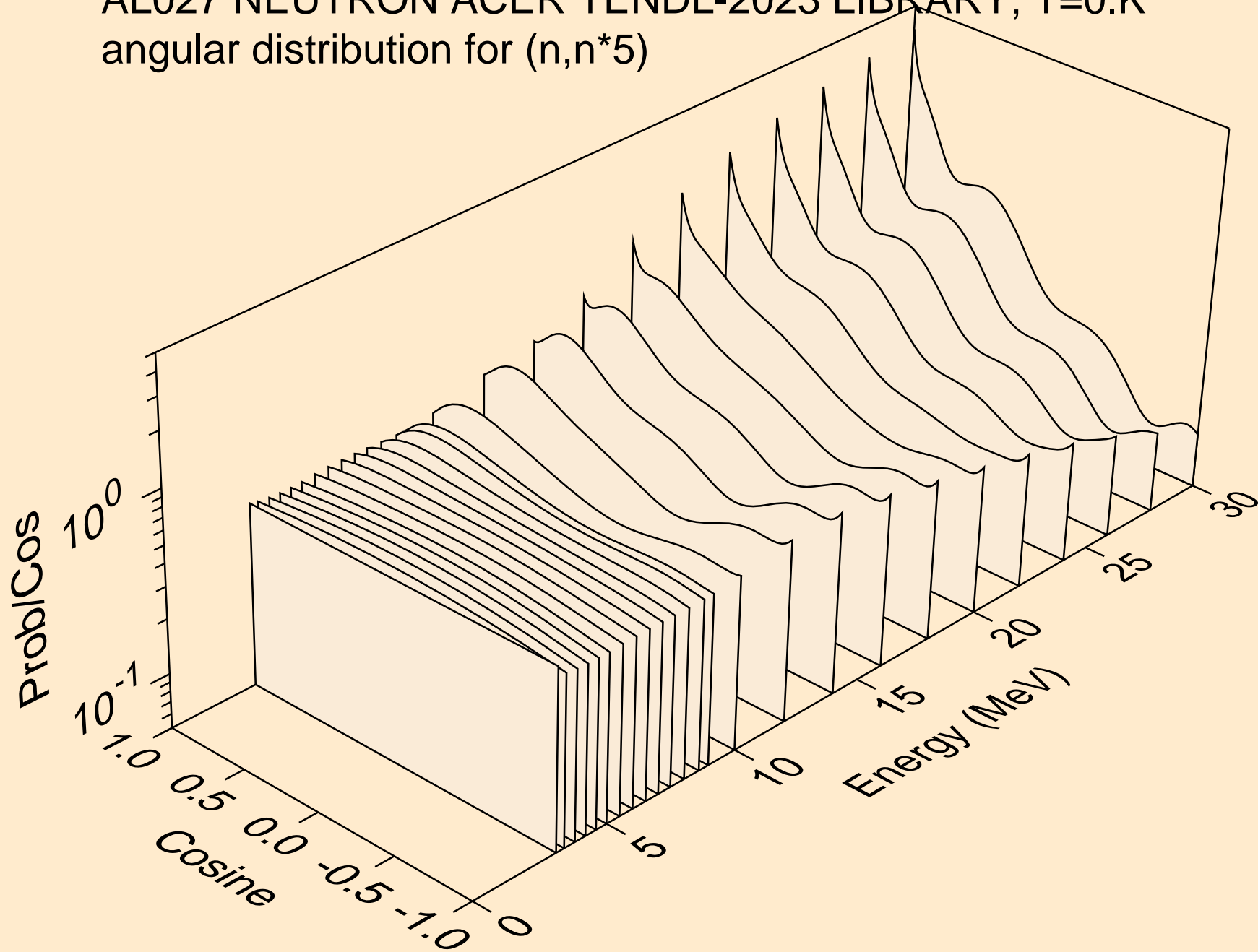

AL027 NEUTRON ACER TENDL-2023 LIBRARY; T=0.K  
angular distribution for (n,n\*6)

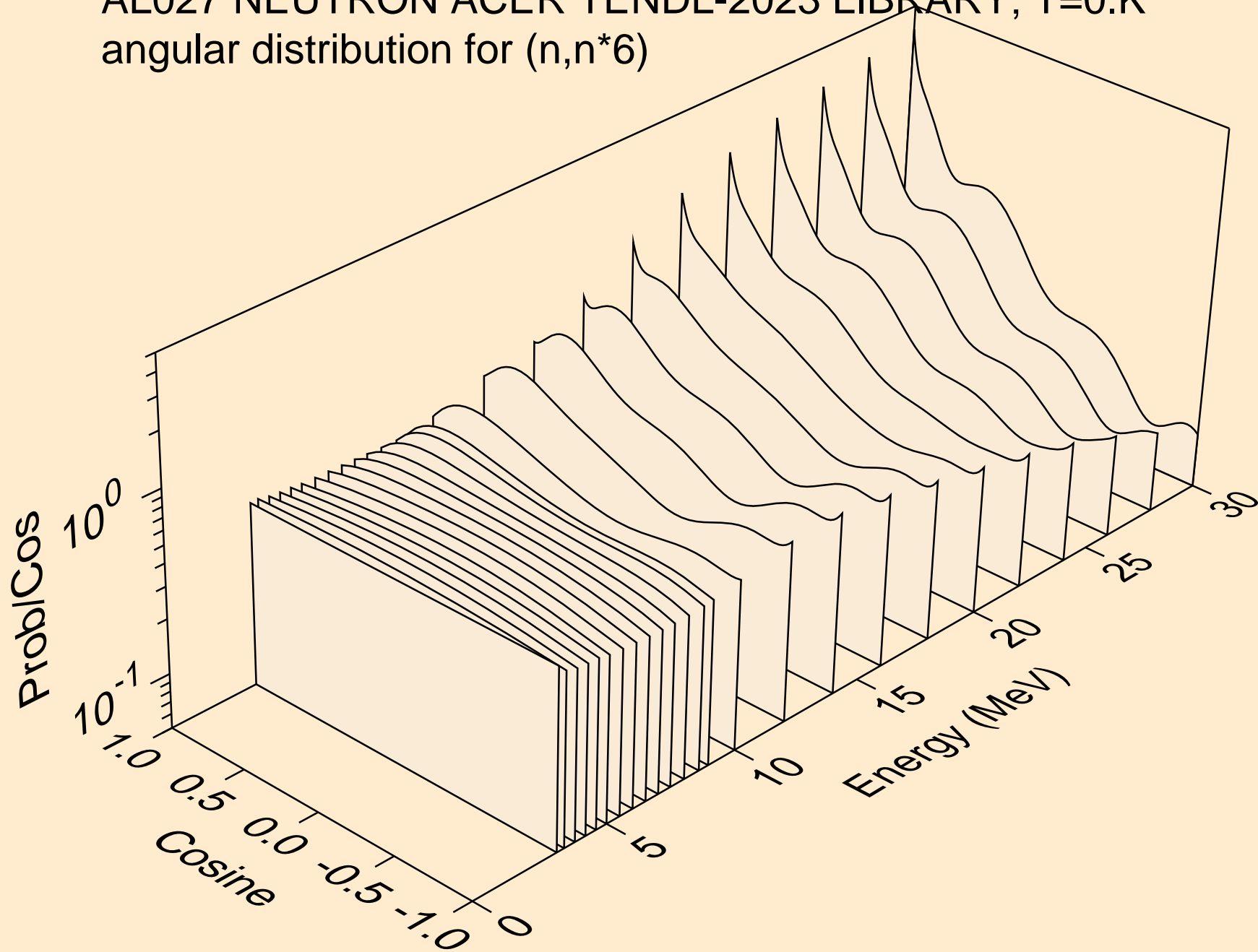

AL027 NEUTRON ACER TENDL-2023 LIBRARY; T=0.K  
angular distribution for (n,n\*7)

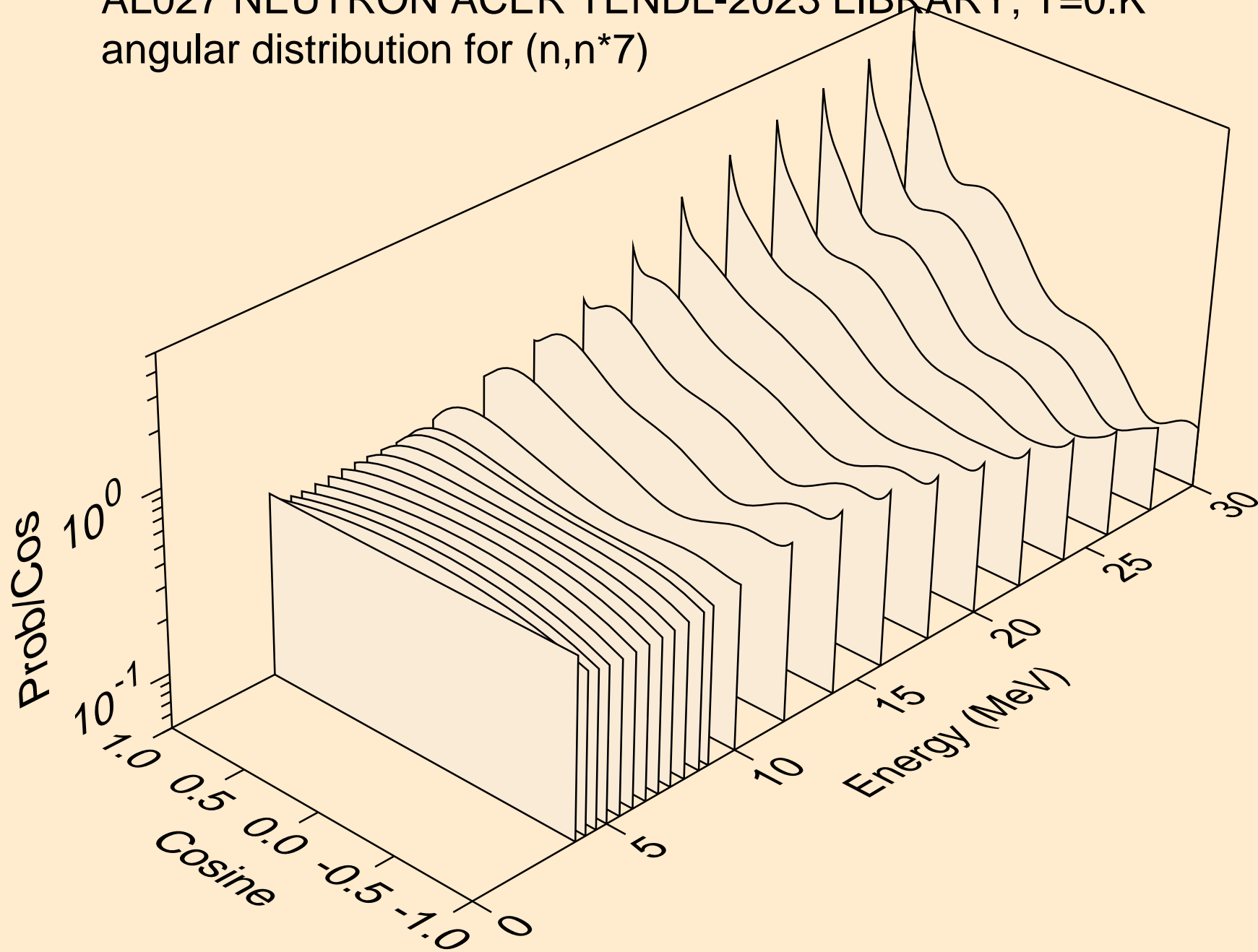

AL027 NEUTRON ACER TENDL-2023 LIBRARY; T=0.K  
angular distribution for (n,n\*8)

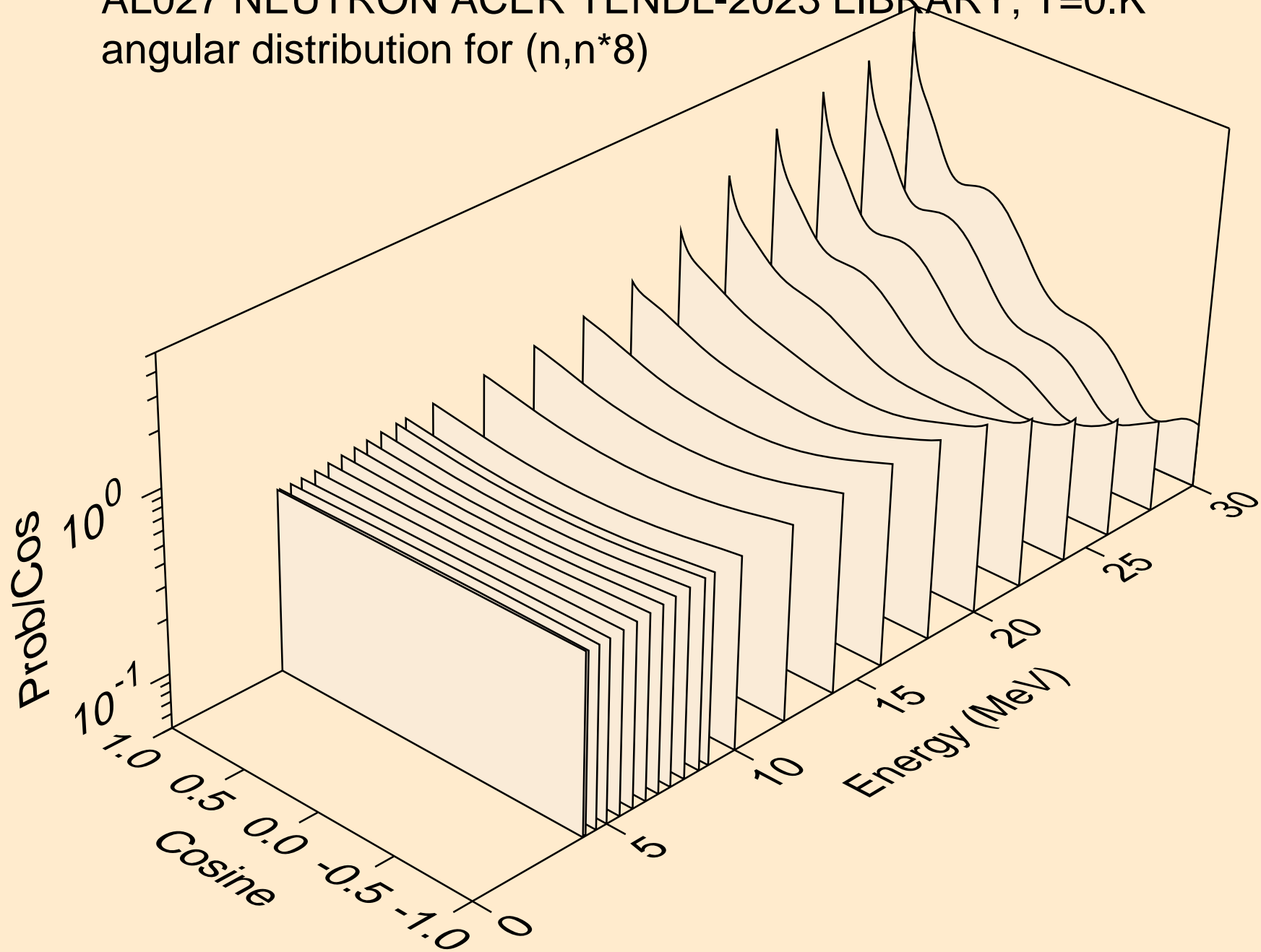

AL027 NEUTRON ACER TENDL-2023 LIBRARY; T=0.K  
angular distribution for (n,n\*9)

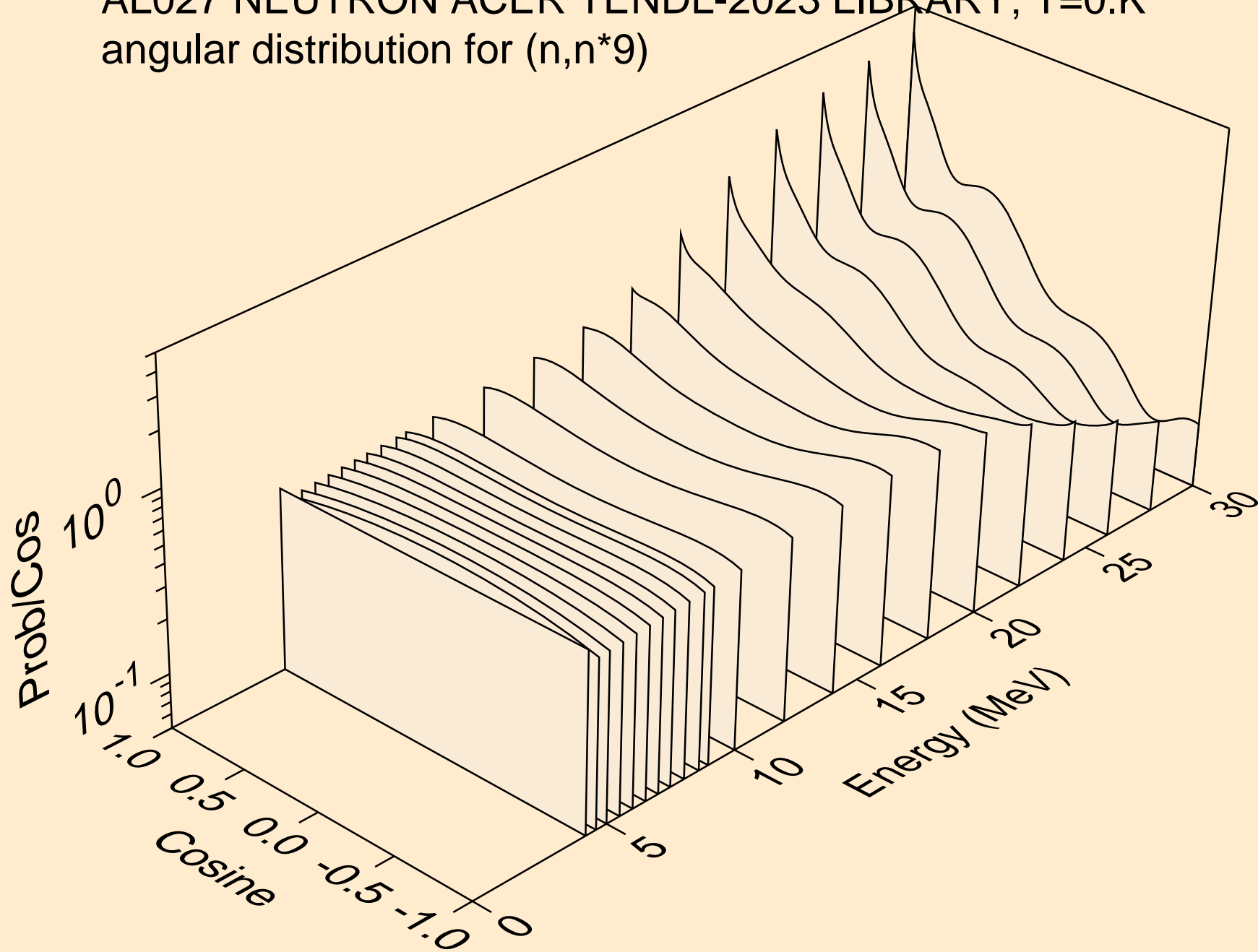

AL027 NEUTRON ACER TENDL-2023 LIBRARY; T=0.K  
angular distribution for (n,n\*10)

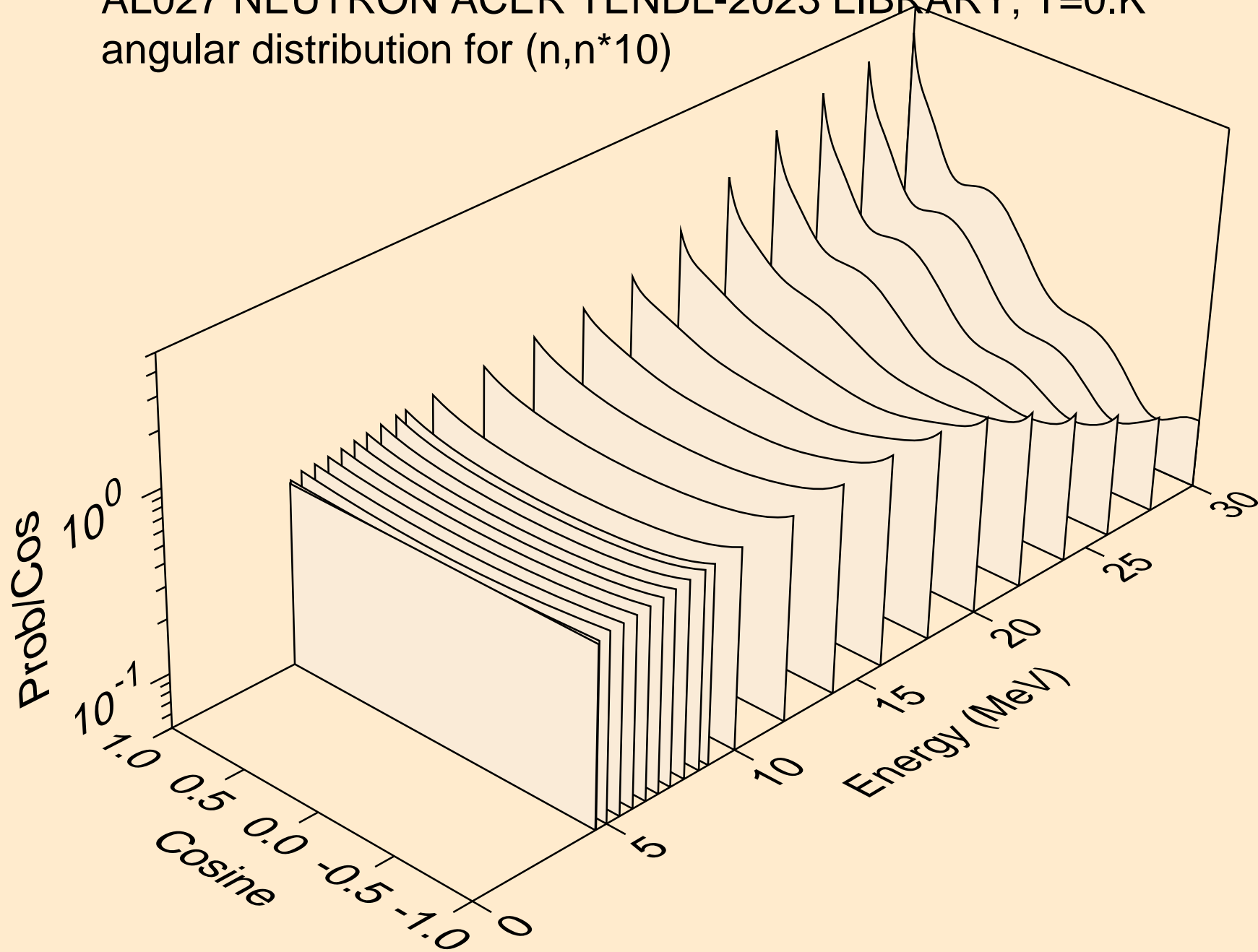

AL027 NEUTRON ACER TENDL-2023 LIBRARY; T=0.K  
angular distribution for (n,n\*11)

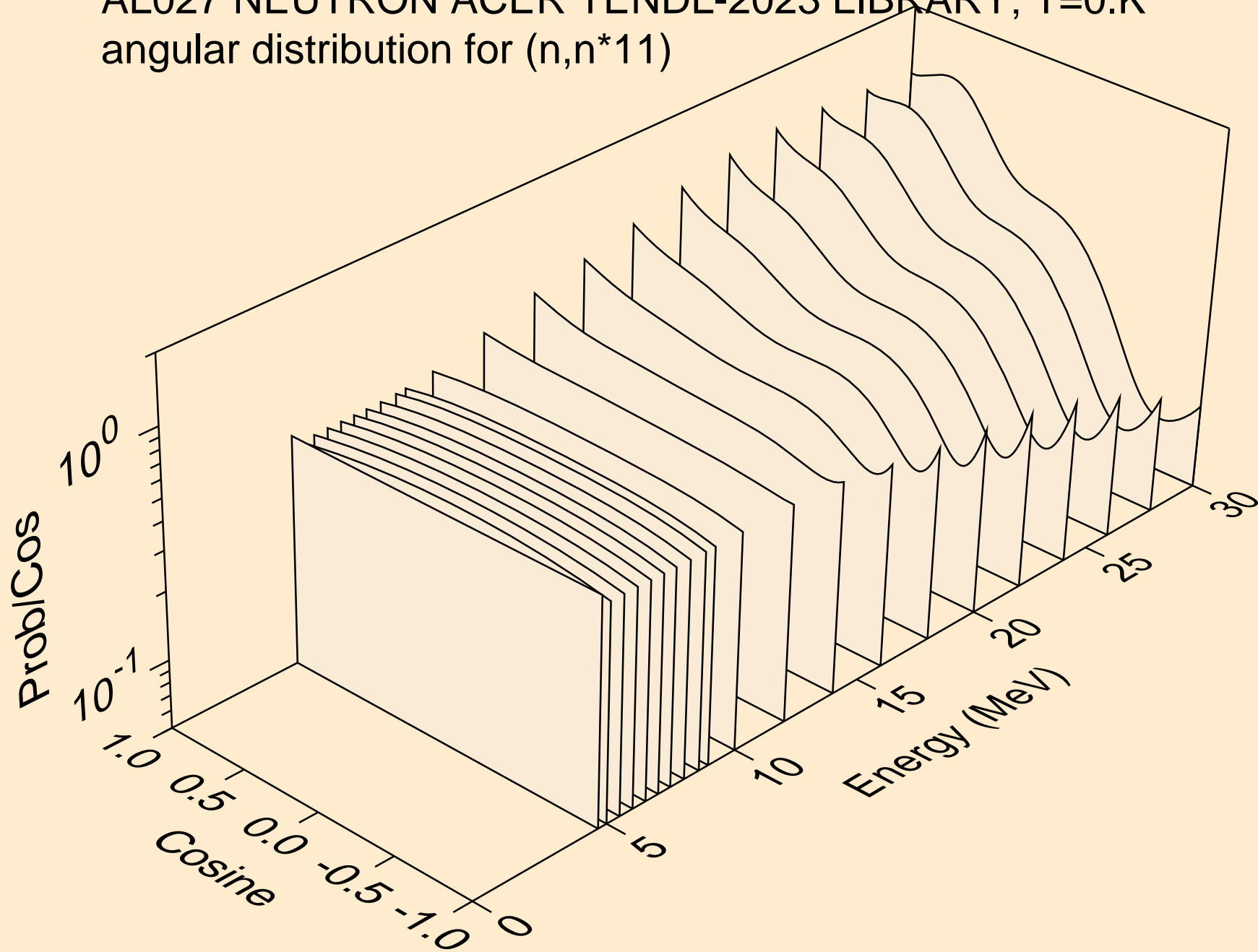

AL027 NEUTRON ACER TENDL-2023 LIBRARY; T=0.K  
angular distribution for (n,n\*12)

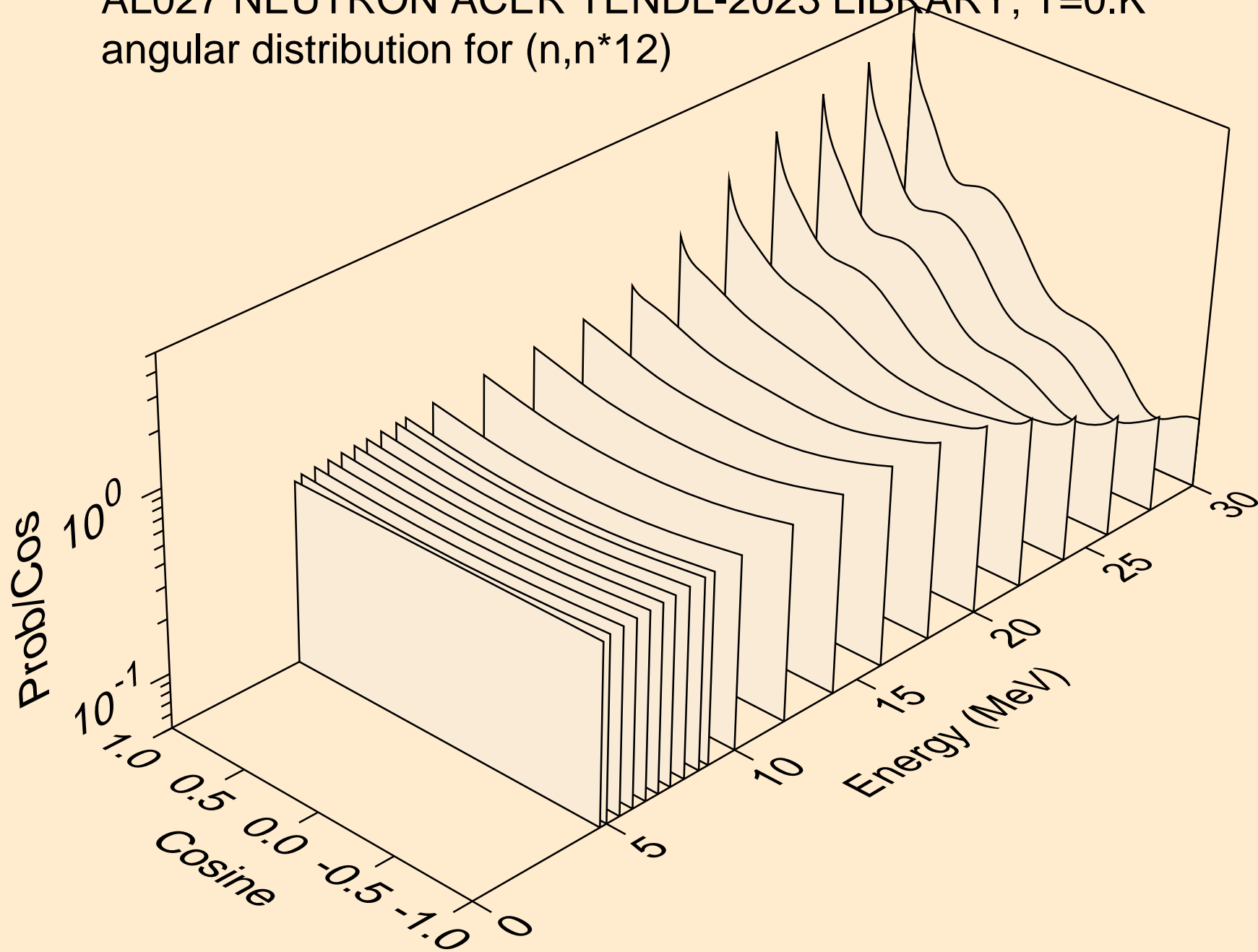

AL027 NEUTRON ACER TENDL-2023 LIBRARY; T=0.K  
angular distribution for (n,n\*13)

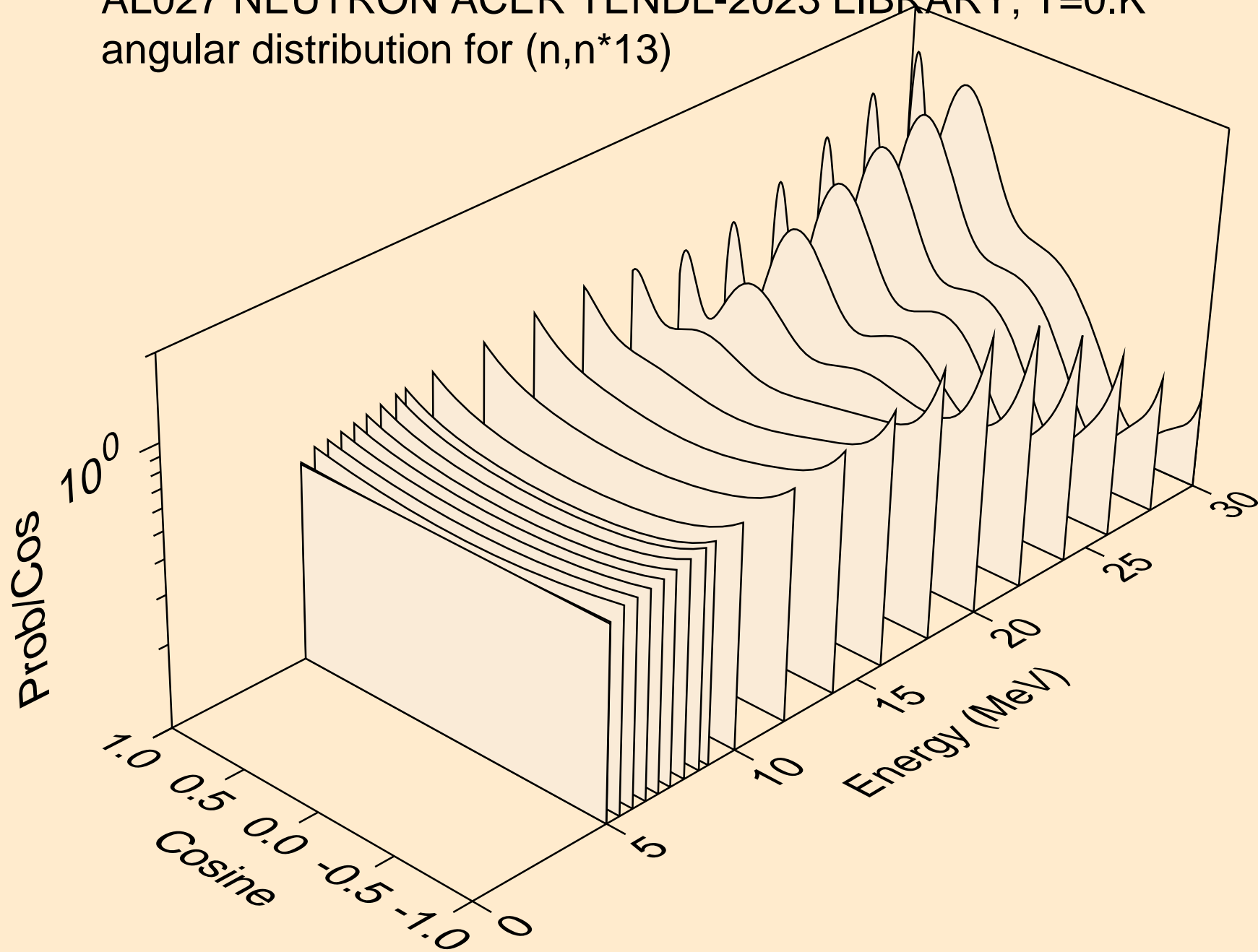

AL027 NEUTRON ACER TENDL-2023 LIBRARY; T=0.K  
angular distribution for (n,n\*14)

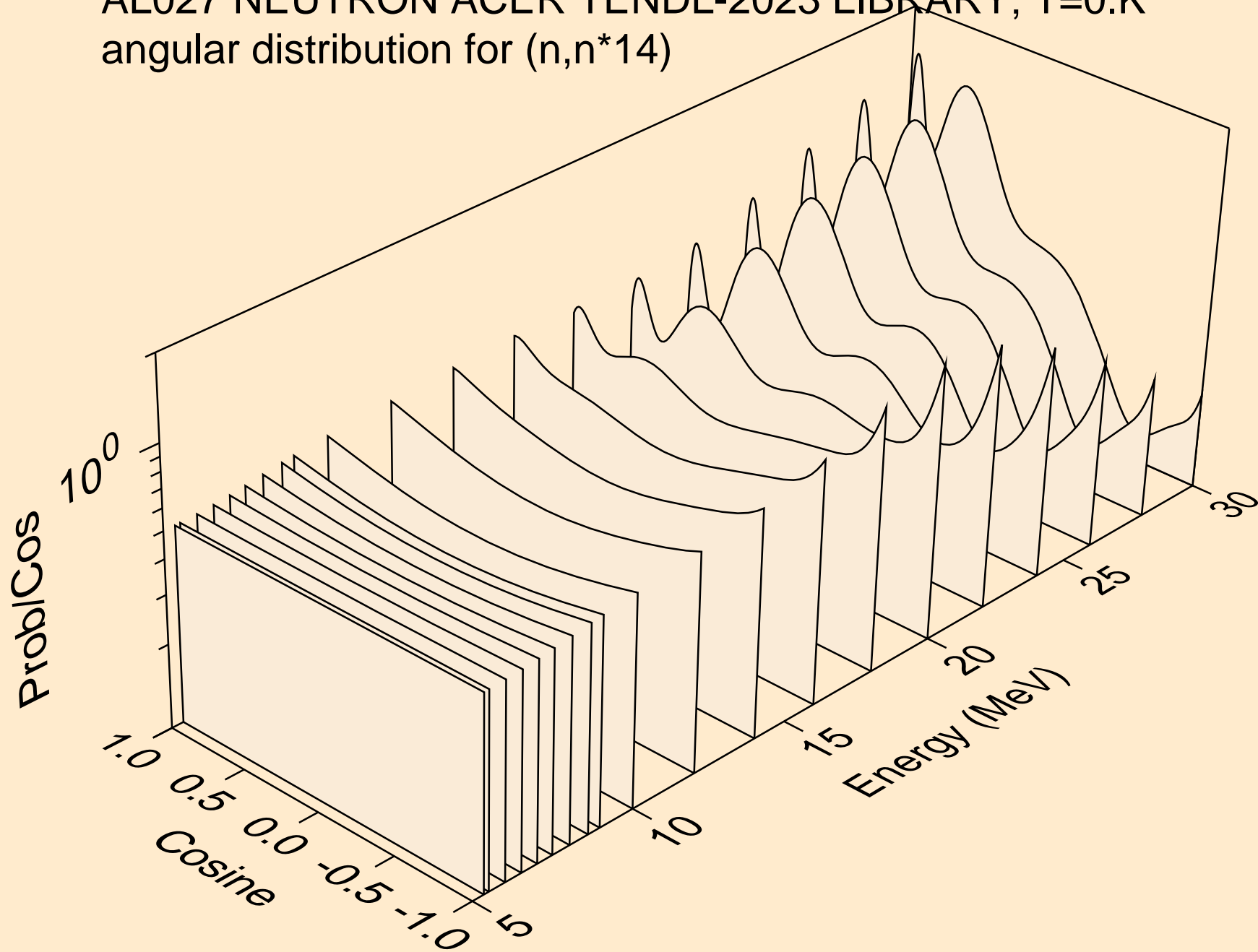

AL027 NEUTRON ACER TENDL-2023 LIBRARY; T=0.K  
angular distribution for (n,n\*15)

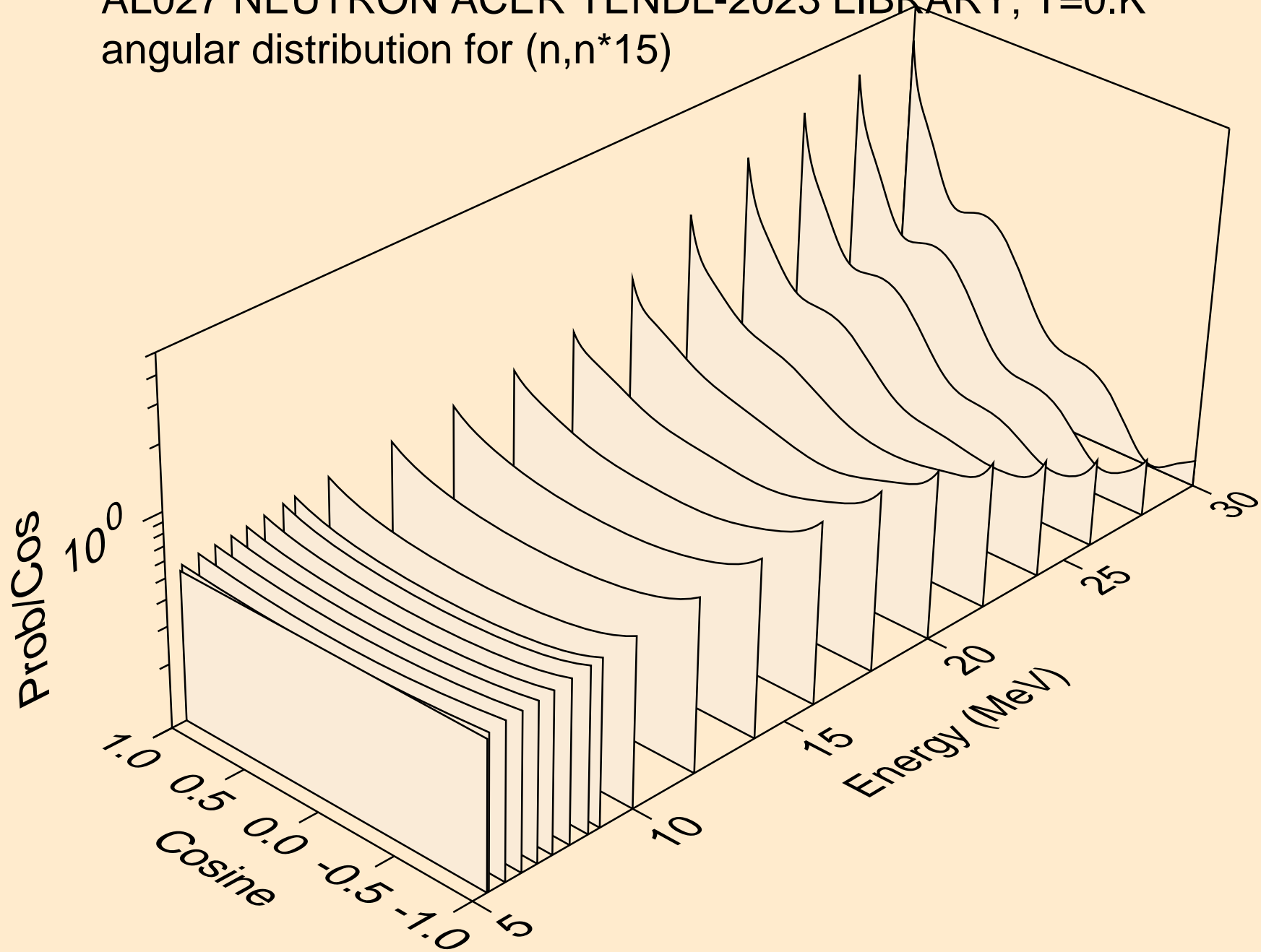

AL027 NEUTRON ACER TENDL-2023 LIBRARY; T=0.K  
angular distribution for (n,n\*16)

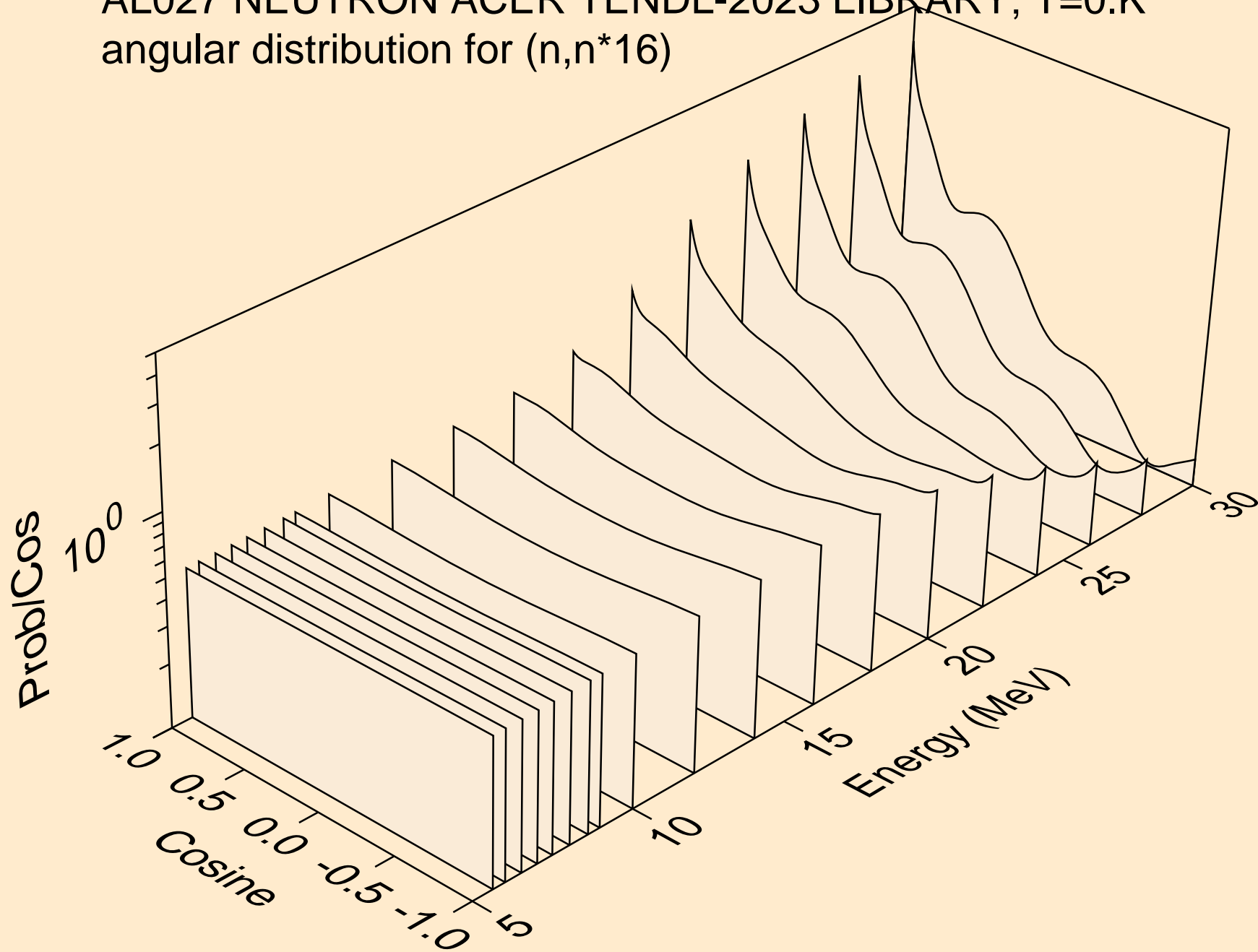

AL027 NEUTRON ACER TENDL-2023 LIBRARY; T=0.K  
angular distribution for (n,n\*17)

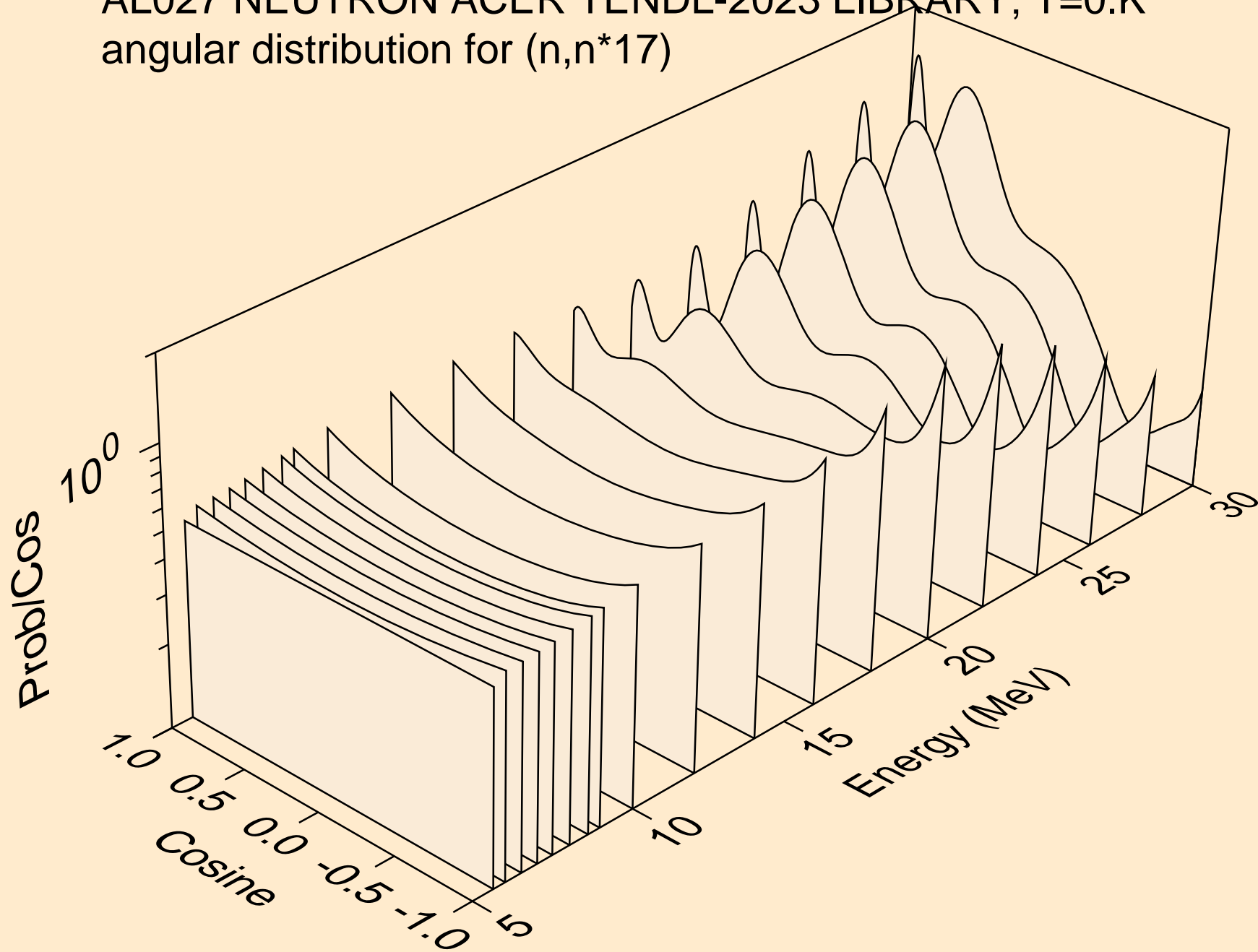

AL027 NEUTRON ACER TENDL-2023 LIBRARY; T=0.K  
Neutron emission for (n,x)

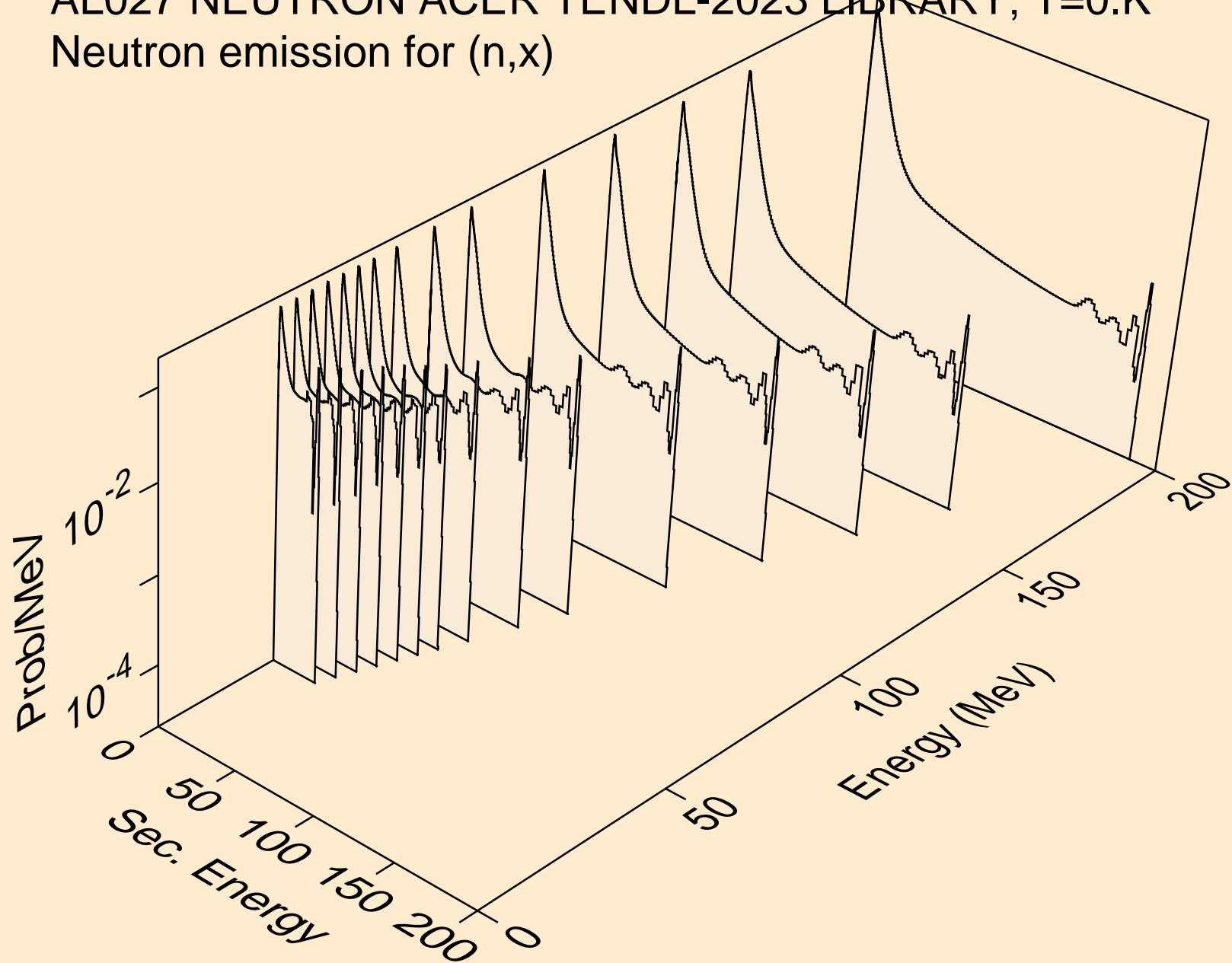

AL027 NEUTRON ACER TENDL-2023 LIBRARY; T=0.K  
Neutron emission for (n,2nd)

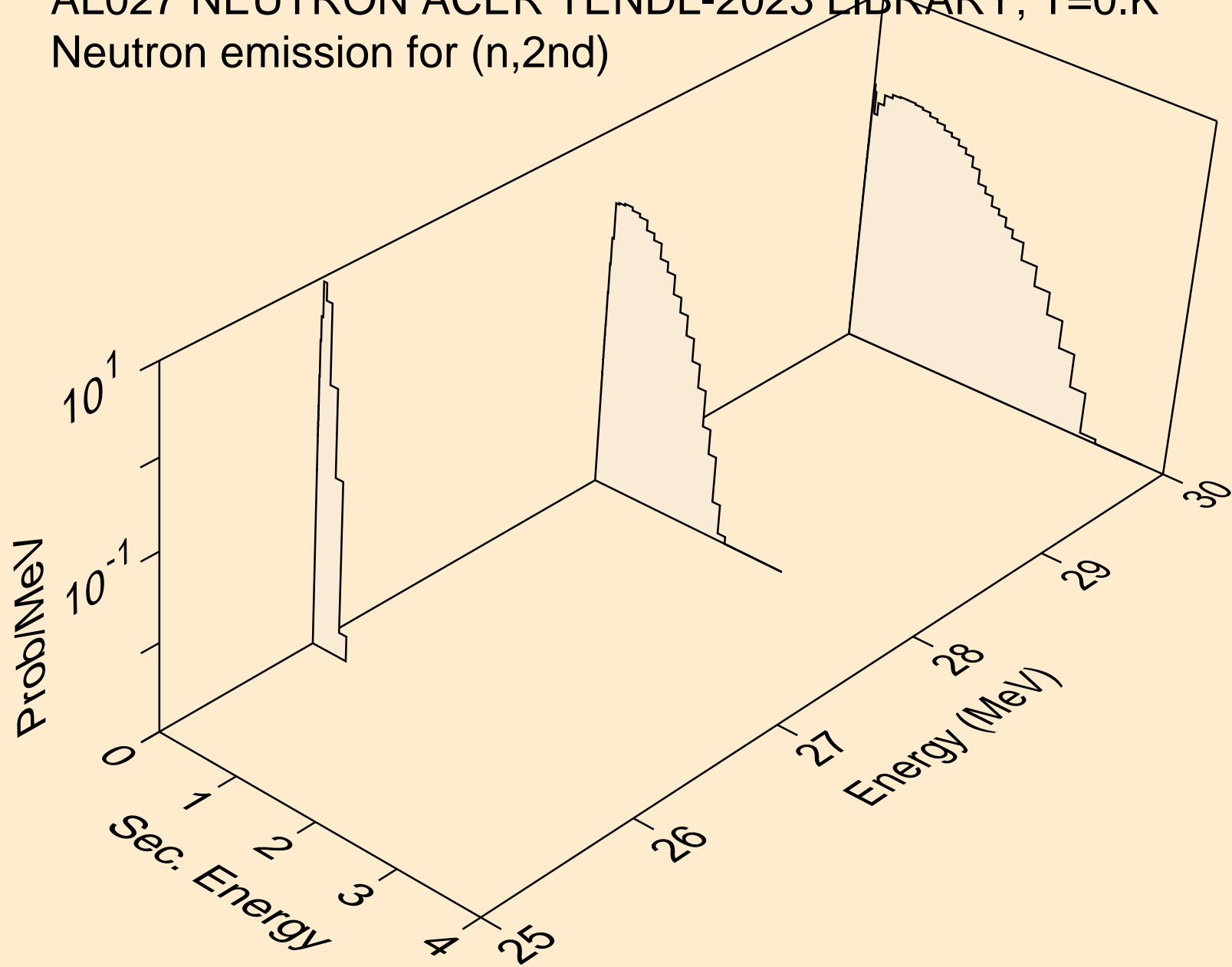

AL027 NEUTRON ACER TENDL-2023 LIBRARY; T=0.K  
Neutron emission for (n,2n)

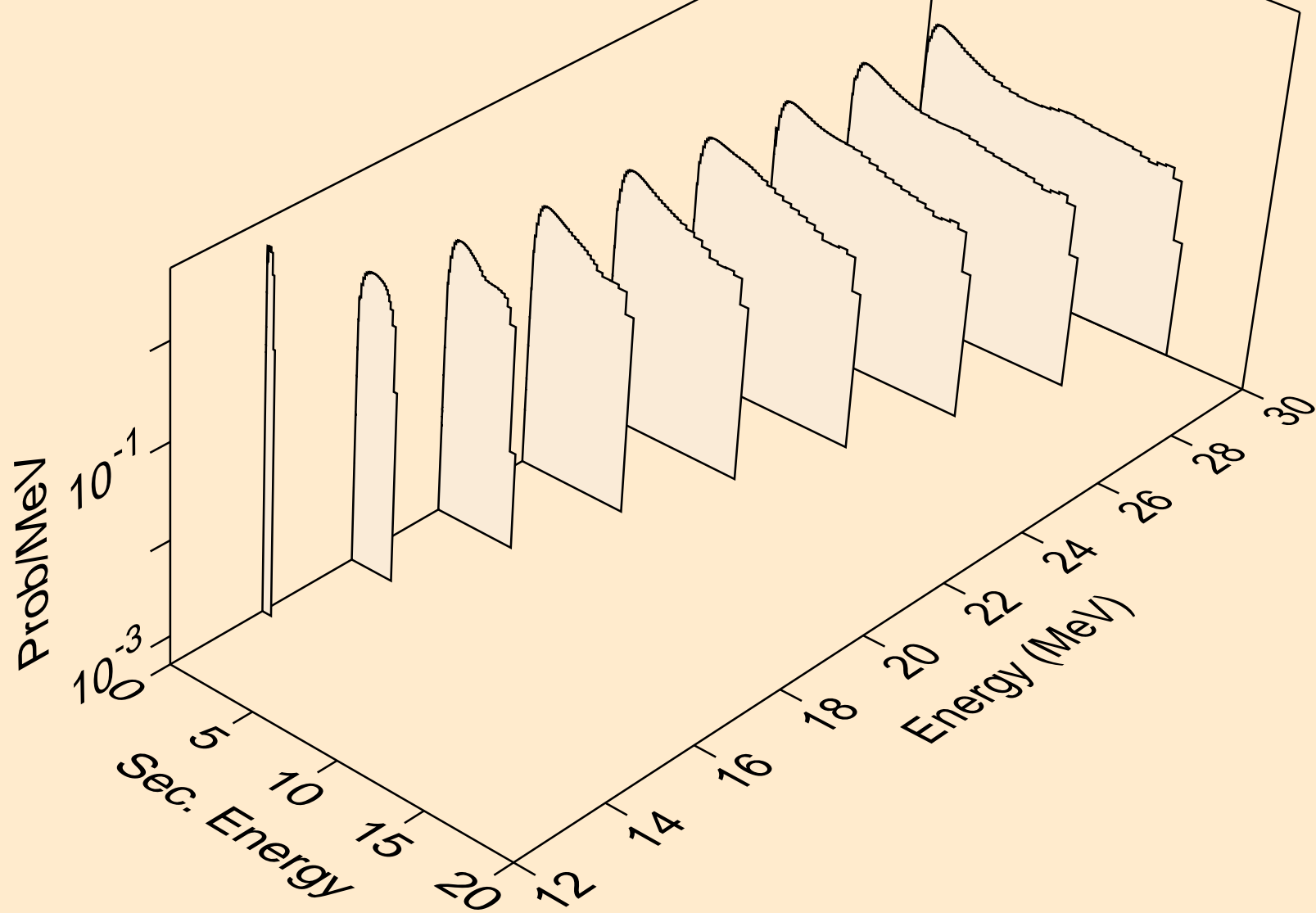

AL027 NEUTRON ACER TENDL-2023 LIBRARY; T=0.K  
Neutron emission for (n,3n)

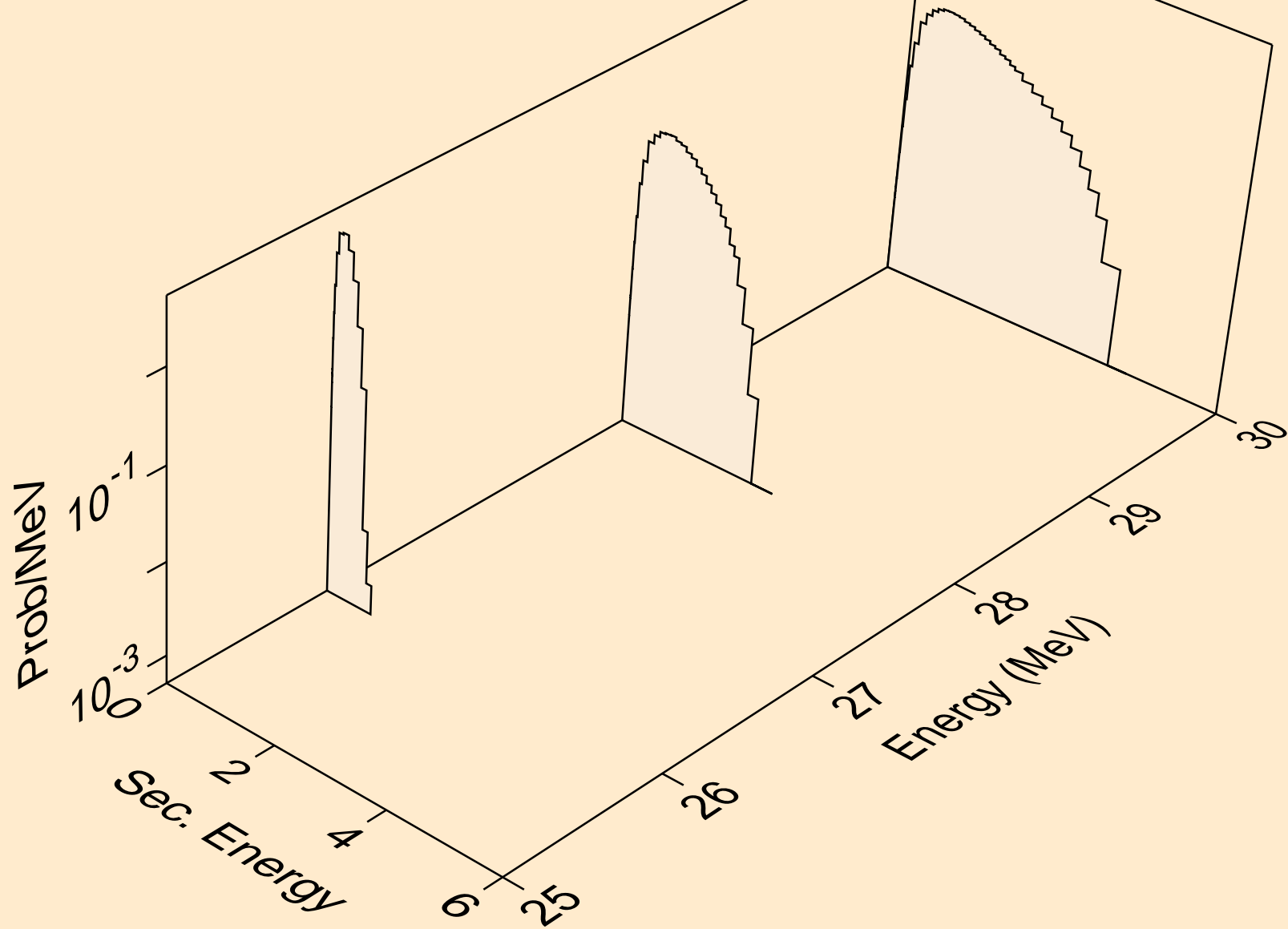

AL027 NEUTRON ACER TENDL-2023 LIBRARY; T=0.K  
Neutron emission for (n,n\*)a

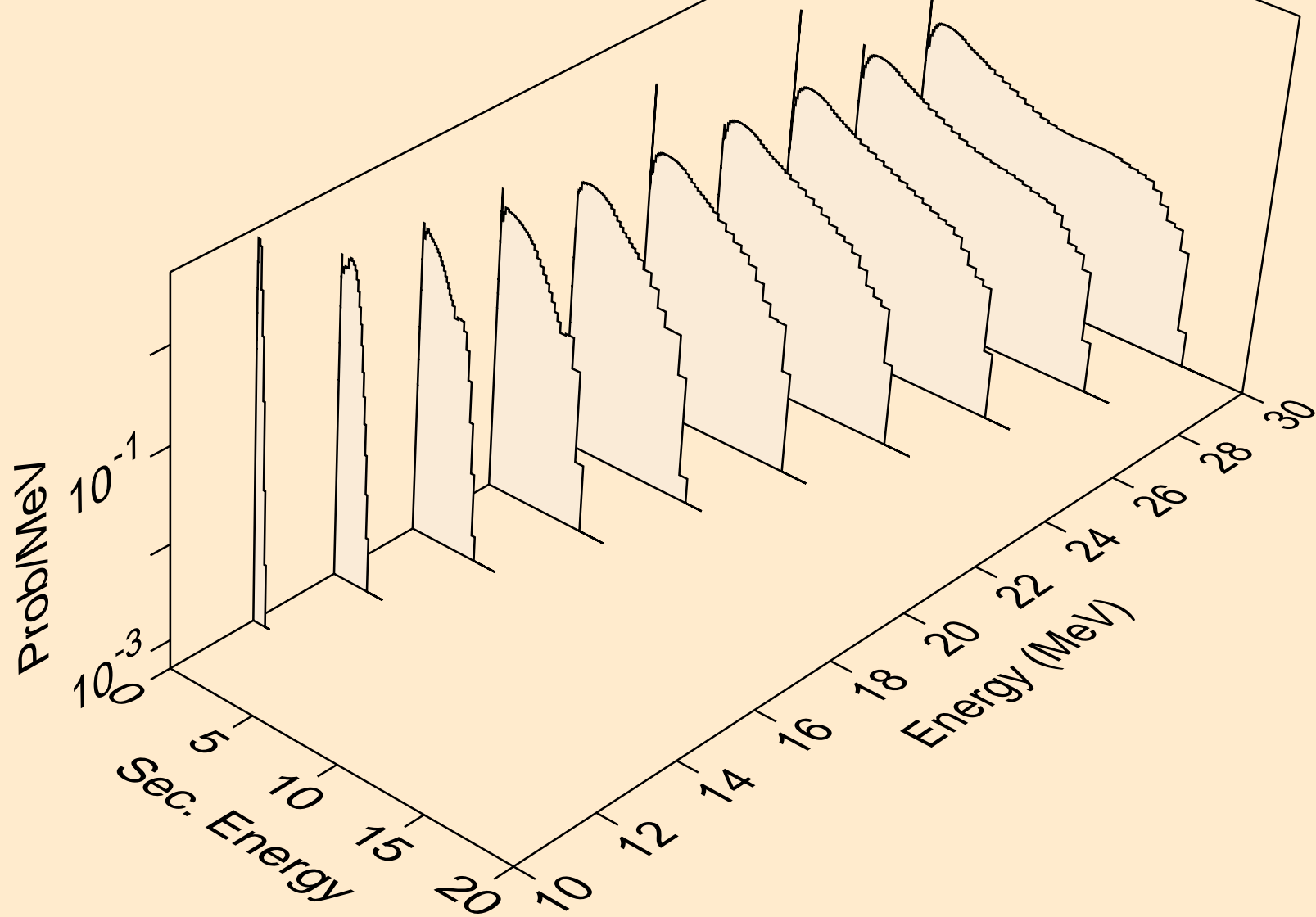

AL027 NEUTRON ACER TENDL-2023 LIBRARY; T=0.K  
Neutron emission for (n,2n)a

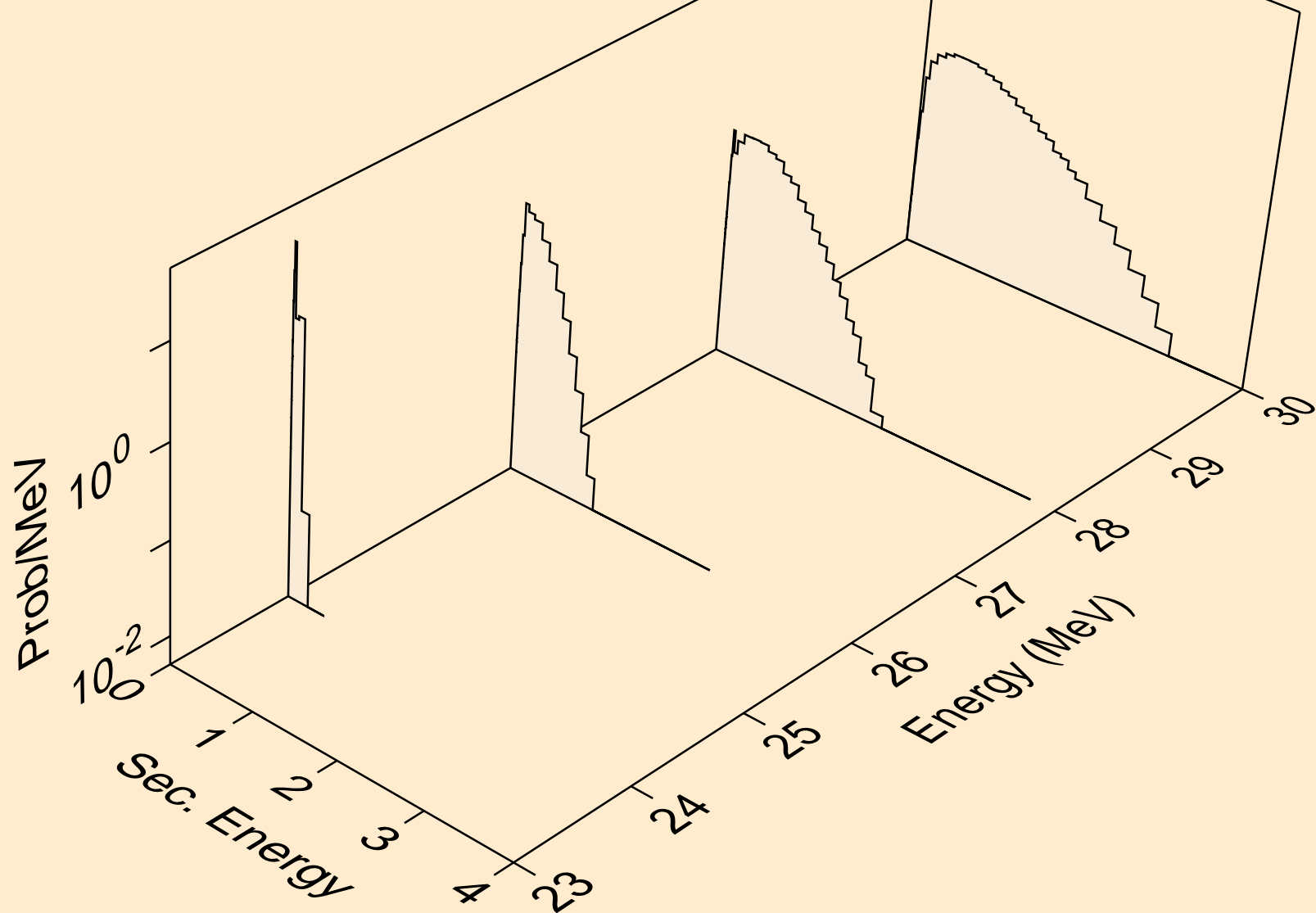

AL027 NEUTRON ACER TENDL-2023 LIBRARY; T=0.K  
Neutron emission for (n,n\*)p

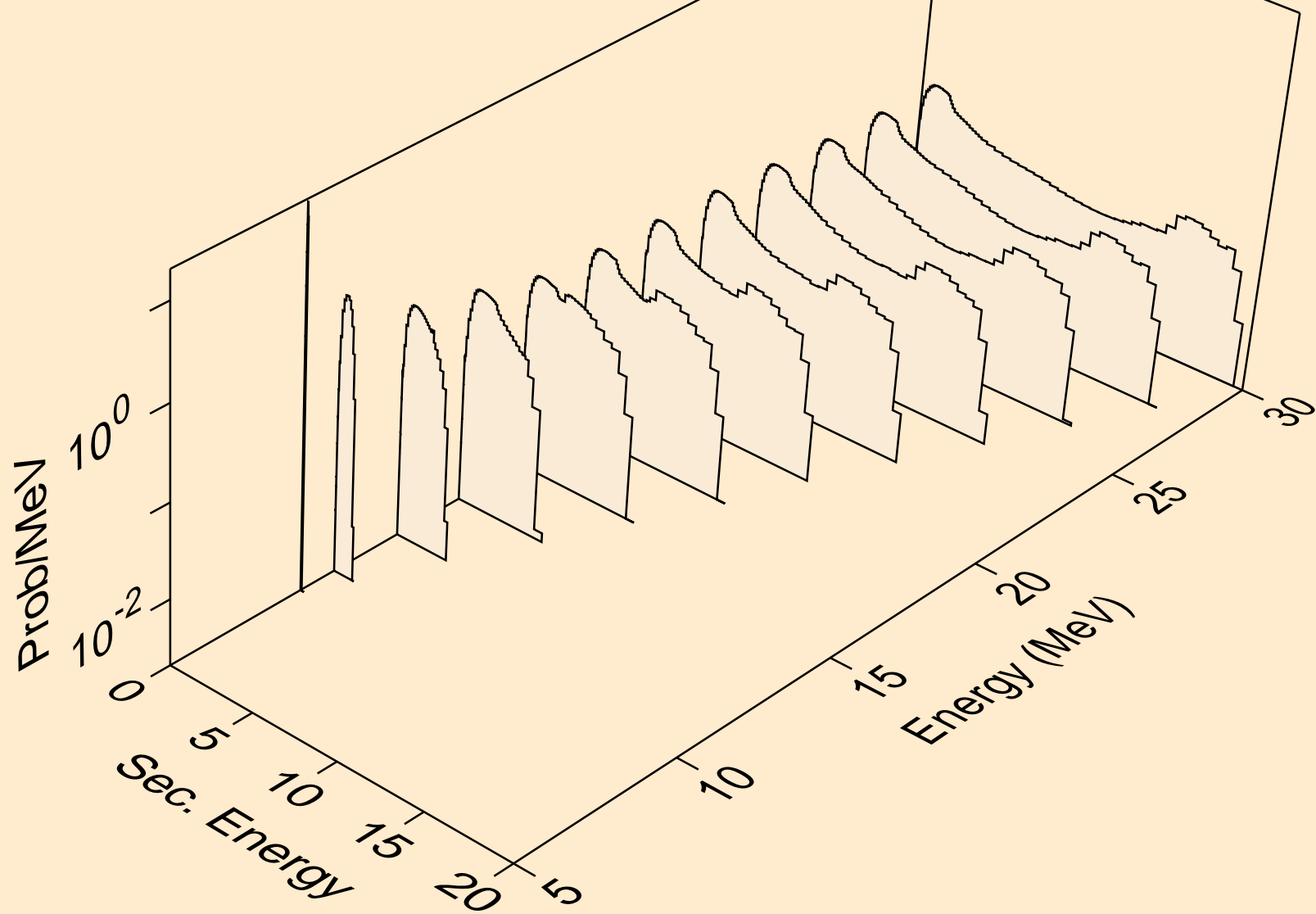

AL027 NEUTRON ACER TENDL-2023 LIBRARY; T=0.K  
Neutron emission for (n,n\*)2a

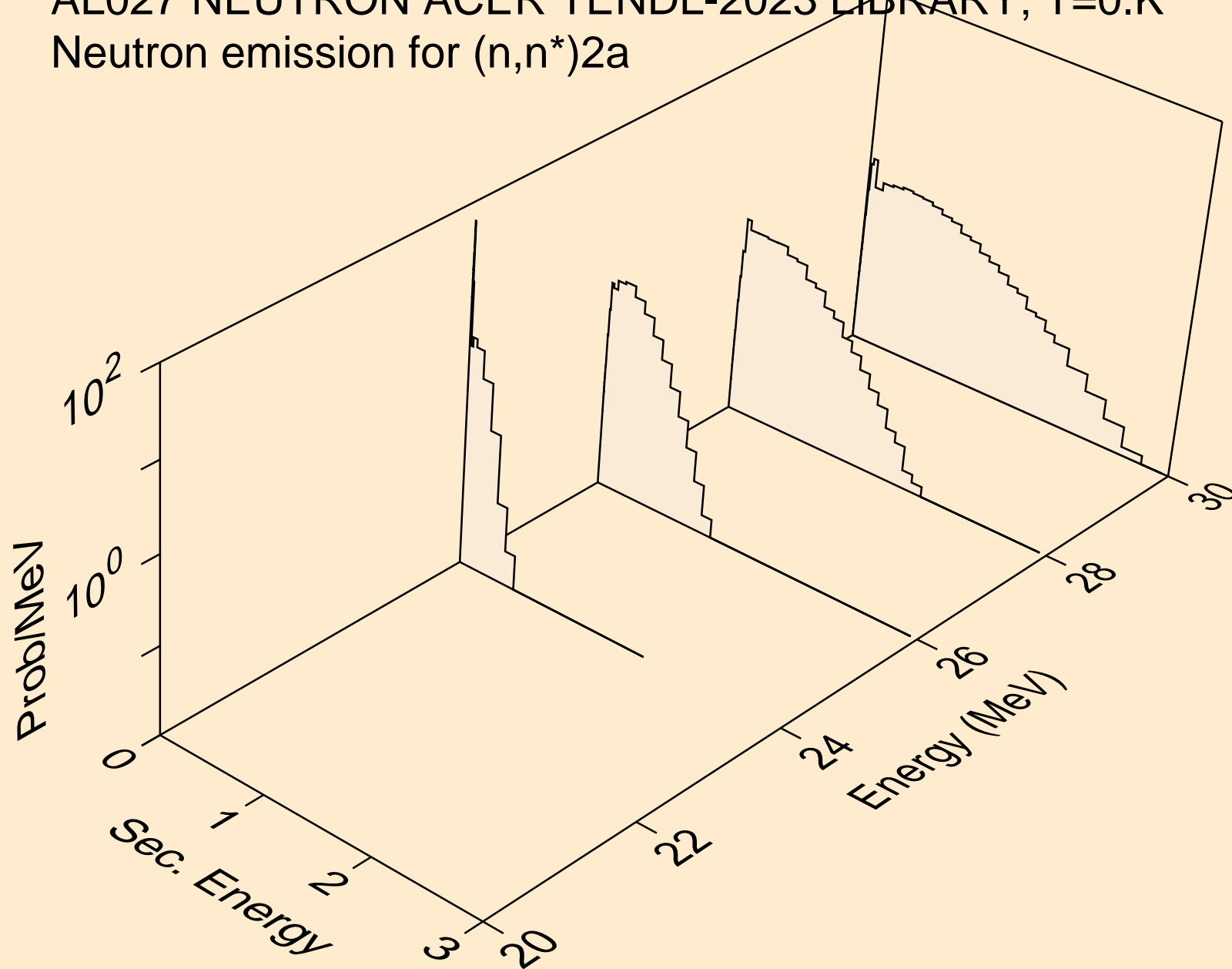

AL027 NEUTRON ACER TENDL-2023 LIBRARY; T=0.K  
Neutron emission for (n,n\*)d

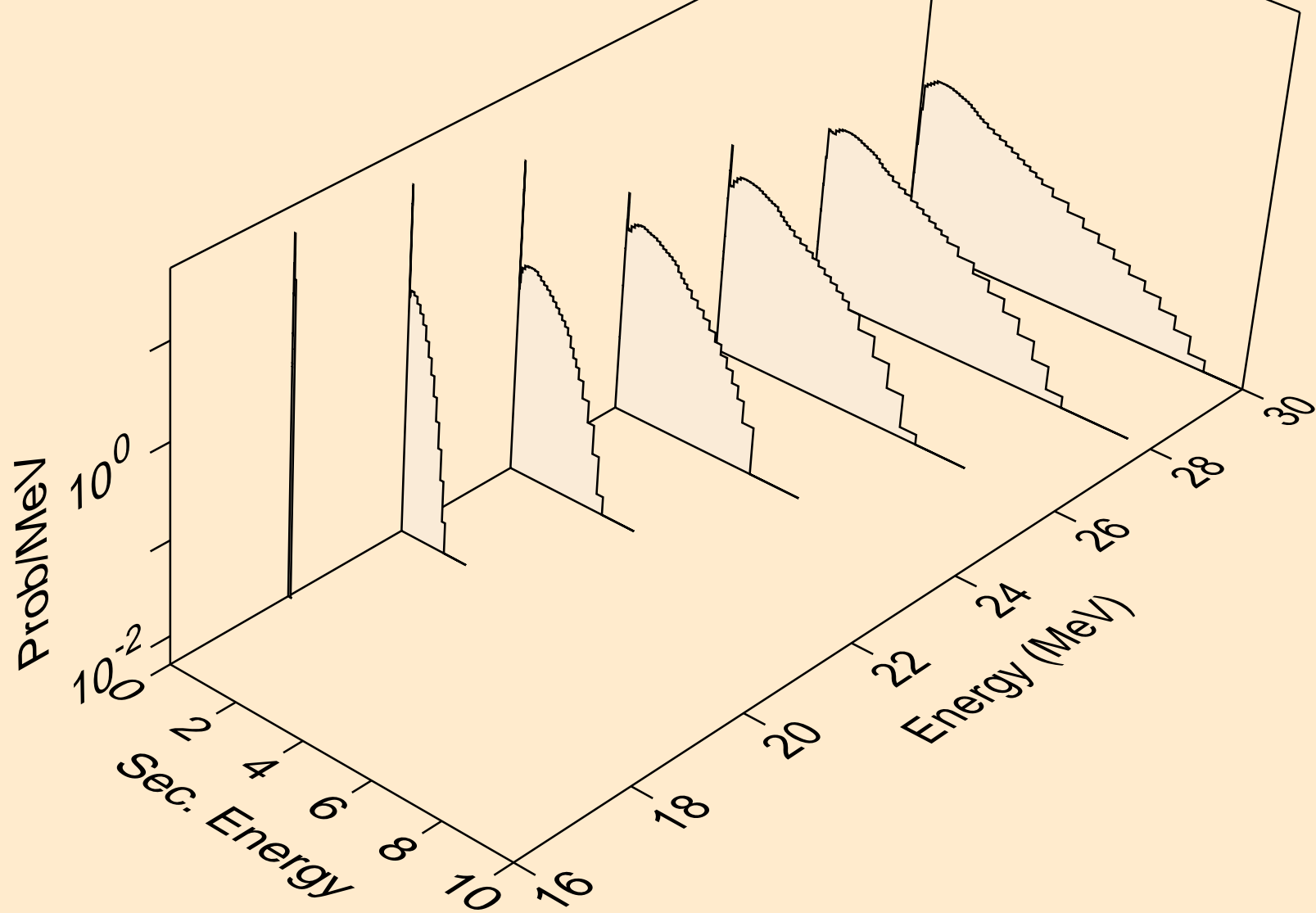

AL027 NEUTRON ACER TENDL-2023 LIBRARY; T=0.K  
Neutron emission for (n,n\*)t

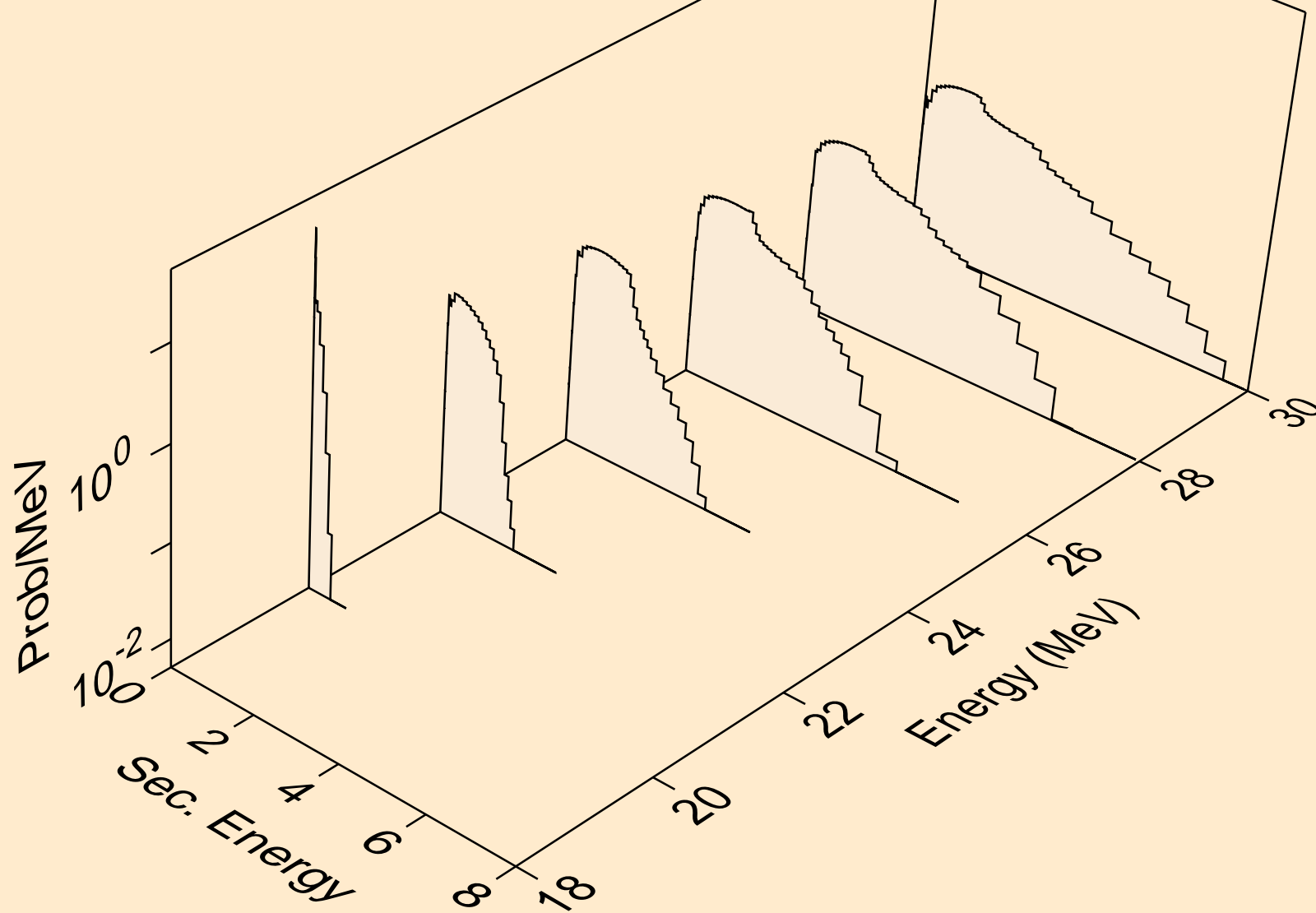

AL027 NEUTRON ACER TENDL-2023 LIBRARY; T=0.K  
Neutron emission for (n,n\*)he3

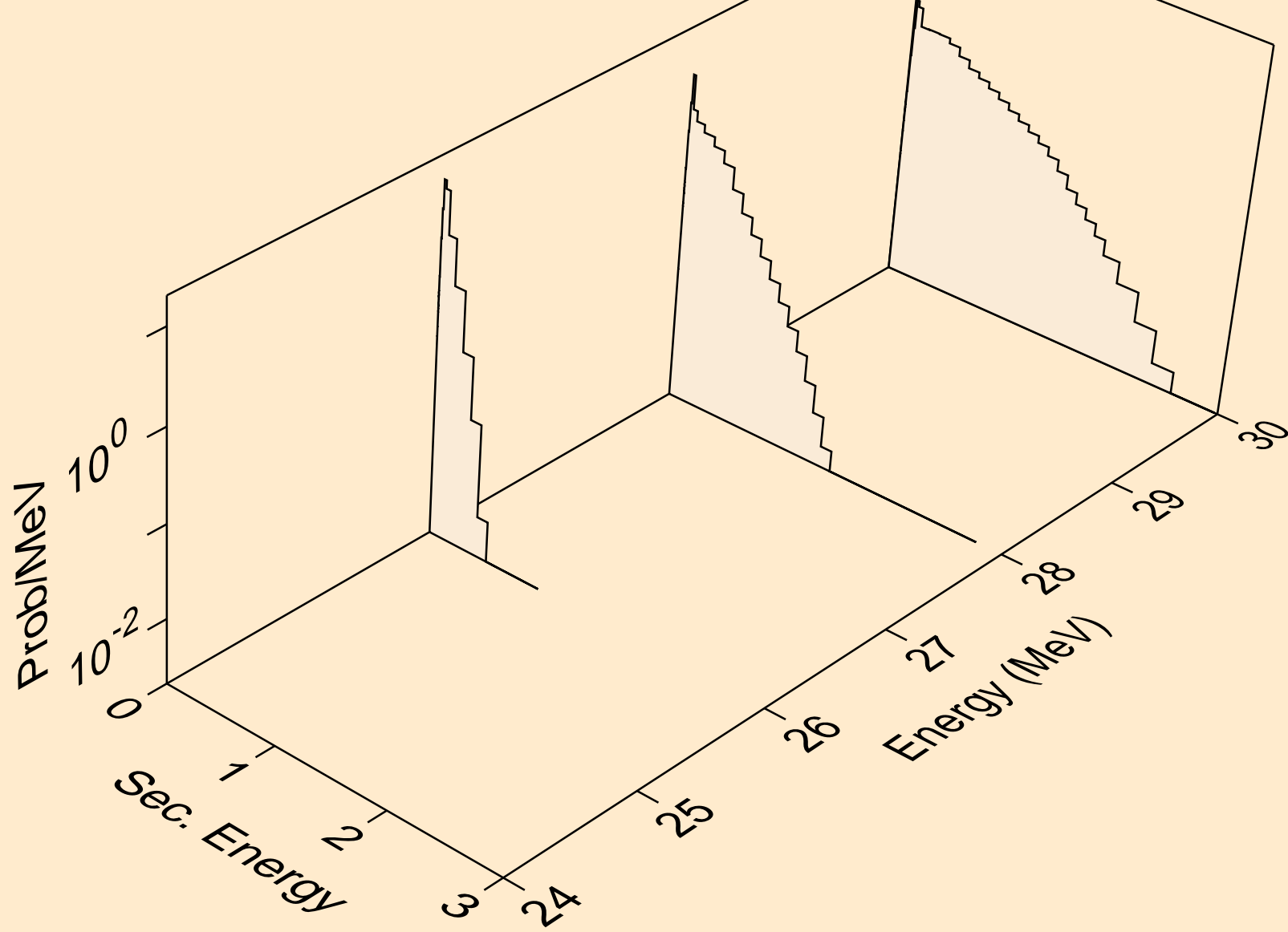

AL027 NEUTRON ACER TENDL-2023 LIBRARY; T=0.K  
Neutron emission for (n,2np)

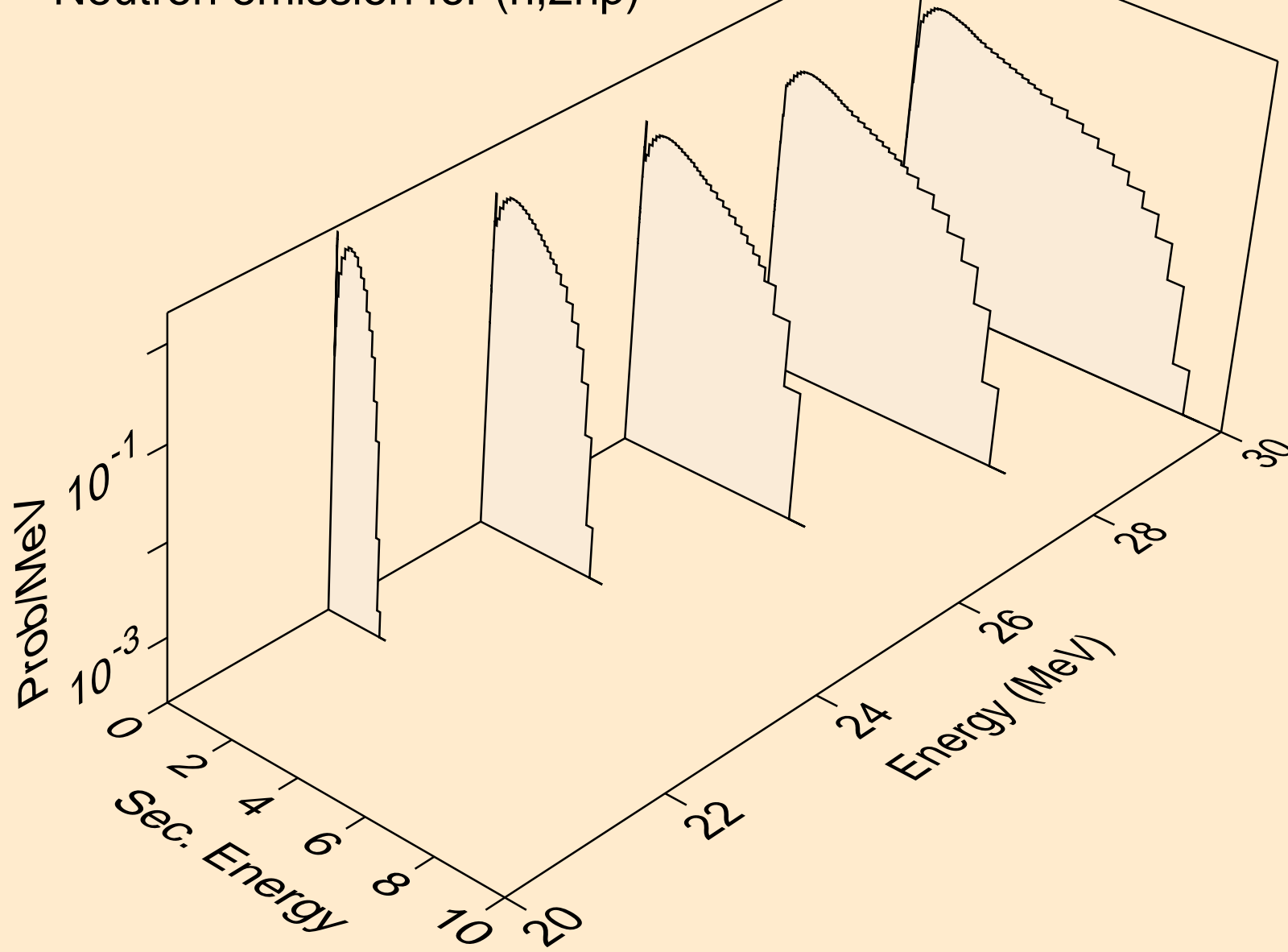

AL027 NEUTRON ACER TENDL-2023 LIBRARY; T=0.K  
Neutron emission for (n,3np)

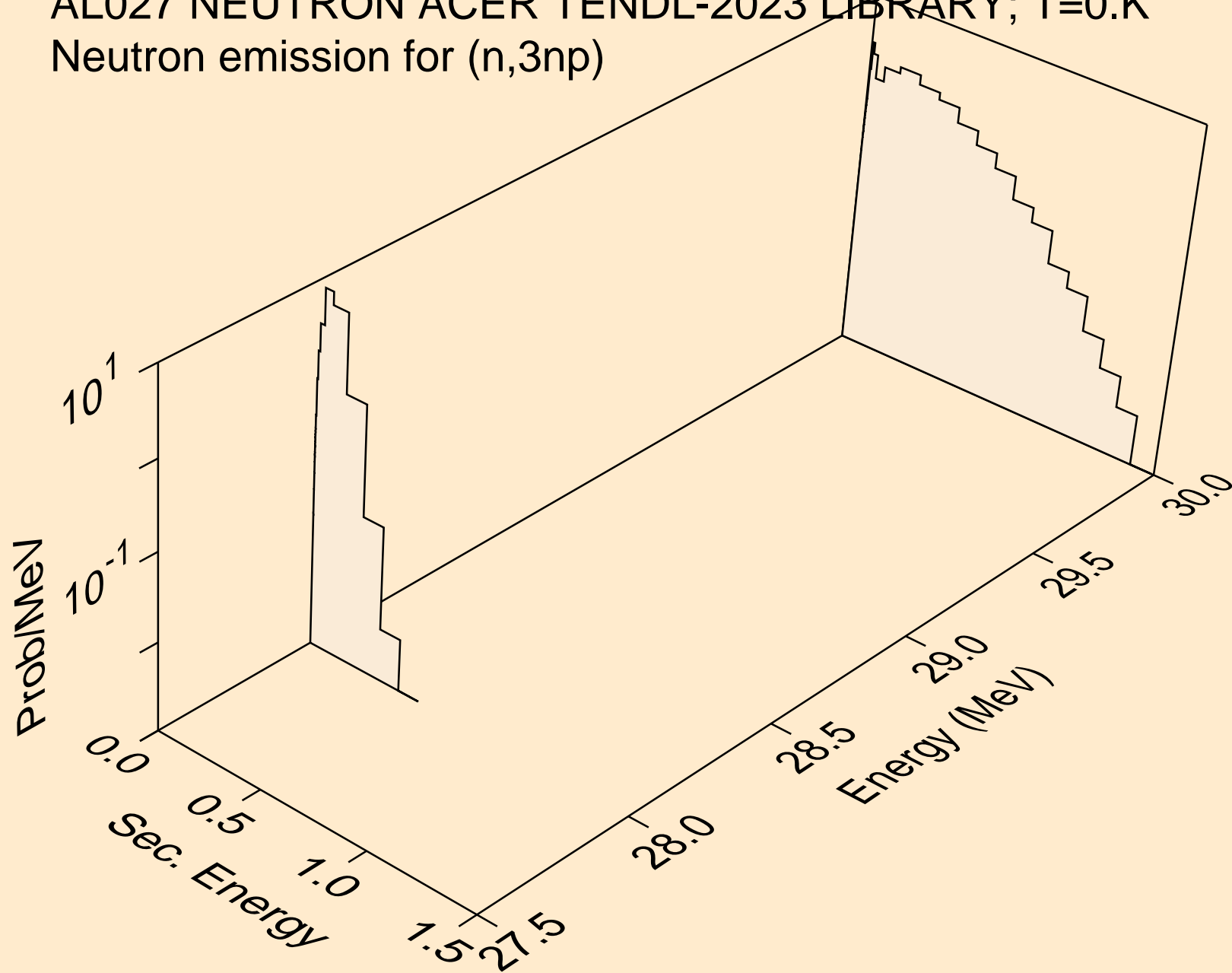

AL027 NEUTRON ACER TENDL-2023 LIBRARY; T=0.K  
Neutron emission for (n,n2p)

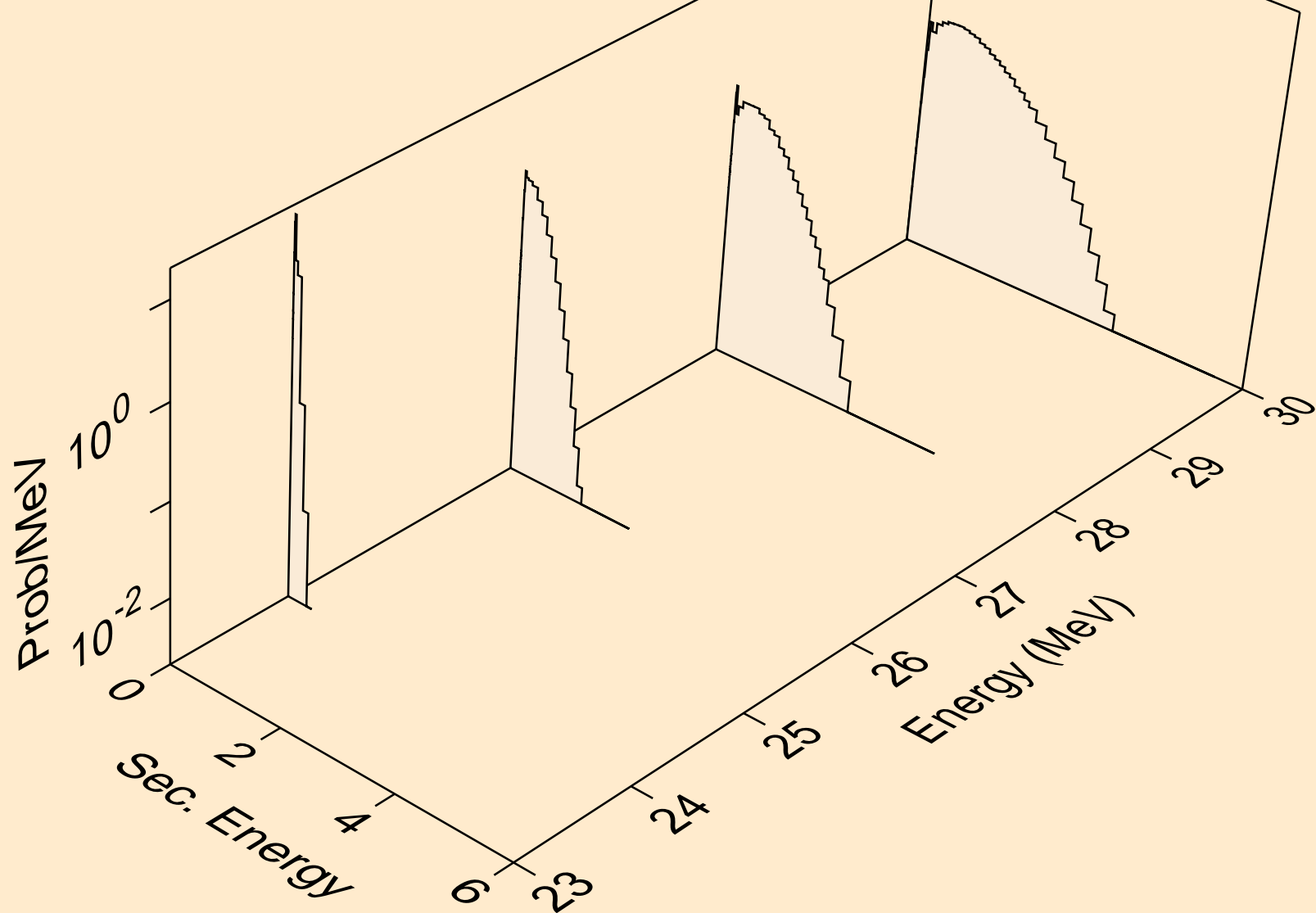

AL027 NEUTRON ACER TENDL-2023 LIBRARY; T=0.K  
Neutron emission for (n,npa)

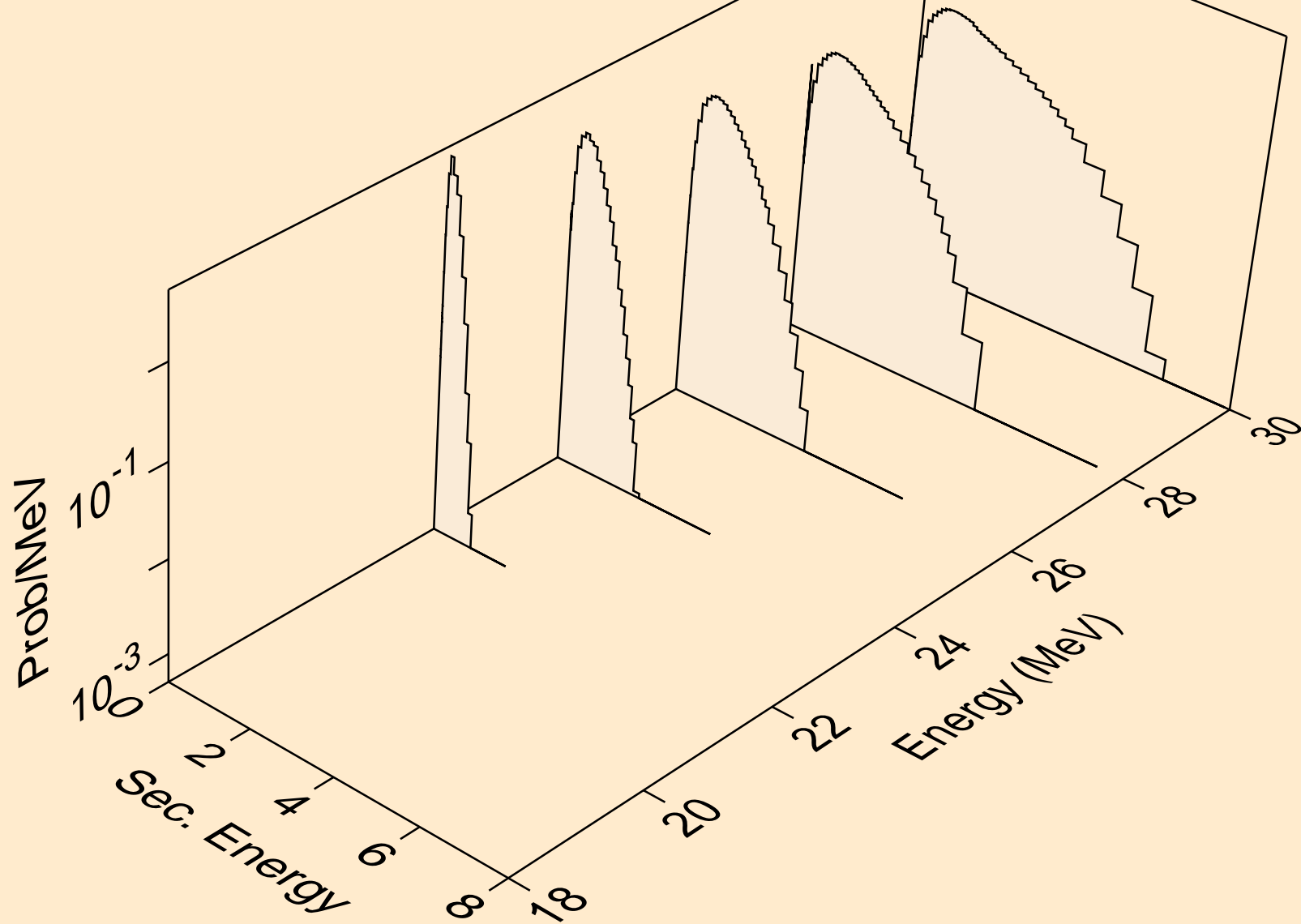

AL027 NEUTRON ACER TENDL-2023 LIBRARY; T=0.K  
Neutron emission for (n,n\*c)

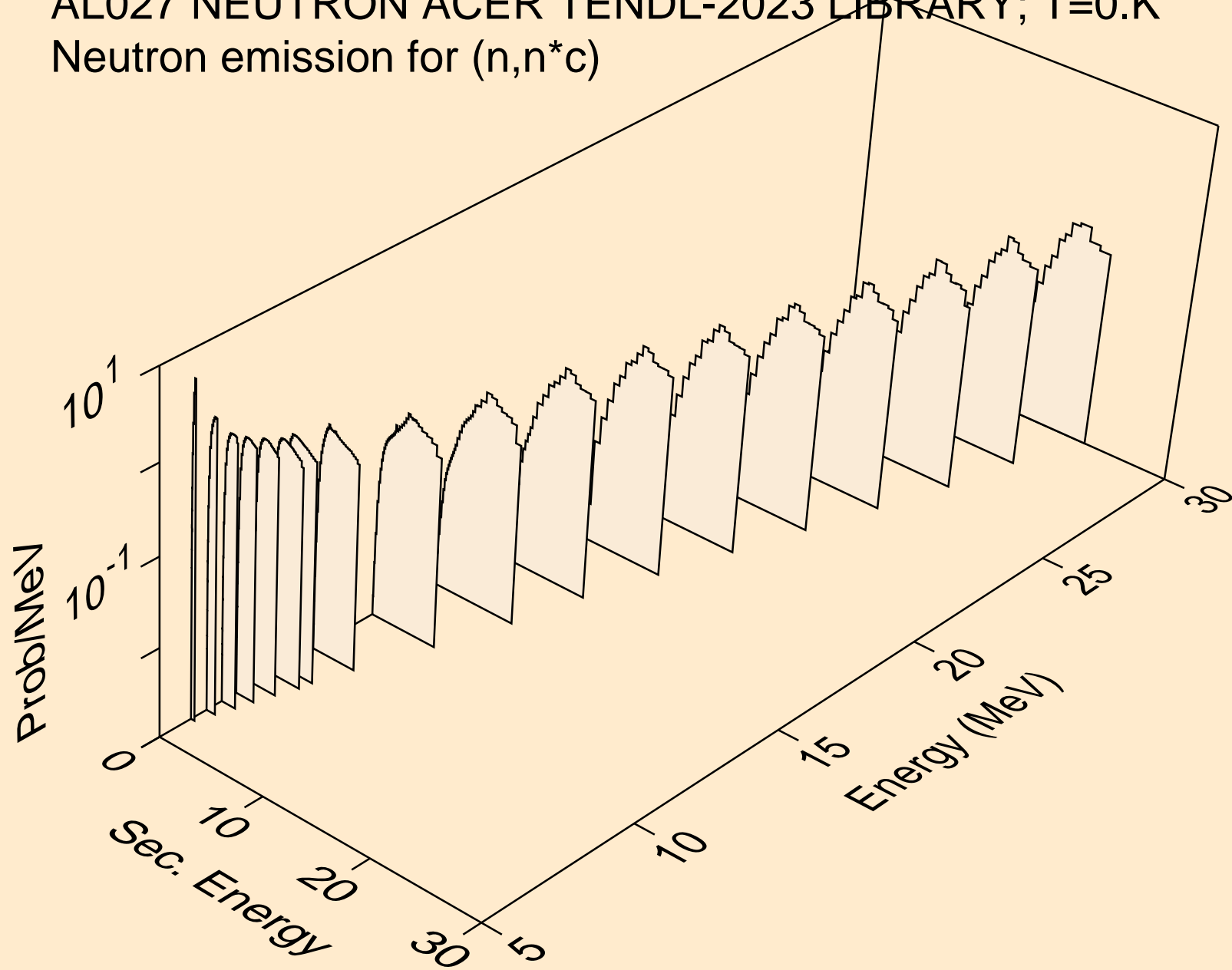

AL027 NEUTRON ACER TENDL-2023 LIBRARY; T=0.K  
Photon emission for (n,x)

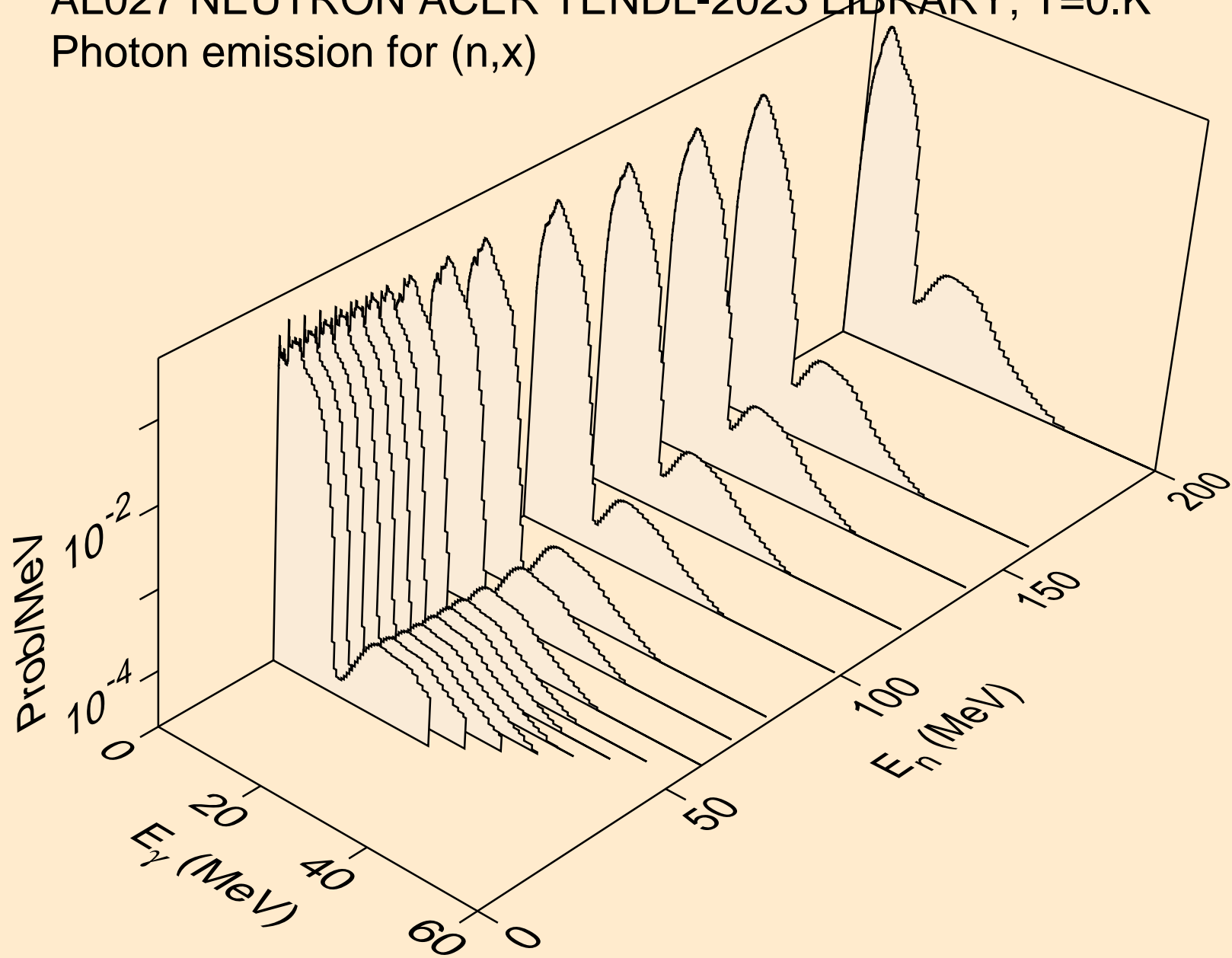

AL027 NEUTRON ACER TENDL-2023 LIBRARY; T=0.K  
Photon emission for (n,2nd)

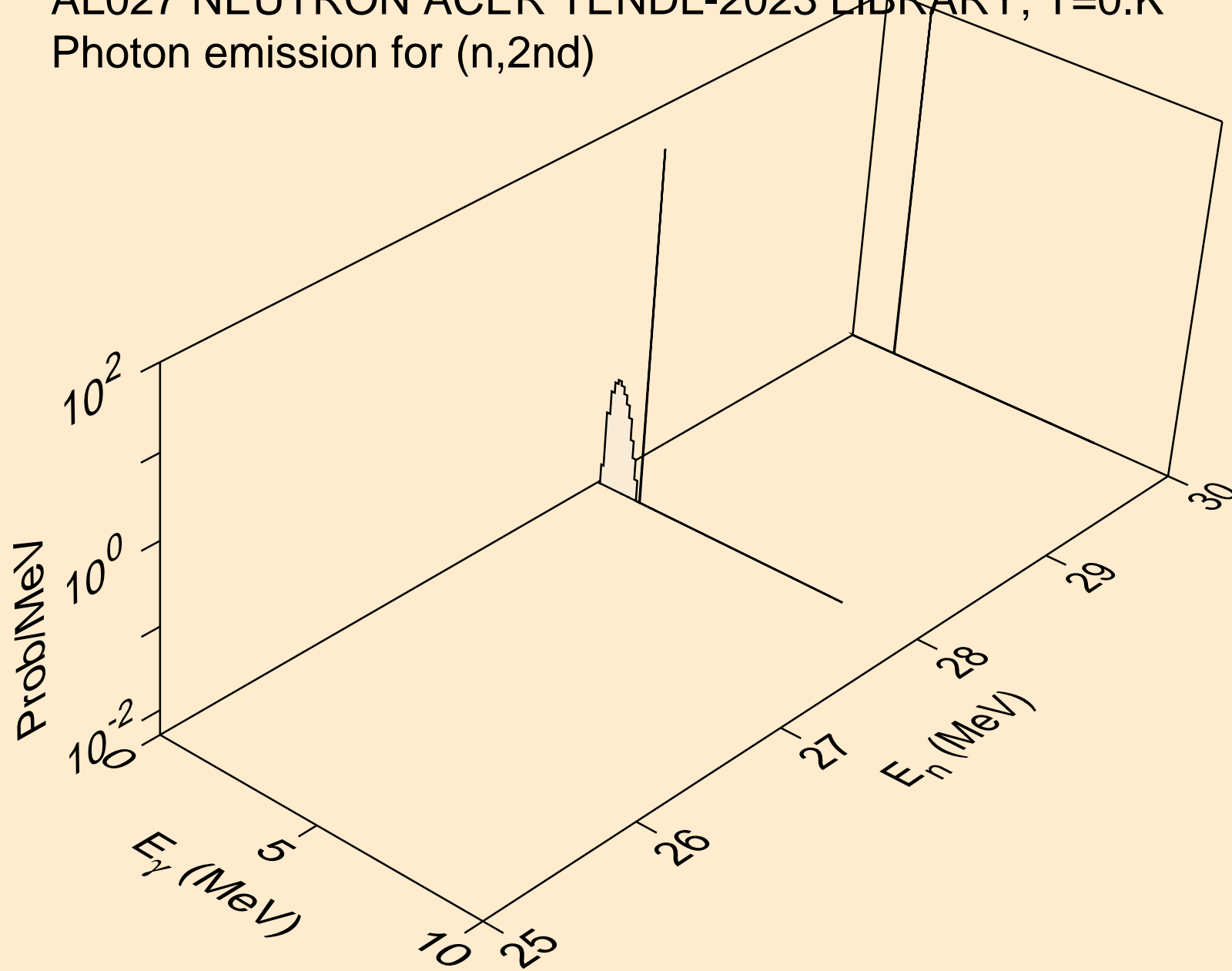

AL027 NEUTRON ACER TENDL-2023 LIBRARY; T=0.K  
Photon emission for (n,2n)

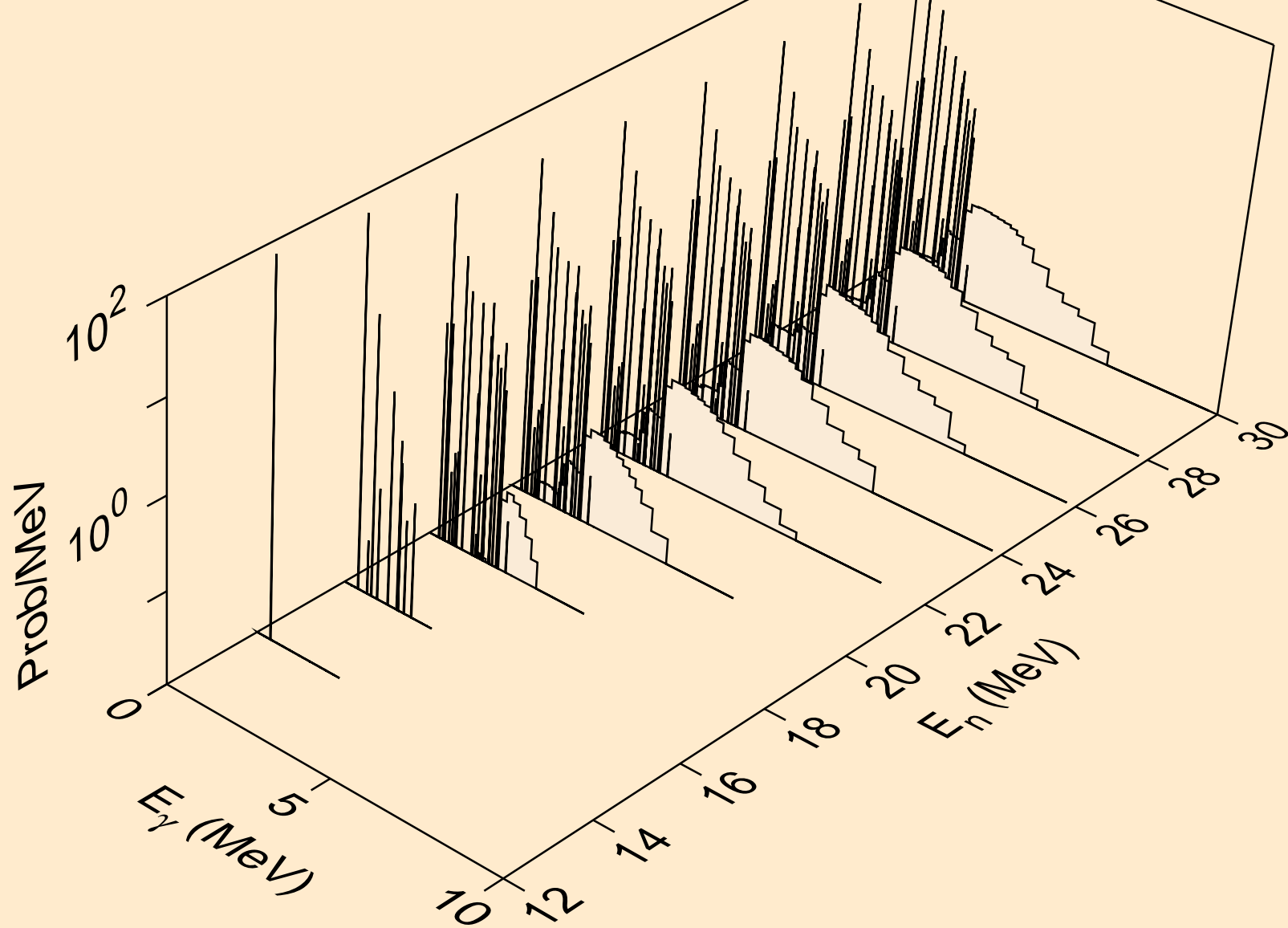

AL027 NEUTRON ACER TENDL-2023 LIBRARY; T=0.K  
Photon emission for (n,3n)

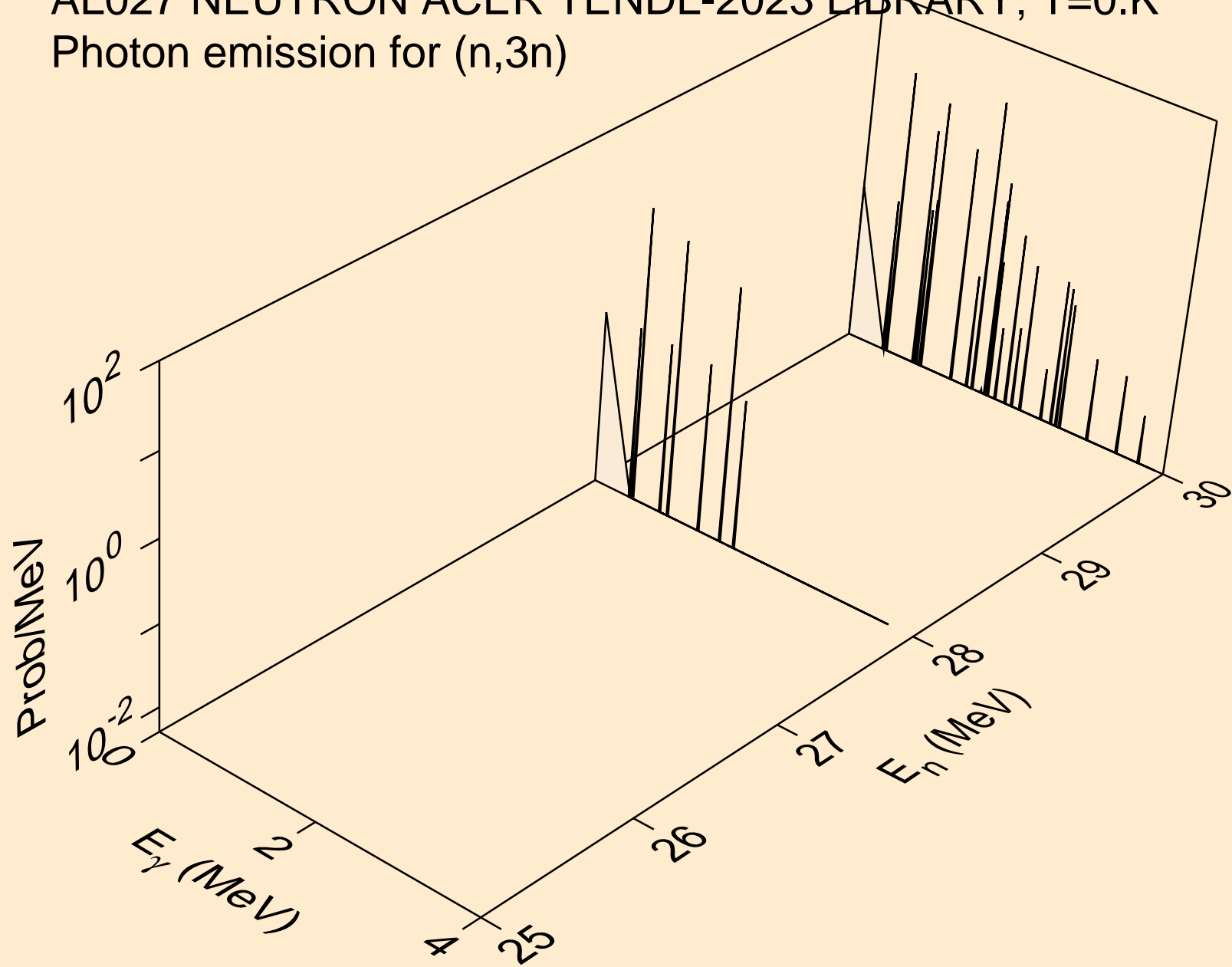

AL027 NEUTRON ACER TENDL-2023 LIBRARY; T=0.K  
Photon emission for (n,n\*)a

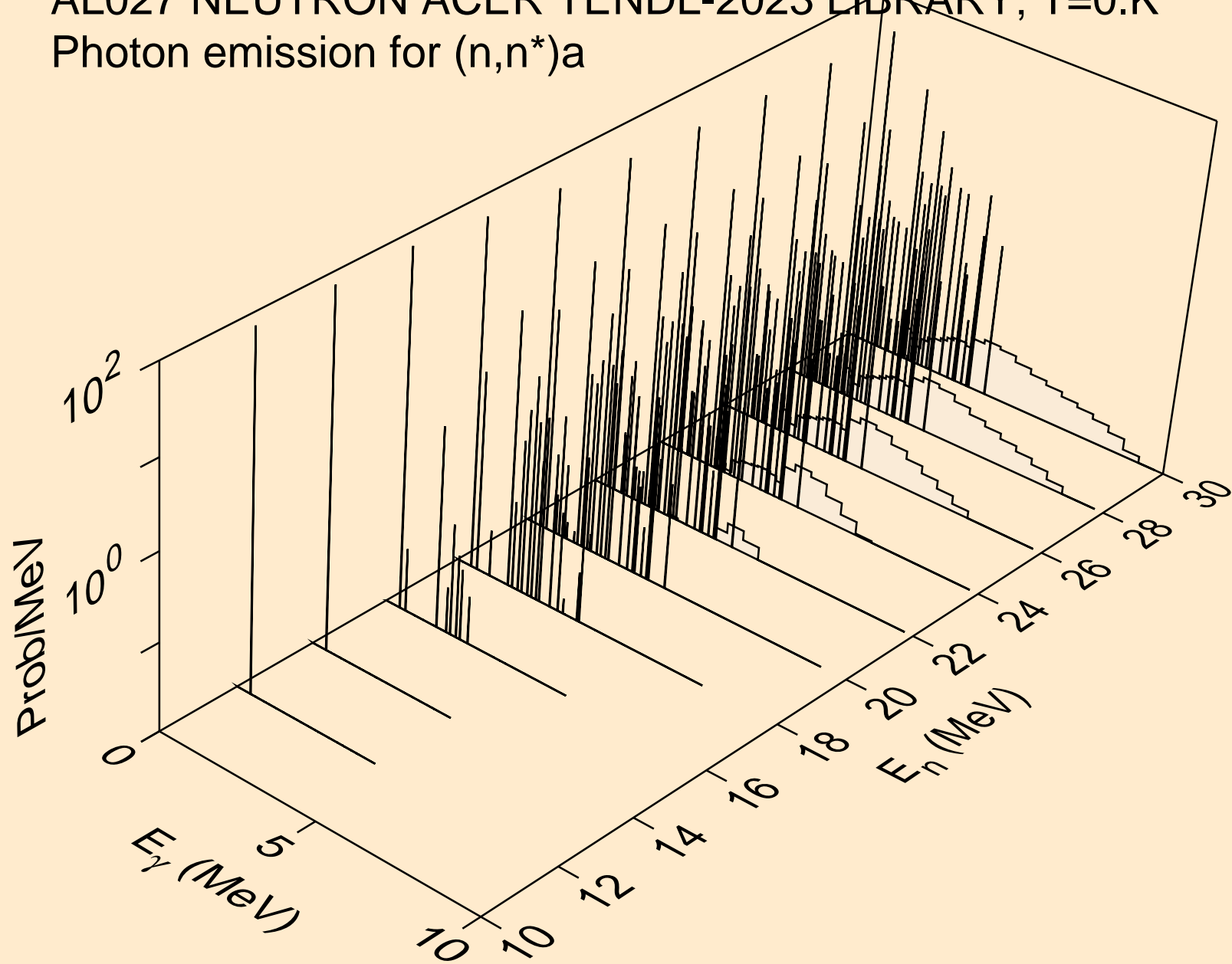

AL027 NEUTRON ACER TENDL-2023 LIBRARY; T=0.K  
Photon emission for (n,2n)a

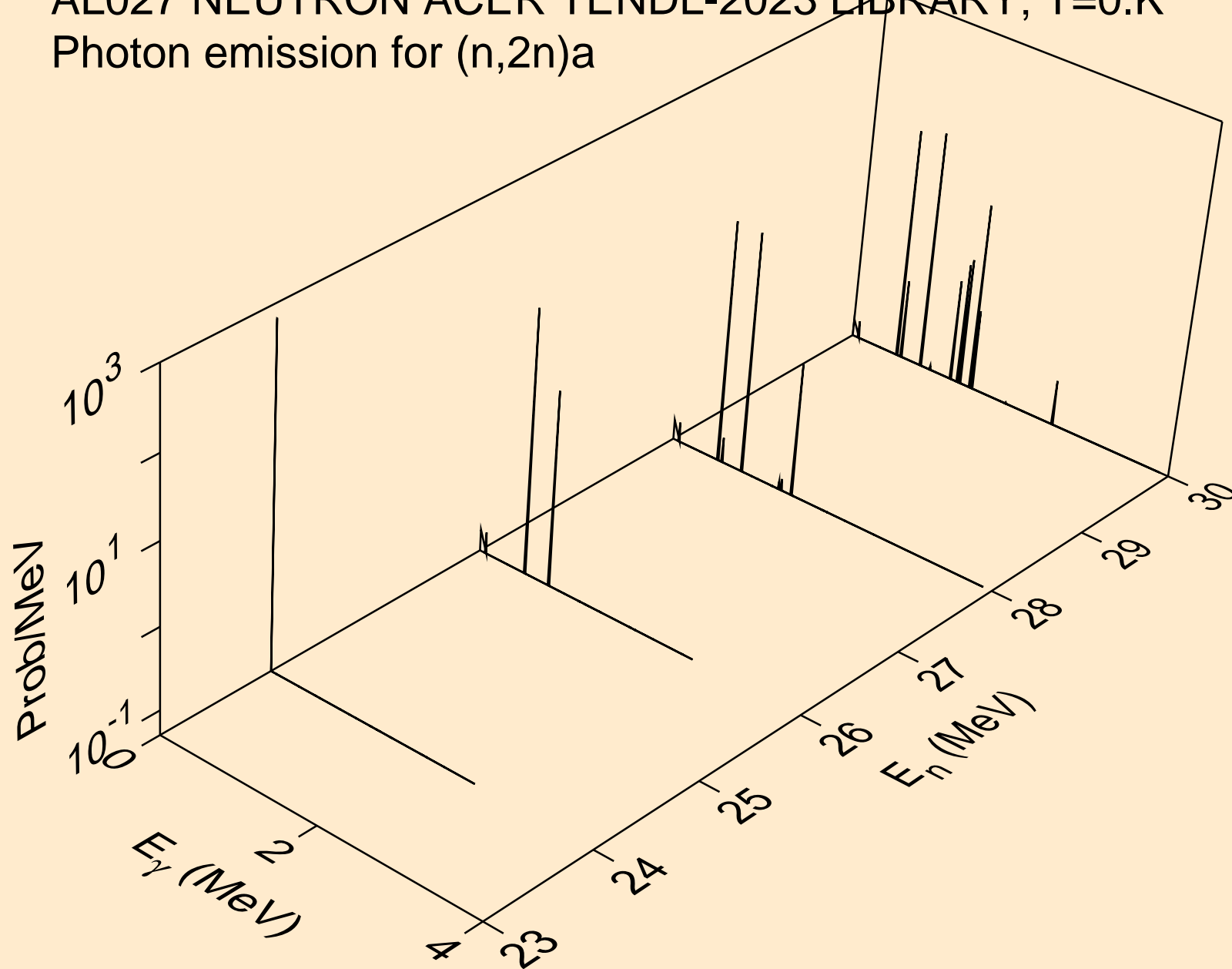

AL027 NEUTRON ACER TENDL-2023 LIBRARY; T=0.K  
Photon emission for (n,n\*)p

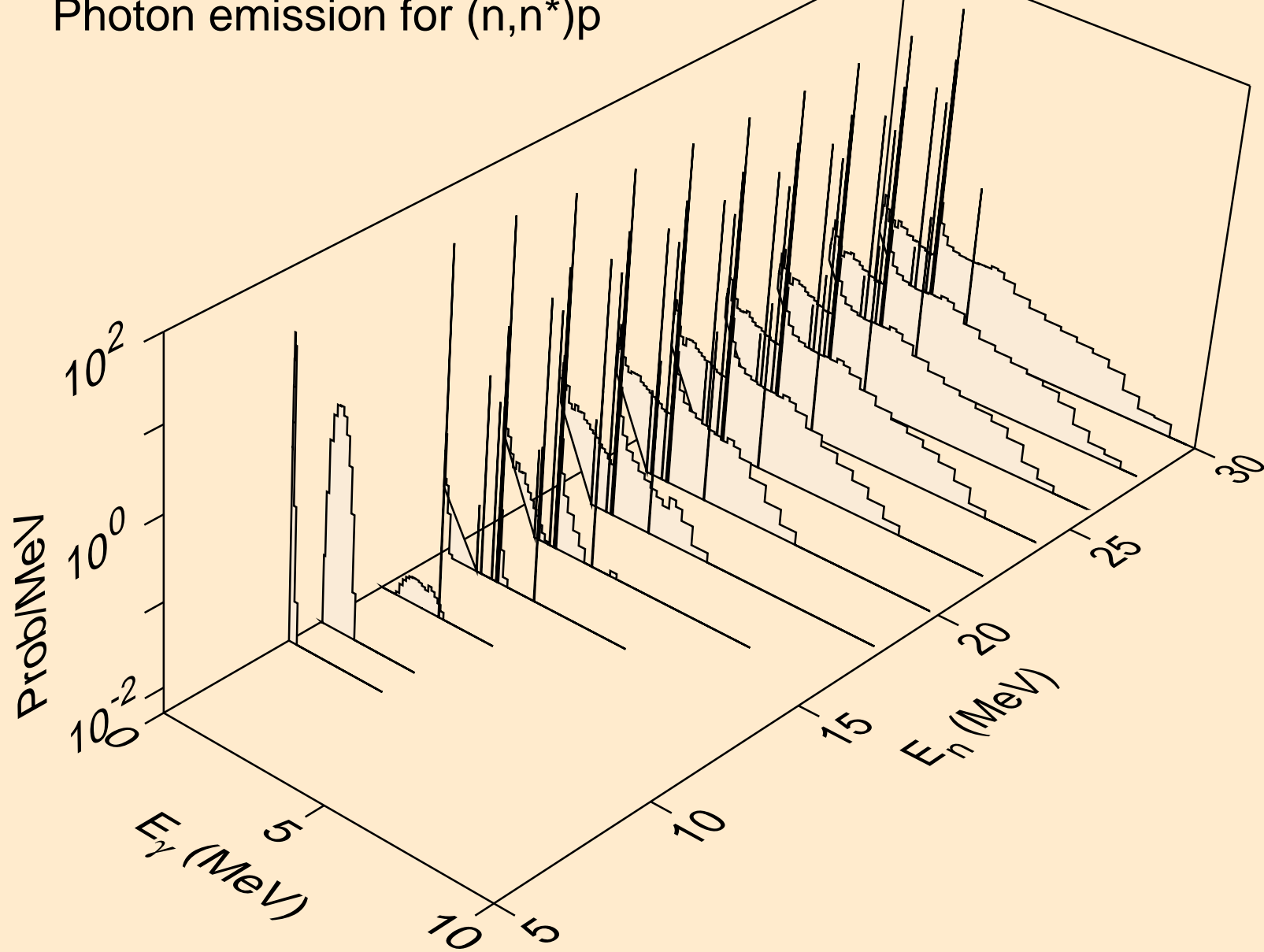

AL027 NEUTRON ACER TENDL-2023 LIBRARY; T=0.K  
Photon emission for (n,n\*)2a

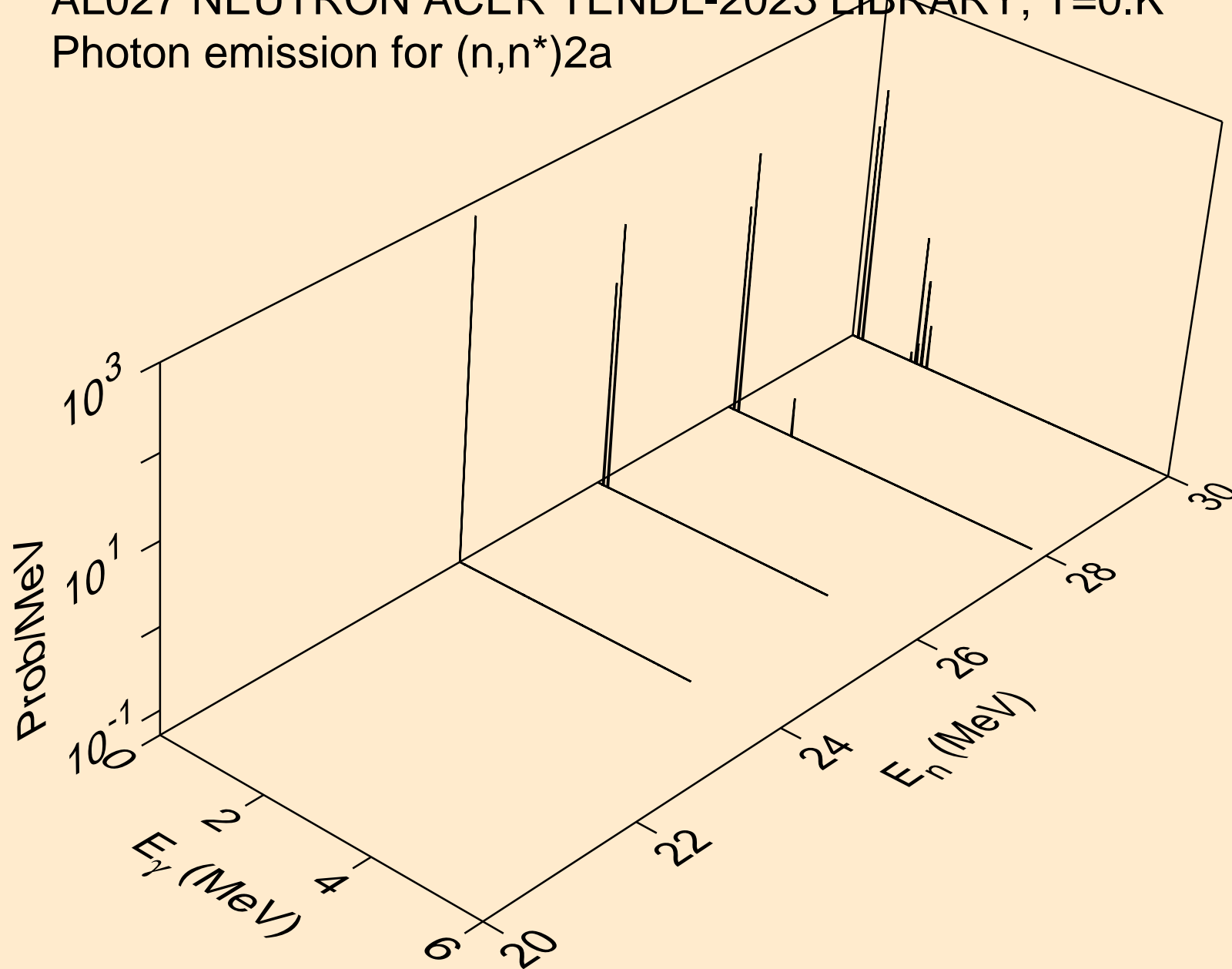

AL027 NEUTRON ACER TENDL-2023 LIBRARY; T=0.K  
Photon emission for (n,n\*)d

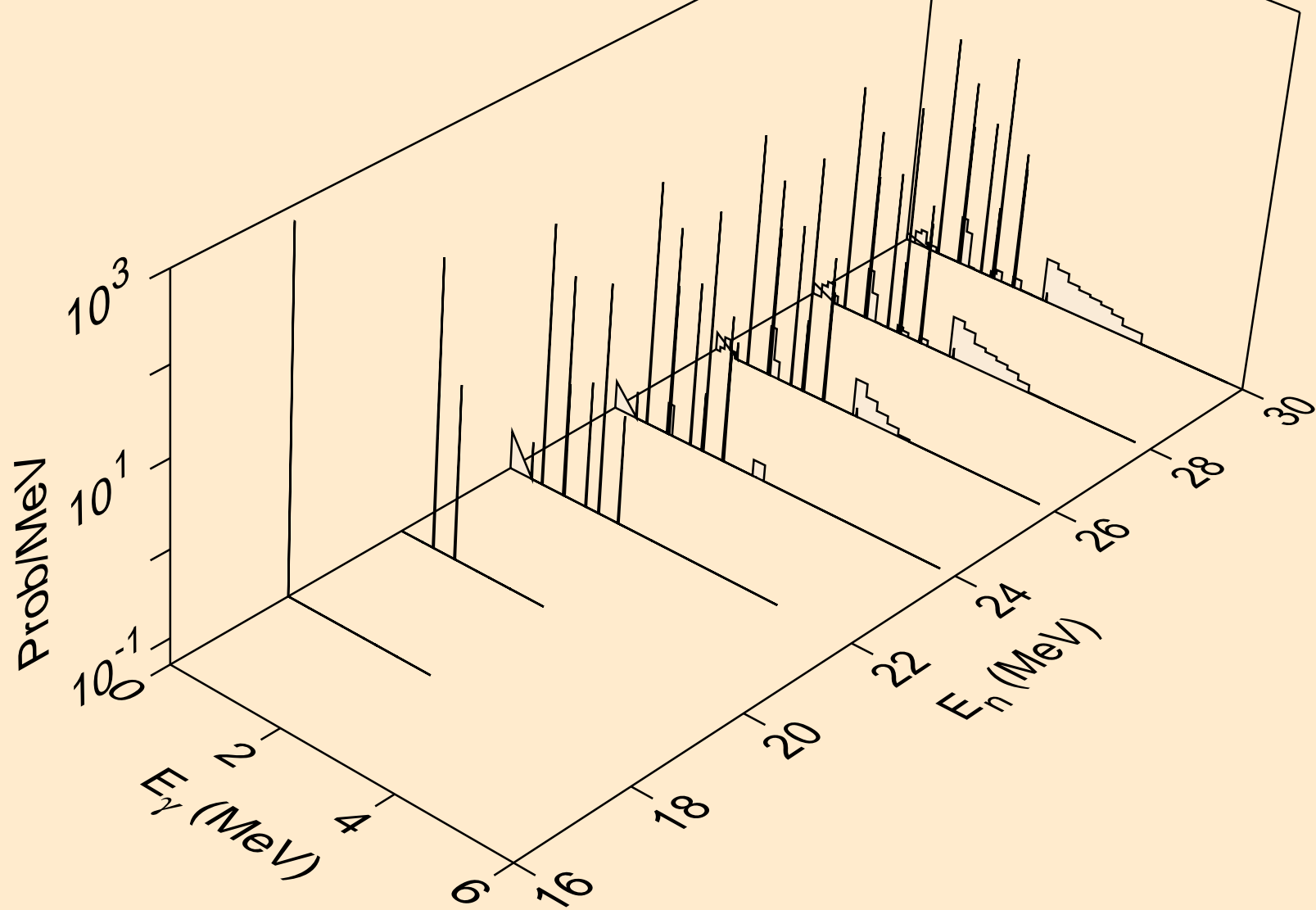

AL027 NEUTRON ACER TENDL-2023 LIBRARY; T=0.K  
Photon emission for (n,n\*)t

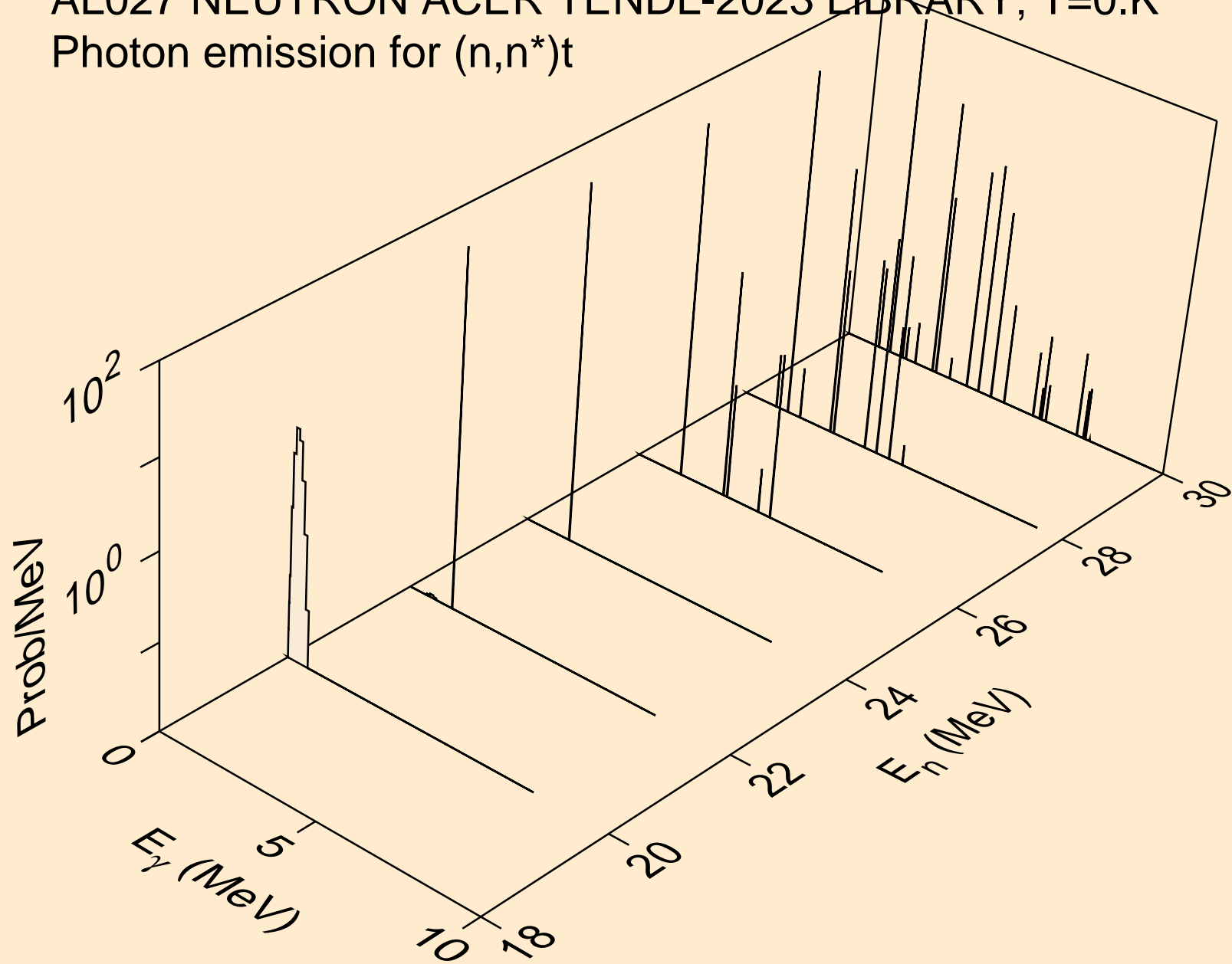

AL027 NEUTRON ACER TENDL-2023 LIBRARY; T=0.K  
Photon emission for (n,n\*)he3

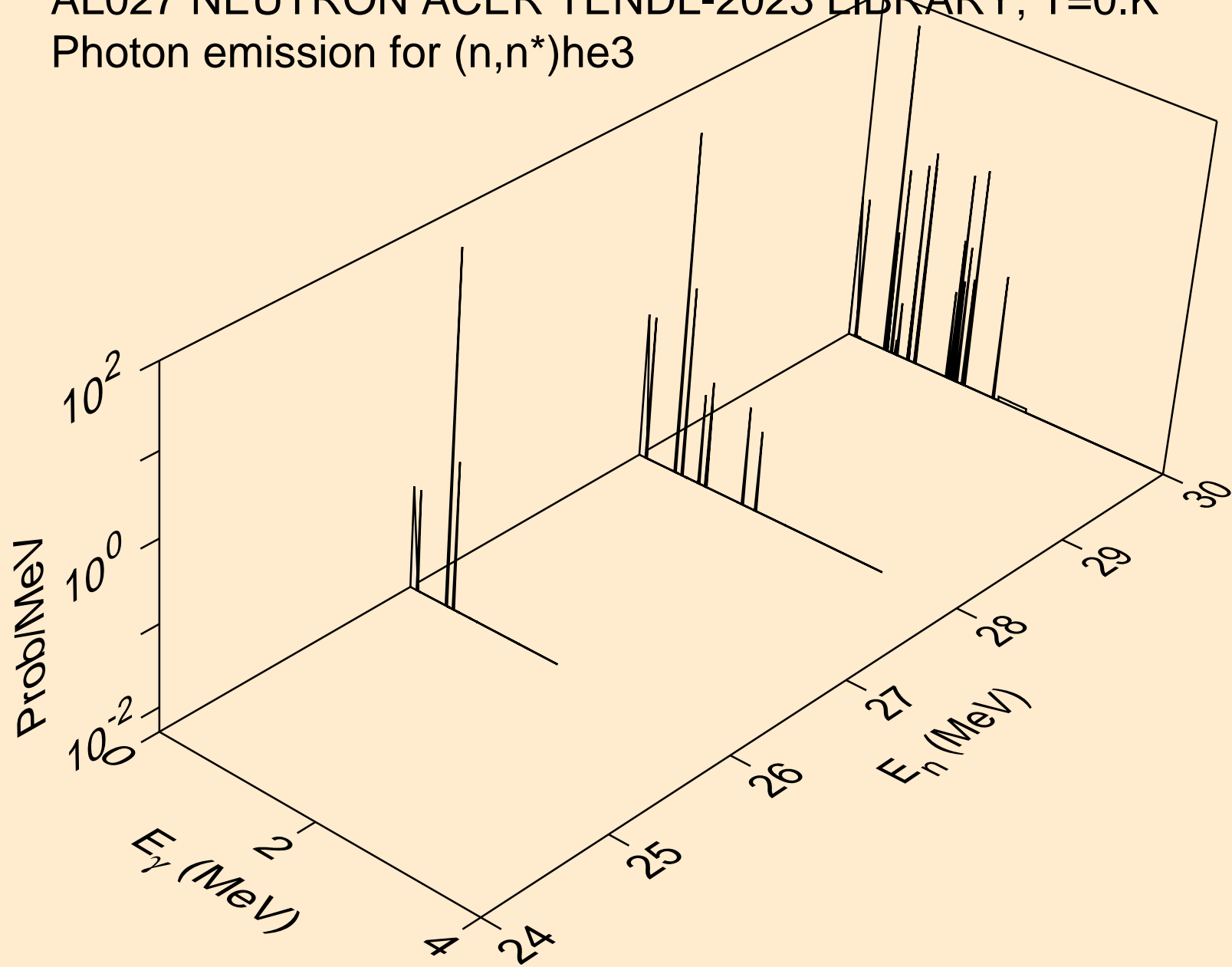

AL027 NEUTRON ACER TENDL-2023 LIBRARY; T=0.K  
Photon emission for (n,2np)

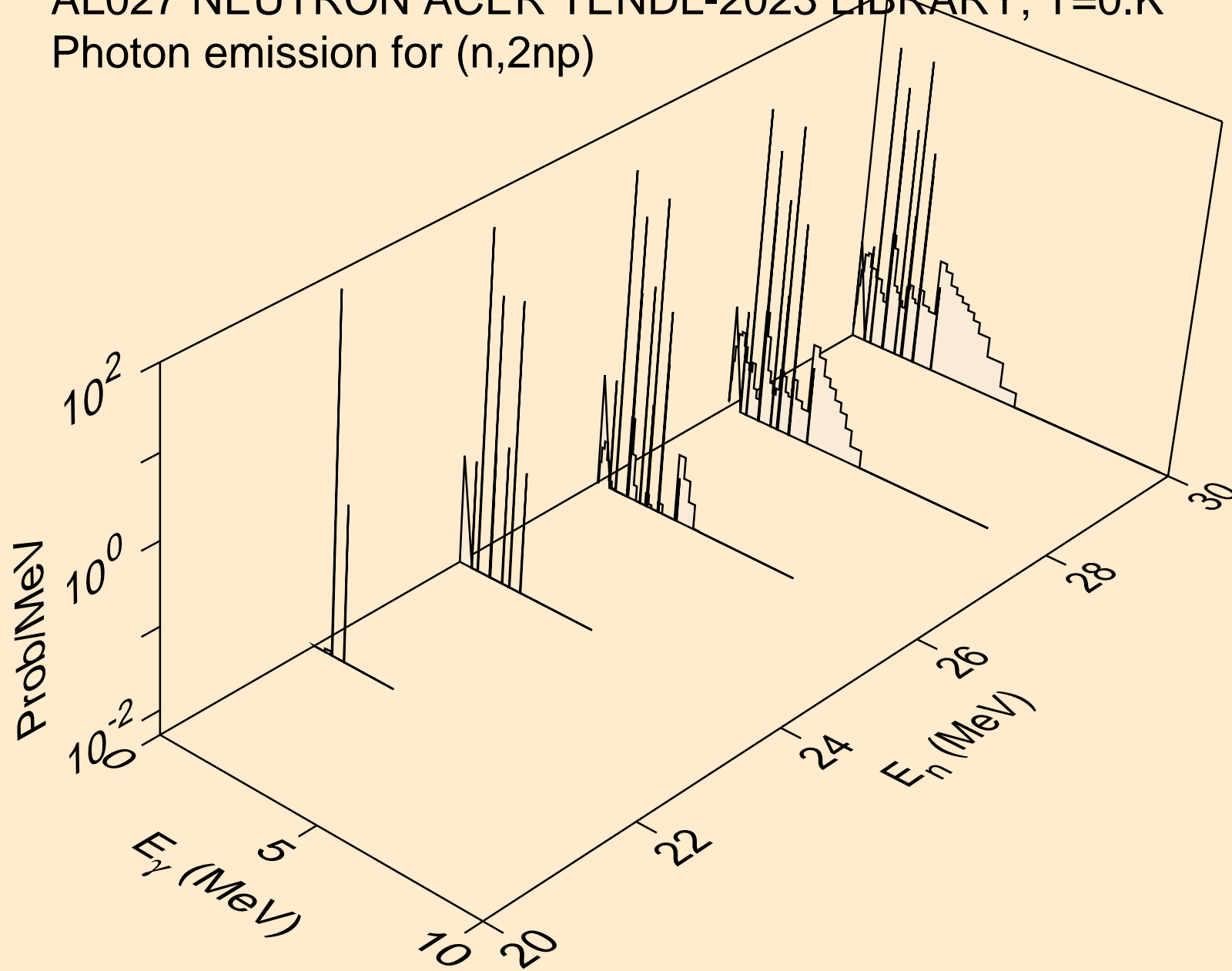

AL027 NEUTRON ACER TENDL-2023 LIBRARY; T=0.K  
Photon emission for (n,3np)

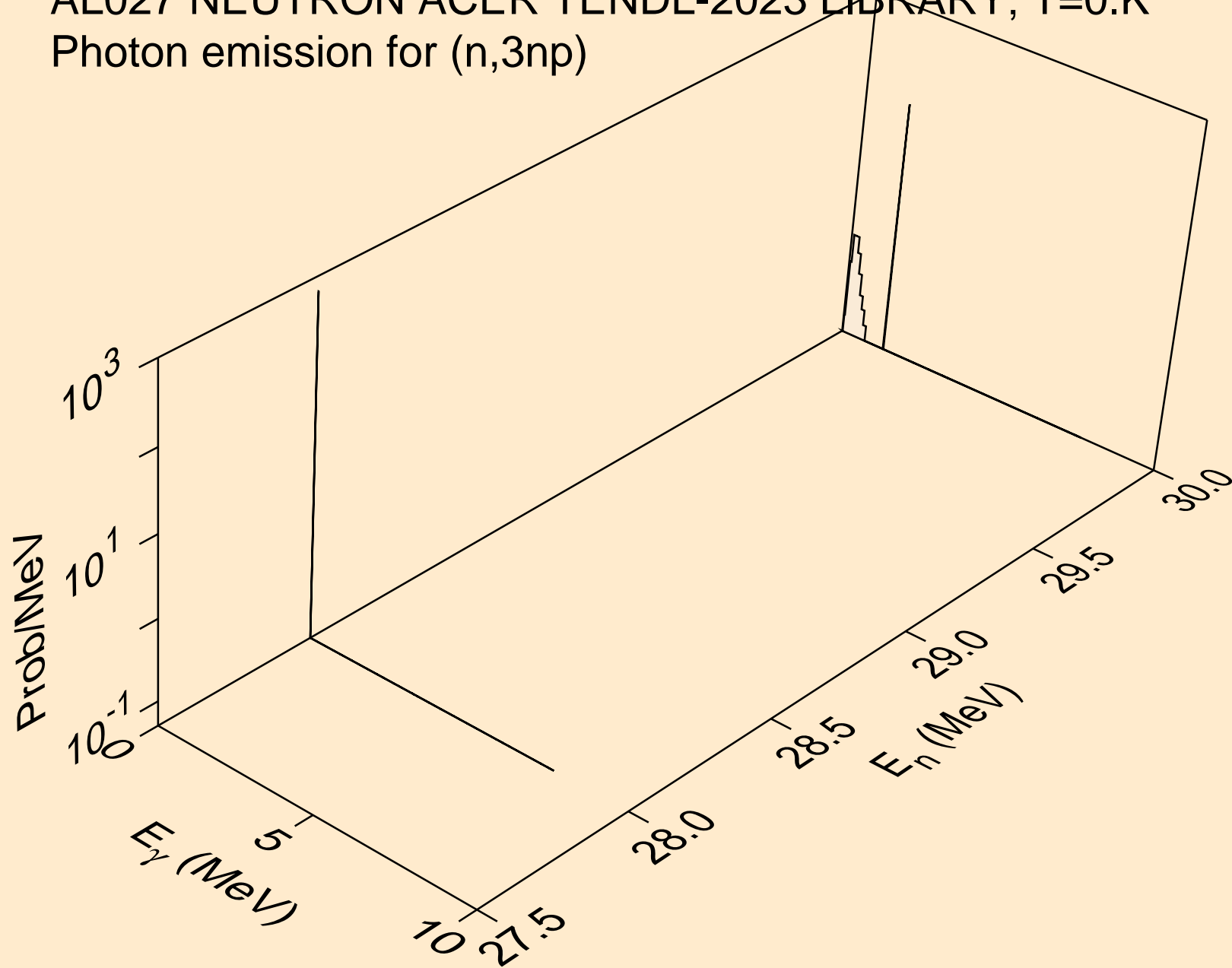

AL027 NEUTRON ACER TENDL-2023 LIBRARY; T=0.K  
Photon emission for (n,n2p)

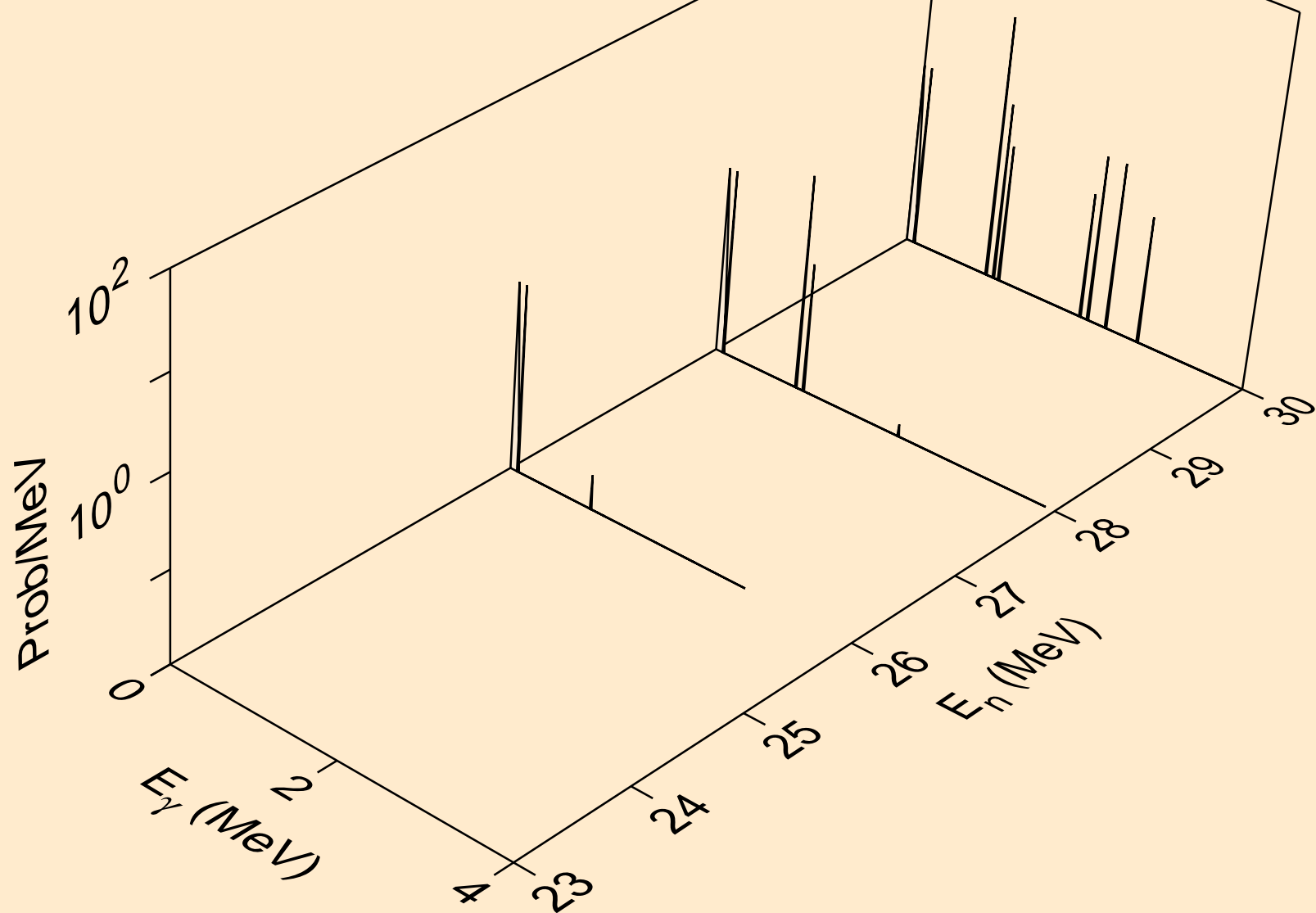

AL027 NEUTRON ACER TENDL-2023 LIBRARY; T=0.K  
Photon emission for (n,npa)

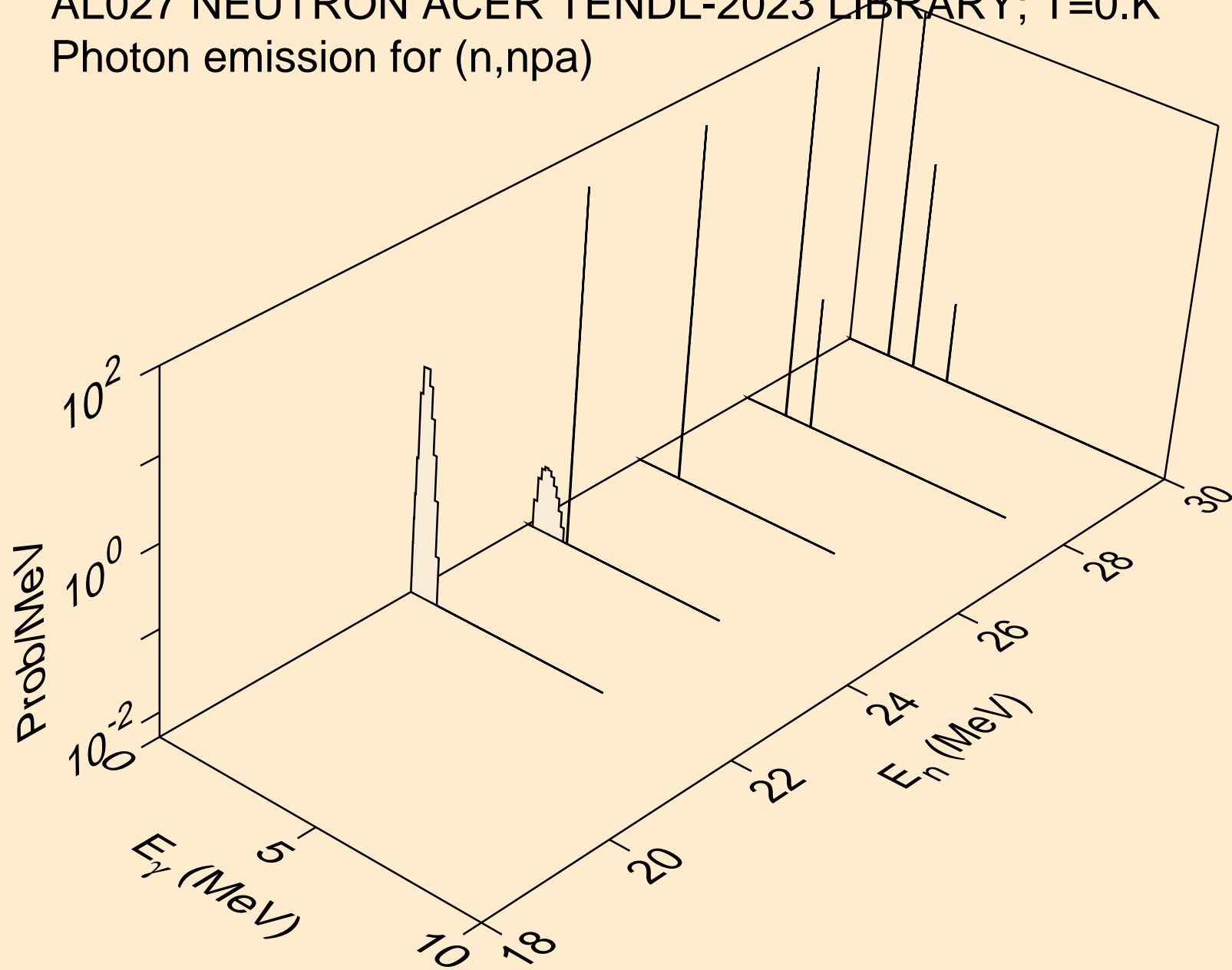

AL027 NEUTRON ACER TENDL-2023 LIBRARY; T=0.K  
Photon emission for (n,n\*c)

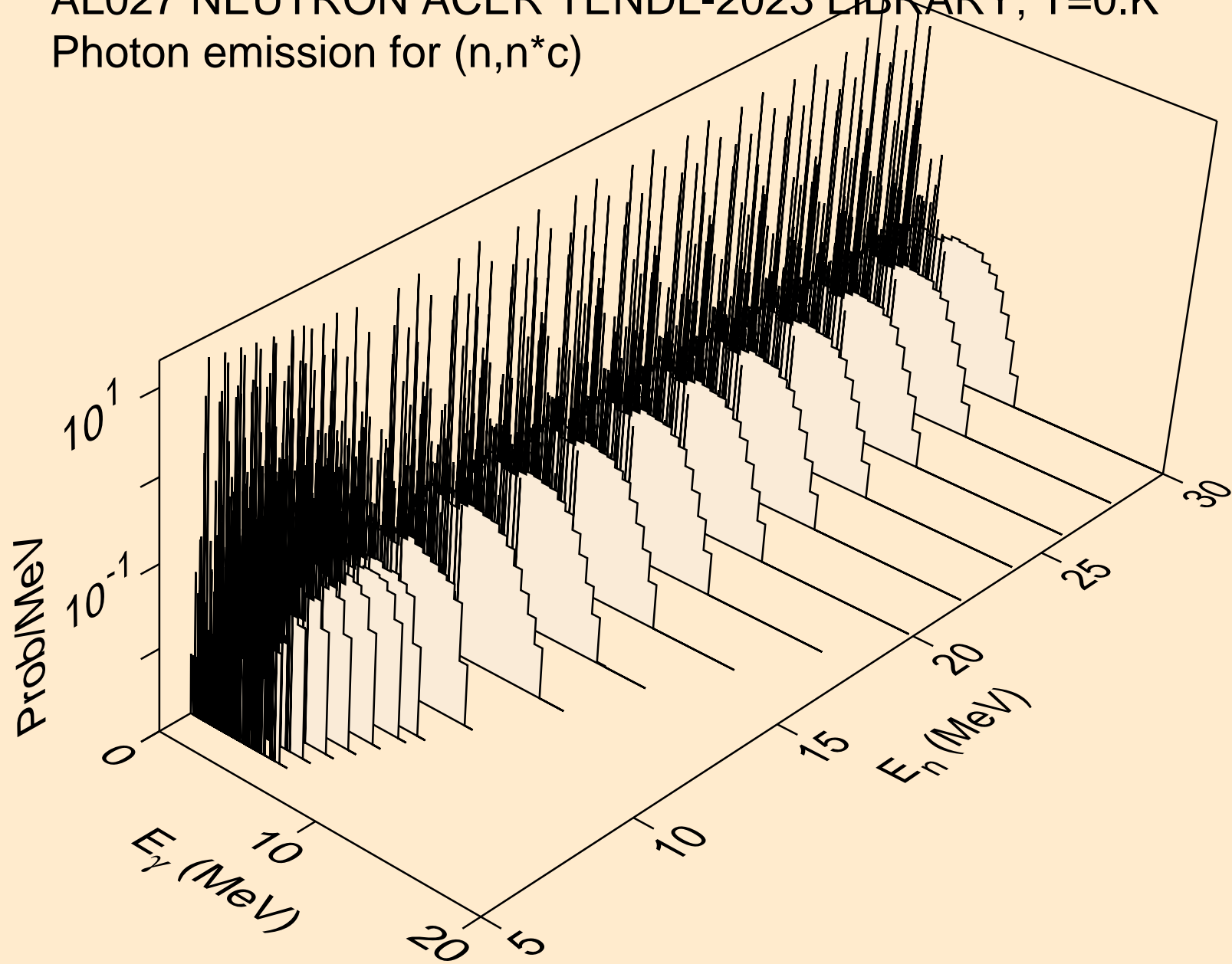

AL027 NEUTRON ACER TENDL-2023 LIBRARY; T=0.K  
Photon emission for (n,gma)

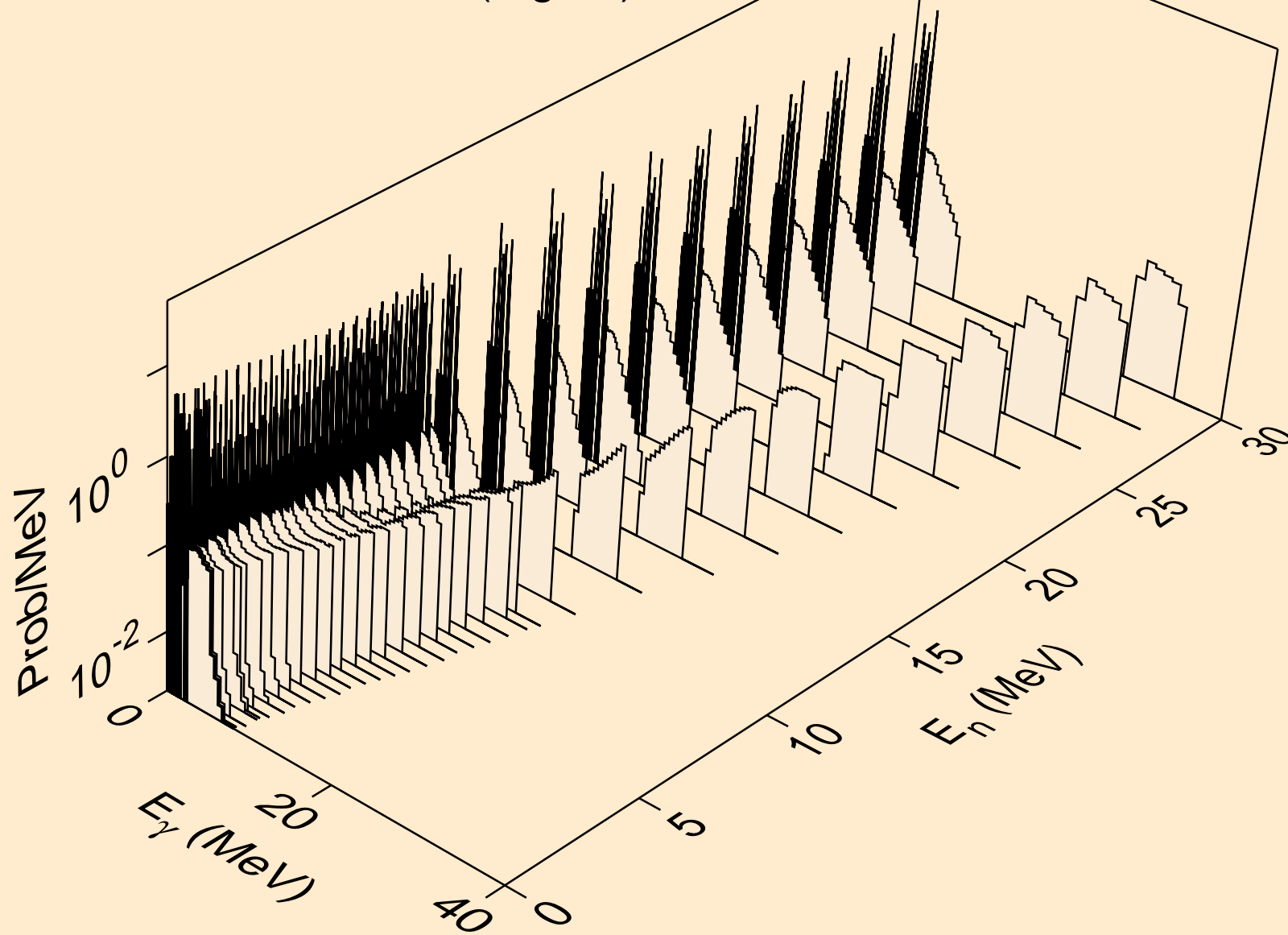

AL027 NEUTRON ACER TENDL-2023 LIBRARY; T=0.K  
Photon emission for (n,p)

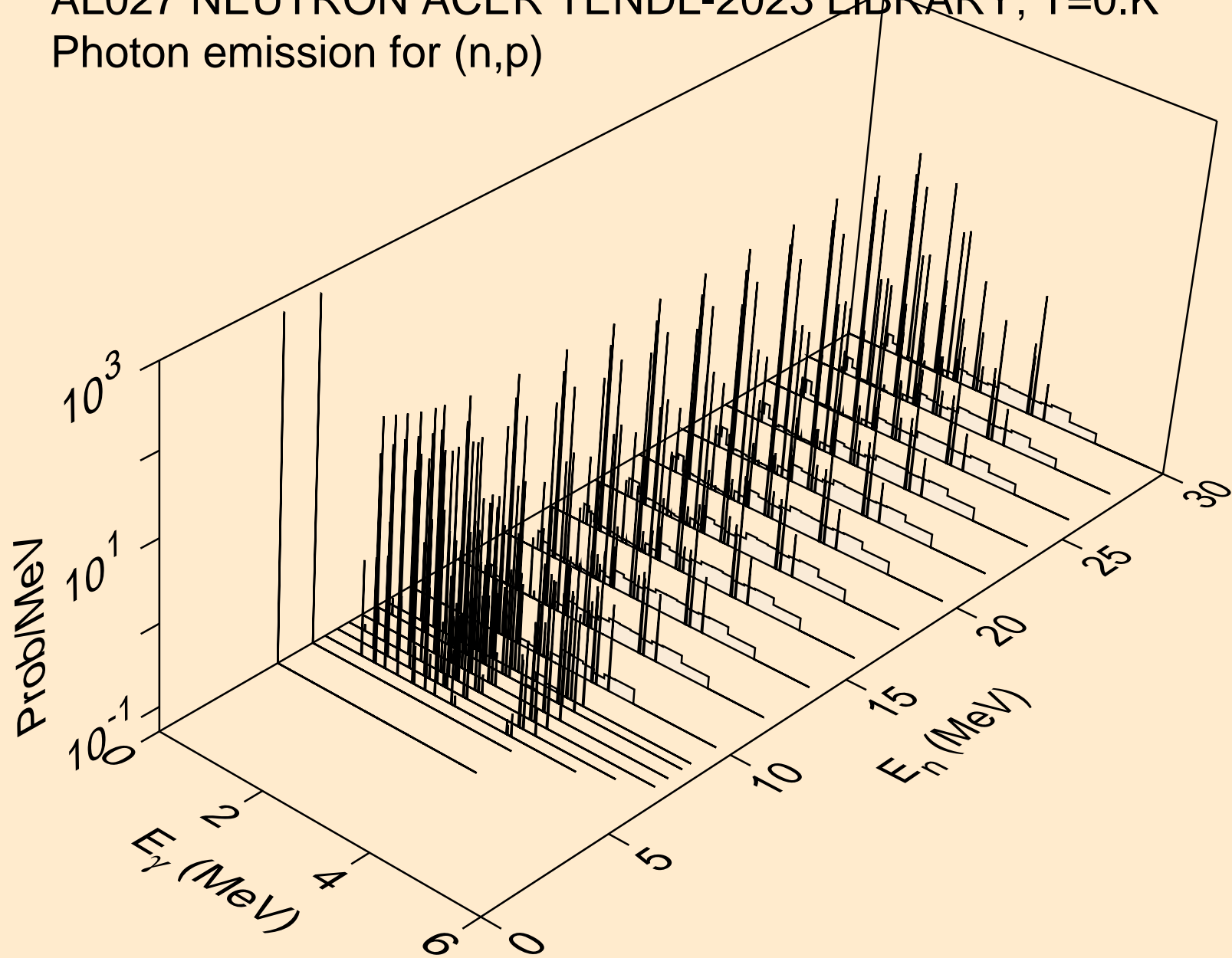

AL027 NEUTRON ACER TENDL-2023 LIBRARY; T=0.K  
Photon emission for (n,d)

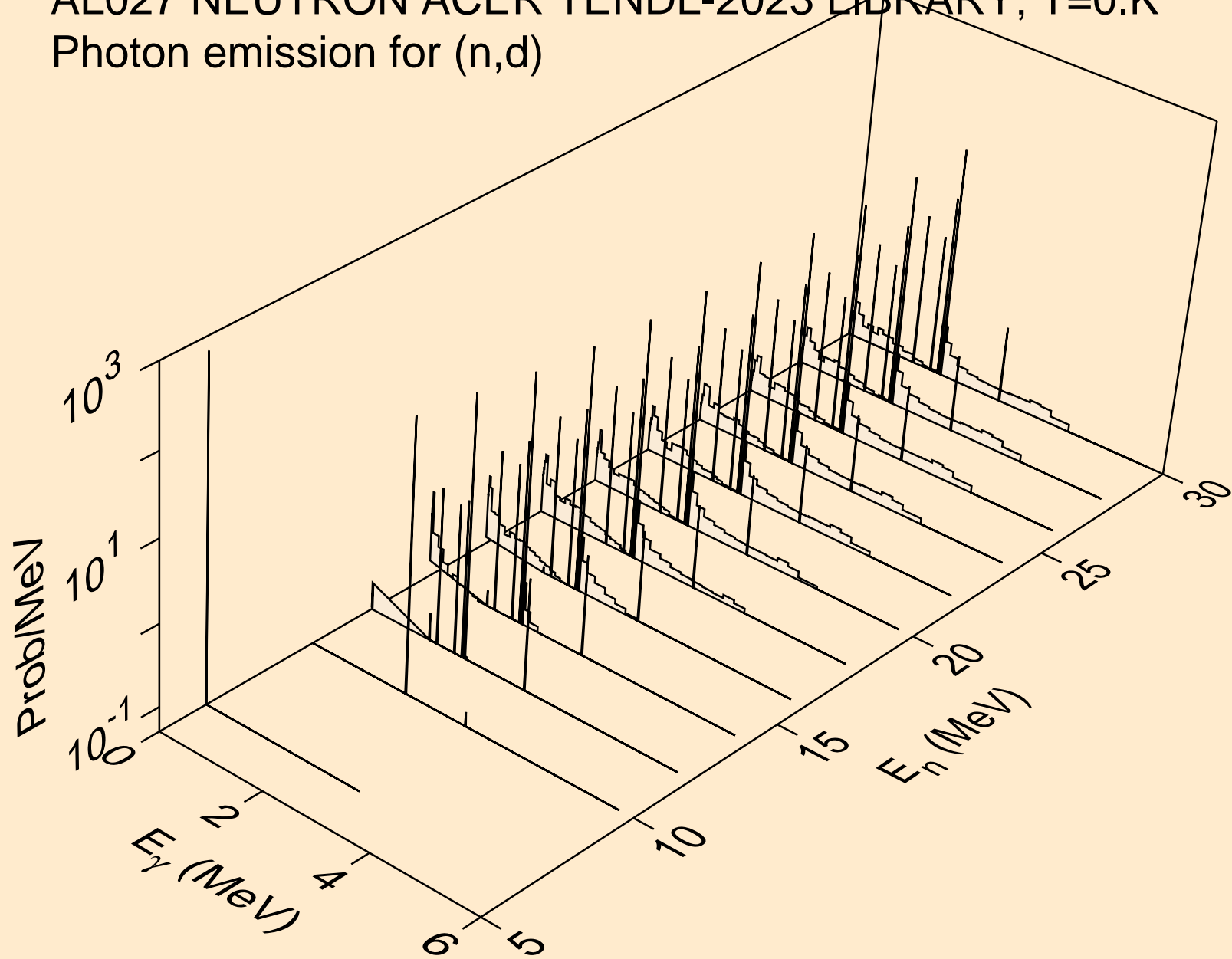

AL027 NEUTRON ACER TENDL-2023 LIBRARY; T=0.K  
Photon emission for (n,t)

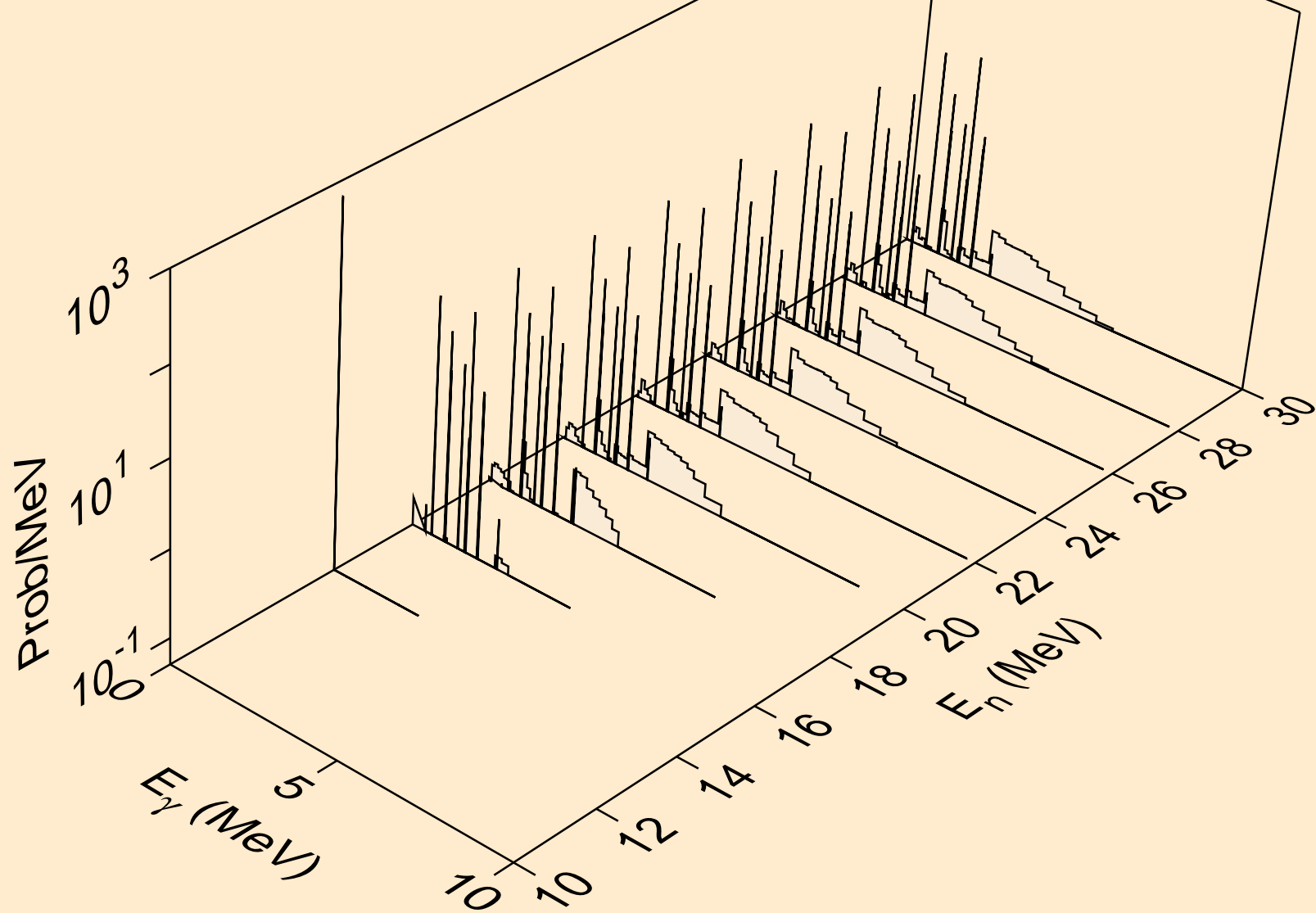

AL027 NEUTRON ACER TENDL-2023 LIBRARY; T=0.K  
Photon emission for (n,he3)

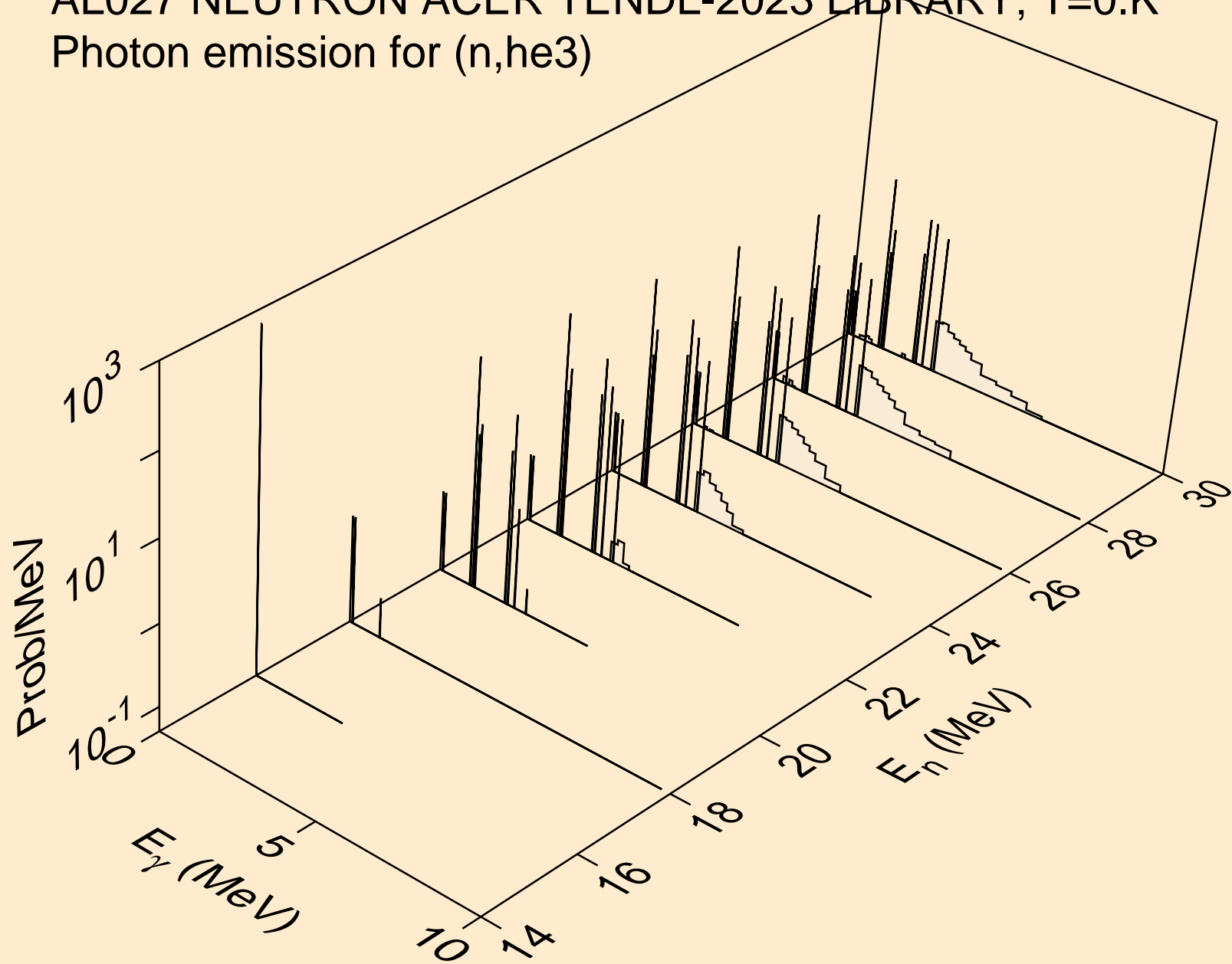

AL027 NEUTRON ACER TENDL-2023 LIBRARY; T=0.K  
Photon emission for (n,a)

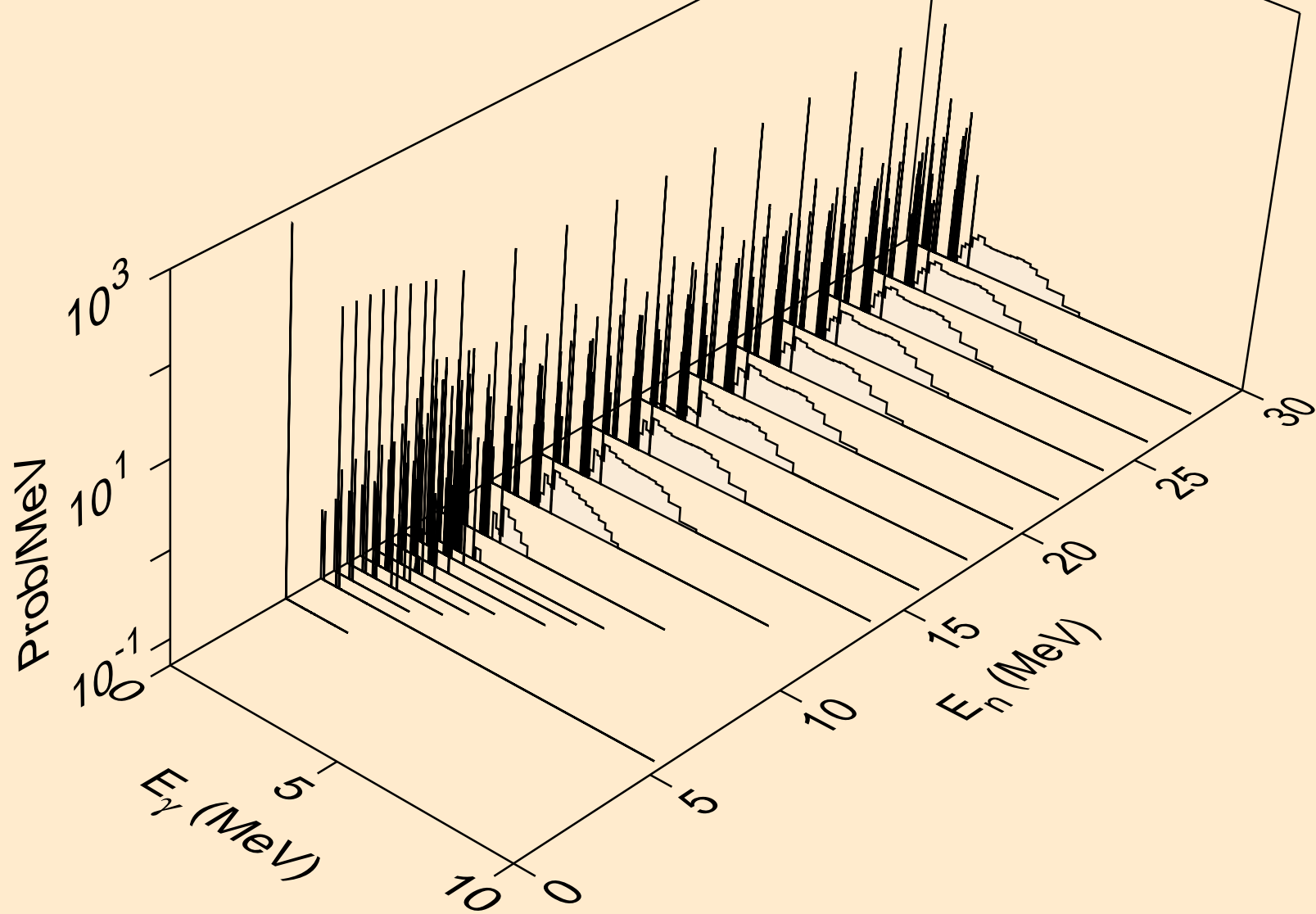

AL027 NEUTRON ACER TENDL-2023 LIBRARY; T=0.K  
Photon emission for (n,2a)

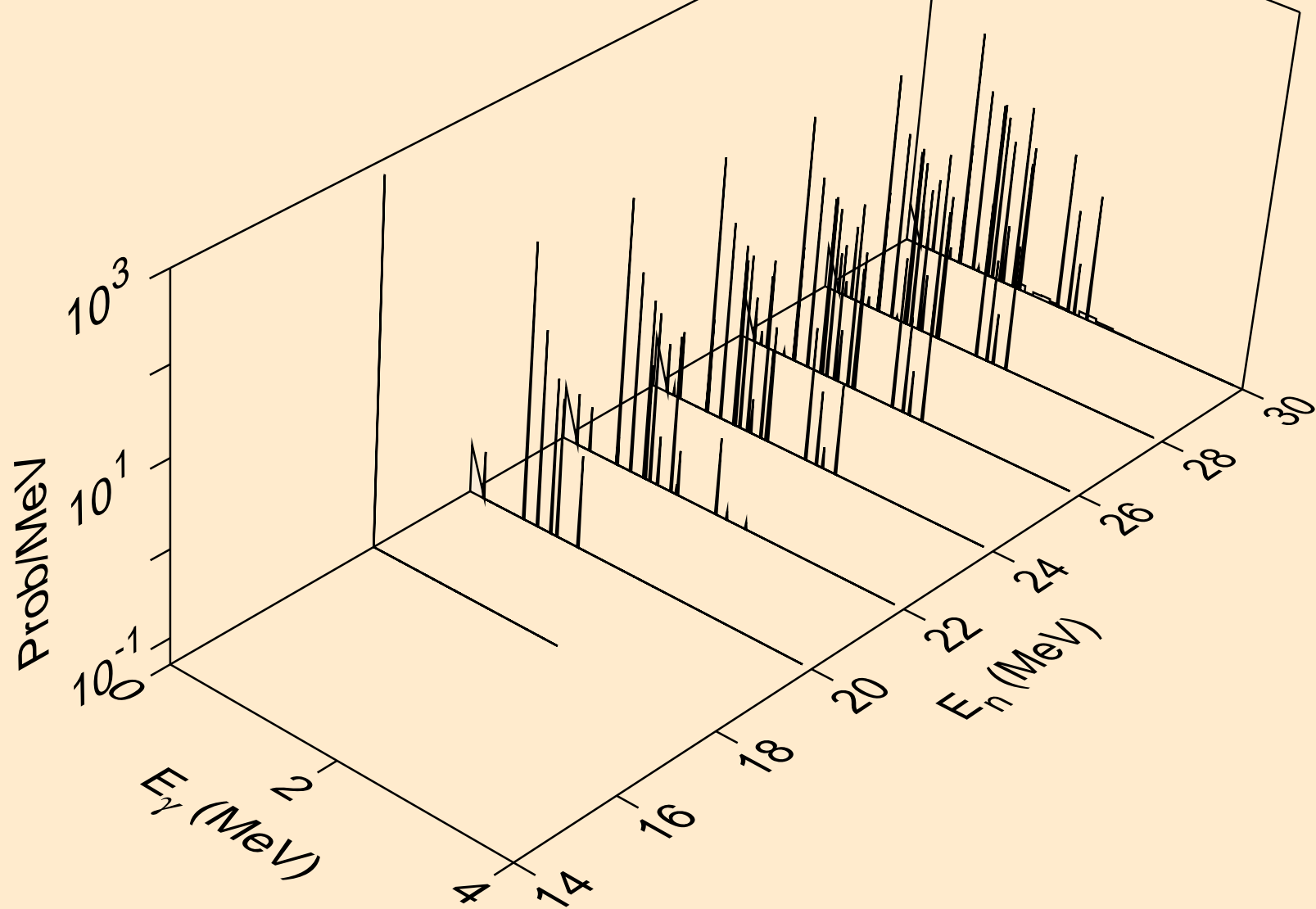

AL027 NEUTRON ACER TENDL-2023 LIBRARY; T=0.K  
Photon emission for (n,2p)

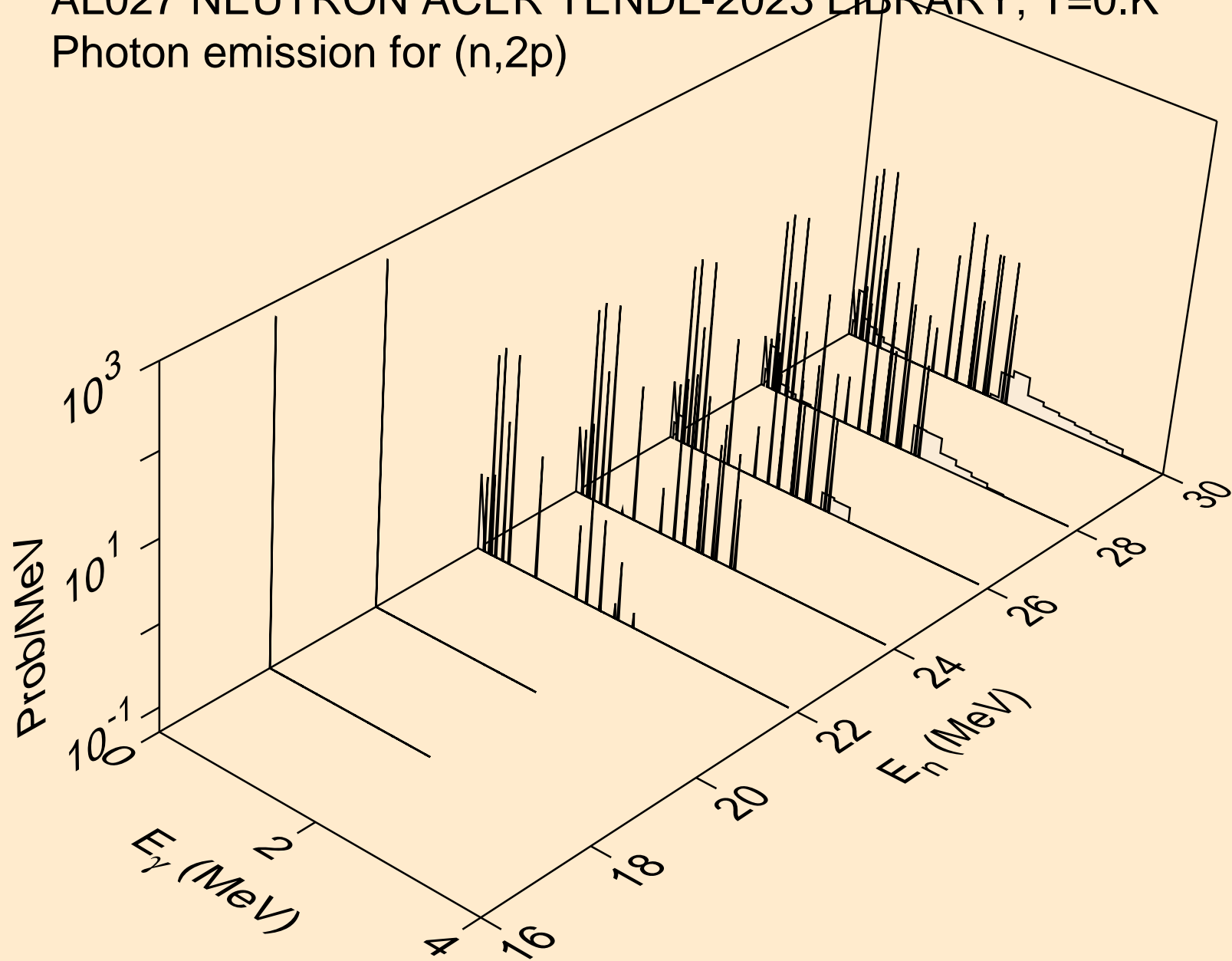

AL027 NEUTRON ACER TENDL-2023 LIBRARY; T=0.K  
Photon emission for (n,p $\alpha$ )

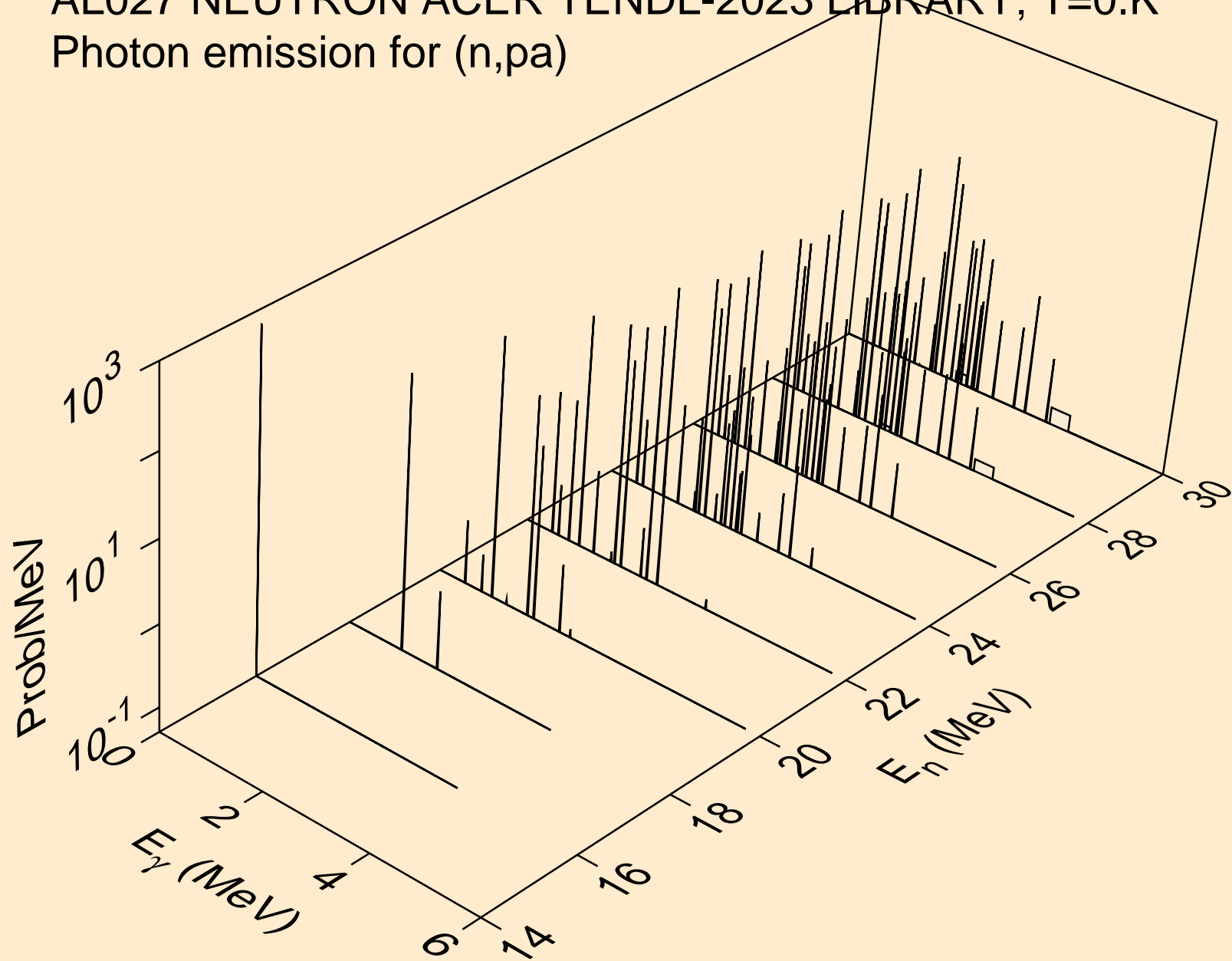

AL027 NEUTRON ACER TENDL-2023 LIBRARY; T=0.K  
Photon emission for (n,pd)

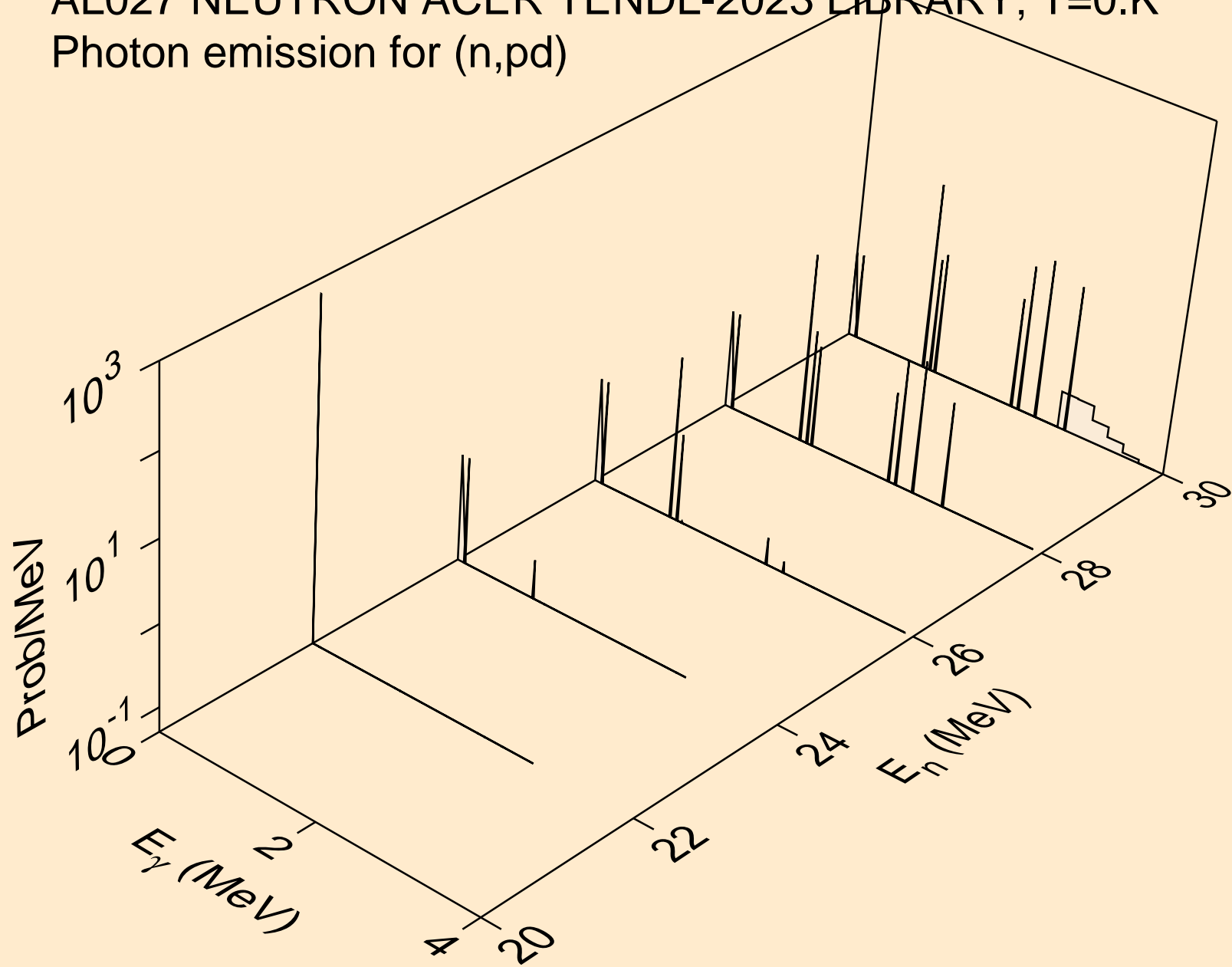

AL027 NEUTRON ACER TENDL-2023 LIBRARY; T=0.K  
Photon emission for (n,pt)

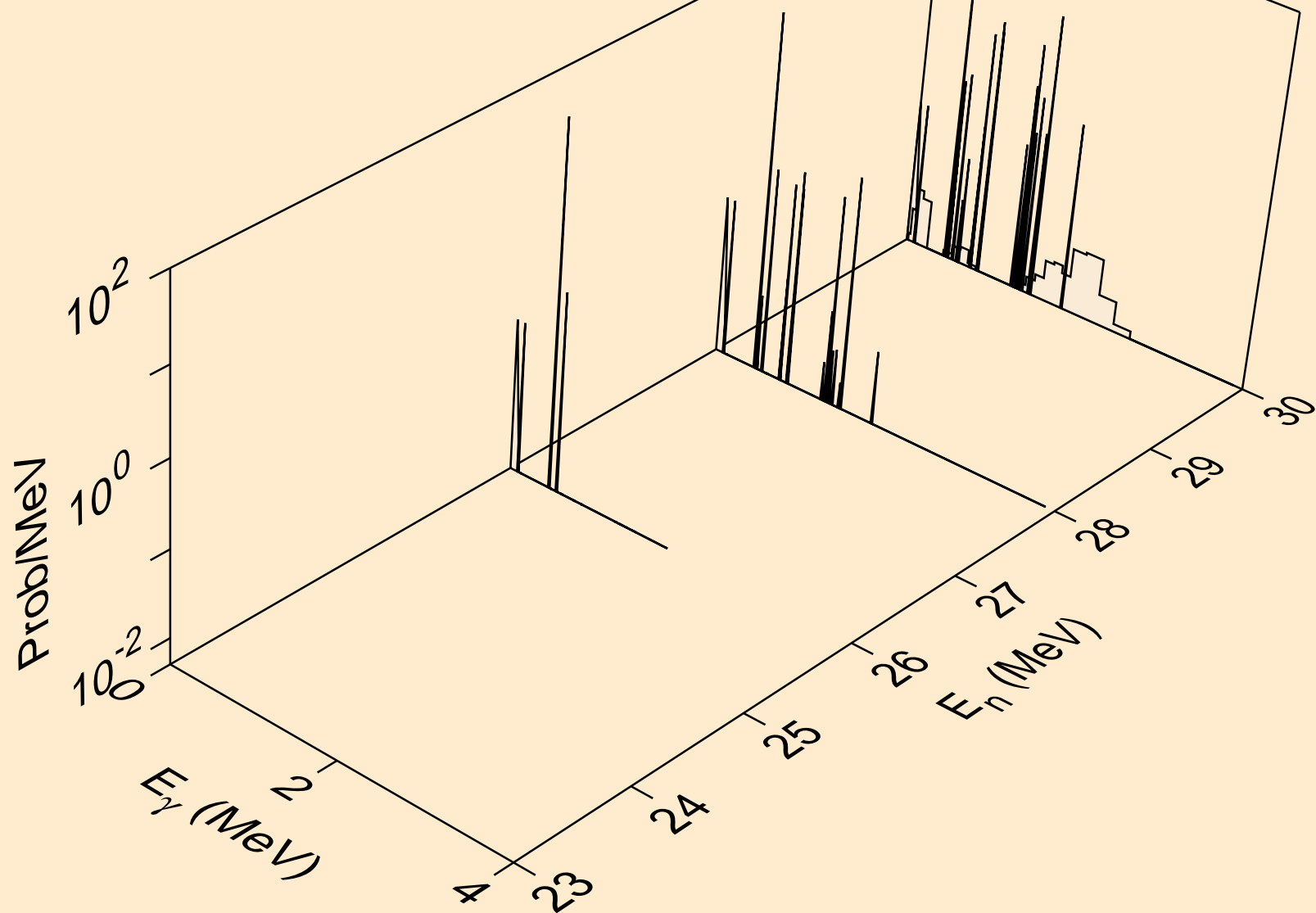

AL027 NEUTRON ACER TENDL-2023 LIBRARY; T=0.K  
Photon emission for (n,da)

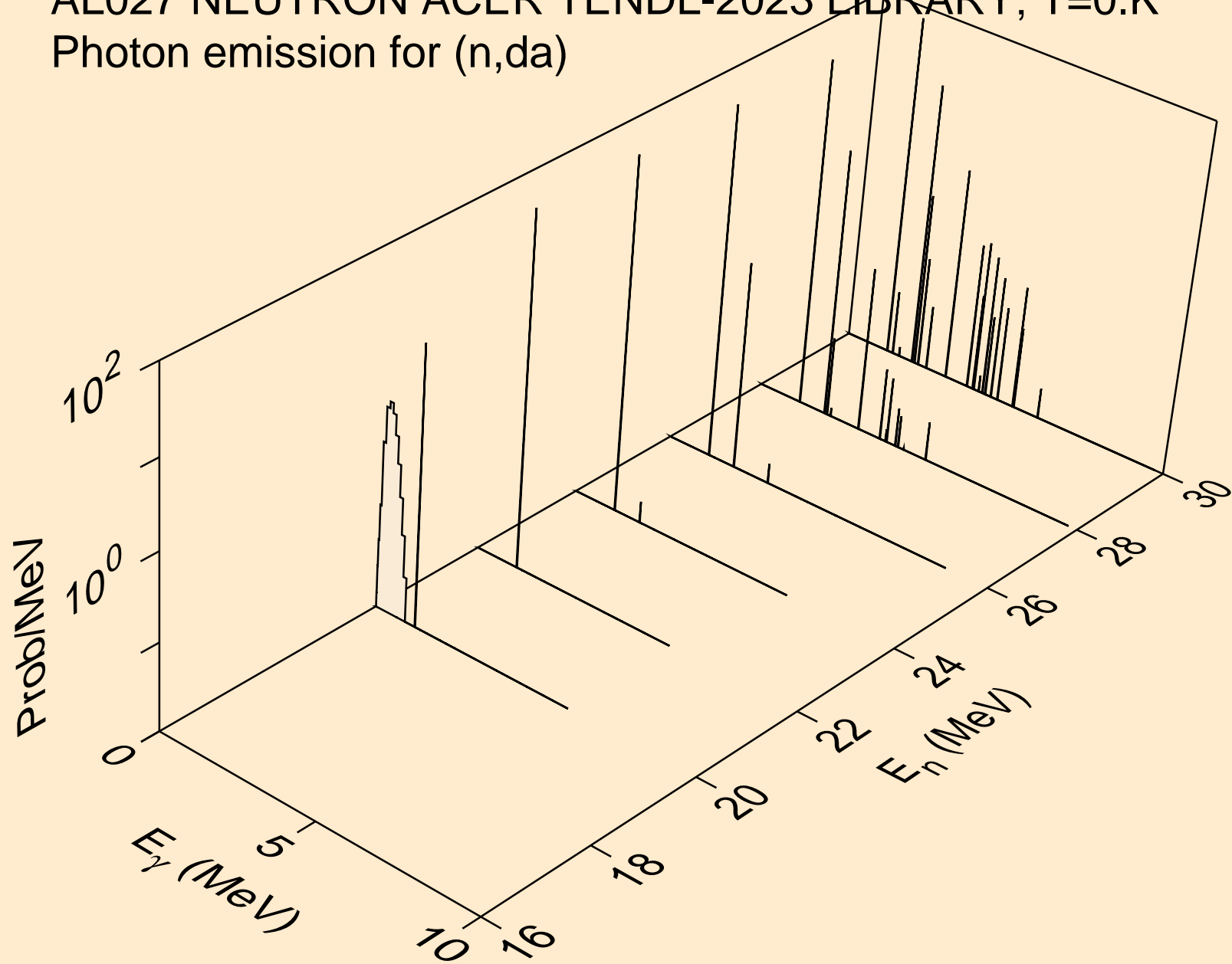

AL027 NEUTRON ACER TENDL-2023 LIBRARY; T=0.K  
thermal capture photon spectrum

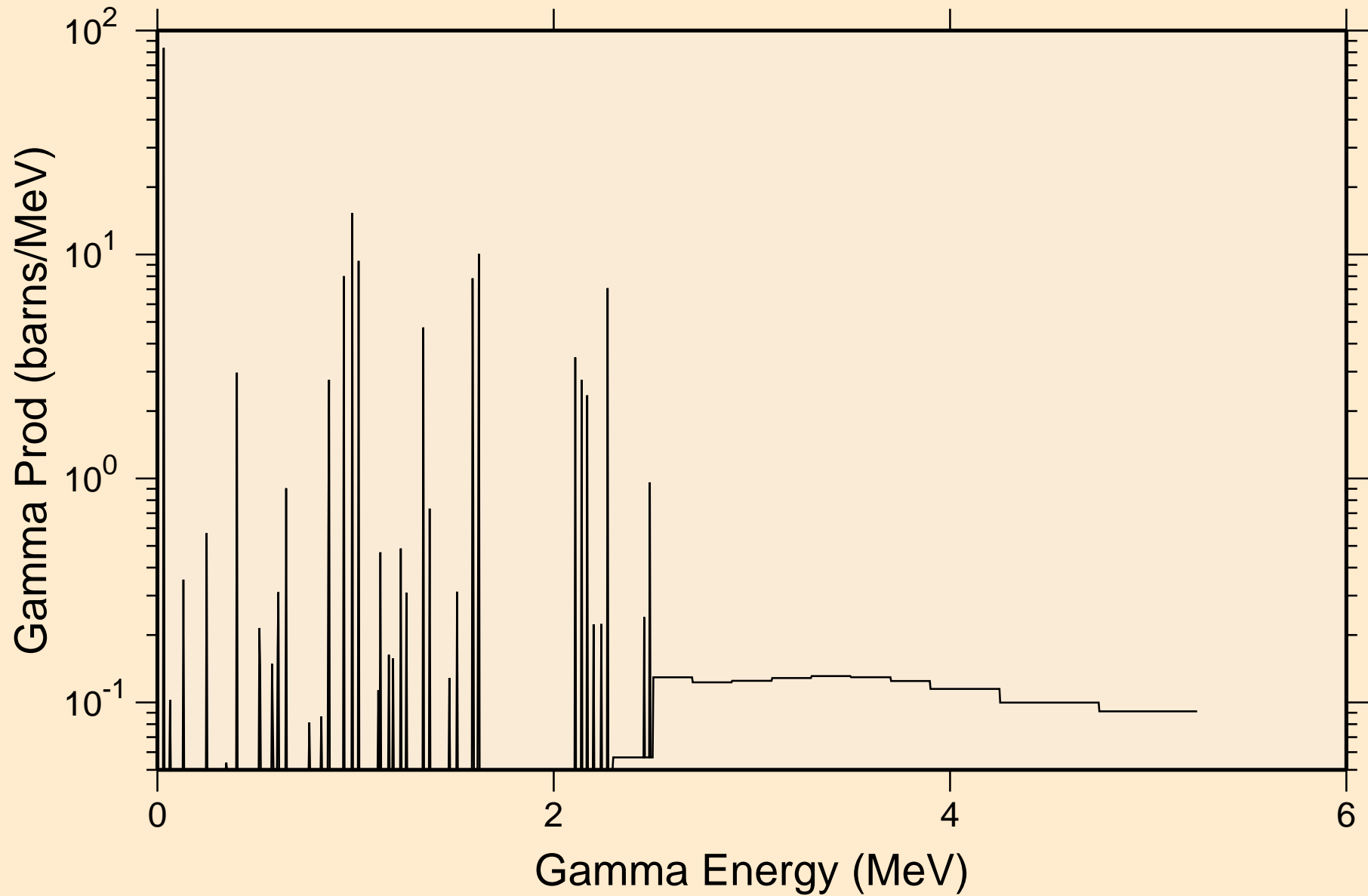

AL027 NEUTRON ACER TENDL-2023 LIBRARY; T=0.K  
14 MeV photon spectrum

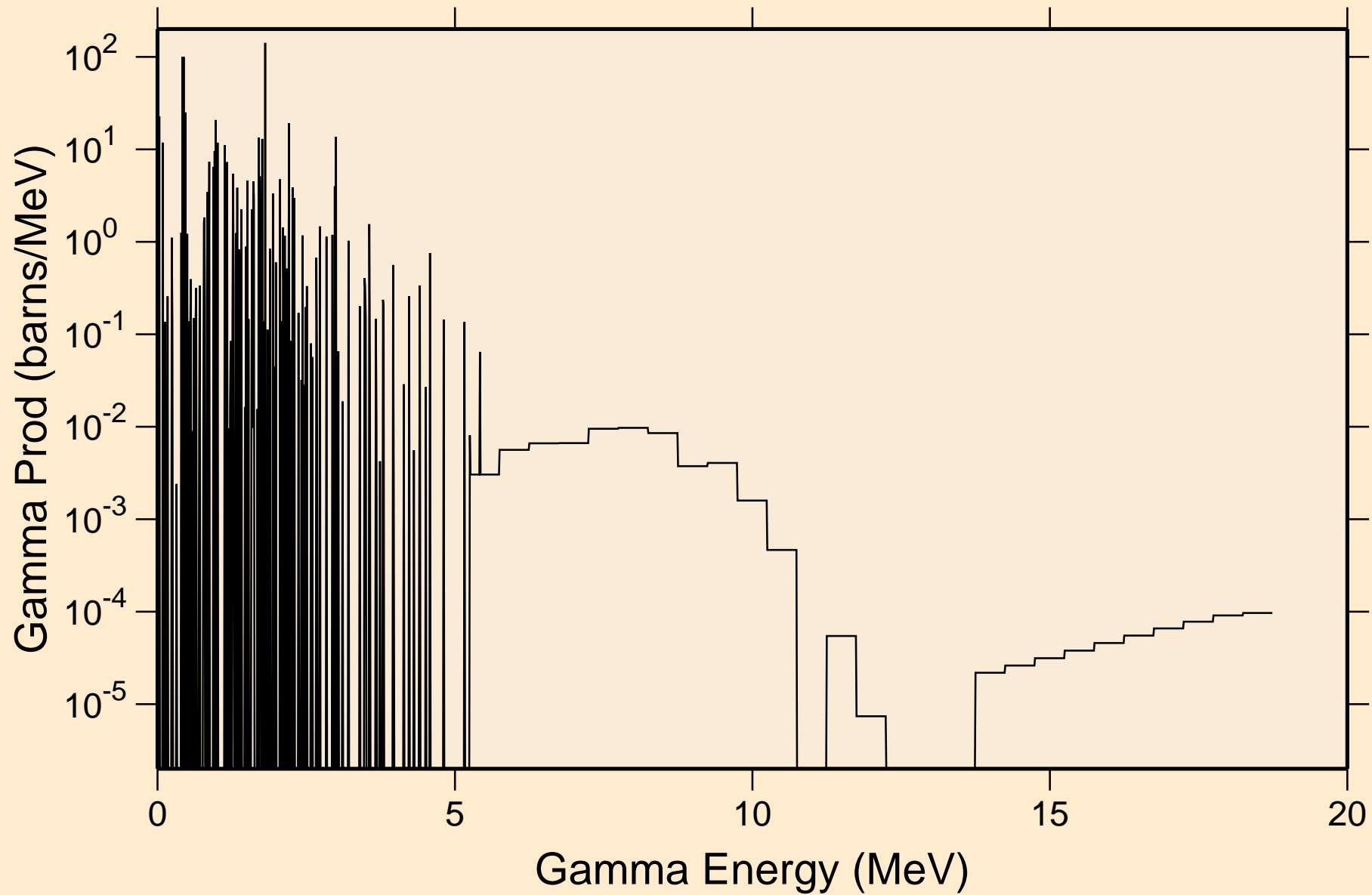

# AL027 NEUTRON ACER TENDL-2023 LIBRARY; T=0.K

## Particle heating contributions

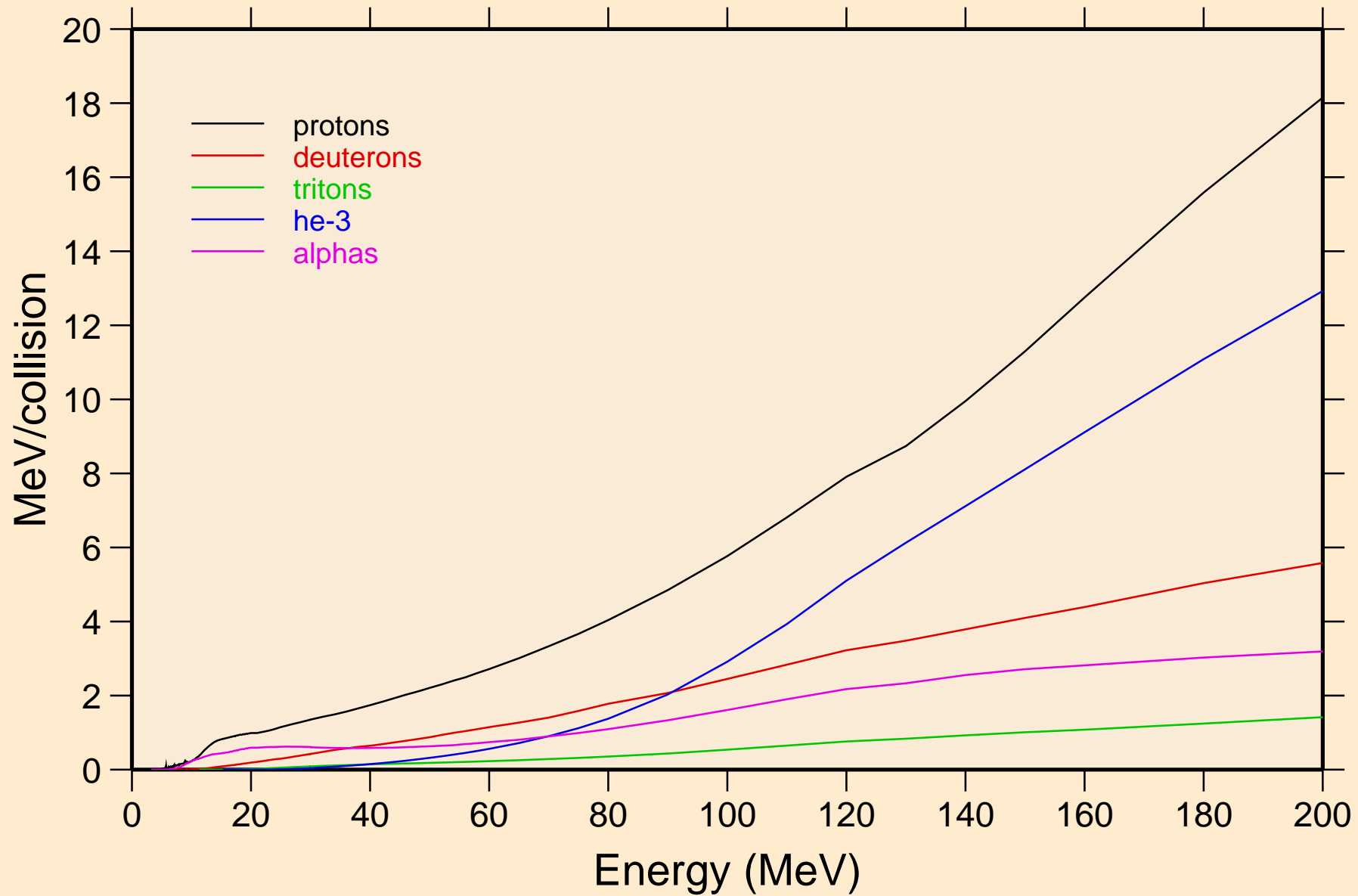

AL027 NEUTRON ACER TENDL-2023 LIBRARY; T=0.K  
Recoil Heating

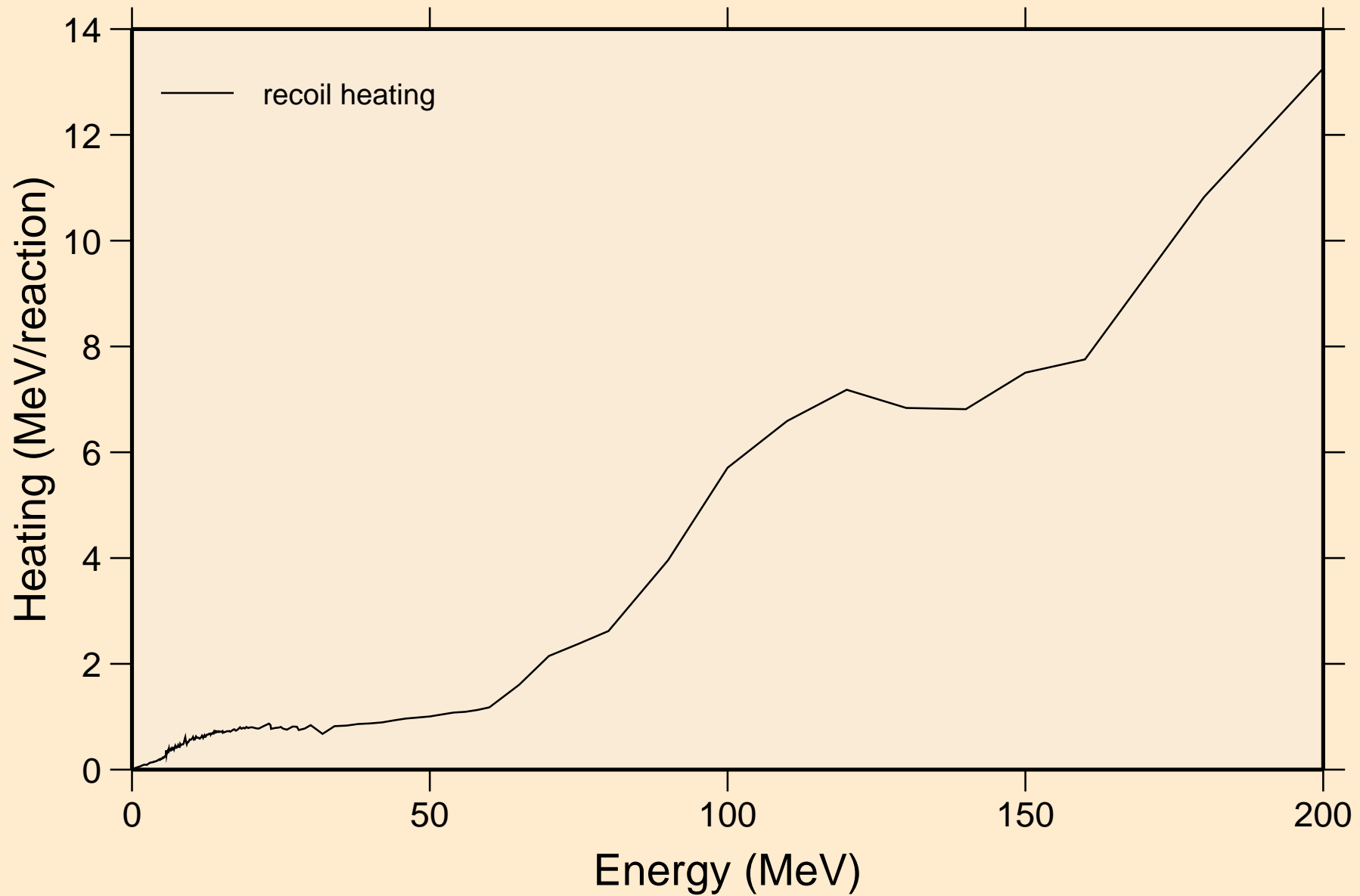

AL027 NEUTRON ACER TENDL-2023 LIBRARY; T=0.K  
Particle production cross sections

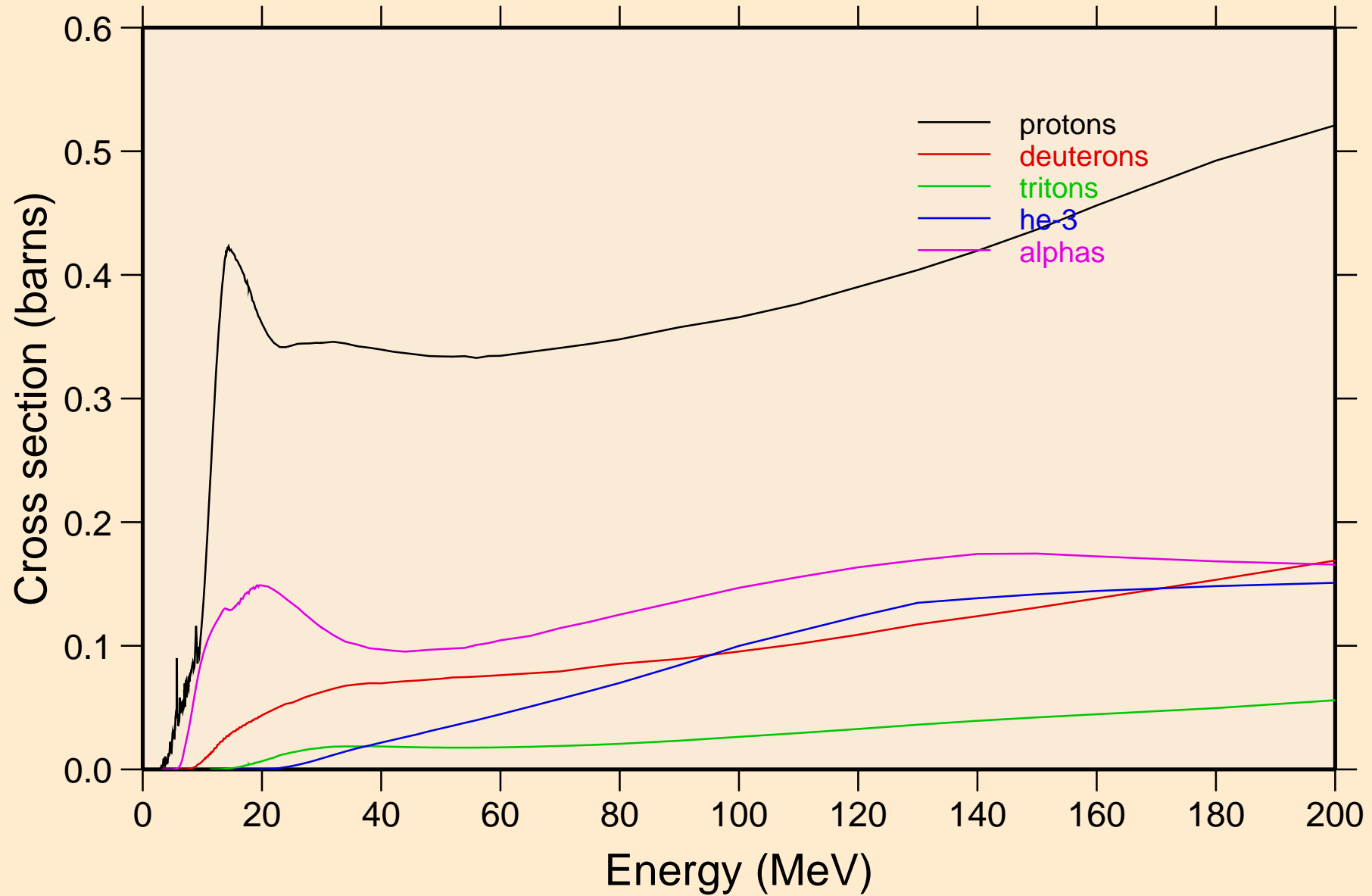

AL027 NEUTRON ACER TENDL-2023 LIBRARY; T=0.K  
protons from (n,x)

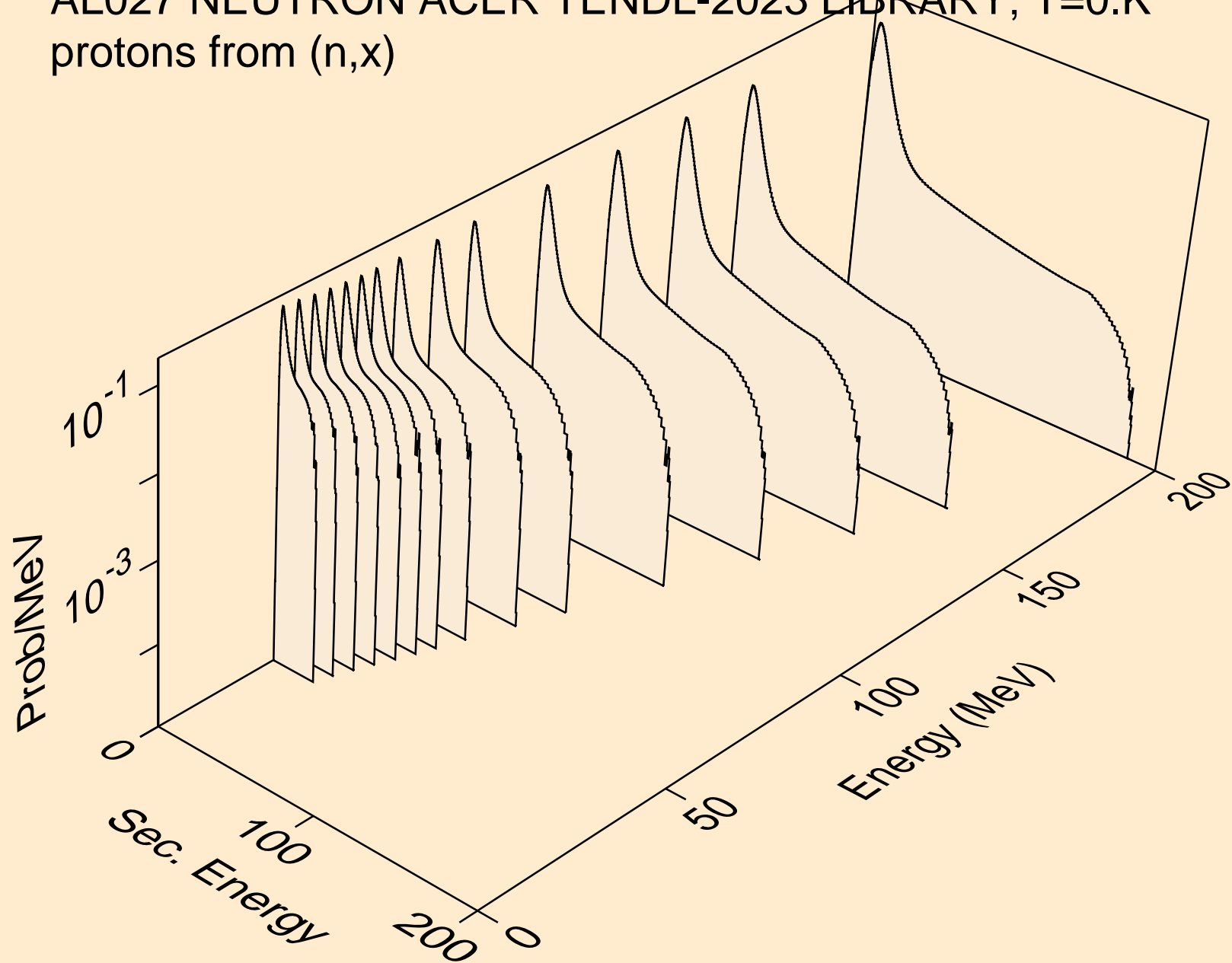

AL027 NEUTRON ACER TENDL-2023 LIBRARY; T=0.K  
protons from (n,n\*)p

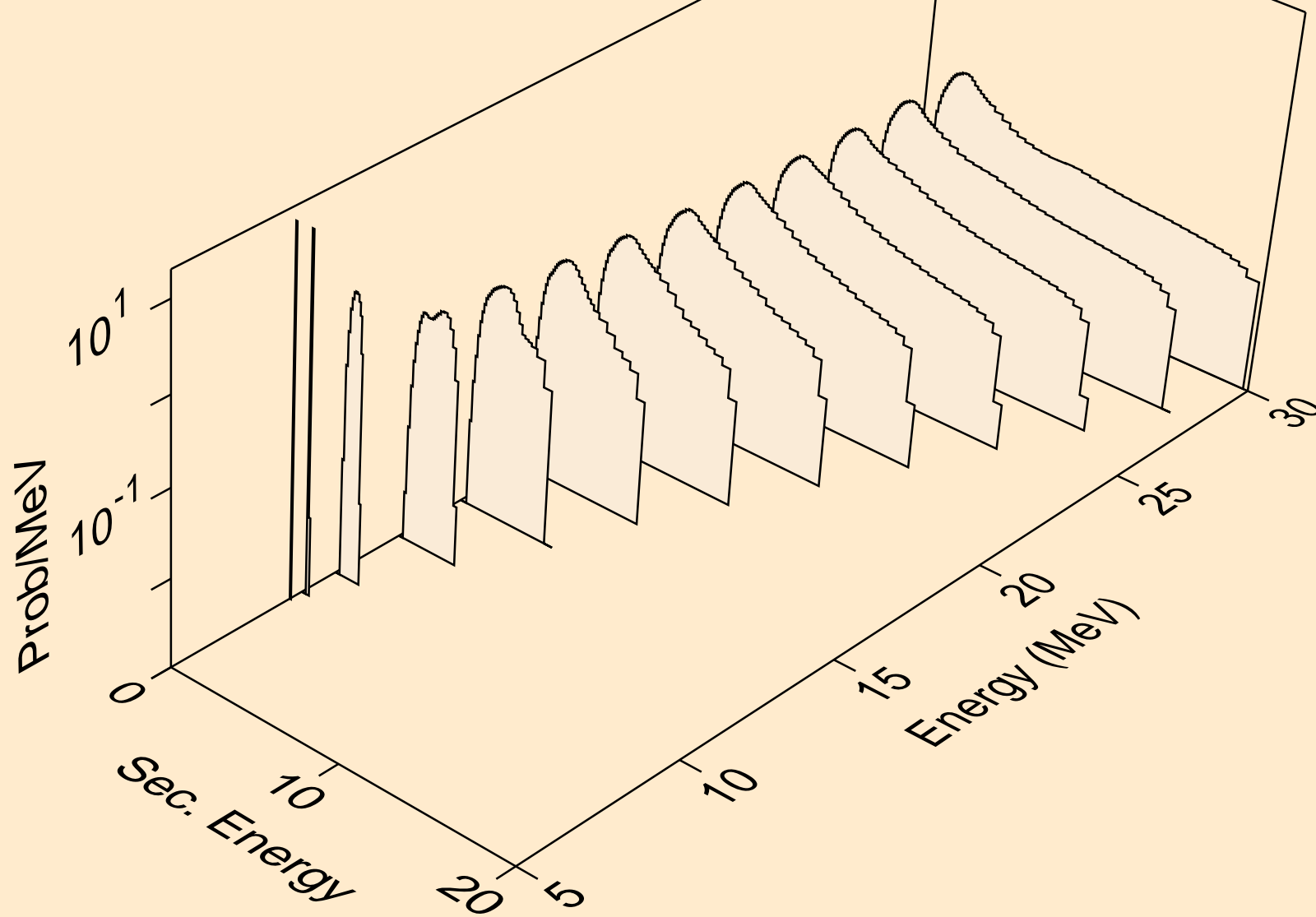

AL027 NEUTRON ACER TENDL-2023 LIBRARY; T=0.K  
protons from (n,2np)

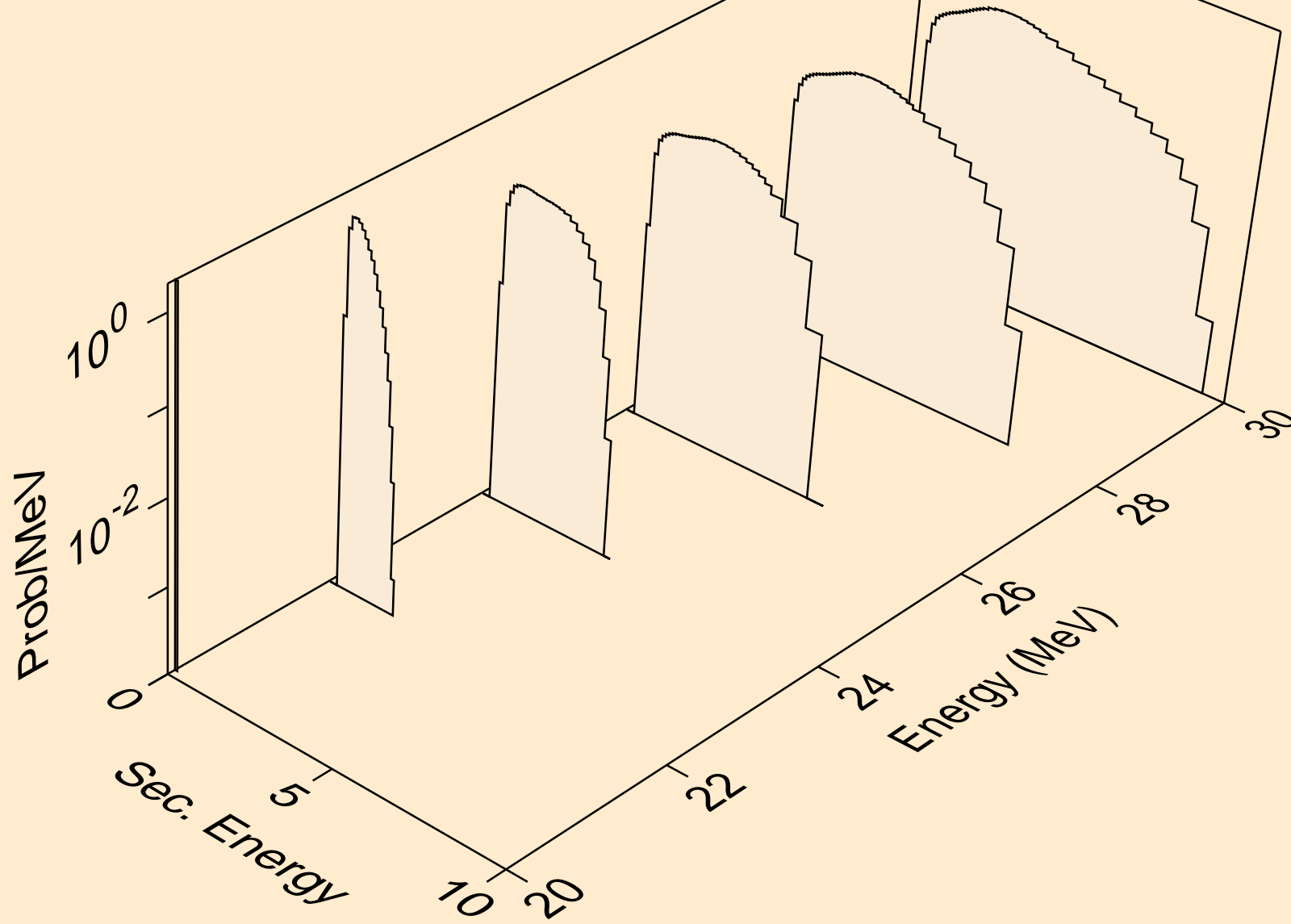

AL027 NEUTRON ACER TENDL-2023 LIBRARY; T=0.K  
protons from (n,3np)

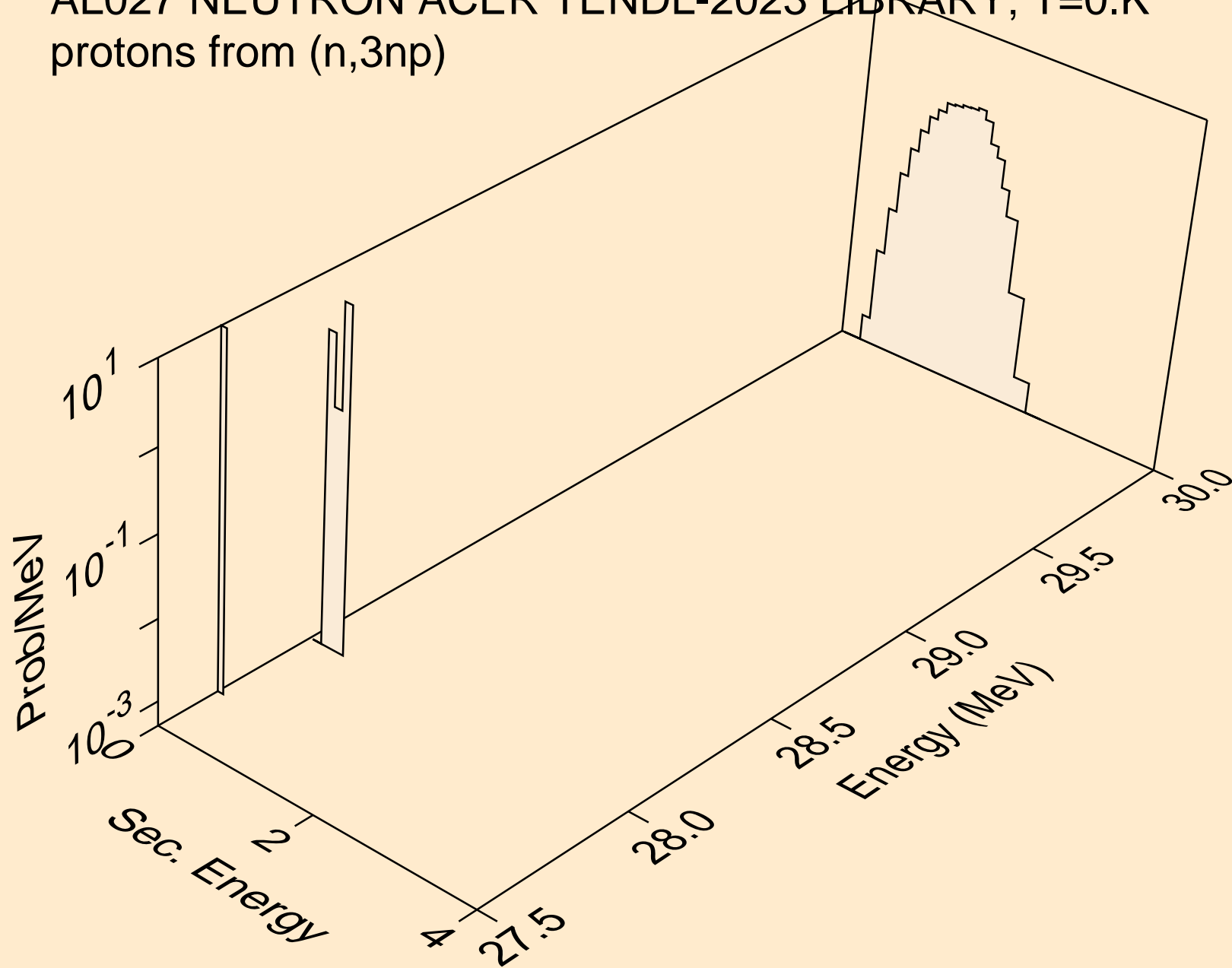

AL027 NEUTRON ACER TENDL-2023 LIBRARY; T=0.K  
protons from (n,n2p)

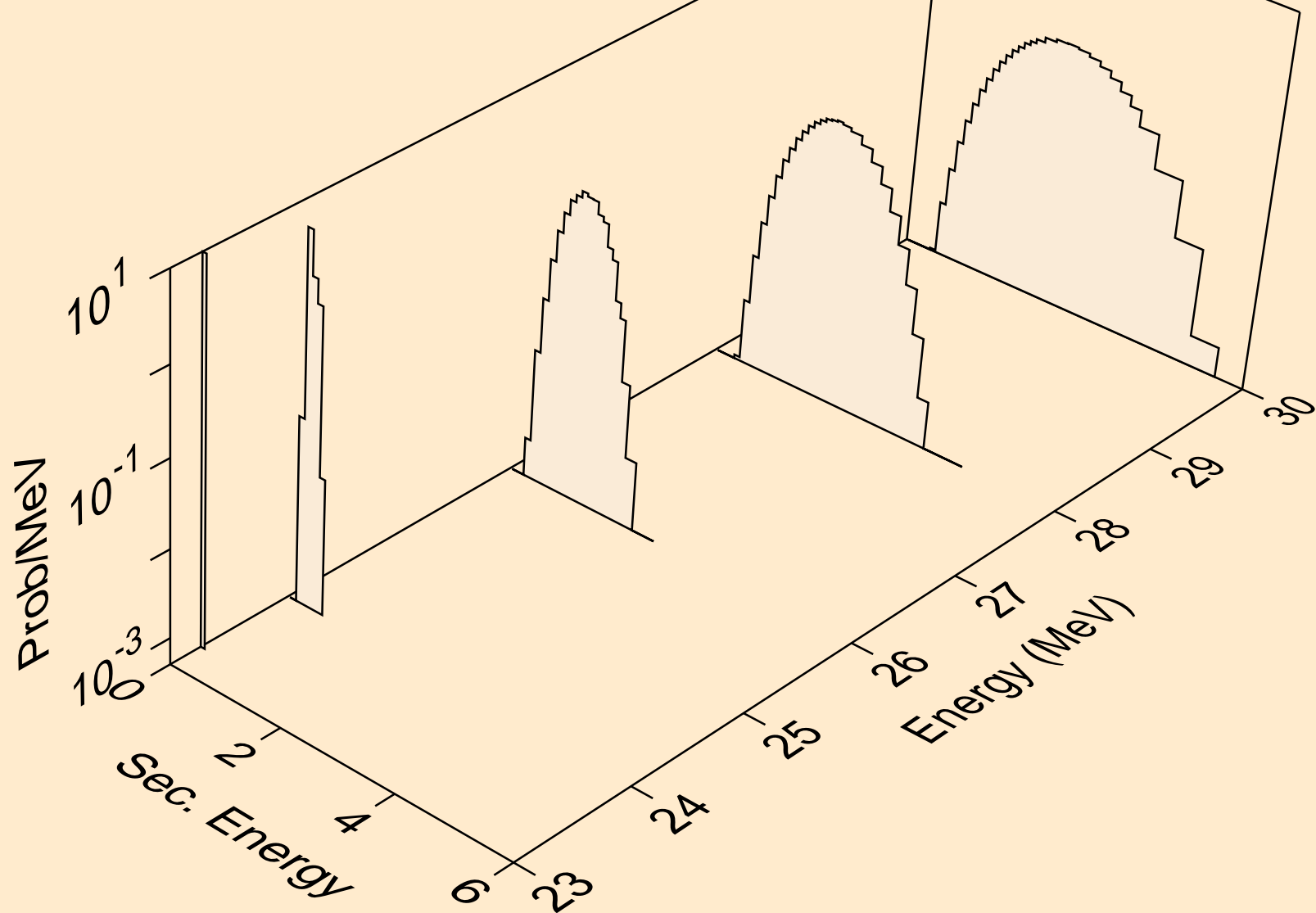

AL027 NEUTRON ACER TENDL-2023 LIBRARY; T=0.K  
protons from (n,npa)

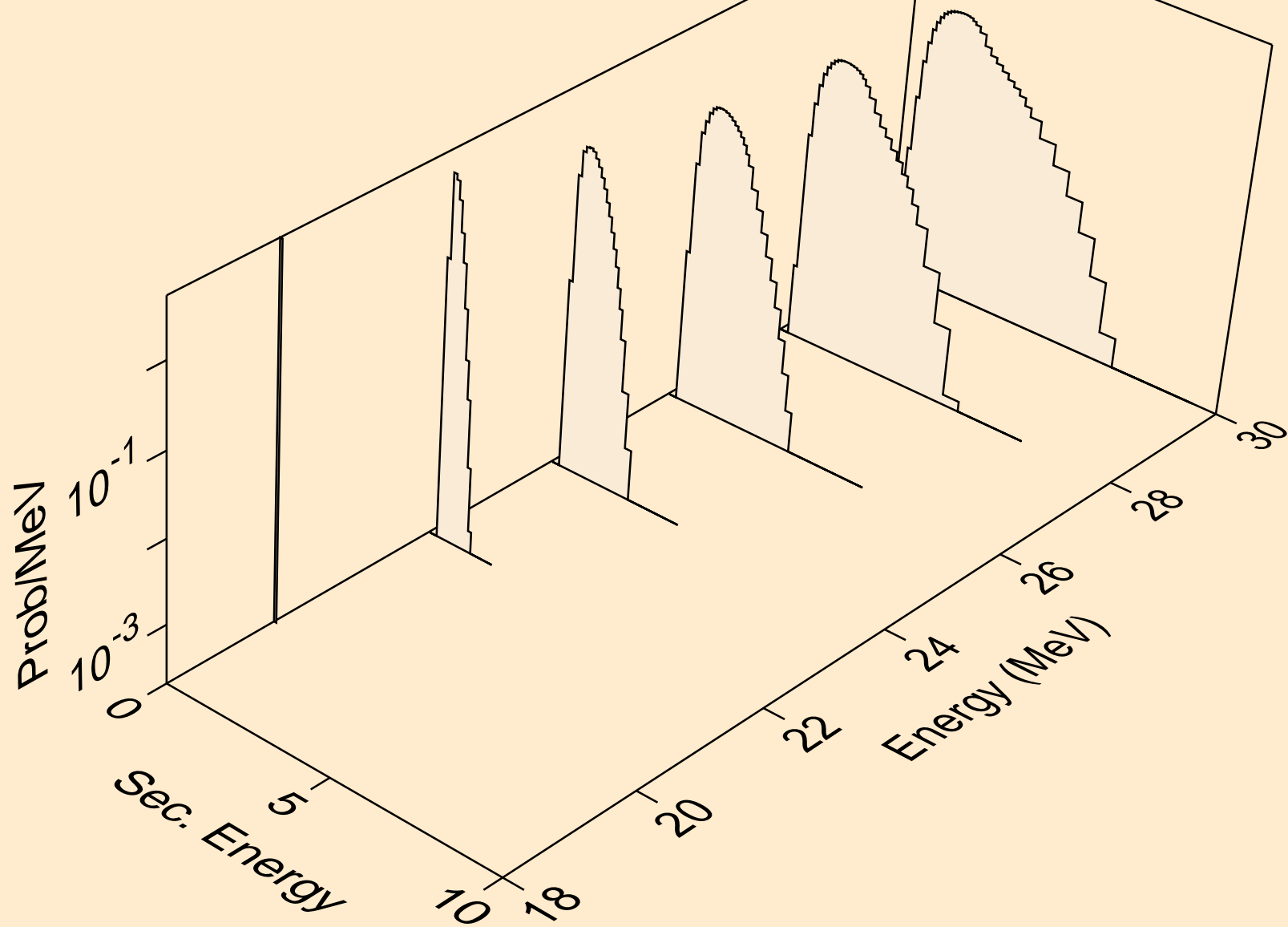

AL027 NEUTRON ACER TENDL-2023 LIBRARY; T=0.K  
protons from (n,p)

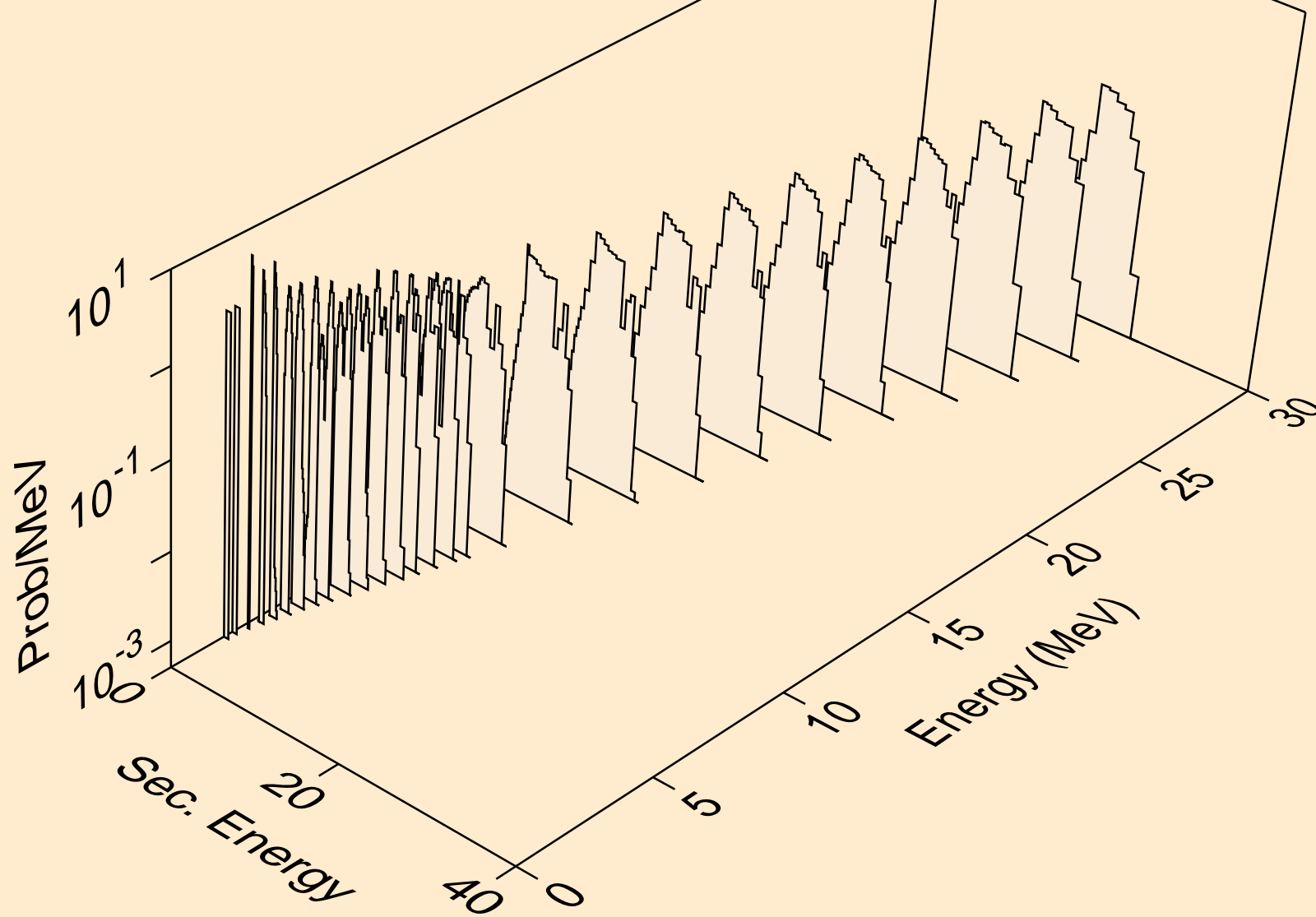

AL027 NEUTRON ACER TENDL-2023 LIBRARY; T=0.K  
protons from (n,2p)

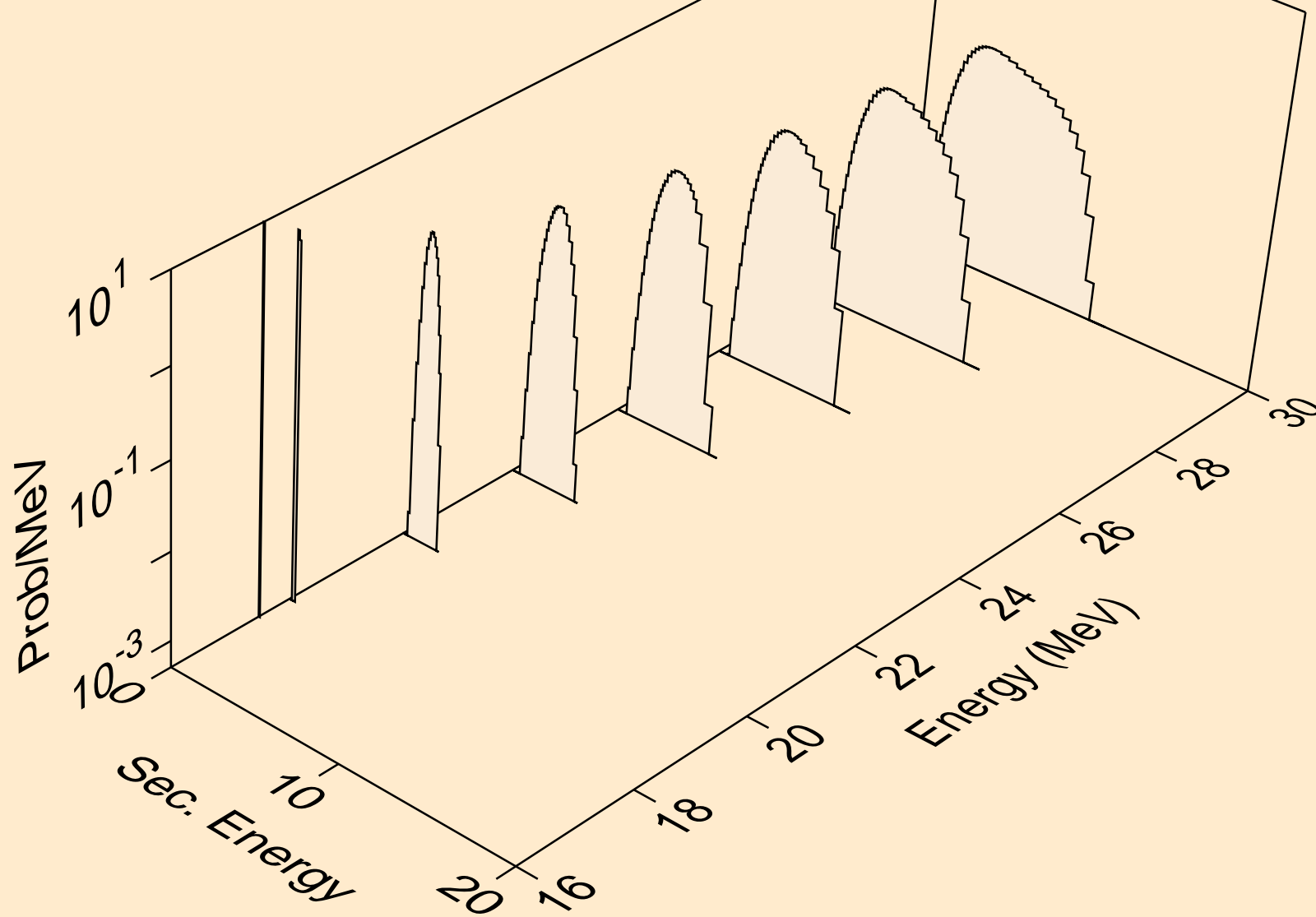

AL027 NEUTRON ACER TENDL-2023 LIBRARY; T=0.K  
protons from (n,p)

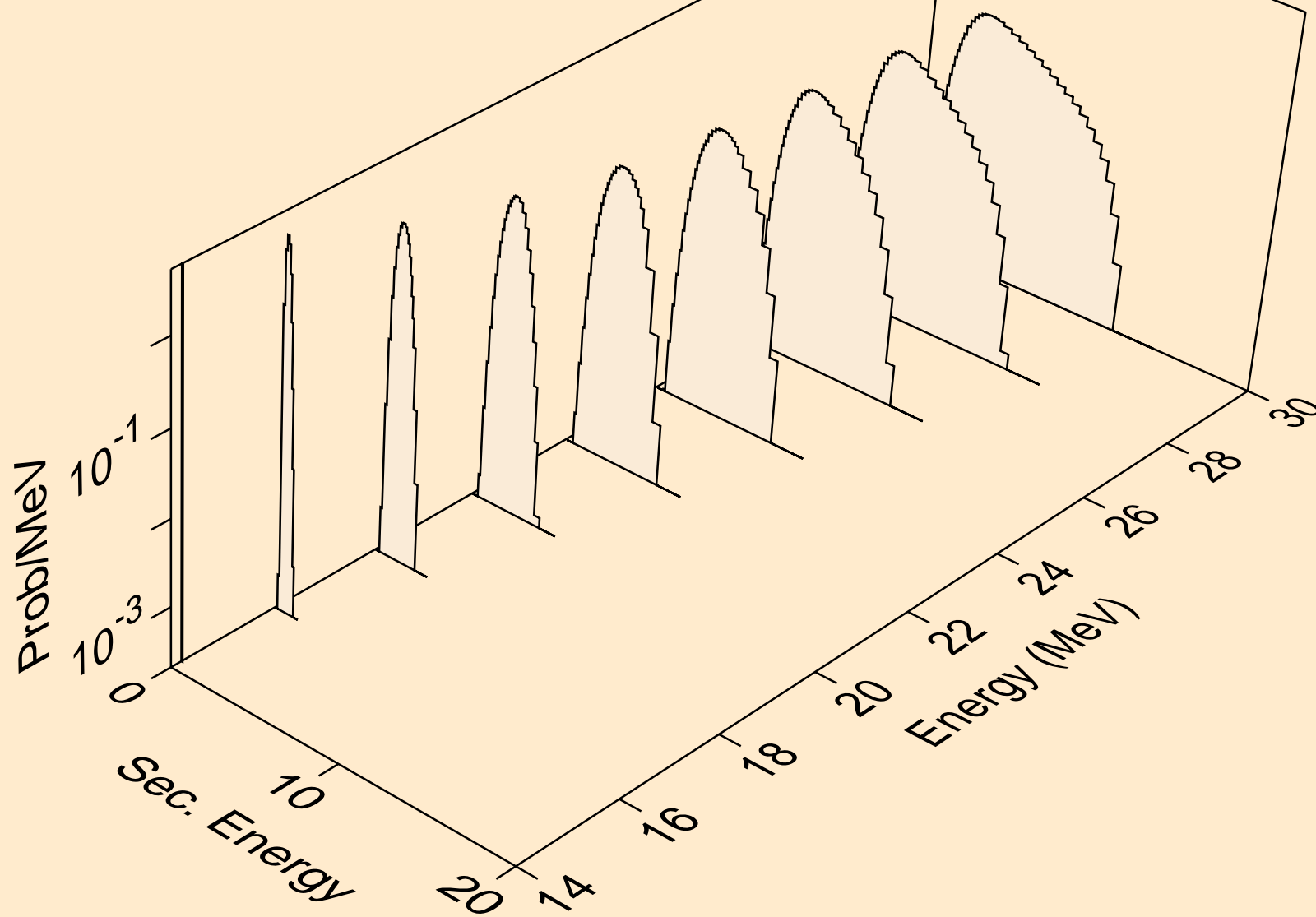

AL027 NEUTRON ACER TENDL-2023 LIBRARY; T=0.K  
protons from (n,pd)

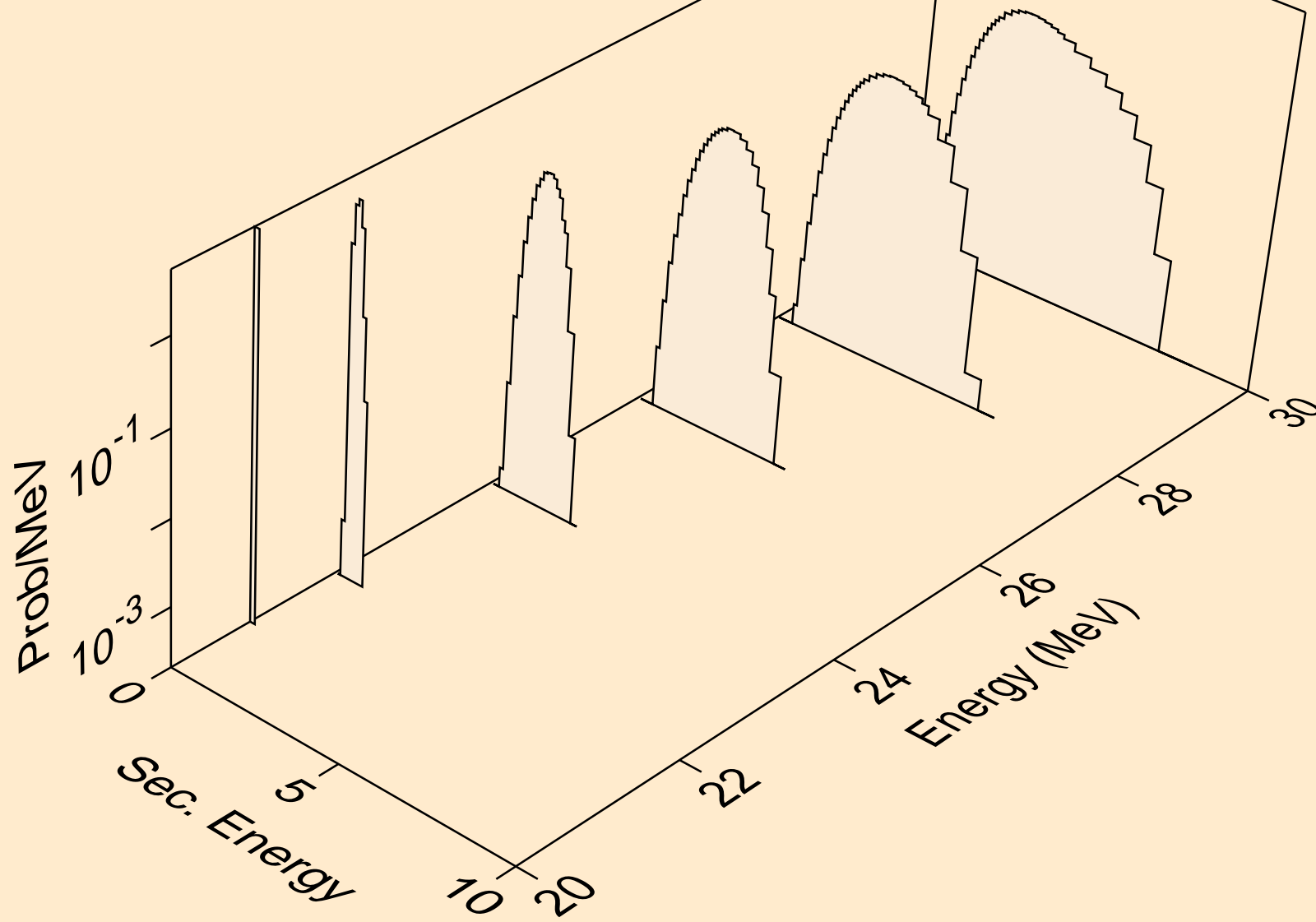

AL027 NEUTRON ACER TENDL-2023 LIBRARY; T=0.K  
protons from (n,pt)

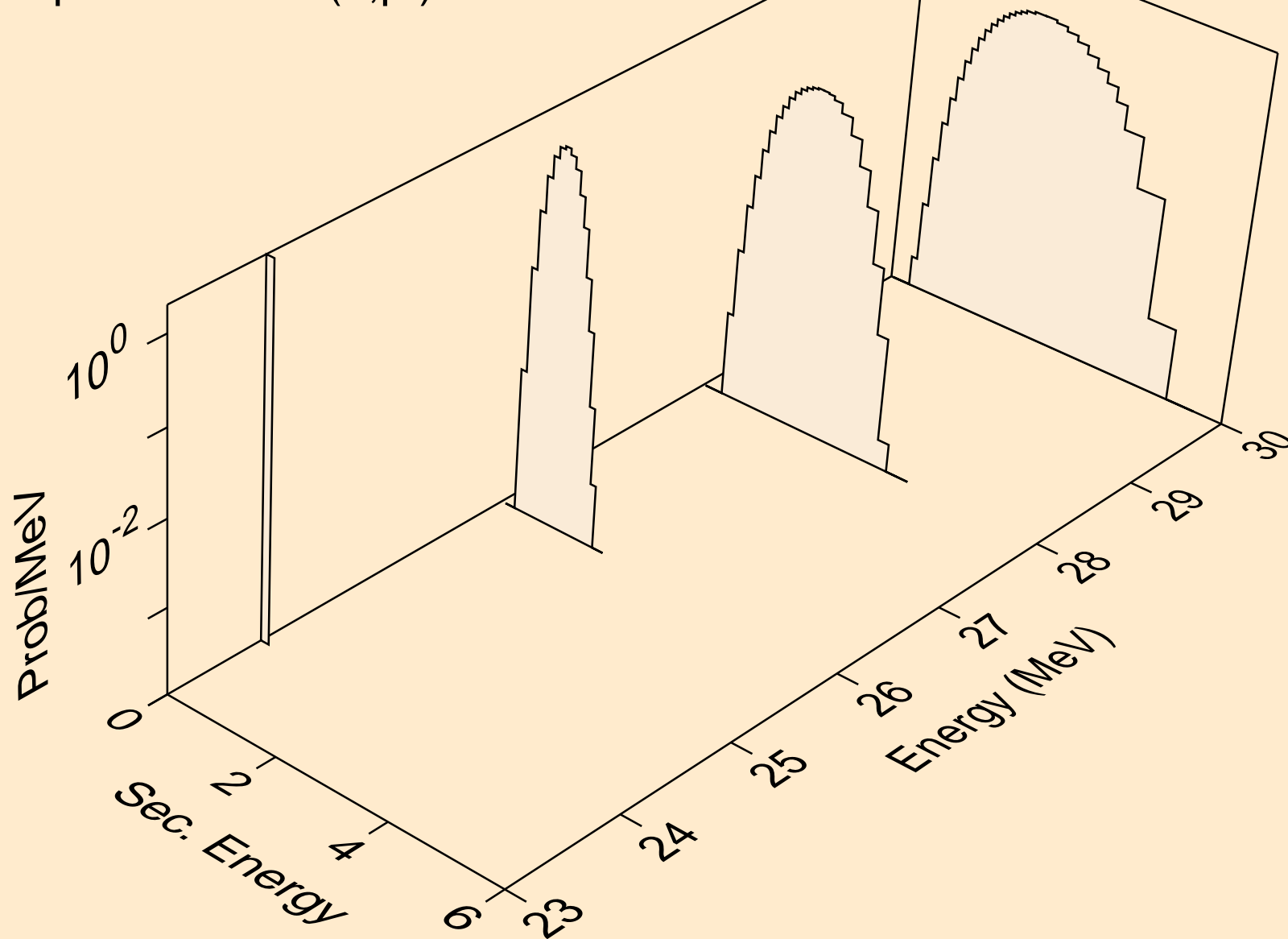

AL027 NEUTRON ACER TENDL-2023 LIBRARY; T=0.K  
deuterons from (n,x)

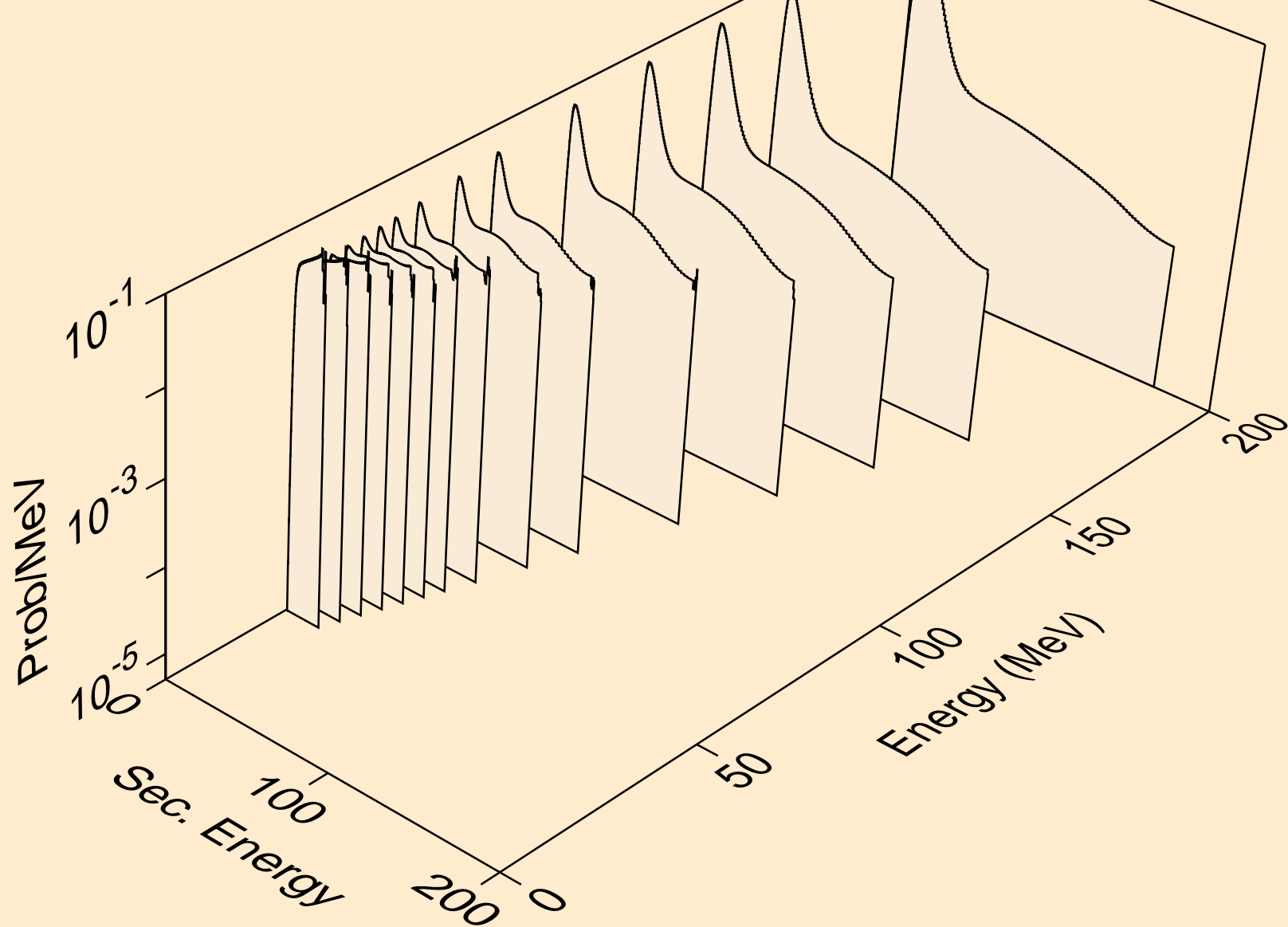

AL027 NEUTRON ACER TENDL-2023 LIBRARY; T=0.K  
deuterons from (n,2nd)

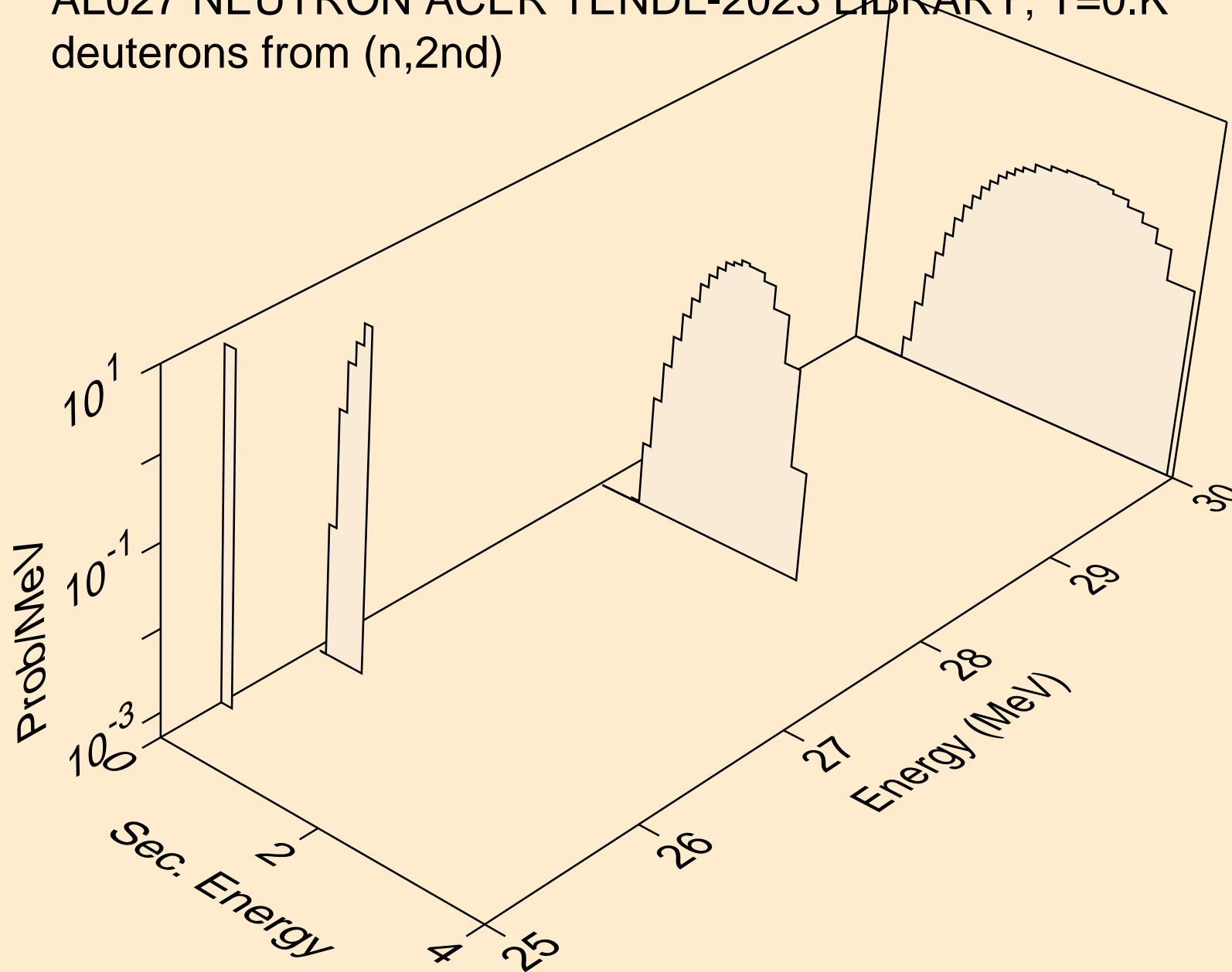

AL027 NEUTRON ACER TENDL-2023 LIBRARY; T=0.K  
deuterons from (n,n\*)d

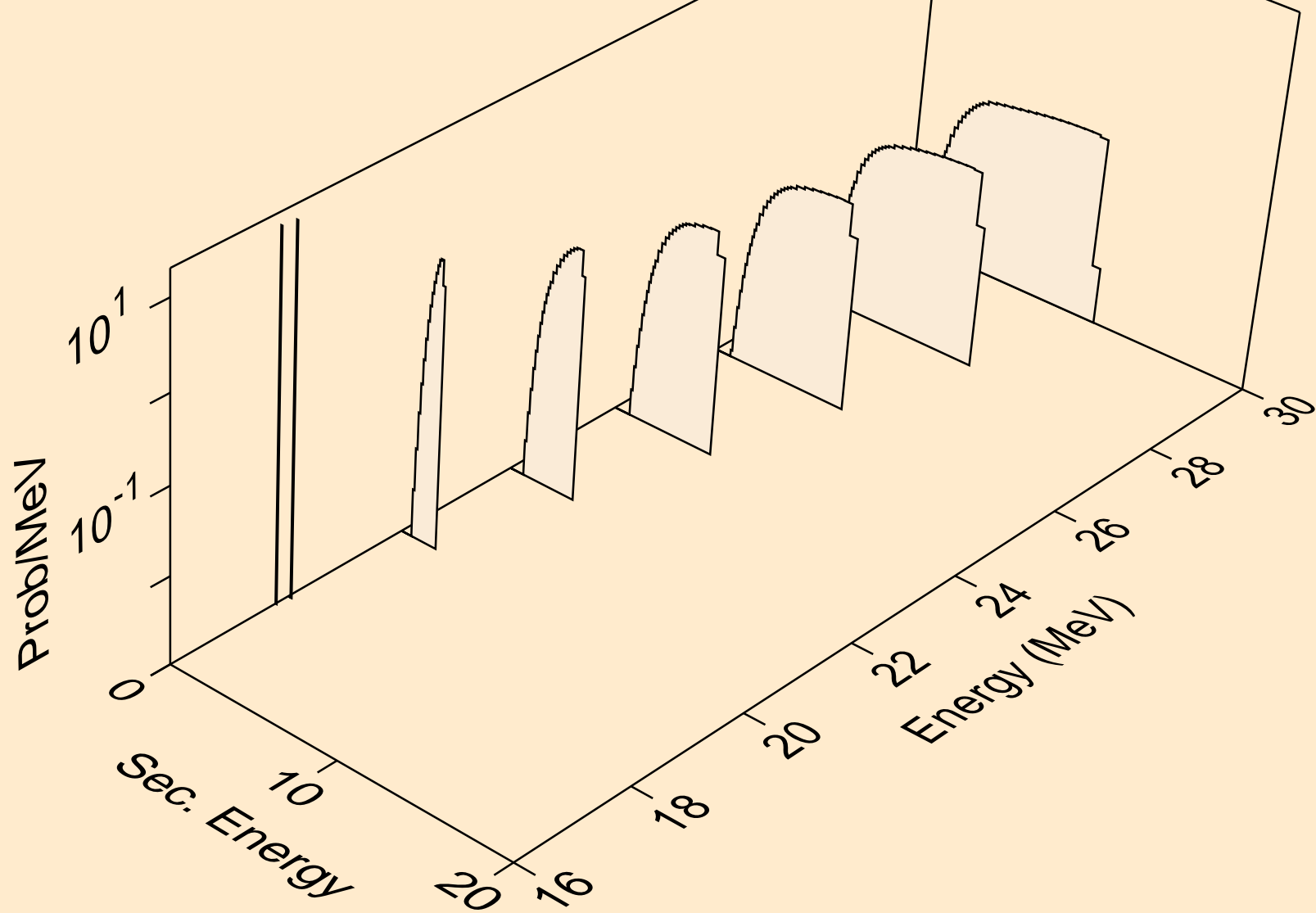

AL027 NEUTRON ACER TENDL-2023 LIBRARY; T=0.K  
deuterons from (n,d)

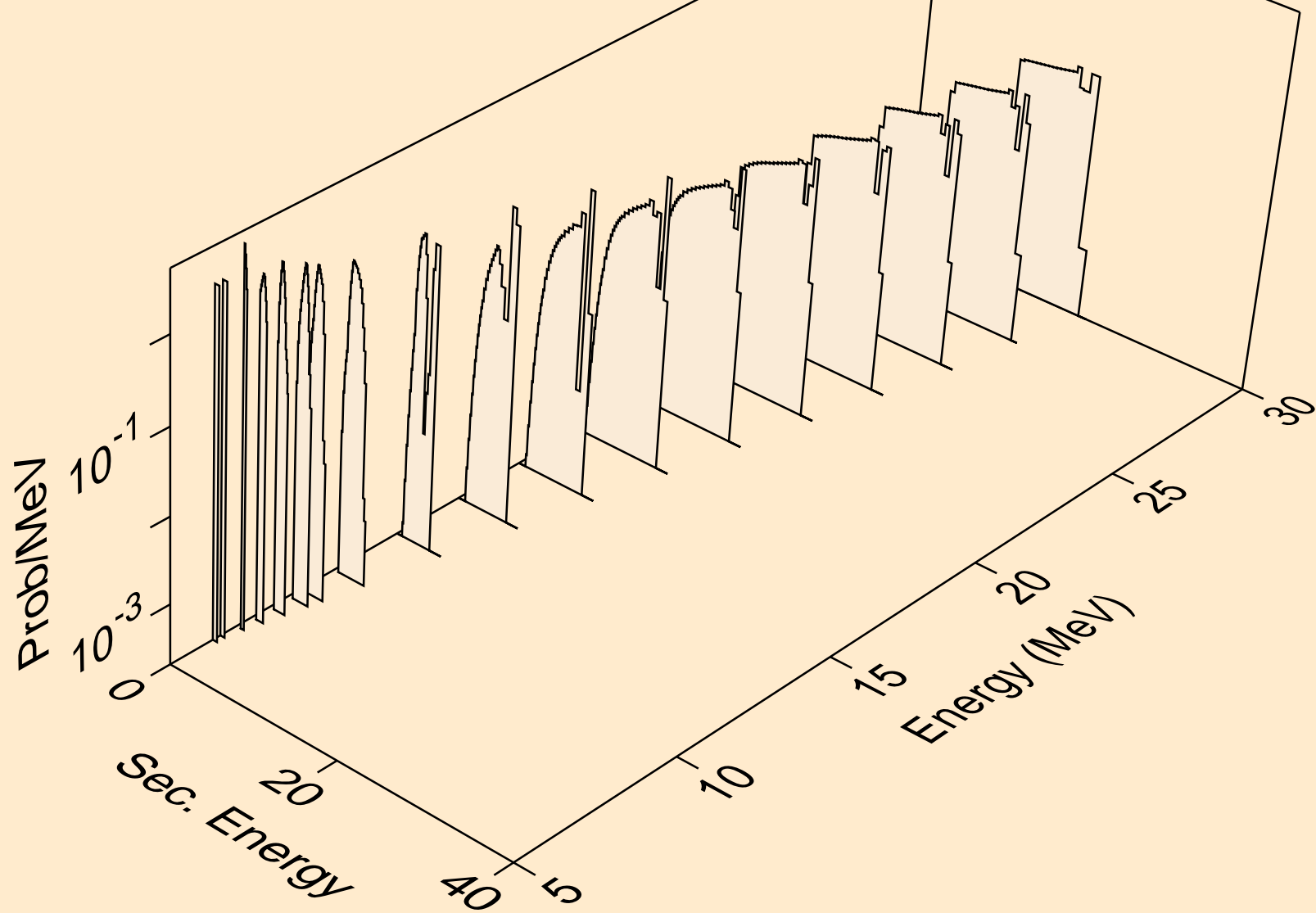

AL027 NEUTRON ACER TENDL-2023 LIBRARY; T=0.K  
deuterons from (n,pd)

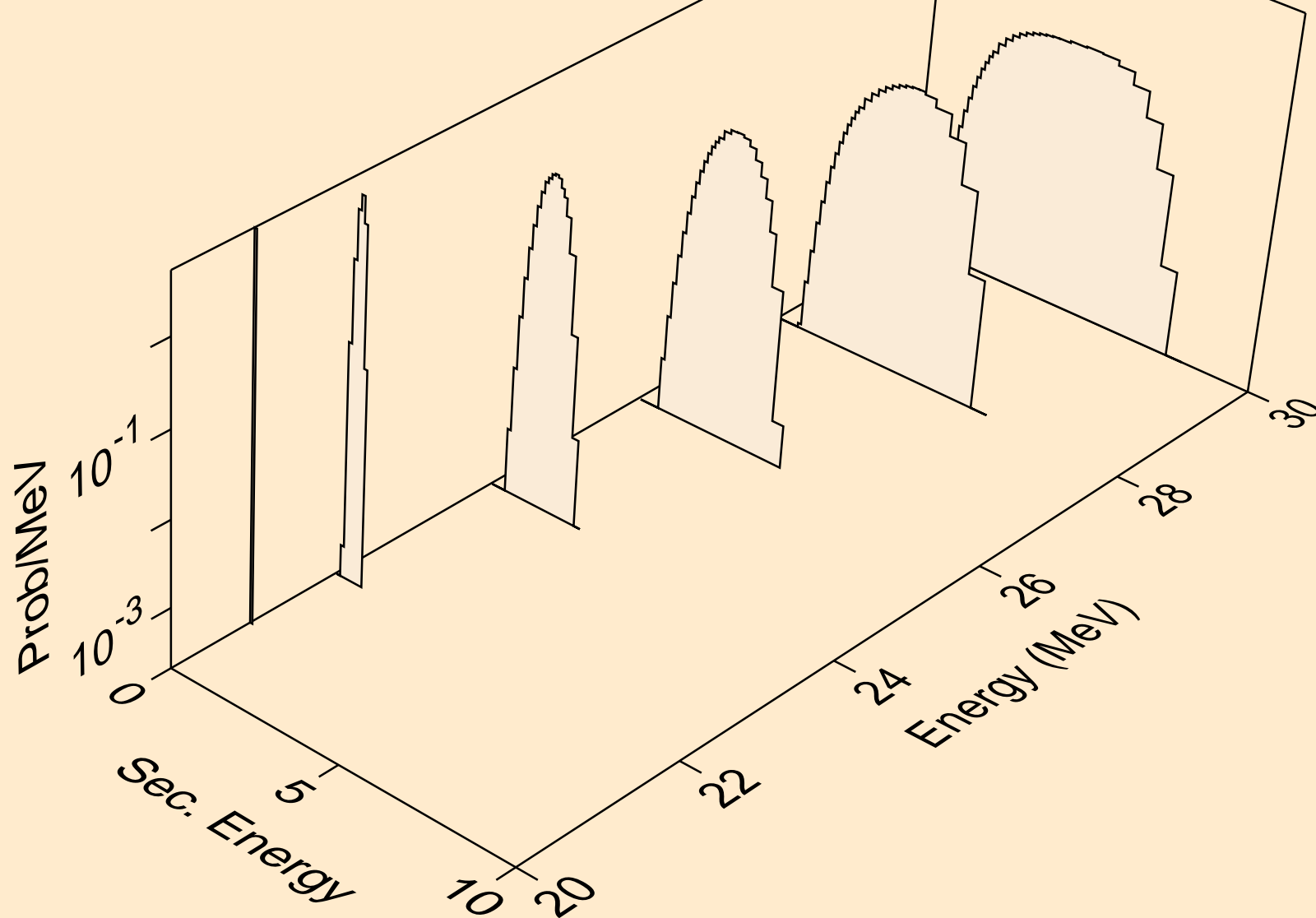

AL027 NEUTRON ACER TENDL-2023 LIBRARY; T=0.K  
deuterons from (n,da)

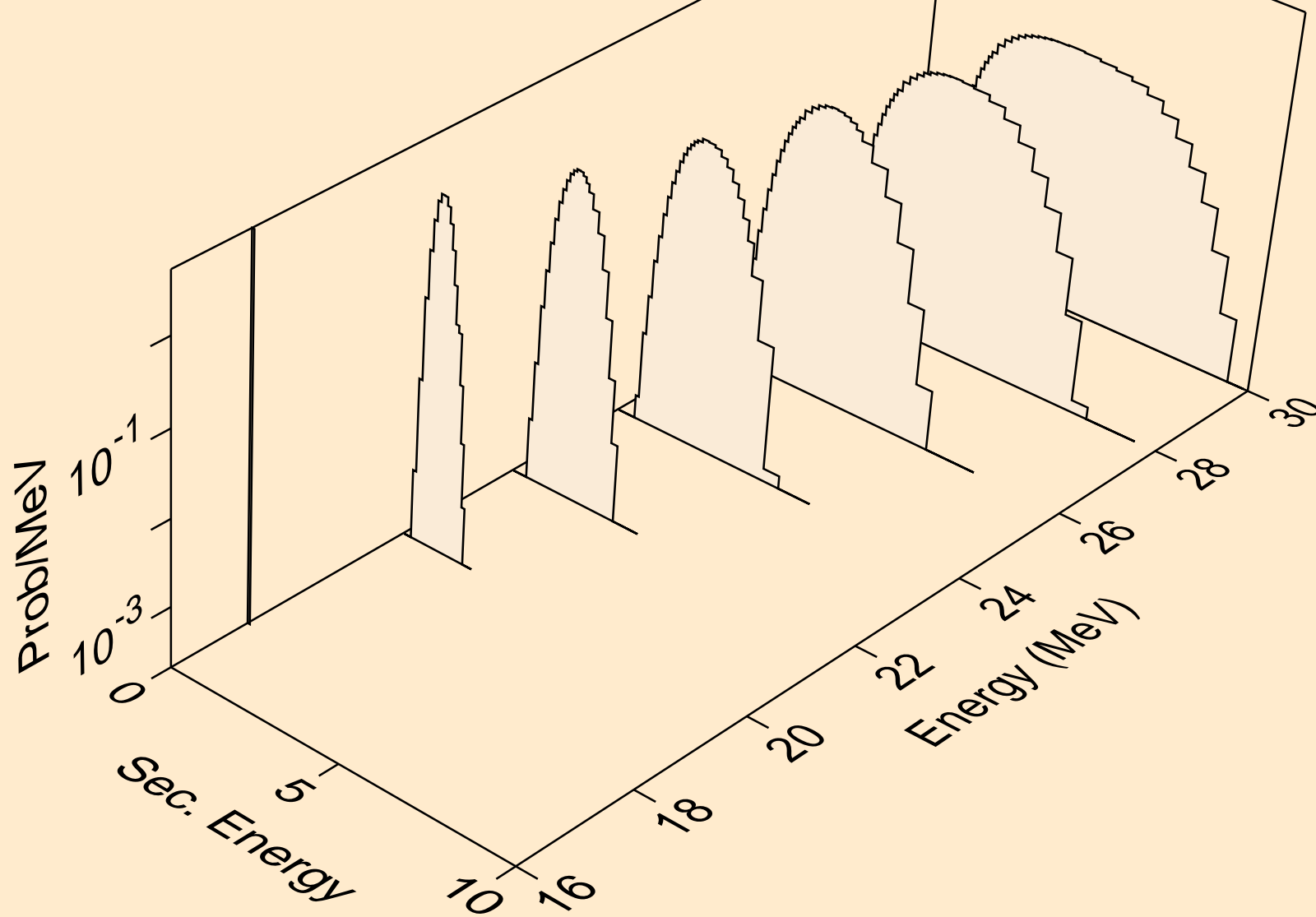

AL027 NEUTRON ACER TENDL-2023 LIBRARY; T=0.K  
tritons from (n,x)

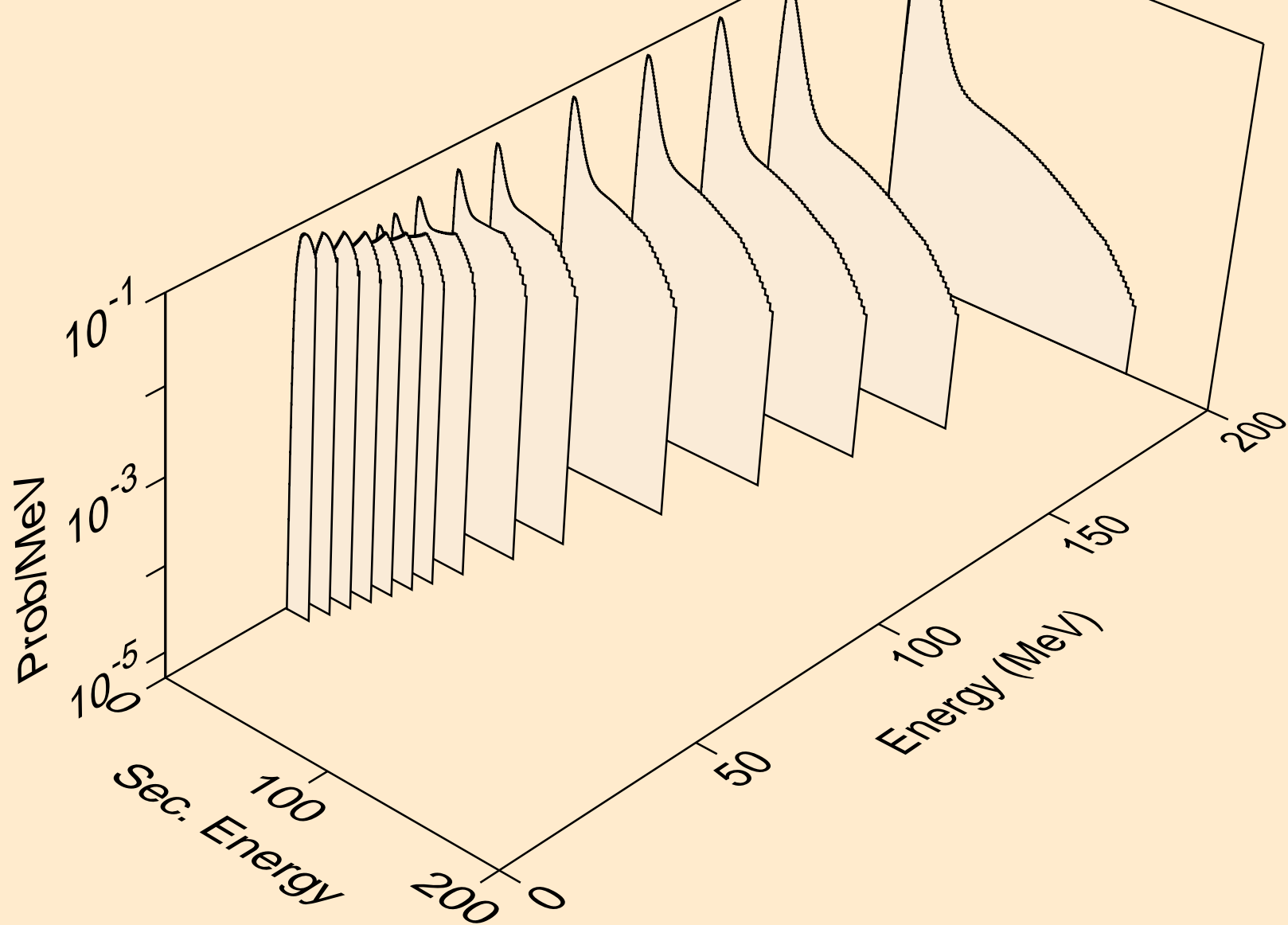

AL027 NEUTRON ACER TENDL-2023 LIBRARY; T=0.K  
tritons from (n,n\*)t

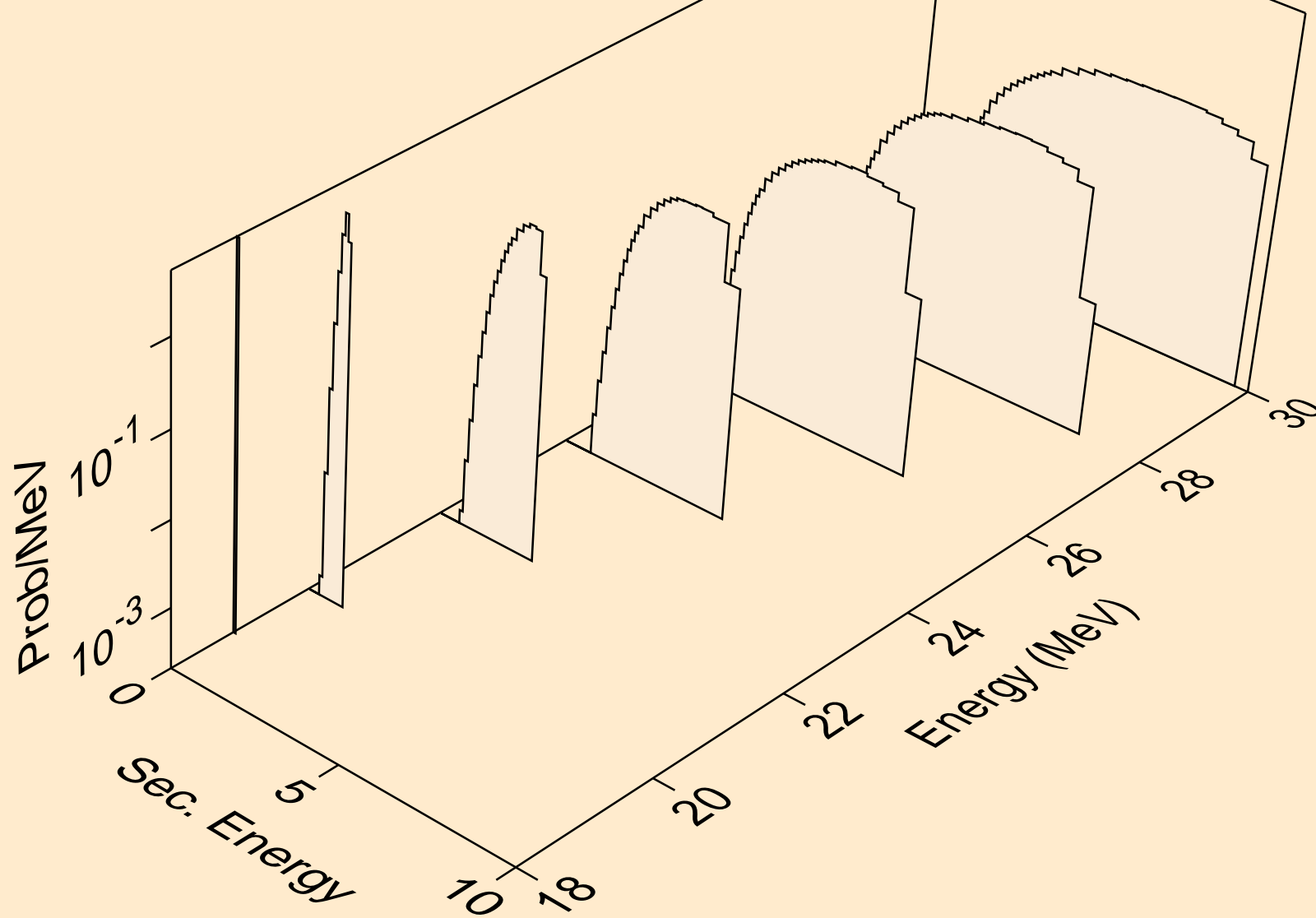

AL027 NEUTRON ACER TENDL-2023 LIBRARY; T=0.K  
tritons from (n,t)

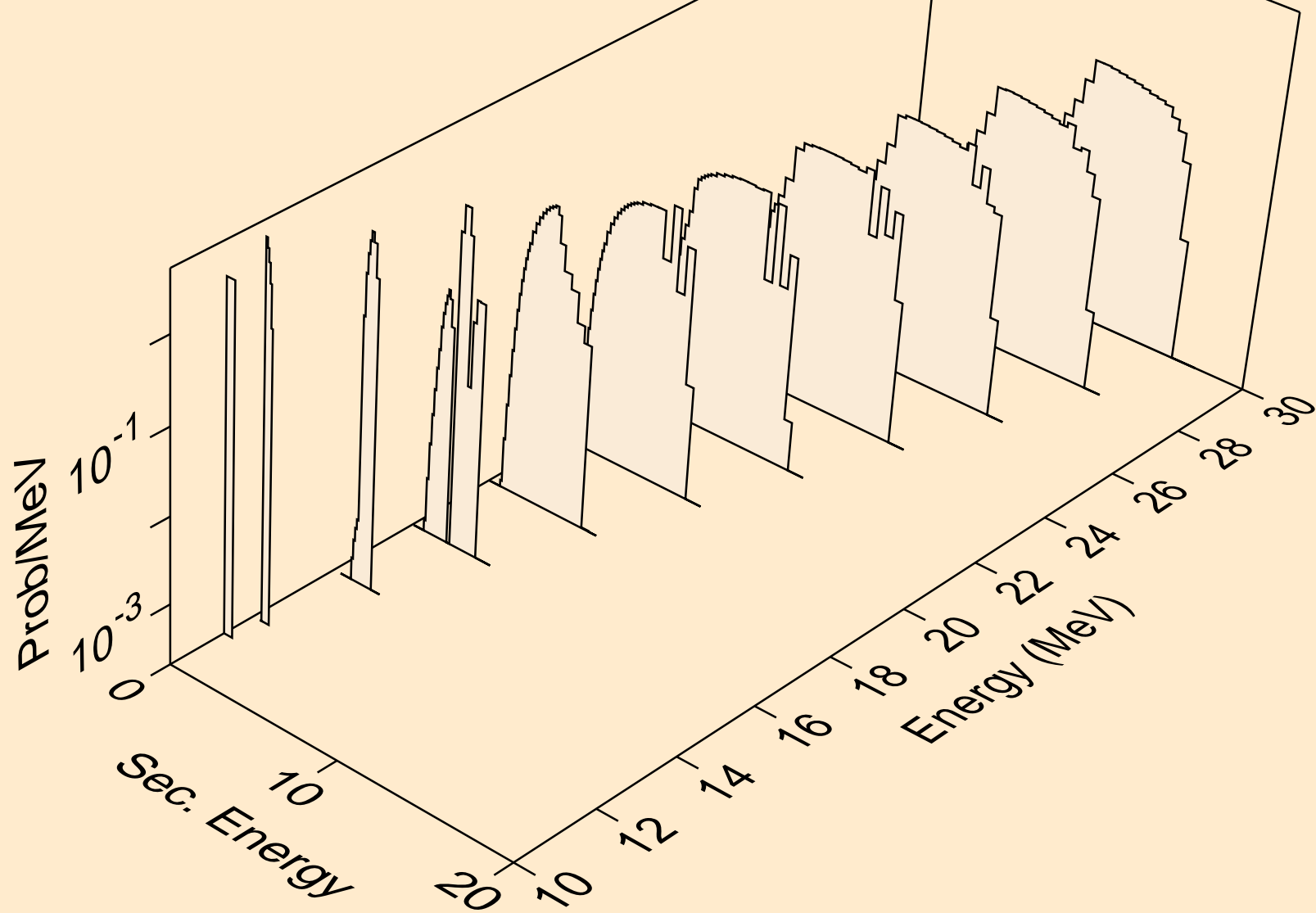

AL027 NEUTRON ACER TENDL-2023 LIBRARY; T=0.K  
tritons from (n,pt)

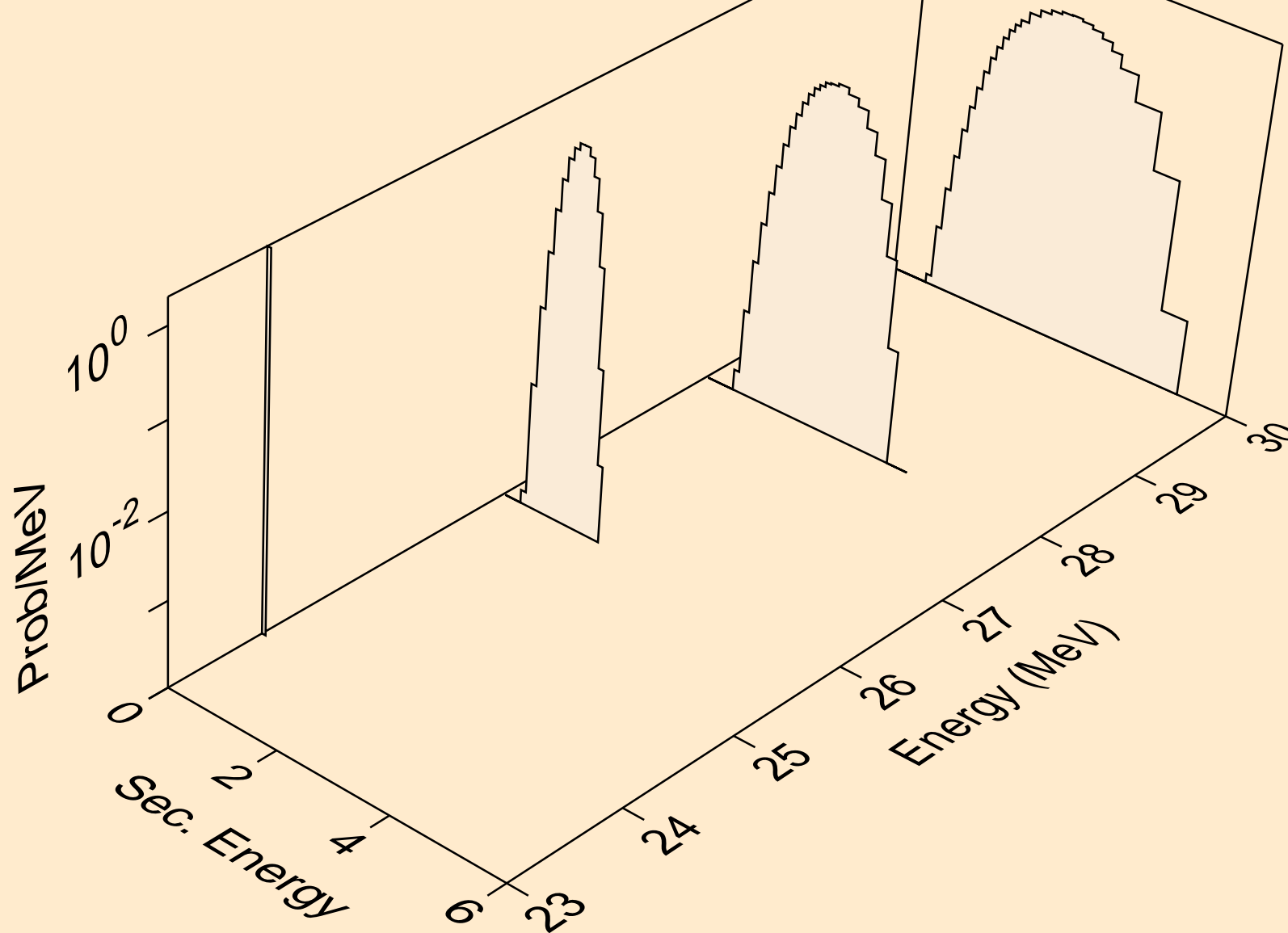

AL027 NEUTRON ACER TENDL-2023 LIBRARY; T=0.K  
he3s from (n,x)

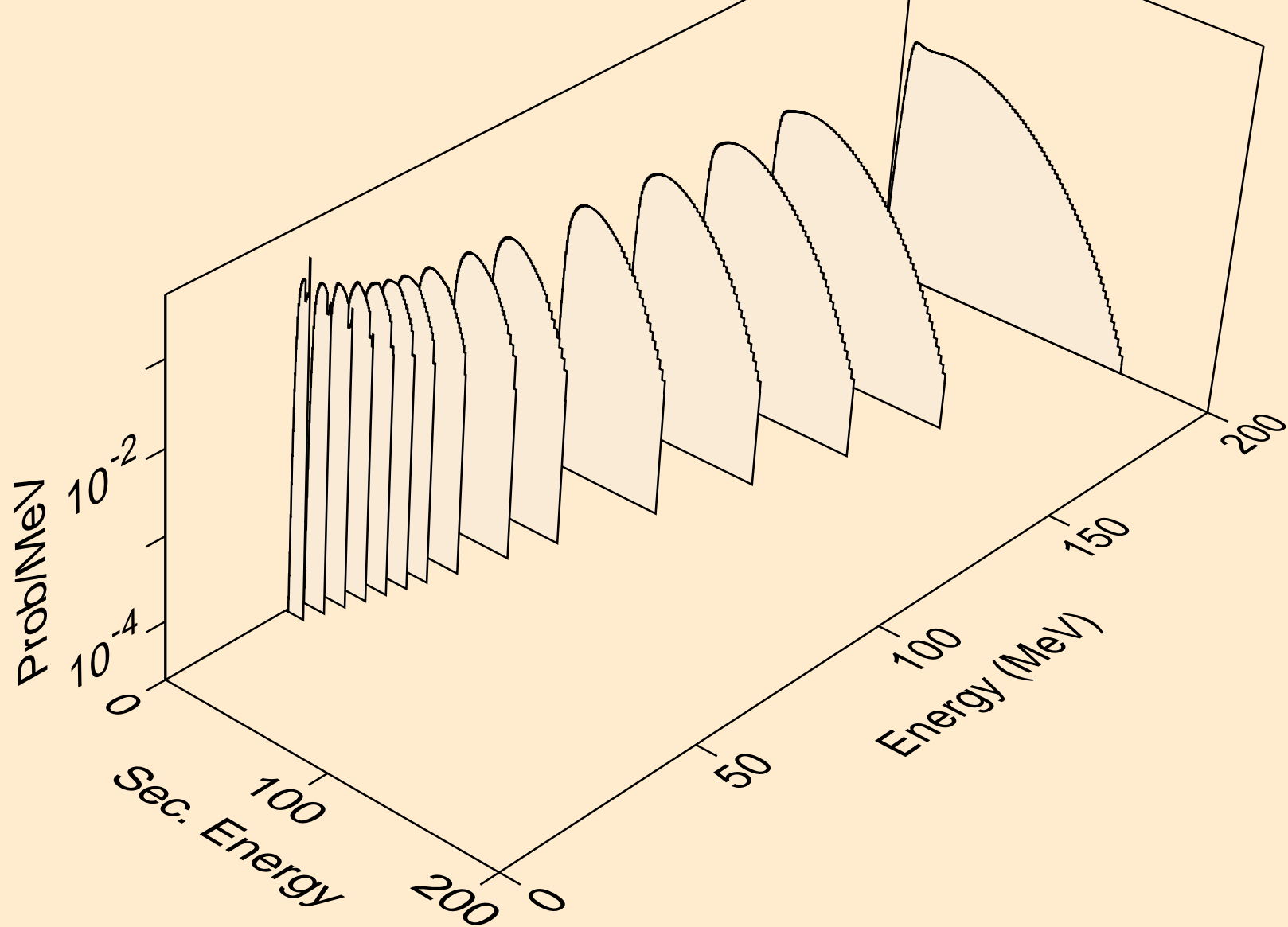

AL027 NEUTRON ACER TENDL-2023 LIBRARY; T=0.K  
he3s from (n,n\*)he3

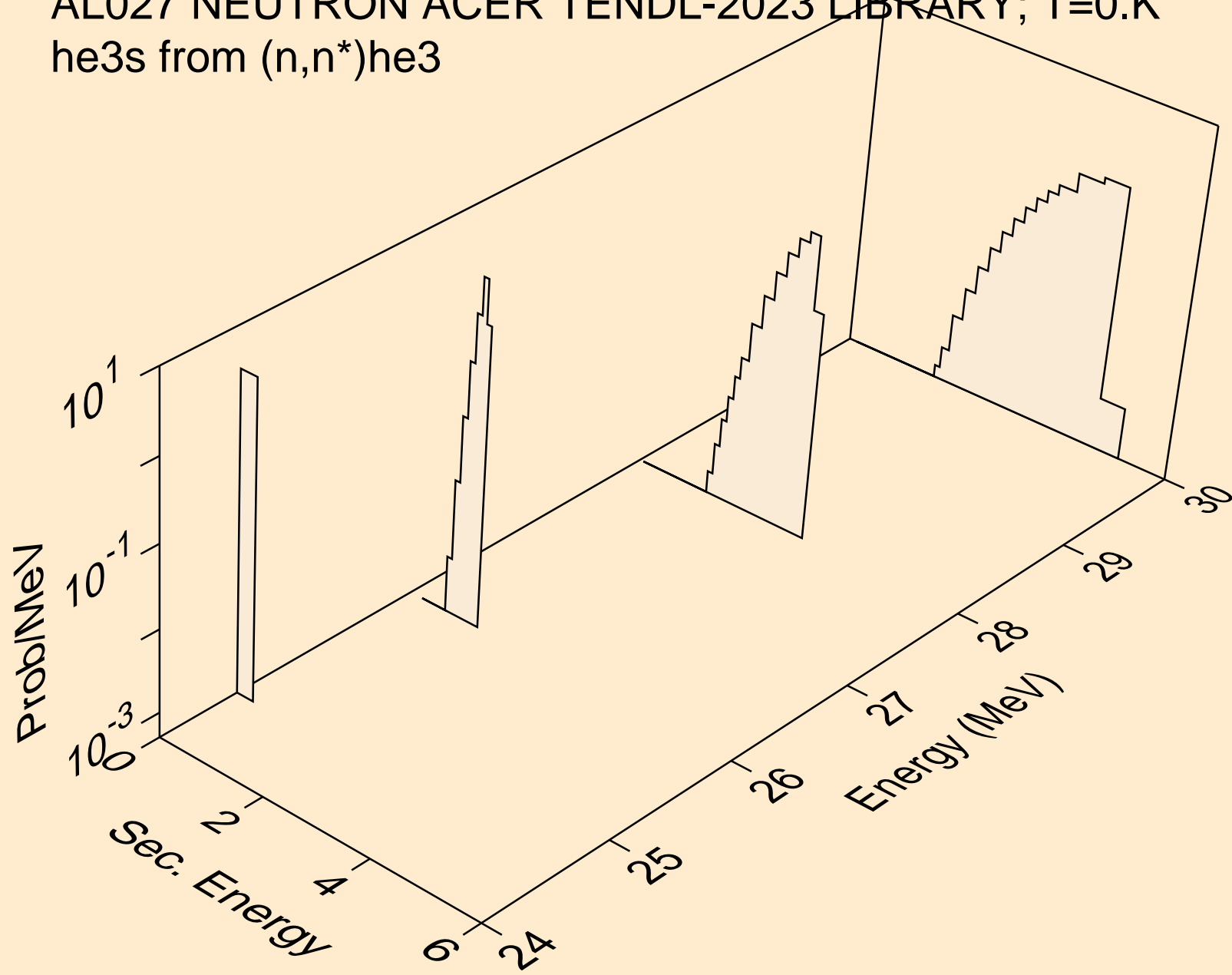

AL027 NEUTRON ACER TENDL-2023 LIBRARY; T=0.K  
he3s from (n,he3)

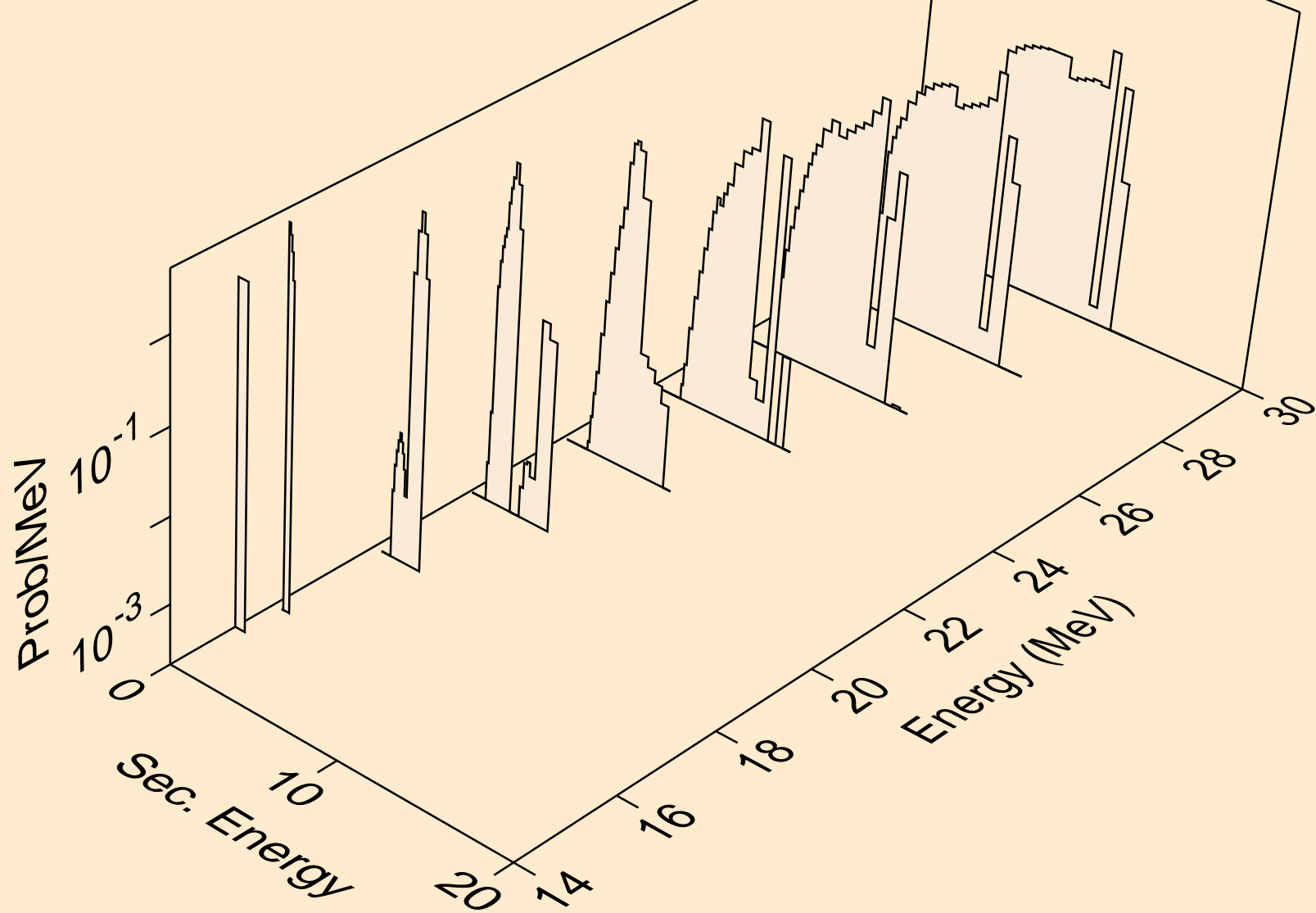

AL027 NEUTRON ACER TENDL-2023 LIBRARY; T=0.K  
alphas from (n,x)

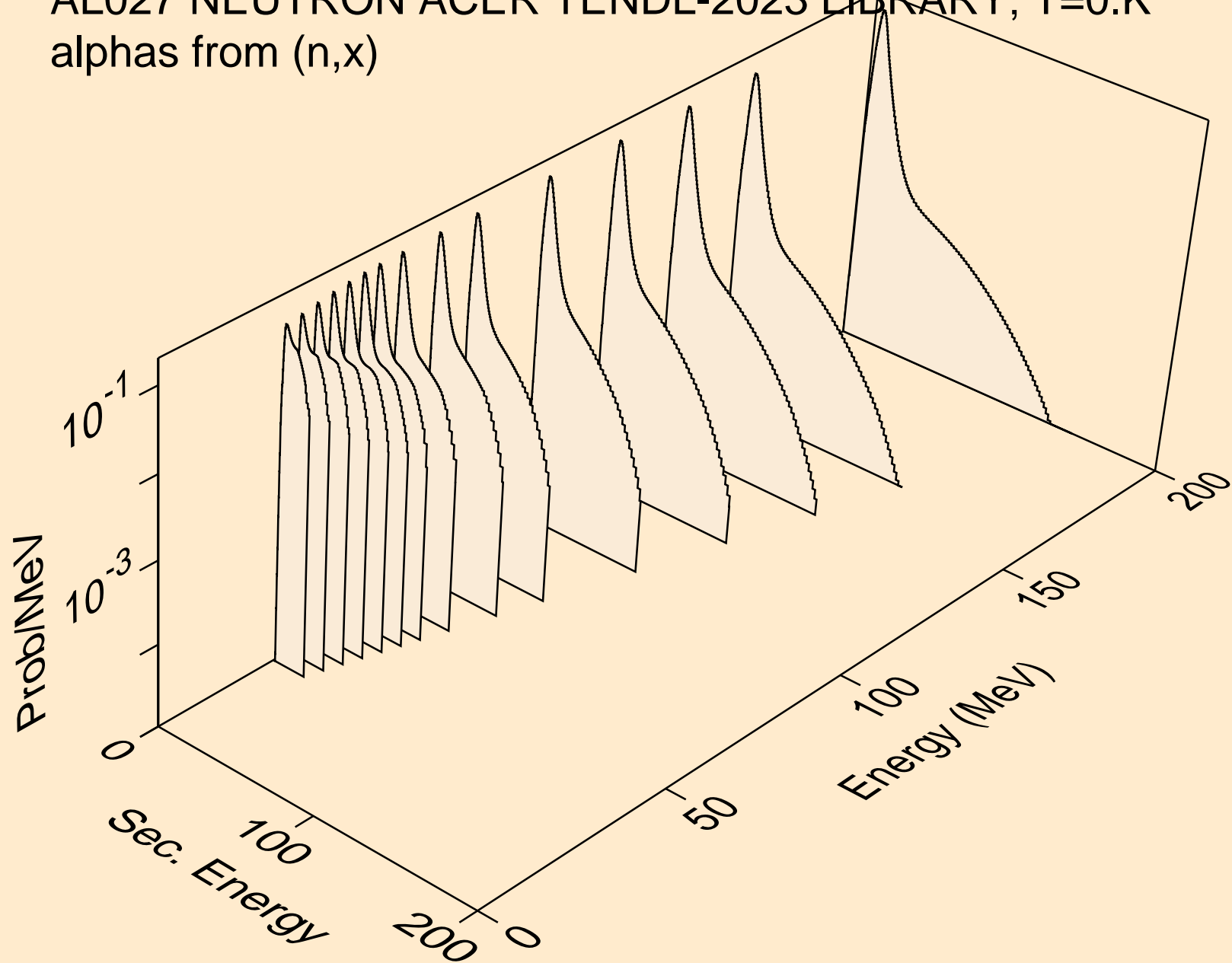

AL027 NEUTRON ACER TENDL-2023 LIBRARY; T=0.K  
alphas from (n,n\*)a

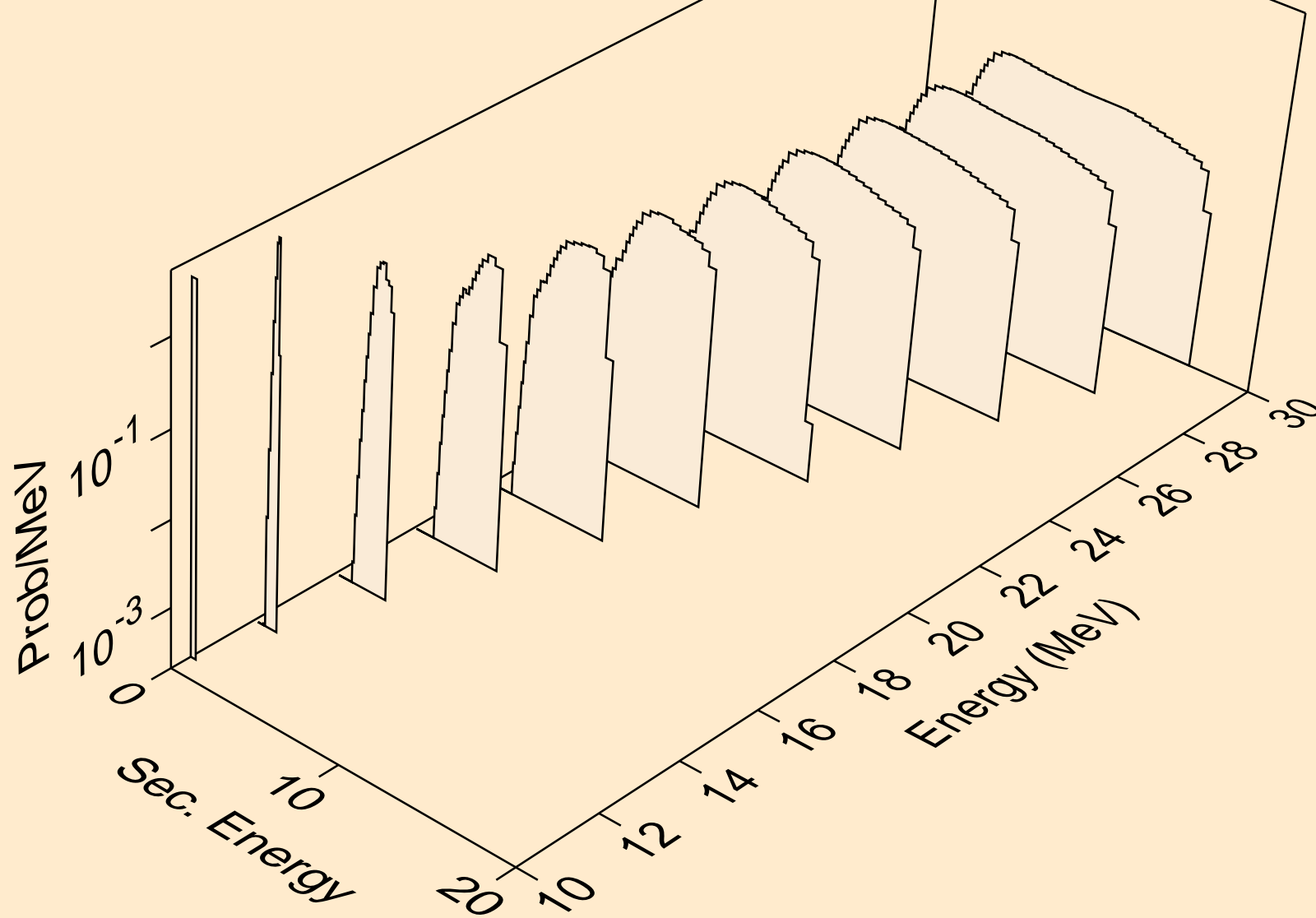

AL027 NEUTRON ACER TENDL-2023 LIBRARY; T=0.K  
alphas from (n,2n)a

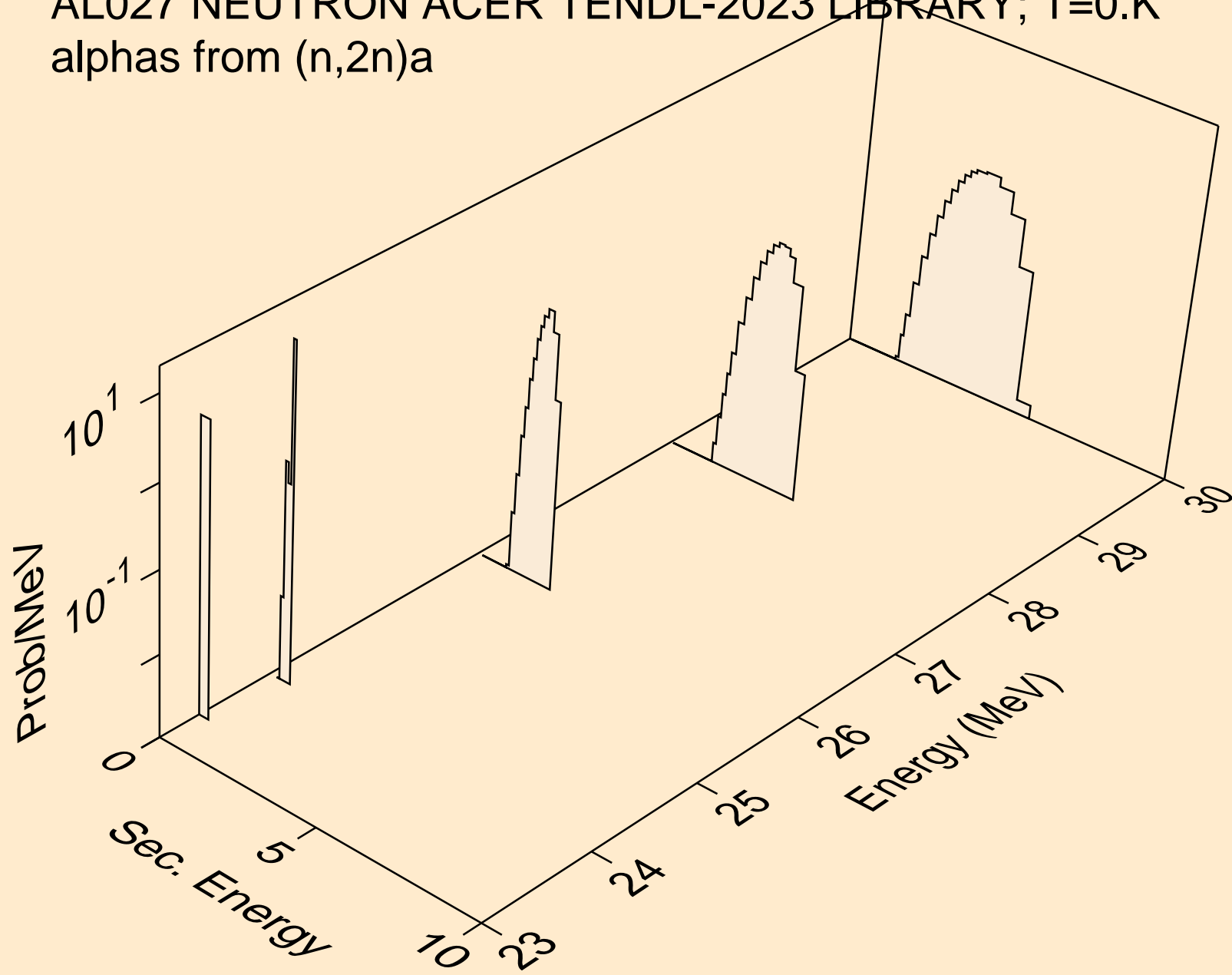

AL027 NEUTRON ACER TENDL-2023 LIBRARY; T=0.K  
alphas from (n,n\*)2a

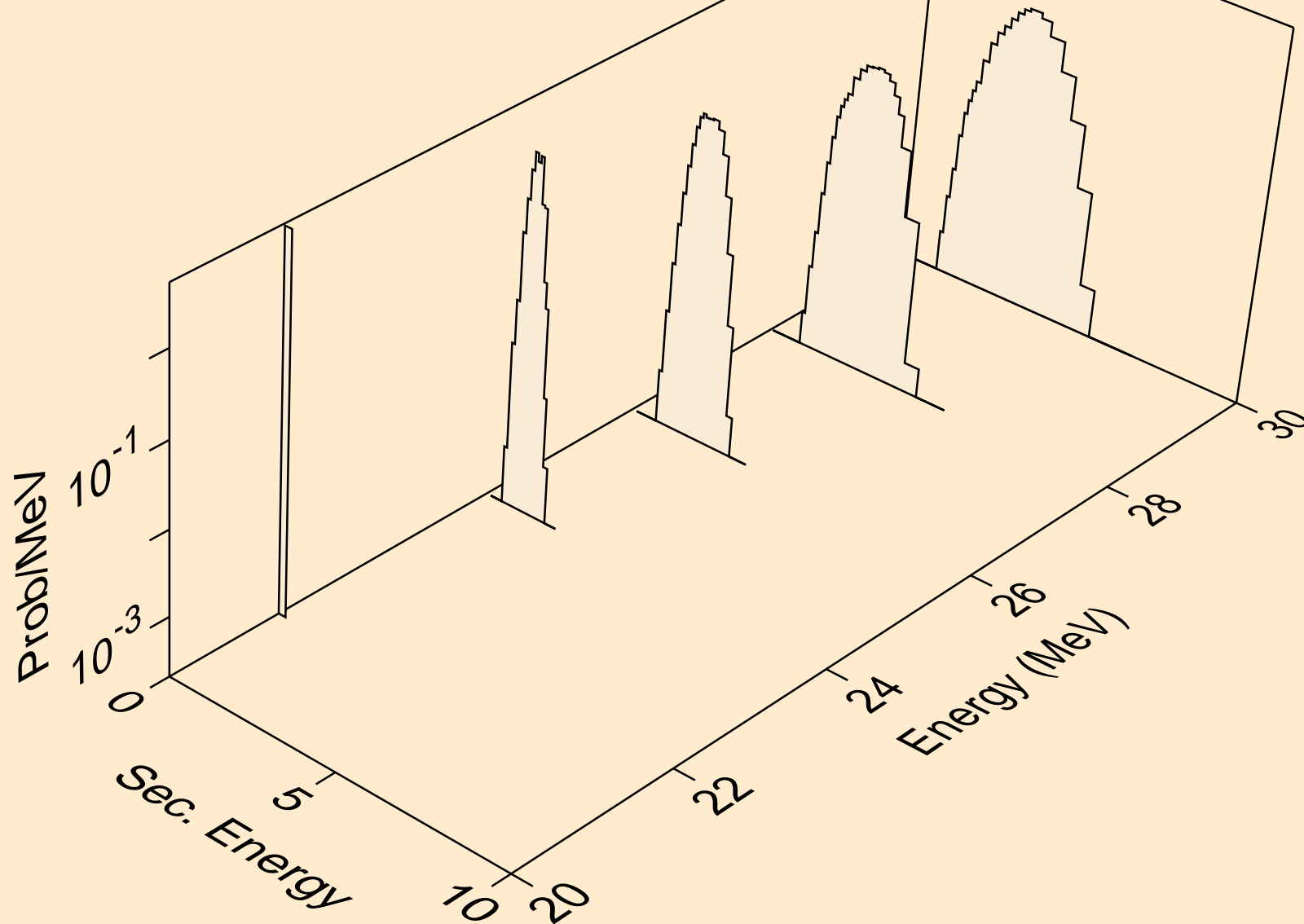

AL027 NEUTRON ACER TENDL-2023 LIBRARY; T=0.K  
alphas from (n,npa)

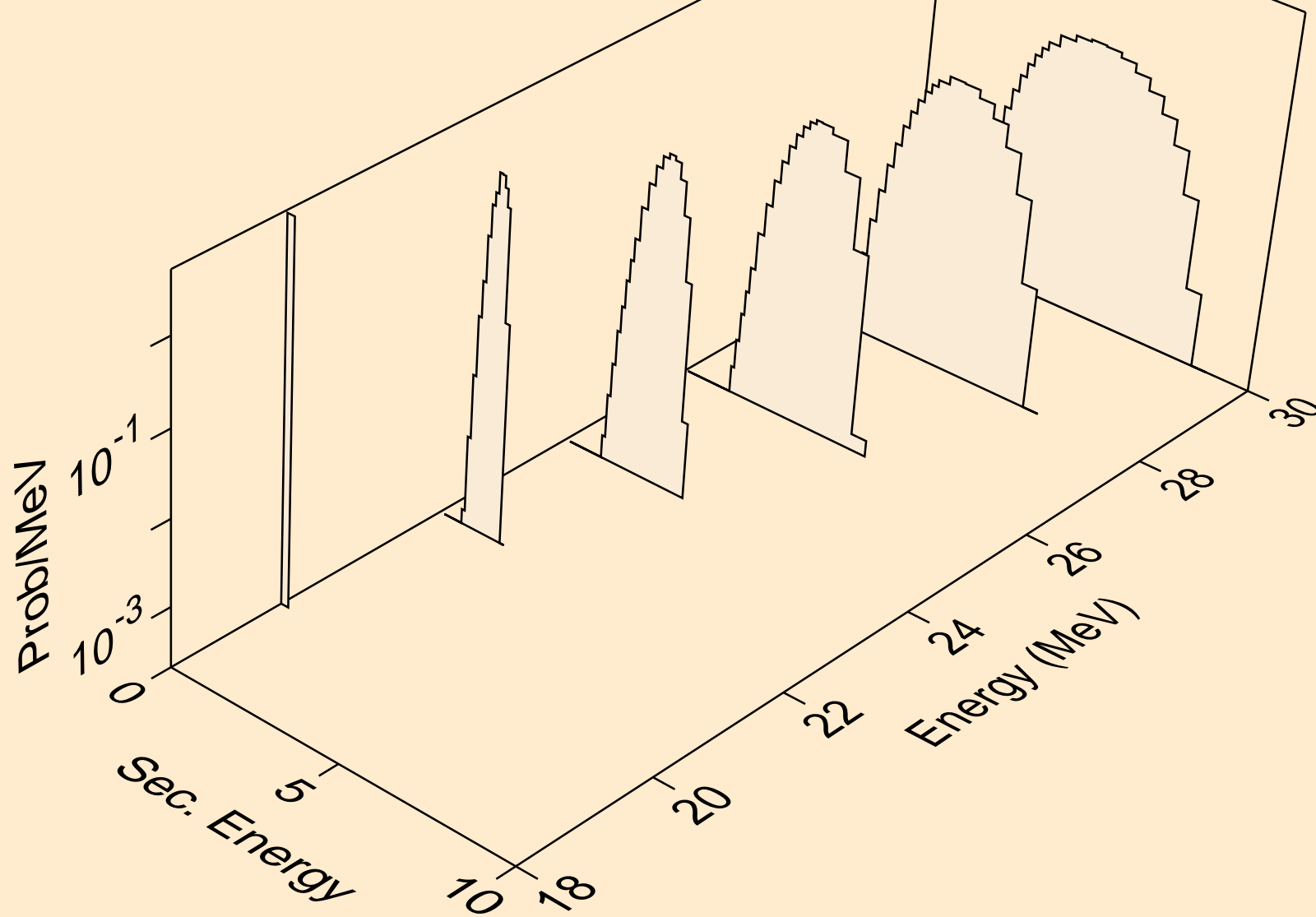

AL027 NEUTRON ACER TENDL-2023 LIBRARY; T=0.K  
alphas from (n,a)

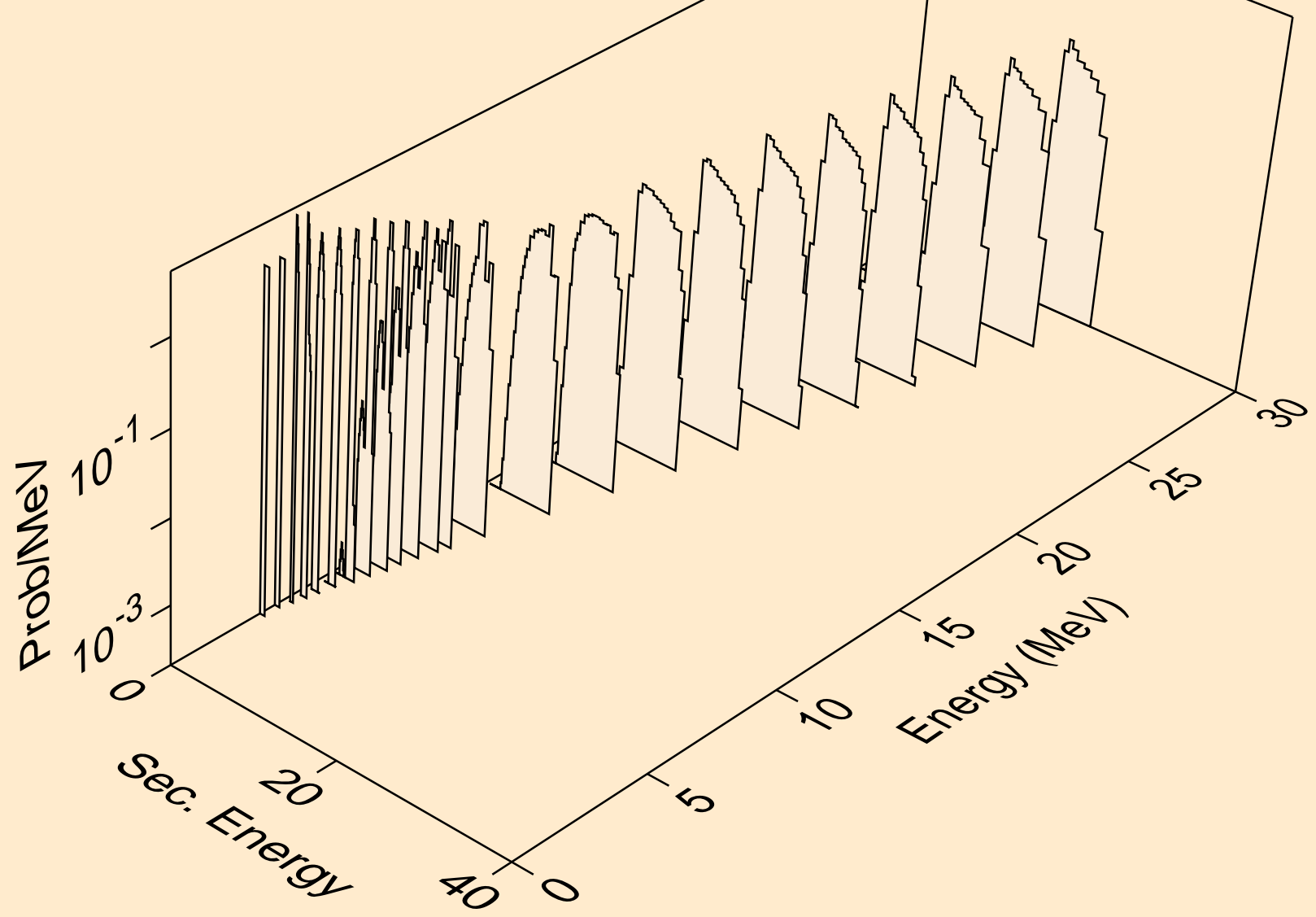

AL027 NEUTRON ACER TENDL-2023 LIBRARY; T=0.K  
alphas from (n,2a)

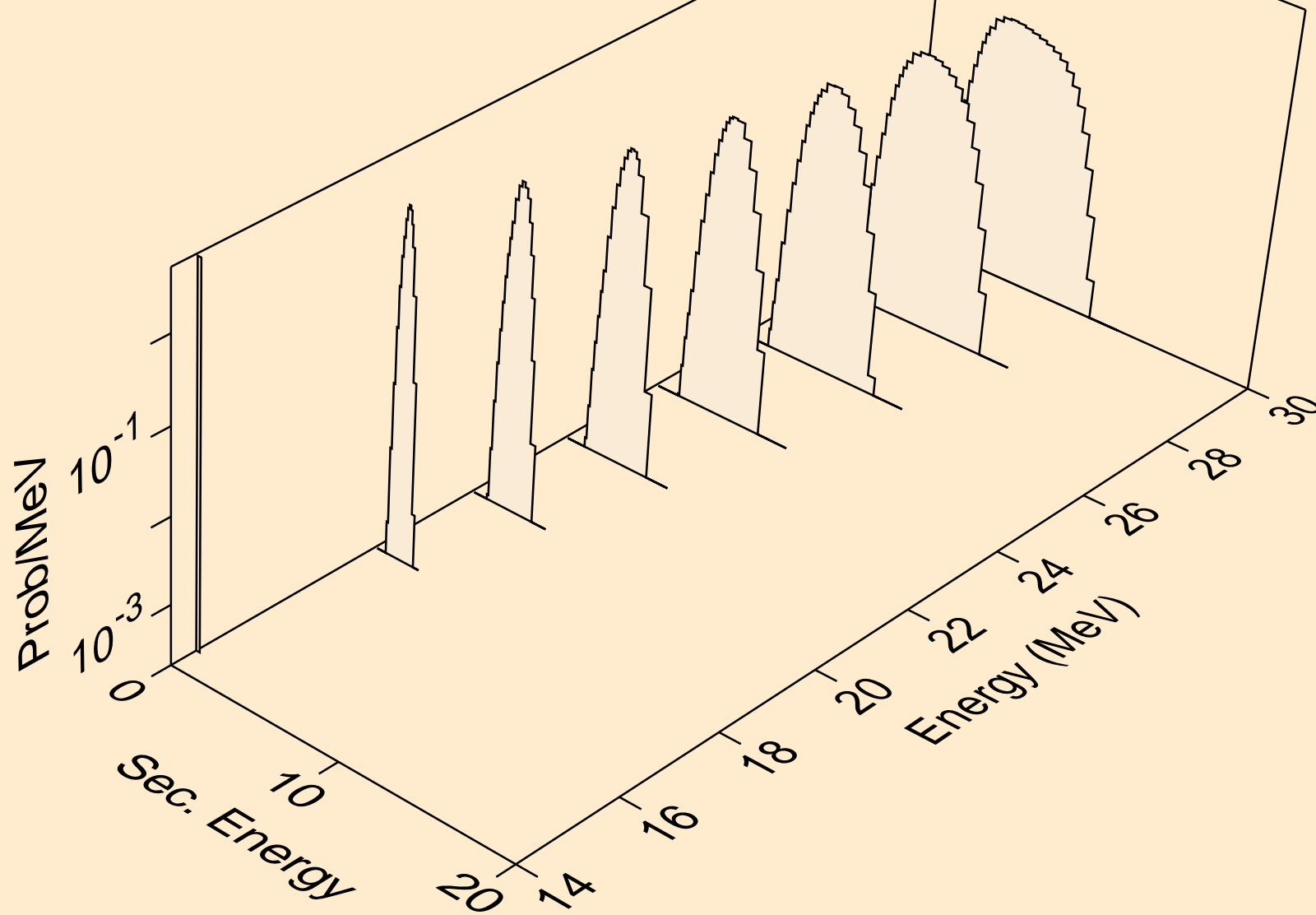

AL027 NEUTRON ACER TENDL-2023 LIBRARY; T=0.K  
alphas from (n,pa)

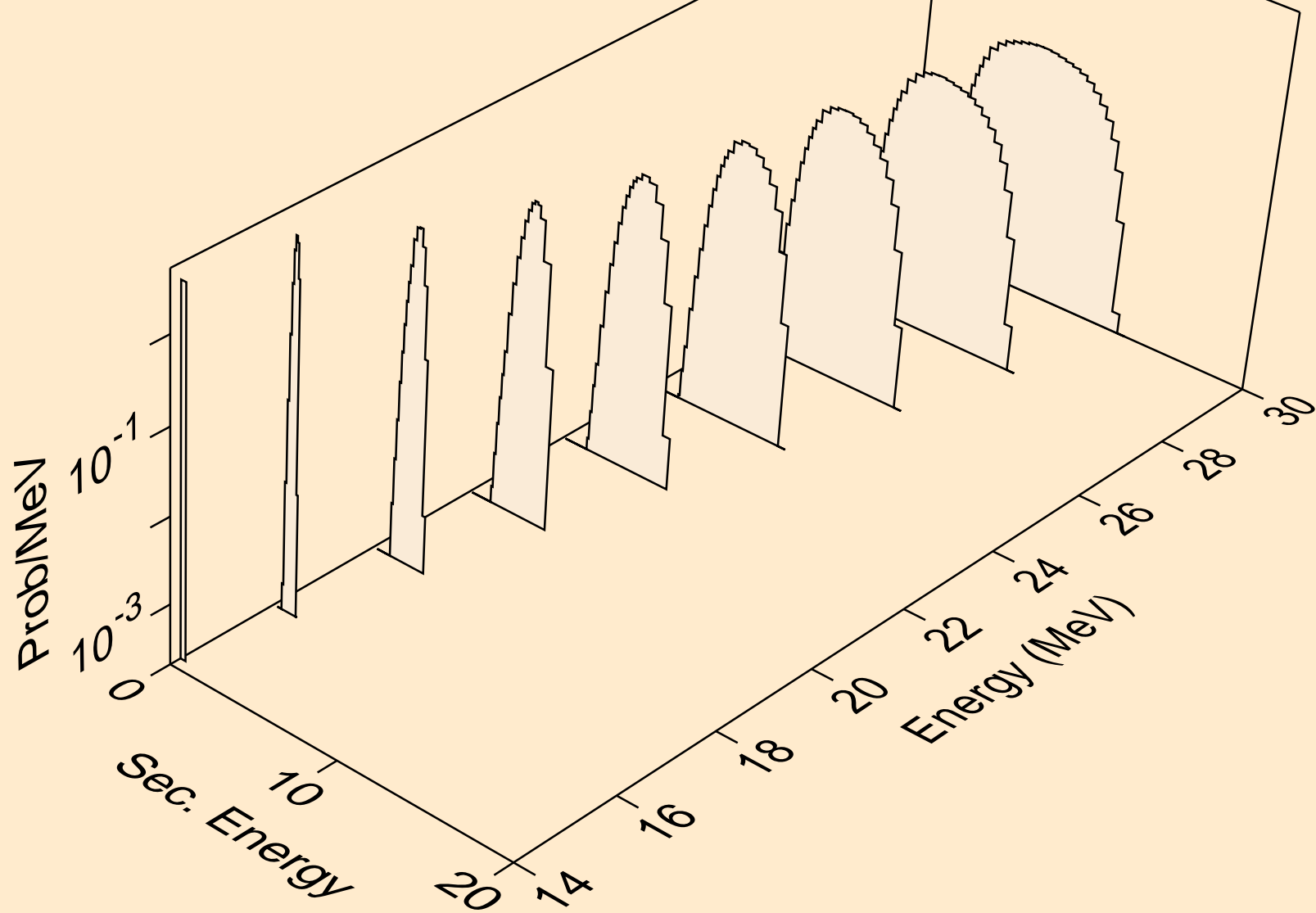

AL027 NEUTRON ACER TENDL-2023 LIBRARY; T=0.K  
alphas from (n,da)

