

AR044 NEUTRON ACER TENDL-2023 LIBRARY; T=0.K

Principal cross sections

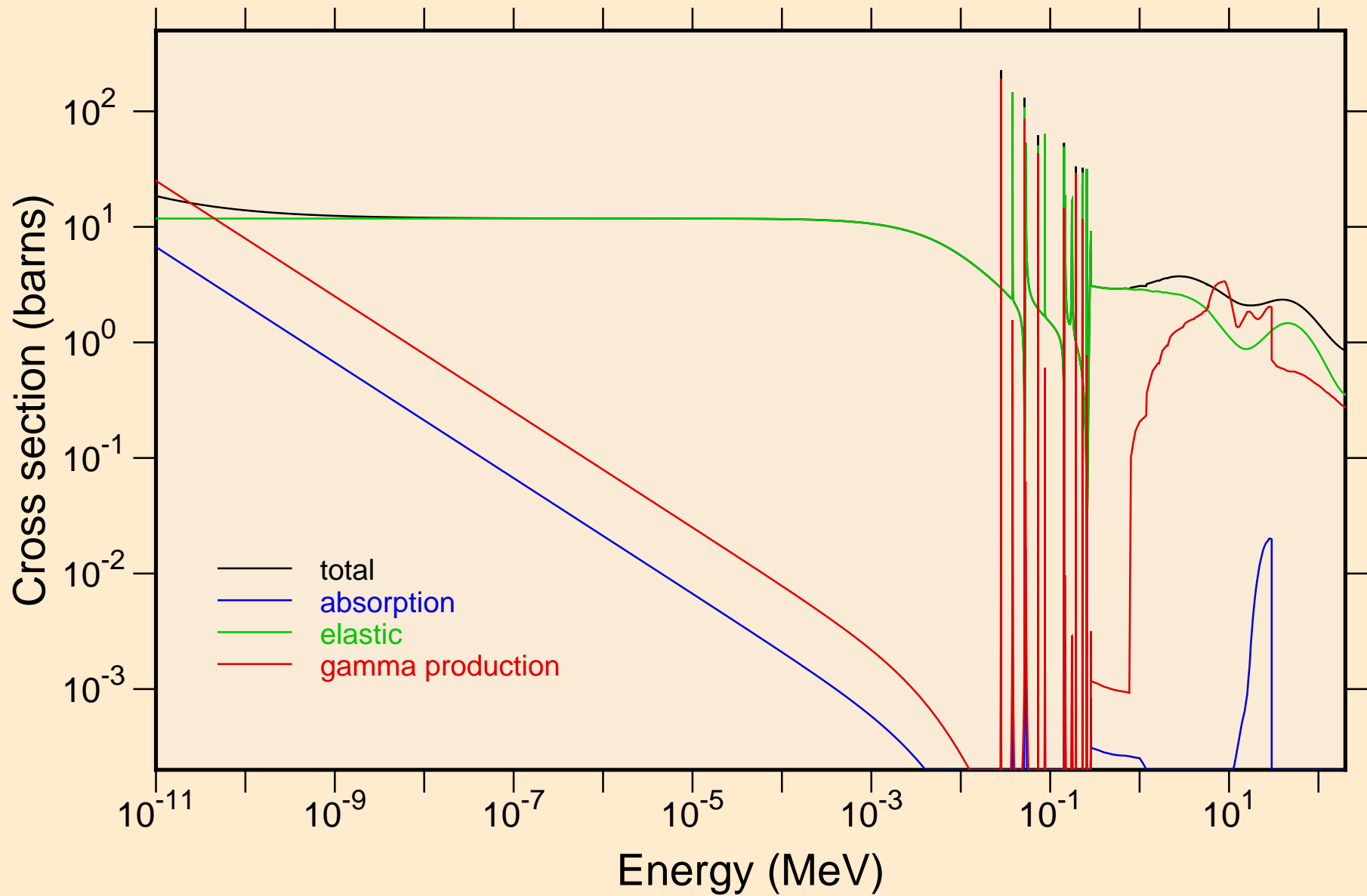

AR044 NEUTRON ACER TENDL-2023 LIBRARY; T=0.K
resonance total cross section

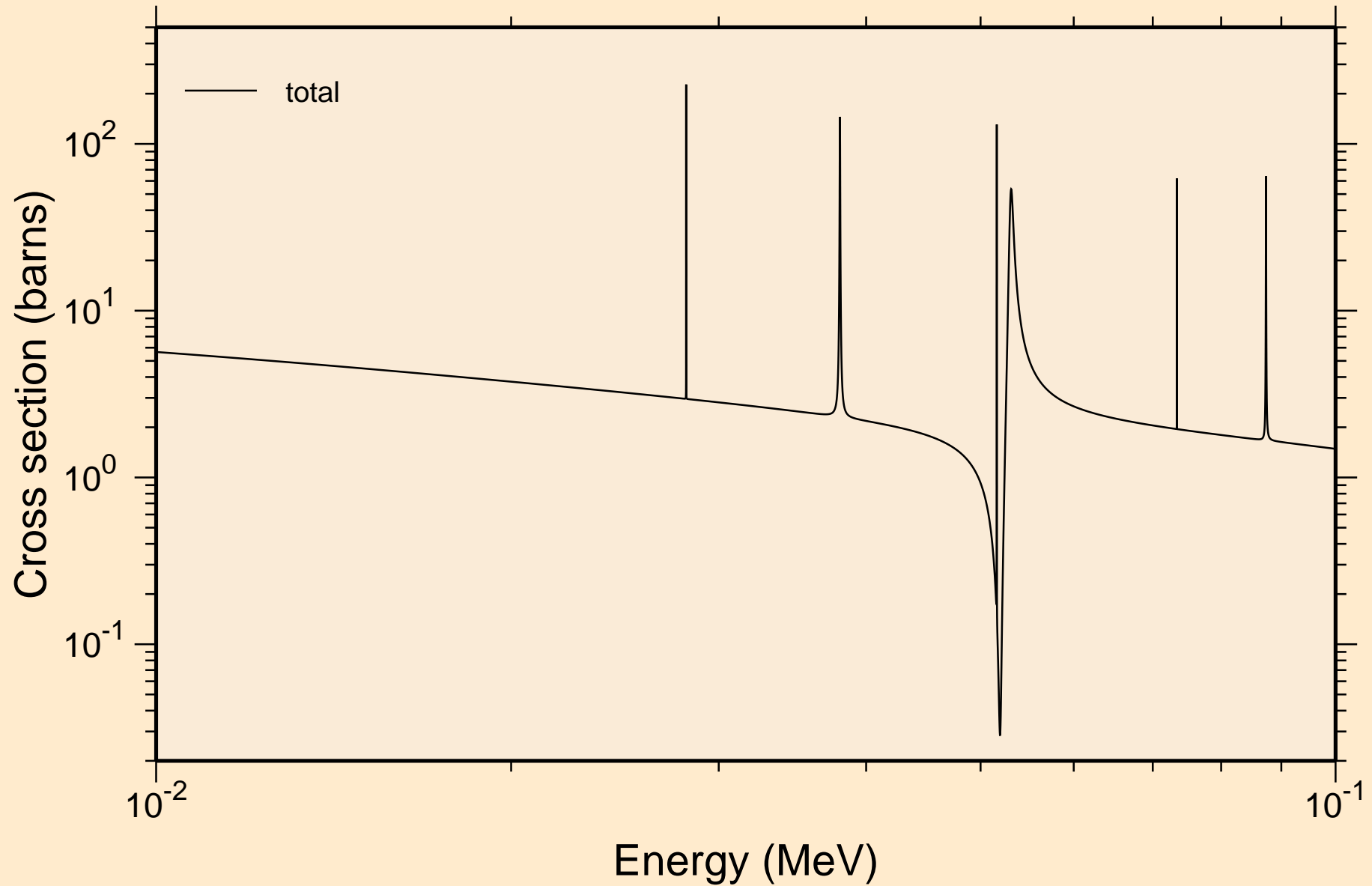

AR044 NEUTRON ACER TENDL-2023 LIBRARY; T=0.K
resonance total cross section

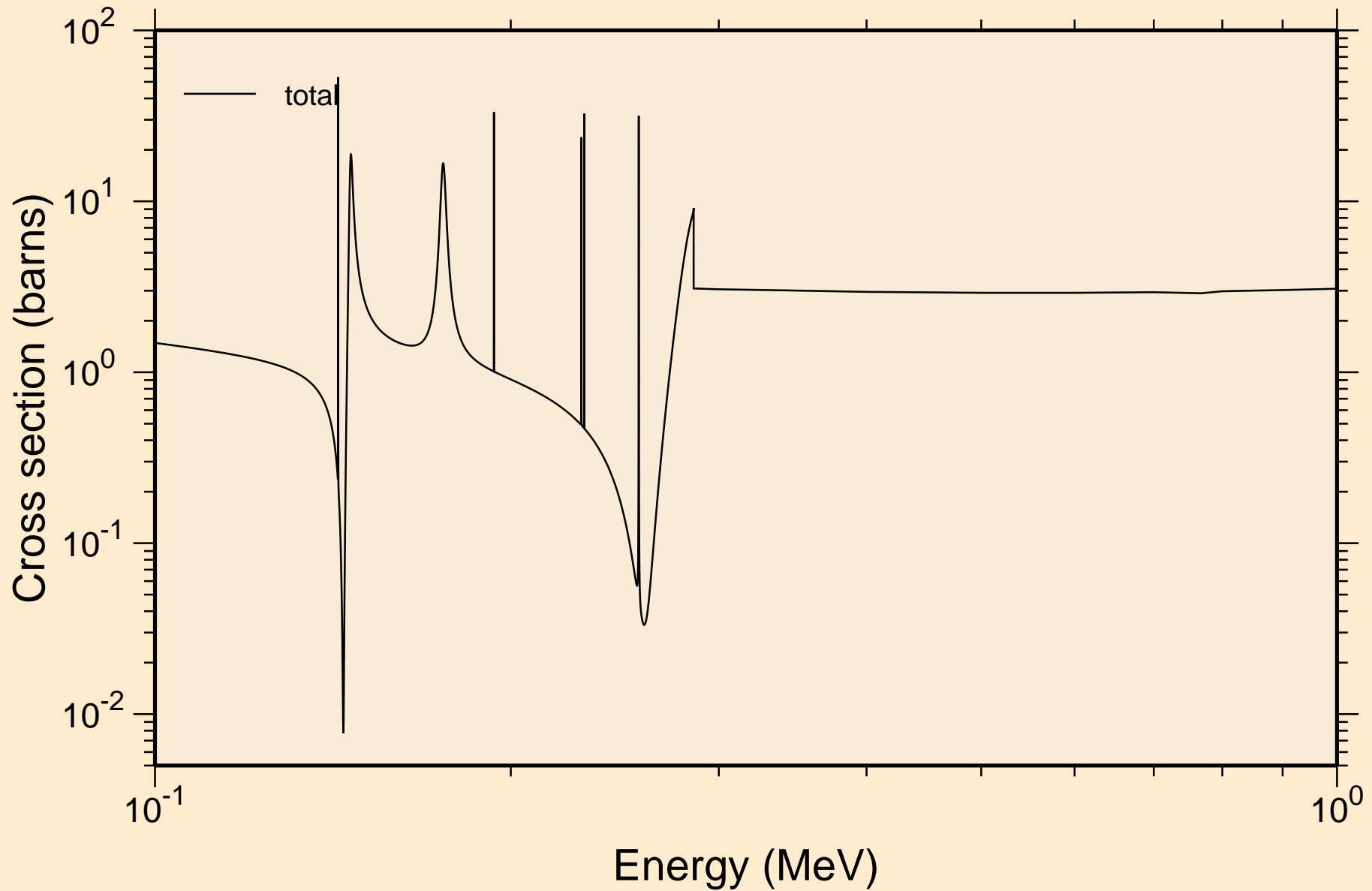

AR044 NEUTRON ACER TENDL-2023 LIBRARY; T=0.K
resonance total cross section

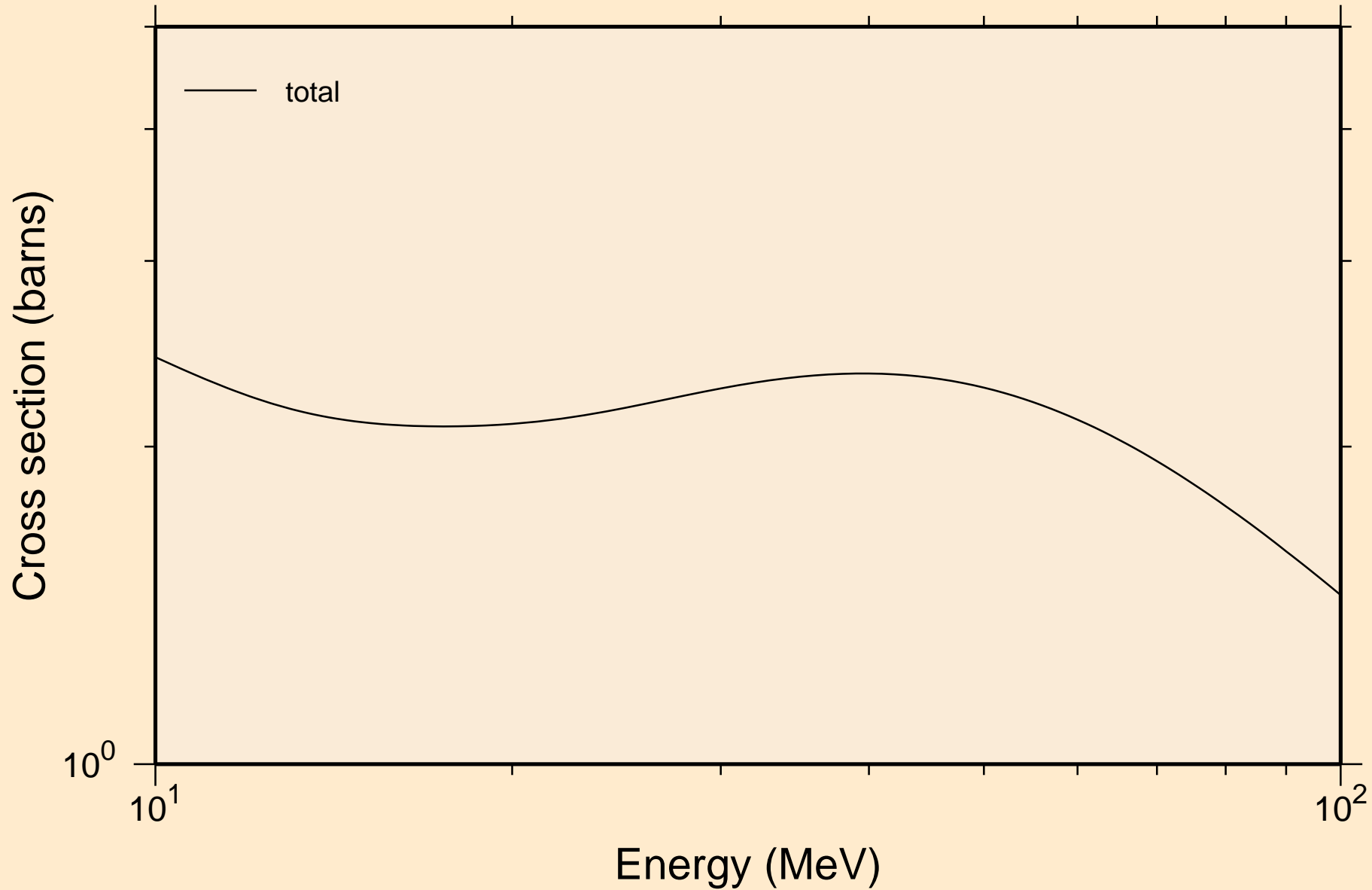

AR044 NEUTRON ACER TENDL-2023 LIBRARY; T=0.K
resonance absorption cross sections

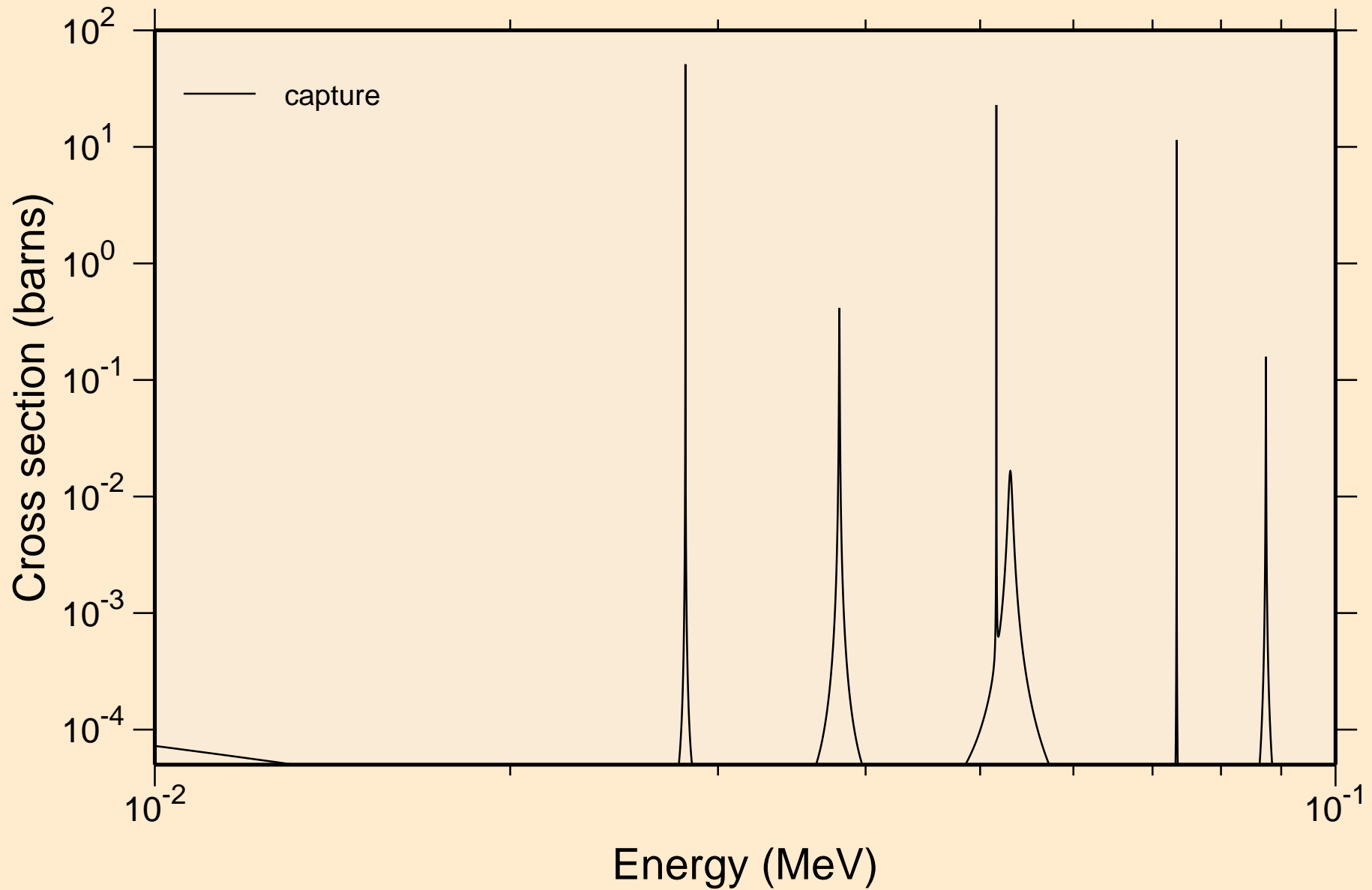

AR044 NEUTRON ACER TENDL-2023 LIBRARY; T=0.K
resonance absorption cross sections

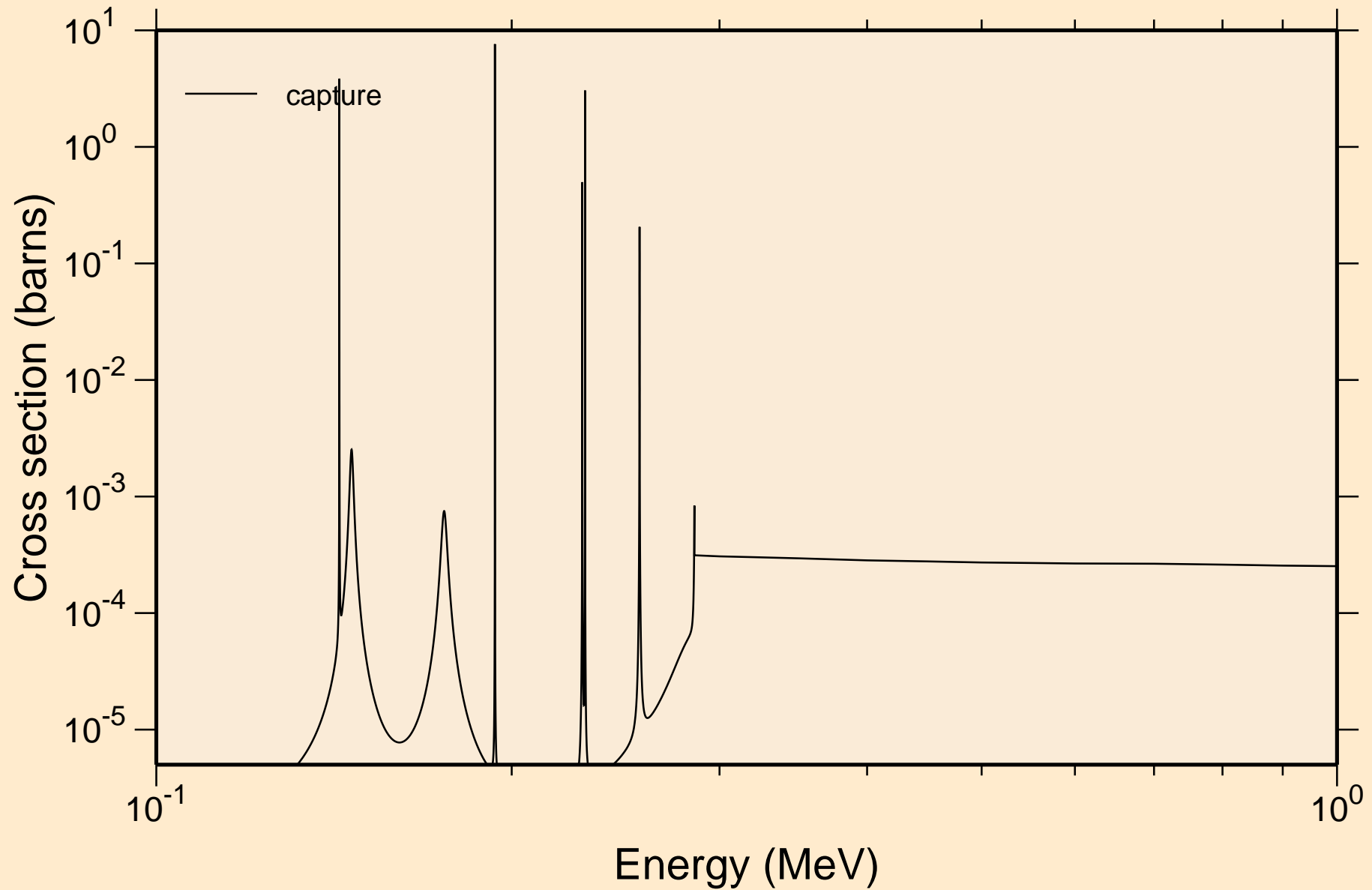

AR044 NEUTRON ACER TENDL-2023 LIBRARY; T=0.K
resonance absorption cross sections

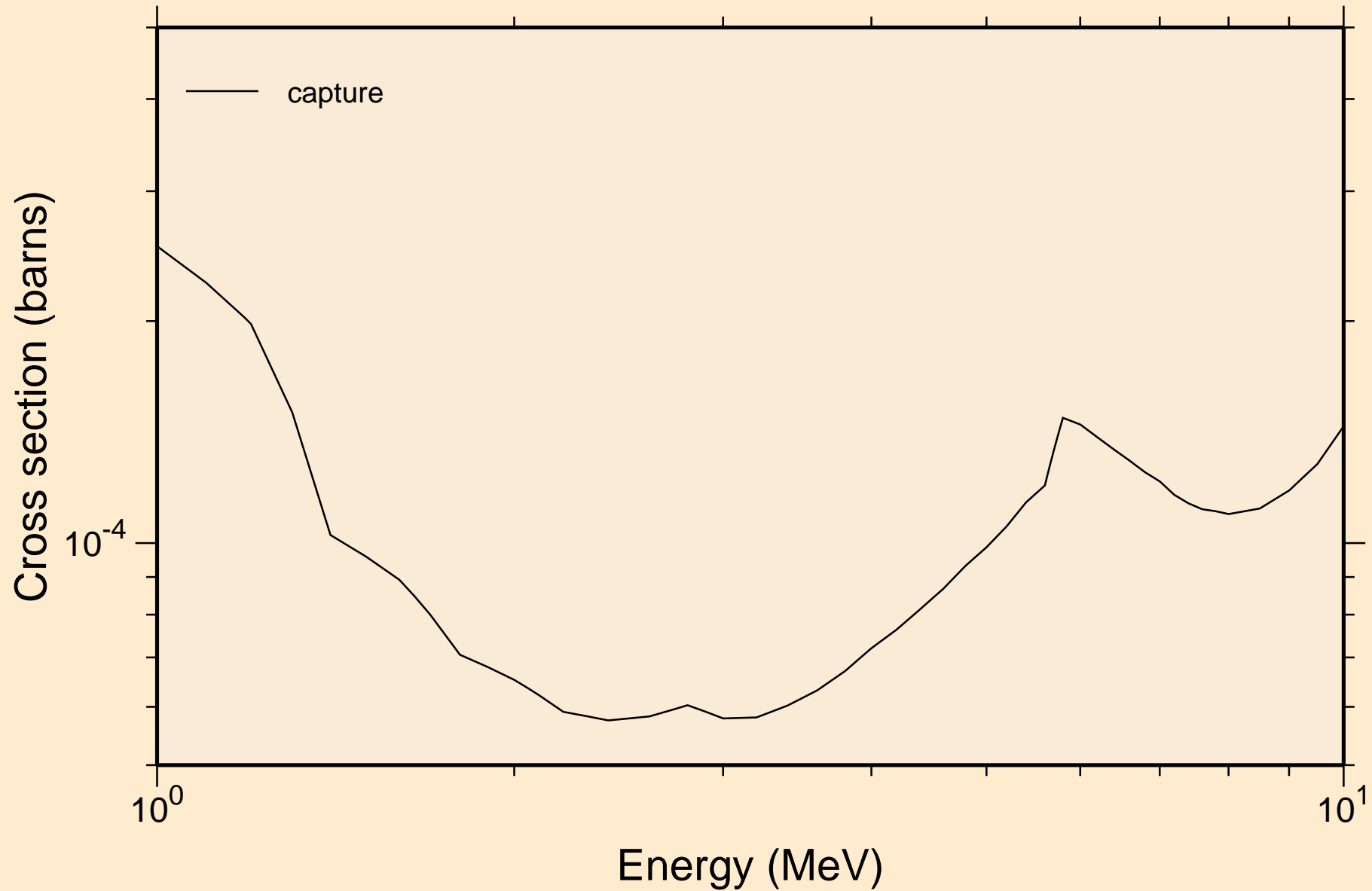

AR044 NEUTRON ACER TENDL-2023 LIBRARY; T=0.K
Heating

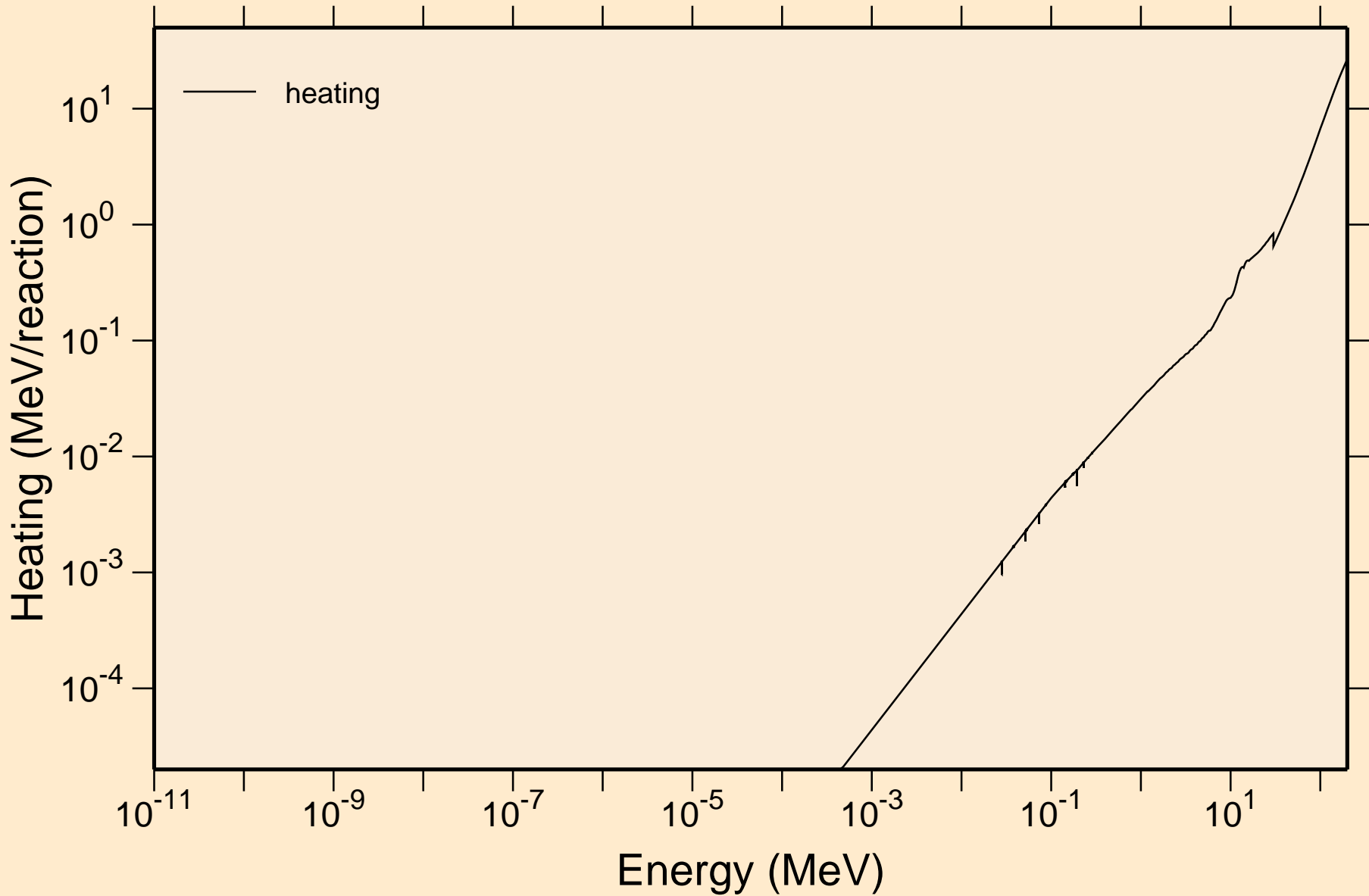

AR044 NEUTRON ACER TENDL-2023 LIBRARY; T=0.K
Damage

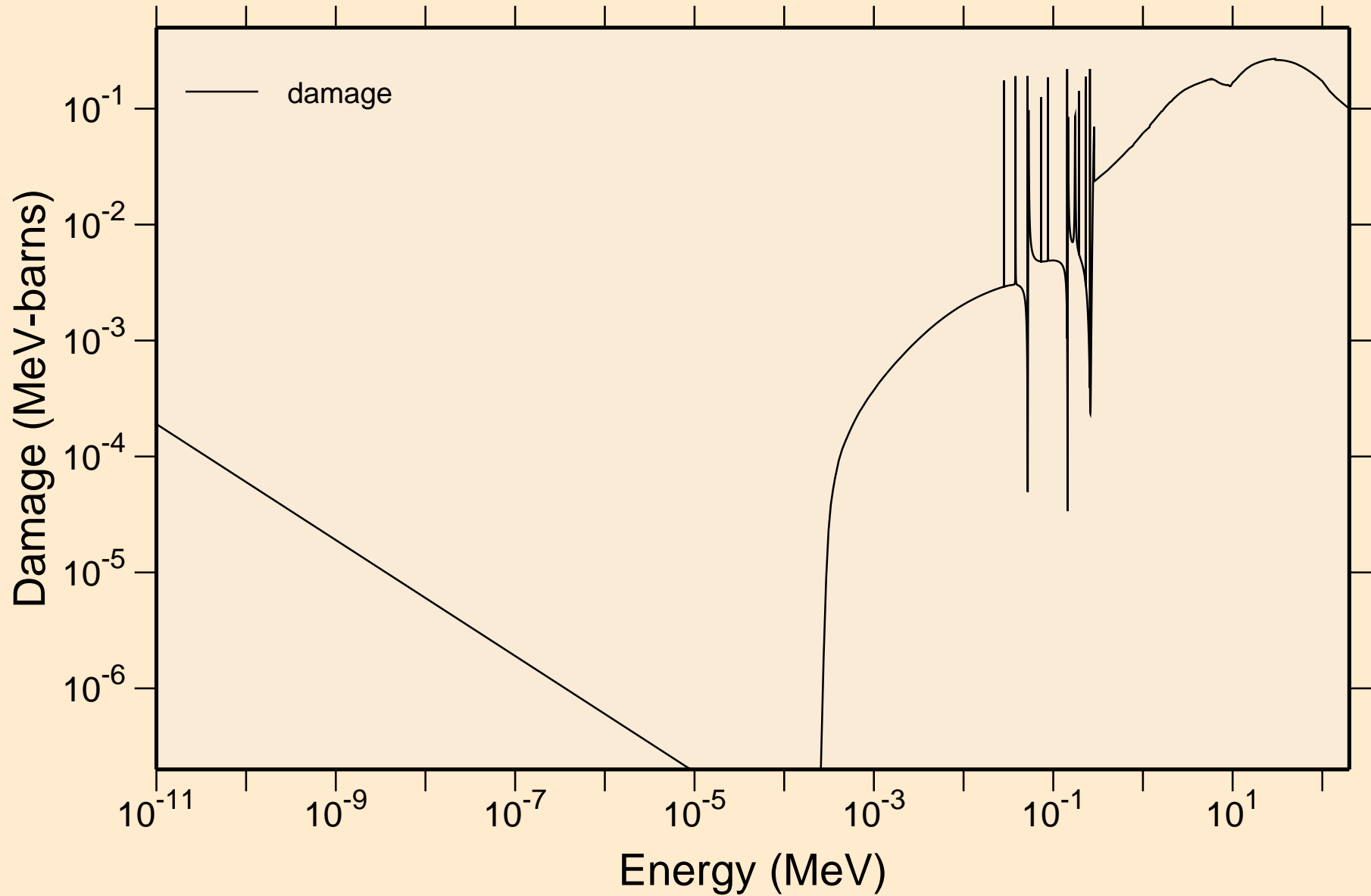

AR044 NEUTRON ACER TENDL-2023 LIBRARY; T=0.K
Non-threshold reactions

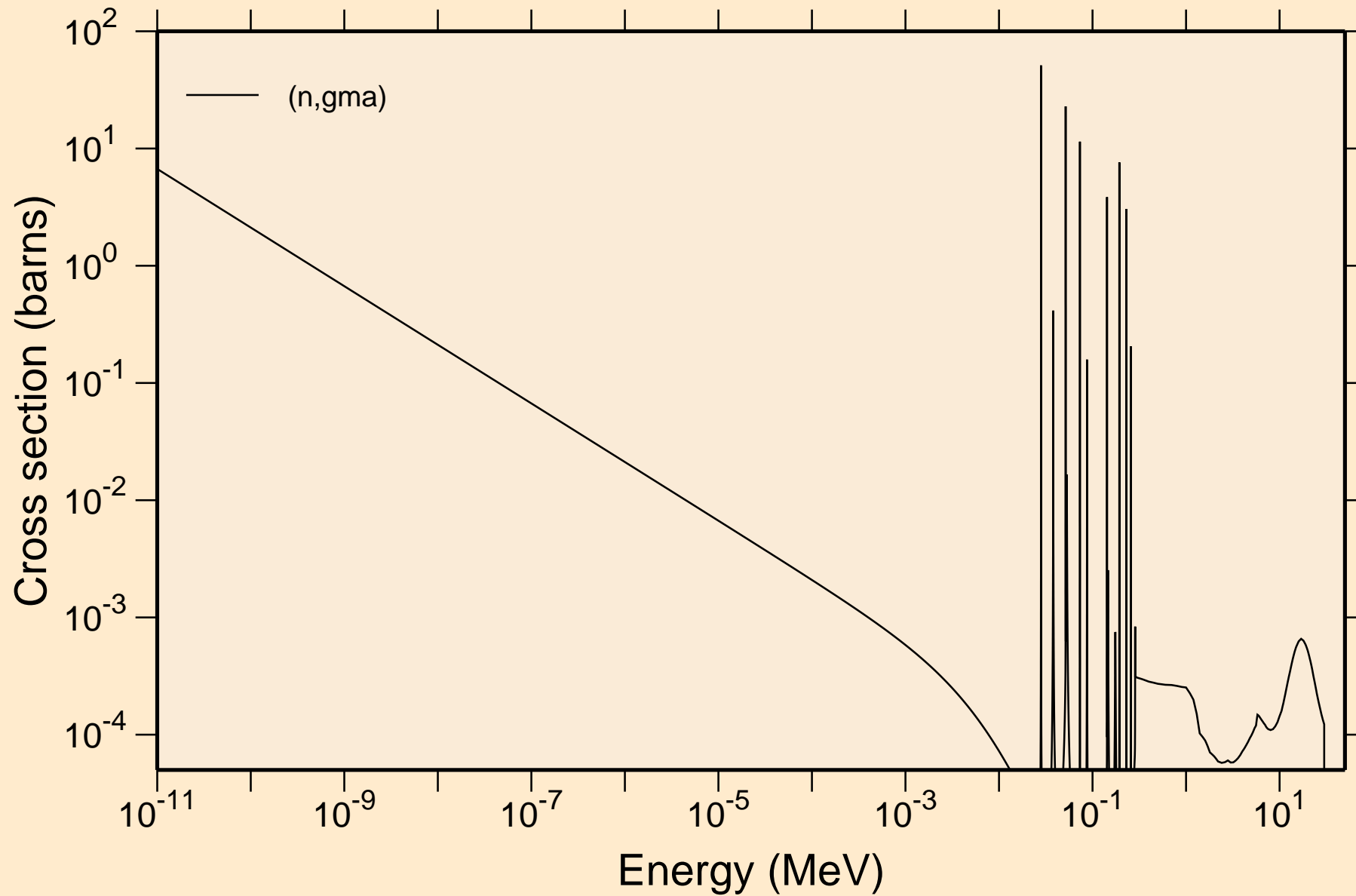

AR044 NEUTRON ACER TENDL-2023 LIBRARY; T=0.K

Principal cross sections

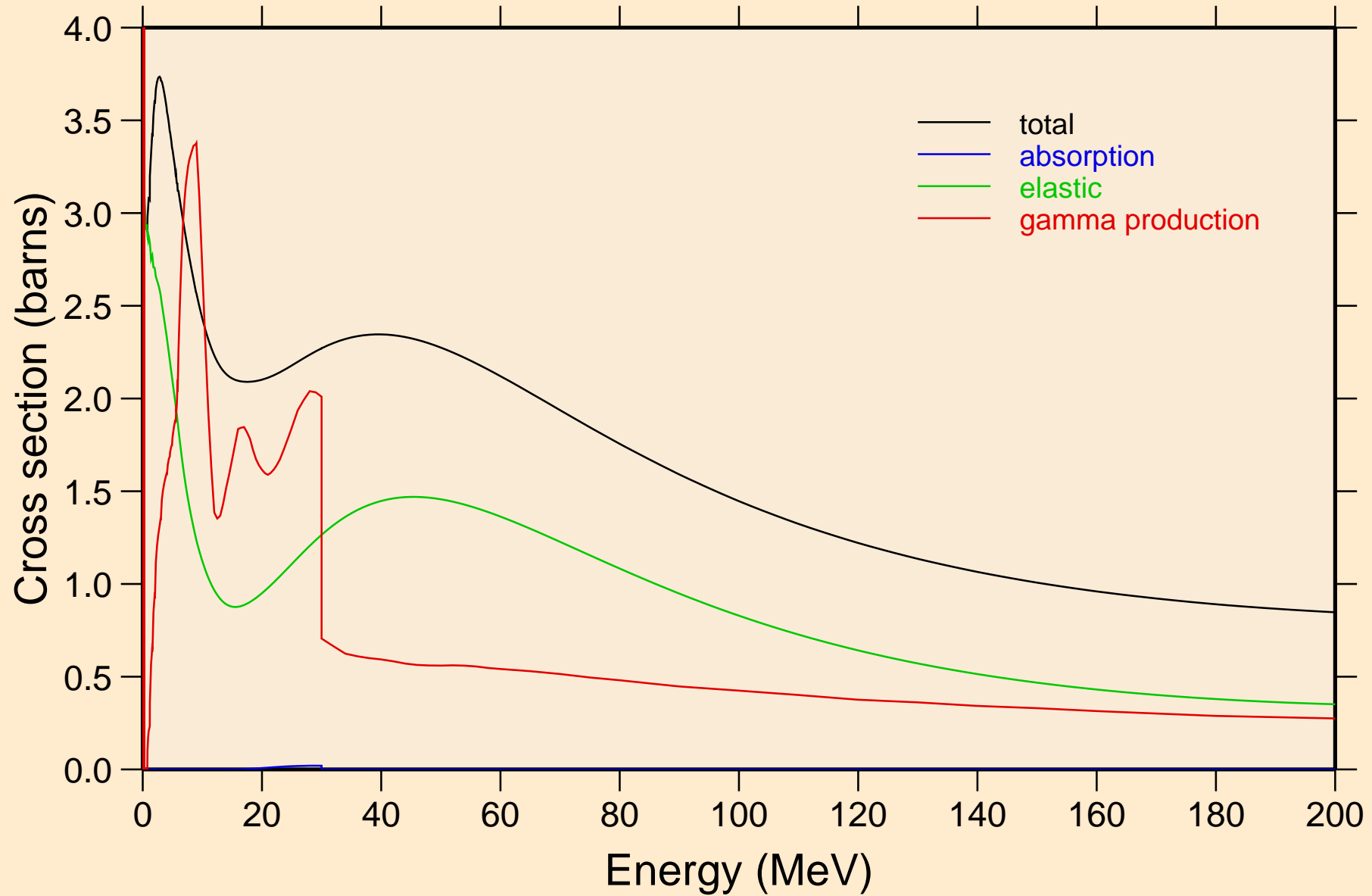

AR044 NEUTRON ACER TENDL-2023 LIBRARY; T=0.K

Heating

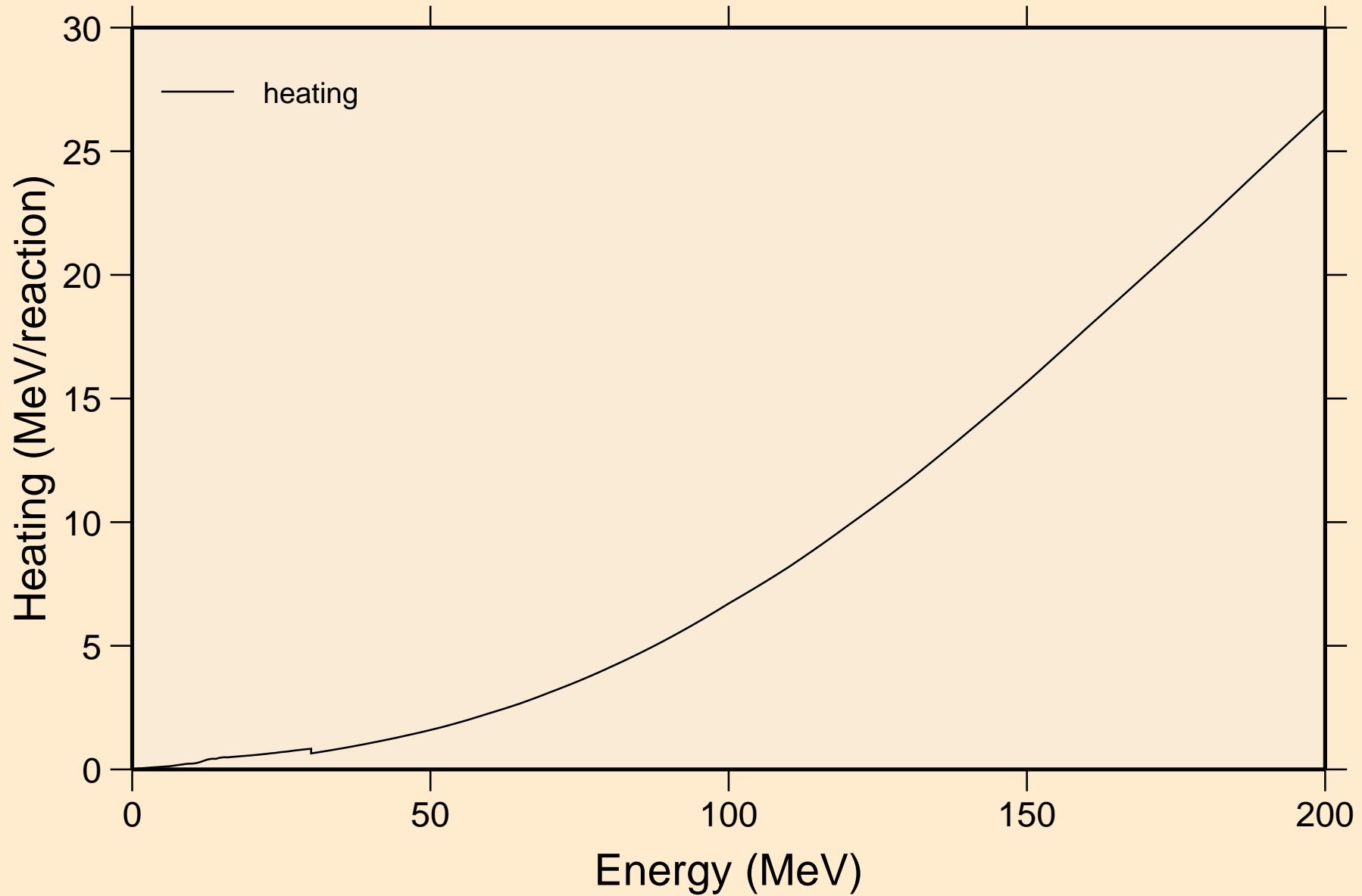

AR044 NEUTRON ACER TENDL-2023 LIBRARY; T=0.K

Damage

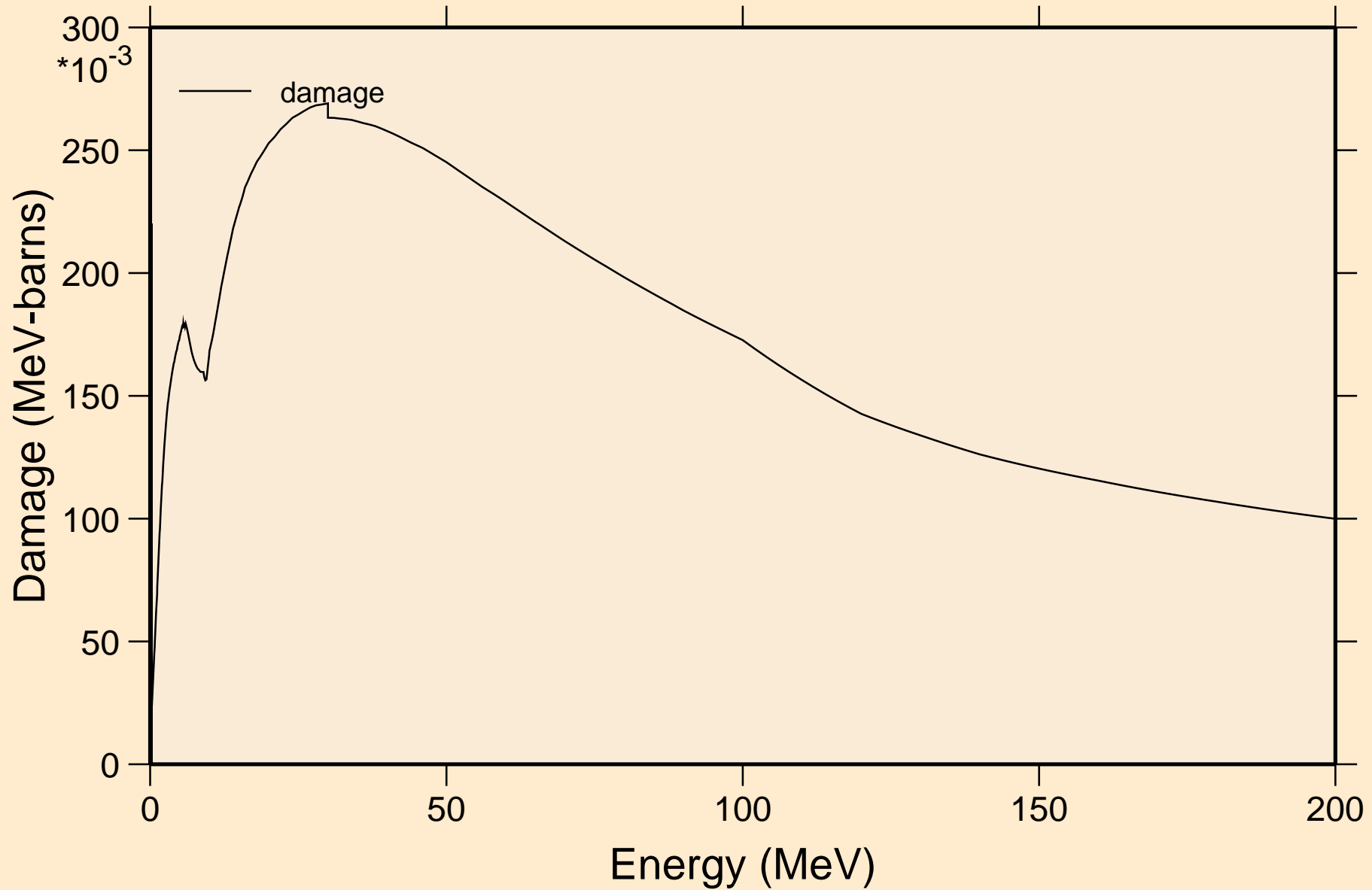

AR044 NEUTRON ACER TENDL-2023 LIBRARY; T=0.K
Non-threshold reactions

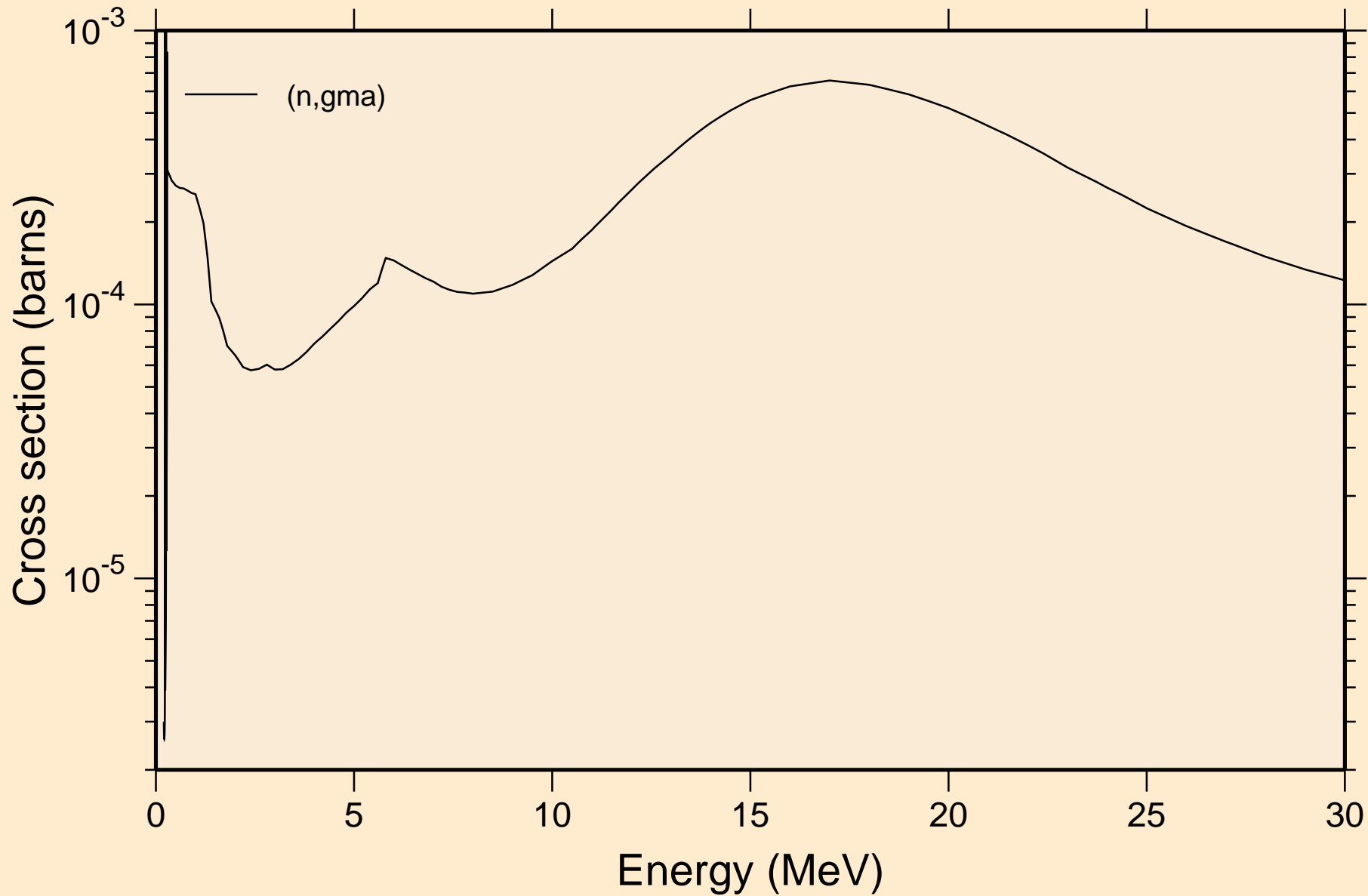

AR044 NEUTRON ACER TENDL-2023 LIBRARY; T=0.K
Inelastic levels

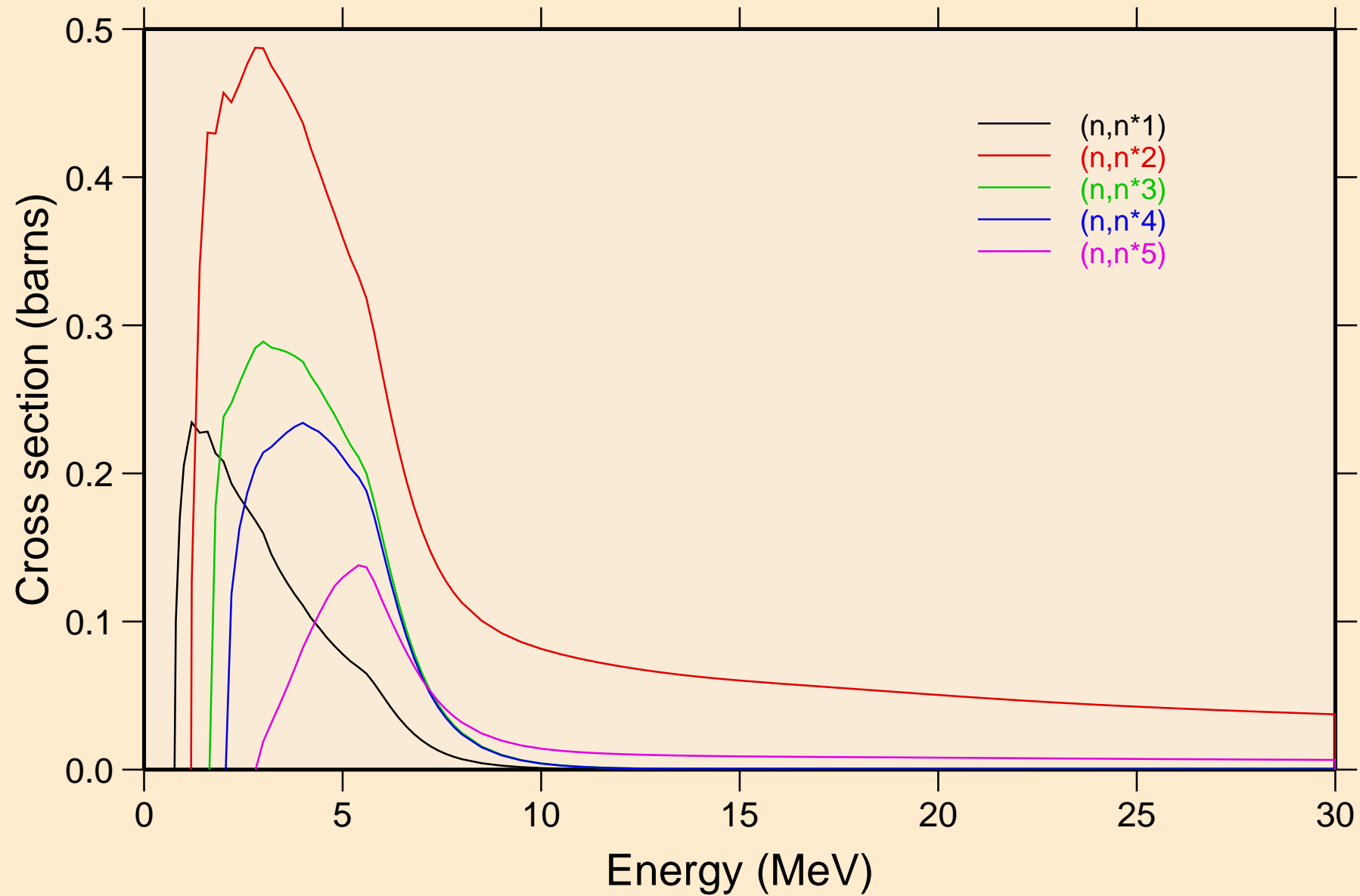

AR044 NEUTRON ACER TENDL-2023 LIBRARY; T=0.K
Inelastic levels

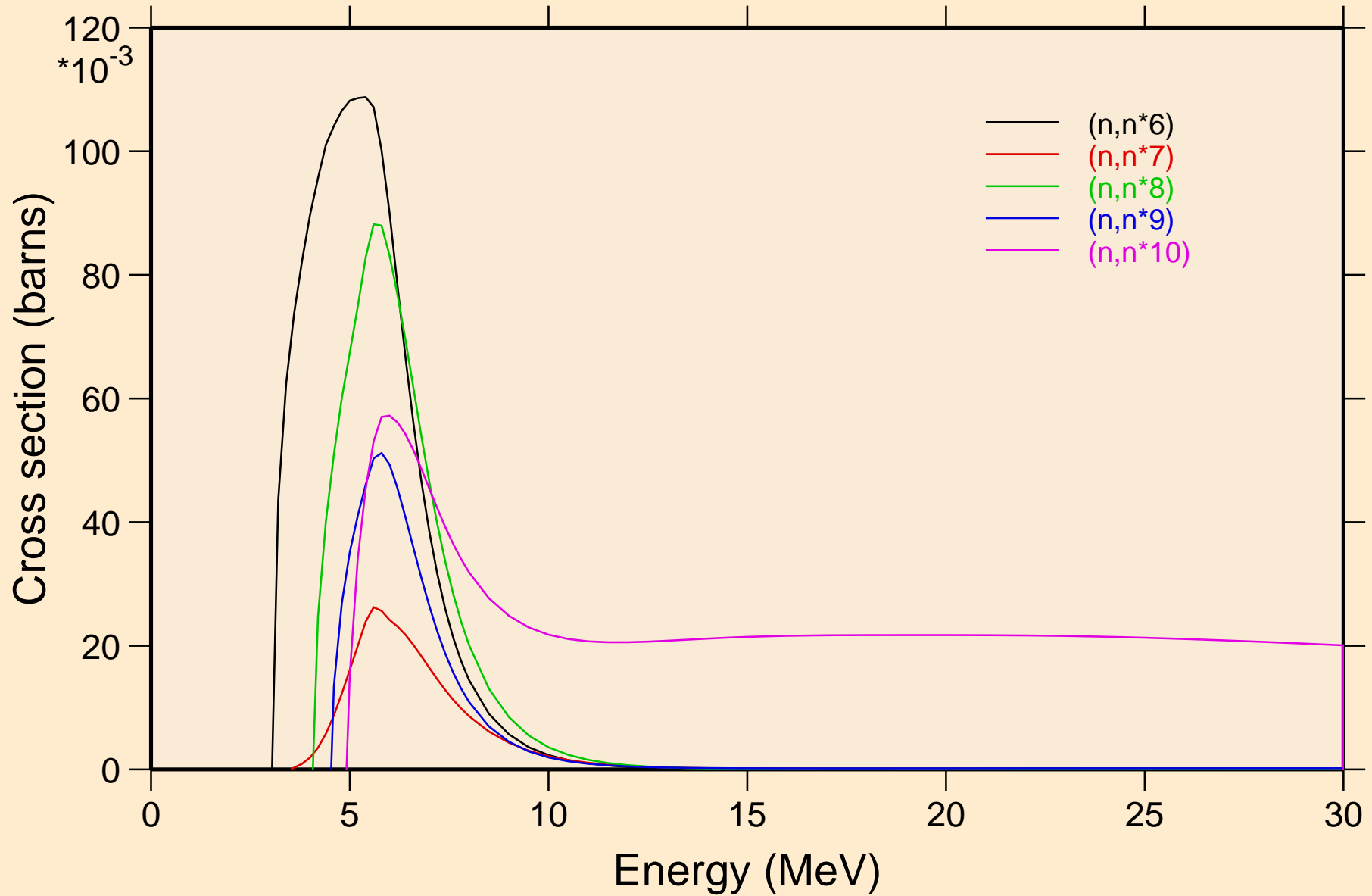

AR044 NEUTRON ACER TENDL-2023 LIBRARY; T=0.K
Inelastic levels

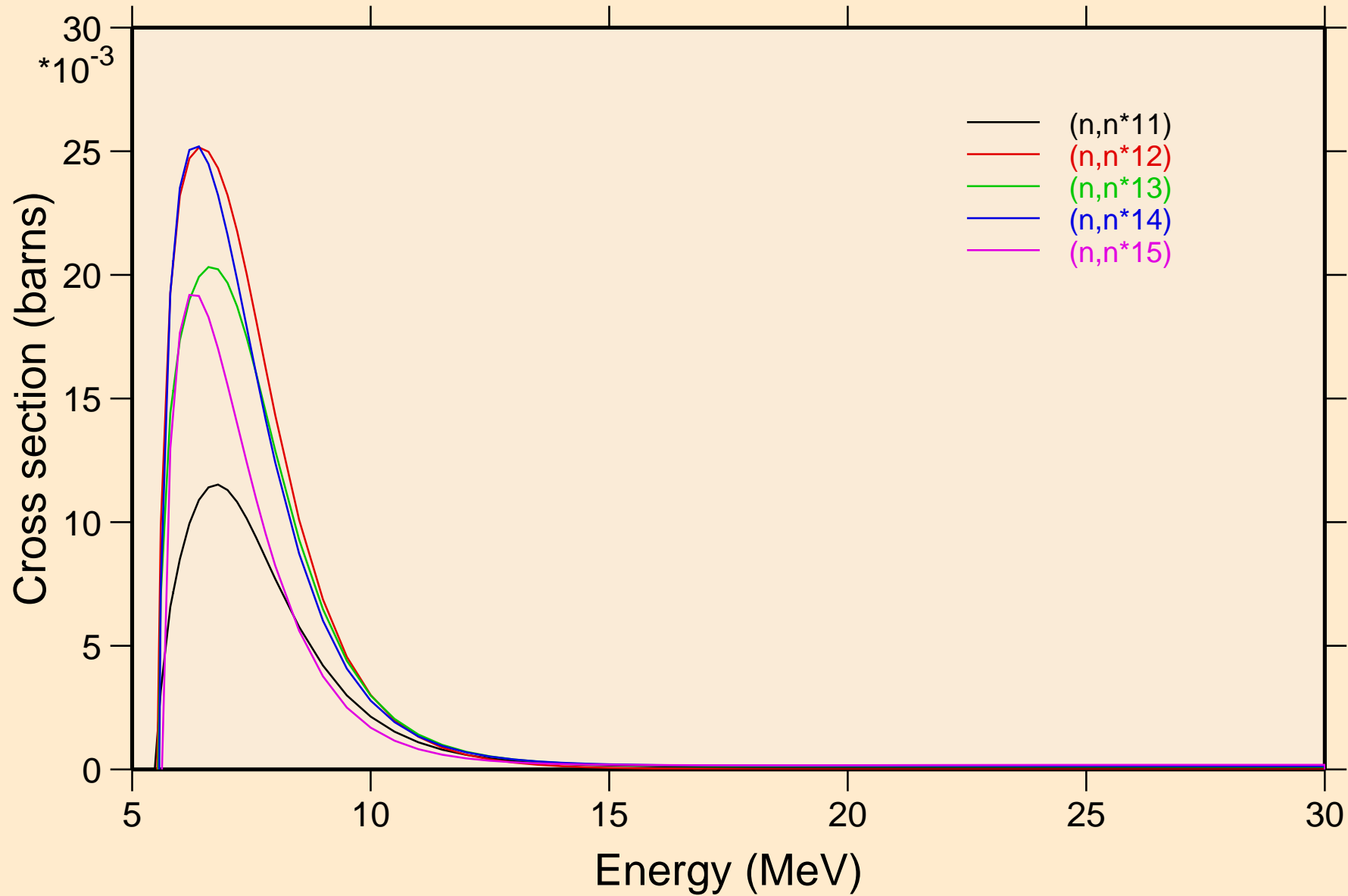

AR044 NEUTRON ACER TENDL-2023 LIBRARY; T=0.K
Inelastic levels

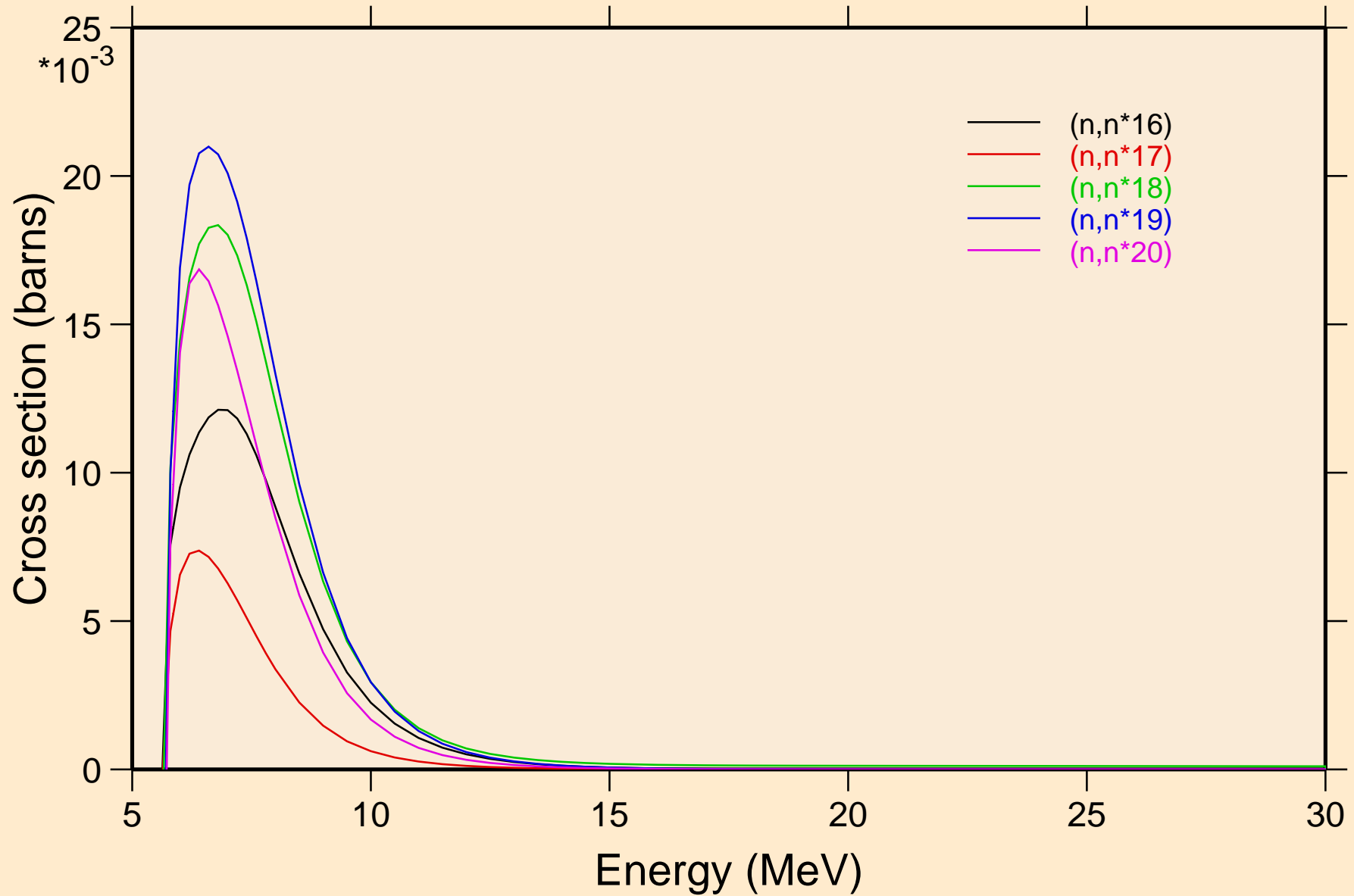

AR044 NEUTRON ACER TENDL-2023 LIBRARY; T=0.K
Inelastic levels

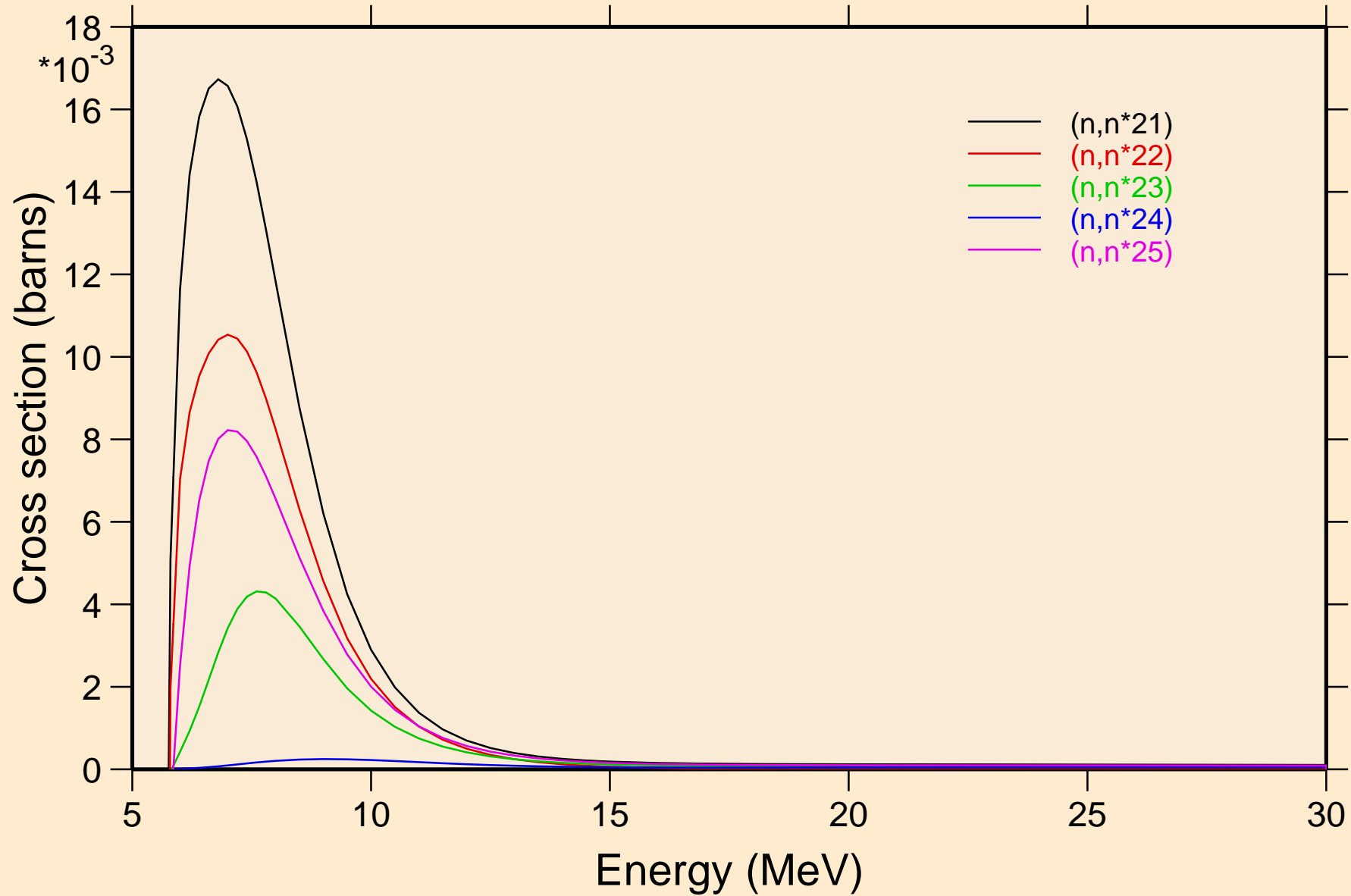

AR044 NEUTRON ACER TENDL-2023 LIBRARY; T=0.K
Inelastic levels

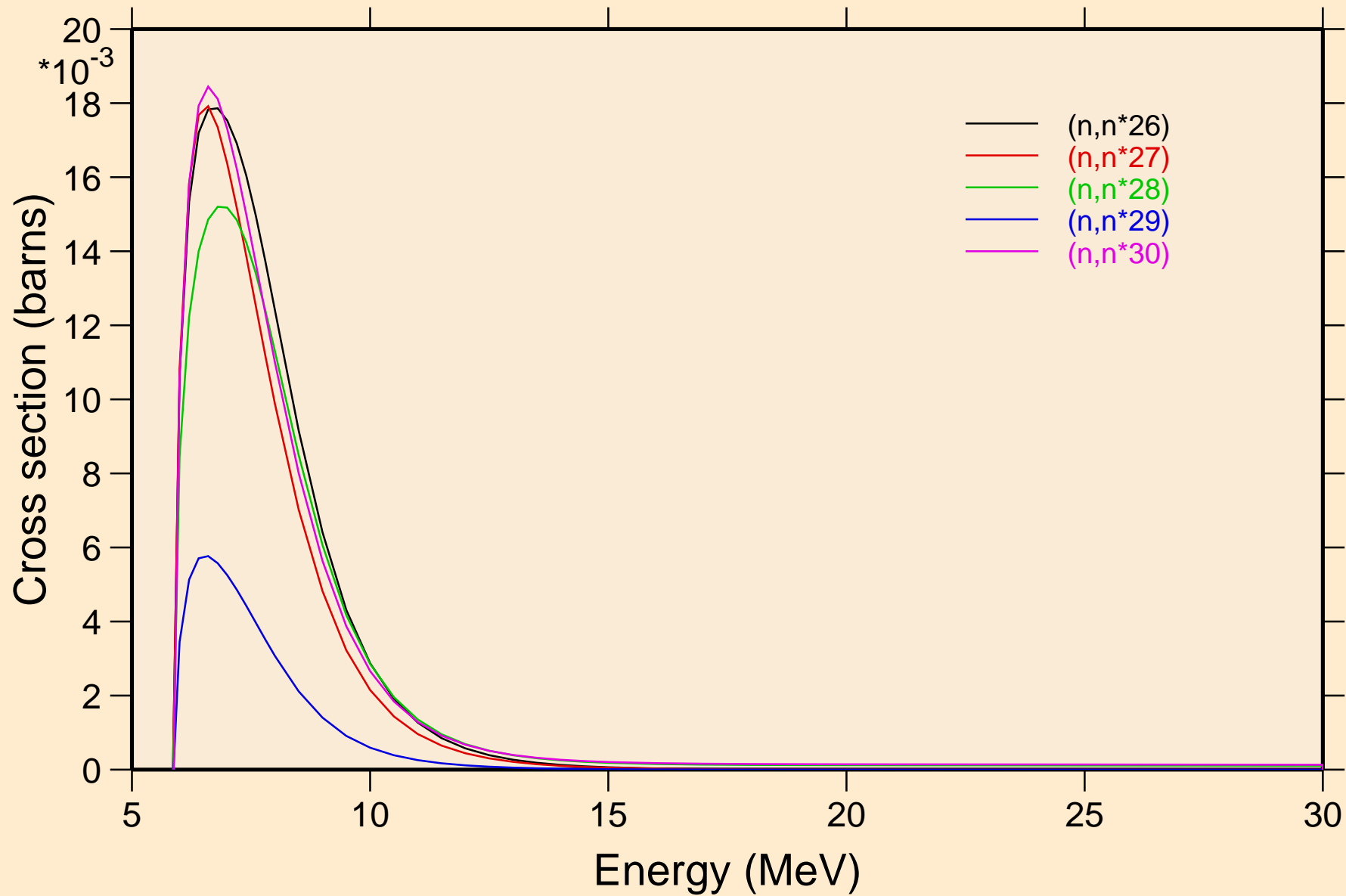

AR044 NEUTRON ACER TENDL-2023 LIBRARY; T=0.K
Threshold reactions

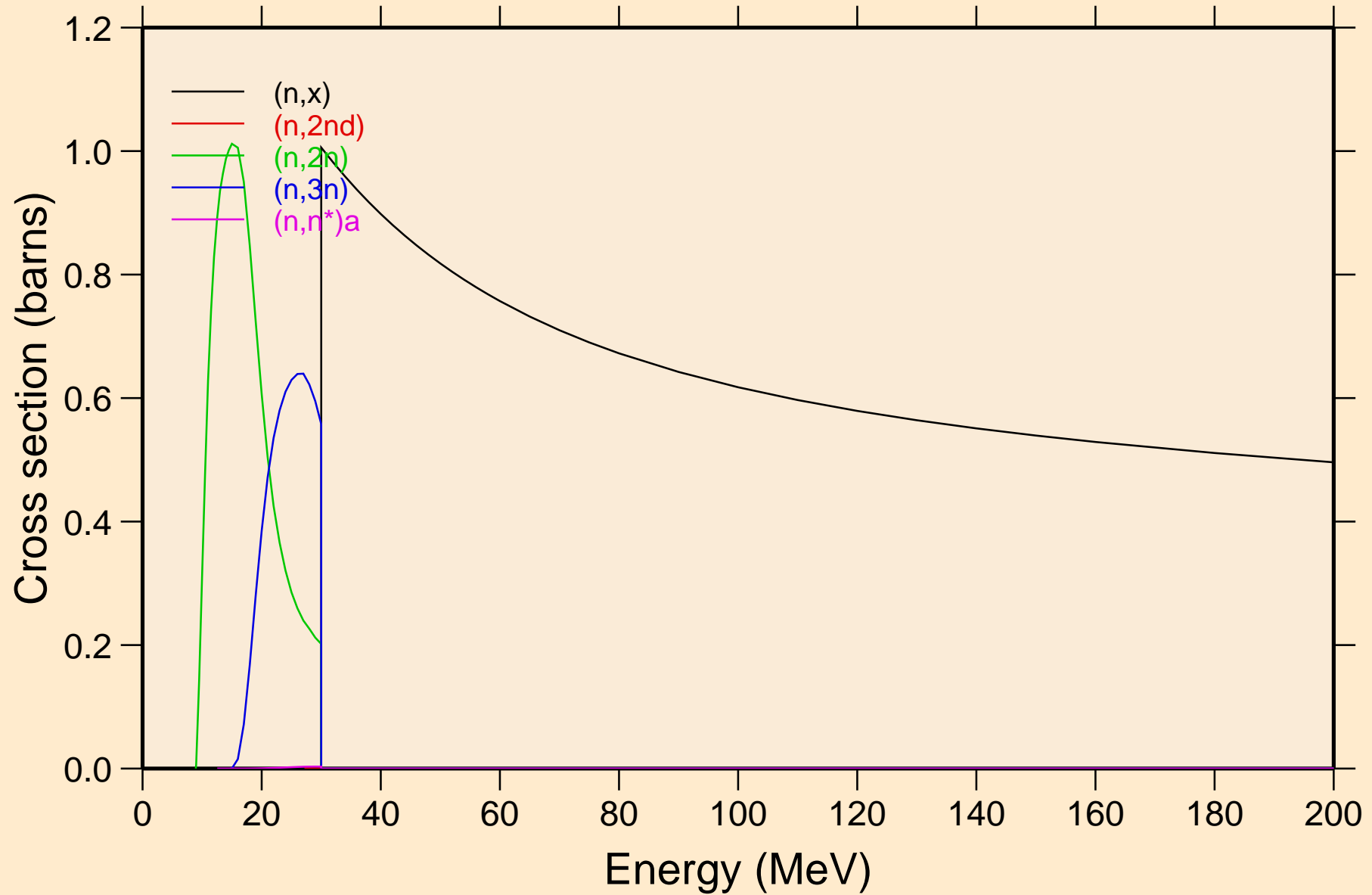

AR044 NEUTRON ACER TENDL-2023 LIBRARY; T=0.K
Threshold reactions

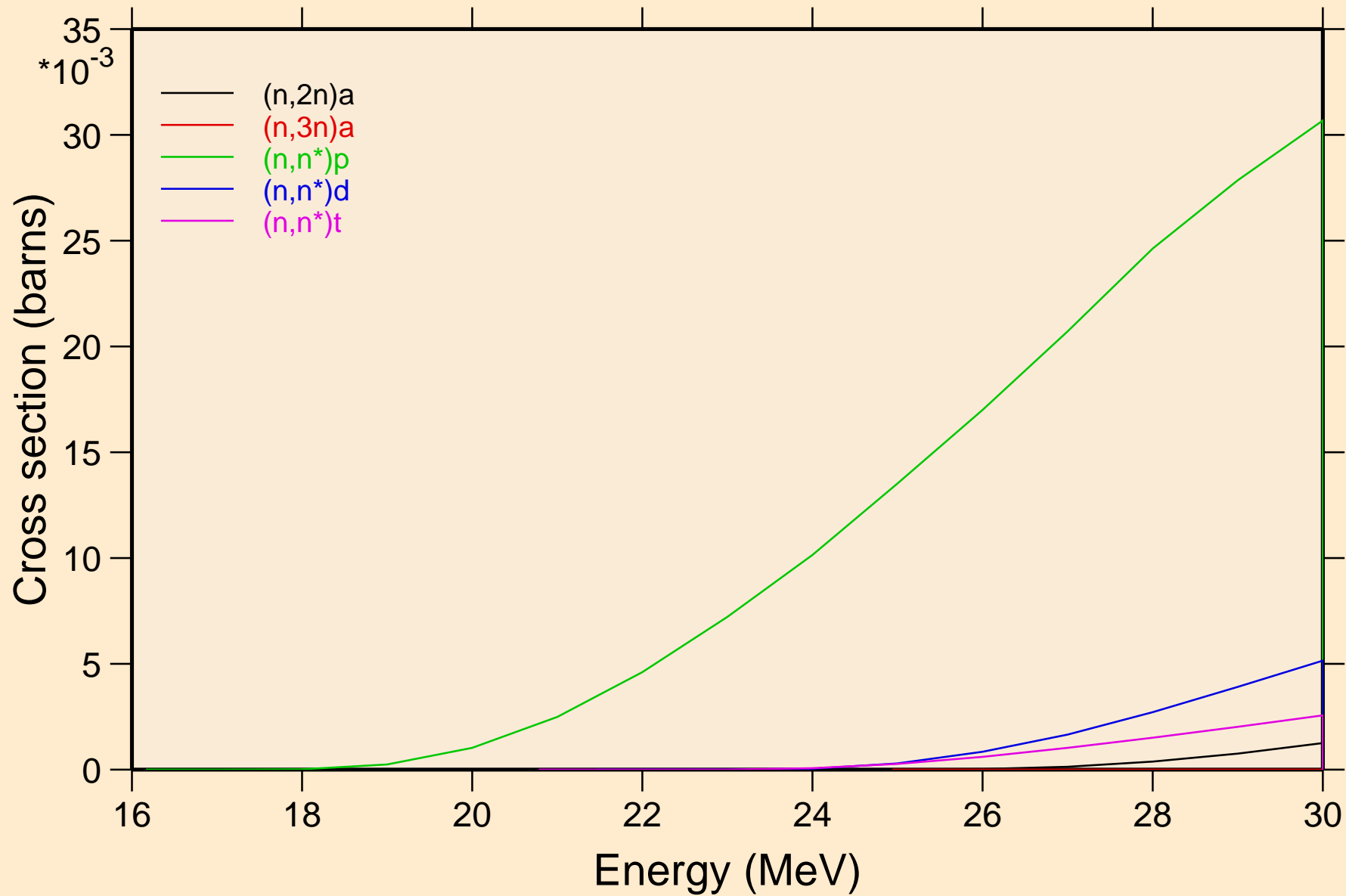

AR044 NEUTRON ACER TENDL-2023 LIBRARY; T=0.K
Threshold reactions

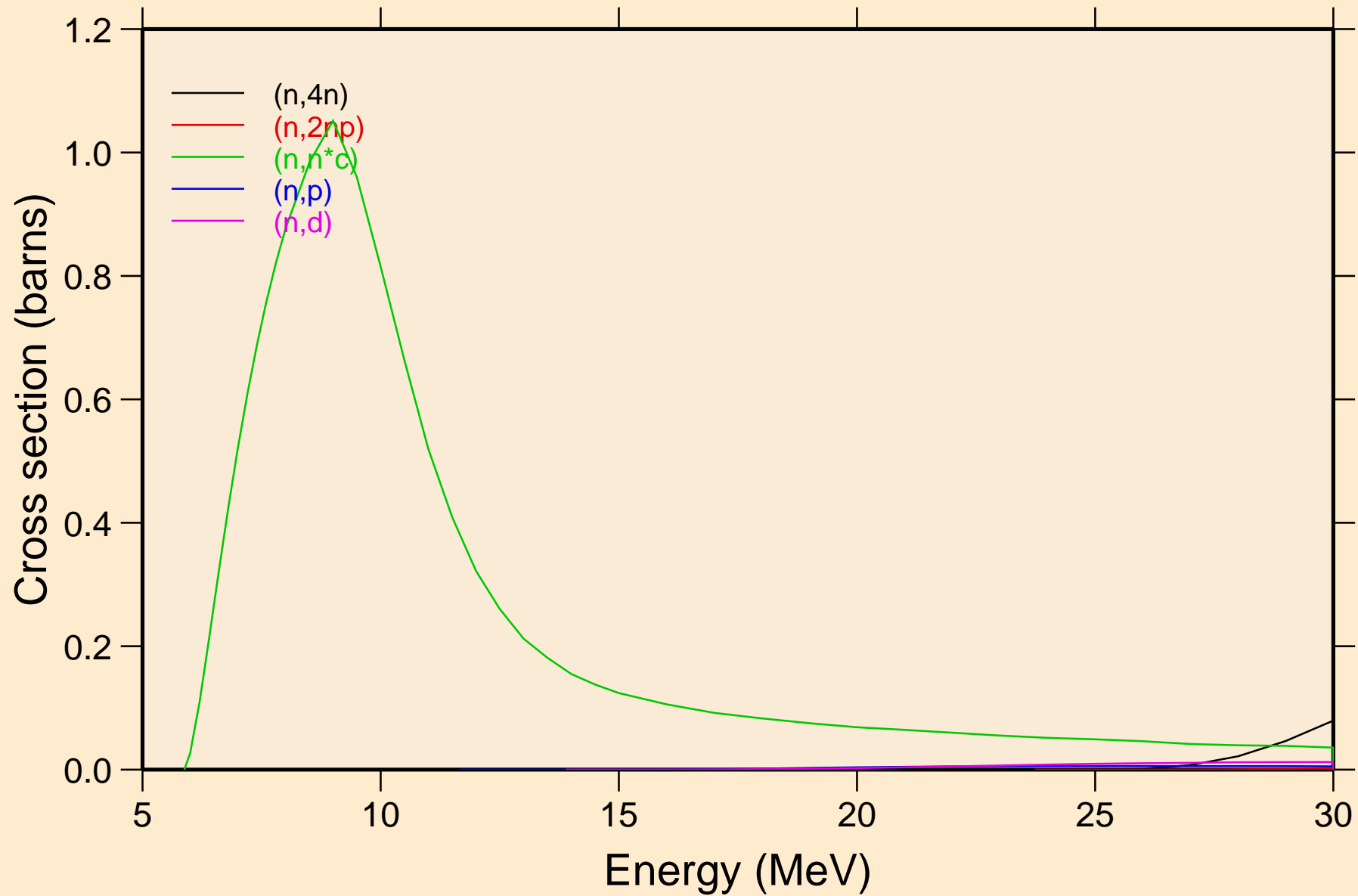

AR044 NEUTRON ACER TENDL-2023 LIBRARY; T=0.K

Threshold reactions

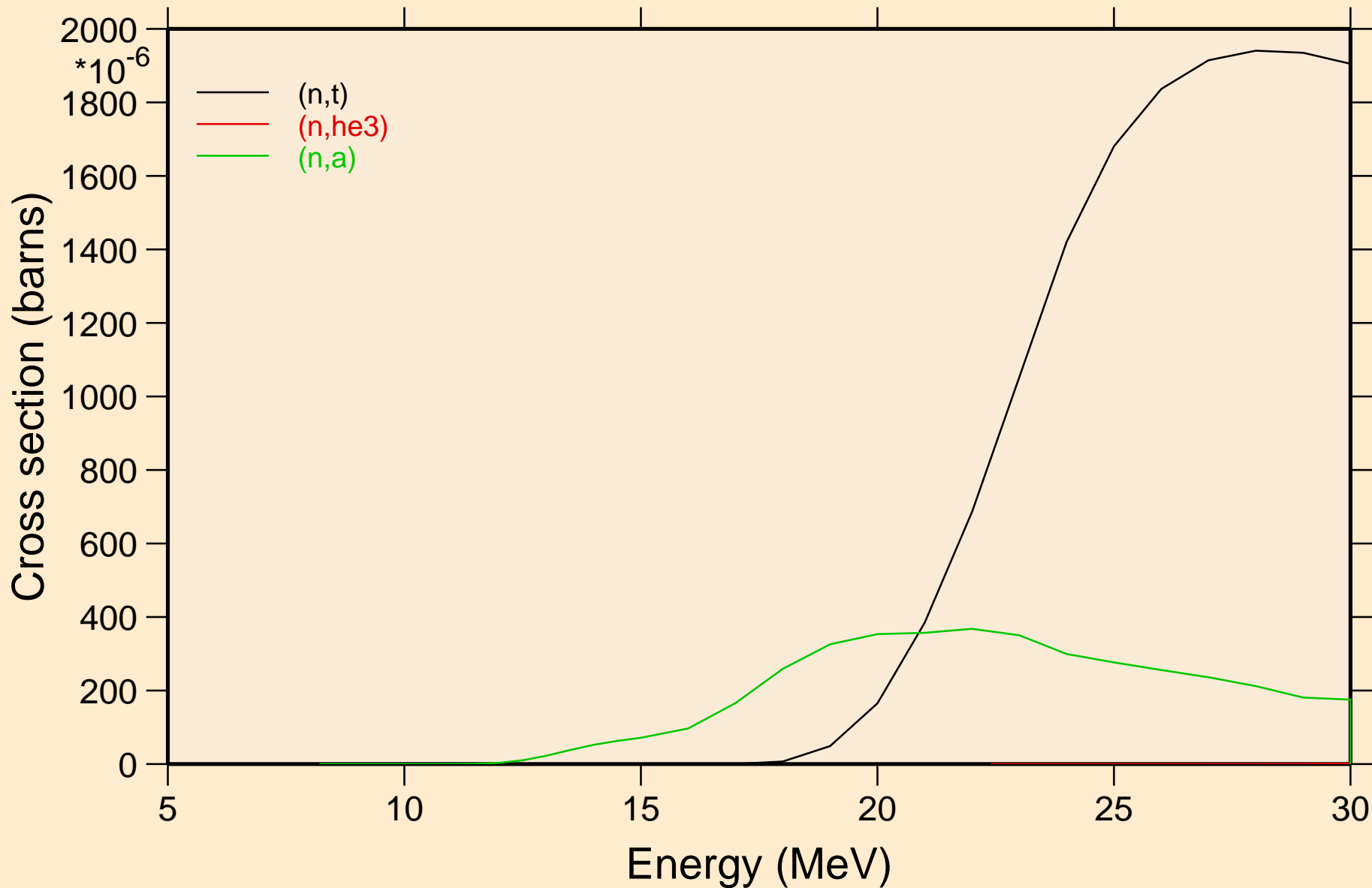

AR044 NEUTRON ACER TENDL-2023 LIBRARY; T=0.K

Threshold reactions

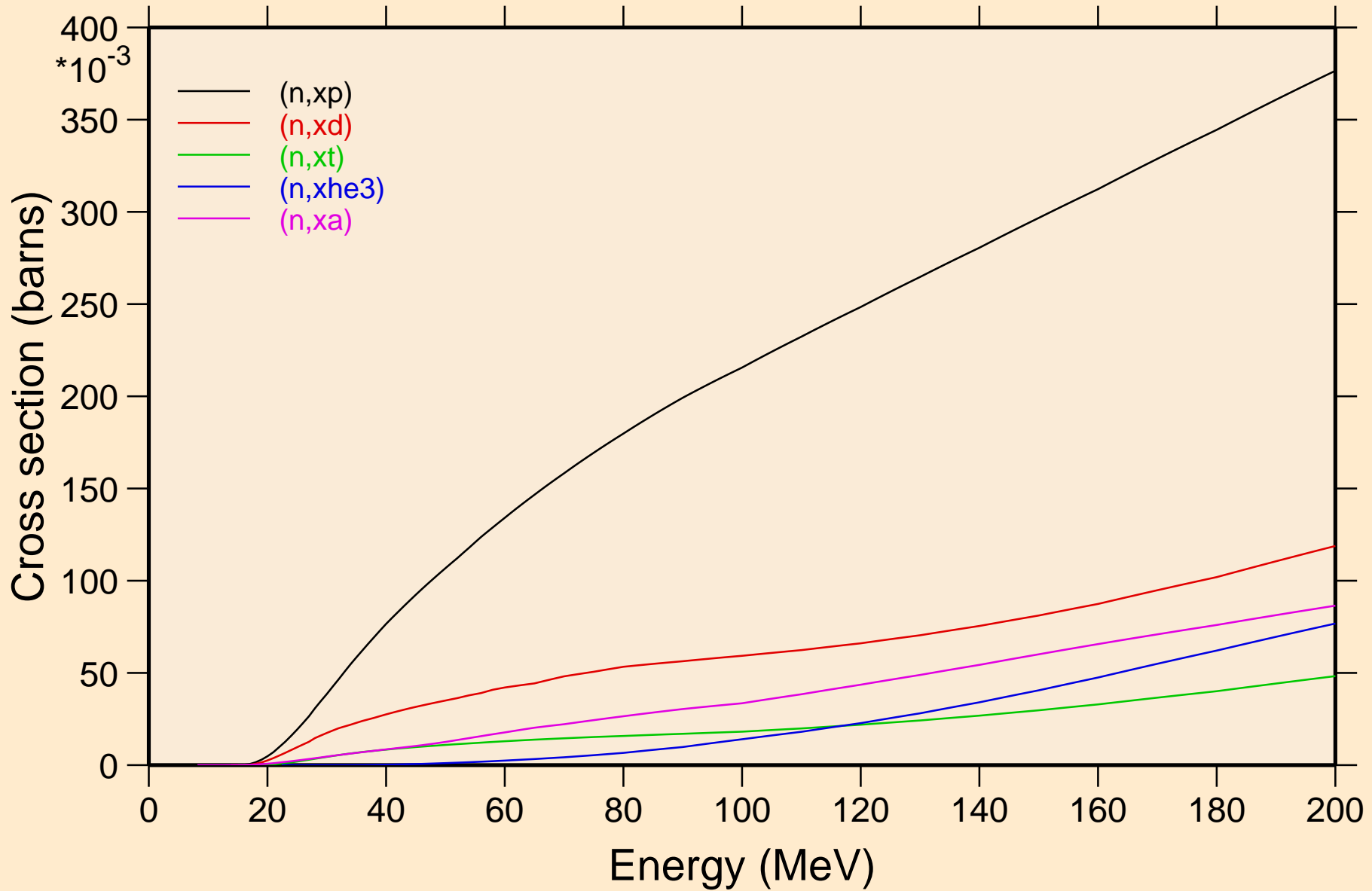

AR044 NEUTRON ACER TENDL-2023 LIBRARY; T=0.K
angular distribution for elastic

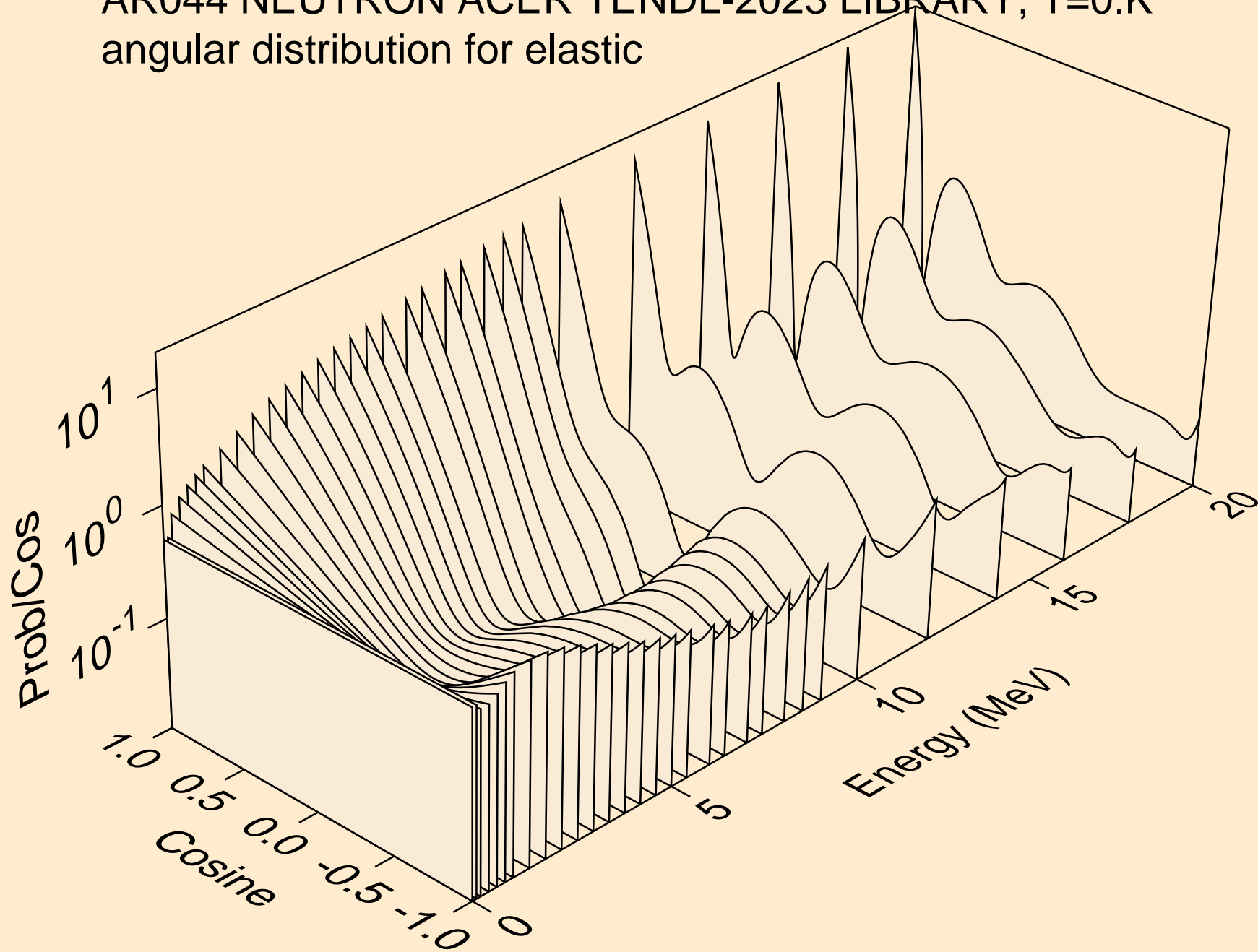

AR044 NEUTRON ACER TENDL-2023 LIBRARY; T=0.K
angular distribution for elastic

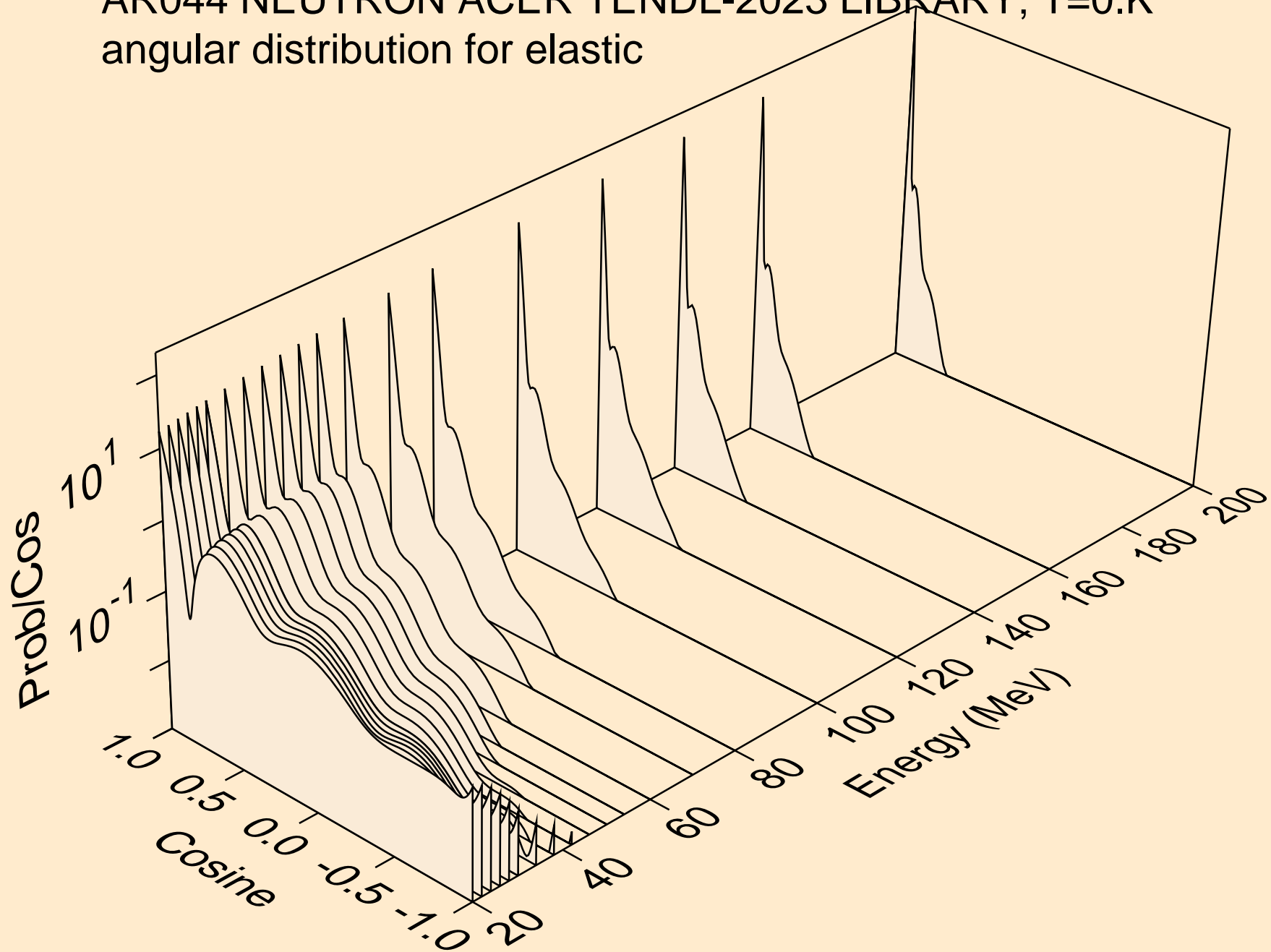

AR044 NEUTRON ACER TENDL-2023 LIBRARY; T=0.K
angular distribution for (n,n*1)

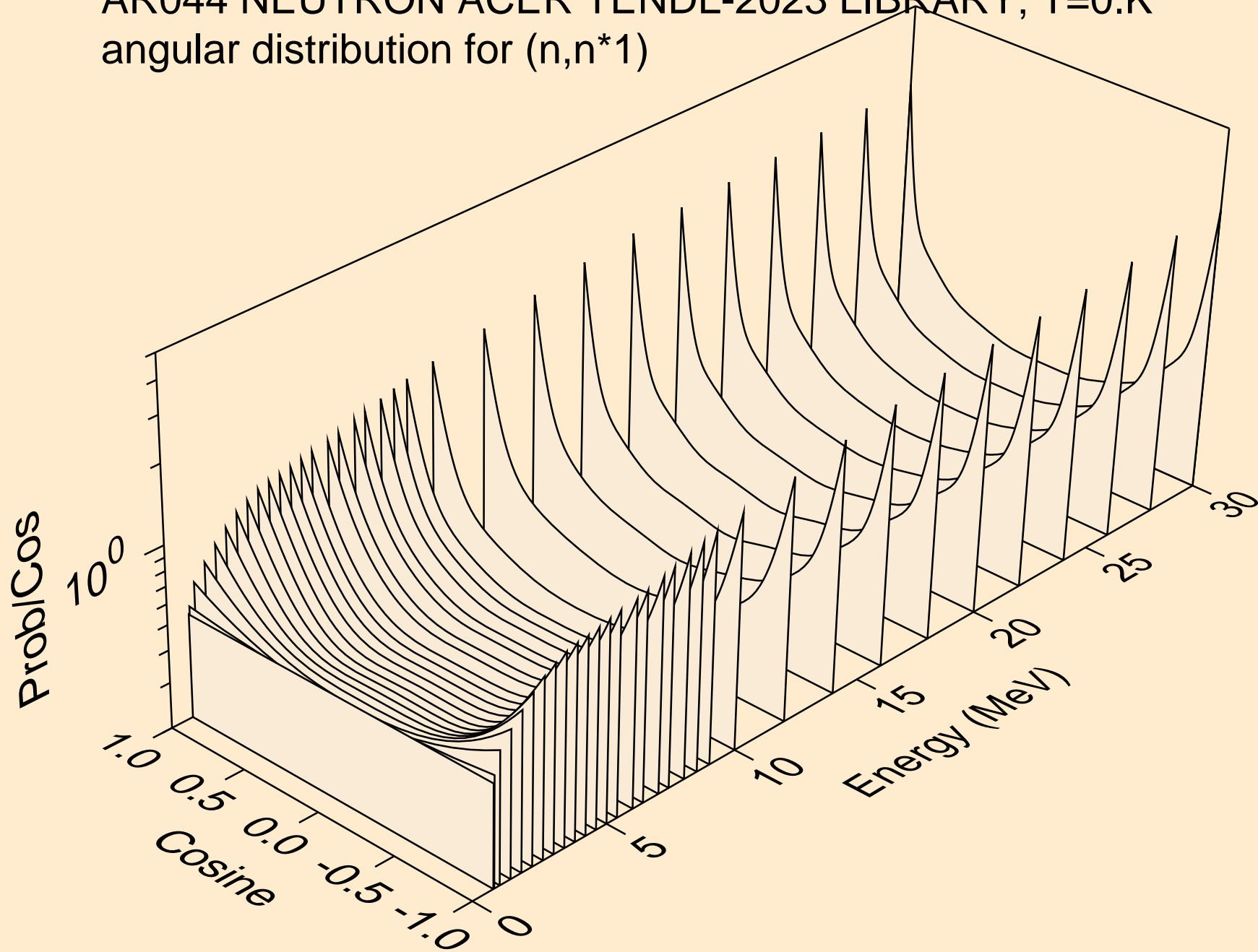

AR044 NEUTRON ACER TENDL-2023 LIBRARY; T=0.K
angular distribution for (n,n*2)

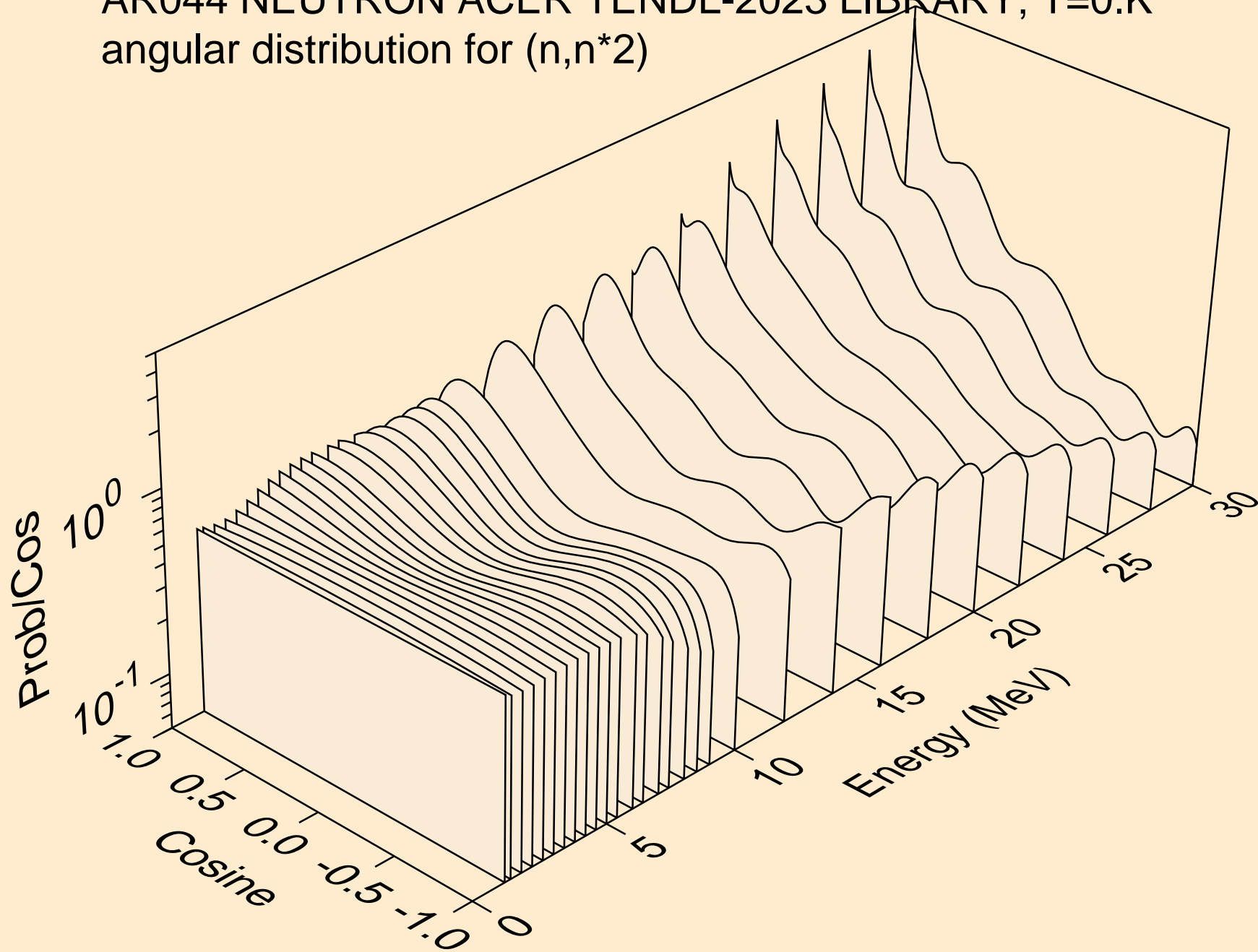

AR044 NEUTRON ACER TENDL-2023 LIBRARY; T=0.K
angular distribution for (n,n*3)

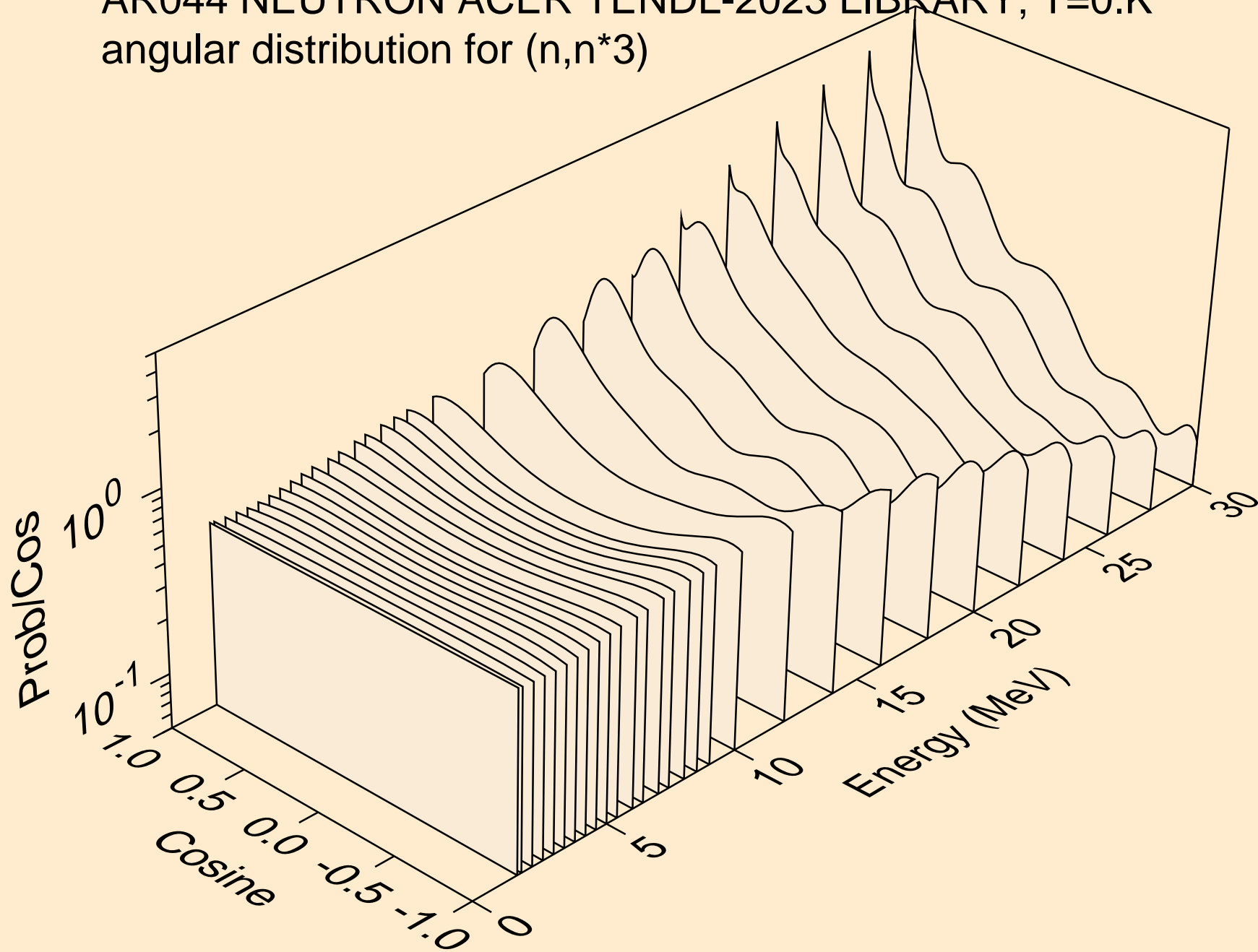

AR044 NEUTRON ACER TENDL-2023 LIBRARY; T=0.K
angular distribution for (n,n*4)

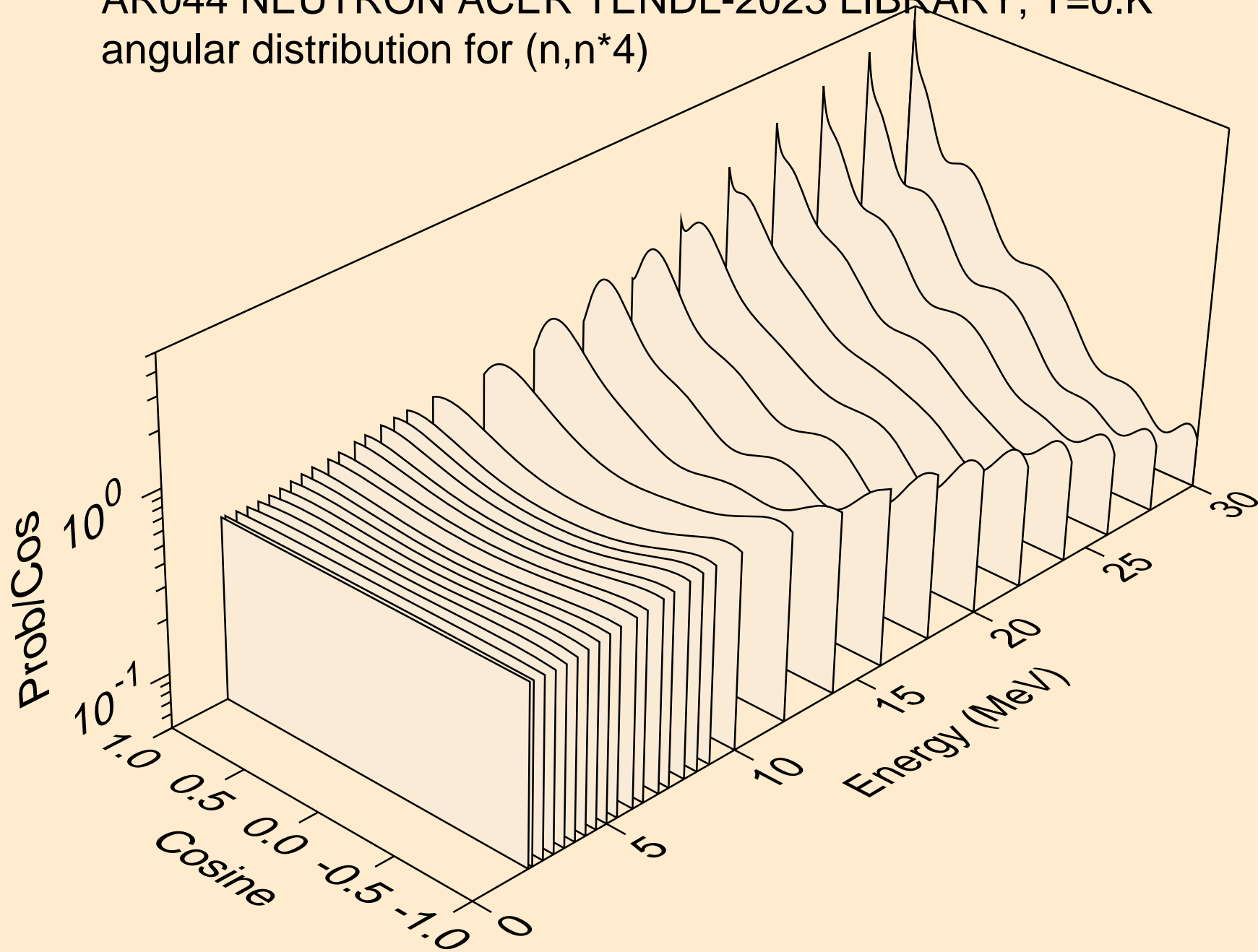

AR044 NEUTRON ACER TENDL-2023 LIBRARY; T=0.K
angular distribution for (n,n*5)

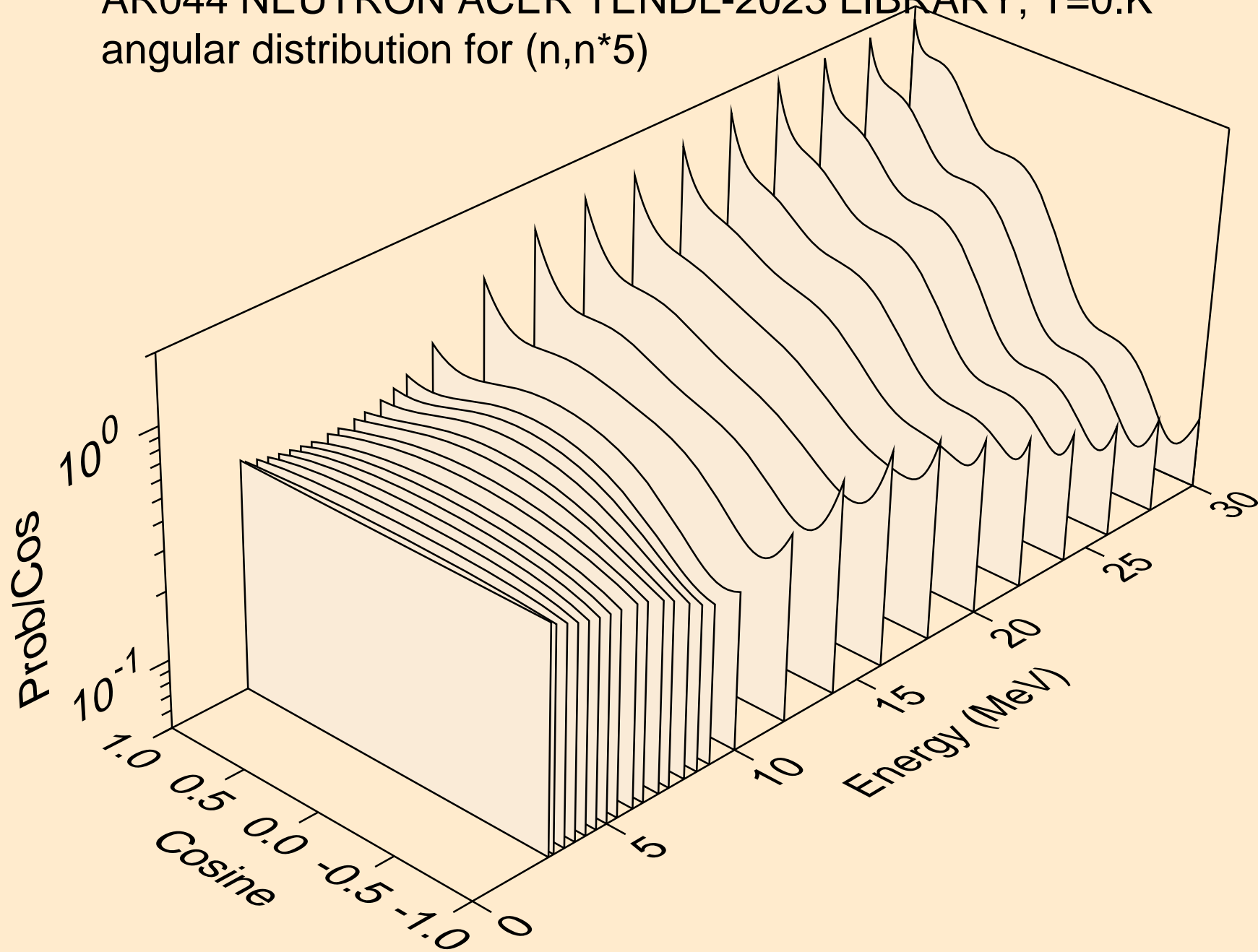

AR044 NEUTRON ACER TENDL-2023 LIBRARY; T=0.K
angular distribution for (n,n*6)

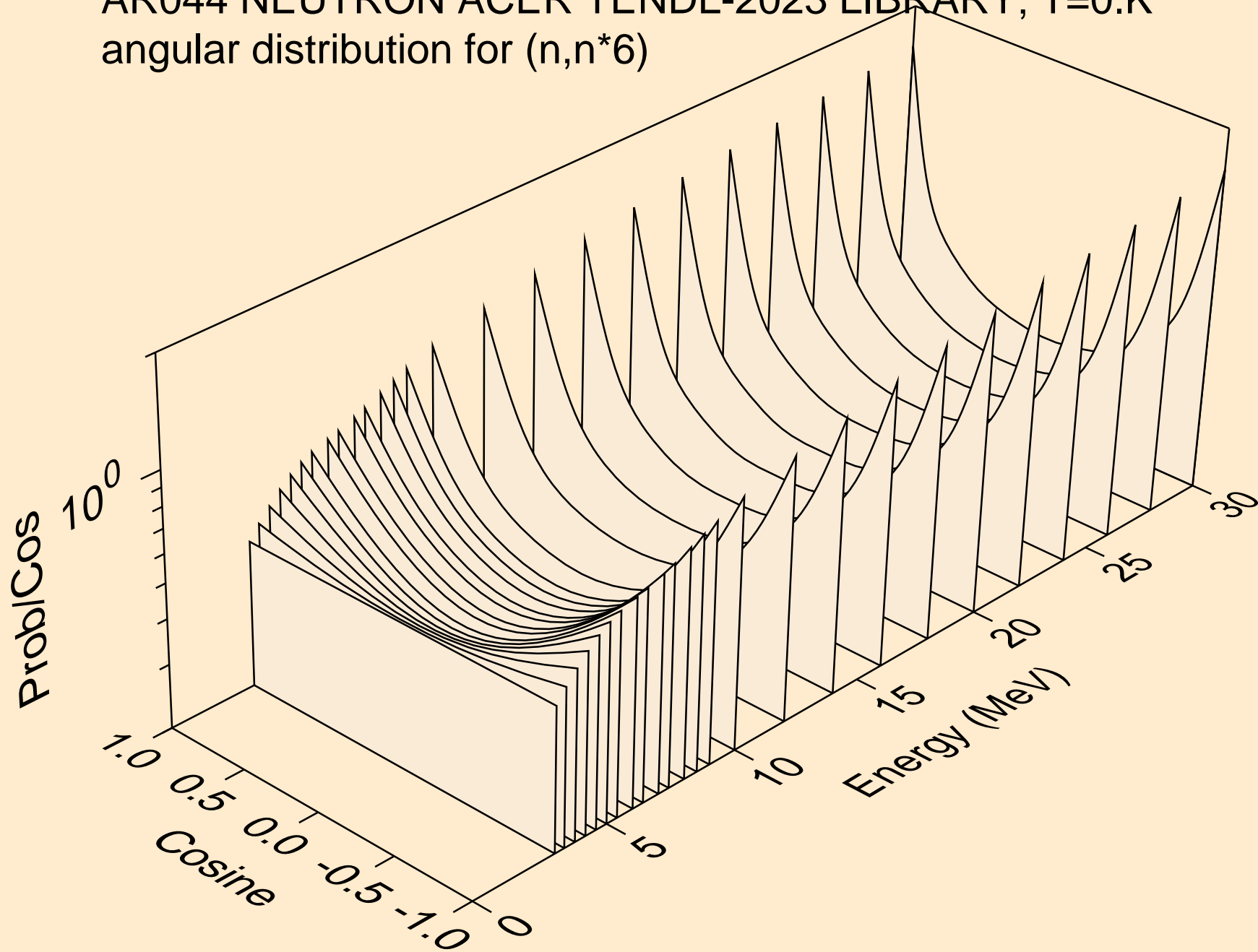

AR044 NEUTRON ACER TENDL-2023 LIBRARY; T=0.K
angular distribution for (n,n*7)

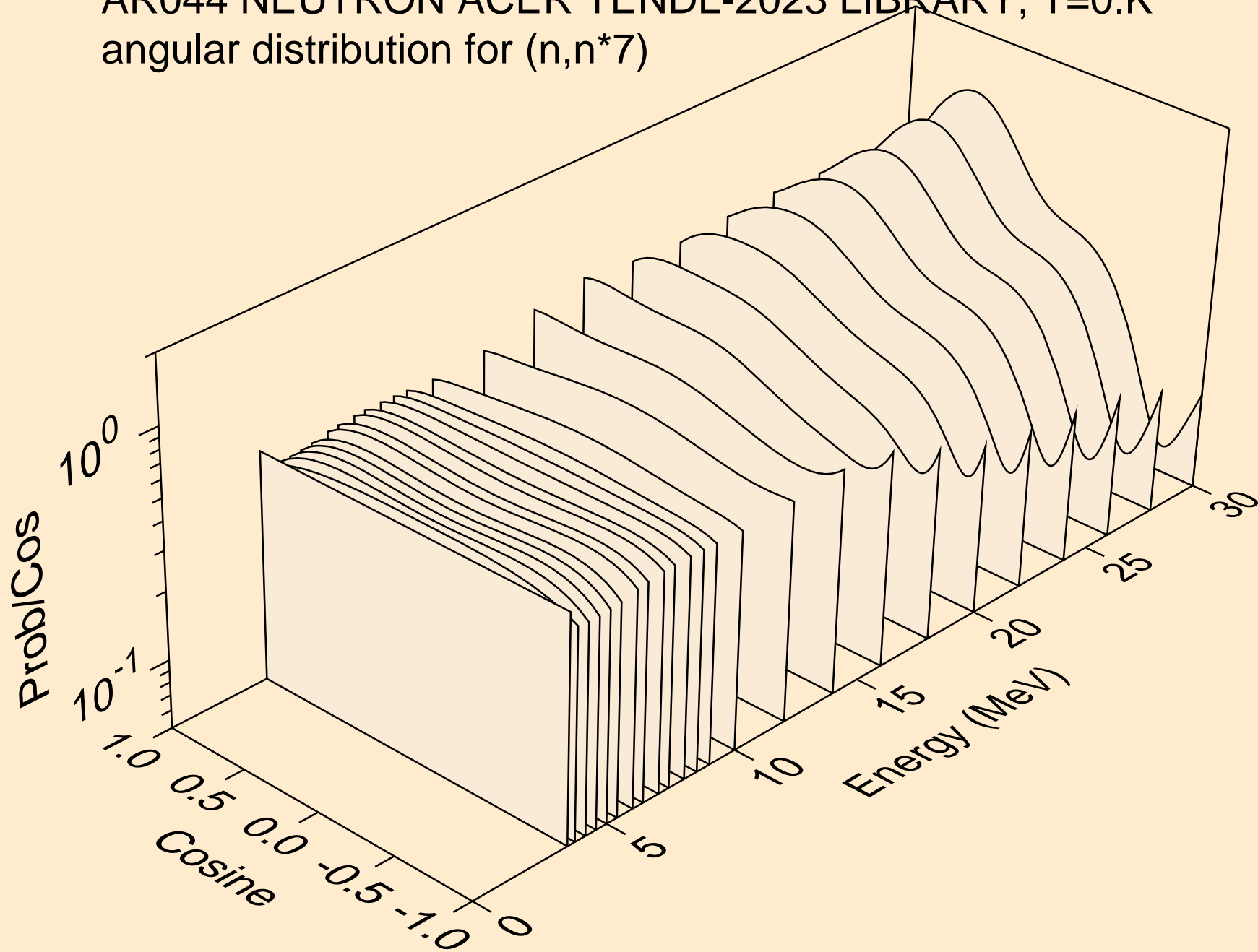

AR044 NEUTRON ACER TENDL-2023 LIBRARY; T=0.K
angular distribution for (n,n*8)

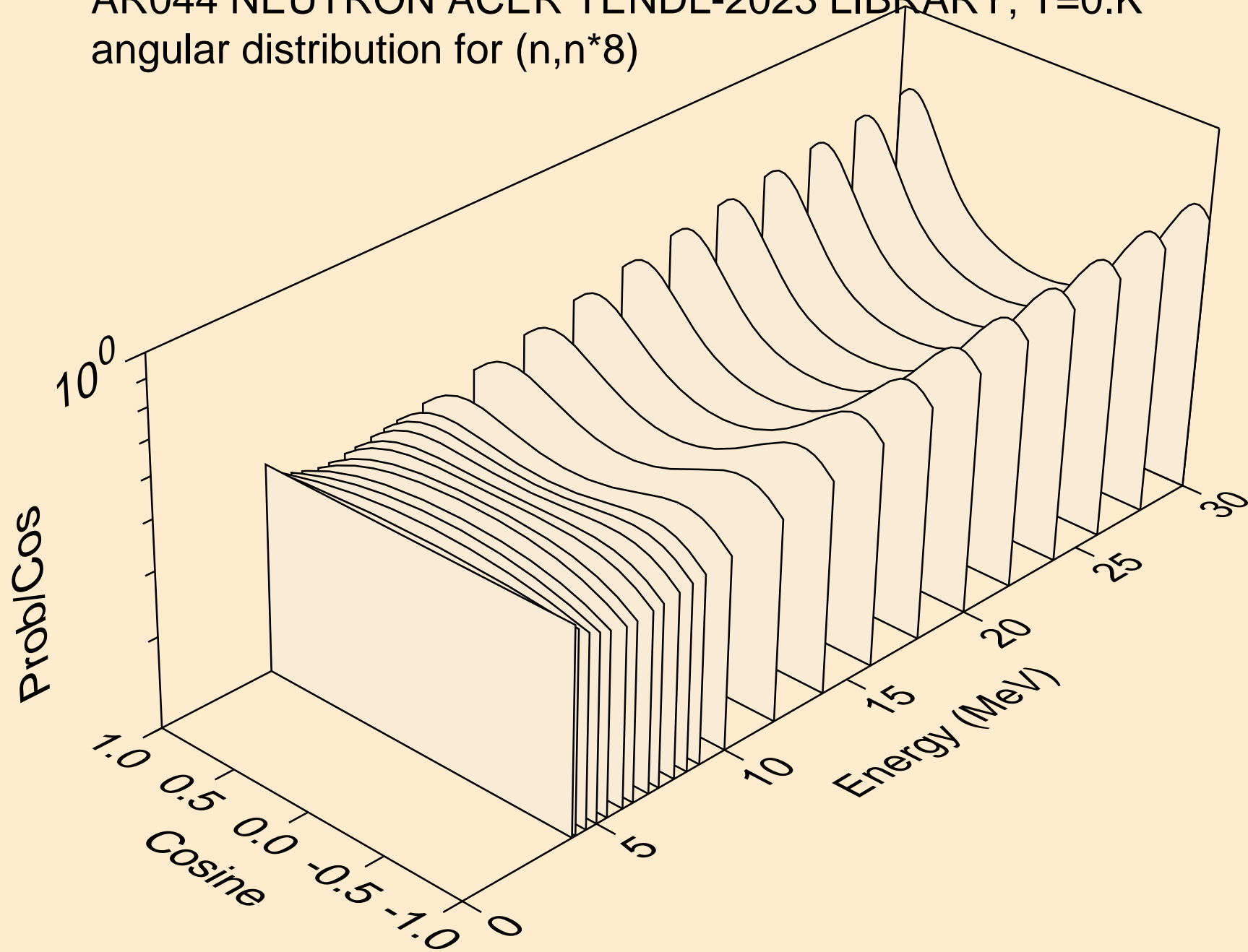

AR044 NEUTRON ACER TENDL-2023 LIBRARY; T=0.K
angular distribution for (n,n*9)

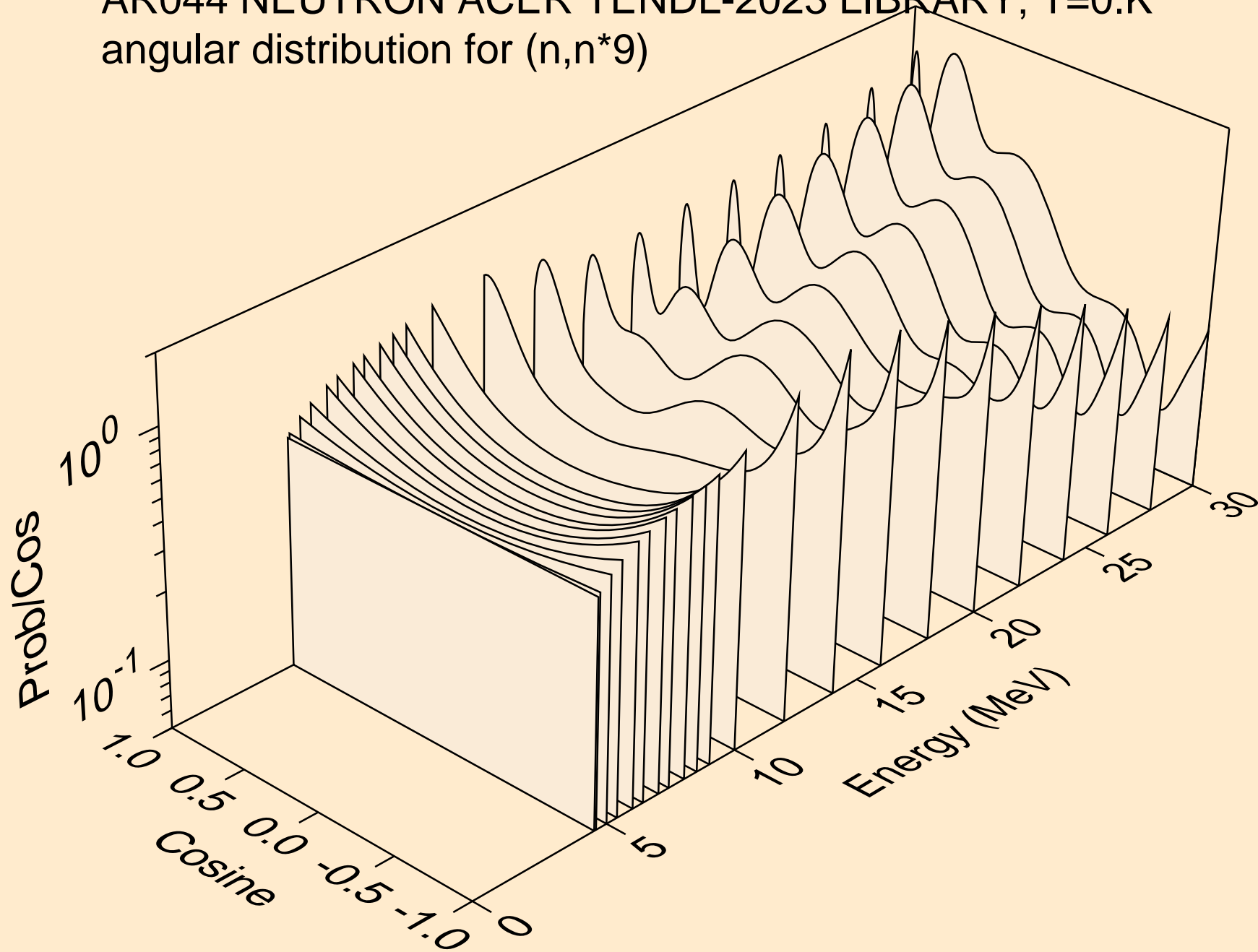

AR044 NEUTRON ACER TENDL-2023 LIBRARY; T=0.K
angular distribution for (n,n*10)

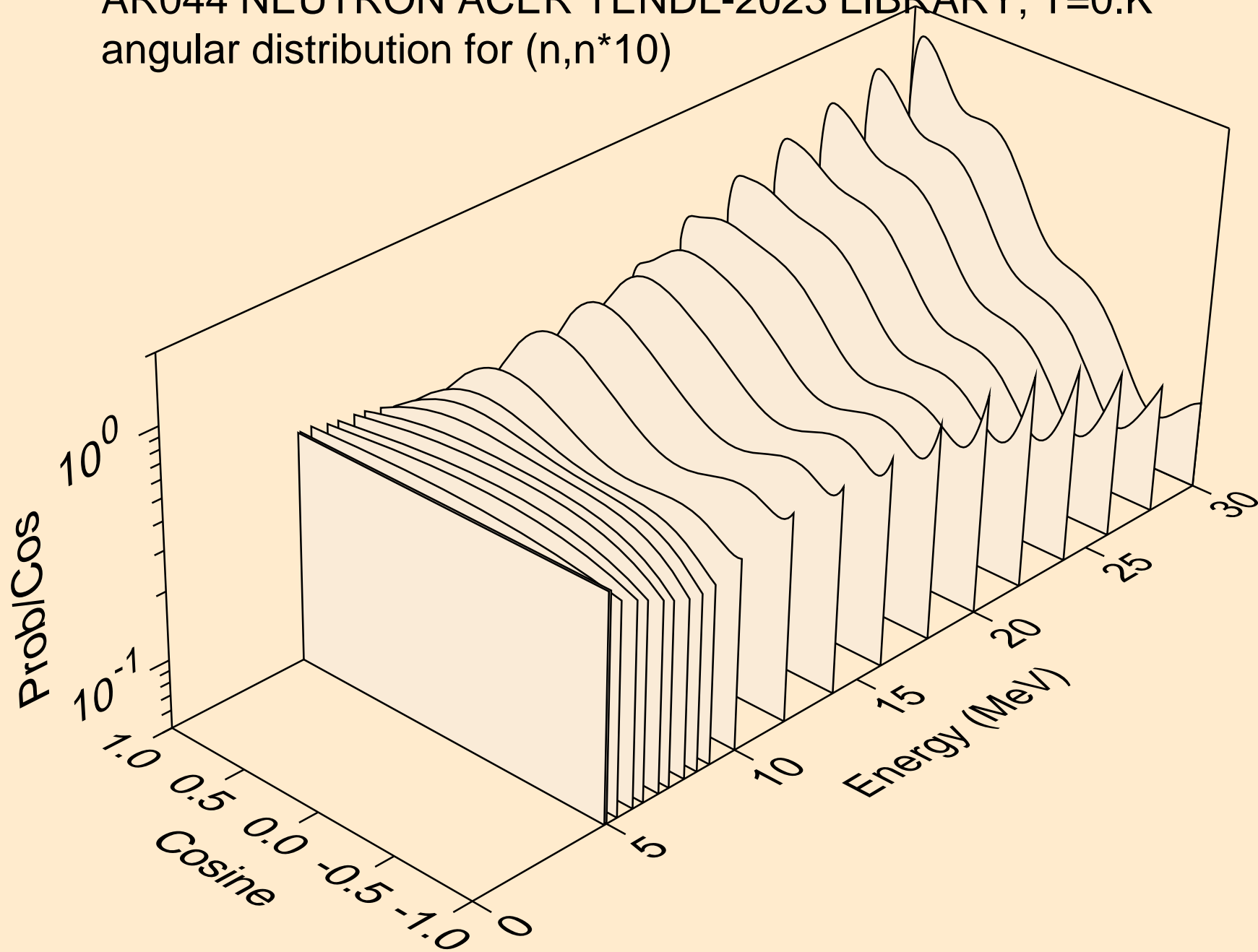

AR044 NEUTRON ACER TENDL-2023 LIBRARY; T=0.K
angular distribution for (n,n*11)

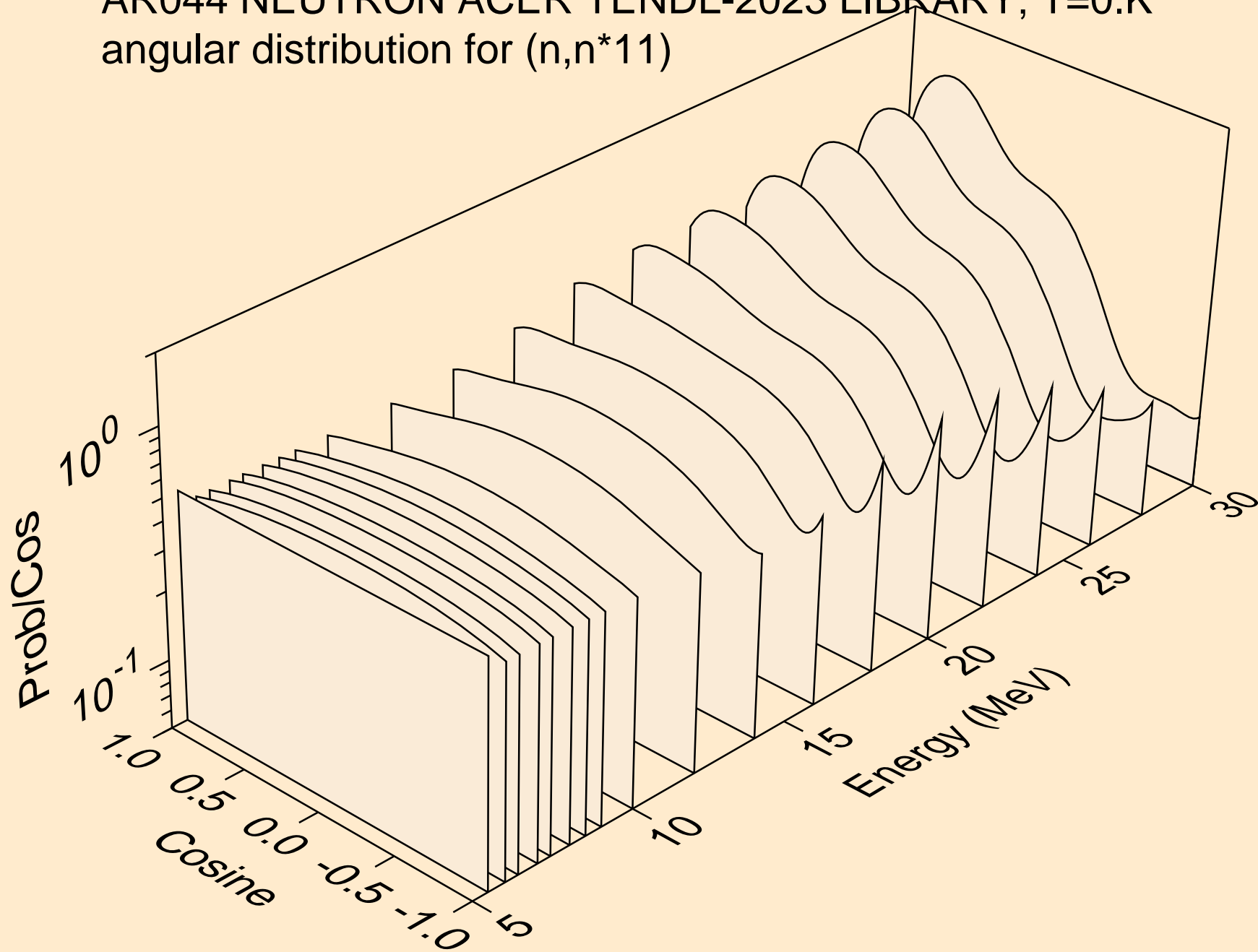

AR044 NEUTRON ACER TENDL-2023 LIBRARY; T=0.K
angular distribution for (n,n*12)

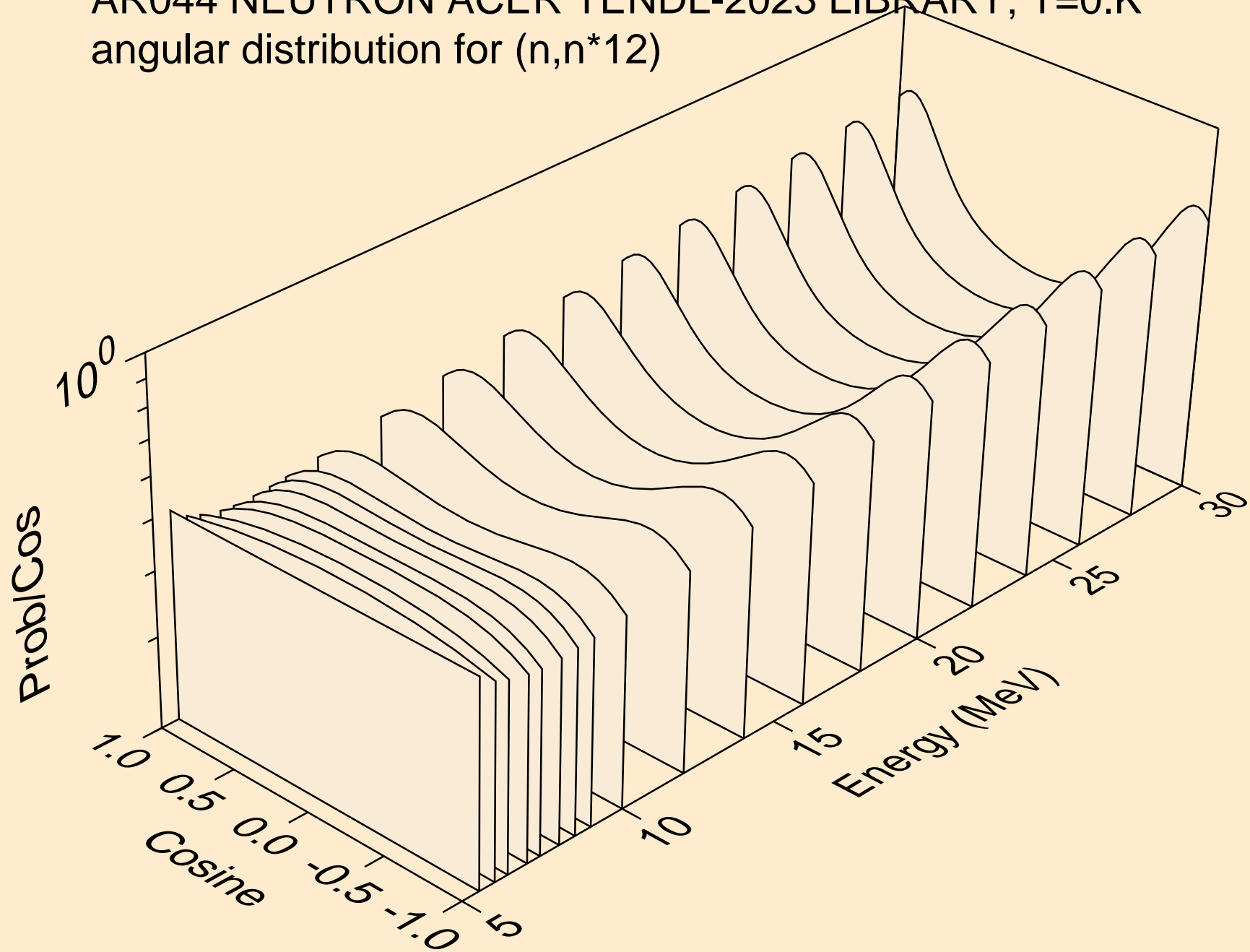

AR044 NEUTRON ACER TENDL-2023 LIBRARY; T=0.K
angular distribution for (n,n*13)

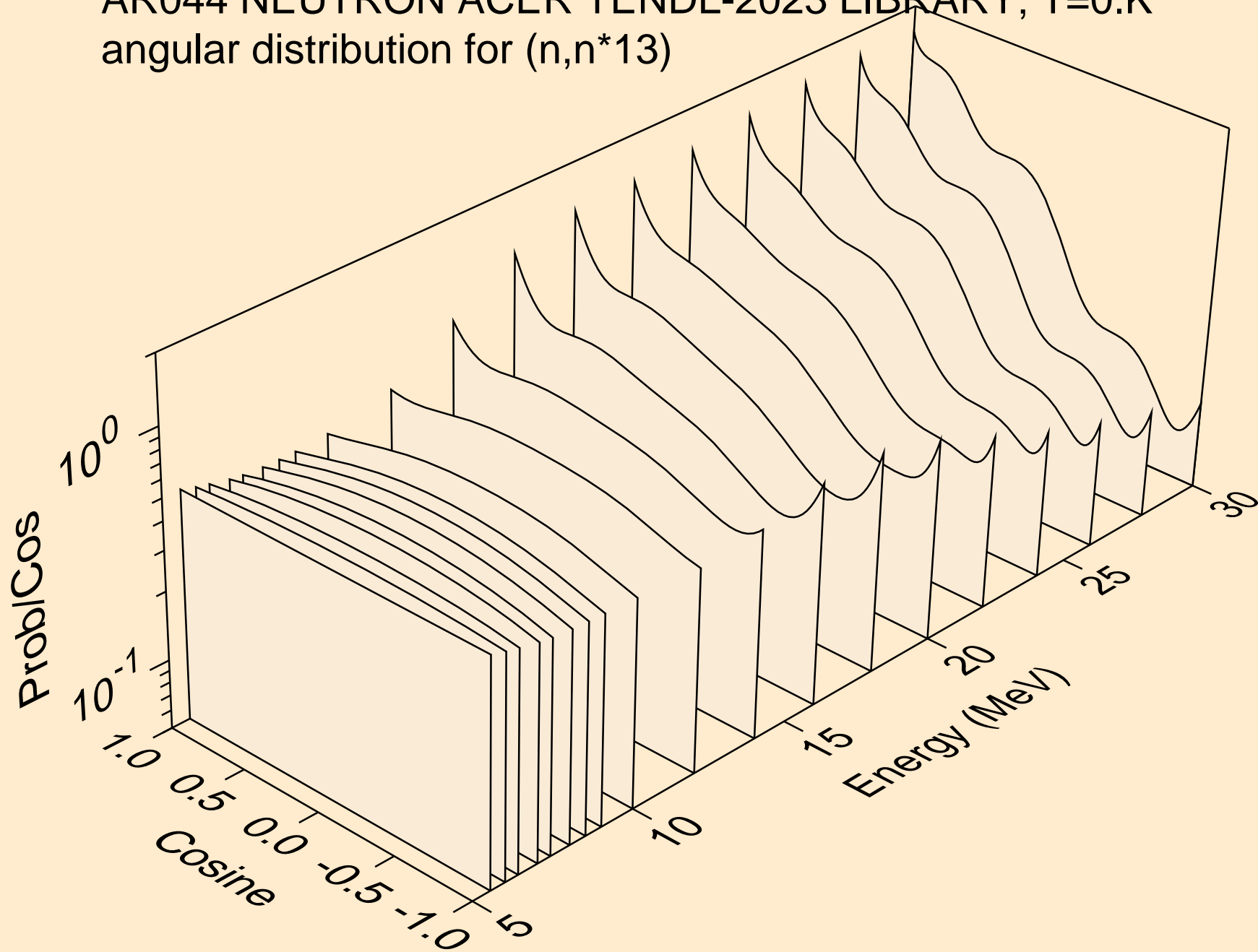

AR044 NEUTRON ACER TENDL-2023 LIBRARY; T=0.K
angular distribution for (n,n*14)

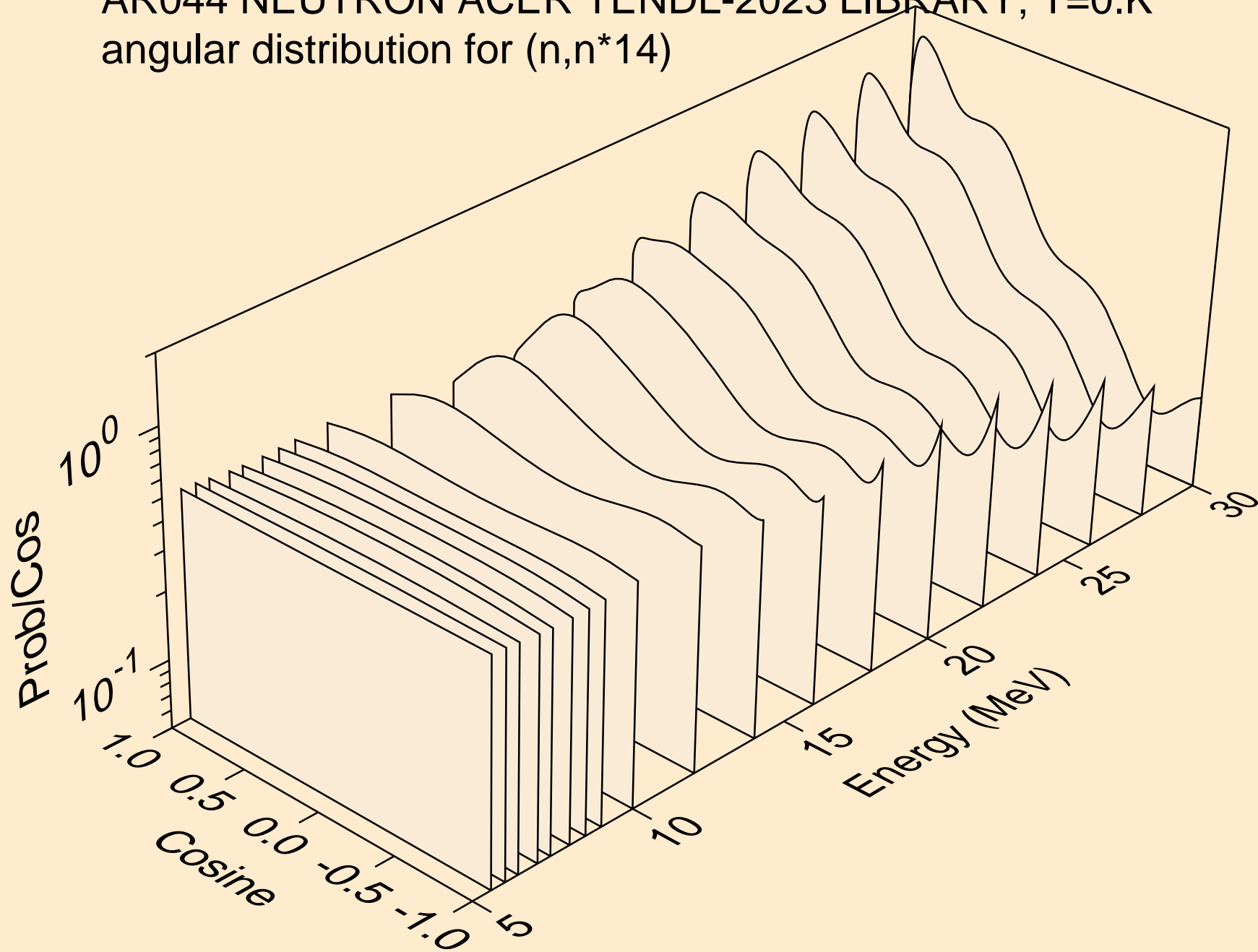

AR044 NEUTRON ACER TENDL-2023 LIBRARY; T=0.K
angular distribution for (n,n*15)

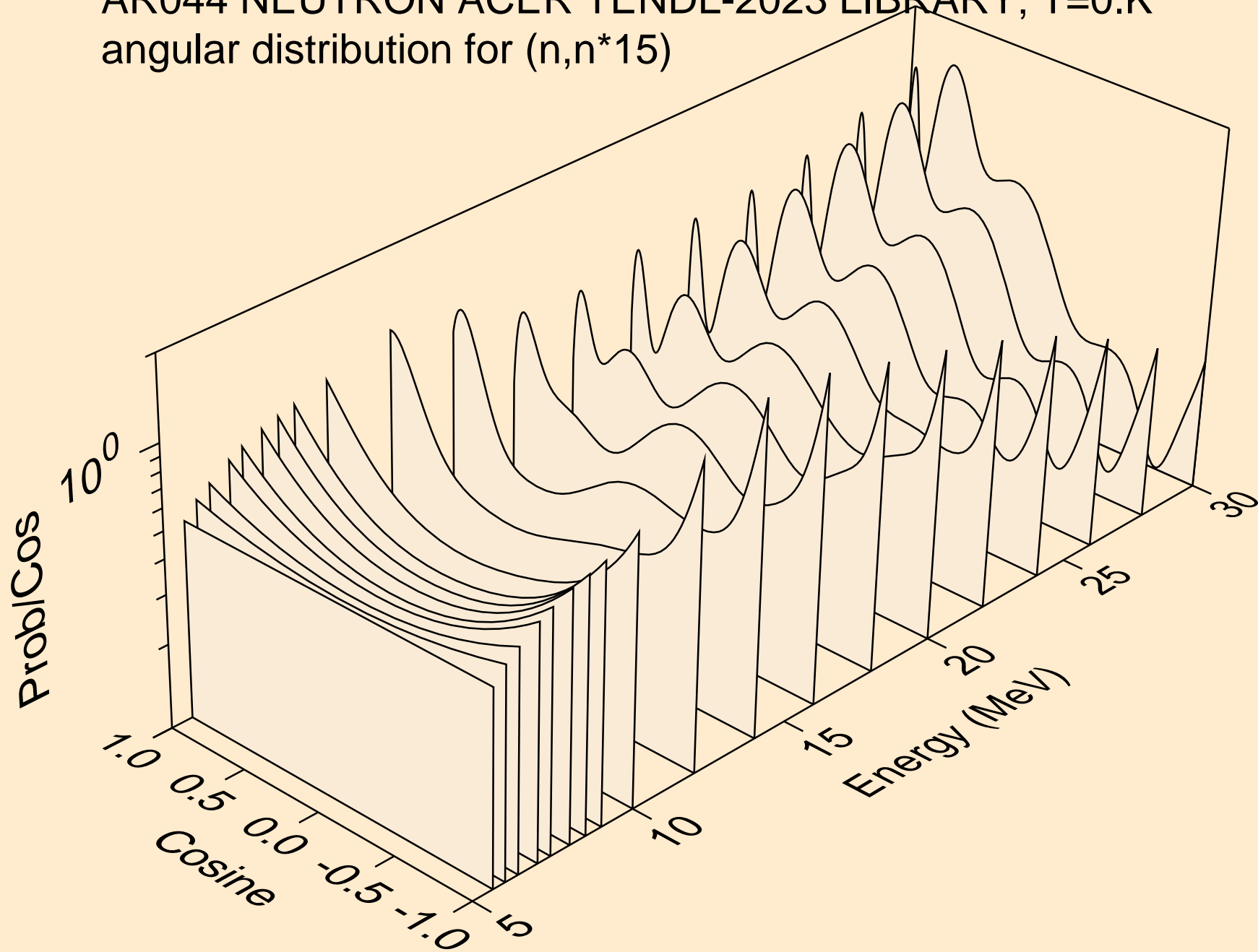

AR044 NEUTRON ACER TENDL-2023 LIBRARY; T=0.K
angular distribution for (n,n*16)

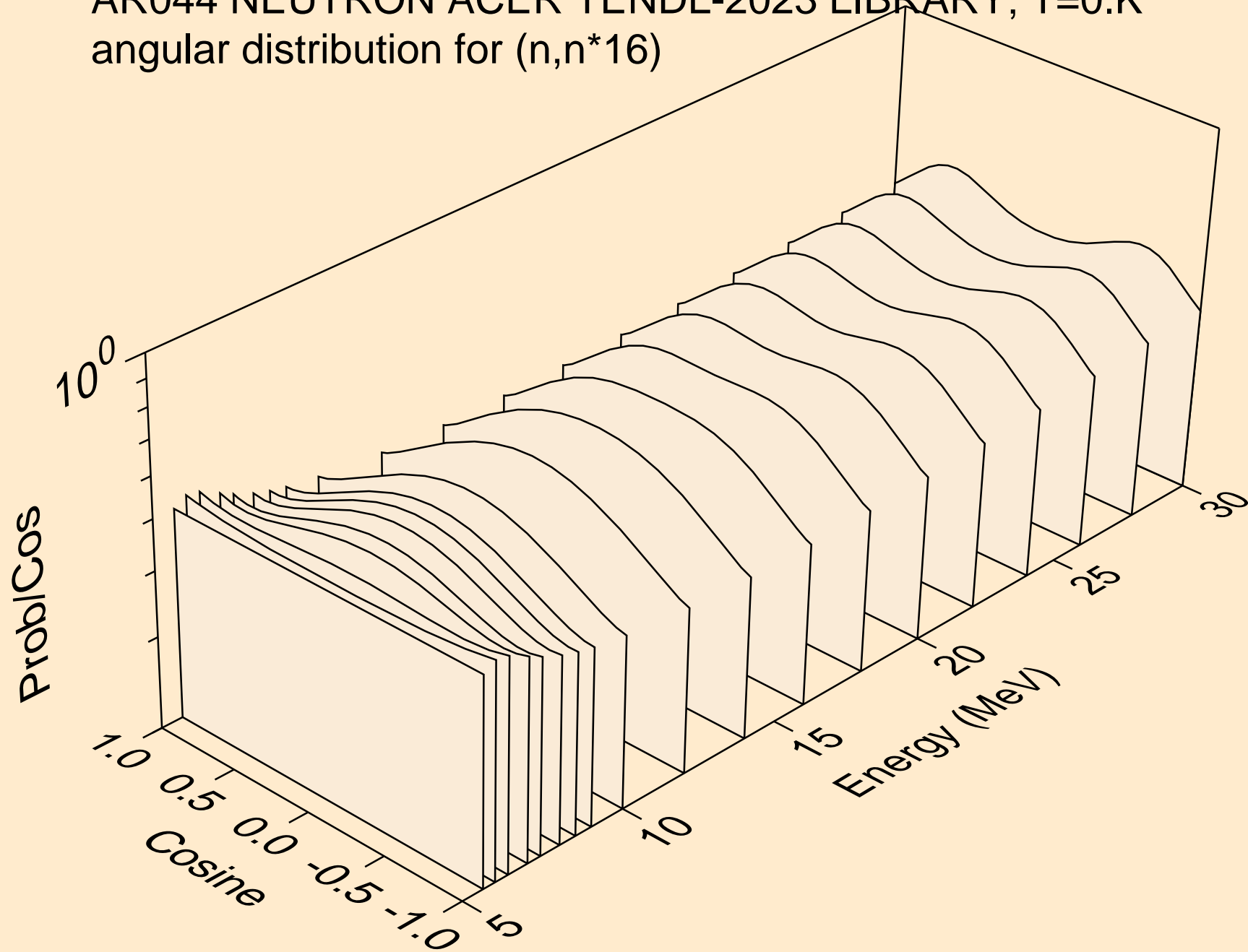

AR044 NEUTRON ACER TENDL-2023 LIBRARY; T=0.K
angular distribution for (n,n*17)

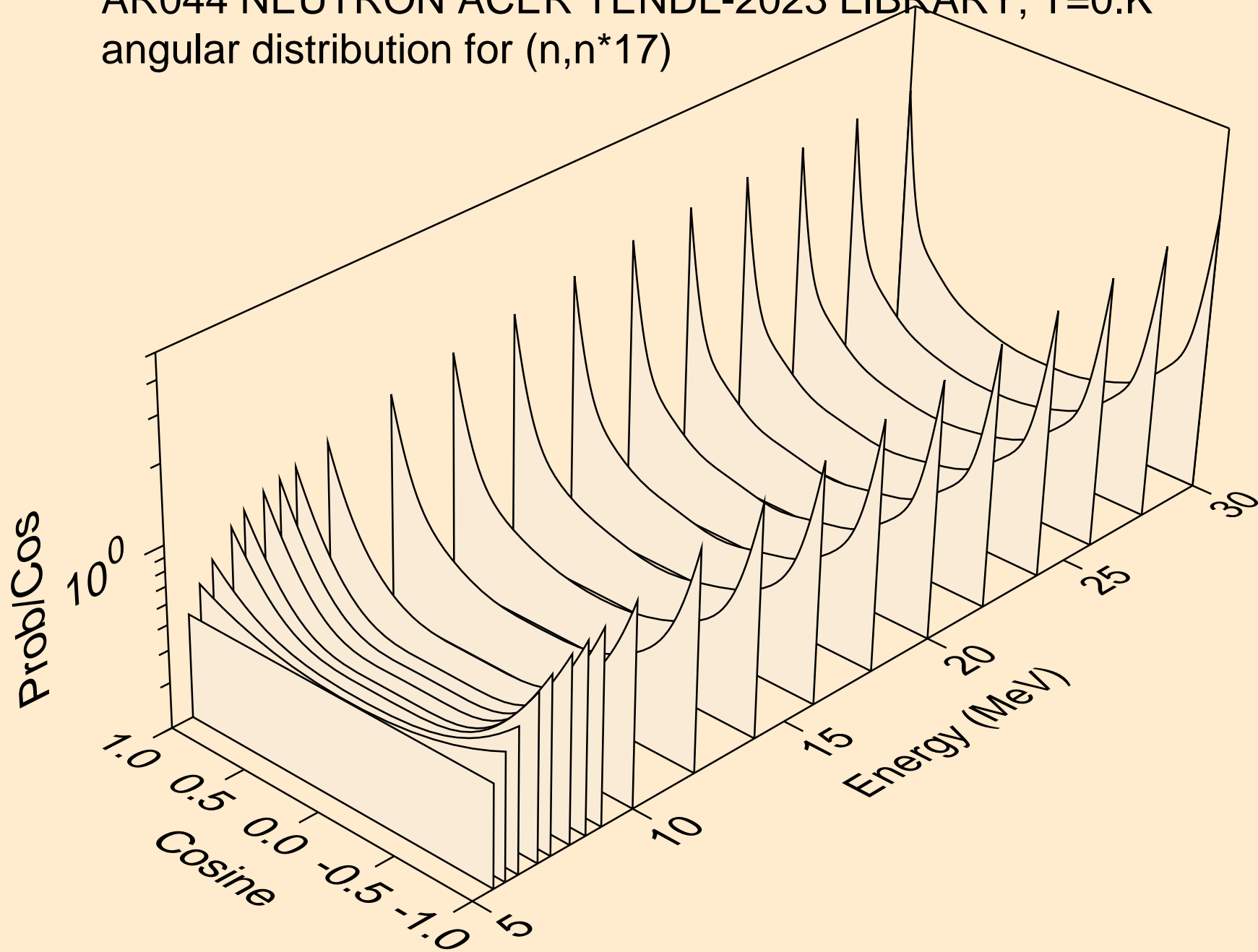

AR044 NEUTRON ACER TENDL-2023 LIBRARY; T=0.K
angular distribution for (n,n*18)

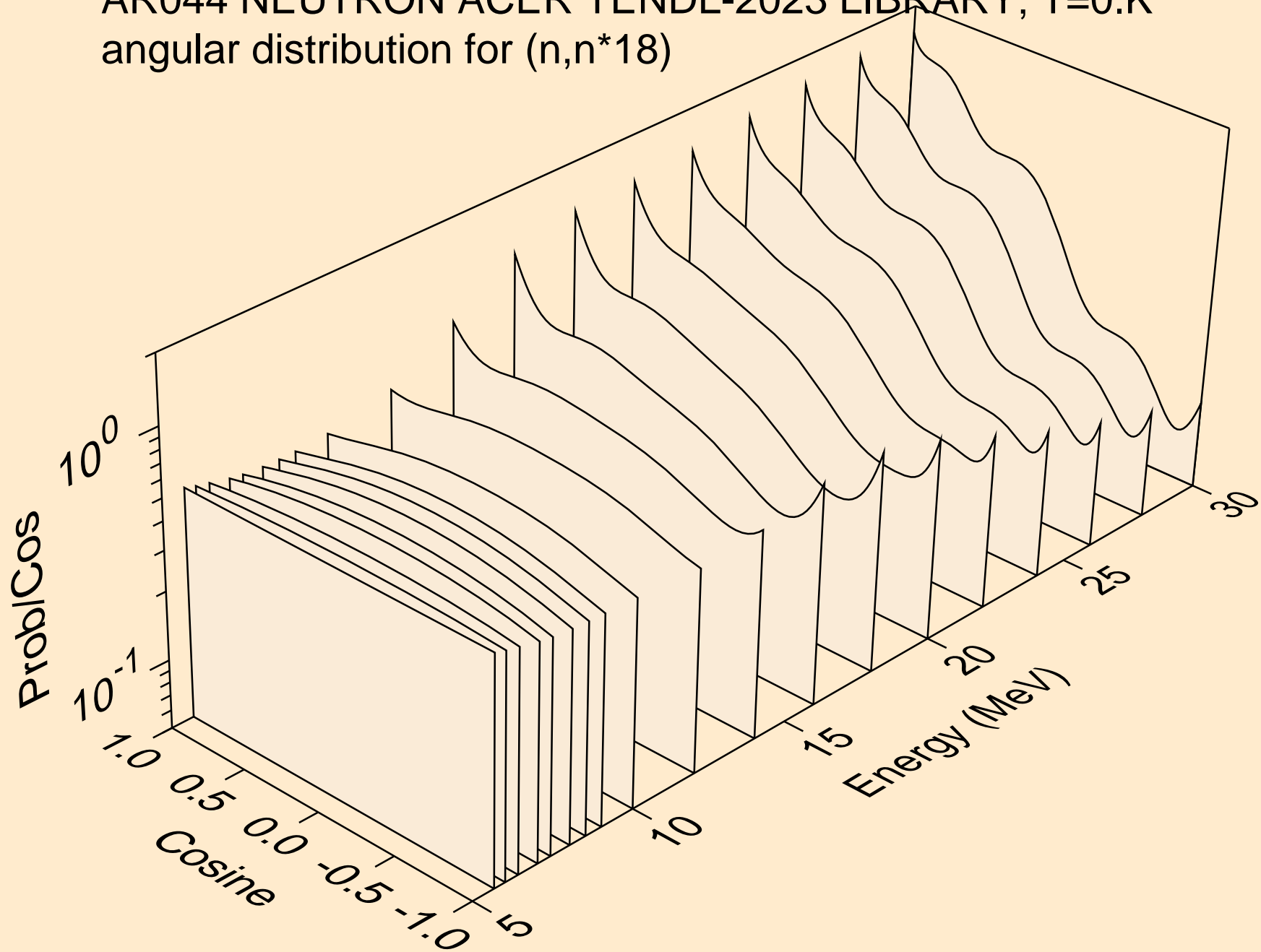

AR044 NEUTRON ACER TENDL-2023 LIBRARY; T=0.K
angular distribution for (n,n*19)

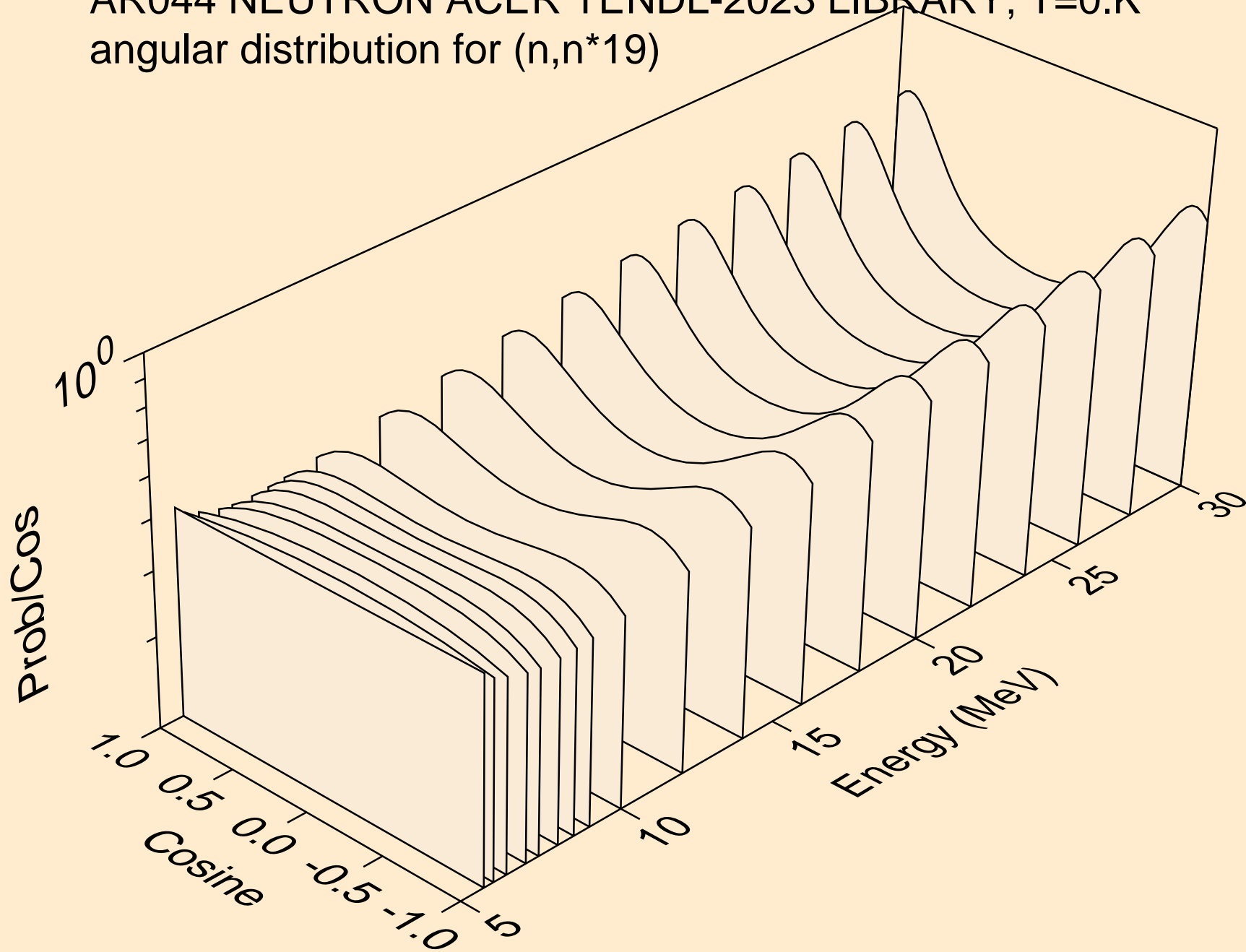

AR044 NEUTRON ACER TENDL-2023 LIBRARY; T=0.K
angular distribution for (n,n*20)

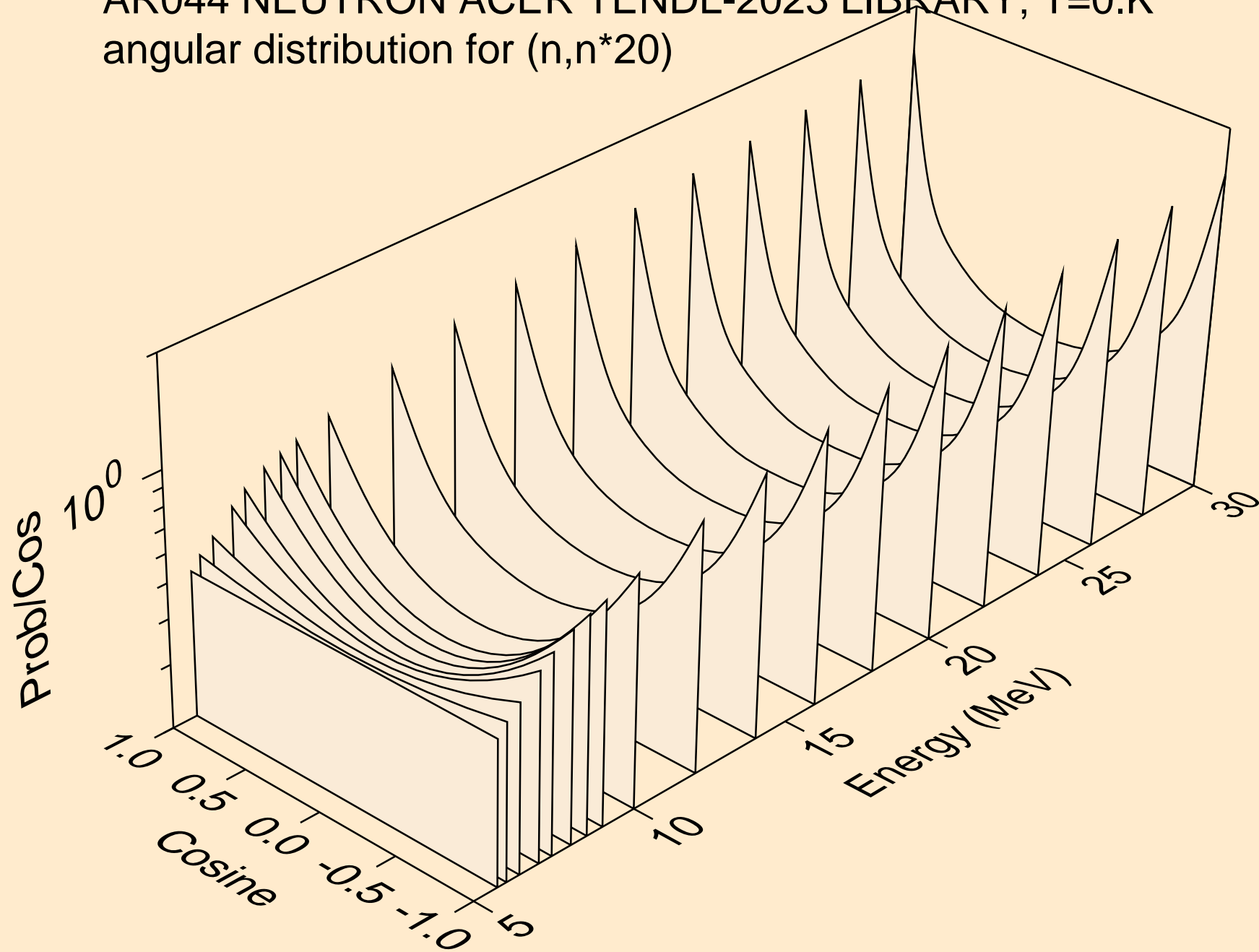

AR044 NEUTRON ACER TENDL-2023 LIBRARY; T=0.K
angular distribution for (n,n*21)

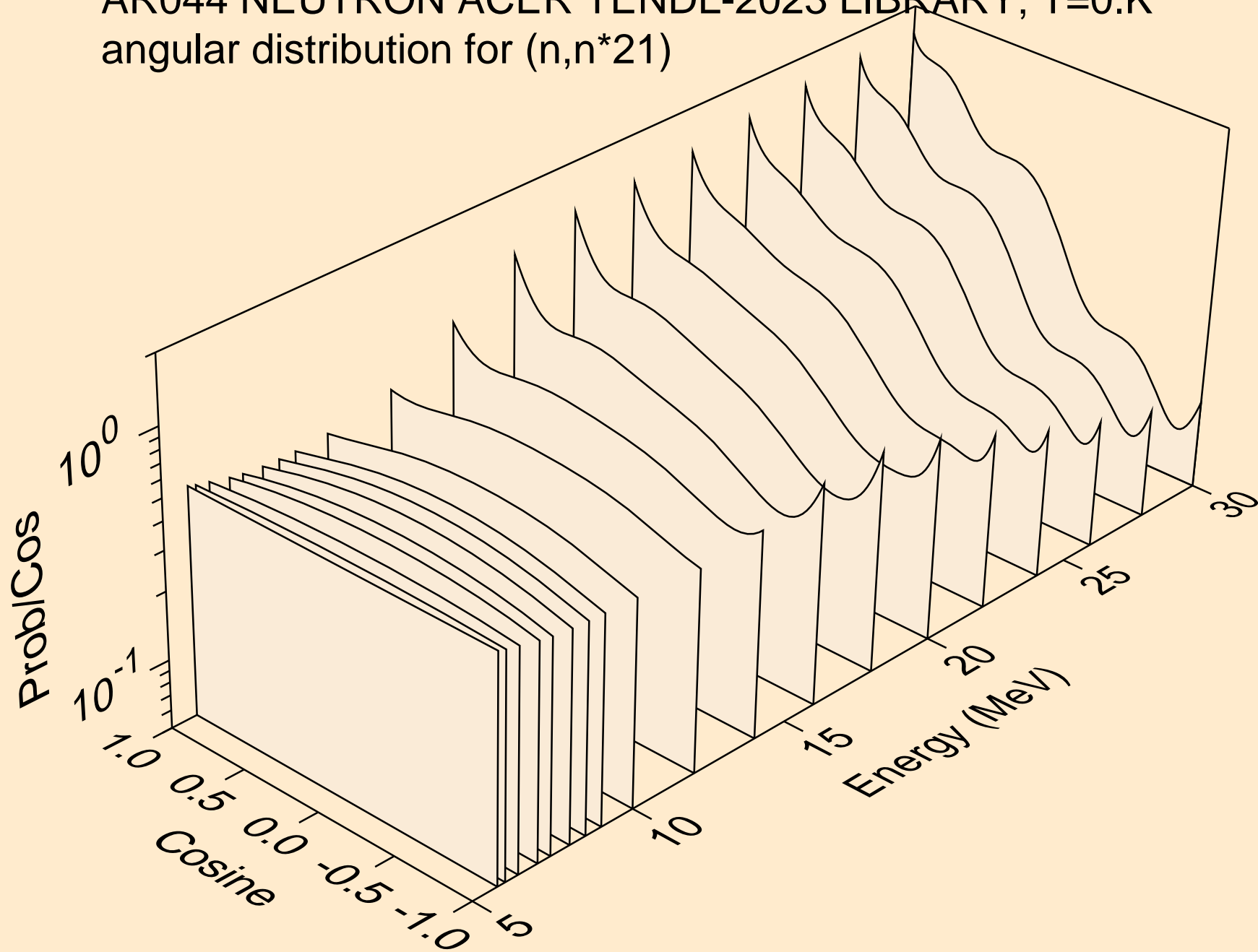

AR044 NEUTRON ACER TENDL-2023 LIBRARY; T=0.K
angular distribution for (n,n*22)

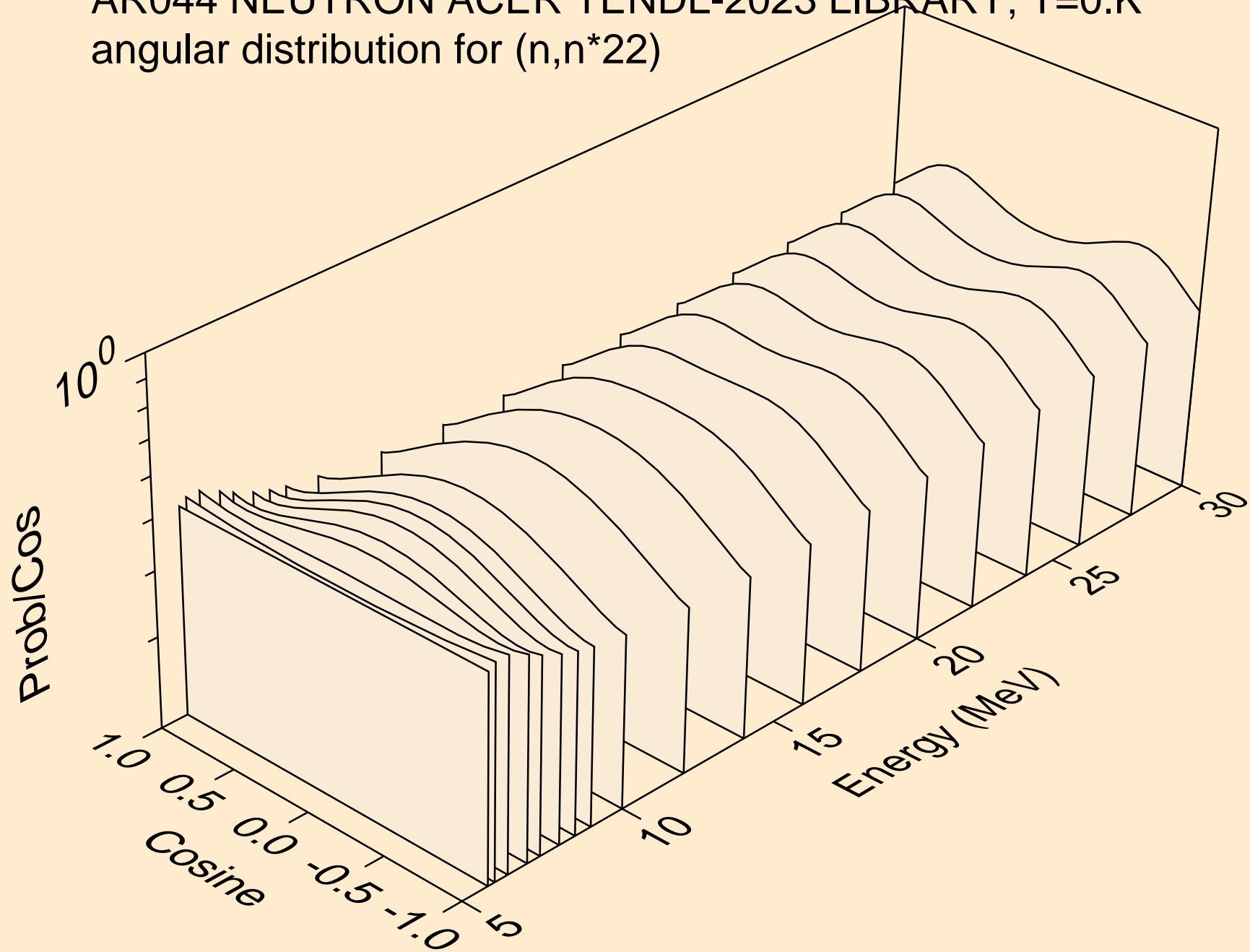

AR044 NEUTRON ACER TENDL-2023 LIBRARY; T=0.K
angular distribution for (n,n*23)

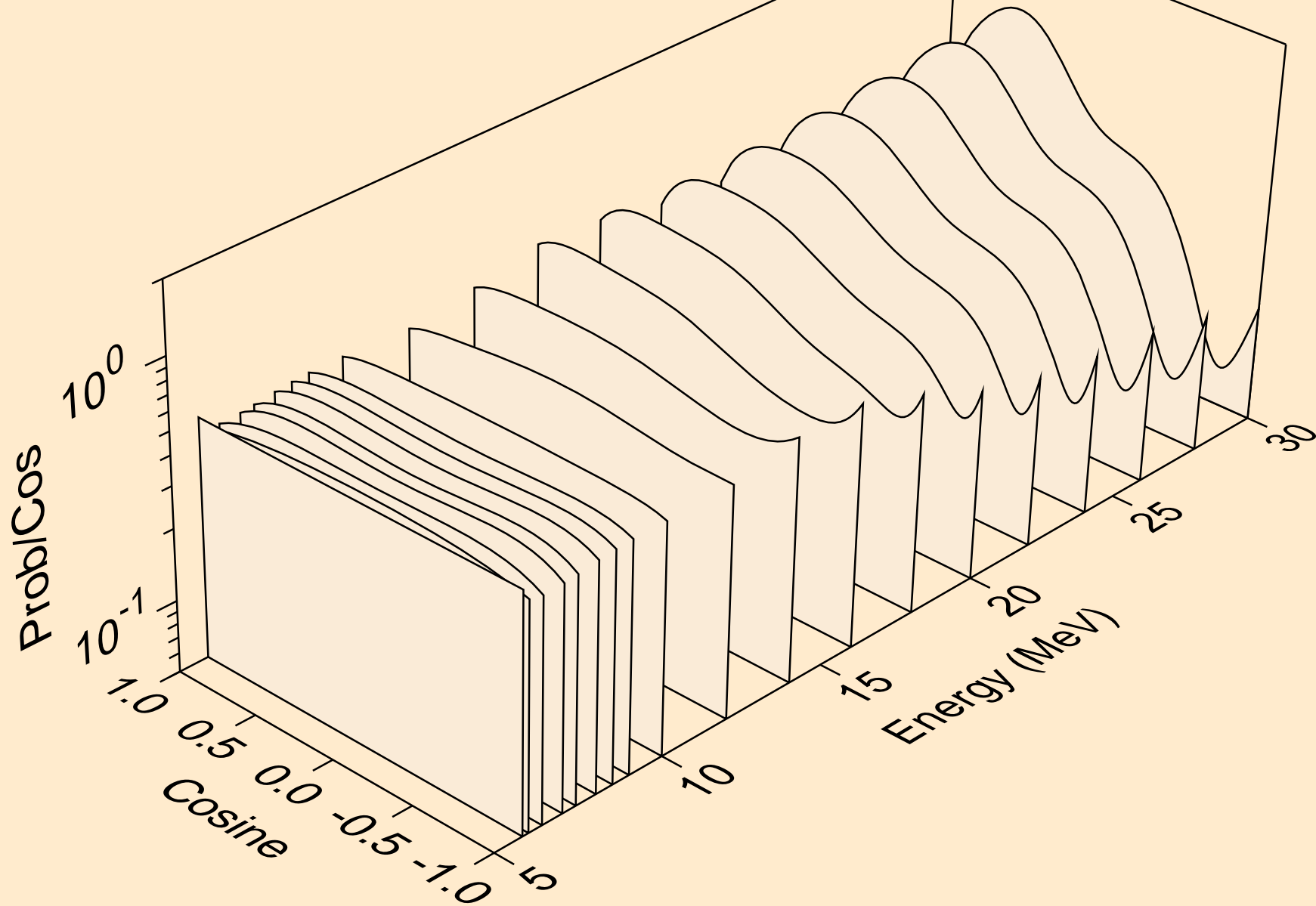

AR044 NEUTRON ACER TENDL-2023 LIBRARY; T=0.K
angular distribution for (n,n*24)

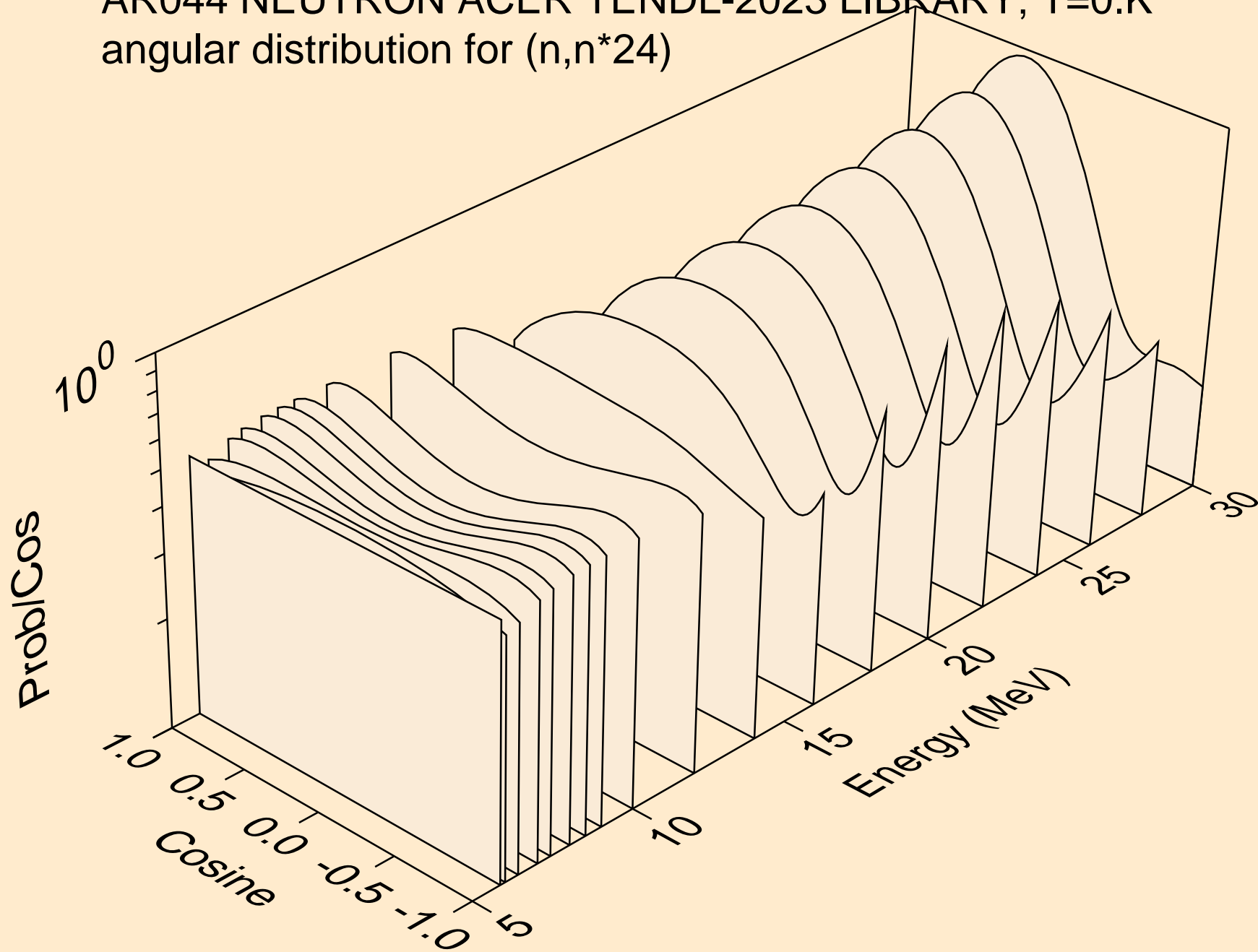

AR044 NEUTRON ACER TENDL-2023 LIBRARY; T=0.K
angular distribution for (n,n*25)

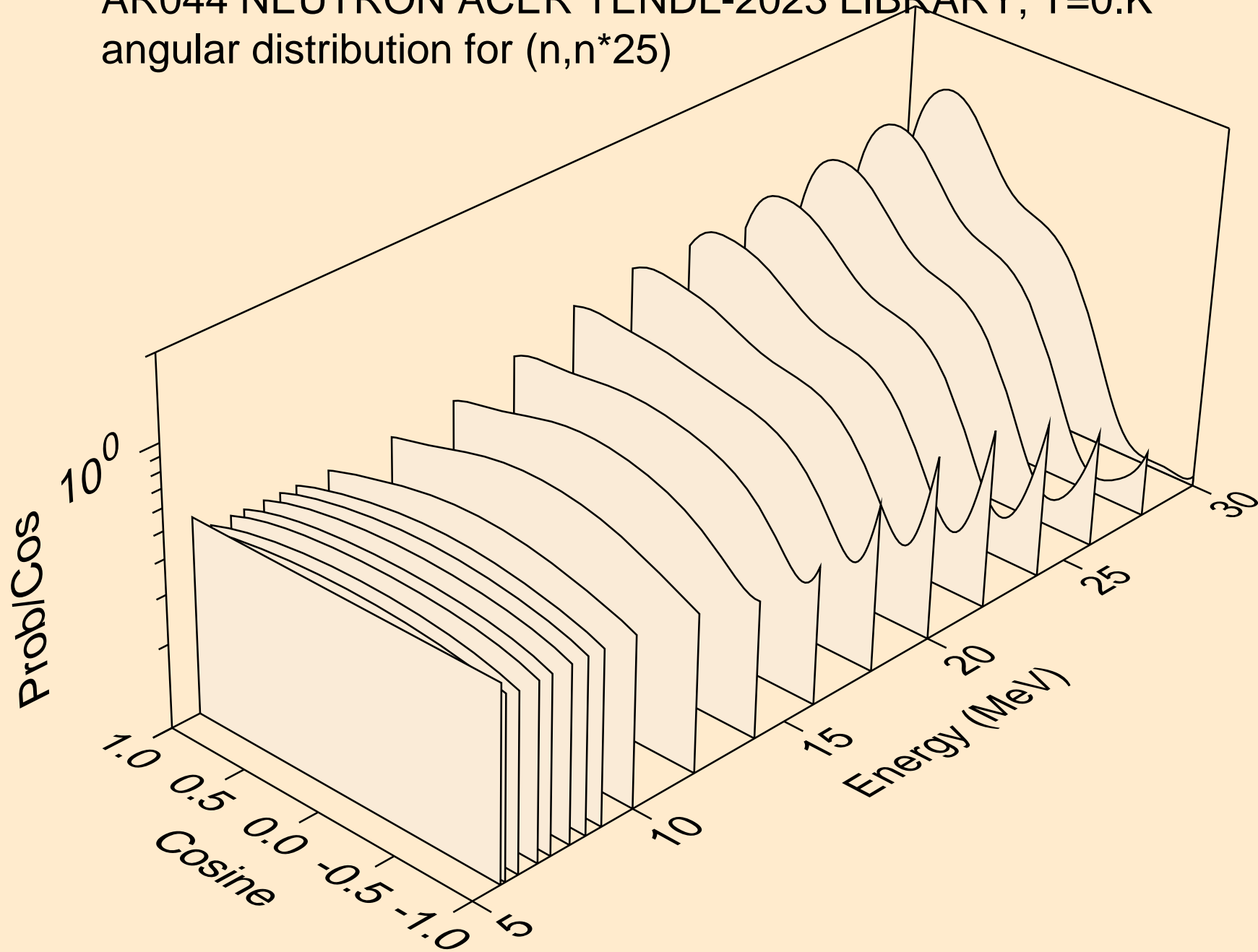

AR044 NEUTRON ACER TENDL-2023 LIBRARY; T=0.K
angular distribution for (n,n*26)

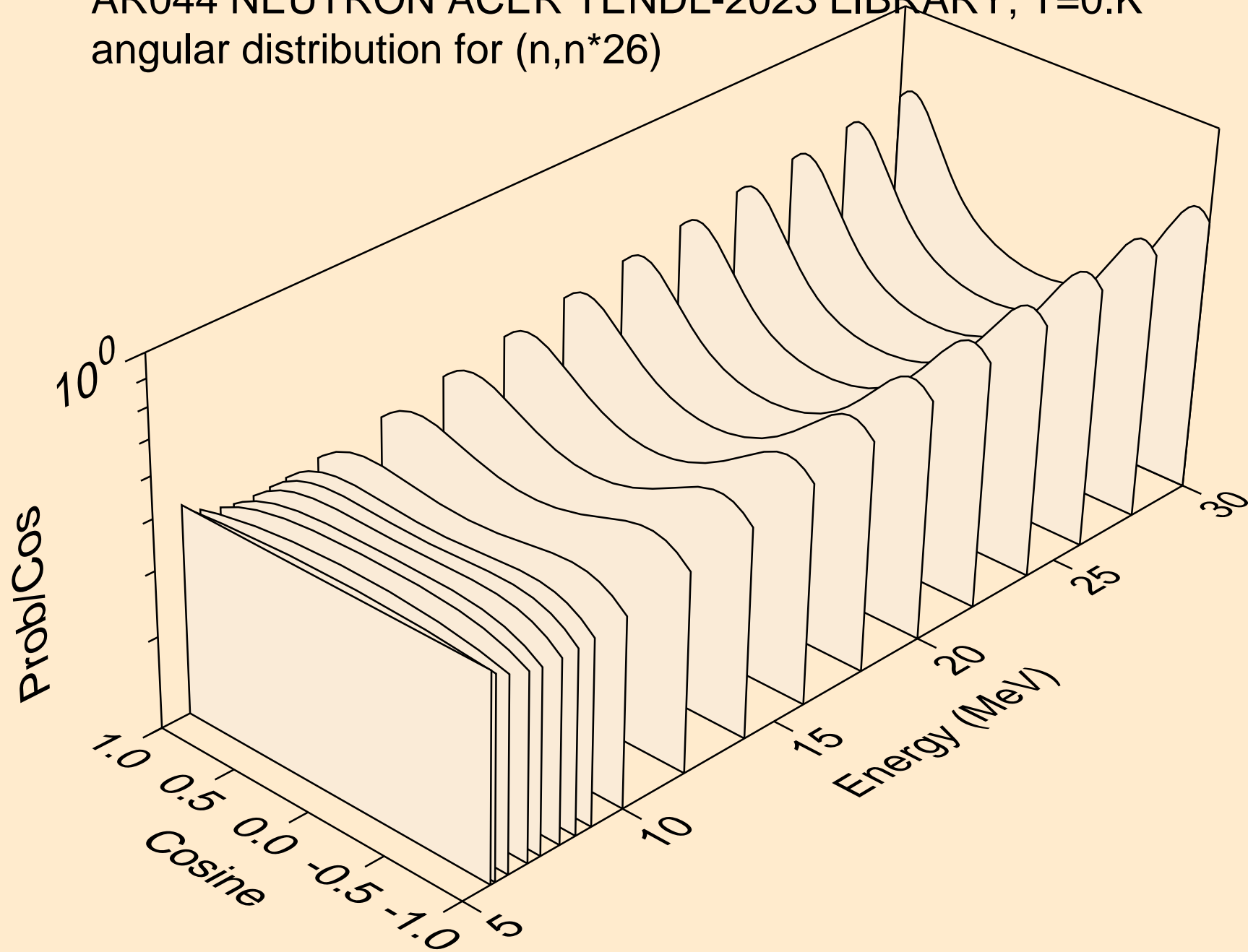

AR044 NEUTRON ACER TENDL-2023 LIBRARY; T=0.K
angular distribution for (n,n*27)

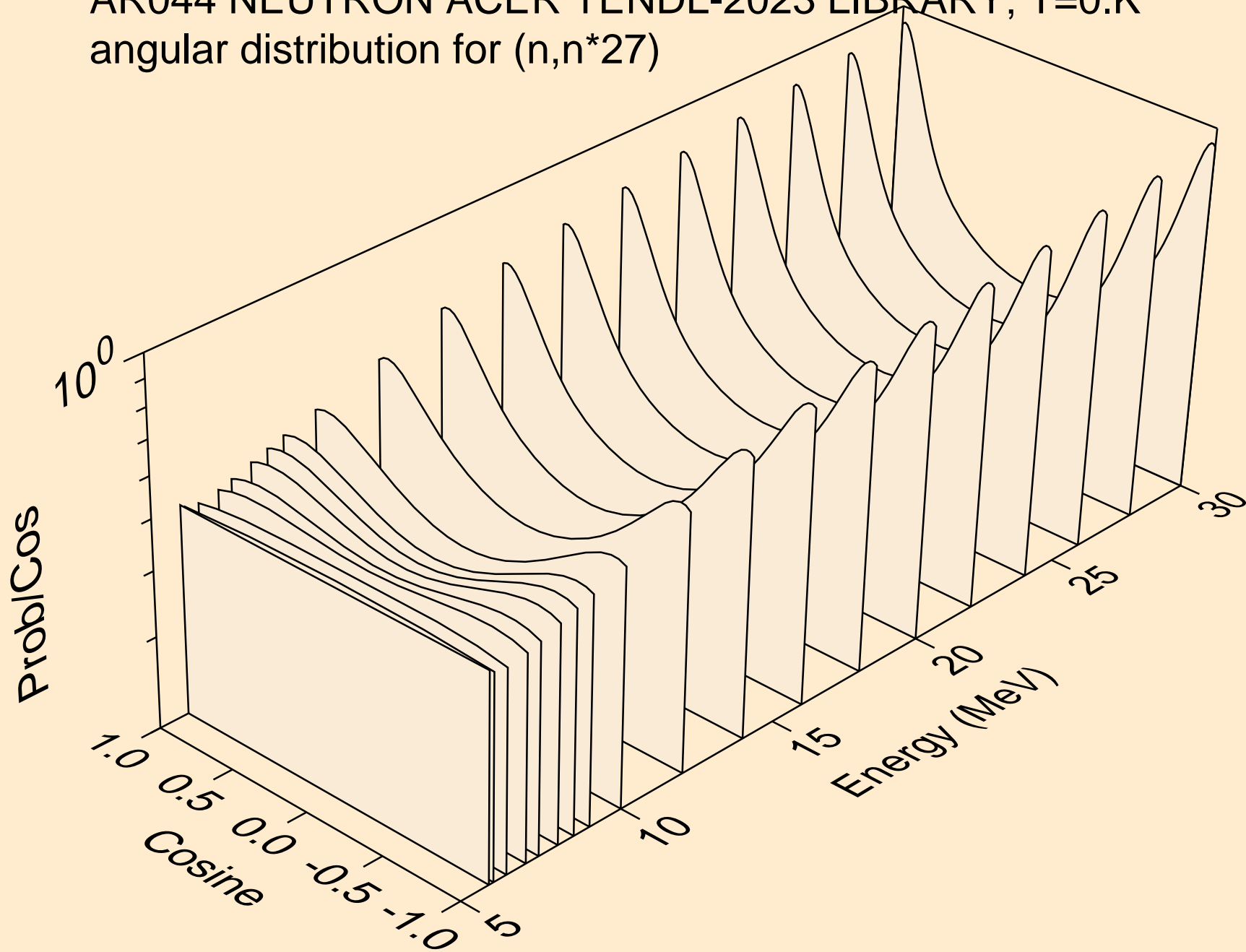

AR044 NEUTRON ACER TENDL-2023 LIBRARY; T=0.K
angular distribution for (n,n*28)

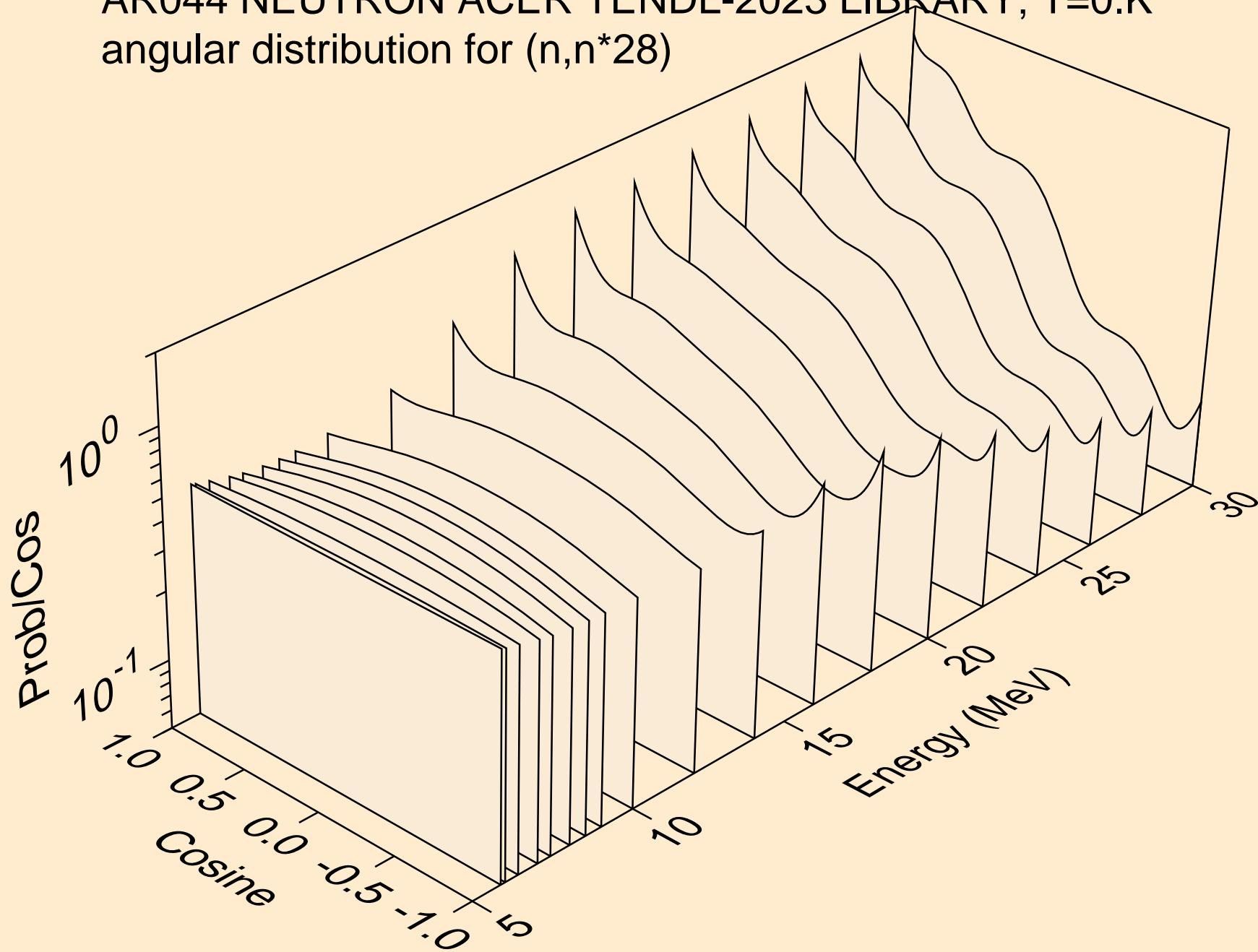

AR044 NEUTRON ACER TENDL-2023 LIBRARY; T=0.K
angular distribution for (n,n*29)

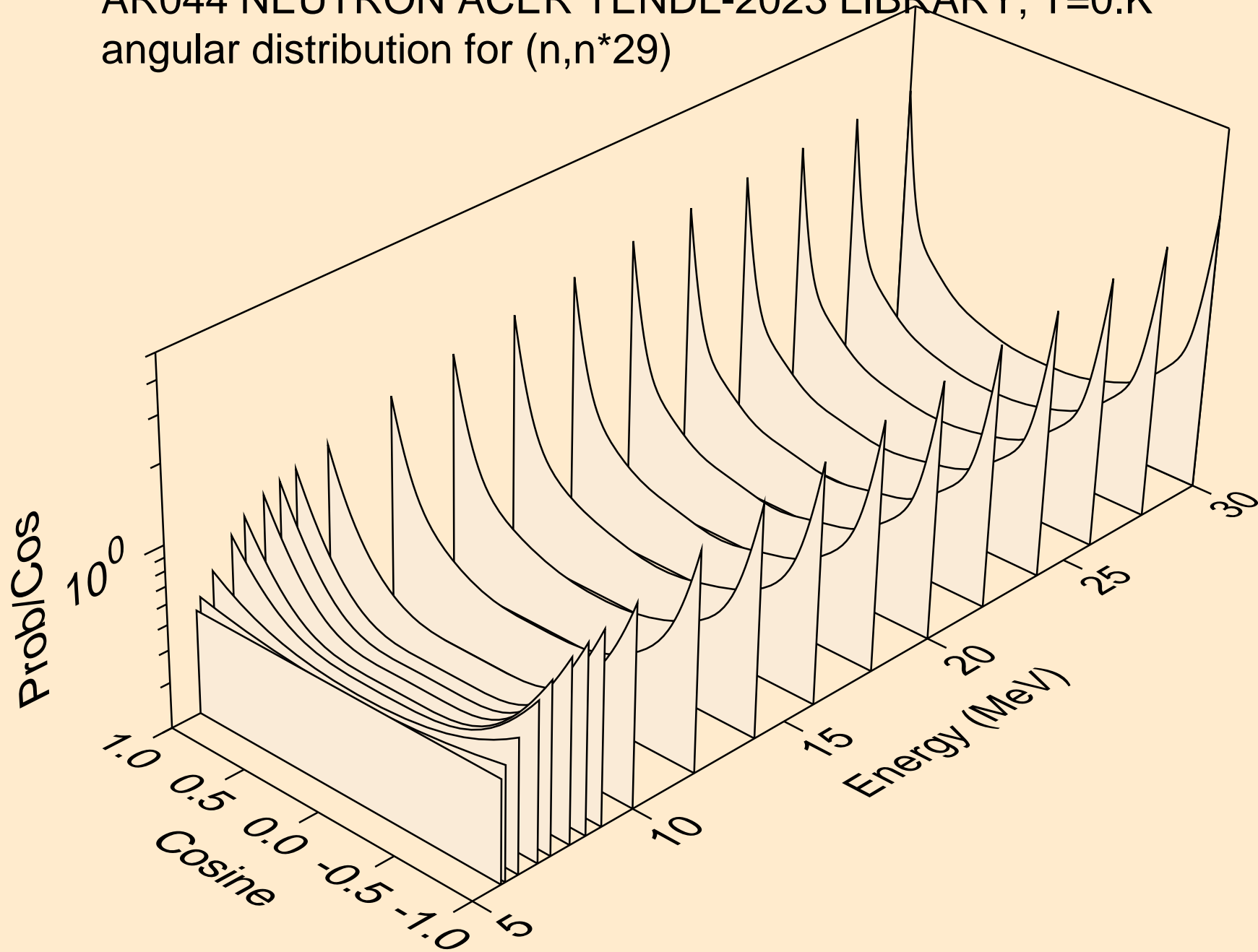

AR044 NEUTRON ACER TENDL-2023 LIBRARY; T=0.K
angular distribution for (n,n*30)

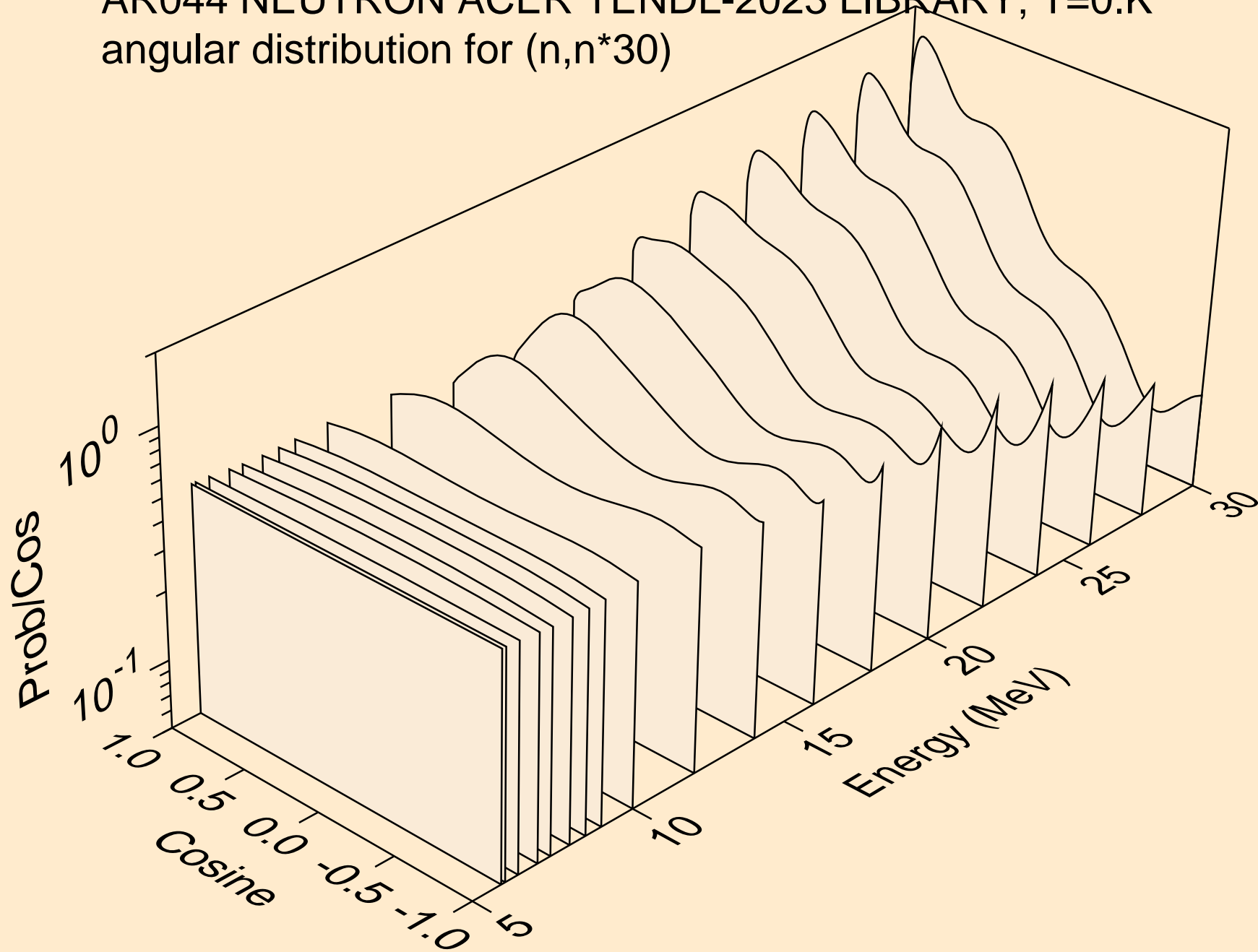

AR044 NEUTRON ACER TENDL-2023 LIBRARY; T=0.K
Neutron emission for (n,x)

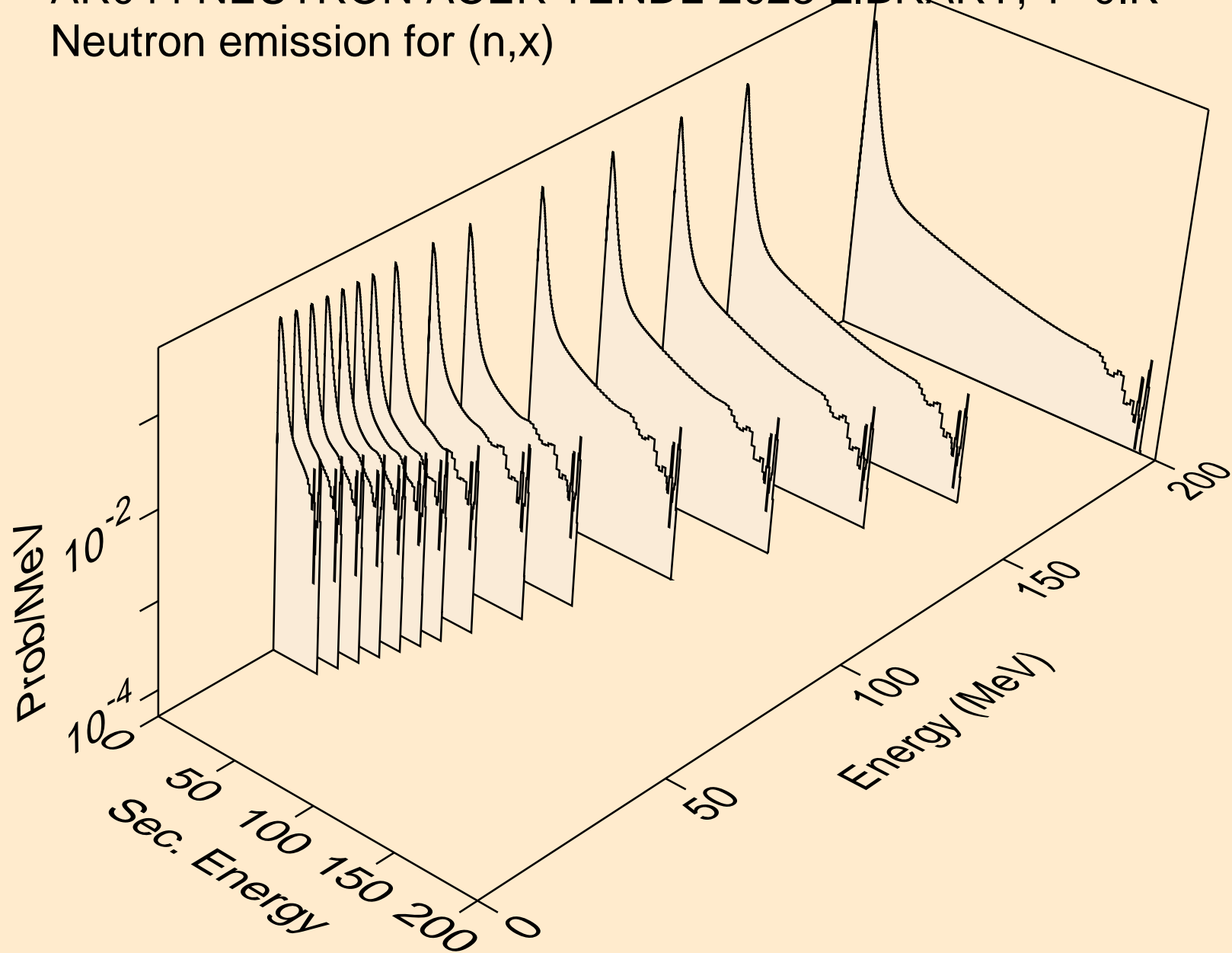

AR044 NEUTRON ACER TENDL-2023 LIBRARY; T=0.K
Neutron emission for (n,2nd)

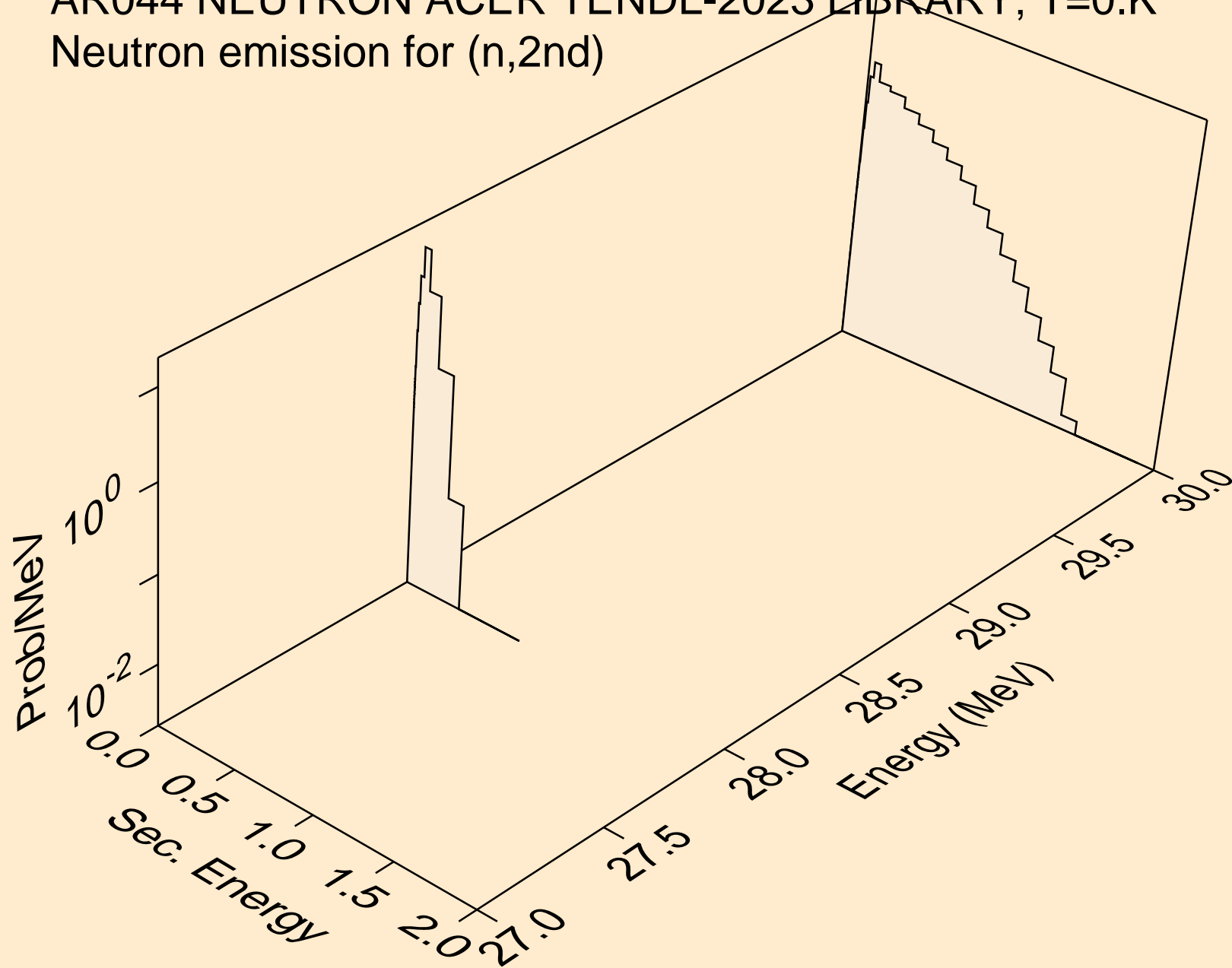

AR044 NEUTRON ACER TENDL-2023 LIBRARY; T=0.K
Neutron emission for (n,2n)

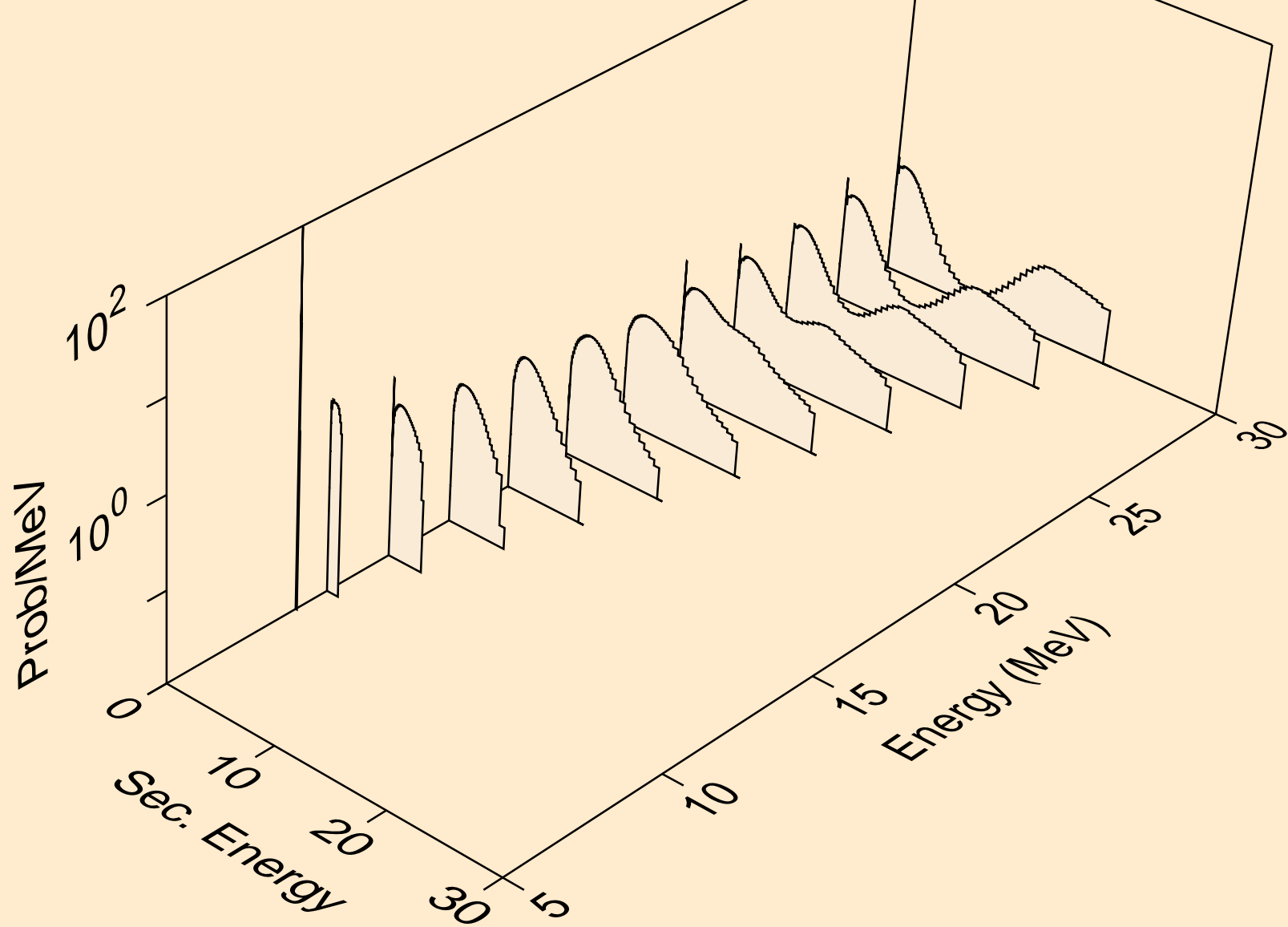

AR044 NEUTRON ACER TENDL-2023 LIBRARY; T=0.K
Neutron emission for (n,3n)

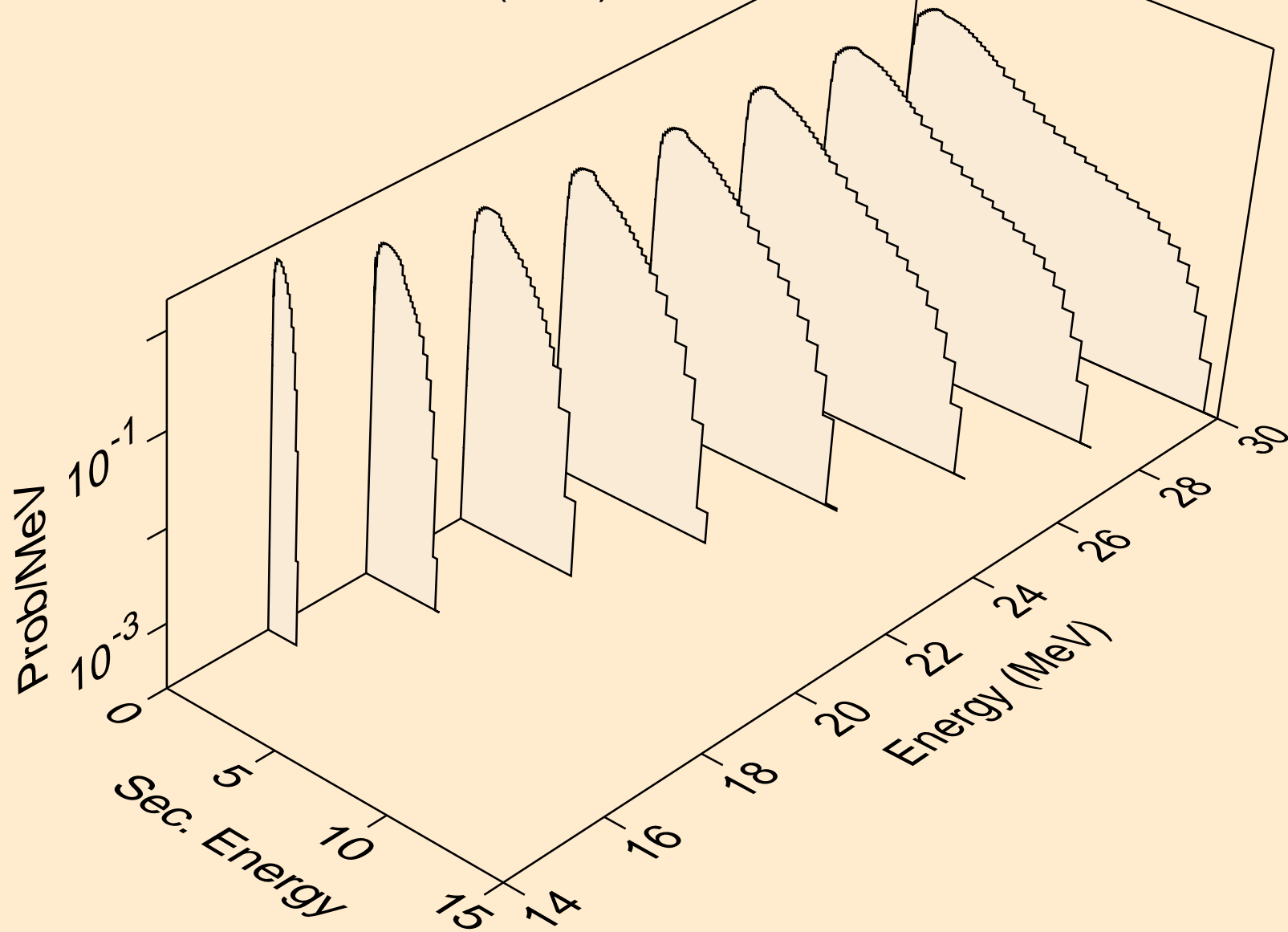

AR044 NEUTRON ACER TENDL-2023 LIBRARY; T=0.K
Neutron emission for (n,n*)a

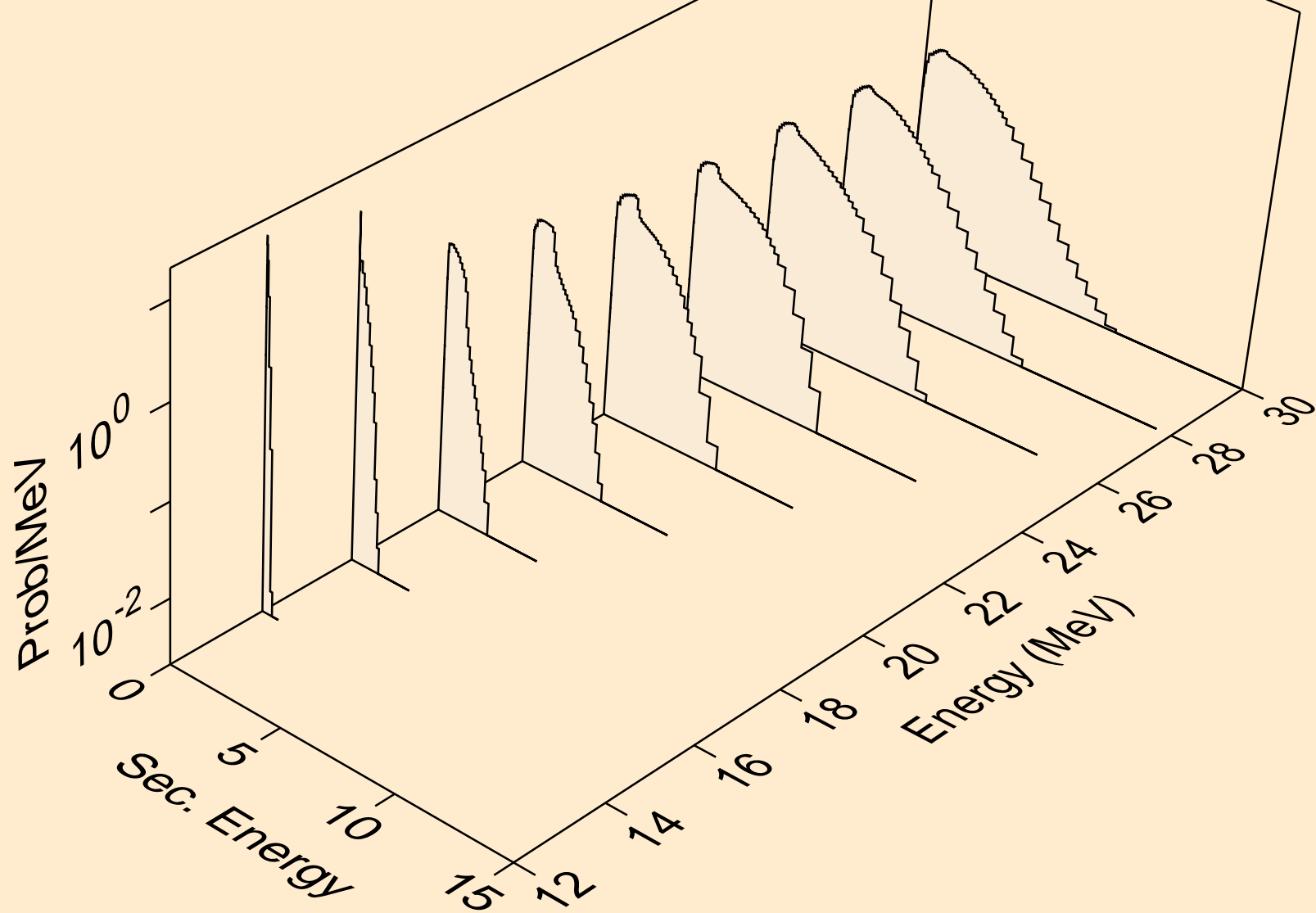

AR044 NEUTRON ACER TENDL-2023 LIBRARY; T=0.K
Neutron emission for (n,2n)a

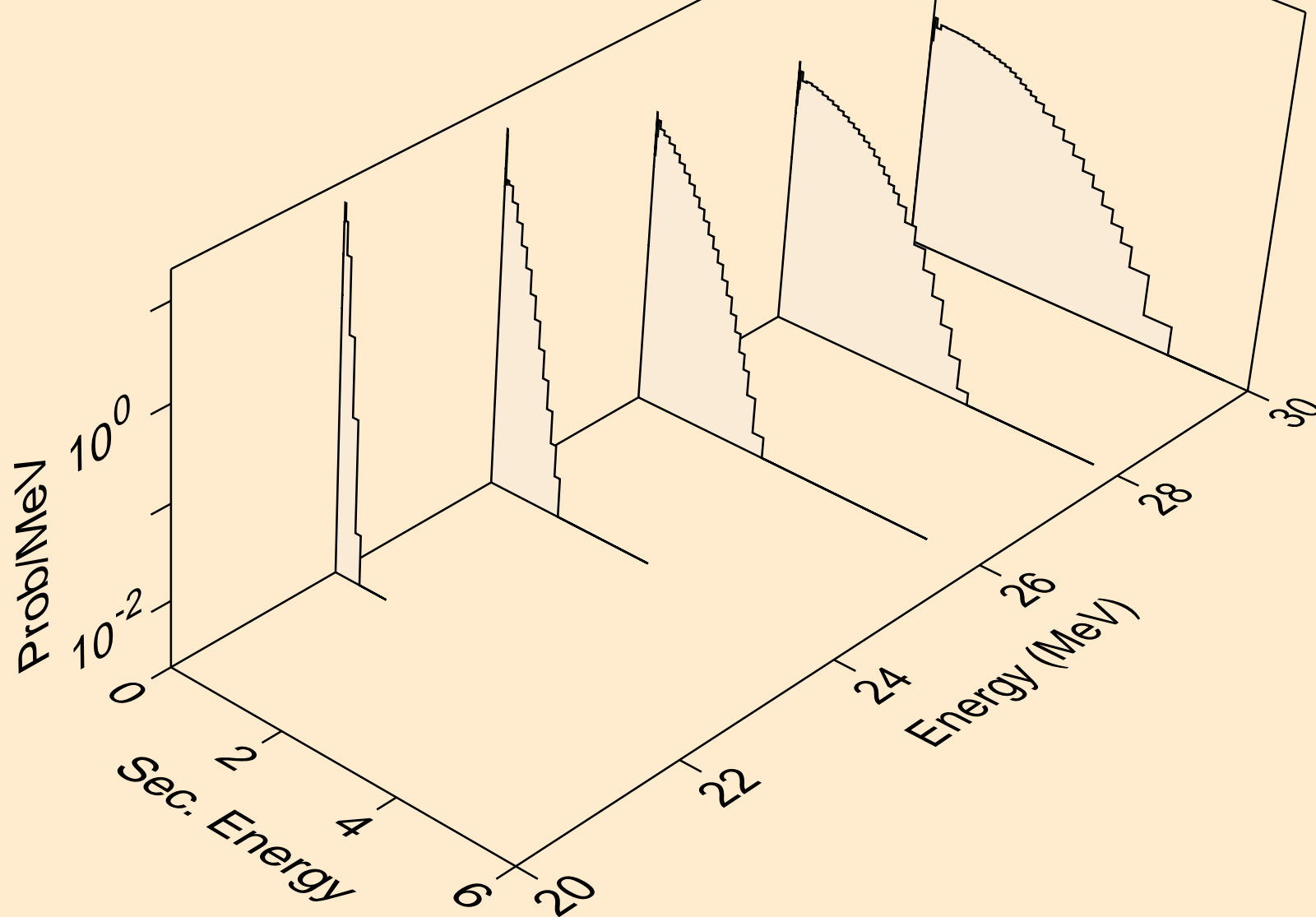

AR044 NEUTRON ACER TENDL-2023 LIBRARY; T=0.K
Neutron emission for (n,3n)a

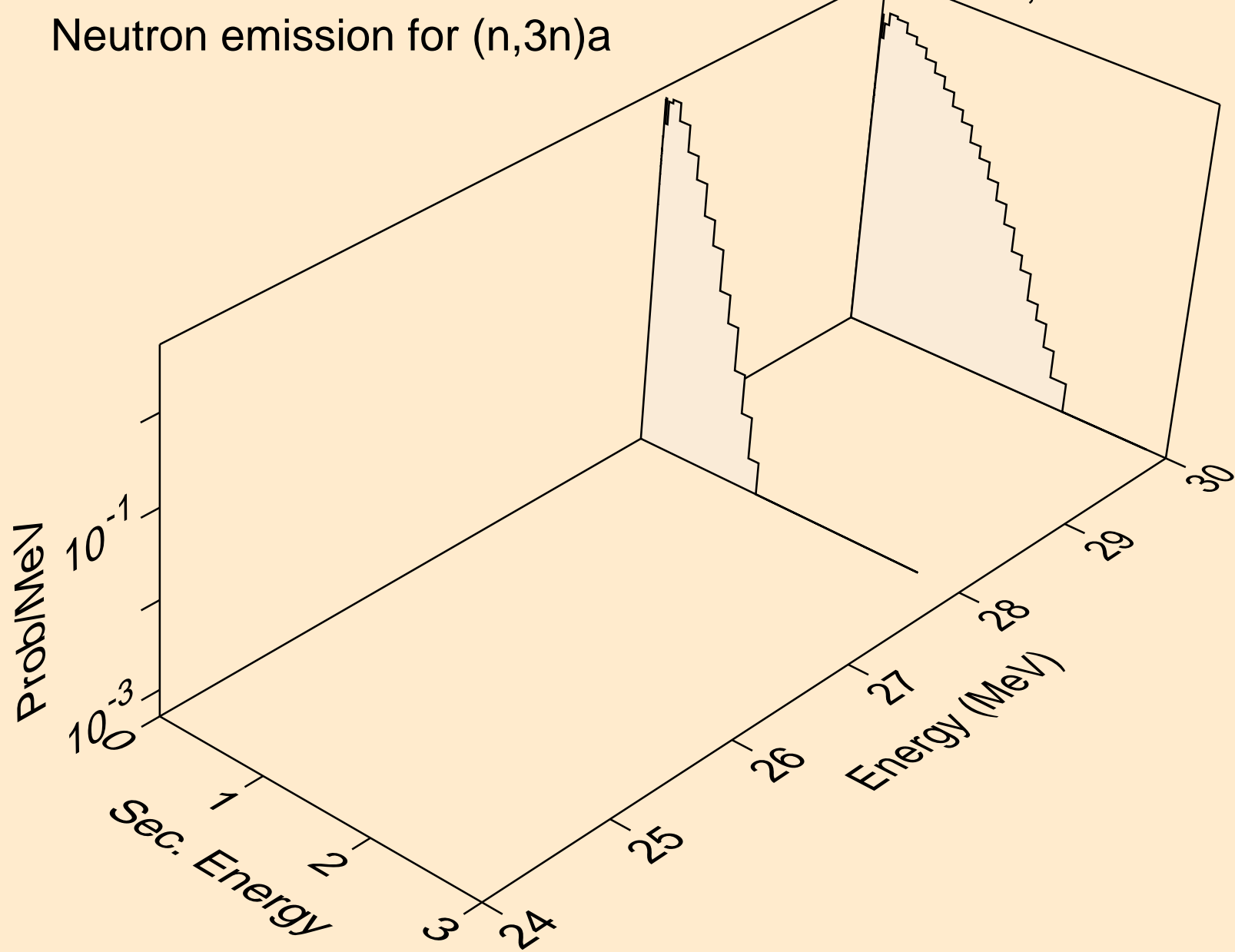

AR044 NEUTRON ACER TENDL-2023 LIBRARY; T=0.K
Neutron emission for (n,n*)p

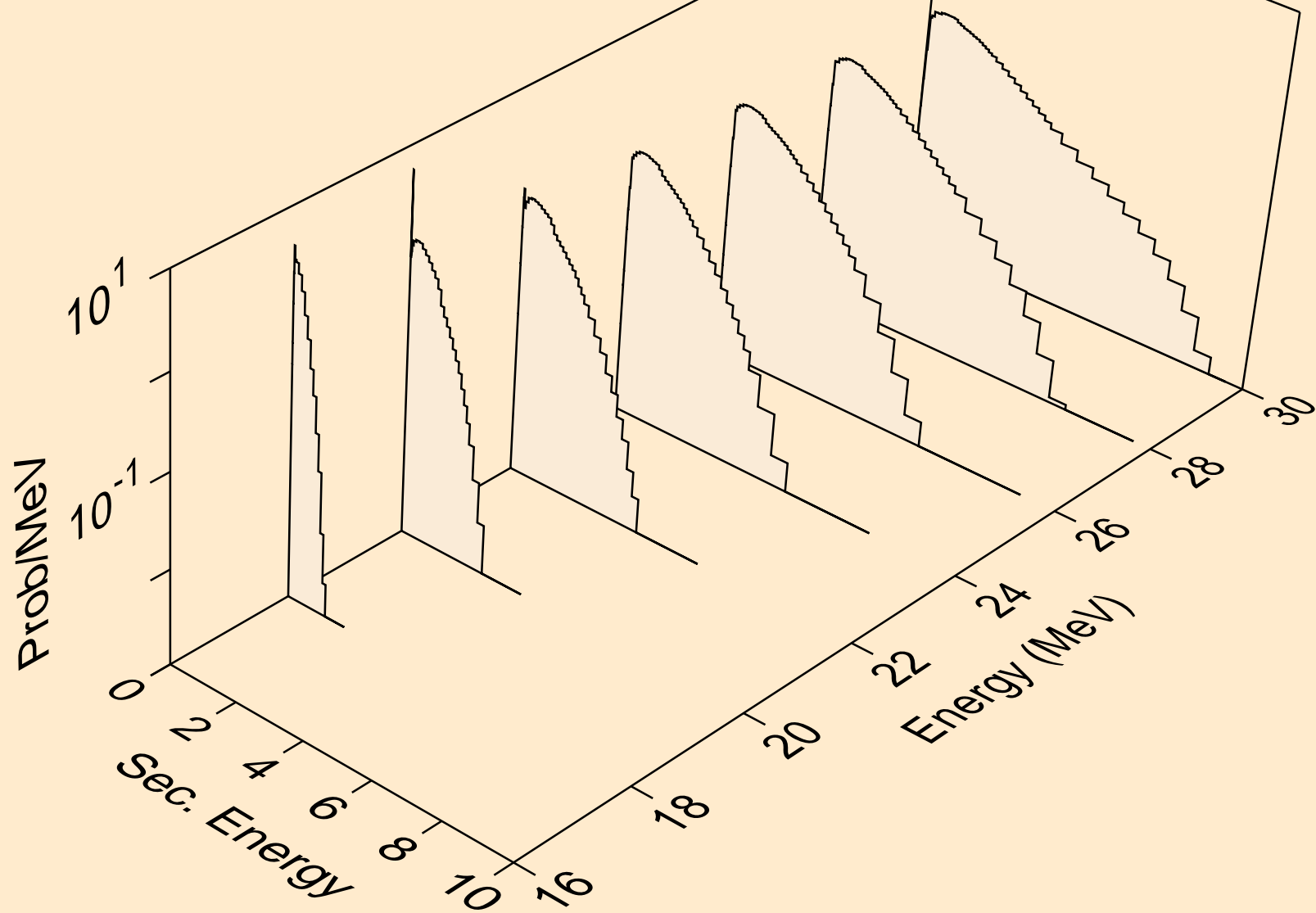

AR044 NEUTRON ACER TENDL-2023 LIBRARY; T=0.K
Neutron emission for (n,n*)d

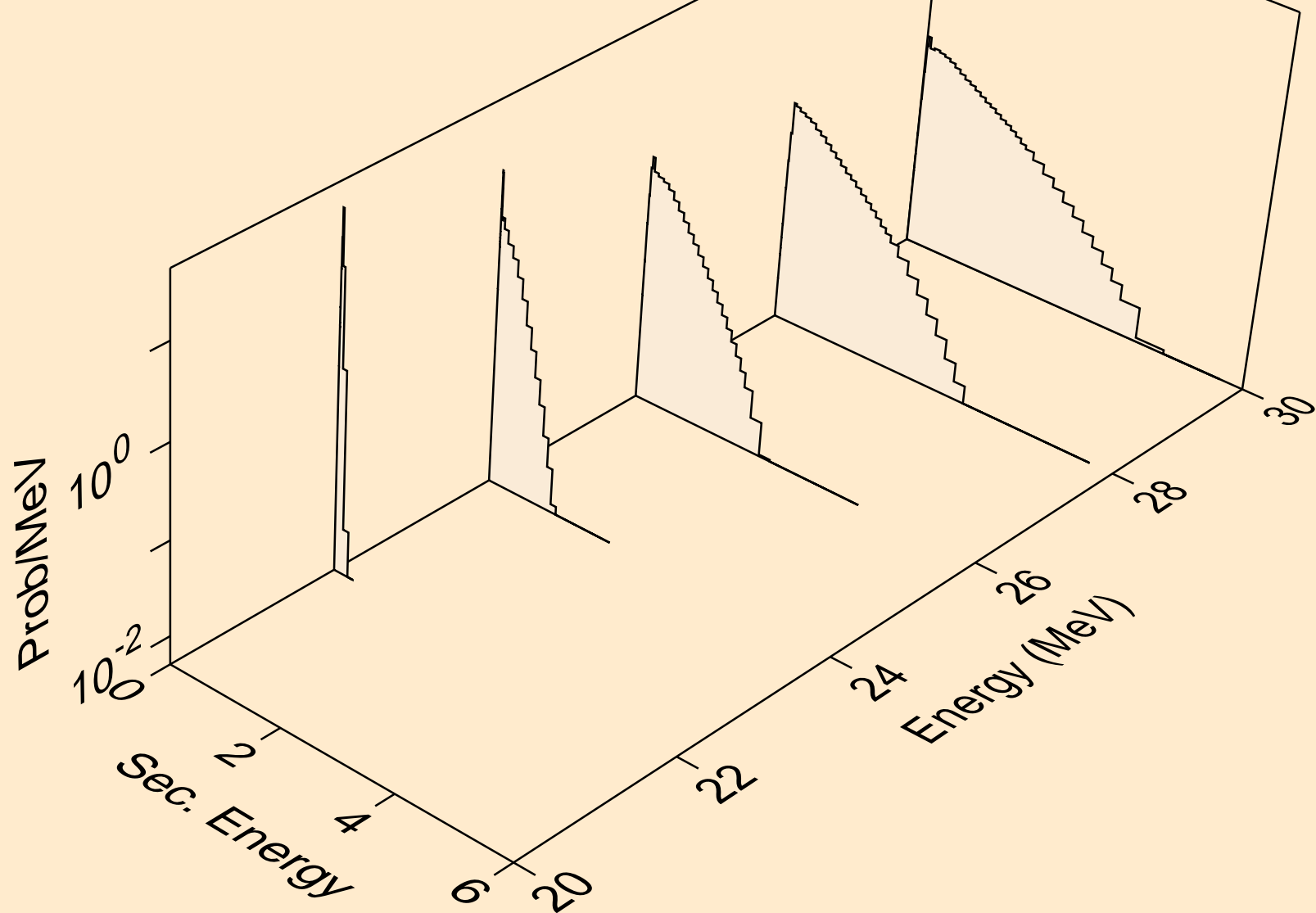

AR044 NEUTRON ACER TENDL-2023 LIBRARY; T=0.K
Neutron emission for (n,n*)t

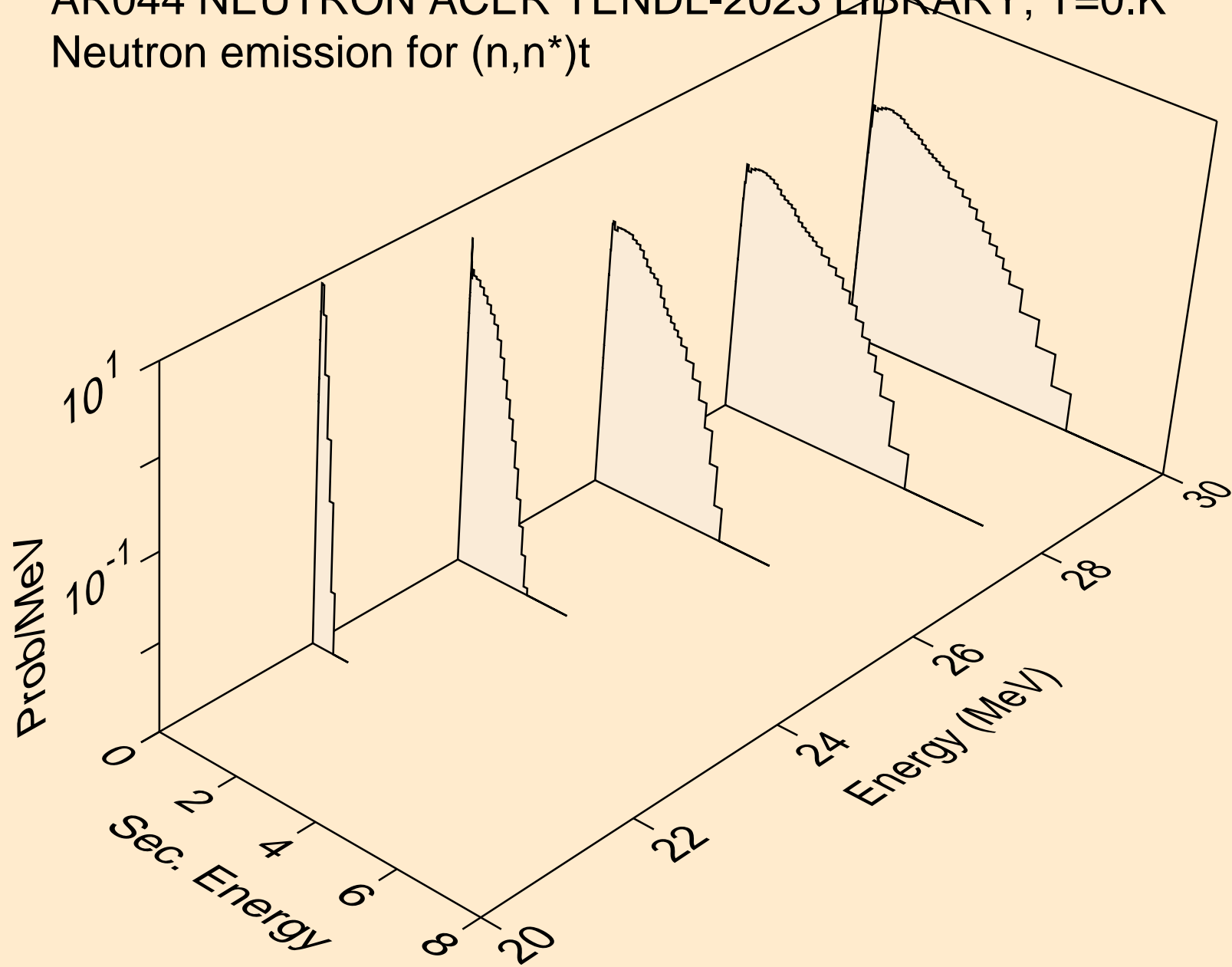

AR044 NEUTRON ACER TENDL-2023 LIBRARY; T=0.K
Neutron emission for (n,4n)

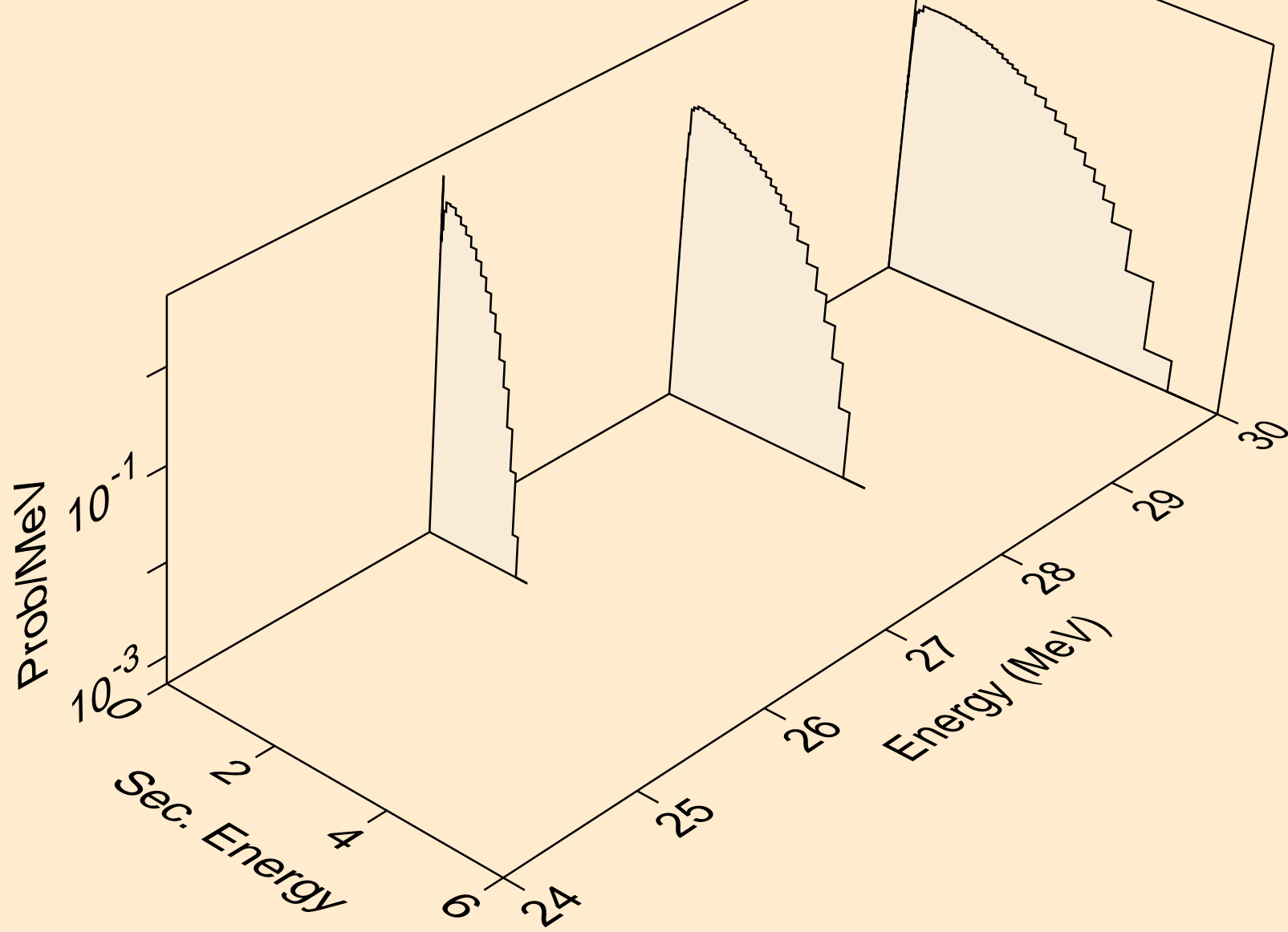

AR044 NEUTRON ACER TENDL-2023 LIBRARY; T=0.K
Neutron emission for (n,2np)

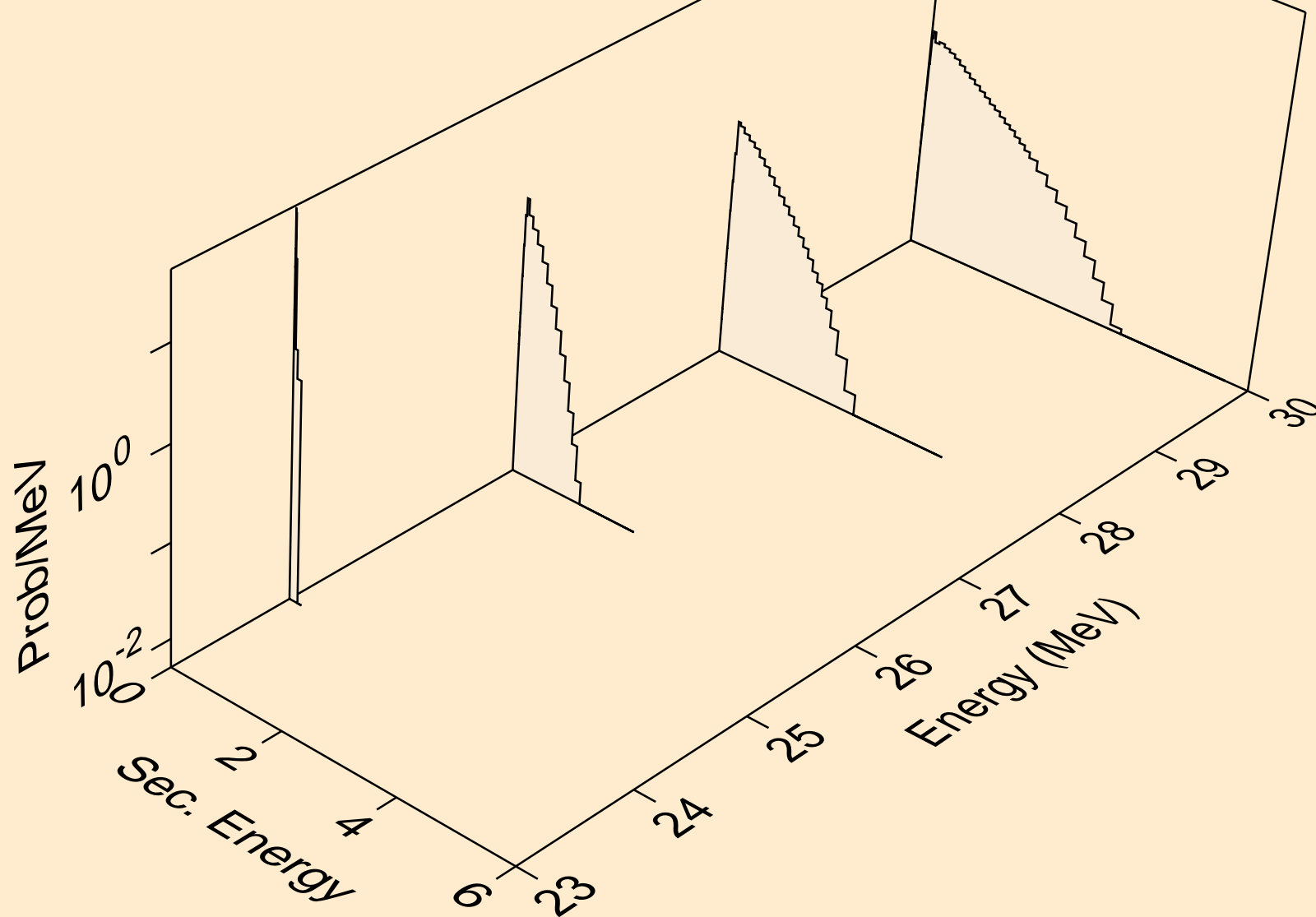

AR044 NEUTRON ACER TENDL-2023 LIBRARY; T=0.K
Neutron emission for (n,n*c)

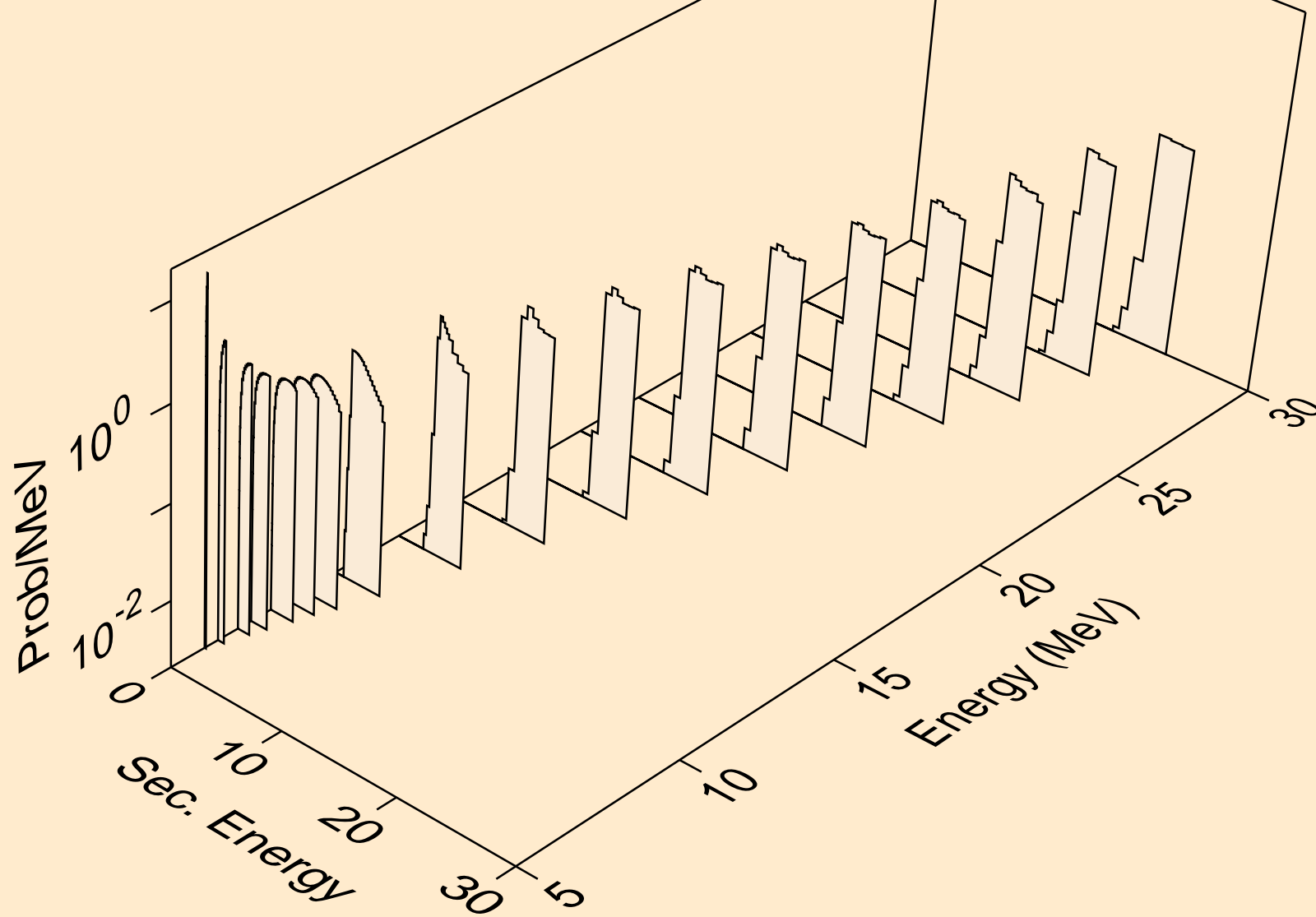

AR044 NEUTRON ACER TENDL-2023 LIBRARY; T=0.K
Photon emission for (n,x)

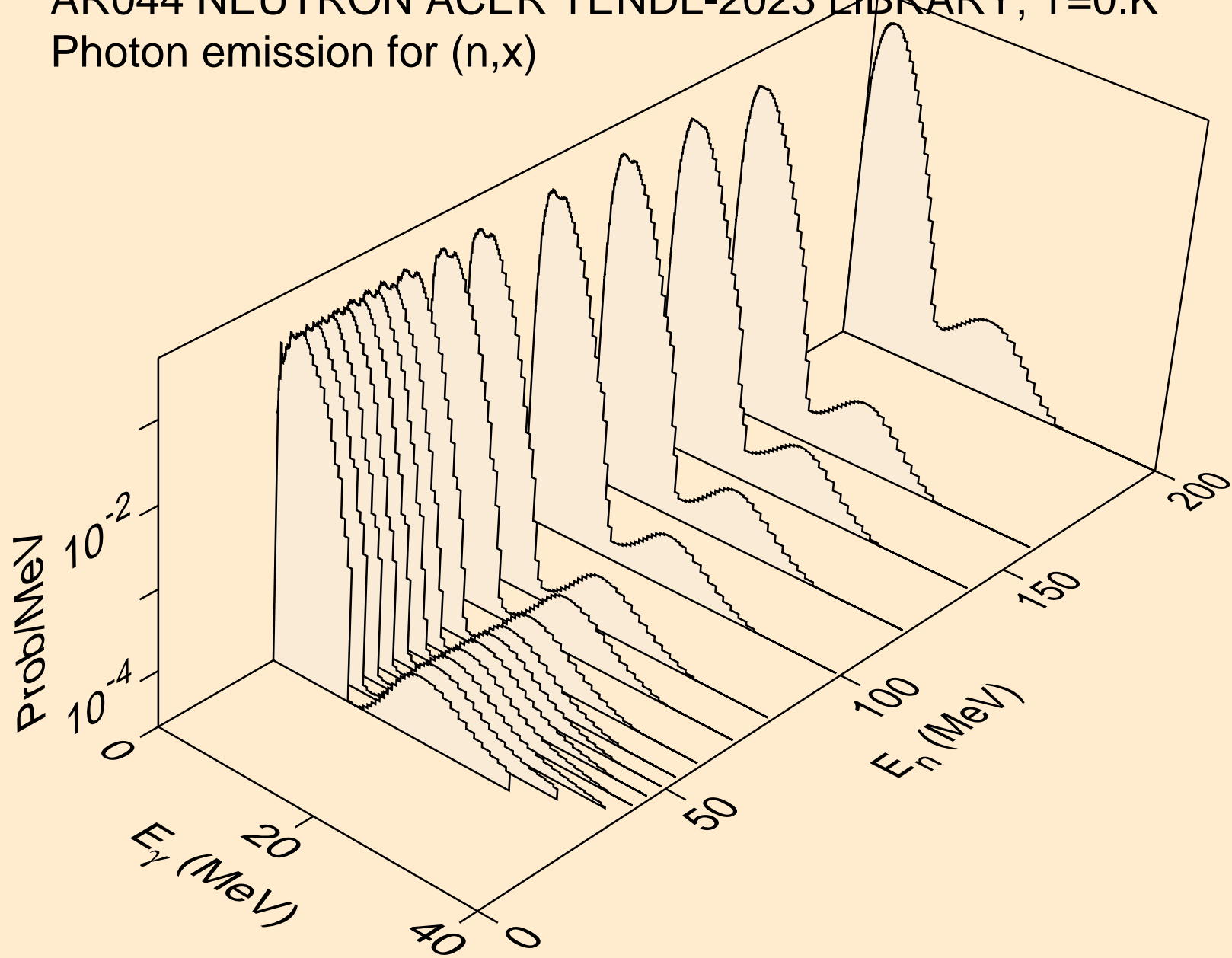

AR044 NEUTRON ACER TENDL-2023 LIBRARY; T=0.K
Photon emission for (n,2nd)

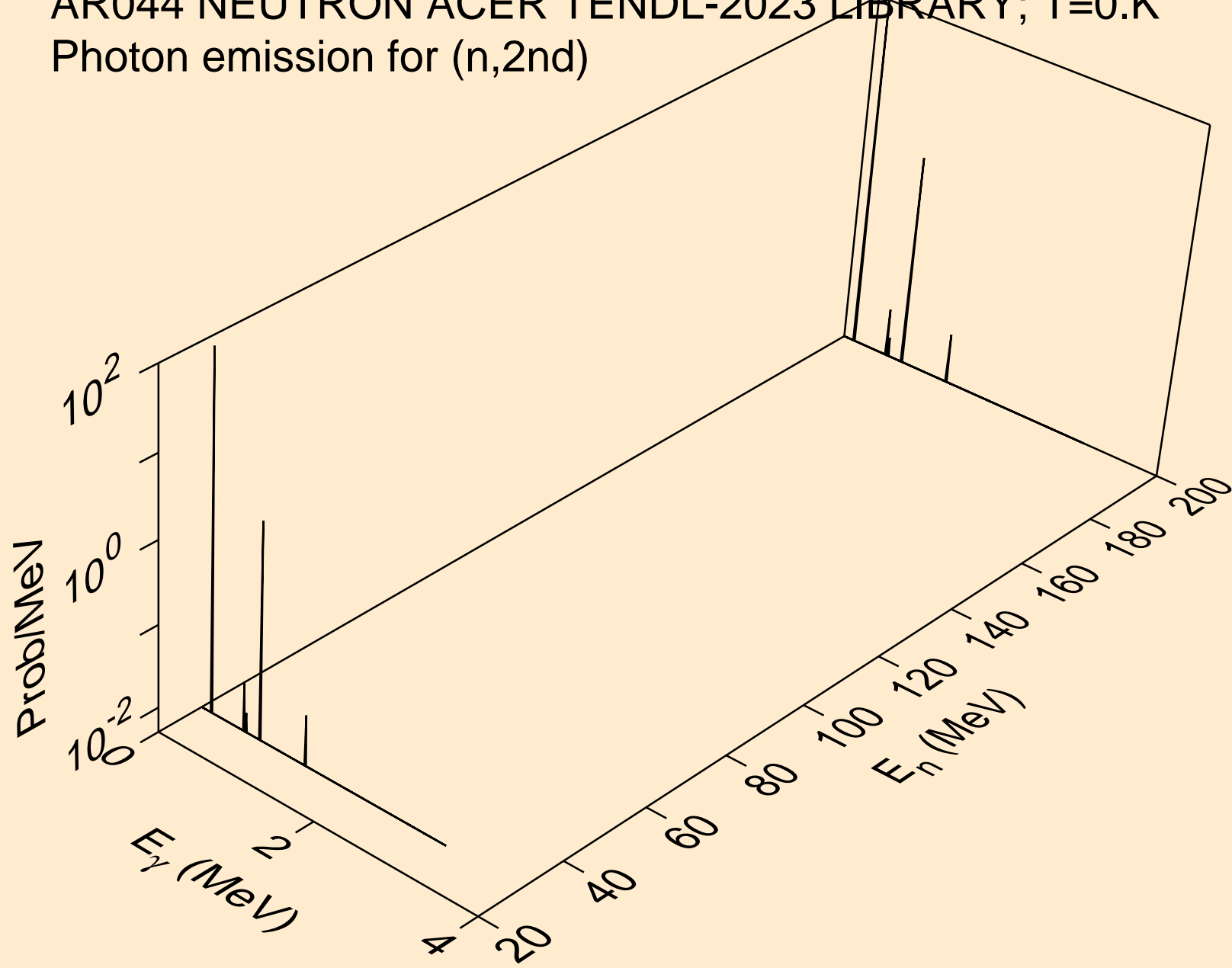

AR044 NEUTRON ACER TENDL-2023 LIBRARY; T=0.K
Photon emission for (n,2n)

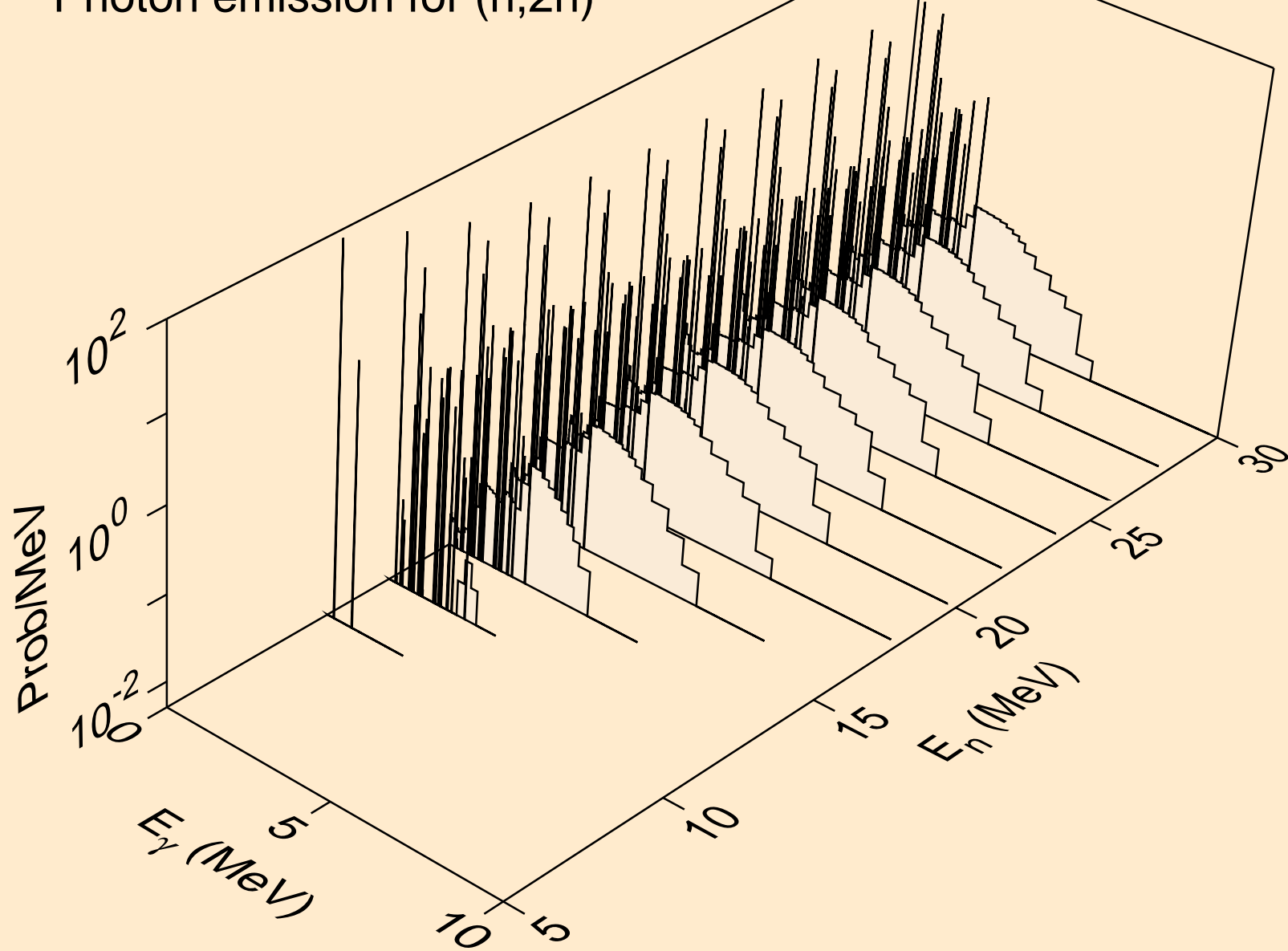

AR044 NEUTRON ACER TENDL-2023 LIBRARY; T=0.K
Photon emission for (n,3n)

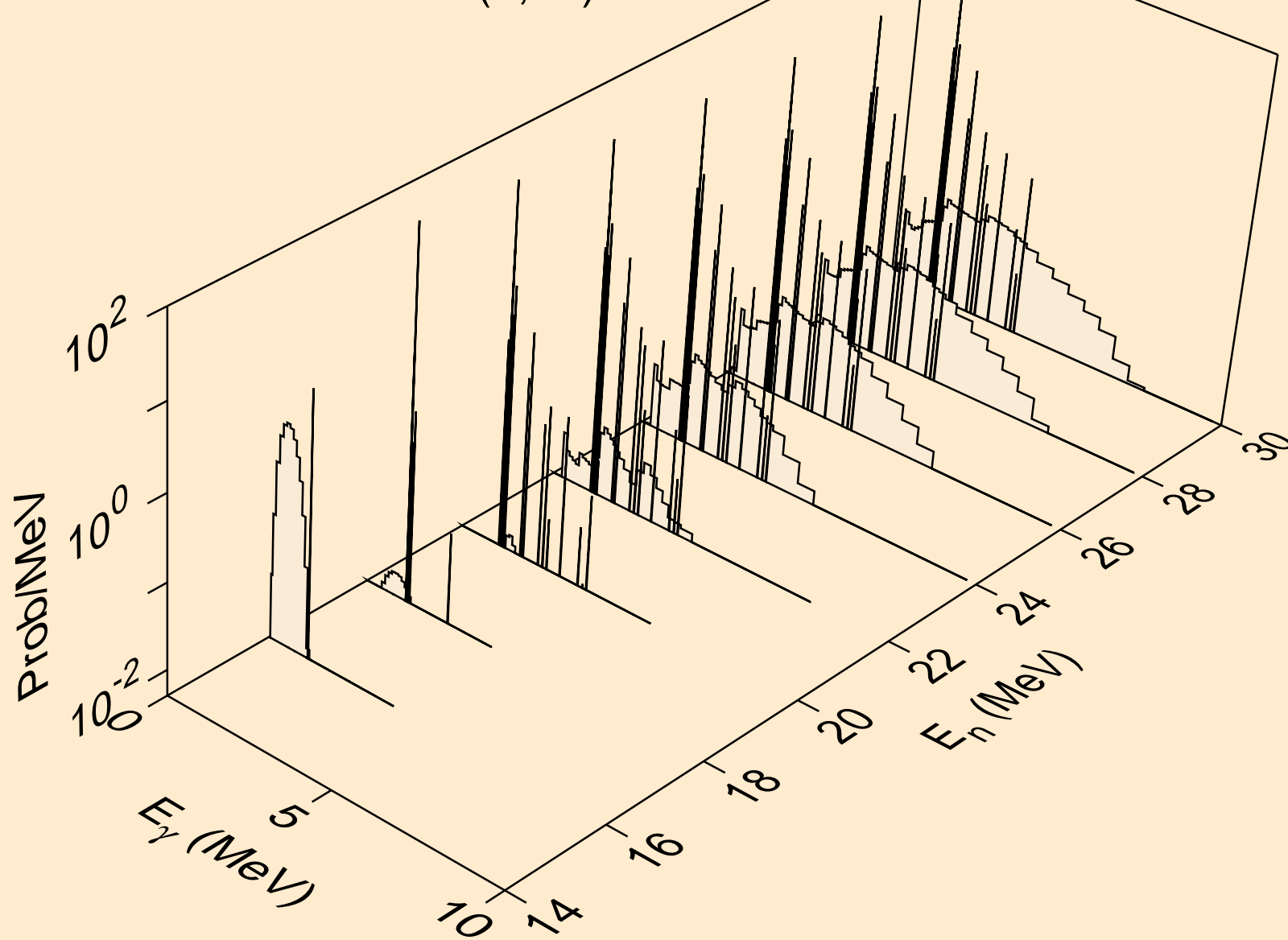

AR044 NEUTRON ACER TENDL-2023 LIBRARY; T=0.K
Photon emission for (n,n*)a

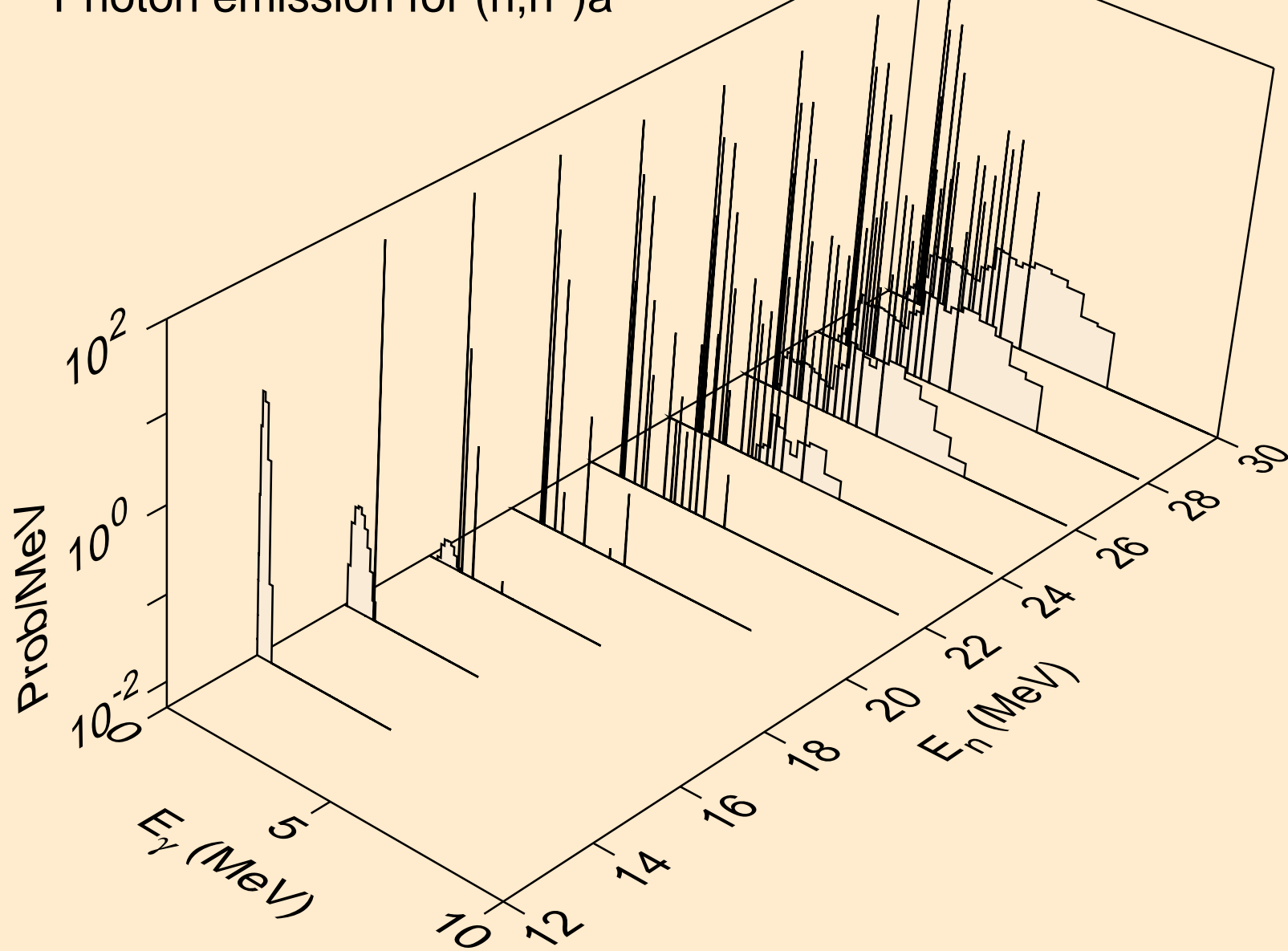

AR044 NEUTRON ACER TENDL-2023 LIBRARY; T=0.K
Photon emission for (n,2n)a

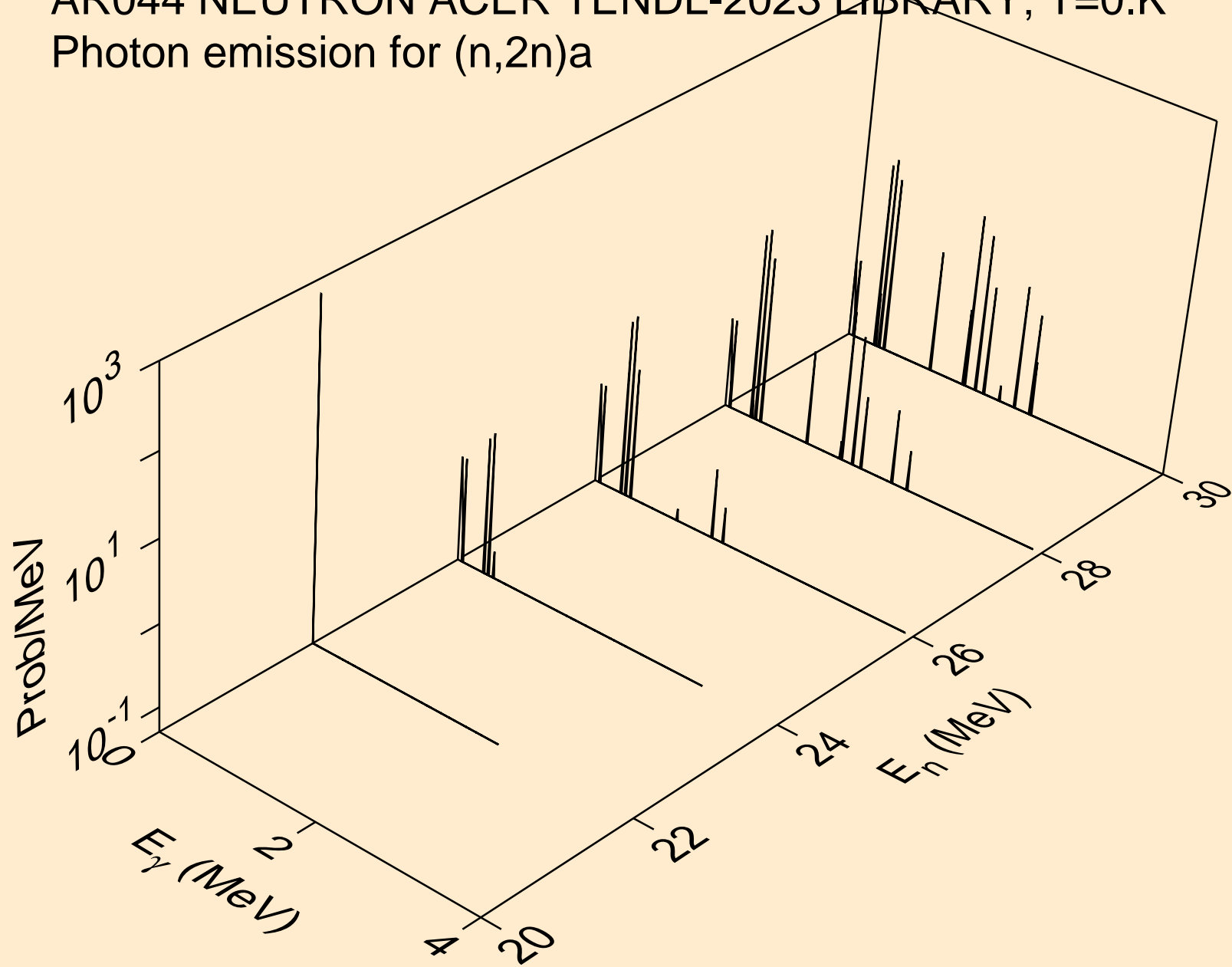

AR044 NEUTRON ACER TENDL-2023 LIBRARY; T=0.K
Photon emission for (n,3n)a

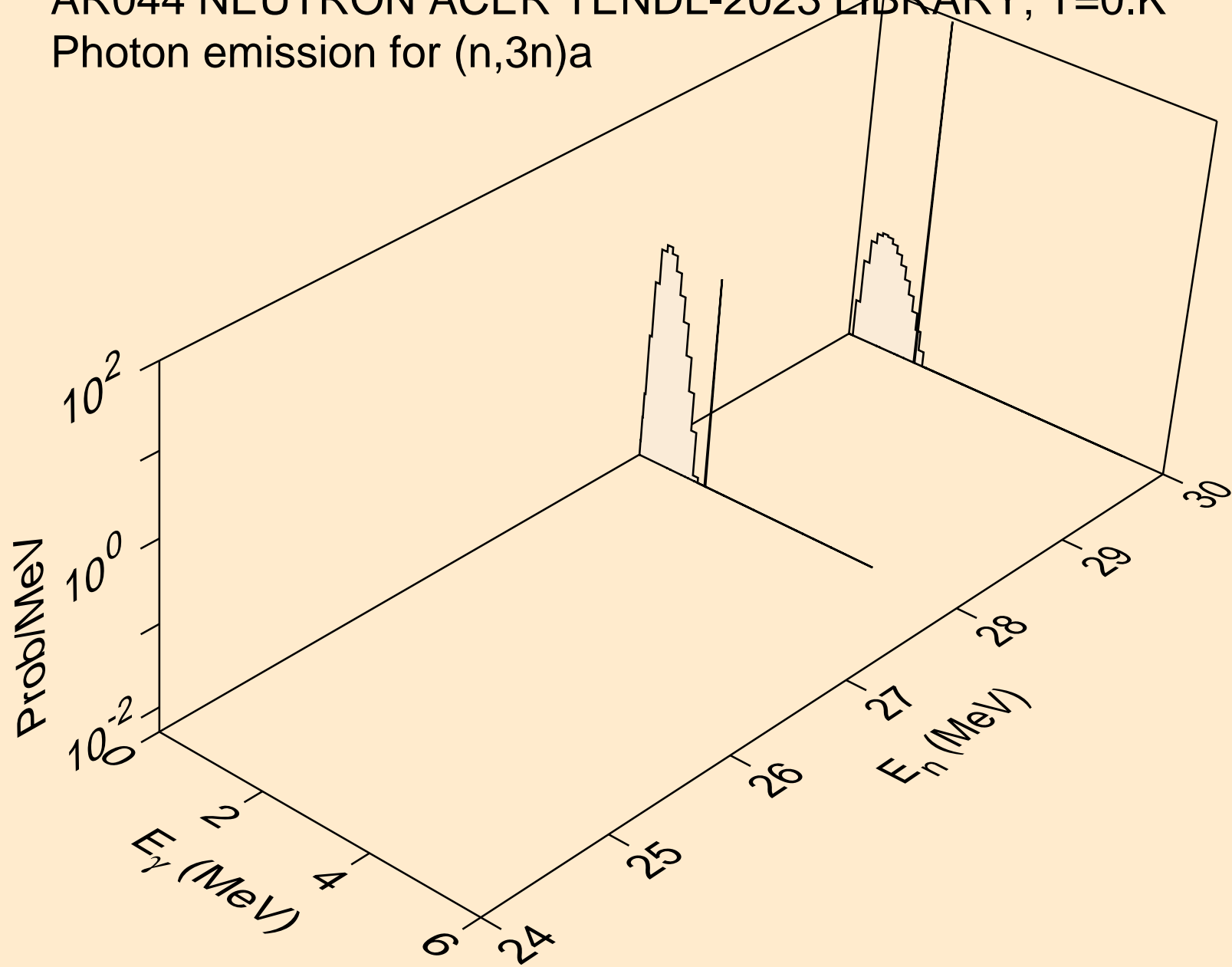

AR044 NEUTRON ACER TENDL-2023 LIBRARY; T=0.K
Photon emission for (n,n*)p

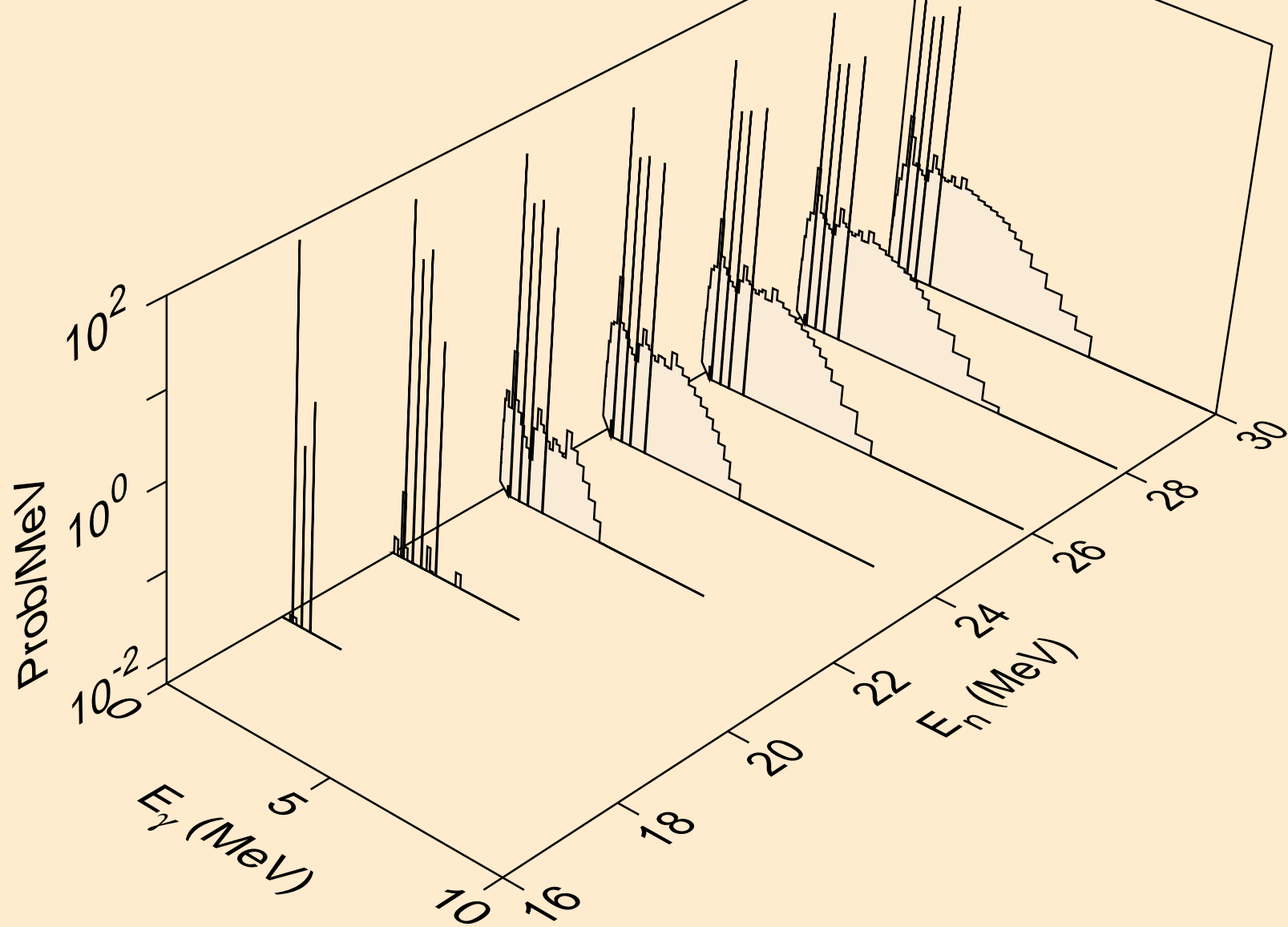

AR044 NEUTRON ACER TENDL-2023 LIBRARY; T=0.K
Photon emission for (n,n*)d

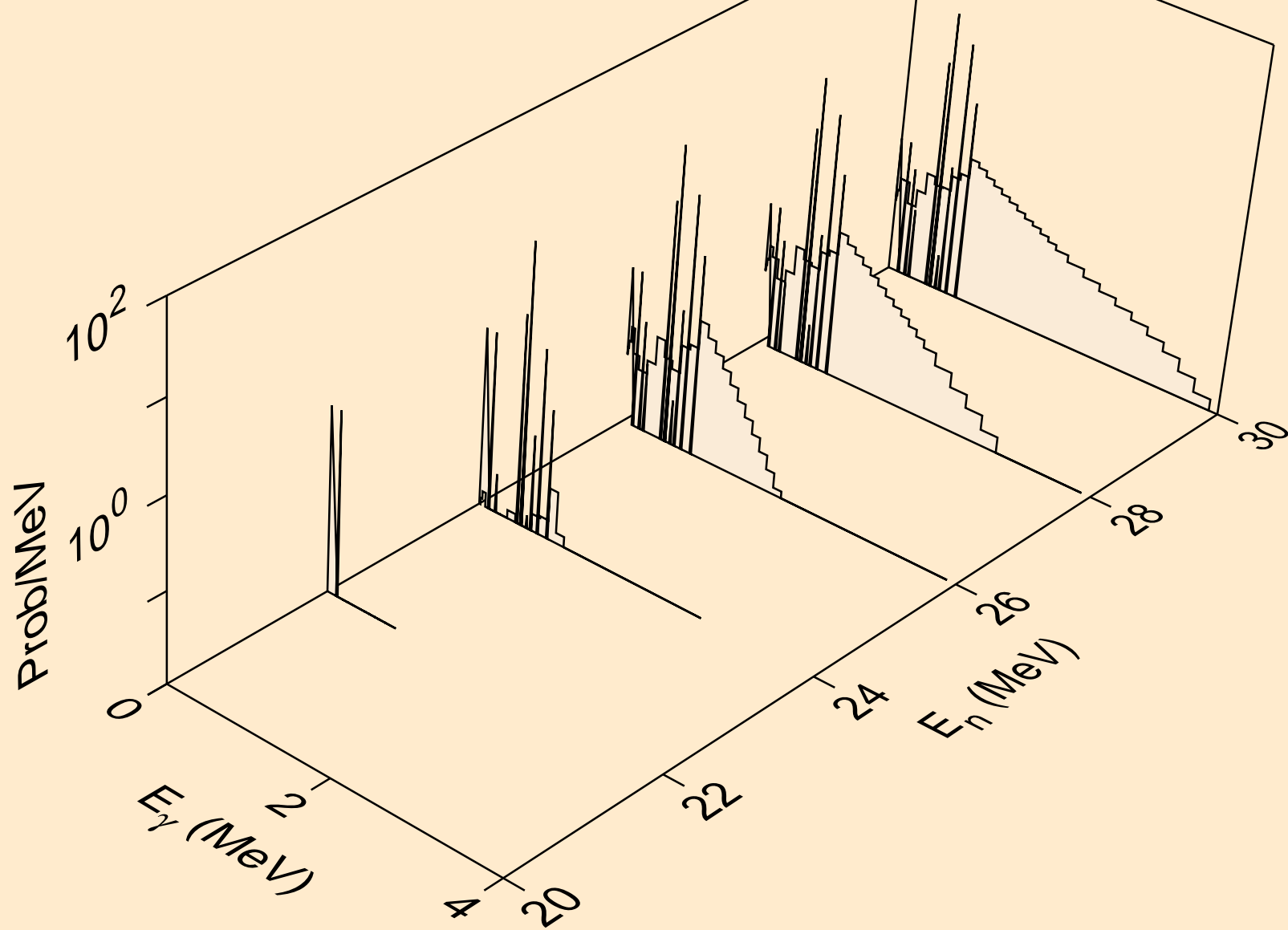

AR044 NEUTRON ACER TENDL-2023 LIBRARY; T=0.K
Photon emission for (n,n*)t

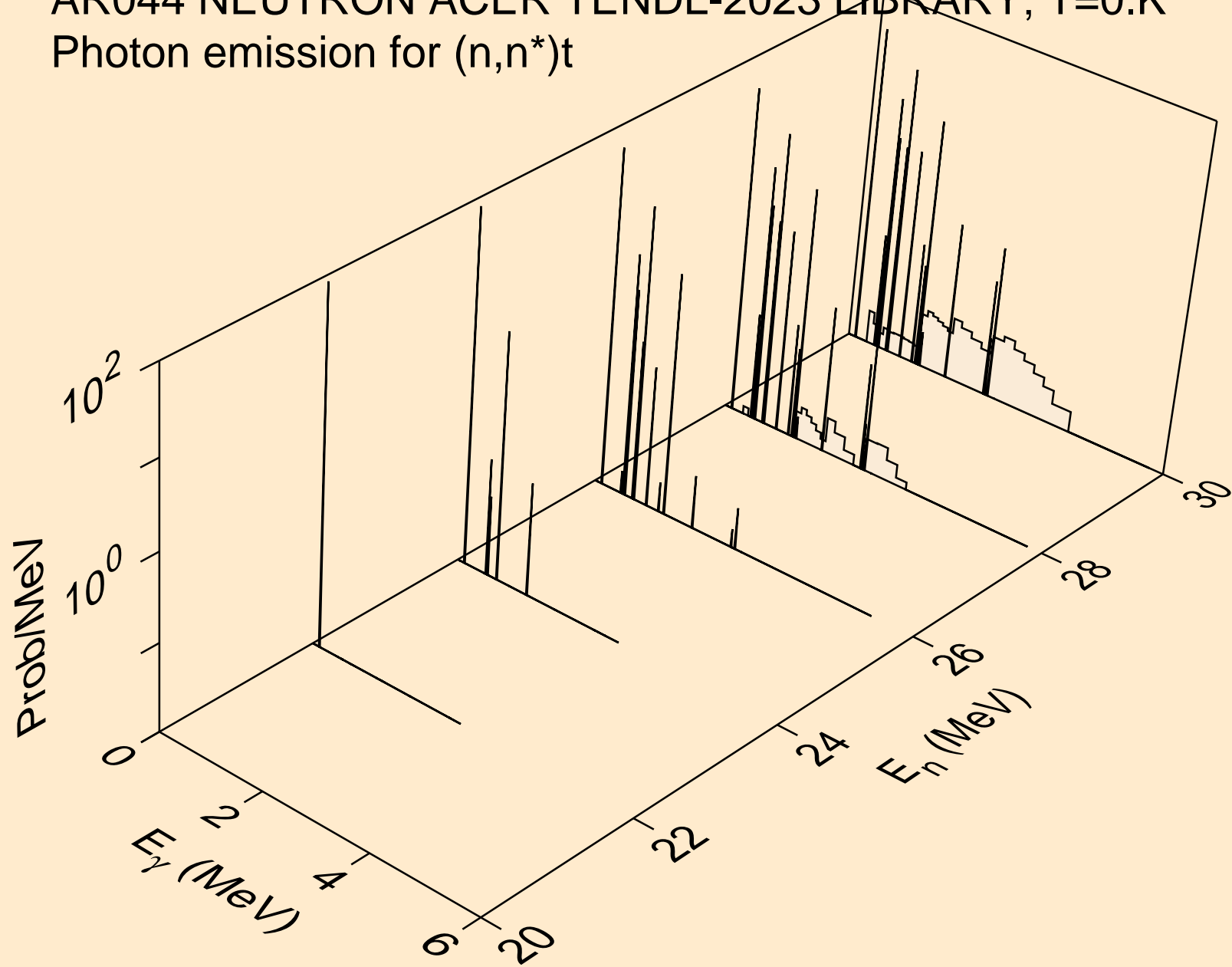

AR044 NEUTRON ACER TENDL-2023 LIBRARY; T=0.K
Photon emission for (n,4n)

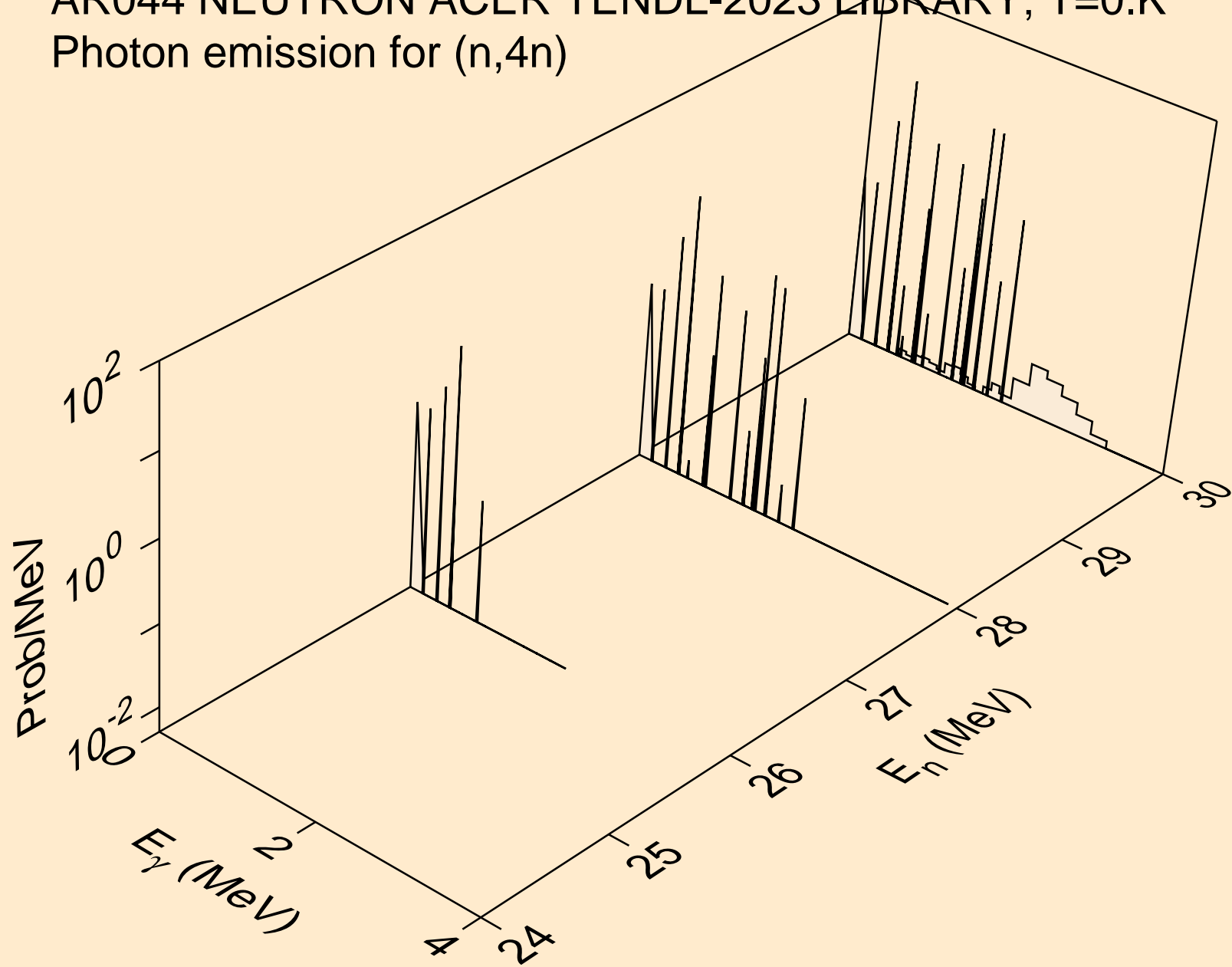

AR044 NEUTRON ACER TENDL-2023 LIBRARY; T=0.K
Photon emission for (n,2np)

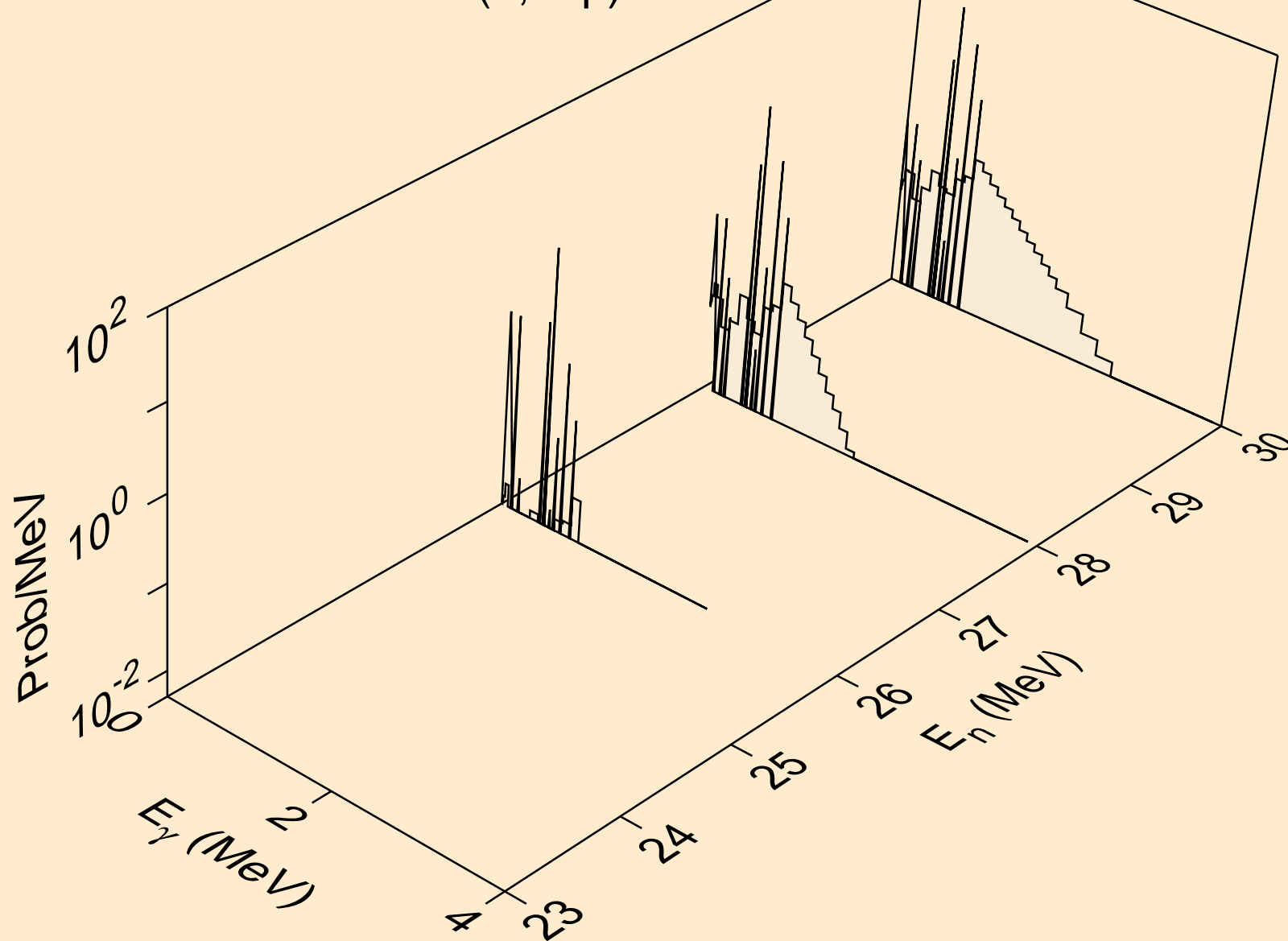

AR044 NEUTRON ACER TENDL-2023 LIBRARY; T=0.K
Photon emission for (n,n*c)

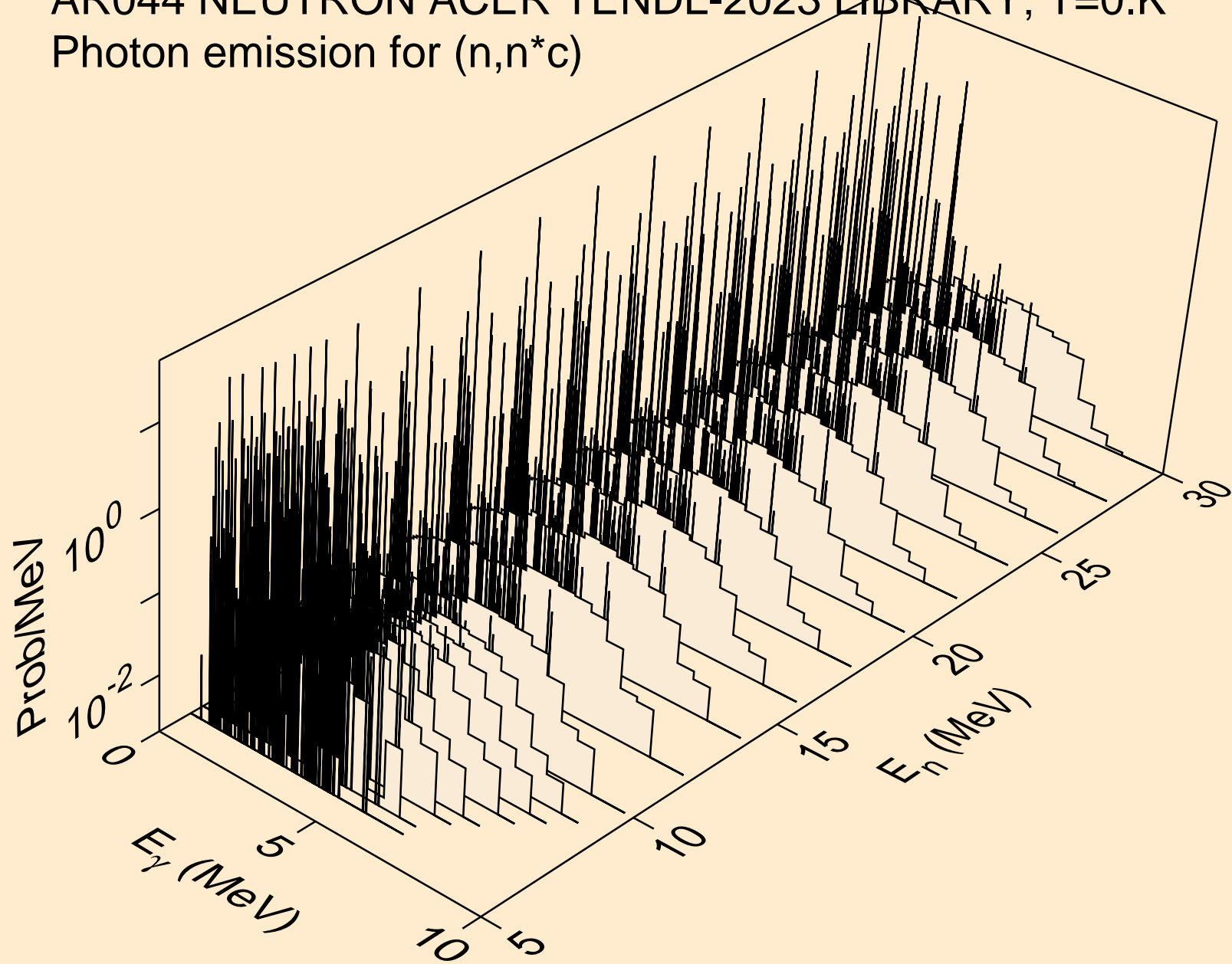

AR044 NEUTRON ACER TENDL-2023 LIBRARY; T=0.K
Photon emission for (n,gma)

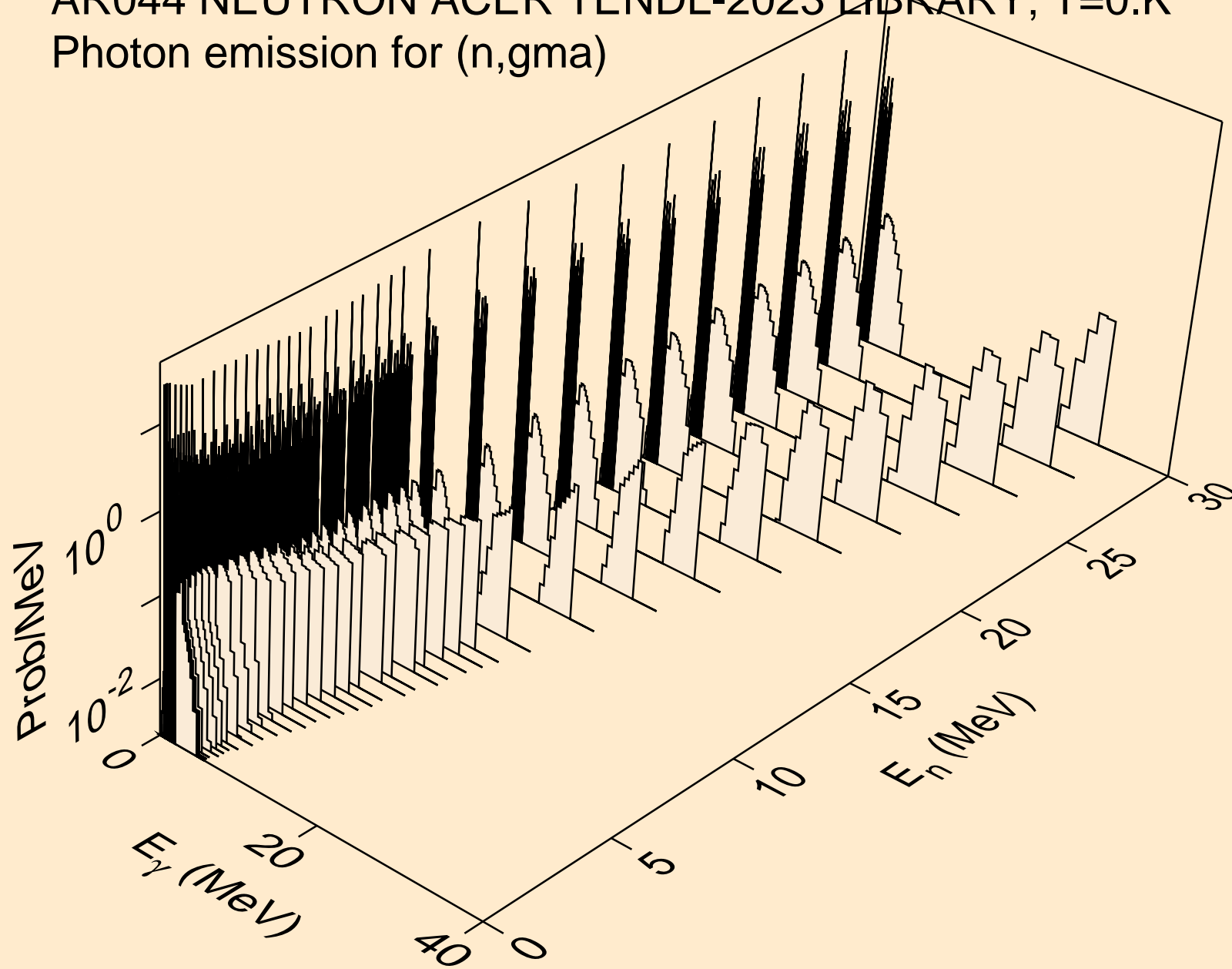

AR044 NEUTRON ACER TENDL-2023 LIBRARY; T=0.K
Photon emission for (n,p)

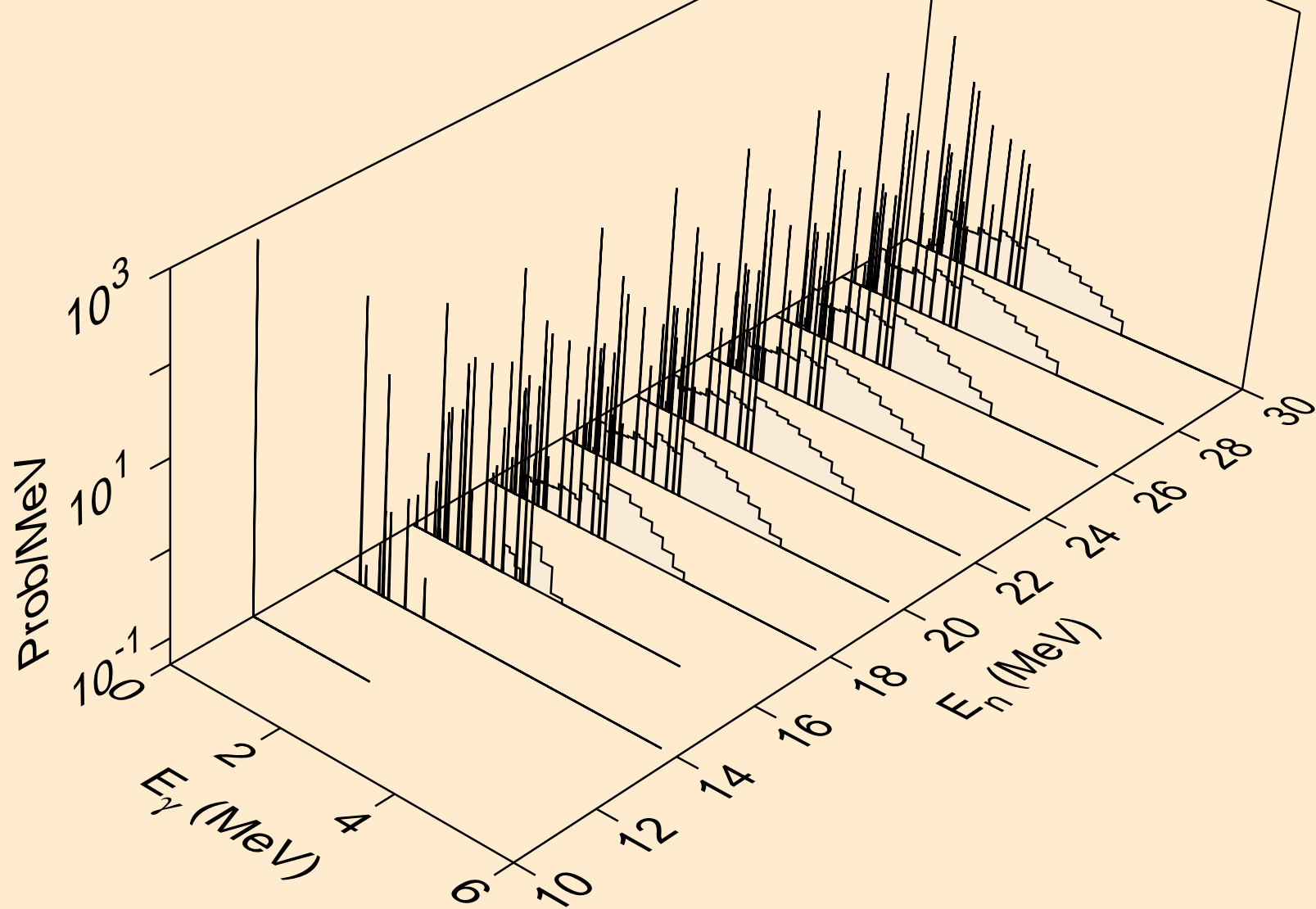

AR044 NEUTRON ACER TENDL-2023 LIBRARY; T=0.K
Photon emission for (n,d)

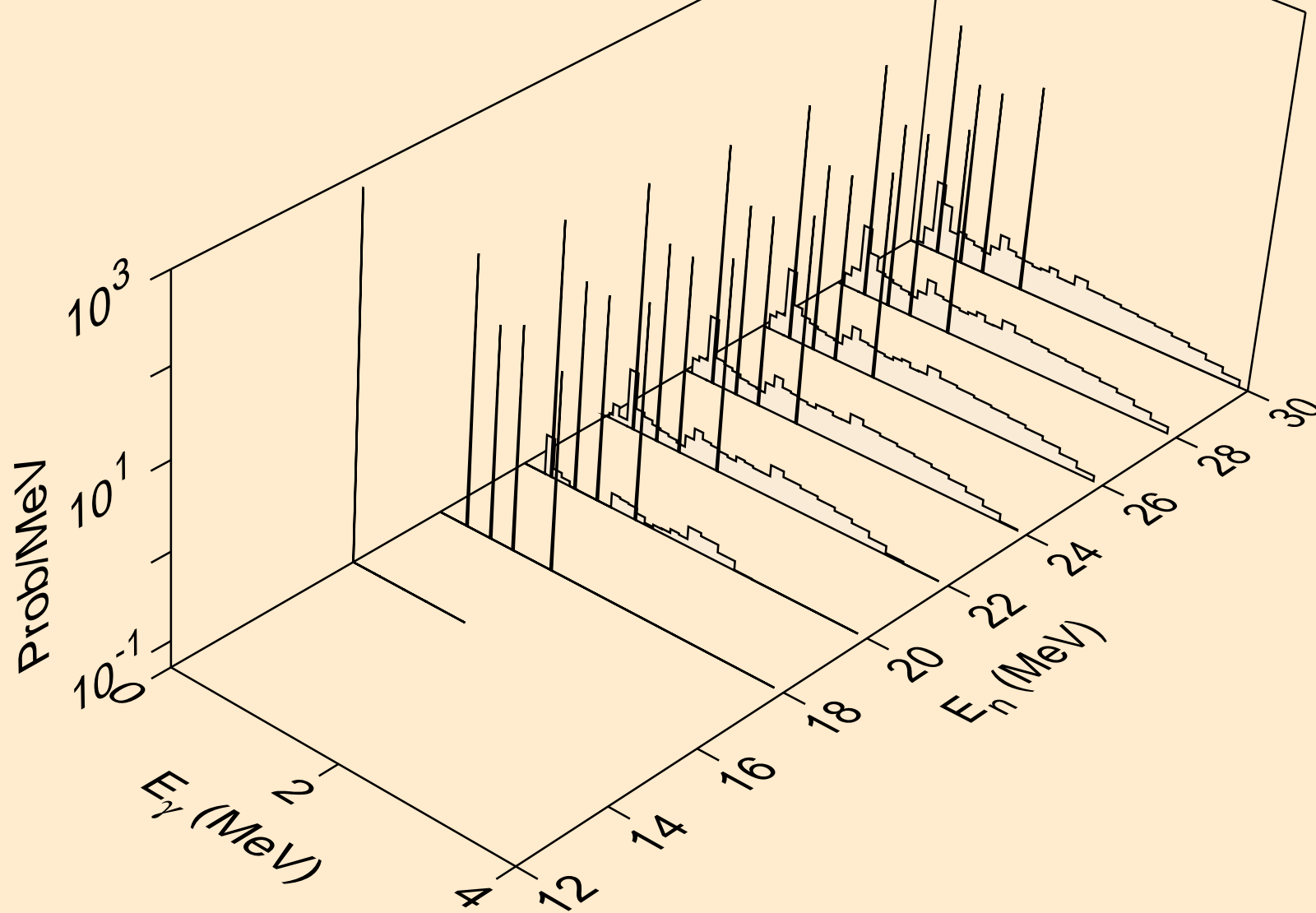

AR044 NEUTRON ACER TENDL-2023 LIBRARY; T=0.K
Photon emission for (n,t)

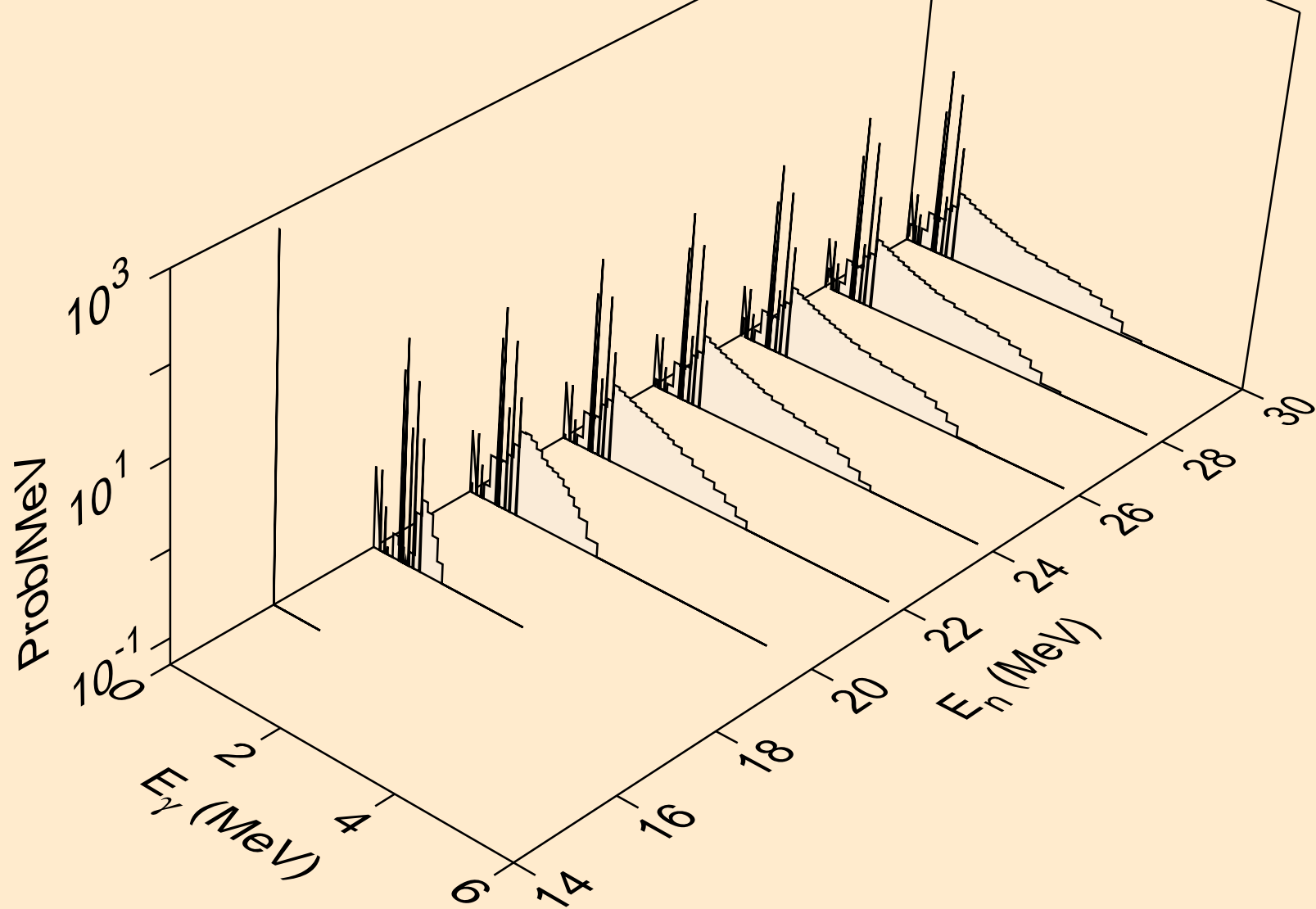

AR044 NEUTRON ACER TENDL-2023 LIBRARY; T=0.K
Photon emission for (n,he3)

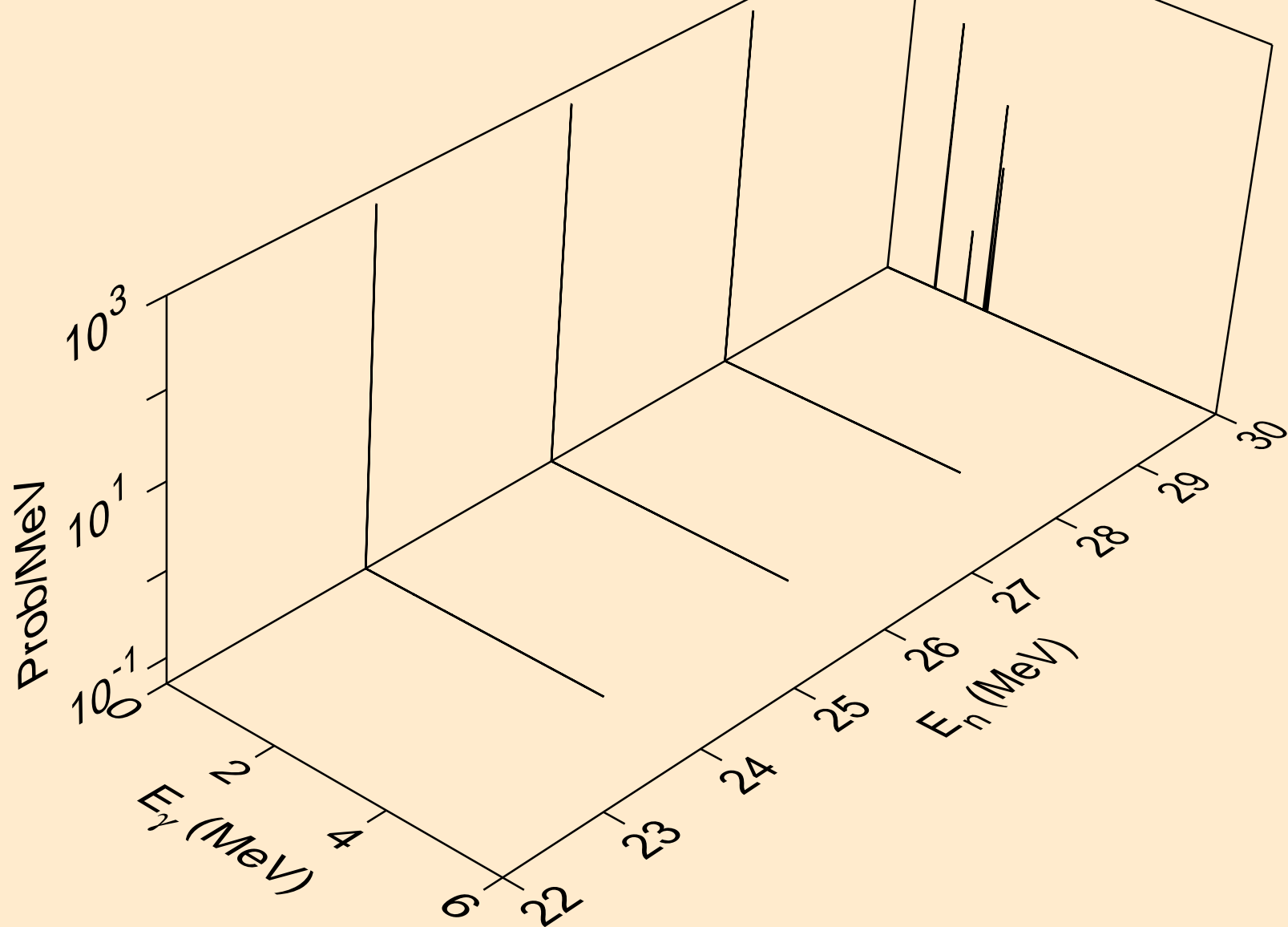

AR044 NEUTRON ACER TENDL-2023 LIBRARY; T=0.K
Photon emission for (n,a)

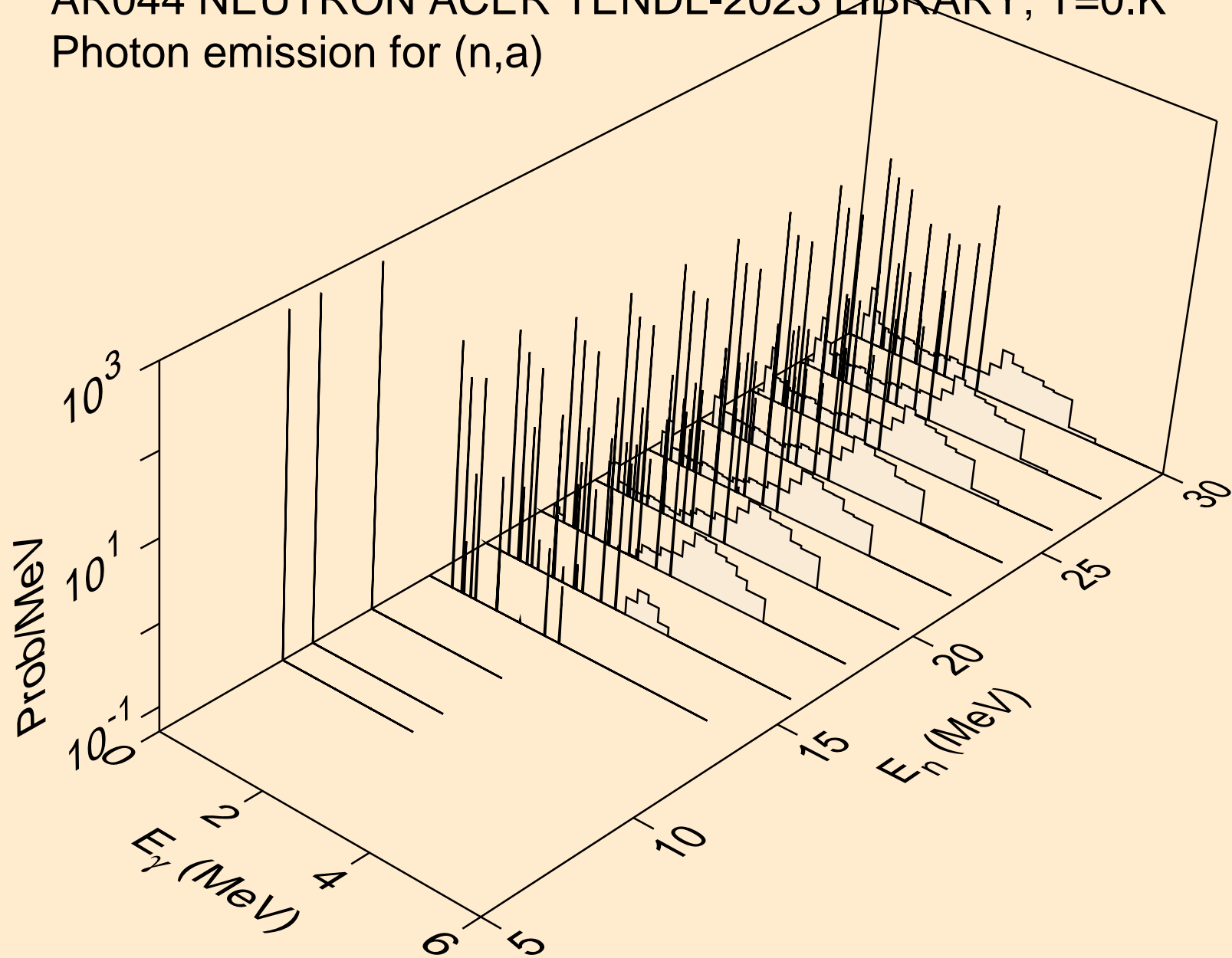

AR044 NEUTRON ACER TENDL-2023 LIBRARY; T=0.K
thermal capture photon spectrum

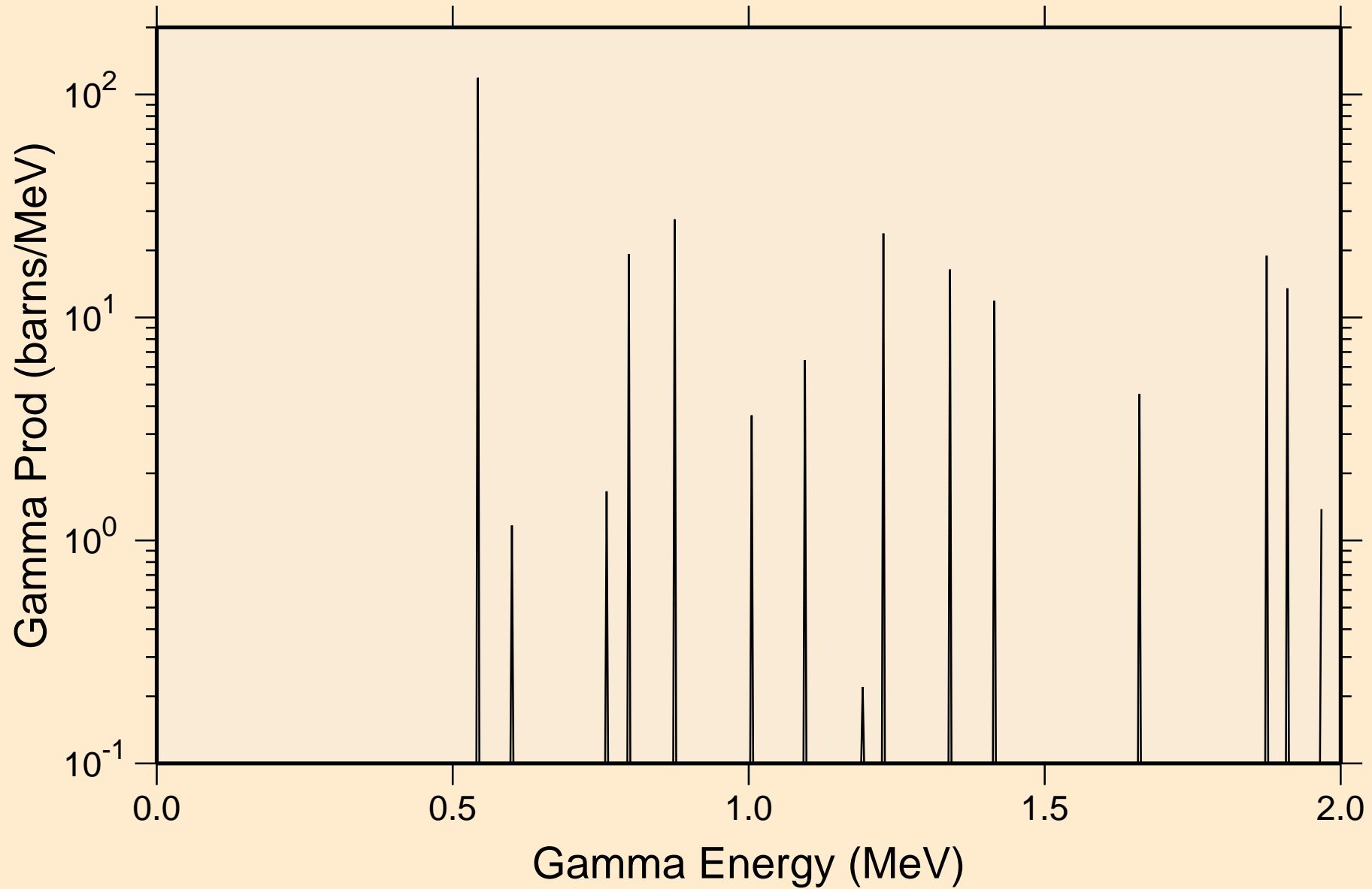

AR044 NEUTRON ACER TENDL-2023 LIBRARY; T=0.K
14 MeV photon spectrum

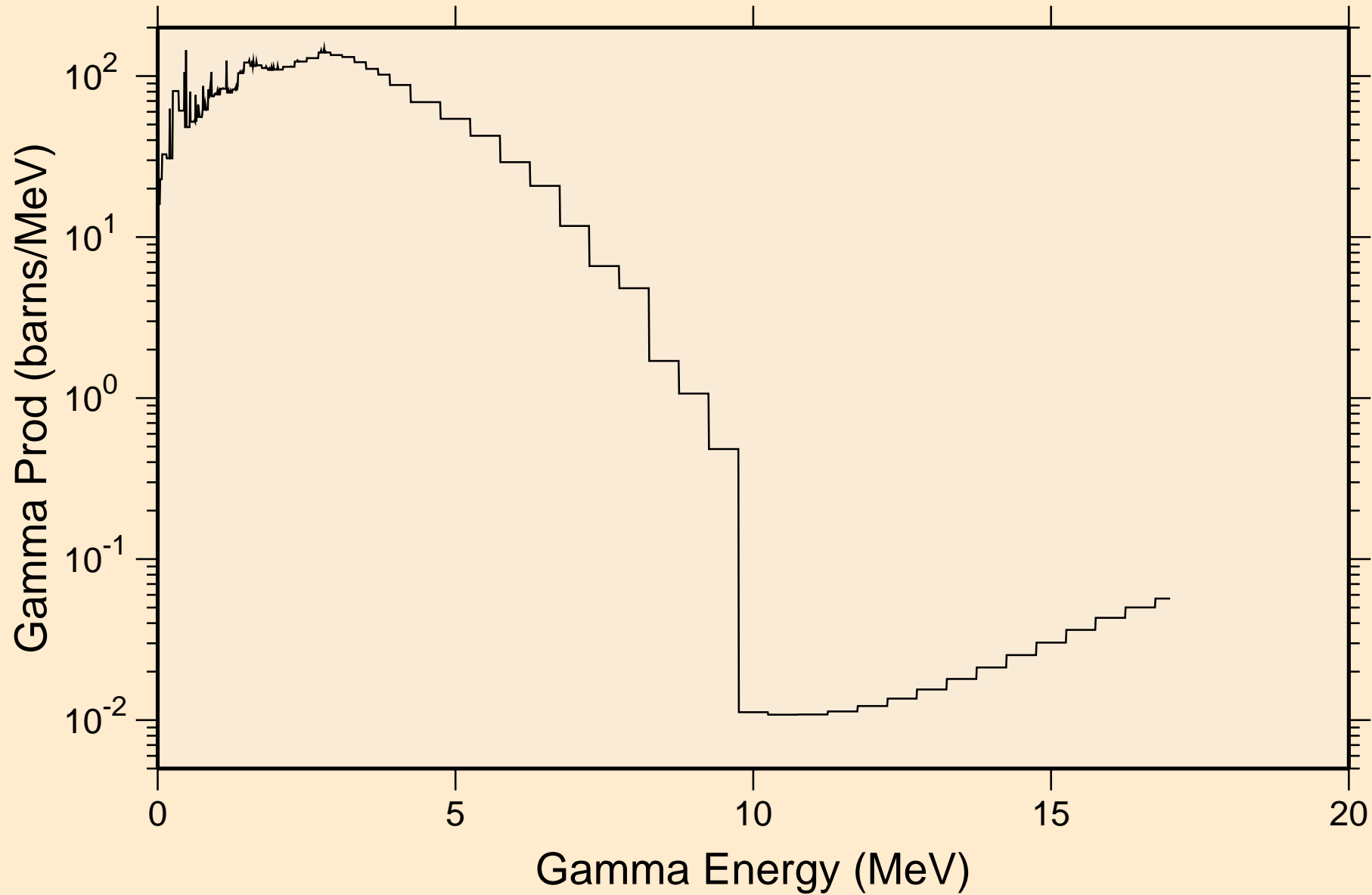

AR044 NEUTRON ACER TENDL-2023 LIBRARY; T=0.K
Particle heating contributions

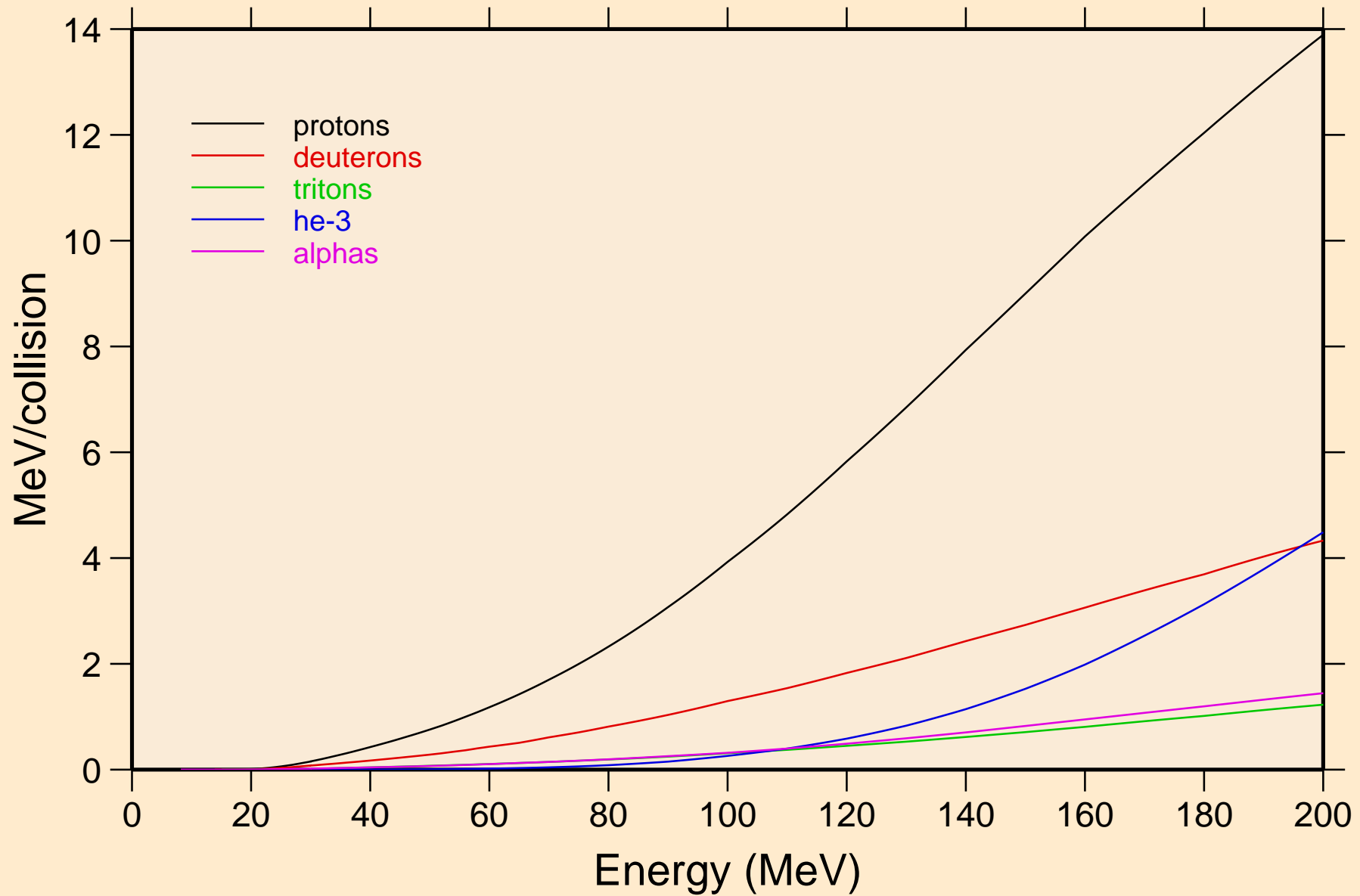

AR044 NEUTRON ACER TENDL-2023 LIBRARY; T=0.K
Recoil Heating

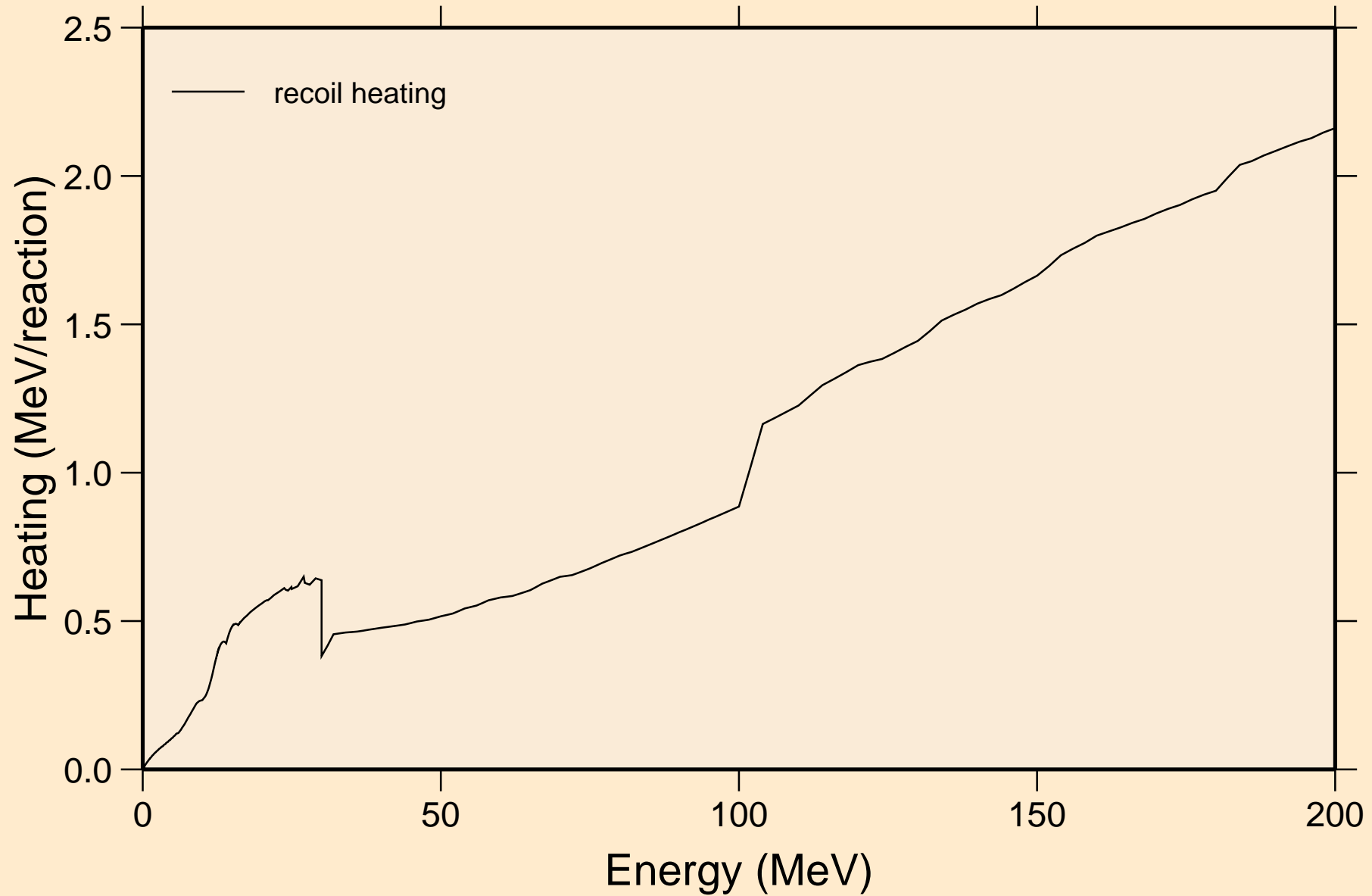

AR044 NEUTRON ACER TENDL-2023 LIBRARY; T=0.K
Particle production cross sections

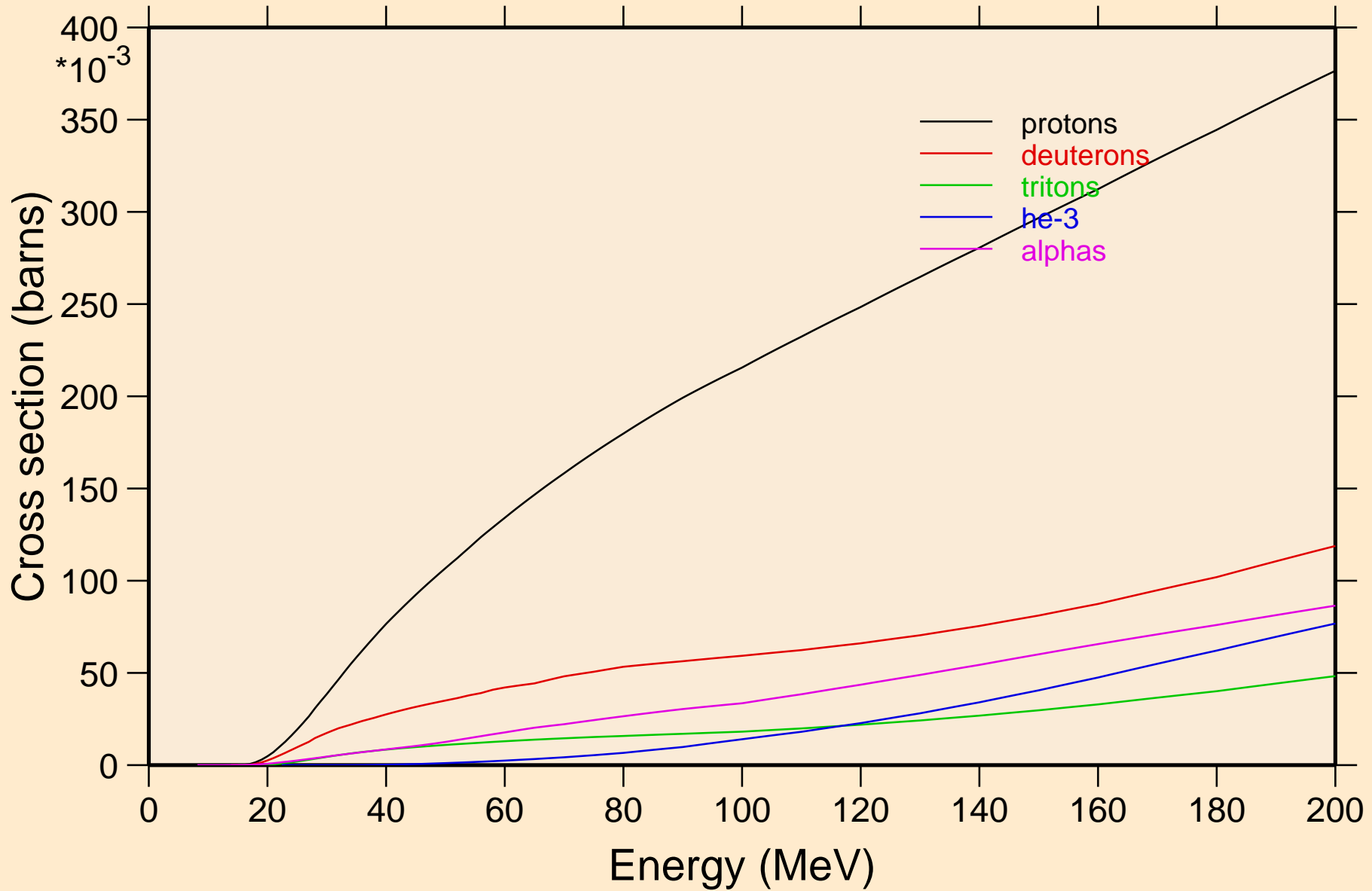

AR044 NEUTRON ACER TENDL-2023 LIBRARY; T=0.K
protons from (n,x)

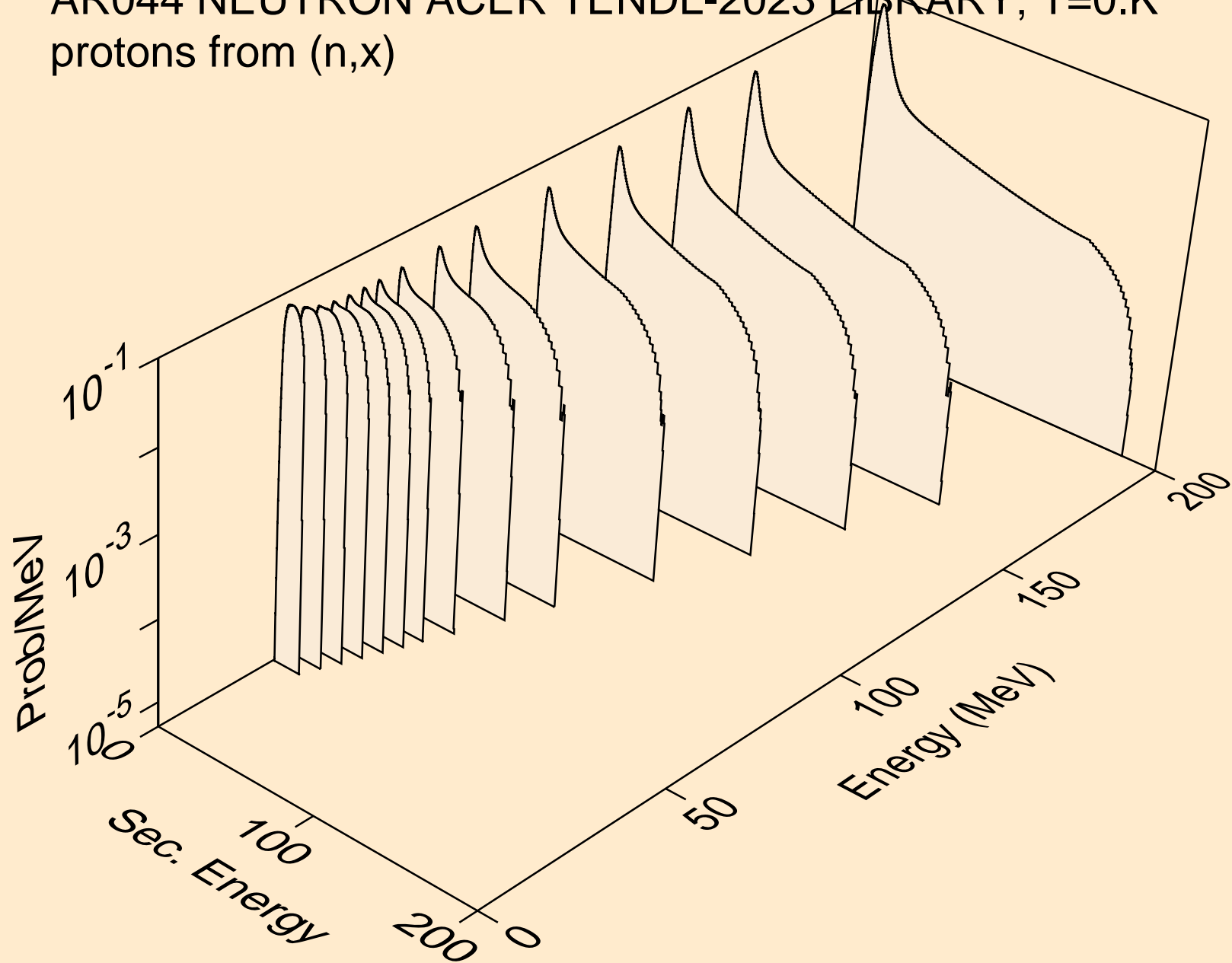

AR044 NEUTRON ACER TENDL-2023 LIBRARY; T=0.K
protons from (n,n*)p

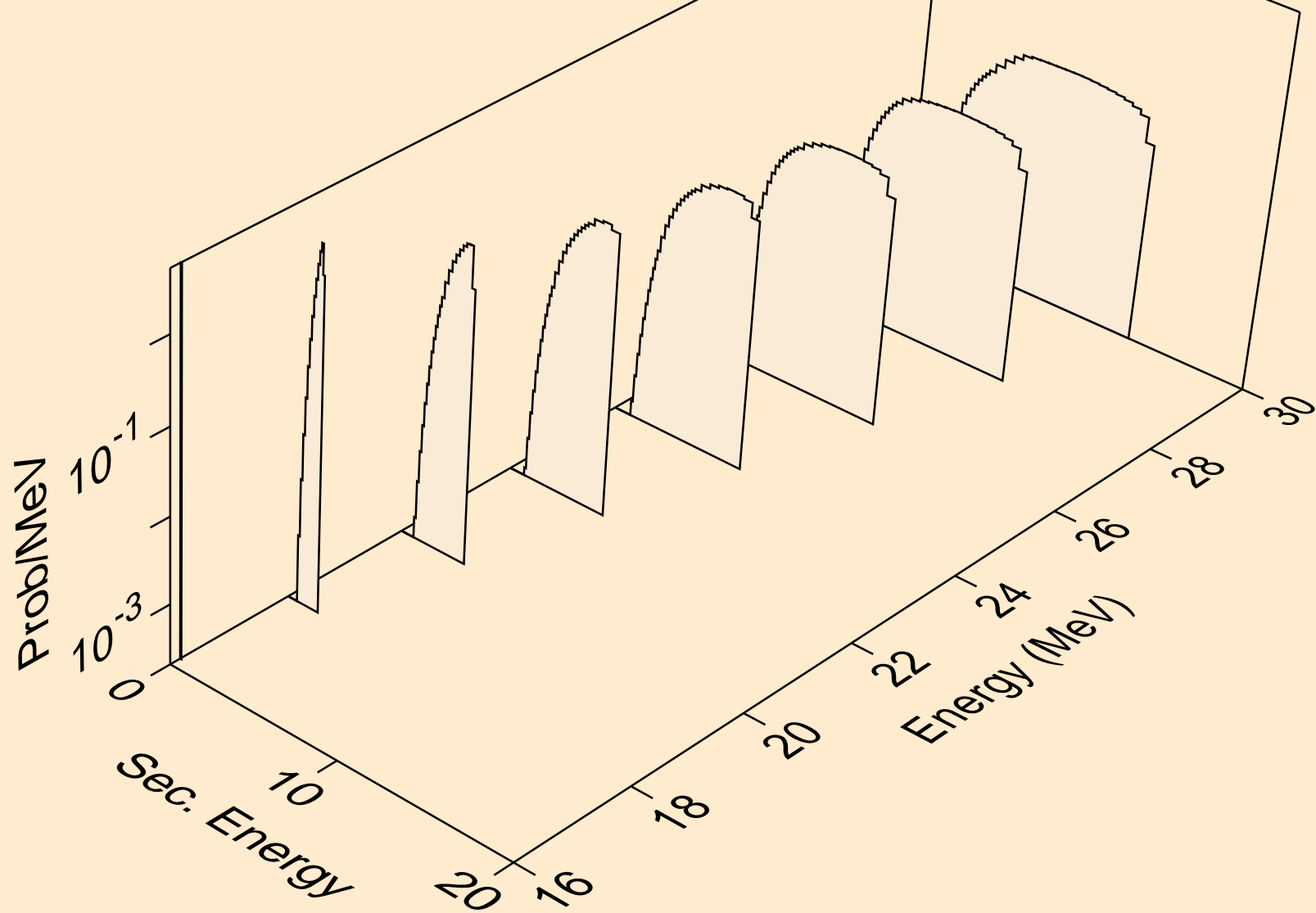

AR044 NEUTRON ACER TENDL-2023 LIBRARY; T=0.K
protons from (n,2np)

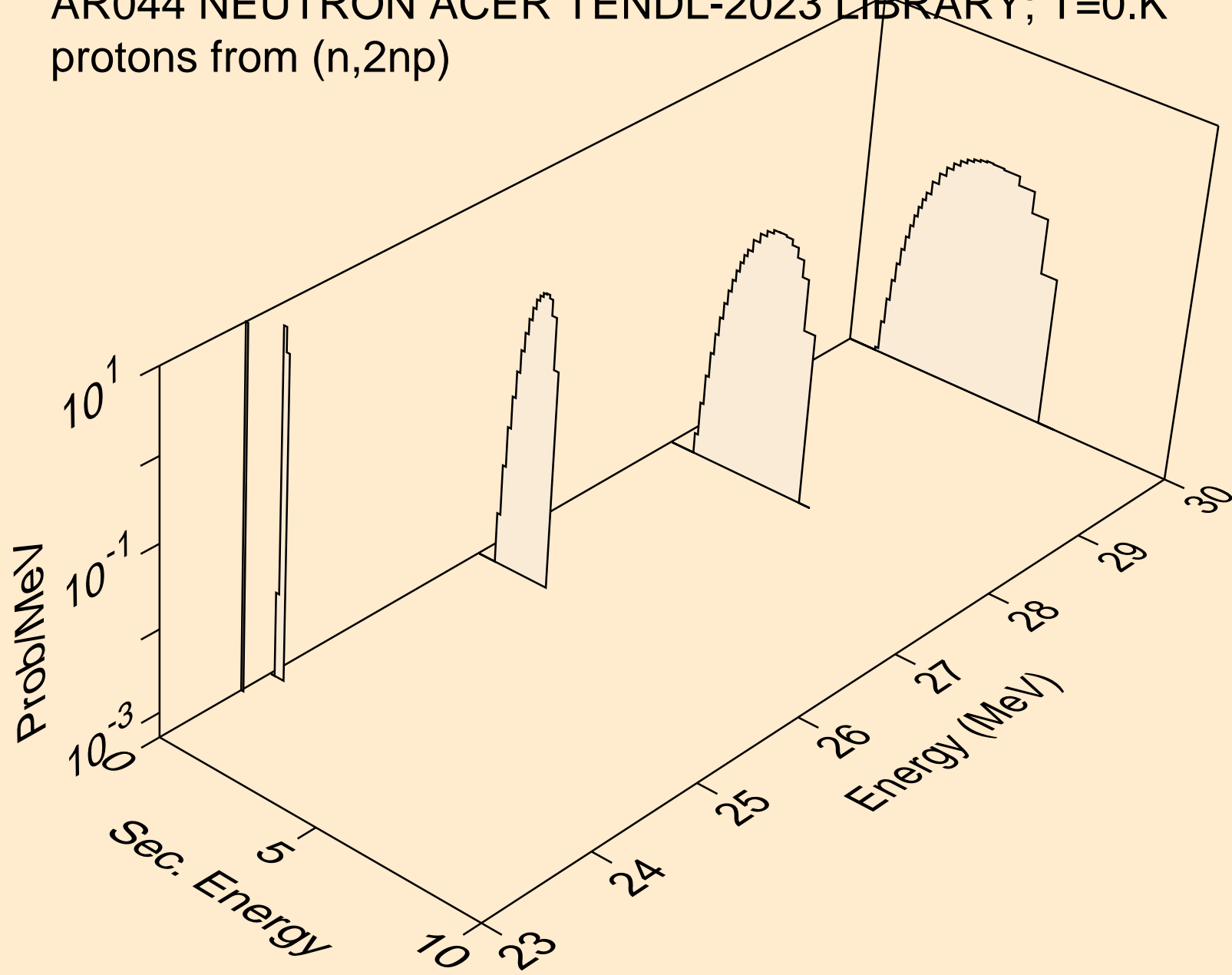

AR044 NEUTRON ACER TENDL-2023 LIBRARY; T=0.K
protons from (n,p)

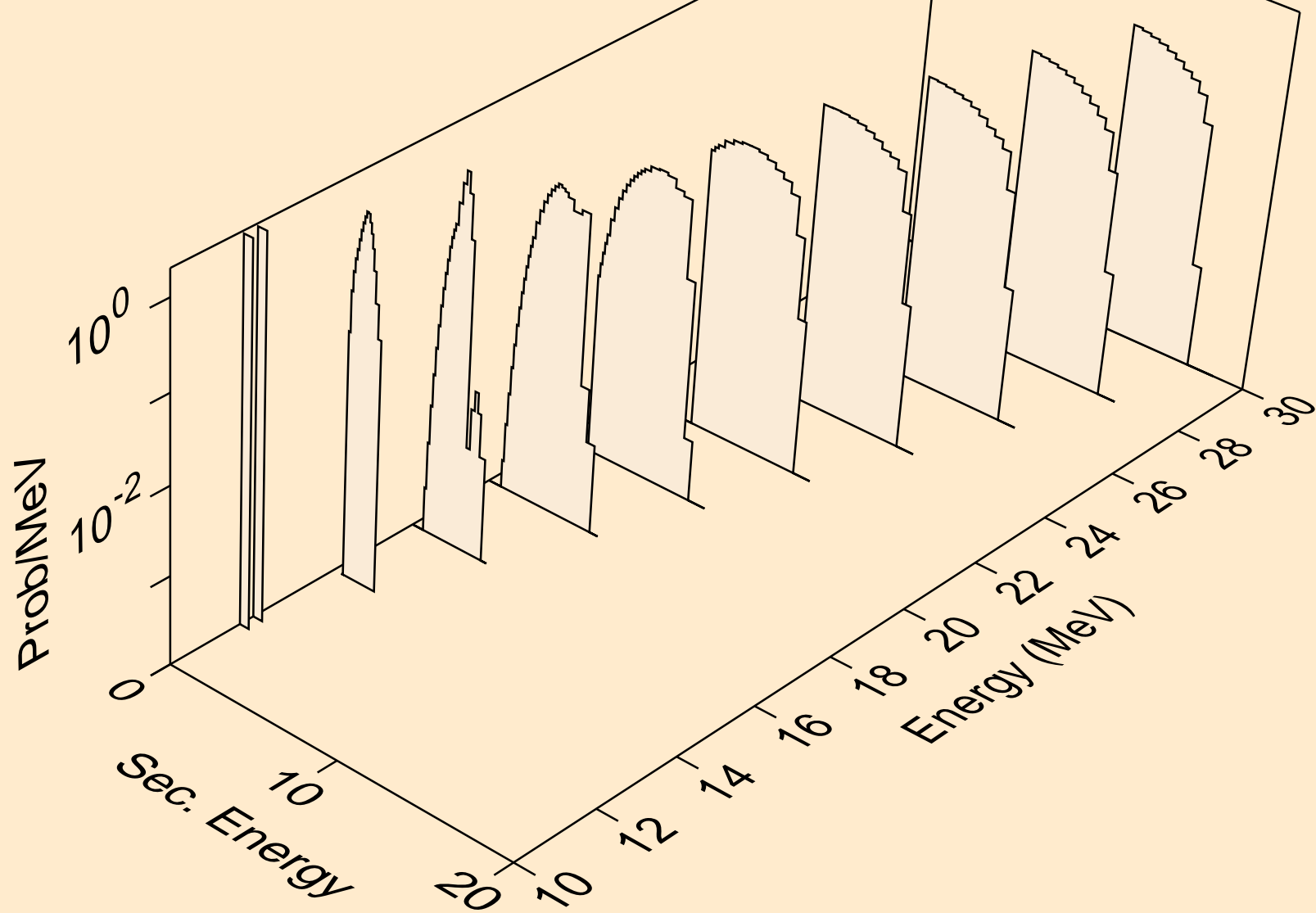

AR044 NEUTRON ACER TENDL-2023 LIBRARY; T=0.K
deuterons from (n,x)

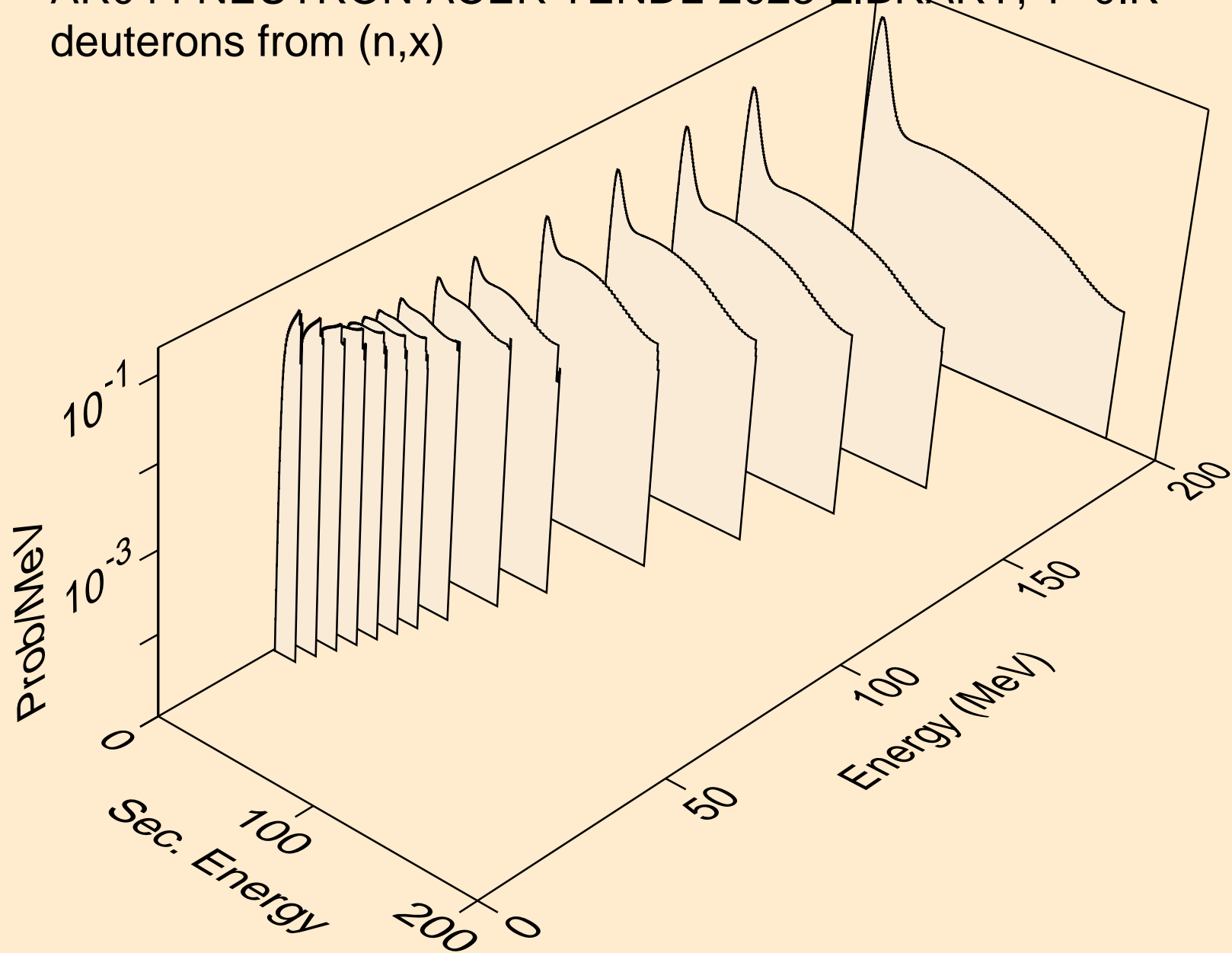

AR044 NEUTRON ACER TENDL-2023 LIBRARY; T=0.K
deuterons from (n,2nd)

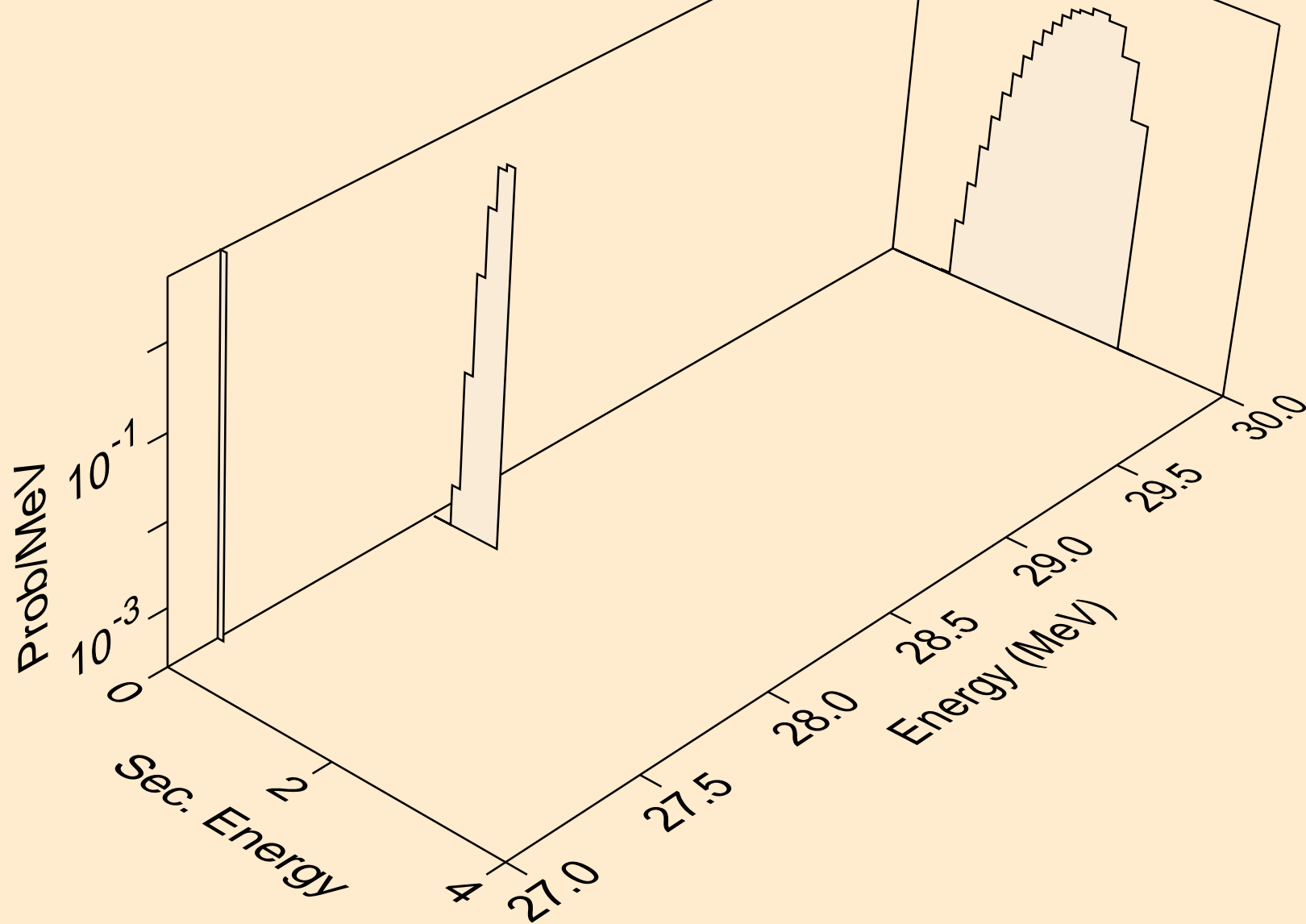

AR044 NEUTRON ACER TENDL-2023 LIBRARY; T=0.K
deuterons from (n,n*)d

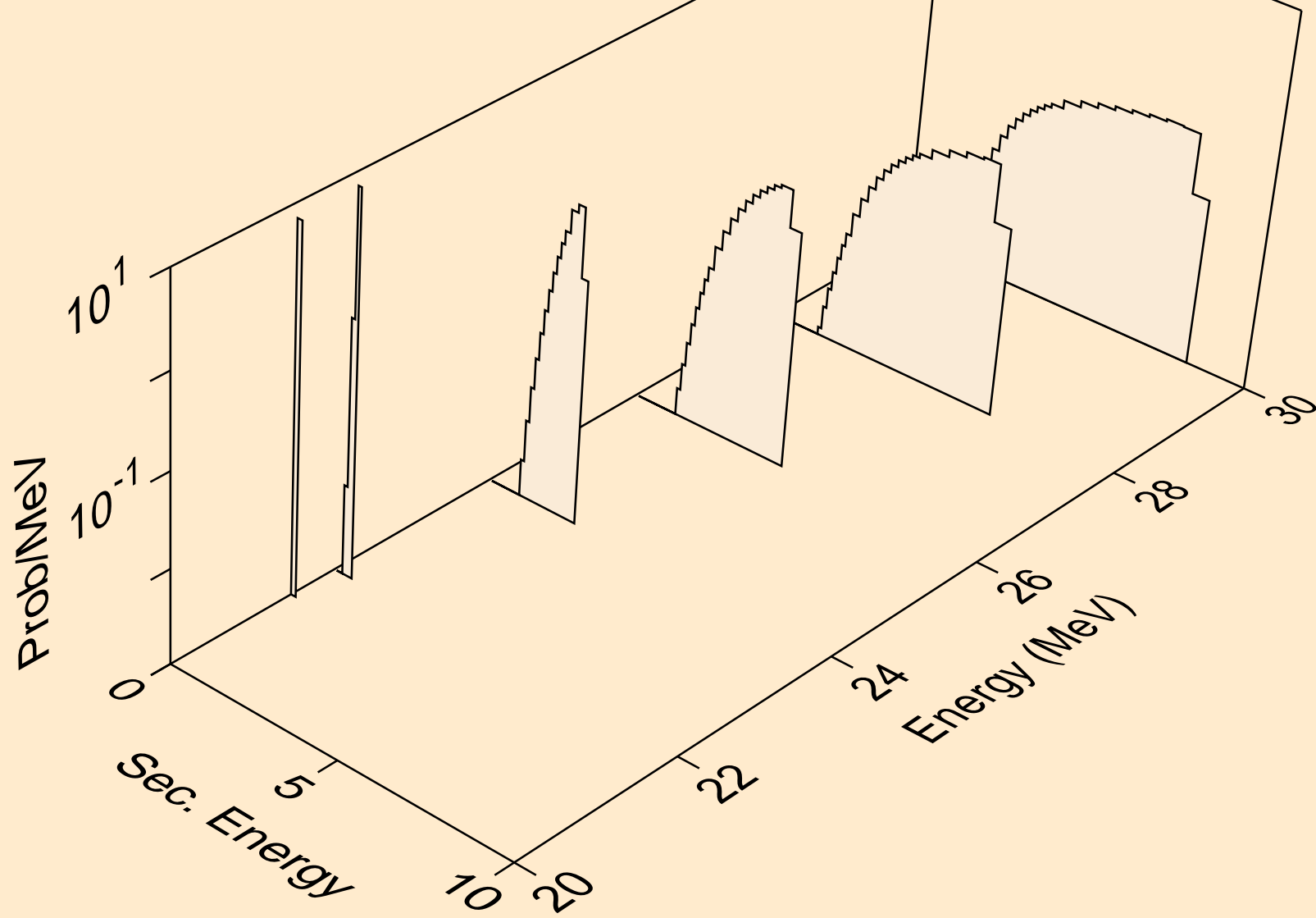

AR044 NEUTRON ACER TENDL-2023 LIBRARY; T=0.K
deuterons from (n,d)

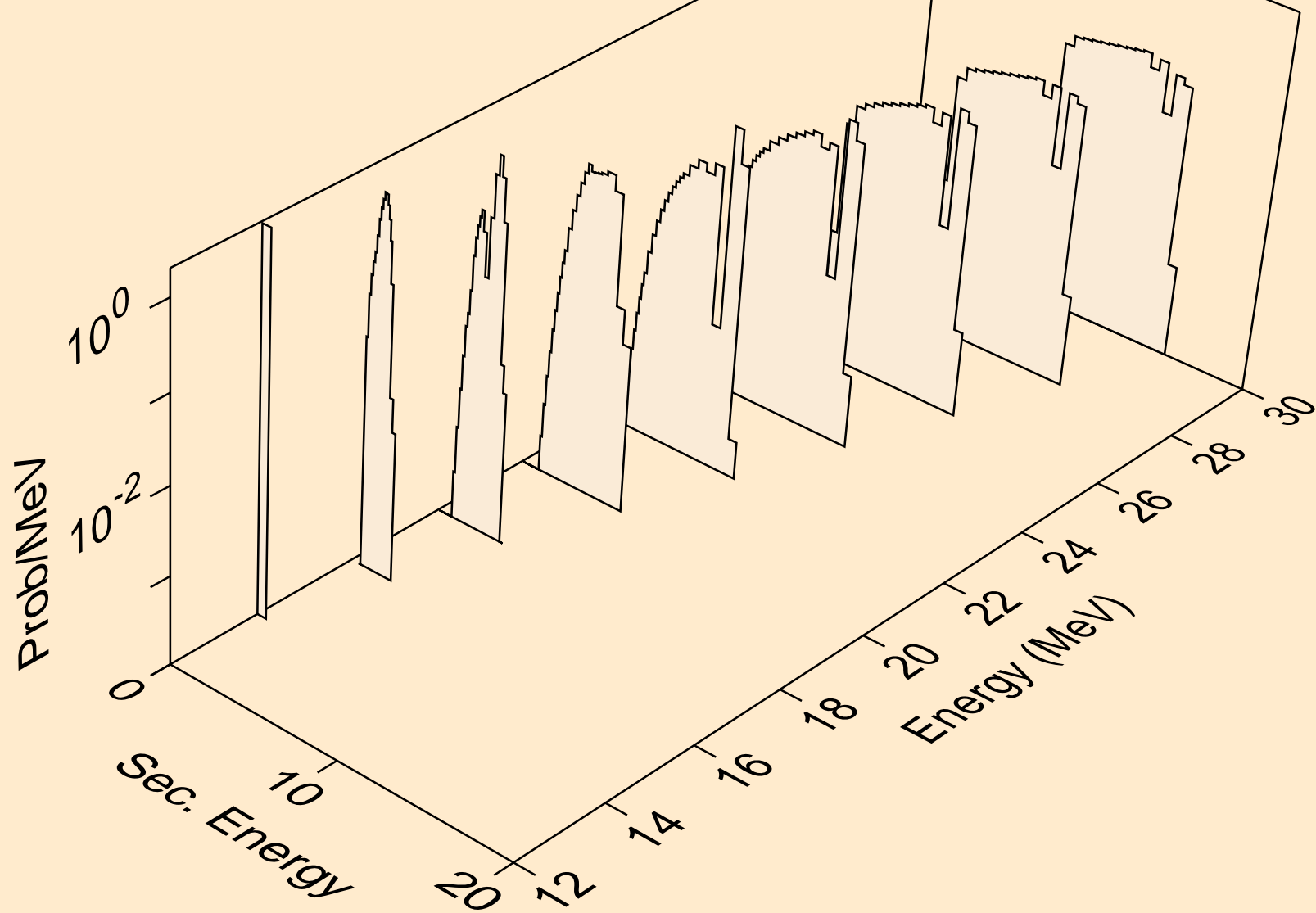

AR044 NEUTRON ACER TENDL-2023 LIBRARY; T=0.K
tritons from (n,x)

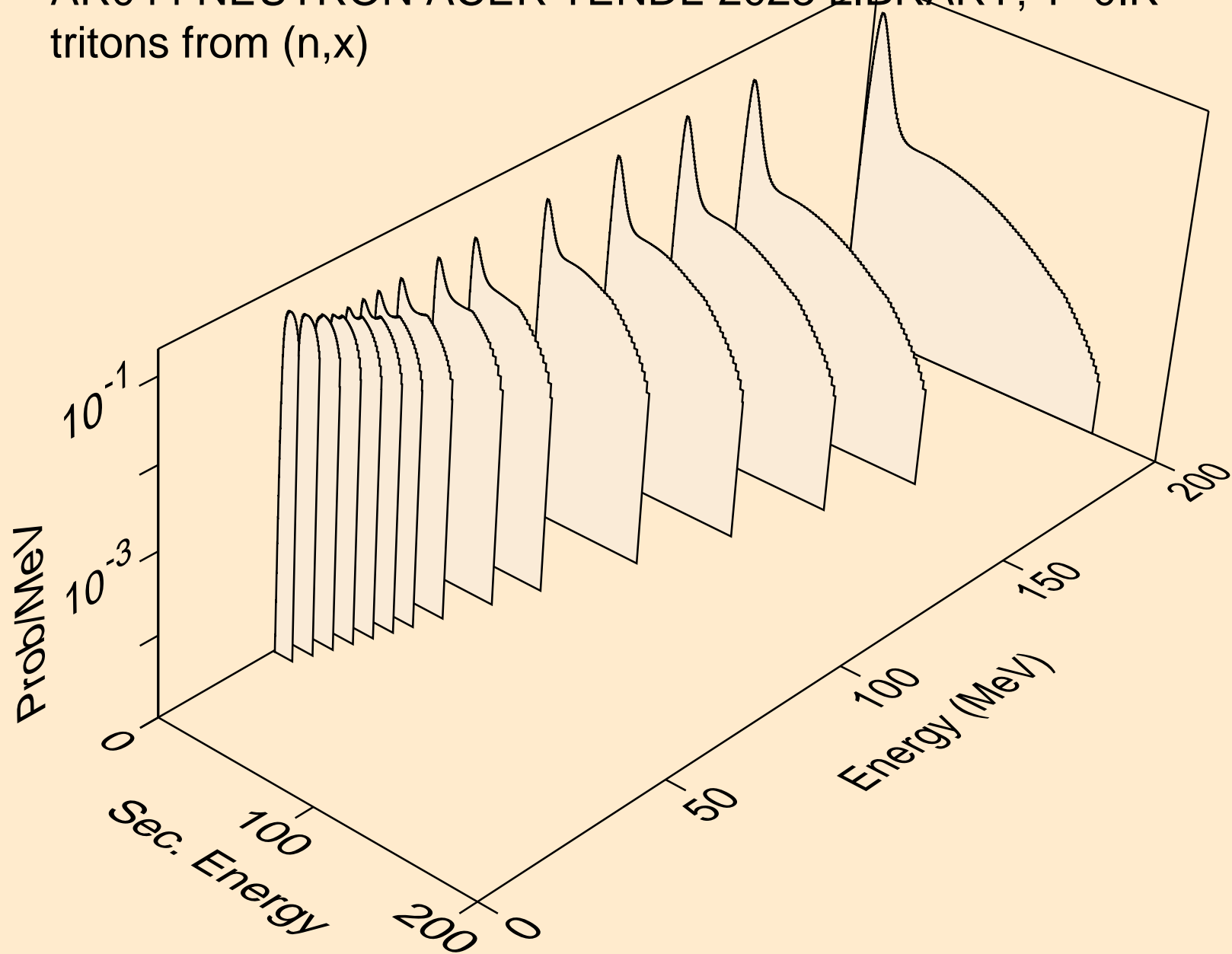

AR044 NEUTRON ACER TENDL-2023 LIBRARY; T=0.K
tritons from (n,n*)t

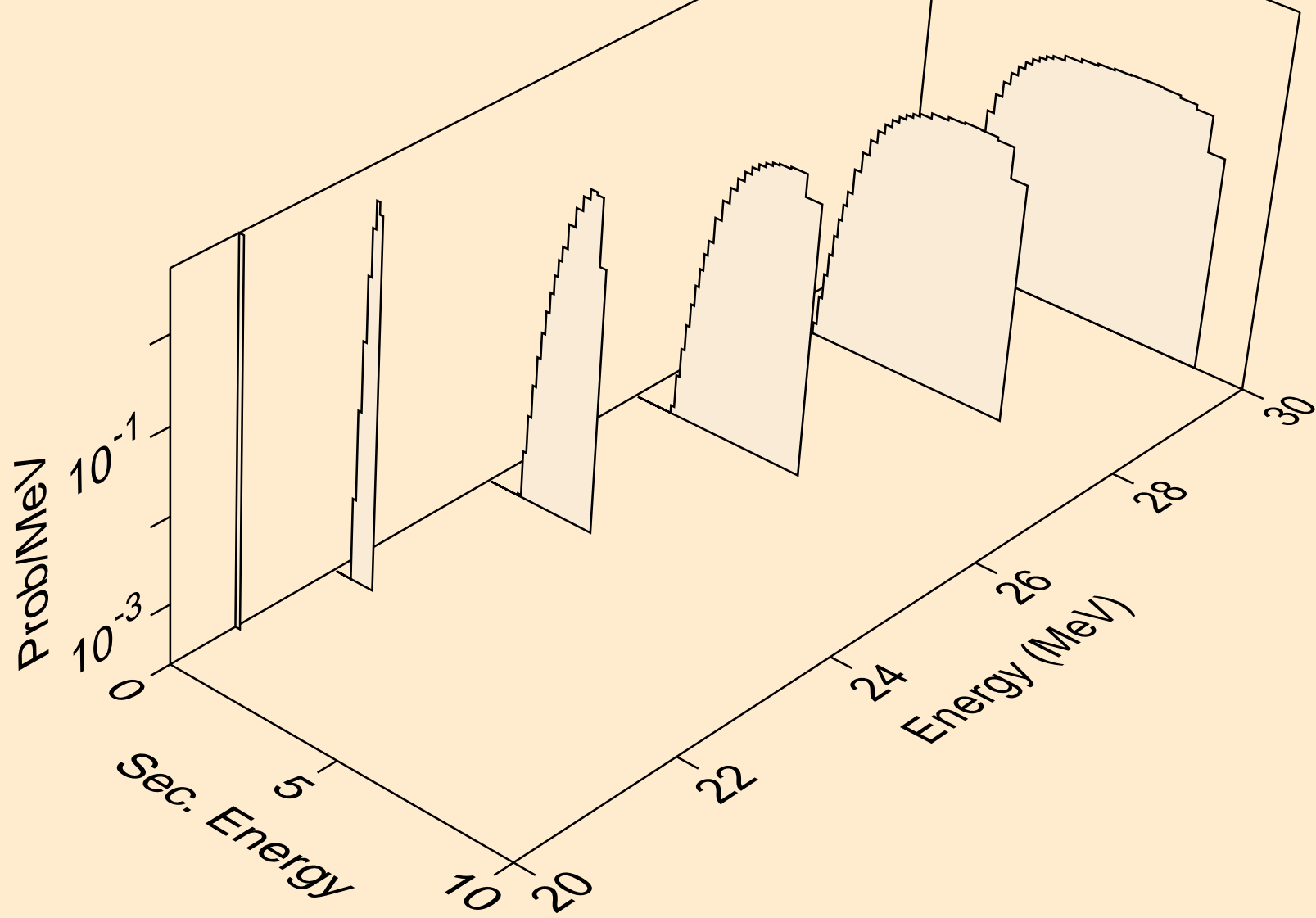

AR044 NEUTRON ACER TENDL-2023 LIBRARY; T=0.K
tritons from (n,t)

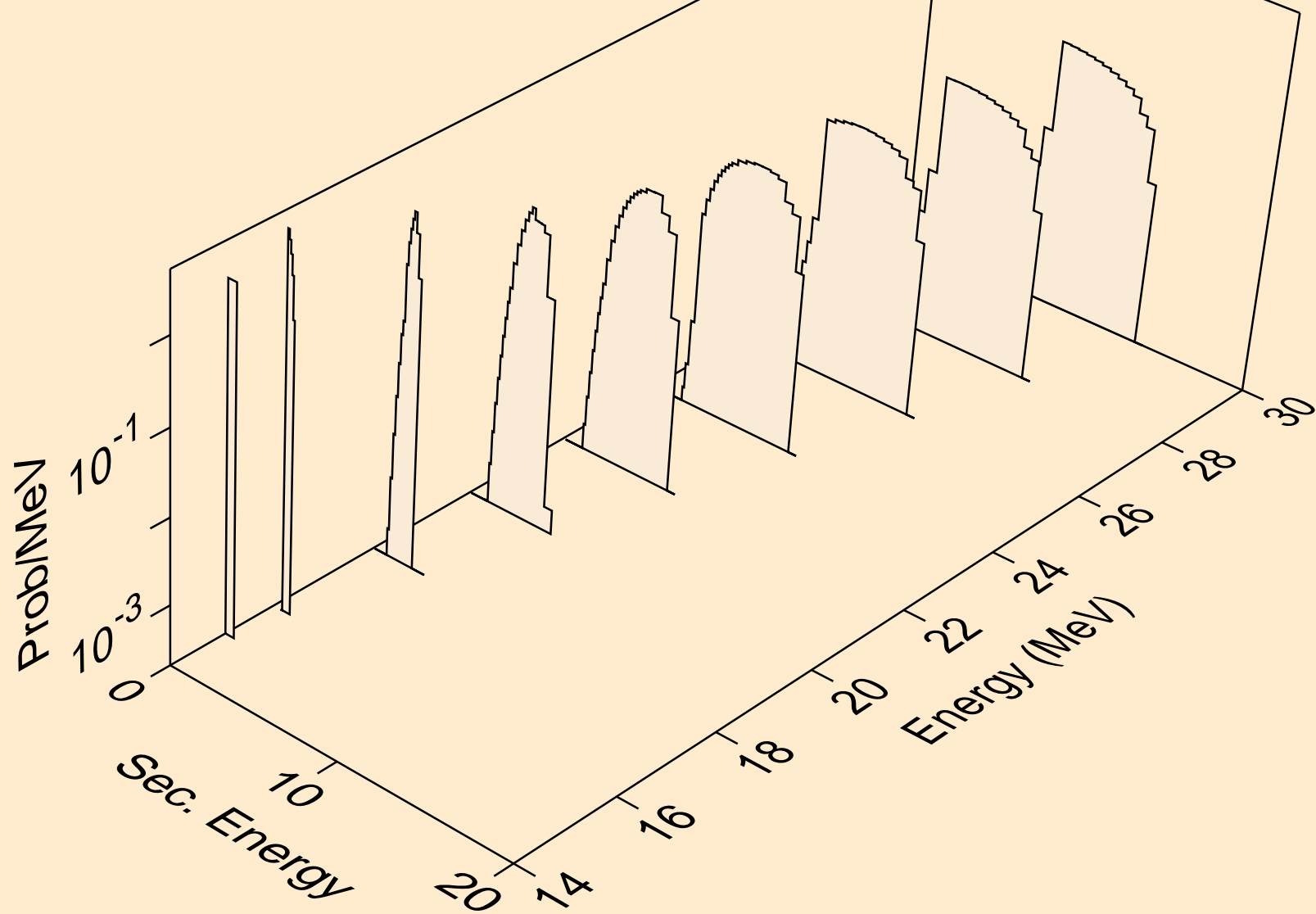

AR044 NEUTRON ACER TENDL-2023 LIBRARY; T=0.K
he3s from (n,x)

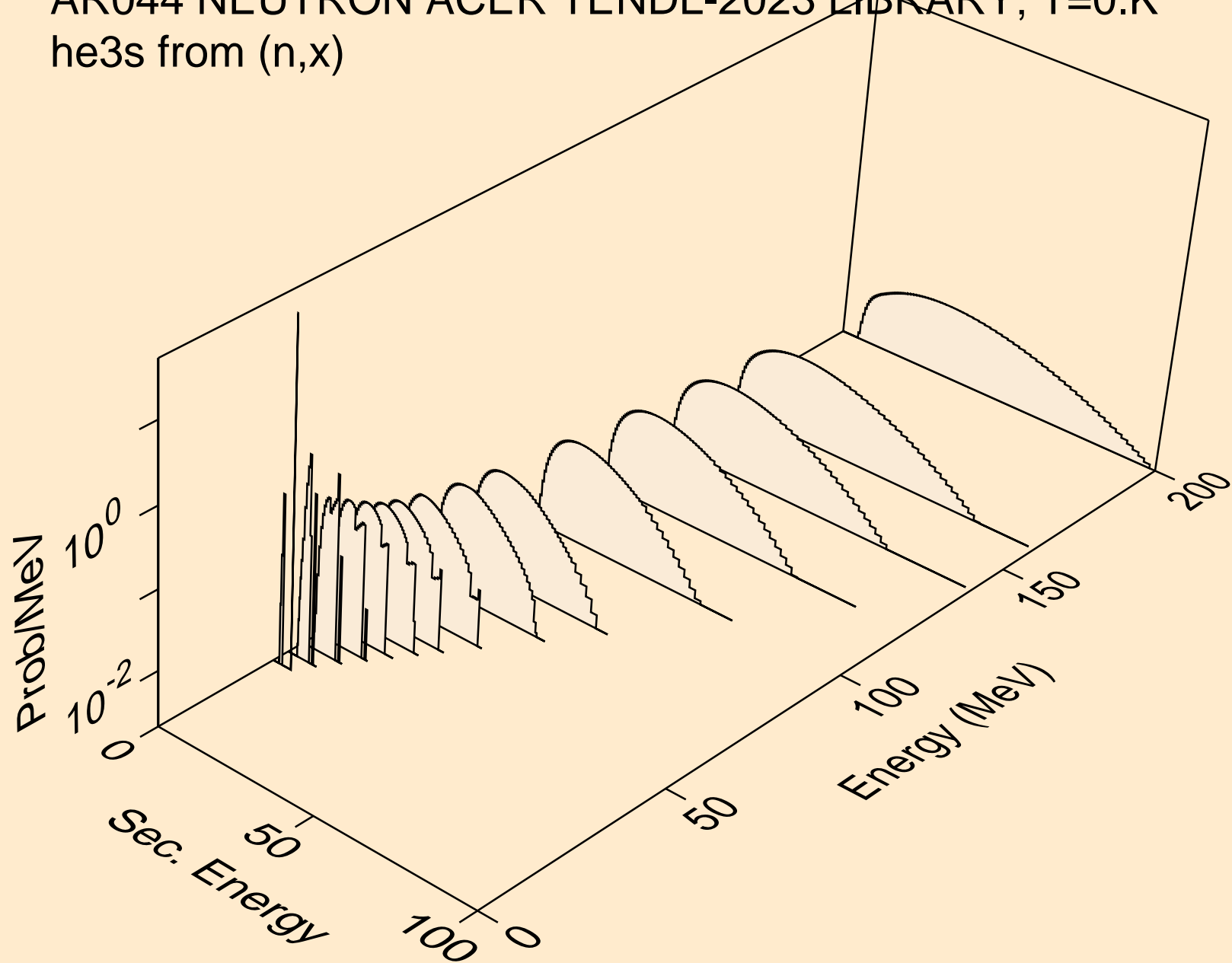

AR044 NEUTRON ACER TENDL-2023 LIBRARY; T=0.K
he3s from (n,he3)

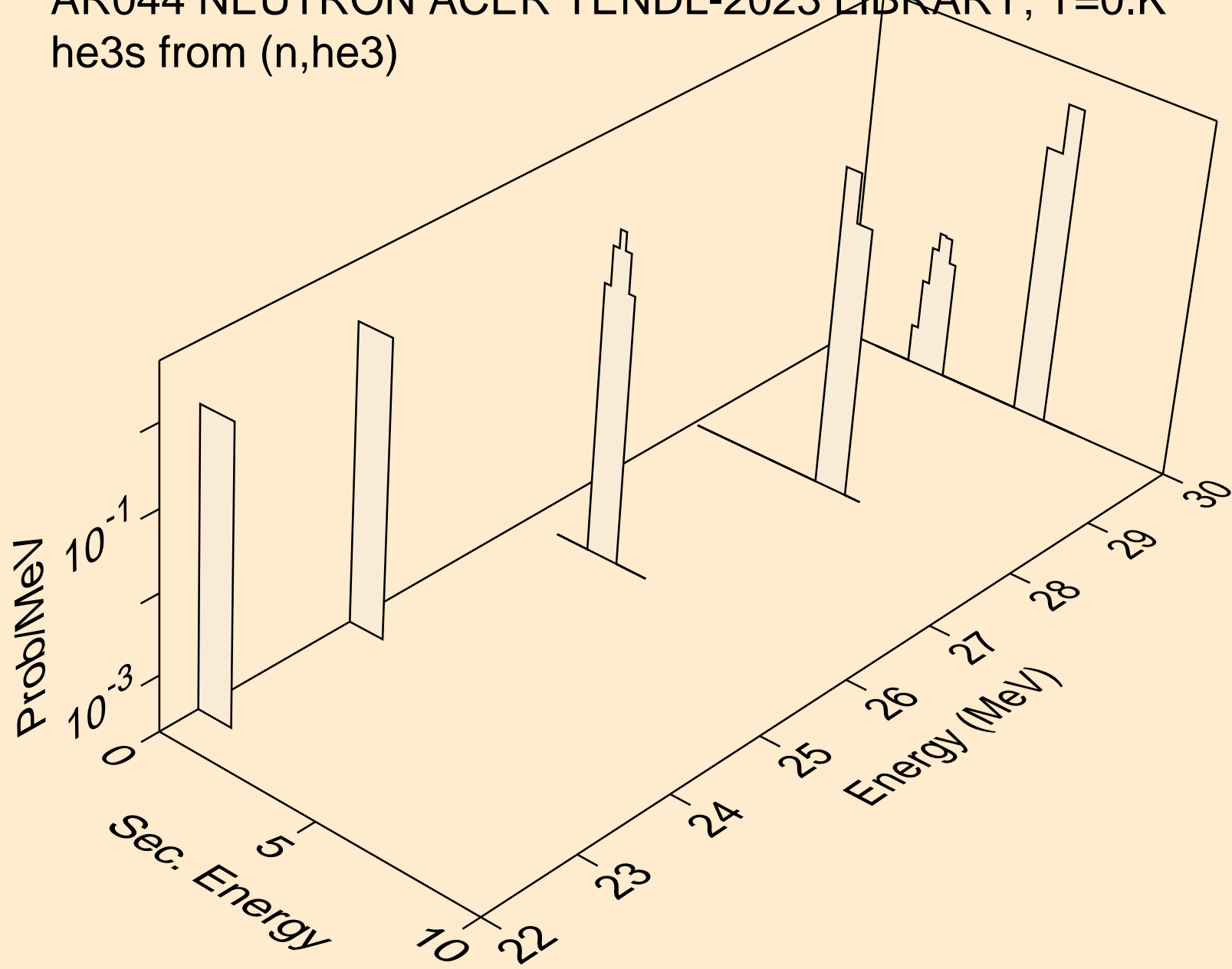

AR044 NEUTRON ACER TENDL-2023 LIBRARY; T=0.K
alphas from (n,x)

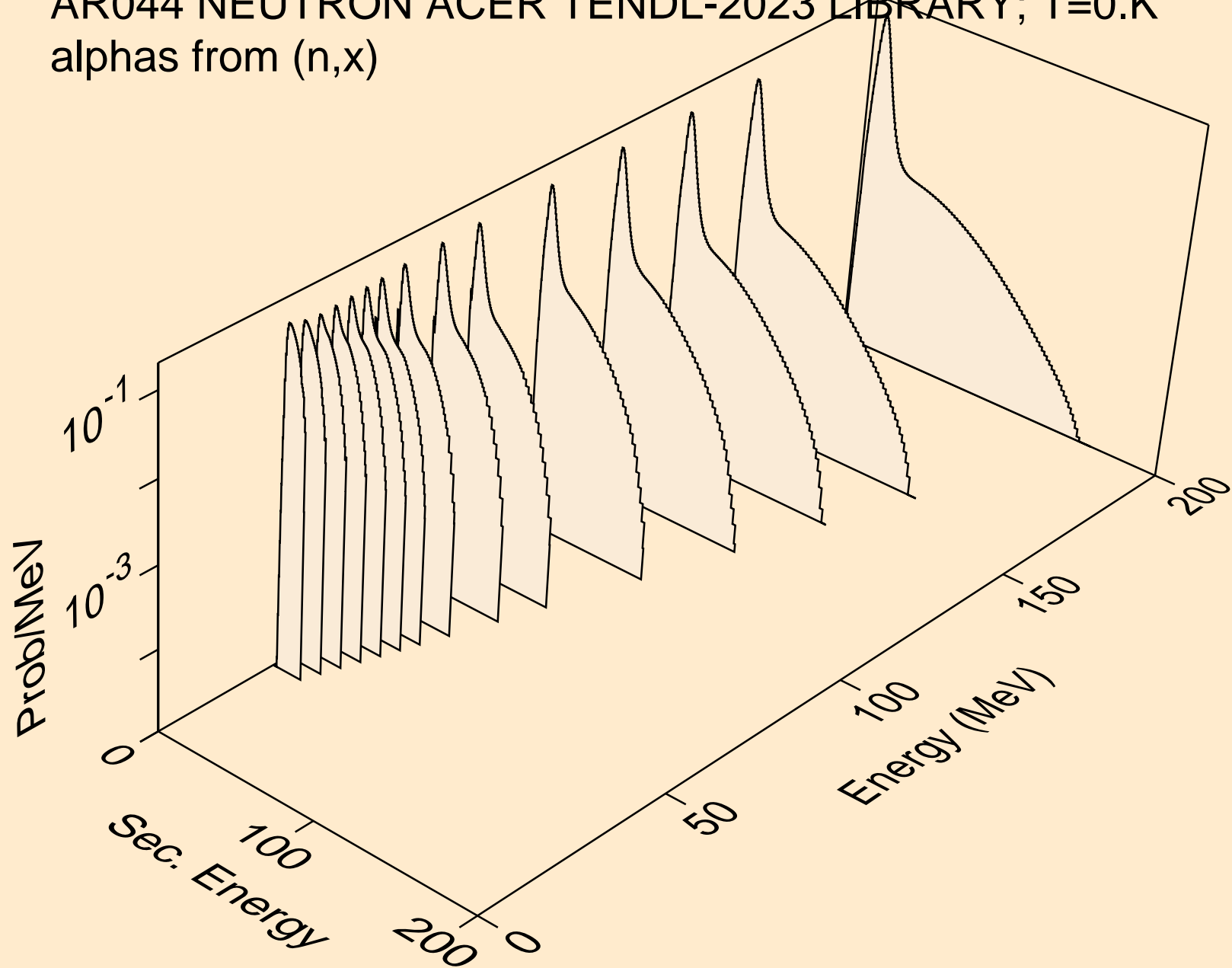

AR044 NEUTRON ACER TENDL-2023 LIBRARY; T=0.K
alphas from (n,n*)a

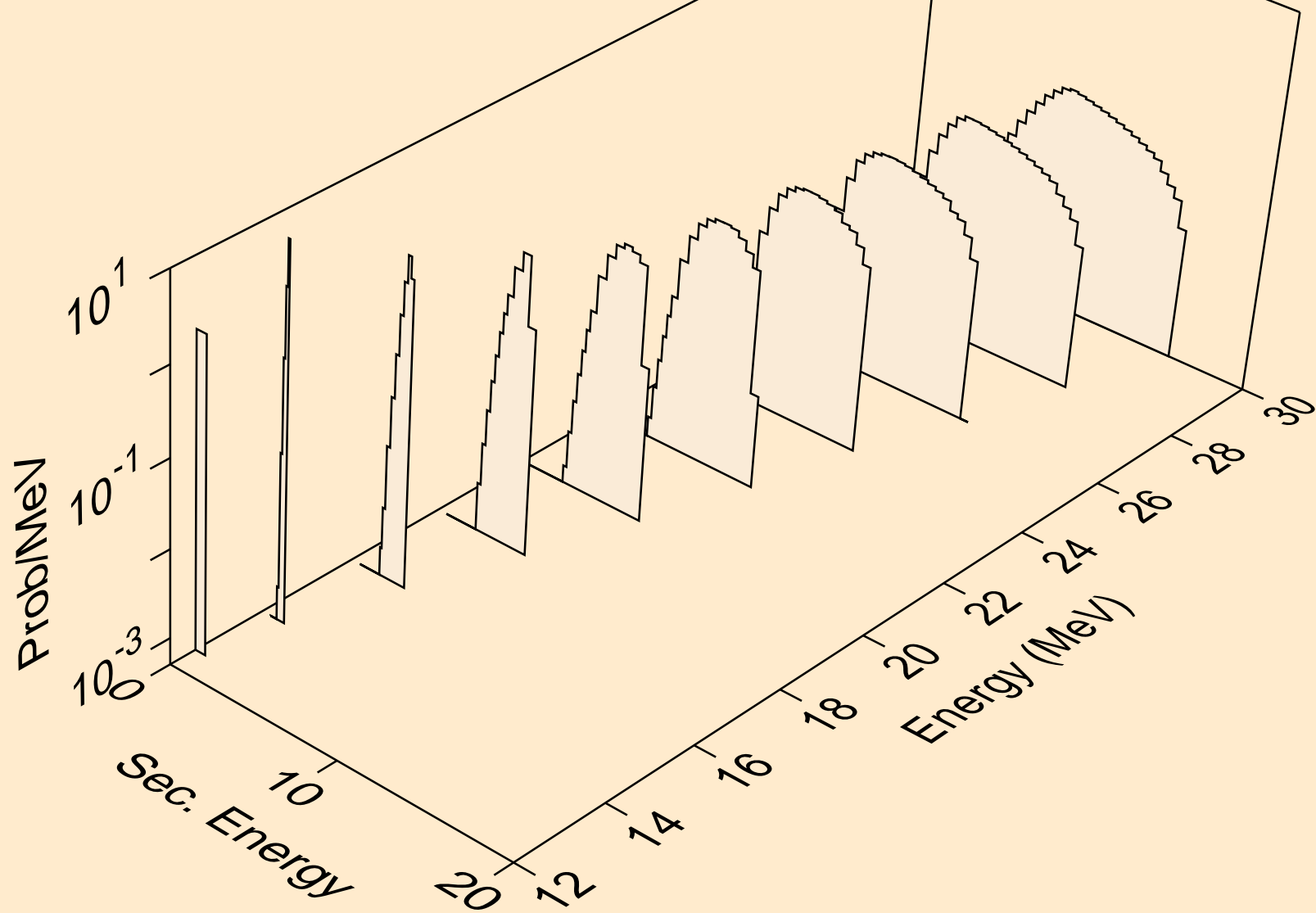

AR044 NEUTRON ACER TENDL-2023 LIBRARY; T=0.K
alphas from (n,2n)a

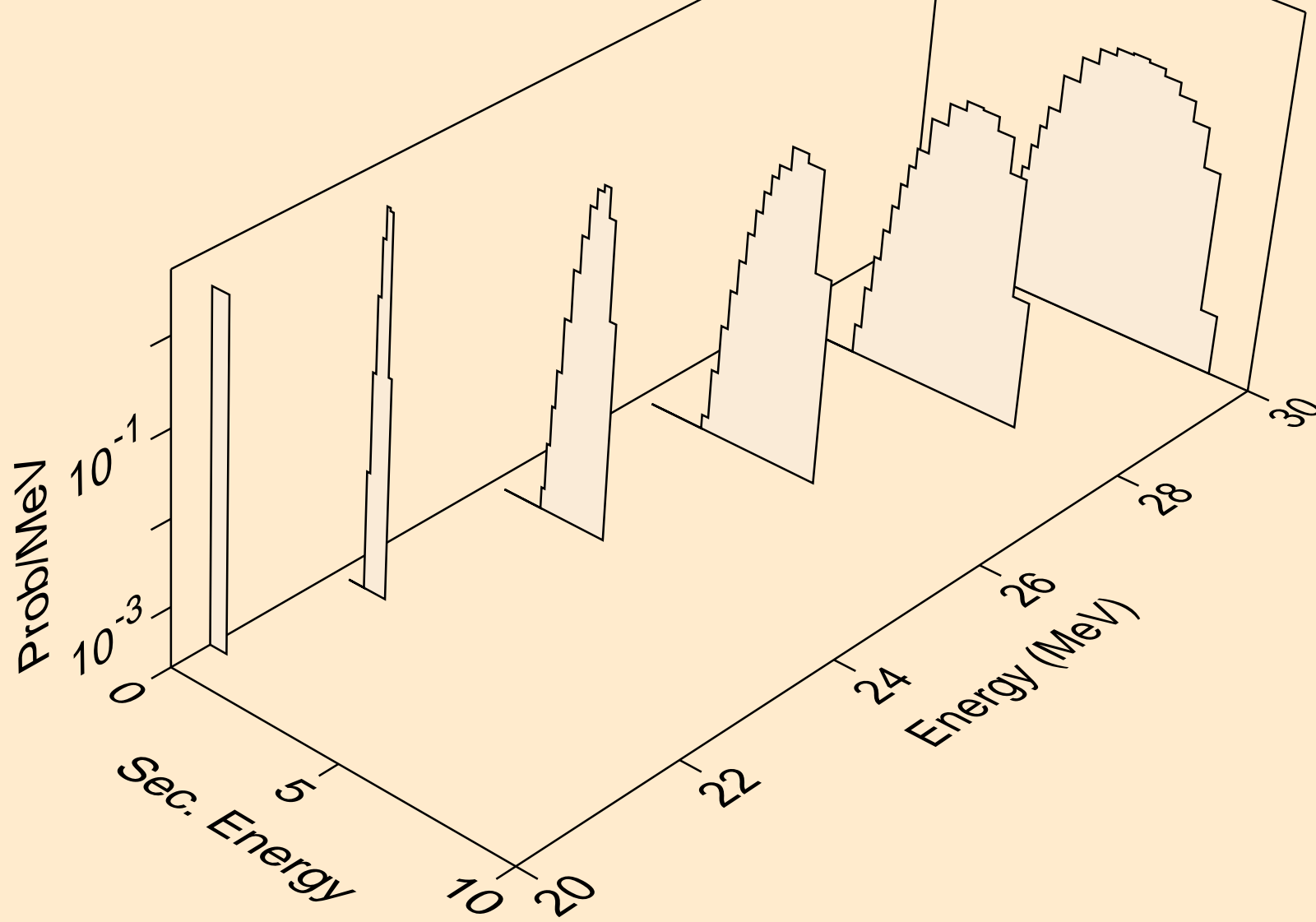

AR044 NEUTRON ACER TENDL-2023 LIBRARY; T=0.K
alphas from (n,3n)a

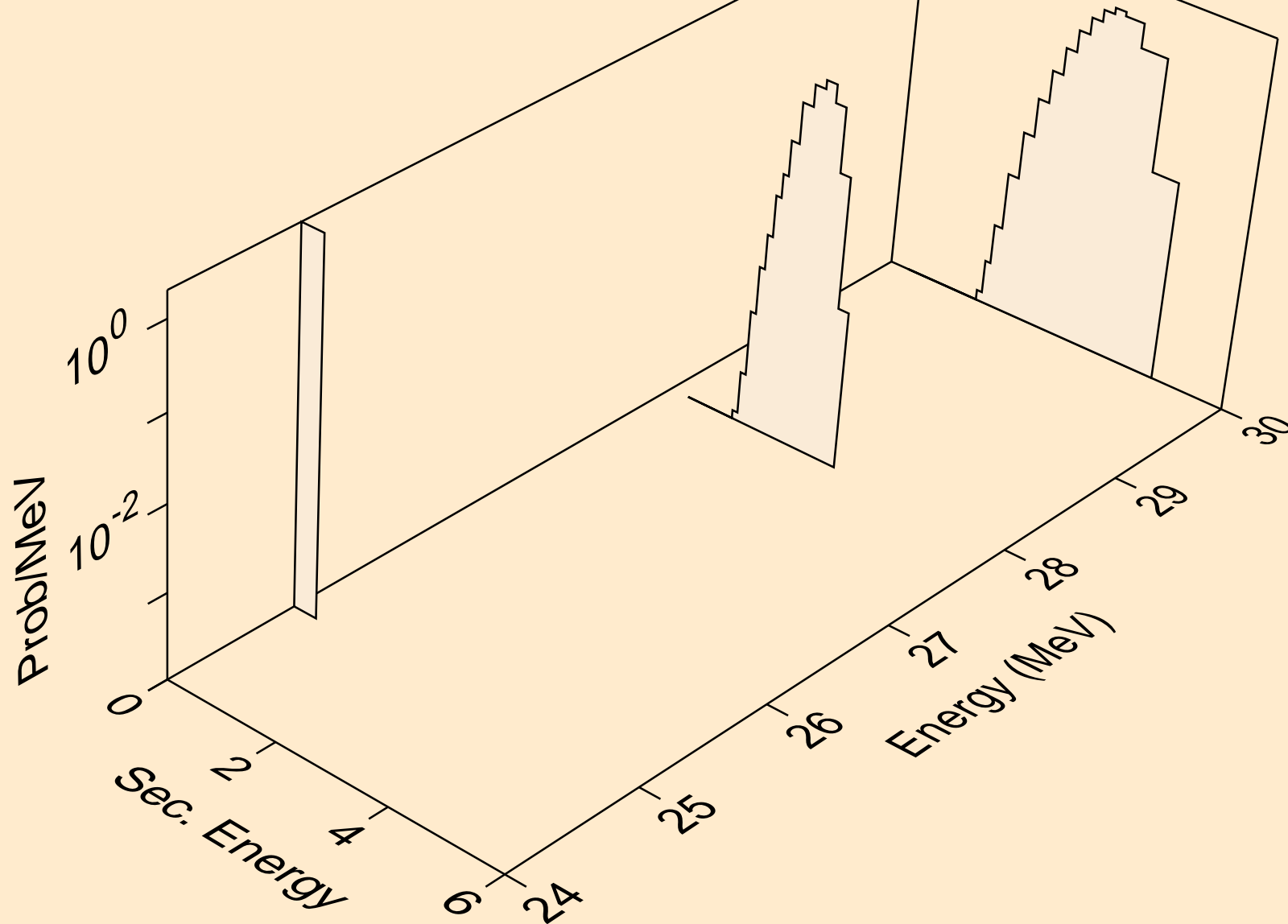

AR044 NEUTRON ACER TENDL-2023 LIBRARY; T=0.K
alphas from (n,a)

