

# AS069 NEUTRON ACER TENDL-2023 LIBRARY; T=0.K

## Principal cross sections

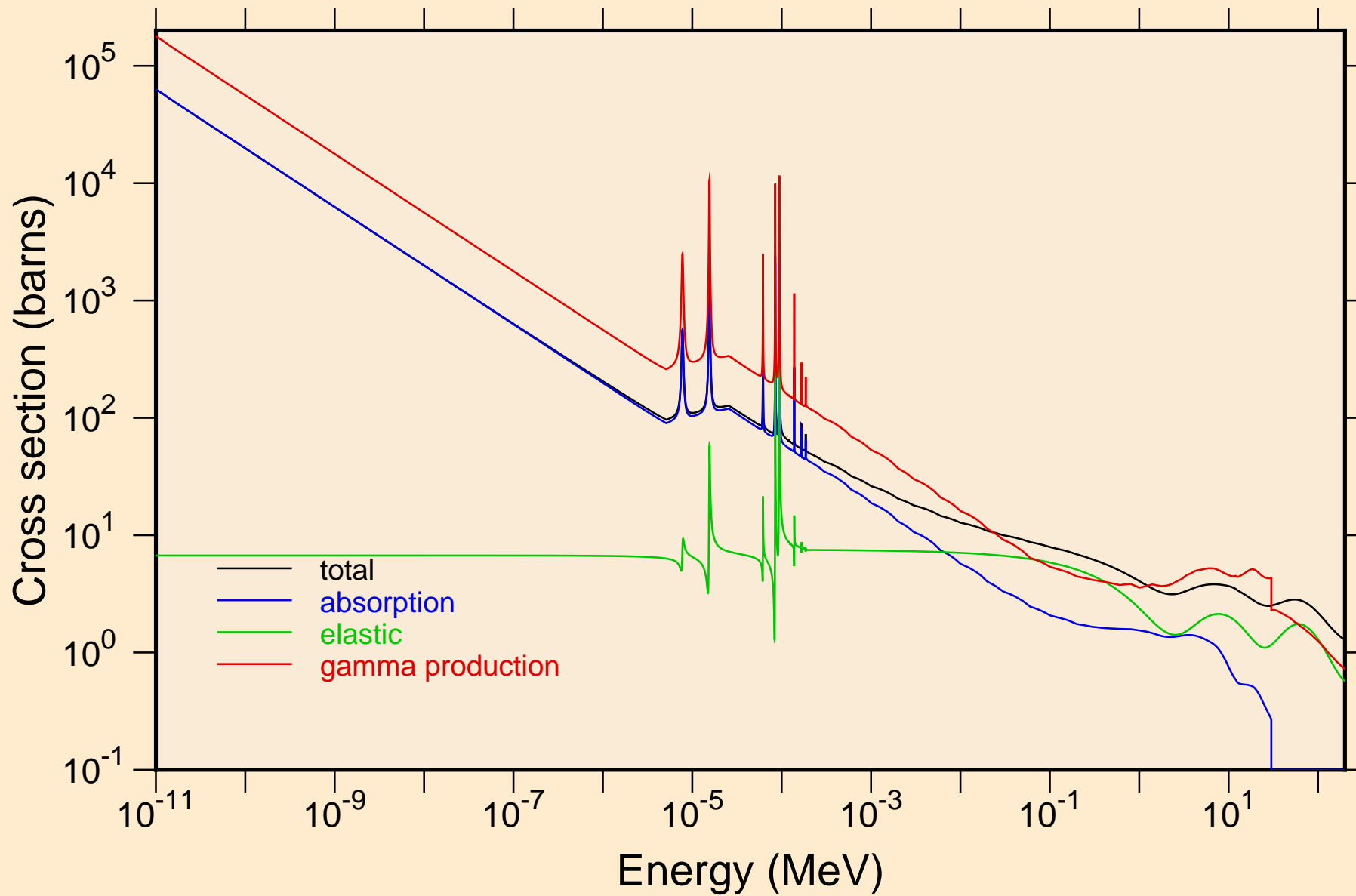

AS069 NEUTRON ACER TENDL-2023 LIBRARY; T=0.K  
resonance total cross section

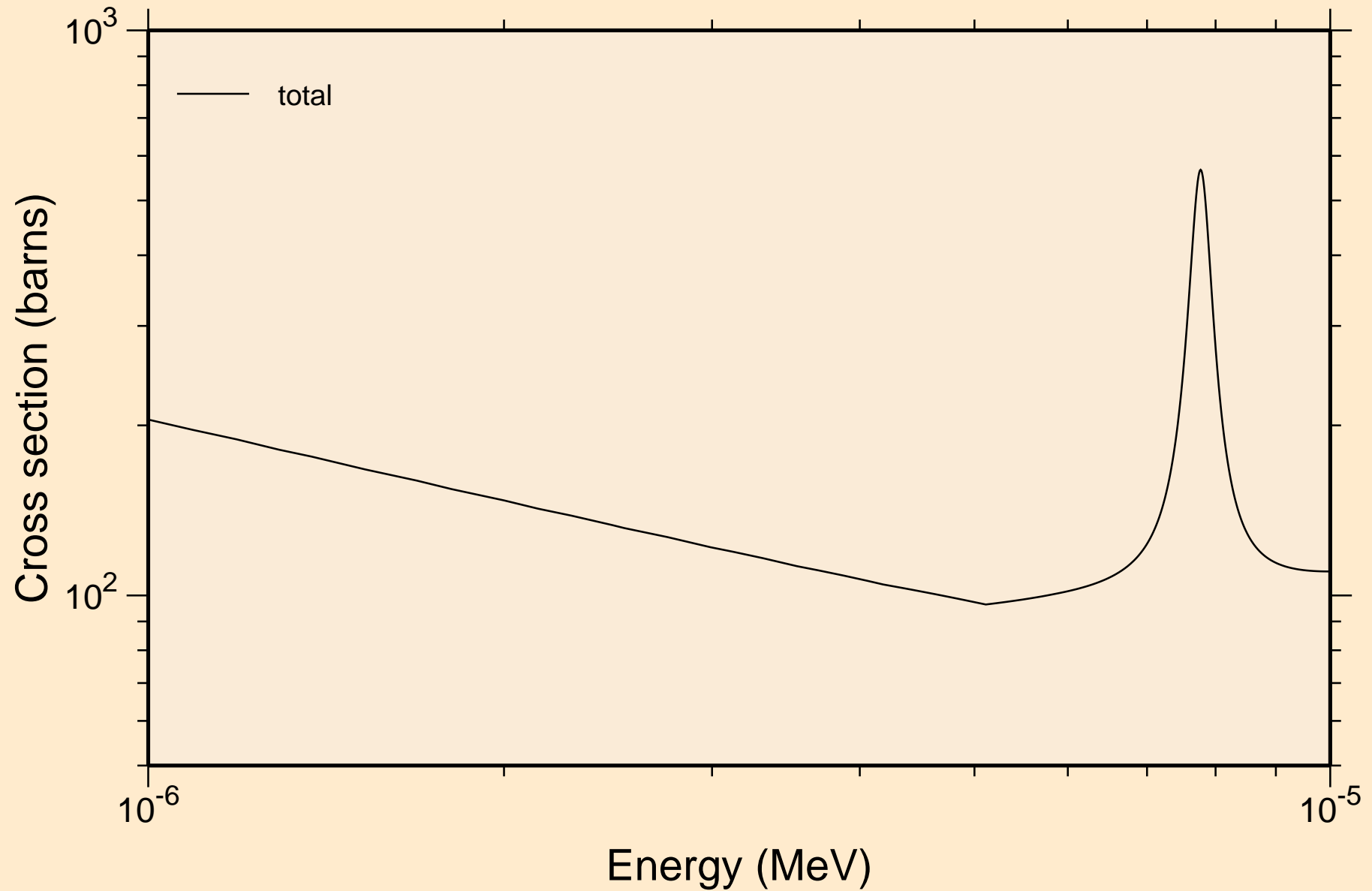

AS069 NEUTRON ACER TENDL-2023 LIBRARY; T=0.K  
resonance total cross section

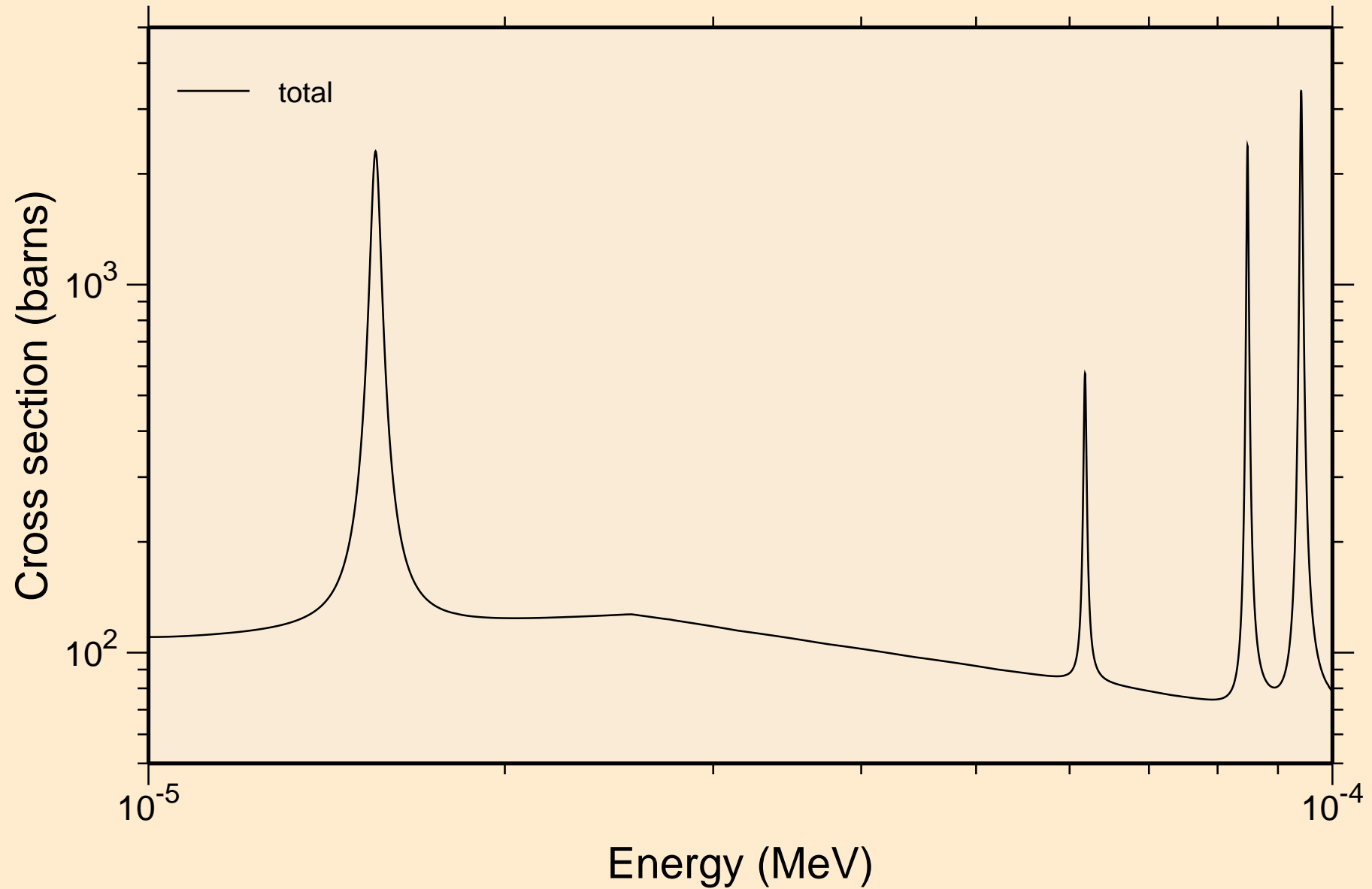

AS069 NEUTRON ACER TENDL-2023 LIBRARY; T=0.K  
resonance total cross section

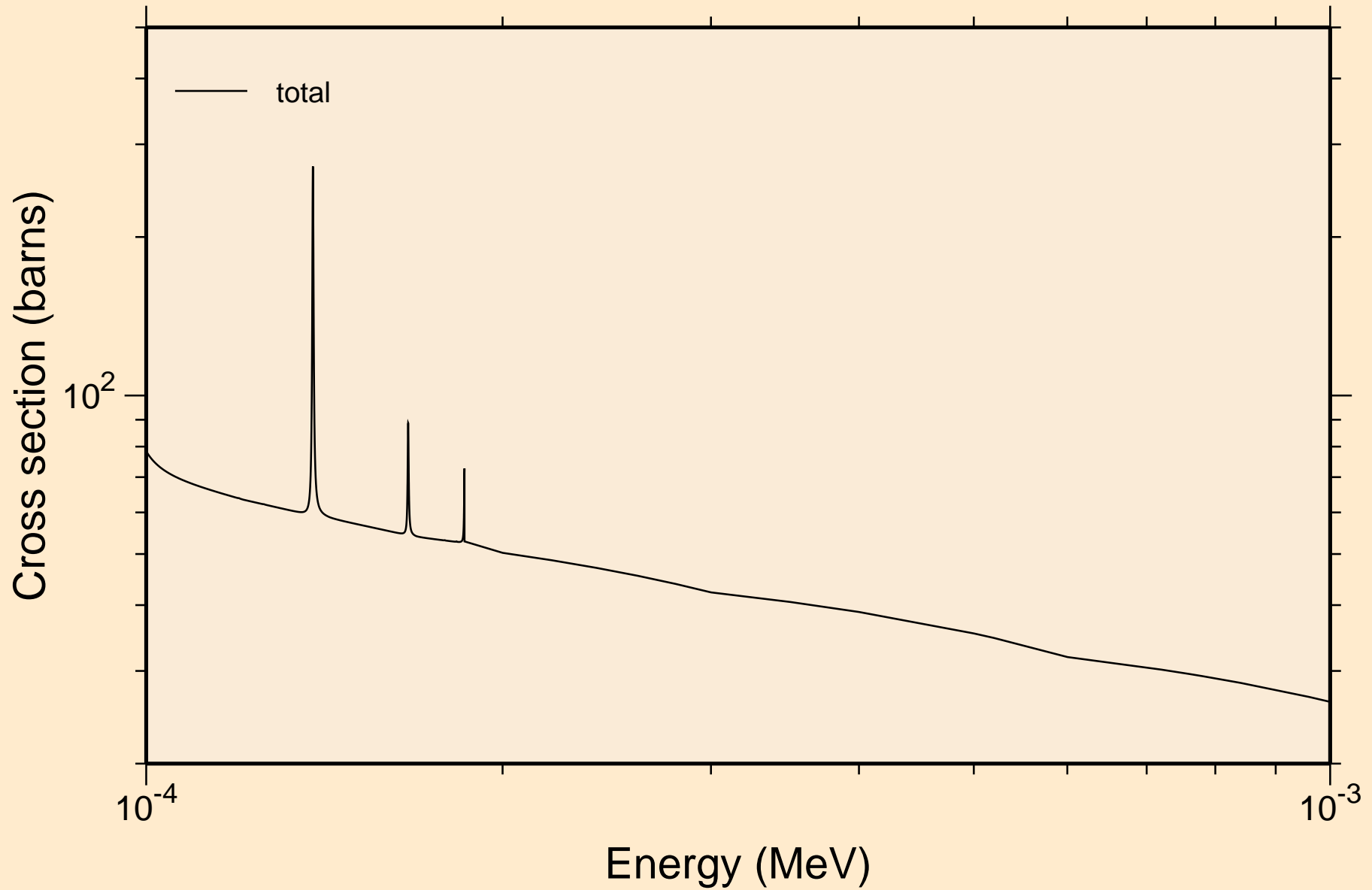

A5069 NEUTRON ACER TENDL-2023 LIBRARY; T=0.K  
resonance total cross section

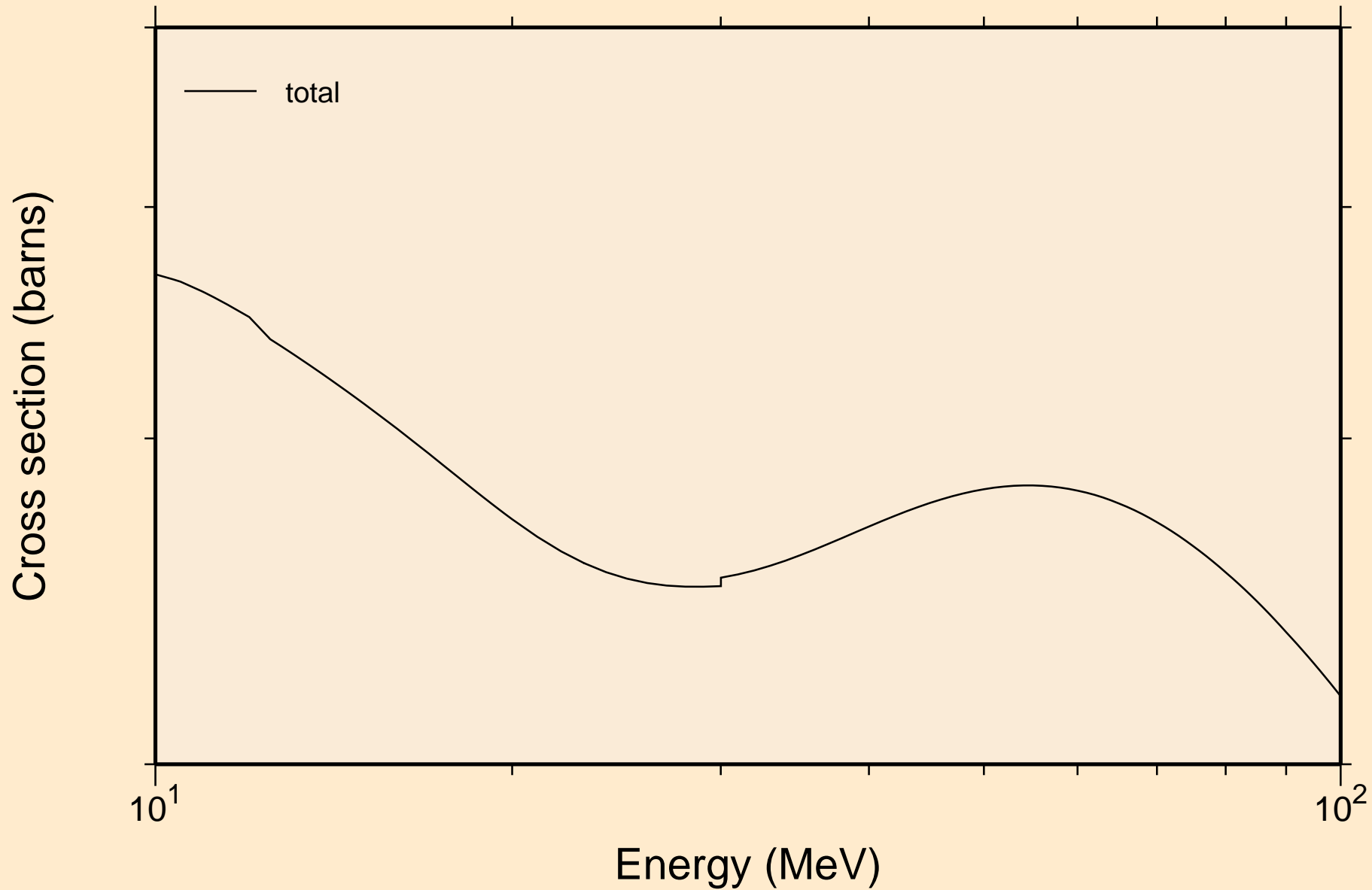

AS069 NEUTRON ACER TENDL-2023 LIBRARY; T=0.K  
resonance absorption cross sections

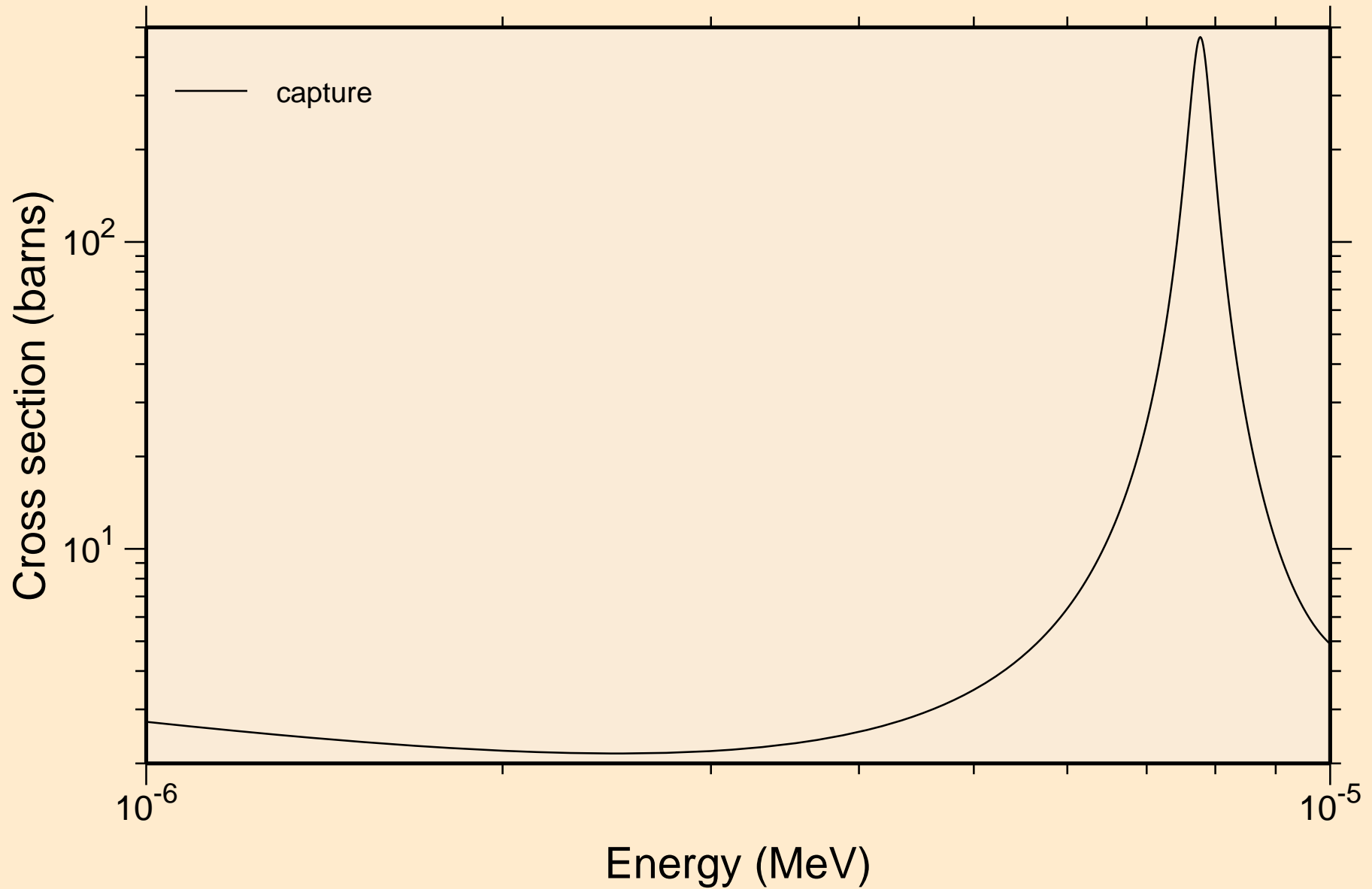

AS069 NEUTRON ACER TENDL-2023 LIBRARY; T=0.K  
resonance absorption cross sections

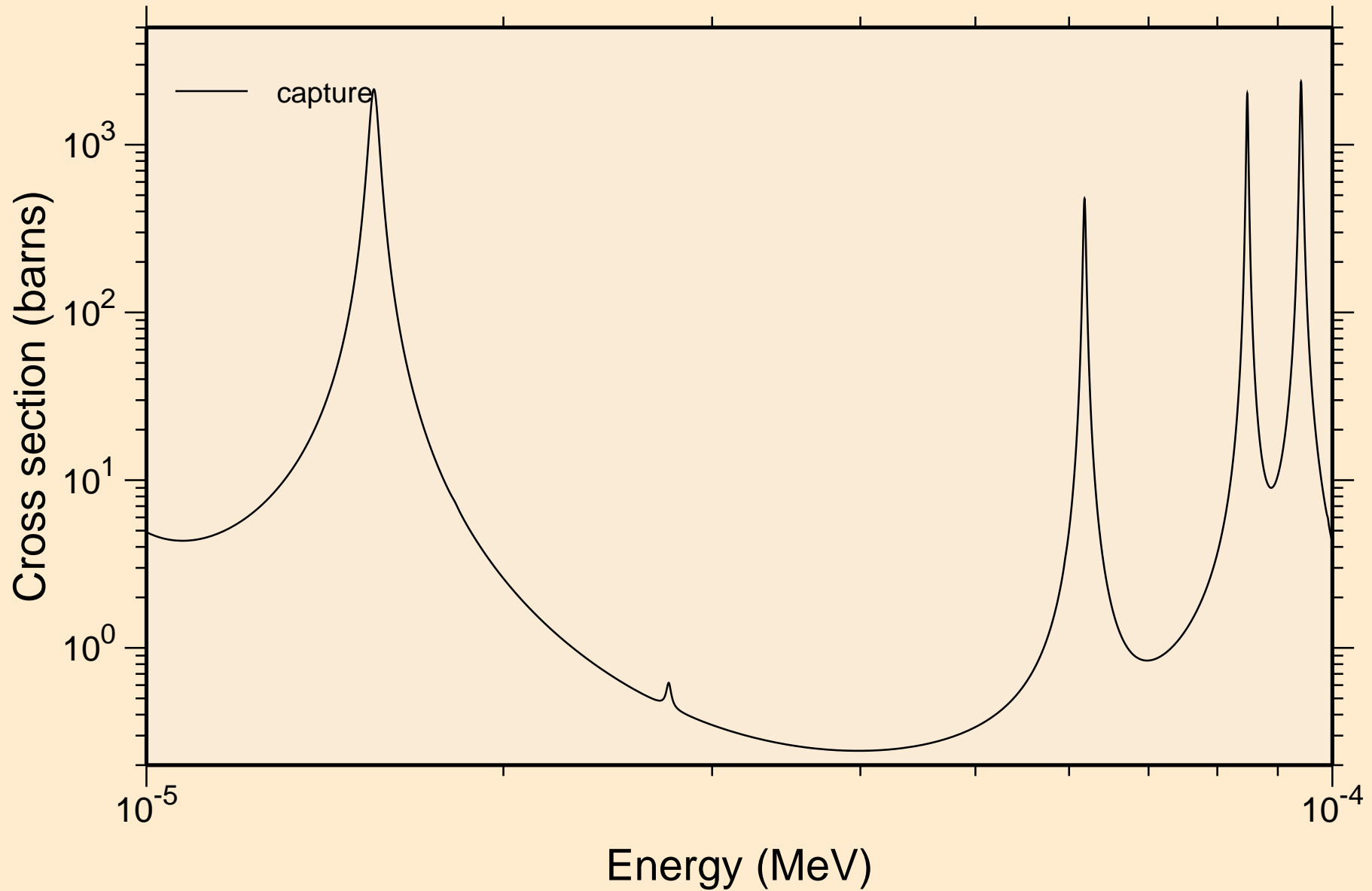

AS069 NEUTRON ACER TENDL-2023 LIBRARY; T=0.K  
resonance absorption cross sections

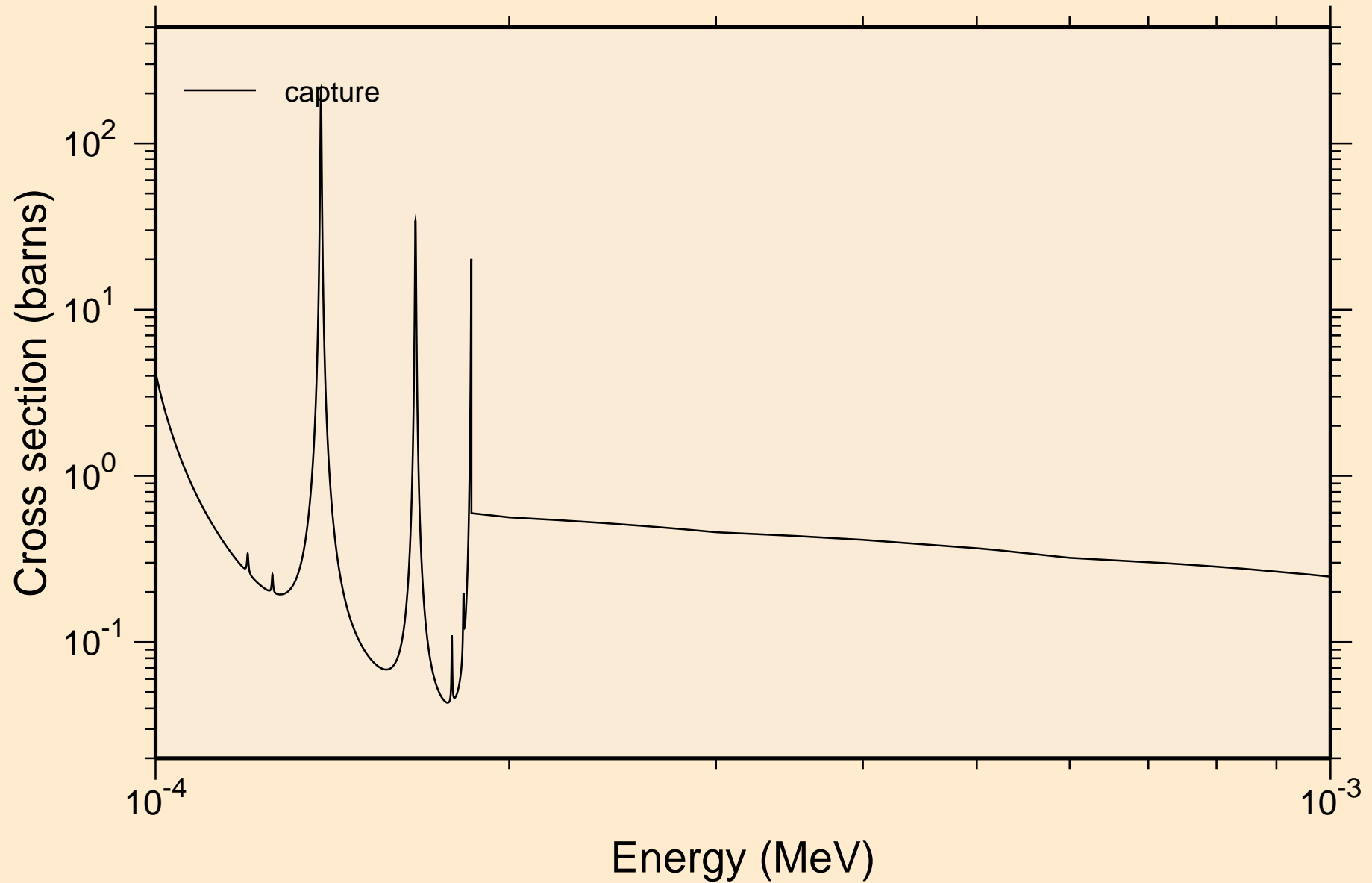

AS069 NEUTRON ACER TENDL-2023 LIBRARY; T=0.K  
resonance absorption cross sections

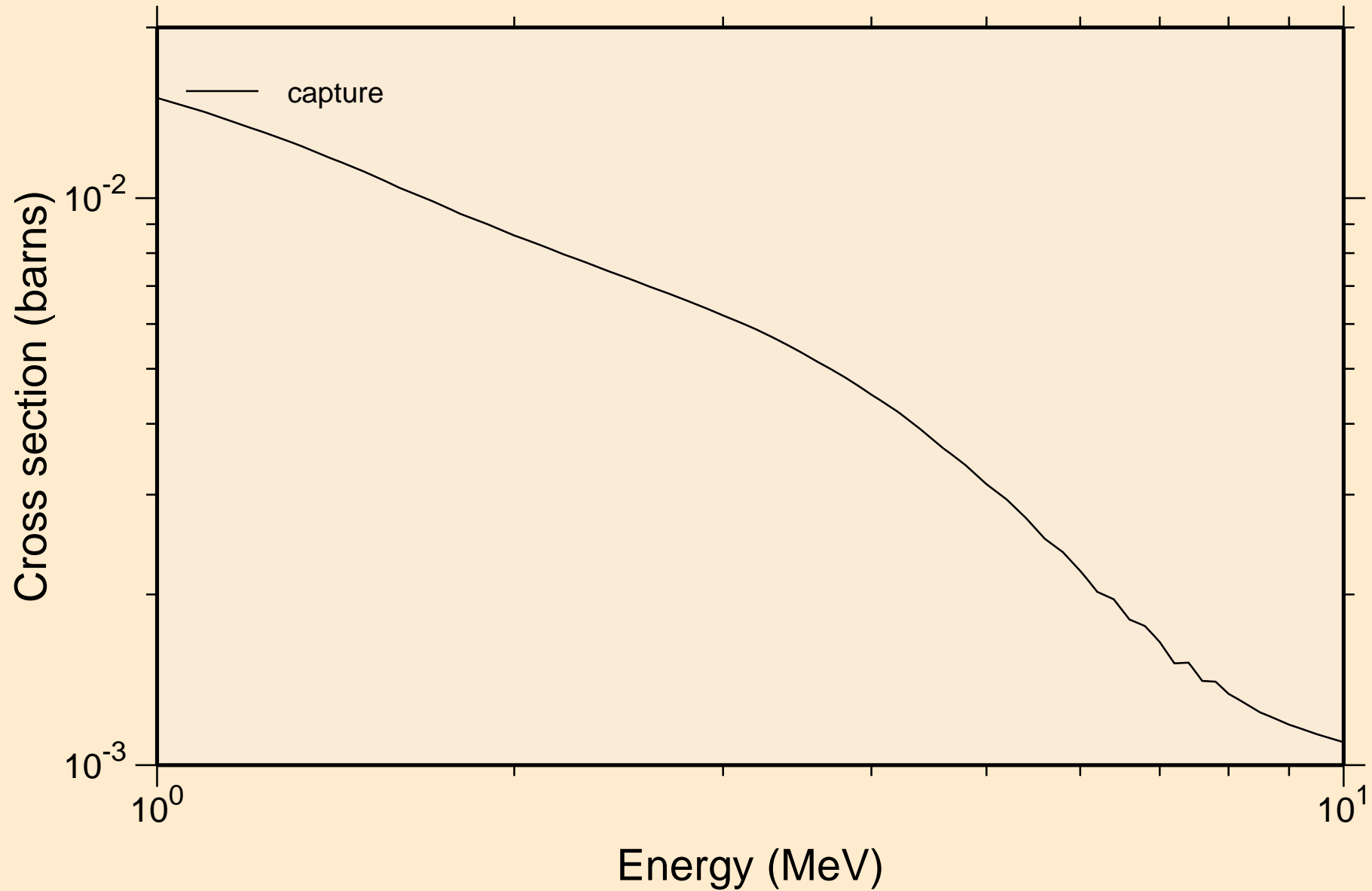

# AS069 NEUTRON ACER TENDL-2023 LIBRARY; T=0.K

## Heating

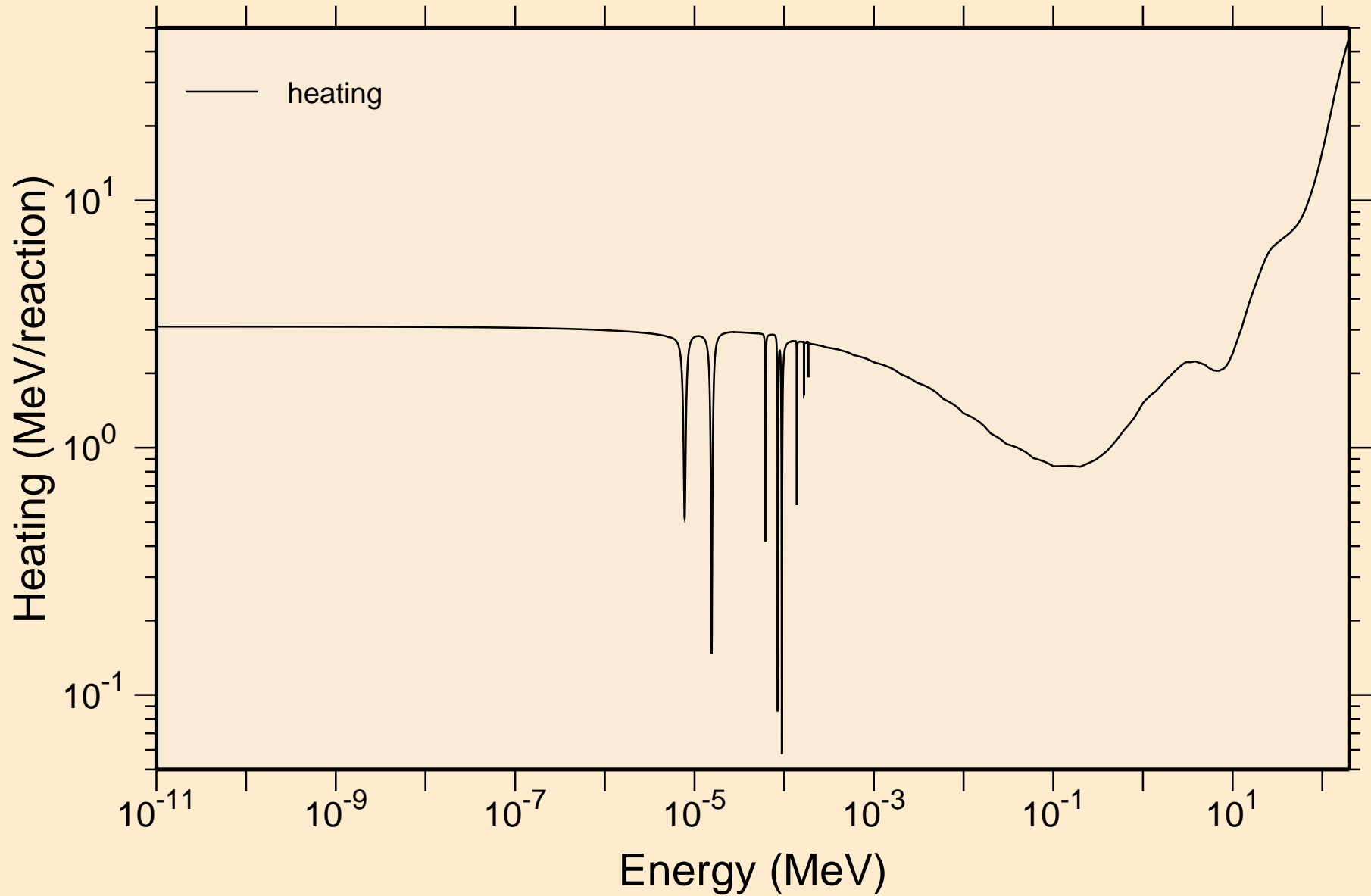

AS069 NEUTRON ACER TENDL-2023 LIBRARY; T=0.K  
Damage

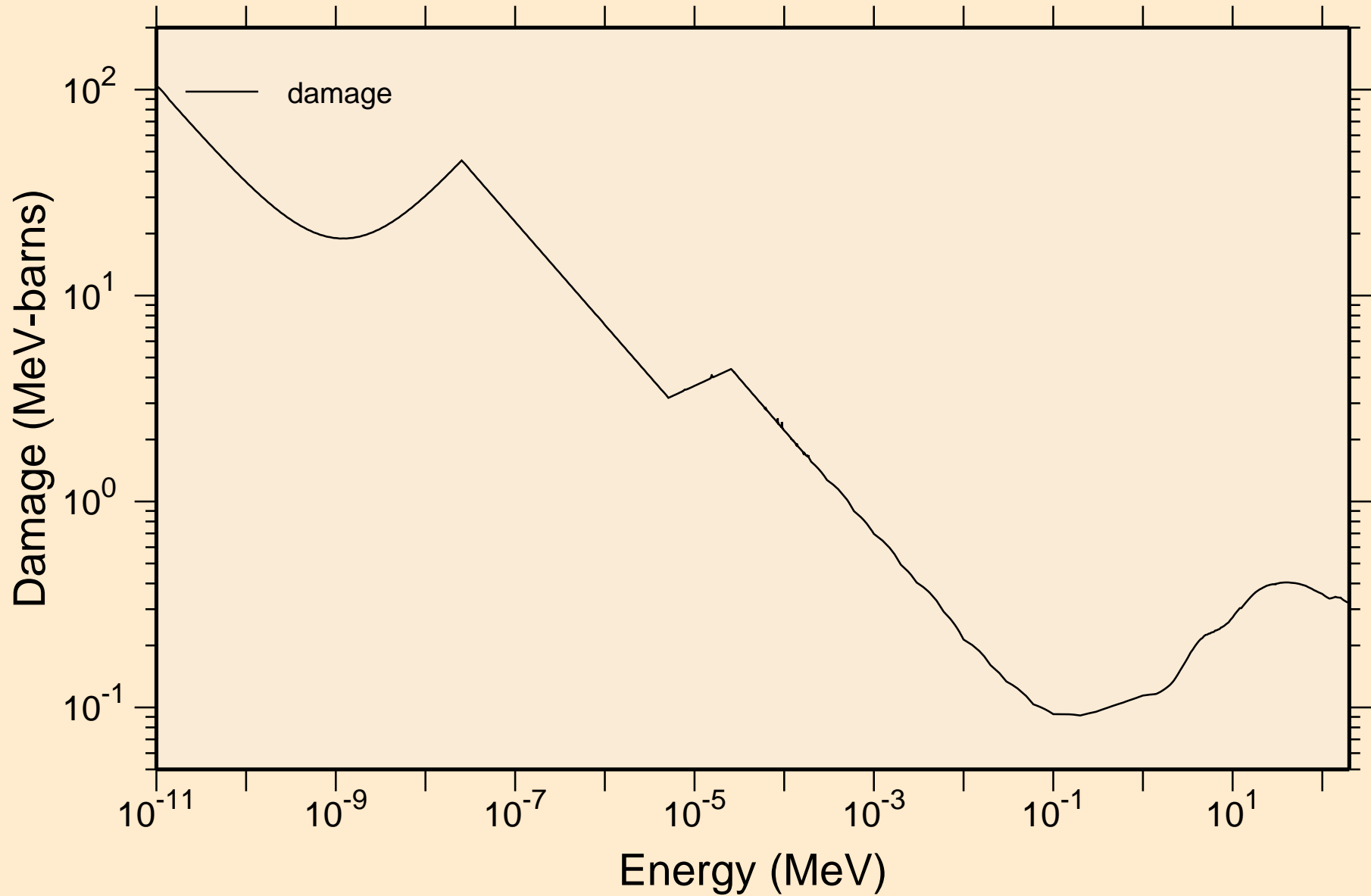

AS069 NEUTRON ACER TENDL-2023 LIBRARY; T=0.K  
Non-threshold reactions

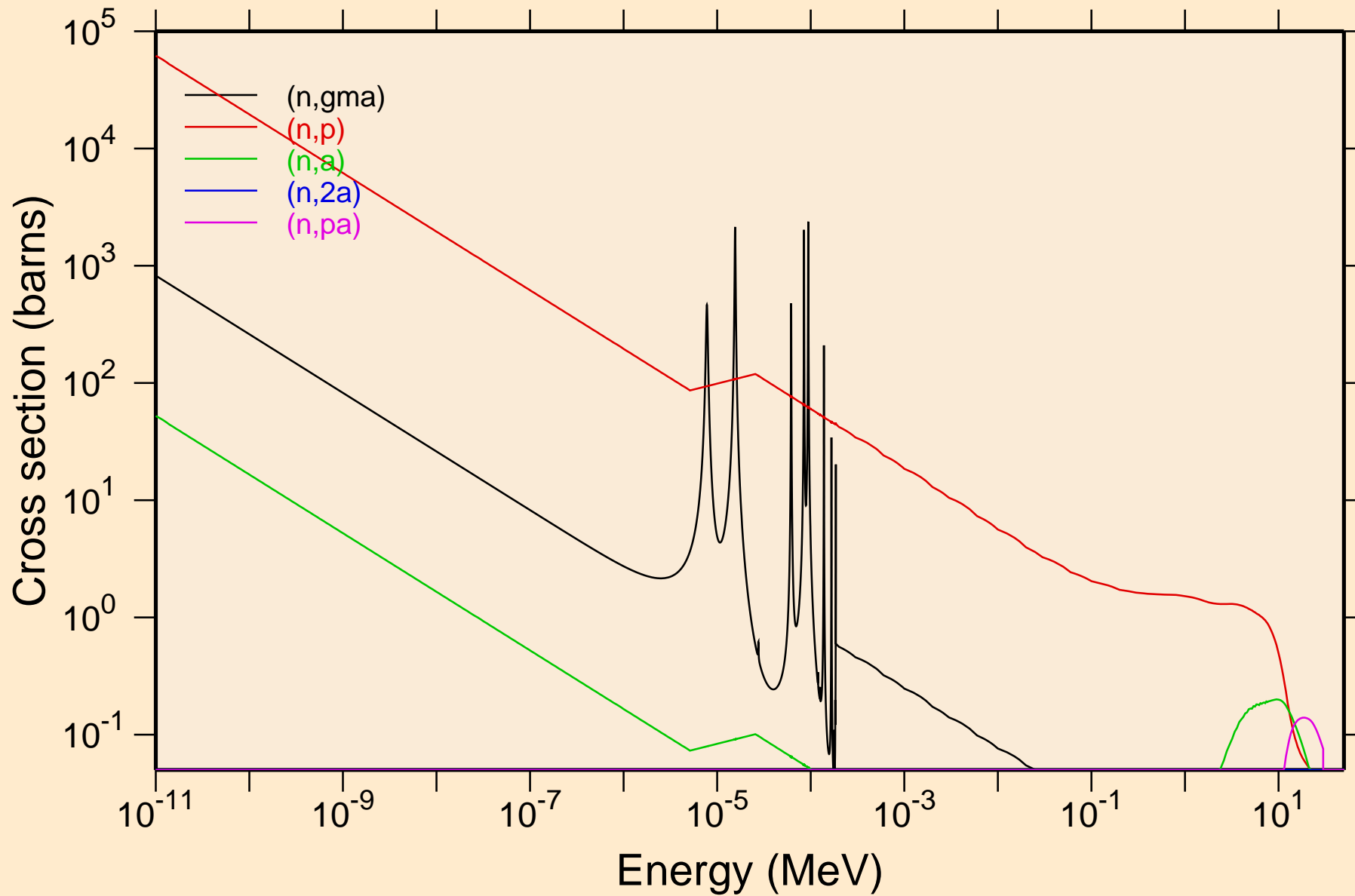

AS069 NEUTRON ACER TENDL-2023 LIBRARY; T=0.K  
Non-threshold reactions

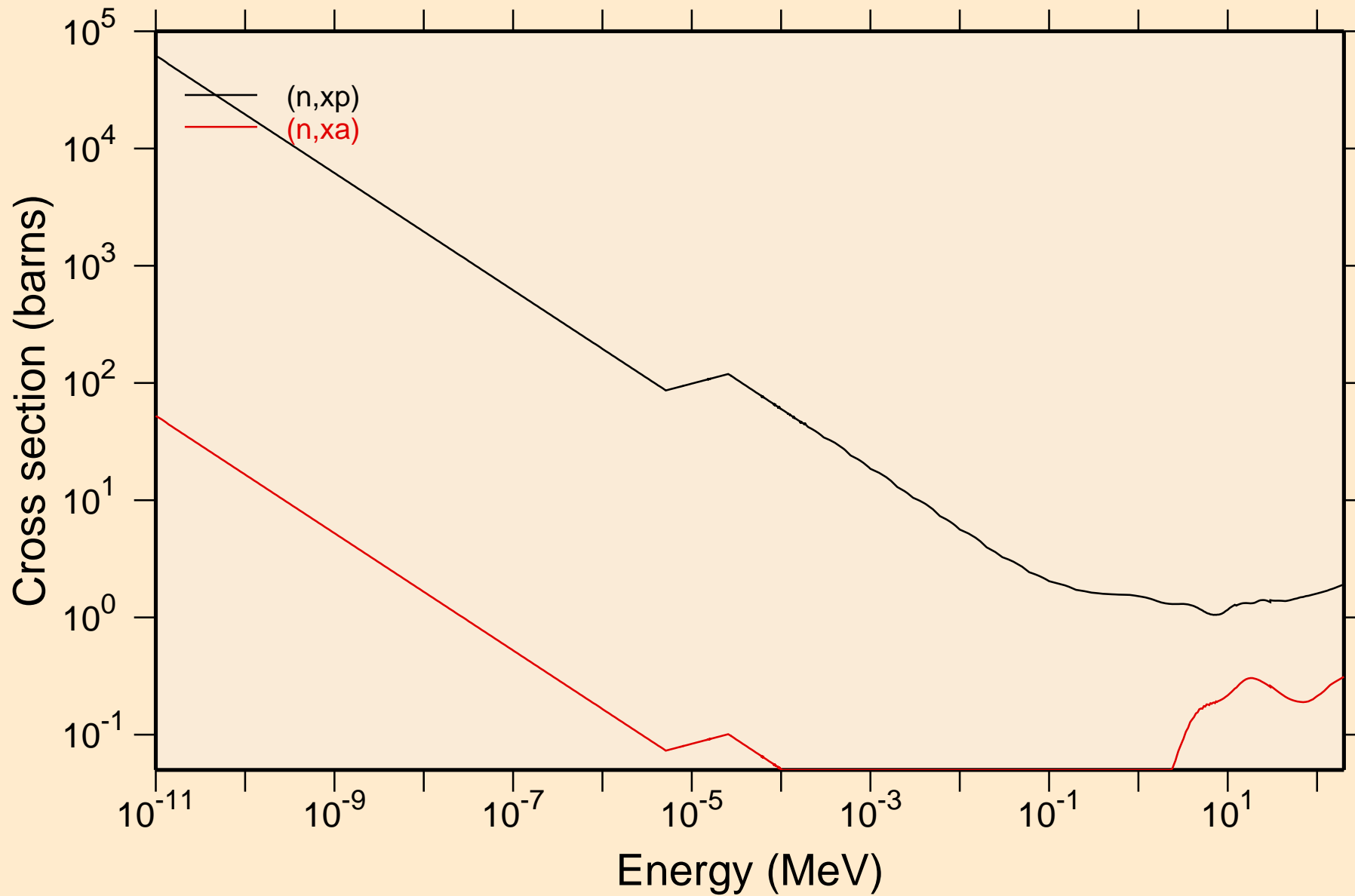

# AS069 NEUTRON ACER TENDL-2023 LIBRARY; T=0.K

## Principal cross sections

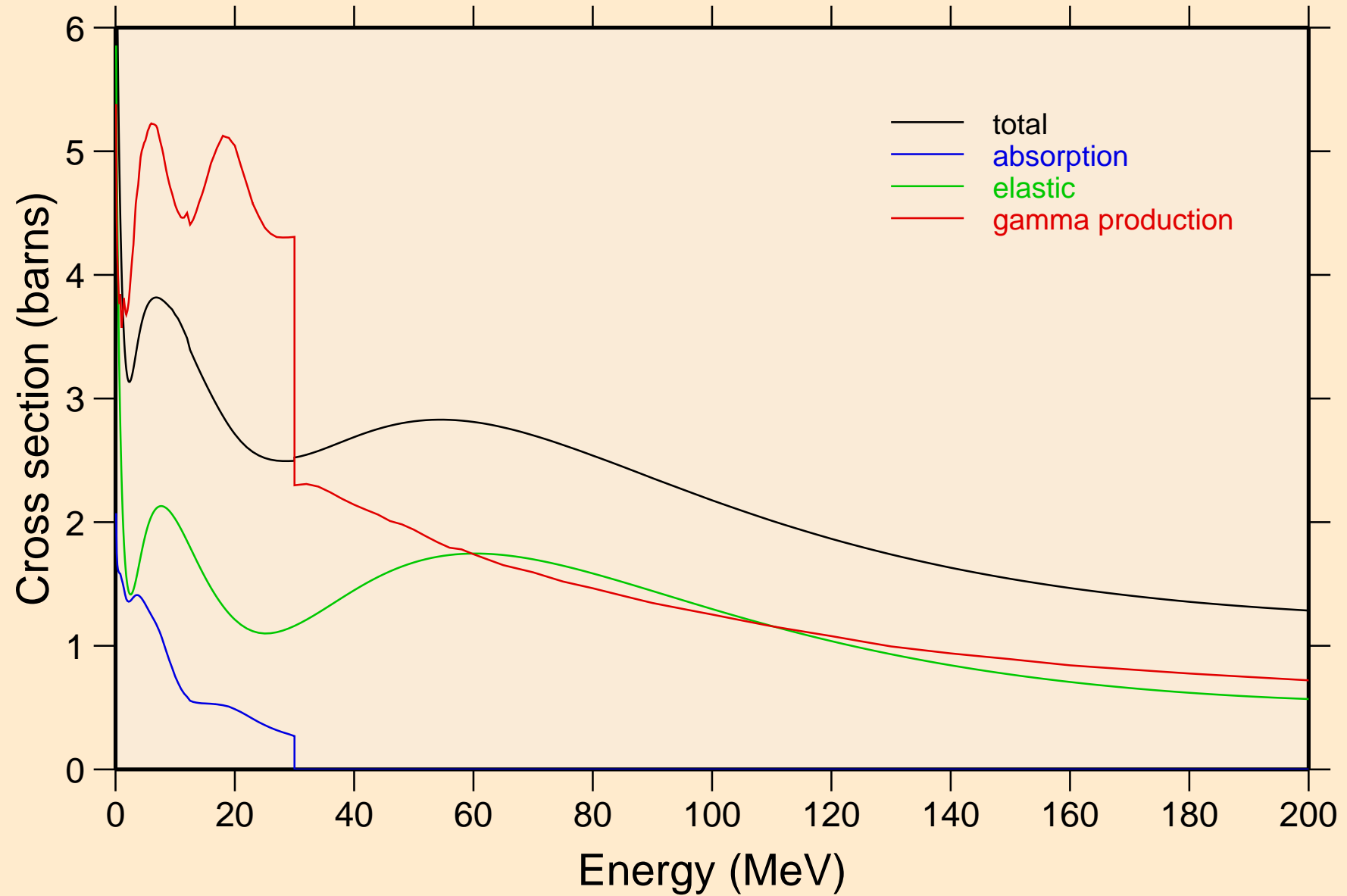

# AS069 NEUTRON ACER TENDL-2023 LIBRARY; T=0.K

## Heating

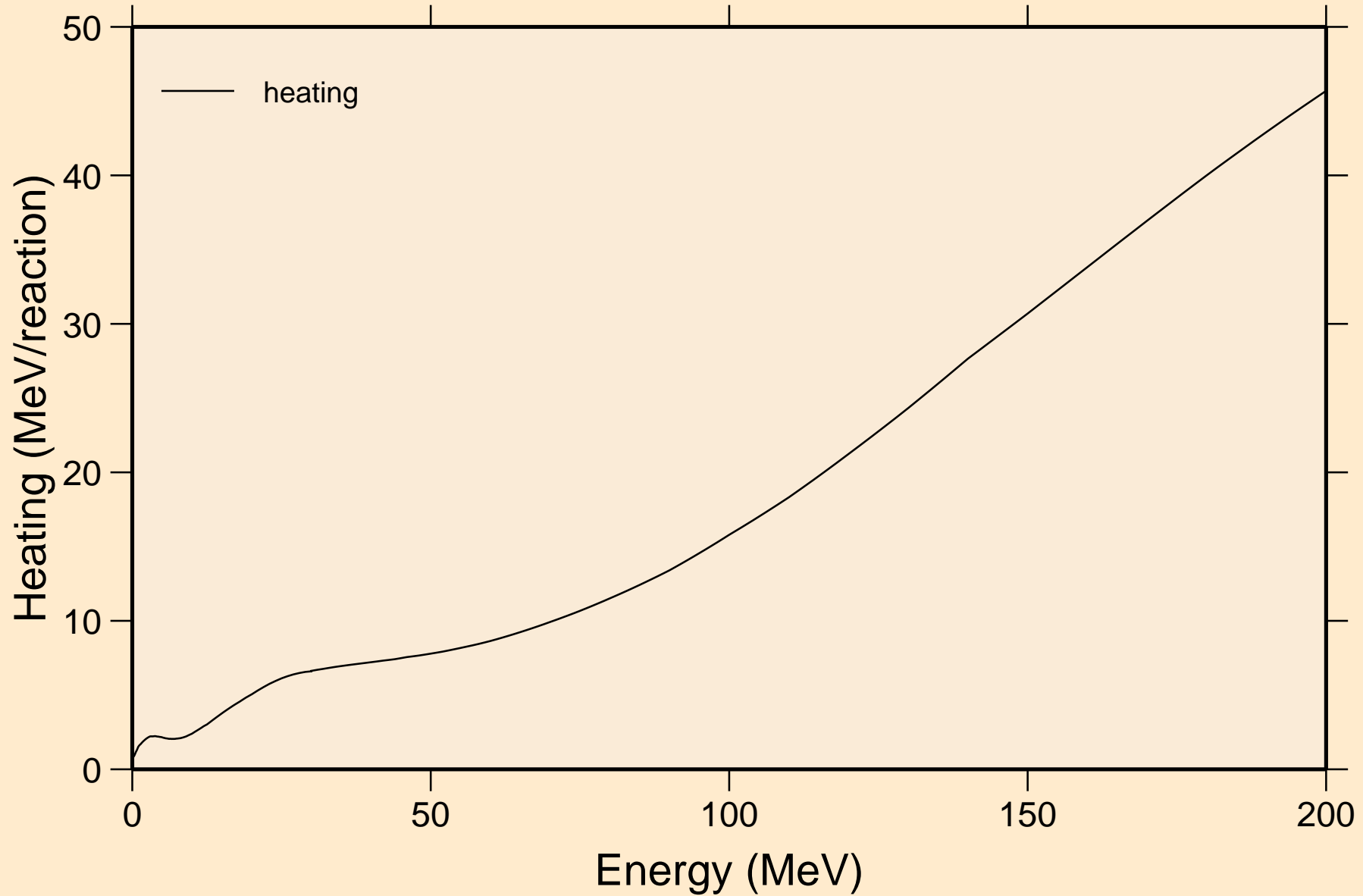

# AS069 NEUTRON ACER TENDL-2023 LIBRARY; T=0.K

## Damage

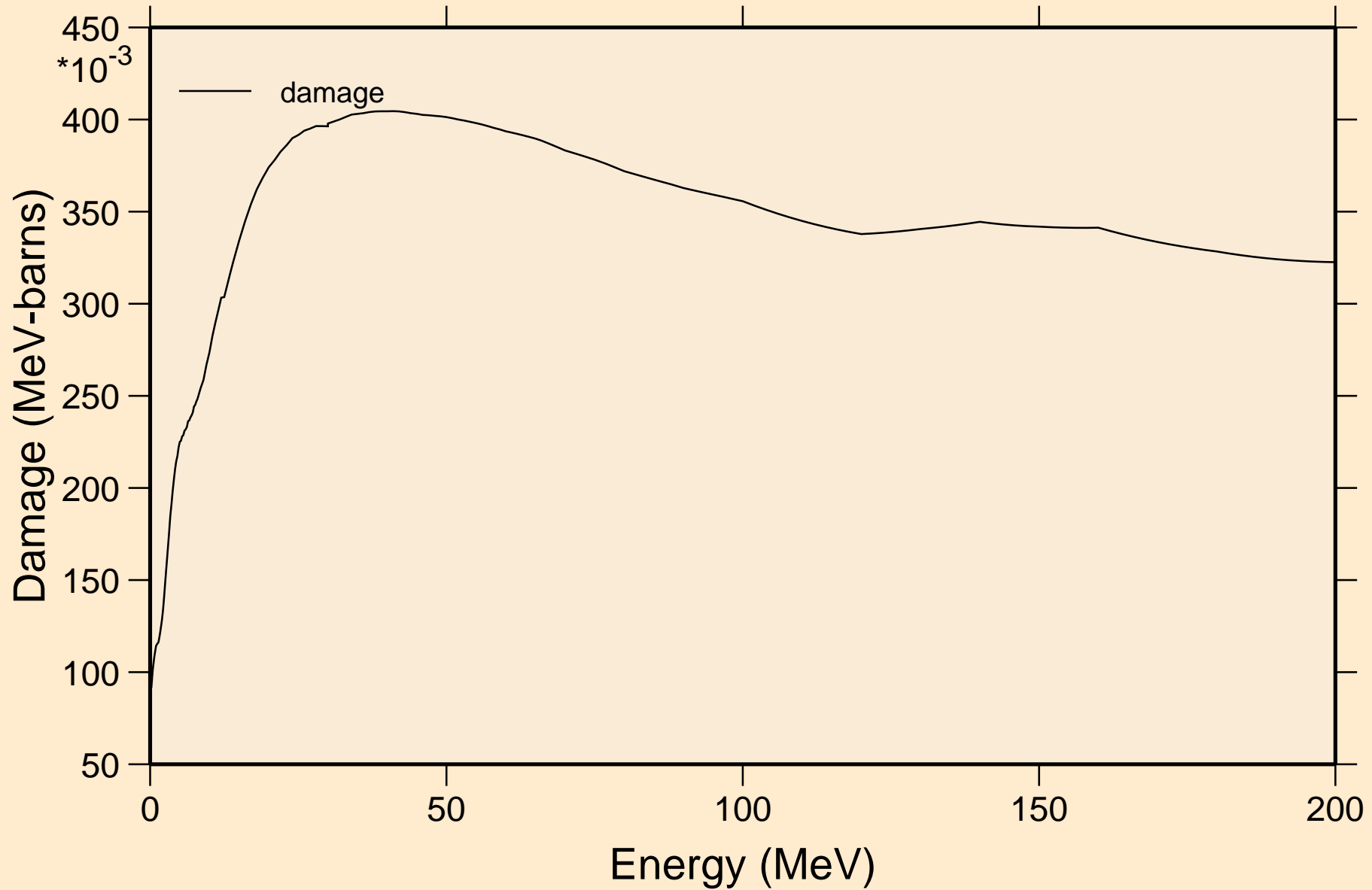

# AS069 NEUTRON ACER TENDL-2023 LIBRARY; T=0.K

## Non-threshold reactions

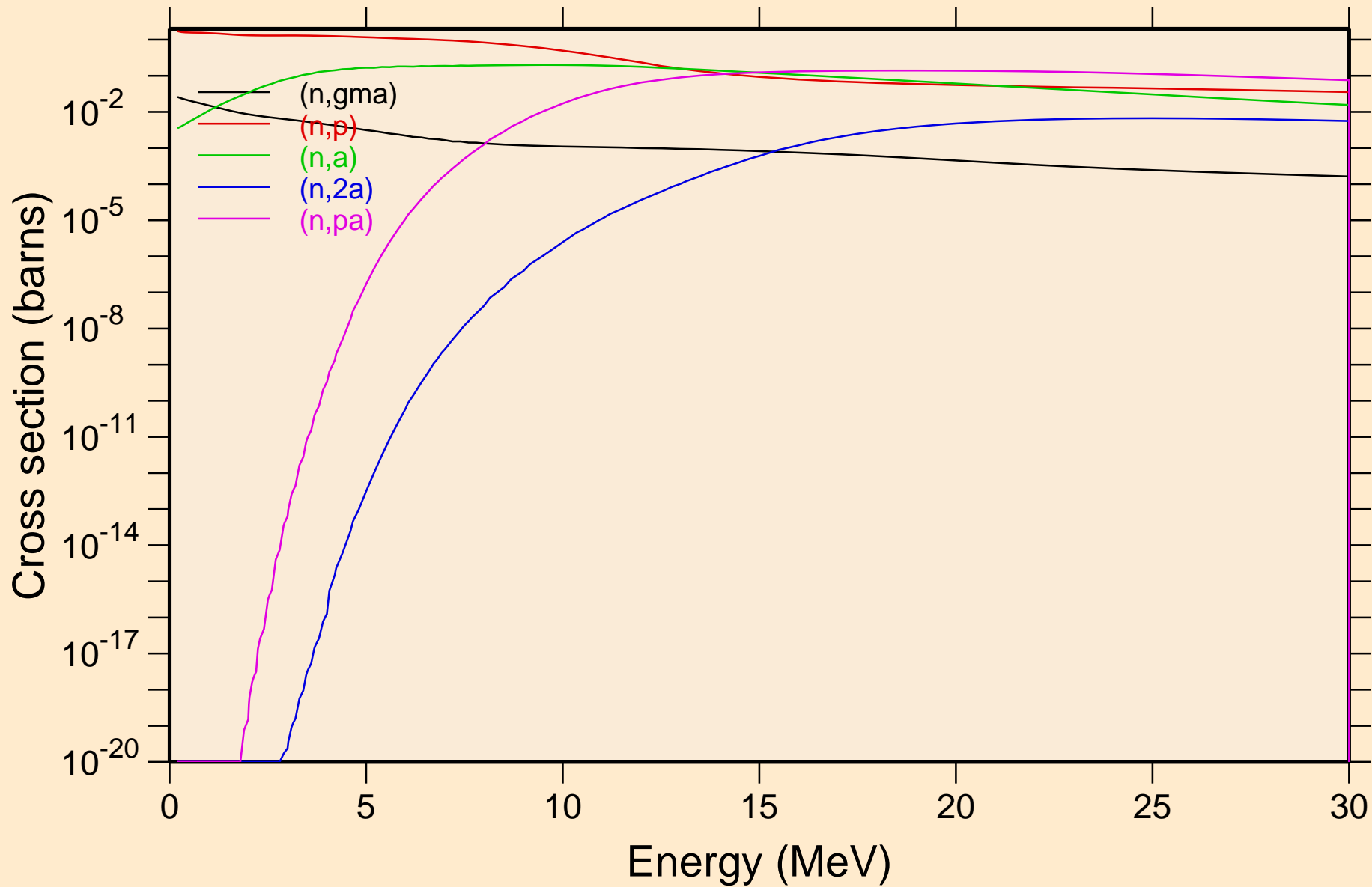

AS069 NEUTRON ACER TENDL-2023 LIBRARY; T=0.K  
Non-threshold reactions

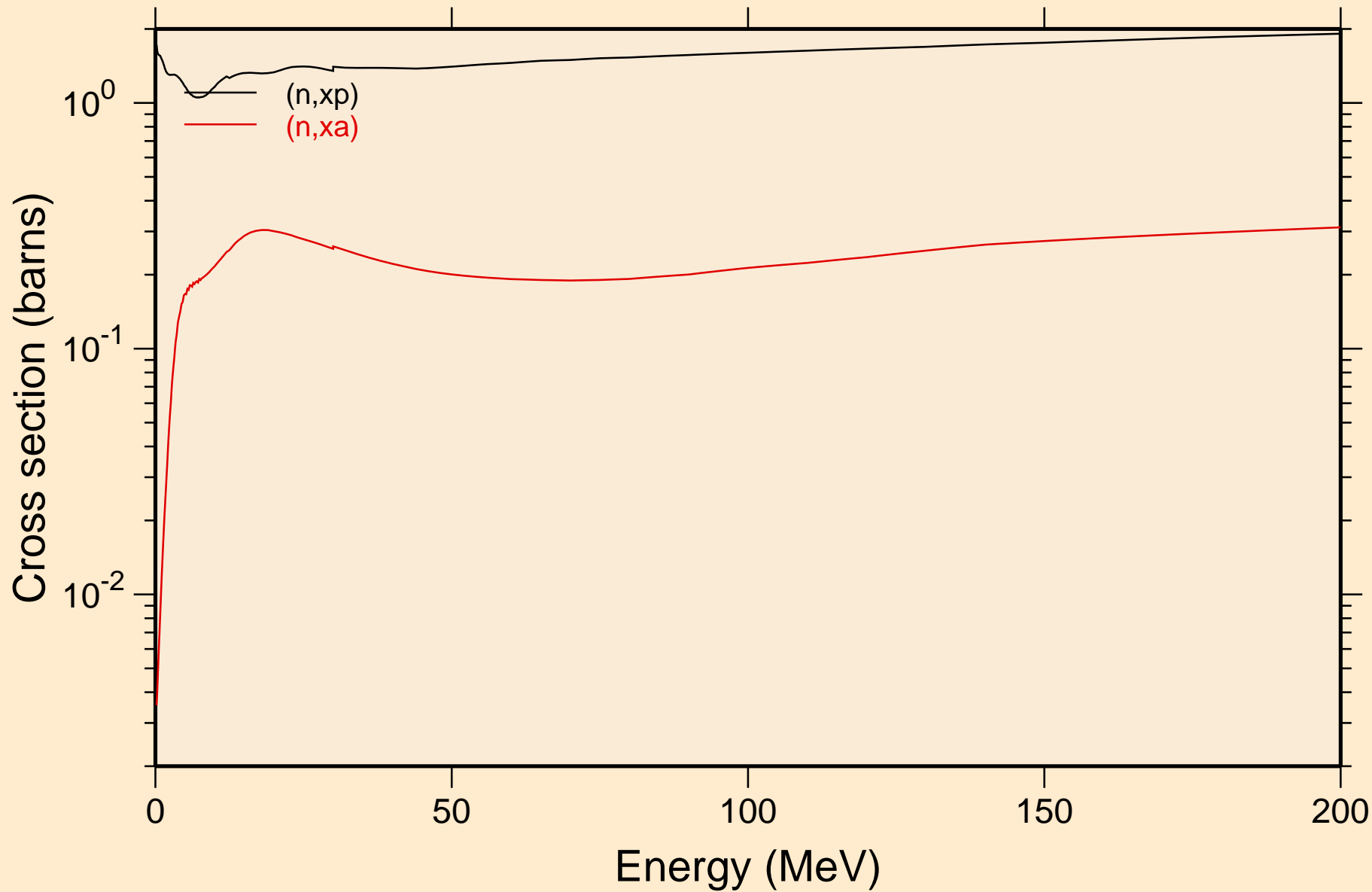

AS069 NEUTRON ACER TENDL-2023 LIBRARY; T=0.K  
Inelastic levels

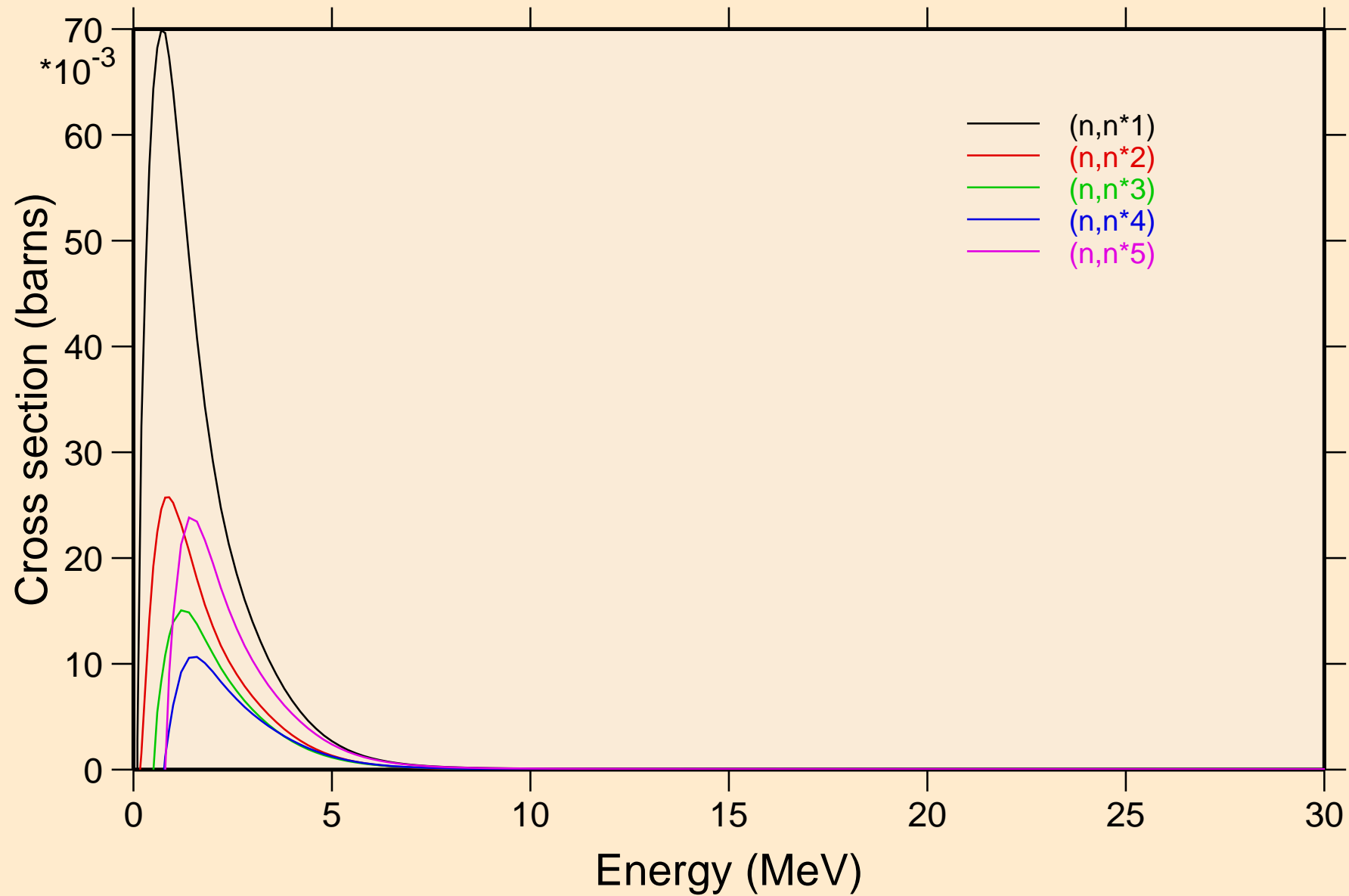

AS069 NEUTRON ACER TENDL-2023 LIBRARY; T=0.K  
Inelastic levels

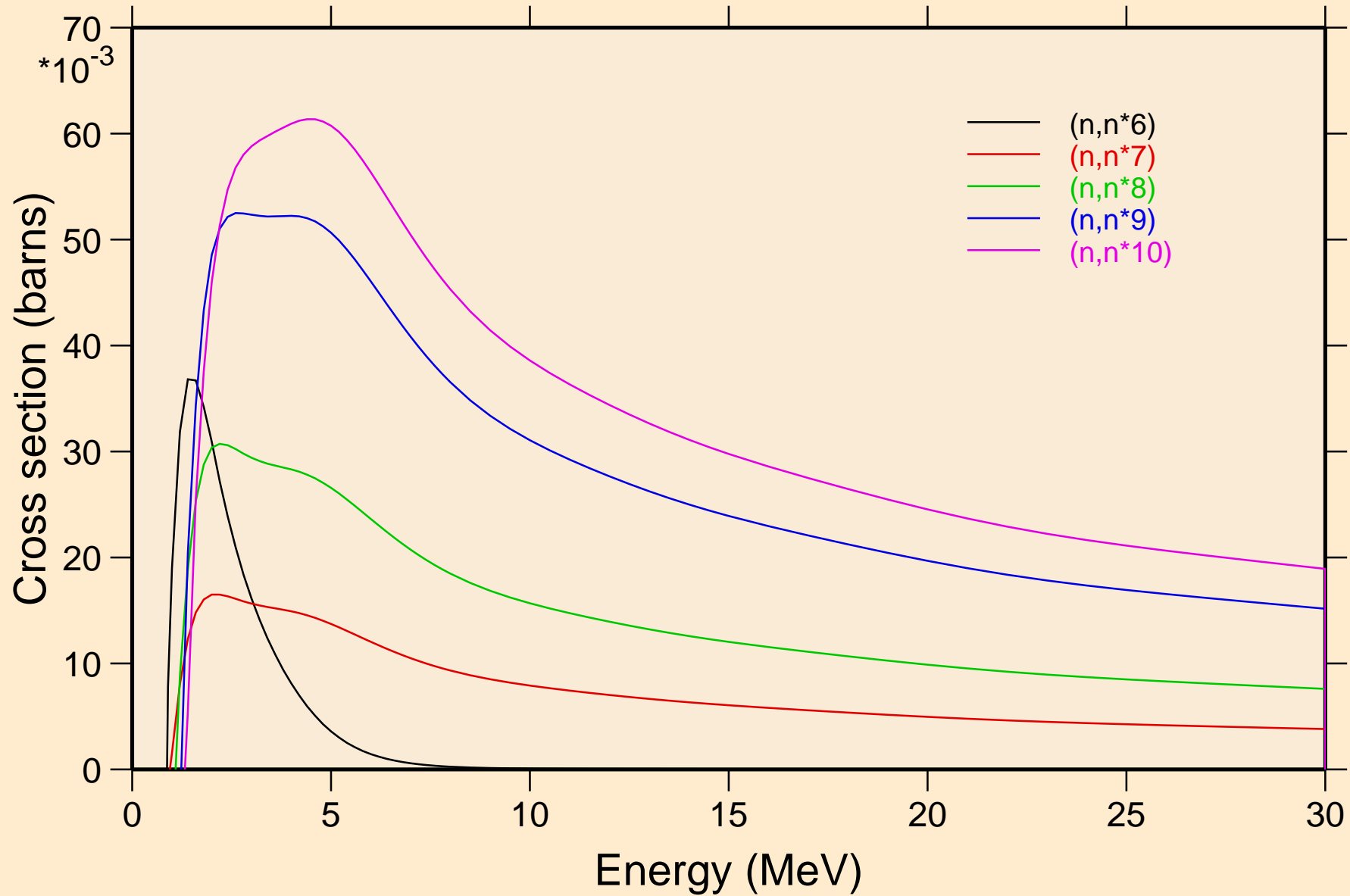

AS069 NEUTRON ACER TENDL-2023 LIBRARY; T=0.K  
Inelastic levels

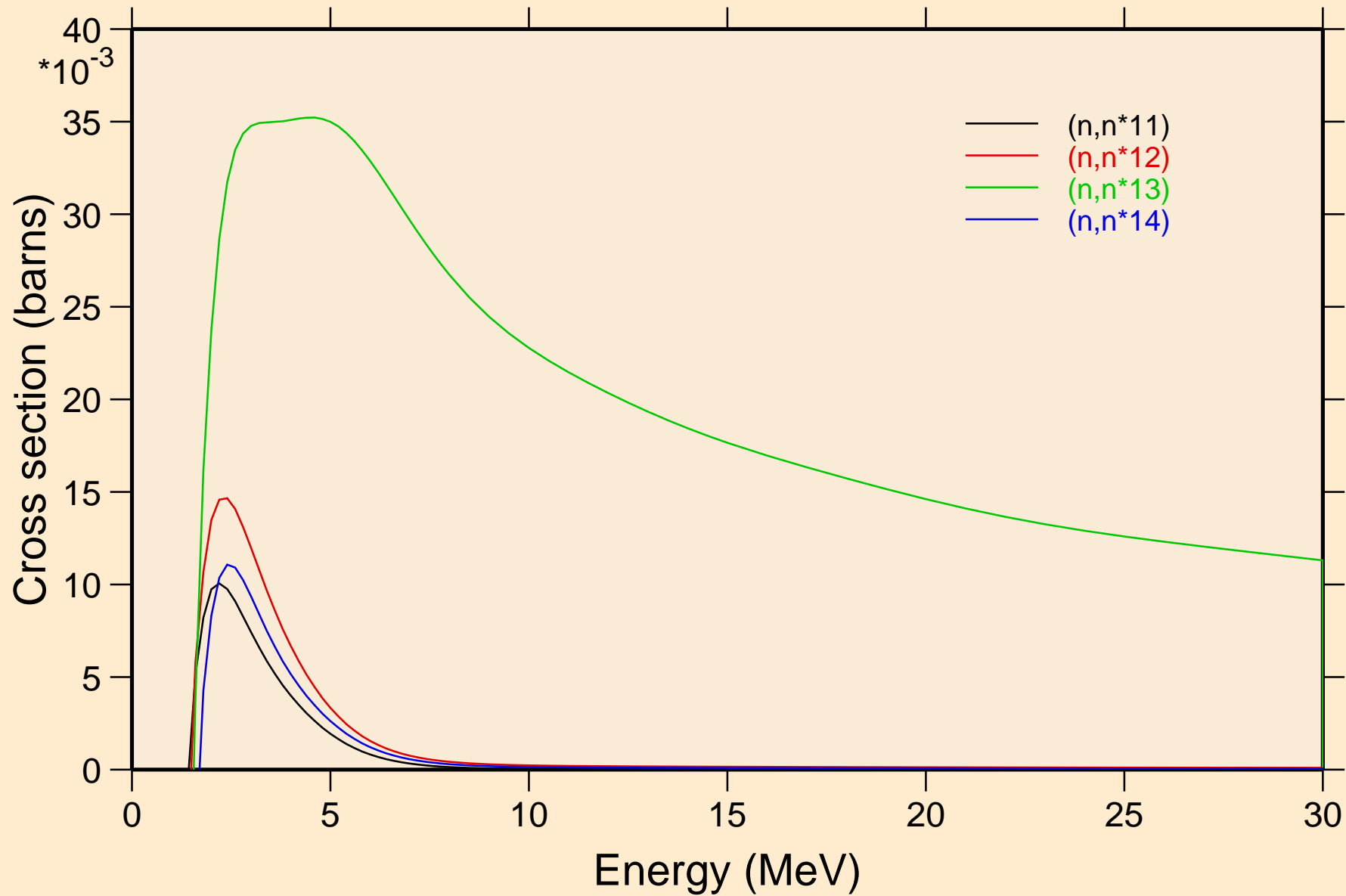

AS069 NEUTRON ACER TENDL-2023 LIBRARY; T=0.K  
Threshold reactions

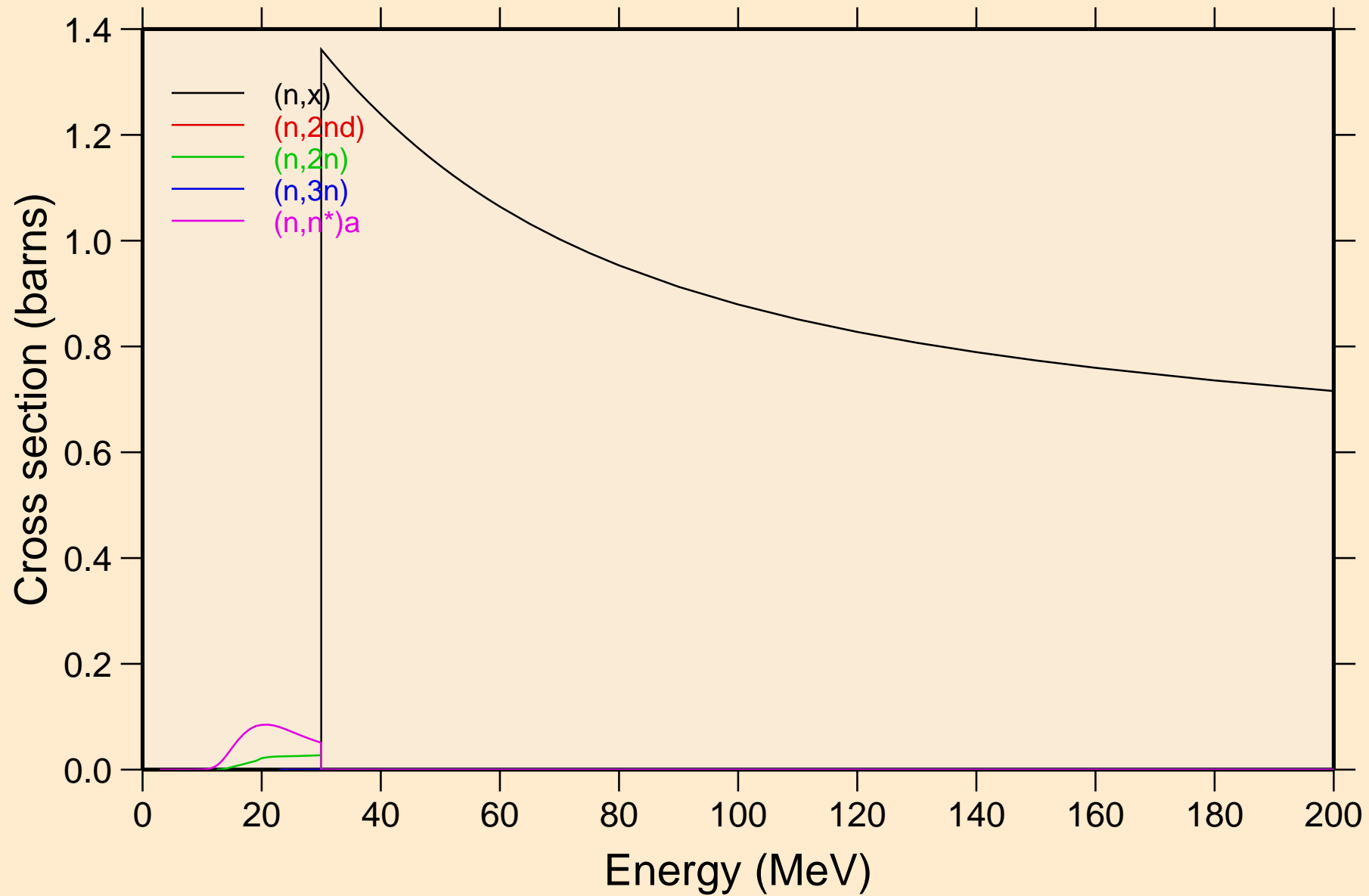

AS069 NEUTRON ACER TENDL-2023 LIBRARY; T=0.K  
Threshold reactions

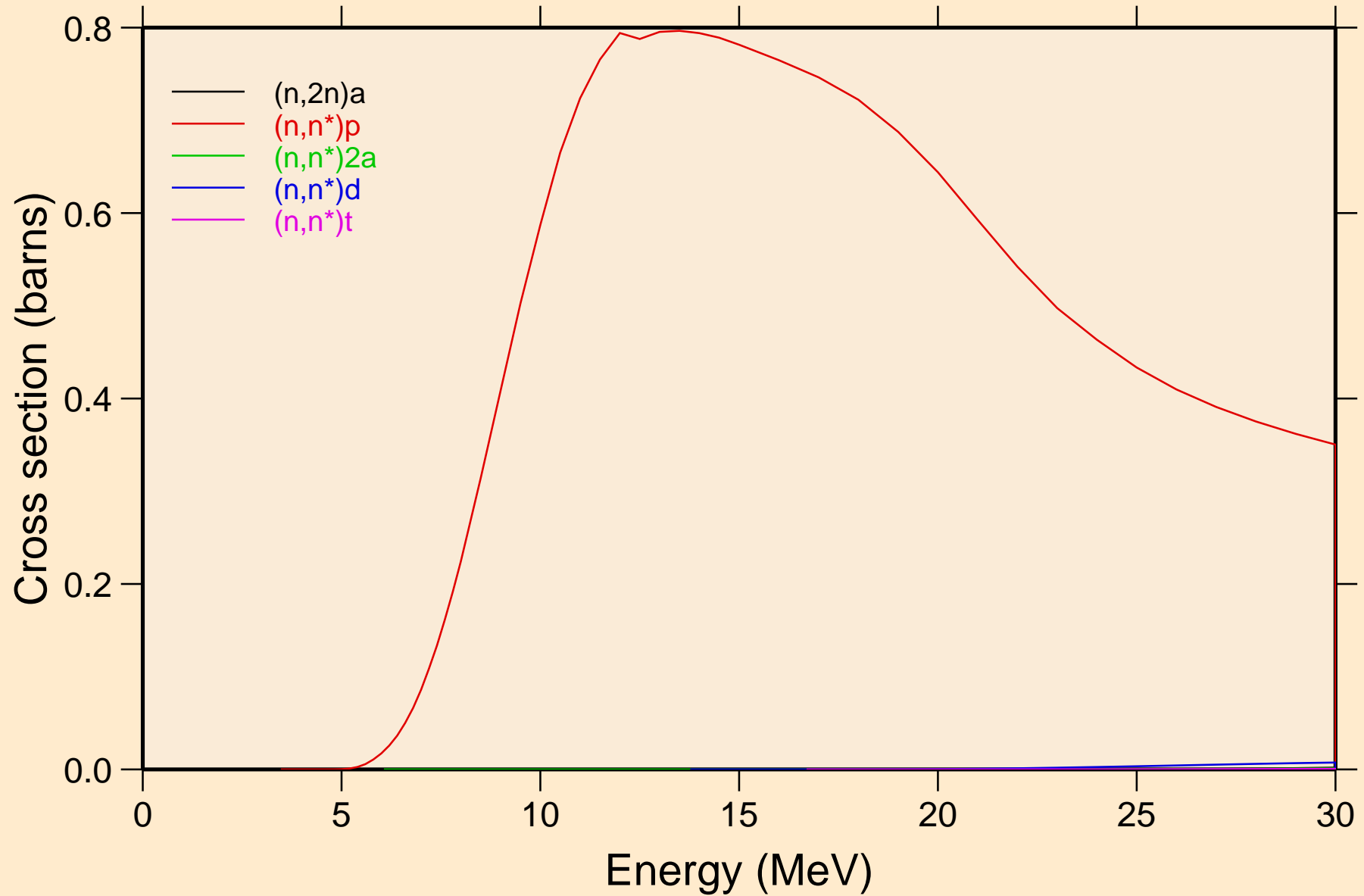

# AS069 NEUTRON ACER TENDL-2023 LIBRARY; T=0.K

## Threshold reactions

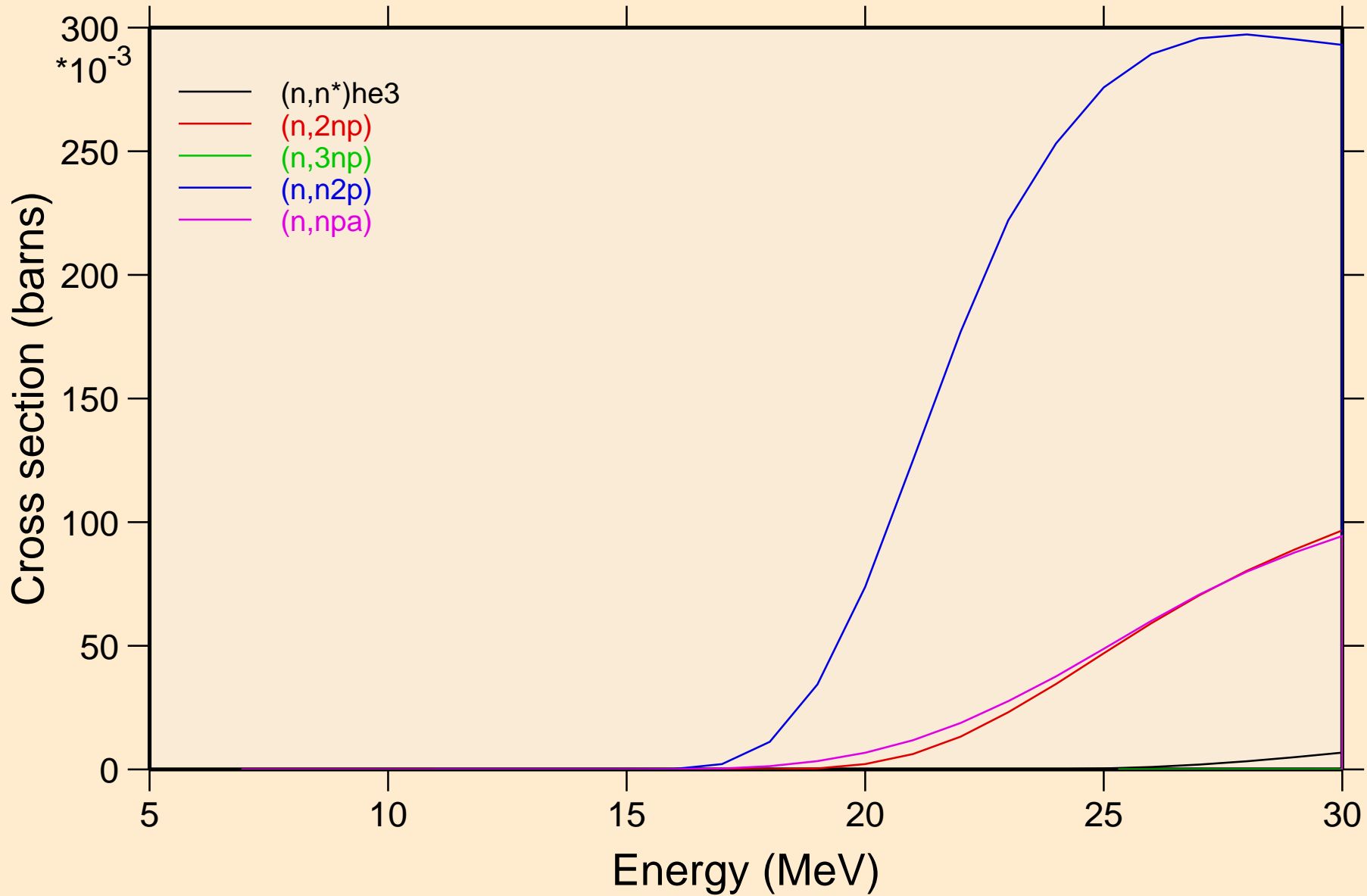

# AS069 NEUTRON ACER TENDL-2023 LIBRARY; T=0.K

## Threshold reactions

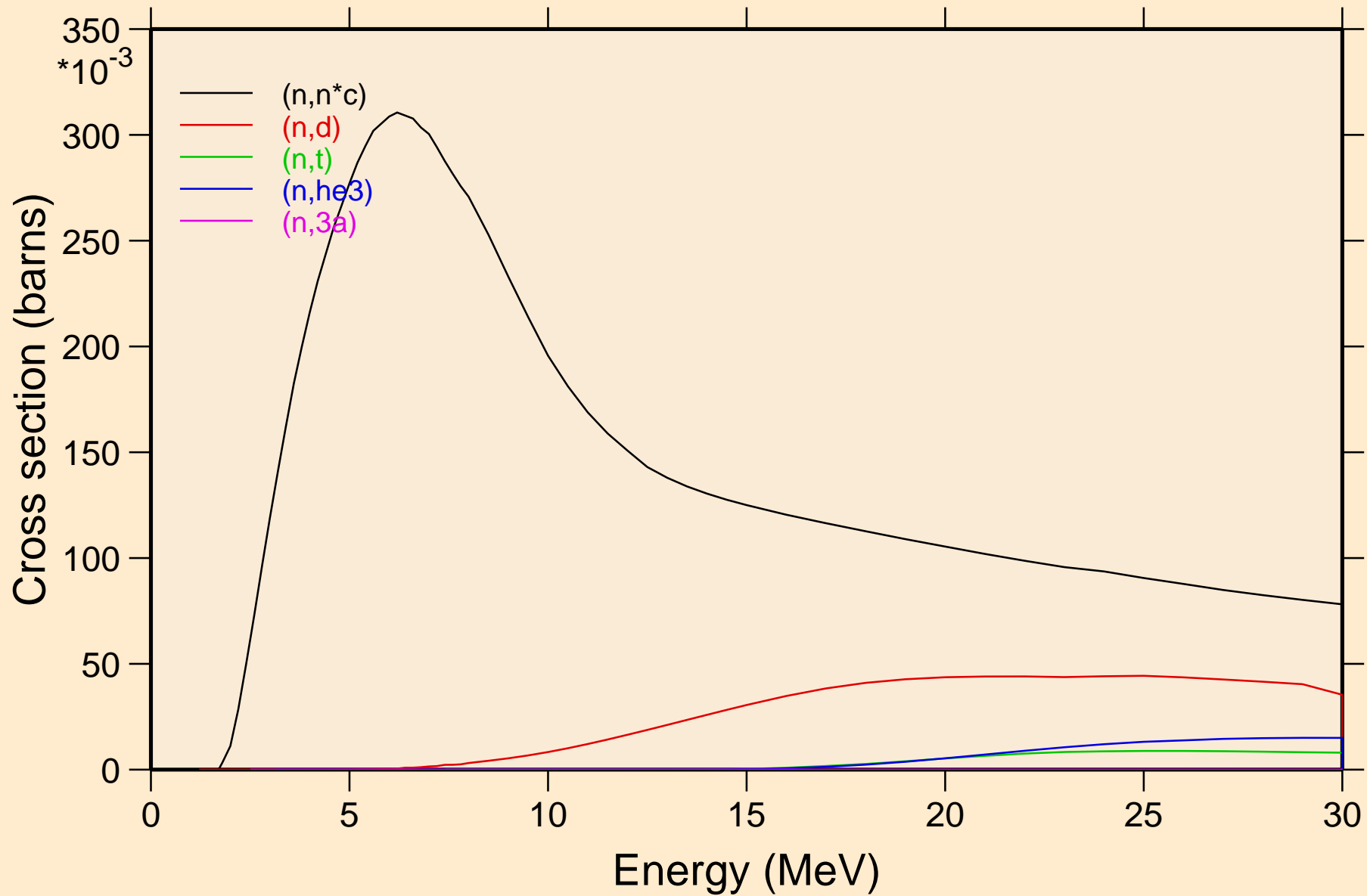

# AS069 NEUTRON ACER TENDL-2023 LIBRARY; T=0.K

## Threshold reactions

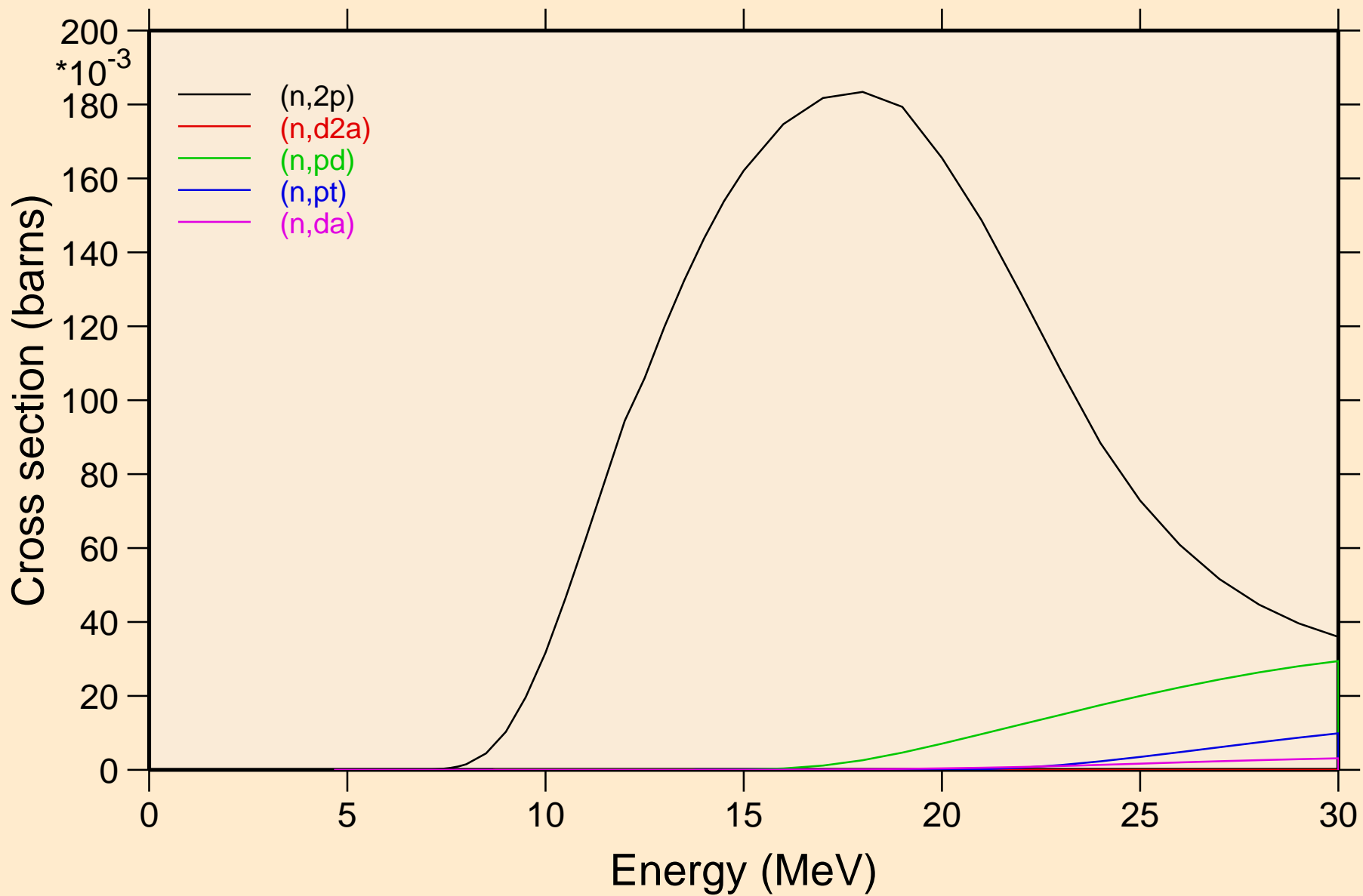

AS069 NEUTRON ACER TENDL-2023 LIBRARY; T=0.K  
Threshold reactions

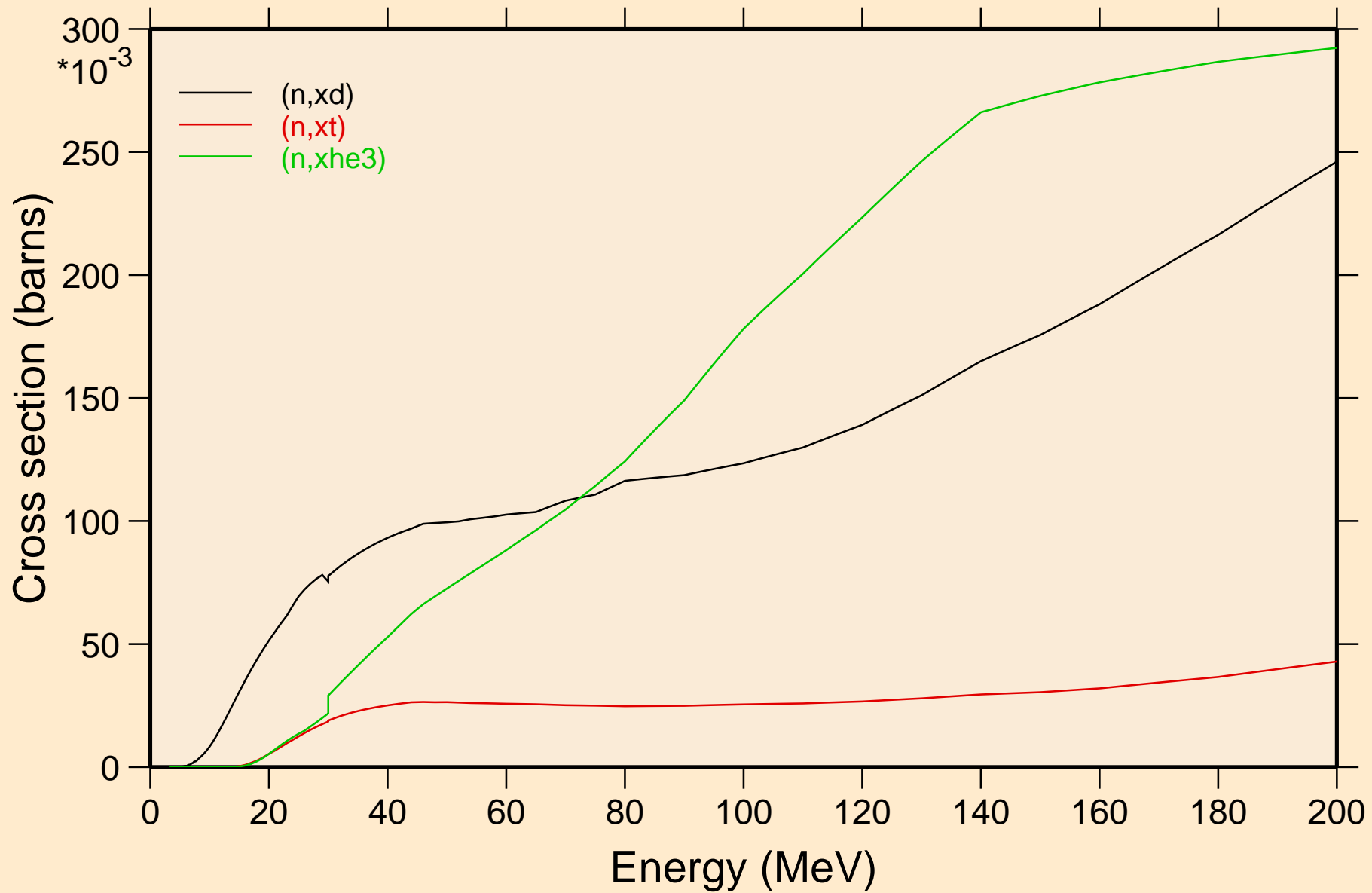

AS069 NEUTRON ACER TENDL-2023 LIBRARY; T=0.K  
angular distribution for elastic

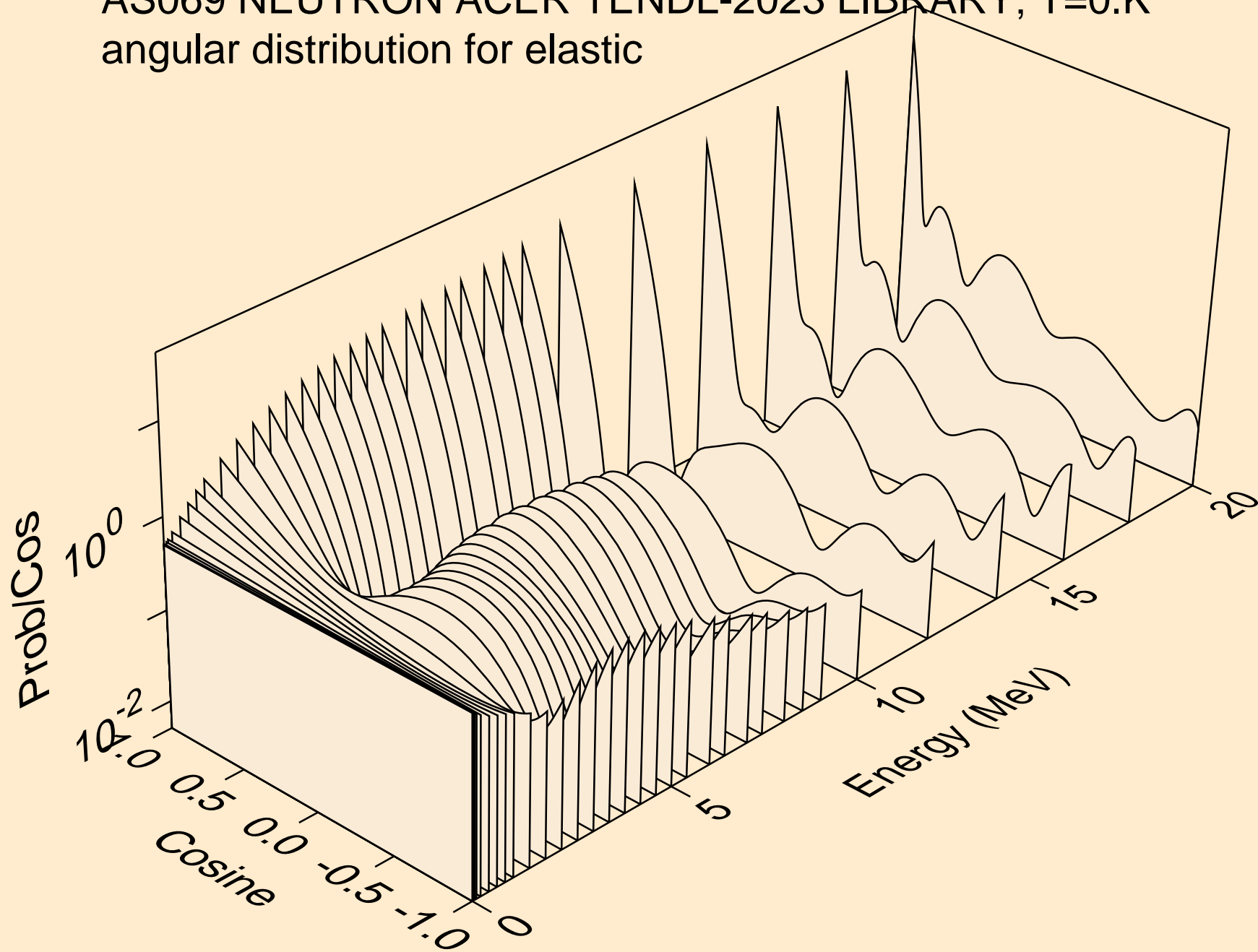

AS069 NEUTRON ACER TENDL-2023 LIBRARY; T=0.K  
angular distribution for elastic

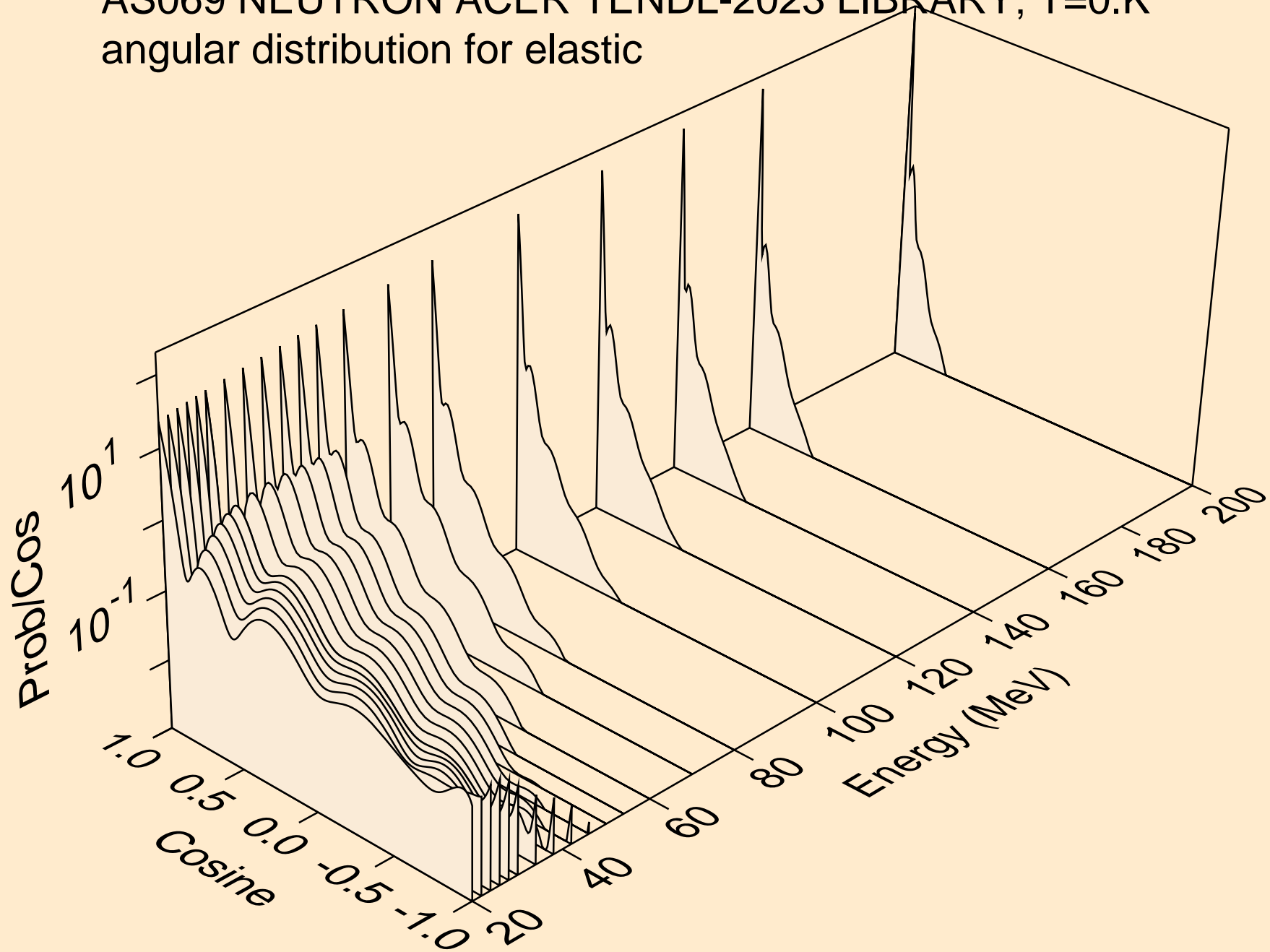

AS069 NEUTRON ACER TENDL-2023 LIBRARY; T=0.K  
angular distribution for (n,n\*1)

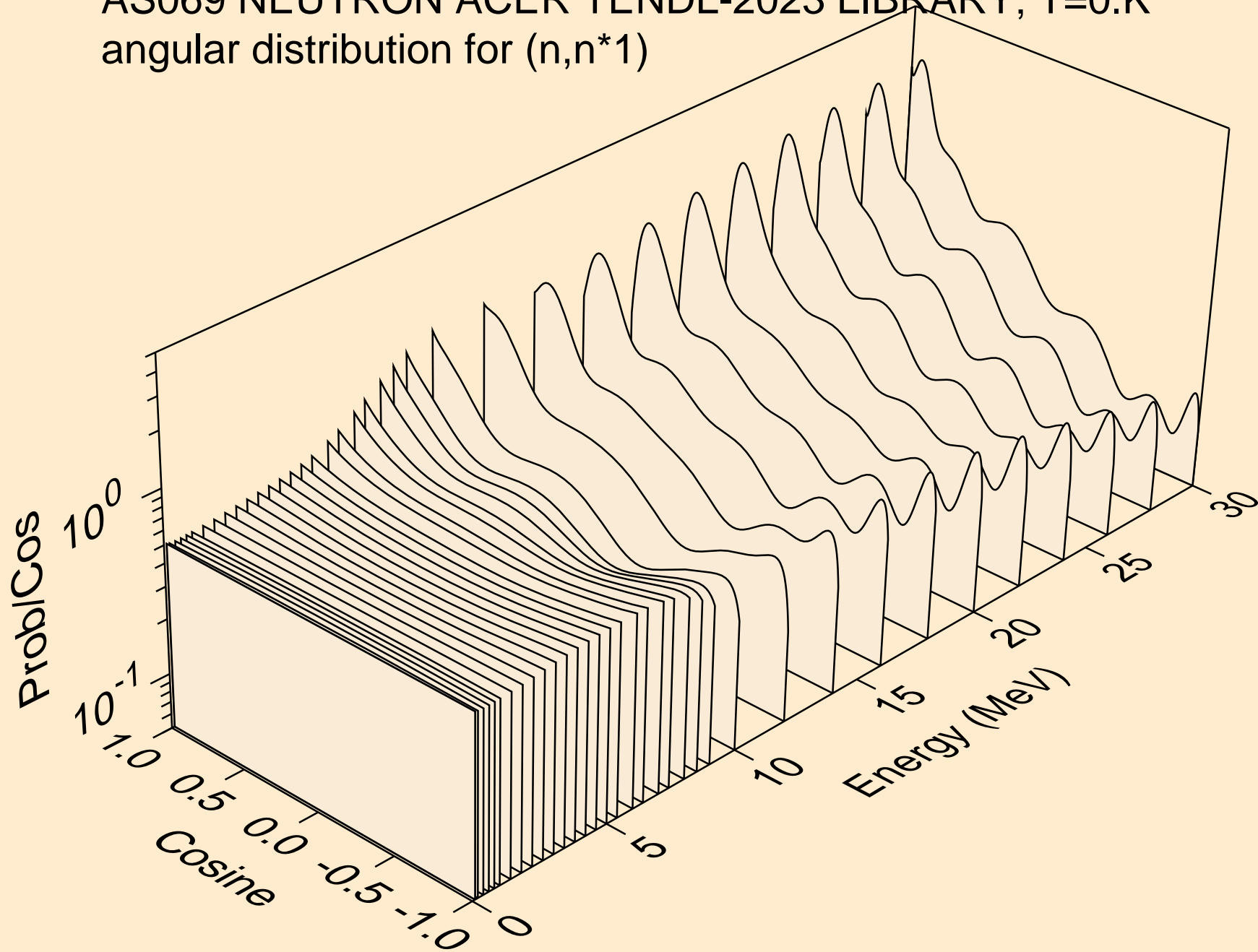

AS069 NEUTRON ACER TENDL-2023 LIBRARY; T=0.K  
angular distribution for (n,n\*2)

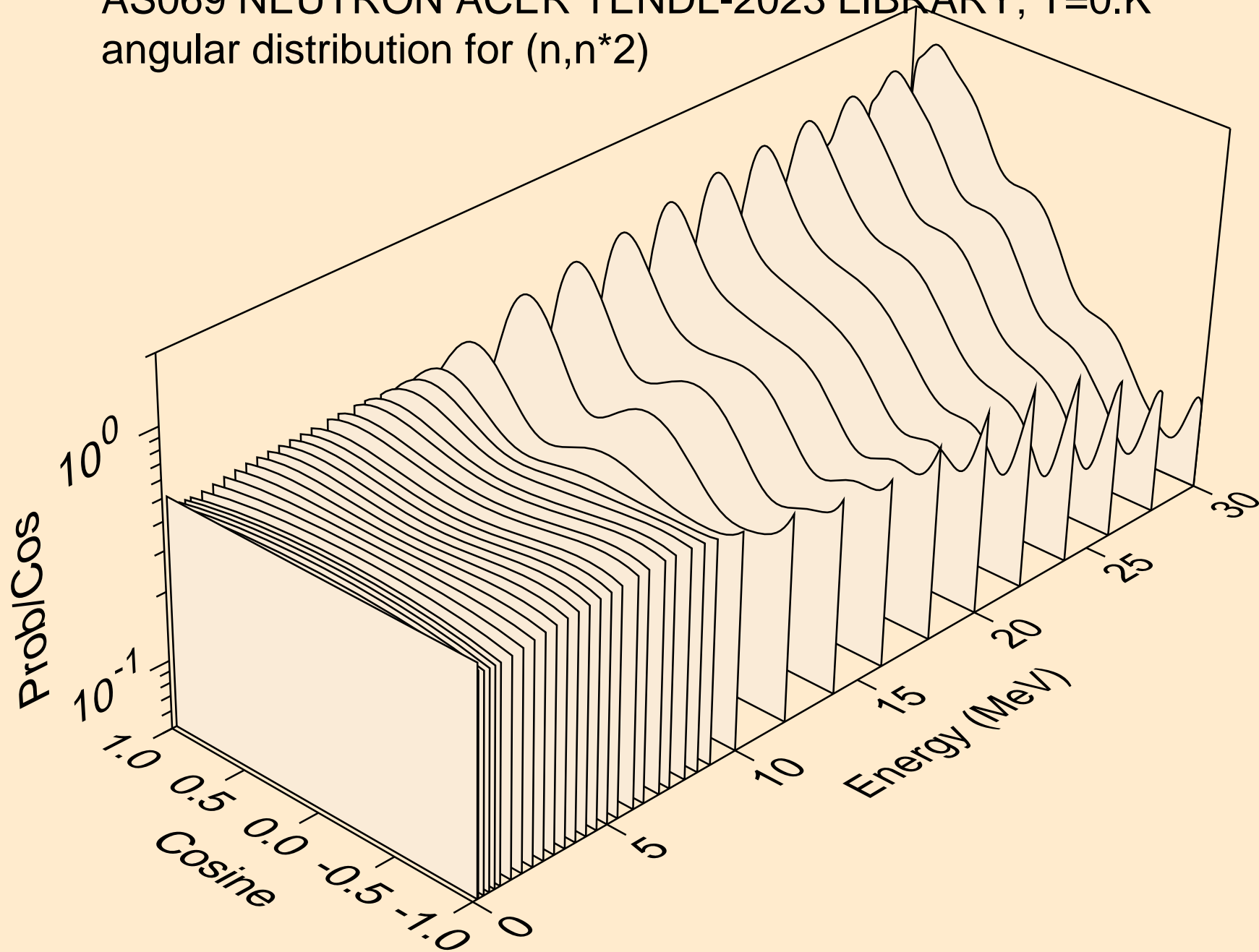

AS069 NEUTRON ACER TENDL-2023 LIBRARY; T=0.K  
angular distribution for (n,n\*3)

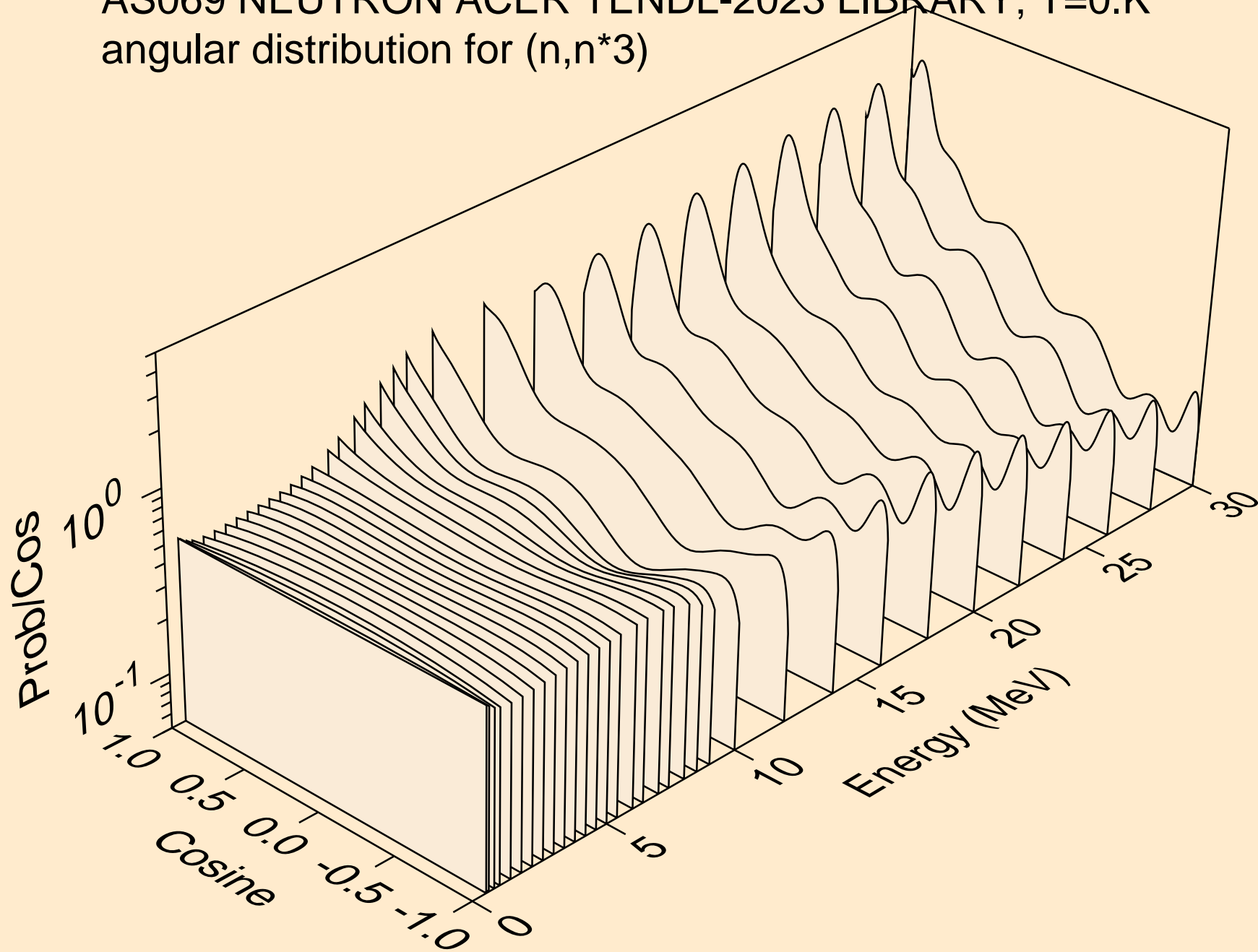

AS069 NEUTRON ACER TENDL-2023 LIBRARY; T=0.K  
angular distribution for (n,n\*4)

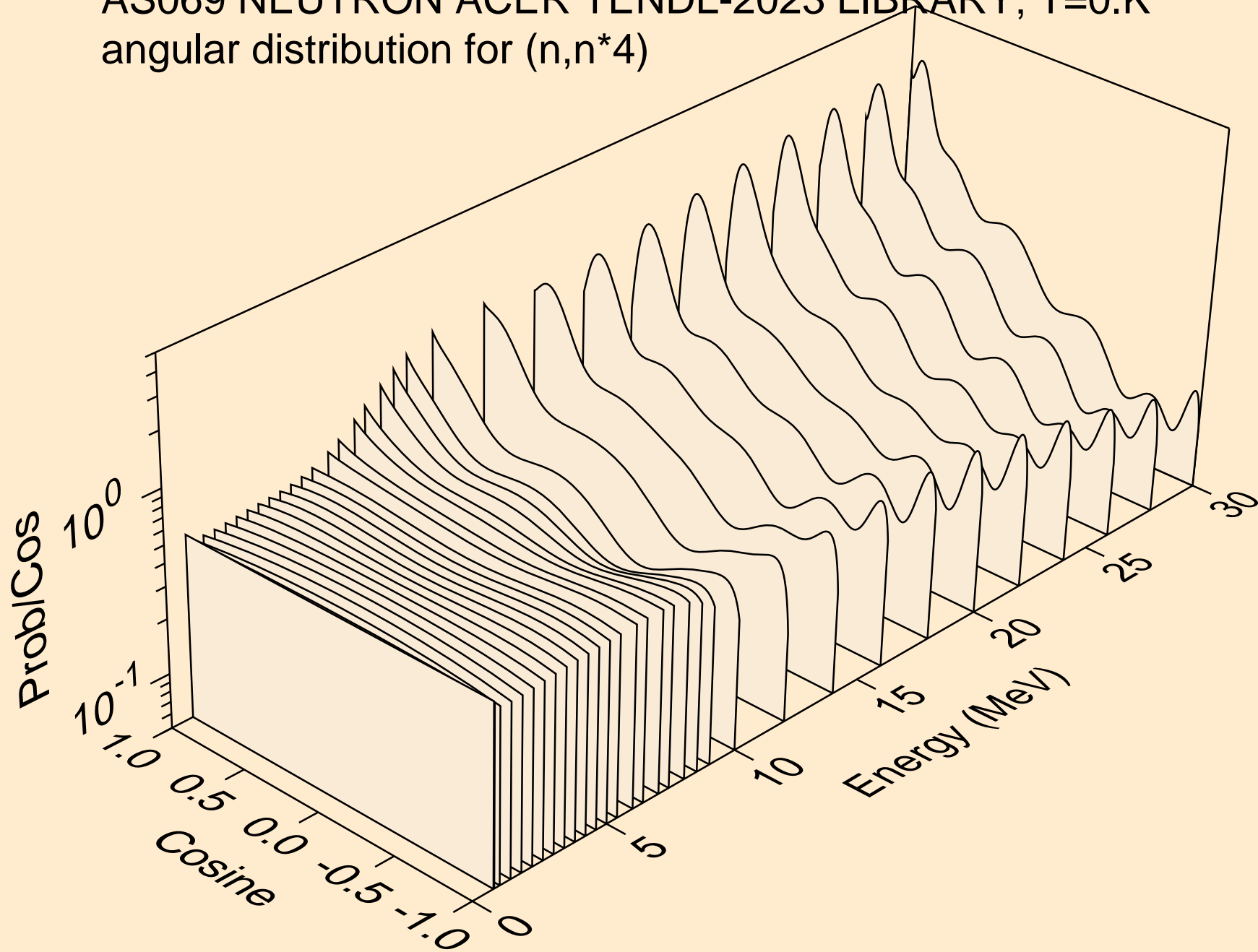

AS069 NEUTRON ACER TENDL-2023 LIBRARY; T=0.K  
angular distribution for (n,n\*5)

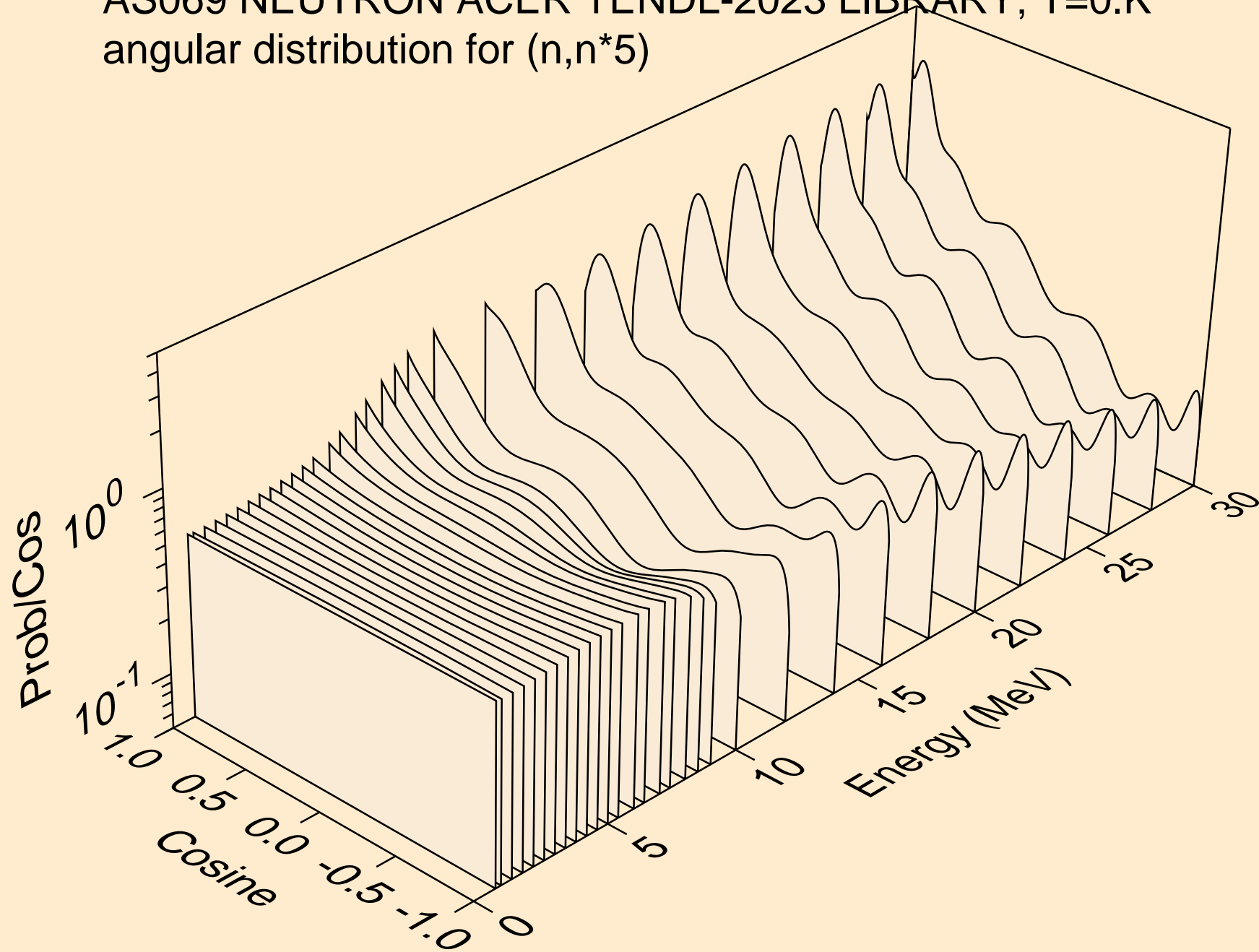

AS069 NEUTRON ACER TENDL-2023 LIBRARY; T=0.K  
angular distribution for (n,n\*6)

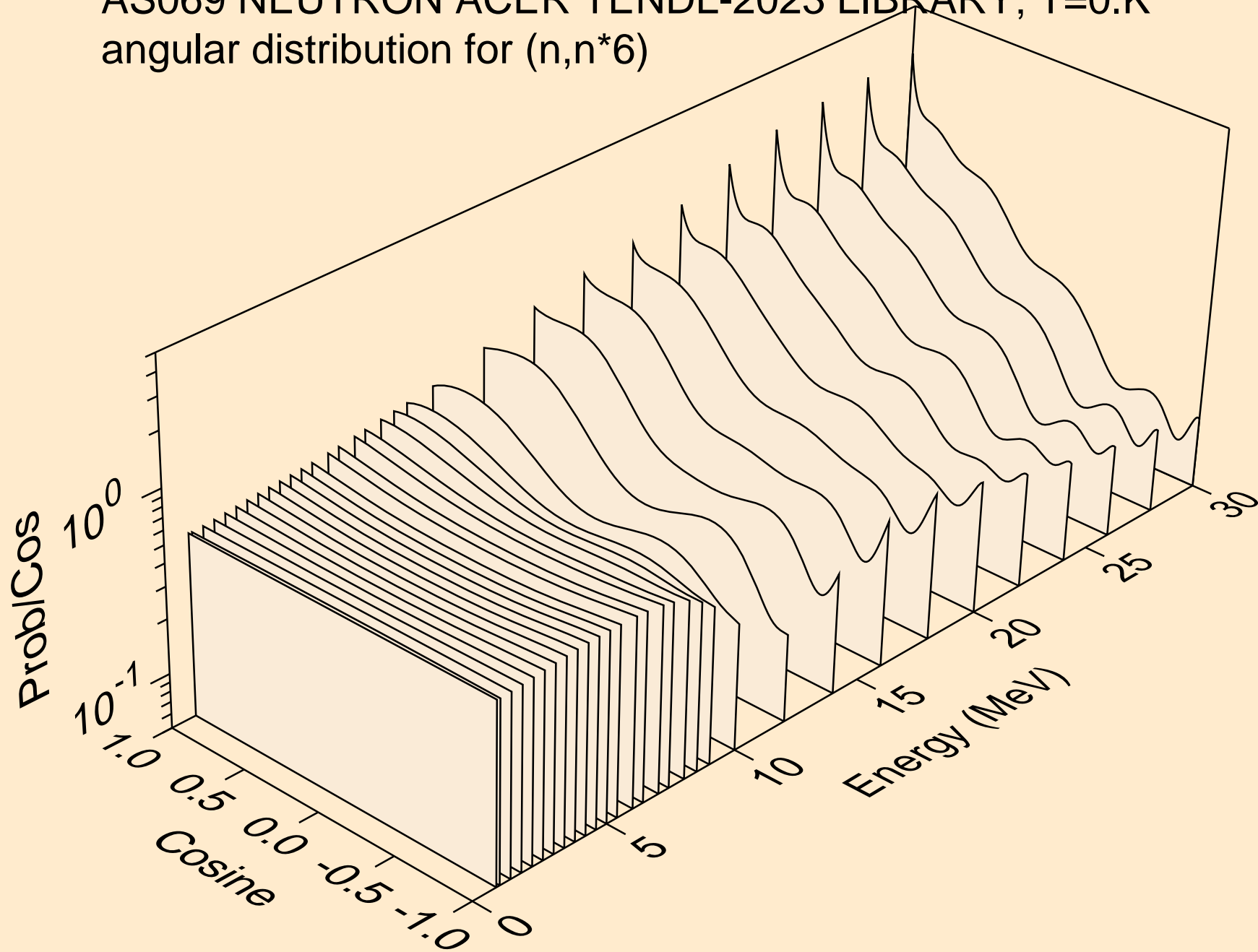

AS069 NEUTRON ACER TENDL-2023 LIBRARY; T=0.K  
angular distribution for (n,n\*7)

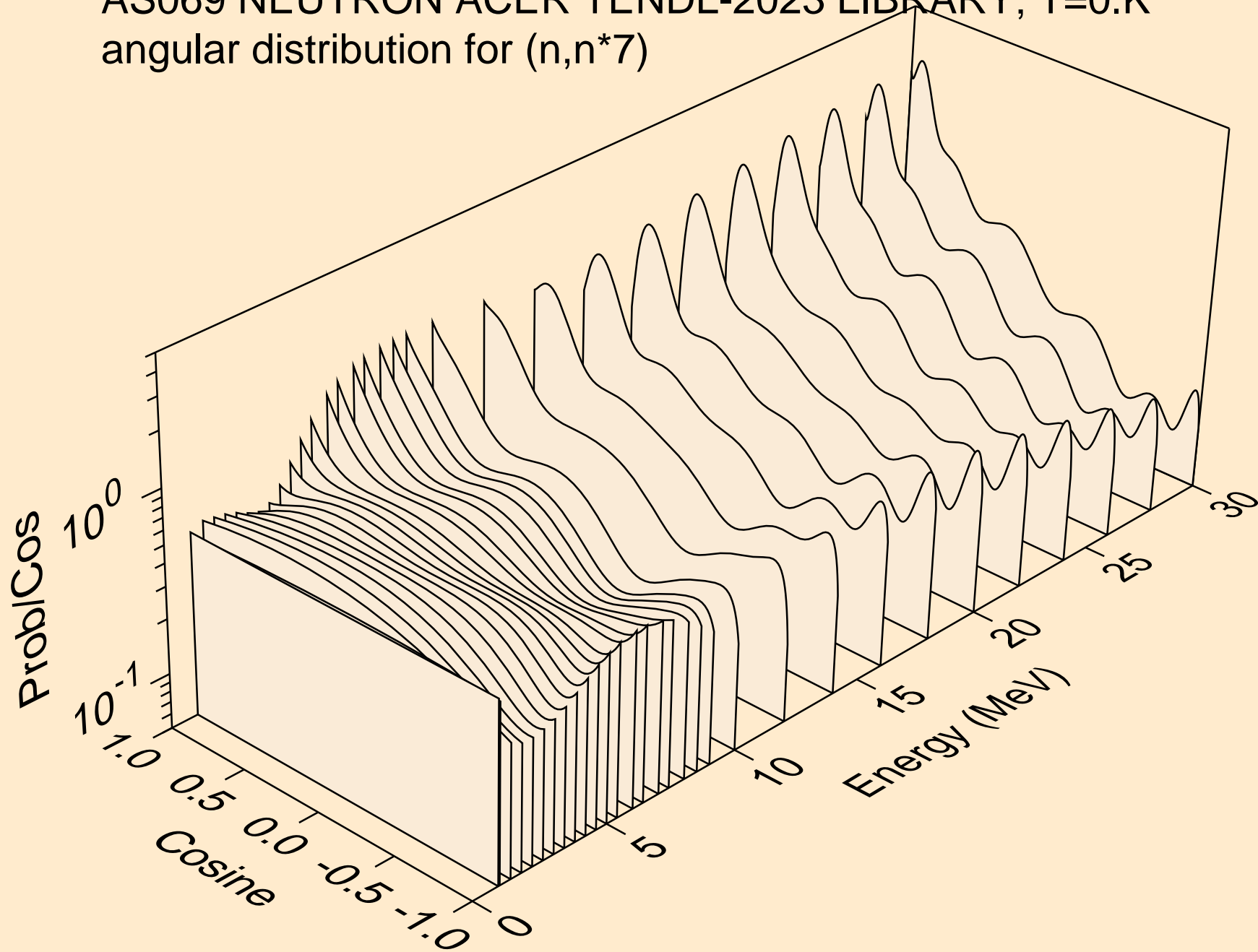

AS069 NEUTRON ACER TENDL-2023 LIBRARY; T=0.K  
angular distribution for (n,n\*8)

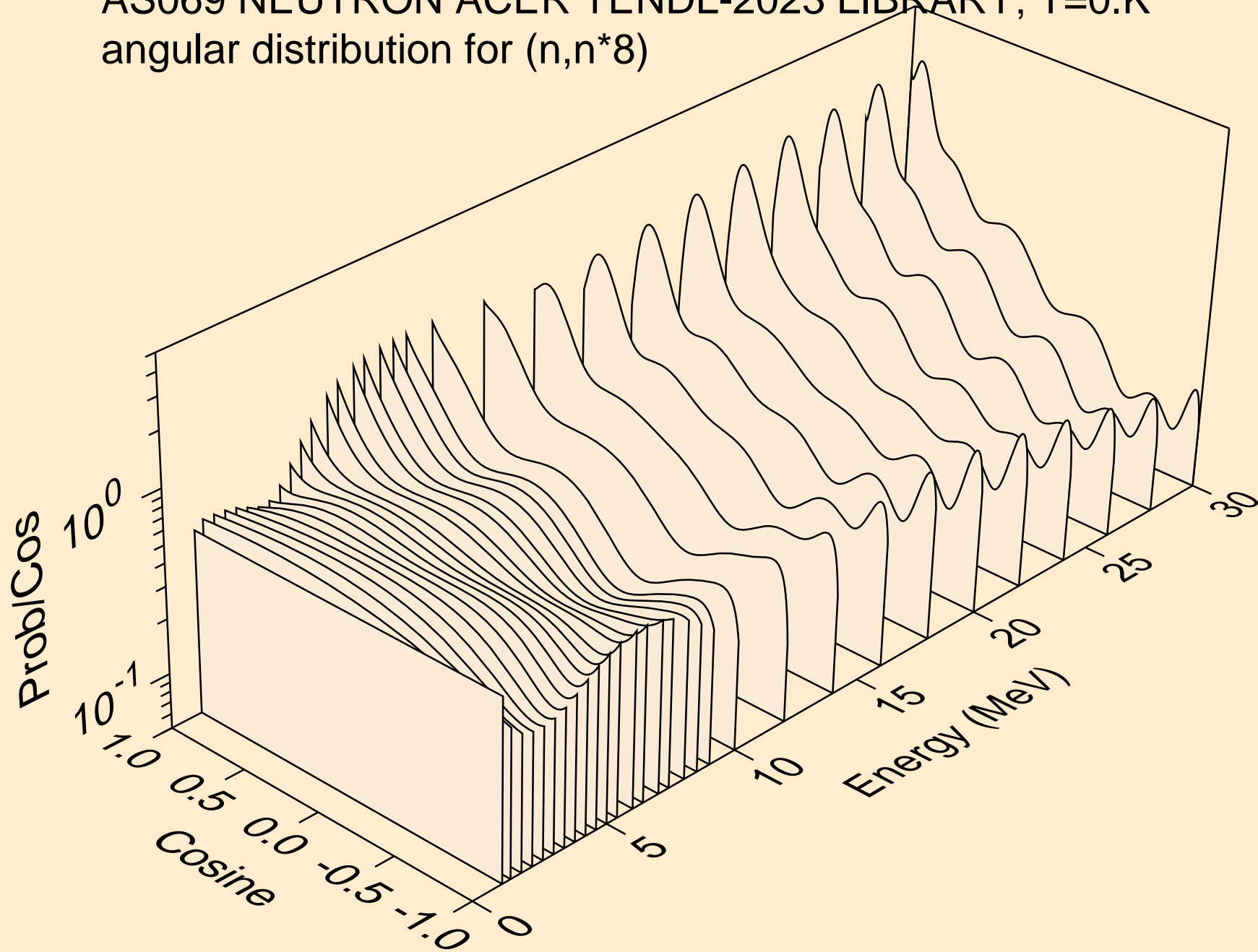

AS069 NEUTRON ACER TENDL-2023 LIBRARY; T=0.K  
angular distribution for (n,n\*9)

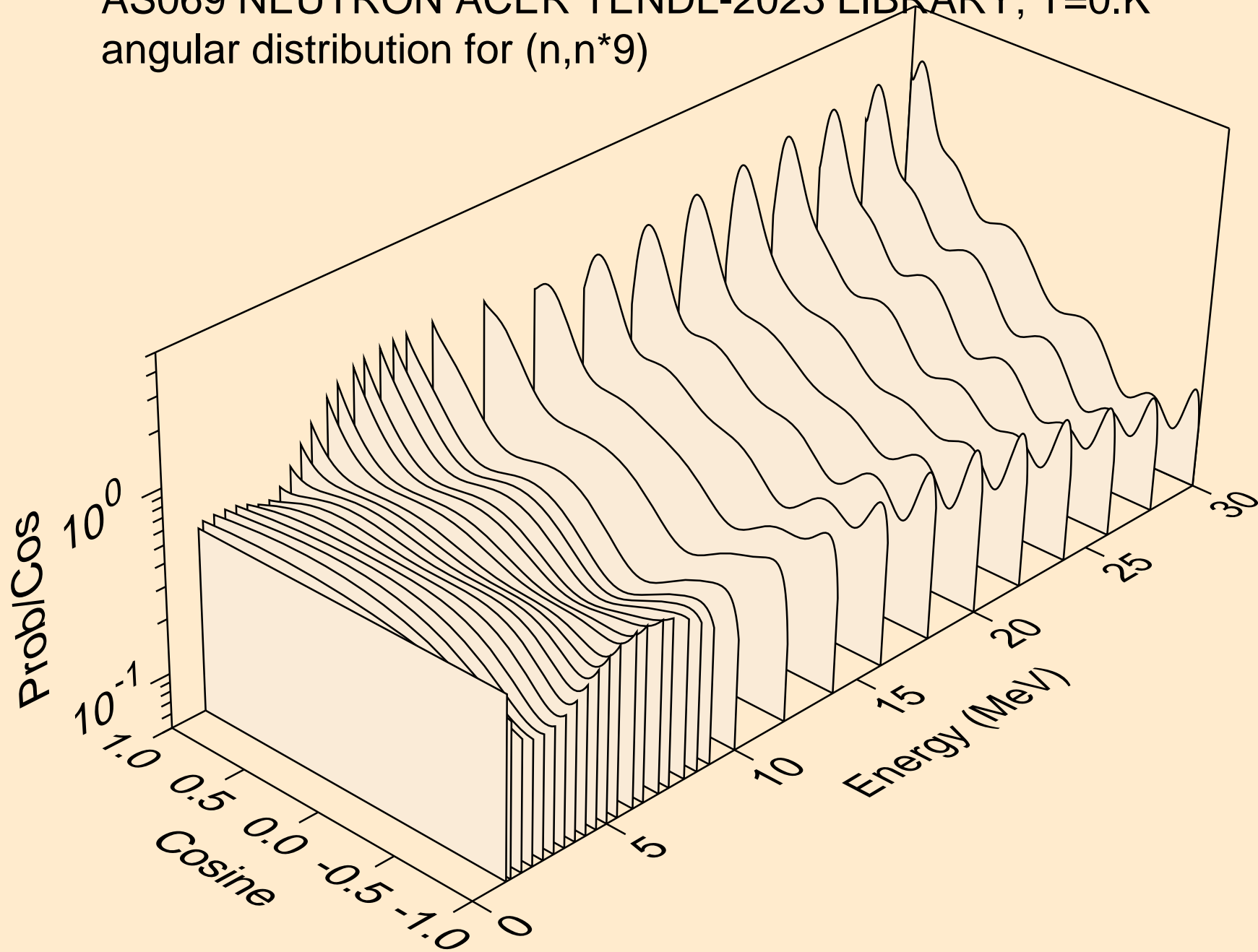

AS069 NEUTRON ACER TENDL-2023 LIBRARY; T=0.K  
angular distribution for (n,n\*10)

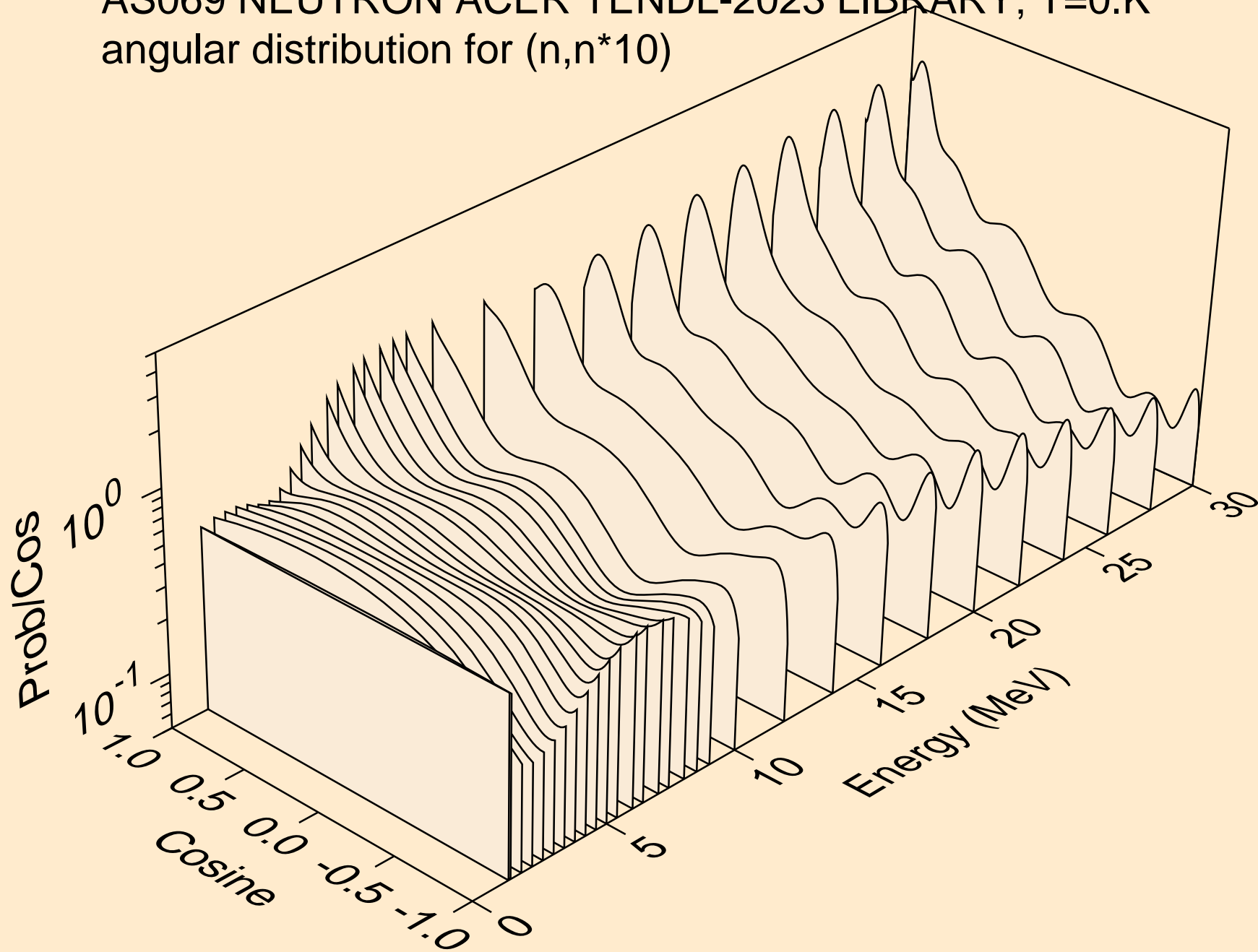

AS069 NEUTRON ACER TENDL-2023 LIBRARY; T=0.K  
angular distribution for (n,n\*11)

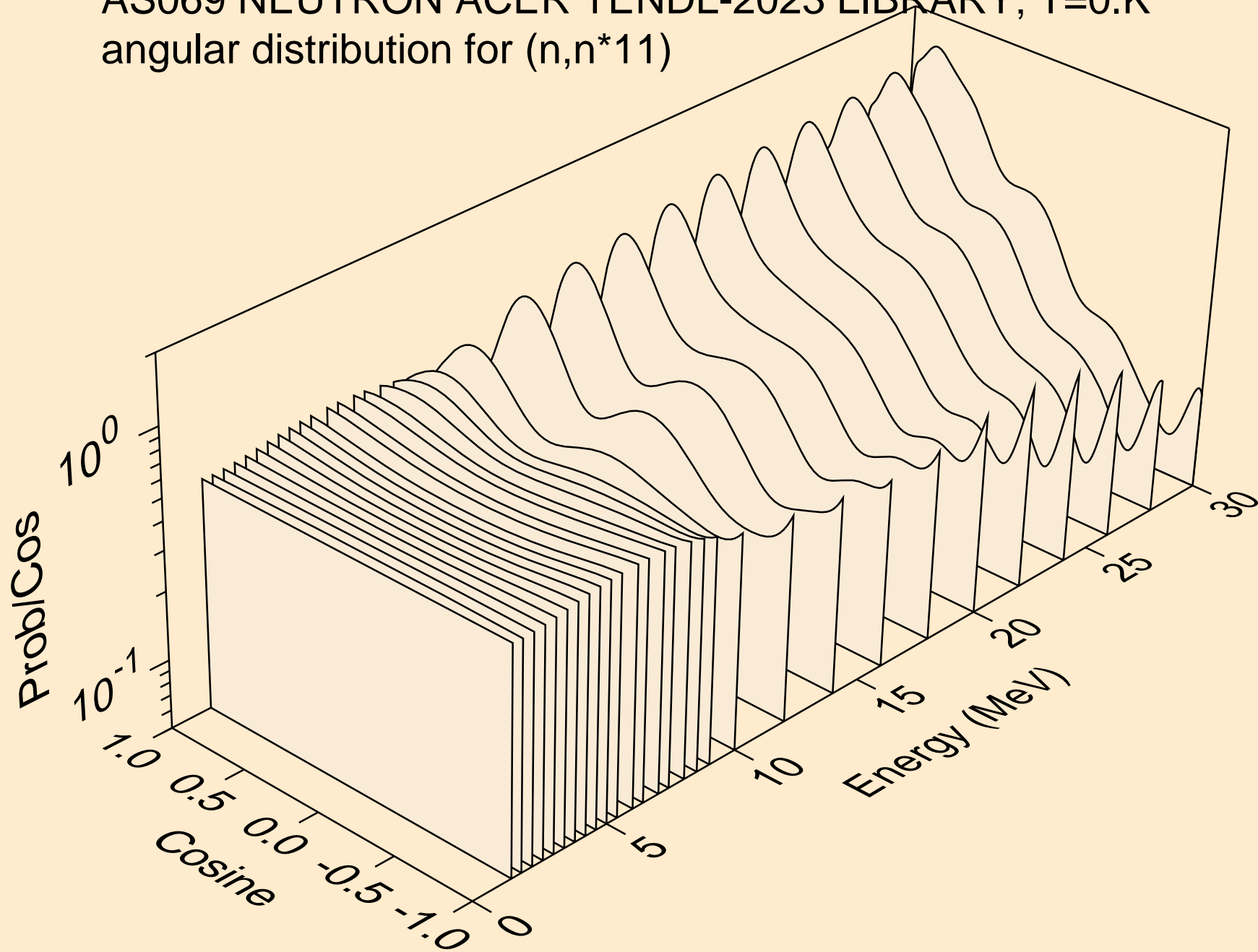

AS069 NEUTRON ACER TENDL-2023 LIBRARY; T=0.K  
angular distribution for (n,n\*12)

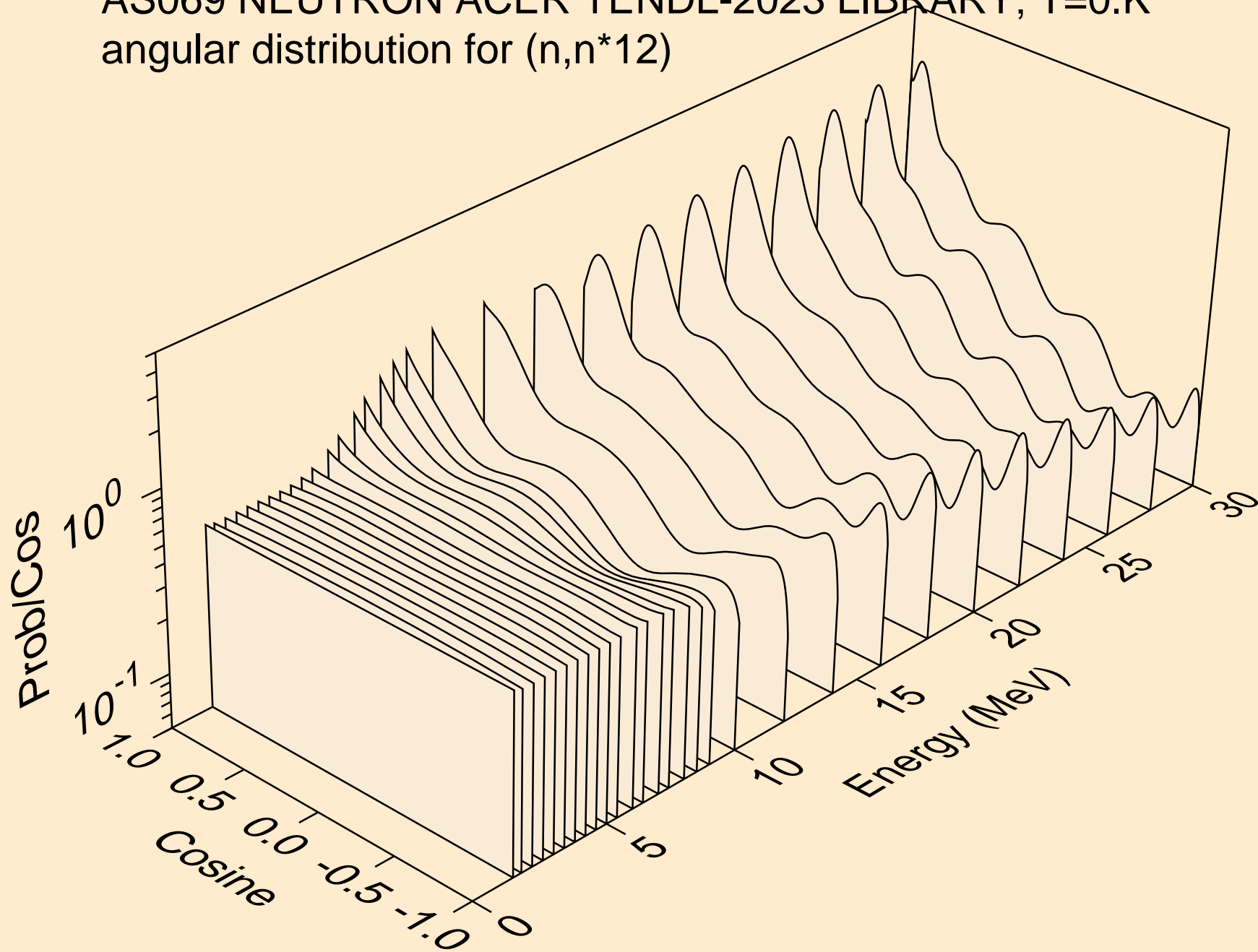

AS069 NEUTRON ACER TENDL-2023 LIBRARY; T=0.K  
angular distribution for (n,n\*13)

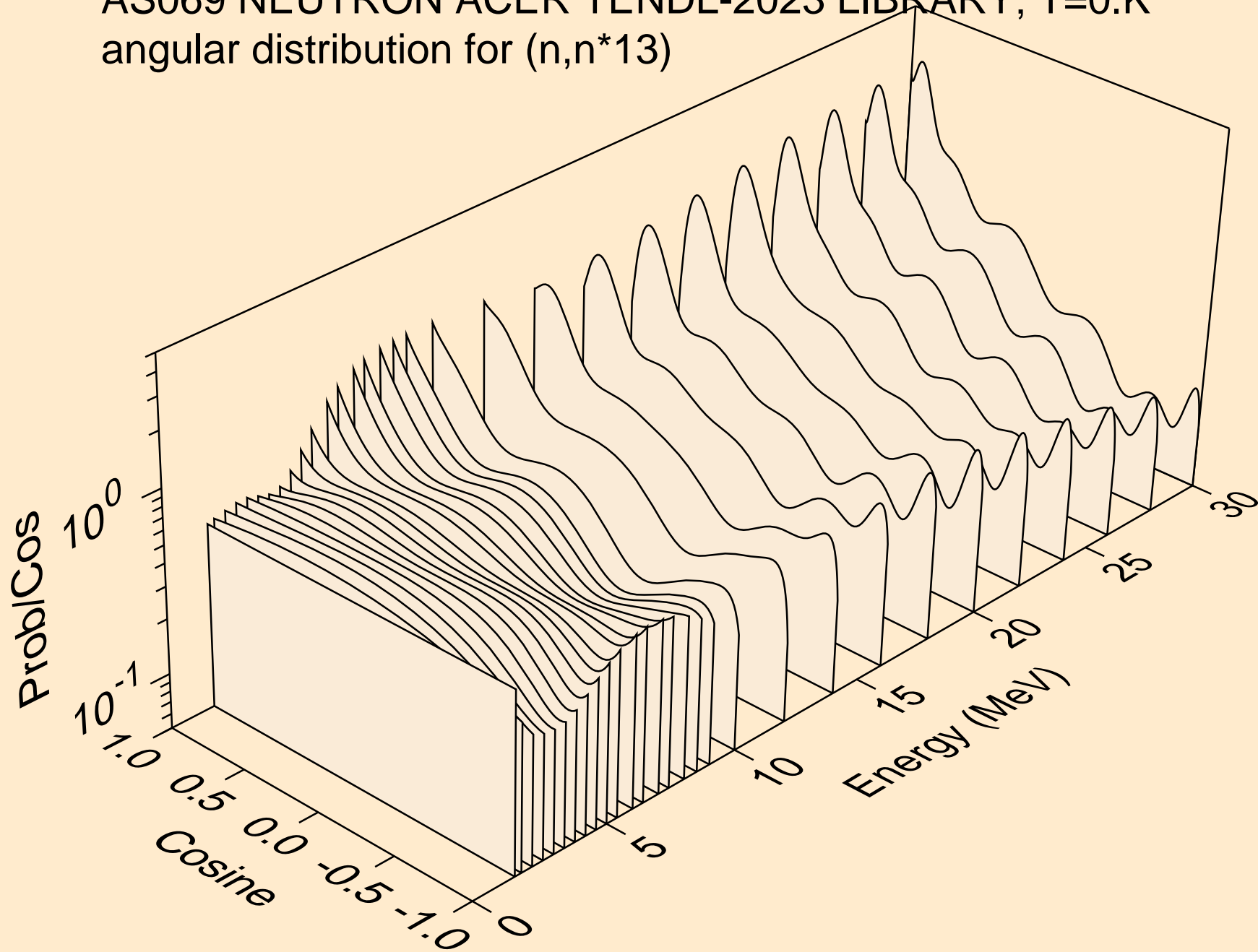

AS069 NEUTRON ACER TENDL-2023 LIBRARY; T=0.K  
angular distribution for (n,n\*14)

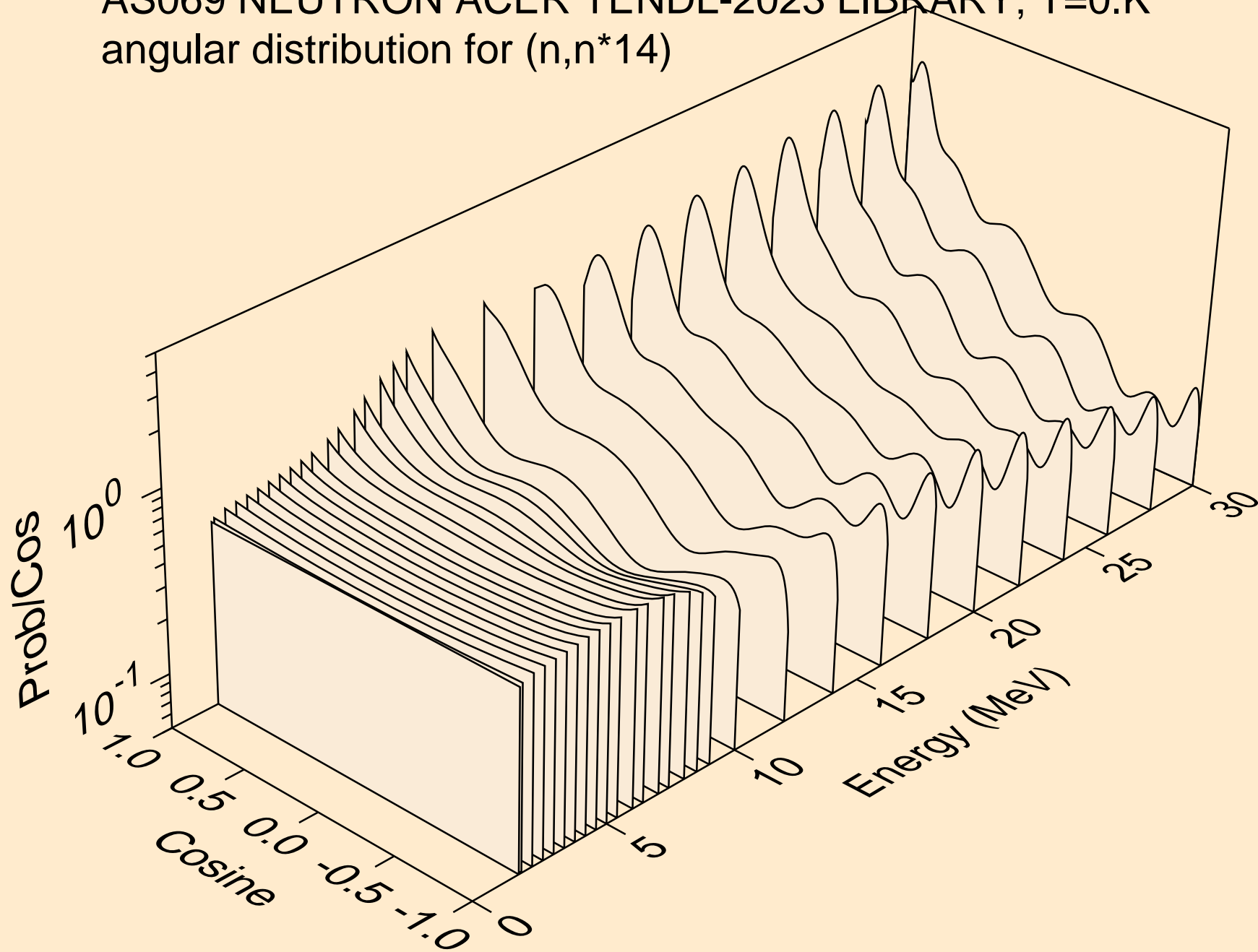

AS069 NEUTRON ACER TENDL-2023 LIBRARY; T=0.K  
Neutron emission for (n,x)

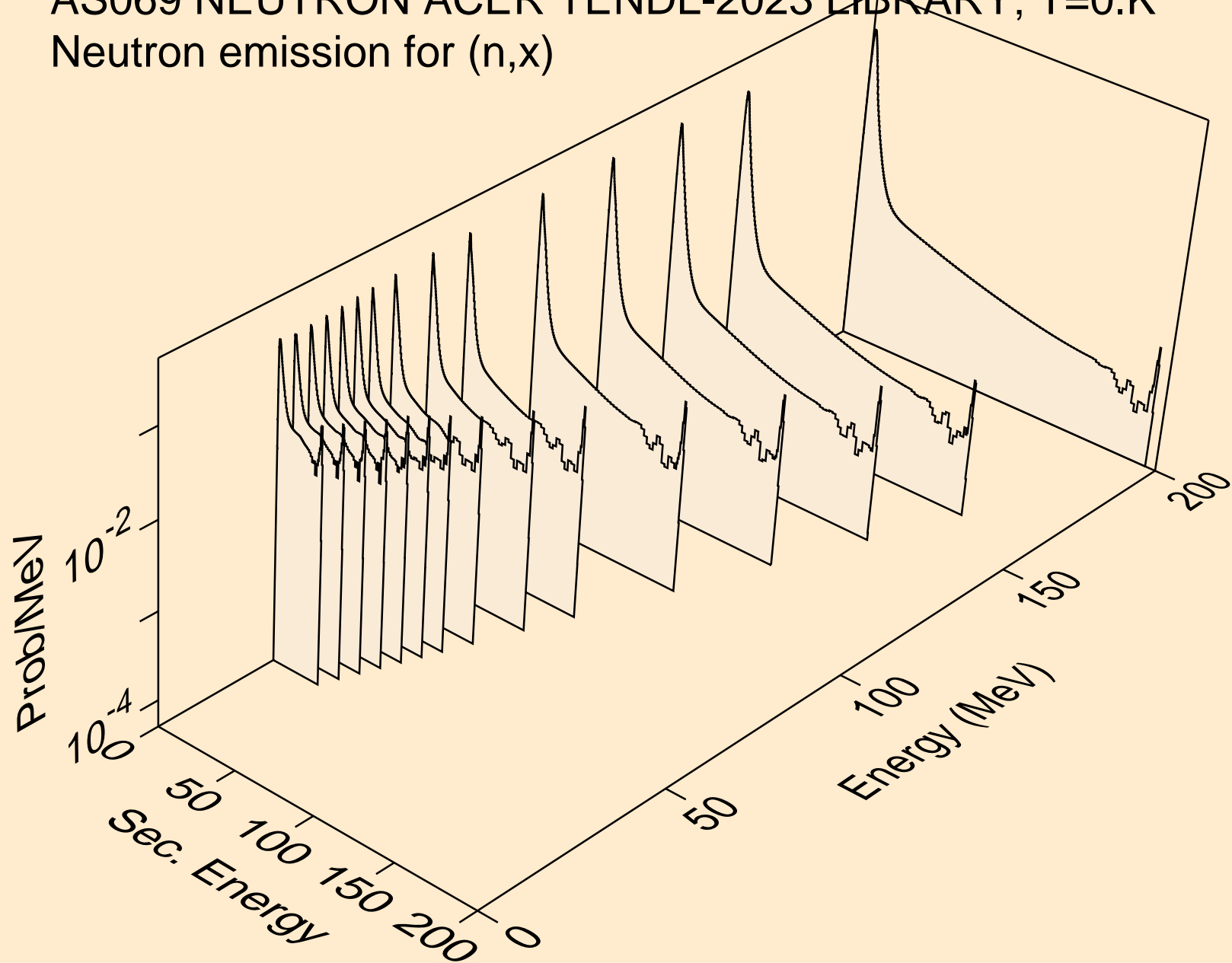

AS069 NEUTRON ACER TENDL-2023 LIBRARY; T=0.K  
Neutron emission for (n,2nd)

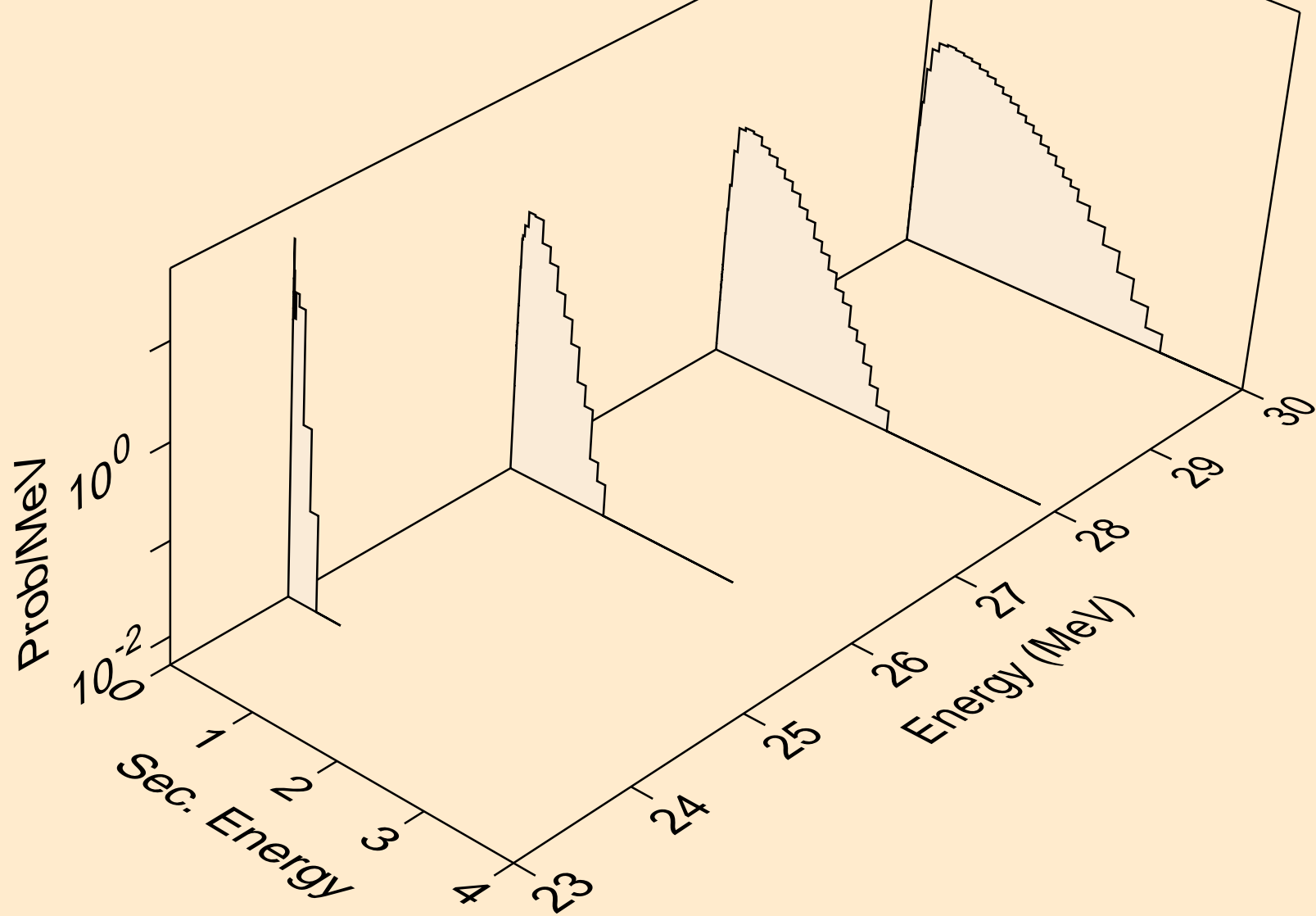

AS069 NEUTRON ACER TENDL-2023 LIBRARY; T=0.K  
Neutron emission for (n,2n)

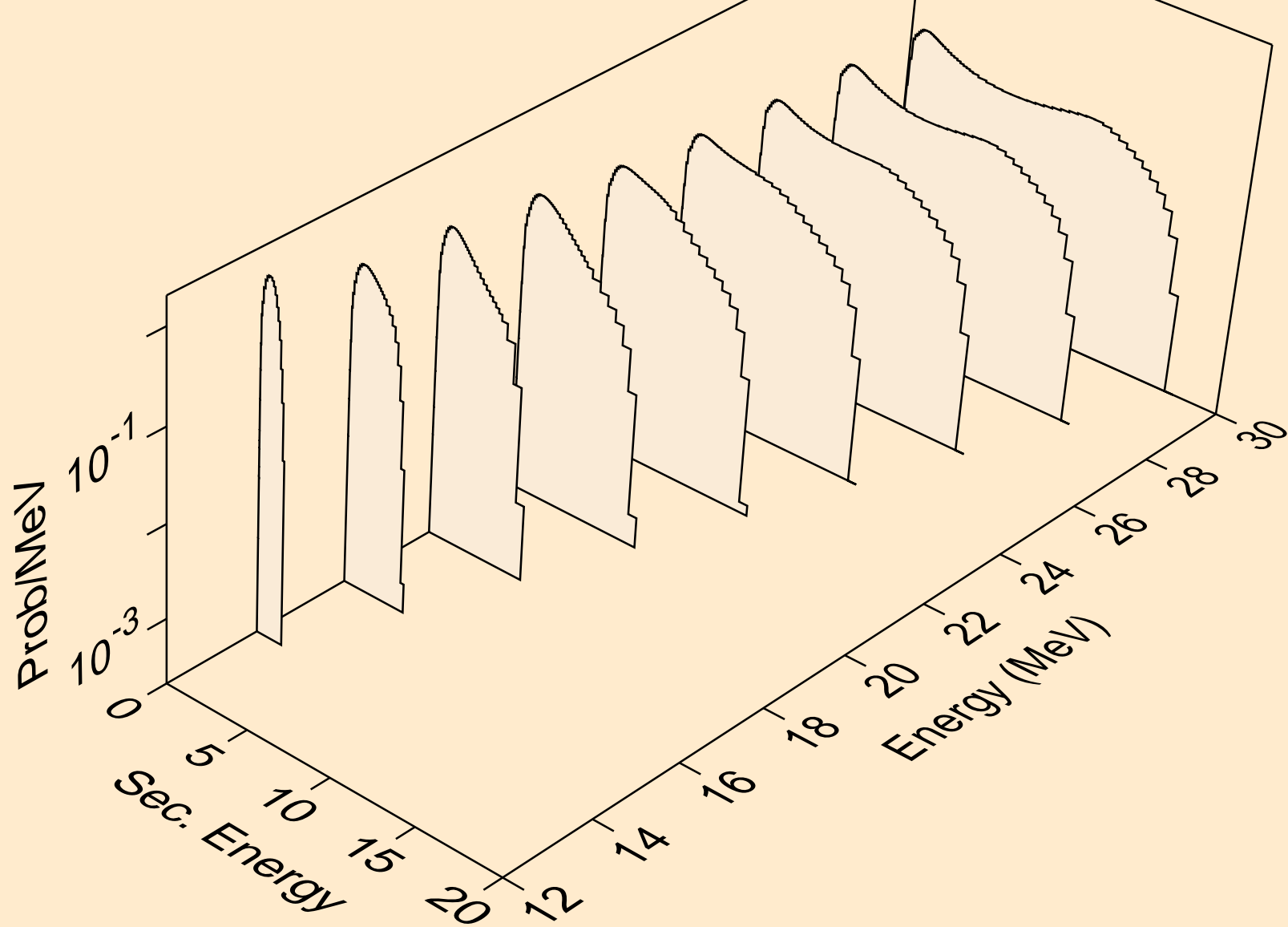

AS069 NEUTRON ACER TENDL-2023 LIBRARY; T=0.K  
Neutron emission for (n,3n)

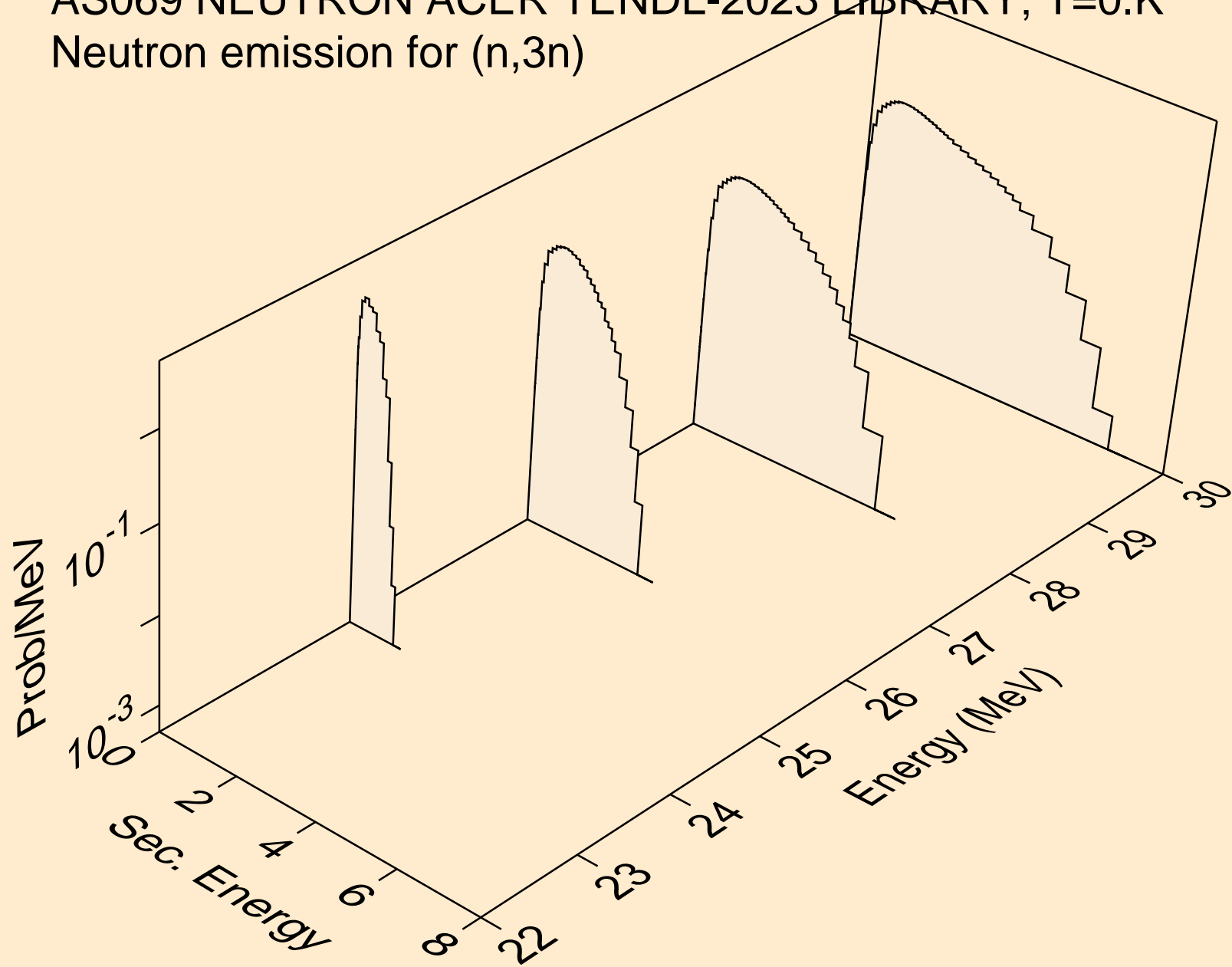

AS069 NEUTRON ACER TENDL-2023 LIBRARY; T=0.K  
Neutron emission for (n,n\*)a

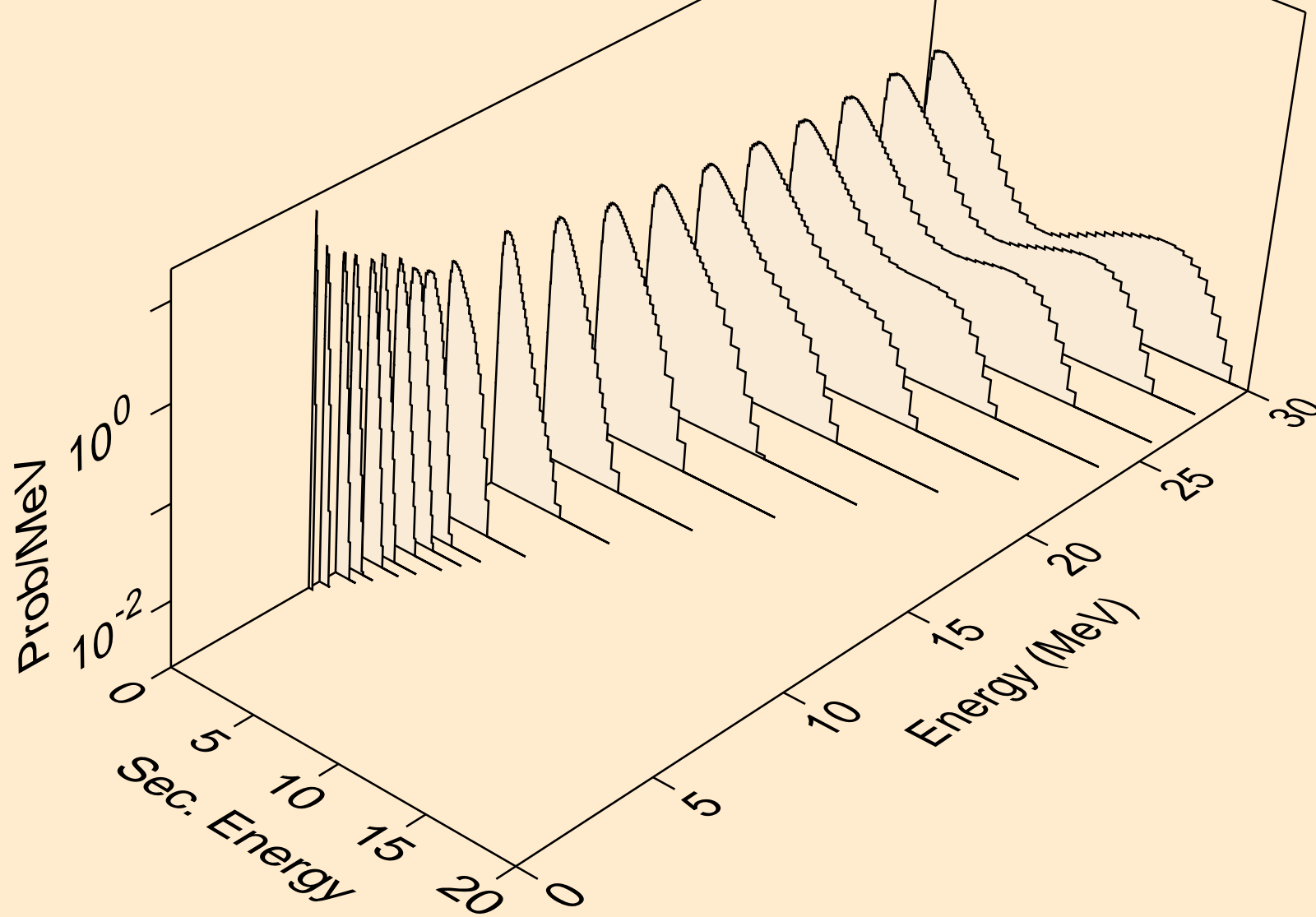

AS069 NEUTRON ACER TENDL-2023 LIBRARY; T=0.K  
Neutron emission for (n,2n)a

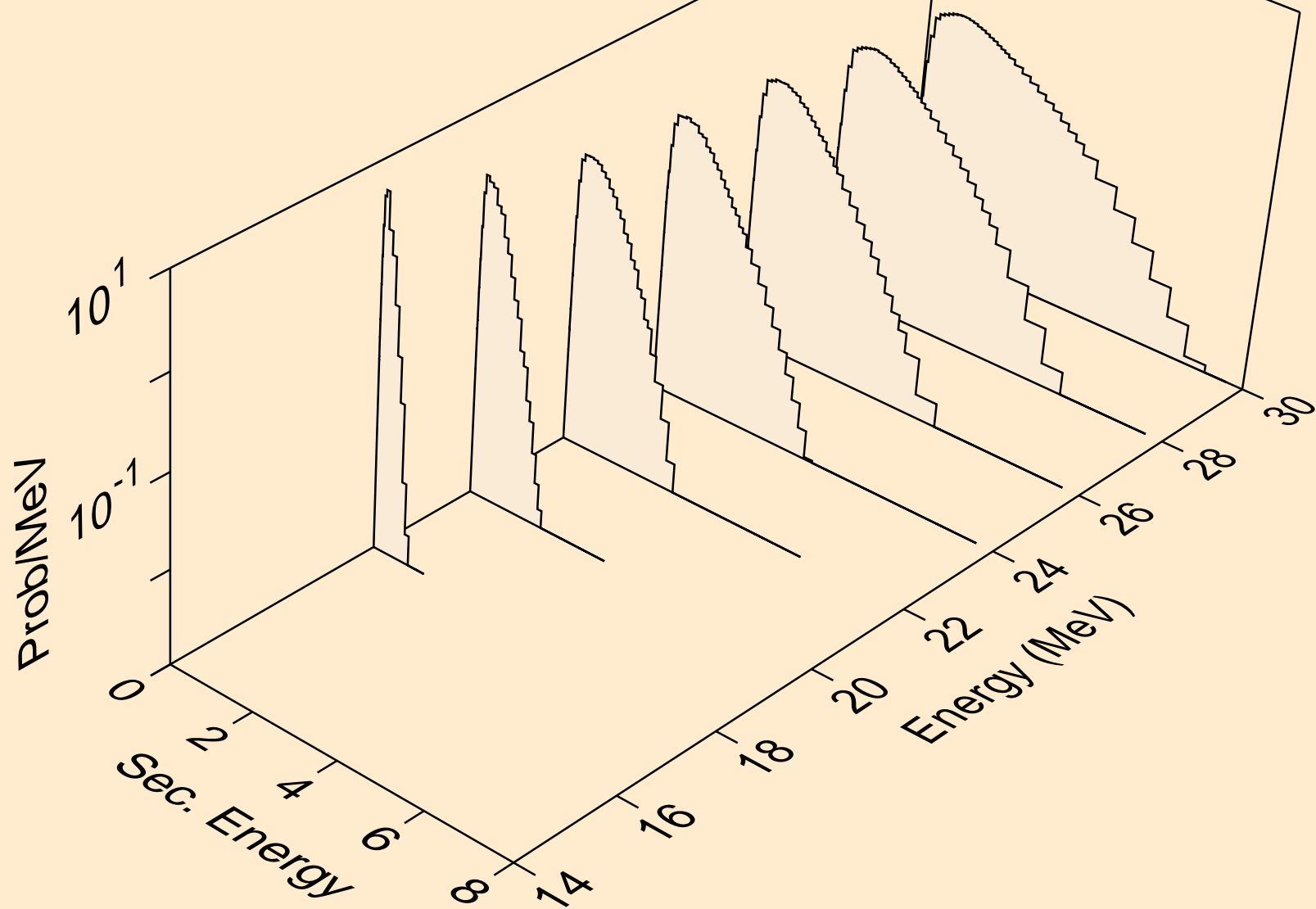

AS069 NEUTRON ACER TENDL-2023 LIBRARY; T=0.K  
Neutron emission for (n,n\*)p

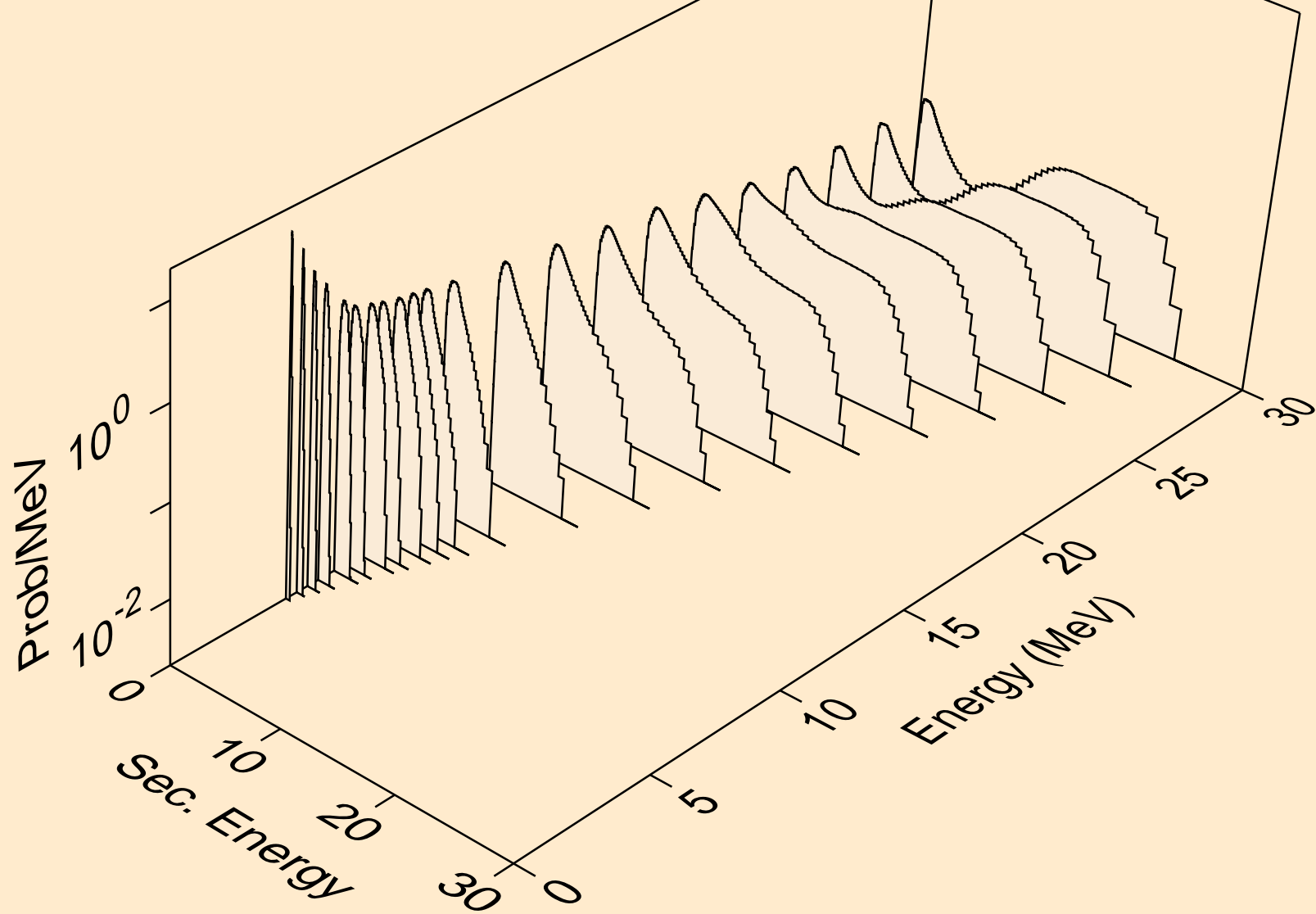

AS069 NEUTRON ACER TENDL-2023 LIBRARY; T=0.K  
Neutron emission for (n,n\*)2a

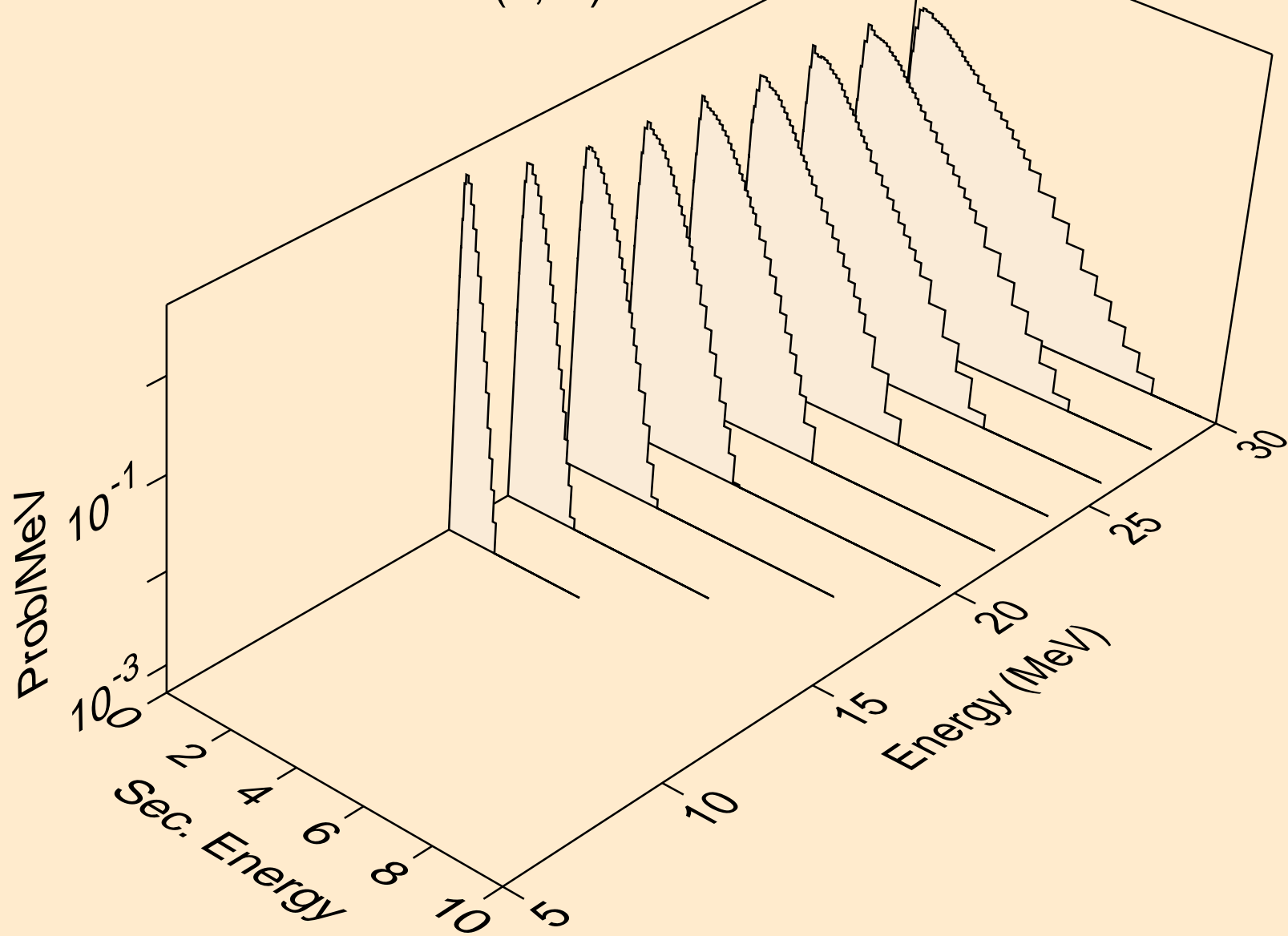

AS069 NEUTRON ACER TENDL-2023 LIBRARY; T=0.K  
Neutron emission for (n,n\*)d

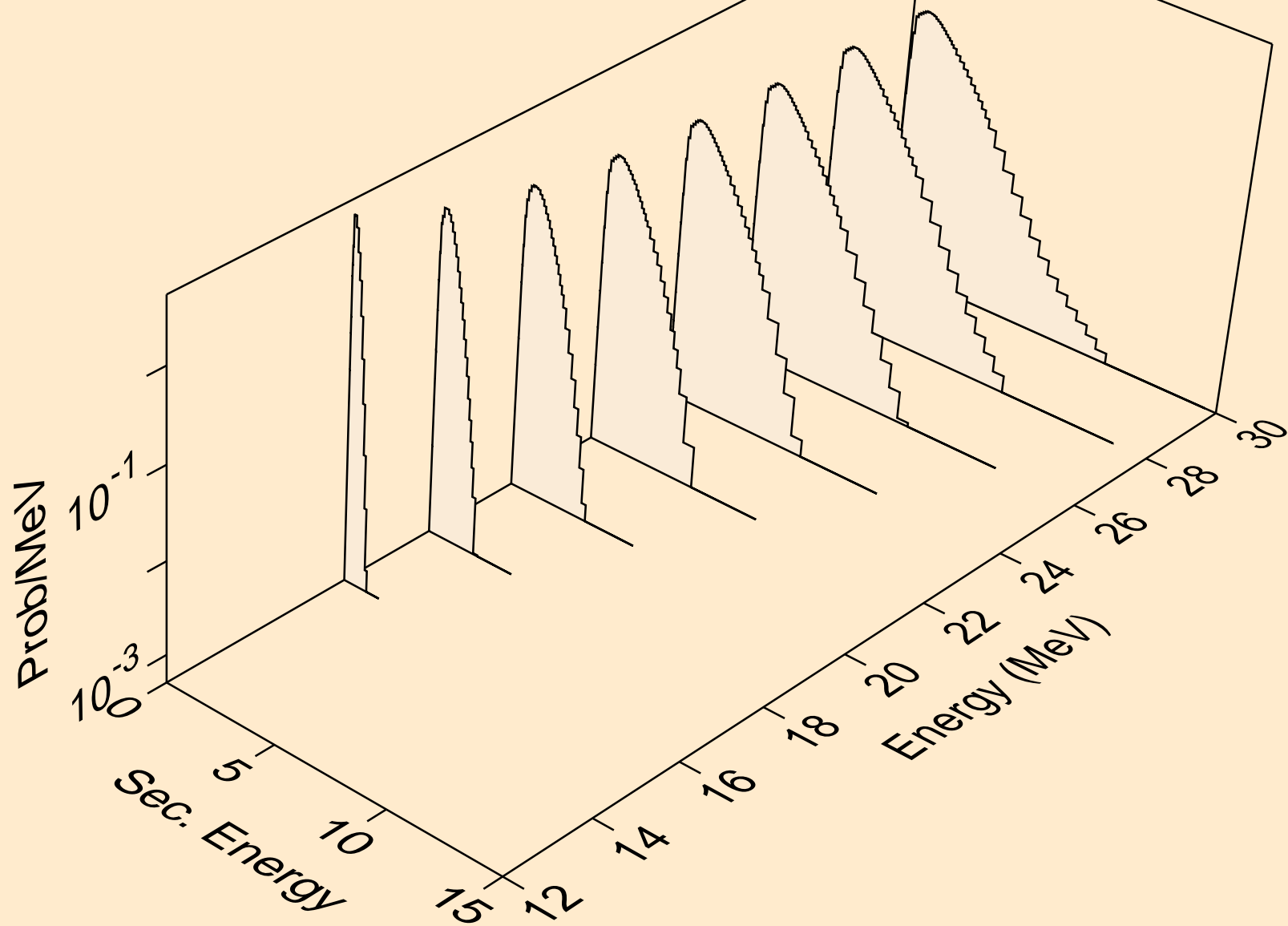

AS069 NEUTRON ACER TENDL-2023 LIBRARY; T=0.K  
Neutron emission for (n,n\*)t

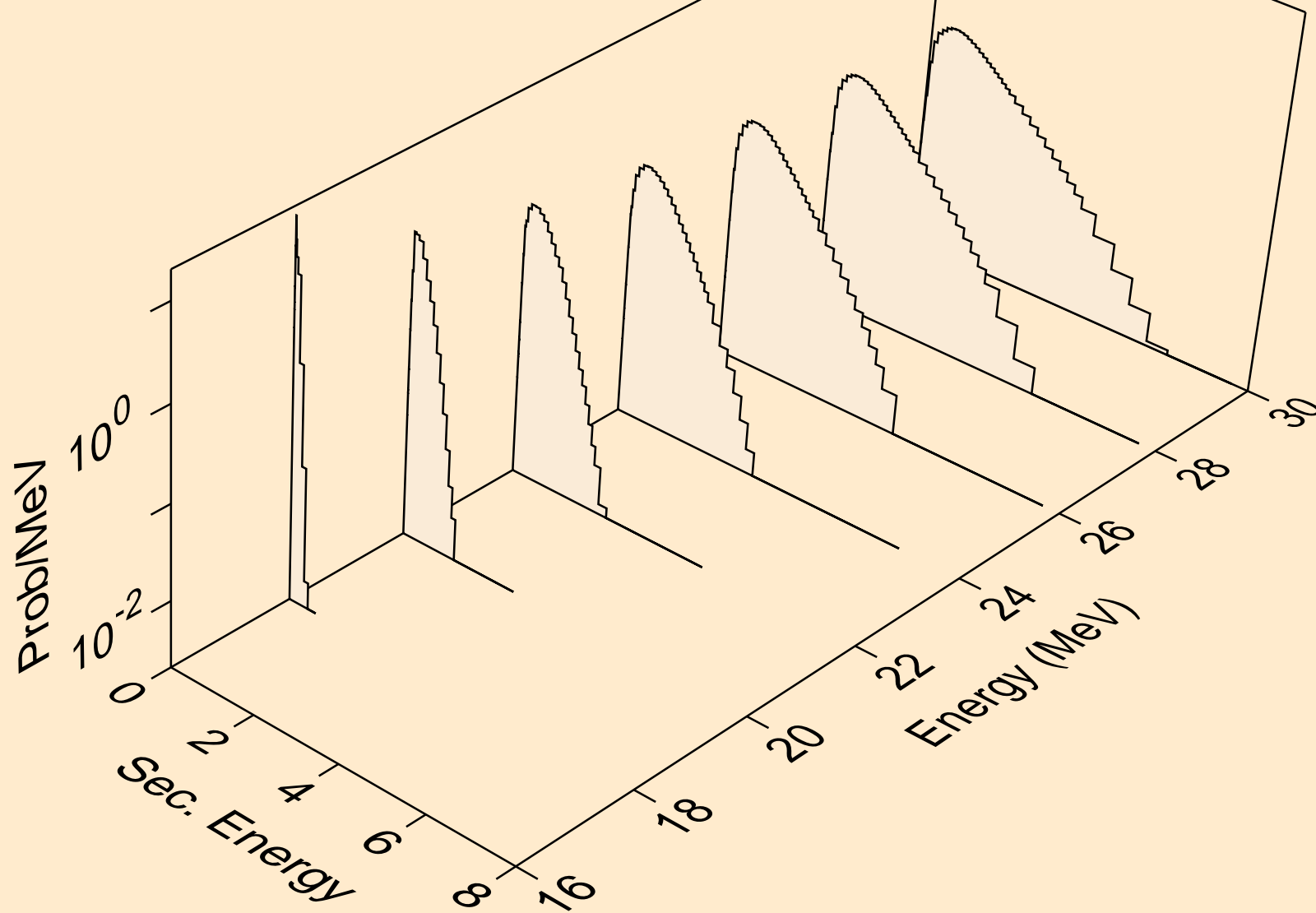

AS069 NEUTRON ACER TENDL-2023 LIBRARY; T=0.K  
Neutron emission for (n,n\*)he3

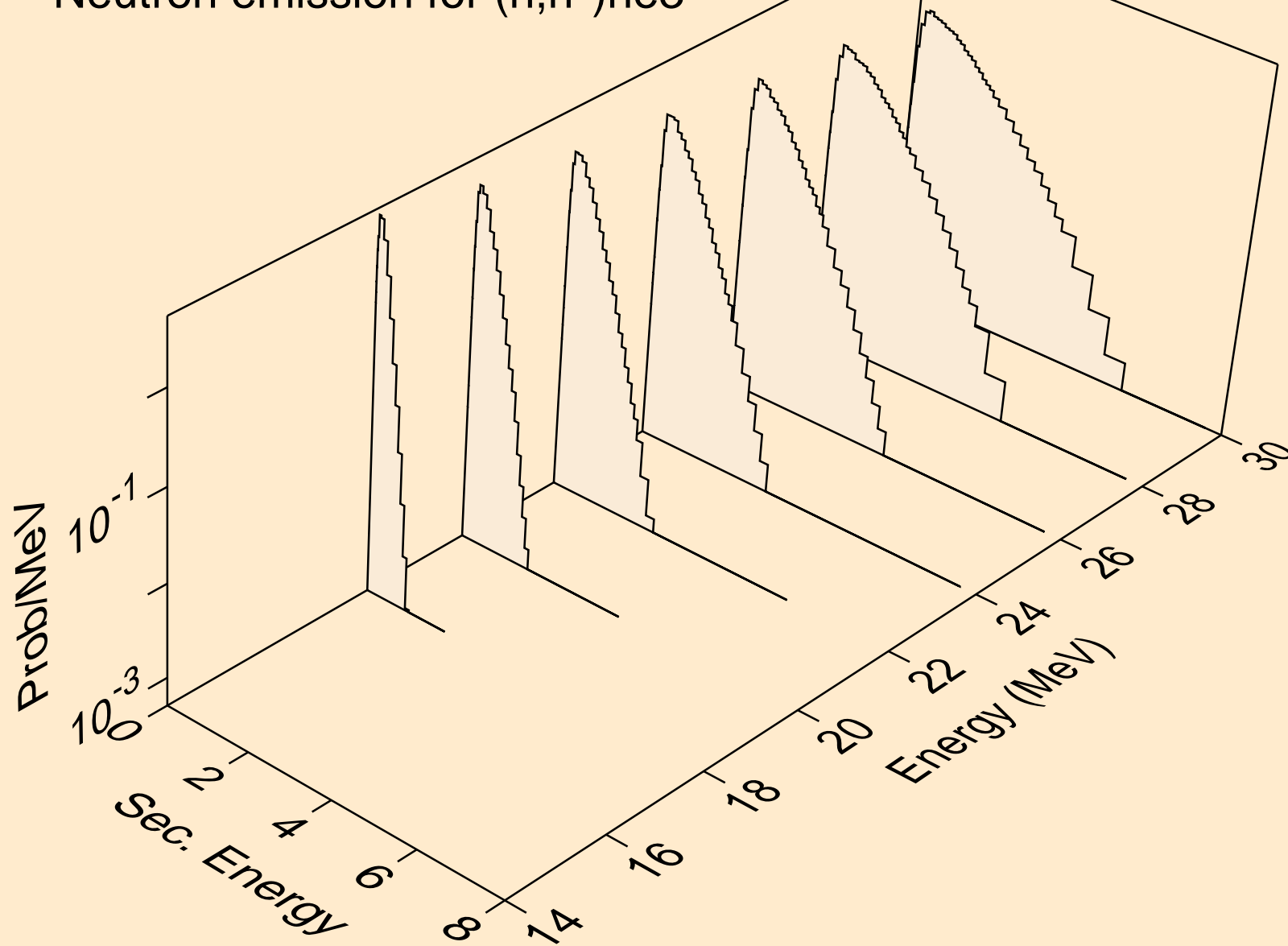

AS069 NEUTRON ACER TENDL-2023 LIBRARY; T=0.K  
Neutron emission for (n,2np)

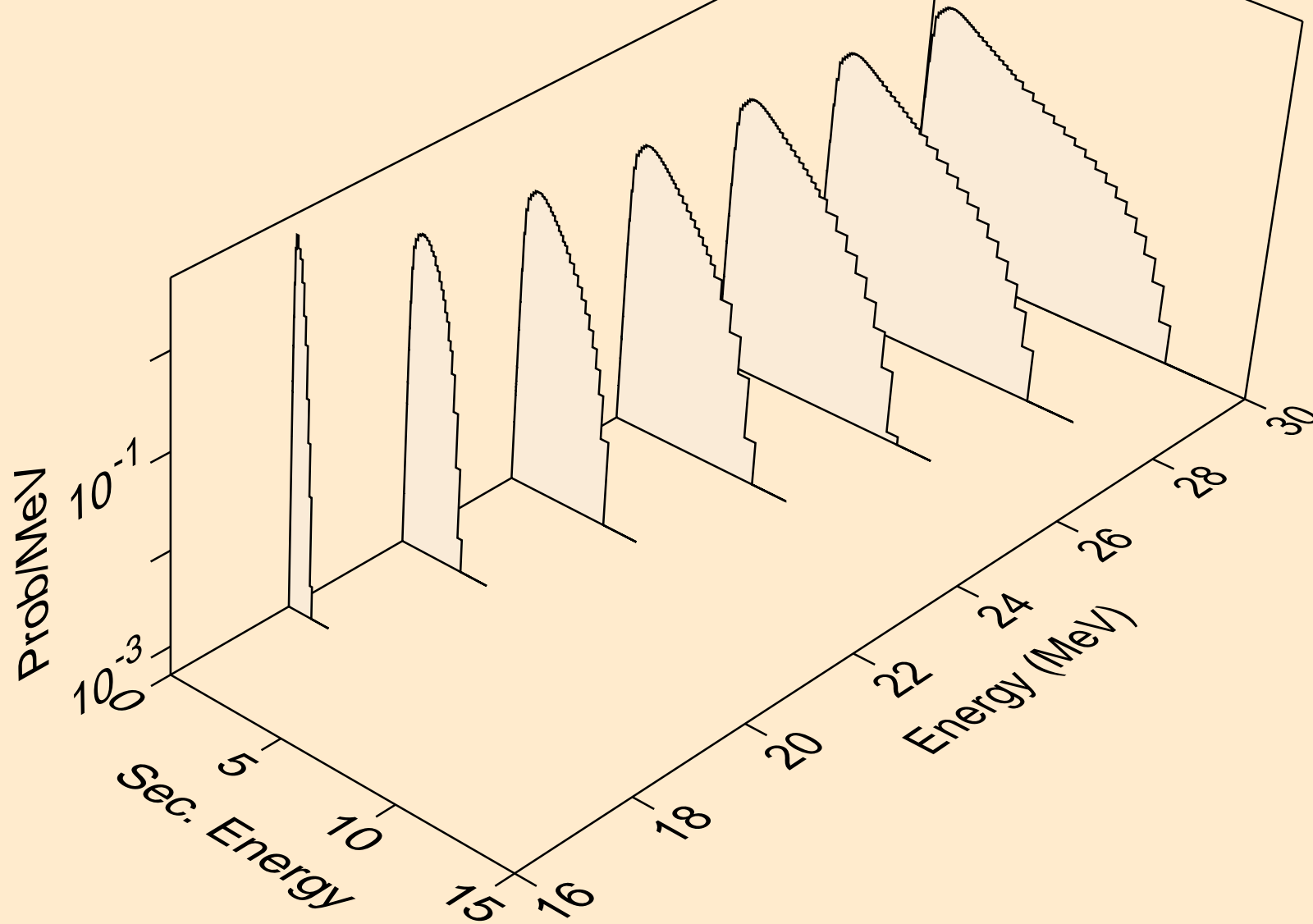

AS069 NEUTRON ACER TENDL-2023 LIBRARY; T=0.K  
Neutron emission for (n,3np)

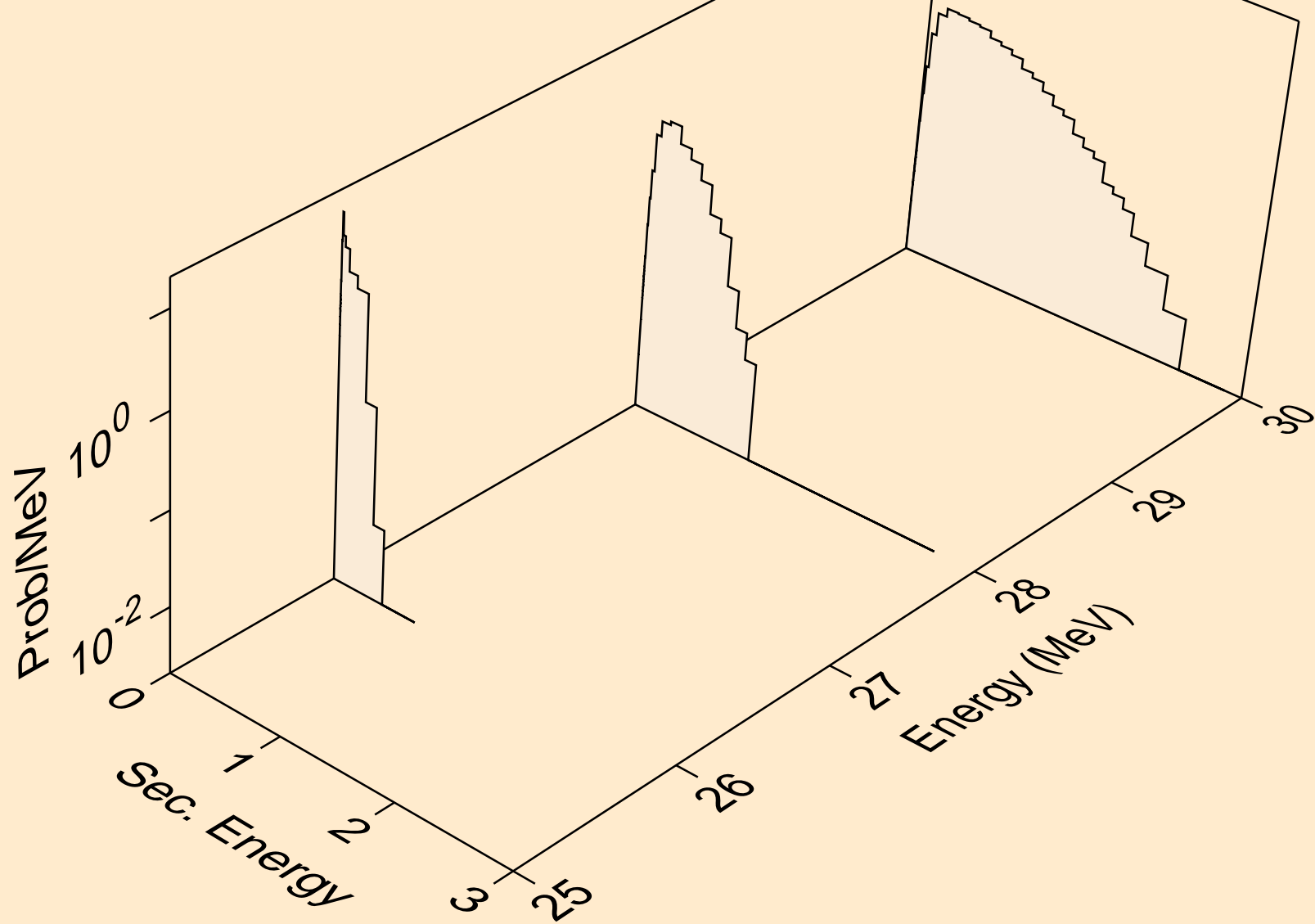

AS069 NEUTRON ACER TENDL-2023 LIBRARY; T=0.K  
Neutron emission for (n,n2p)

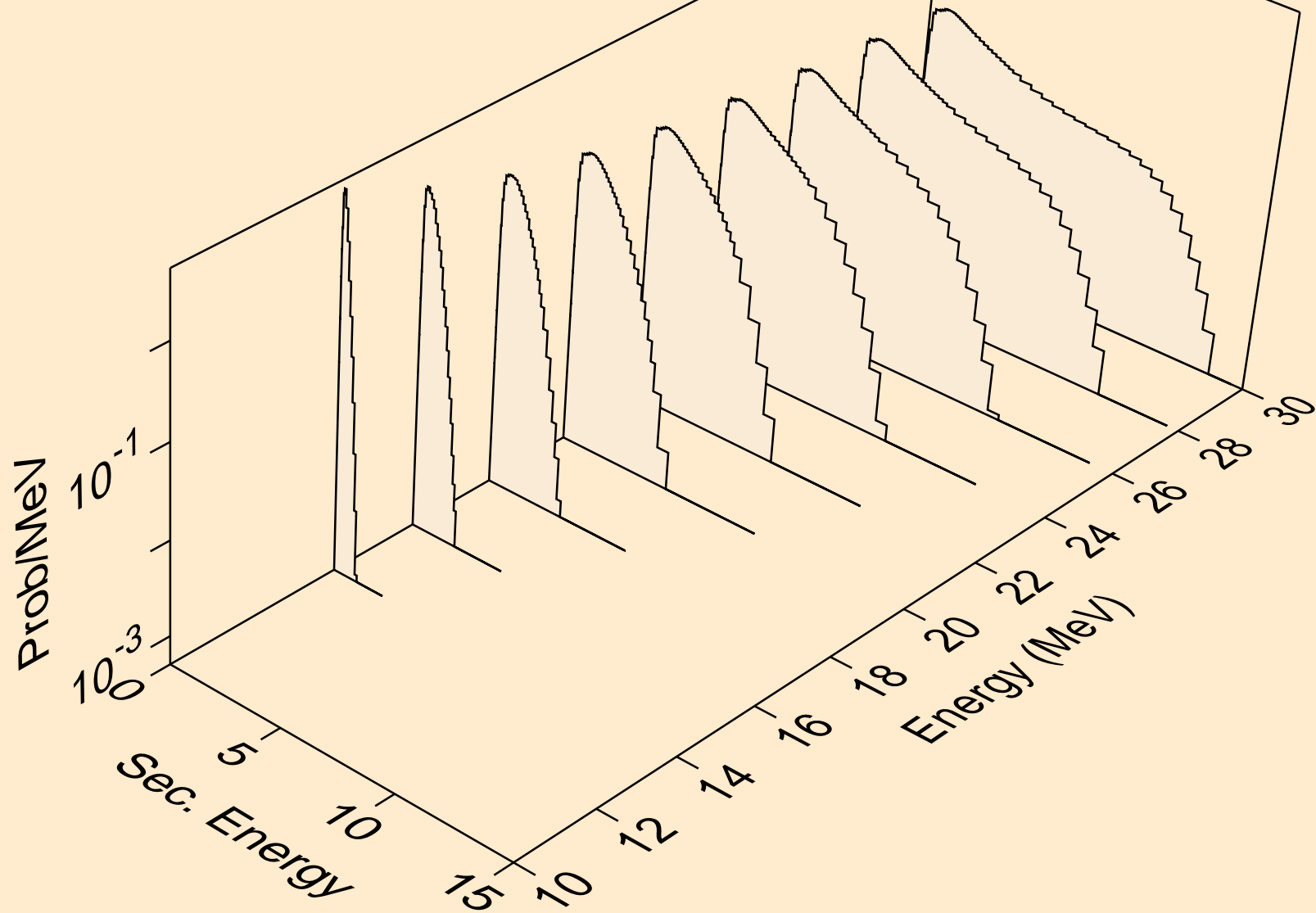

AS069 NEUTRON ACER TENDL-2023 LIBRARY; T=0.K  
Neutron emission for (n,npa)

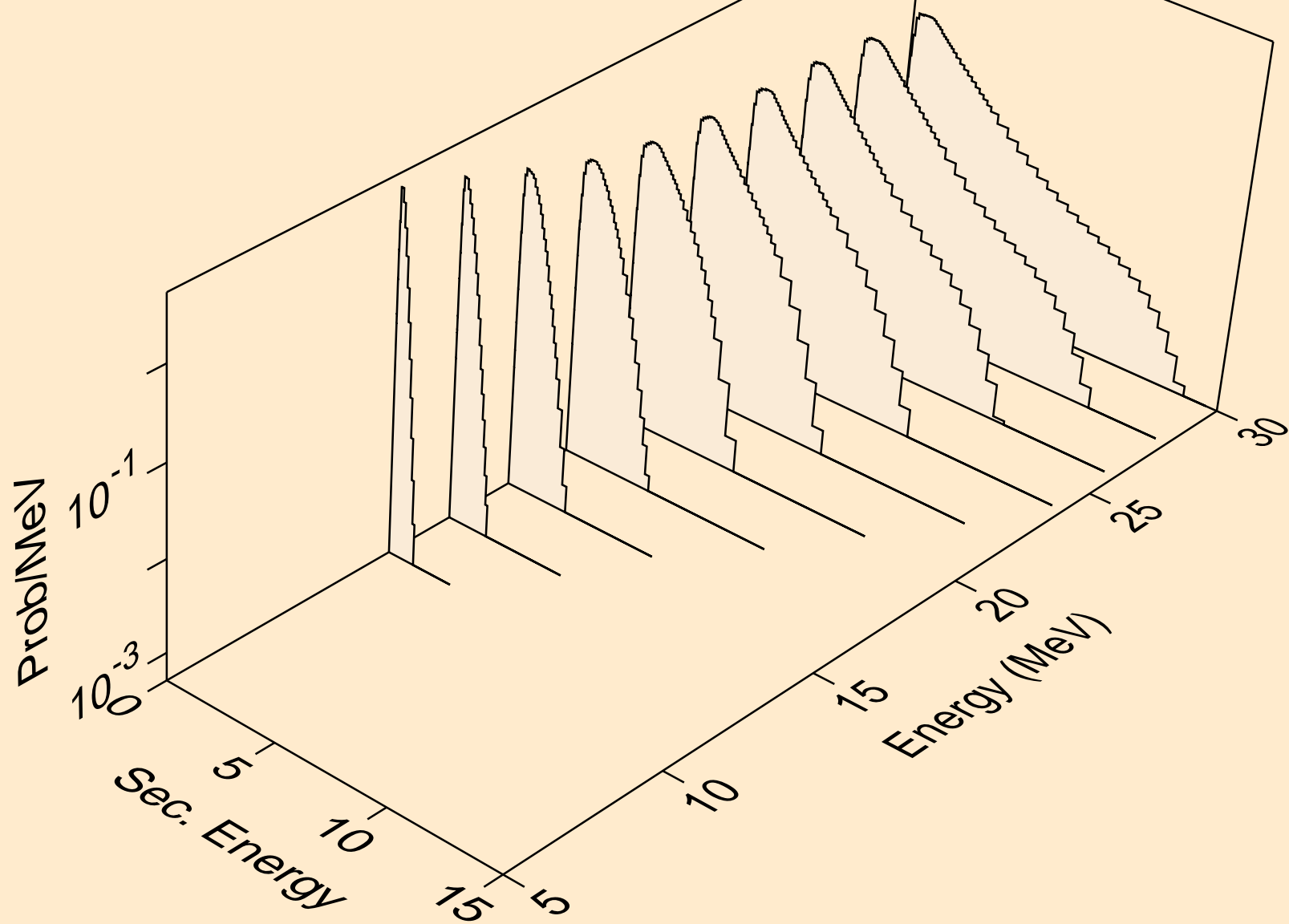

AS069 NEUTRON ACER TENDL-2023 LIBRARY; T=0.K  
Neutron emission for (n,n\*c)

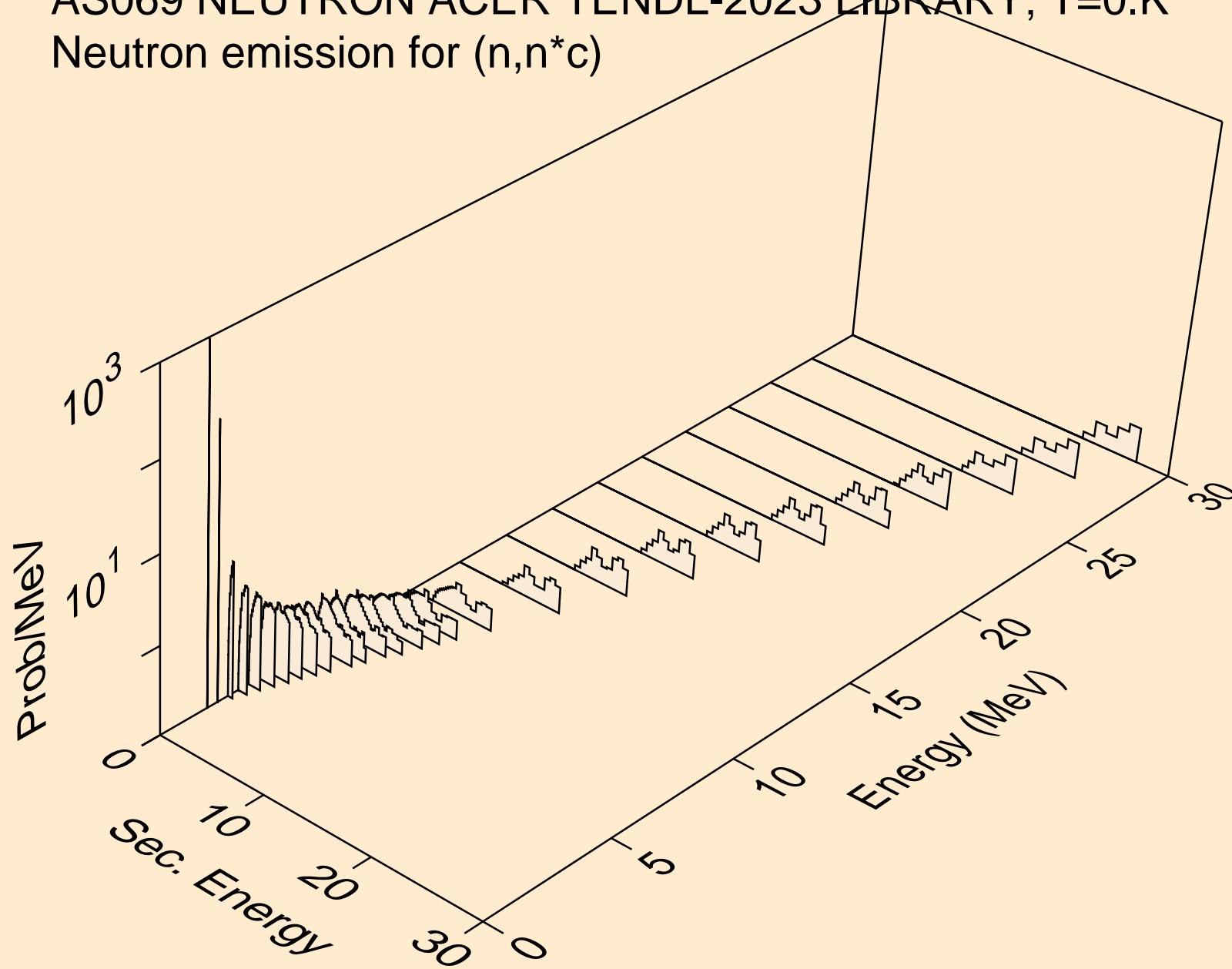

AS069 NEUTRON ACER TENDL-2023 LIBRARY; T=0.K  
Photon emission for (n,x)

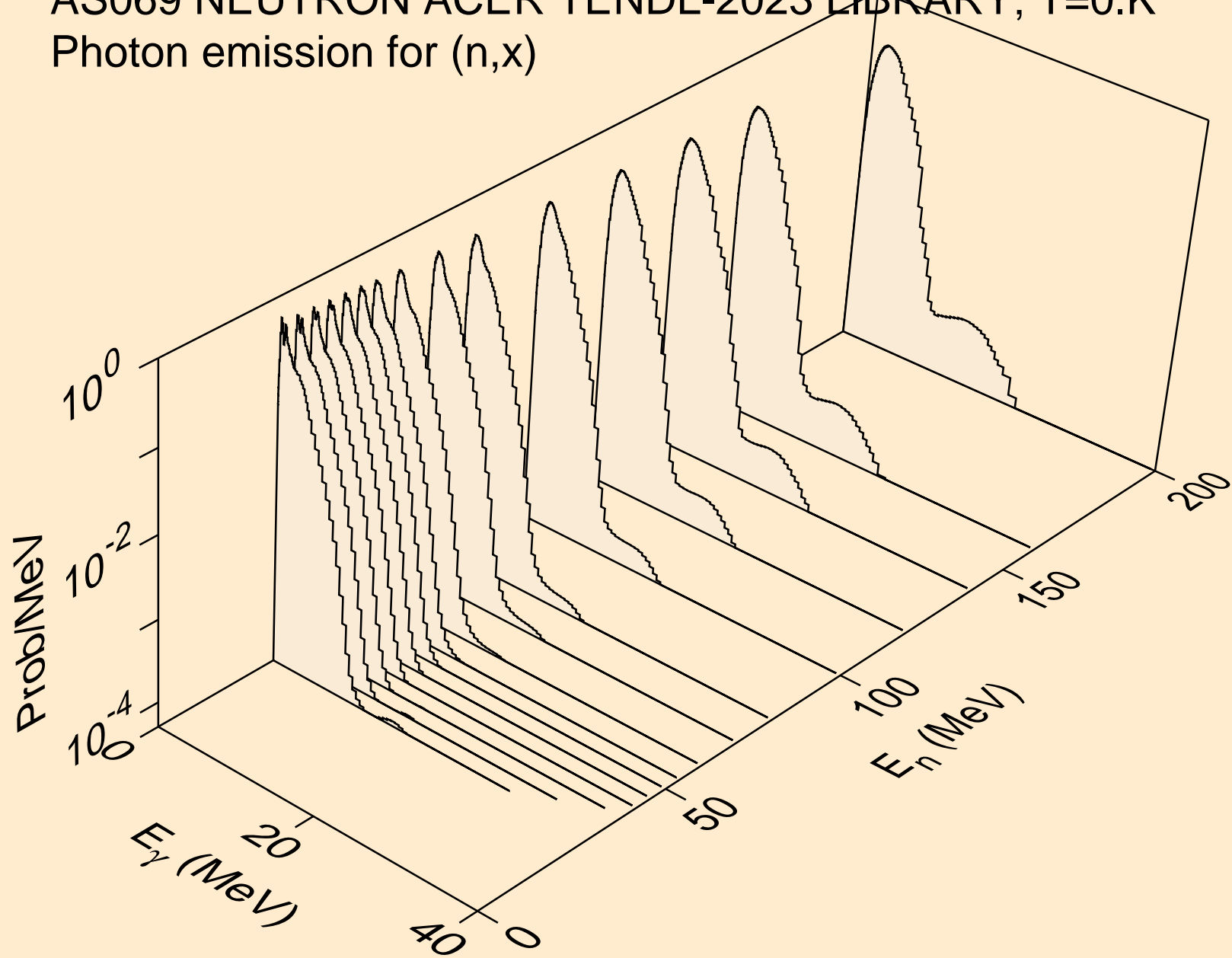

AS069 NEUTRON ACER TENDL-2023 LIBRARY; T=0.K  
Photon emission for (n,2nd)

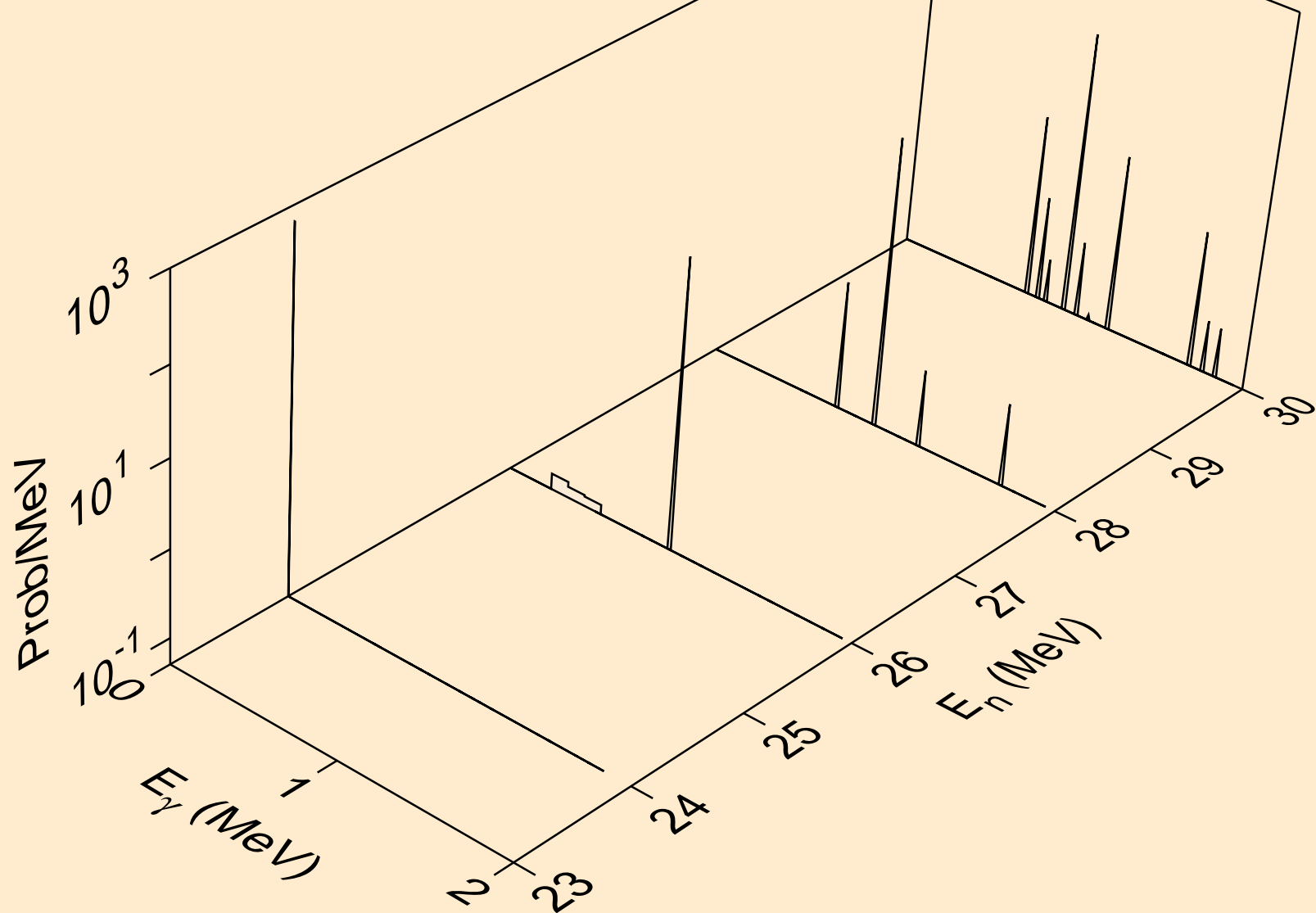

AS069 NEUTRON ACER TENDL-2023 LIBRARY; T=0.K  
Photon emission for (n,2n)

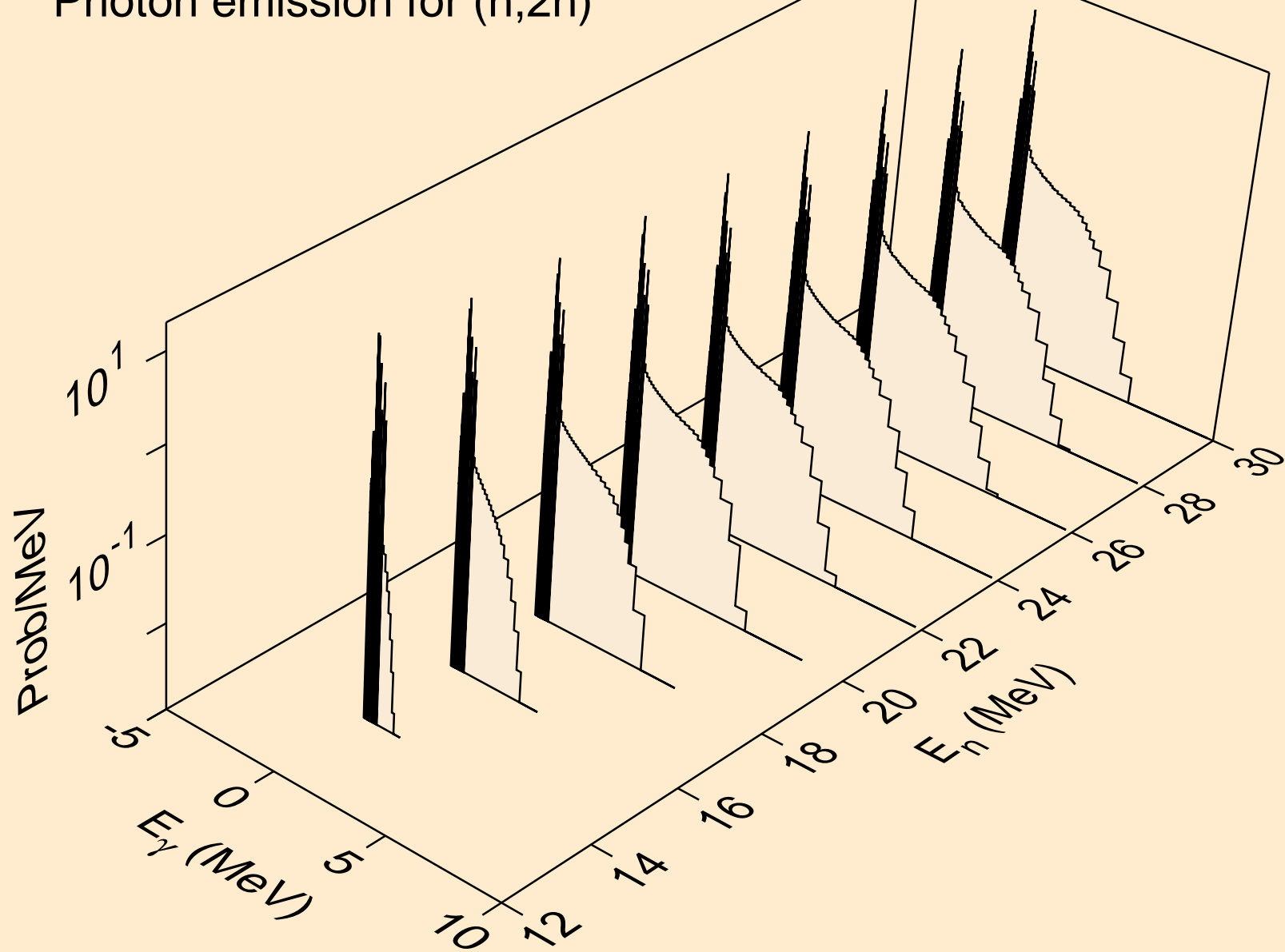

AS069 NEUTRON ACER TENDL-2023 LIBRARY; T=0.K  
Photon emission for (n,3n)

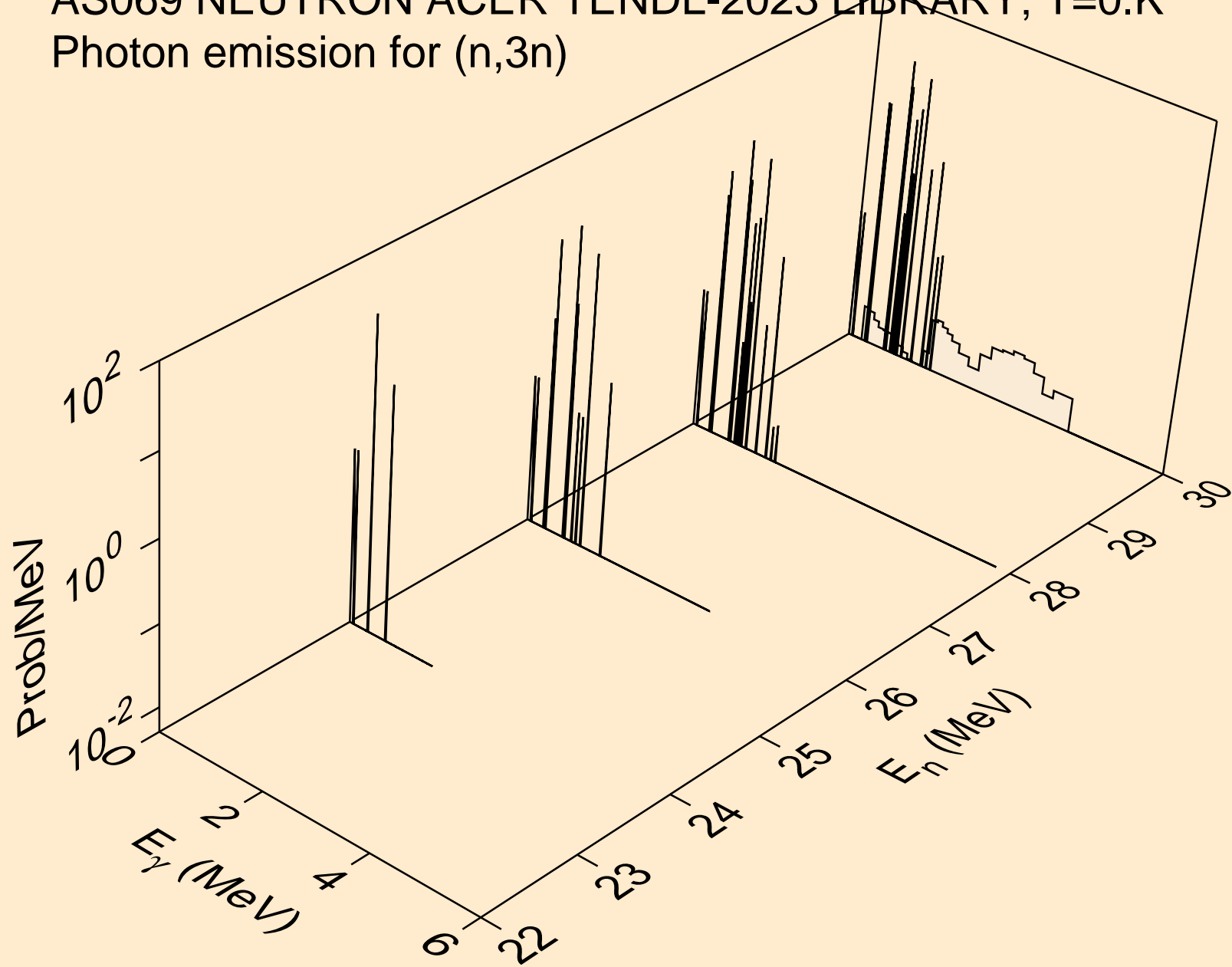

AS069 NEUTRON ACER TENDL-2023 LIBRARY; T=0.K  
Photon emission for (n,n\*)a

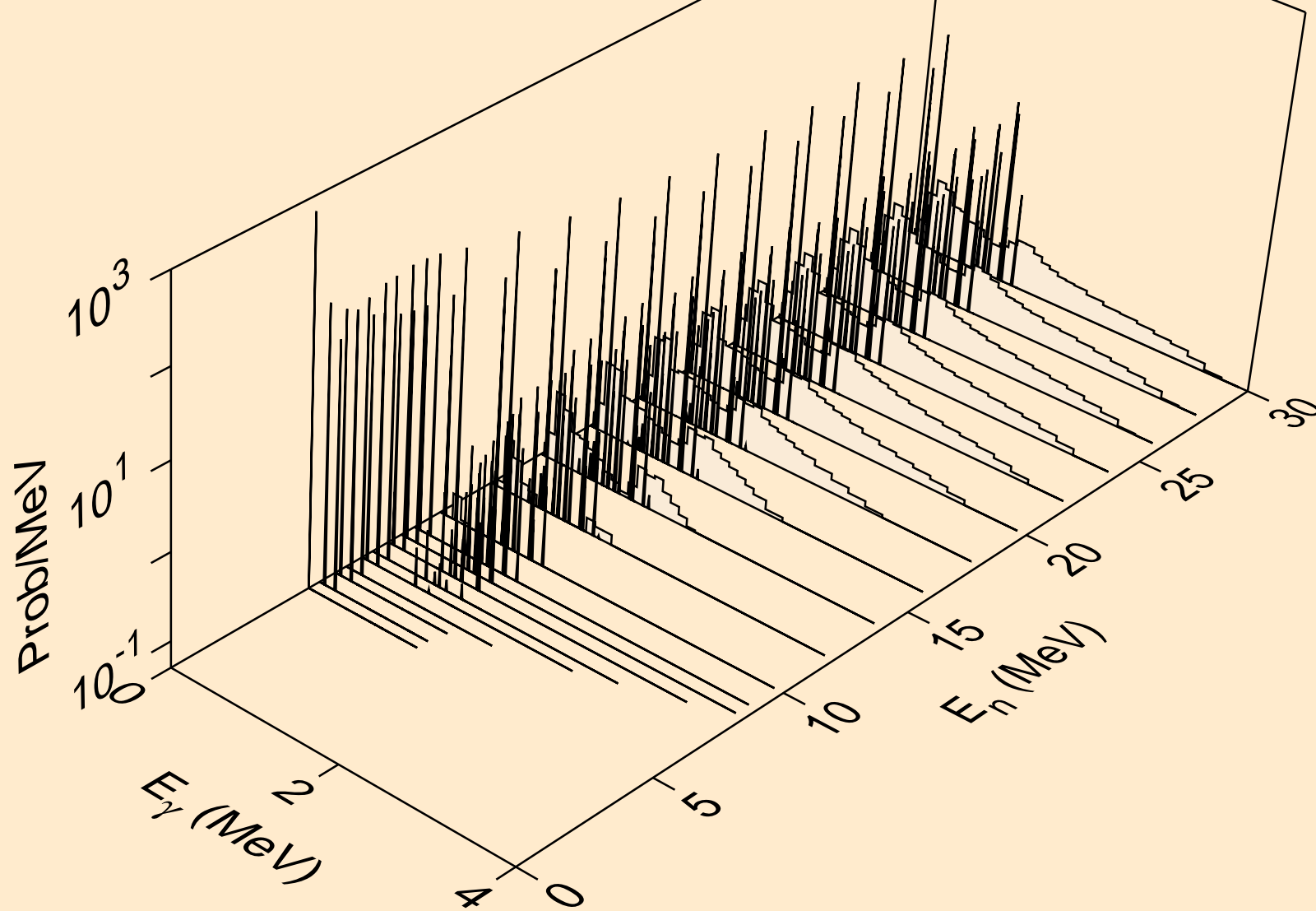

AS069 NEUTRON ACER TENDL-2023 LIBRARY; T=0.K  
Photon emission for (n,2n)a

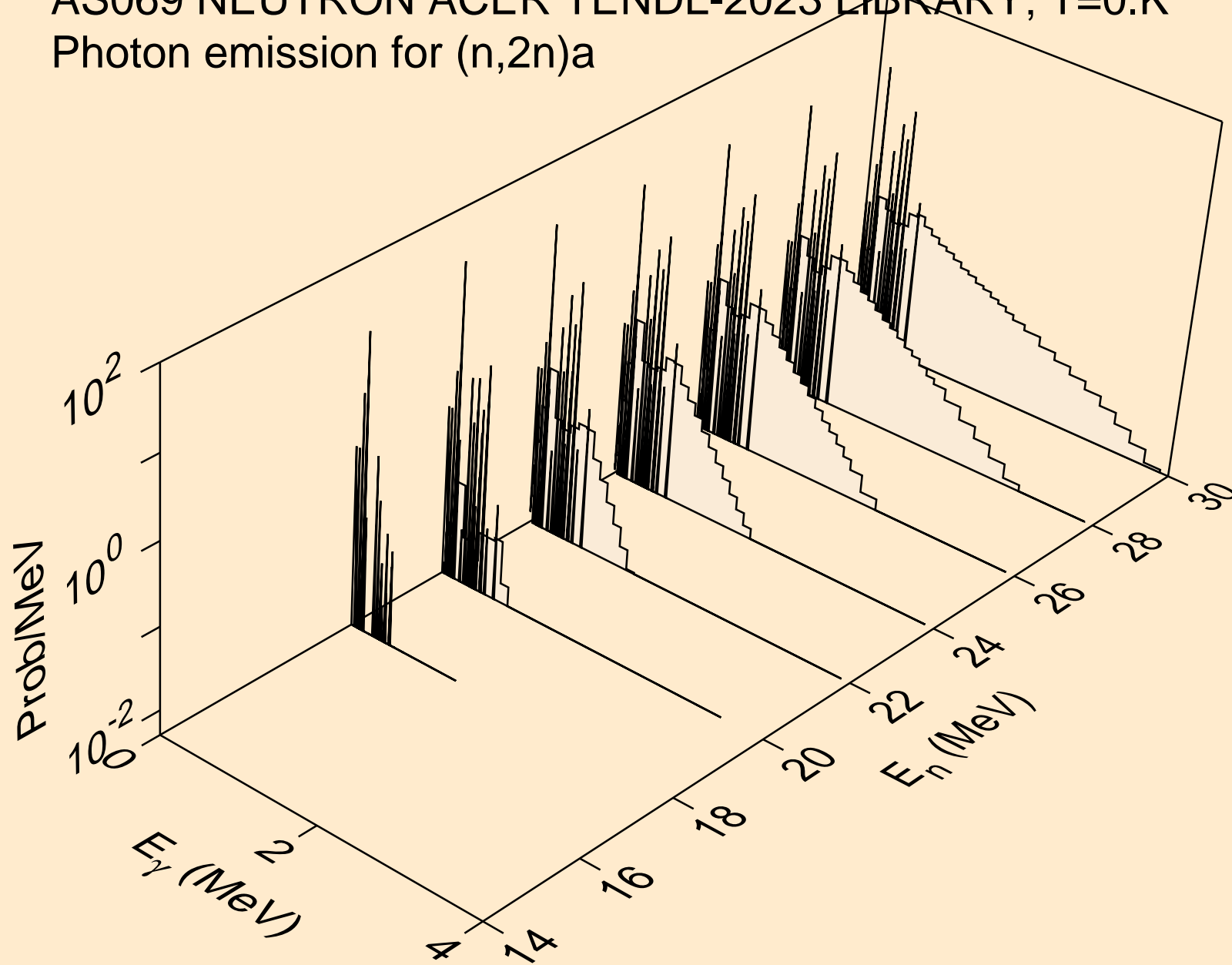

AS069 NEUTRON ACER TENDL-2023 LIBRARY; T=0.K  
Photon emission for (n,n\*)p

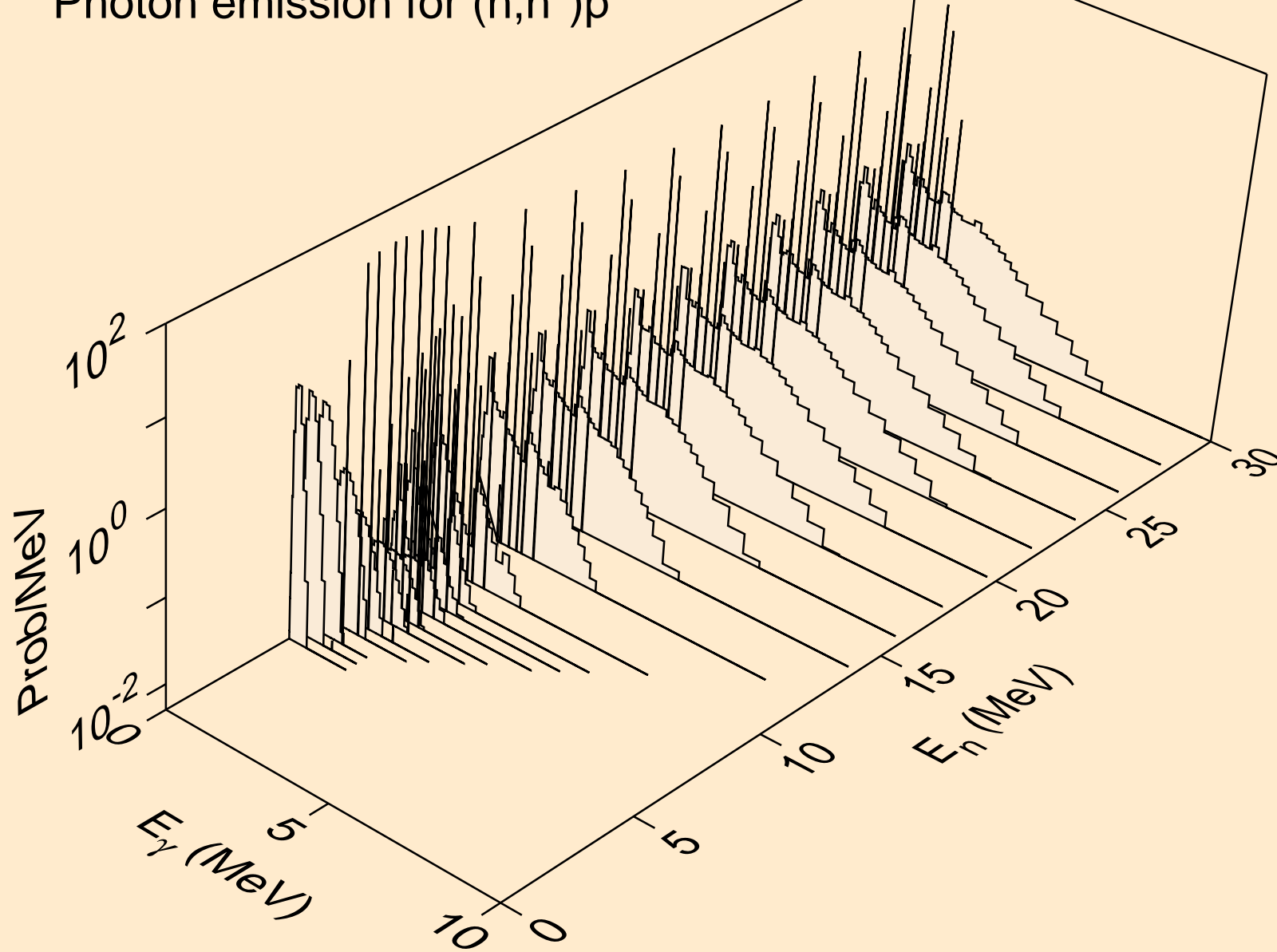

AS069 NEUTRON ACER TENDL-2023 LIBRARY; T=0.K  
Photon emission for (n,n\*)2a

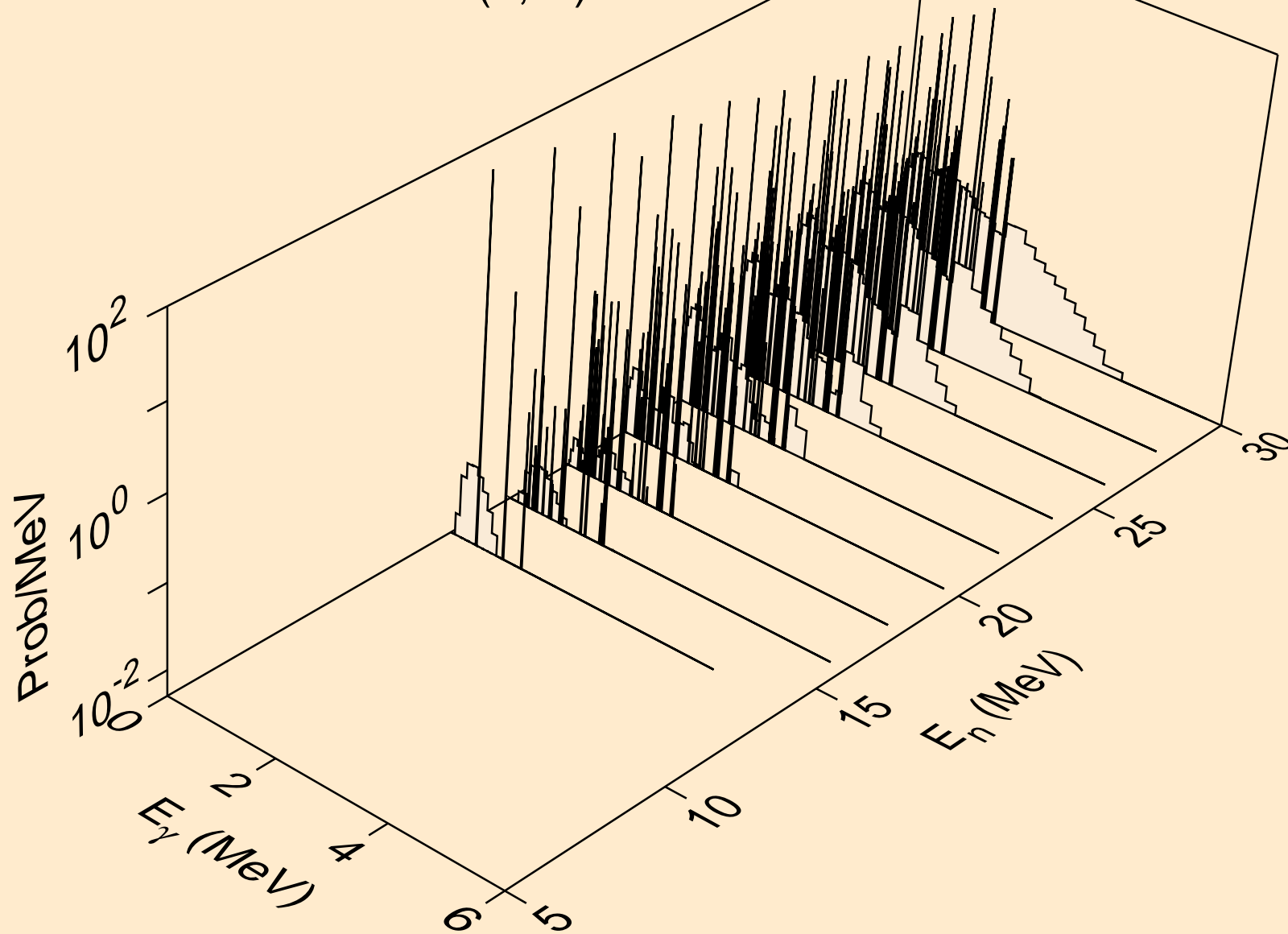

AS069 NEUTRON ACER TENDL-2023 LIBRARY; T=0.K  
Photon emission for (n,n\*)d

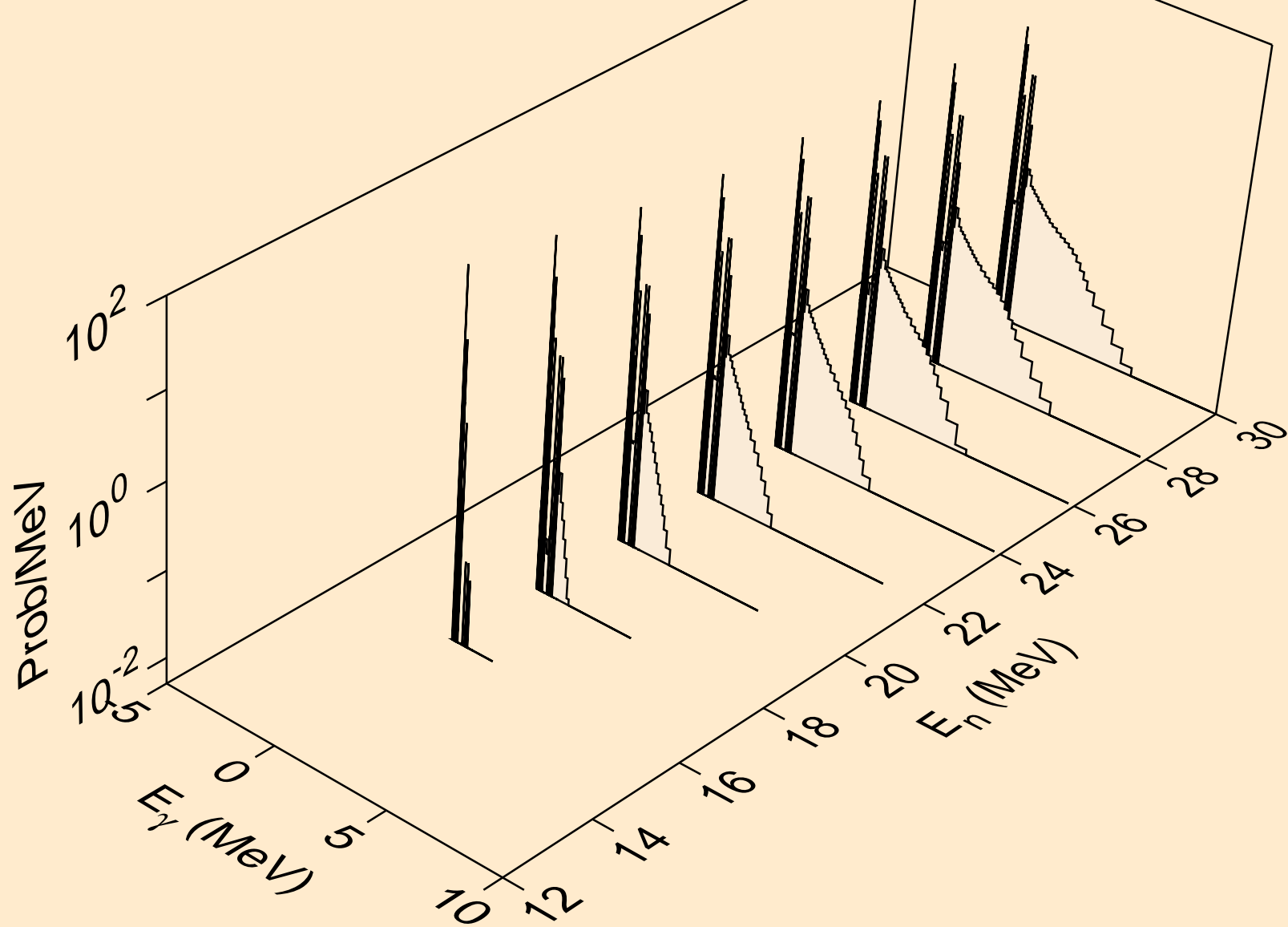

AS069 NEUTRON ACER TENDL-2023 LIBRARY; T=0.K  
Photon emission for (n,n\*)t

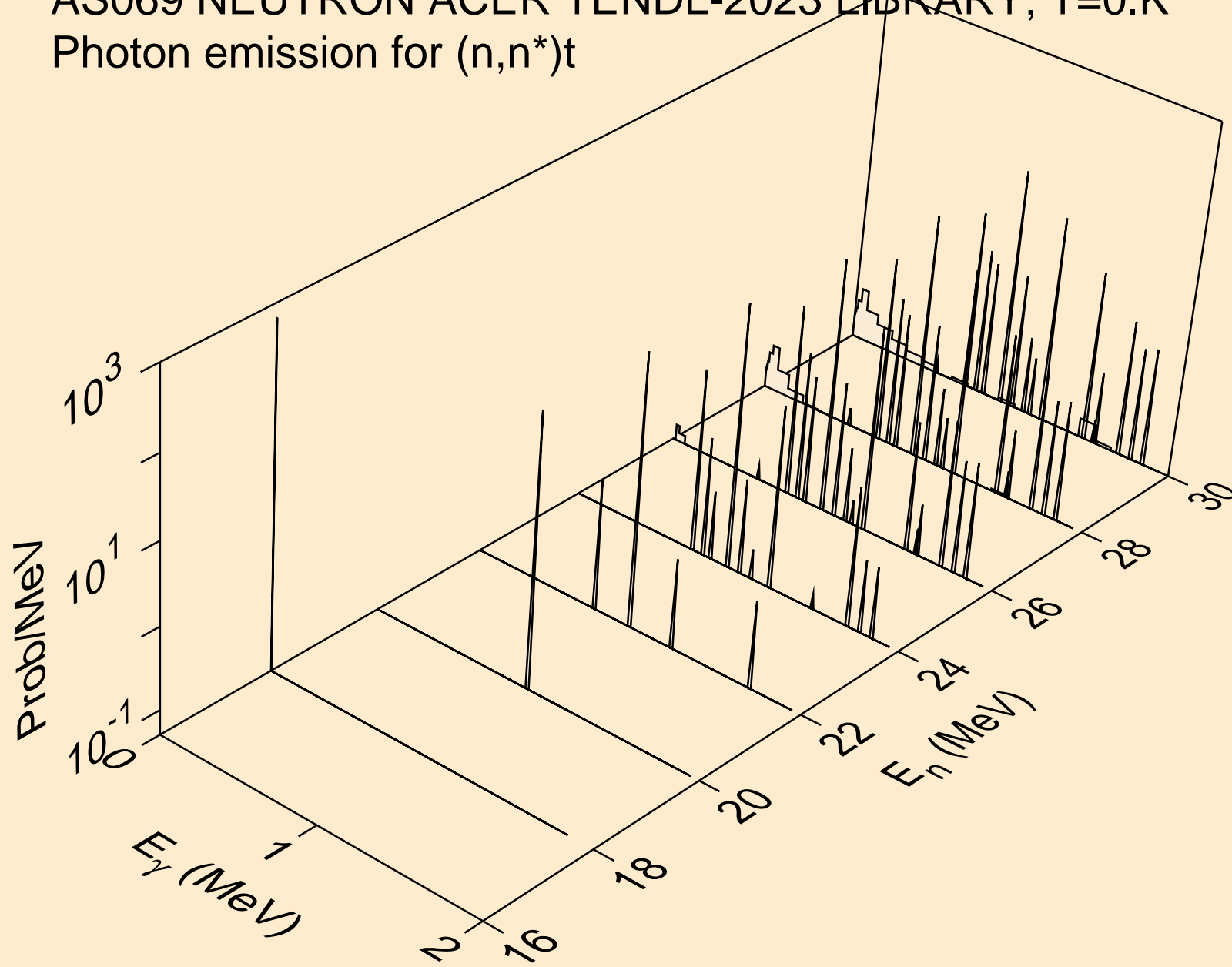

AS069 NEUTRON ACER TENDL-2023 LIBRARY; T=0.K  
Photon emission for (n,n\*)he3

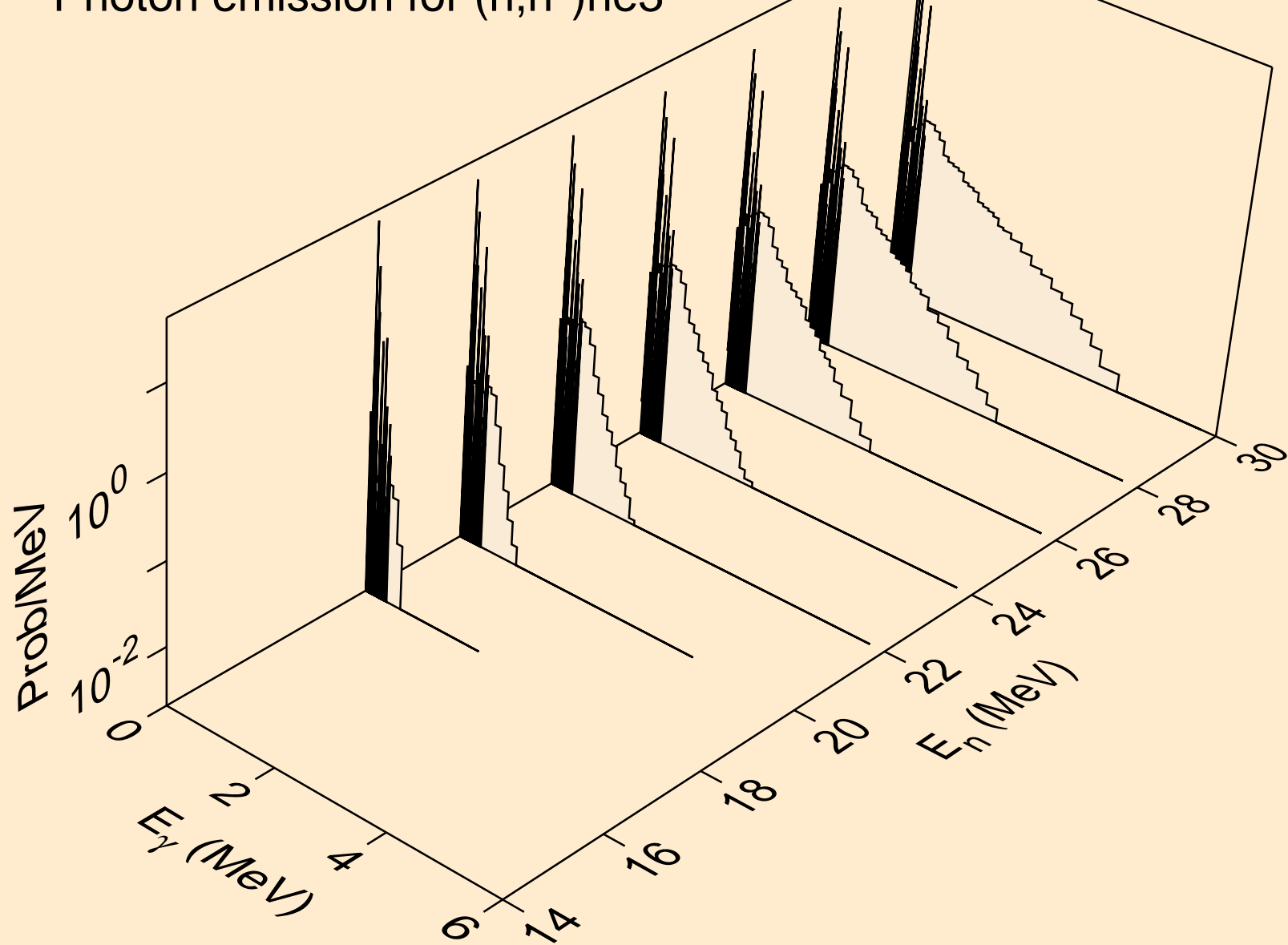

AS069 NEUTRON ACER TENDL-2023 LIBRARY; T=0.K  
Photon emission for (n,2np)

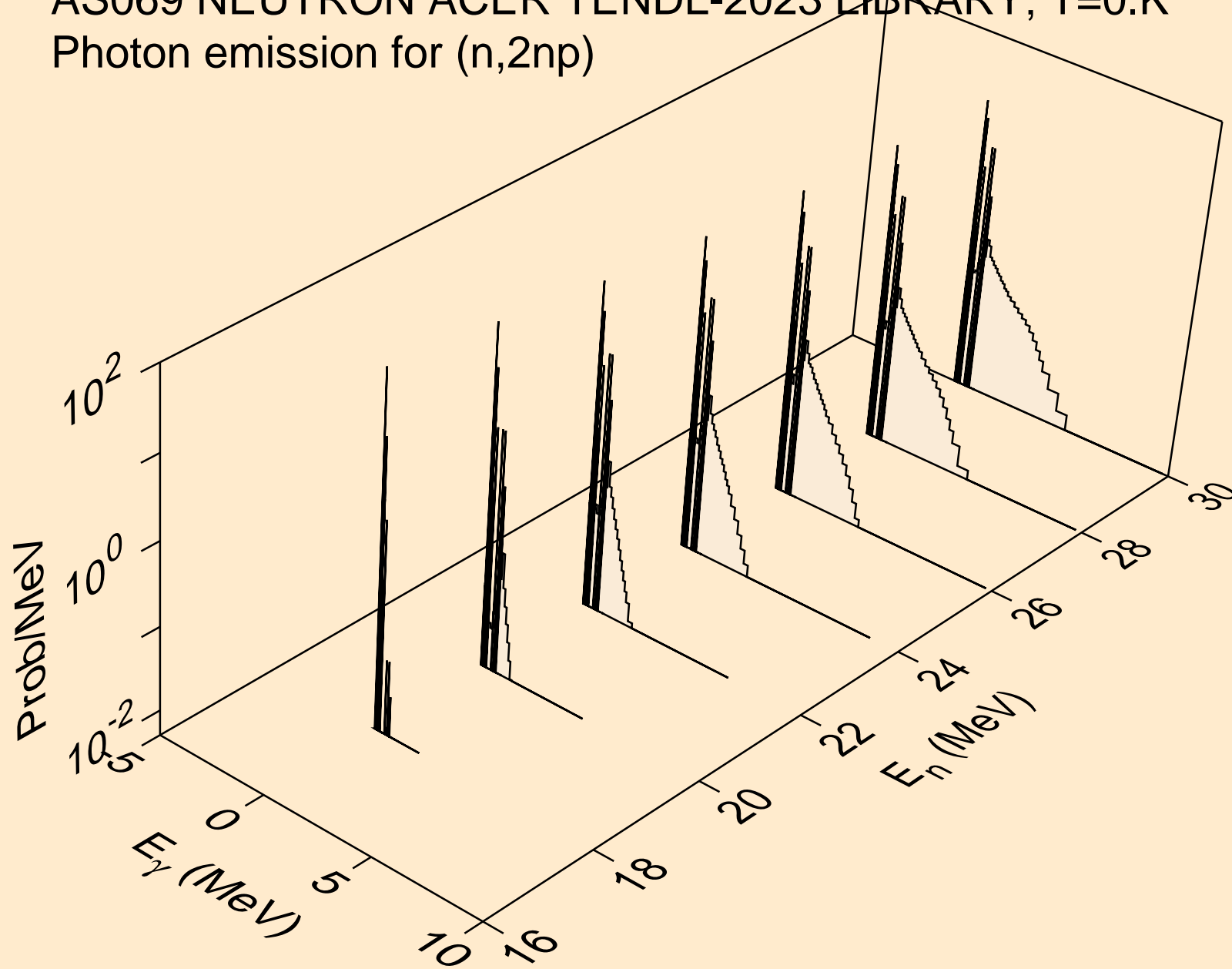

AS069 NEUTRON ACER TENDL-2023 LIBRARY; T=0.K  
Photon emission for (n,3np)

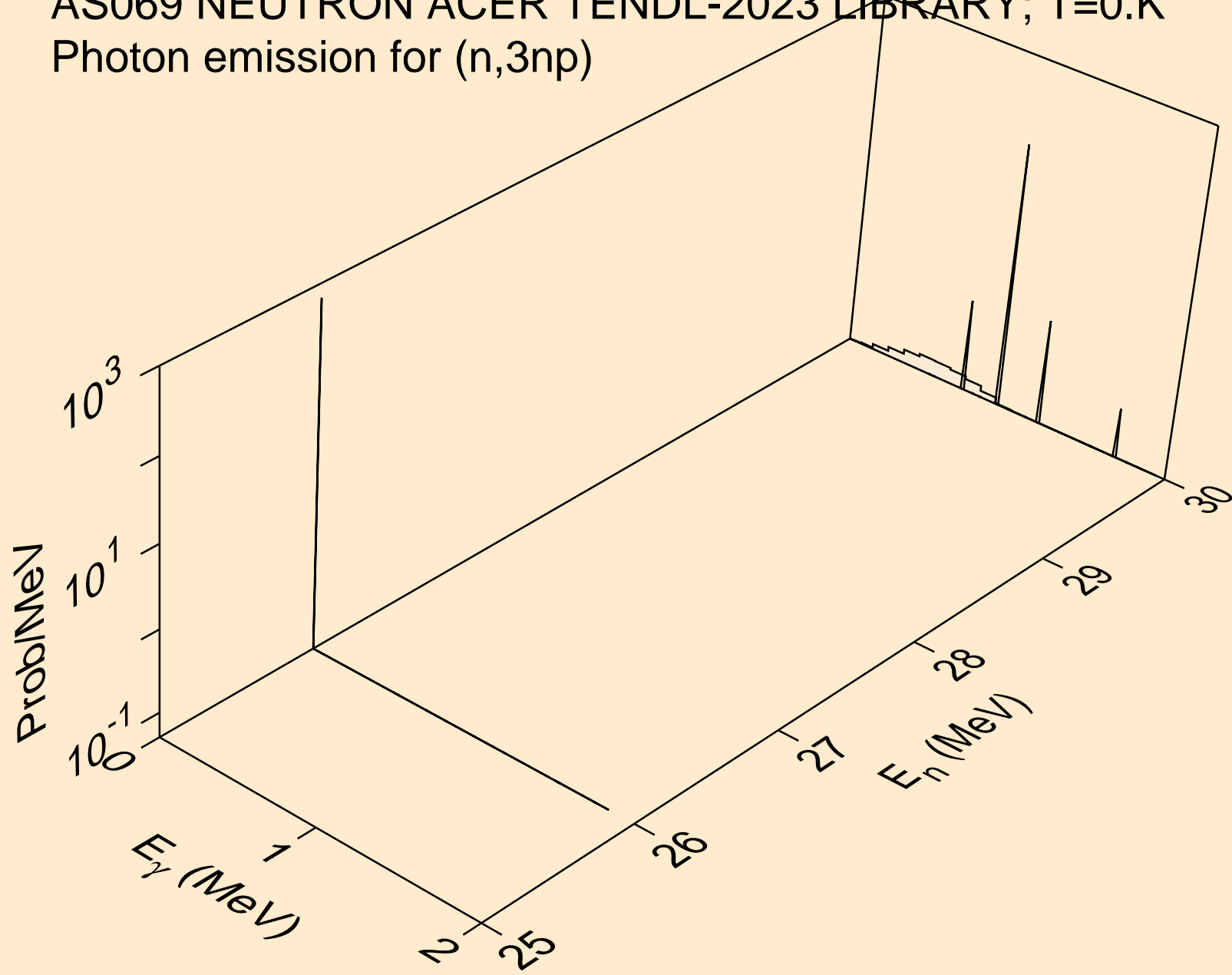

AS069 NEUTRON ACER TENDL-2023 LIBRARY; T=0.K  
Photon emission for (n,n2p)

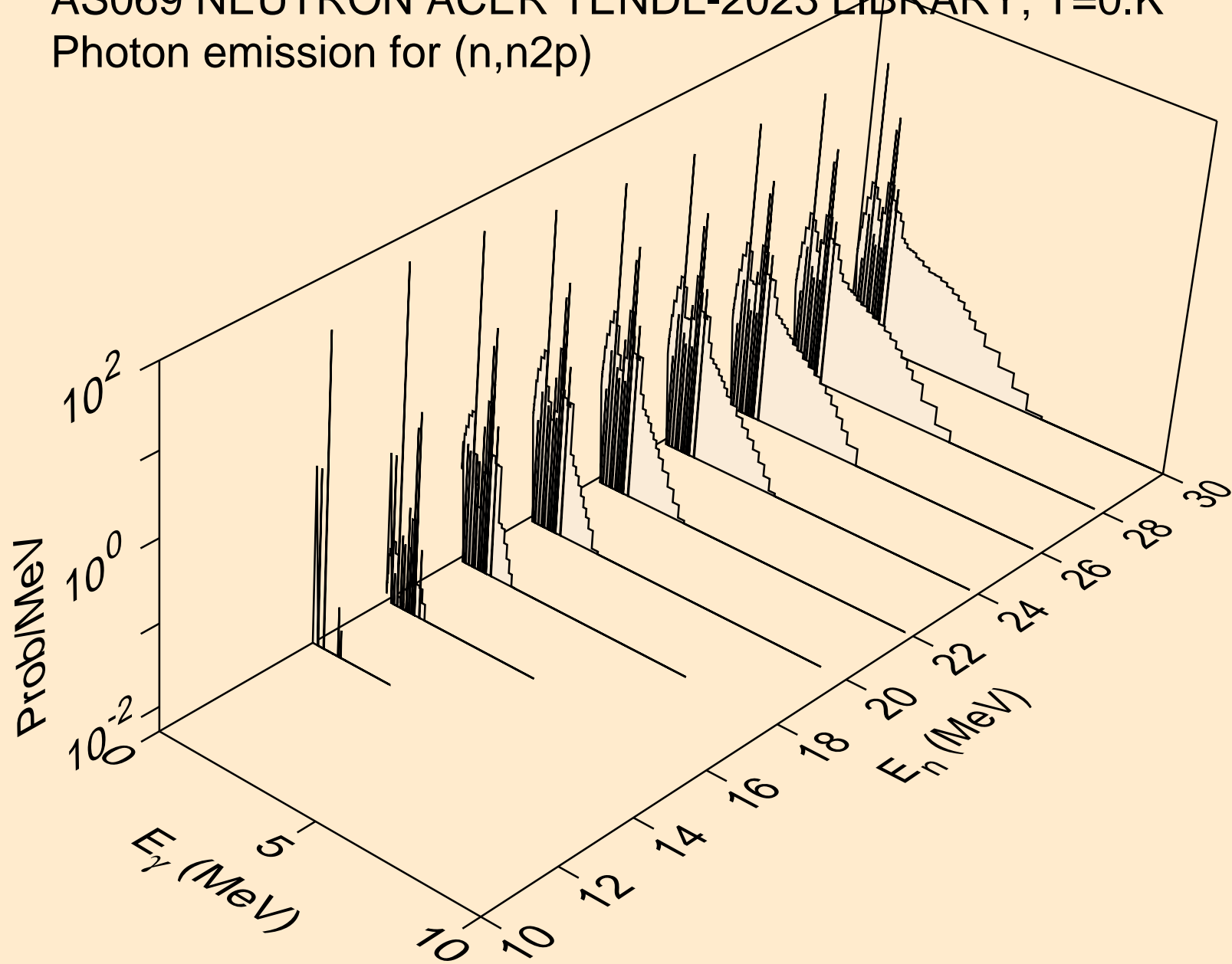

AS069 NEUTRON ACER TENDL-2023 LIBRARY; T=0.K  
Photon emission for (n,npa)

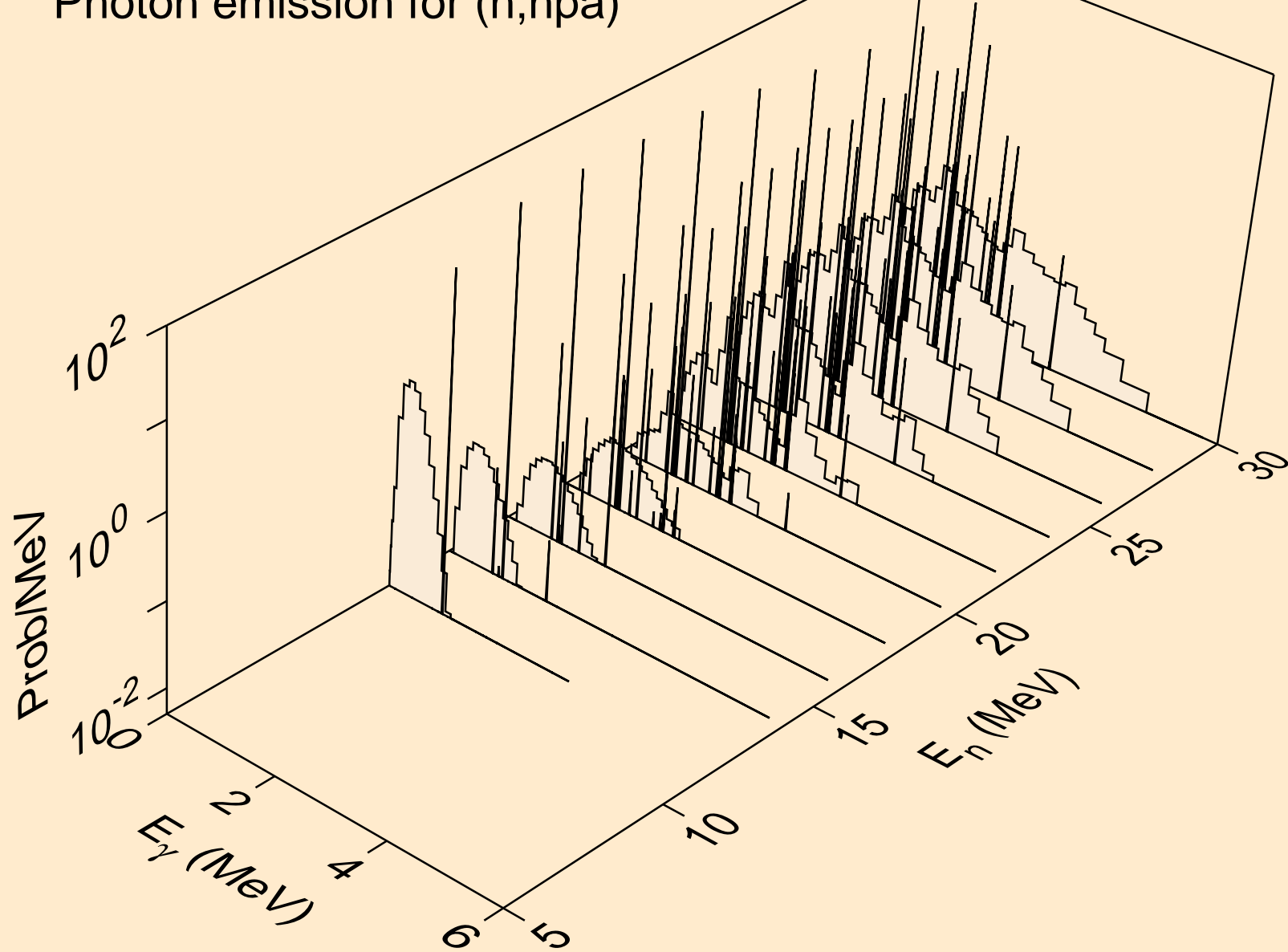

AS069 NEUTRON ACER TENDL-2023 LIBRARY; T=0.K  
Photon emission for (n,n\*c)

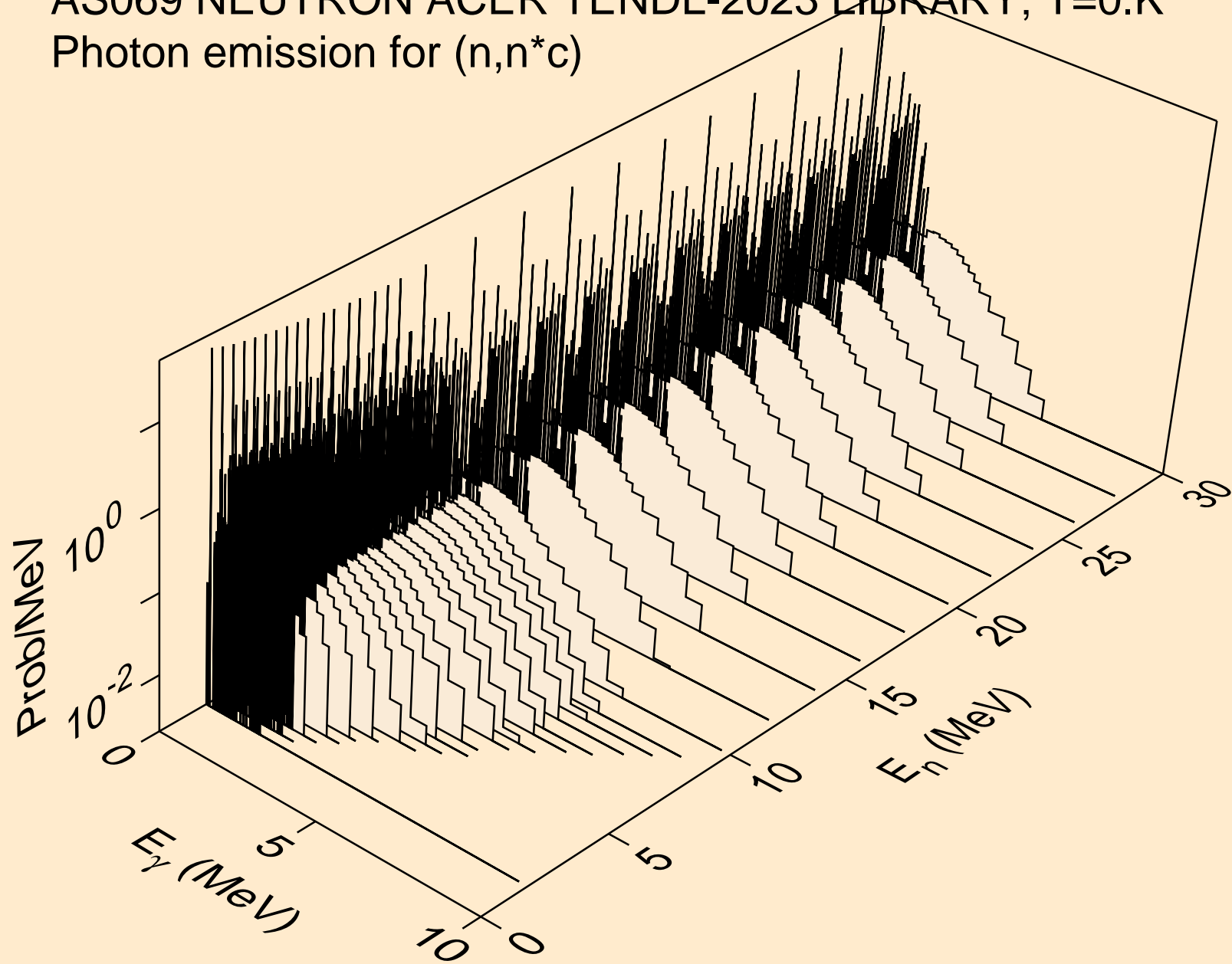

AS069 NEUTRON ACER TENDL-2023 LIBRARY; T=0.K  
Photon emission for (n,gma)

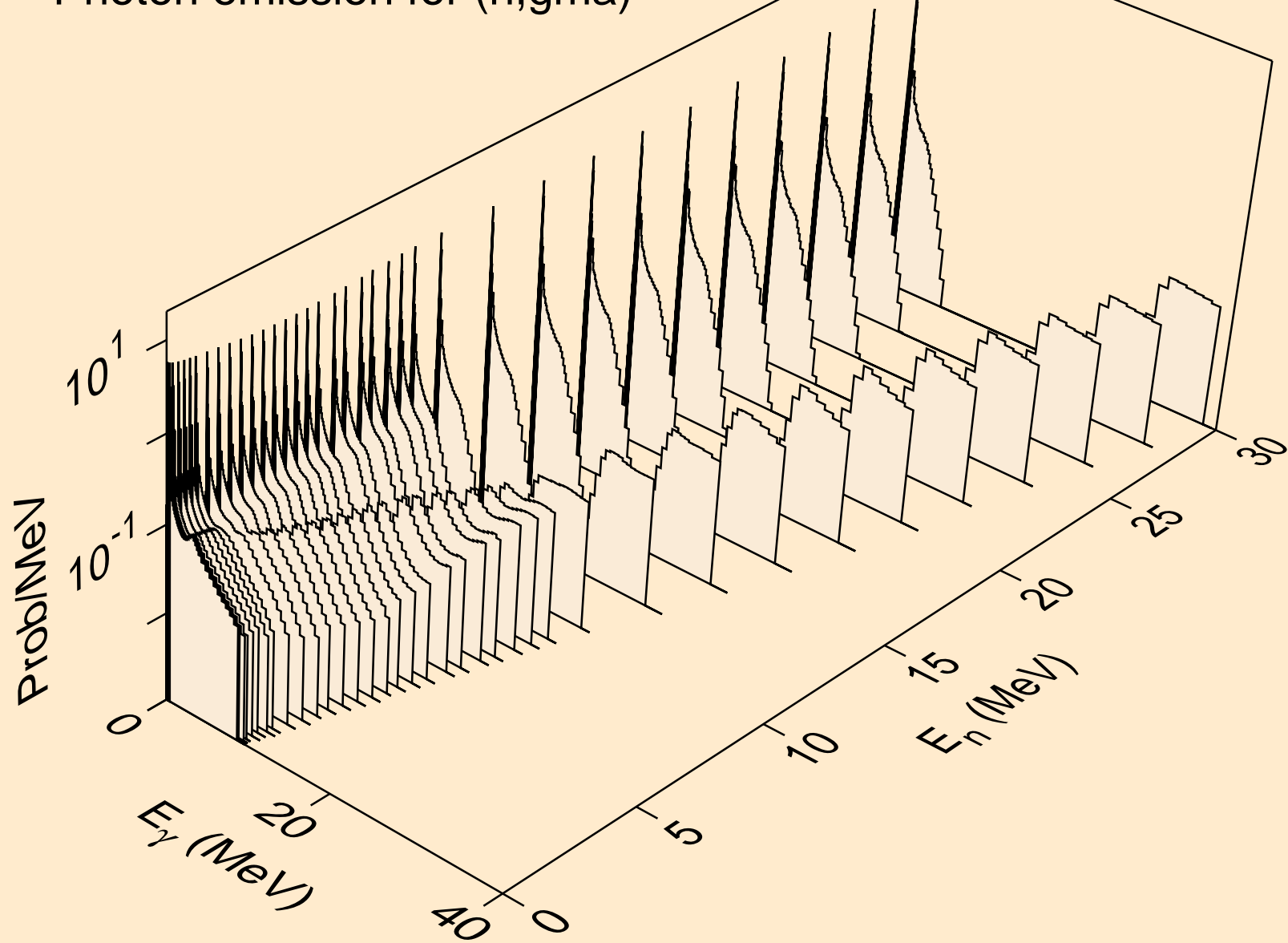

AS069 NEUTRON ACER TENDL-2023 LIBRARY; T=0.K  
Photon emission for (n,p)

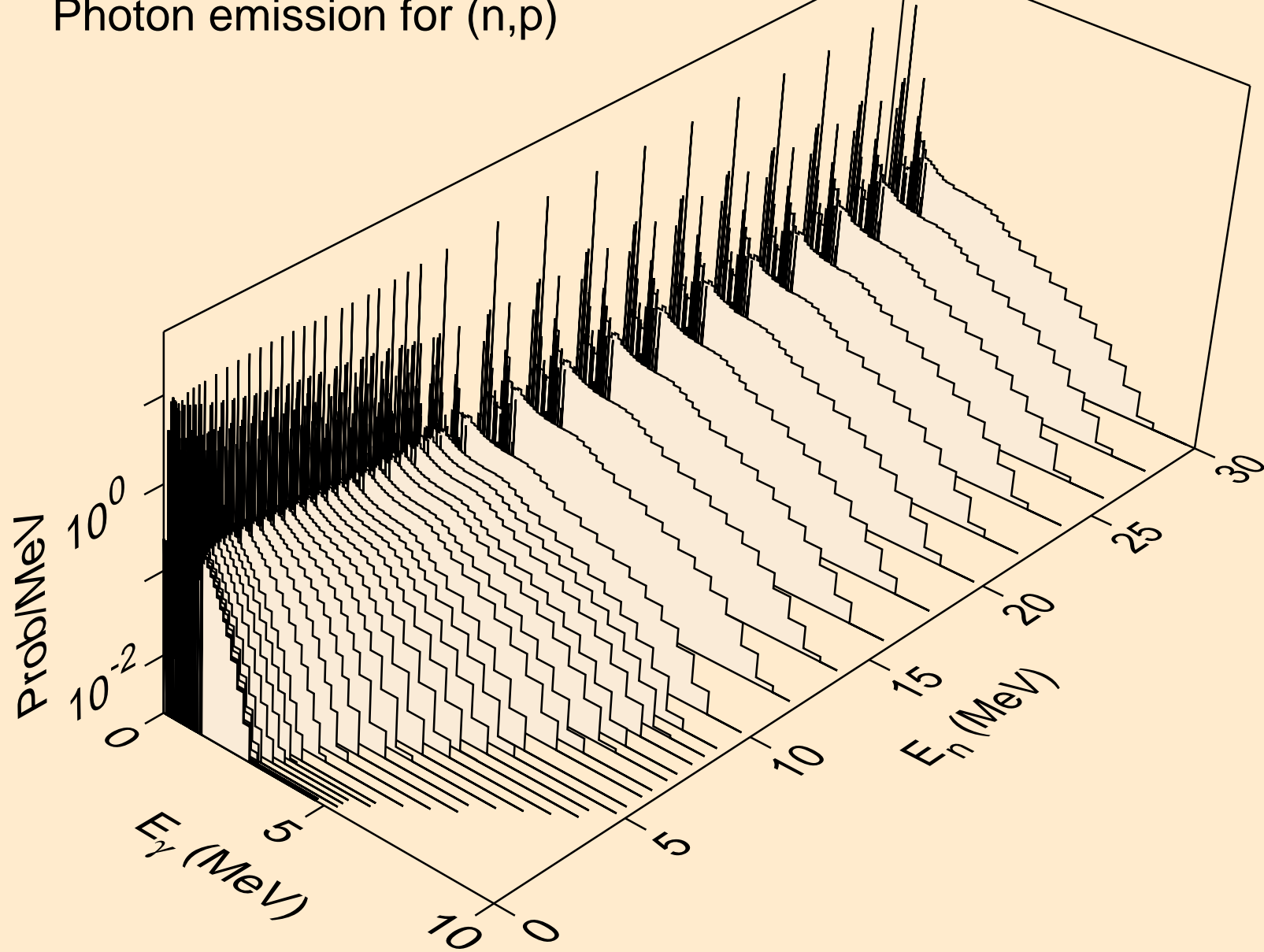

AS069 NEUTRON ACER TENDL-2023 LIBRARY; T=0.K  
Photon emission for (n,d)

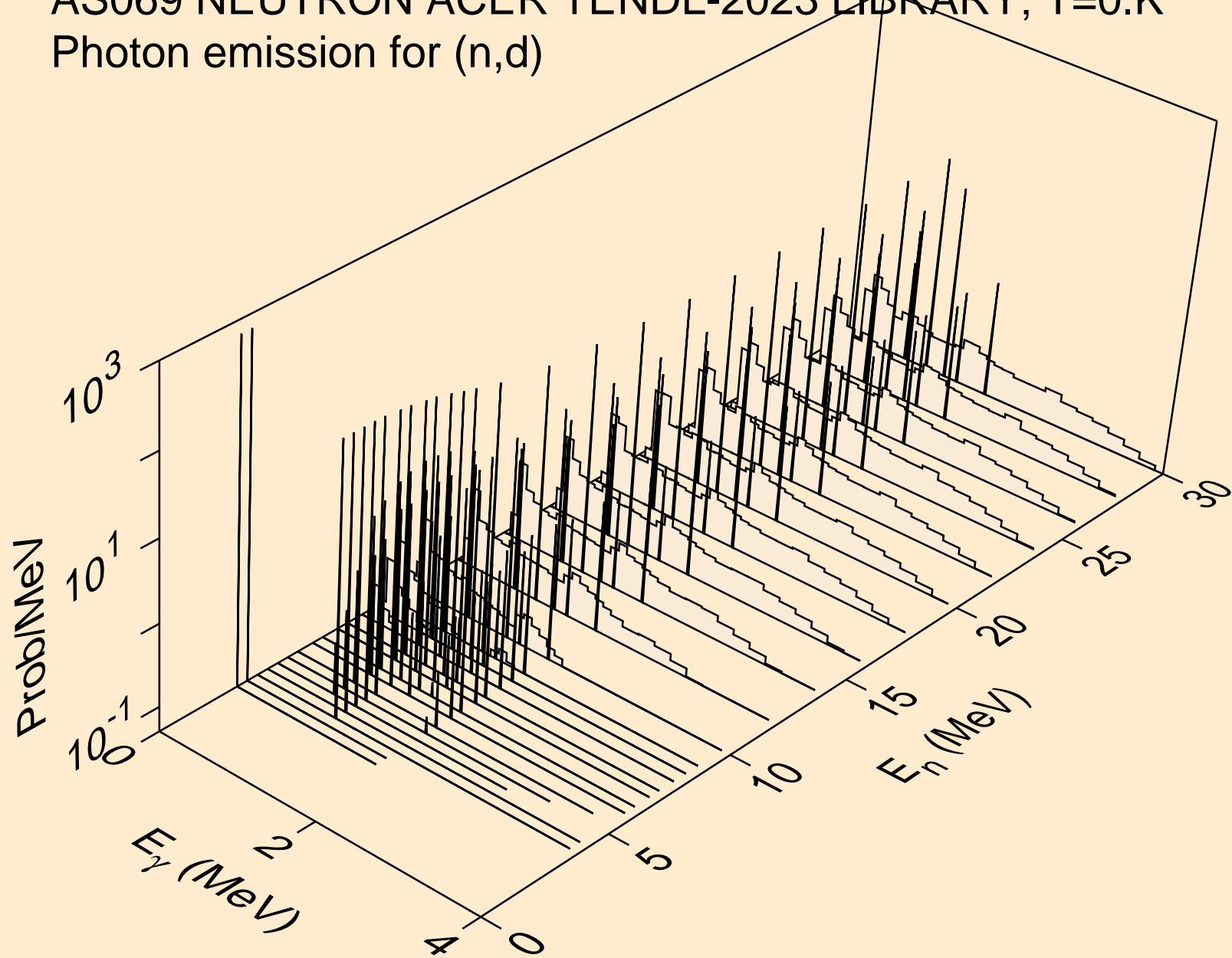

AS069 NEUTRON ACER TENDL-2023 LIBRARY; T=0.K  
Photon emission for (n,t)

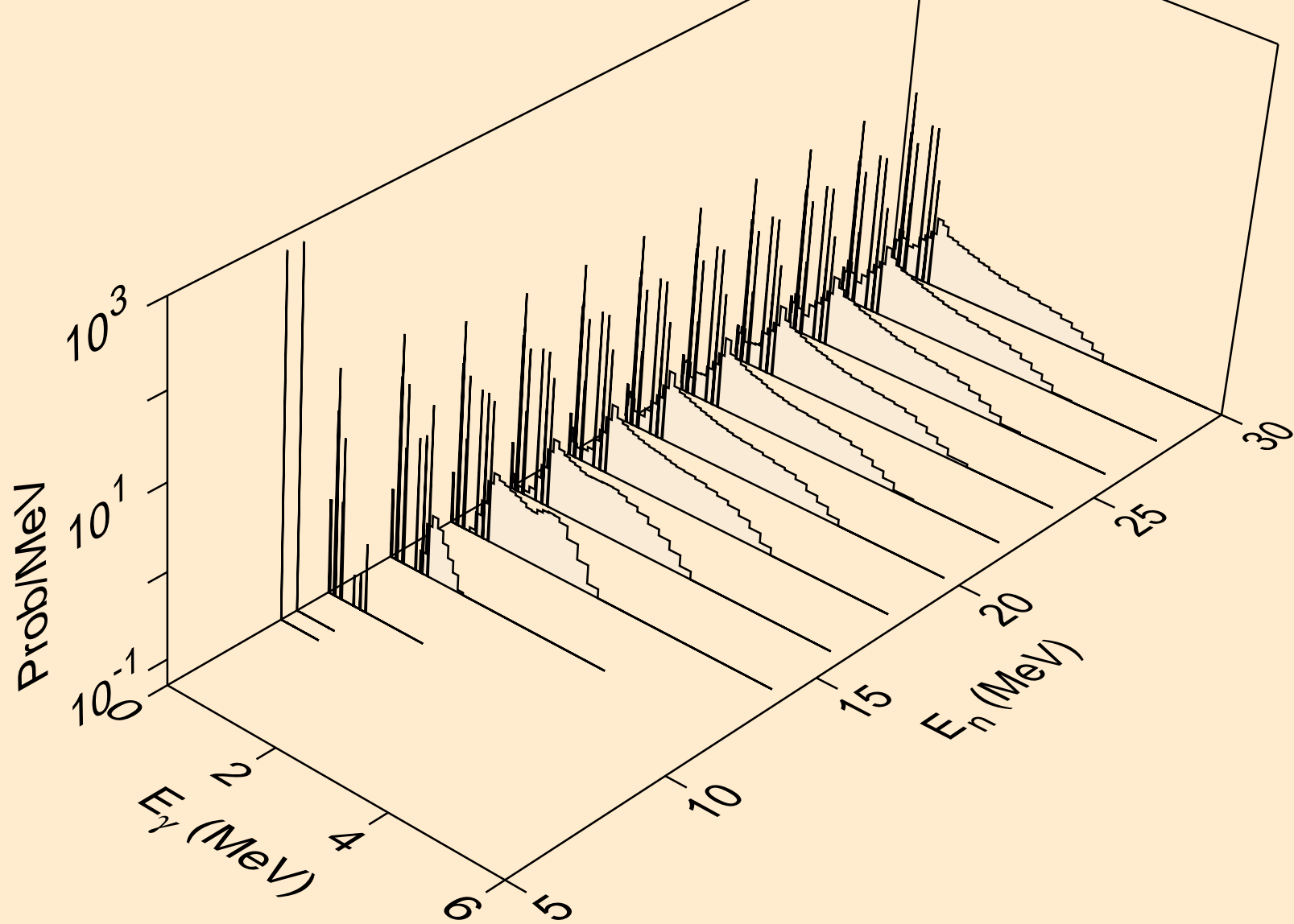

AS069 NEUTRON ACER TENDL-2023 LIBRARY; T=0.K  
Photon emission for (n,he3)

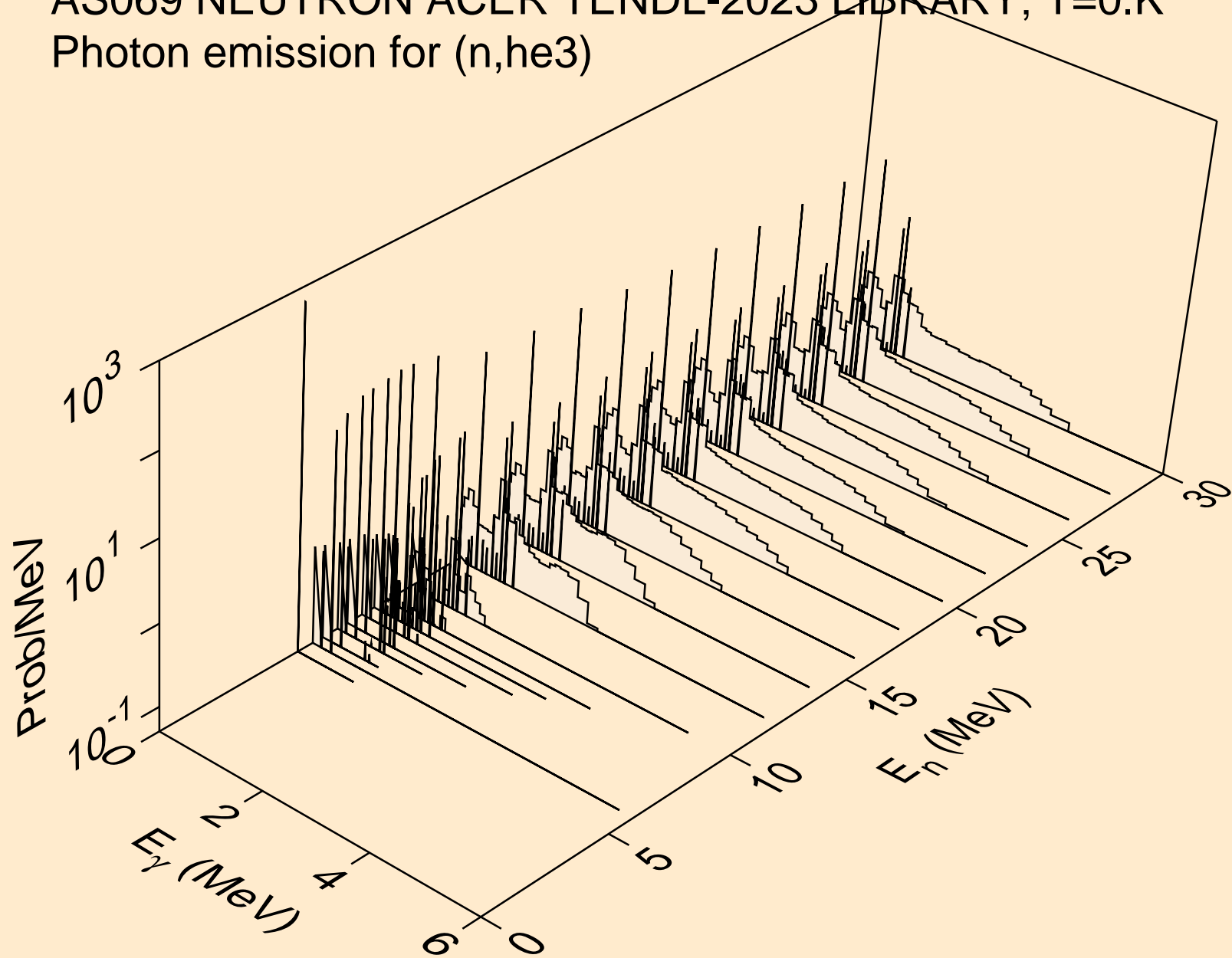

AS069 NEUTRON ACER TENDL-2023 LIBRARY; T=0.K  
Photon emission for (n,a)

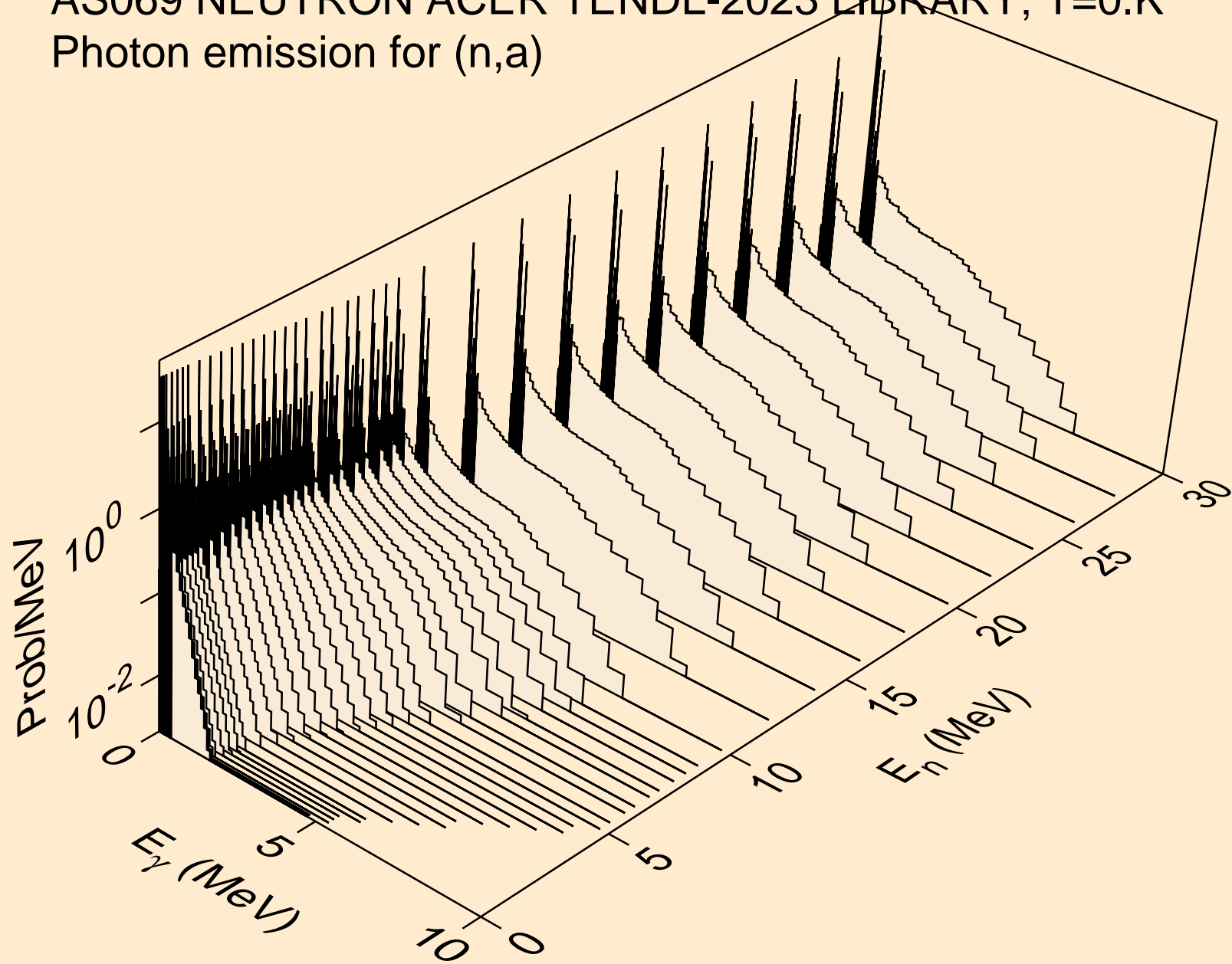

AS069 NEUTRON ACER TENDL-2023 LIBRARY; T=0.K  
Photon emission for (n,2a)

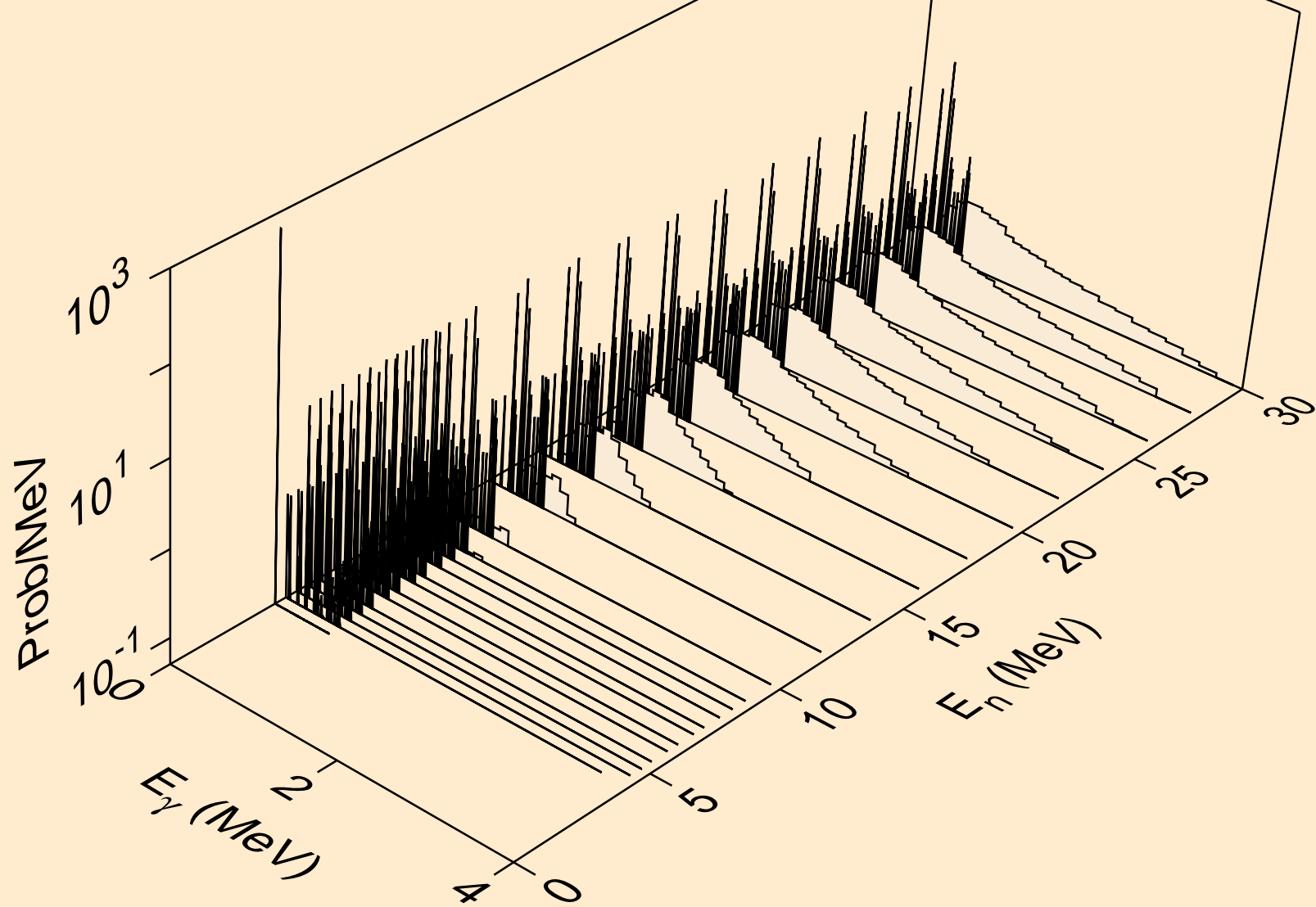

AS069 NEUTRON ACER TENDL-2023 LIBRARY; T=0.K  
Photon emission for (n,3a)

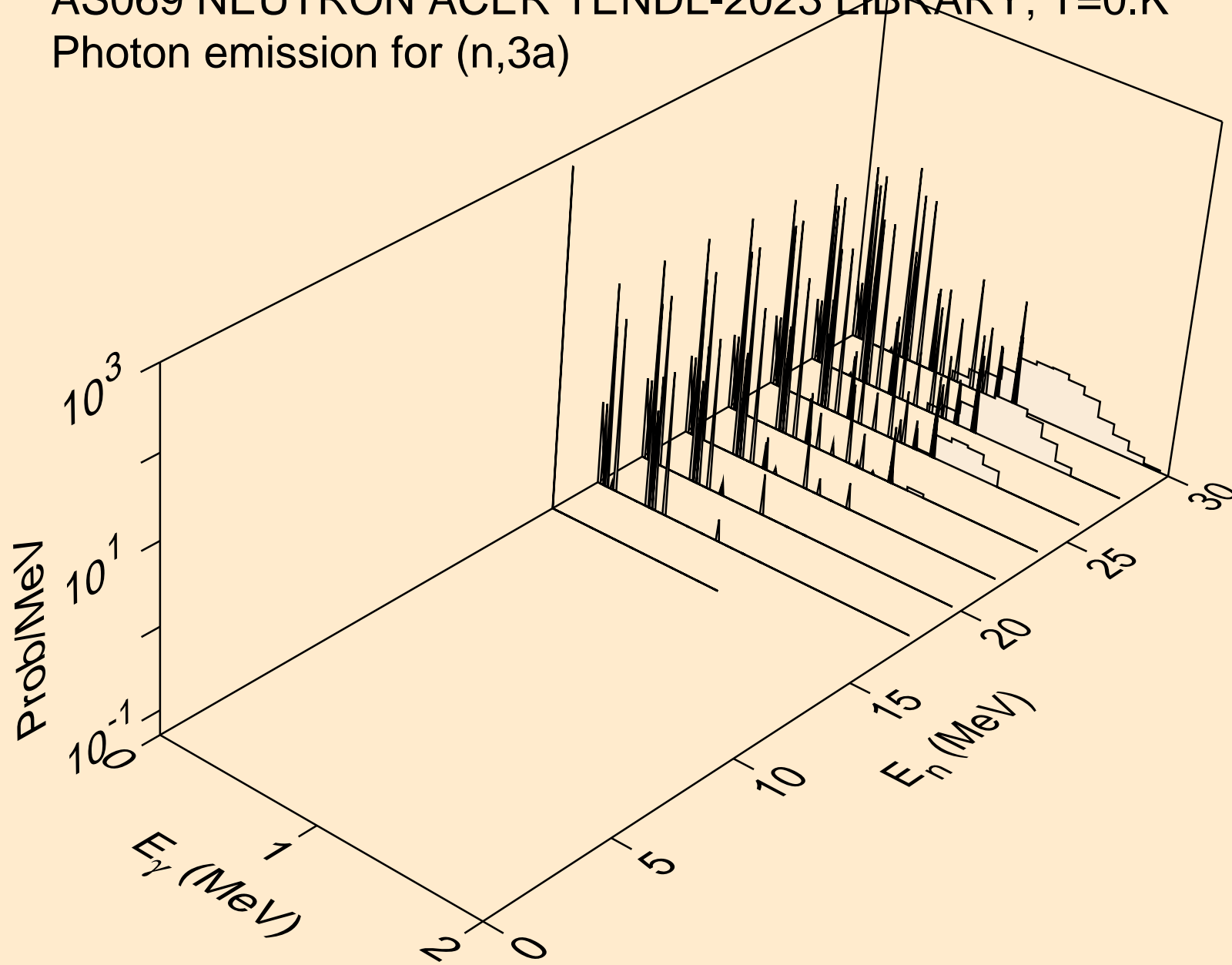

AS069 NEUTRON ACER TENDL-2023 LIBRARY; T=0.K  
Photon emission for (n,2p)

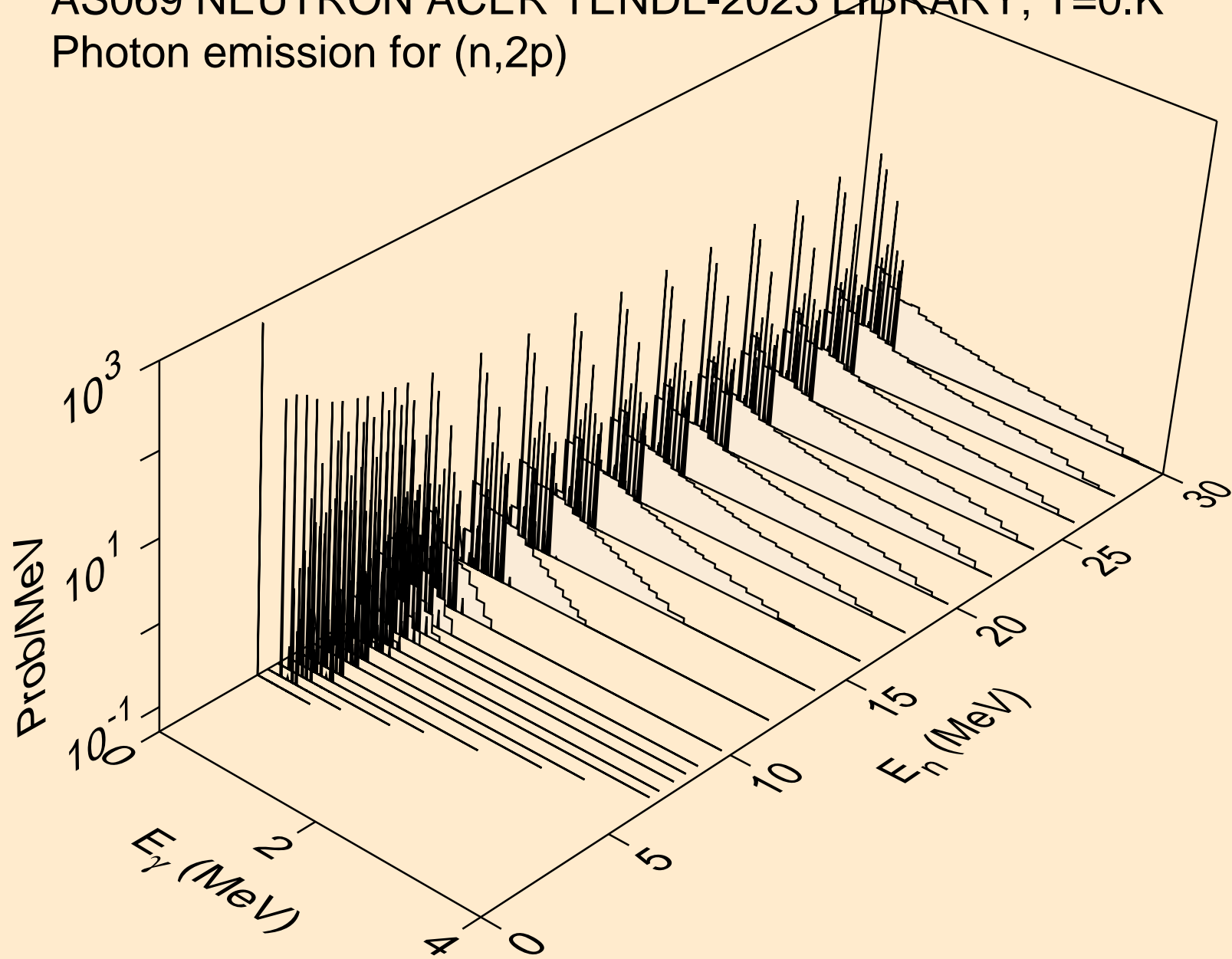

AS069 NEUTRON ACER TENDL-2023 LIBRARY; T=0.K  
Photon emission for (n,p $\alpha$ )

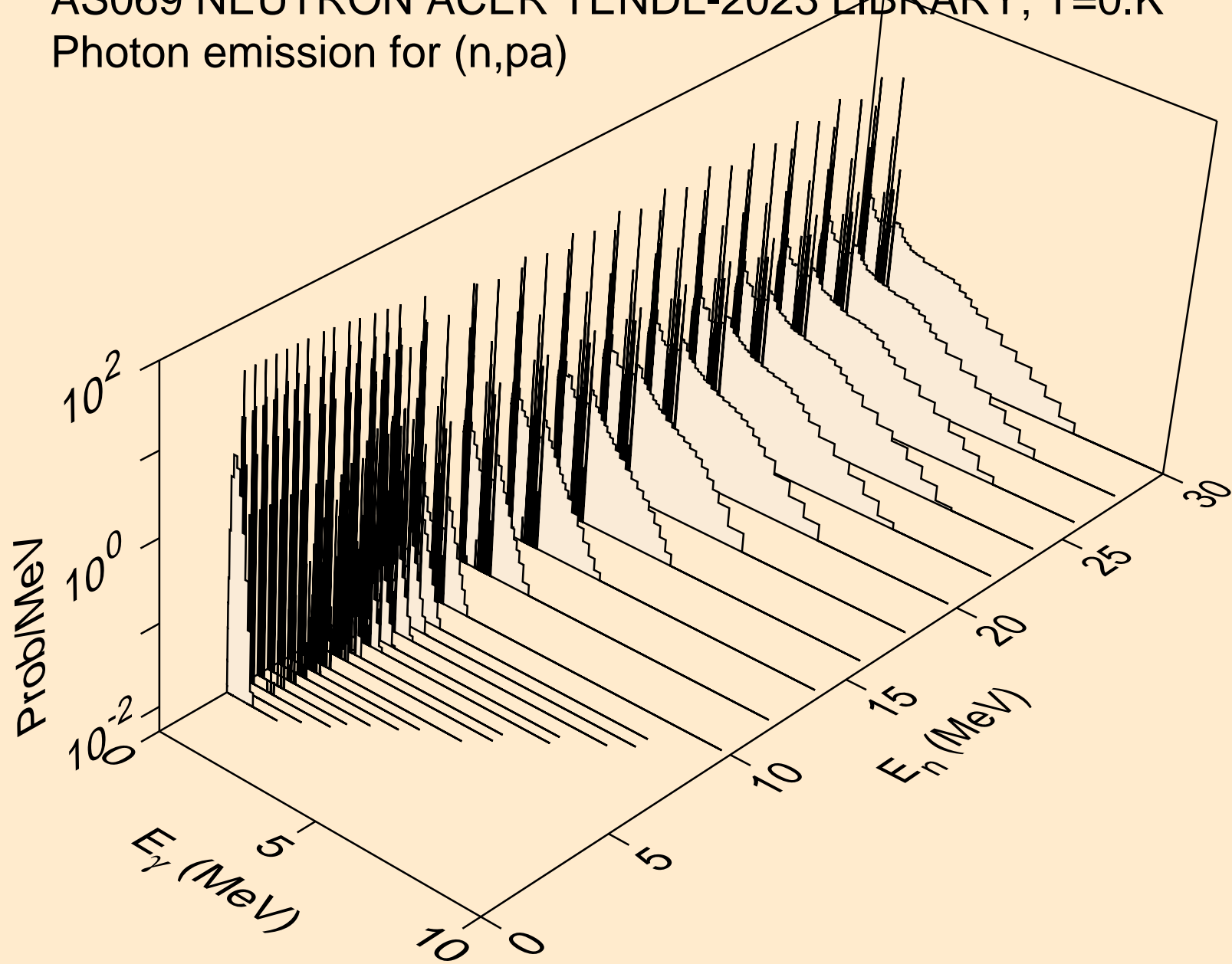

AS069 NEUTRON ACER TENDL-2023 LIBRARY; T=0.K  
Photon emission for (n,d2a)

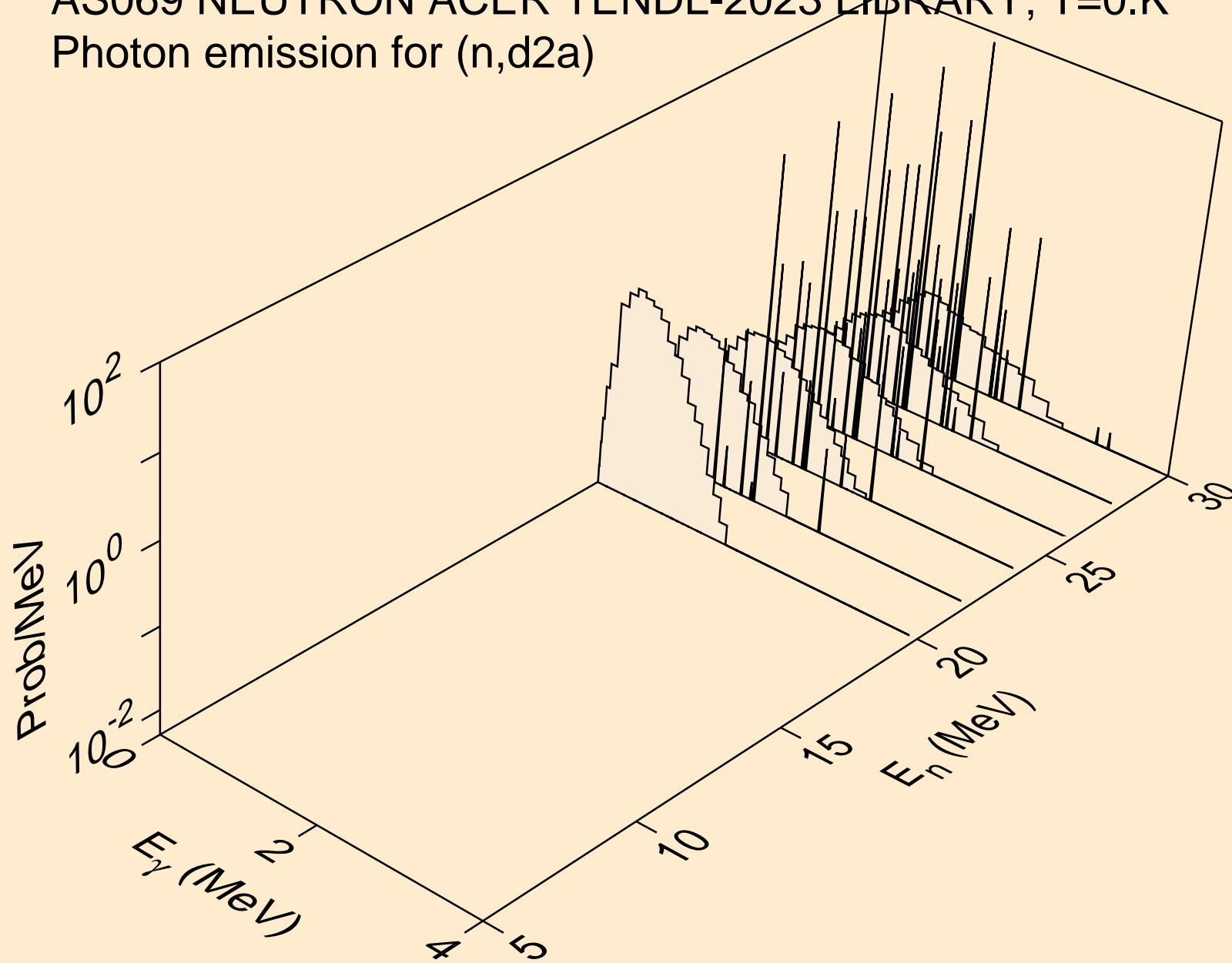

AS069 NEUTRON ACER TENDL-2023 LIBRARY; T=0.K  
Photon emission for (n,pd)

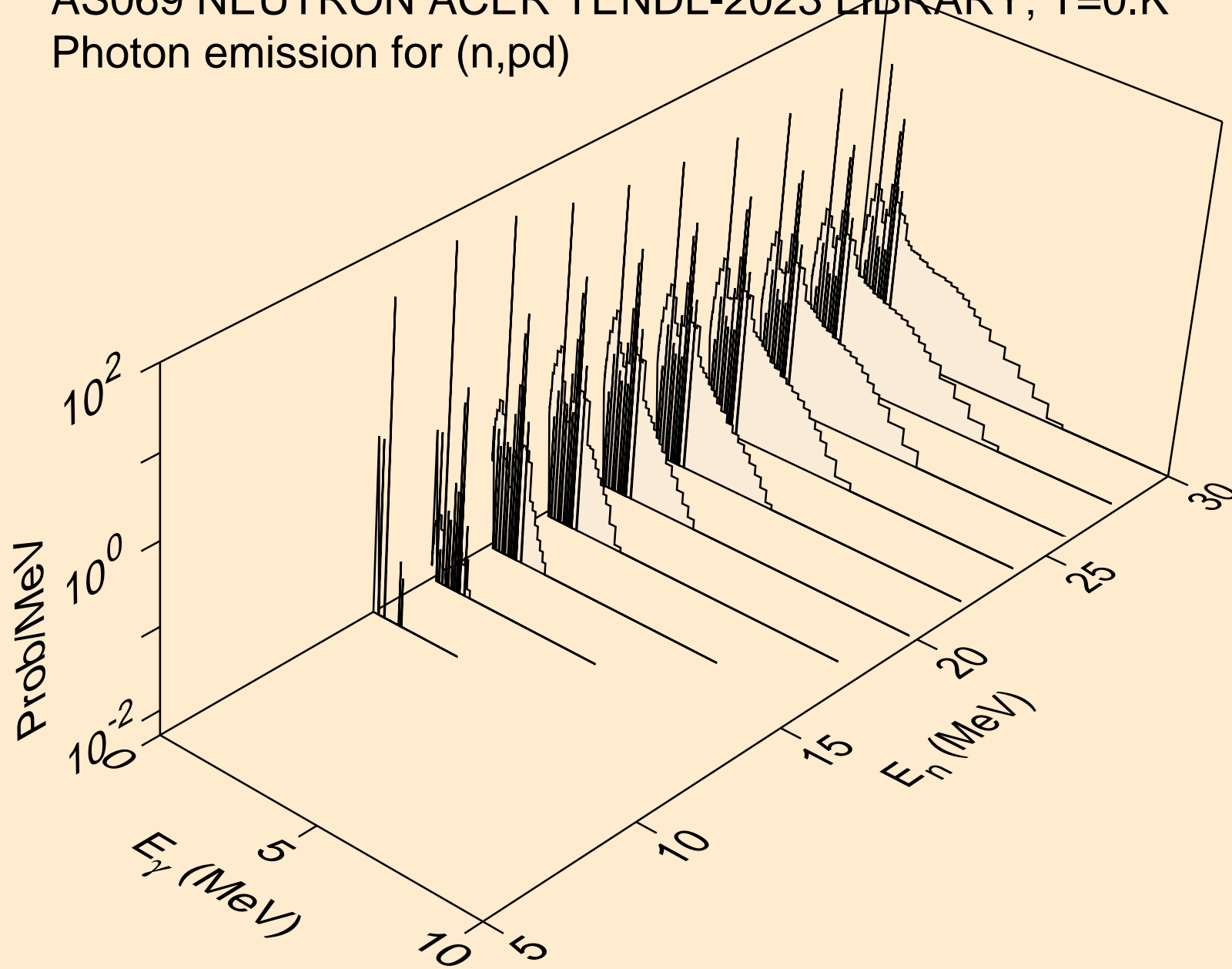

AS069 NEUTRON ACER TENDL-2023 LIBRARY; T=0.K  
Photon emission for (n,pt)

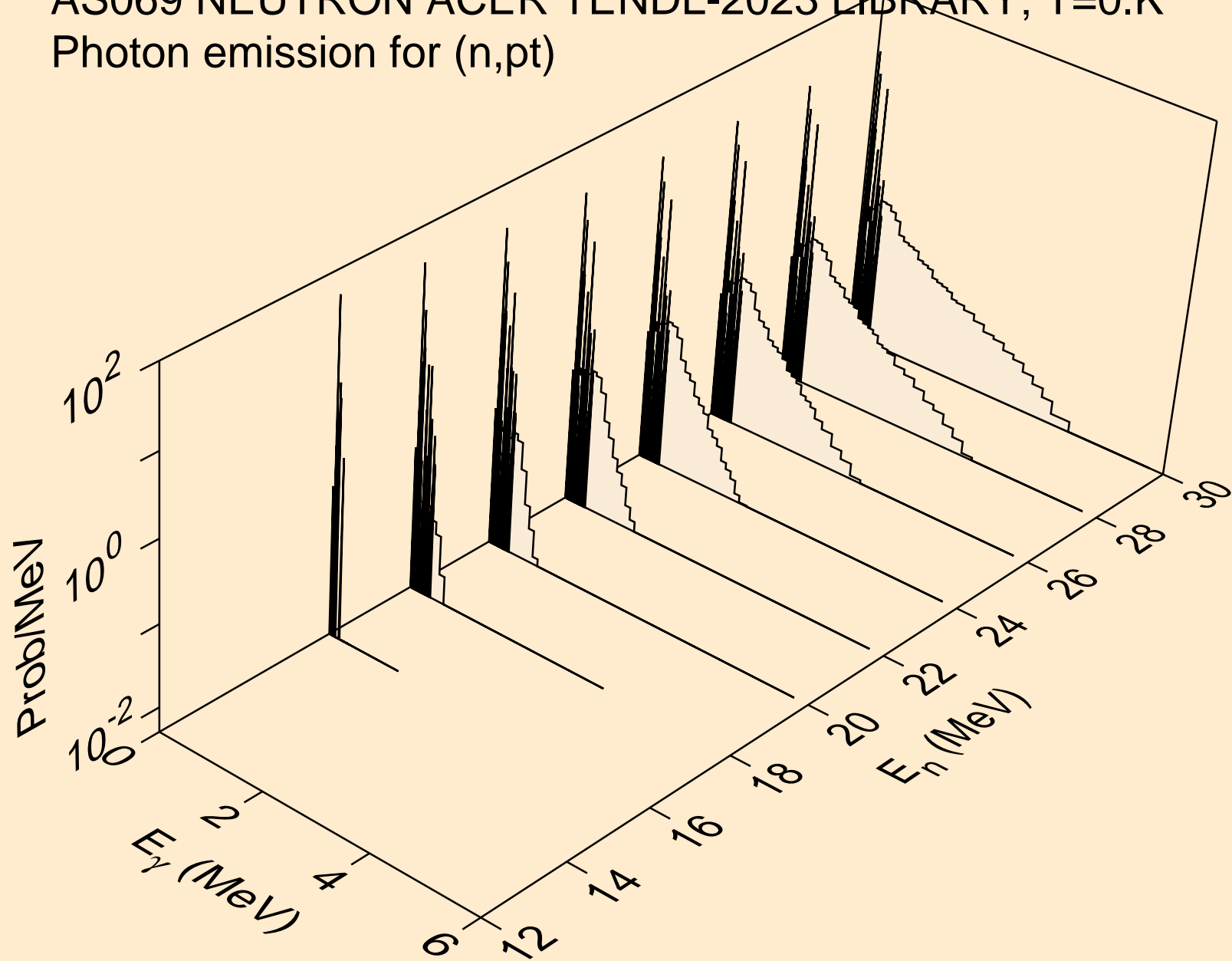

AS069 NEUTRON ACER TENDL-2023 LIBRARY; T=0.K  
Photon emission for (n,da)

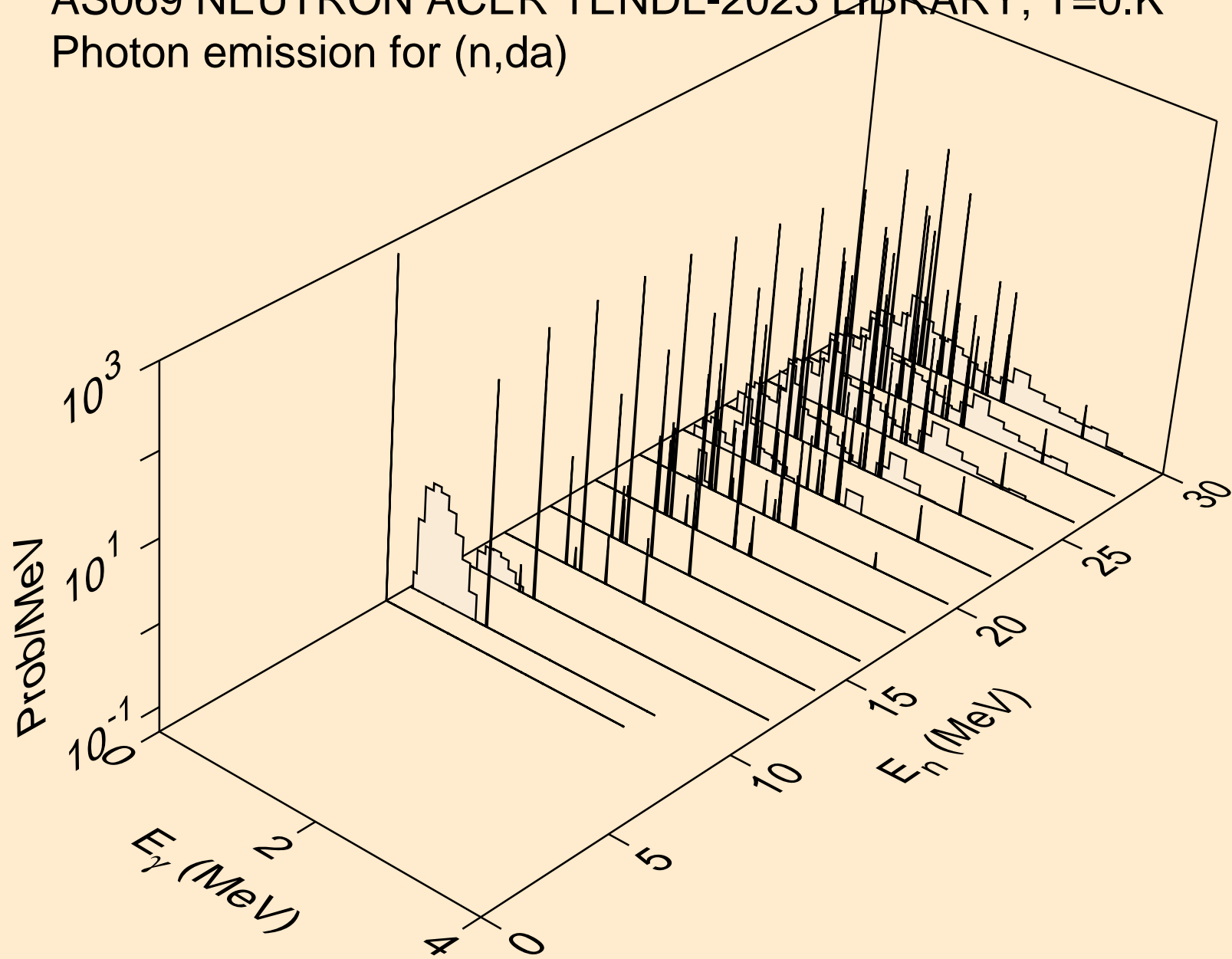

AS069 NEUTRON ACER TENDL-2023 LIBRARY; T=0.K  
thermal capture photon spectrum

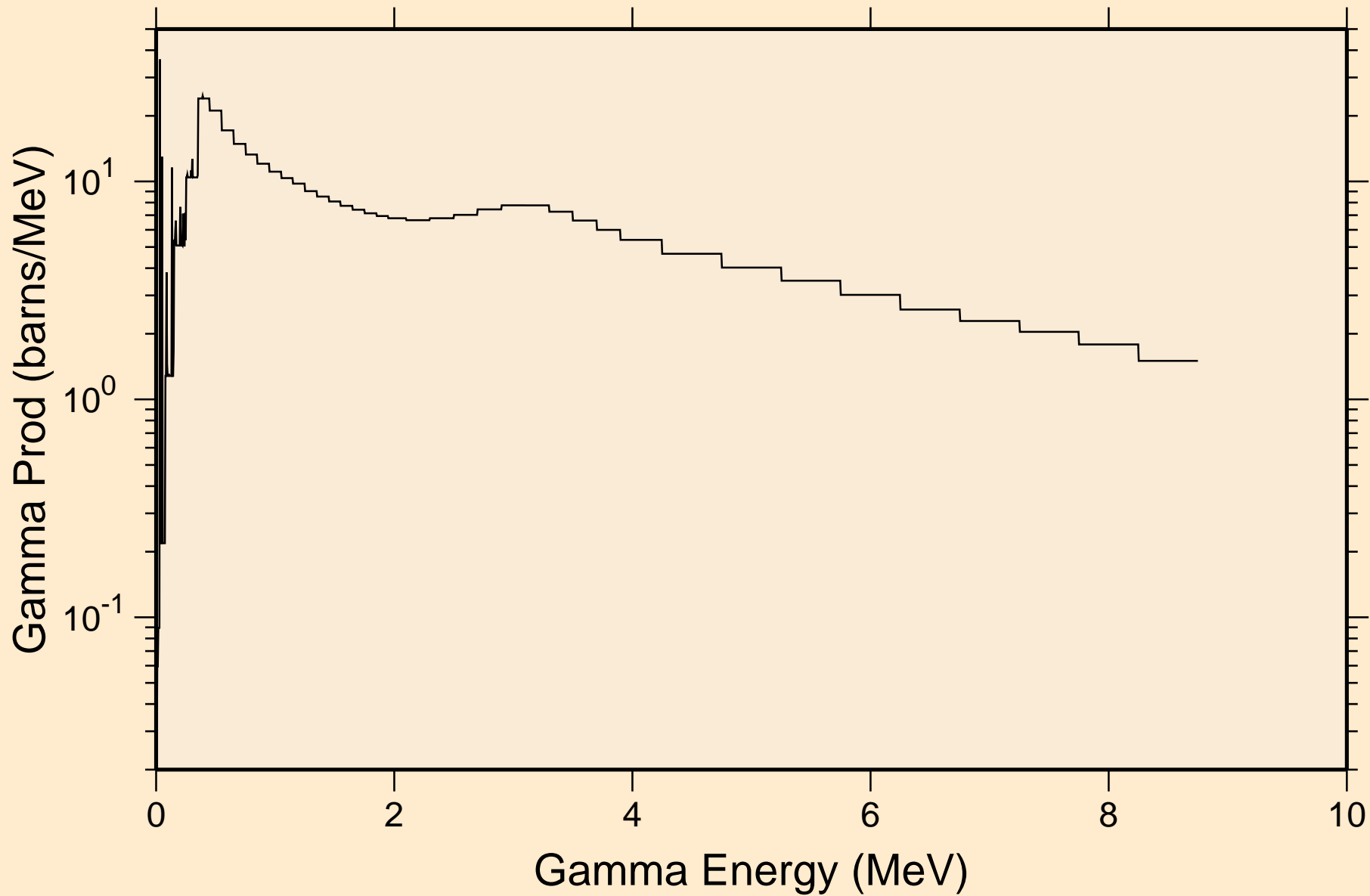

AS069 NEUTRON ACER TENDL-2023 LIBRARY; T=0.K  
14 MeV photon spectrum

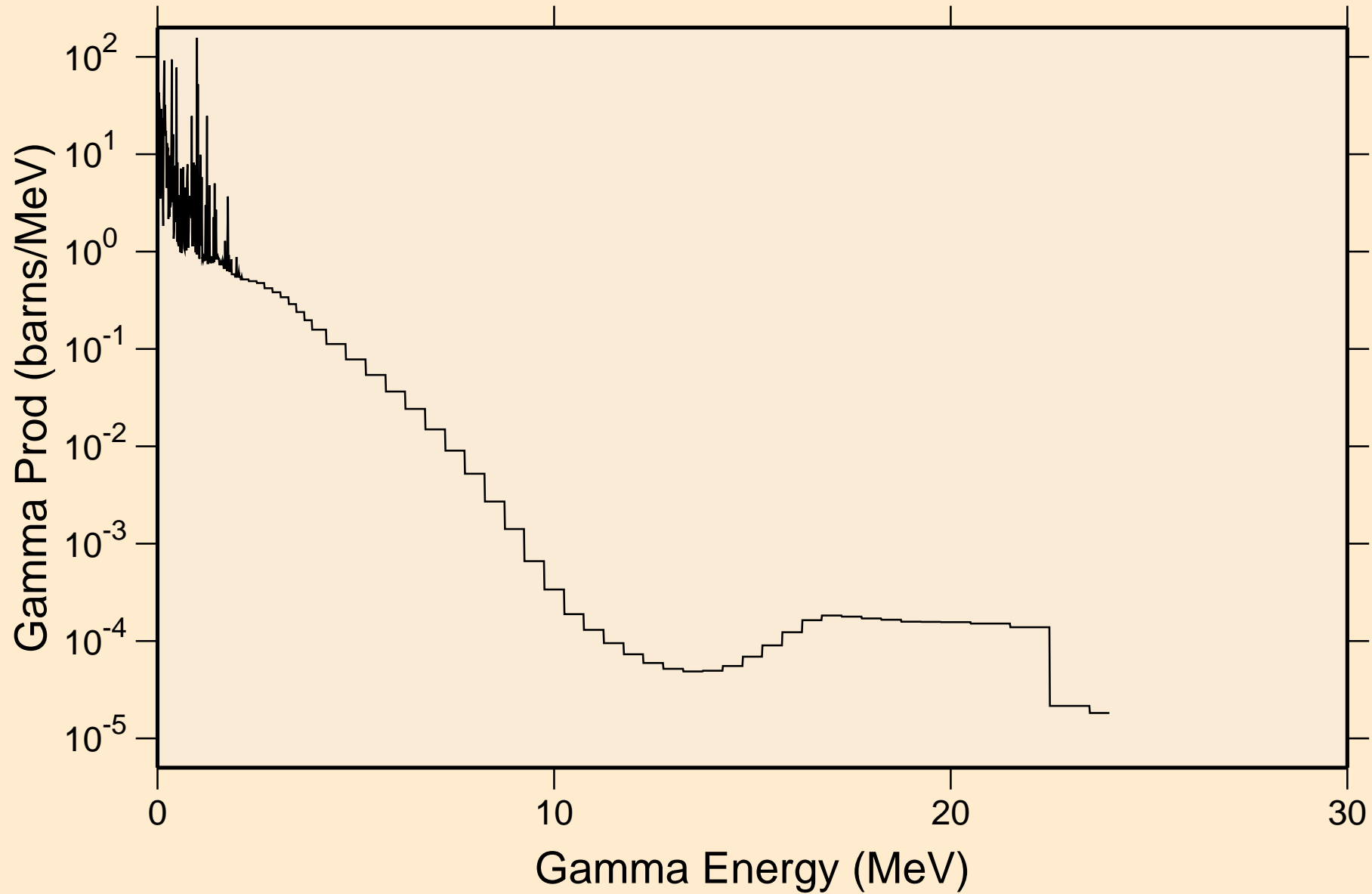

AS069 NEUTRON ACER TENDL-2023 LIBRARY; T=0.K  
Particle heating contributions

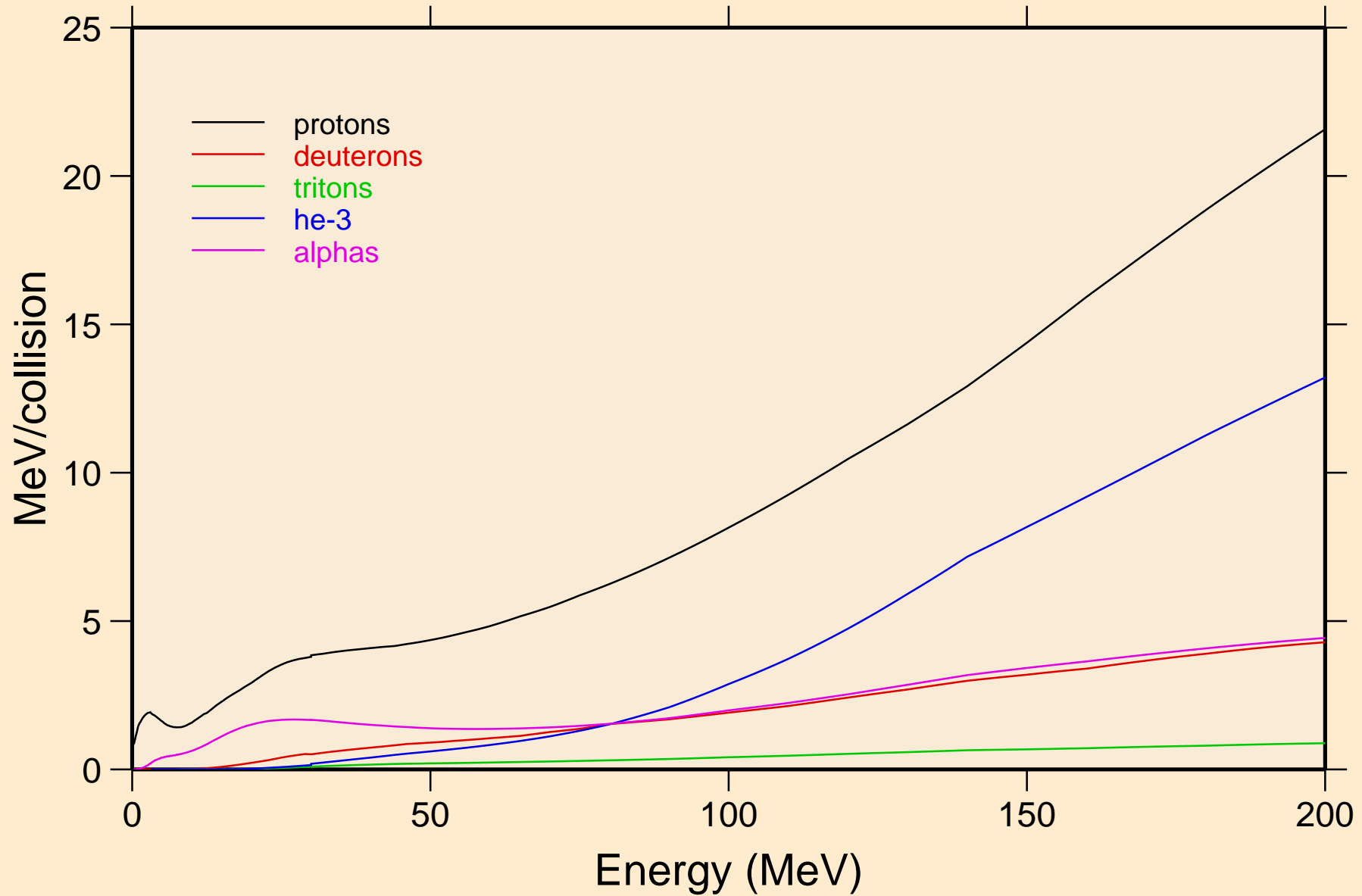

AS069 NEUTRON ACER TENDL-2023 LIBRARY; T=0.K  
Recoil Heating

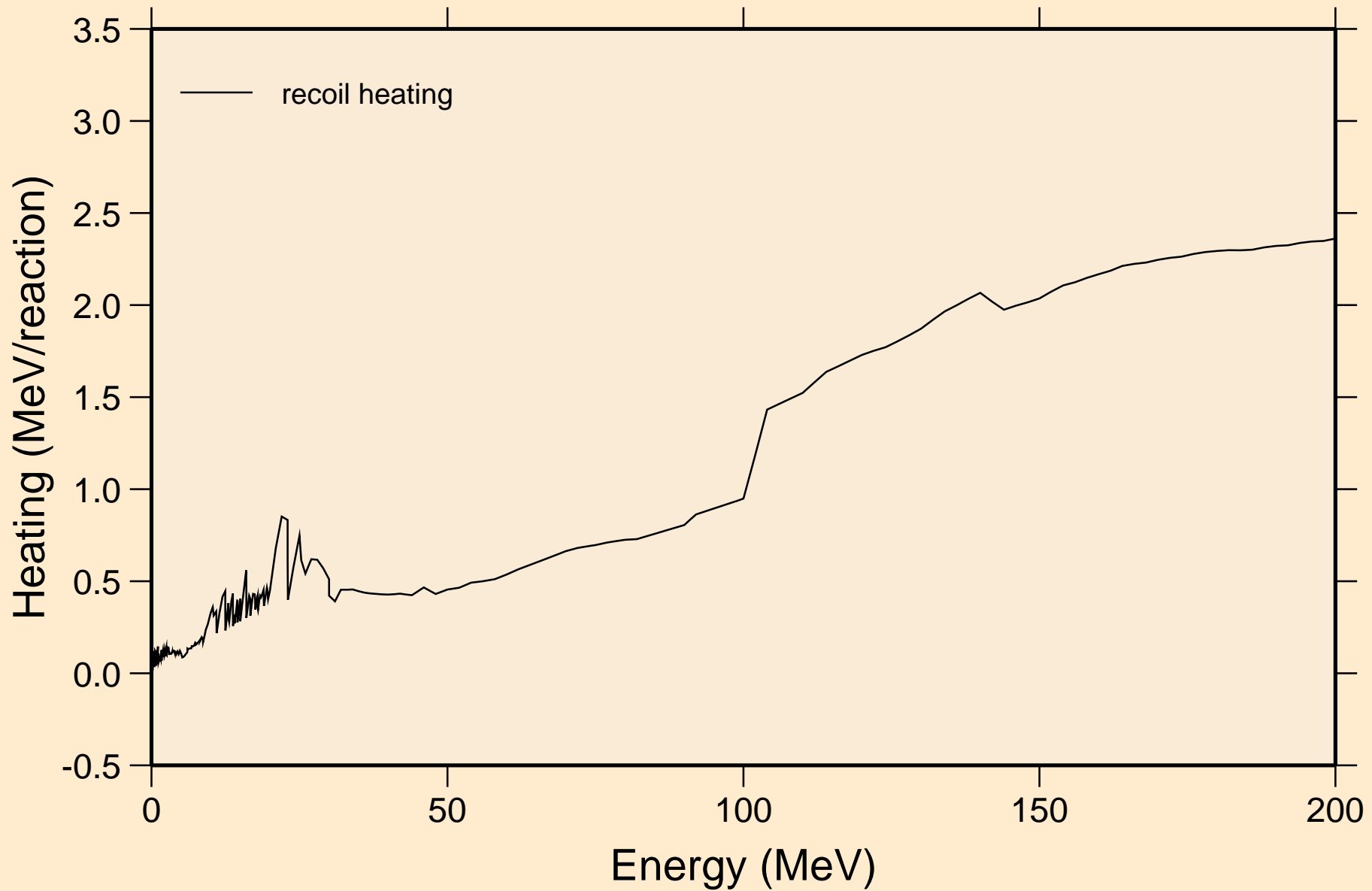

AS069 NEUTRON ACER TENDL-2023 LIBRARY; T=0.K  
Particle production cross sections

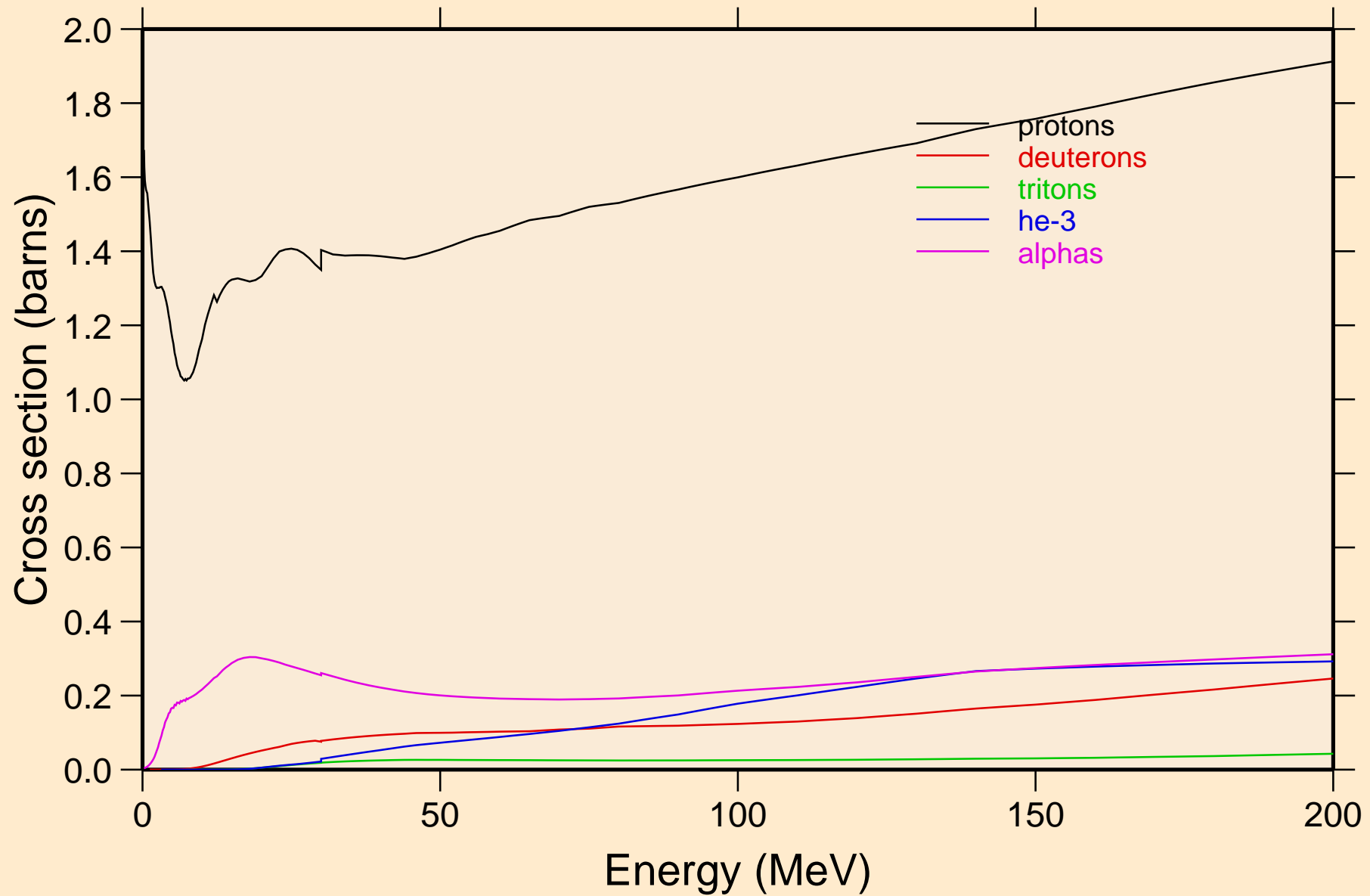

AS069 NEUTRON ACER TENDL-2023 LIBRARY; T=0.K  
protons from (n,x)

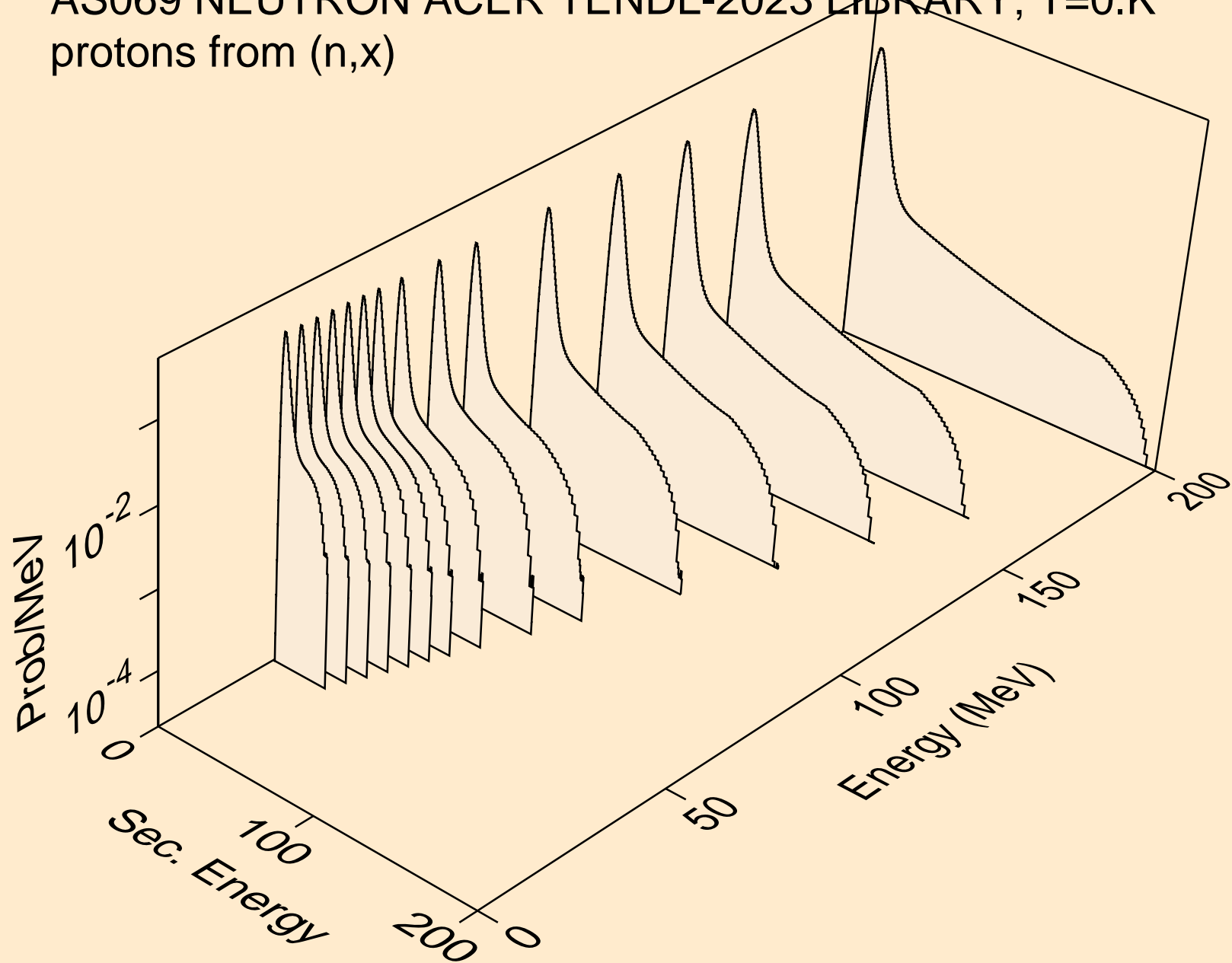

AS069 NEUTRON ACER TENDL-2023 LIBRARY; T=0.K  
protons from (n,n\*)p

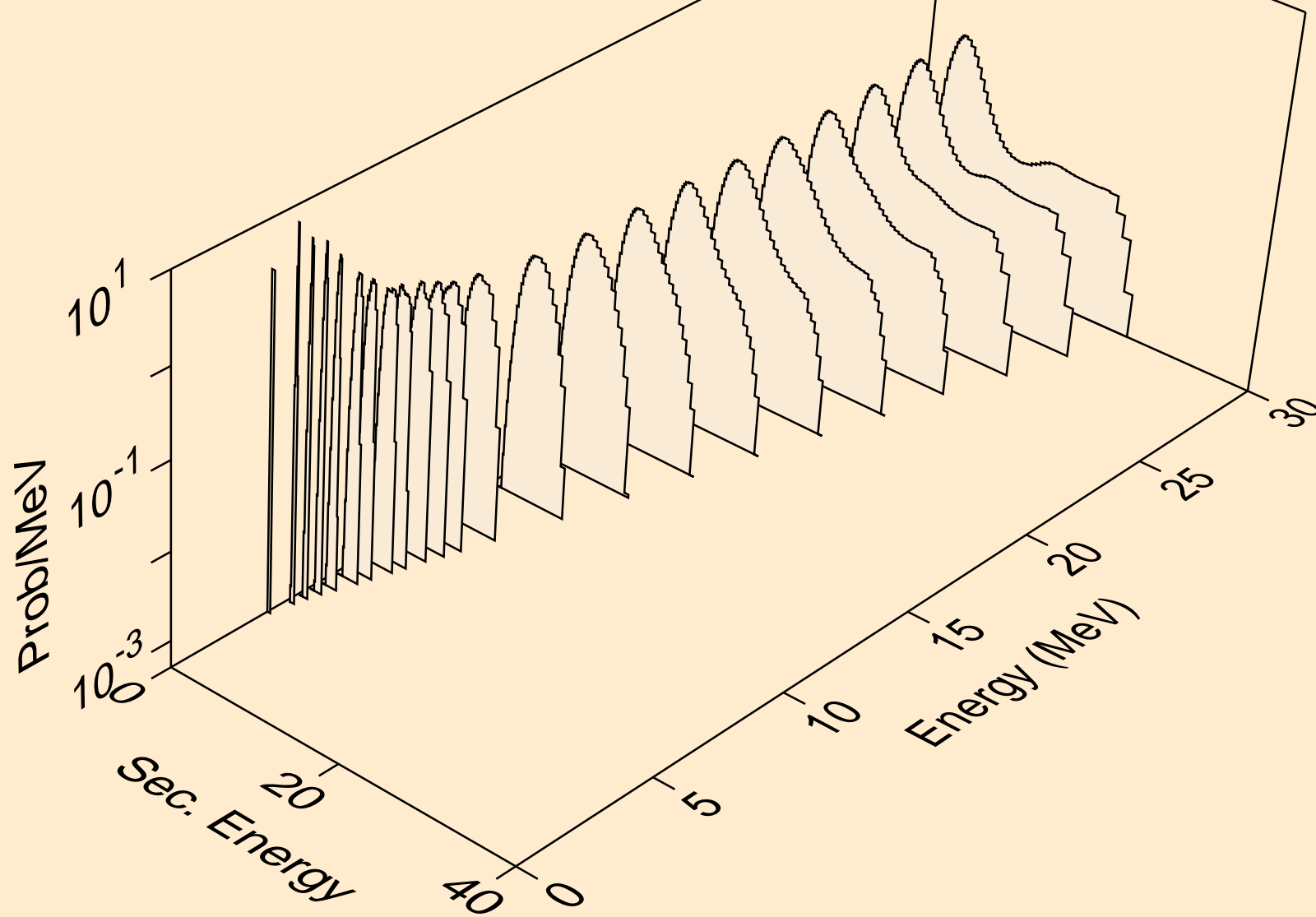

AS069 NEUTRON ACER TENDL-2023 LIBRARY; T=0.K  
protons from (n,2np)

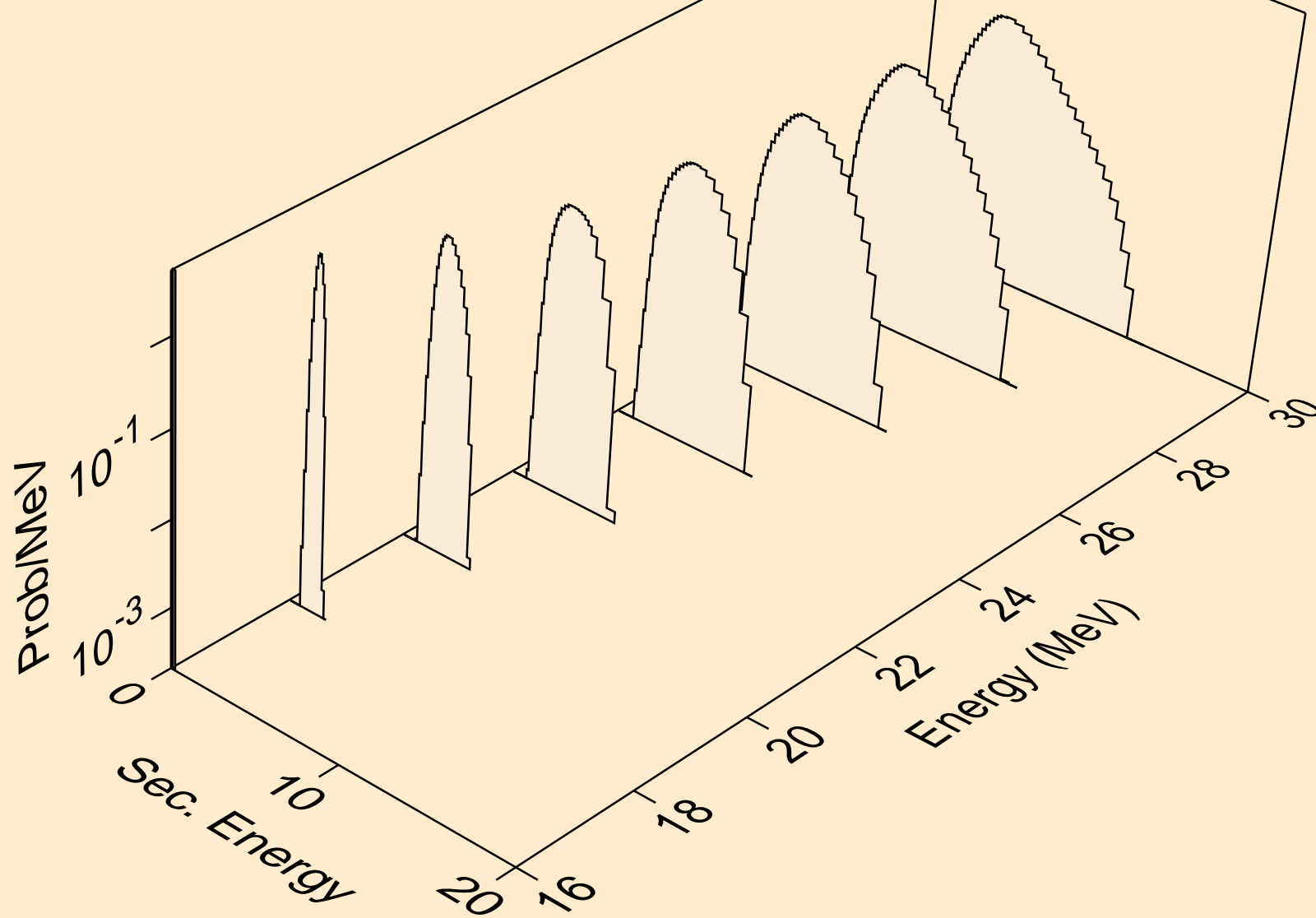

AS069 NEUTRON ACER TENDL-2023 LIBRARY; T=0.K  
protons from (n,3np)

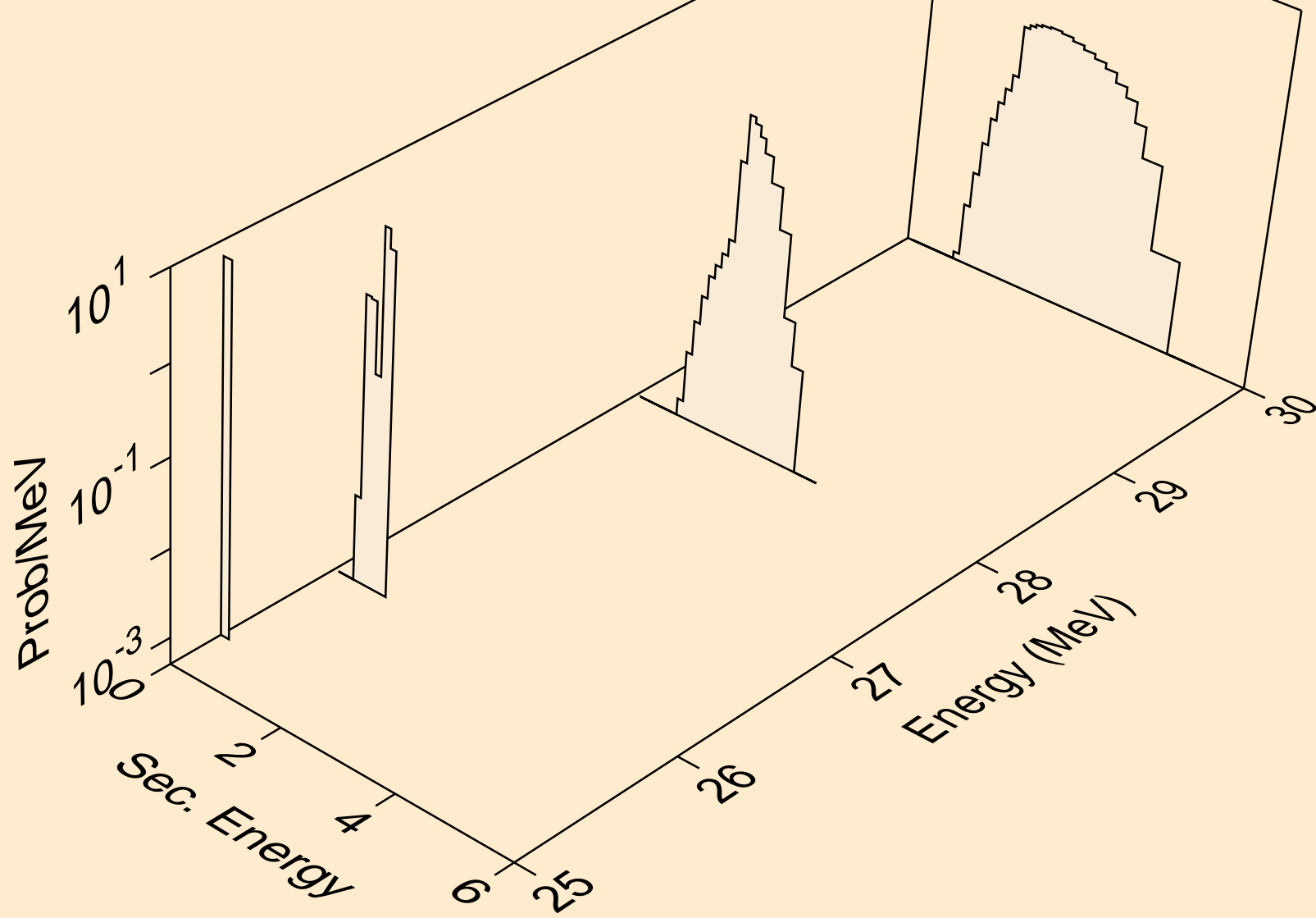

AS069 NEUTRON ACER TENDL-2023 LIBRARY; T=0.K  
protons from (n,n2p)

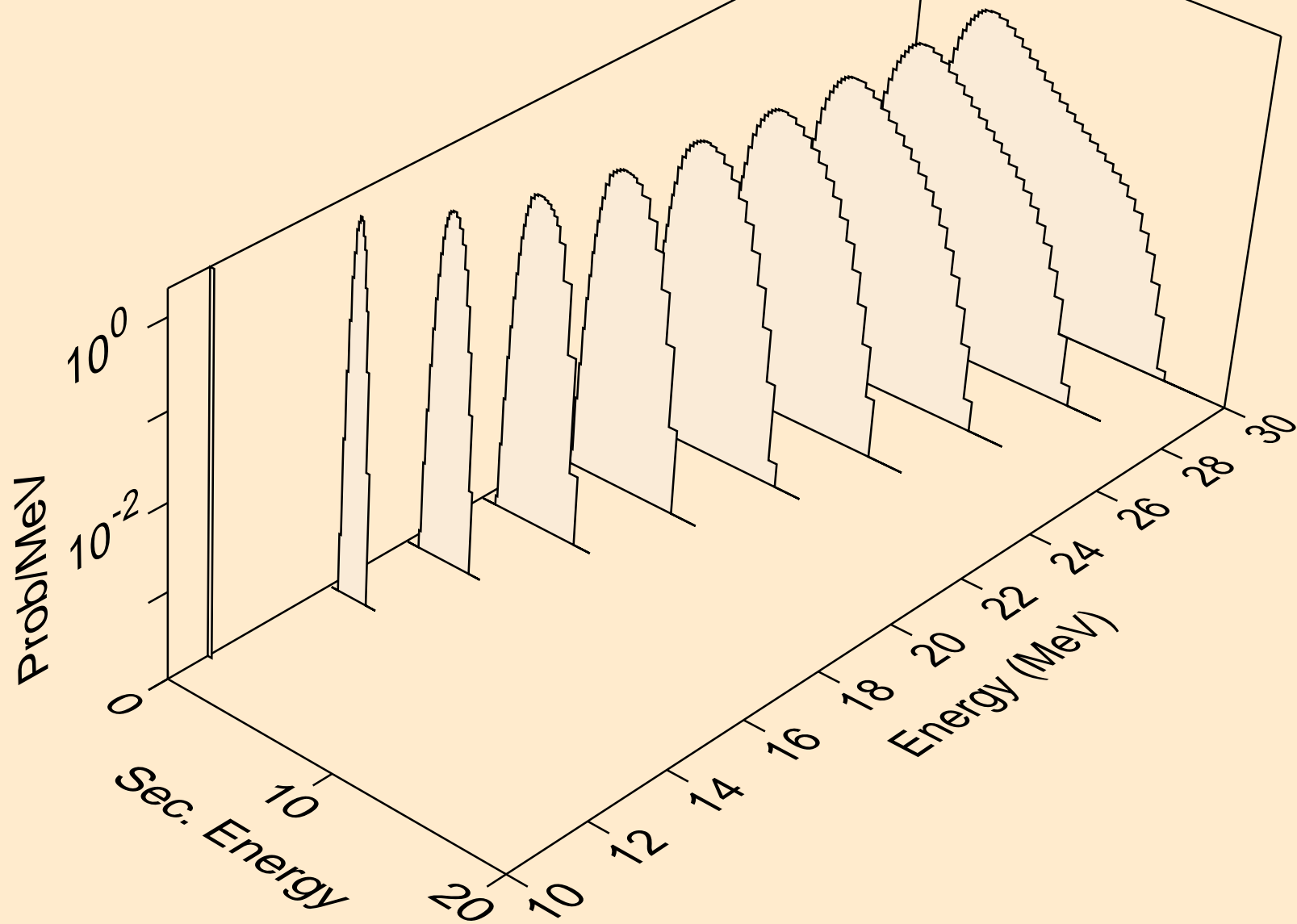

AS069 NEUTRON ACER TENDL-2023 LIBRARY; T=0.K  
protons from (n,npa)

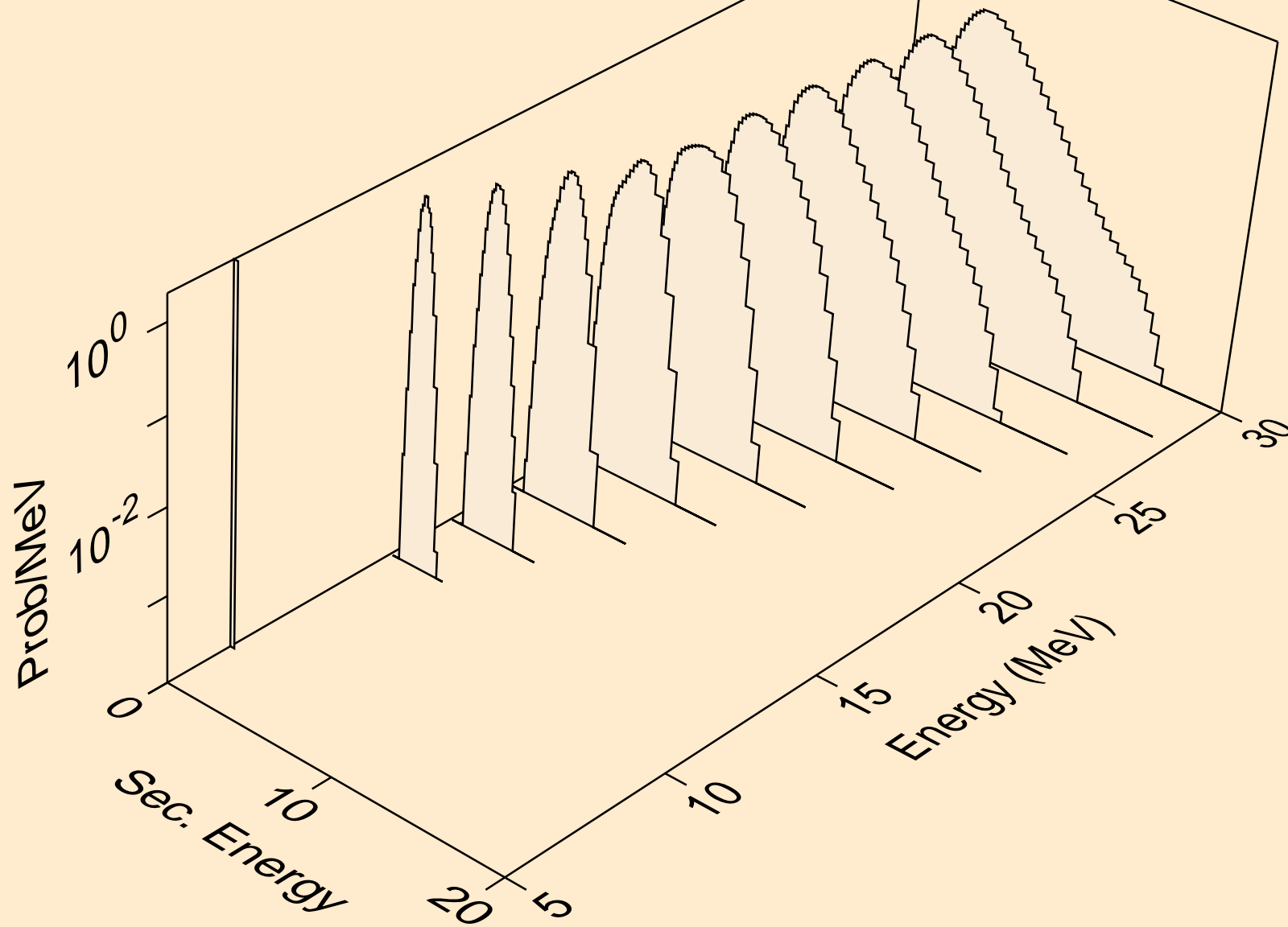

AS069 NEUTRON ACER TENDL-2023 LIBRARY; T=0.K  
protons from (n,p)

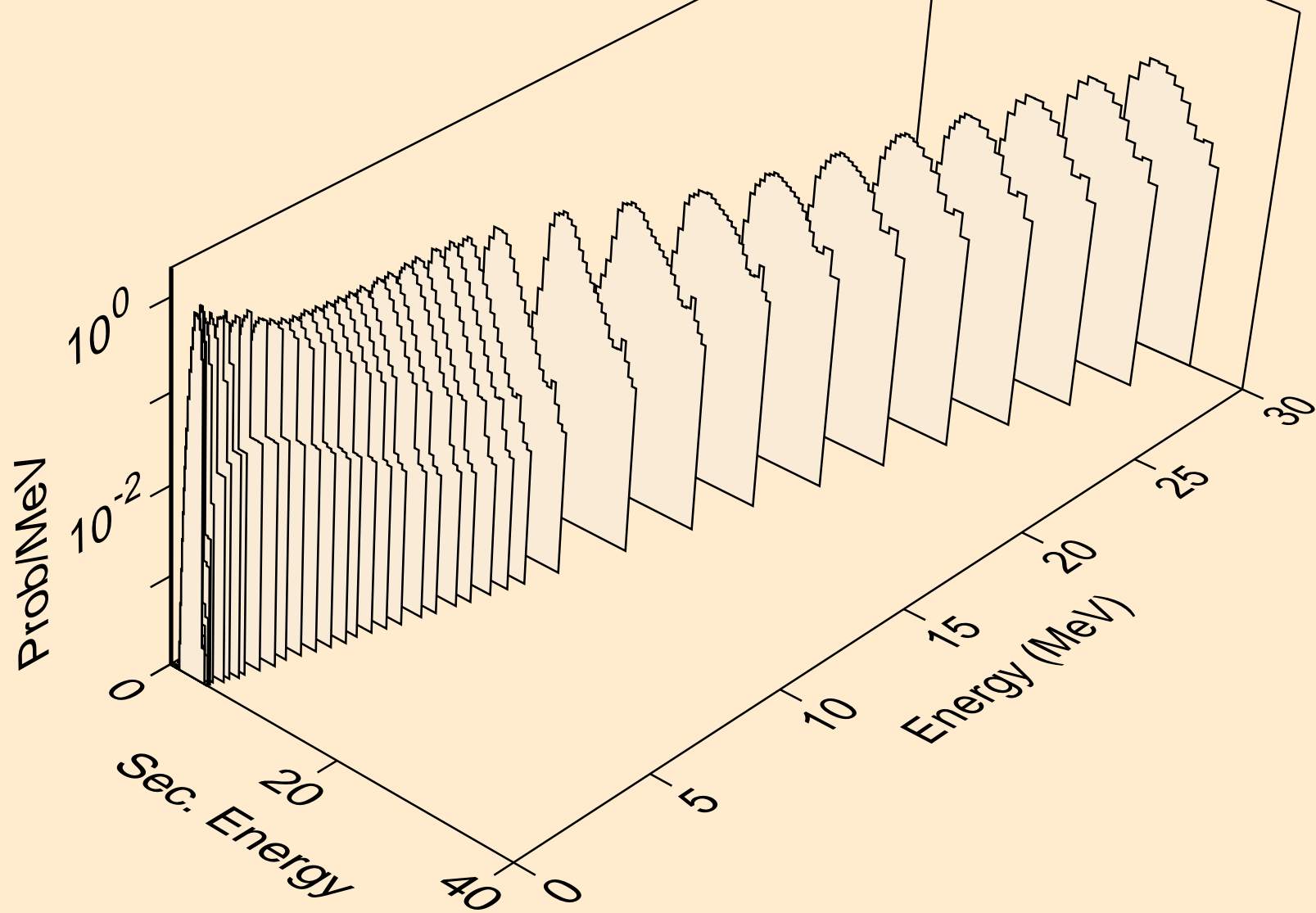

AS069 NEUTRON ACER TENDL-2023 LIBRARY; T=0.K  
protons from (n,2p)

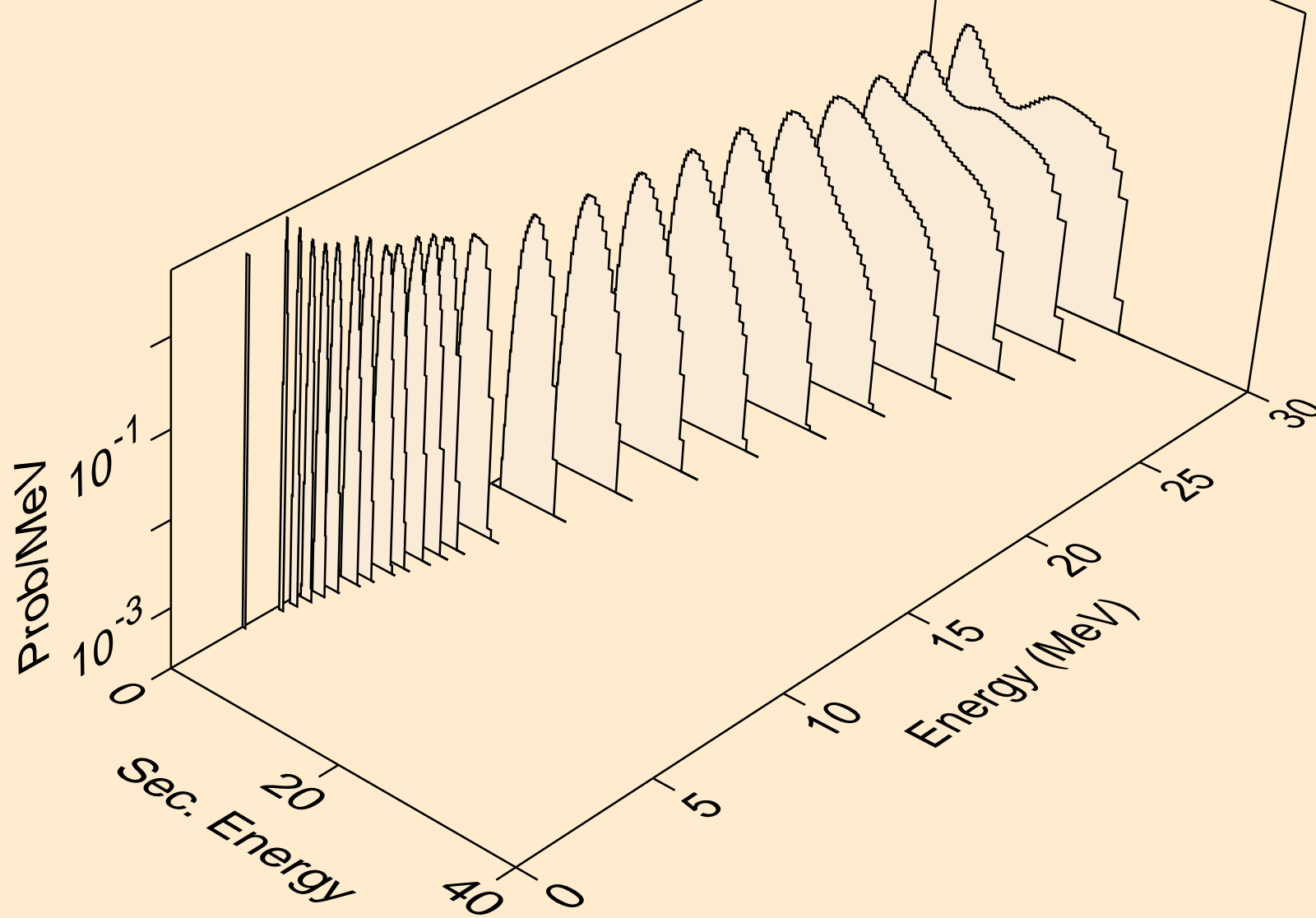

AS069 NEUTRON ACER TENDL-2023 LIBRARY; T=0.K  
protons from (n,p)

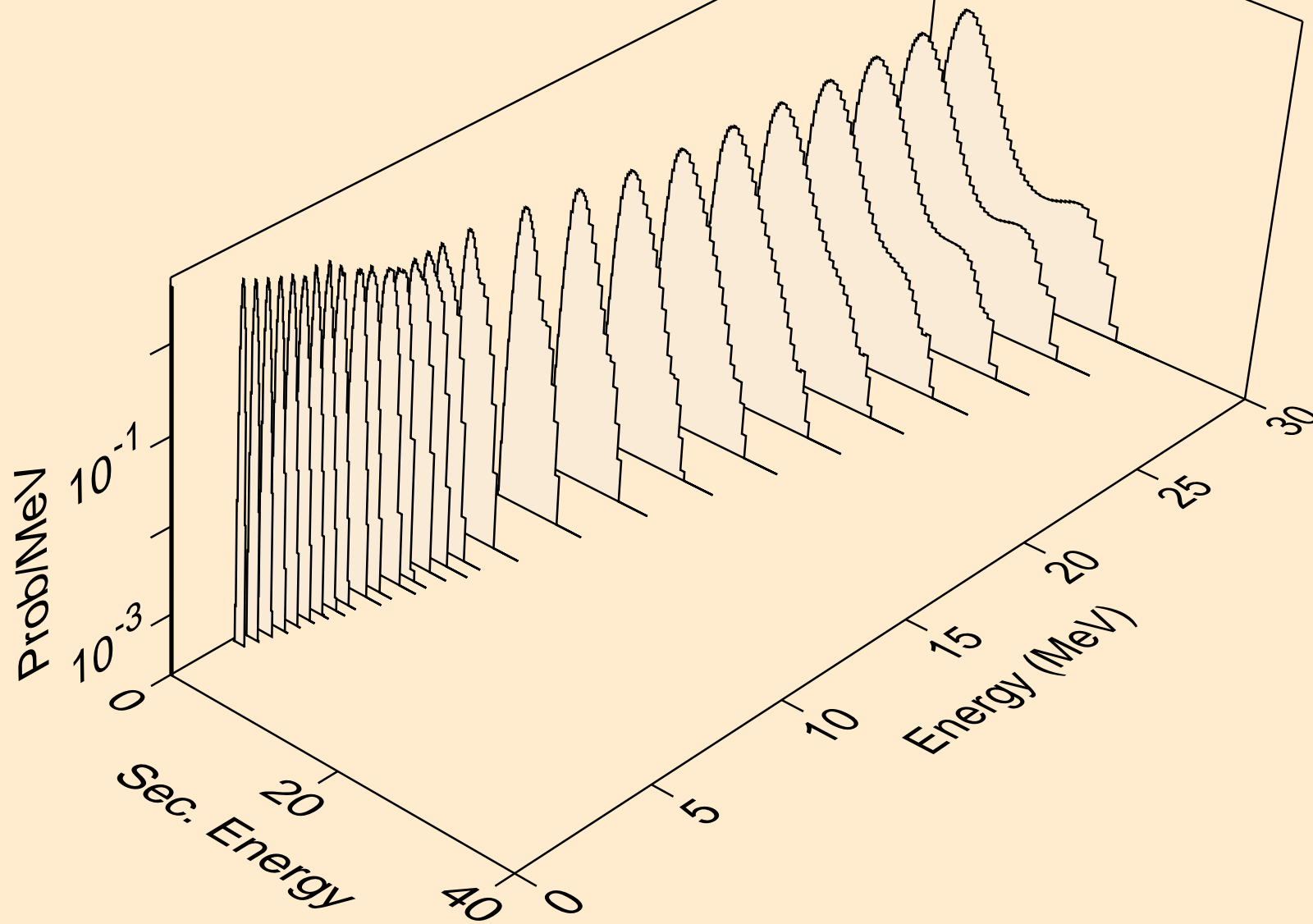

AS069 NEUTRON ACER TENDL-2023 LIBRARY; T=0.K  
protons from (n,pd)

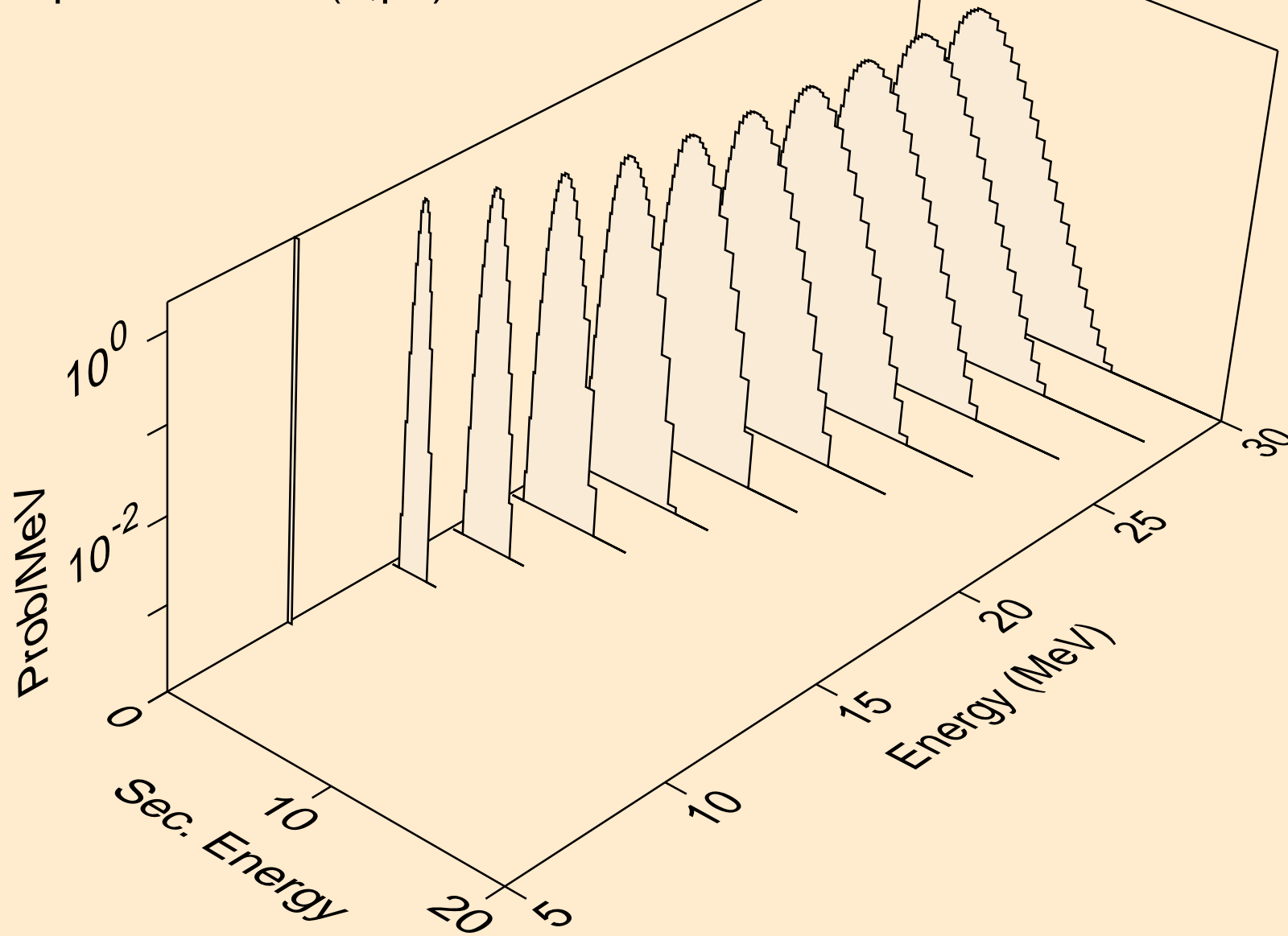

AS069 NEUTRON ACER TENDL-2023 LIBRARY; T=0.K  
protons from (n,pt)

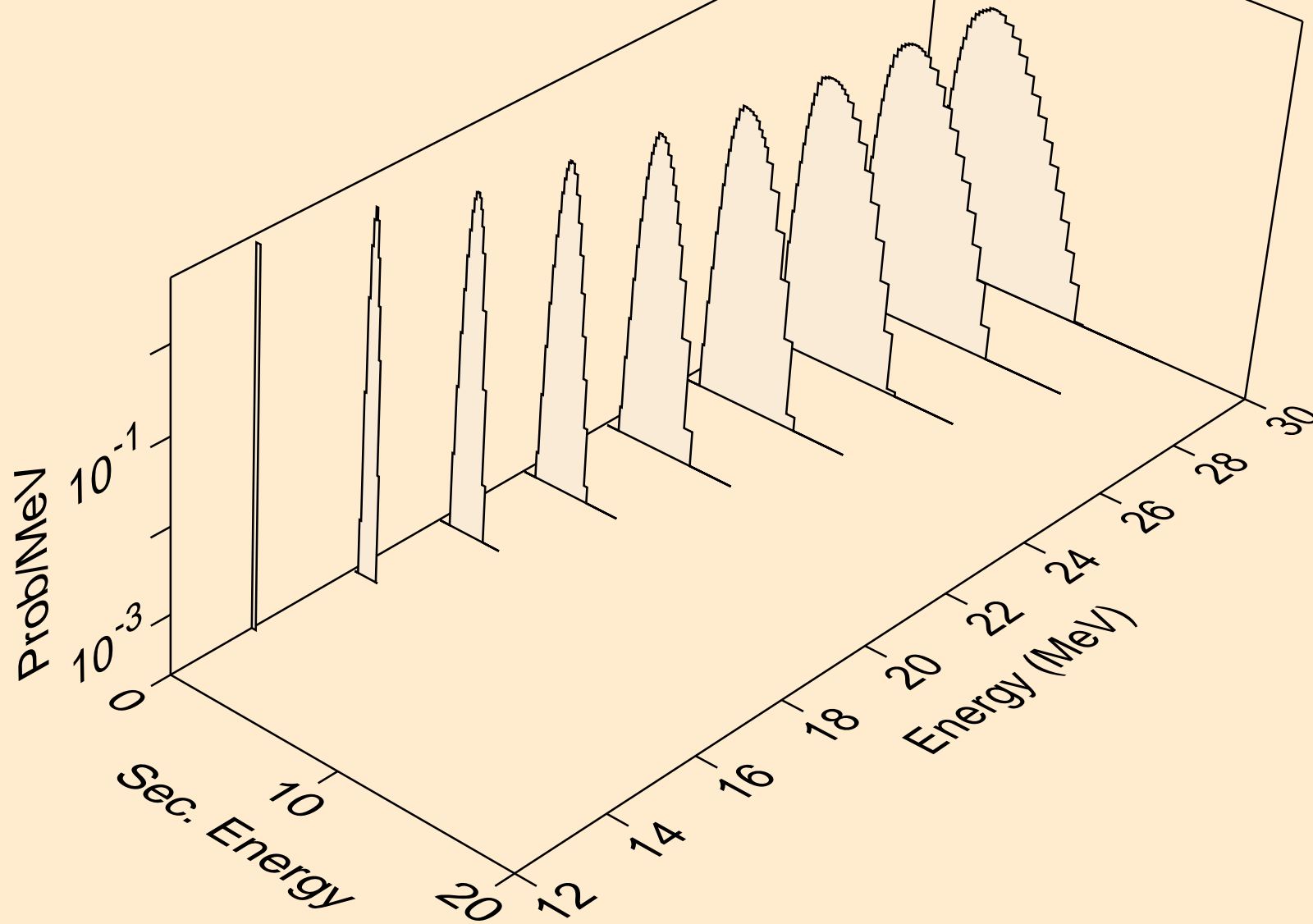

AS069 NEUTRON ACER TENDL-2023 LIBRARY; T=0.K  
deuterons from (n,x)

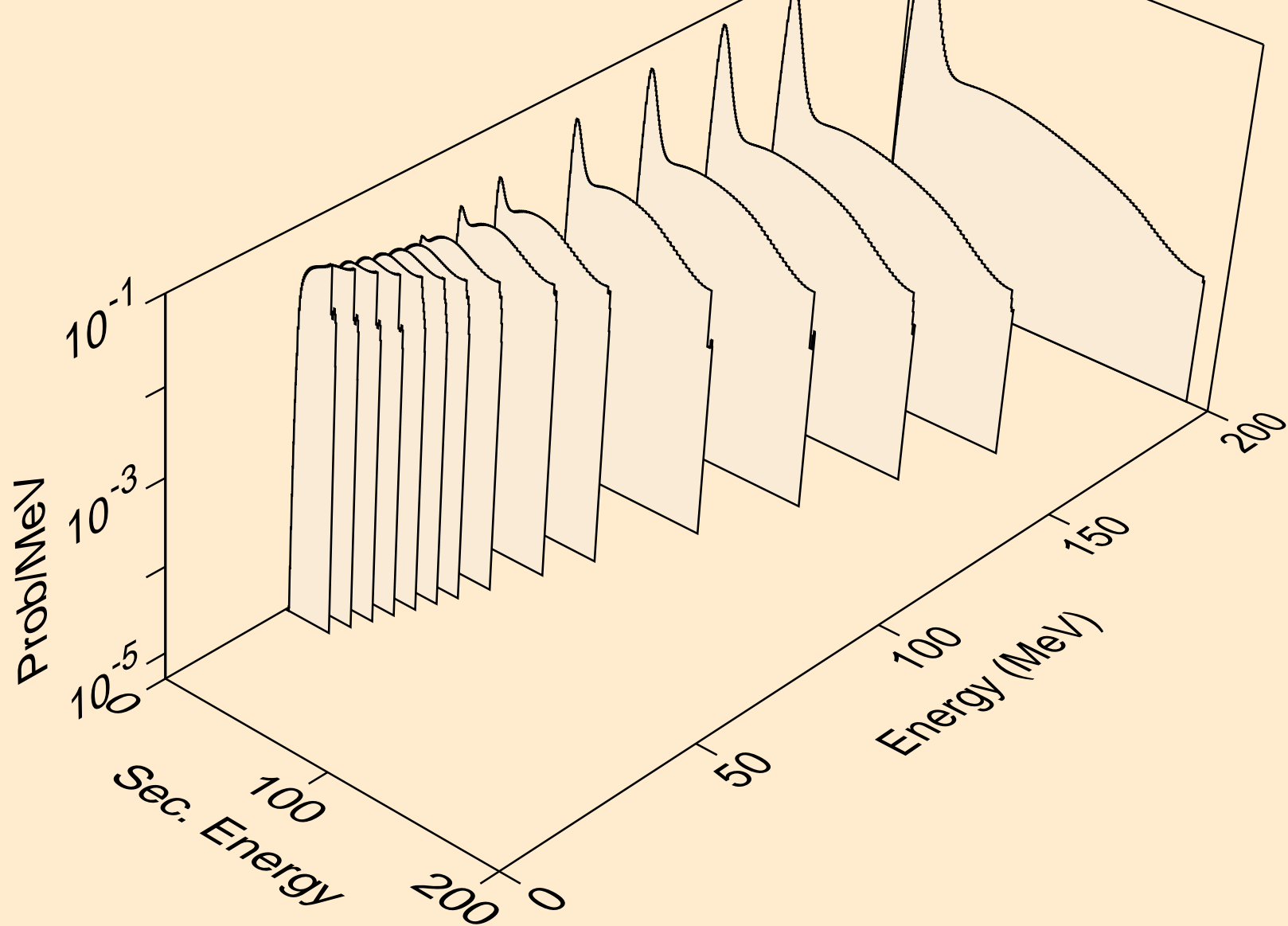

AS069 NEUTRON ACER TENDL-2023 LIBRARY; T=0.K  
deuterons from (n,2nd)

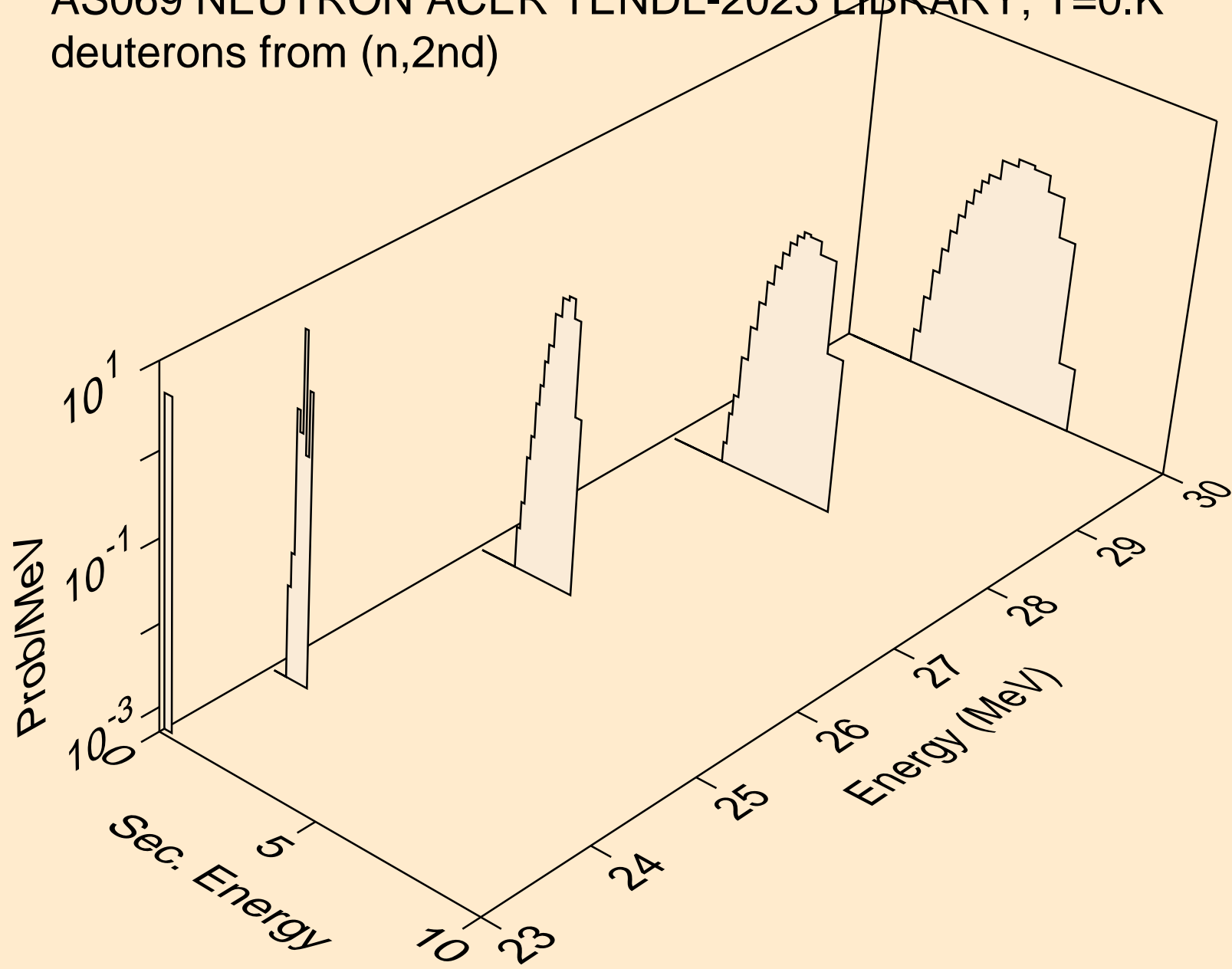

AS069 NEUTRON ACER TENDL-2023 LIBRARY; T=0.K  
deuterons from (n,n\*)d

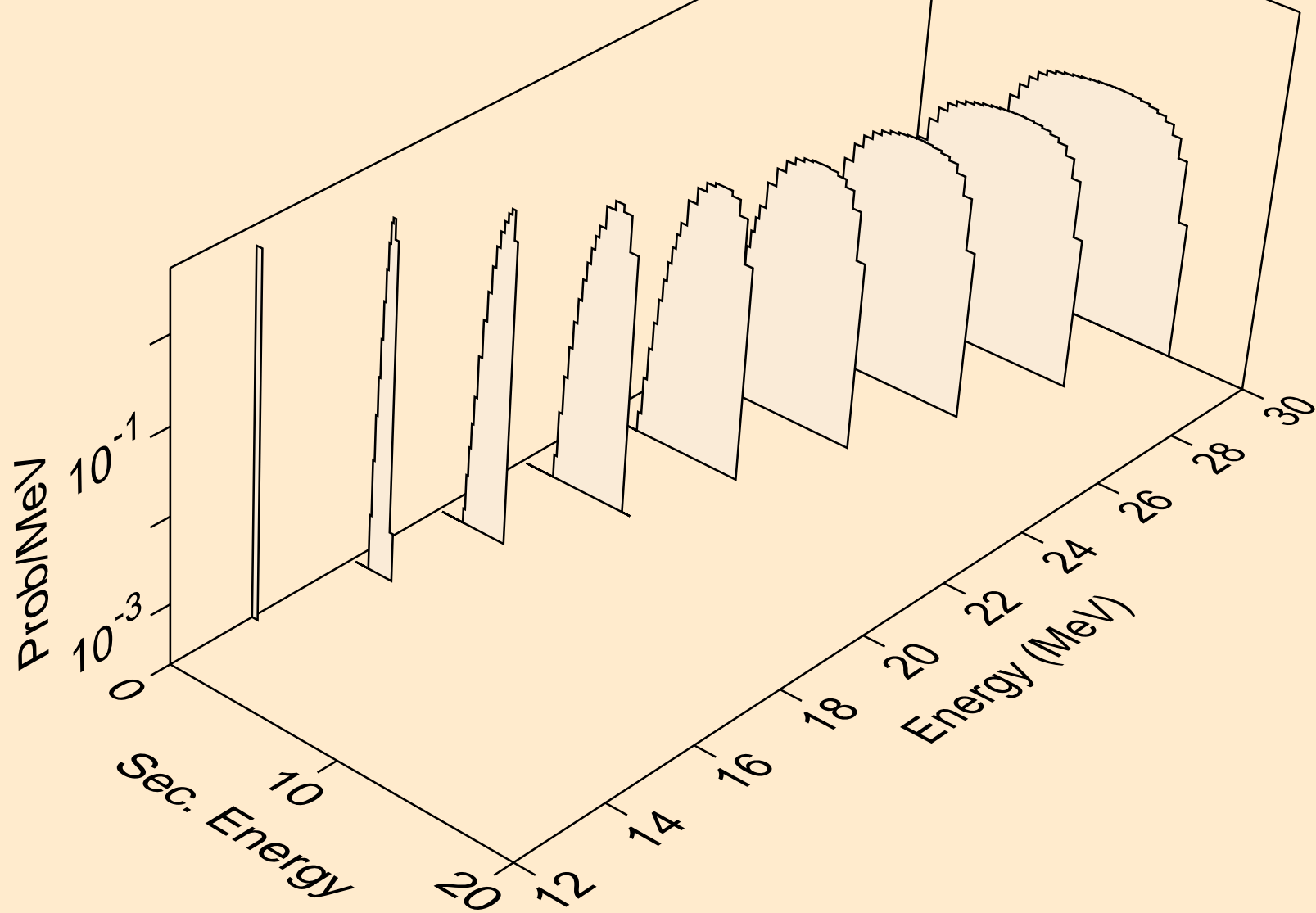

AS069 NEUTRON ACER TENDL-2023 LIBRARY; T=0.K  
deuterons from (n,d)

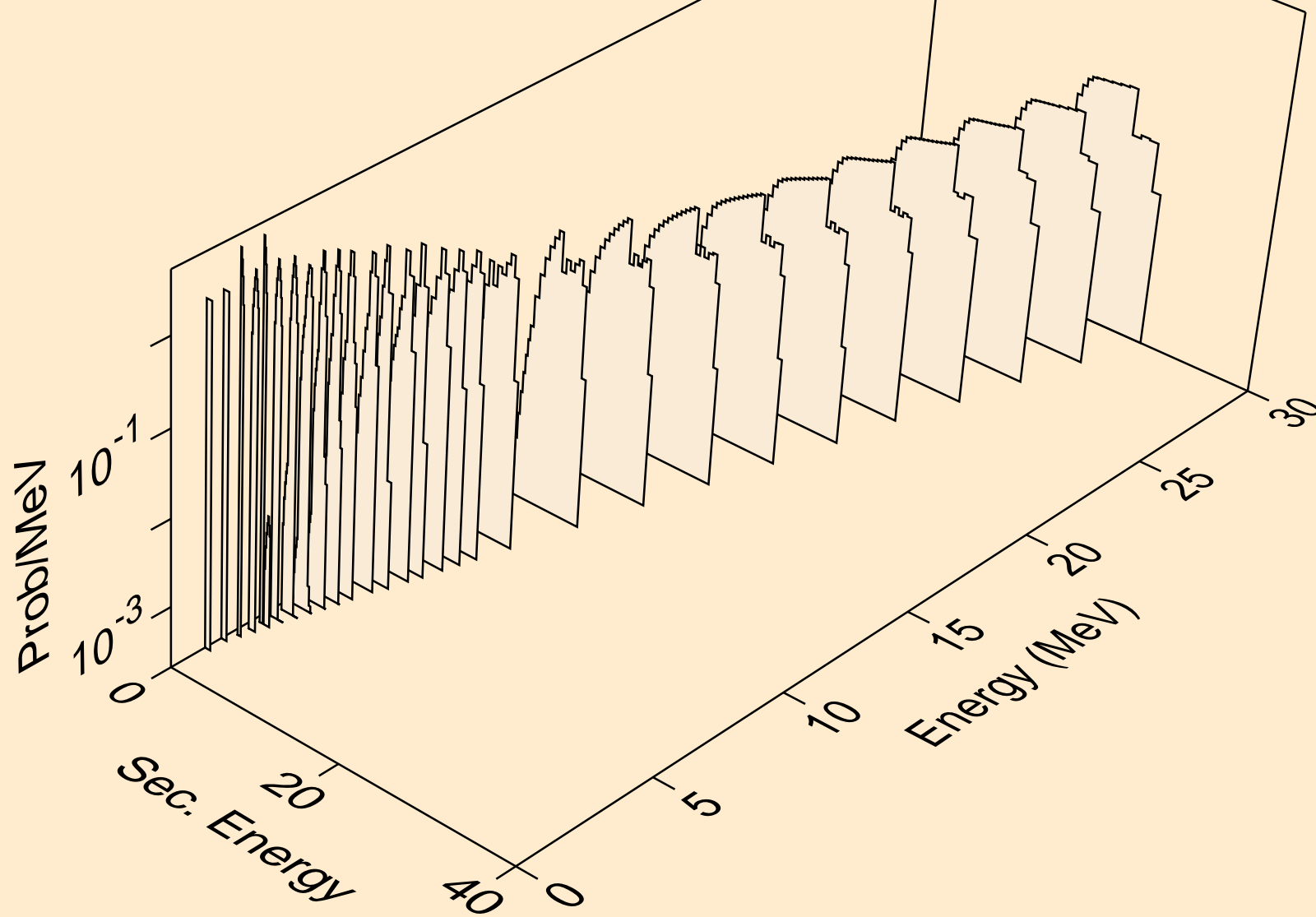

AS069 NEUTRON ACER TENDL-2023 LIBRARY; T=0.K  
deuterons from (n,d2a)

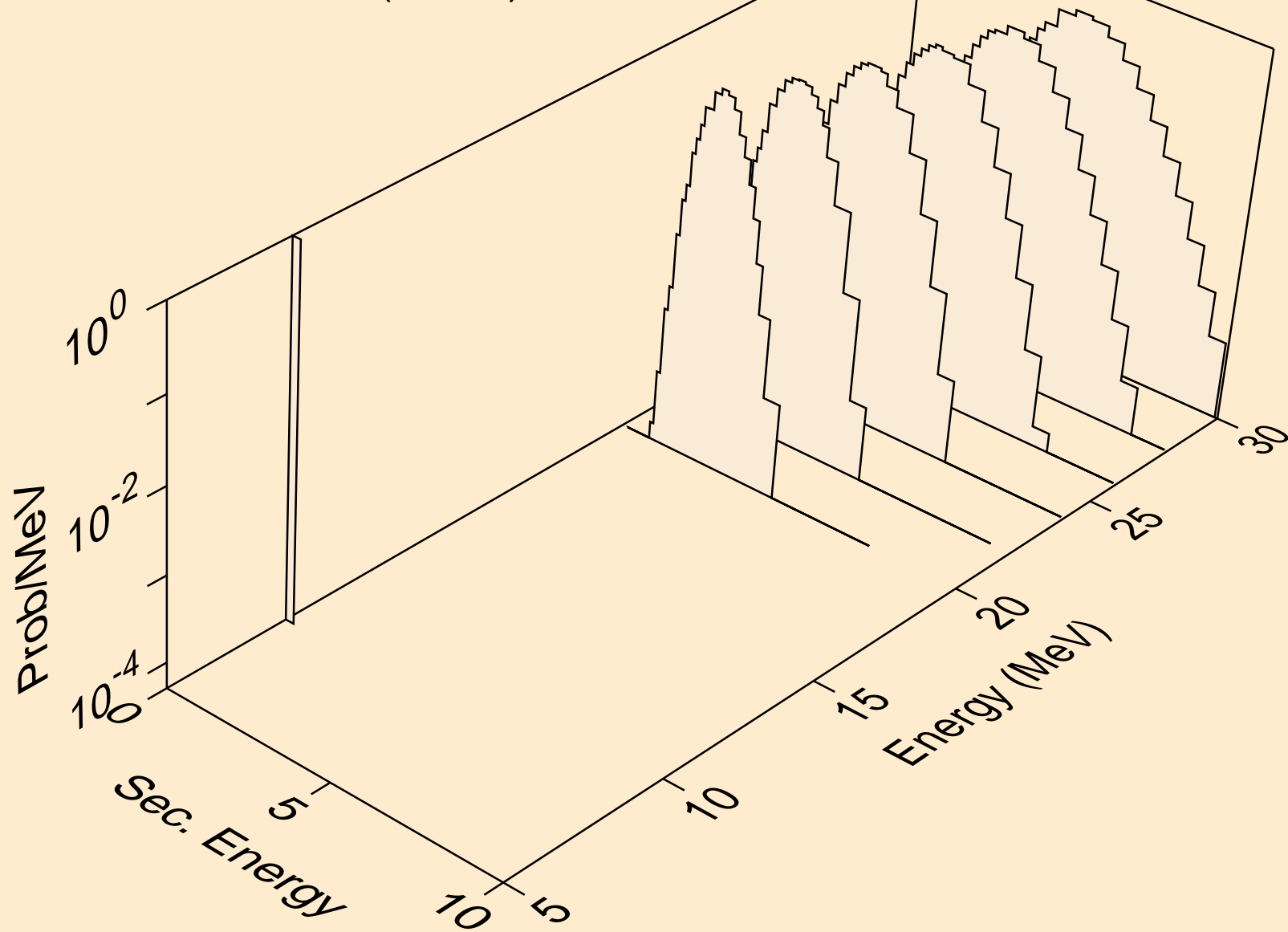

AS069 NEUTRON ACER TENDL-2023 LIBRARY; T=0.K  
deuterons from (n,pd)

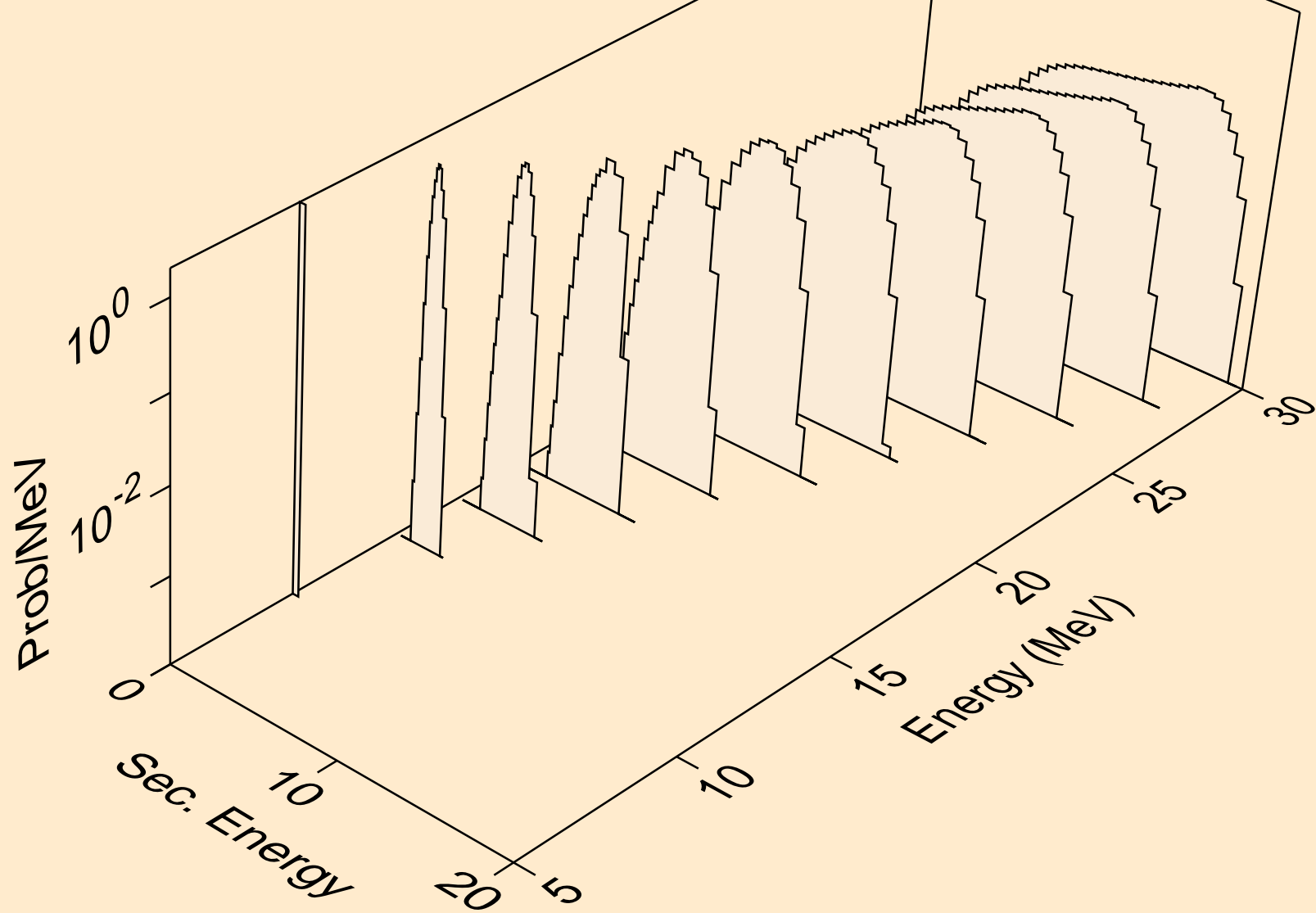

AS069 NEUTRON ACER TENDL-2023 LIBRARY; T=0.K  
deuterons from (n,da)

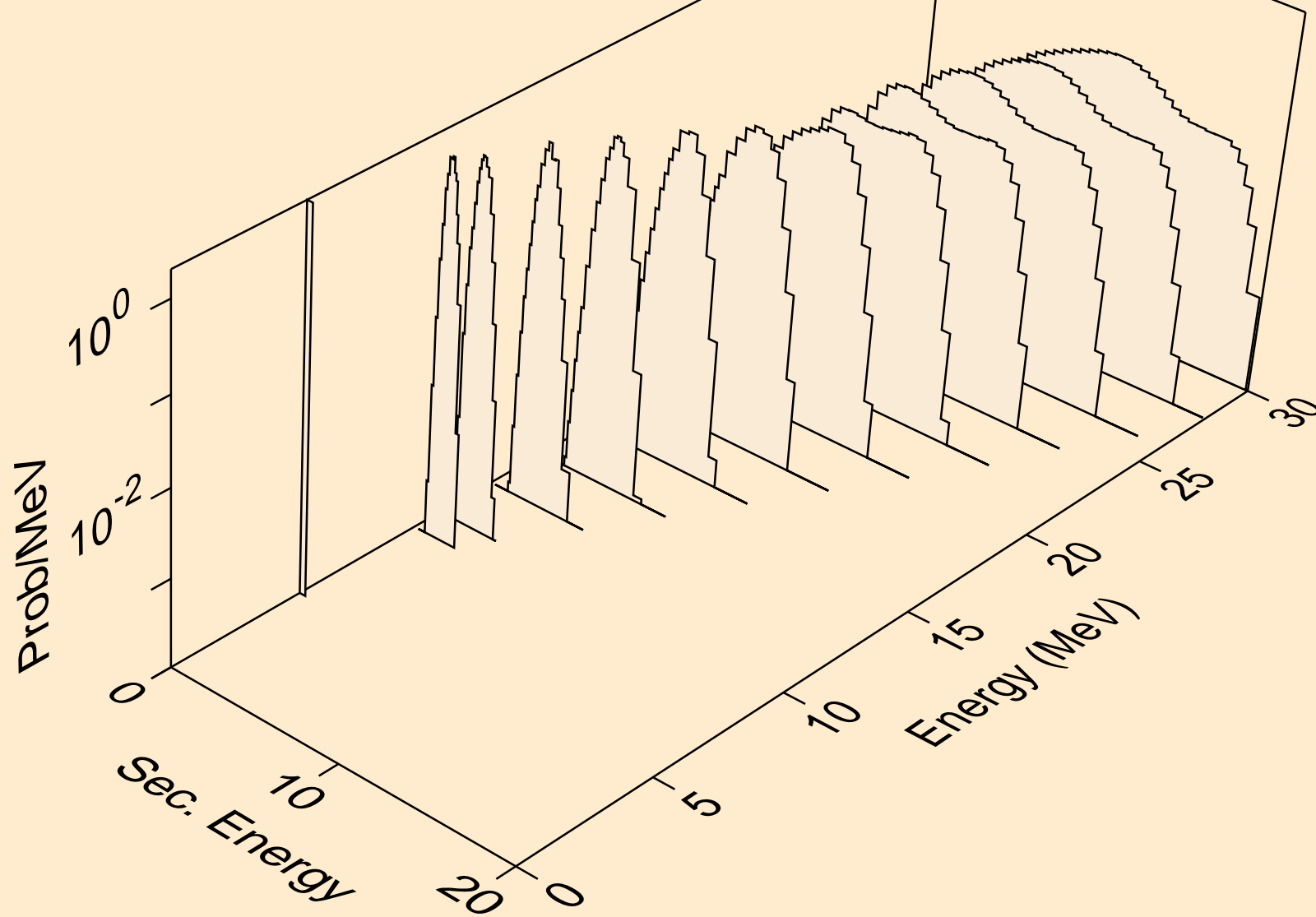

AS069 NEUTRON ACER TENDL-2023 LIBRARY; T=0.K  
tritons from (n,x)

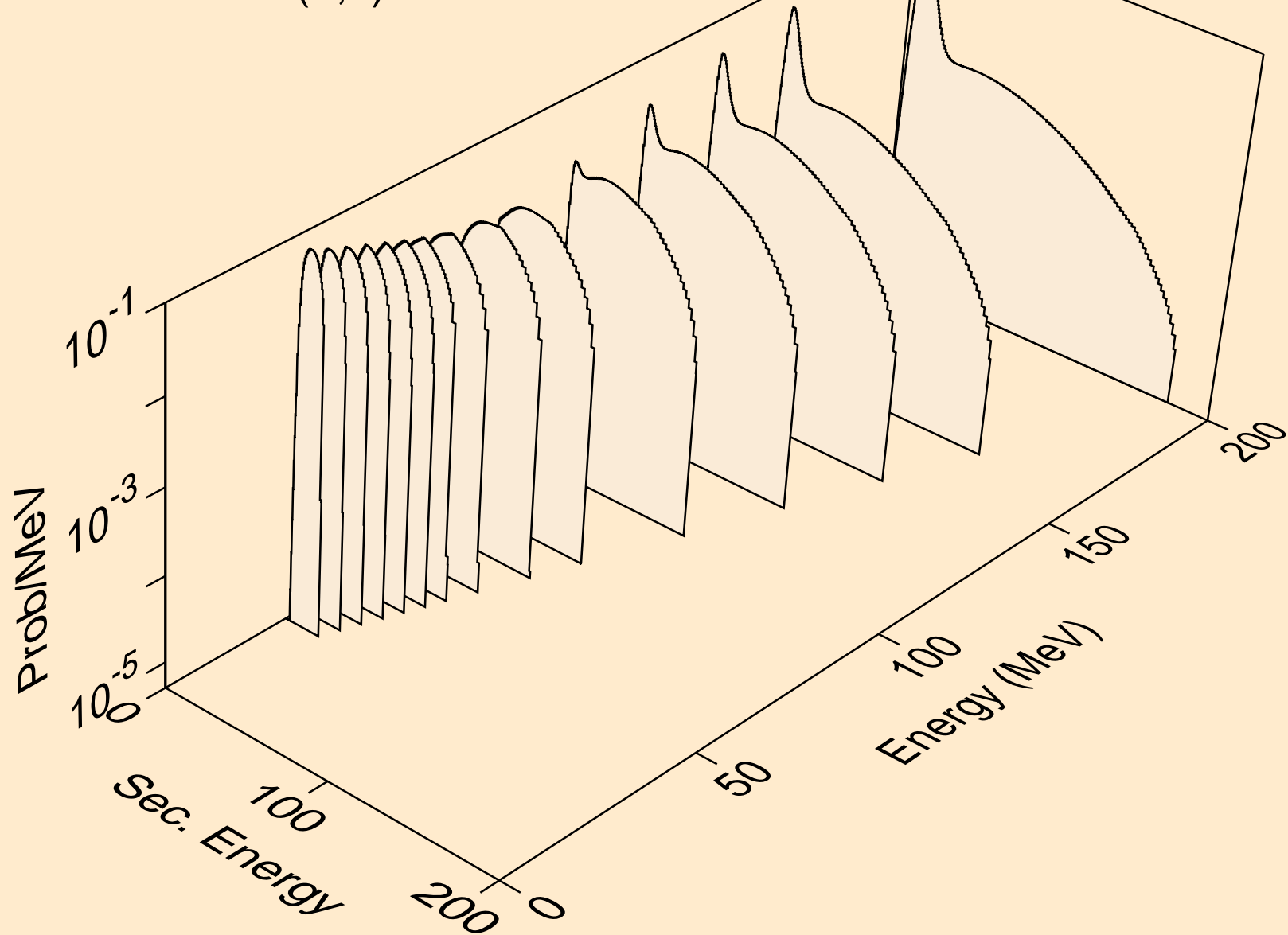

AS069 NEUTRON ACER TENDL-2023 LIBRARY; T=0.K  
tritons from (n,n\*)t

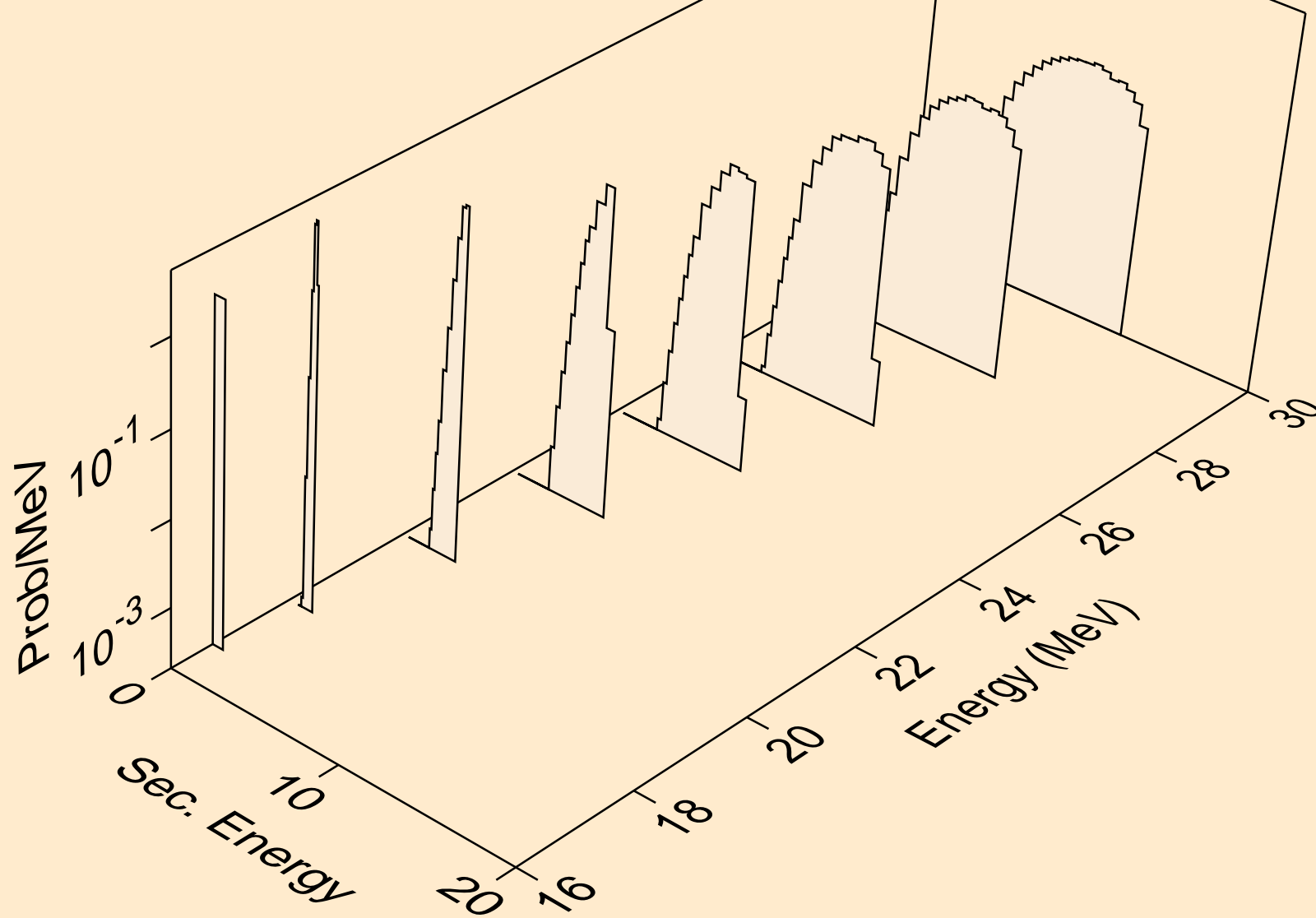

AS069 NEUTRON ACER TENDL-2023 LIBRARY; T=0.K  
tritons from (n,t)

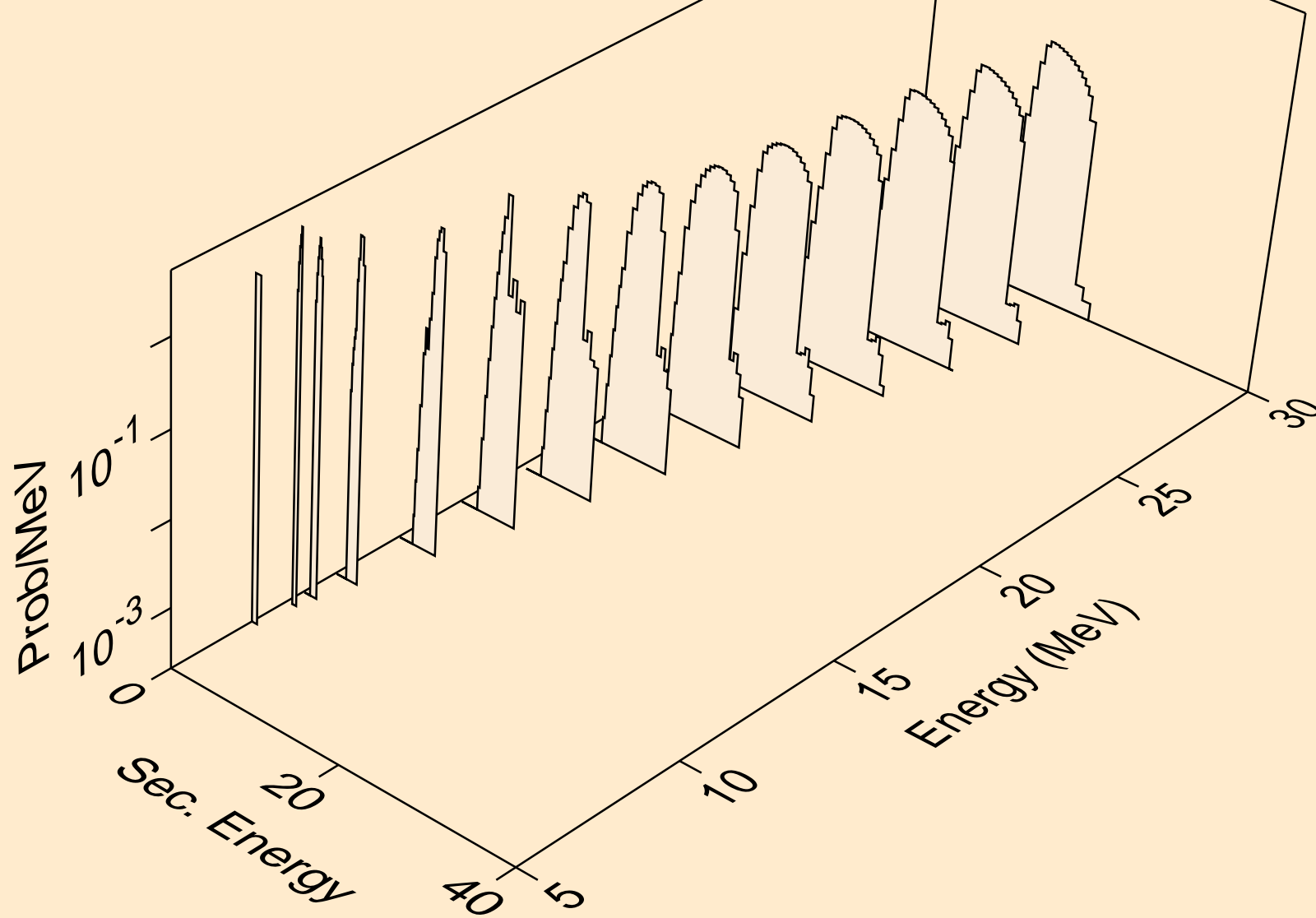

AS069 NEUTRON ACER TENDL-2023 LIBRARY; T=0.K  
tritons from (n,pt)

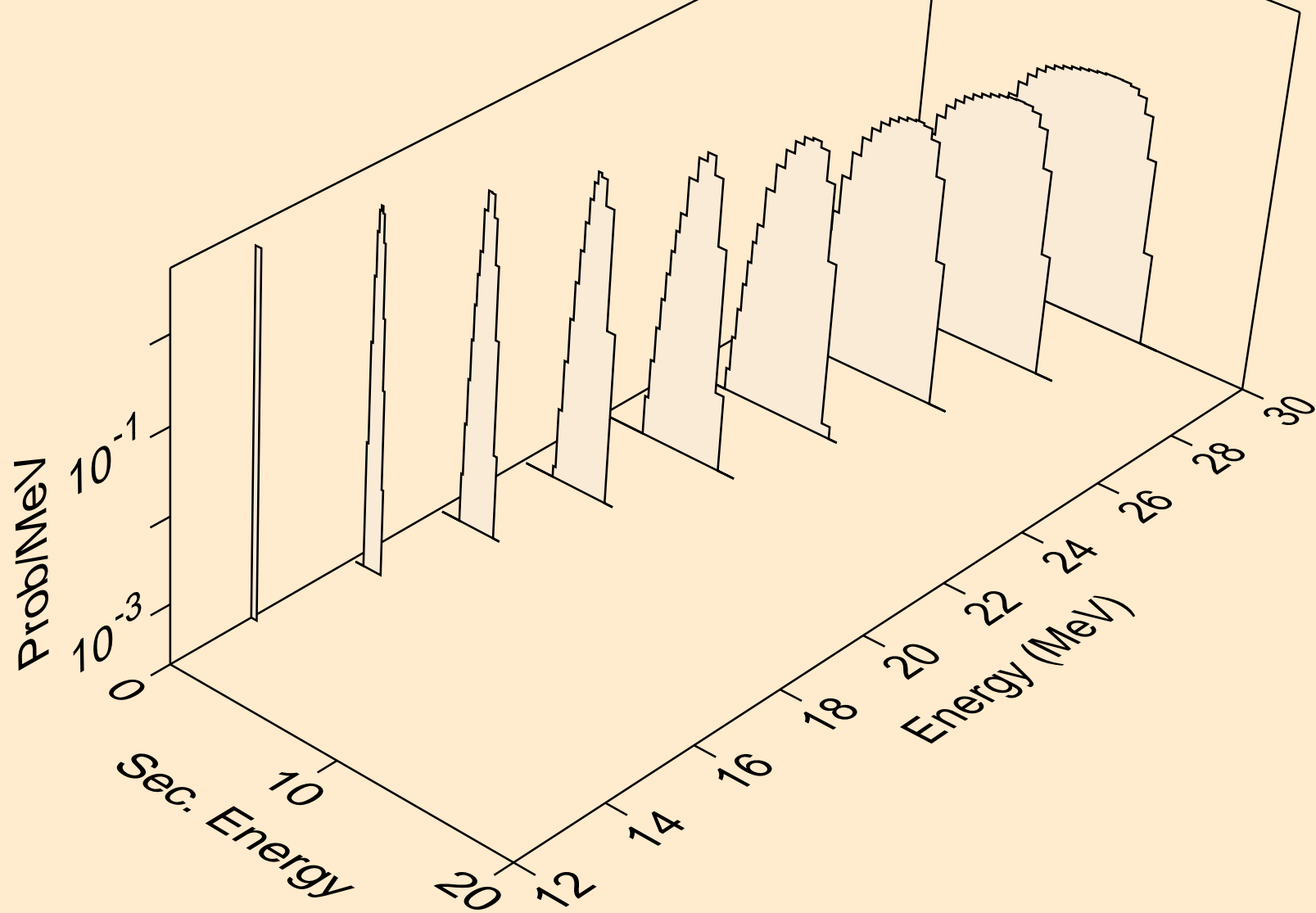

AS069 NEUTRON ACER TENDL-2023 LIBRARY; T=0.K  
he3s from (n,x)

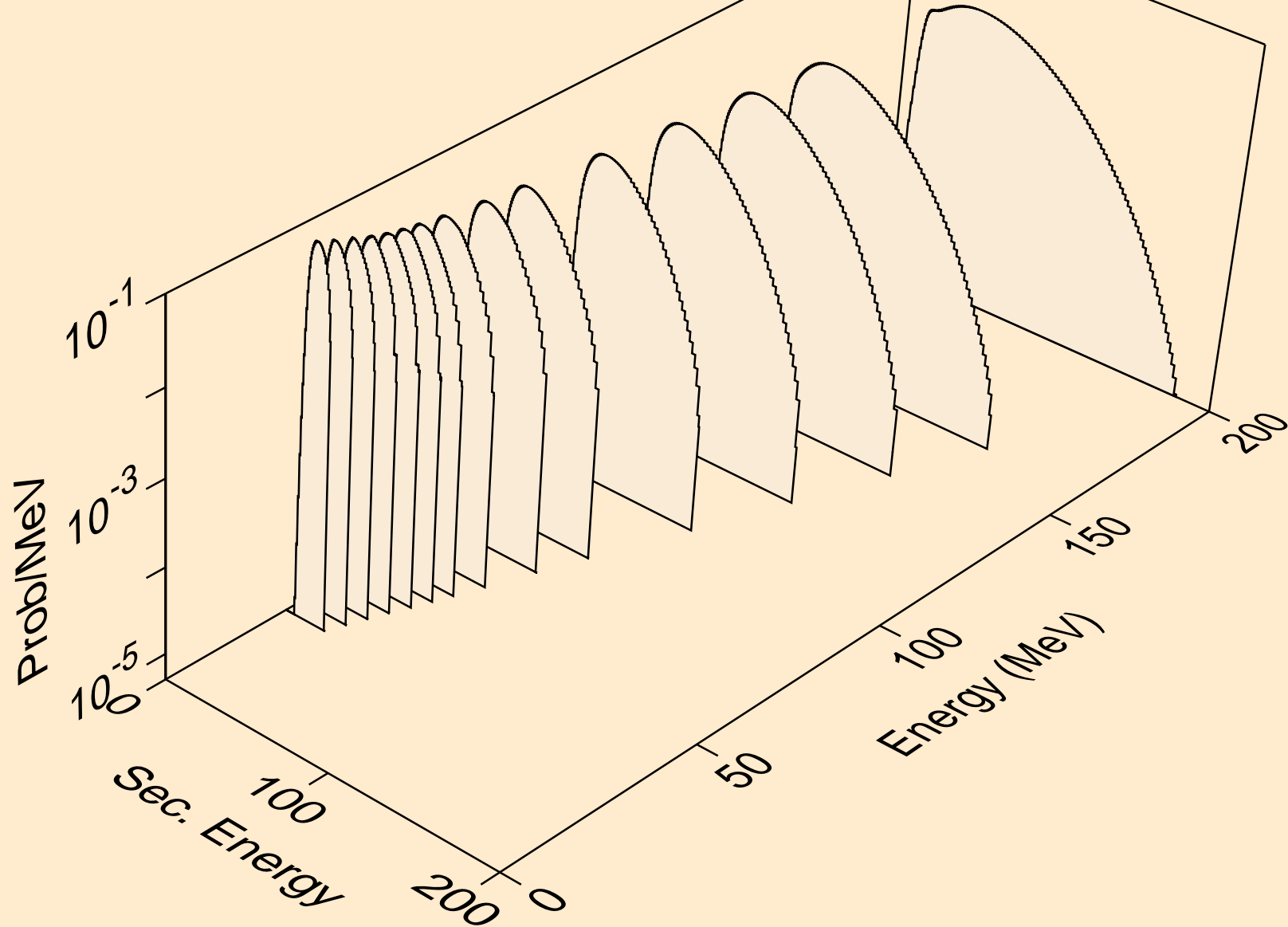

AS069 NEUTRON ACER TENDL-2023 LIBRARY; T=0.K  
he3s from (n,n\*)he3

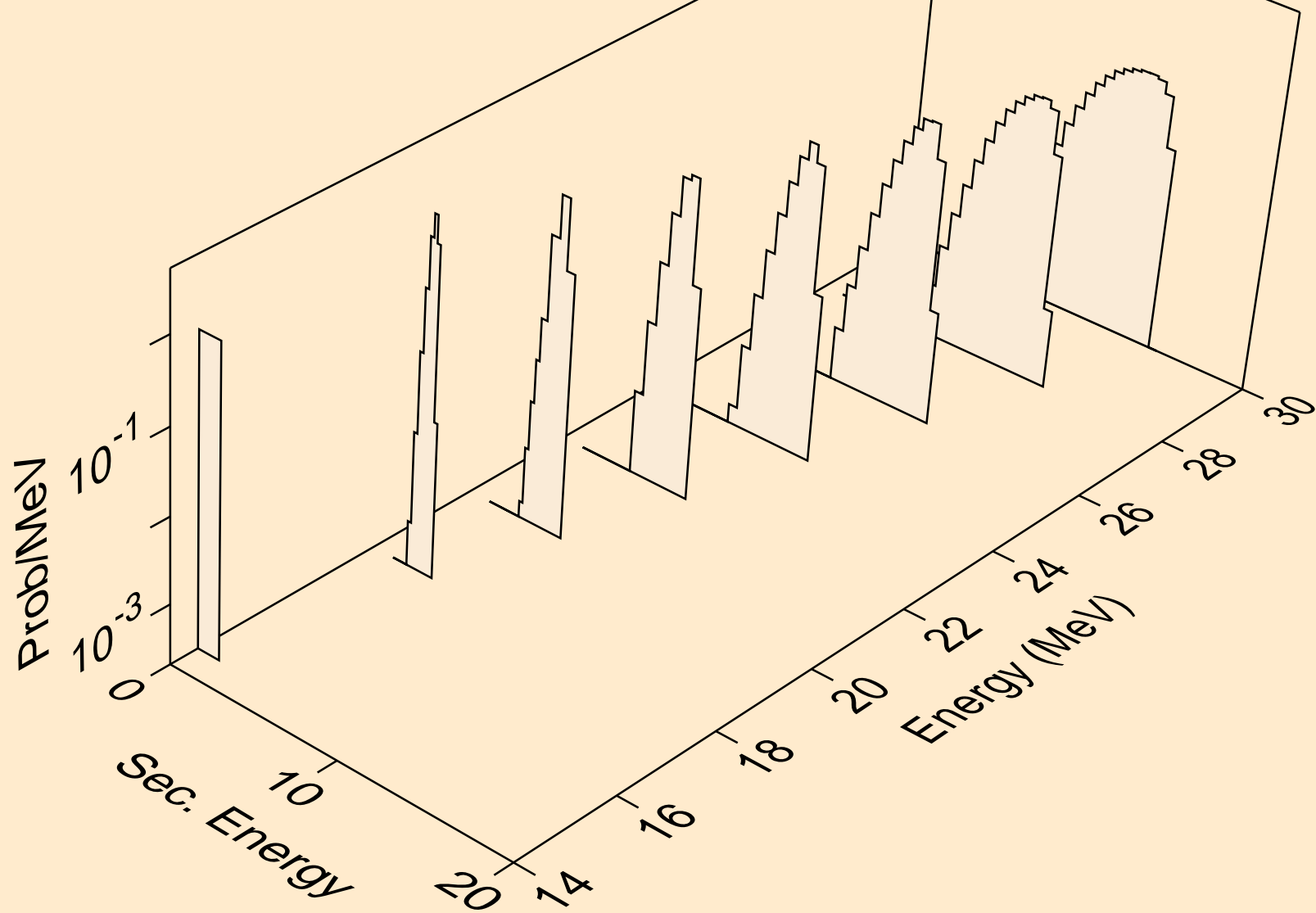

AS069 NEUTRON ACER TENDL-2023 LIBRARY; T=0.K  
he3s from (n,he3)

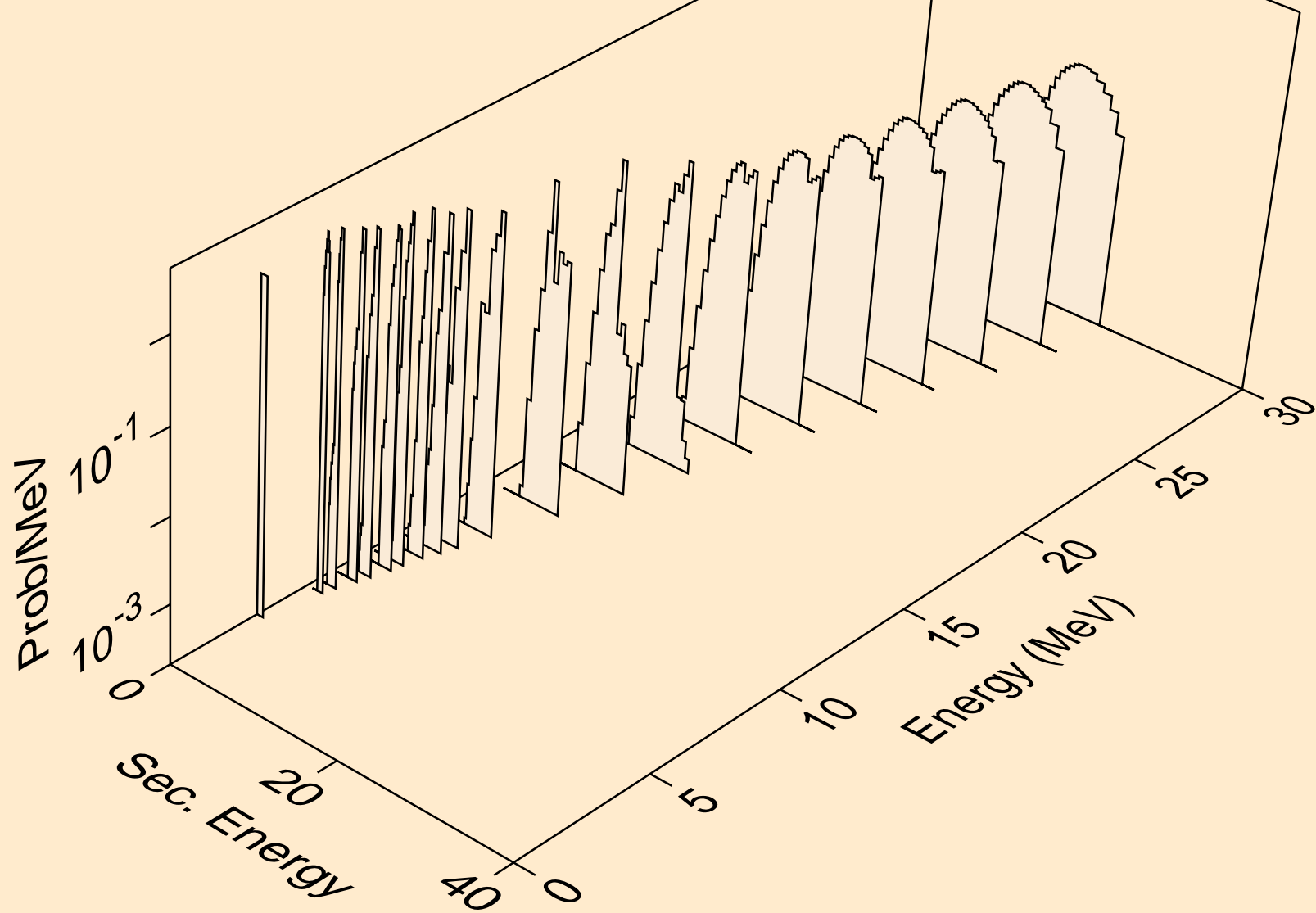

AS069 NEUTRON ACER TENDL-2023 LIBRARY; T=0.K  
alphas from (n,x)

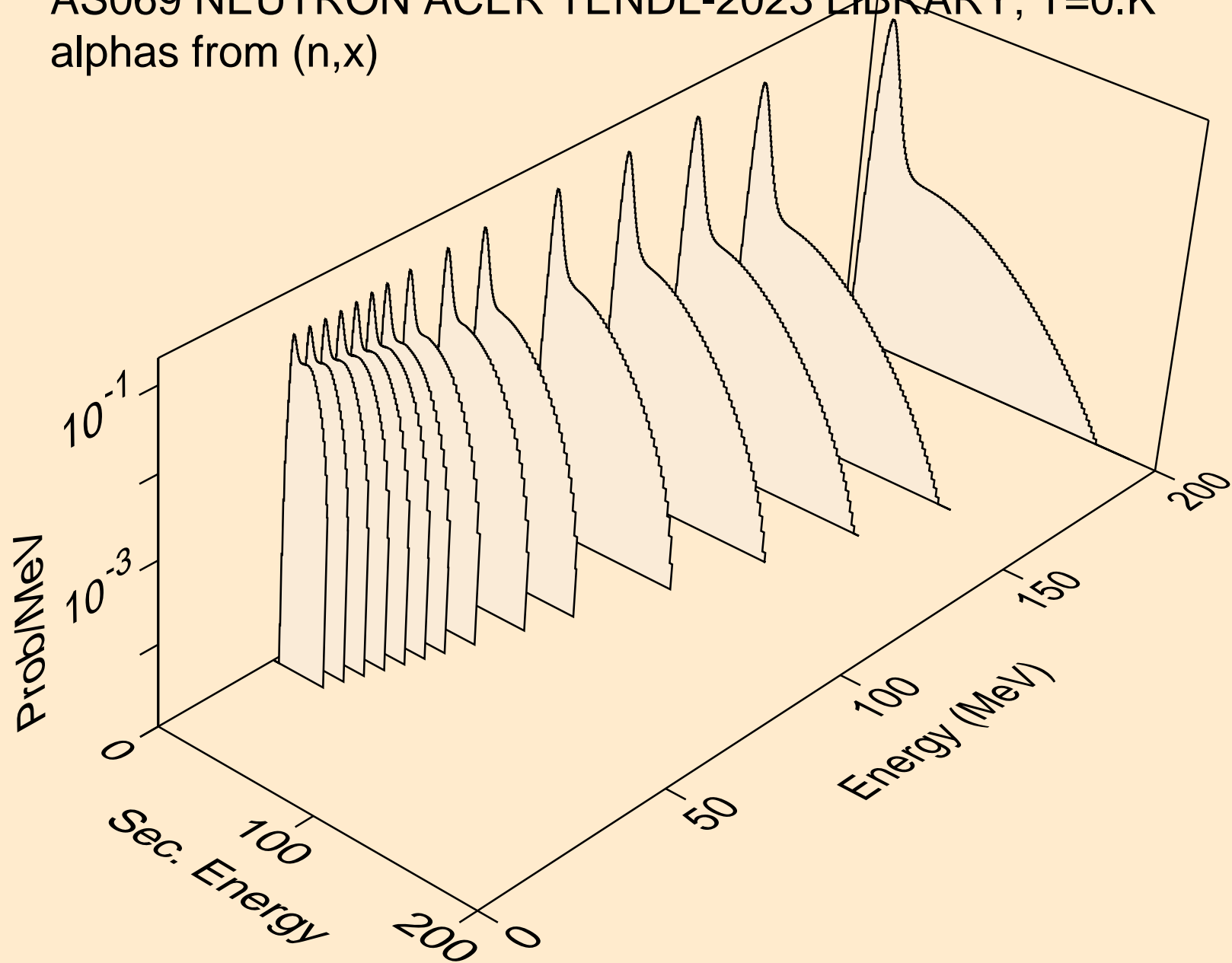

AS069 NEUTRON ACER TENDL-2023 LIBRARY; T=0.K  
alphas from (n,n\*)a

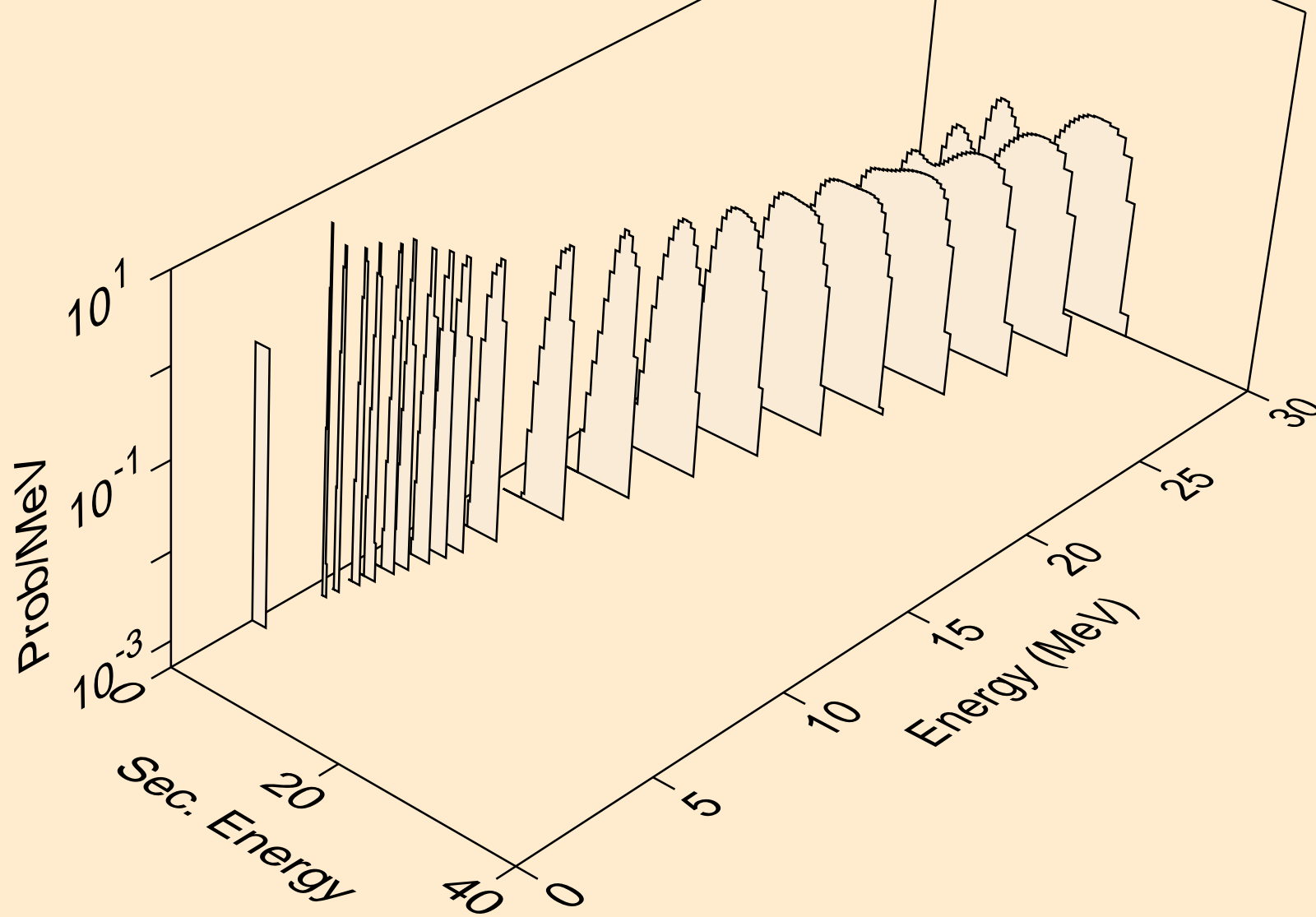

AS069 NEUTRON ACER TENDL-2023 LIBRARY; T=0.K  
alphas from (n,2n)a

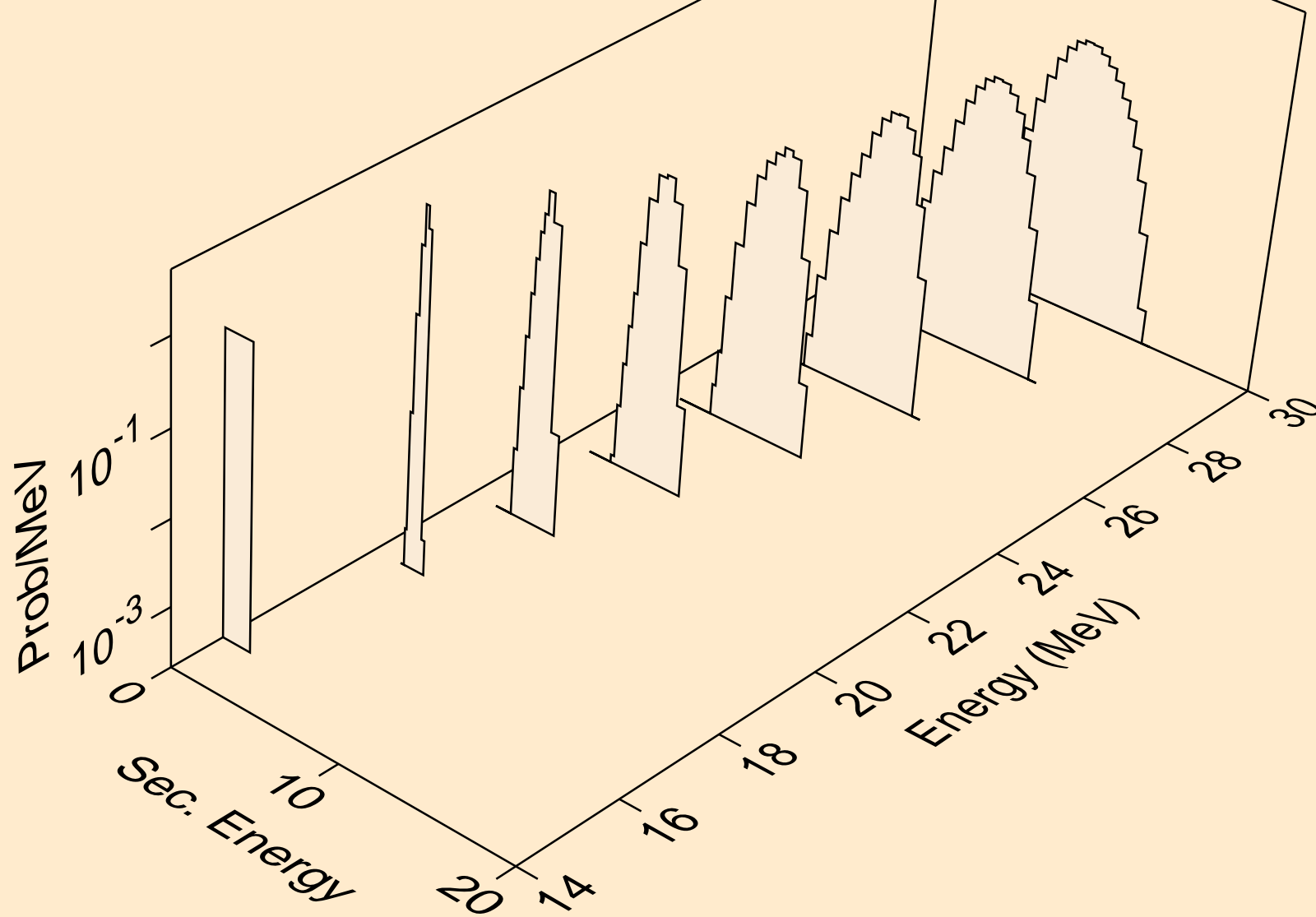

AS069 NEUTRON ACER TENDL-2023 LIBRARY; T=0.K  
alphas from (n,n\*)2a

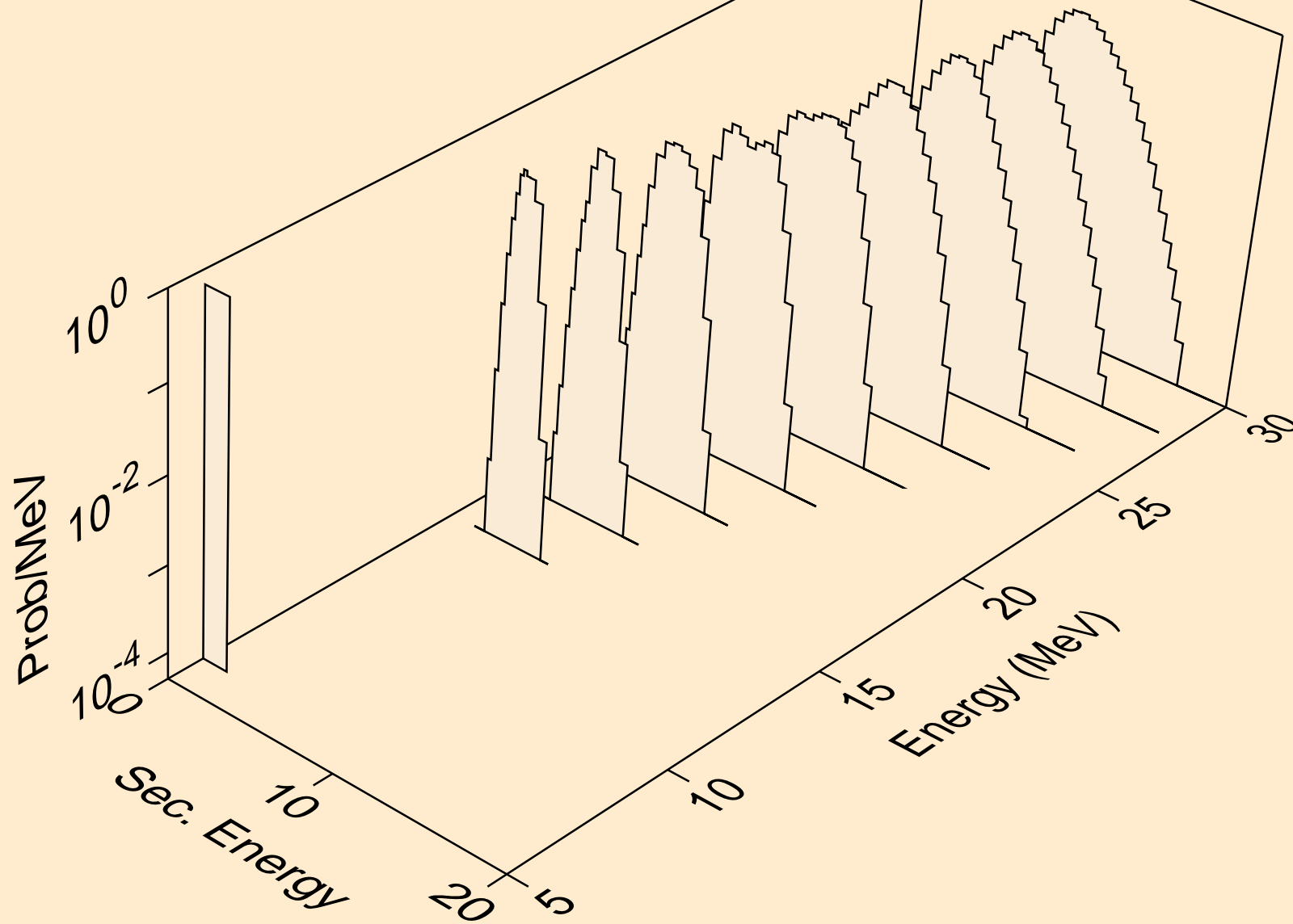

AS069 NEUTRON ACER TENDL-2023 LIBRARY; T=0.K  
alphas from (n,npa)

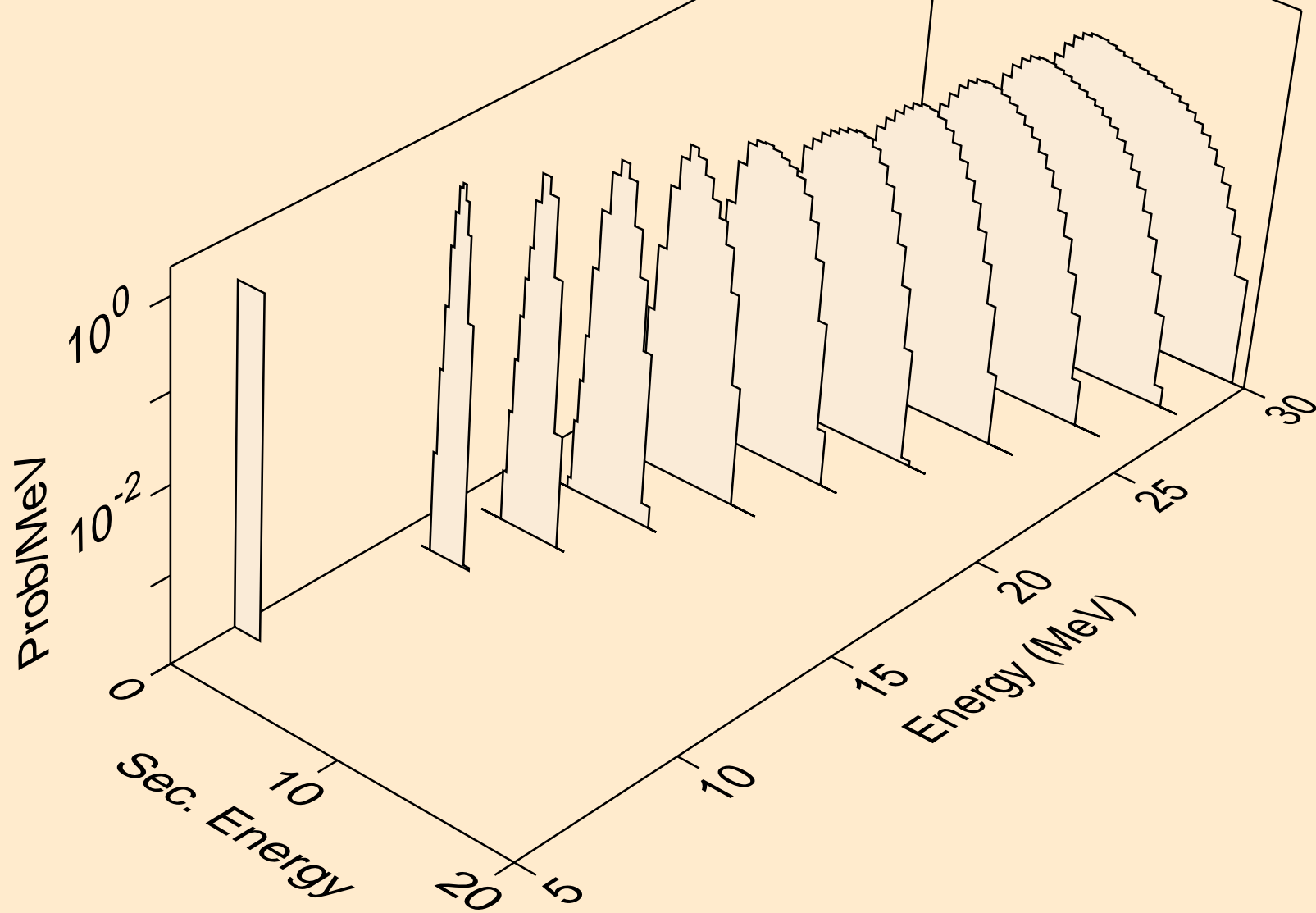

AS069 NEUTRON ACER TENDL-2023 LIBRARY; T=0.K  
alphas from (n,a)

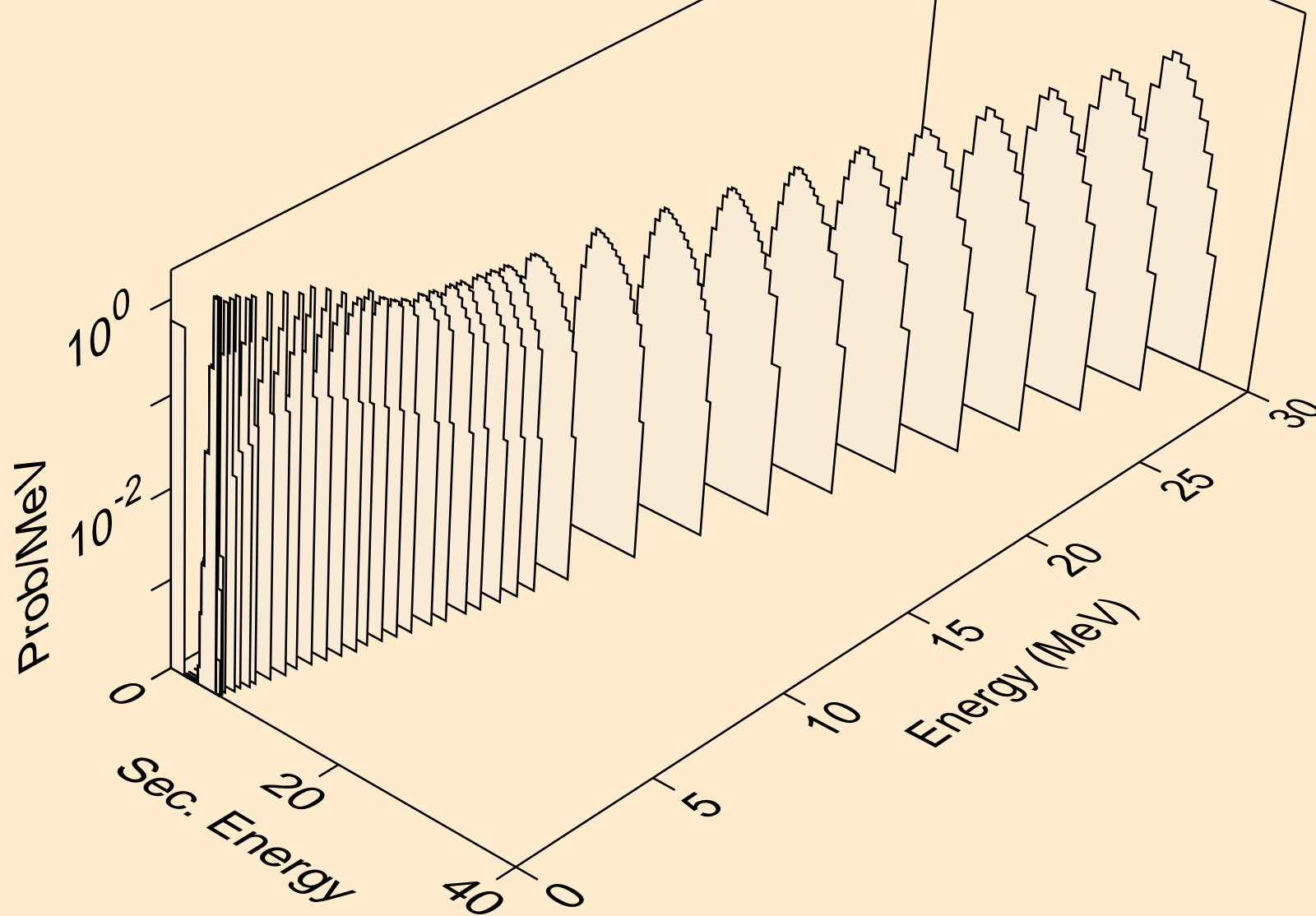

AS069 NEUTRON ACER TENDL-2023 LIBRARY; T=0.K  
alphas from (n,2a)

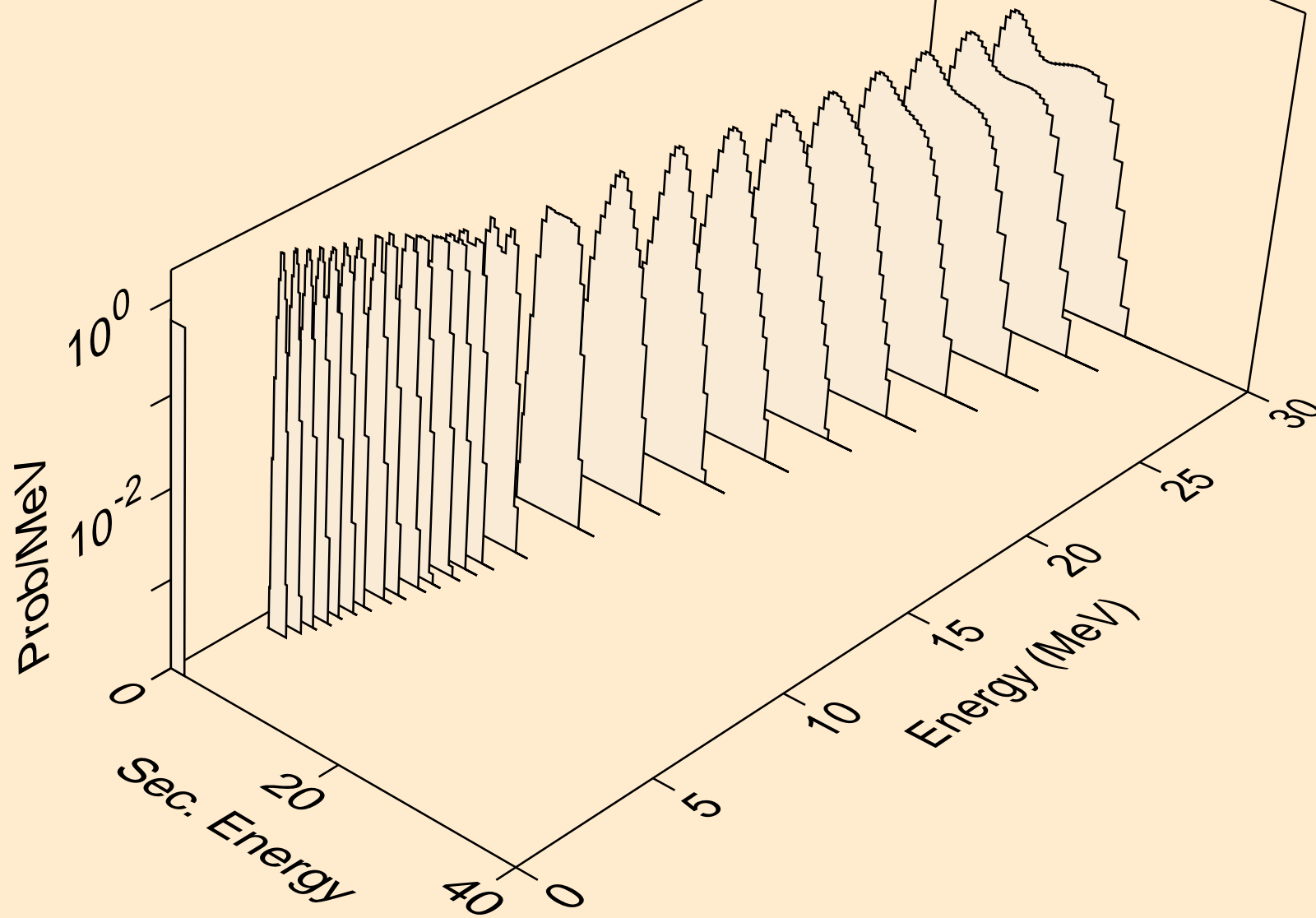

AS069 NEUTRON ACER TENDL-2023 LIBRARY; T=0.K  
alphas from (n,3a)

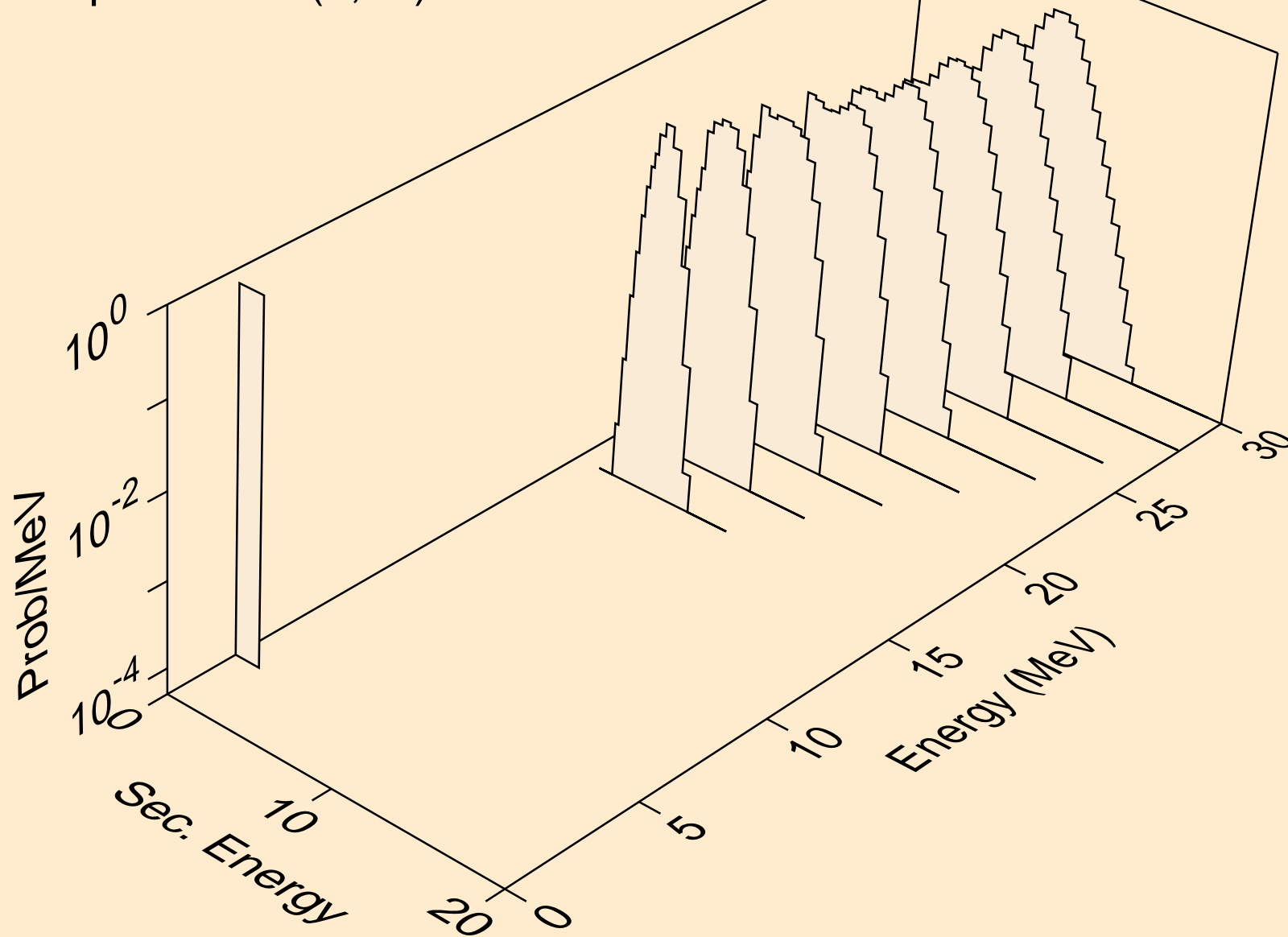

AS069 NEUTRON ACER TENDL-2023 LIBRARY; T=0.K  
alphas from (n,pa)

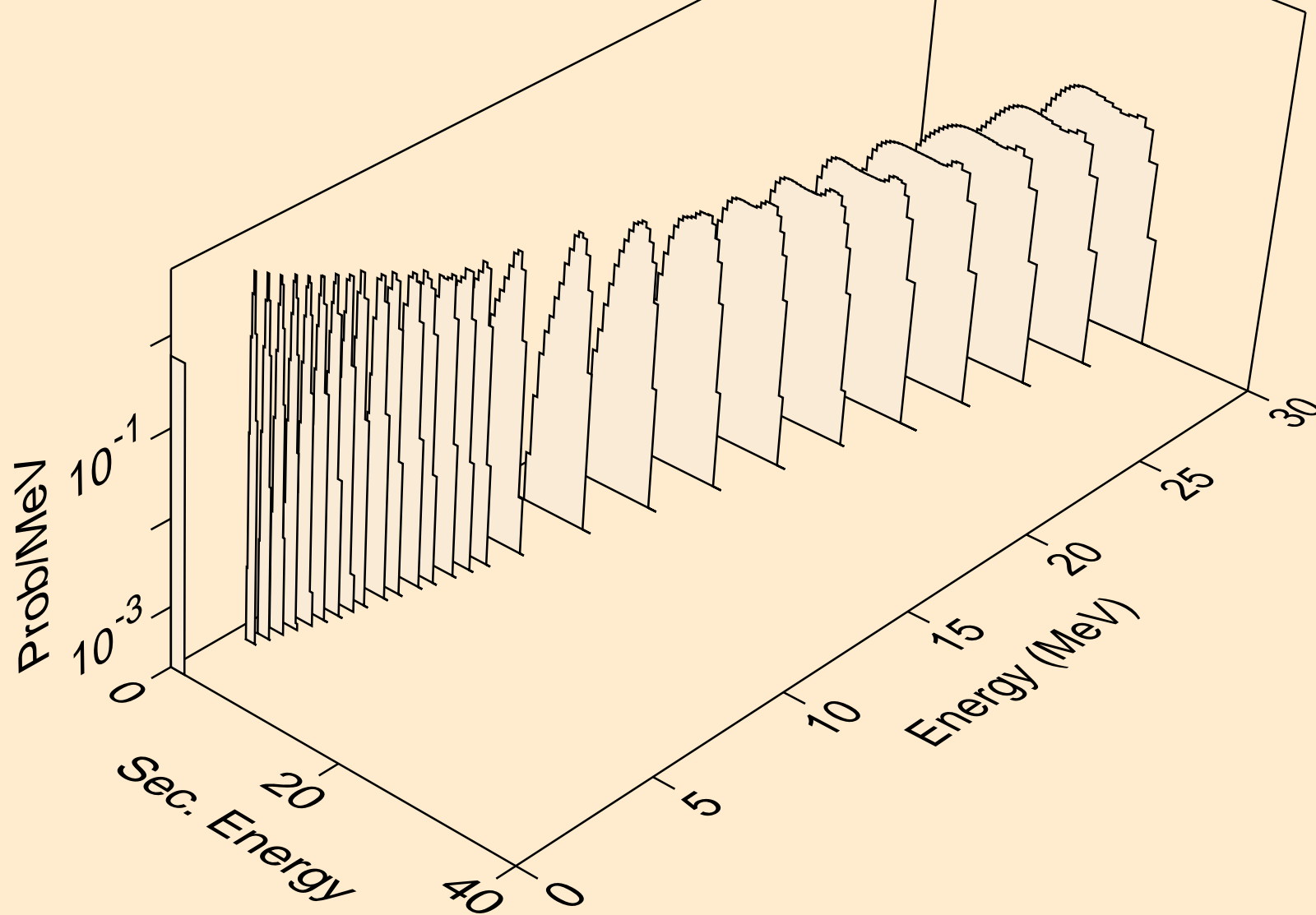

AS069 NEUTRON ACER TENDL-2023 LIBRARY; T=0.K  
alphas from (n,d2a)

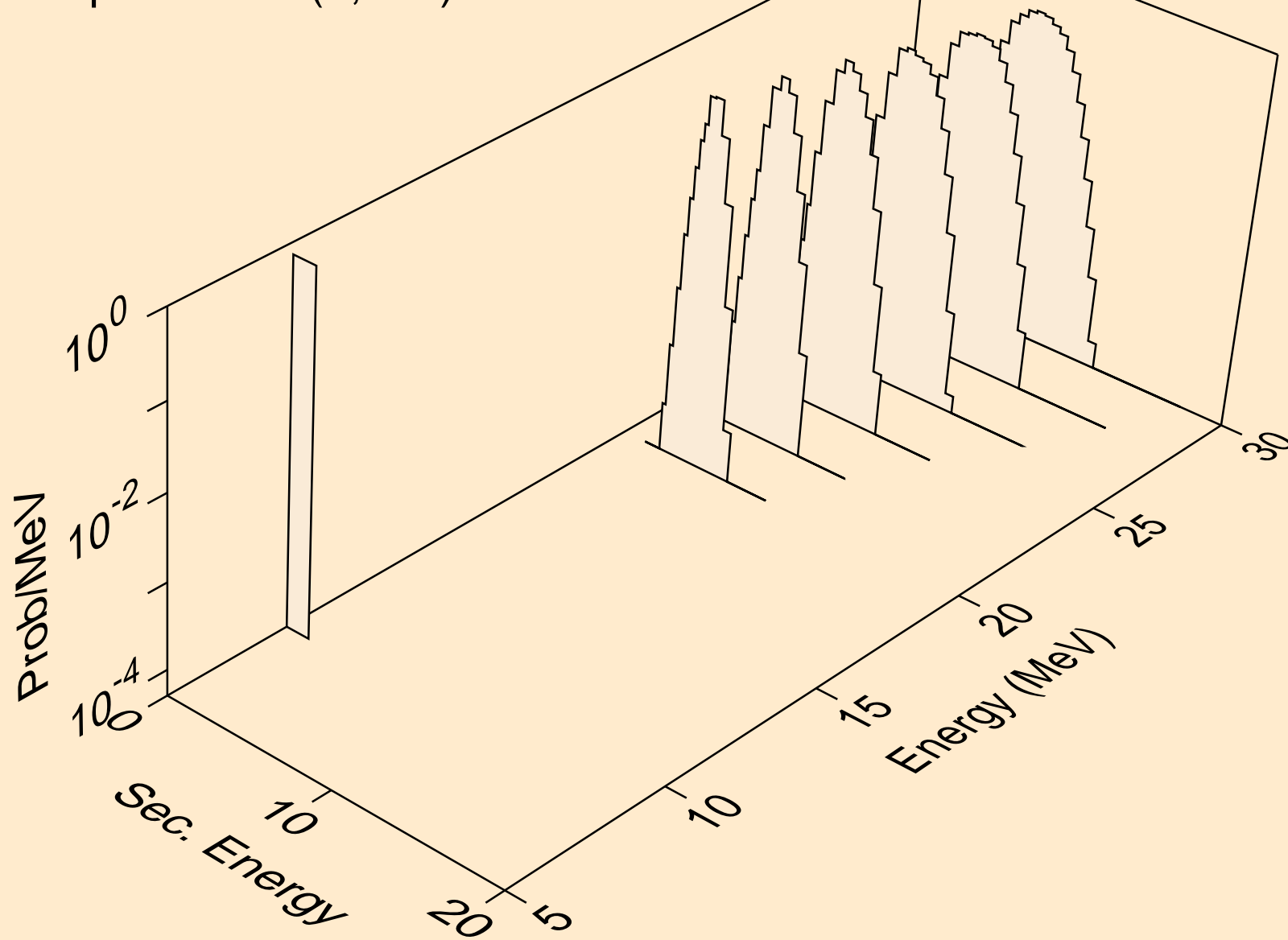

AS069 NEUTRON ACER TENDL-2023 LIBRARY; T=0.K  
alphas from (n,da)

