

BI195 NEUTRON ACER TENDL-2023 LIBRARY; T=0.K

Principal cross sections

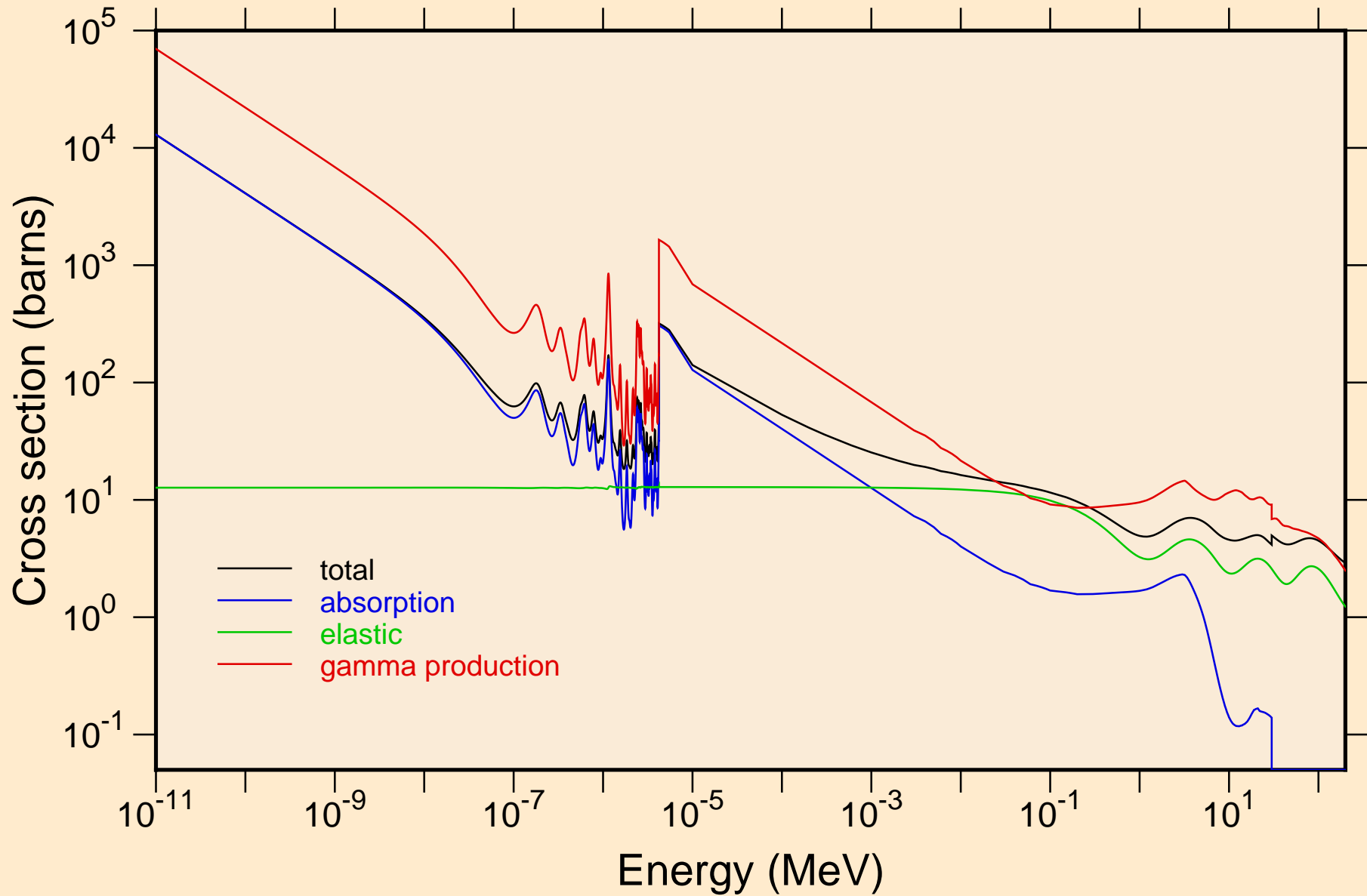

BI195 NEUTRON ACER TENDL-2023 LIBRARY; T=0.K
resonance total cross section

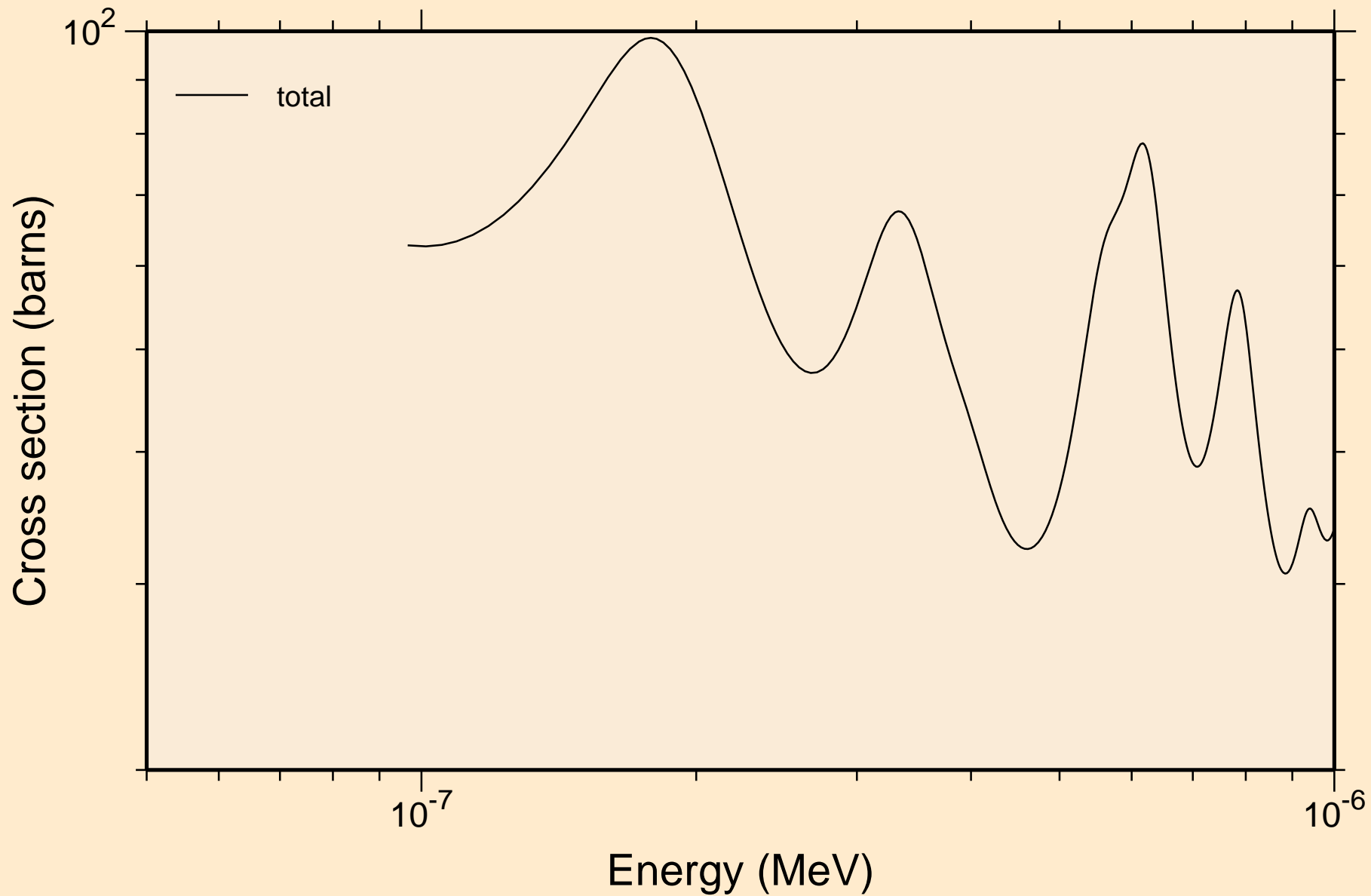

BI195 NEUTRON ACER TENDL-2023 LIBRARY; T=0.K
resonance total cross section

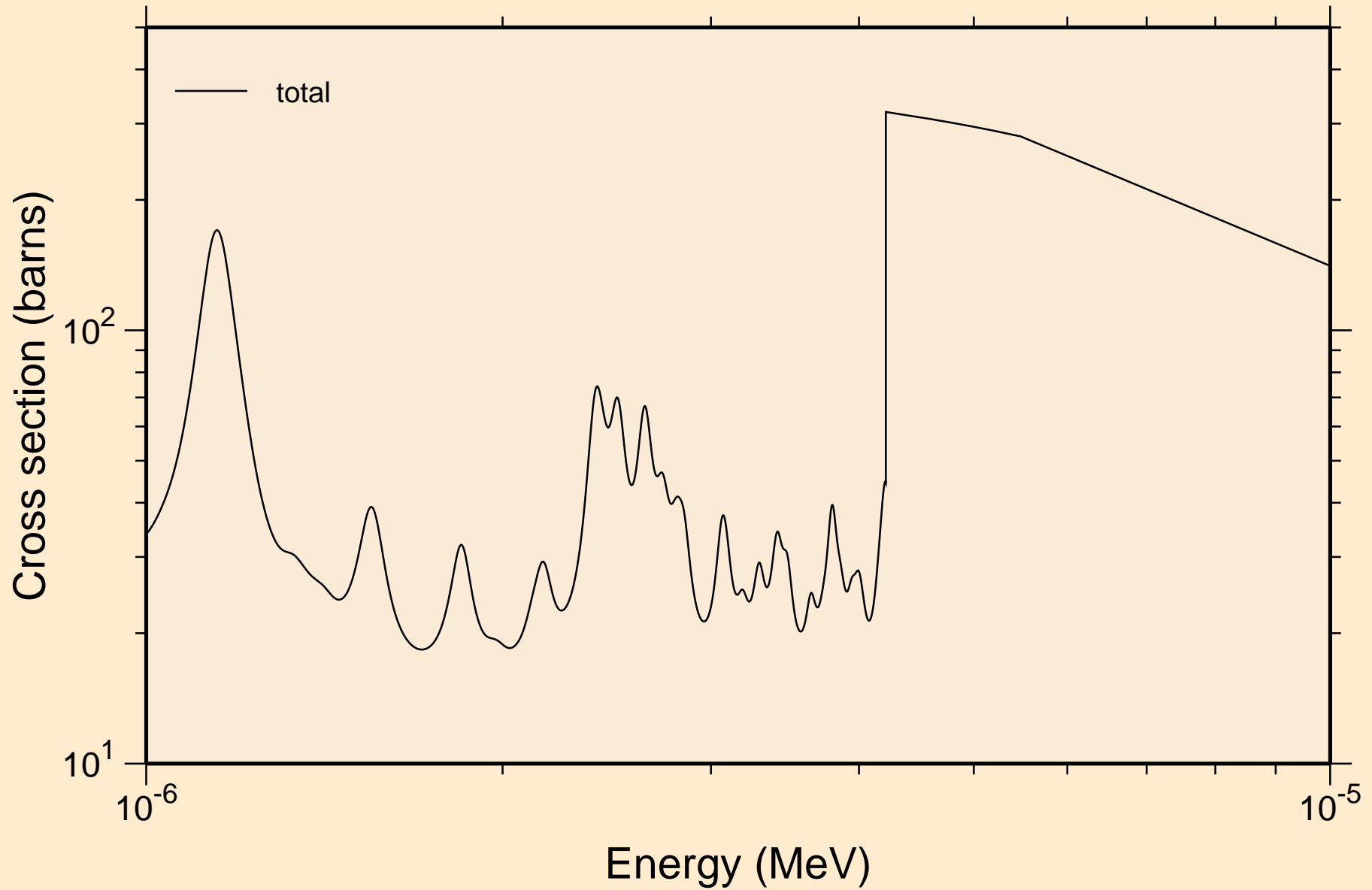

BI195 NEUTRON ACER TENDL-2023 LIBRARY; T=0.K
resonance total cross section

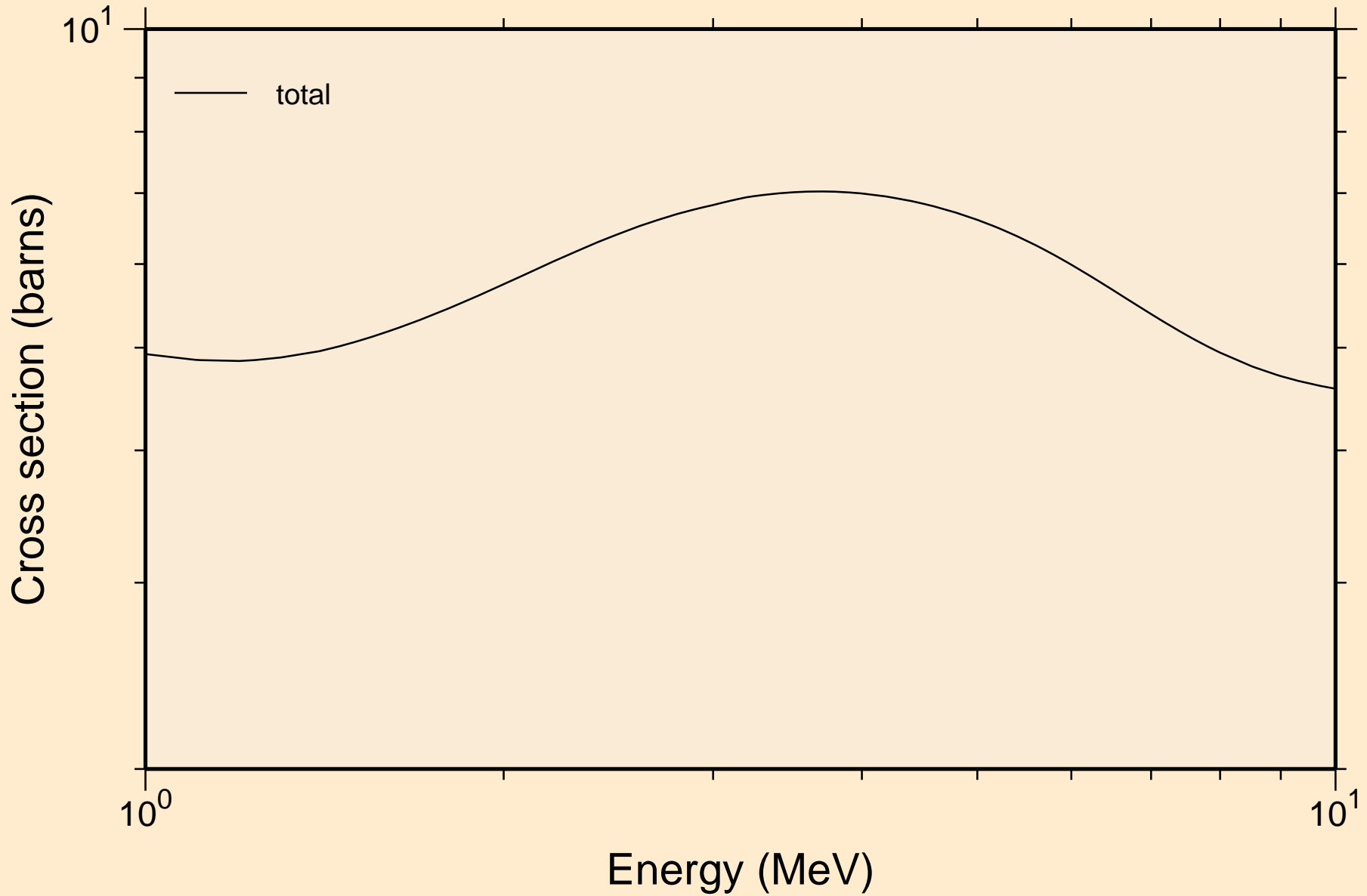

BI195 NEUTRON ACER TENDL-2023 LIBRARY; T=0.K
resonance absorption cross sections

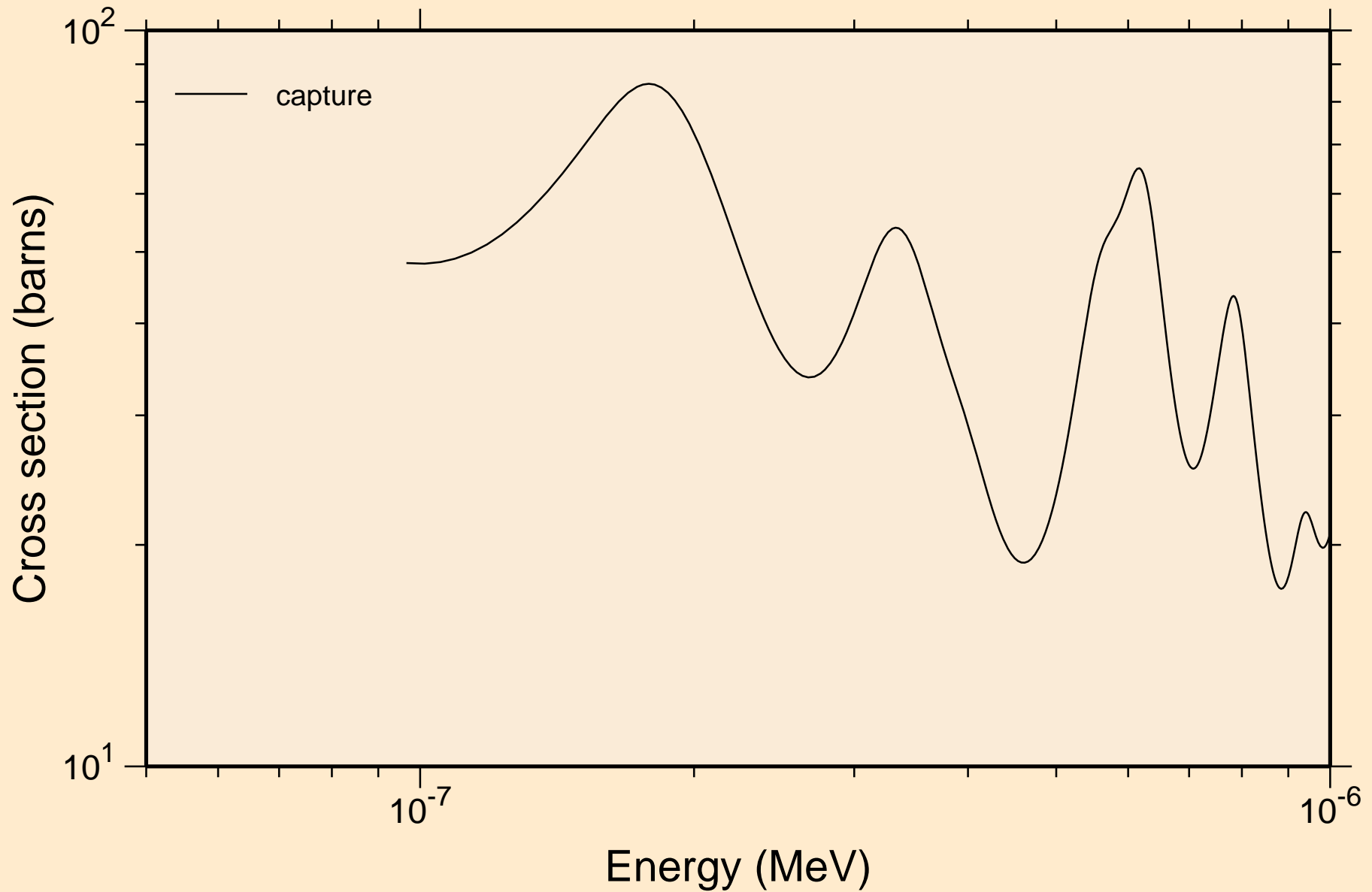

BI195 NEUTRON ACER TENDL-2023 LIBRARY; T=0.K
resonance absorption cross sections

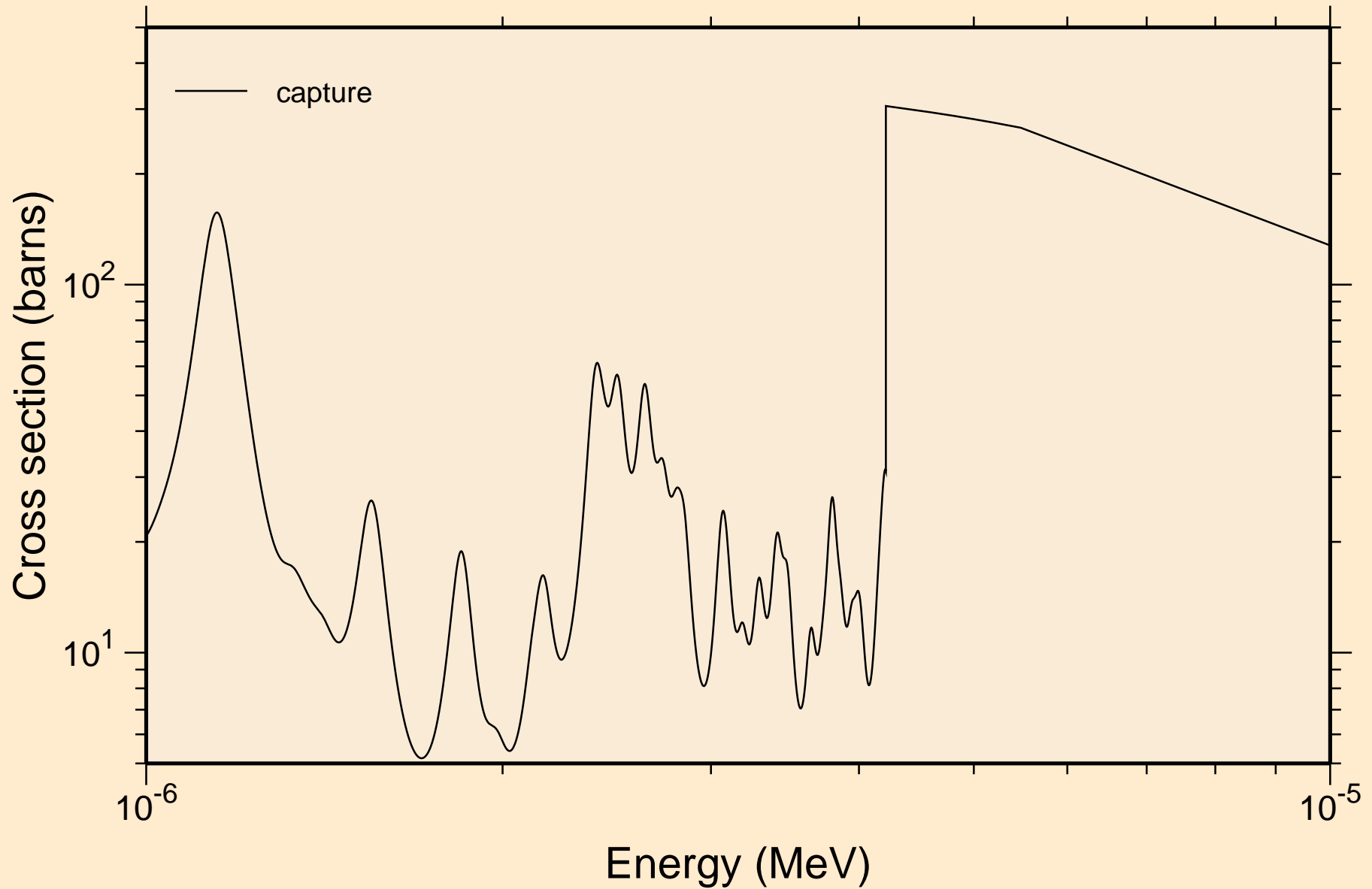

BI195 NEUTRON ACER TENDL-2023 LIBRARY; T=0.K
resonance absorption cross sections

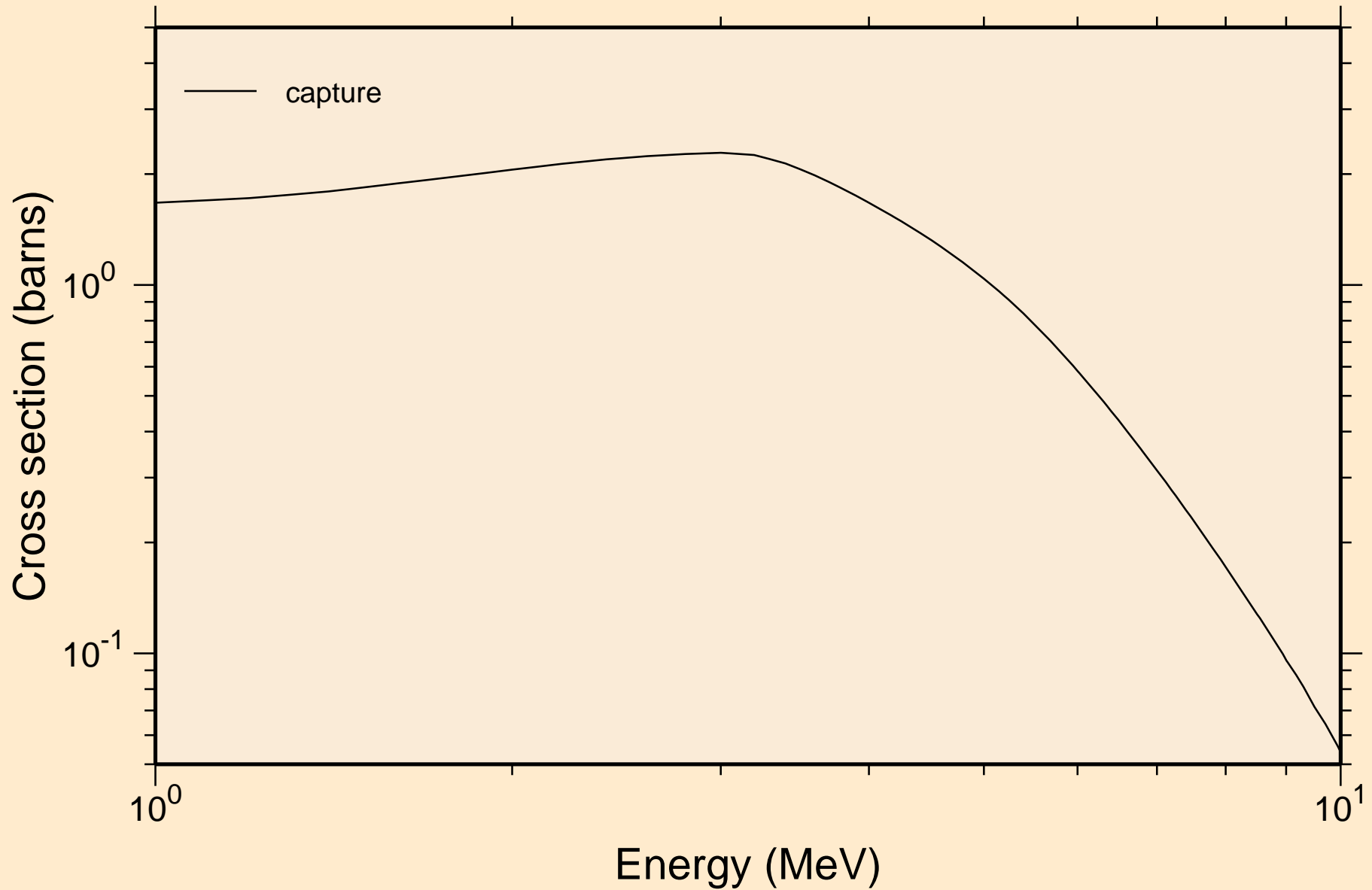

BI195 NEUTRON ACER TENDL-2023 LIBRARY; T=0.K

Heating

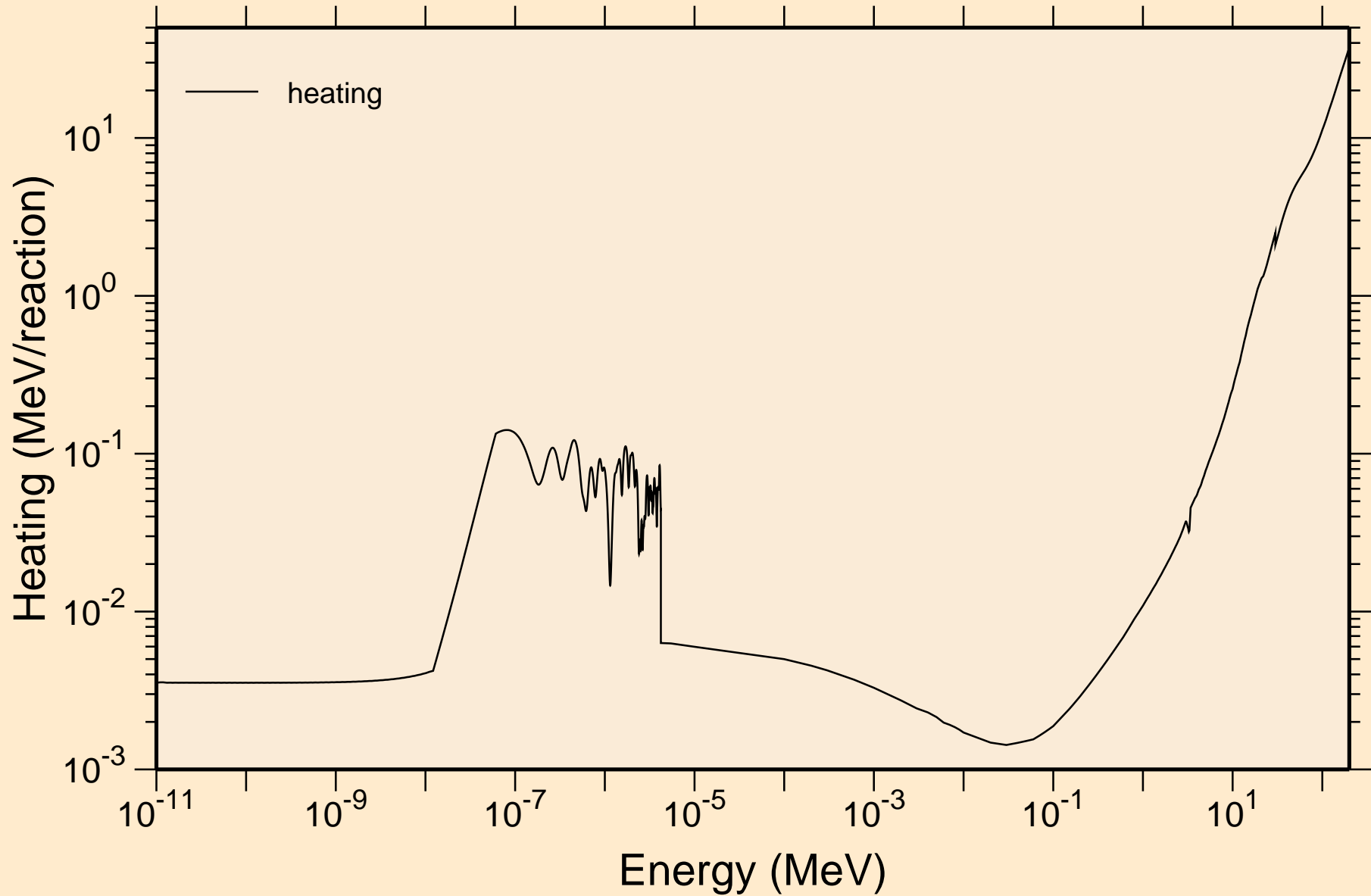

BI195 NEUTRON ACER TENDL-2023 LIBRARY; T=0.K
Damage

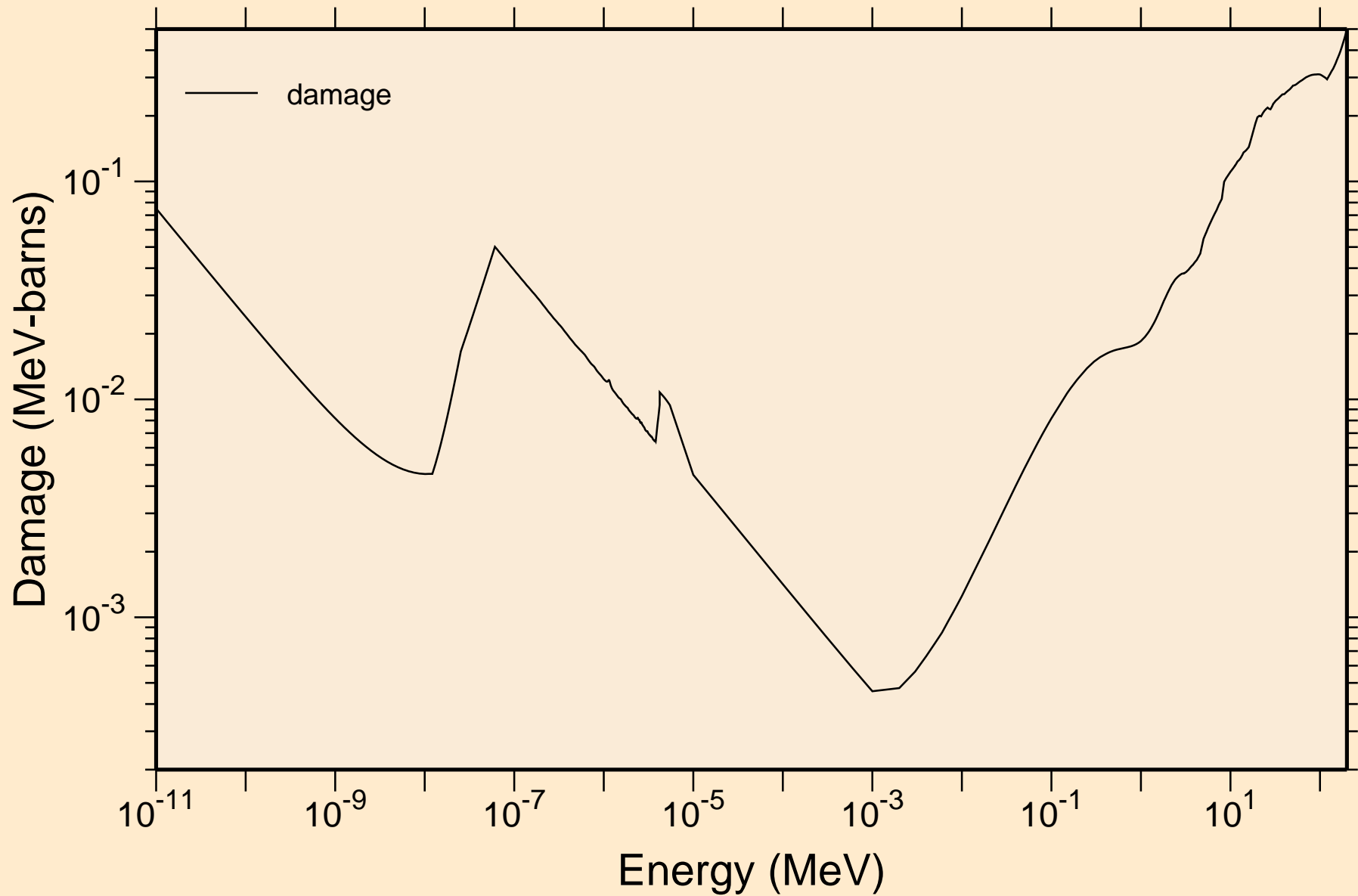

BI195 NEUTRON ACER TENDL-2023 LIBRARY; T=0.K
Non-threshold reactions

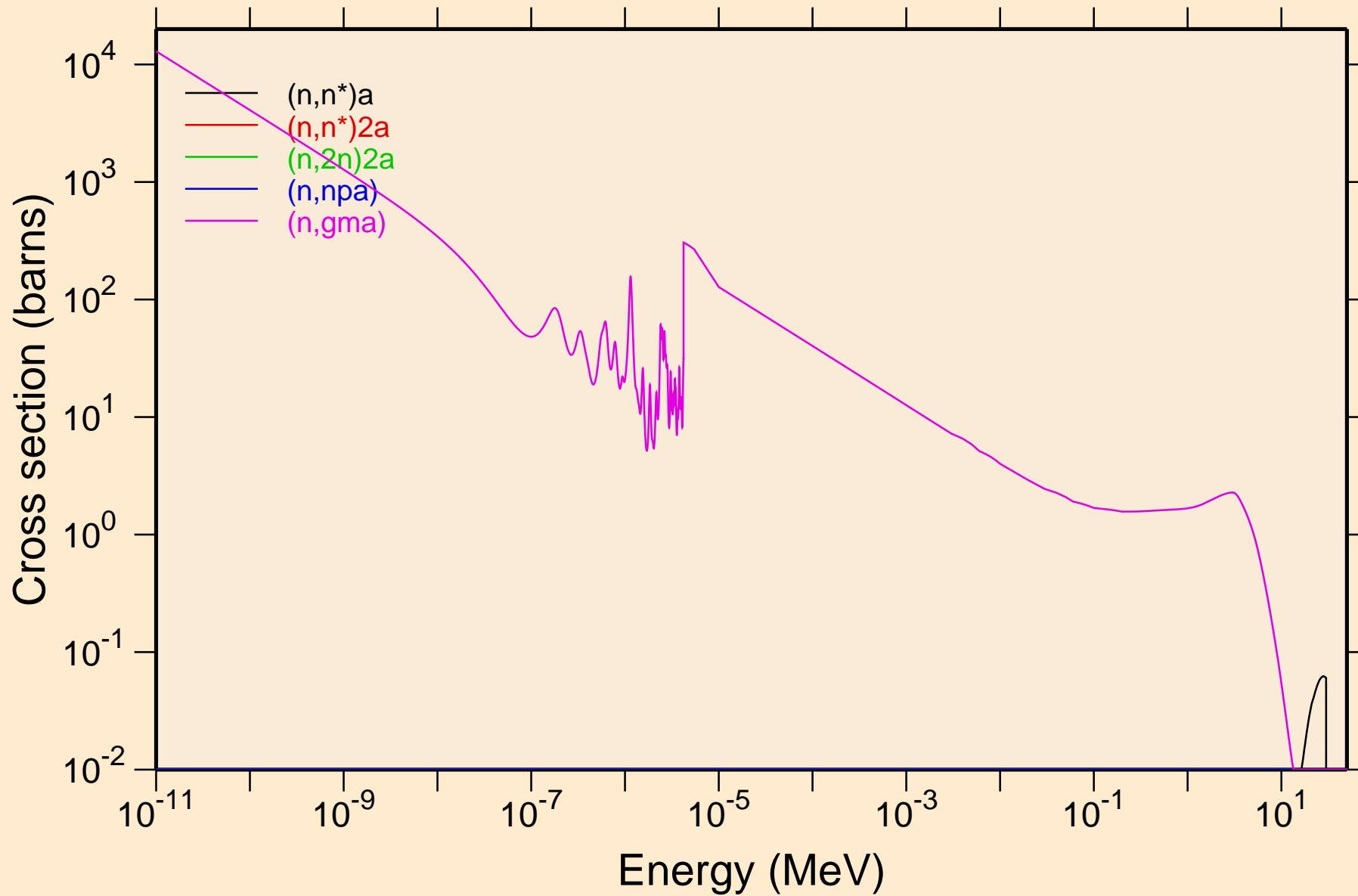

BI195 NEUTRON ACER TENDL-2023 LIBRARY; T=0.K
Non-threshold reactions

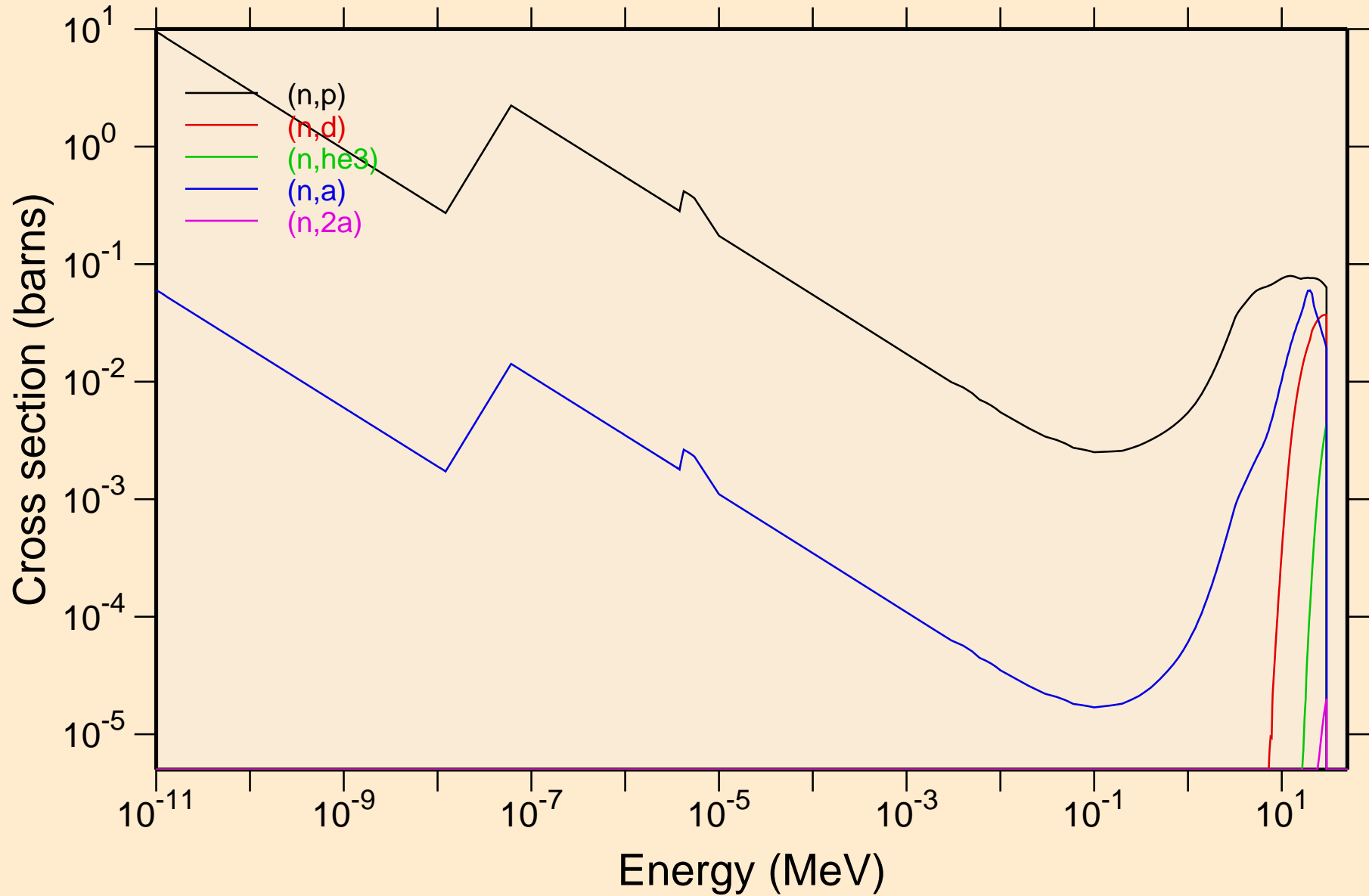

BI195 NEUTRON ACER TENDL-2023 LIBRARY; T=0.K
Non-threshold reactions

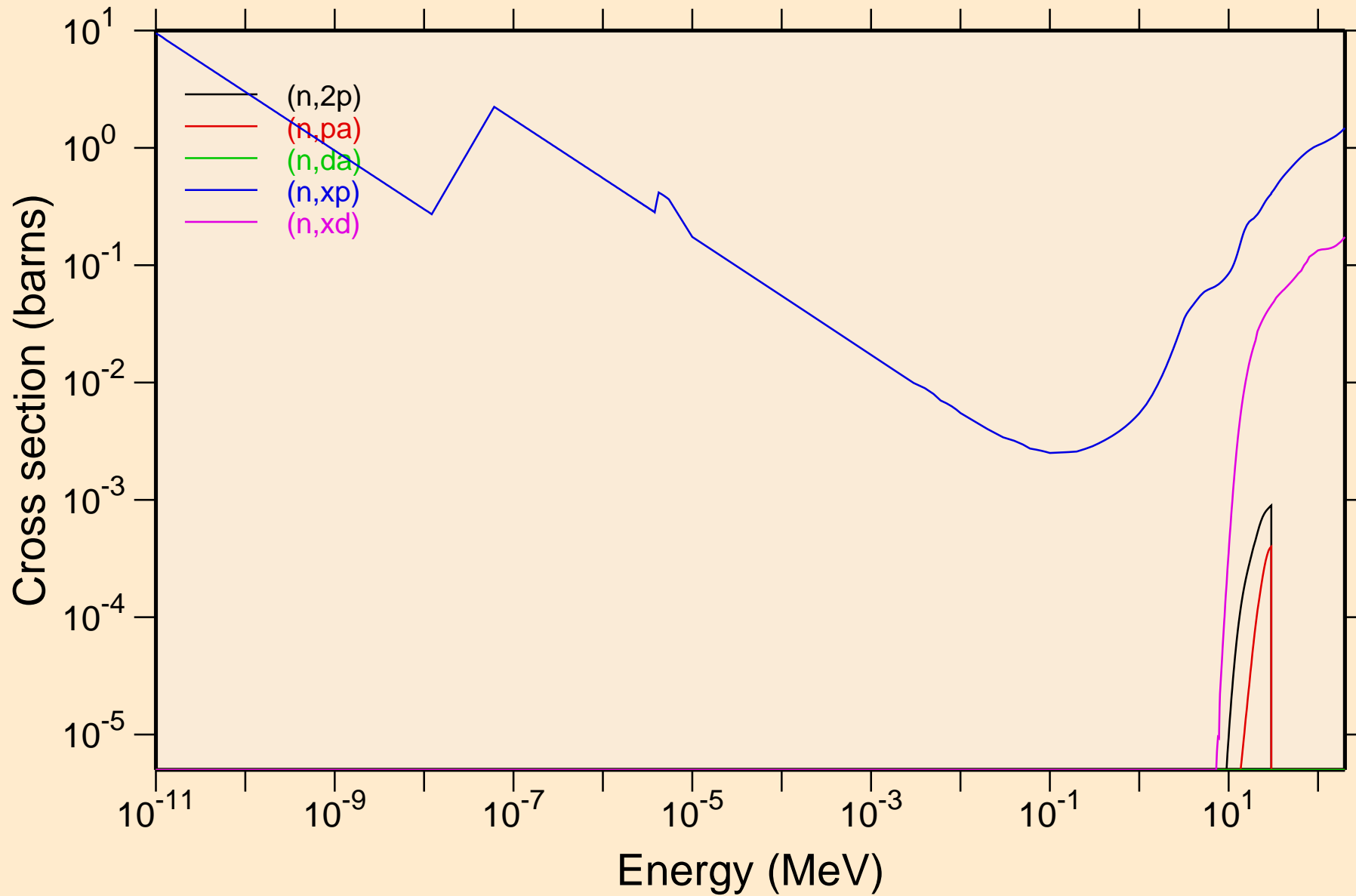

BI195 NEUTRON ACER TENDL-2023 LIBRARY; T=0.K
Non-threshold reactions

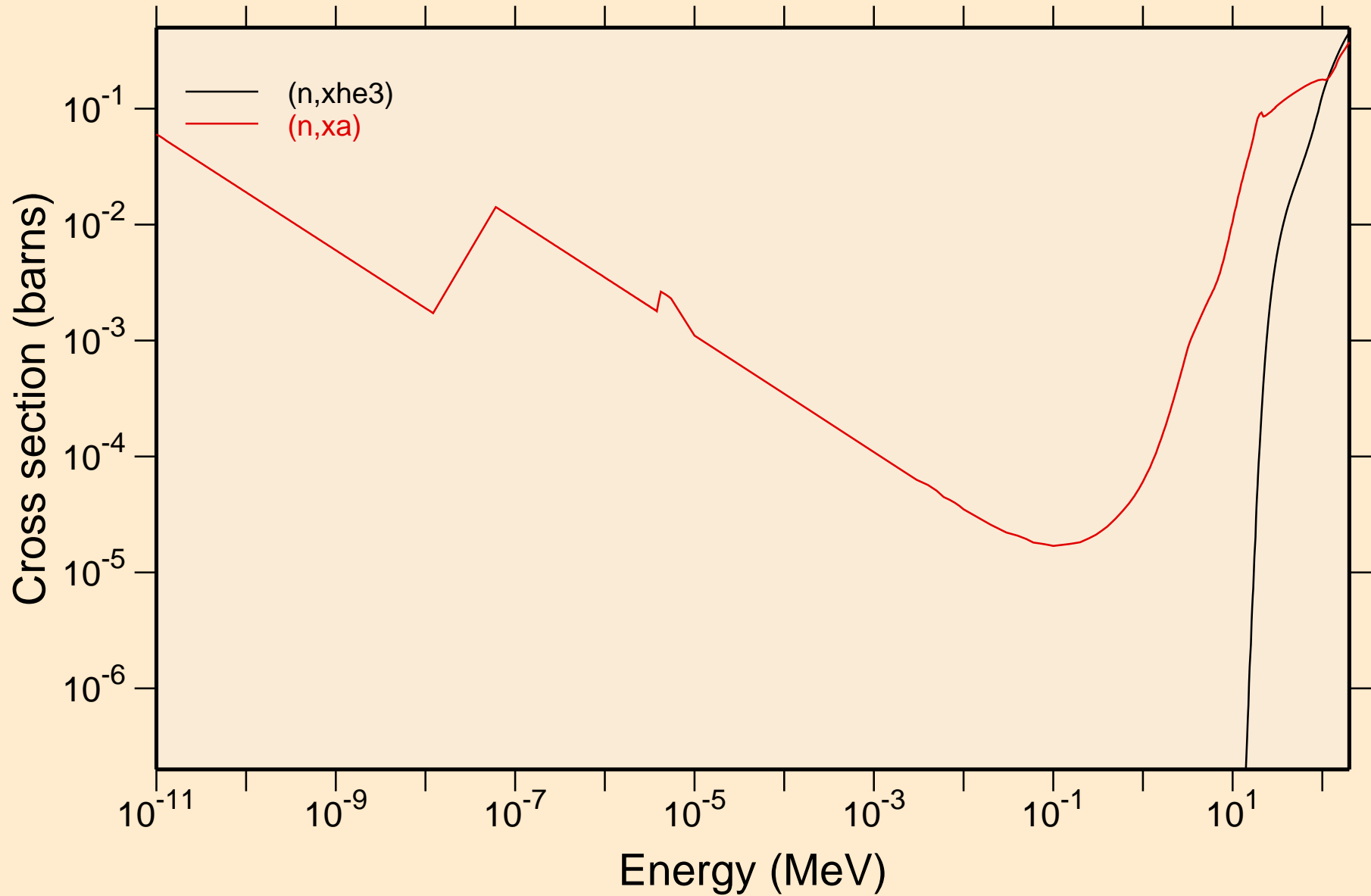

BI195 NEUTRON ACER TENDL-2023 LIBRARY; T=0.K

Principal cross sections

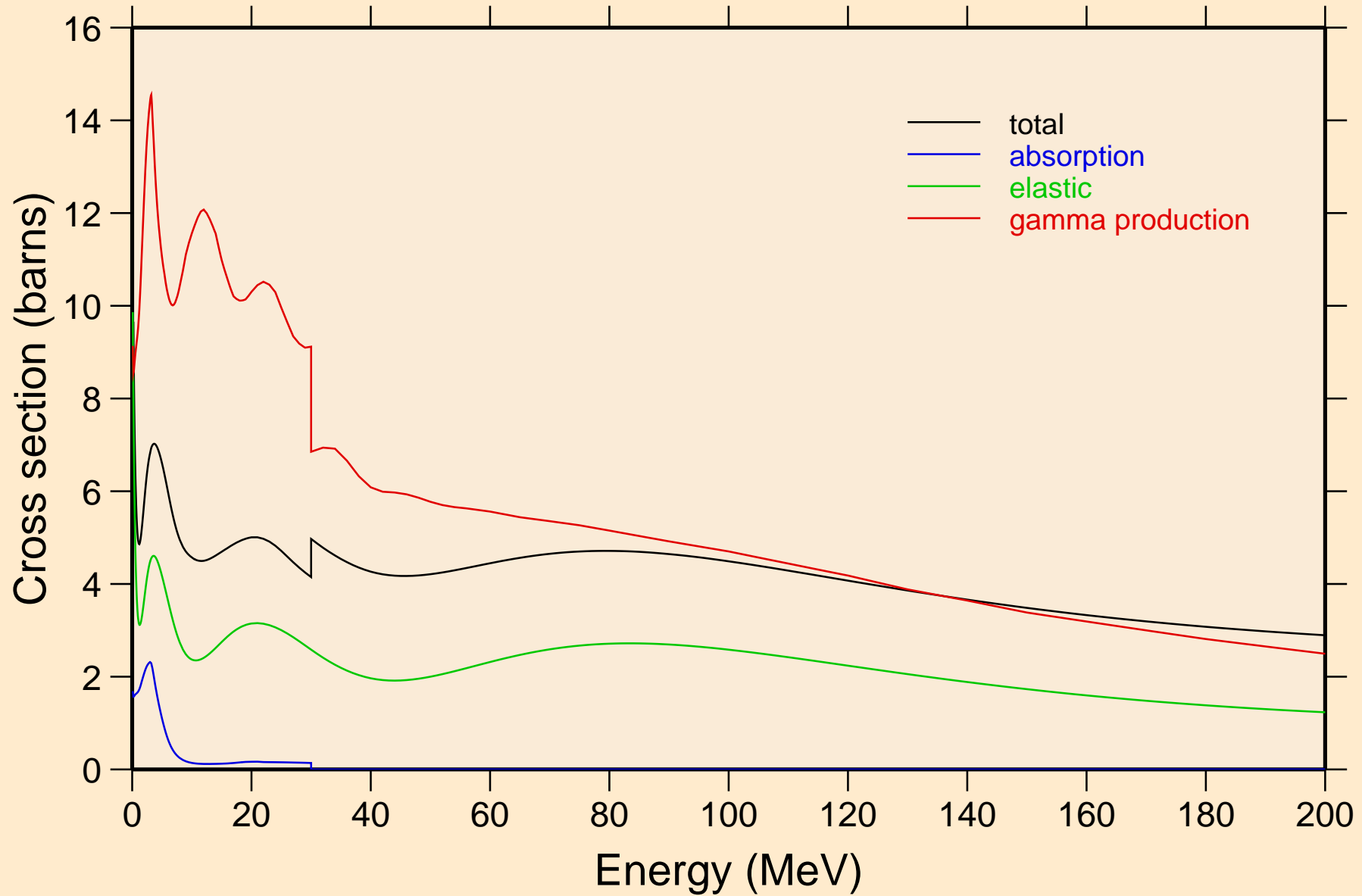

BI195 NEUTRON ACER TENDL-2023 LIBRARY; T=0.K

Heating

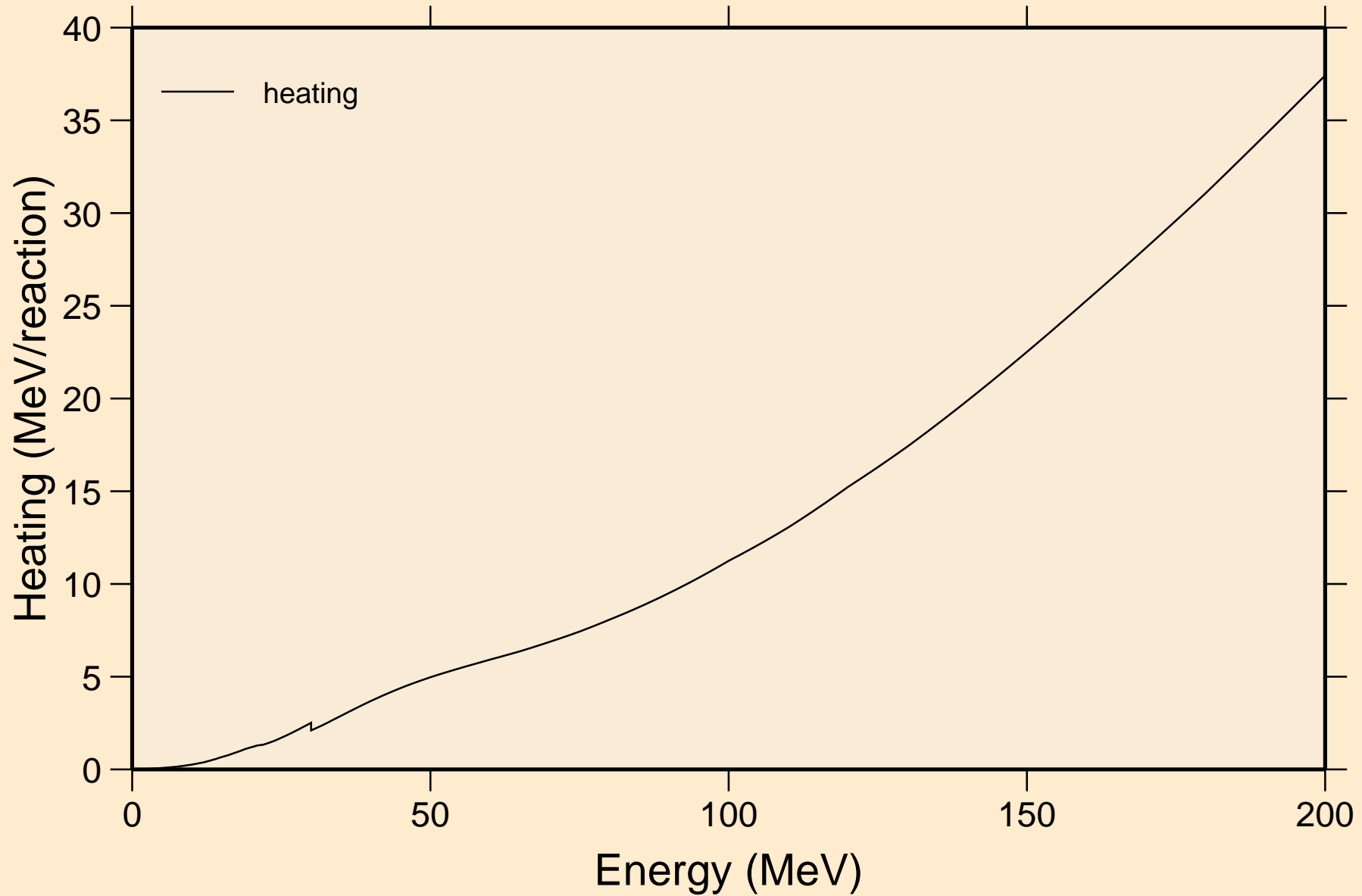

BI195 NEUTRON ACER TENDL-2023 LIBRARY; T=0.K
Damage

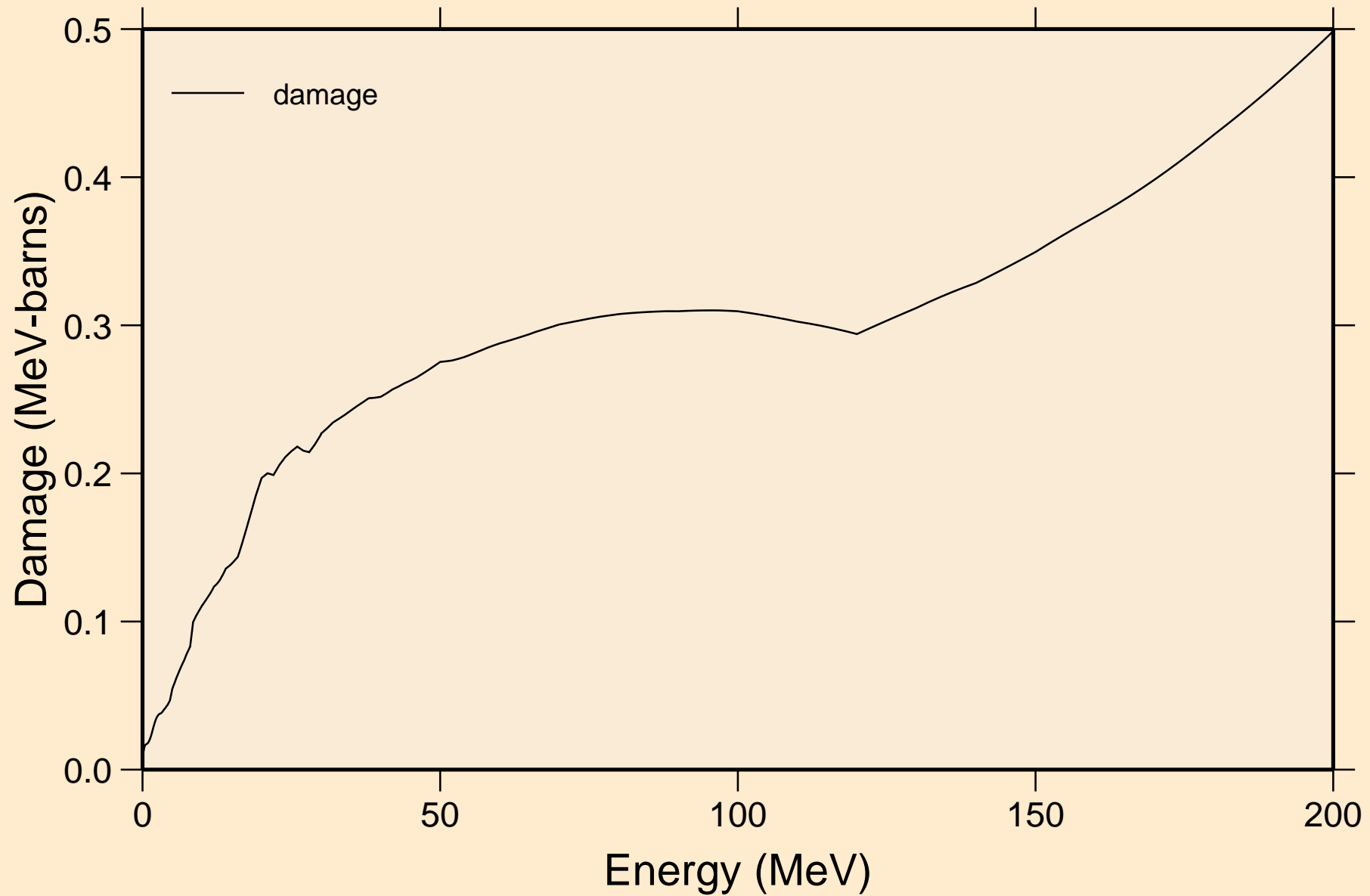

BI195 NEUTRON ACER TENDL-2023 LIBRARY; T=0.K
Non-threshold reactions

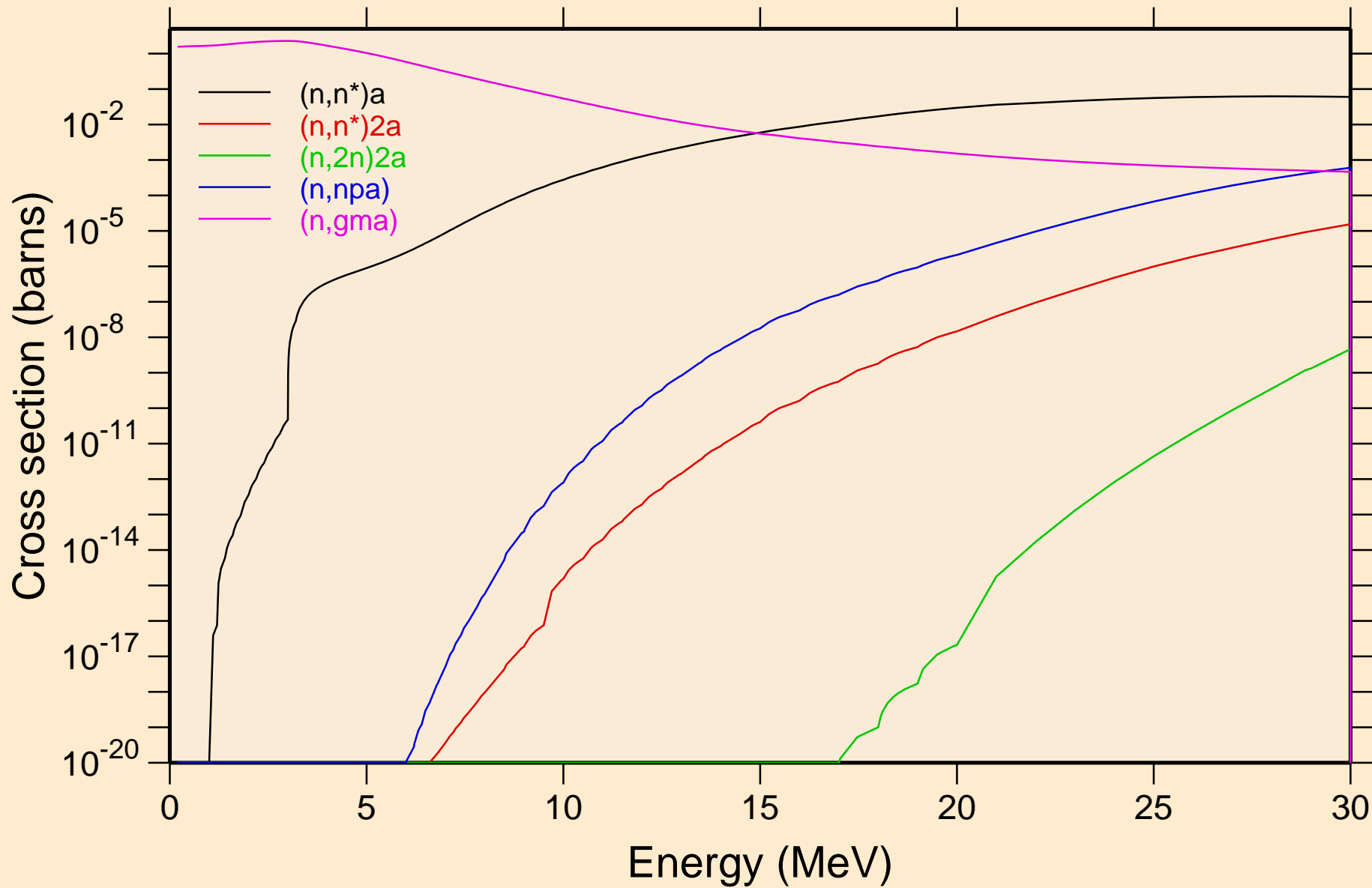

BI195 NEUTRON ACER TENDL-2023 LIBRARY; T=0.K
Non-threshold reactions

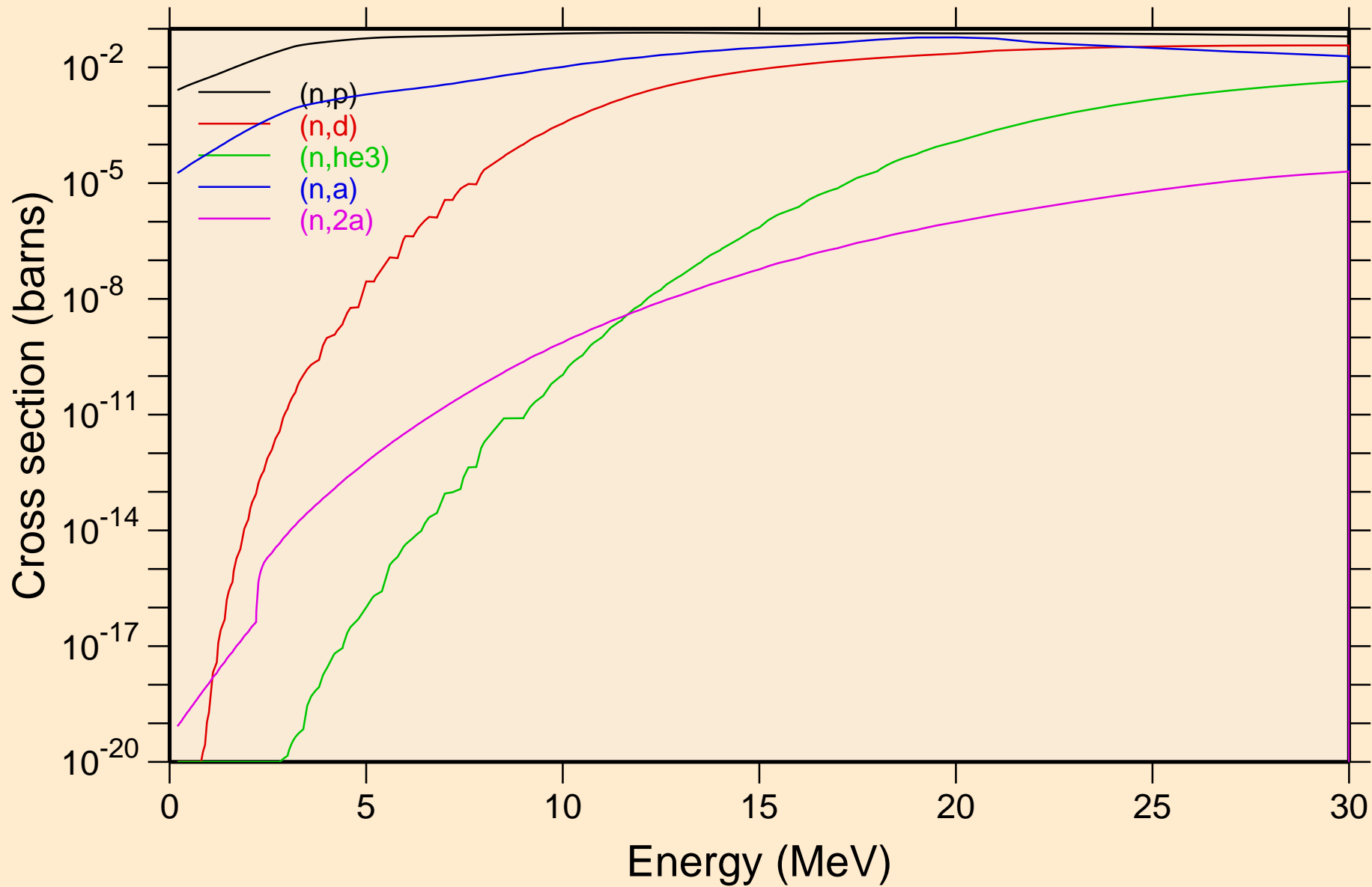

BI195 NEUTRON ACER TENDL-2023 LIBRARY; T=0.K

Non-threshold reactions

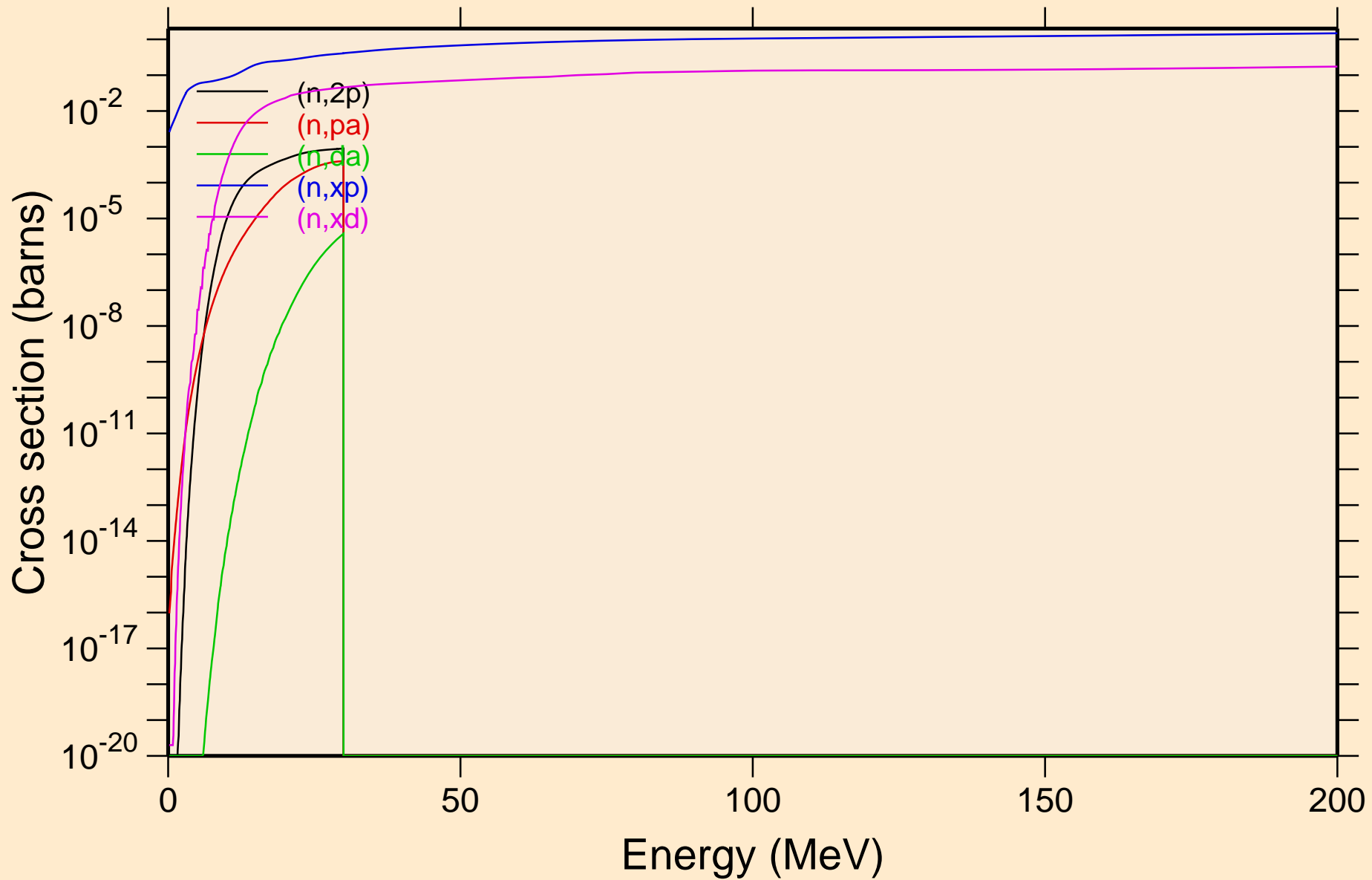

BI195 NEUTRON ACER TENDL-2023 LIBRARY; T=0.K
Non-threshold reactions

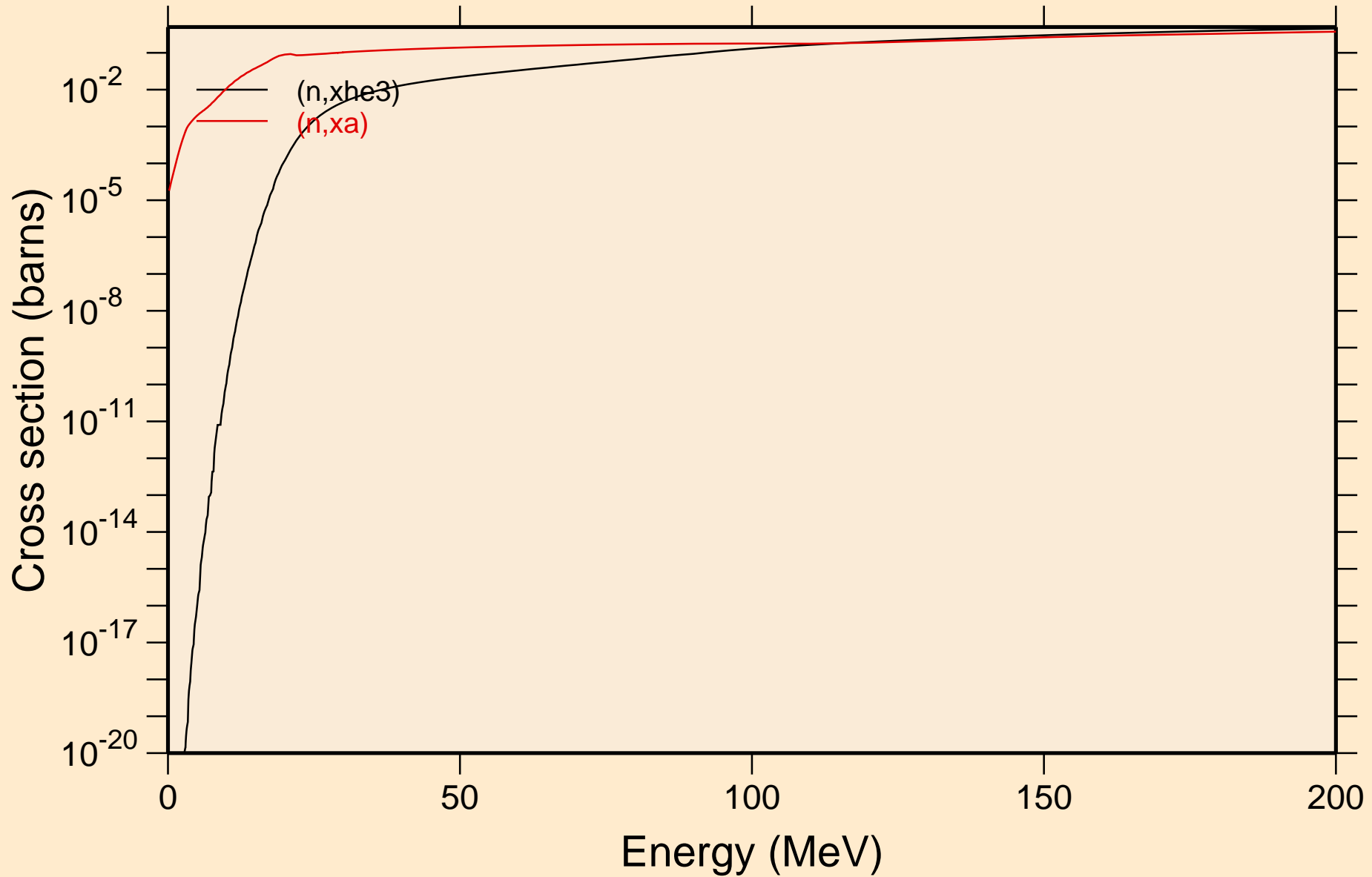

BI195 NEUTRON ACER TENDL-2023 LIBRARY; T=0.K
Inelastic levels

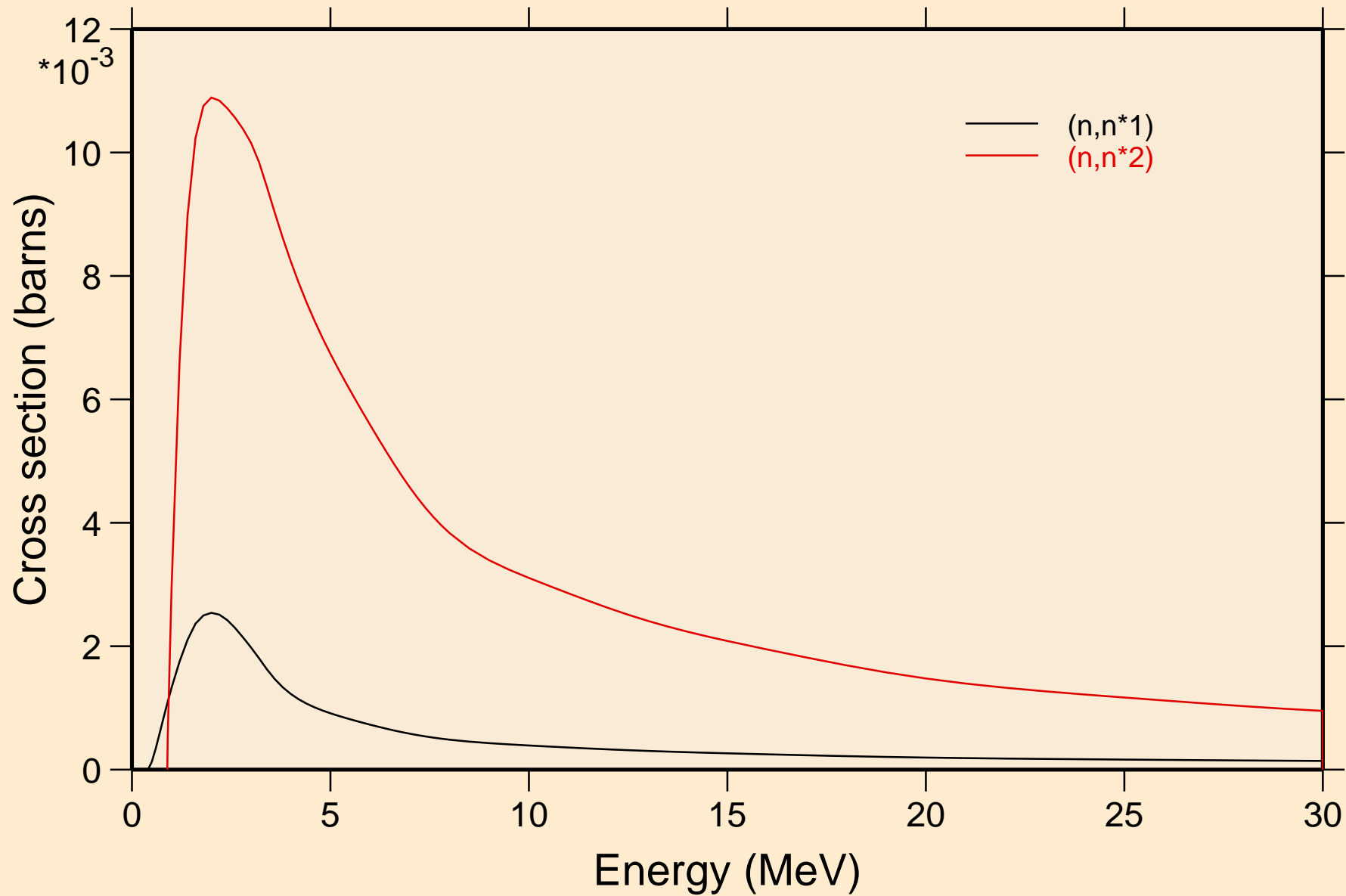

BI195 NEUTRON ACER TENDL-2023 LIBRARY; T=0.K

Threshold reactions

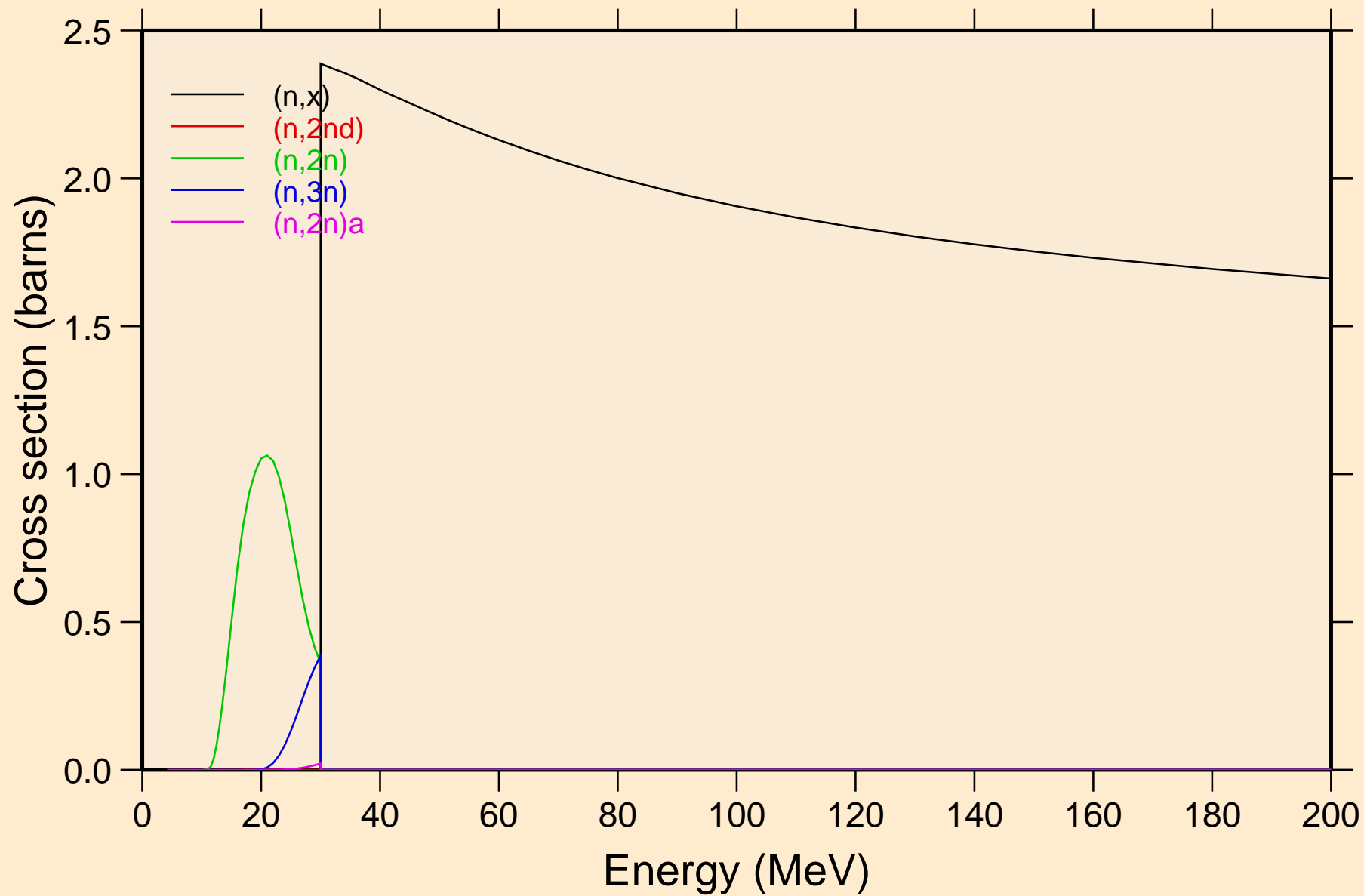

BI195 NEUTRON ACER TENDL-2023 LIBRARY; T=0.K
Threshold reactions

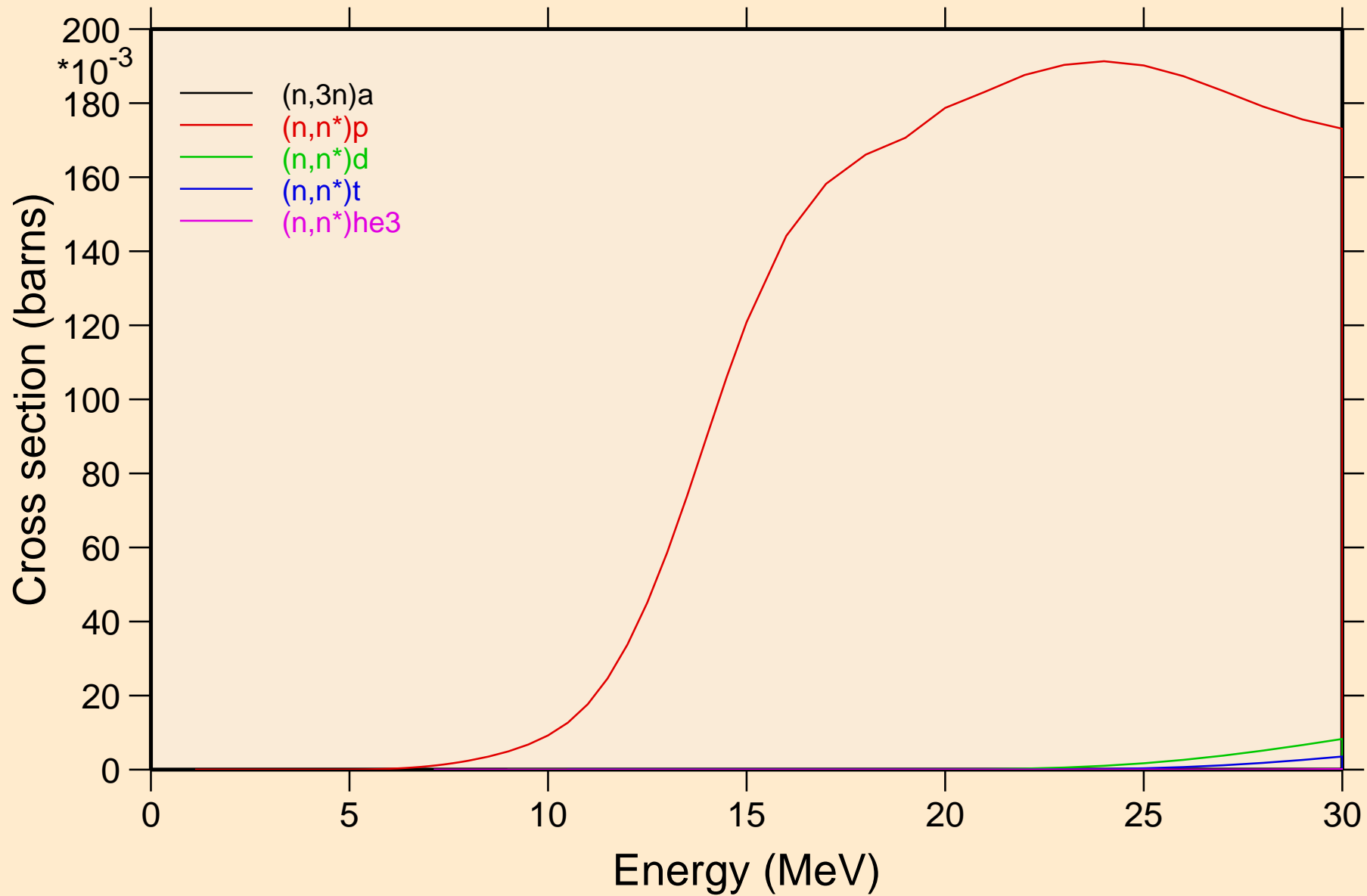

BI195 NEUTRON ACER TENDL-2023 LIBRARY; T=0.K
Threshold reactions

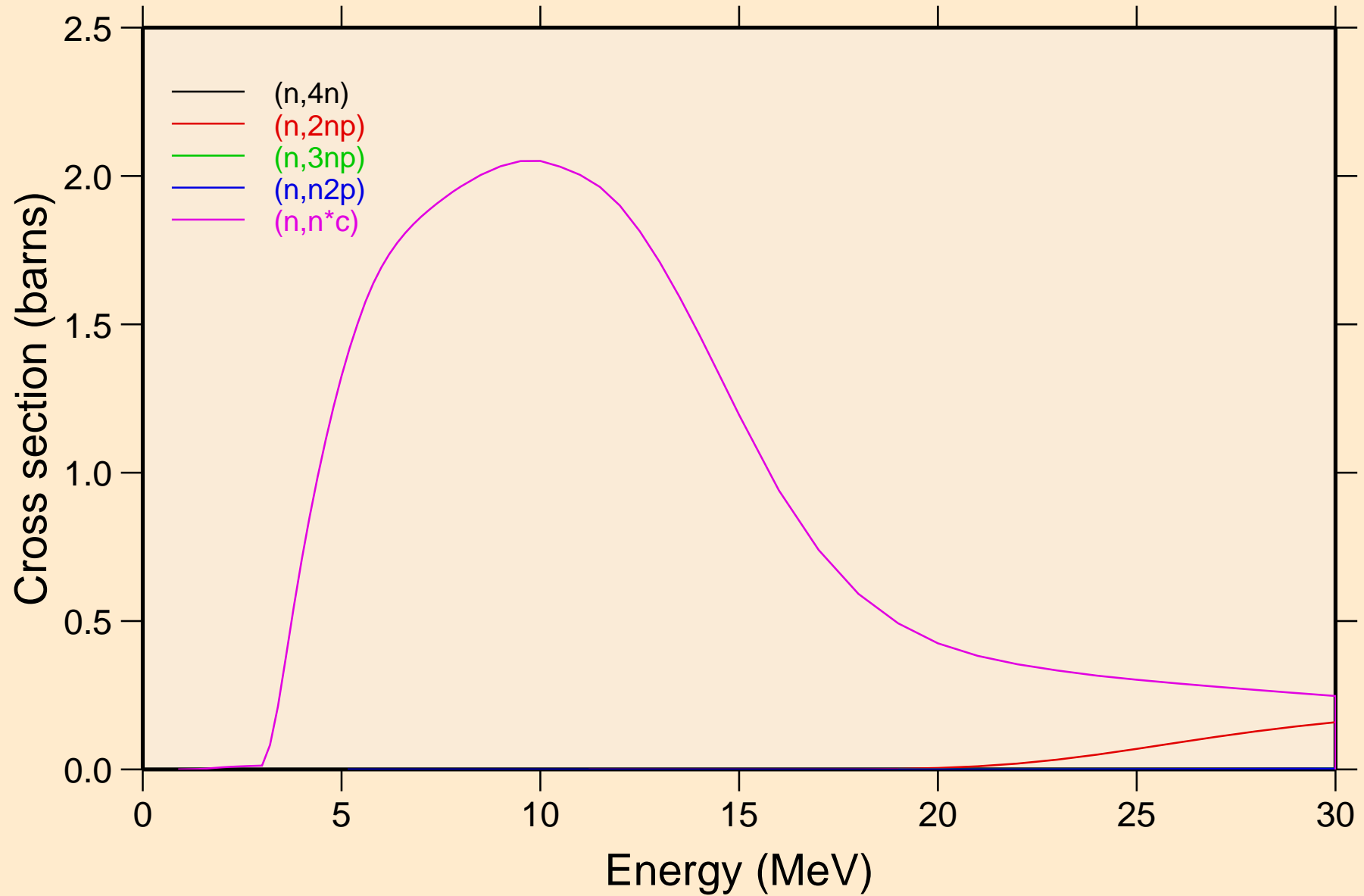

BI195 NEUTRON ACER TENDL-2023 LIBRARY; T=0.K
Threshold reactions

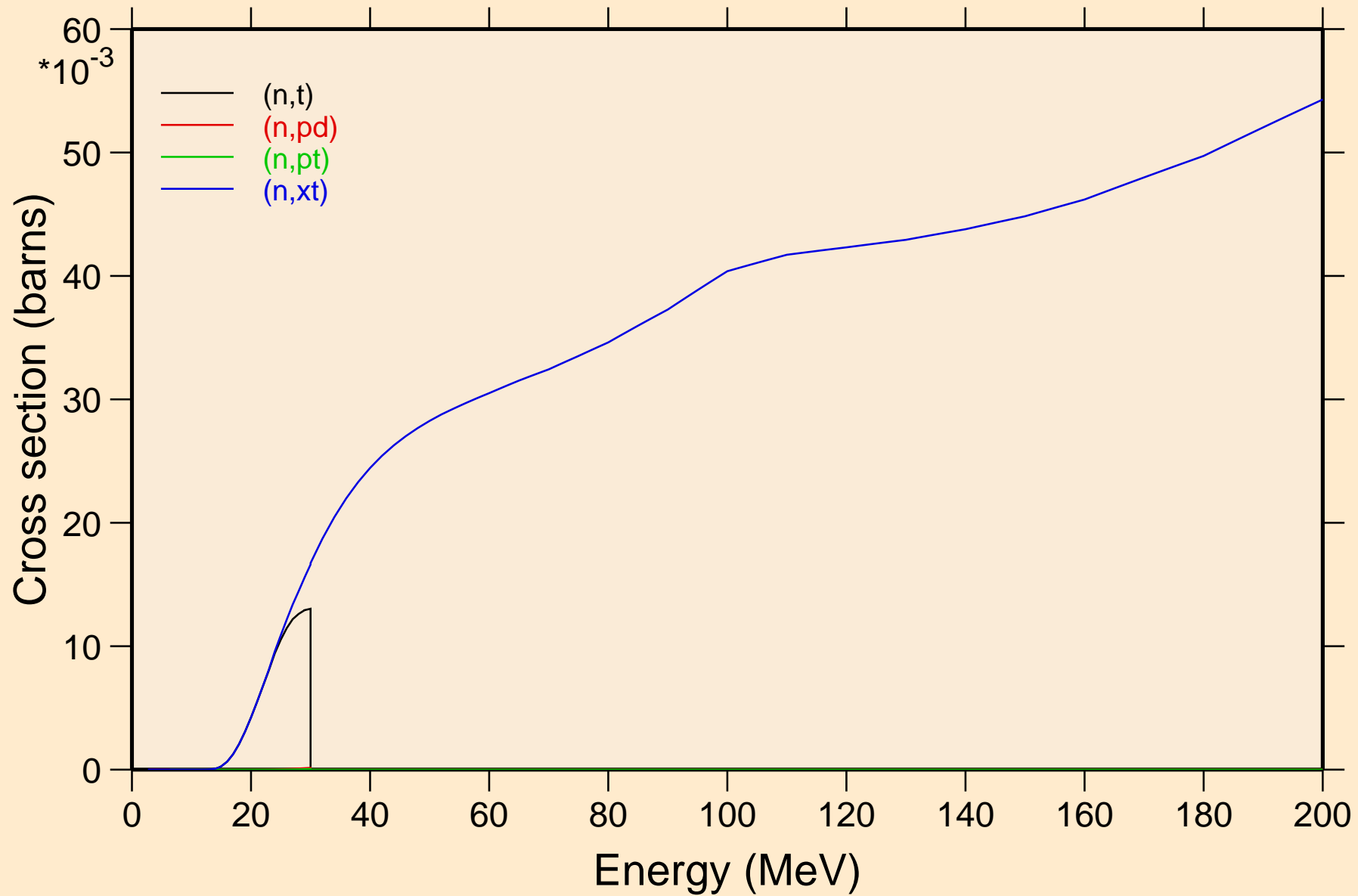

BI195 NEUTRON ACER TENDL-2023 LIBRARY; T=0.K
angular distribution for elastic

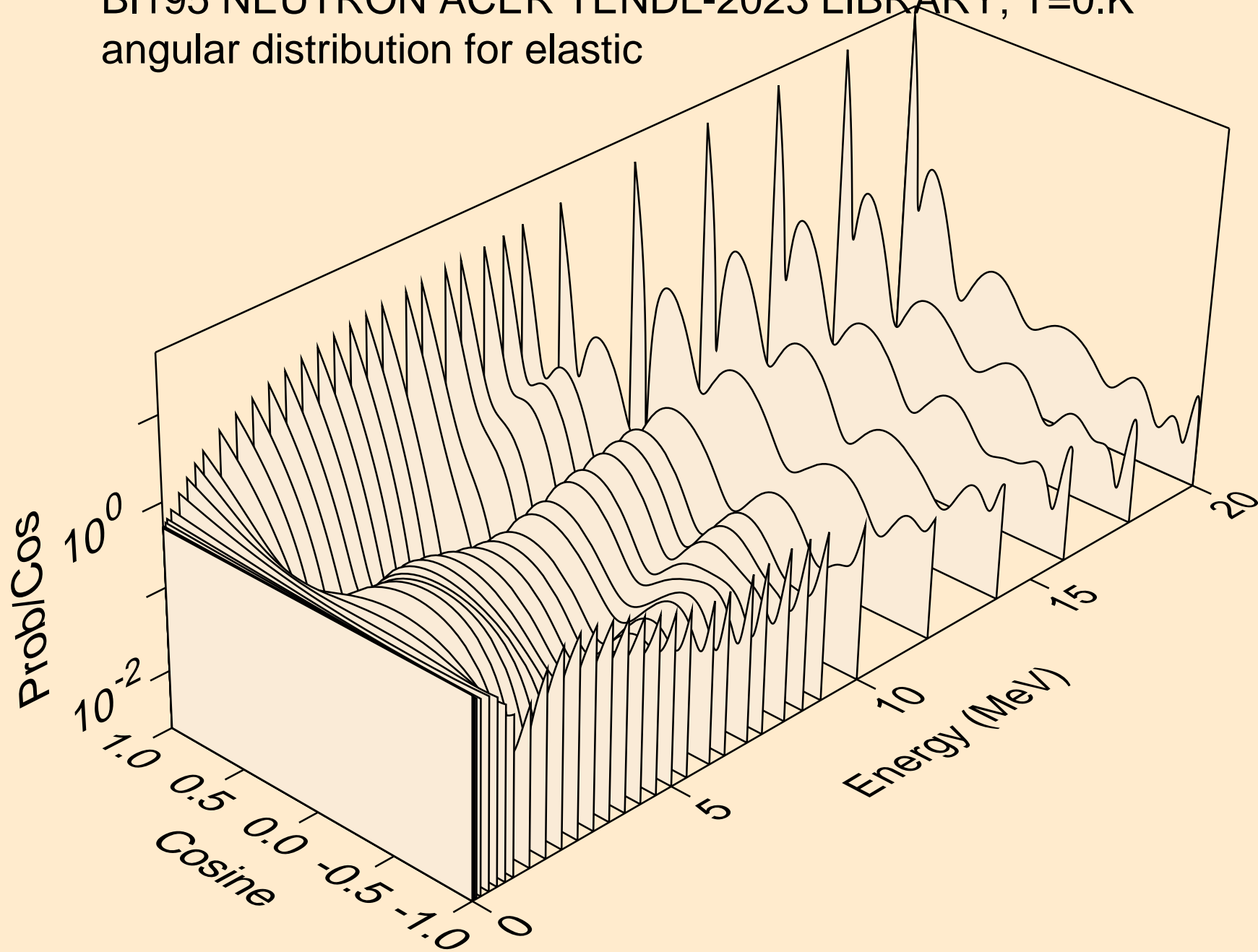

BI195 NEUTRON ACER TENDL-2023 LIBRARY; T=0.K
angular distribution for elastic

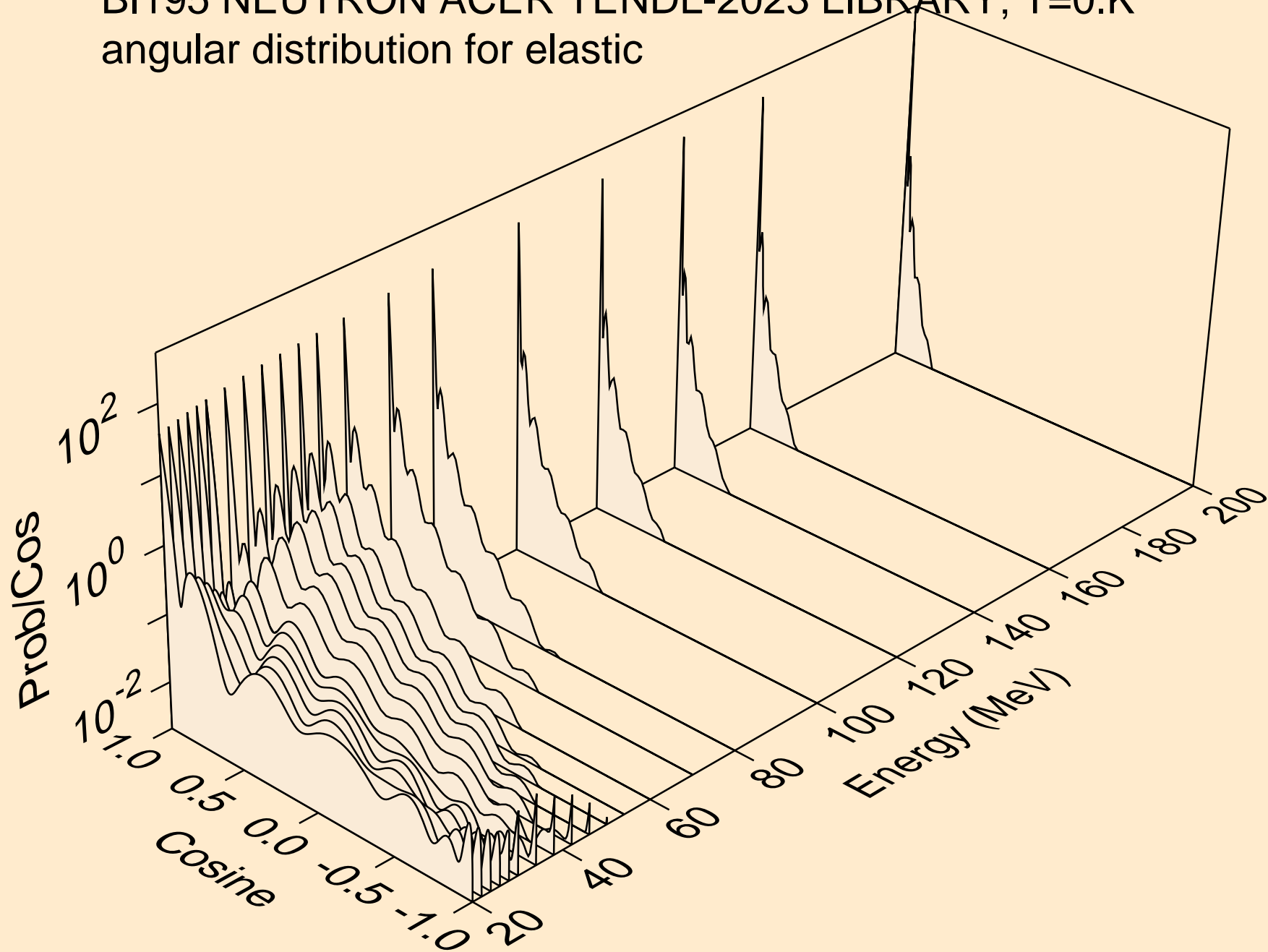

BI195 NEUTRON ACER TENDL-2023 LIBRARY; T=0.K
angular distribution for (n,n*1)

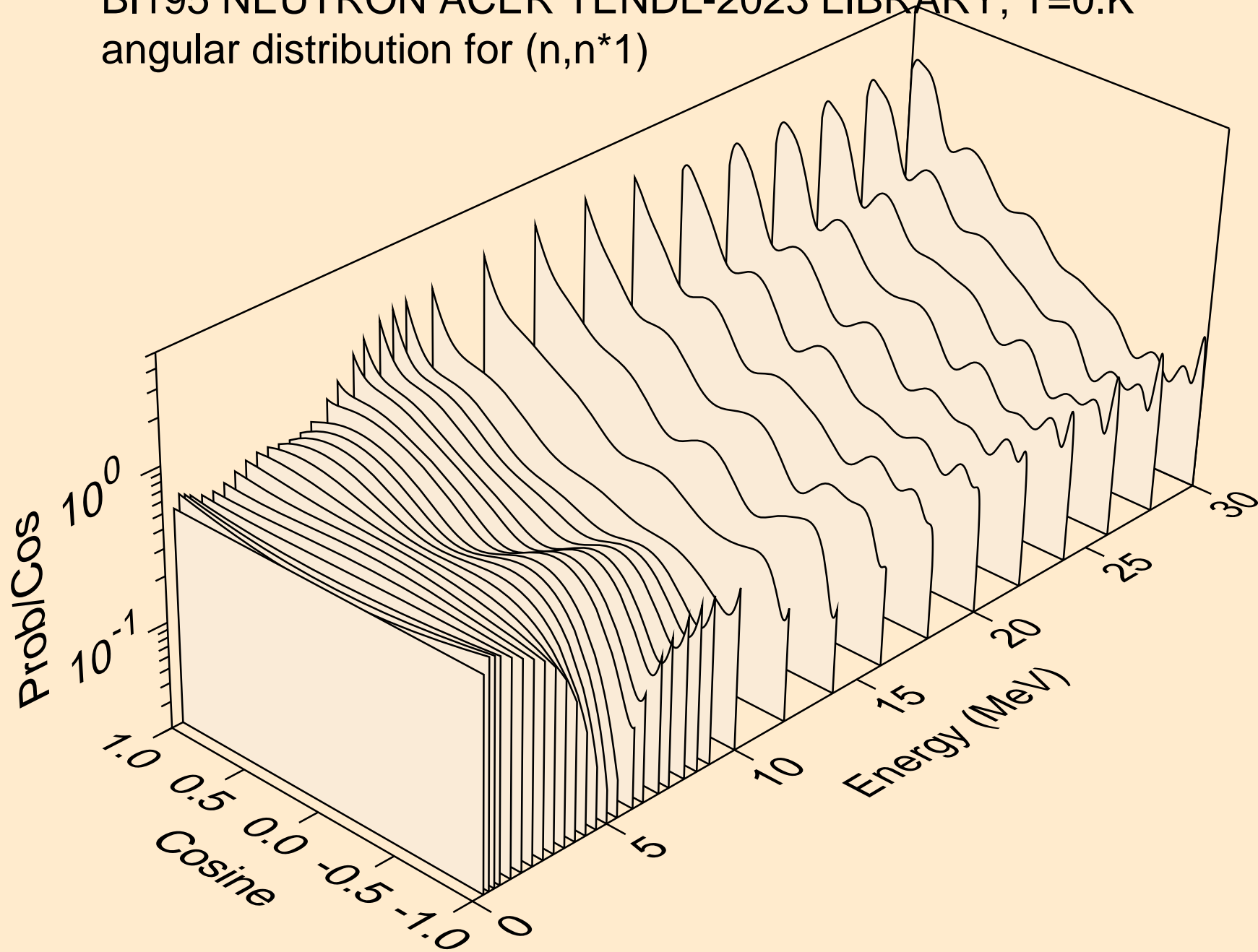

BI195 NEUTRON ACER TENDL-2023 LIBRARY; T=0.K
angular distribution for (n,n*2)

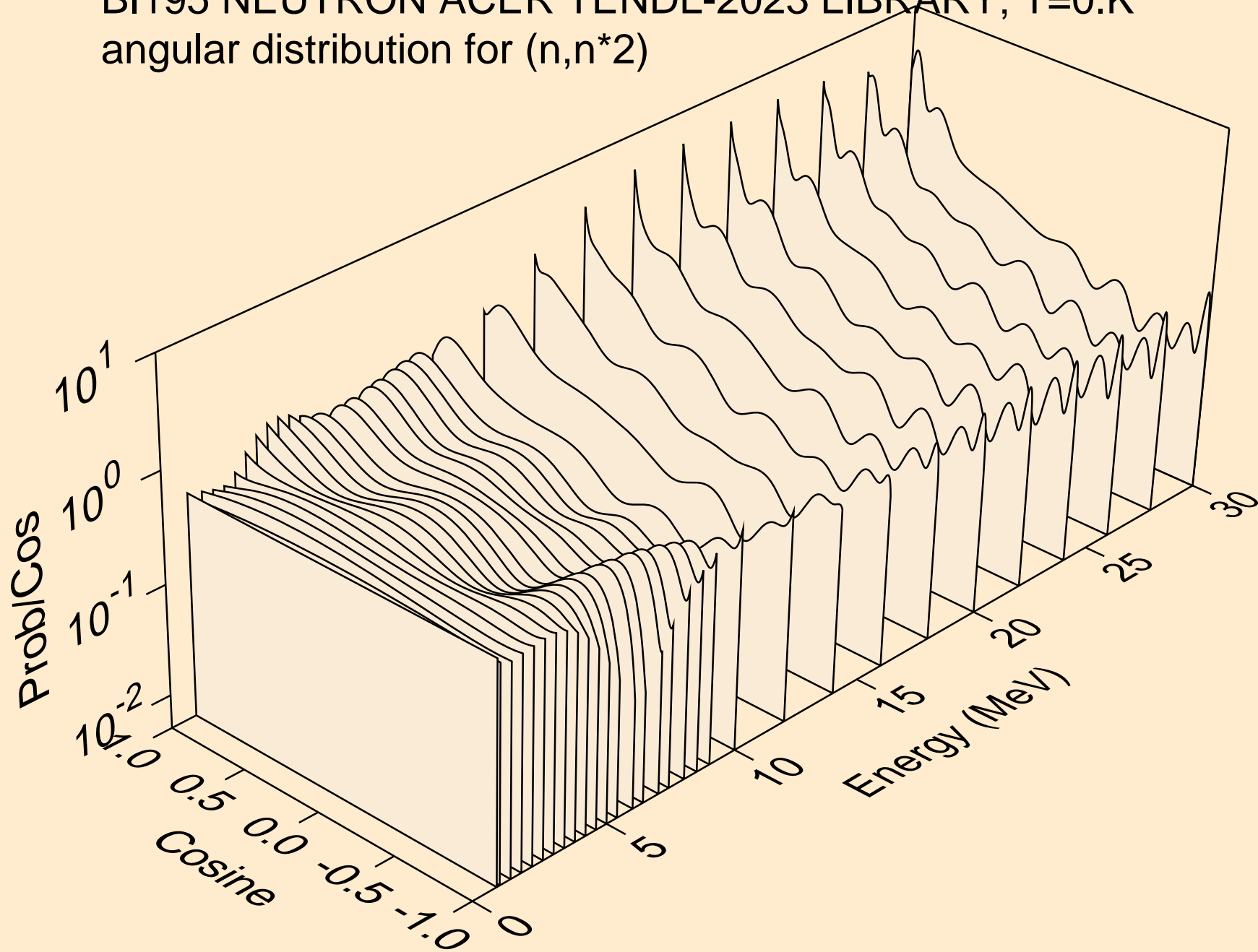

BI195 NEUTRON ACER TENDL-2023 LIBRARY; T=0.K
Neutron emission for (n,x)

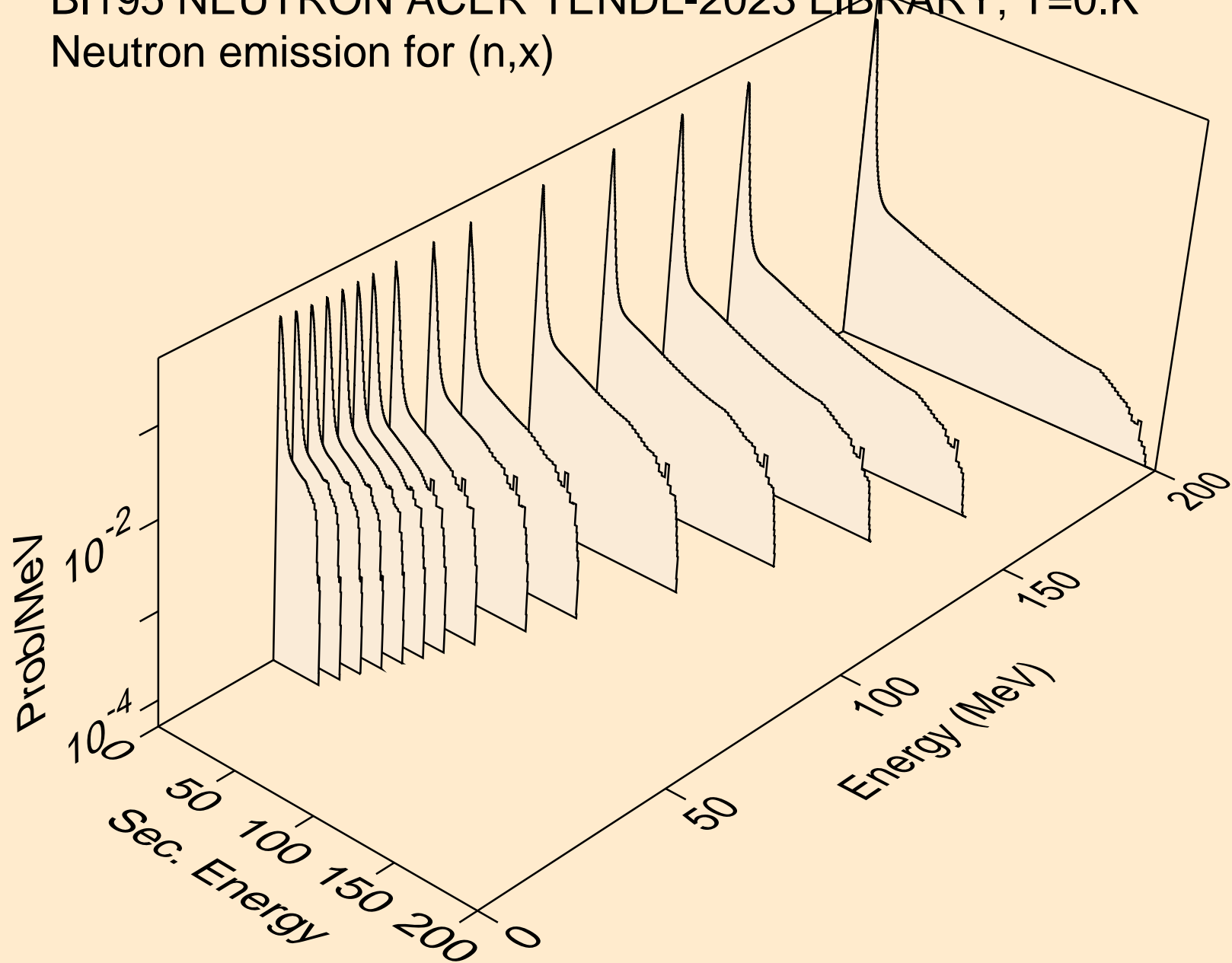

BI195 NEUTRON ACER TENDL-2023 LIBRARY; T=0.K
Neutron emission for (n,2nd)

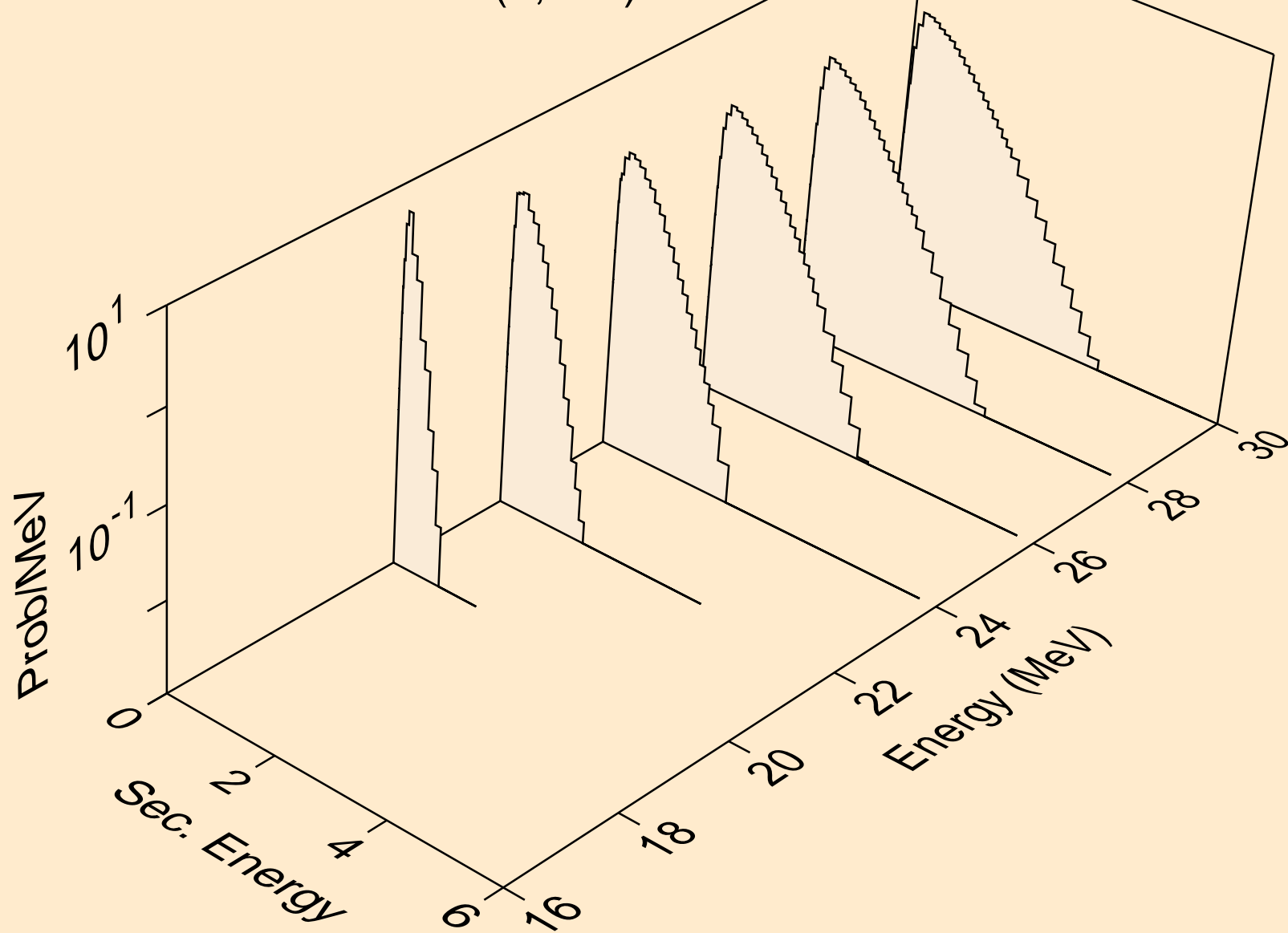

BI195 NEUTRON ACER TENDL-2023 LIBRARY; T=0.K
Neutron emission for (n,2n)

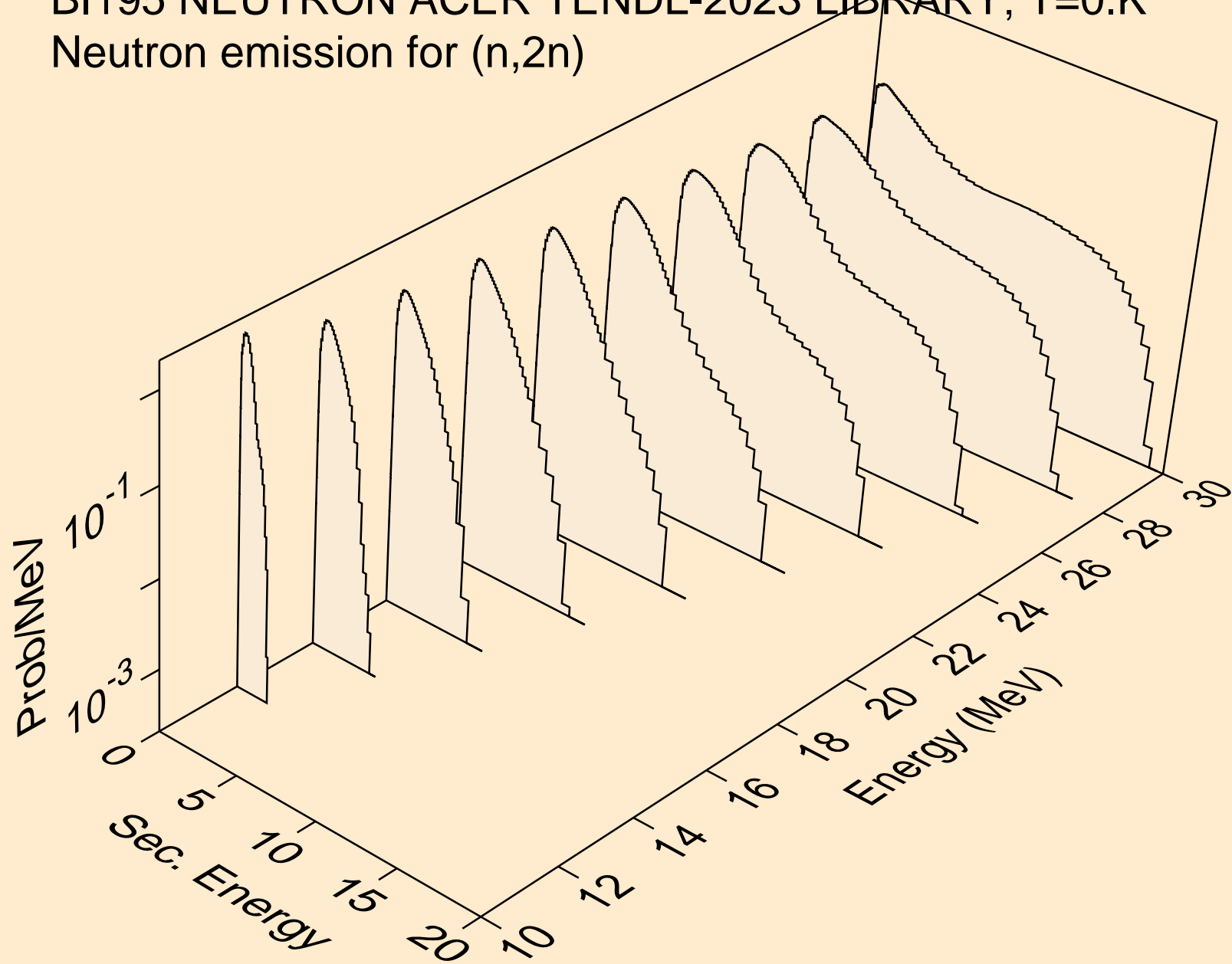

BI195 NEUTRON ACER TENDL-2023 LIBRARY; T=0.K
Neutron emission for (n,3n)

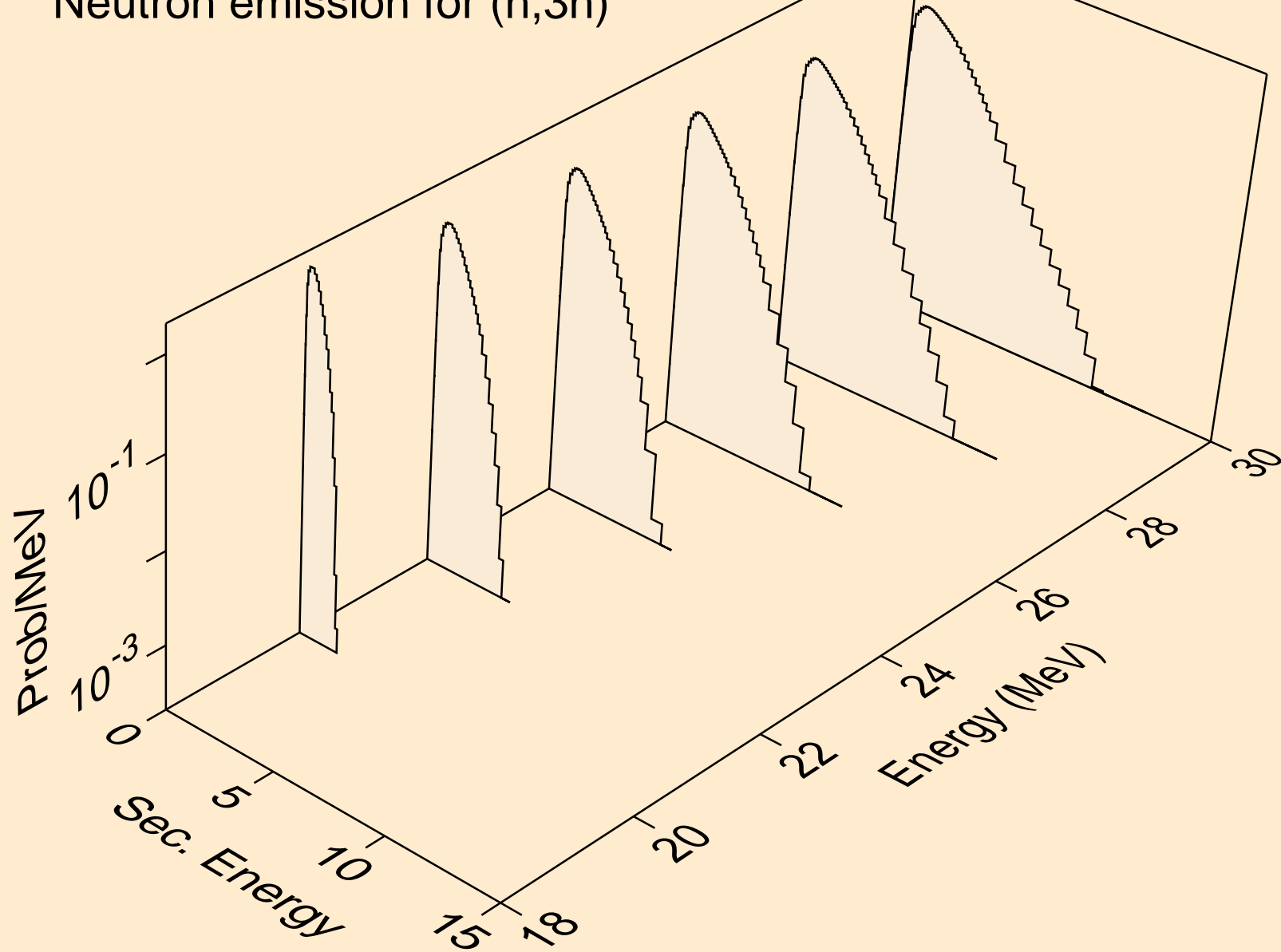

BI195 NEUTRON ACER TENDL-2023 LIBRARY; T=0.K
Neutron emission for (n,n*)a

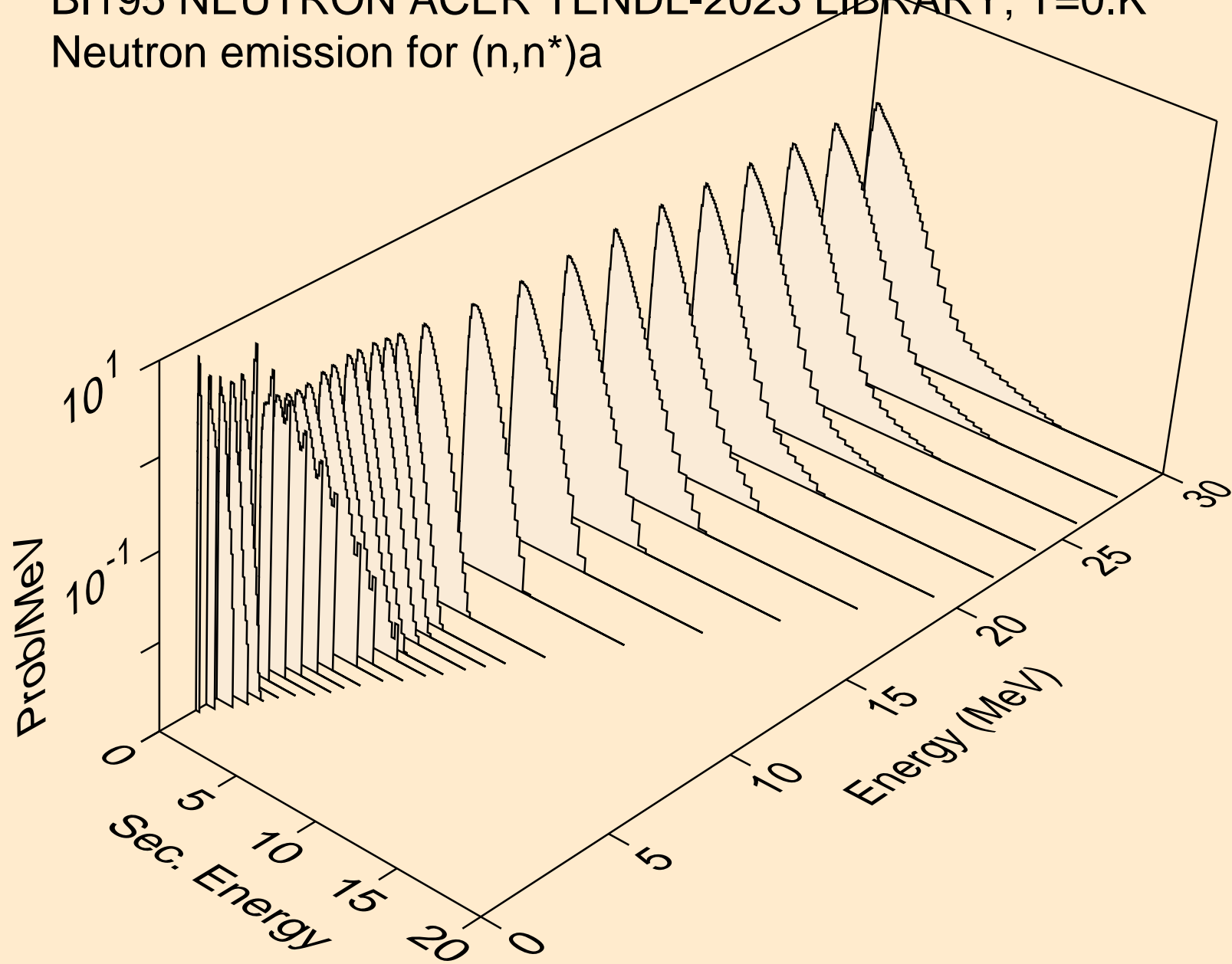

BI195 NEUTRON ACER TENDL-2023 LIBRARY; T=0.K
Neutron emission for (n,2n)a

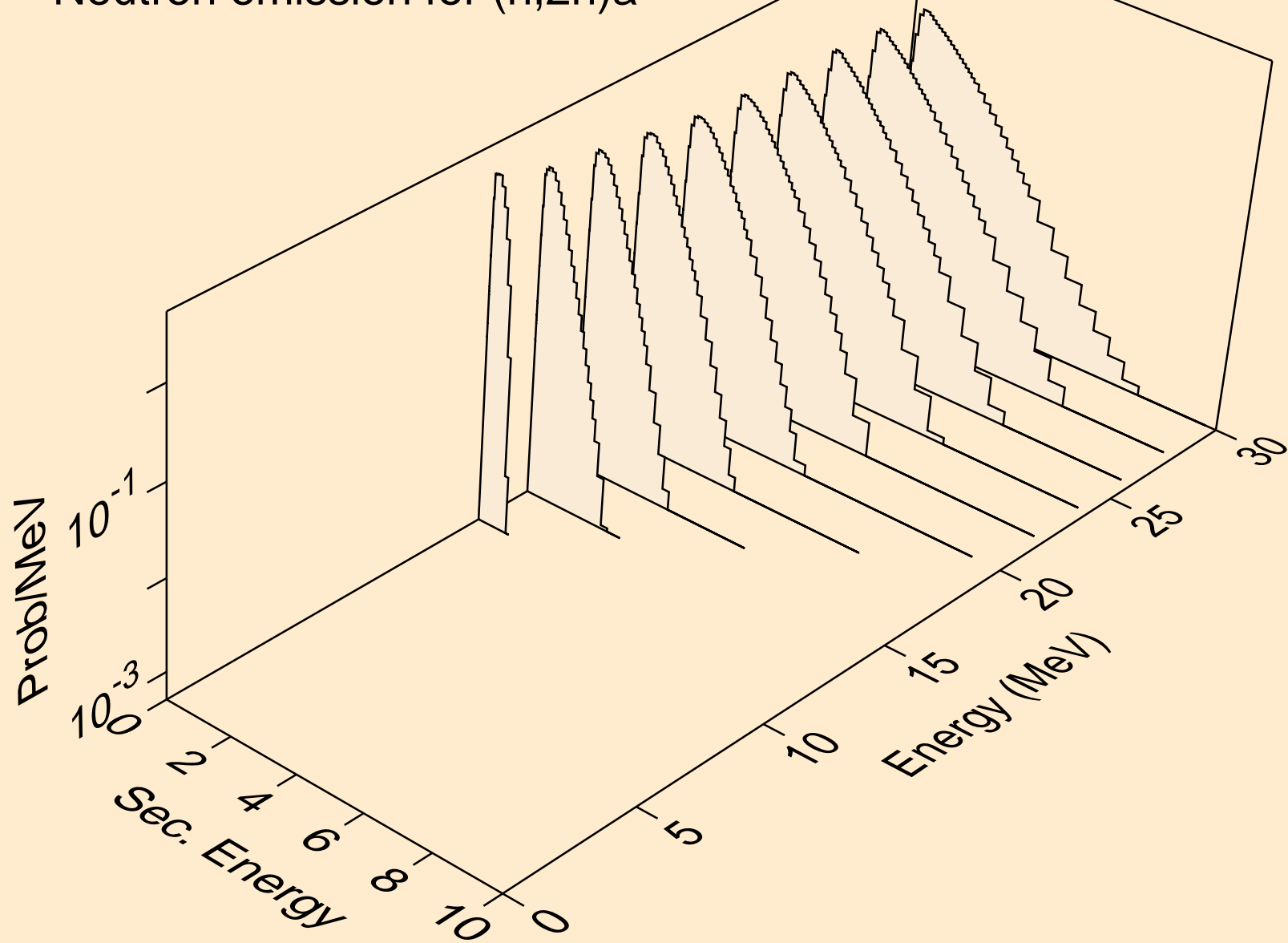

BI195 NEUTRON ACER TENDL-2023 LIBRARY; T=0.K
Neutron emission for (n,3n)a

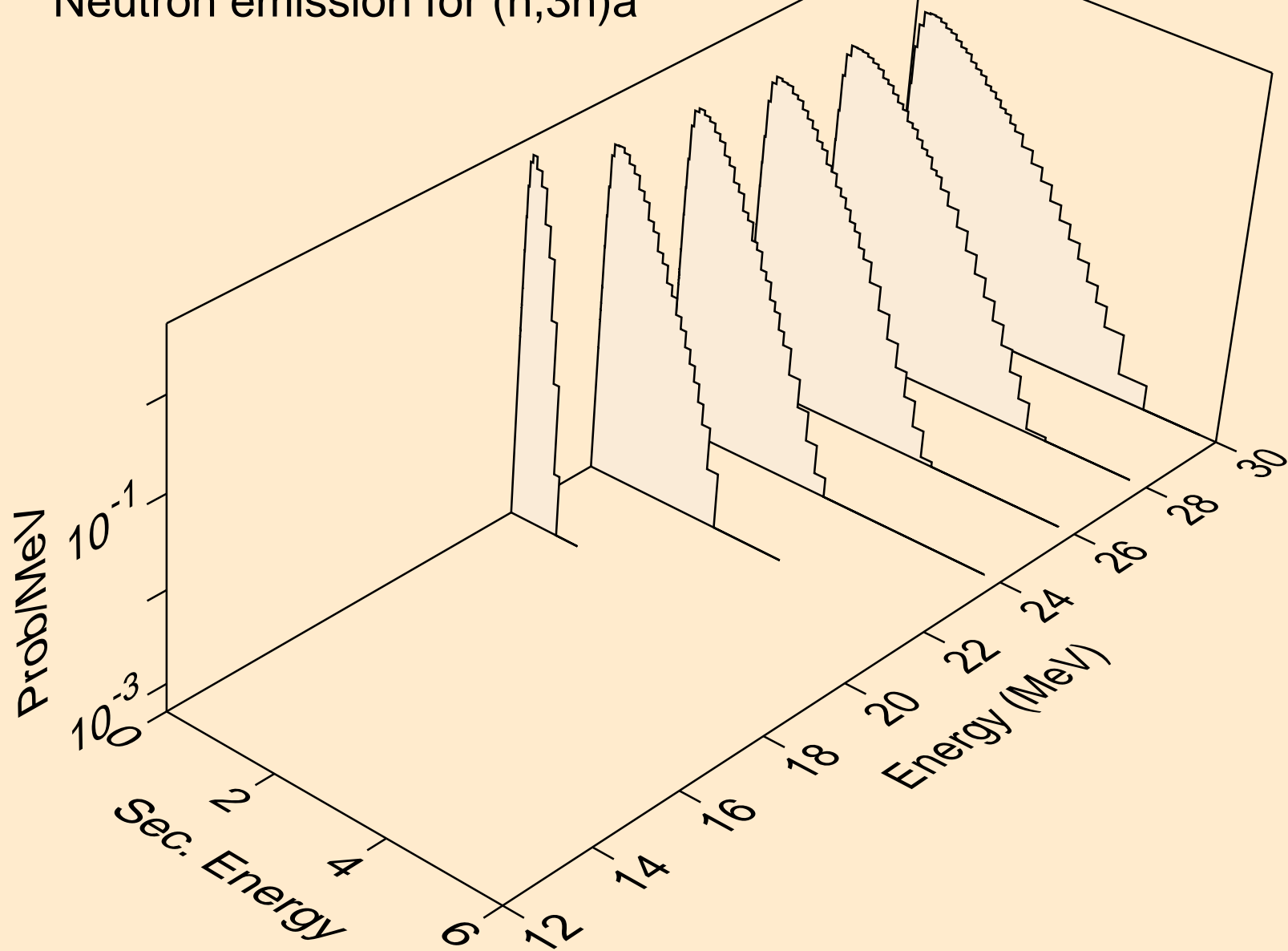

BI195 NEUTRON ACER TENDL-2023 LIBRARY; T=0.K
Neutron emission for (n,n*)p

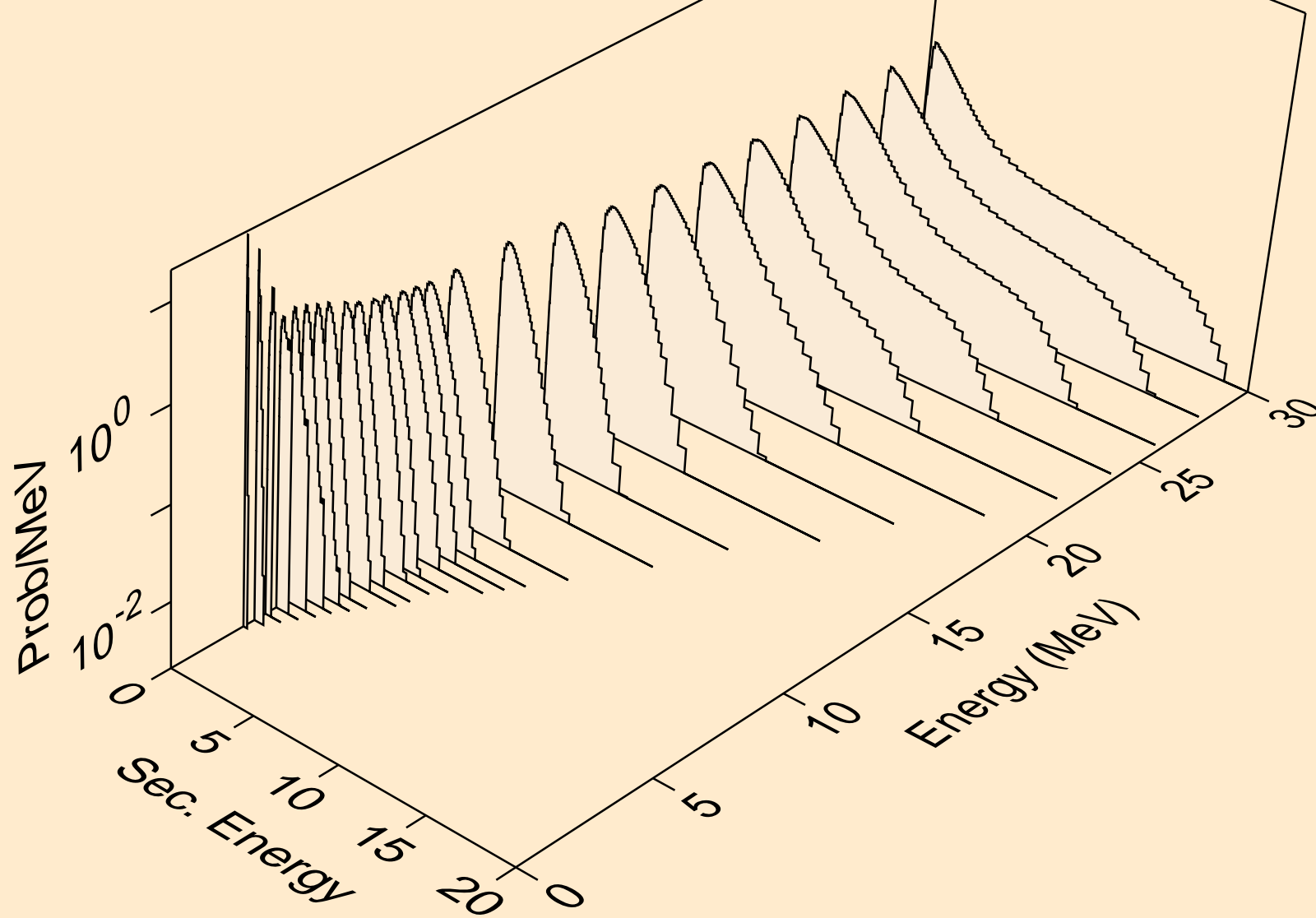

BI195 NEUTRON ACER TENDL-2023 LIBRARY; T=0.K
Neutron emission for (n,n*)2a

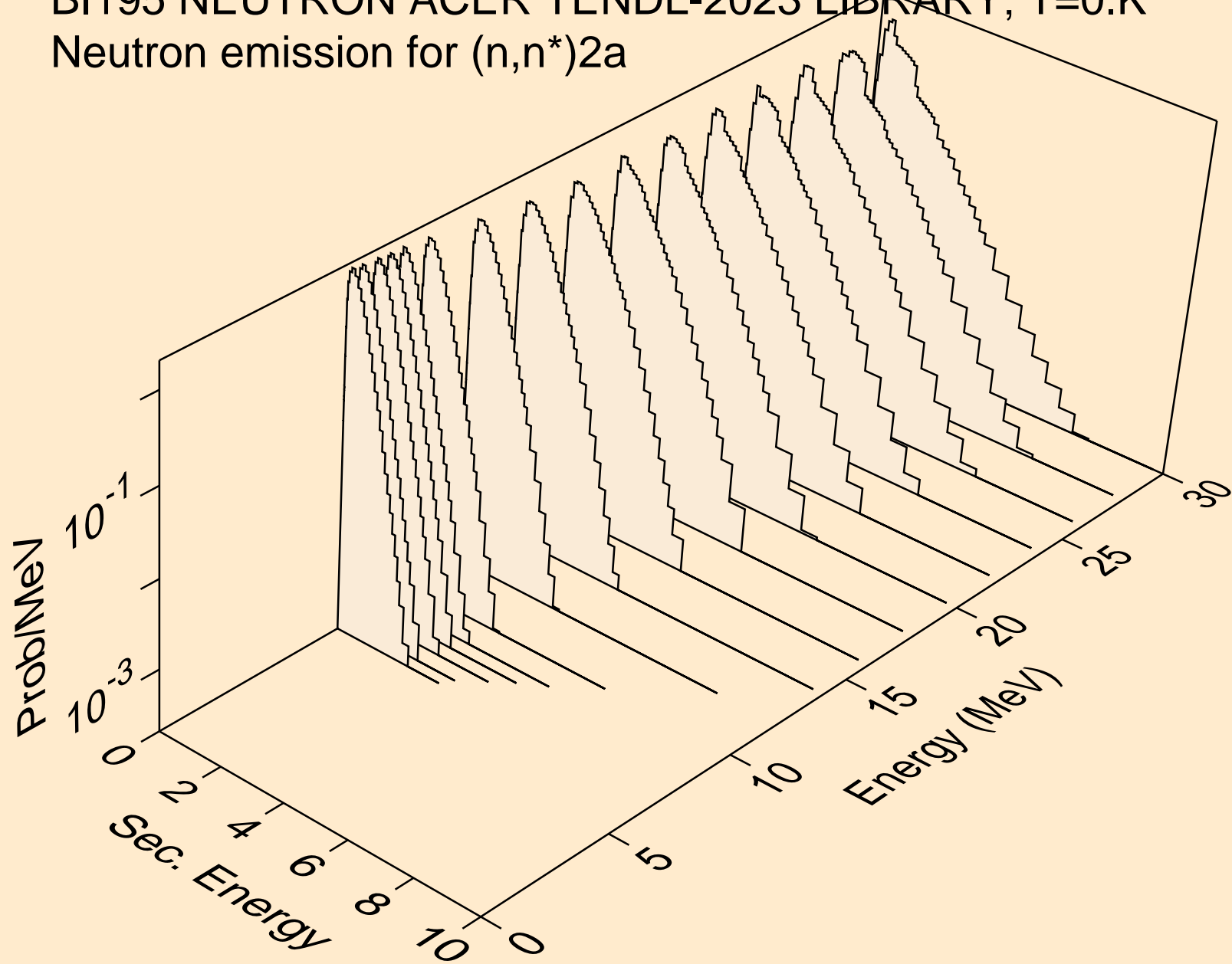

BI195 NEUTRON ACER TENDL-2023 LIBRARY; T=0.K
Neutron emission for (n,2n)2a

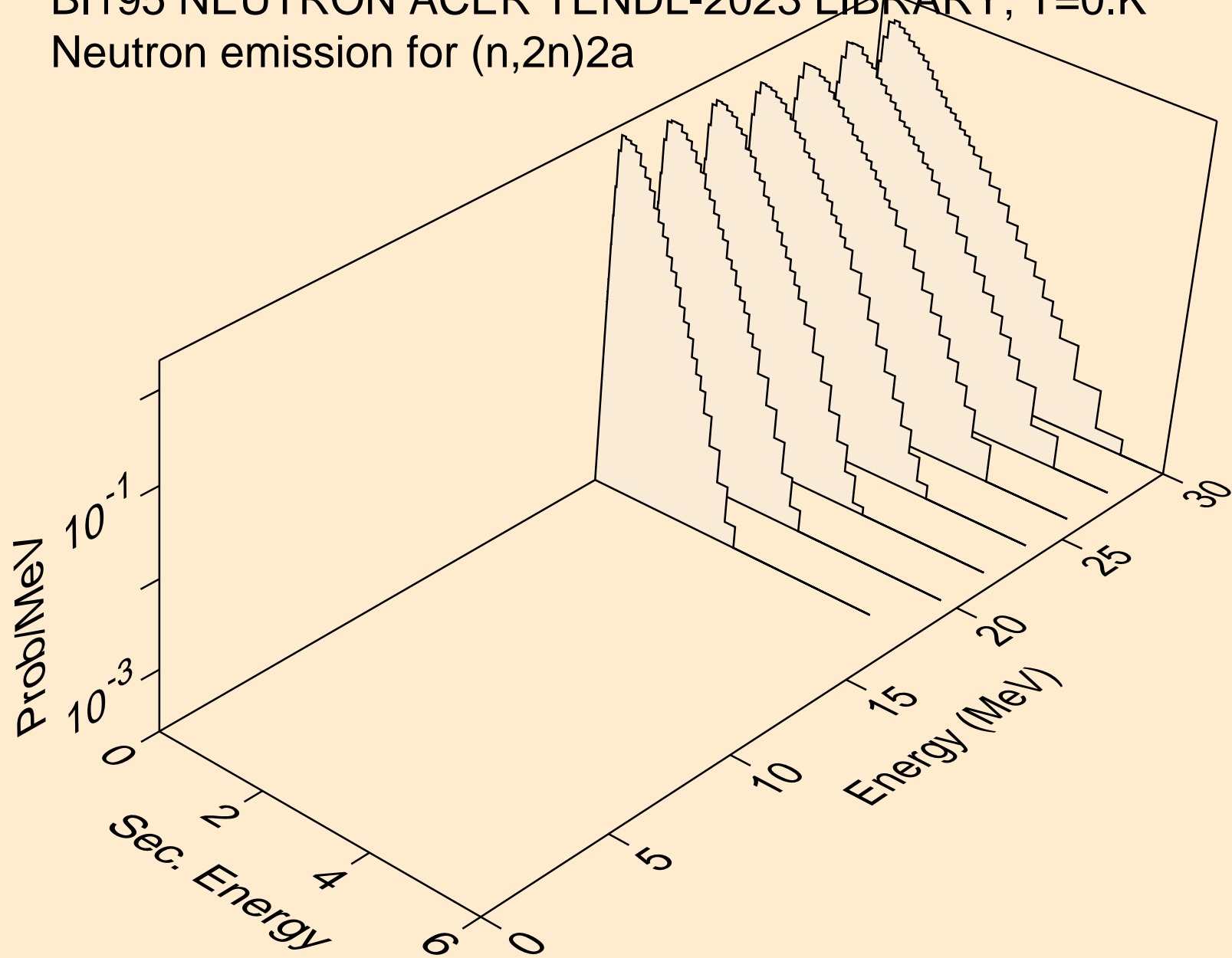

BI195 NEUTRON ACER TENDL-2023 LIBRARY; T=0.K
Neutron emission for (n,n*)d

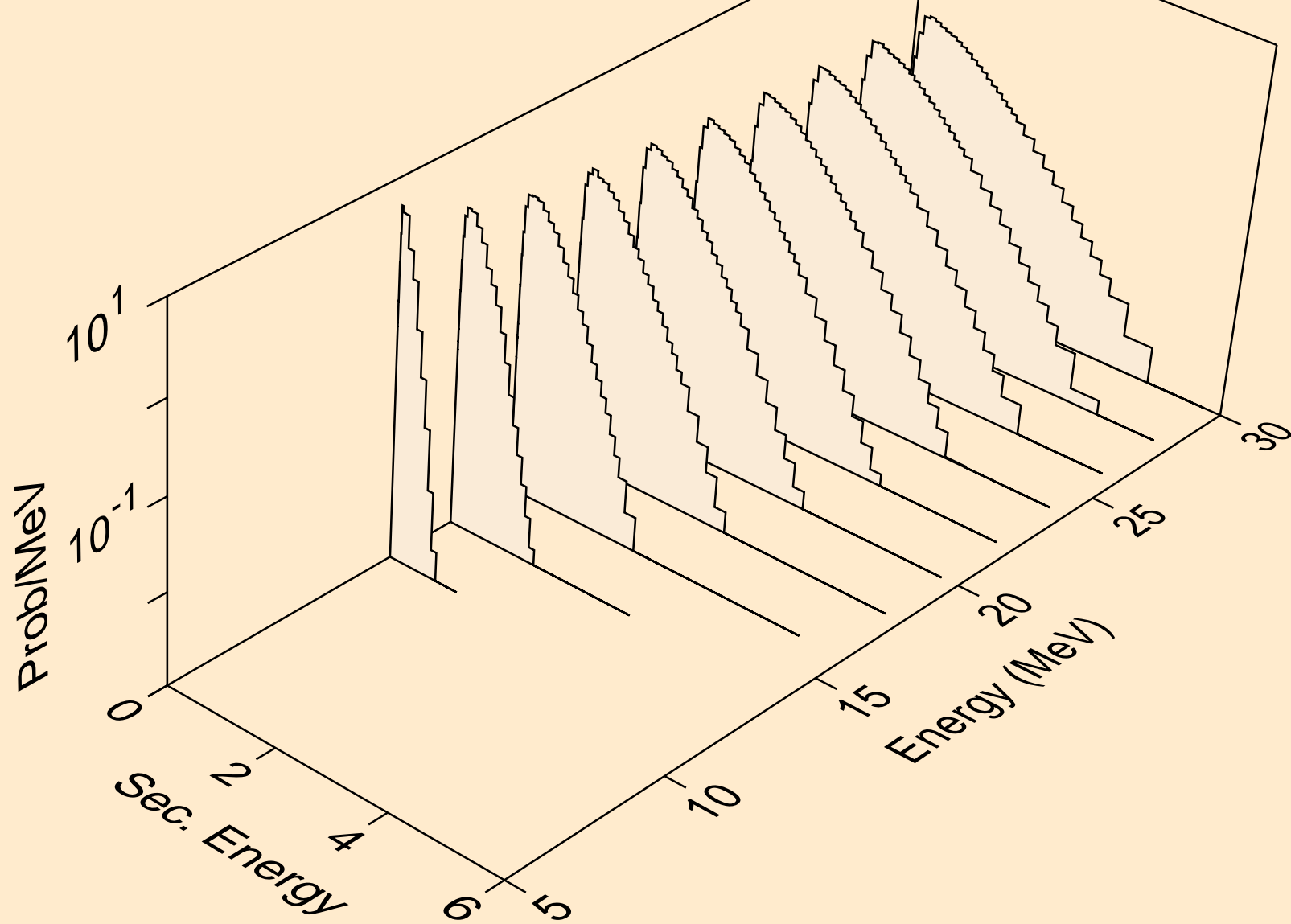

BI195 NEUTRON ACER TENDL-2023 LIBRARY; T=0.K
Neutron emission for (n,n*)t

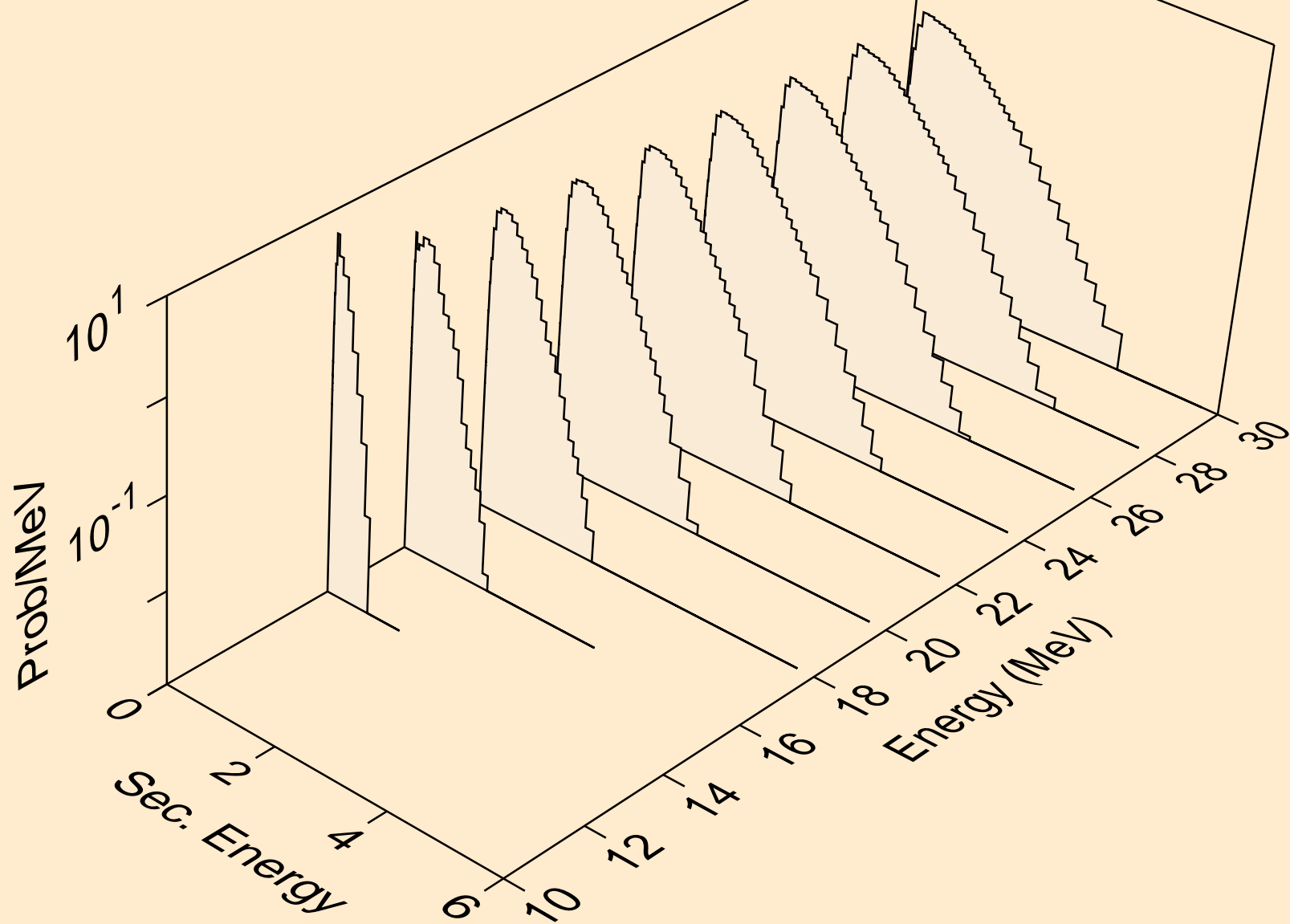

BI195 NEUTRON ACER TENDL-2023 LIBRARY; T=0.K
Neutron emission for (n,n*)he3

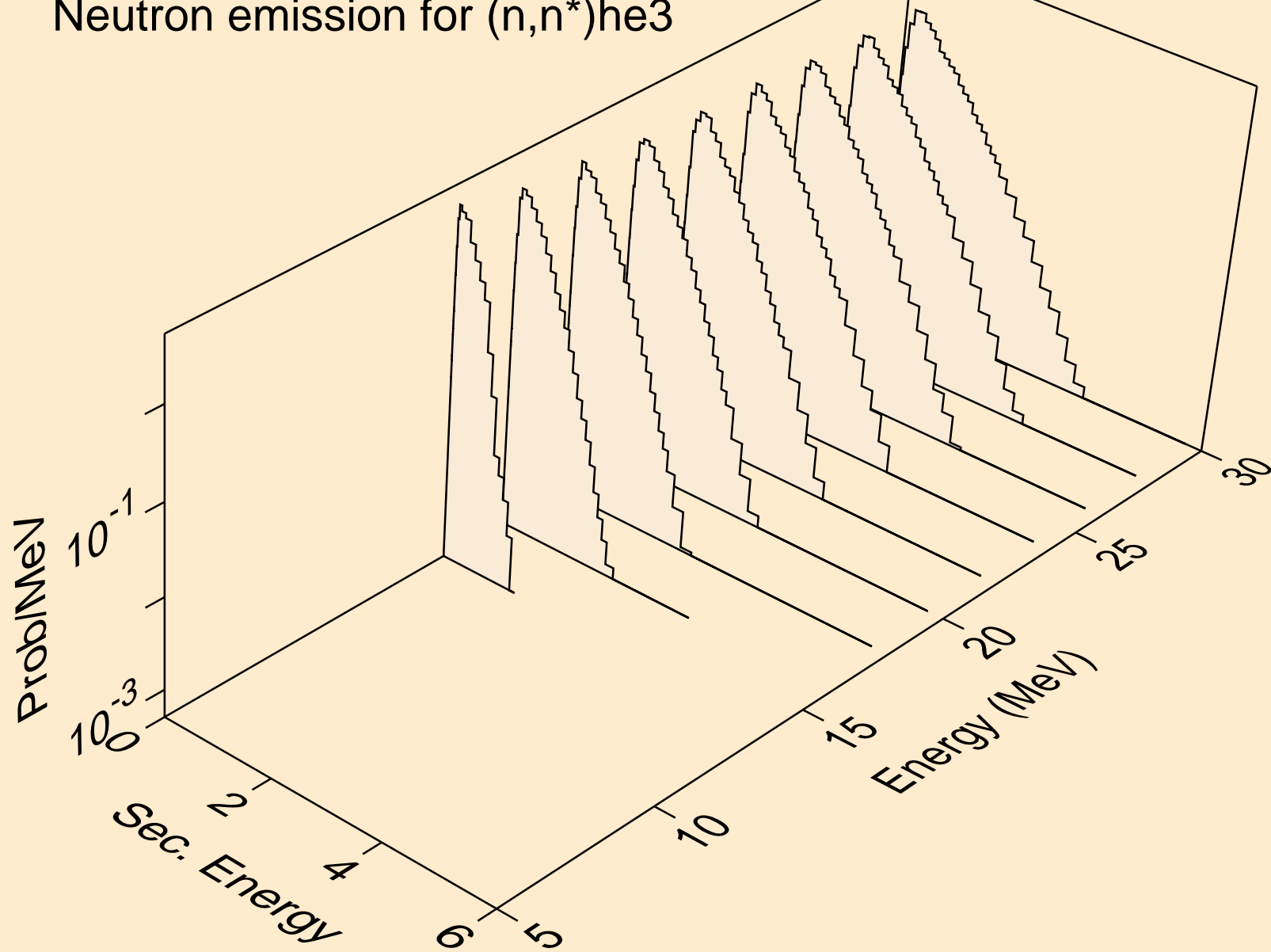

BI195 NEUTRON ACER TENDL-2023 LIBRARY; T=0.K
Neutron emission for (n,4n)

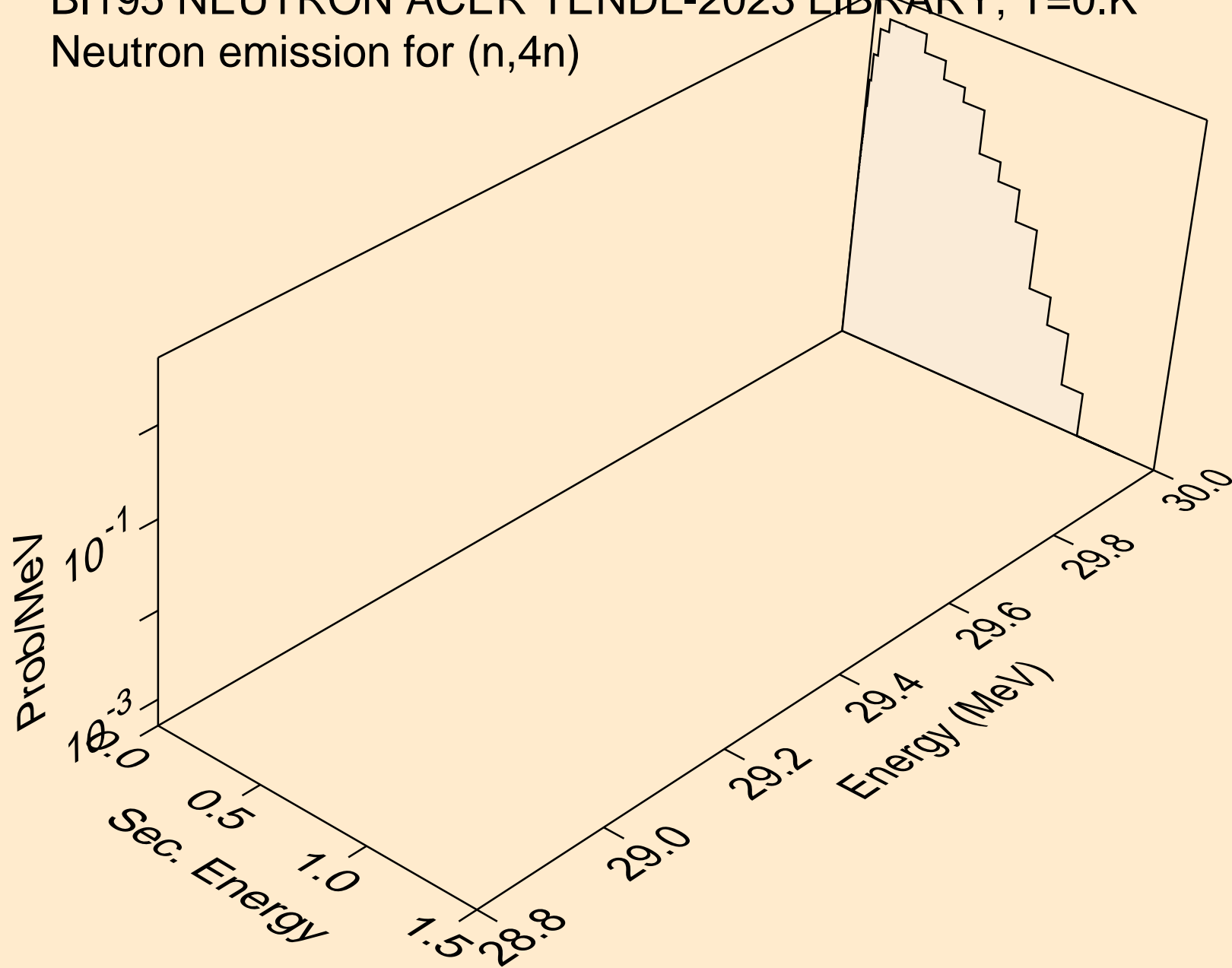

BI195 NEUTRON ACER TENDL-2023 LIBRARY; T=0.K
Neutron emission for (n,2np)

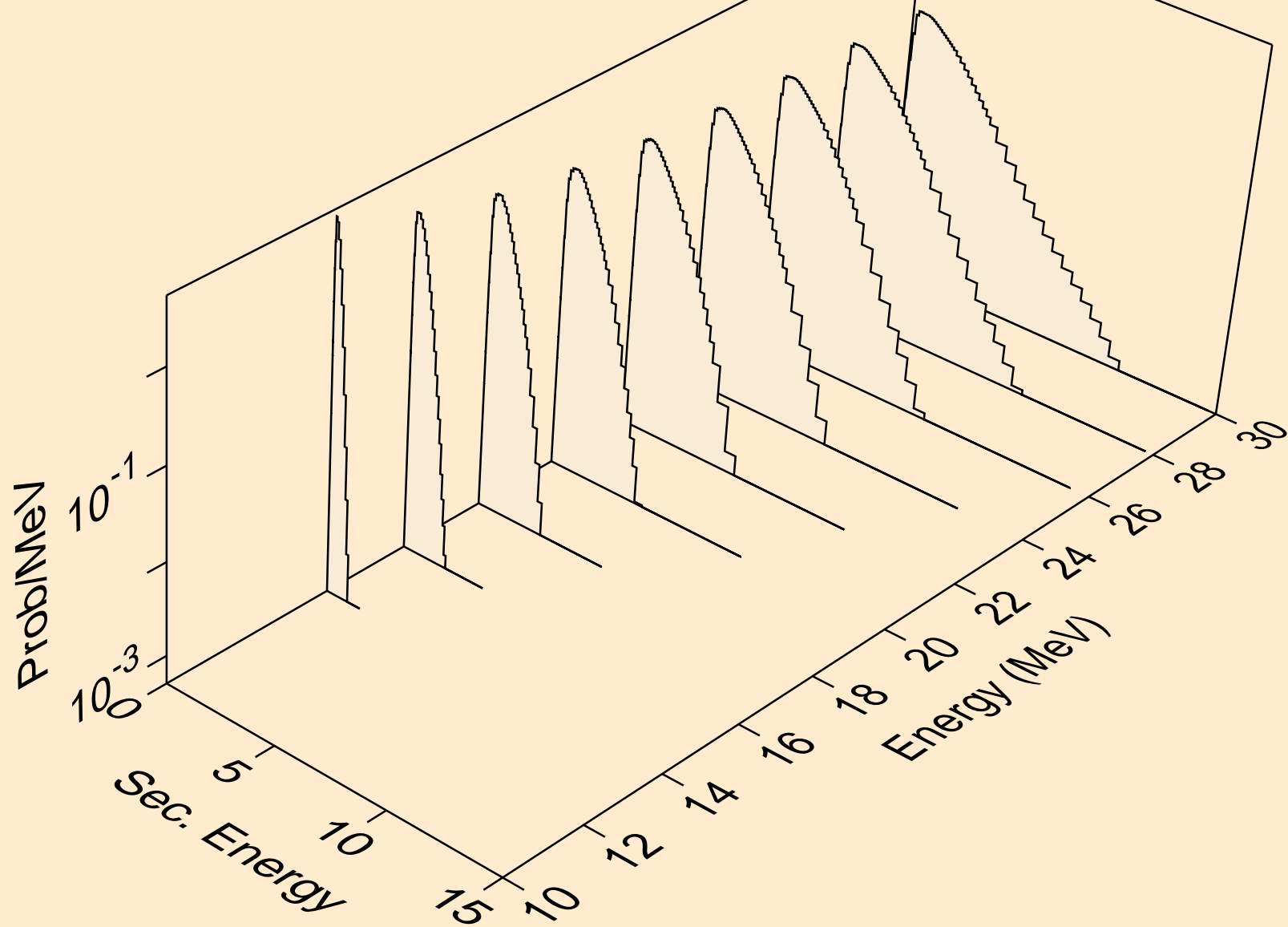

BI195 NEUTRON ACER TENDL-2023 LIBRARY; T=0.K
Neutron emission for (n,3np)

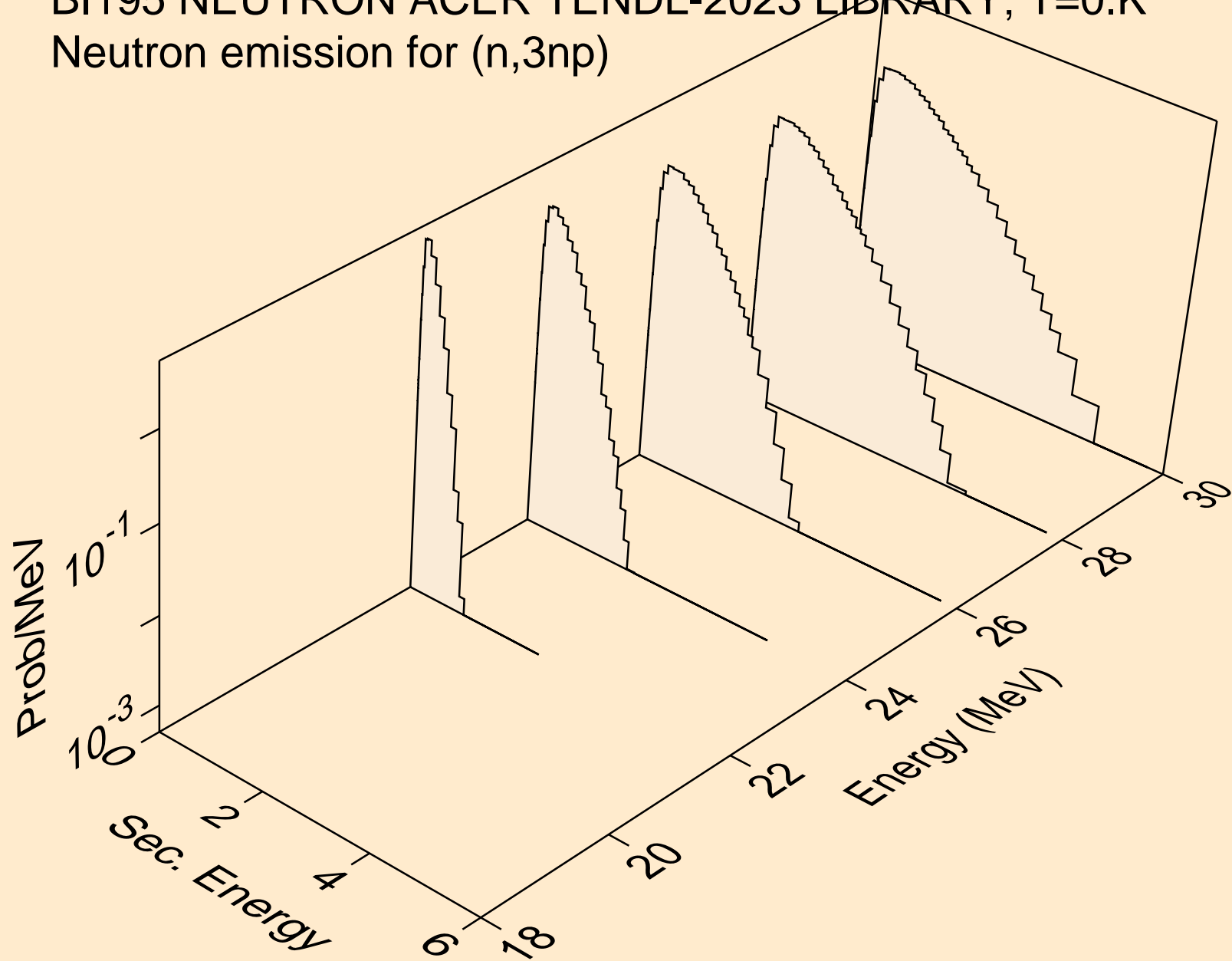

BI195 NEUTRON ACER TENDL-2023 LIBRARY; T=0.K
Neutron emission for (n,n2p)

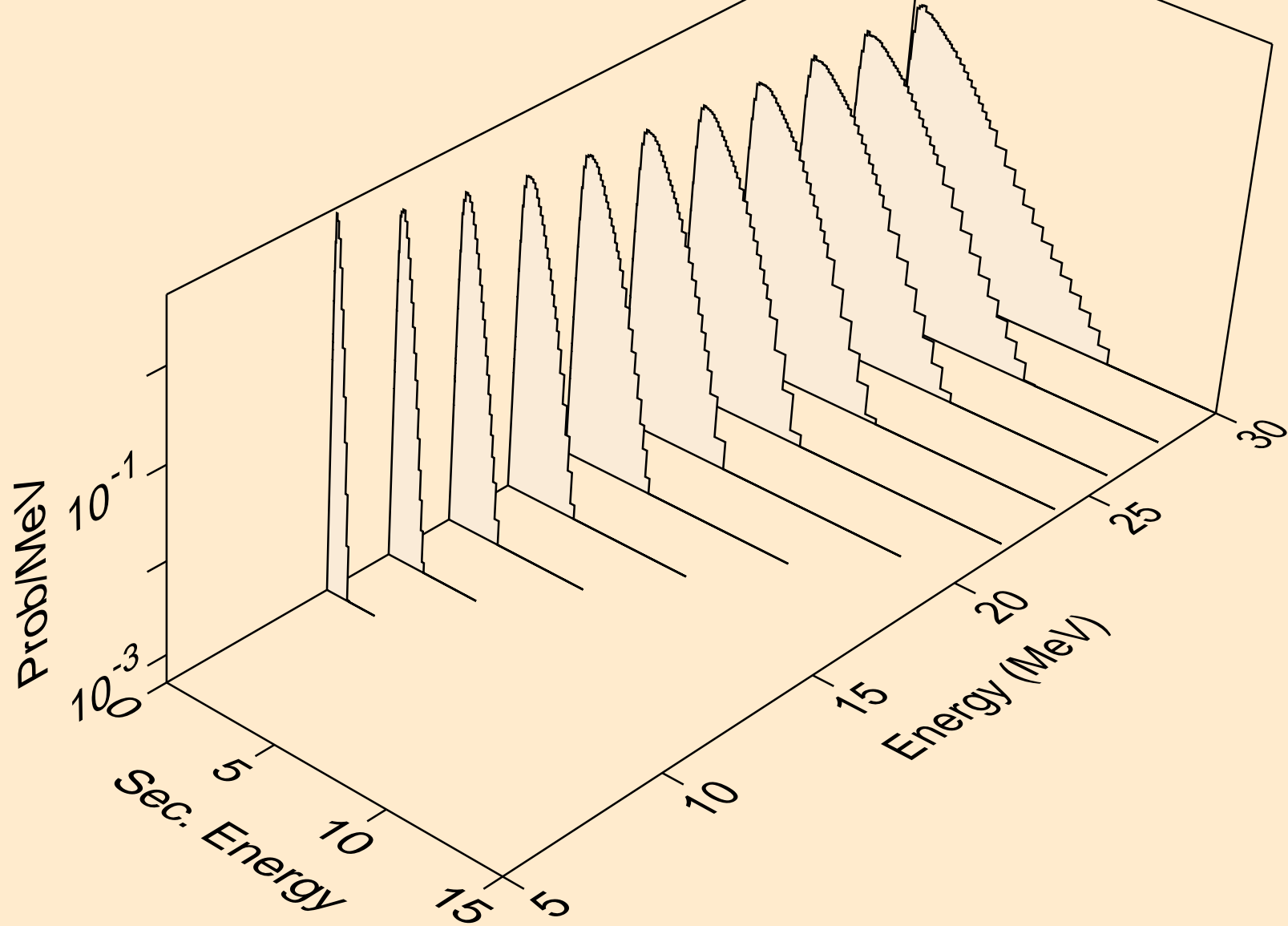

BI195 NEUTRON ACER TENDL-2023 LIBRARY; T=0.K
Neutron emission for (n,npa)

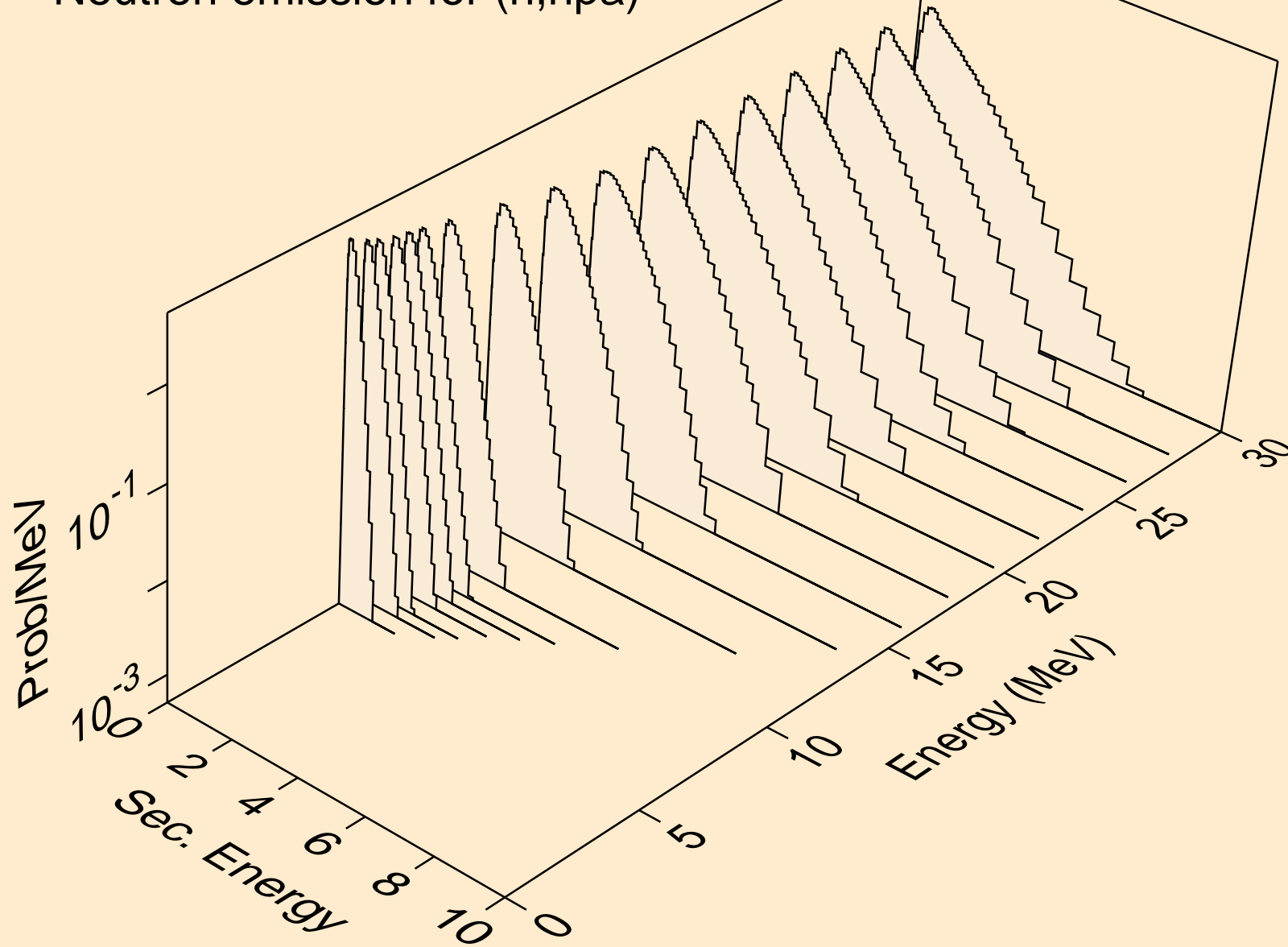

BI195 NEUTRON ACER TENDL-2023 LIBRARY; T=0.K
Neutron emission for (n,n*c)

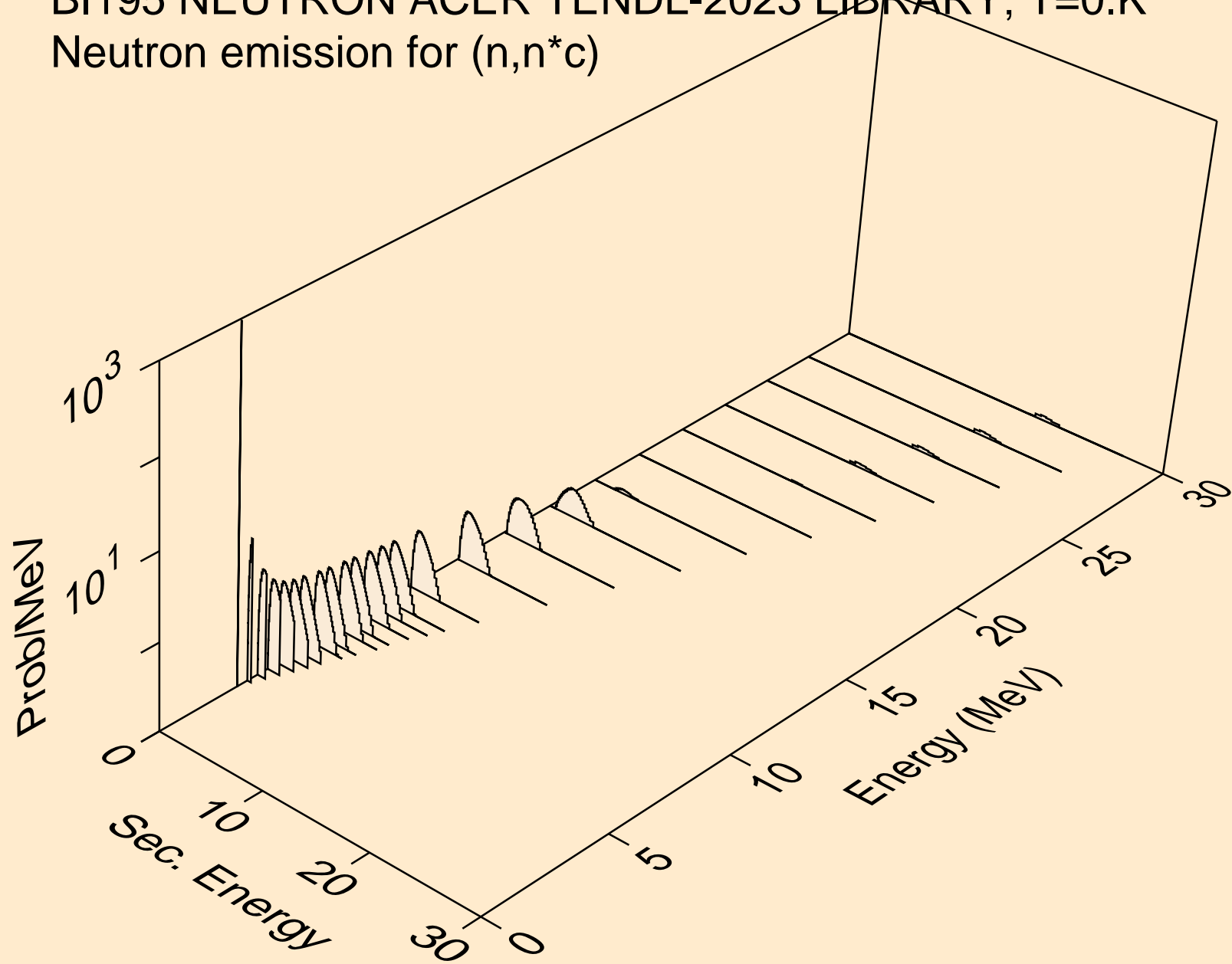

BI195 NEUTRON ACER TENDL-2023 LIBRARY; T=0.K
Photon emission for (n,x)

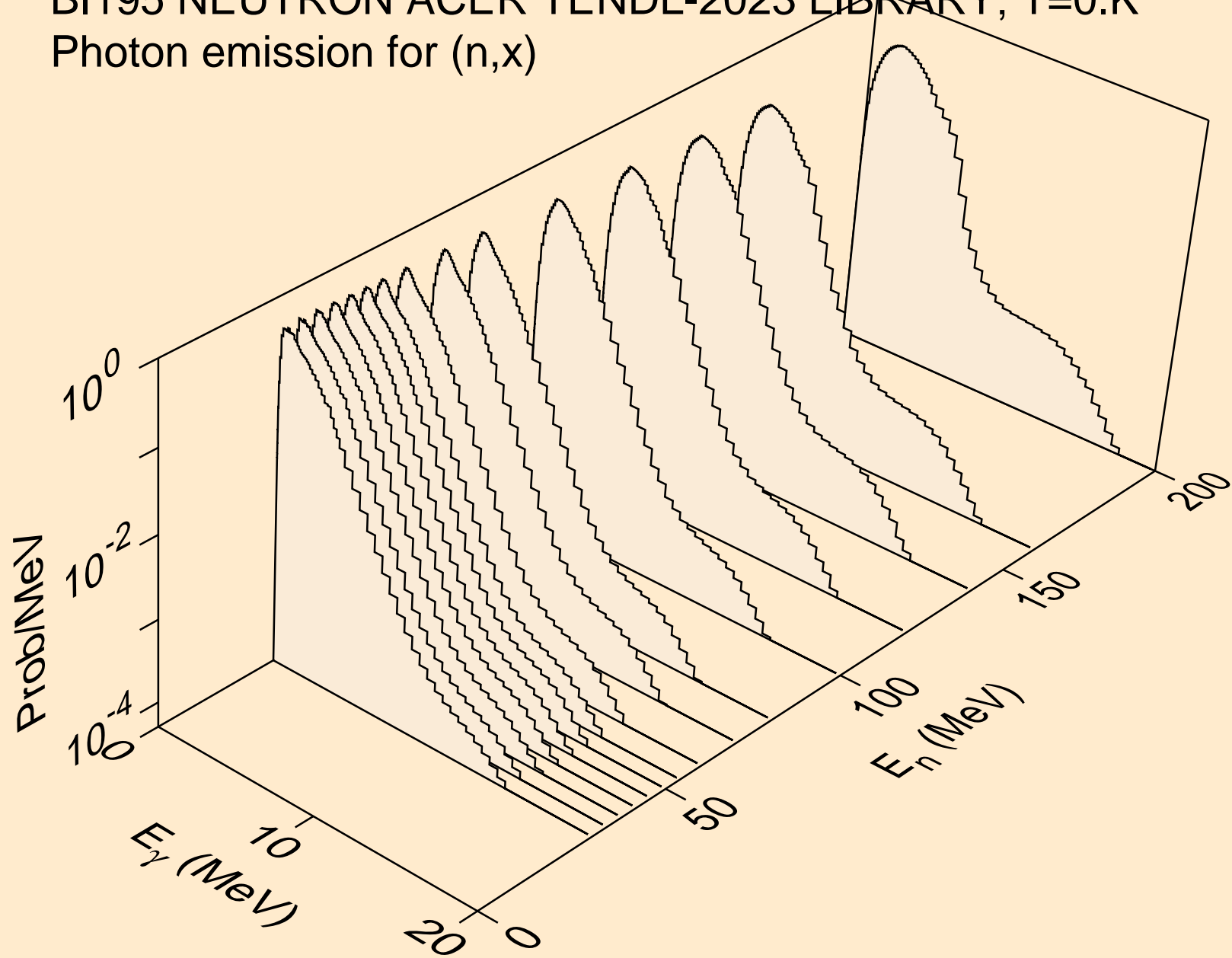

BI195 NEUTRON ACER TENDL-2023 LIBRARY; T=0.K
Photon emission for (n,2nd)

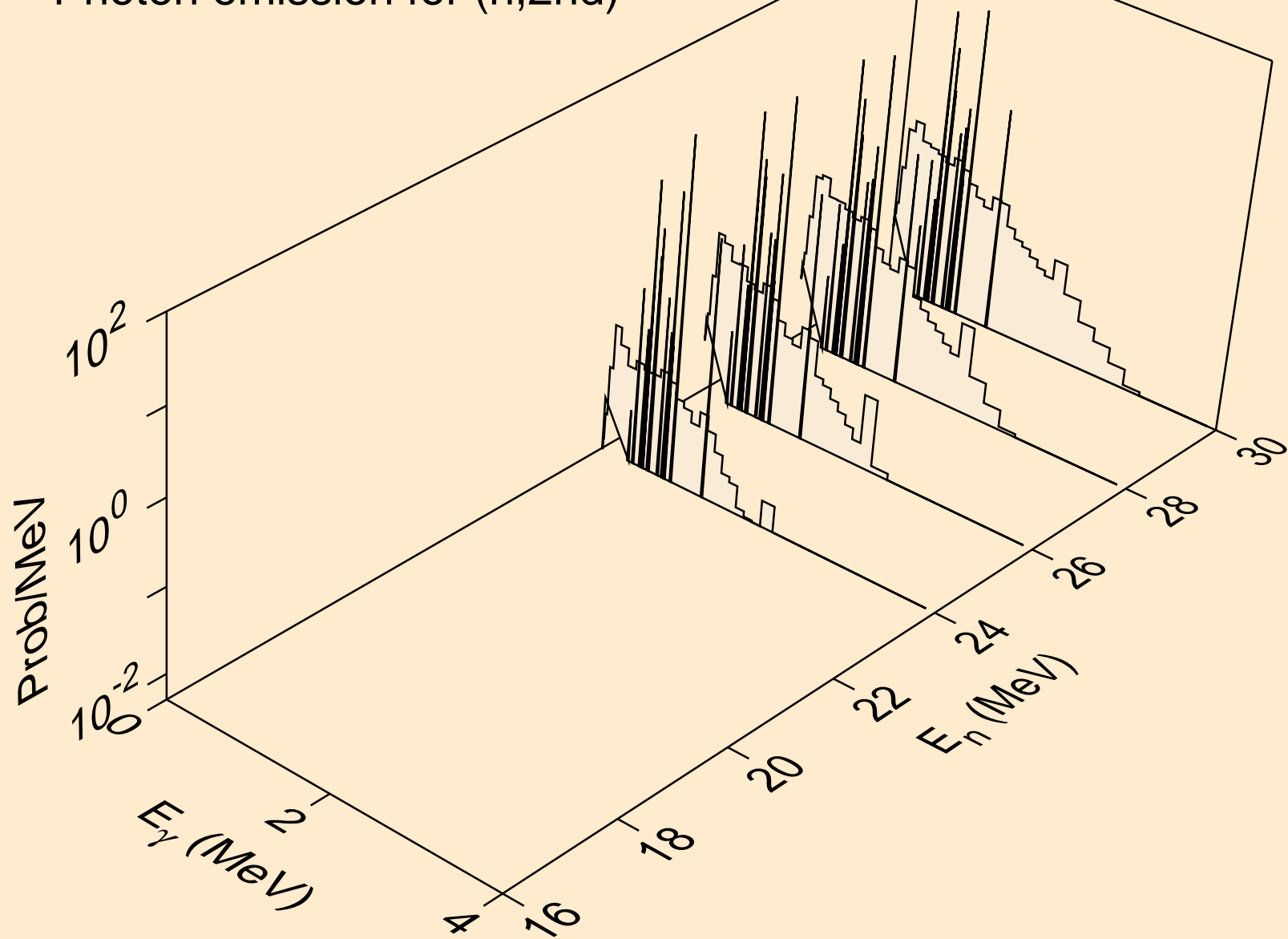

BI195 NEUTRON ACER TENDL-2023 LIBRARY; T=0.K
Photon emission for (n,2n)

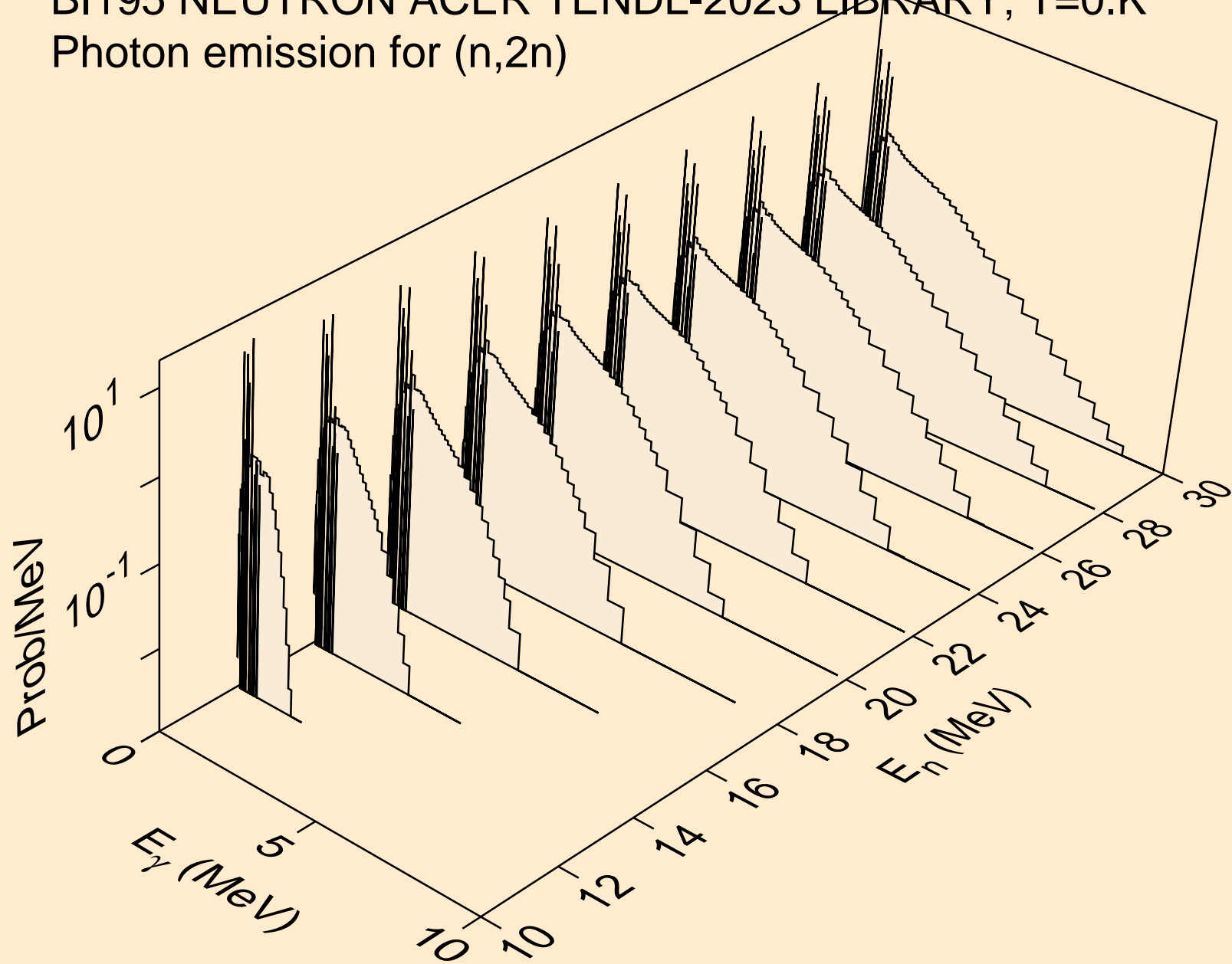

BI195 NEUTRON ACER TENDL-2023 LIBRARY; T=0.K
Photon emission for (n,3n)

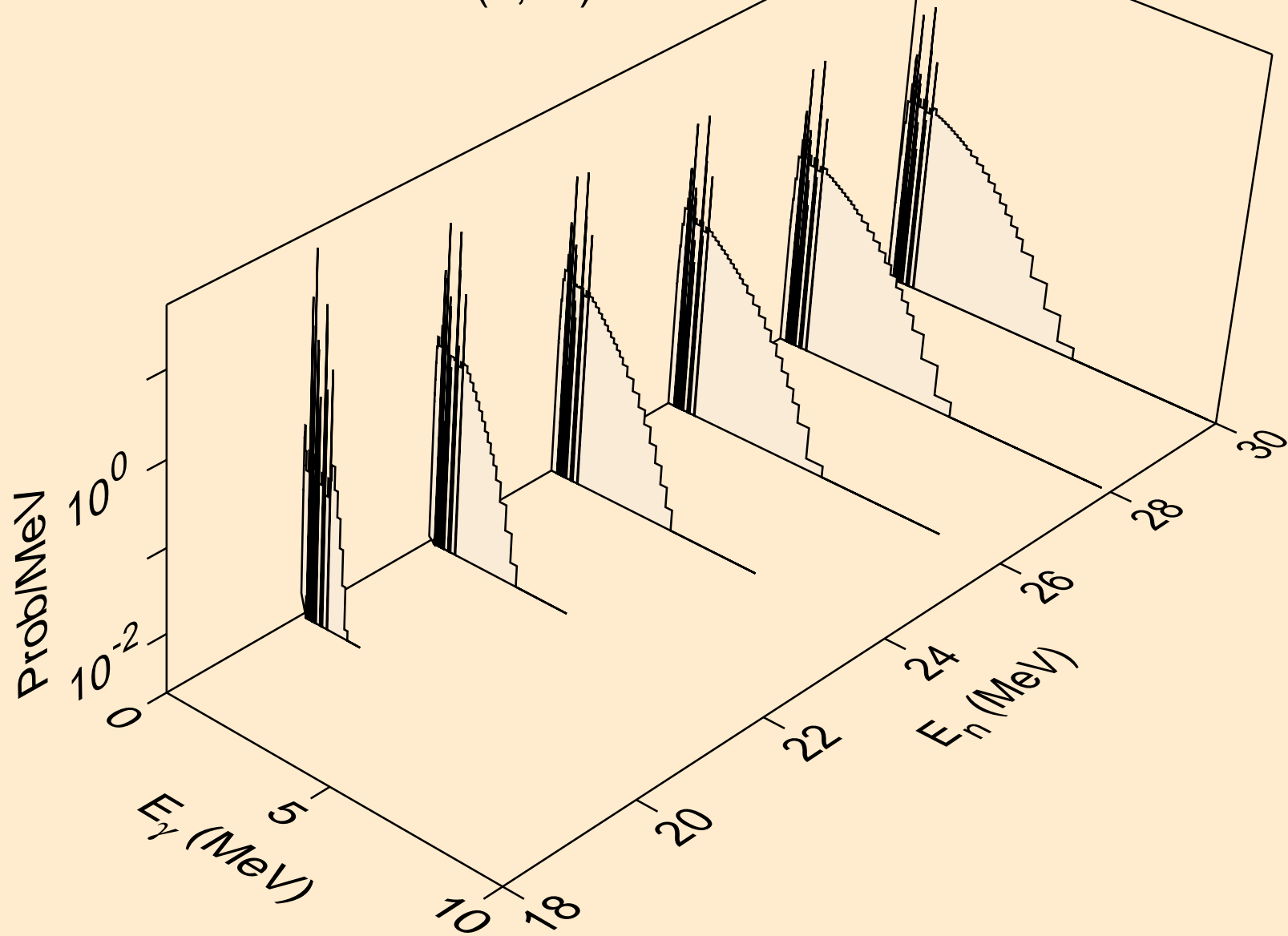

BI195 NEUTRON ACER TENDL-2023 LIBRARY; T=0.K
Photon emission for (n,n*)a

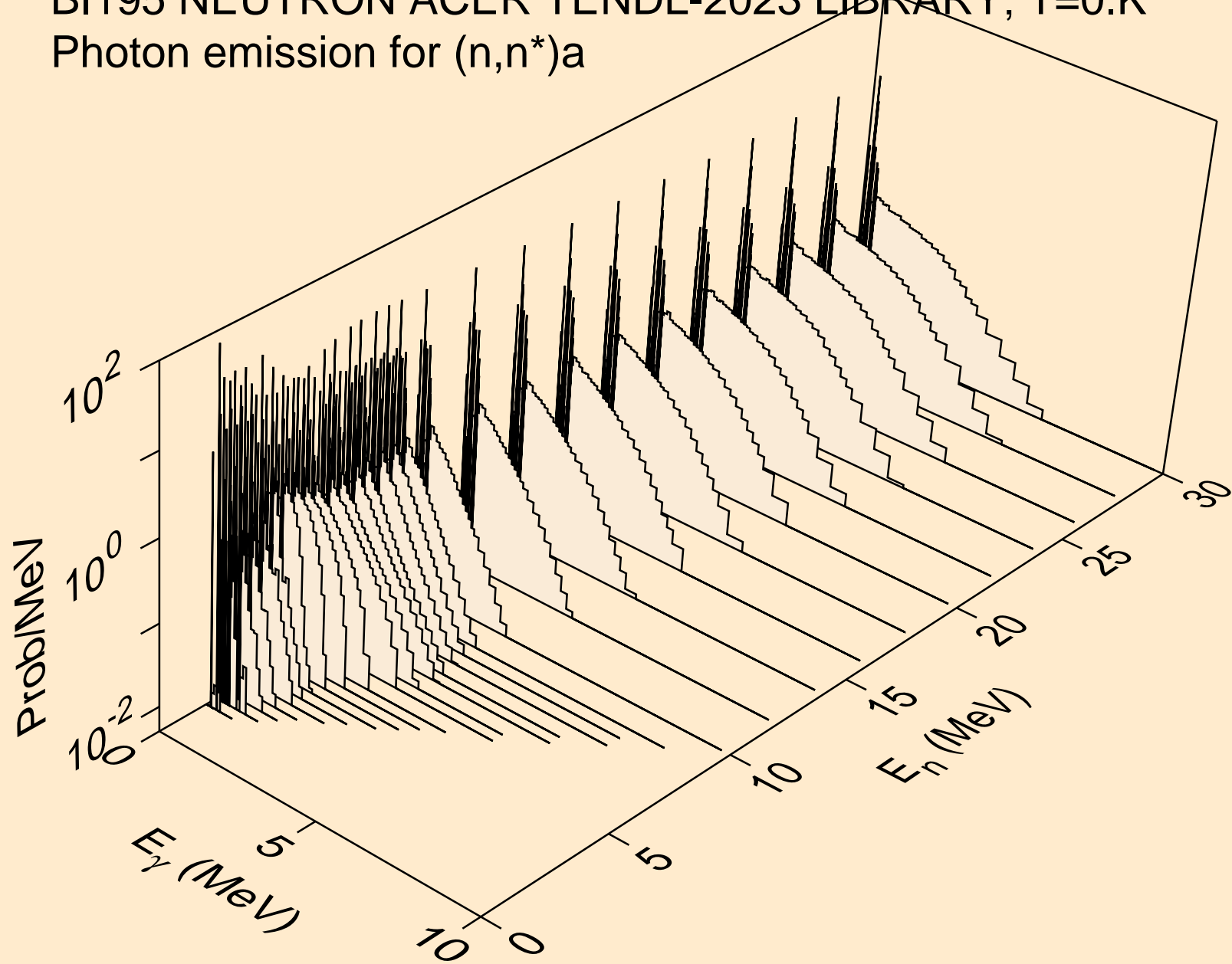

BI195 NEUTRON ACER TENDL-2023 LIBRARY; T=0.K
Photon emission for (n,2n)a

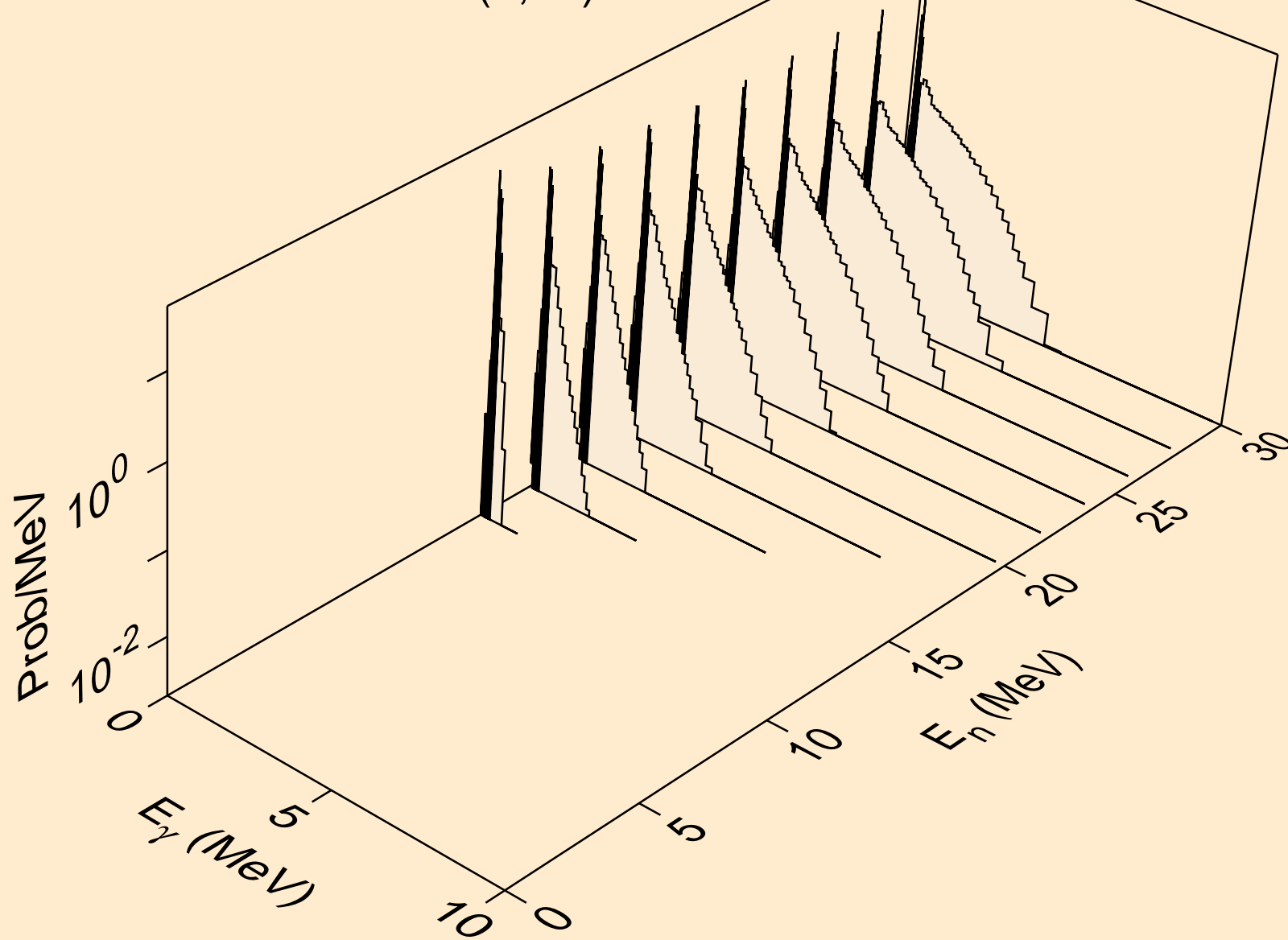

BI195 NEUTRON ACER TENDL-2023 LIBRARY; T=0.K
Photon emission for (n,3n)a

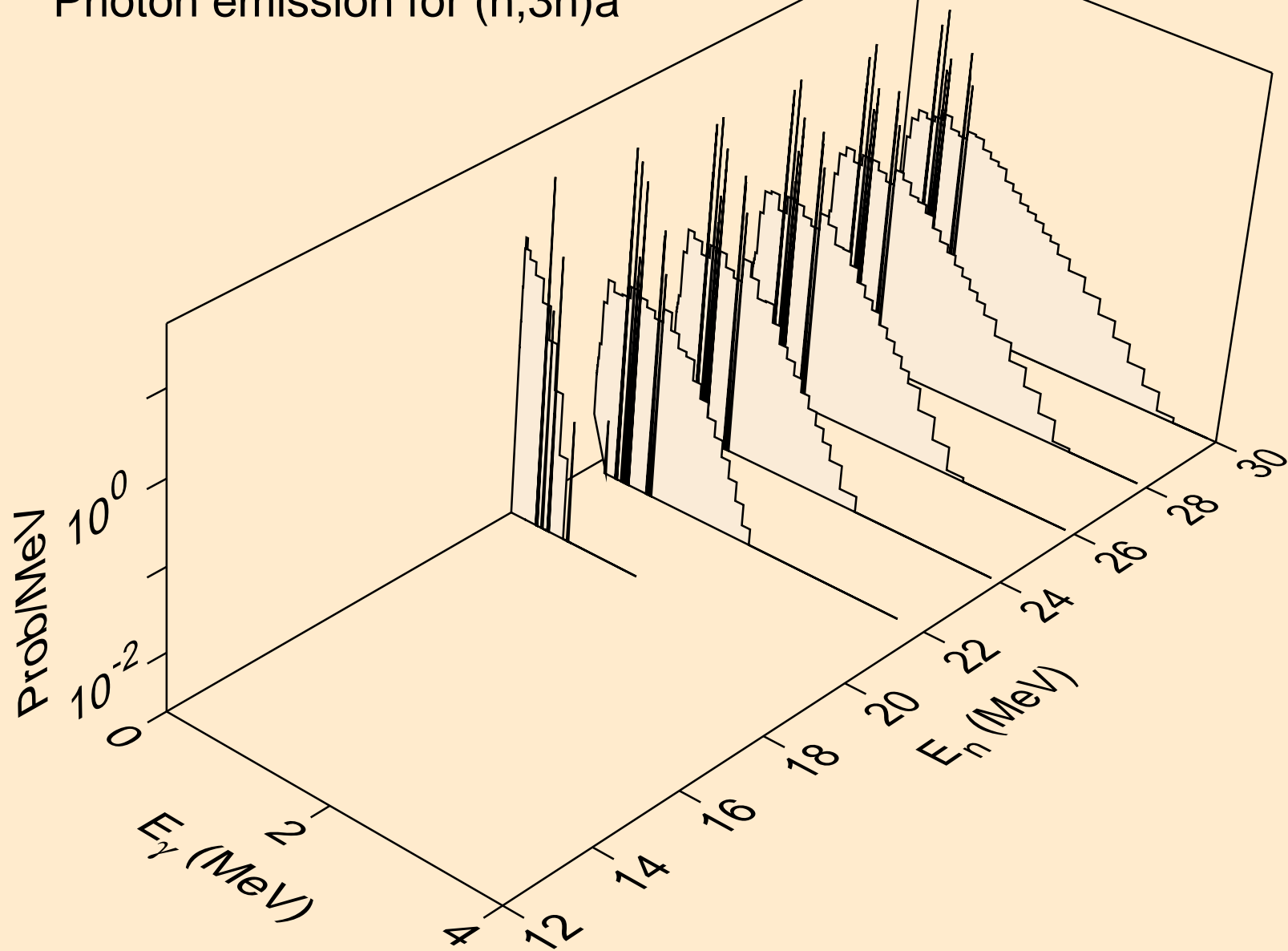

BI195 NEUTRON ACER TENDL-2023 LIBRARY; T=0.K
Photon emission for (n,n*)p

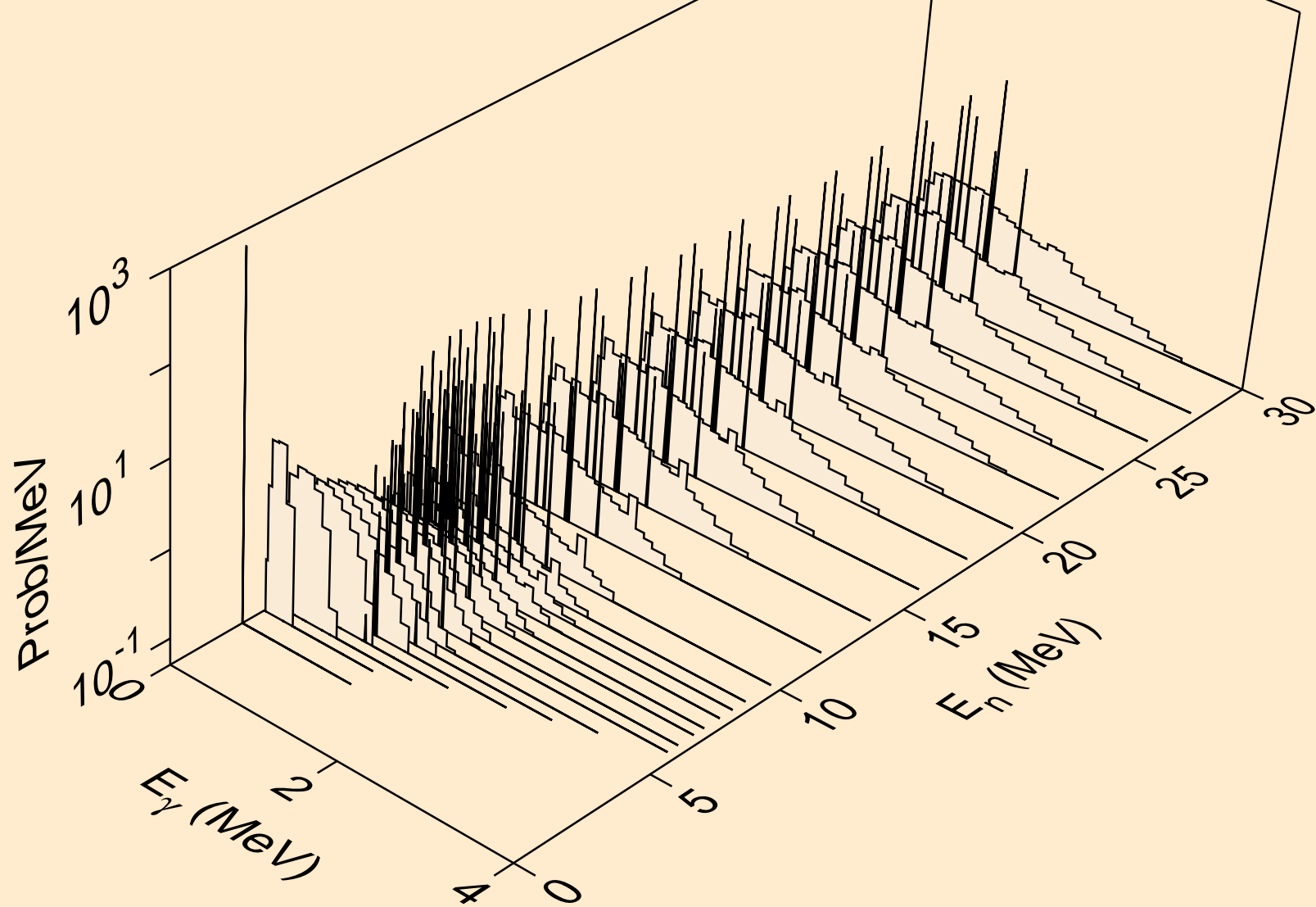

BI195 NEUTRON ACER TENDL-2023 LIBRARY; T=0.K
Photon emission for (n,n*)2a

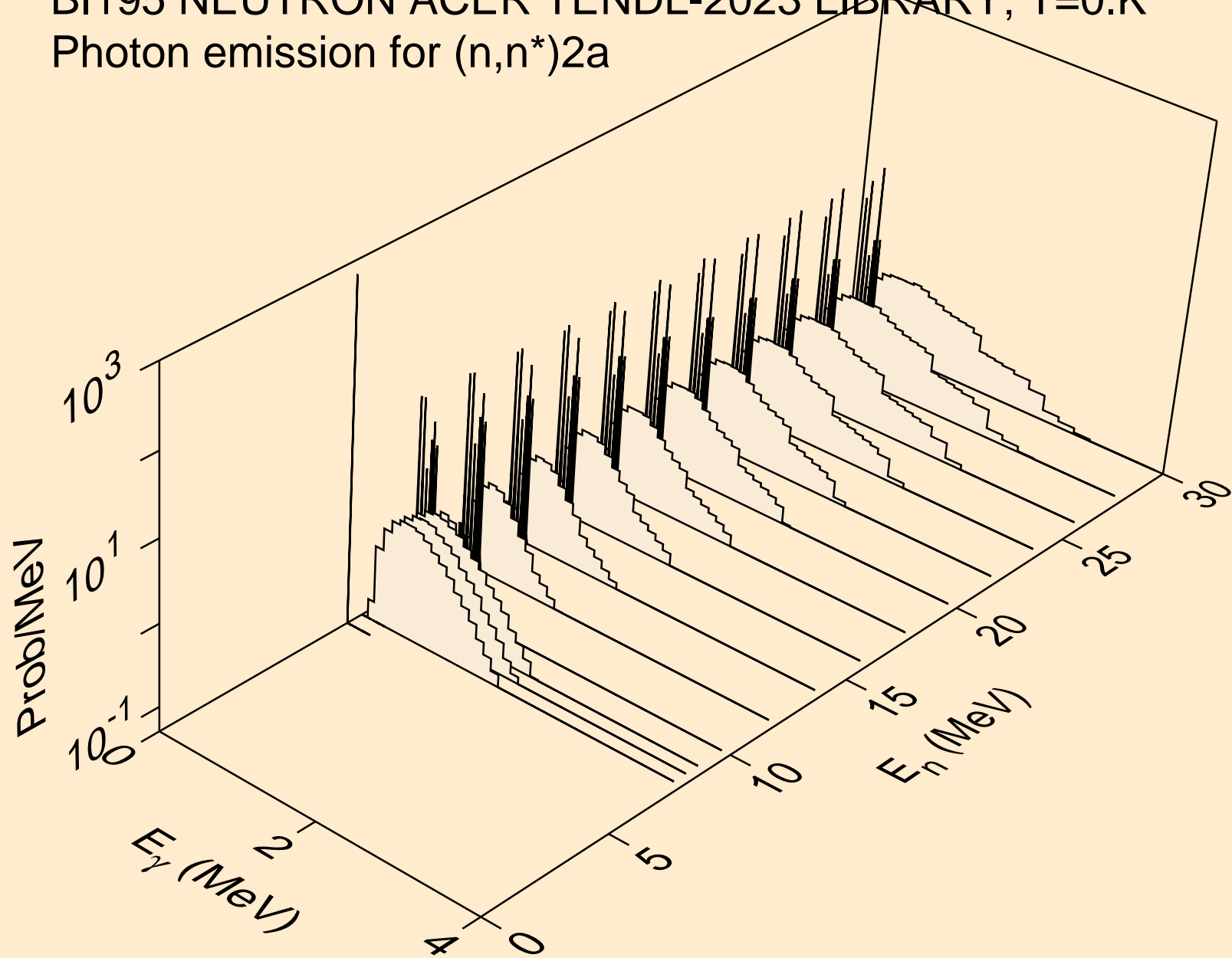

BI195 NEUTRON ACER TENDL-2023 LIBRARY; T=0.K
Photon emission for (n,2n)2a

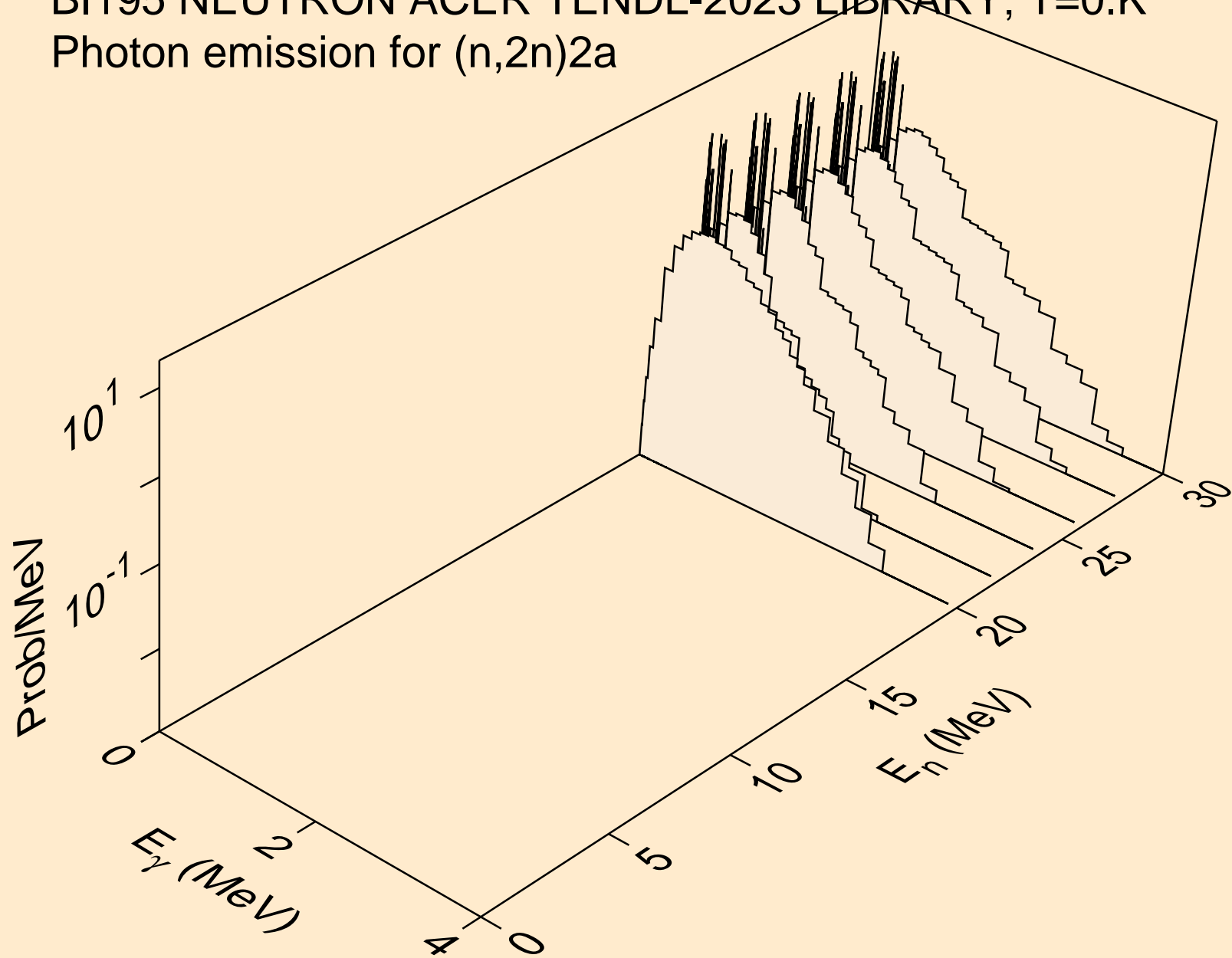

BI195 NEUTRON ACER TENDL-2023 LIBRARY; T=0.K
Photon emission for (n,n*)d

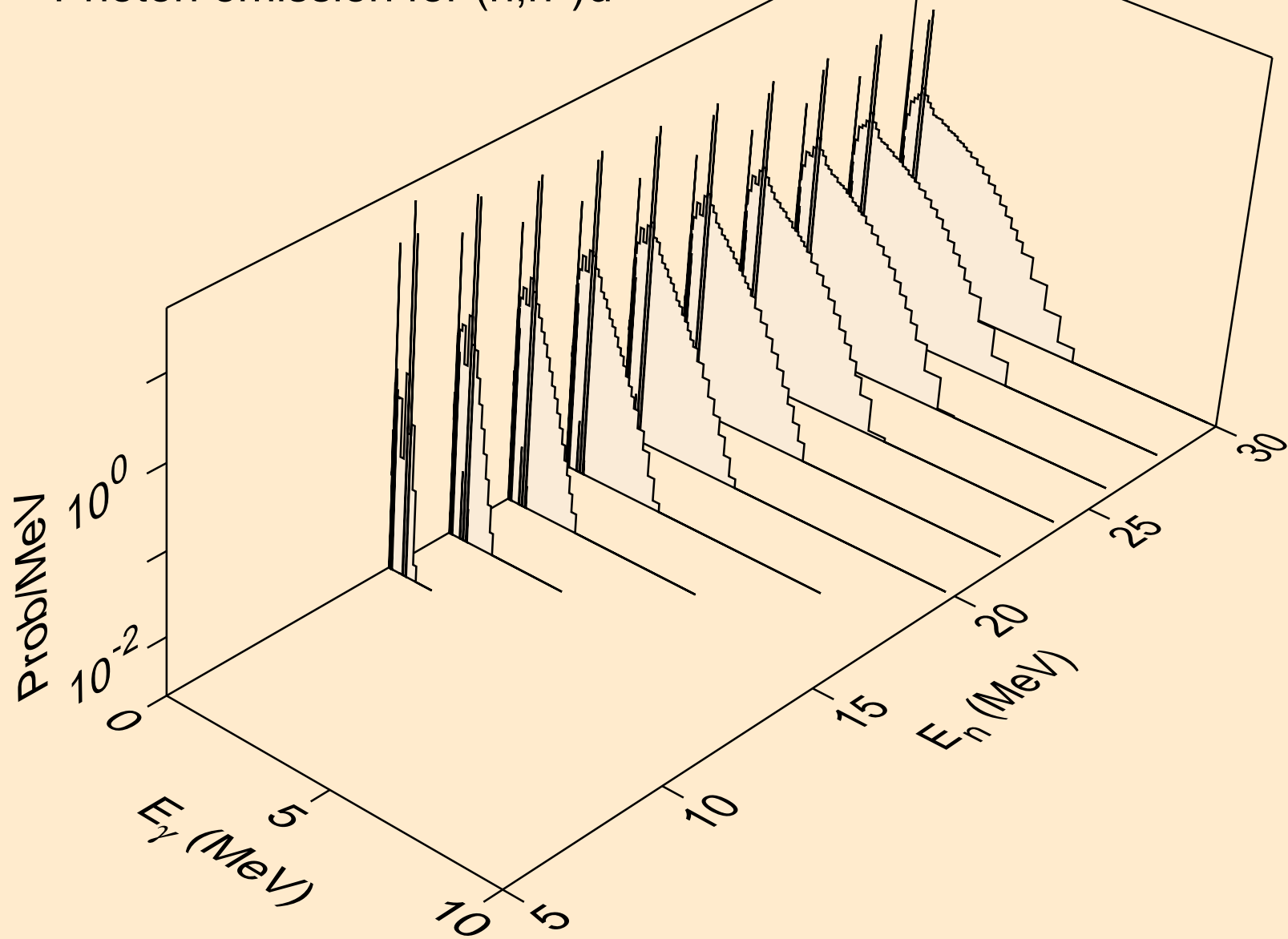

BI195 NEUTRON ACER TENDL-2023 LIBRARY; T=0.K
Photon emission for (n,n*)t

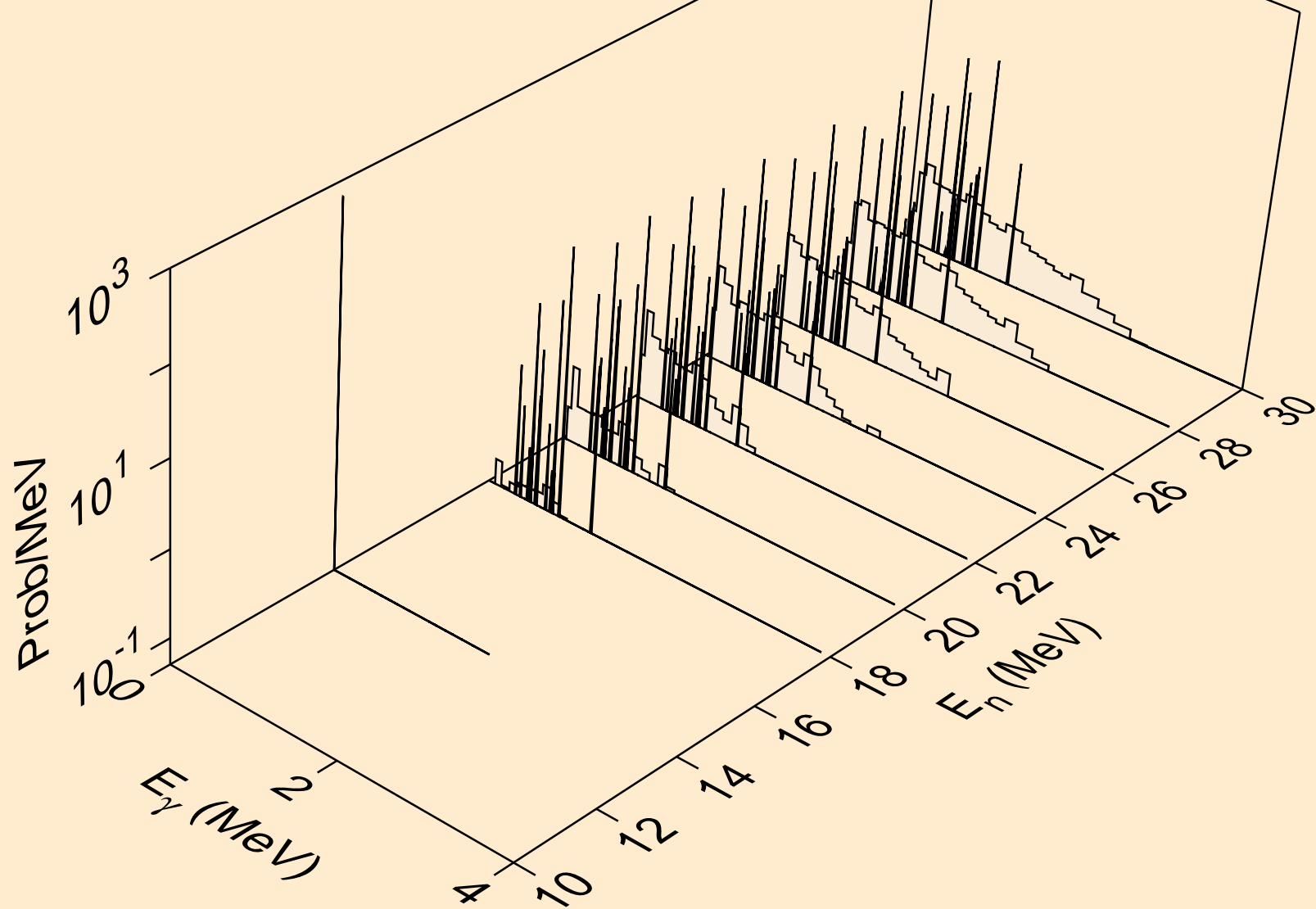

BI195 NEUTRON ACER TENDL-2023 LIBRARY; T=0.K
Photon emission for (n,n*)he3

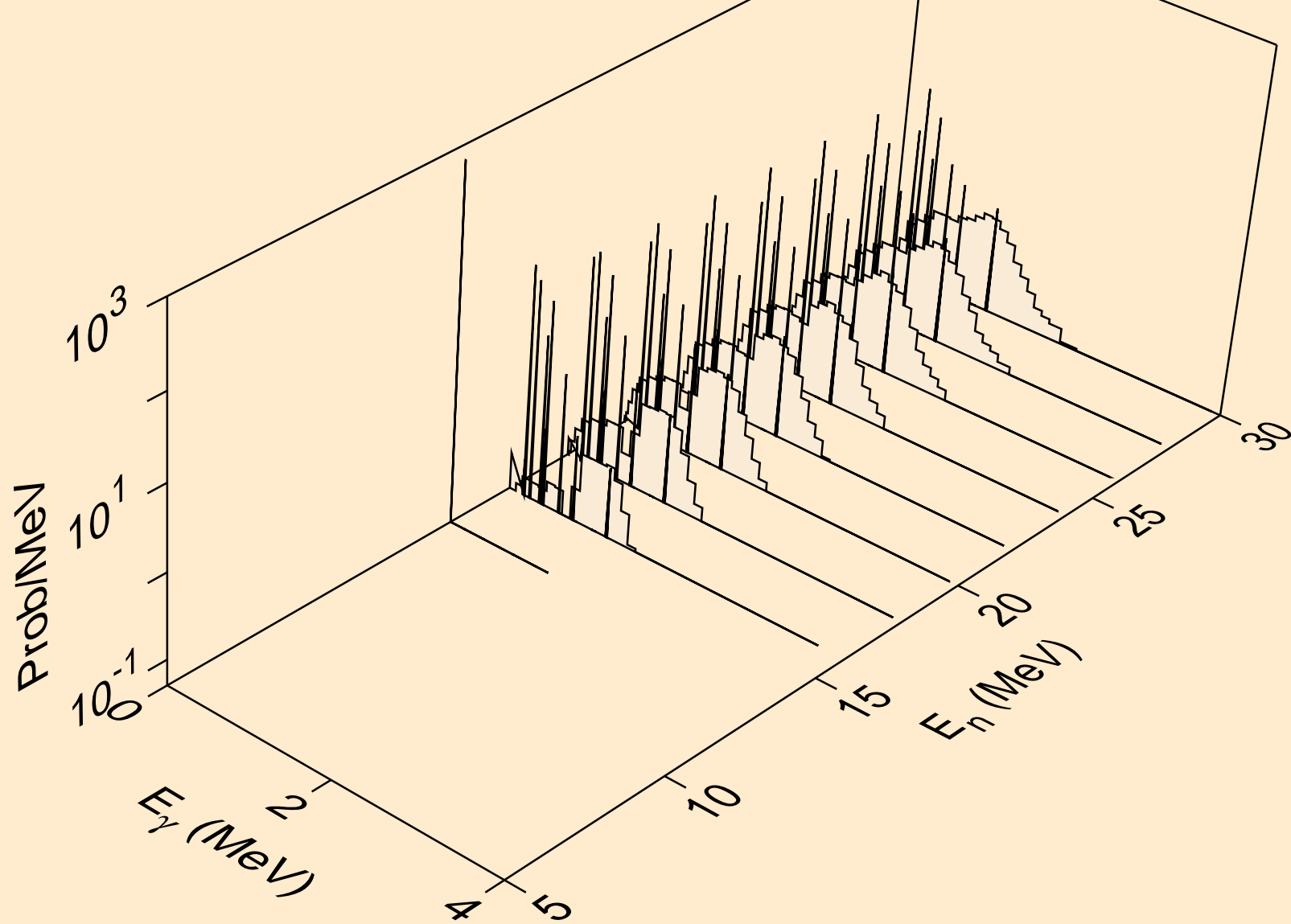

BI195 NEUTRON ACER TENDL-2023 LIBRARY; T=0.K
Photon emission for (n,4n)

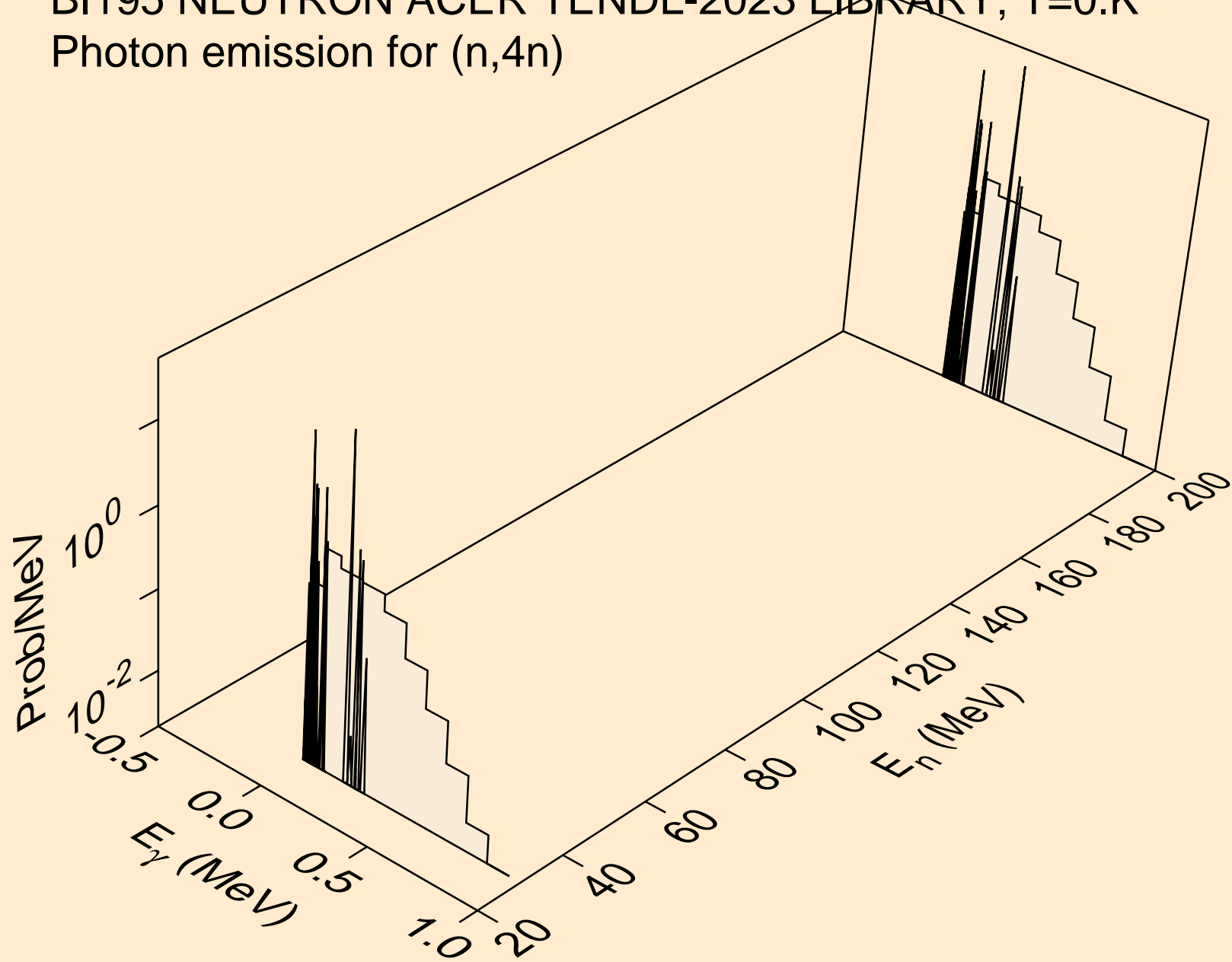

BI195 NEUTRON ACER TENDL-2023 LIBRARY; T=0.K
Photon emission for (n,2np)

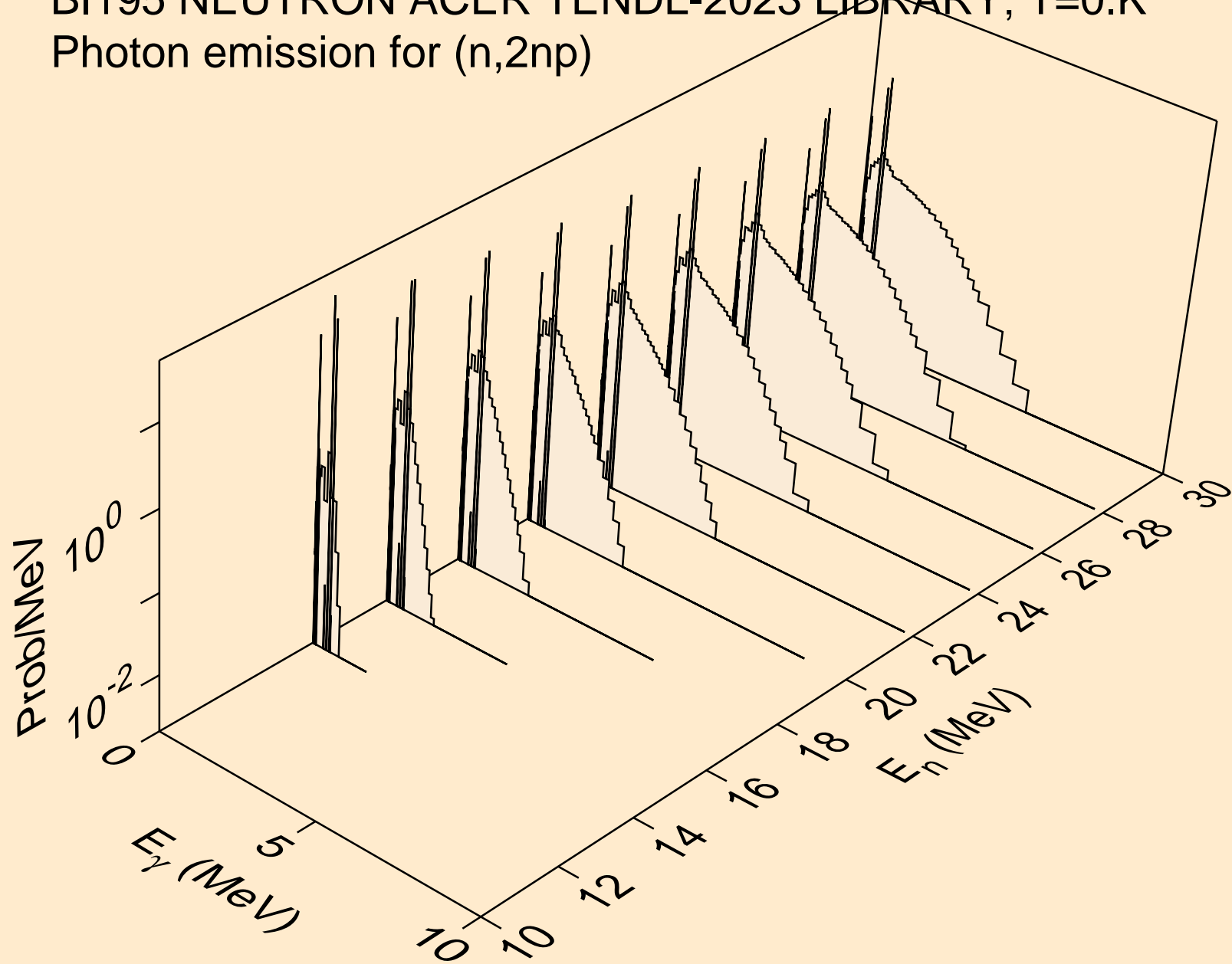

BI195 NEUTRON ACER TENDL-2023 LIBRARY; T=0.K
Photon emission for (n,3np)

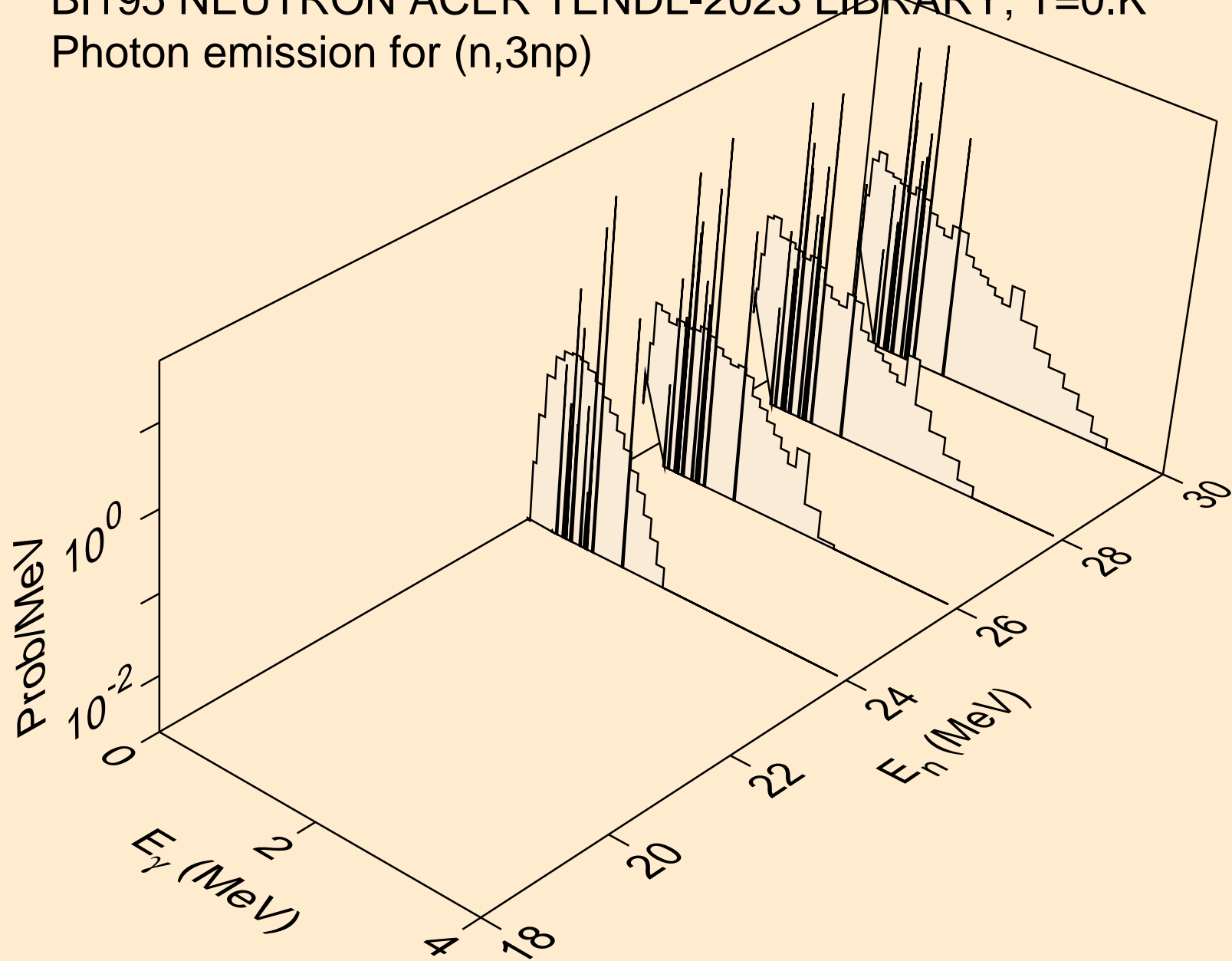

BI195 NEUTRON ACER TENDL-2023 LIBRARY; T=0.K
Photon emission for (n,n2p)

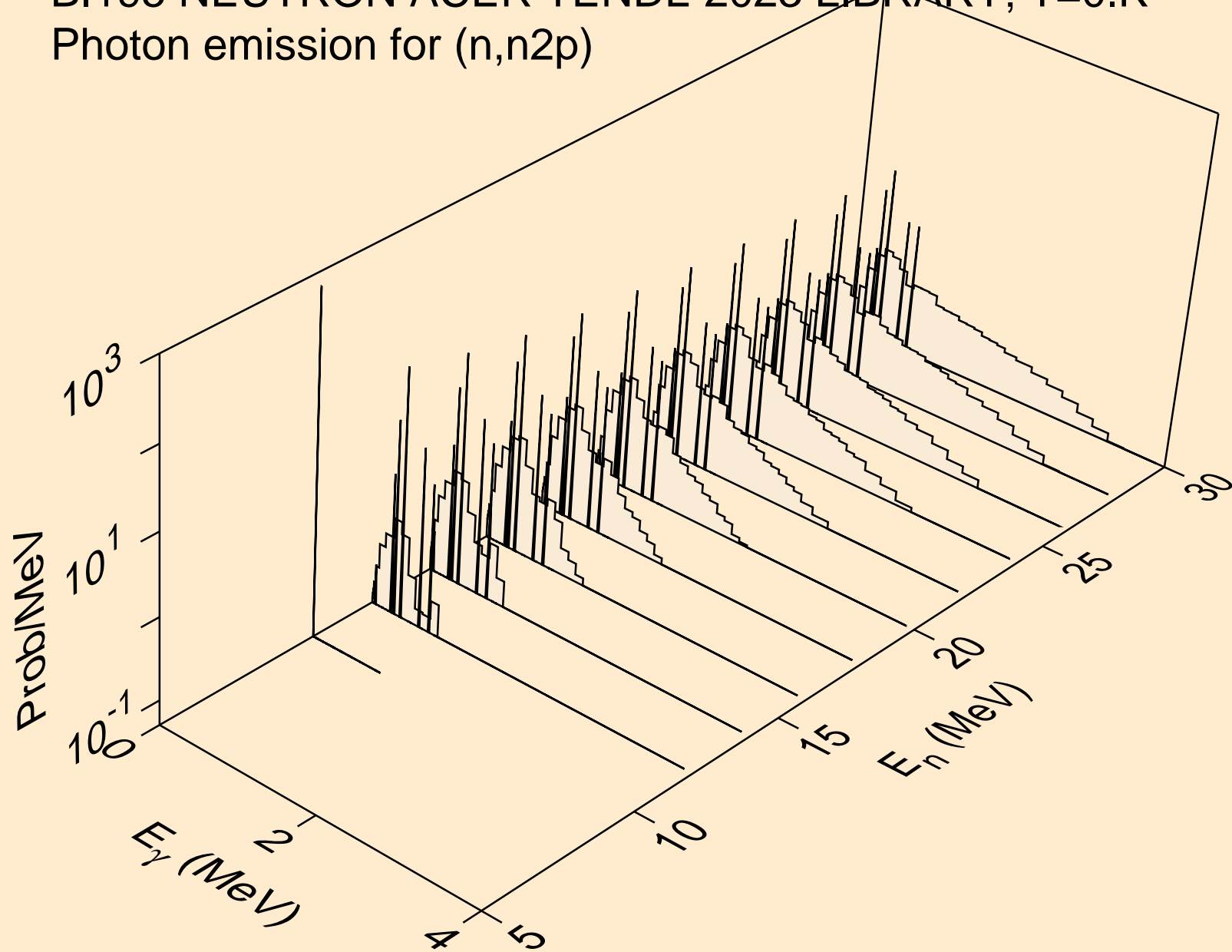

BI195 NEUTRON ACER TENDL-2023 LIBRARY; T=0.K
Photon emission for (n,npa)

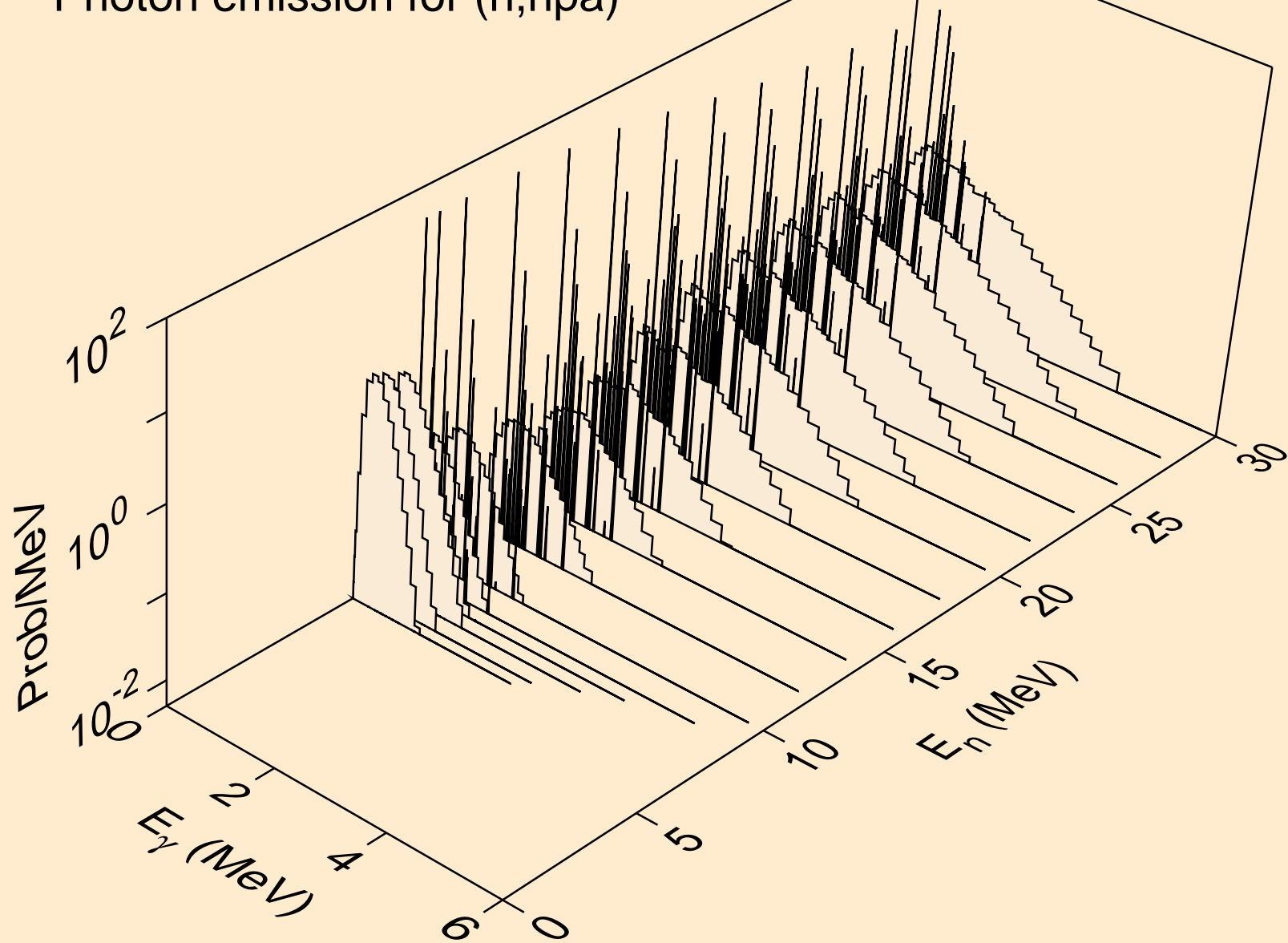

BI195 NEUTRON ACER TENDL-2023 LIBRARY; T=0.K
Photon emission for (n,n*c)

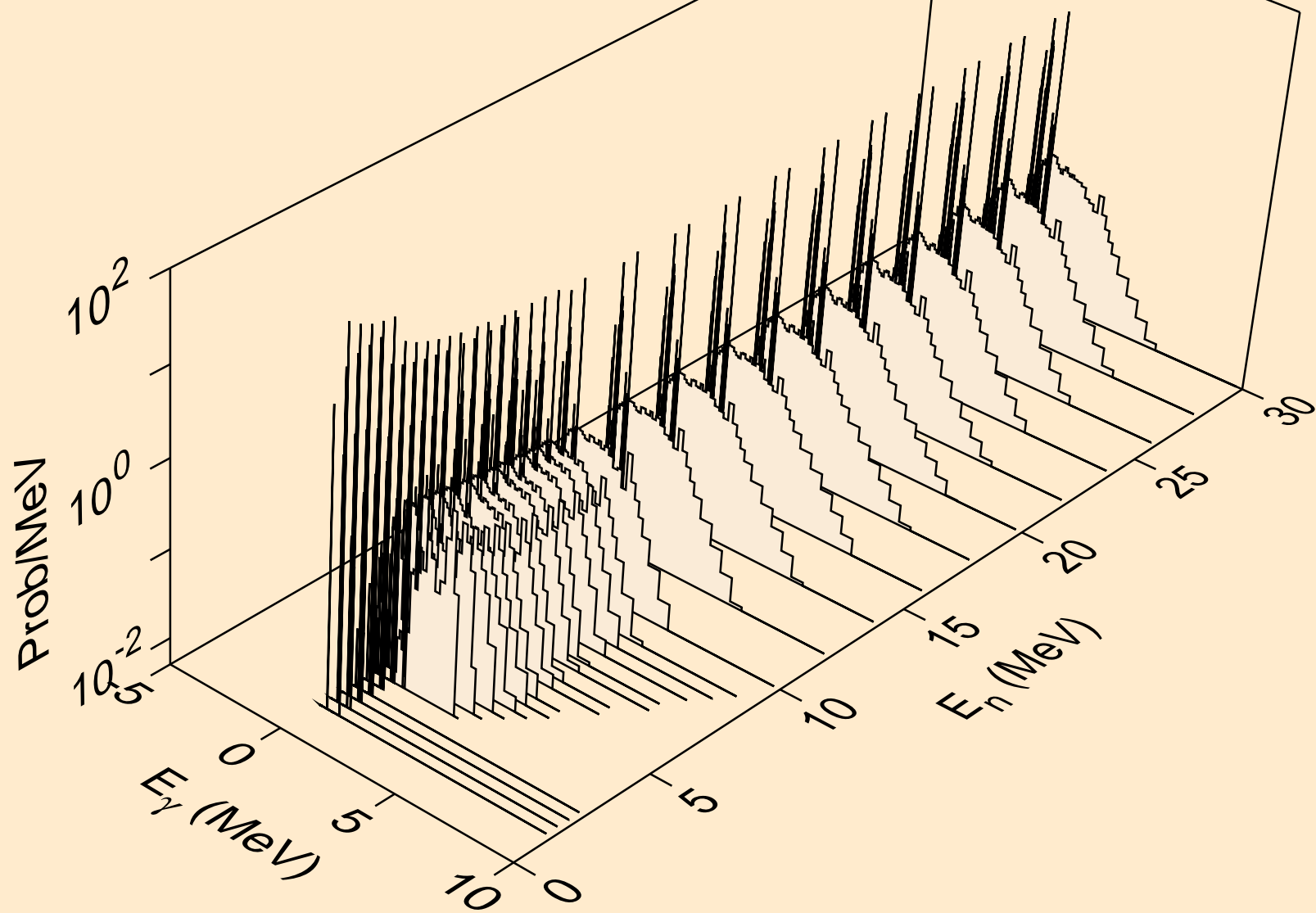

BI195 NEUTRON ACER TENDL-2023 LIBRARY; T=0.K
Photon emission for (n,gma)

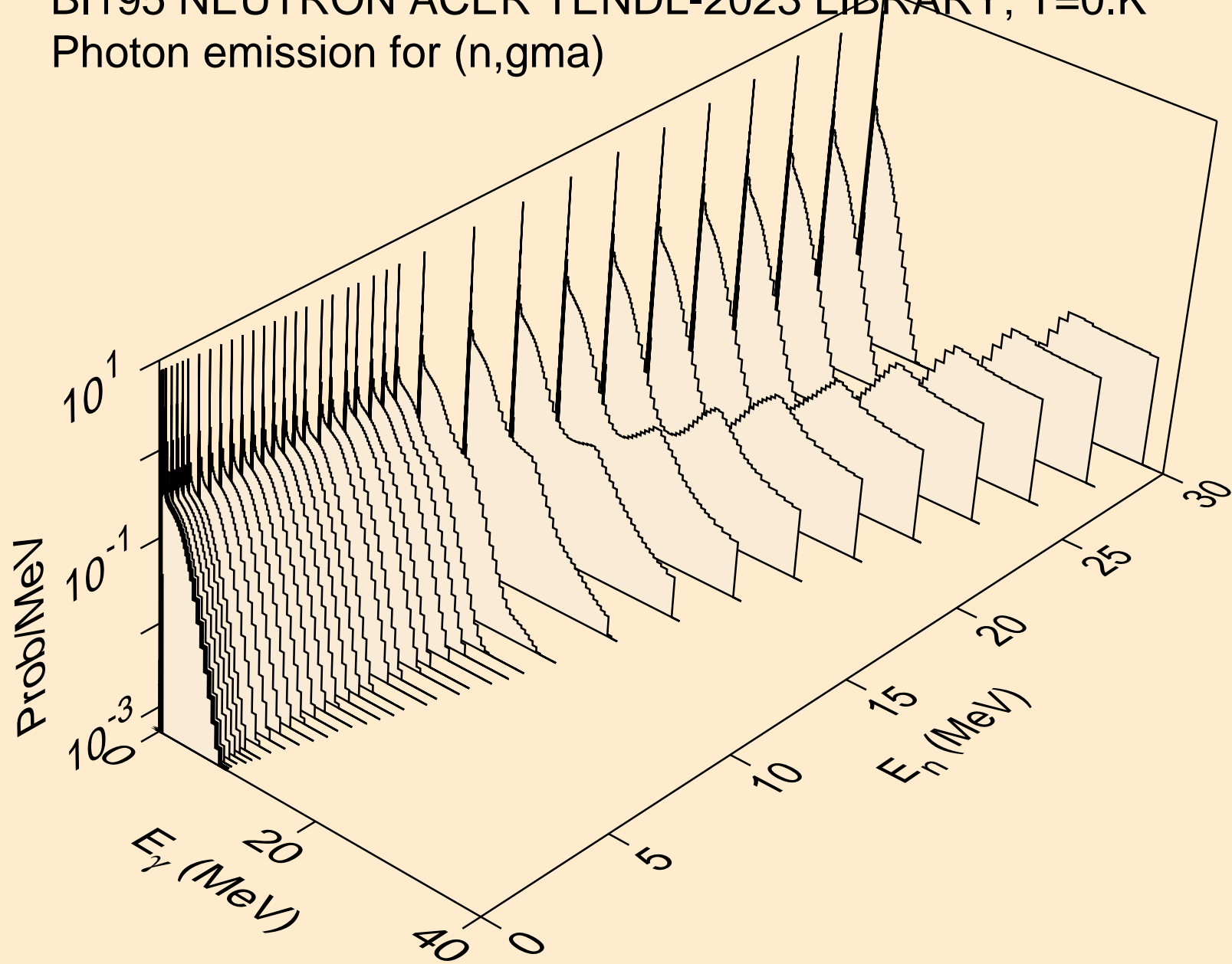

BI195 NEUTRON ACER TENDL-2023 LIBRARY; T=0.K
Photon emission for (n,p)

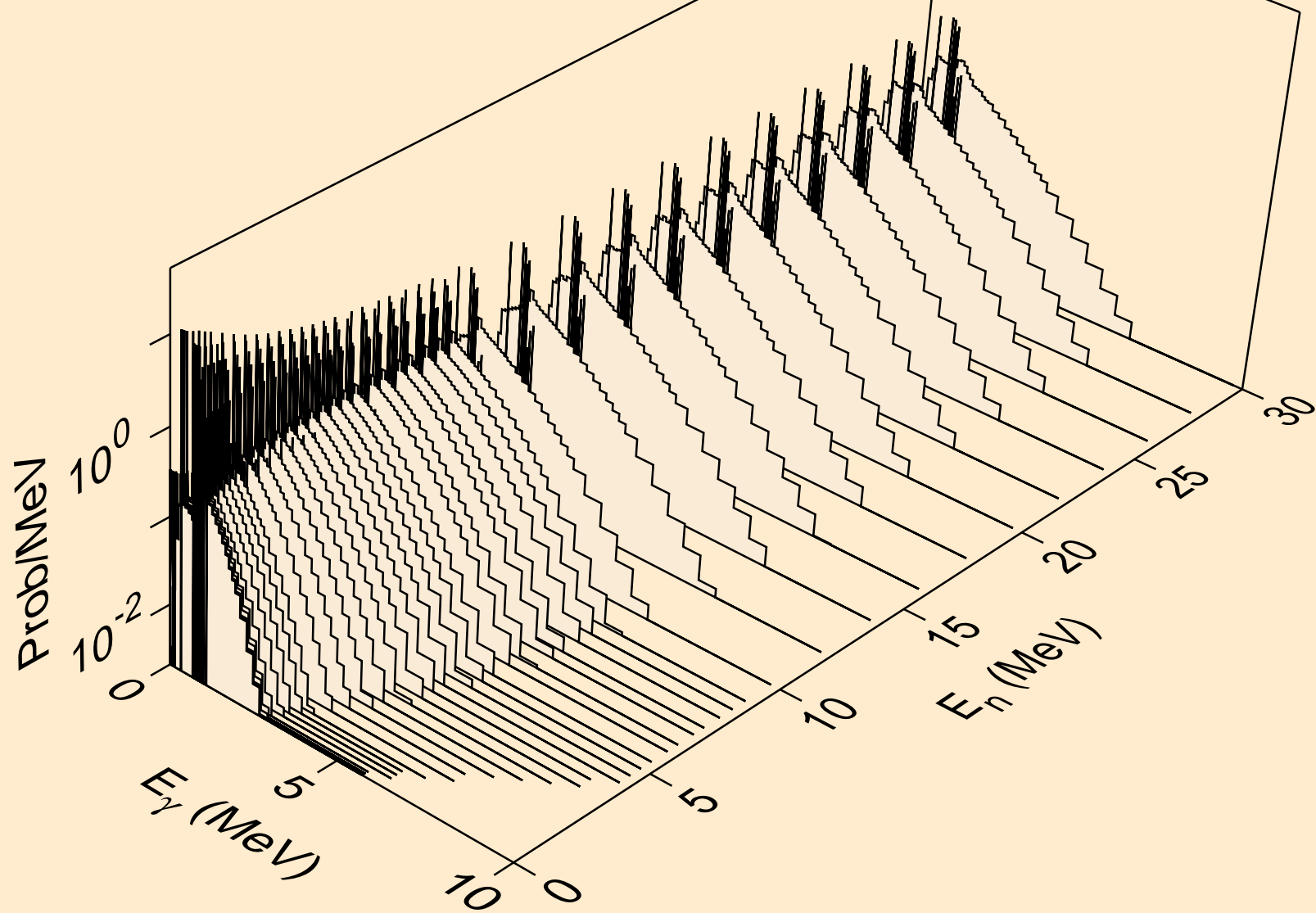

BI195 NEUTRON ACER TENDL-2023 LIBRARY; T=0.K
Photon emission for (n,d)

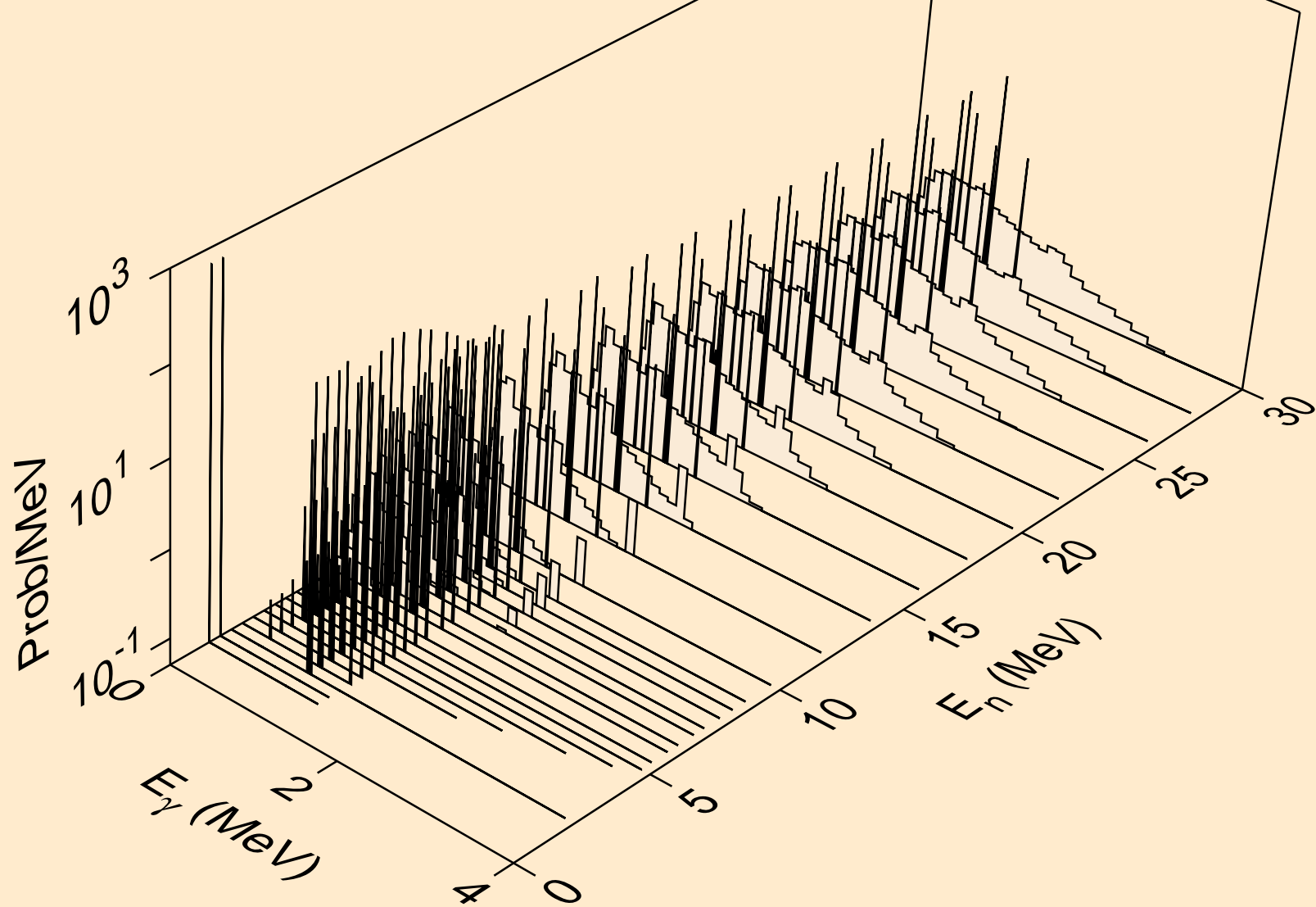

BI195 NEUTRON ACER TENDL-2023 LIBRARY; T=0.K
Photon emission for (n,t)

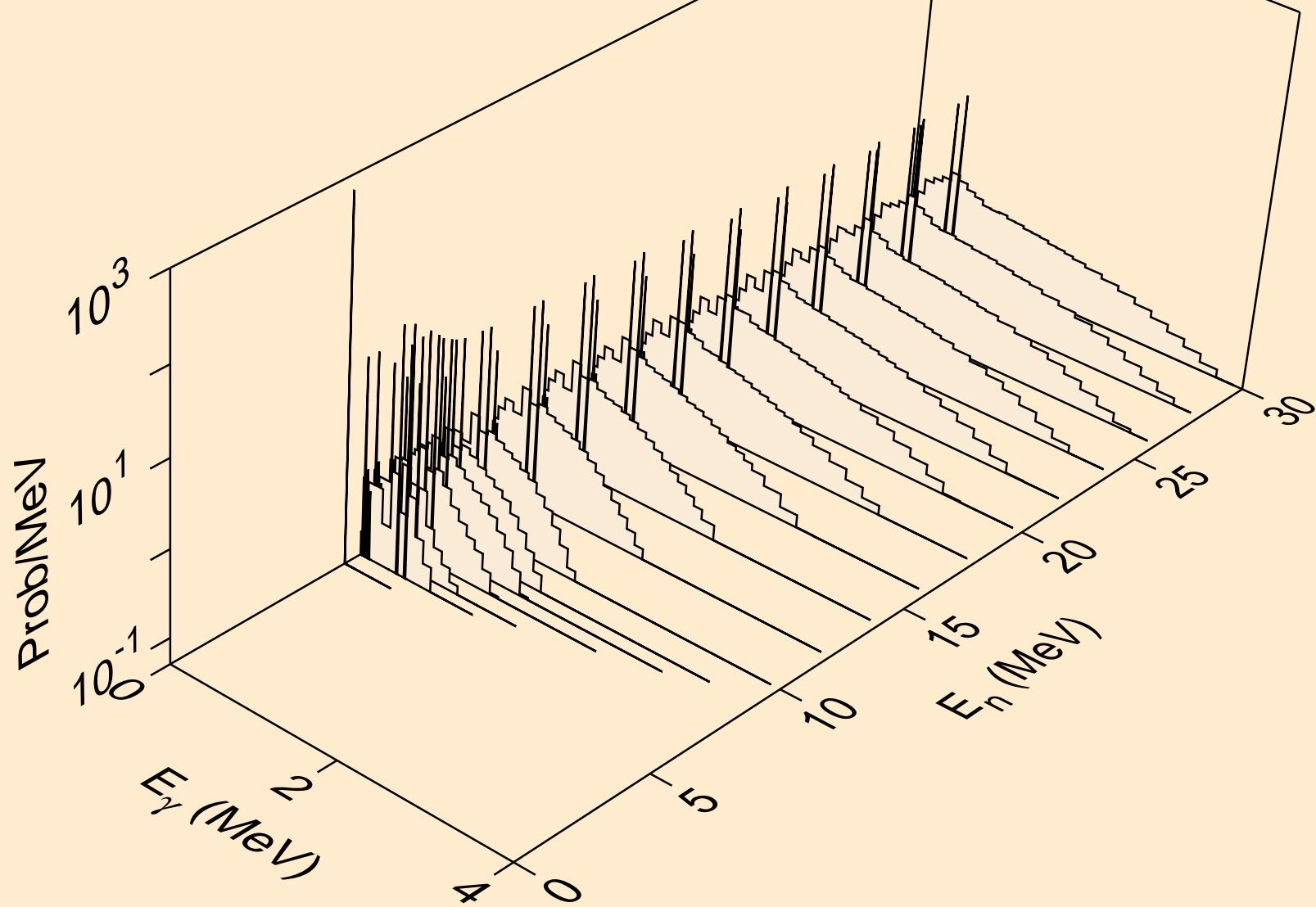

BI195 NEUTRON ACER TENDL-2023 LIBRARY; T=0.K
Photon emission for (n,he3)

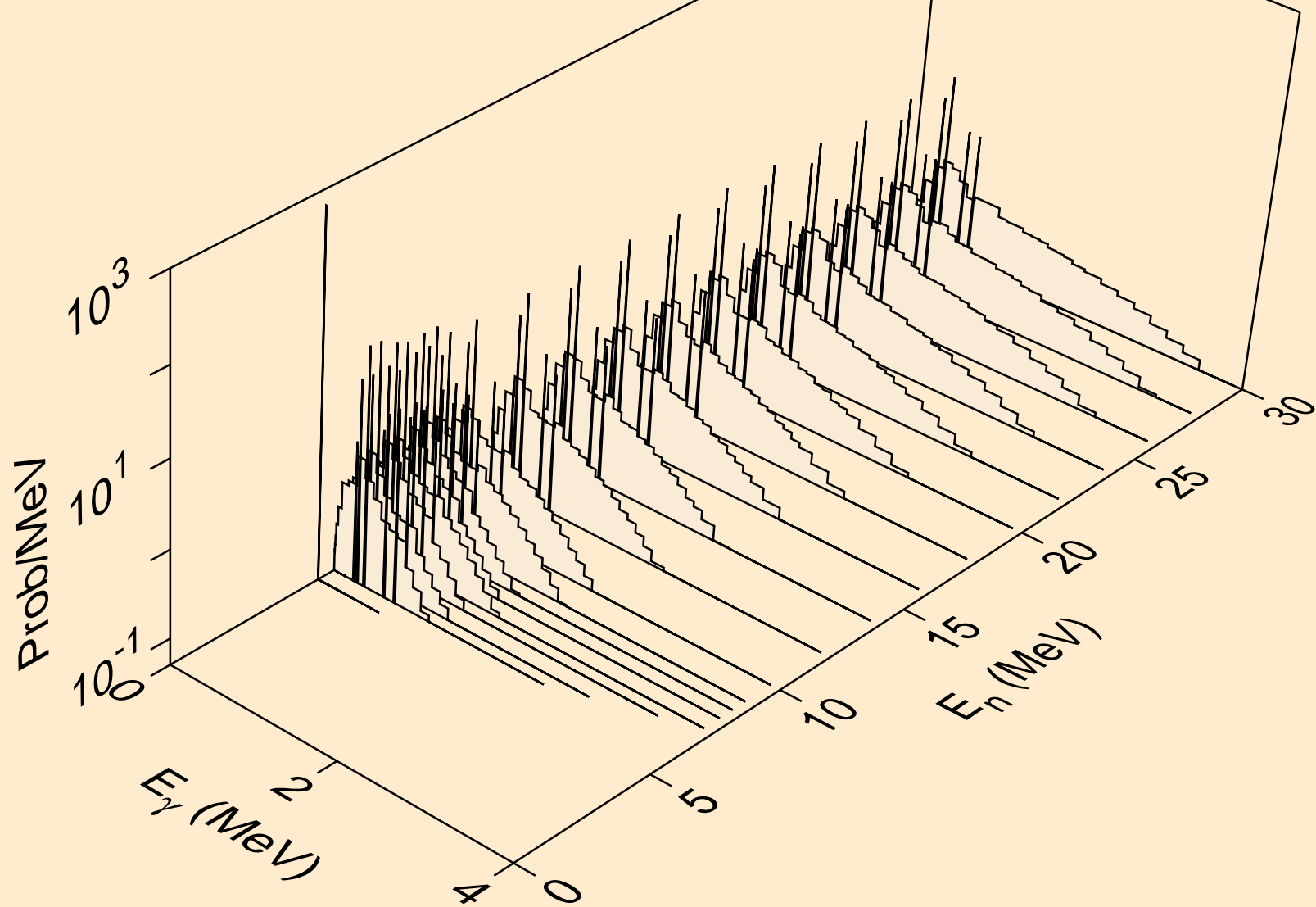

BI195 NEUTRON ACER TENDL-2023 LIBRARY; T=0.K
Photon emission for (n,a)

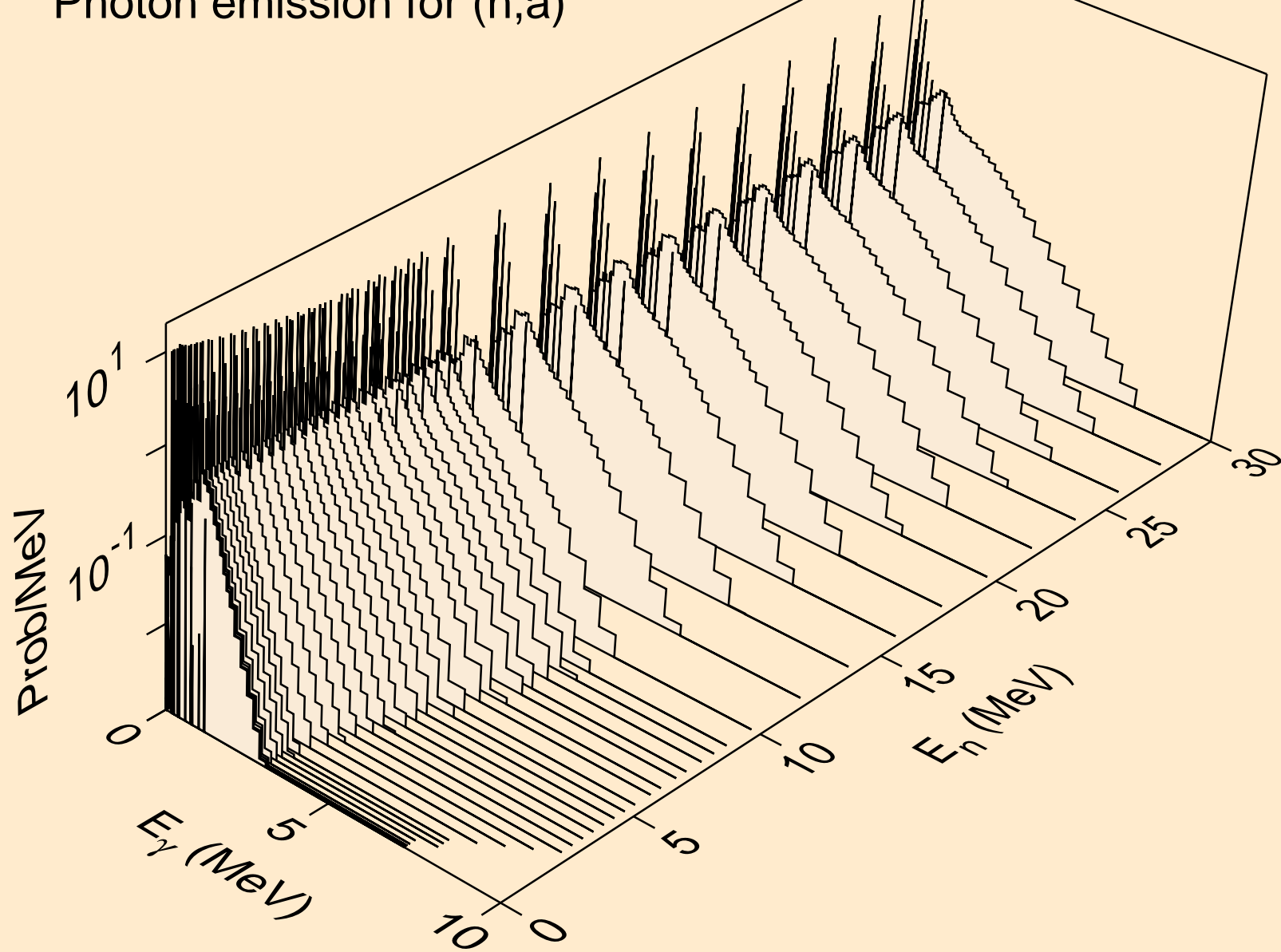

BI195 NEUTRON ACER TENDL-2023 LIBRARY; T=0.K
Photon emission for (n,2a)

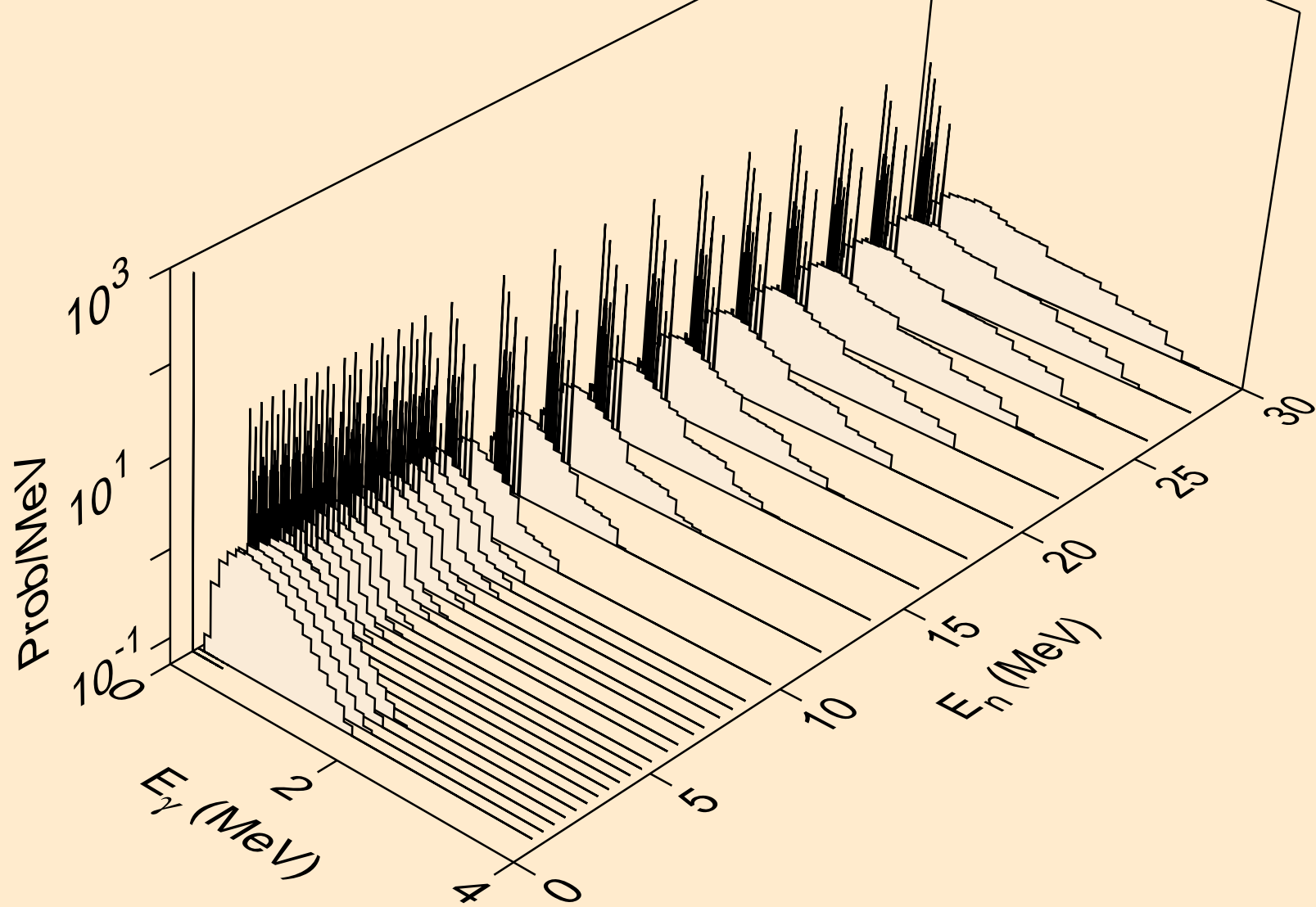

BI195 NEUTRON ACER TENDL-2023 LIBRARY; T=0.K
Photon emission for (n,2p)

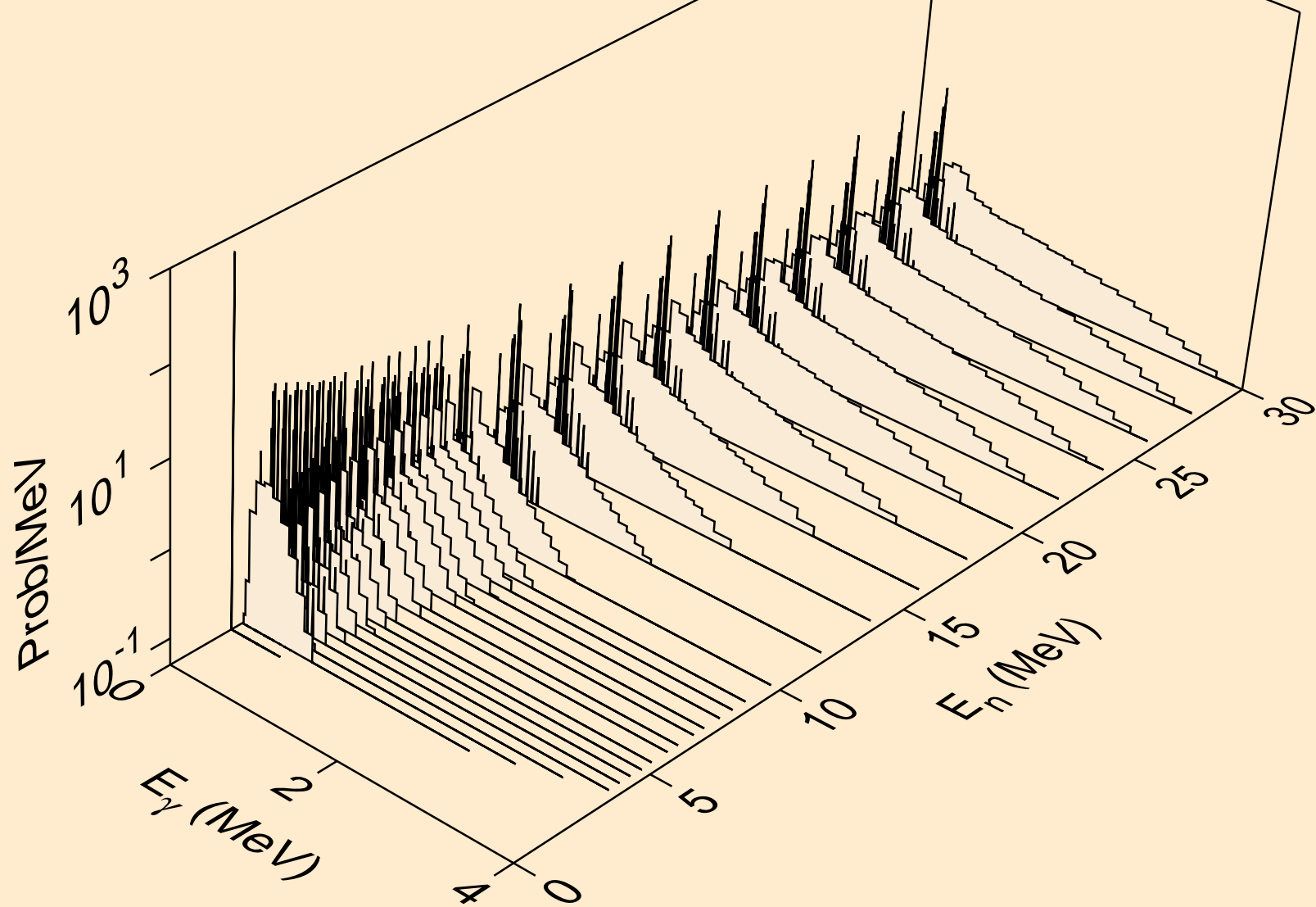

BI195 NEUTRON ACER TENDL-2023 LIBRARY; T=0.K
Photon emission for (n,p)

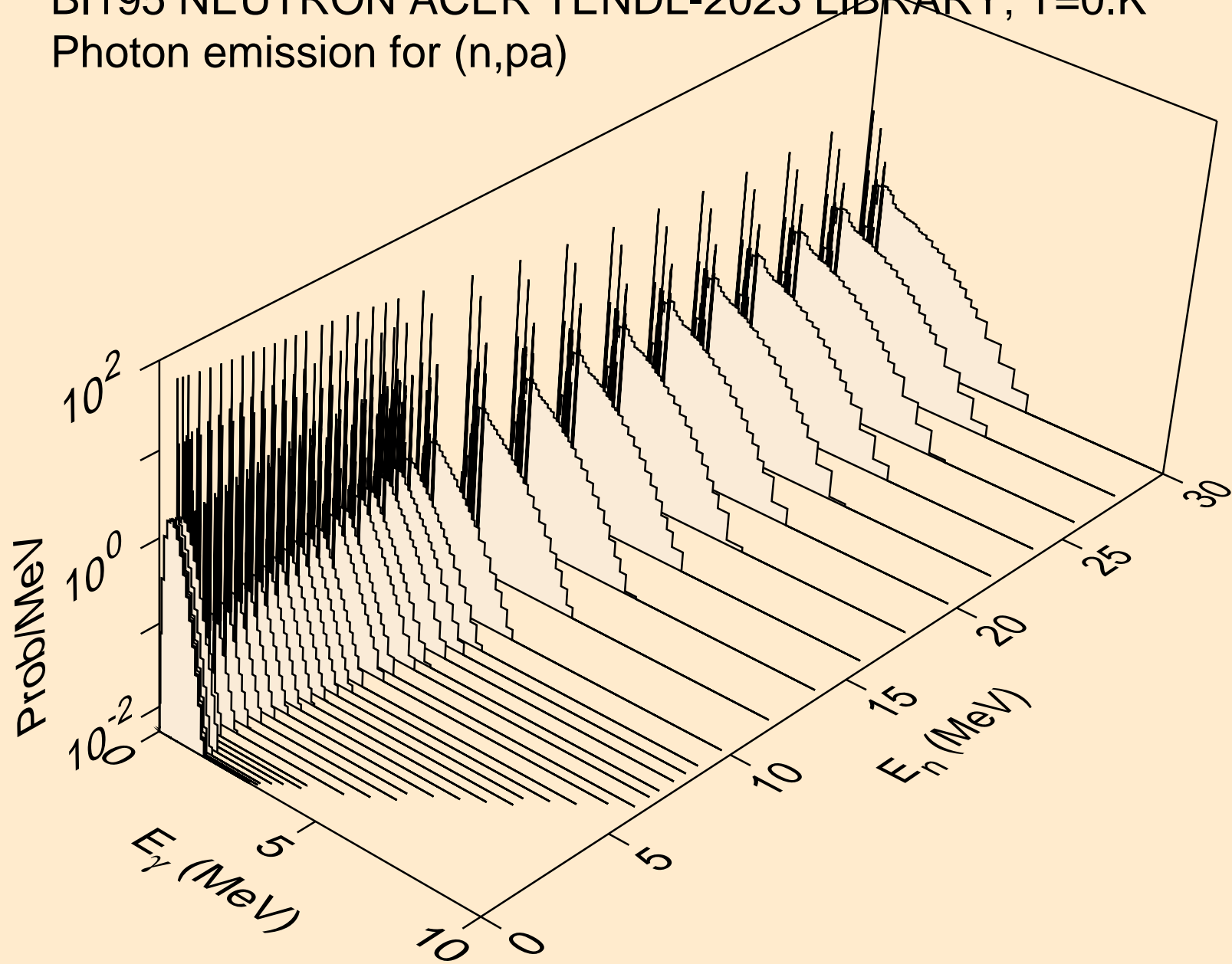

BI195 NEUTRON ACER TENDL-2023 LIBRARY; T=0.K
Photon emission for (n,pd)

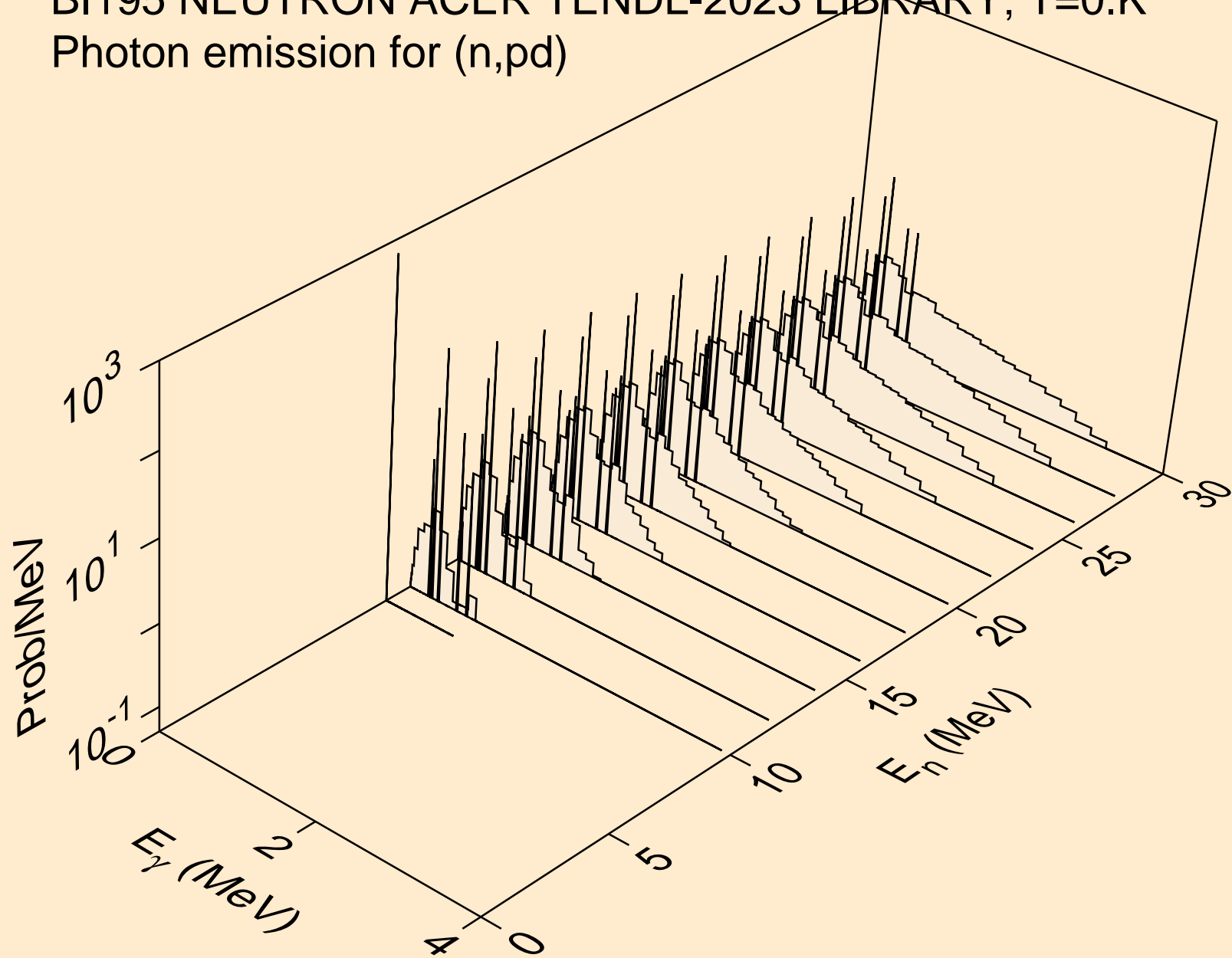

BI195 NEUTRON ACER TENDL-2023 LIBRARY; T=0.K
Photon emission for (n,pt)

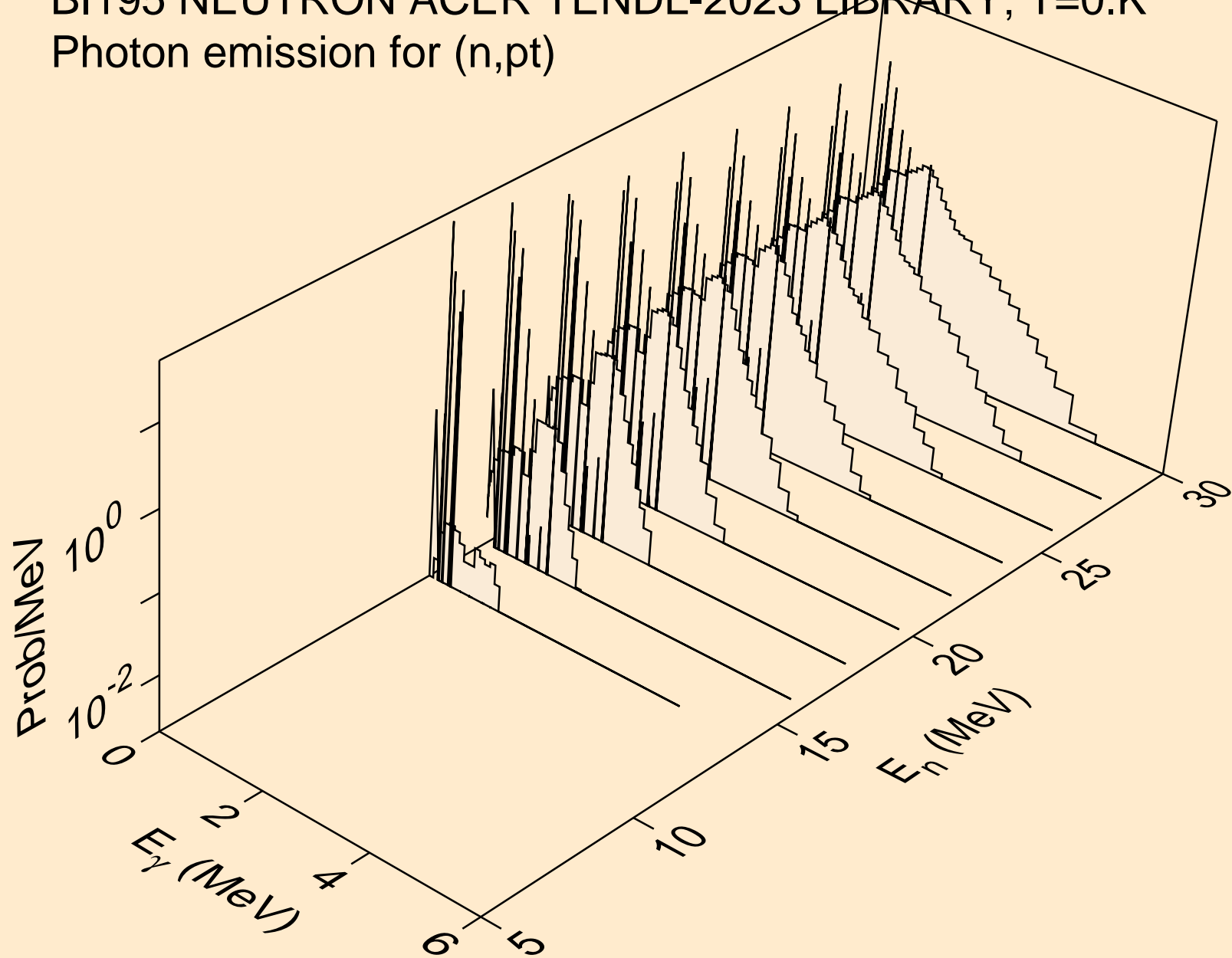

BI195 NEUTRON ACER TENDL-2023 LIBRARY; T=0.K
Photon emission for (n,da)

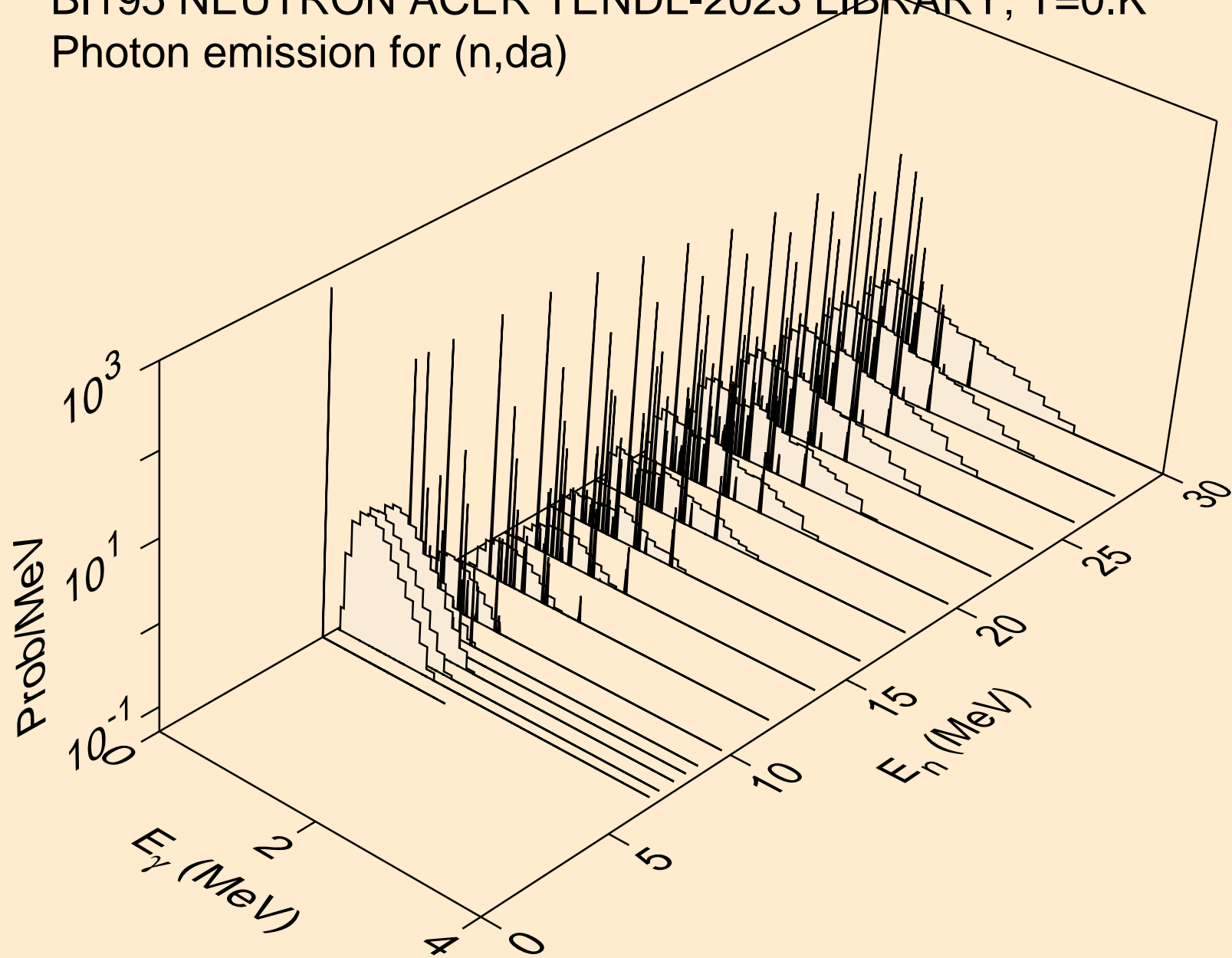

BI195 NEUTRON ACER TENDL-2023 LIBRARY; T=0.K
thermal capture photon spectrum

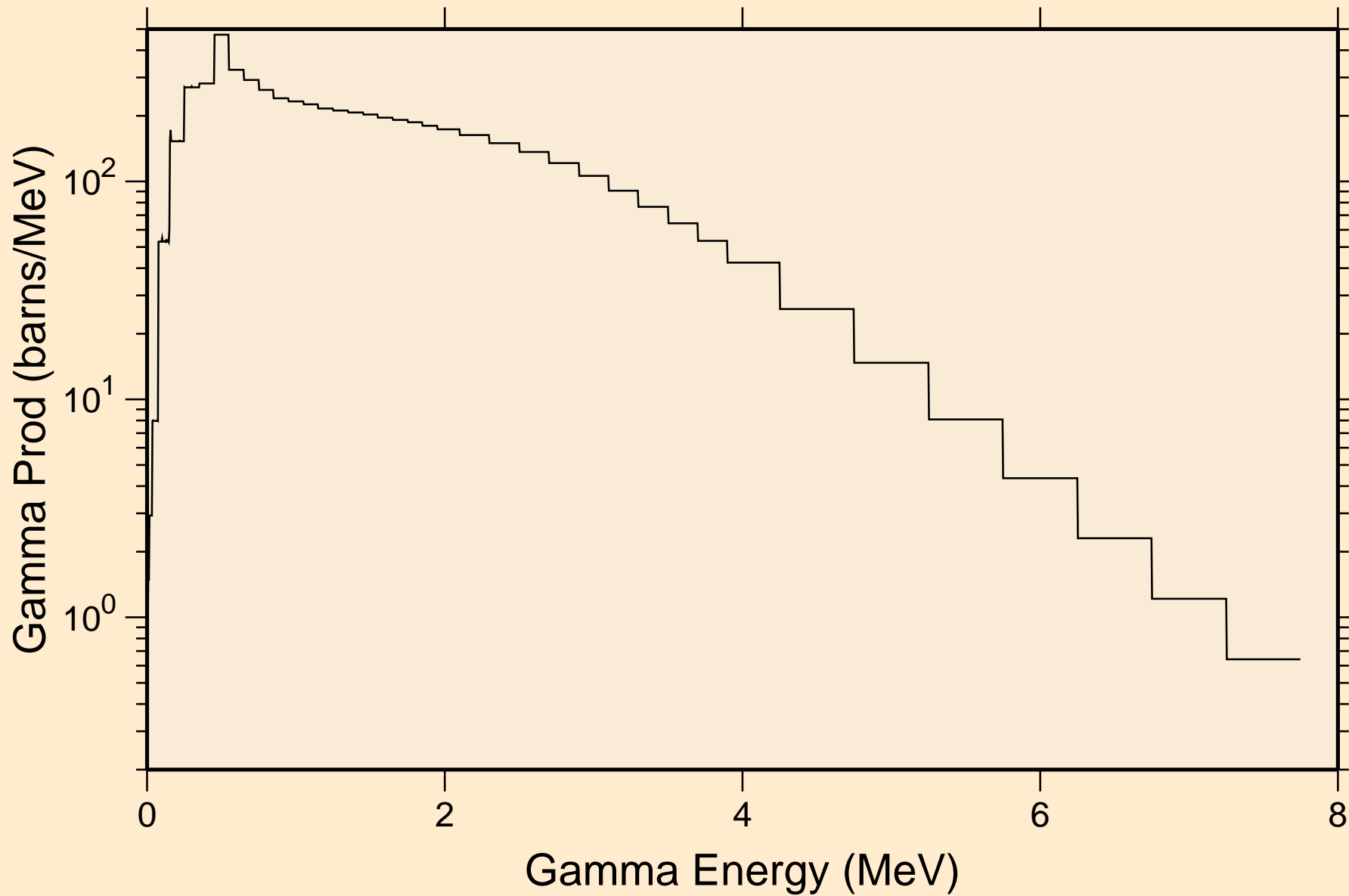

BI195 NEUTRON ACER TENDL-2023 LIBRARY; T=0.K
14 MeV photon spectrum

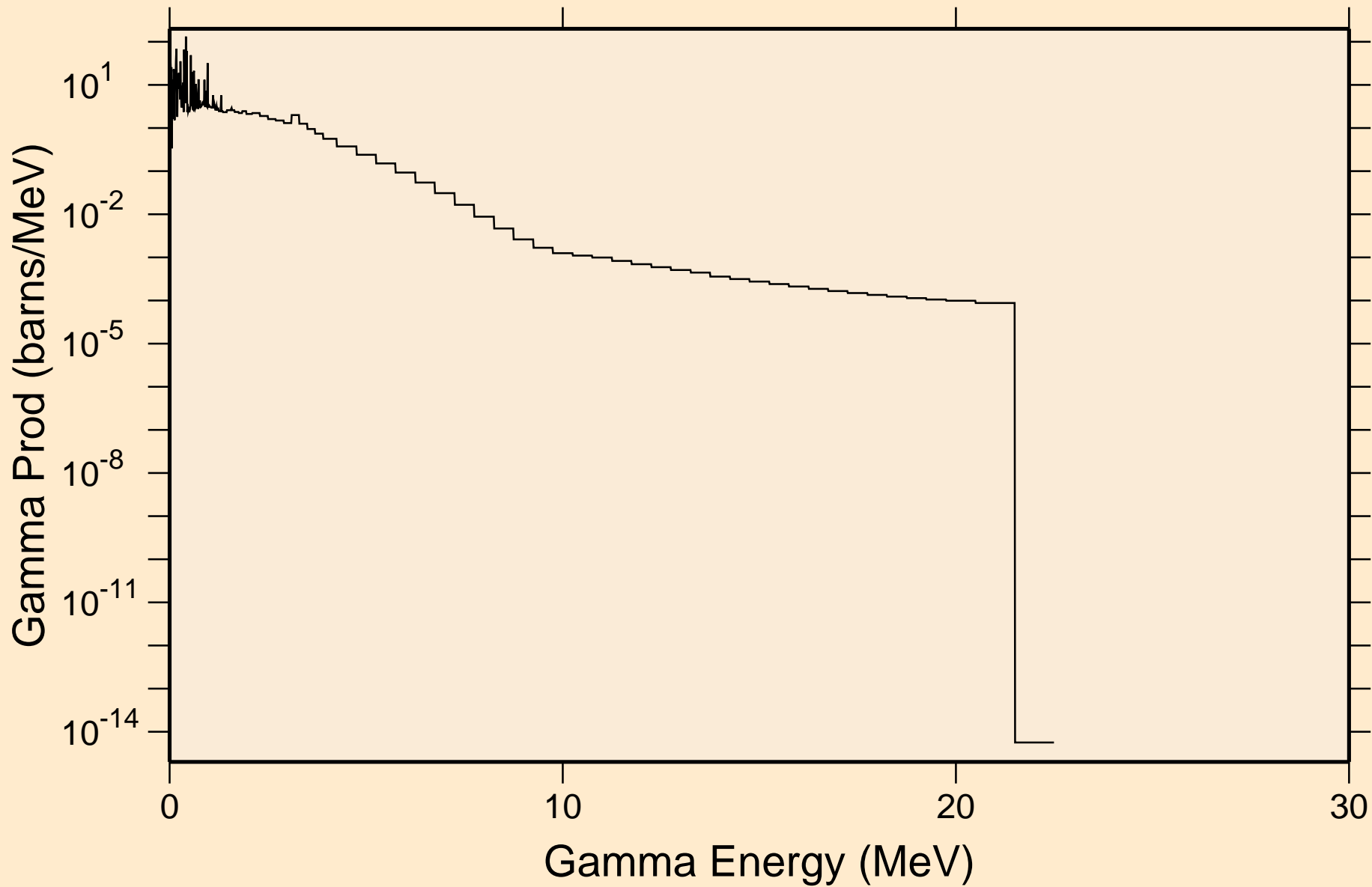

BI195 NEUTRON ACER TENDL-2023 LIBRARY; T=0.K
Particle heating contributions

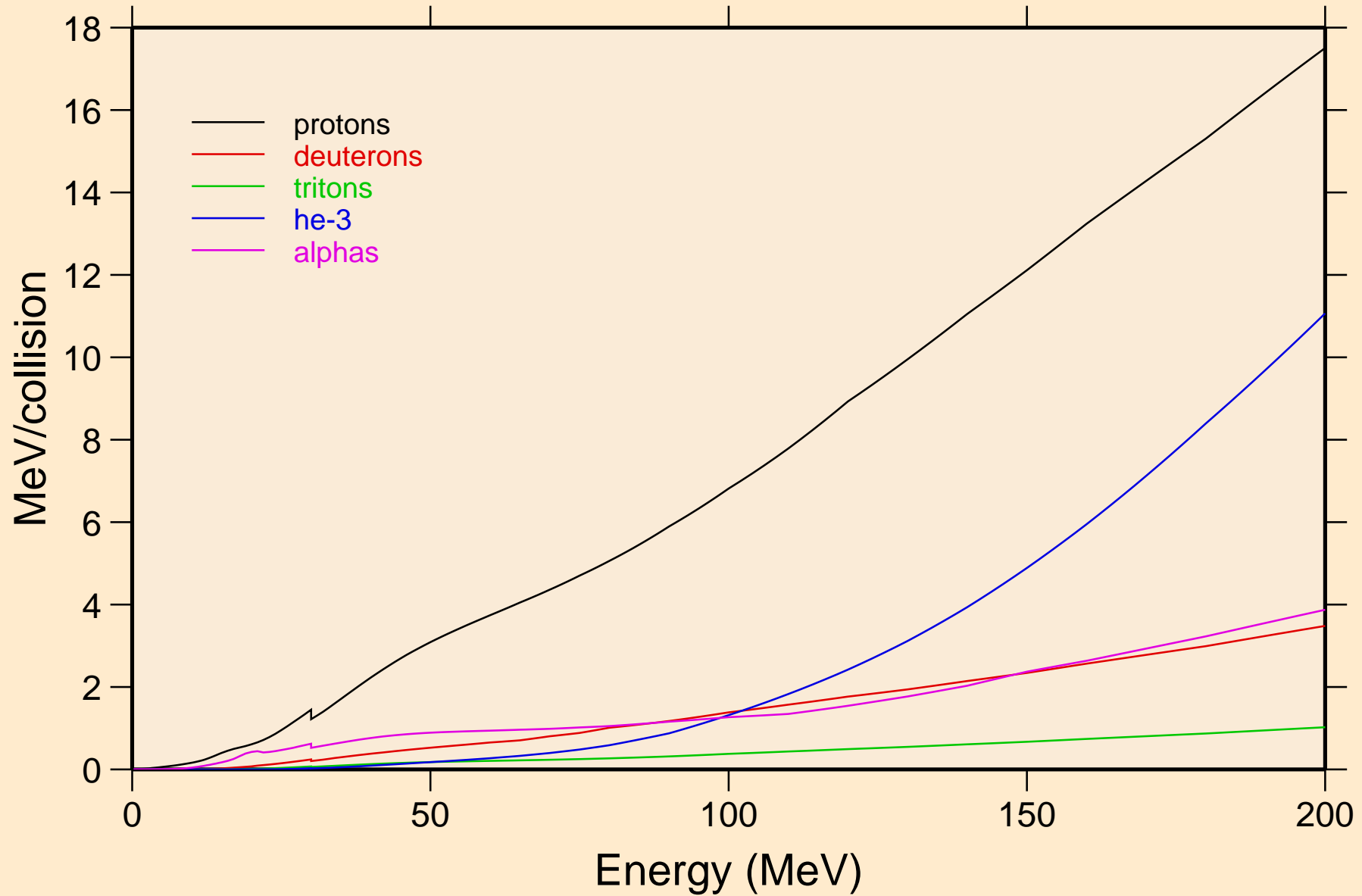

BI195 NEUTRON ACER TENDL-2023 LIBRARY; T=0.K
Recoil Heating

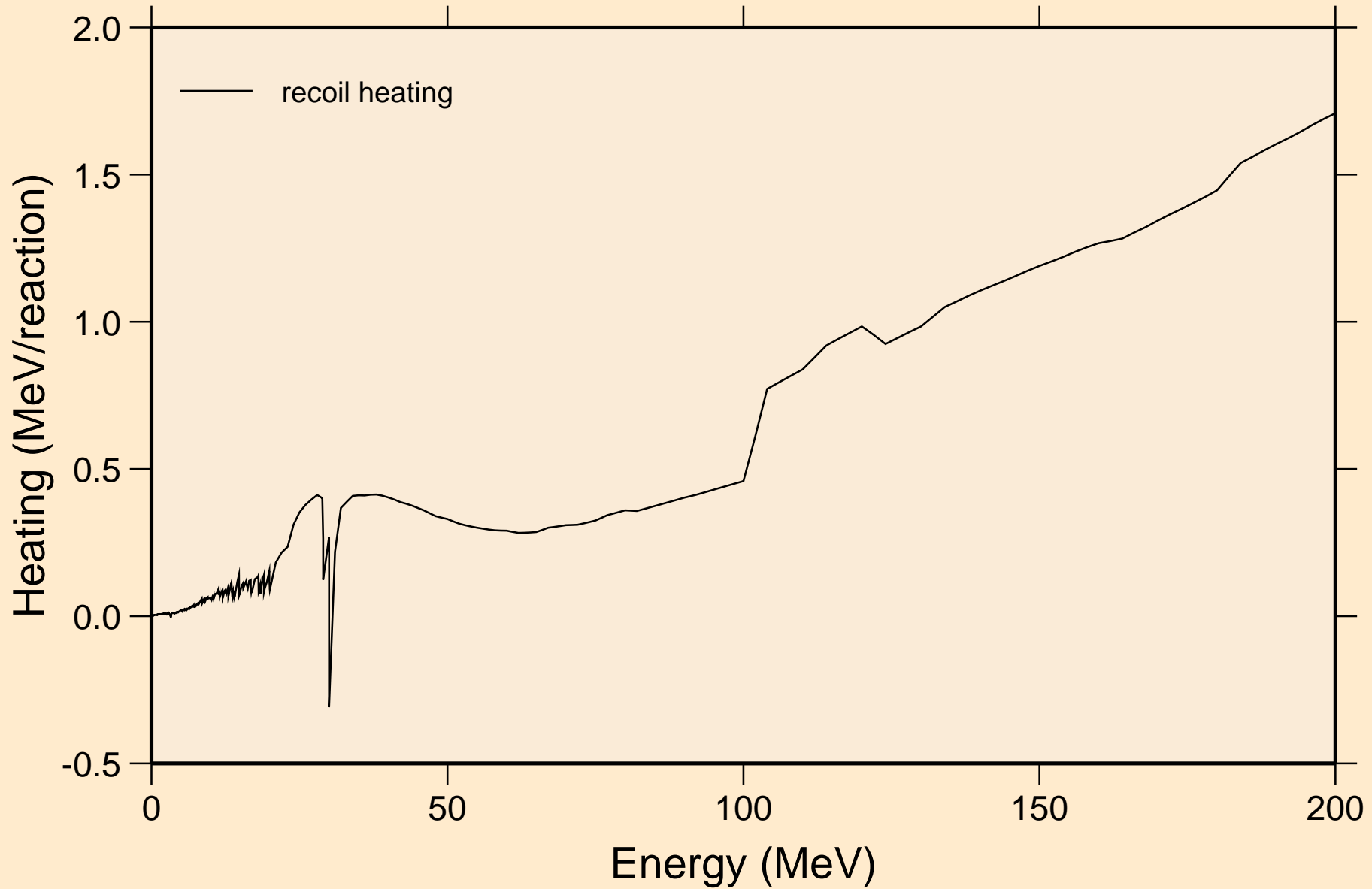

BI195 NEUTRON ACER TENDL-2023 LIBRARY; T=0.K
Particle production cross sections

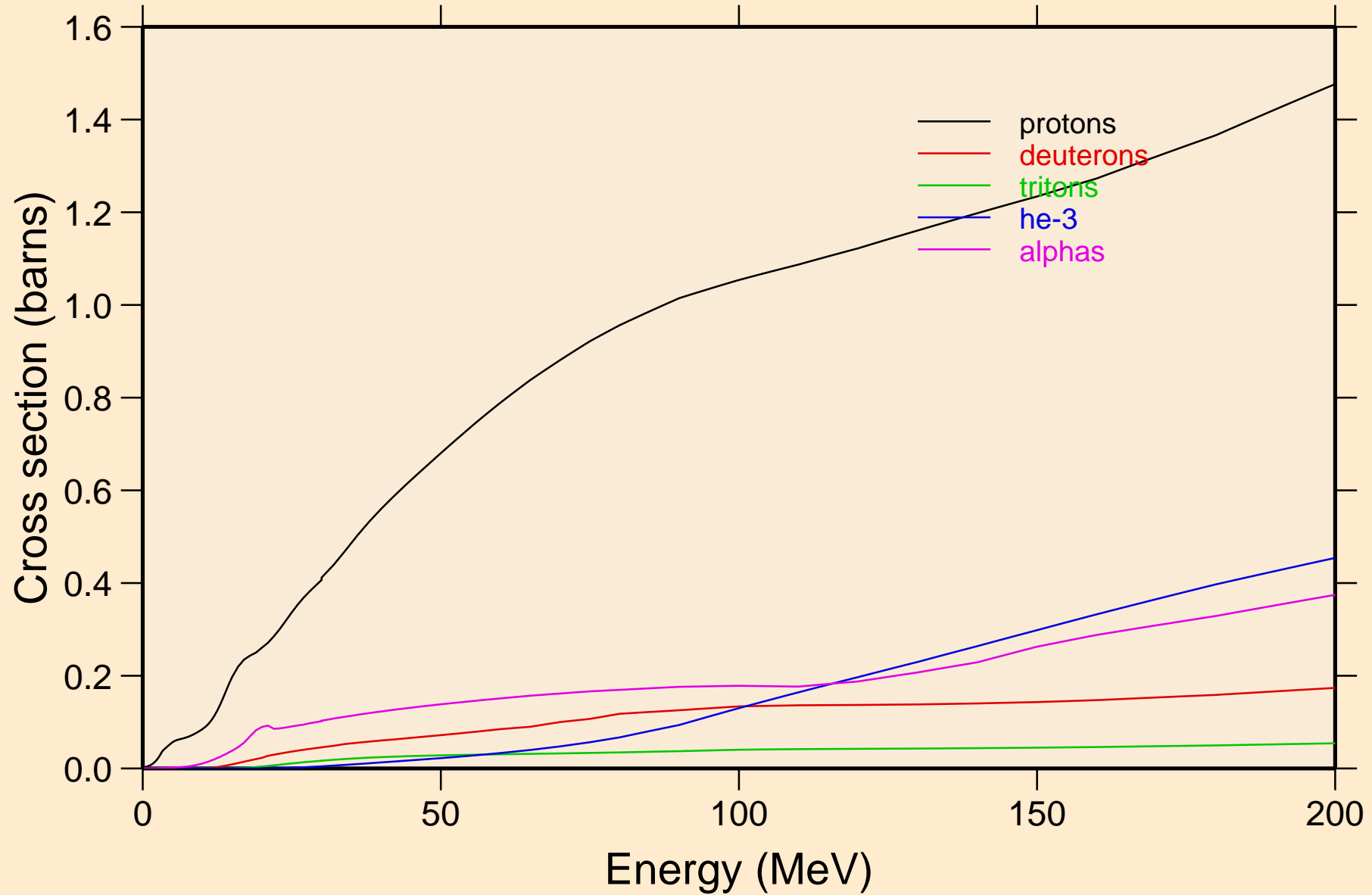

BI195 NEUTRON ACER TENDL-2023 LIBRARY; T=0.K
protons from (n,x)

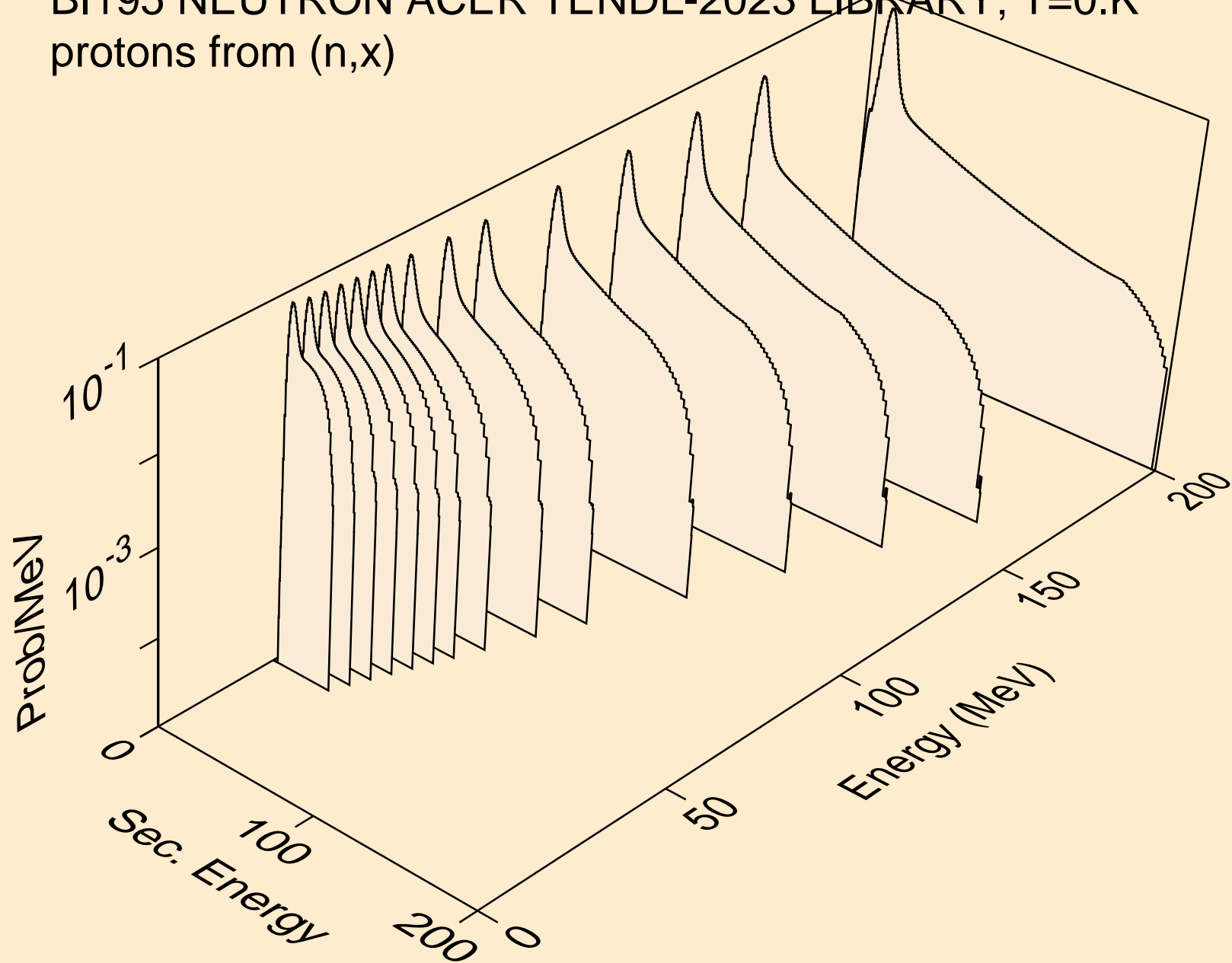

BI195 NEUTRON ACER TENDL-2023 LIBRARY; T=0.K
protons from (n,n*)p

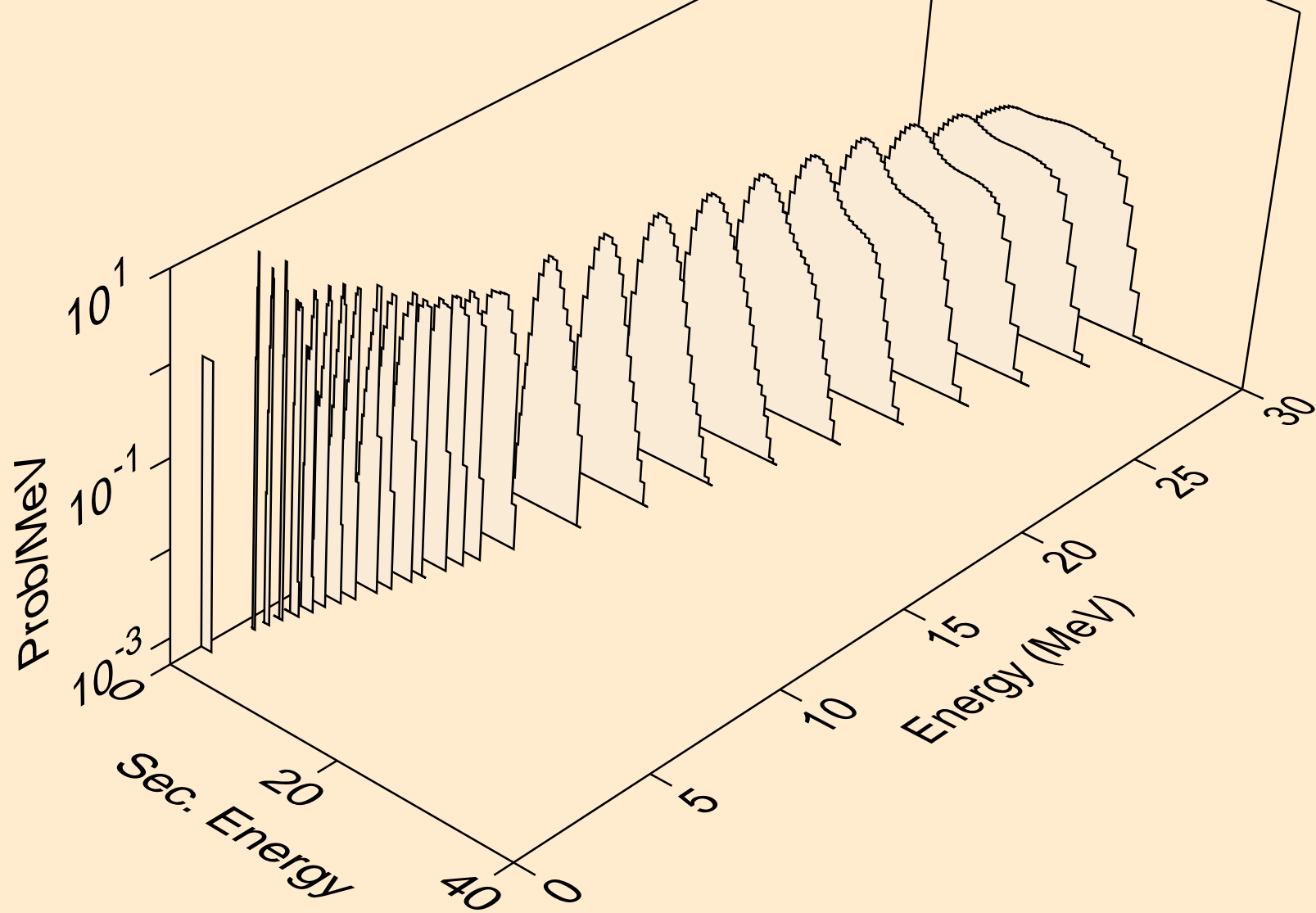

BI195 NEUTRON ACER TENDL-2023 LIBRARY; T=0.K
protons from (n,2np)

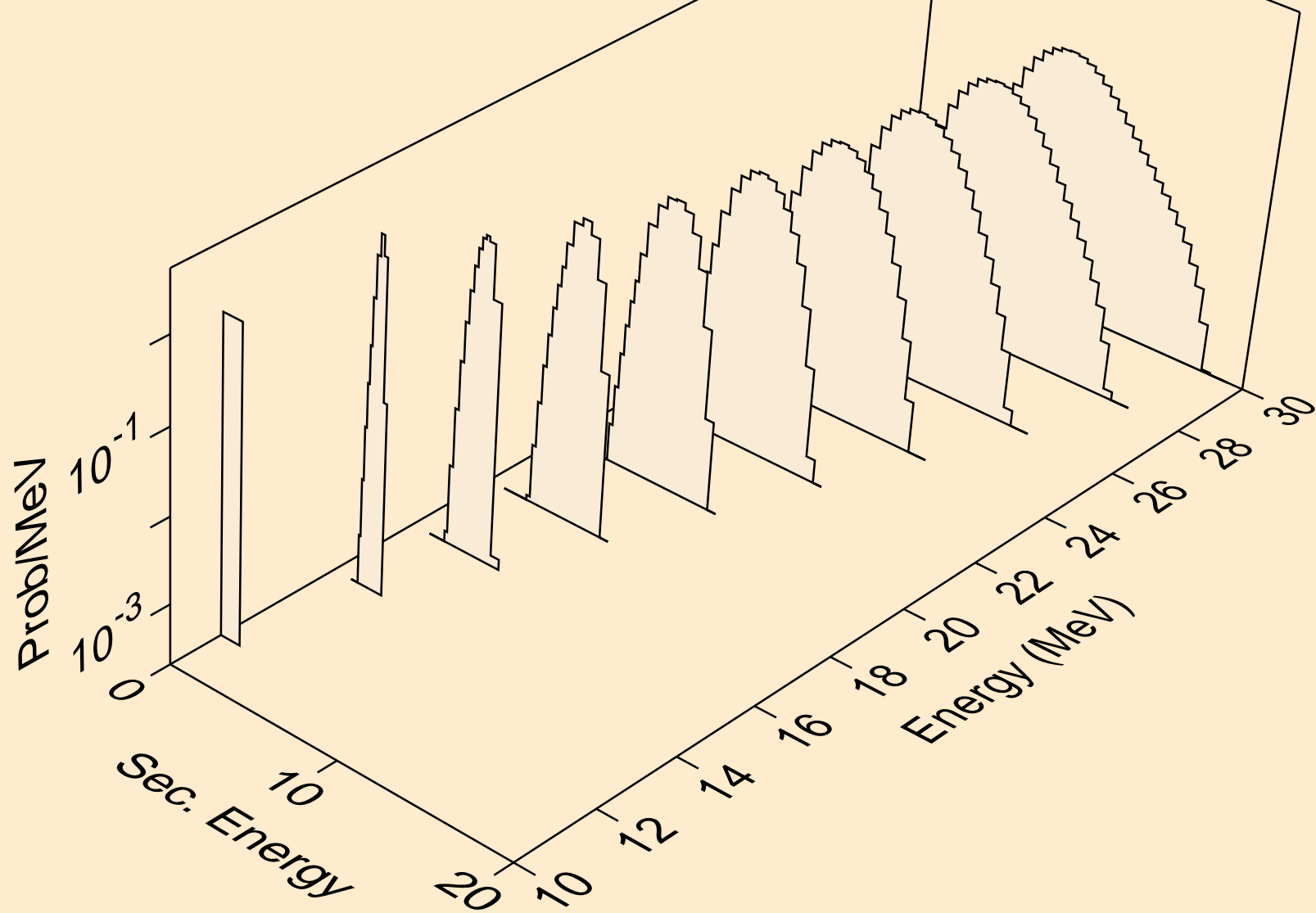

BI195 NEUTRON ACER TENDL-2023 LIBRARY; T=0.K
protons from (n,3np)

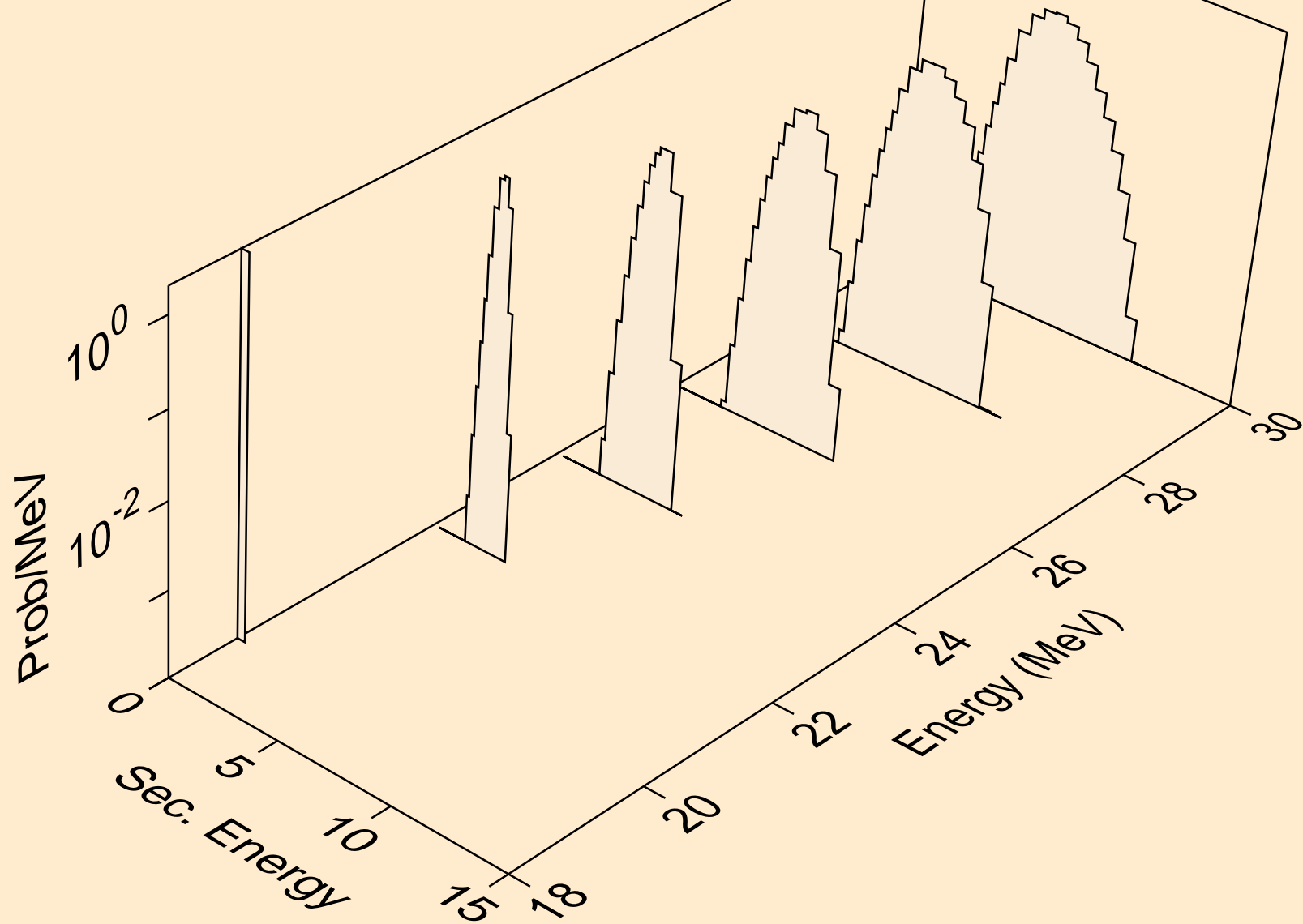

BI195 NEUTRON ACER TENDL-2023 LIBRARY; T=0.K
protons from (n,n2p)

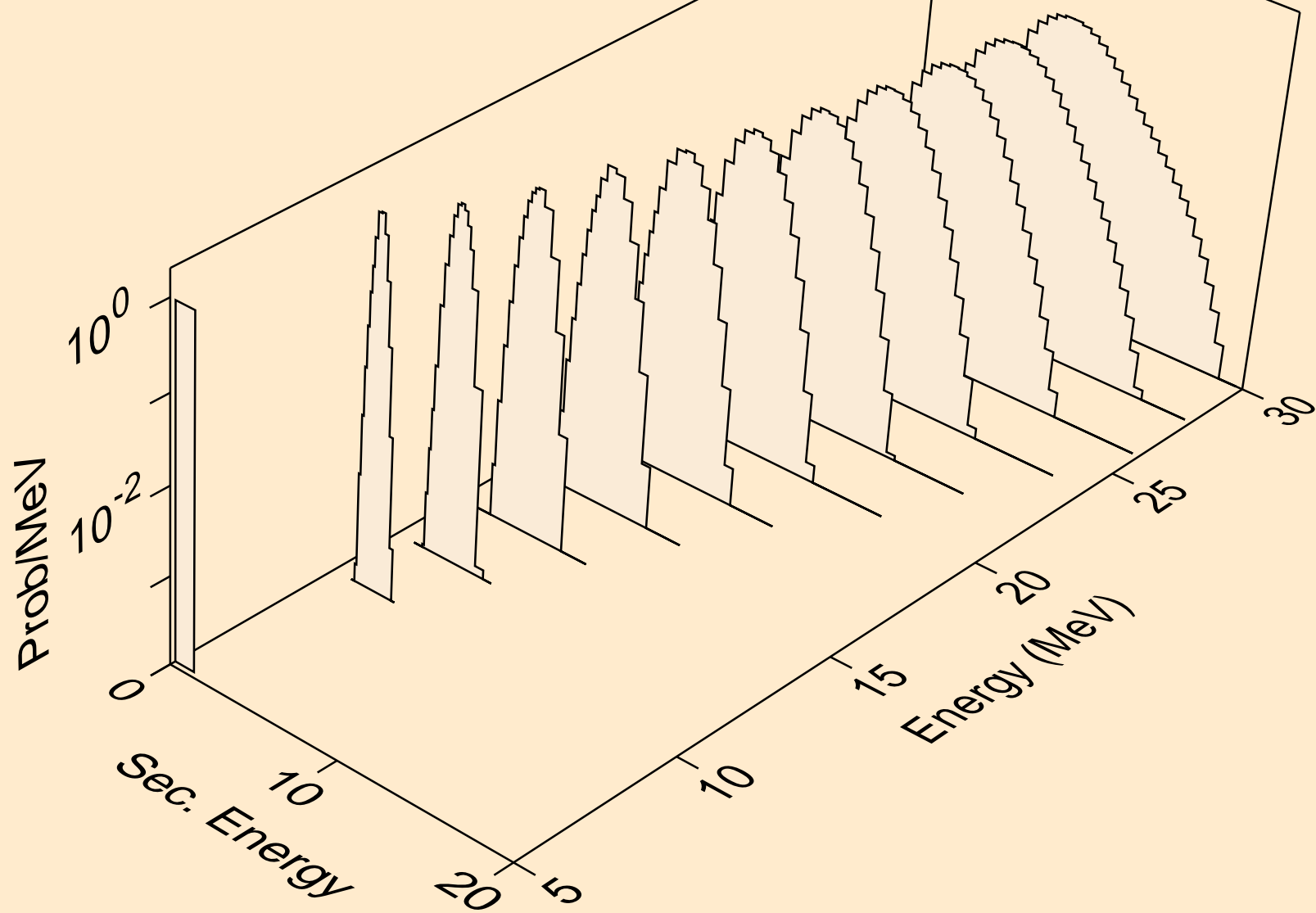

BI195 NEUTRON ACER TENDL-2023 LIBRARY; T=0.K
protons from (n,npa)

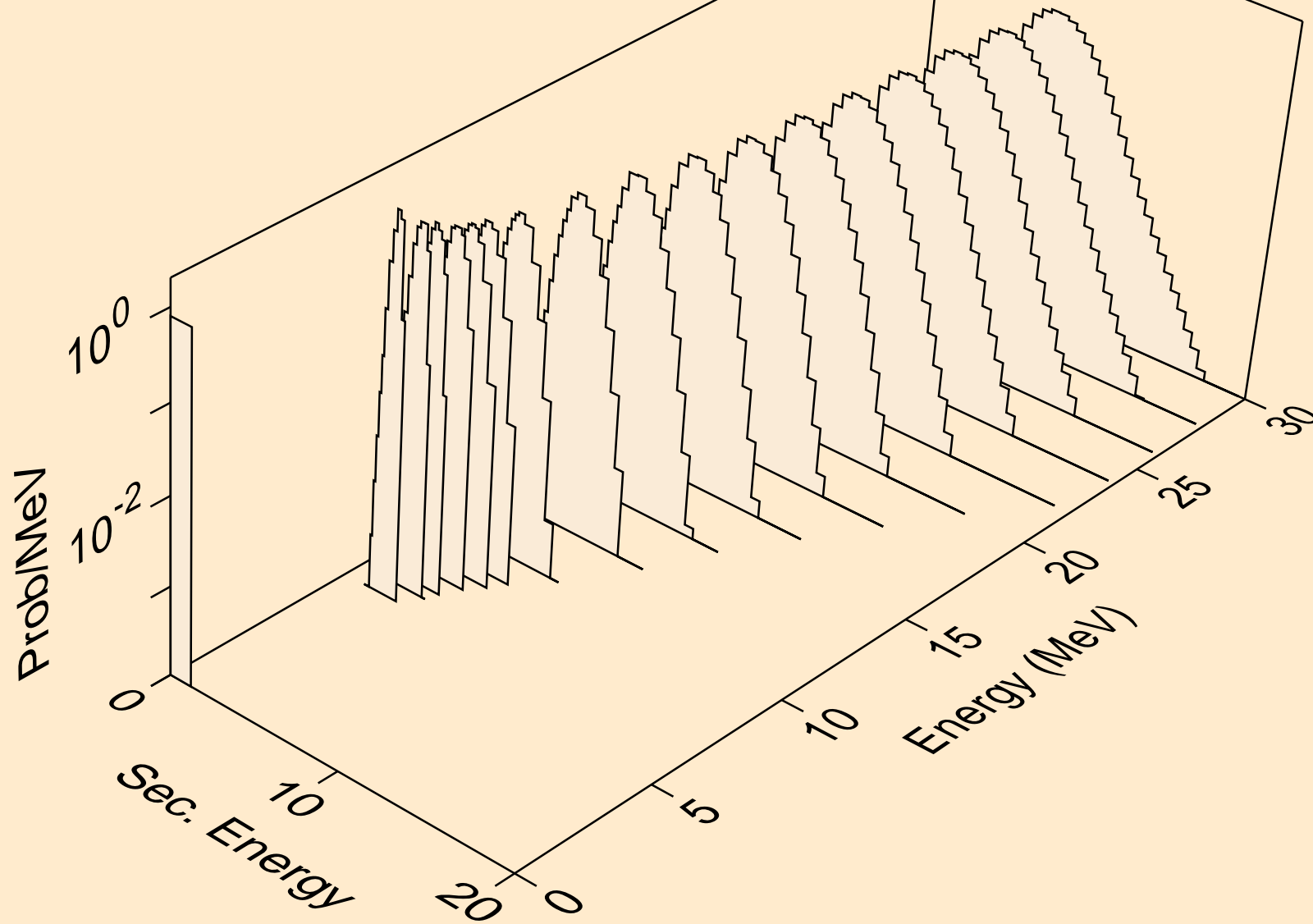

BI195 NEUTRON ACER TENDL-2023 LIBRARY; T=0.K
protons from (n,p)

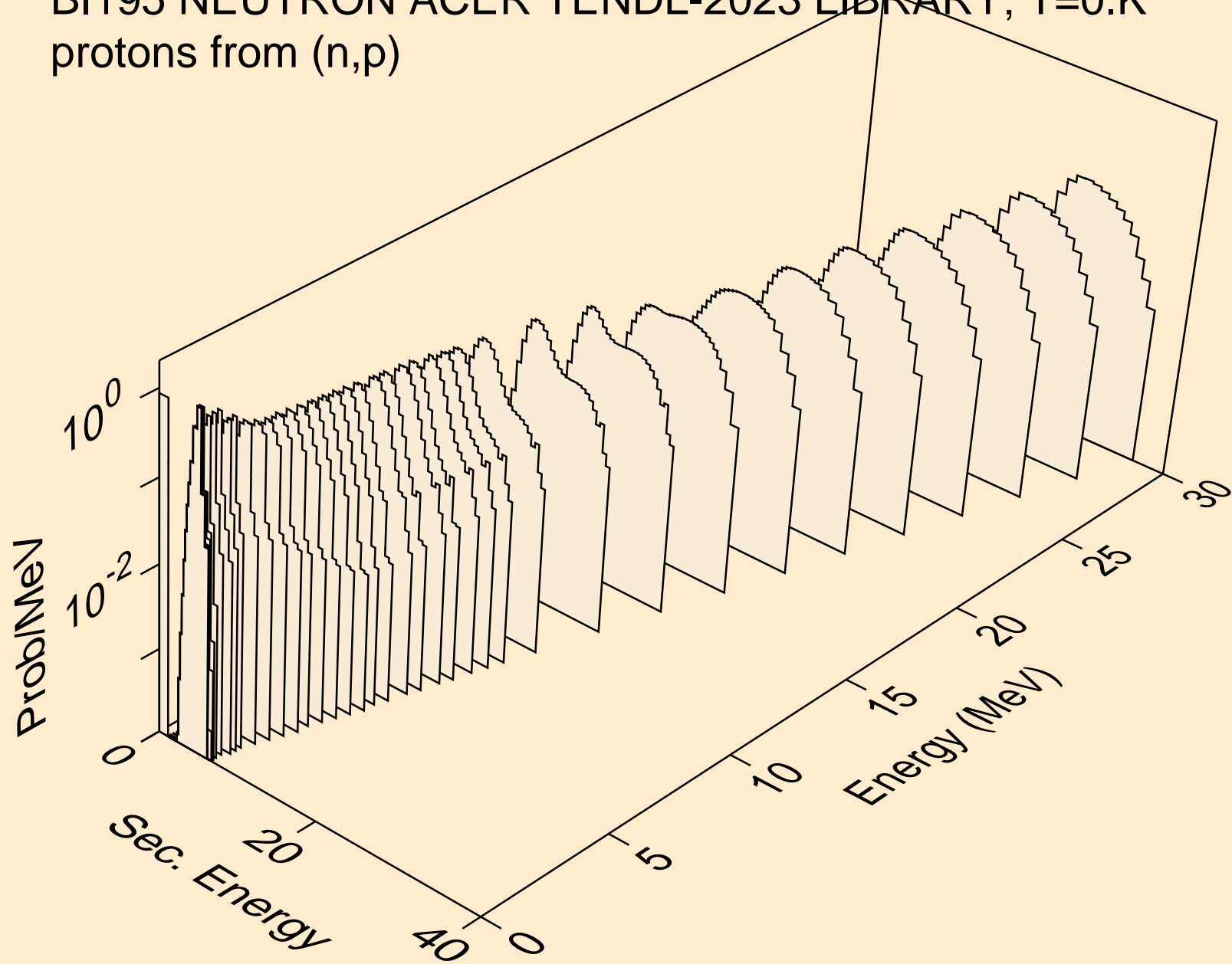

BI195 NEUTRON ACER TENDL-2023 LIBRARY; T=0.K
protons from (n,2p)

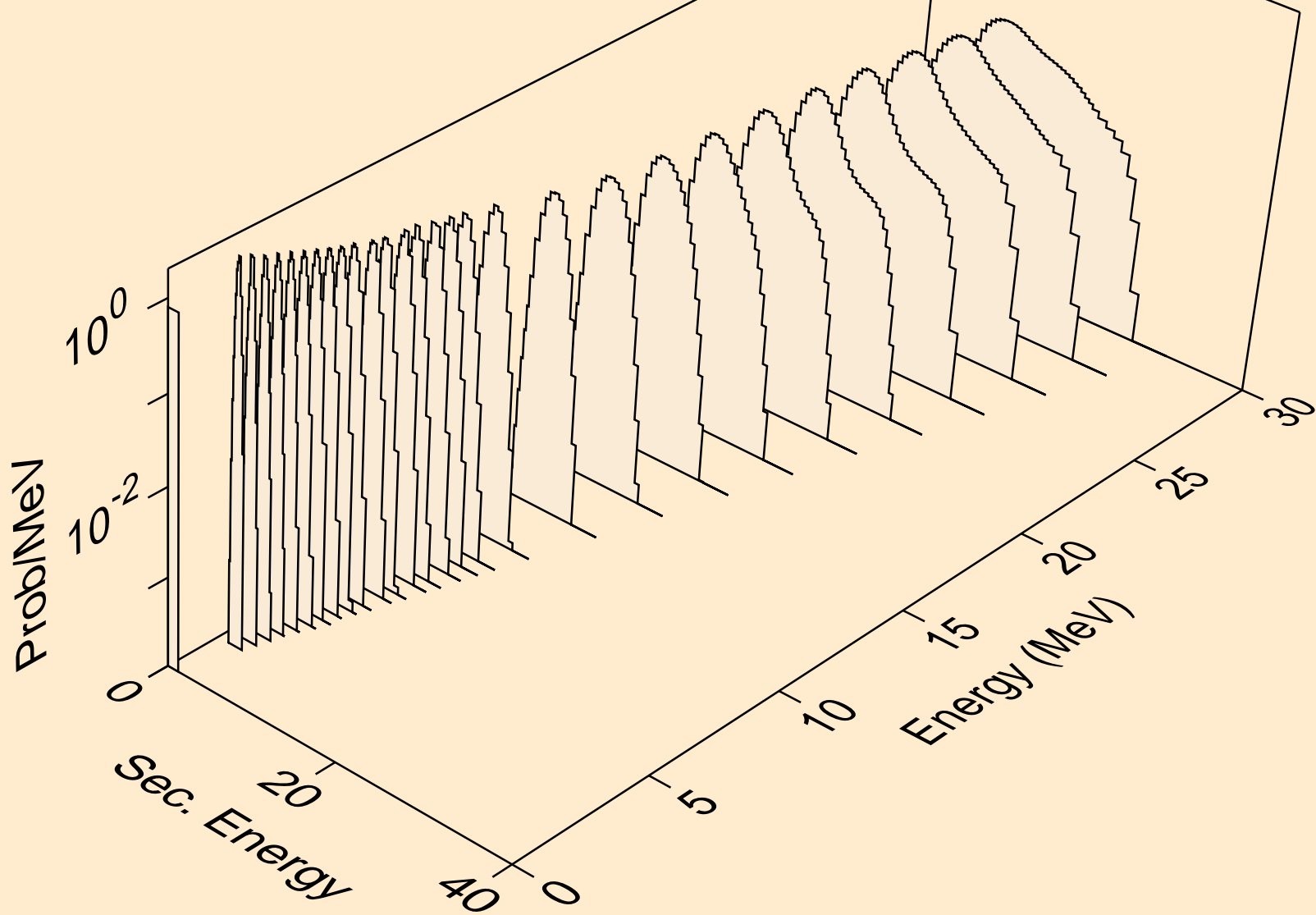

BI195 NEUTRON ACER TENDL-2023 LIBRARY; T=0.K
protons from (n,p)

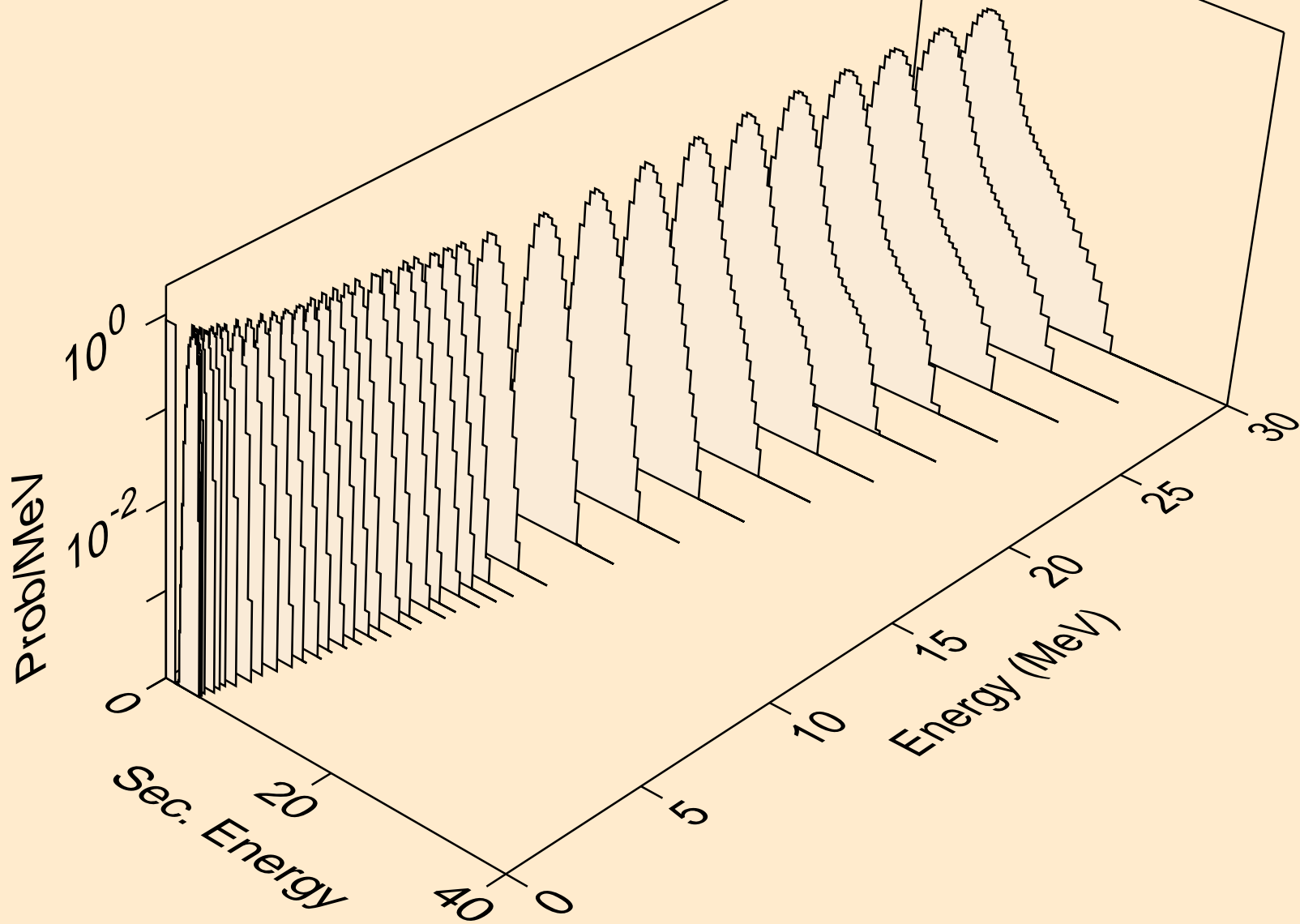

BI195 NEUTRON ACER TENDL-2023 LIBRARY; T=0.K
protons from (n,pd)

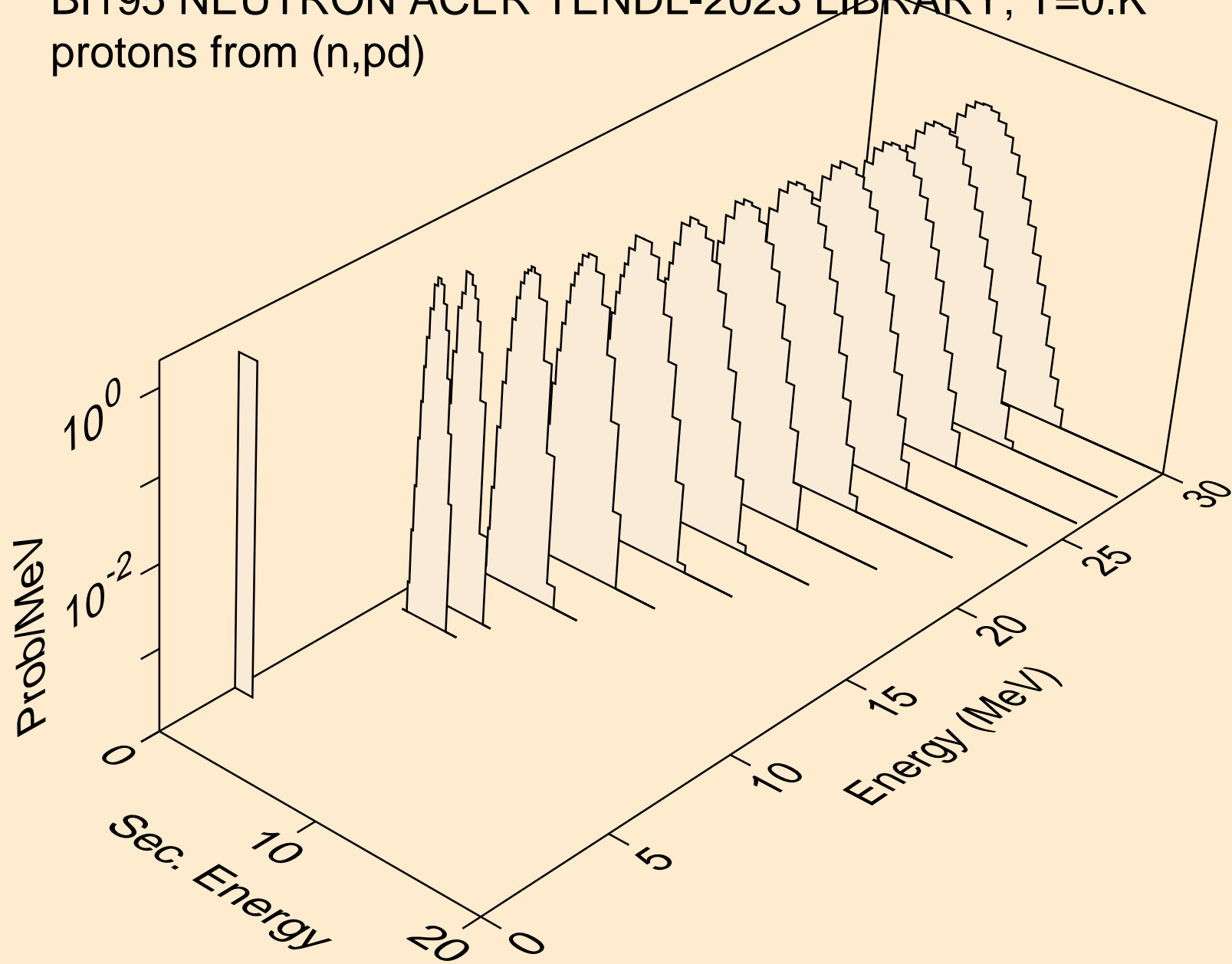

BI195 NEUTRON ACER TENDL-2023 LIBRARY; T=0.K
protons from (n,pt)

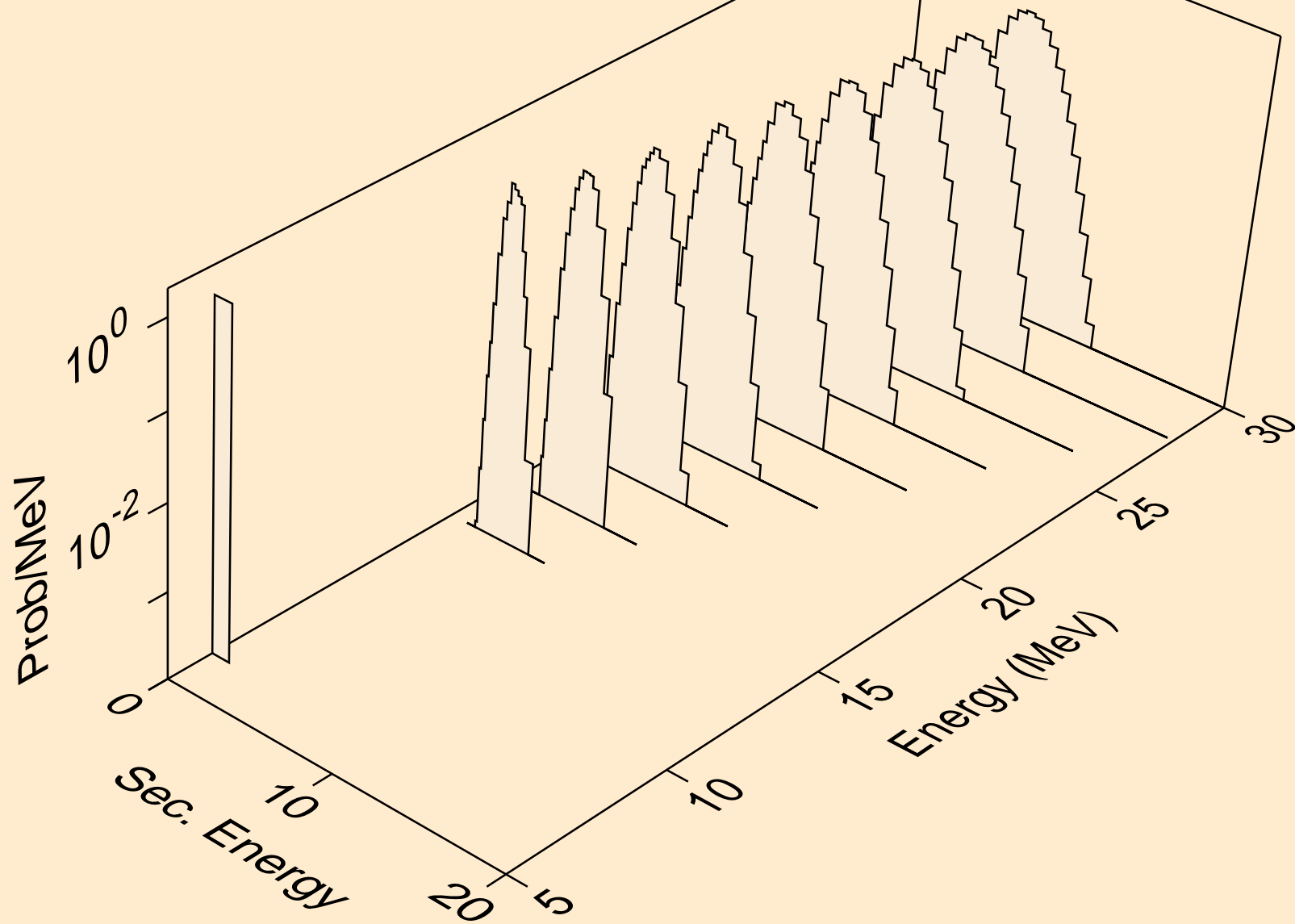

BI195 NEUTRON ACER TENDL-2023 LIBRARY; T=0.K
deuterons from (n,x)

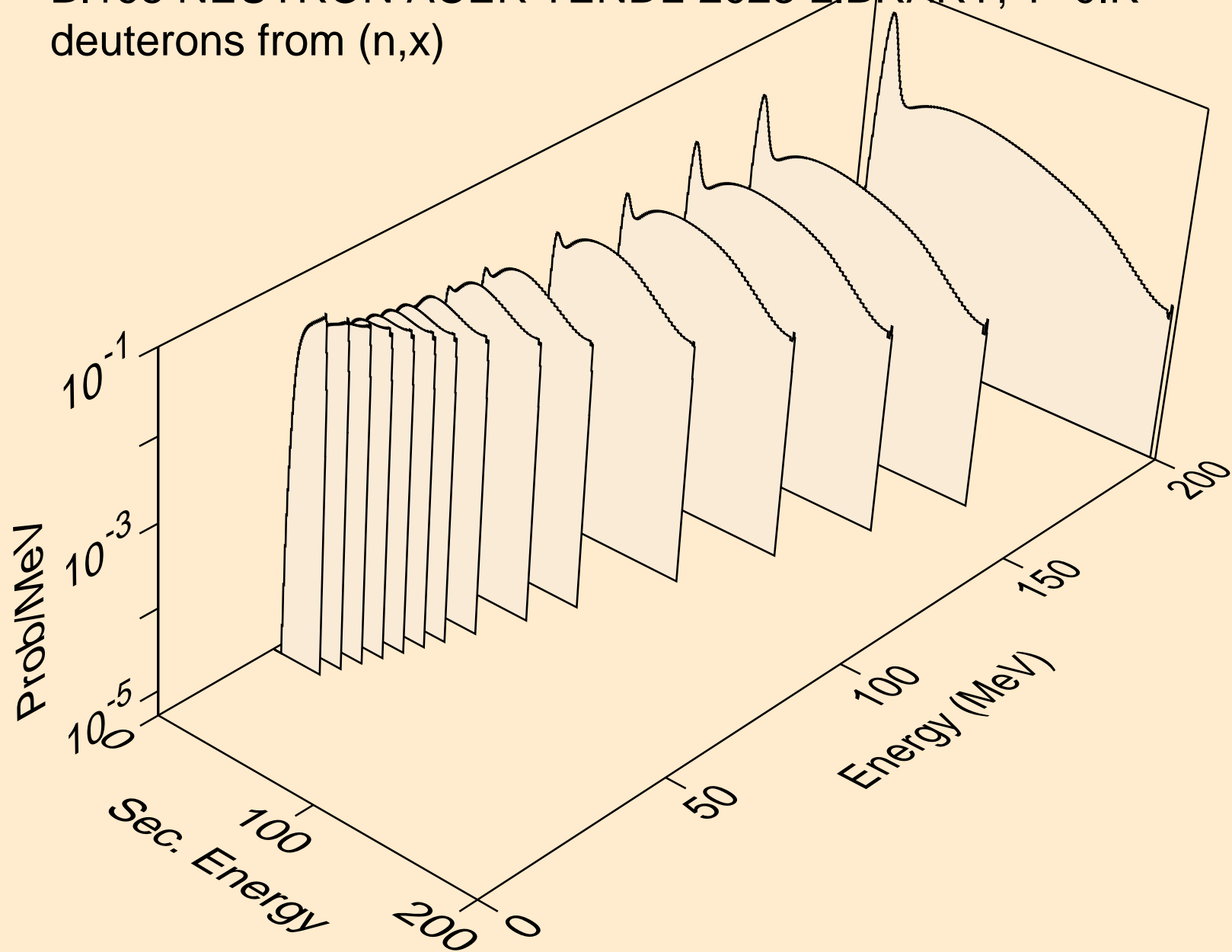

BI195 NEUTRON ACER TENDL-2023 LIBRARY; T=0.K
deuterons from (n,2nd)

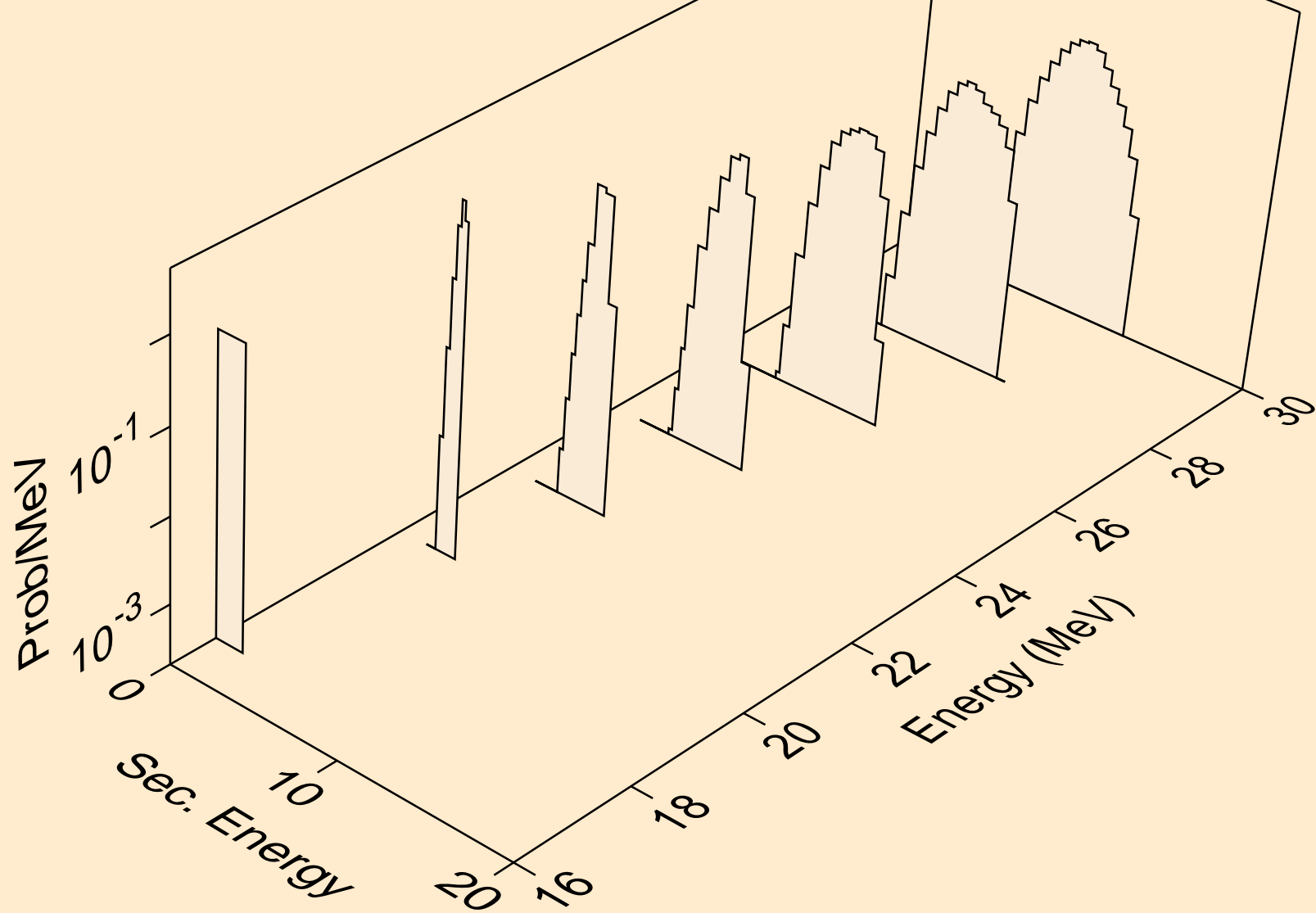

BI195 NEUTRON ACER TENDL-2023 LIBRARY; T=0.K
deuterons from (n,n*)d

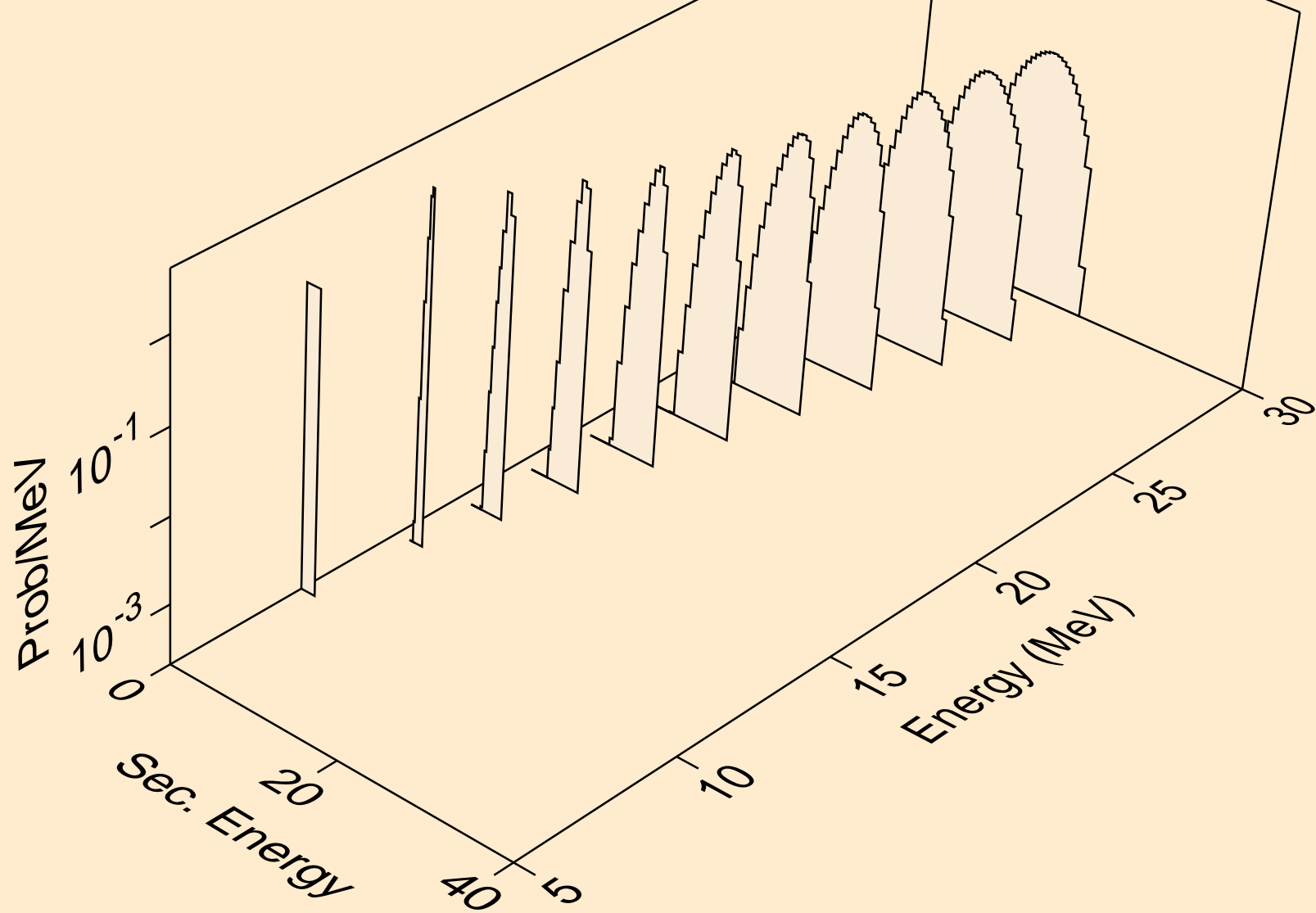

BI195 NEUTRON ACER TENDL-2023 LIBRARY; T=0.K
deuterons from (n,d)

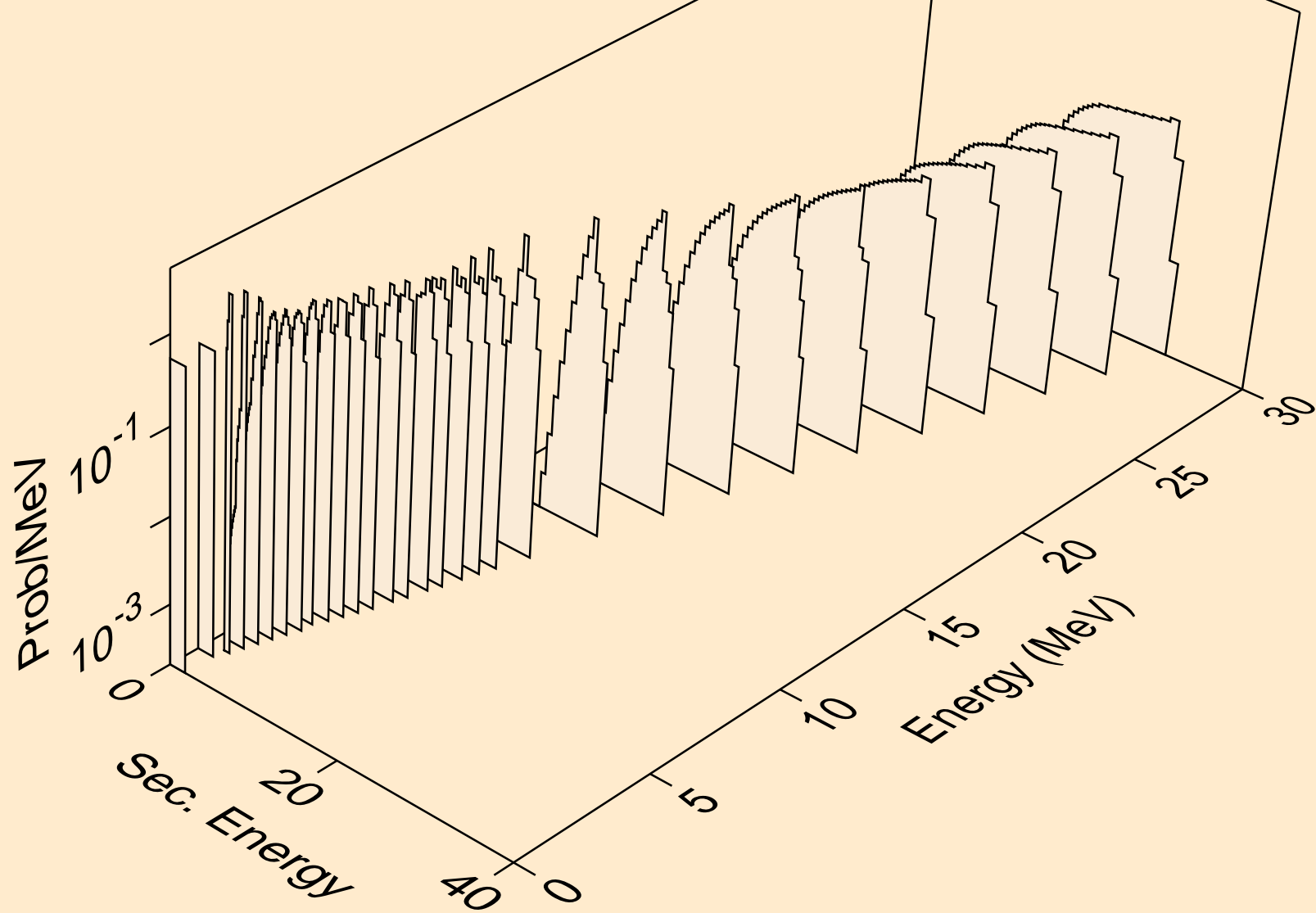

BI195 NEUTRON ACER TENDL-2023 LIBRARY; T=0.K
deuterons from (n,pd)

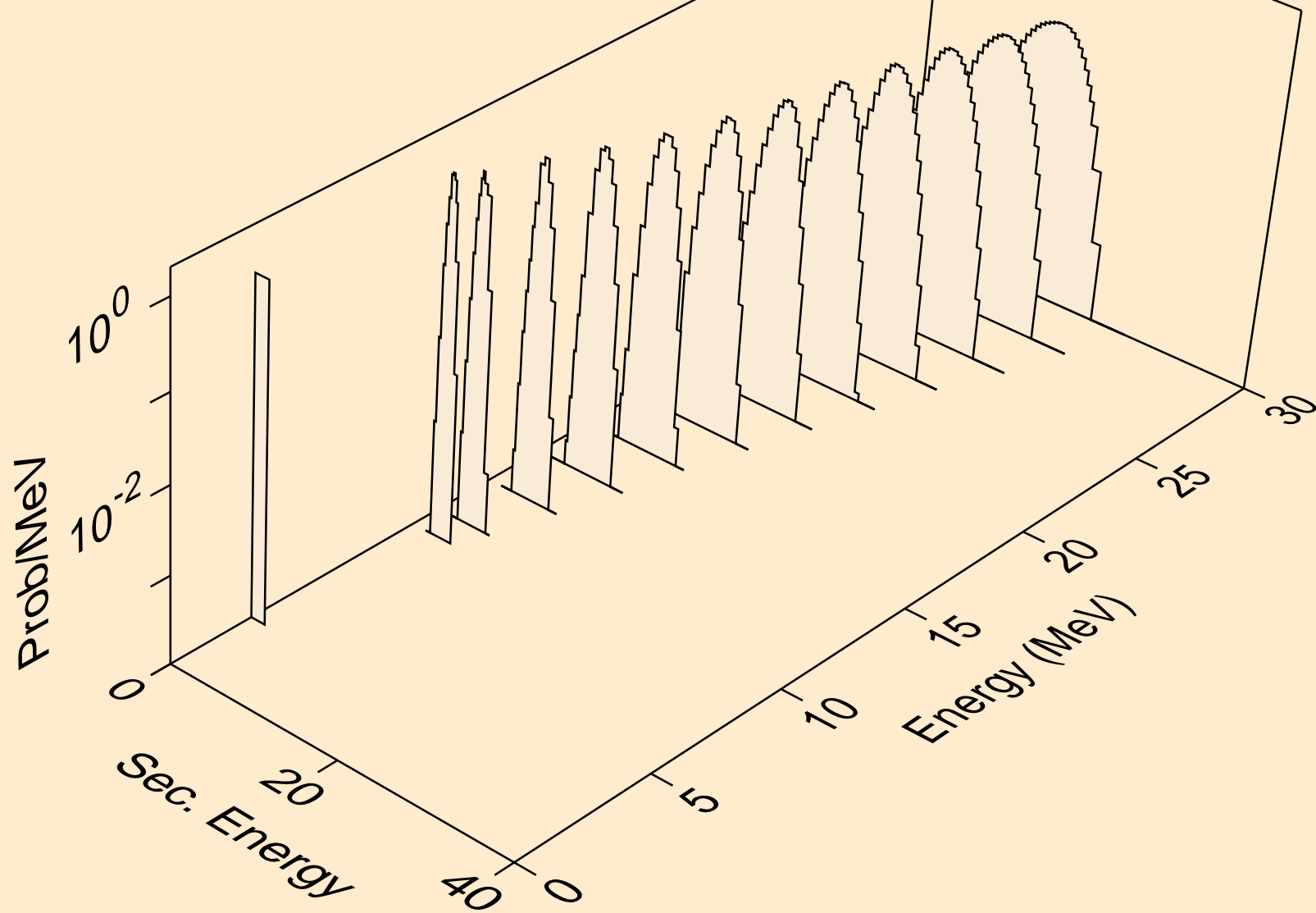

BI195 NEUTRON ACER TENDL-2023 LIBRARY; T=0.K
deuterons from (n,da)

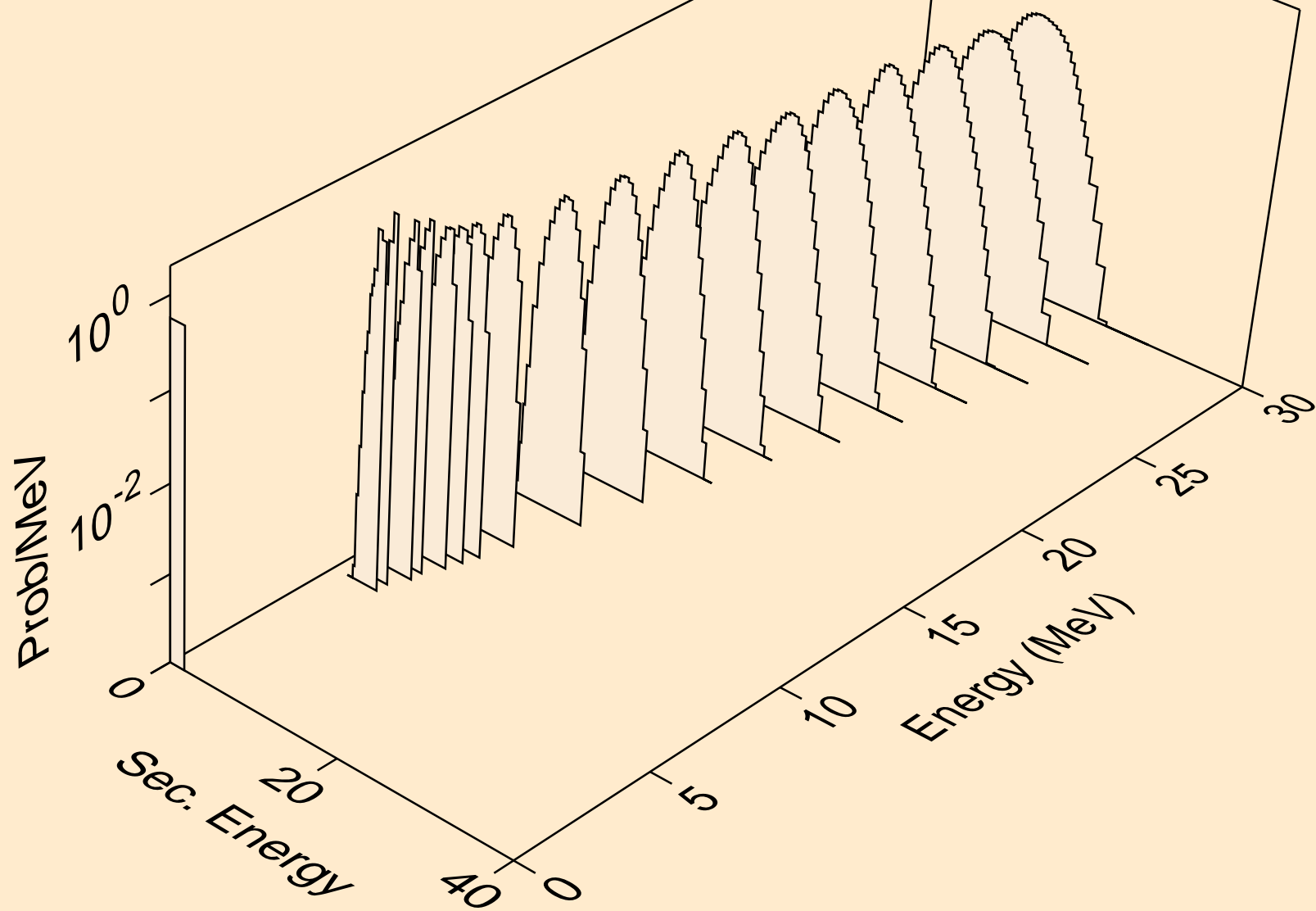

BI195 NEUTRON ACER TENDL-2023 LIBRARY; T=0.K
tritons from (n,x)

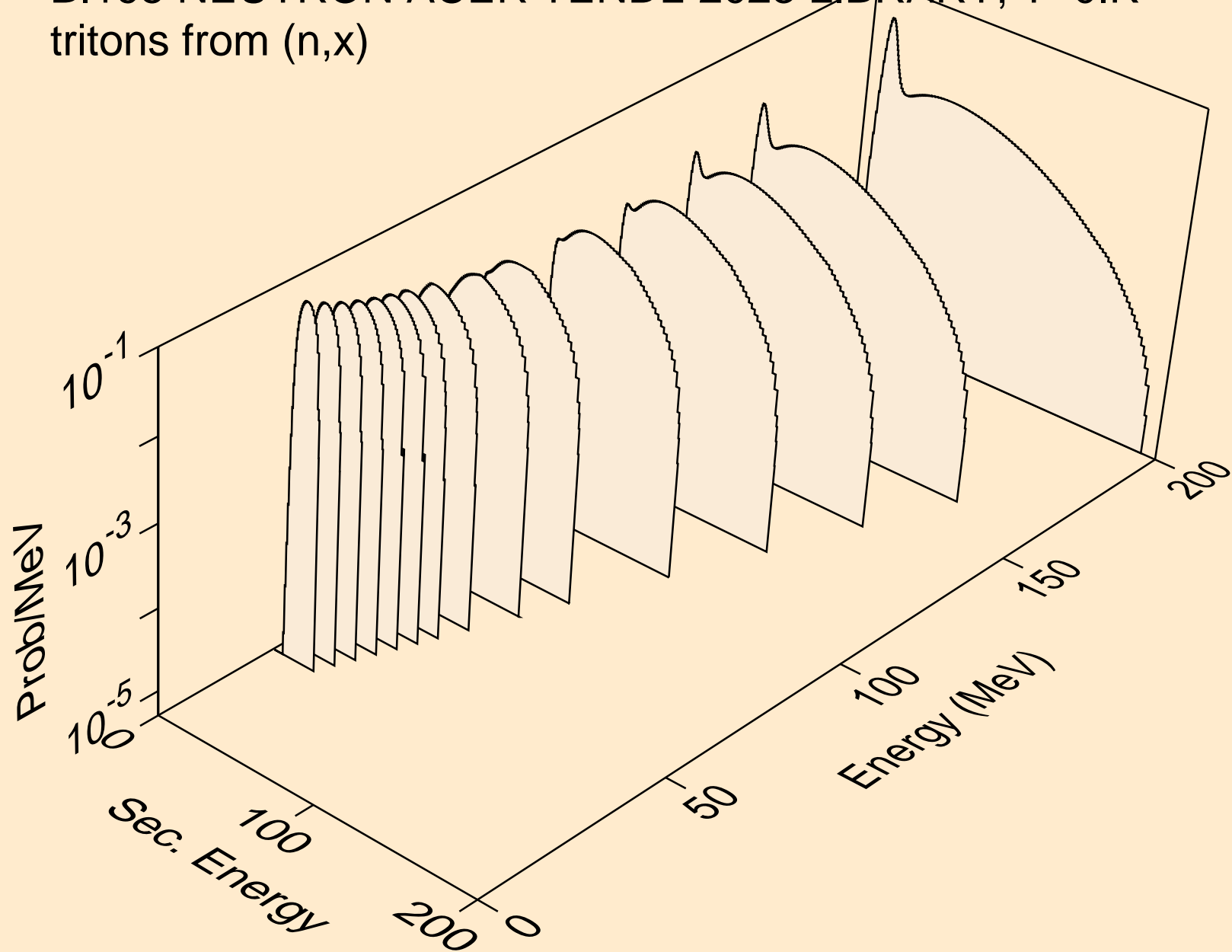

BI195 NEUTRON ACER TENDL-2023 LIBRARY; T=0.K
tritons from (n,n*)t

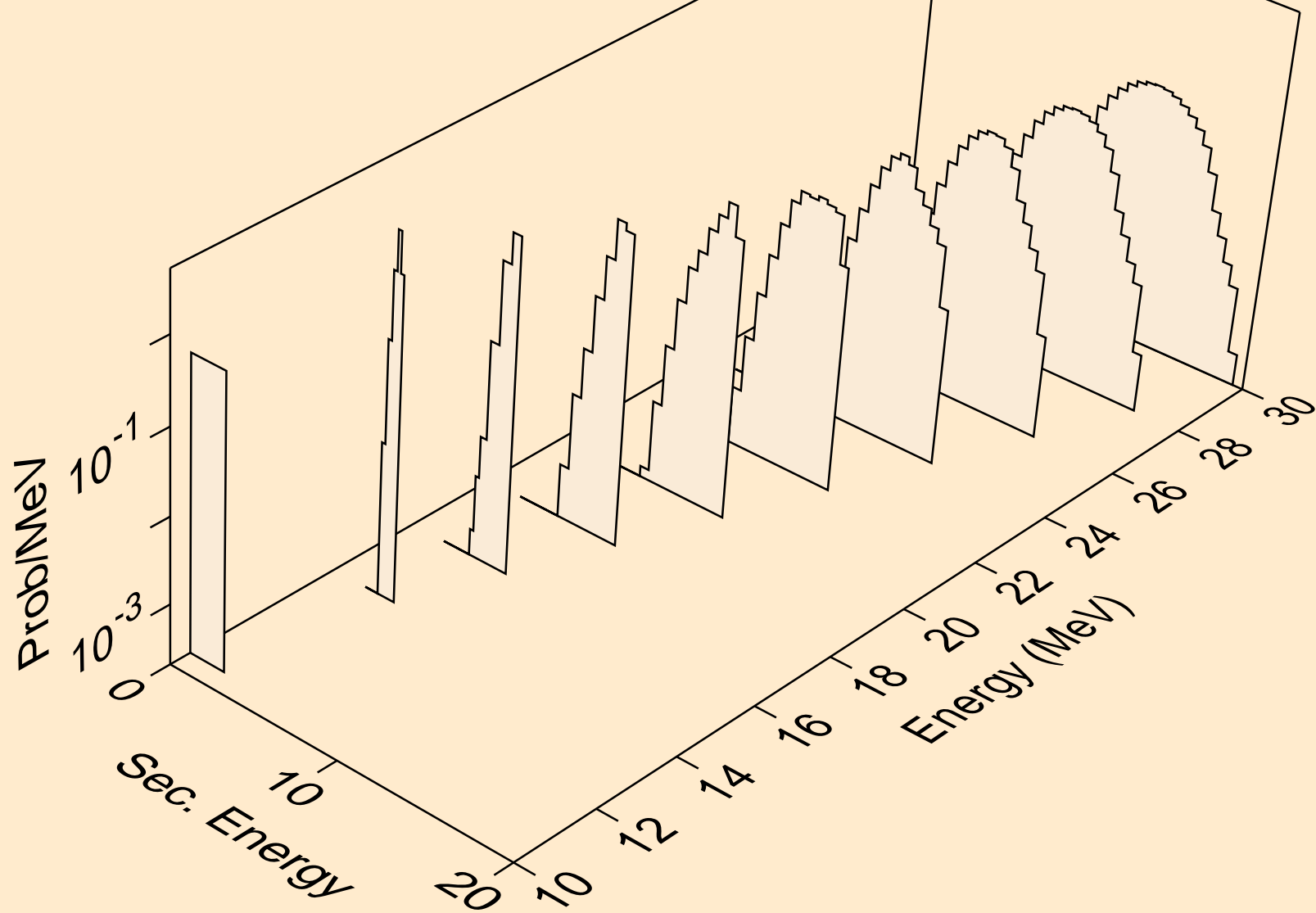

BI195 NEUTRON ACER TENDL-2023 LIBRARY; T=0.K
tritons from (n,t)

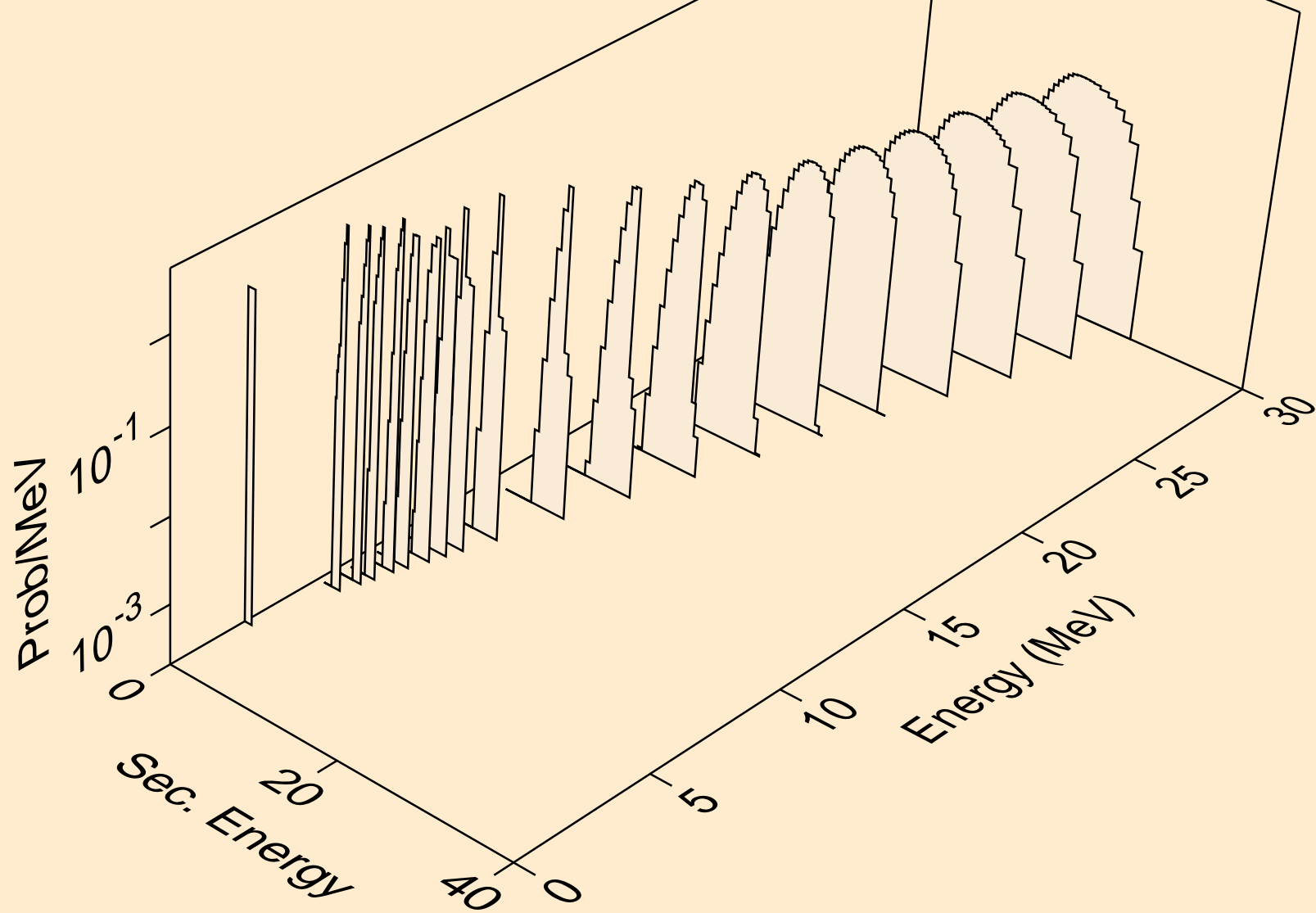

BI195 NEUTRON ACER TENDL-2023 LIBRARY; T=0.K
tritons from (n,pt)

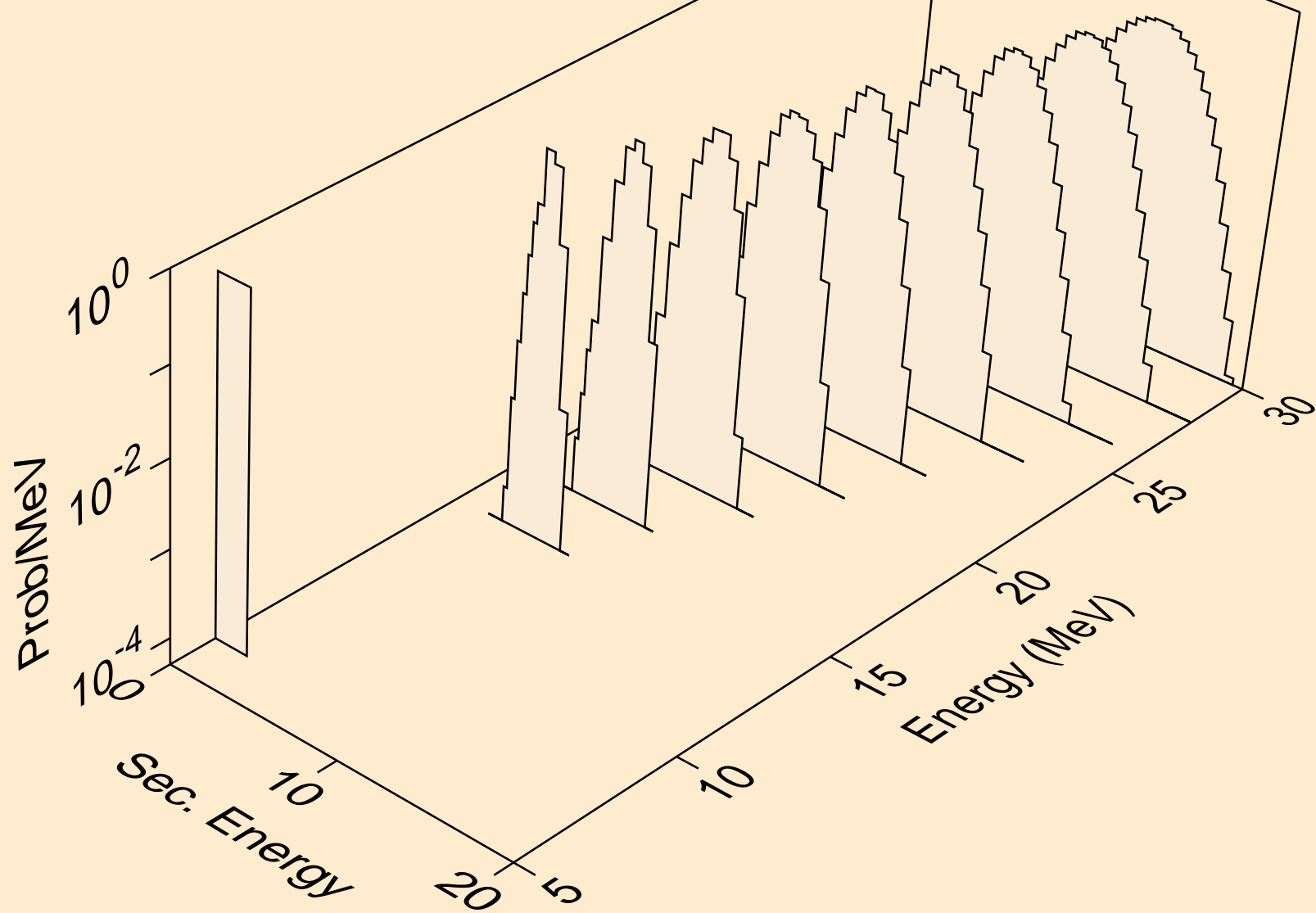

BI195 NEUTRON ACER TENDL-2023 LIBRARY; T=0.K
he3s from (n,x)

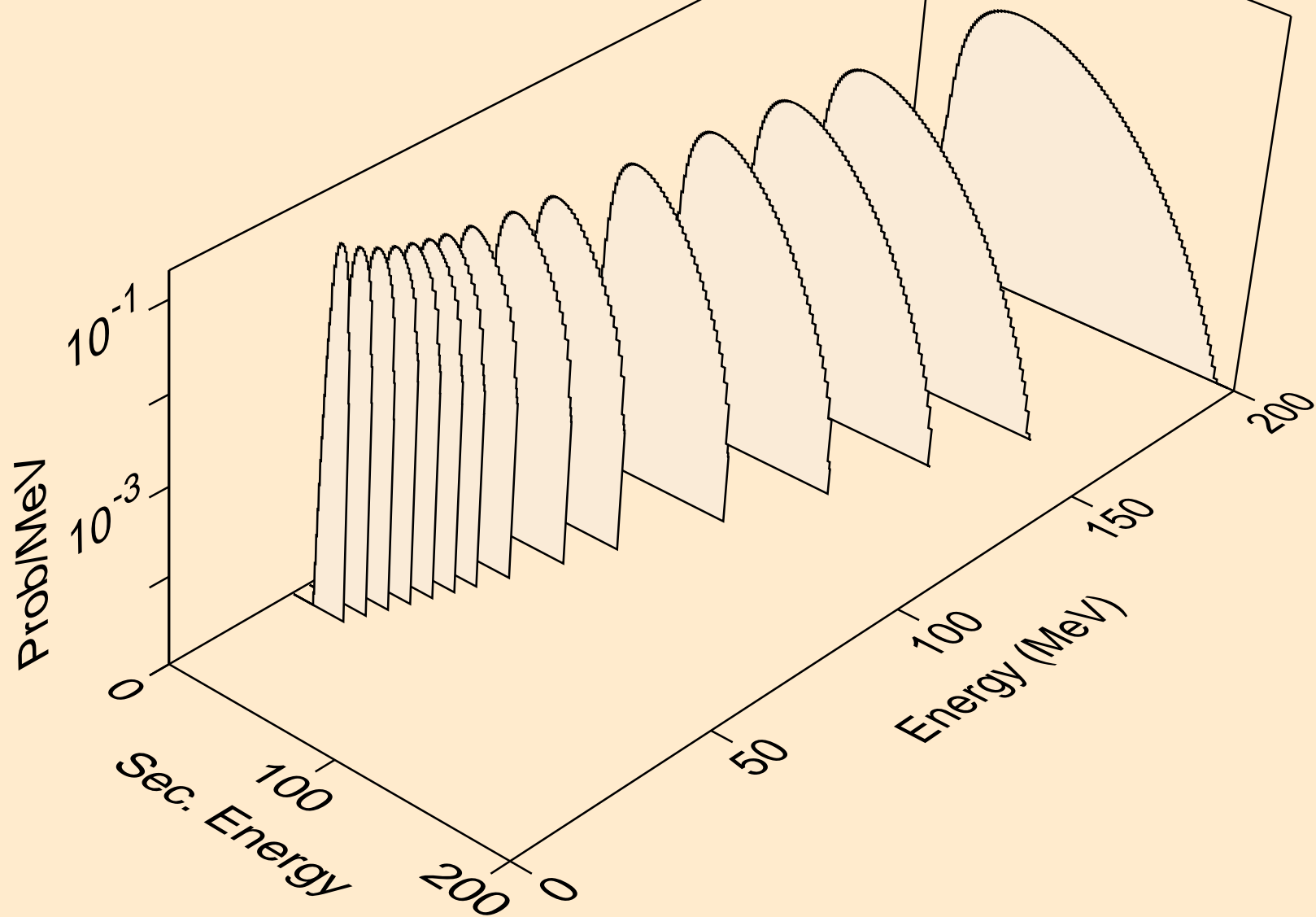

BI195 NEUTRON ACER TENDL-2023 LIBRARY; T=0.K
he3s from (n,n*)he3

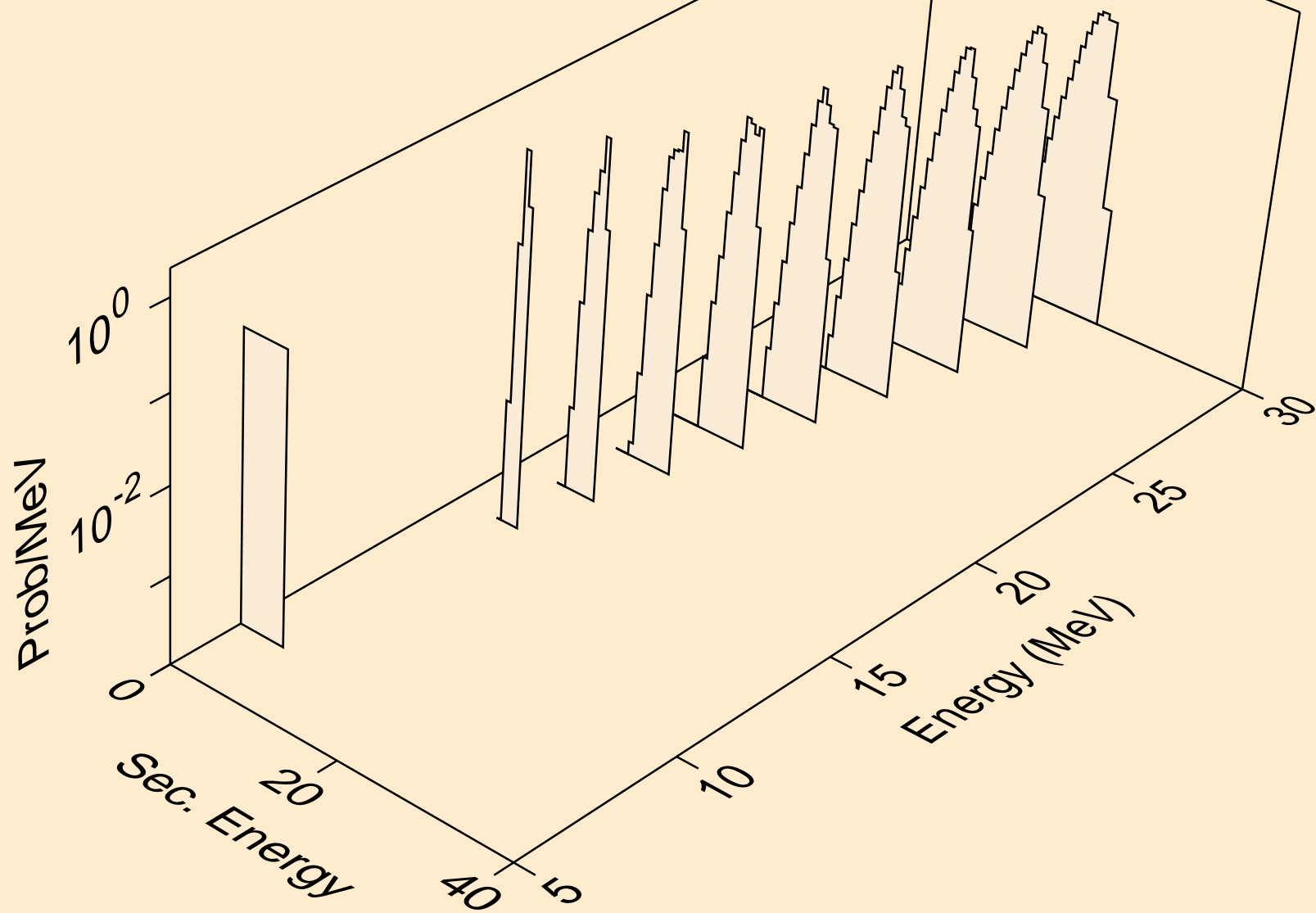

BI195 NEUTRON ACER TENDL-2023 LIBRARY; T=0.K
he3s from (n,he3)

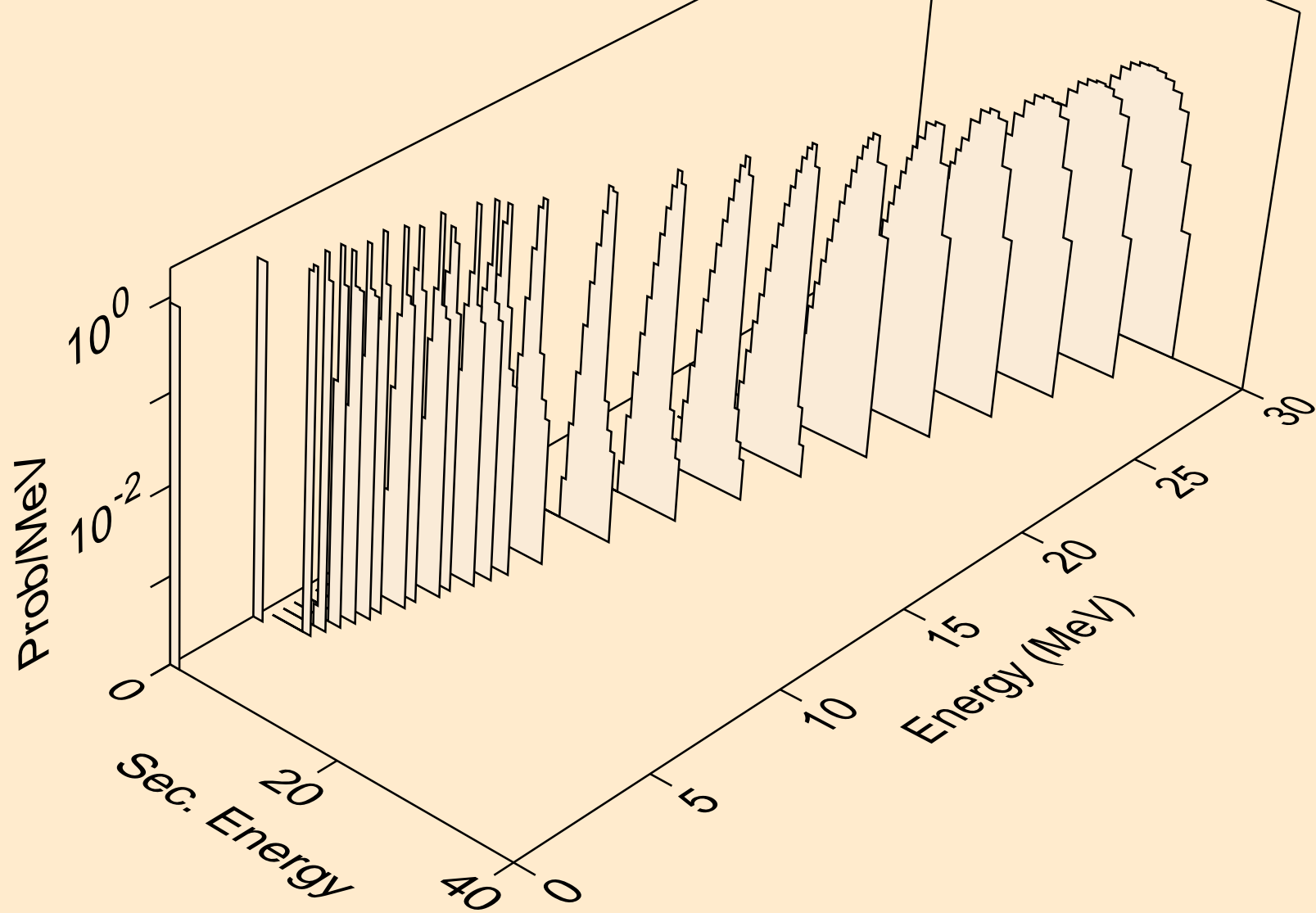

BI195 NEUTRON ACER TENDL-2023 LIBRARY; T=0.K
alphas from (n,x)

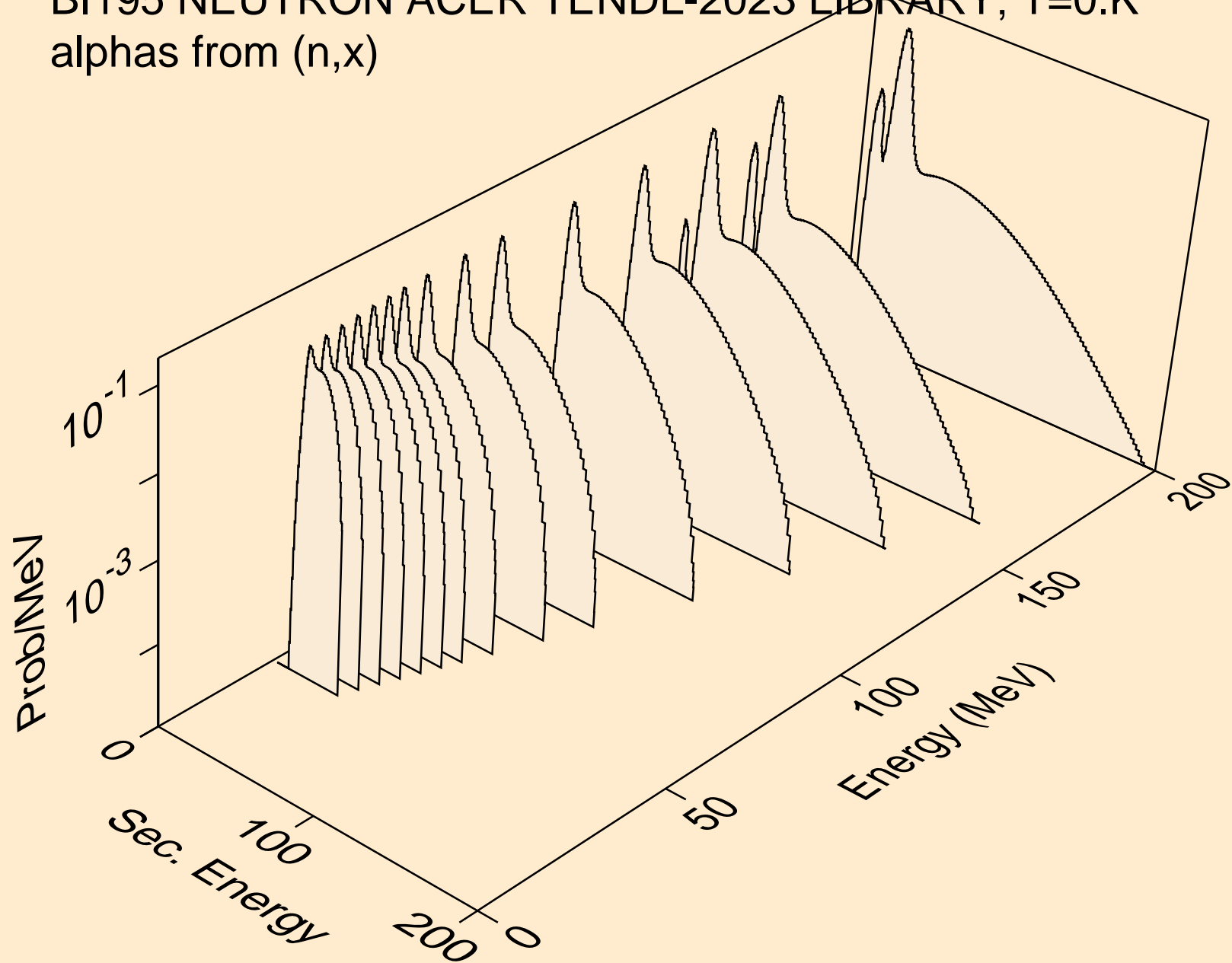

BI195 NEUTRON ACER TENDL-2023 LIBRARY; T=0.K
alphas from (n,n*)a

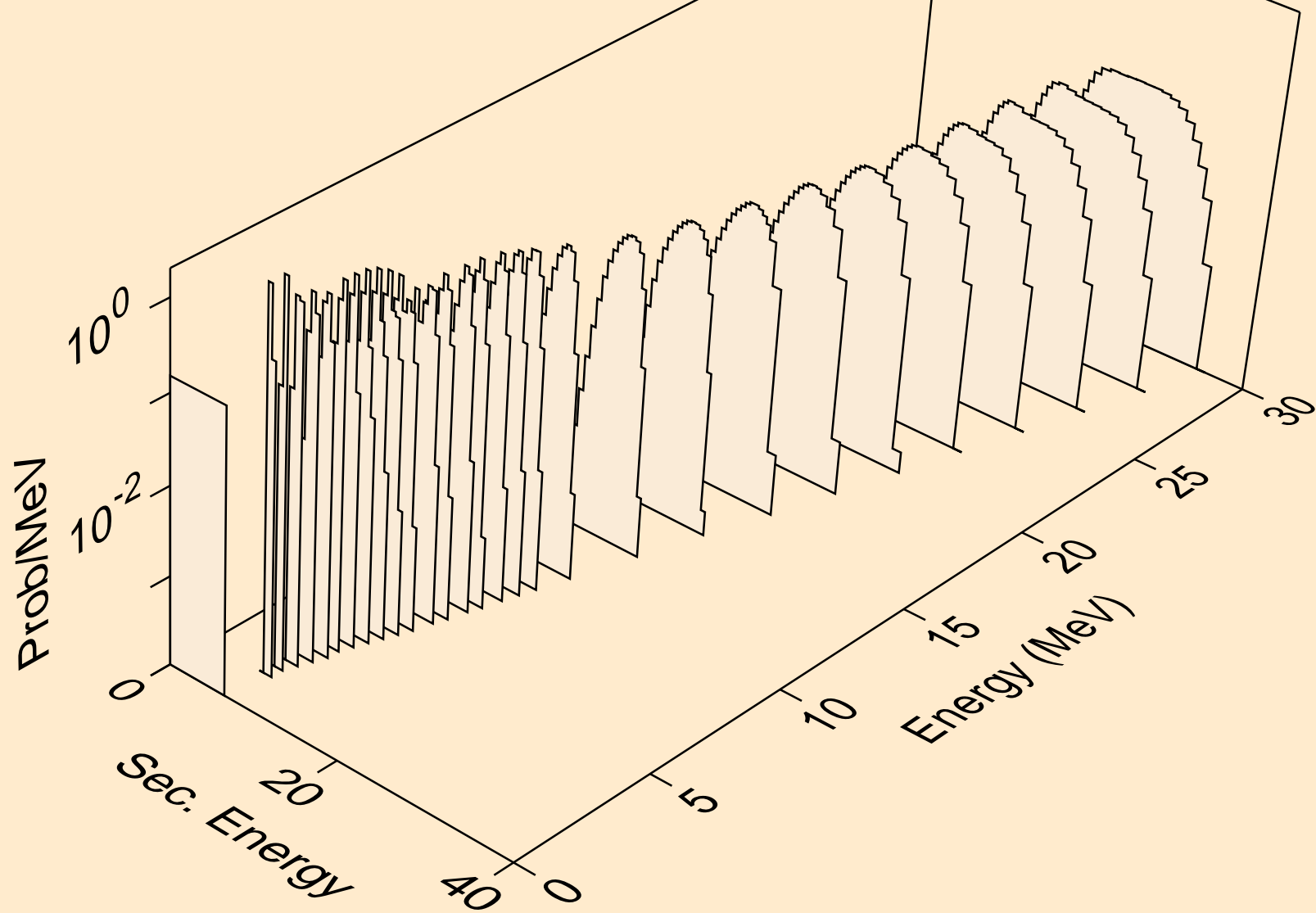

BI195 NEUTRON ACER TENDL-2023 LIBRARY; T=0.K
alphas from (n,2n)a

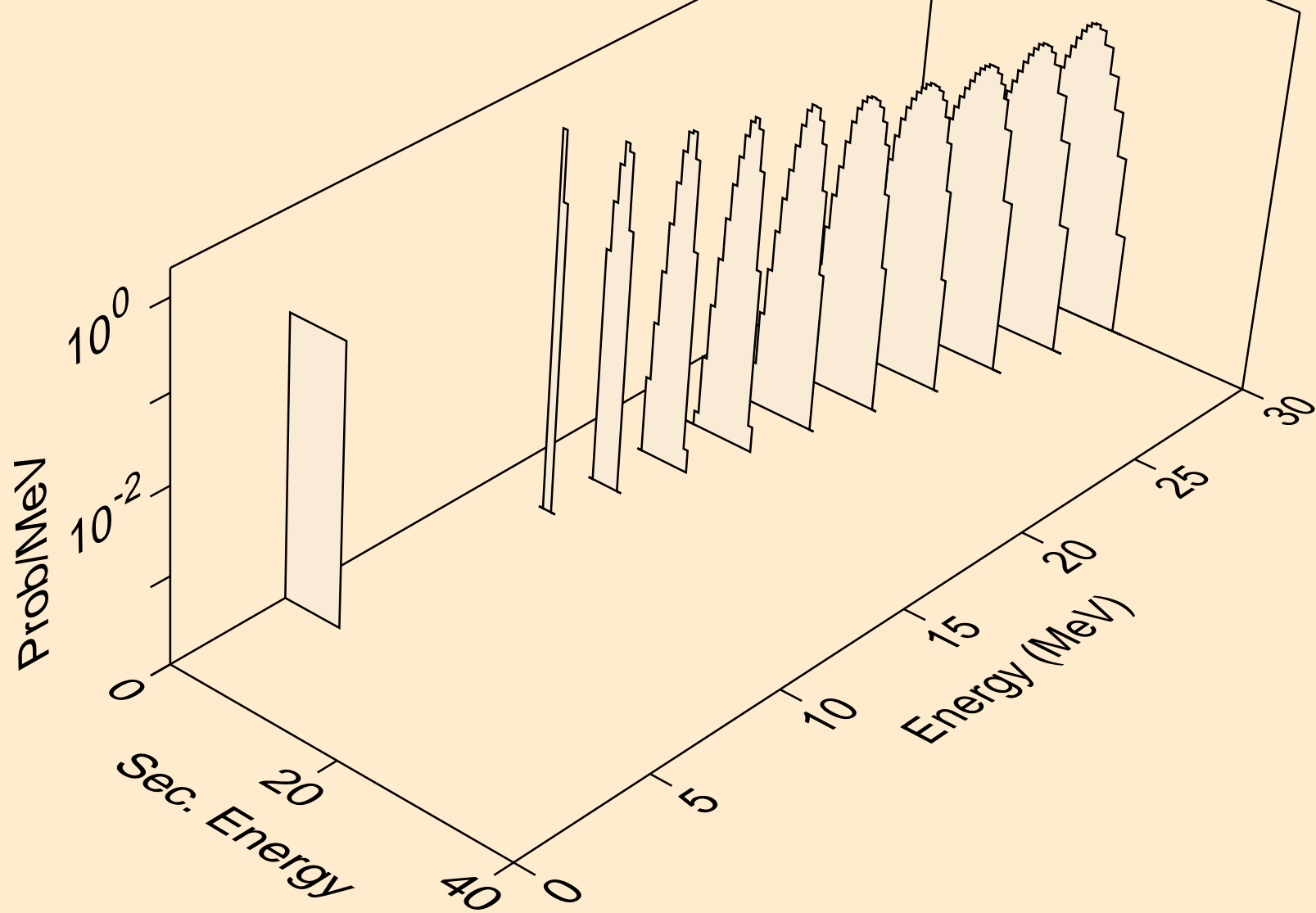

BI195 NEUTRON ACER TENDL-2023 LIBRARY; T=0.K
alphas from (n,3n)a

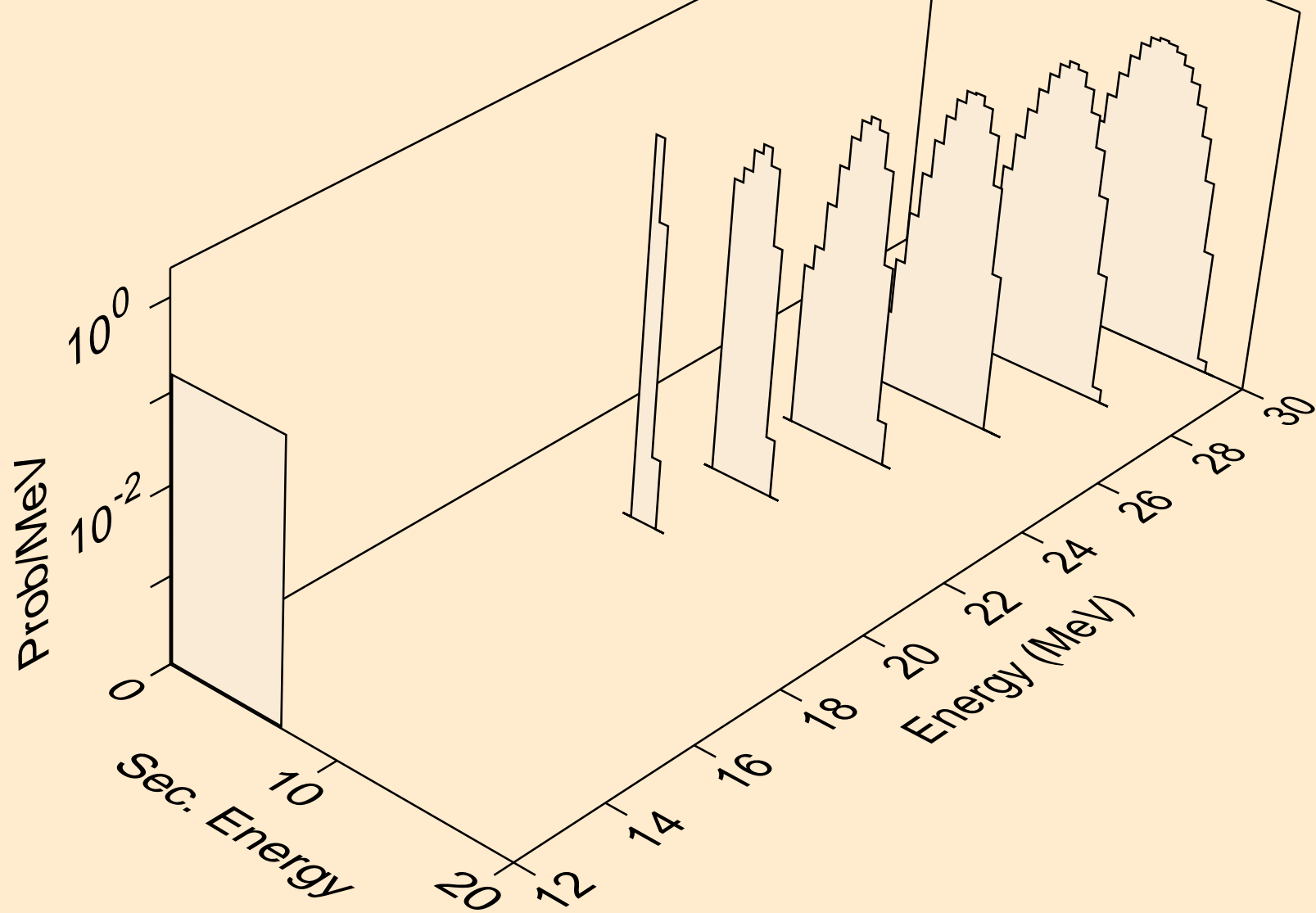

BI195 NEUTRON ACER TENDL-2023 LIBRARY; T=0.K
alphas from (n,n*)2a

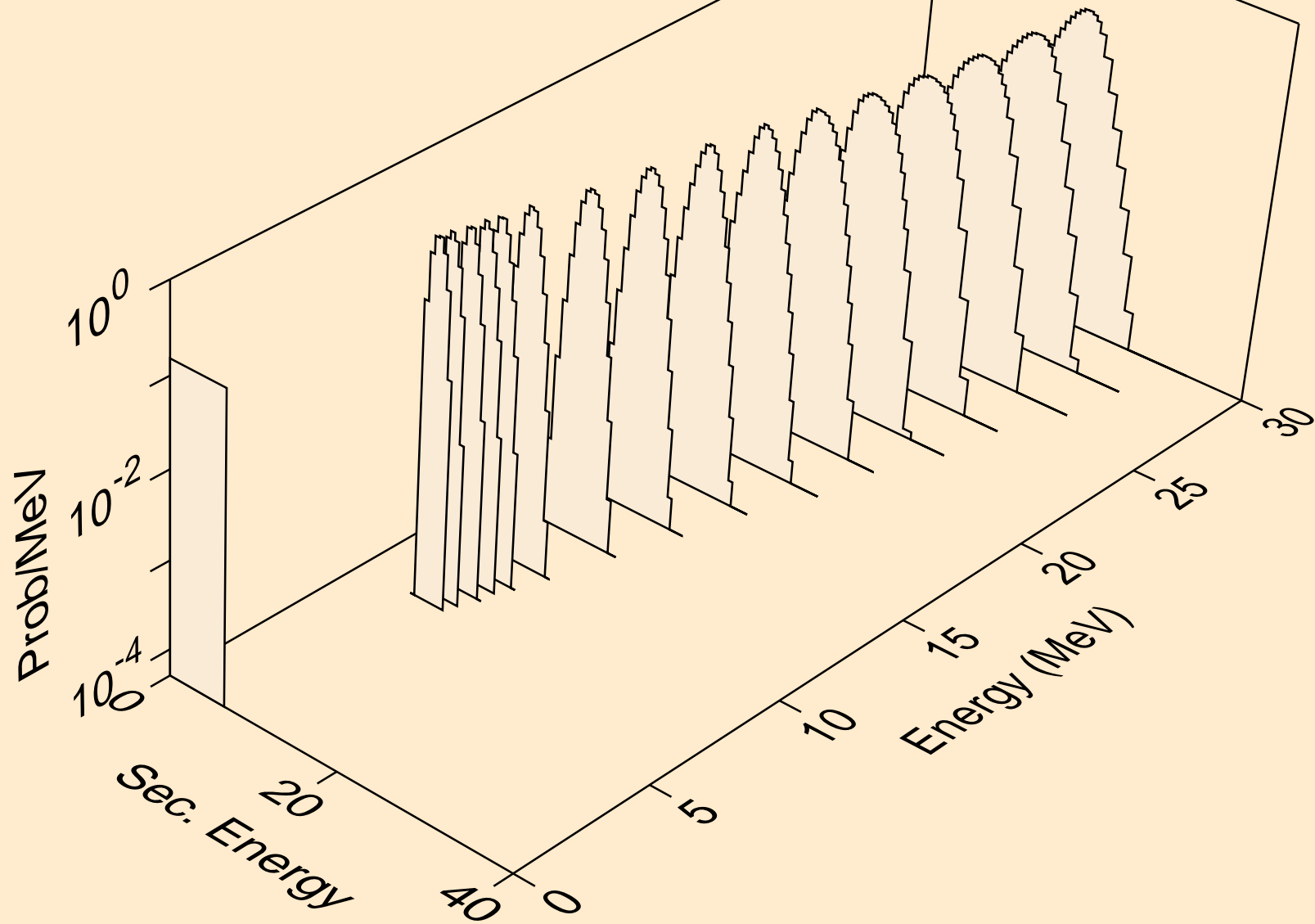

BI195 NEUTRON ACER TENDL-2023 LIBRARY; T=0.K
alphas from (n,2n)2a

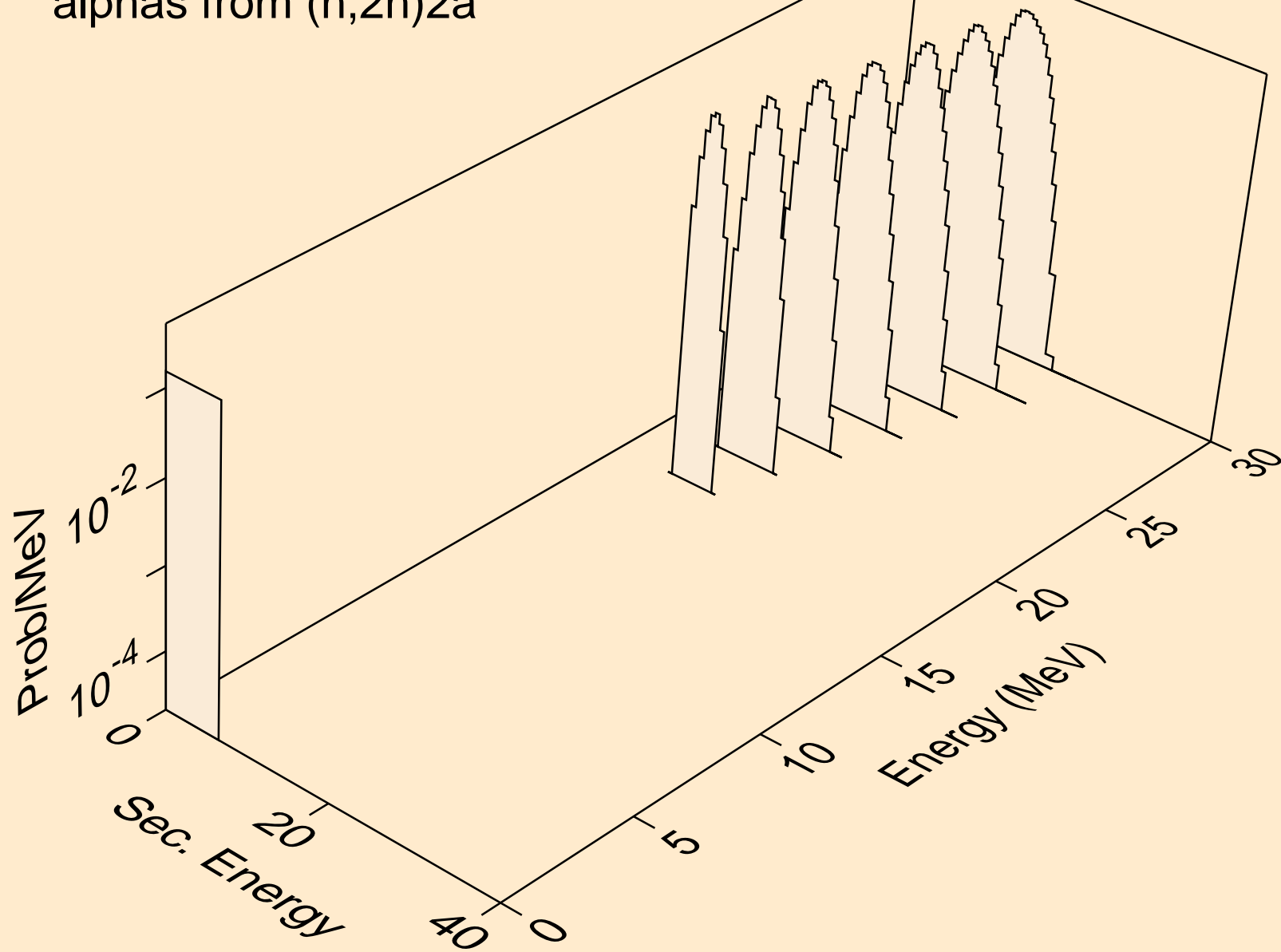

BI195 NEUTRON ACER TENDL-2023 LIBRARY; T=0.K
alphas from (n,npa)

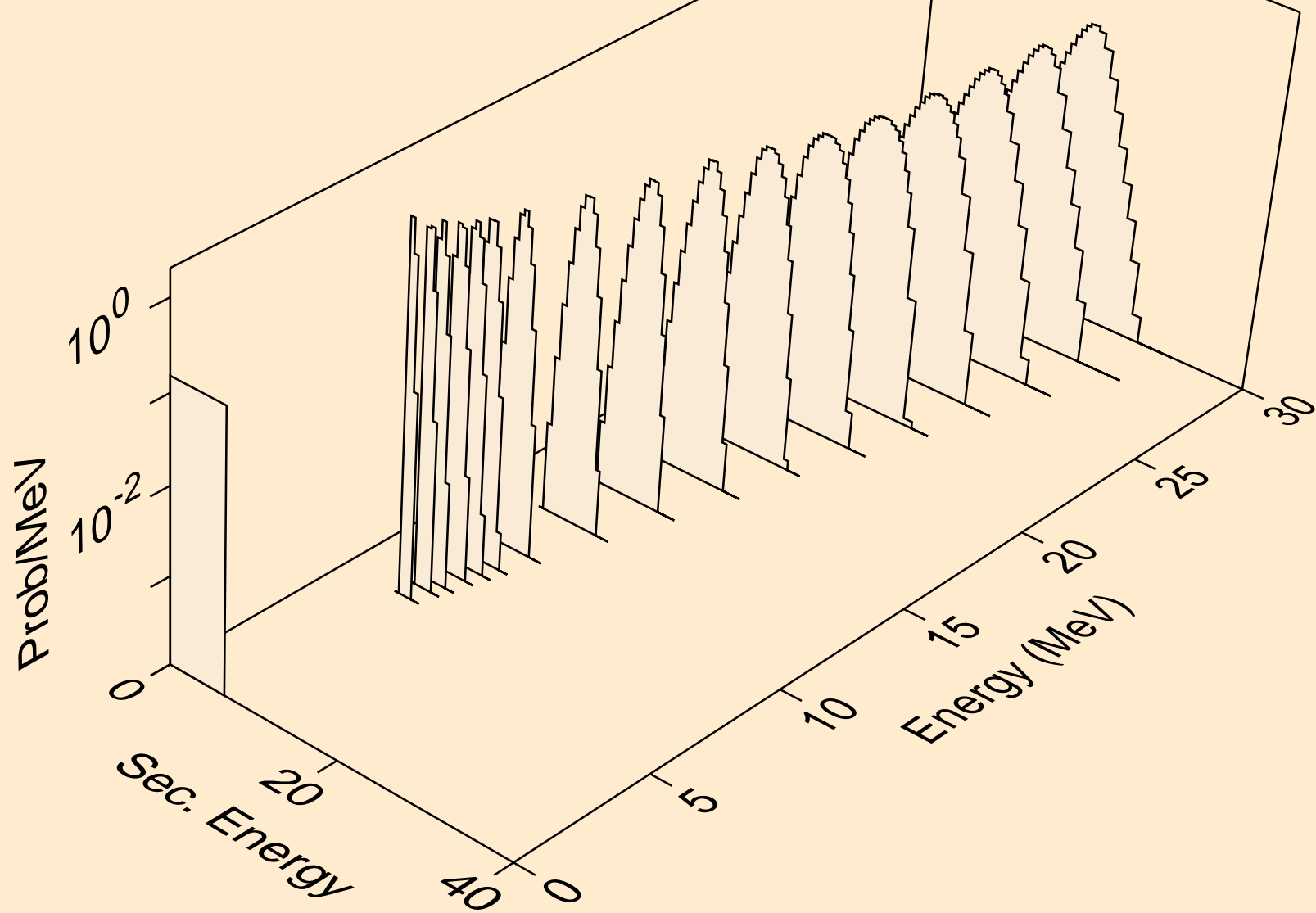

BI195 NEUTRON ACER TENDL-2023 LIBRARY; T=0.K
alphas from (n,a)

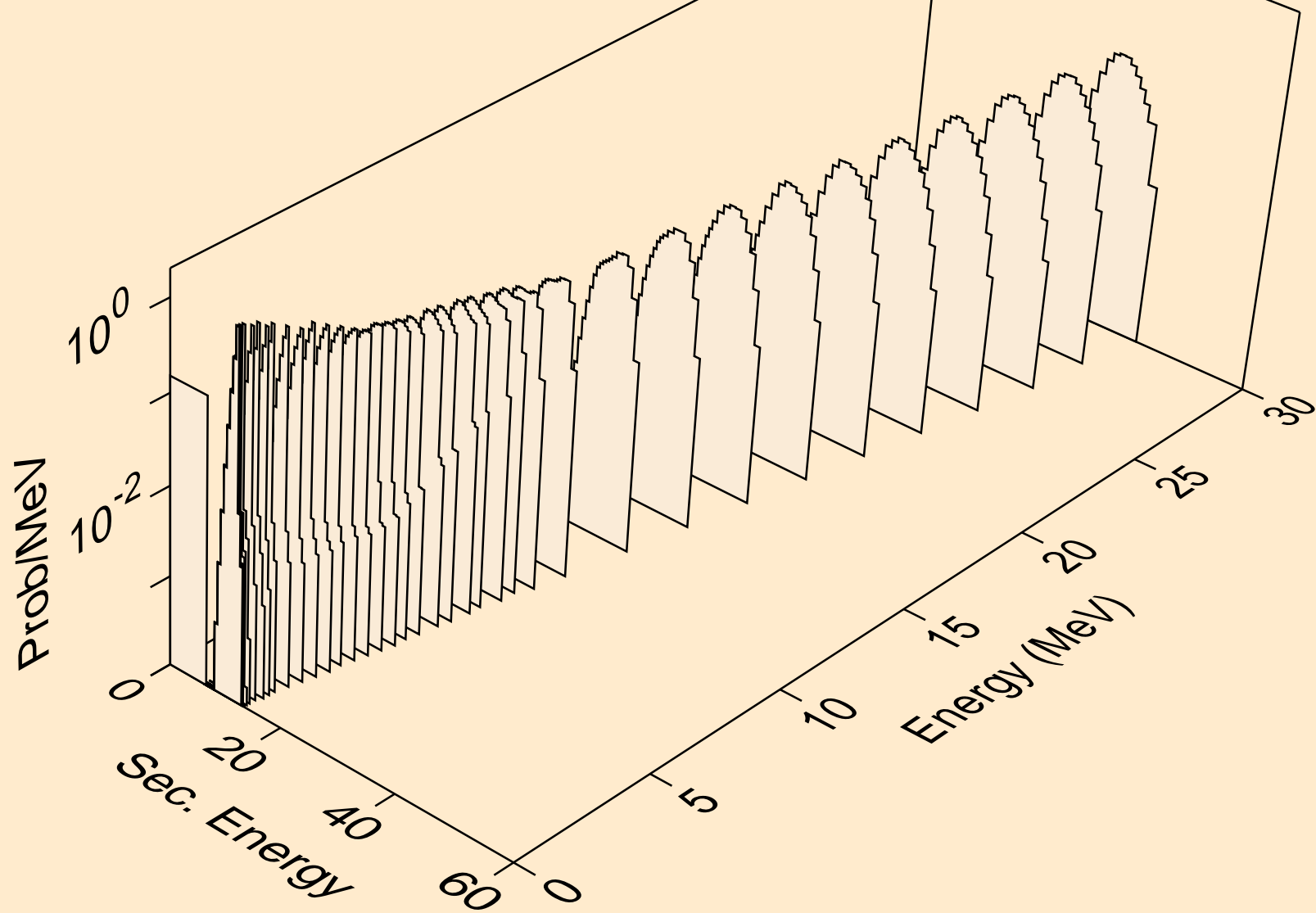

BI195 NEUTRON ACER TENDL-2023 LIBRARY; T=0.K
alphas from (n,2a)

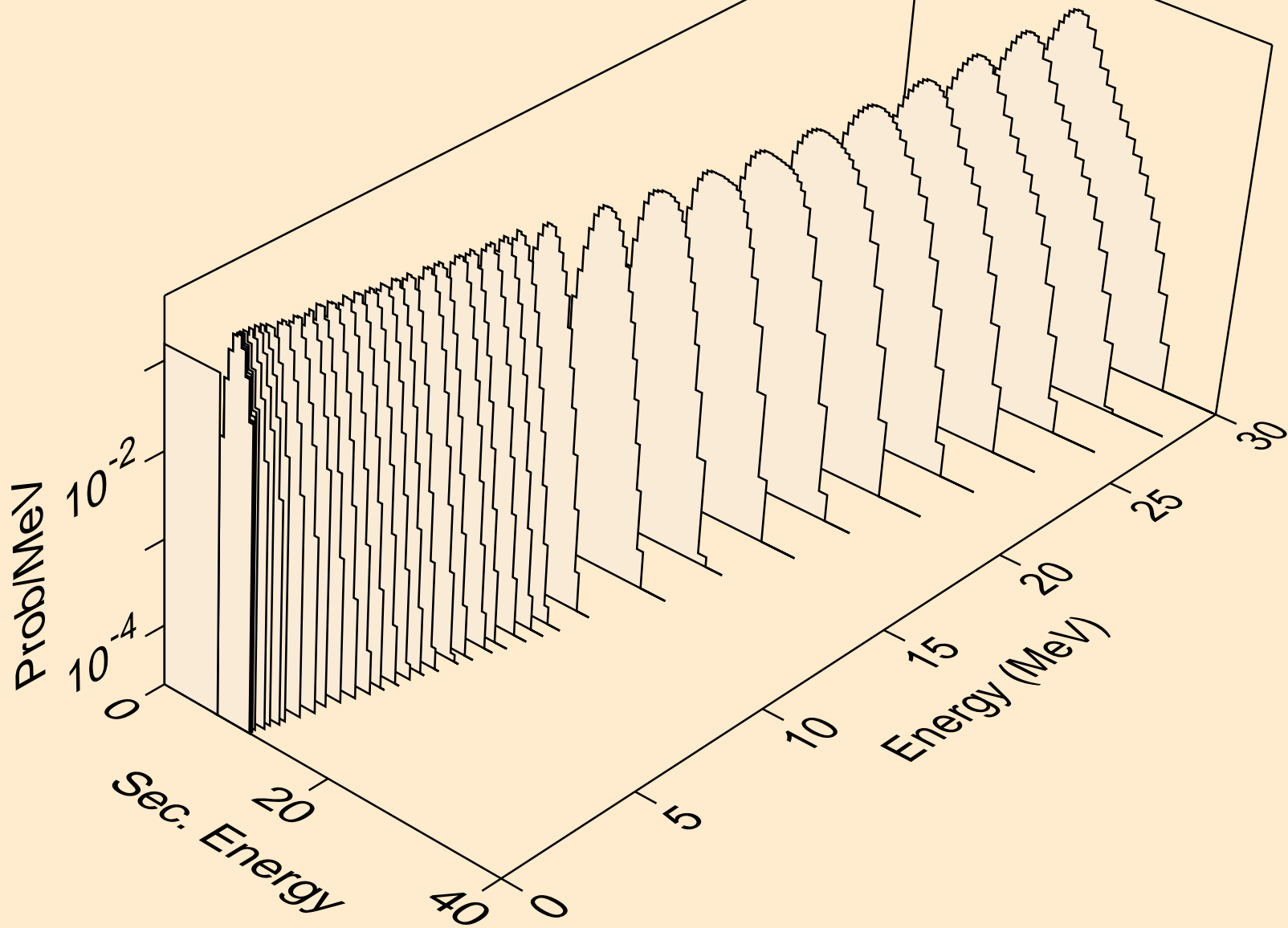

BI195 NEUTRON ACER TENDL-2023 LIBRARY; T=0.K
alphas from (n,pa)

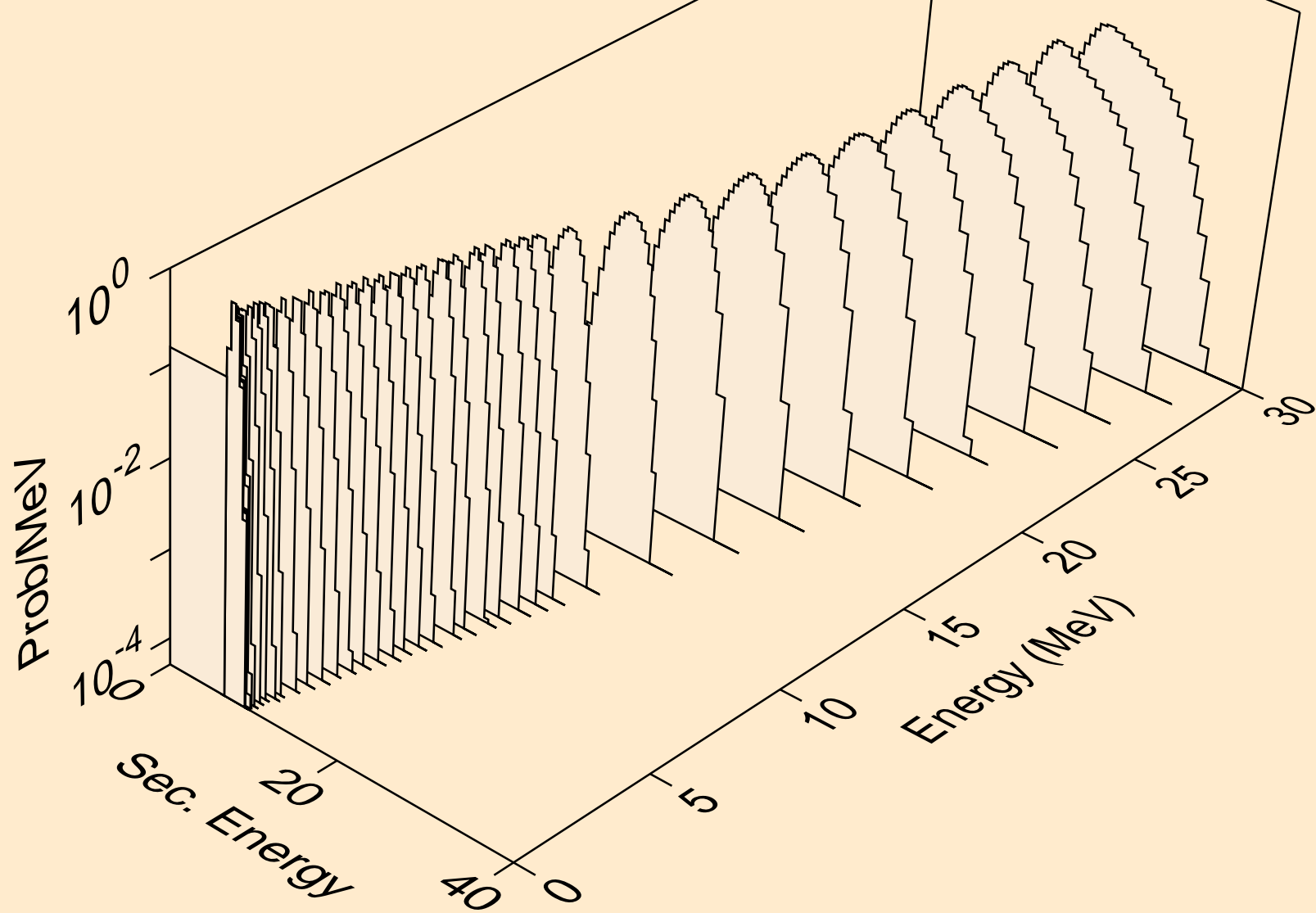

BI195 NEUTRON ACER TENDL-2023 LIBRARY; T=0.K
alphas from (n,da)

