

# BK252 NEUTRON ACER TENDL-2023 LIBRARY; T=0.K

## Principal cross sections

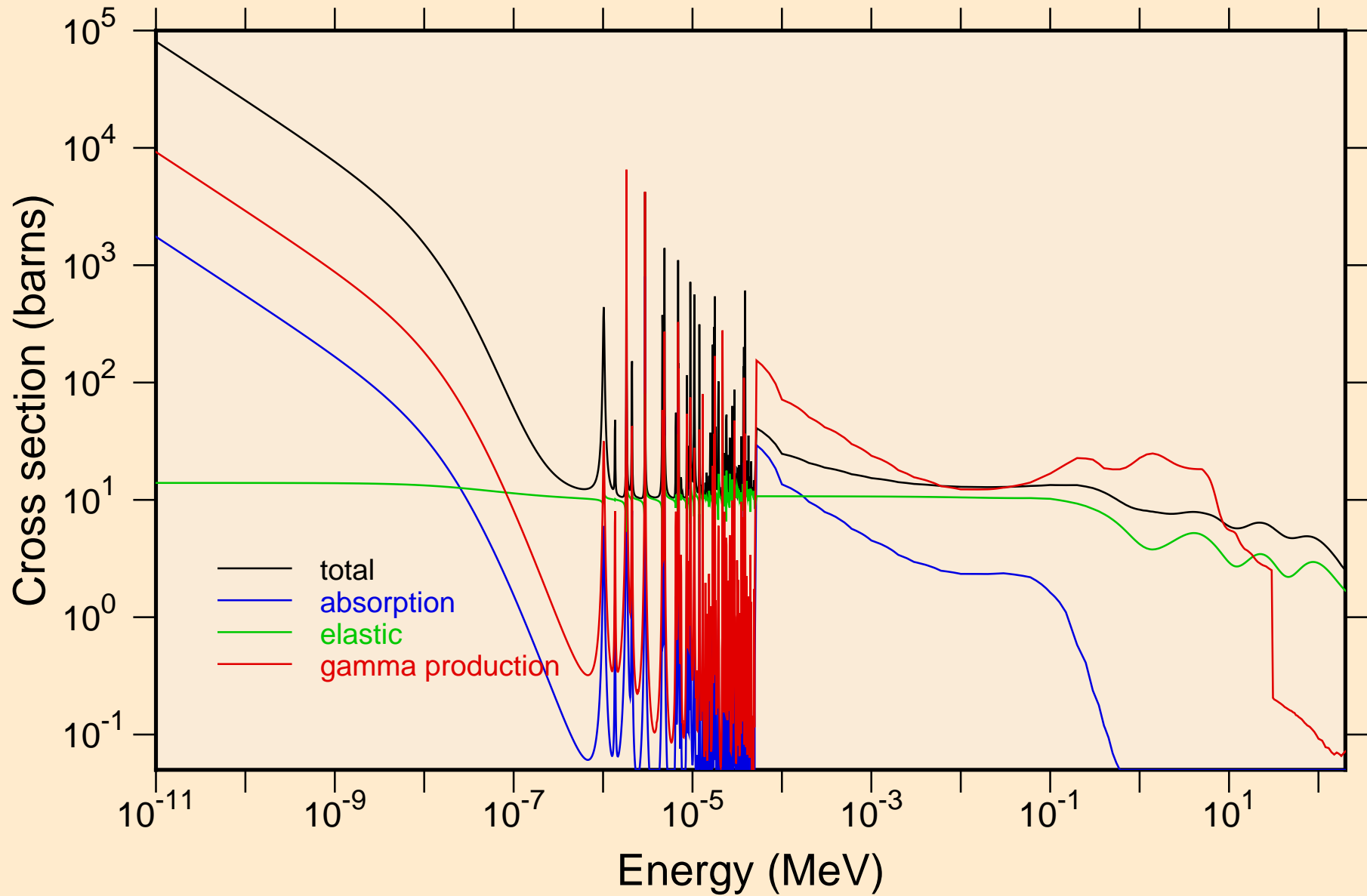

BK252 NEUTRON ACER TENDL-2023 LIBRARY; T=0.K  
resonance total cross section

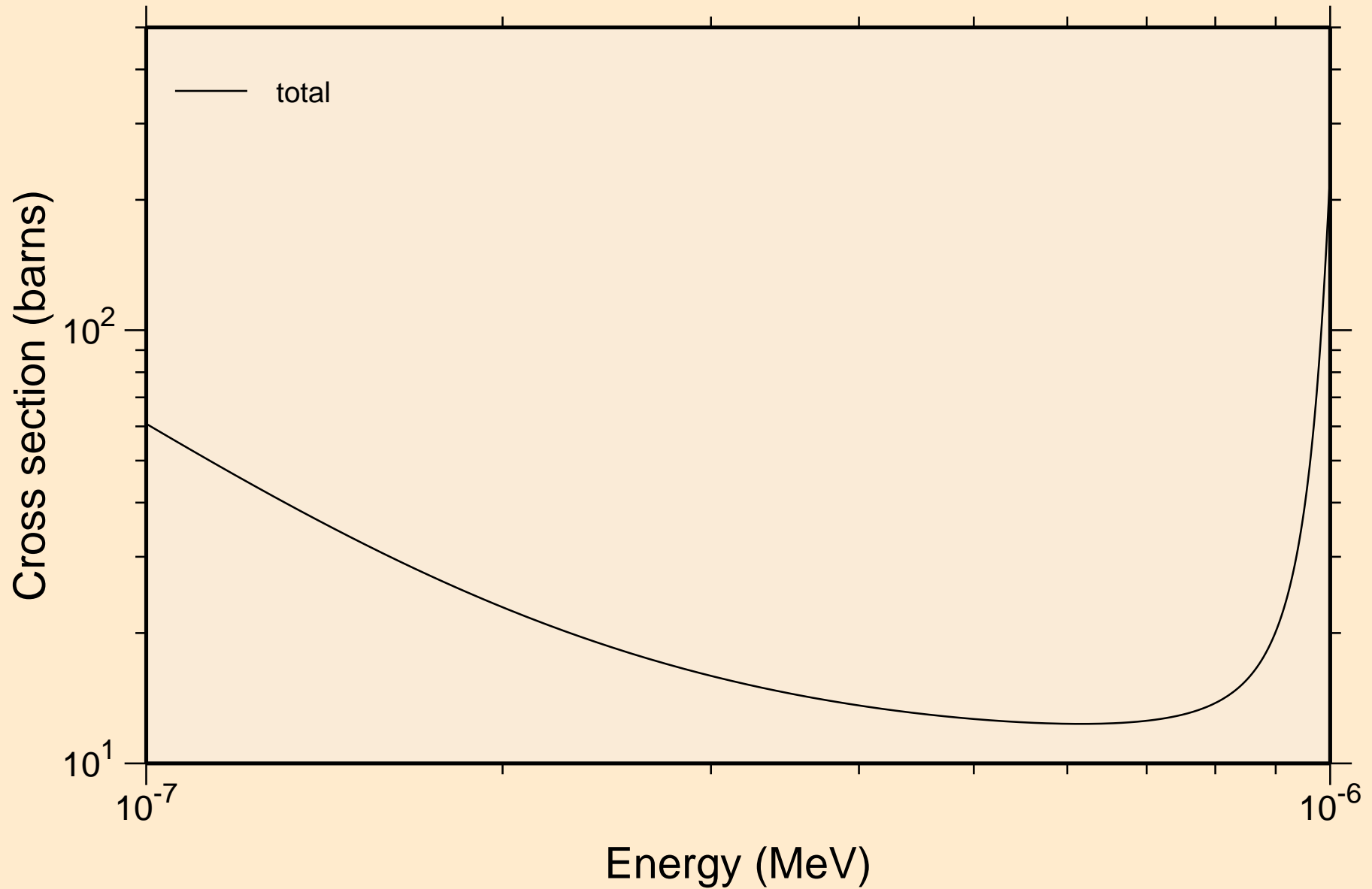

BK252 NEUTRON ACER TENDL-2023 LIBRARY; T=0.K  
resonance total cross section

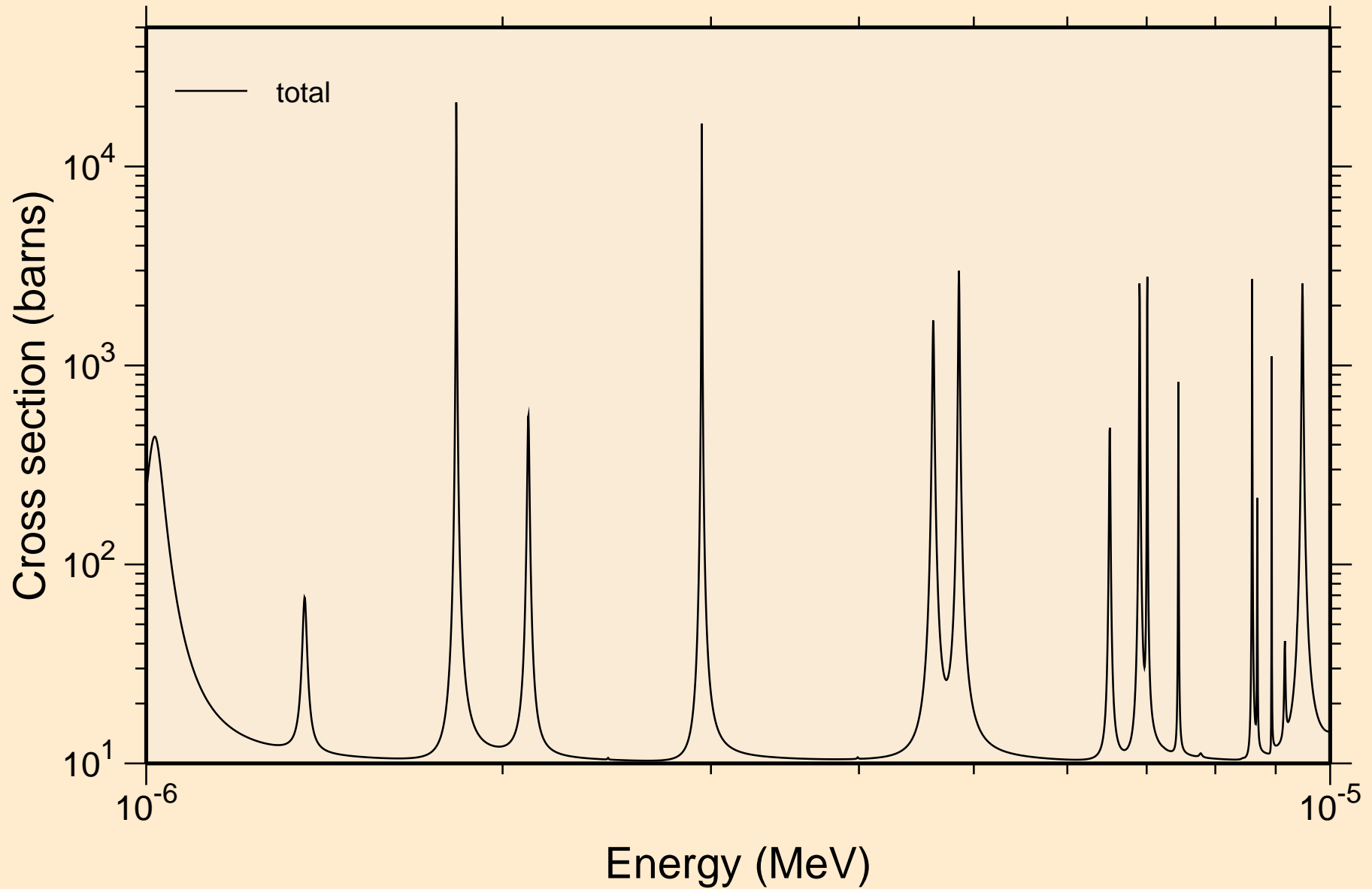

BK252 NEUTRON ACER TENDL-2023 LIBRARY; T=0.K  
resonance total cross section

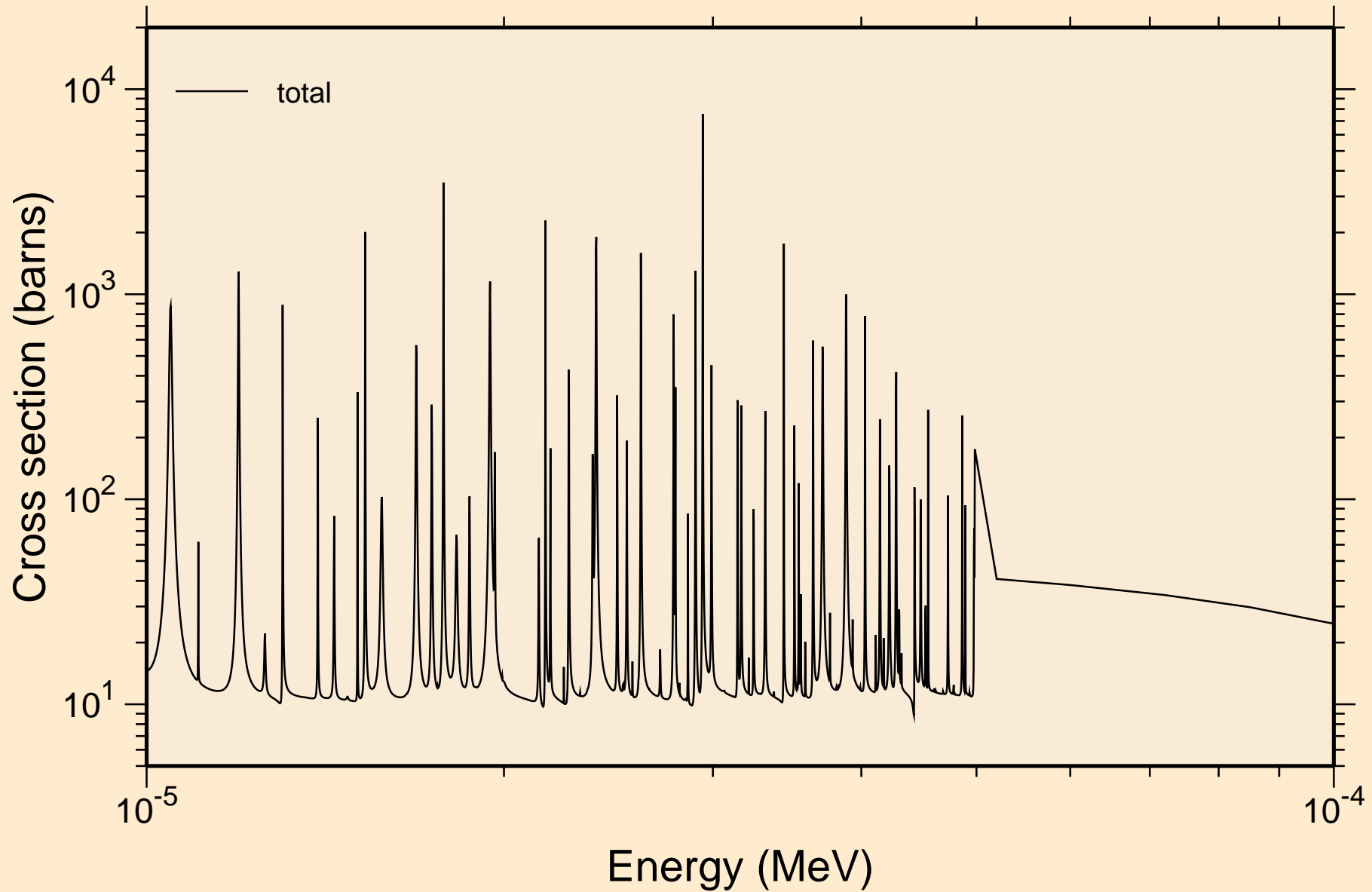

BK252 NEUTRON ACER TENDL-2023 LIBRARY; T=0.K  
resonance total cross section

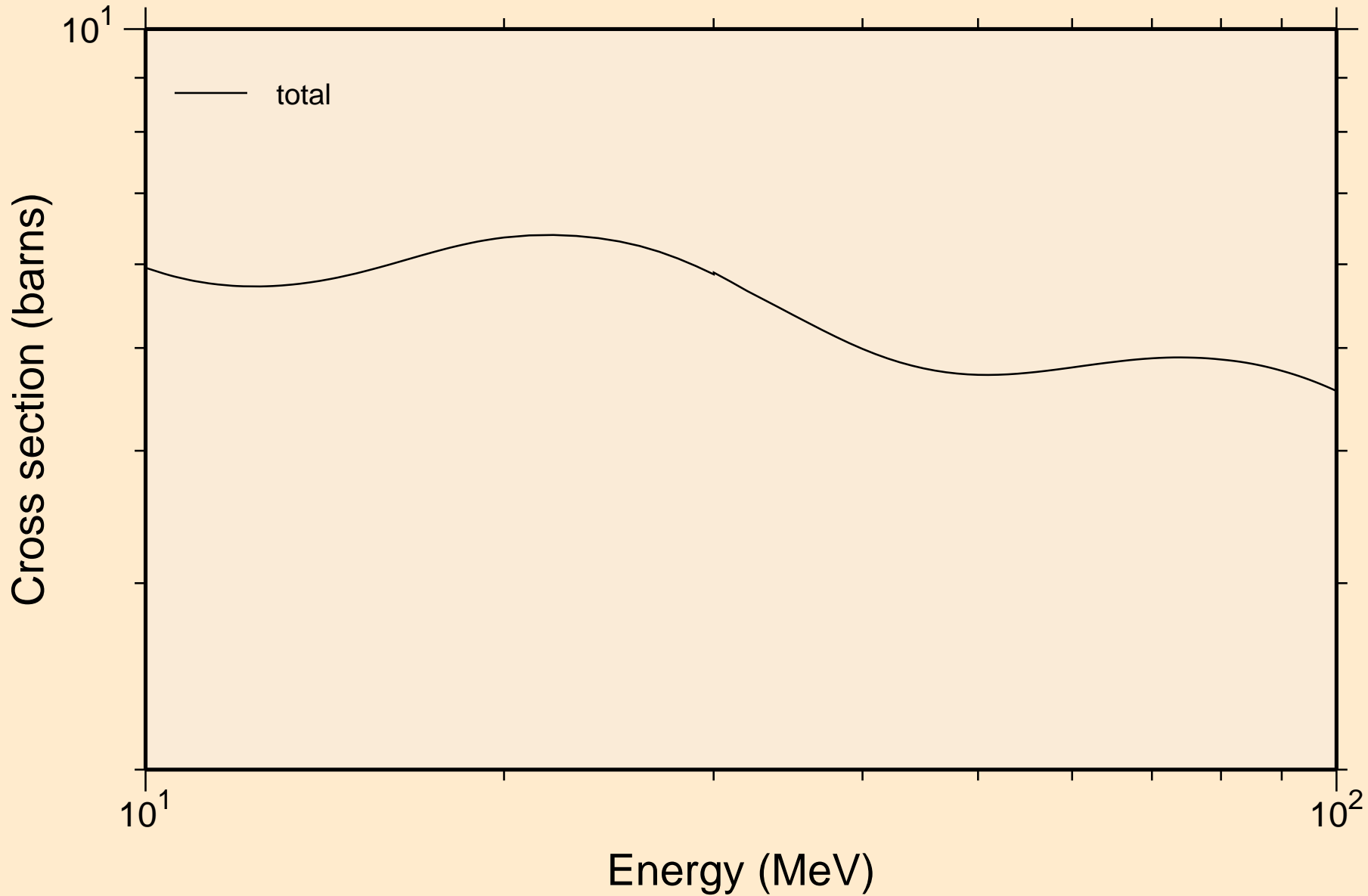

BK252 NEUTRON ACER TENDL-2023 LIBRARY; T=0.K  
resonance absorption cross sections

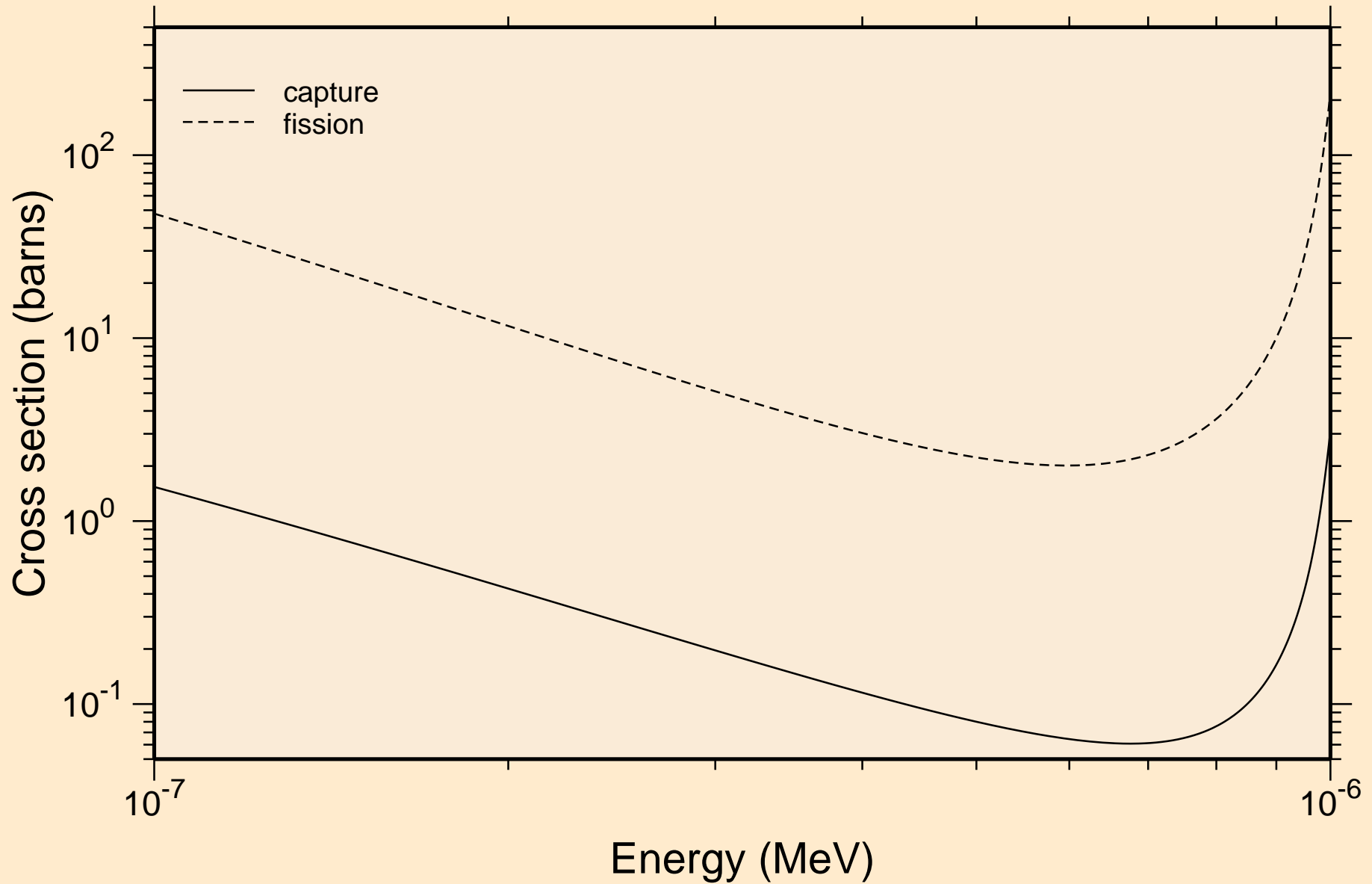

BK252 NEUTRON ACER TENDL-2023 LIBRARY; T=0.K  
resonance absorption cross sections

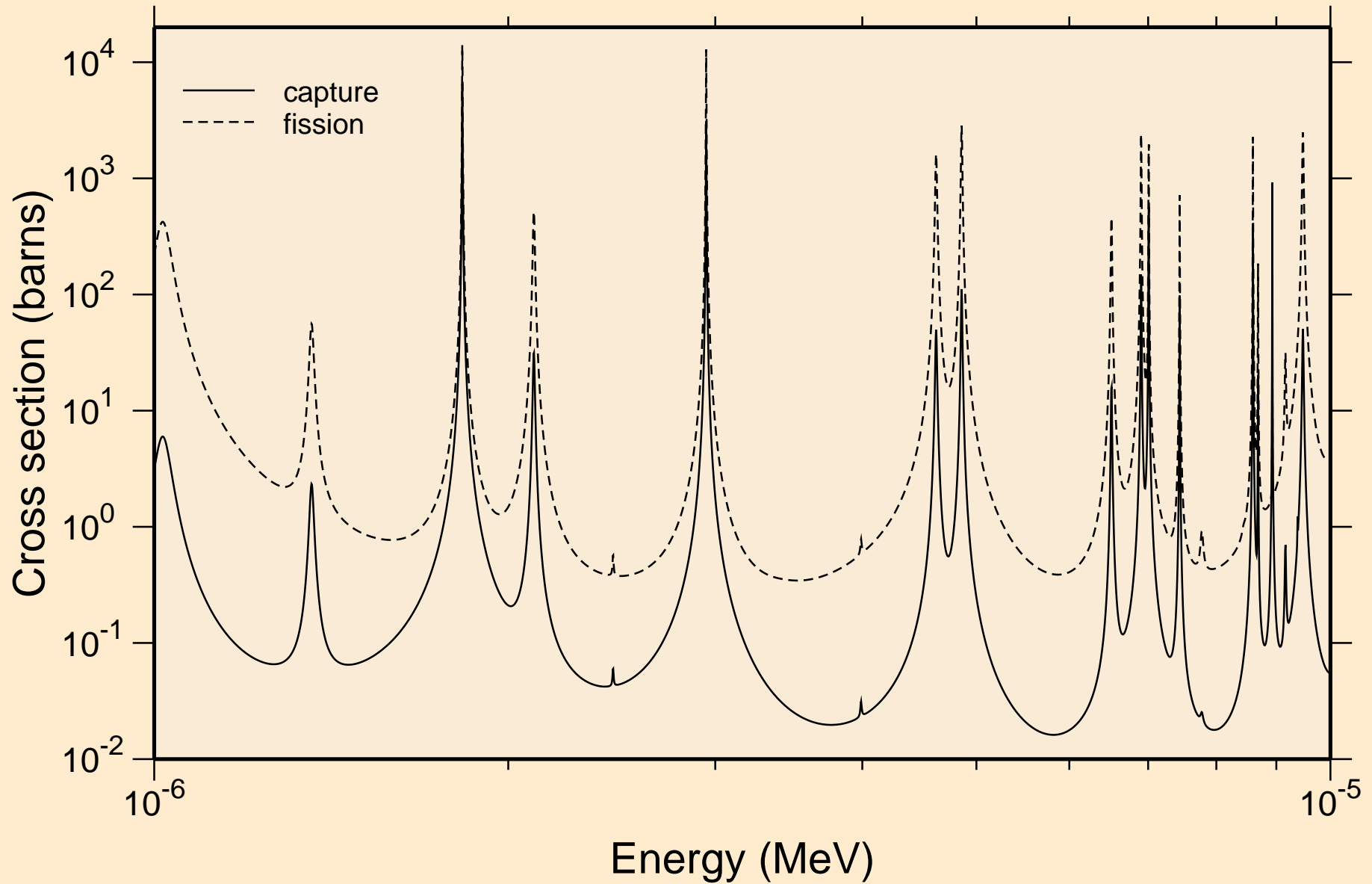

BK252 NEUTRON ACER TENDL-2023 LIBRARY; T=0.K  
resonance absorption cross sections

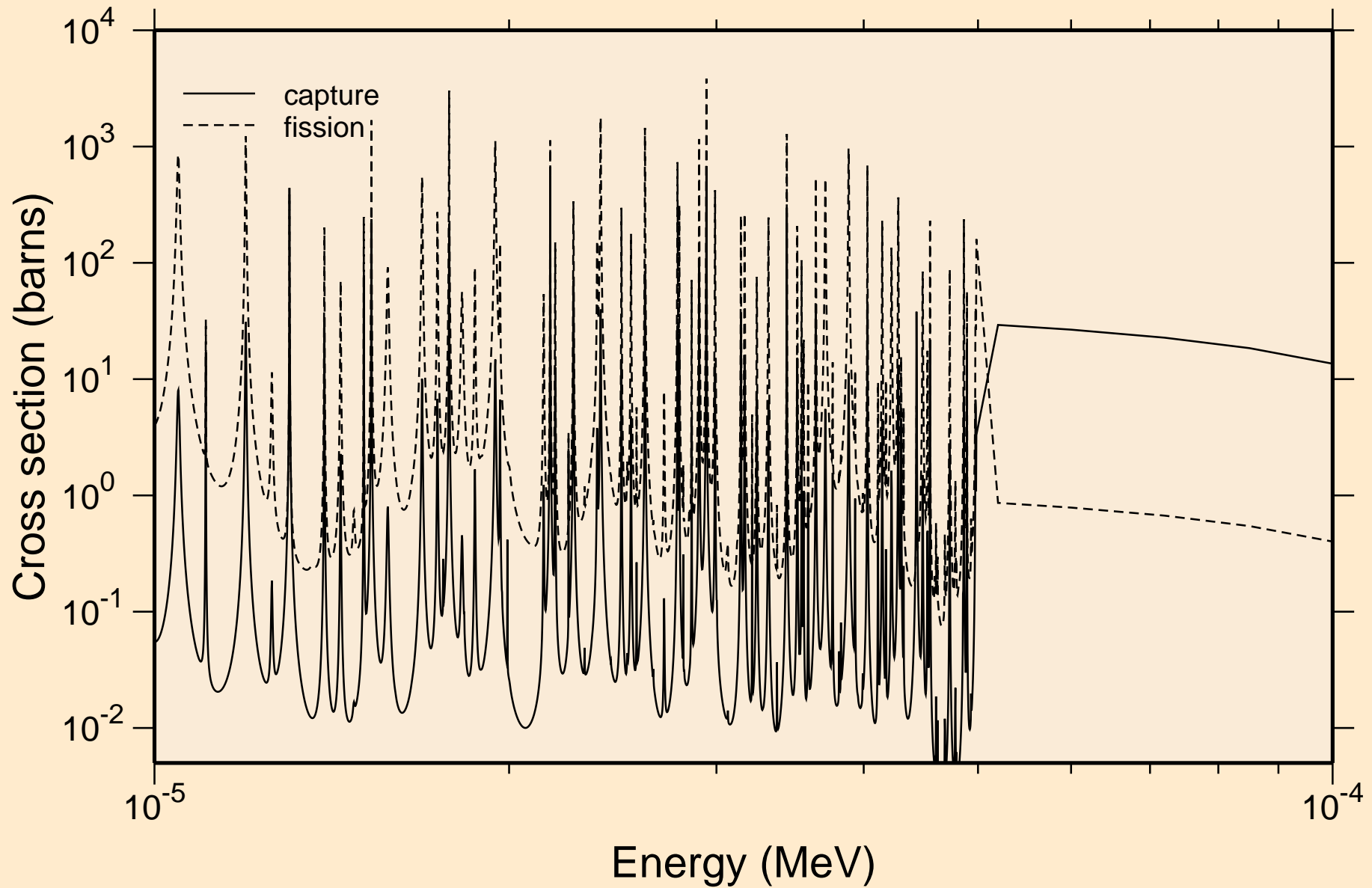

BK252 NEUTRON ACER TENDL-2023 LIBRARY; T=0.K  
resonance absorption cross sections

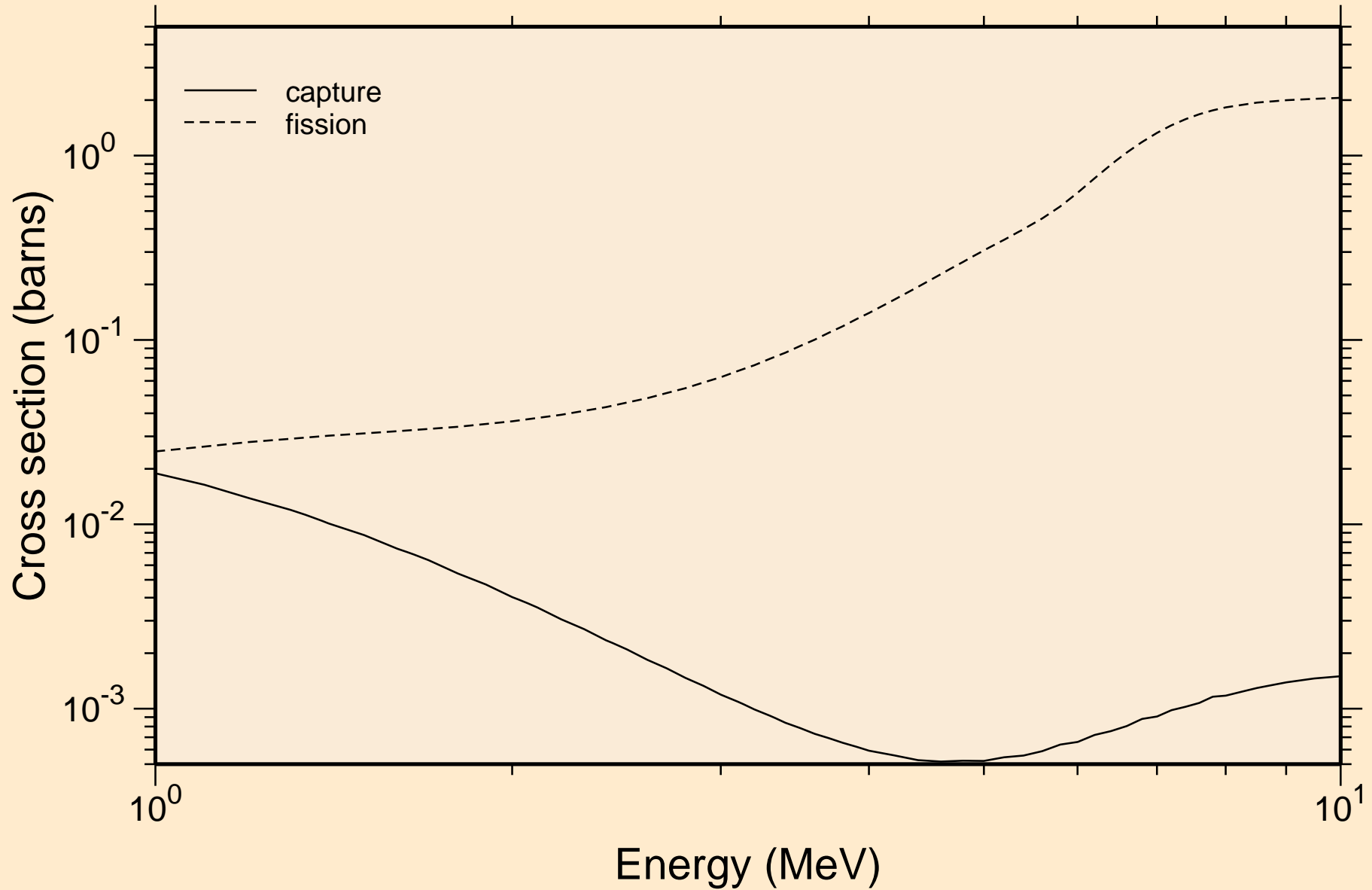

# BK252 NEUTRON ACER TENDL-2023 LIBRARY; T=0.K

## Heating

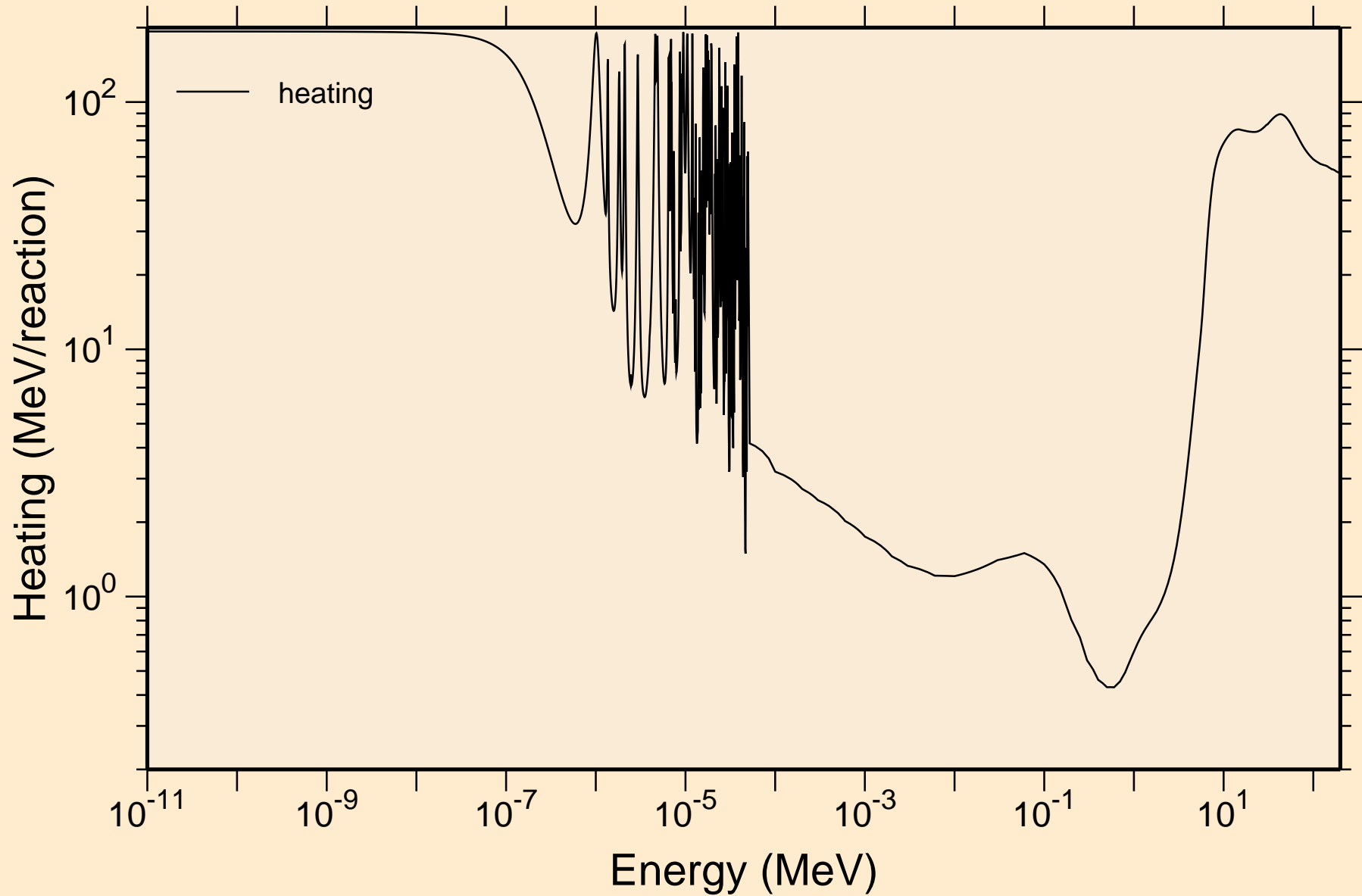

BK252 NEUTRON ACER TENDL-2023 LIBRARY; T=0.K  
Damage

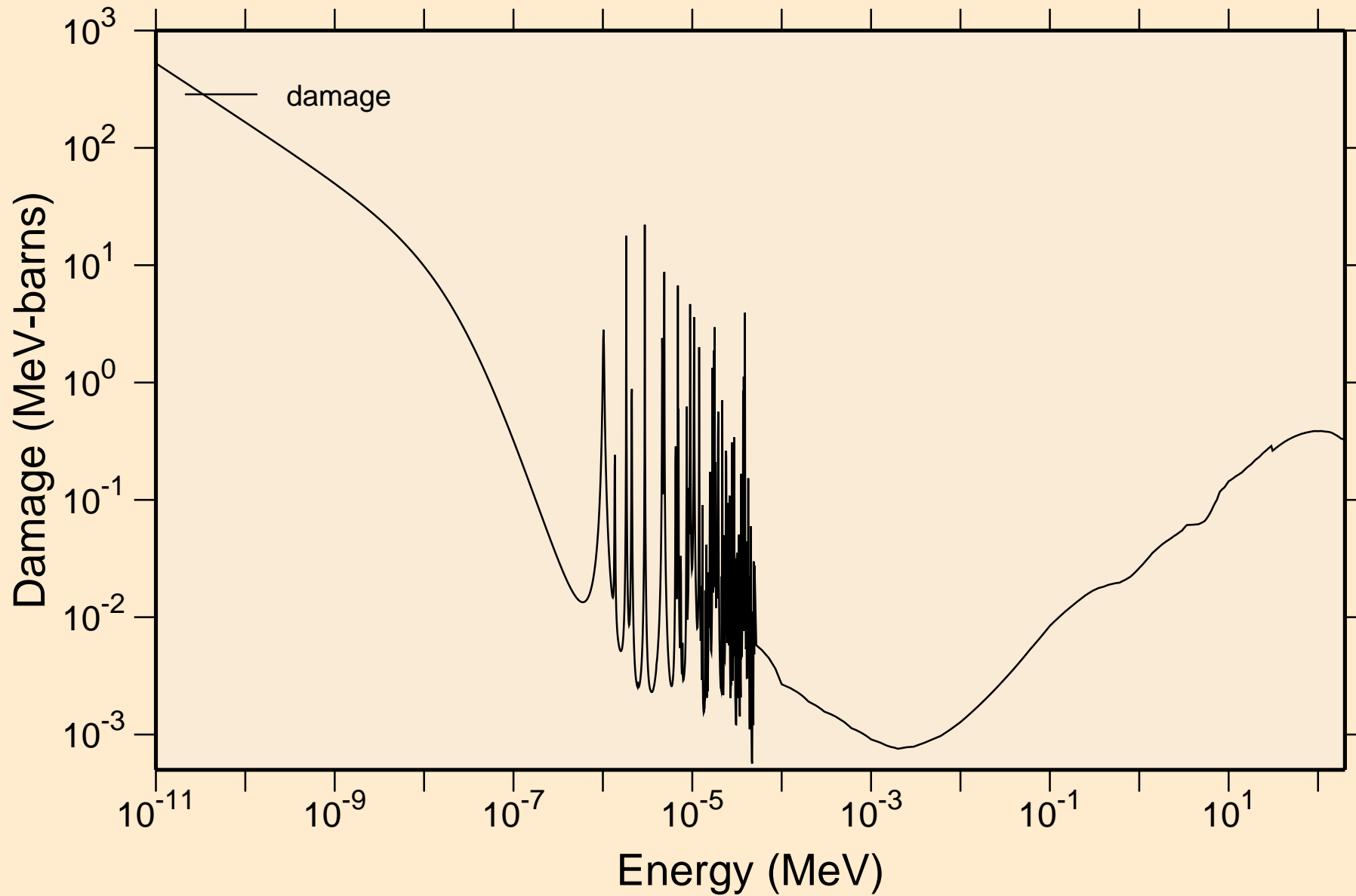

BK252 NEUTRON ACER TENDL-2023 LIBRARY; T=0.K  
Non-threshold reactions

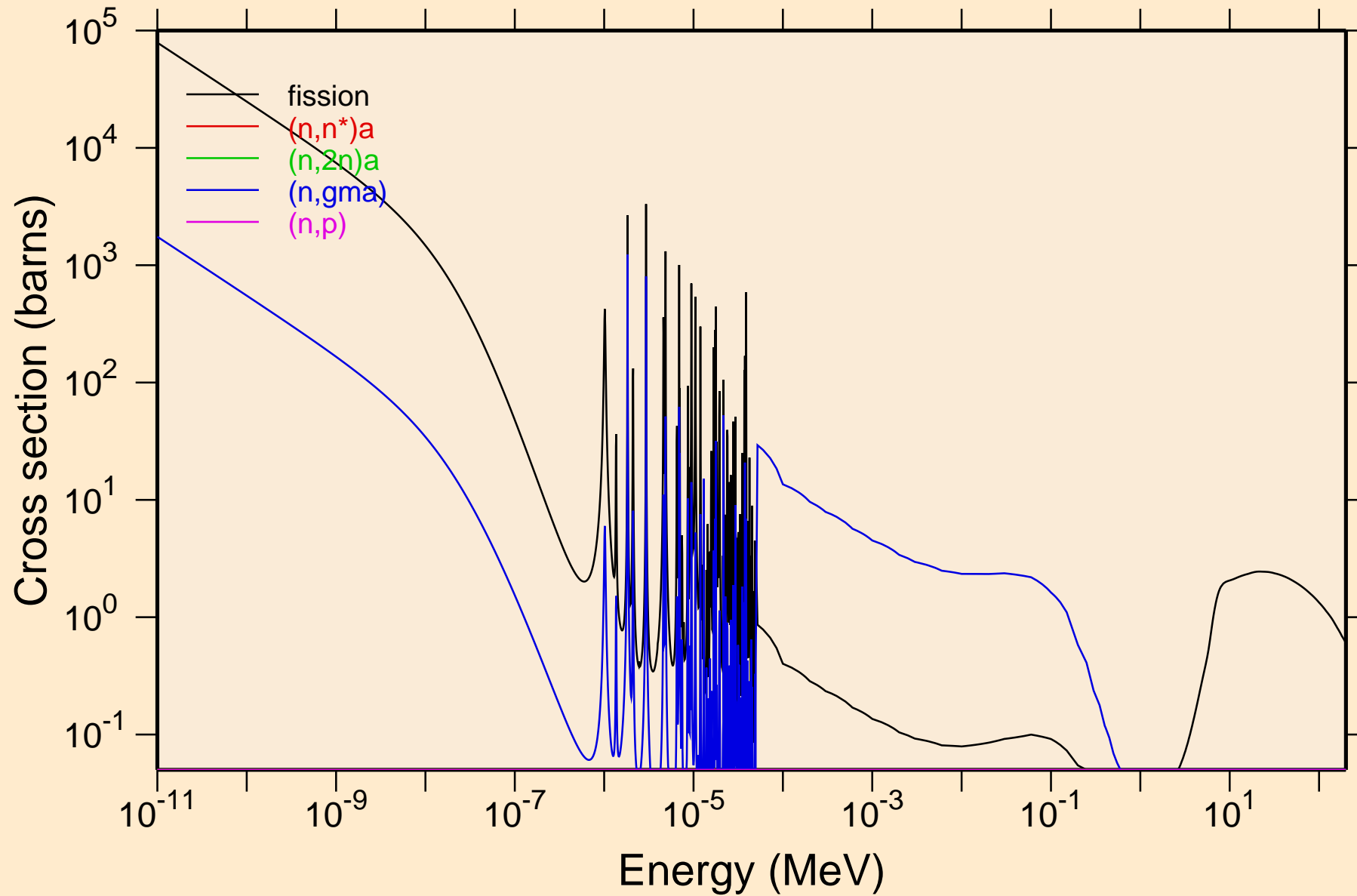

BK252 NEUTRON ACER TENDL-2023 LIBRARY; T=0.K  
Non-threshold reactions

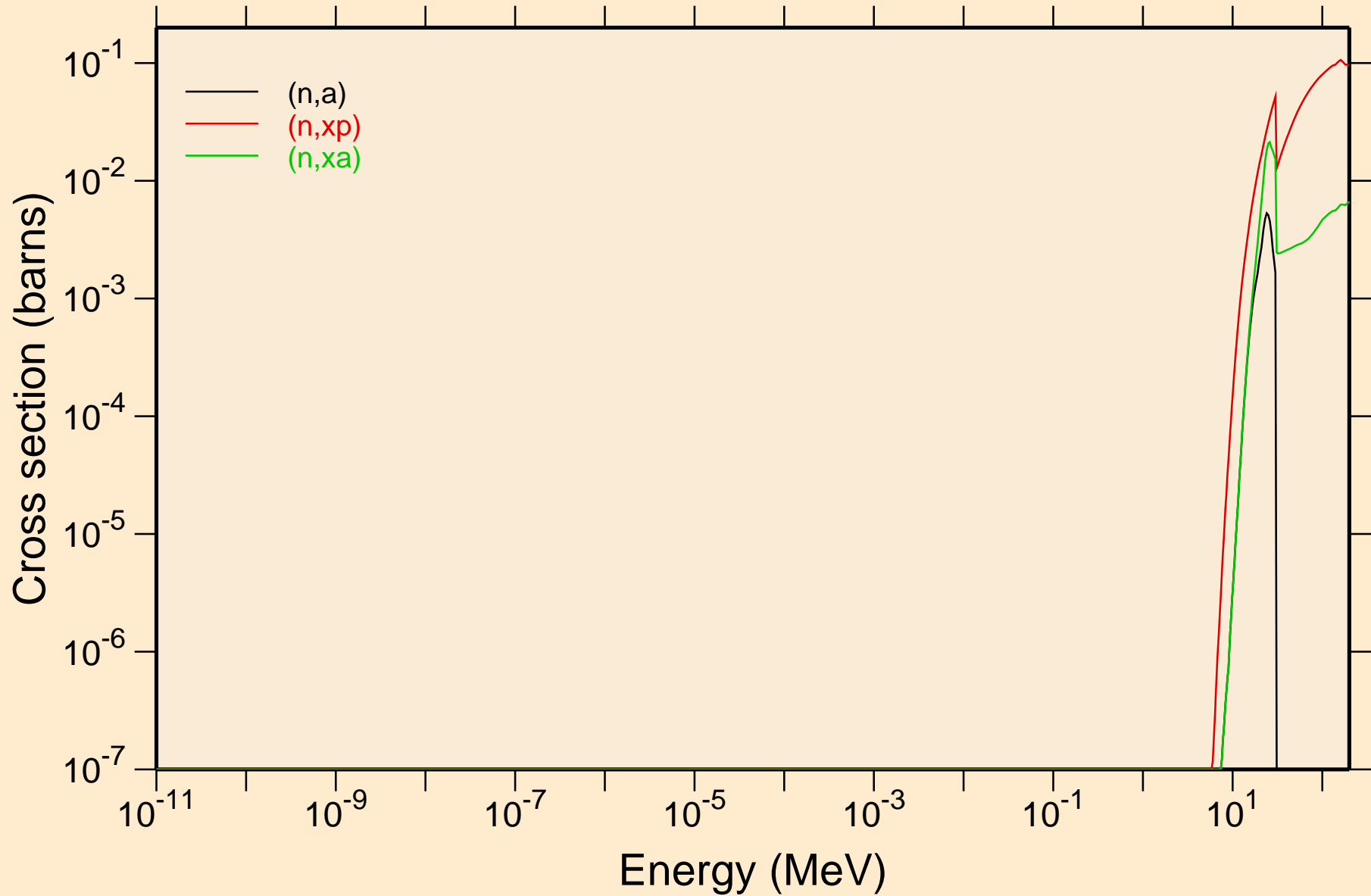

# BK252 NEUTRON ACER TENDL-2023 LIBRARY; T=0.K

## Principal cross sections

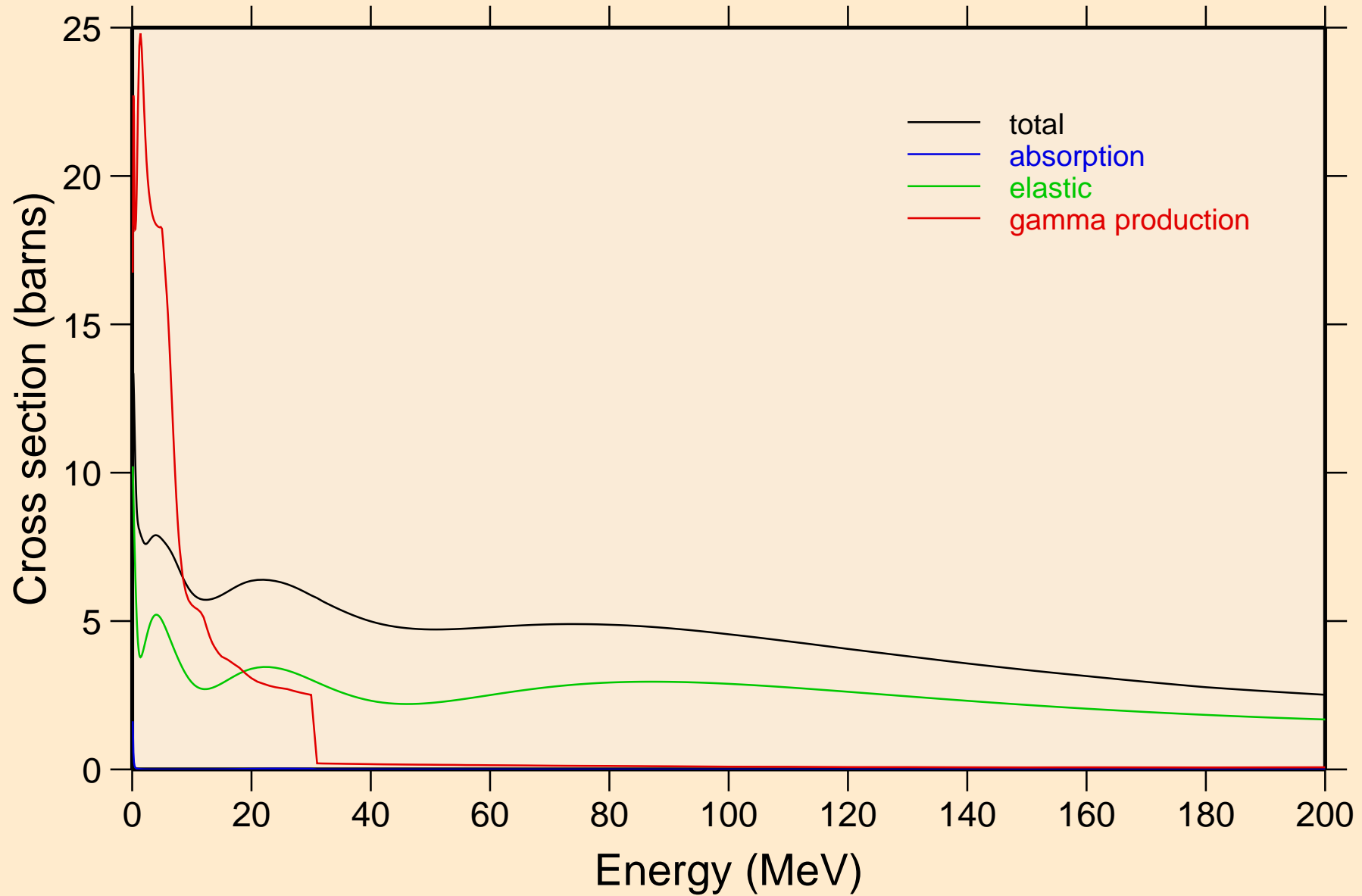

# BK252 NEUTRON ACER TENDL-2023 LIBRARY; T=0.K

## Heating

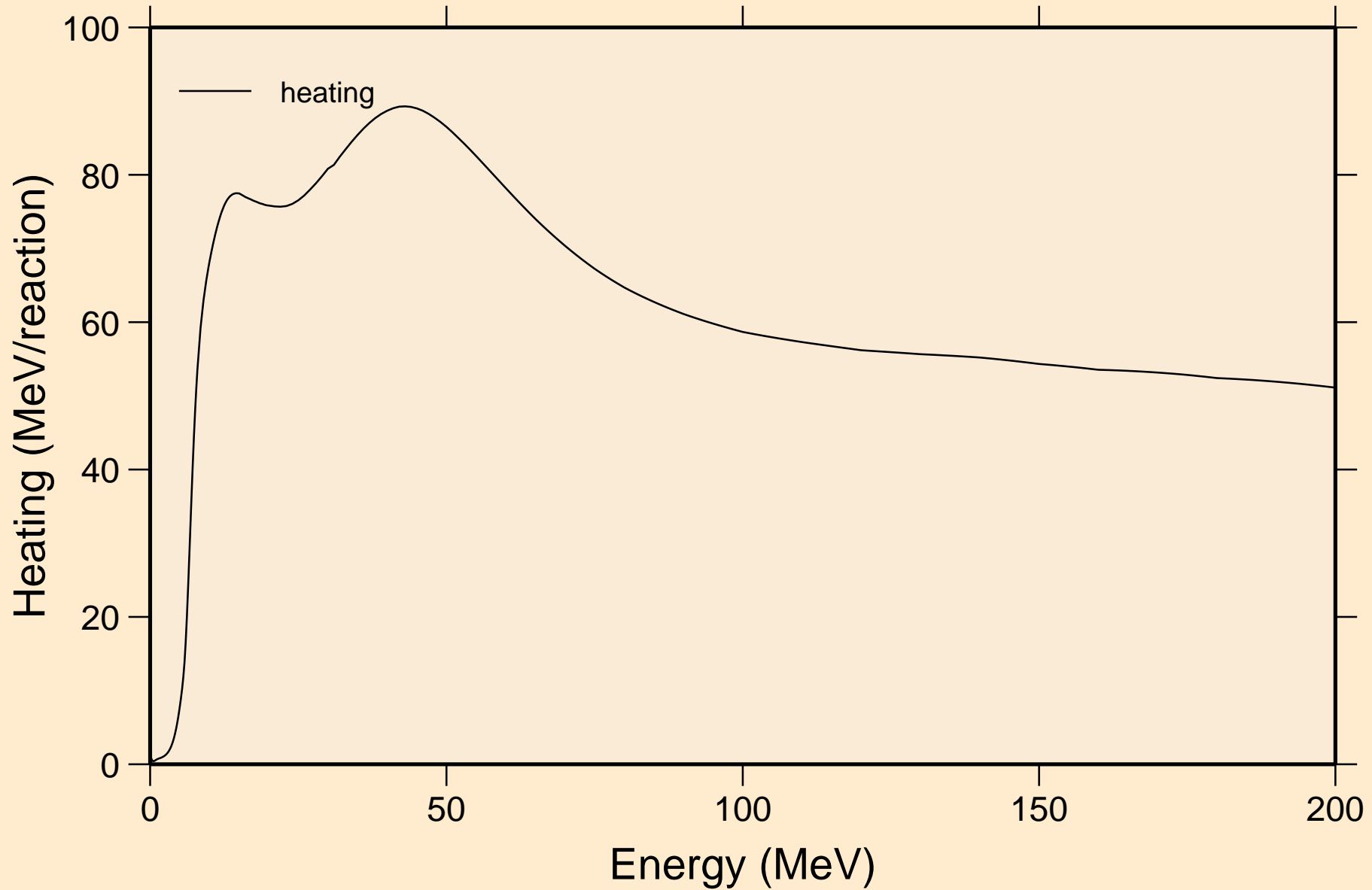

# BK252 NEUTRON ACER TENDL-2023 LIBRARY; T=0.K

## Damage

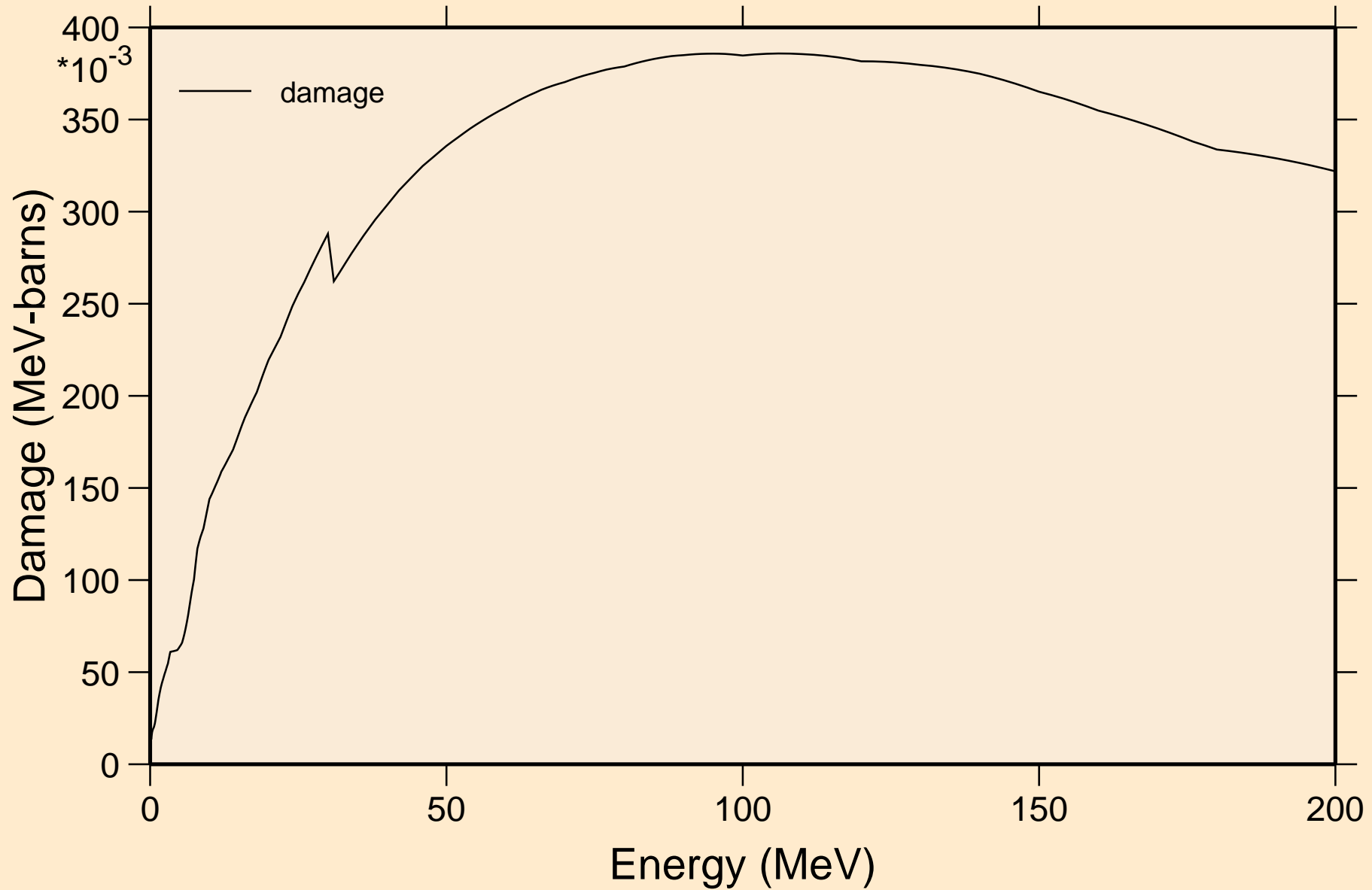

# BK252 NEUTRON ACER TENDL-2023 LIBRARY; T=0.K

## Non-threshold reactions

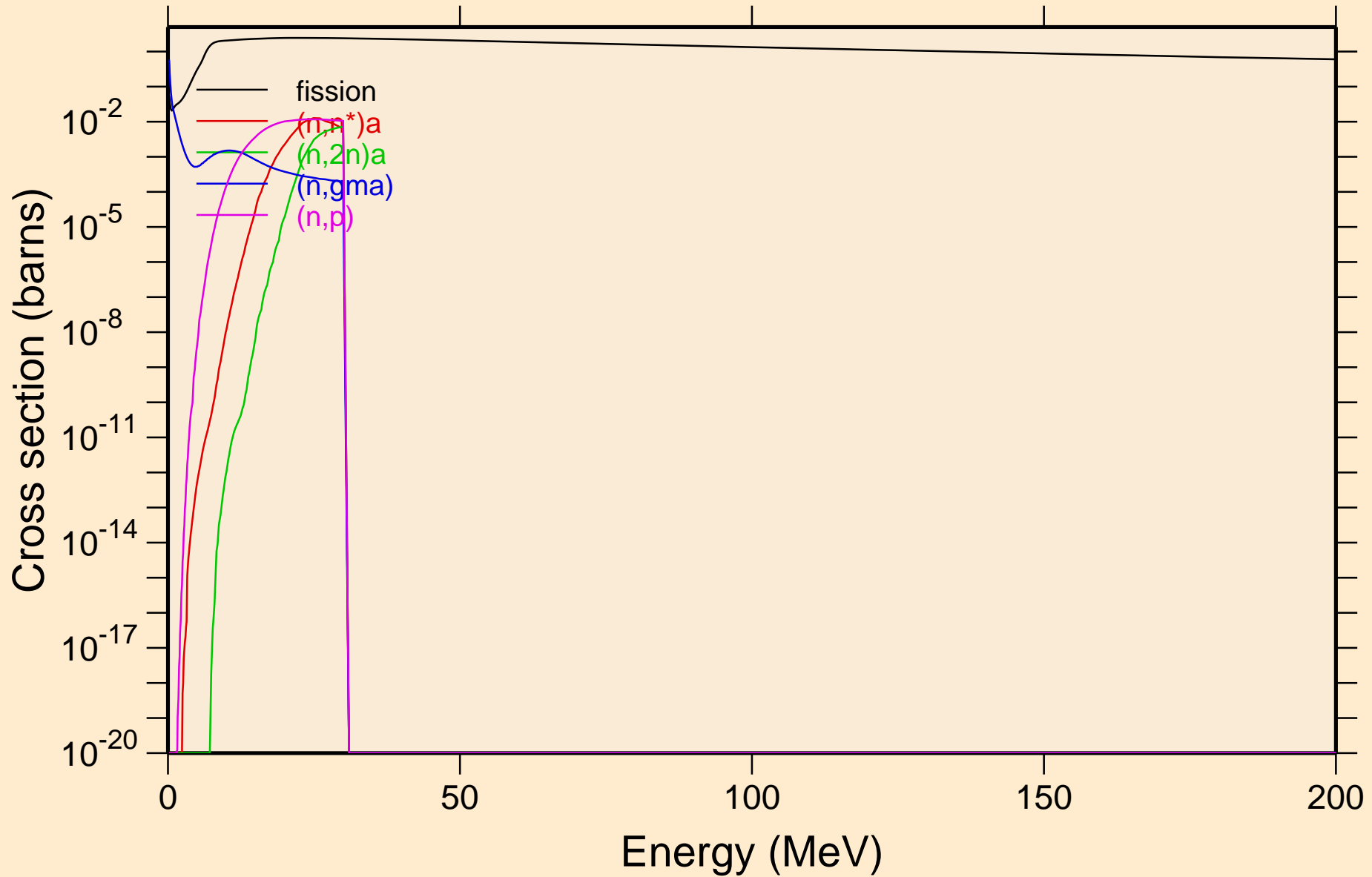

BK252 NEUTRON ACER TENDL-2023 LIBRARY; T=0.K  
Non-threshold reactions

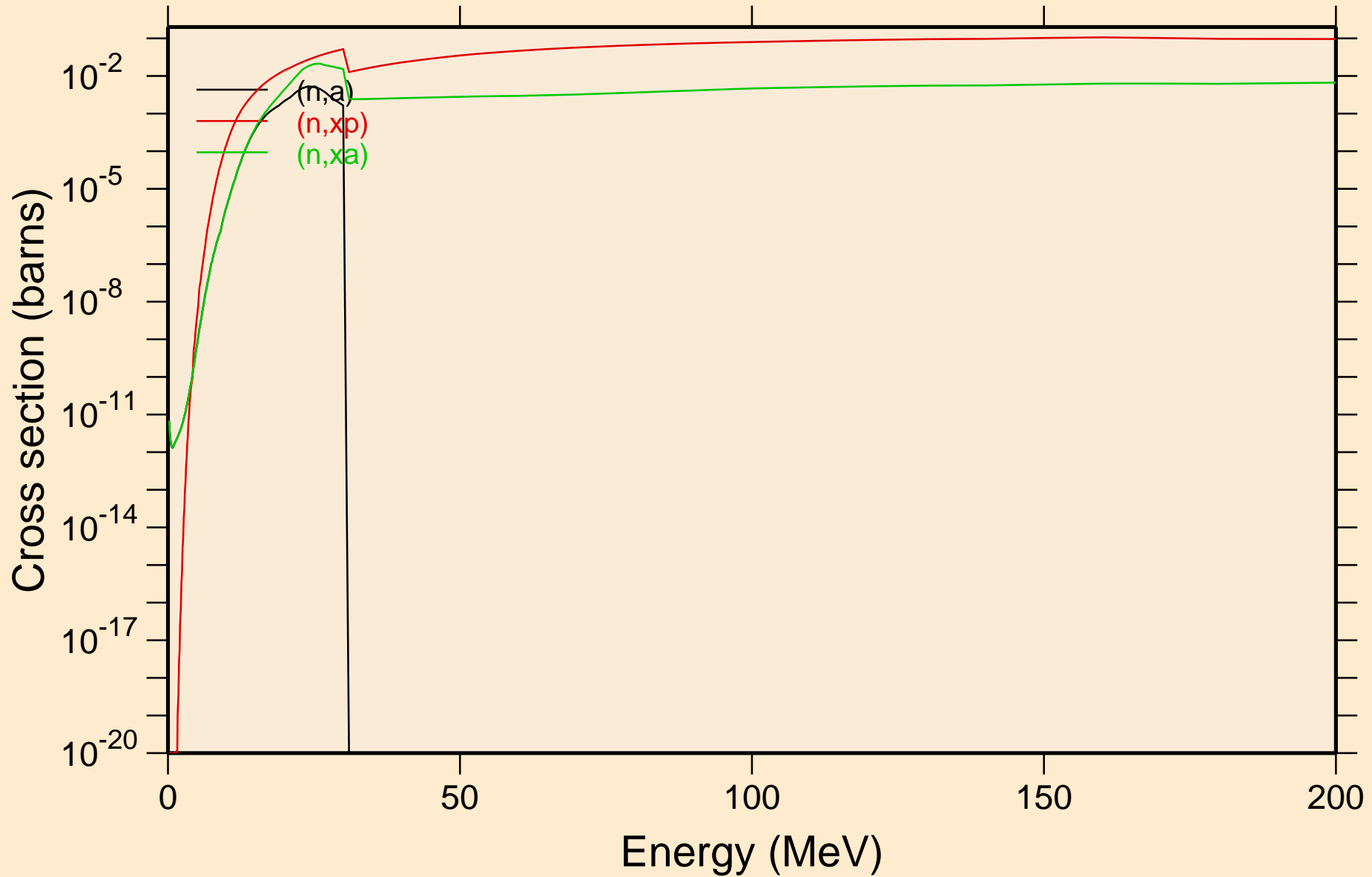

BK252 NEUTRON ACER TENDL-2023 LIBRARY; T=0.K  
Inelastic levels

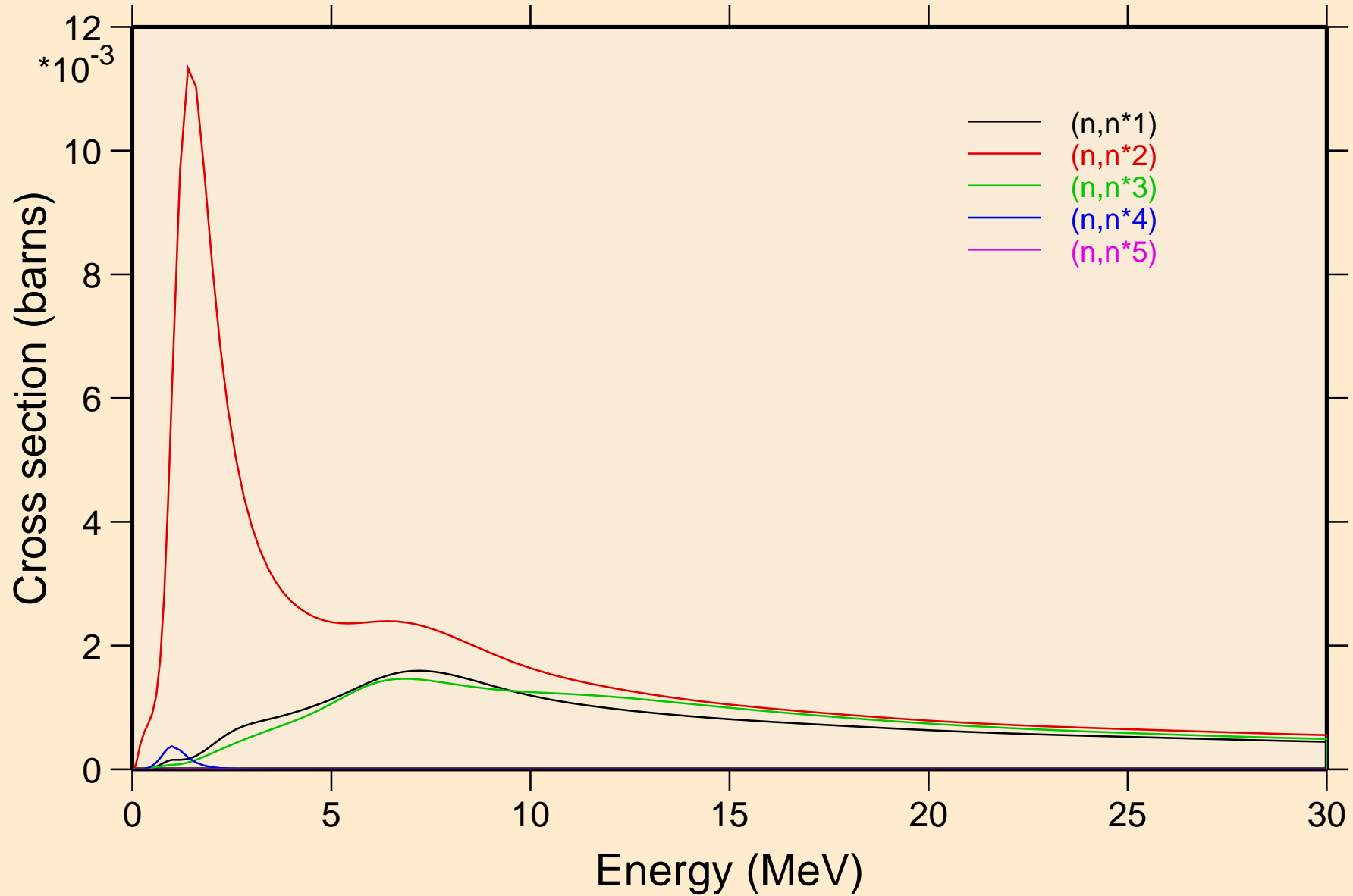

BK252 NEUTRON ACER TENDL-2023 LIBRARY; T=0.K  
Inelastic levels

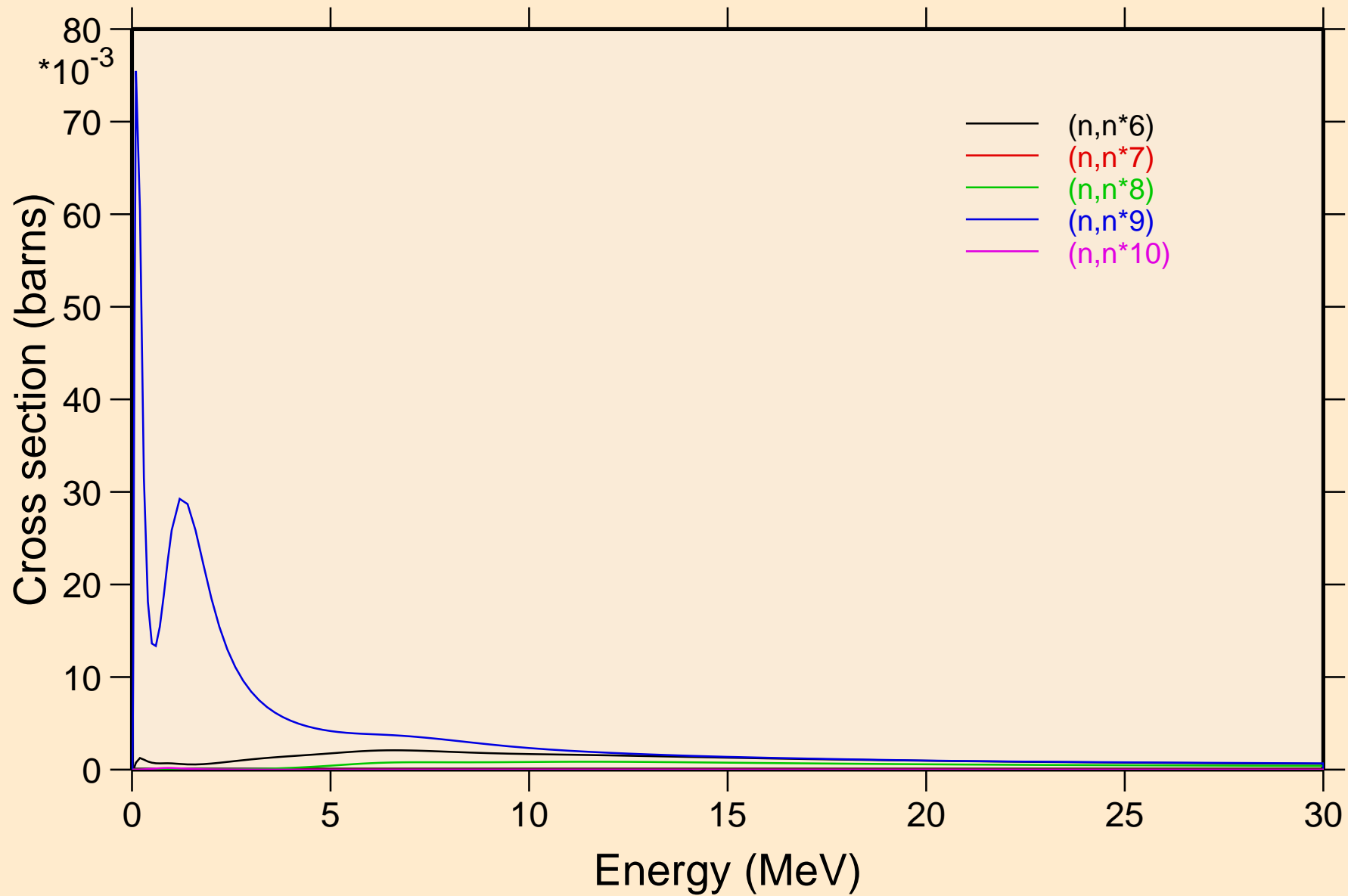

BK252 NEUTRON ACER TENDL-2023 LIBRARY; T=0.K  
Inelastic levels

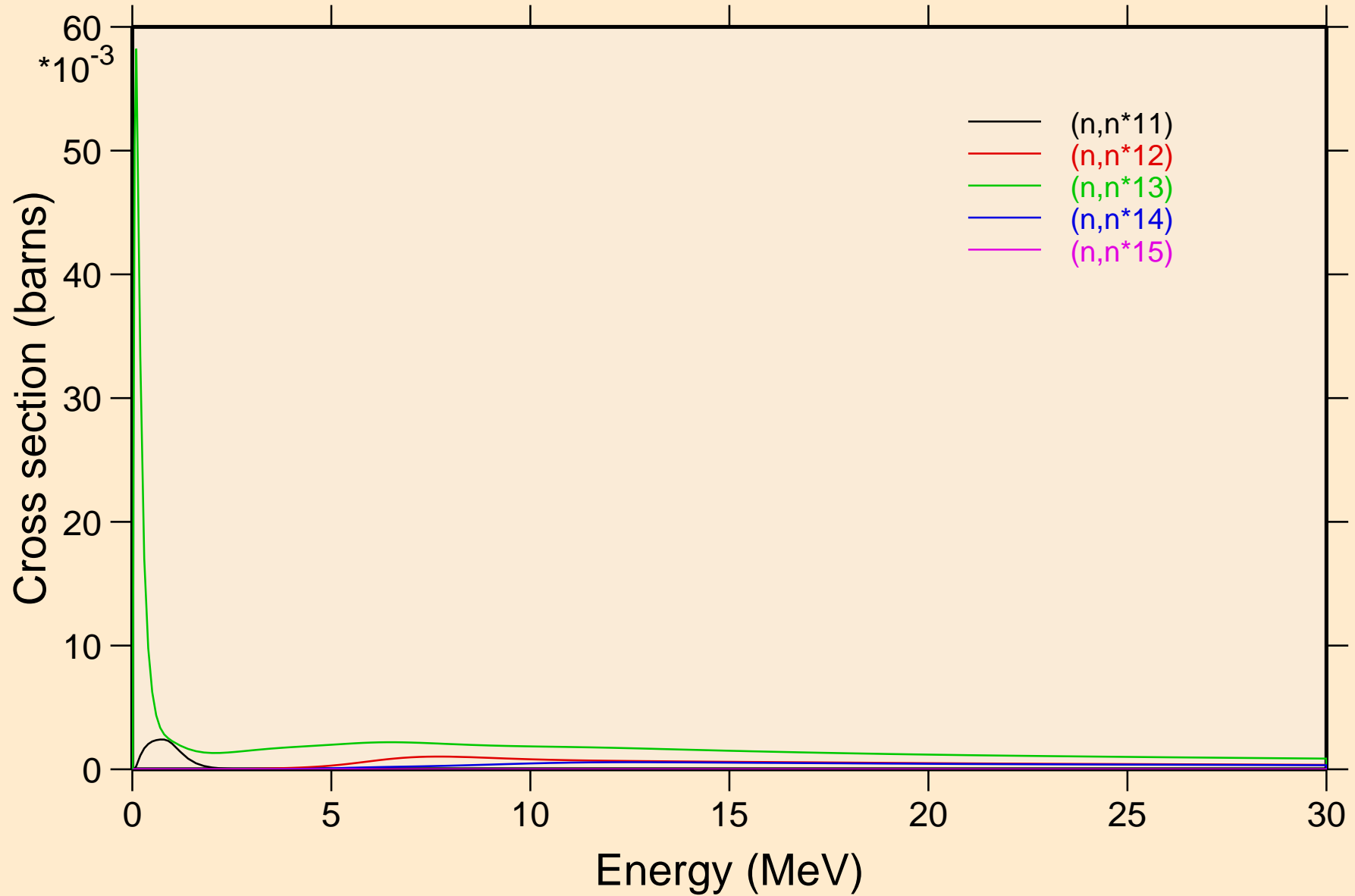

BK252 NEUTRON ACER TENDL-2023 LIBRARY; T=0.K  
Inelastic levels

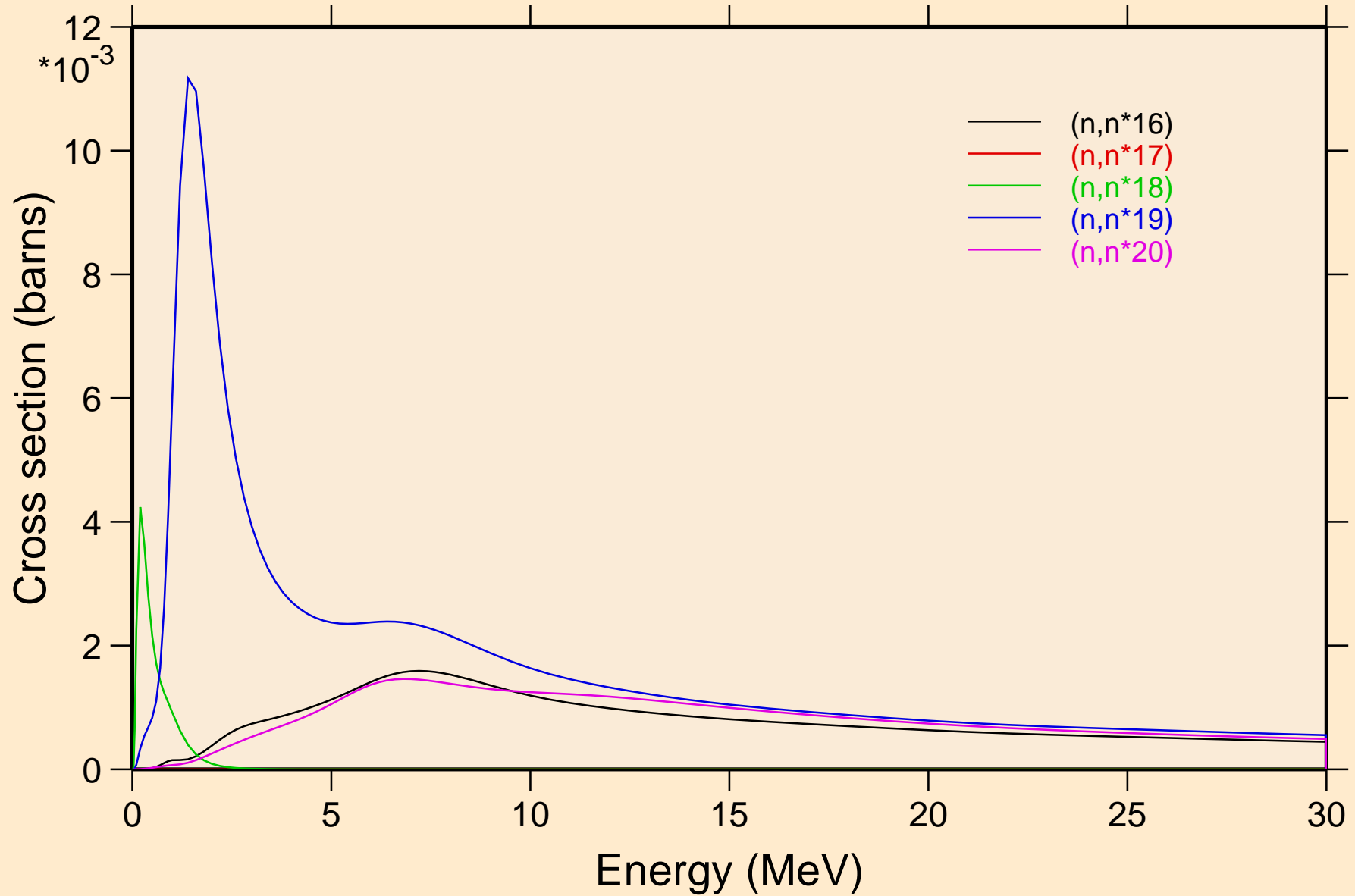

BK252 NEUTRON ACER TENDL-2023 LIBRARY; T=0.K  
Inelastic levels

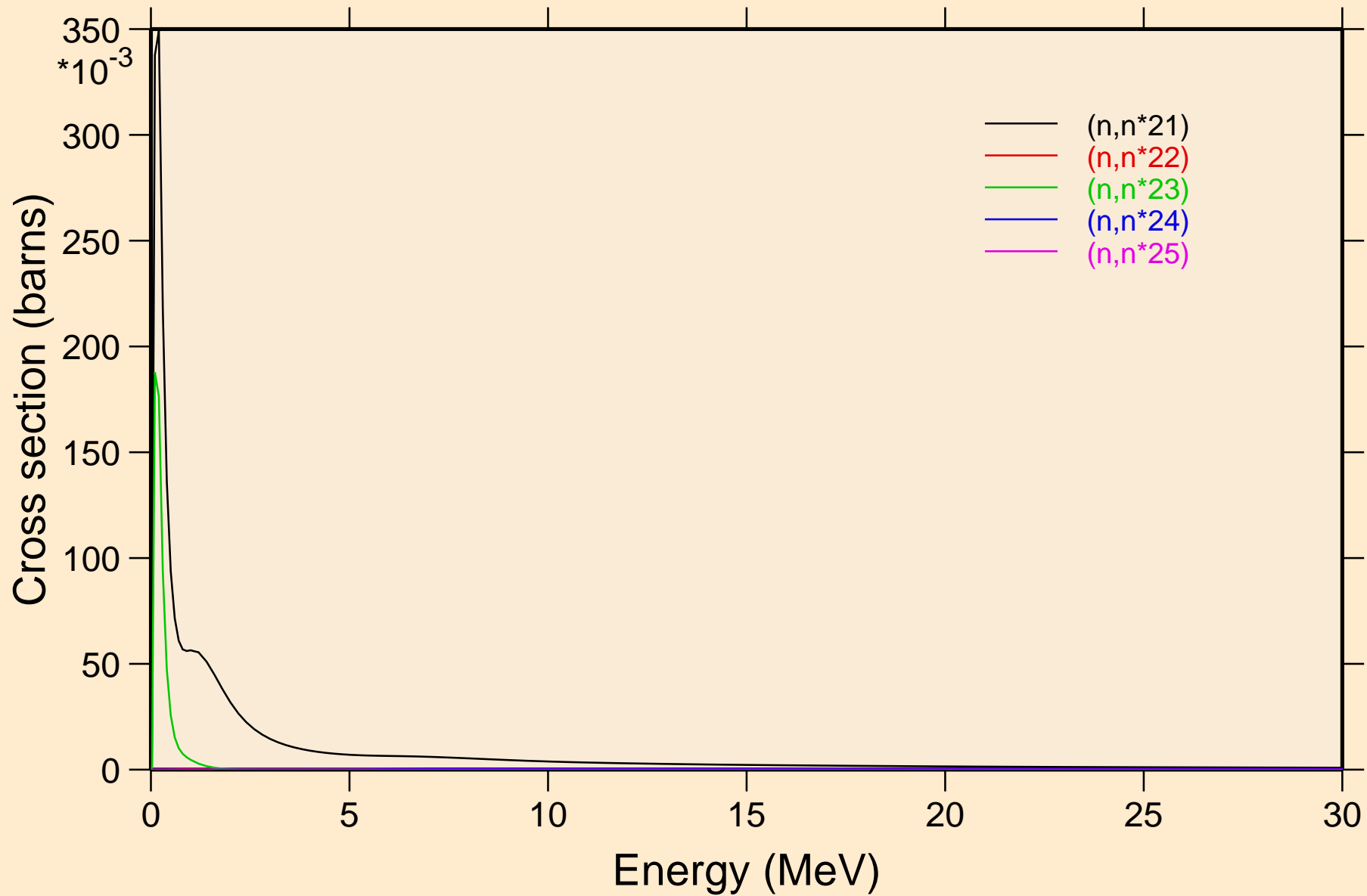

BK252 NEUTRON ACER TENDL-2023 LIBRARY; T=0.K  
Inelastic levels

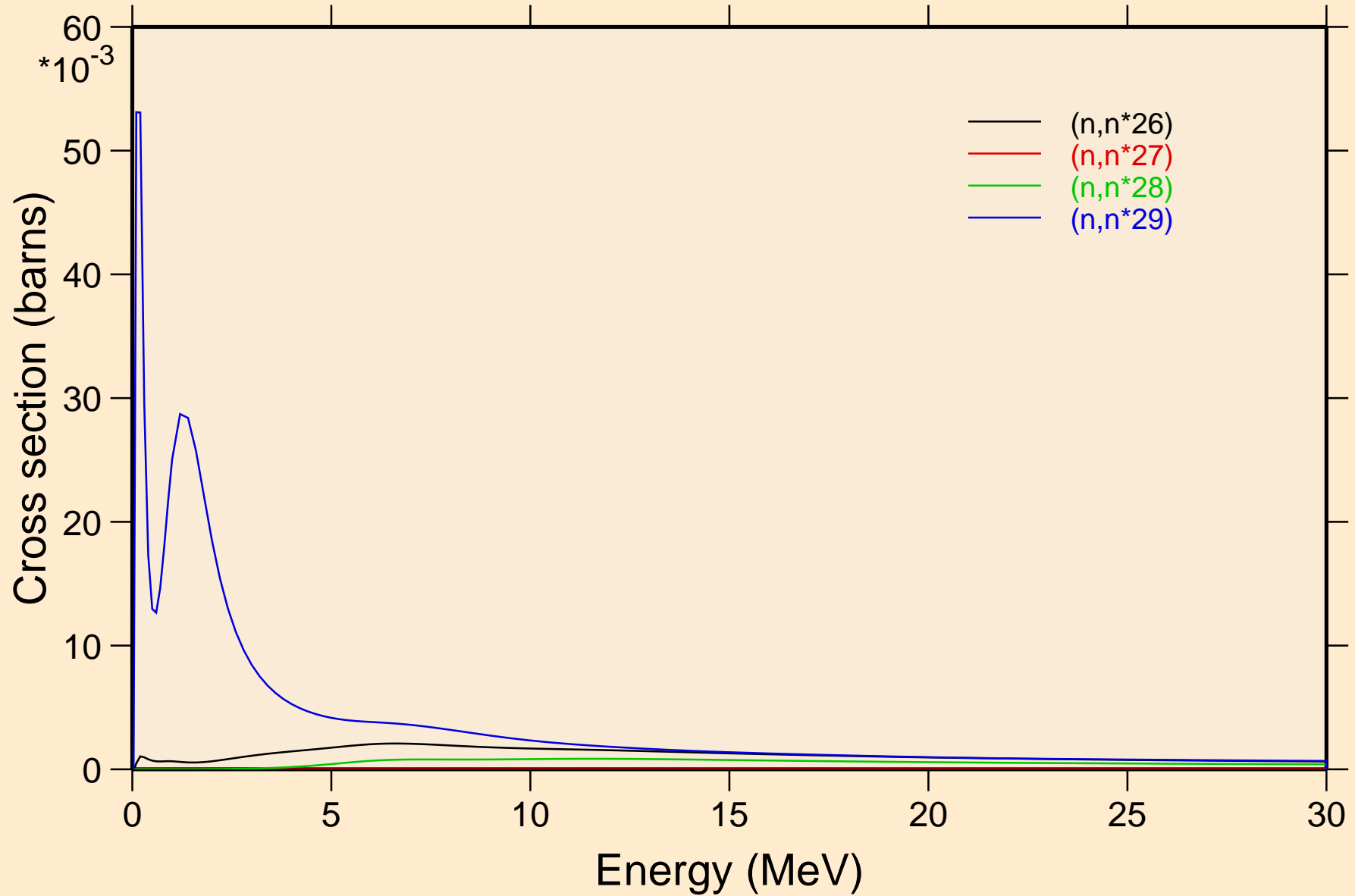

BK252 NEUTRON ACER TENDL-2023 LIBRARY; T=0.K  
Threshold reactions

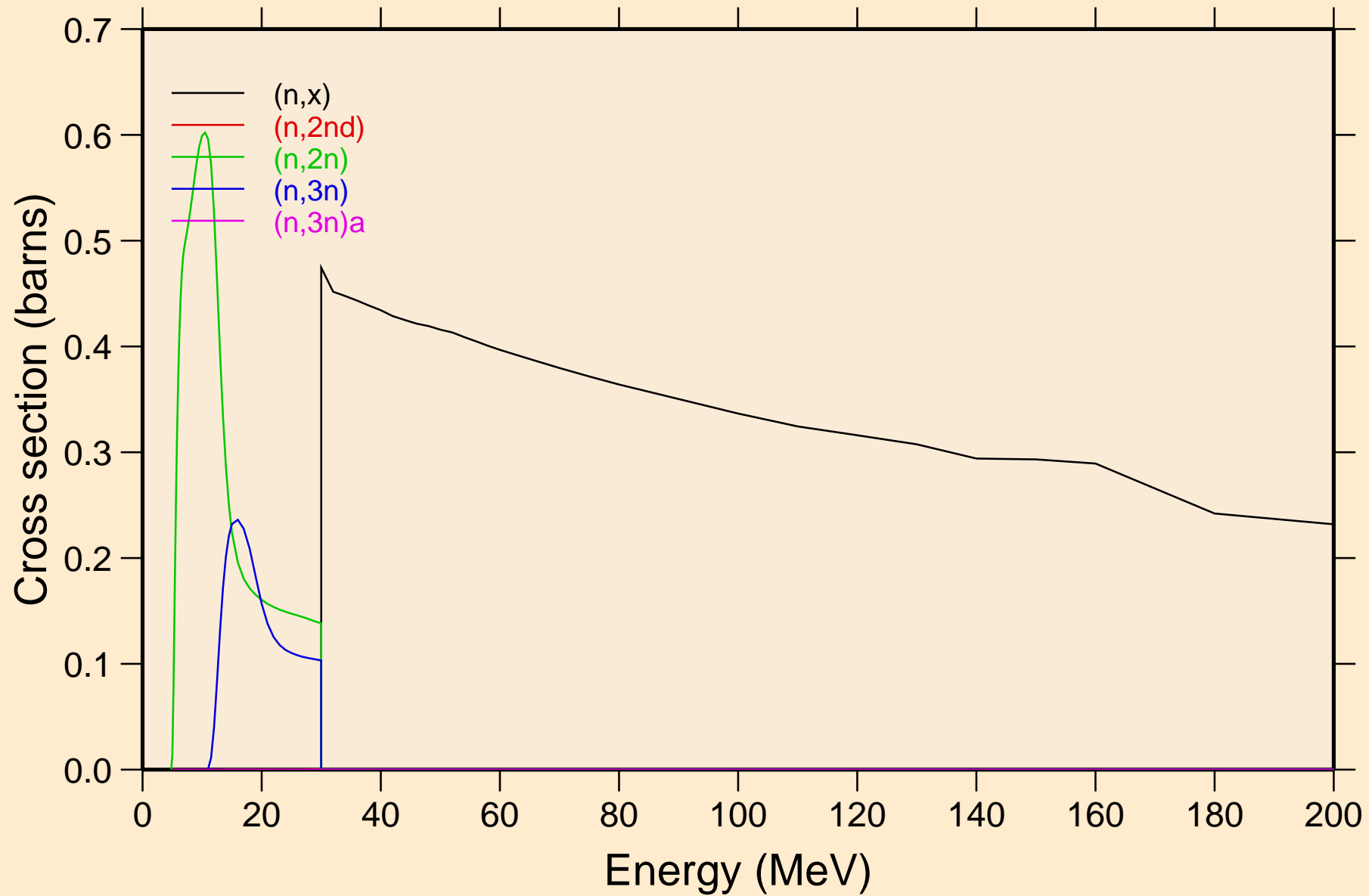

BK252 NEUTRON ACER TENDL-2023 LIBRARY; T=0.K  
Threshold reactions

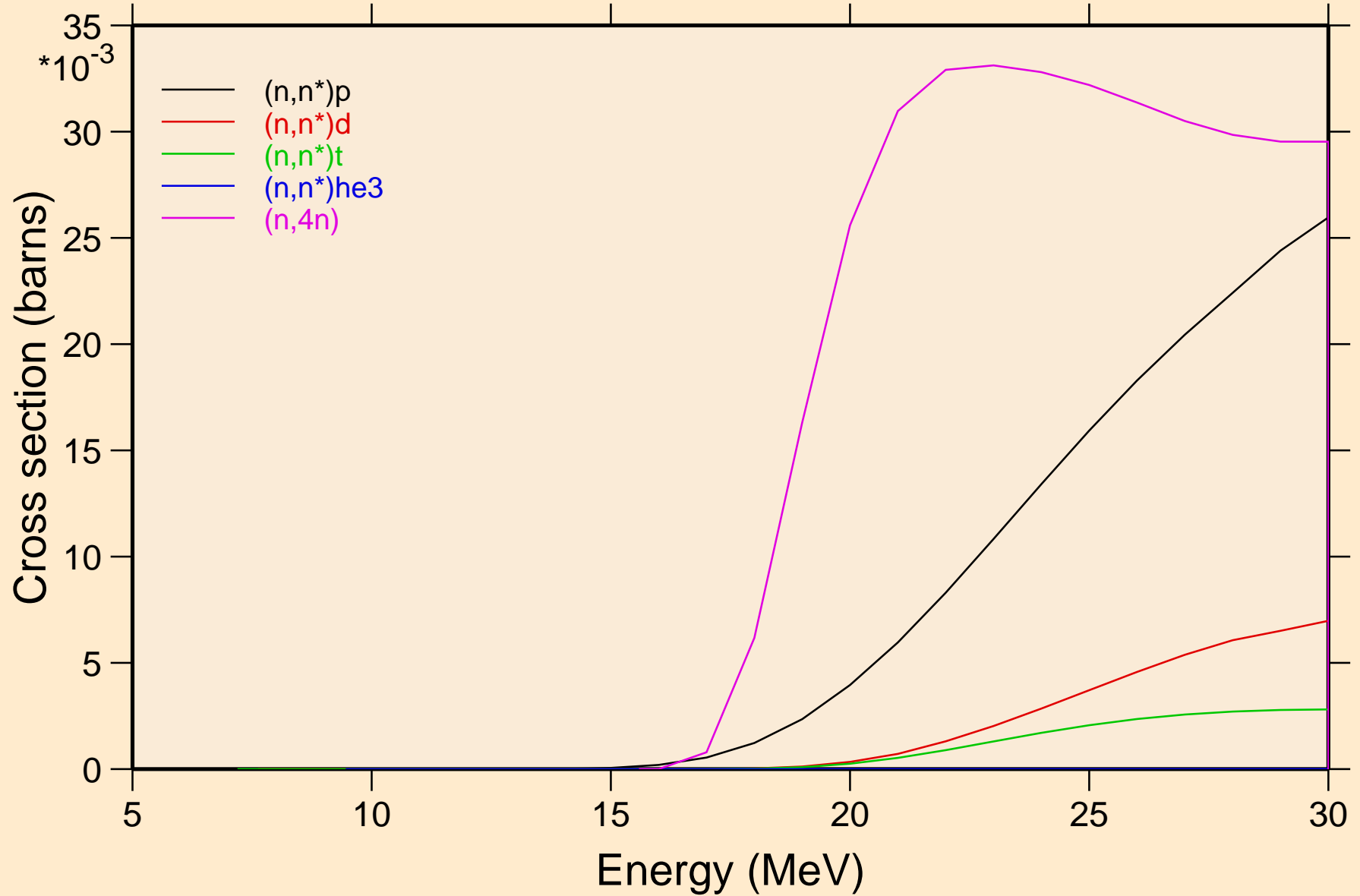

BK252 NEUTRON ACER TENDL-2023 LIBRARY; T=0.K  
Threshold reactions

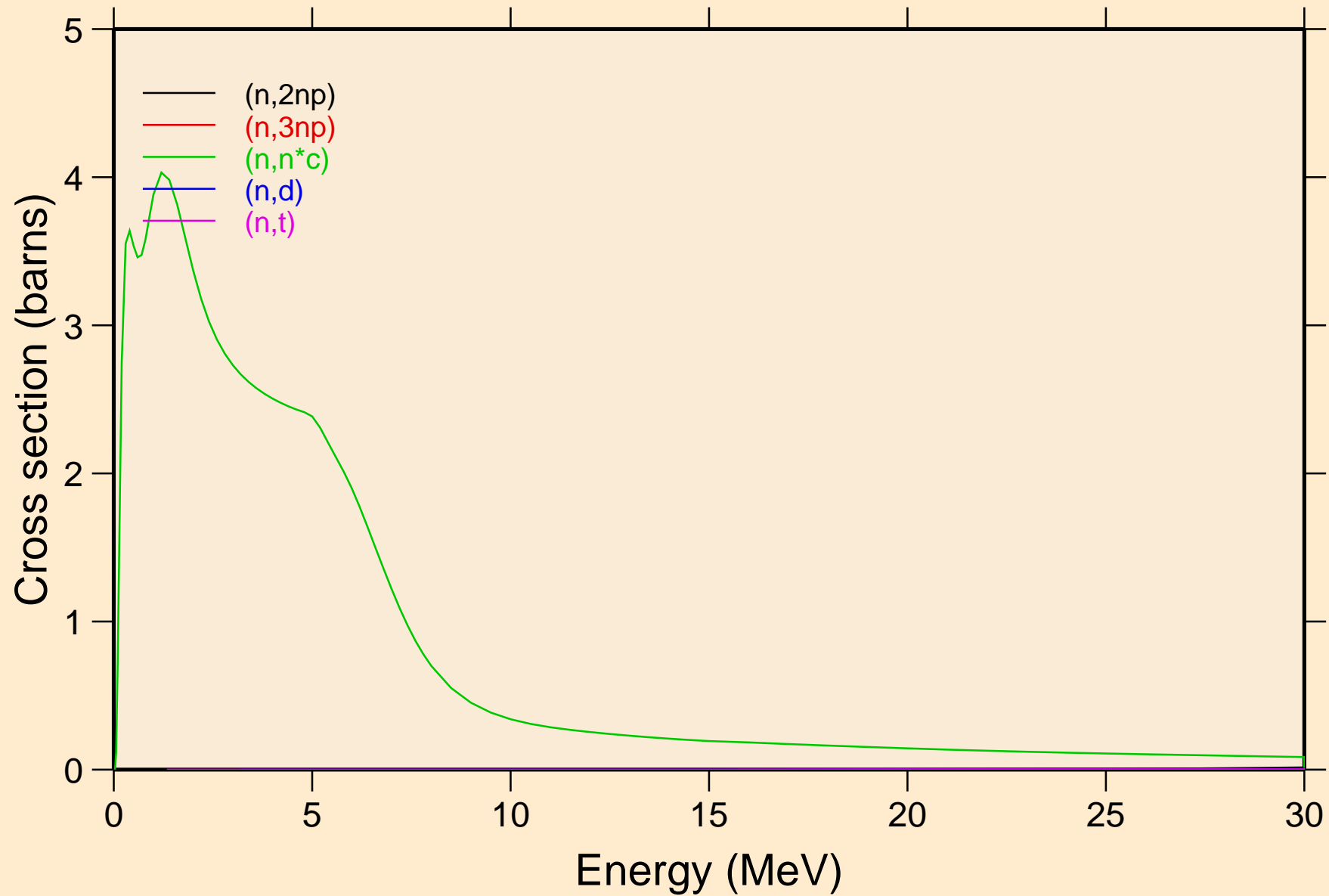

BK252 NEUTRON ACER TENDL-2023 LIBRARY; T=0.K  
Threshold reactions

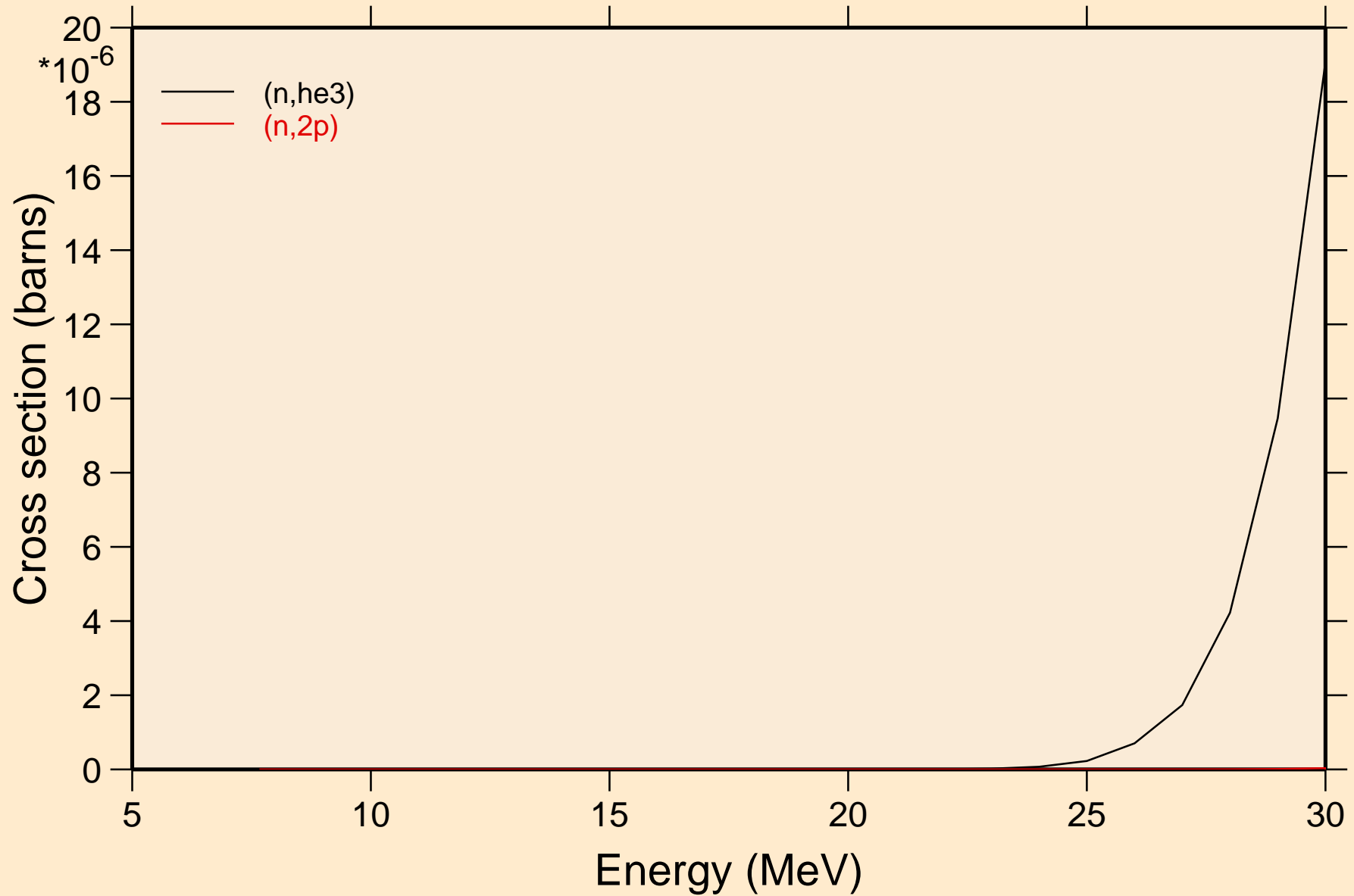

BK252 NEUTRON ACER TENDL-2023 LIBRARY; T=0.K  
Threshold reactions

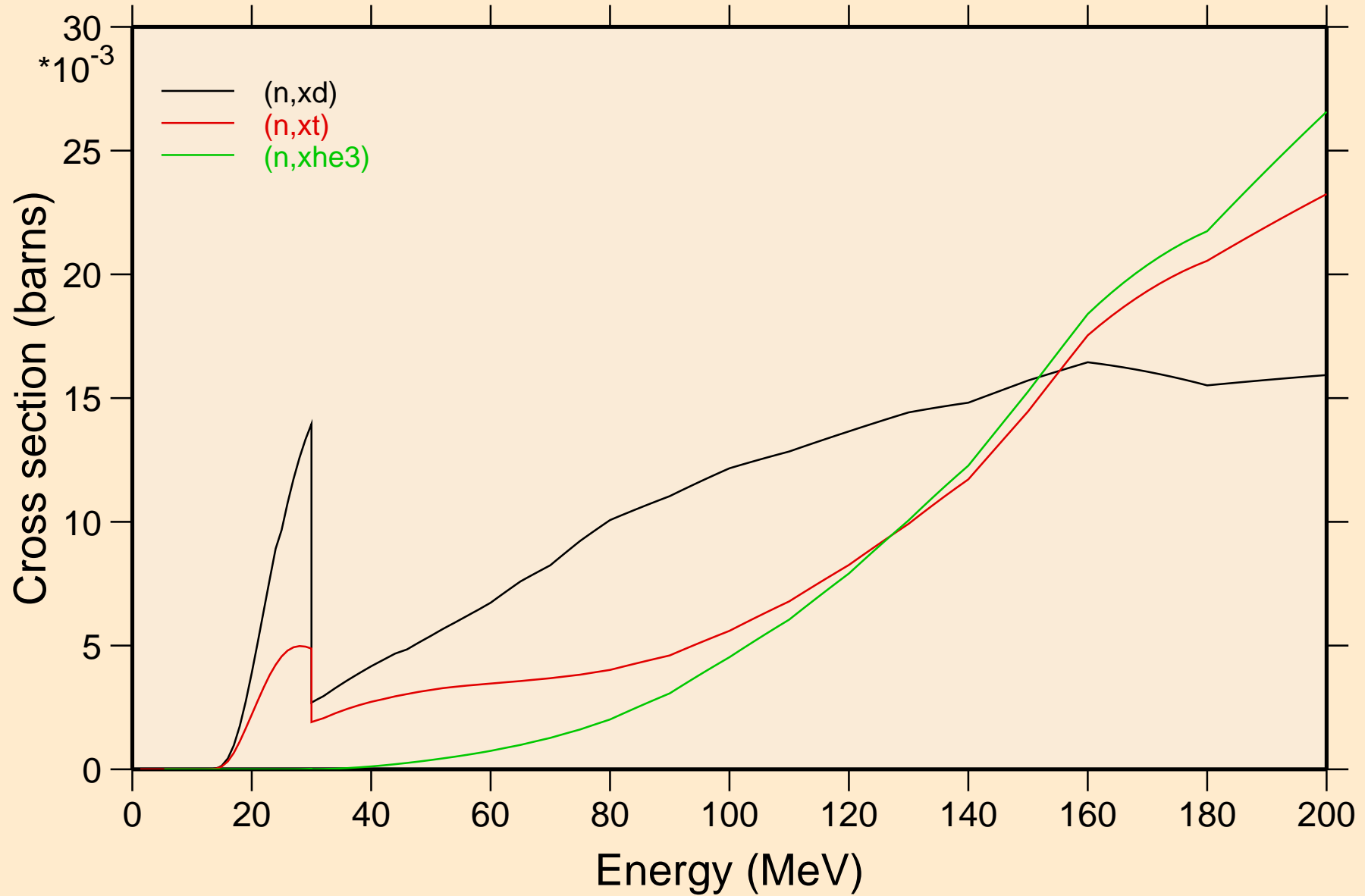

BK252 NEUTRON ACER TENDL-2023 LIBRARY; T=0.K  
angular distribution for elastic

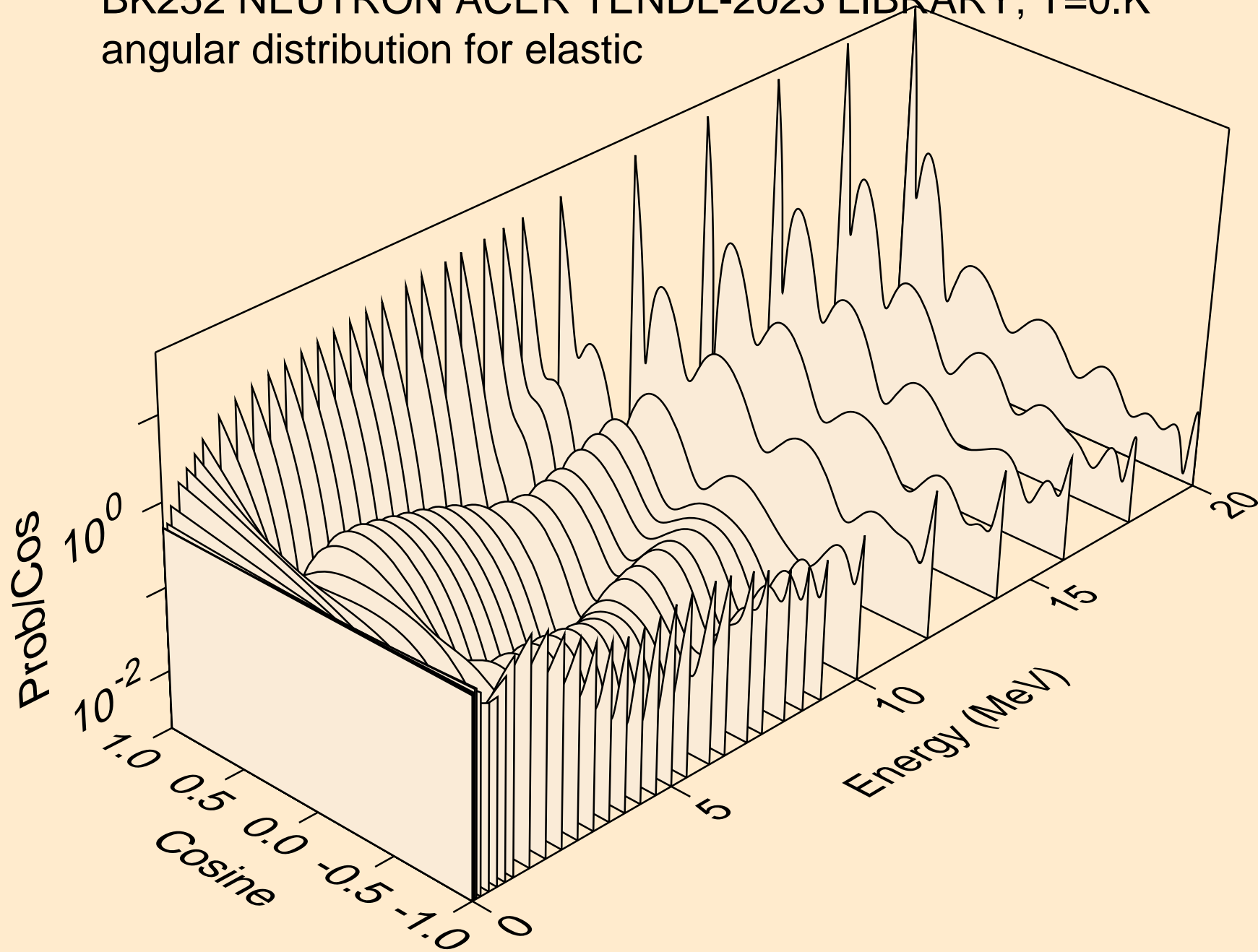

BK252 NEUTRON ACER TENDL-2023 LIBRARY; T=0.K  
angular distribution for elastic

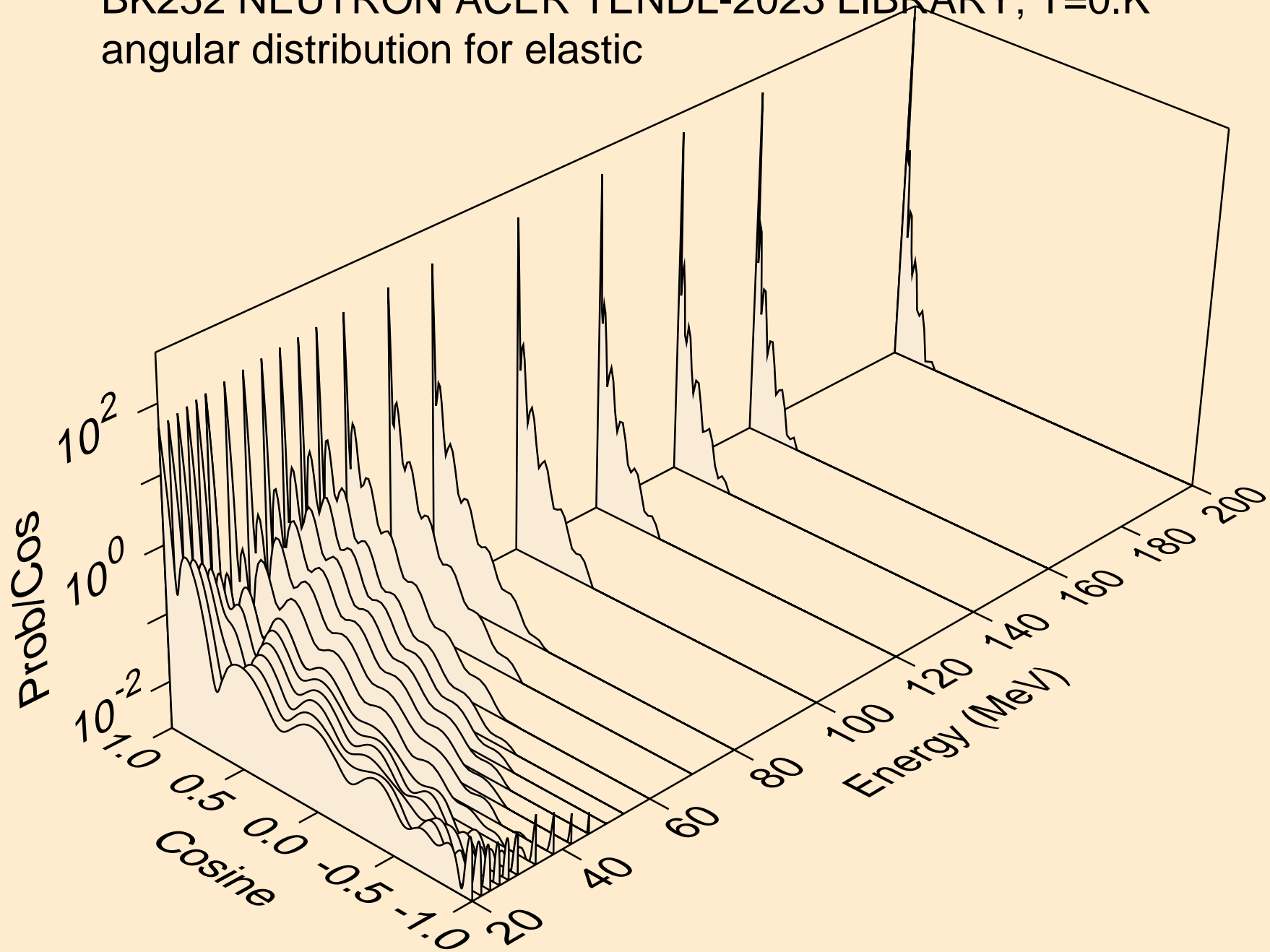

BK252 NEUTRON ACER TENDL-2023 LIBRARY; T=0.K  
angular distribution for (n,n\*1)

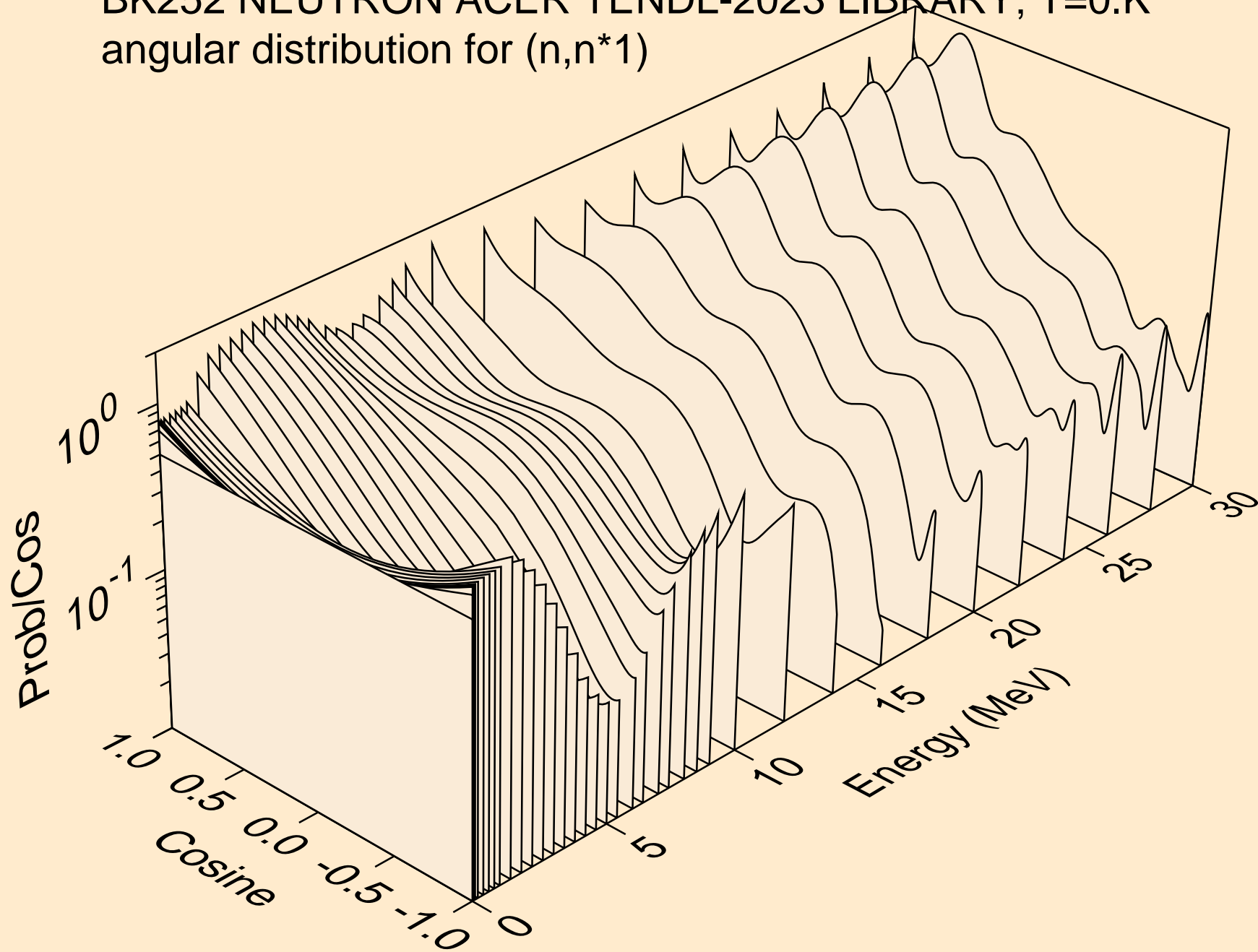

BK252 NEUTRON ACER TENDL-2023 LIBRARY; T=0.K  
angular distribution for (n,n\*2)

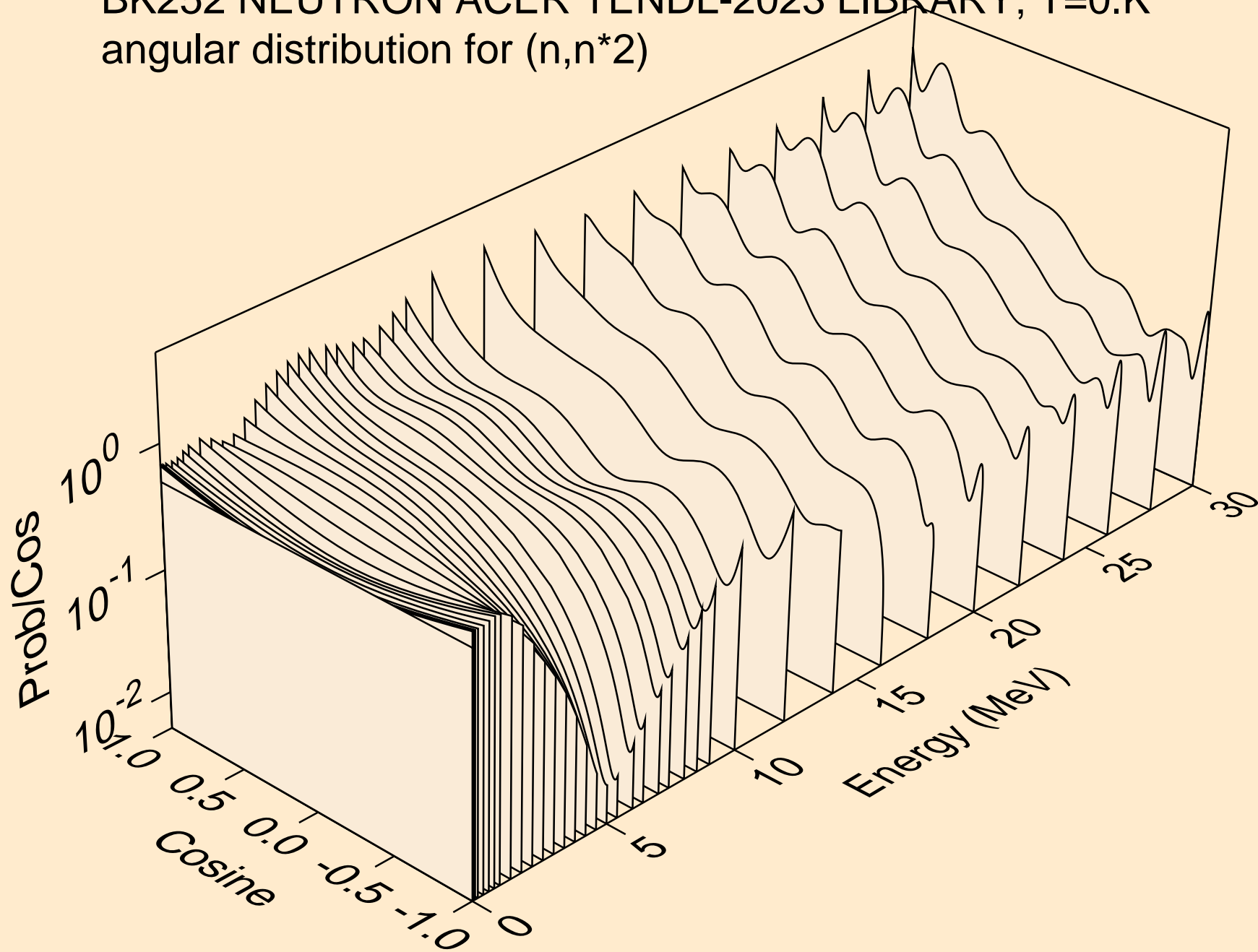

BK252 NEUTRON ACER TENDL-2023 LIBRARY; T=0.K  
angular distribution for (n,n\*3)

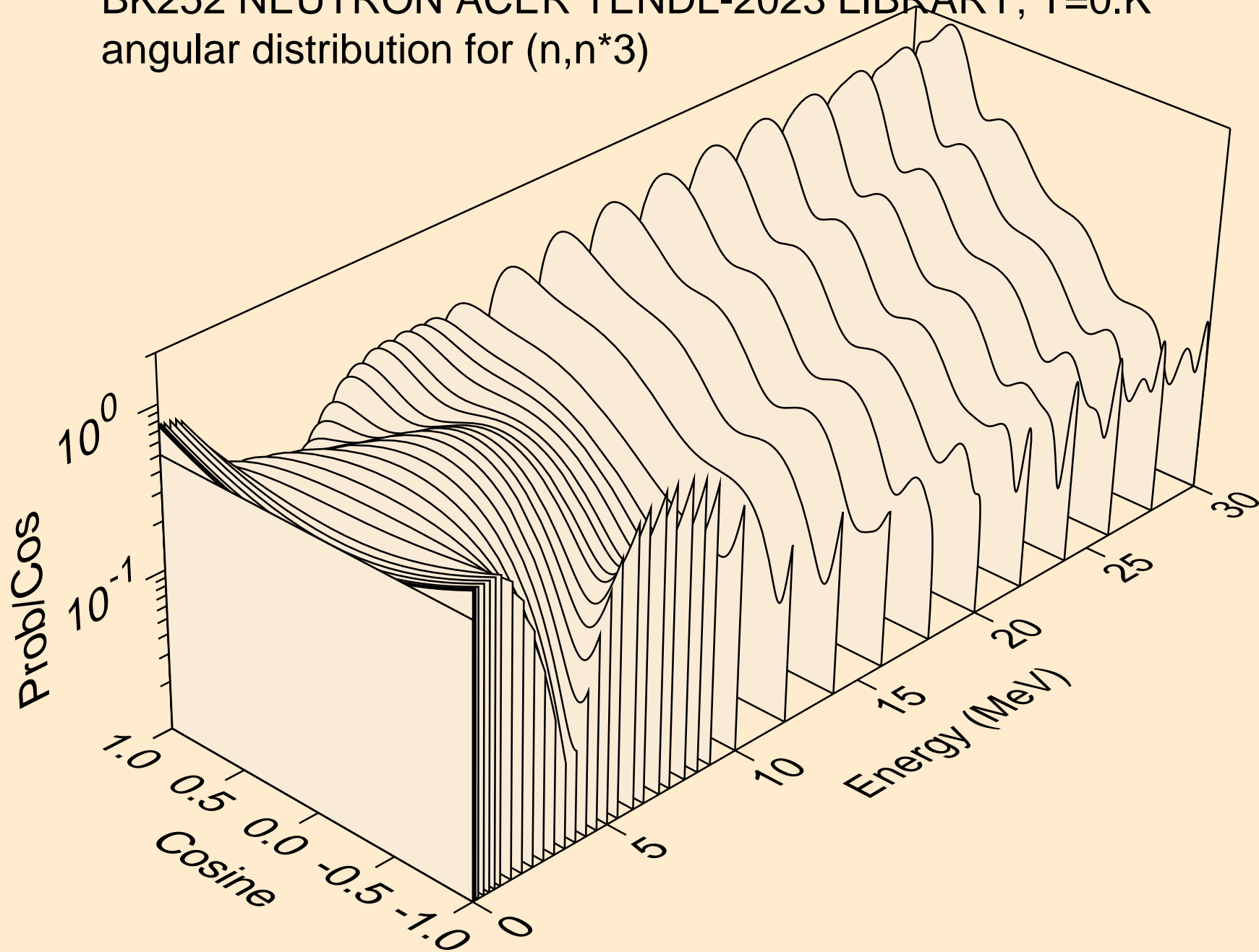

BK252 NEUTRON ACER TENDL-2023 LIBRARY; T=0.K  
angular distribution for (n,n\*4)

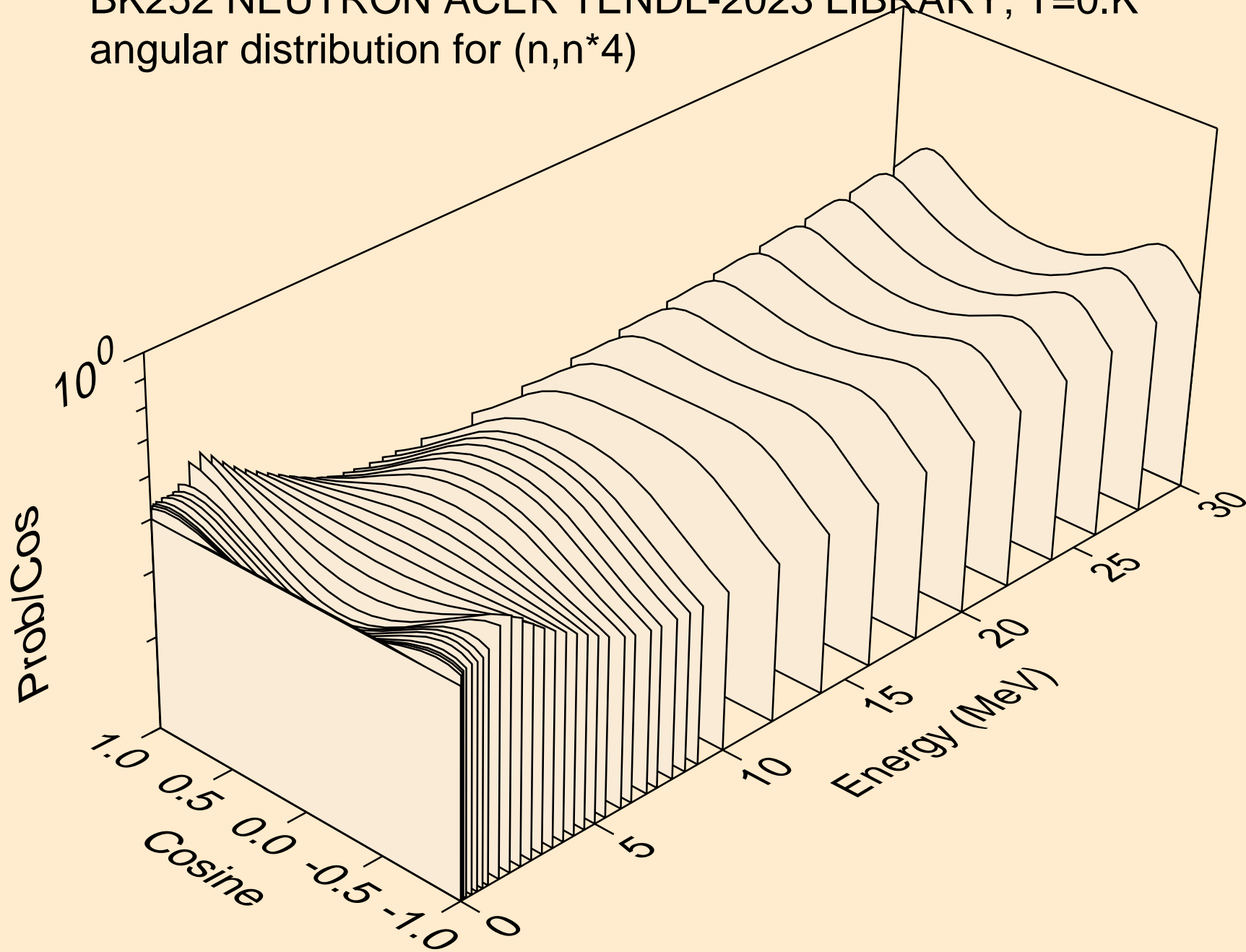

BK252 NEUTRON ACER TENDL-2023 LIBRARY; T=0.K  
angular distribution for (n,n\*5)

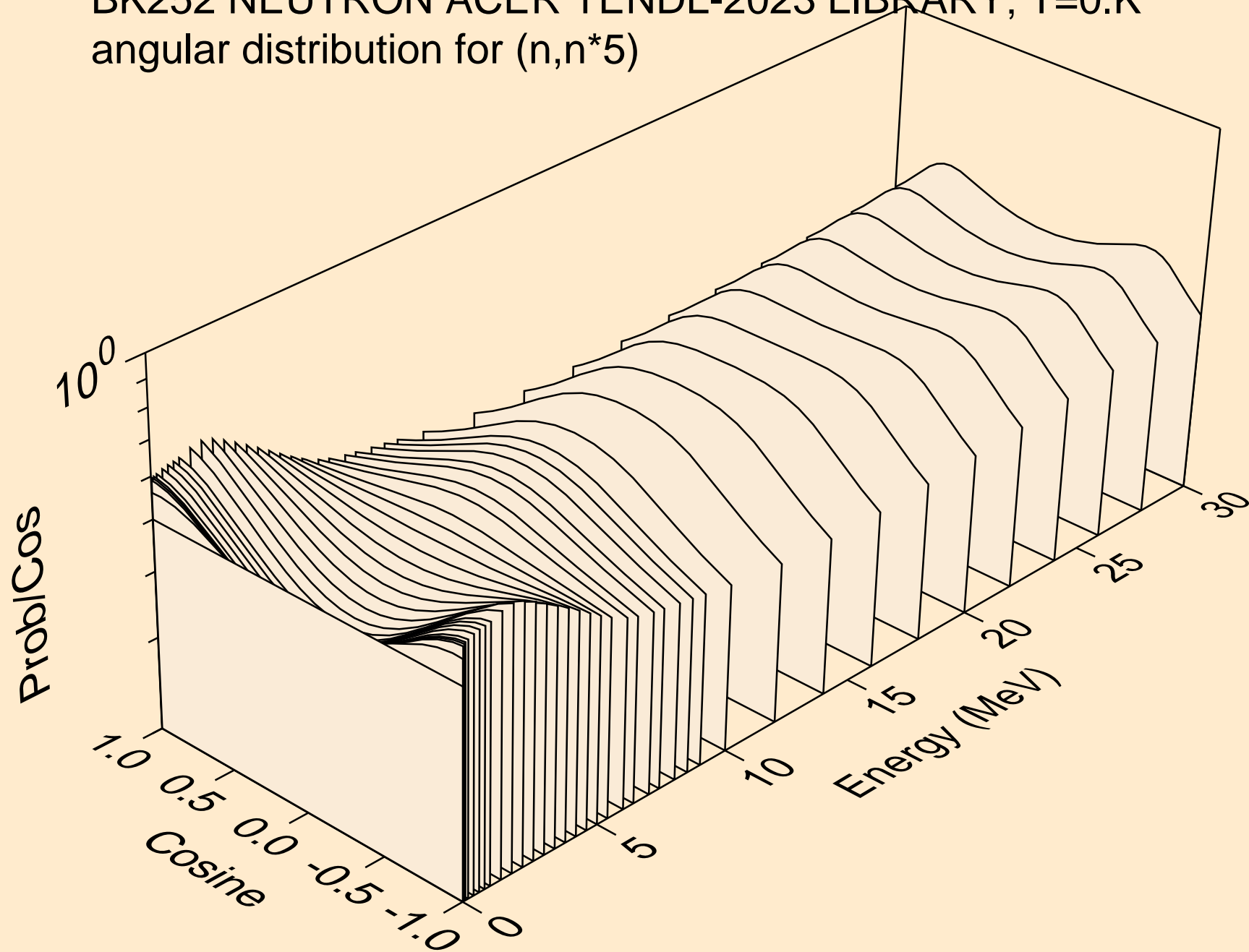

BK252 NEUTRON ACER TENDL-2023 LIBRARY; T=0.K  
angular distribution for (n,n\*6)

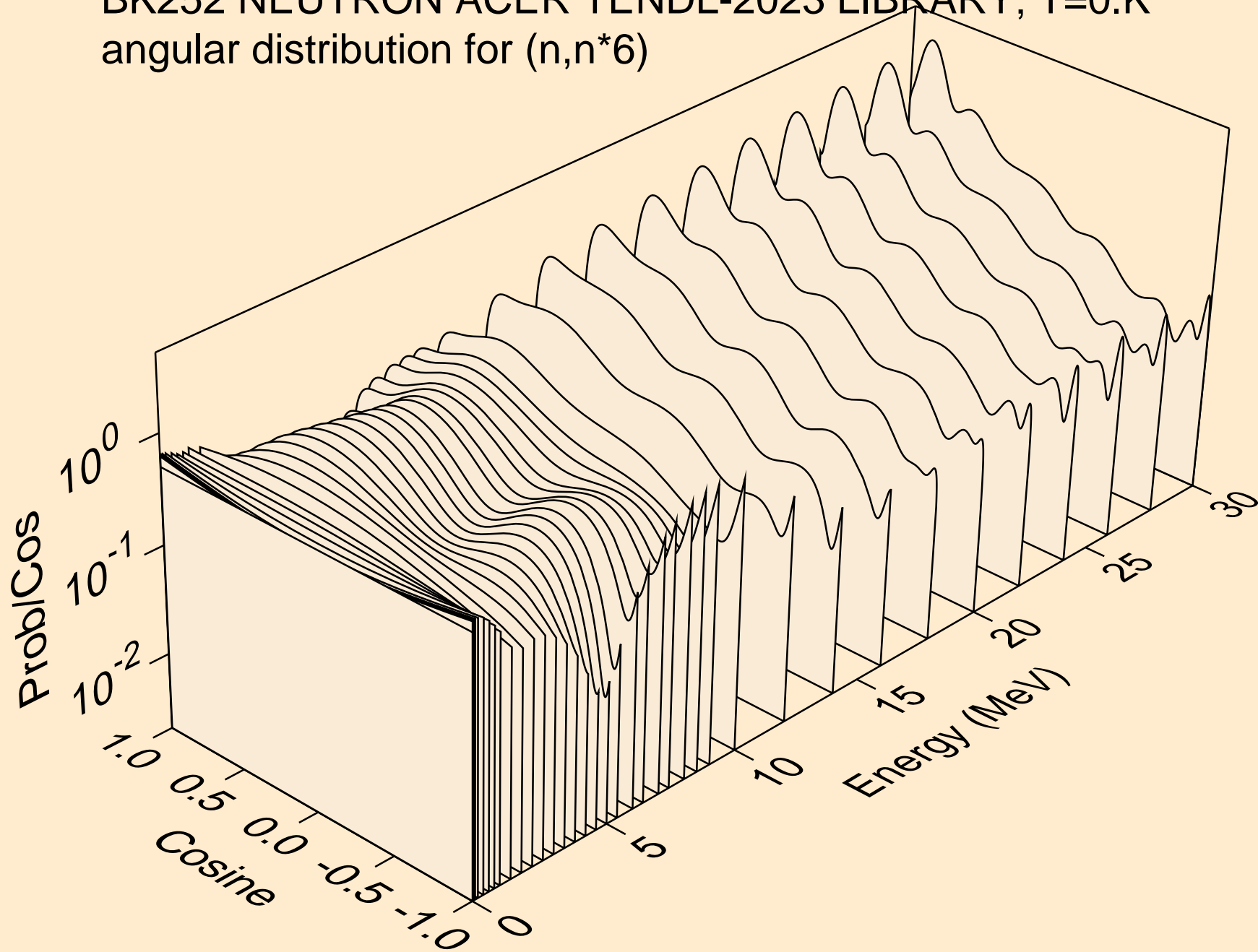

BK252 NEUTRON ACER TENDL-2023 LIBRARY; T=0.K  
angular distribution for (n,n\*7)

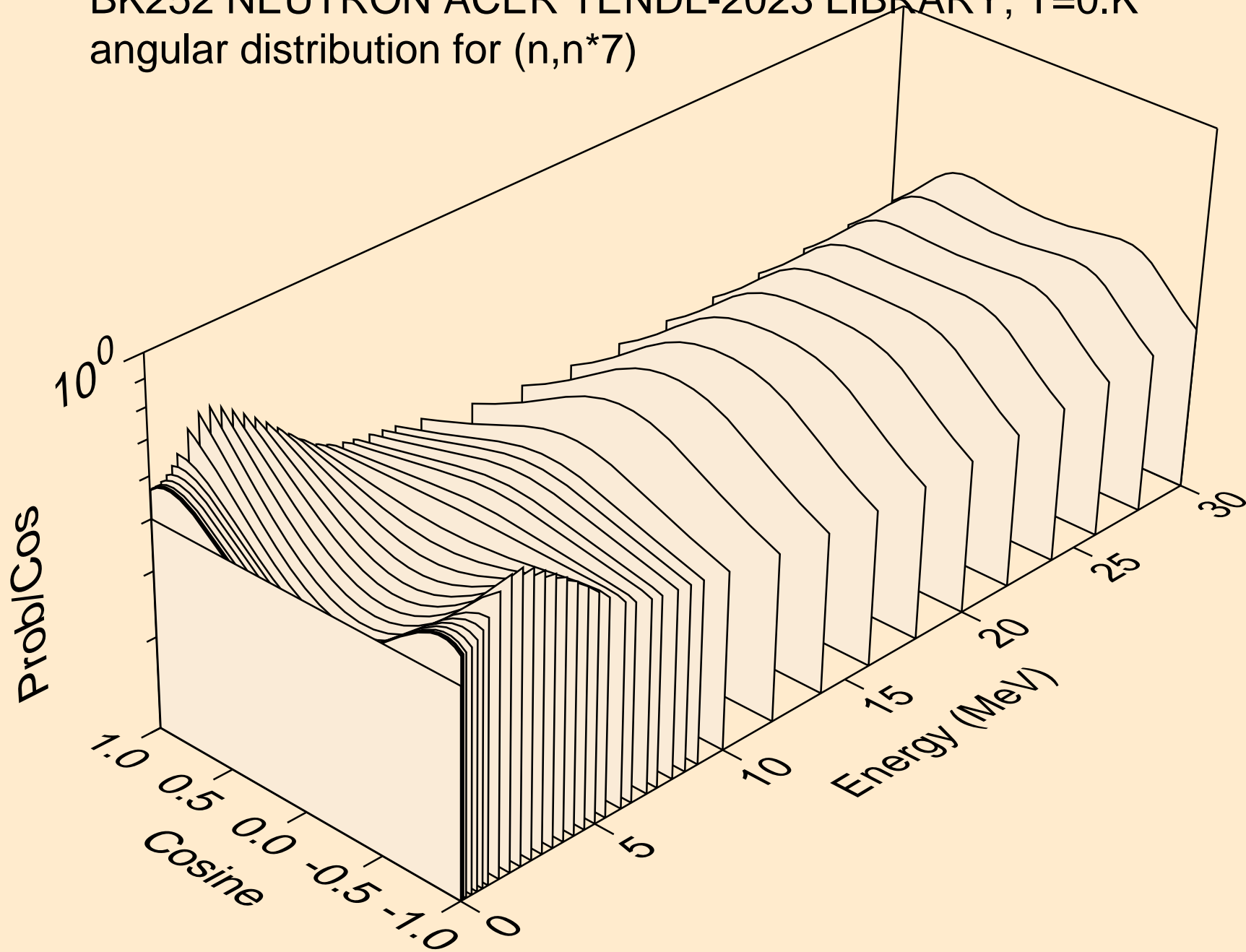

BK252 NEUTRON ACER TENDL-2023 LIBRARY; T=0.K  
angular distribution for (n,n\*8)

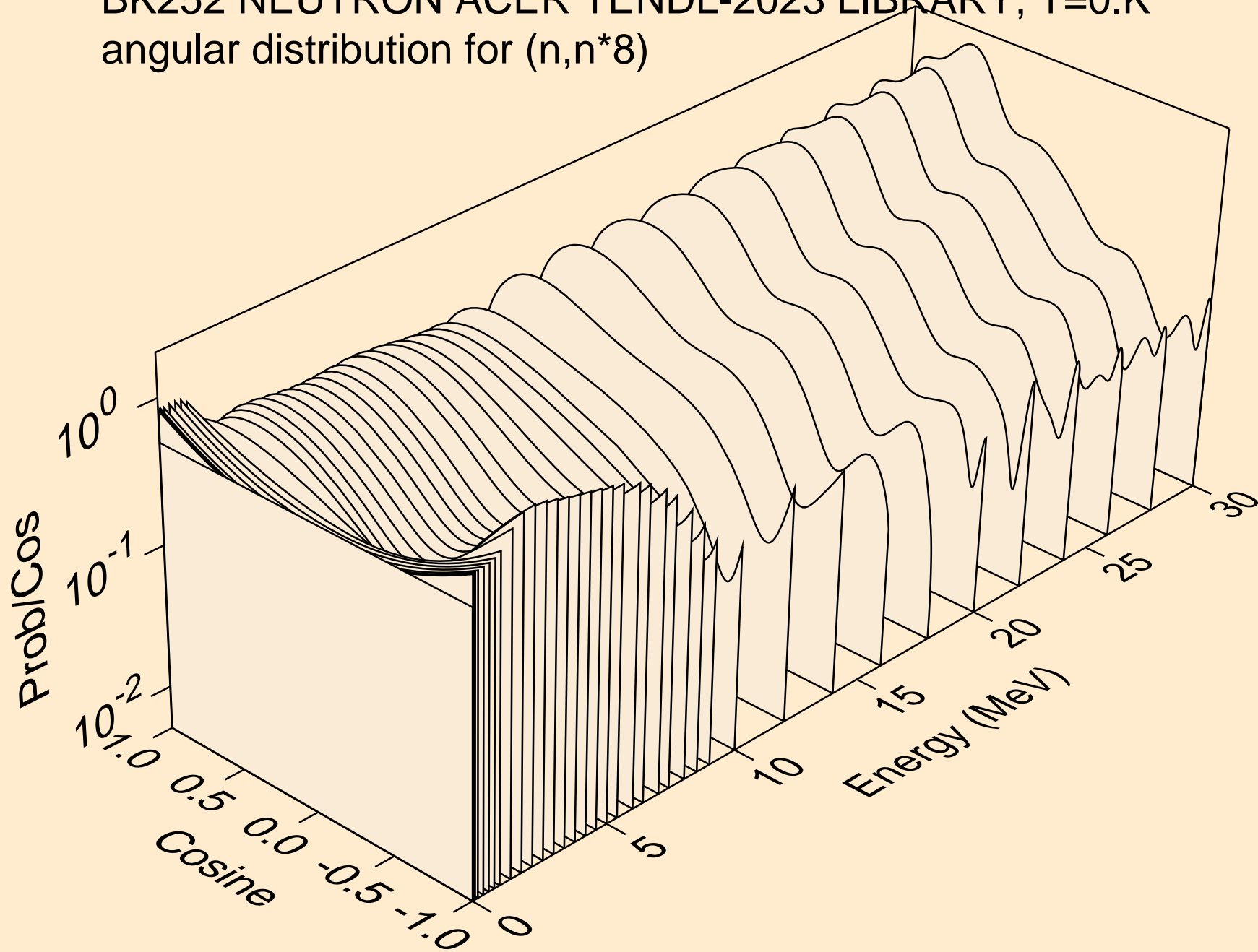

BK252 NEUTRON ACER TENDL-2023 LIBRARY; T=0.K  
angular distribution for (n,n\*9)

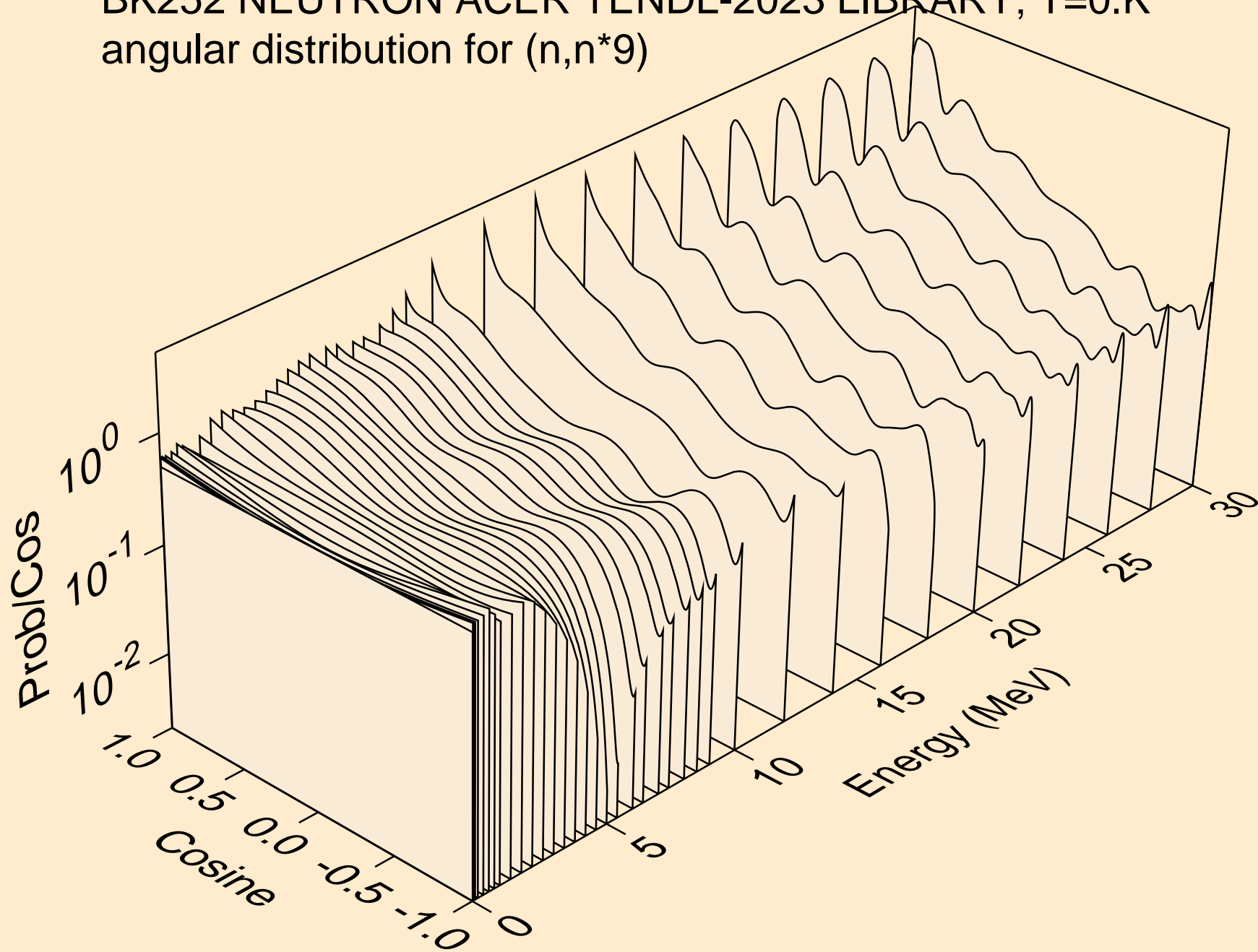

BK252 NEUTRON ACER TENDL-2023 LIBRARY; T=0.K  
angular distribution for (n,n\*10)

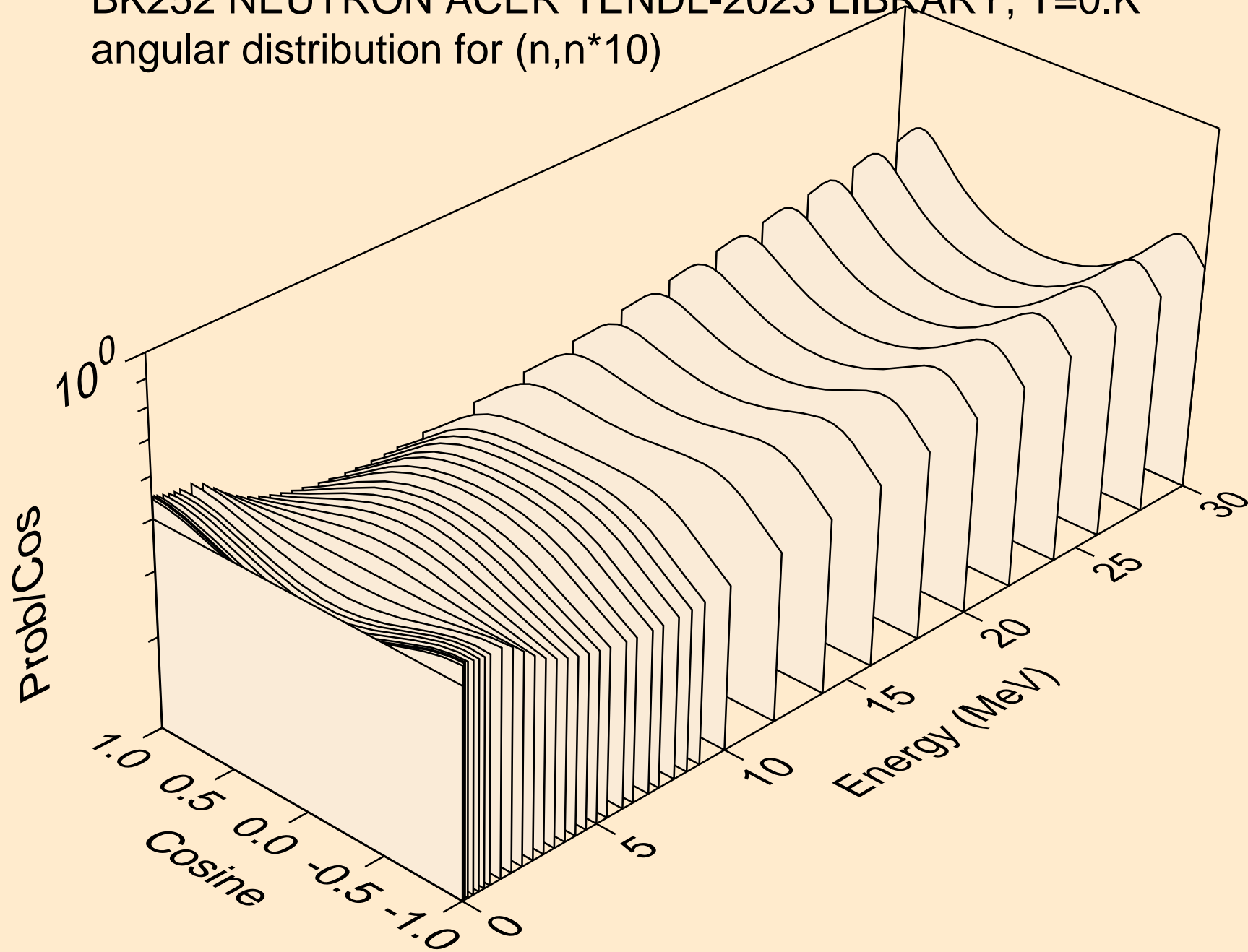

BK252 NEUTRON ACER TENDL-2023 LIBRARY; T=0.K  
angular distribution for (n,n\*11)

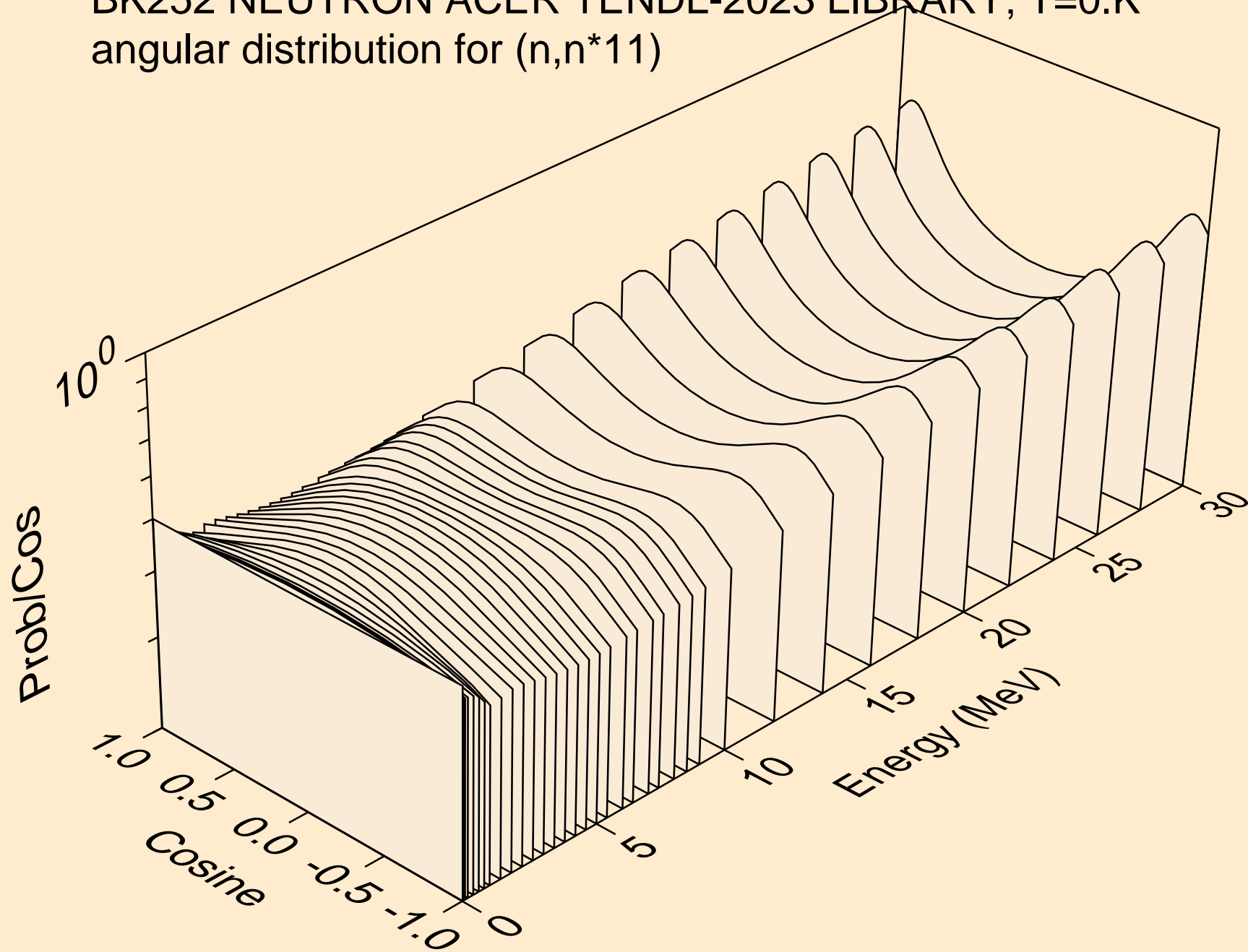

BK252 NEUTRON ACER TENDL-2023 LIBRARY; T=0.K  
angular distribution for (n,n\*12)

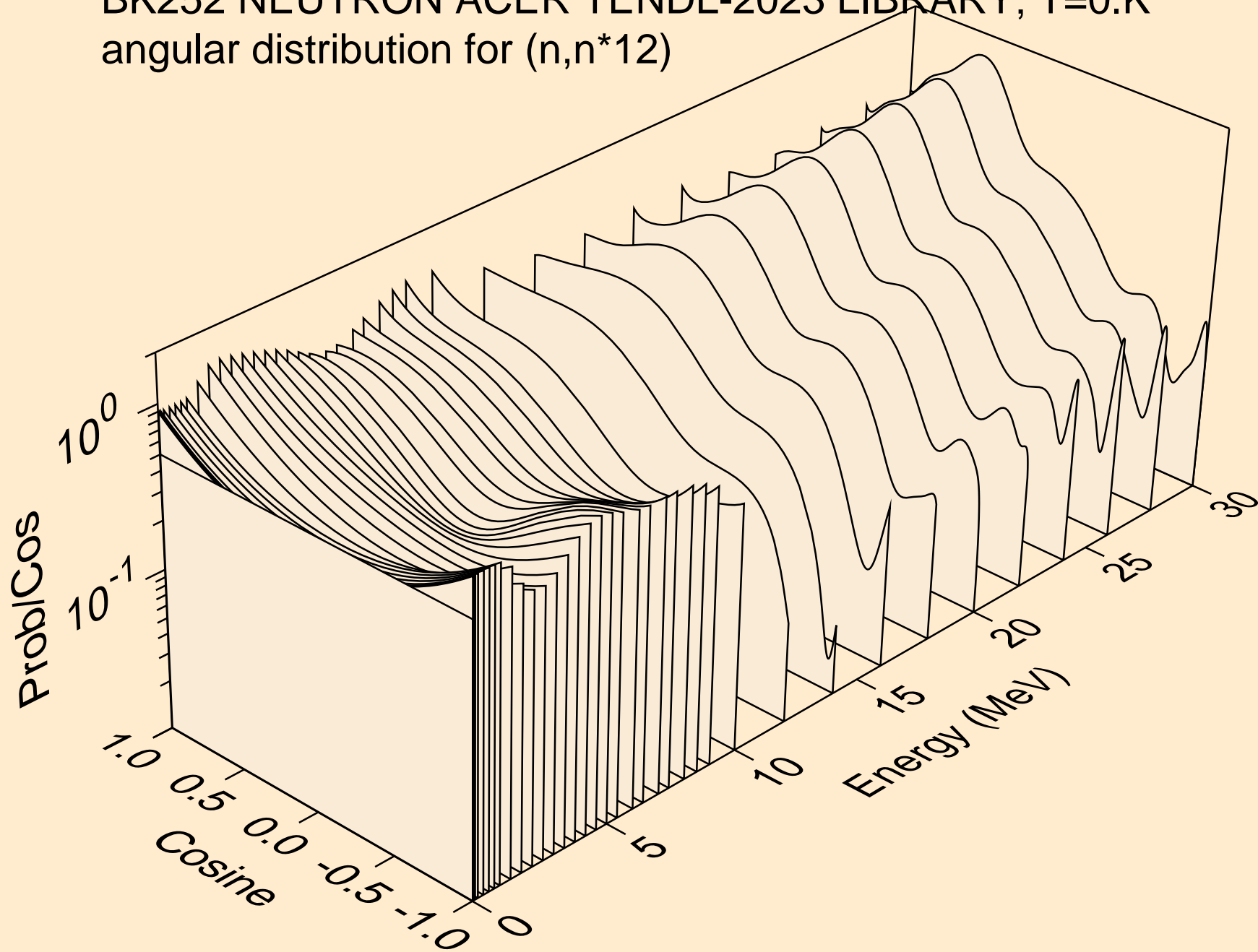

BK252 NEUTRON ACER TENDL-2023 LIBRARY; T=0.K  
angular distribution for (n,n\*13)

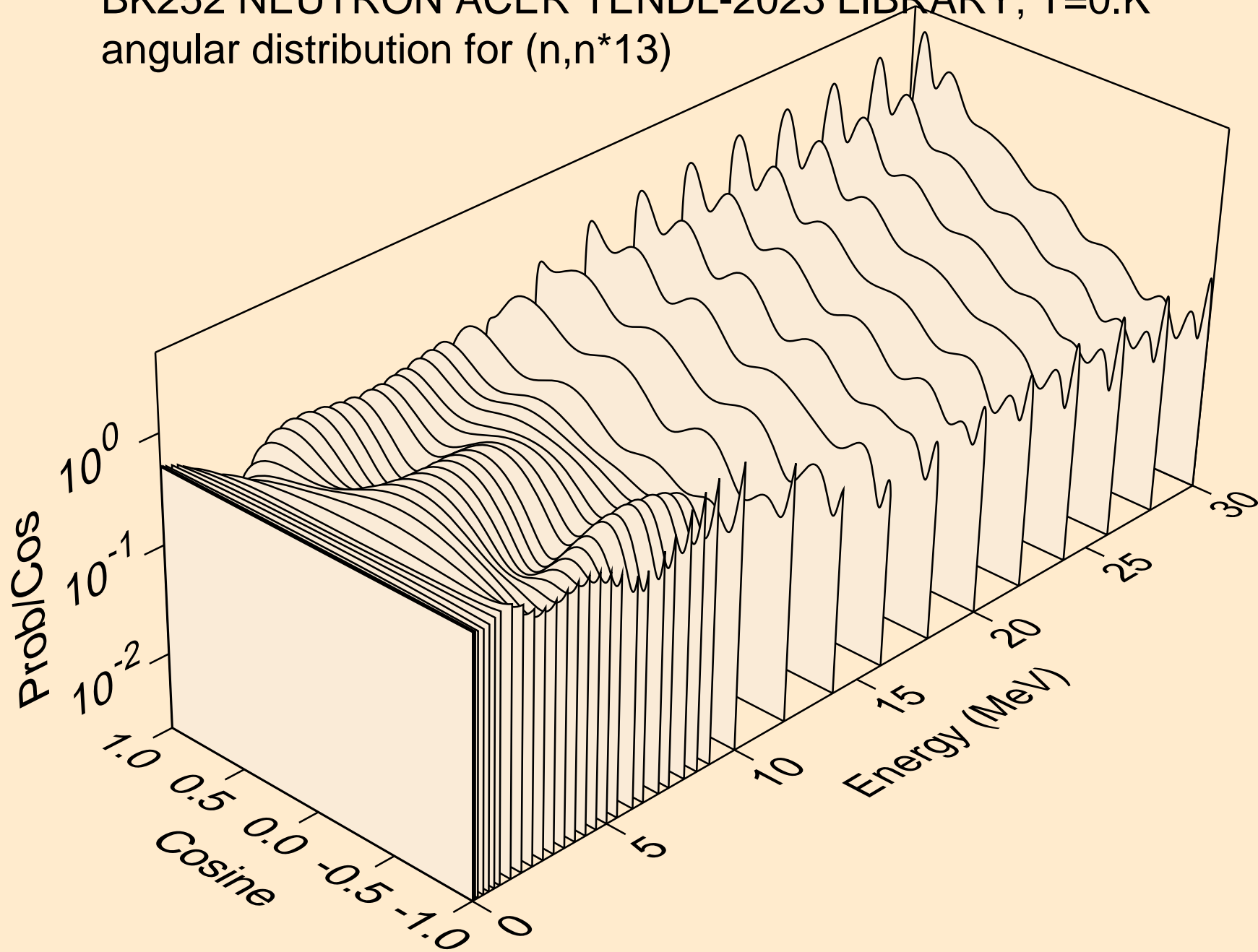

BK252 NEUTRON ACER TENDL-2023 LIBRARY; T=0.K  
angular distribution for (n,n\*14)

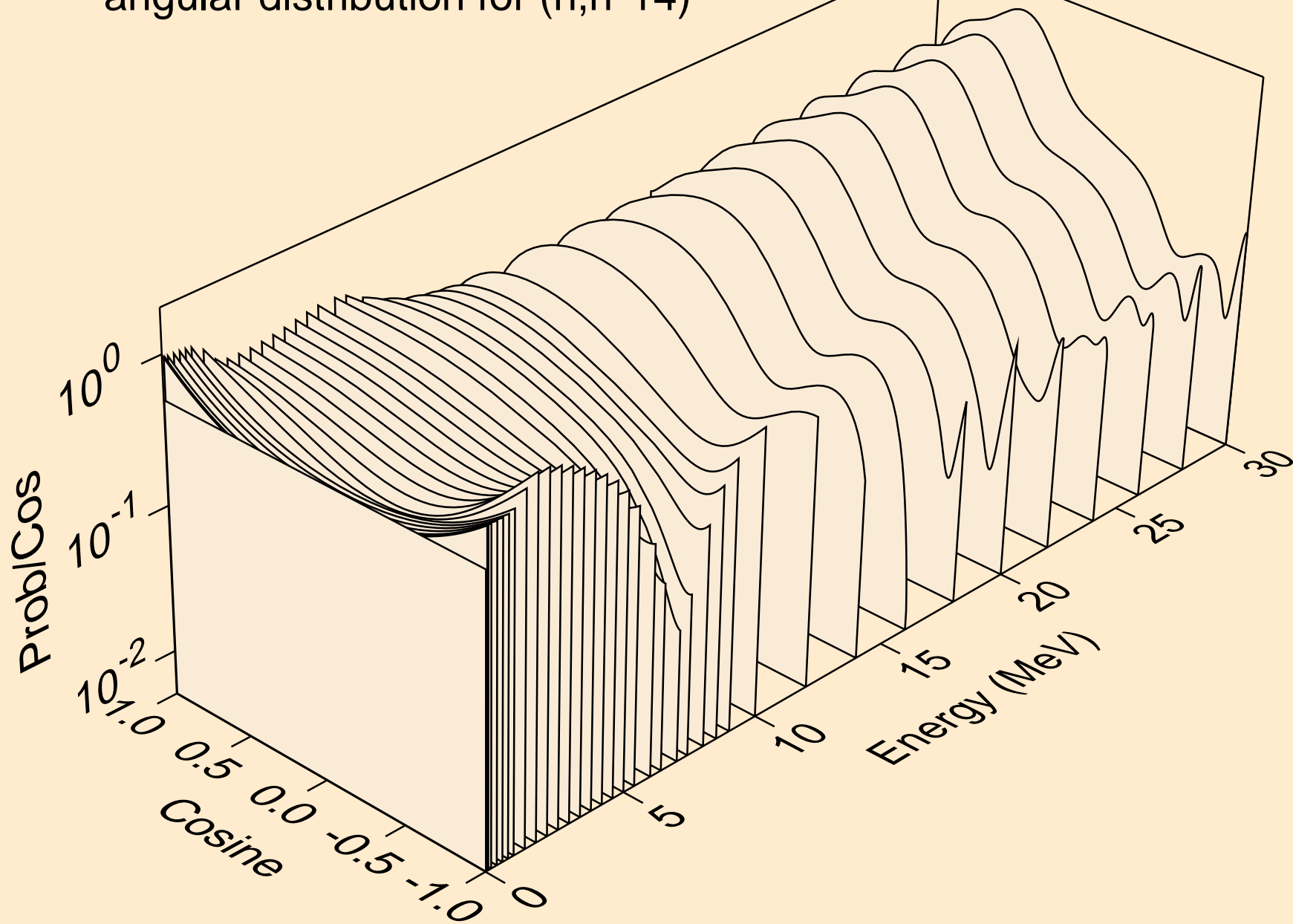

BK252 NEUTRON ACER TENDL-2023 LIBRARY; T=0.K  
angular distribution for (n,n\*15)

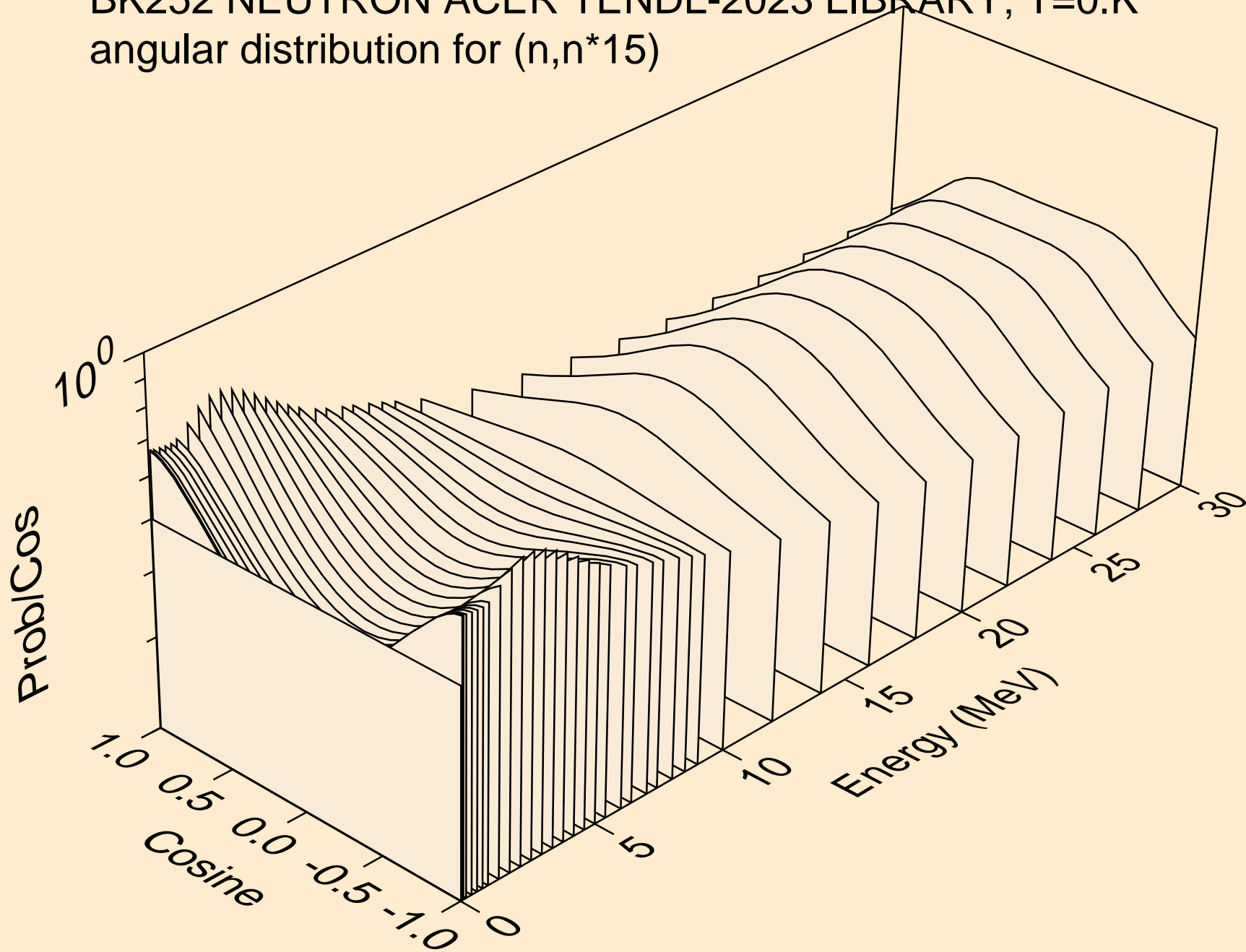

BK252 NEUTRON ACER TENDL-2023 LIBRARY; T=0.K  
angular distribution for (n,n\*16)

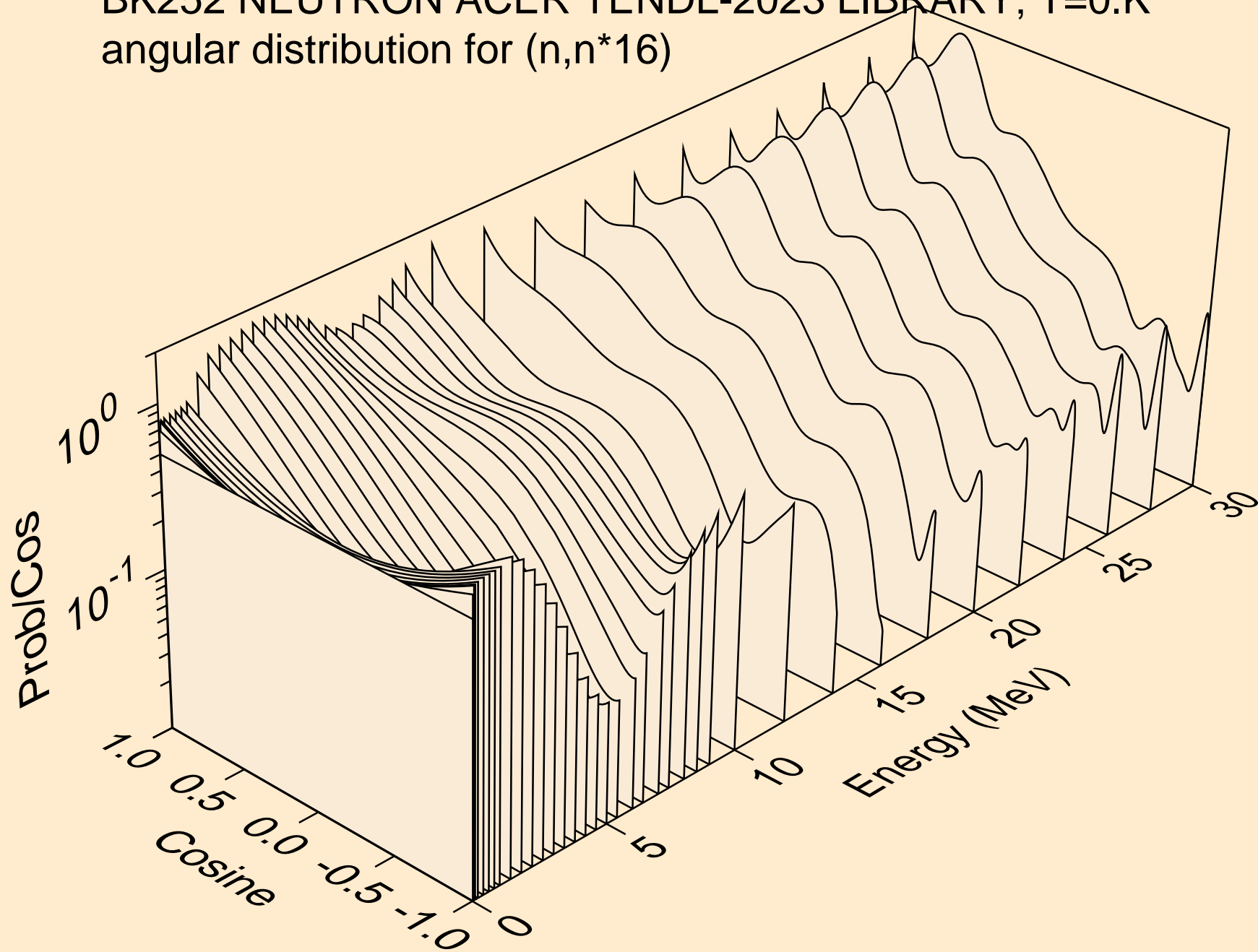

BK252 NEUTRON ACER TENDL-2023 LIBRARY; T=0.K  
angular distribution for (n,n\*17)

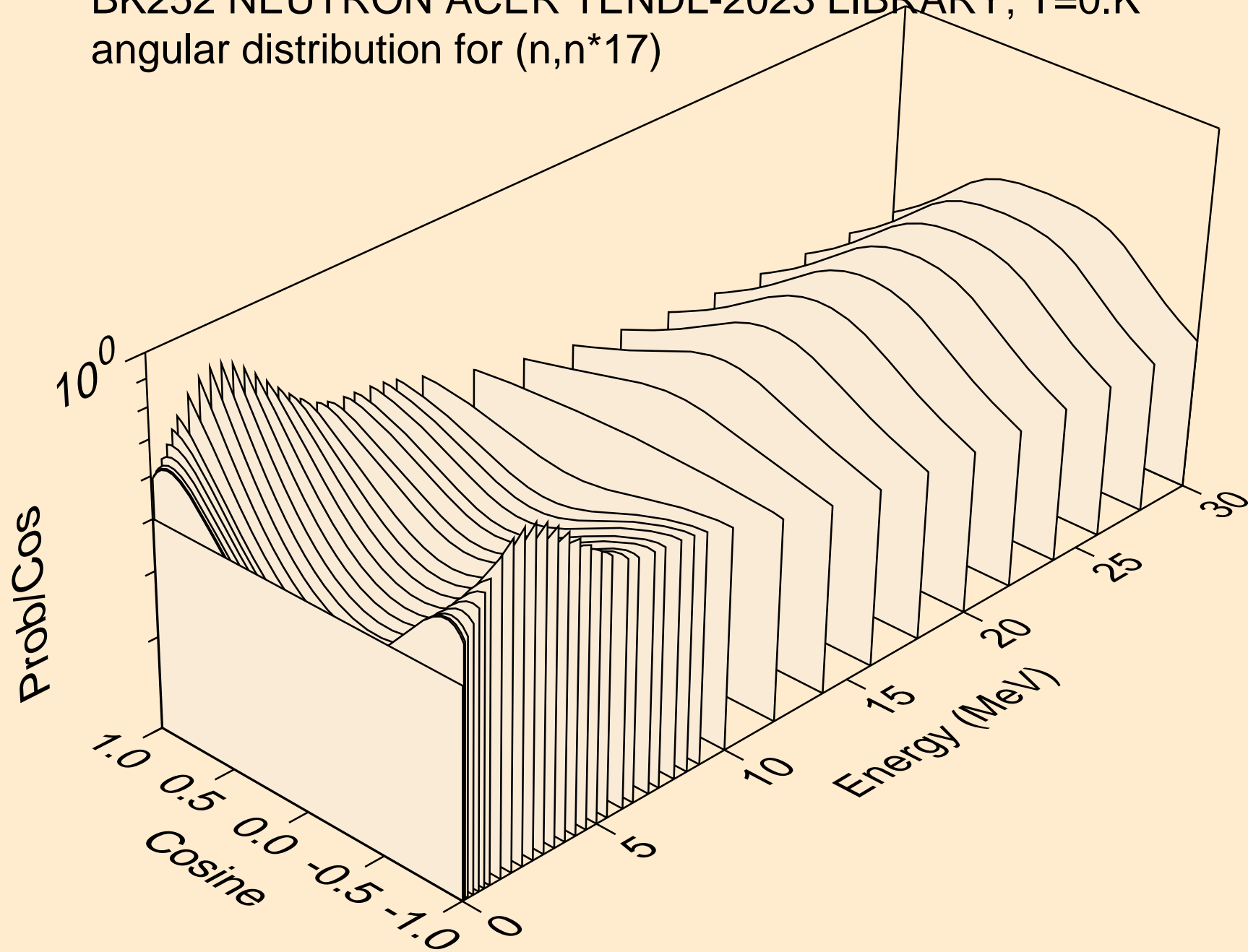

BK252 NEUTRON ACER TENDL-2023 LIBRARY; T=0.K  
angular distribution for (n,n\*18)

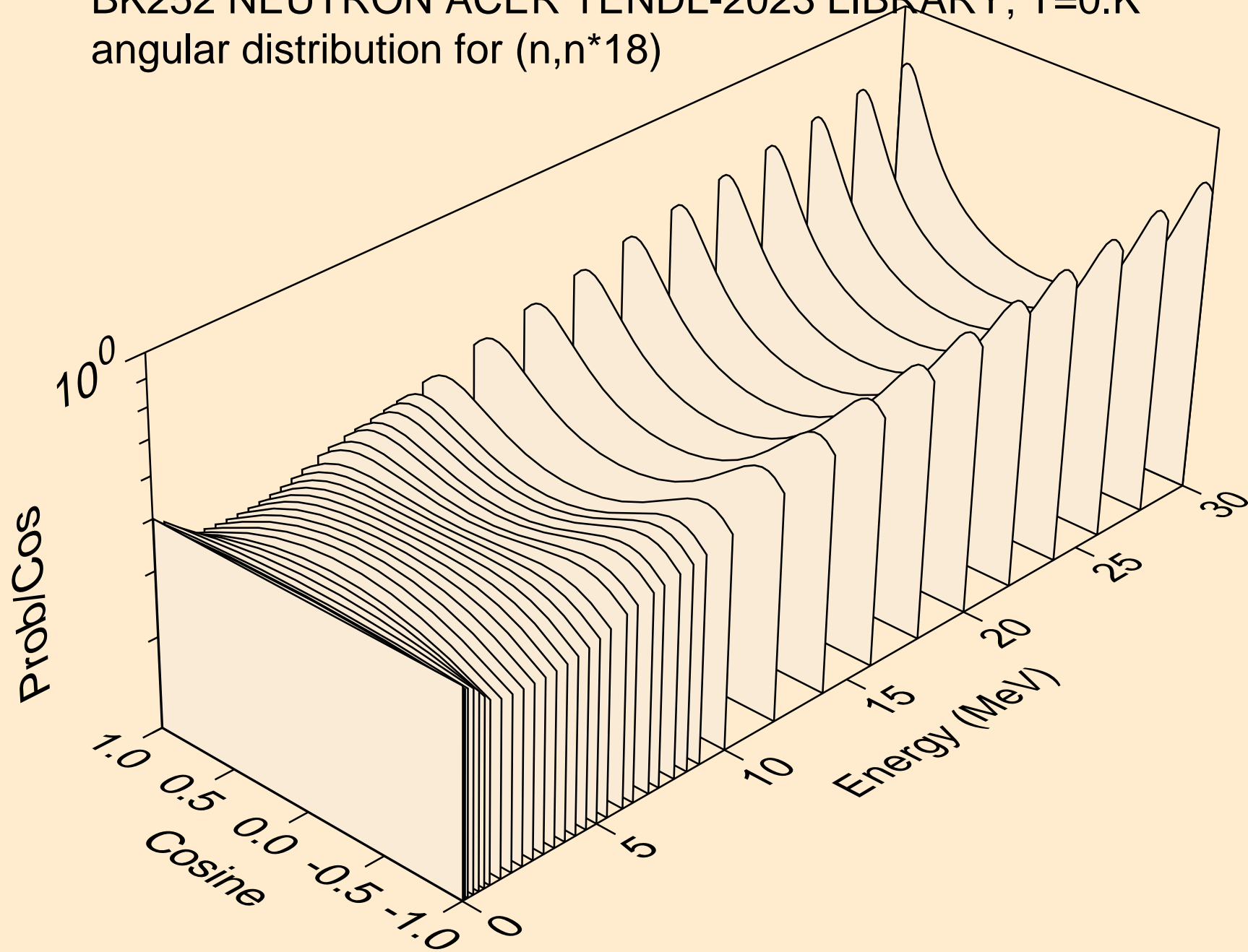

BK252 NEUTRON ACER TENDL-2023 LIBRARY; T=0.K  
angular distribution for (n,n\*19)

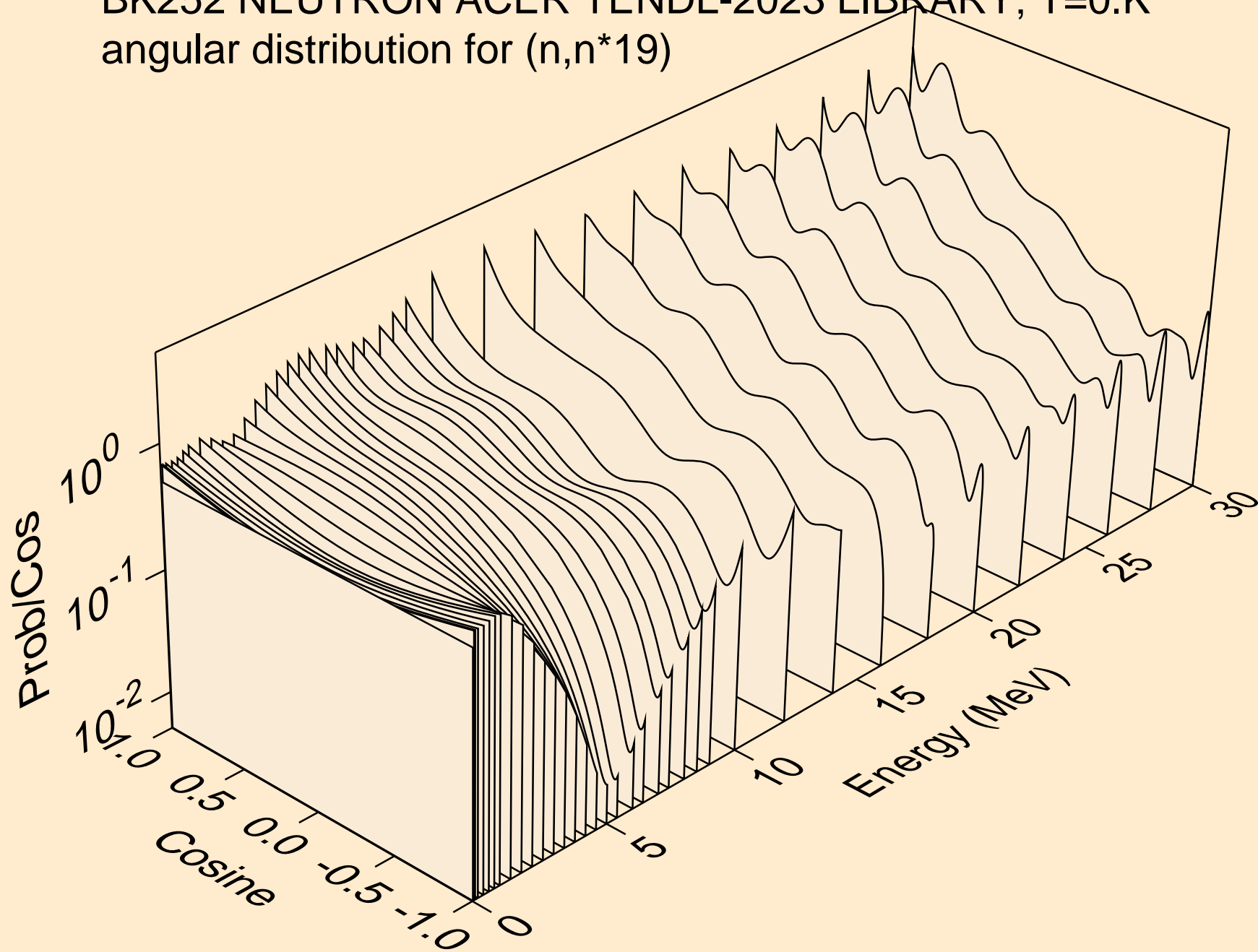

BK252 NEUTRON ACER TENDL-2023 LIBRARY; T=0.K  
angular distribution for (n,n\*20)

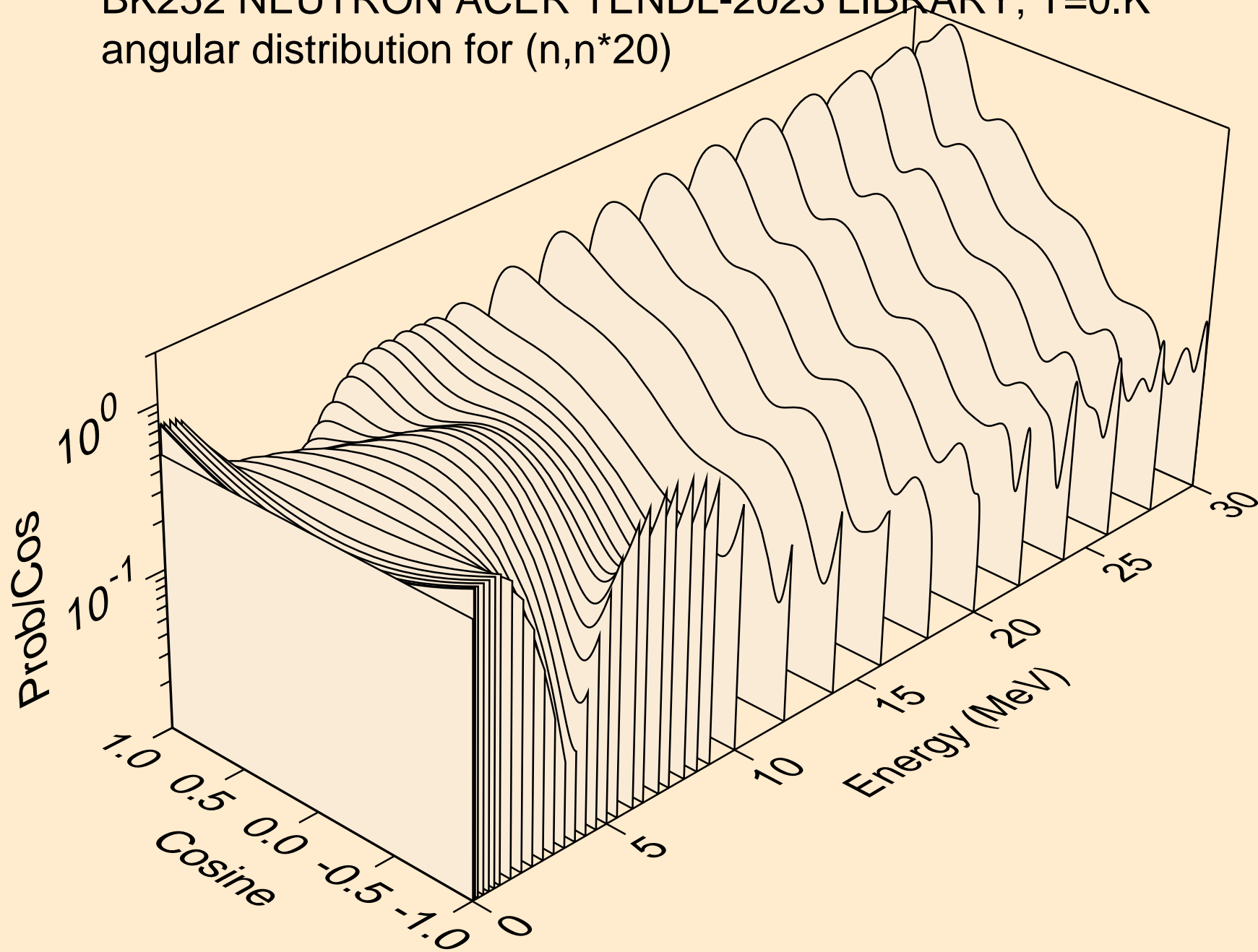

BK252 NEUTRON ACER TENDL-2023 LIBRARY; T=0.K  
angular distribution for (n,n\*21)

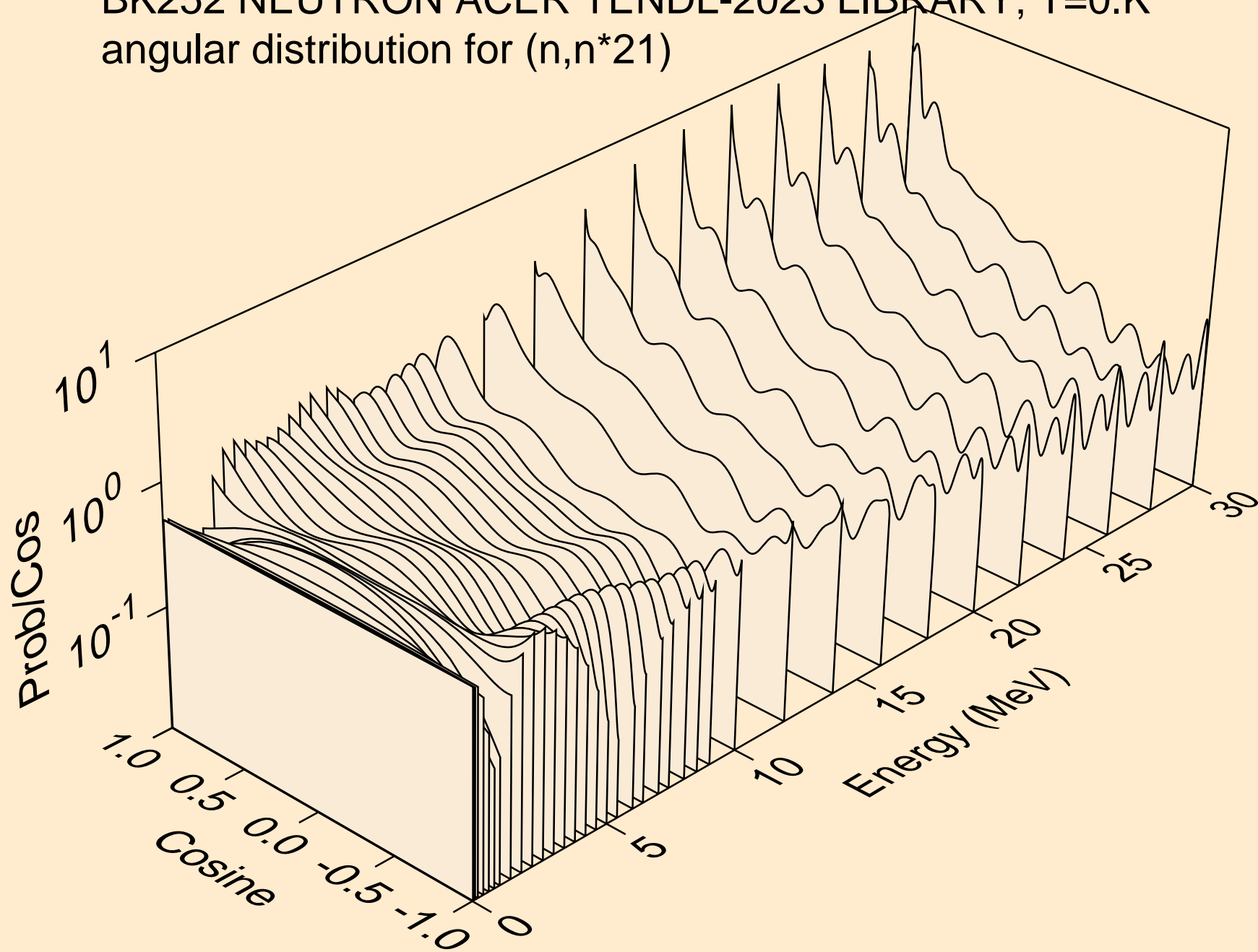

BK252 NEUTRON ACER TENDL-2023 LIBRARY; T=0.K  
angular distribution for (n,n\*22)

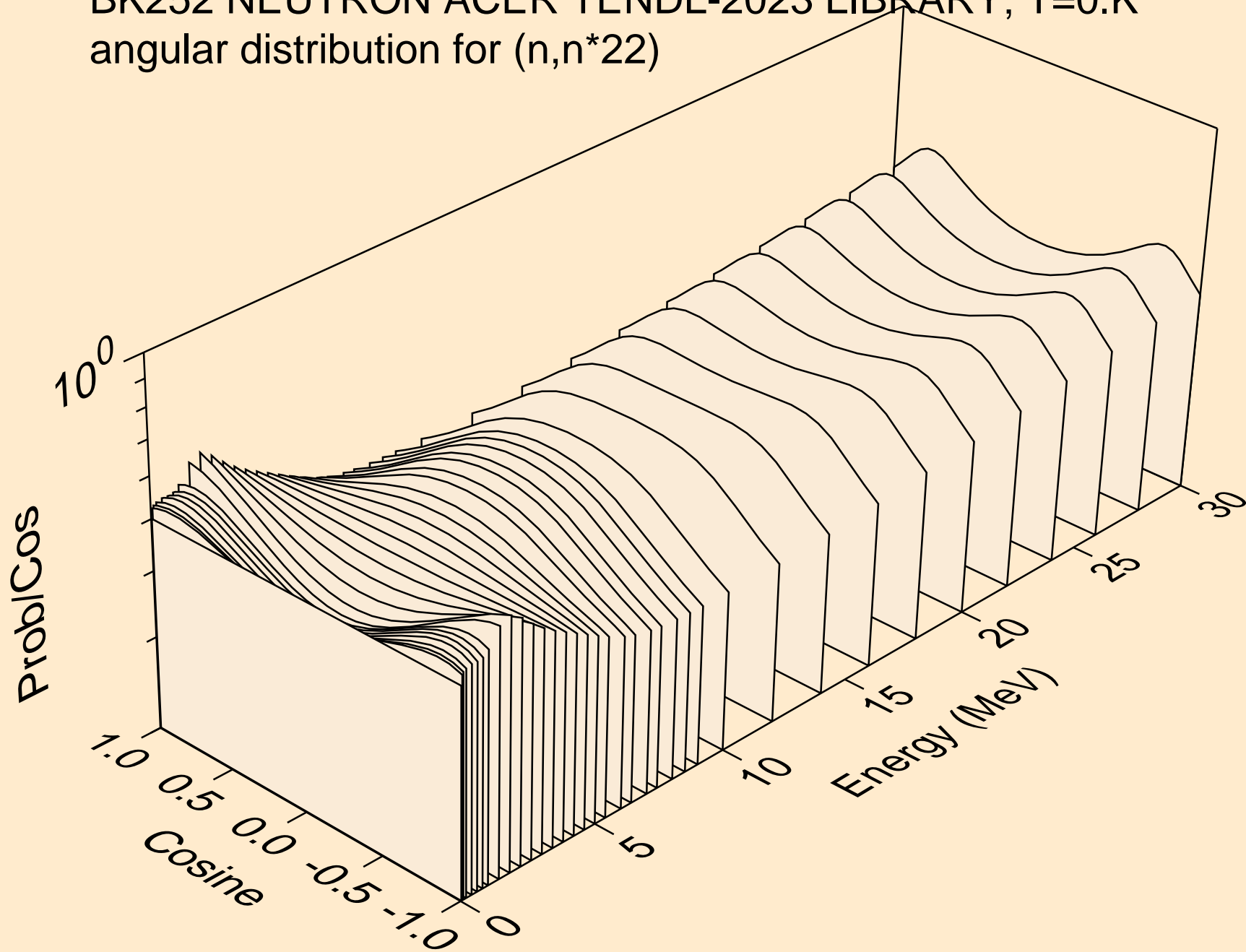

BK252 NEUTRON ACER TENDL-2023 LIBRARY; T=0.K  
angular distribution for (n,n\*23)

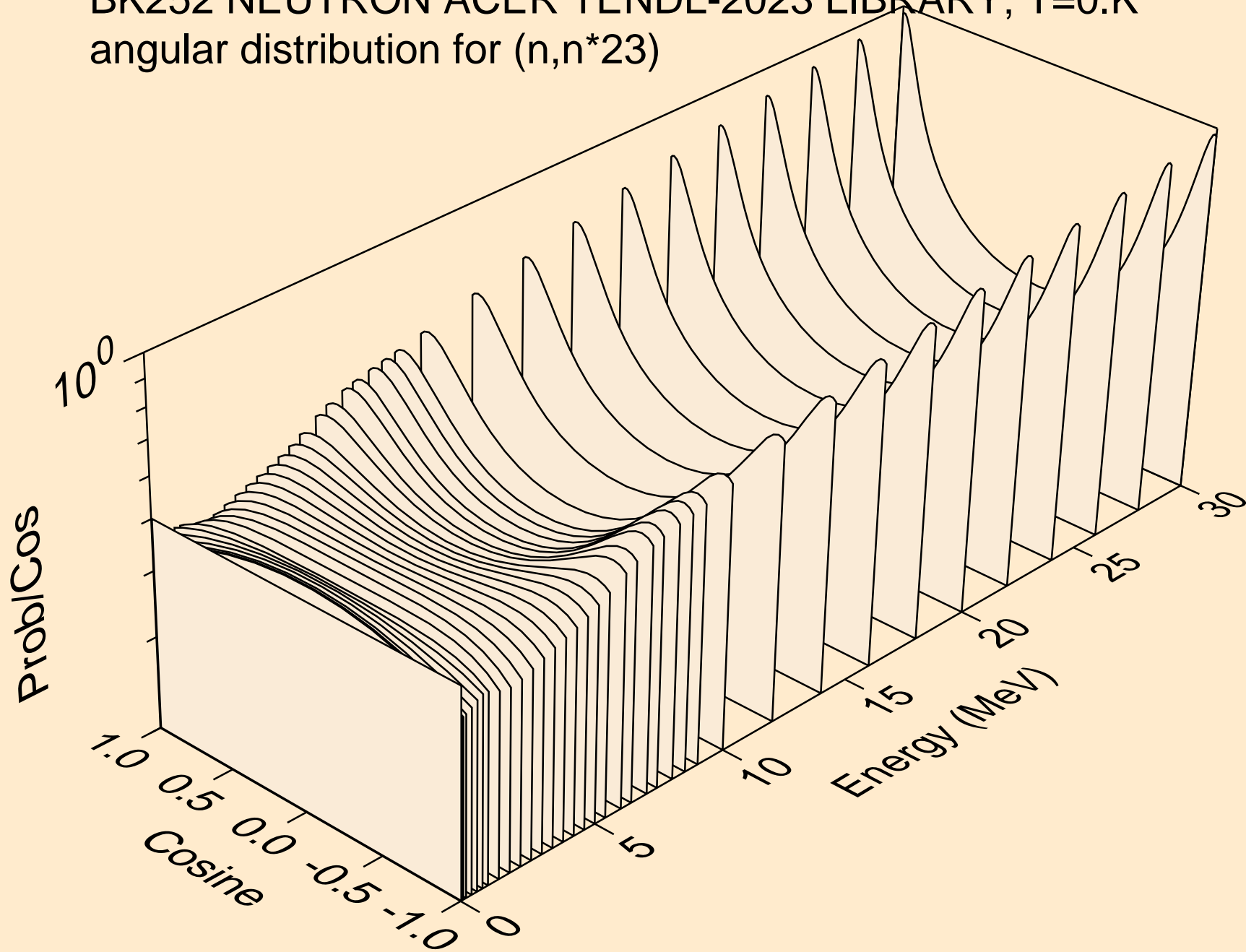

BK252 NEUTRON ACER TENDL-2023 LIBRARY; T=0.K  
angular distribution for (n,n\*24)

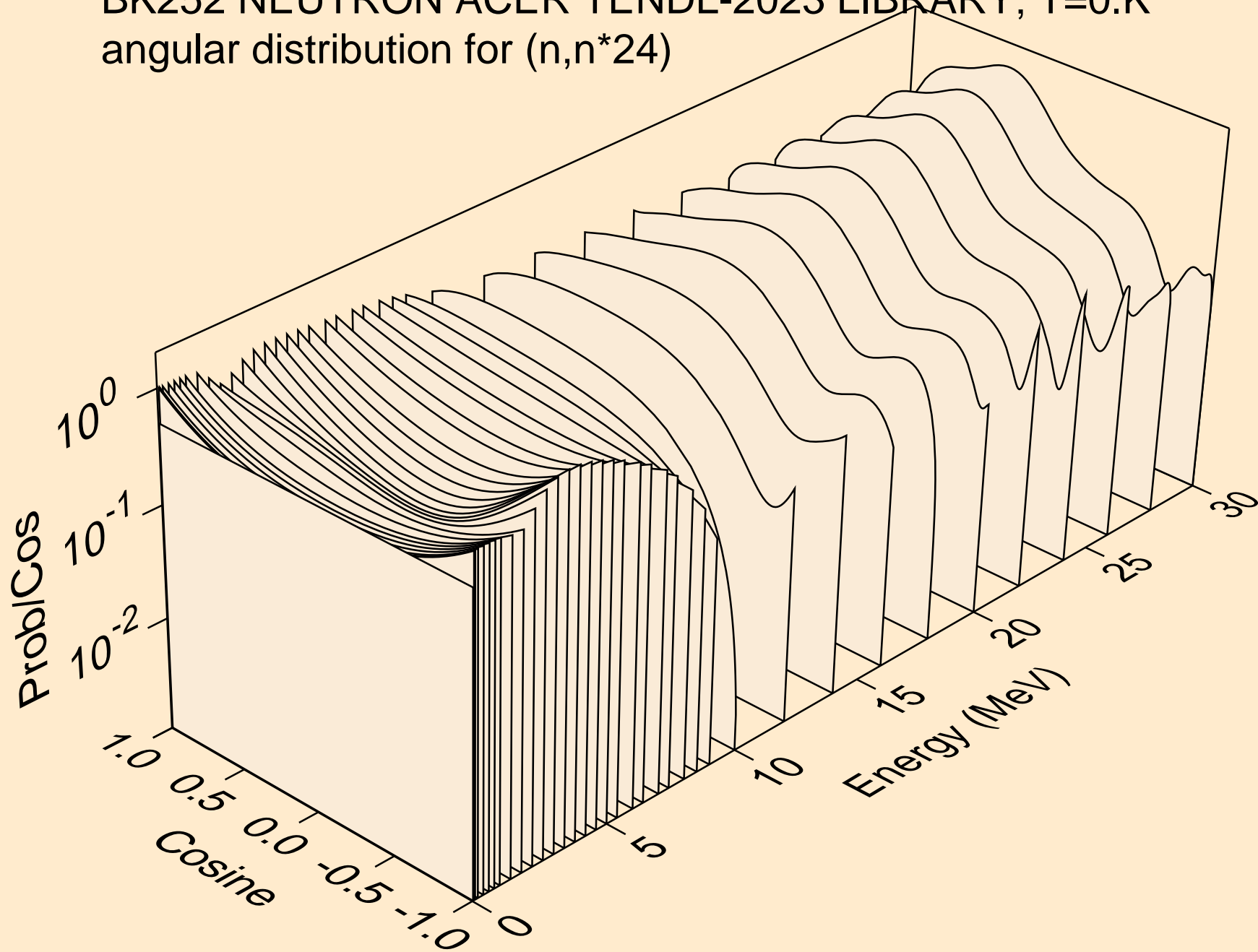

BK252 NEUTRON ACER TENDL-2023 LIBRARY; T=0.K  
angular distribution for (n,n\*25)

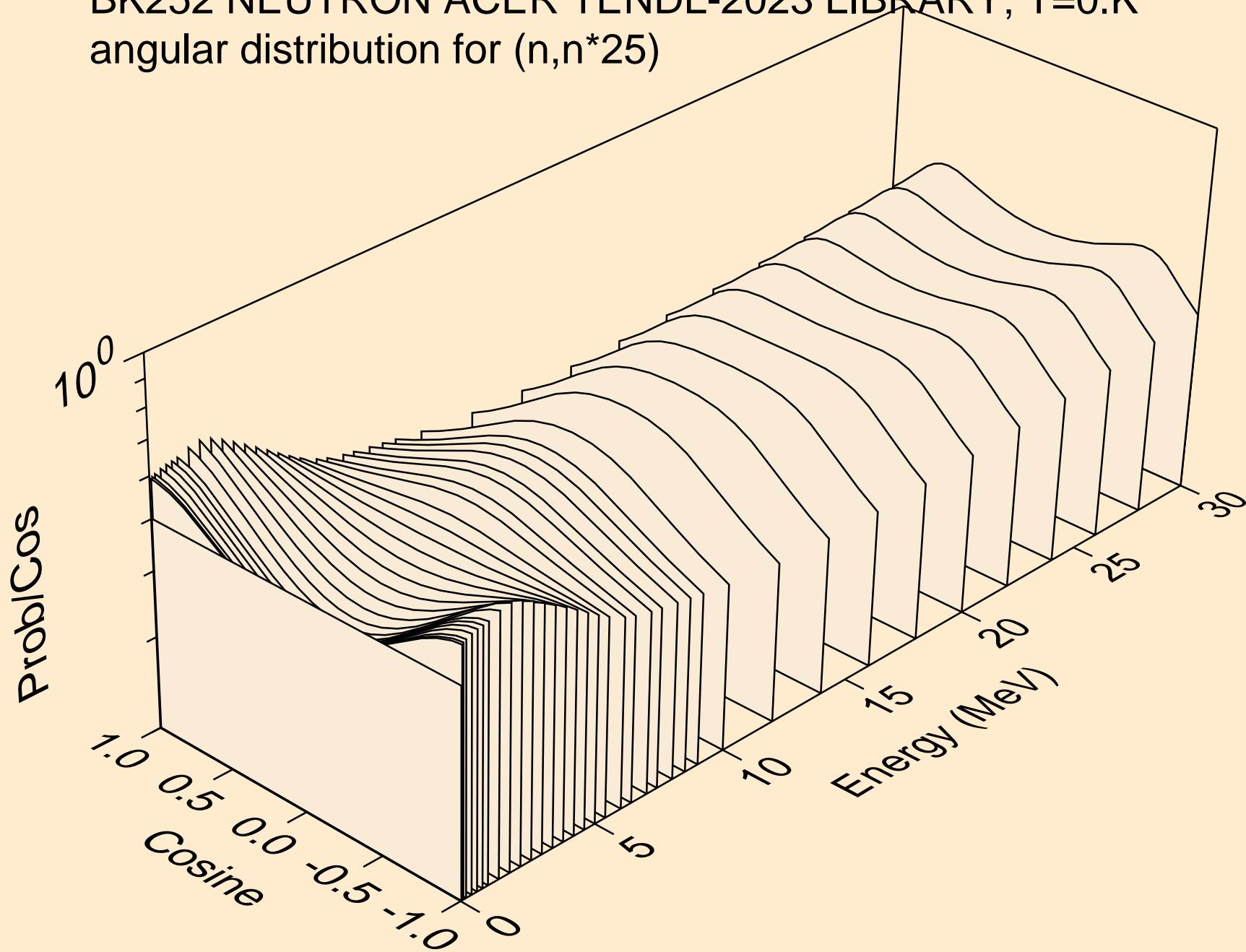

BK252 NEUTRON ACER TENDL-2023 LIBRARY; T=0.K  
angular distribution for (n,n\*26)

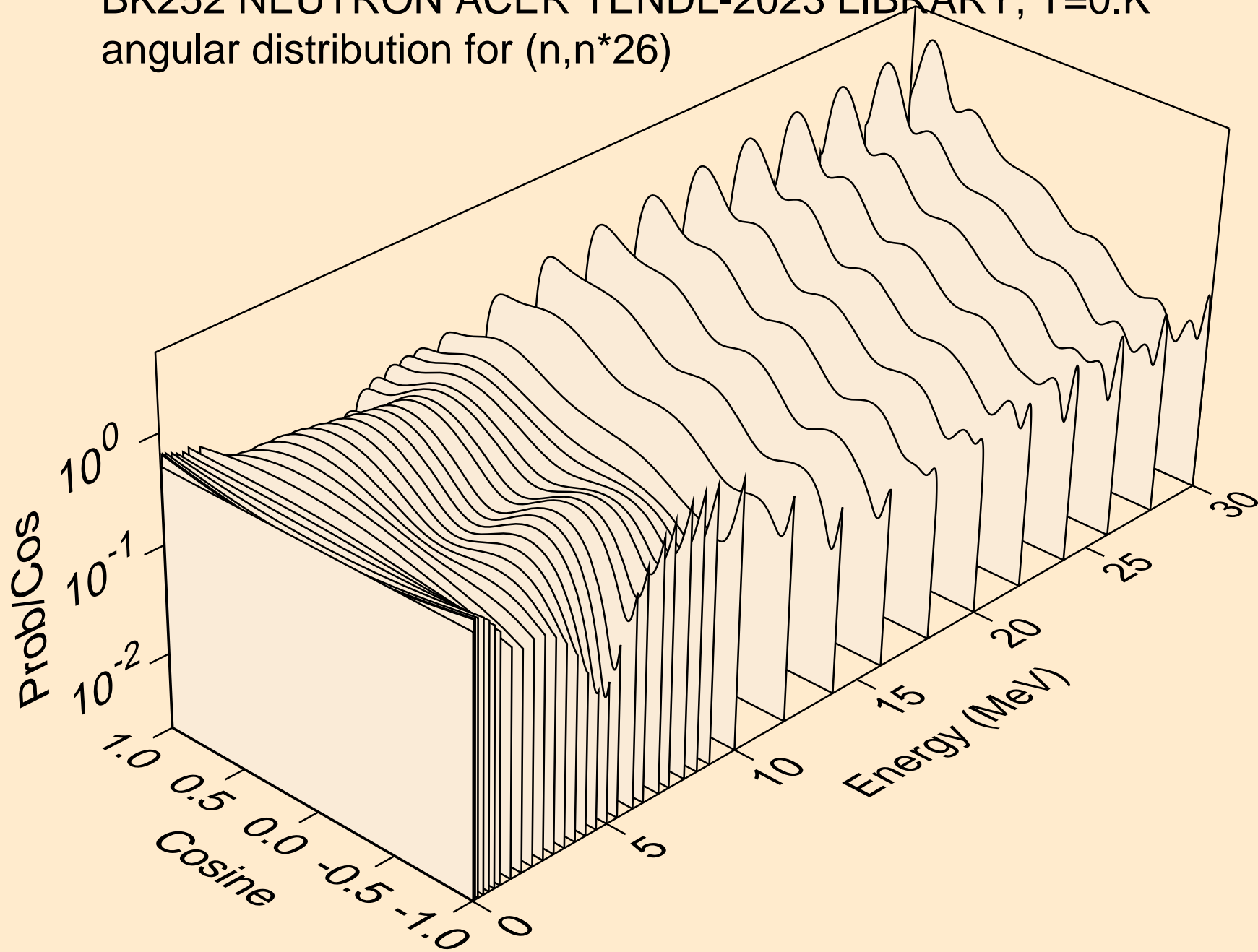

BK252 NEUTRON ACER TENDL-2023 LIBRARY; T=0.K  
angular distribution for (n,n\*27)

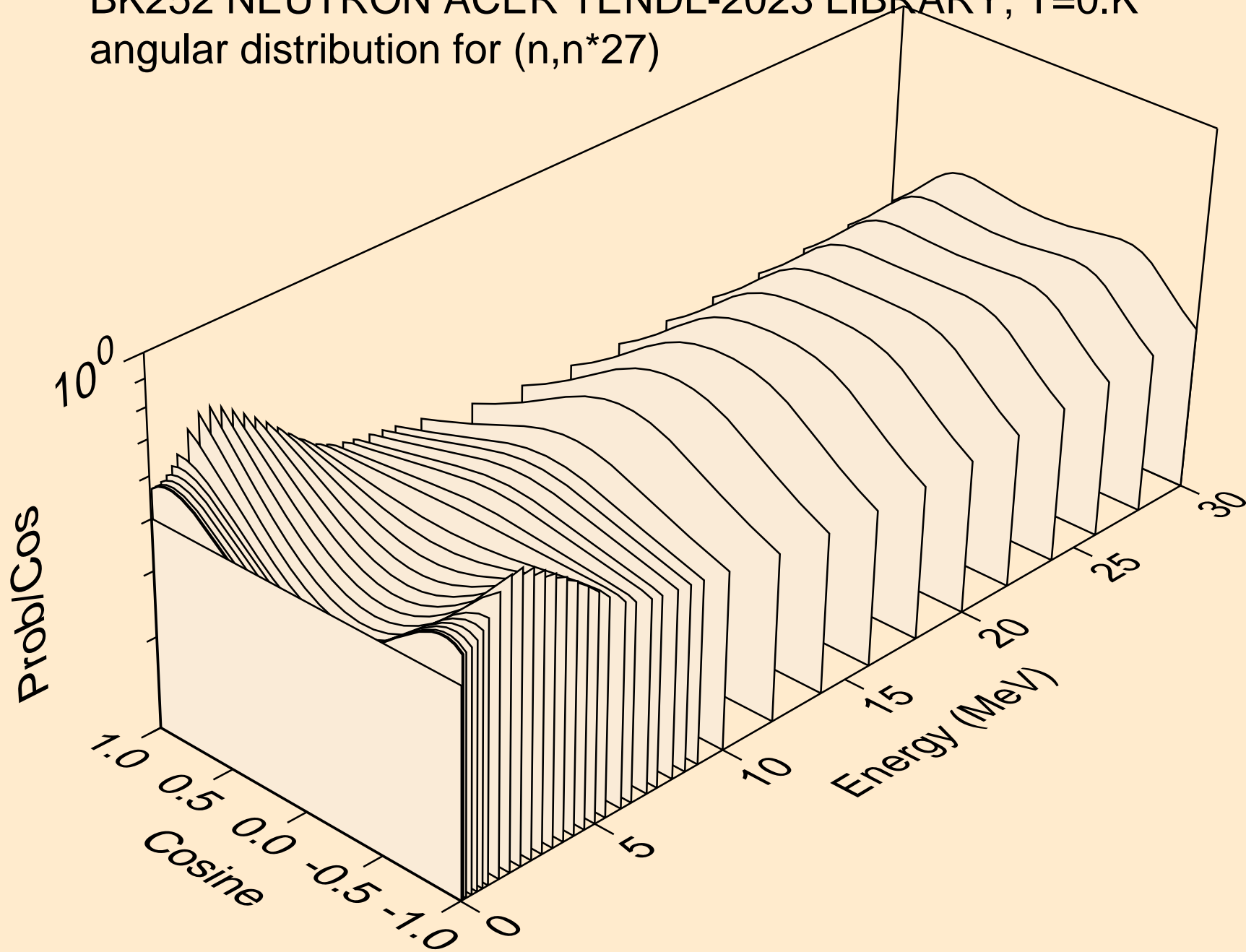

BK252 NEUTRON ACER TENDL-2023 LIBRARY; T=0.K  
angular distribution for (n,n\*28)

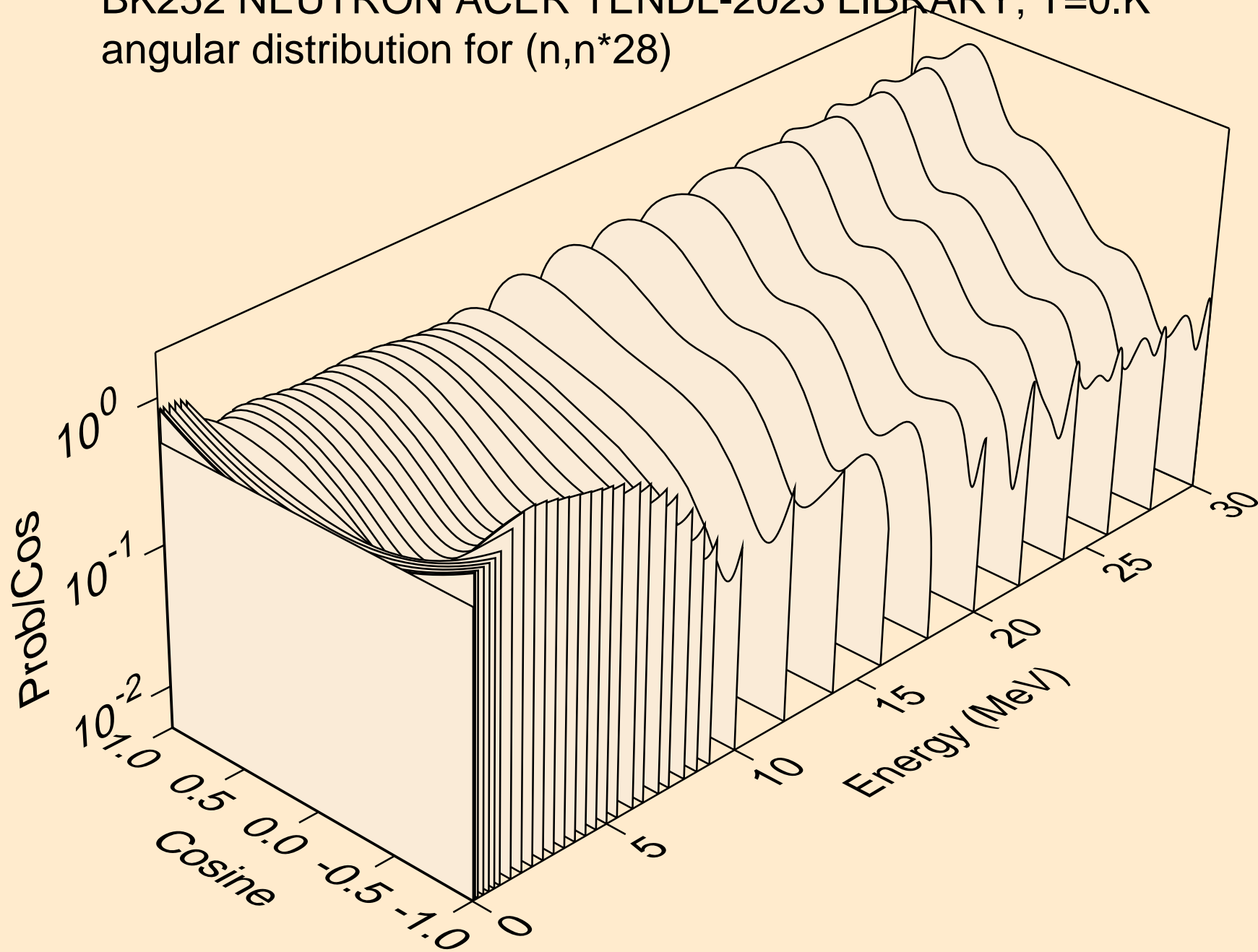

BK252 NEUTRON ACER TENDL-2023 LIBRARY; T=0.K  
angular distribution for (n,n\*29)

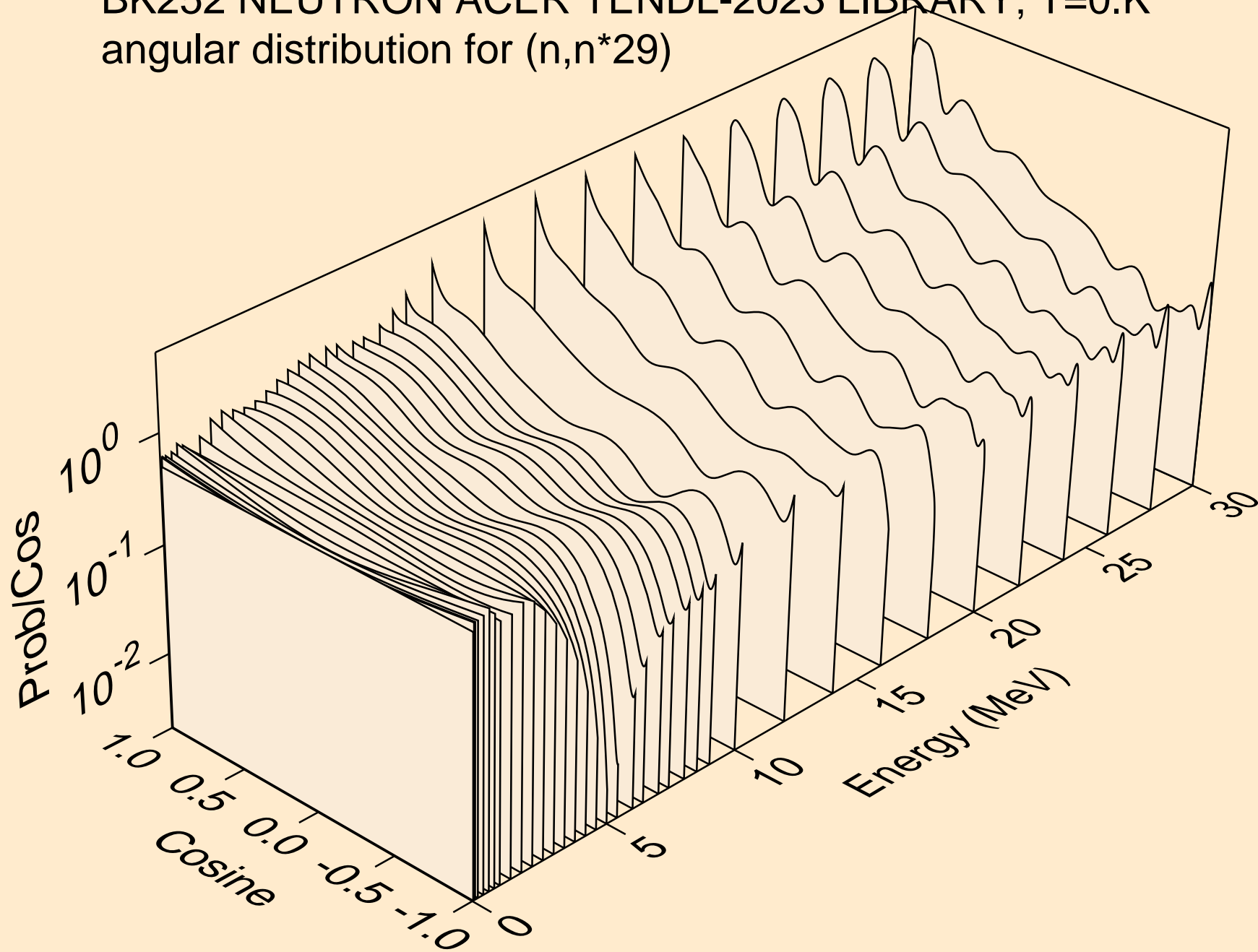

# BK252 NEUTRON ACER TENDL-2023 LIBRARY; T=0.K

## Total fission nubar

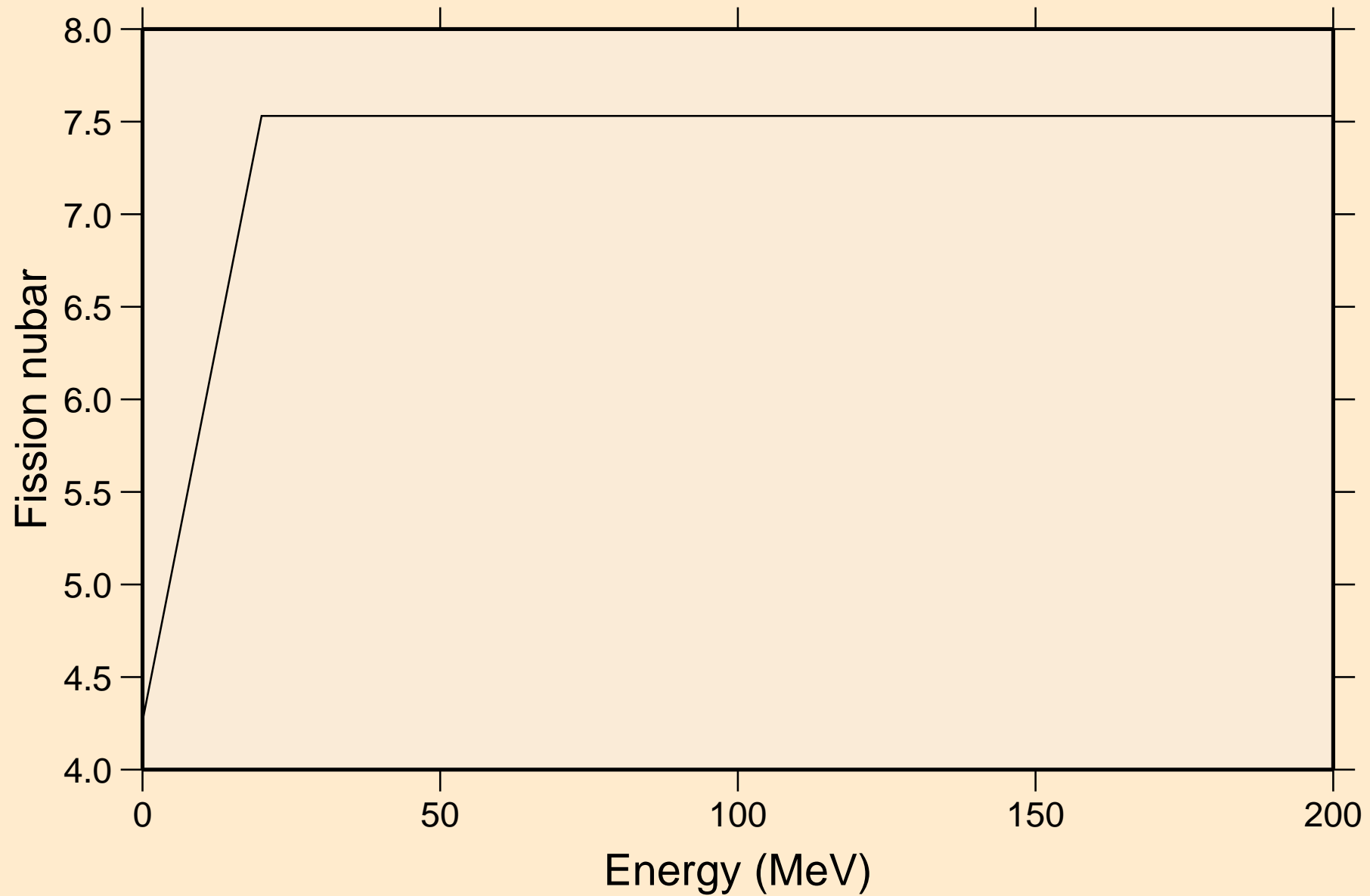

BK252 NEUTRON ACER TENDL-2023 LIBRARY; T=0.K  
Neutron emission for (n,x)

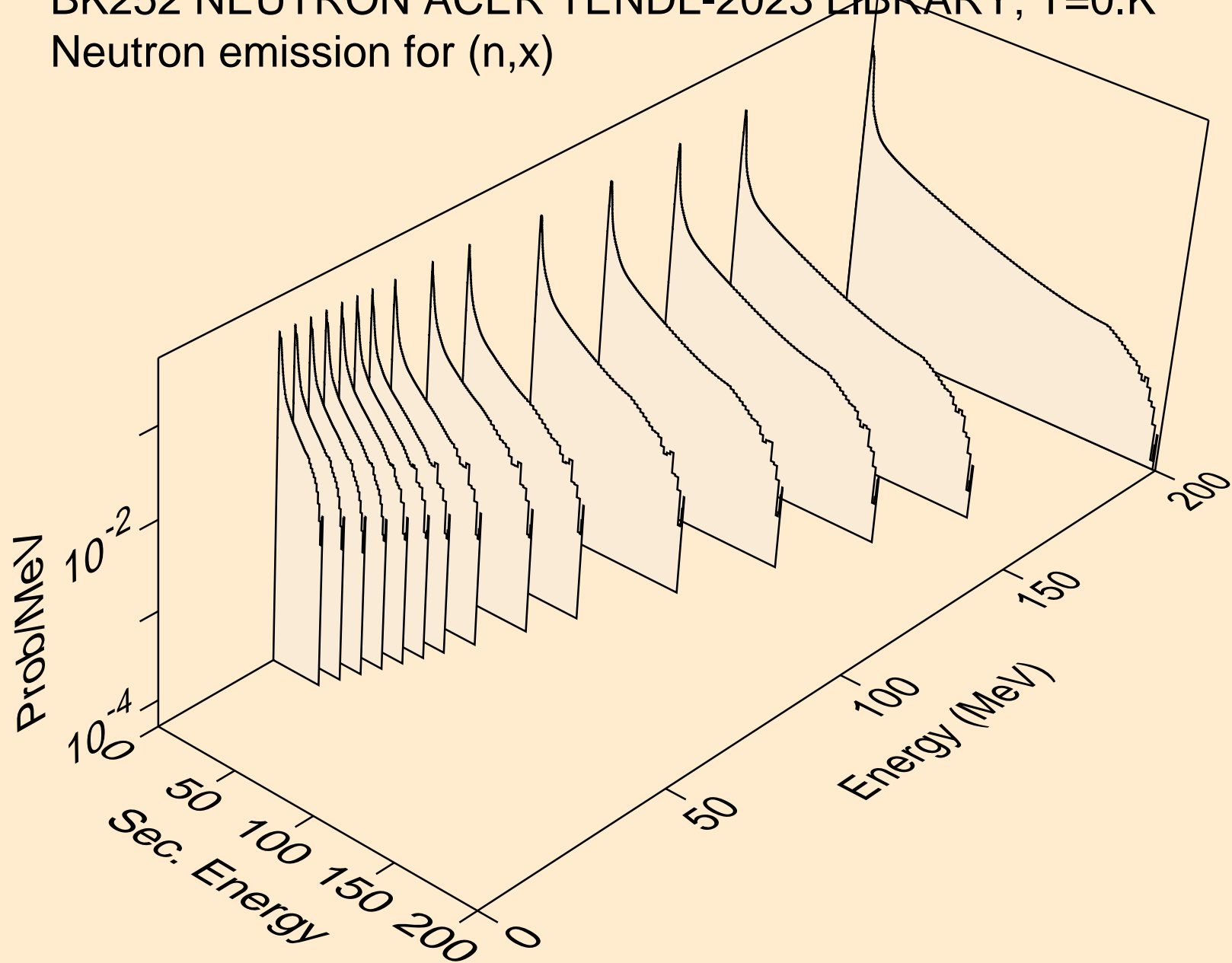

BK252 NEUTRON ACER TENDL-2023 LIBRARY; T=0.K  
Neutron emission for (n,2nd)

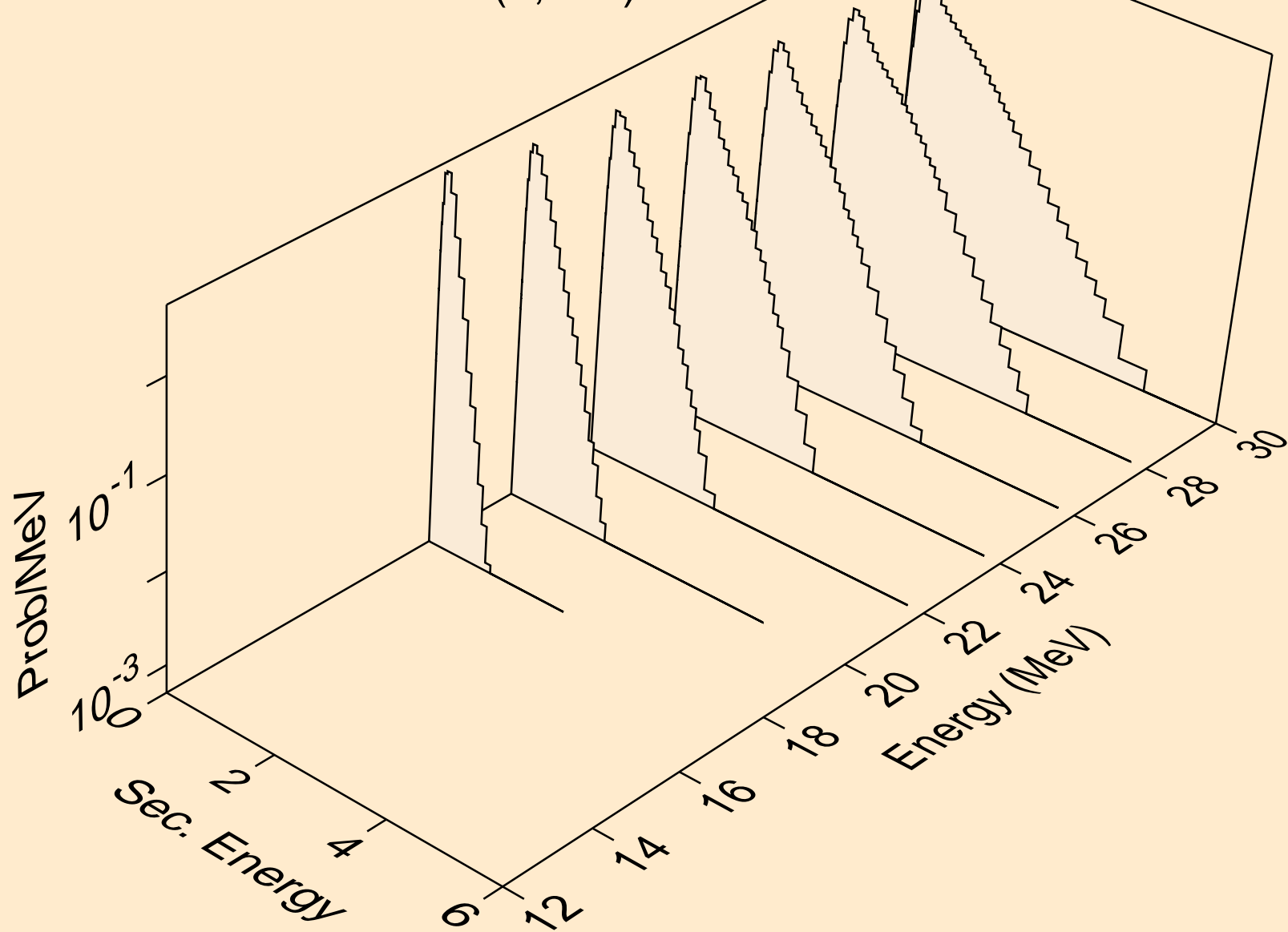

BK252 NEUTRON ACER TENDL-2023 LIBRARY; T=0.K  
Neutron emission for (n,2n)

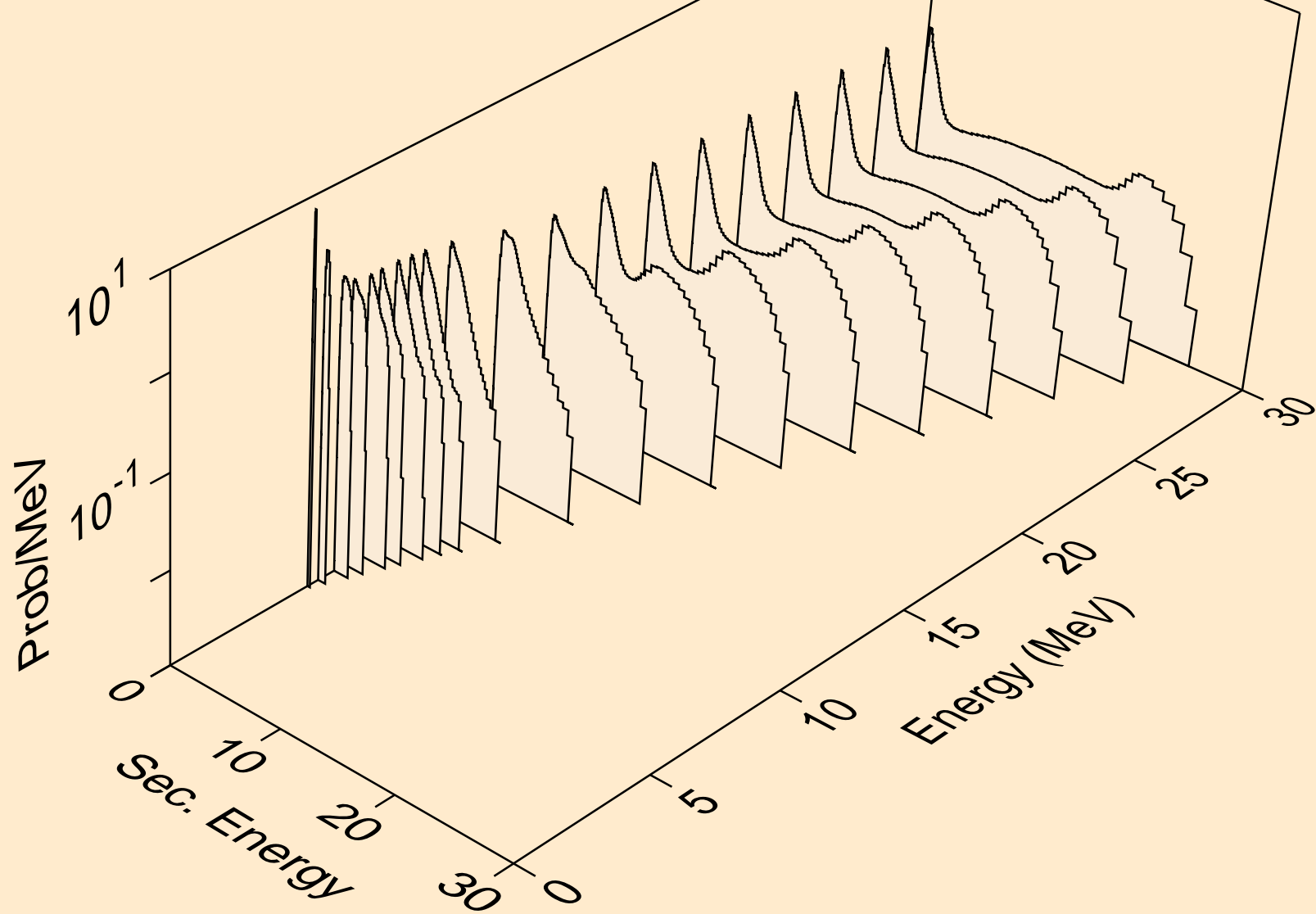

BK252 NEUTRON ACER TENDL-2023 LIBRARY; T=0.K  
Neutron emission for (n,3n)

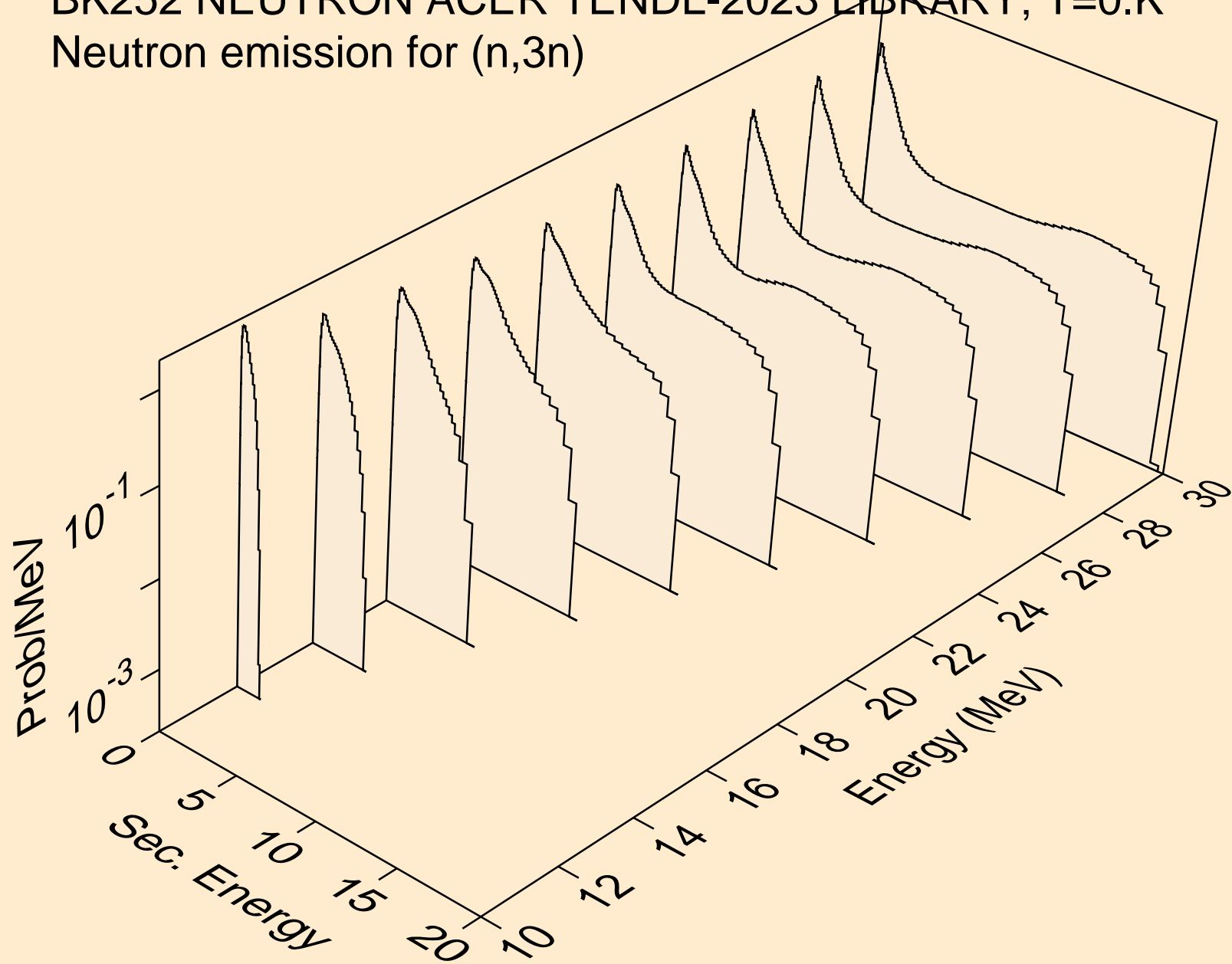

BK252 NEUTRON ACER TENDL-2023 LIBRARY; T=0.K  
Neutron emission for fission

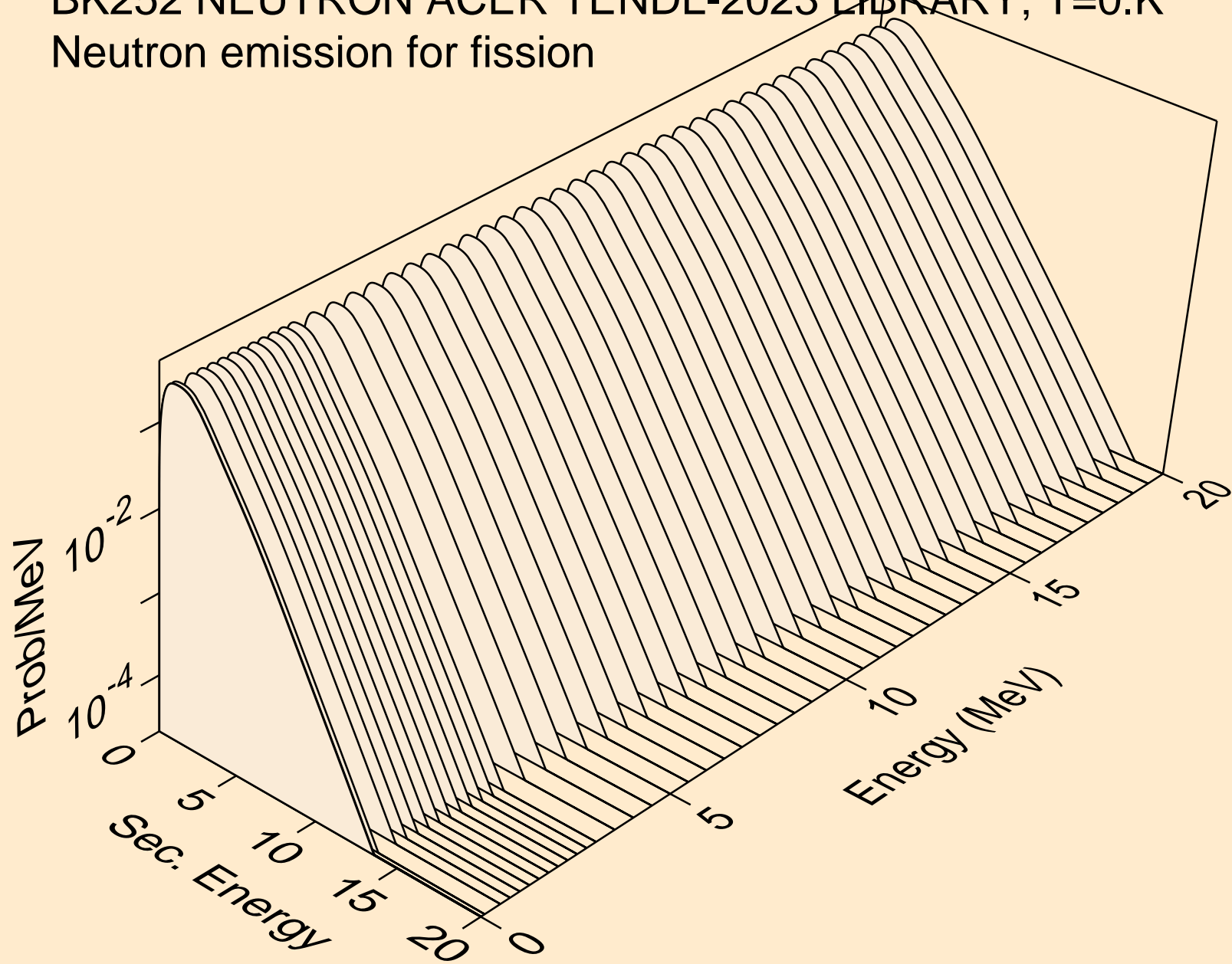

BK252 NEUTRON ACER TENDL-2023 LIBRARY; T=0.K  
Neutron emission for (n,n\*)a

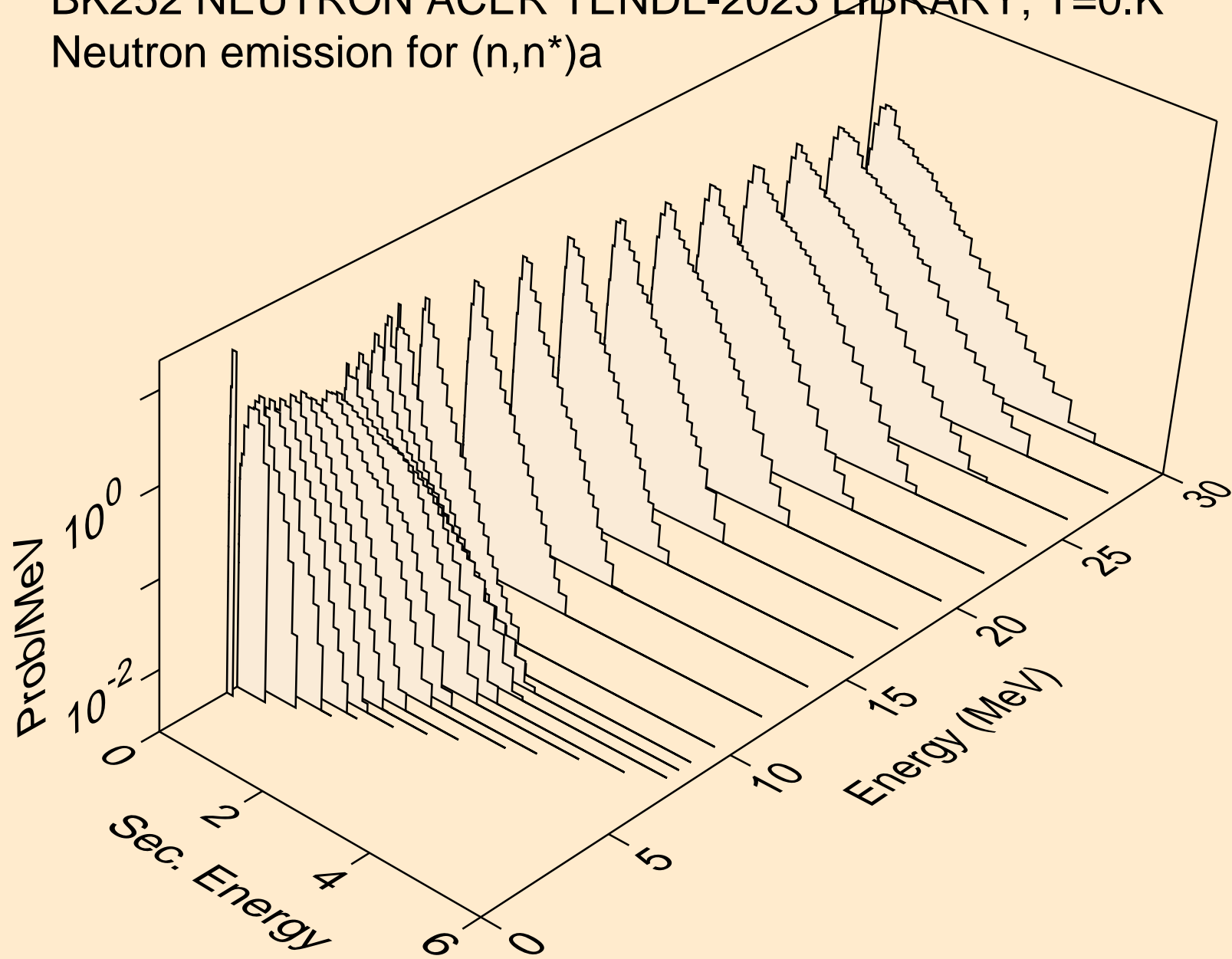

BK252 NEUTRON ACER TENDL-2023 LIBRARY; T=0.K  
Neutron emission for (n,2n)a

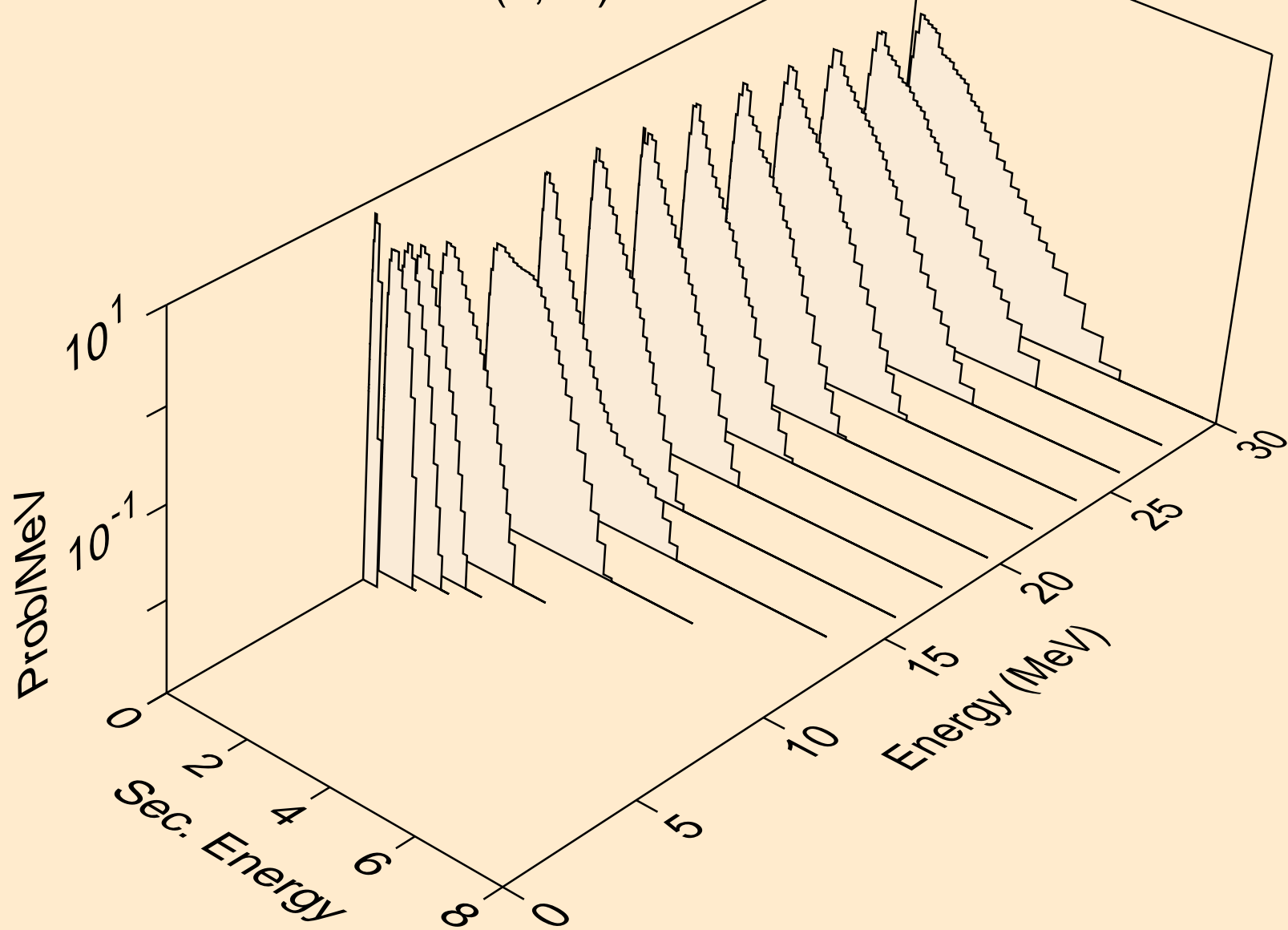

BK252 NEUTRON ACER TENDL-2023 LIBRARY; T=0.K  
Neutron emission for (n,3n)a

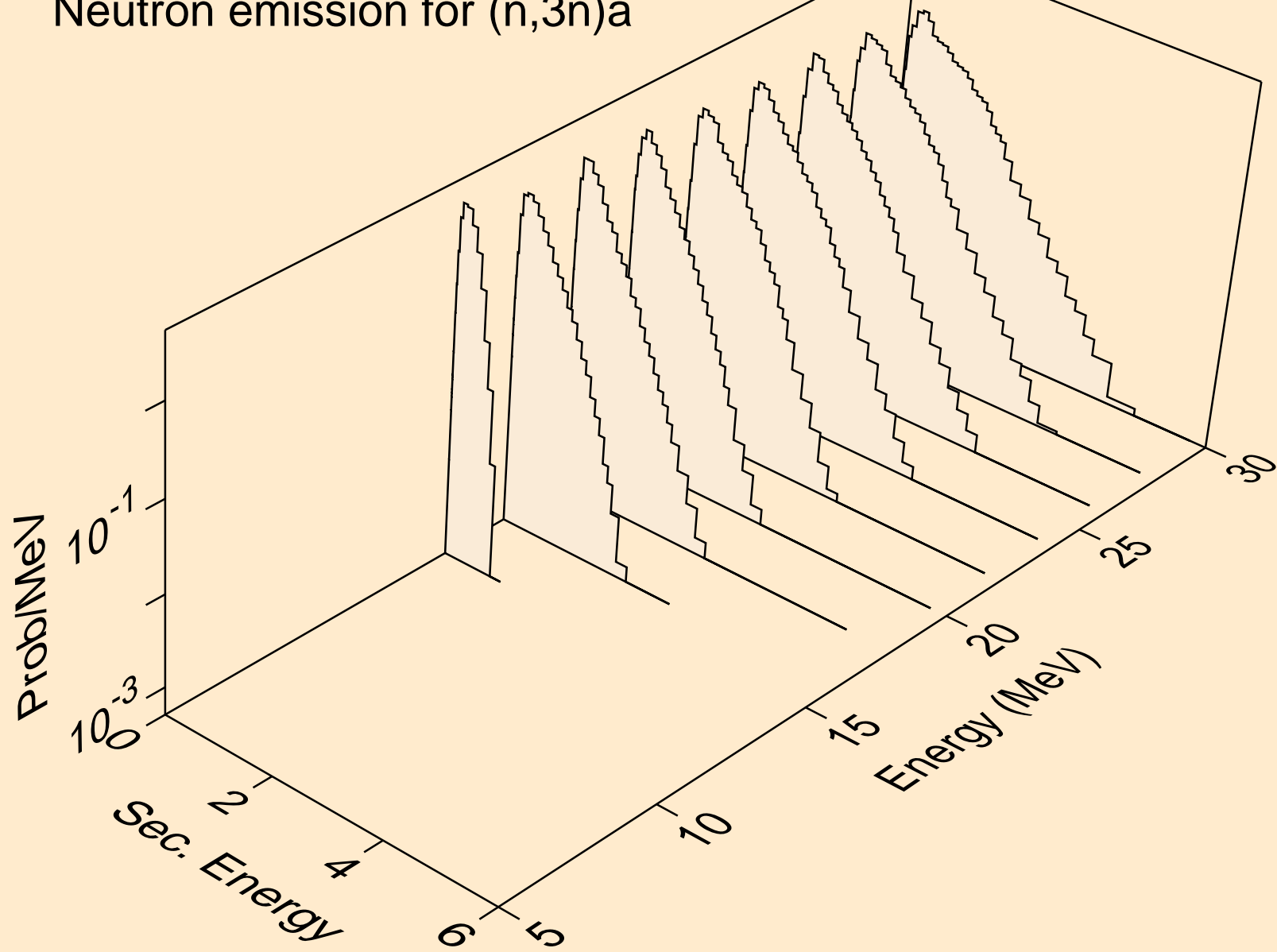

BK252 NEUTRON ACER TENDL-2023 LIBRARY; T=0.K  
Neutron emission for (n,n\*)p

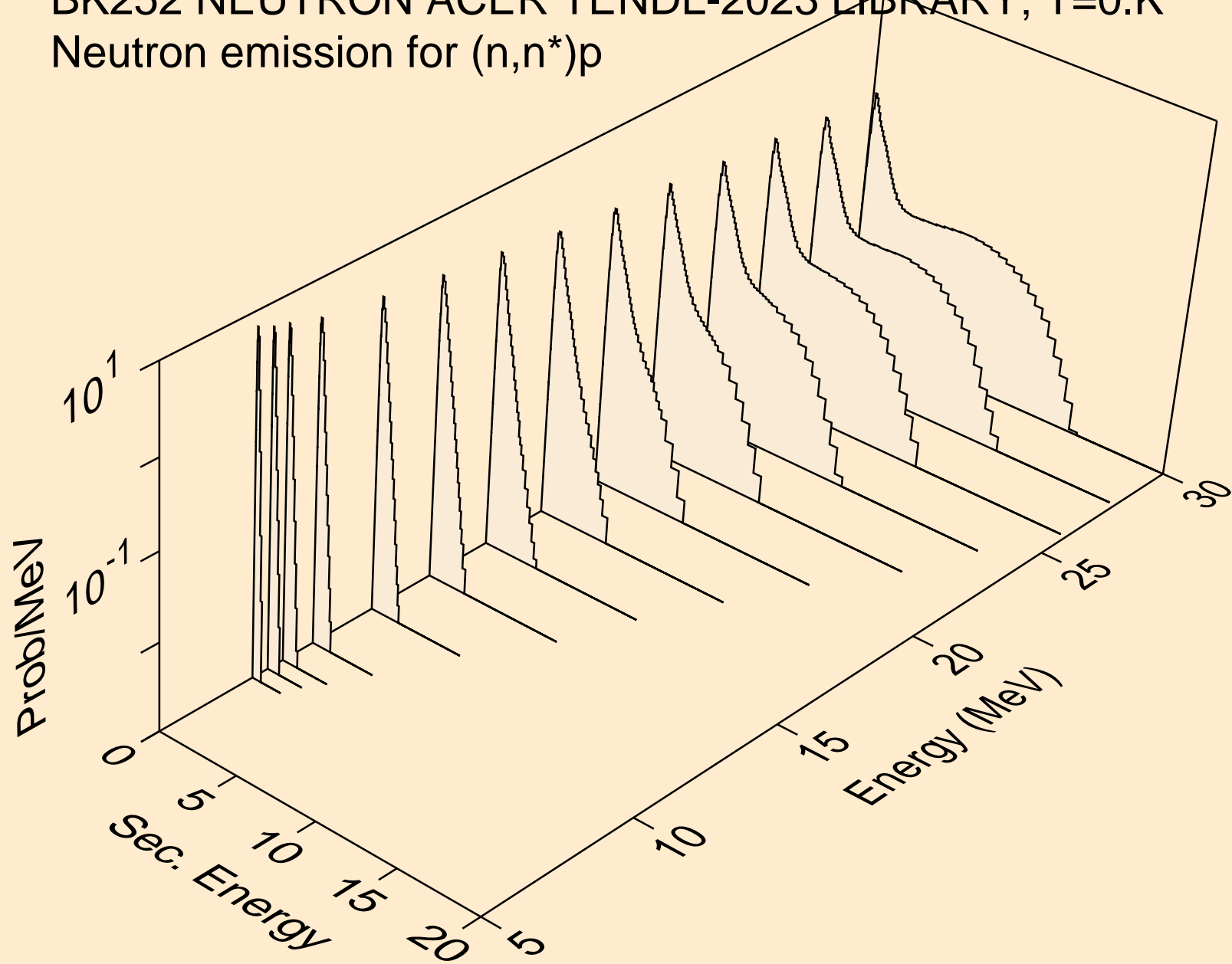

BK252 NEUTRON ACER TENDL-2023 LIBRARY; T=0.K  
Neutron emission for (n,n\*)d

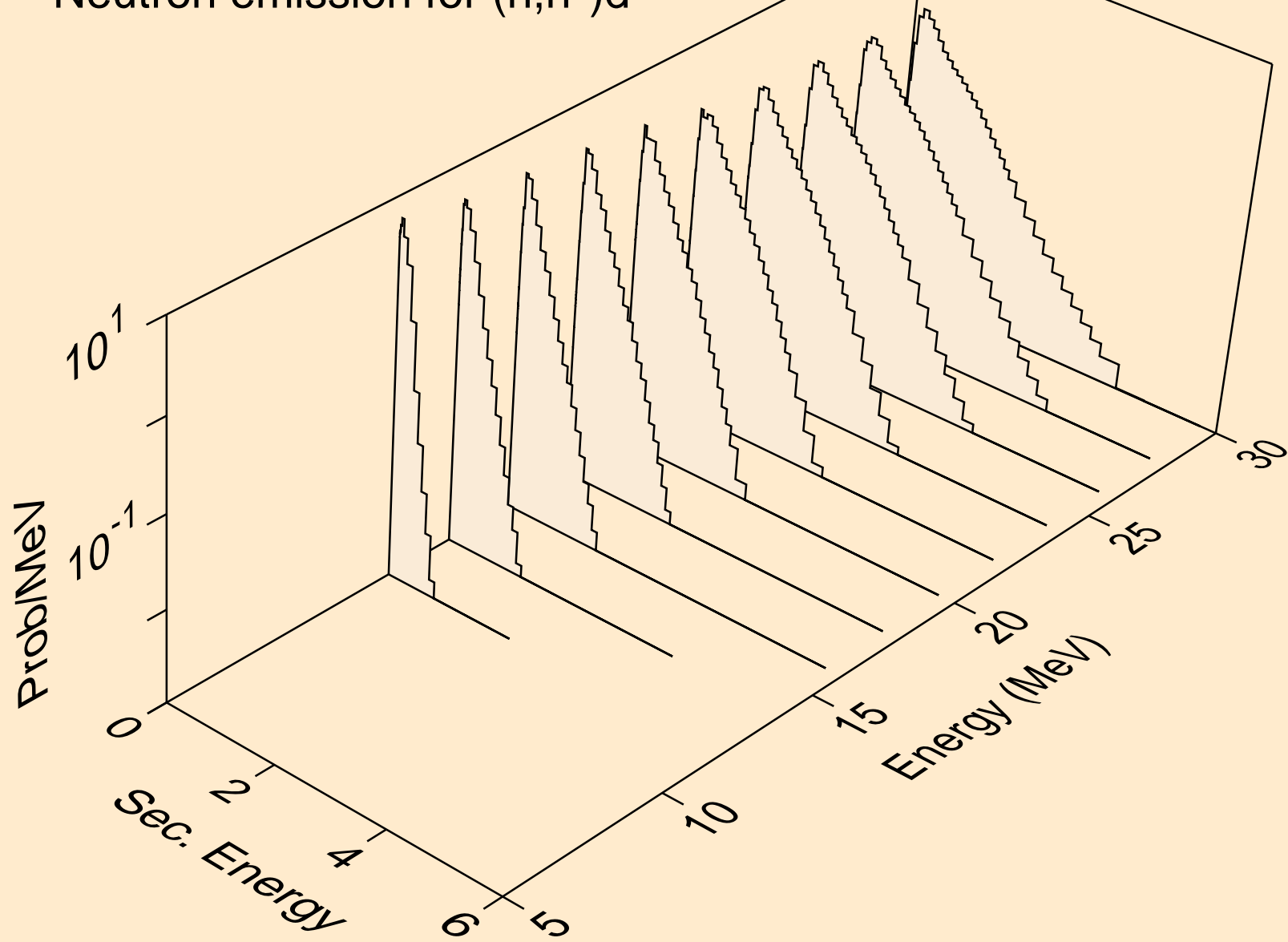

BK252 NEUTRON ACER TENDL-2023 LIBRARY; T=0.K  
Neutron emission for (n,n\*)t

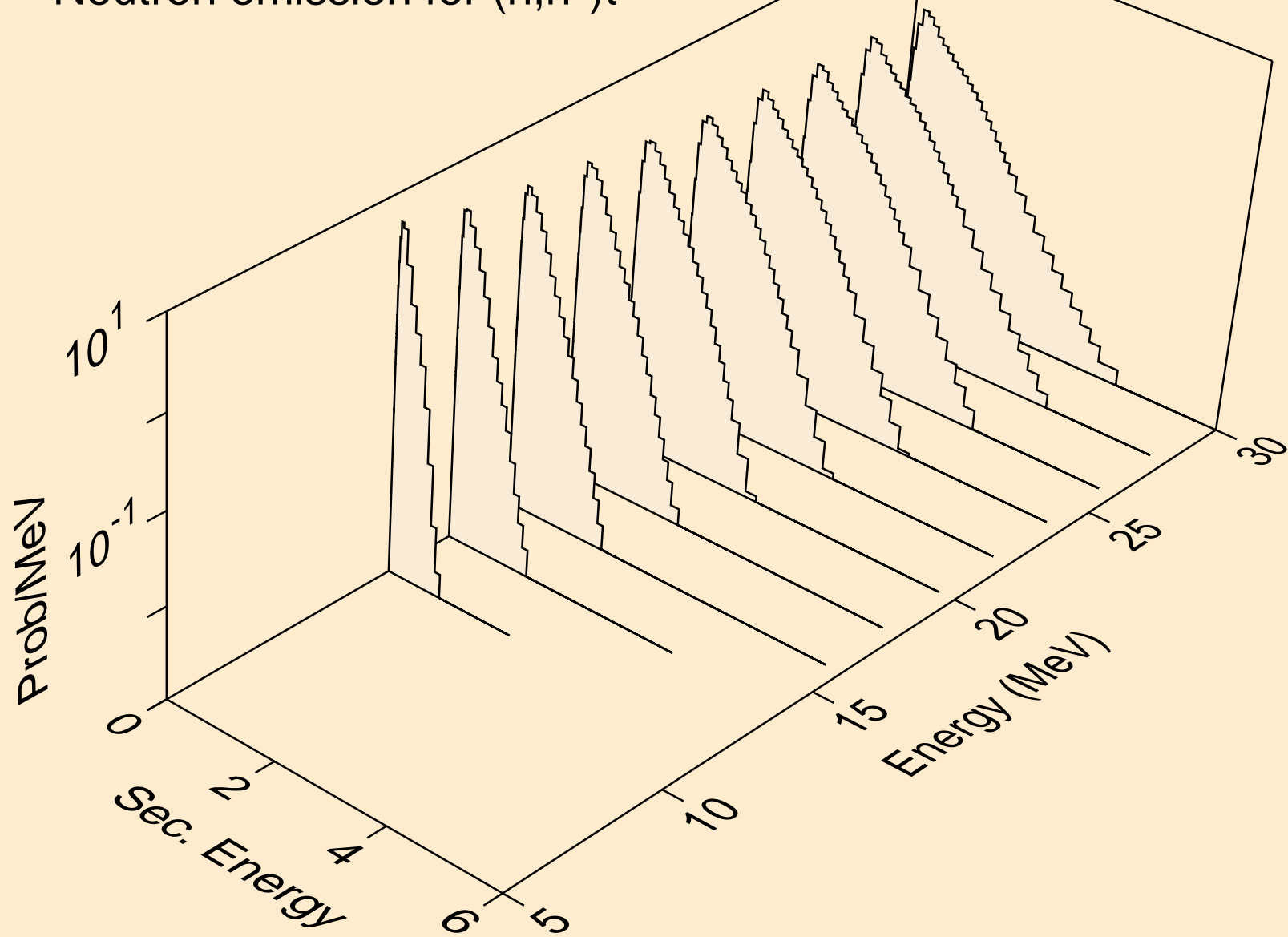

BK252 NEUTRON ACER TENDL-2023 LIBRARY; T=0.K  
Neutron emission for (n,n\*)he3

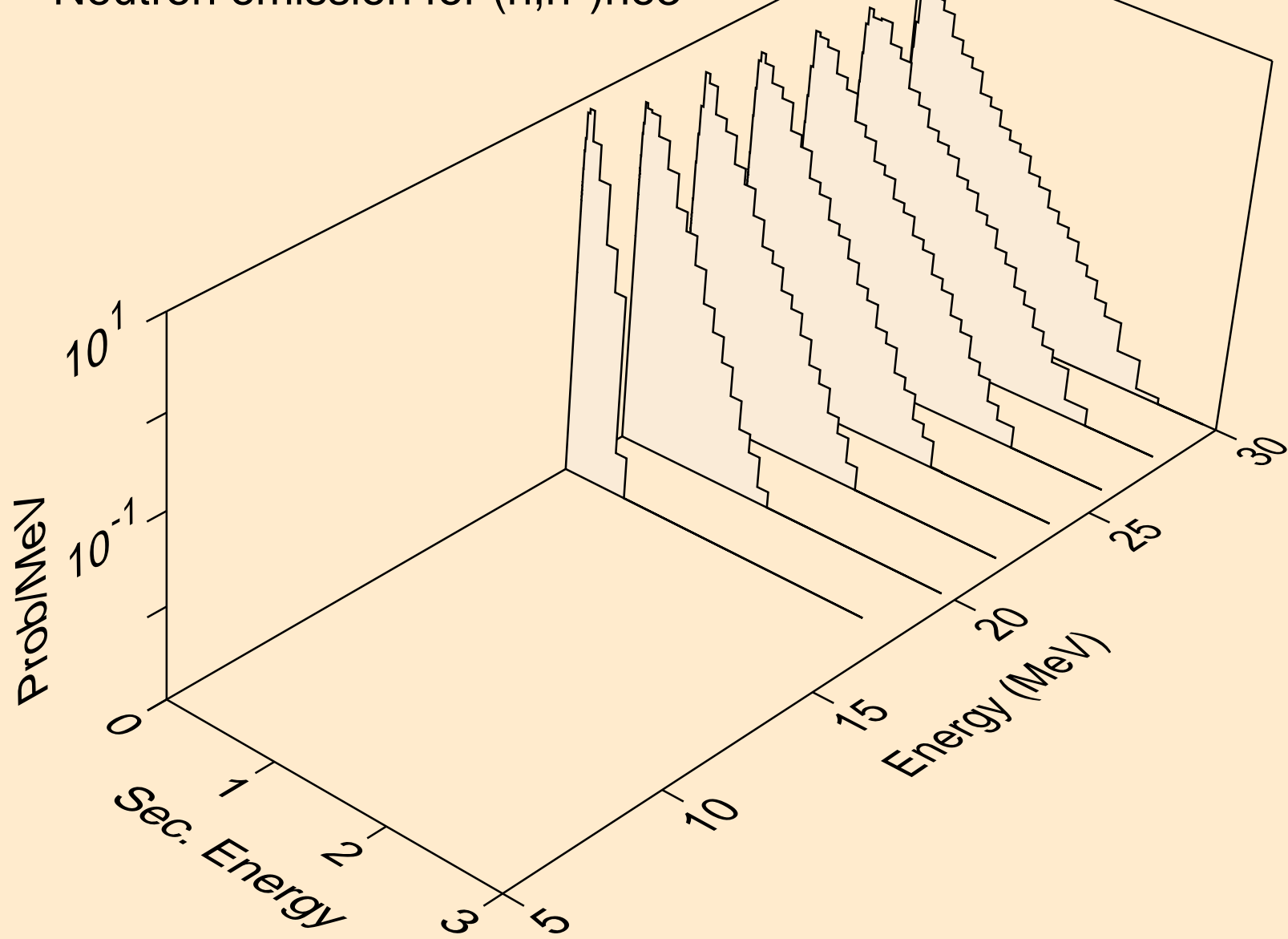

BK252 NEUTRON ACER TENDL-2023 LIBRARY; T=0.K  
Neutron emission for (n,4n)

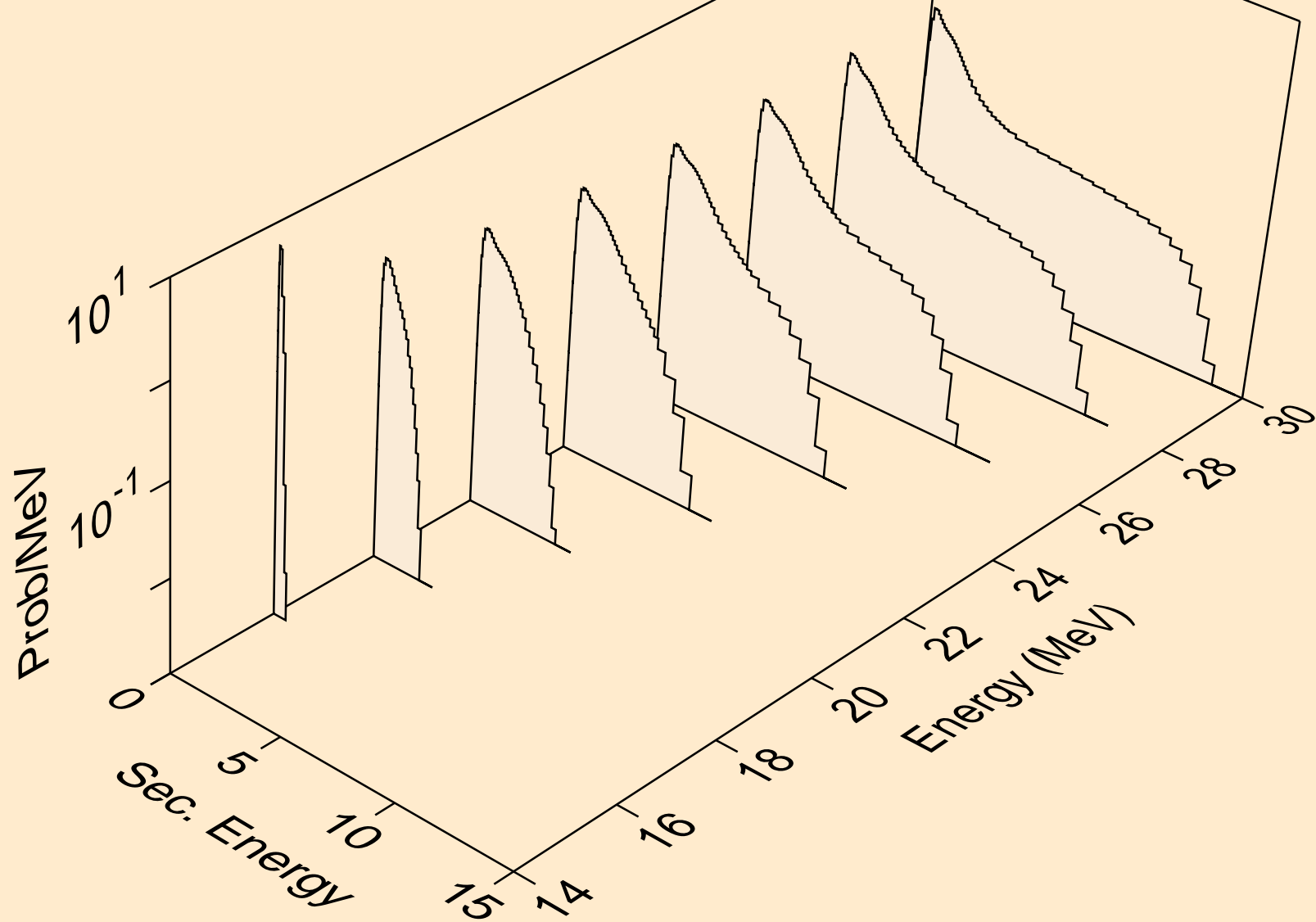

BK252 NEUTRON ACER TENDL-2023 LIBRARY; T=0.K  
Neutron emission for (n,2np)

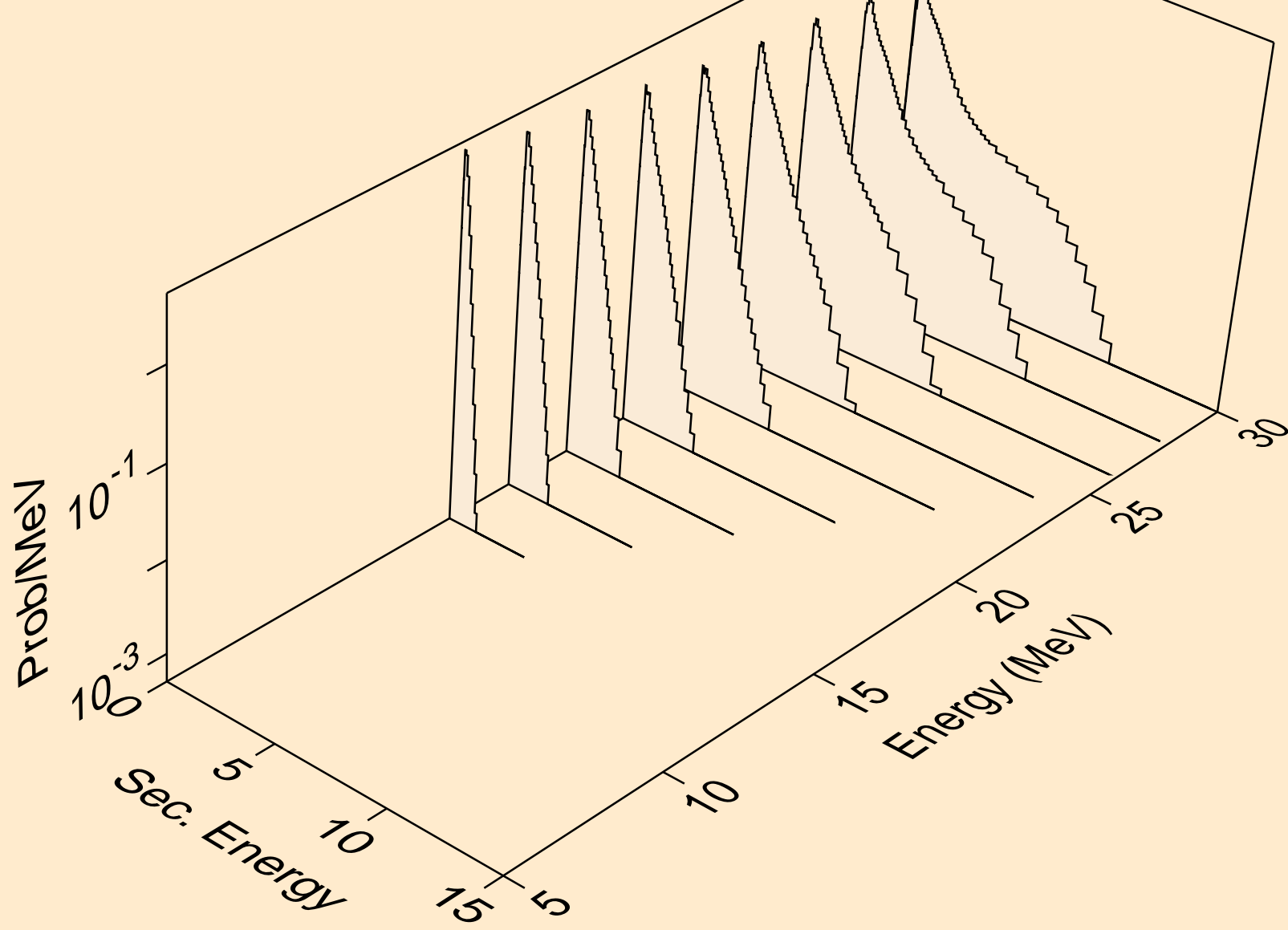

BK252 NEUTRON ACER TENDL-2023 LIBRARY; T=0.K  
Neutron emission for (n,3np)

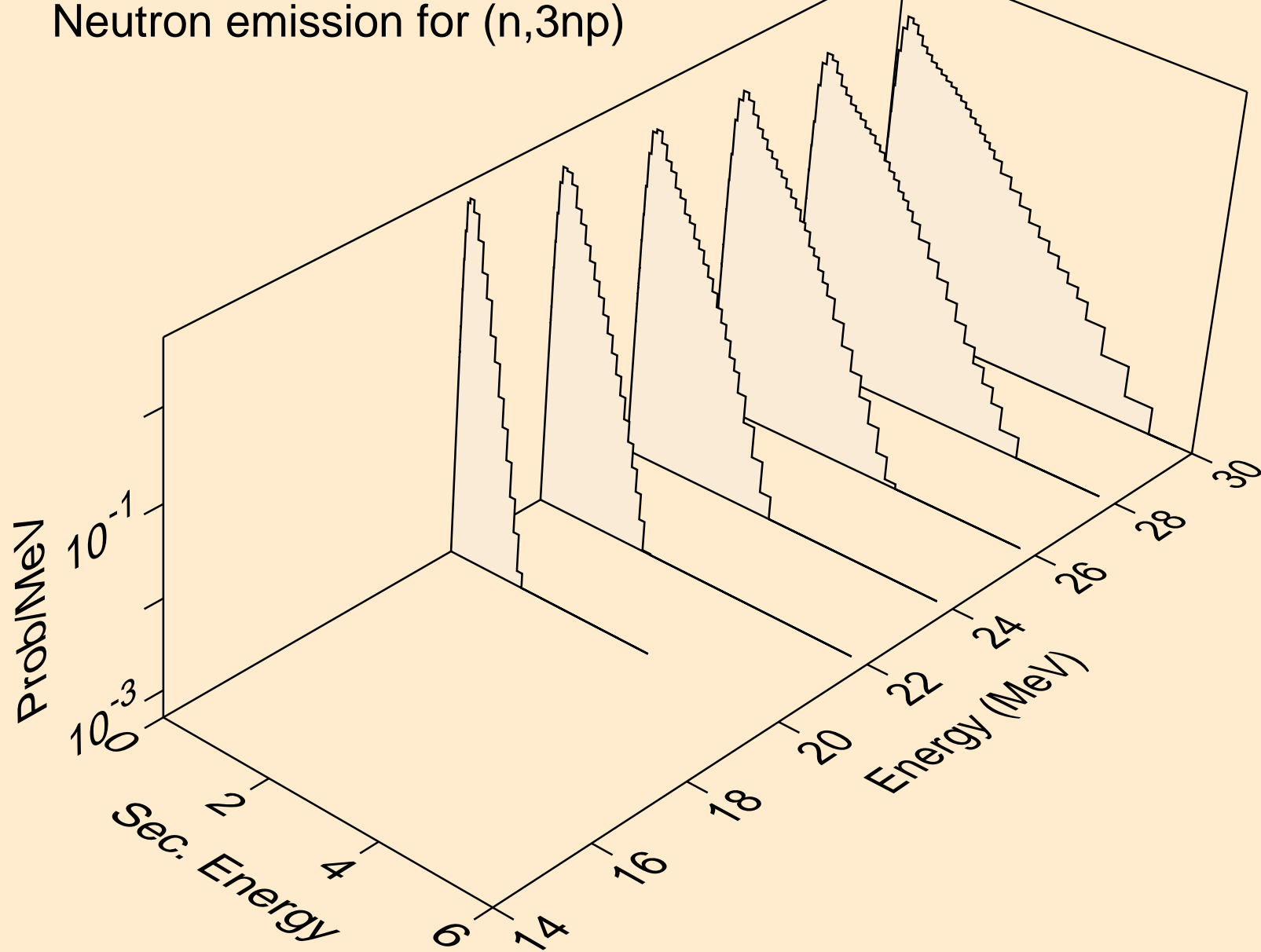

BK252 NEUTRON ACER TENDL-2023 LIBRARY; T=0.K  
Neutron emission for (n,n\*c)

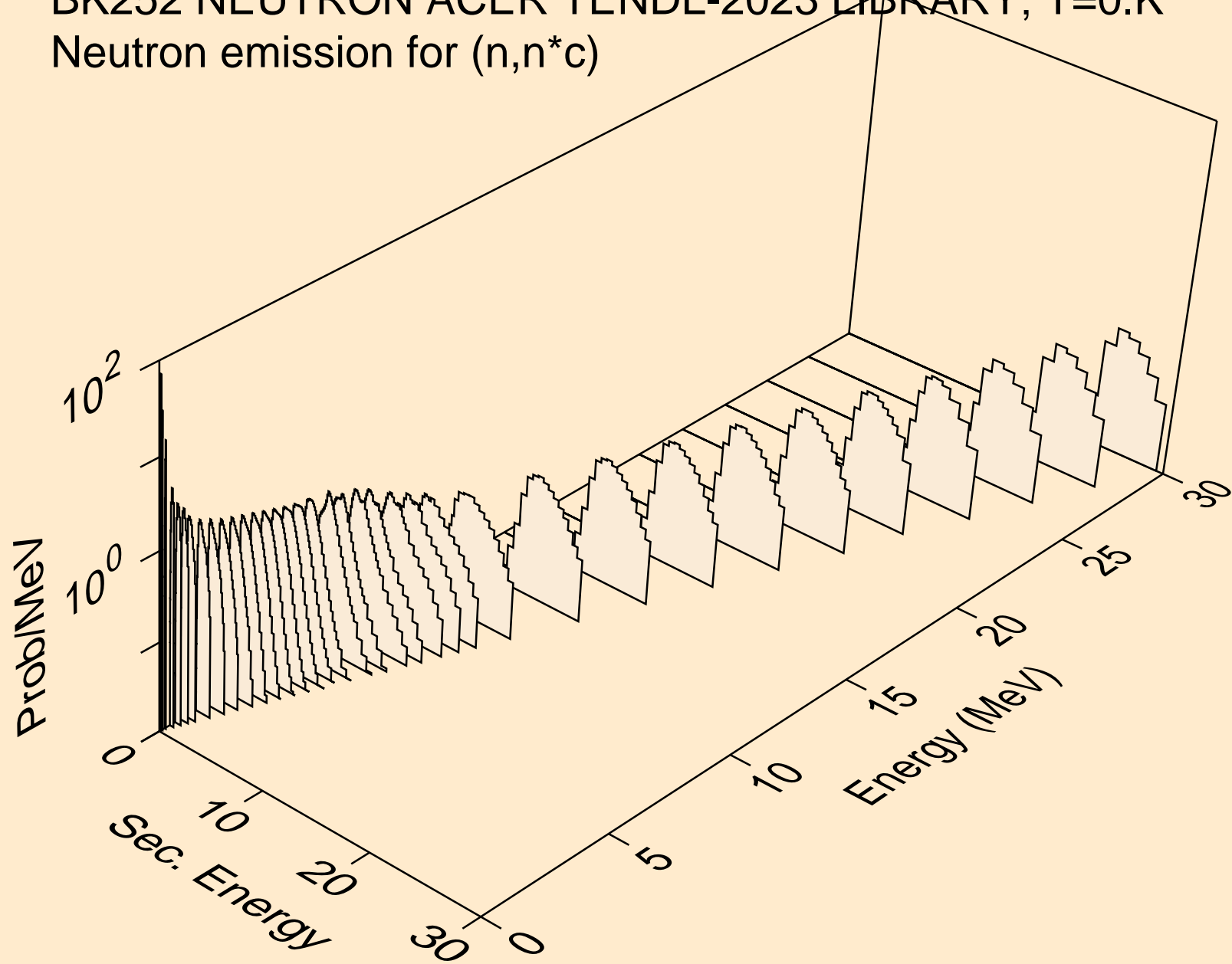

BK252 NEUTRON ACER TENDL-2023 LIBRARY; T=0.K

Delayed nubar

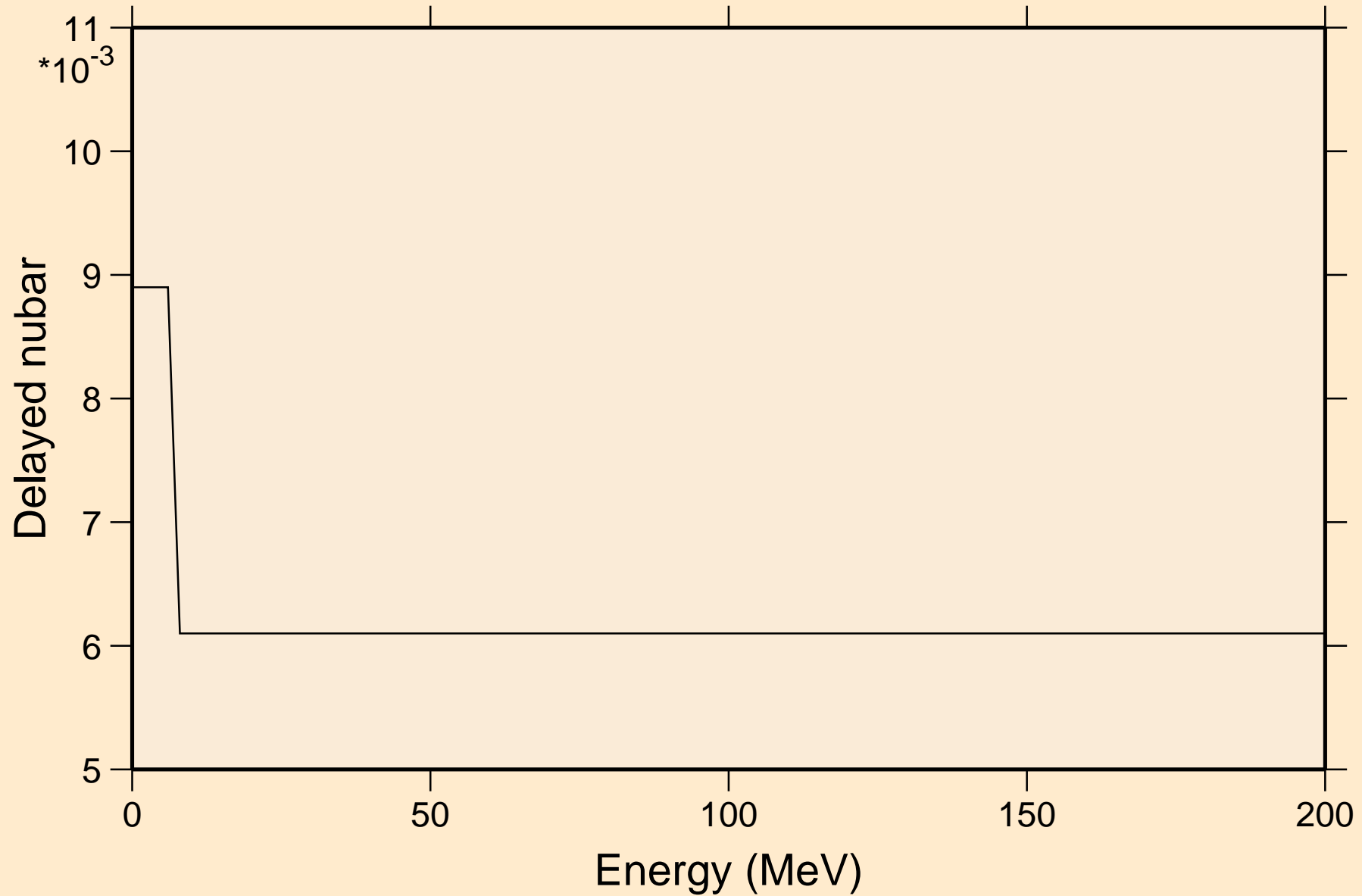

# BK252 NEUTRON ACER TENDL-2023 LIBRARY; T=0.K

## Delayed neutron spectra

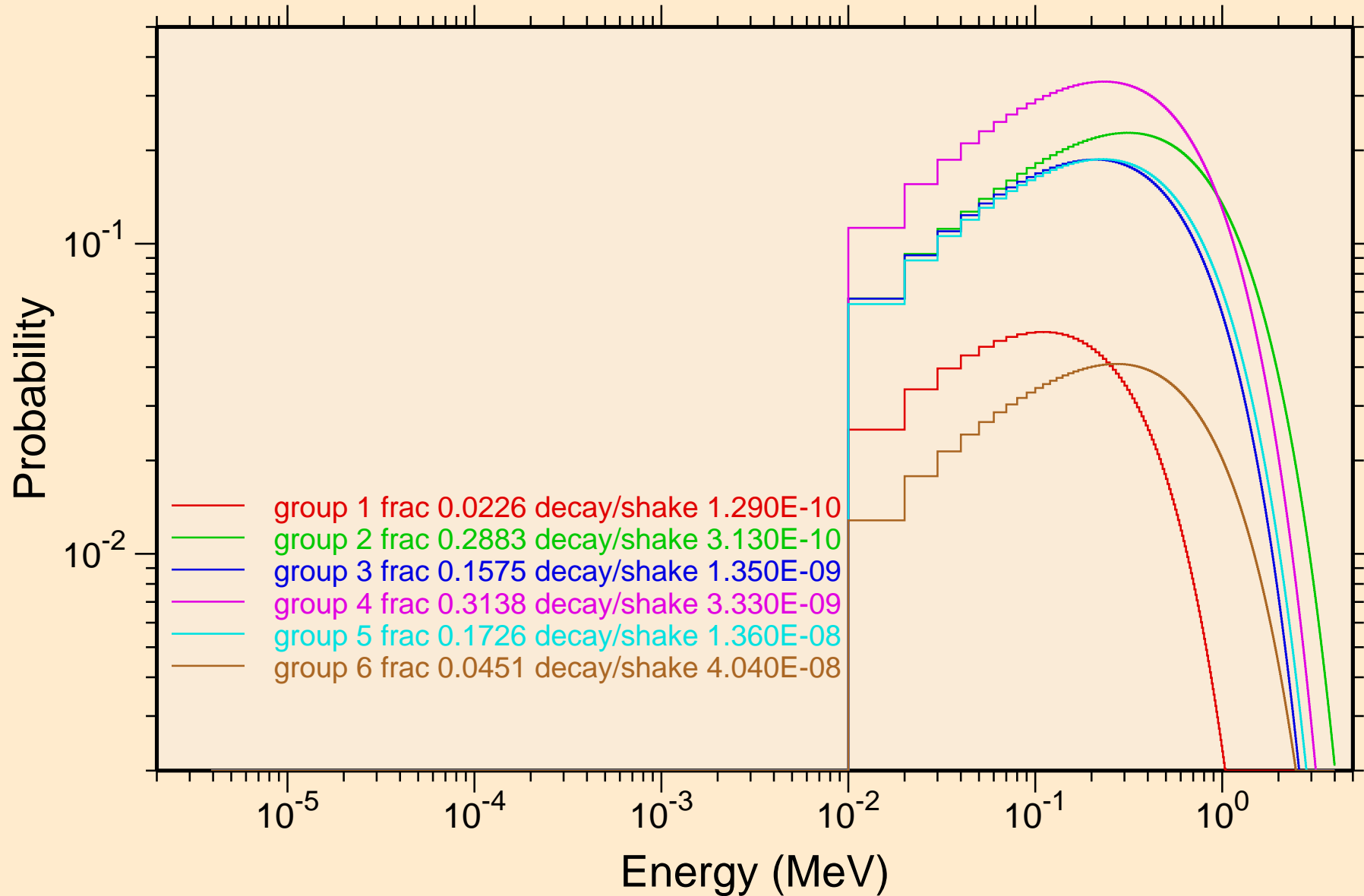

BK252 NEUTRON ACER TENDL-2023 LIBRARY; T=0.K  
Photon emission for (n,x)

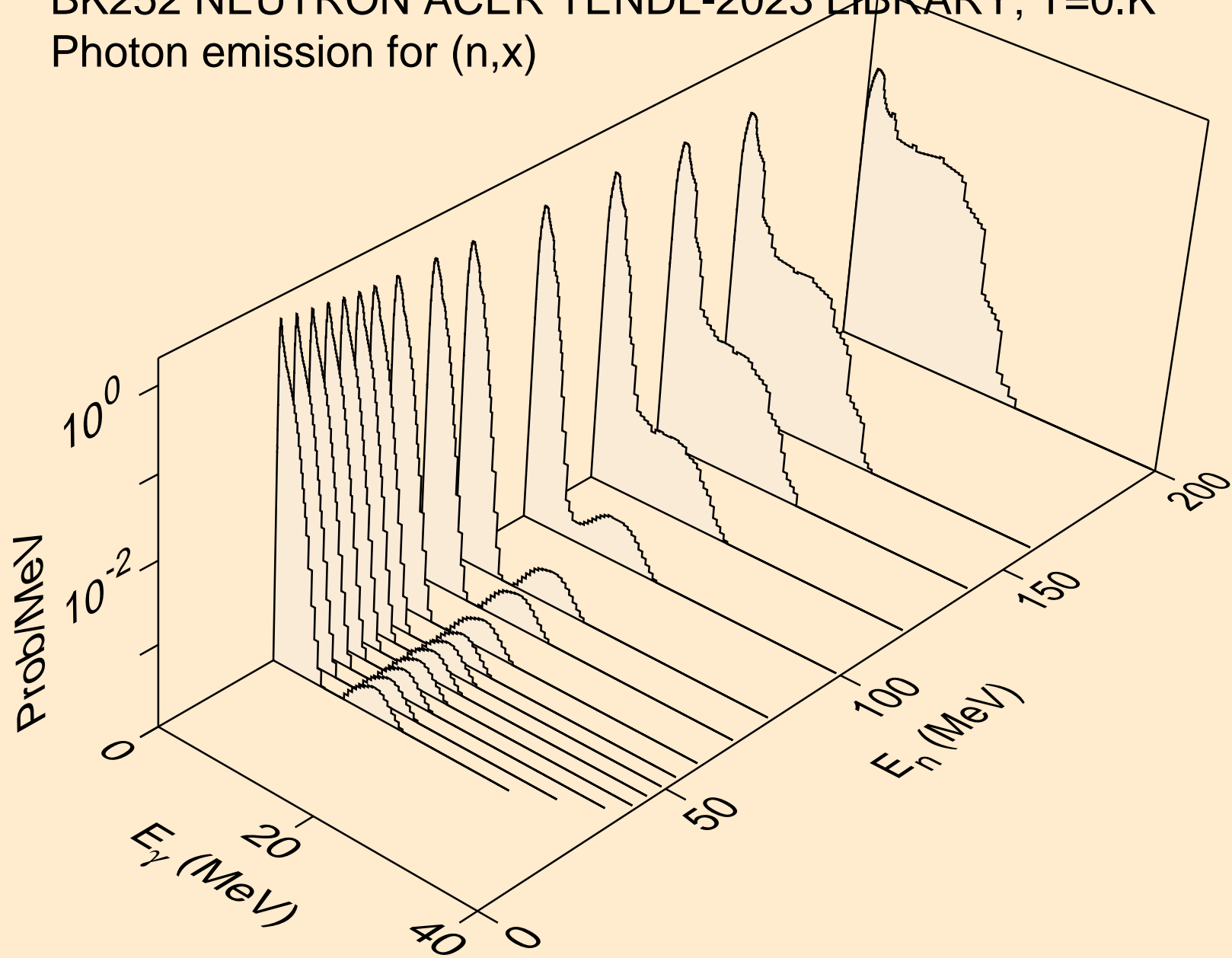

BK252 NEUTRON ACER TENDL-2023 LIBRARY; T=0.K  
Photon emission for (n,2nd)

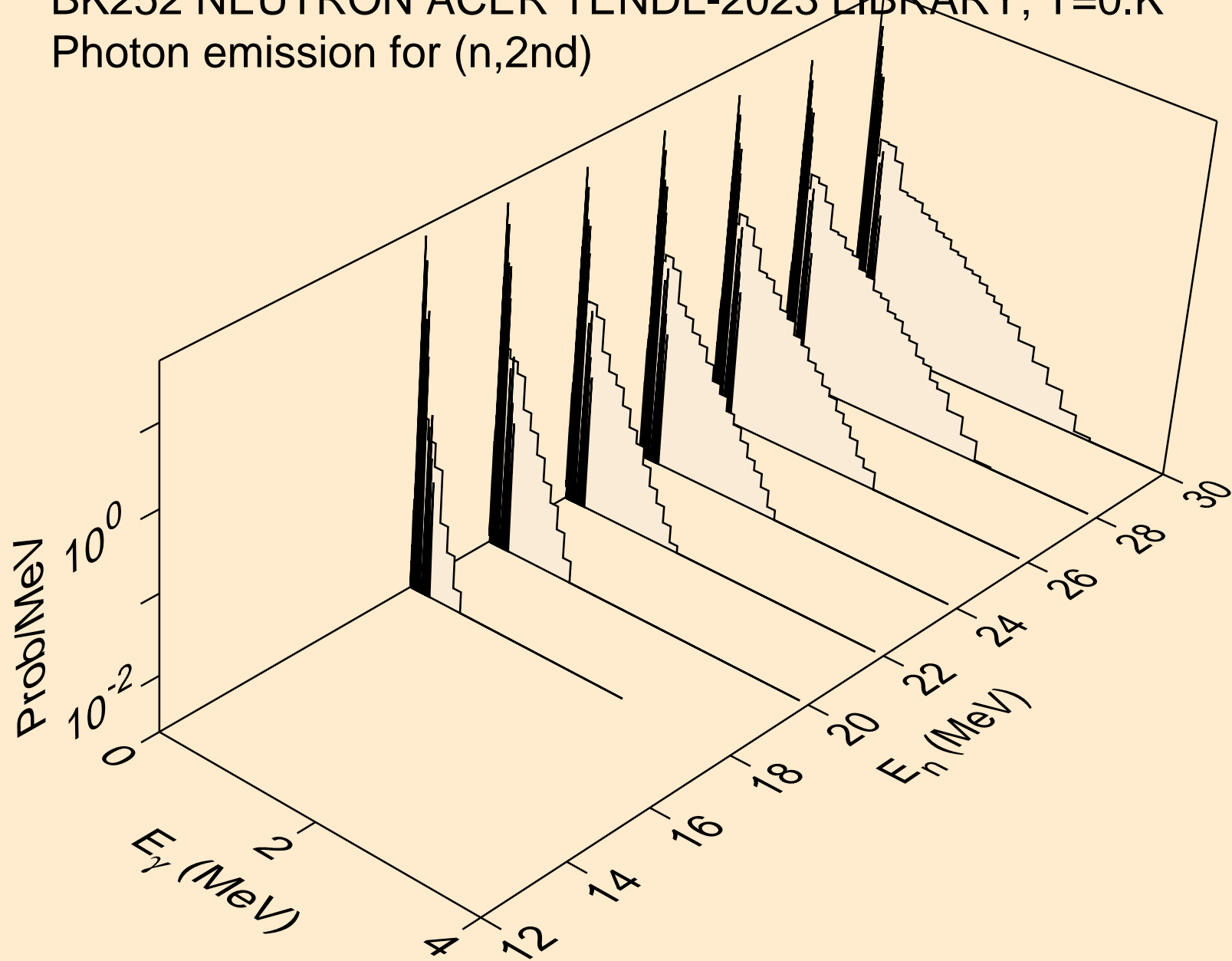

BK252 NEUTRON ACER TENDL-2023 LIBRARY; T=0.K  
Photon emission for (n,2n)

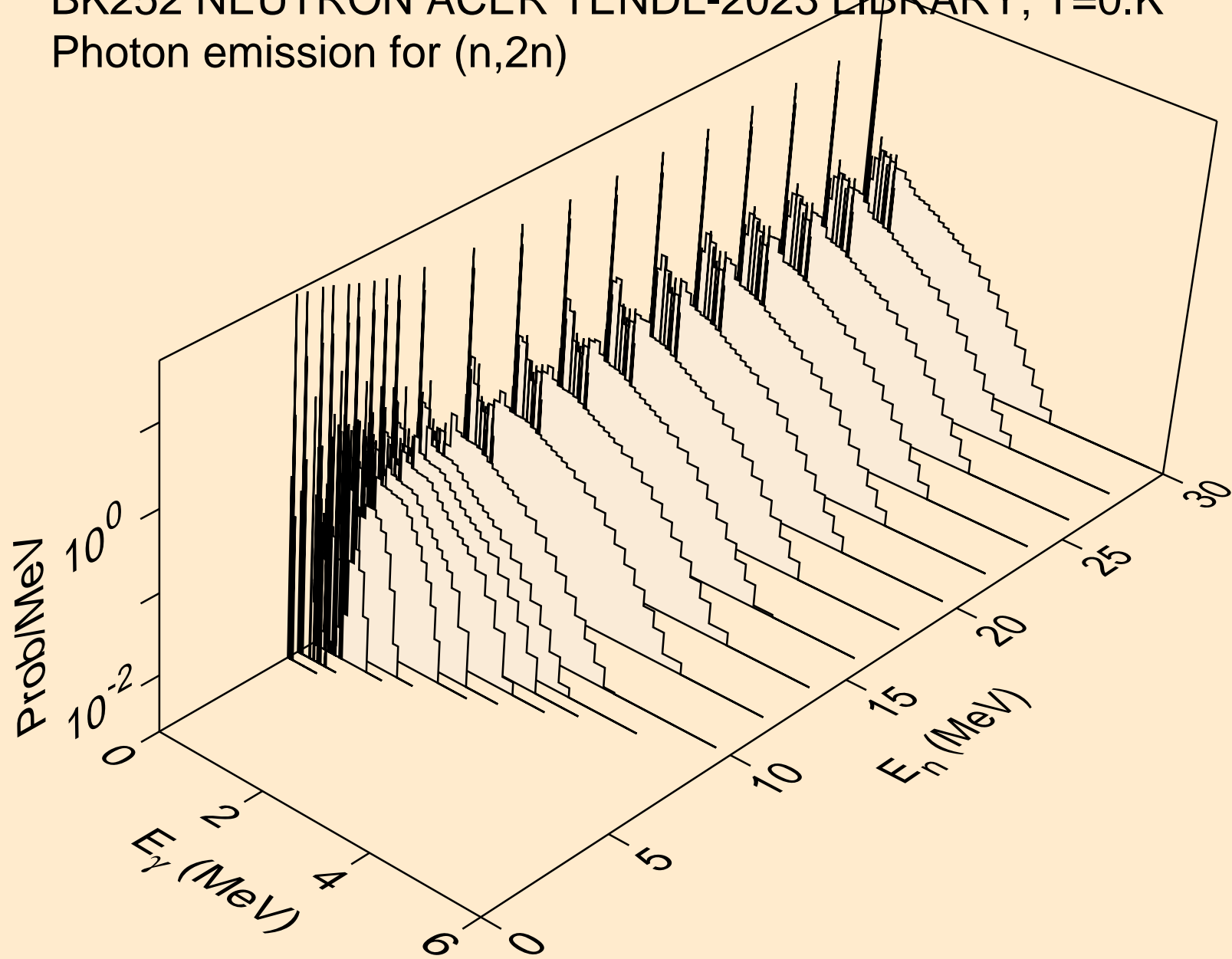

BK252 NEUTRON ACER TENDL-2023 LIBRARY; T=0.K  
Photon emission for (n,3n)

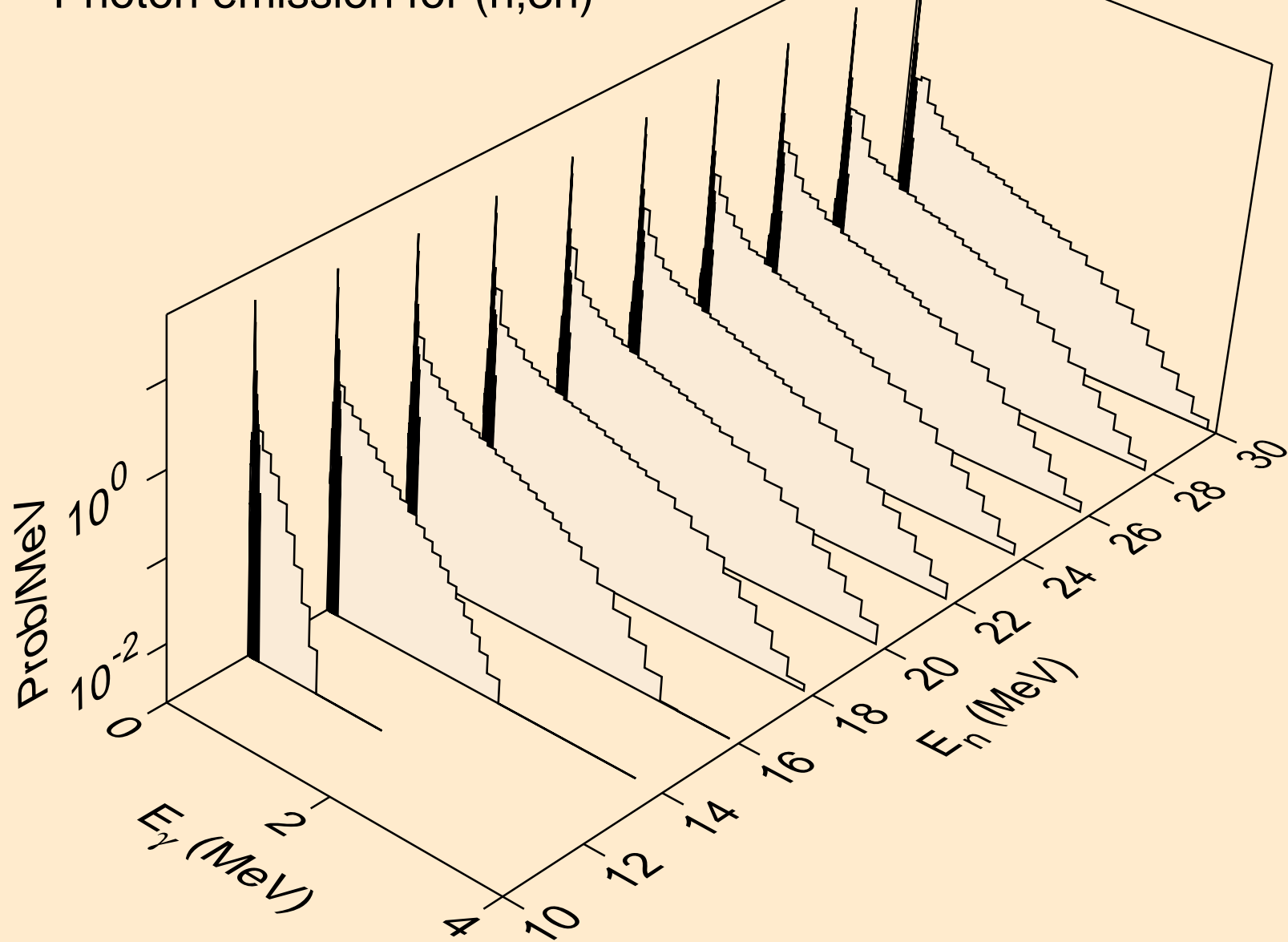

BK252 NEUTRON ACER TENDL-2023 LIBRARY; T=0.K  
Photon emission for (n,n\*)a

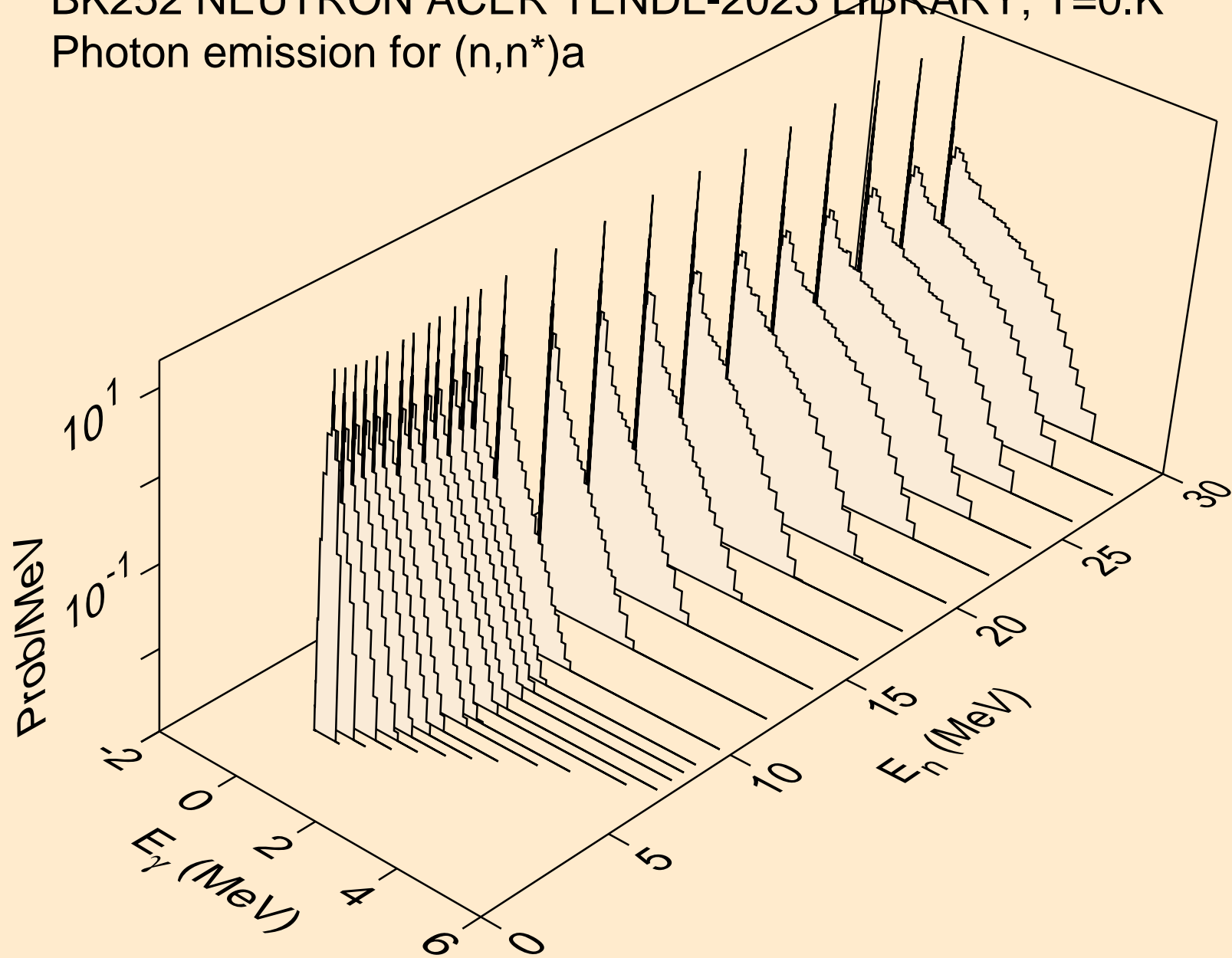

BK252 NEUTRON ACER TENDL-2023 LIBRARY; T=0.K  
Photon emission for (n,2n)a

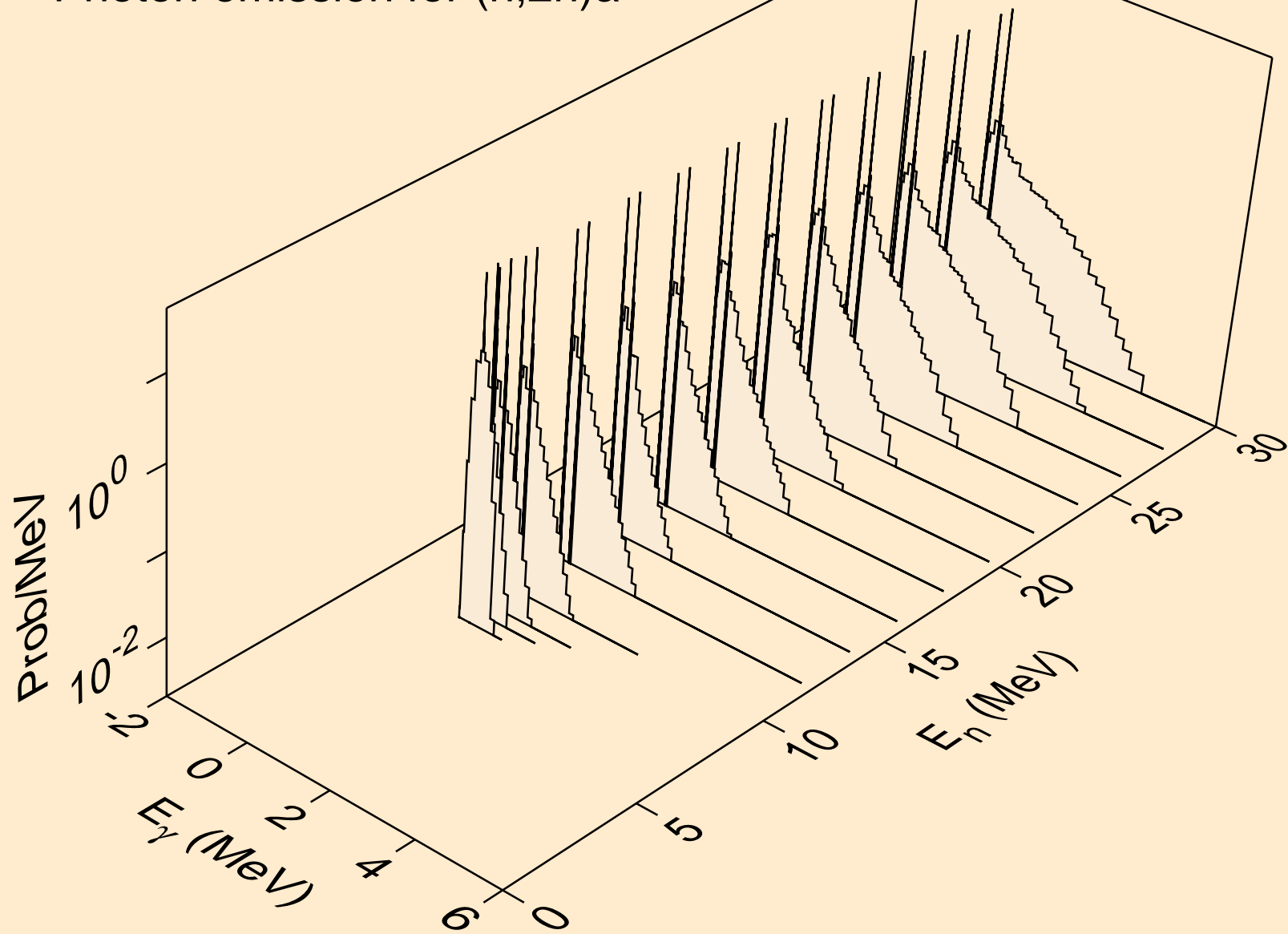

BK252 NEUTRON ACER TENDL-2023 LIBRARY; T=0.K  
Photon emission for (n,3n)a

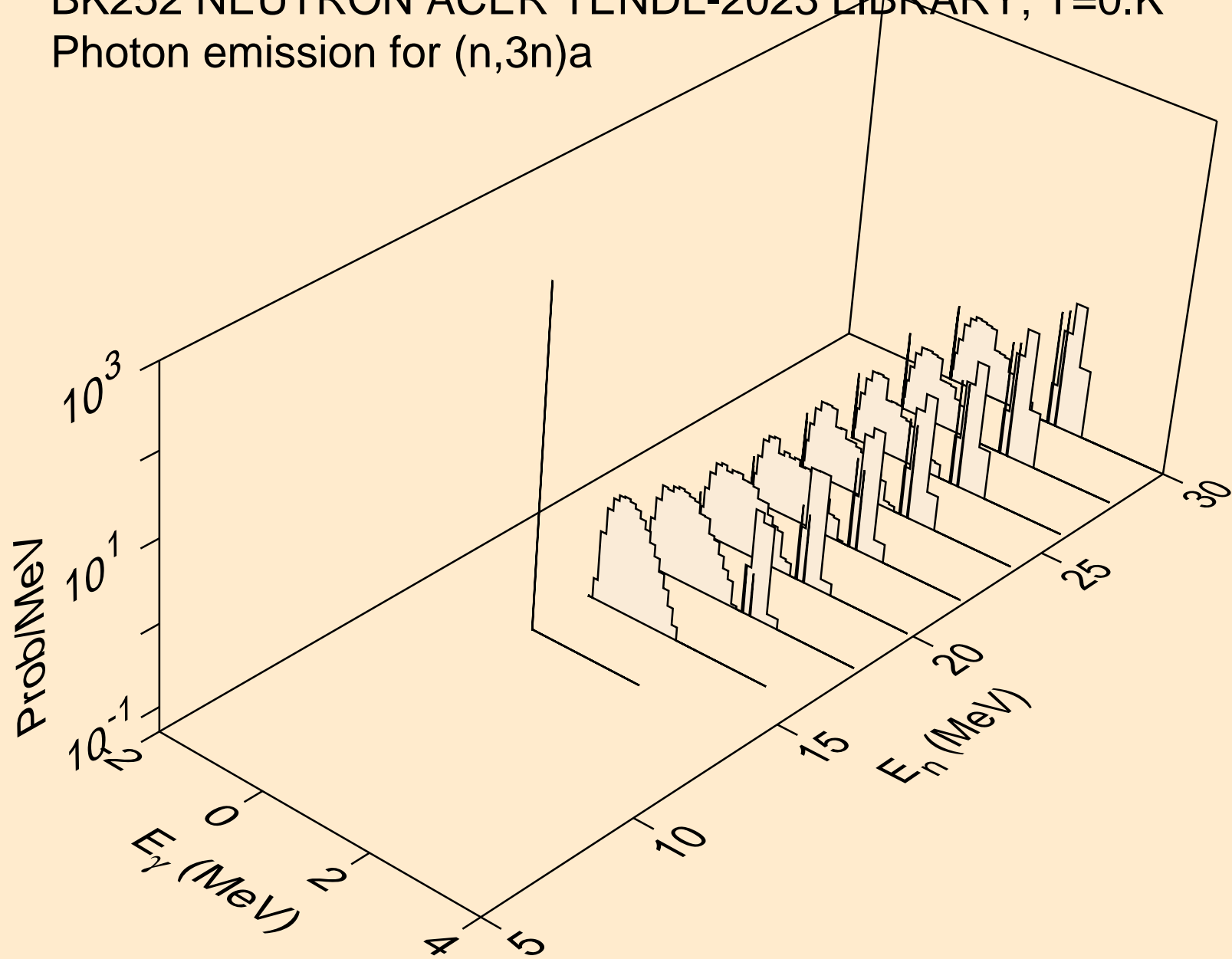

BK252 NEUTRON ACER TENDL-2023 LIBRARY; T=0.K  
Photon emission for (n,n\*)p

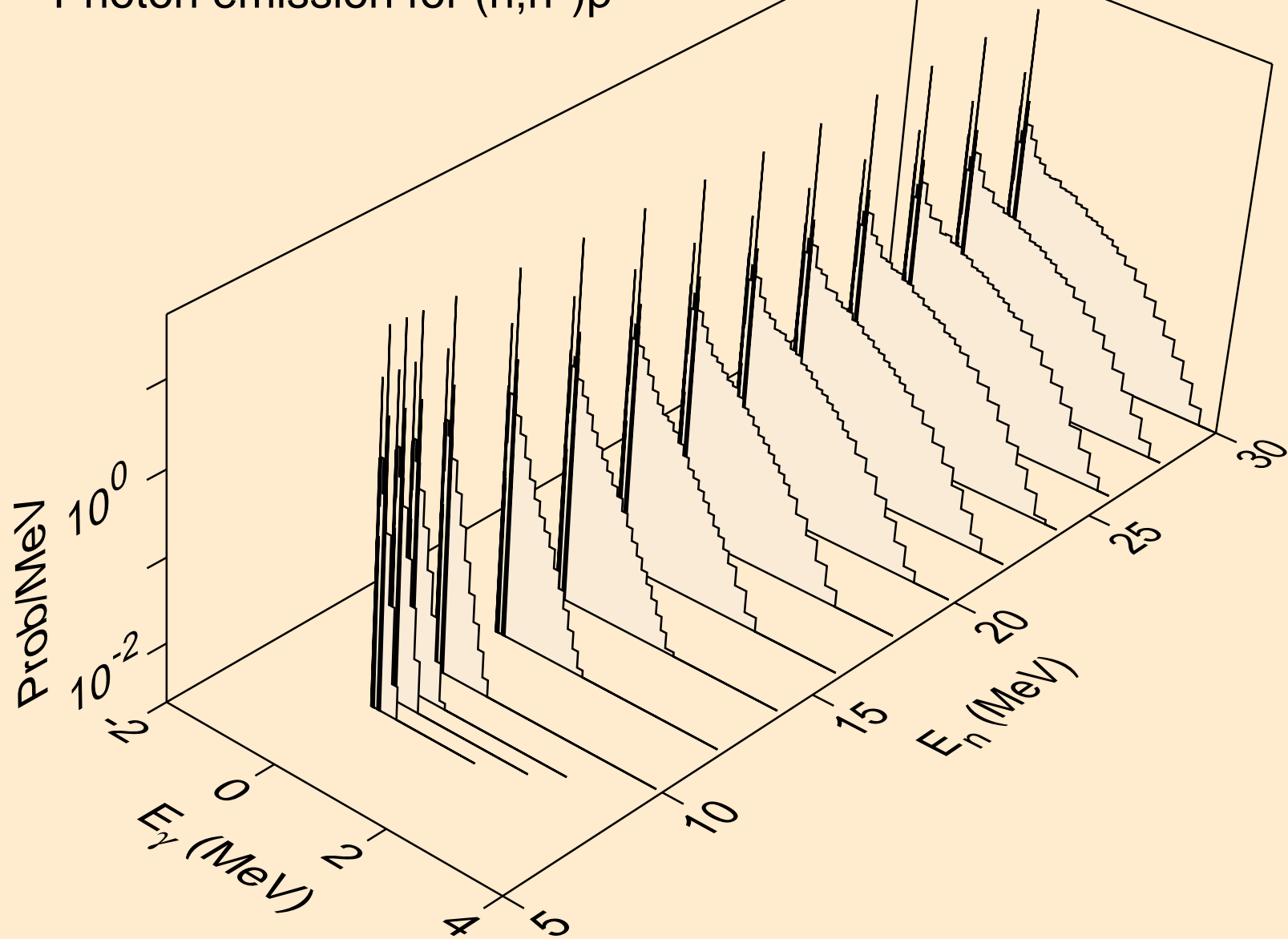

BK252 NEUTRON ACER TENDL-2023 LIBRARY; T=0.K  
Photon emission for (n,n\*)d

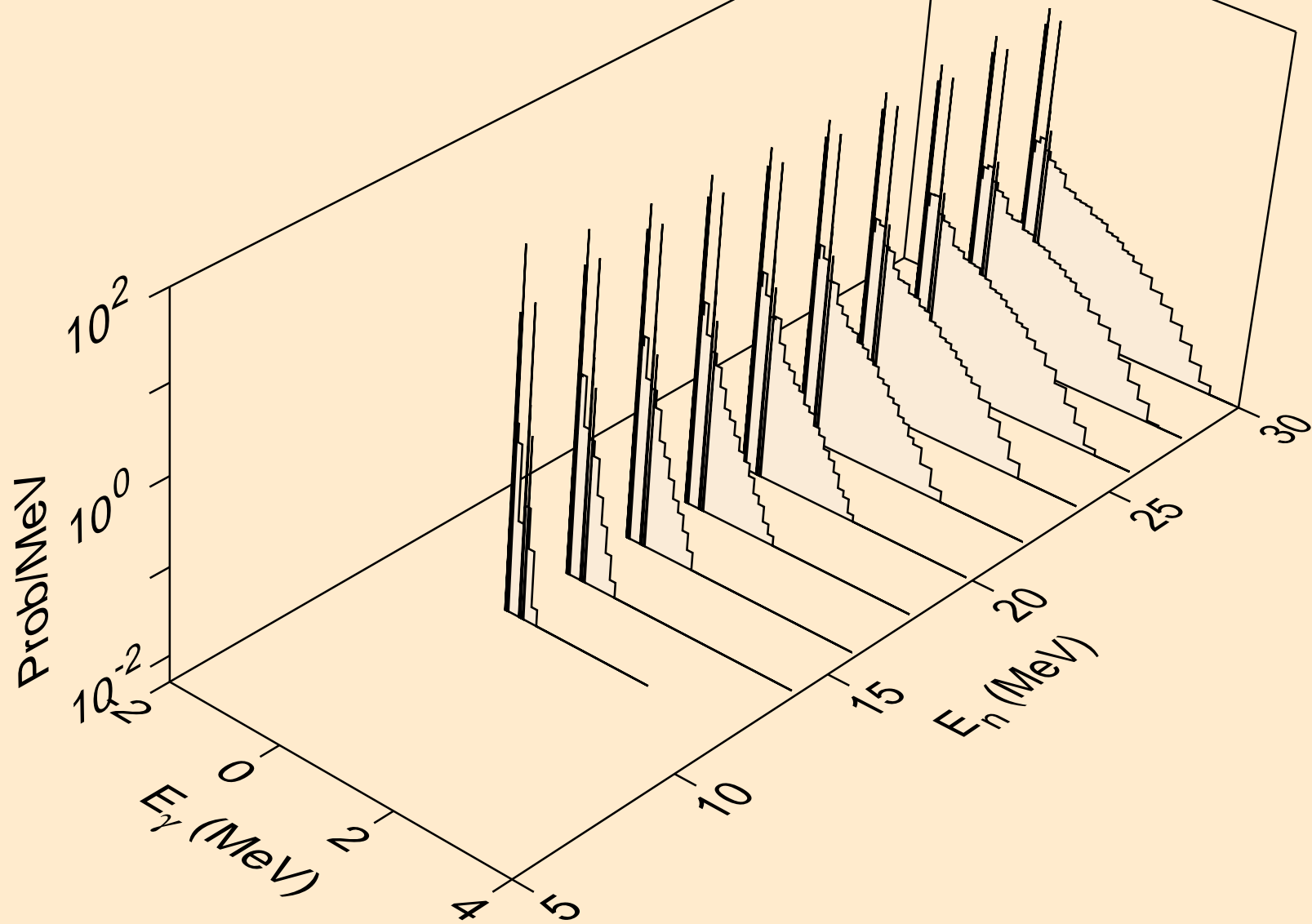

BK252 NEUTRON ACER TENDL-2023 LIBRARY; T=0.K  
Photon emission for (n,n\*)t

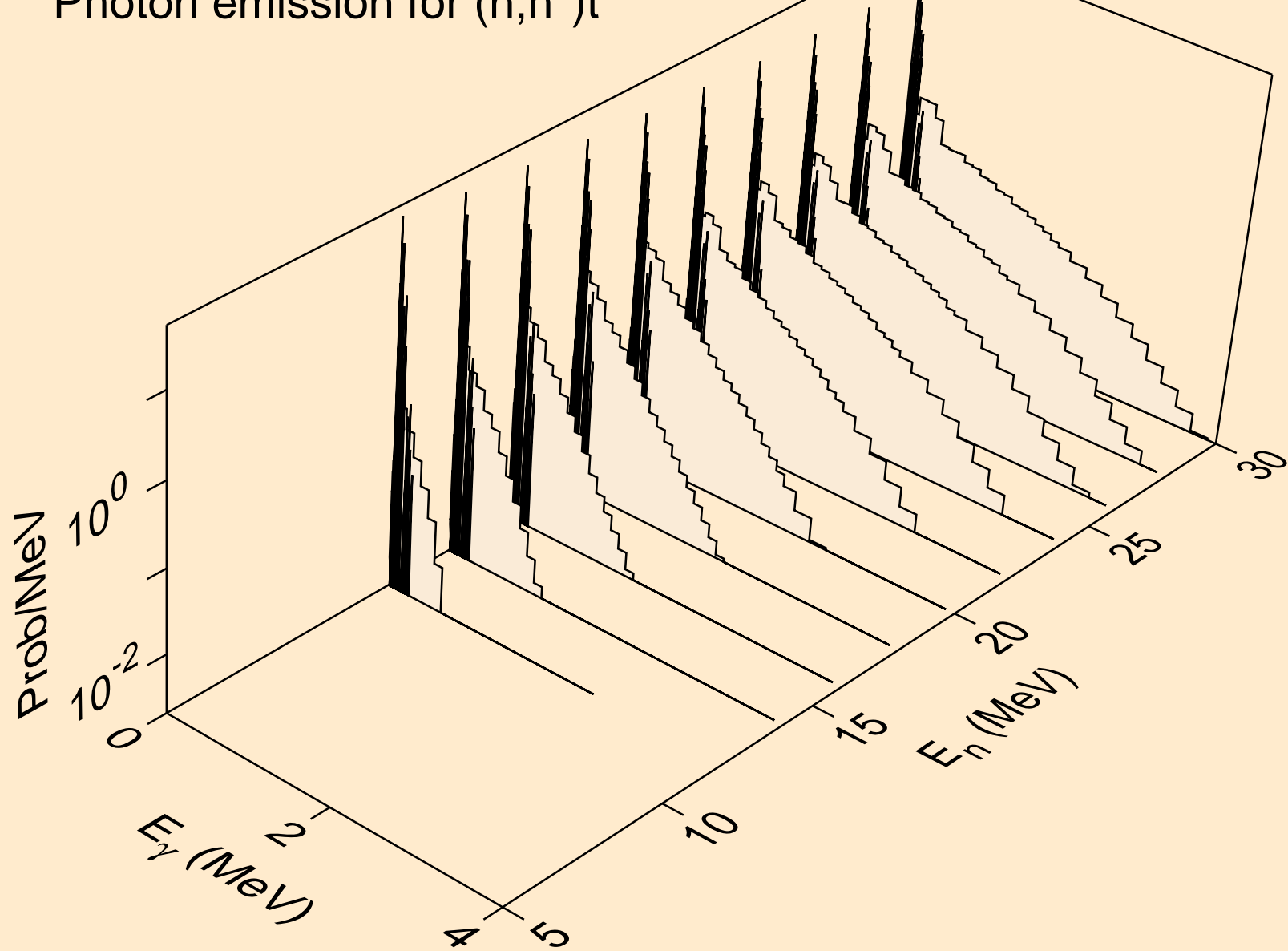

BK252 NEUTRON ACER TENDL-2023 LIBRARY; T=0.K  
Photon emission for (n,n\*)he3

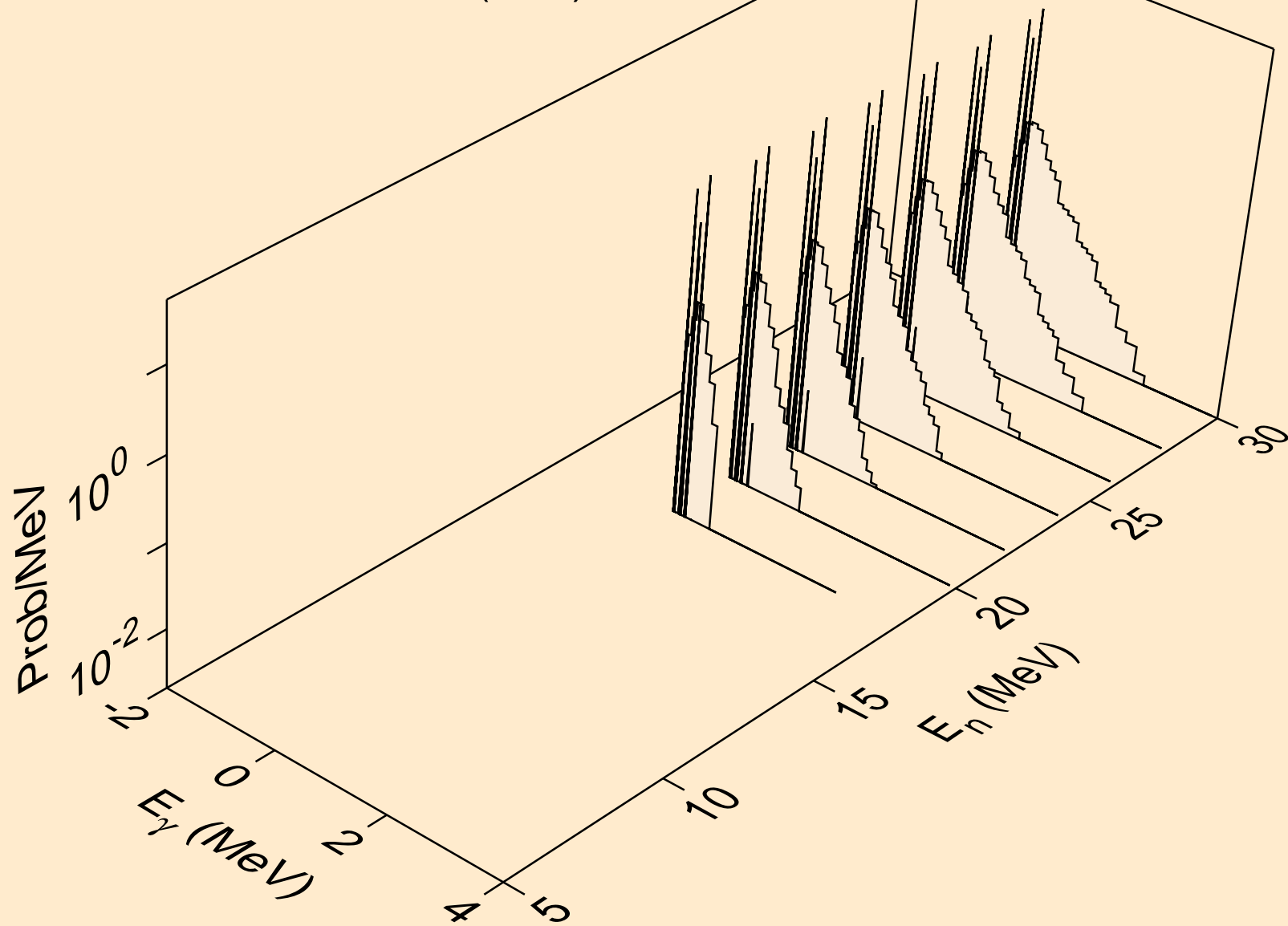

BK252 NEUTRON ACER TENDL-2023 LIBRARY; T=0.K  
Photon emission for (n,4n)

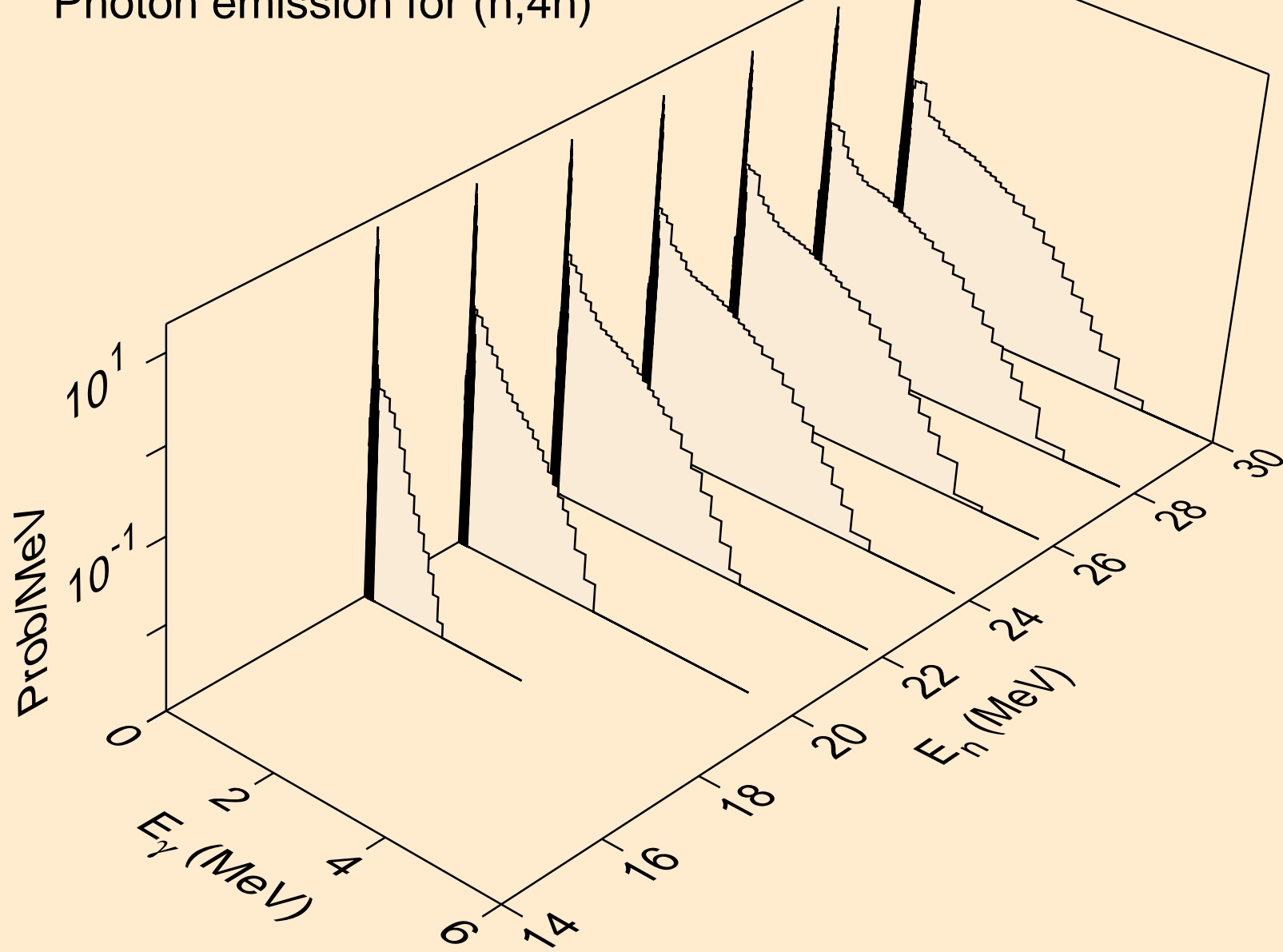

BK252 NEUTRON ACER TENDL-2023 LIBRARY; T=0.K  
Photon emission for (n,2np)

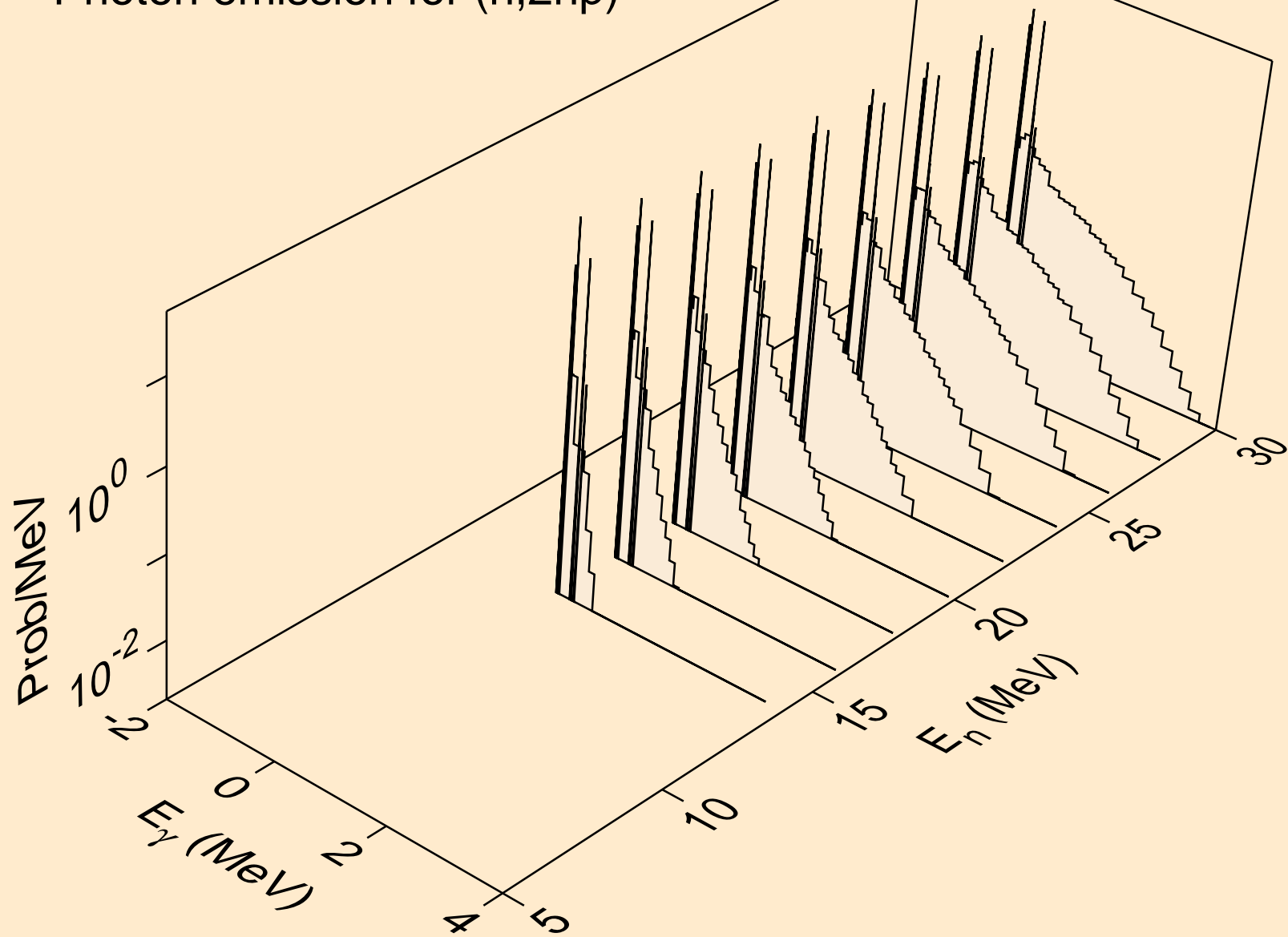

BK252 NEUTRON ACER TENDL-2023 LIBRARY; T=0.K  
Photon emission for (n,3np)

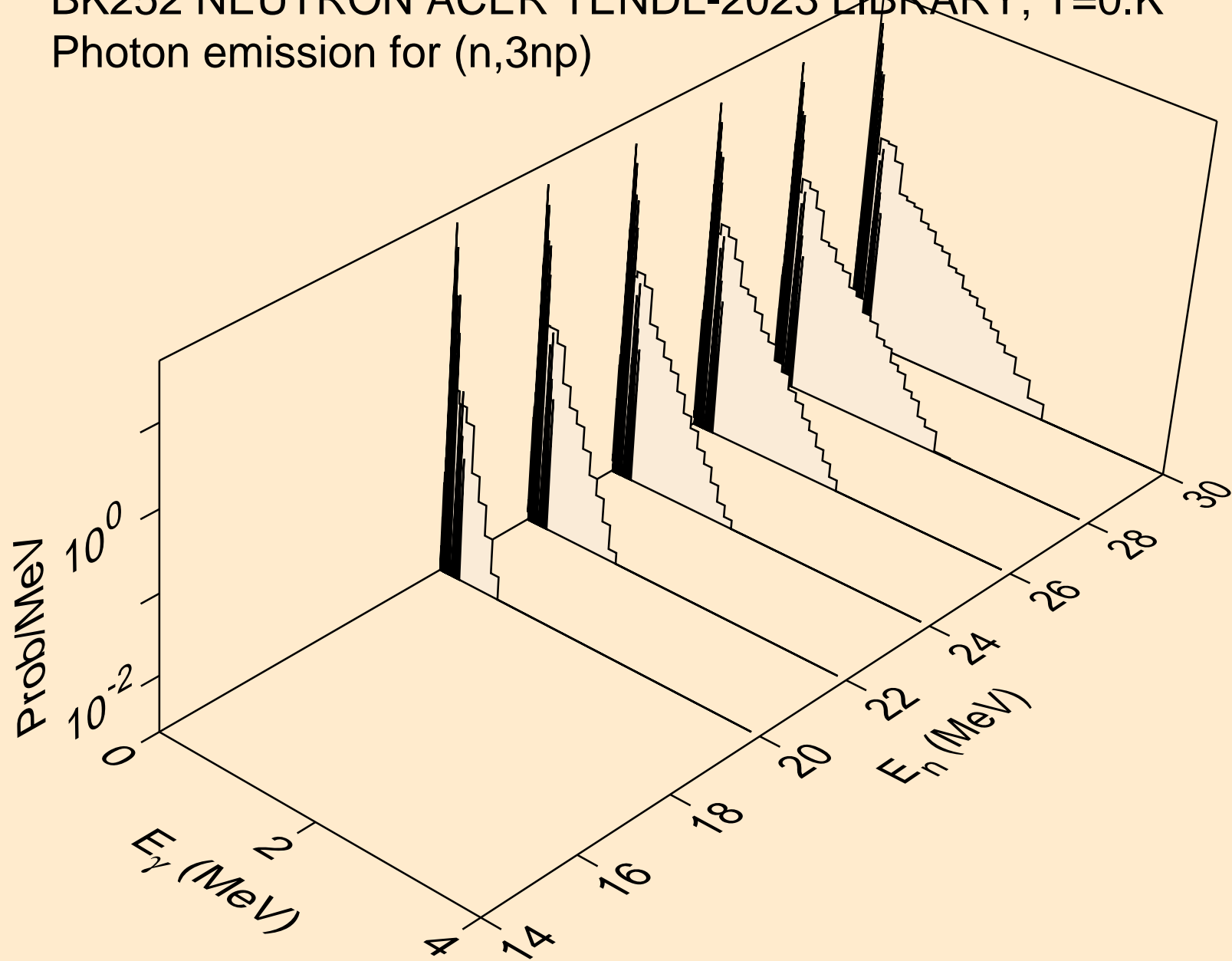

BK252 NEUTRON ACER TENDL-2023 LIBRARY; T=0.K  
Photon emission for (n,n\*c)

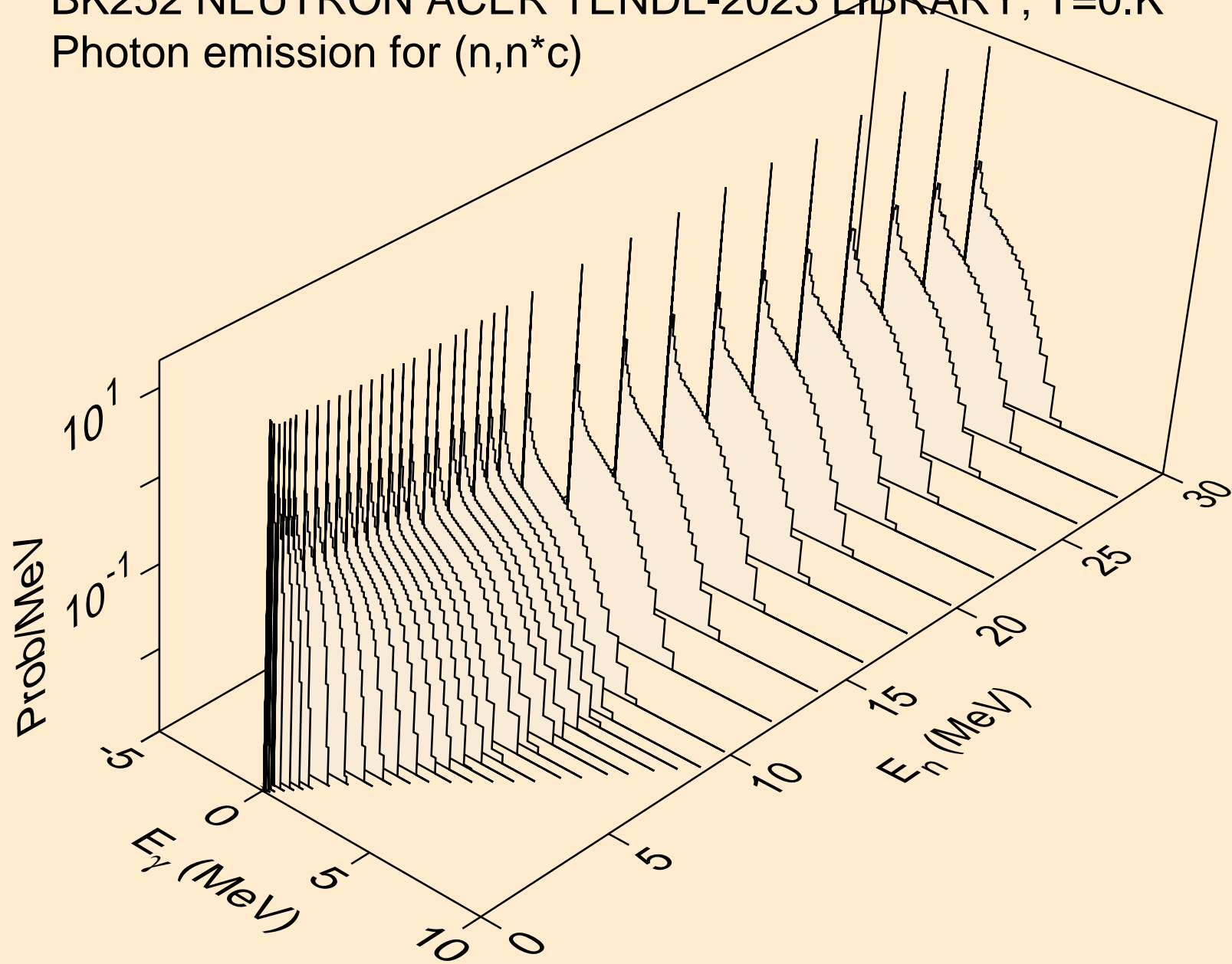

BK252 NEUTRON ACER TENDL-2023 LIBRARY; T=0.K  
Photon emission for (n,gma)

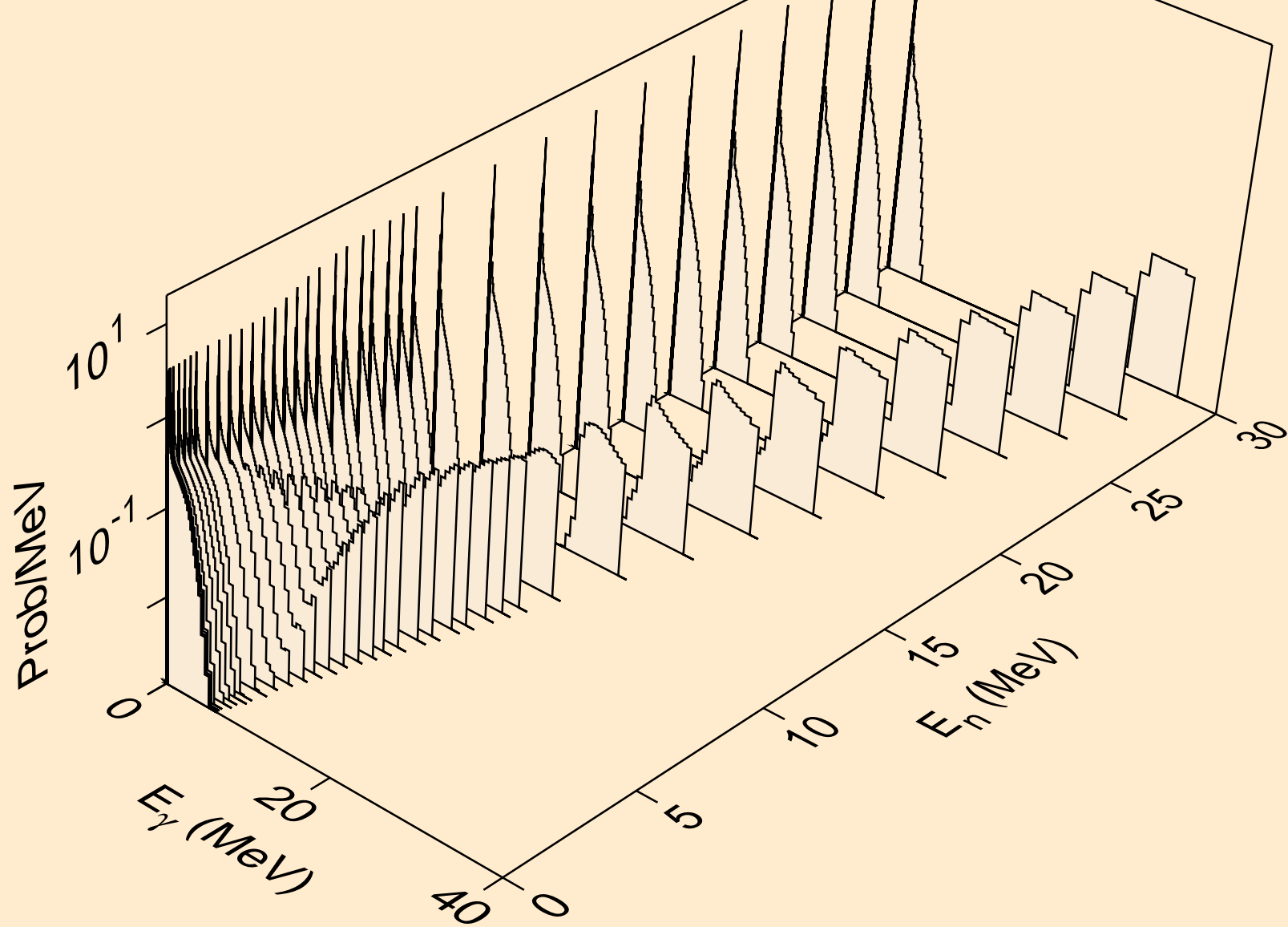

BK252 NEUTRON ACER TENDL-2023 LIBRARY; T=0.K  
Photon emission for (n,p)

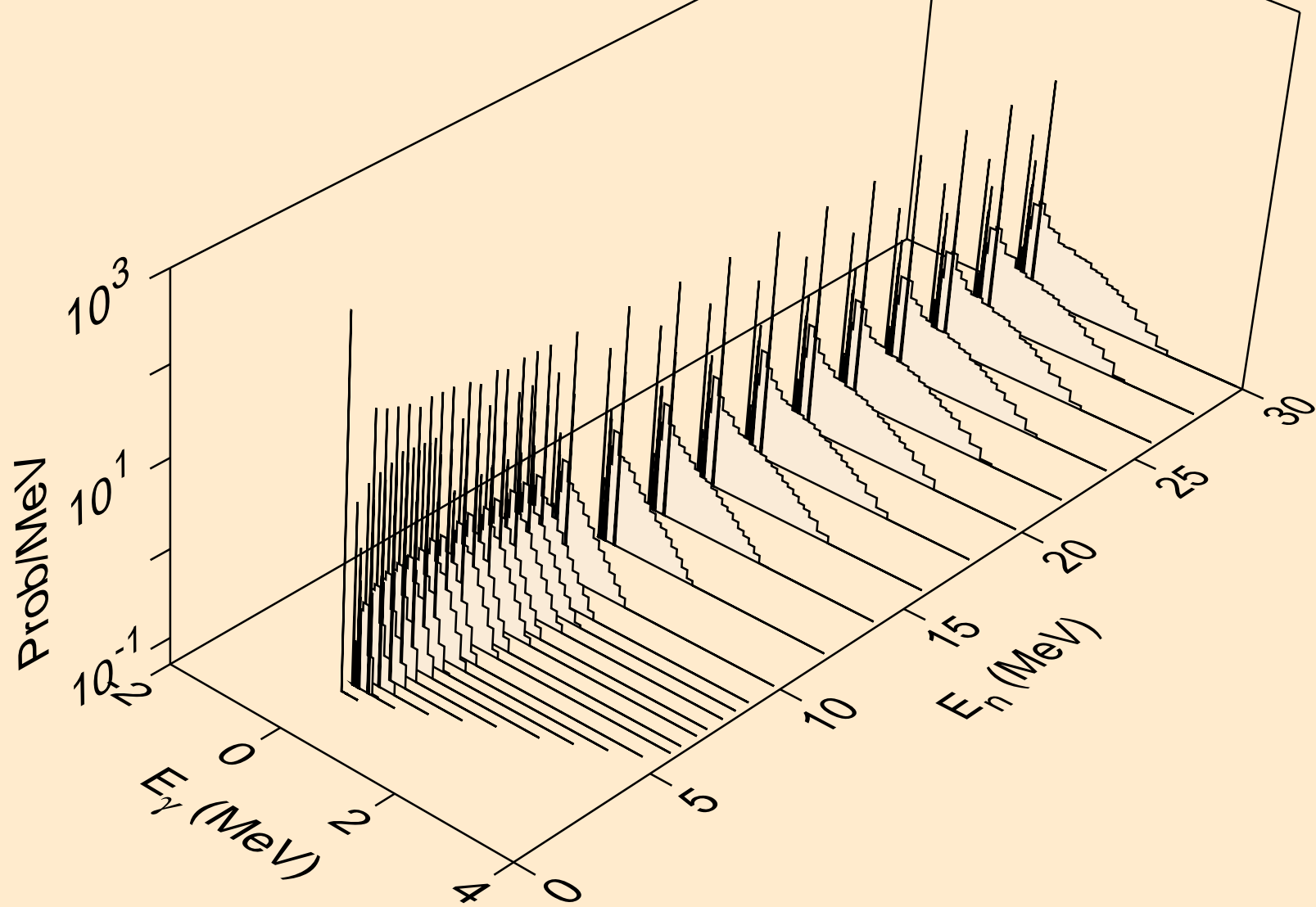

BK252 NEUTRON ACER TENDL-2023 LIBRARY; T=0.K  
Photon emission for (n,d)

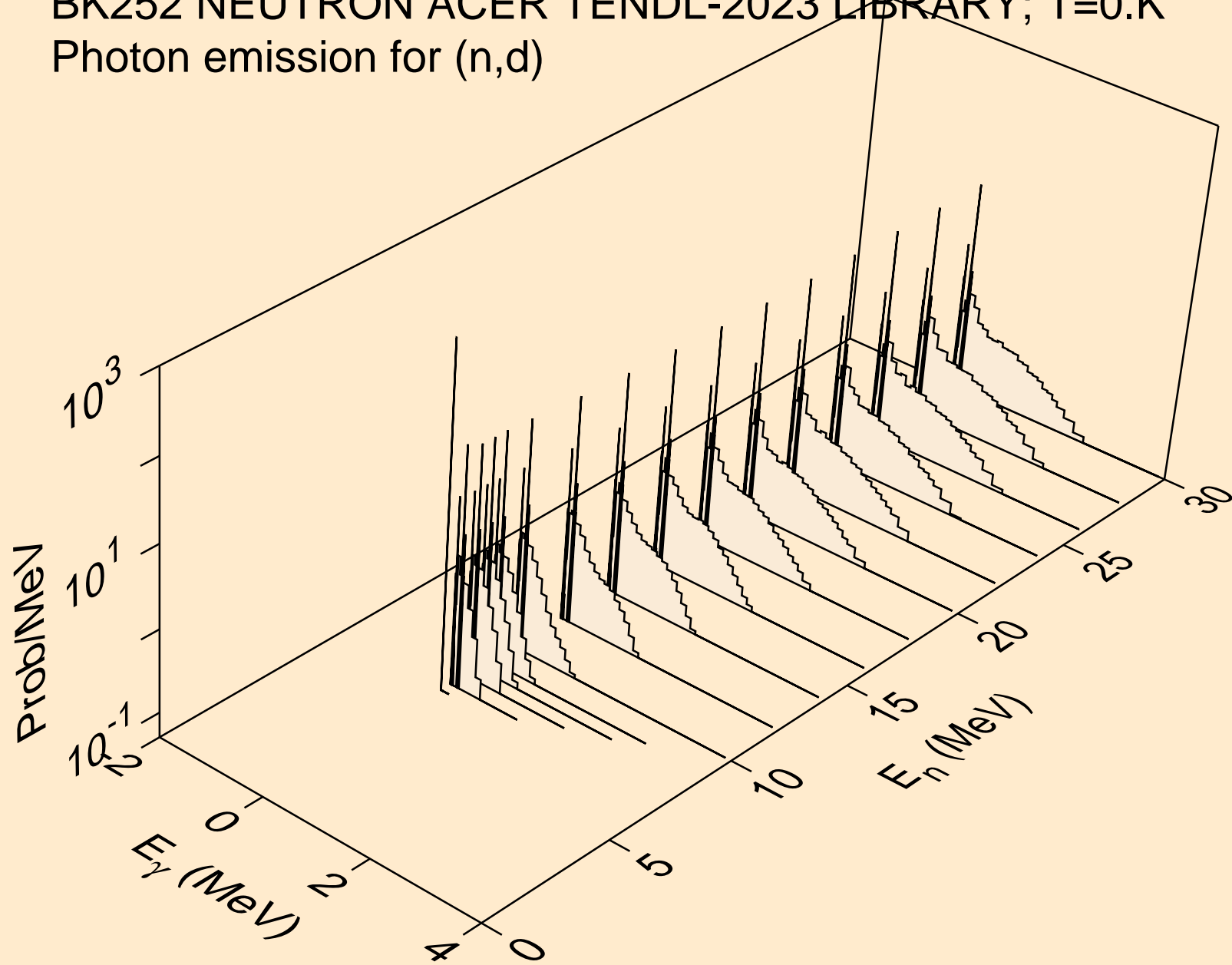

BK252 NEUTRON ACER TENDL-2023 LIBRARY; T=0.K  
Photon emission for (n,t)

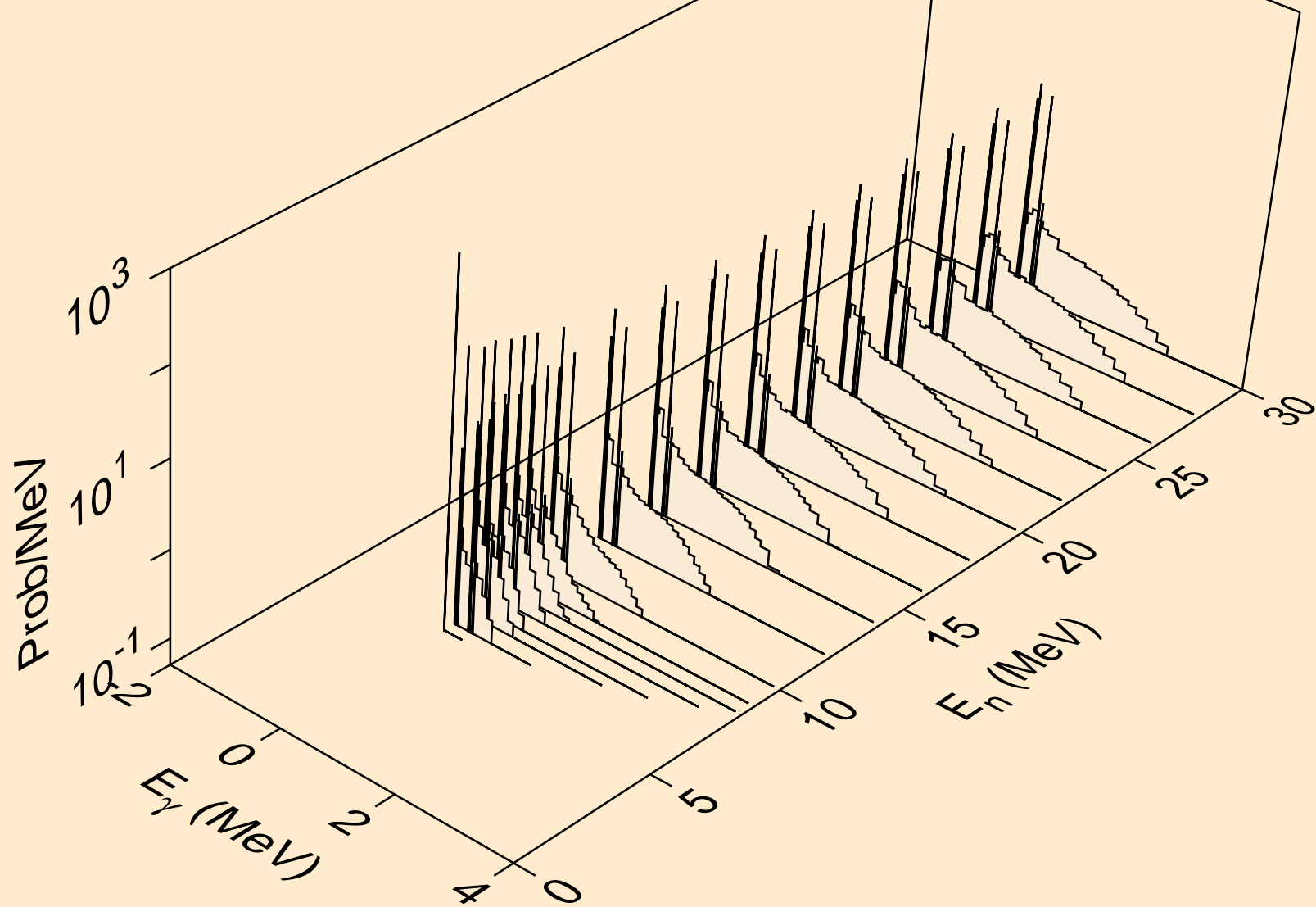

BK252 NEUTRON ACER TENDL-2023 LIBRARY; T=0.K  
Photon emission for (n,he3)

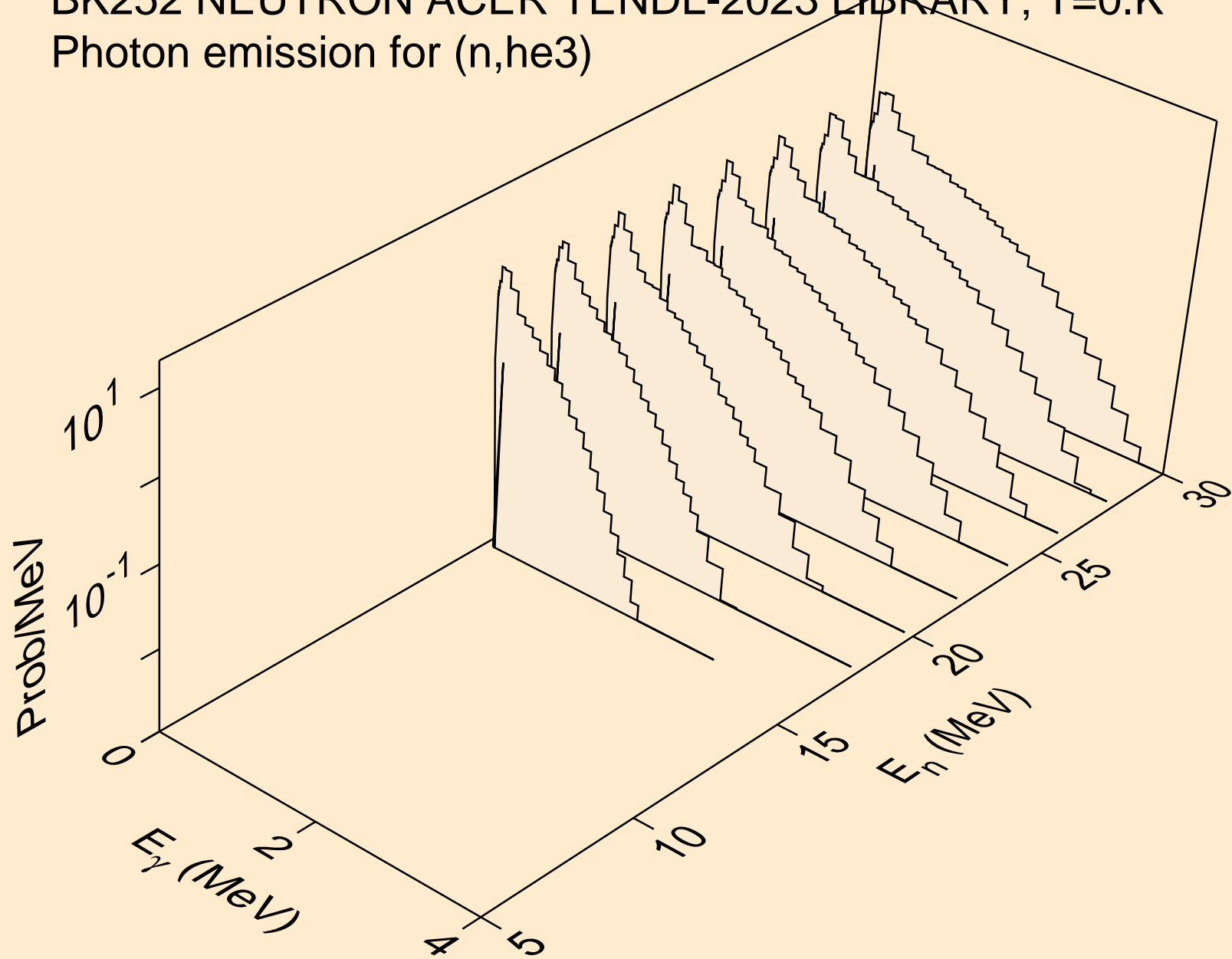

BK252 NEUTRON ACER TENDL-2023 LIBRARY; T=0.K  
Photon emission for (n,a)

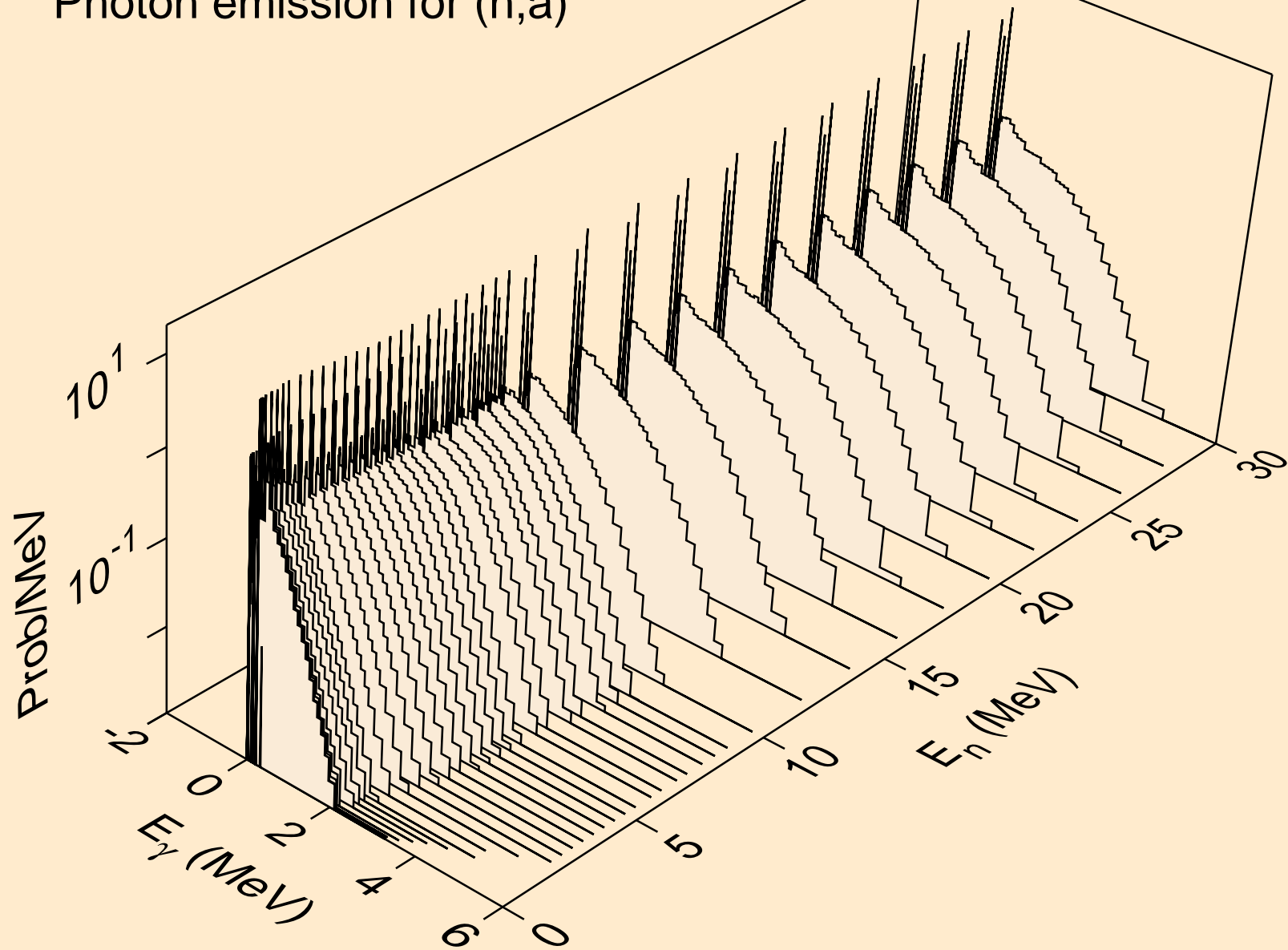

BK252 NEUTRON ACER TENDL-2023 LIBRARY; T=0.K  
Photon emission for (n,2p)

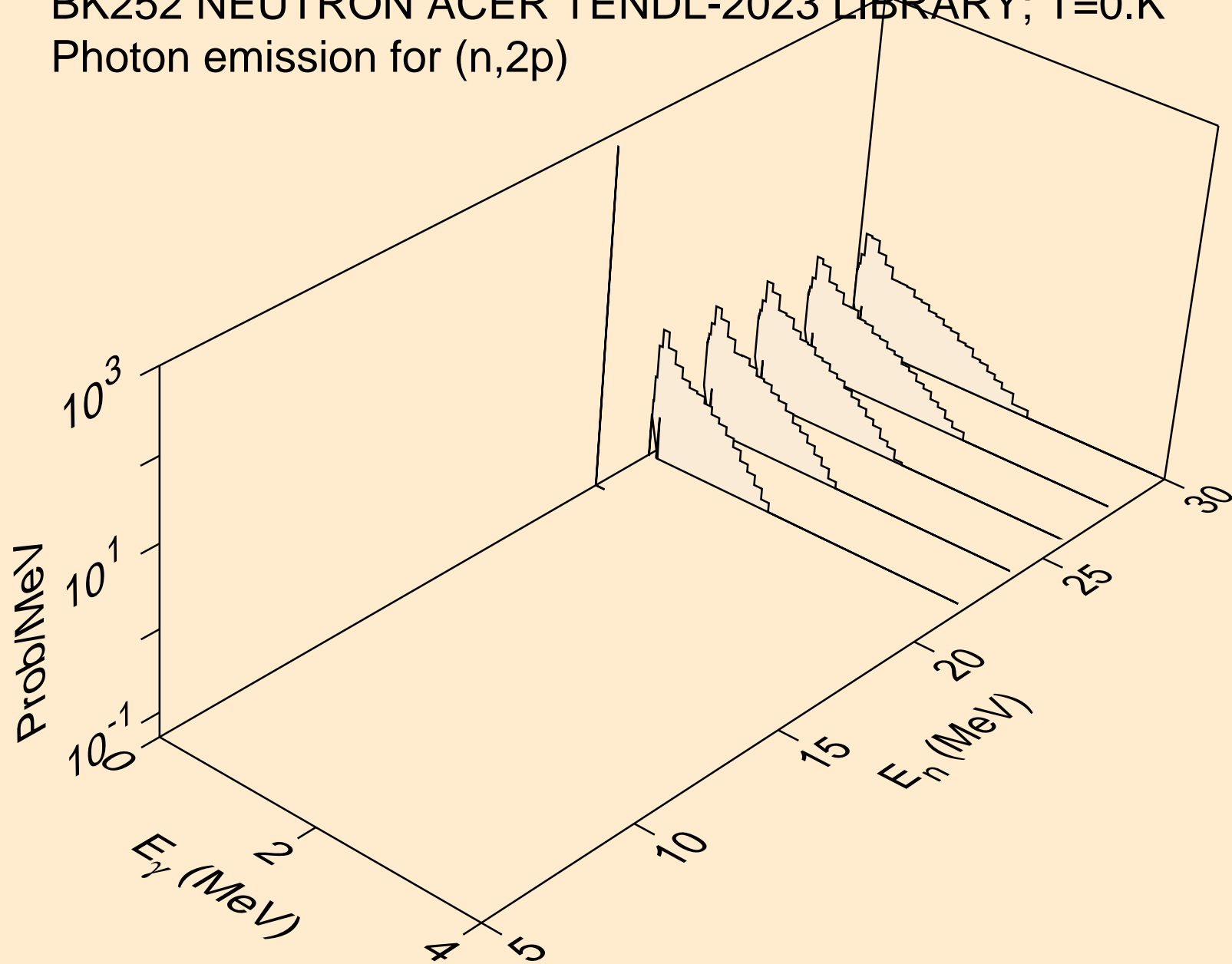

BK252 NEUTRON ACER TENDL-2023 LIBRARY; T=0.K  
thermal capture photon spectrum

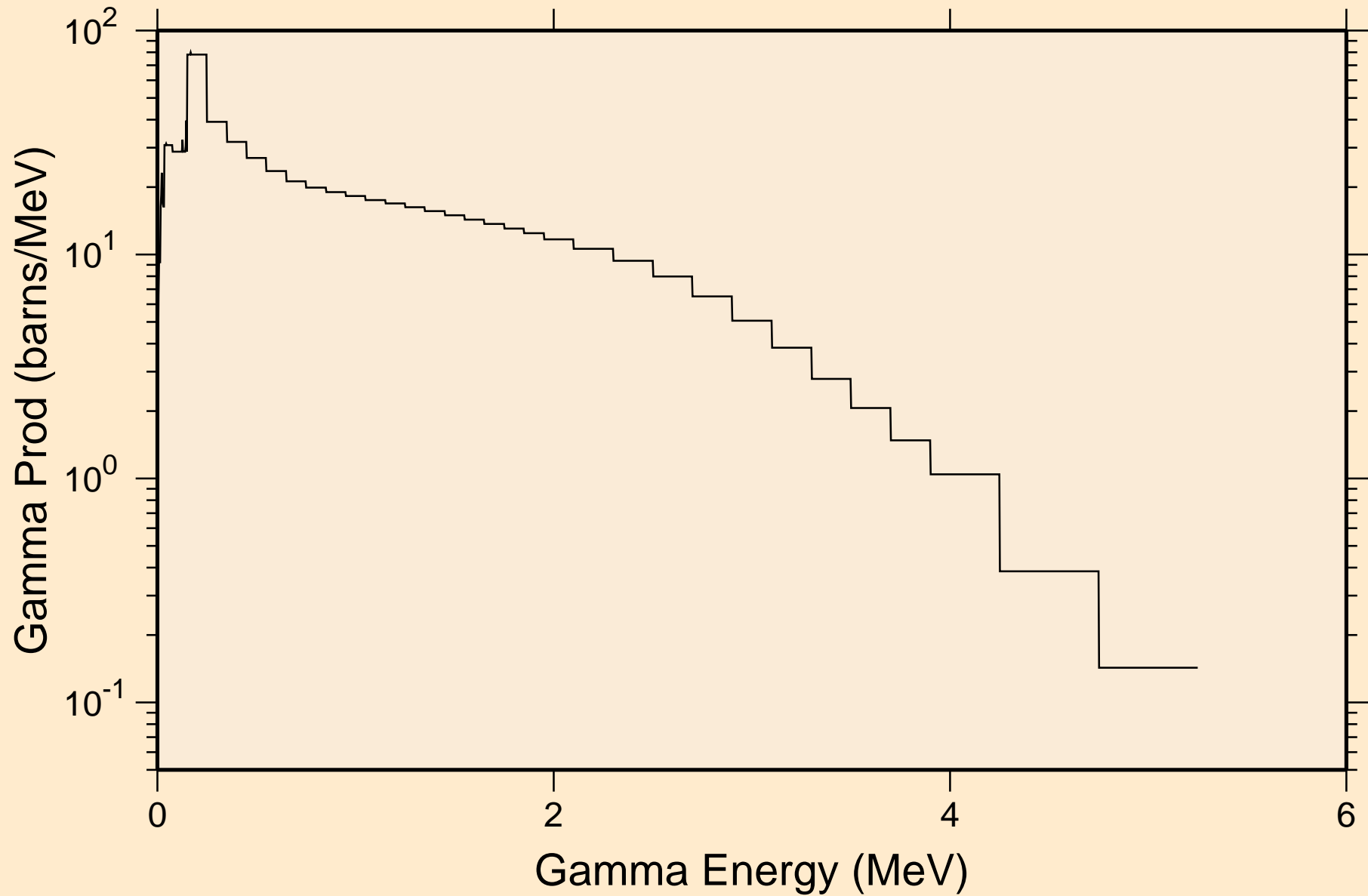

BK252 NEUTRON ACER TENDL-2023 LIBRARY; T=0.K  
14 MeV photon spectrum

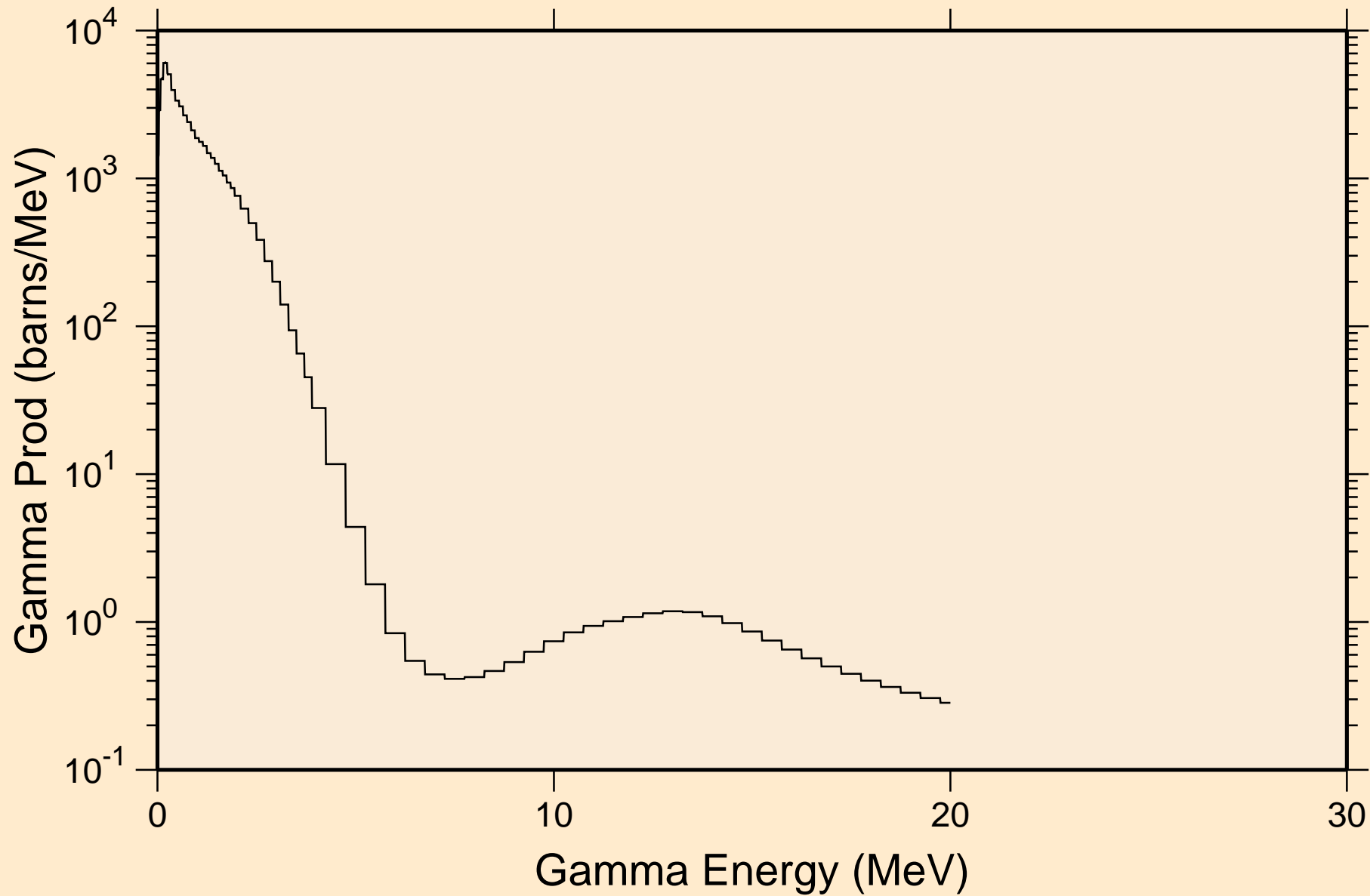

BK252 NEUTRON ACER TENDL-2023 LIBRARY; T=0.K  
Particle heating contributions

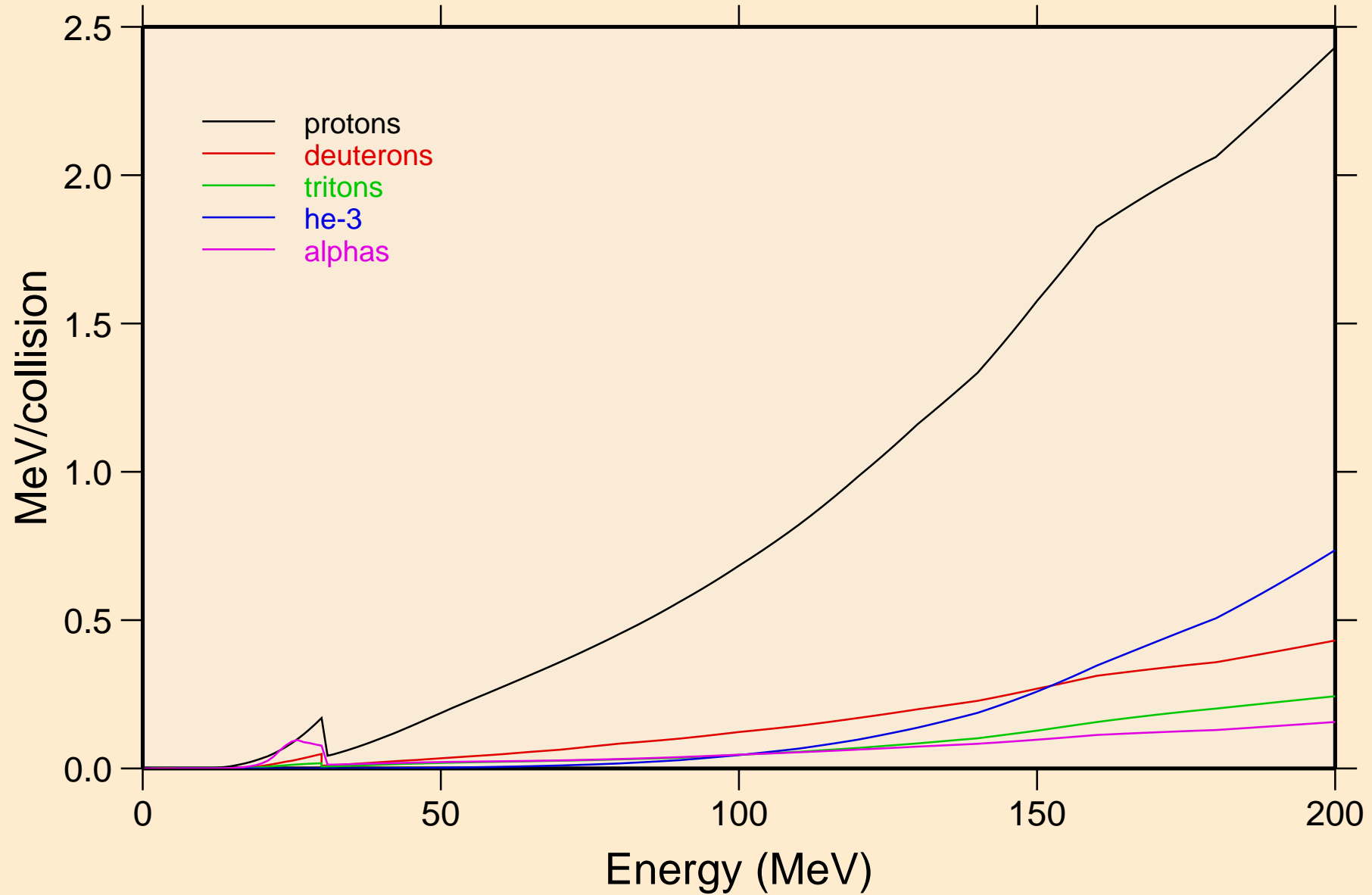

BK252 NEUTRON ACER TENDL-2023 LIBRARY; T=0.K  
Recoil Heating

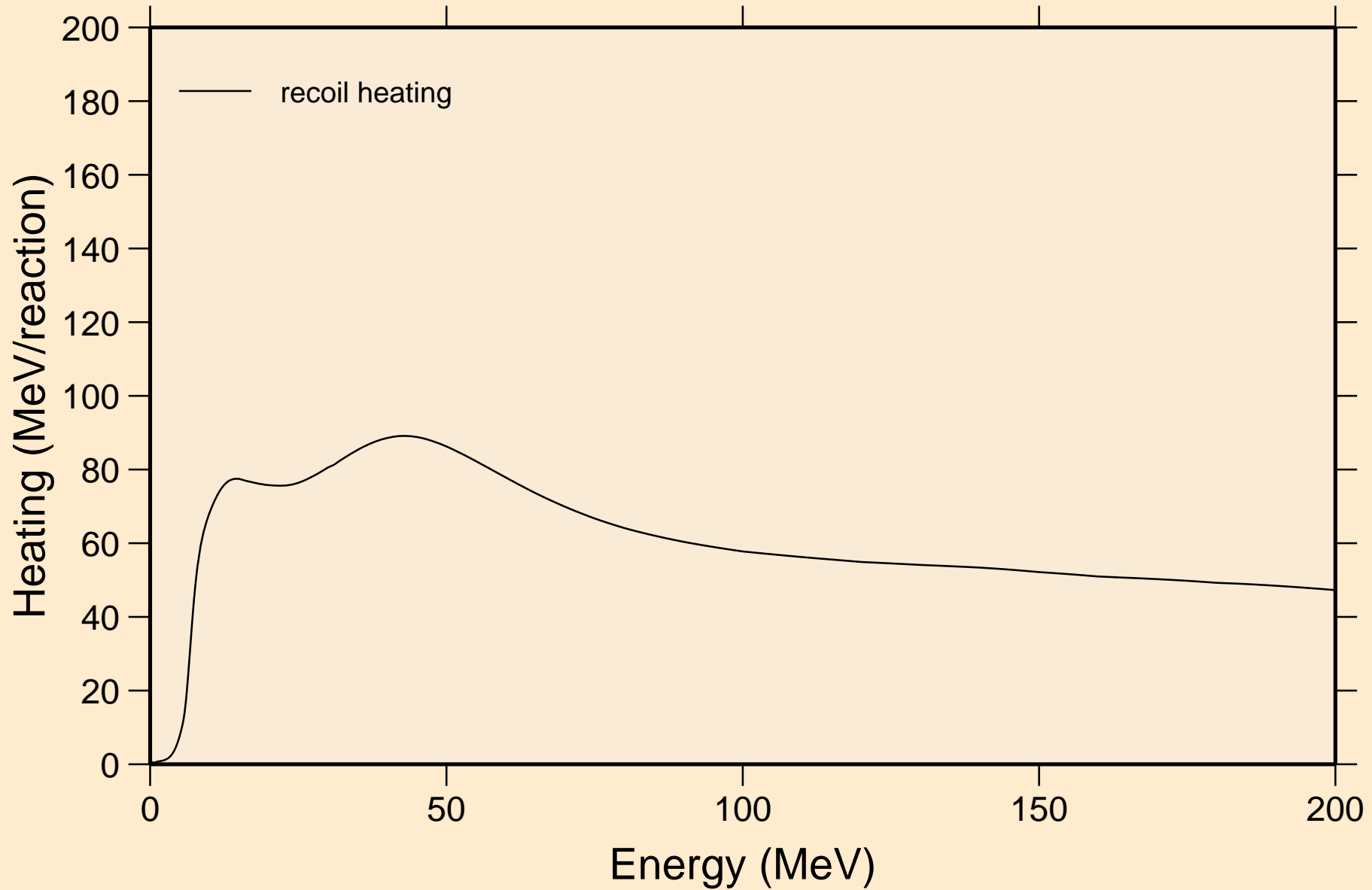

BK252 NEUTRON ACER TENDL-2023 LIBRARY; T=0.K  
Particle production cross sections

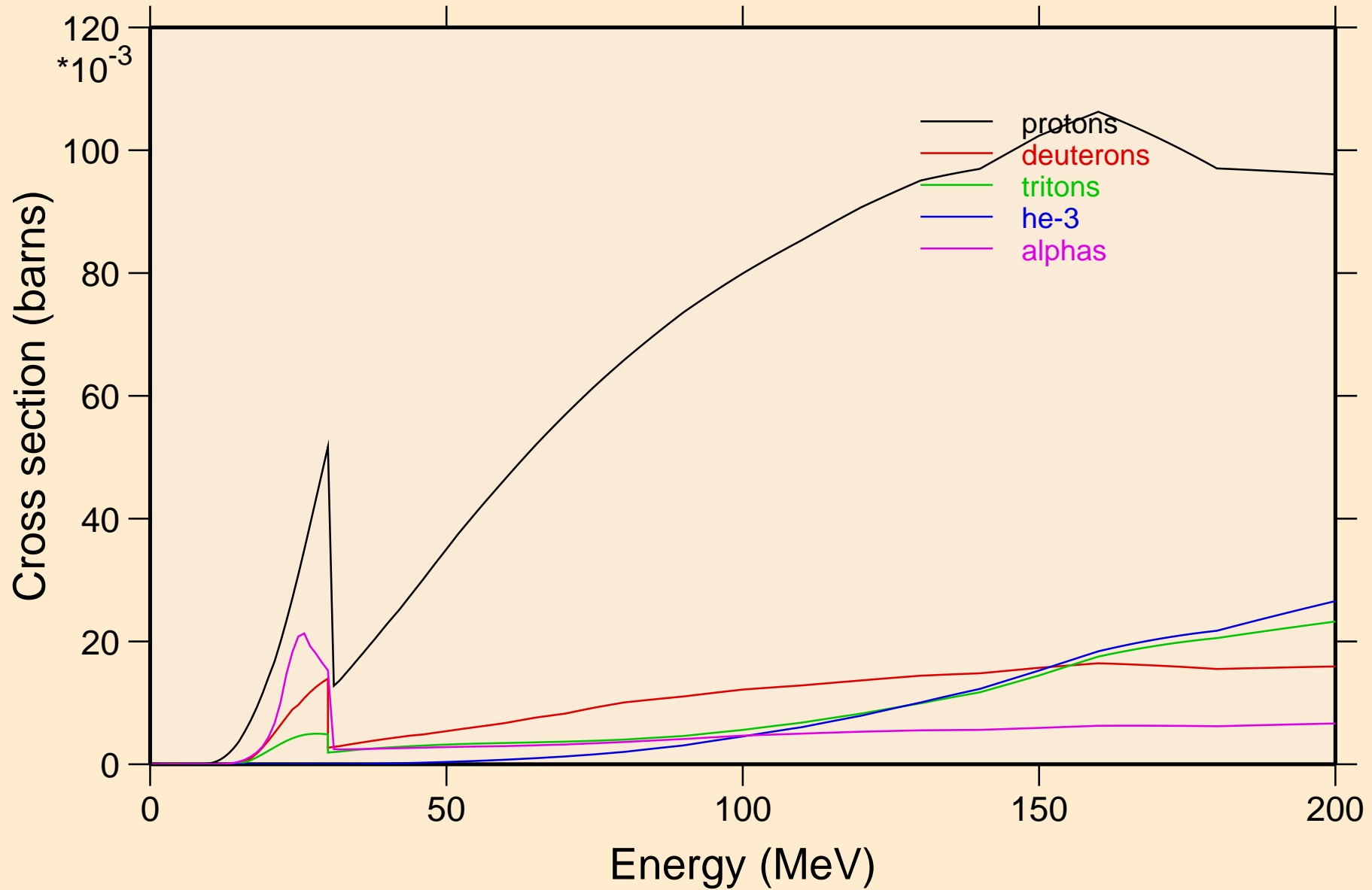

BK252 NEUTRON ACER TENDL-2023 LIBRARY; T=0.K  
protons from (n,x)

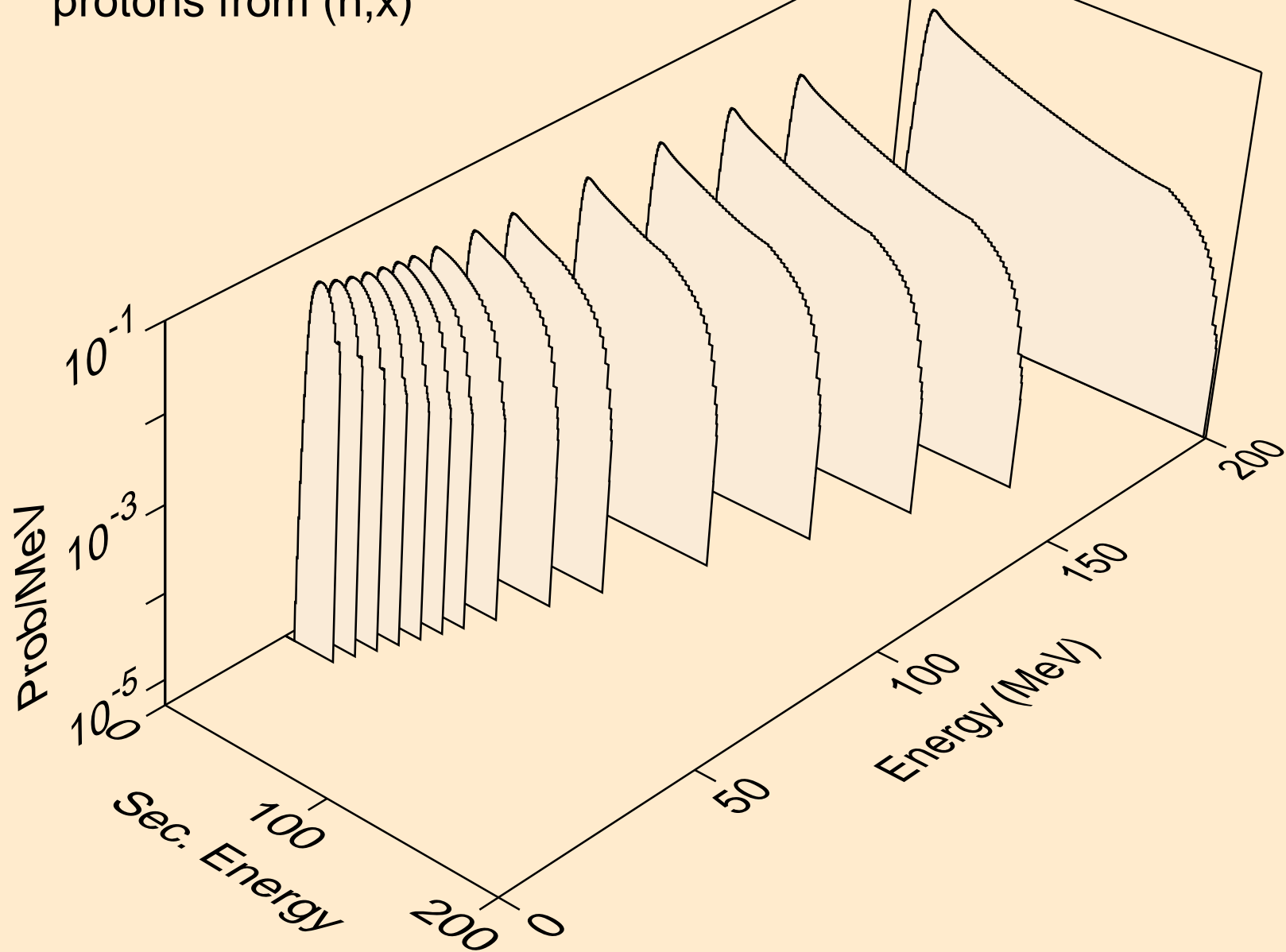

BK252 NEUTRON ACER TENDL-2023 LIBRARY; T=0.K  
protons from (n,n\*)p

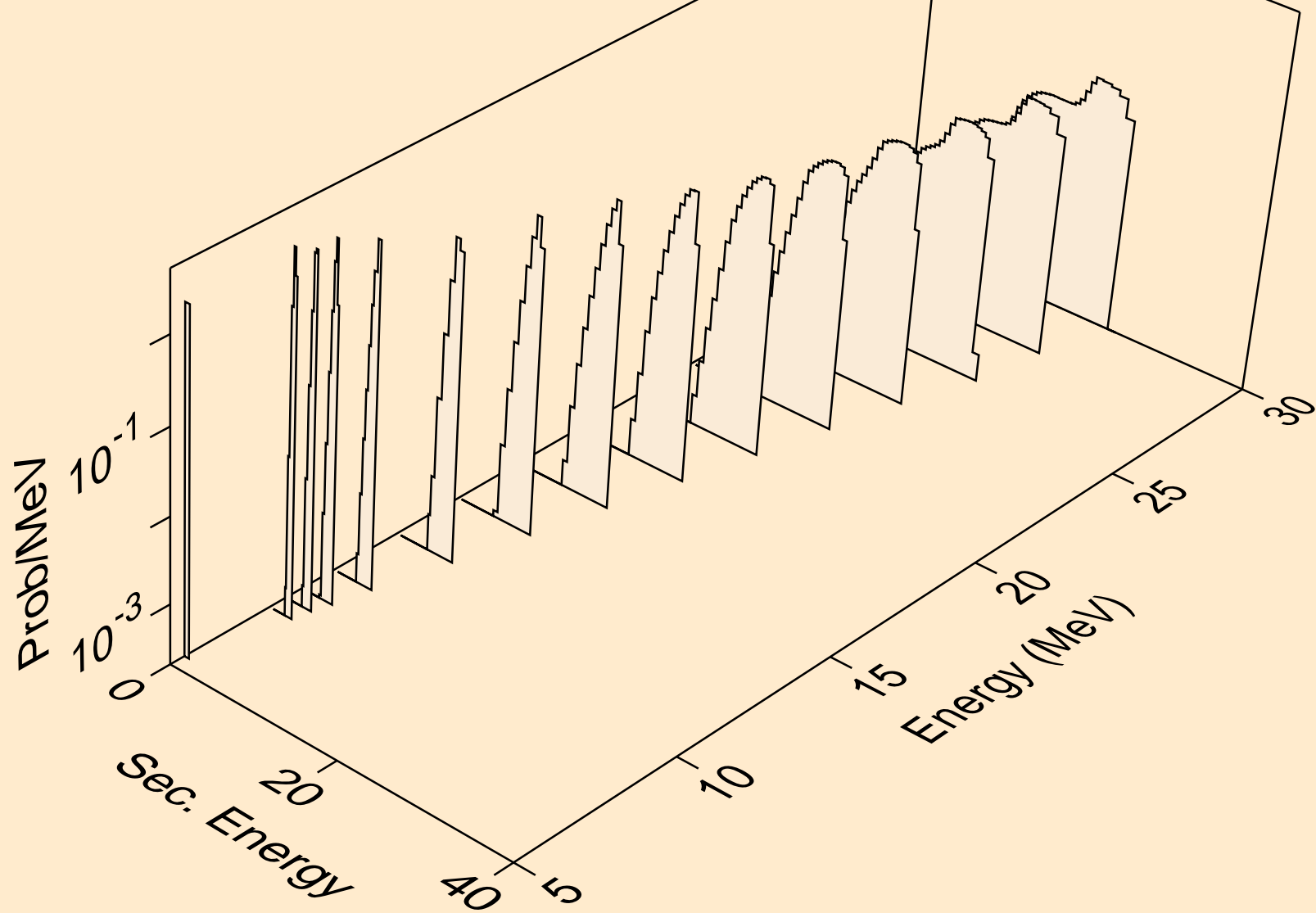

BK252 NEUTRON ACER TENDL-2023 LIBRARY; T=0.K  
protons from (n,2np)

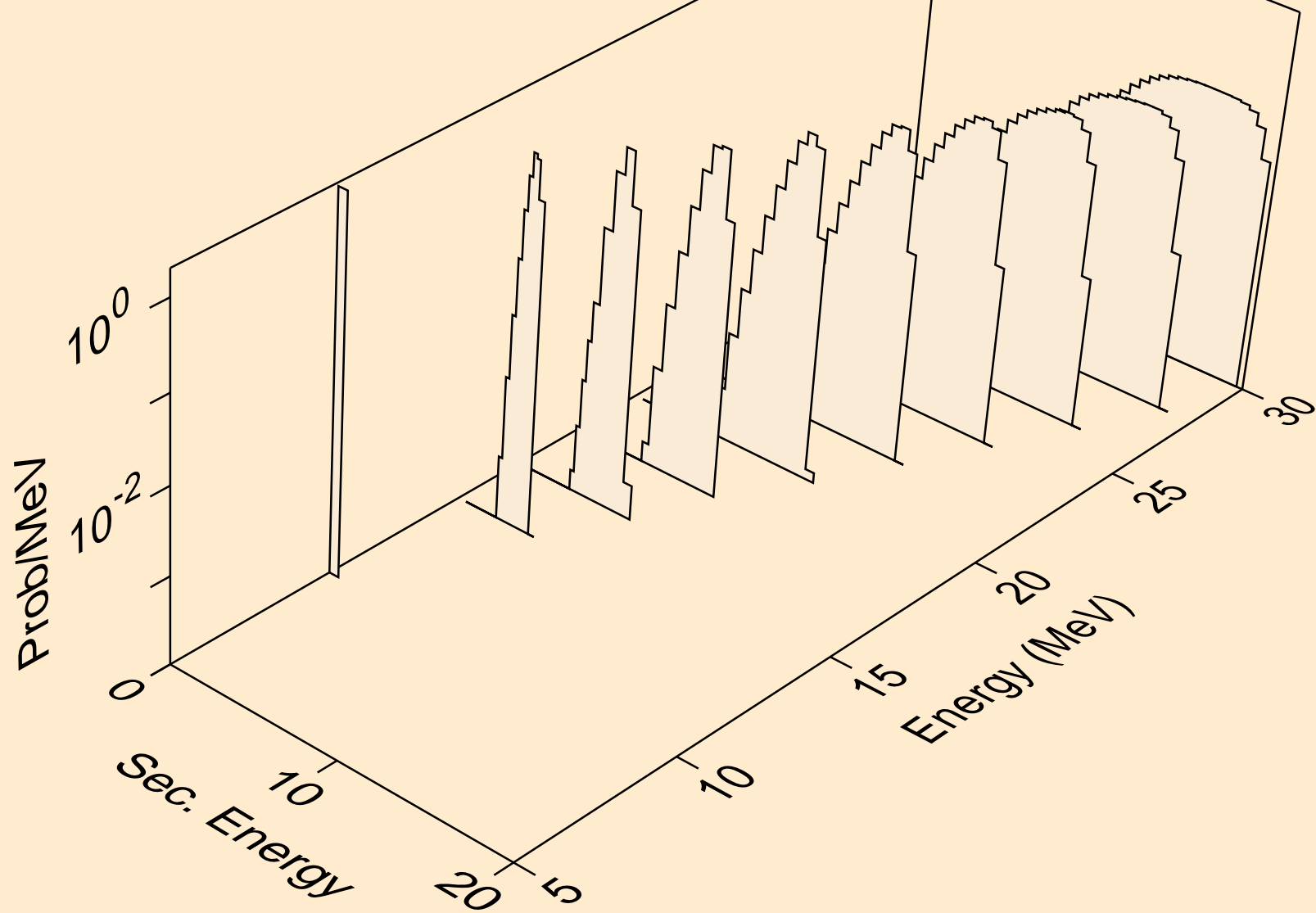

BK252 NEUTRON ACER TENDL-2023 LIBRARY; T=0.K  
protons from (n,3np)

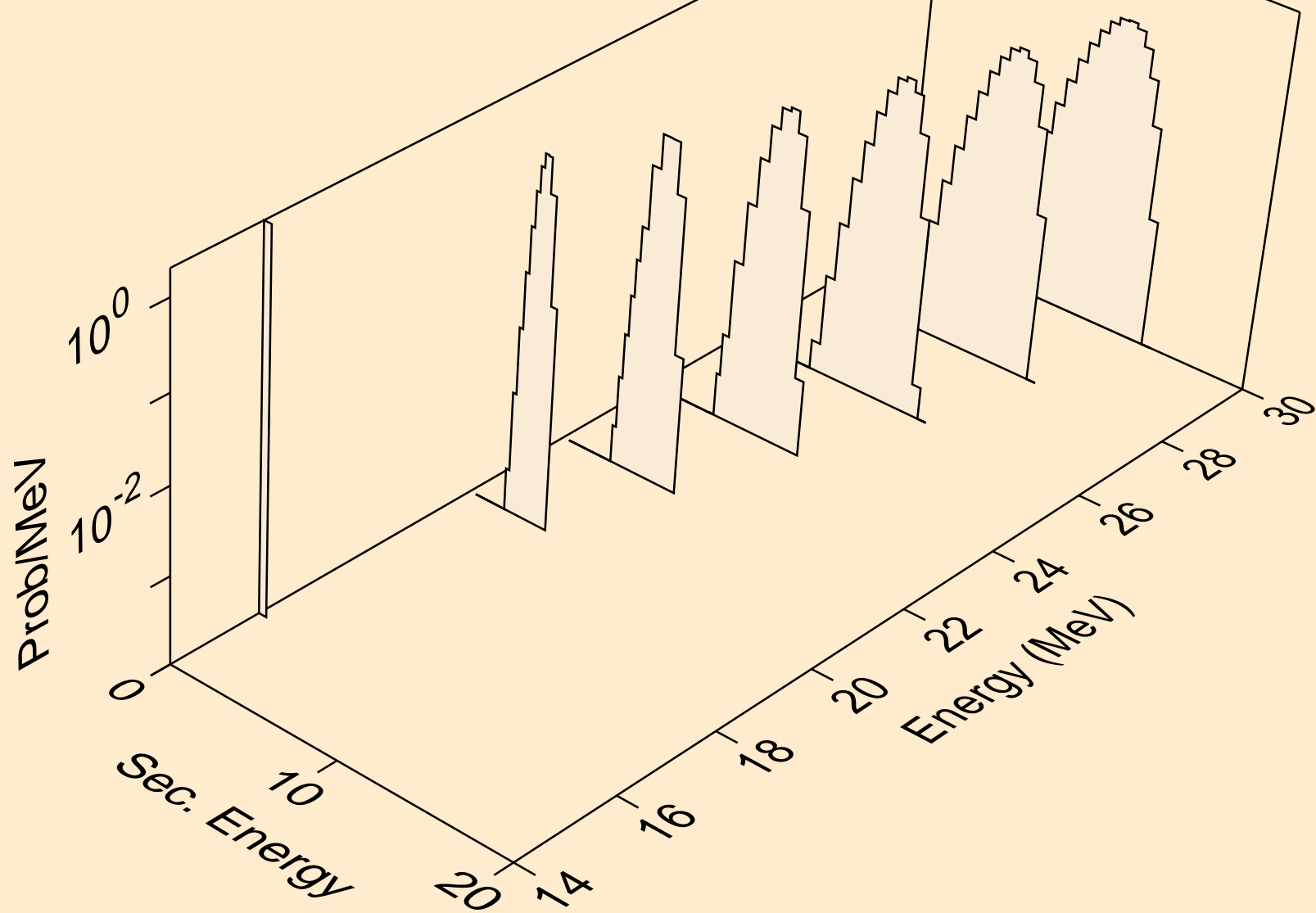

BK252 NEUTRON ACER TENDL-2023 LIBRARY; T=0.K  
protons from (n,p)

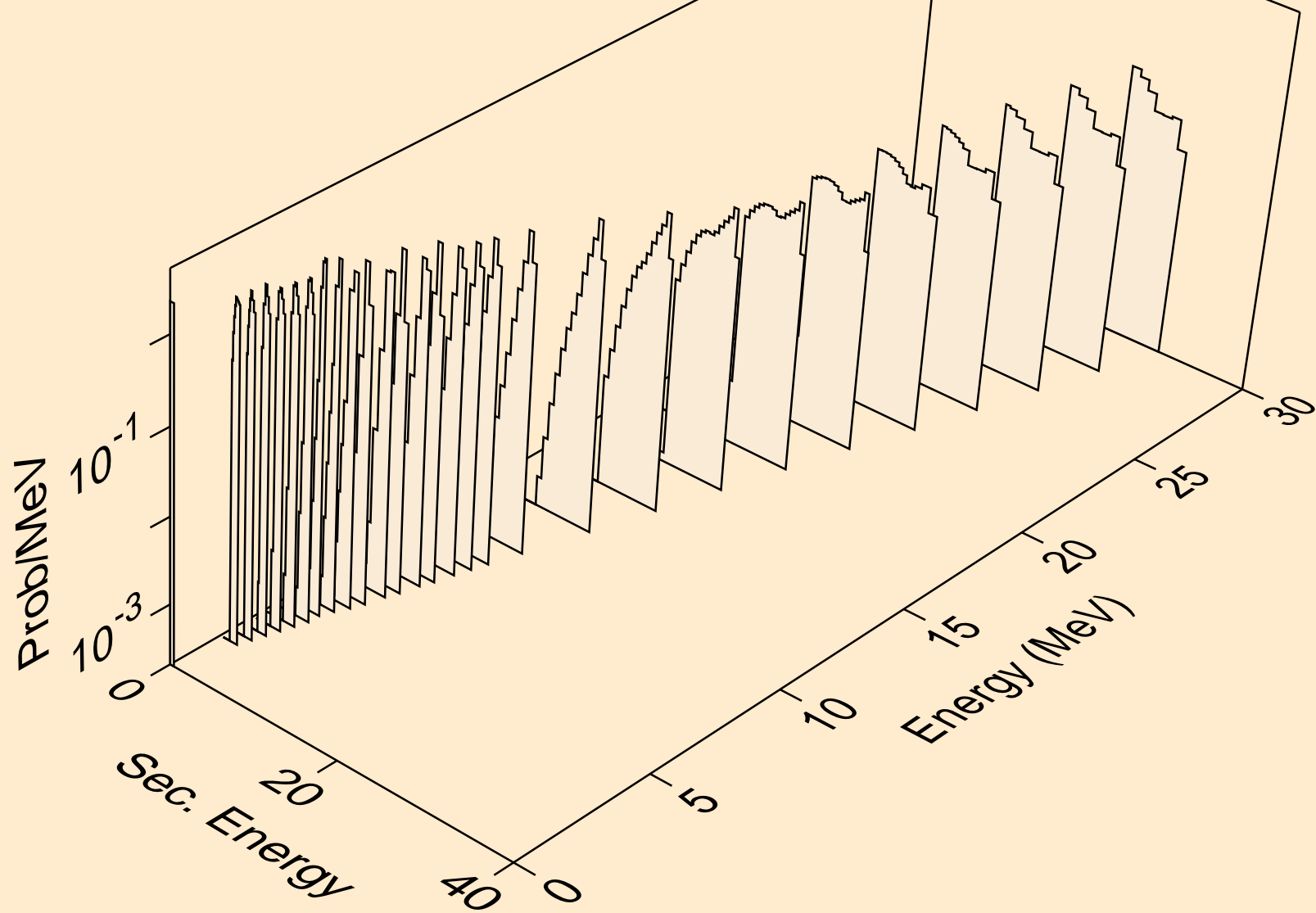

BK252 NEUTRON ACER TENDL-2023 LIBRARY; T=0.K  
protons from (n,2p)

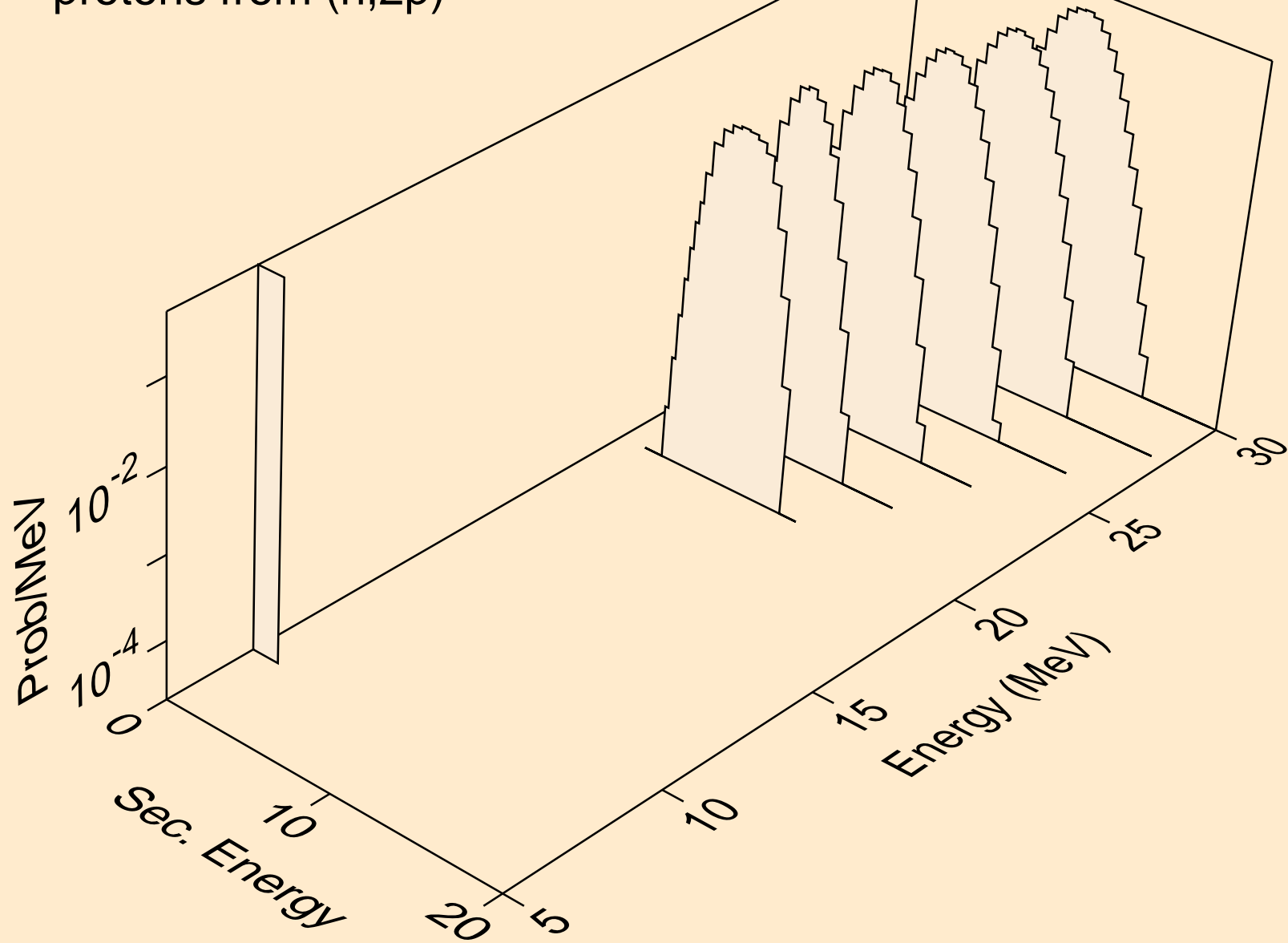

BK252 NEUTRON ACER TENDL-2023 LIBRARY; T=0.K  
deuterons from (n,x)

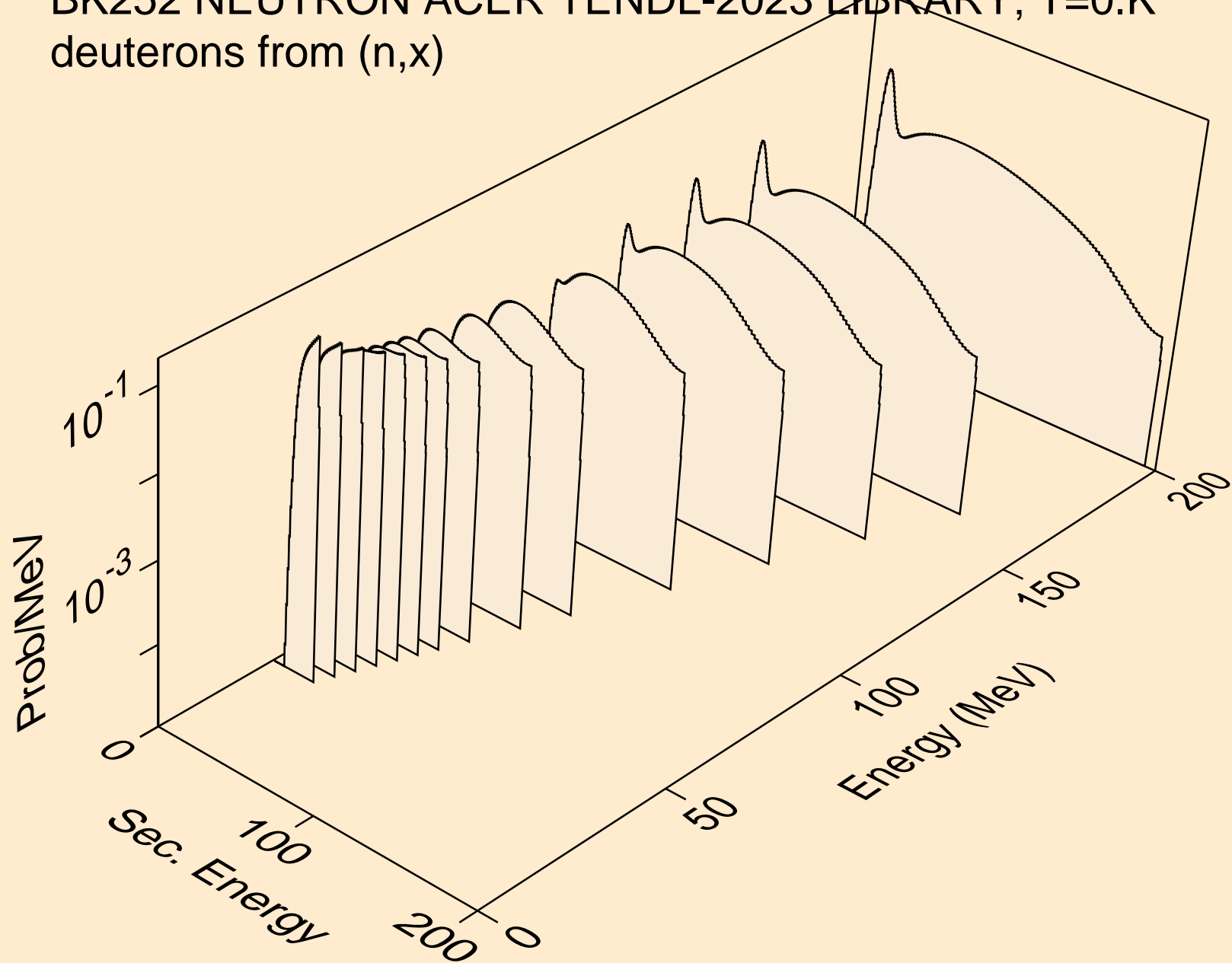

BK252 NEUTRON ACER TENDL-2023 LIBRARY; T=0.K  
deuterons from (n,2nd)

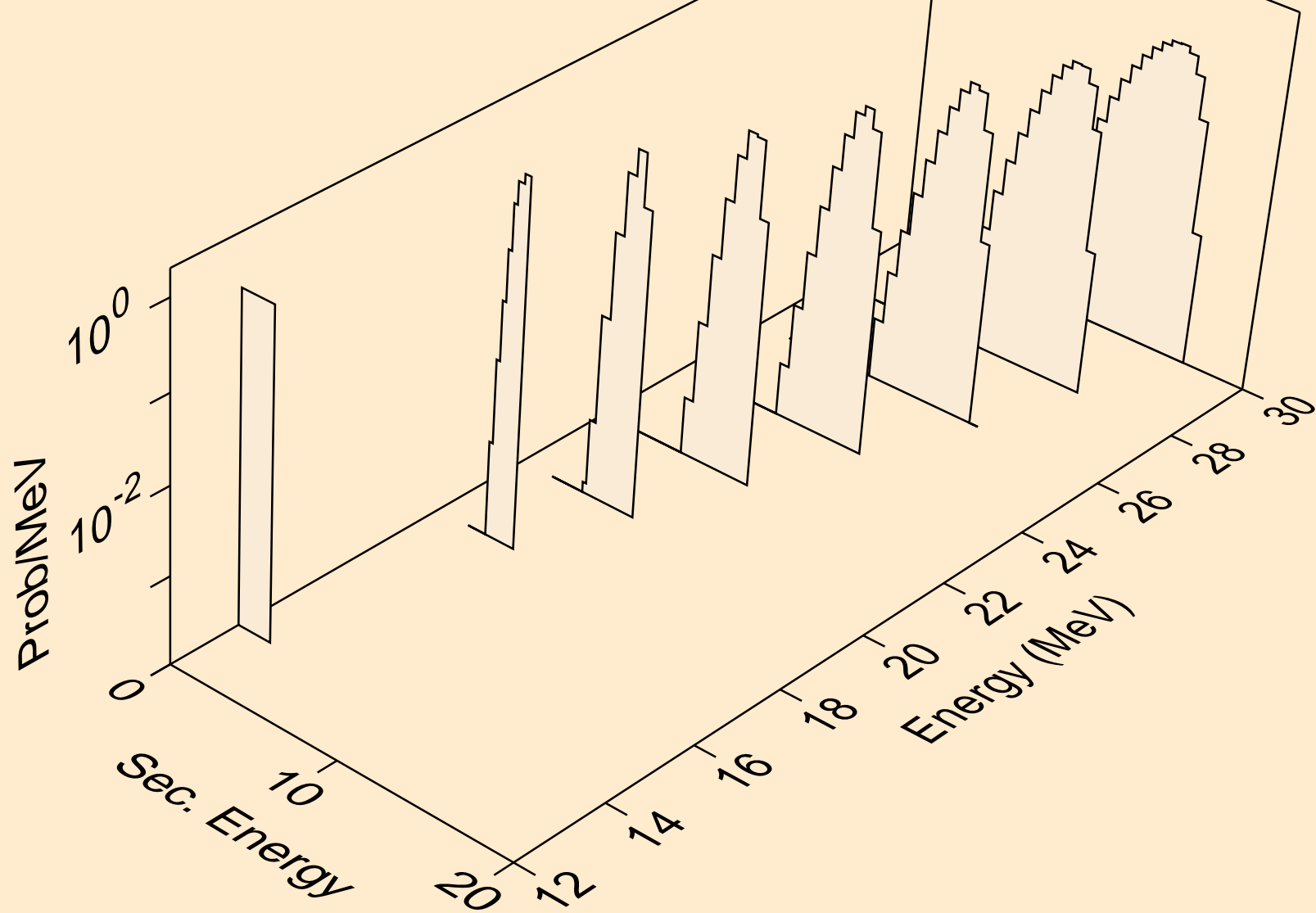

BK252 NEUTRON ACER TENDL-2023 LIBRARY; T=0.K  
deuterons from (n,n\*)d

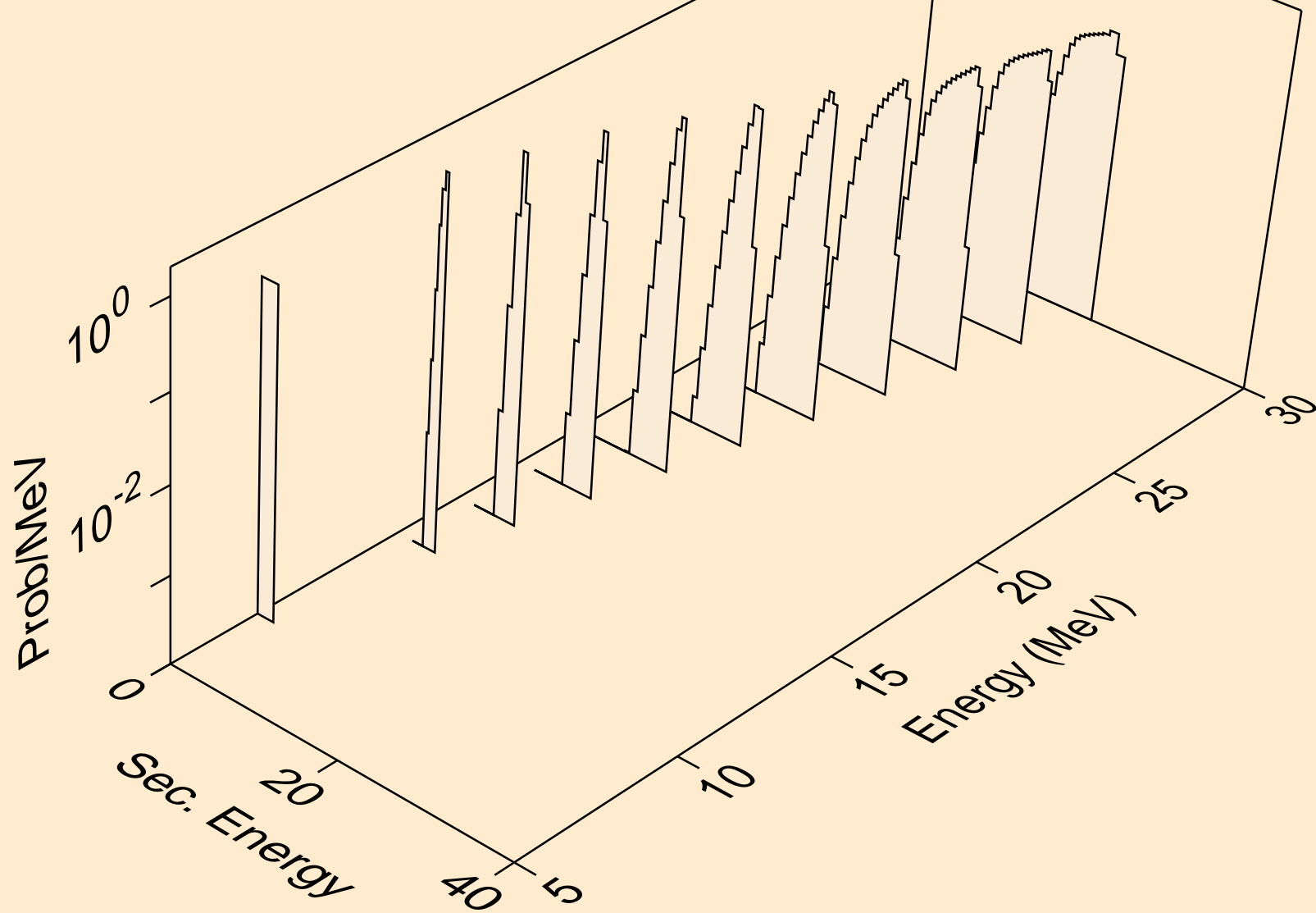

BK252 NEUTRON ACER TENDL-2023 LIBRARY; T=0.K  
deuterons from (n,d)

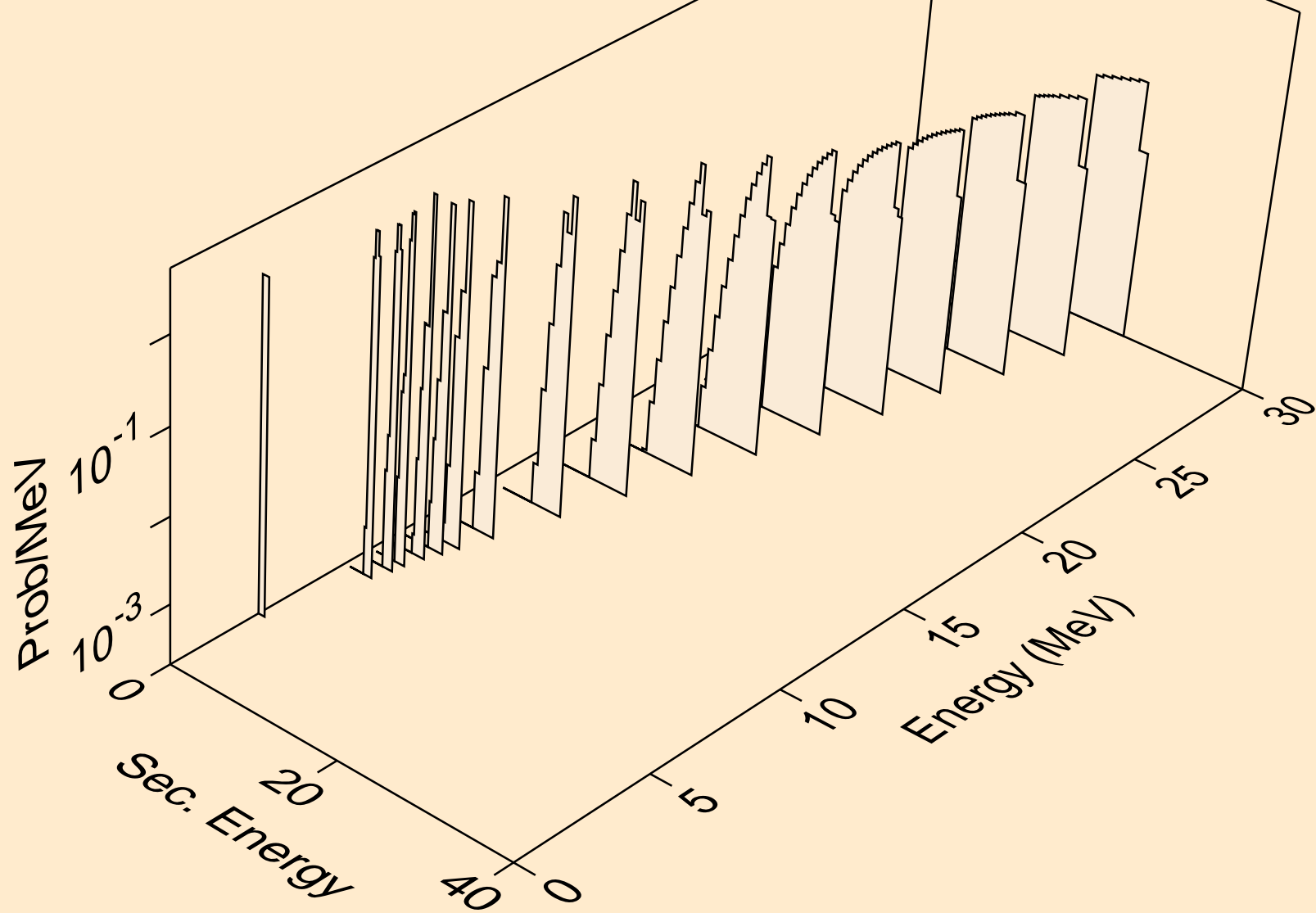

BK252 NEUTRON ACER TENDL-2023 LIBRARY; T=0.K  
tritons from (n,x)

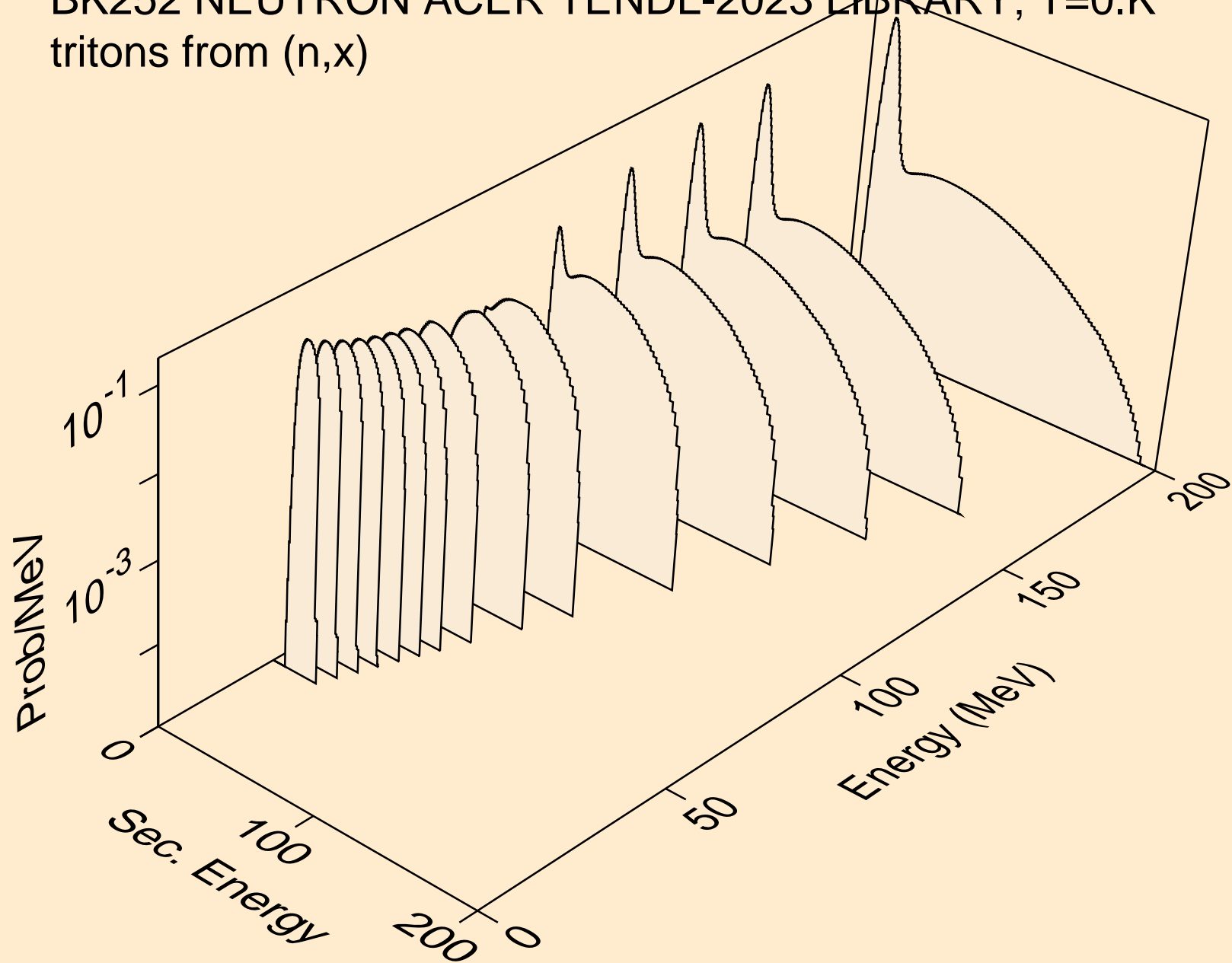

BK252 NEUTRON ACER TENDL-2023 LIBRARY; T=0.K  
tritons from (n,n\*)t

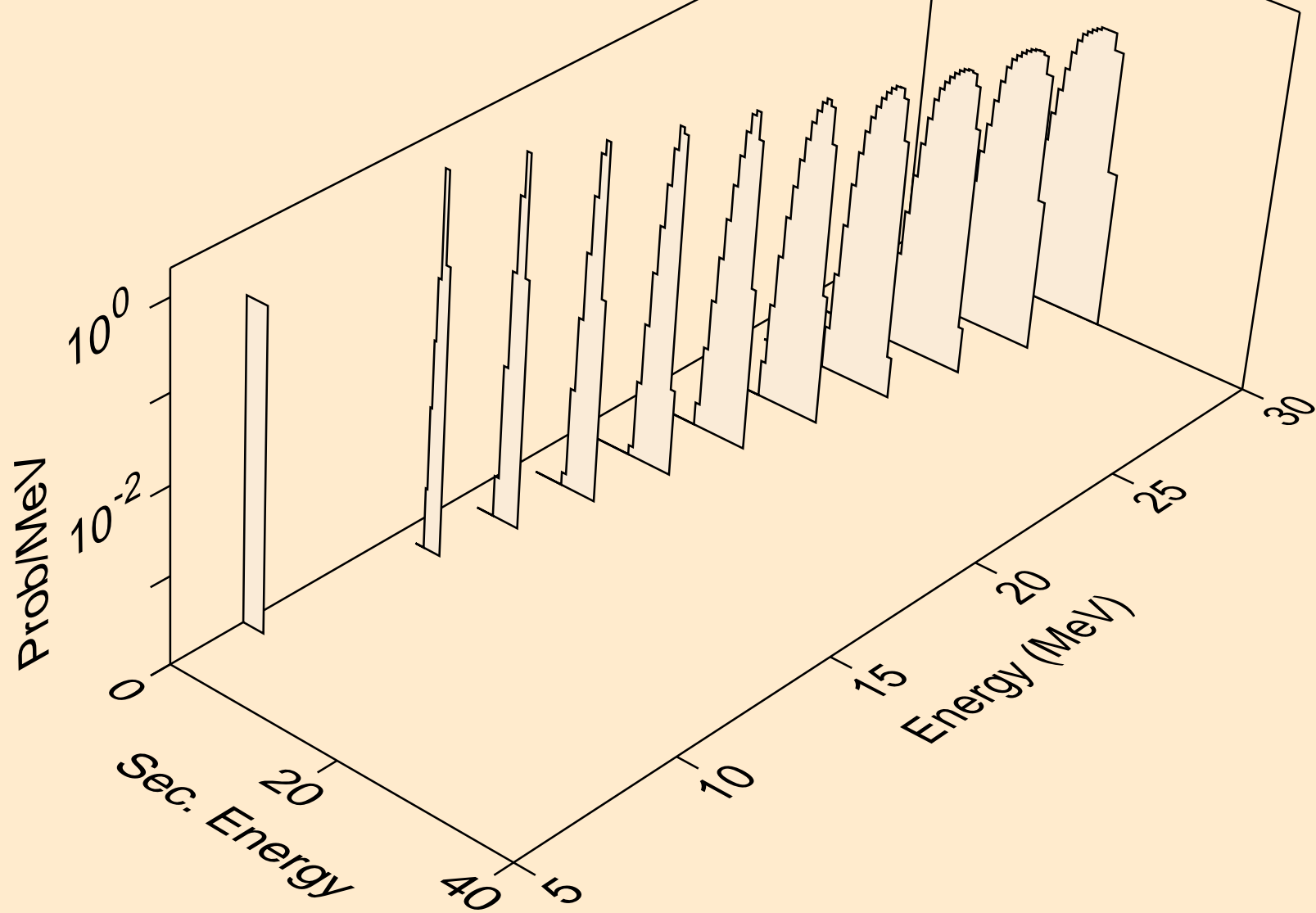

BK252 NEUTRON ACER TENDL-2023 LIBRARY; T=0.K  
tritons from (n,t)

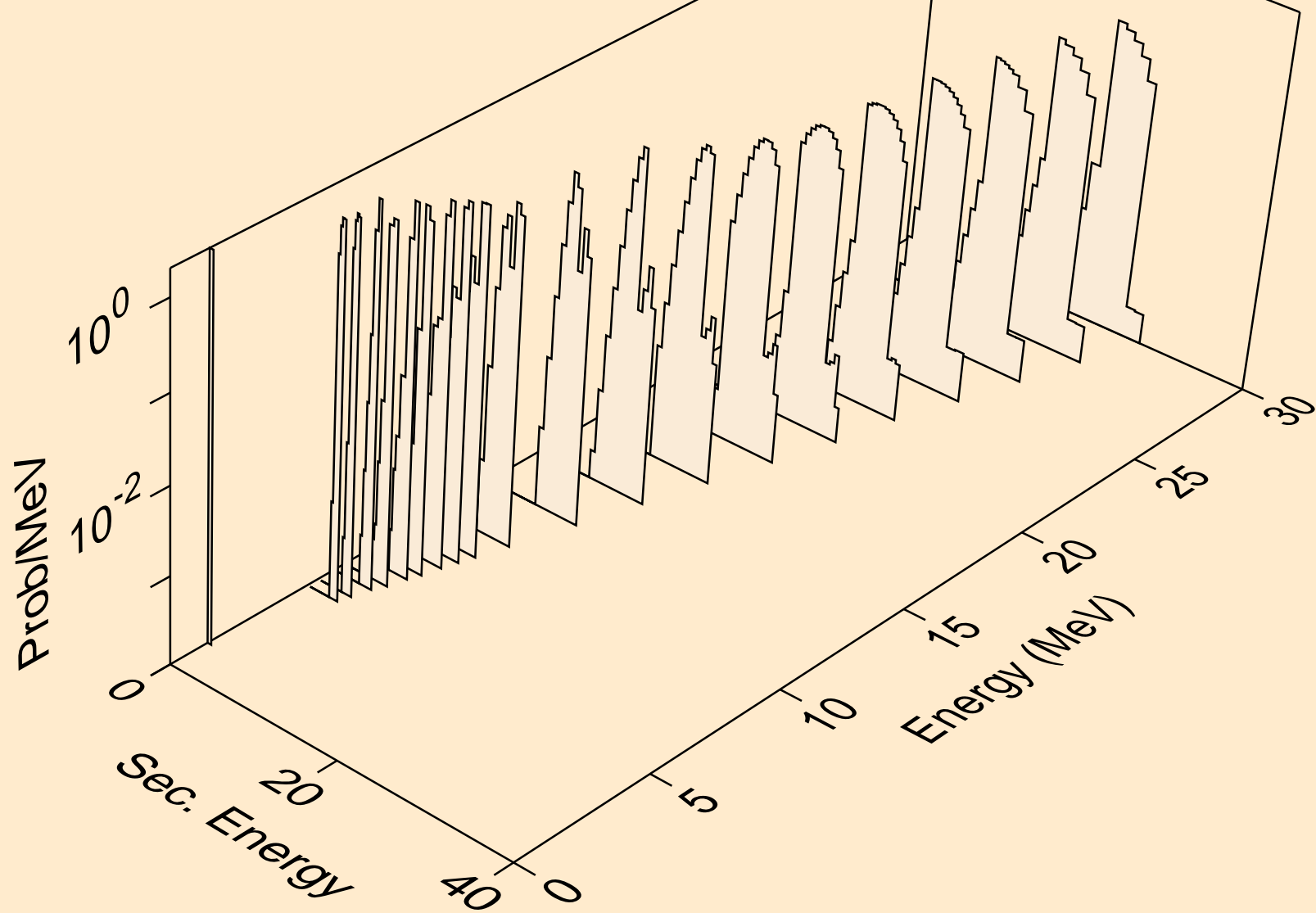

BK252 NEUTRON ACER TENDL-2023 LIBRARY; T=0.K  
he3s from (n,x)

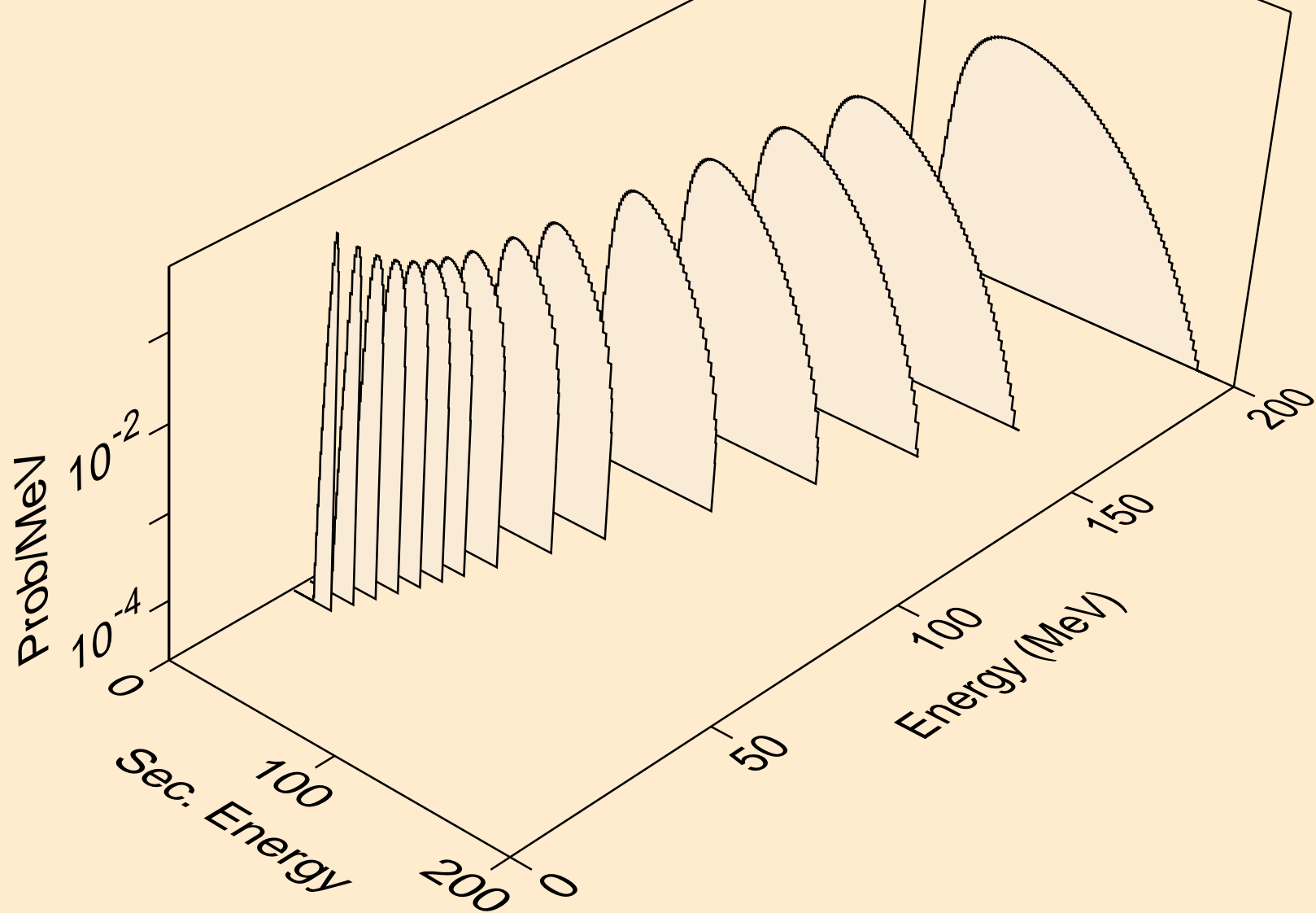

BK252 NEUTRON ACER TENDL-2023 LIBRARY; T=0.K  
he3s from (n,n\*)he3

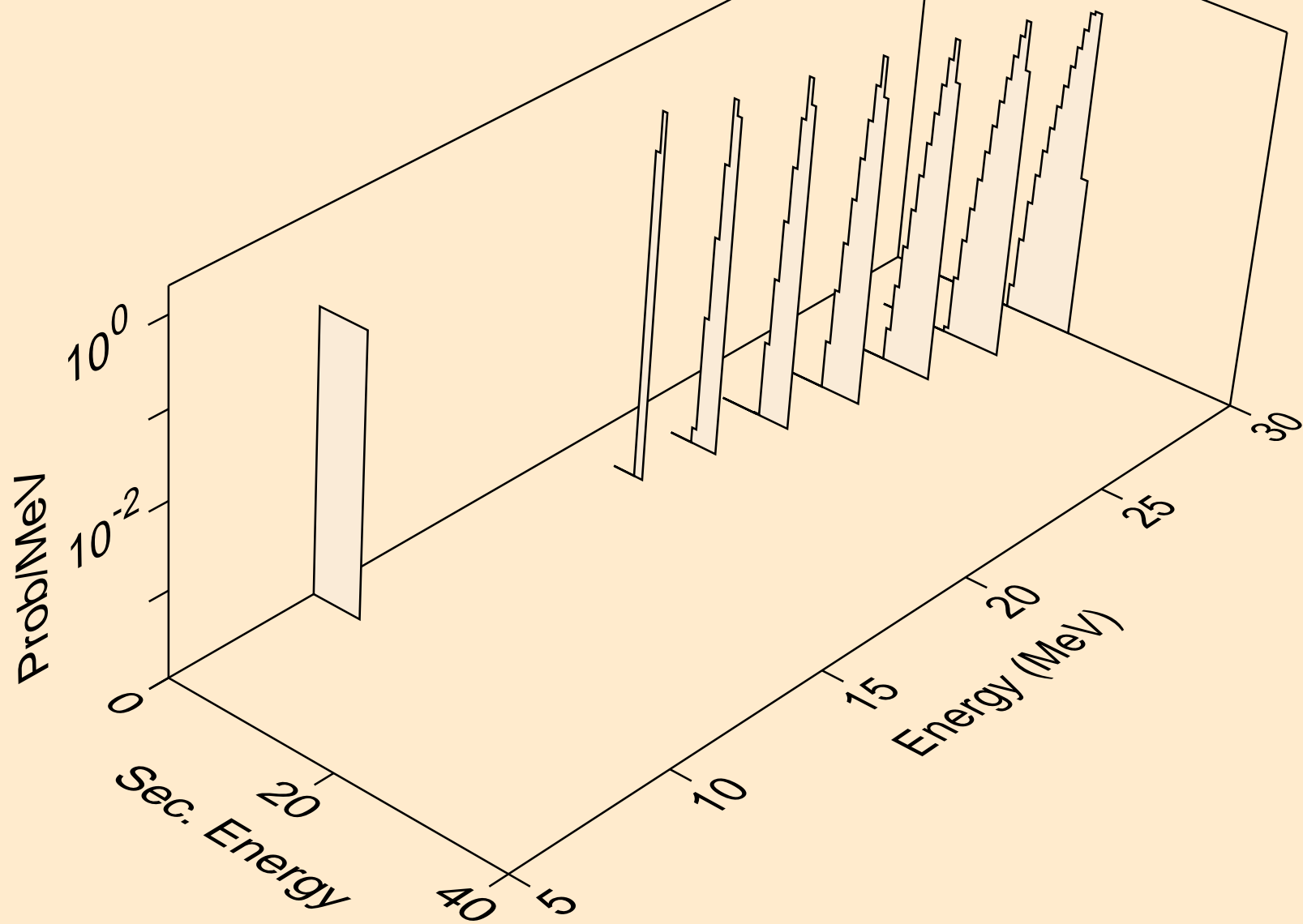

BK252 NEUTRON ACER TENDL-2023 LIBRARY; T=0.K  
he3s from (n,he3)

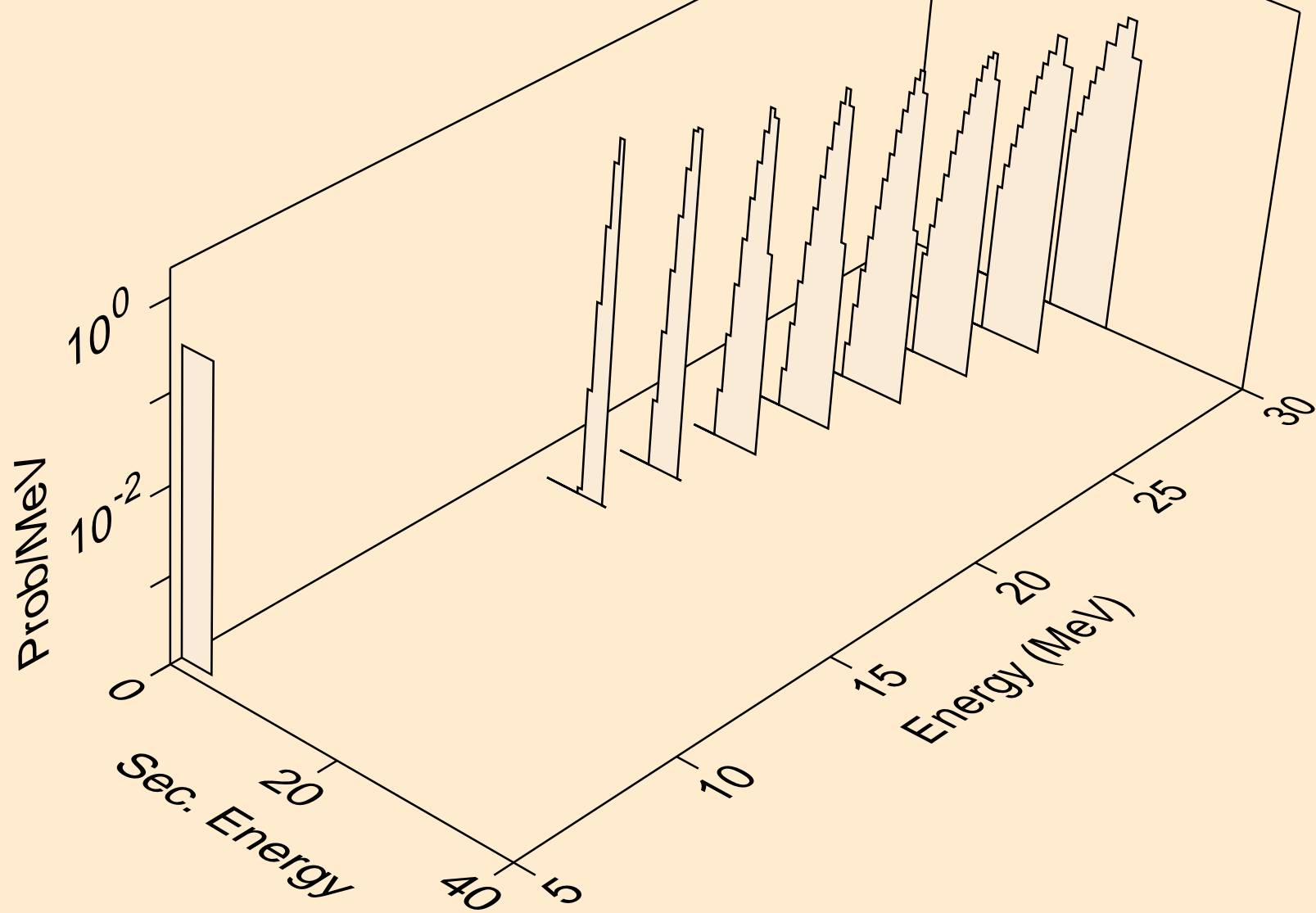

BK252 NEUTRON ACER TENDL-2023 LIBRARY; T=0.K  
alphas from (n,x)

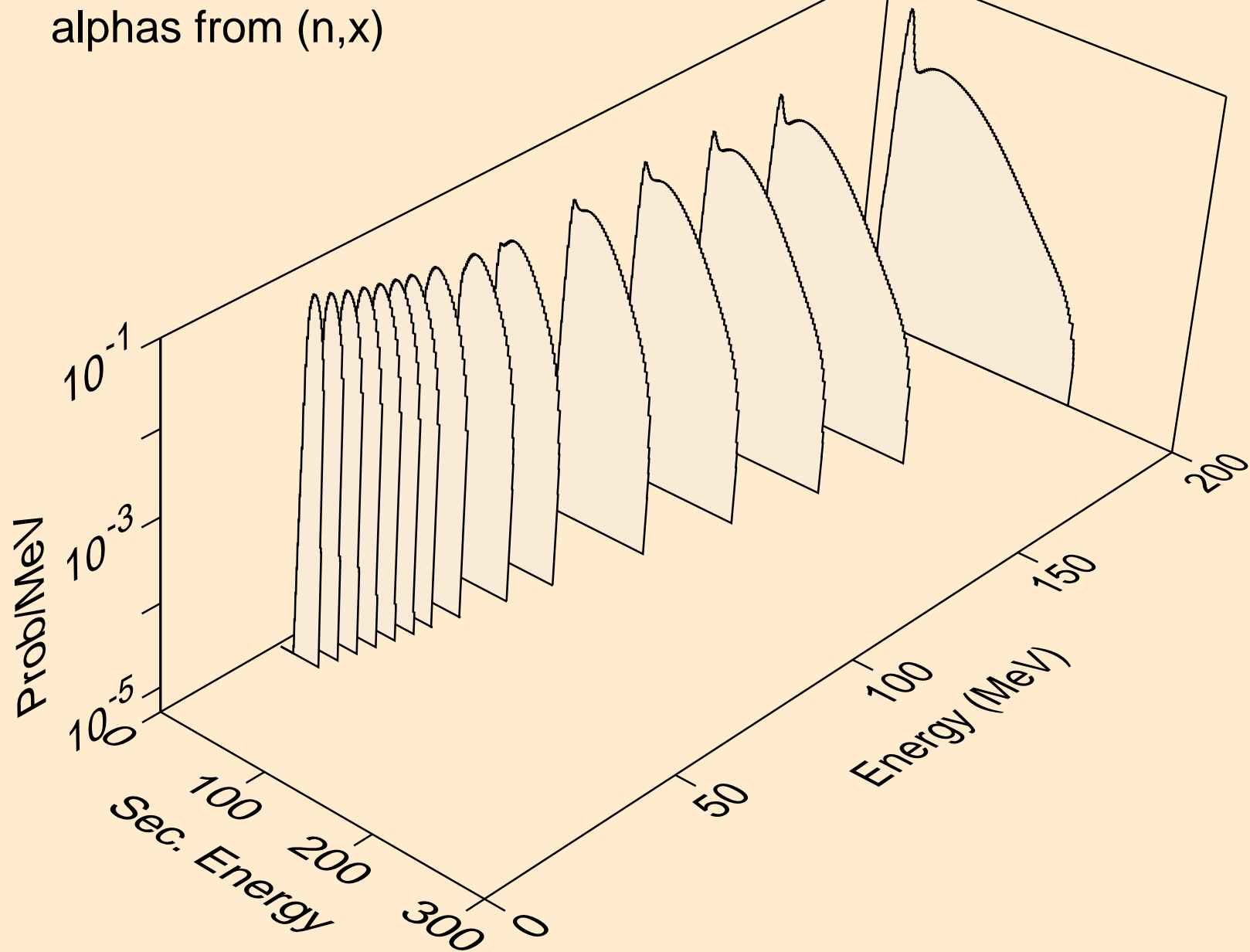

BK252 NEUTRON ACER TENDL-2023 LIBRARY; T=0.K  
alphas from (n,n\*)a

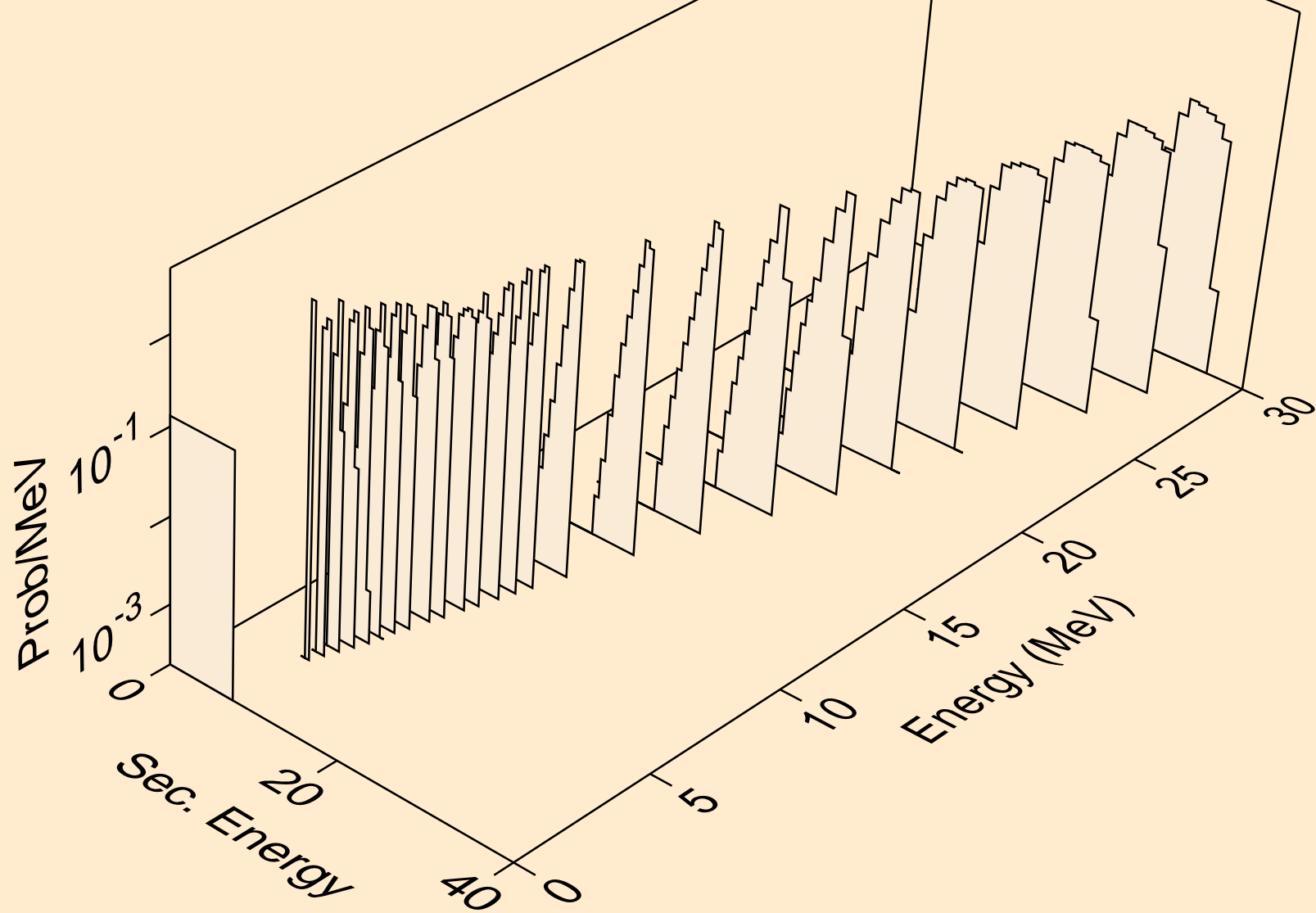

BK252 NEUTRON ACER TENDL-2023 LIBRARY; T=0.K  
alphas from (n,2n)a

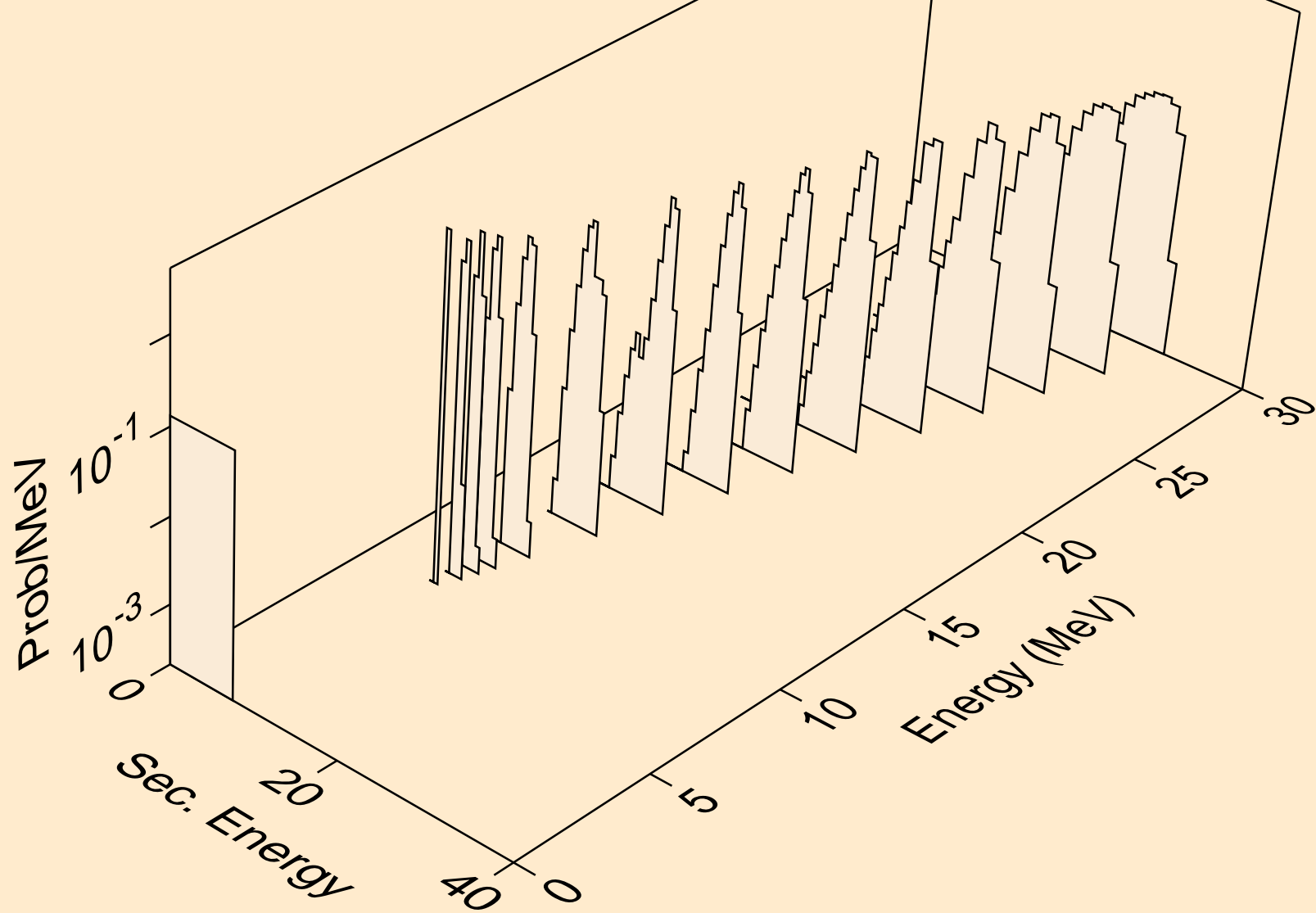

BK252 NEUTRON ACER TENDL-2023 LIBRARY; T=0.K  
alphas from (n,3n)a

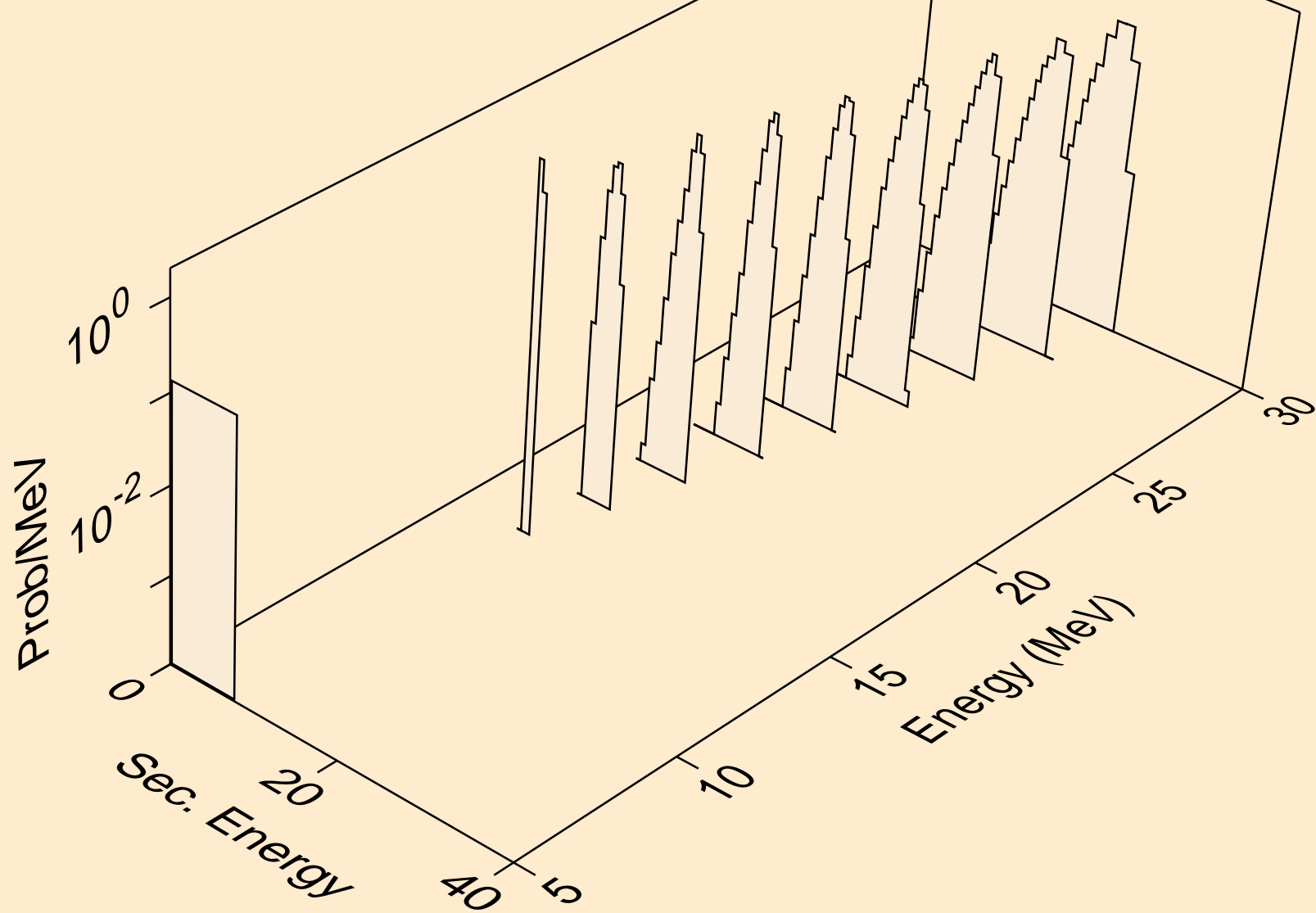

BK252 NEUTRON ACER TENDL-2023 LIBRARY; T=0.K  
alphas from (n,a)

