

# CD098 NEUTRON ACER TENDL-2023 LIBRARY; T=0.K

## Principal cross sections

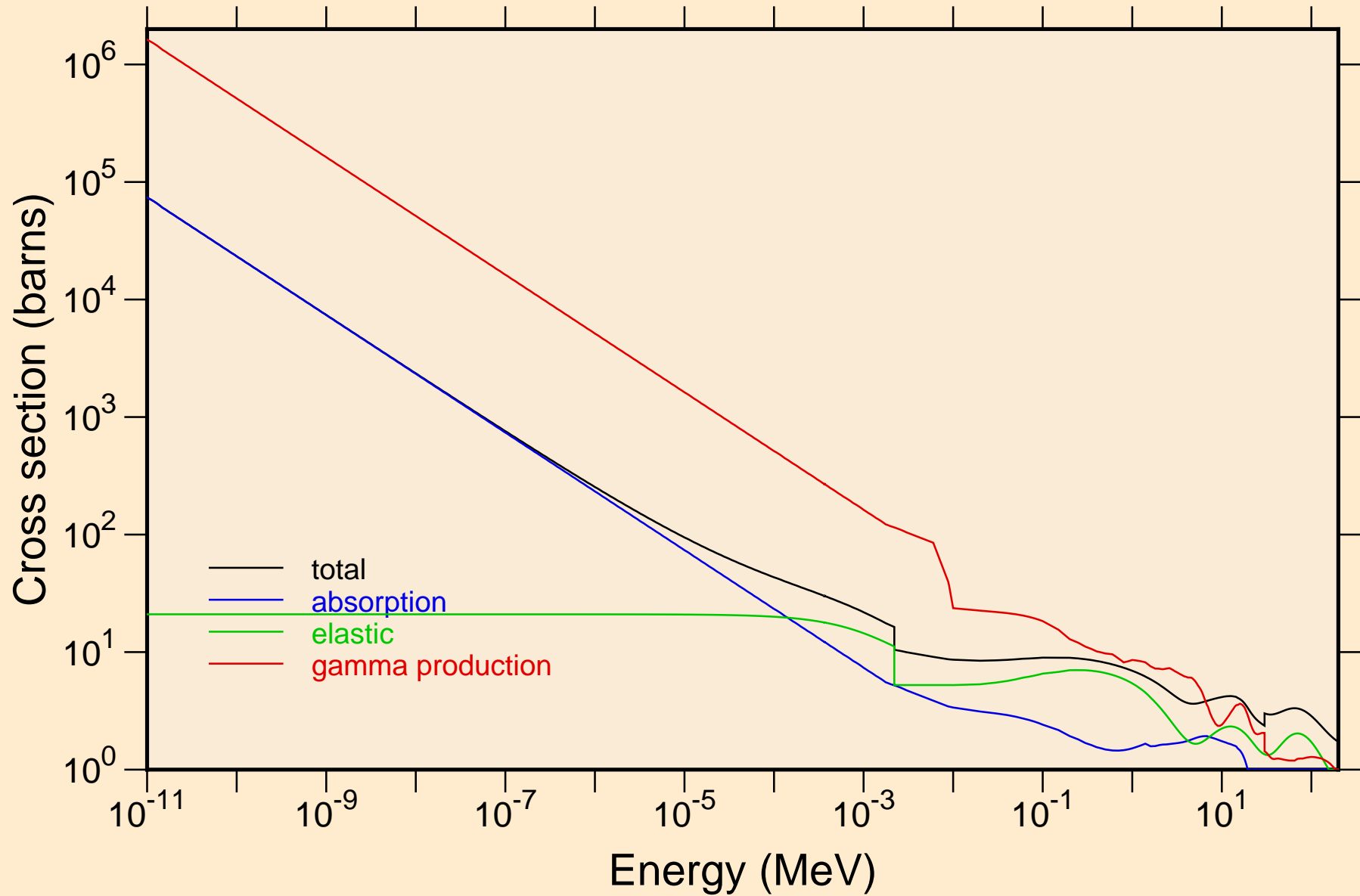

# CD098 NEUTRON ACER TENDL-2023 LIBRARY; T=0.K

## Heating

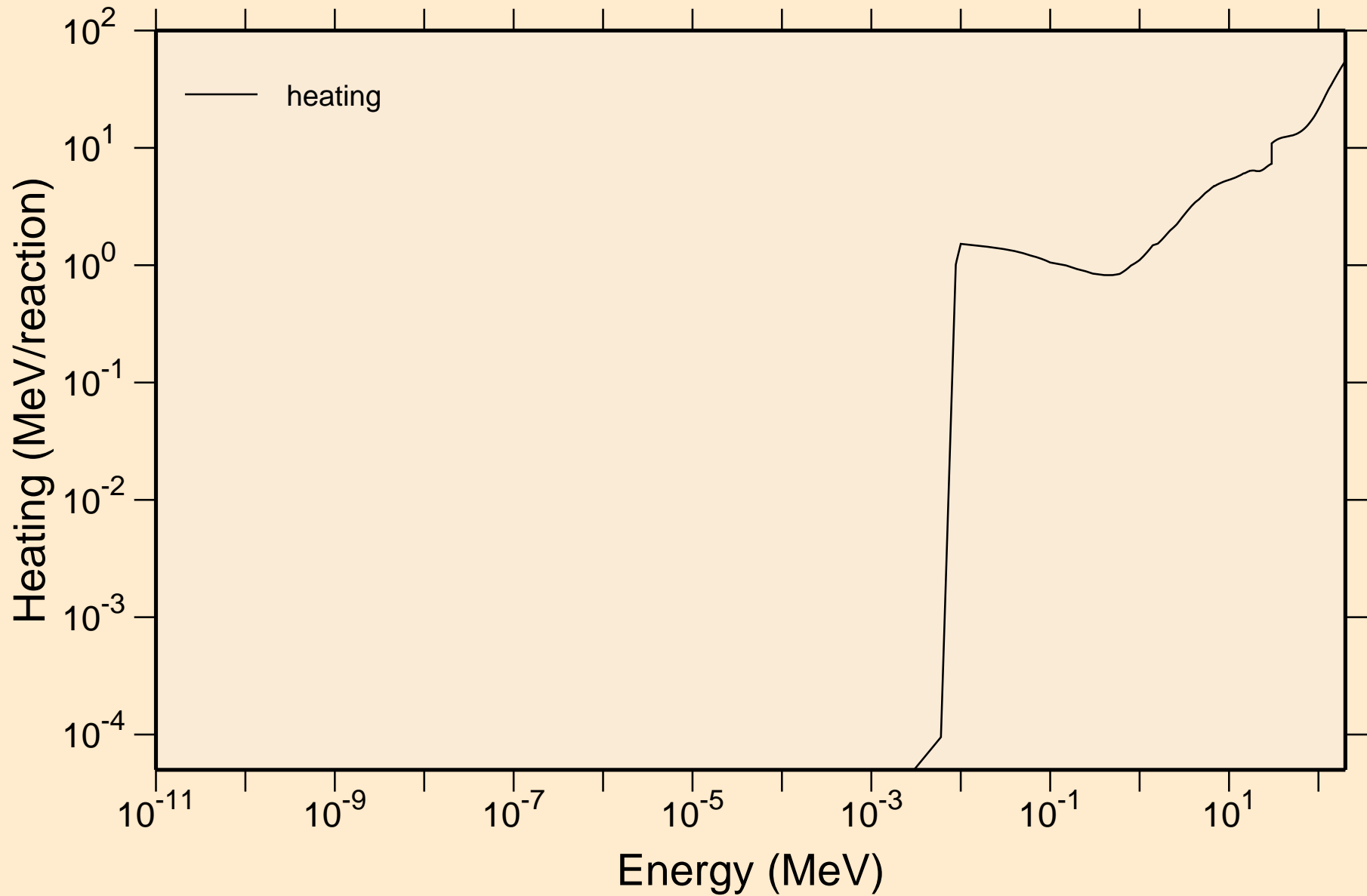

CD098 NEUTRON ACER TENDL-2023 LIBRARY; T=0.K  
Damage

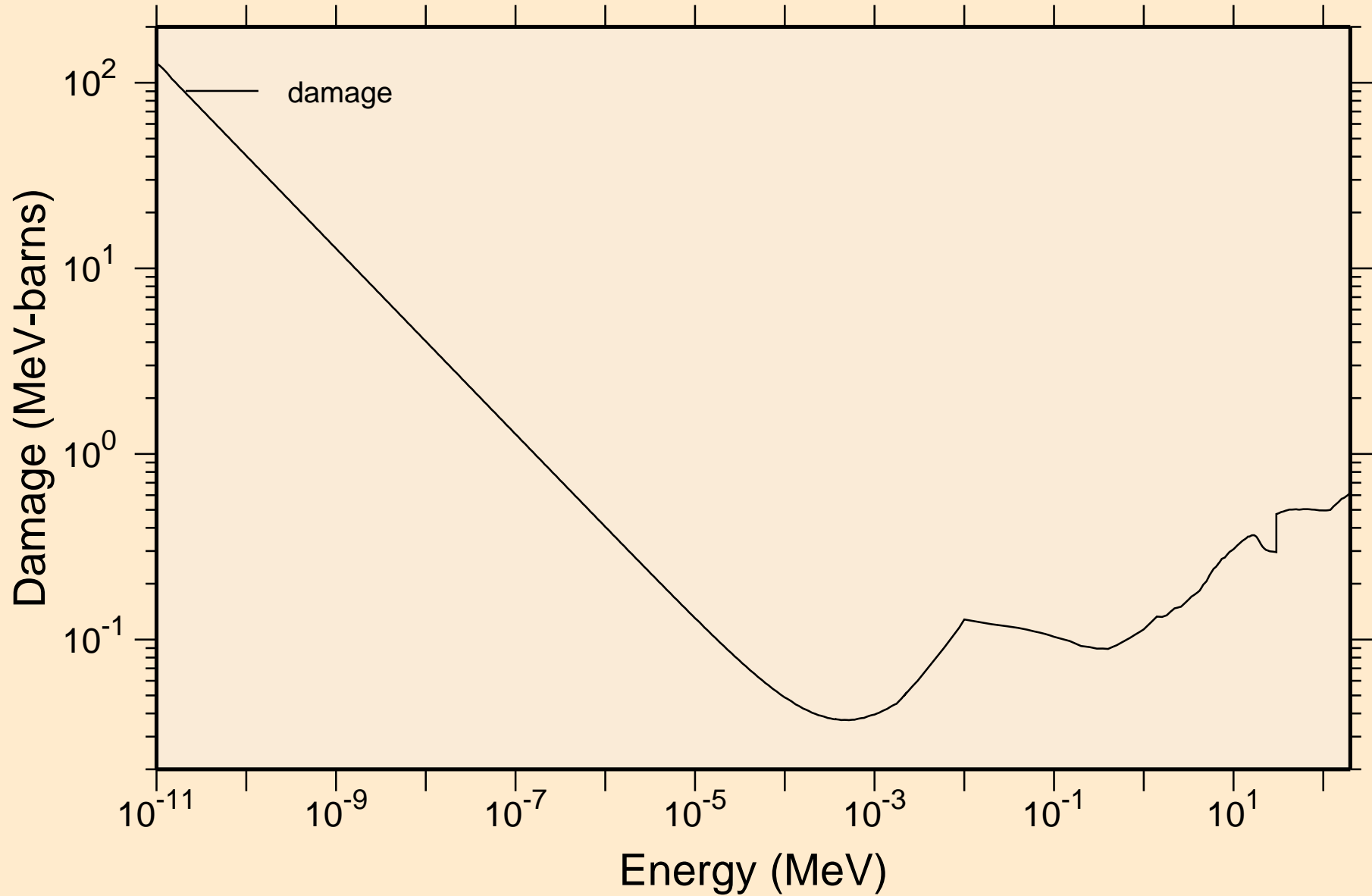

# CD098 NEUTRON ACER TENDL-2023 LIBRARY; T=0.K

## Non-threshold reactions

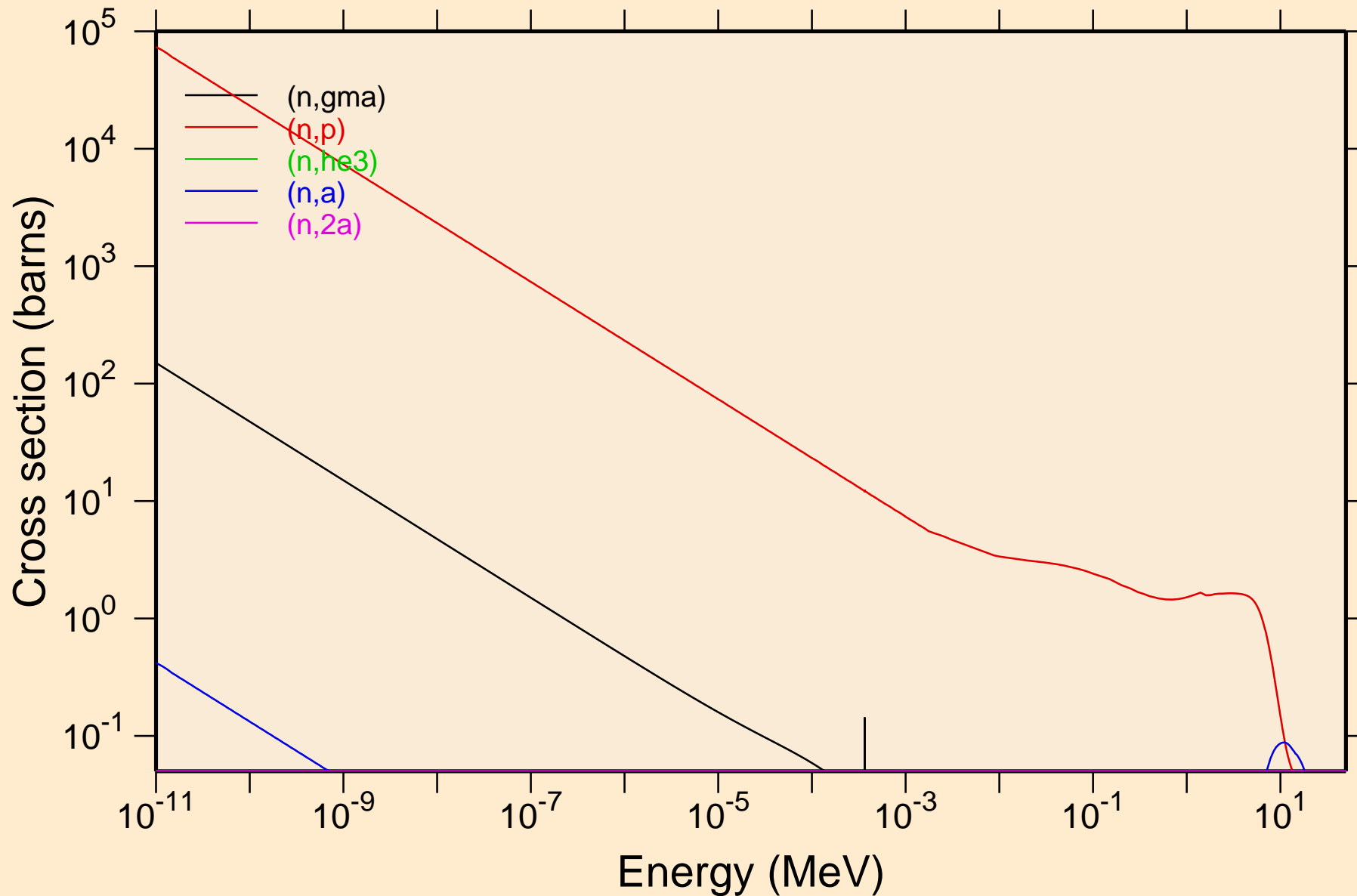

# CD098 NEUTRON ACER TENDL-2023 LIBRARY; T=0.K

## Non-threshold reactions

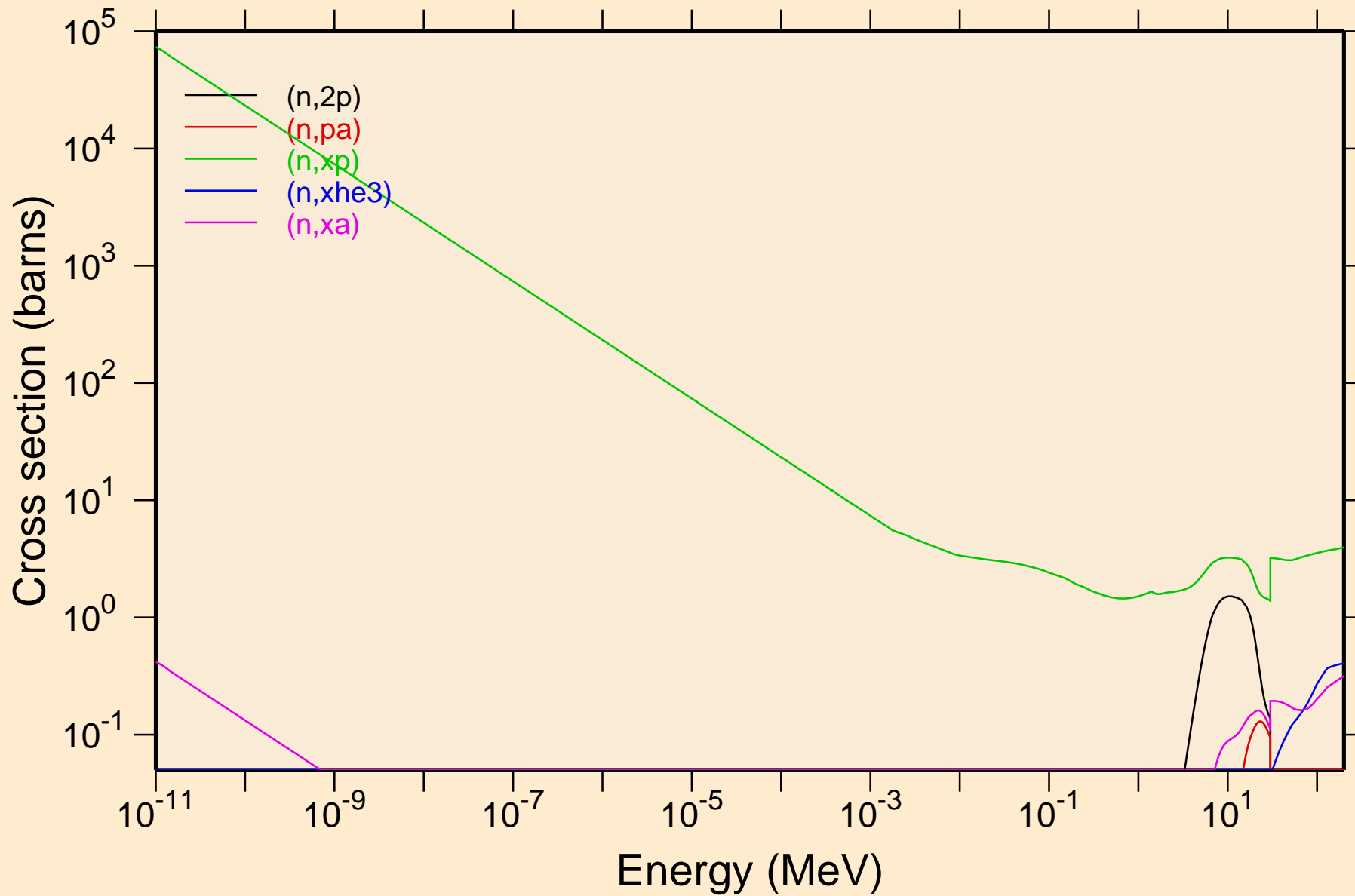

# CD098 NEUTRON ACER TENDL-2023 LIBRARY; T=0.K

## Principal cross sections

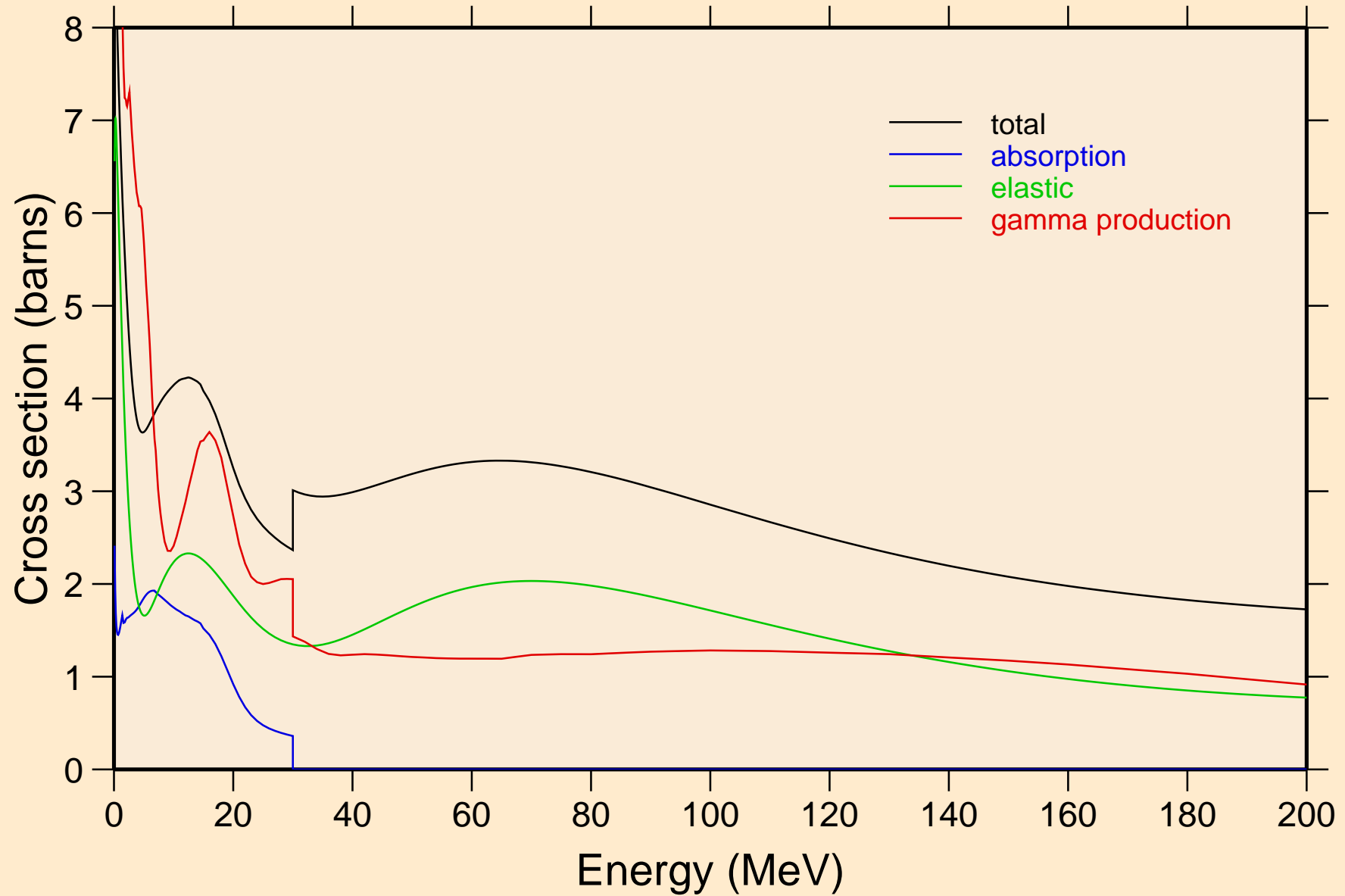

# CD098 NEUTRON ACER TENDL-2023 LIBRARY; T=0.K

## Heating

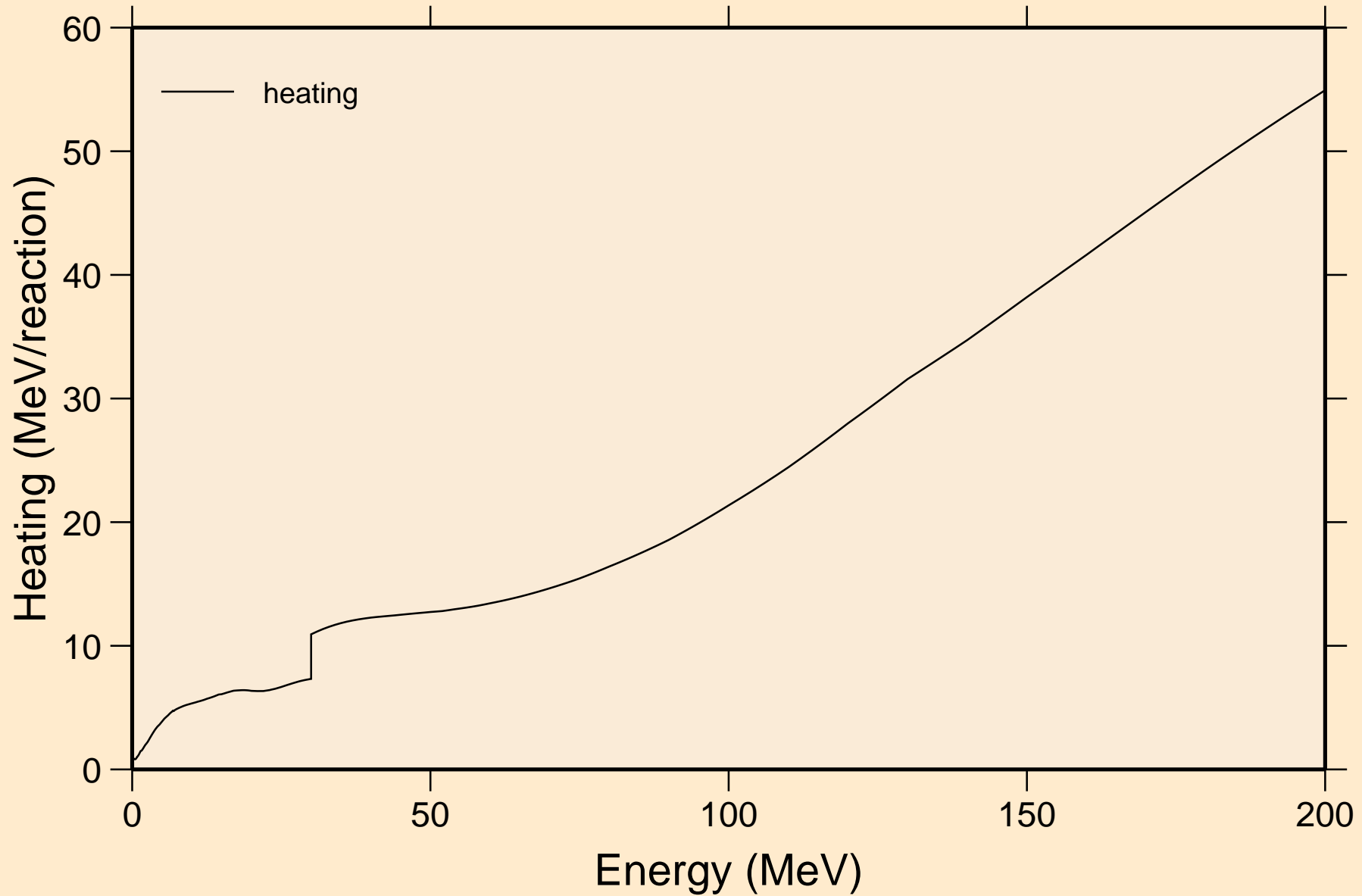

# CD098 NEUTRON ACER TENDL-2023 LIBRARY; T=0.K

## Damage

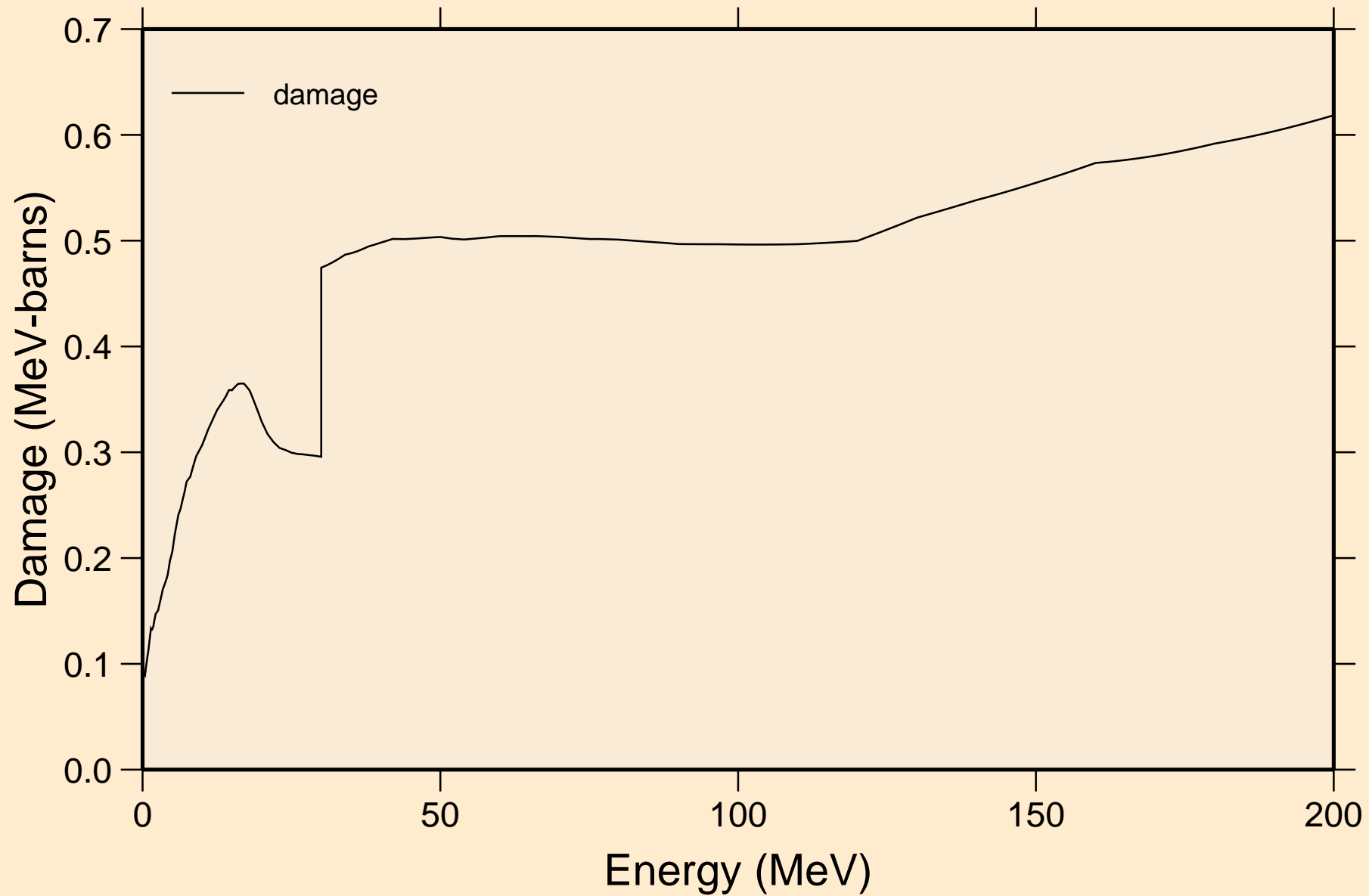

# CD098 NEUTRON ACER TENDL-2023 LIBRARY; T=0.K

## Non-threshold reactions

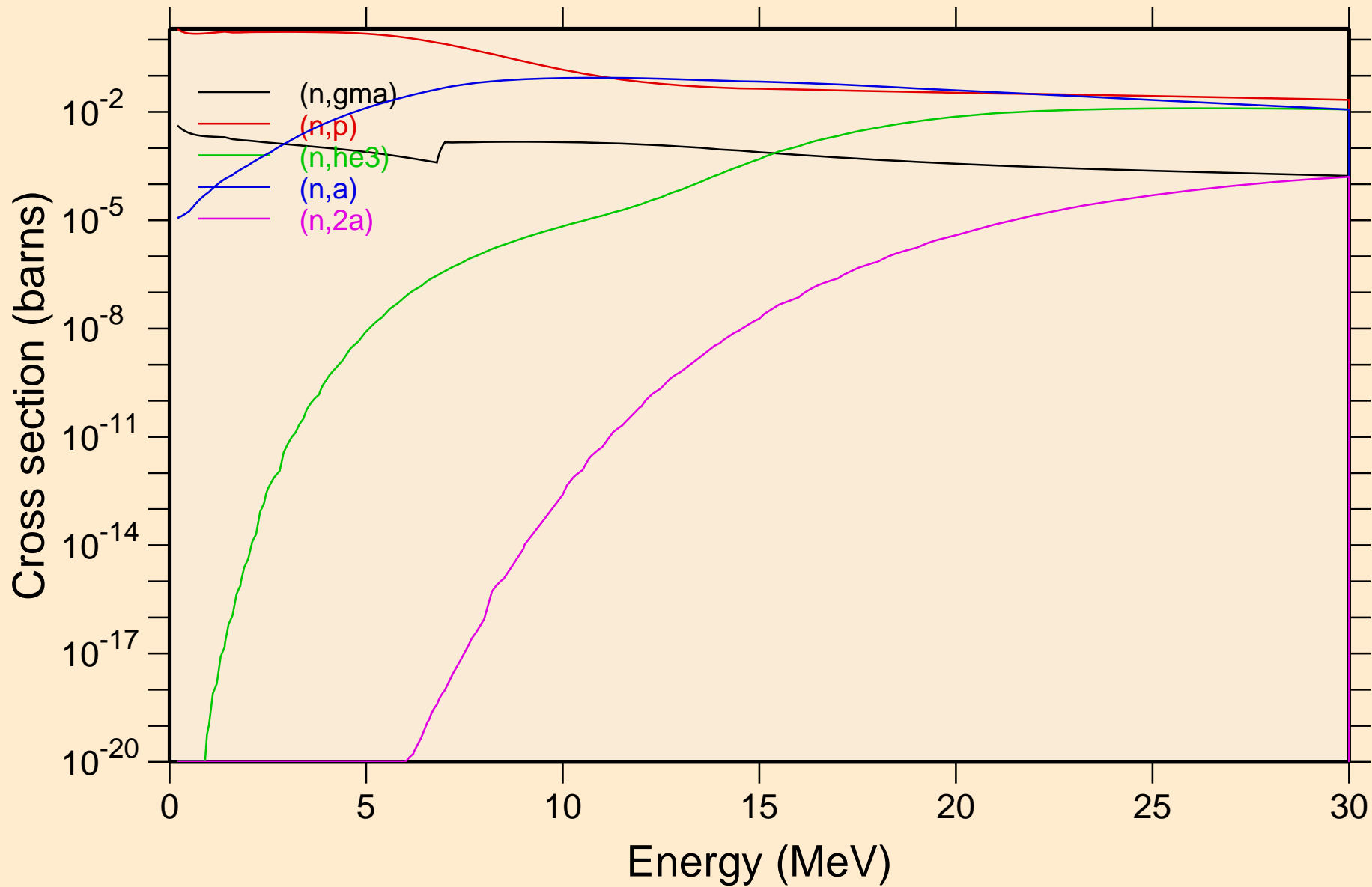

# CD098 NEUTRON ACER TENDL-2023 LIBRARY; T=0.K

## Non-threshold reactions

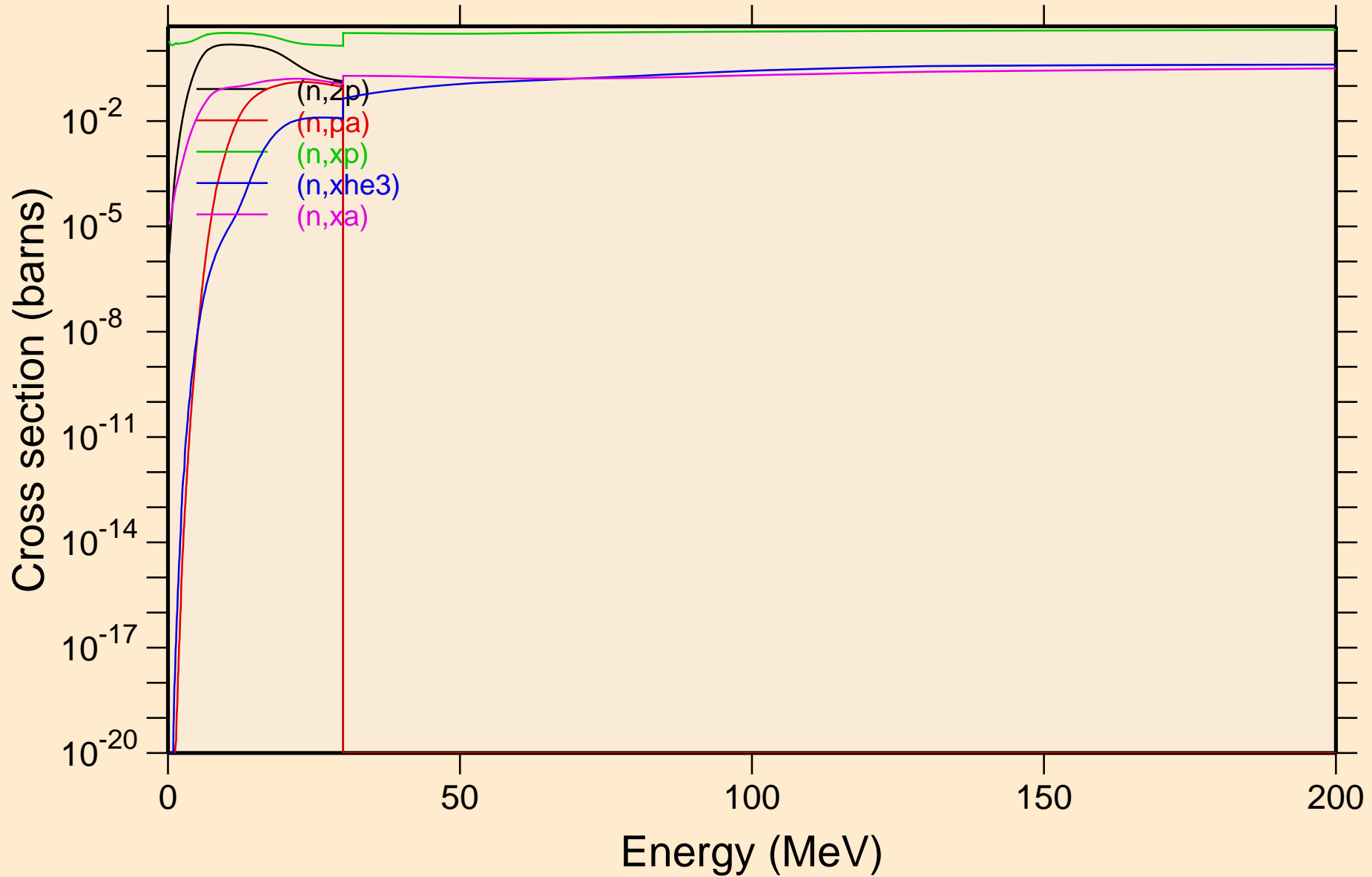

# CD098 NEUTRON ACER TENDL-2023 LIBRARY; T=0.K

## Inelastic levels

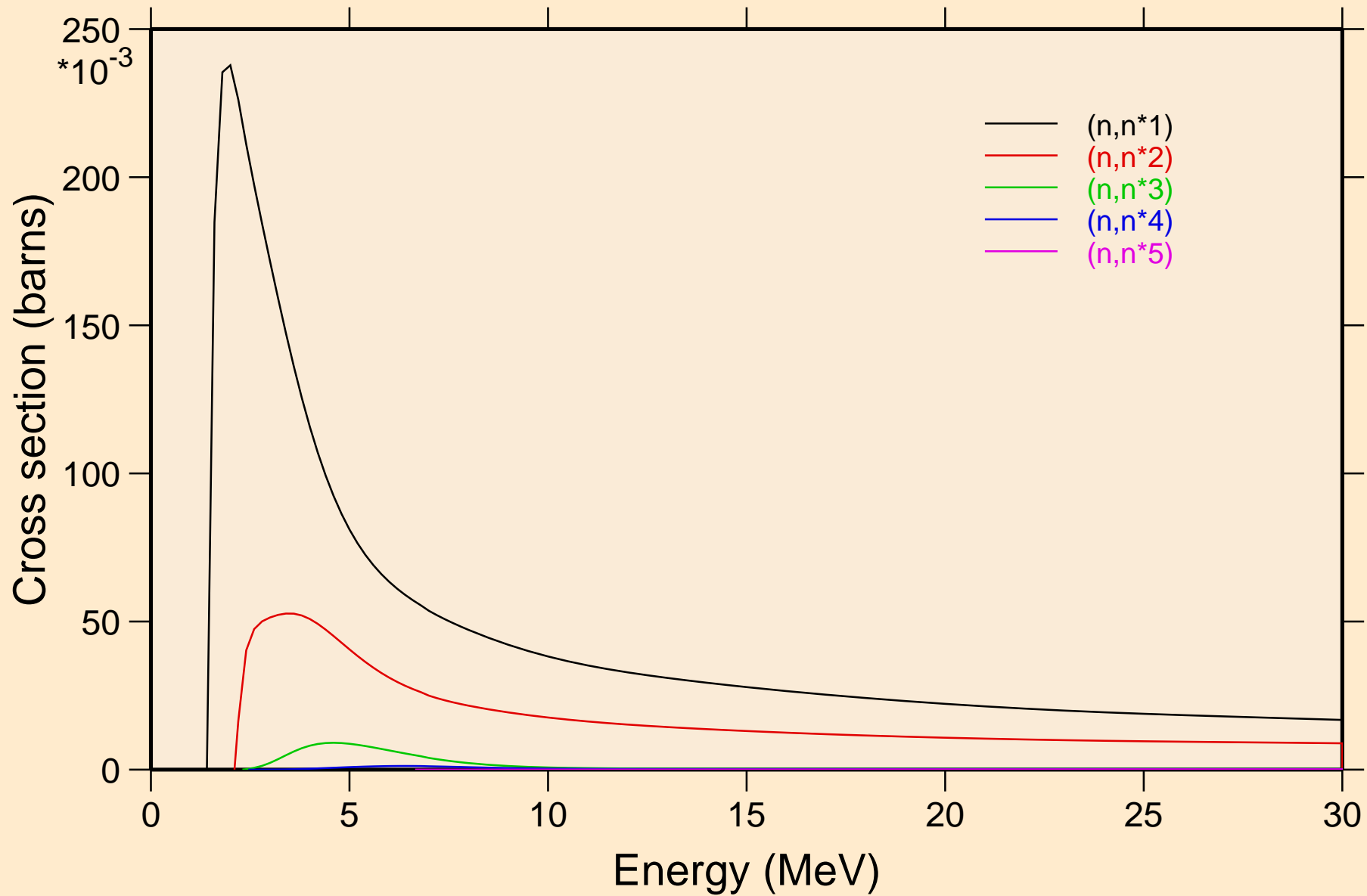

CD098 NEUTRON ACER TENDL-2023 LIBRARY; T=0.K  
Inelastic levels

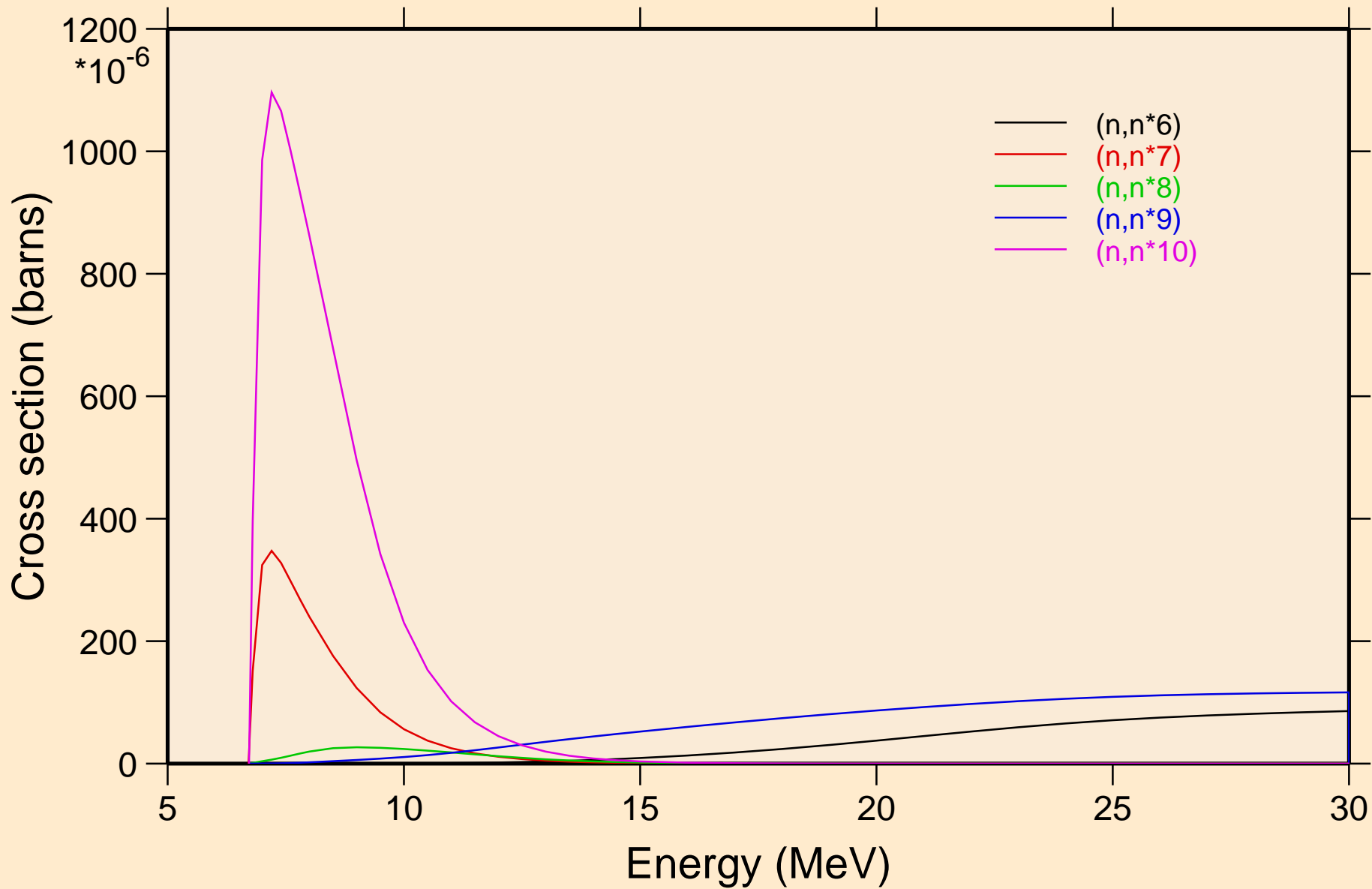

CD098 NEUTRON ACER TENDL-2023 LIBRARY; T=0.K  
Inelastic levels

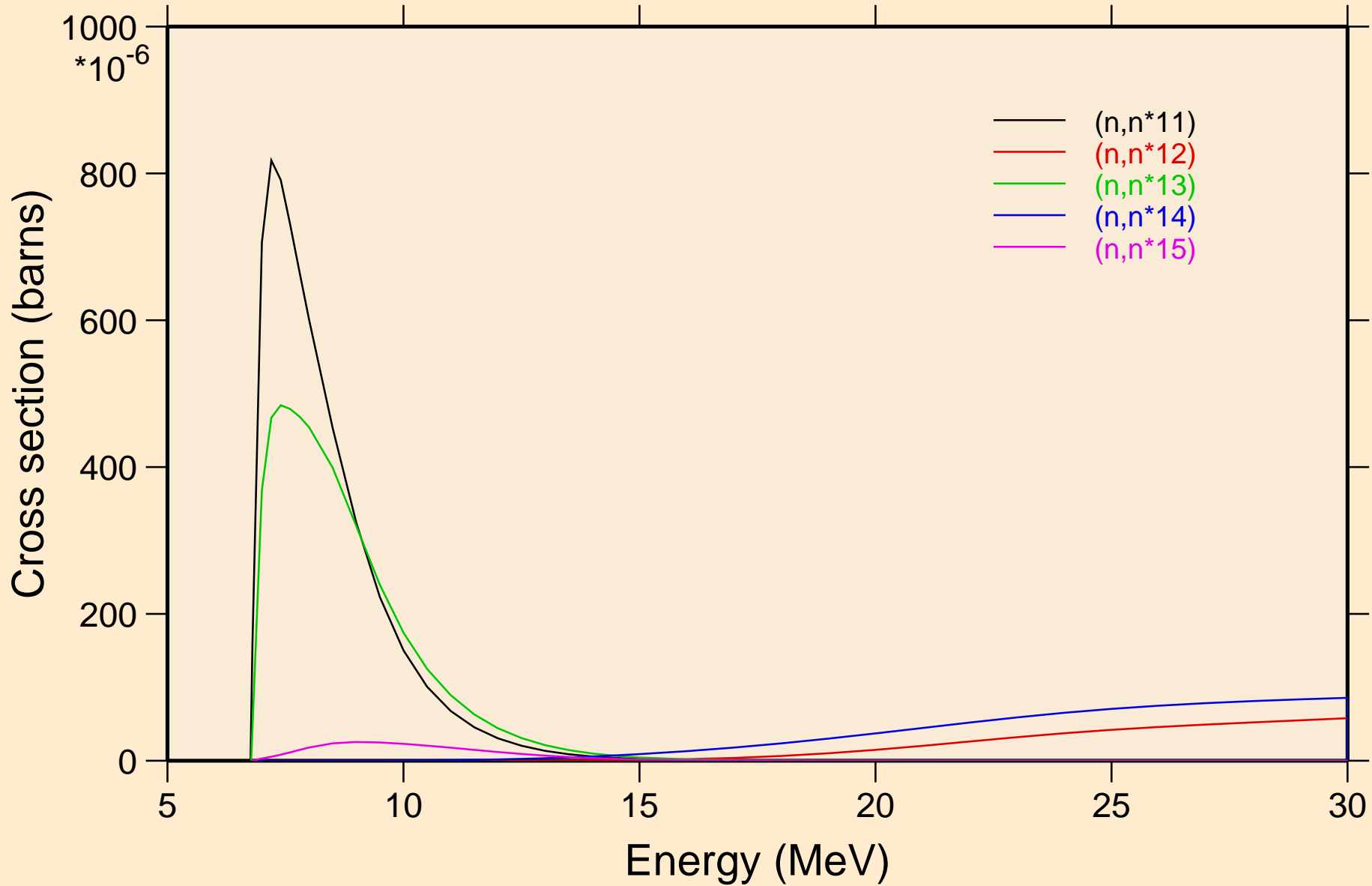

CD098 NEUTRON ACER TENDL-2023 LIBRARY; T=0.K  
Inelastic levels

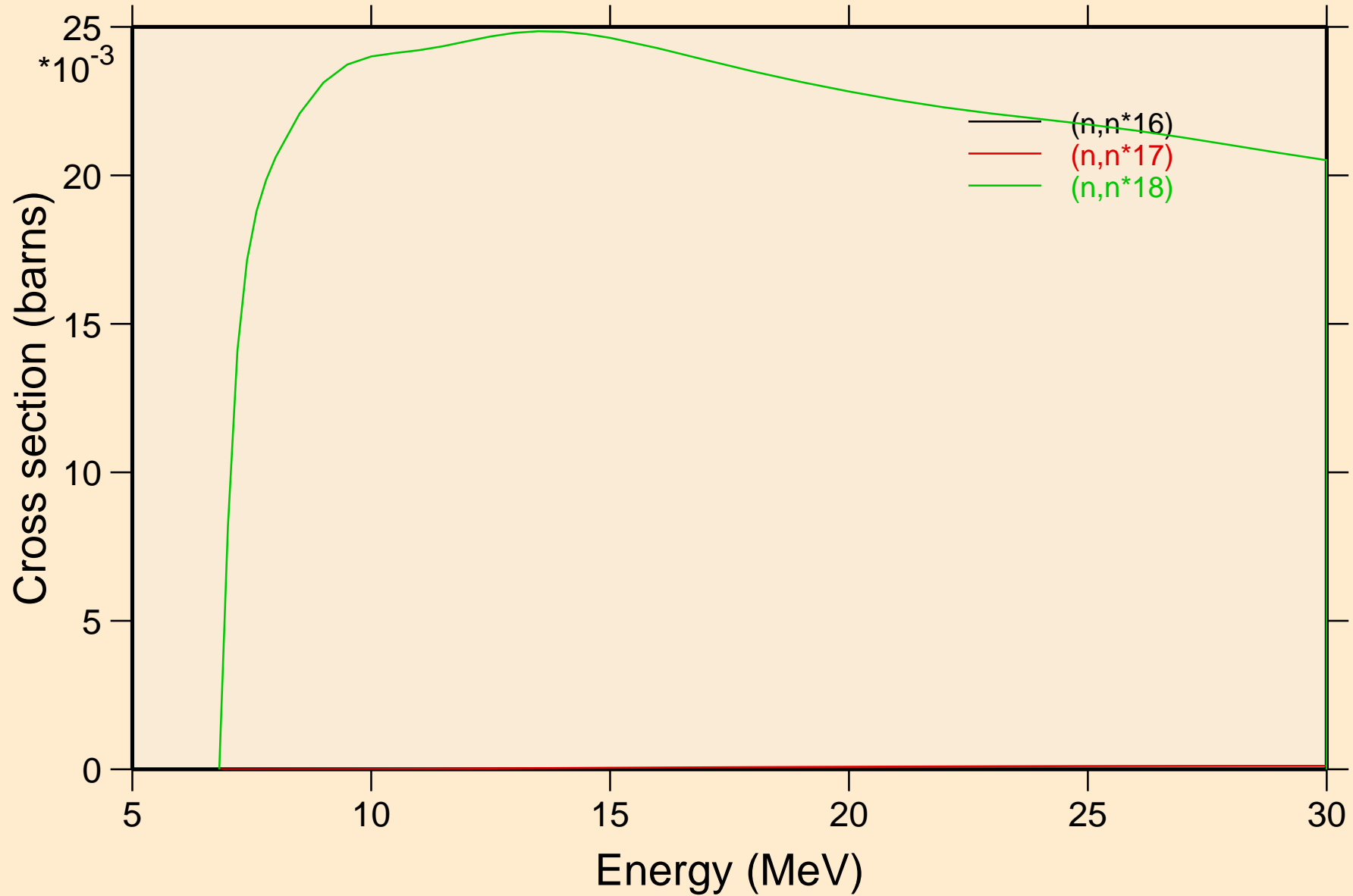

CD098 NEUTRON ACER TENDL-2023 LIBRARY; T=0.K  
Threshold reactions

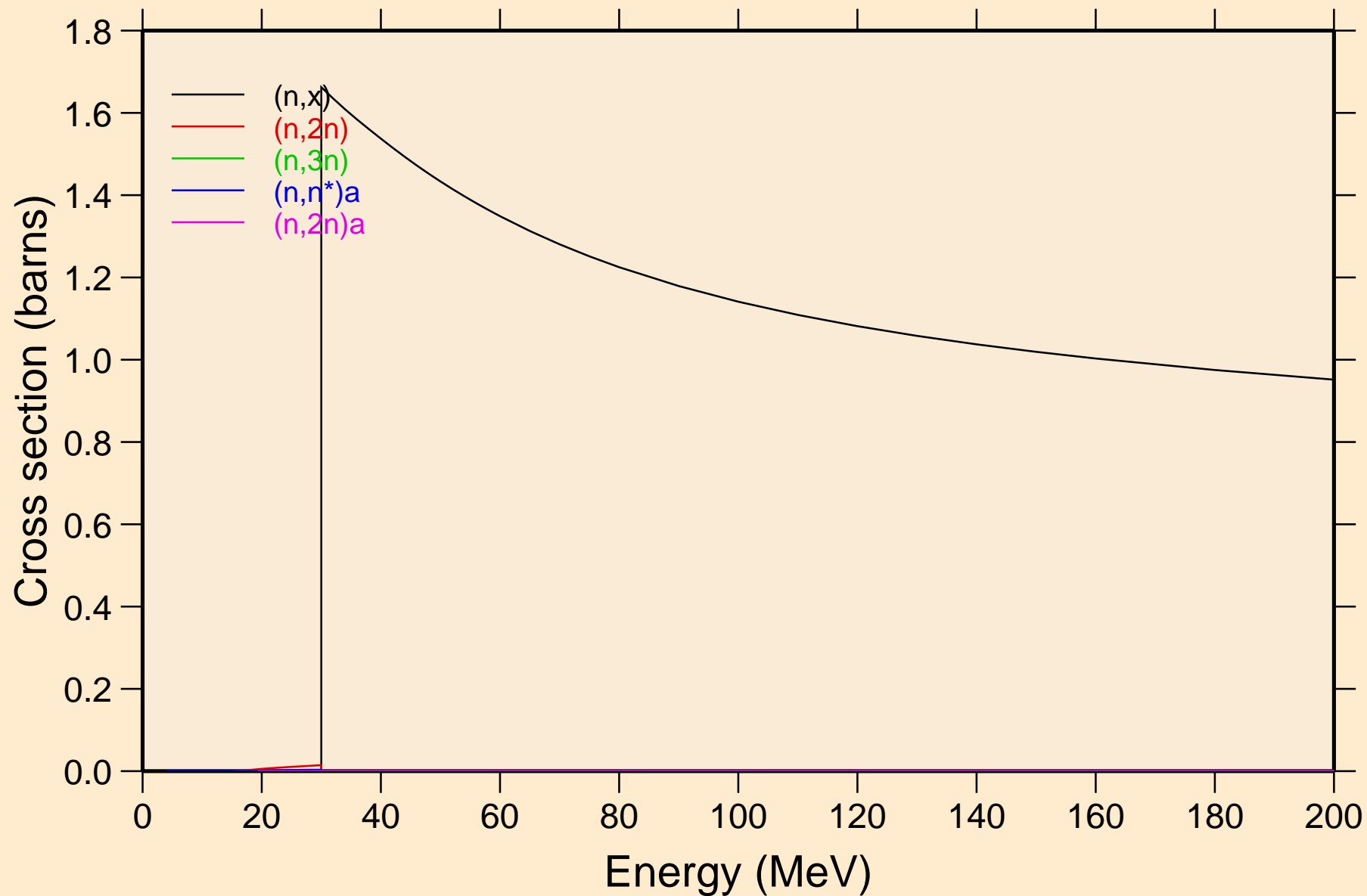

# CD098 NEUTRON ACER TENDL-2023 LIBRARY; T=0.K

## Threshold reactions

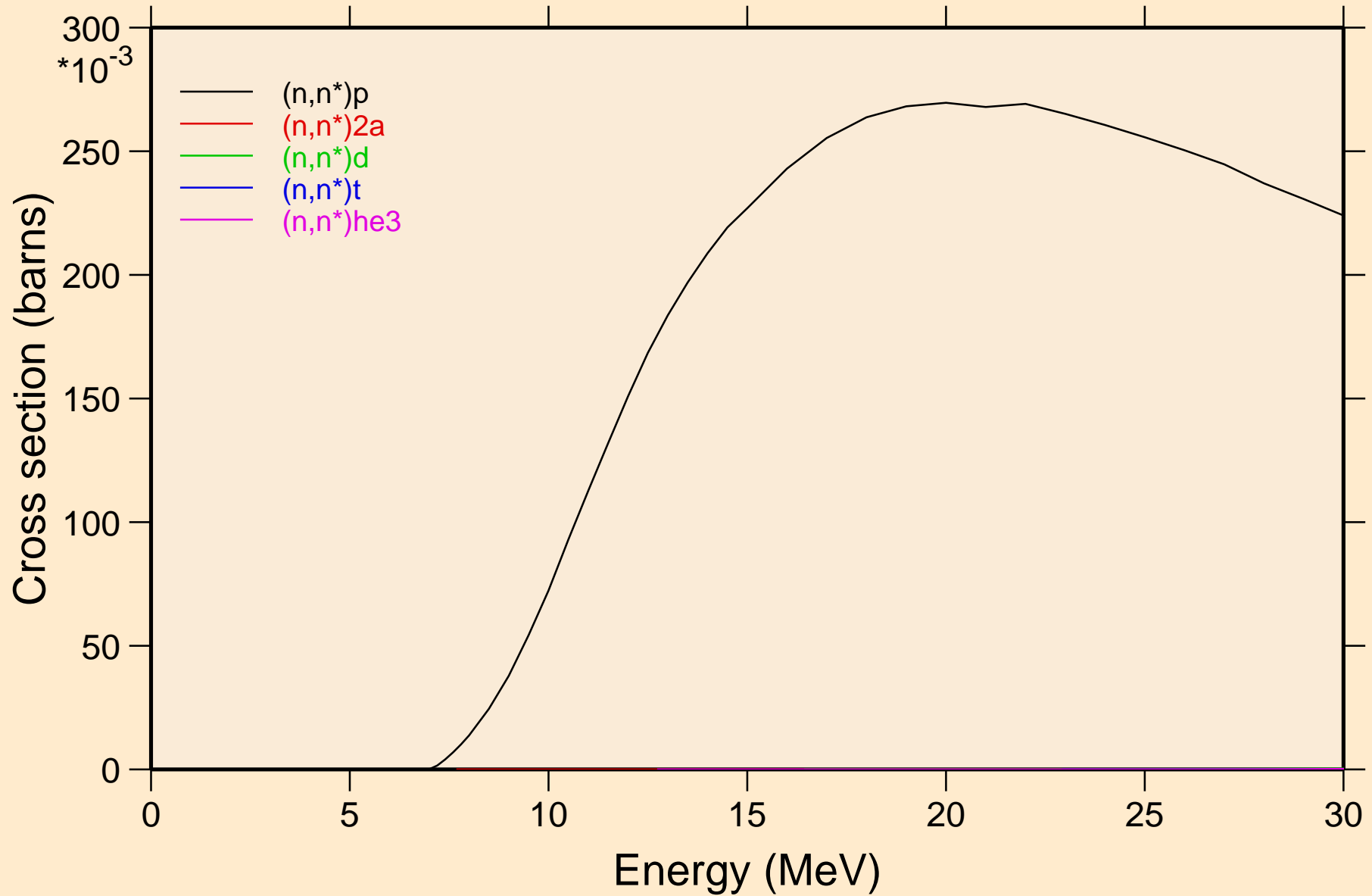

# CD098 NEUTRON ACER TENDL-2023 LIBRARY; T=0.K

## Threshold reactions

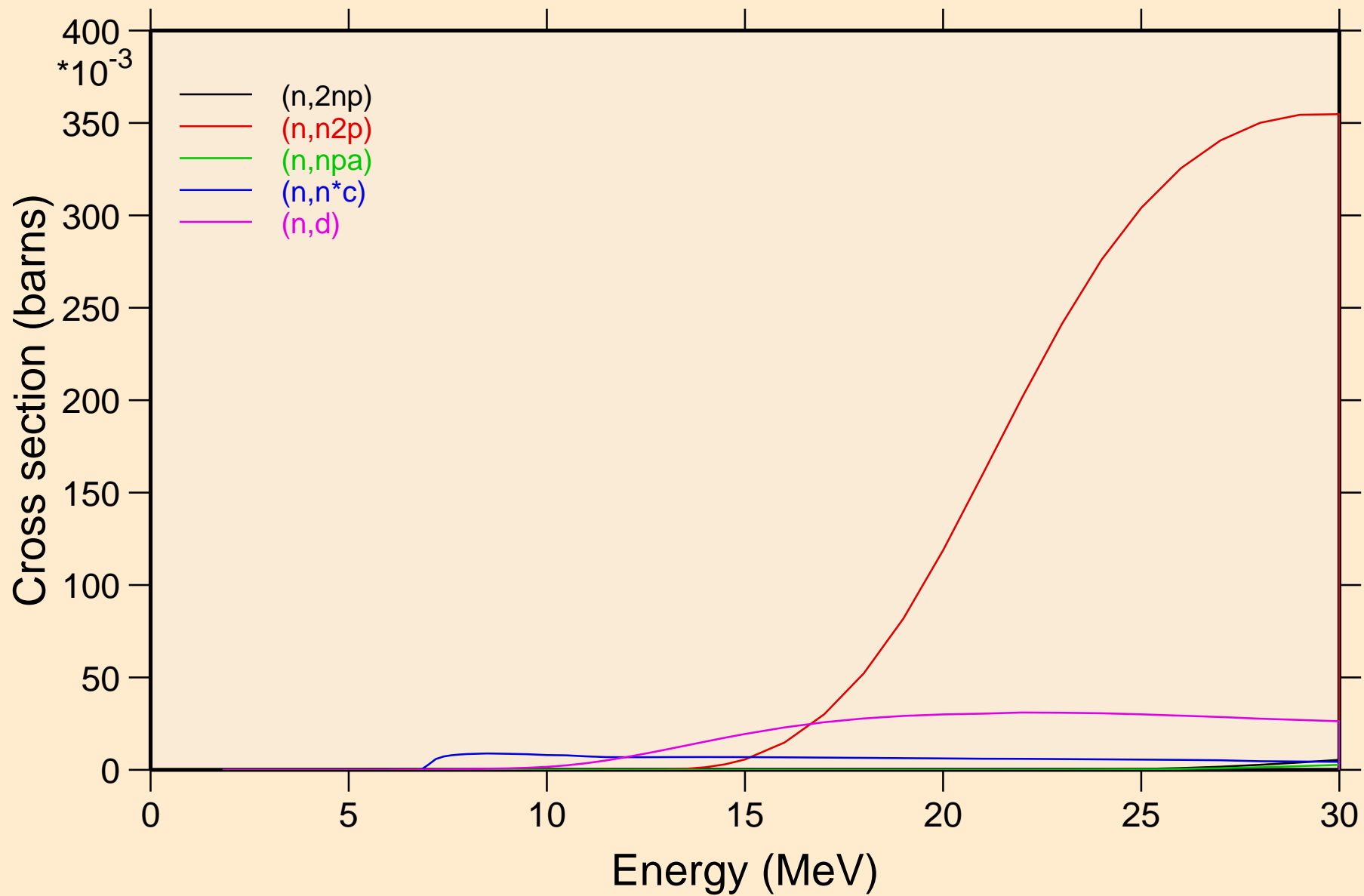

CD098 NEUTRON ACER TENDL-2023 LIBRARY; T=0.K  
Threshold reactions

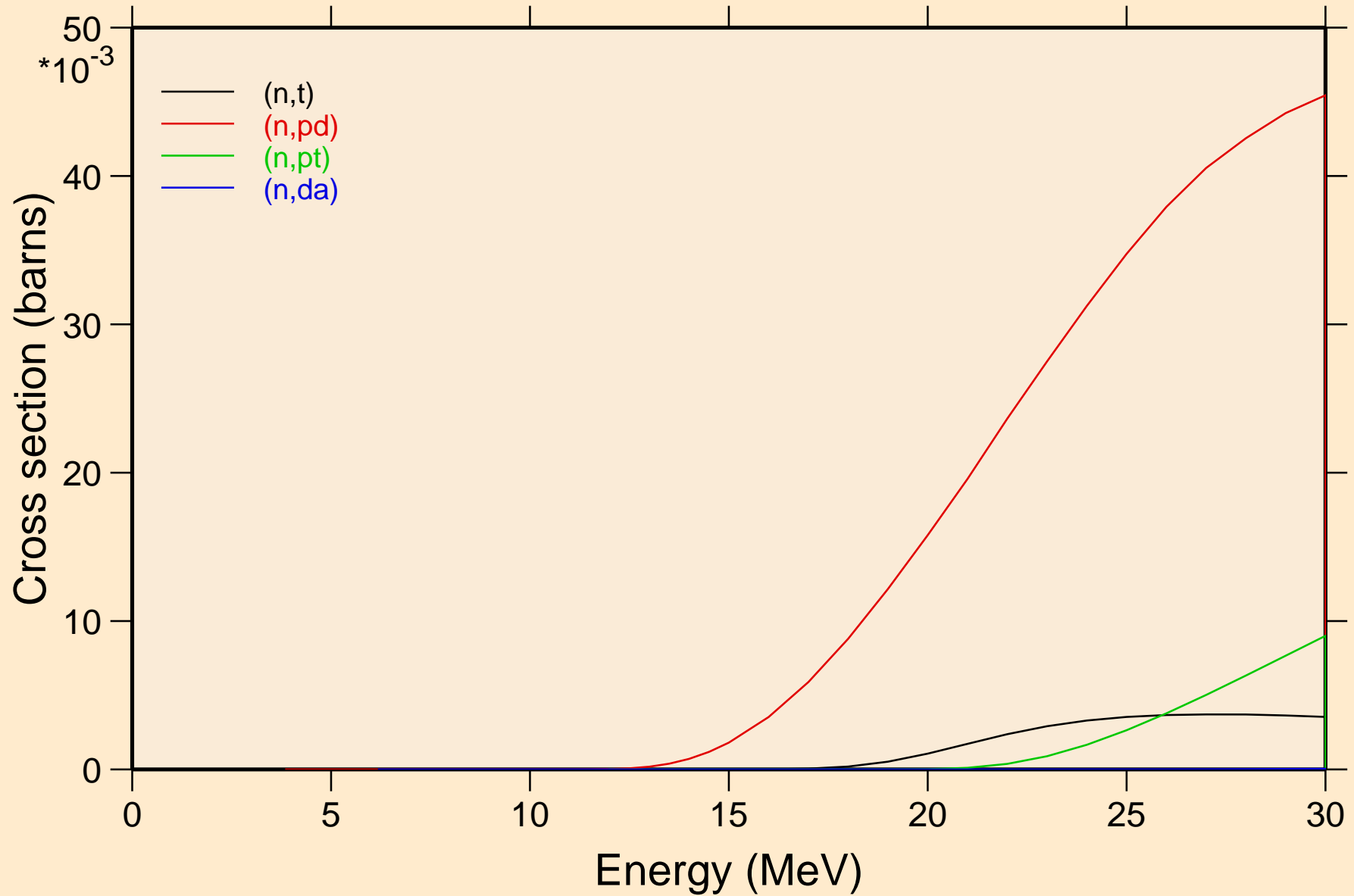

# CD098 NEUTRON ACER TENDL-2023 LIBRARY; T=0.K

## Threshold reactions

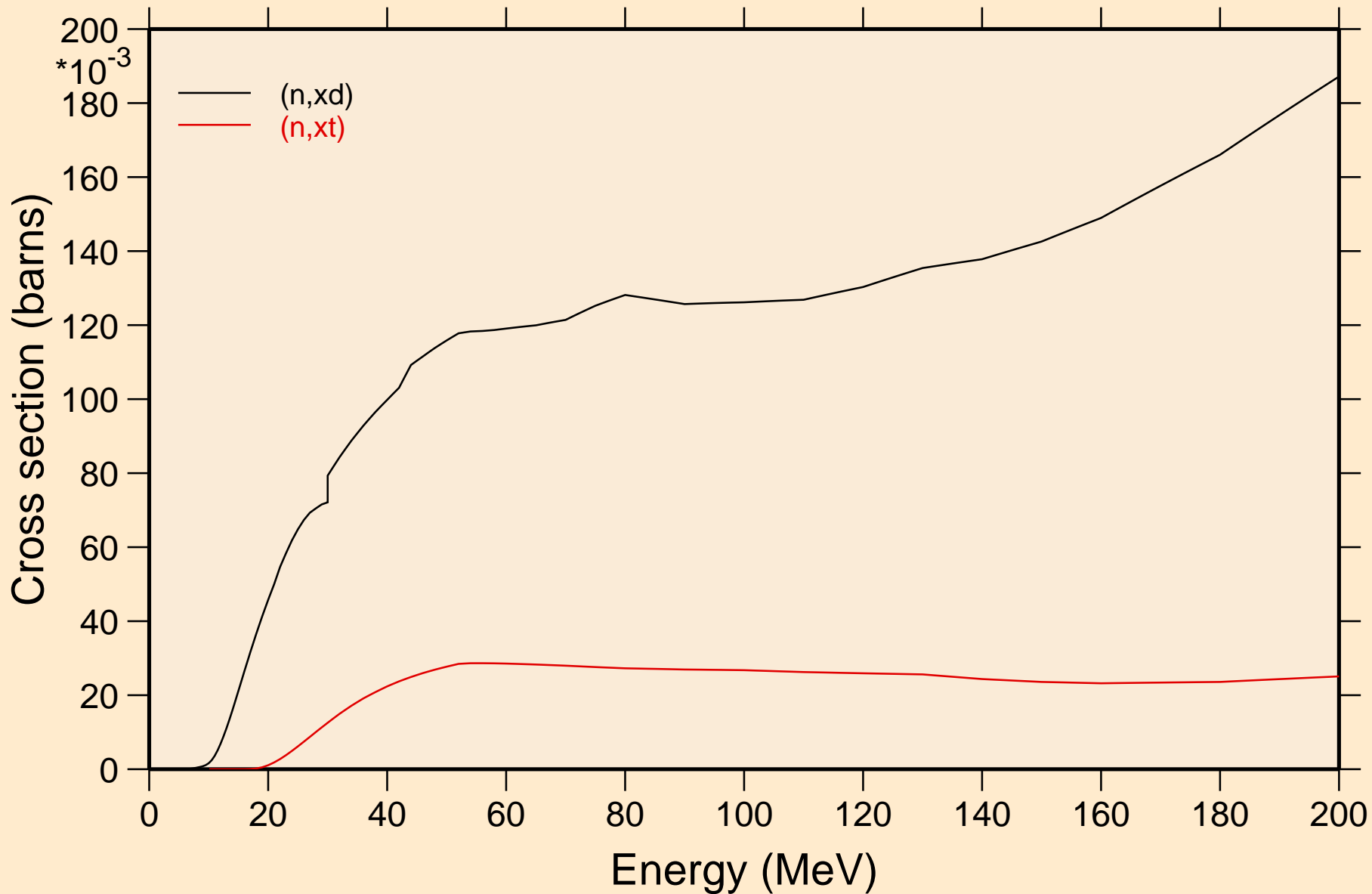

CD098 NEUTRON ACER TENDL-2023 LIBRARY; T=0.K  
angular distribution for elastic

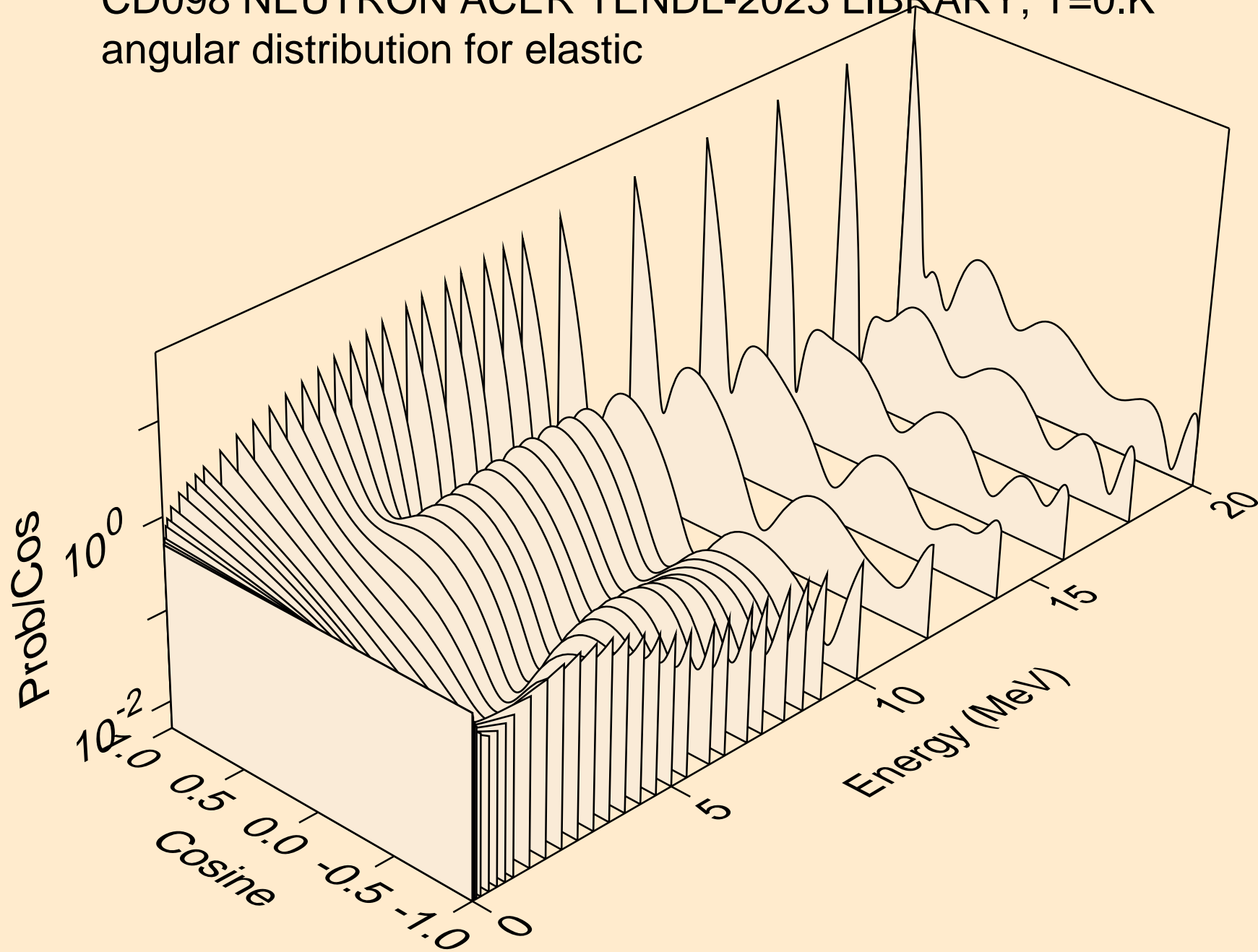

CD098 NEUTRON ACER TENDL-2023 LIBRARY; T=0.K  
angular distribution for elastic

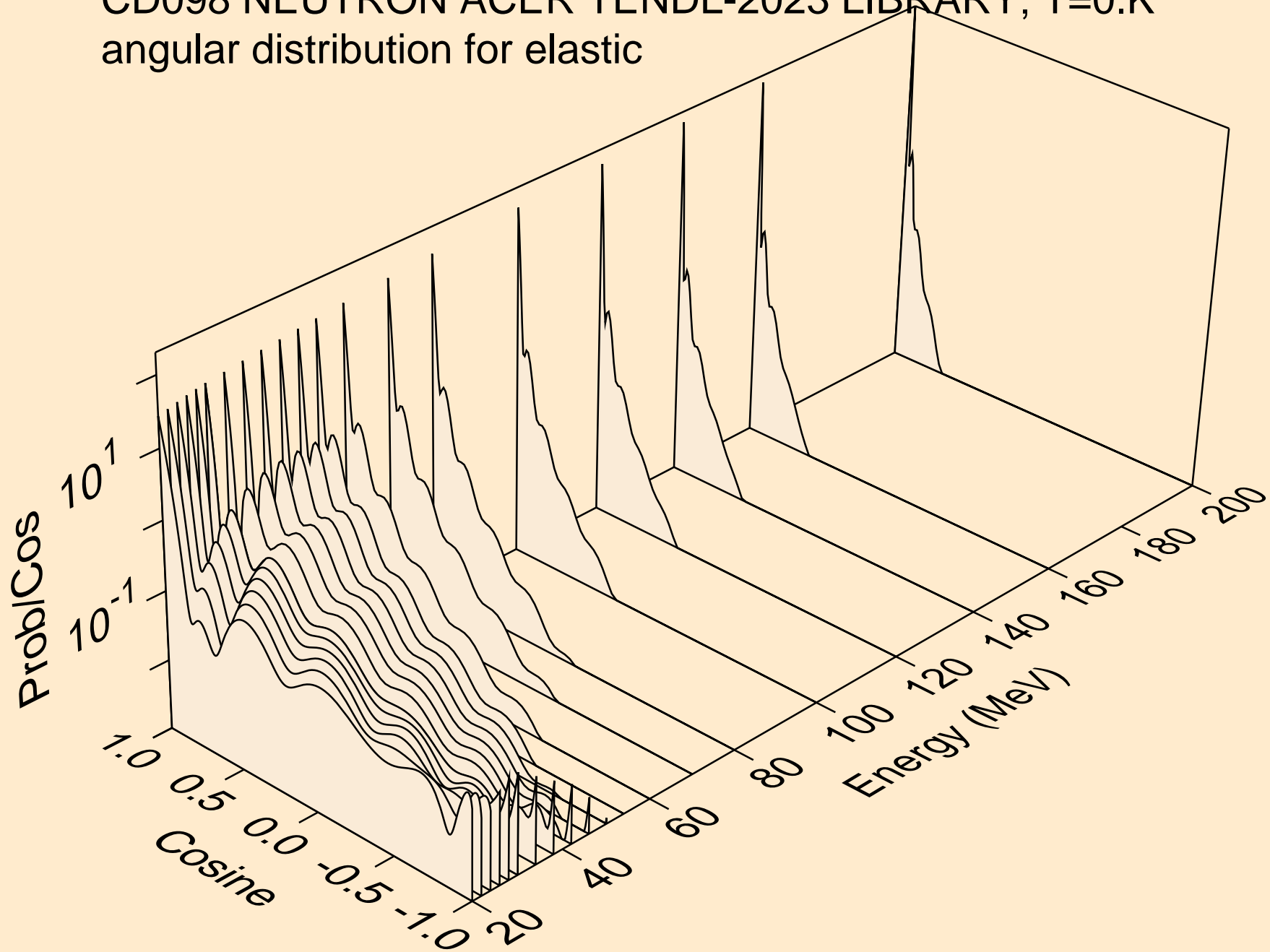

CD098 NEUTRON ACER TENDL-2023 LIBRARY; T=0.K  
angular distribution for (n,n\*1)

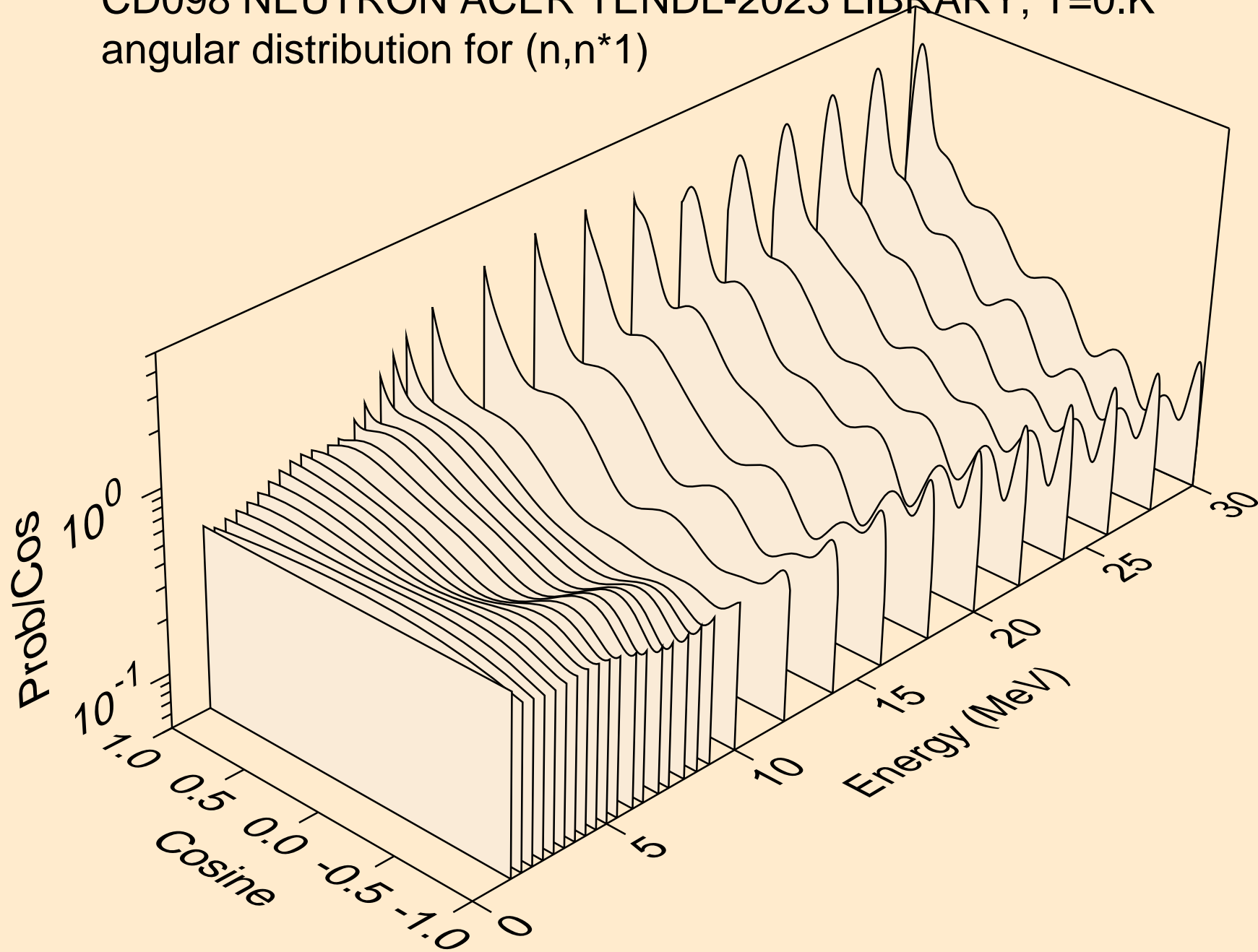

CD098 NEUTRON ACER TENDL-2023 LIBRARY; T=0.K  
angular distribution for (n,n\*2)

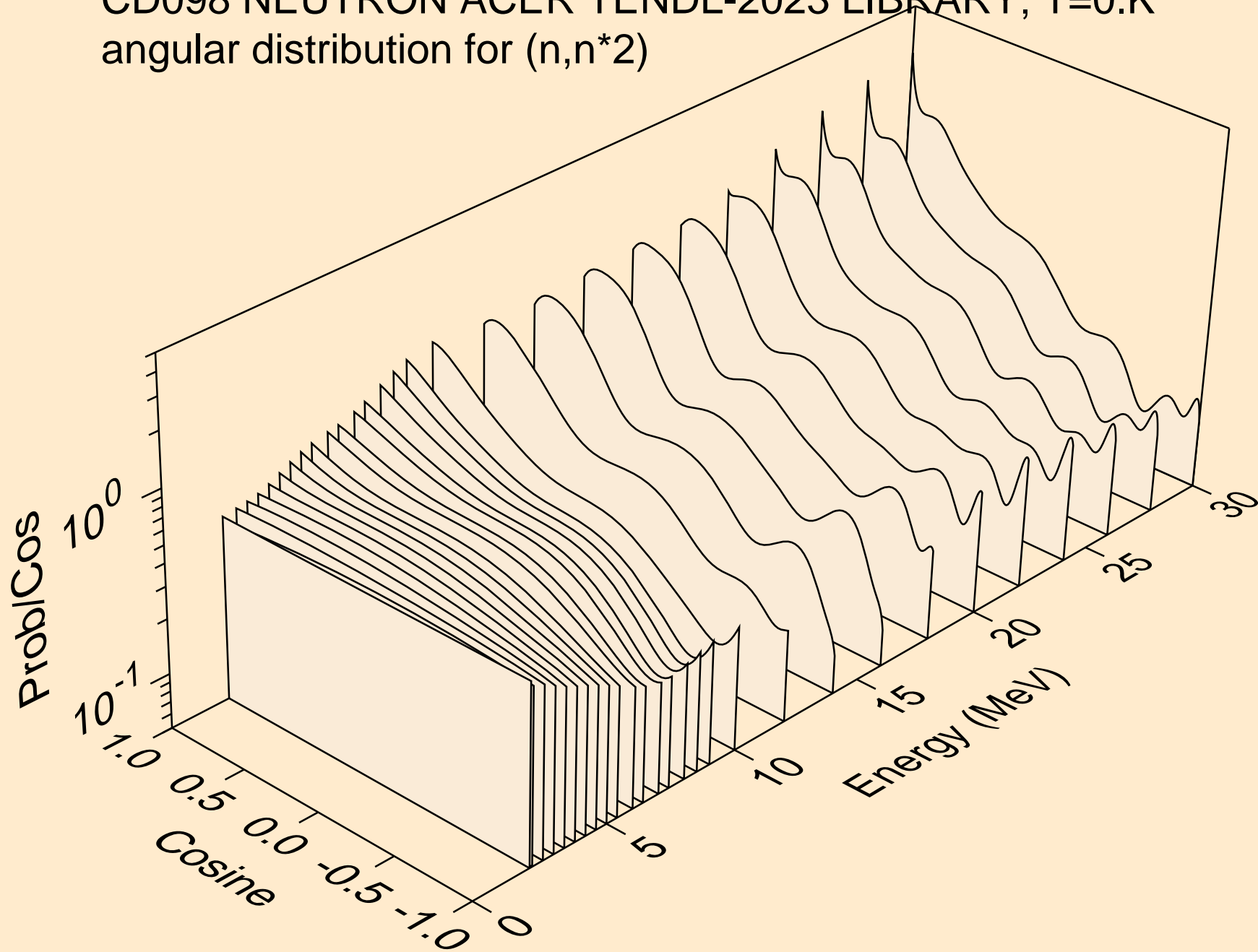

CD098 NEUTRON ACER TENDL-2023 LIBRARY; T=0.K  
angular distribution for (n,n\*3)

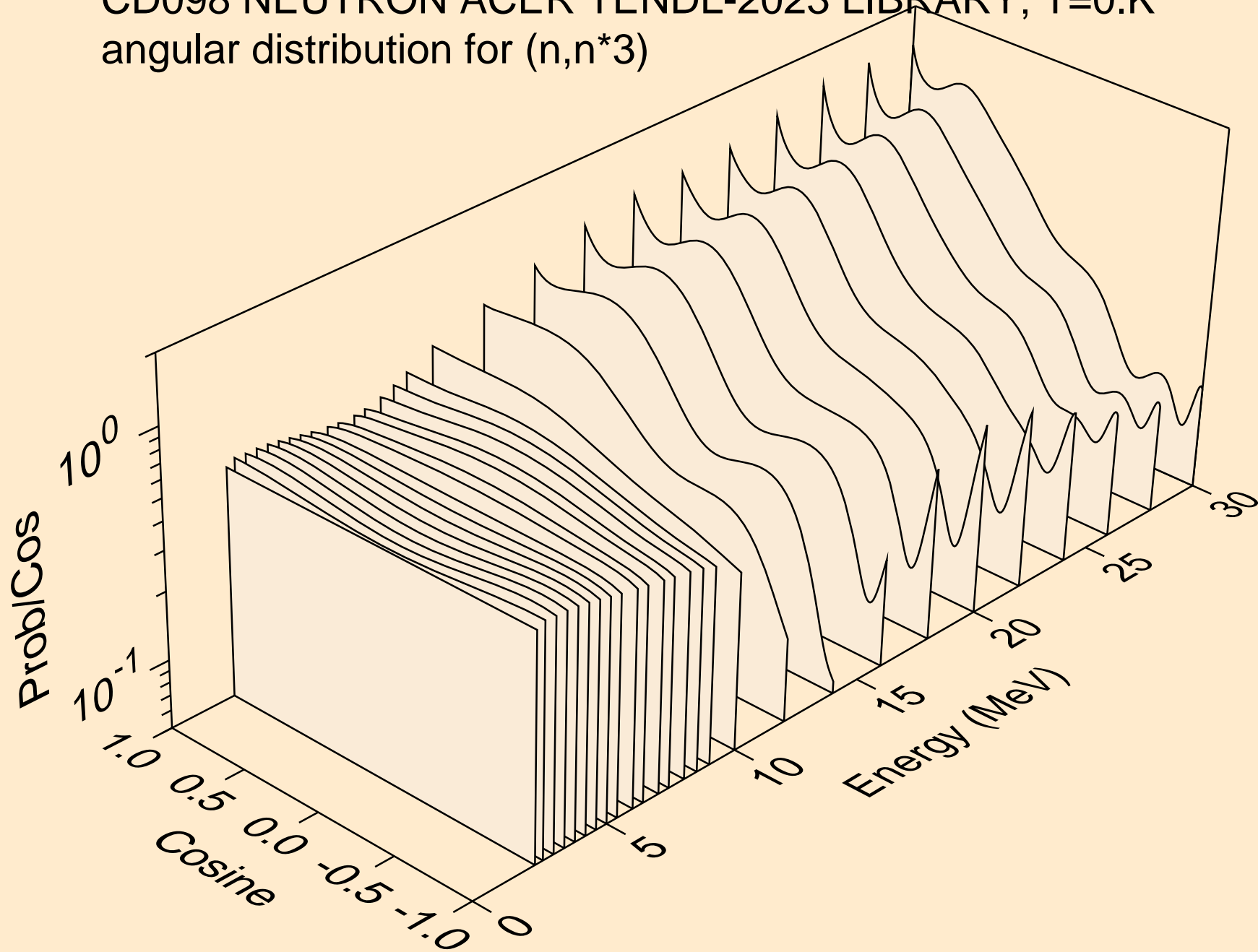

CD098 NEUTRON ACER TENDL-2023 LIBRARY; T=0.K  
angular distribution for (n,n\*4)

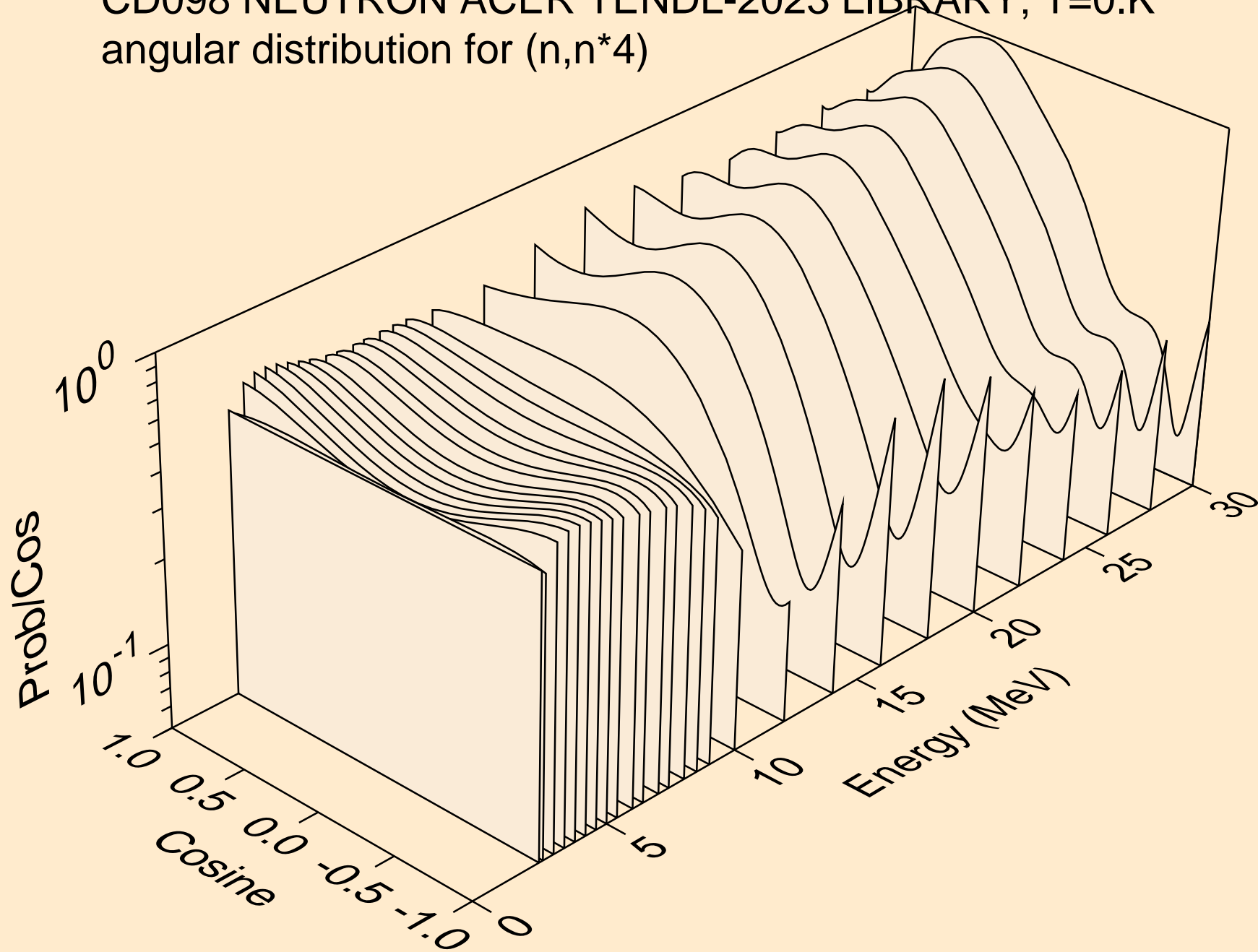

CD098 NEUTRON ACER TENDL-2023 LIBRARY; T=0.K  
angular distribution for (n,n\*5)

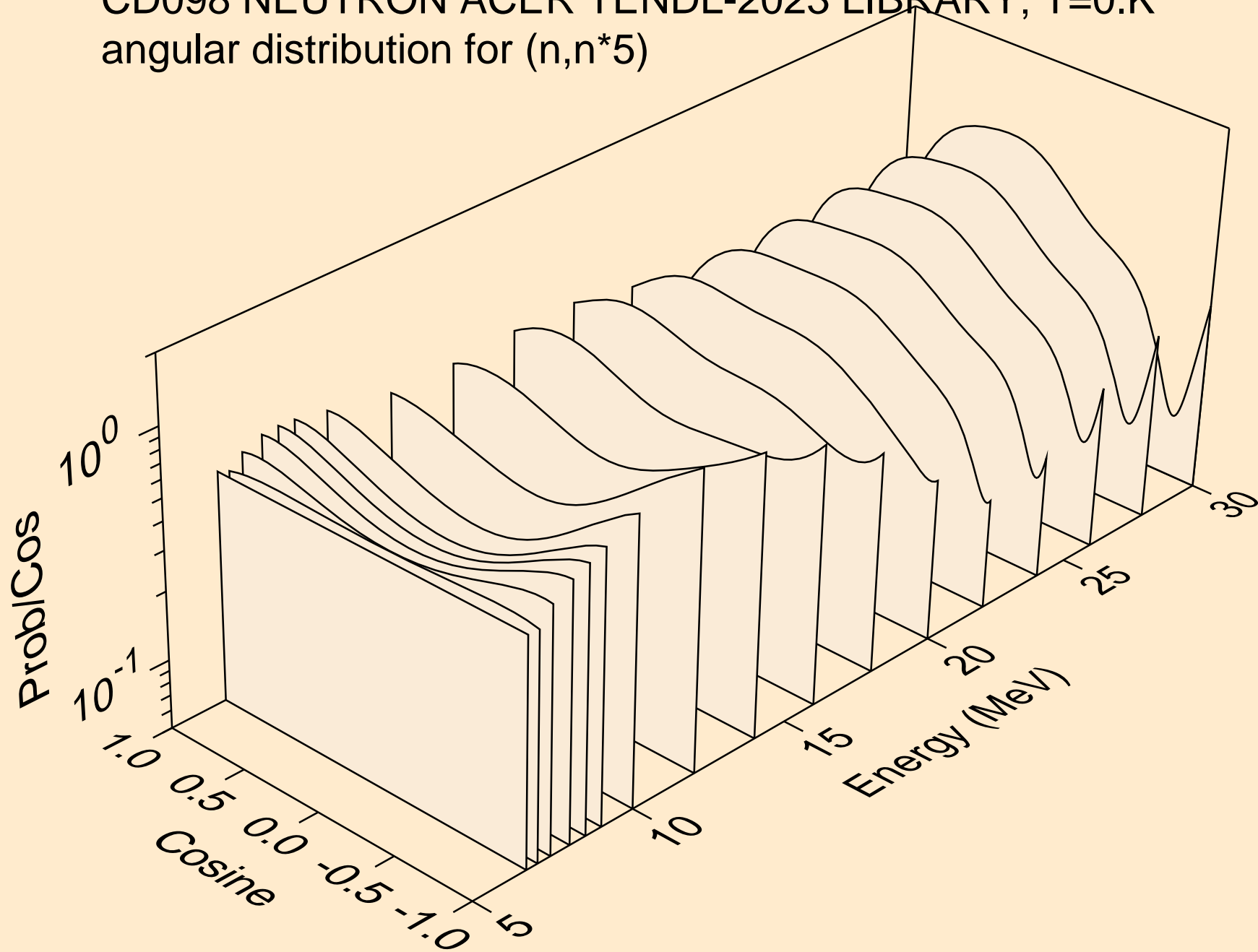

CD098 NEUTRON ACER TENDL-2023 LIBRARY; T=0.K  
angular distribution for (n,n\*6)

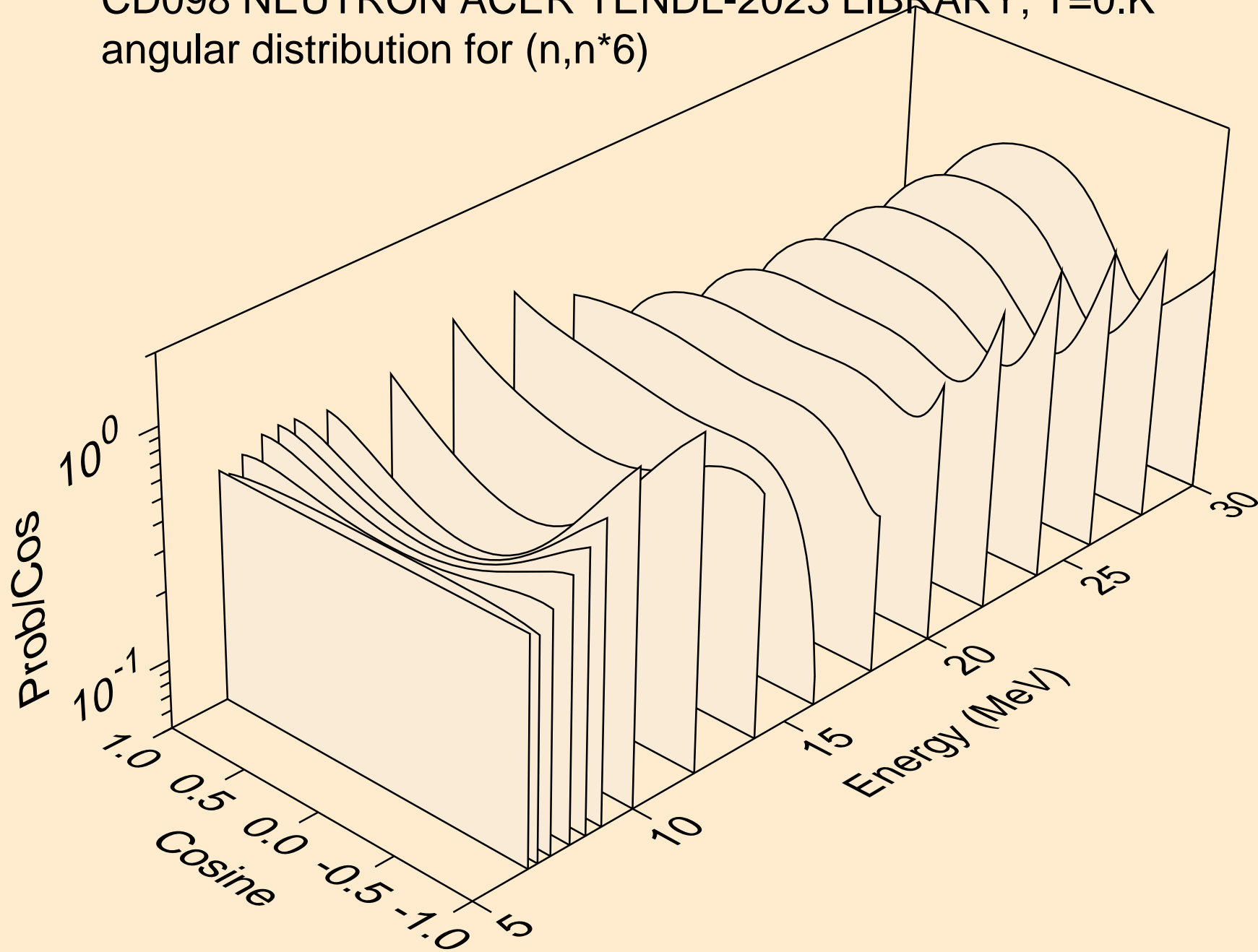

CD098 NEUTRON ACER TENDL-2023 LIBRARY; T=0.K  
angular distribution for (n,n\*7)

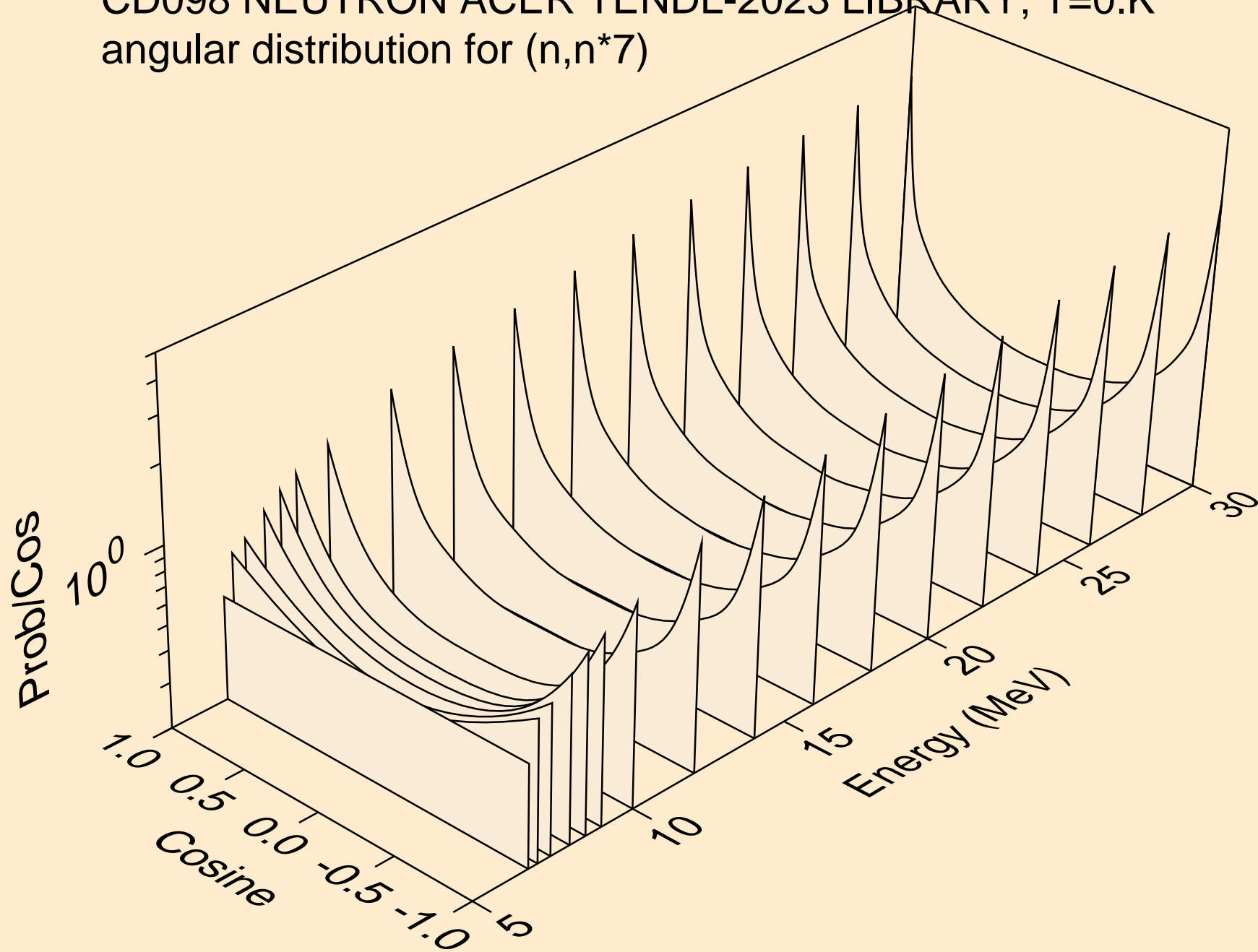

CD098 NEUTRON ACER TENDL-2023 LIBRARY; T=0.K  
angular distribution for (n,n\*8)

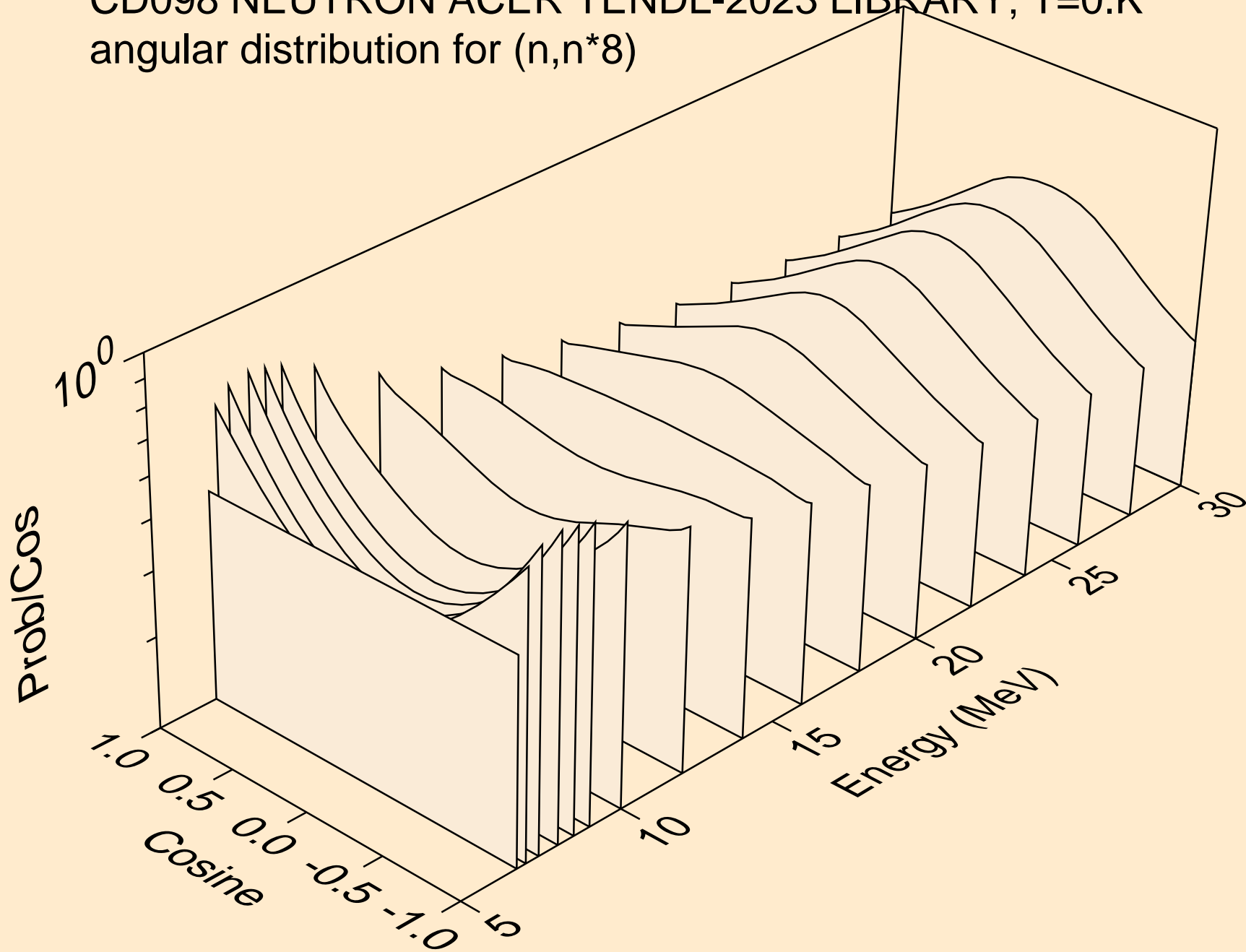

CD098 NEUTRON ACER TENDL-2023 LIBRARY; T=0.K  
angular distribution for (n,n\*9)

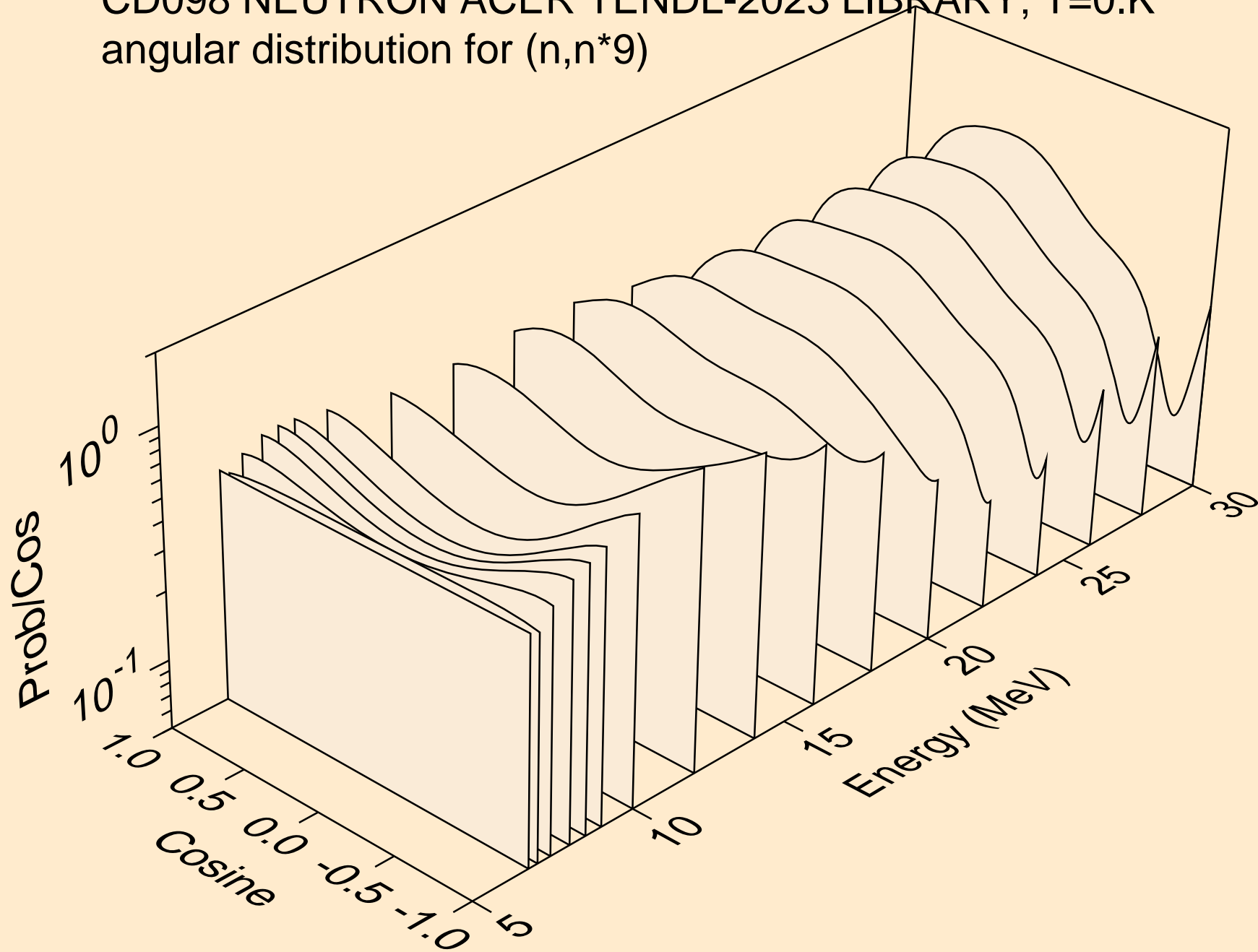

CD098 NEUTRON ACER TENDL-2023 LIBRARY; T=0.K  
angular distribution for (n,n\*10)

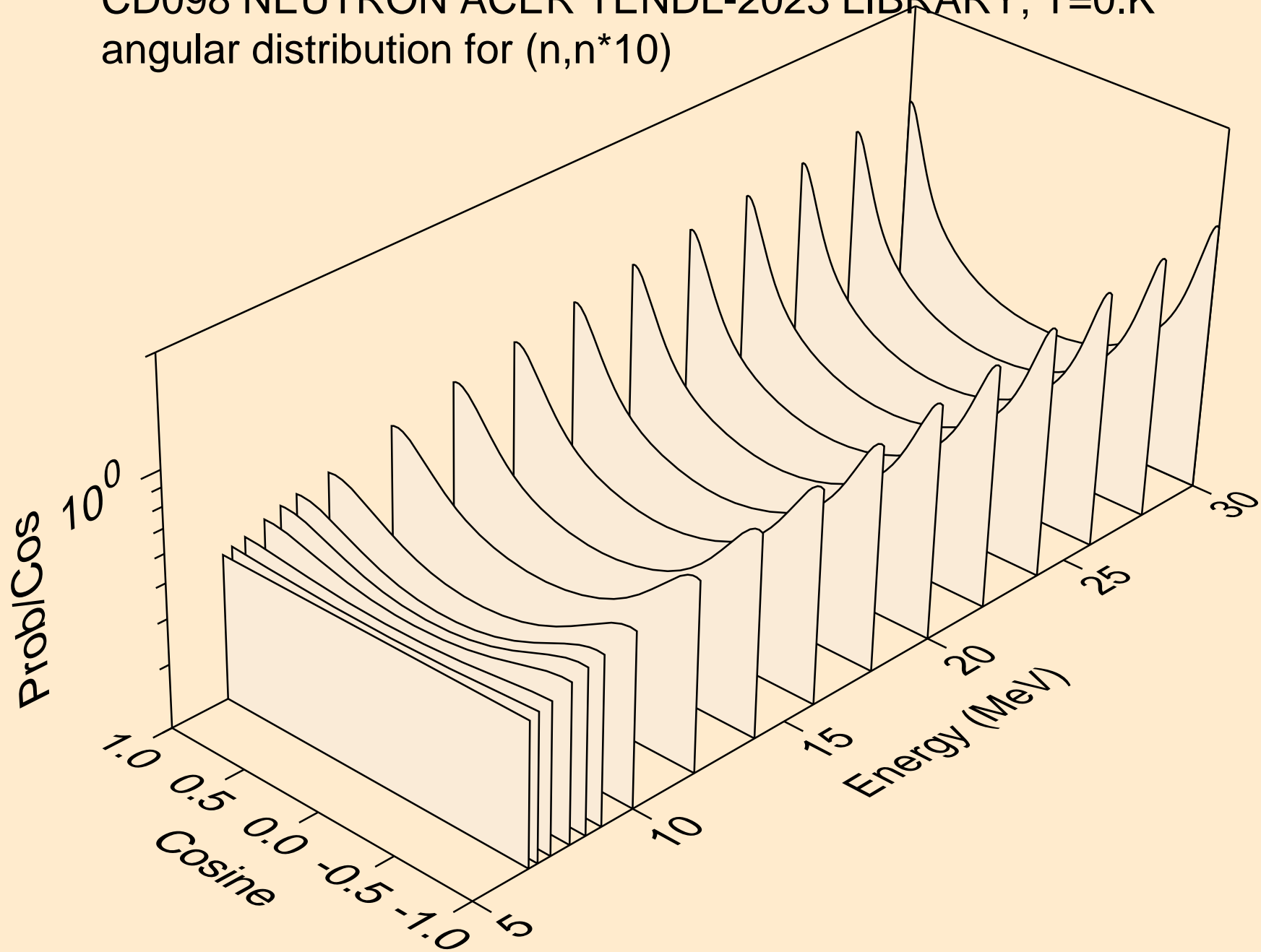

CD098 NEUTRON ACER TENDL-2023 LIBRARY; T=0.K  
angular distribution for (n,n\*11)

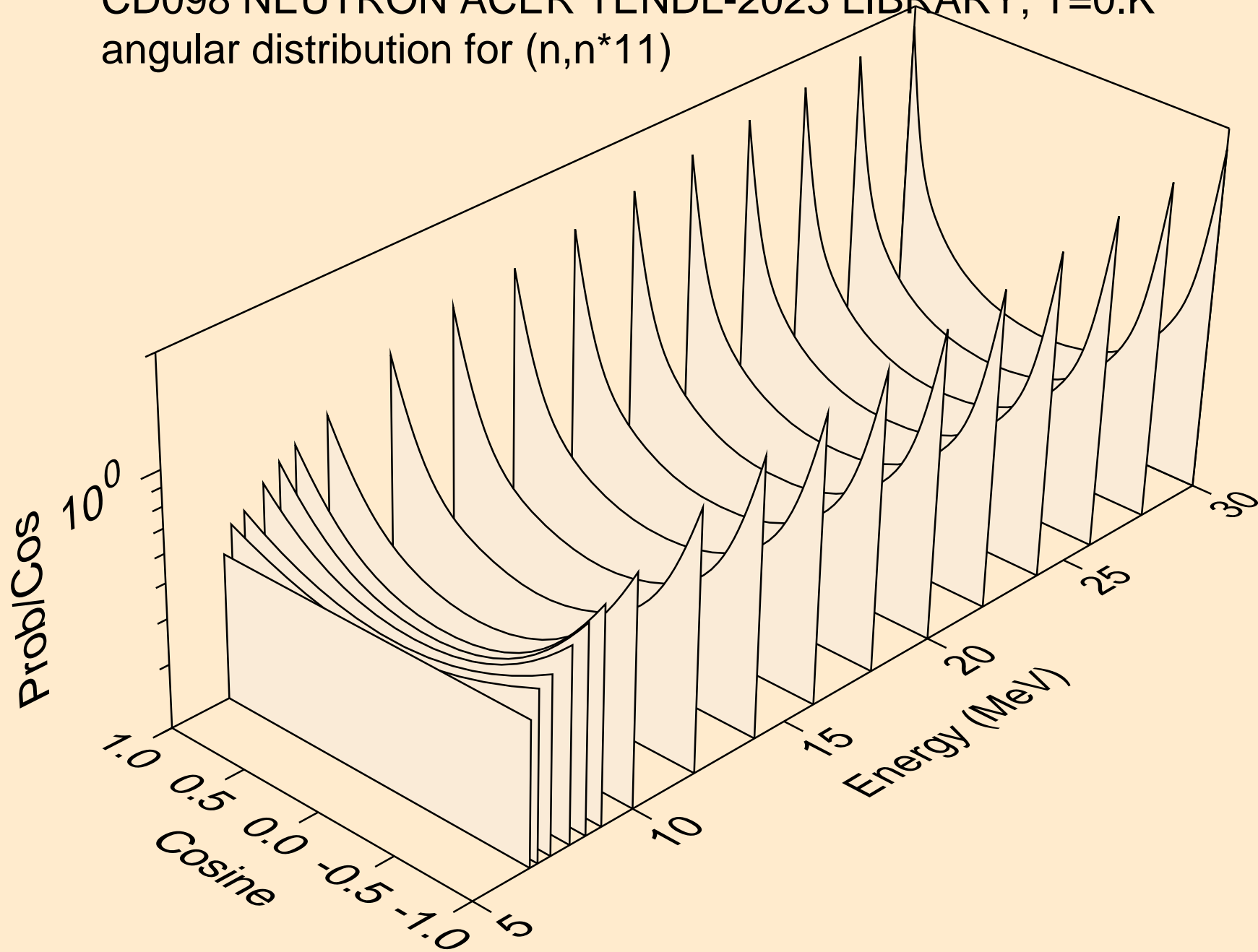

CD098 NEUTRON ACER TENDL-2023 LIBRARY; T=0.K  
angular distribution for (n,n\*12)

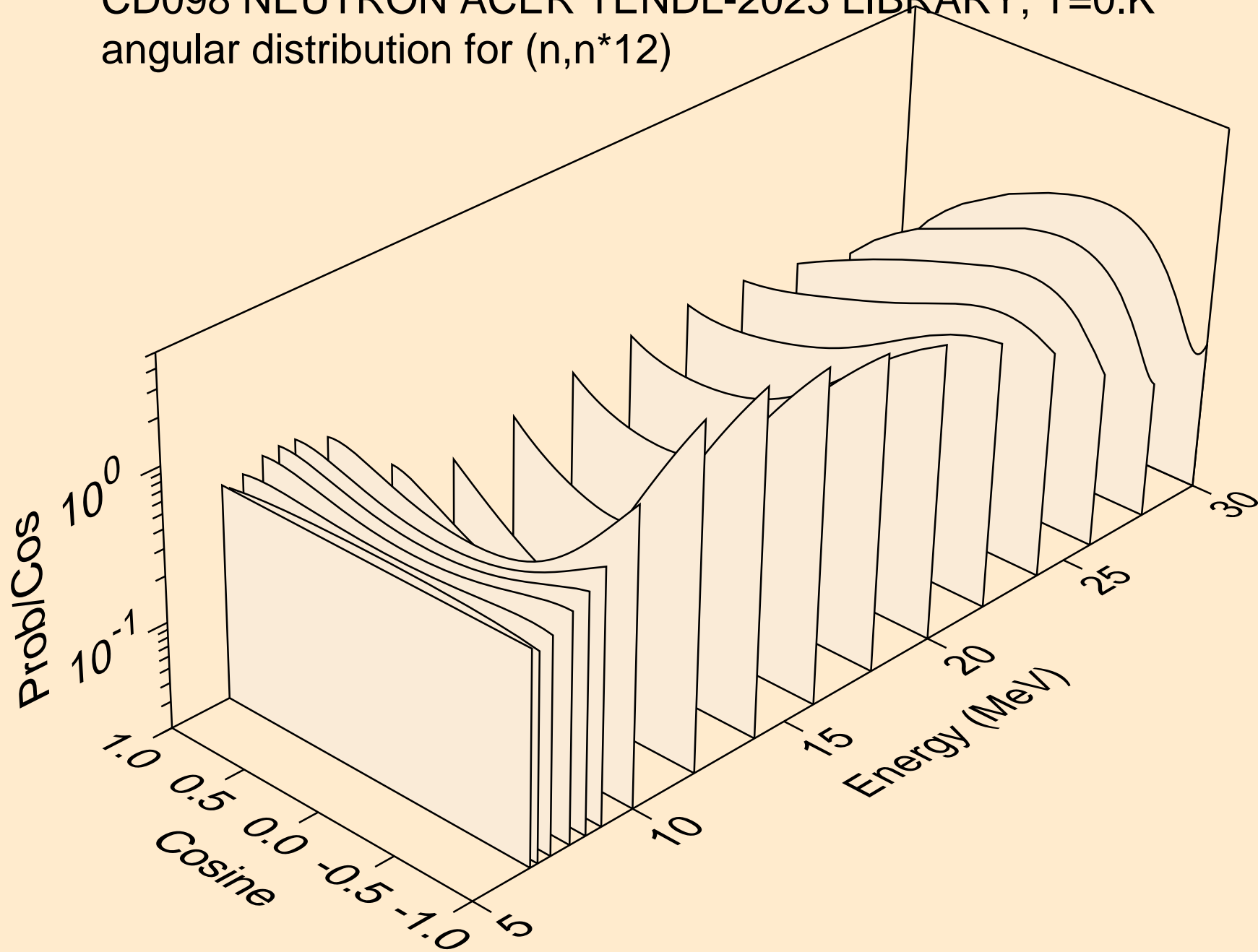

CD098 NEUTRON ACER TENDL-2023 LIBRARY; T=0.K  
angular distribution for (n,n\*13)

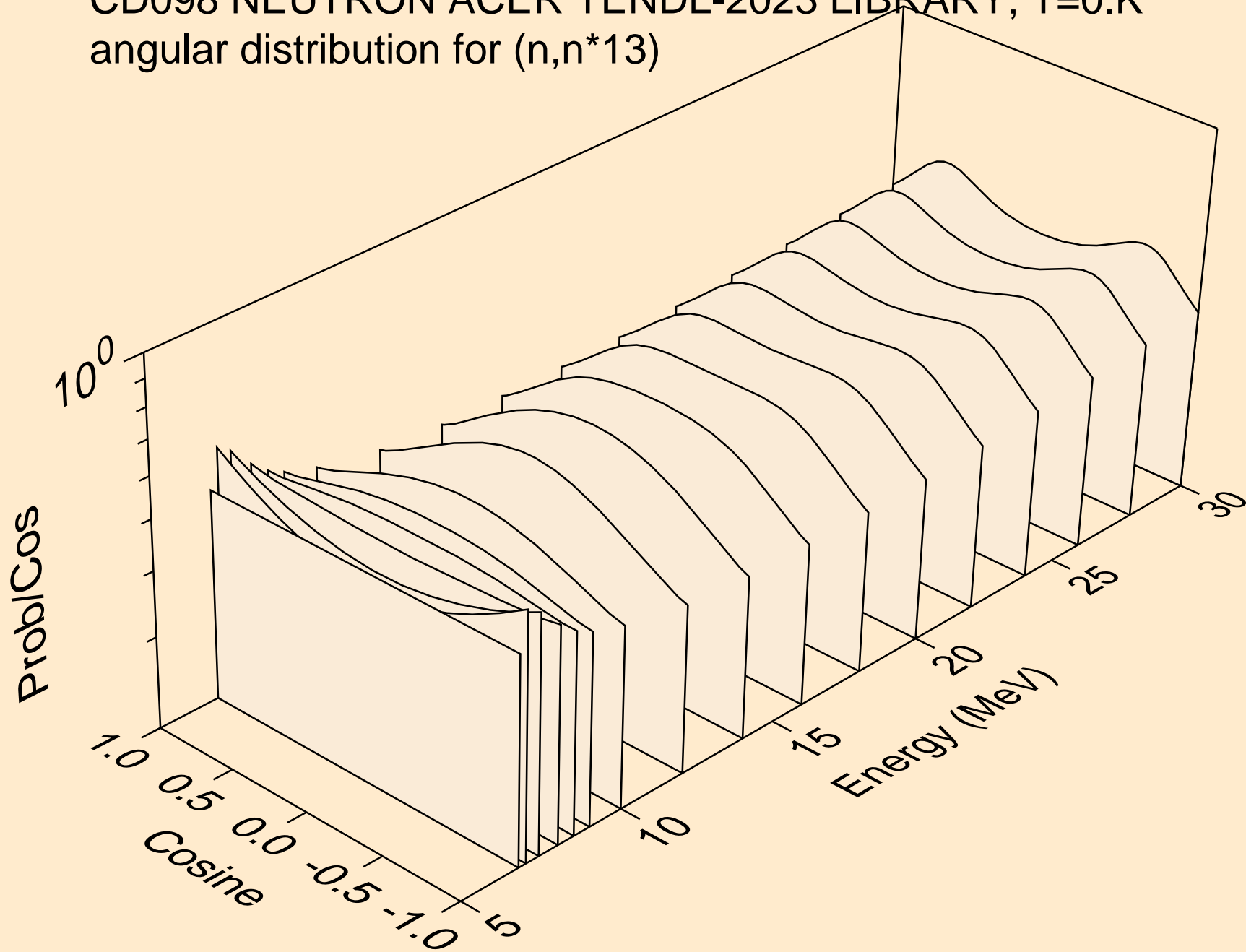

CD098 NEUTRON ACER TENDL-2023 LIBRARY; T=0.K  
angular distribution for (n,n\*14)

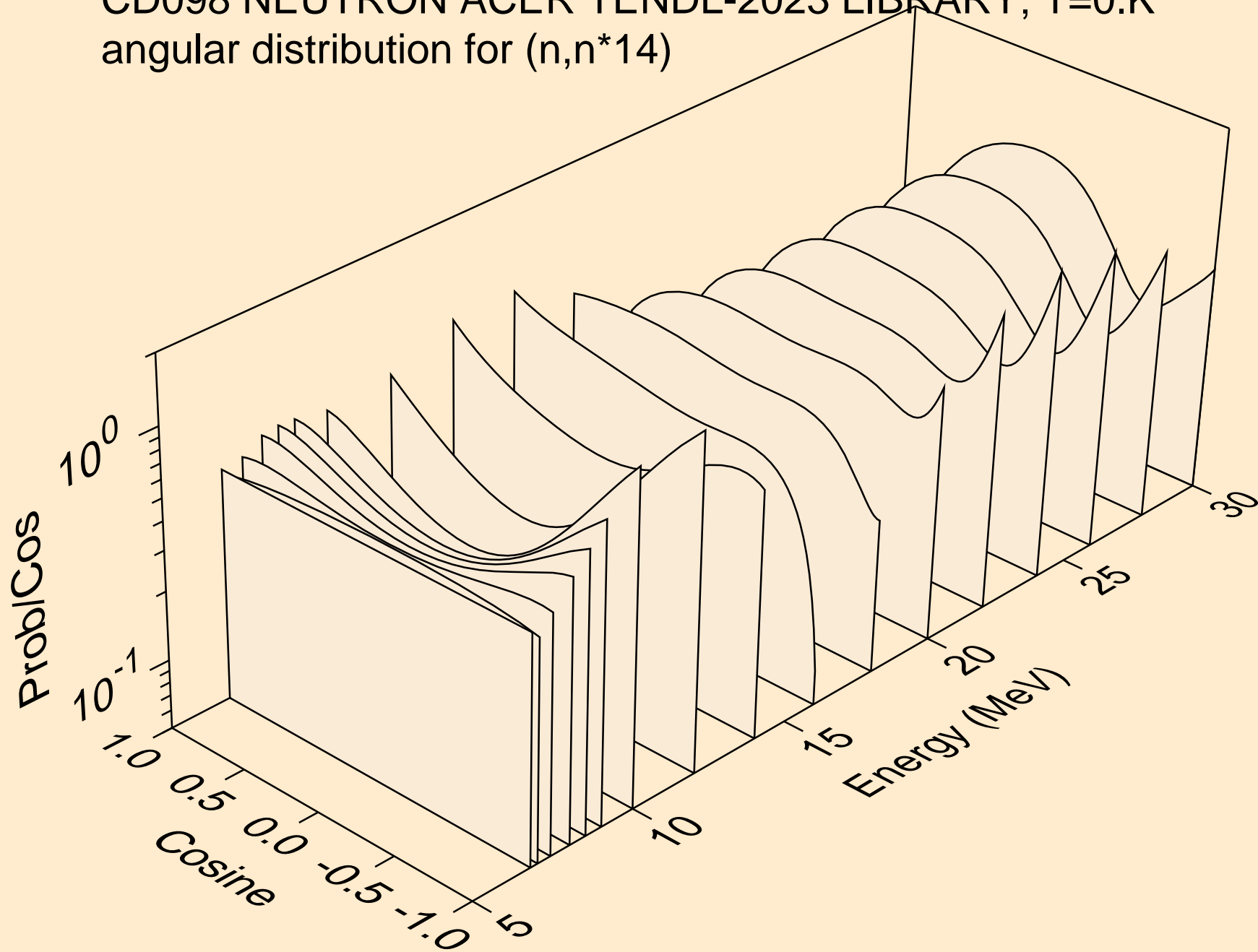

CD098 NEUTRON ACER TENDL-2023 LIBRARY; T=0.K  
angular distribution for (n,n\*15)

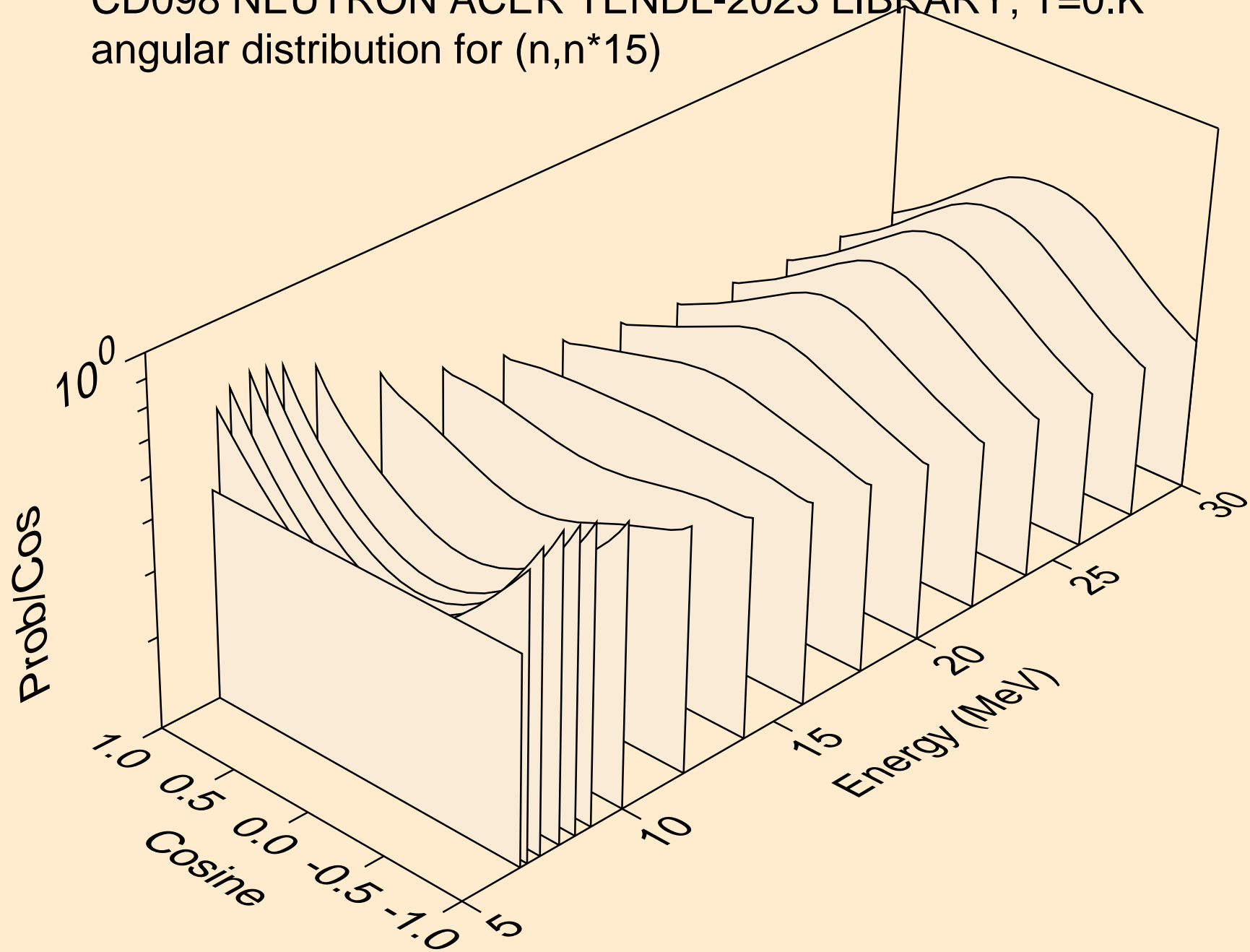

CD098 NEUTRON ACER TENDL-2023 LIBRARY; T=0.K  
angular distribution for (n,n\*16)

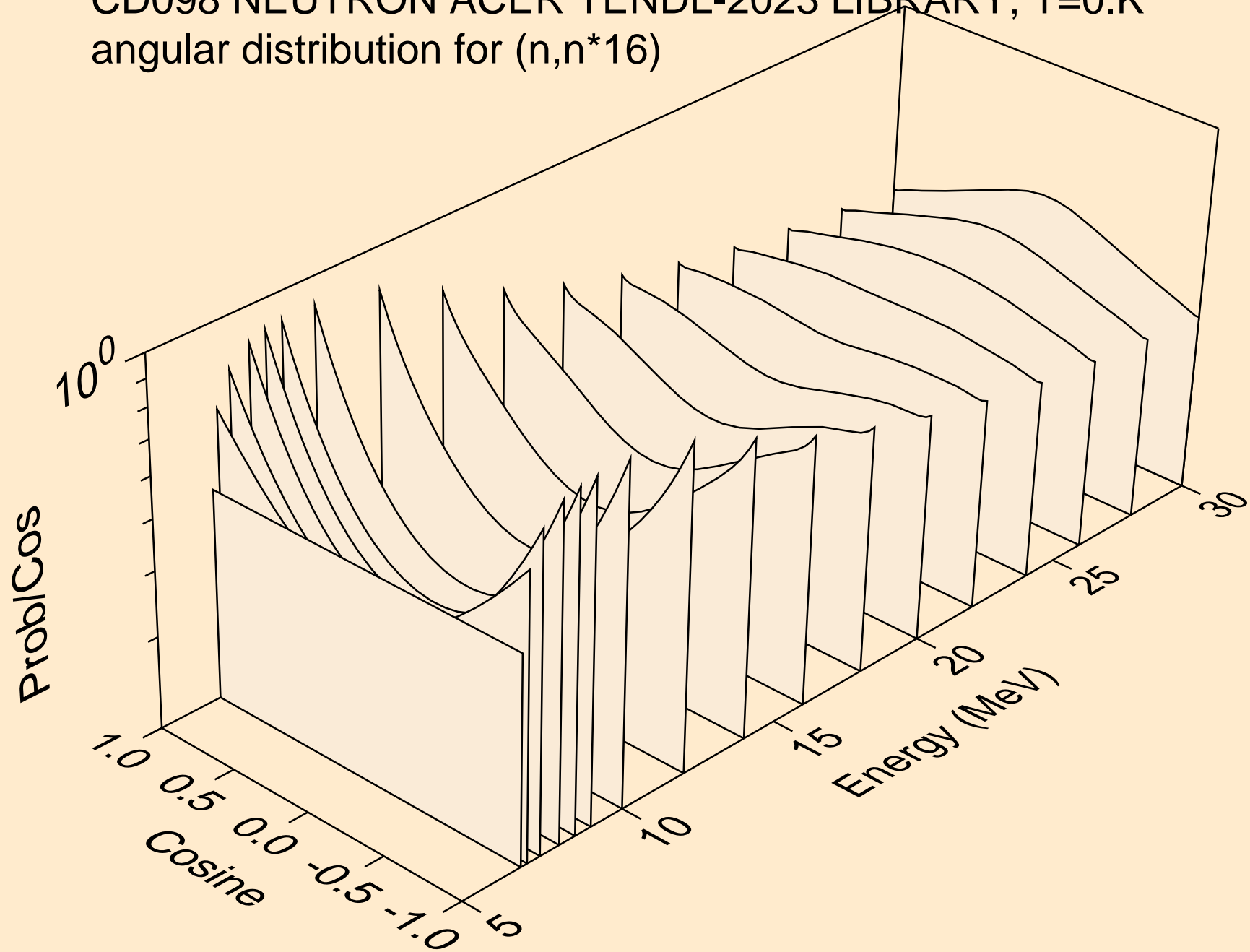

CD098 NEUTRON ACER TENDL-2023 LIBRARY; T=0.K  
angular distribution for (n,n\*17)

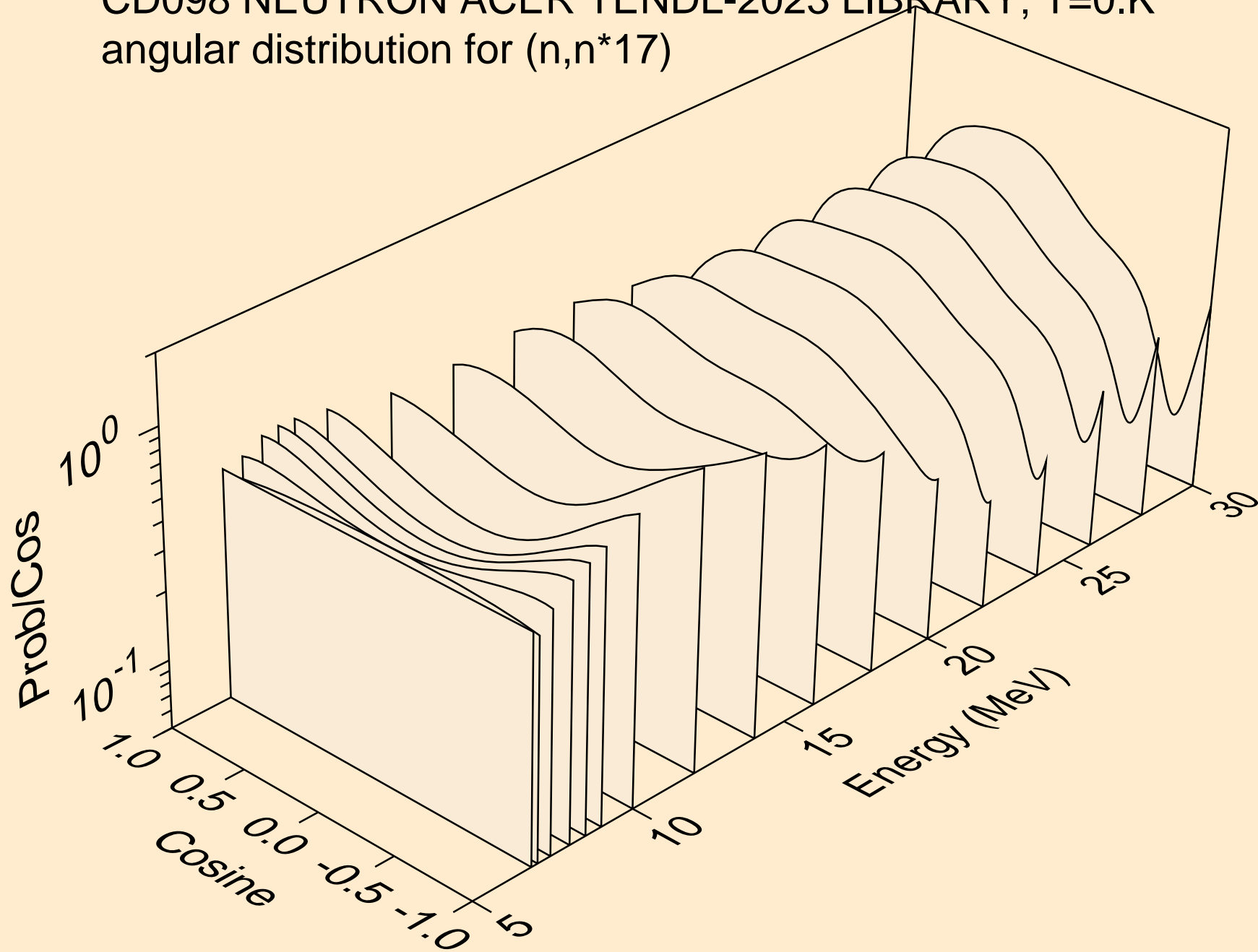

CD098 NEUTRON ACER TENDL-2023 LIBRARY; T=0.K  
angular distribution for (n,n\*18)

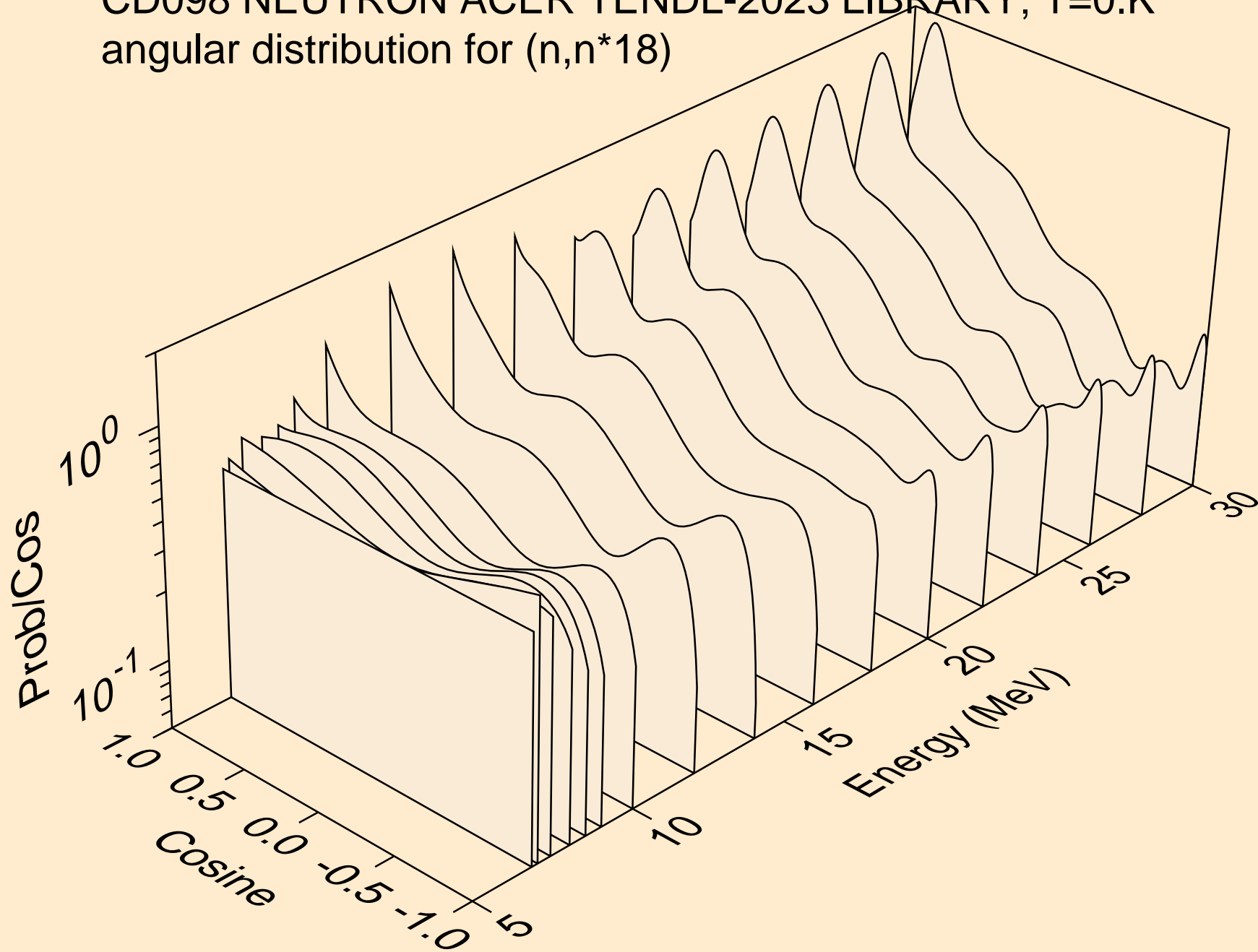

CD098 NEUTRON ACER TENDL-2023 LIBRARY; T=0.K  
Neutron emission for (n,x)

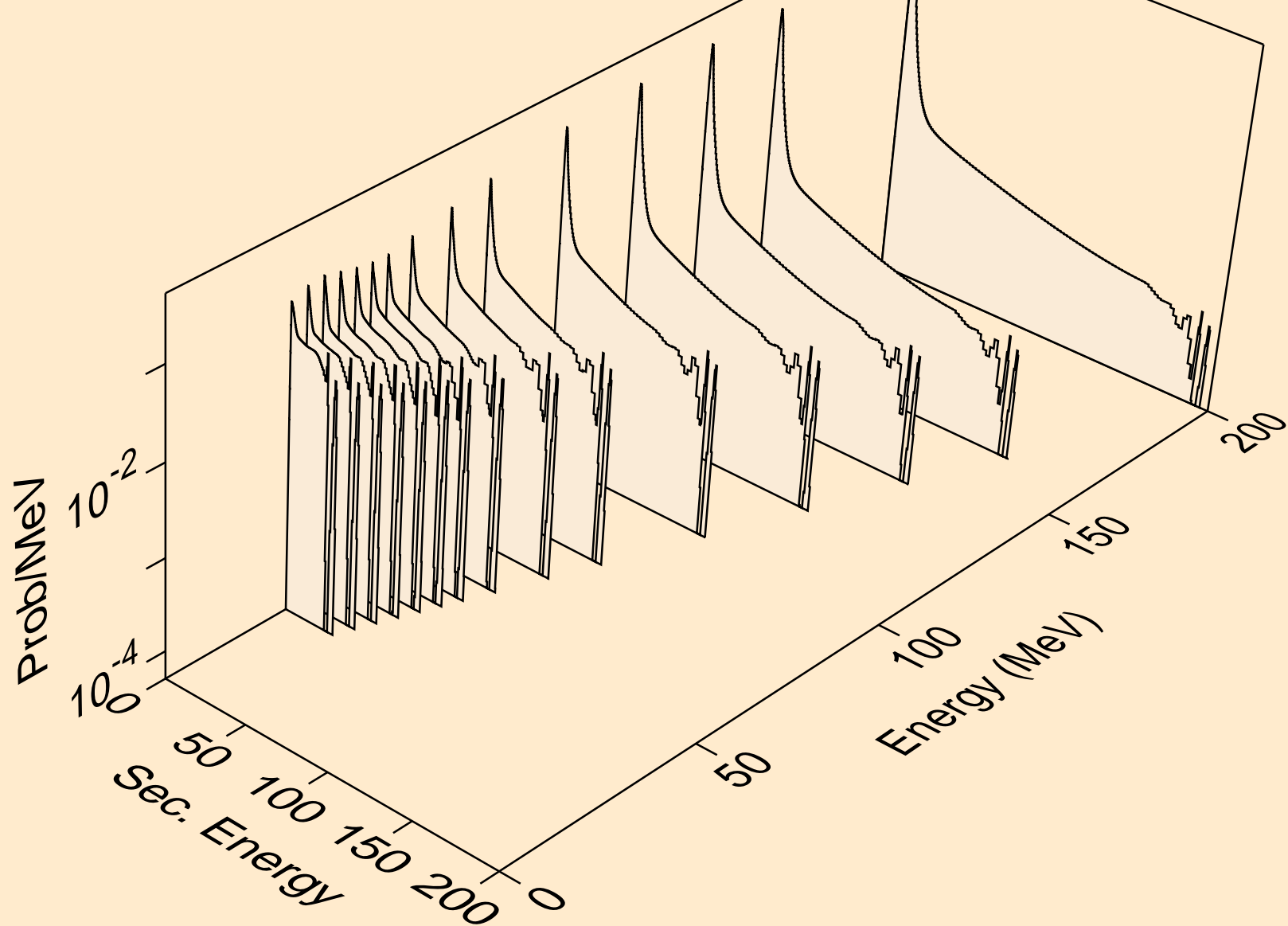

CD098 NEUTRON ACER TENDL-2023 LIBRARY; T=0.K  
Neutron emission for (n,2n)

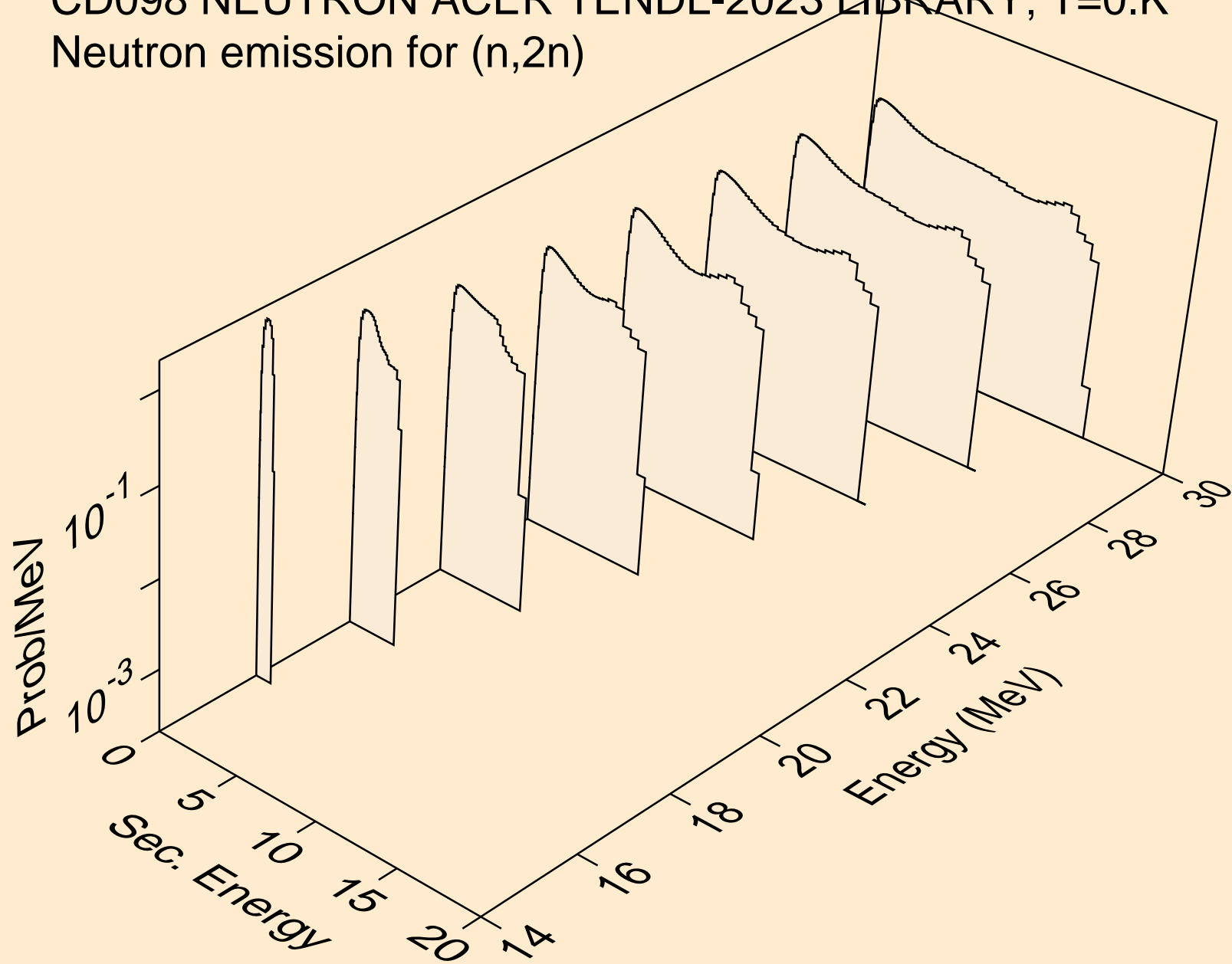

CD098 NEUTRON ACER TENDL-2023 LIBRARY; T=0.K  
Neutron emission for (n,3n)

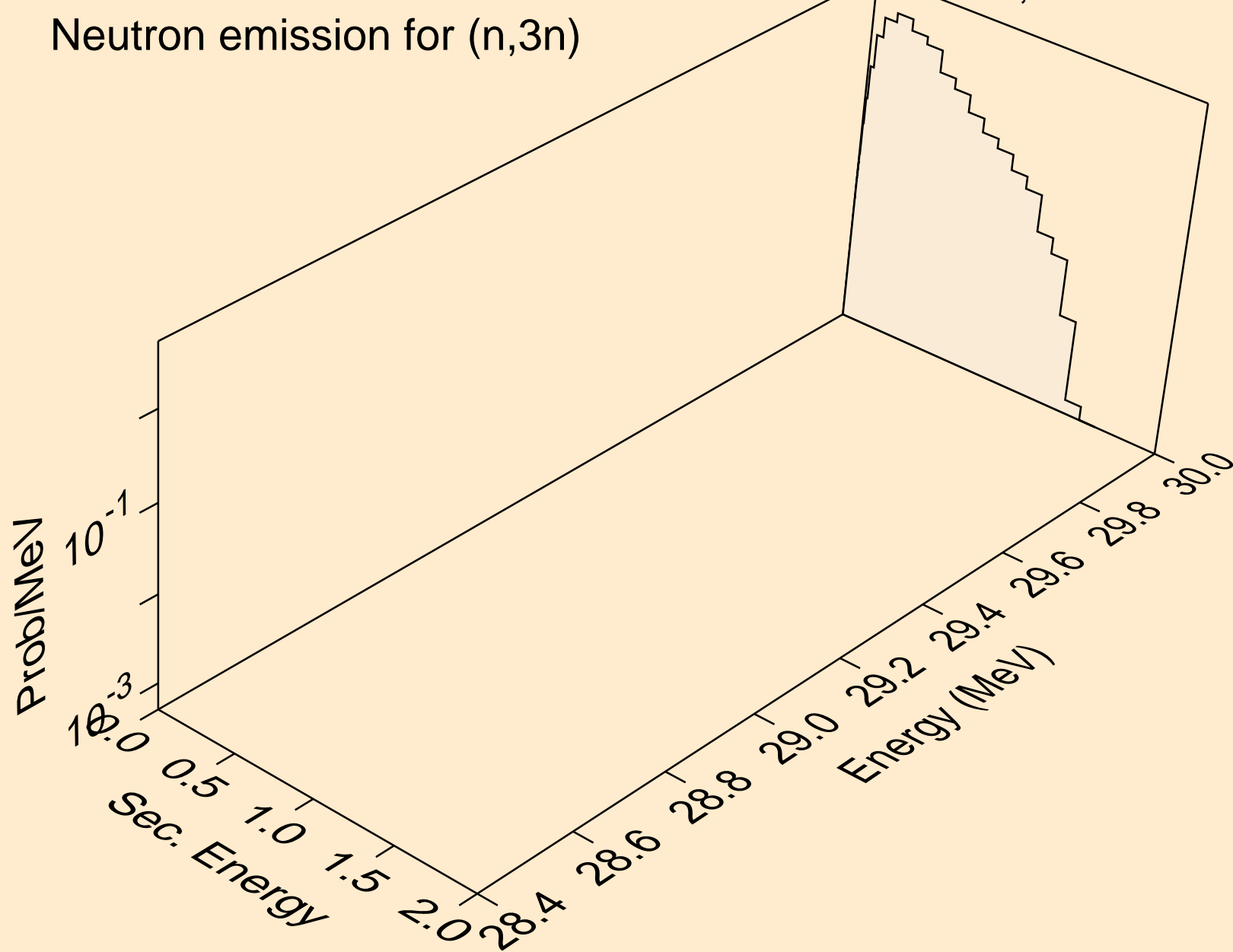

CD098 NEUTRON ACER TENDL-2023 LIBRARY; T=0.K  
Neutron emission for (n,n\*)a

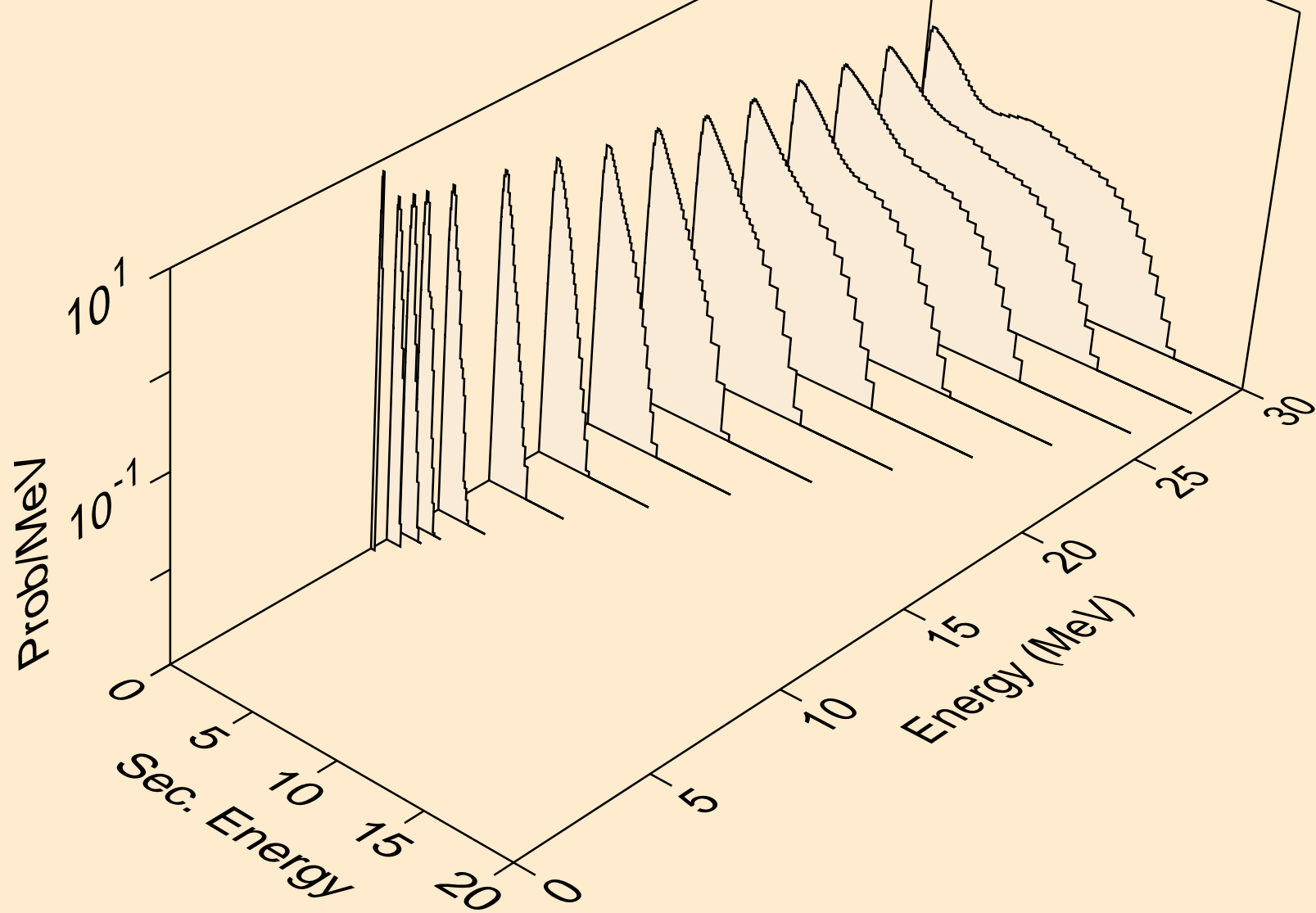

CD098 NEUTRON ACER TENDL-2023 LIBRARY; T=0.K  
Neutron emission for (n,2n)a

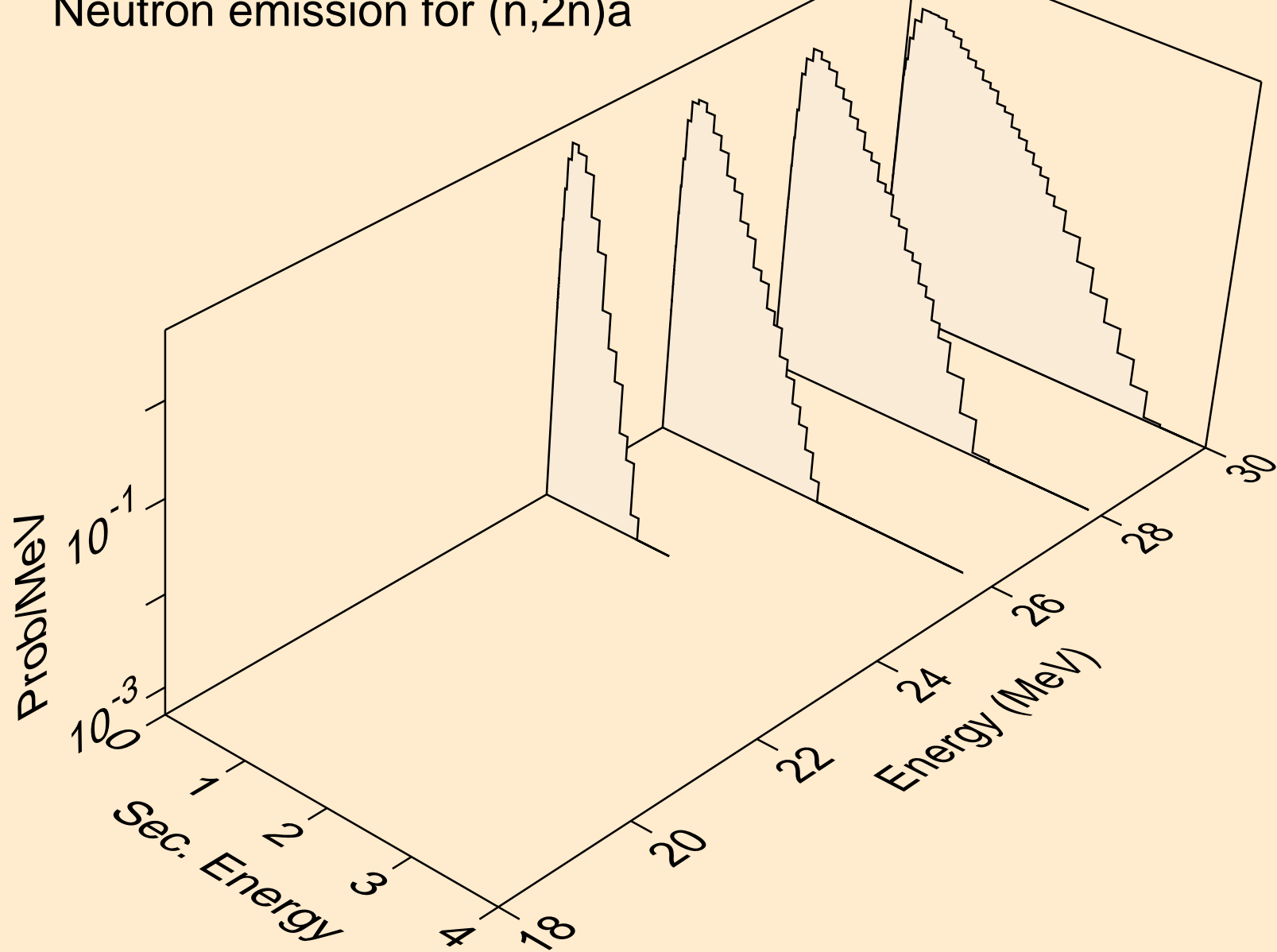

CD098 NEUTRON ACER TENDL-2023 LIBRARY; T=0.K  
Neutron emission for (n,n\*)p

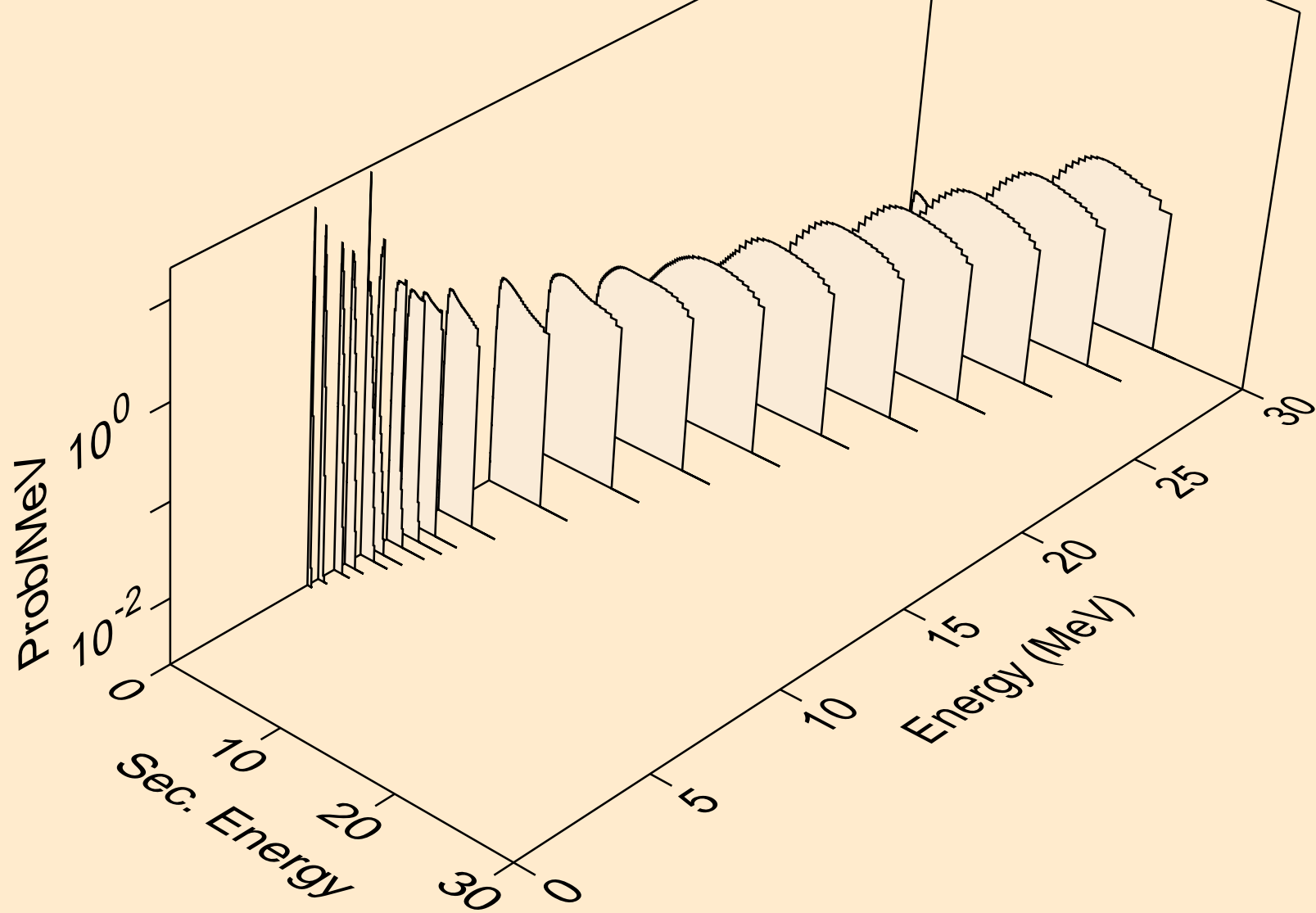

CD098 NEUTRON ACER TENDL-2023 LIBRARY; T=0.K  
Neutron emission for (n,n\*)2a

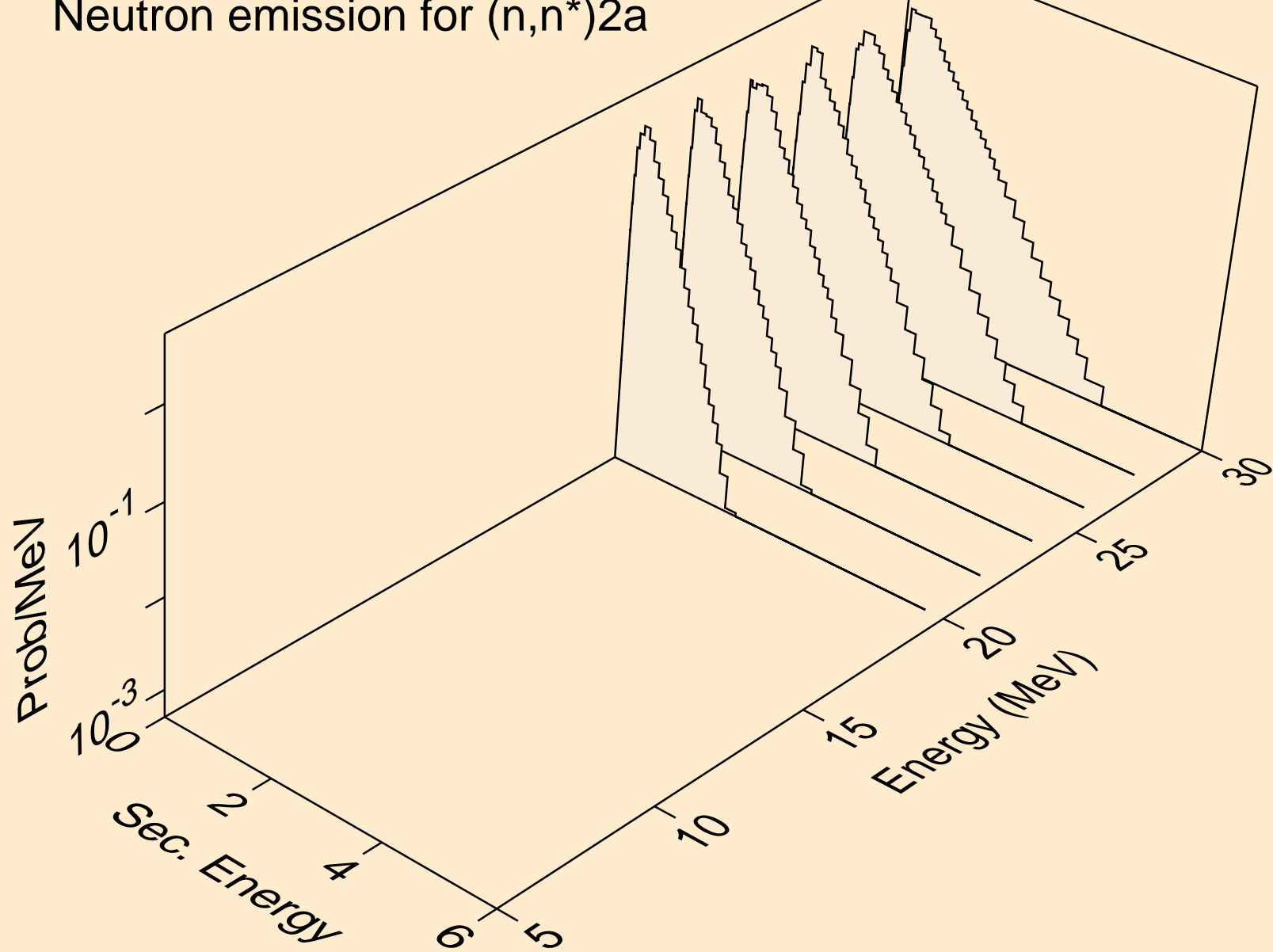

CD098 NEUTRON ACER TENDL-2023 LIBRARY; T=0.K  
Neutron emission for (n,n\*)d

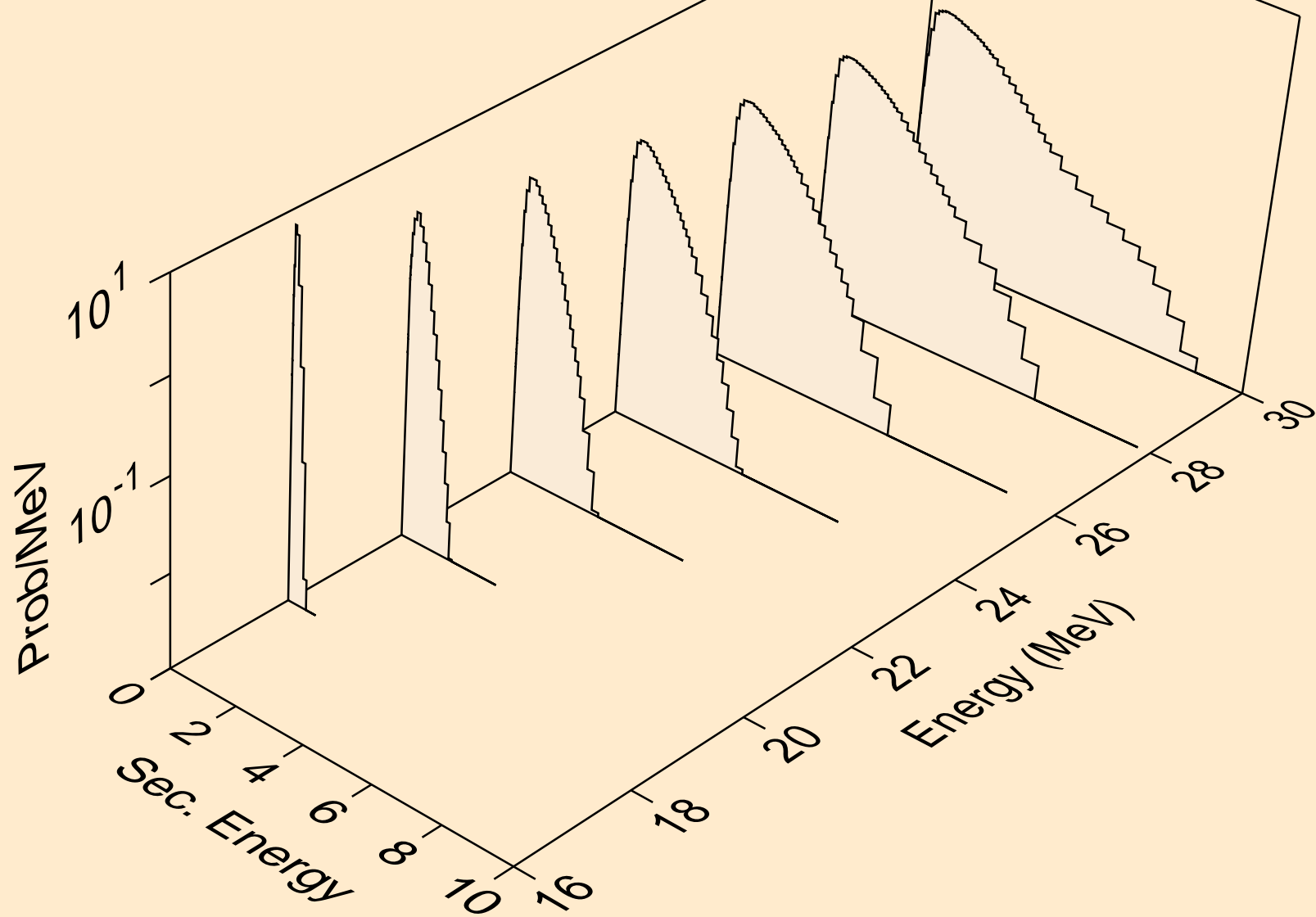

CD098 NEUTRON ACER TENDL-2023 LIBRARY; T=0.K  
Neutron emission for (n,n\*)t

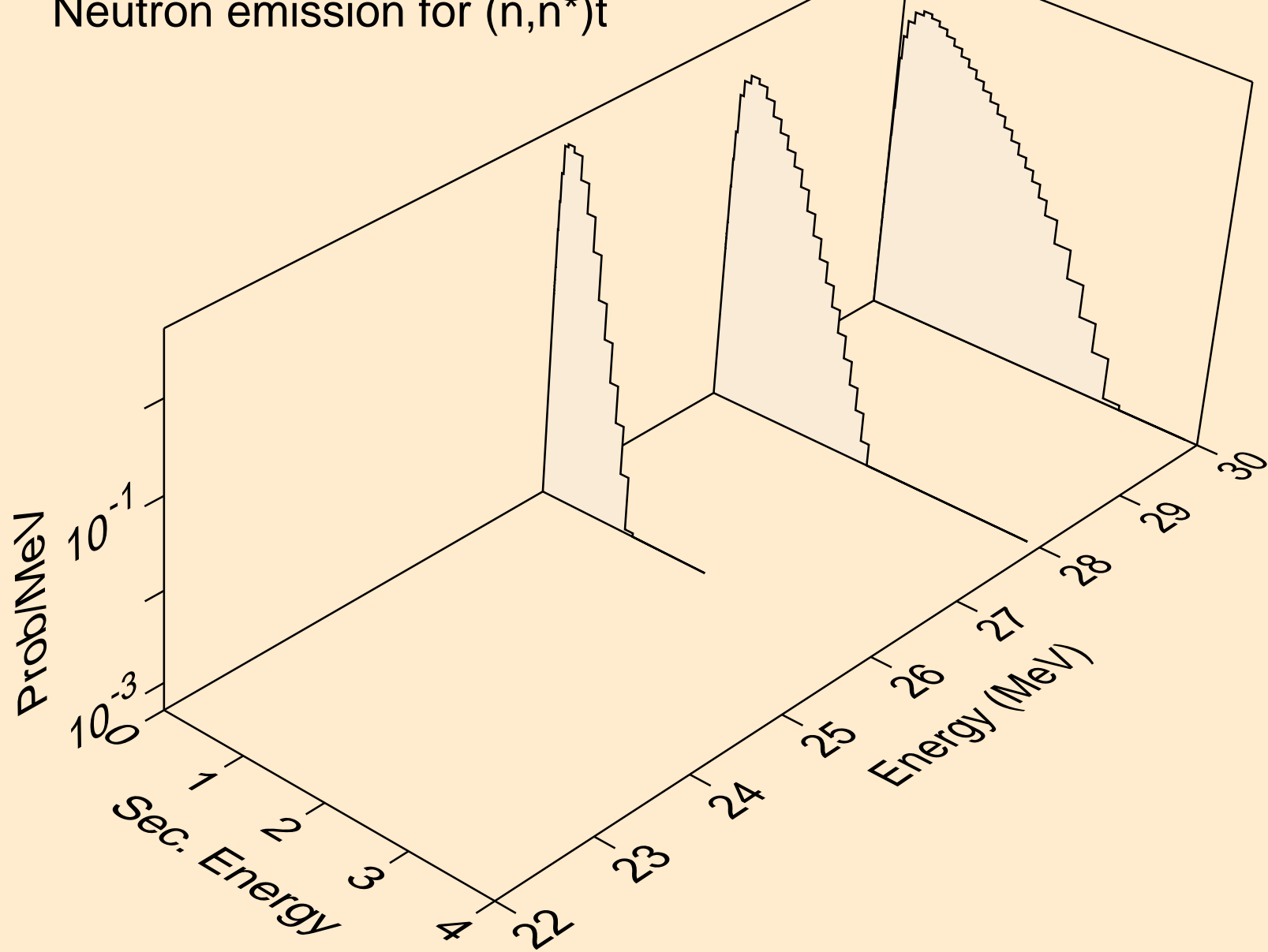

CD098 NEUTRON ACER TENDL-2023 LIBRARY; T=0.K  
Neutron emission for (n,n\*)he3

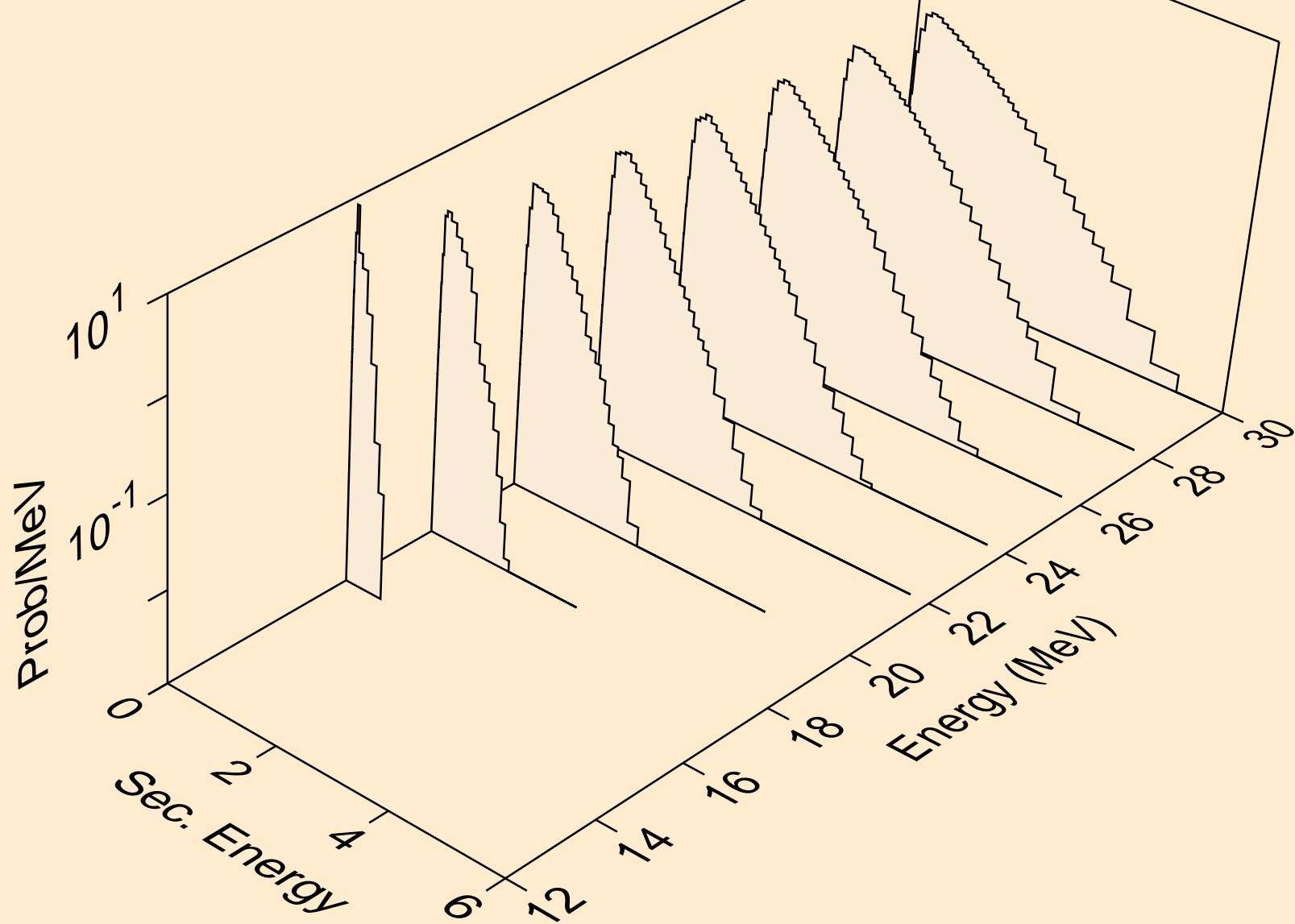

CD098 NEUTRON ACER TENDL-2023 LIBRARY; T=0.K  
Neutron emission for (n,2np)

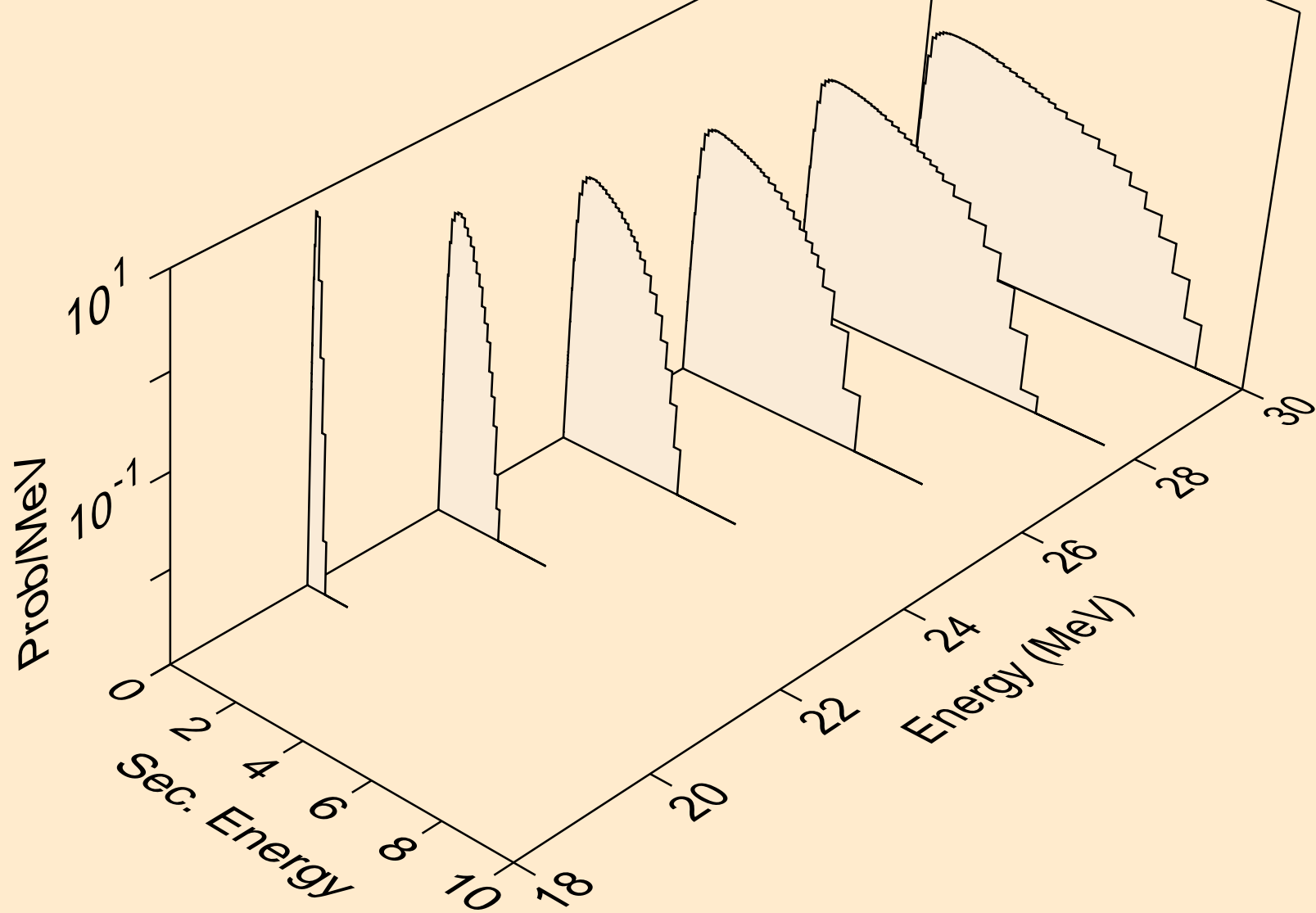

CD098 NEUTRON ACER TENDL-2023 LIBRARY; T=0.K  
Neutron emission for (n,n2p)

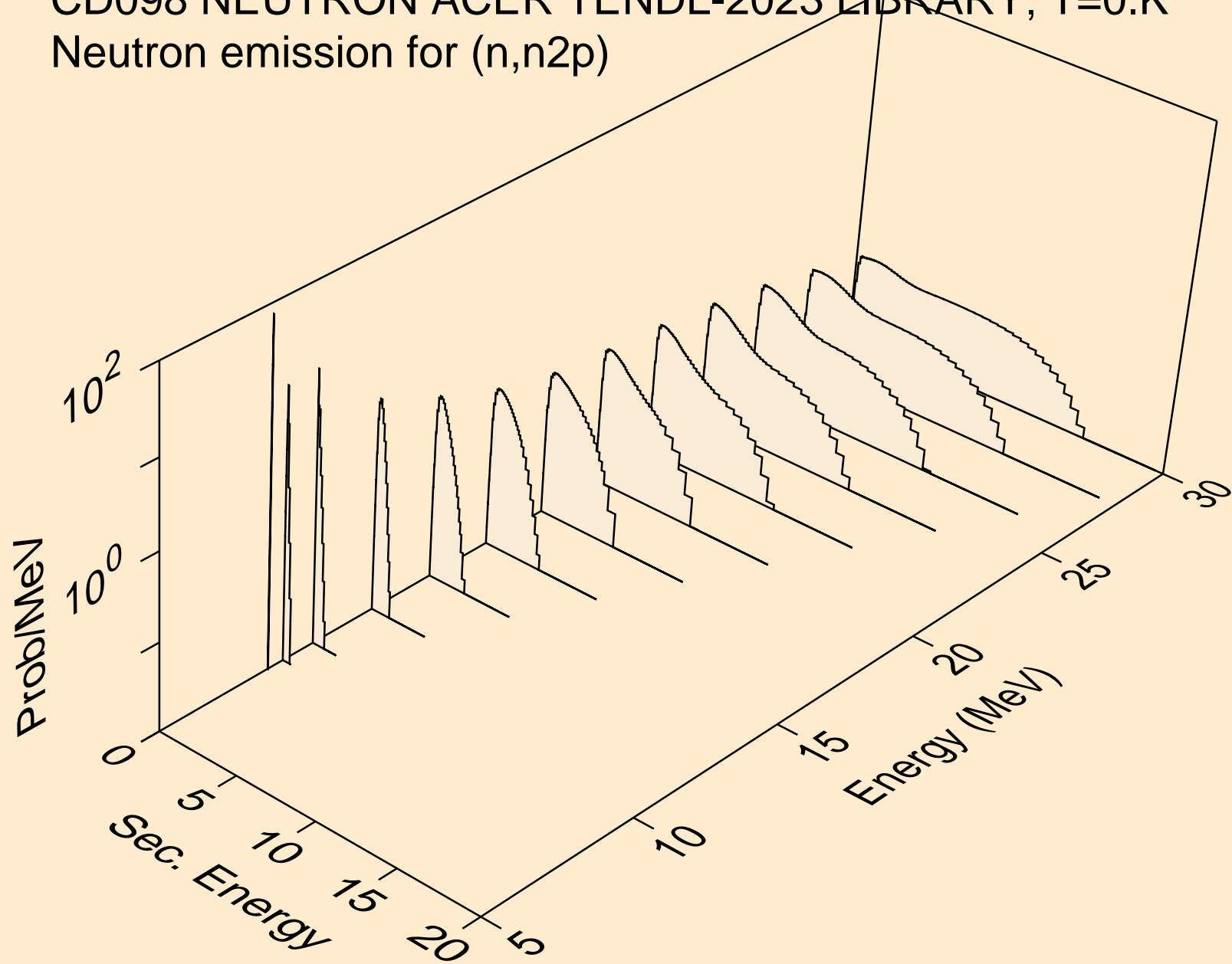

CD098 NEUTRON ACER TENDL-2023 LIBRARY; T=0.K  
Neutron emission for (n,npa)

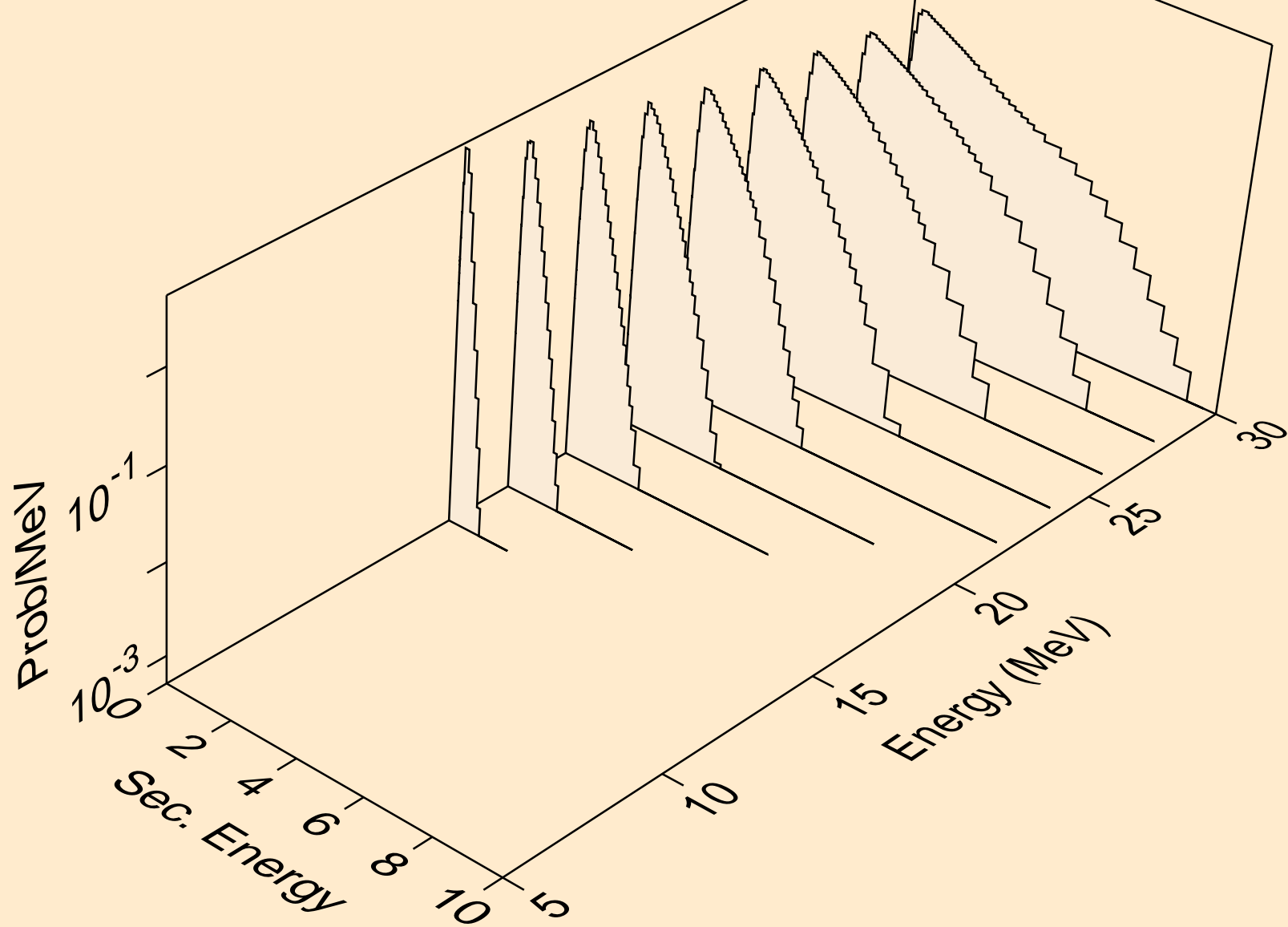

CD098 NEUTRON ACER TENDL-2023 LIBRARY; T=0.K  
Neutron emission for (n,n\*c)

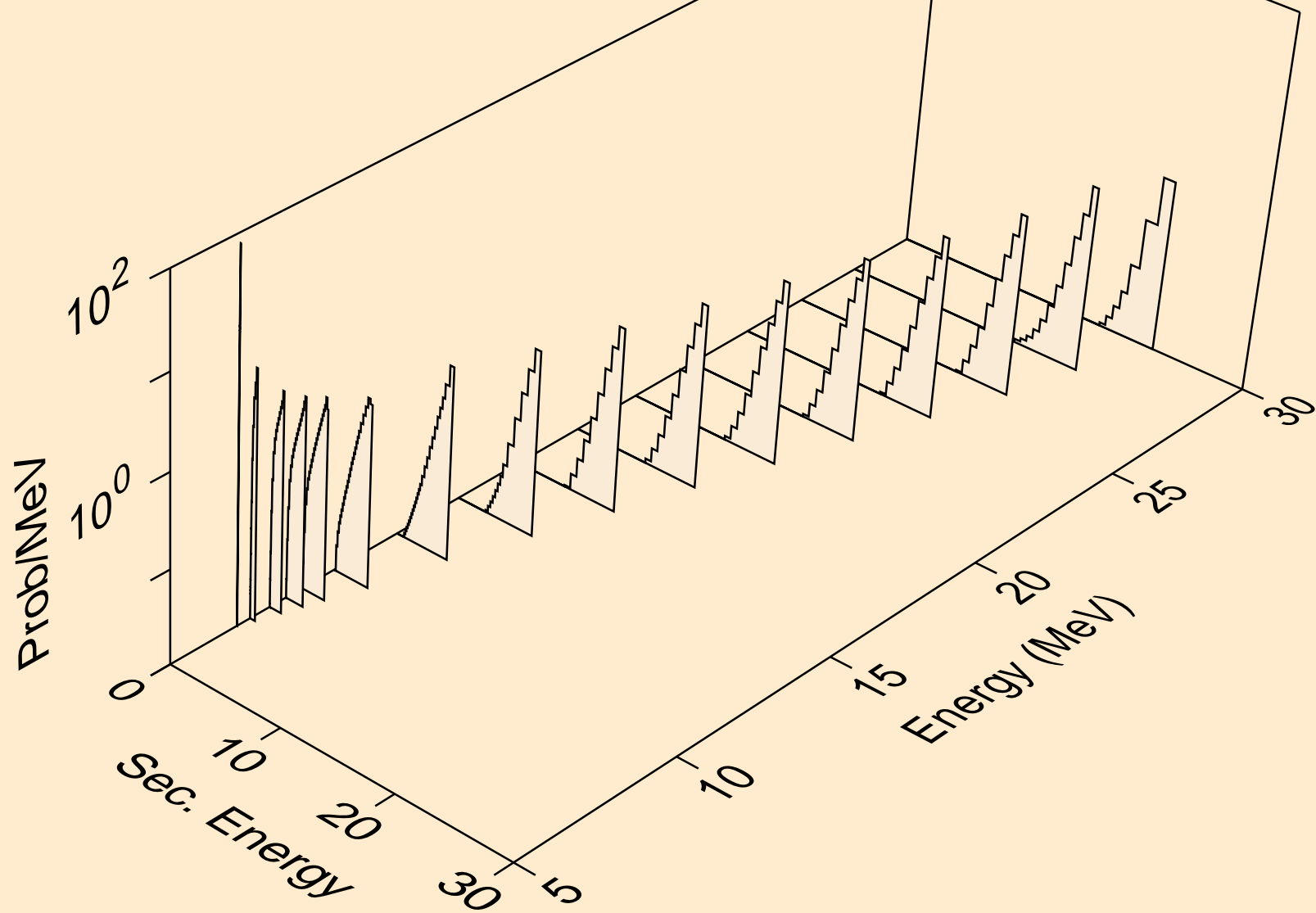

CD098 NEUTRON ACER TENDL-2023 LIBRARY; T=0.K  
Photon emission for (n,x)

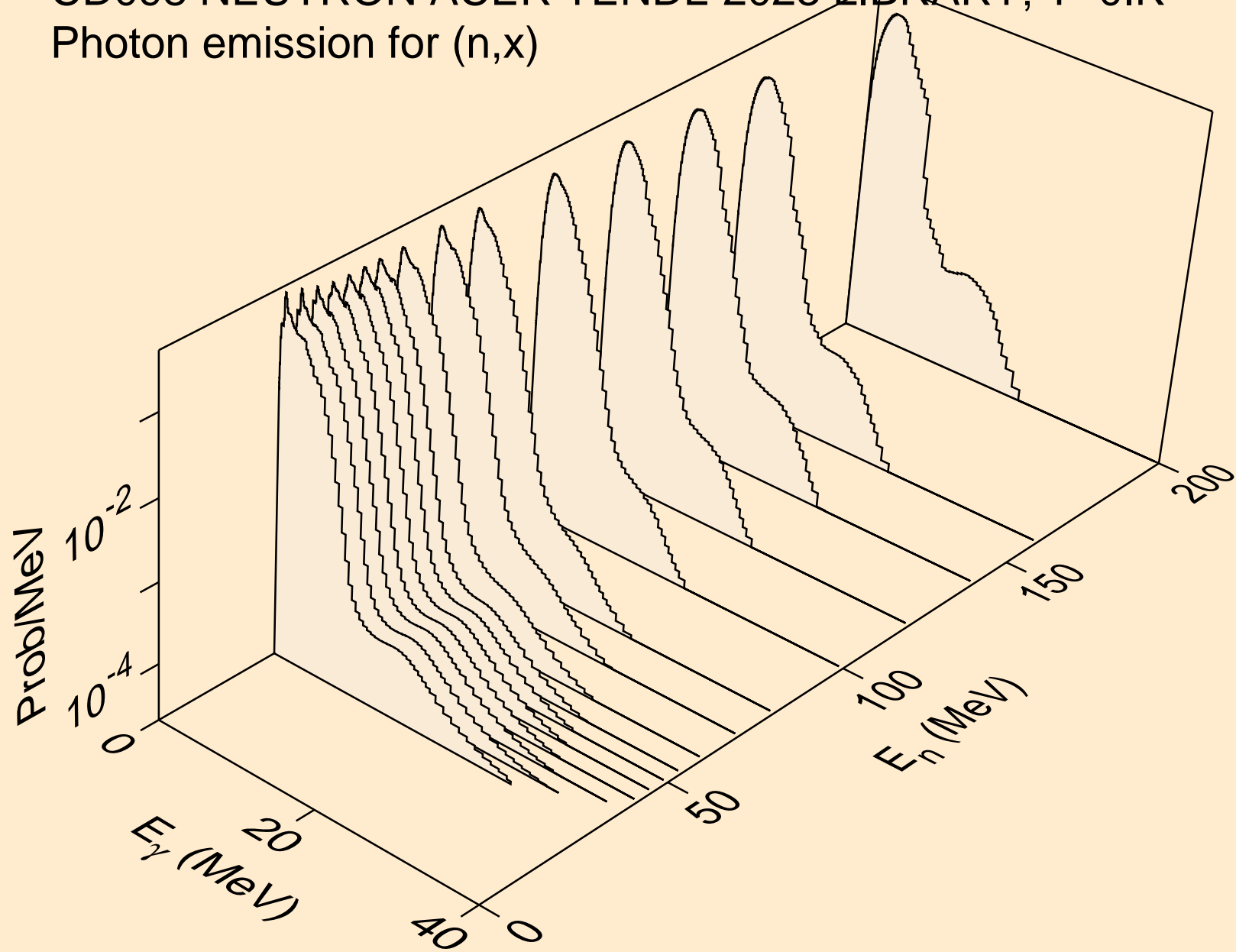

CD098 NEUTRON ACER TENDL-2023 LIBRARY; T=0.K  
Photon emission for (n,2n)

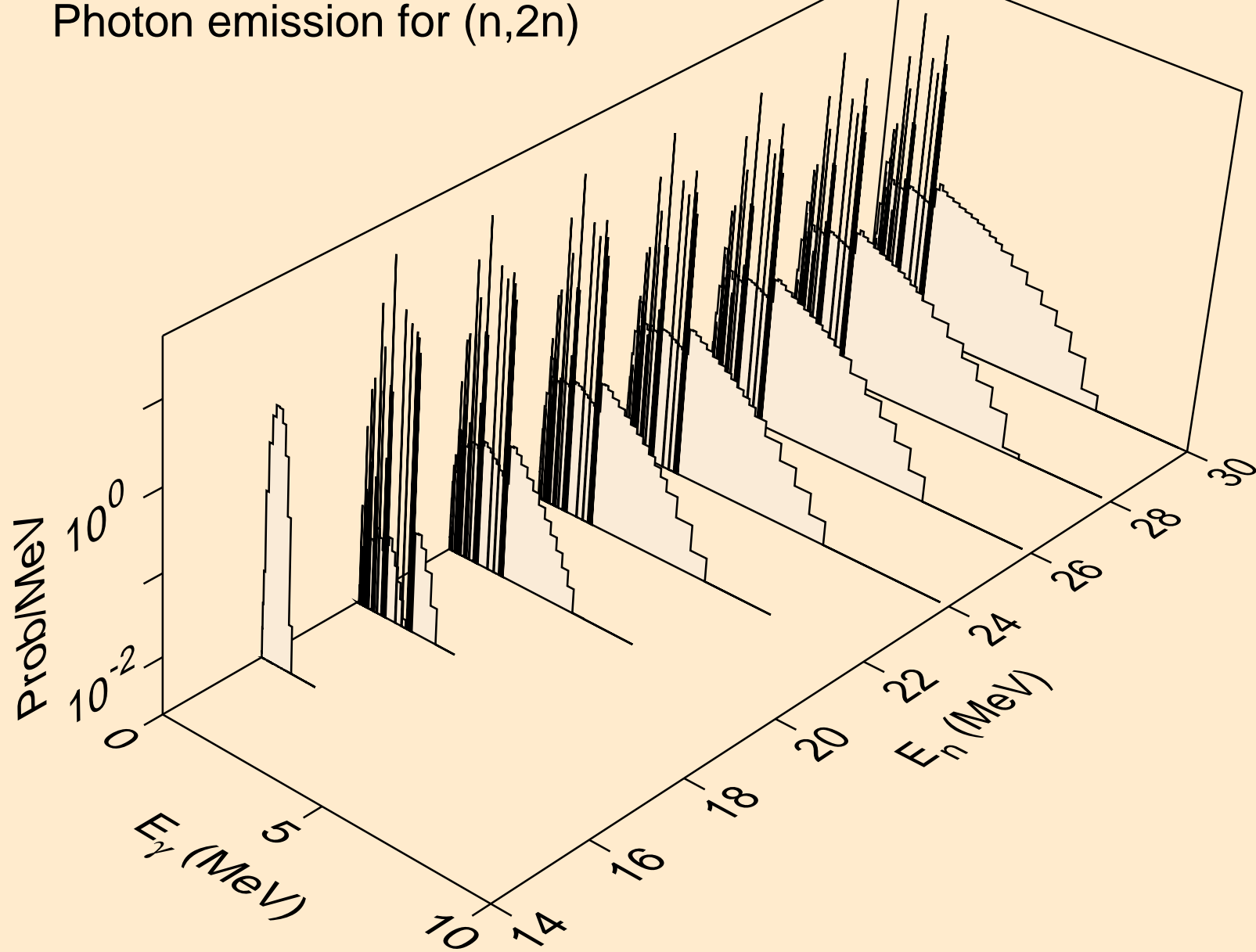

CD098 NEUTRON ACER TENDL-2023 LIBRARY; T=0.K  
Photon emission for (n,3n)

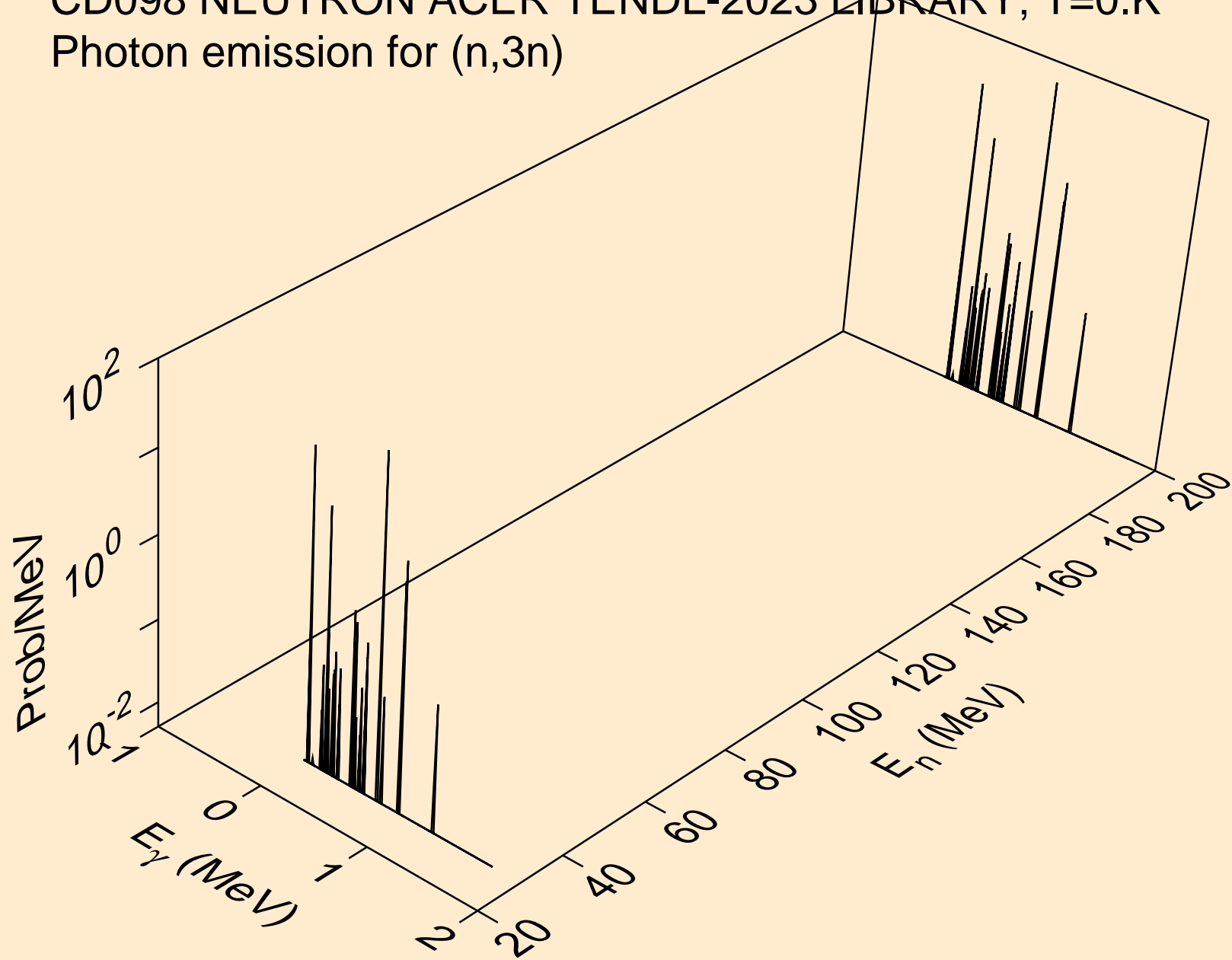

CD098 NEUTRON ACER TENDL-2023 LIBRARY; T=0.K  
Photon emission for (n,n\*)a

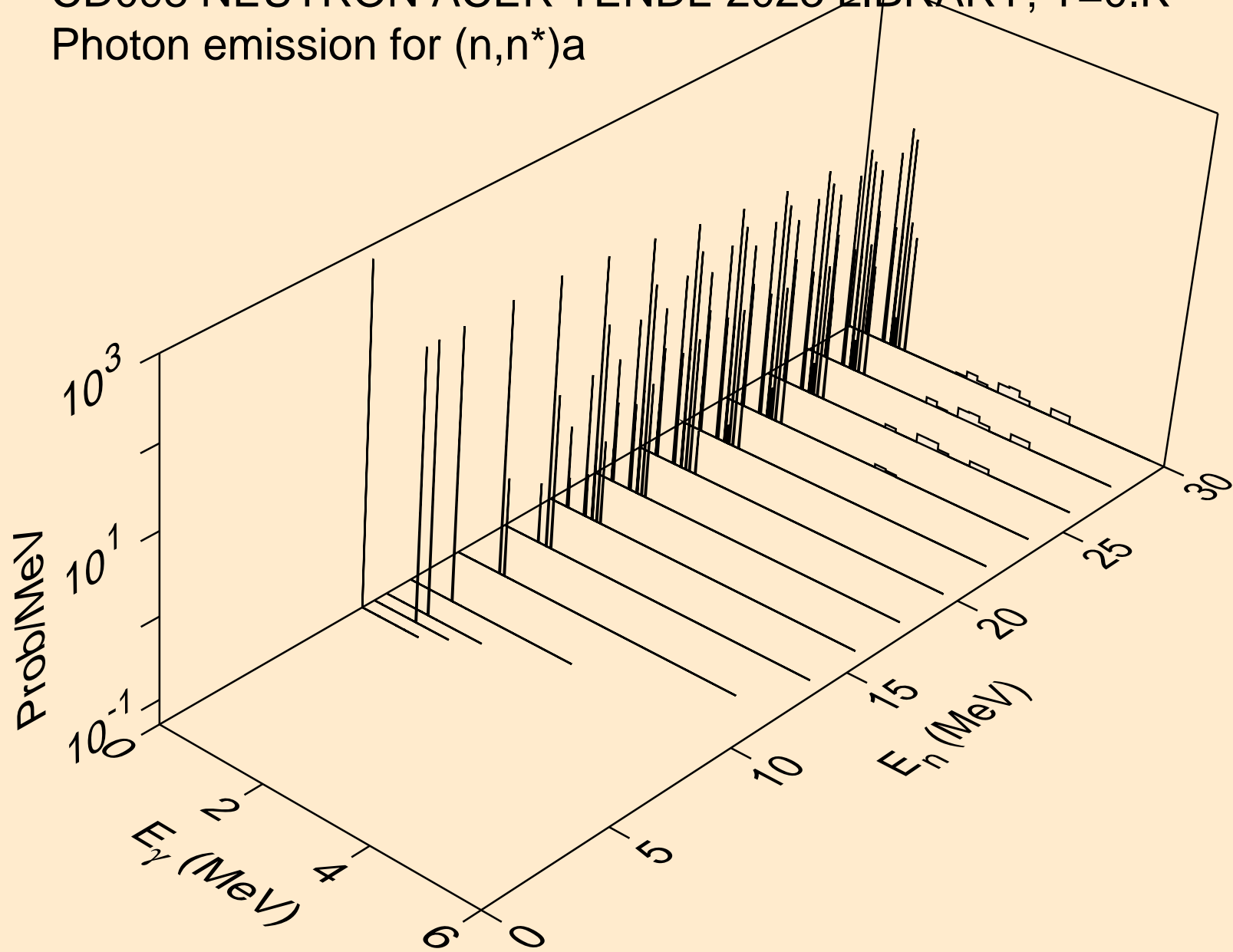

CD098 NEUTRON ACER TENDL-2023 LIBRARY; T=0.K  
Photon emission for (n,2n)a

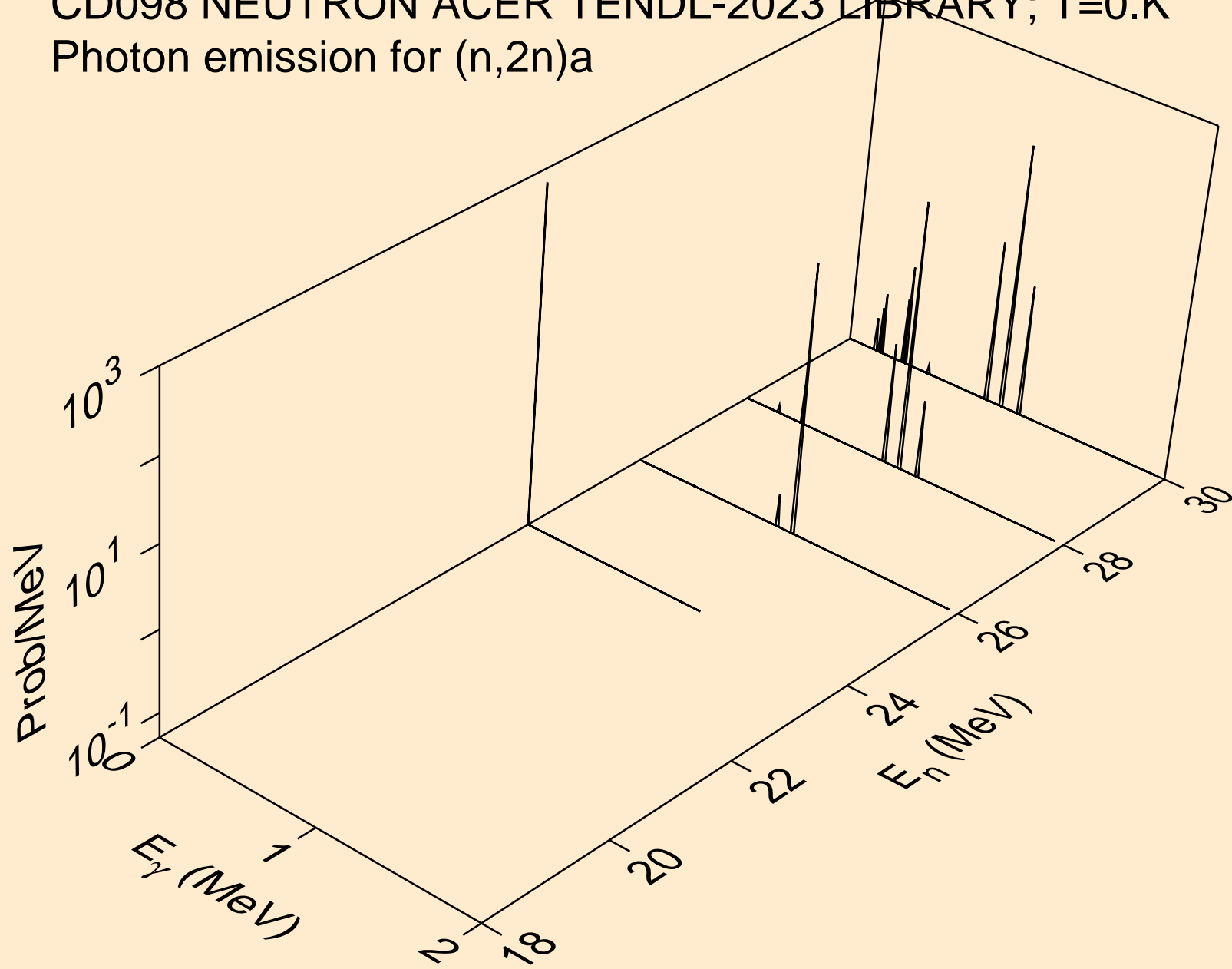

CD098 NEUTRON ACER TENDL-2023 LIBRARY; T=0.K  
Photon emission for (n,n\*)p

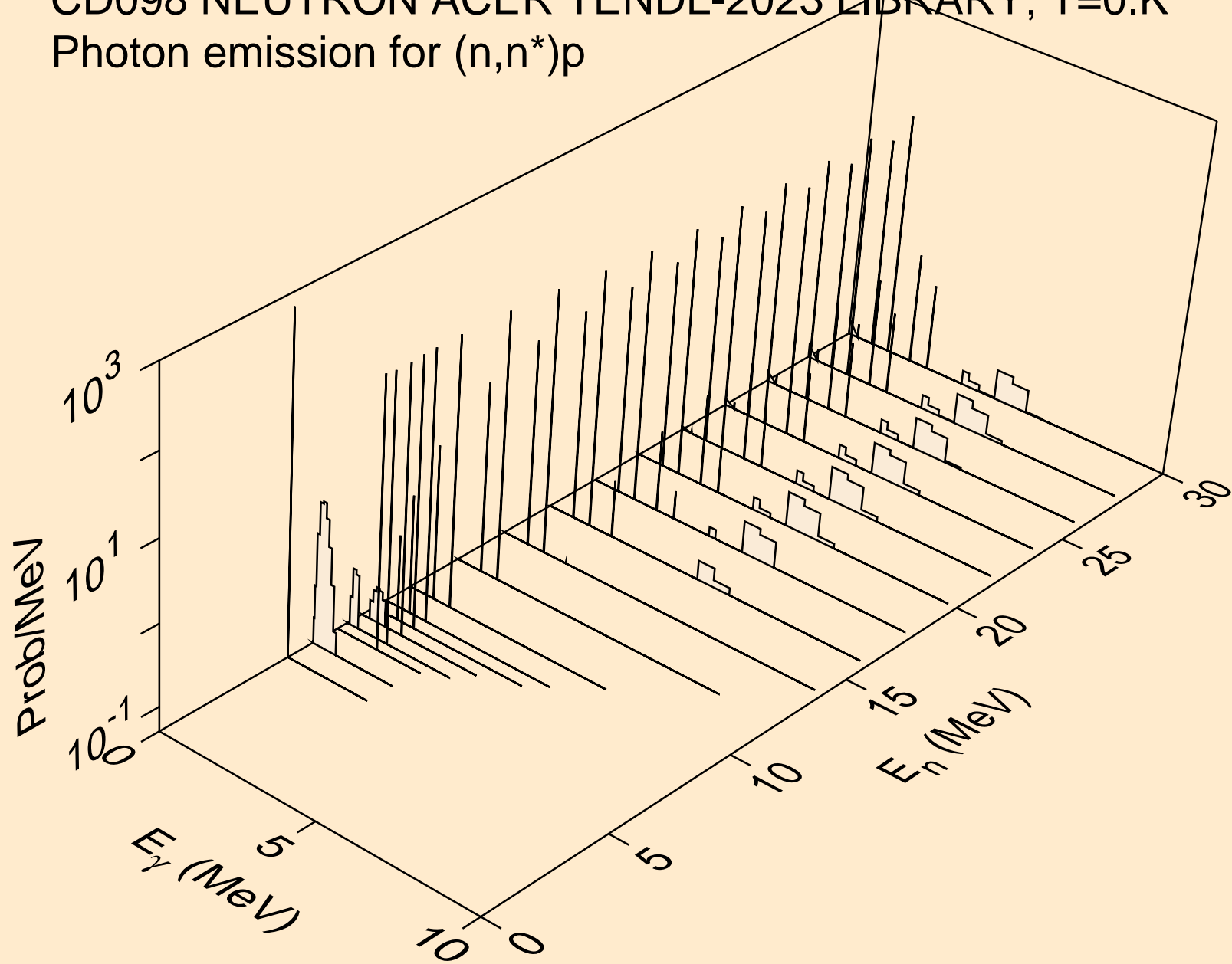

CD098 NEUTRON ACER TENDL-2023 LIBRARY; T=0.K  
Photon emission for (n,n\*)2a

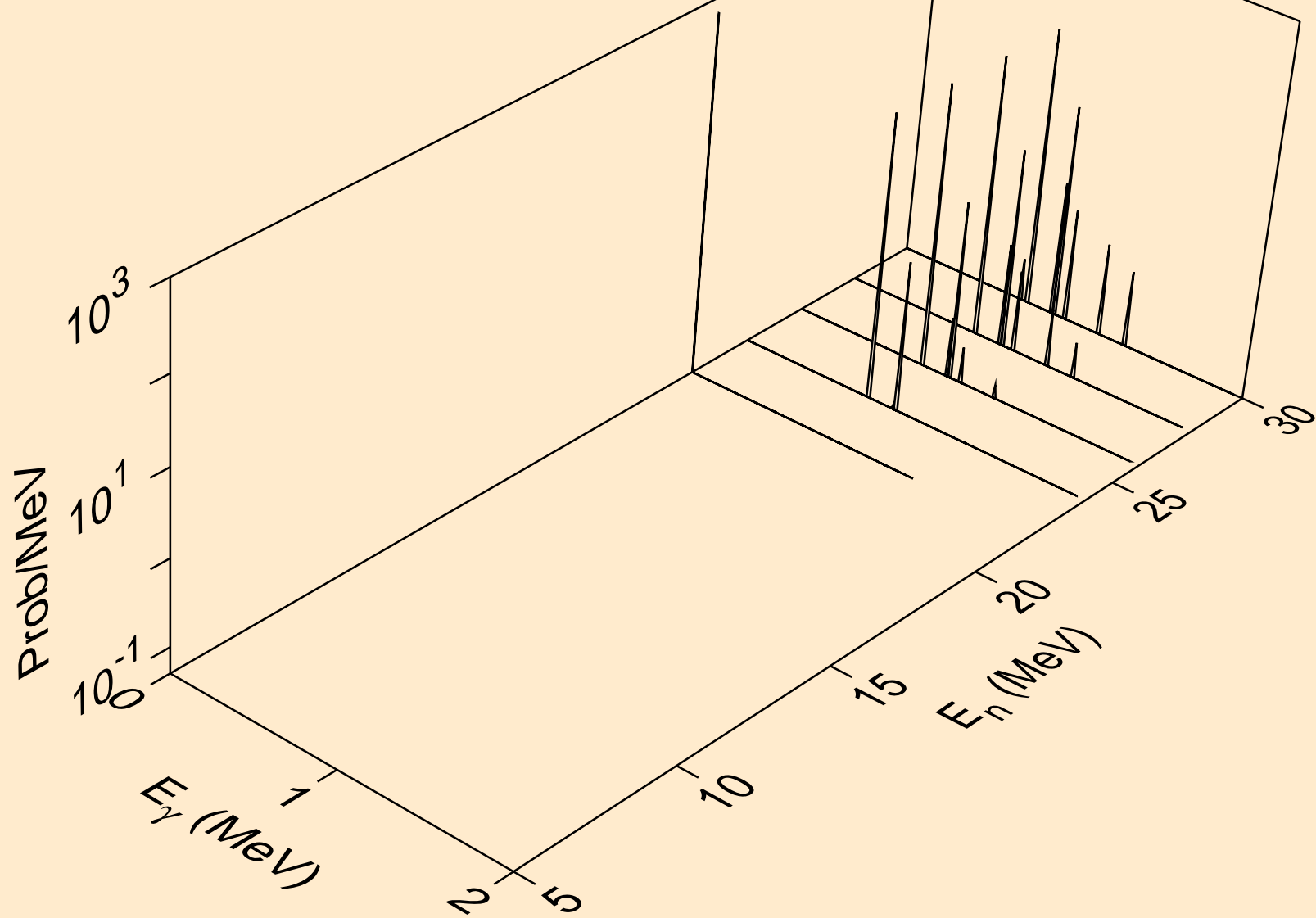

CD098 NEUTRON ACER TENDL-2023 LIBRARY; T=0.K  
Photon emission for (n,n\*)d

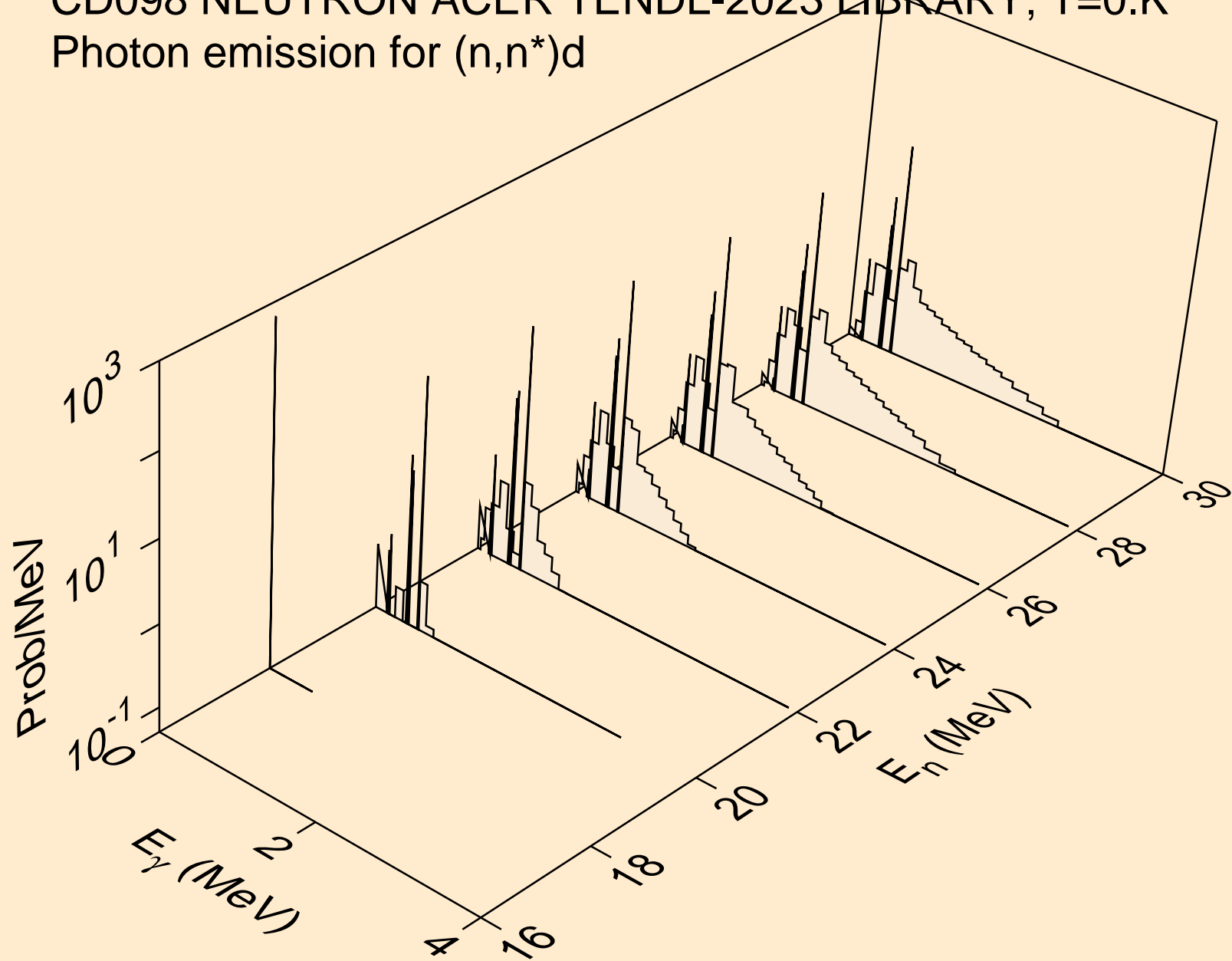

CD098 NEUTRON ACER TENDL-2023 LIBRARY; T=0.K  
Photon emission for (n,n\*)t

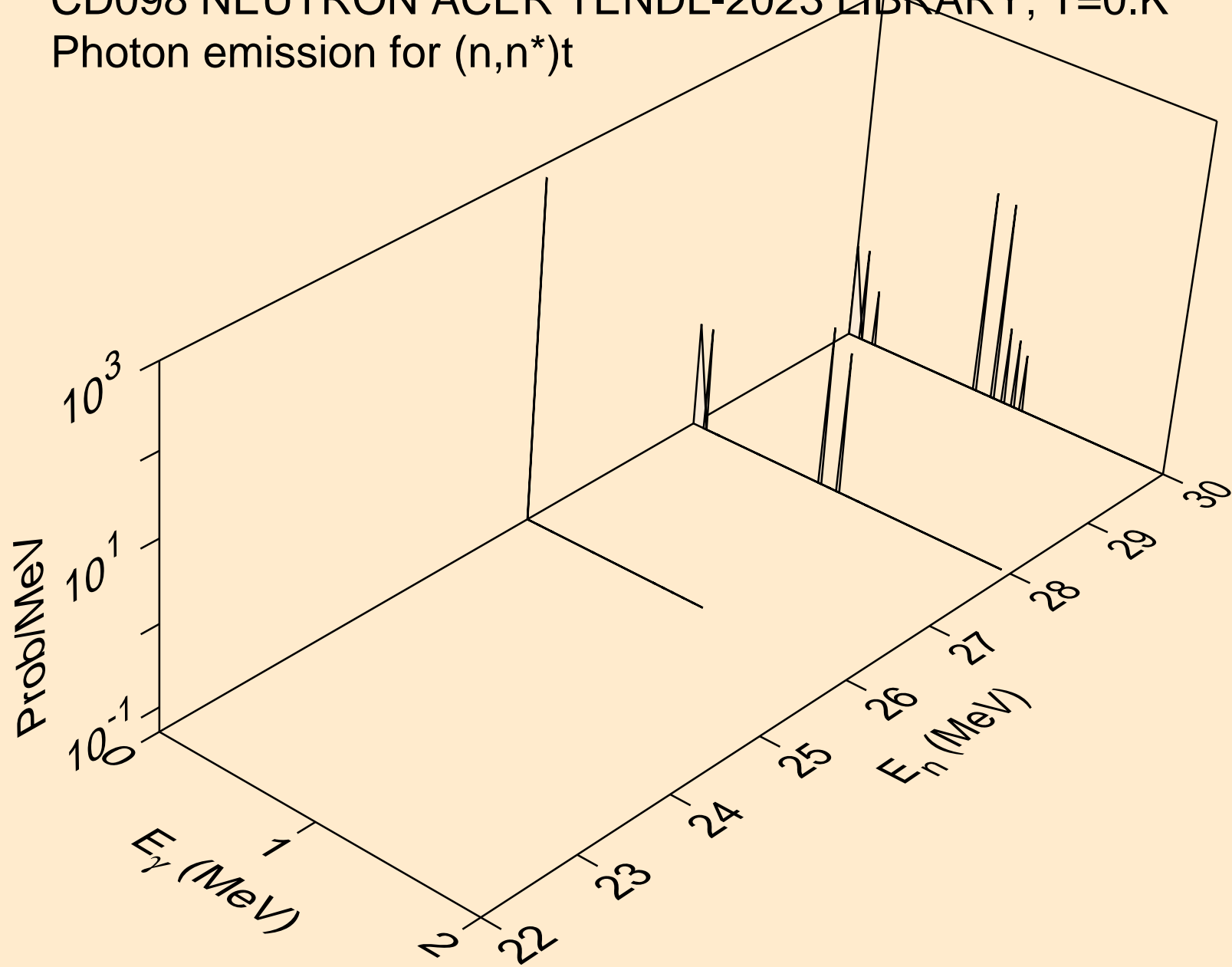

CD098 NEUTRON ACER TENDL-2023 LIBRARY; T=0.K  
Photon emission for (n,n\*)he3

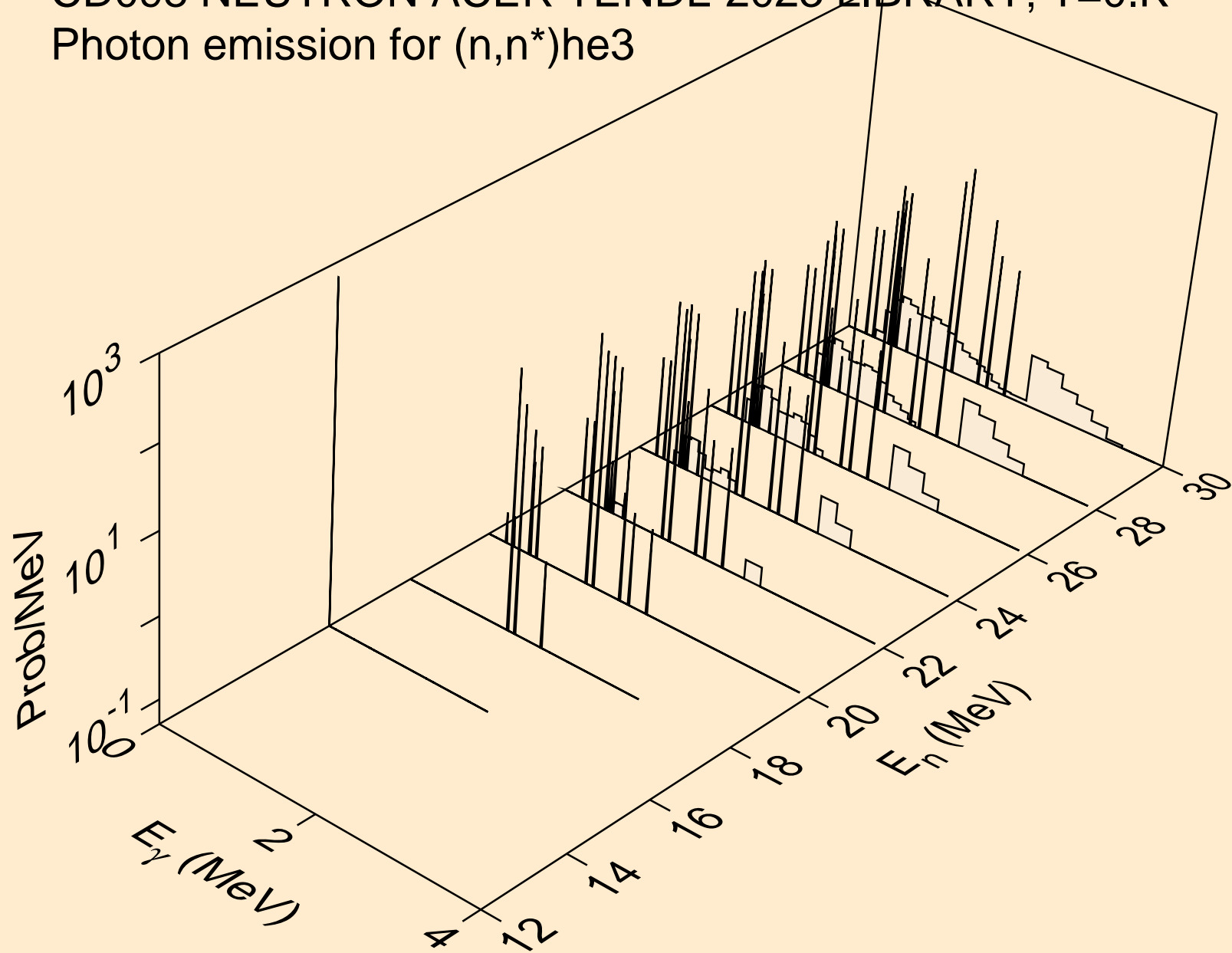

CD098 NEUTRON ACER TENDL-2023 LIBRARY; T=0.K  
Photon emission for (n,2np)

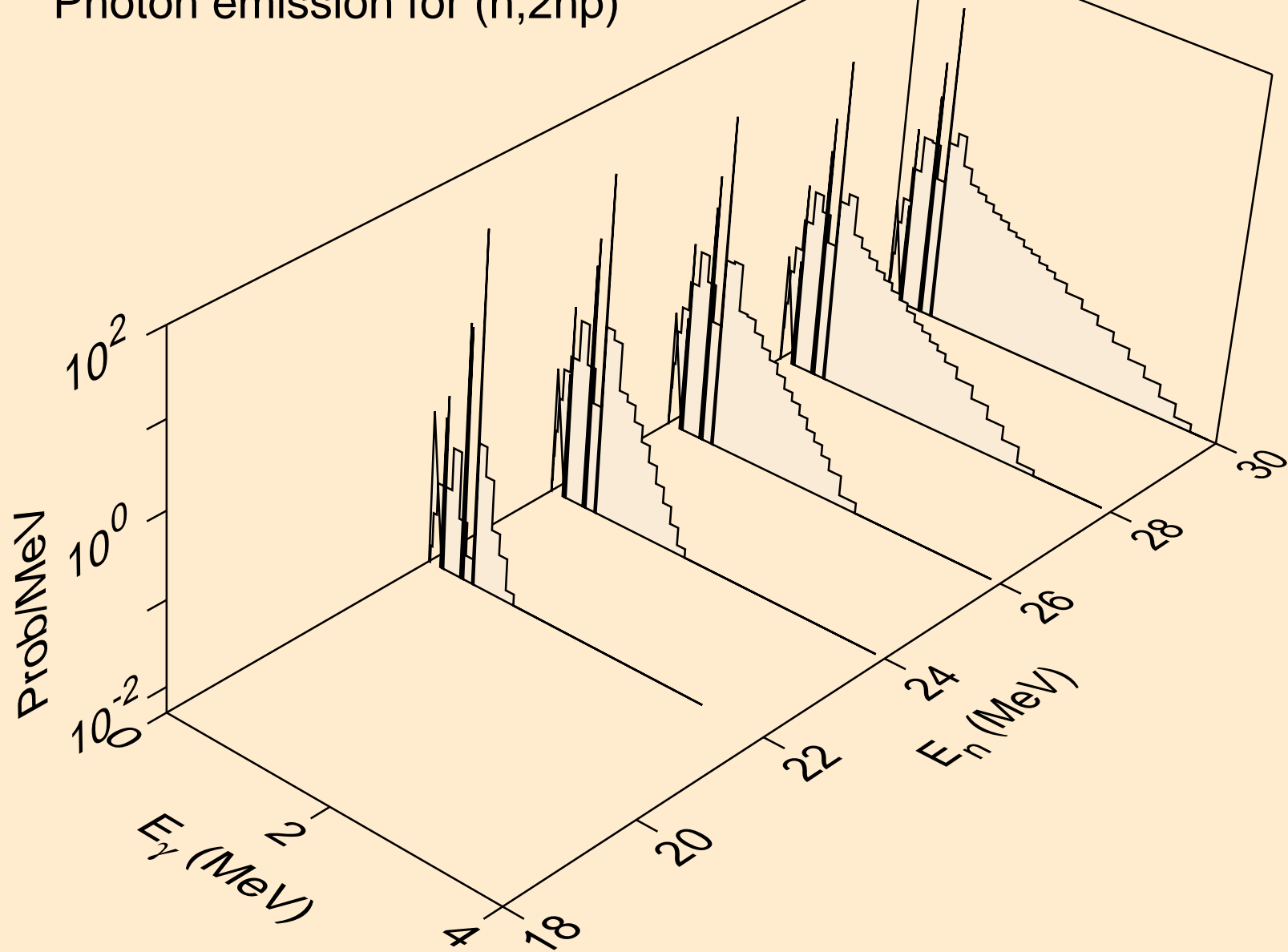

CD098 NEUTRON ACER TENDL-2023 LIBRARY; T=0.K  
Photon emission for (n,n2p)

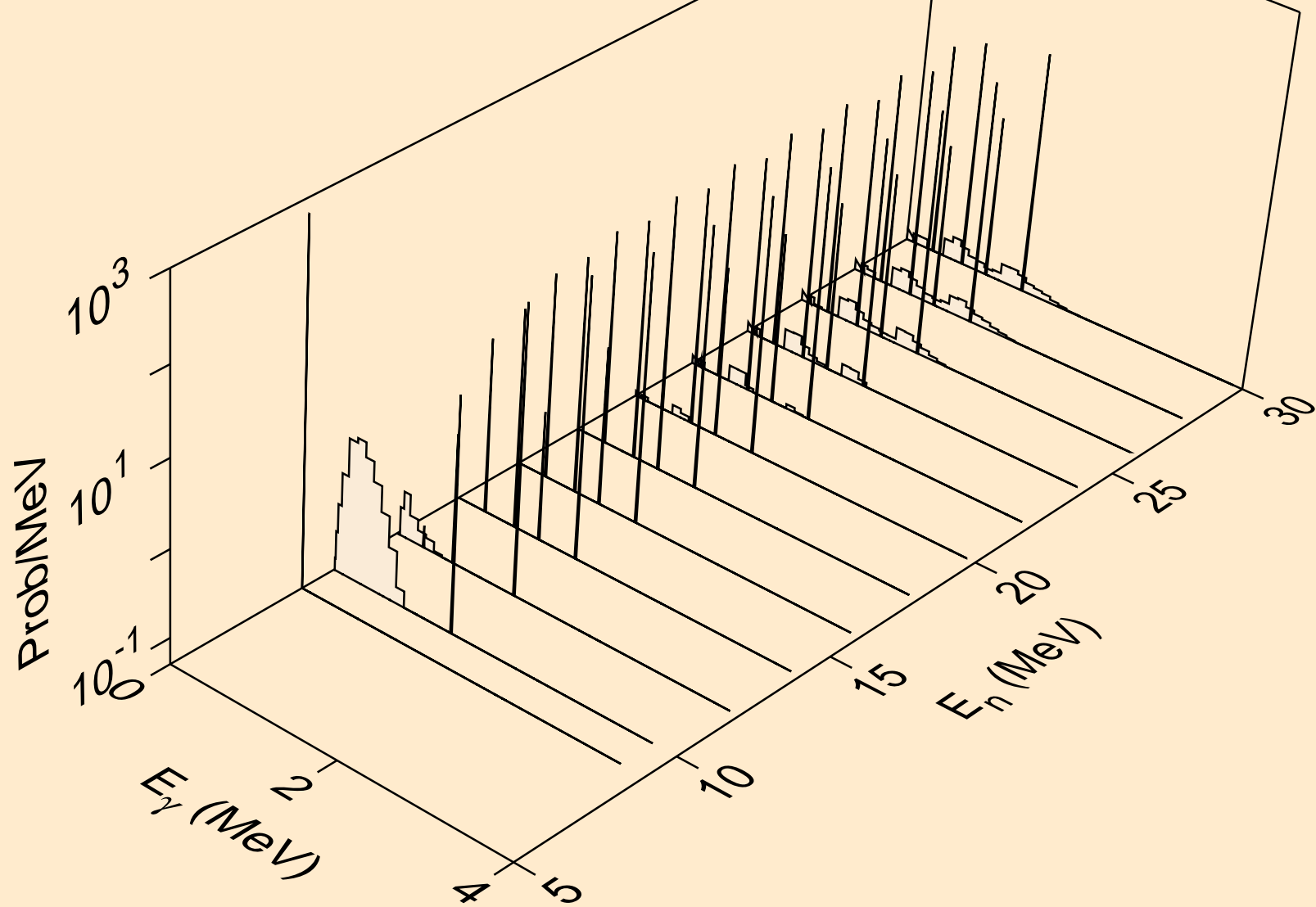

CD098 NEUTRON ACER TENDL-2023 LIBRARY; T=0.K  
Photon emission for (n,npa)

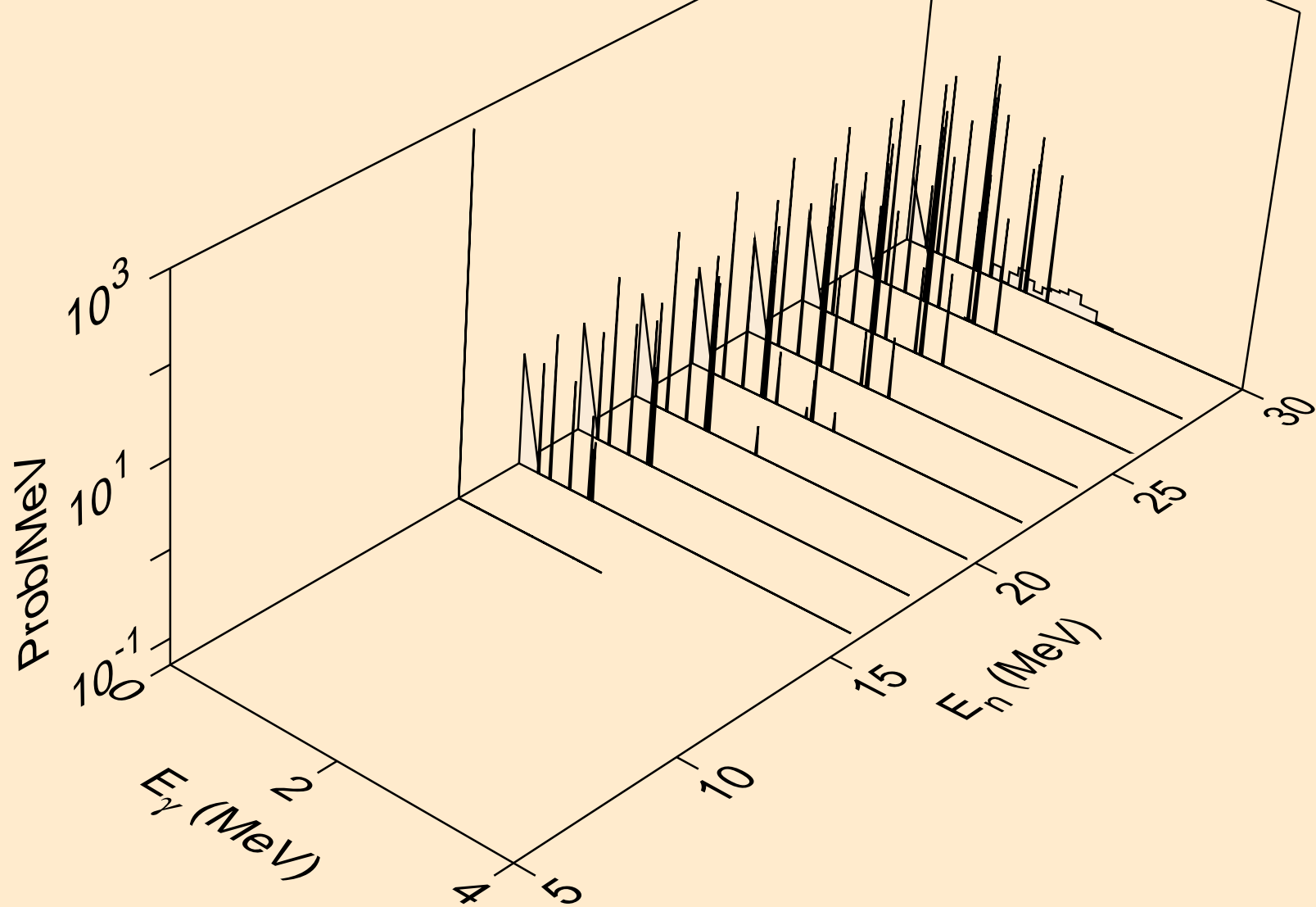

CD098 NEUTRON ACER TENDL-2023 LIBRARY; T=0.K  
Photon emission for (n,n\*c)

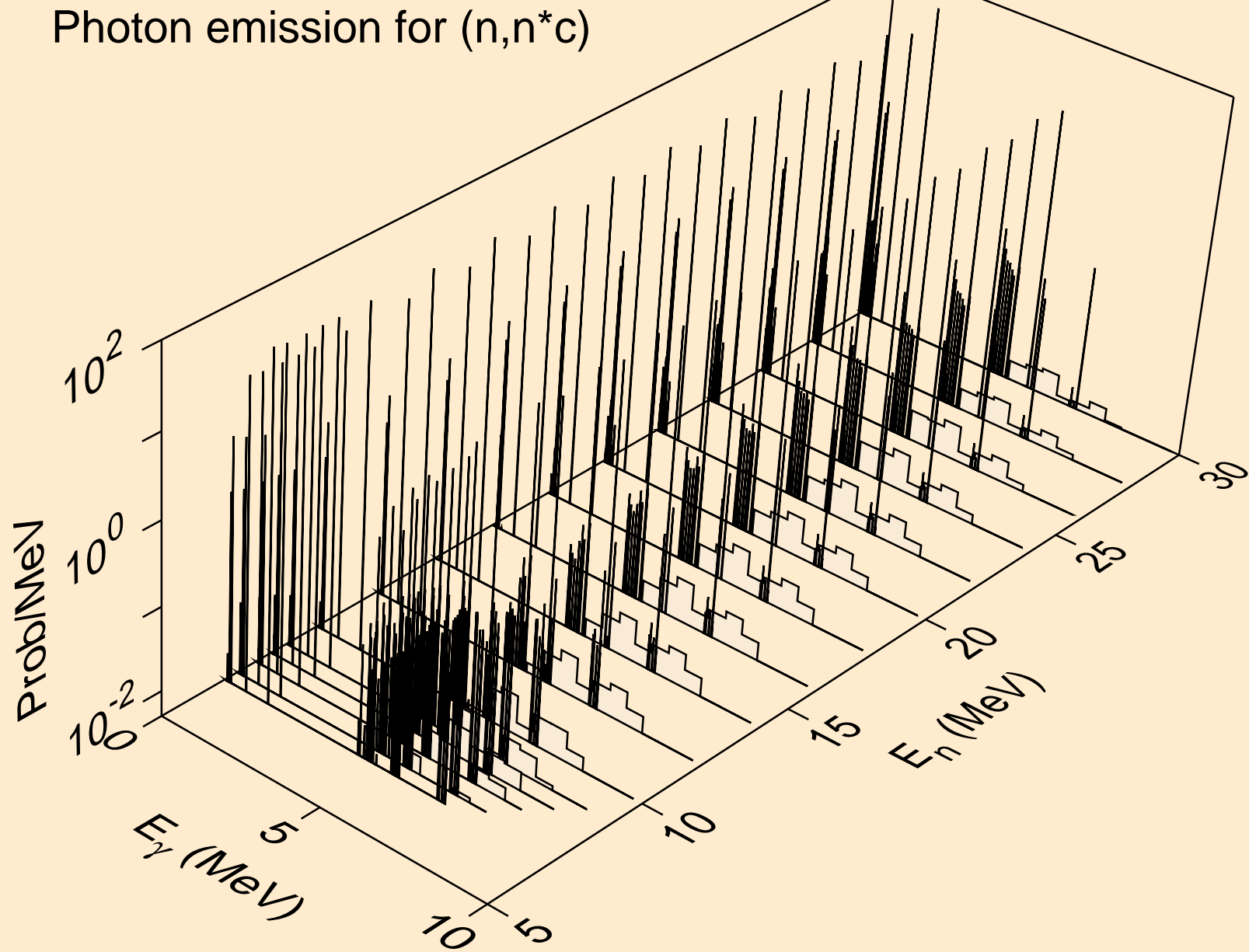

CD098 NEUTRON ACER TENDL-2023 LIBRARY; T=0.K  
Photon emission for (n,gma)

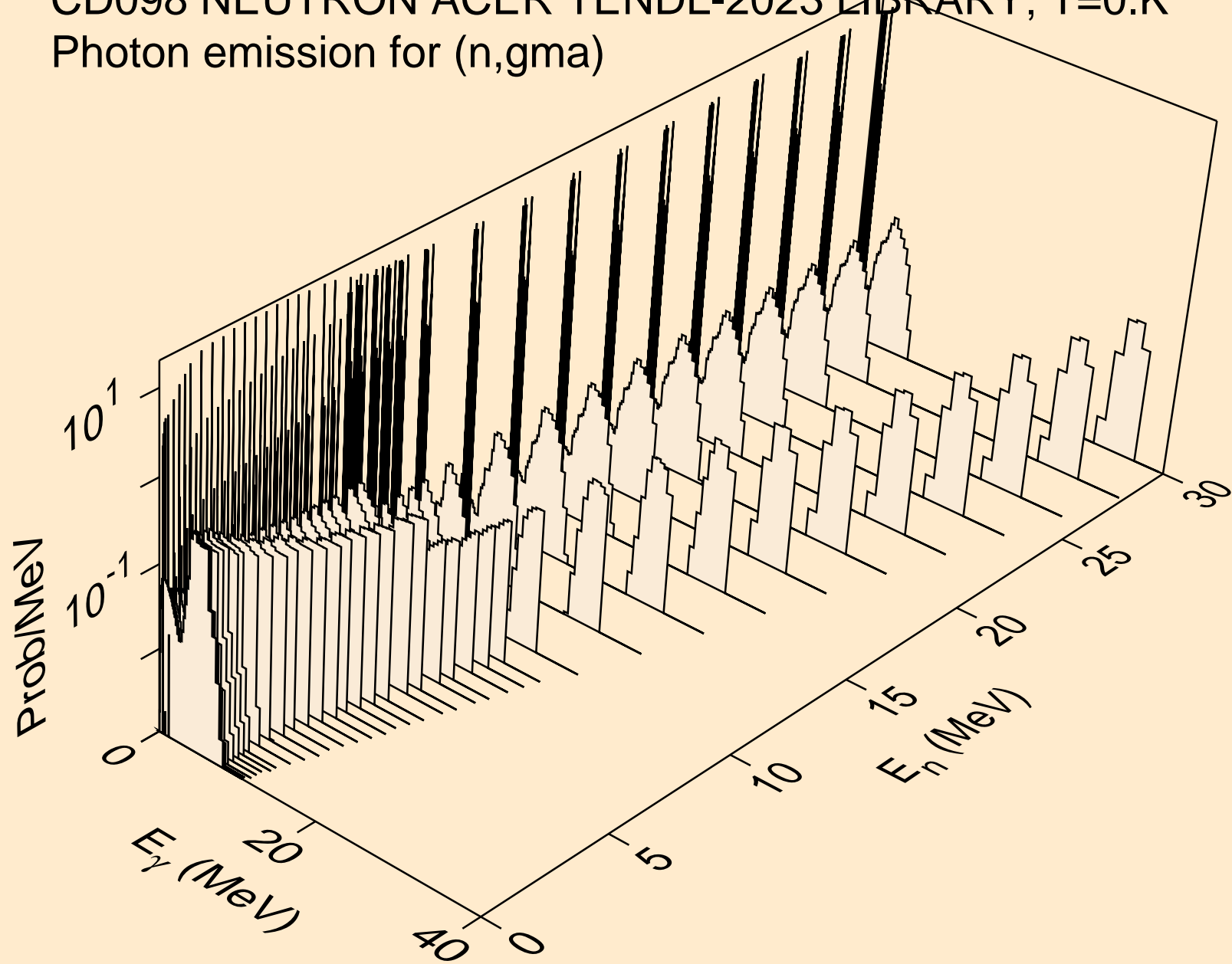

CD098 NEUTRON ACER TENDL-2023 LIBRARY; T=0.K  
Photon emission for (n,p)

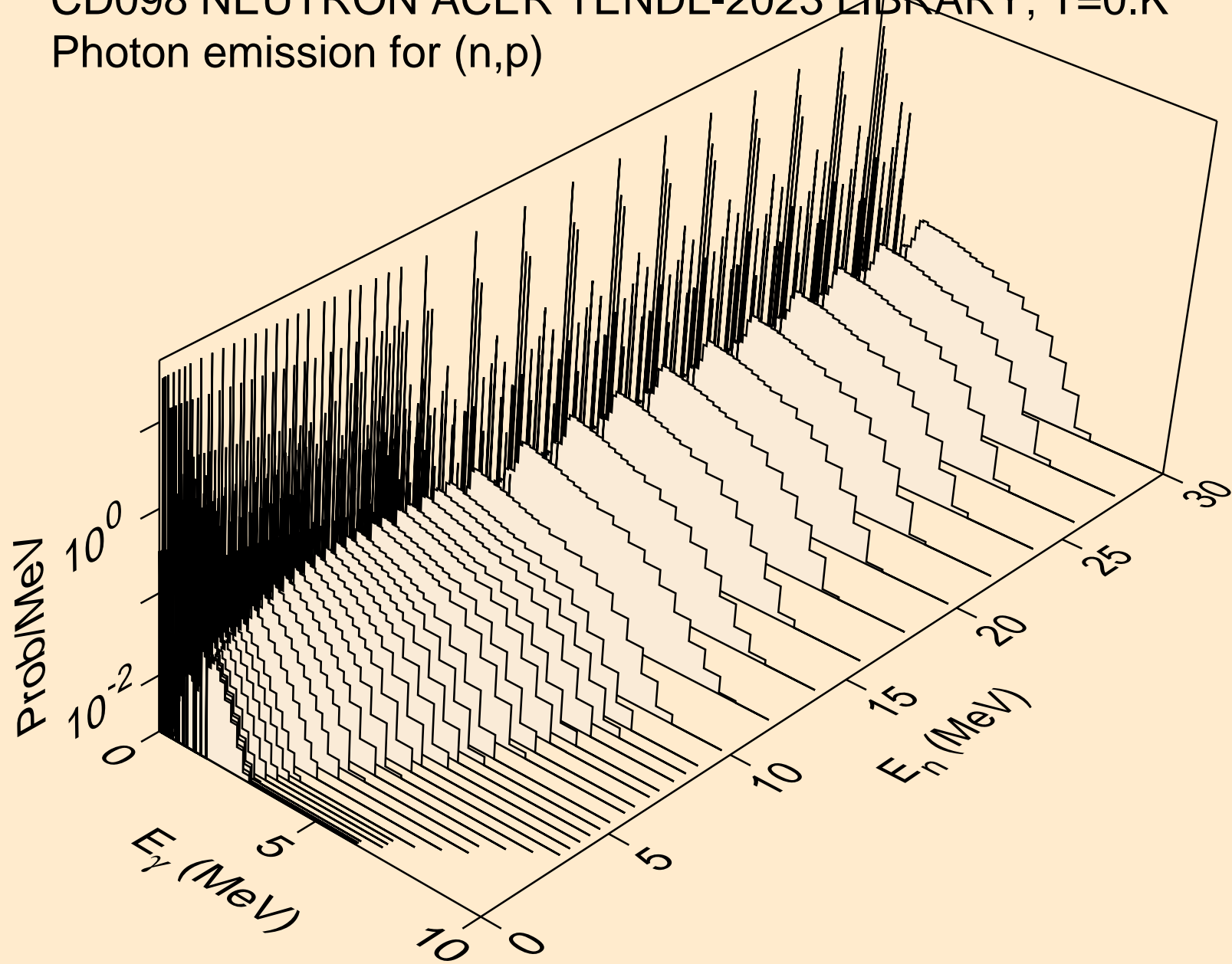

CD098 NEUTRON ACER TENDL-2023 LIBRARY; T=0.K  
Photon emission for (n,d)

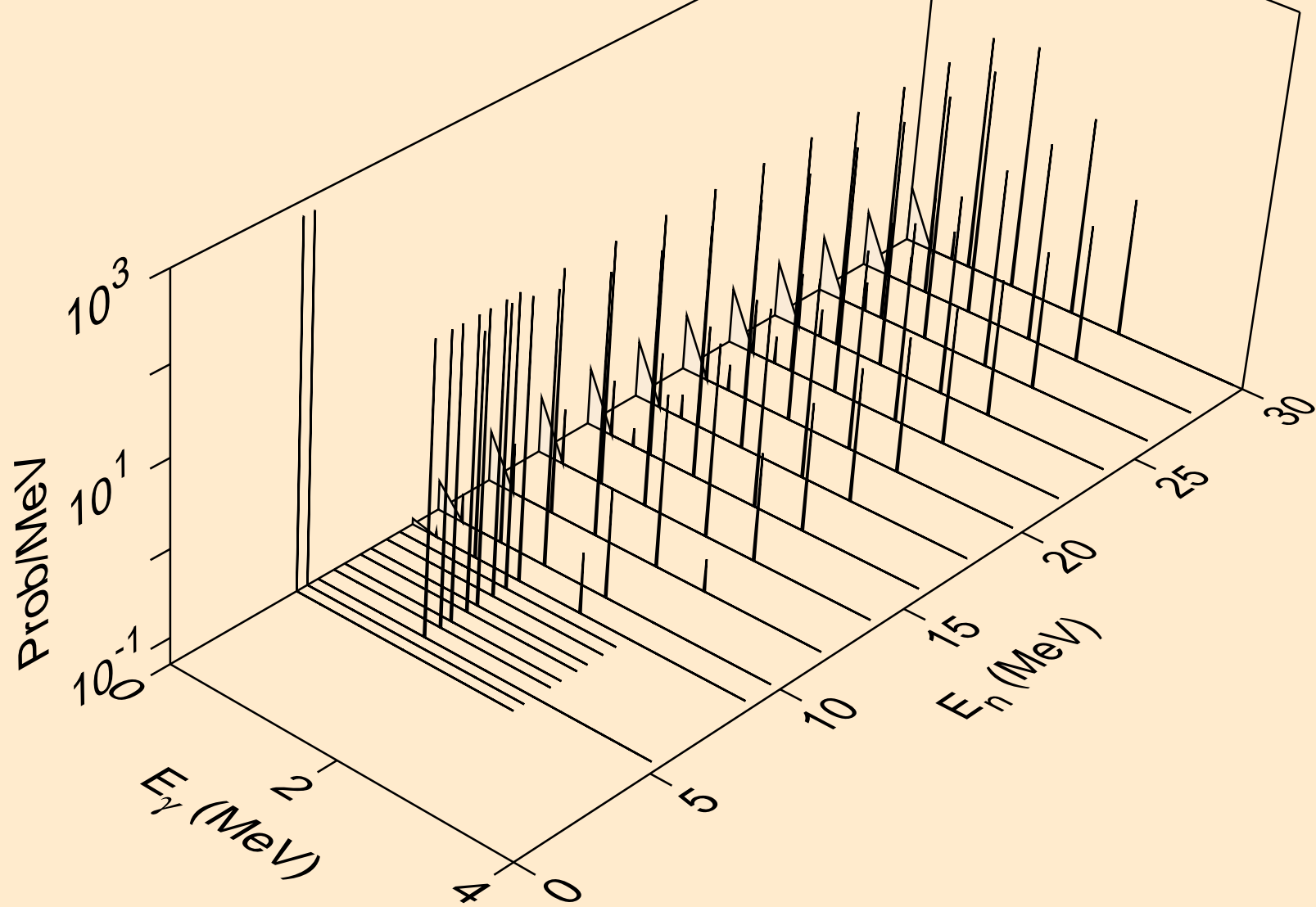

CD098 NEUTRON ACER TENDL-2023 LIBRARY; T=0.K  
Photon emission for (n,t)

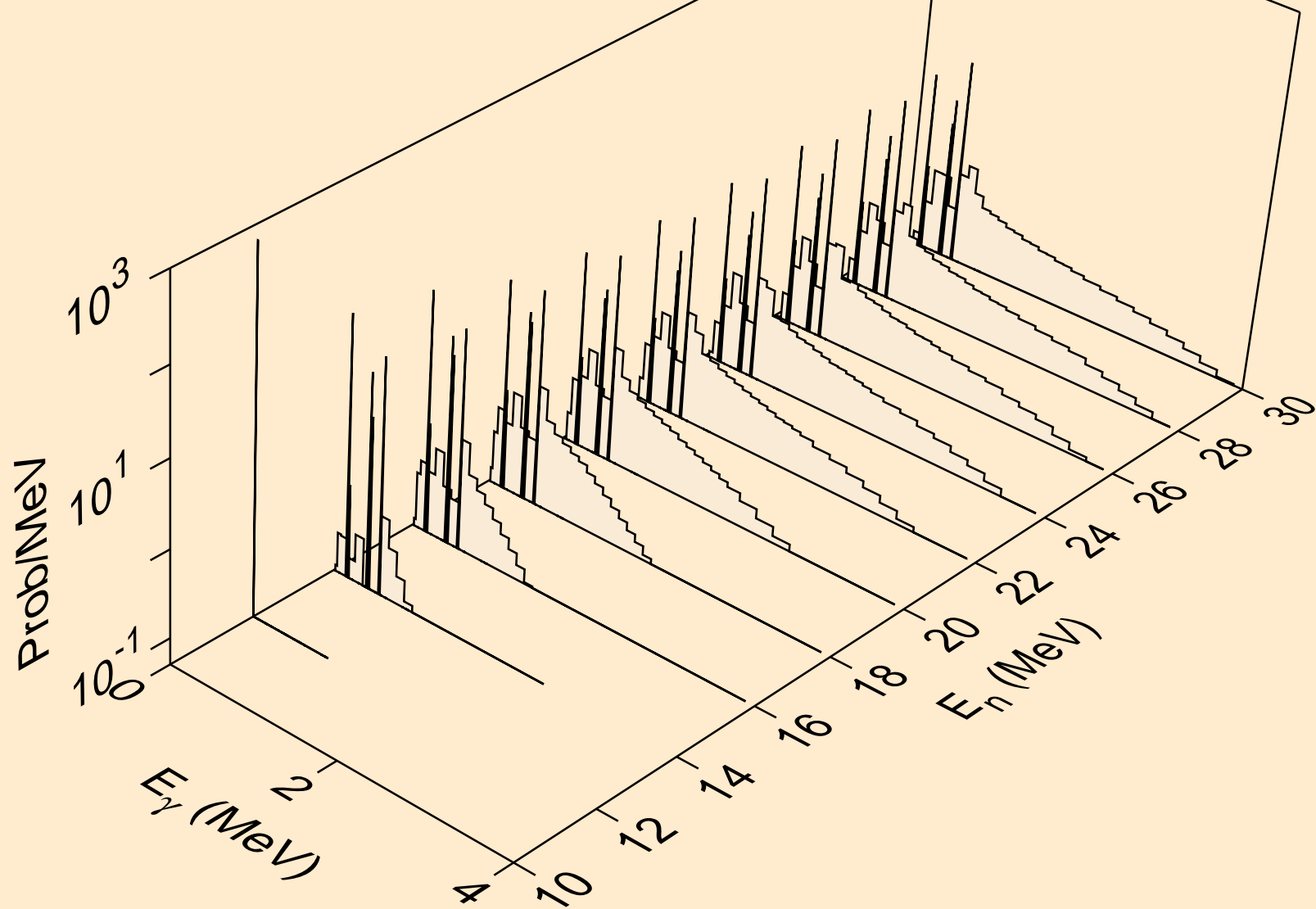

CD098 NEUTRON ACER TENDL-2023 LIBRARY; T=0.K  
Photon emission for (n,he3)

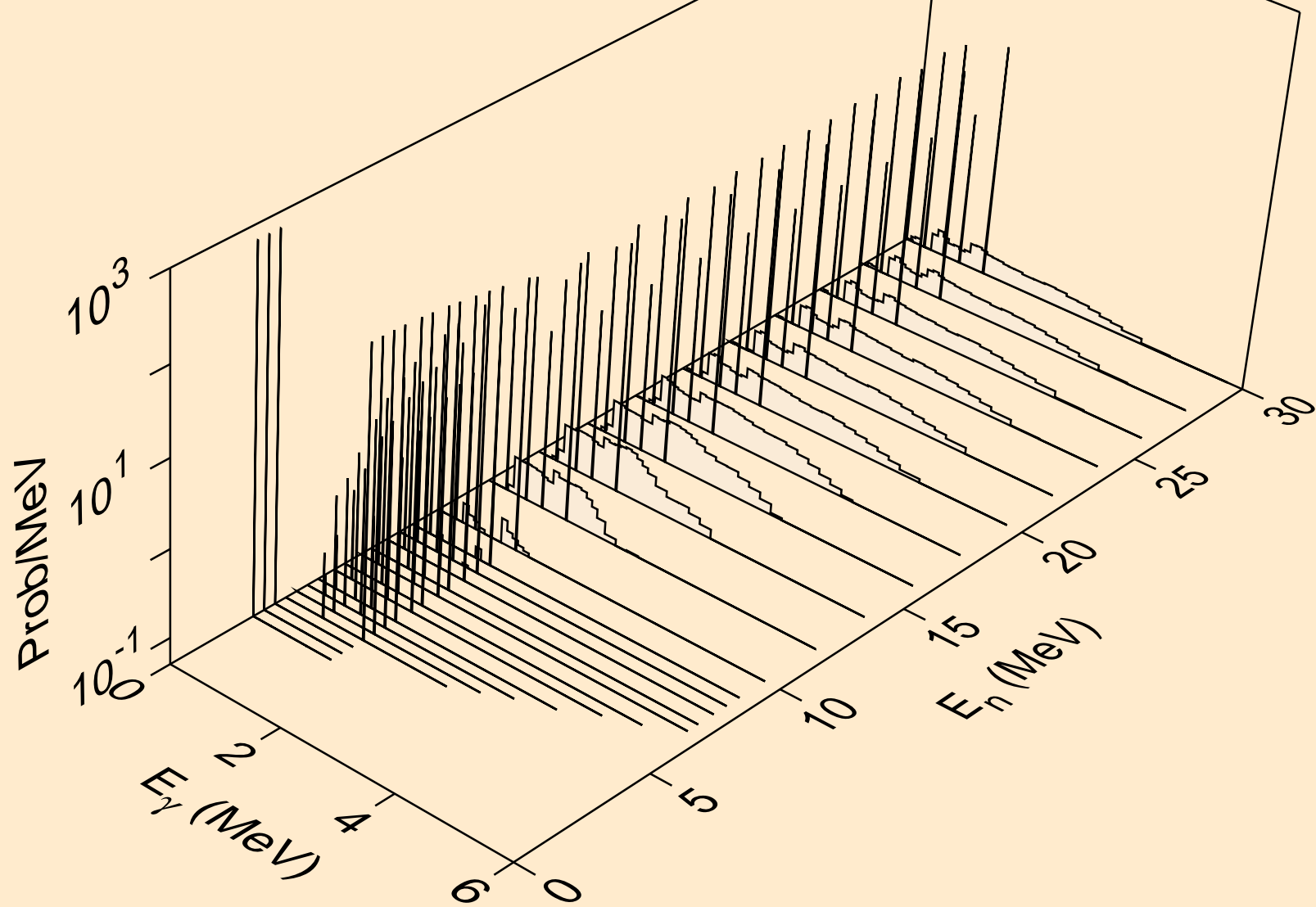

CD098 NEUTRON ACER TENDL-2023 LIBRARY; T=0.K  
Photon emission for (n,a)

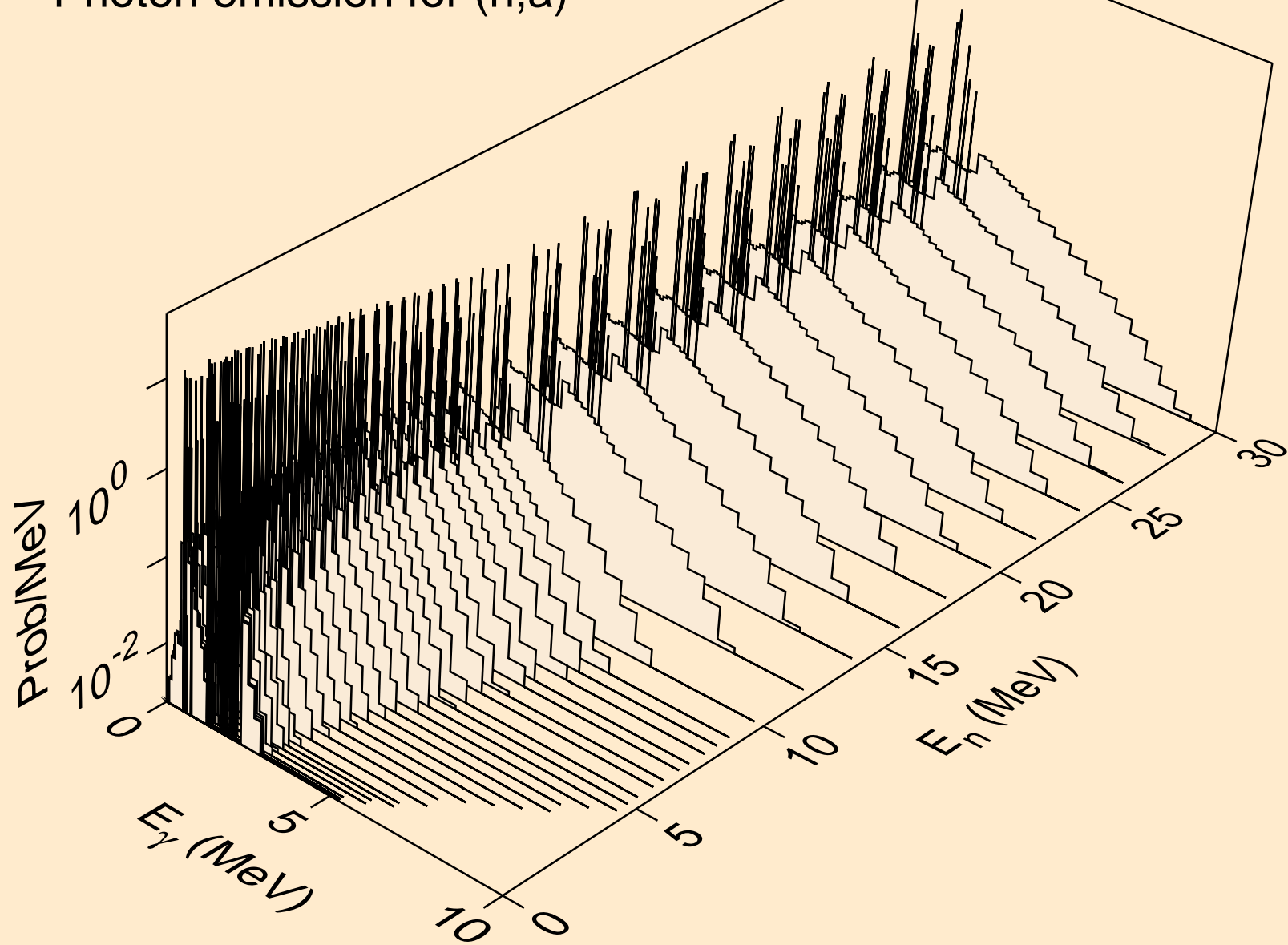

CD098 NEUTRON ACER TENDL-2023 LIBRARY; T=0.K  
Photon emission for (n,2a)

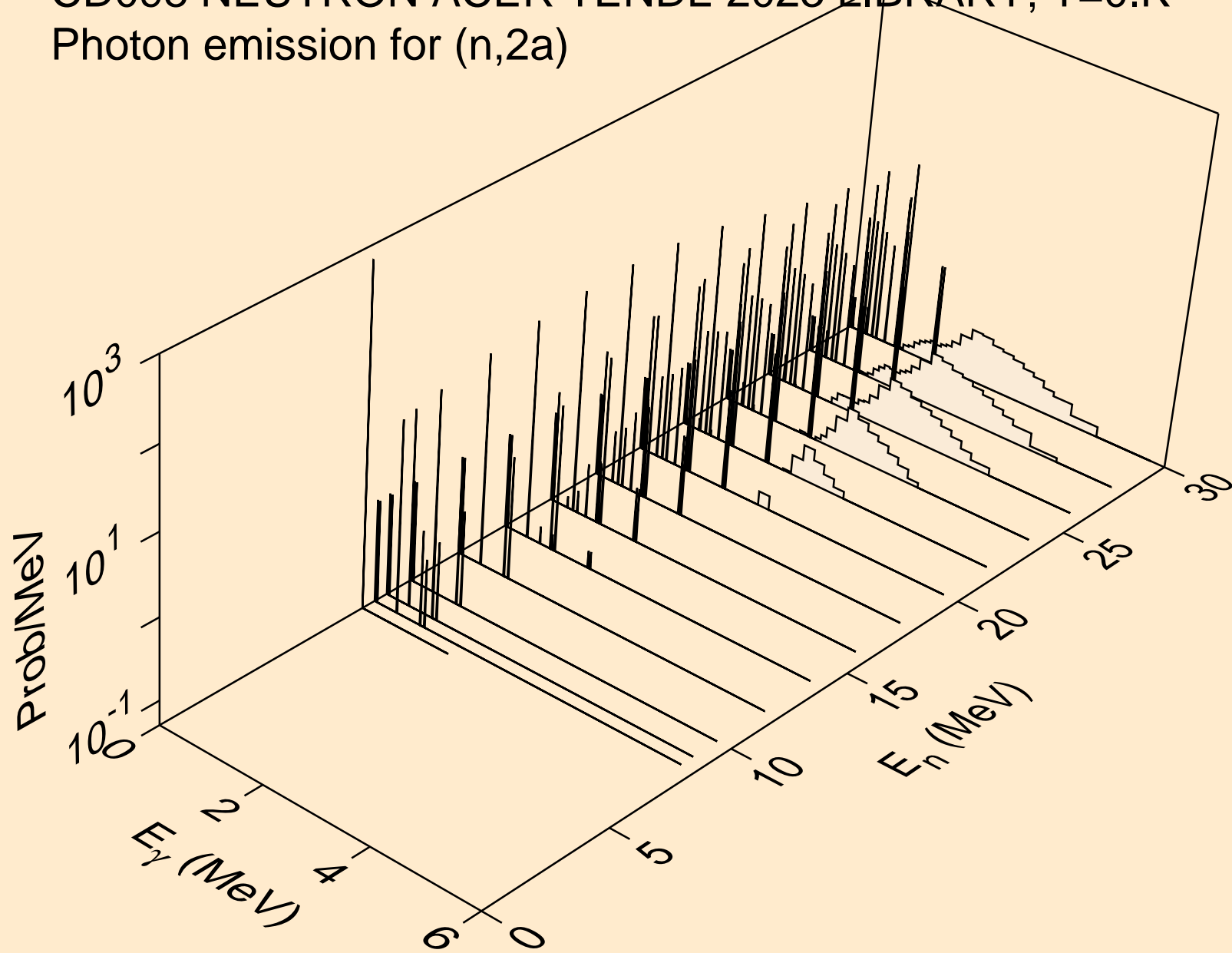

CD098 NEUTRON ACER TENDL-2023 LIBRARY; T=0.K  
Photon emission for (n,2p)

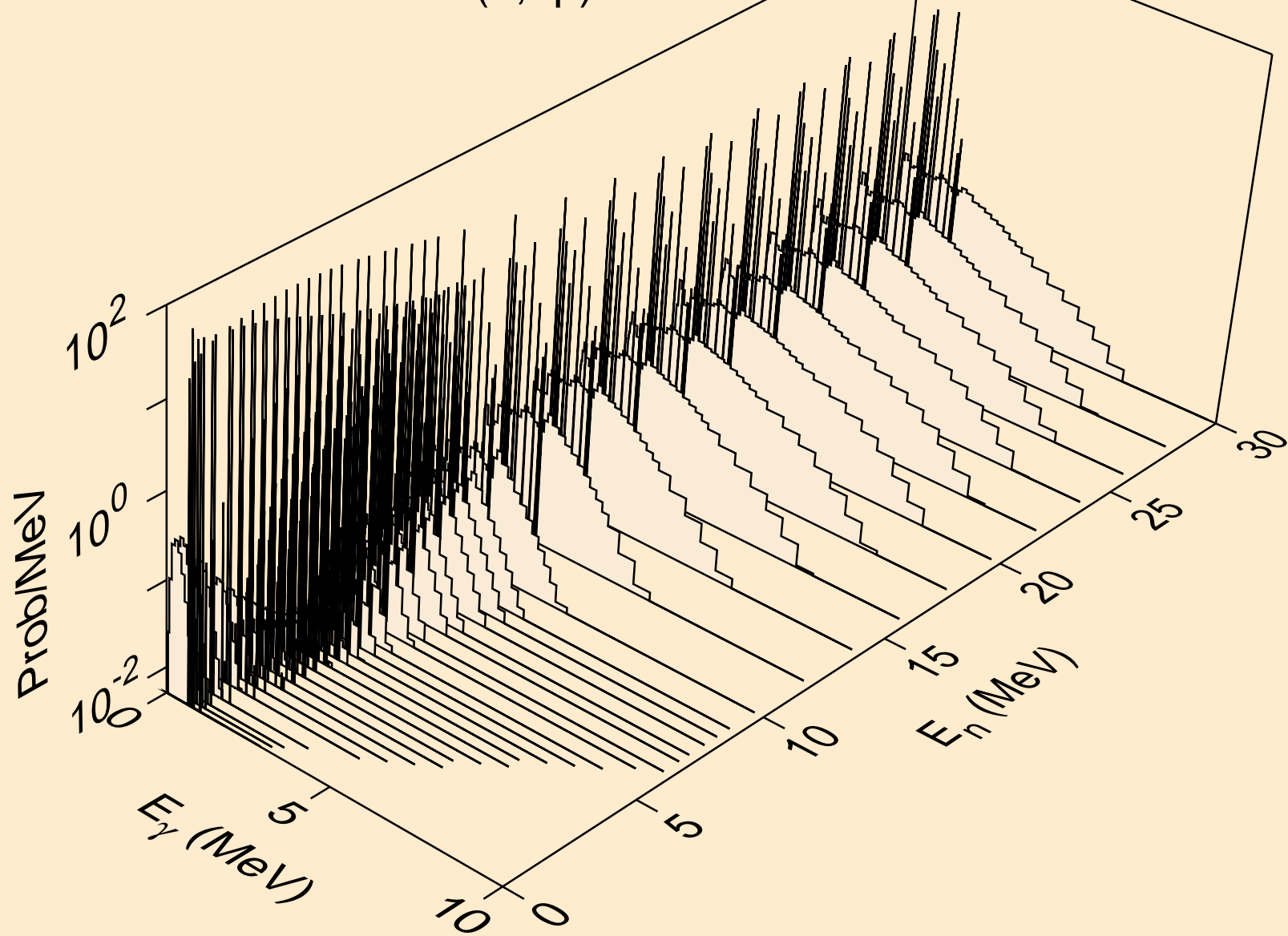

CD098 NEUTRON ACER TENDL-2023 LIBRARY; T=0.K  
Photon emission for (n,p)

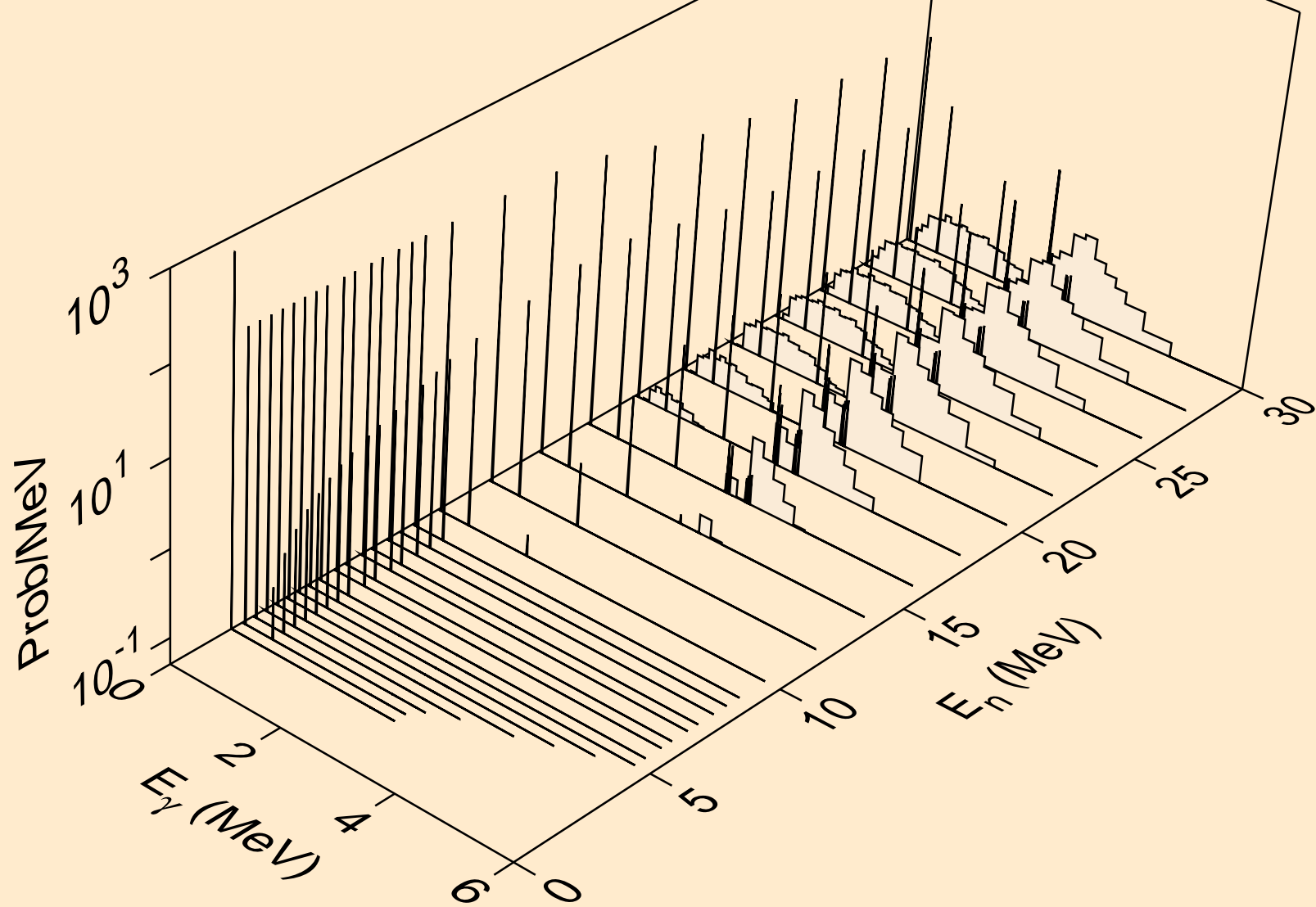

CD098 NEUTRON ACER TENDL-2023 LIBRARY; T=0.K  
Photon emission for (n,pd)

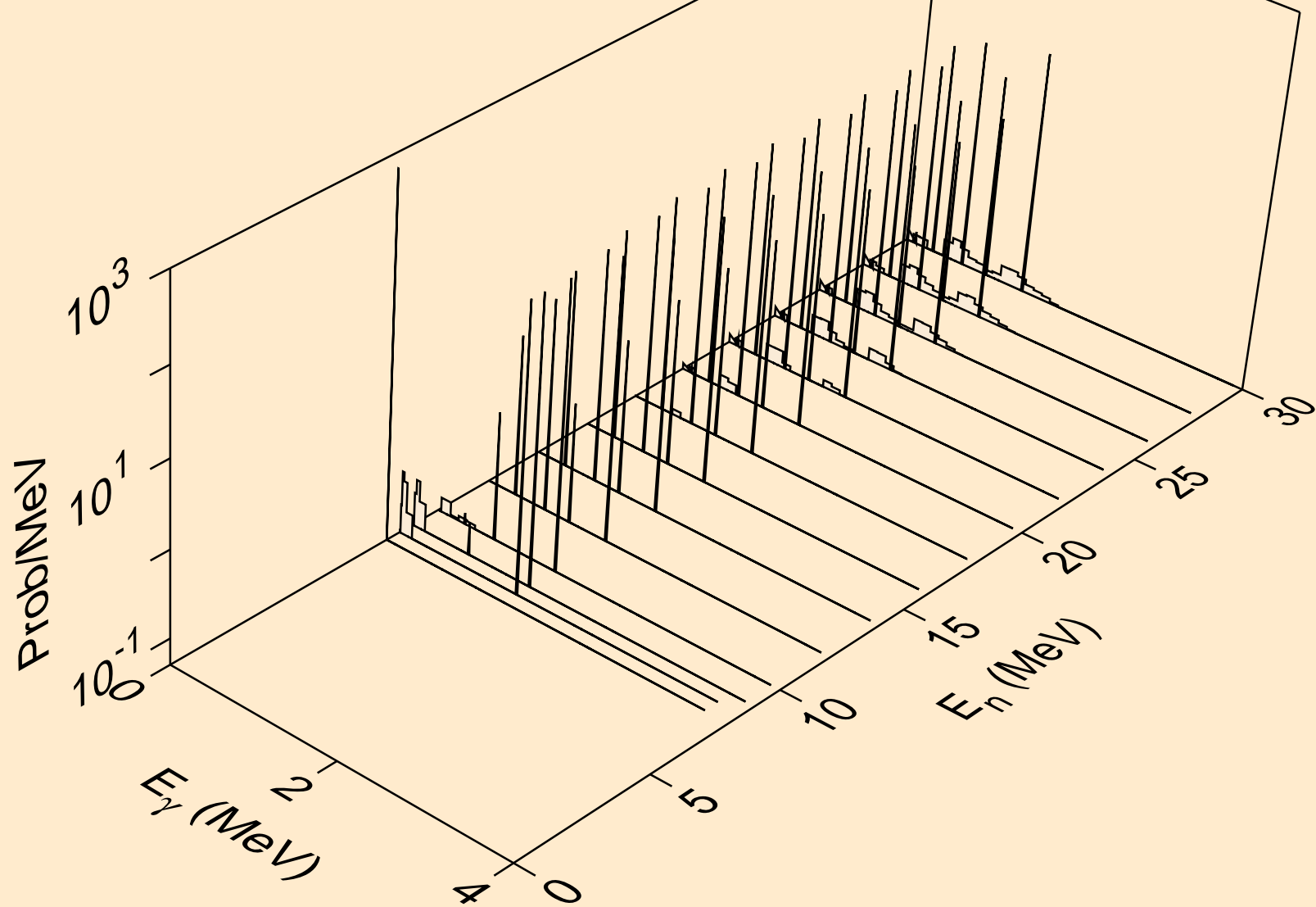

CD098 NEUTRON ACER TENDL-2023 LIBRARY; T=0.K  
Photon emission for (n,pt)

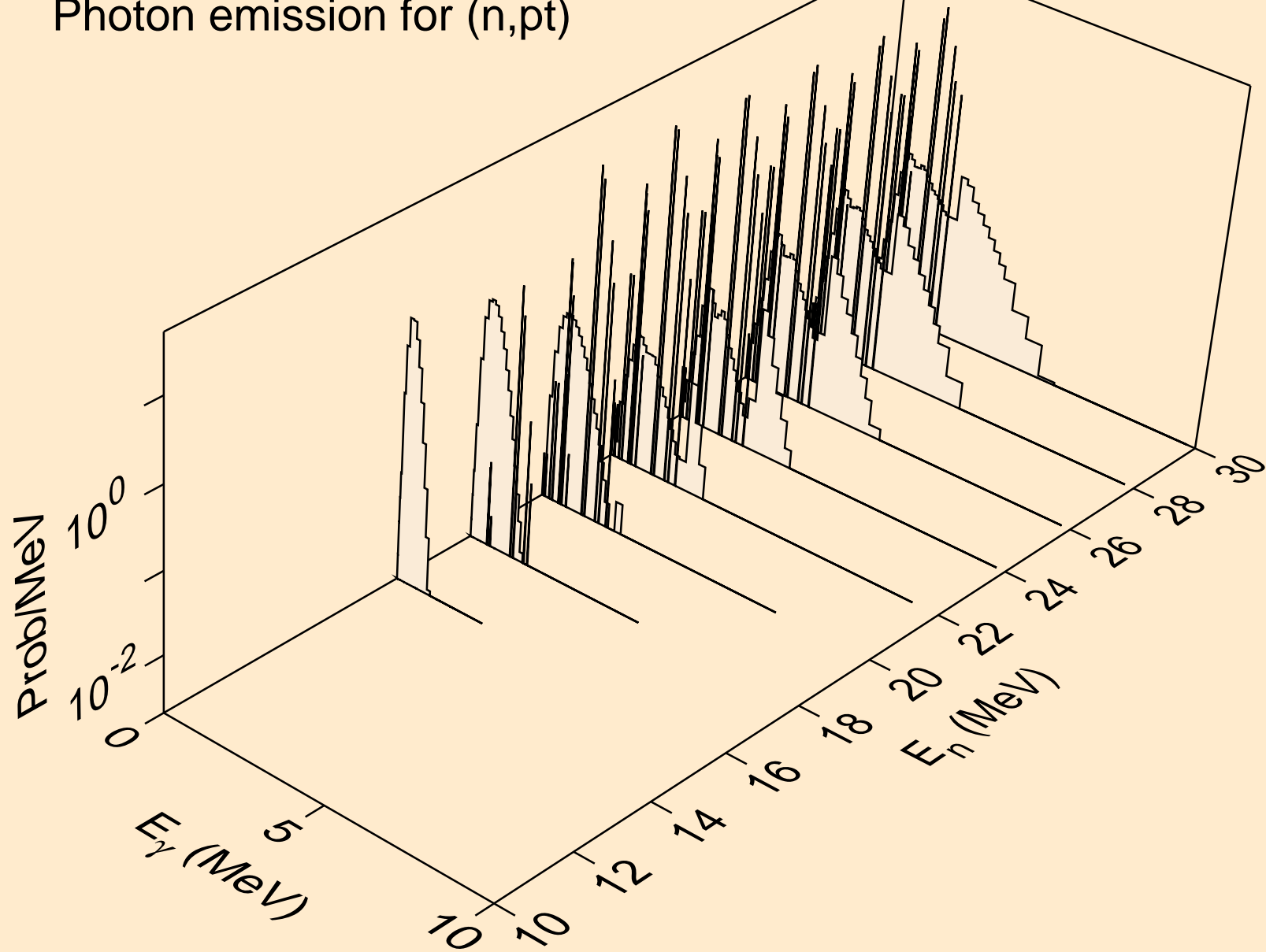

CD098 NEUTRON ACER TENDL-2023 LIBRARY; T=0.K  
Photon emission for (n,da)

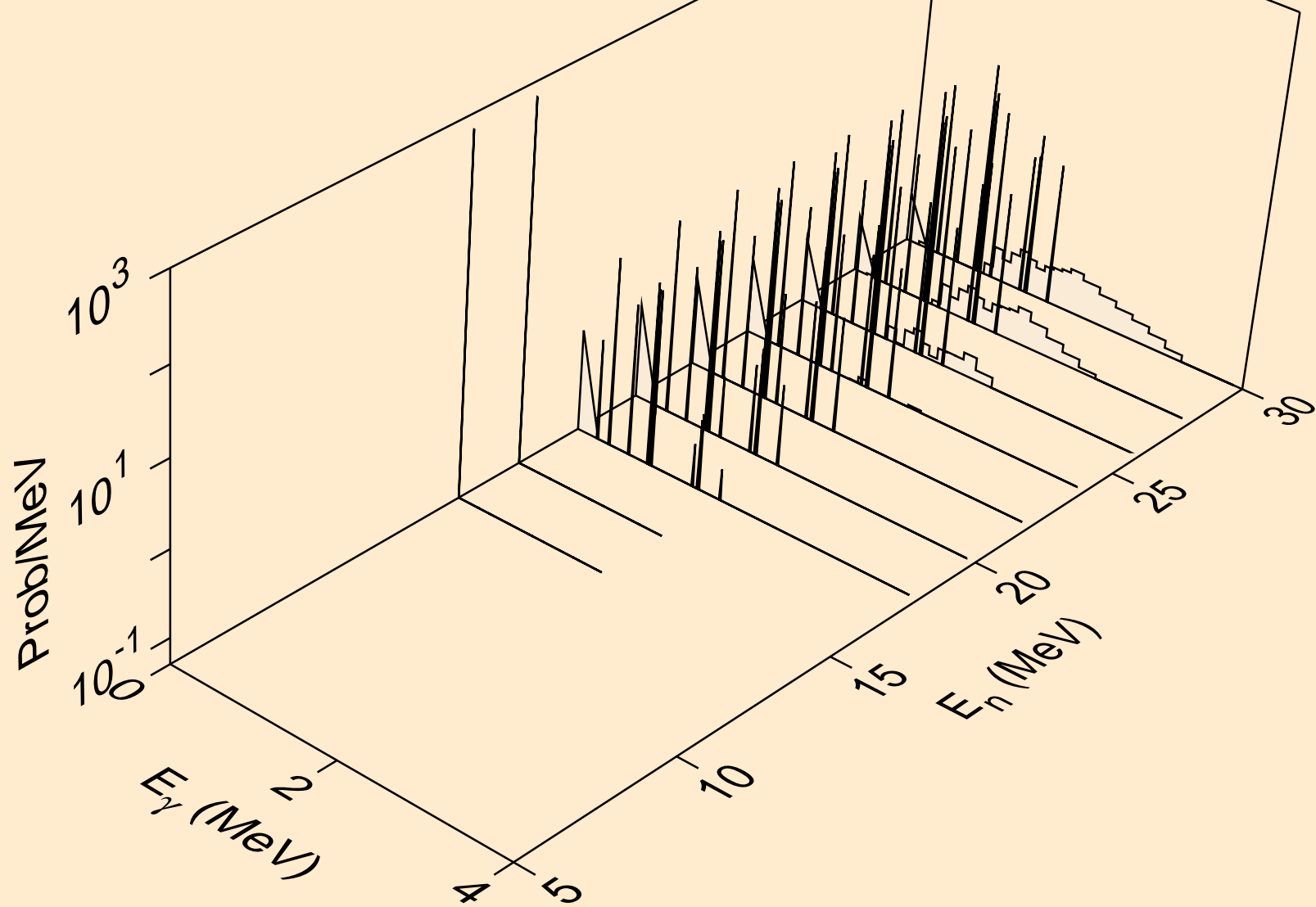

CD098 NEUTRON ACER TENDL-2023 LIBRARY; T=0.K  
thermal capture photon spectrum

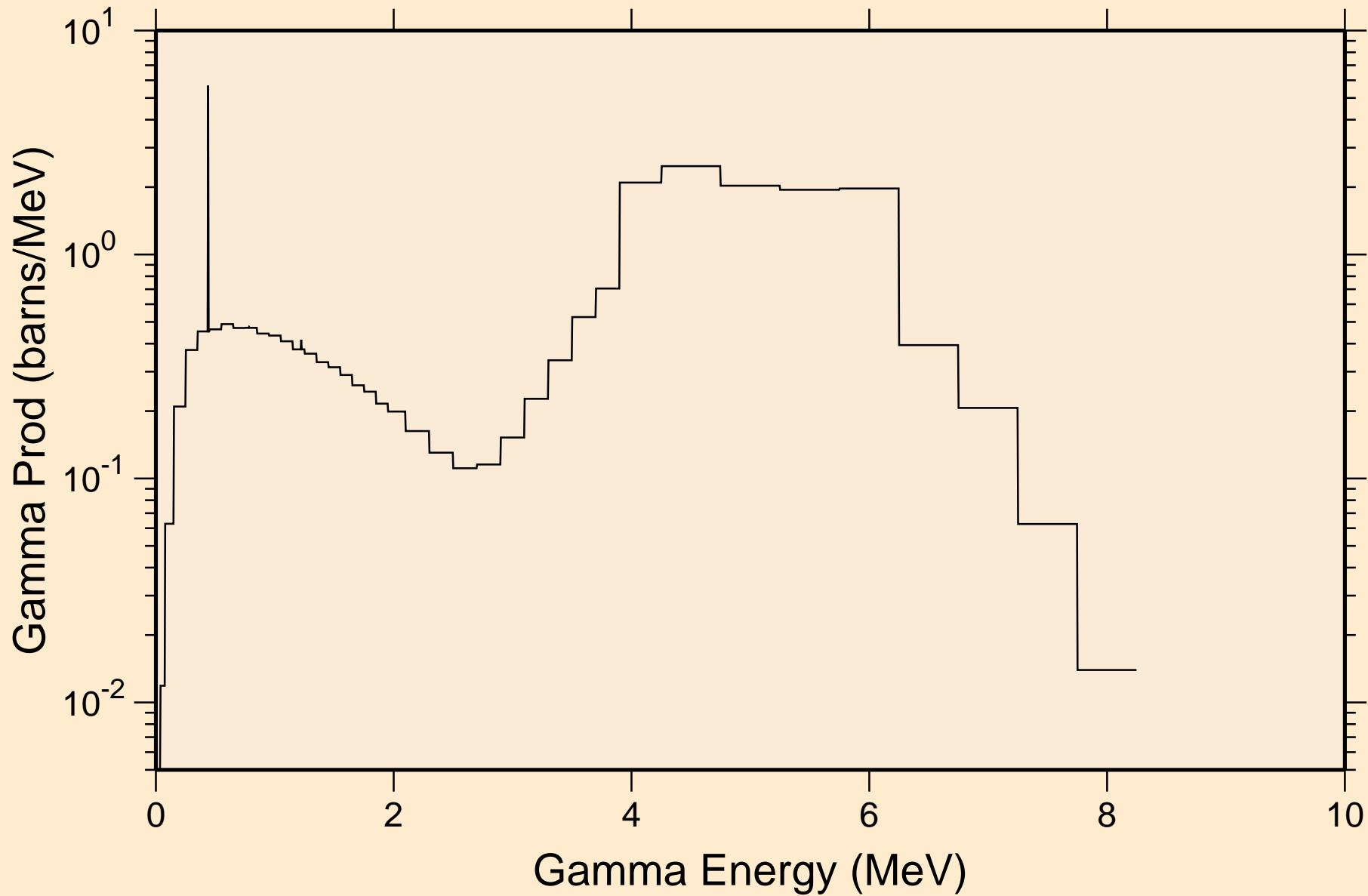

CD098 NEUTRON ACER TENDL-2023 LIBRARY; T=0.K  
14 MeV photon spectrum

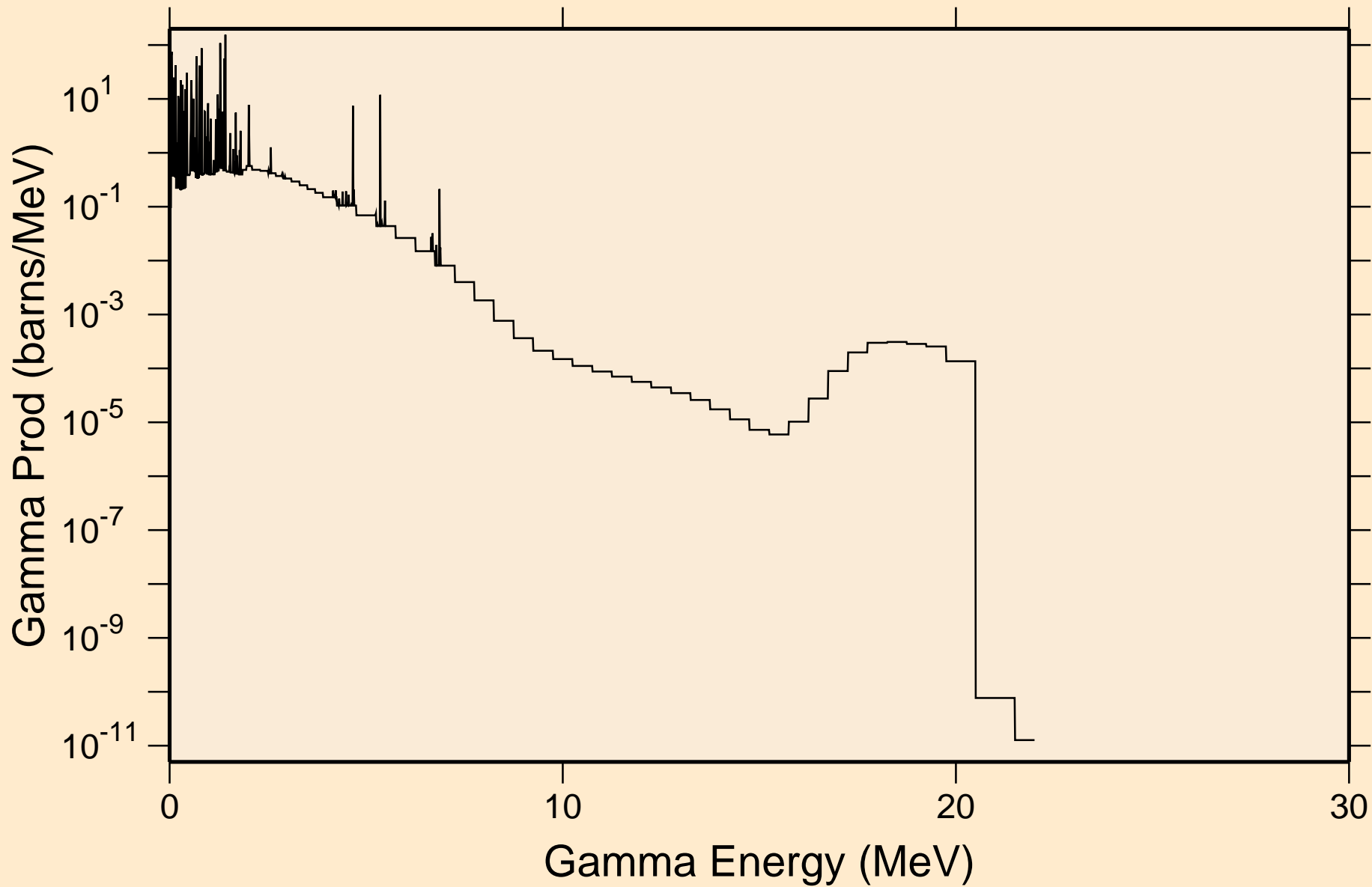

# CD098 NEUTRON ACER TENDL-2023 LIBRARY; T=0.K

## Particle heating contributions

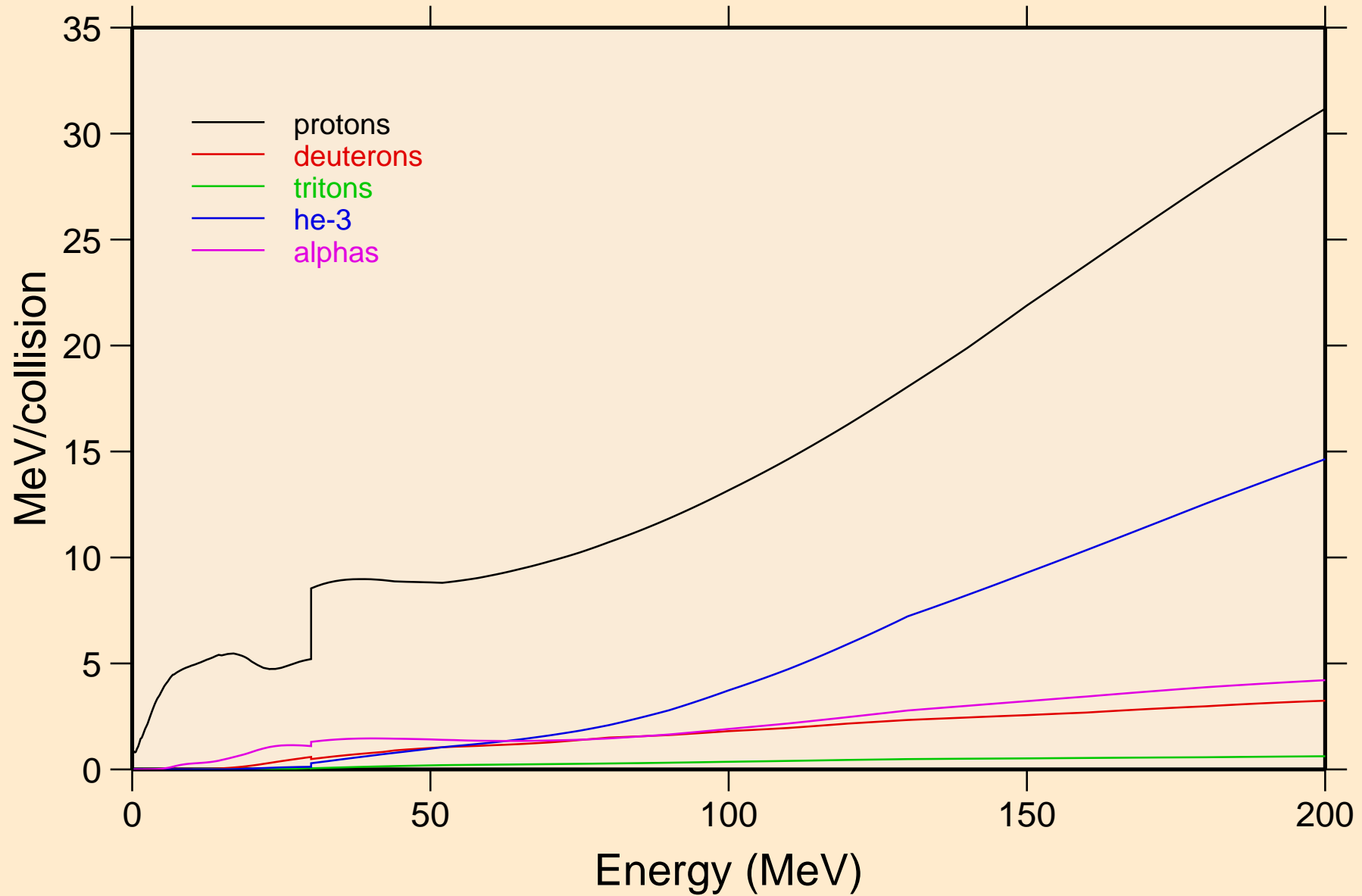

CD098 NEUTRON ACER TENDL-2023 LIBRARY; T=0.K  
Recoil Heating

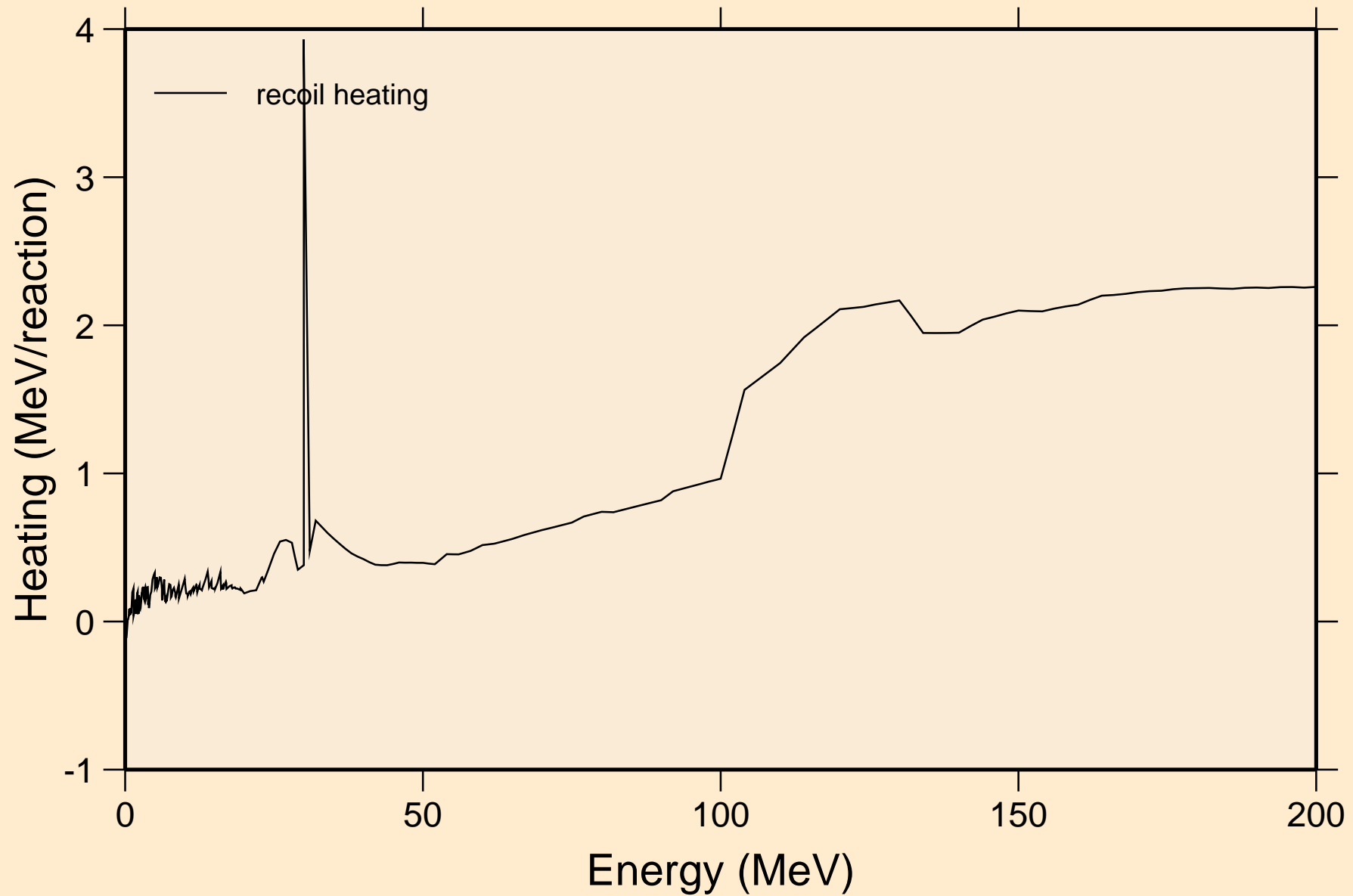

# CD098 NEUTRON ACER TENDL-2023 LIBRARY; T=0.K

## Particle production cross sections

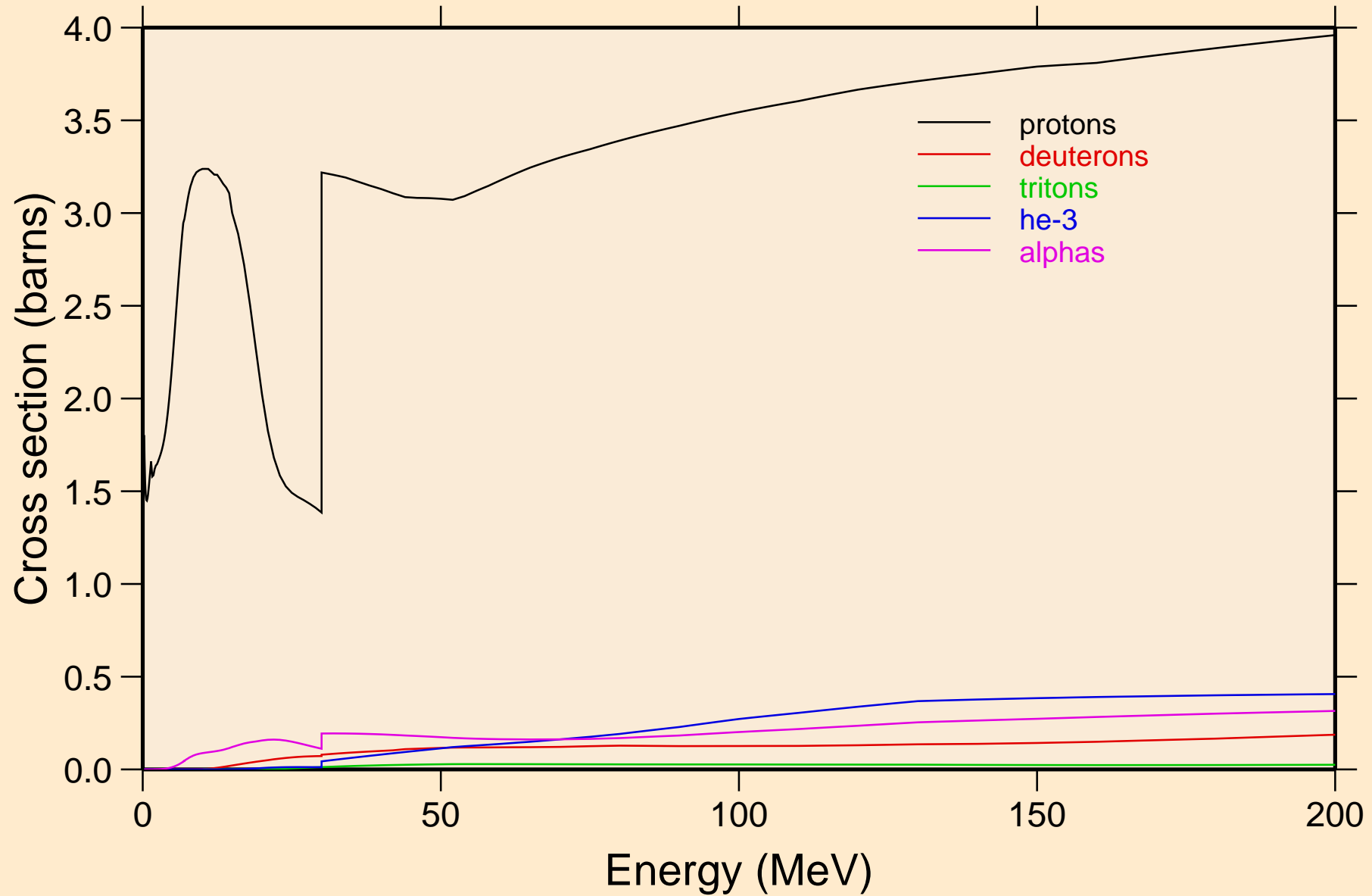

CD098 NEUTRON ACER TENDL-2023 LIBRARY; T=0.K  
protons from (n,x)

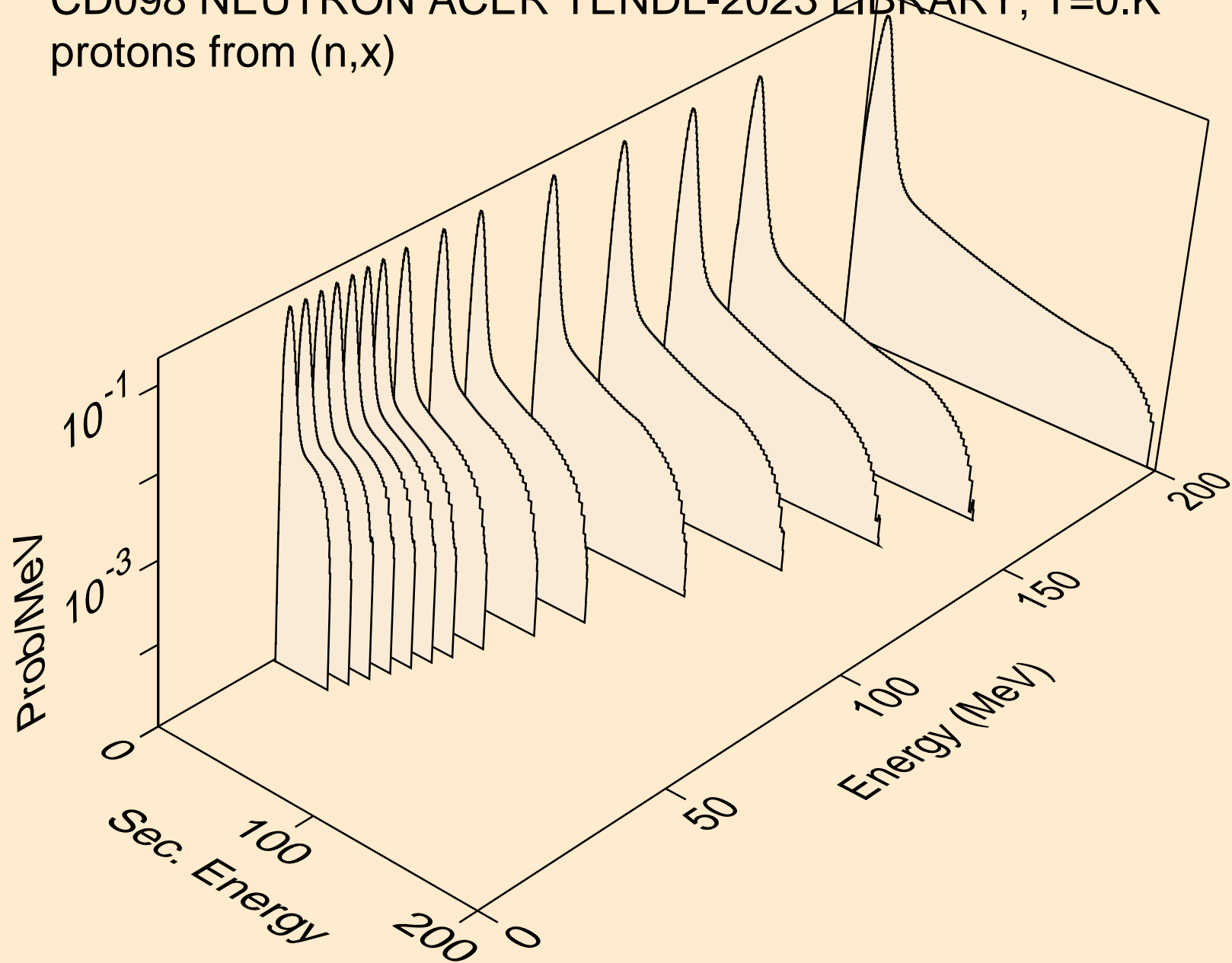

CD098 NEUTRON ACER TENDL-2023 LIBRARY; T=0.K  
protons from (n,n\*)p

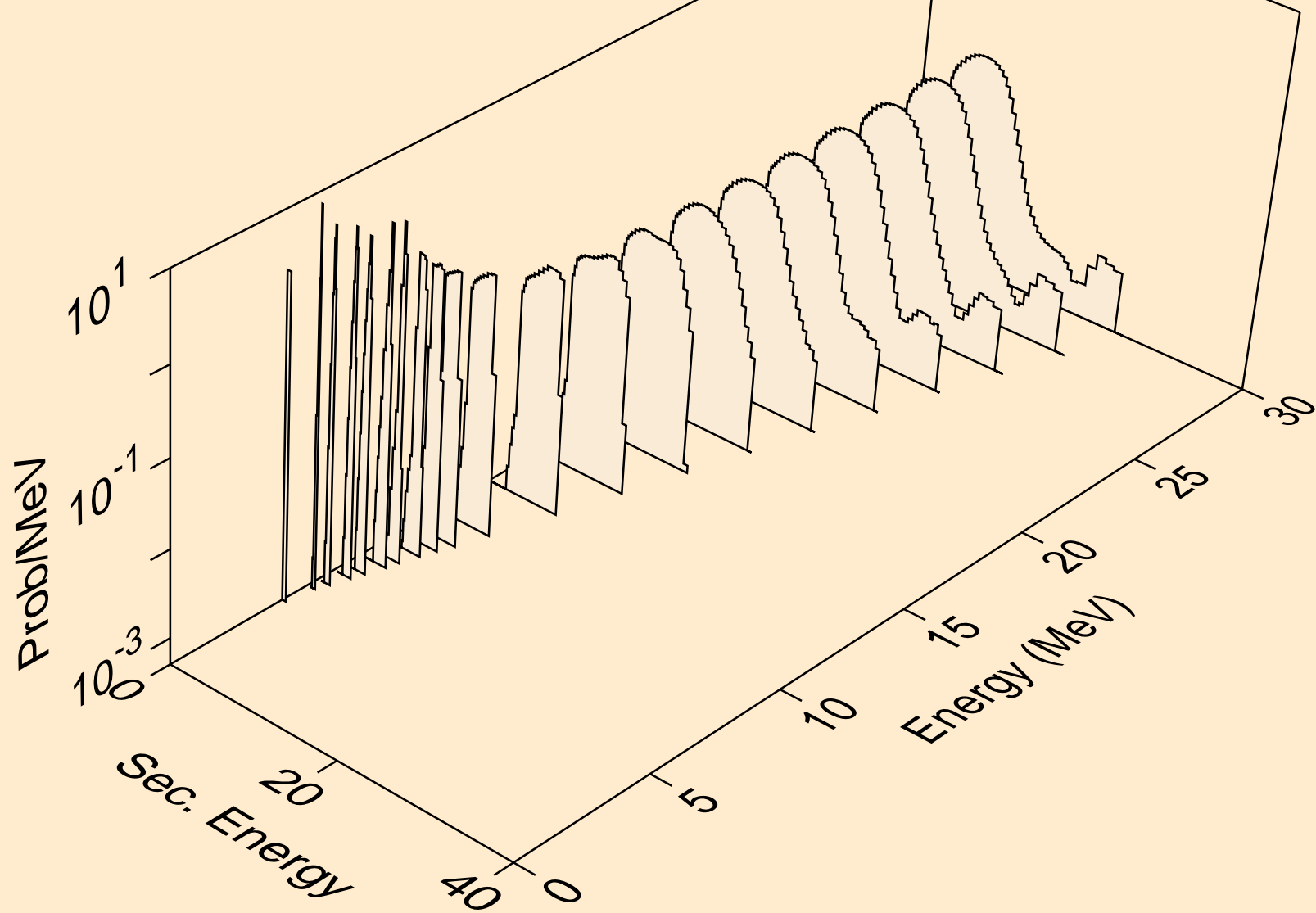

CD098 NEUTRON ACER TENDL-2023 LIBRARY; T=0.K  
protons from (n,2np)

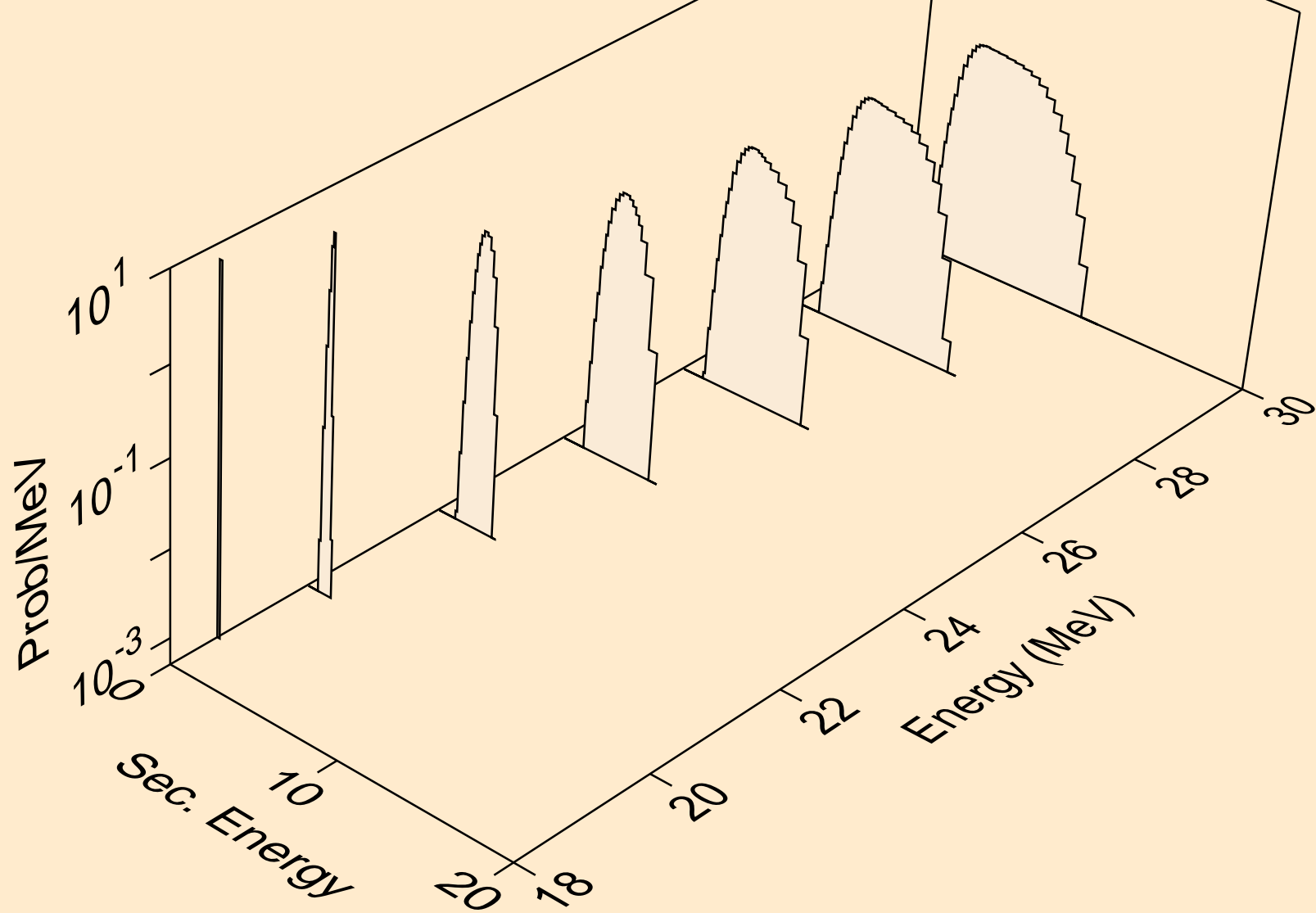

CD098 NEUTRON ACER TENDL-2023 LIBRARY; T=0.K  
protons from (n,n2p)

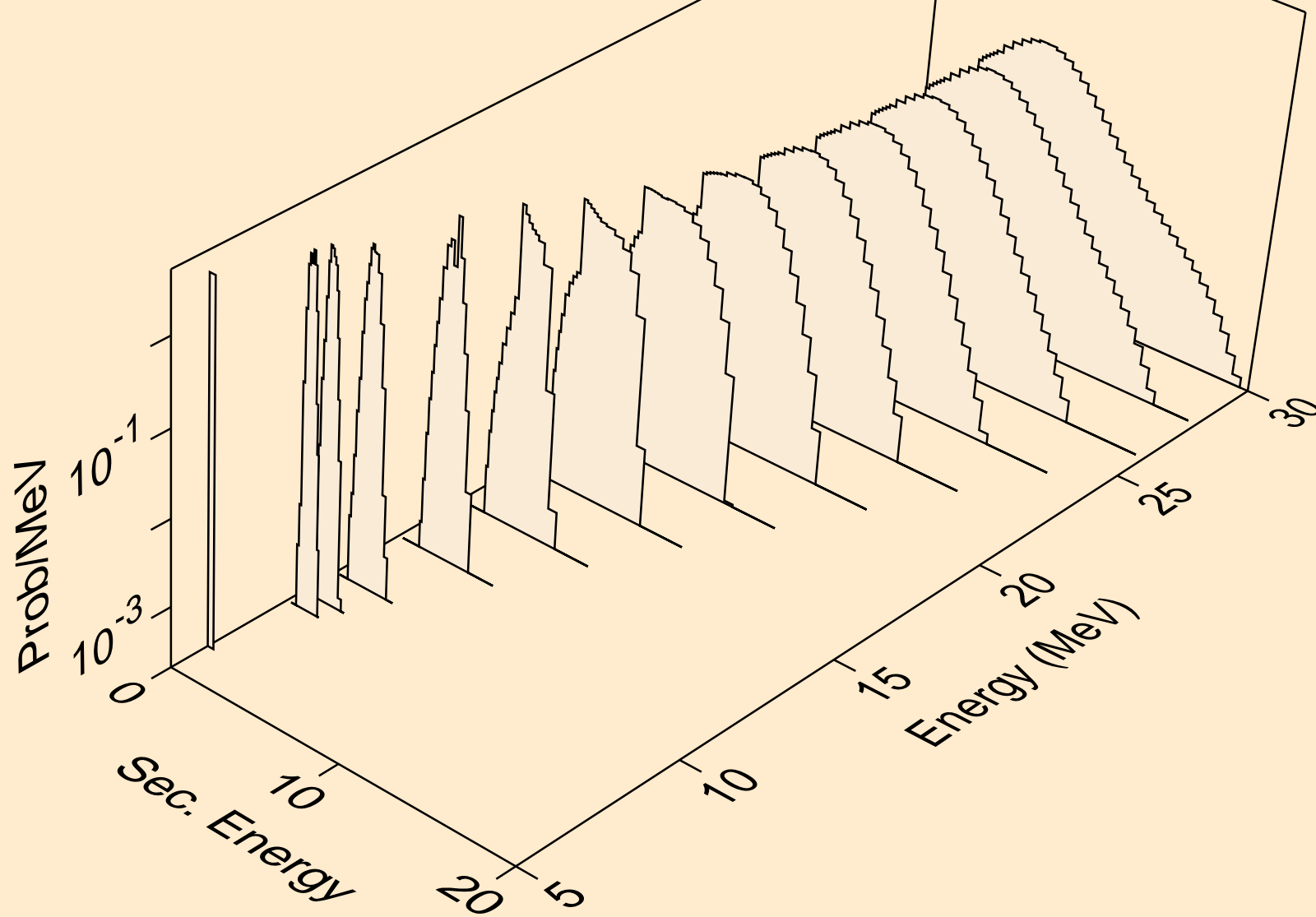

CD098 NEUTRON ACER TENDL-2023 LIBRARY; T=0.K  
protons from (n,npa)

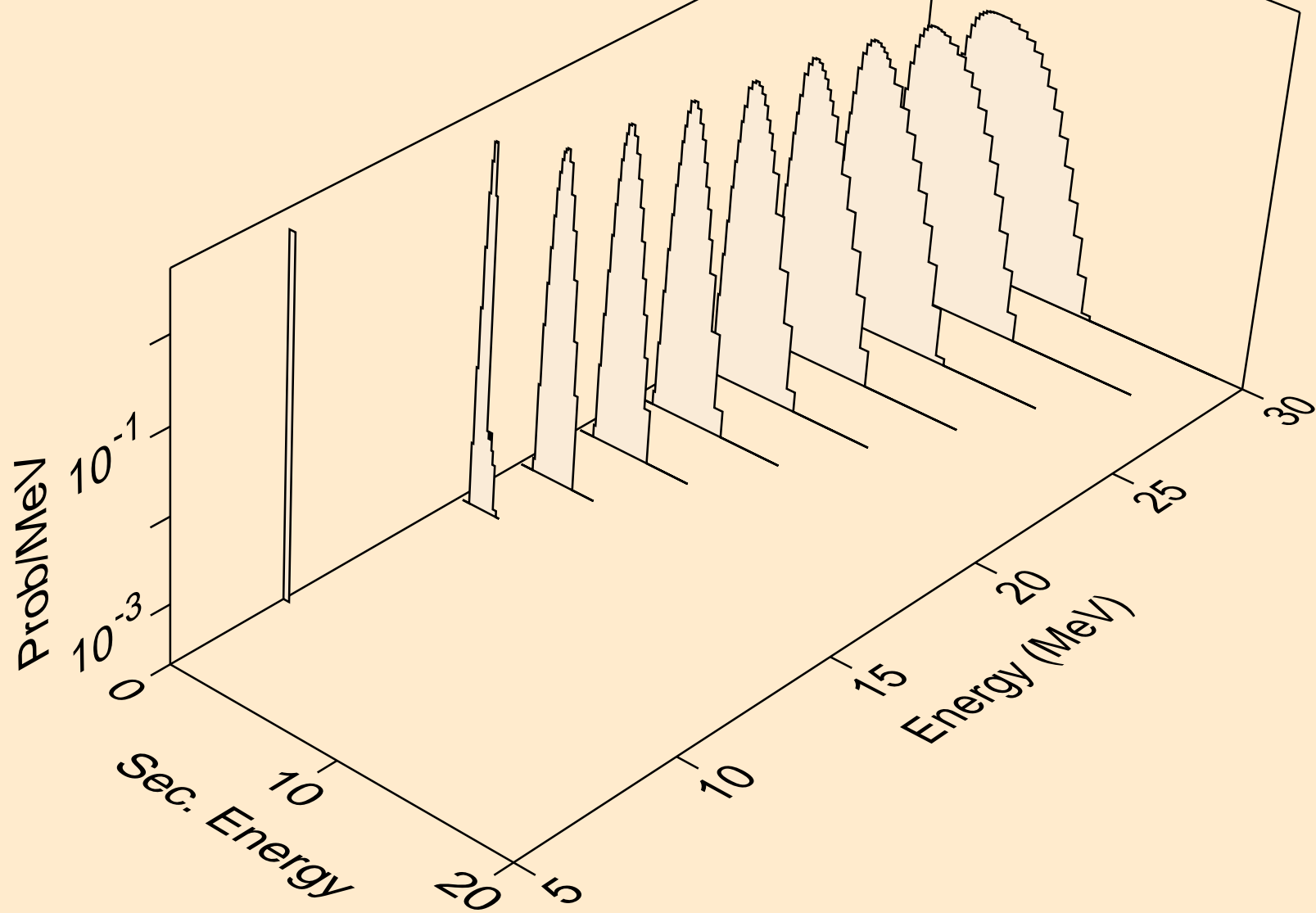

CD098 NEUTRON ACER TENDL-2023 LIBRARY; T=0.K  
protons from (n,p)

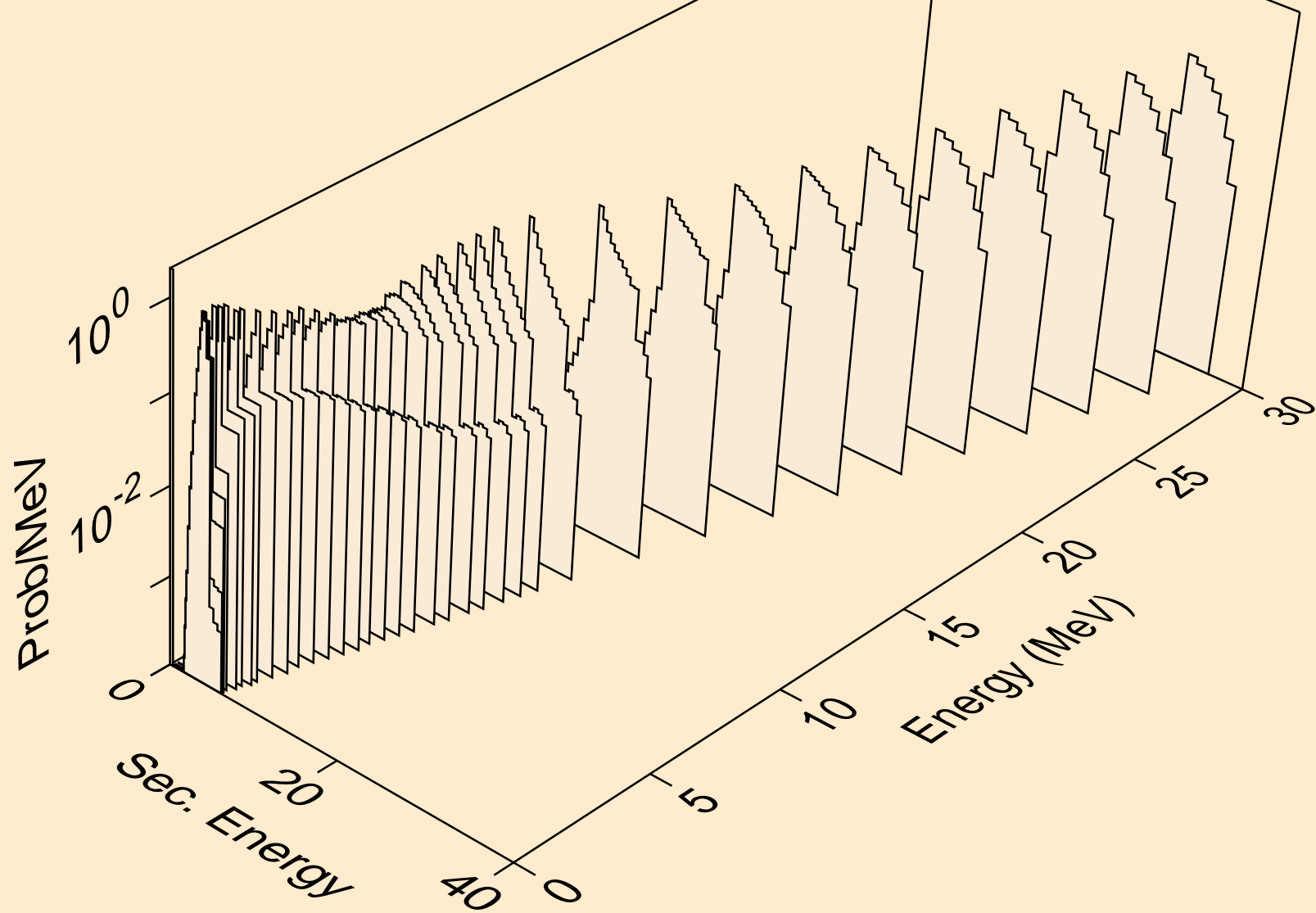

CD098 NEUTRON ACER TENDL-2023 LIBRARY; T=0.K  
protons from (n,2p)

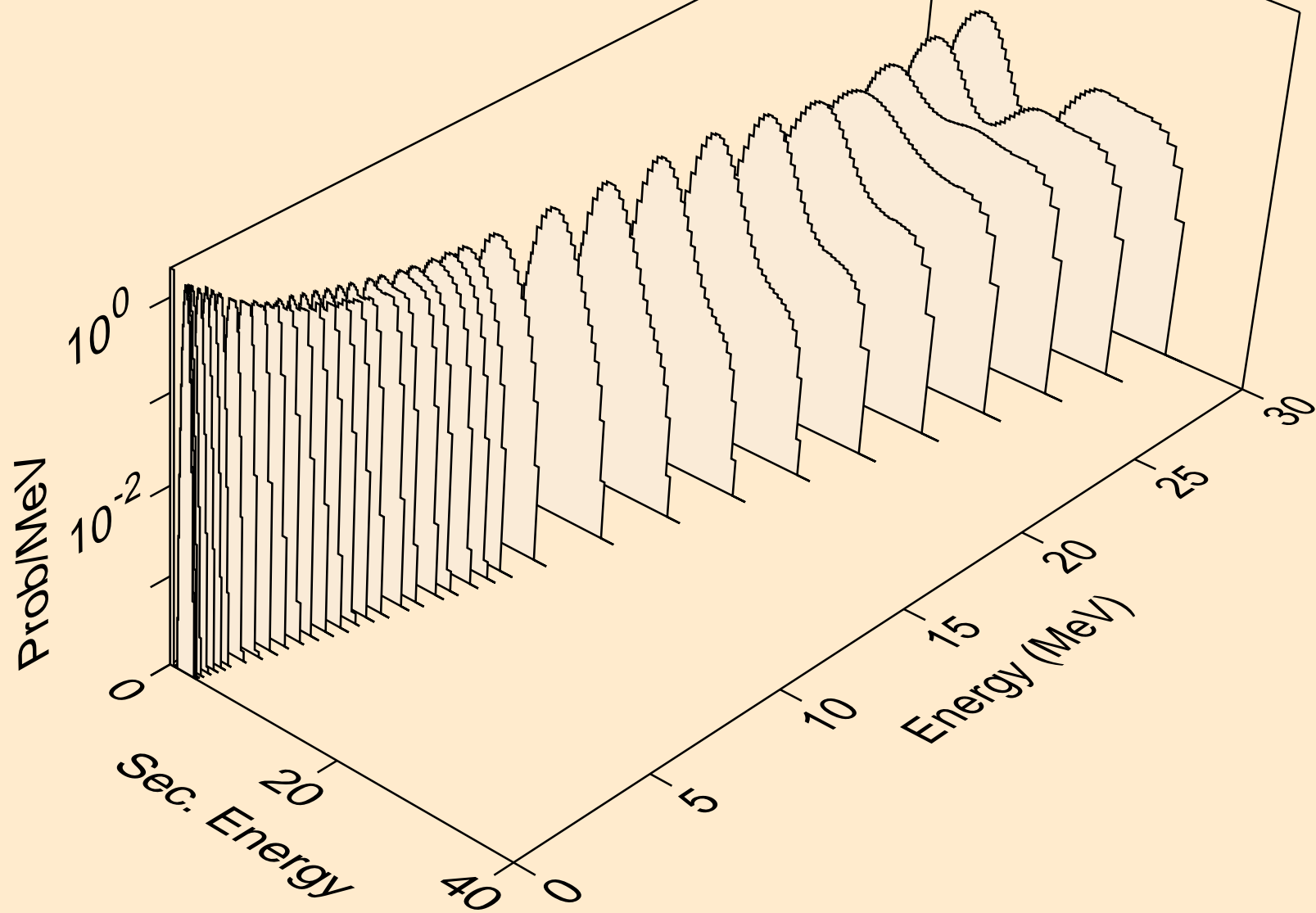

CD098 NEUTRON ACER TENDL-2023 LIBRARY; T=0.K  
protons from (n,p)

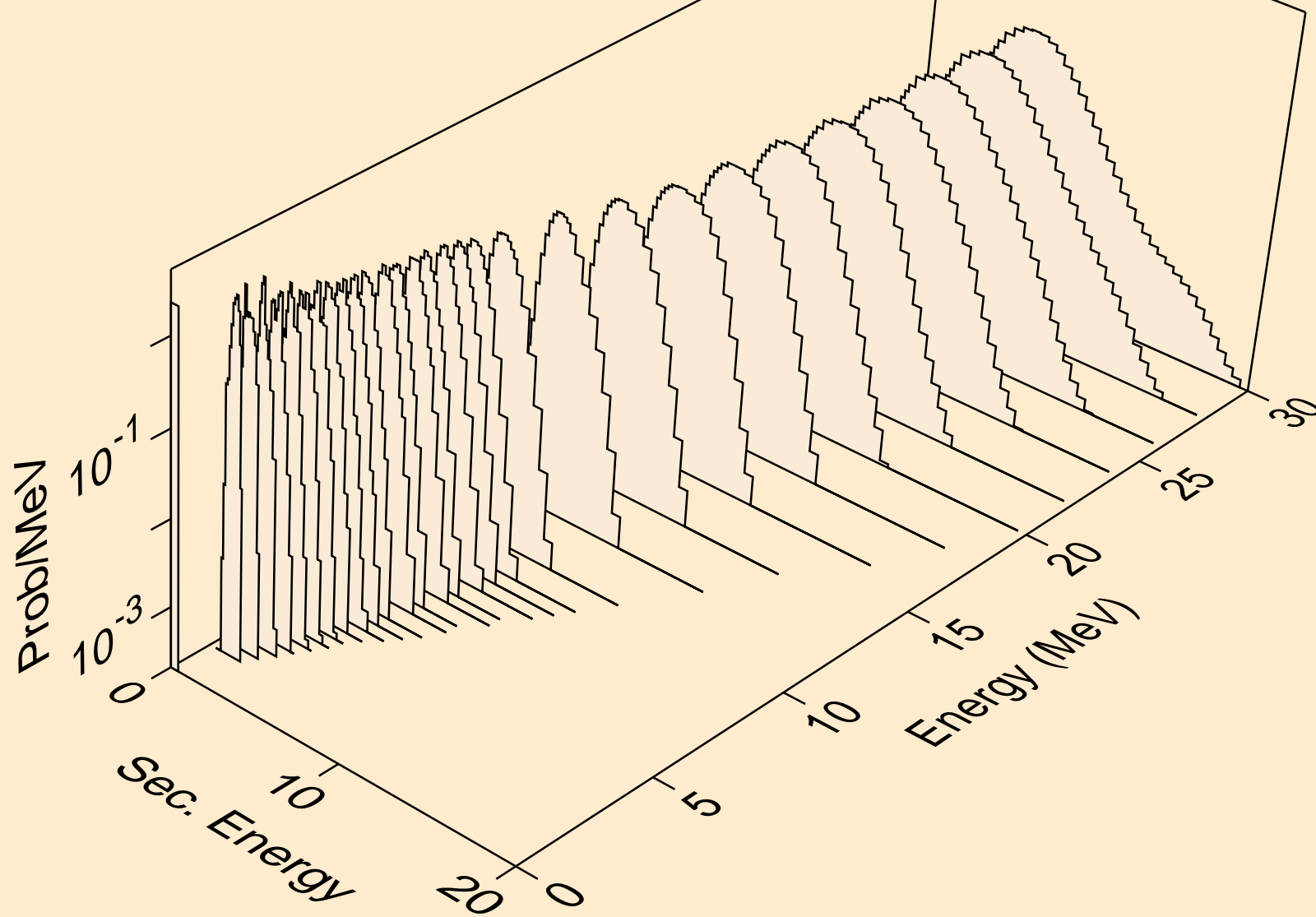

CD098 NEUTRON ACER TENDL-2023 LIBRARY; T=0.K  
protons from (n,pd)

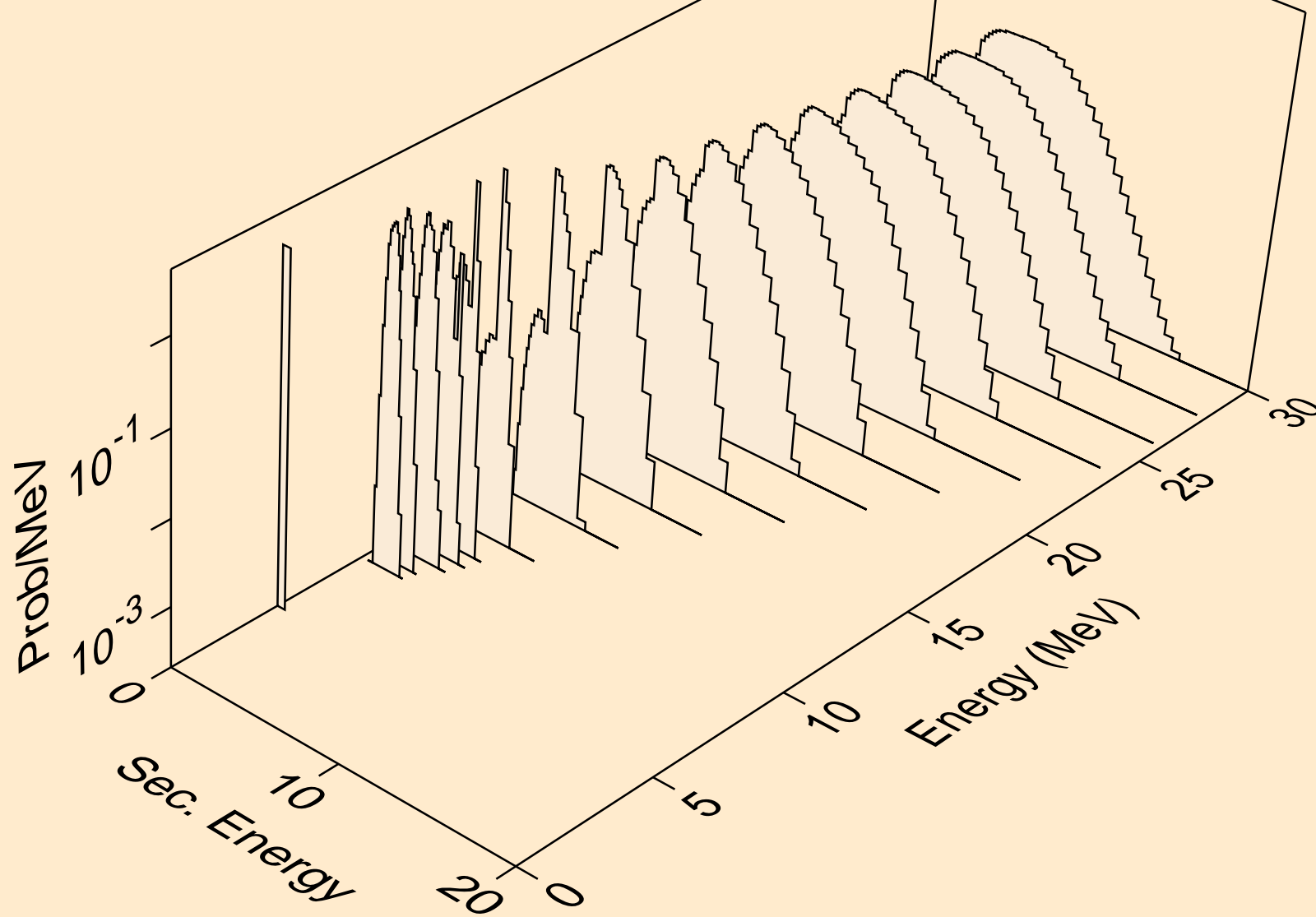

CD098 NEUTRON ACER TENDL-2023 LIBRARY; T=0.K  
protons from (n,pt)

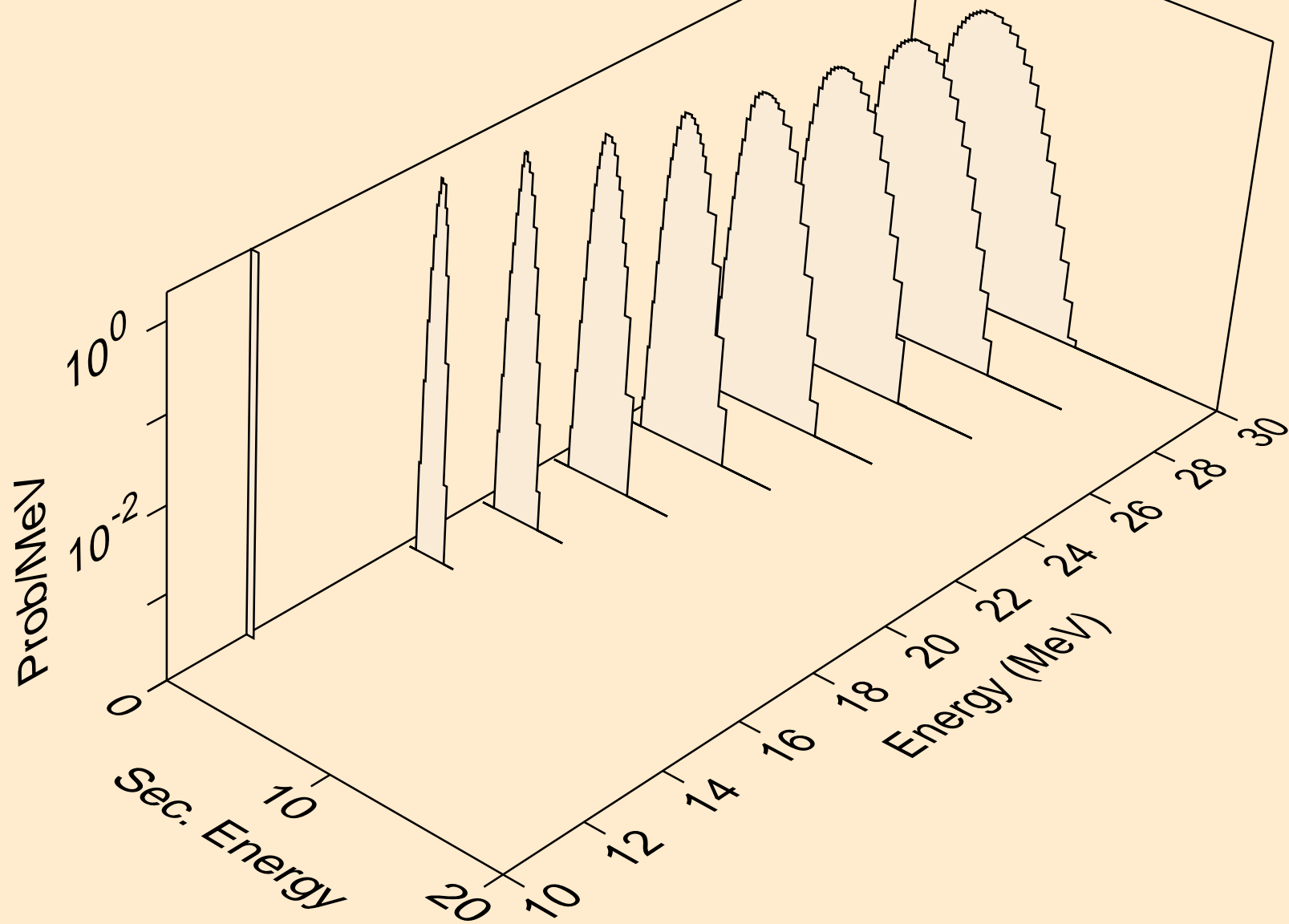

CD098 NEUTRON ACER TENDL-2023 LIBRARY; T=0.K  
deuterons from (n,x)

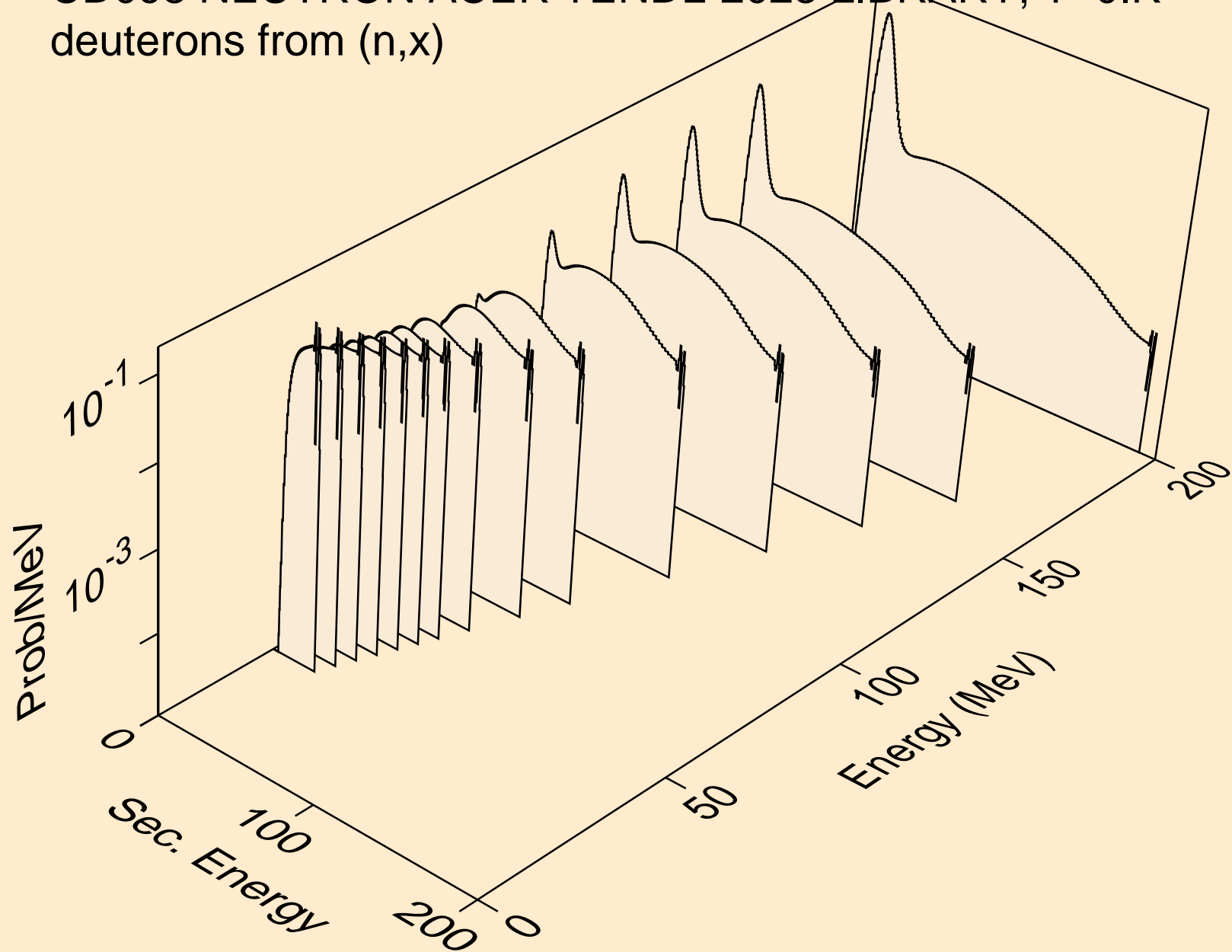

CD098 NEUTRON ACER TENDL-2023 LIBRARY; T=0.K  
deuterons from (n,n\*)d

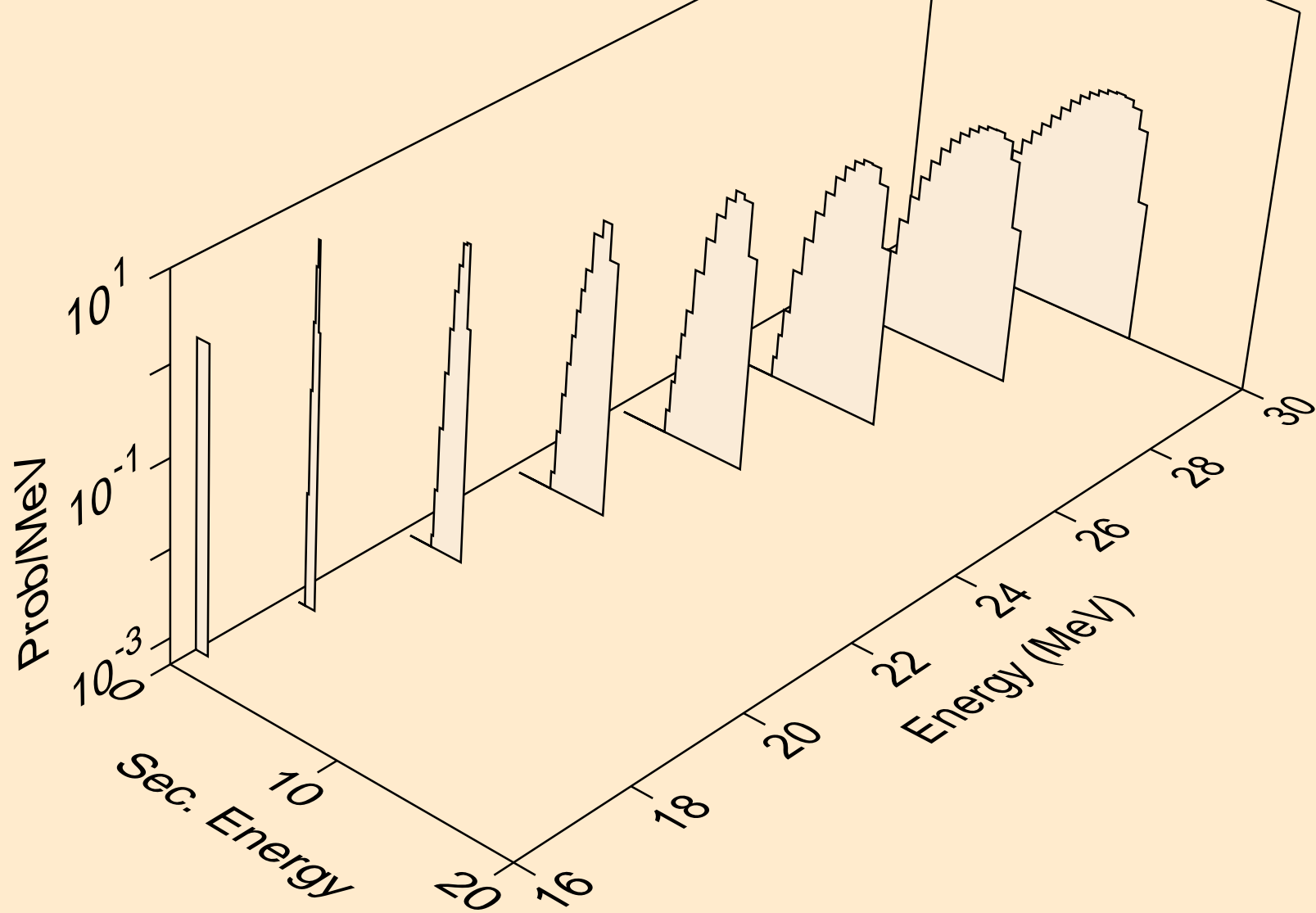

CD098 NEUTRON ACER TENDL-2023 LIBRARY; T=0.K  
deuterons from (n,d)

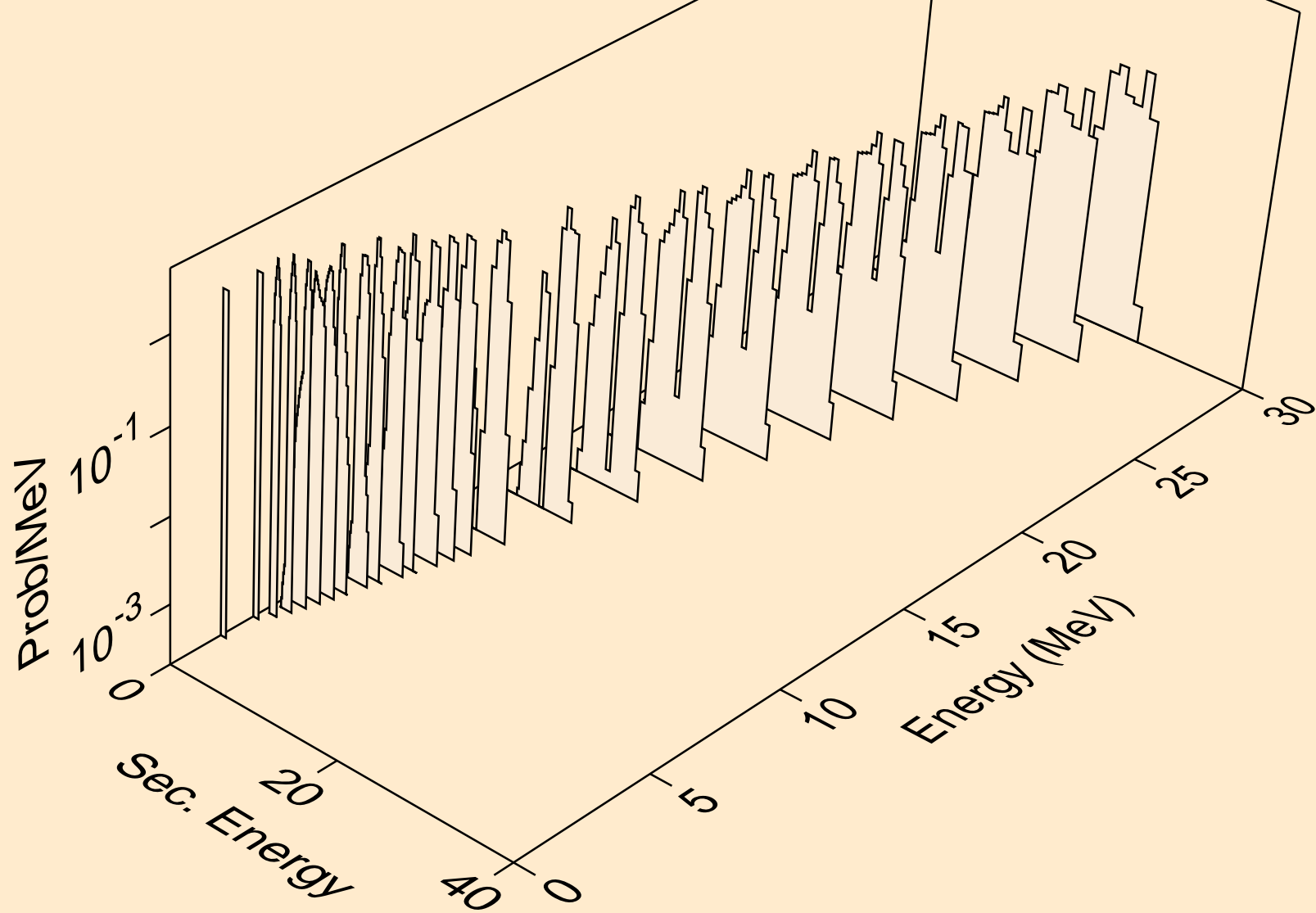

CD098 NEUTRON ACER TENDL-2023 LIBRARY; T=0.K  
deuterons from (n,pd)

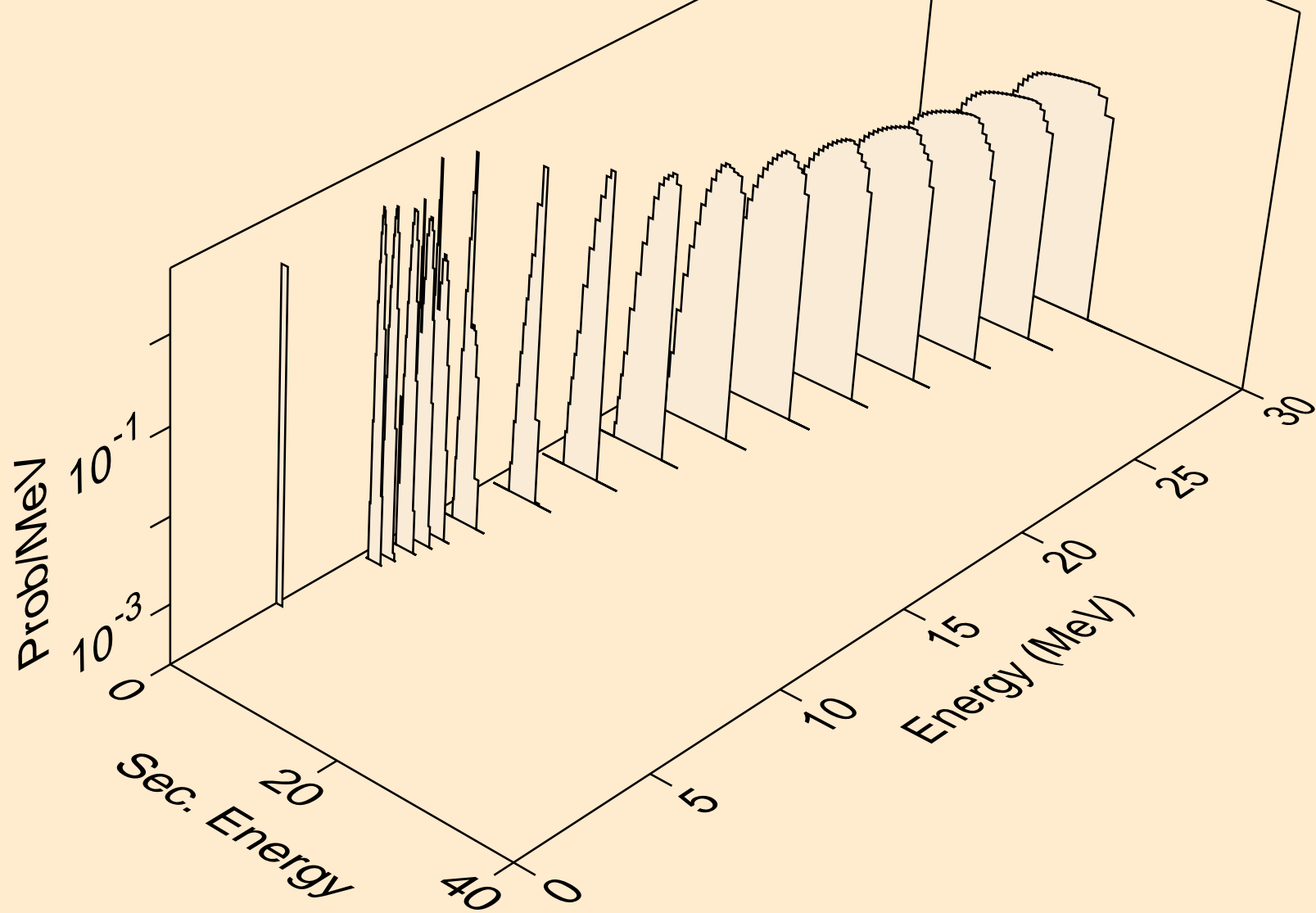

CD098 NEUTRON ACER TENDL-2023 LIBRARY; T=0.K  
deuterons from (n,da)

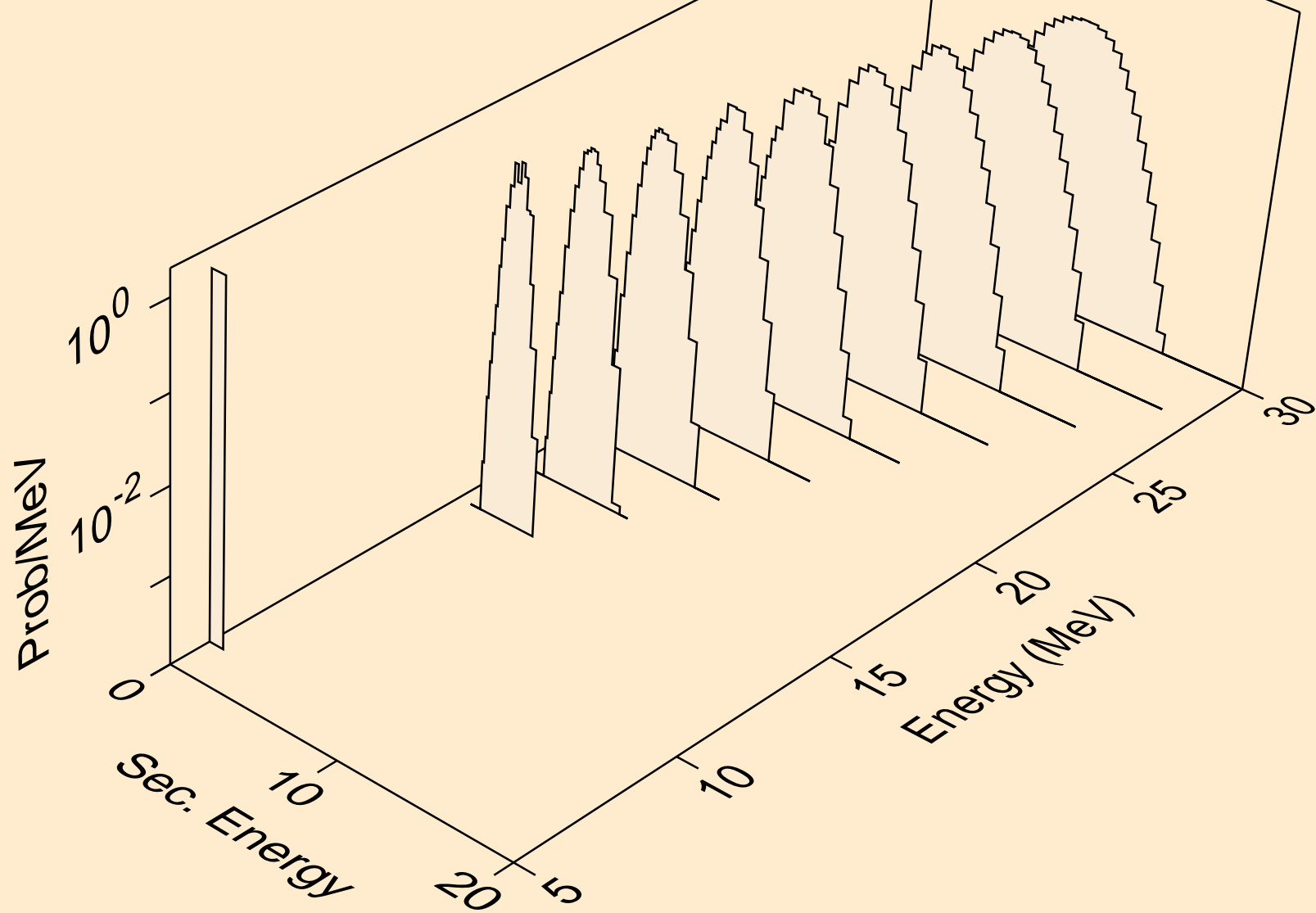

CD098 NEUTRON ACER TENDL-2023 LIBRARY; T=0.K  
tritons from (n,x)

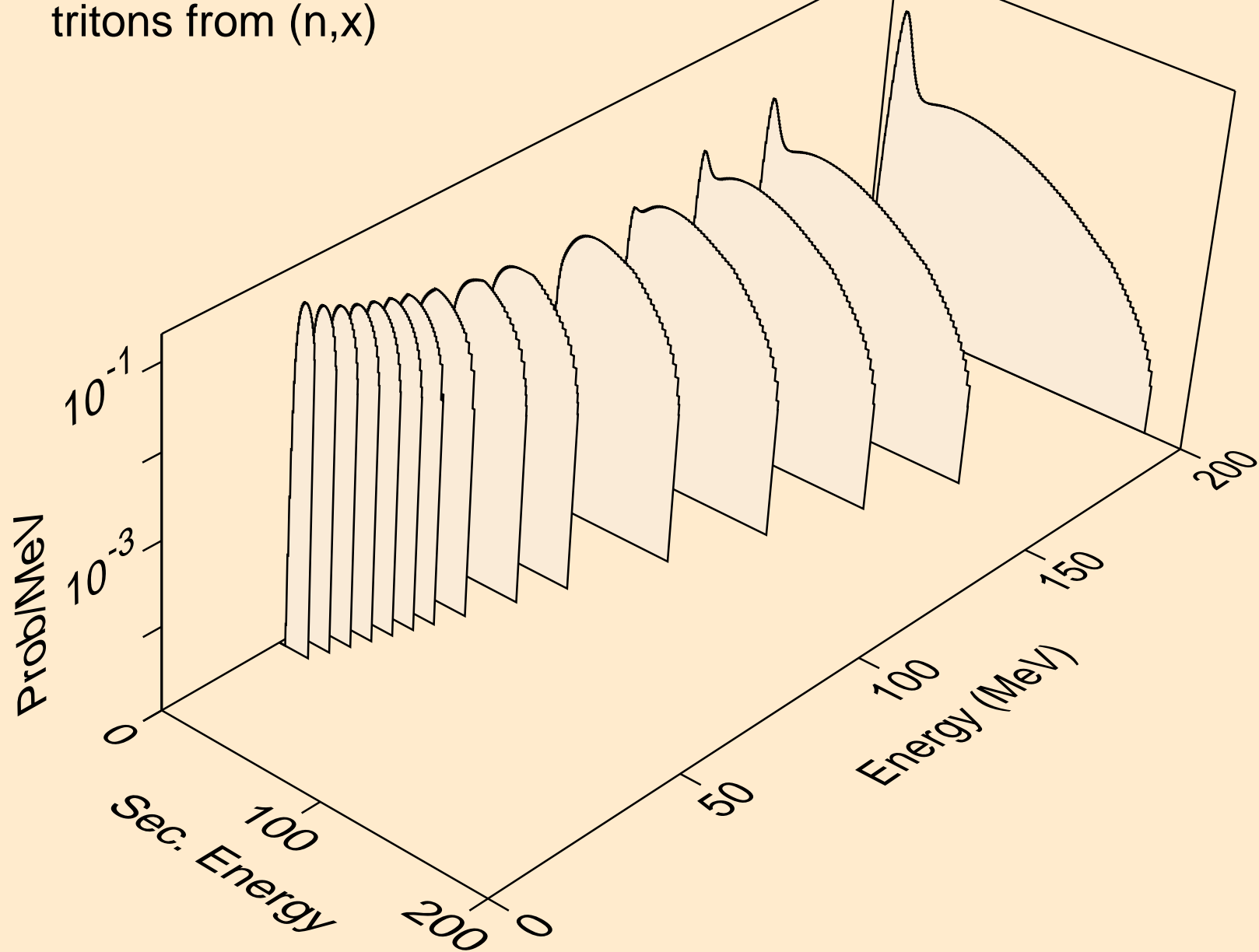

CD098 NEUTRON ACER TENDL-2023 LIBRARY; T=0.K  
tritons from (n,n\*)t

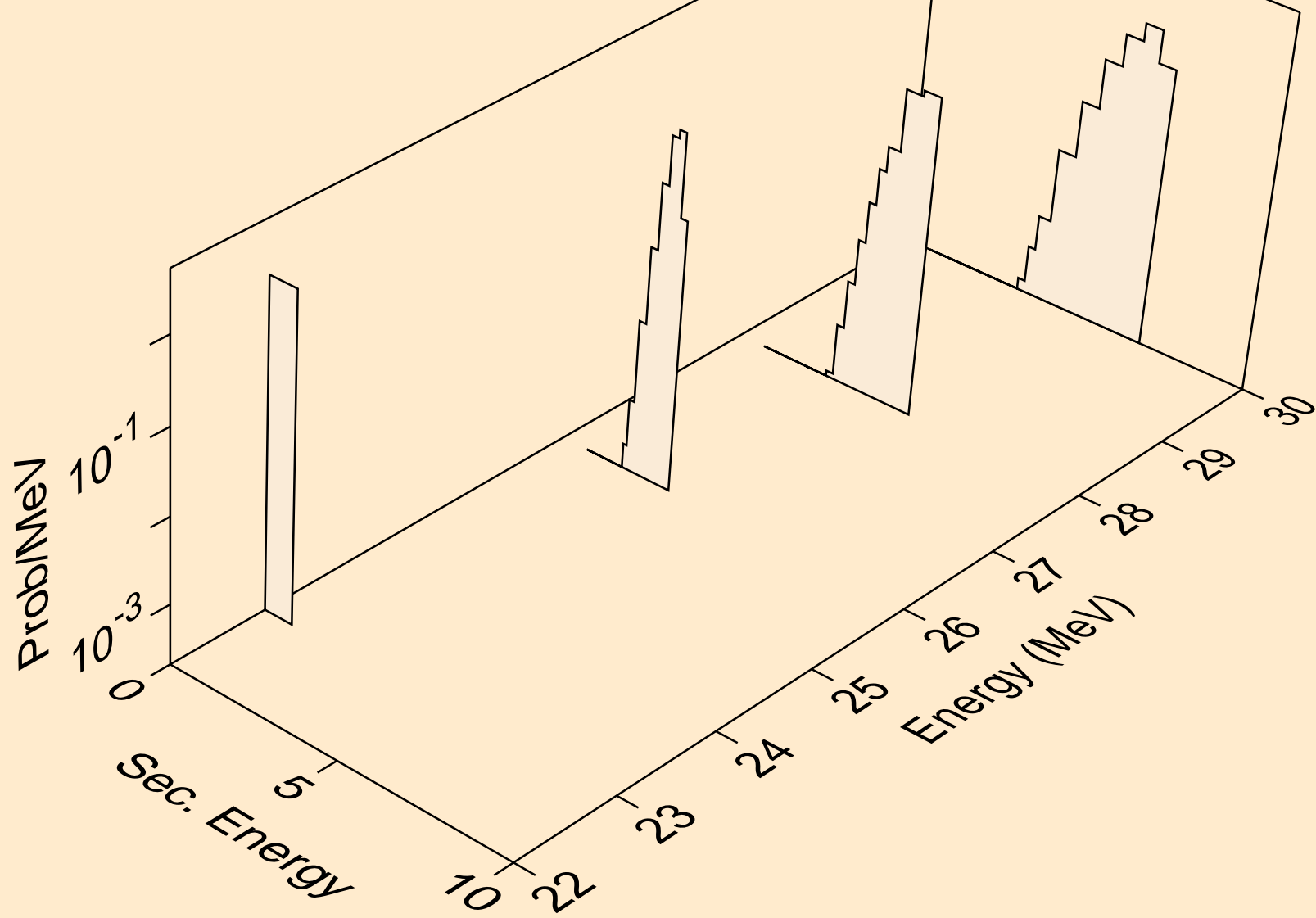

CD098 NEUTRON ACER TENDL-2023 LIBRARY; T=0.K  
tritons from (n,t)

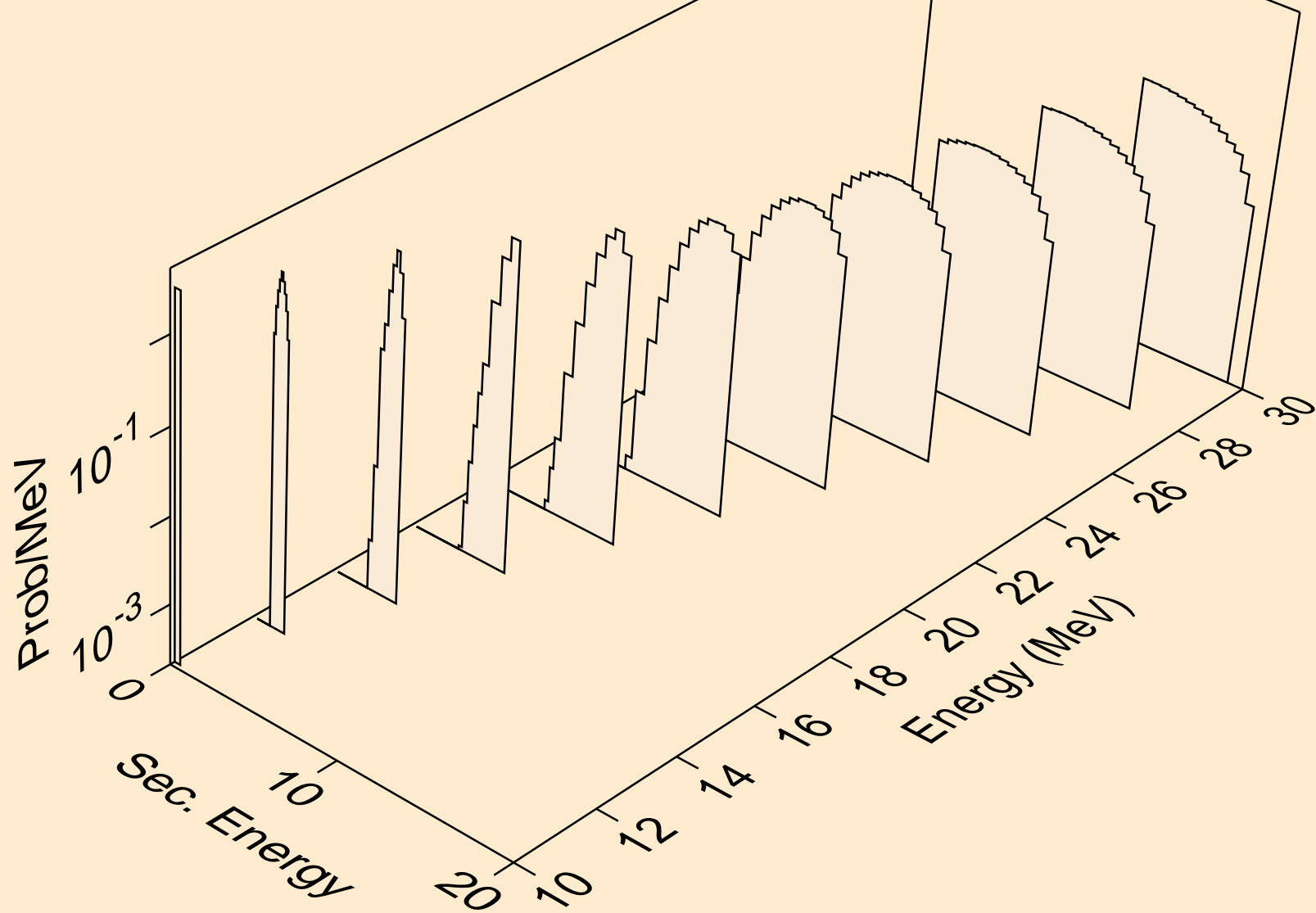

CD098 NEUTRON ACER TENDL-2023 LIBRARY; T=0.K  
tritons from (n,pt)

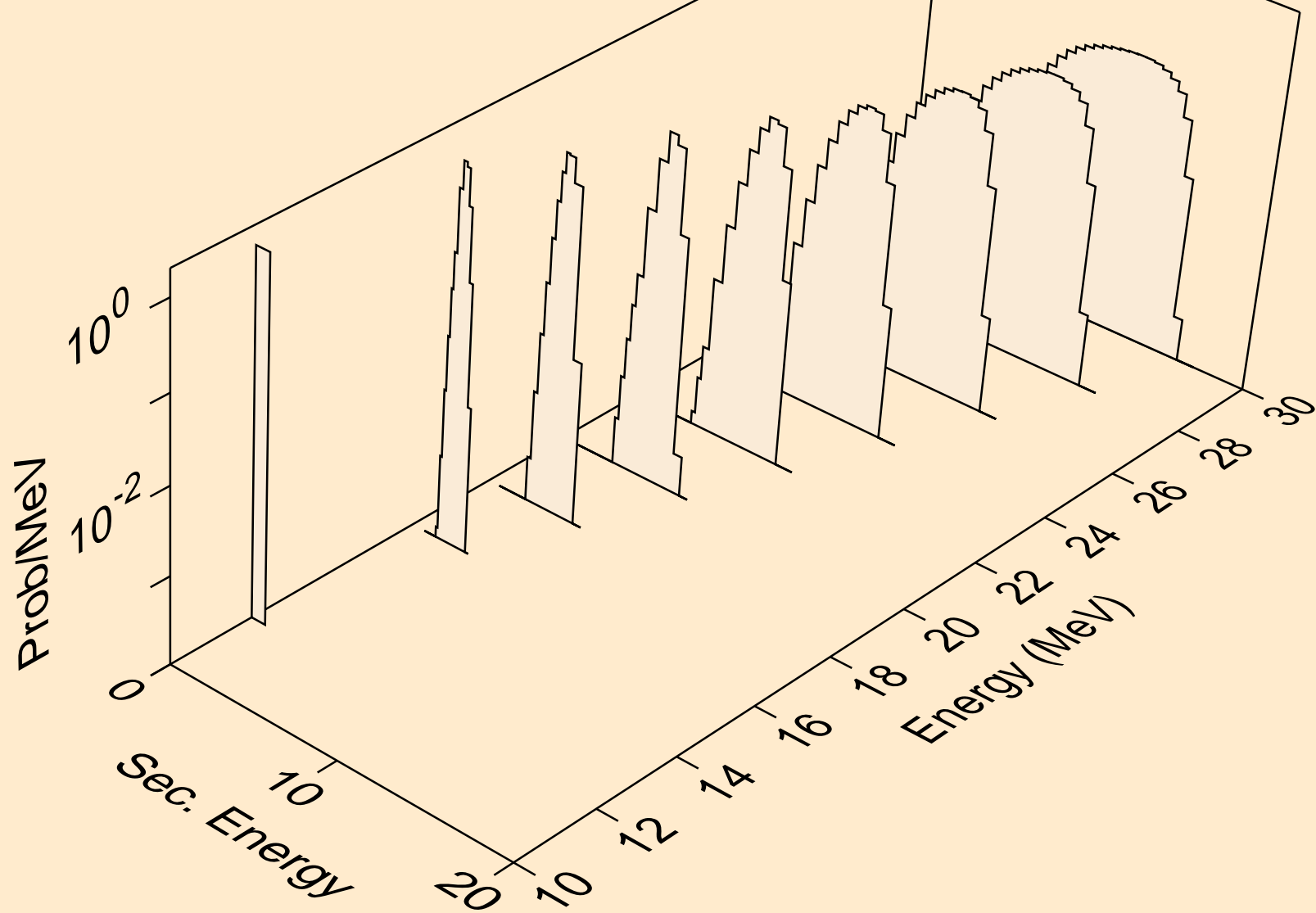

CD098 NEUTRON ACER TENDL-2023 LIBRARY; T=0.K  
he3s from (n,x)

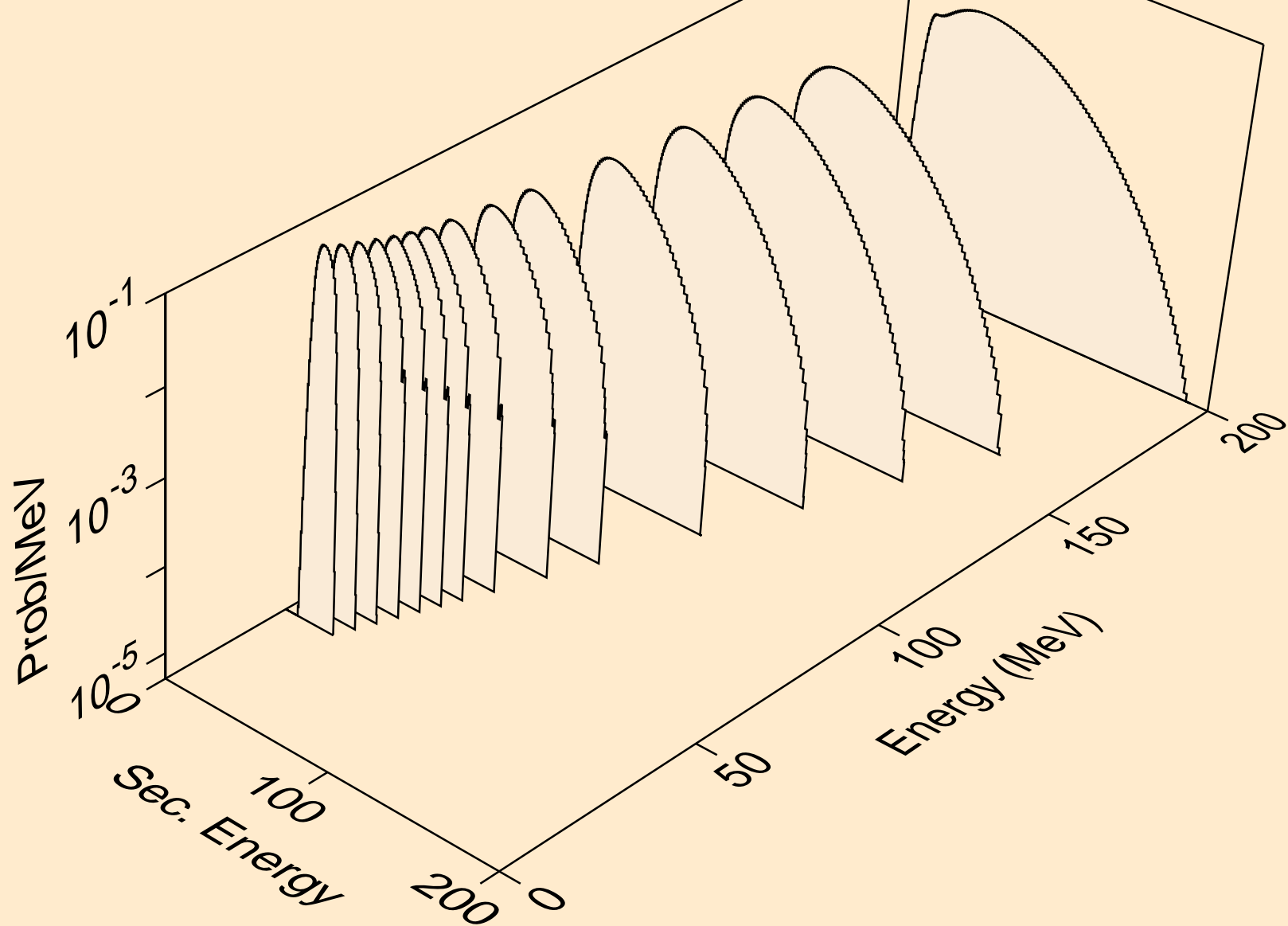

CD098 NEUTRON ACER TENDL-2023 LIBRARY; T=0.K  
he3s from (n,n\*)he3

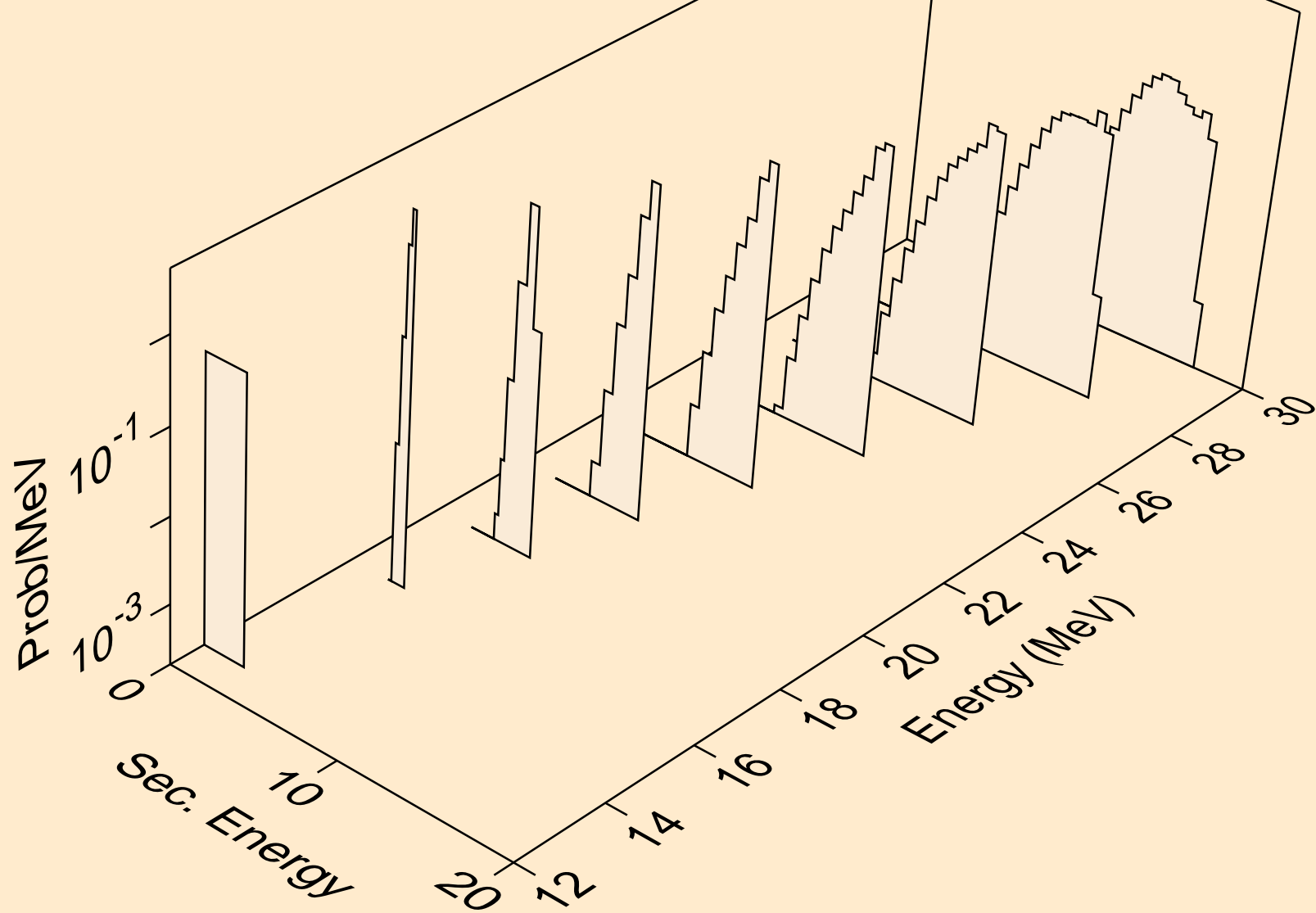

CD098 NEUTRON ACER TENDL-2023 LIBRARY; T=0.K  
he3s from (n,he3)

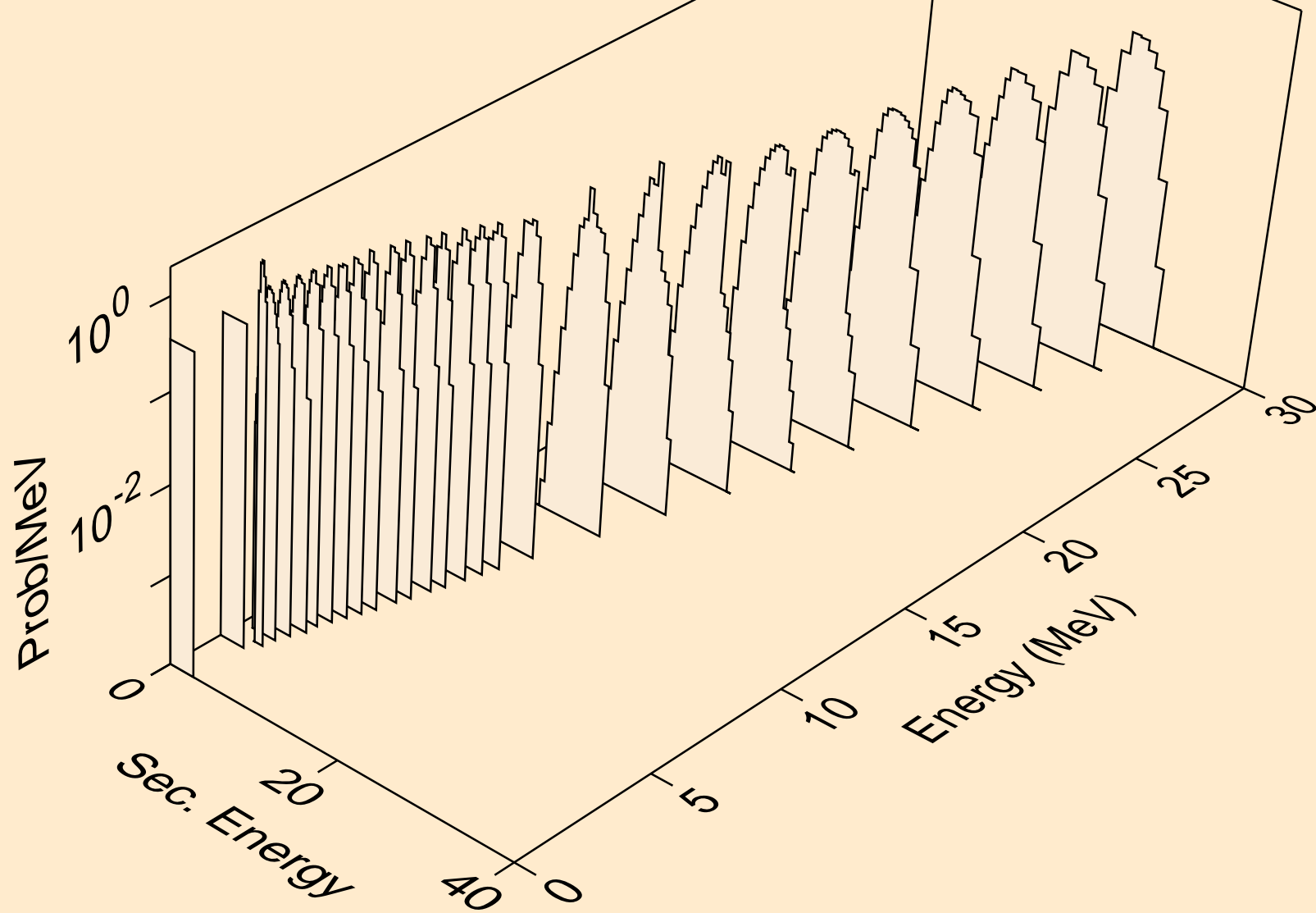

CD098 NEUTRON ACER TENDL-2023 LIBRARY; T=0.K  
alphas from (n,x)

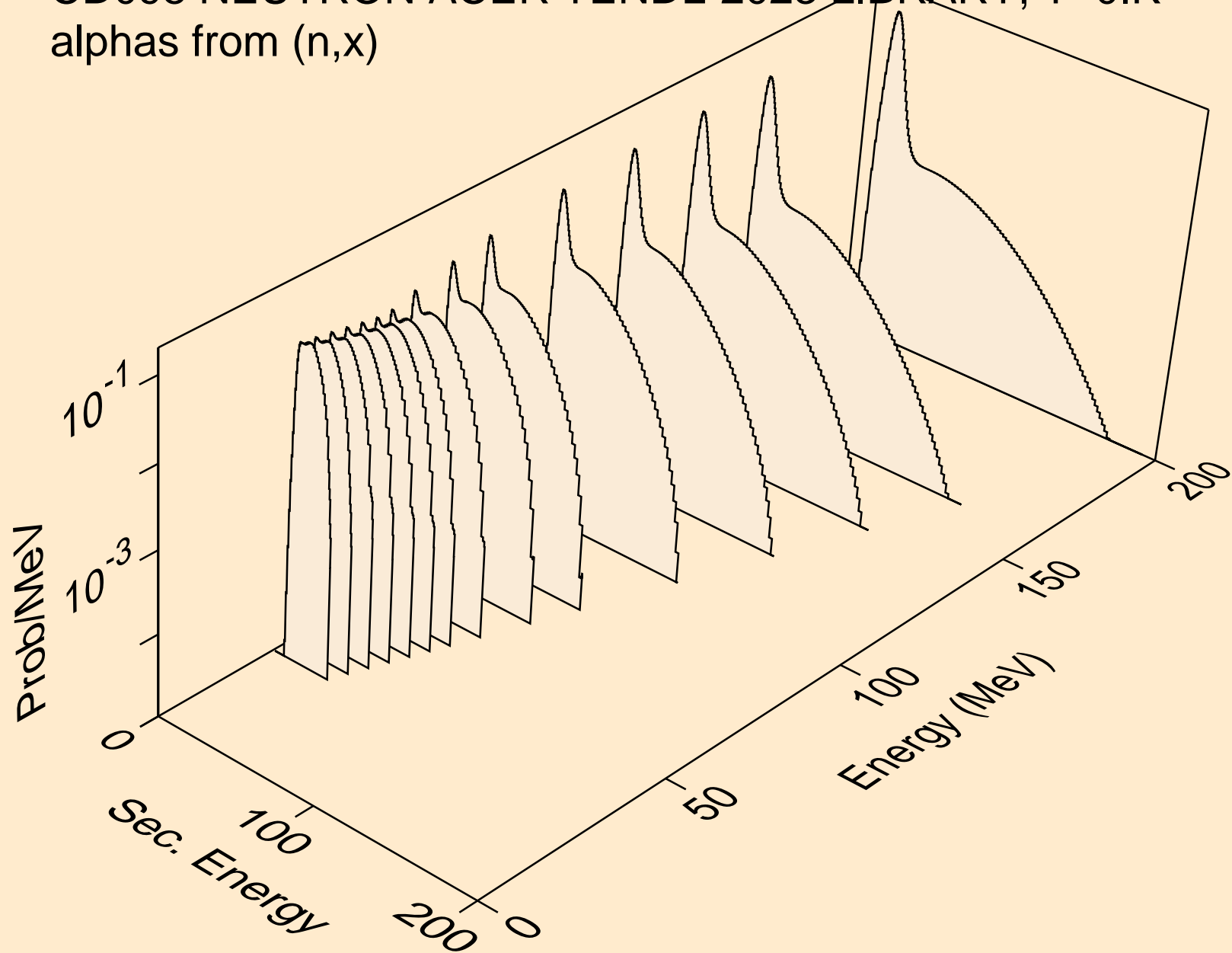

CD098 NEUTRON ACER TENDL-2023 LIBRARY; T=0.K  
alphas from (n,n\*)a

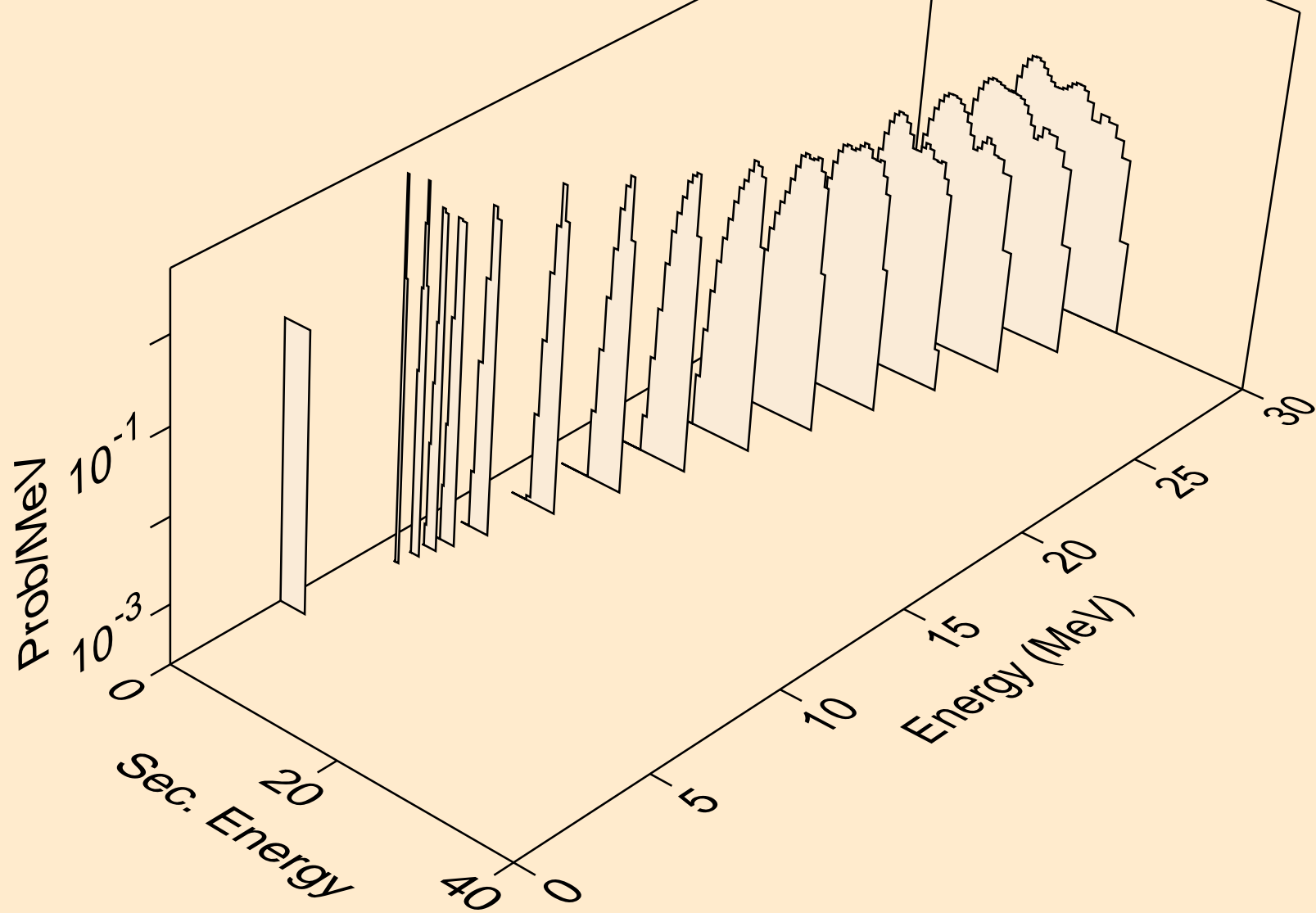

CD098 NEUTRON ACER TENDL-2023 LIBRARY; T=0.K  
alphas from (n,2n)a

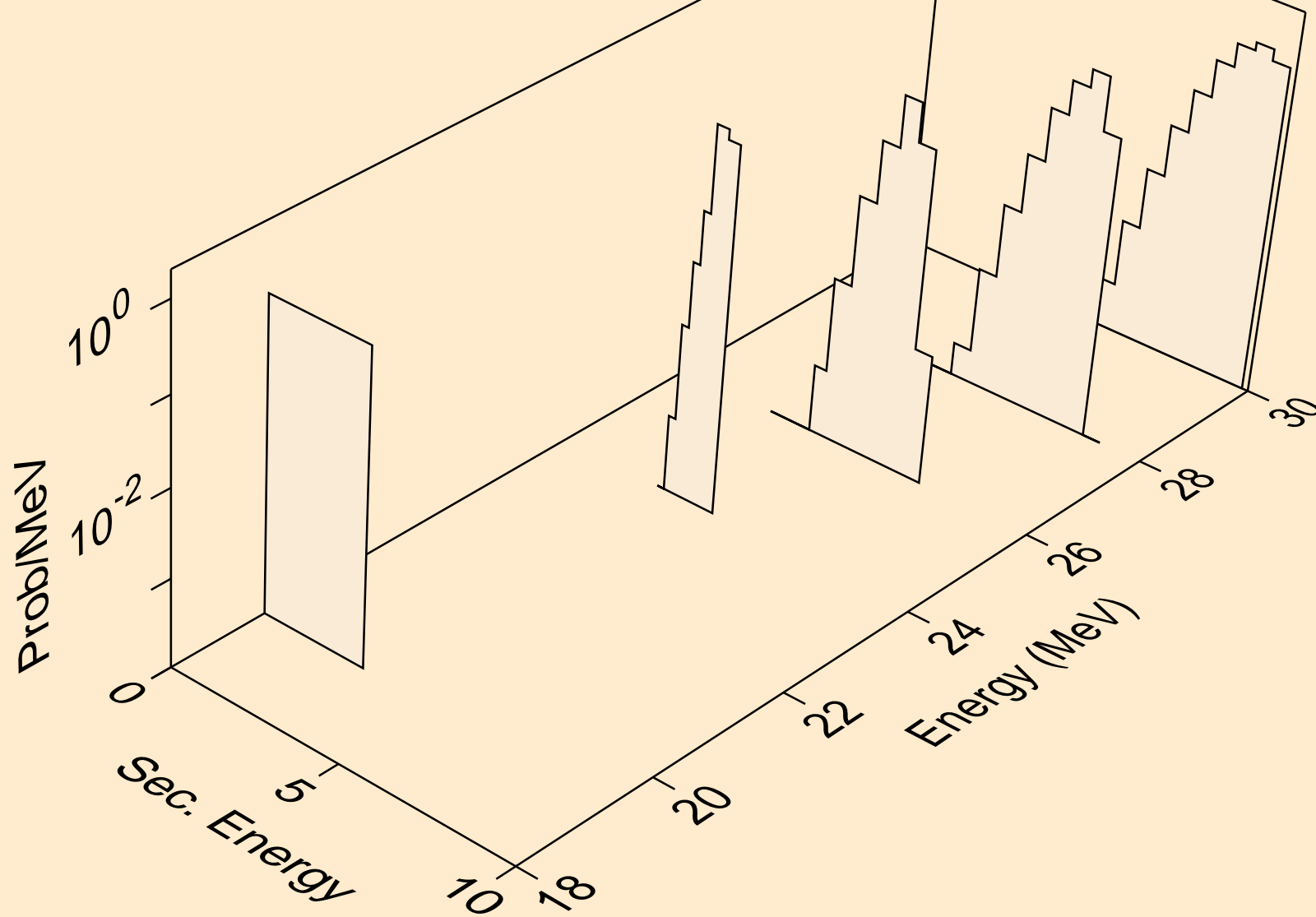

CD098 NEUTRON ACER TENDL-2023 LIBRARY; T=0.K  
alphas from (n,n\*)2a

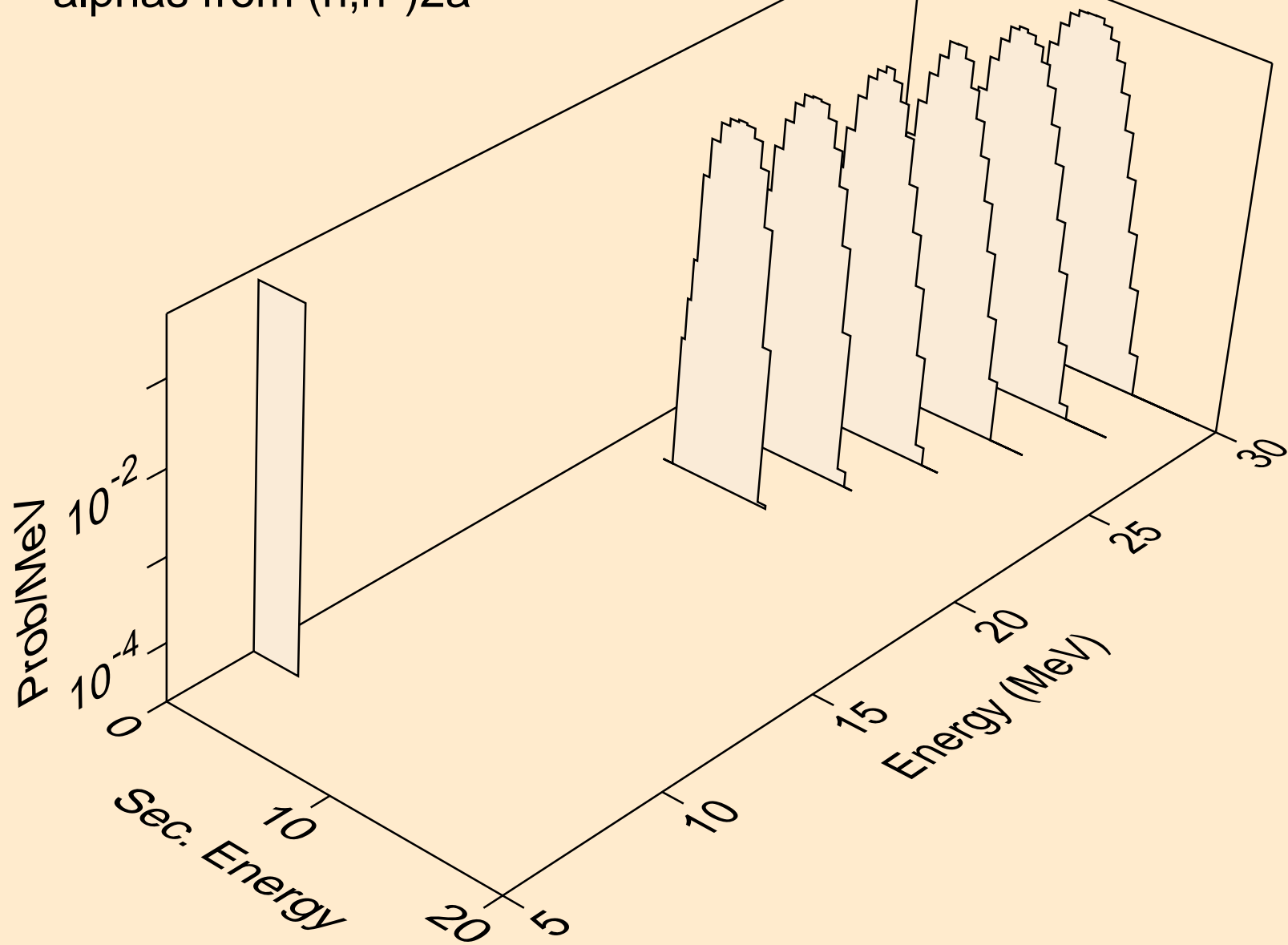

CD098 NEUTRON ACER TENDL-2023 LIBRARY; T=0.K  
alphas from (n,npa)

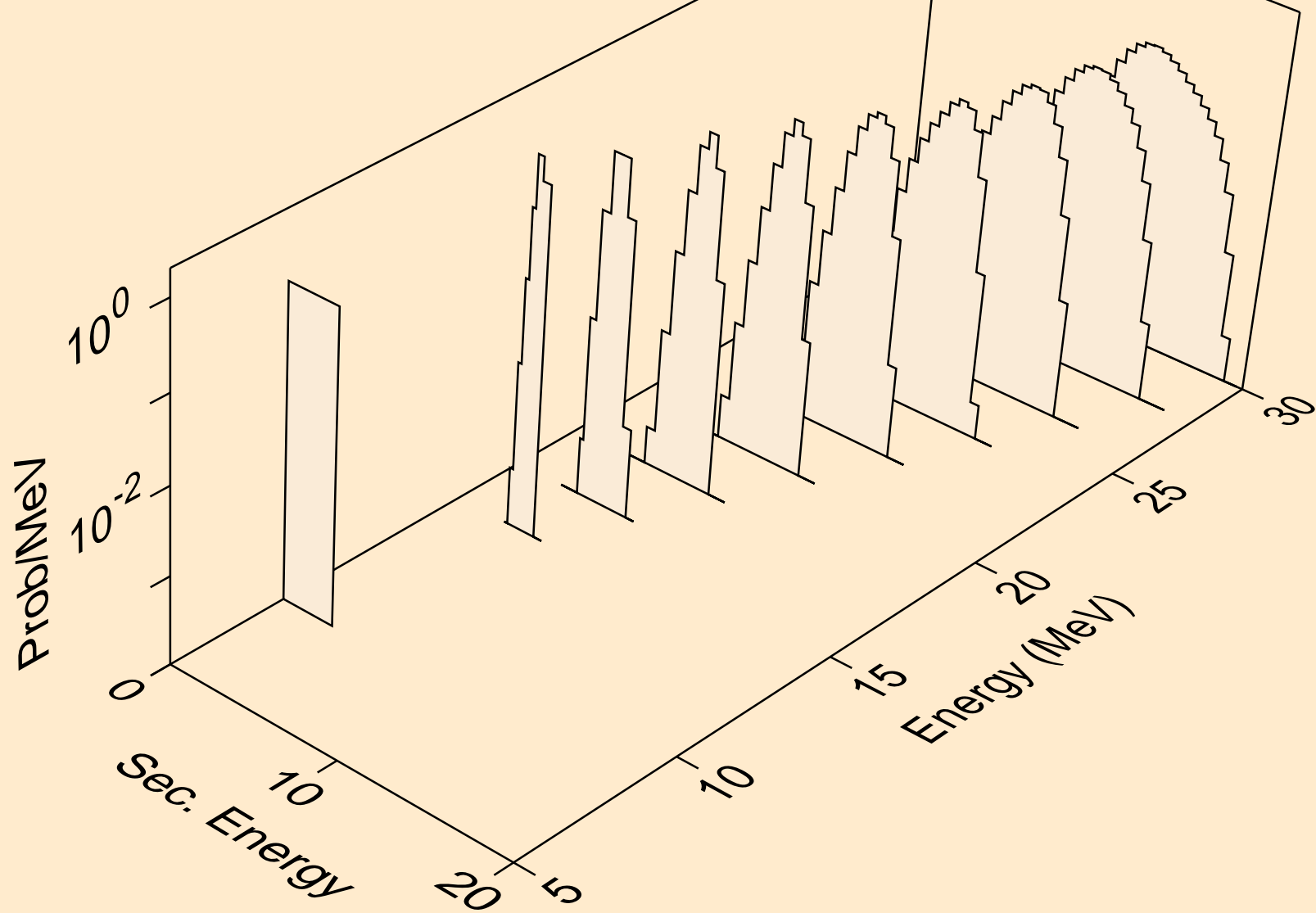

CD098 NEUTRON ACER TENDL-2023 LIBRARY; T=0.K  
alphas from (n,a)

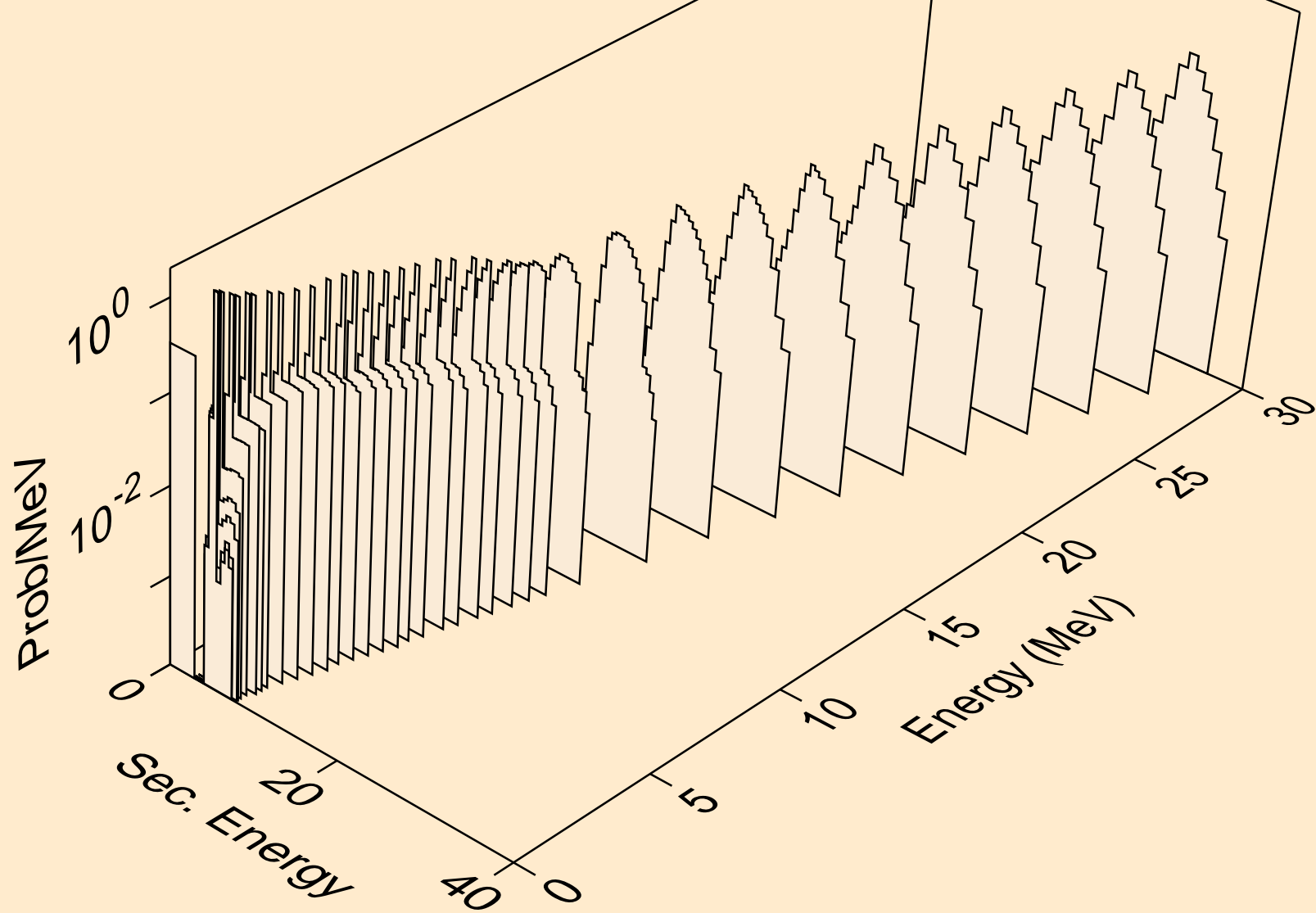

CD098 NEUTRON ACER TENDL-2023 LIBRARY; T=0.K  
alphas from (n,2a)

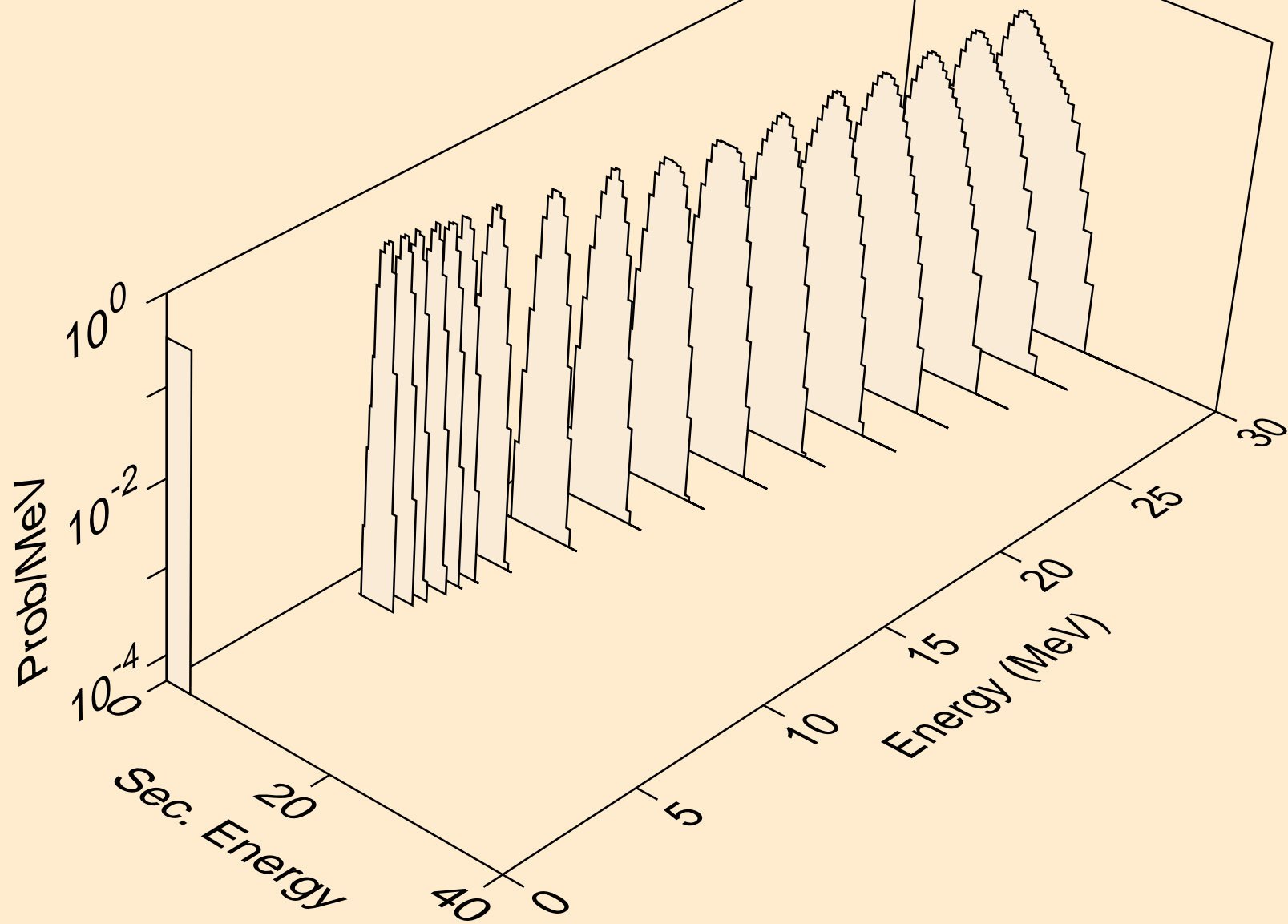

CD098 NEUTRON ACER TENDL-2023 LIBRARY; T=0.K  
alphas from (n,pa)

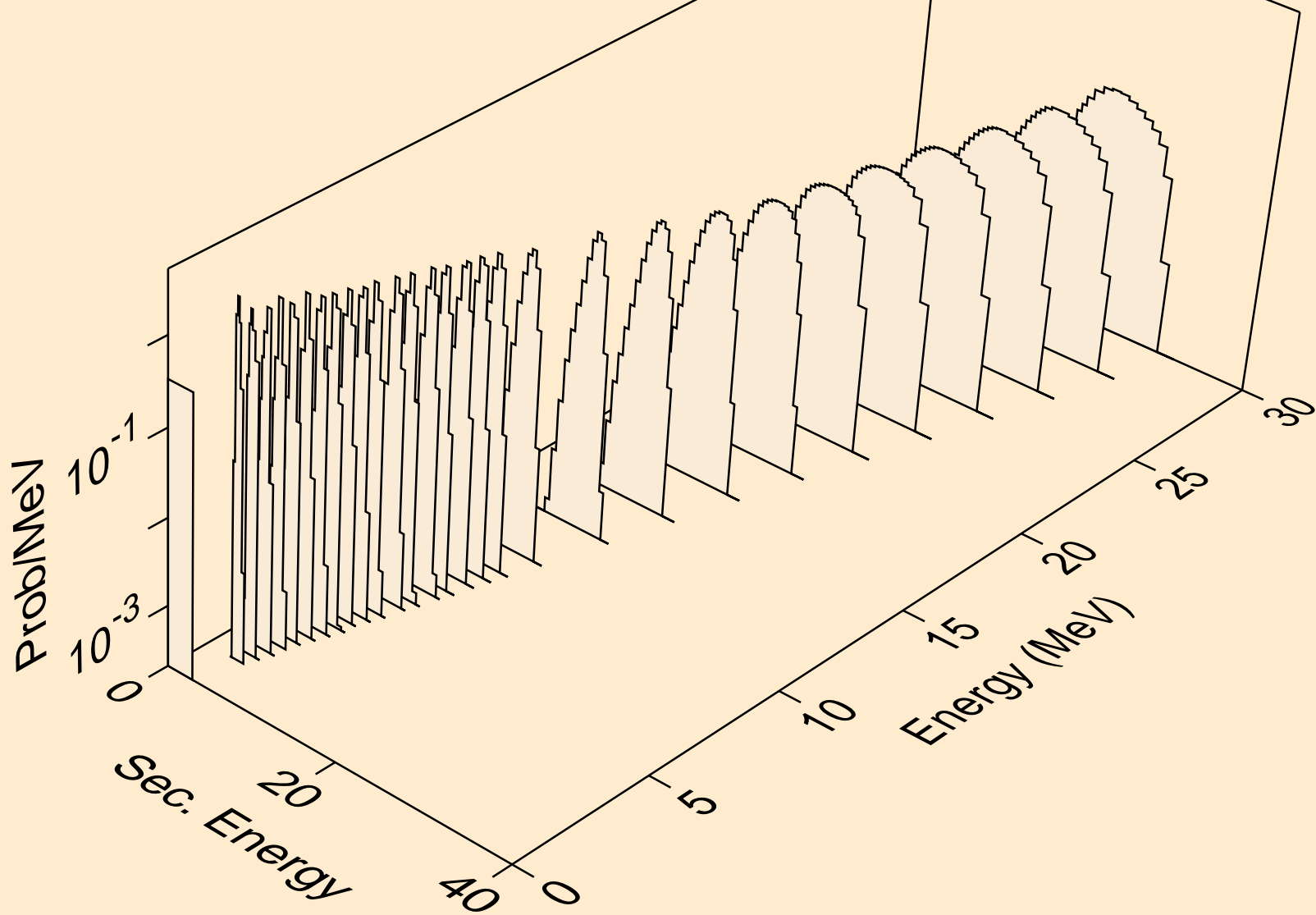

CD098 NEUTRON ACER TENDL-2023 LIBRARY; T=0.K  
alphas from (n,da)

