

# CF252 NEUTRON ACER TENDL-2023 LIBRARY; T=0.K

## Principal cross sections

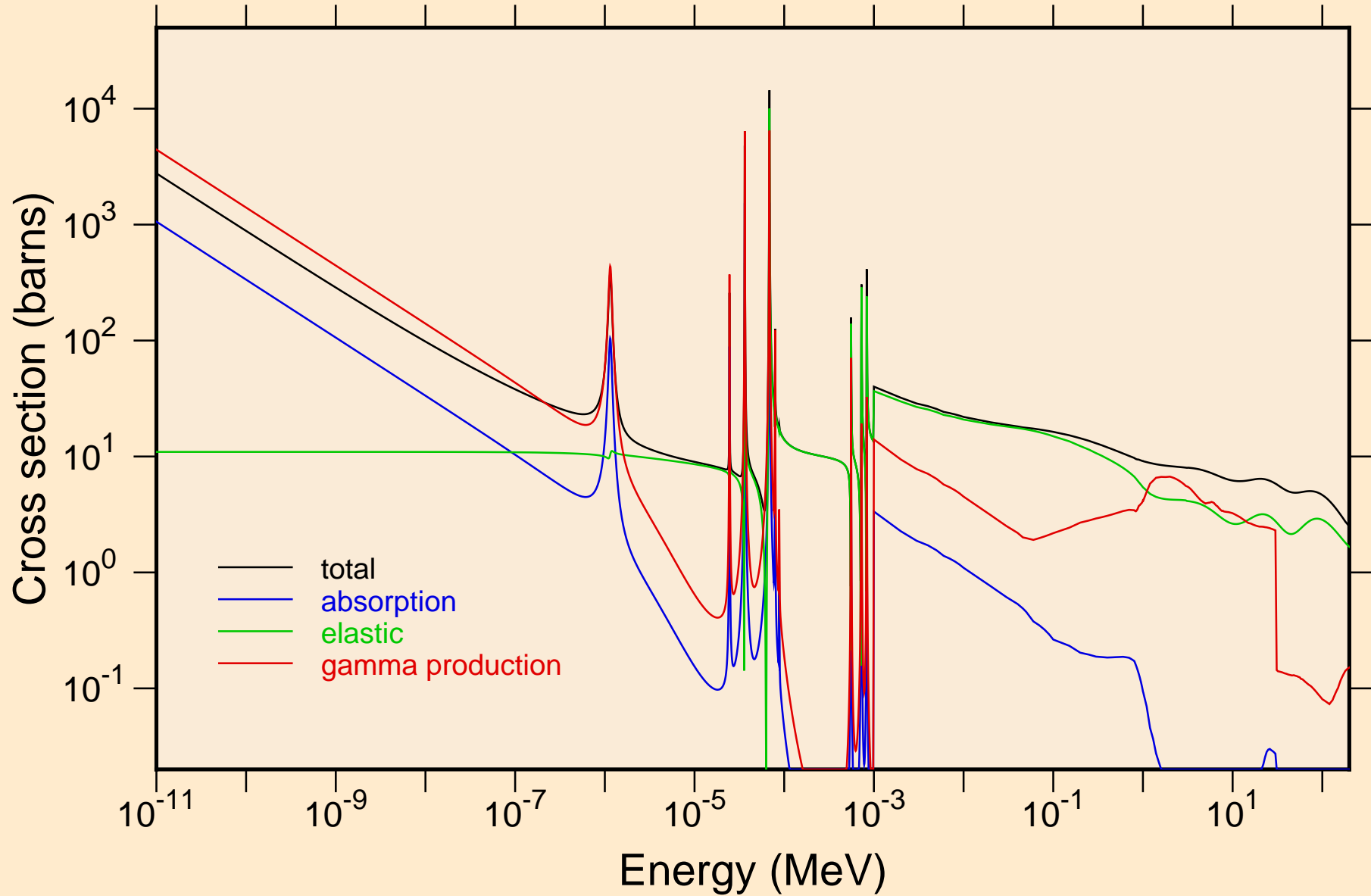

CF252 NEUTRON ACER TENDL-2023 LIBRARY; T=0.K  
resonance total cross section

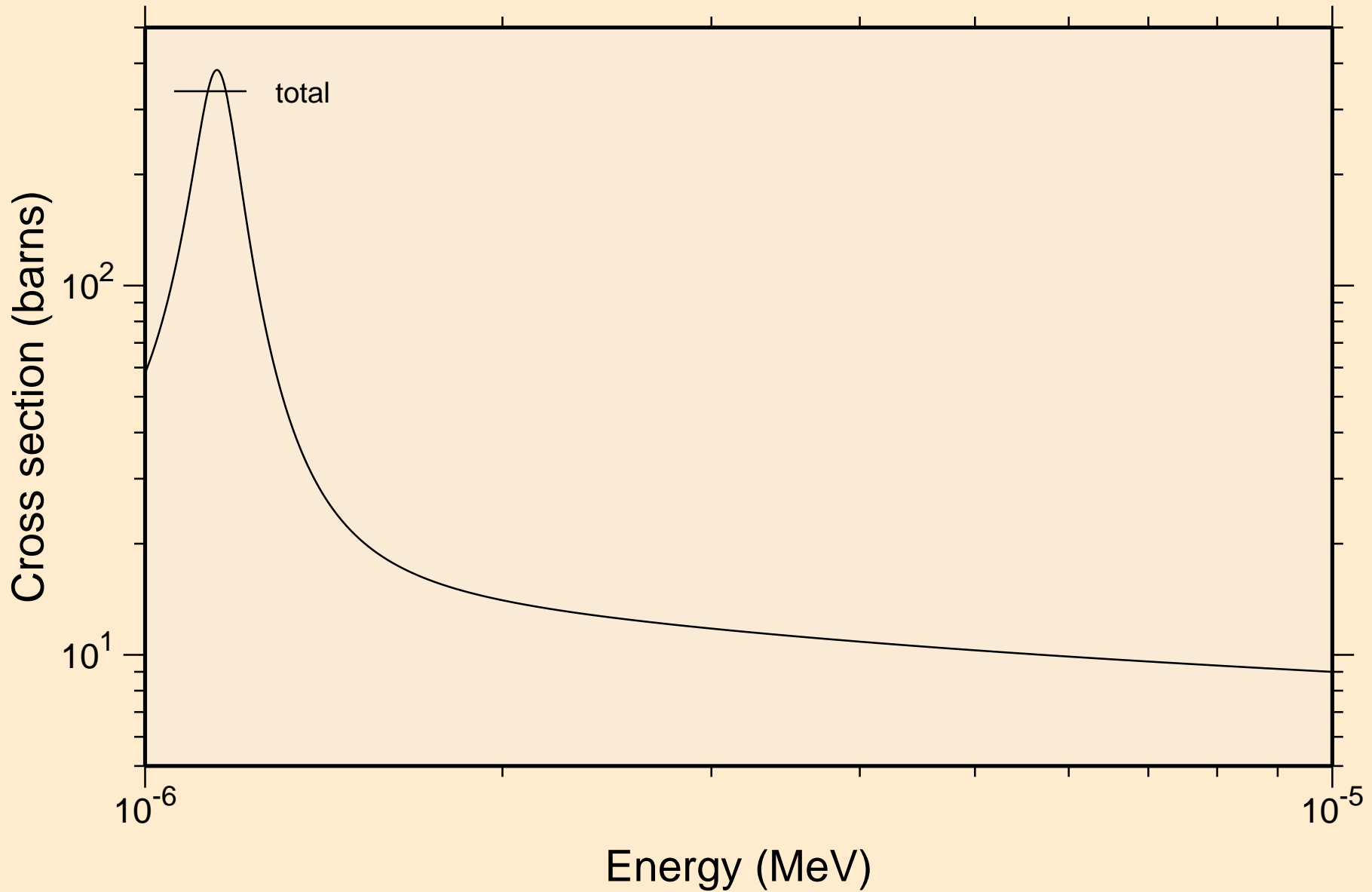

CF252 NEUTRON ACER TENDL-2023 LIBRARY; T=0.K  
resonance total cross section

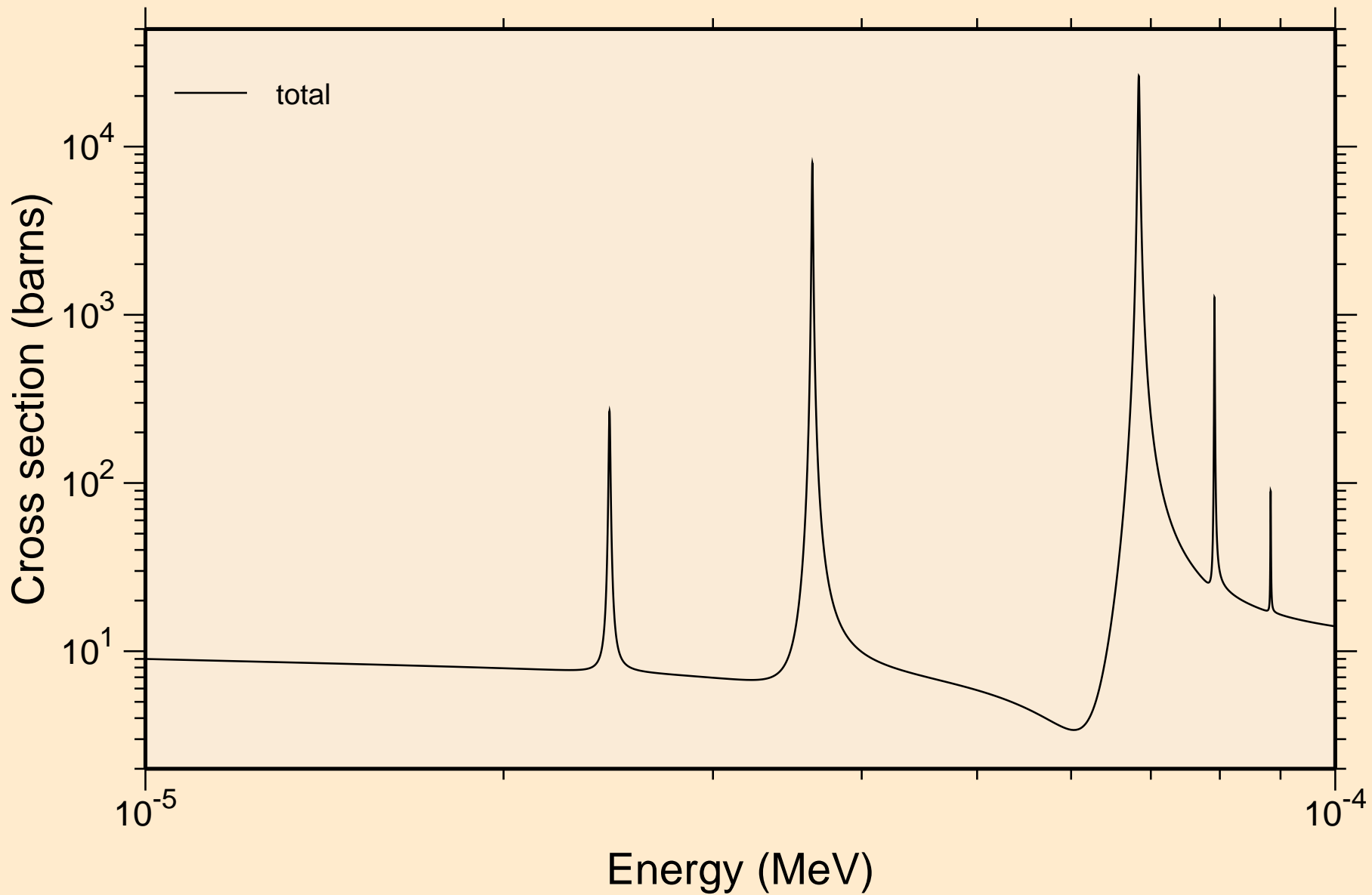

CF252 NEUTRON ACER TENDL-2023 LIBRARY; T=0.K  
resonance total cross section

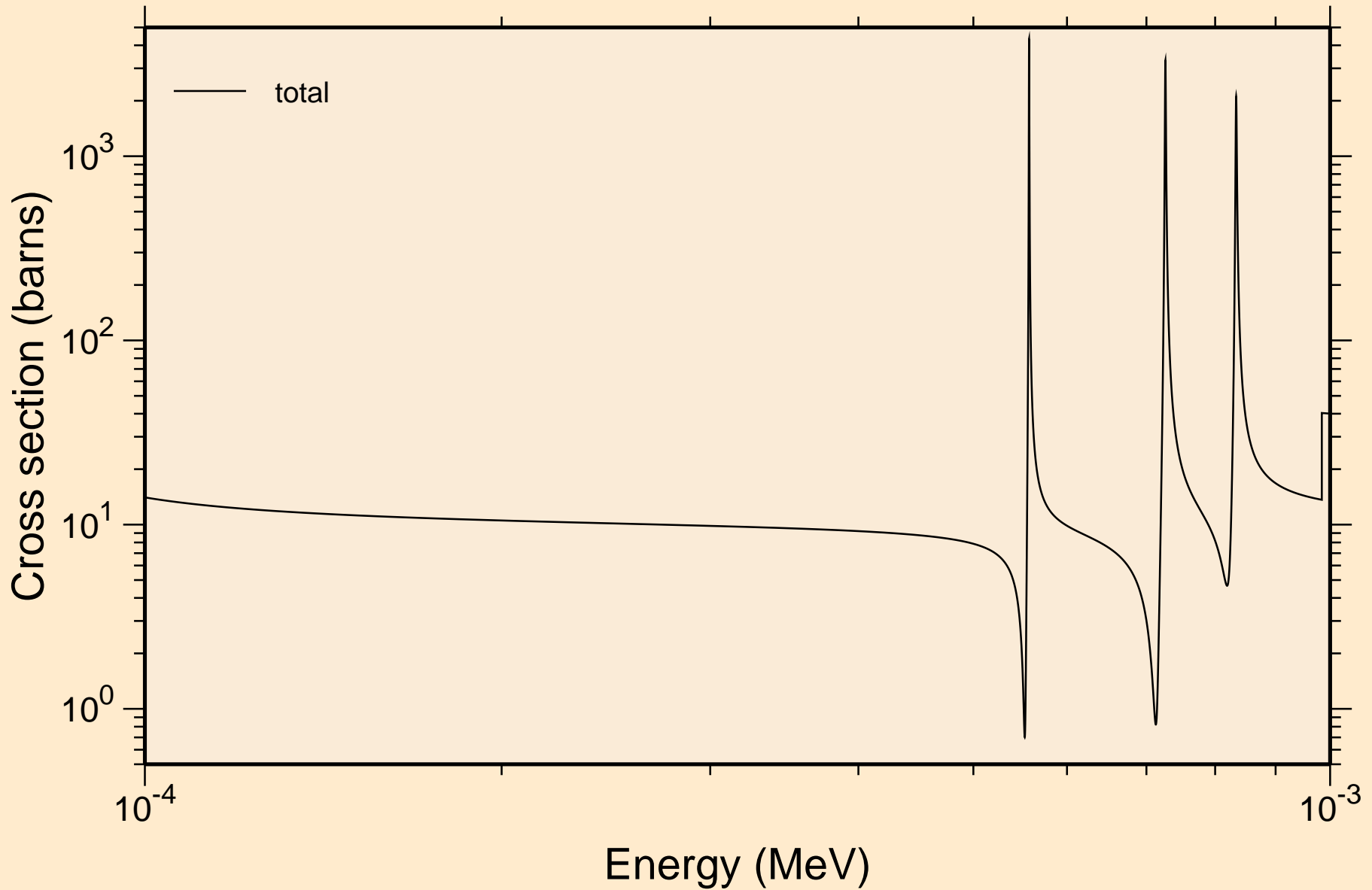

CF252 NEUTRON ACER TENDL-2023 LIBRARY; T=0.K  
resonance total cross section

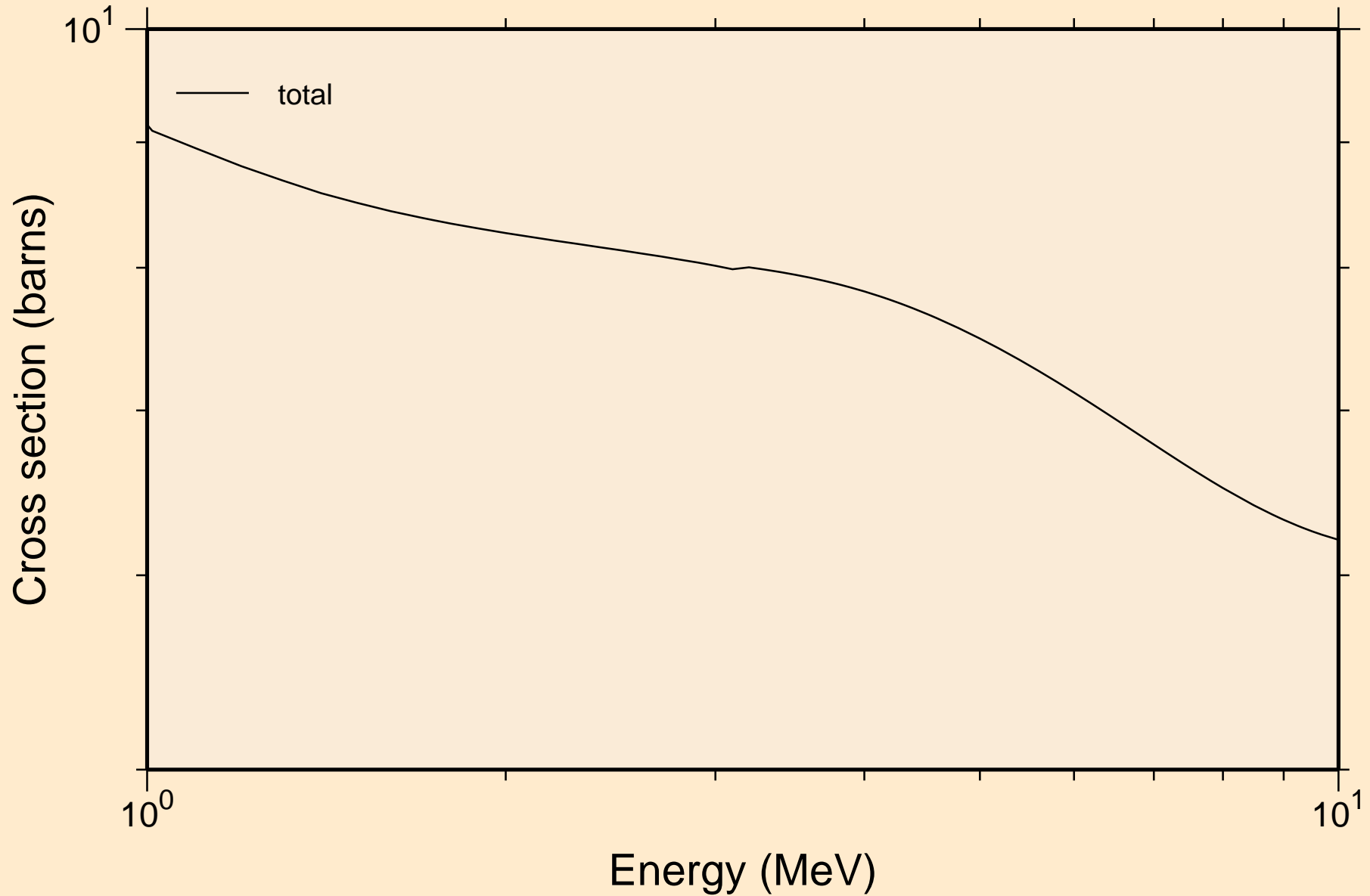

CF252 NEUTRON ACER TENDL-2023 LIBRARY; T=0.K  
resonance absorption cross sections

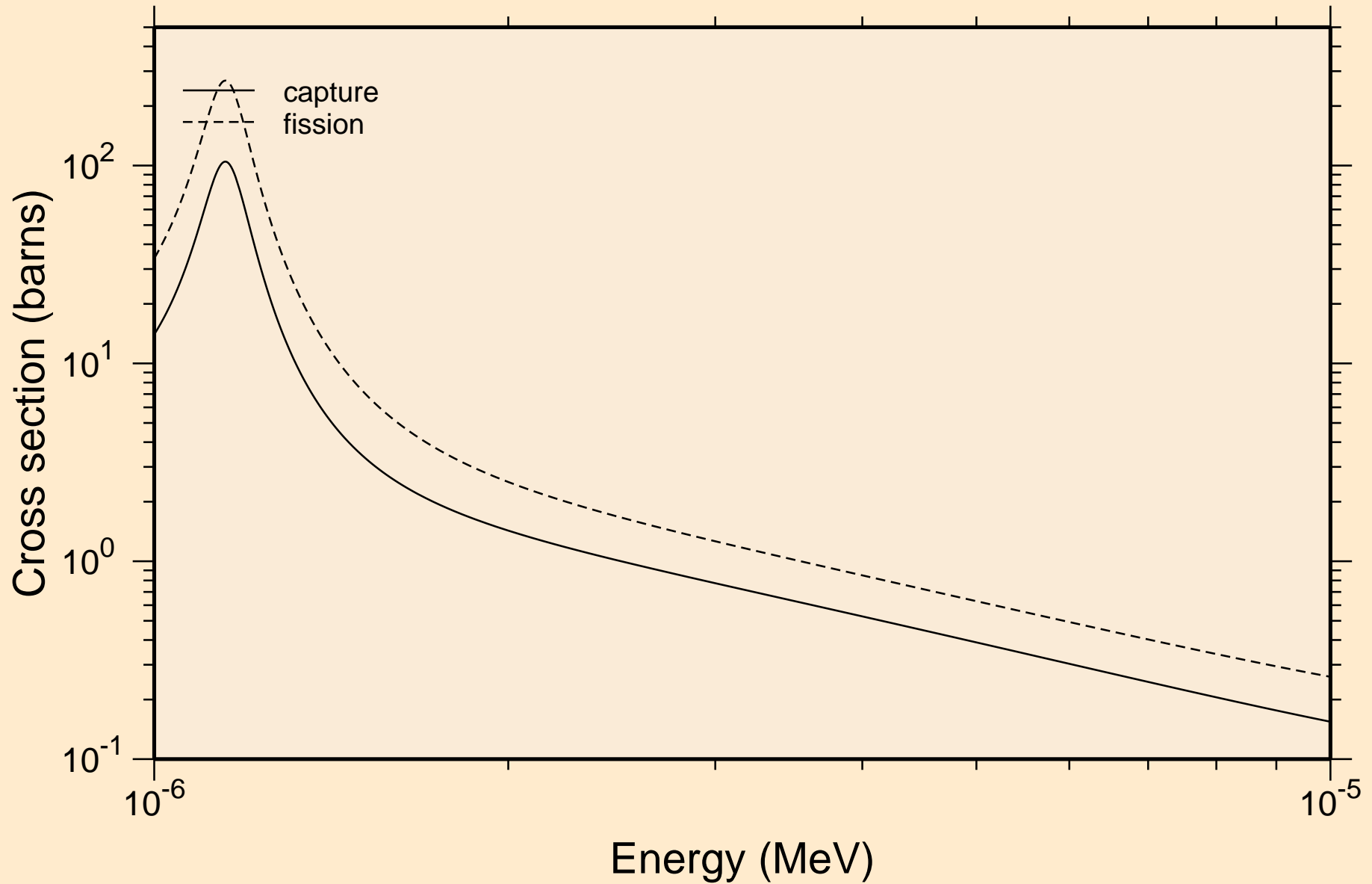

CF252 NEUTRON ACER TENDL-2023 LIBRARY; T=0.K  
resonance absorption cross sections

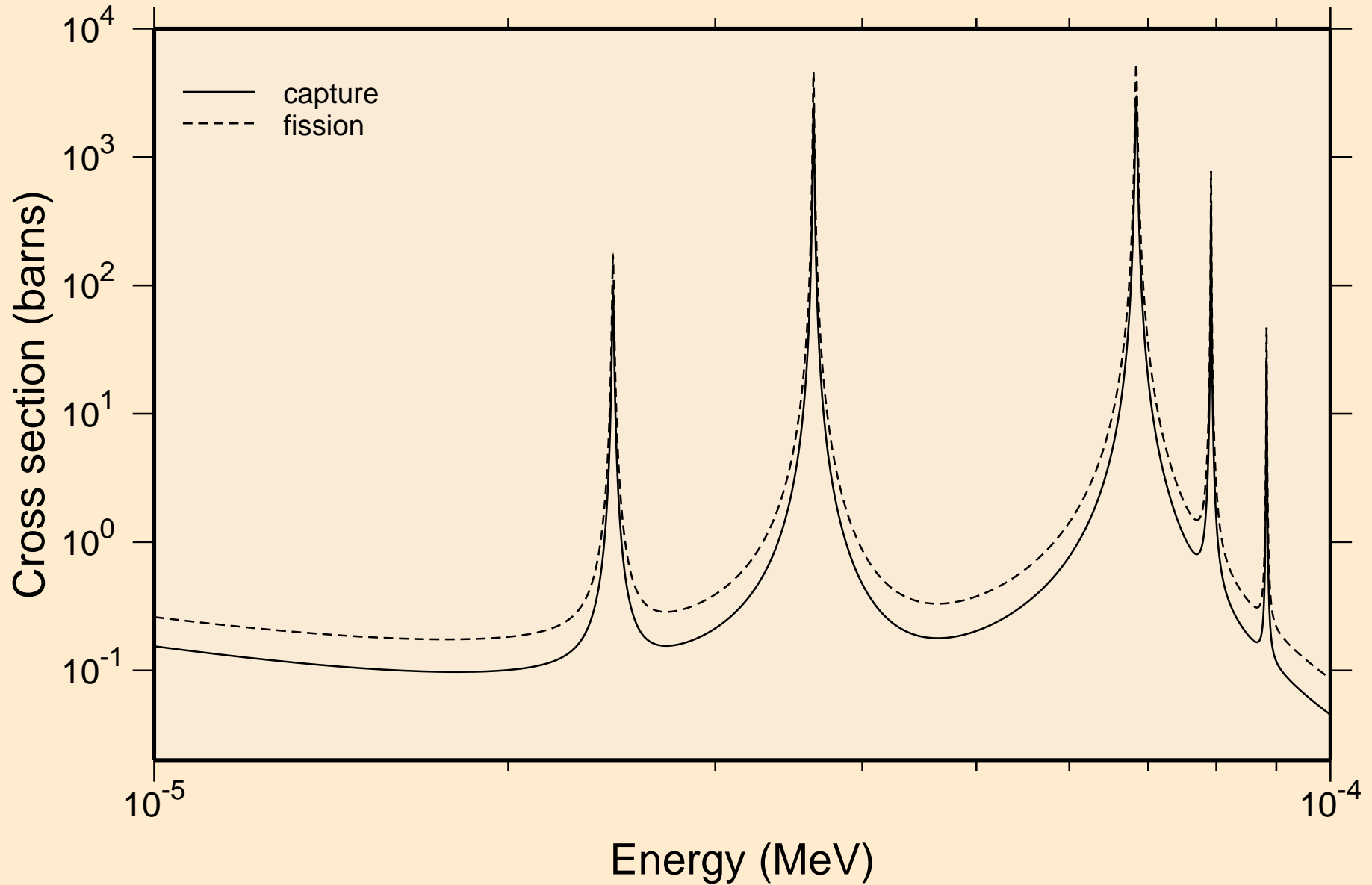

# CF252 NEUTRON ACER TENDL-2023 LIBRARY; T=0.K

## resonance absorption cross sections

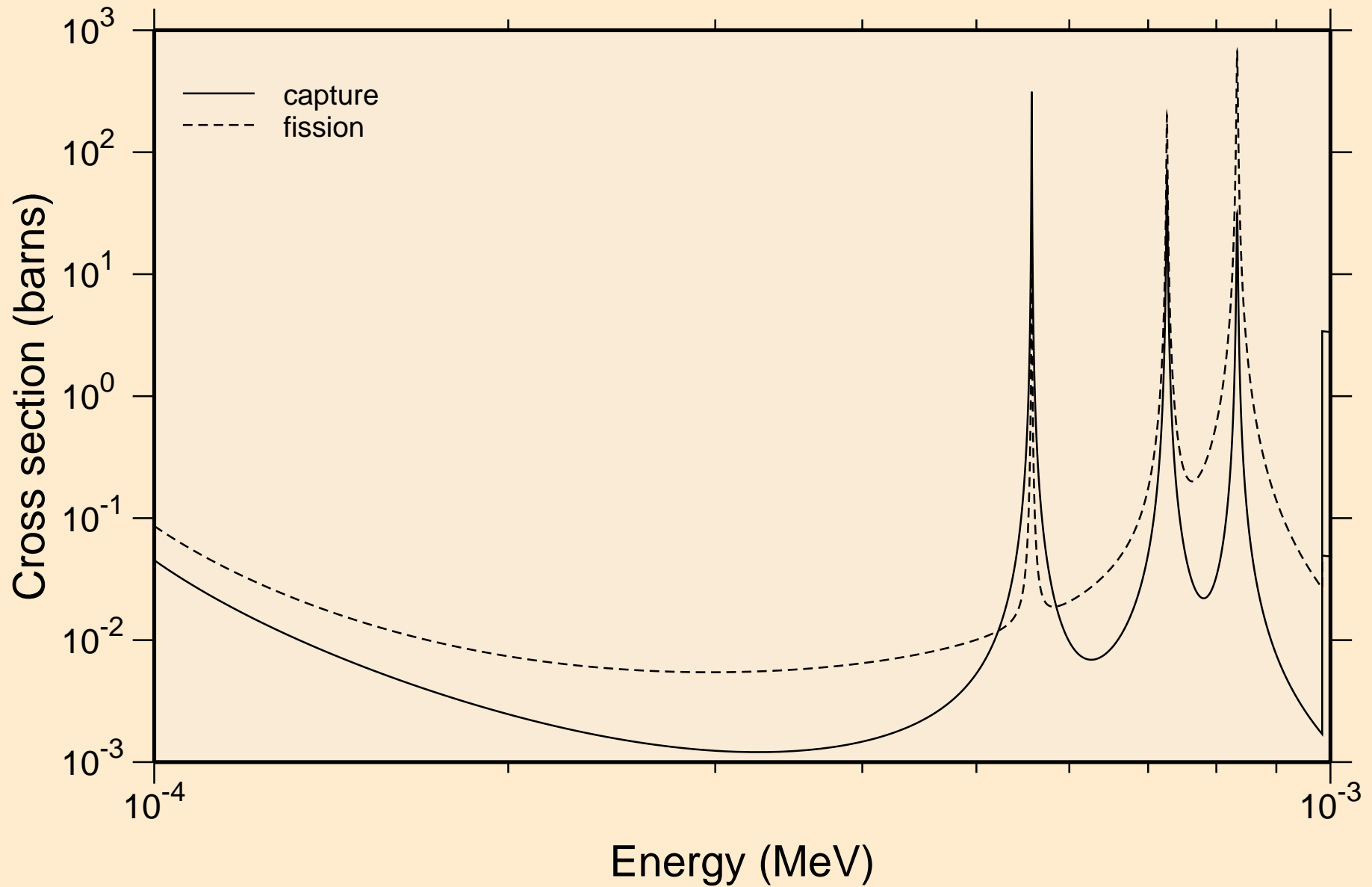



CF252 NEUTRON ACER TENDL-2023 LIBRARY; T=0.K  
resonance absorption cross sections

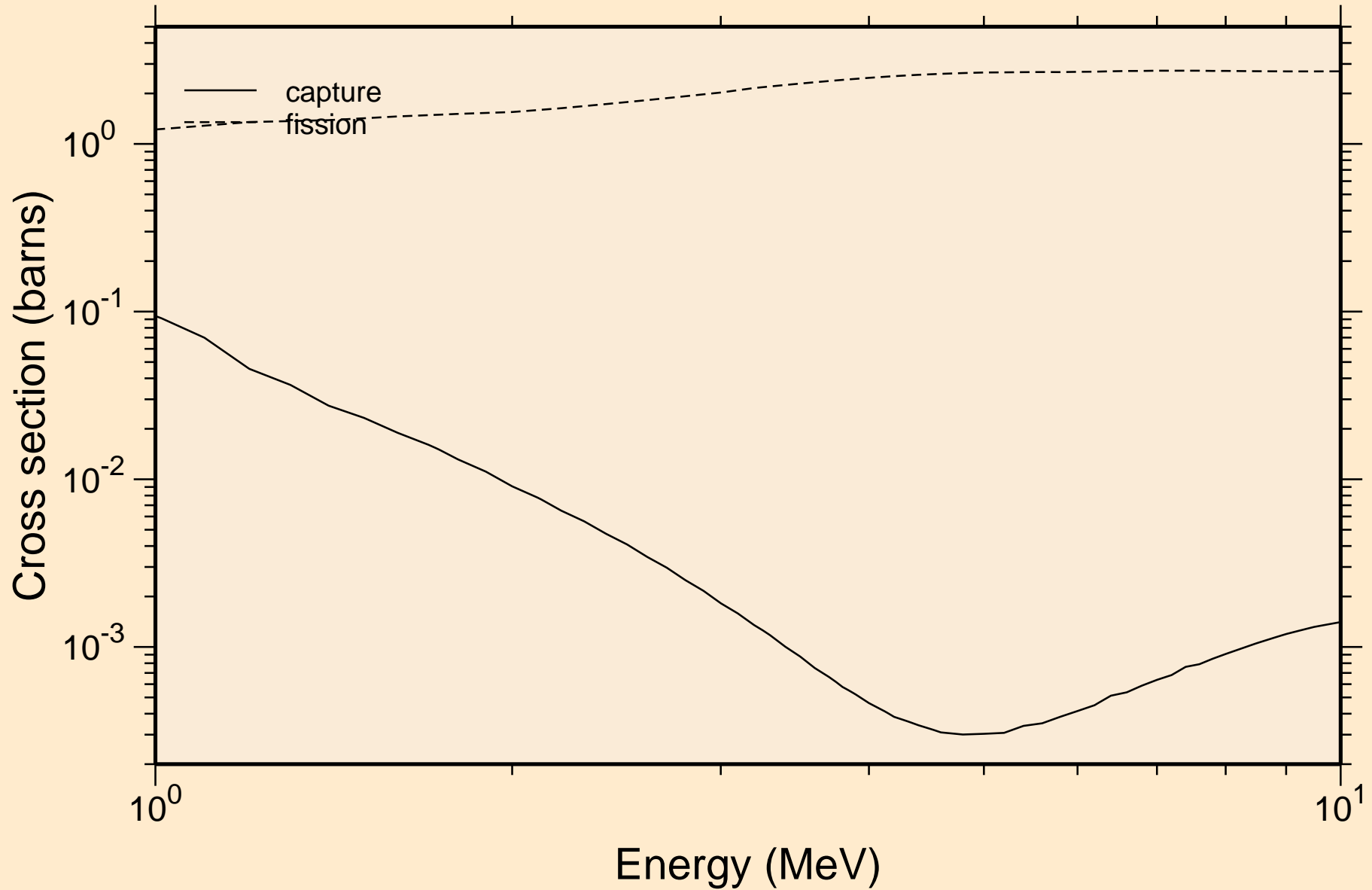

# CF252 NEUTRON ACER TENDL-2023 LIBRARY; T=0.K

## Heating

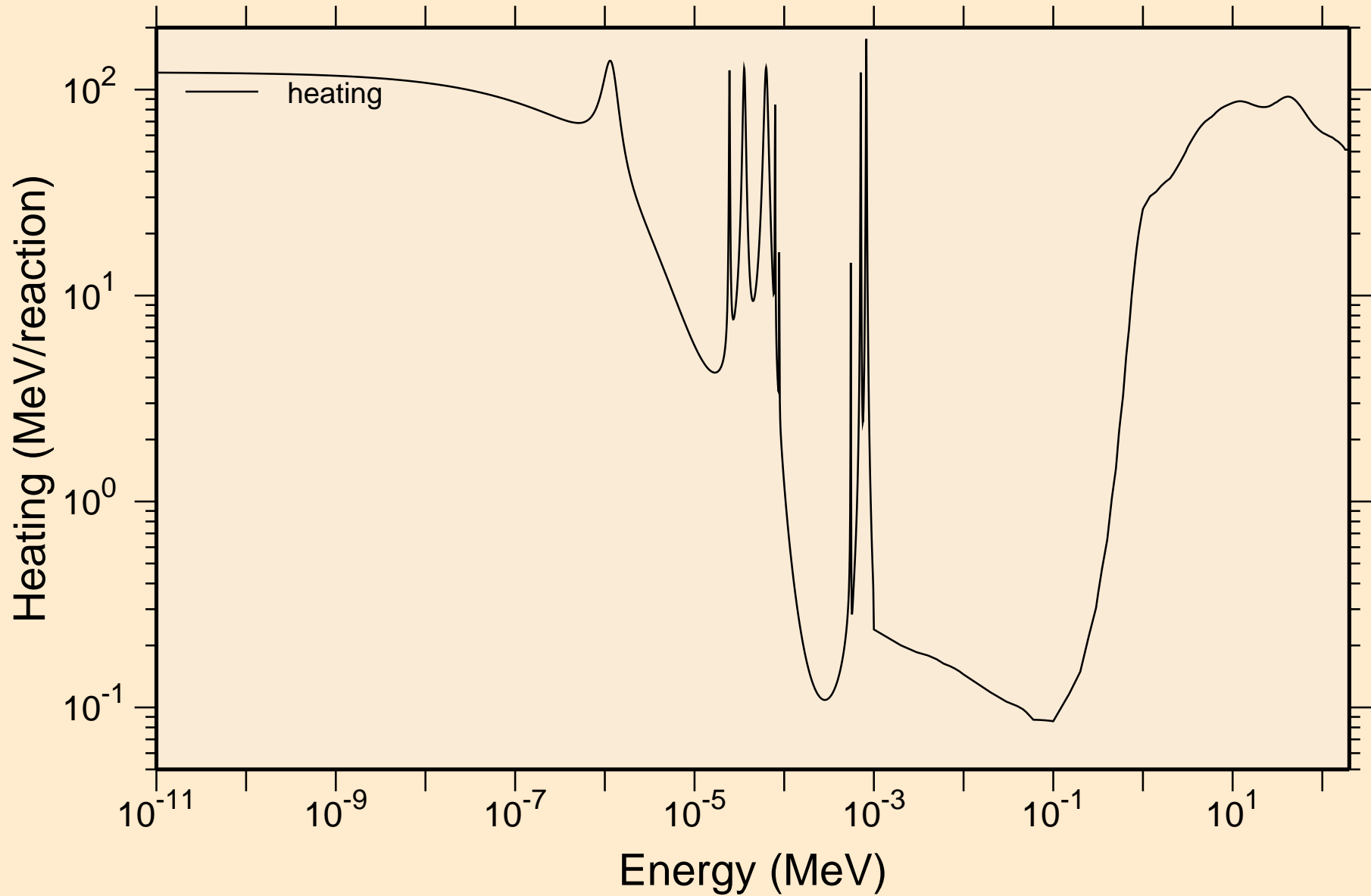

CF252 NEUTRON ACER TENDL-2023 LIBRARY; T=0.K  
Damage

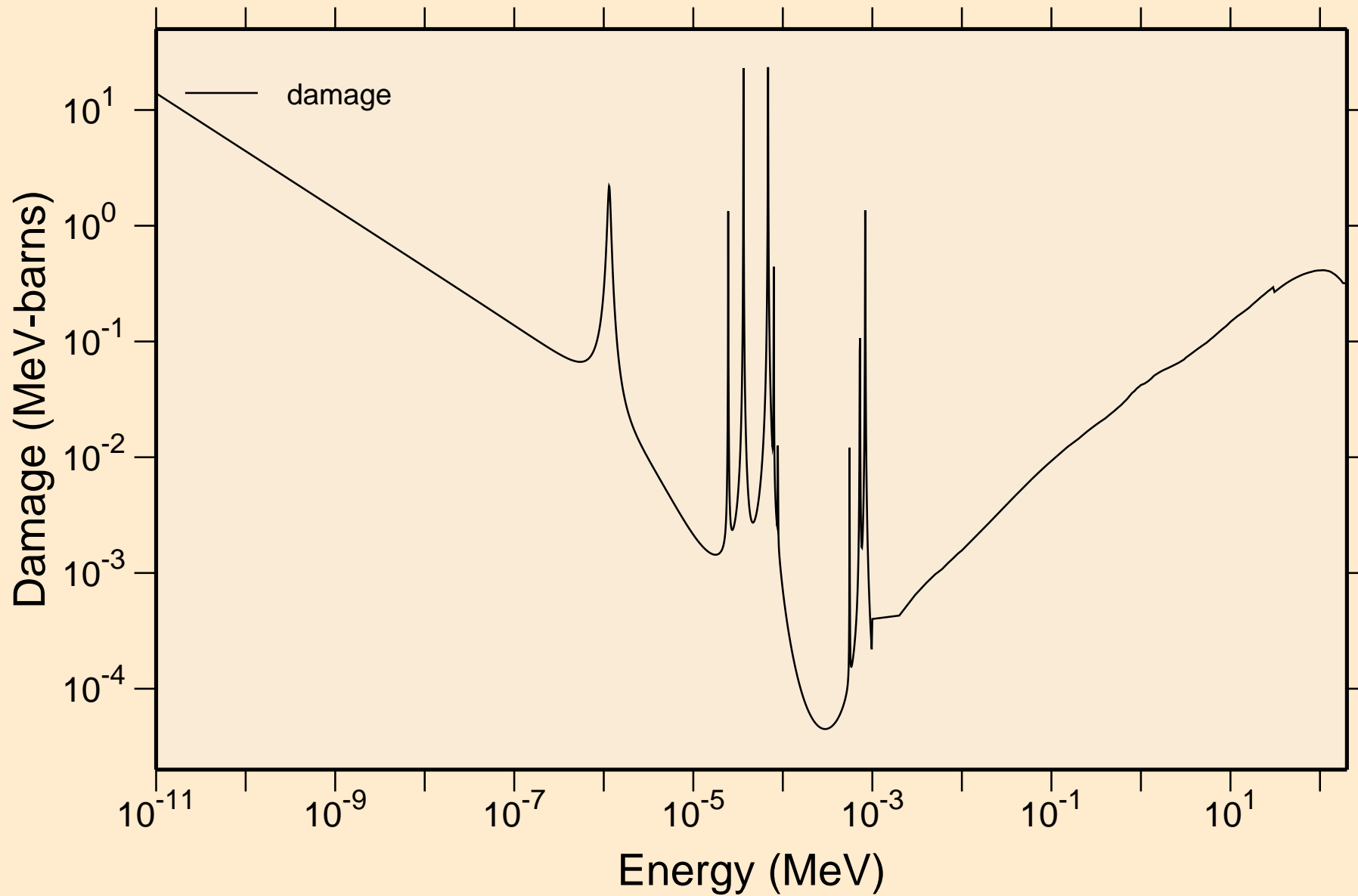

# CF252 NEUTRON ACER TENDL-2023 LIBRARY; T=0.K

## Non-threshold reactions

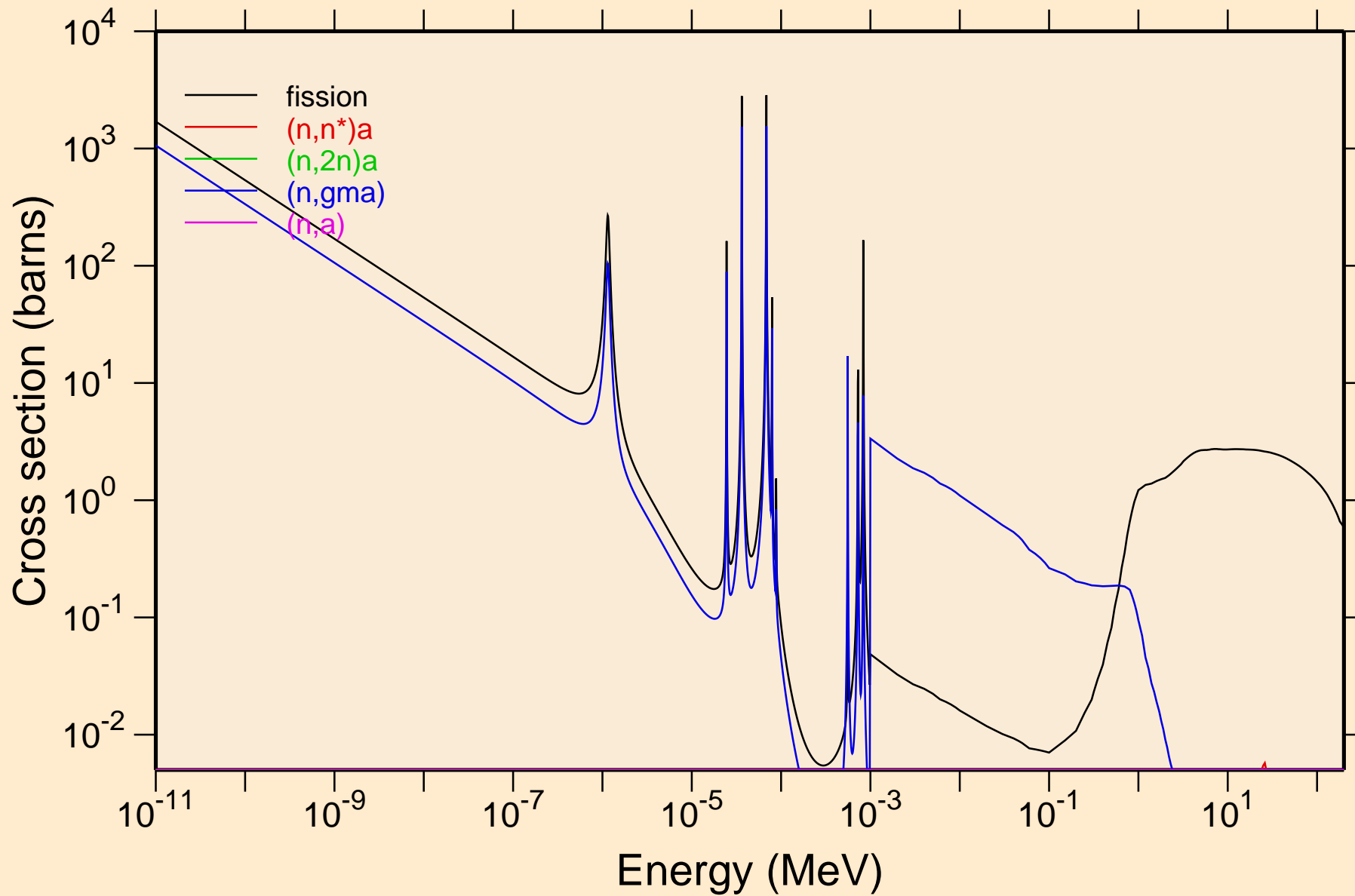

CF252 NEUTRON ACER TENDL-2023 LIBRARY; T=0.K  
Non-threshold reactions

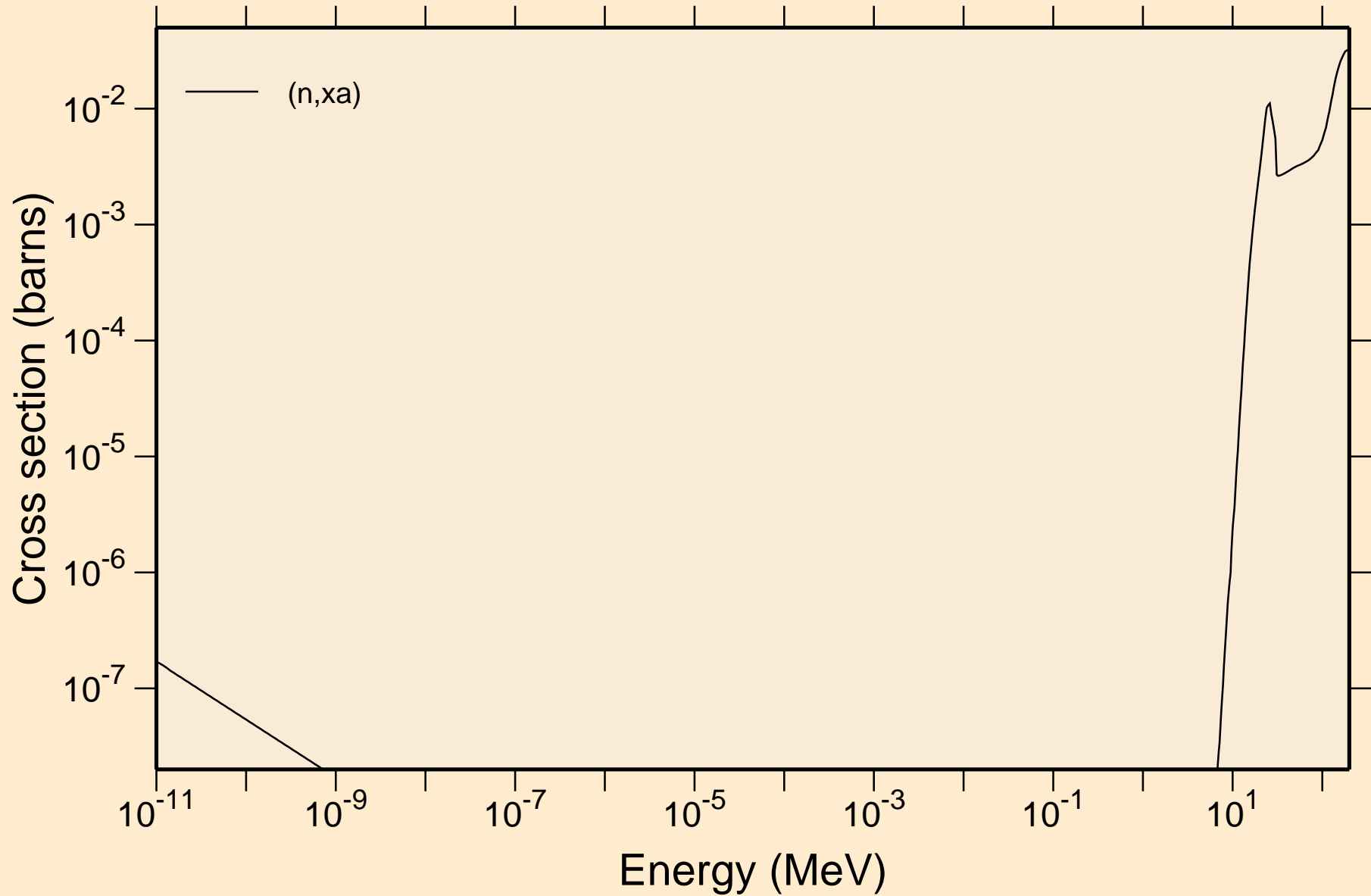

# CF252 NEUTRON ACER TENDL-2023 LIBRARY; T=0.K

## Principal cross sections

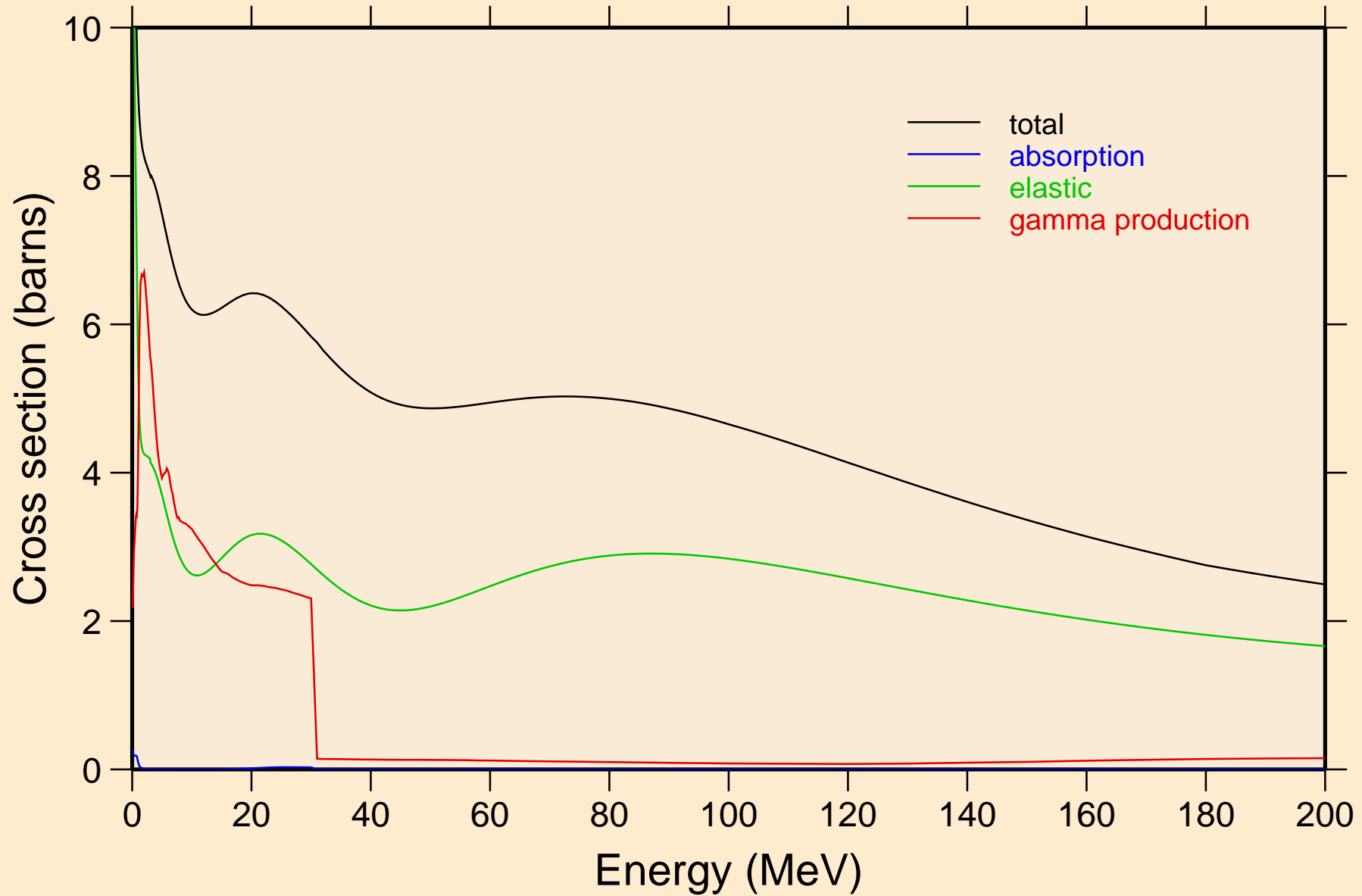

CF252 NEUTRON ACER TENDL-2023 LIBRARY; T=0.K  
Heating

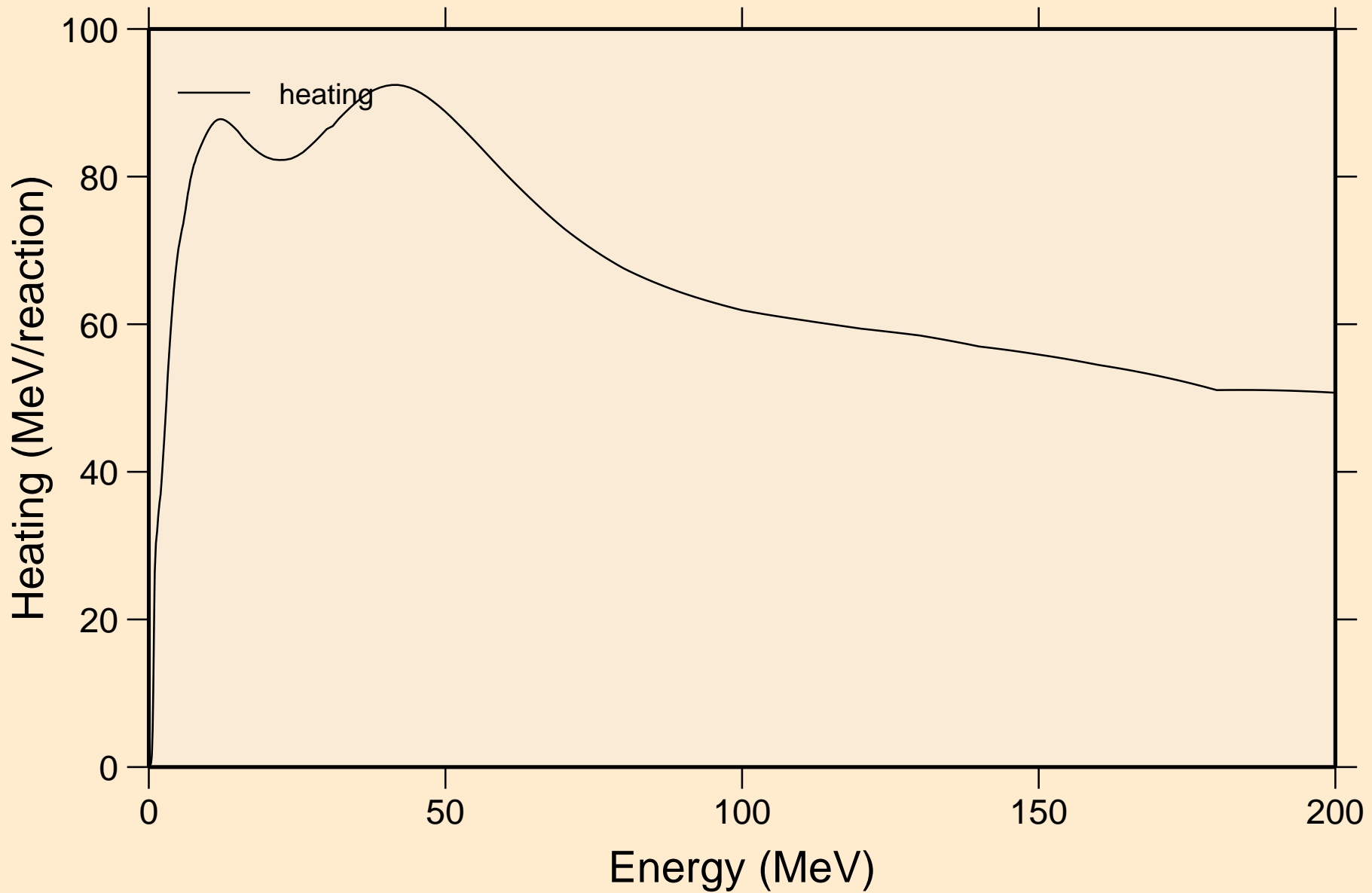

CF252 NEUTRON ACER TENDL-2023 LIBRARY; T=0.K  
Damage

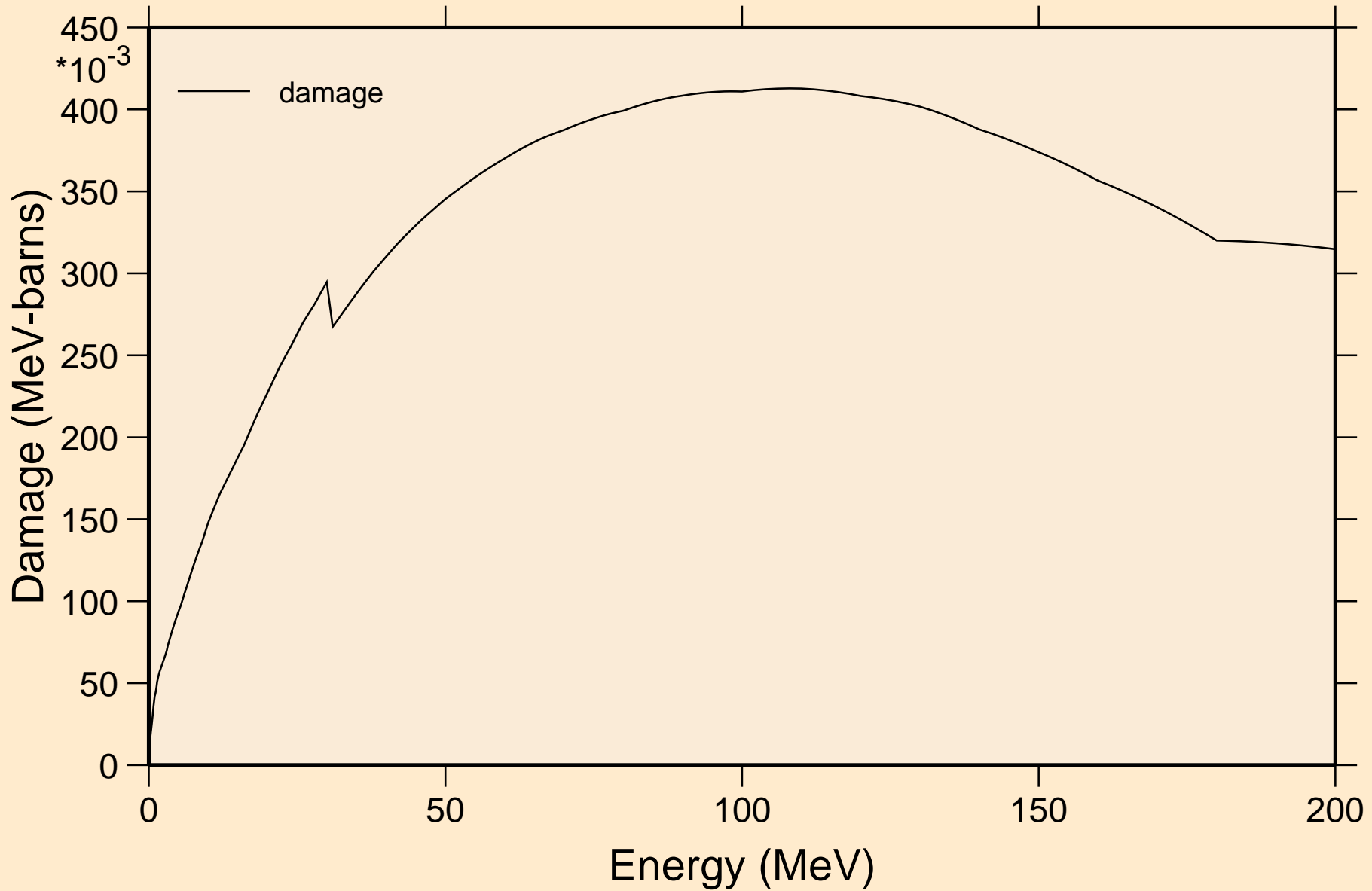



# CF252 NEUTRON ACER TENDL-2023 LIBRARY; T=0.K

## Non-threshold reactions

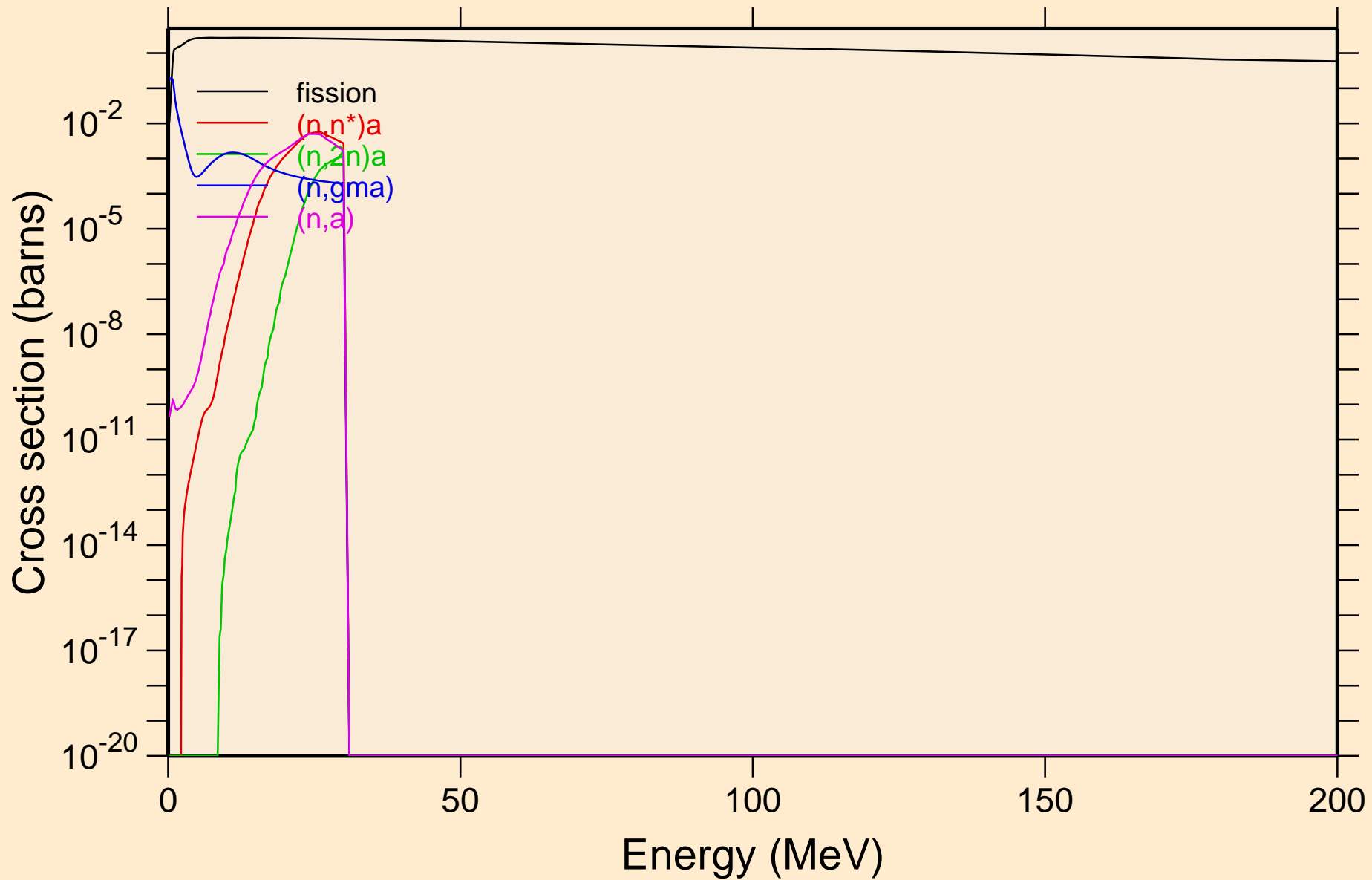

CF252 NEUTRON ACER TENDL-2023 LIBRARY; T=0.K  
Non-threshold reactions

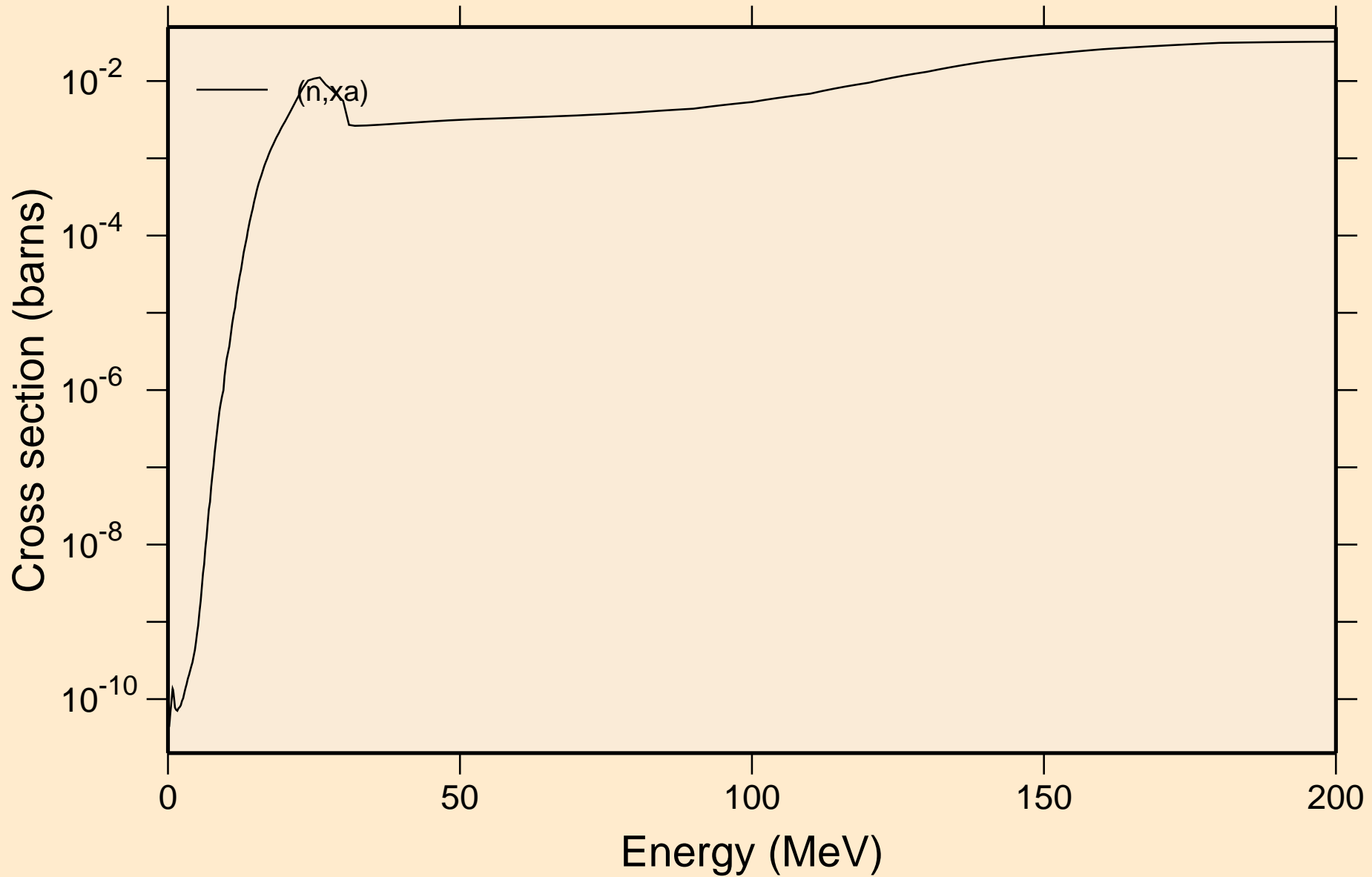

CF252 NEUTRON ACER TENDL-2023 LIBRARY; T=0.K  
Inelastic levels

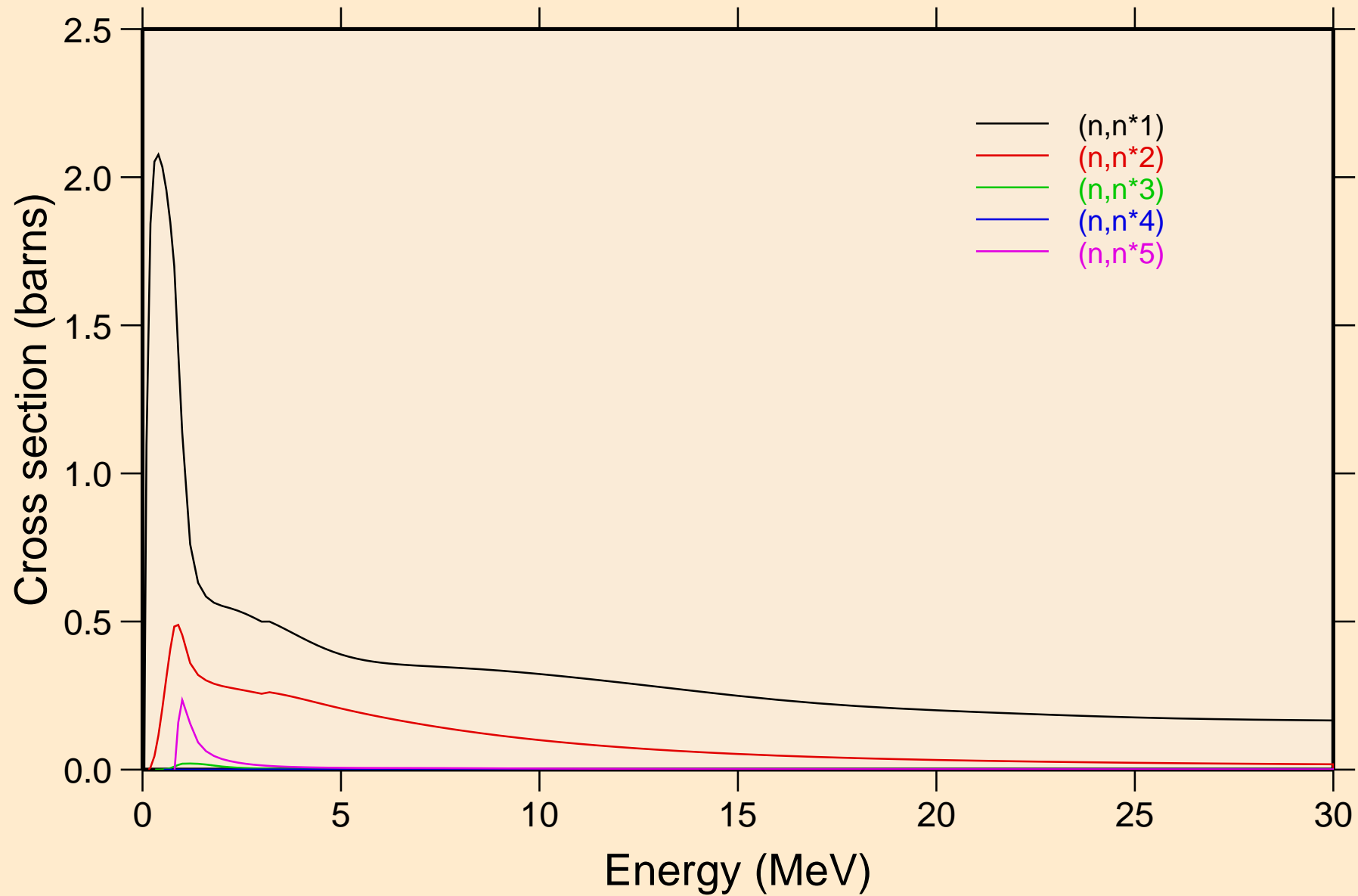

CF252 NEUTRON ACER TENDL-2023 LIBRARY; T=0.K  
Inelastic levels

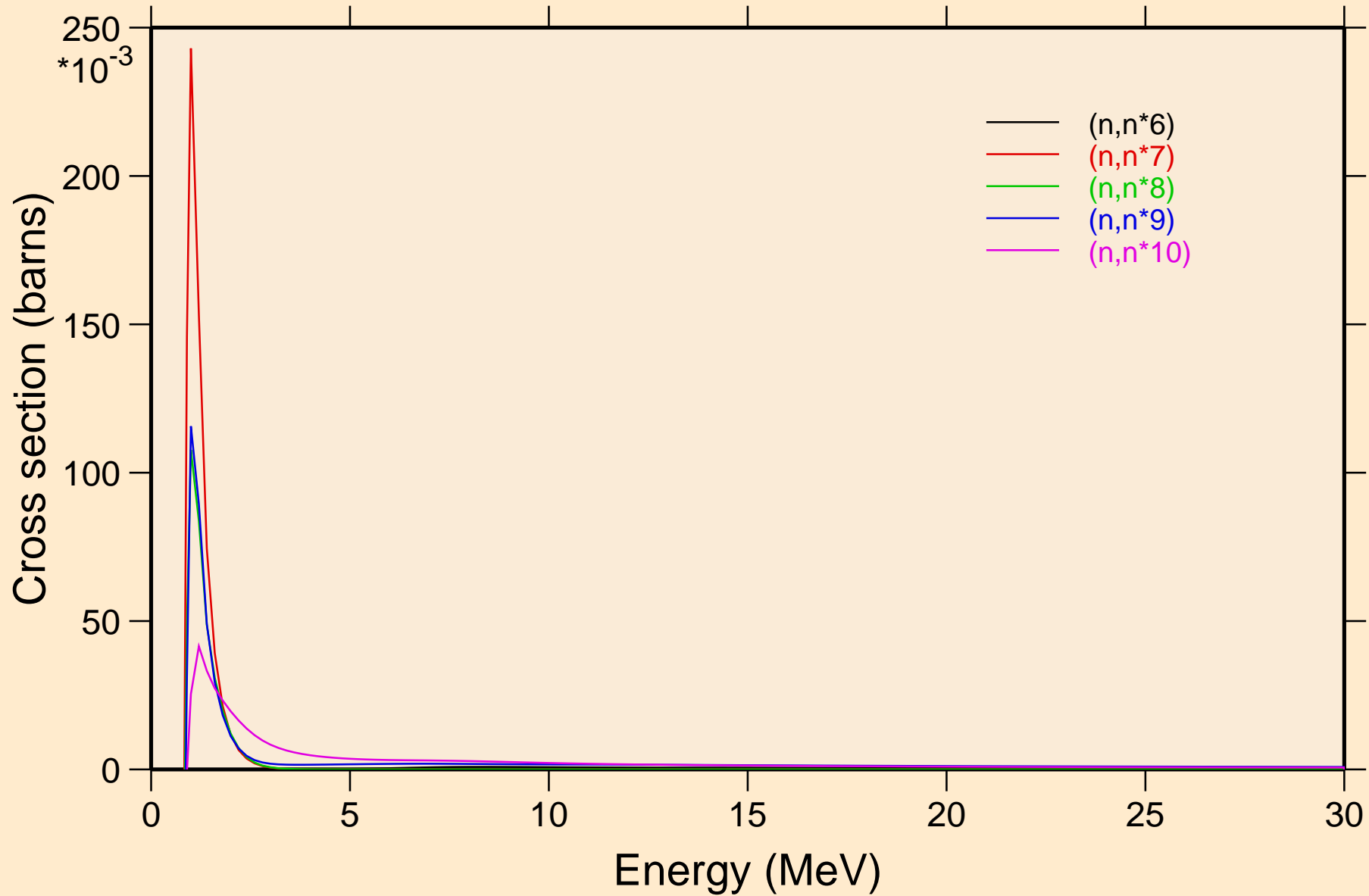

CF252 NEUTRON ACER TENDL-2023 LIBRARY; T=0.K  
Inelastic levels

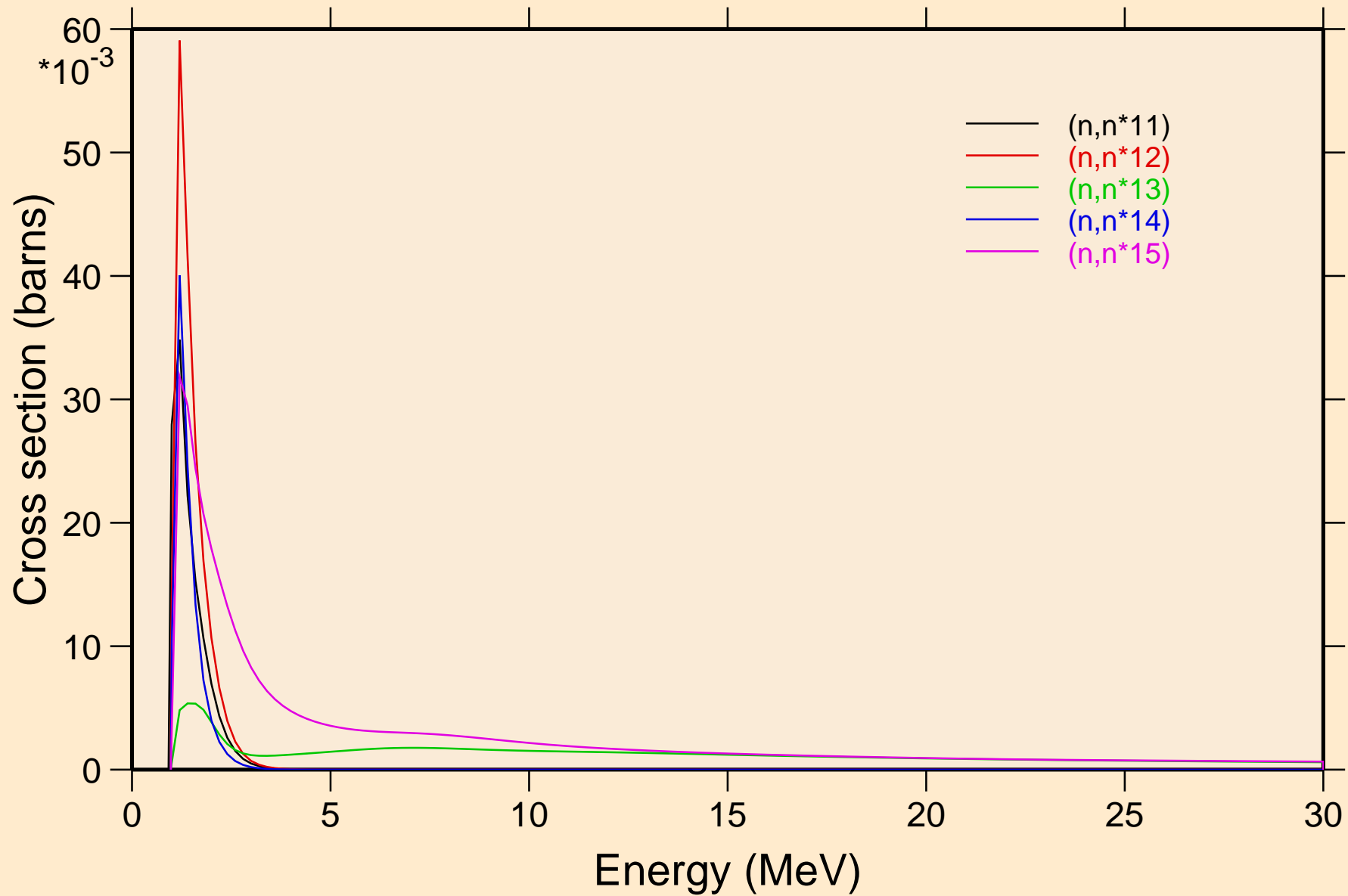

CF252 NEUTRON ACER TENDL-2023 LIBRARY; T=0.K  
Inelastic levels

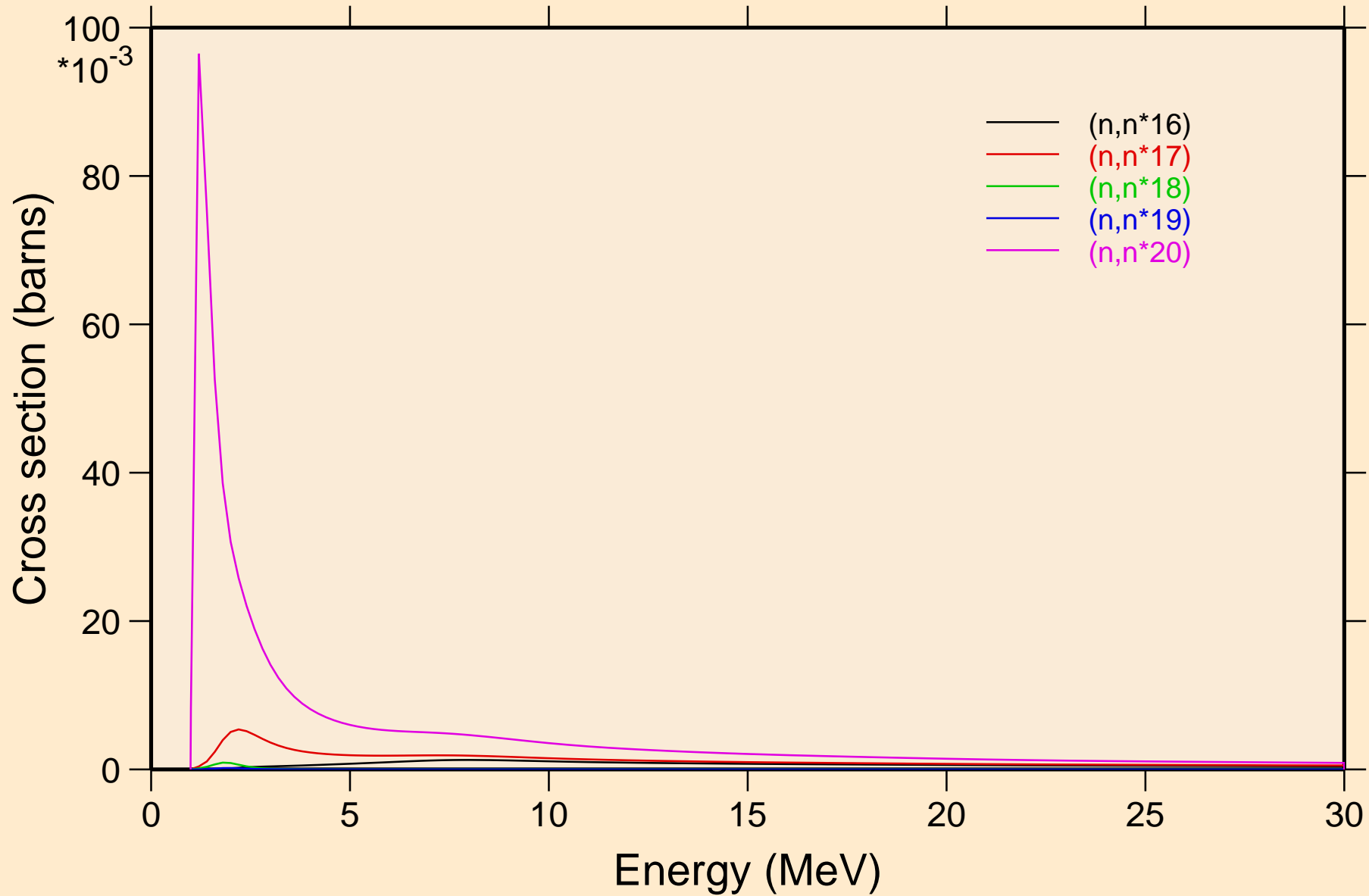

CF252 NEUTRON ACER TENDL-2023 LIBRARY; T=0.K  
Inelastic levels

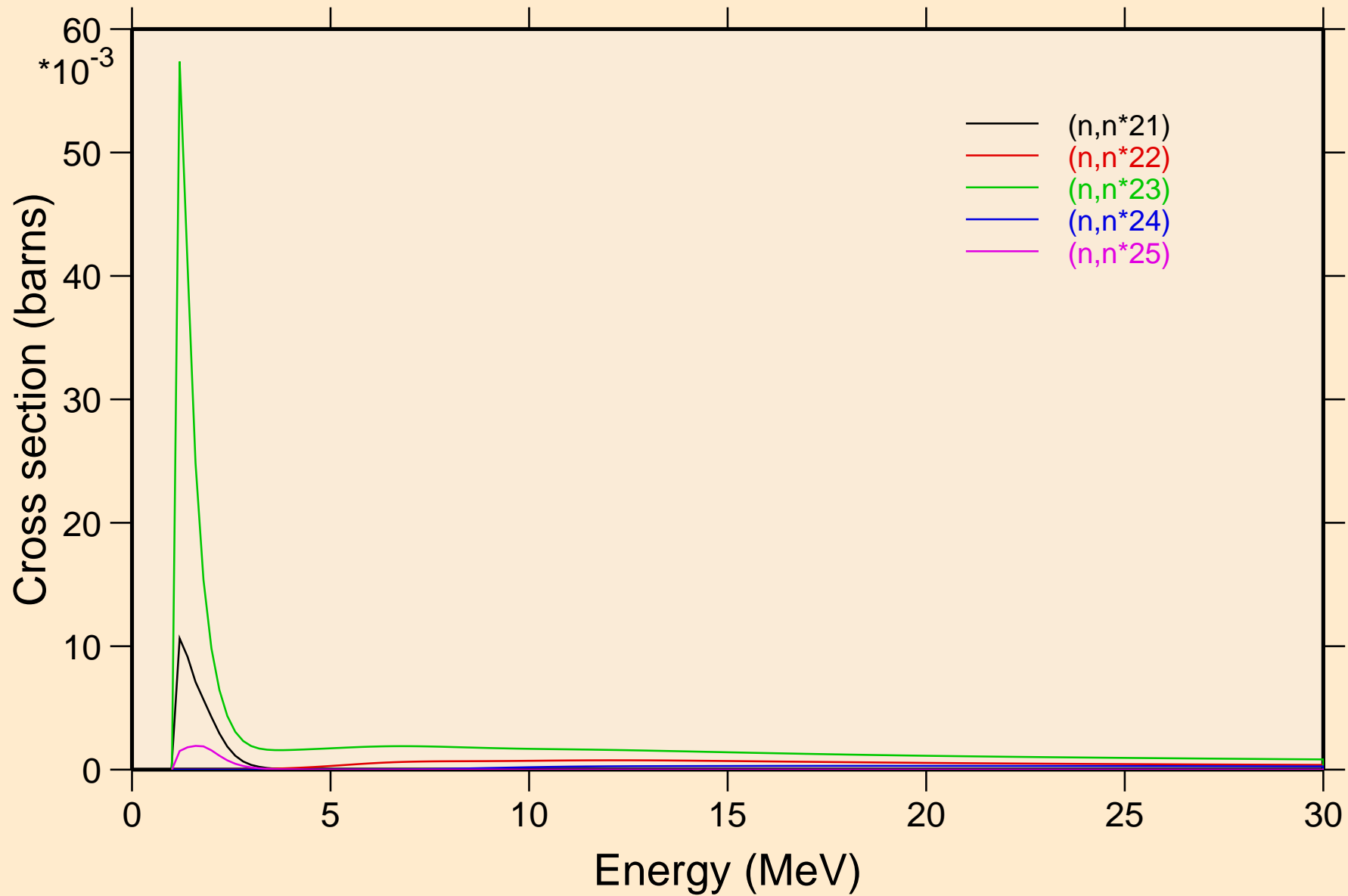

CF252 NEUTRON ACER TENDL-2023 LIBRARY; T=0.K  
Inelastic levels

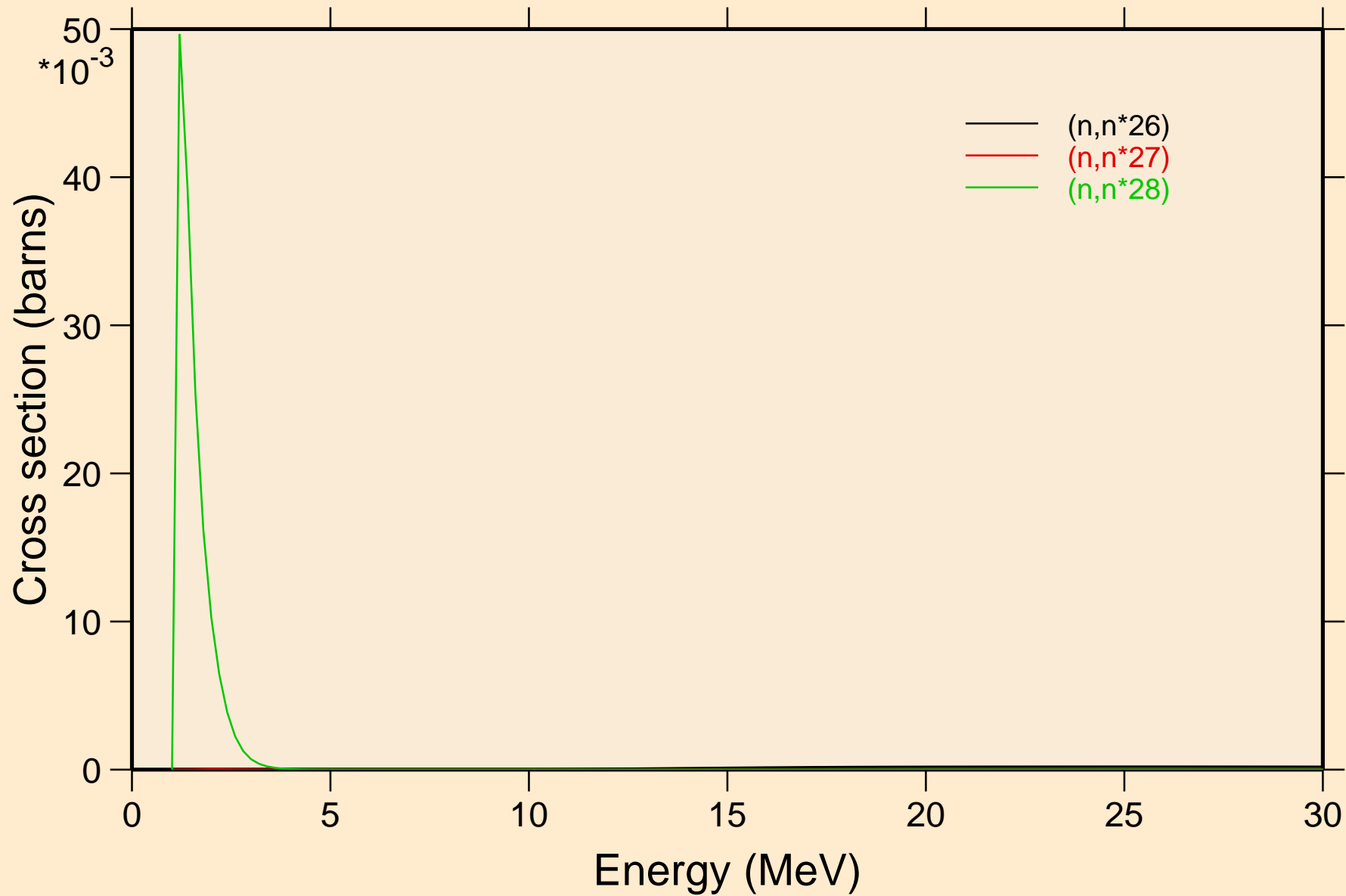



CF252 NEUTRON ACER TENDL-2023 LIBRARY; T=0.K  
Threshold reactions

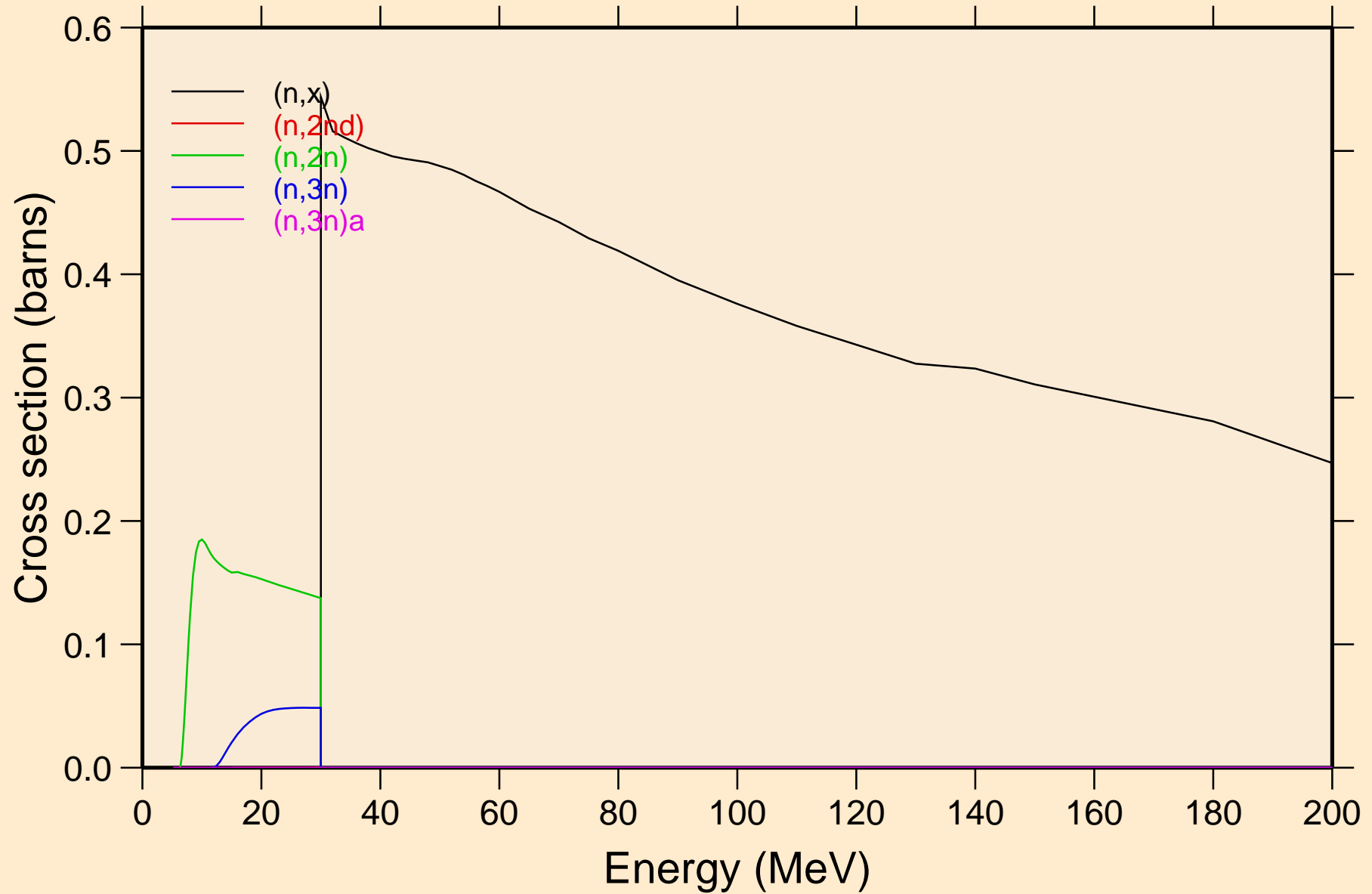

# CF252 NEUTRON ACER TENDL-2023 LIBRARY; T=0.K

## Threshold reactions

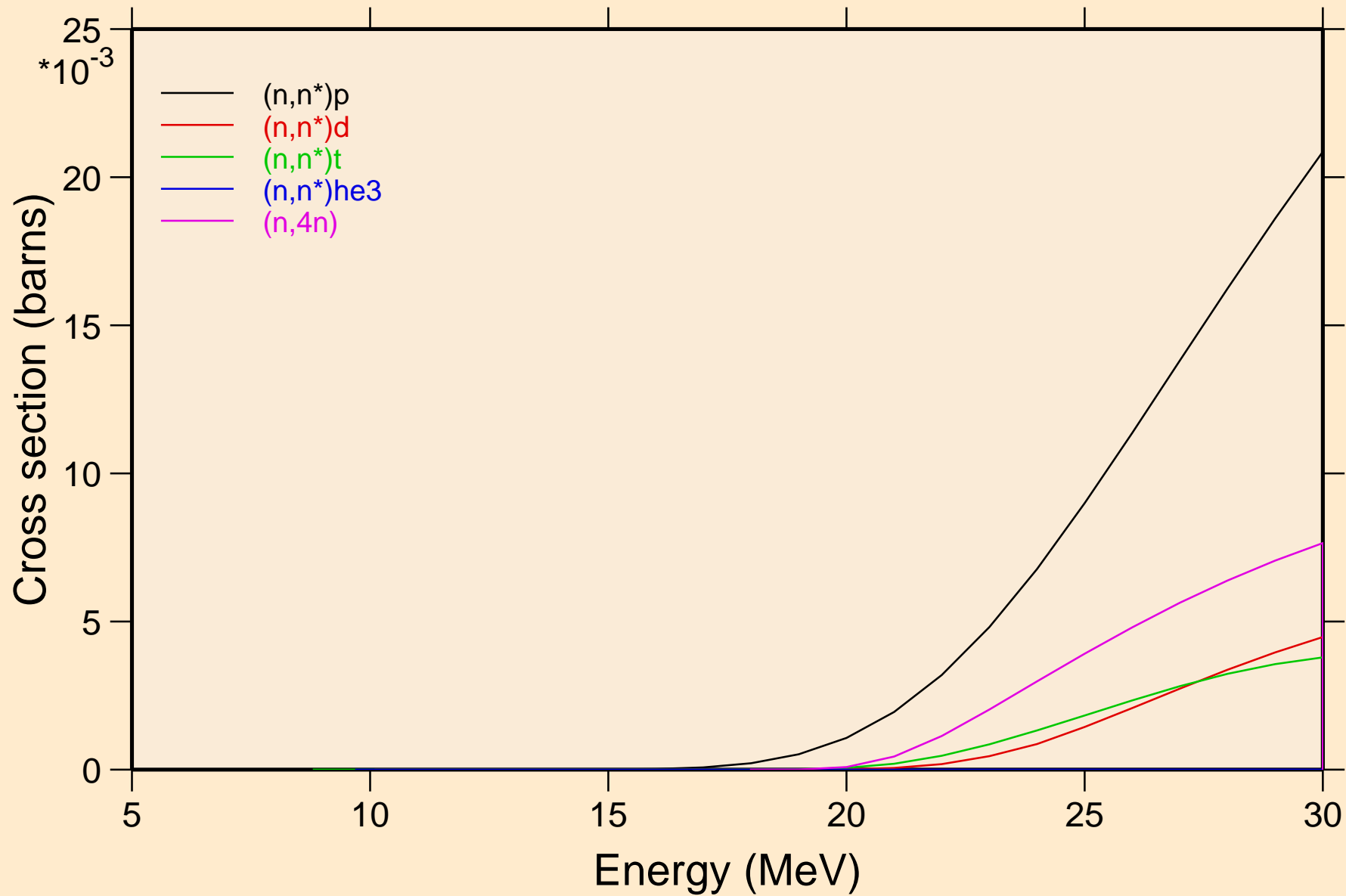

# CF252 NEUTRON ACER TENDL-2023 LIBRARY; T=0.K

## Threshold reactions

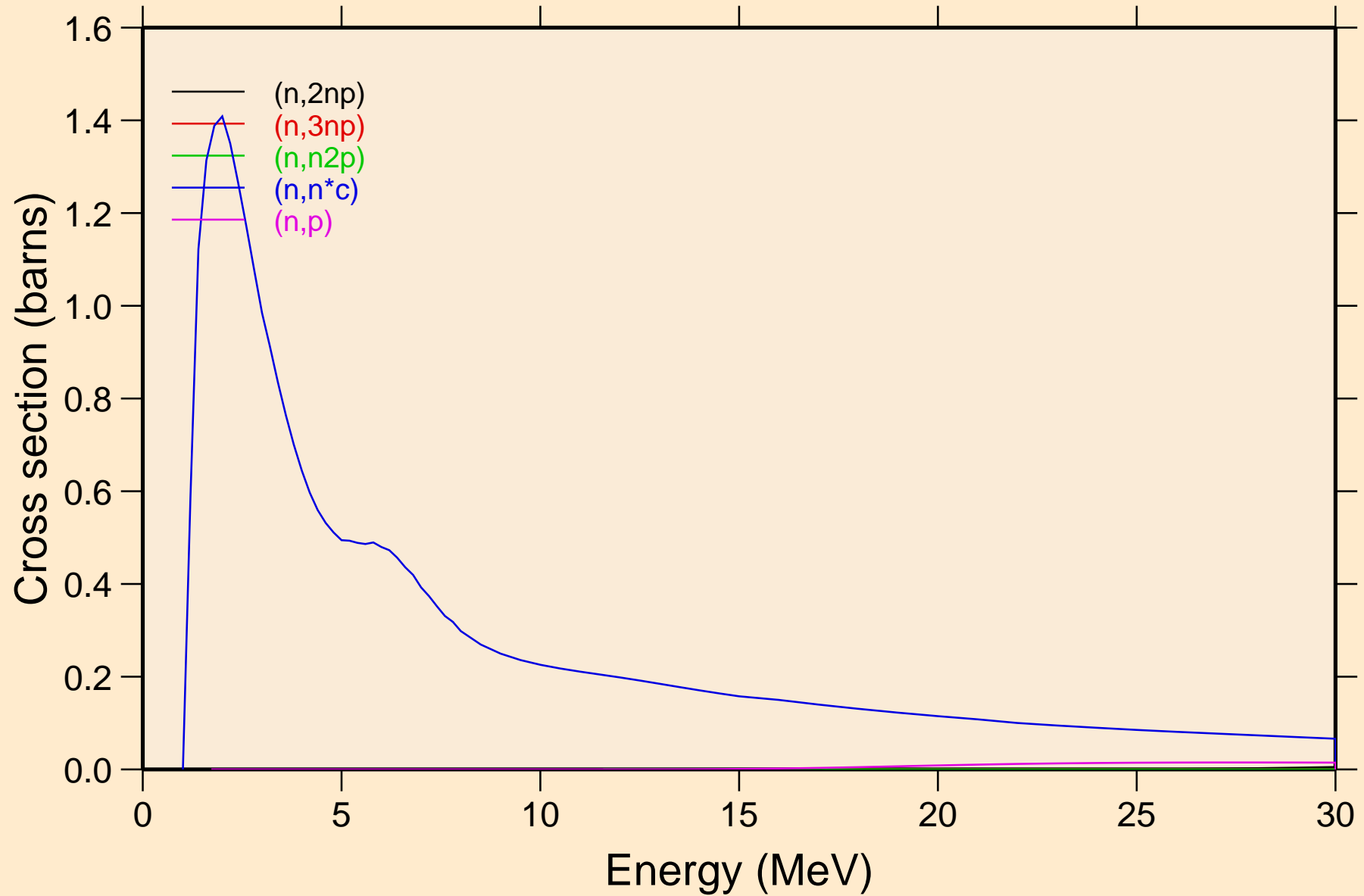

CF252 NEUTRON ACER TENDL-2023 LIBRARY; T=0.K  
Threshold reactions

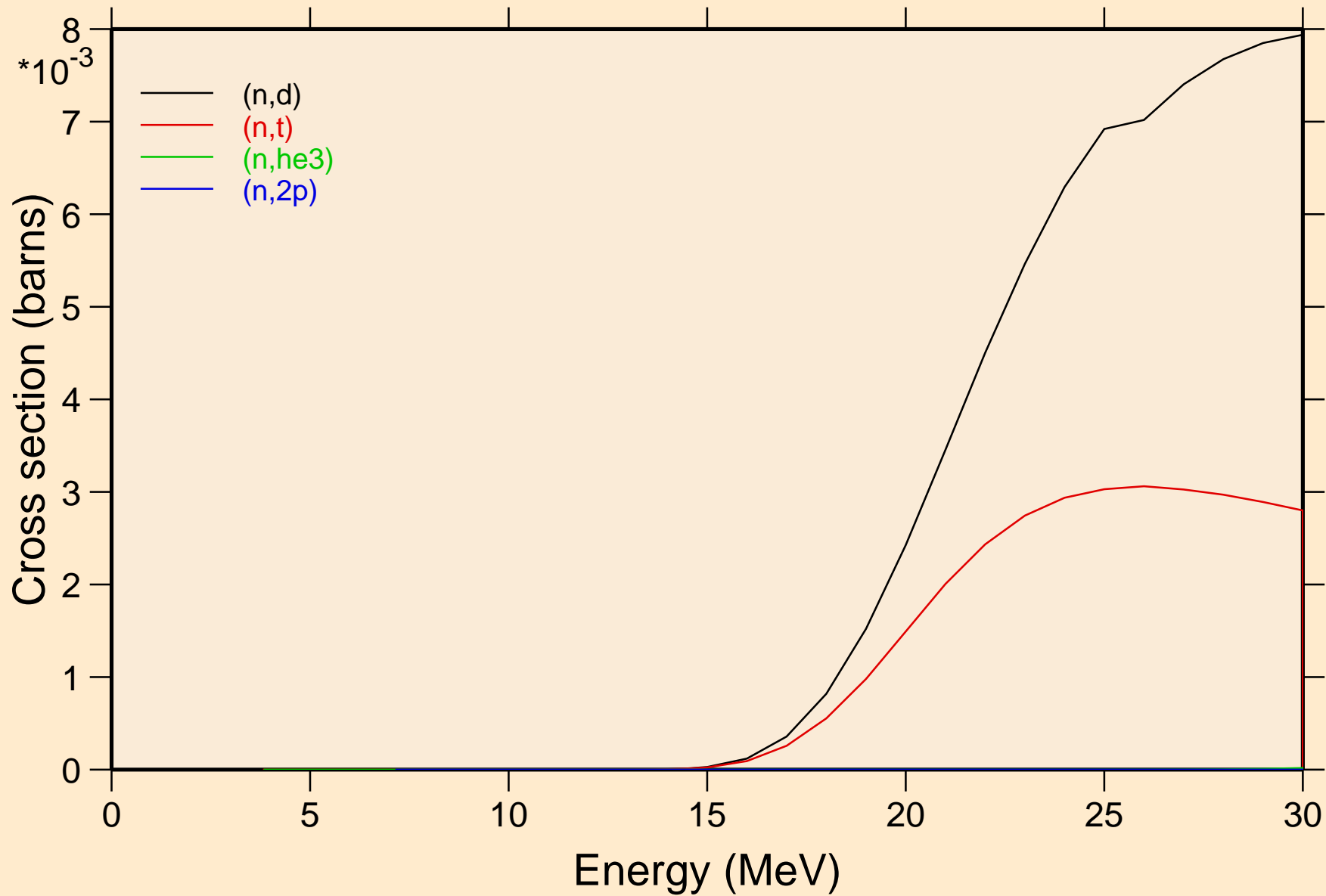

# CF252 NEUTRON ACER TENDL-2023 LIBRARY; T=0.K

## Threshold reactions

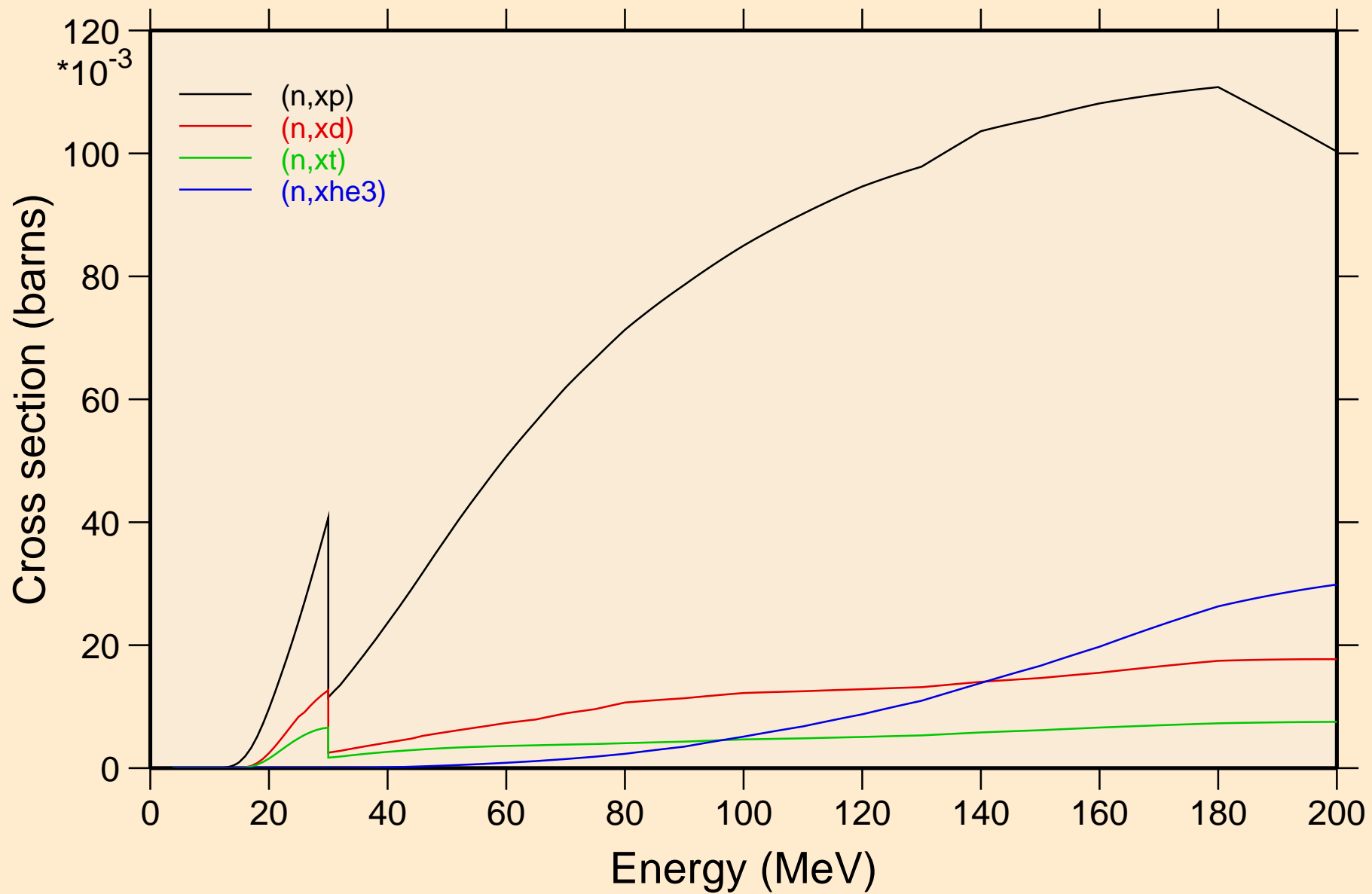

CF252 NEUTRON ACER TENDL-2023 LIBRARY; T=0.K  
angular distribution for elastic

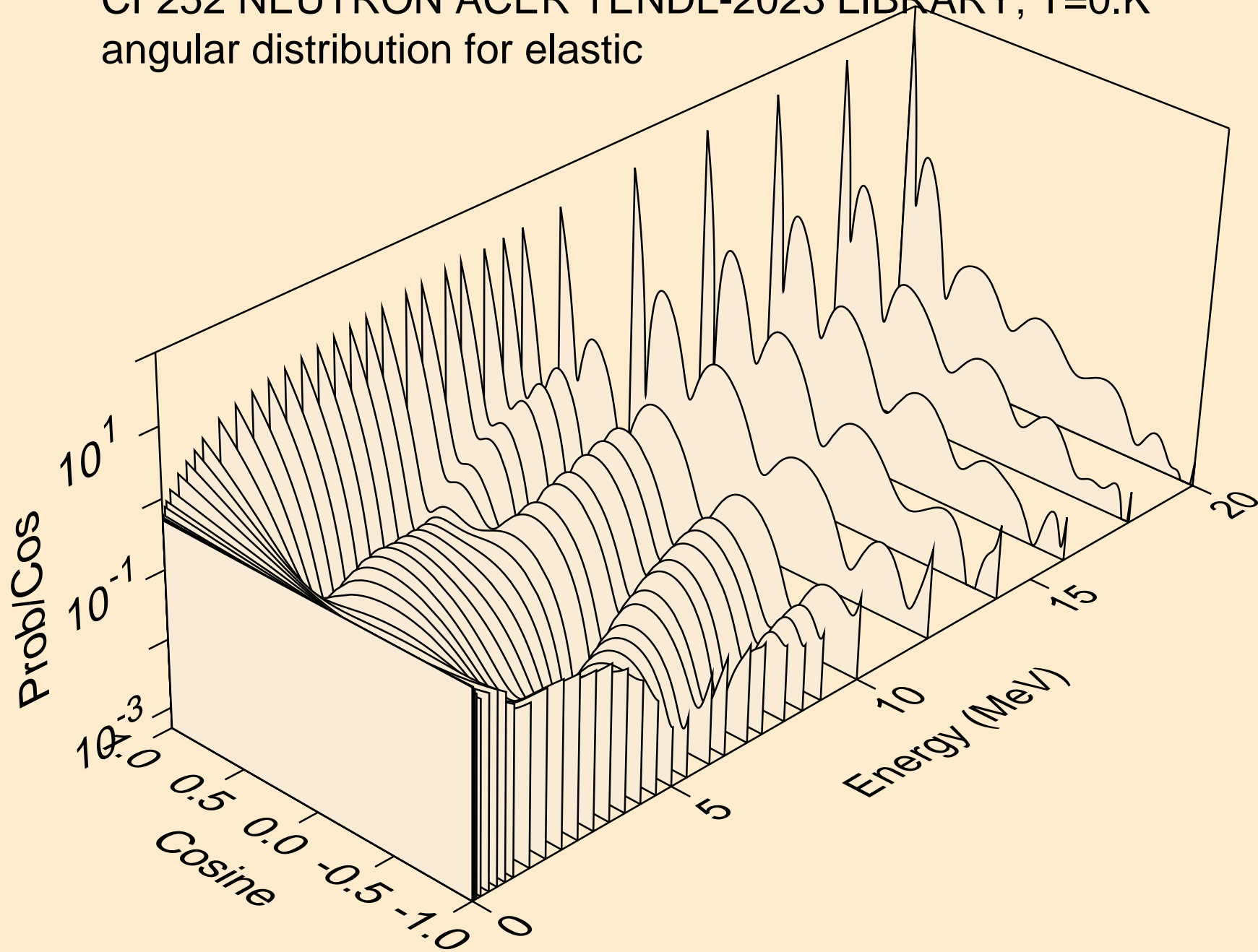

CF252 NEUTRON ACER TENDL-2023 LIBRARY; T=0.K  
angular distribution for elastic

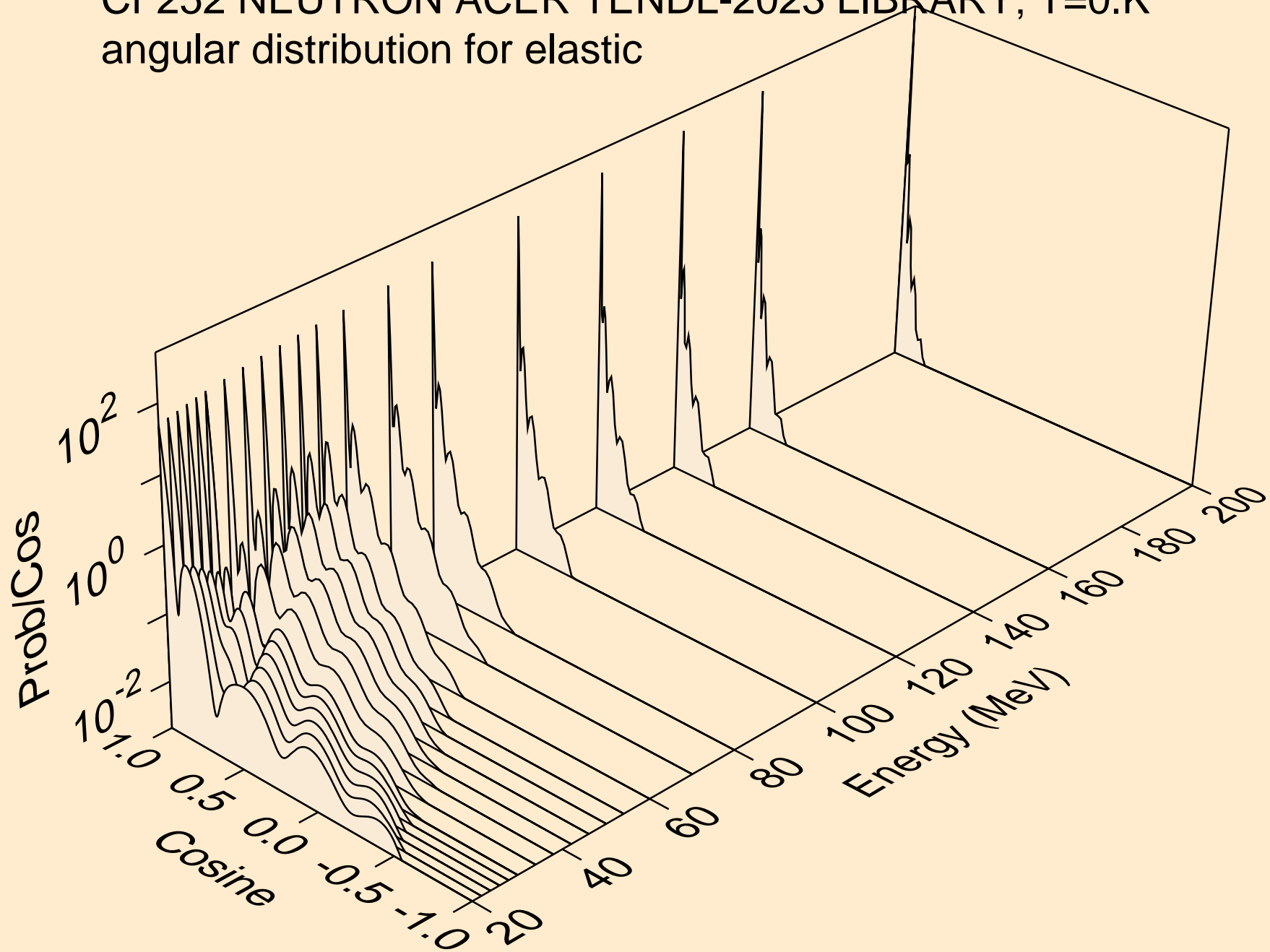

CF252 NEUTRON ACER TENDL-2023 LIBRARY; T=0.K  
angular distribution for (n,n\*1)

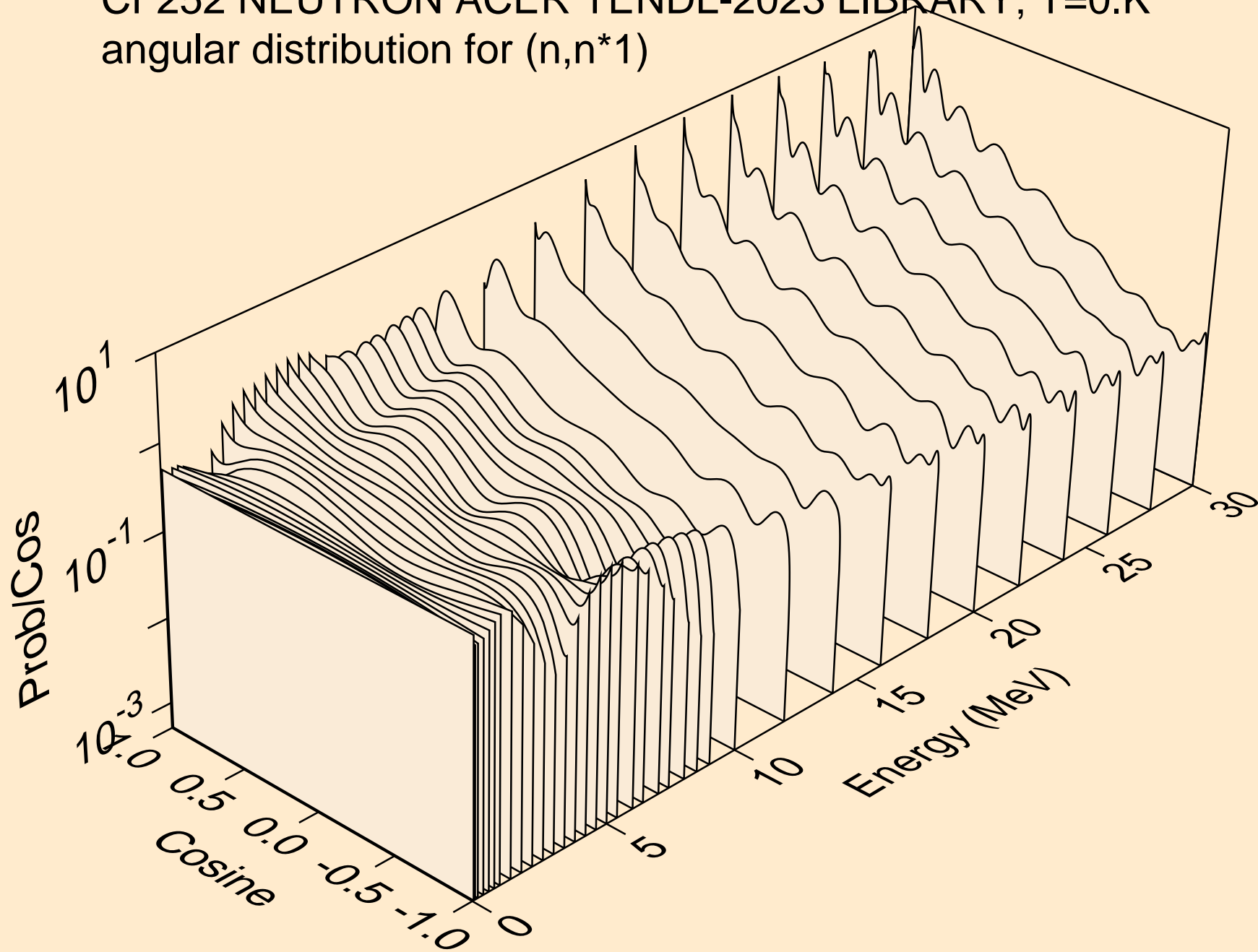



CF252 NEUTRON ACER TENDL-2023 LIBRARY; T=0.K  
angular distribution for (n,n\*2)

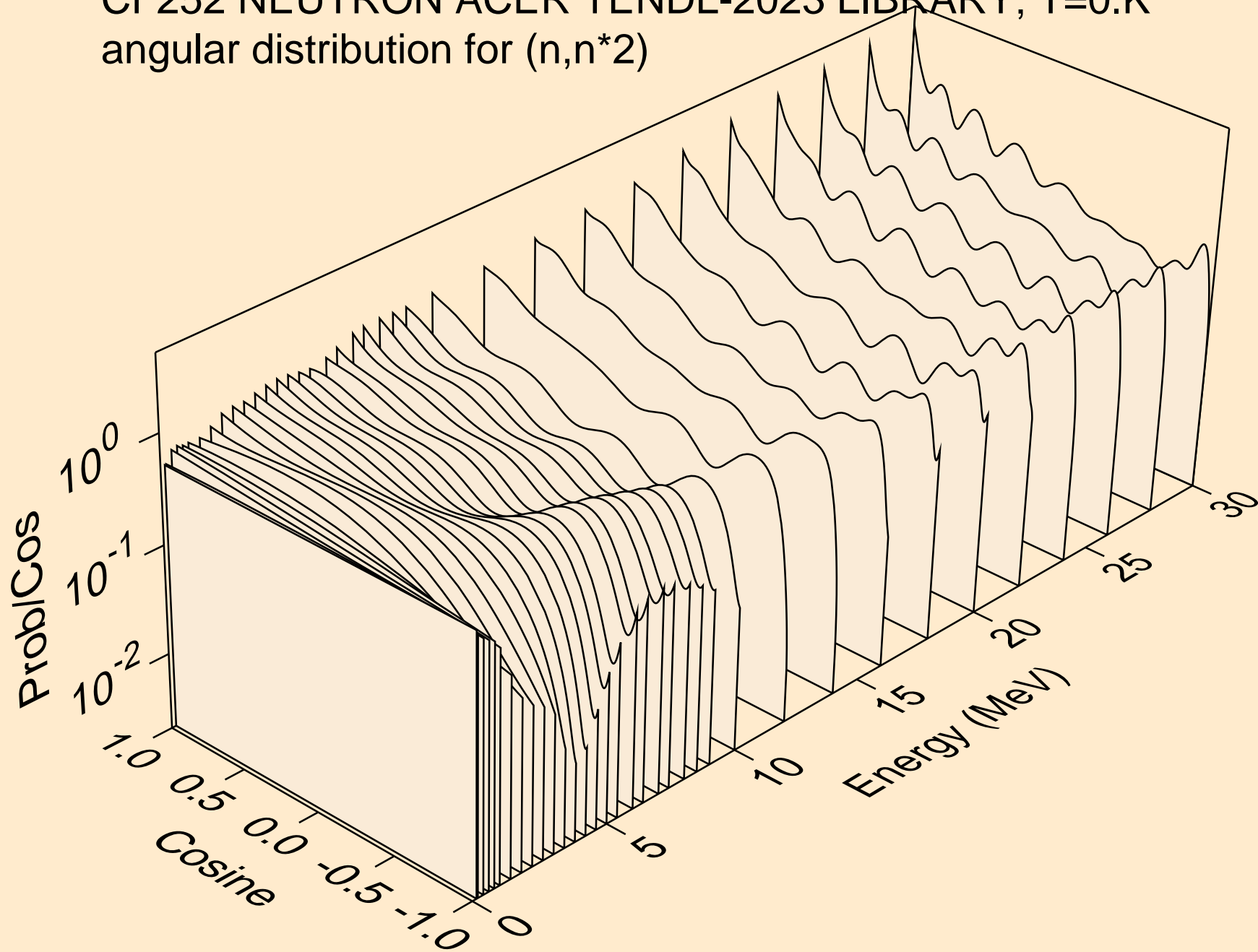

CF252 NEUTRON ACER TENDL-2023 LIBRARY; T=0.K  
angular distribution for (n,n\*3)

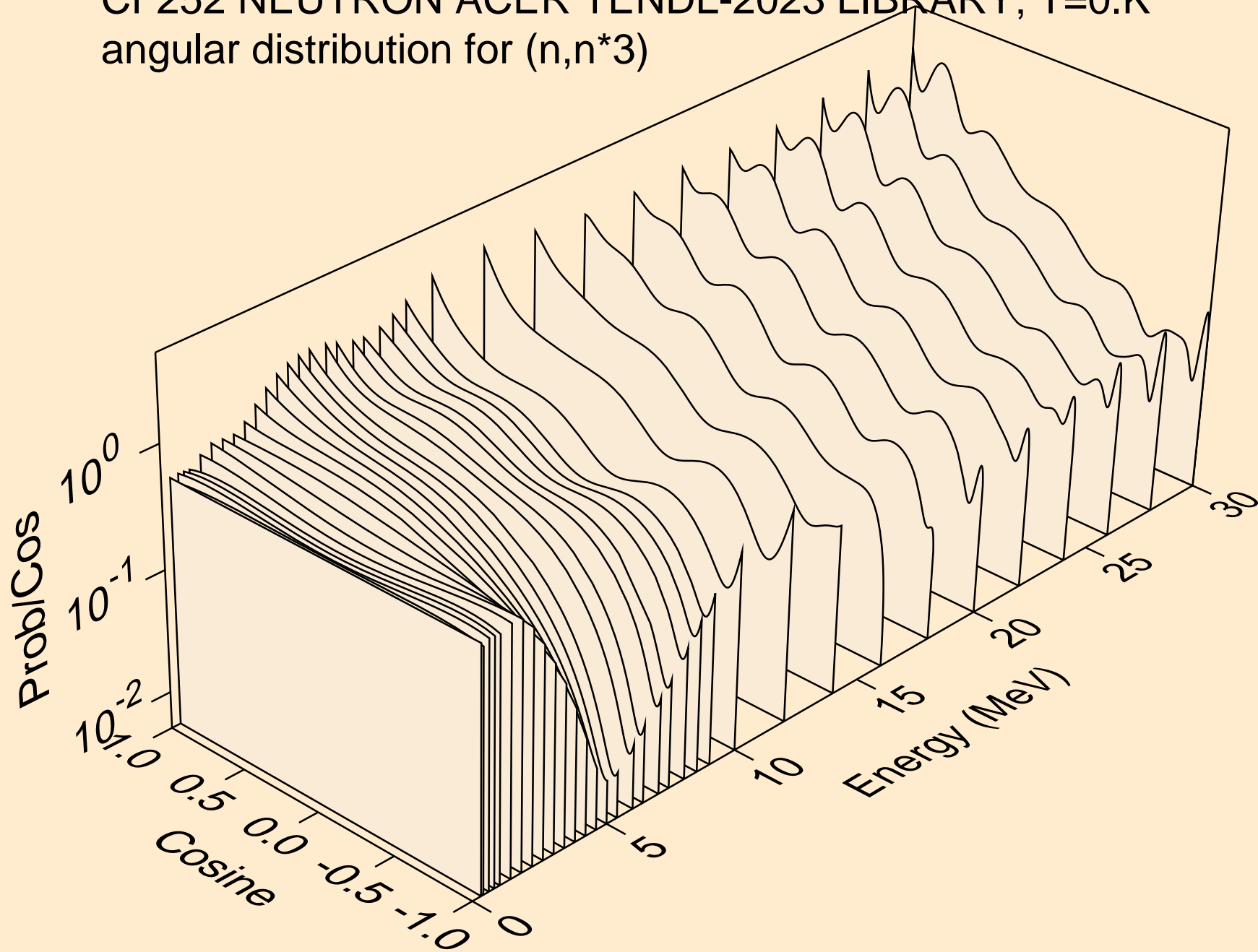

CF252 NEUTRON ACER TENDL-2023 LIBRARY; T=0.K  
angular distribution for (n,n\*4)

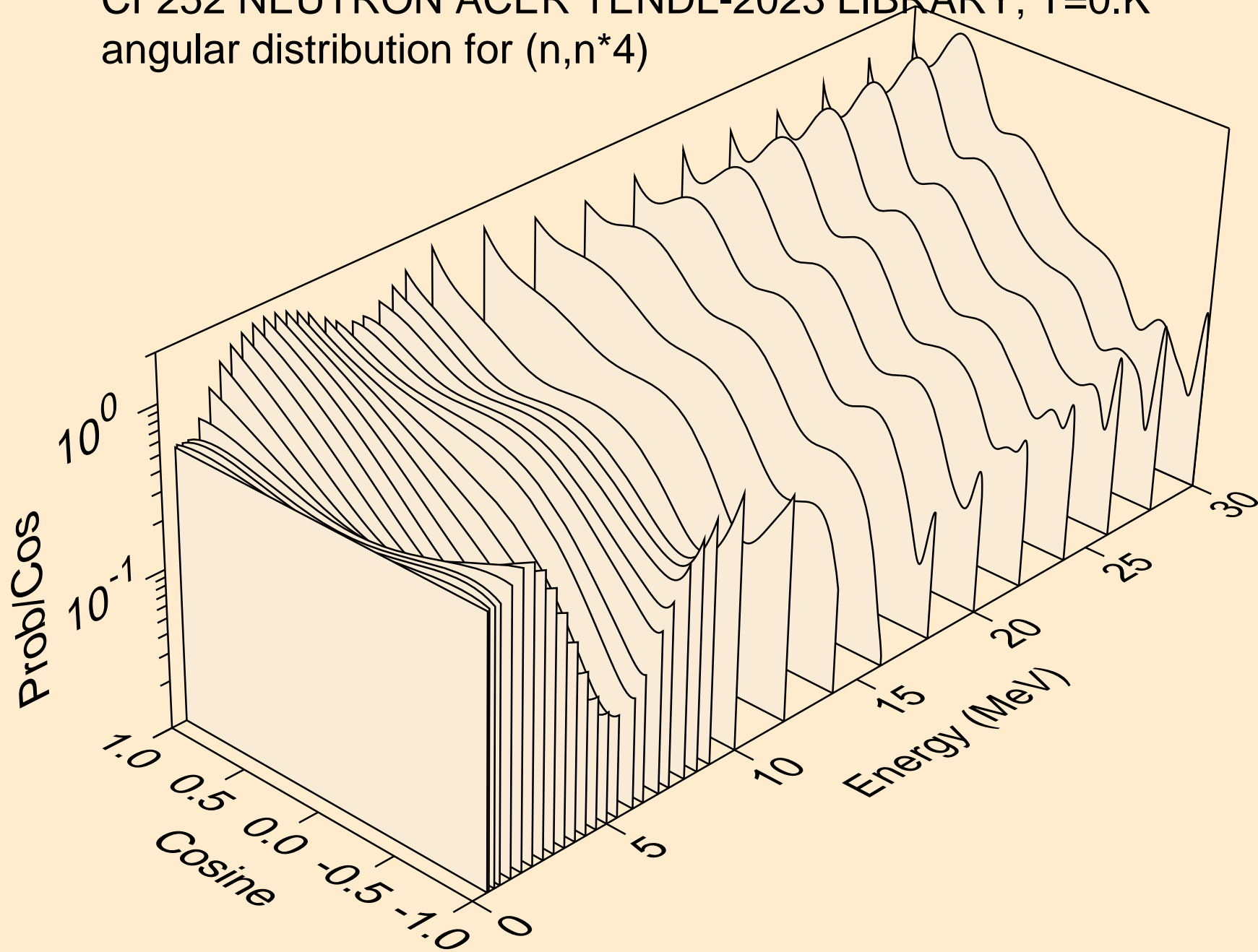

CF252 NEUTRON ACER TENDL-2023 LIBRARY; T=0.K  
angular distribution for (n,n\*5)

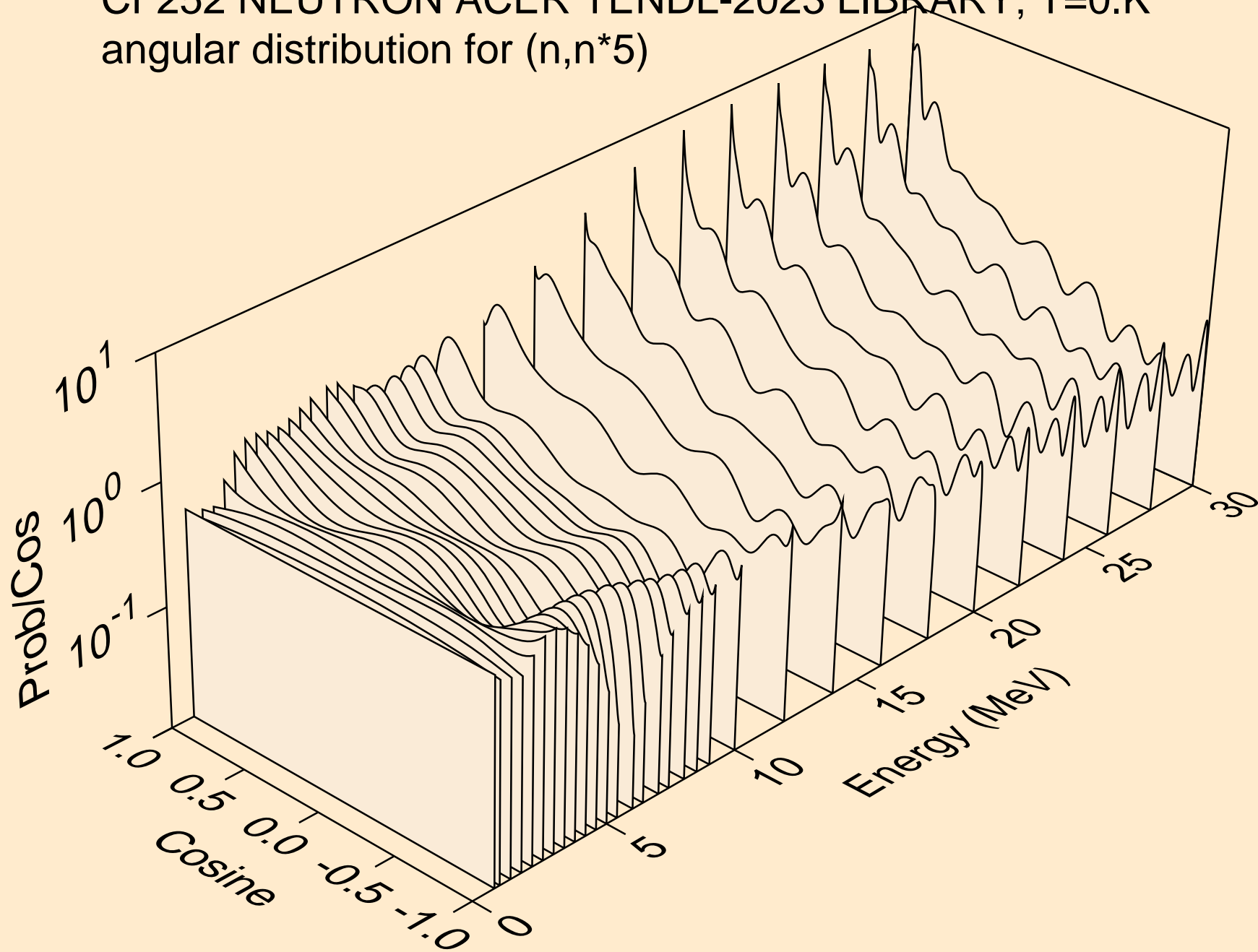

CF252 NEUTRON ACER TENDL-2023 LIBRARY; T=0.K  
angular distribution for (n,n\*6)

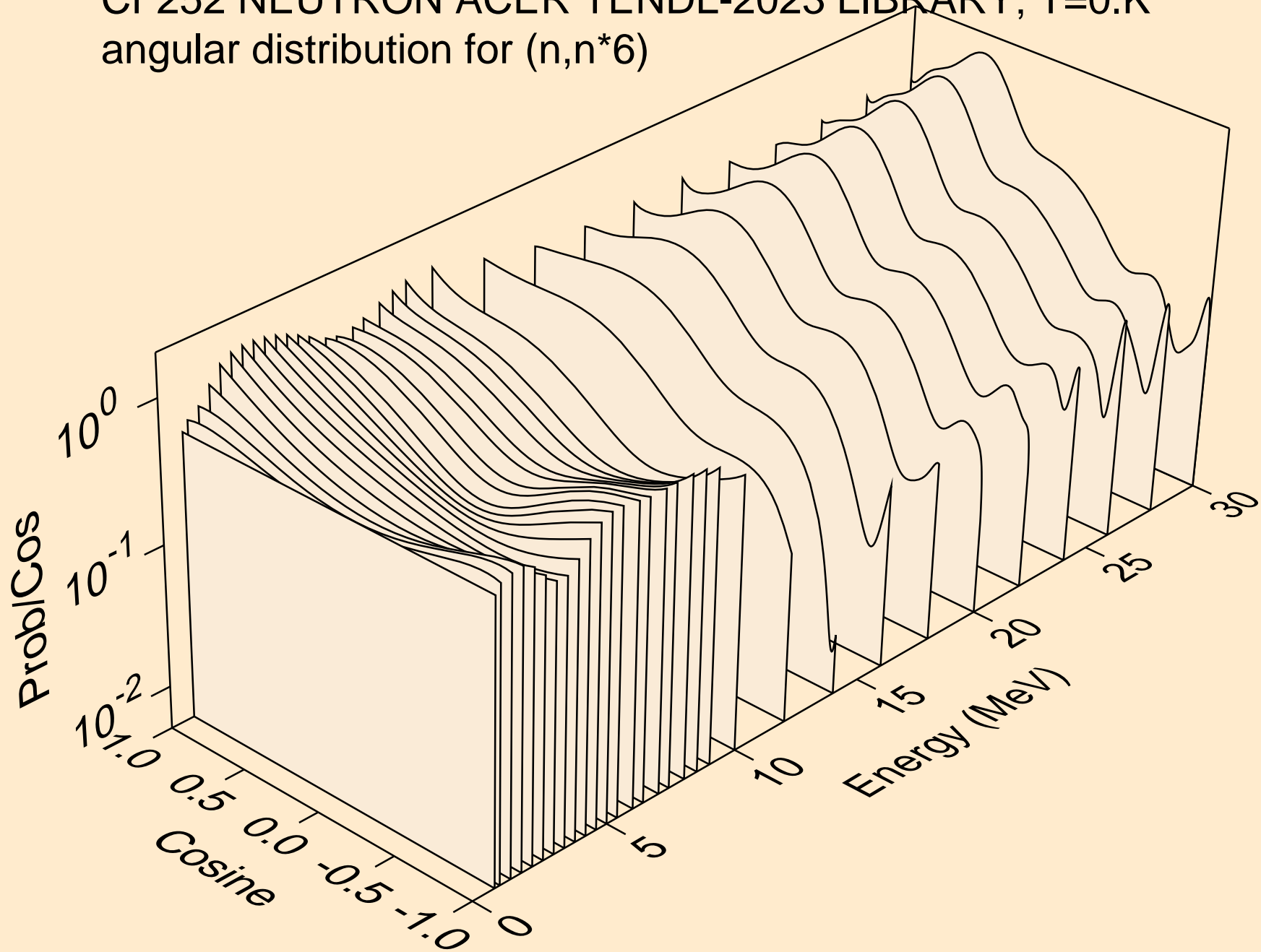

CF252 NEUTRON ACER TENDL-2023 LIBRARY; T=0.K  
angular distribution for (n,n\*7)

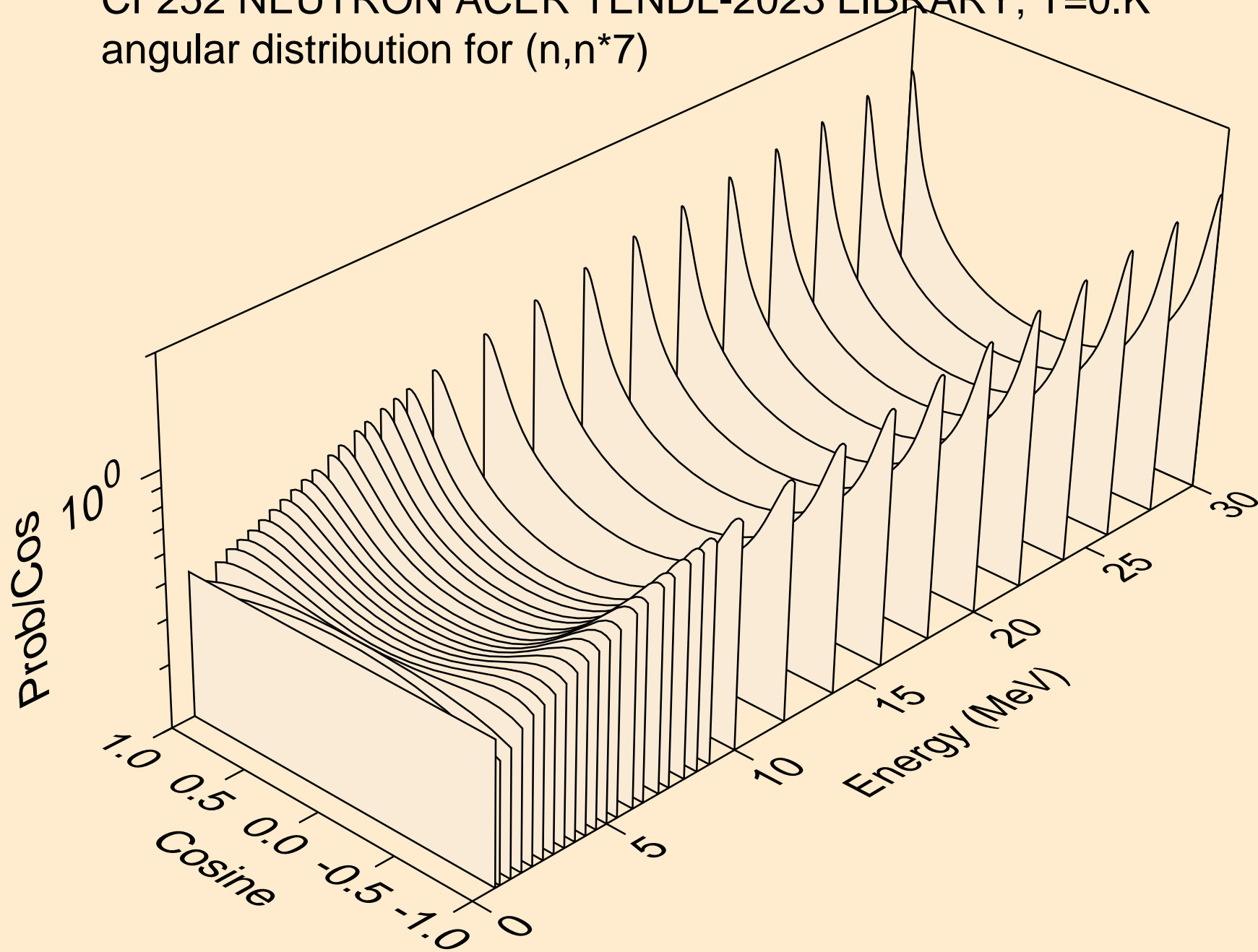

CF252 NEUTRON ACER TENDL-2023 LIBRARY; T=0.K  
angular distribution for (n,n\*8)

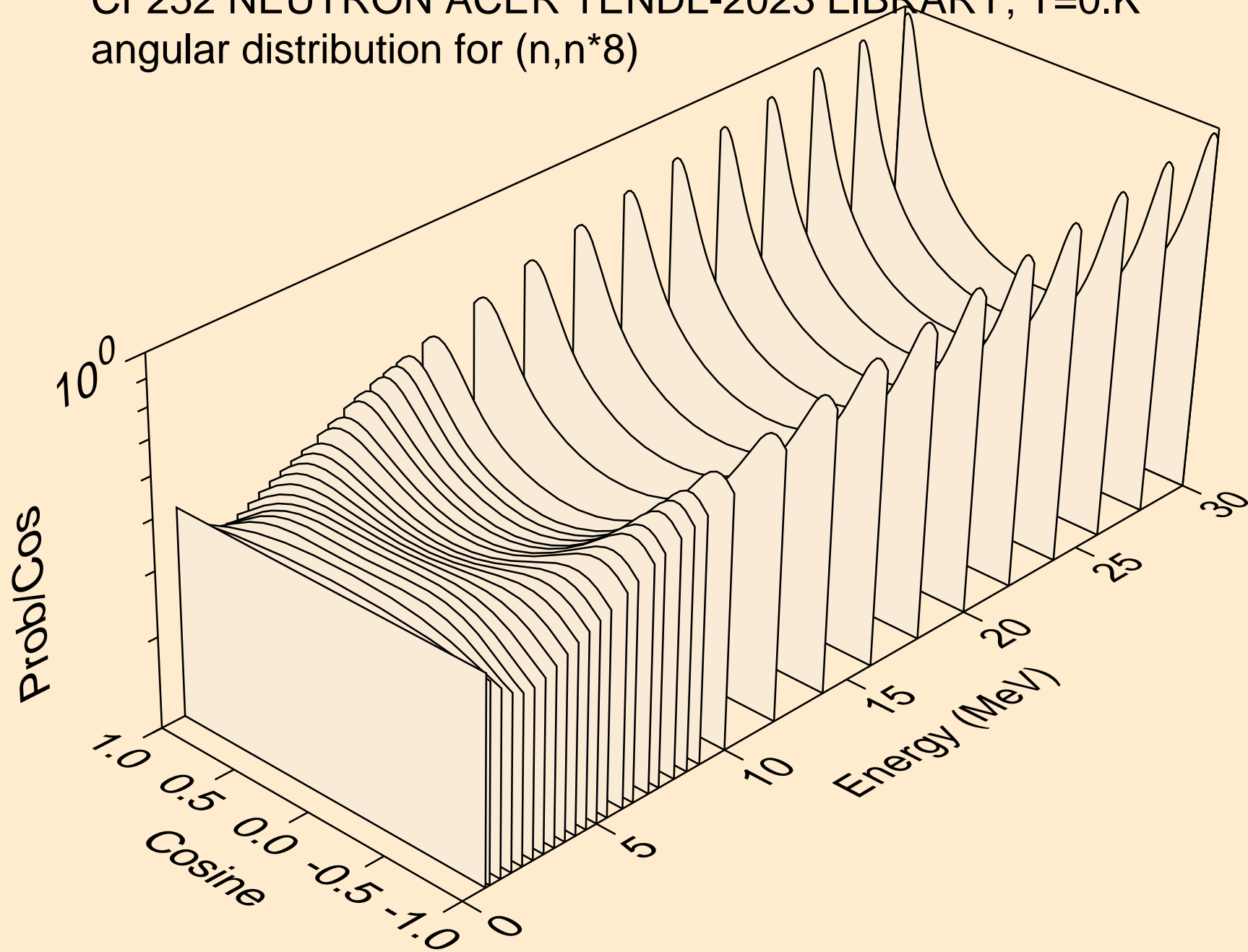

CF252 NEUTRON ACER TENDL-2023 LIBRARY; T=0.K  
angular distribution for (n,n\*9)

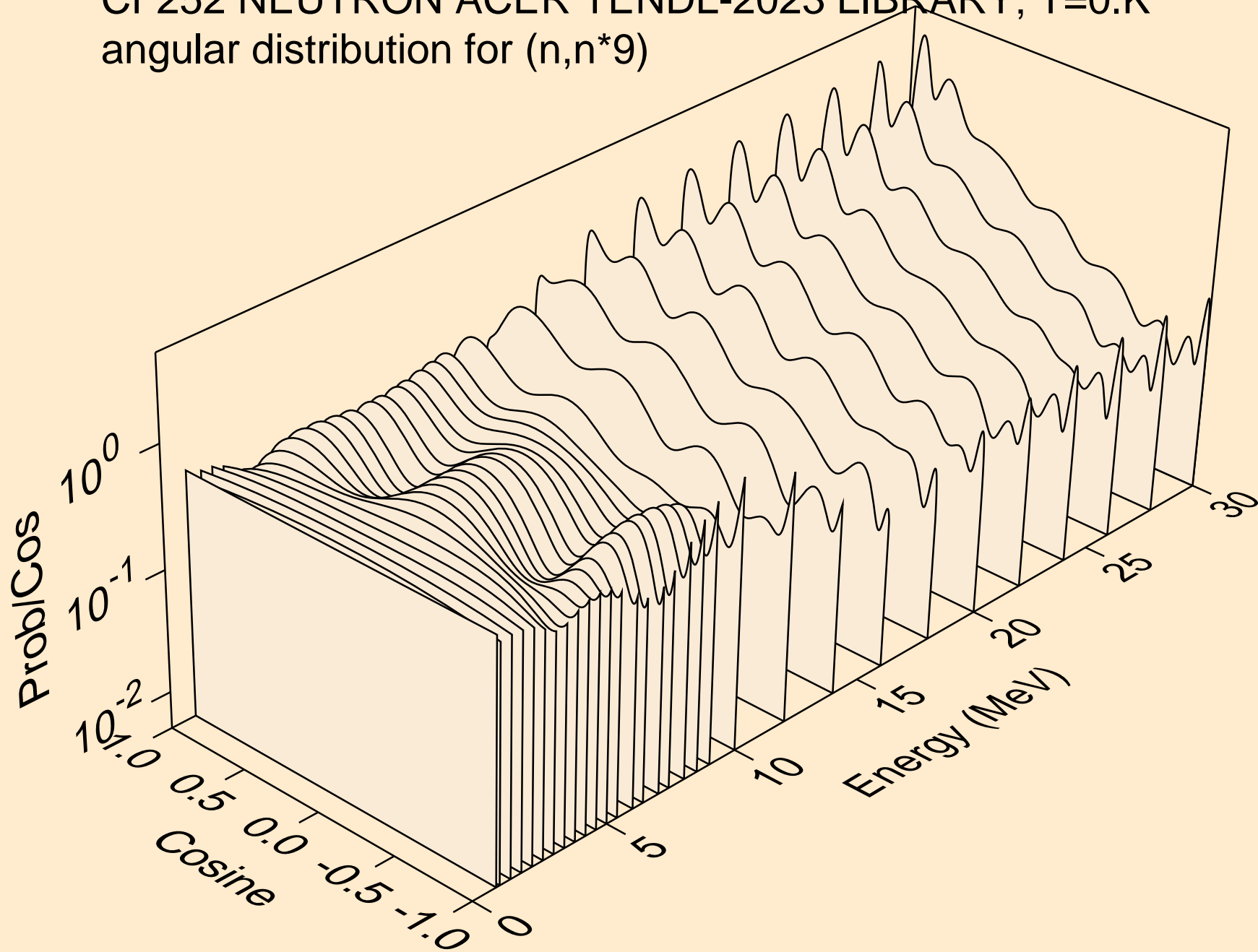



CF252 NEUTRON ACER TENDL-2023 LIBRARY; T=0.K  
angular distribution for (n,n\*10)

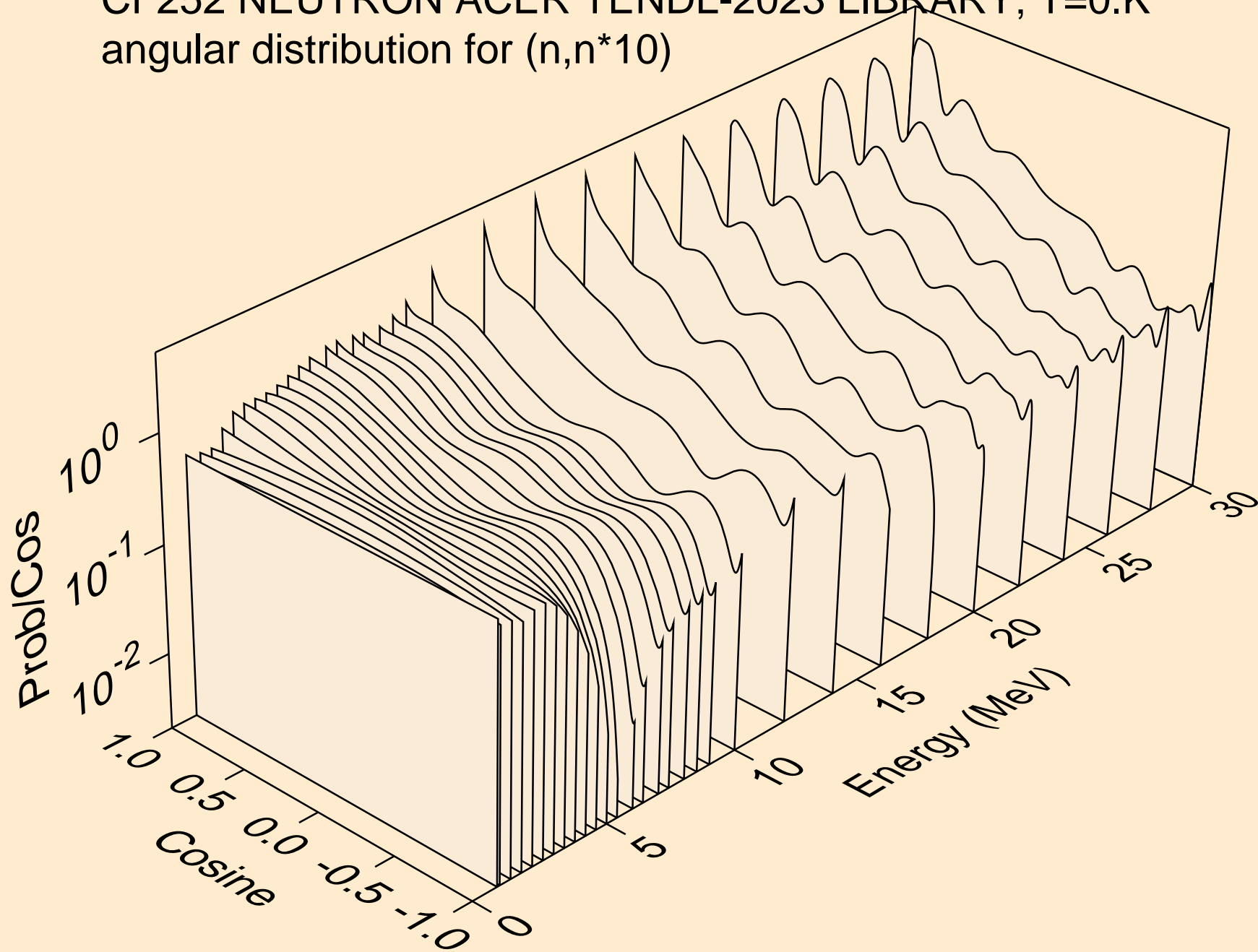

CF252 NEUTRON ACER TENDL-2023 LIBRARY; T=0.K  
angular distribution for (n,n\*11)

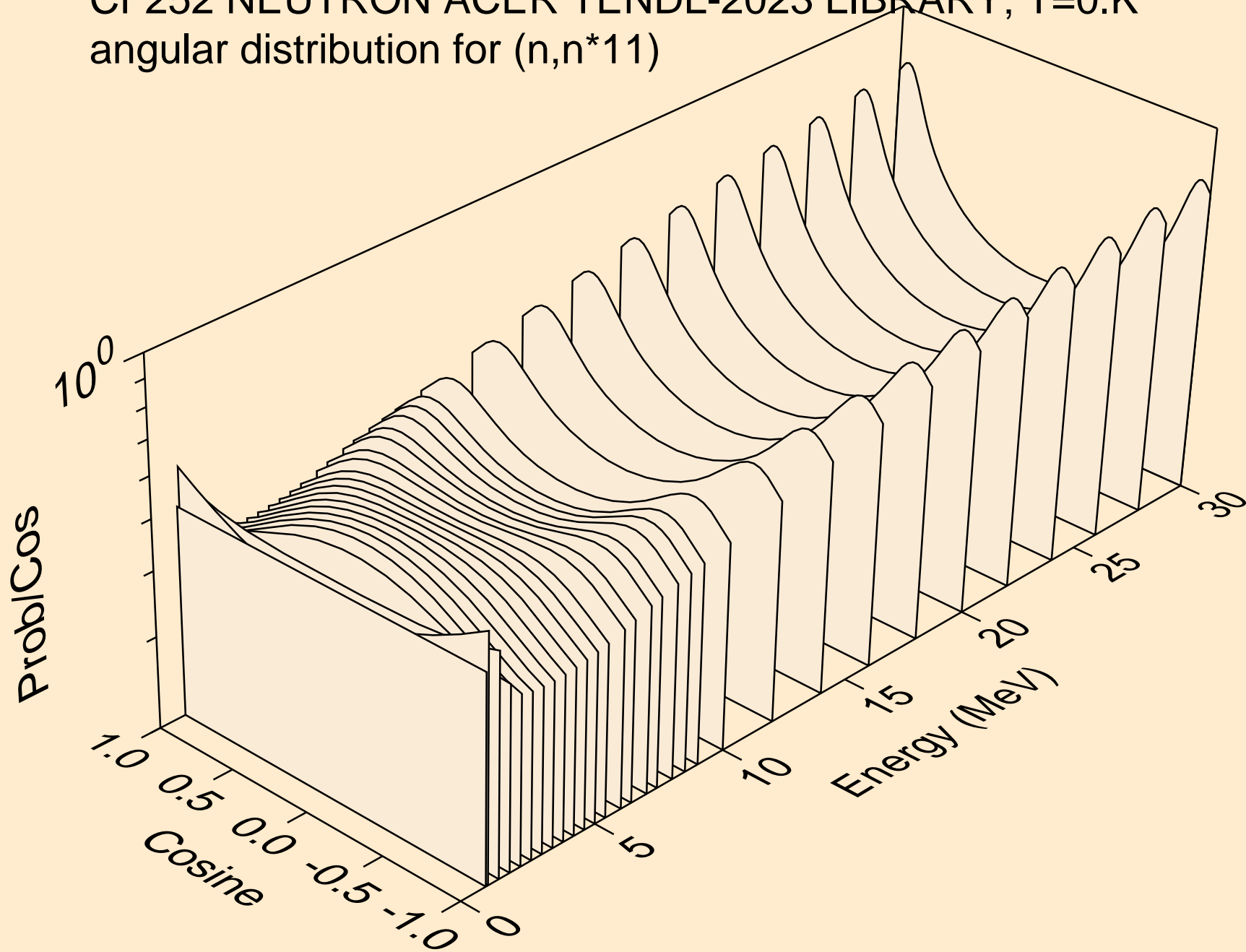

CF252 NEUTRON ACER TENDL-2023 LIBRARY; T=0.K  
angular distribution for (n,n\*12)

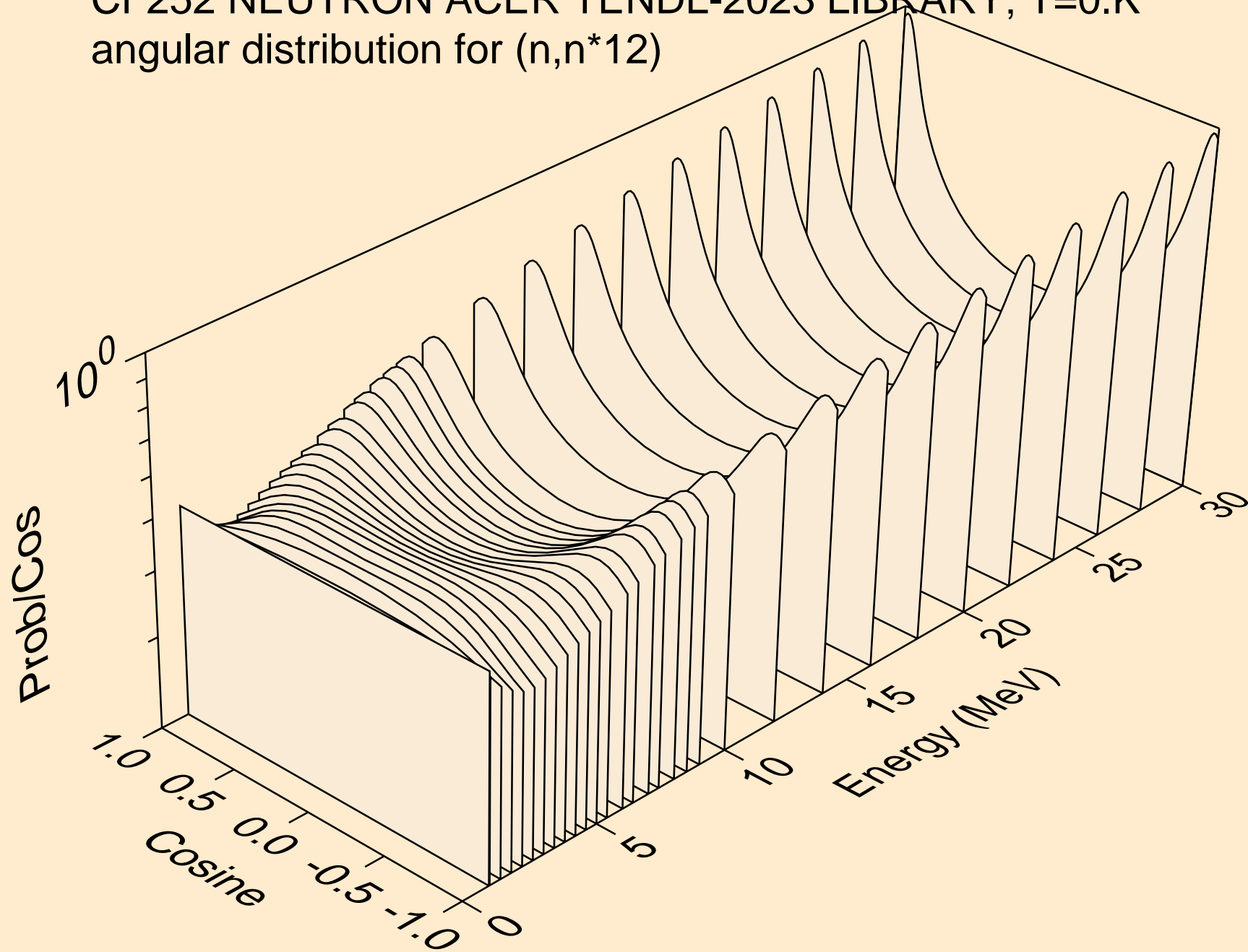

CF252 NEUTRON ACER TENDL-2023 LIBRARY; T=0.K  
angular distribution for (n,n\*13)

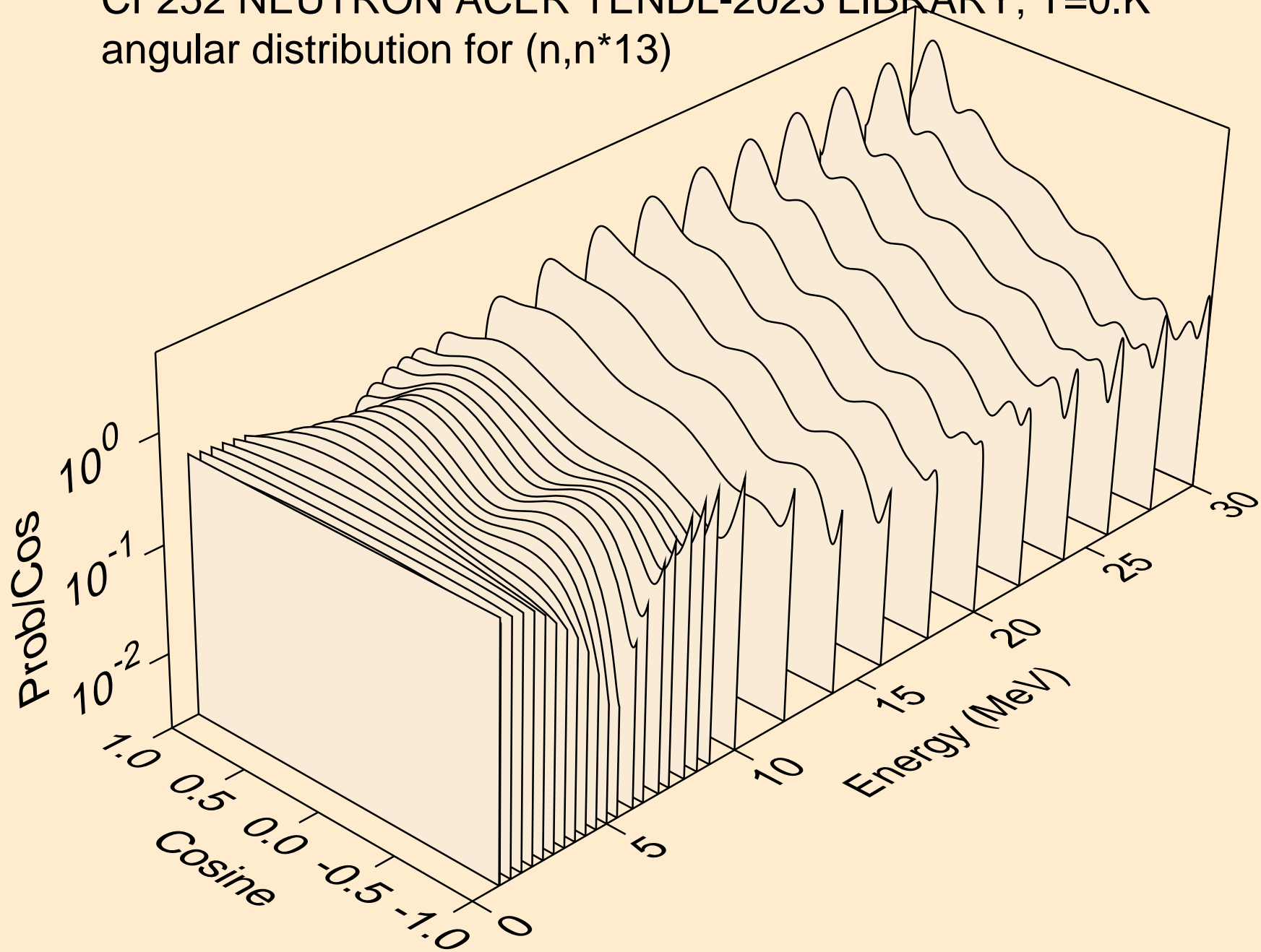

CF252 NEUTRON ACER TENDL-2023 LIBRARY; T=0.K  
angular distribution for (n,n\*14)

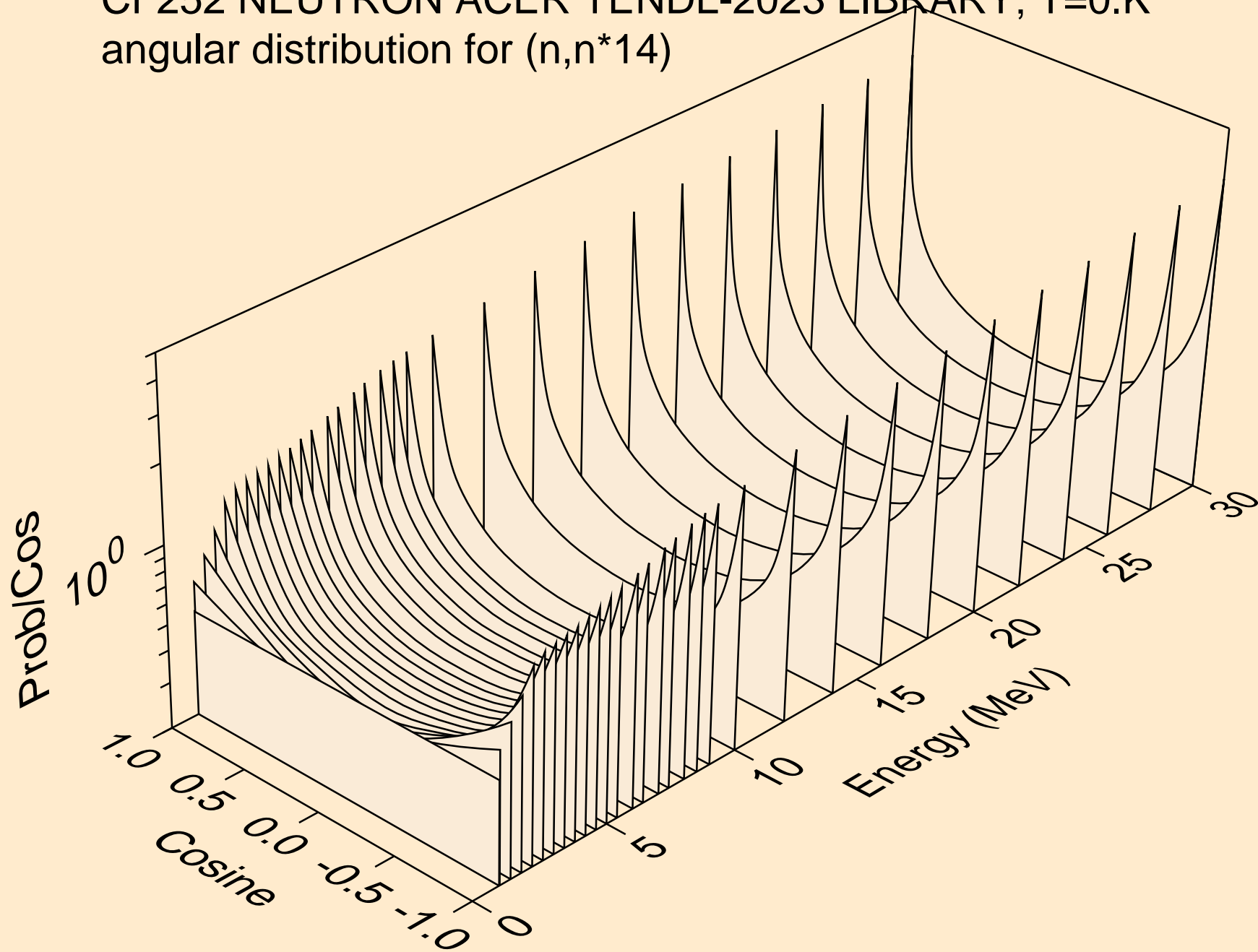

CF252 NEUTRON ACER TENDL-2023 LIBRARY; T=0.K  
angular distribution for (n,n\*15)

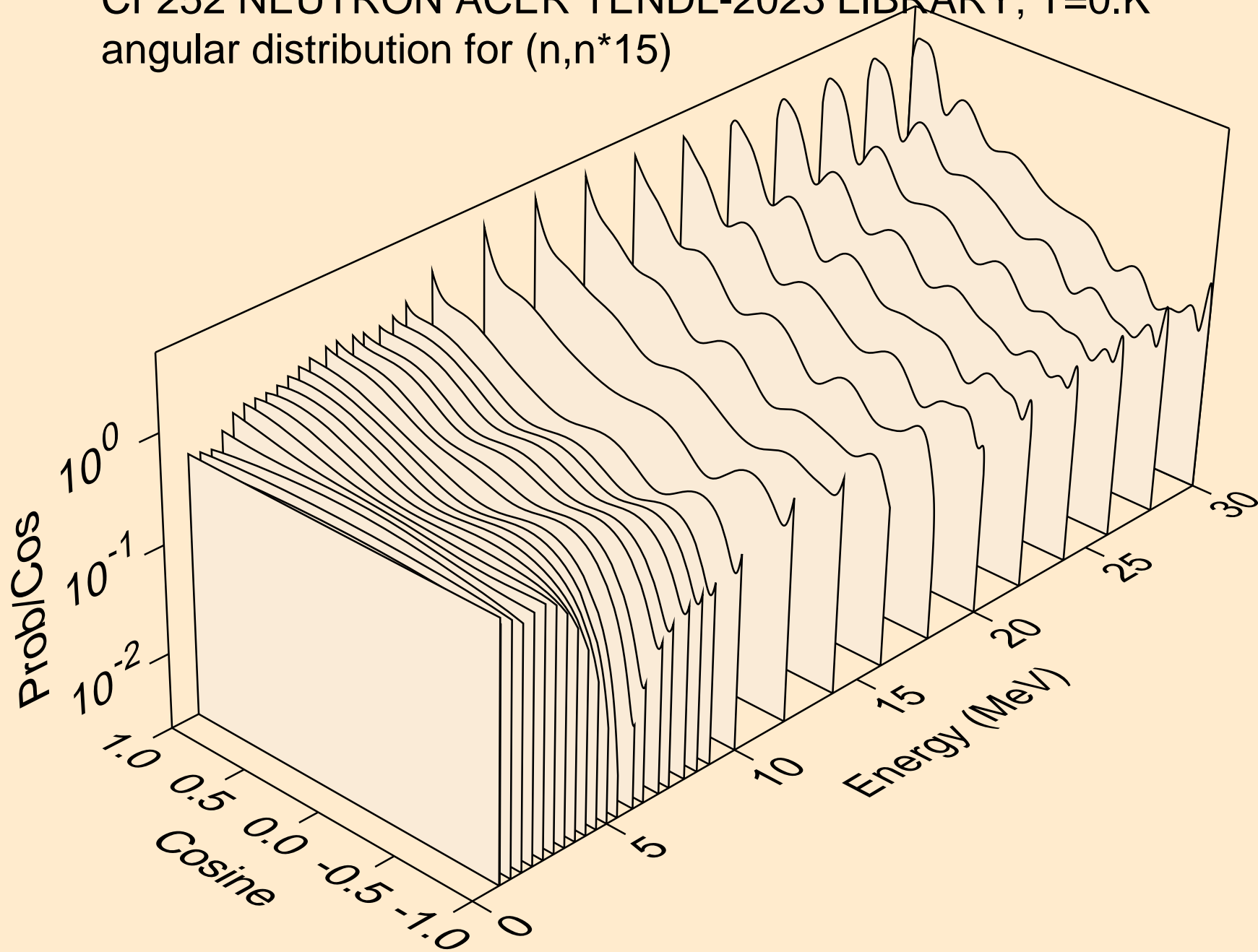

CF252 NEUTRON ACER TENDL-2023 LIBRARY; T=0.K  
angular distribution for (n,n\*16)

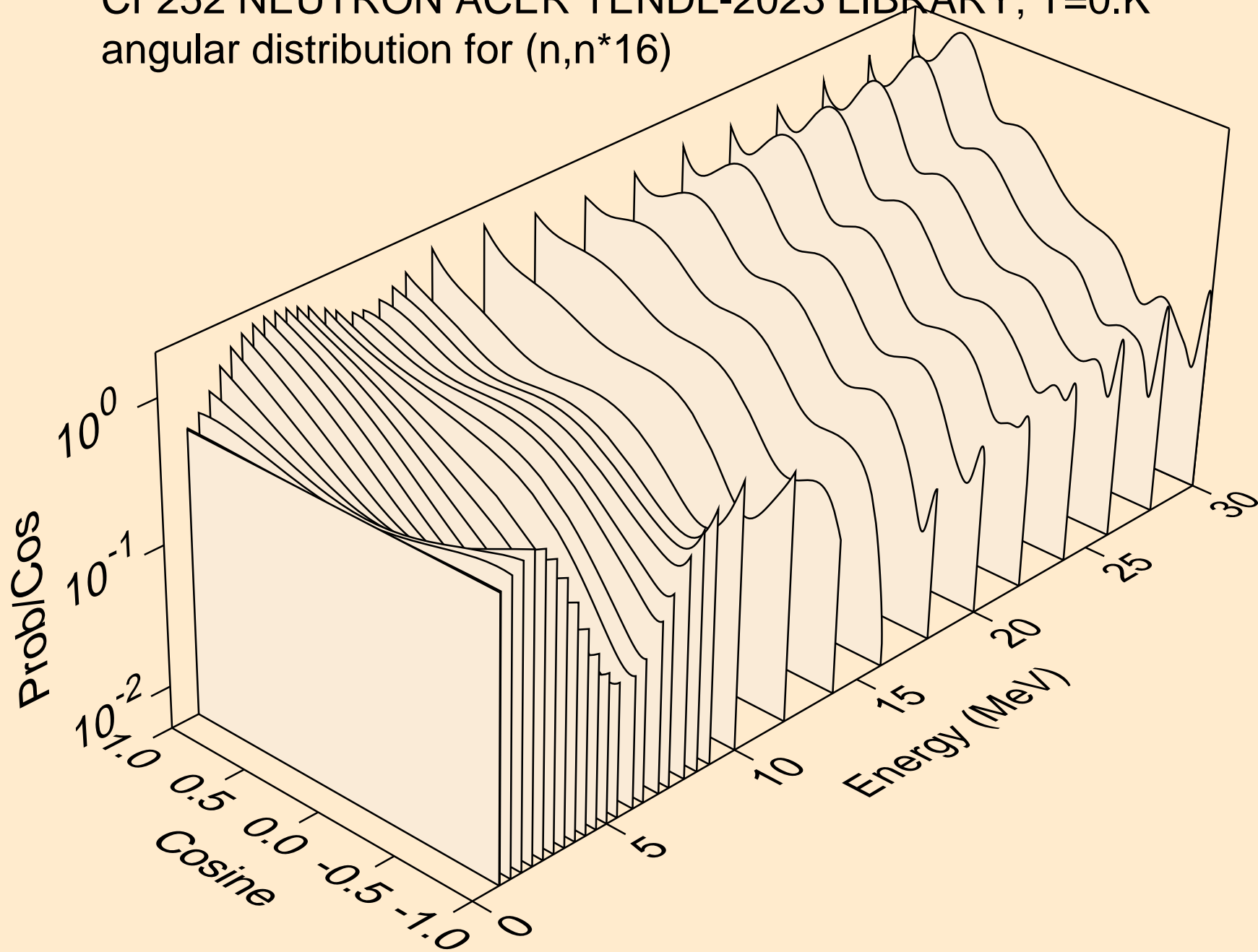

CF252 NEUTRON ACER TENDL-2023 LIBRARY; T=0.K  
angular distribution for (n,n\*17)

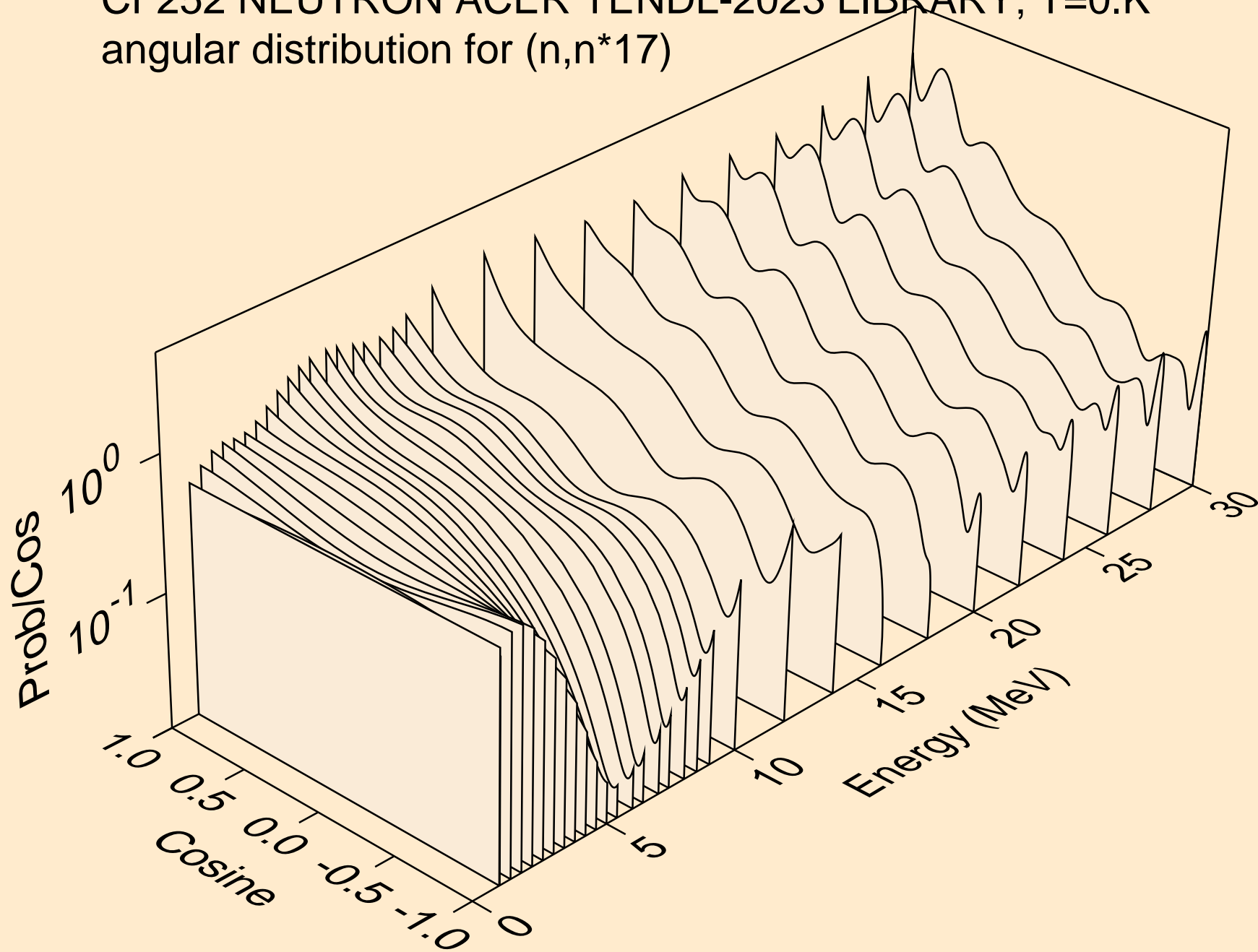



CF252 NEUTRON ACER TENDL-2023 LIBRARY; T=0.K  
angular distribution for (n,n\*18)

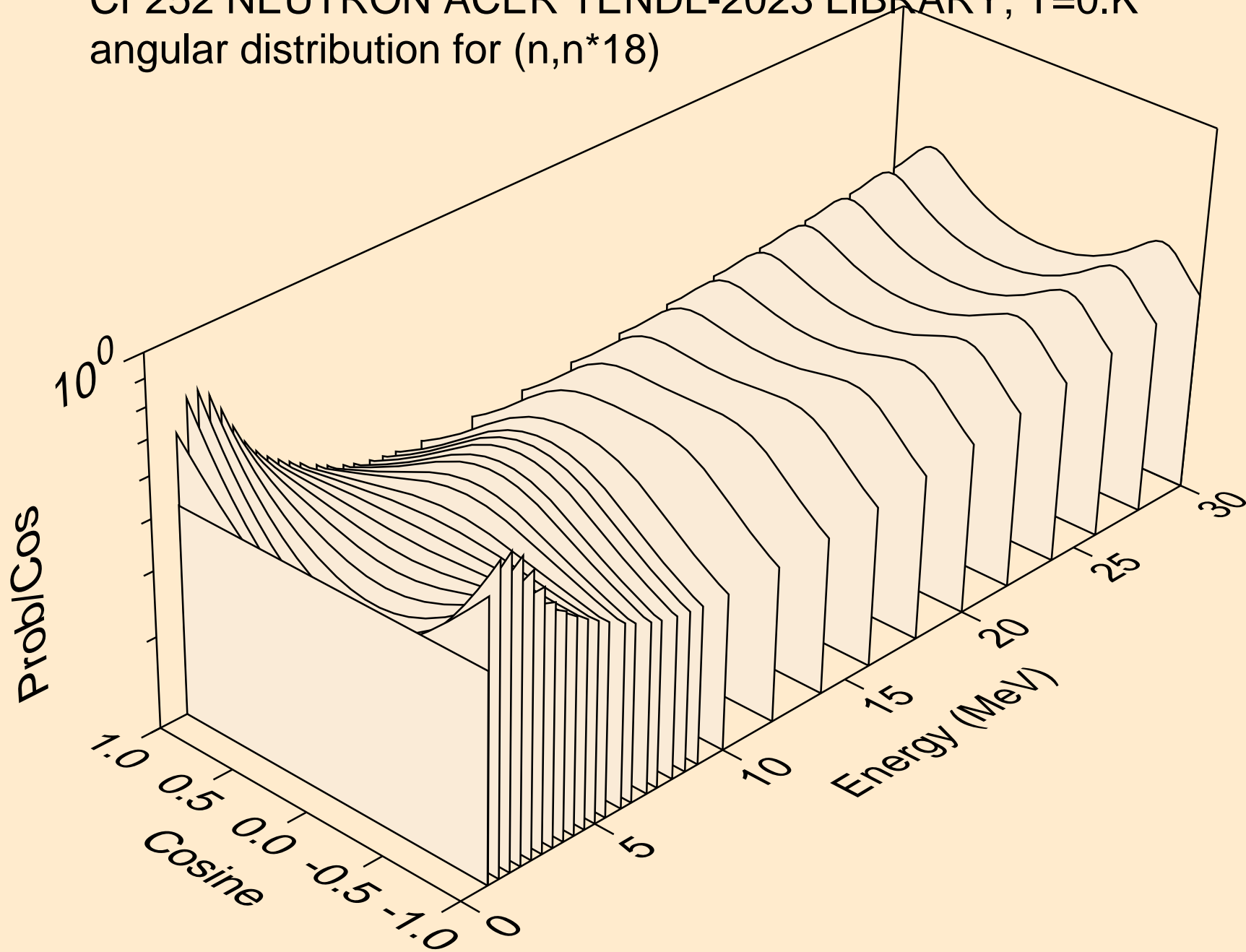

CF252 NEUTRON ACER TENDL-2023 LIBRARY; T=0.K  
angular distribution for (n,n\*19)

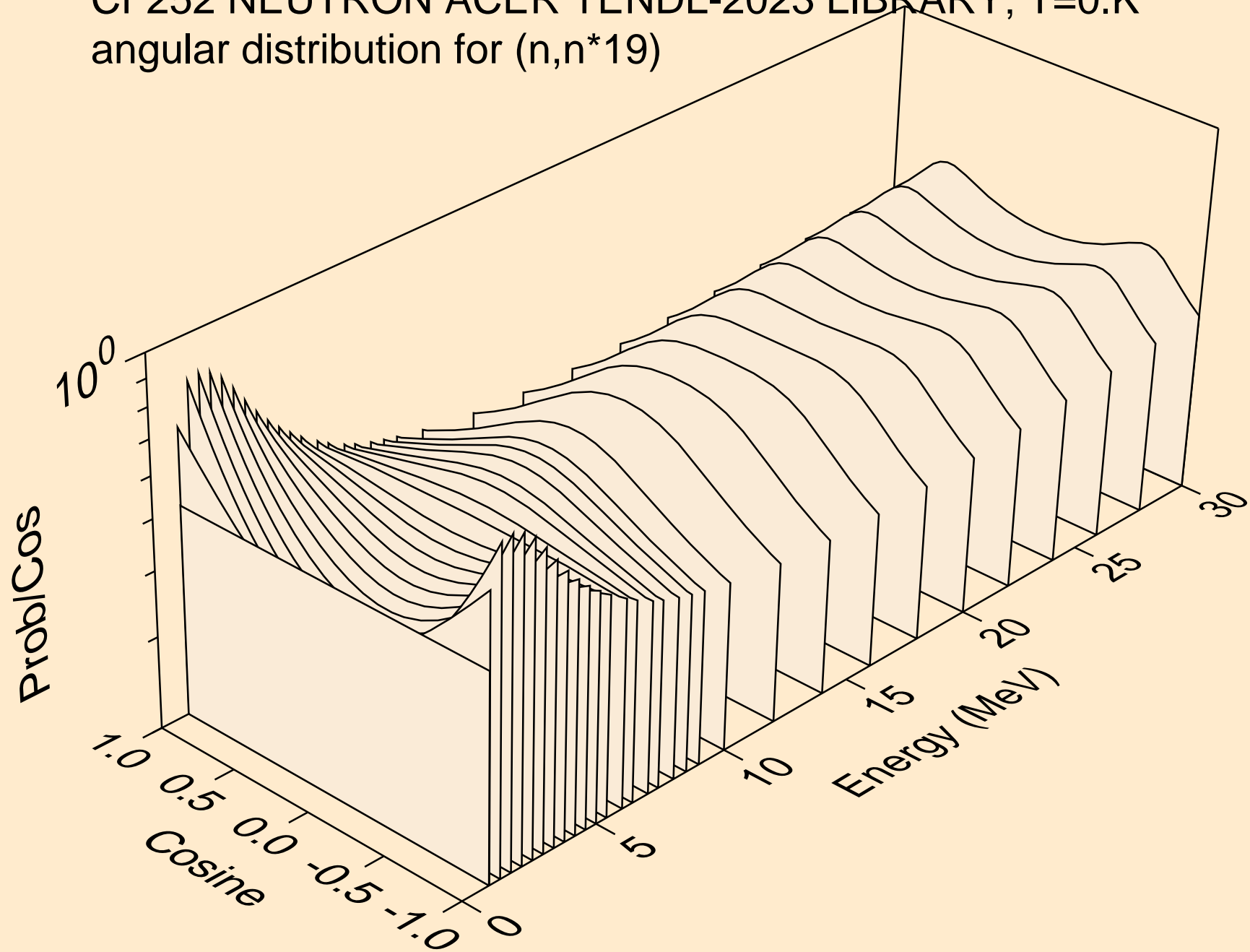

CF252 NEUTRON ACER TENDL-2023 LIBRARY; T=0.K  
angular distribution for (n,n\*20)

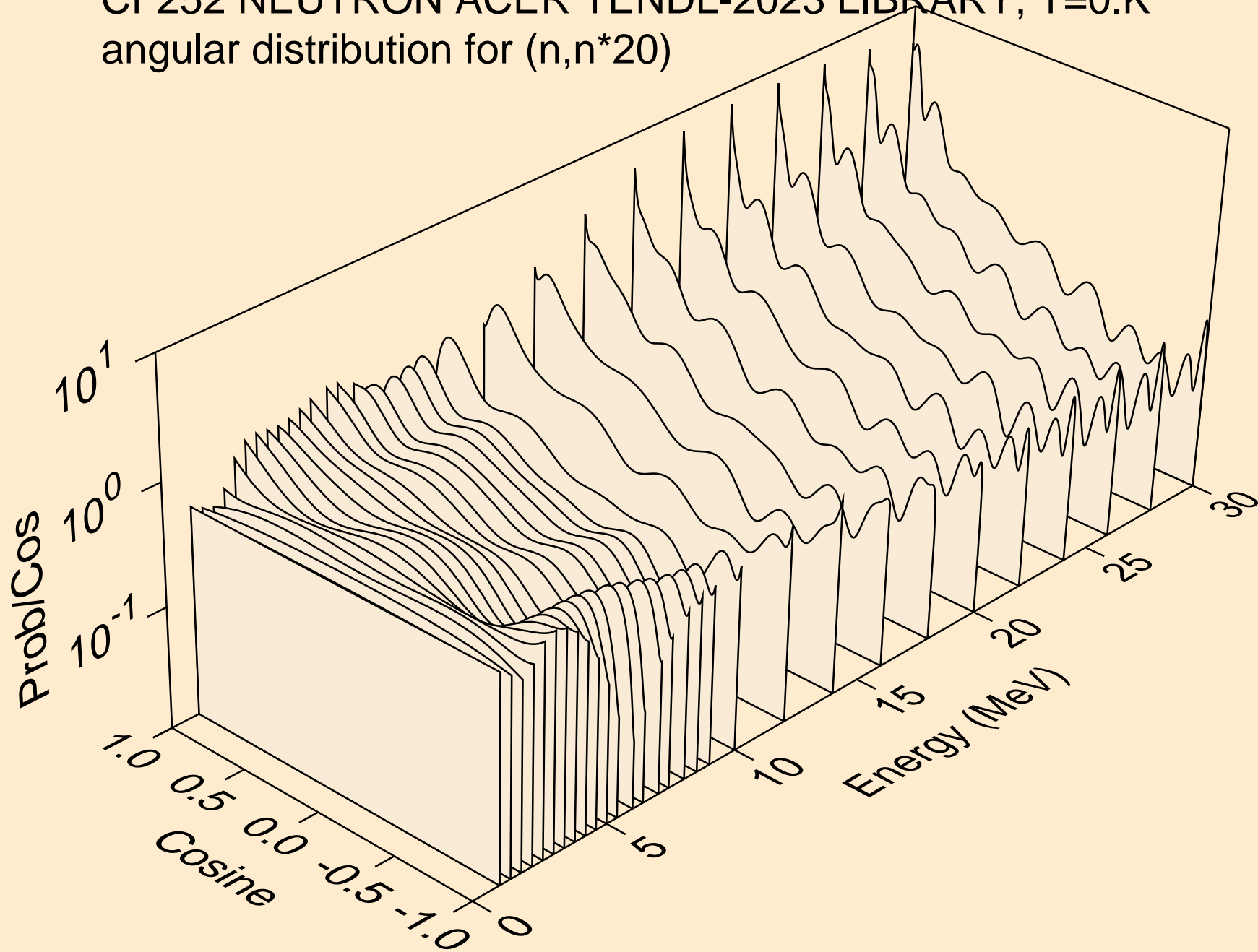

CF252 NEUTRON ACER TENDL-2023 LIBRARY; T=0.K  
angular distribution for (n,n\*21)

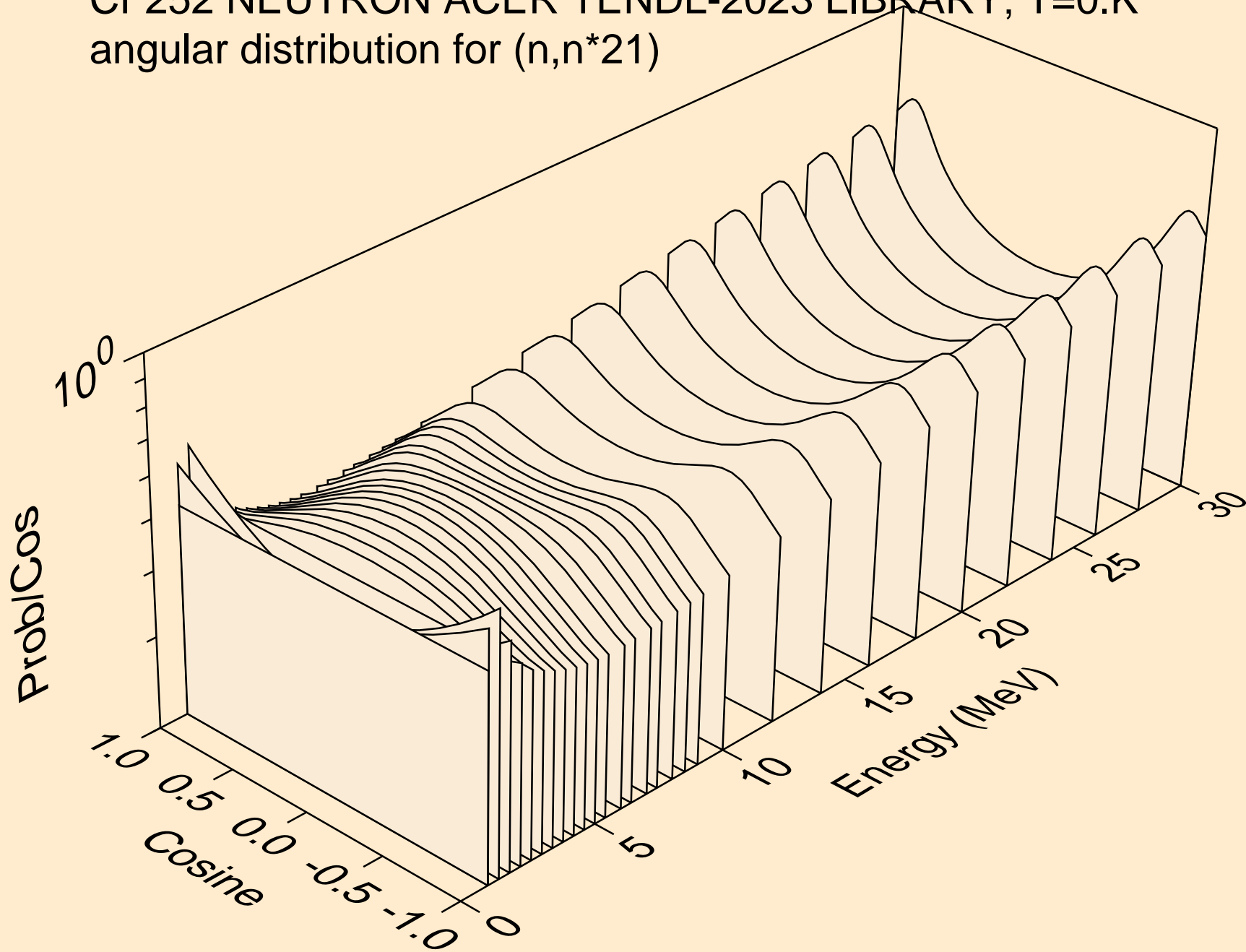

CF252 NEUTRON ACER TENDL-2023 LIBRARY; T=0.K  
angular distribution for (n,n\*22)

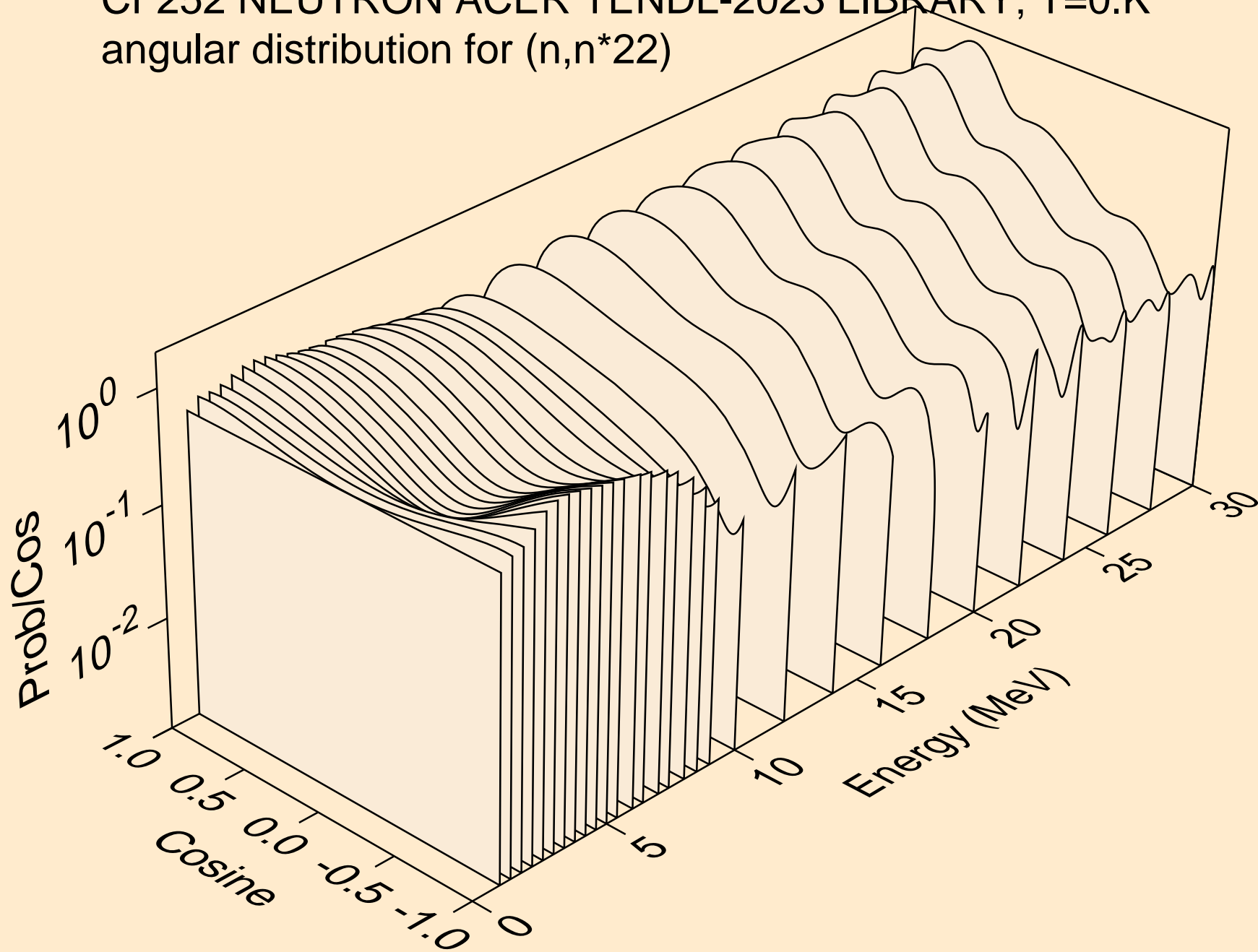

CF252 NEUTRON ACER TENDL-2023 LIBRARY; T=0.K  
angular distribution for (n,n\*23)

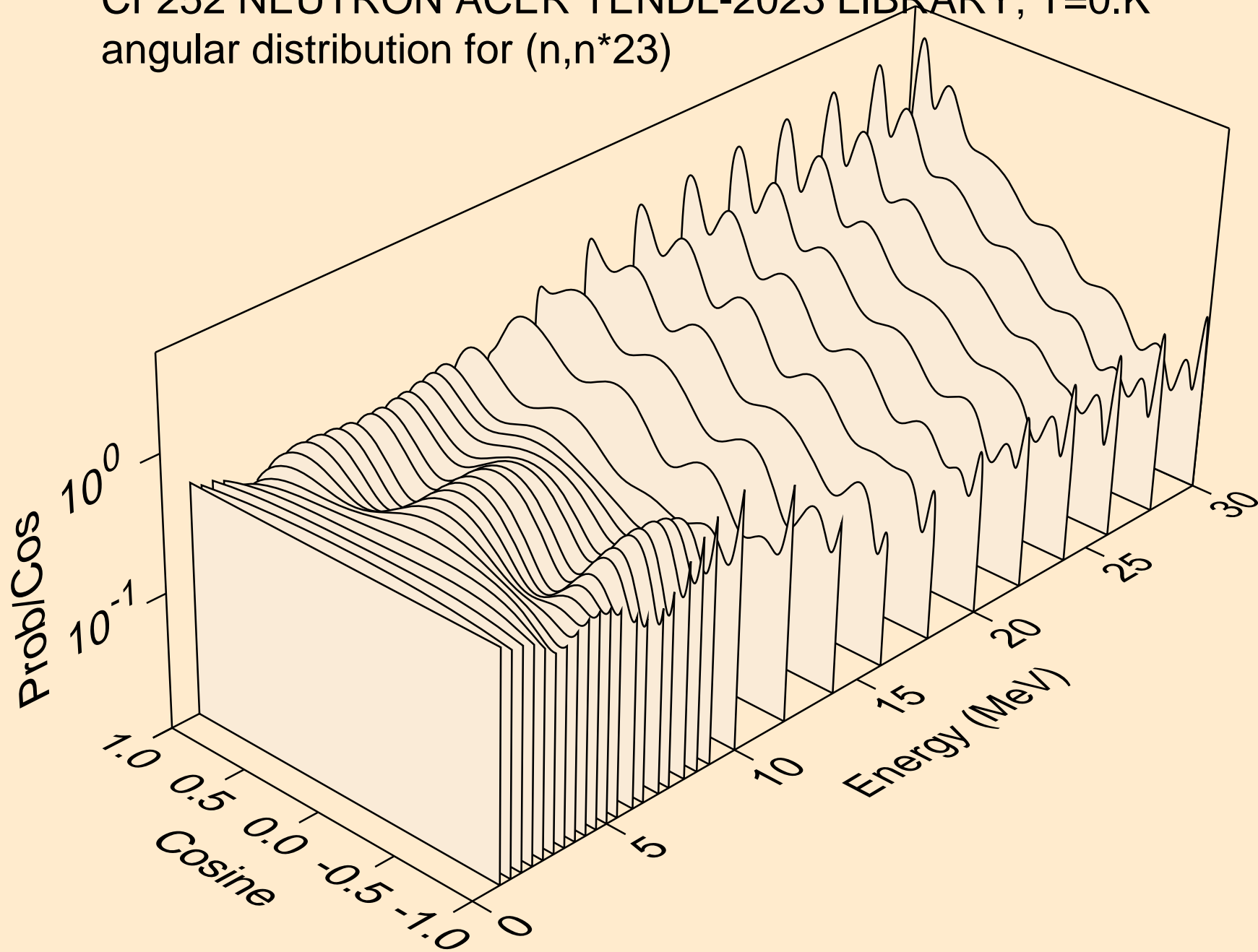

CF252 NEUTRON ACER TENDL-2023 LIBRARY; T=0.K  
angular distribution for (n,n\*24)

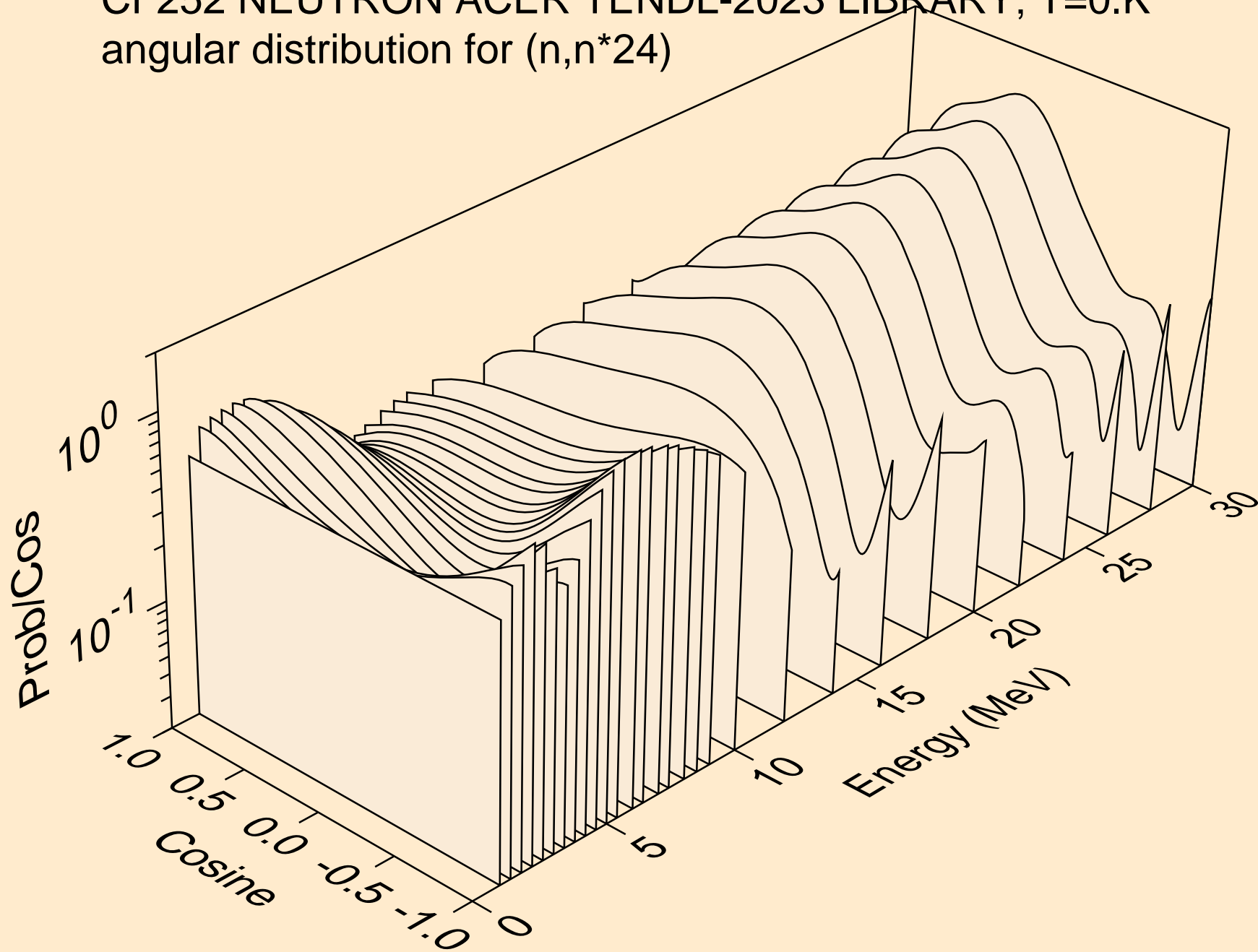

CF252 NEUTRON ACER TENDL-2023 LIBRARY; T=0.K  
angular distribution for (n,n\*25)

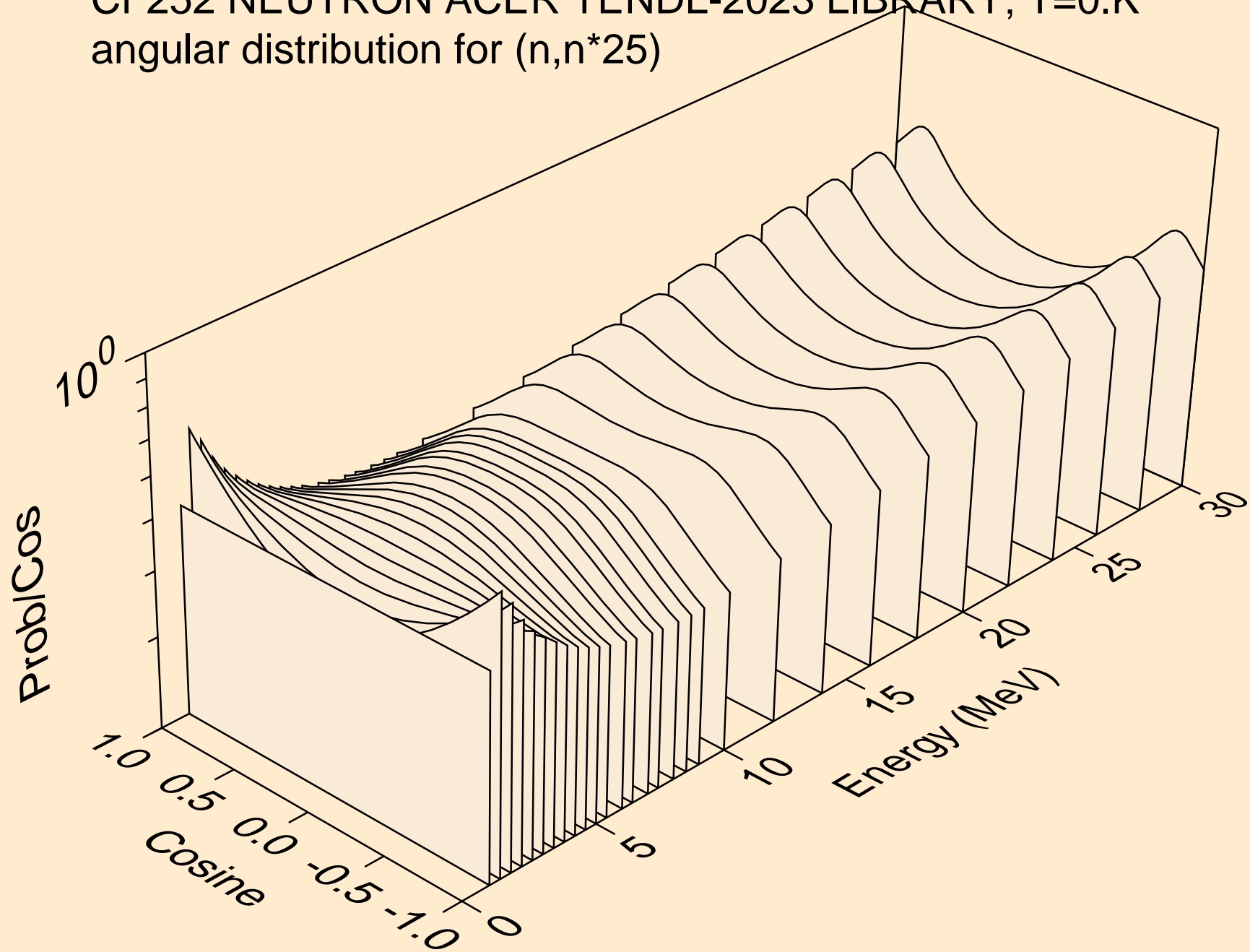



CF252 NEUTRON ACER TENDL-2023 LIBRARY; T=0.K  
angular distribution for (n,n\*26)

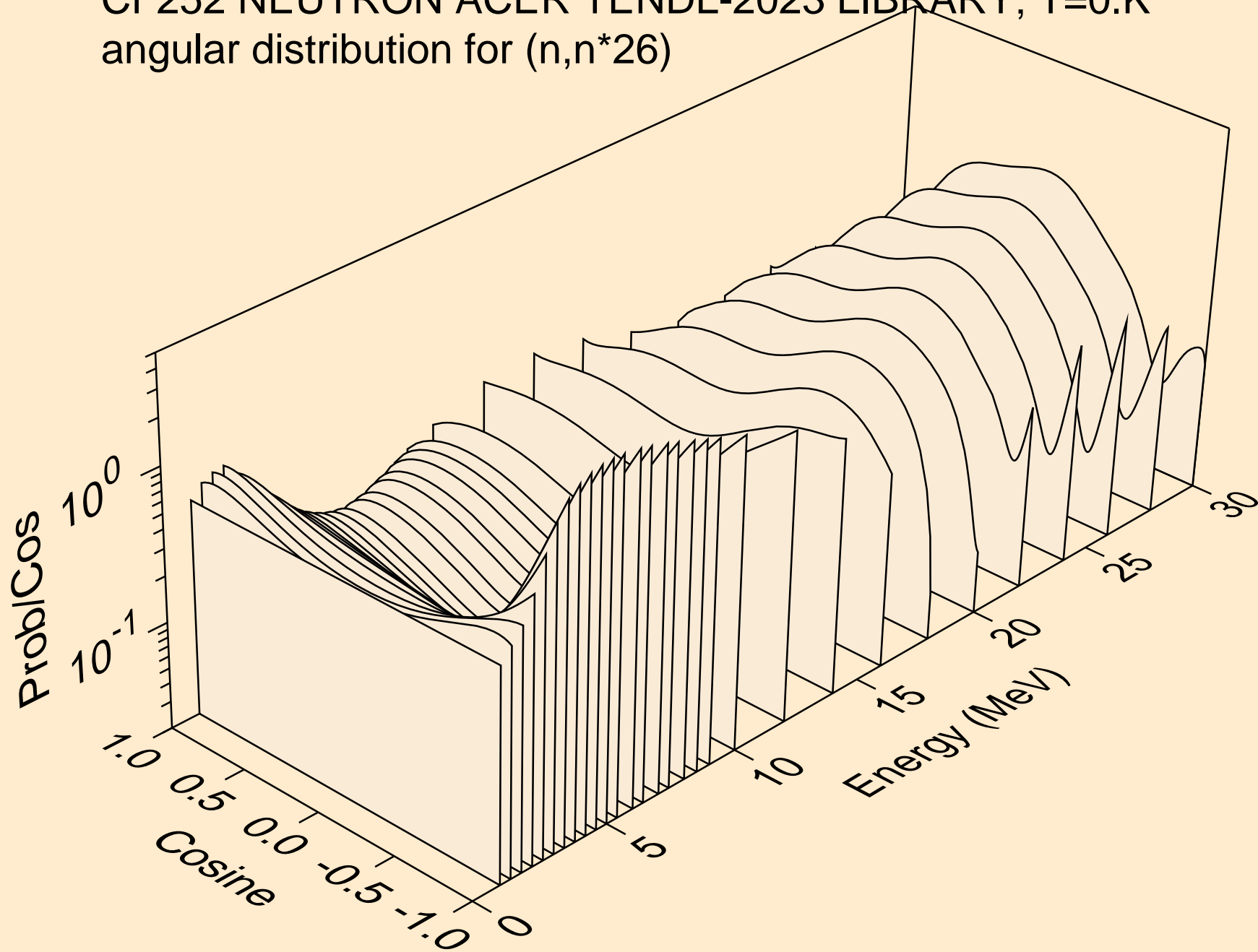

CF252 NEUTRON ACER TENDL-2023 LIBRARY; T=0.K  
angular distribution for (n,n\*27)

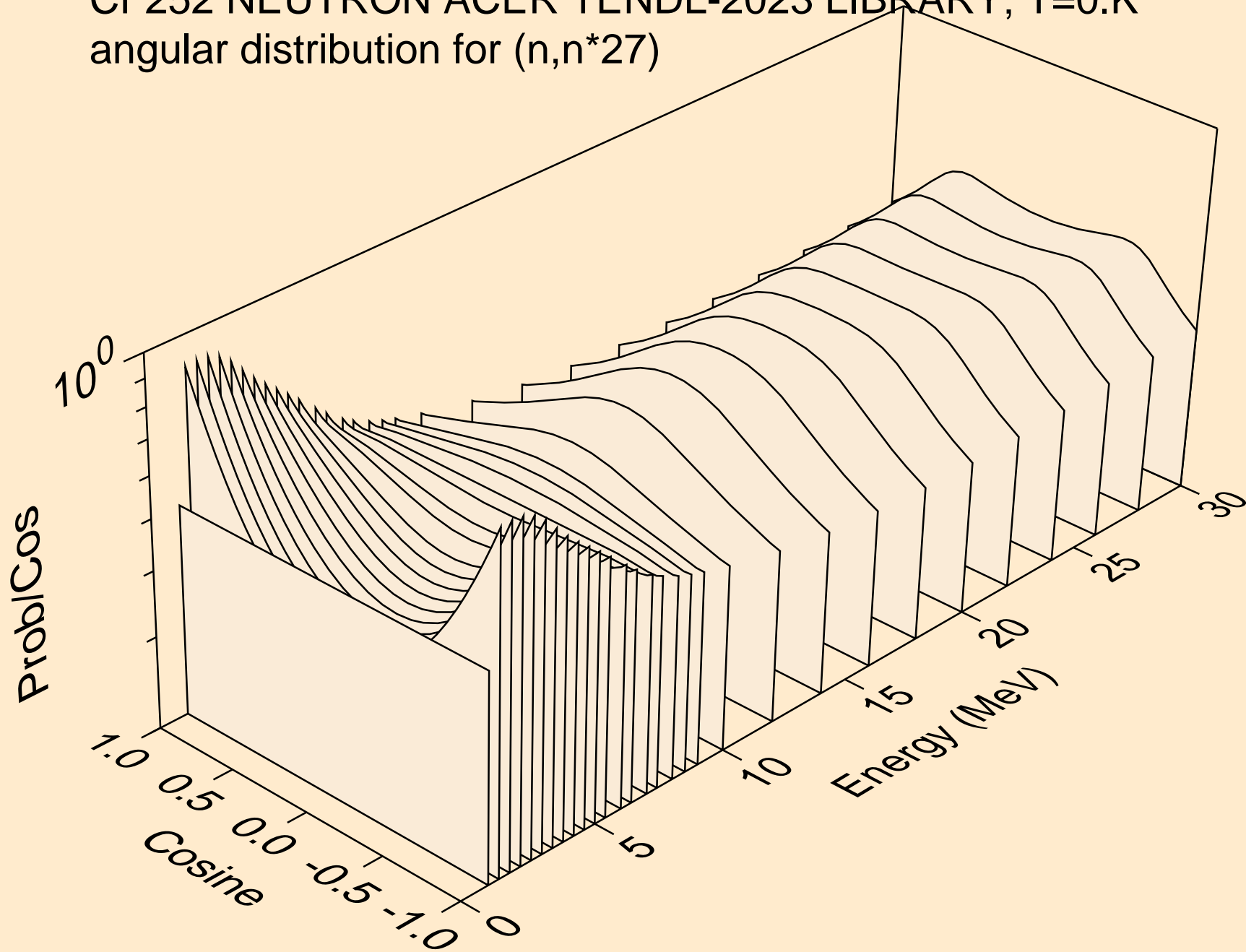

CF252 NEUTRON ACER TENDL-2023 LIBRARY; T=0.K  
angular distribution for (n,n\*28)

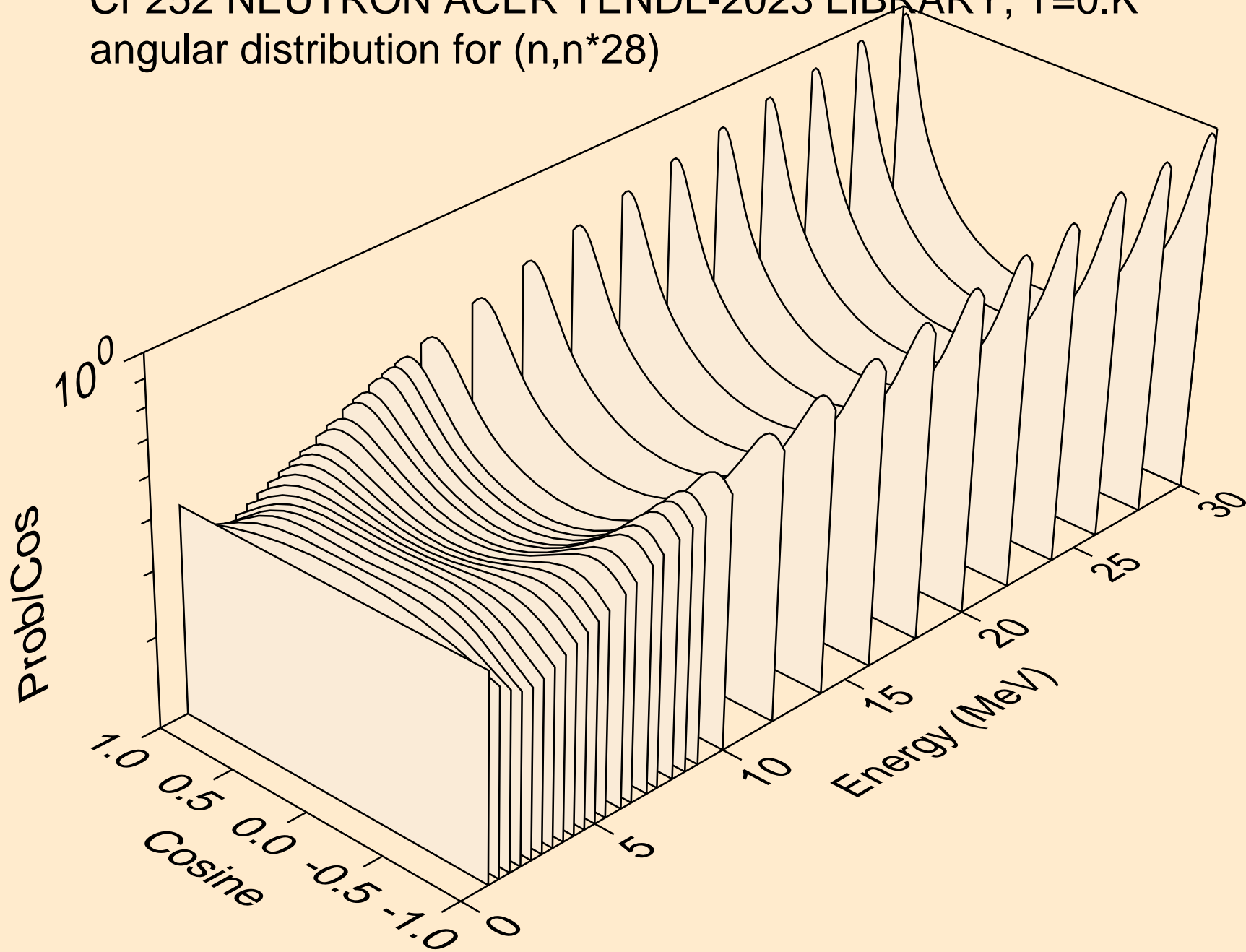

# CF252 NEUTRON ACER TENDL-2023 LIBRARY; T=0.K

Total fission nubar

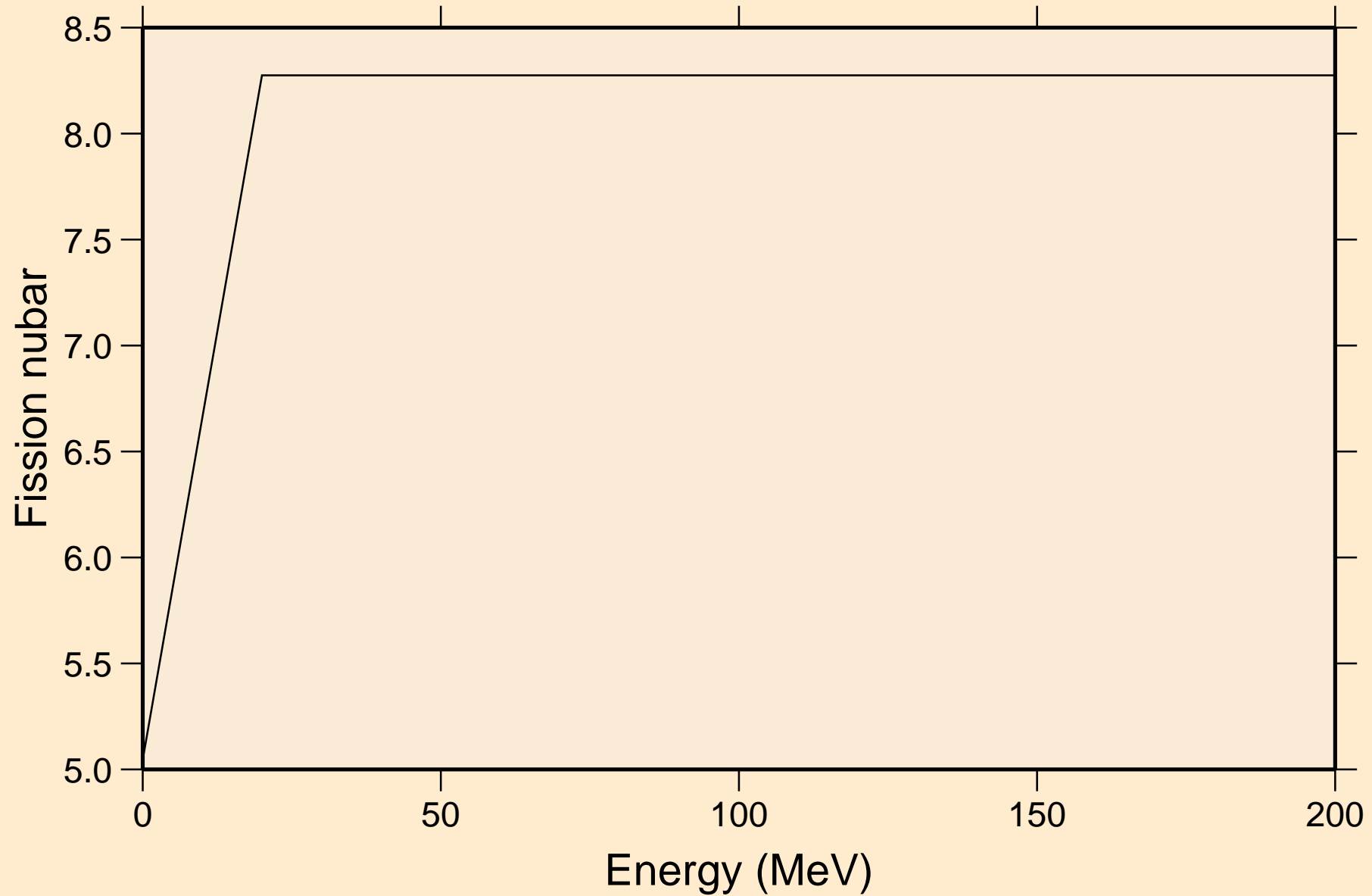

CF252 NEUTRON ACER TENDL-2023 LIBRARY; T=0.K  
Neutron emission for (n,x)

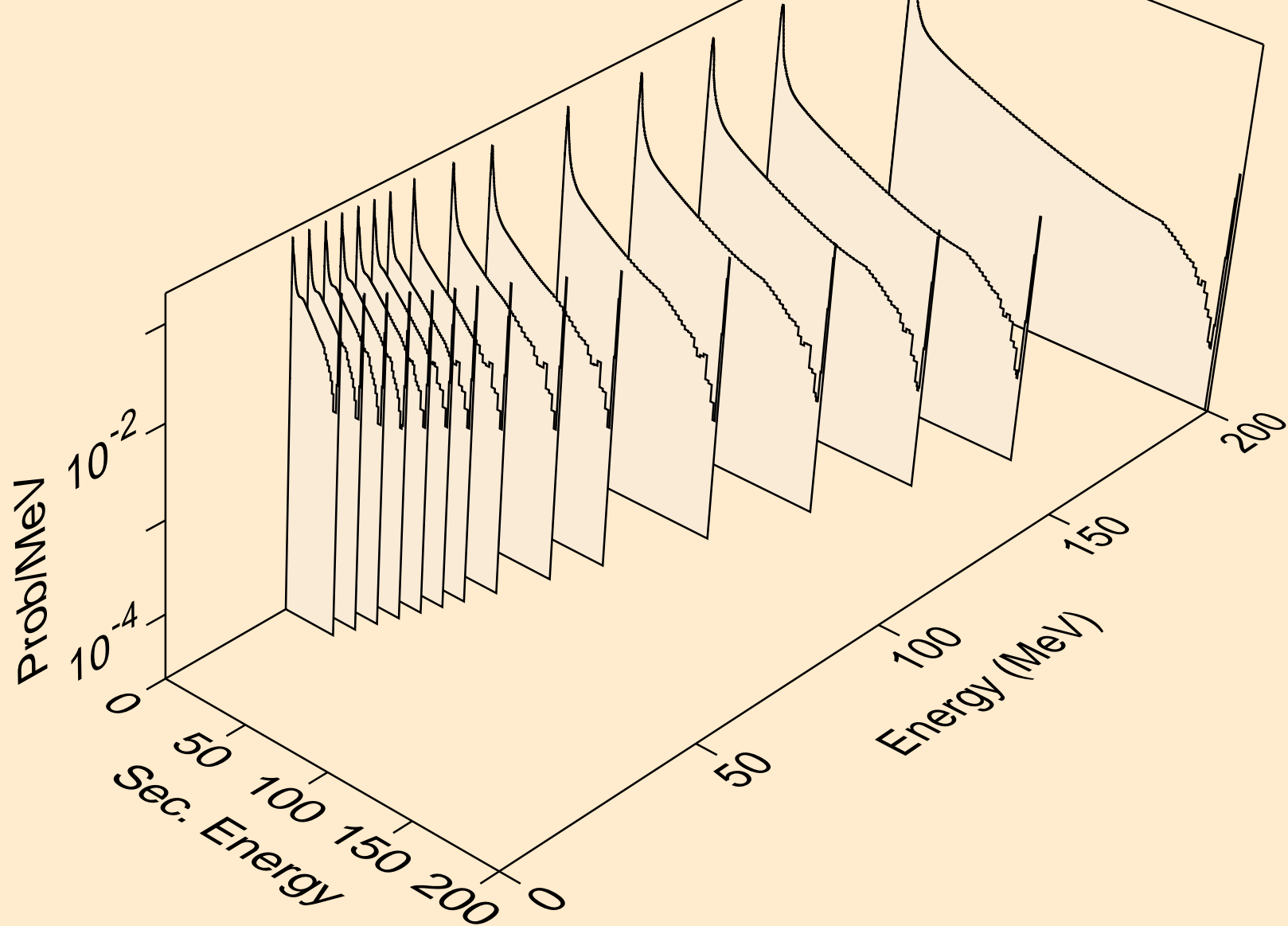

CF252 NEUTRON ACER TENDL-2023 LIBRARY; T=0.K  
Neutron emission for (n,2nd)

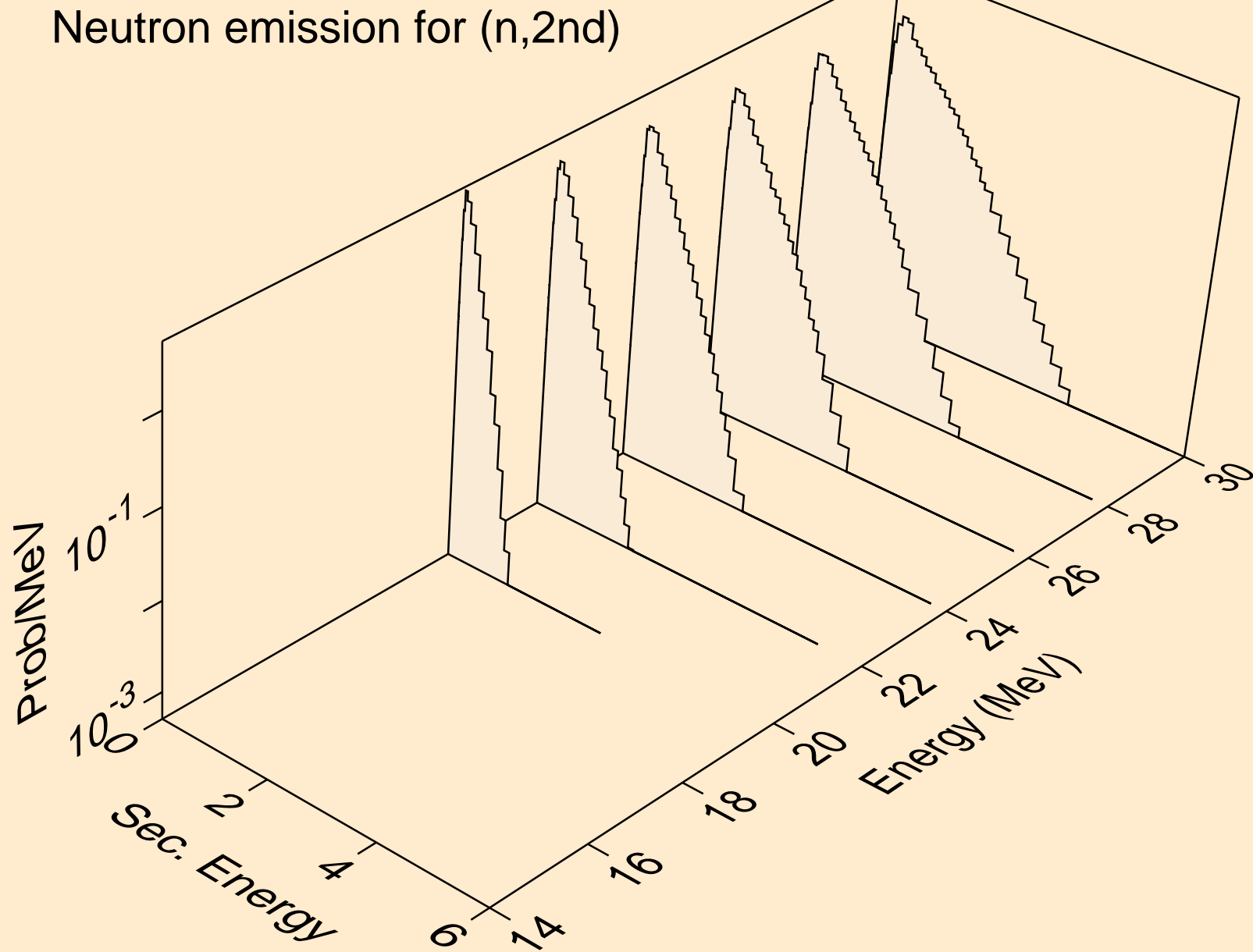

CF252 NEUTRON ACER TENDL-2023 LIBRARY; T=0.K  
Neutron emission for (n,2n)

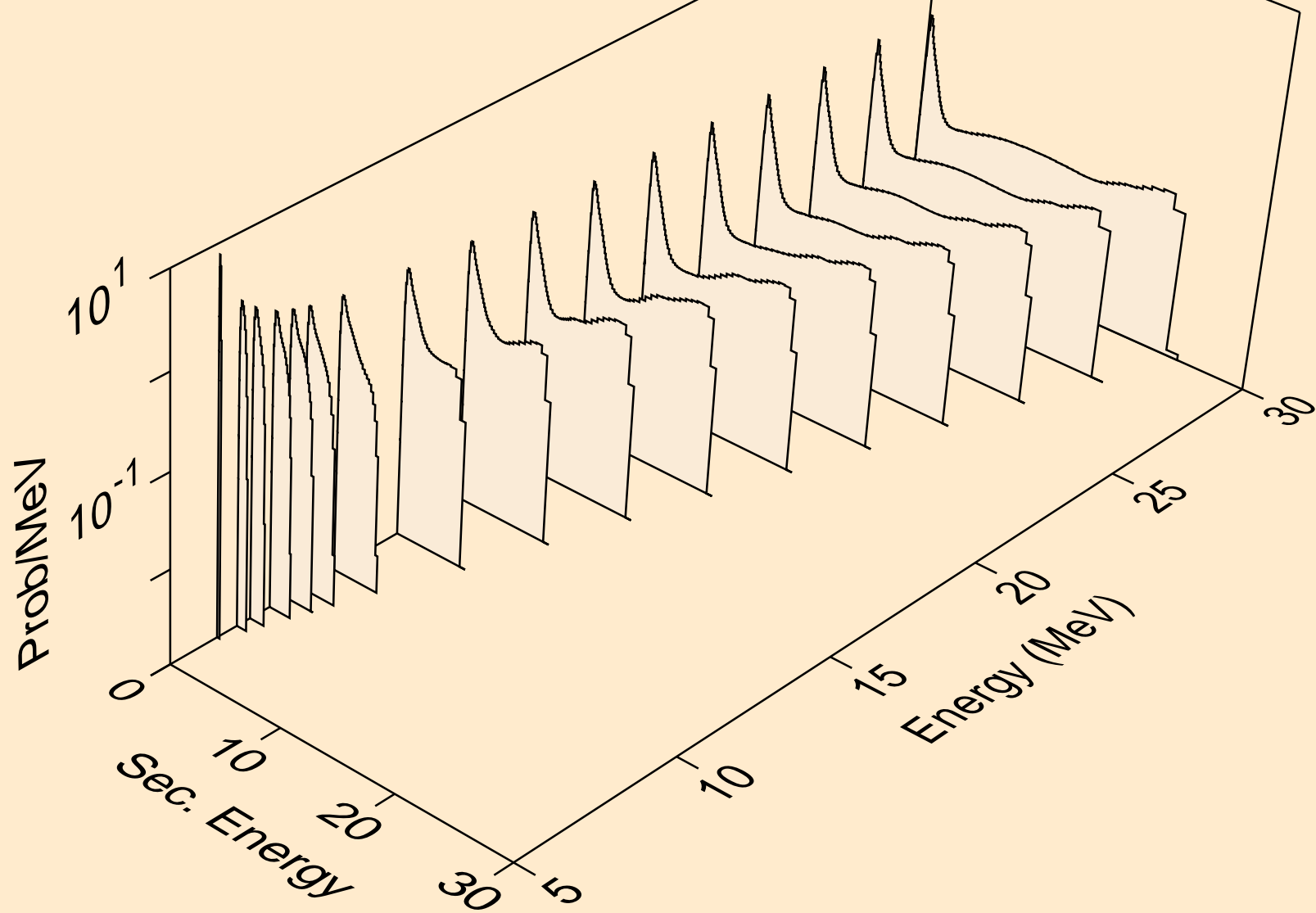

CF252 NEUTRON ACER TENDL-2023 LIBRARY; T=0.K  
Neutron emission for (n,3n)

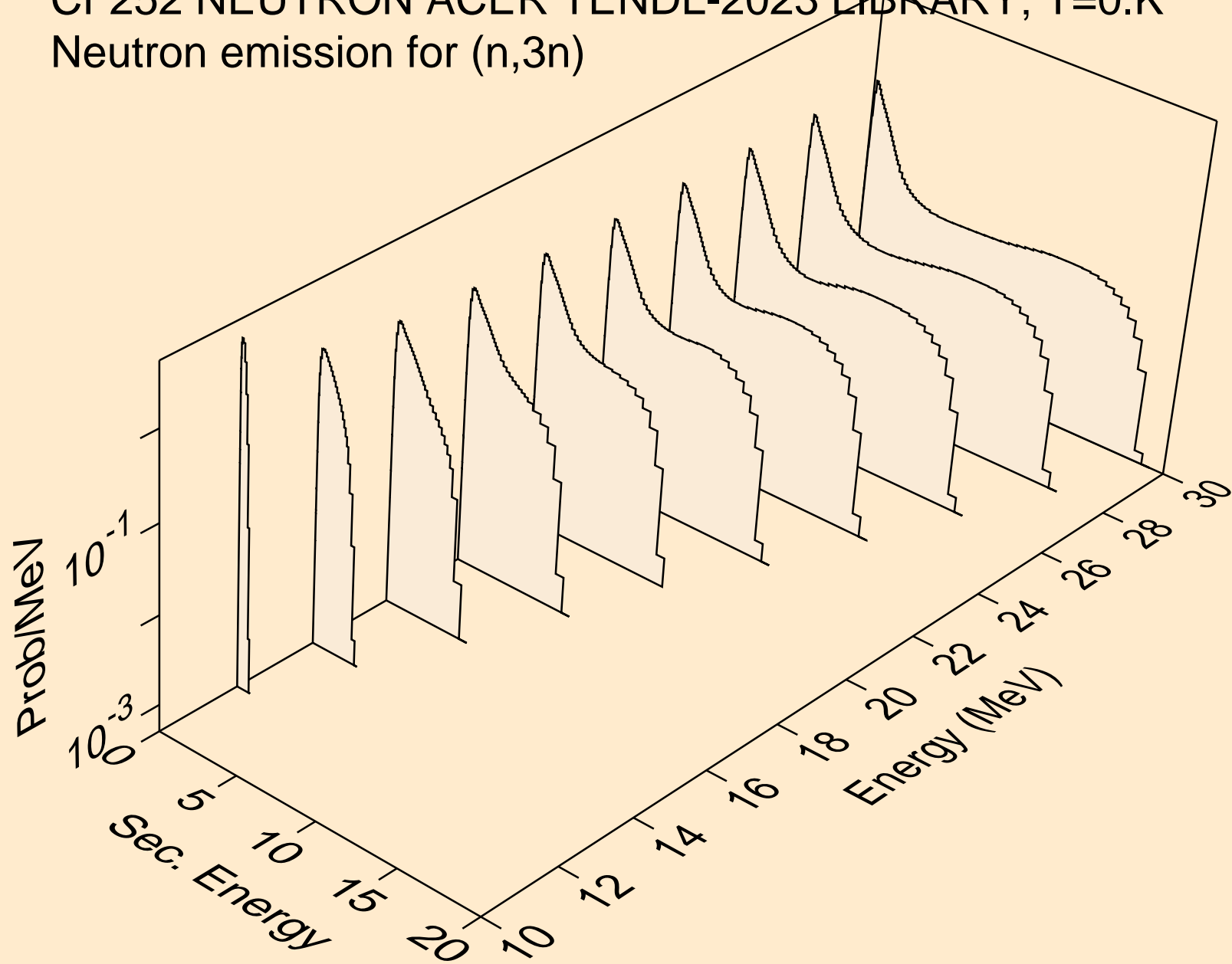



CF252 NEUTRON ACER TENDL-2023 LIBRARY; T=0.K  
Neutron emission for fission

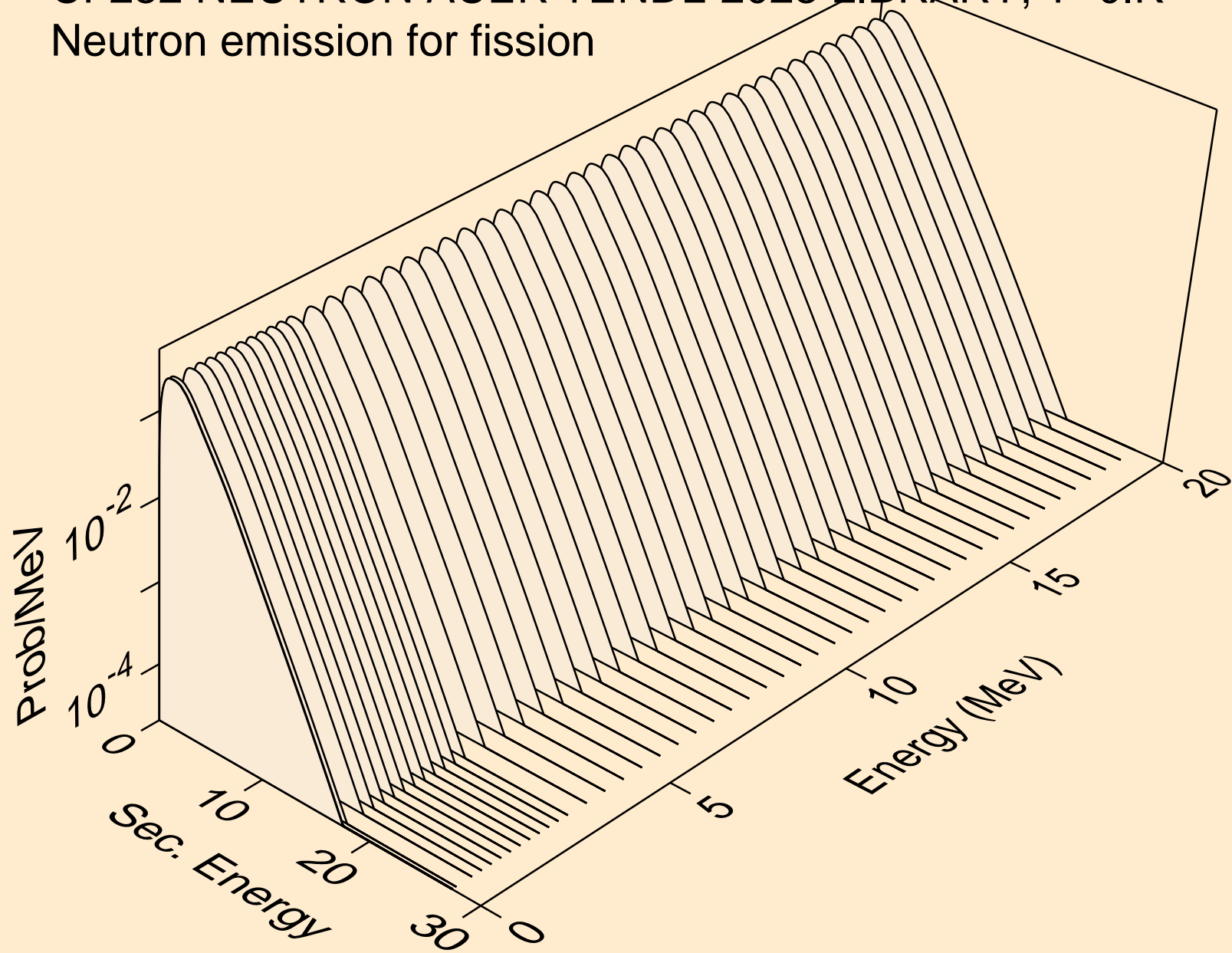

CF252 NEUTRON ACER TENDL-2023 LIBRARY; T=0.K  
Neutron emission for (n,n\*)a

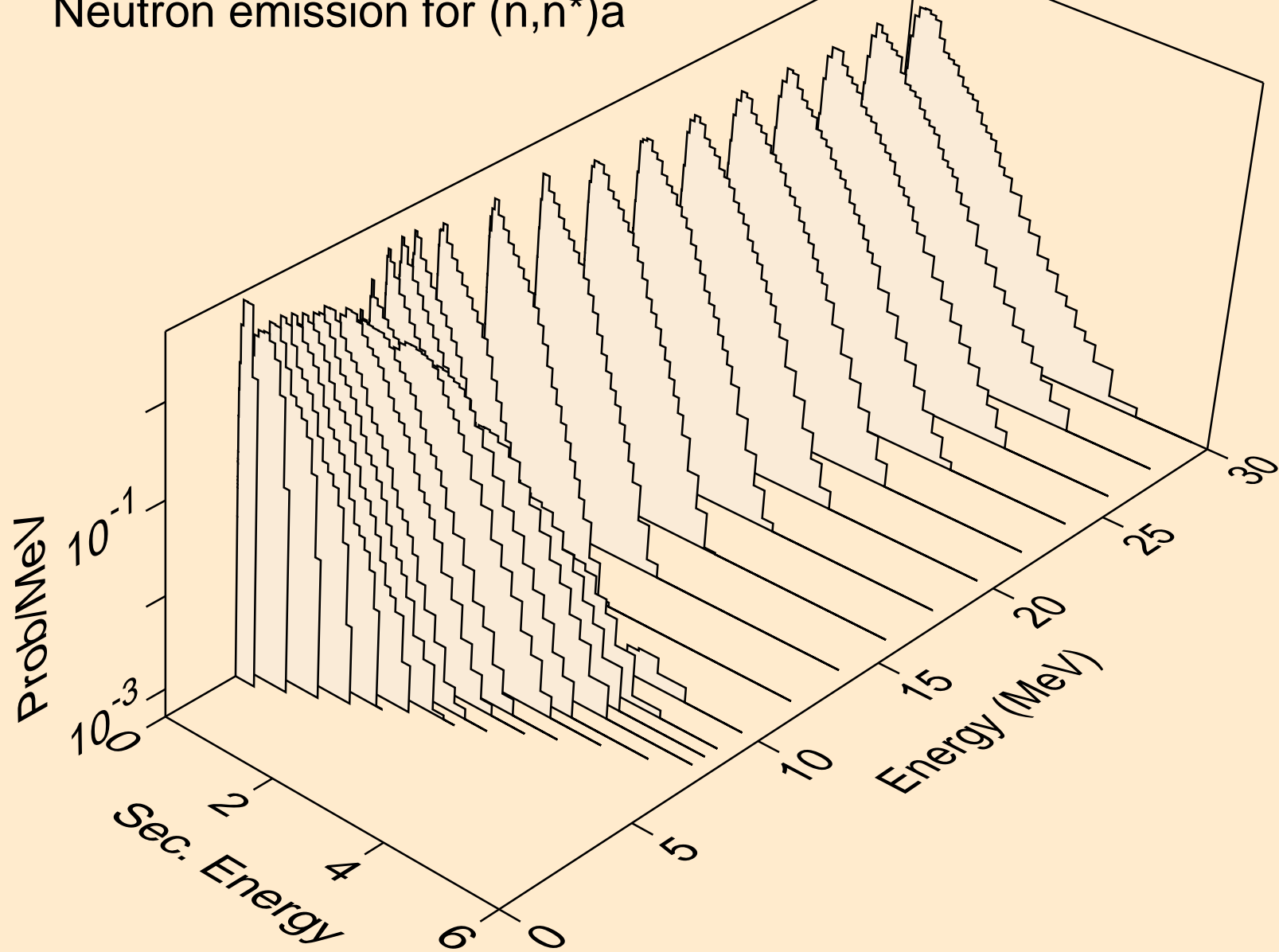

CF252 NEUTRON ACER TENDL-2023 LIBRARY; T=0.K  
Neutron emission for (n,2n)a

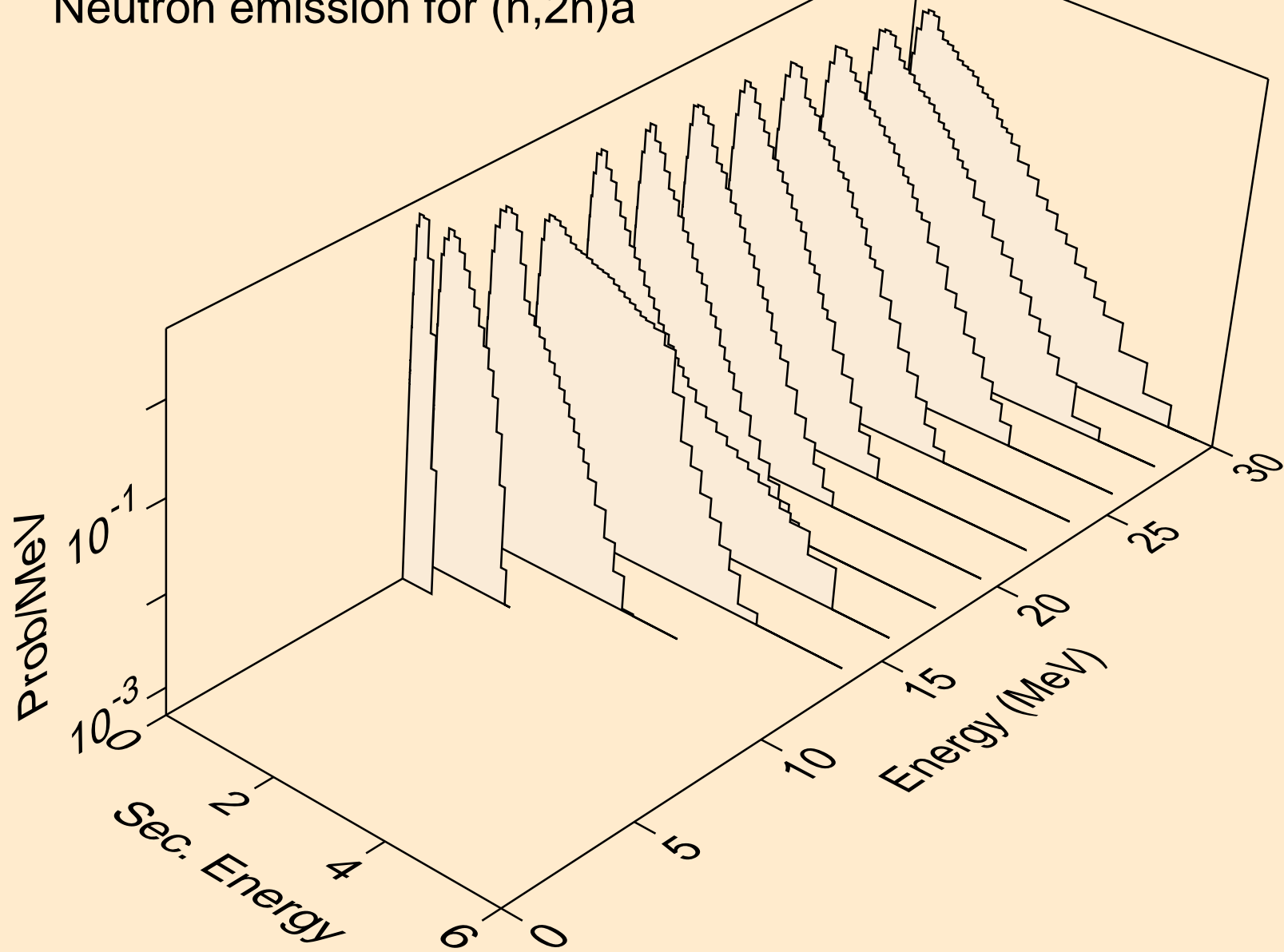

CF252 NEUTRON ACER TENDL-2023 LIBRARY; T=0.K  
Neutron emission for (n,3n)a

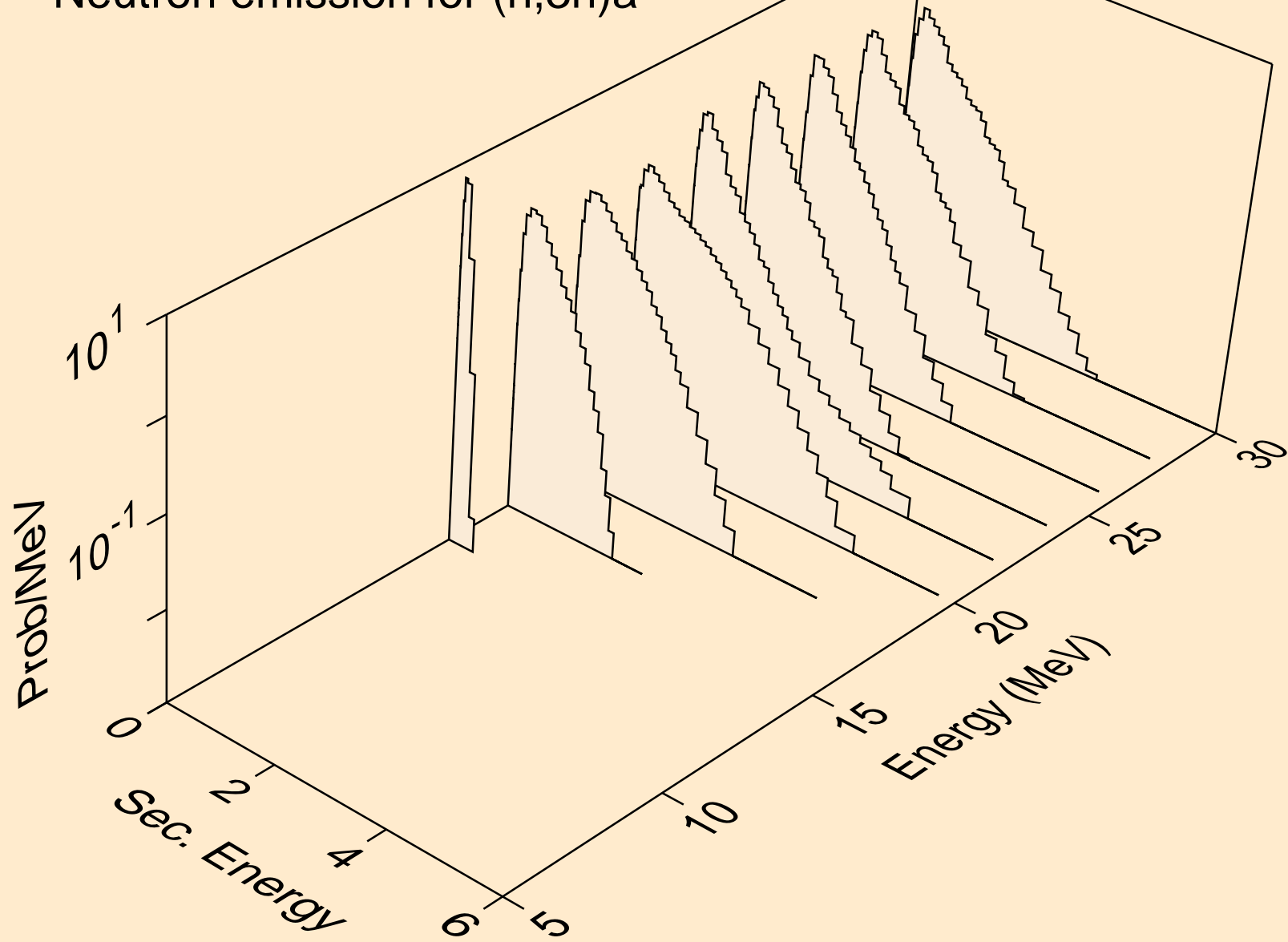

CF252 NEUTRON ACER TENDL-2023 LIBRARY; T=0.K  
Neutron emission for (n,n\*)p

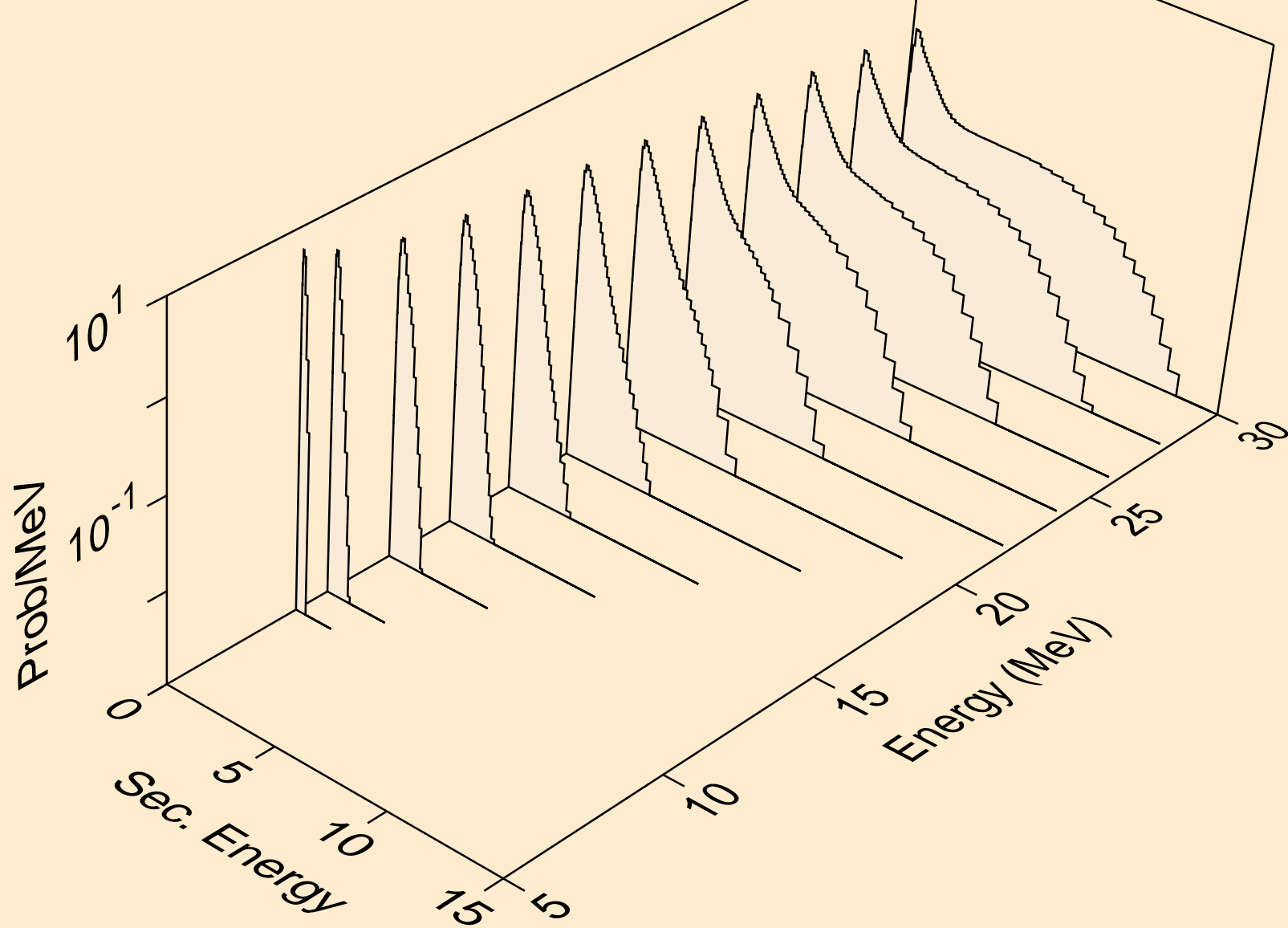

CF252 NEUTRON ACER TENDL-2023 LIBRARY; T=0.K  
Neutron emission for (n,n\*)d

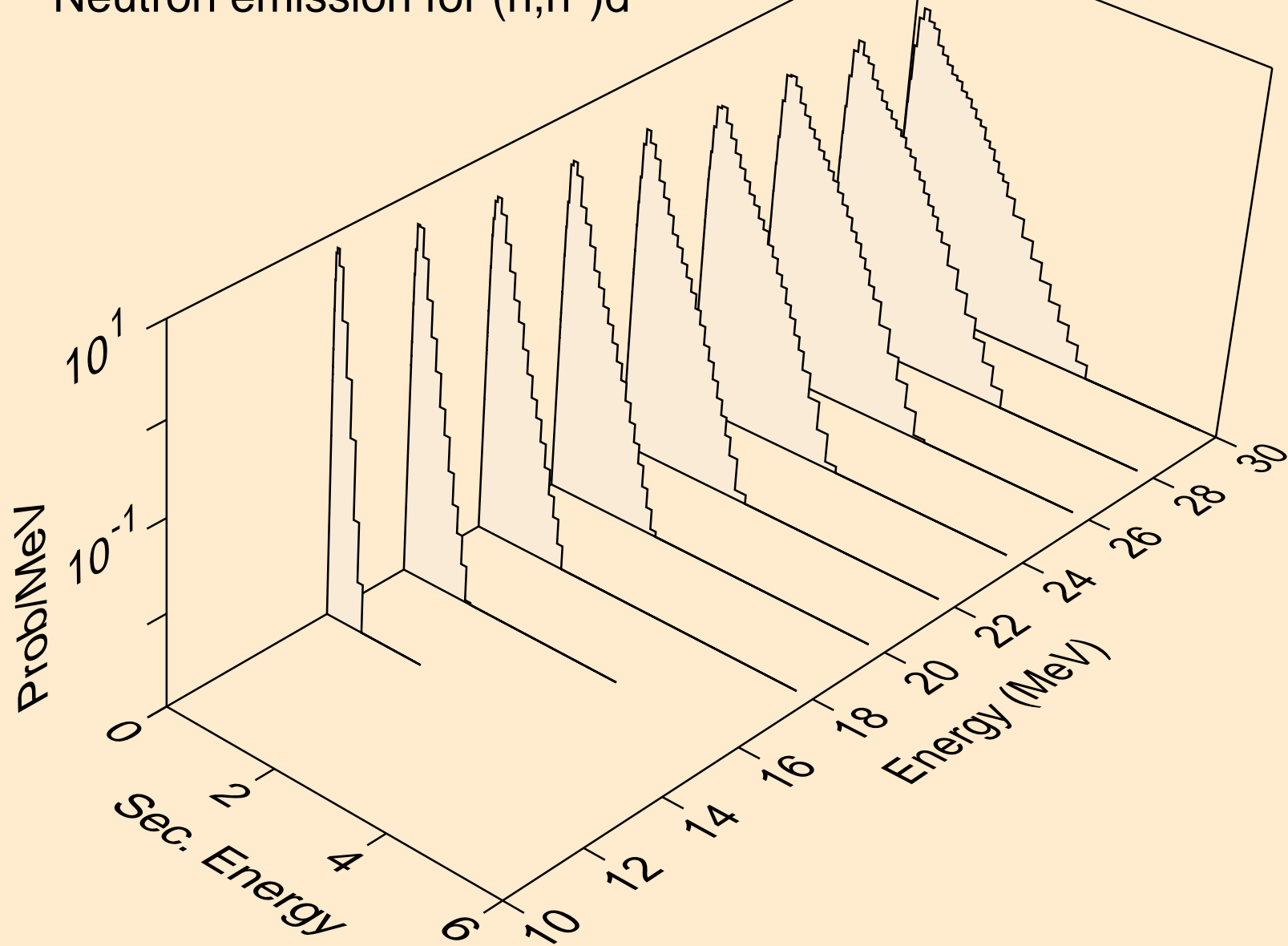

CF252 NEUTRON ACER TENDL-2023 LIBRARY; T=0.K  
Neutron emission for (n,n\*)t

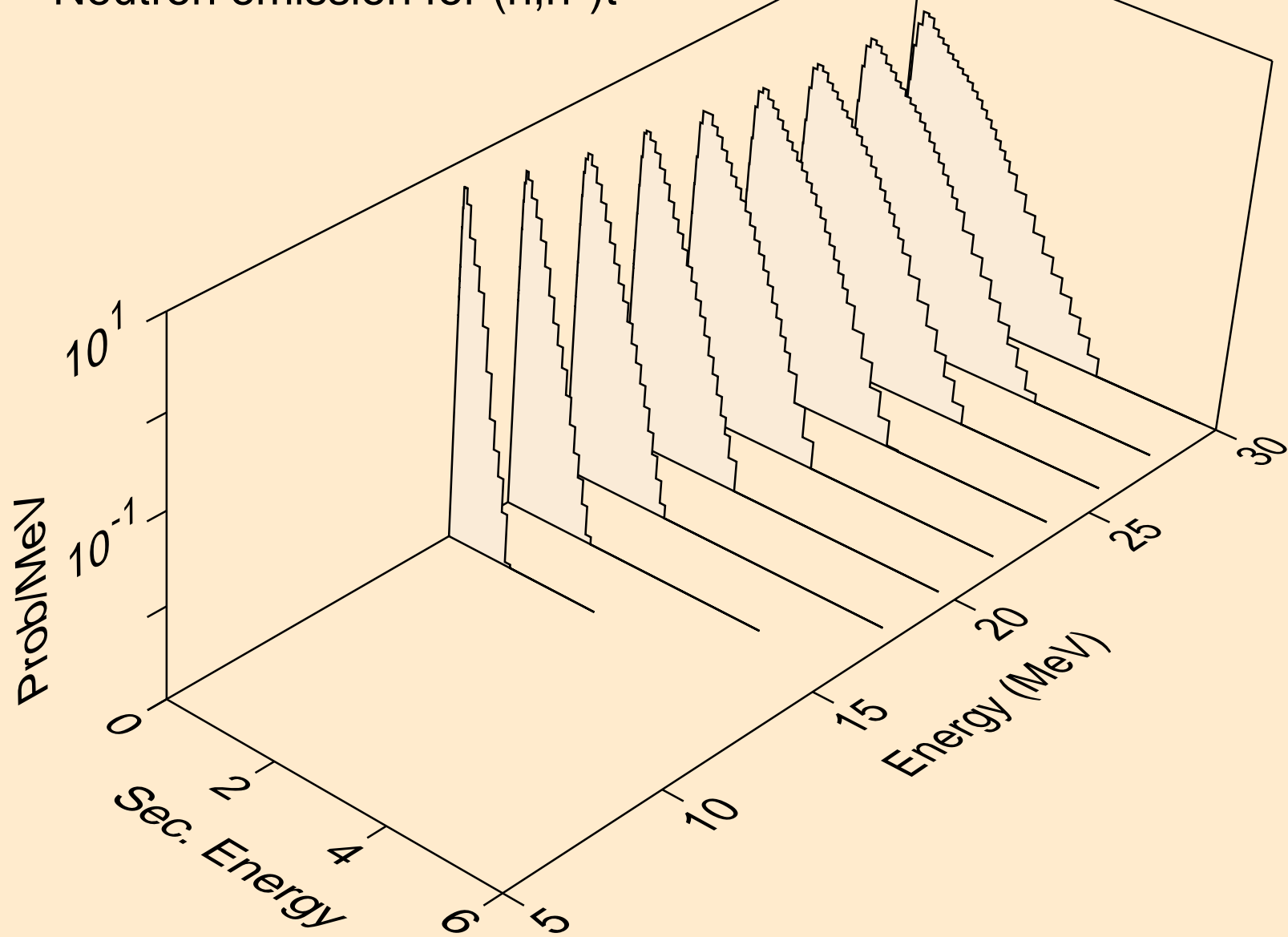

CF252 NEUTRON ACER TENDL-2023 LIBRARY; T=0.K  
Neutron emission for (n,n\*)he3

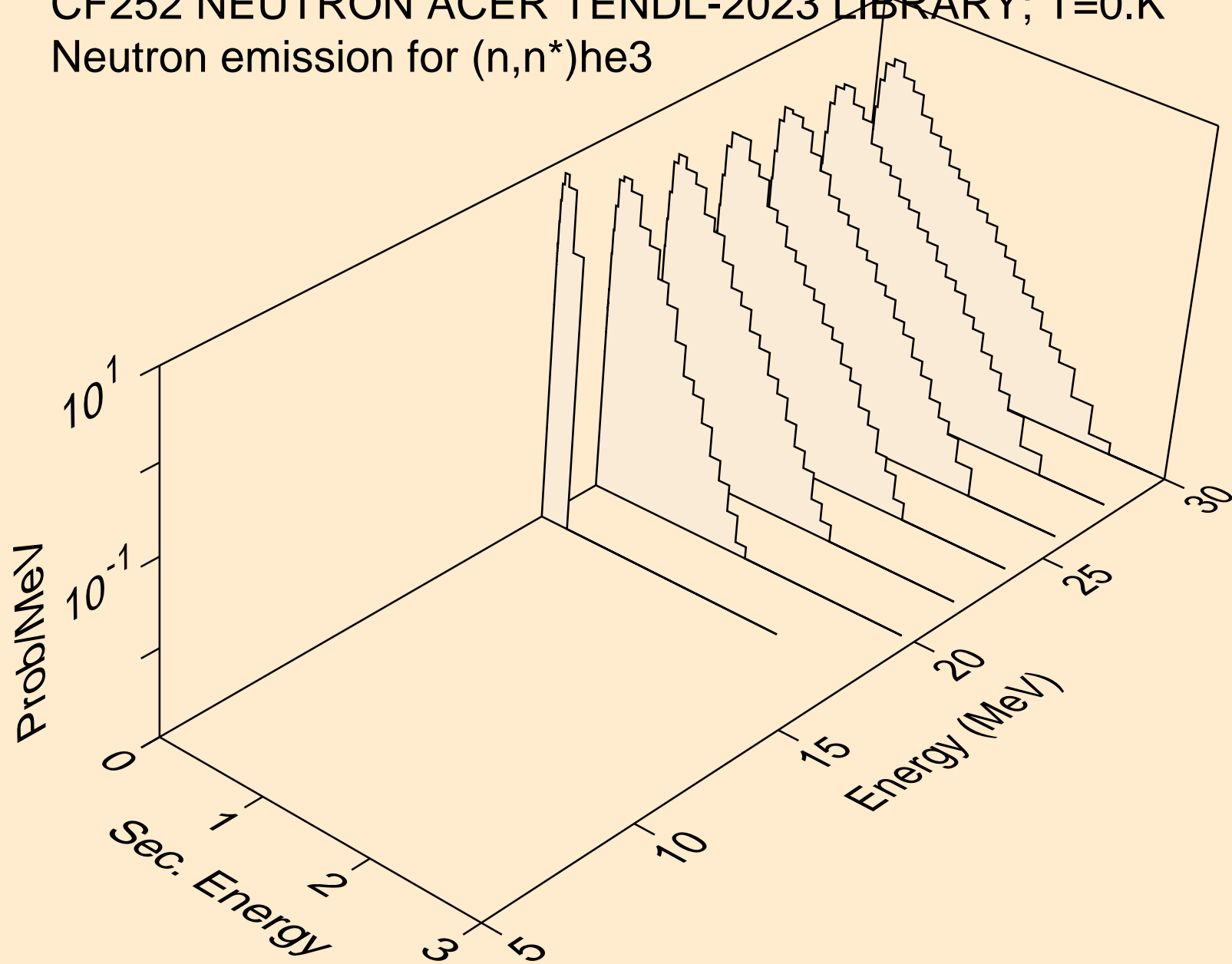



CF252 NEUTRON ACER TENDL-2023 LIBRARY; T=0.K  
Neutron emission for (n,4n)

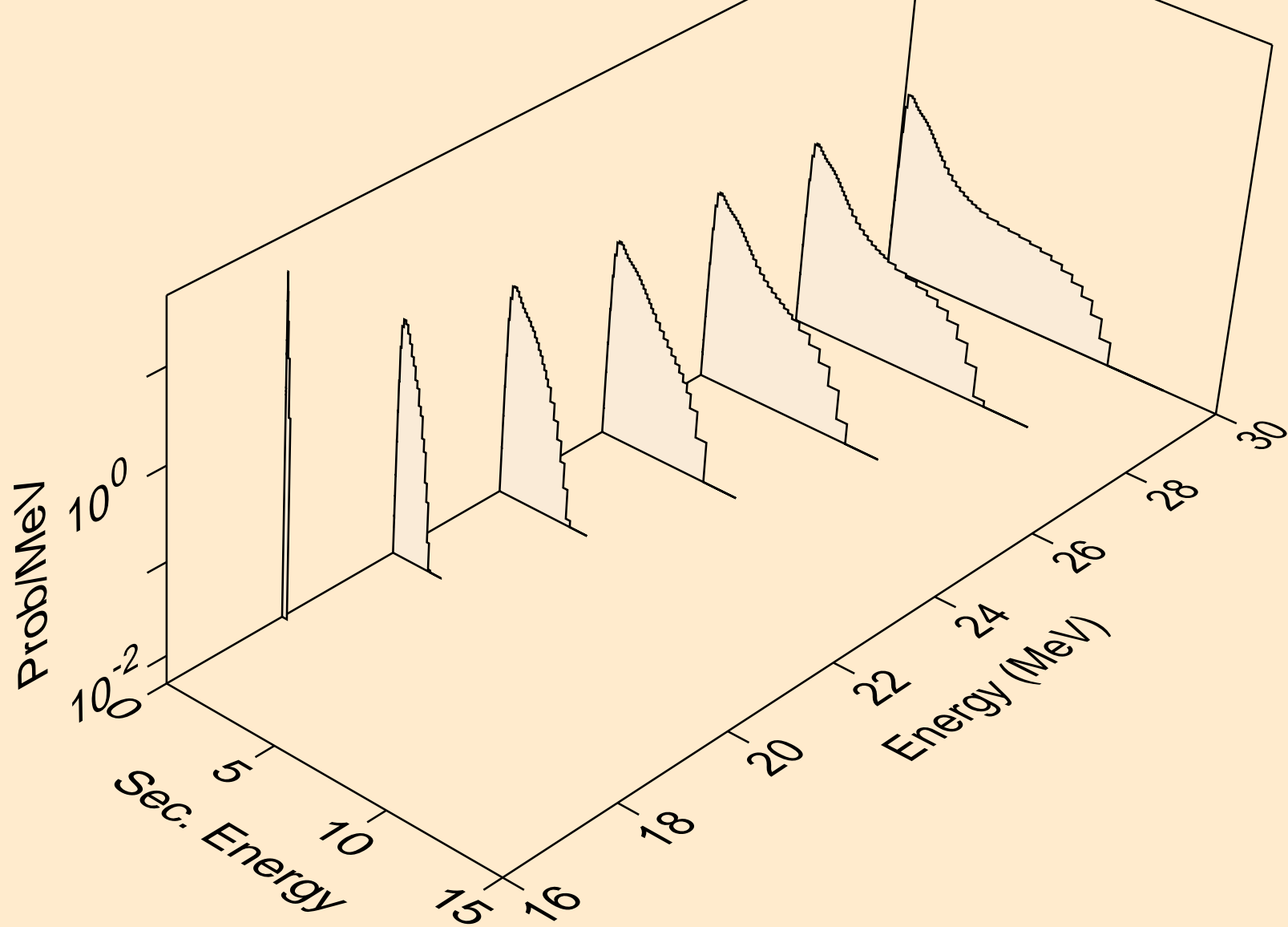

CF252 NEUTRON ACER TENDL-2023 LIBRARY; T=0.K  
Neutron emission for (n,2np)

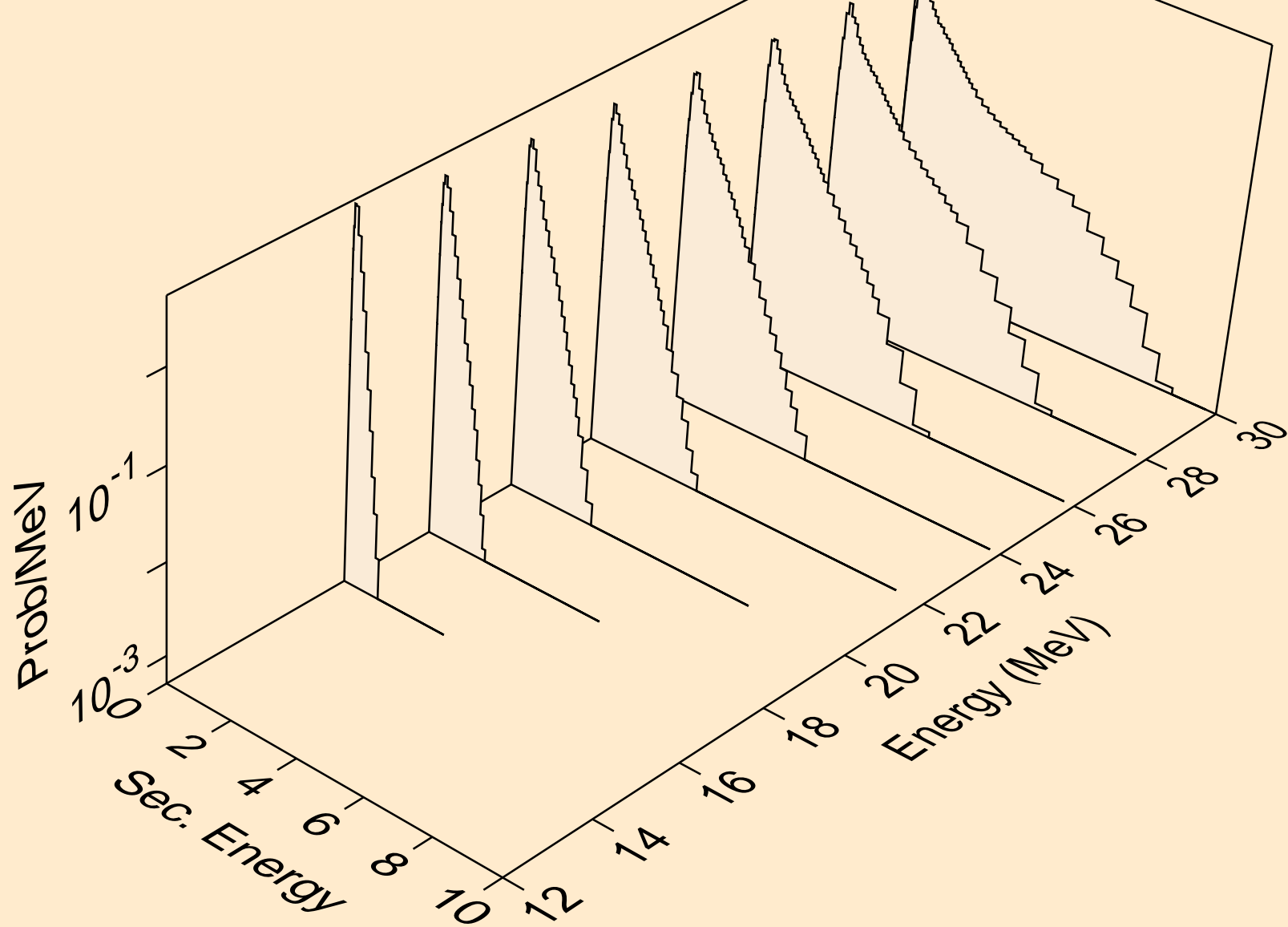

CF252 NEUTRON ACER TENDL-2023 LIBRARY; T=0.K  
Neutron emission for (n,3np)

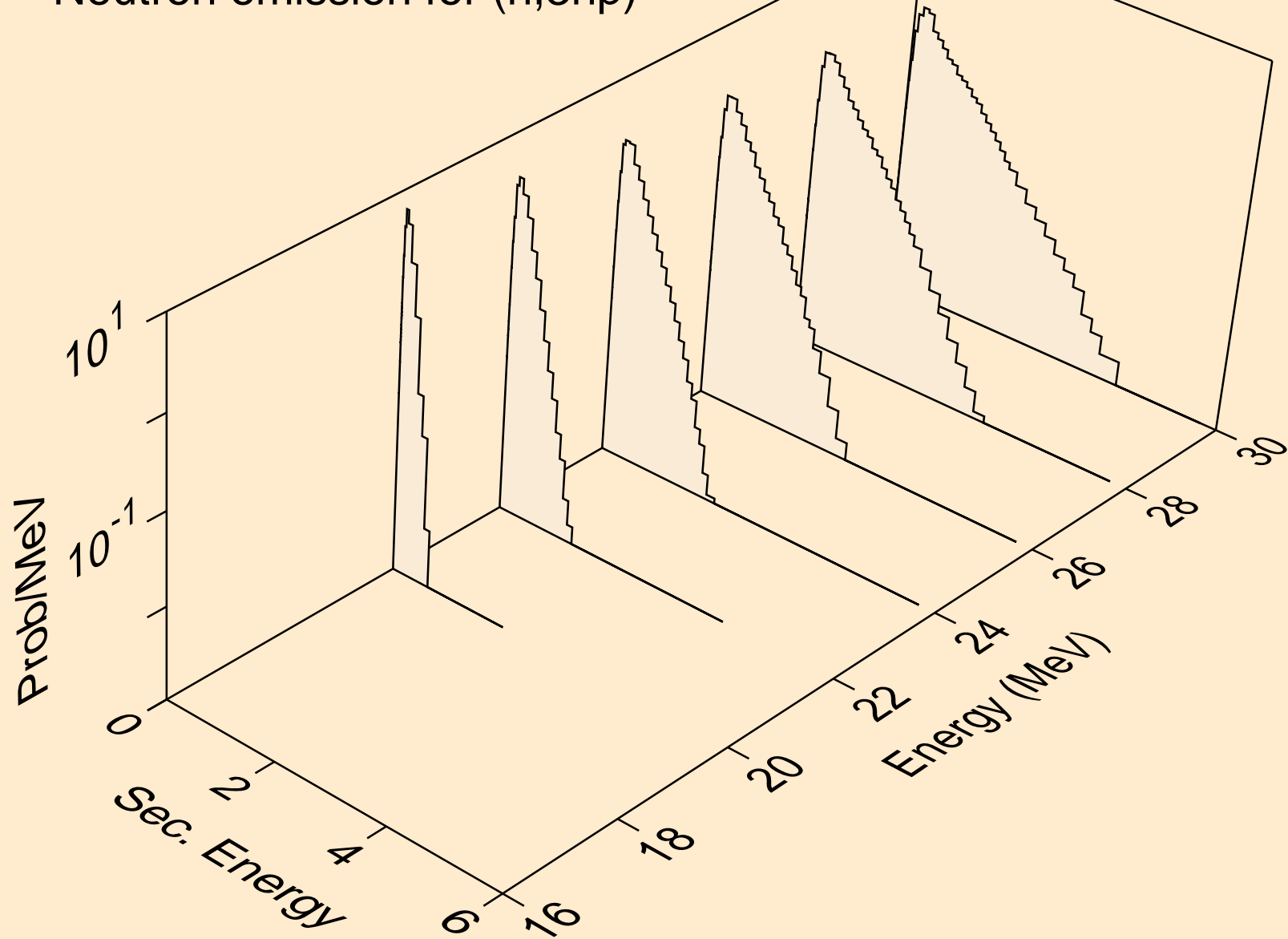

CF252 NEUTRON ACER TENDL-2023 LIBRARY; T=0.K  
Neutron emission for (n,n2p)

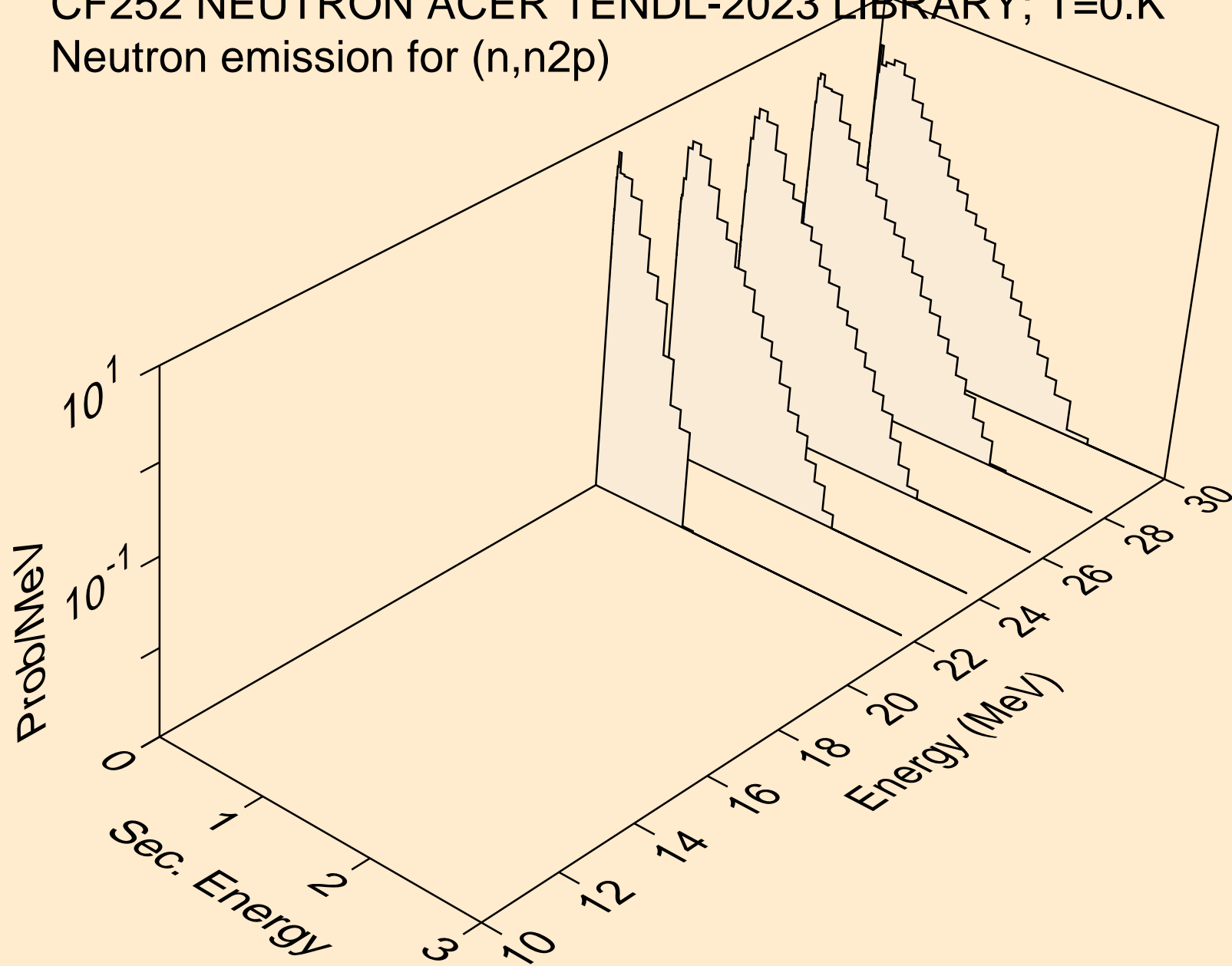

CF252 NEUTRON ACER TENDL-2023 LIBRARY; T=0.K  
Neutron emission for (n,n\*c)

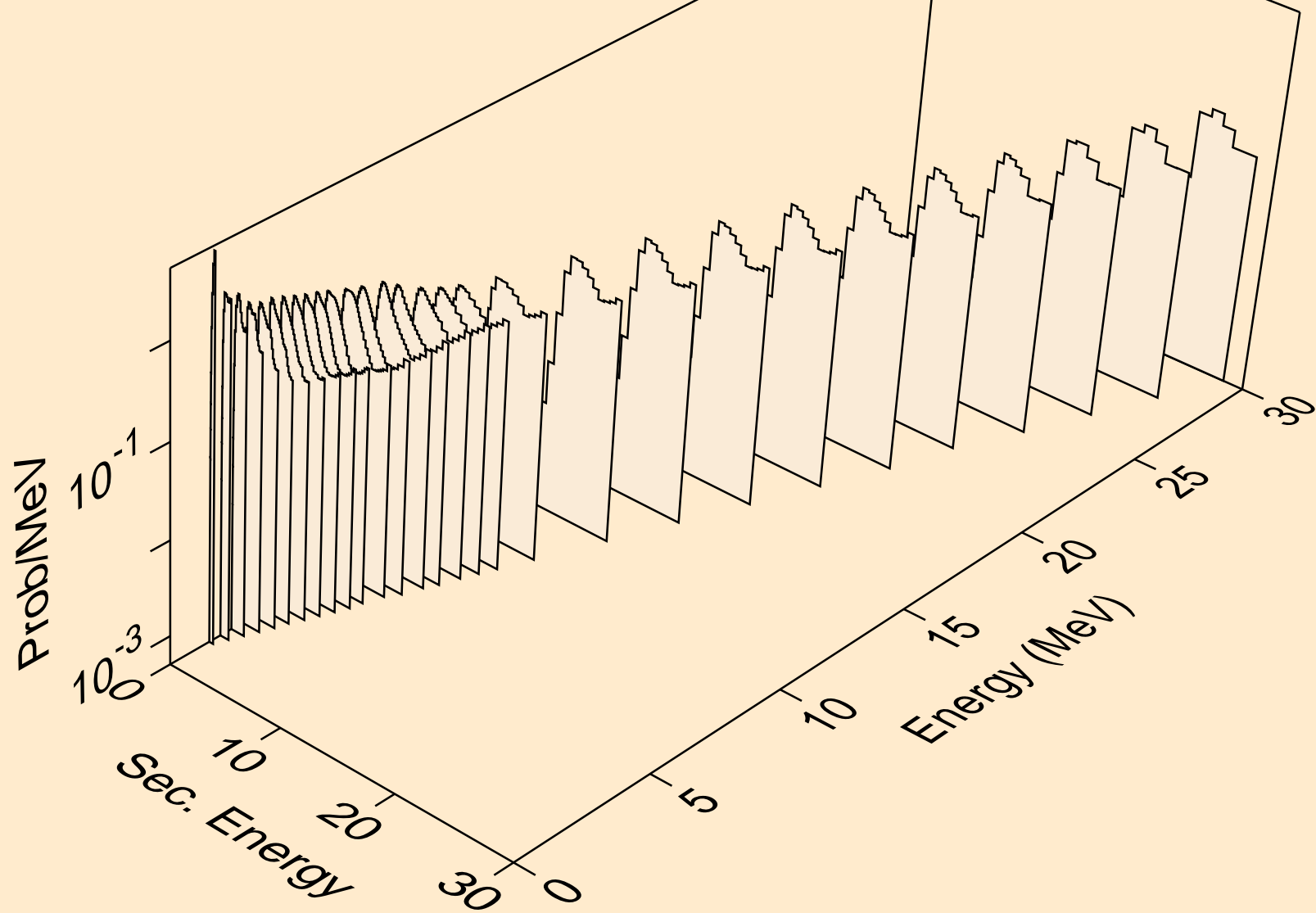

# CF252 NEUTRON ACER TENDL-2023 LIBRARY; T=0.K

Delayed nubar

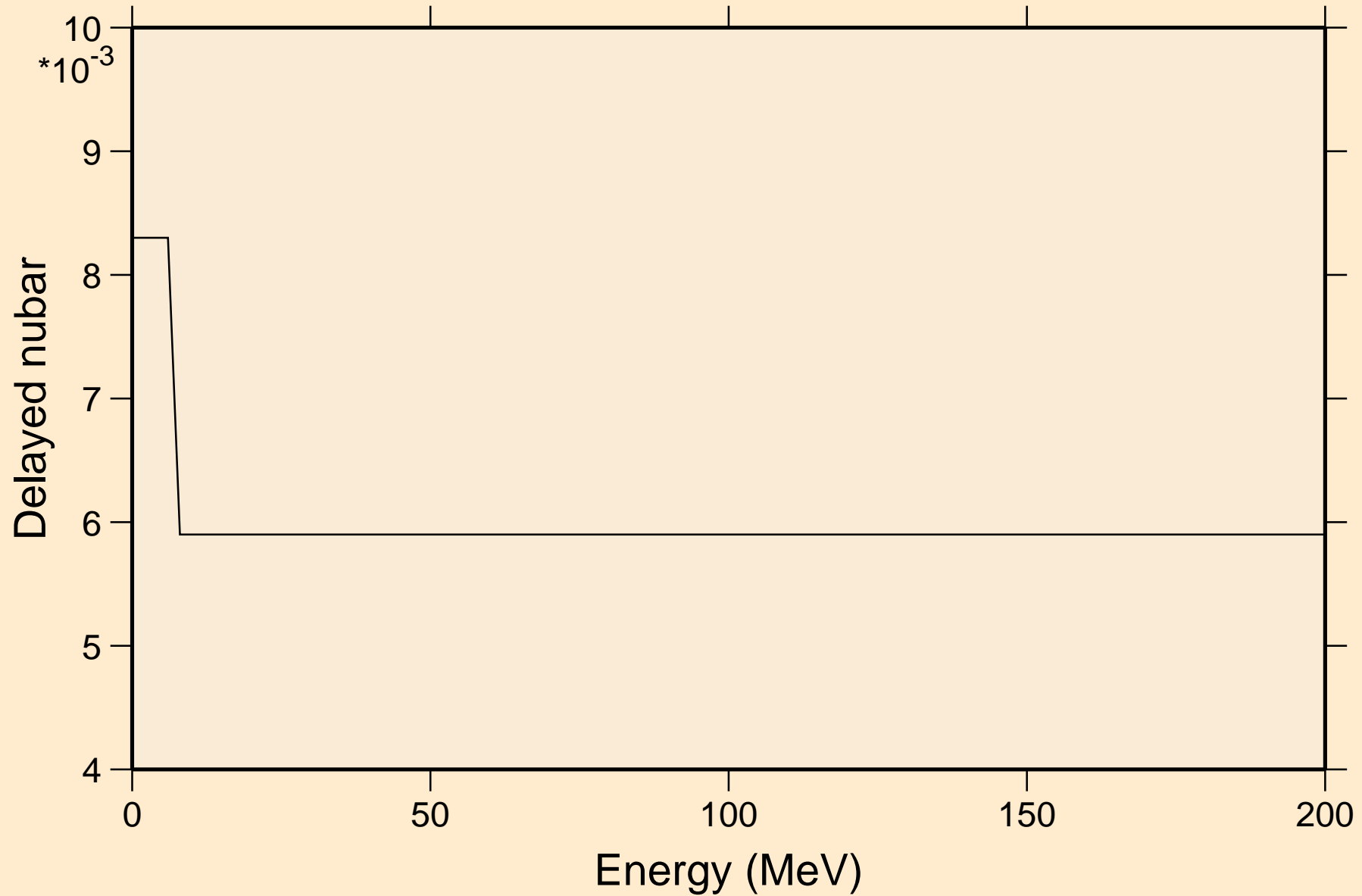

# CF252 NEUTRON ACER TENDL-2023 LIBRARY; T=0.K

## Delayed neutron spectra

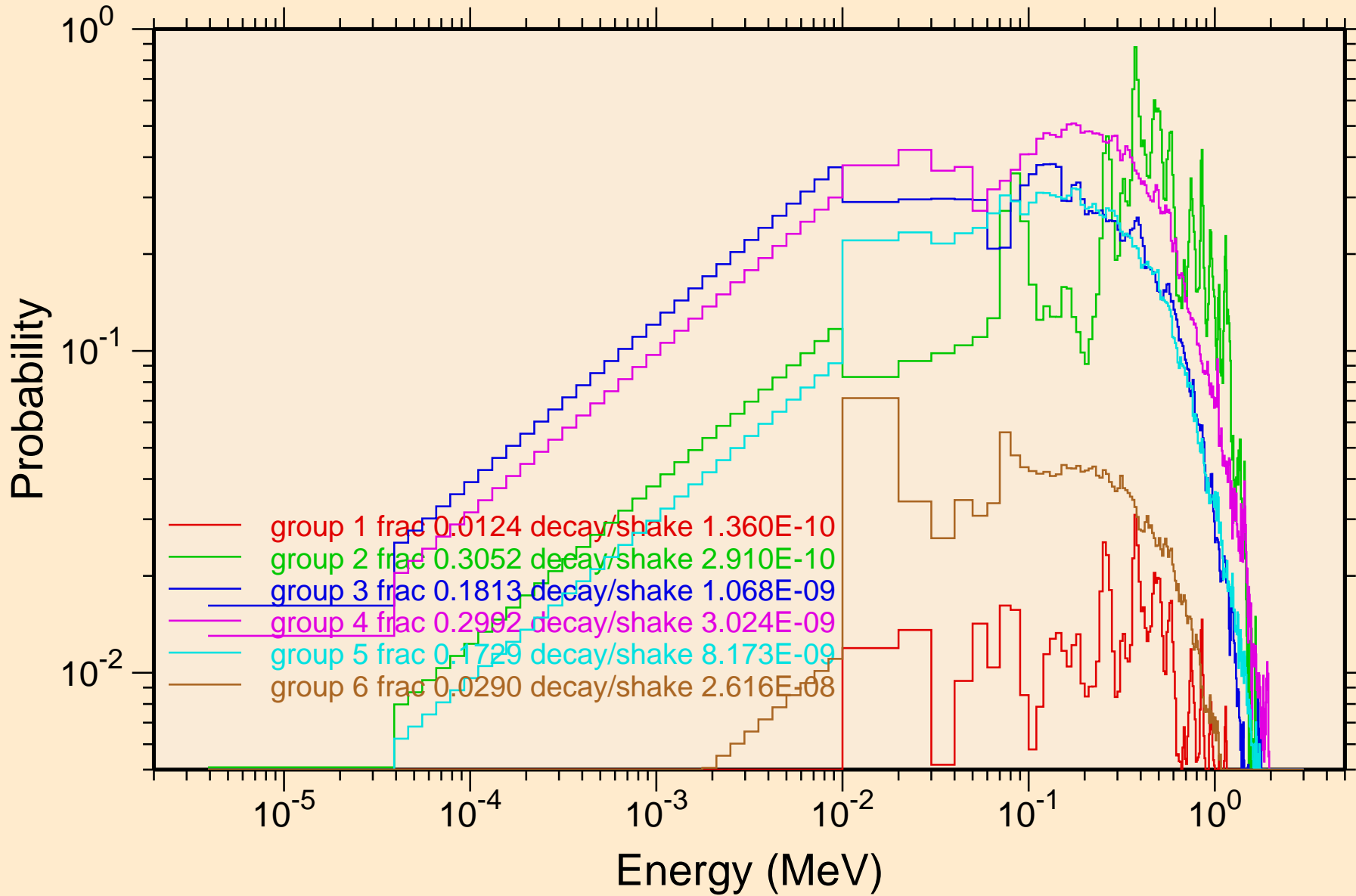

CF252 NEUTRON ACER TENDL-2023 LIBRARY; T=0.K  
Photon emission for (n,x)

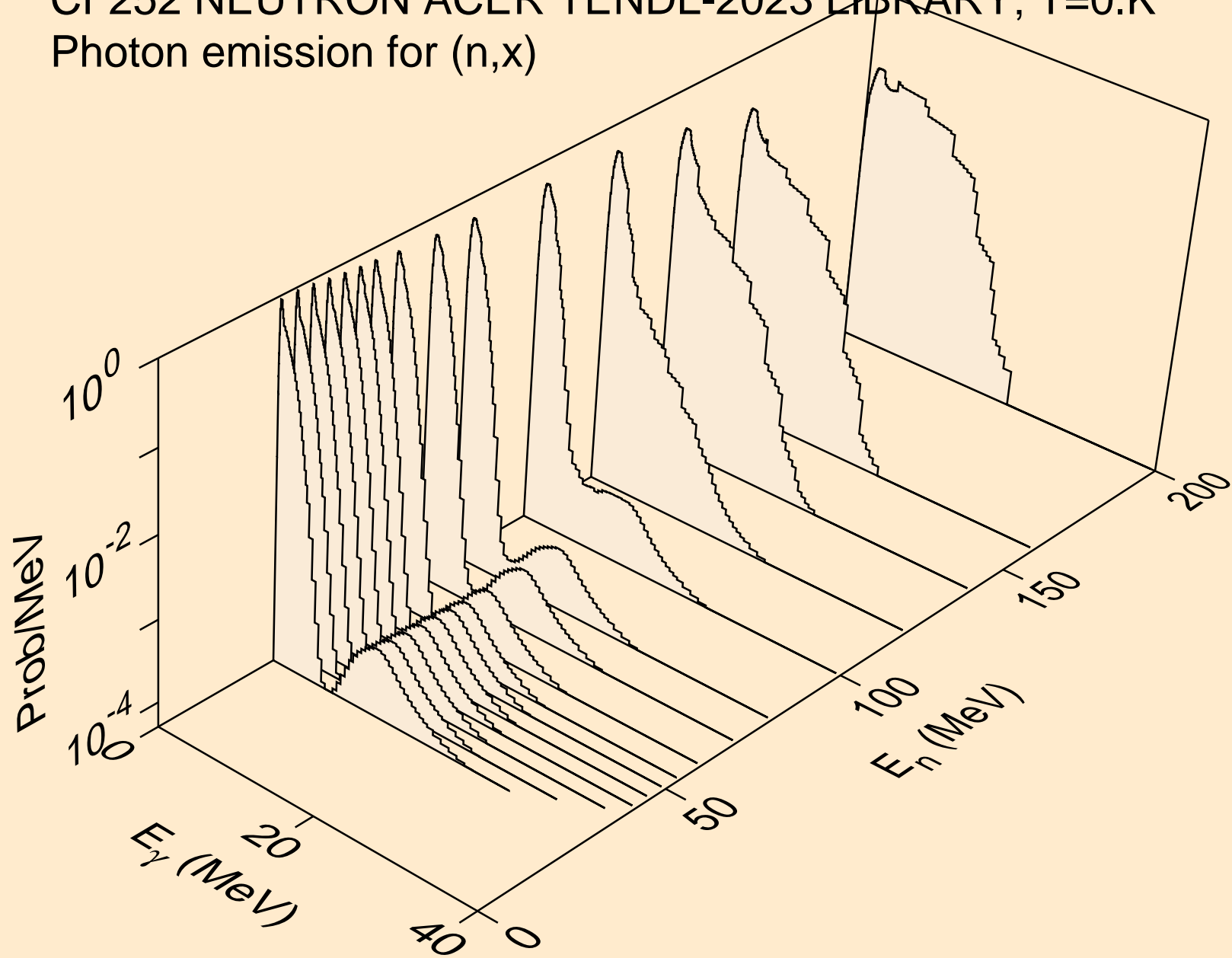



CF252 NEUTRON ACER TENDL-2023 LIBRARY; T=0.K  
Photon emission for (n,2nd)

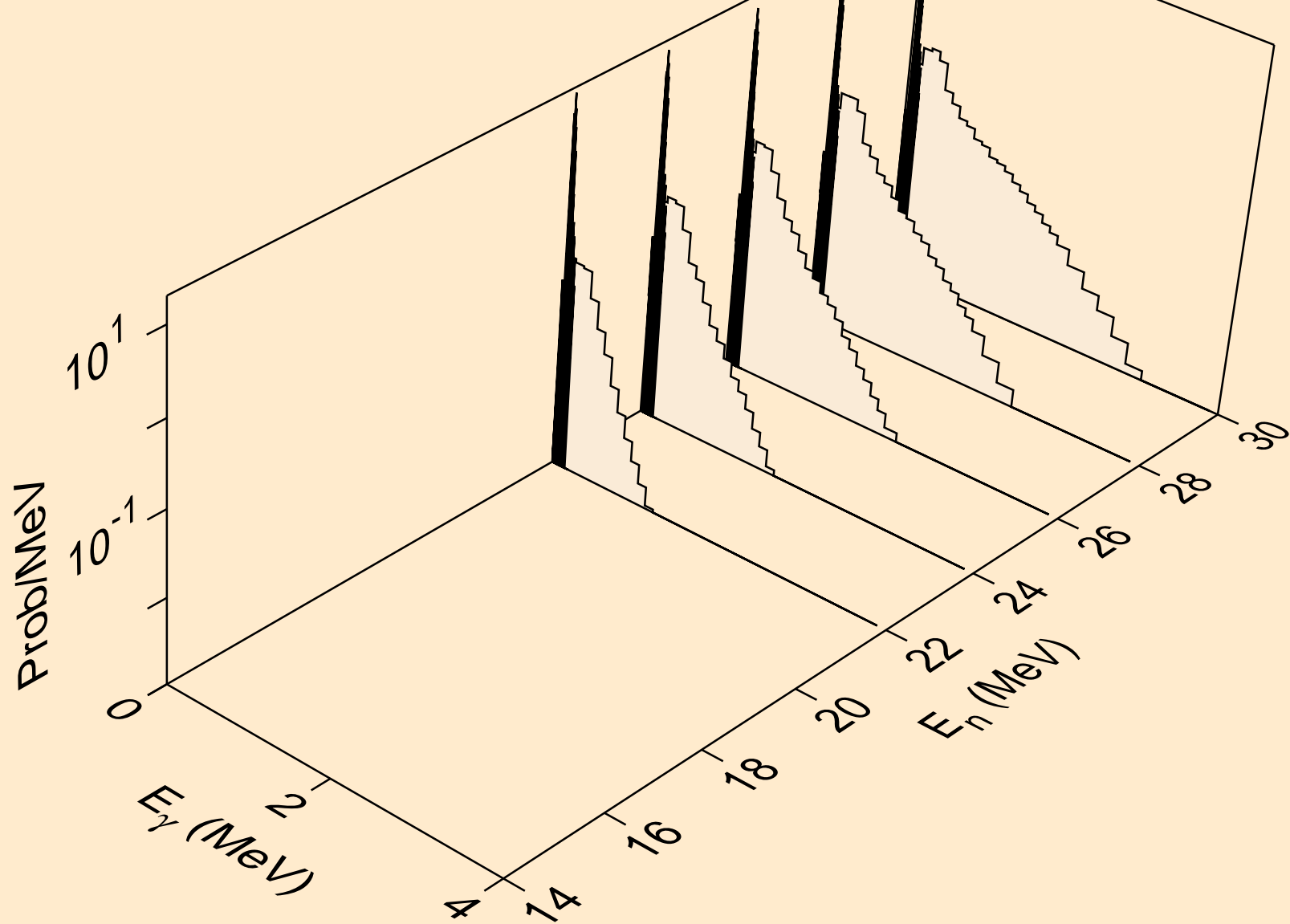

CF252 NEUTRON ACER TENDL-2023 LIBRARY; T=0.K  
Photon emission for (n,2n)

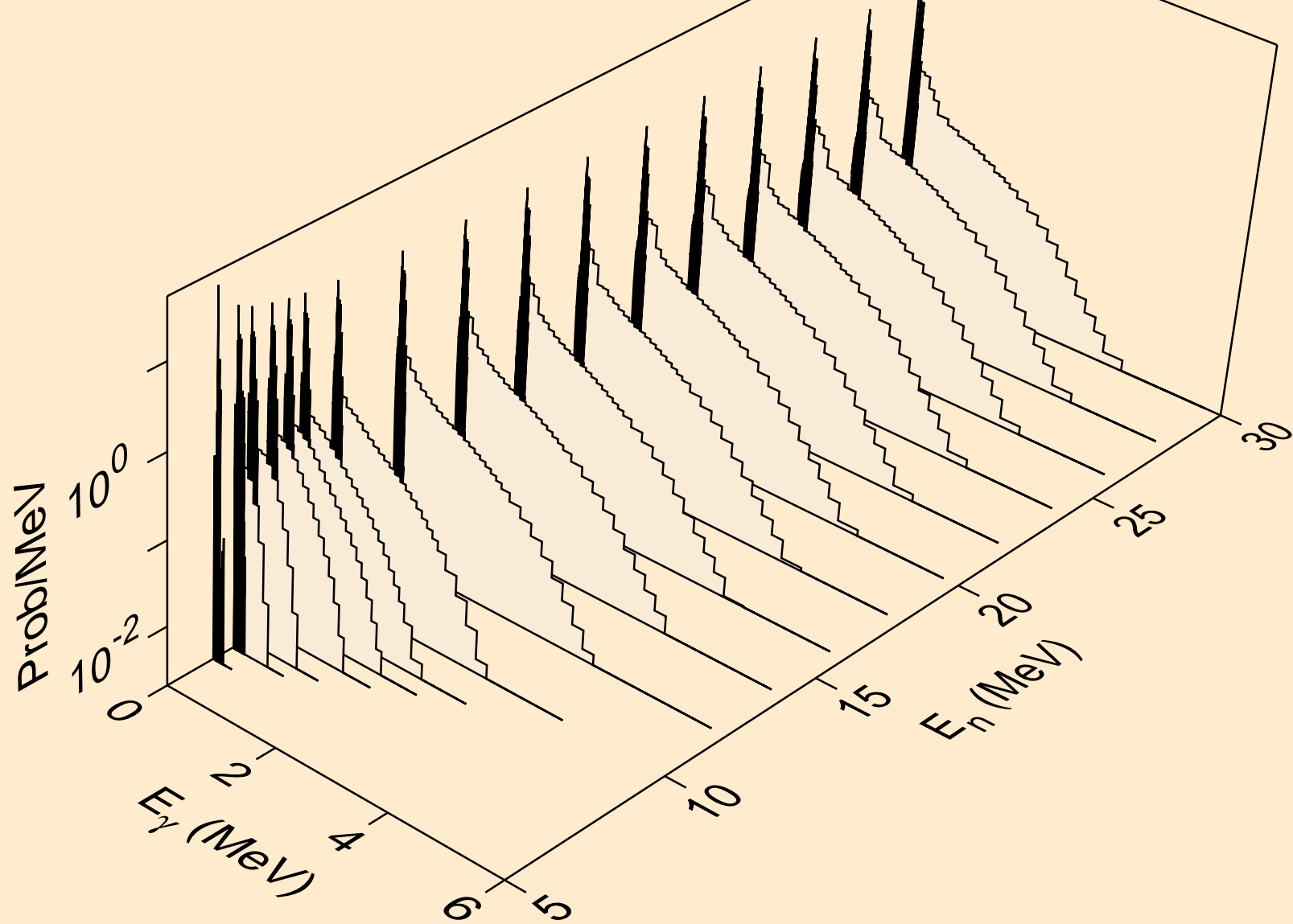

CF252 NEUTRON ACER TENDL-2023 LIBRARY; T=0.K  
Photon emission for (n,3n)

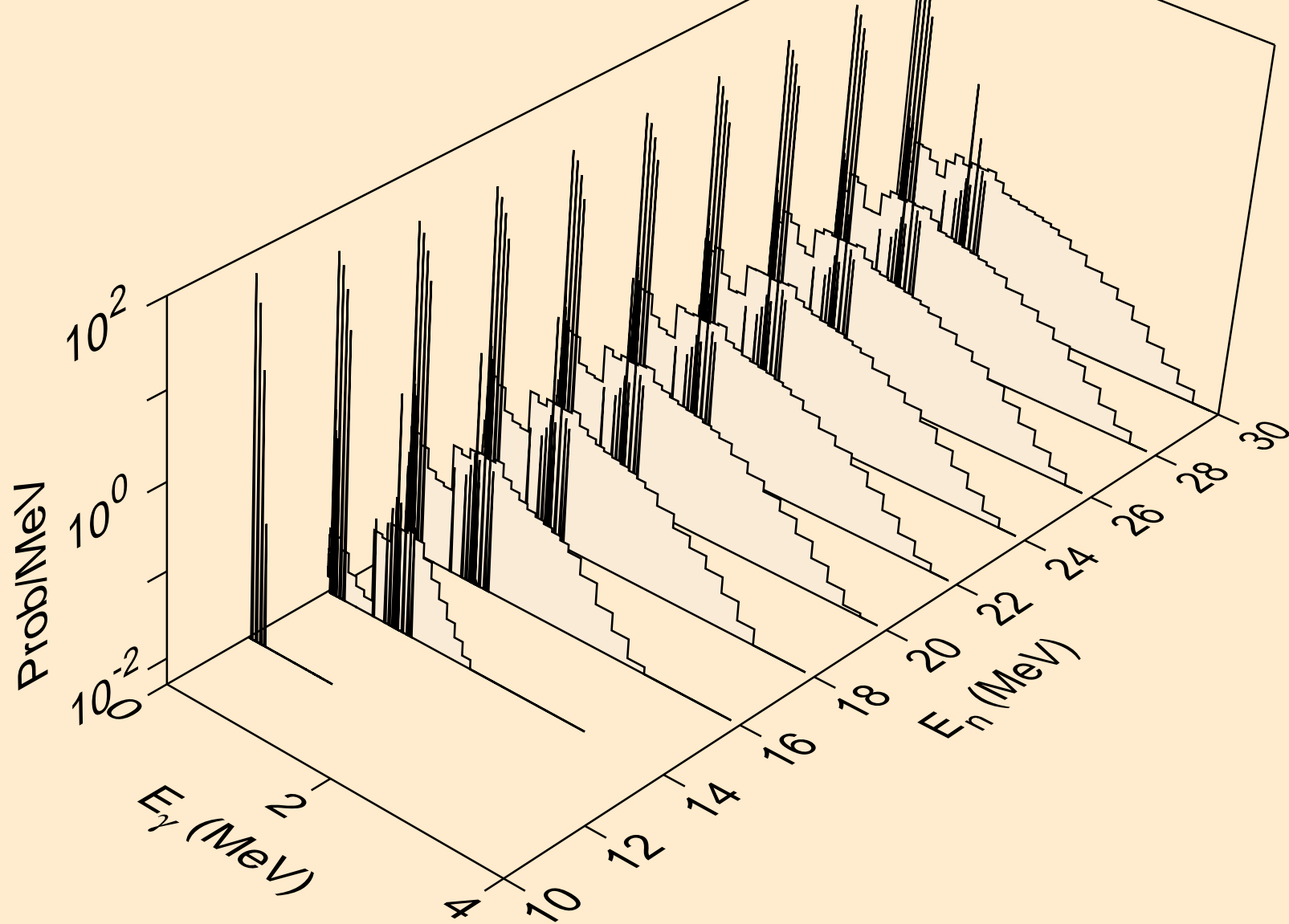

CF252 NEUTRON ACER TENDL-2023 LIBRARY; T=0.K  
Photon emission for (n,n\*)a

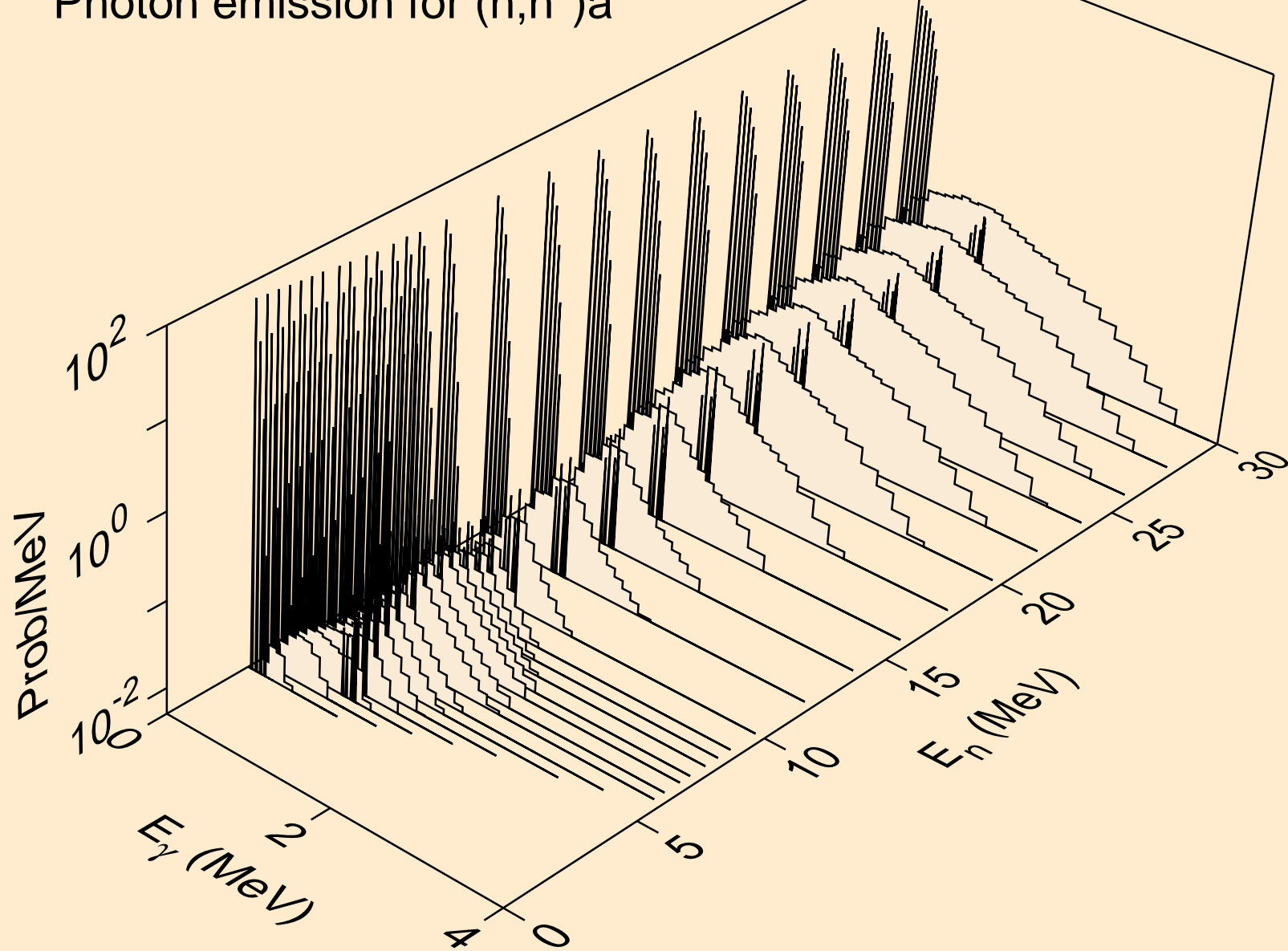

CF252 NEUTRON ACER TENDL-2023 LIBRARY; T=0.K  
Photon emission for (n,2n)a

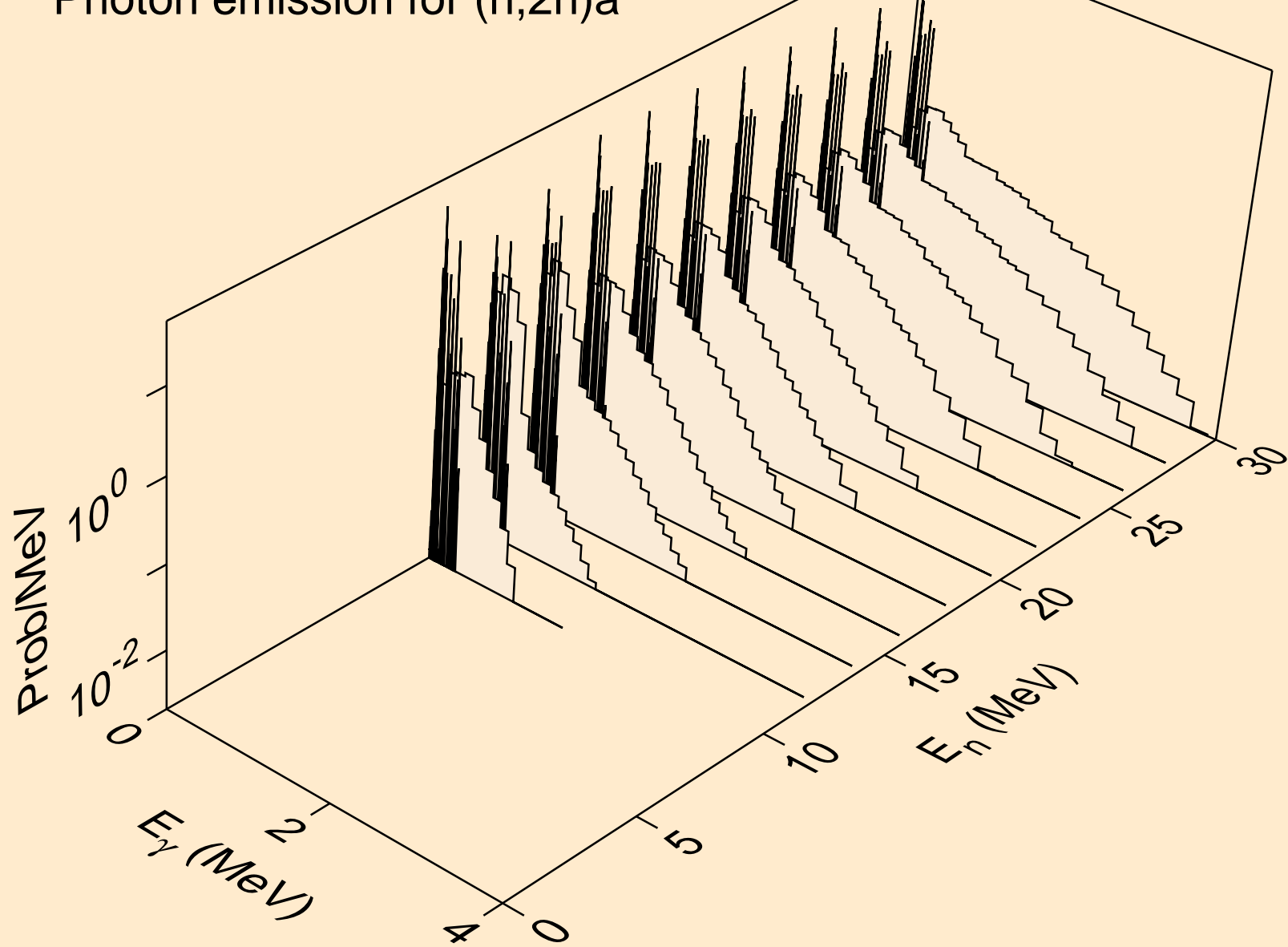

CF252 NEUTRON ACER TENDL-2023 LIBRARY; T=0.K  
Photon emission for (n,3n)a

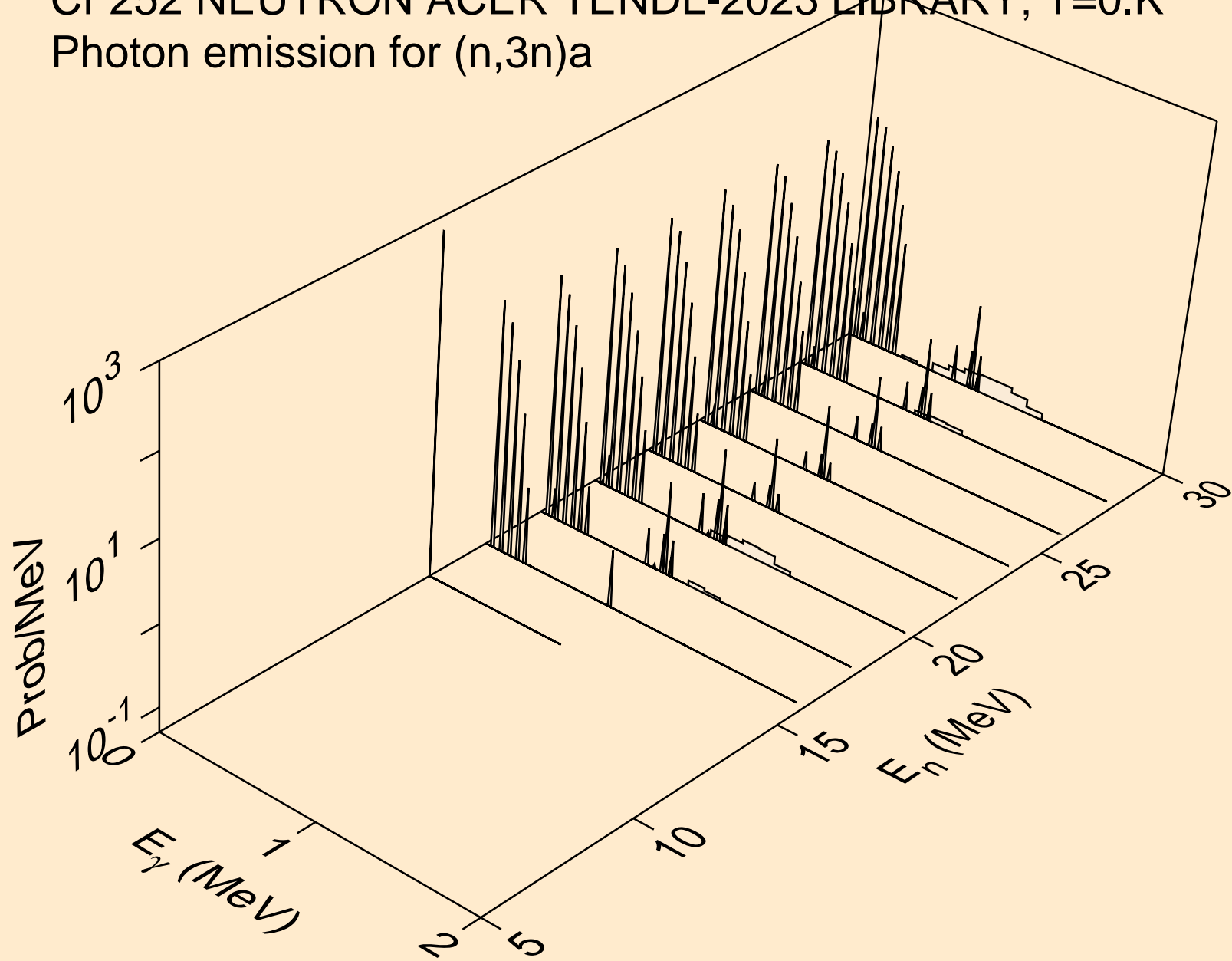

CF252 NEUTRON ACER TENDL-2023 LIBRARY; T=0.K  
Photon emission for (n,n\*)p

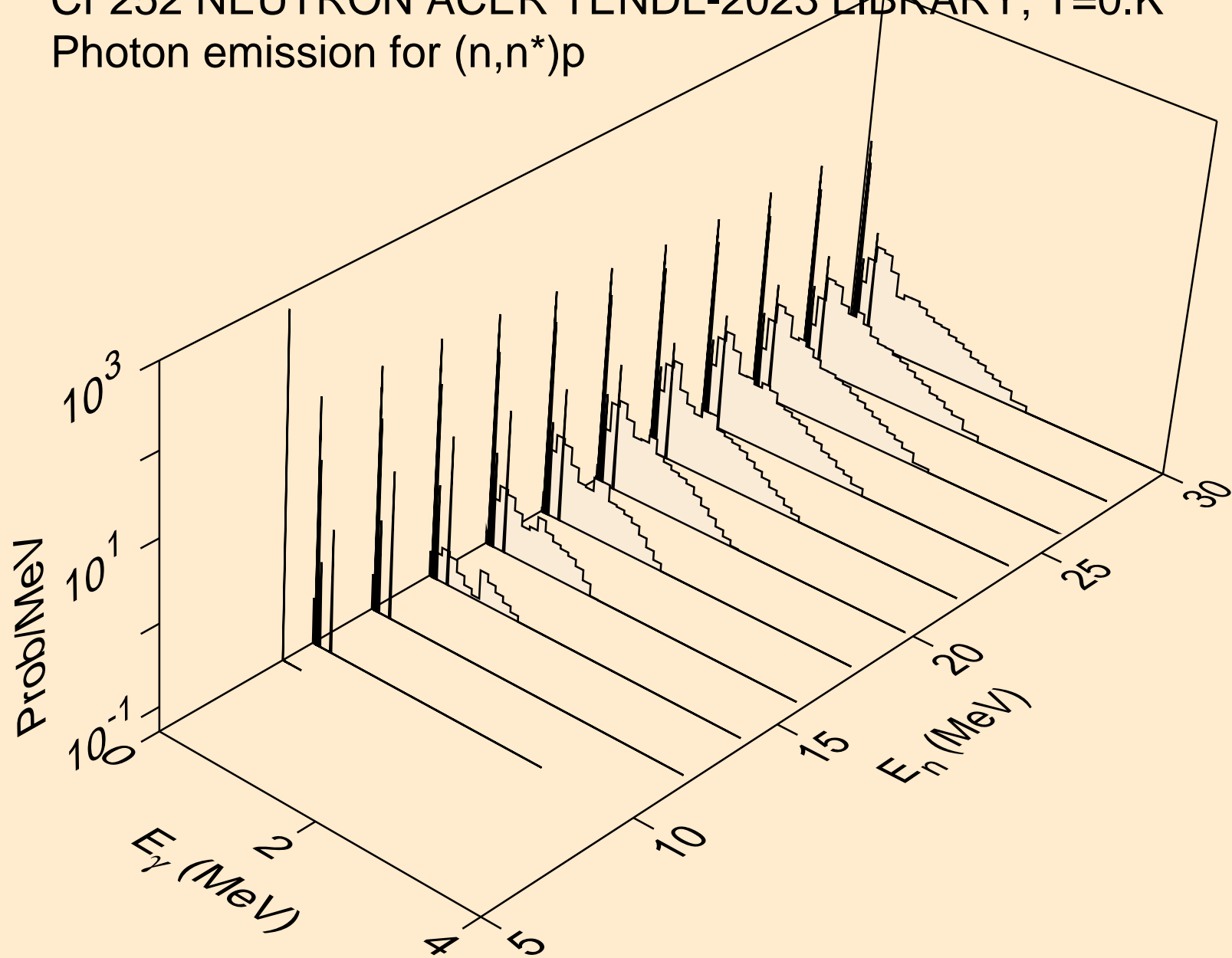

CF252 NEUTRON ACER TENDL-2023 LIBRARY; T=0.K  
Photon emission for (n,n\*)d

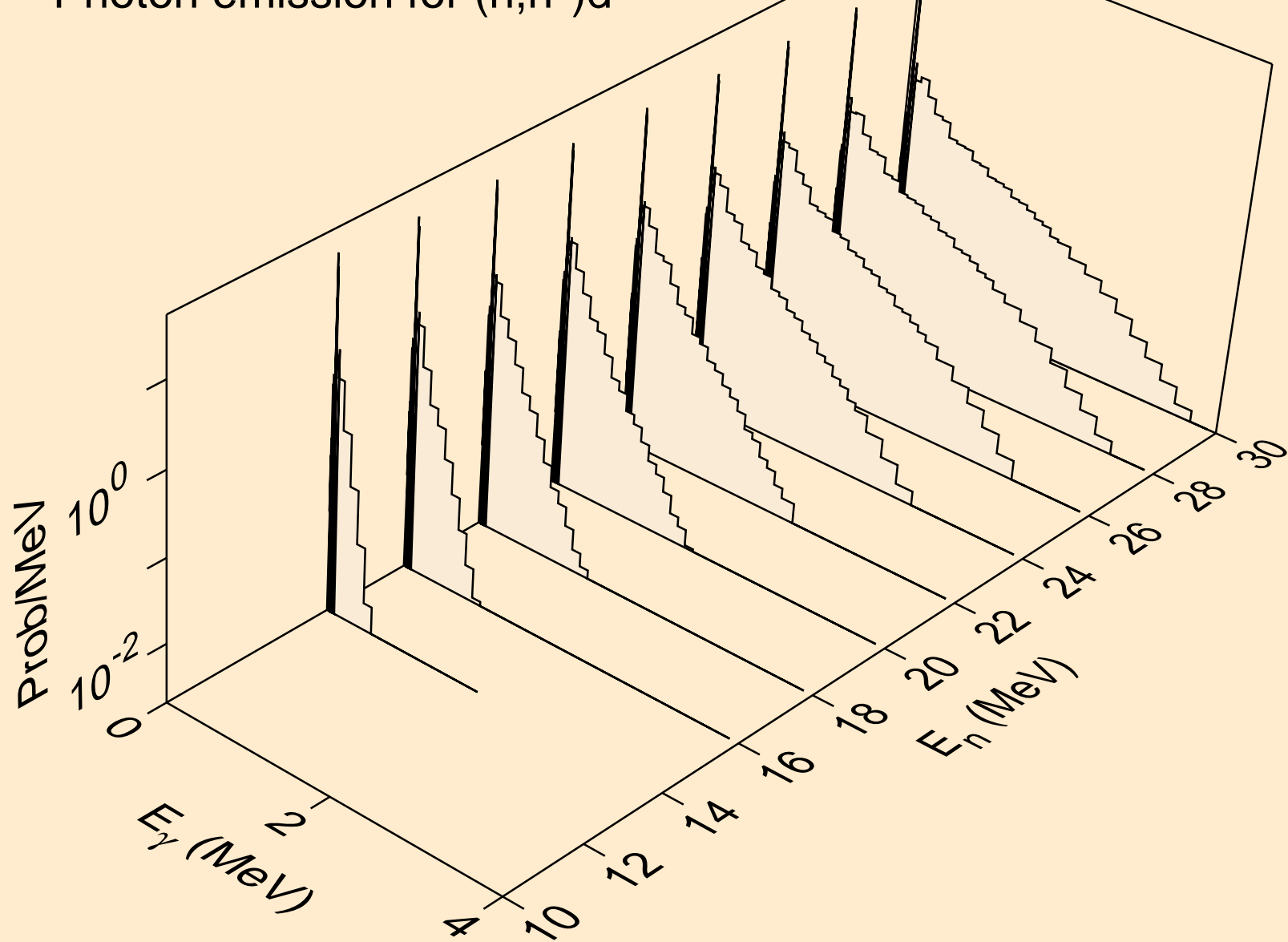



CF252 NEUTRON ACER TENDL-2023 LIBRARY; T=0.K  
Photon emission for (n,n\*)t

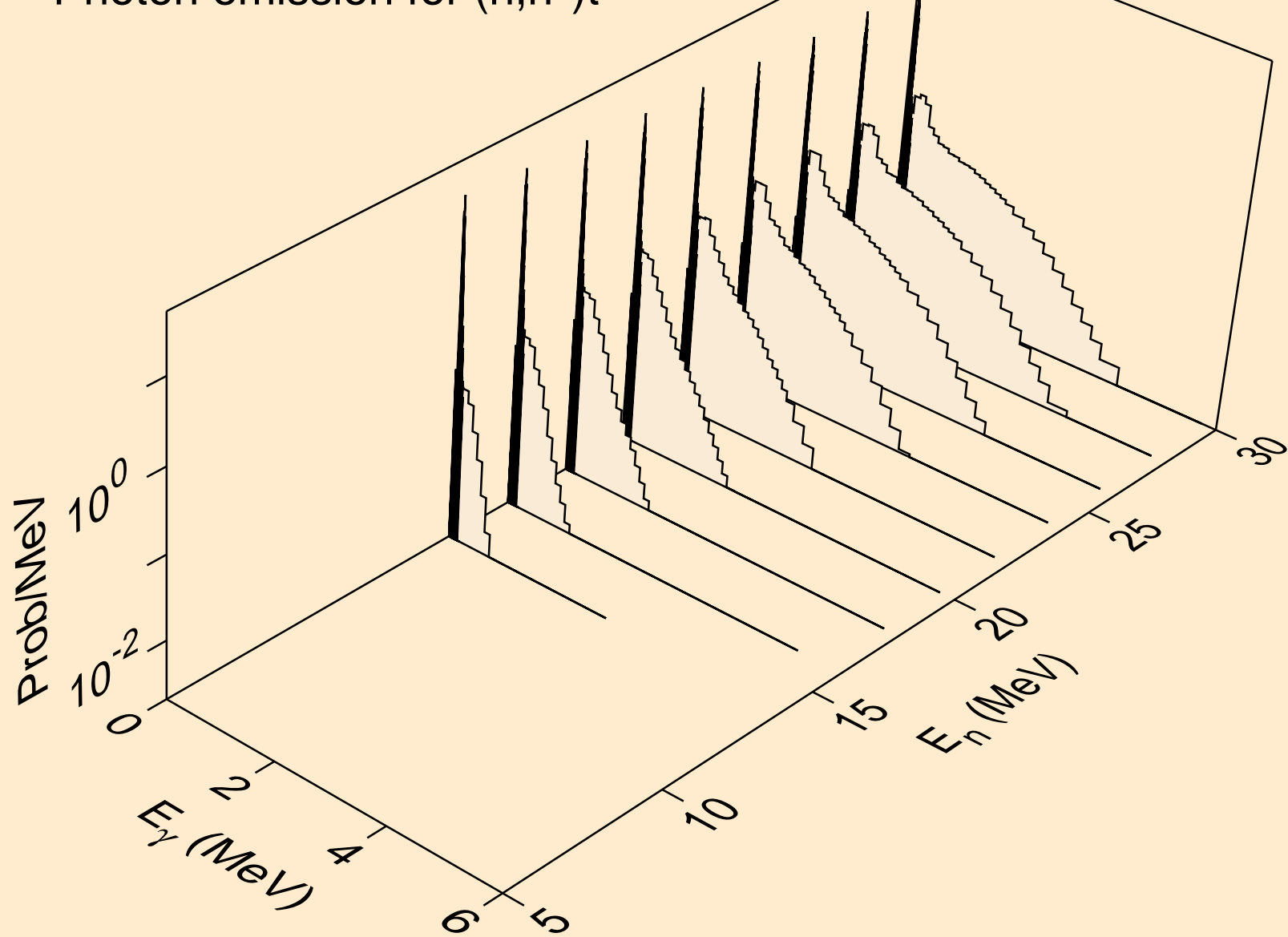

CF252 NEUTRON ACER TENDL-2023 LIBRARY; T=0.K  
Photon emission for (n,n\*)he3

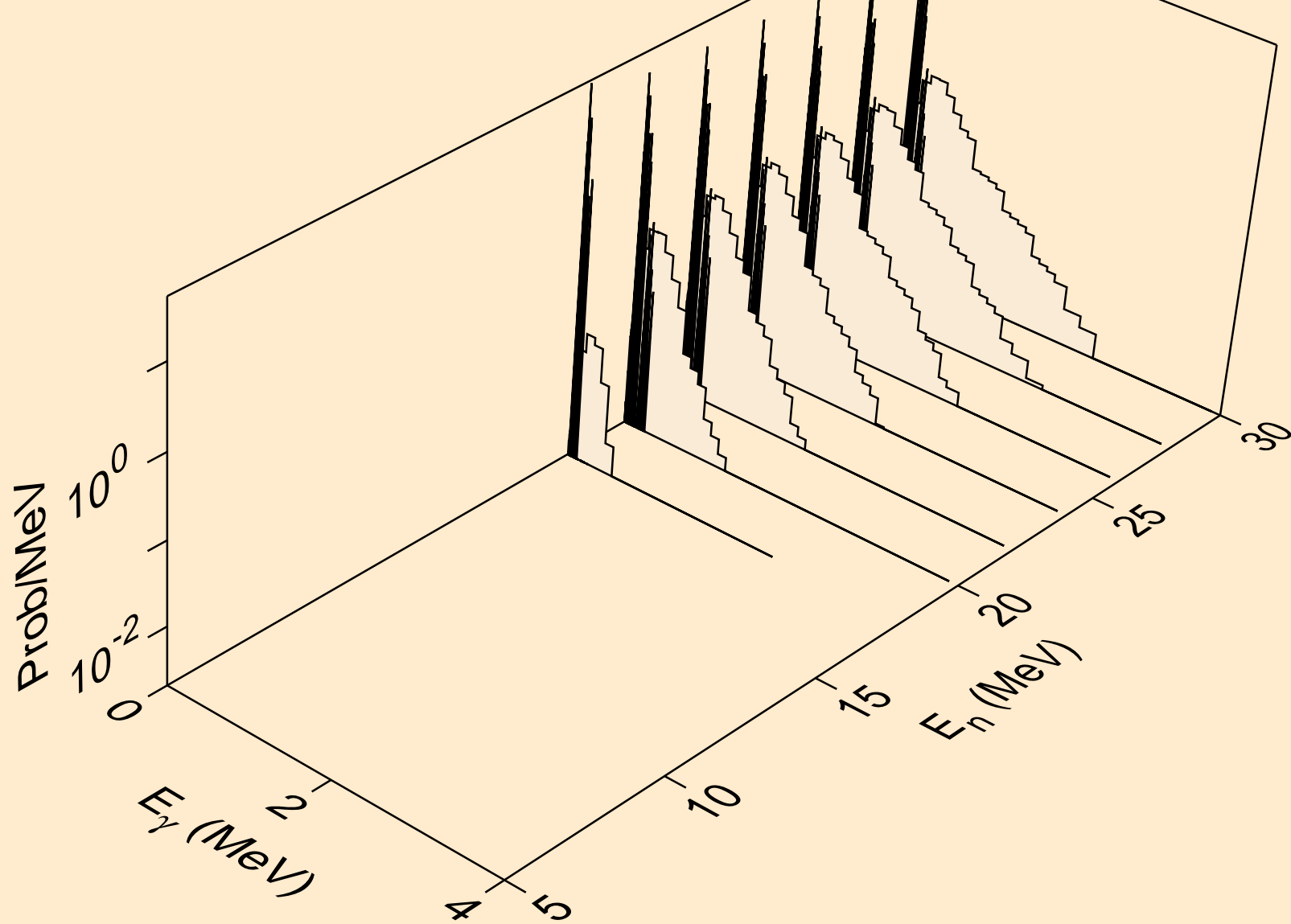

CF252 NEUTRON ACER TENDL-2023 LIBRARY; T=0.K  
Photon emission for (n,4n)

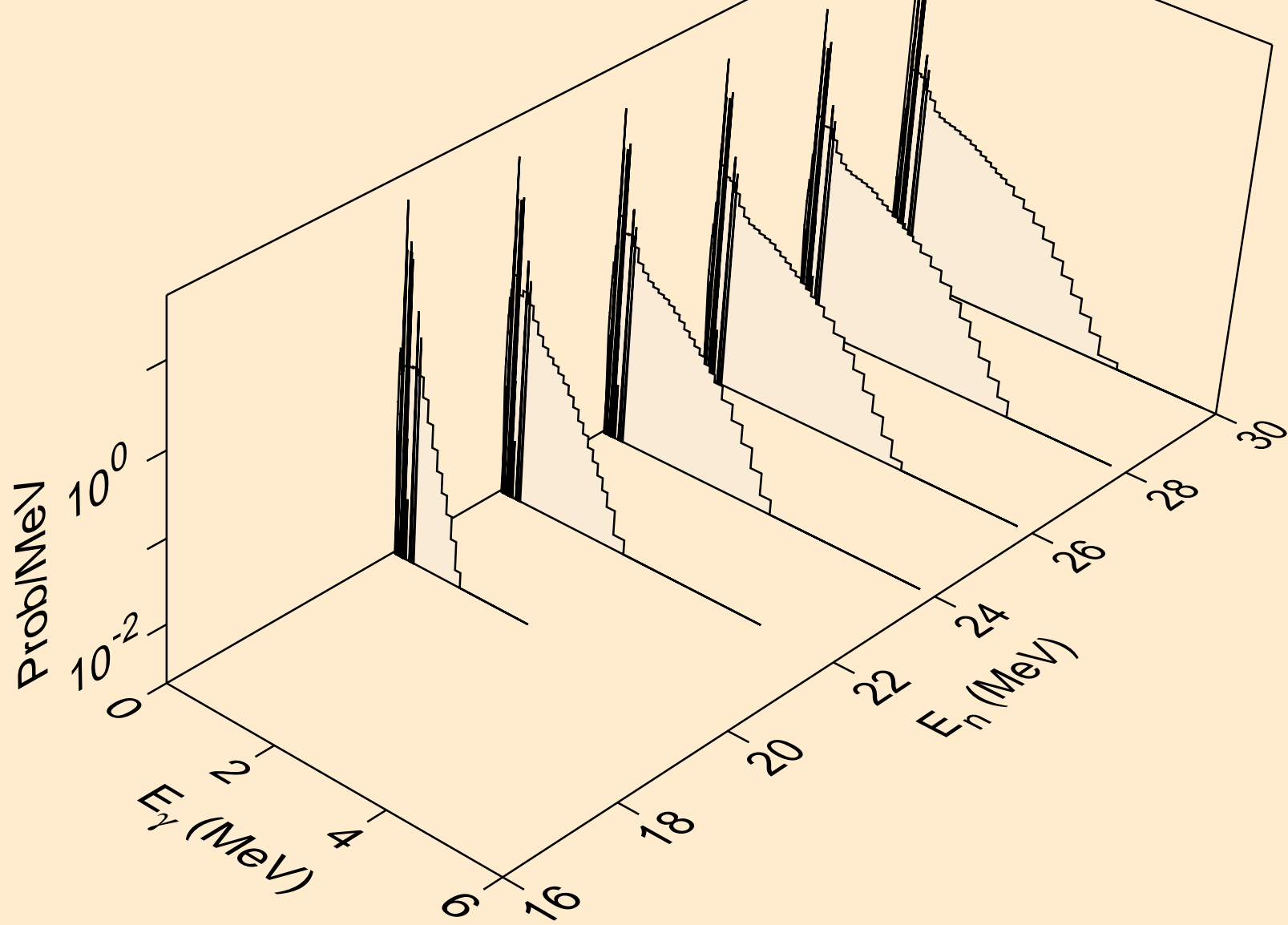

CF252 NEUTRON ACER TENDL-2023 LIBRARY; T=0.K  
Photon emission for (n,2np)

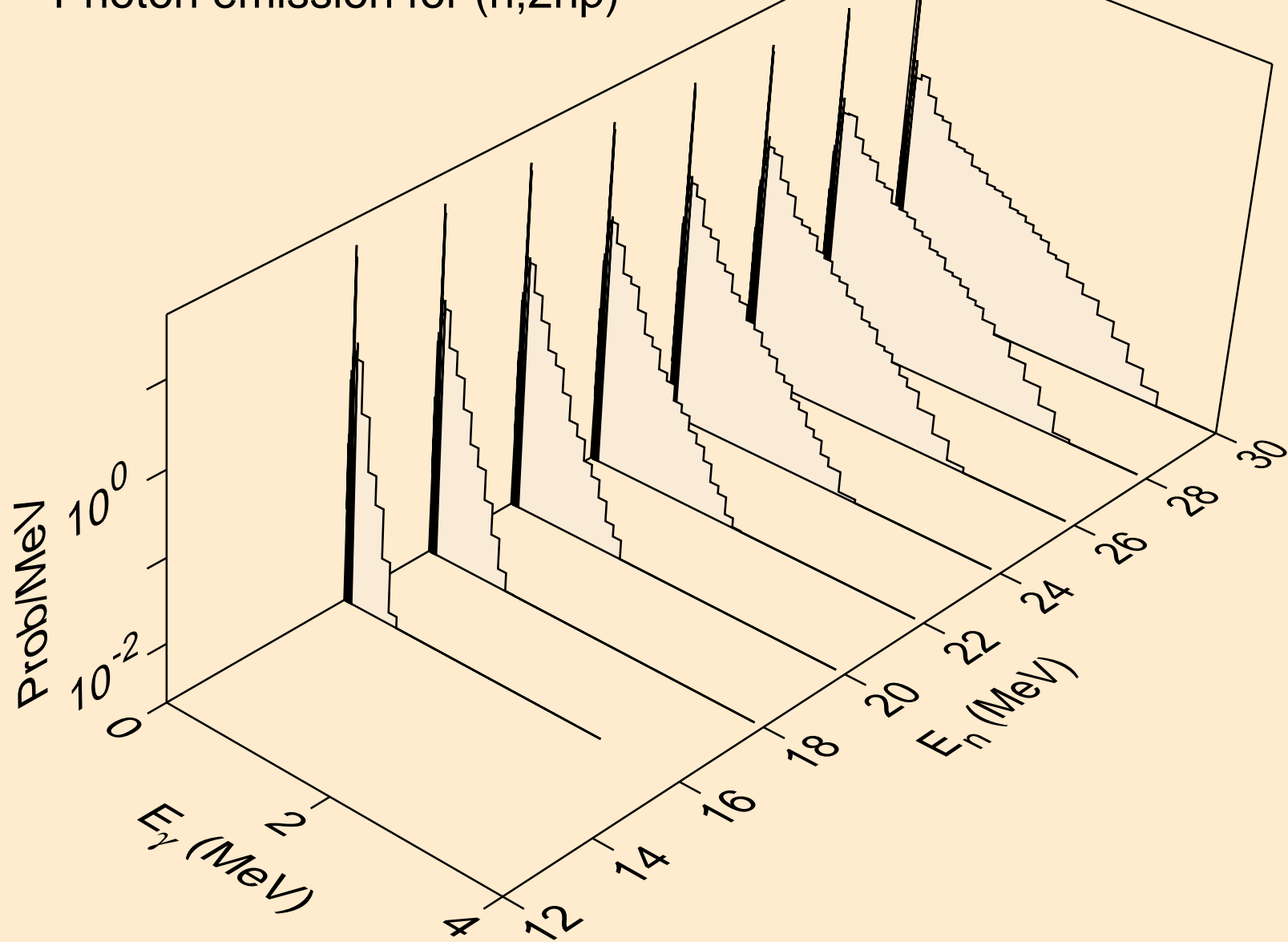

CF252 NEUTRON ACER TENDL-2023 LIBRARY; T=0.K  
Photon emission for (n,3np)

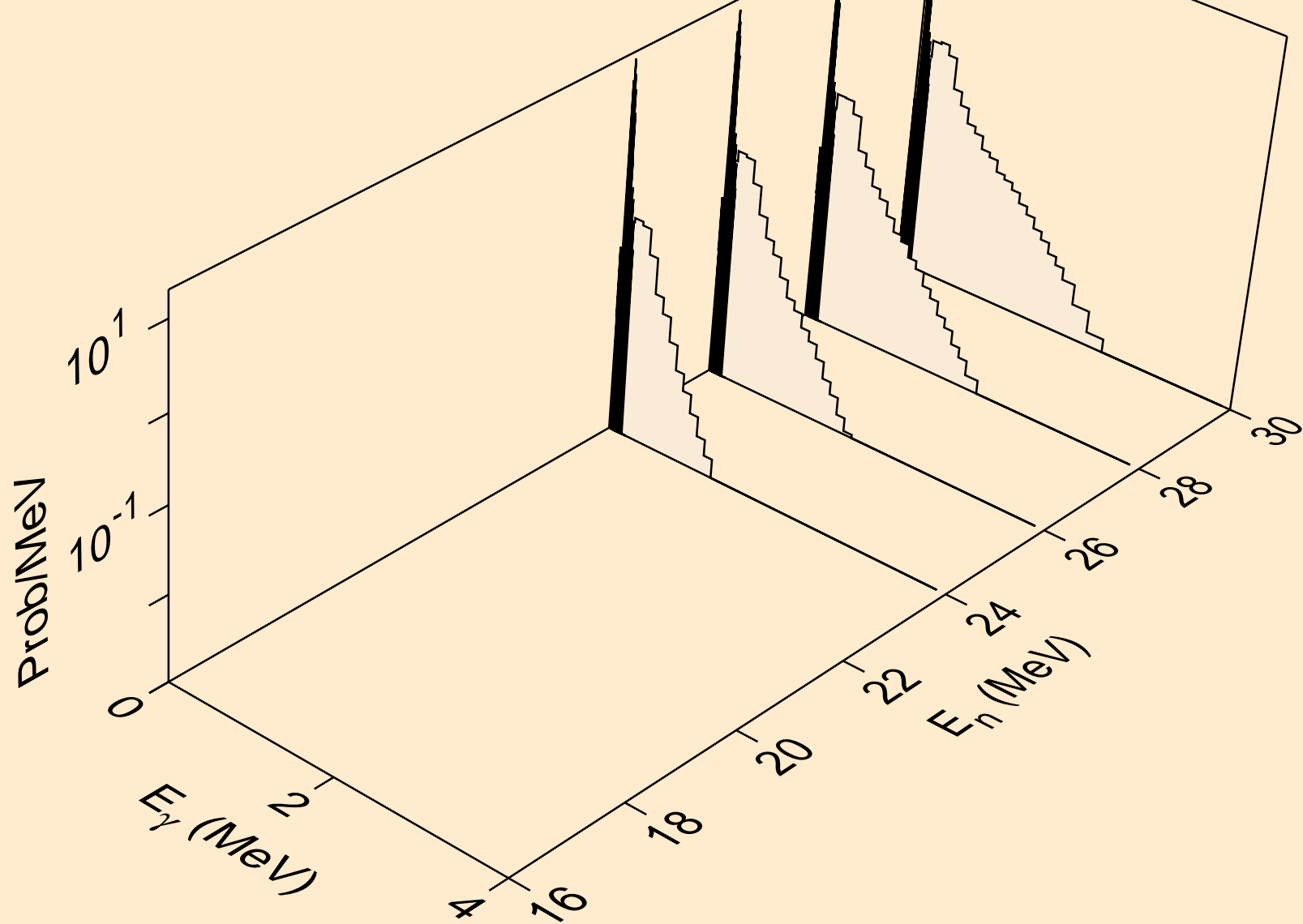

CF252 NEUTRON ACER TENDL-2023 LIBRARY; T=0.K  
Photon emission for (n,n2p)

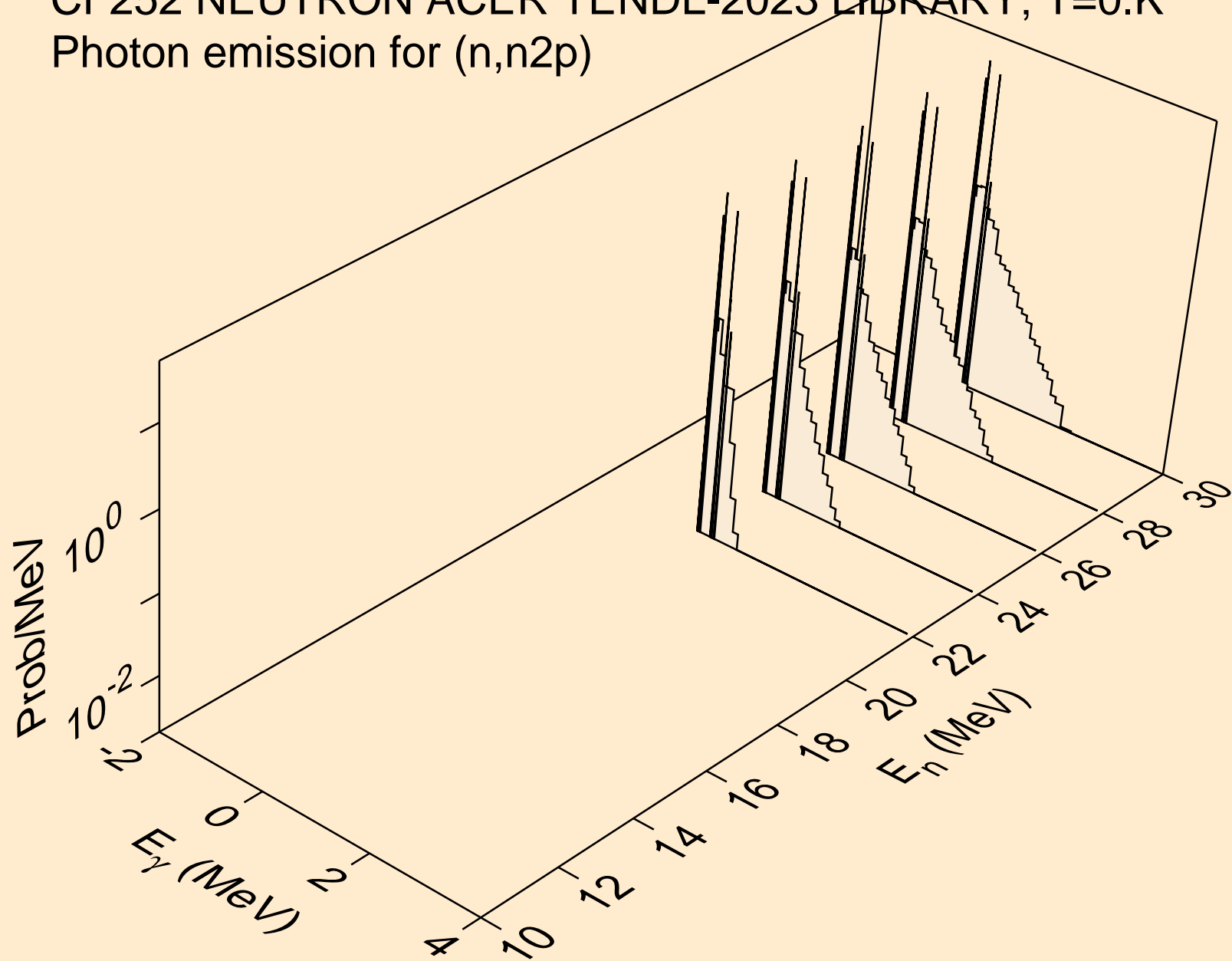

CF252 NEUTRON ACER TENDL-2023 LIBRARY; T=0.K  
Photon emission for (n,n\*c)

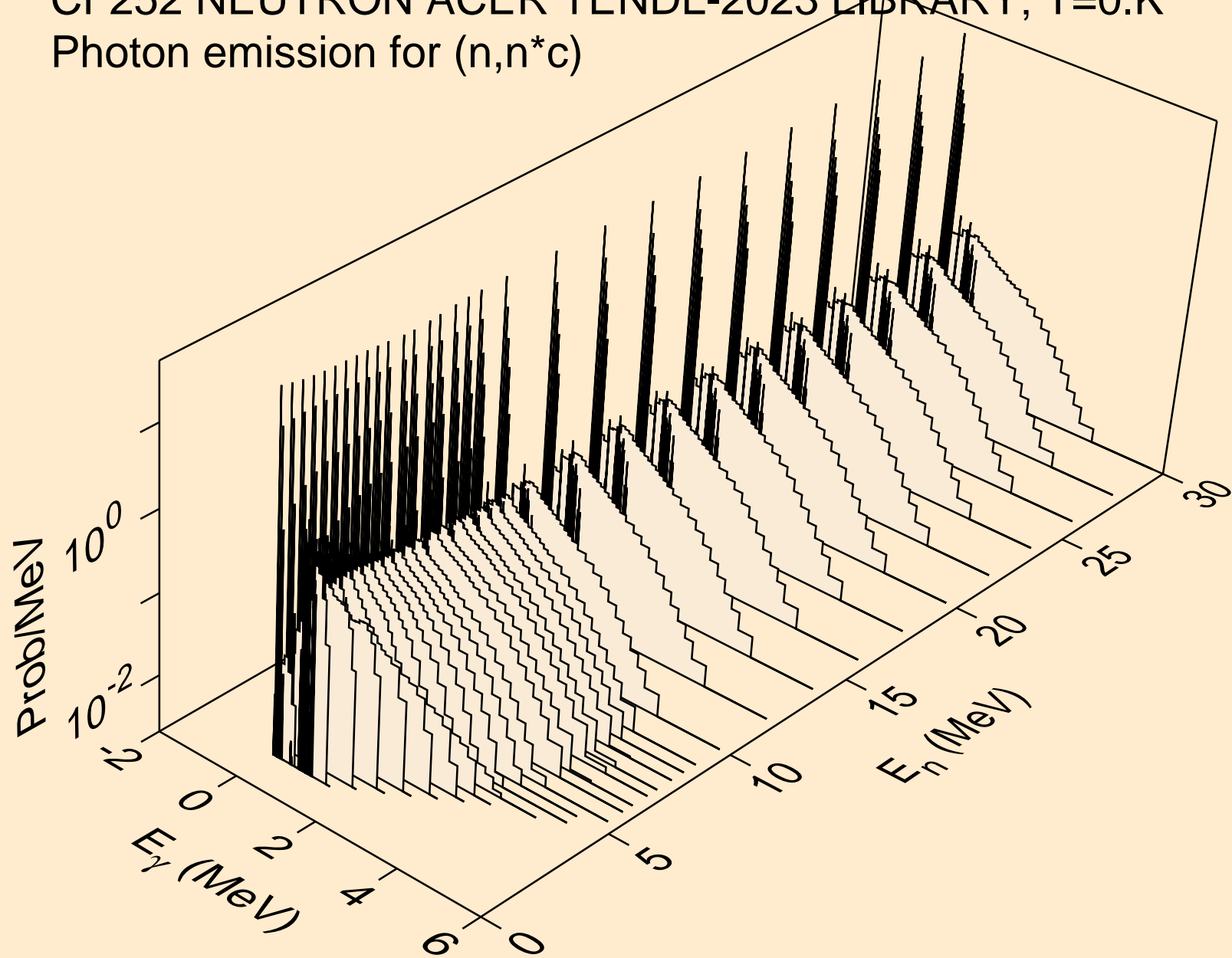

CF252 NEUTRON ACER TENDL-2023 LIBRARY; T=0.K  
Photon emission for (n,gma)

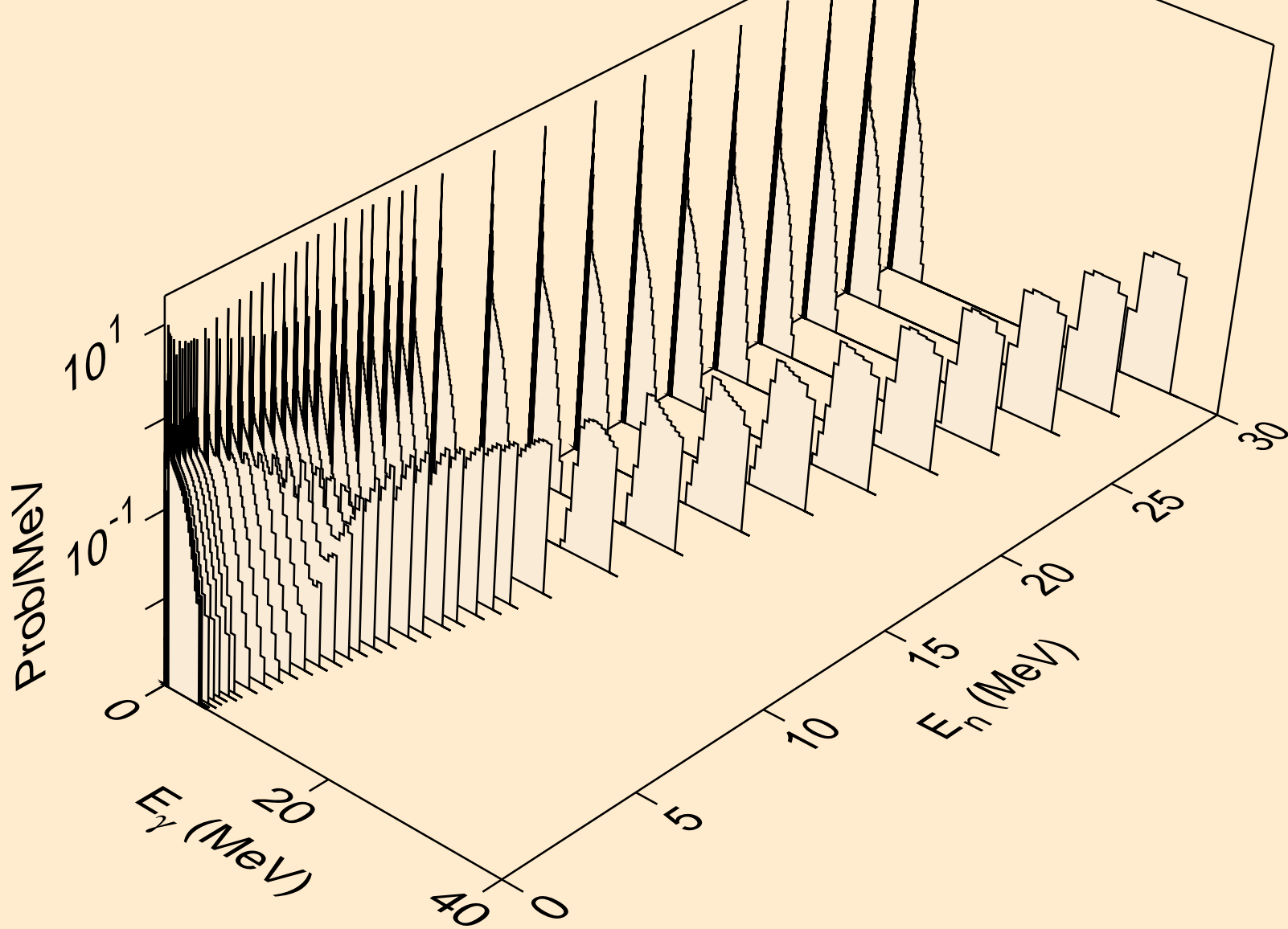



CF252 NEUTRON ACER TENDL-2023 LIBRARY; T=0.K  
Photon emission for (n,p)

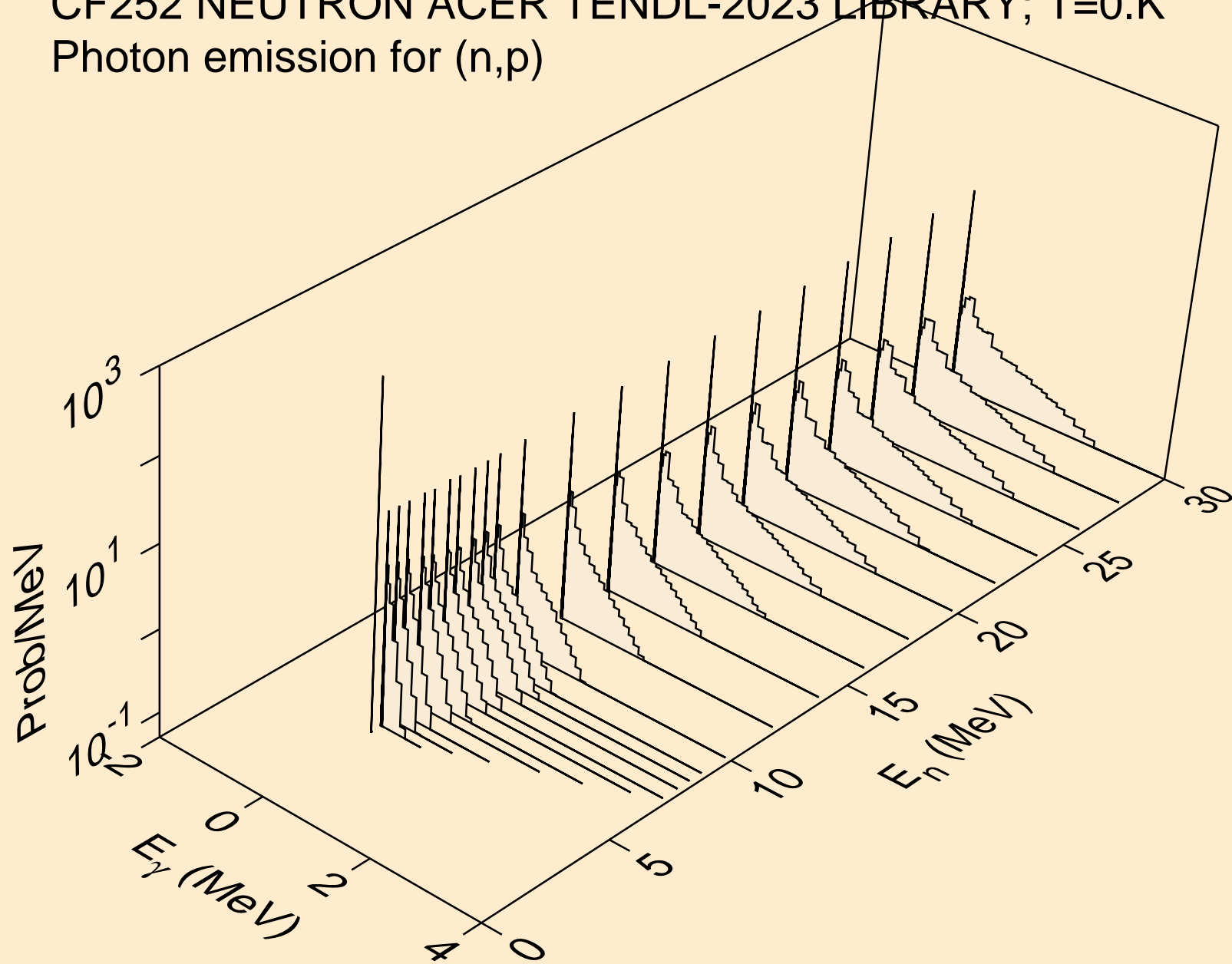

CF252 NEUTRON ACER TENDL-2023 LIBRARY; T=0.K  
Photon emission for (n,d)

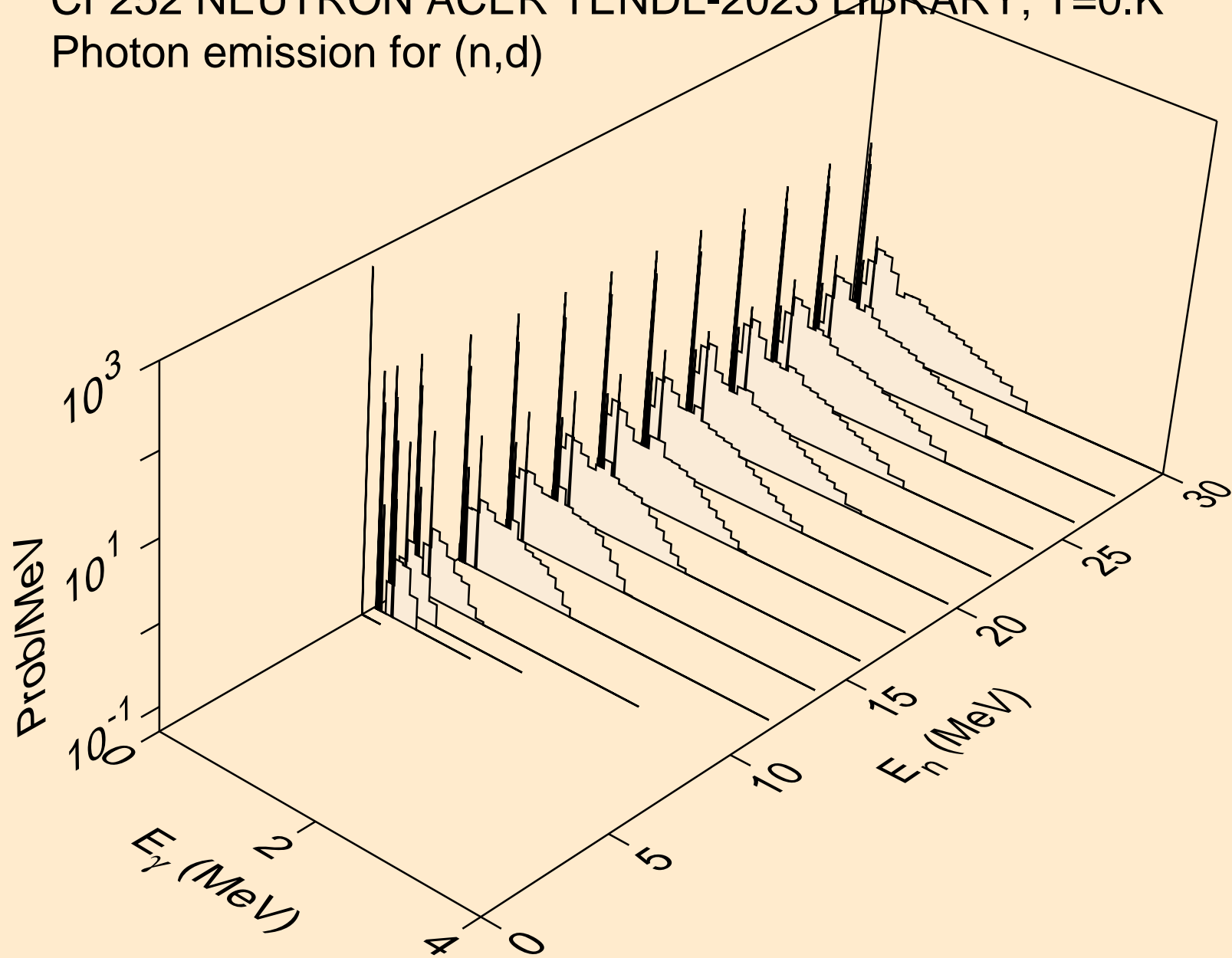

CF252 NEUTRON ACER TENDL-2023 LIBRARY; T=0.K  
Photon emission for (n,t)

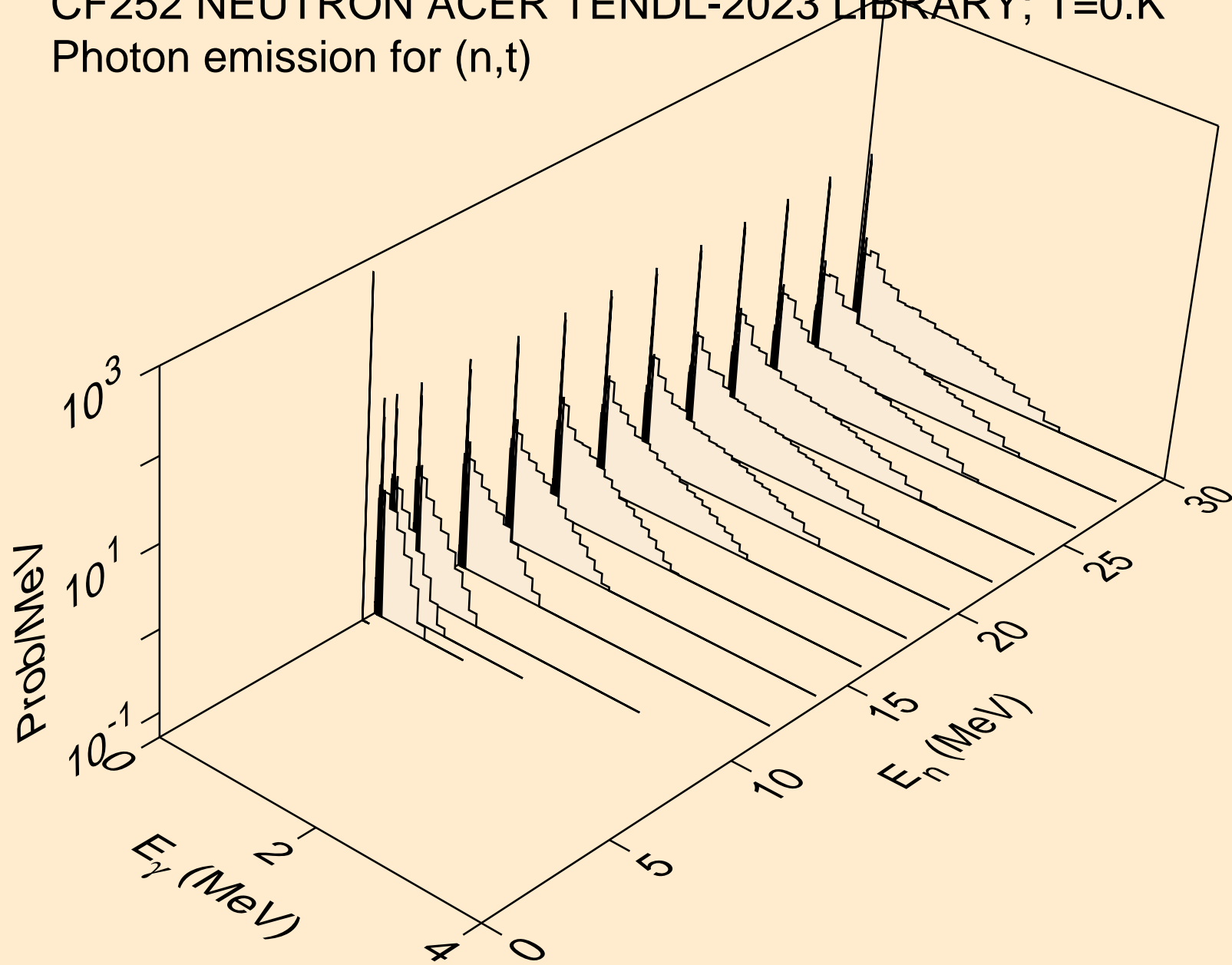

CF252 NEUTRON ACER TENDL-2023 LIBRARY; T=0.K  
Photon emission for (n,he3)

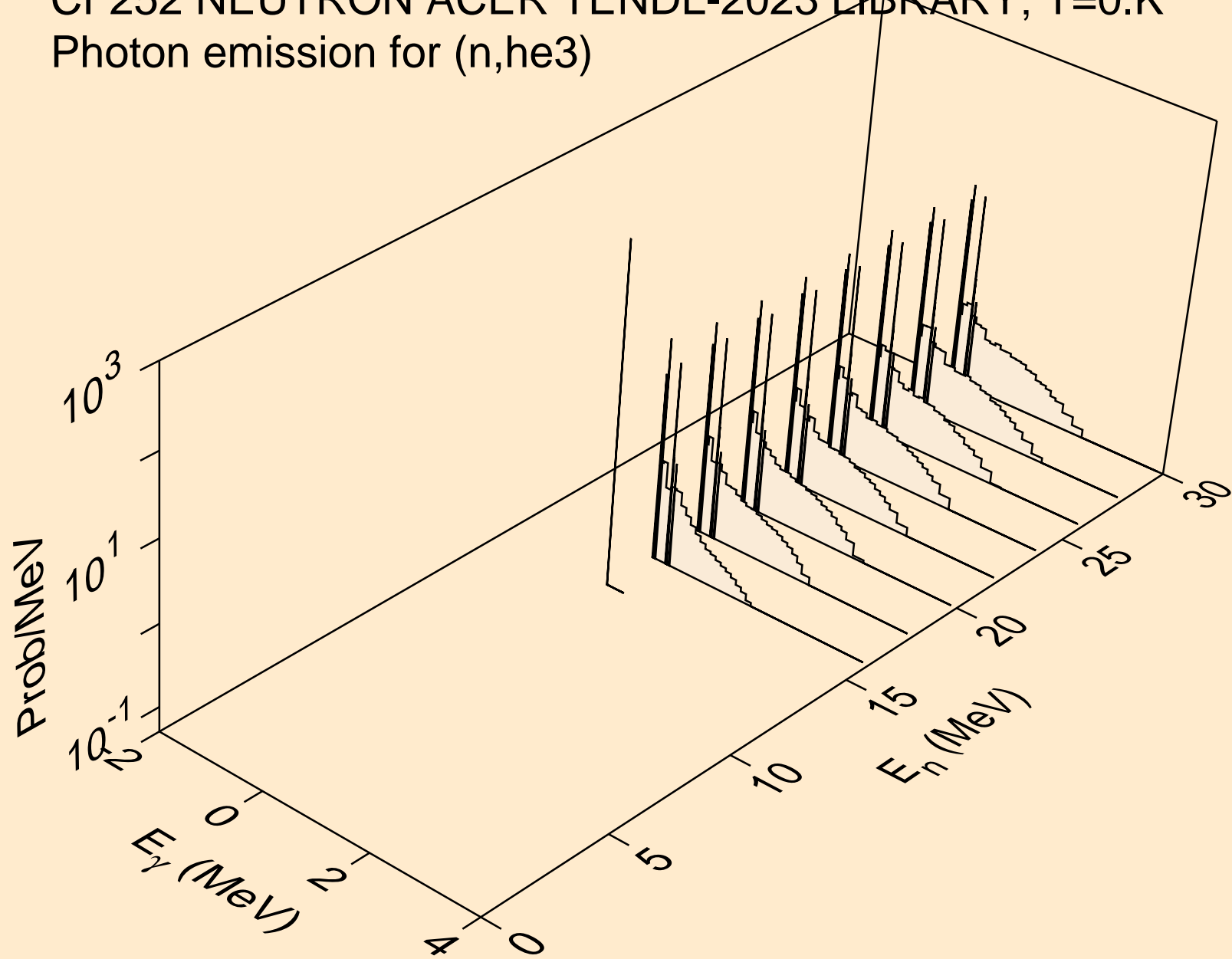

CF252 NEUTRON ACER TENDL-2023 LIBRARY; T=0.K  
Photon emission for (n,a)

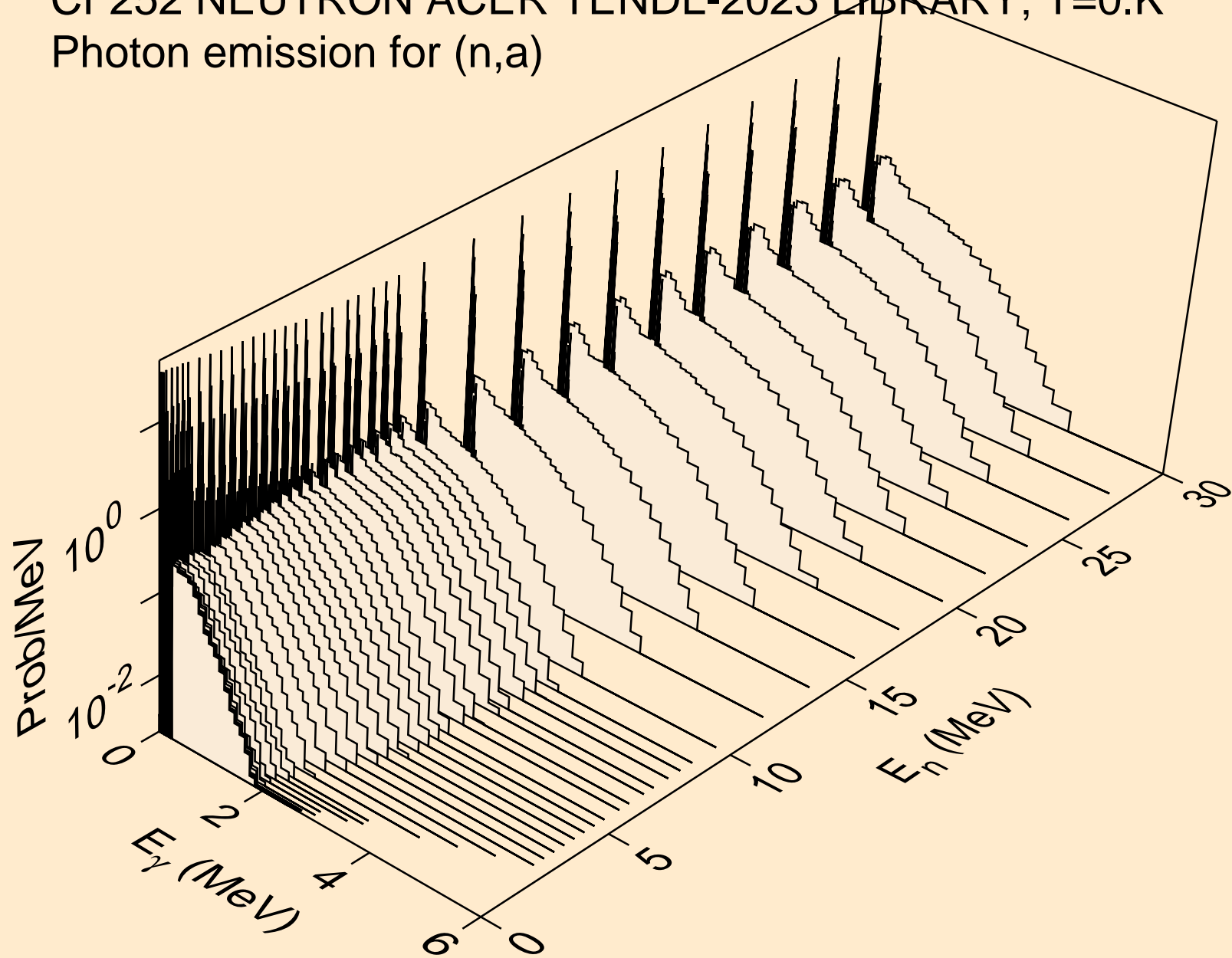

CF252 NEUTRON ACER TENDL-2023 LIBRARY; T=0.K  
Photon emission for (n,2p)

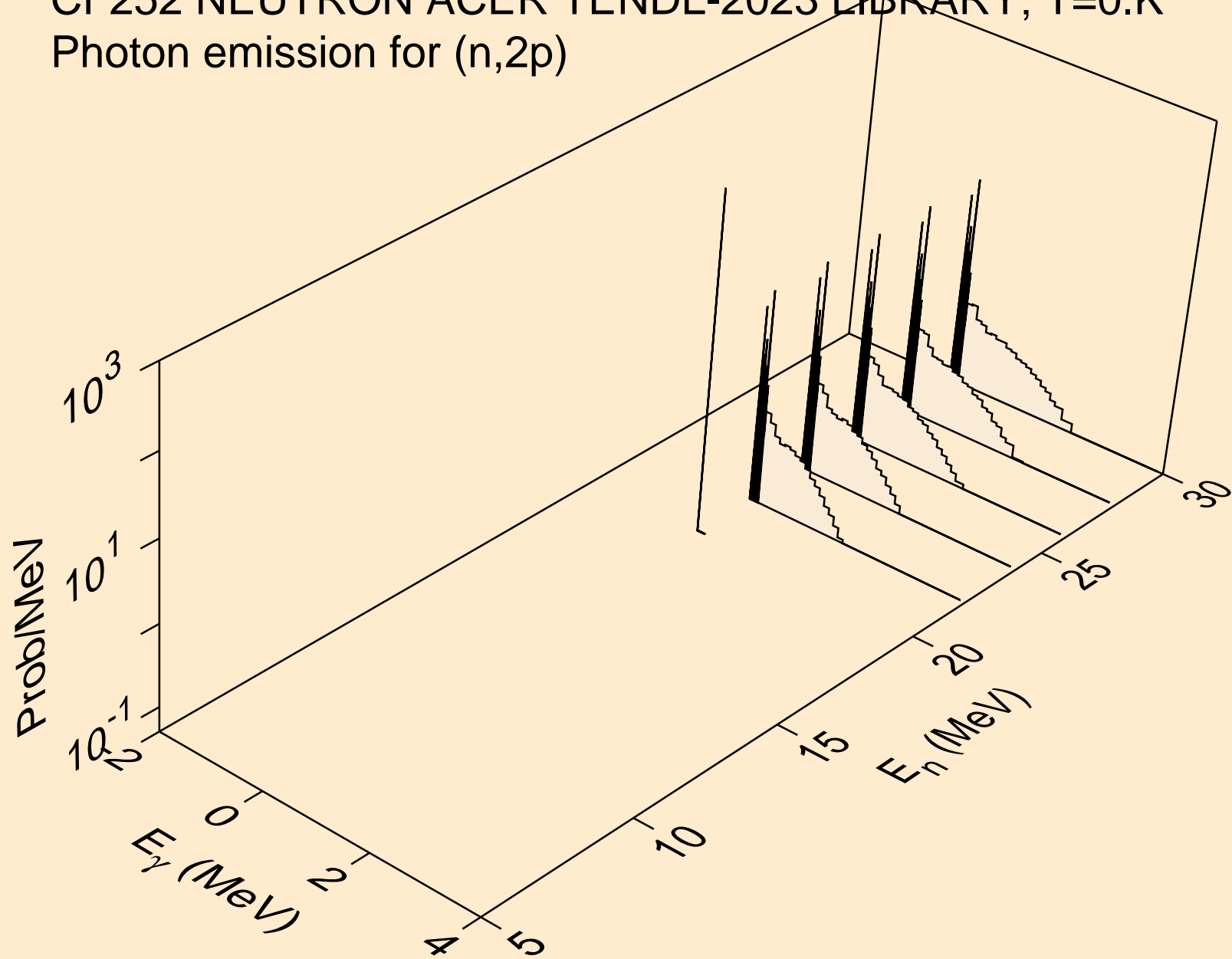

CF252 NEUTRON ACER TENDL-2023 LIBRARY; T=0.K  
thermal capture photon spectrum

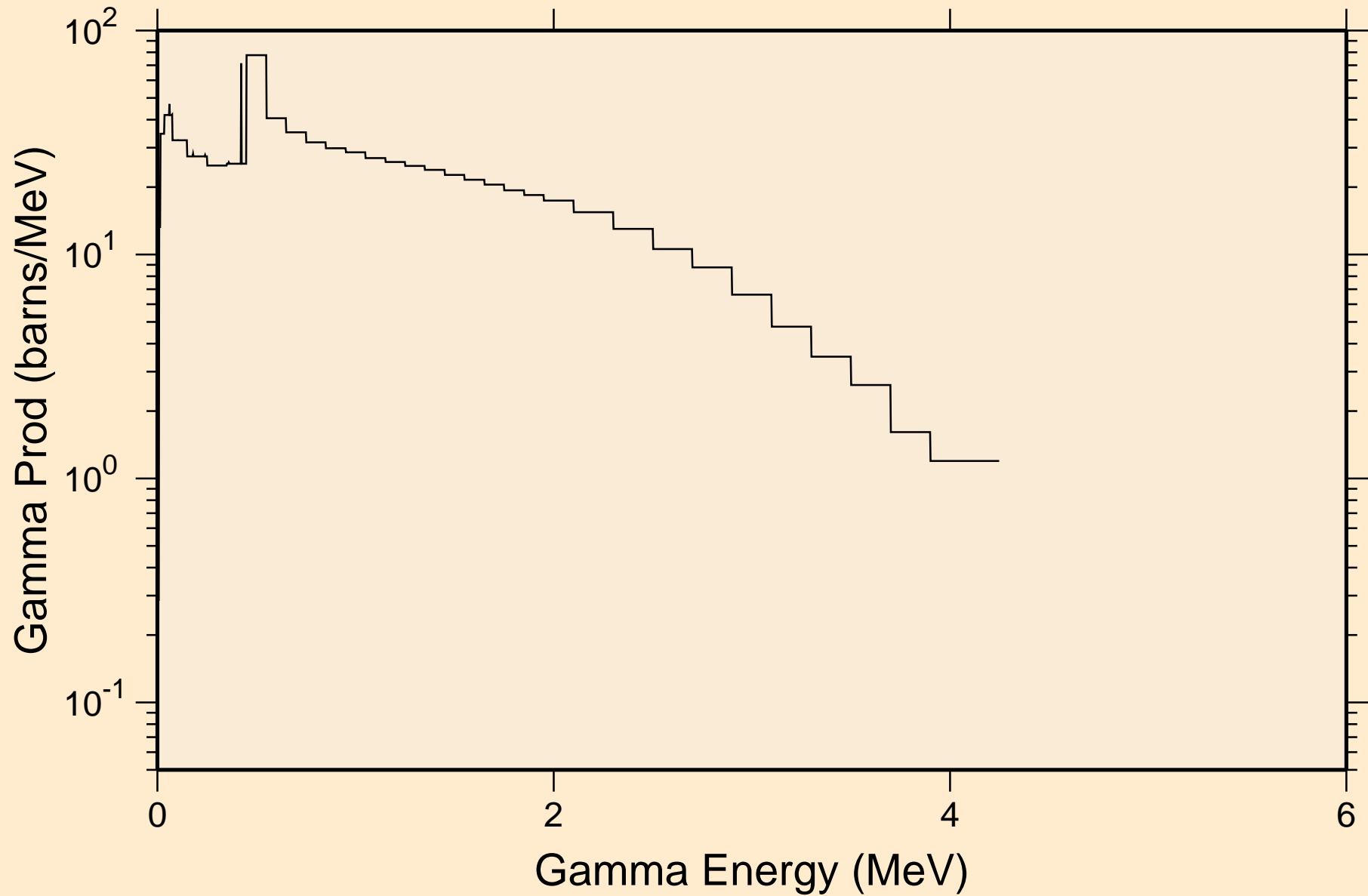

CF252 NEUTRON ACER TENDL-2023 LIBRARY; T=0.K  
14 MeV photon spectrum

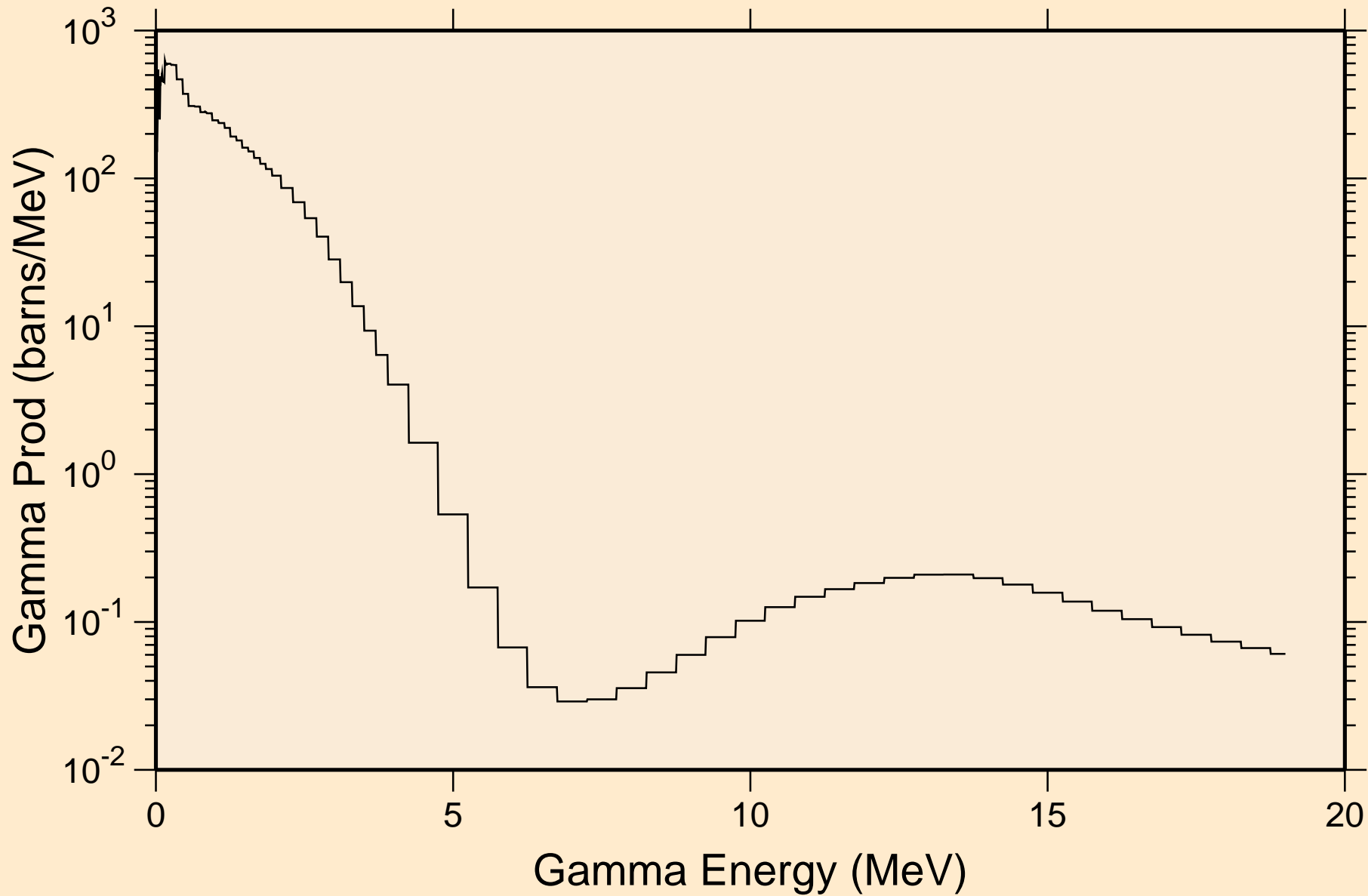



# CF252 NEUTRON ACER TENDL-2023 LIBRARY; T=0.K

## Particle heating contributions

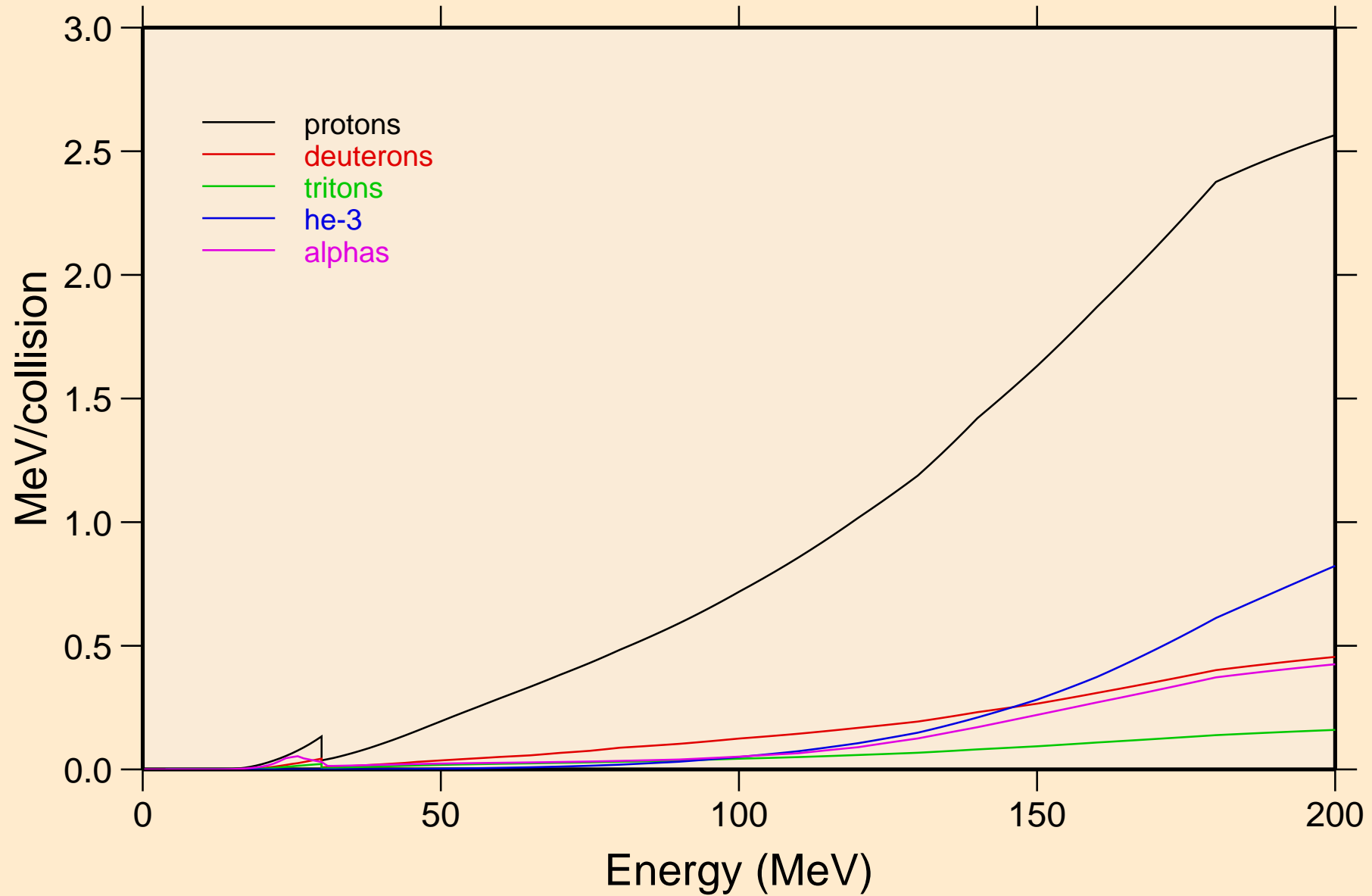

CF252 NEUTRON ACER TENDL-2023 LIBRARY; T=0.K  
Recoil Heating

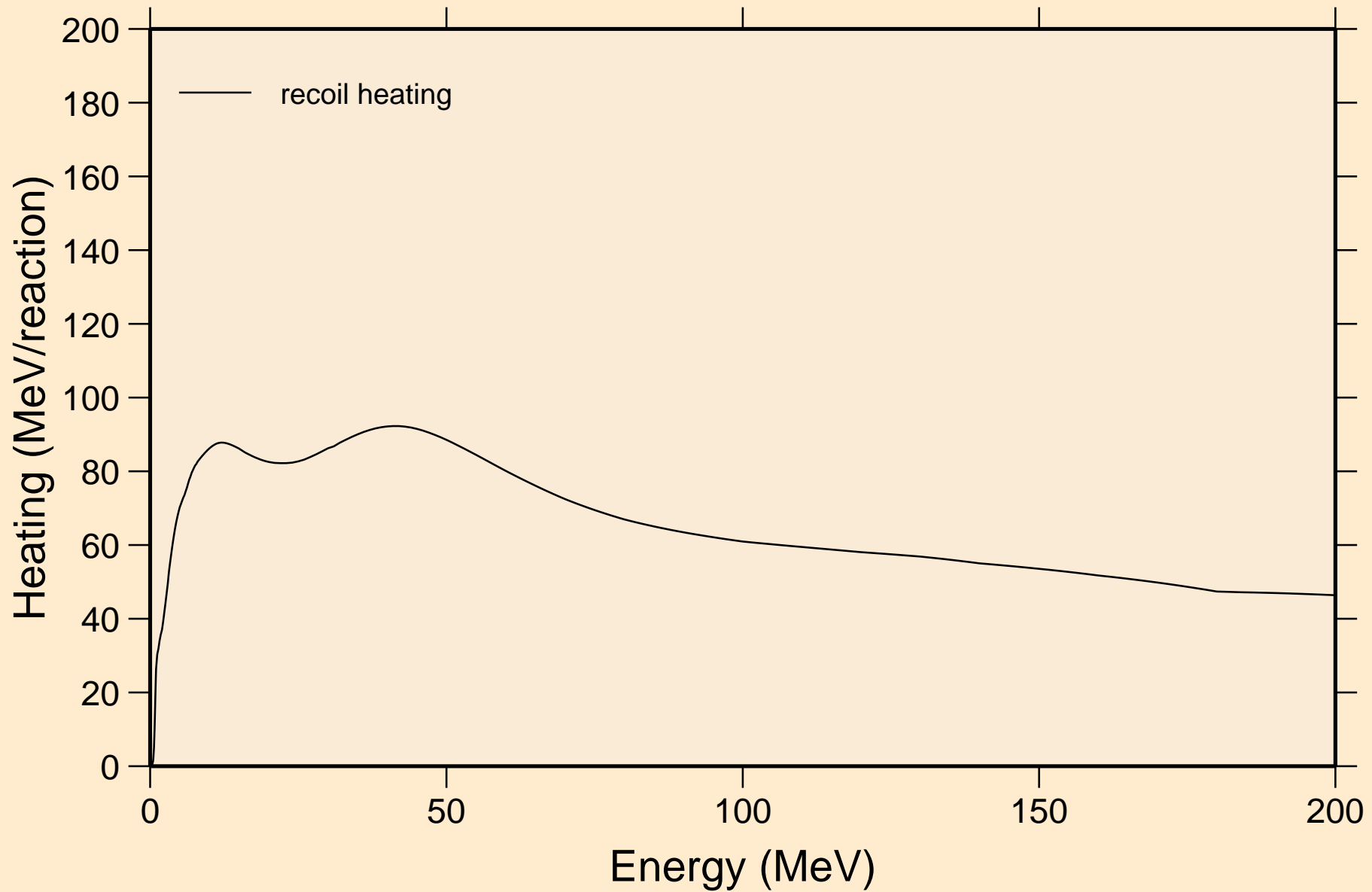

# CF252 NEUTRON ACER TENDL-2023 LIBRARY; T=0.K

## Particle production cross sections

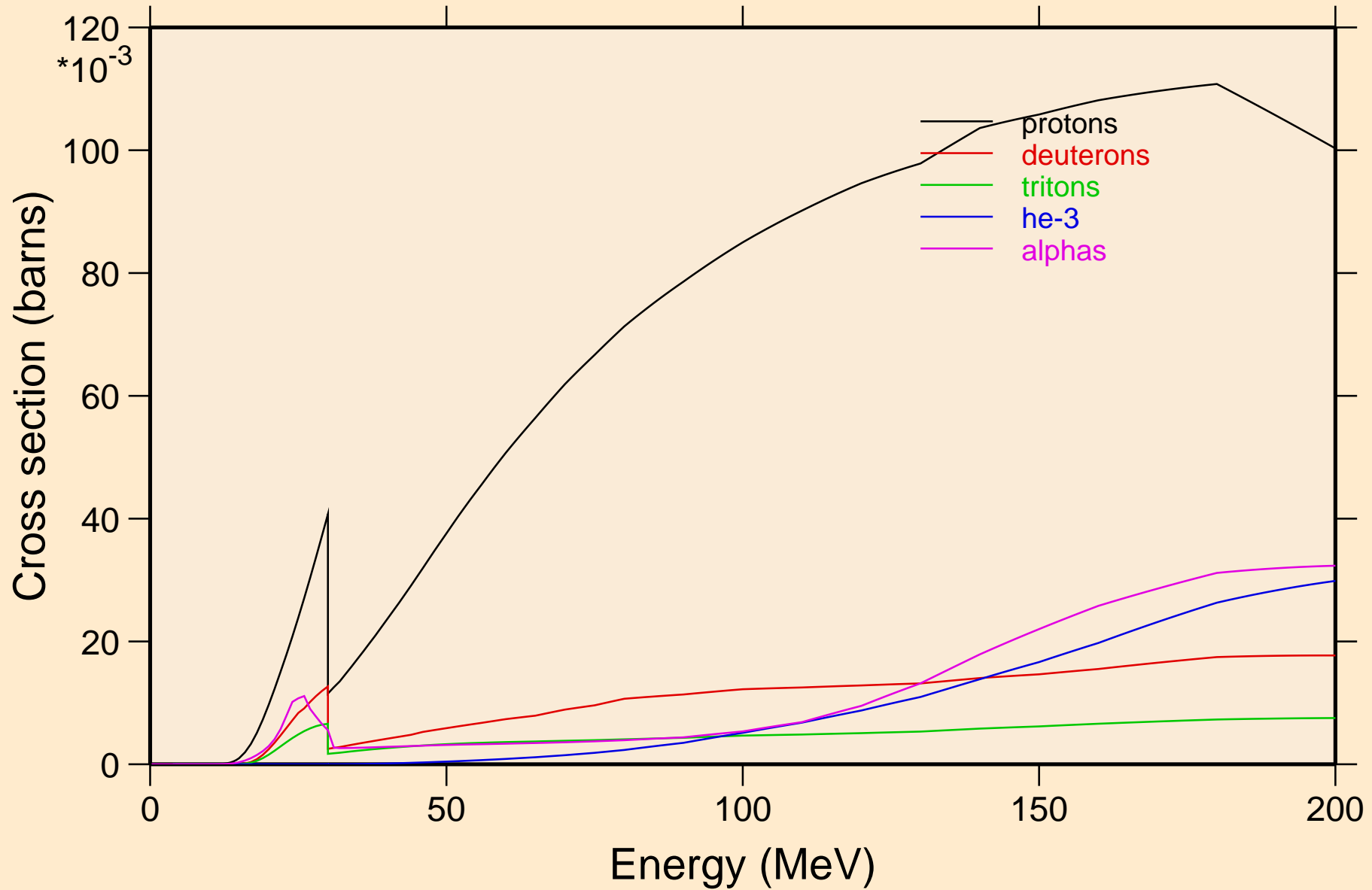

CF252 NEUTRON ACER TENDL-2023 LIBRARY; T=0.K  
protons from (n,x)

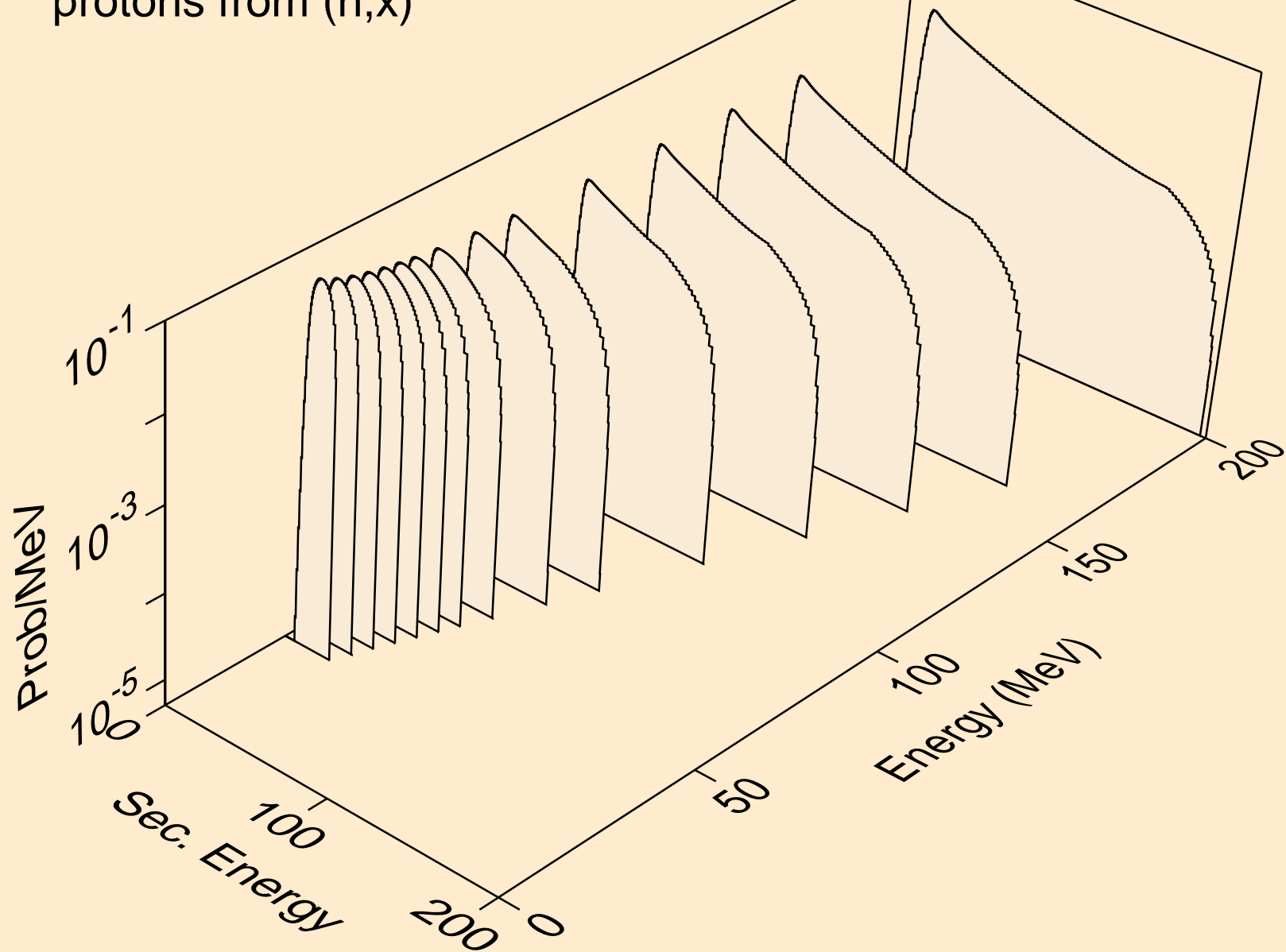

CF252 NEUTRON ACER TENDL-2023 LIBRARY; T=0.K  
protons from (n,n\*)p

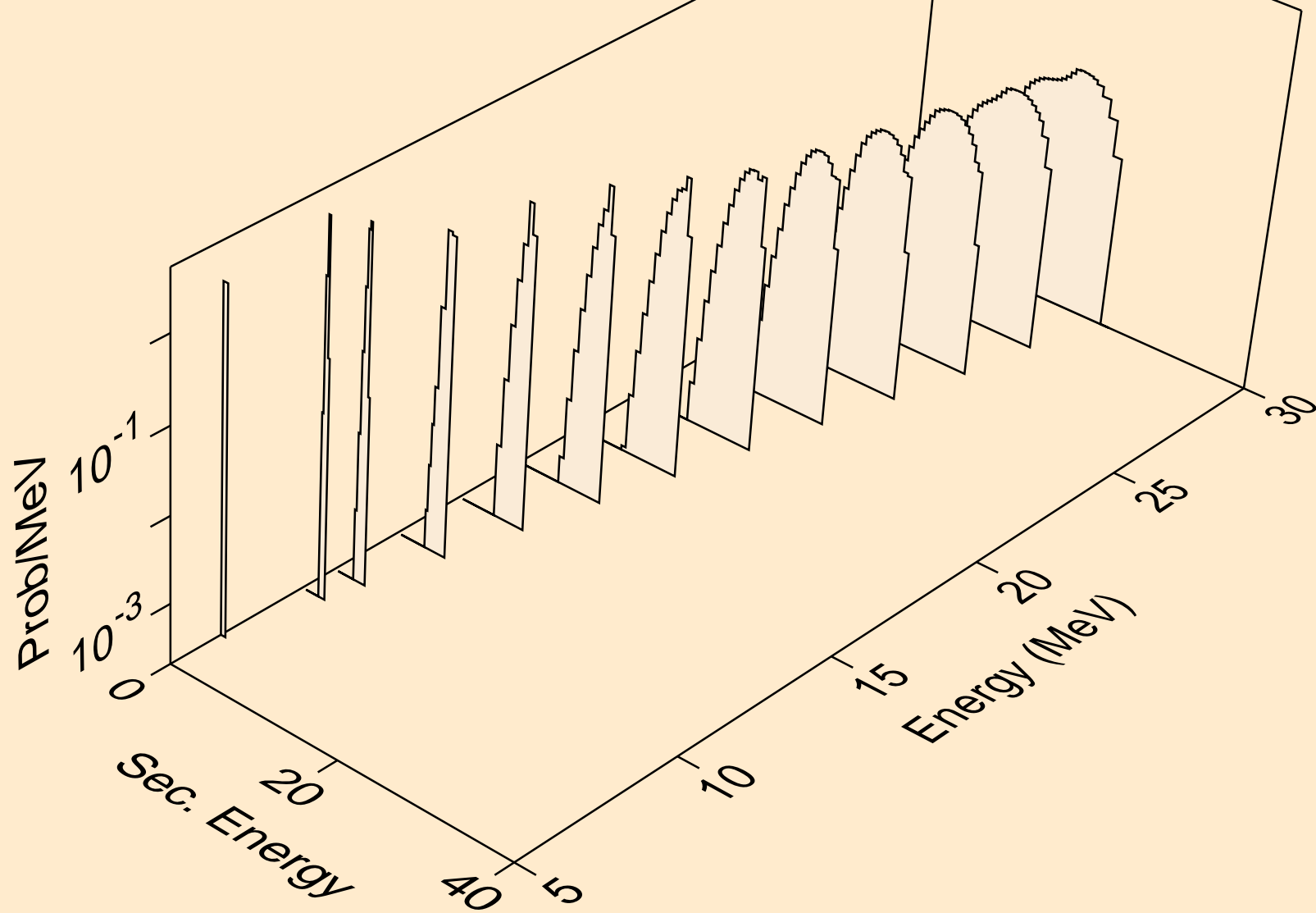

CF252 NEUTRON ACER TENDL-2023 LIBRARY; T=0.K  
protons from (n,2np)

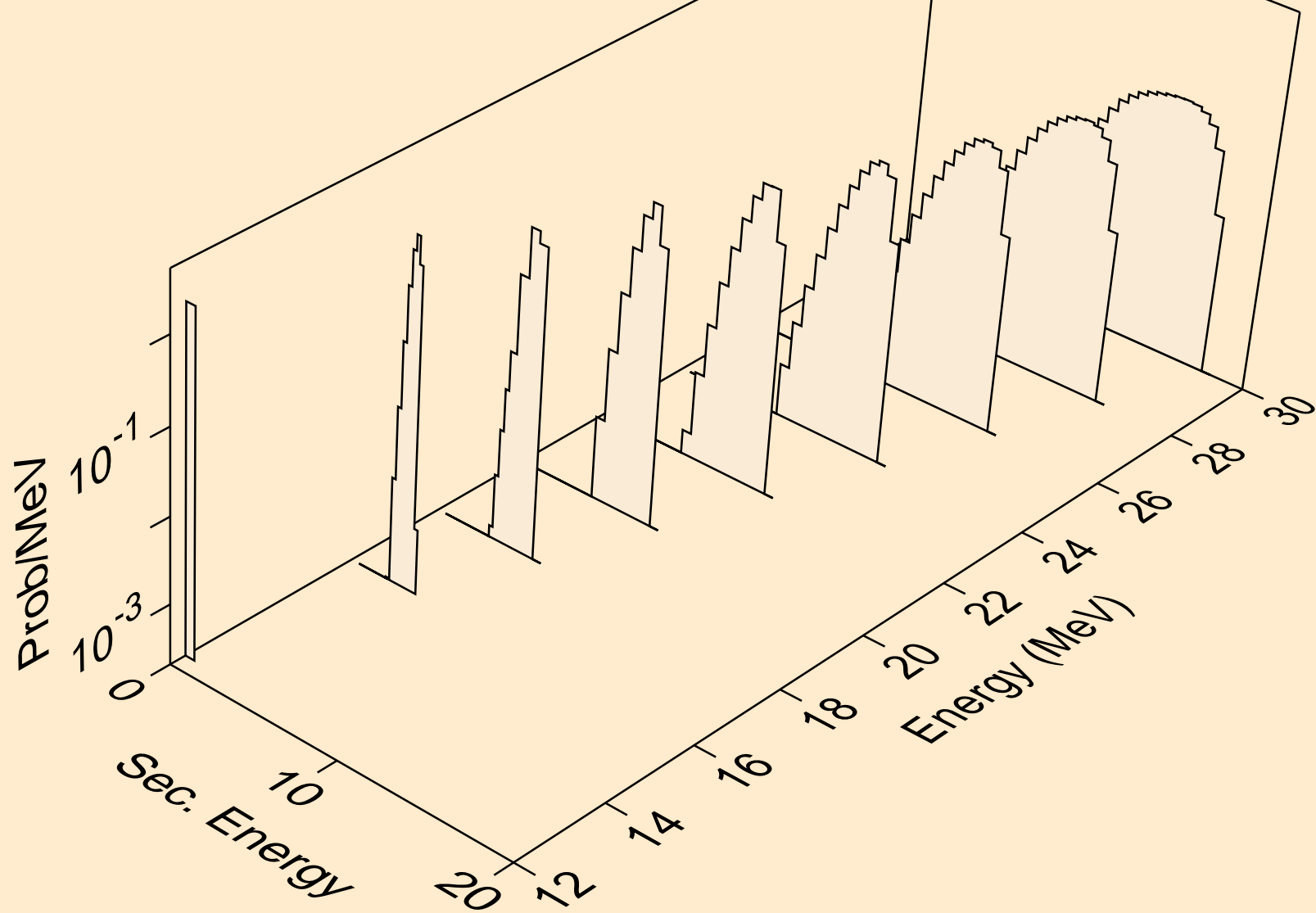

CF252 NEUTRON ACER TENDL-2023 LIBRARY; T=0.K  
protons from (n,3np)

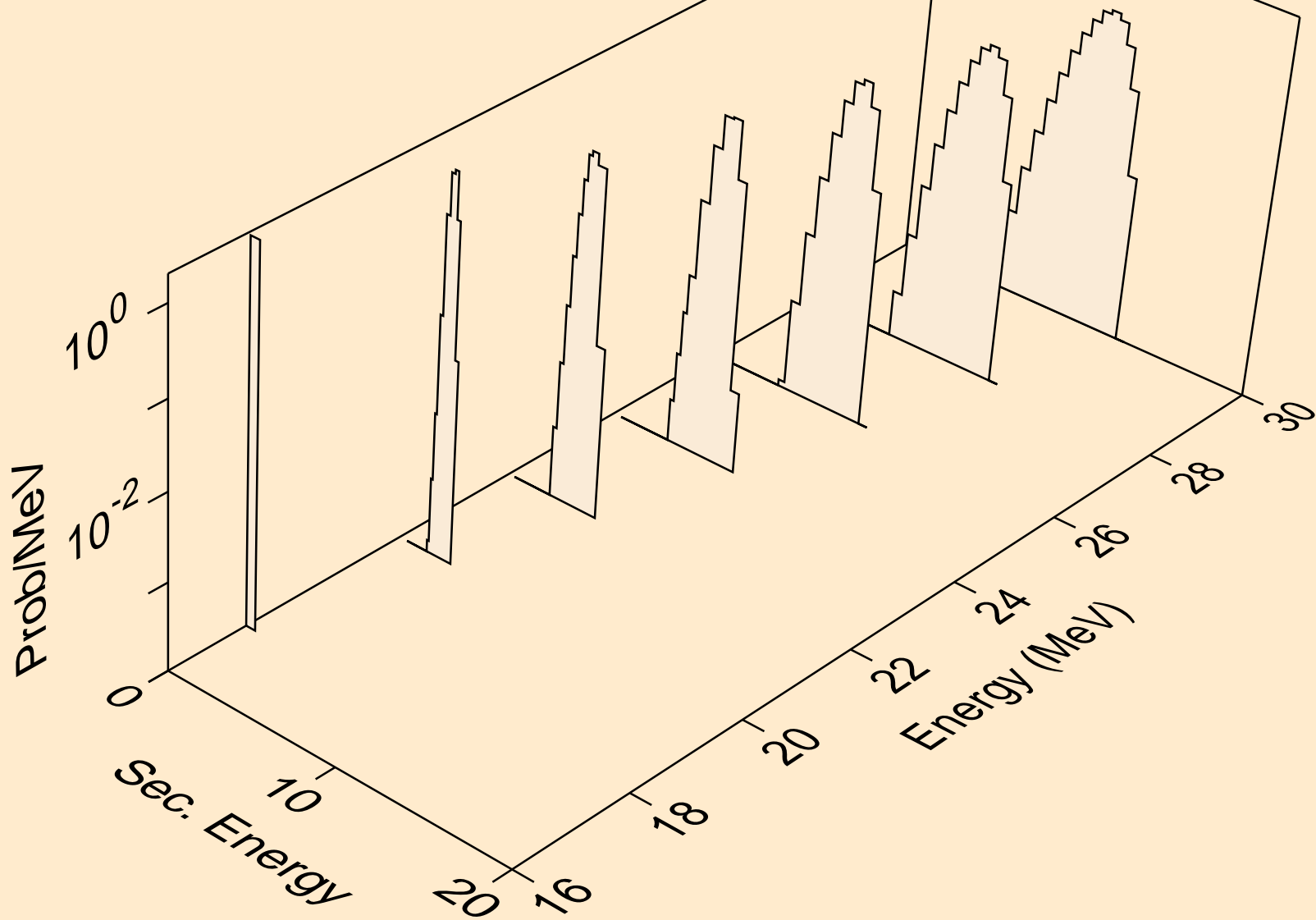

CF252 NEUTRON ACER TENDL-2023 LIBRARY; T=0.K  
protons from (n,n2p)

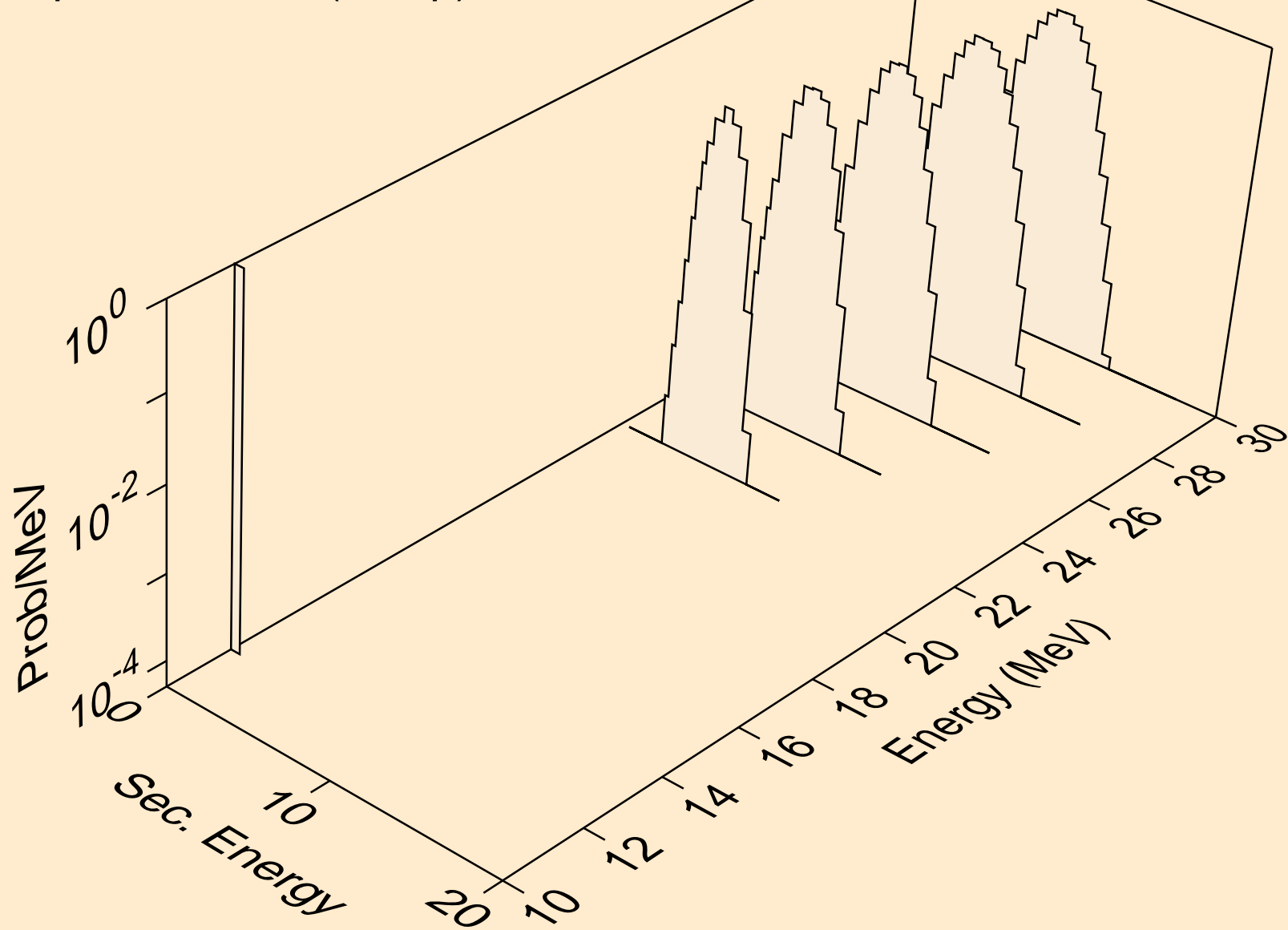



CF252 NEUTRON ACER TENDL-2023 LIBRARY; T=0.K  
protons from (n,p)

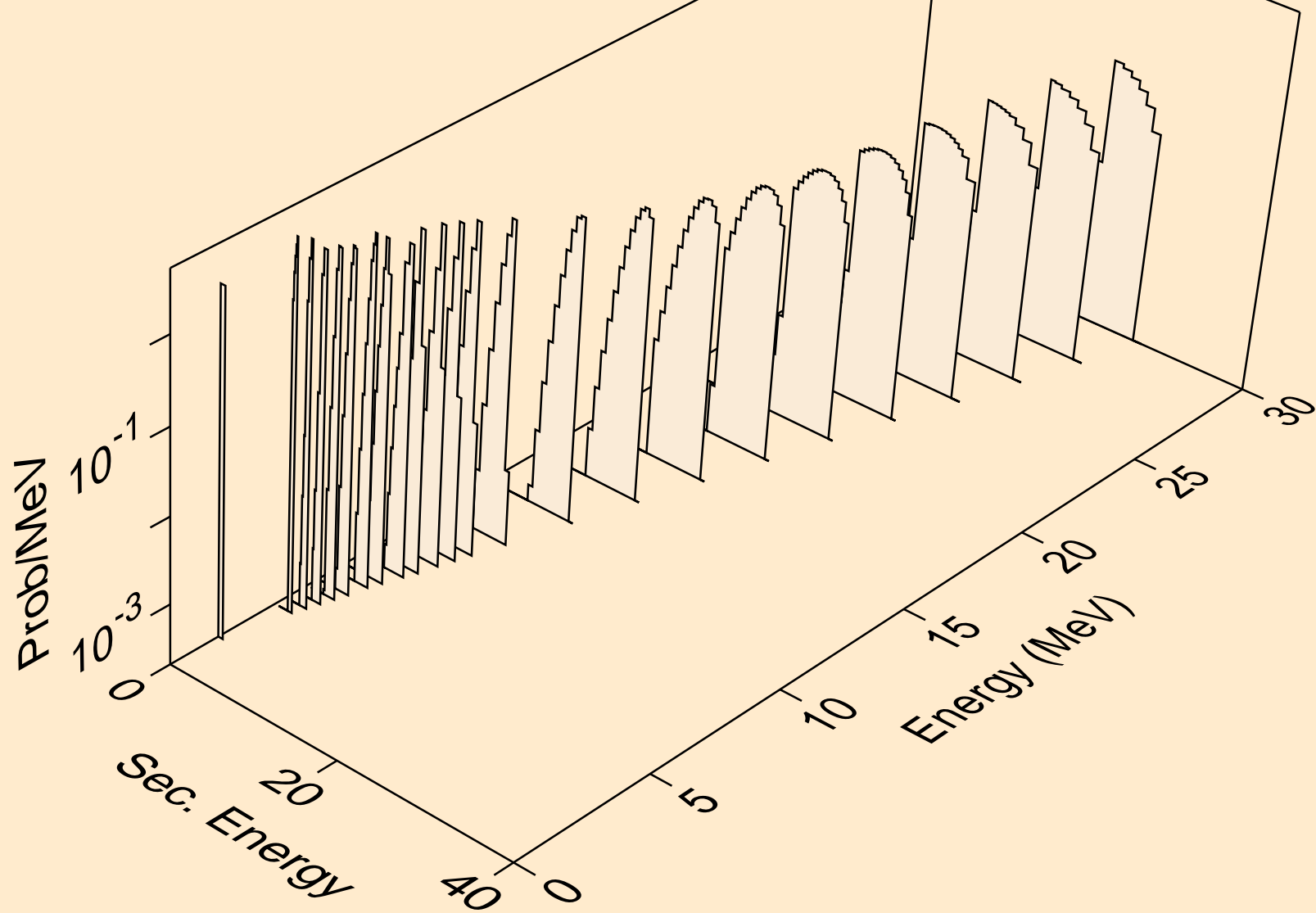

CF252 NEUTRON ACER TENDL-2023 LIBRARY; T=0.K  
protons from (n,2p)

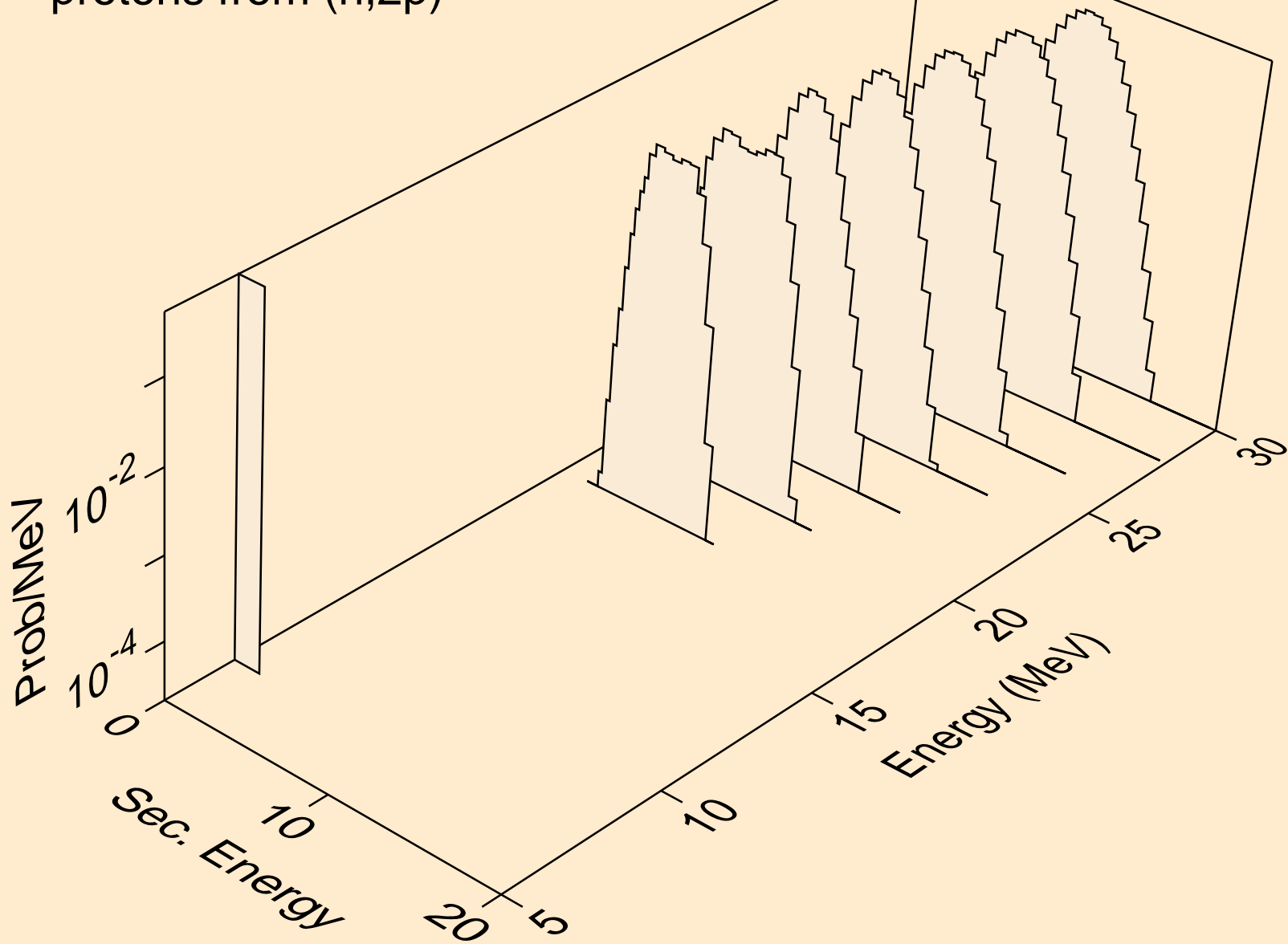

CF252 NEUTRON ACER TENDL-2023 LIBRARY; T=0.K  
deuterons from (n,x)

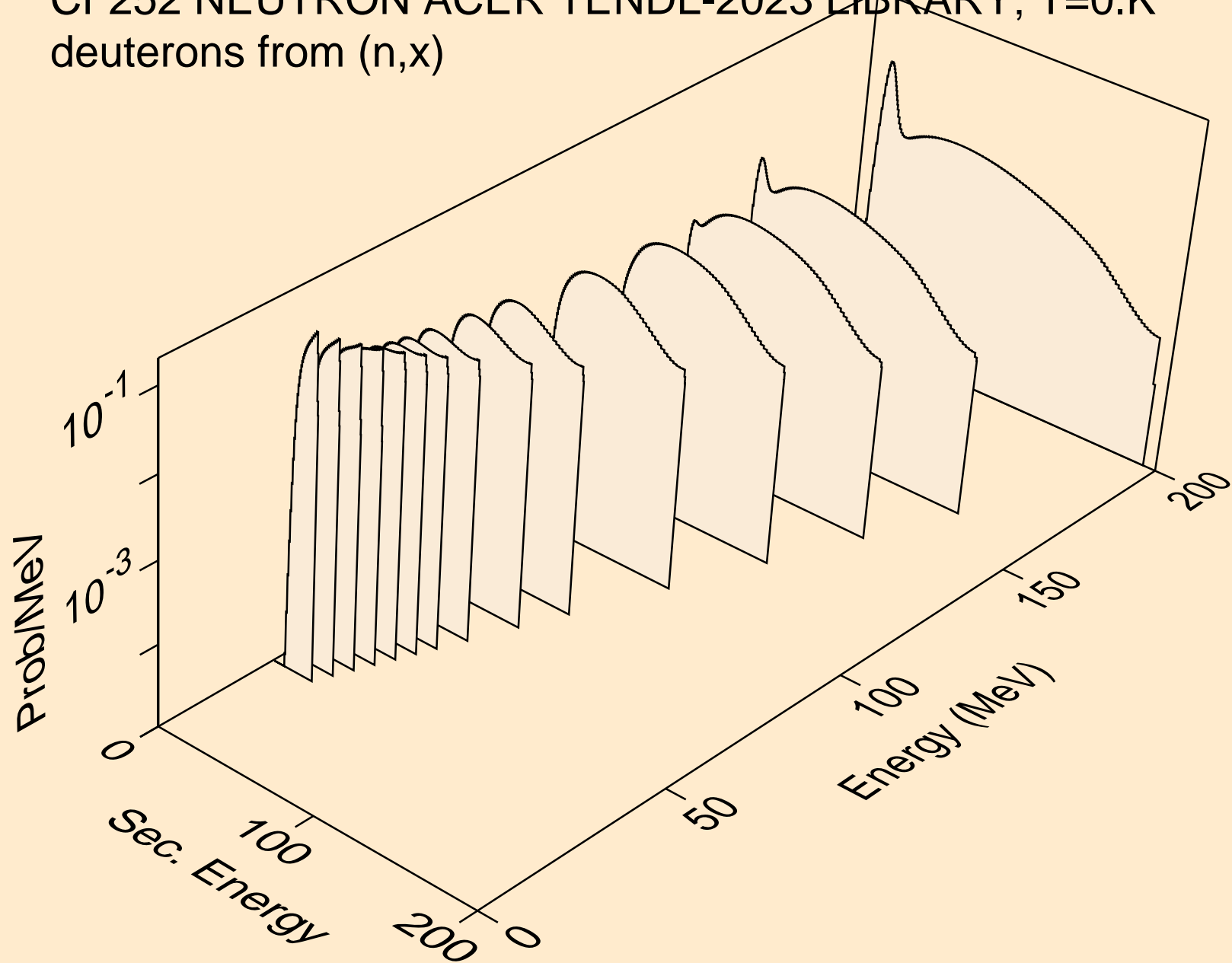

CF252 NEUTRON ACER TENDL-2023 LIBRARY; T=0.K  
deuterons from (n,2nd)

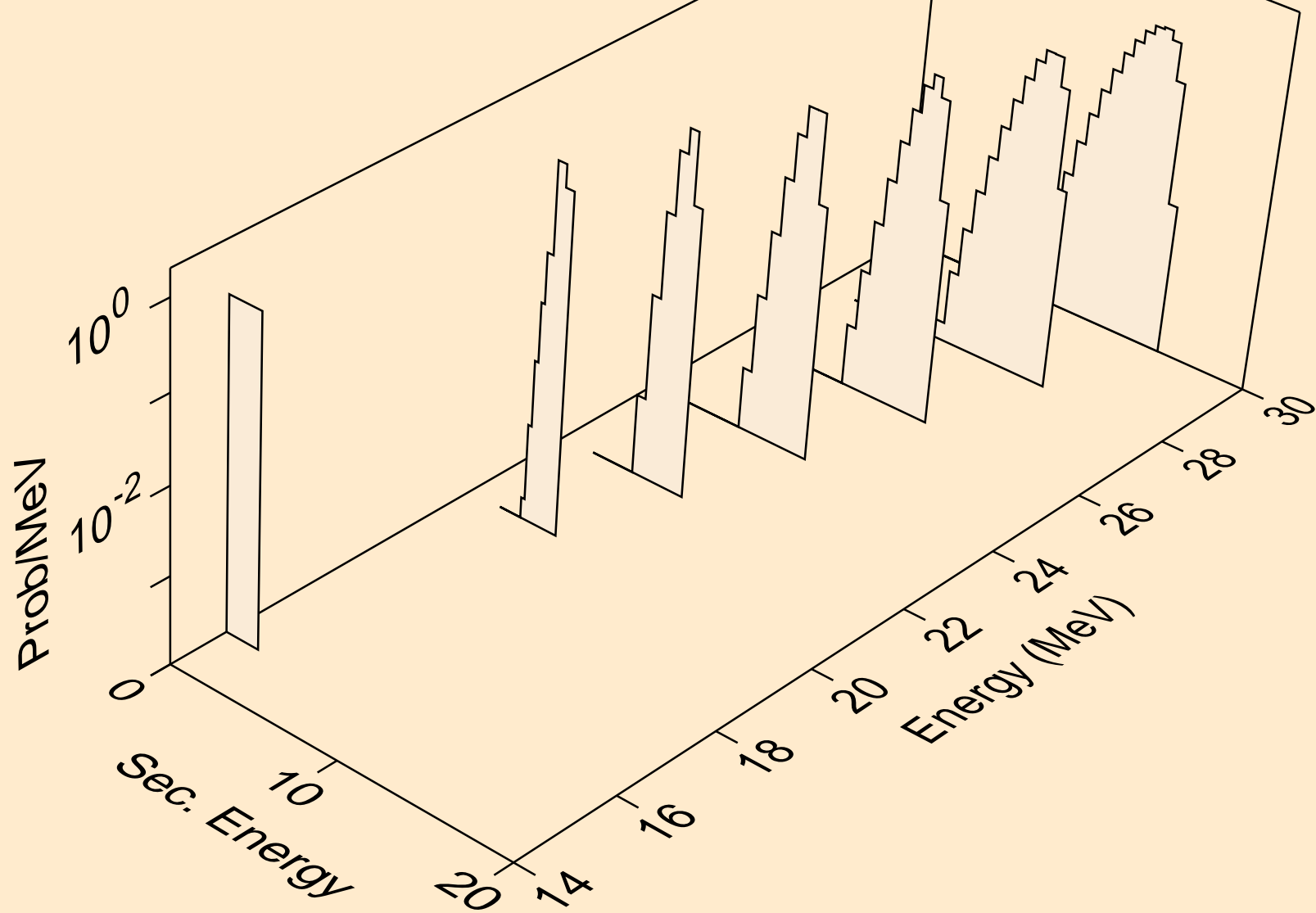

CF252 NEUTRON ACER TENDL-2023 LIBRARY; T=0.K  
deuterons from (n,n\*)d

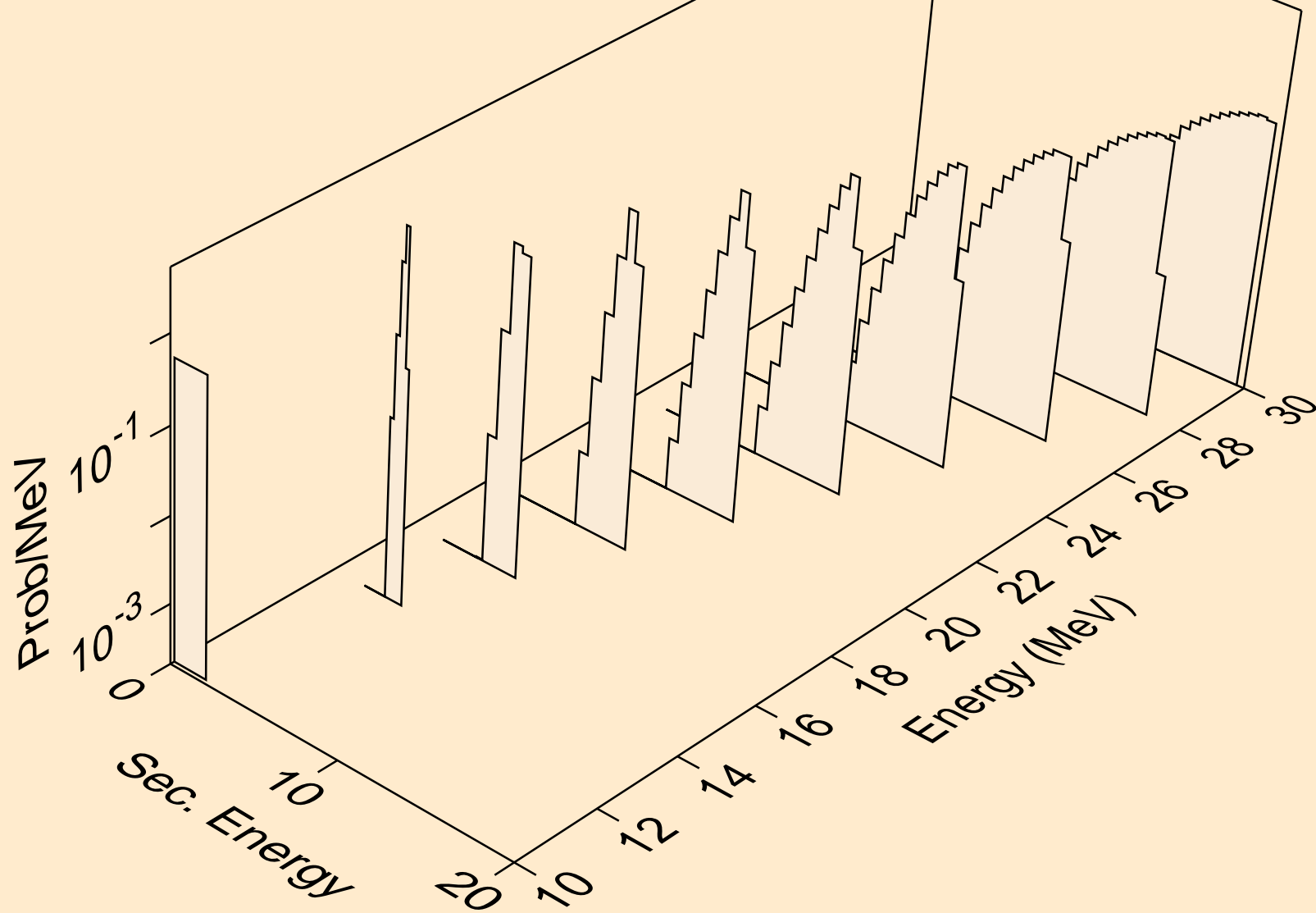

CF252 NEUTRON ACER TENDL-2023 LIBRARY; T=0.K  
deuterons from (n,d)

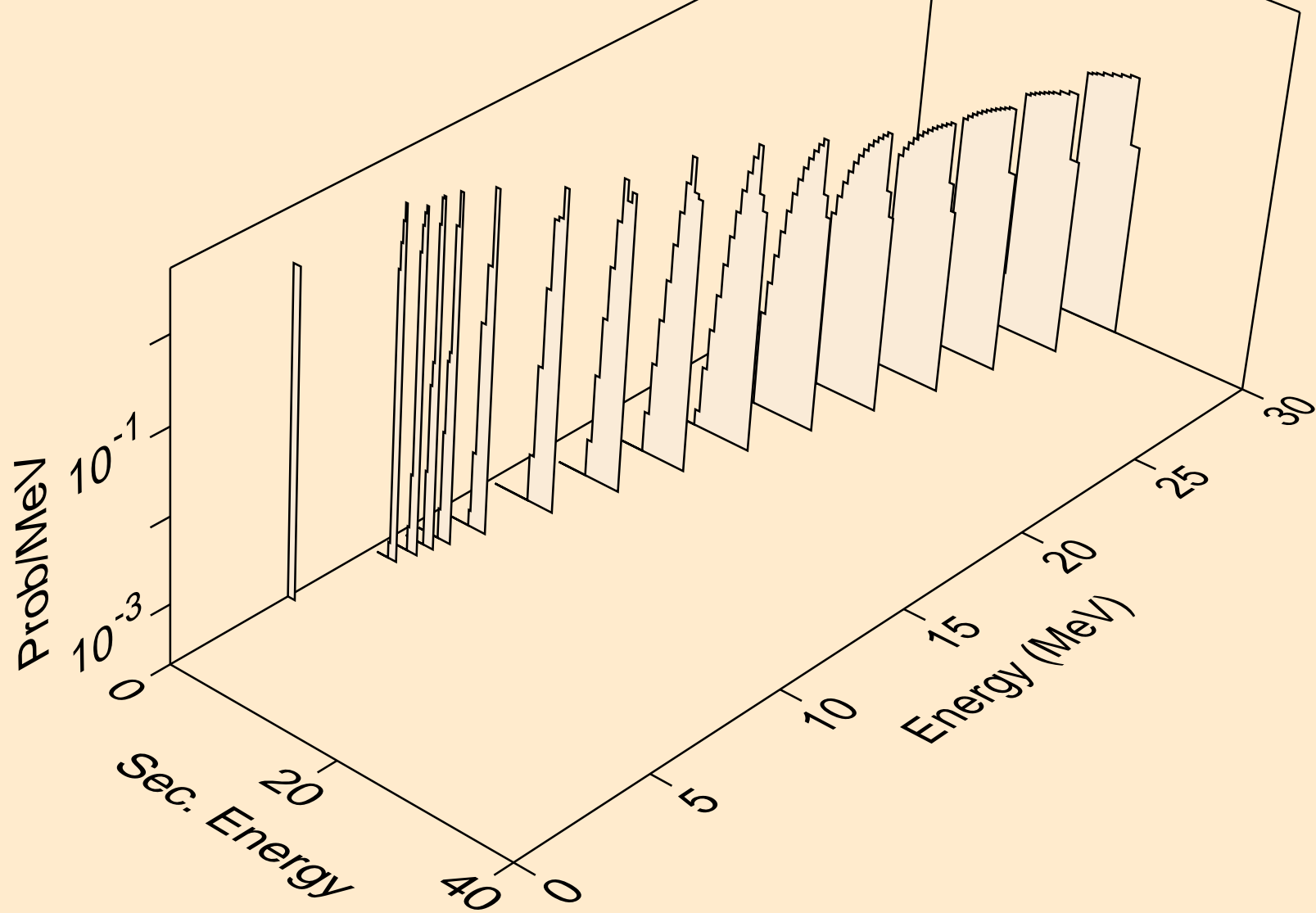

CF252 NEUTRON ACER TENDL-2023 LIBRARY; T=0.K  
tritons from (n,x)

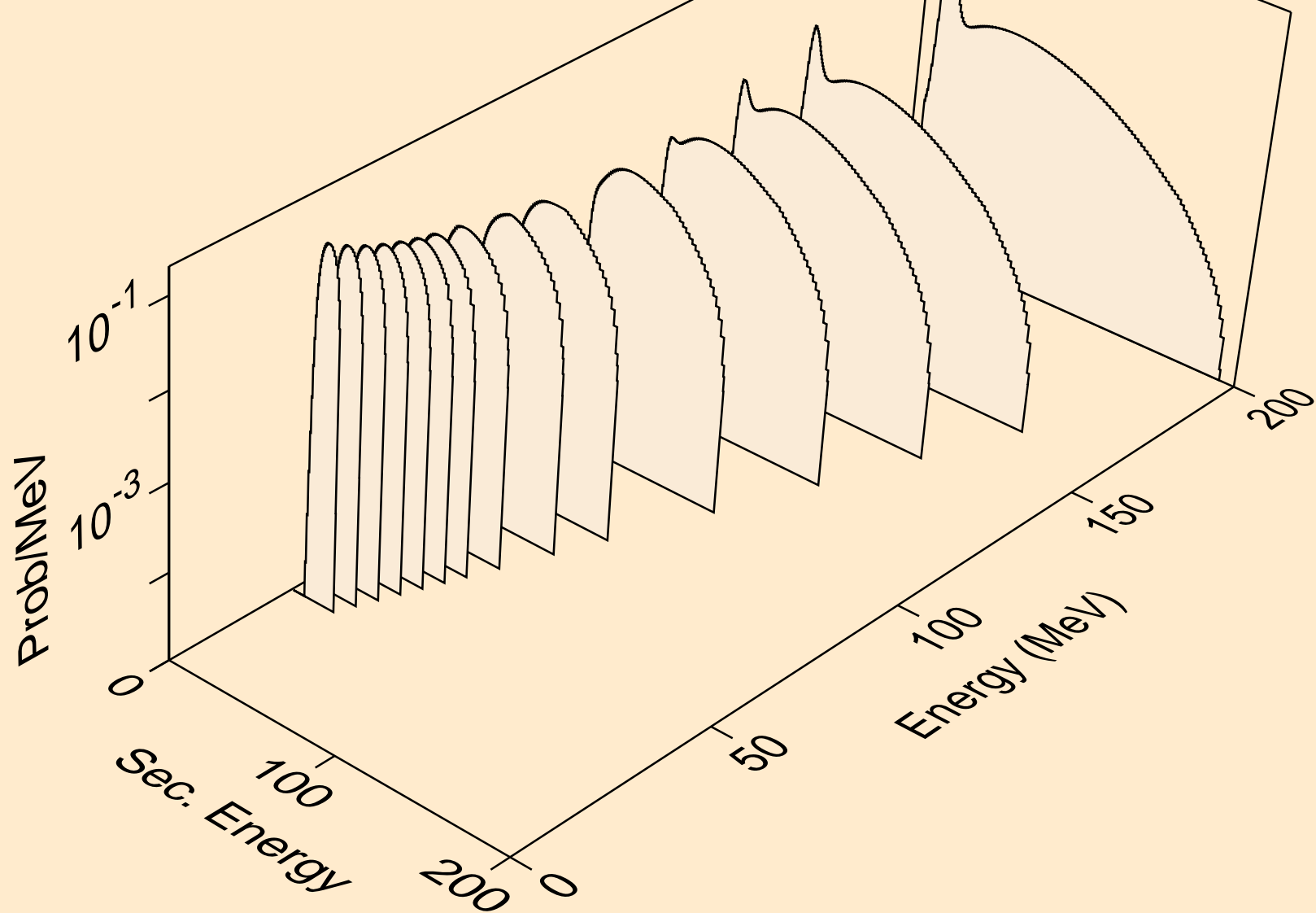

CF252 NEUTRON ACER TENDL-2023 LIBRARY; T=0.K  
tritons from (n,n\*)t

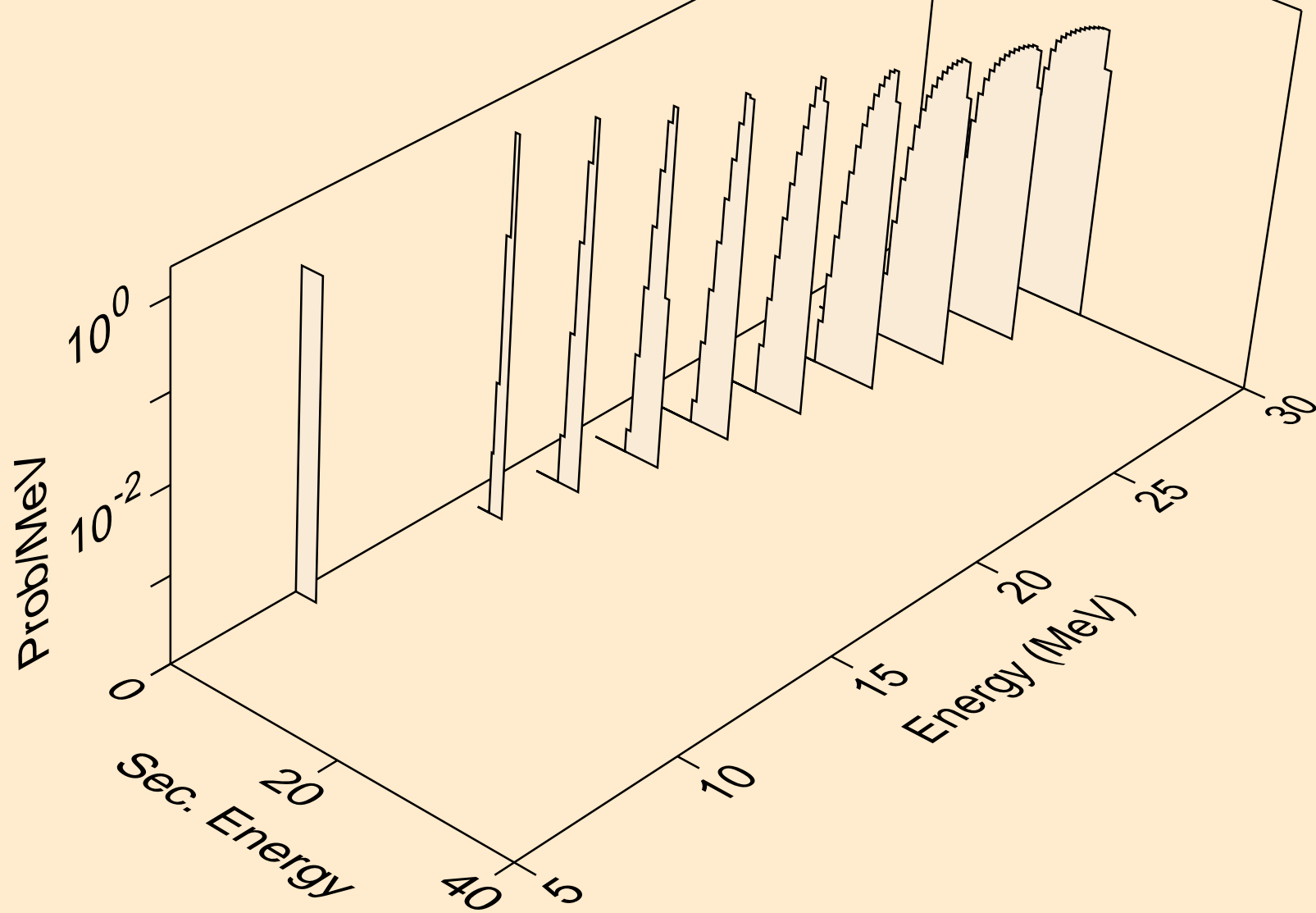



CF252 NEUTRON ACER TENDL-2023 LIBRARY; T=0.K  
tritons from (n,t)

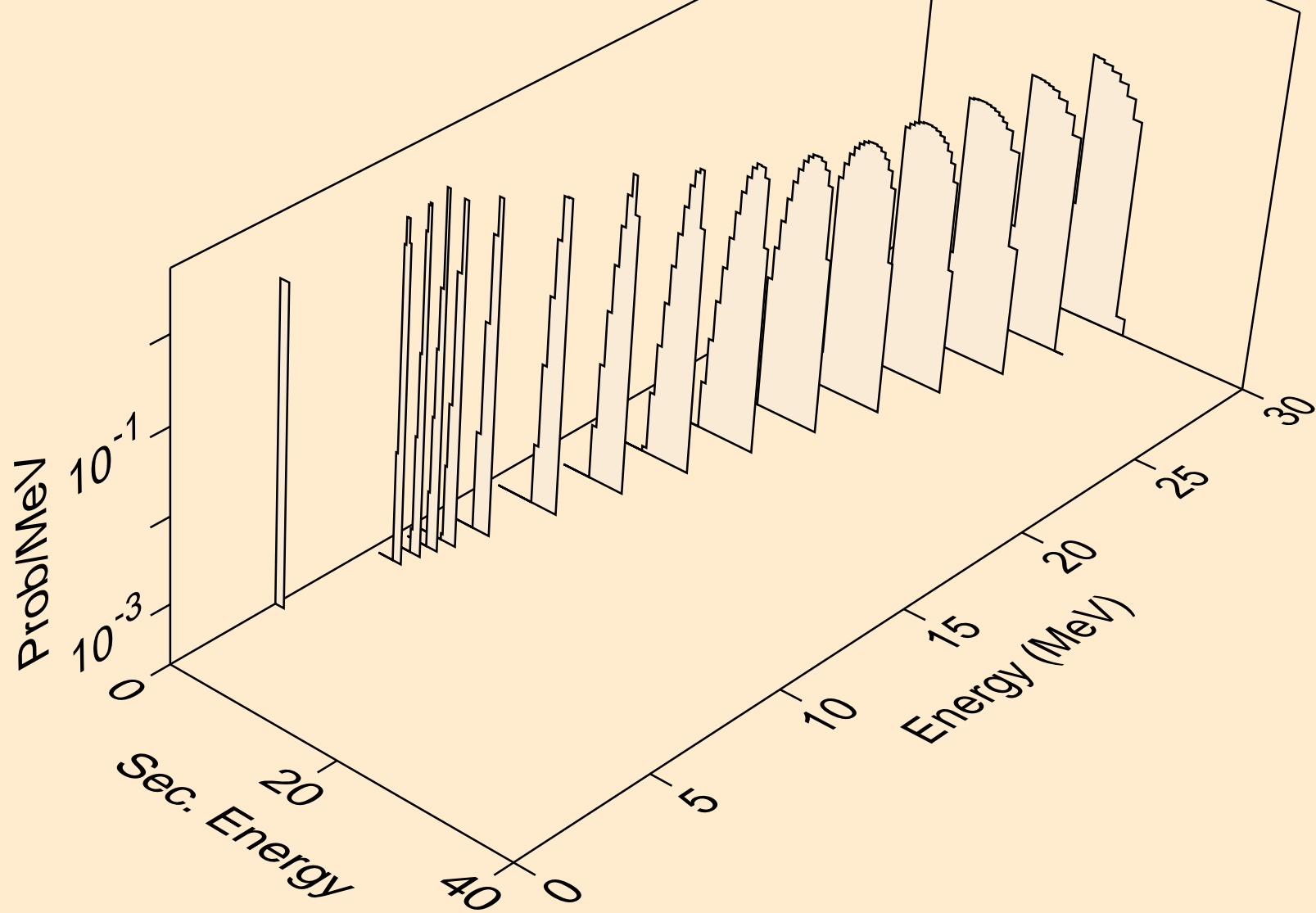

CF252 NEUTRON ACER TENDL-2023 LIBRARY; T=0.K  
he3s from (n,x)

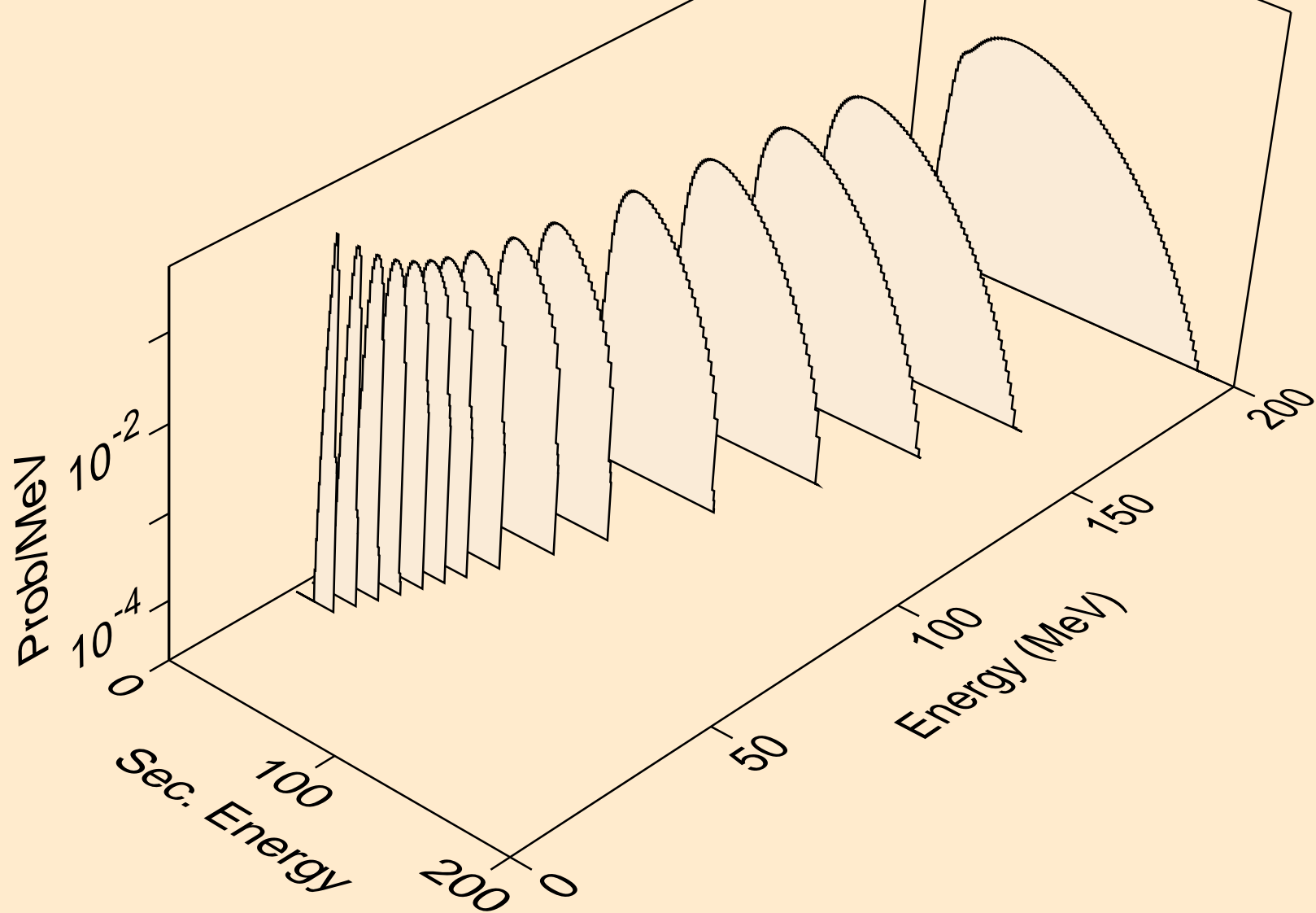

CF252 NEUTRON ACER TENDL-2023 LIBRARY; T=0.K  
he3s from (n,n\*)he3

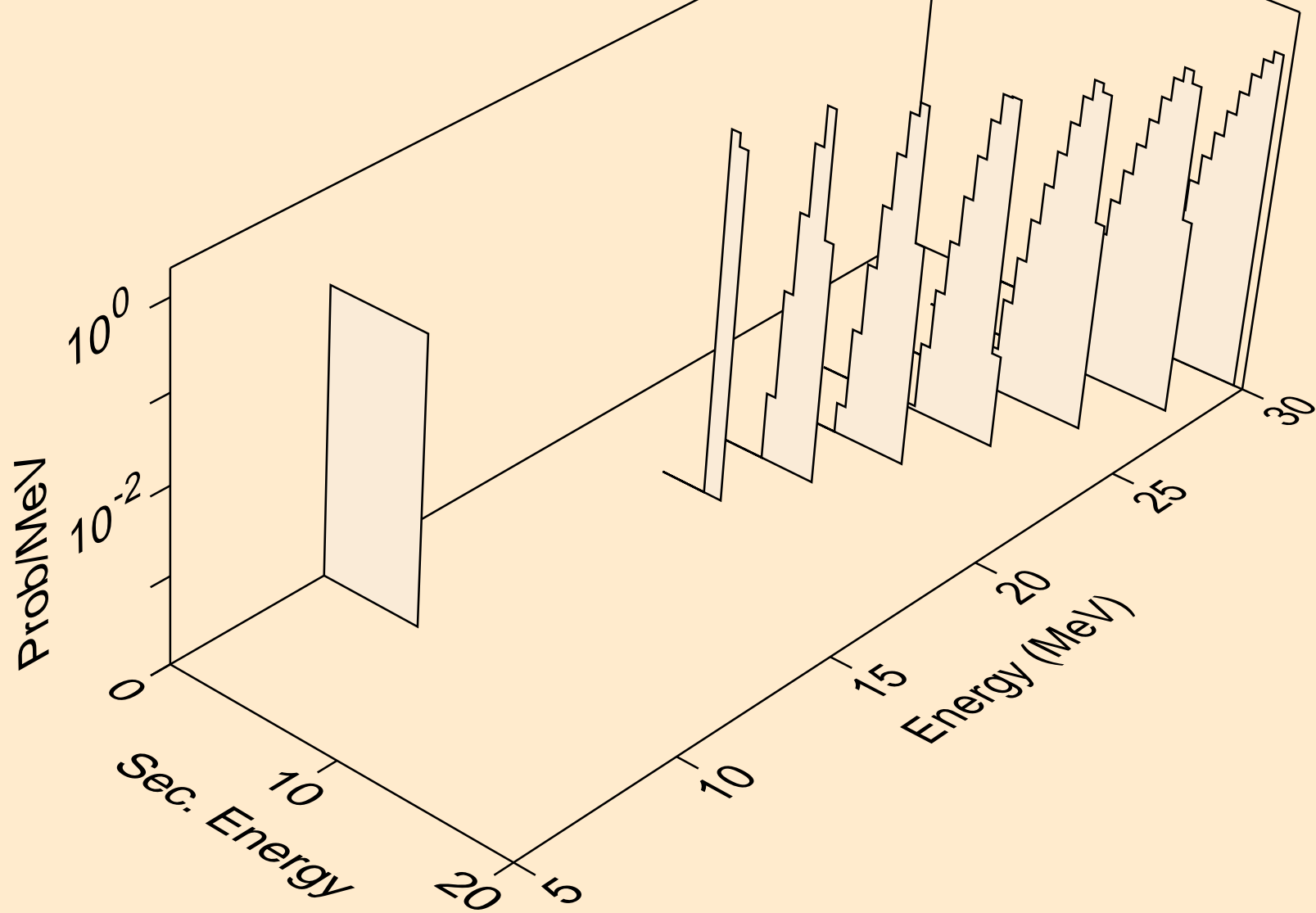

CF252 NEUTRON ACER TENDL-2023 LIBRARY; T=0.K  
he3s from (n,he3)

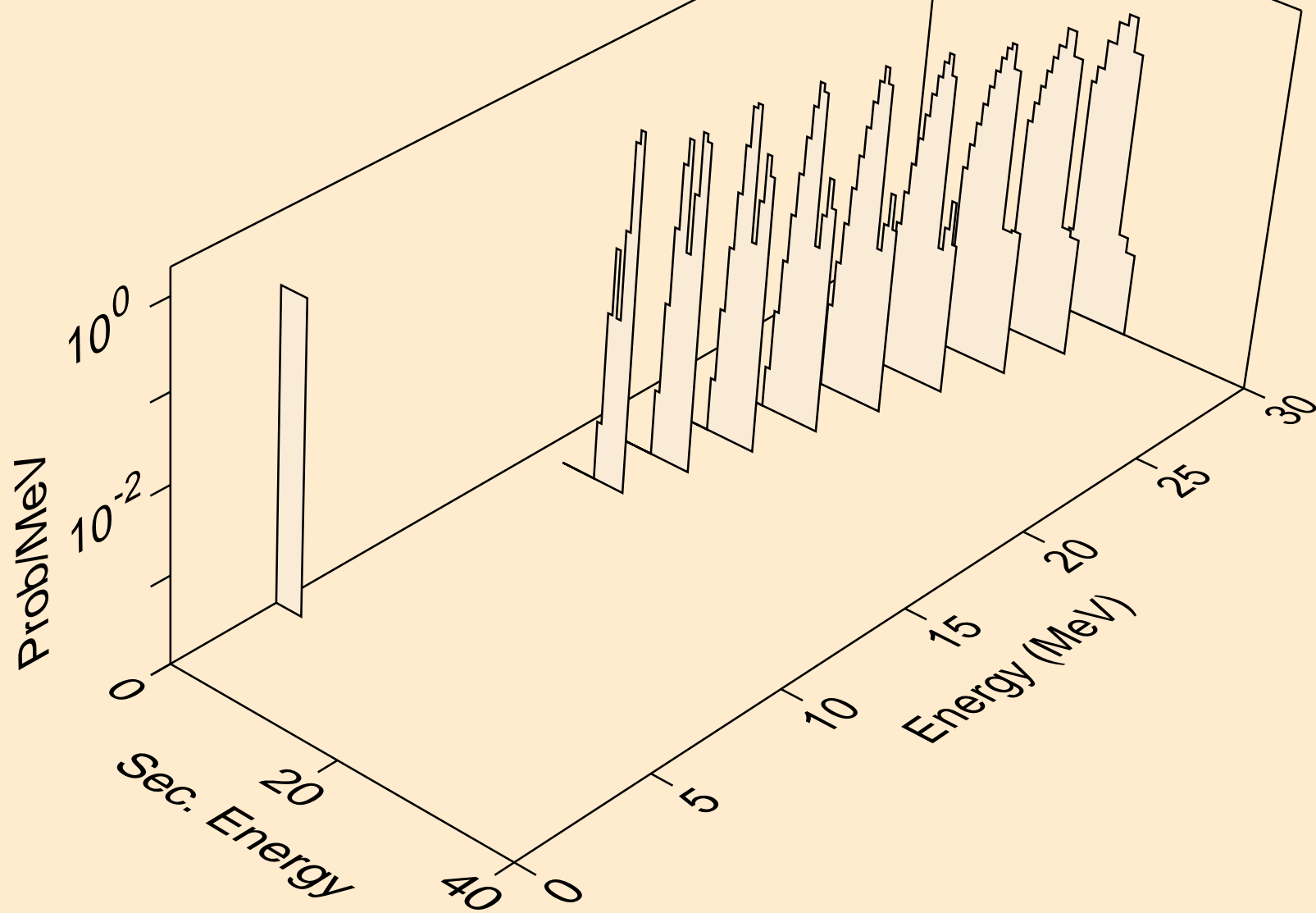

CF252 NEUTRON ACER TENDL-2023 LIBRARY; T=0.K  
alphas from (n,x)

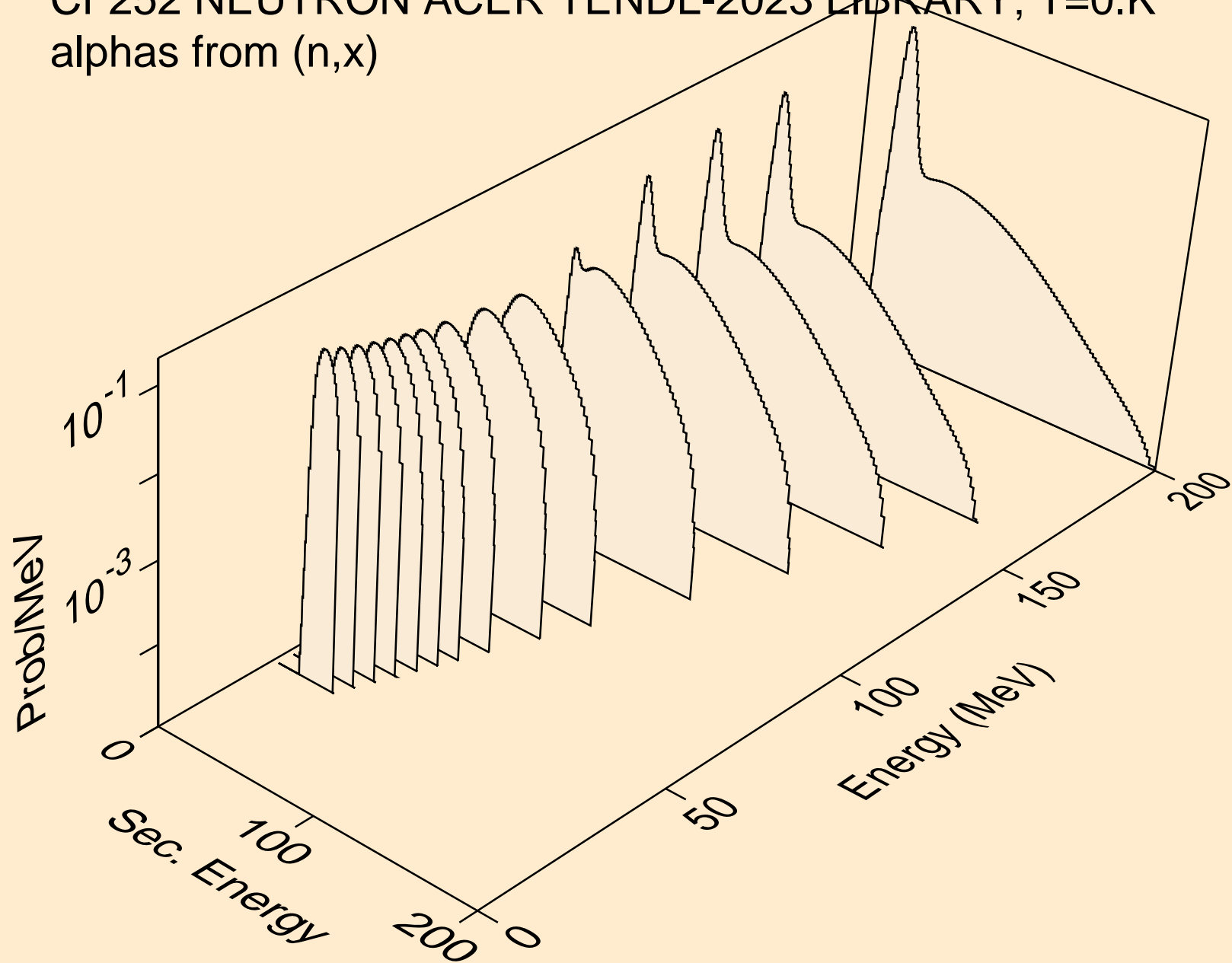

CF252 NEUTRON ACER TENDL-2023 LIBRARY; T=0.K  
alphas from (n,n\*)a

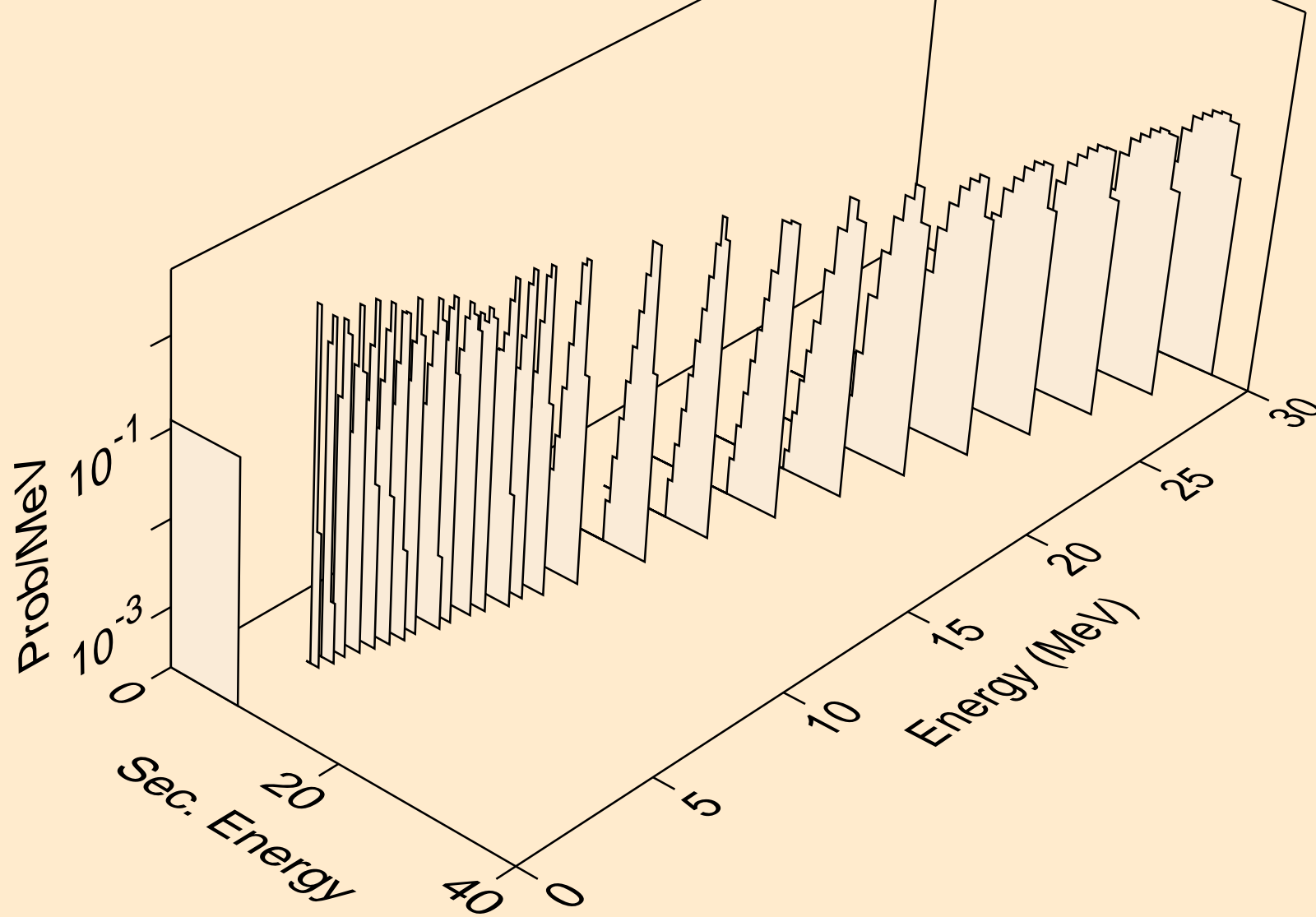

CF252 NEUTRON ACER TENDL-2023 LIBRARY; T=0.K  
alphas from (n,2n)a

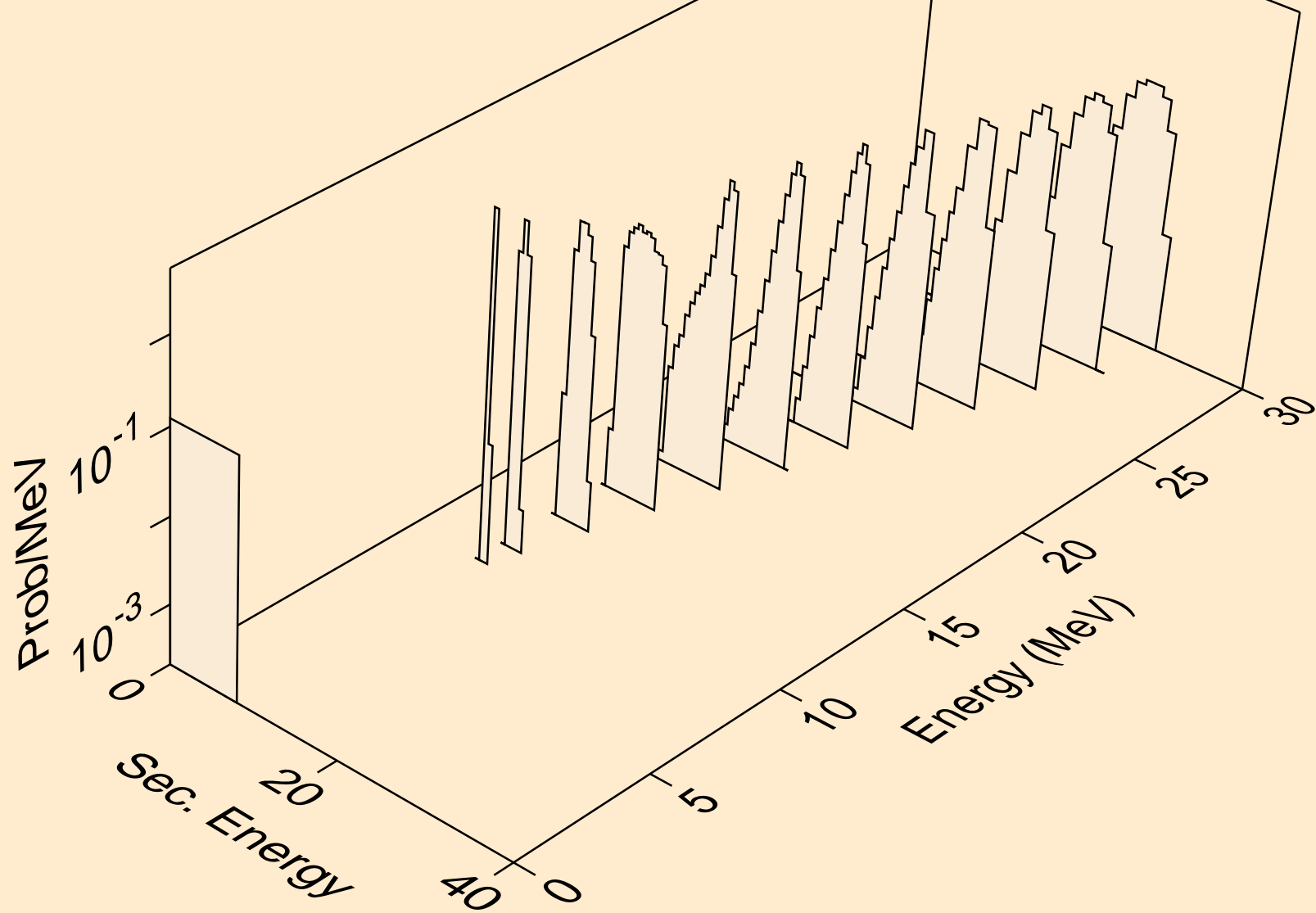

CF252 NEUTRON ACER TENDL-2023 LIBRARY; T=0.K  
alphas from (n,3n)a

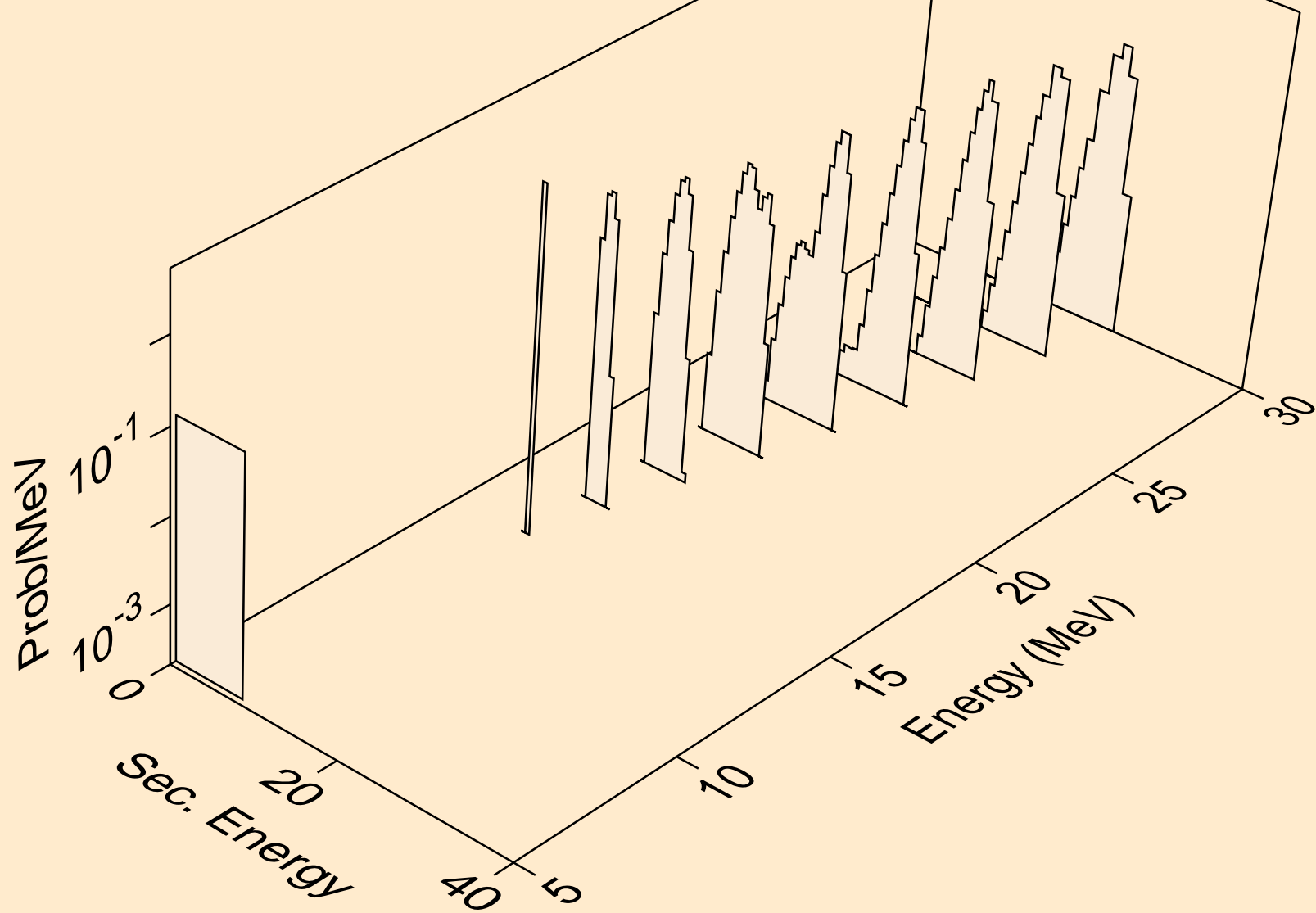



CF252 NEUTRON ACER TENDL-2023 LIBRARY; T=0.K  
alphas from (n,a)

