

# CM237 NEUTRON ACER TENDL-2023 LIBRARY; T=0.K

## Principal cross sections

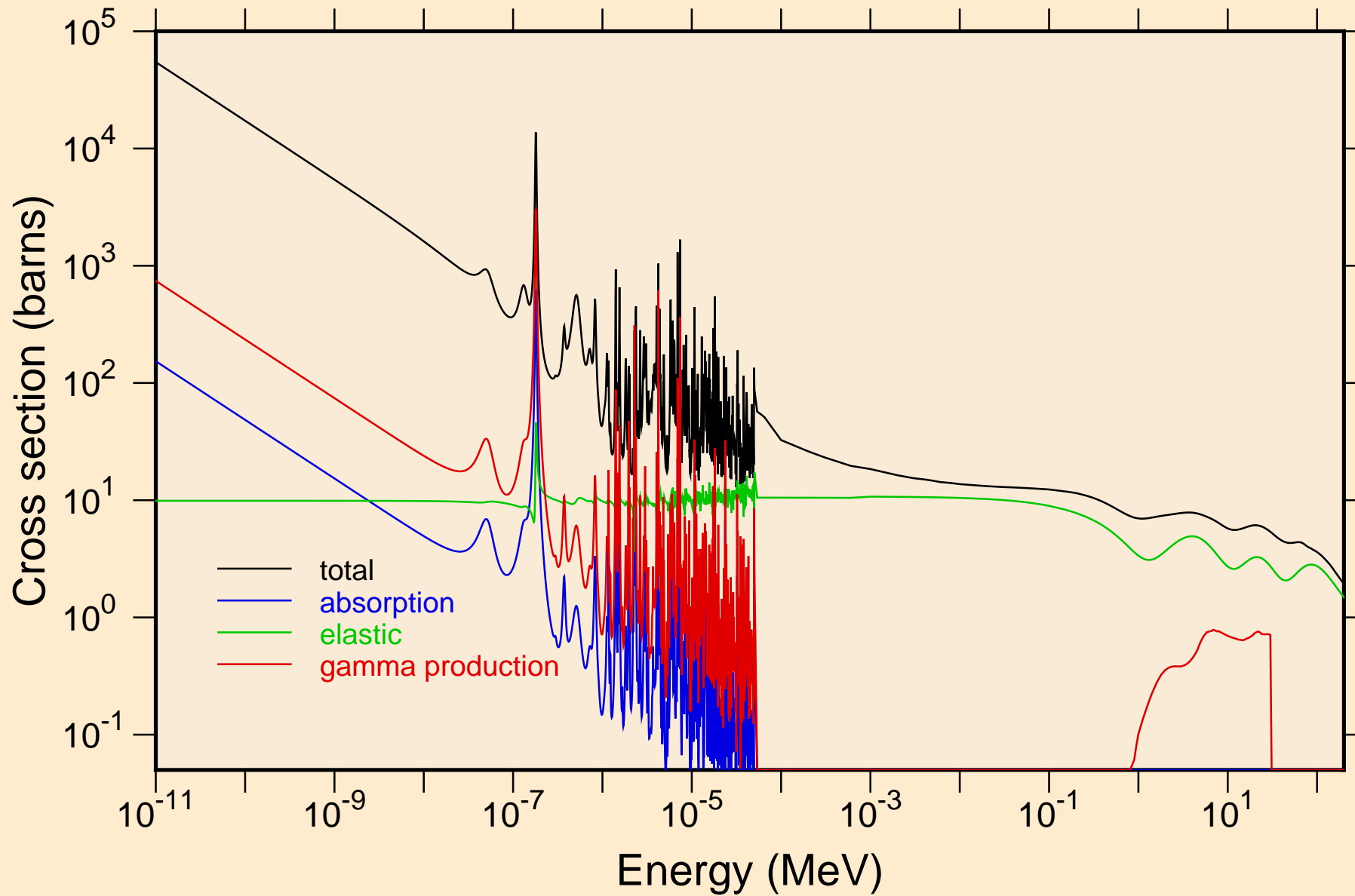

CM237 NEUTRON ACER TENDL-2023 LIBRARY; T=0.K  
resonance total cross section

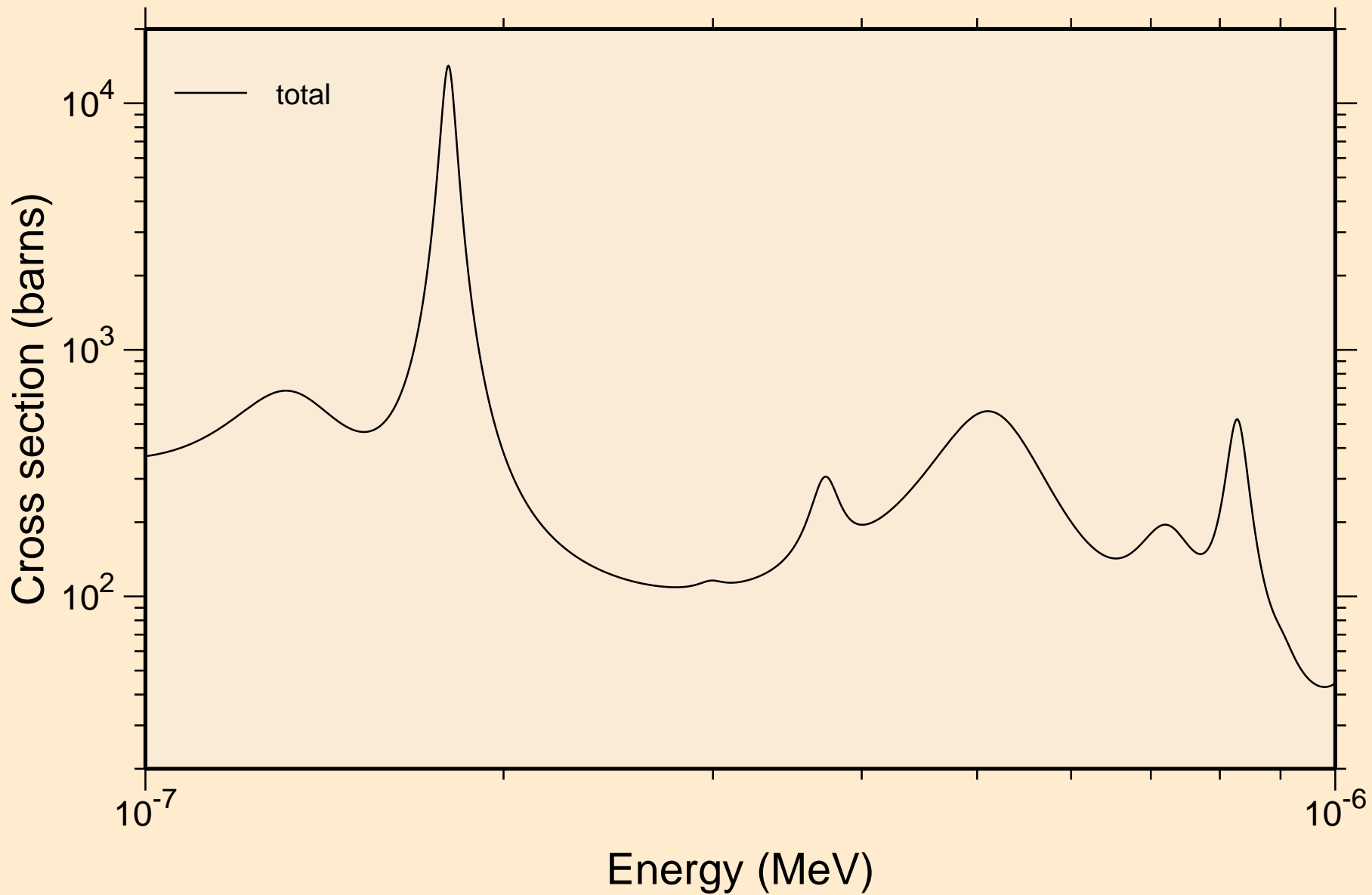

CM237 NEUTRON ACER TENDL-2023 LIBRARY; T=0.K  
resonance total cross section

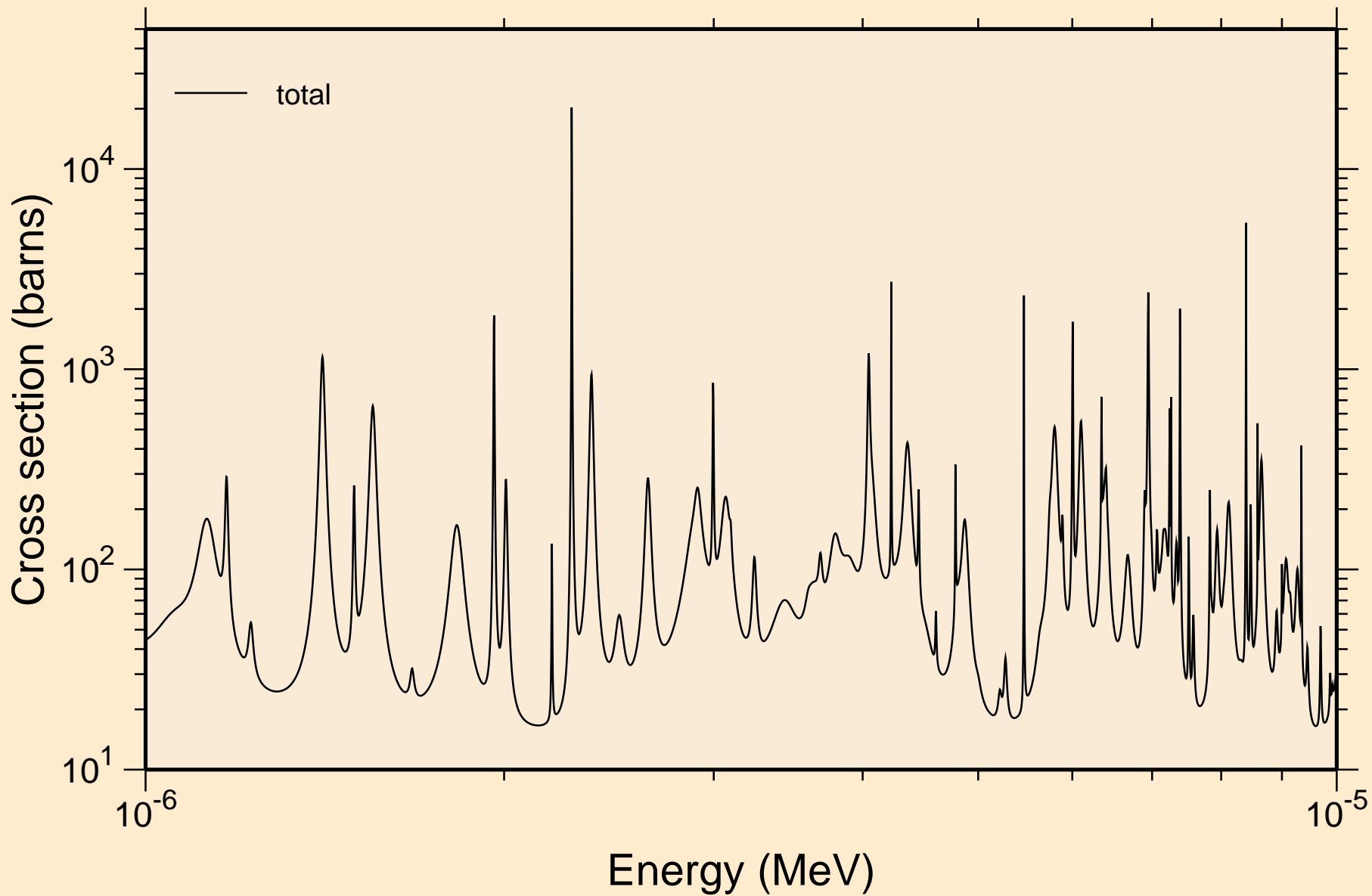

CM237 NEUTRON ACER TENDL-2023 LIBRARY; T=0.K  
resonance total cross section

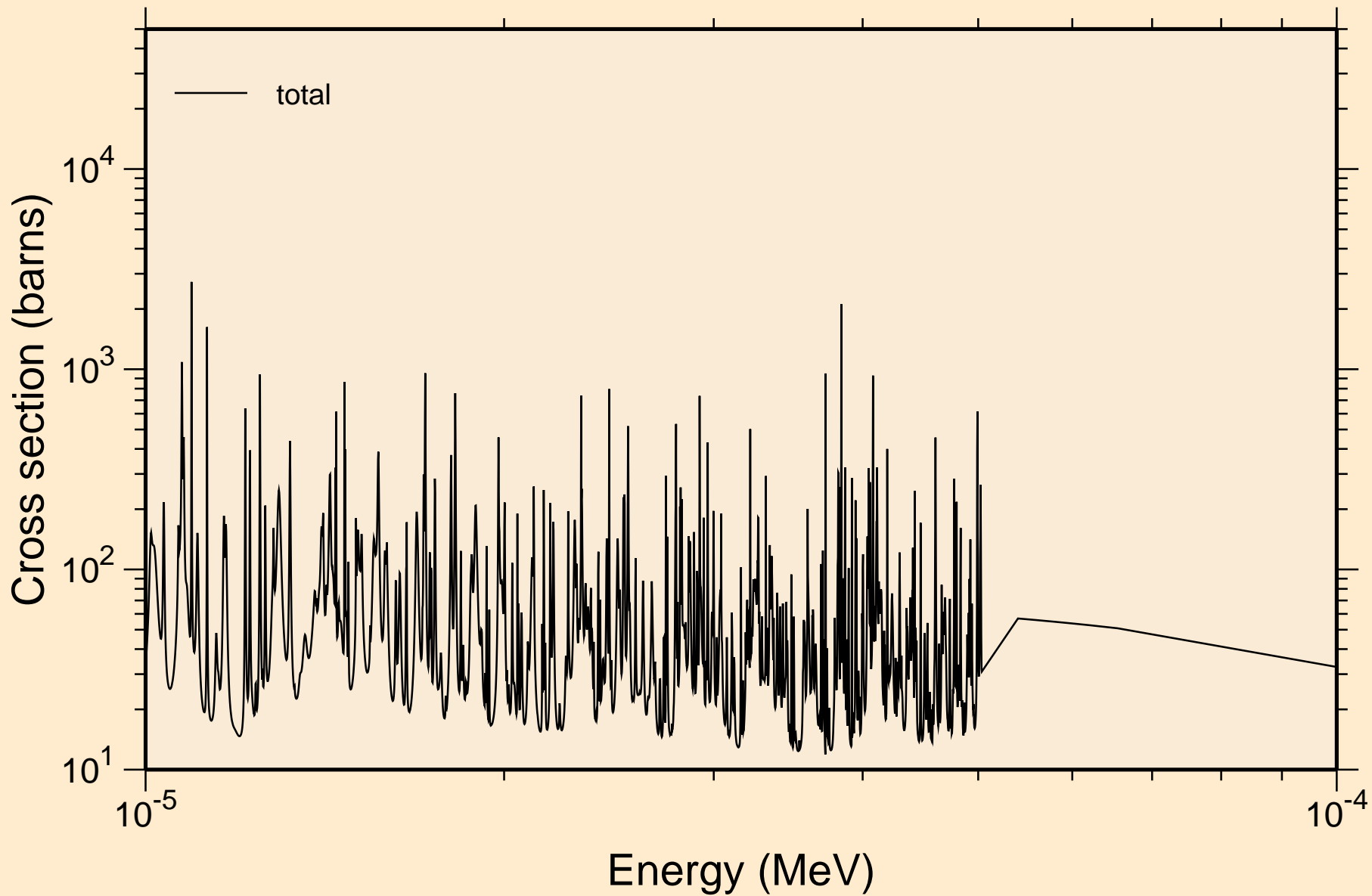

CM237 NEUTRON ACER TENDL-2023 LIBRARY; T=0.K  
resonance total cross section

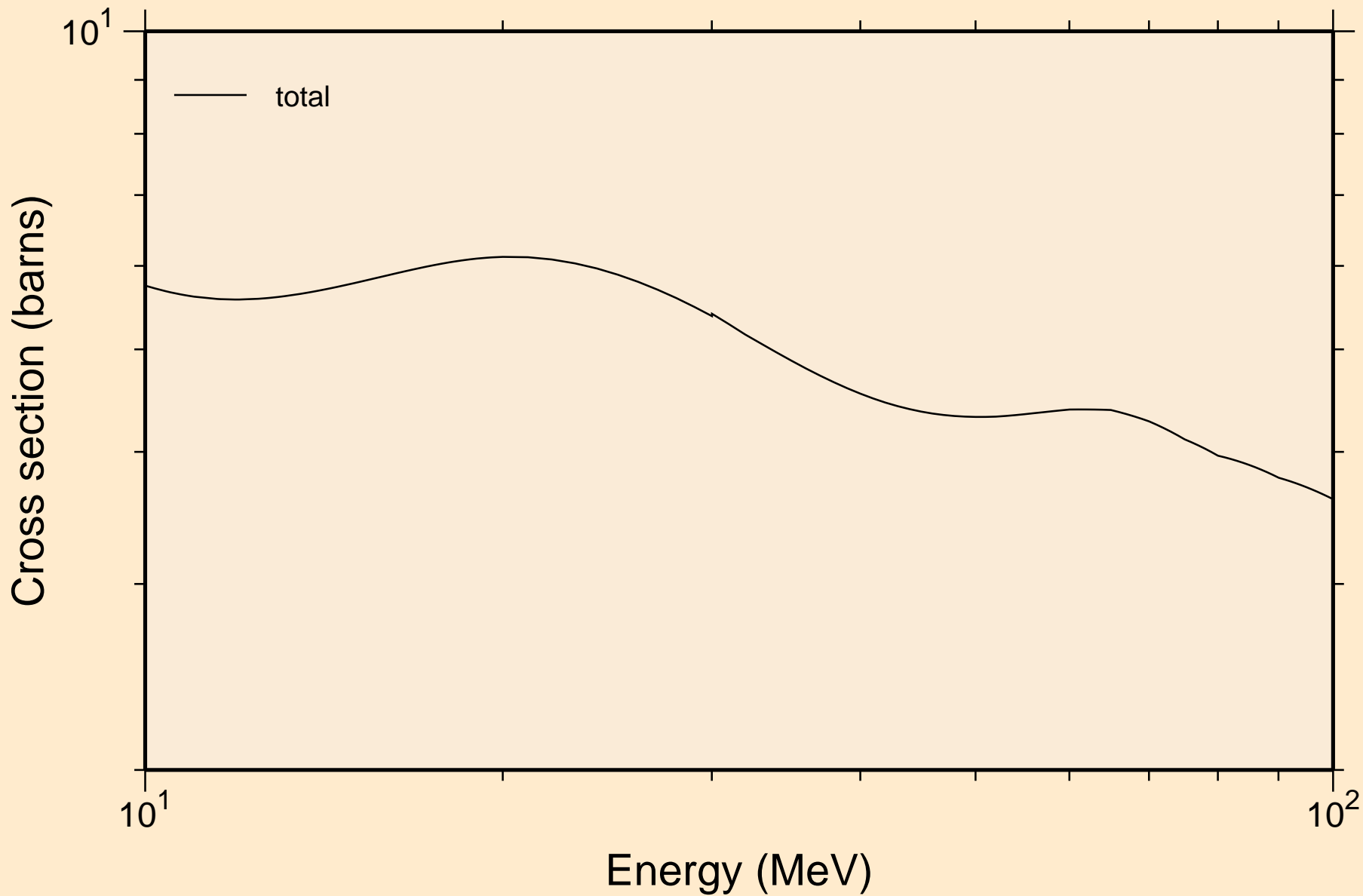

CM237 NEUTRON ACER TENDL-2023 LIBRARY; T=0.K  
resonance absorption cross sections

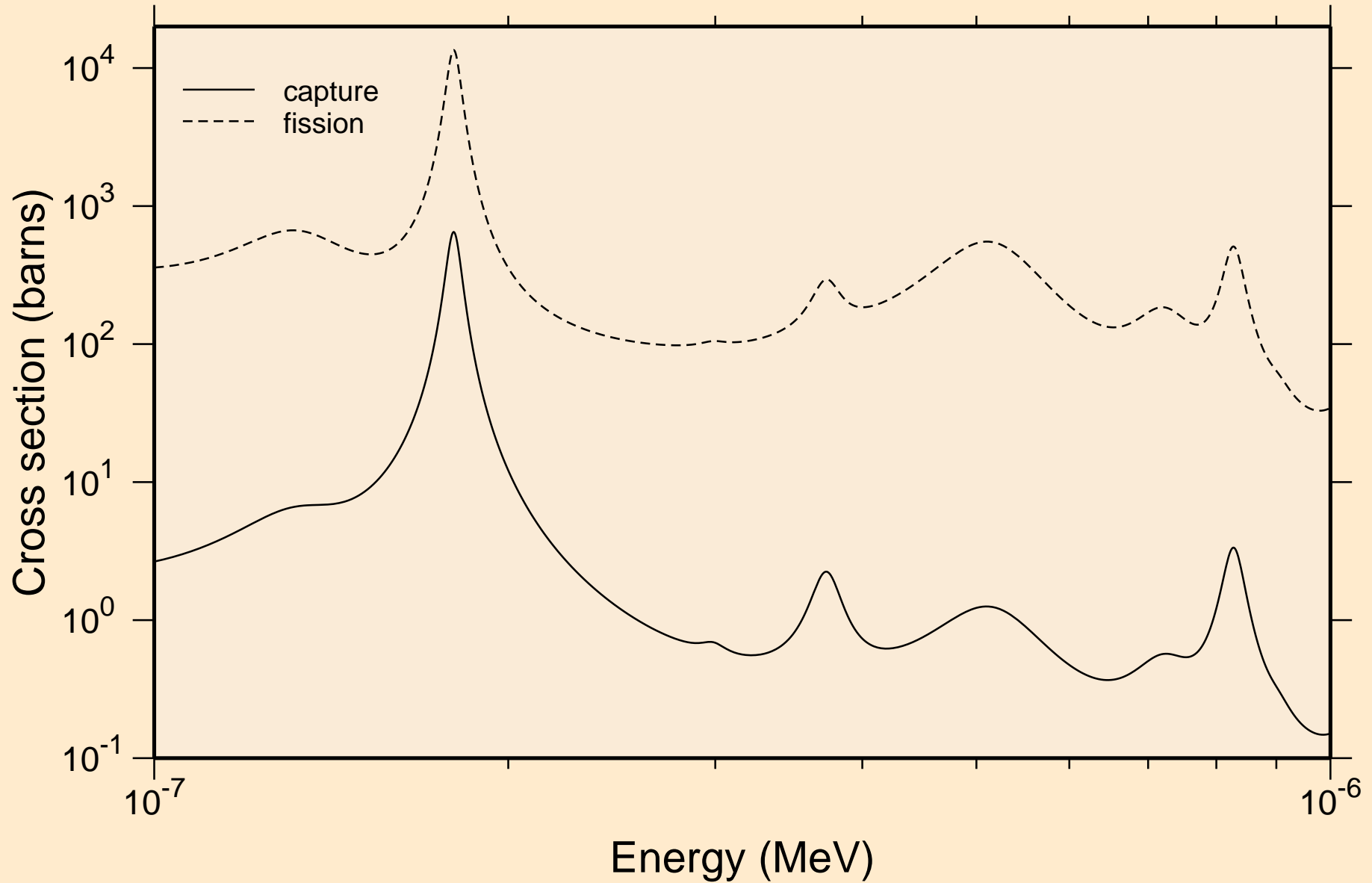

CM237 NEUTRON ACER TENDL-2023 LIBRARY; T=0.K  
resonance absorption cross sections

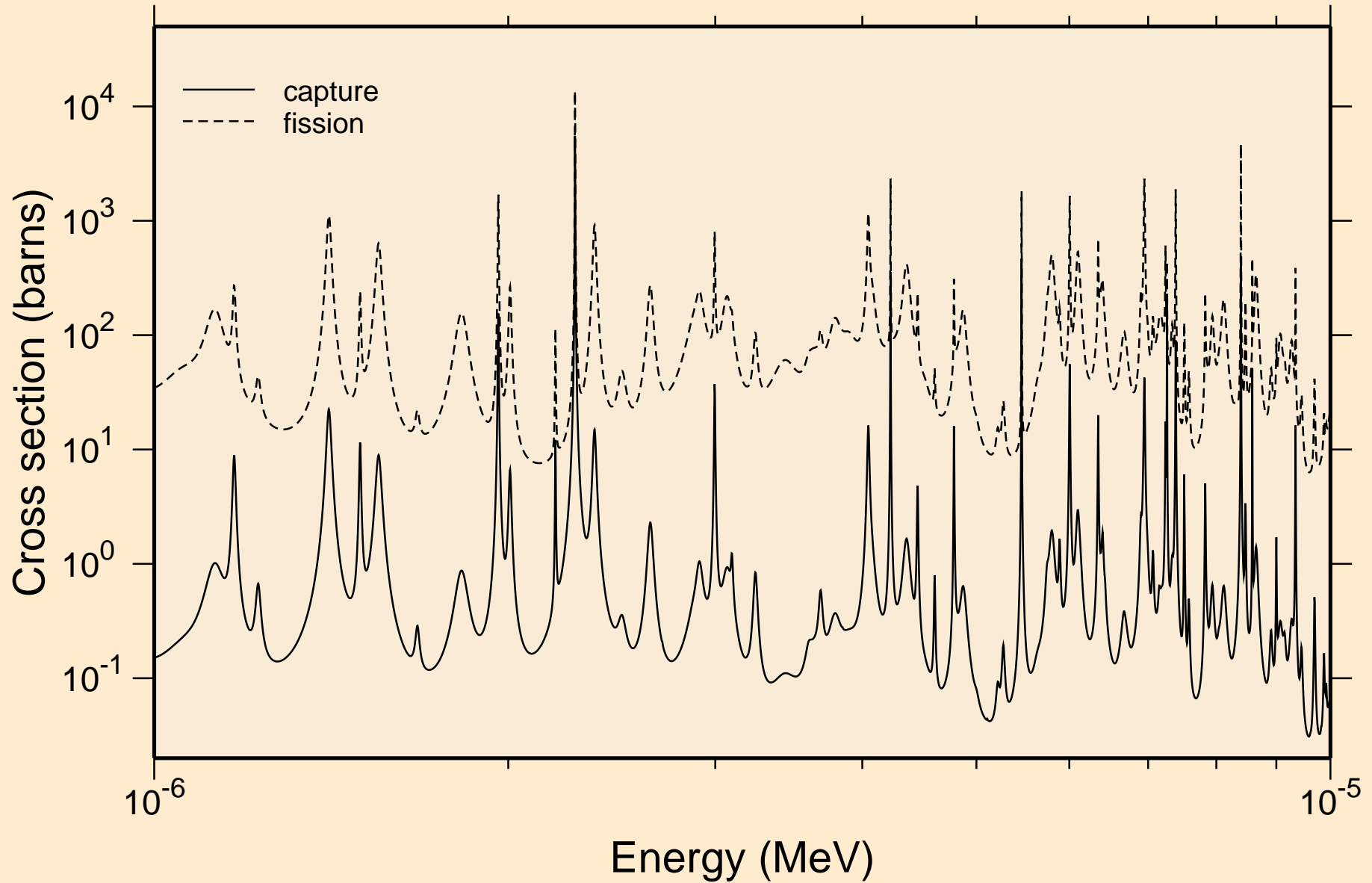

CM237 NEUTRON ACER TENDL-2023 LIBRARY; T=0.K  
resonance absorption cross sections

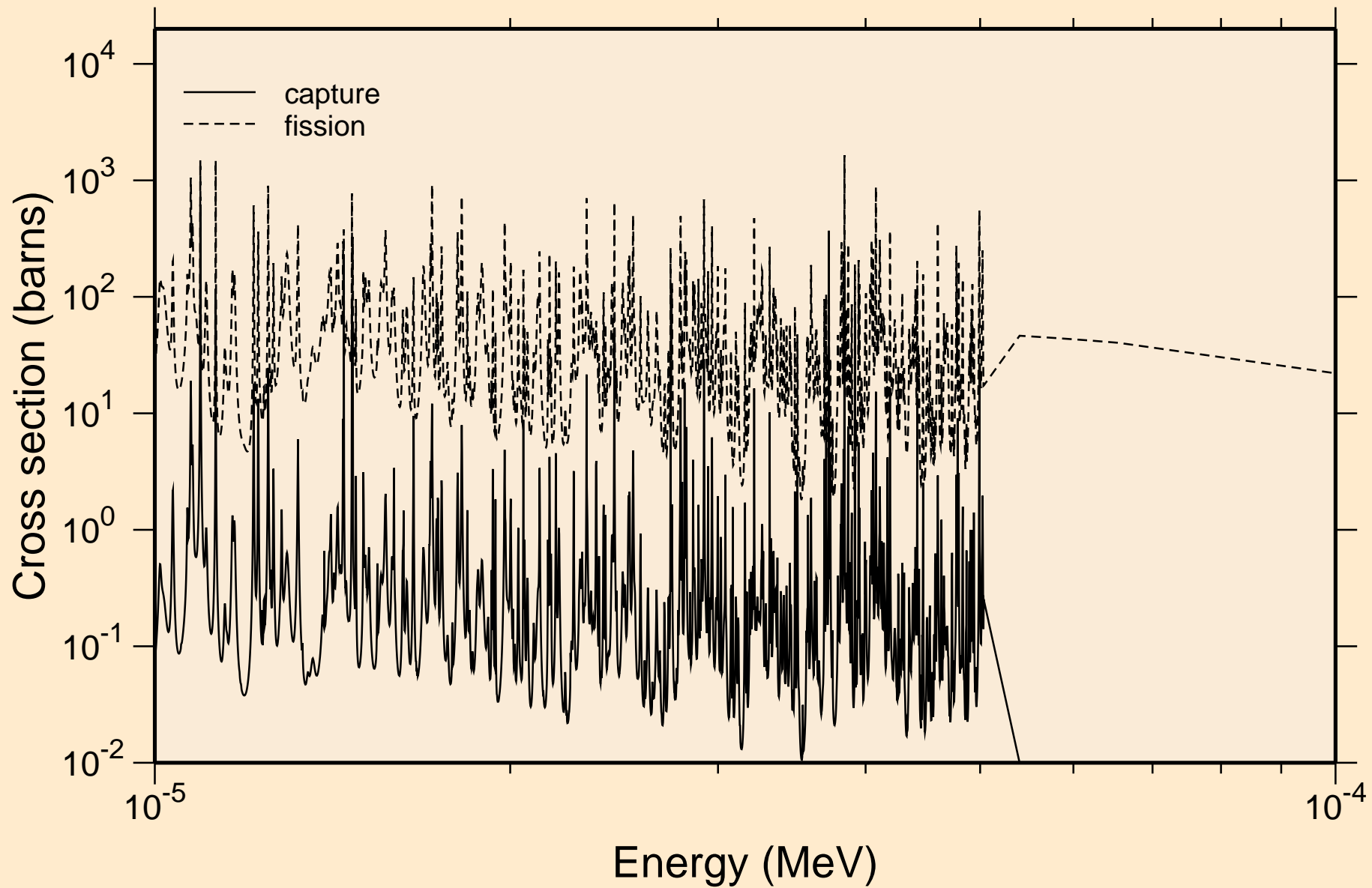

CM237 NEUTRON ACER TENDL-2023 LIBRARY; T=0.K  
resonance absorption cross sections

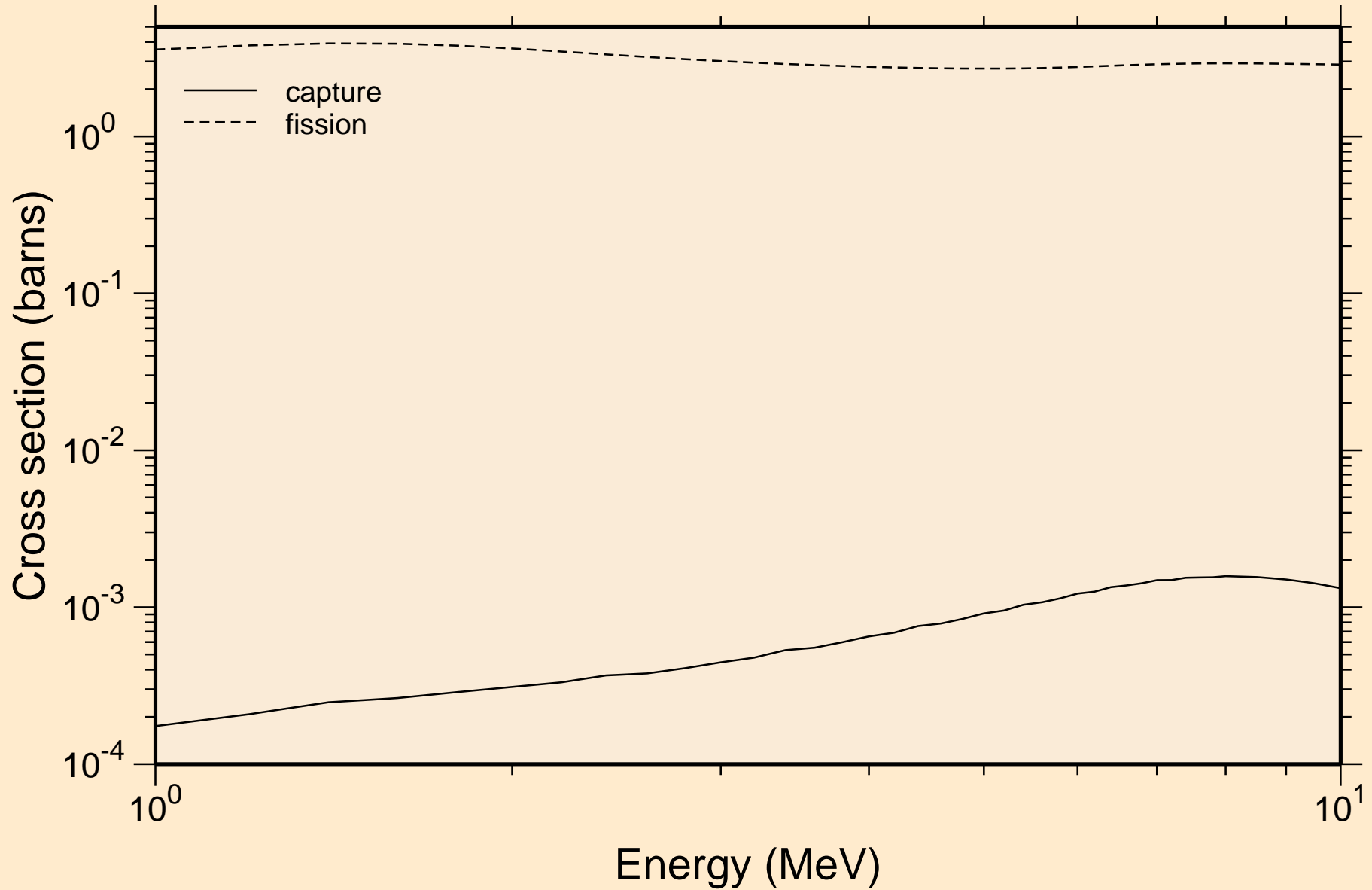

# CM237 NEUTRON ACER TENDL-2023 LIBRARY; T=0.K

## Heating

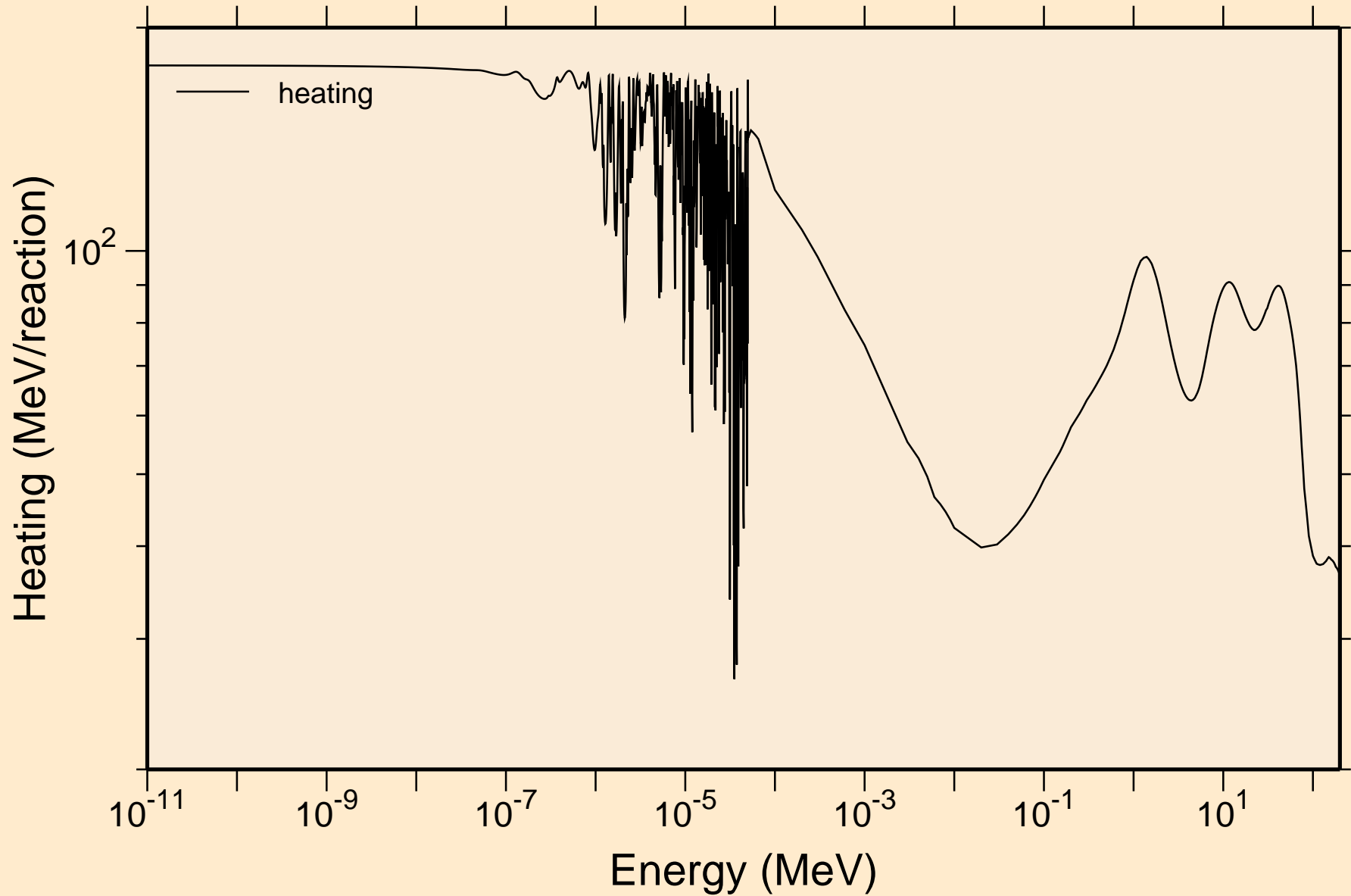

# CM237 NEUTRON ACER TENDL-2023 LIBRARY; T=0.K

## Damage

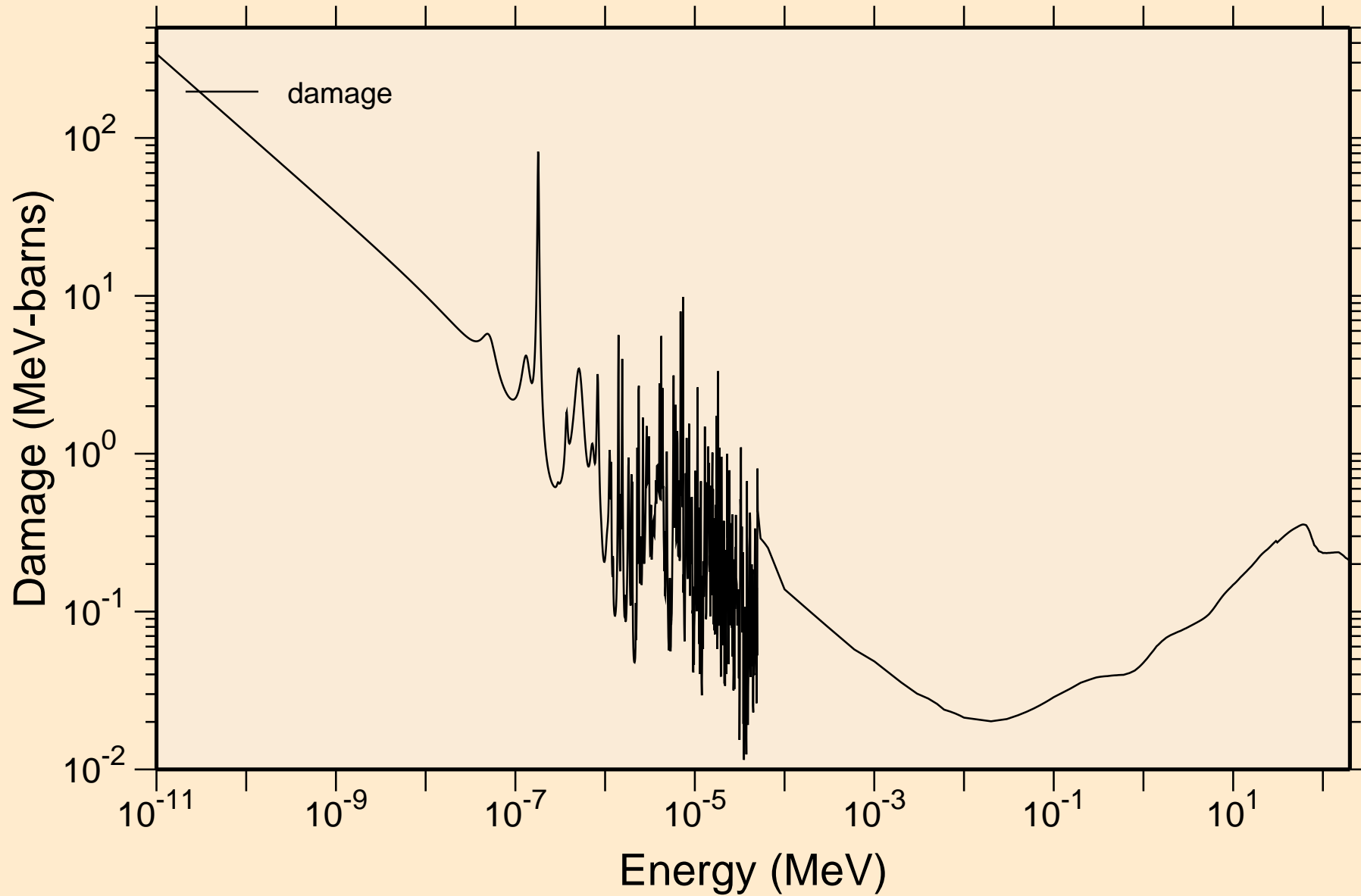

# CM237 NEUTRON ACER TENDL-2023 LIBRARY; T=0.K

## Non-threshold reactions

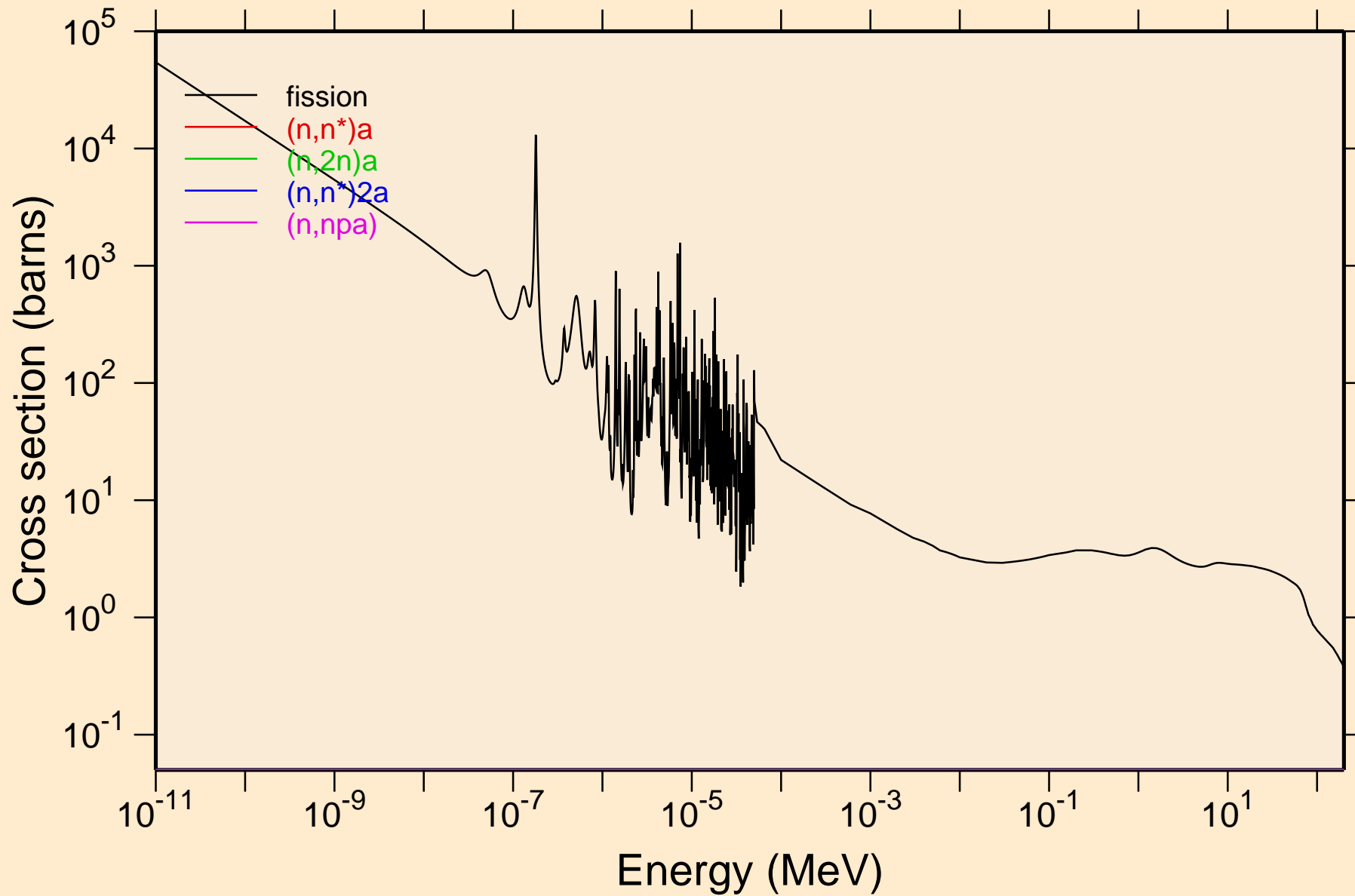

CM237 NEUTRON ACER TENDL-2023 LIBRARY; T=0.K  
Non-threshold reactions

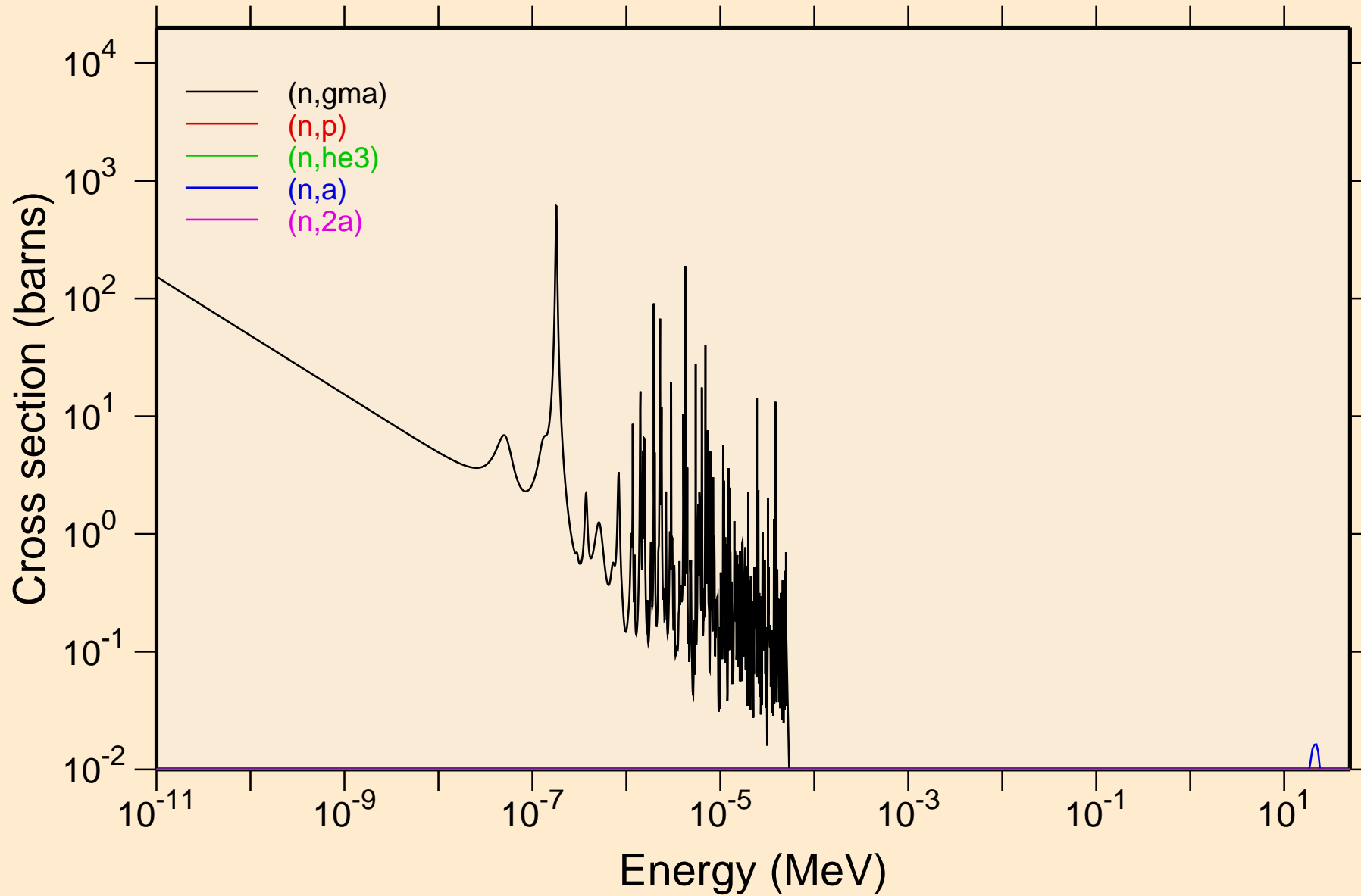

CM237 NEUTRON ACER TENDL-2023 LIBRARY; T=0.K  
Non-threshold reactions

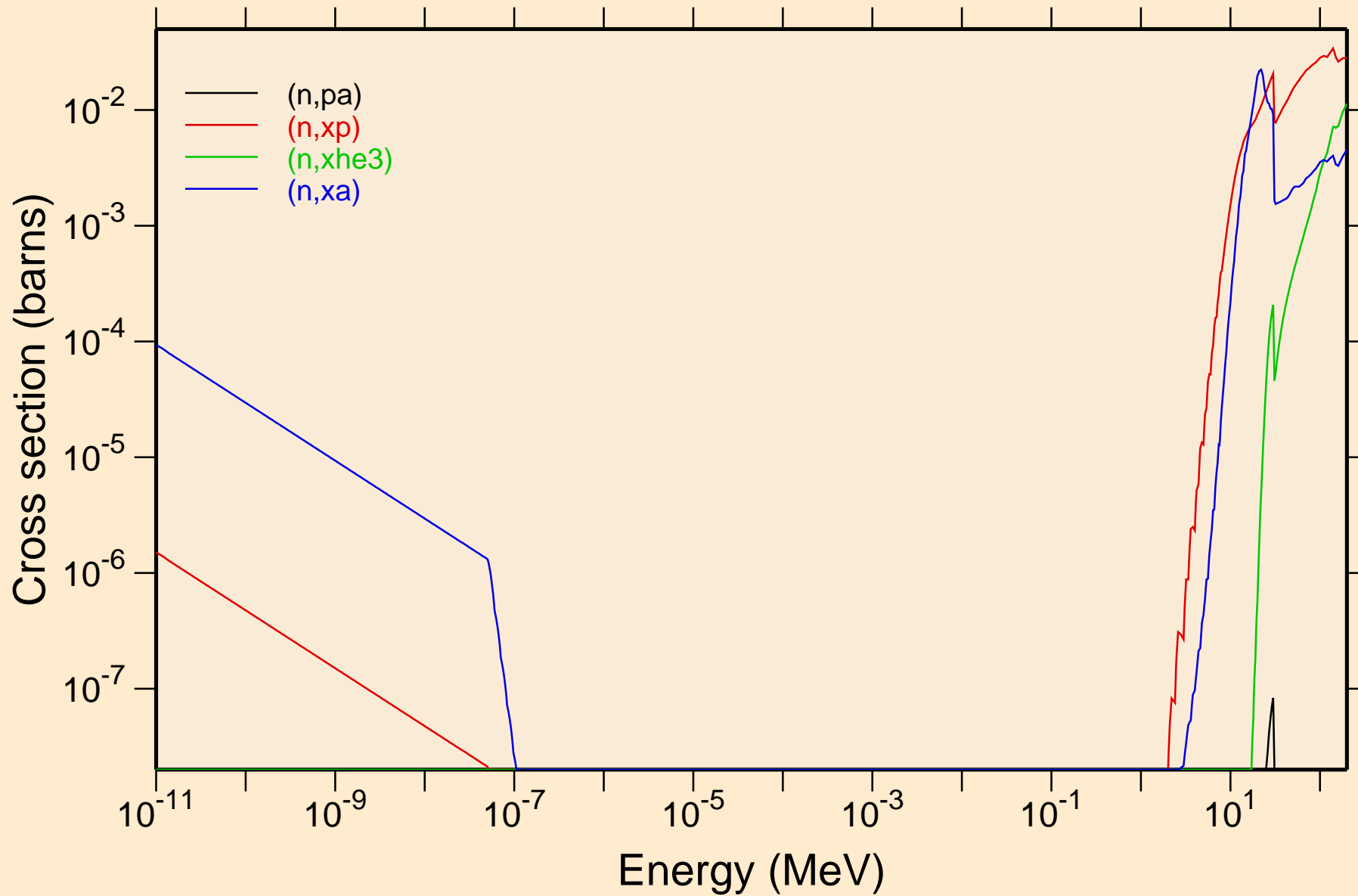

# CM237 NEUTRON ACER TENDL-2023 LIBRARY; T=0.K

## Principal cross sections

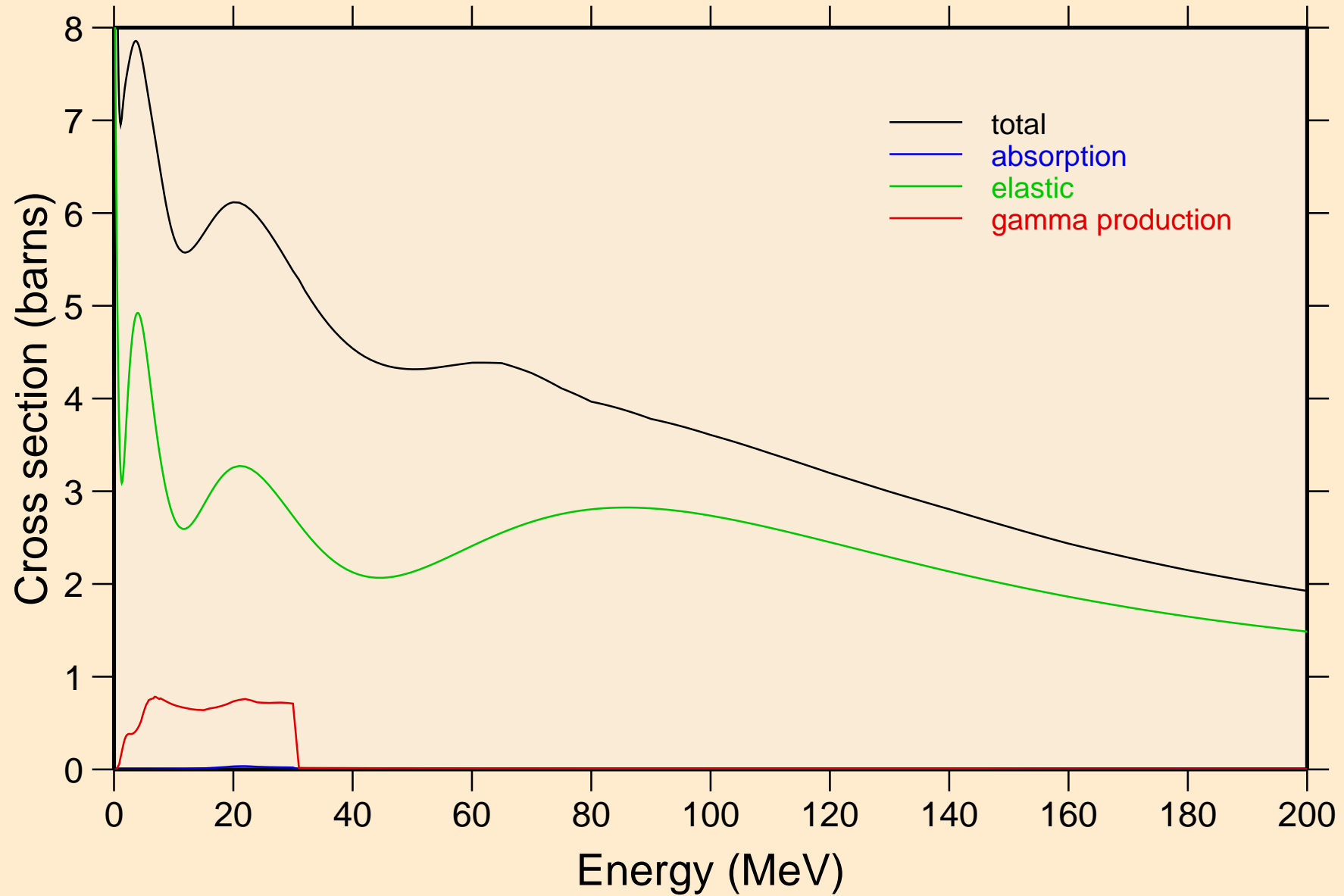

# CM237 NEUTRON ACER TENDL-2023 LIBRARY; T=0.K

## Heating

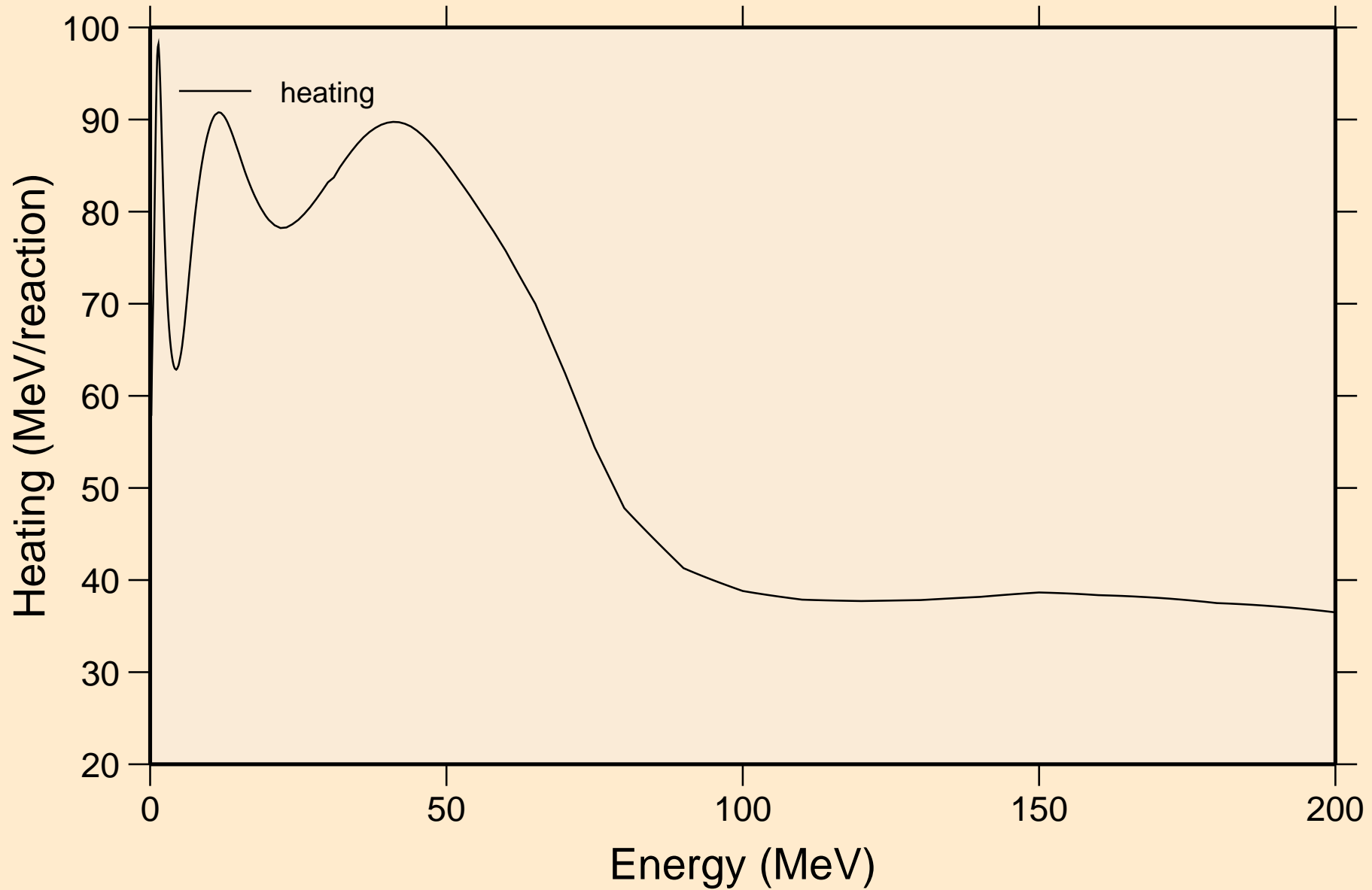

# CM237 NEUTRON ACER TENDL-2023 LIBRARY; T=0.K

## Damage

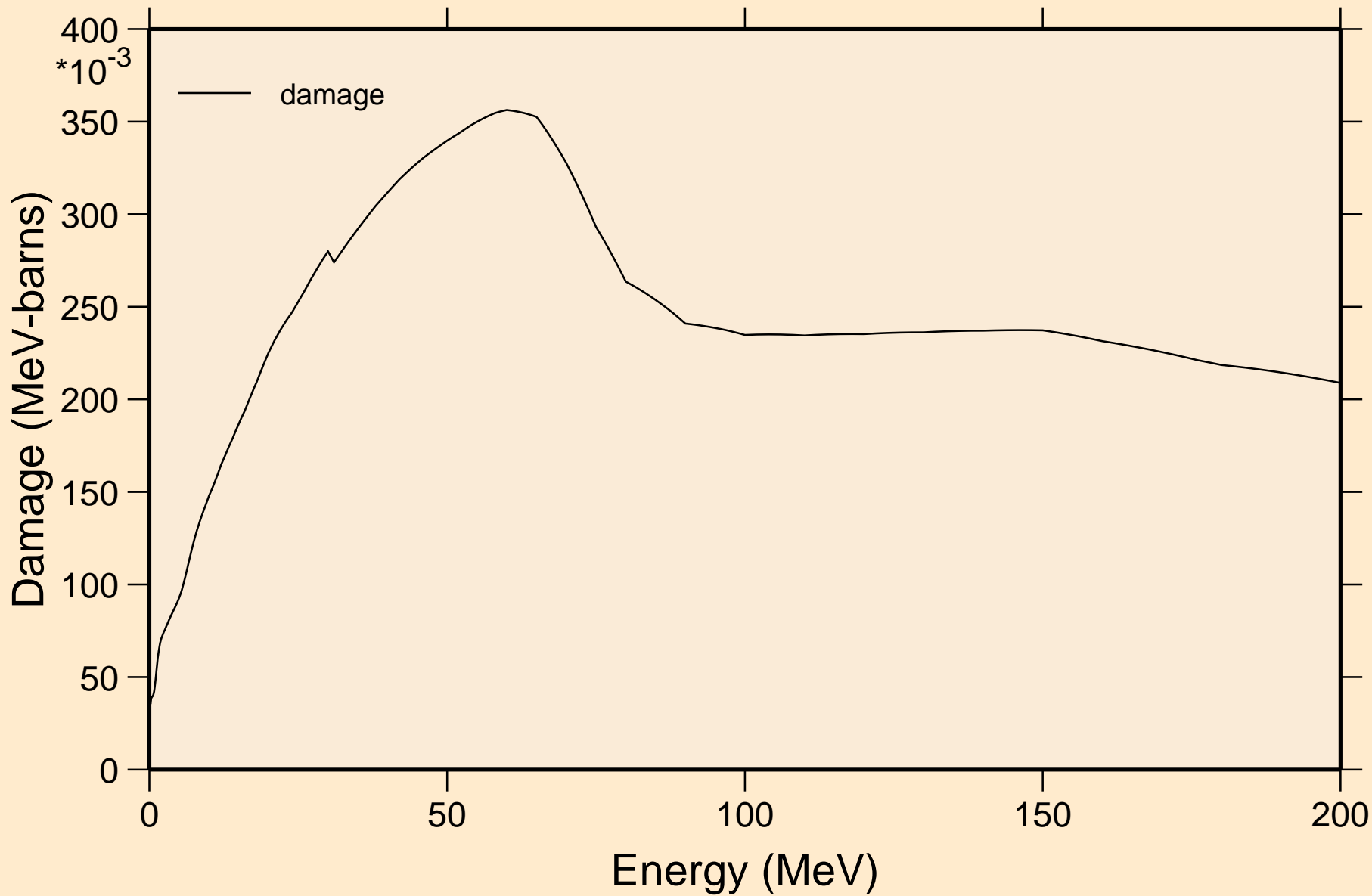

# CM237 NEUTRON ACER TENDL-2023 LIBRARY; T=0.K

## Non-threshold reactions

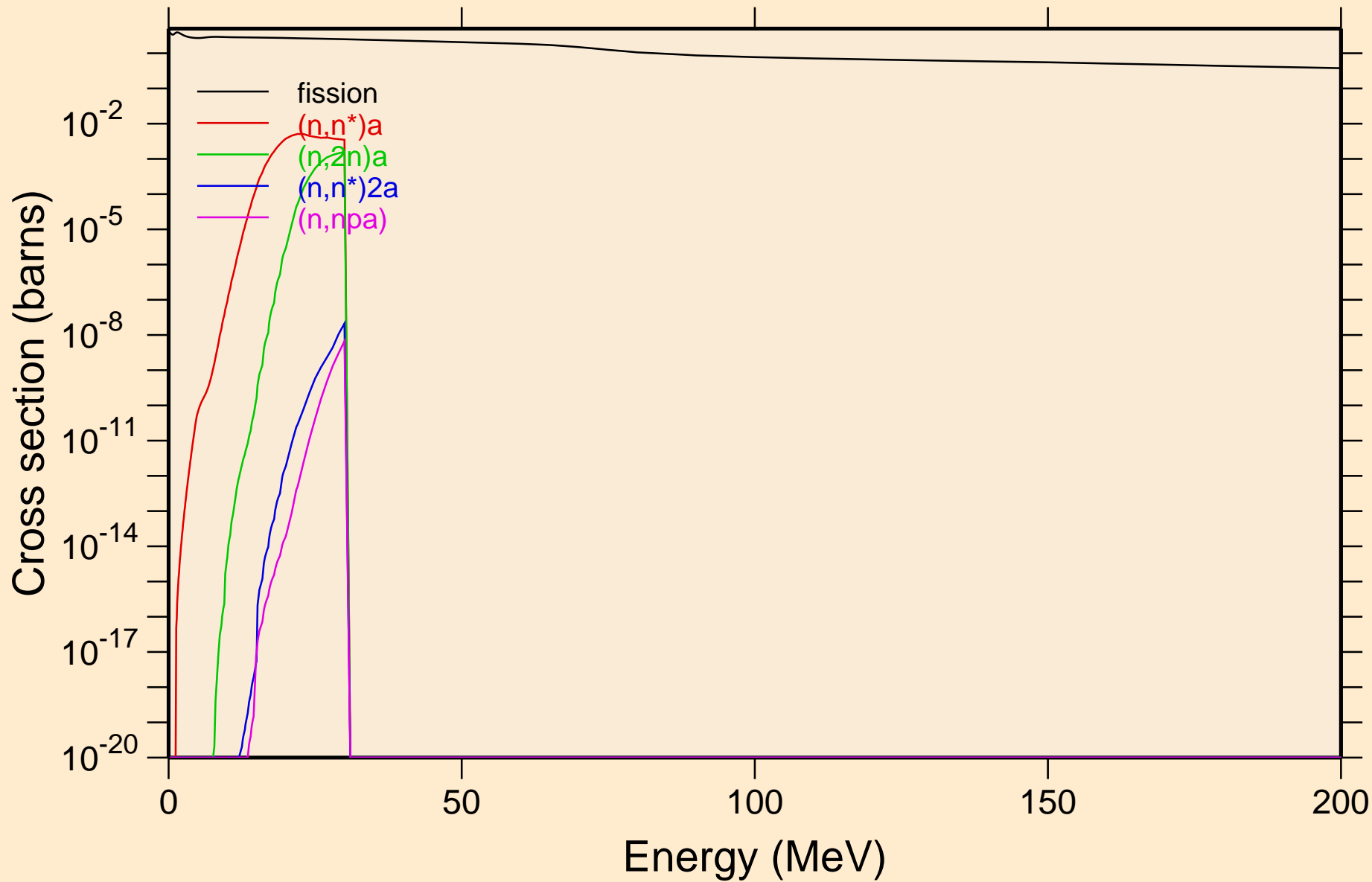

# CM237 NEUTRON ACER TENDL-2023 LIBRARY; T=0.K

## Non-threshold reactions

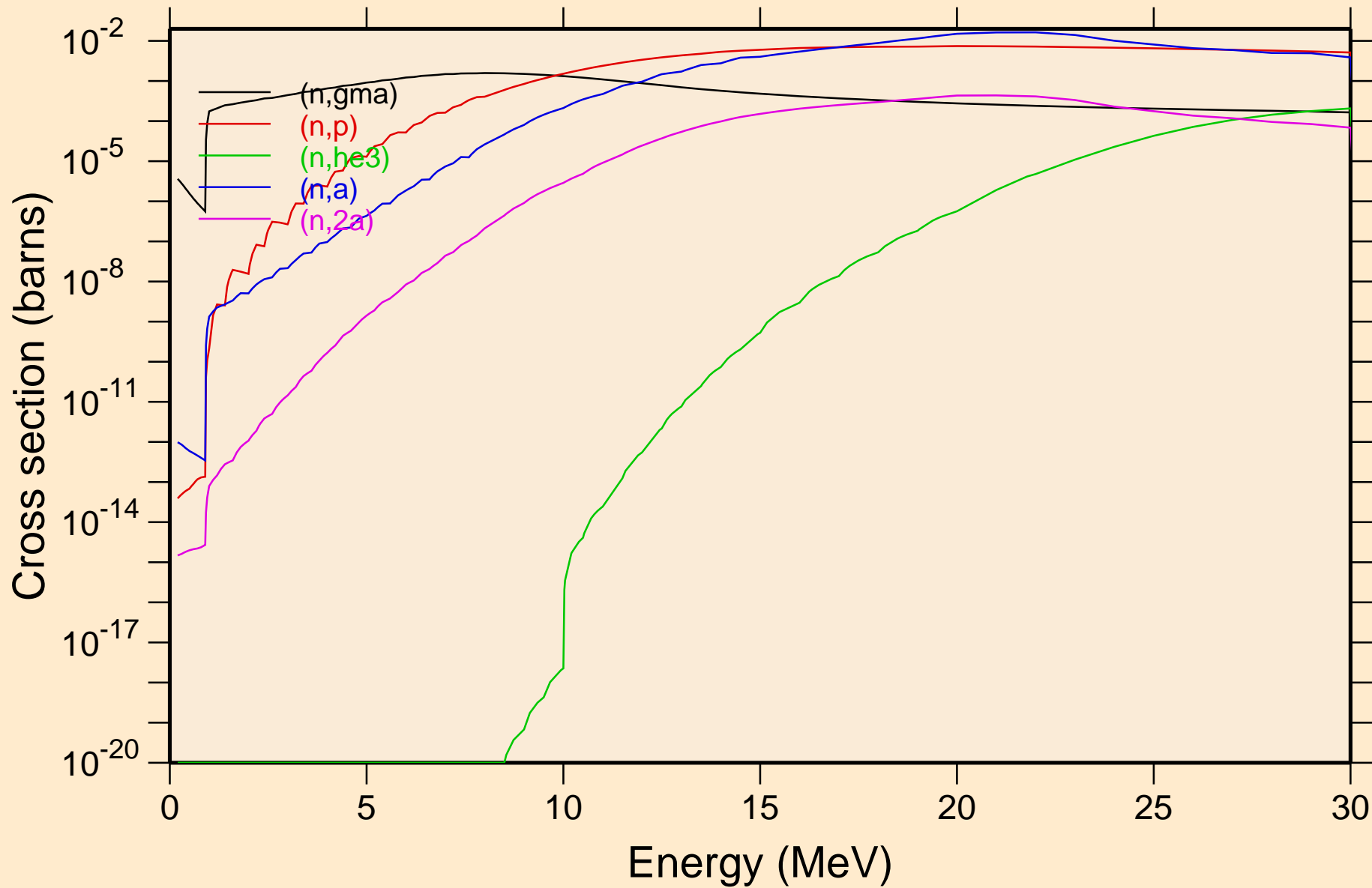

# CM237 NEUTRON ACER TENDL-2023 LIBRARY; T=0.K

## Non-threshold reactions

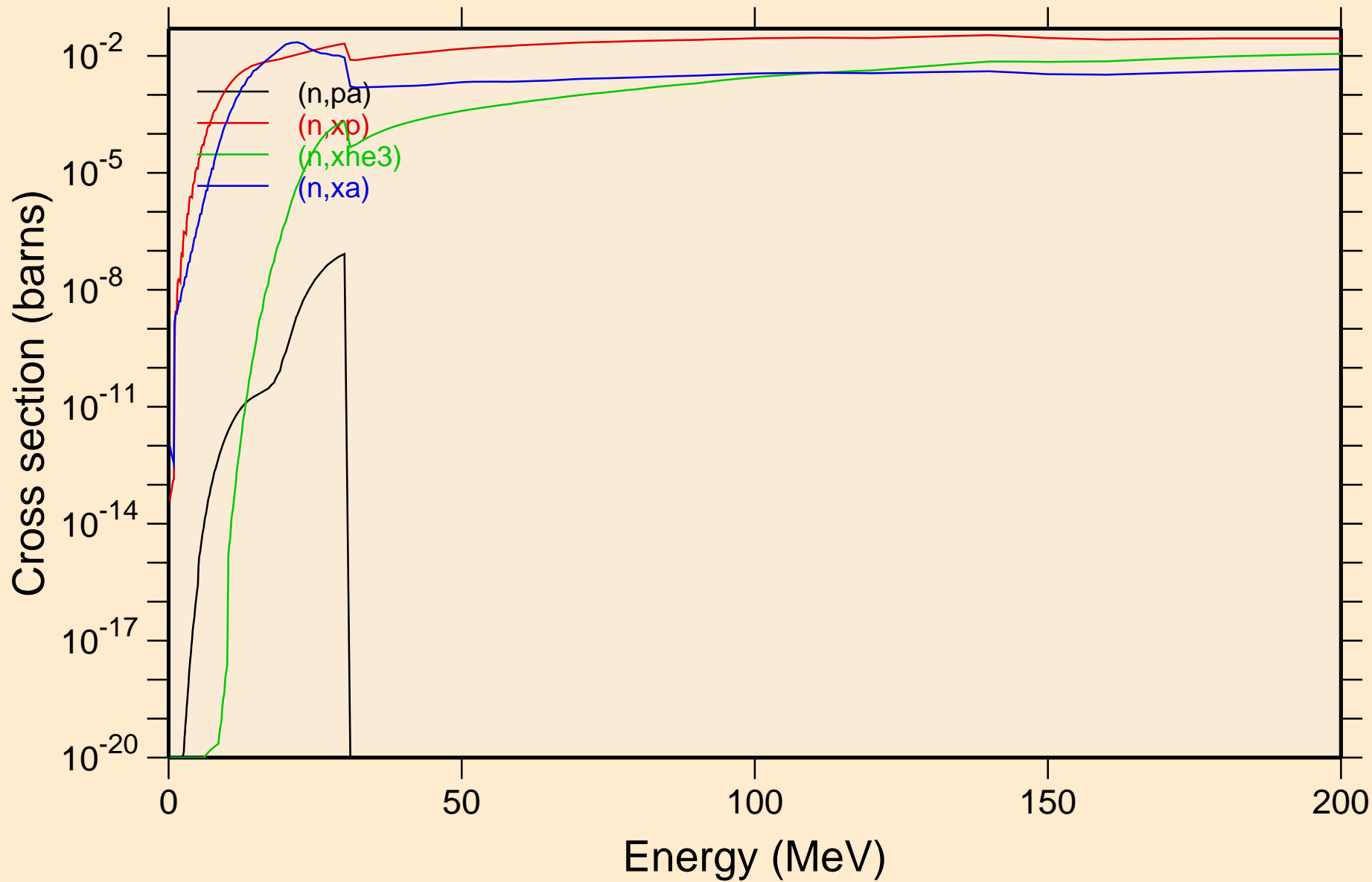

CM237 NEUTRON ACER TENDL-2023 LIBRARY; T=0.K  
Inelastic levels

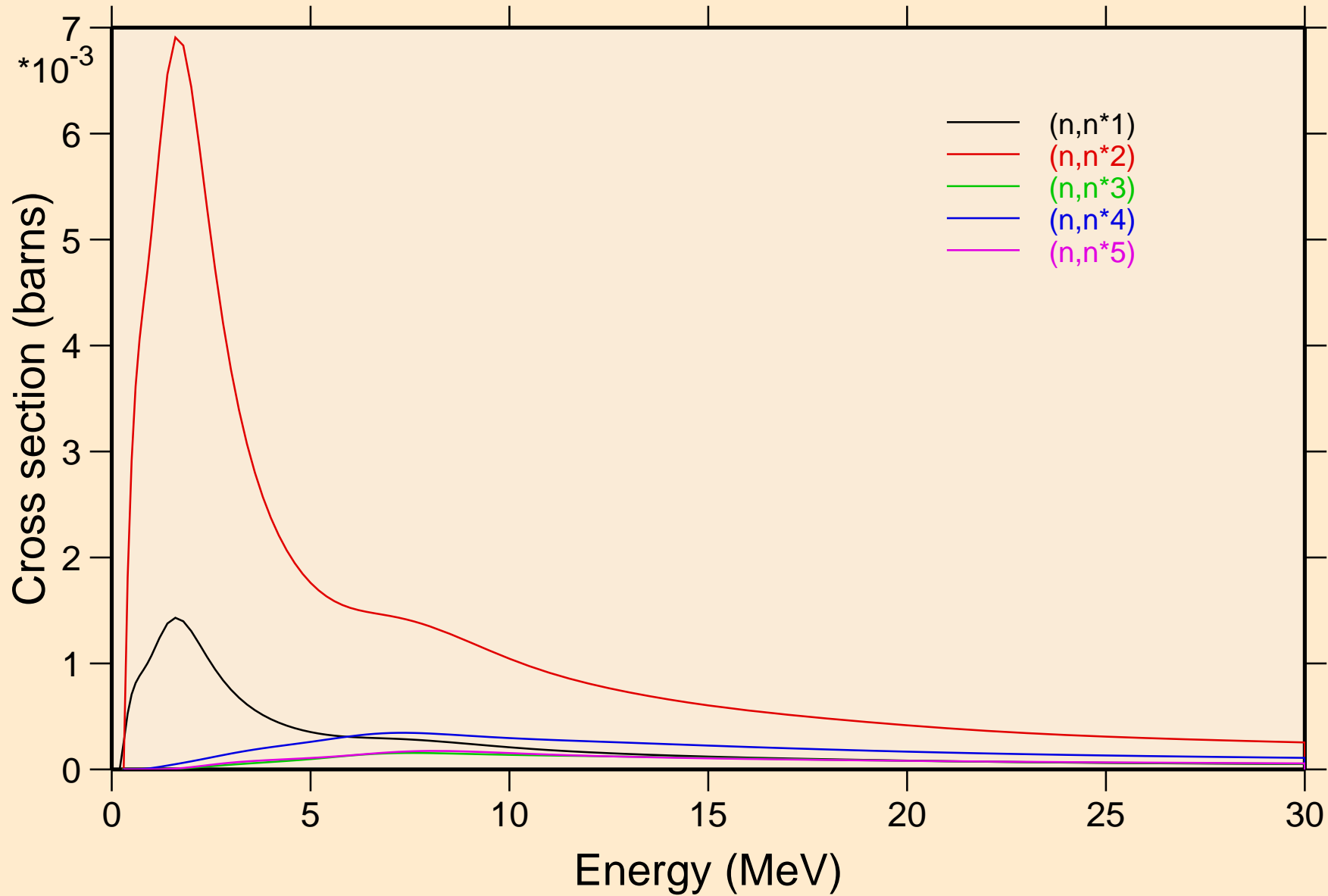

CM237 NEUTRON ACER TENDL-2023 LIBRARY; T=0.K  
Inelastic levels

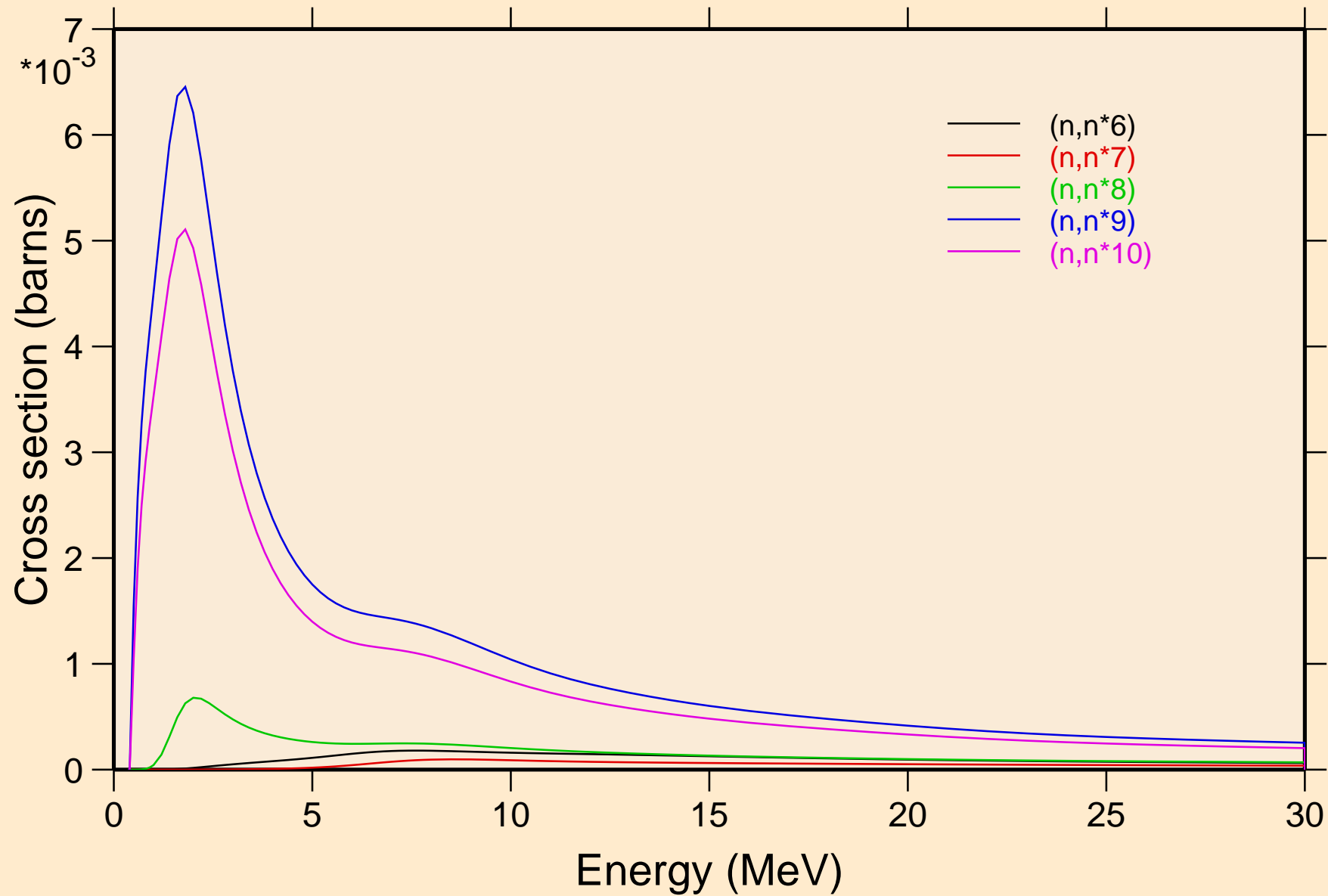

CM237 NEUTRON ACER TENDL-2023 LIBRARY; T=0.K  
Inelastic levels

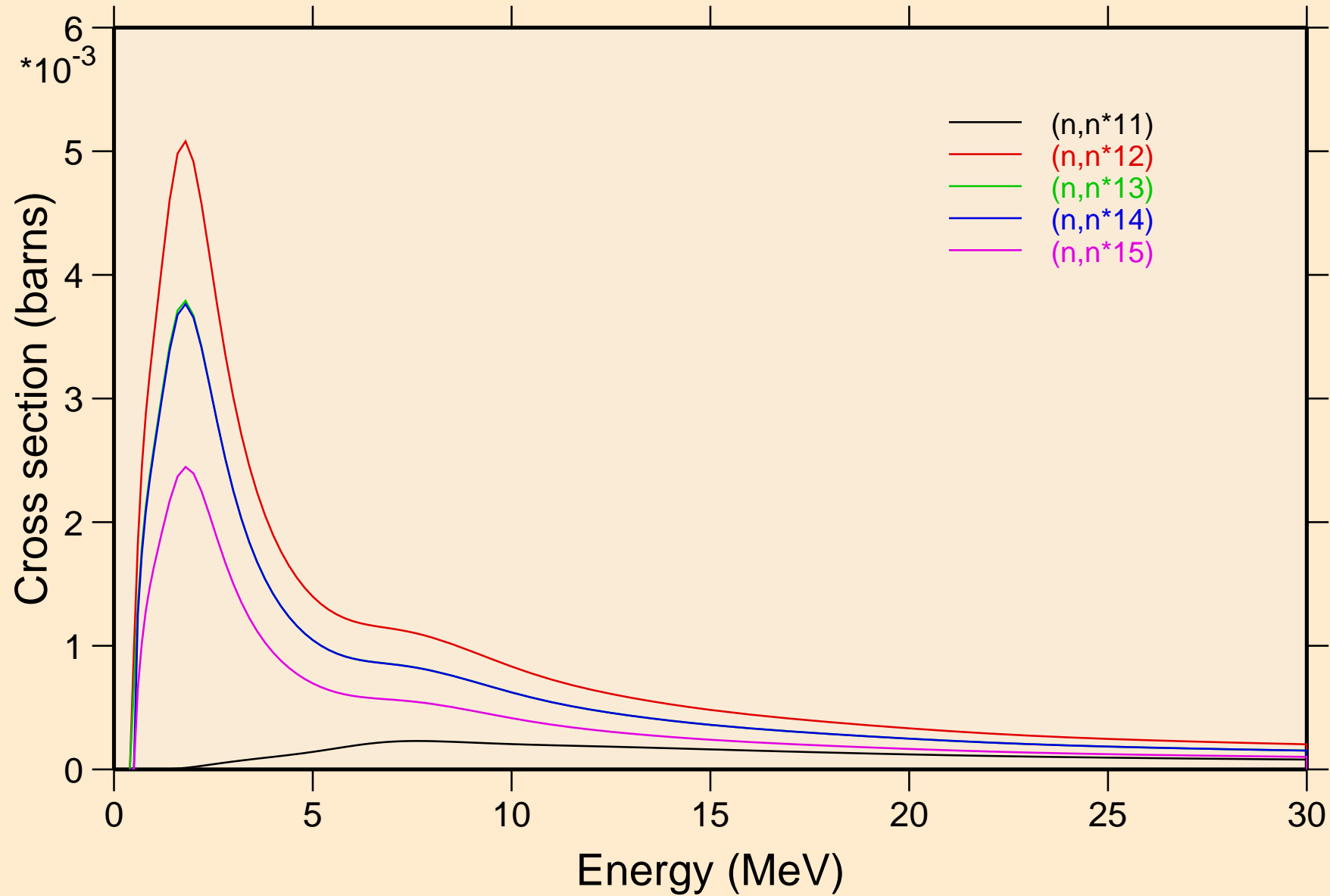

CM237 NEUTRON ACER TENDL-2023 LIBRARY; T=0.K  
Inelastic levels

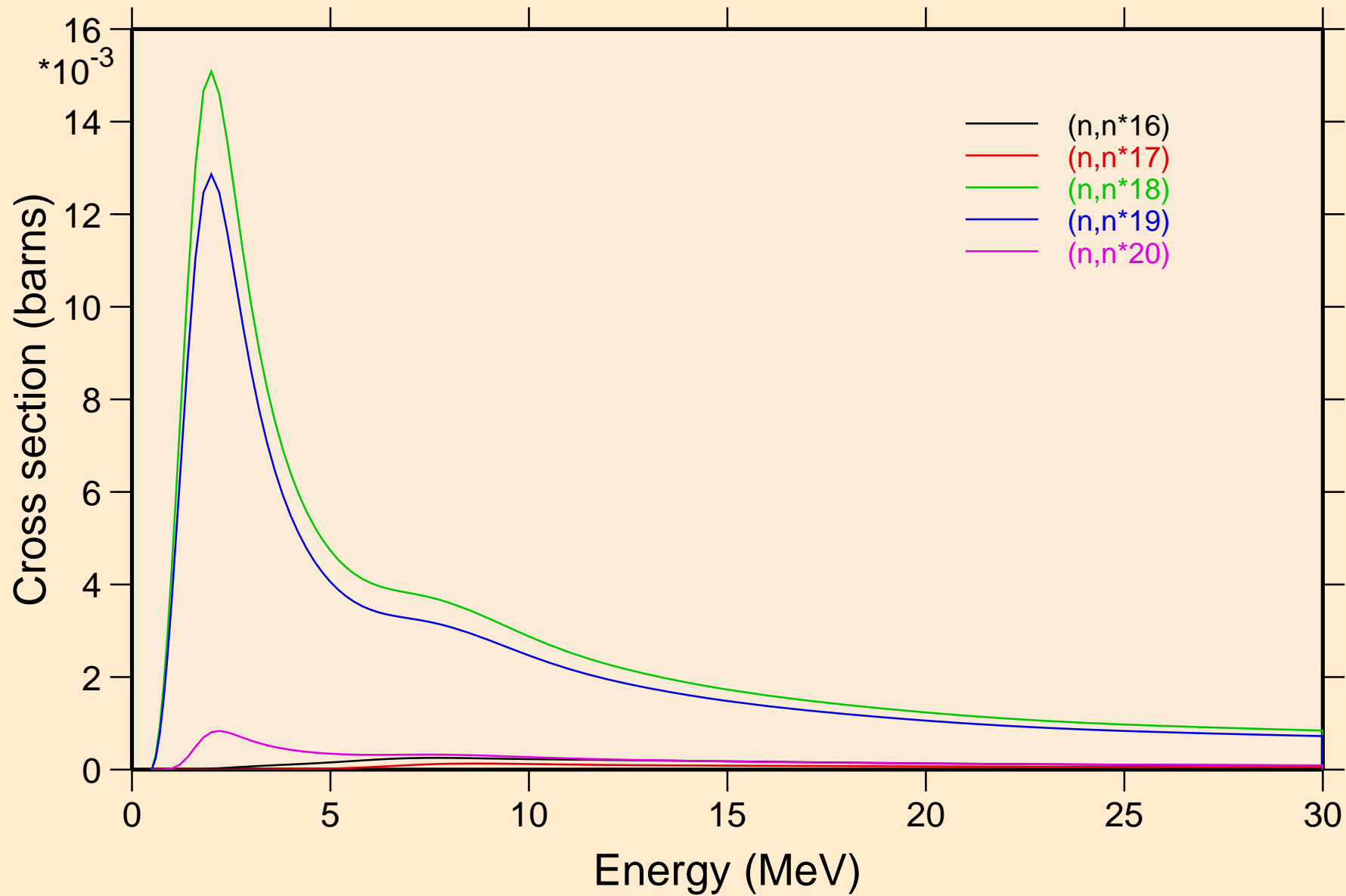

CM237 NEUTRON ACER TENDL-2023 LIBRARY; T=0.K  
Inelastic levels

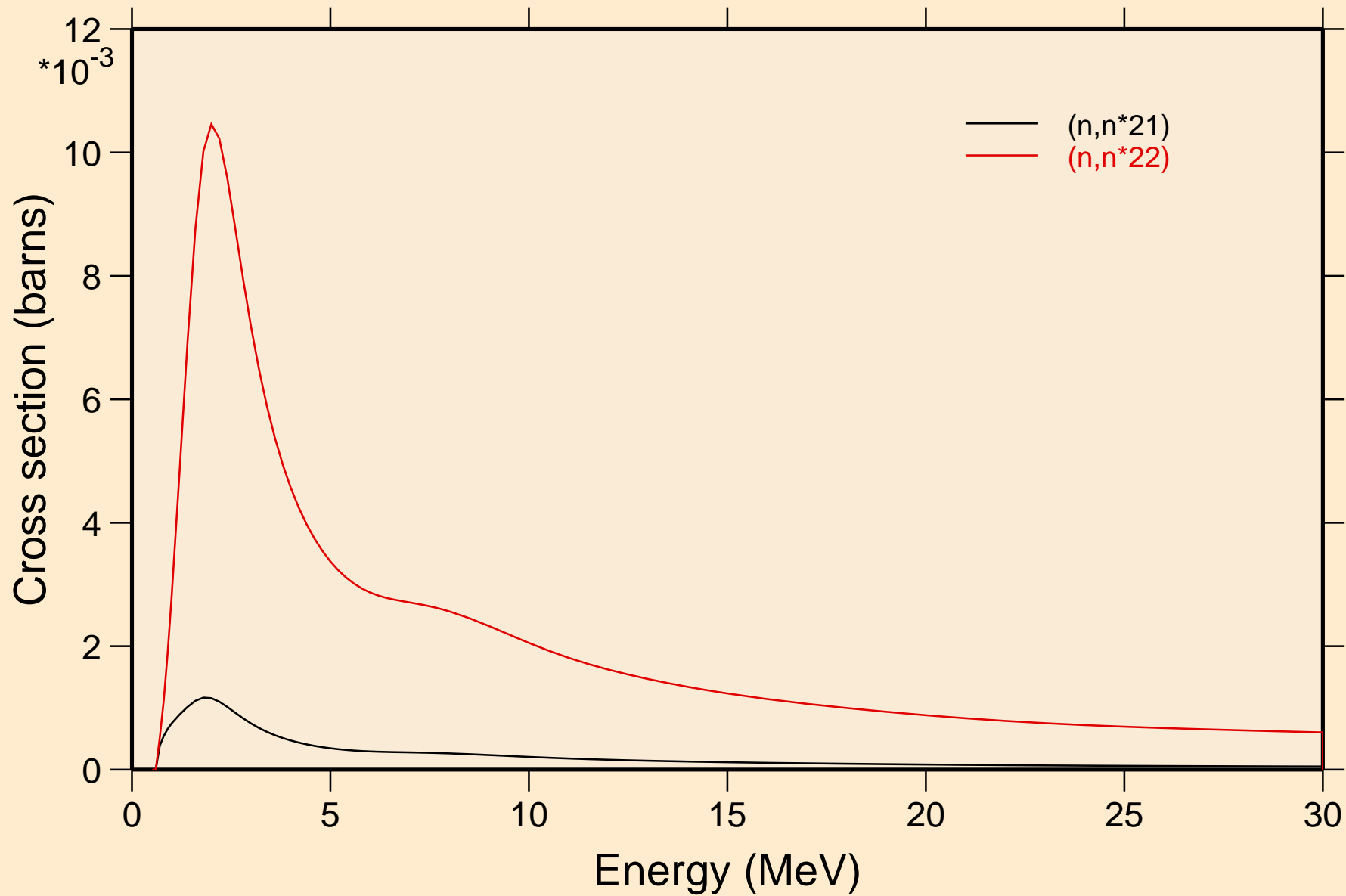

# CM237 NEUTRON ACER TENDL-2023 LIBRARY; T=0.K

## Threshold reactions

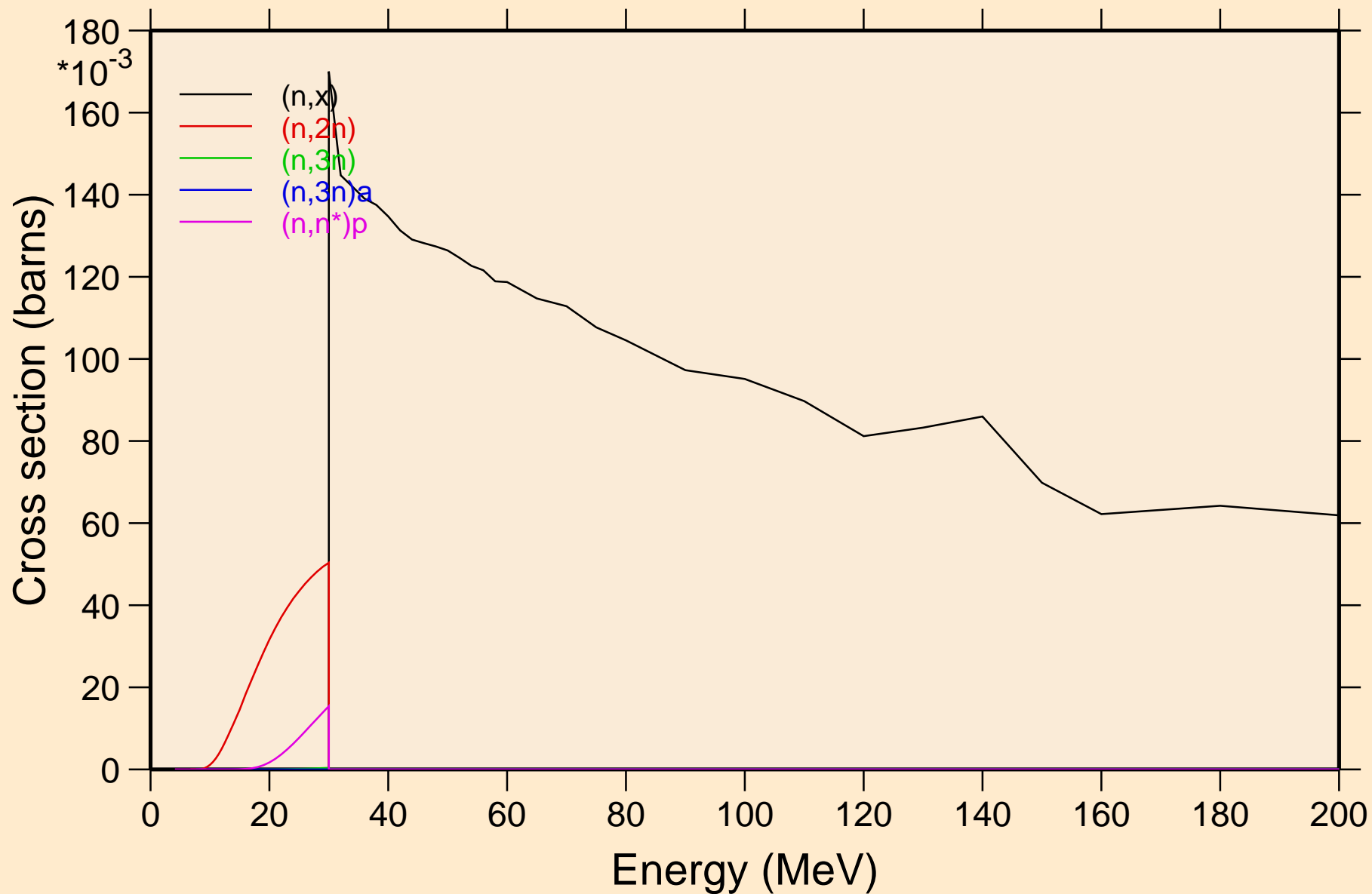

# CM237 NEUTRON ACER TENDL-2023 LIBRARY; T=0.K

## Threshold reactions

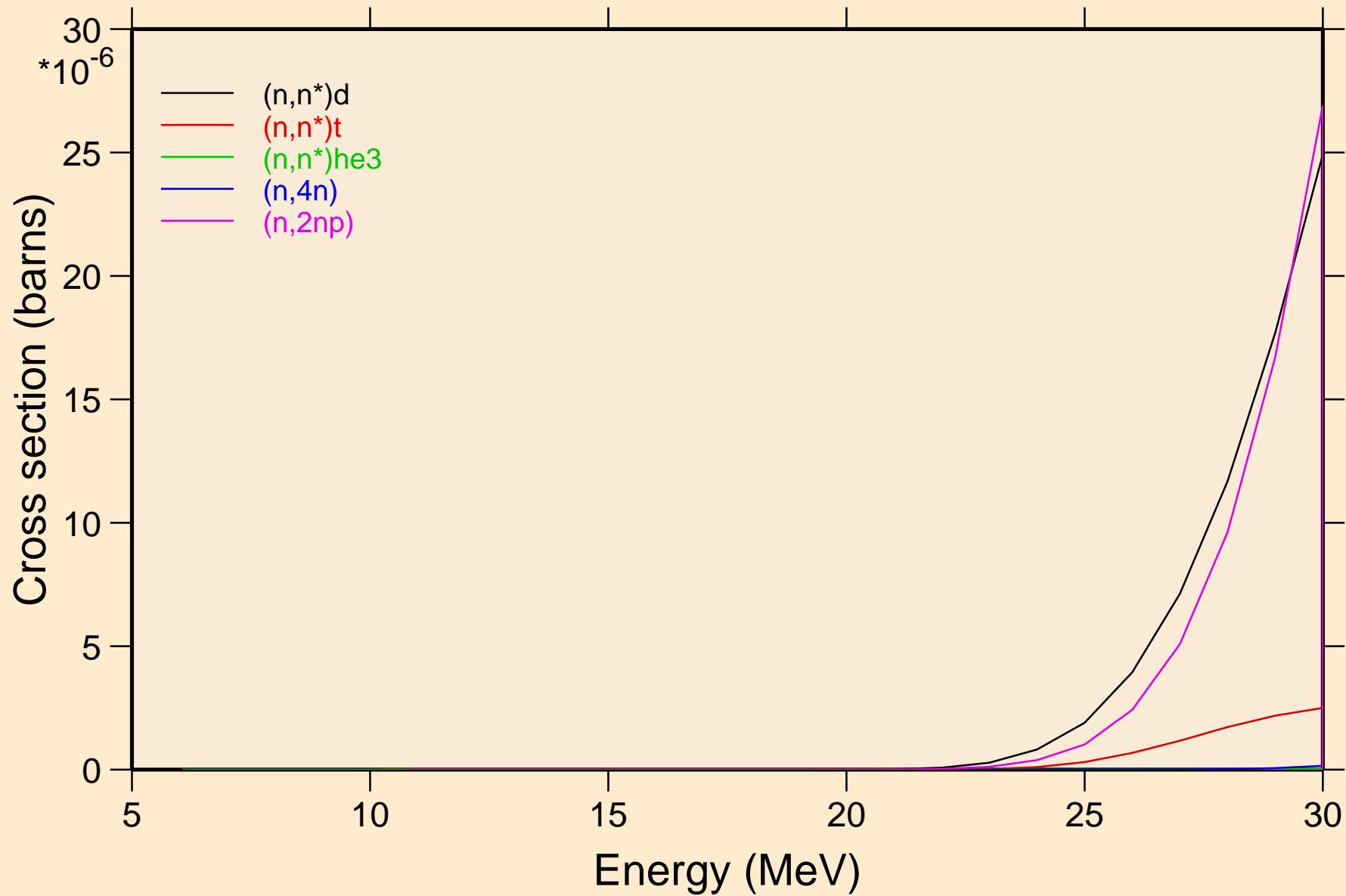

# CM237 NEUTRON ACER TENDL-2023 LIBRARY; T=0.K

## Threshold reactions

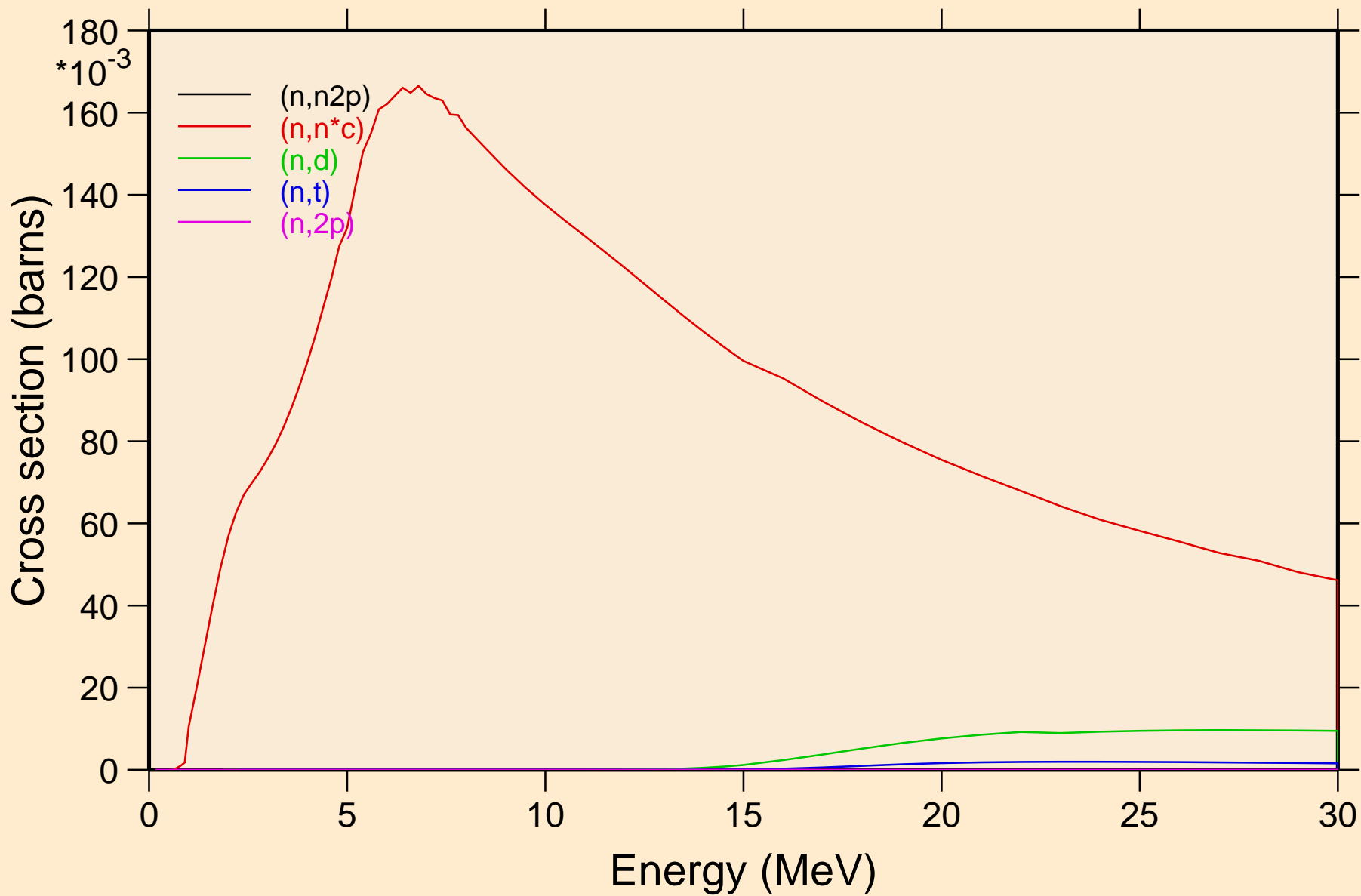

CM237 NEUTRON ACER TENDL-2023 LIBRARY; T=0.K  
Threshold reactions

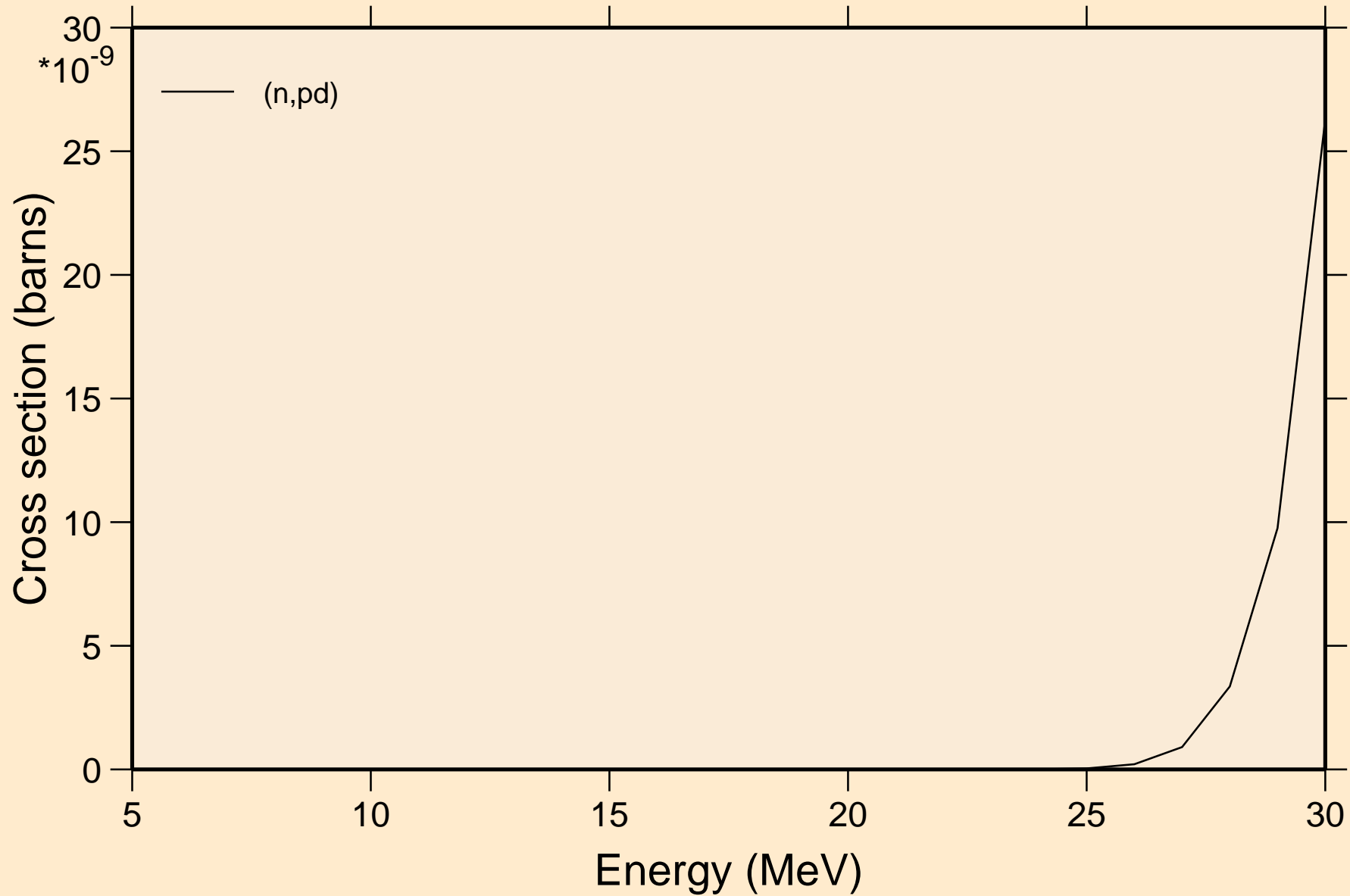

# CM237 NEUTRON ACER TENDL-2023 LIBRARY; T=0.K

## Threshold reactions

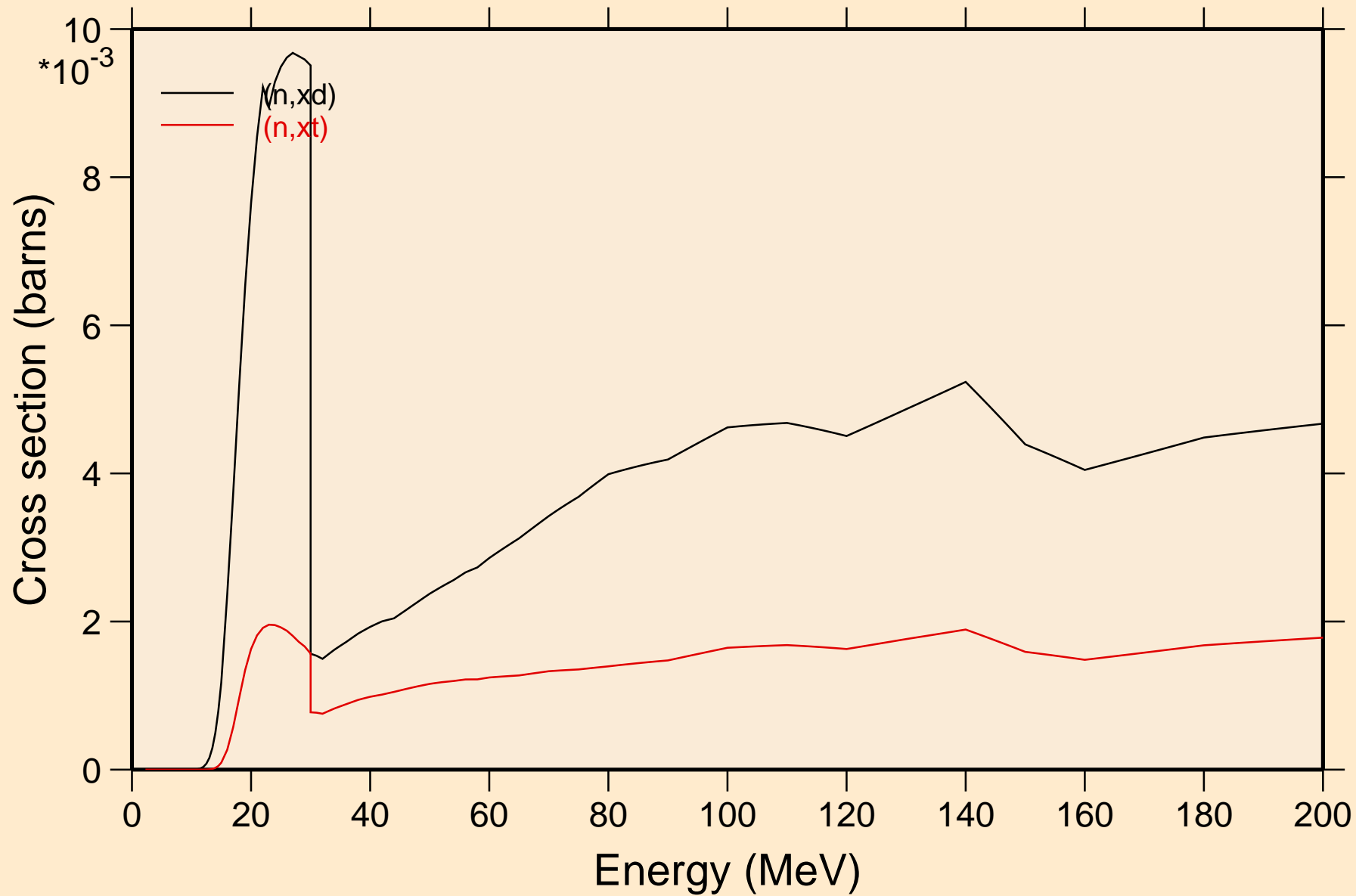

CM237 NEUTRON ACER TENDL-2023 LIBRARY; T=0.K  
angular distribution for elastic

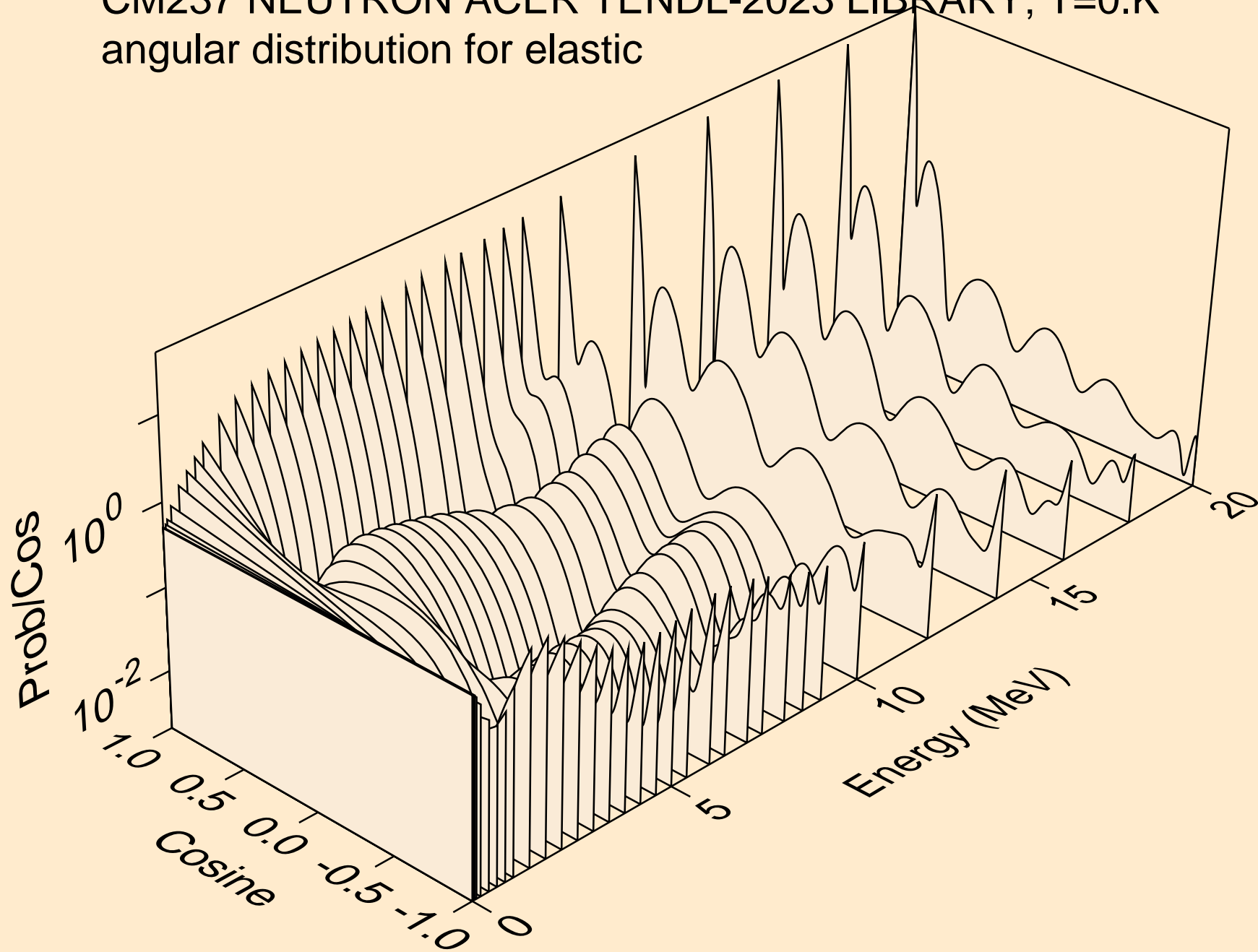

CM237 NEUTRON ACER TENDL-2023 LIBRARY; T=0.K  
angular distribution for elastic

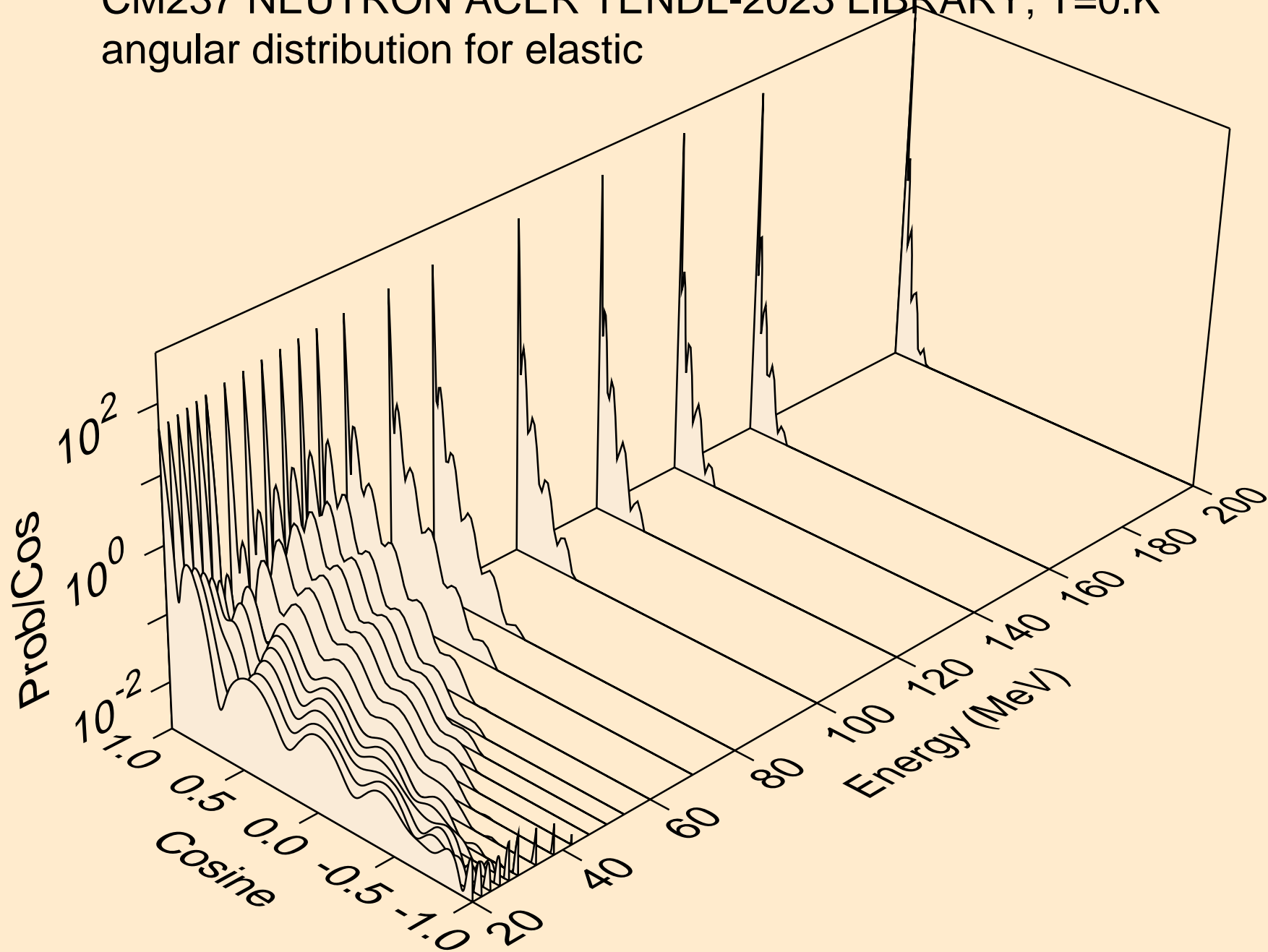

CM237 NEUTRON ACER TENDL-2023 LIBRARY; T=0.K  
angular distribution for (n,n\*1)

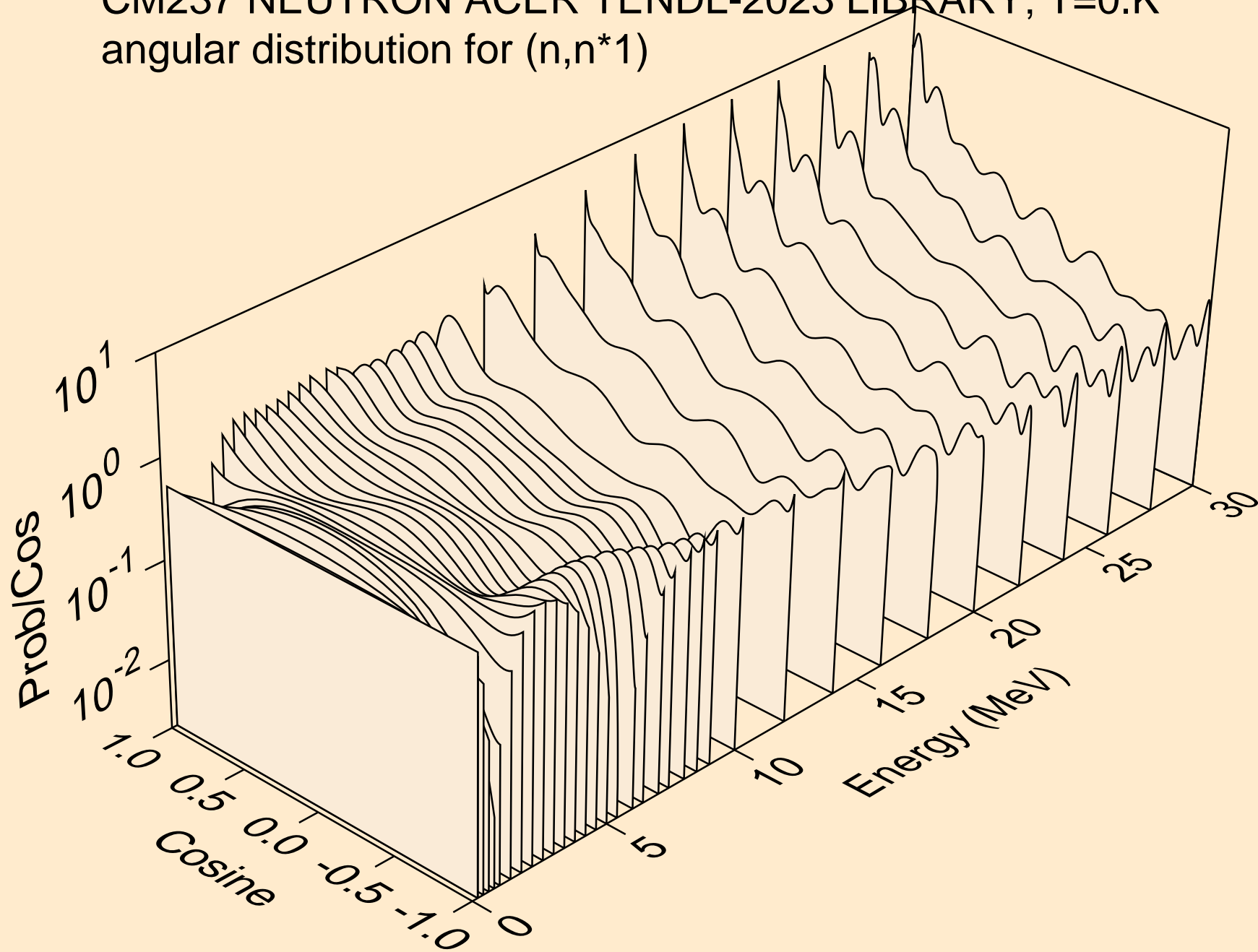

CM237 NEUTRON ACER TENDL-2023 LIBRARY; T=0.K  
angular distribution for (n,n\*2)

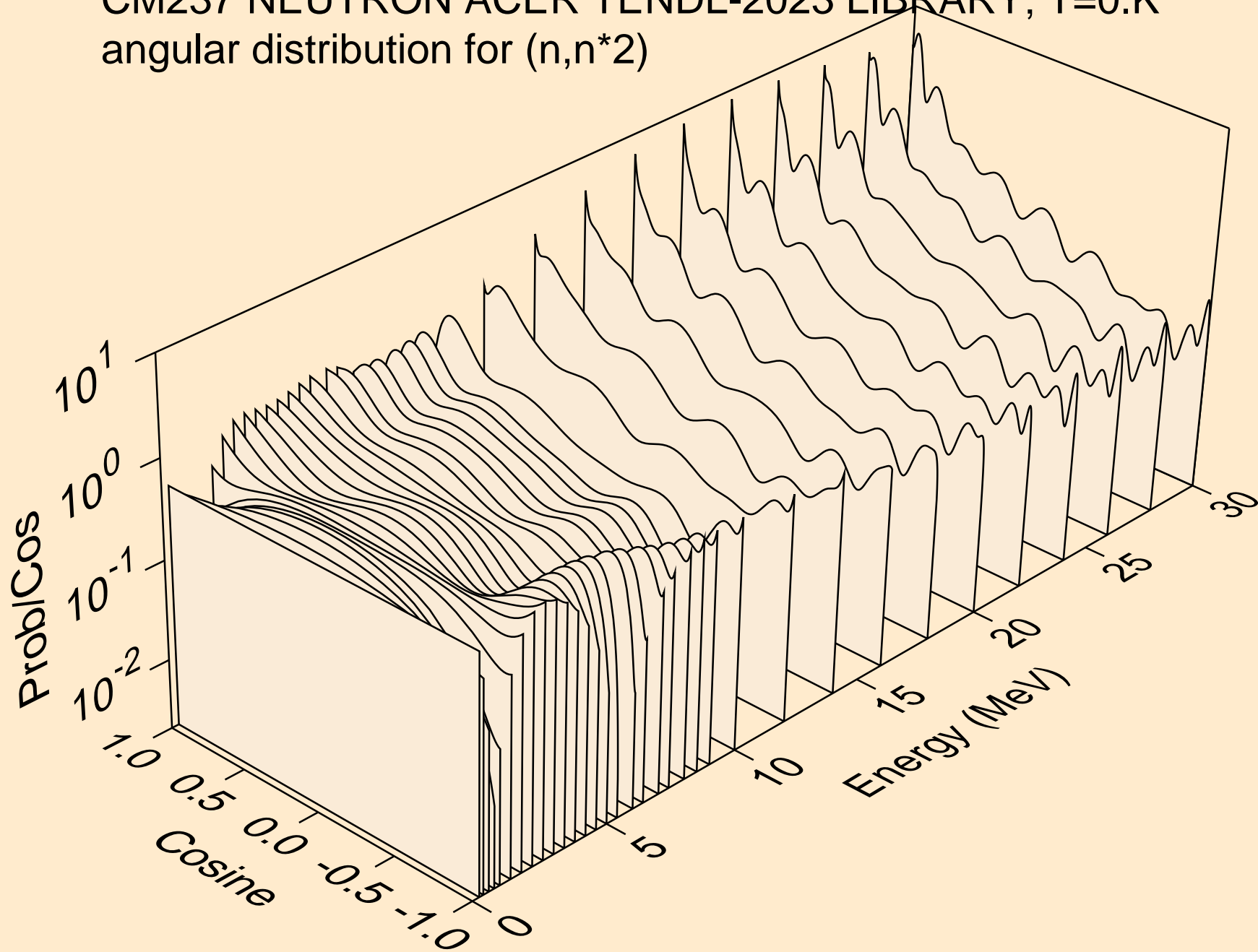

CM237 NEUTRON ACER TENDL-2023 LIBRARY; T=0.K  
angular distribution for (n,n\*3)

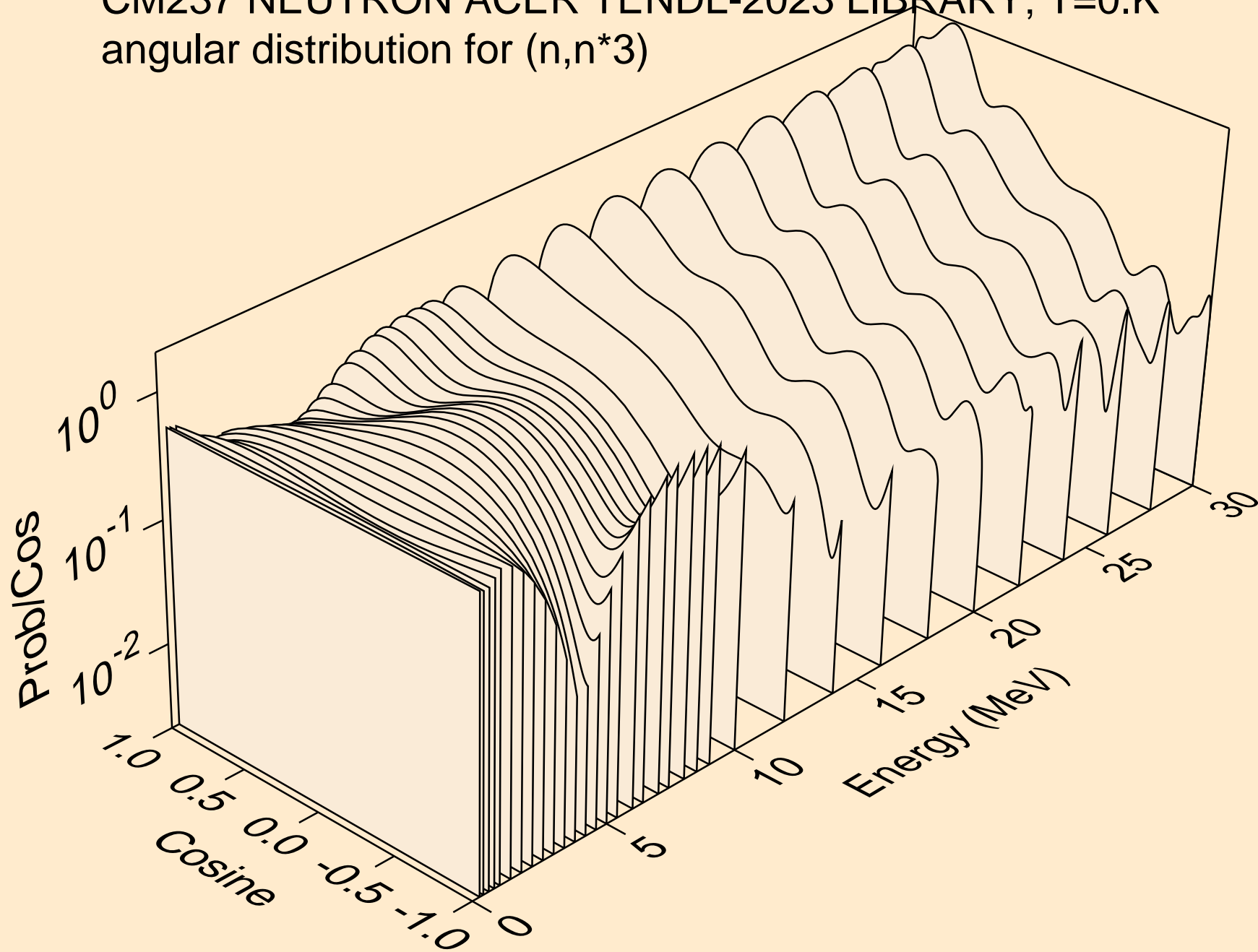

CM237 NEUTRON ACER TENDL-2023 LIBRARY; T=0.K  
angular distribution for (n,n\*4)

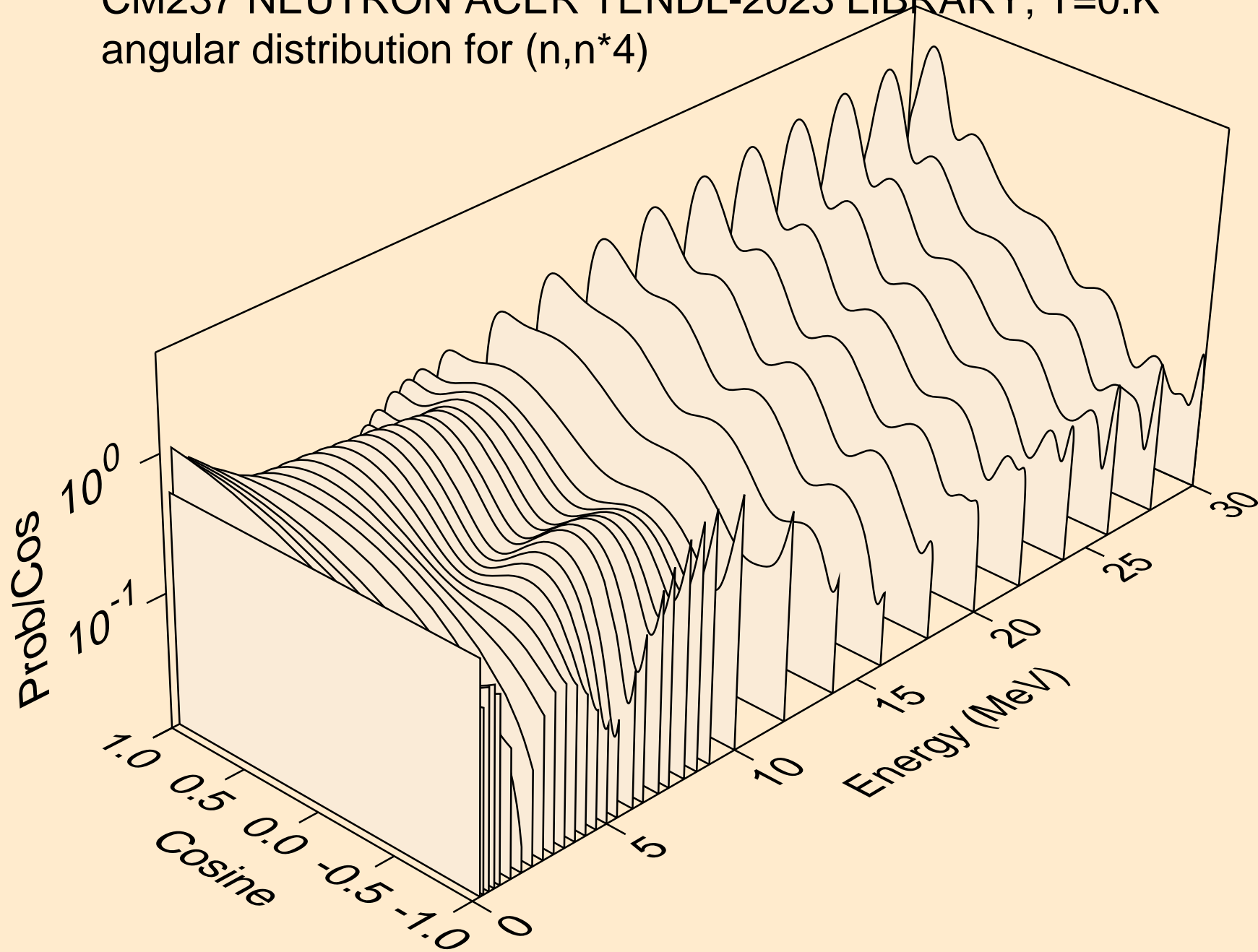

CM237 NEUTRON ACER TENDL-2023 LIBRARY; T=0.K  
angular distribution for (n,n\*5)

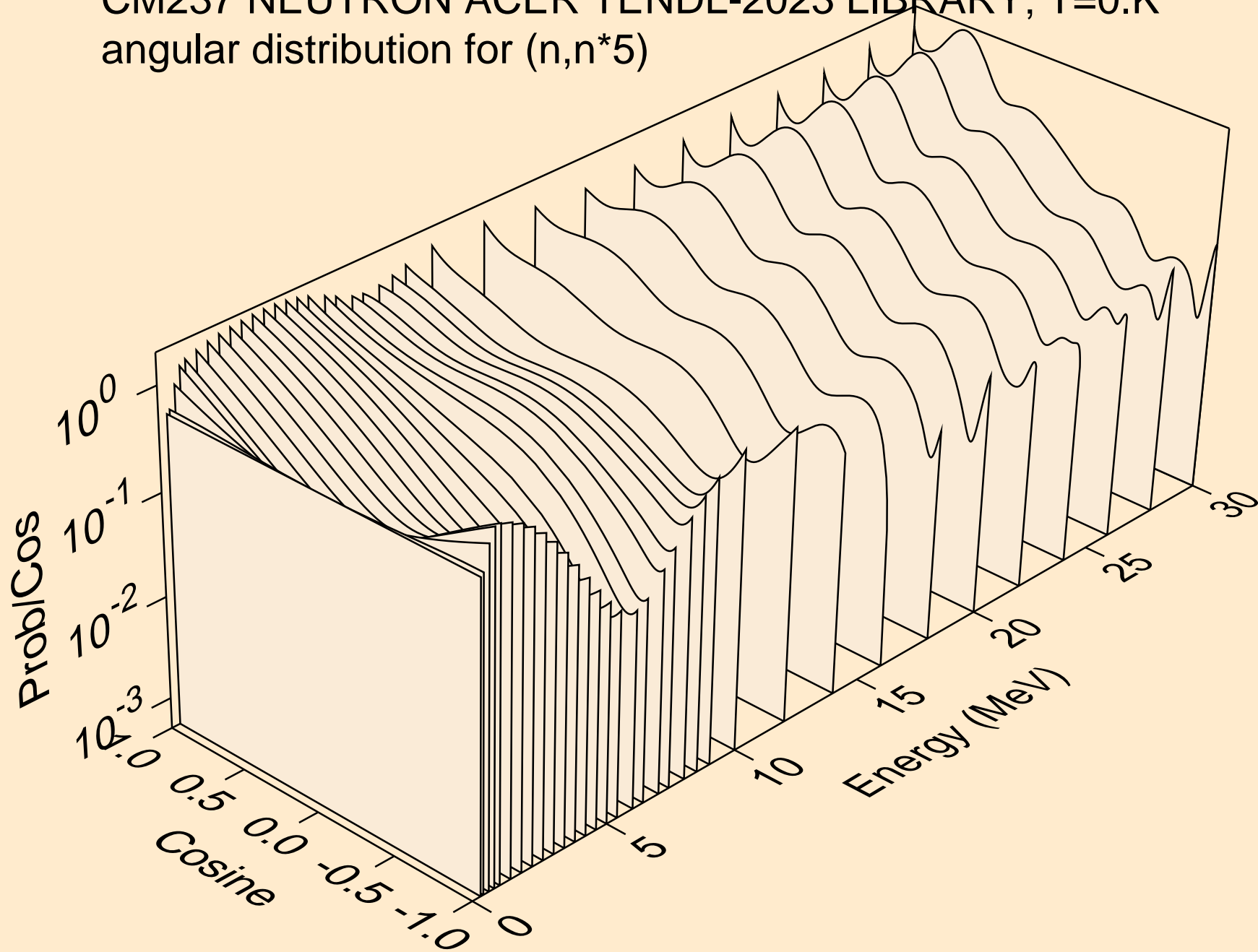

CM237 NEUTRON ACER TENDL-2023 LIBRARY; T=0.K  
angular distribution for (n,n\*6)

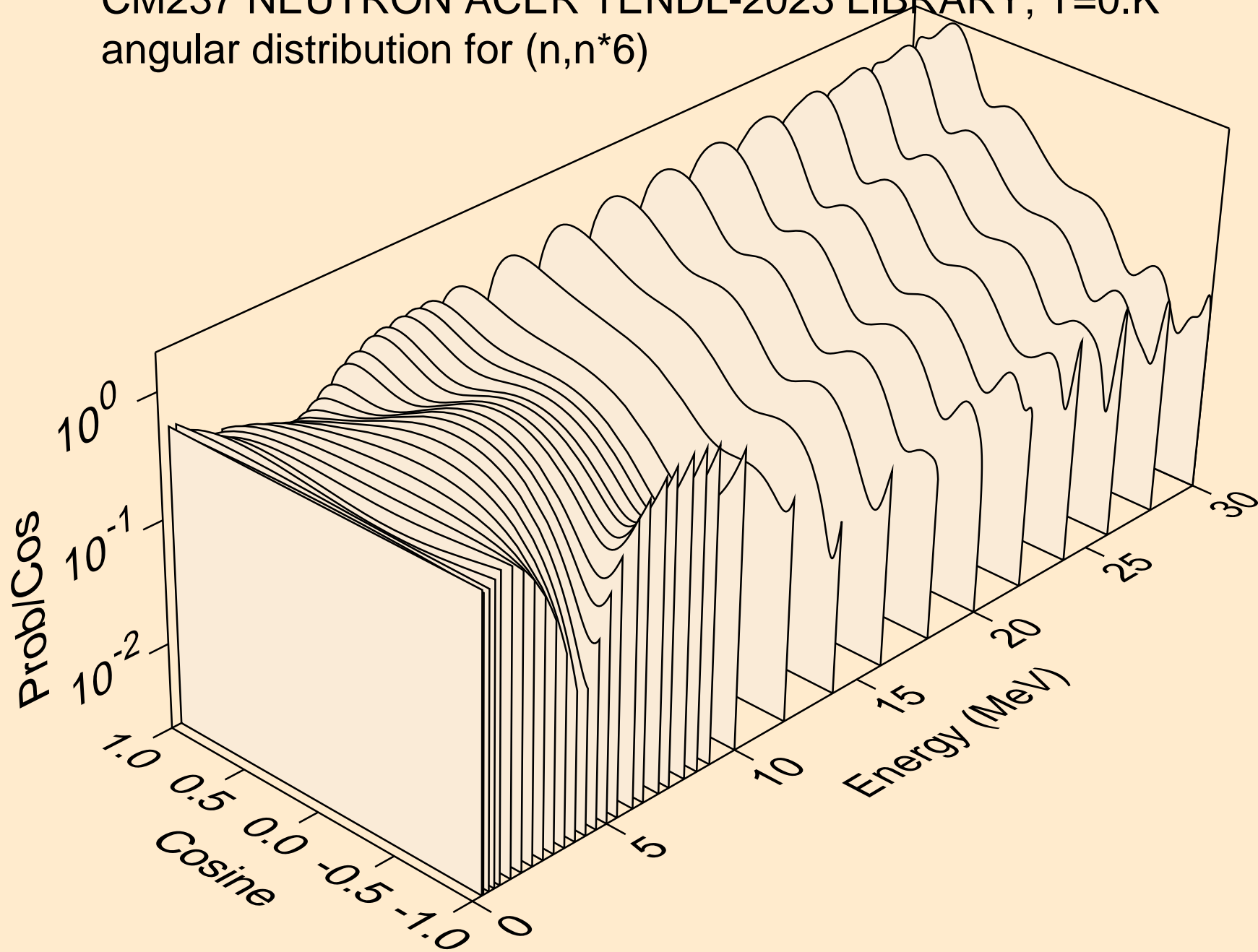

CM237 NEUTRON ACER TENDL-2023 LIBRARY; T=0.K  
angular distribution for (n,n\*7)

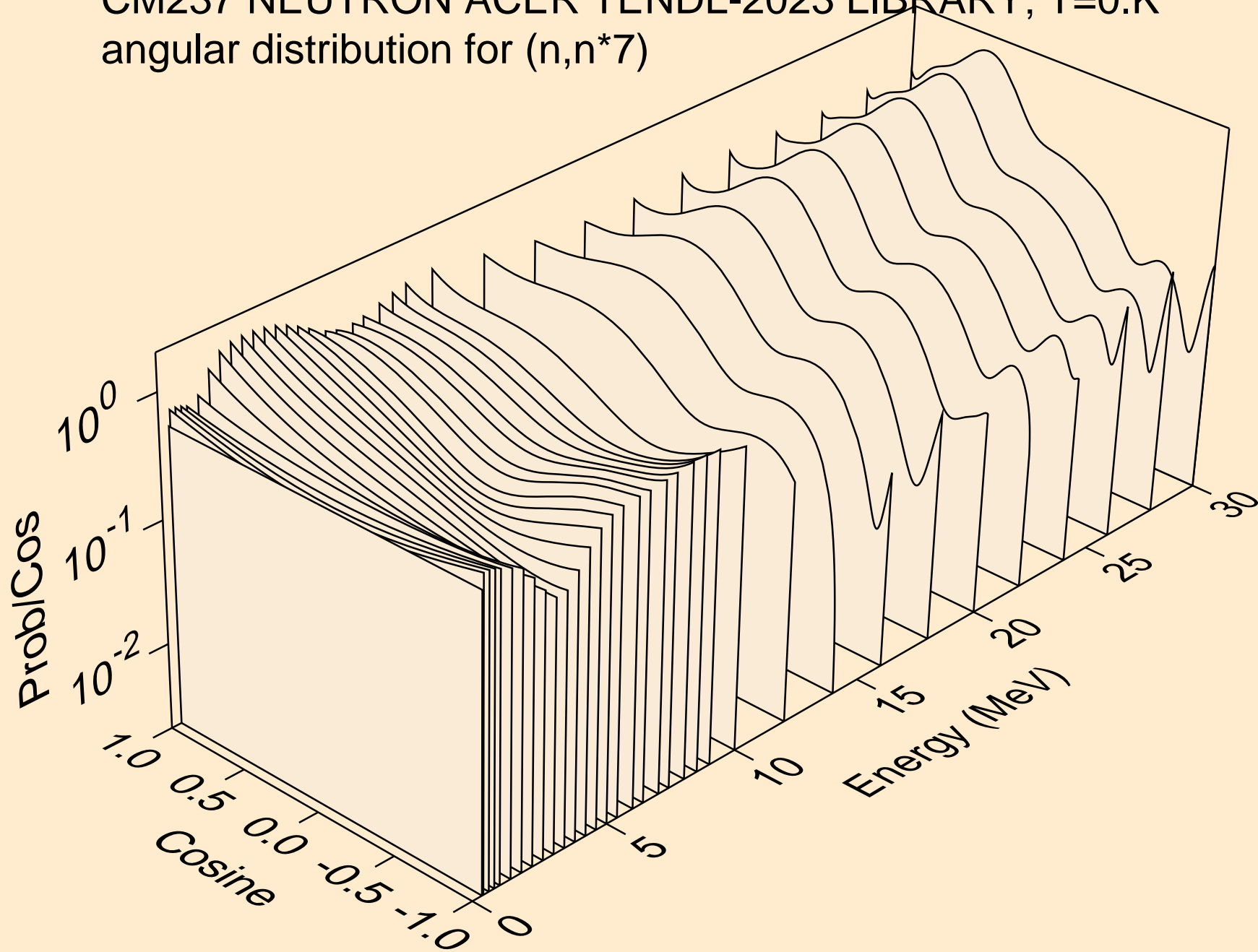

CM237 NEUTRON ACER TENDL-2023 LIBRARY; T=0.K  
angular distribution for (n,n\*8)

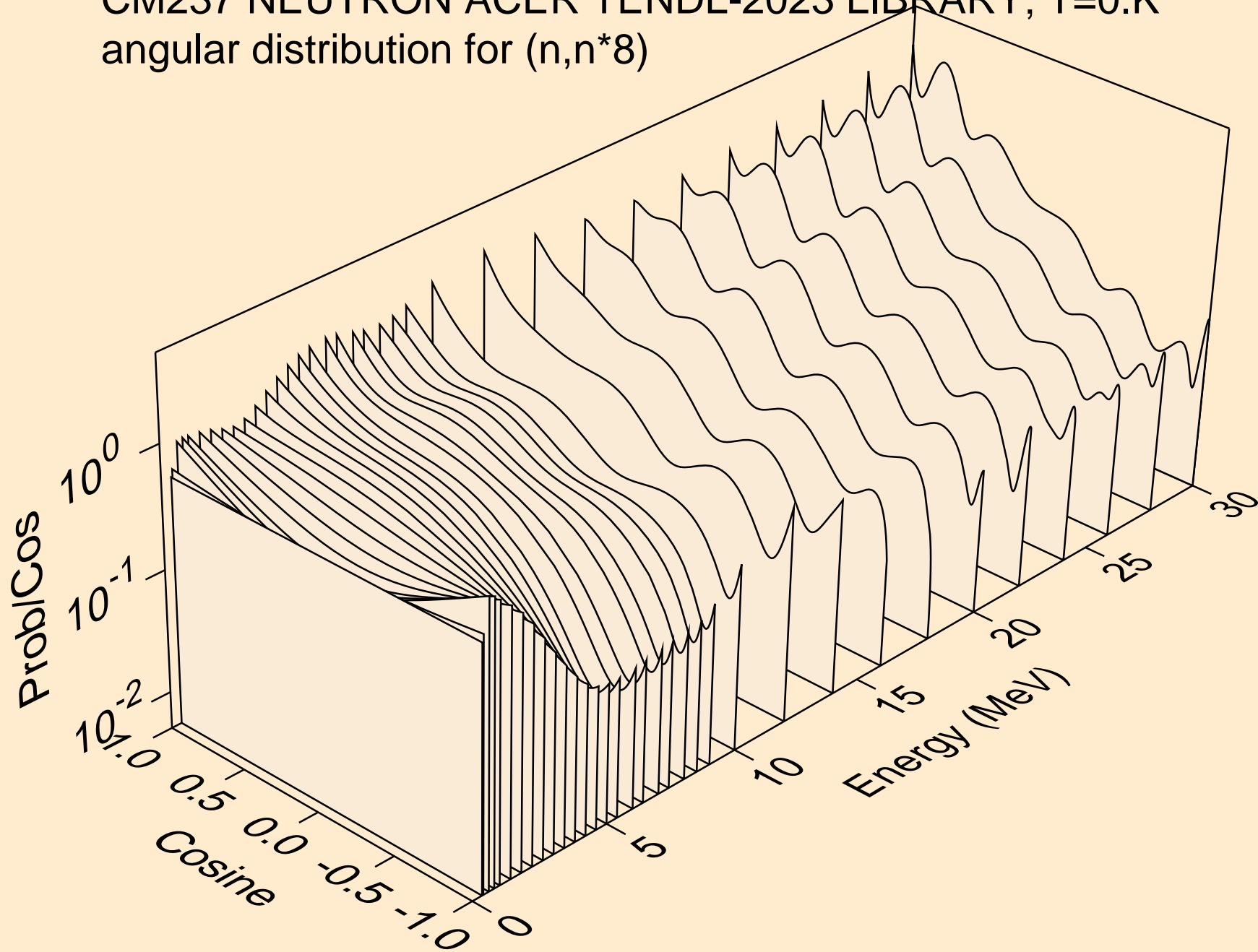

CM237 NEUTRON ACER TENDL-2023 LIBRARY; T=0.K  
angular distribution for (n,n\*9)

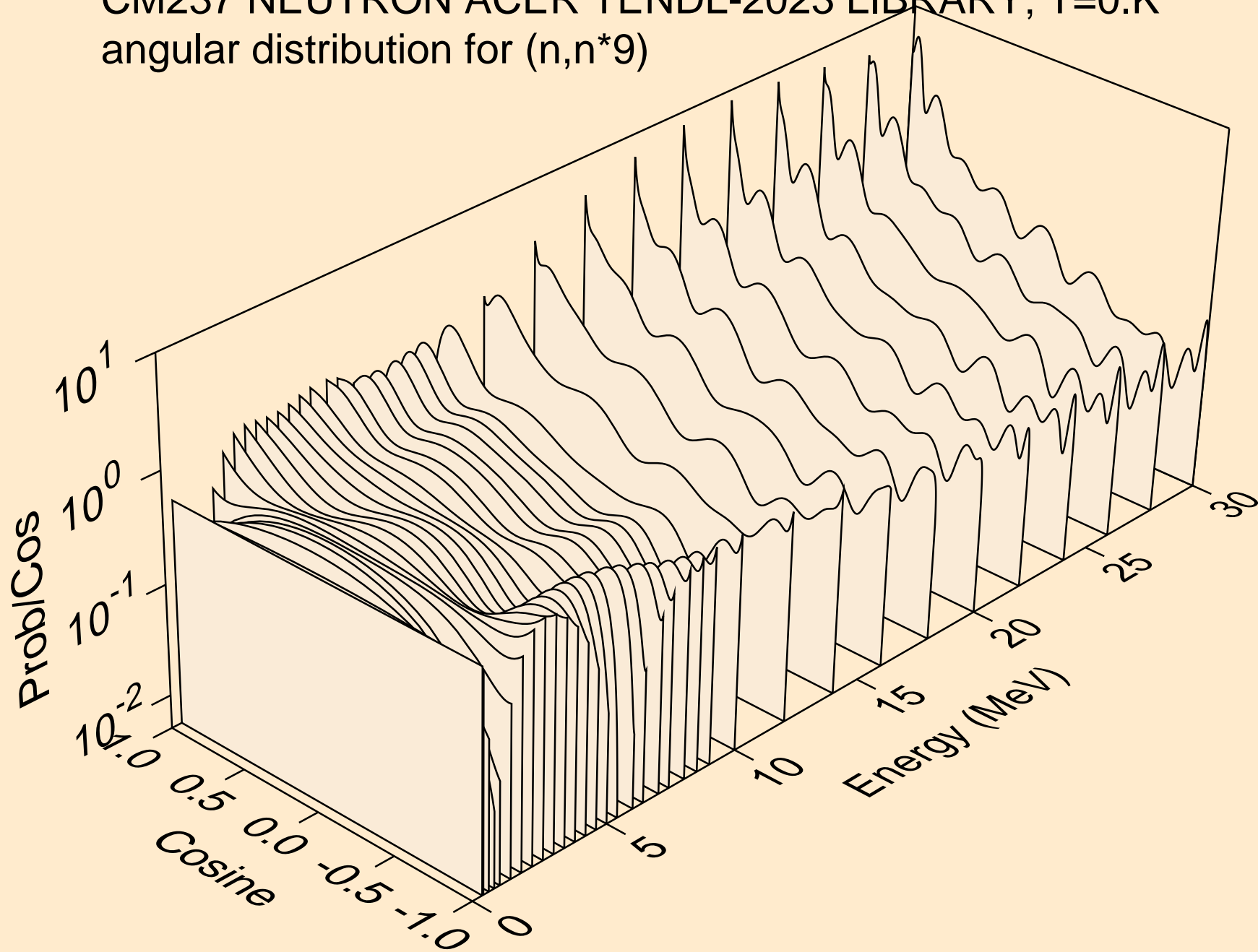

CM237 NEUTRON ACER TENDL-2023 LIBRARY; T=0.K  
angular distribution for (n,n\*10)

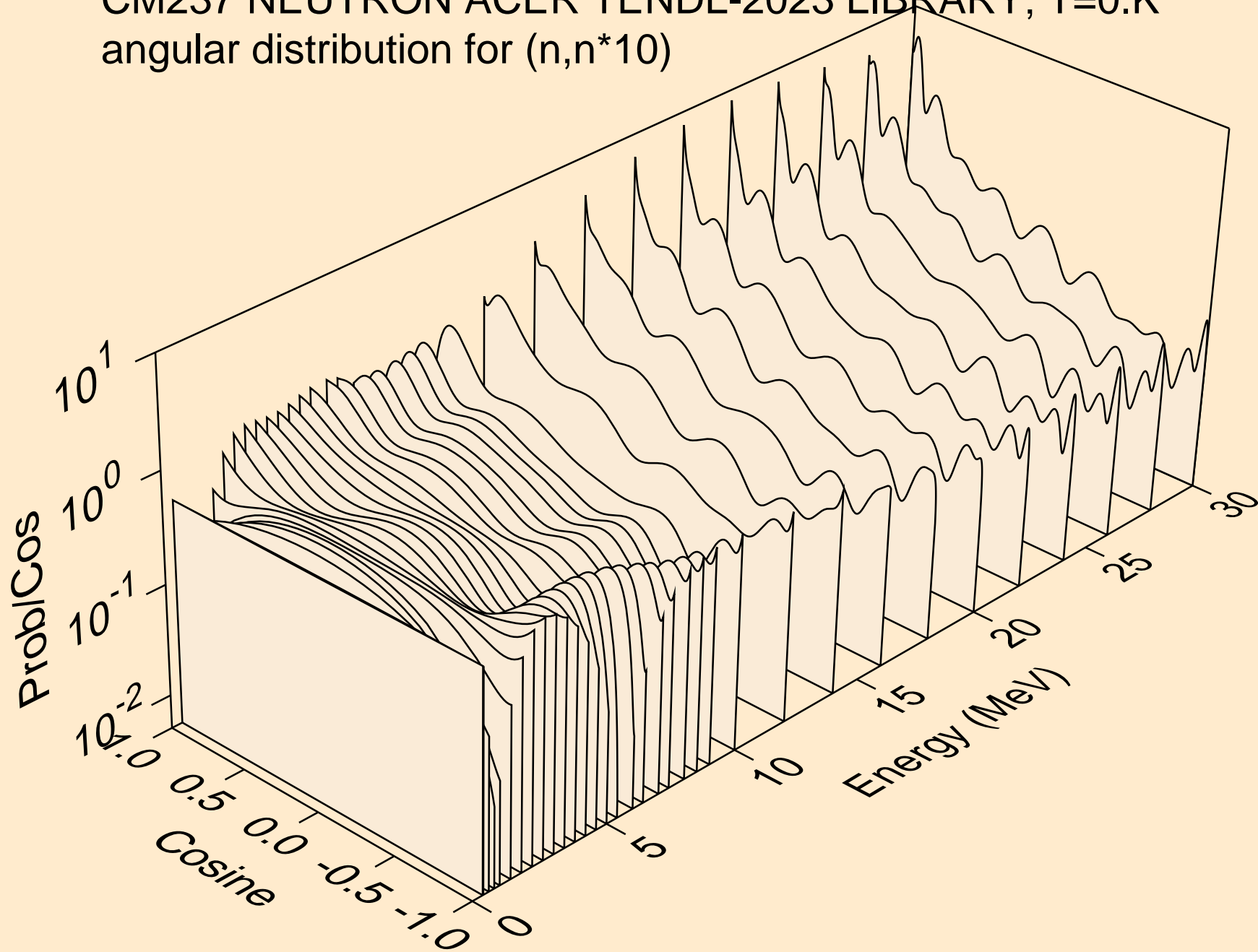

CM237 NEUTRON ACER TENDL-2023 LIBRARY; T=0.K  
angular distribution for (n,n\*11)

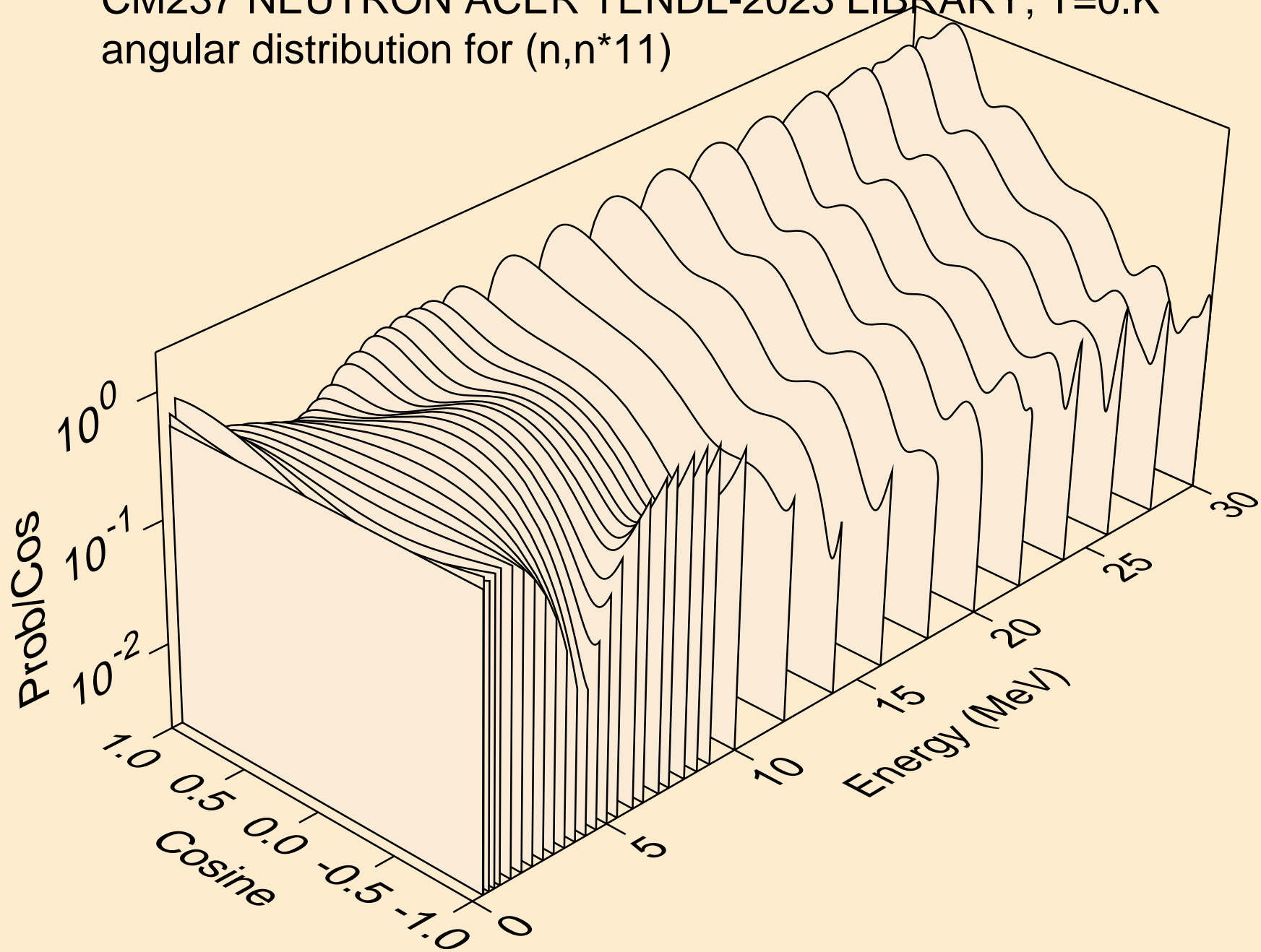

CM237 NEUTRON ACER TENDL-2023 LIBRARY; T=0.K  
angular distribution for (n,n\*12)

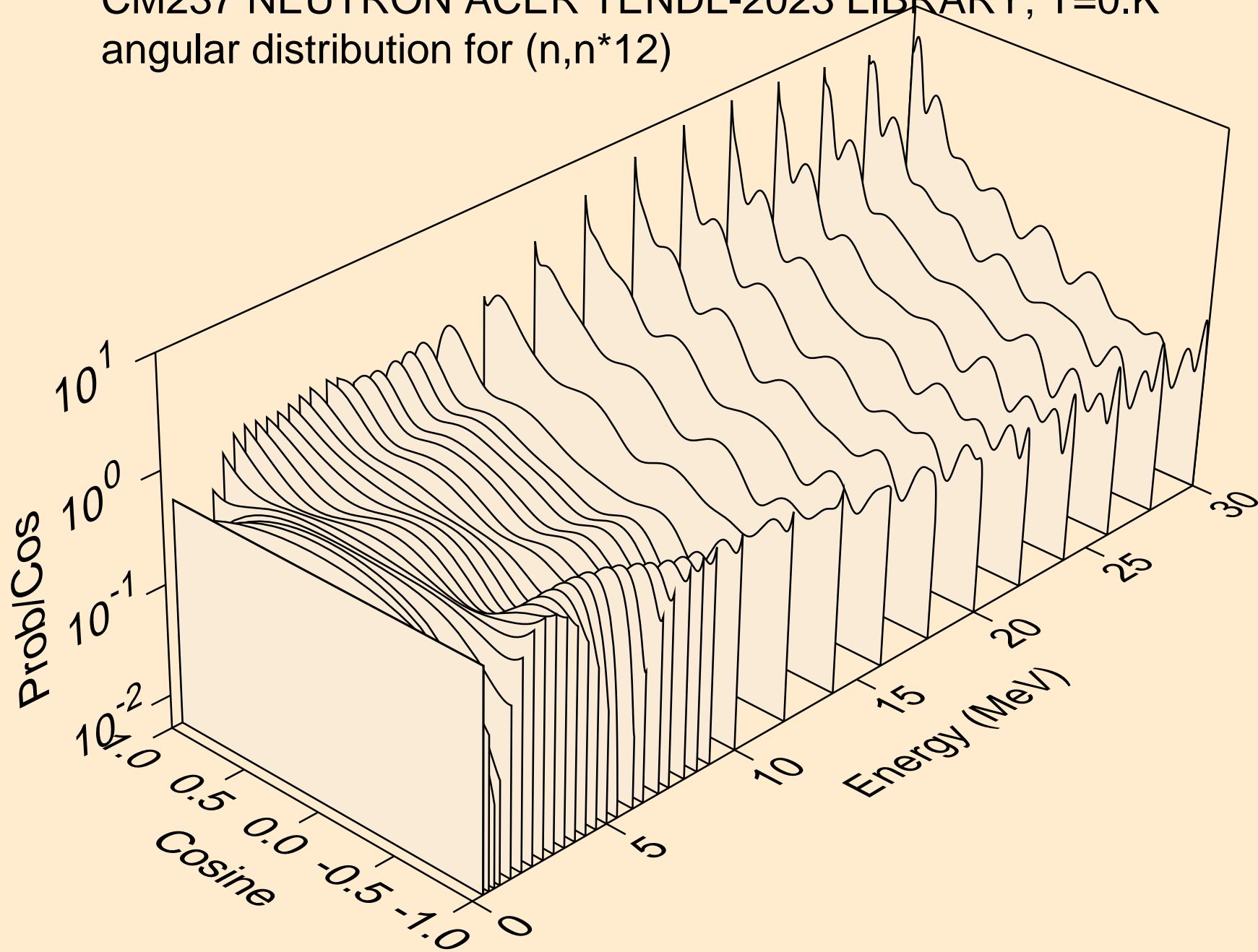

CM237 NEUTRON ACER TENDL-2023 LIBRARY; T=0.K  
angular distribution for (n,n\*13)

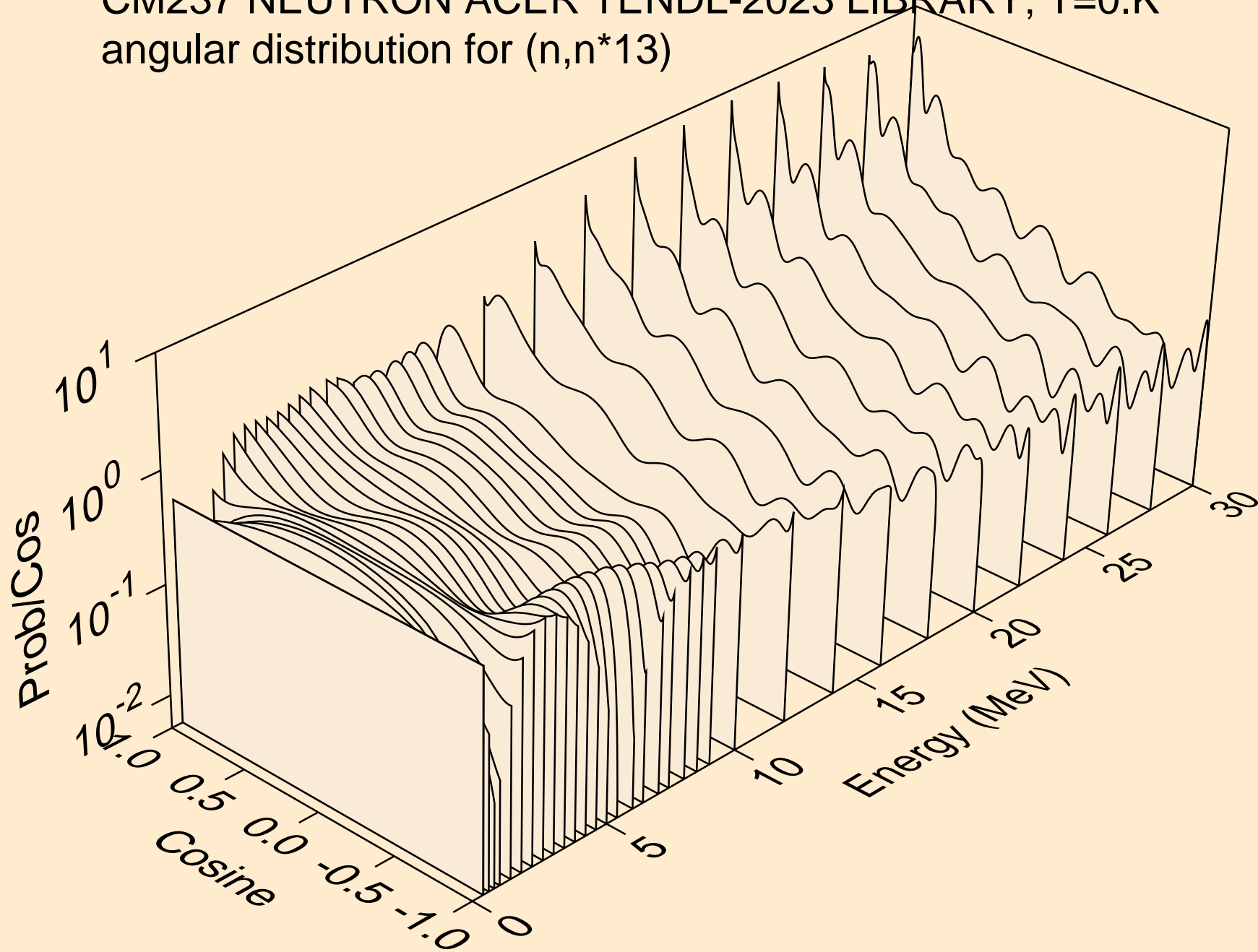

CM237 NEUTRON ACER TENDL-2023 LIBRARY; T=0.K  
angular distribution for (n,n\*14)

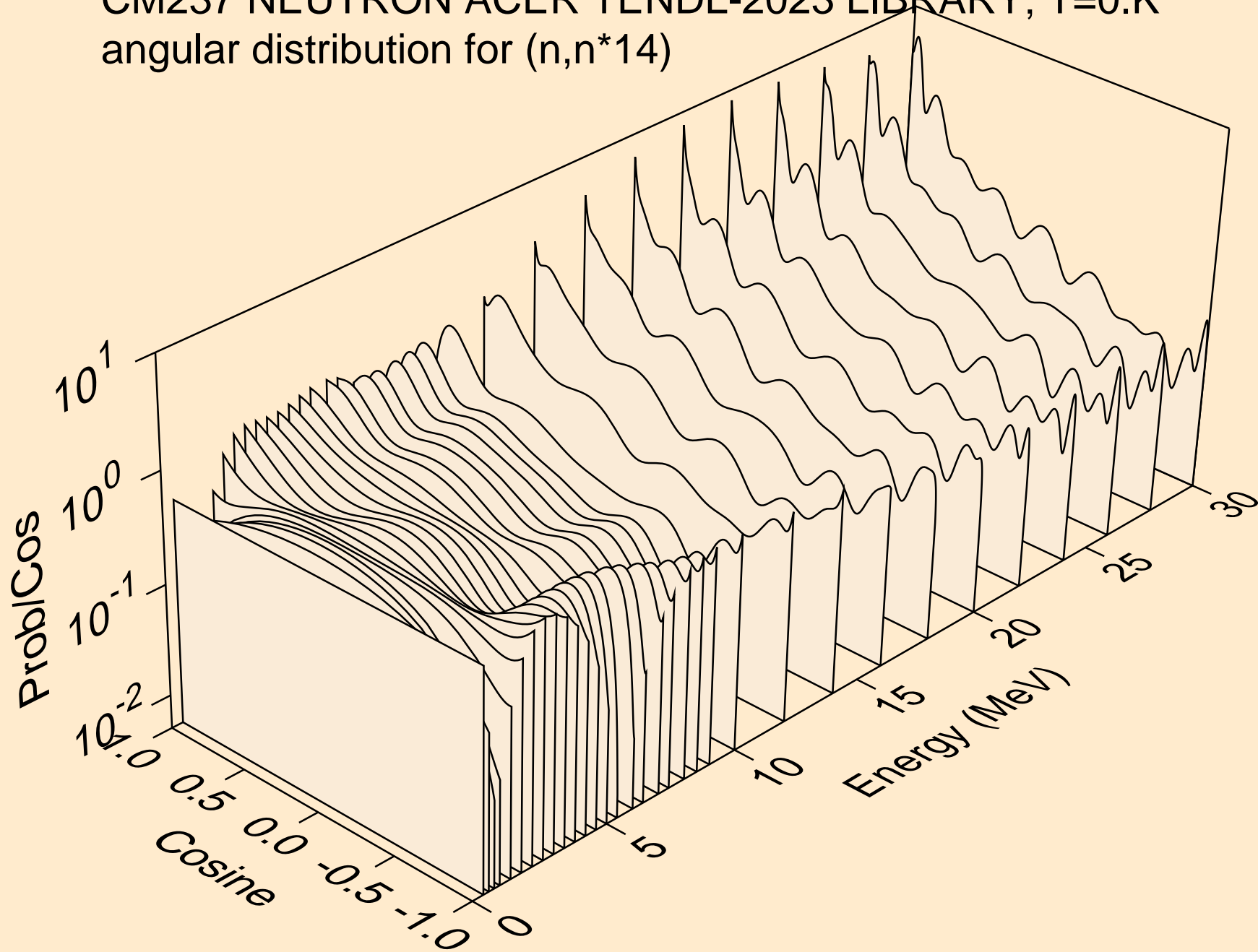

CM237 NEUTRON ACER TENDL-2023 LIBRARY; T=0.K  
angular distribution for (n,n\*15)

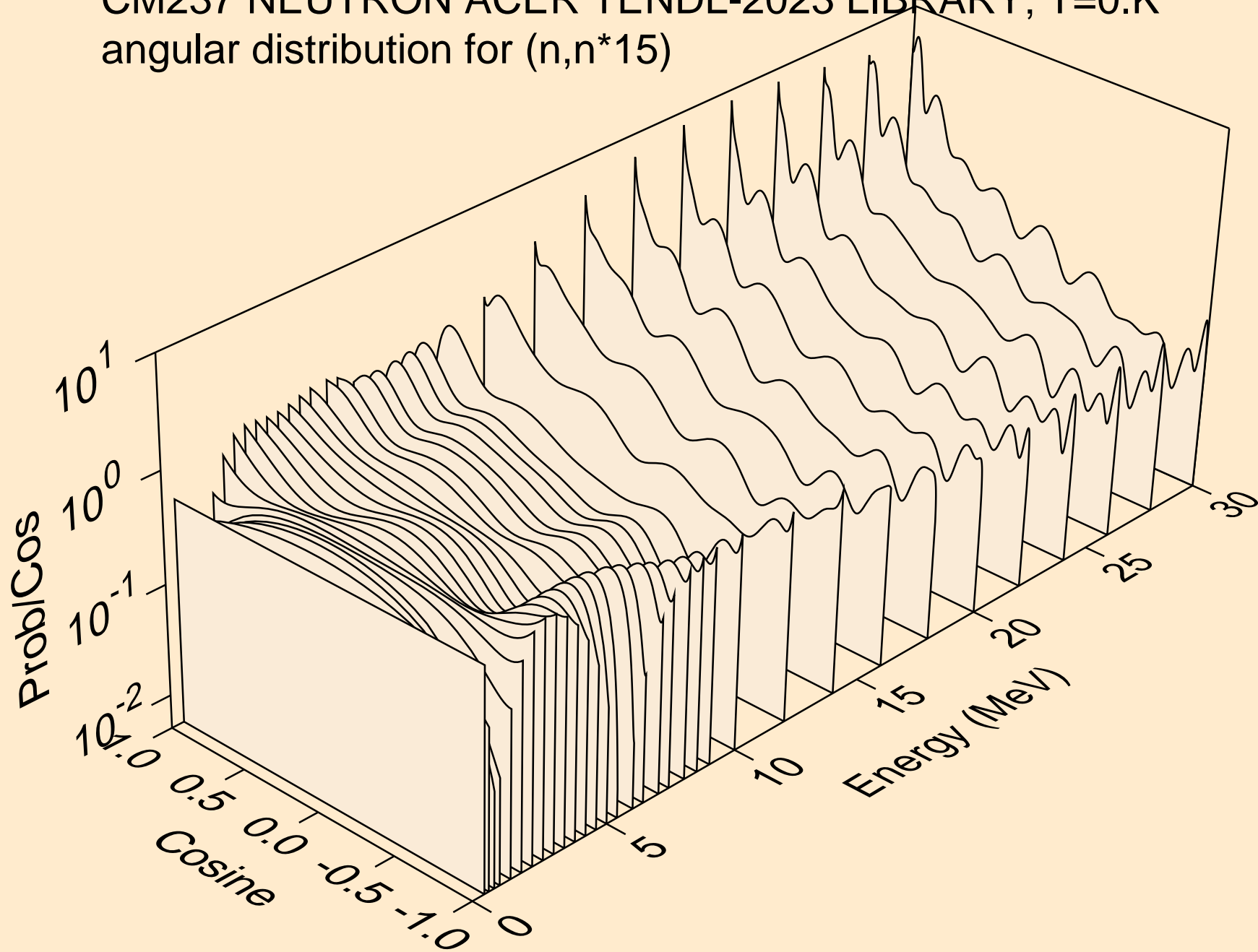

CM237 NEUTRON ACER TENDL-2023 LIBRARY; T=0.K  
angular distribution for (n,n\*16)

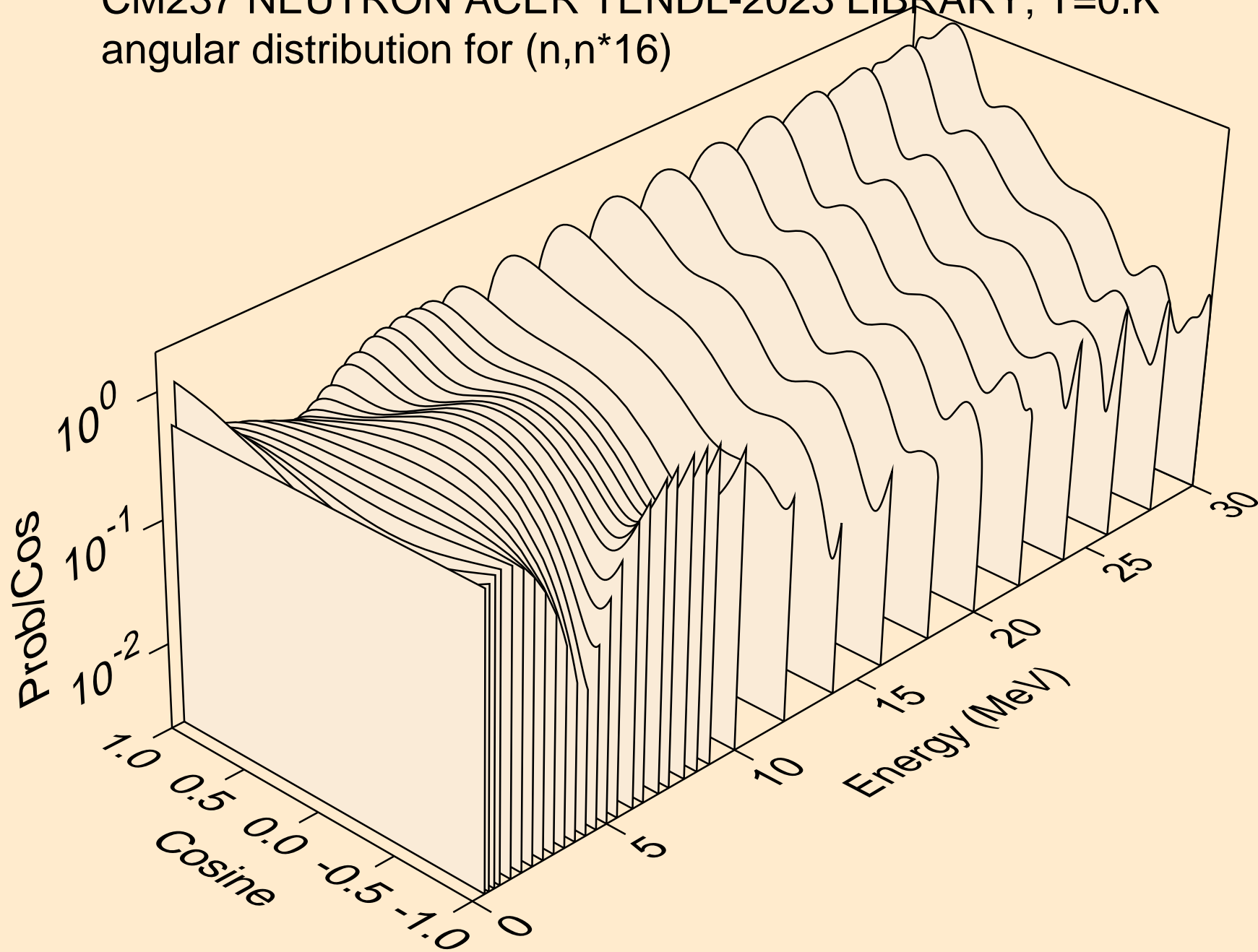

CM237 NEUTRON ACER TENDL-2023 LIBRARY; T=0.K  
angular distribution for (n,n\*17)

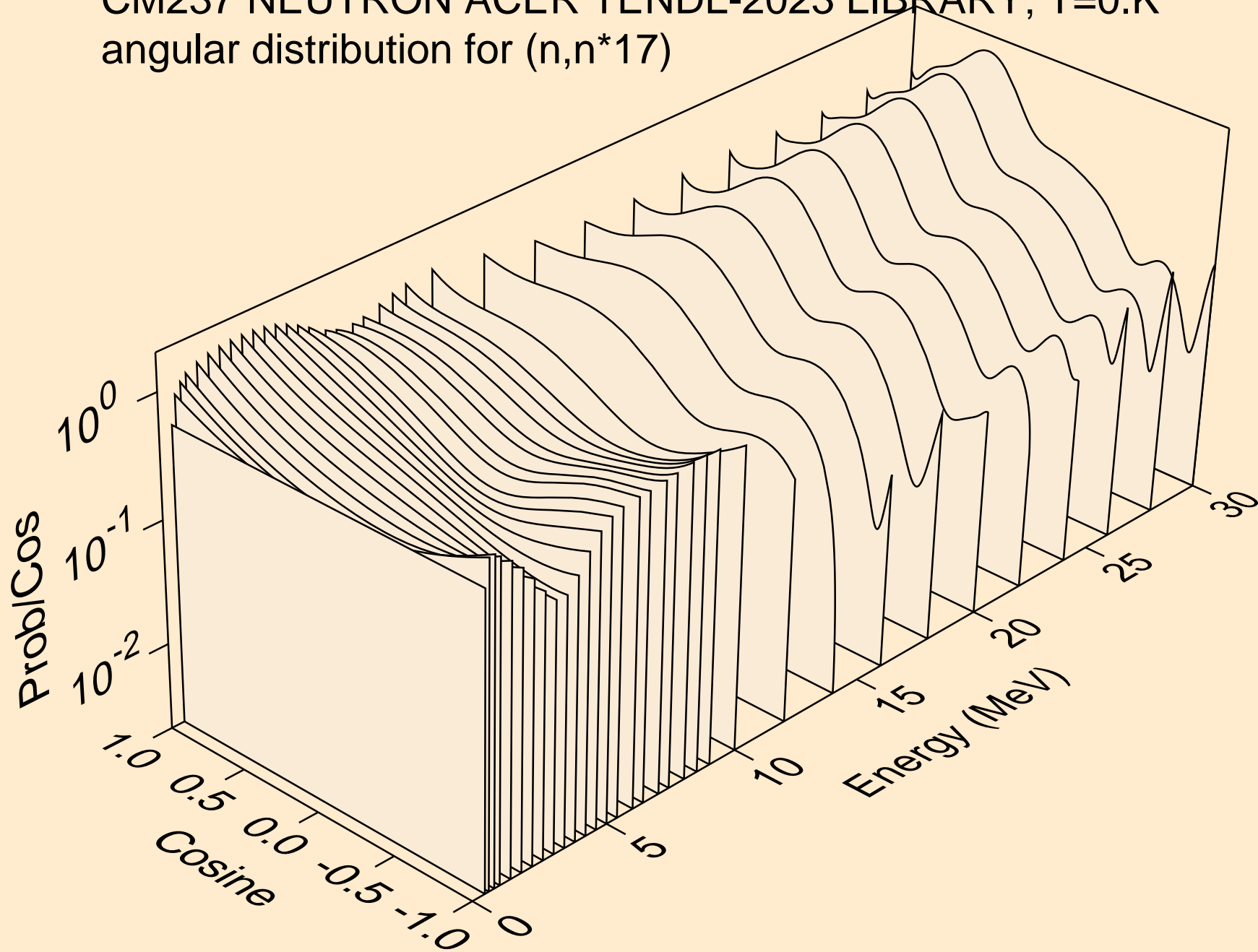

CM237 NEUTRON ACER TENDL-2023 LIBRARY; T=0.K  
angular distribution for (n,n\*18)

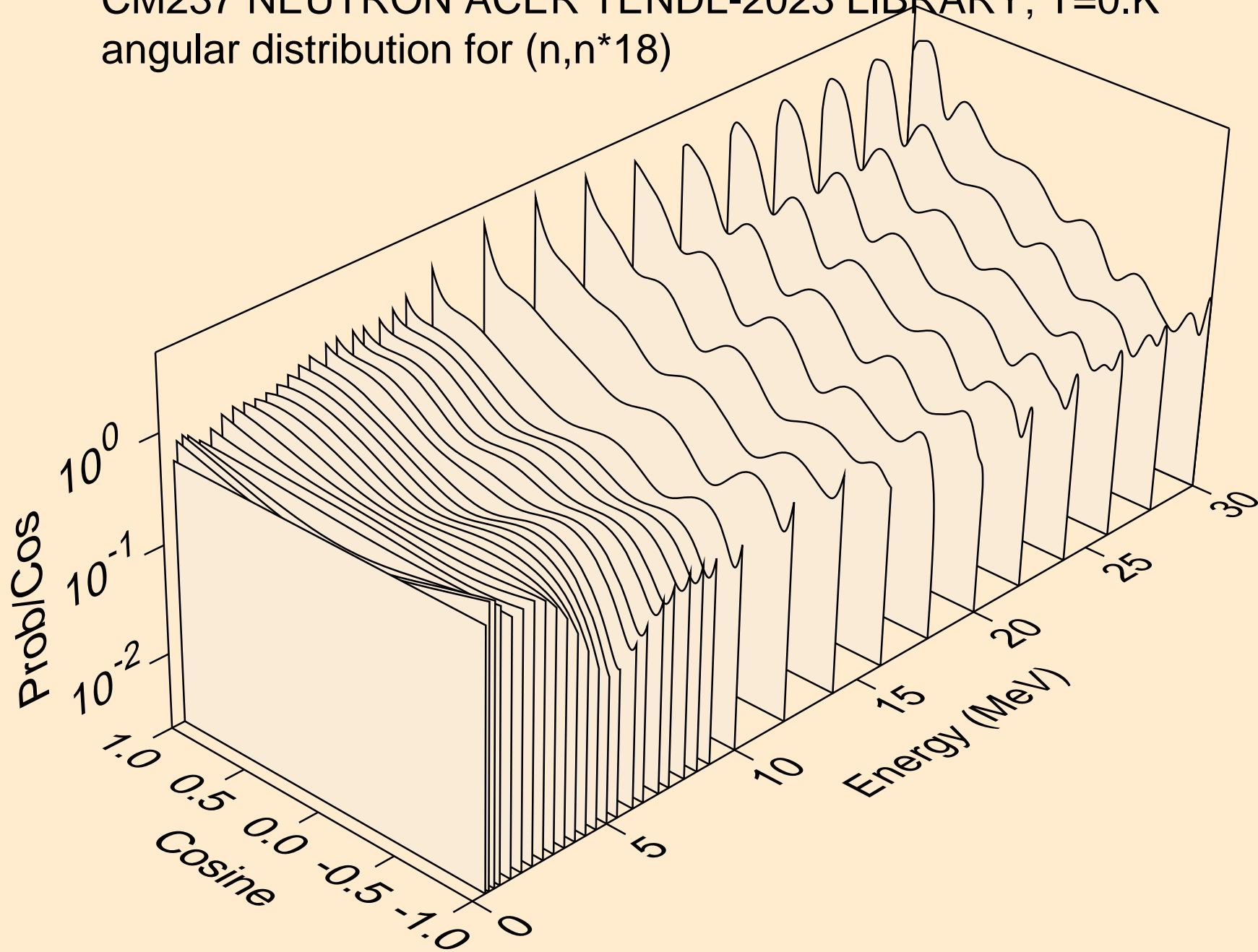

CM237 NEUTRON ACER TENDL-2023 LIBRARY; T=0.K  
angular distribution for (n,n\*19)

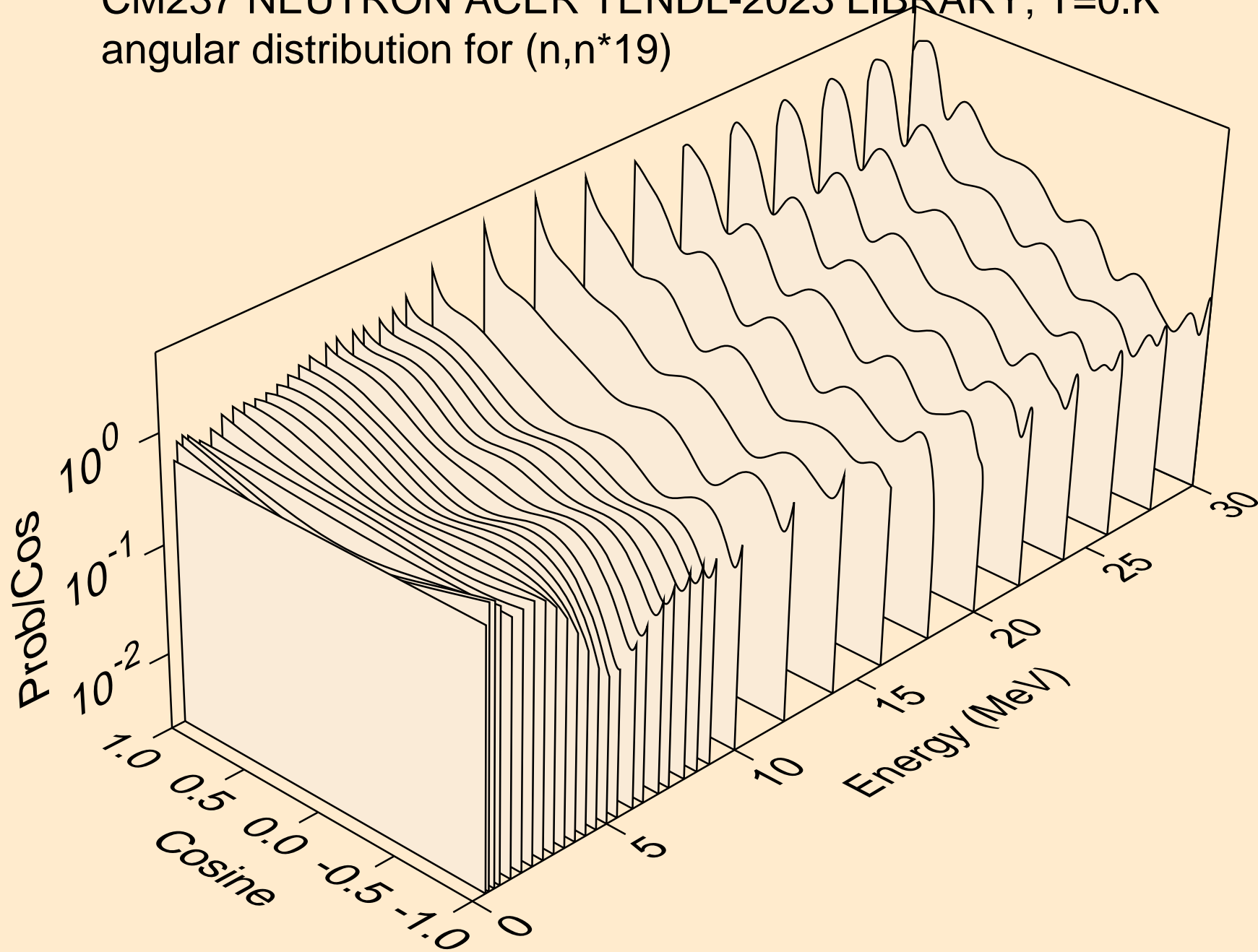

CM237 NEUTRON ACER TENDL-2023 LIBRARY; T=0.K  
angular distribution for (n,n\*20)

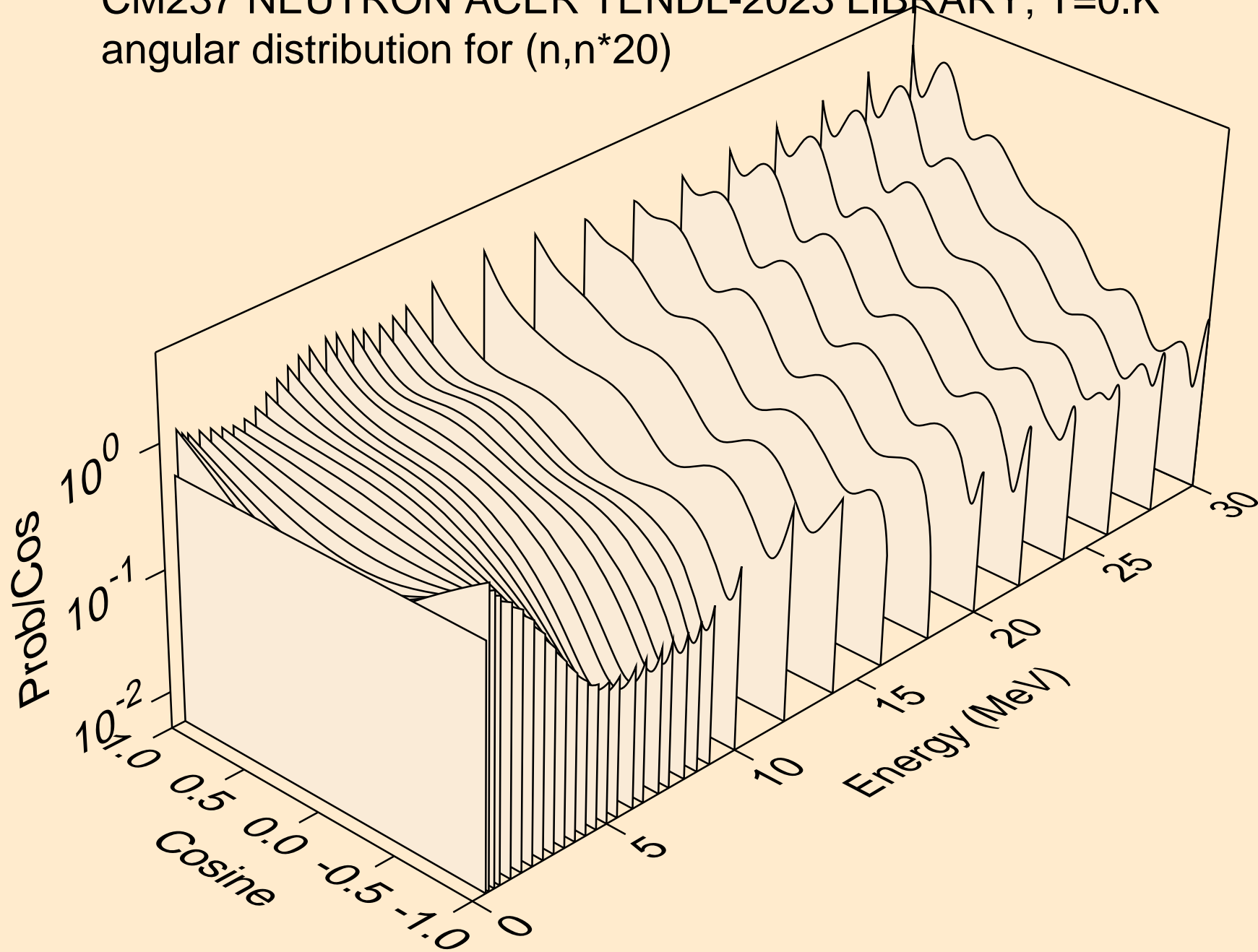

CM237 NEUTRON ACER TENDL-2023 LIBRARY; T=0.K  
angular distribution for (n,n\*21)

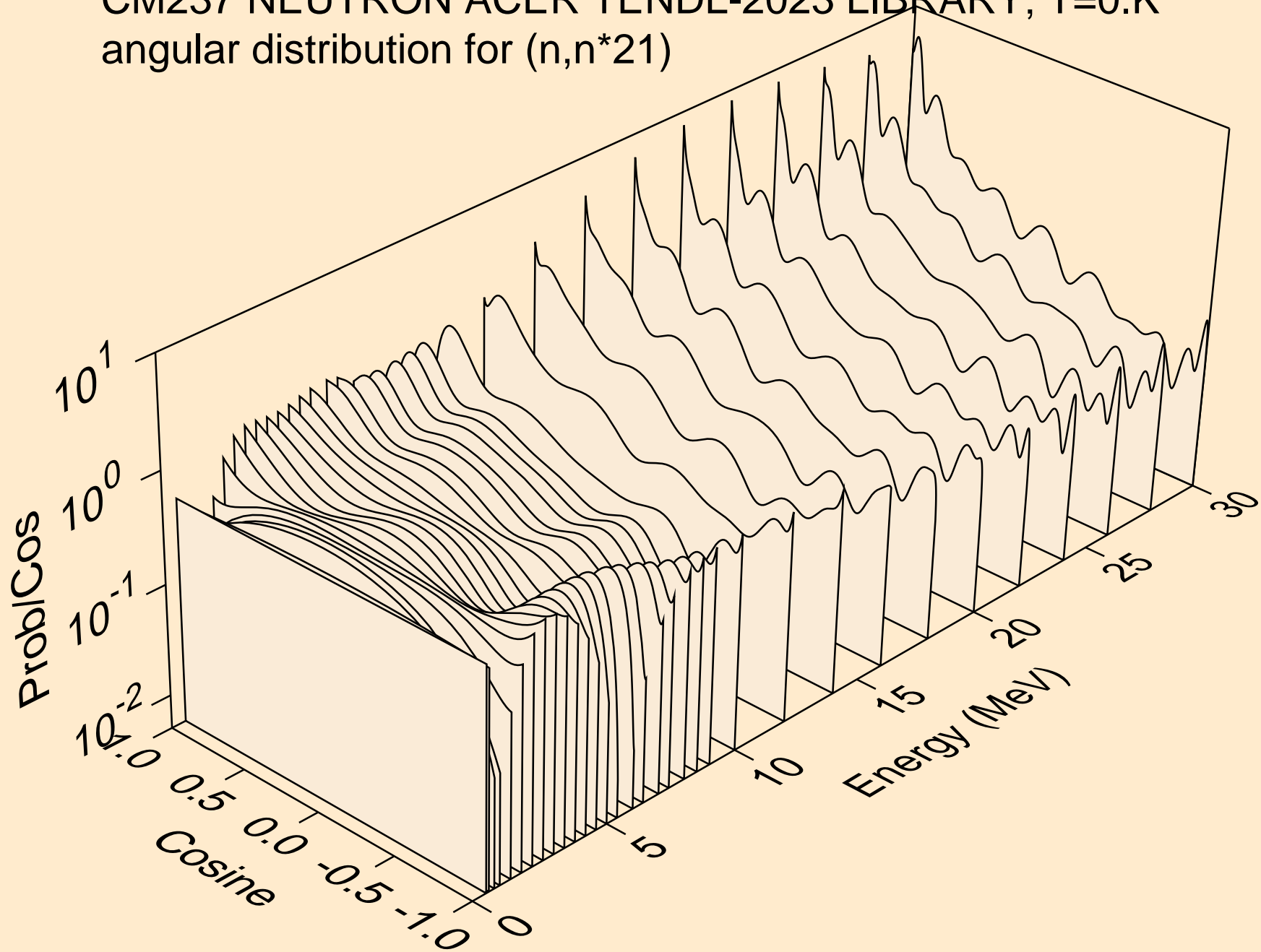

CM237 NEUTRON ACER TENDL-2023 LIBRARY; T=0.K  
angular distribution for (n,n\*22)

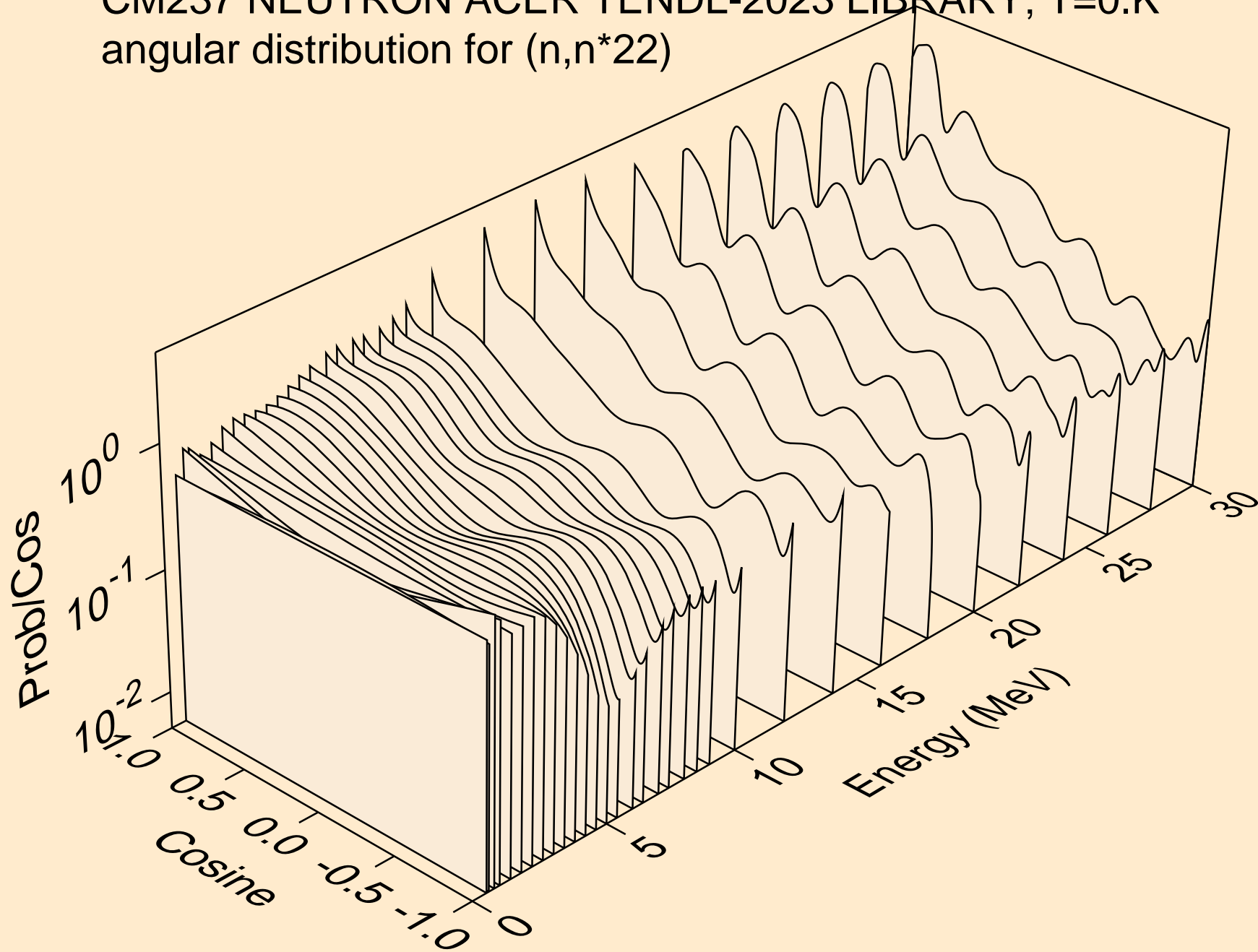

# CM237 NEUTRON ACER TENDL-2023 LIBRARY; T=0.K

## Total fission nubar

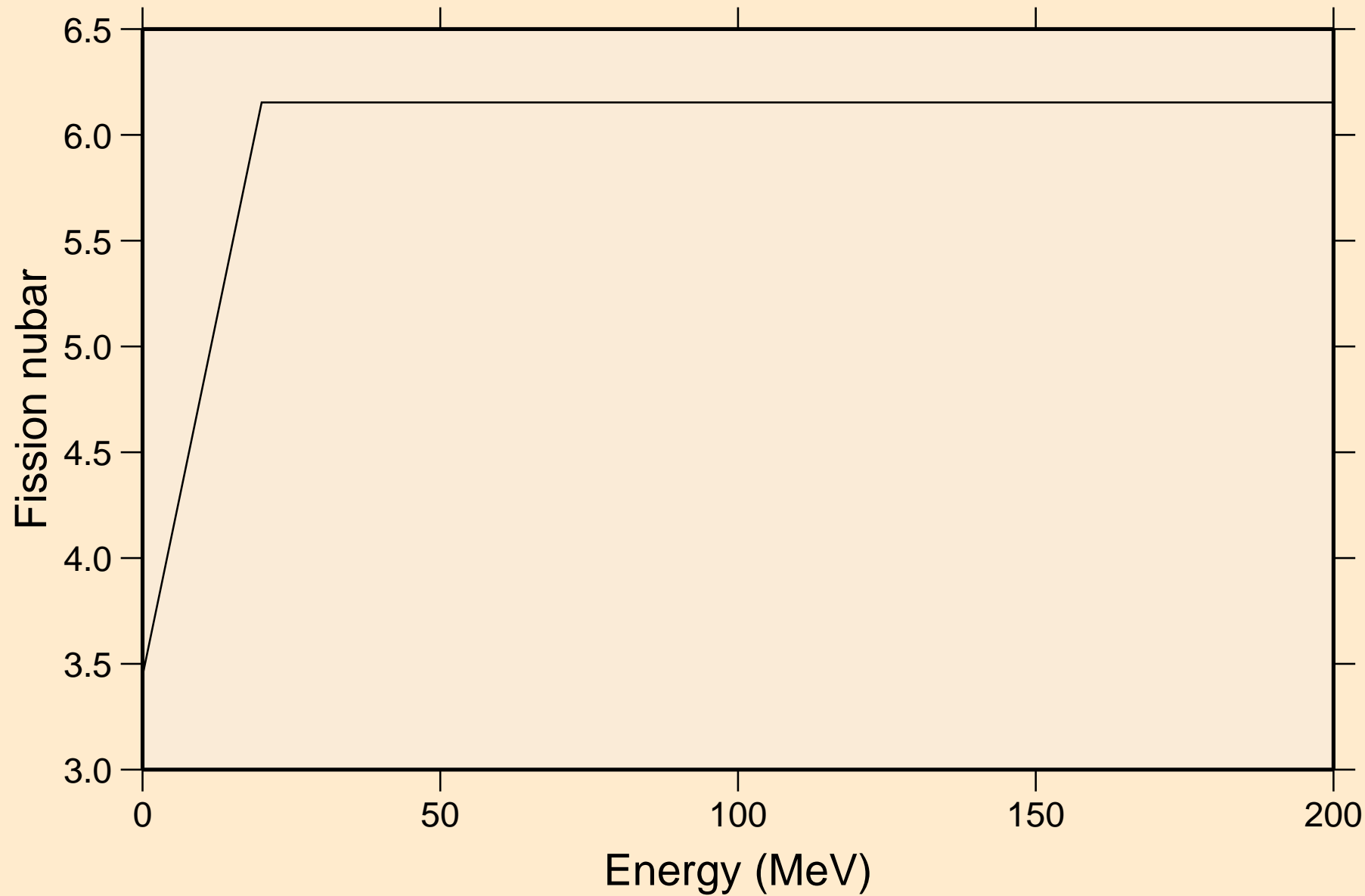

CM237 NEUTRON ACER TENDL-2023 LIBRARY; T=0.K  
Neutron emission for (n,x)

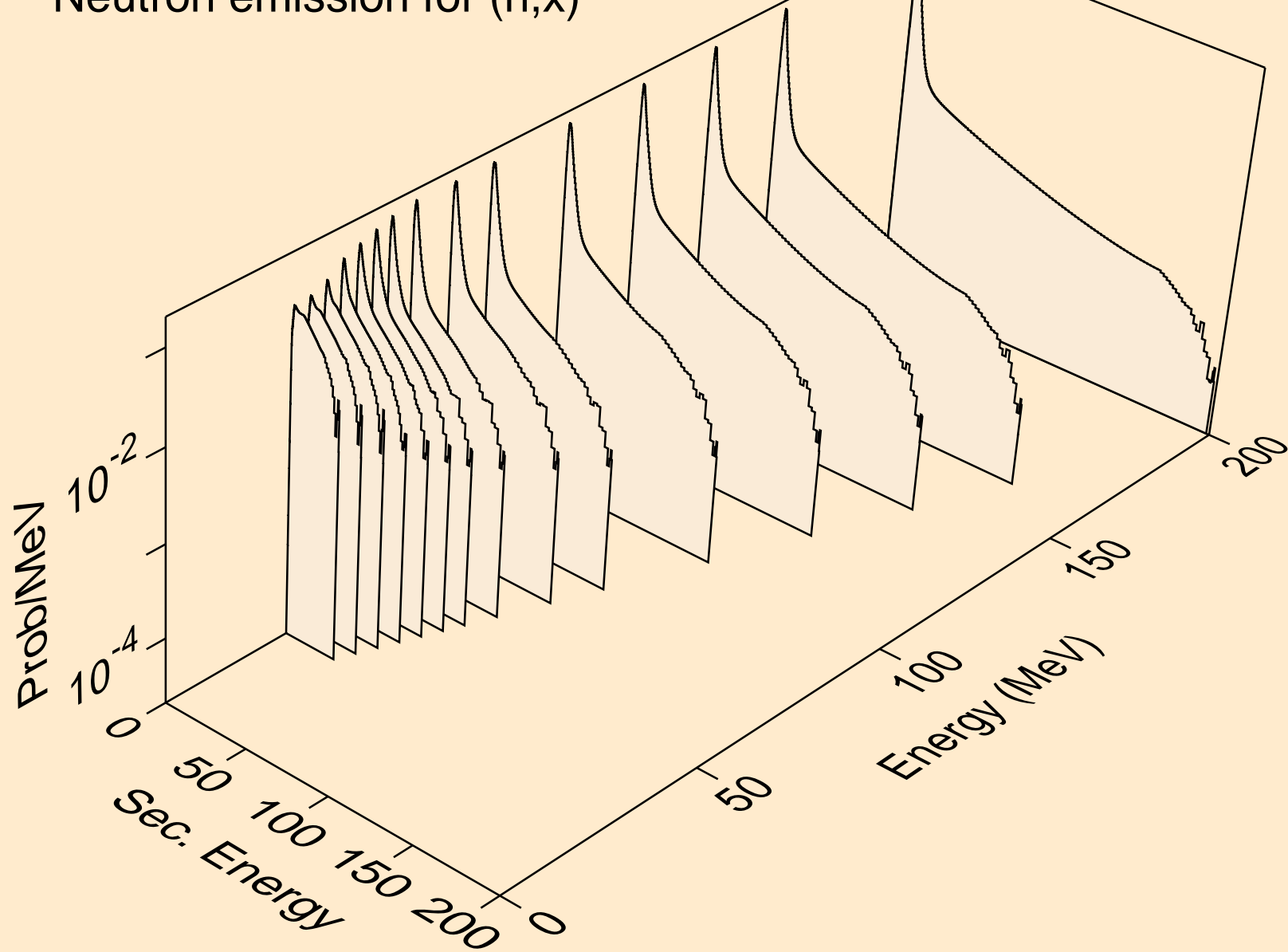

CM237 NEUTRON ACER TENDL-2023 LIBRARY; T=0.K  
Neutron emission for (n,2n)

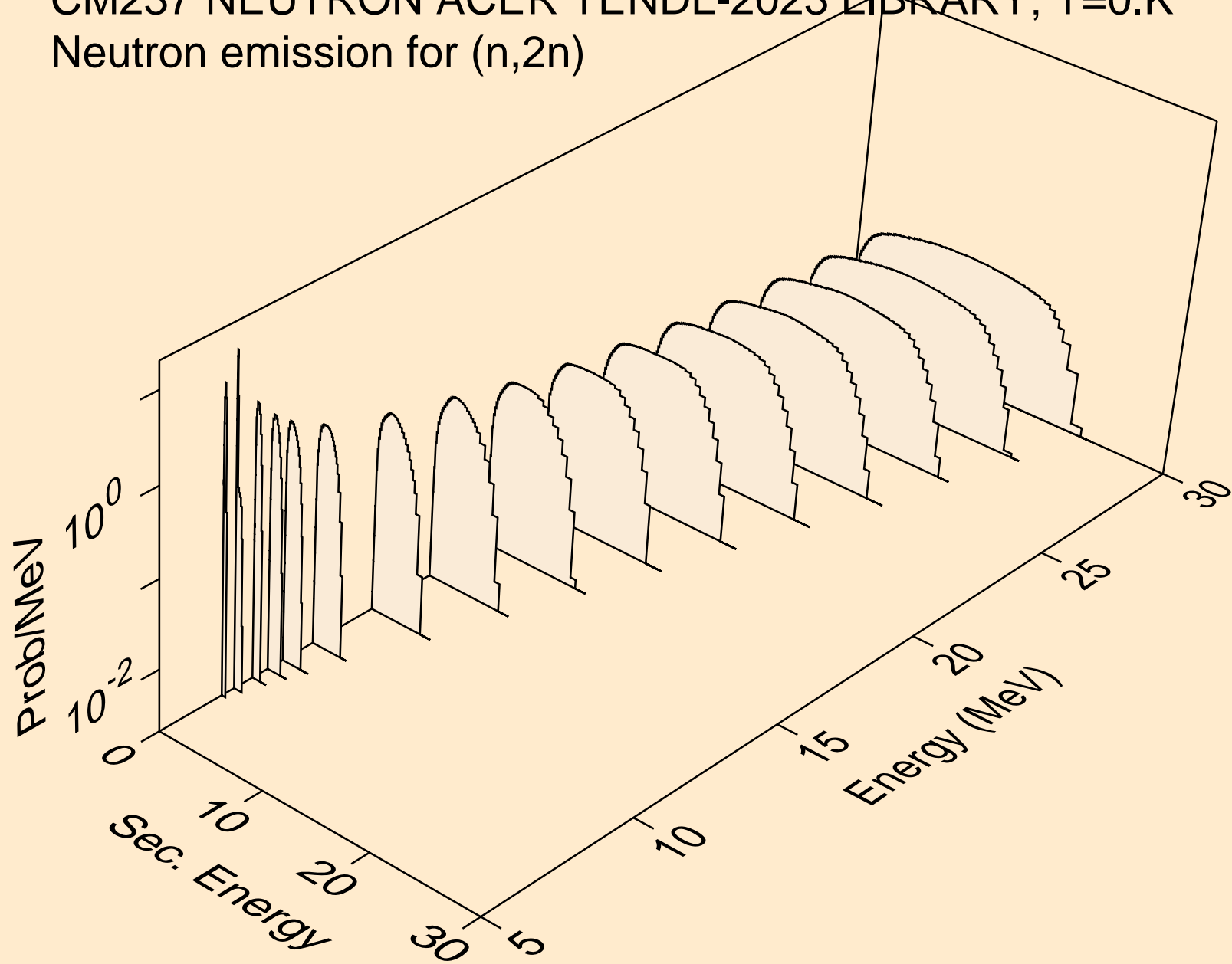

CM237 NEUTRON ACER TENDL-2023 LIBRARY; T=0.K  
Neutron emission for (n,3n)

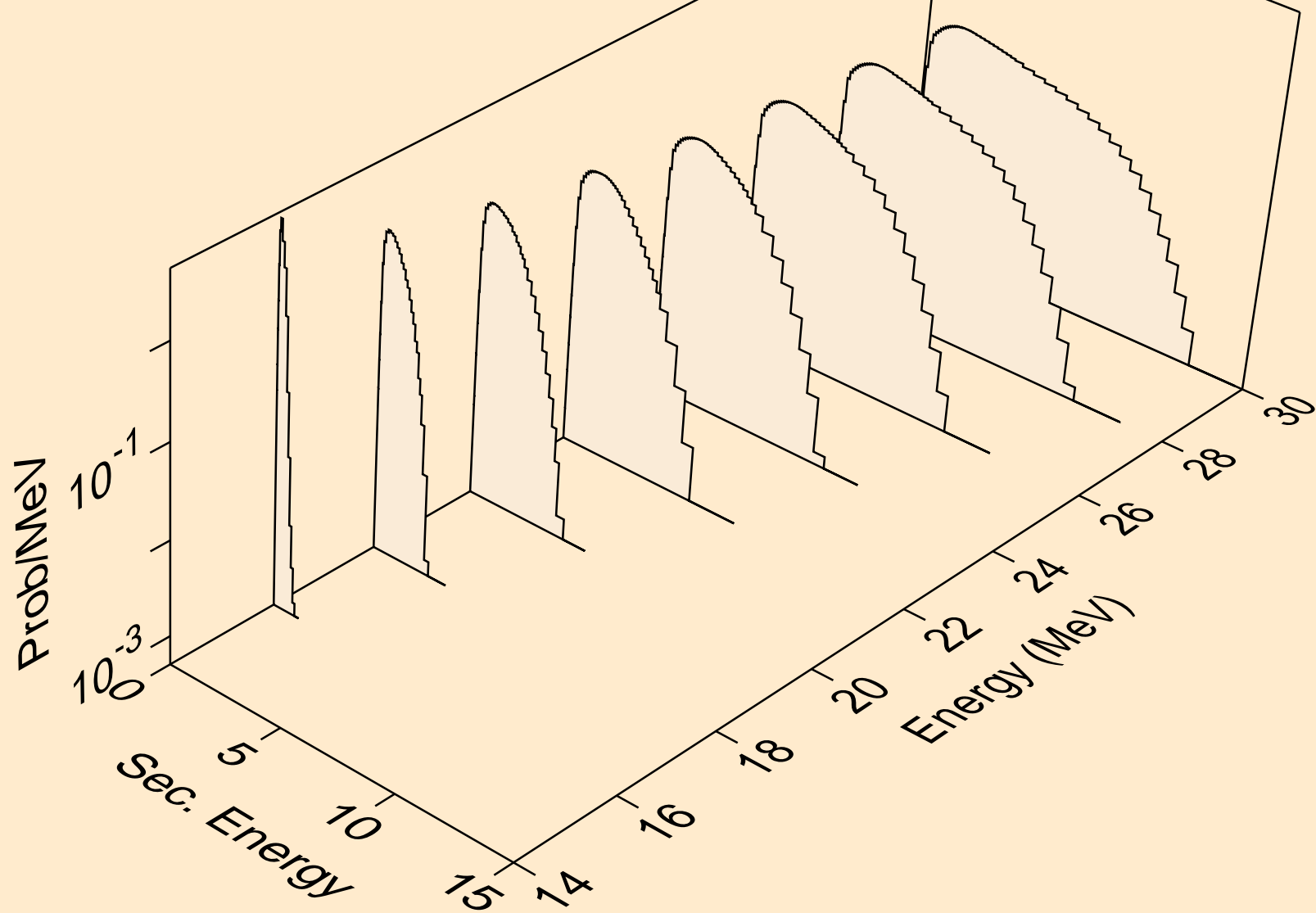

CM237 NEUTRON ACER TENDL-2023 LIBRARY; T=0.K  
Neutron emission for fission

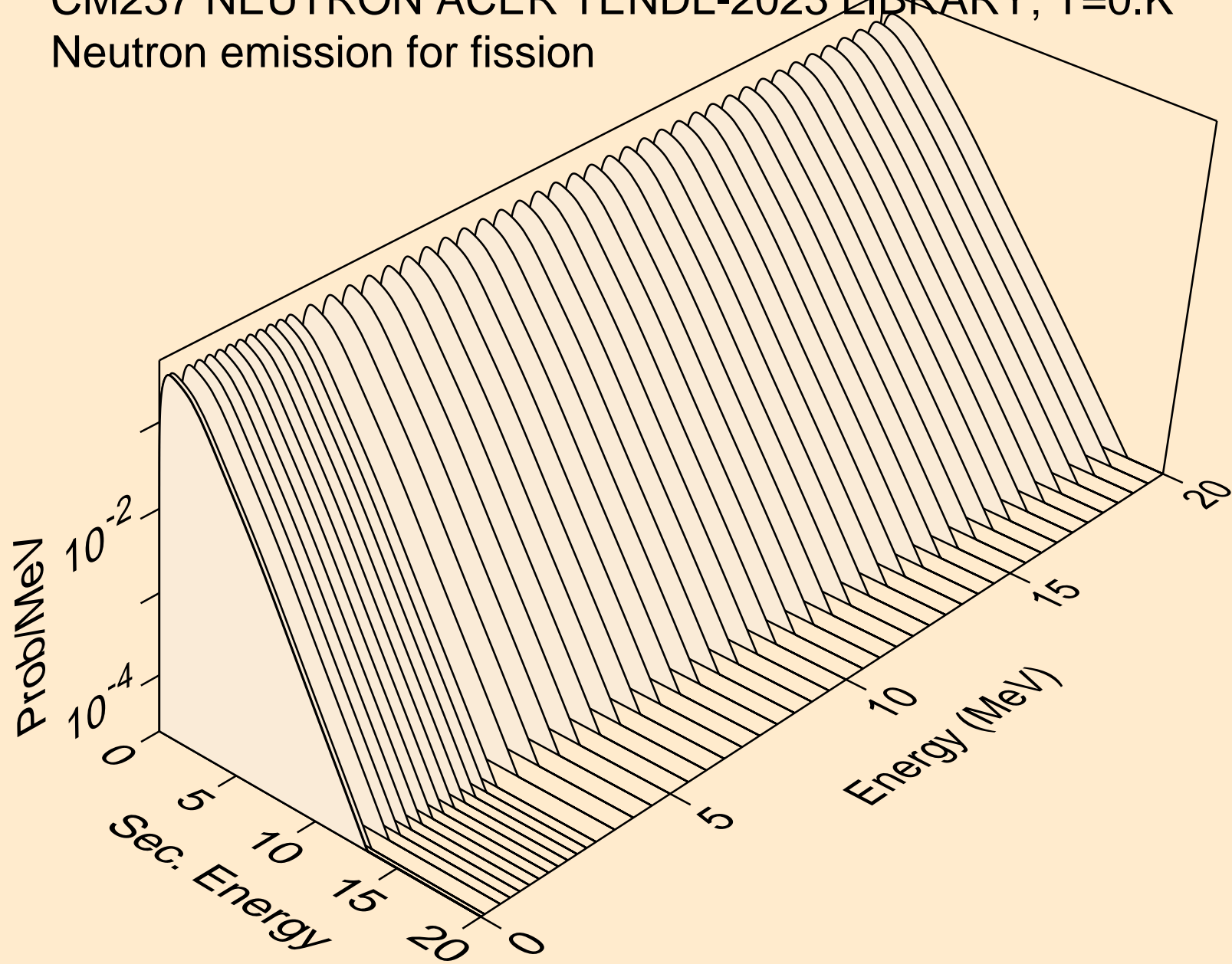

CM237 NEUTRON ACER TENDL-2023 LIBRARY; T=0.K  
Neutron emission for (n,n\*)a

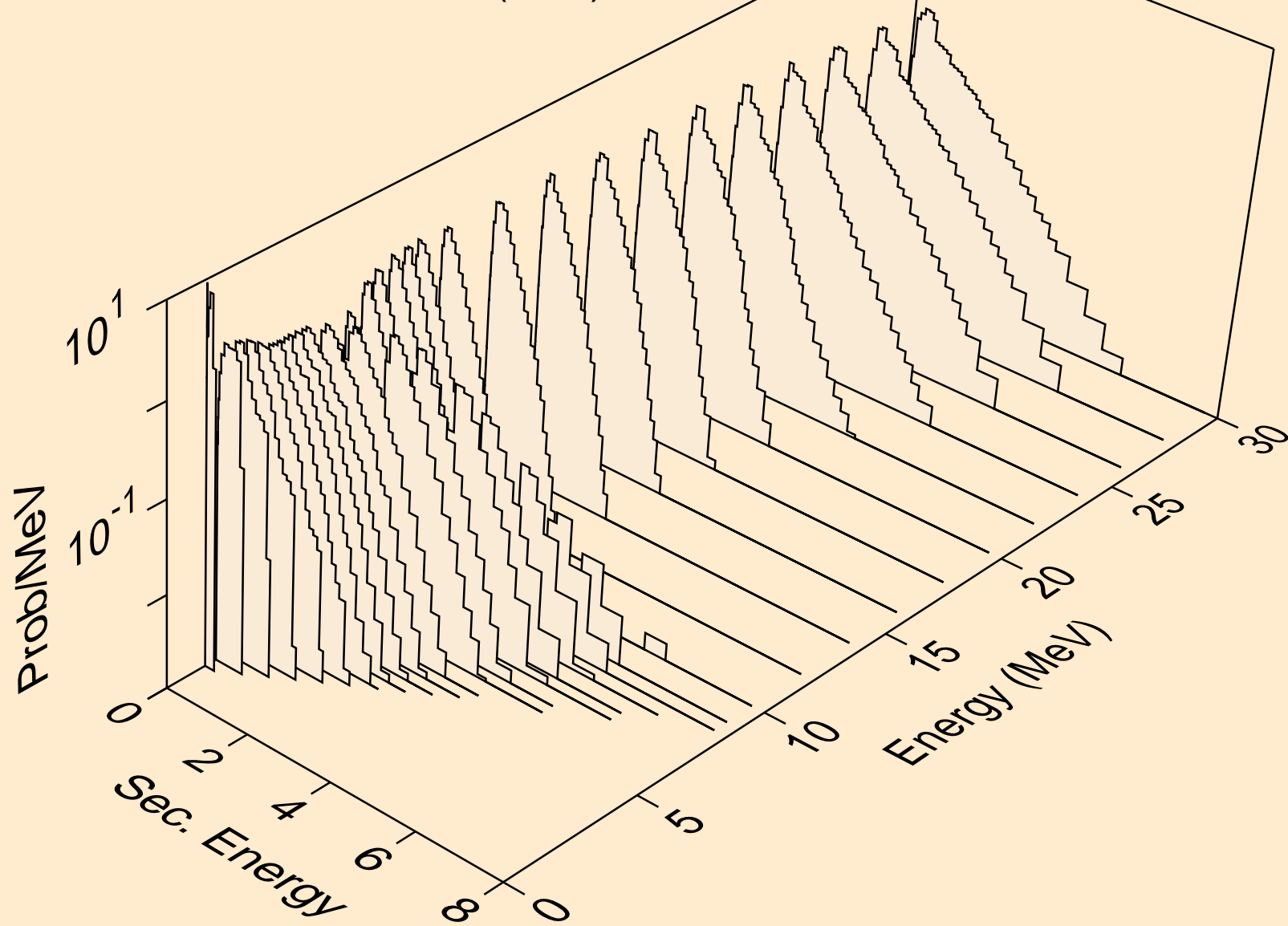

CM237 NEUTRON ACER TENDL-2023 LIBRARY; T=0.K  
Neutron emission for (n,2n)a

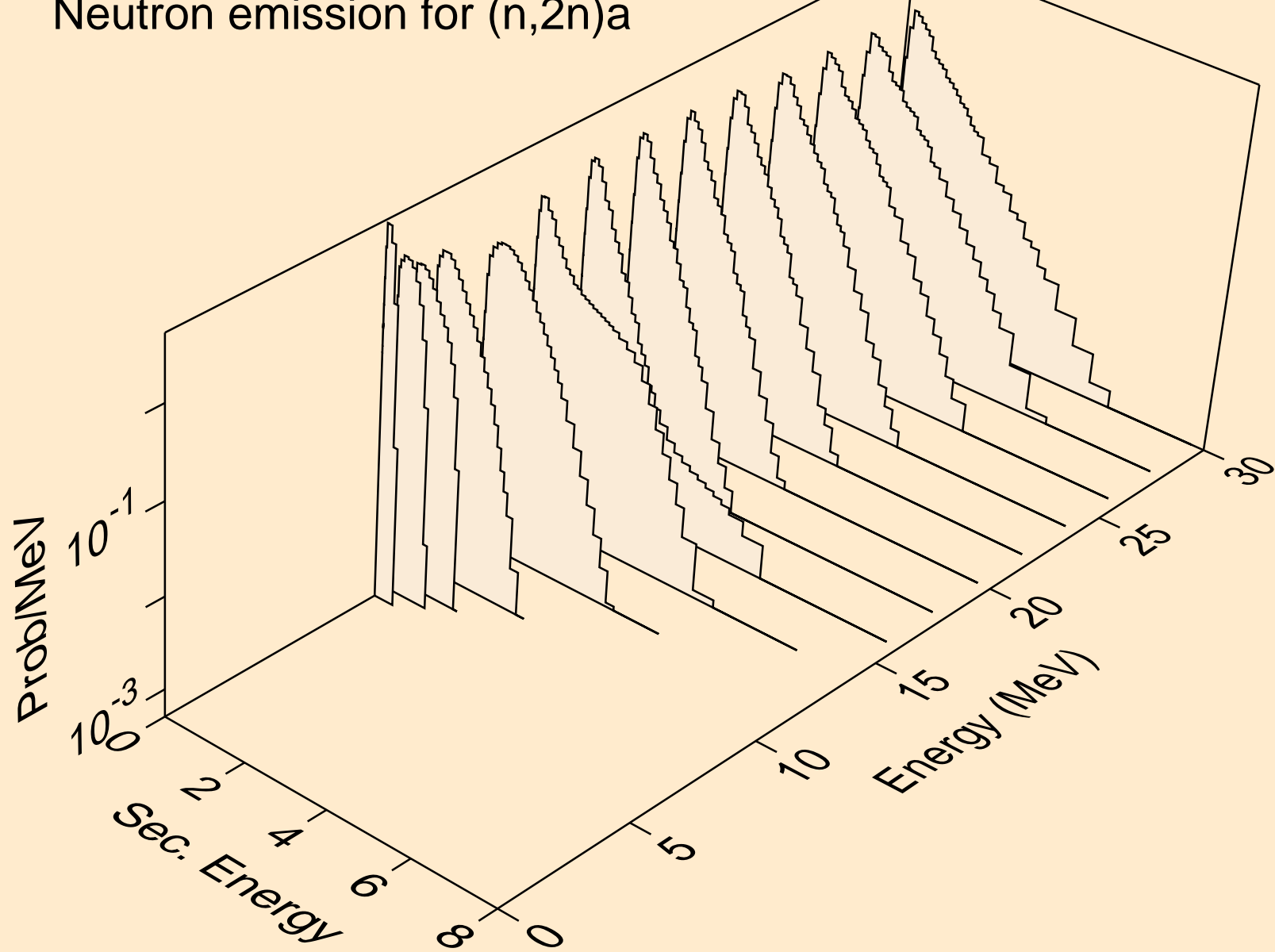

CM237 NEUTRON ACER TENDL-2023 LIBRARY; T=0.K  
Neutron emission for (n,3n)a

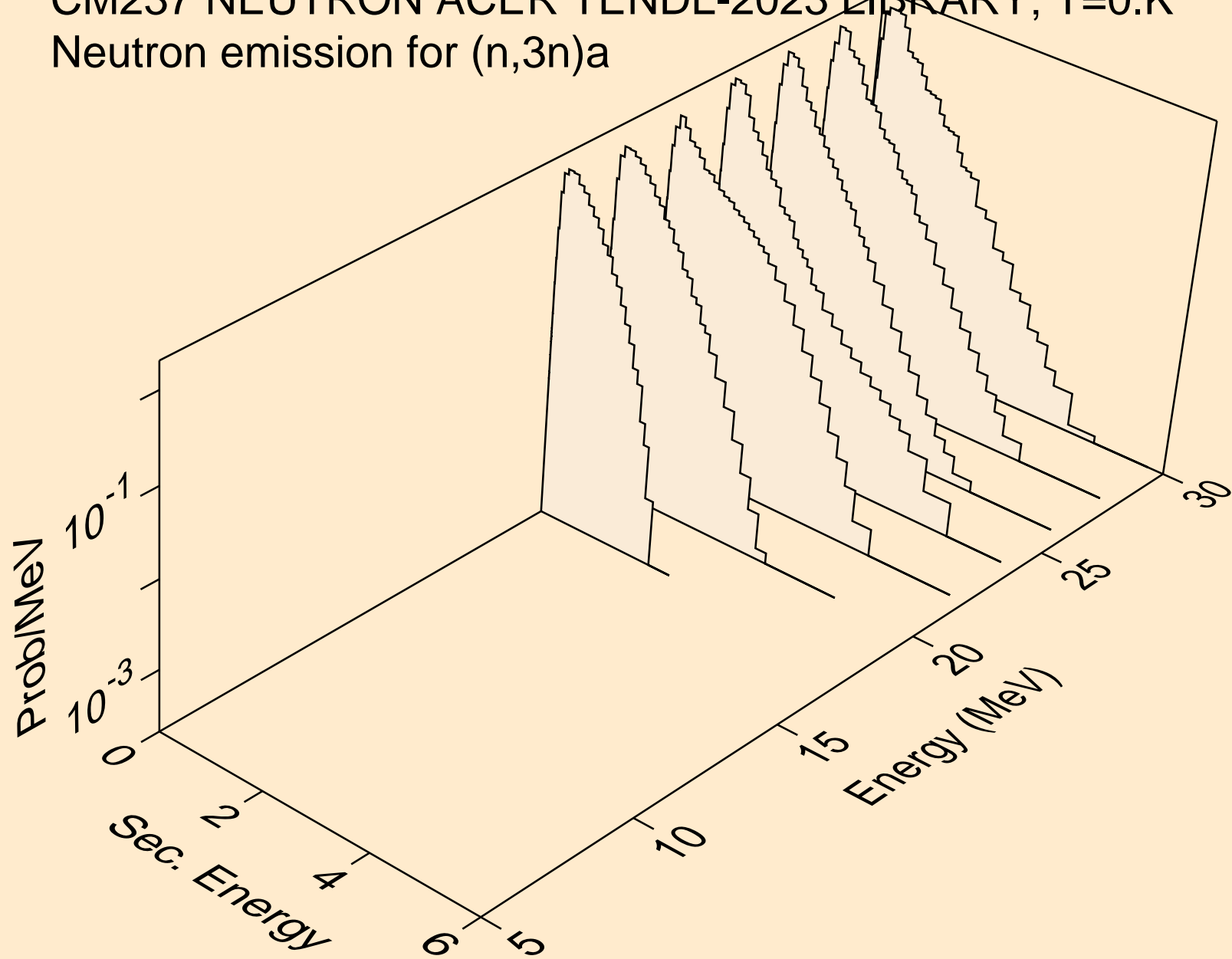

CM237 NEUTRON ACER TENDL-2023 LIBRARY; T=0.K  
Neutron emission for (n,n\*)p

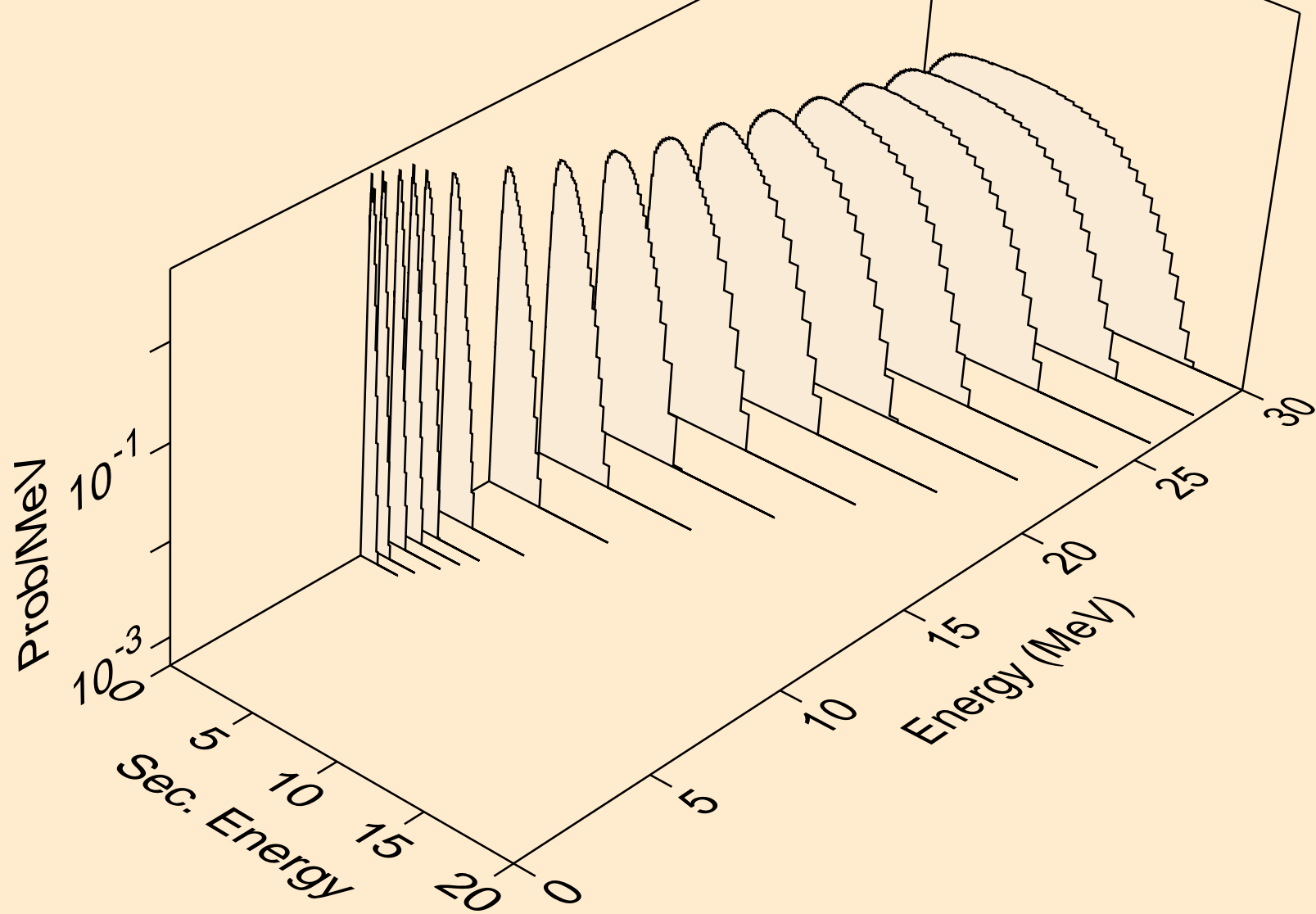

CM237 NEUTRON ACER TENDL-2023 LIBRARY; T=0.K  
Neutron emission for (n,n\*)2a

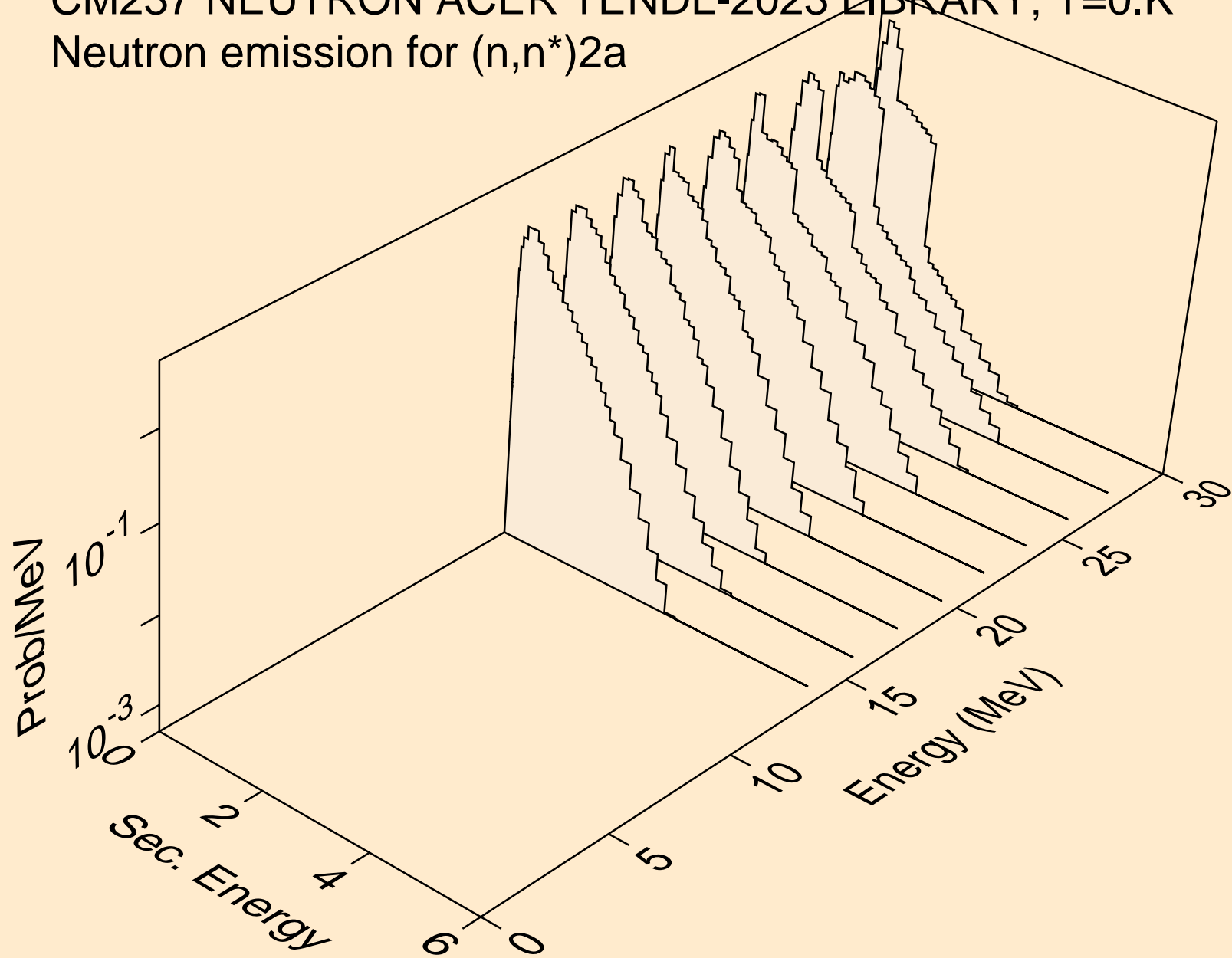

CM237 NEUTRON ACER TENDL-2023 LIBRARY; T=0.K  
Neutron emission for (n,n\*)d

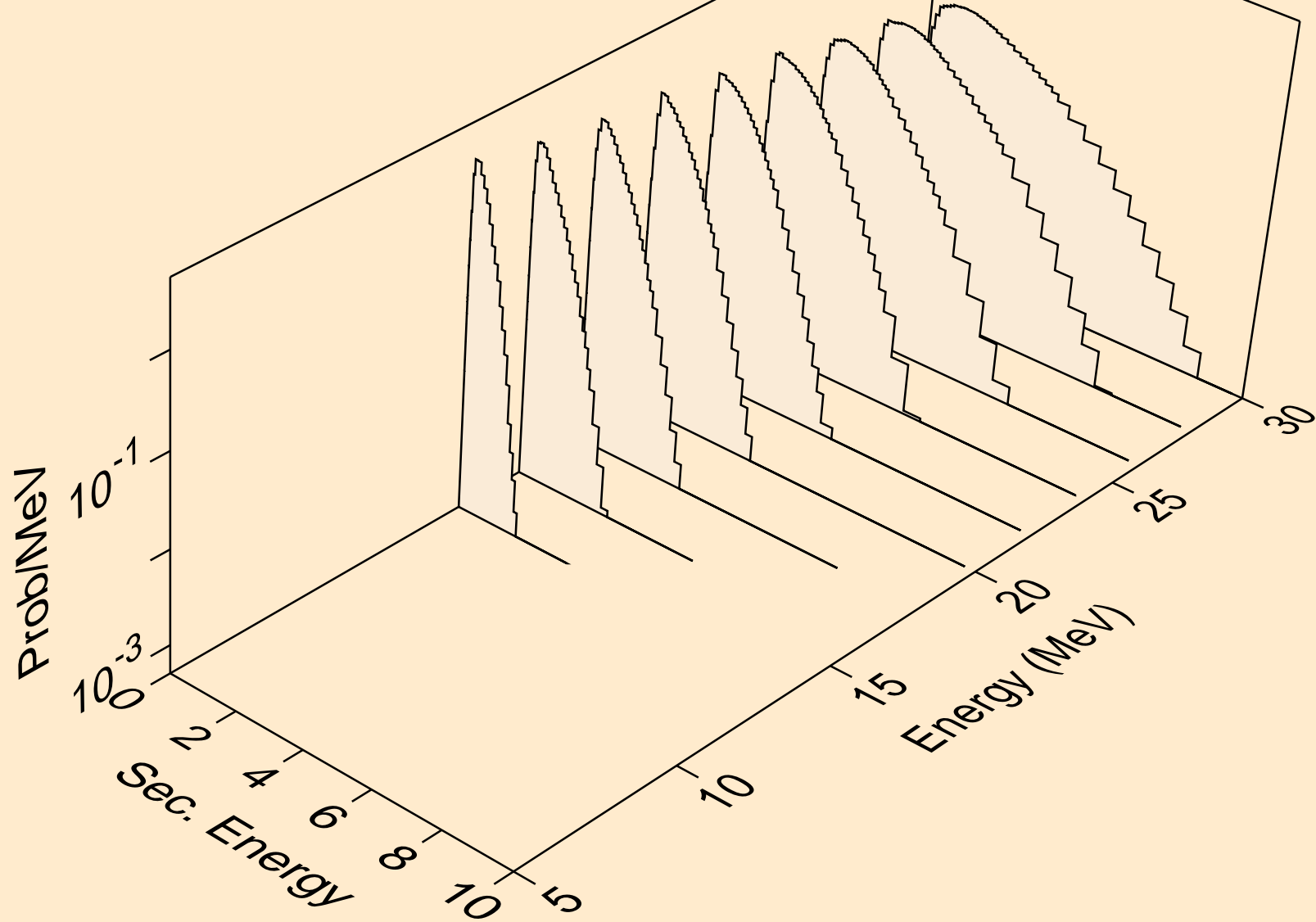

CM237 NEUTRON ACER TENDL-2023 LIBRARY; T=0.K  
Neutron emission for (n,n\*)t

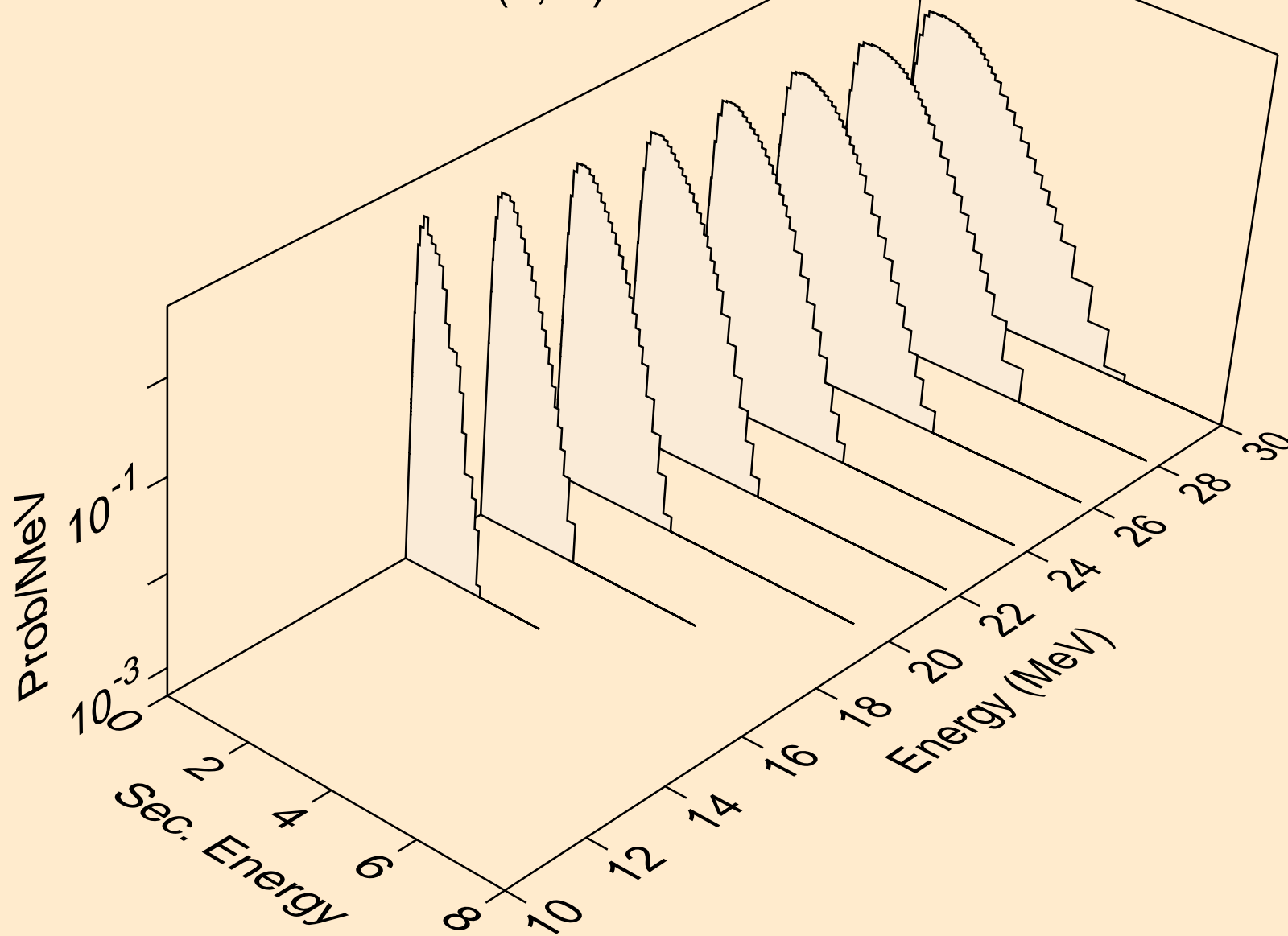

CM237 NEUTRON ACER TENDL-2023 LIBRARY; T=0.K  
Neutron emission for (n,n\*)he3

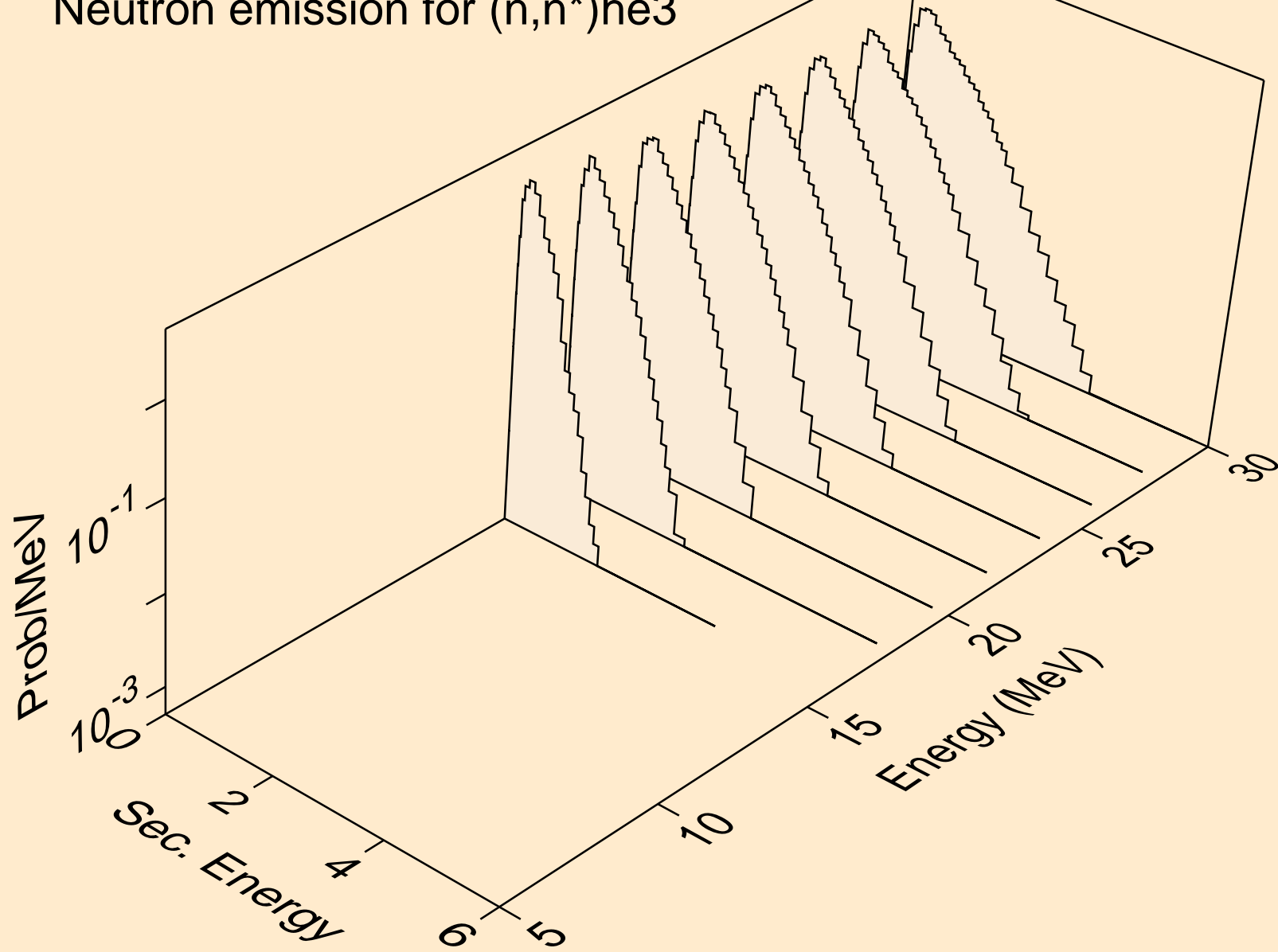

CM237 NEUTRON ACER TENDL-2023 LIBRARY; T=0.K  
Neutron emission for (n,4n)

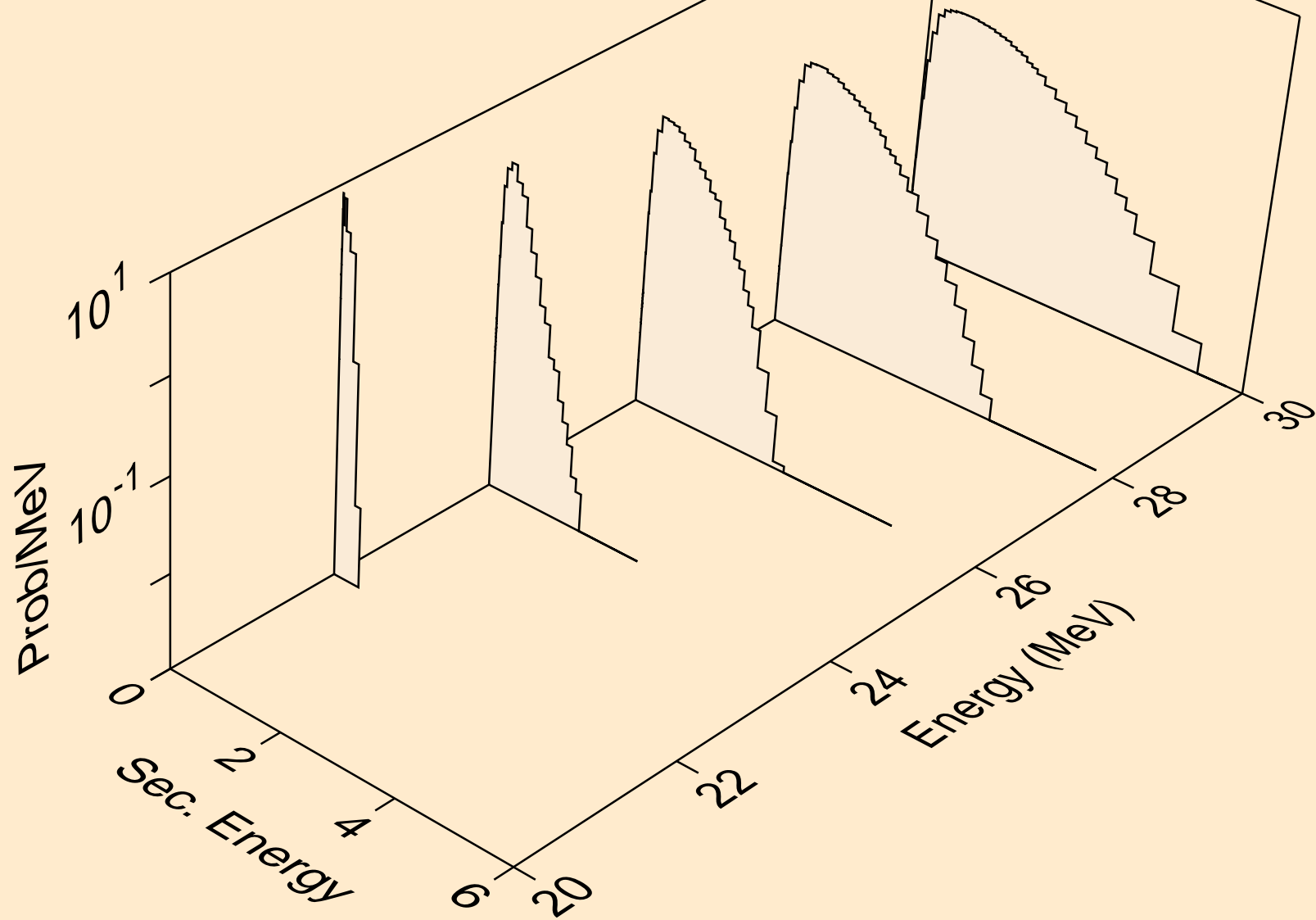

CM237 NEUTRON ACER TENDL-2023 LIBRARY; T=0.K  
Neutron emission for (n,2np)

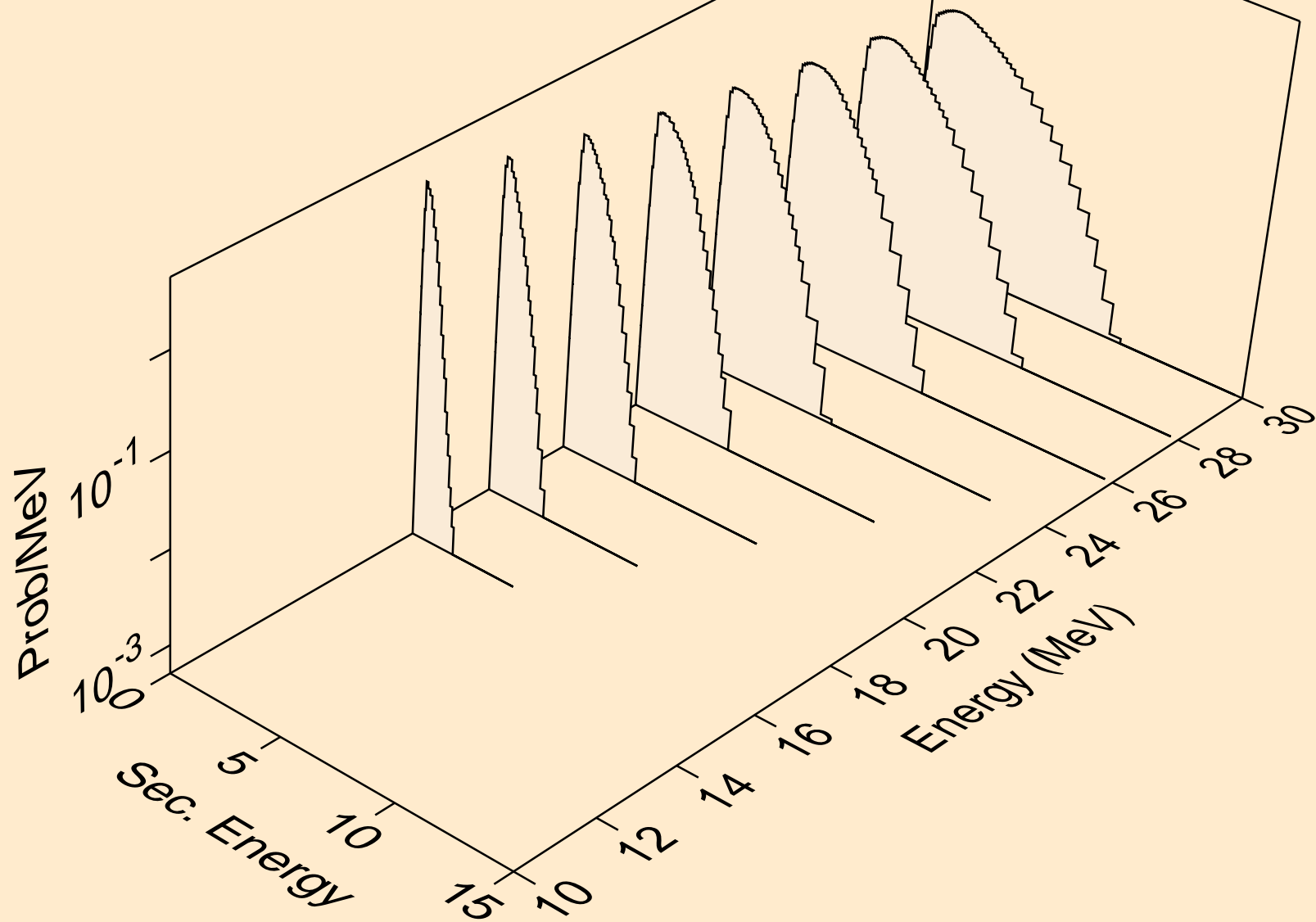

CM237 NEUTRON ACER TENDL-2023 LIBRARY; T=0.K  
Neutron emission for (n,n2p)

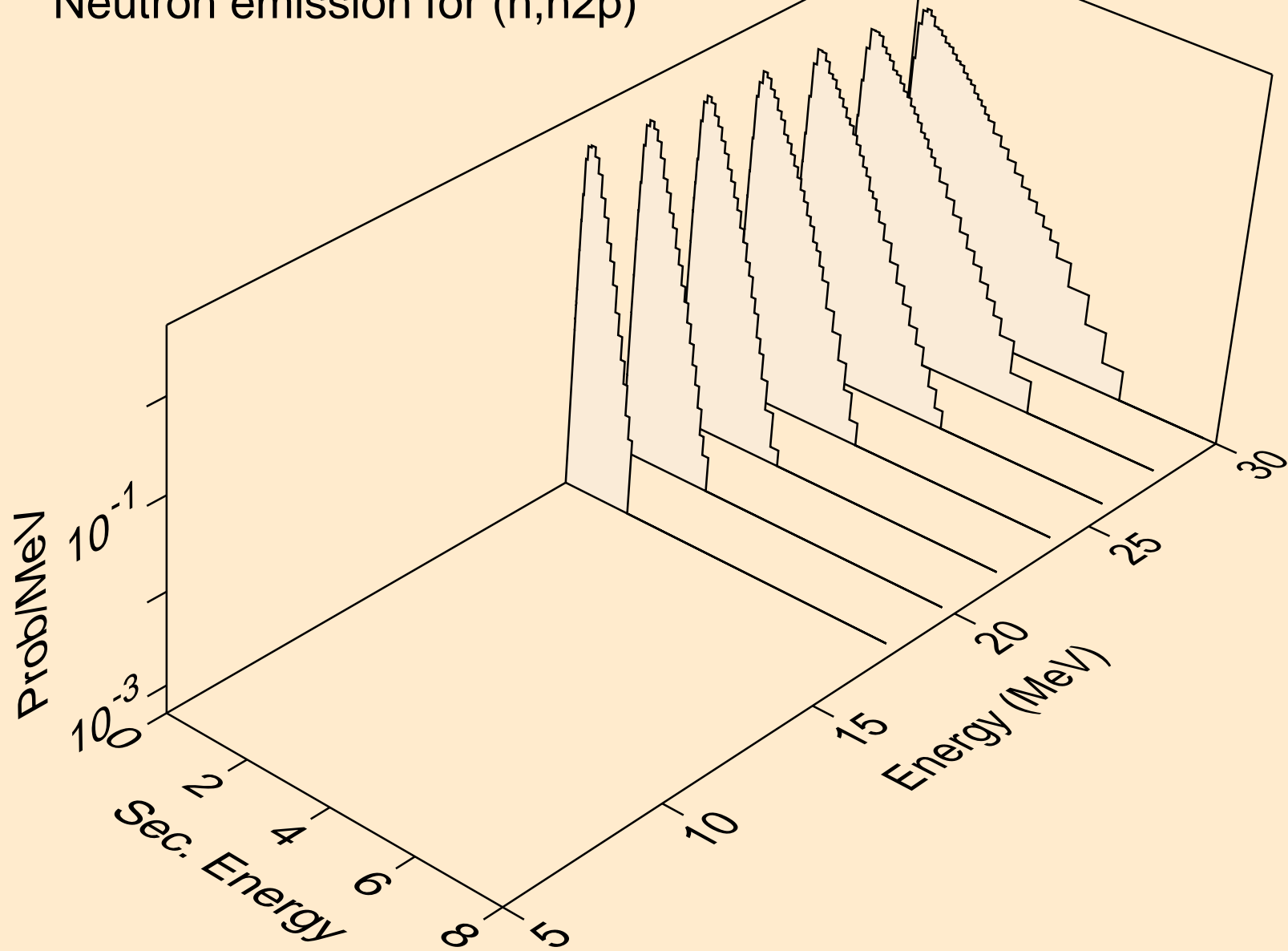

CM237 NEUTRON ACER TENDL-2023 LIBRARY; T=0.K  
Neutron emission for (n,npa)

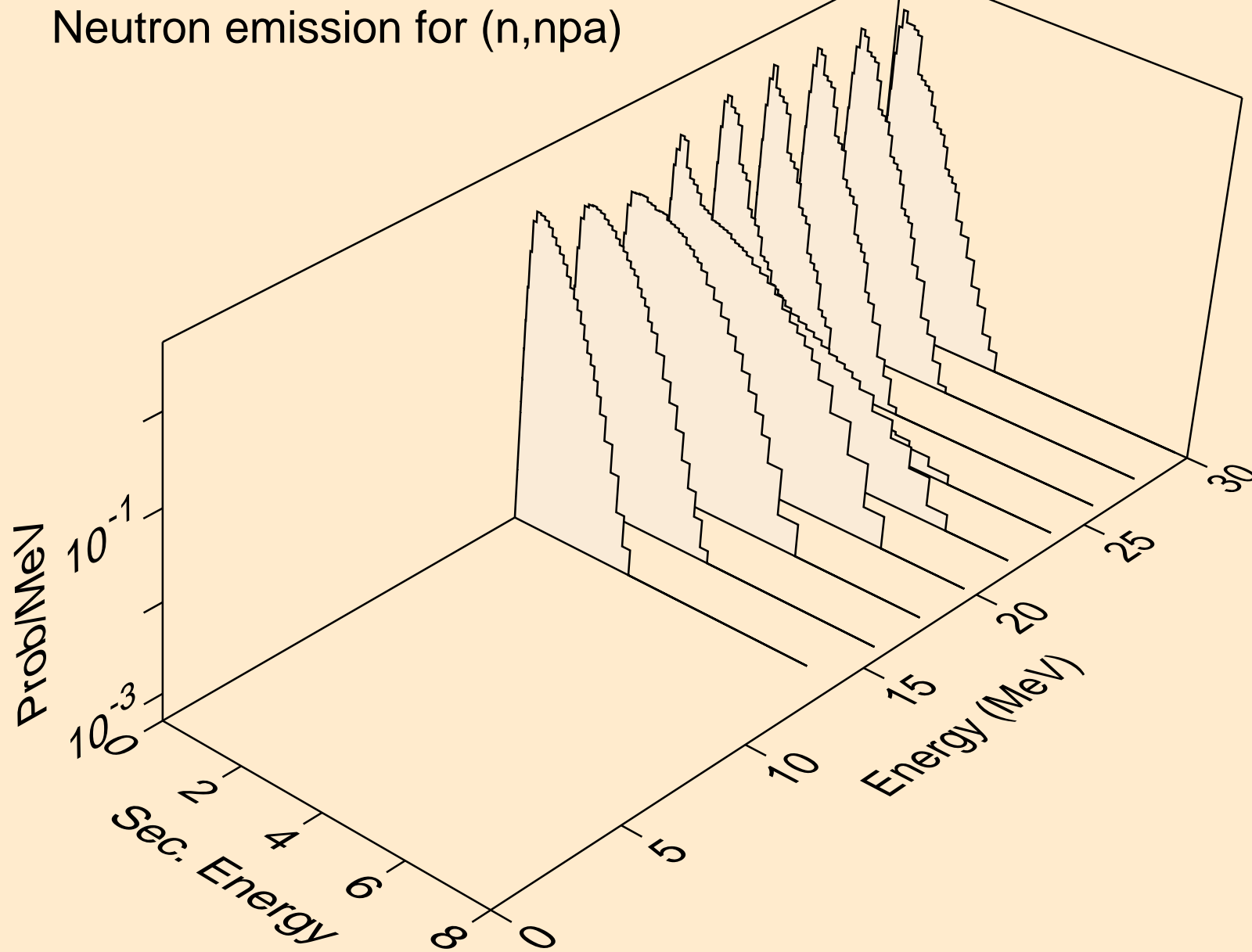

CM237 NEUTRON ACER TENDL-2023 LIBRARY; T=0.K  
Neutron emission for (n,n\*c)

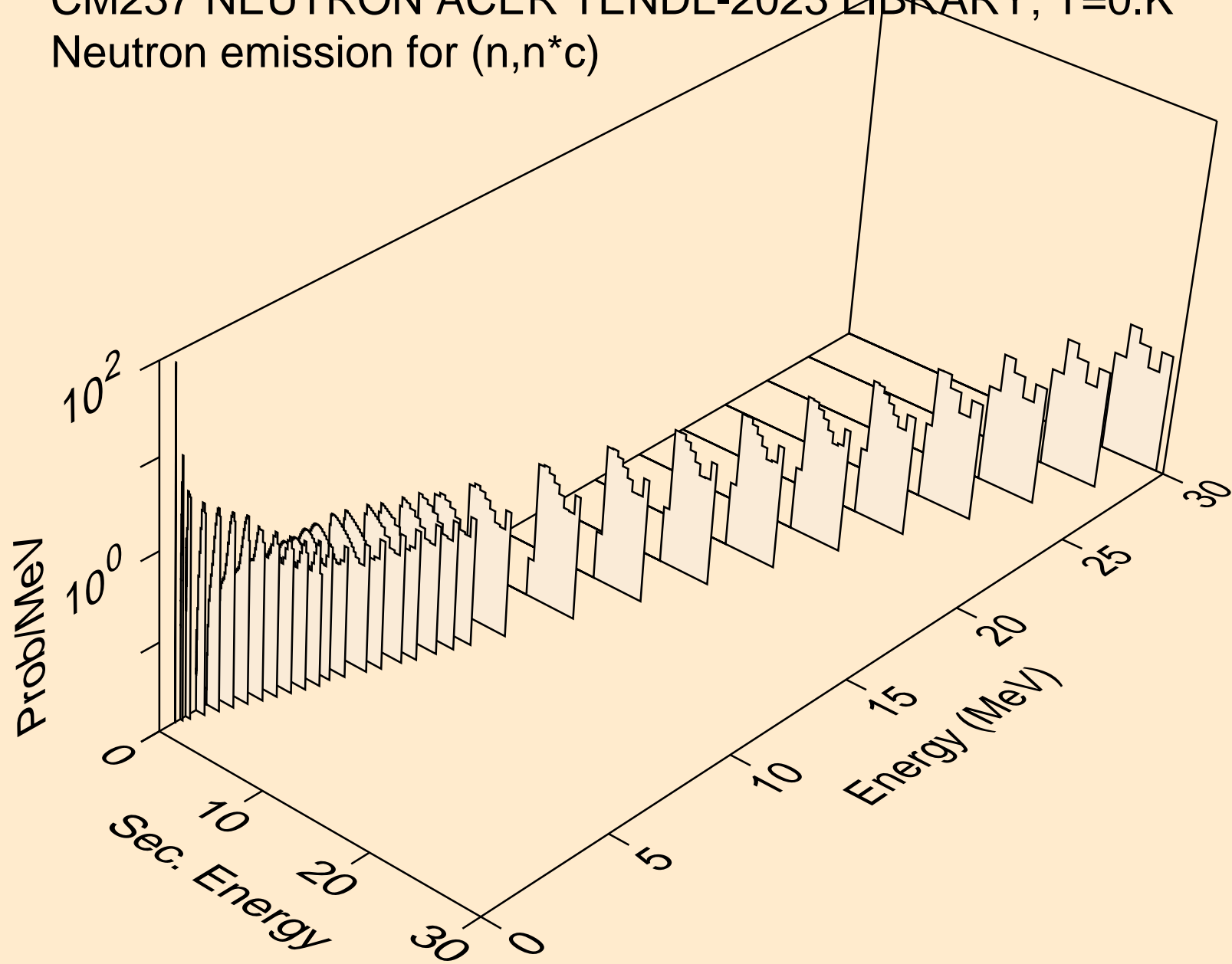

# CM237 NEUTRON ACER TENDL-2023 LIBRARY; T=0.K

## Delayed nubar

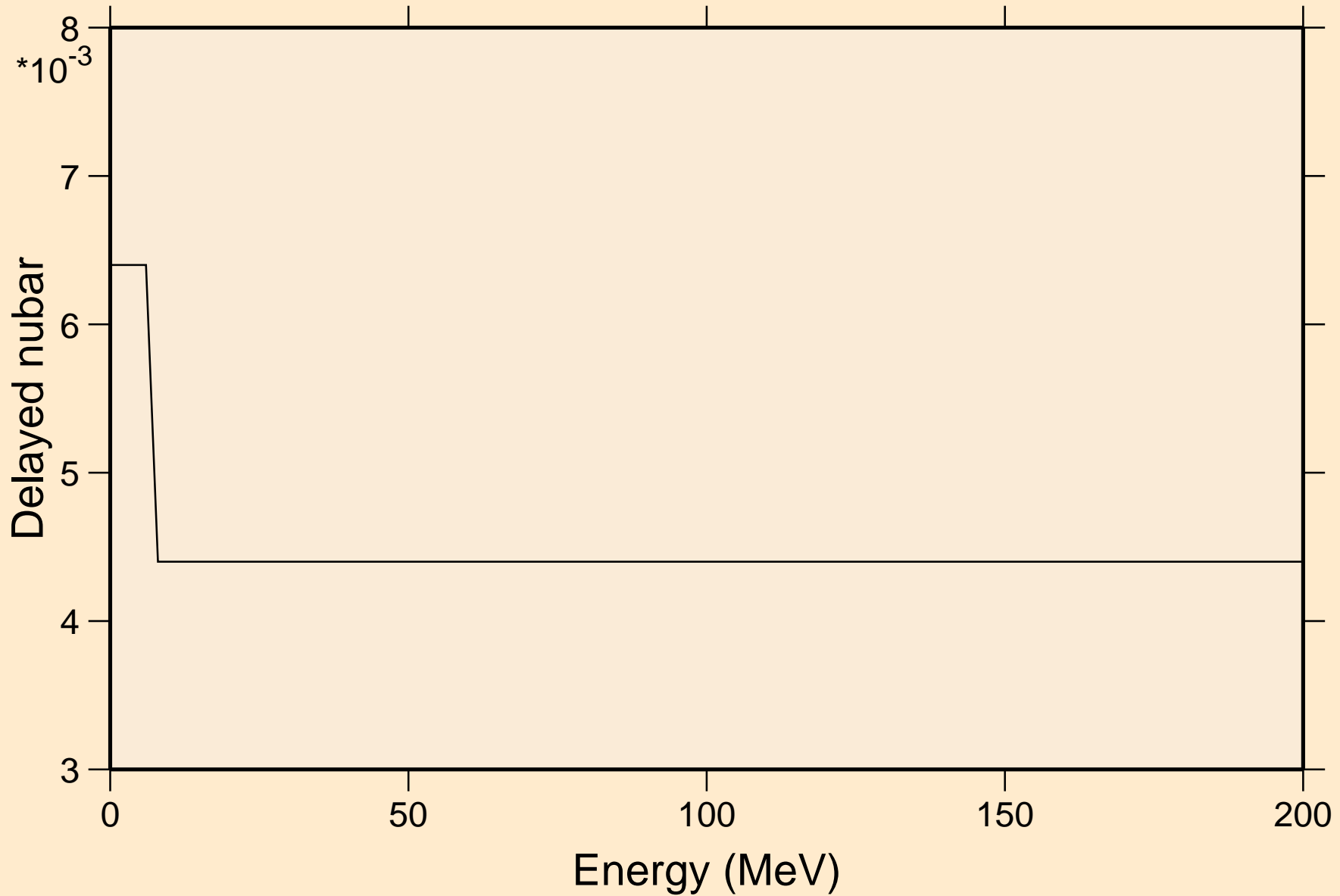

# CM237 NEUTRON ACER TENDL-2023 LIBRARY; T=0.K

## Delayed neutron spectra

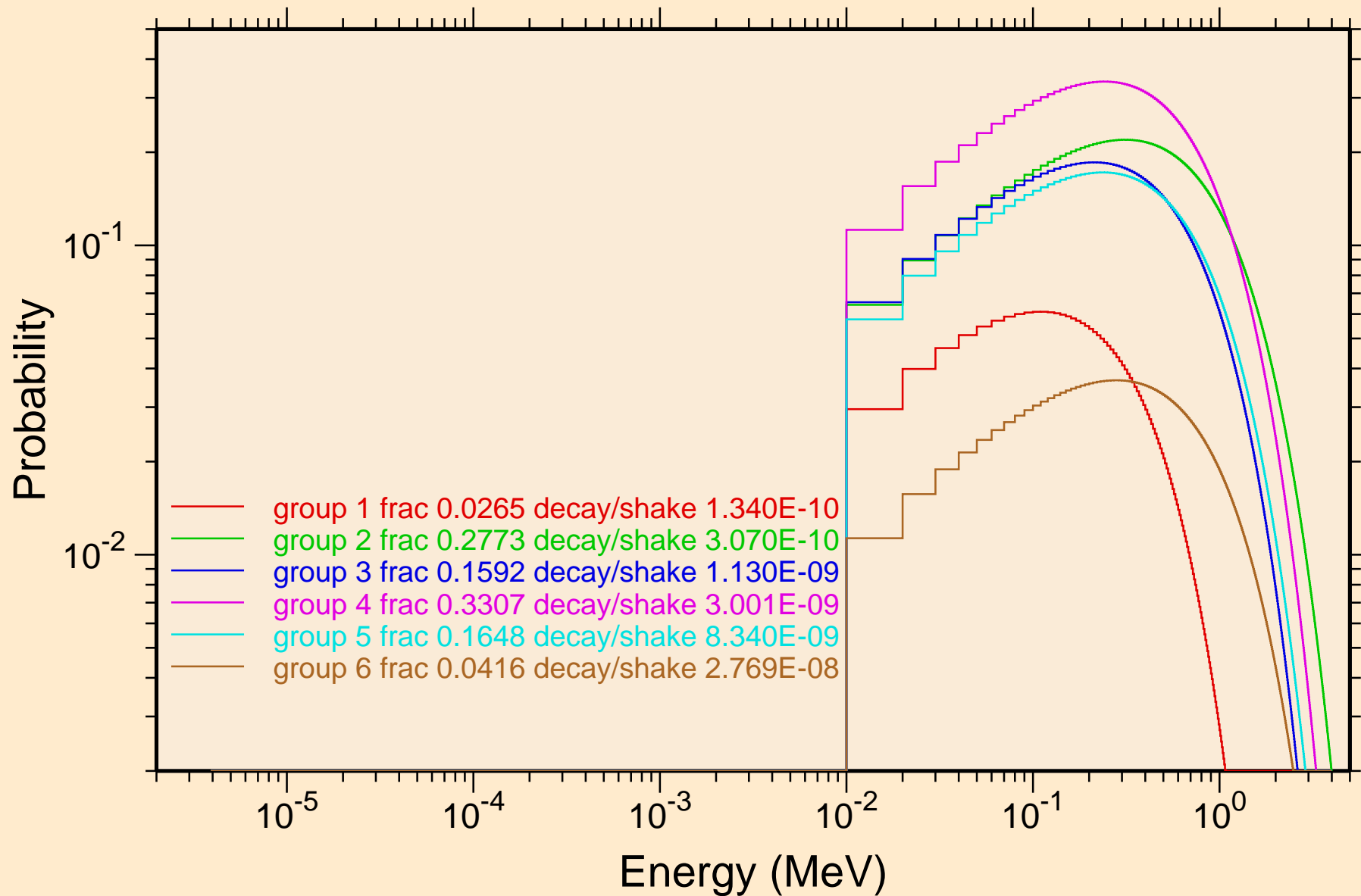

CM237 NEUTRON ACER TENDL-2023 LIBRARY; T=0.K  
Photon emission for (n,x)

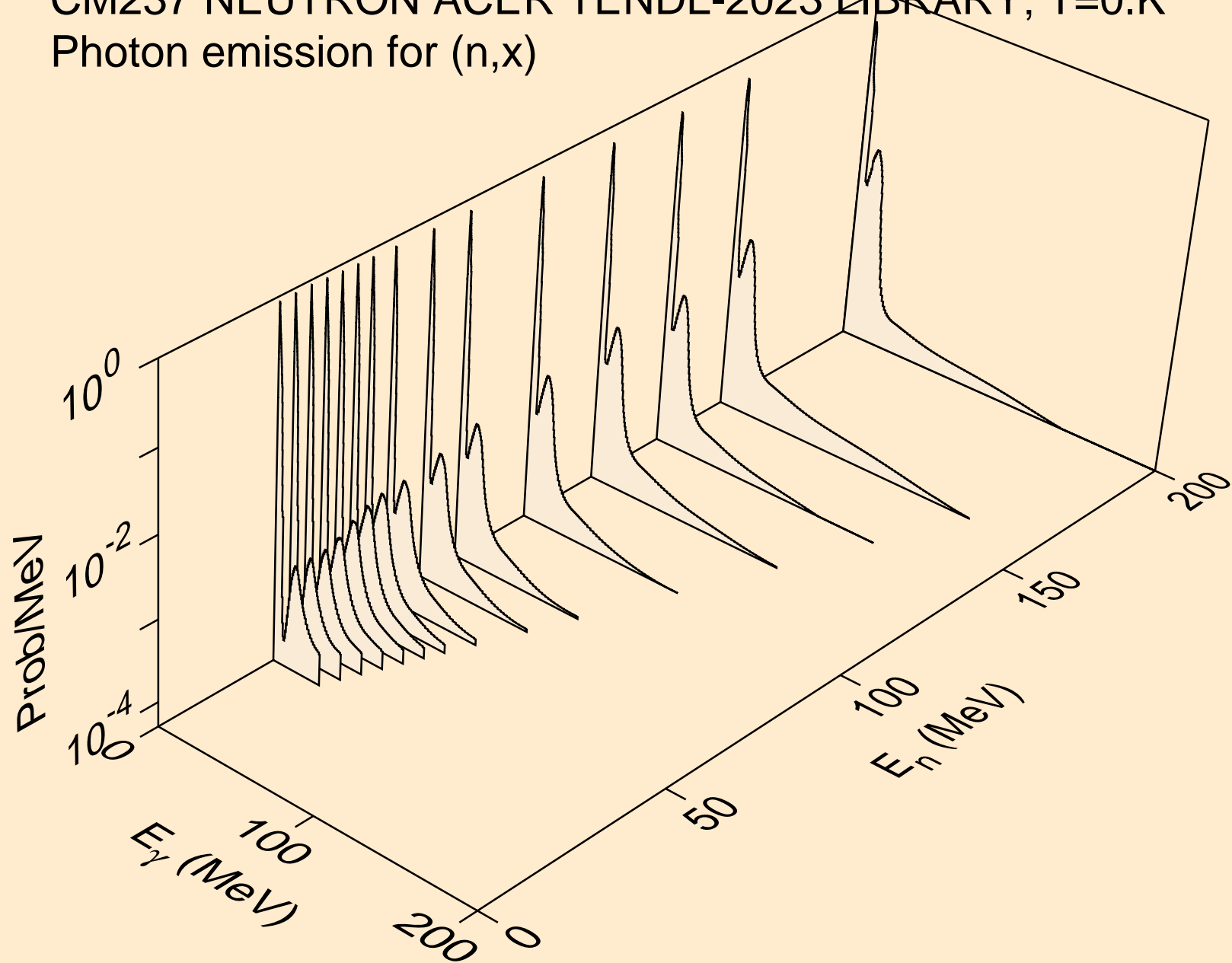

CM237 NEUTRON ACER TENDL-2023 LIBRARY; T=0.K  
Photon emission for (n,2n)

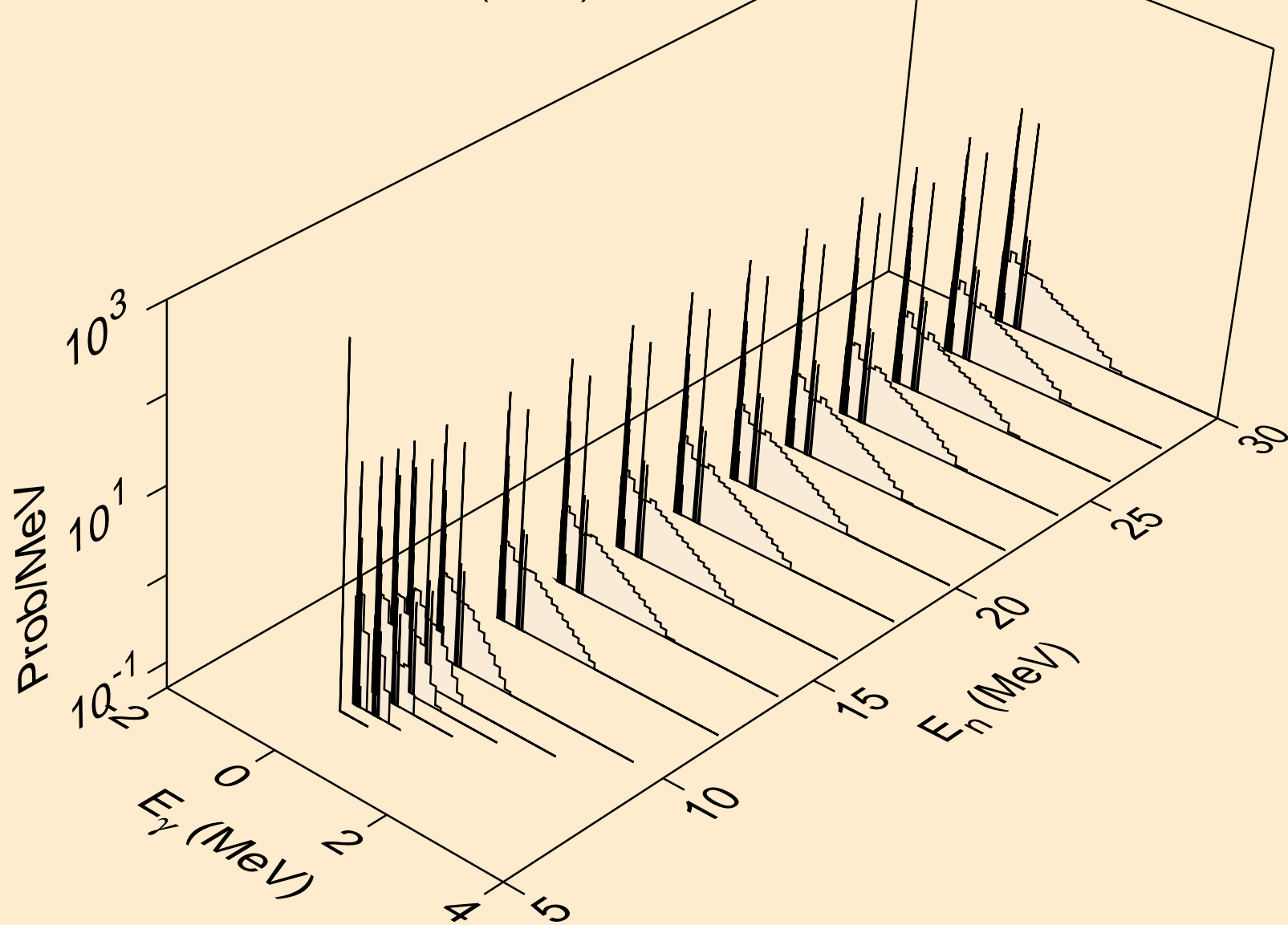

CM237 NEUTRON ACER TENDL-2023 LIBRARY; T=0.K  
Photon emission for (n,3n)

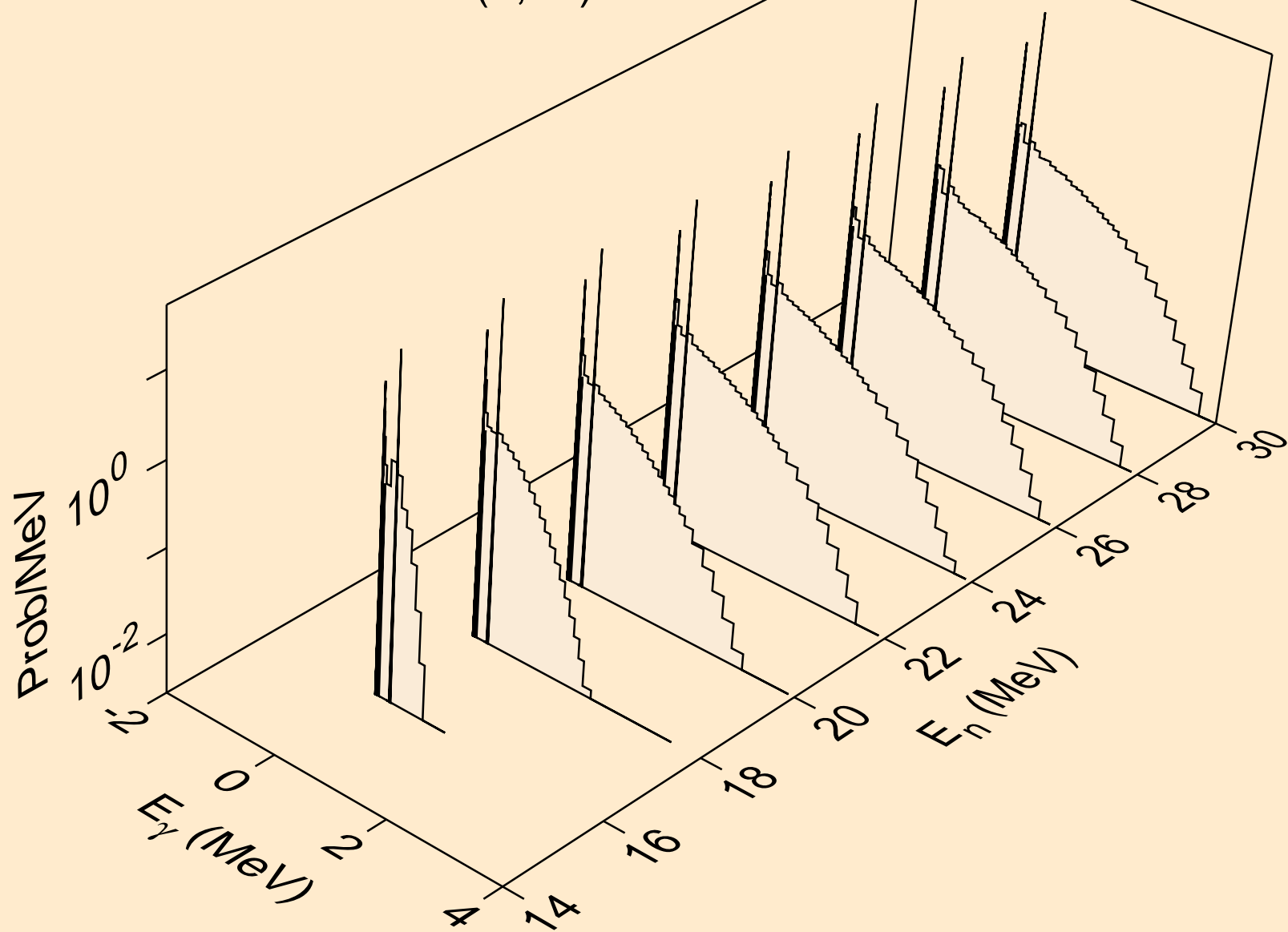

CM237 NEUTRON ACER TENDL-2023 LIBRARY; T=0.K  
Photon emission for (n,n\*)a

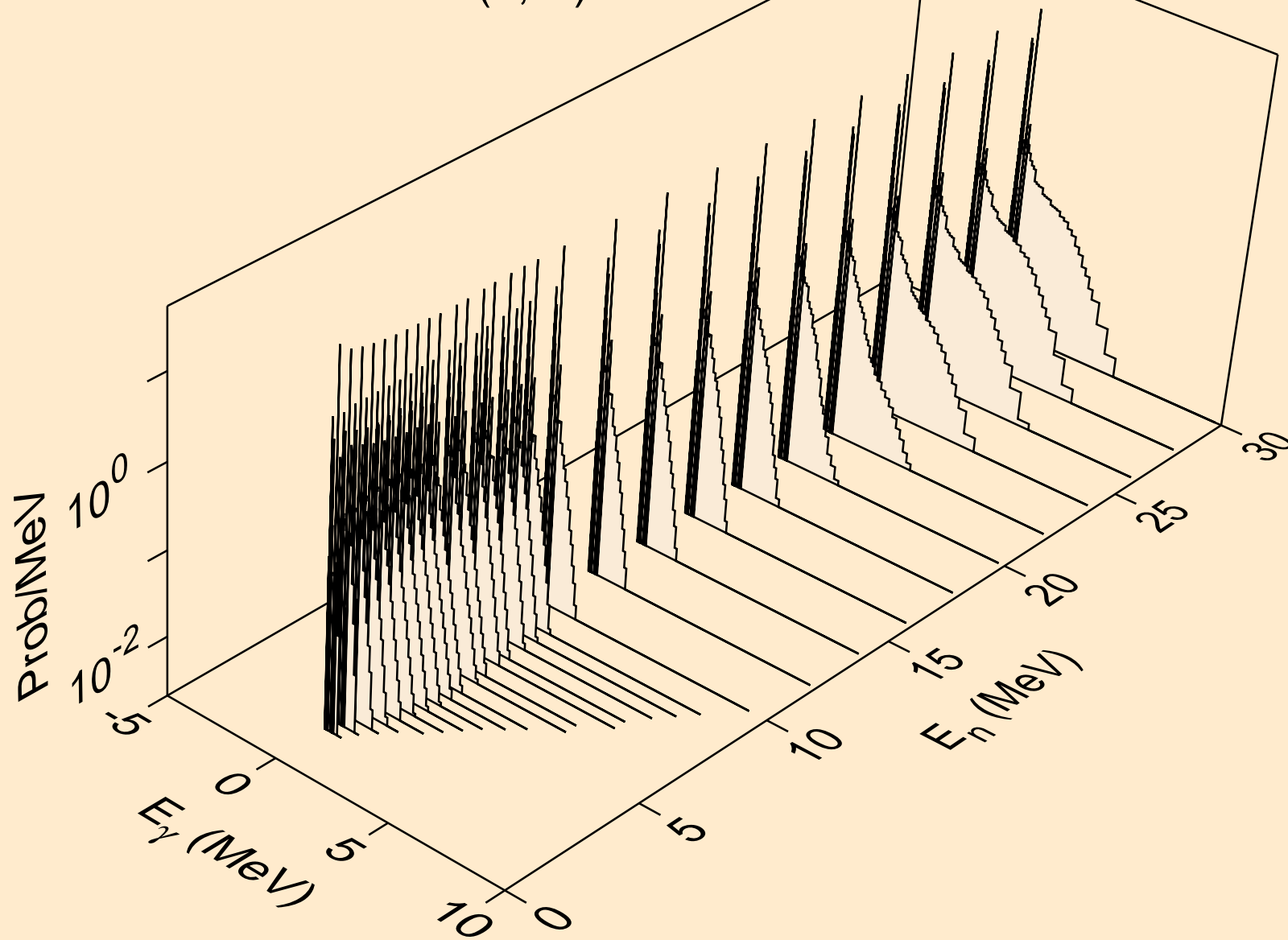

CM237 NEUTRON ACER TENDL-2023 LIBRARY; T=0.K  
Photon emission for (n,2n)a

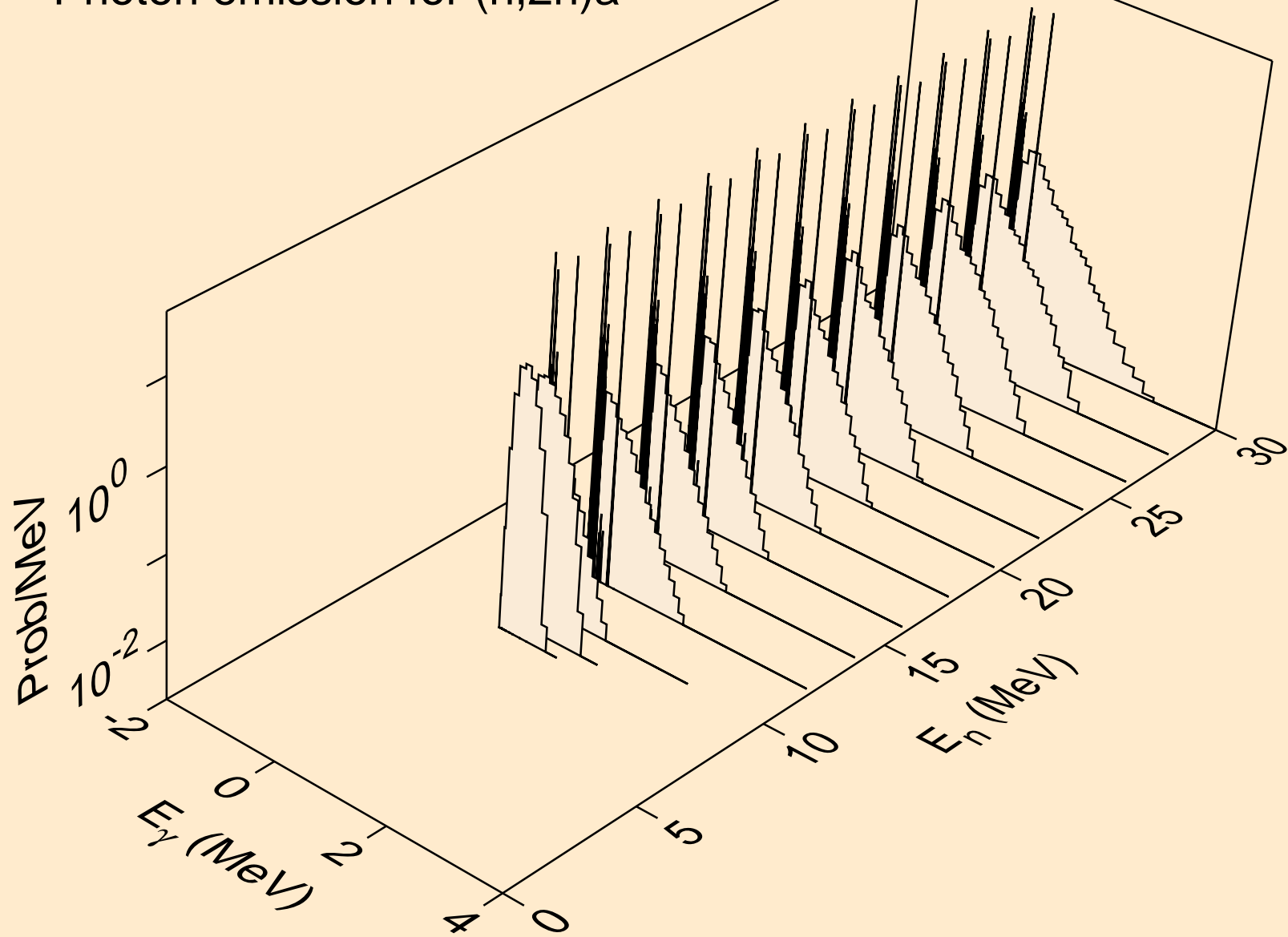

CM237 NEUTRON ACER TENDL-2023 LIBRARY; T=0.K  
Photon emission for (n,3n)a

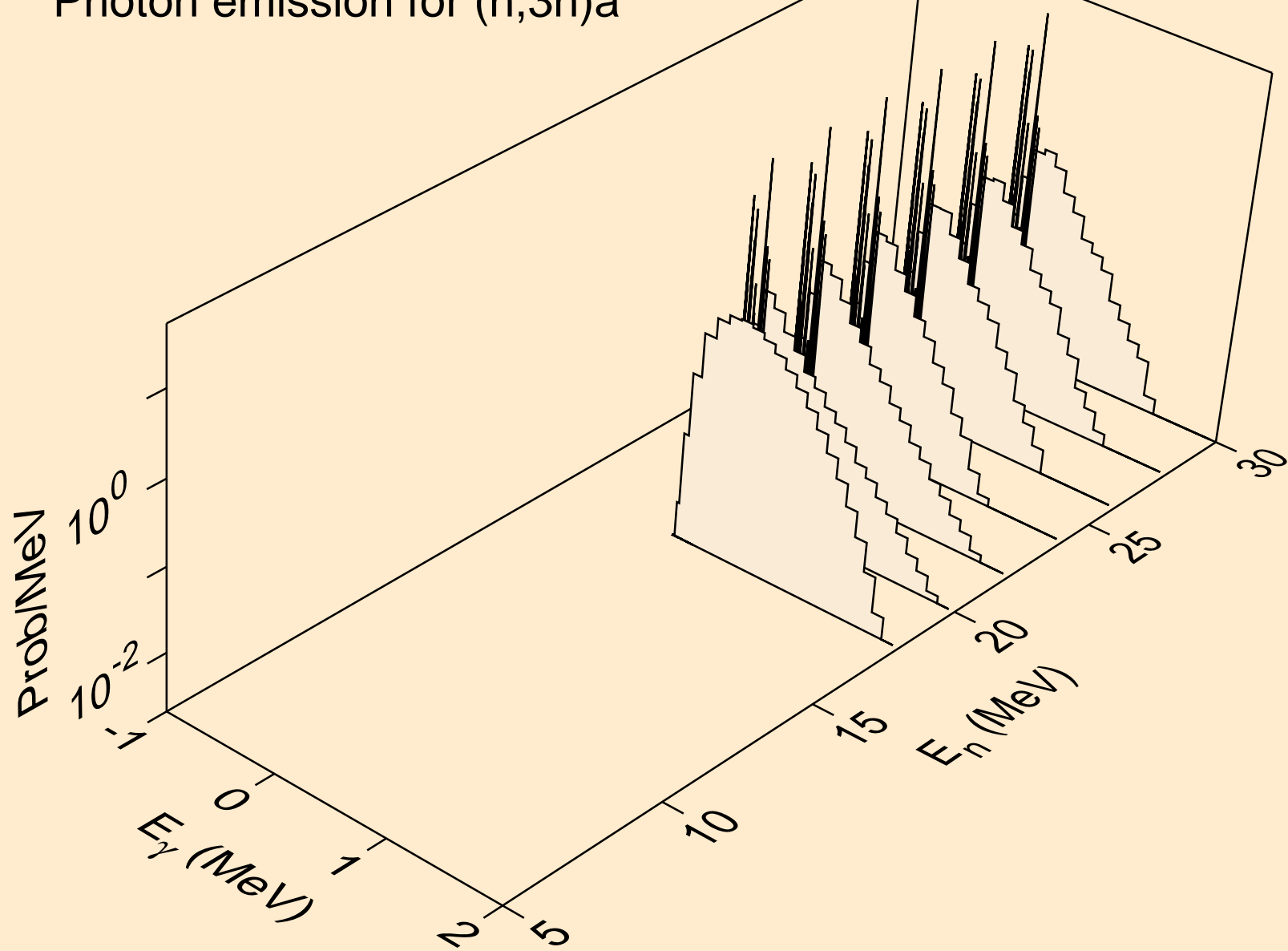

CM237 NEUTRON ACER TENDL-2023 LIBRARY; T=0.K  
Photon emission for (n,n\*)p

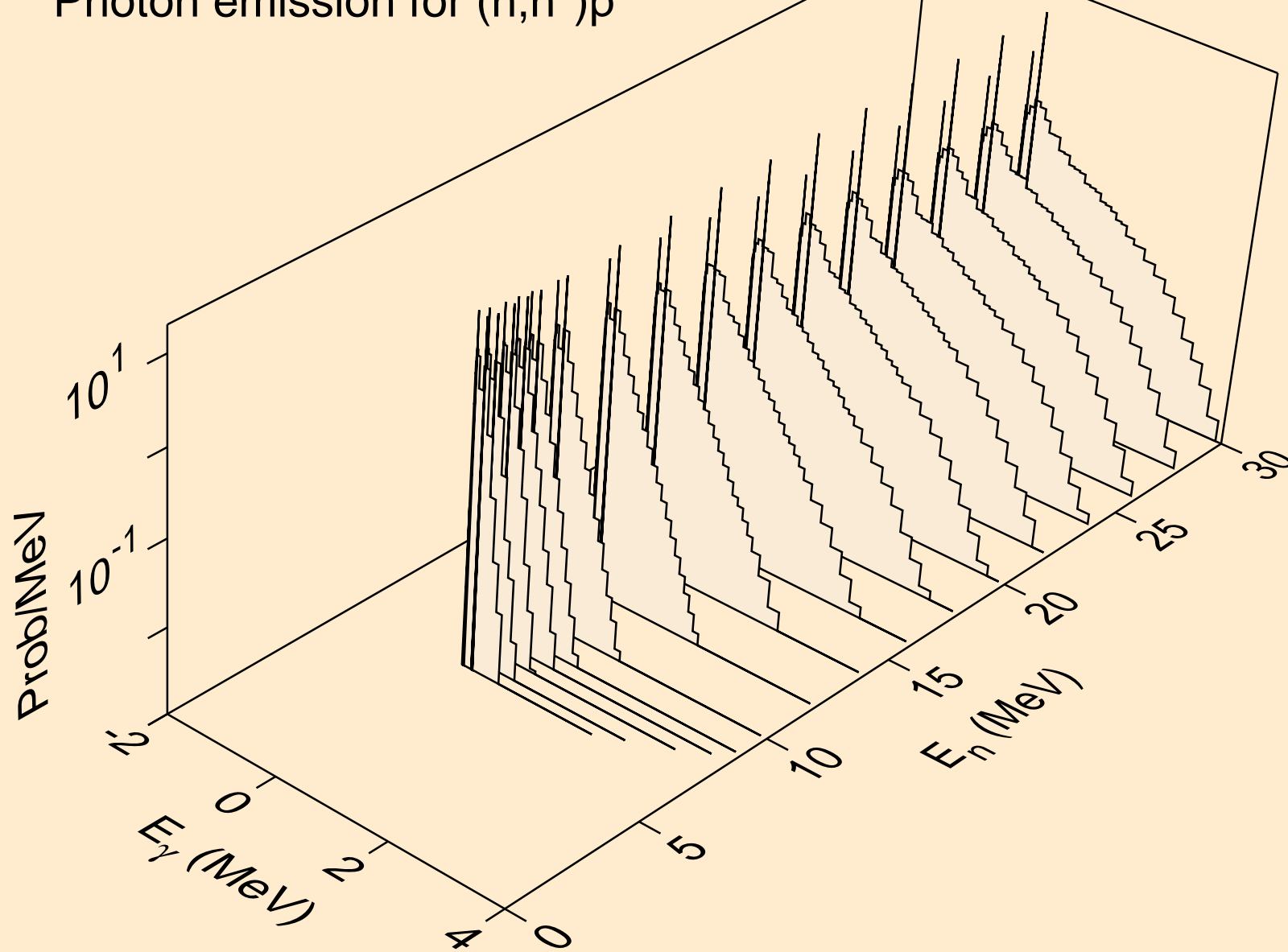

CM237 NEUTRON ACER TENDL-2023 LIBRARY; T=0.K  
Photon emission for (n,n\*)2a

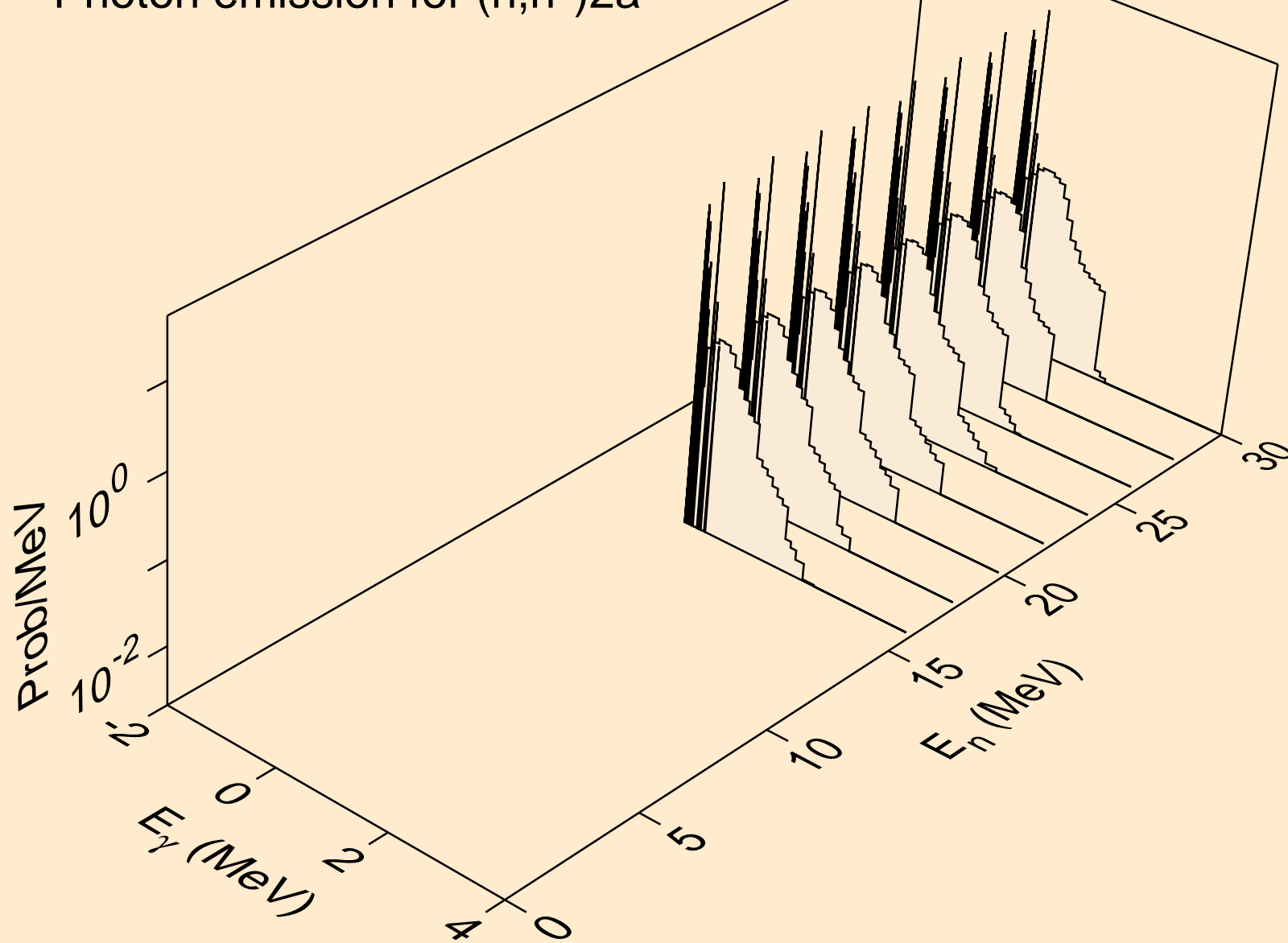

CM237 NEUTRON ACER TENDL-2023 LIBRARY; T=0.K  
Photon emission for (n,n\*)d

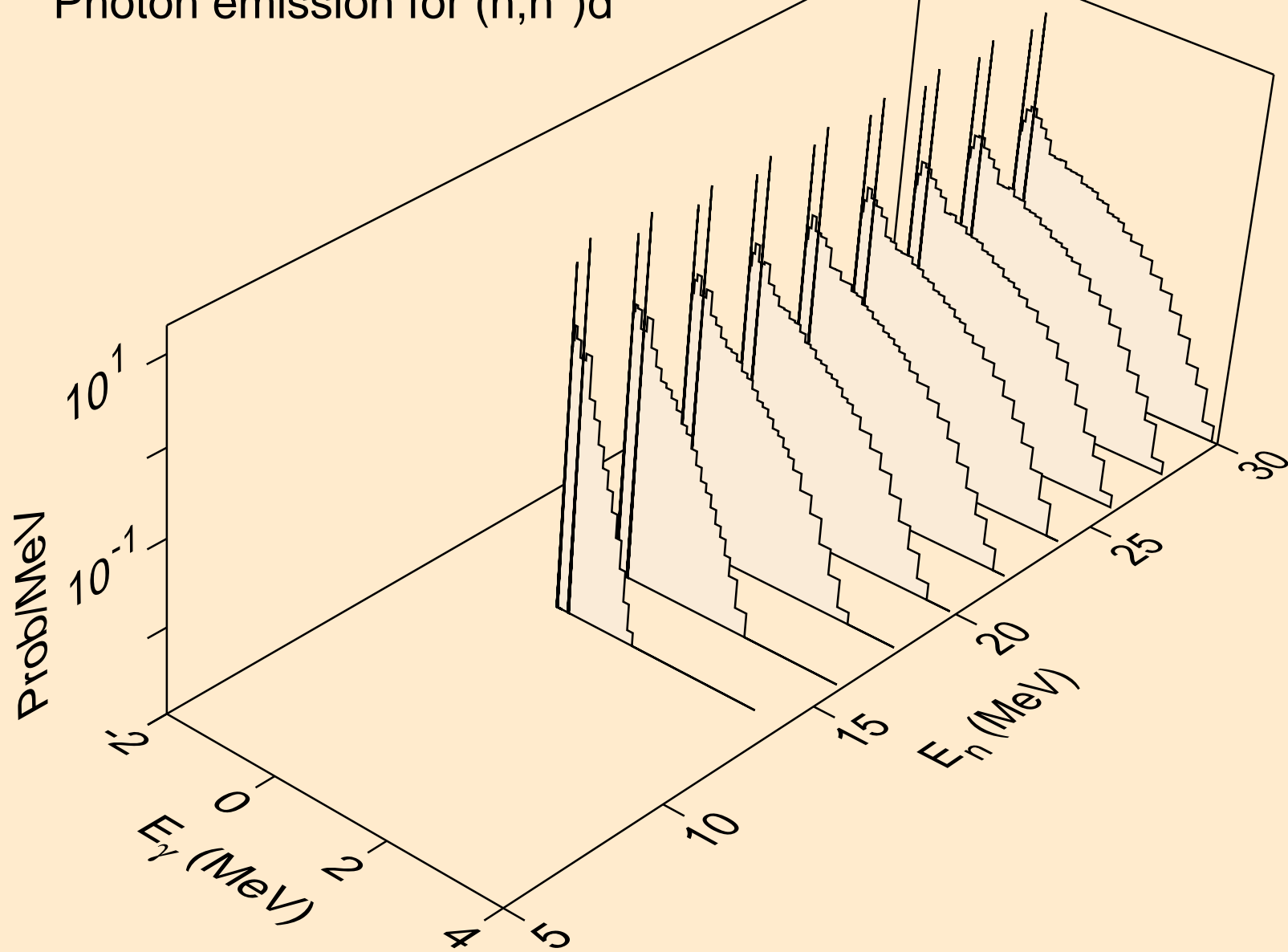

CM237 NEUTRON ACER TENDL-2023 LIBRARY; T=0.K  
Photon emission for (n,n\*)t

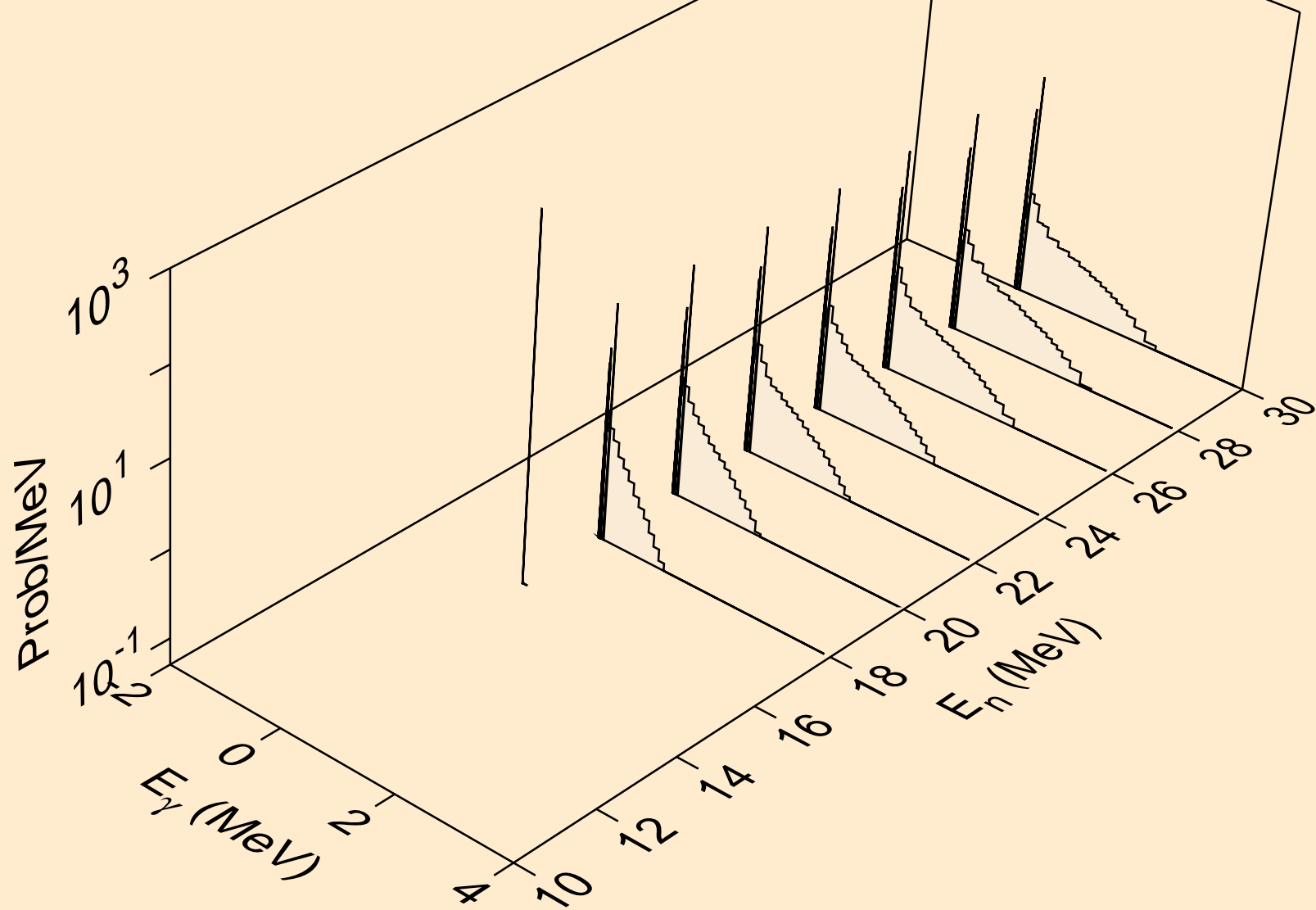

CM237 NEUTRON ACER TENDL-2023 LIBRARY; T=0.K  
Photon emission for (n,n\*)he3

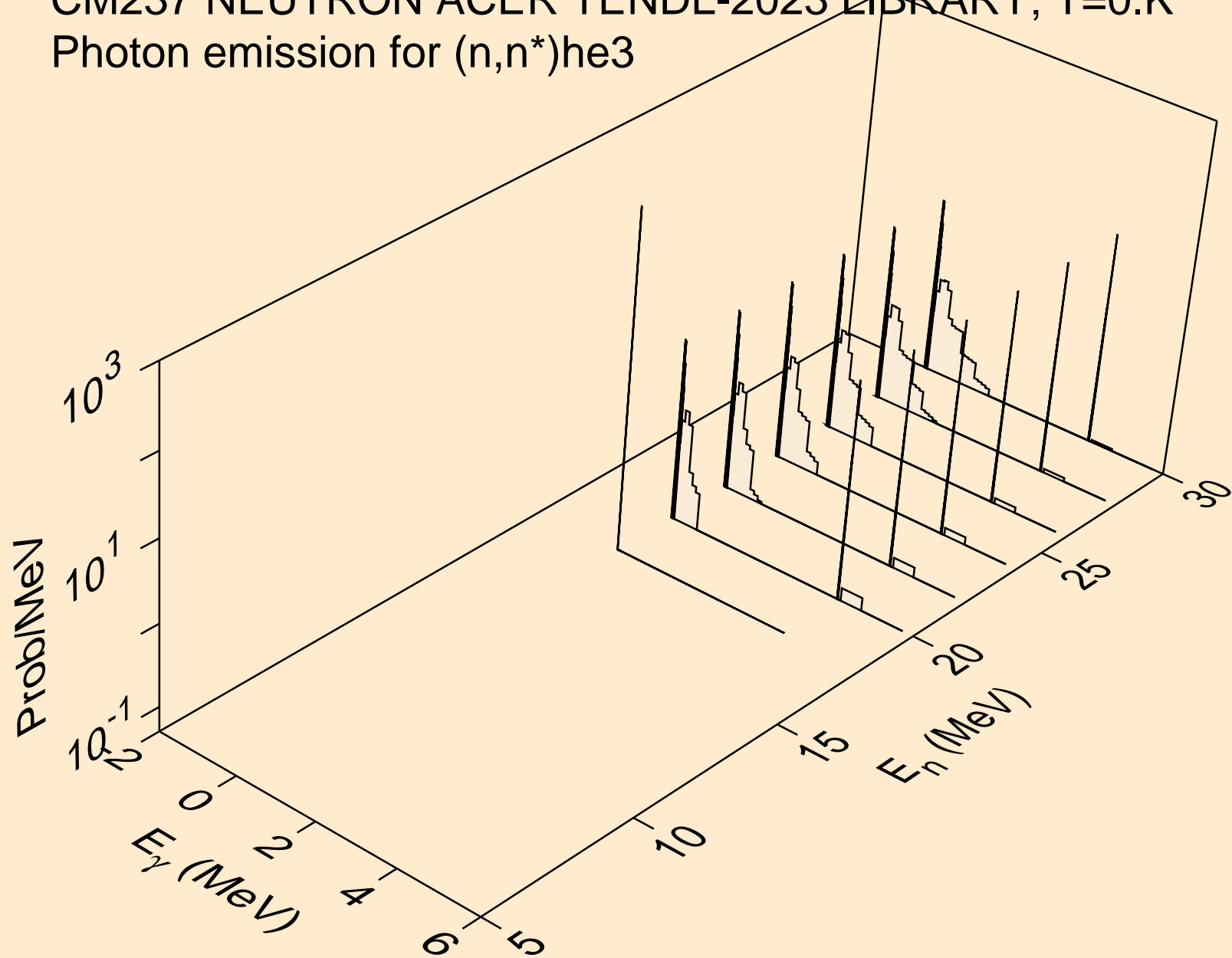

CM237 NEUTRON ACER TENDL-2023 LIBRARY; T=0.K  
Photon emission for (n,4n)

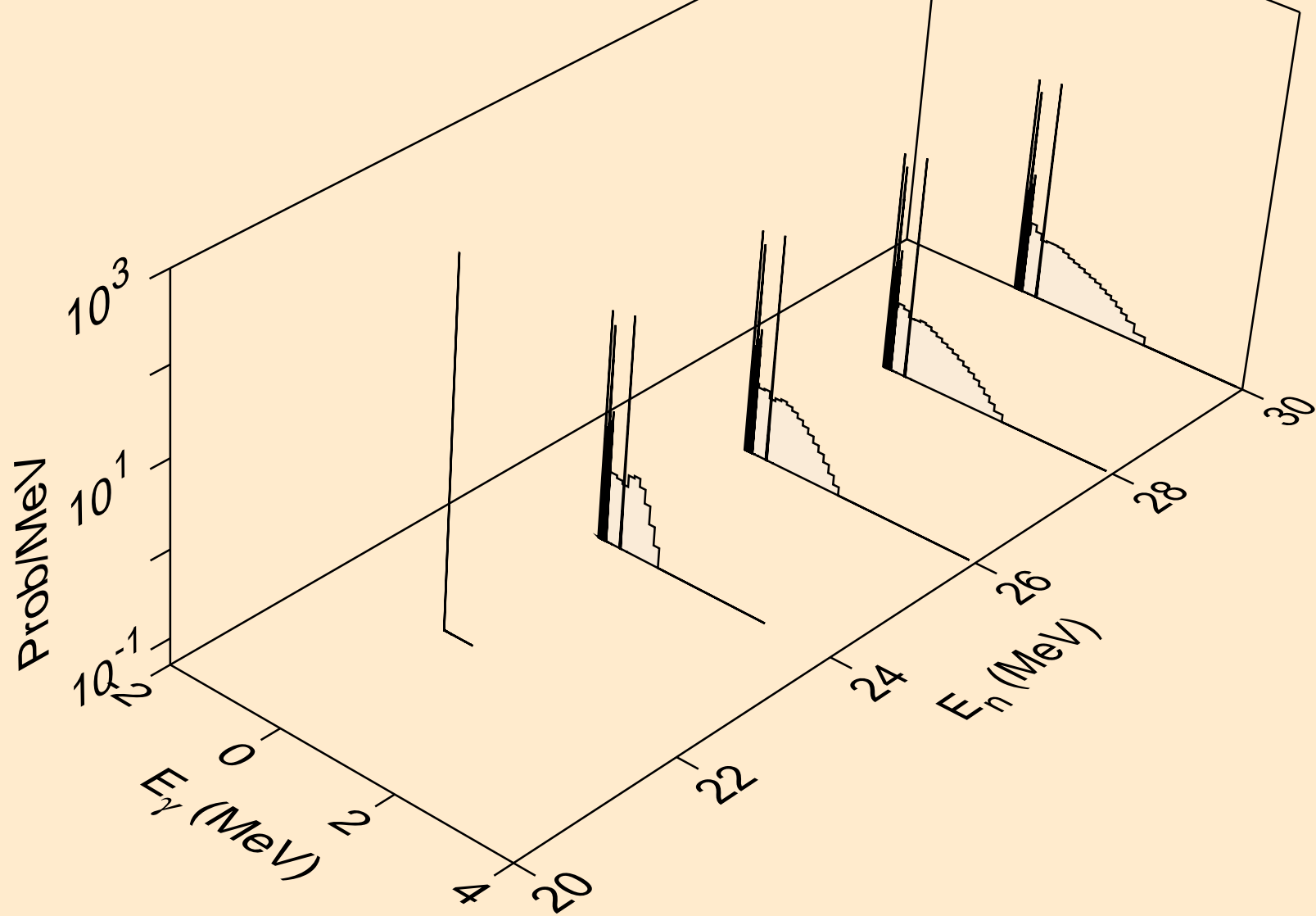

CM237 NEUTRON ACER TENDL-2023 LIBRARY; T=0.K  
Photon emission for (n,2np)

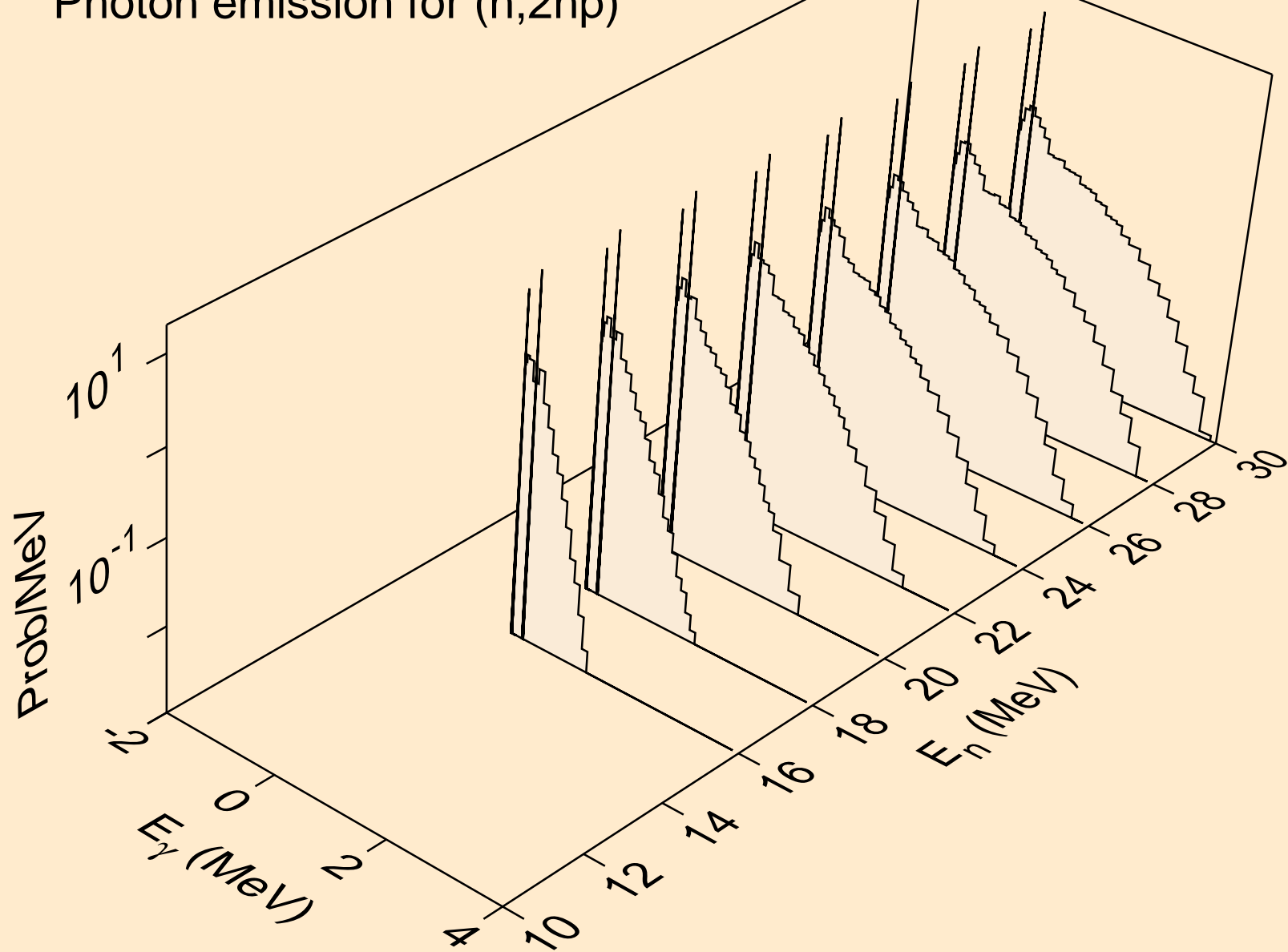

CM237 NEUTRON ACER TENDL-2023 LIBRARY; T=0.K  
Photon emission for (n,n2p)

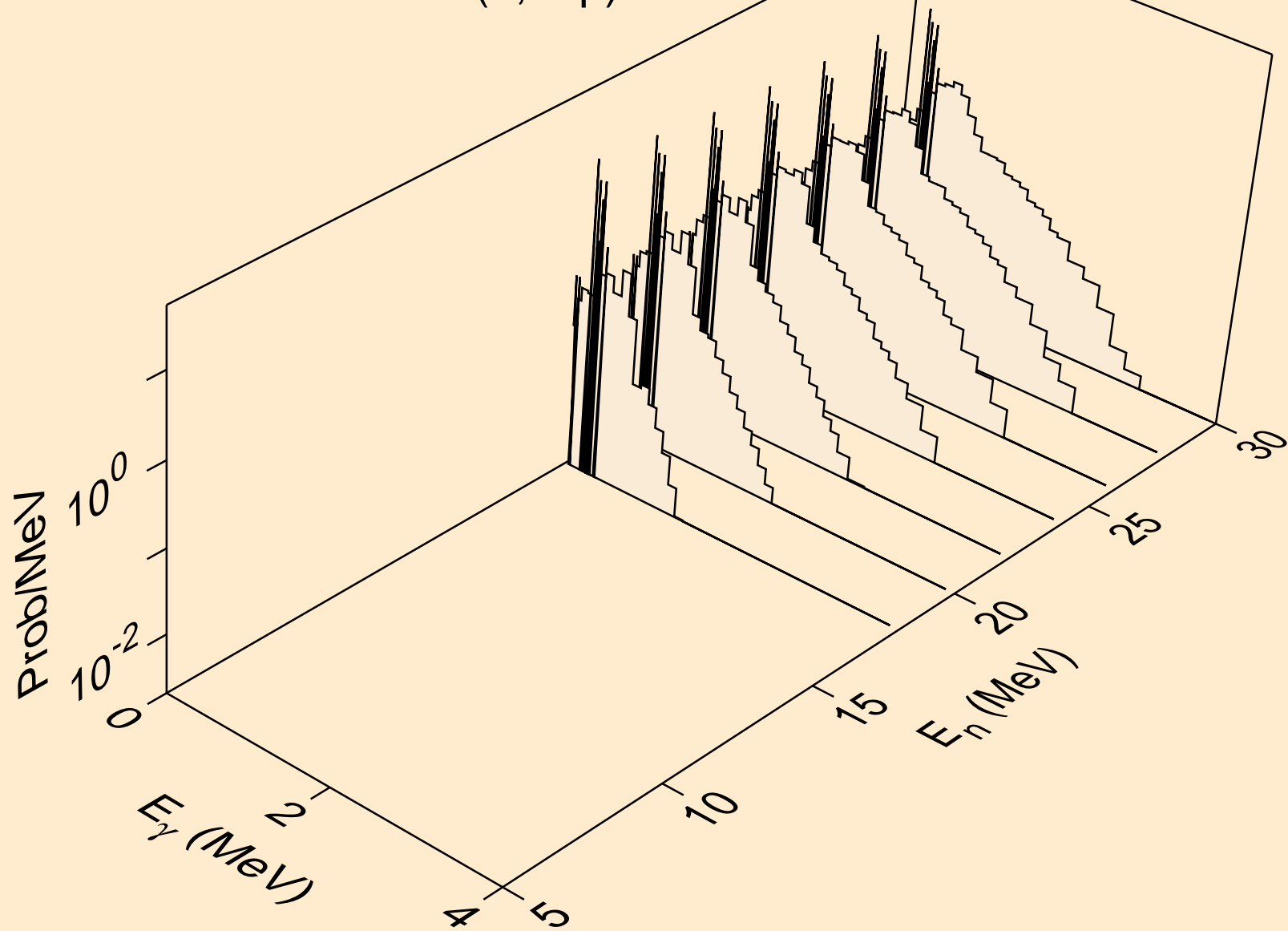

CM237 NEUTRON ACER TENDL-2023 LIBRARY; T=0.K  
Photon emission for (n,npa)

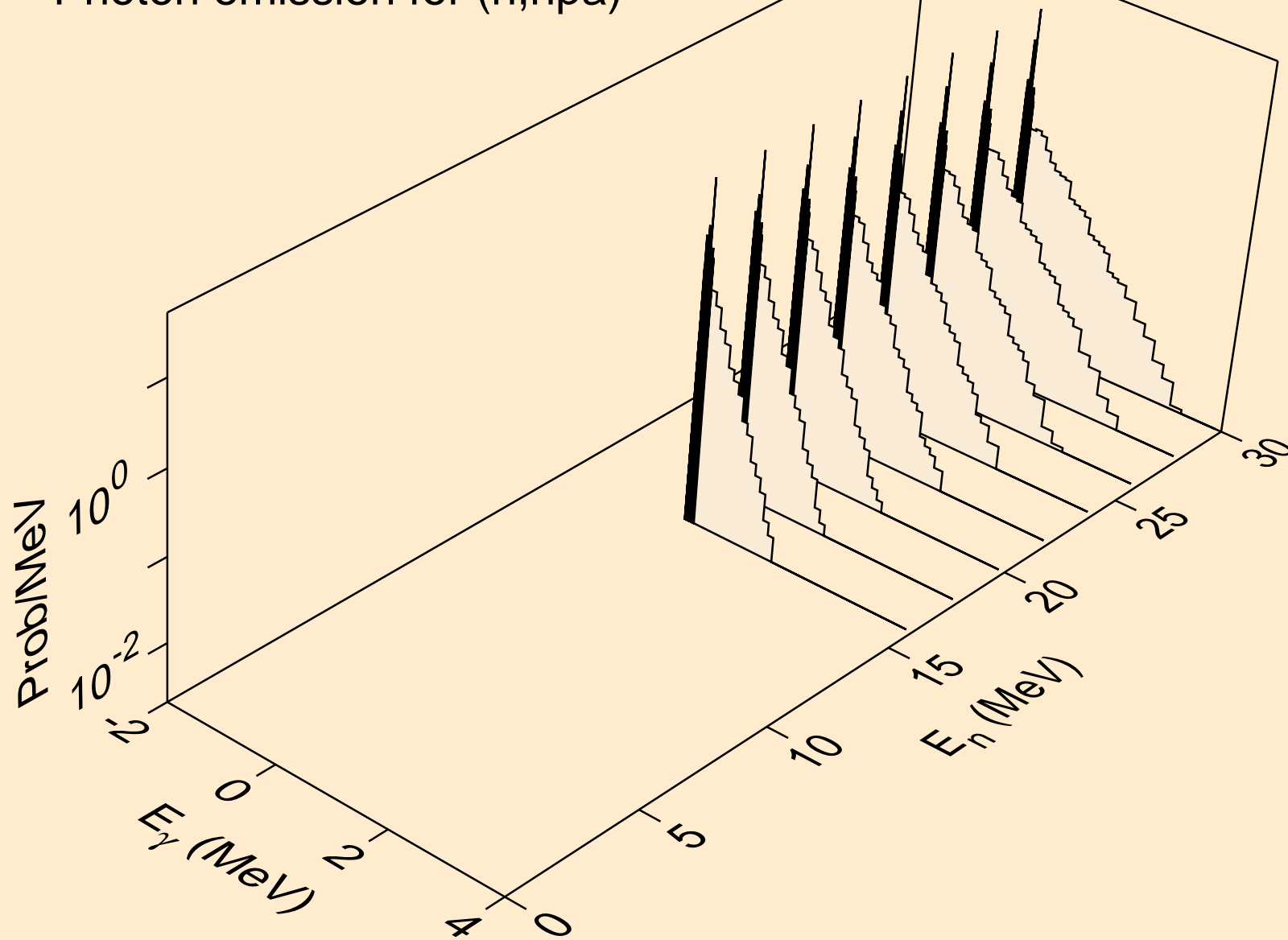

CM237 NEUTRON ACER TENDL-2023 LIBRARY; T=0.K  
Photon emission for (n,n\*c)

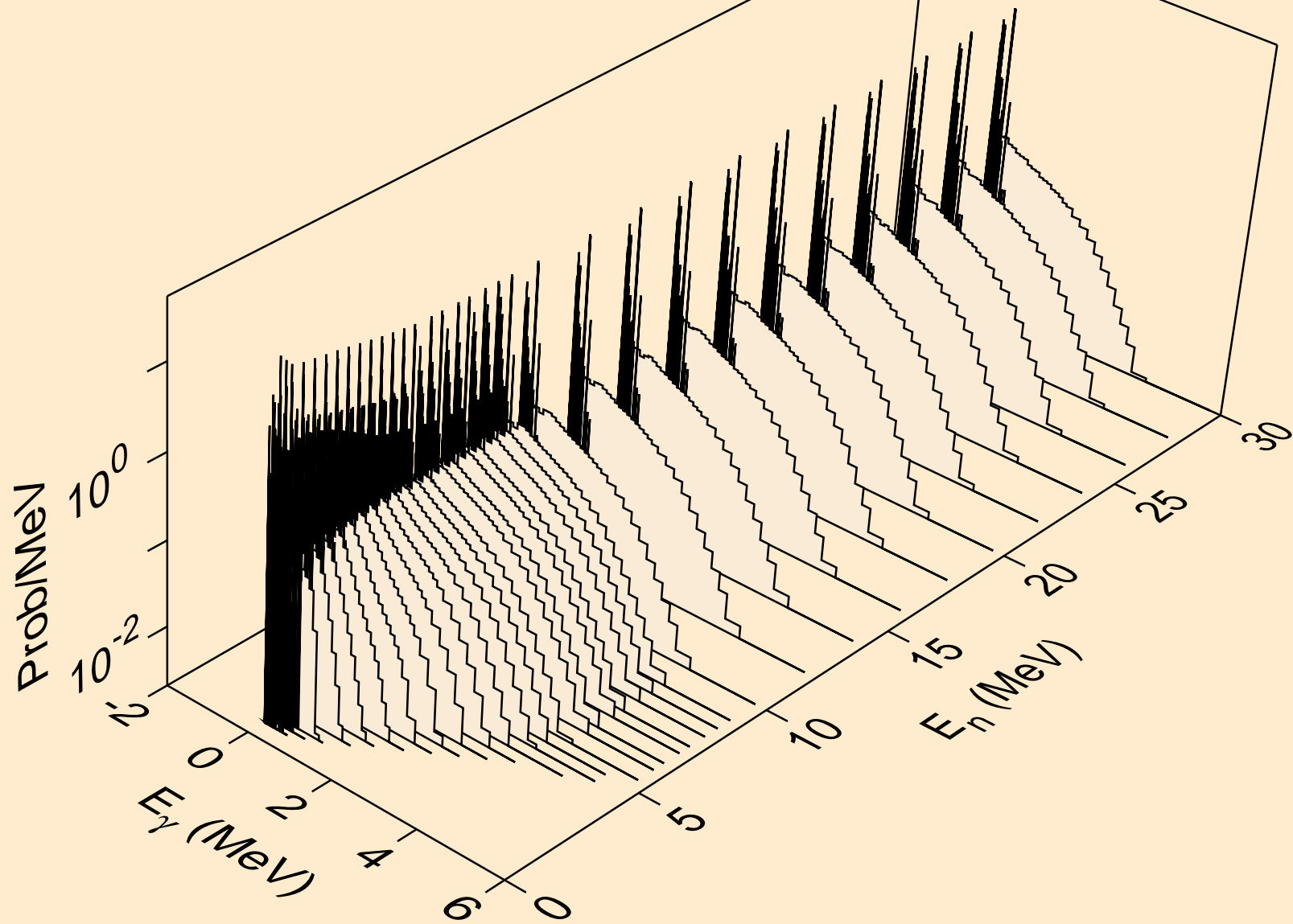

CM237 NEUTRON ACER TENDL-2023 LIBRARY; T=0.K  
Photon emission for (n,gma)

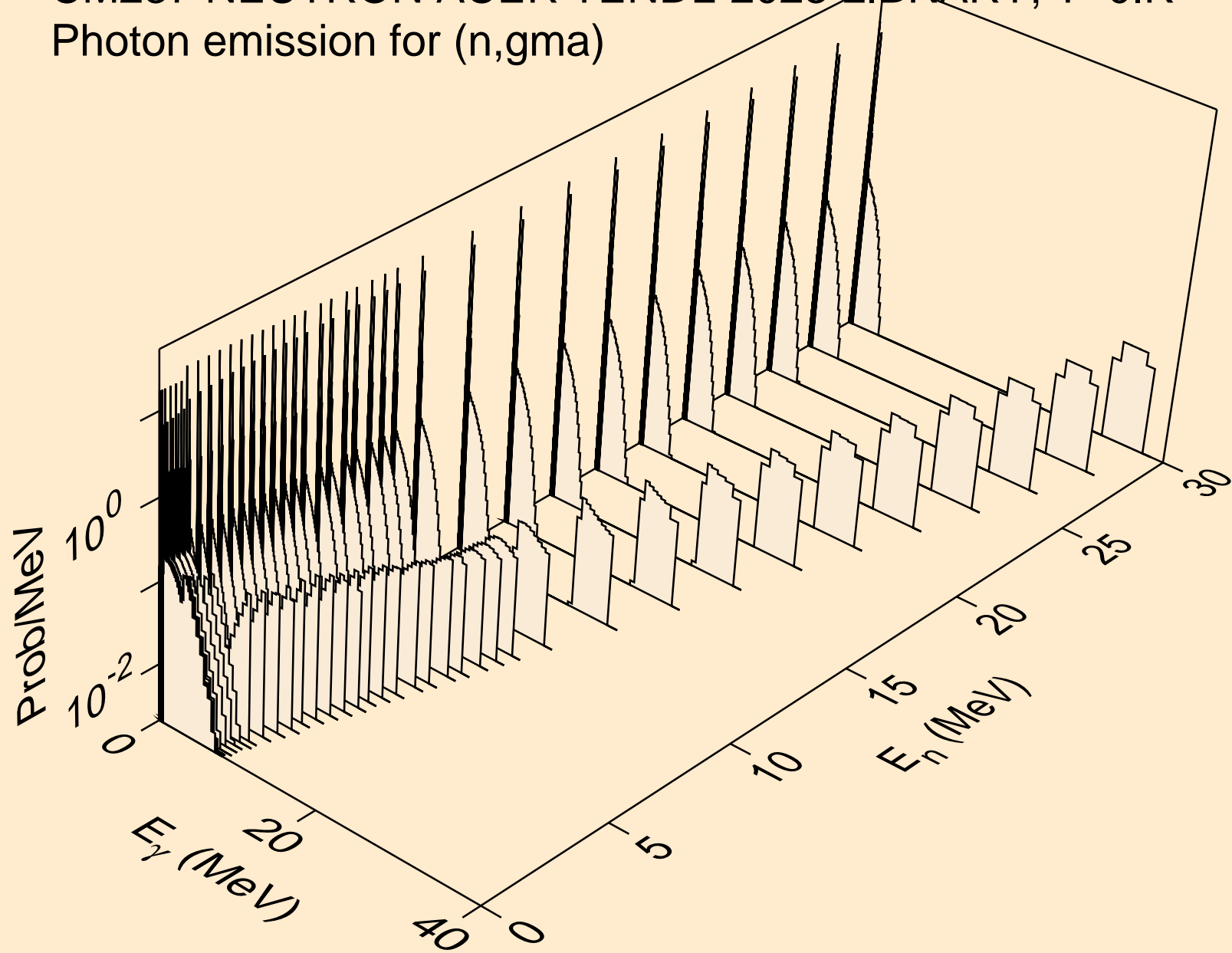

CM237 NEUTRON ACER TENDL-2023 LIBRARY; T=0.K  
Photon emission for (n,p)

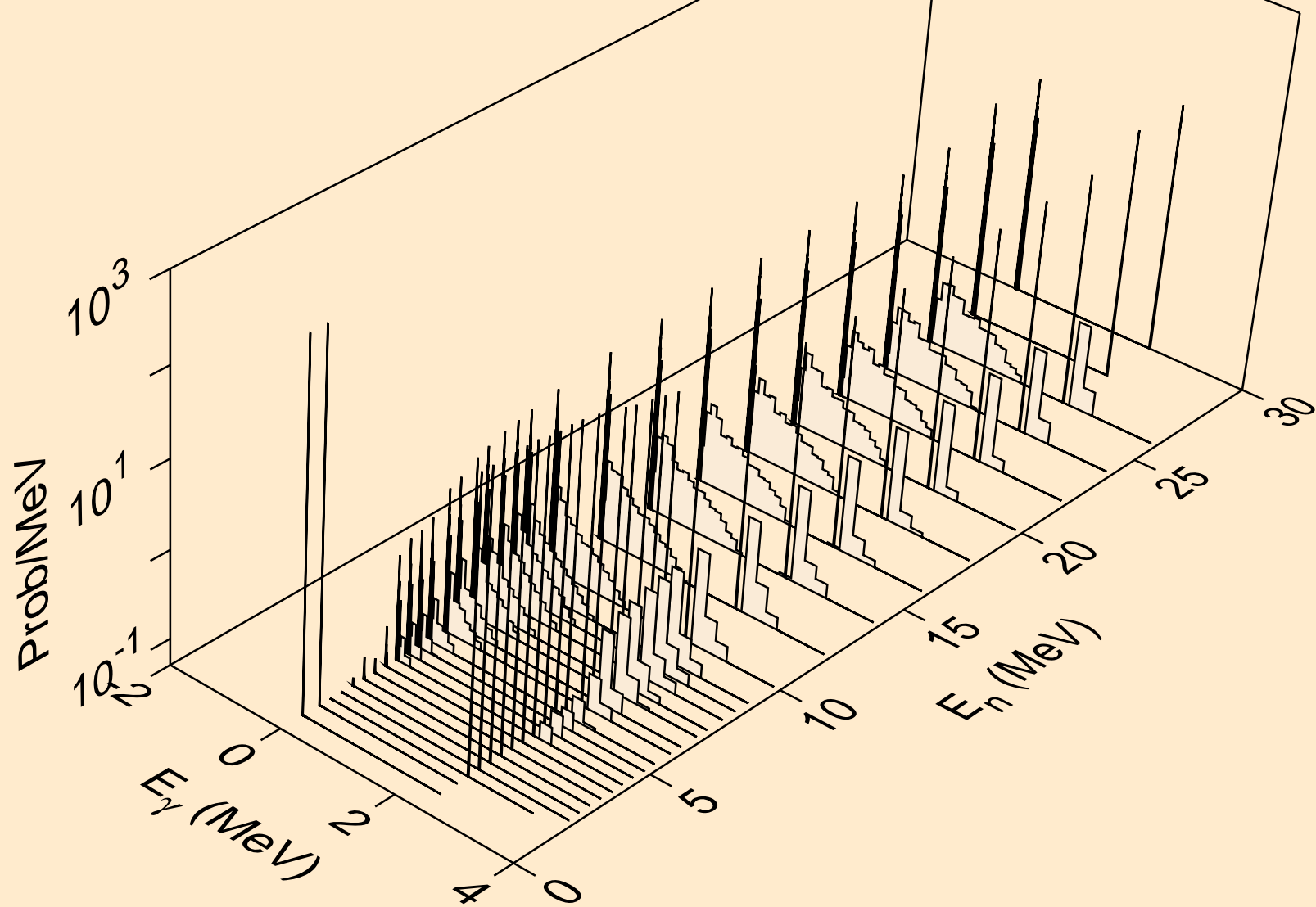

CM237 NEUTRON ACER TENDL-2023 LIBRARY; T=0.K  
Photon emission for (n,d)

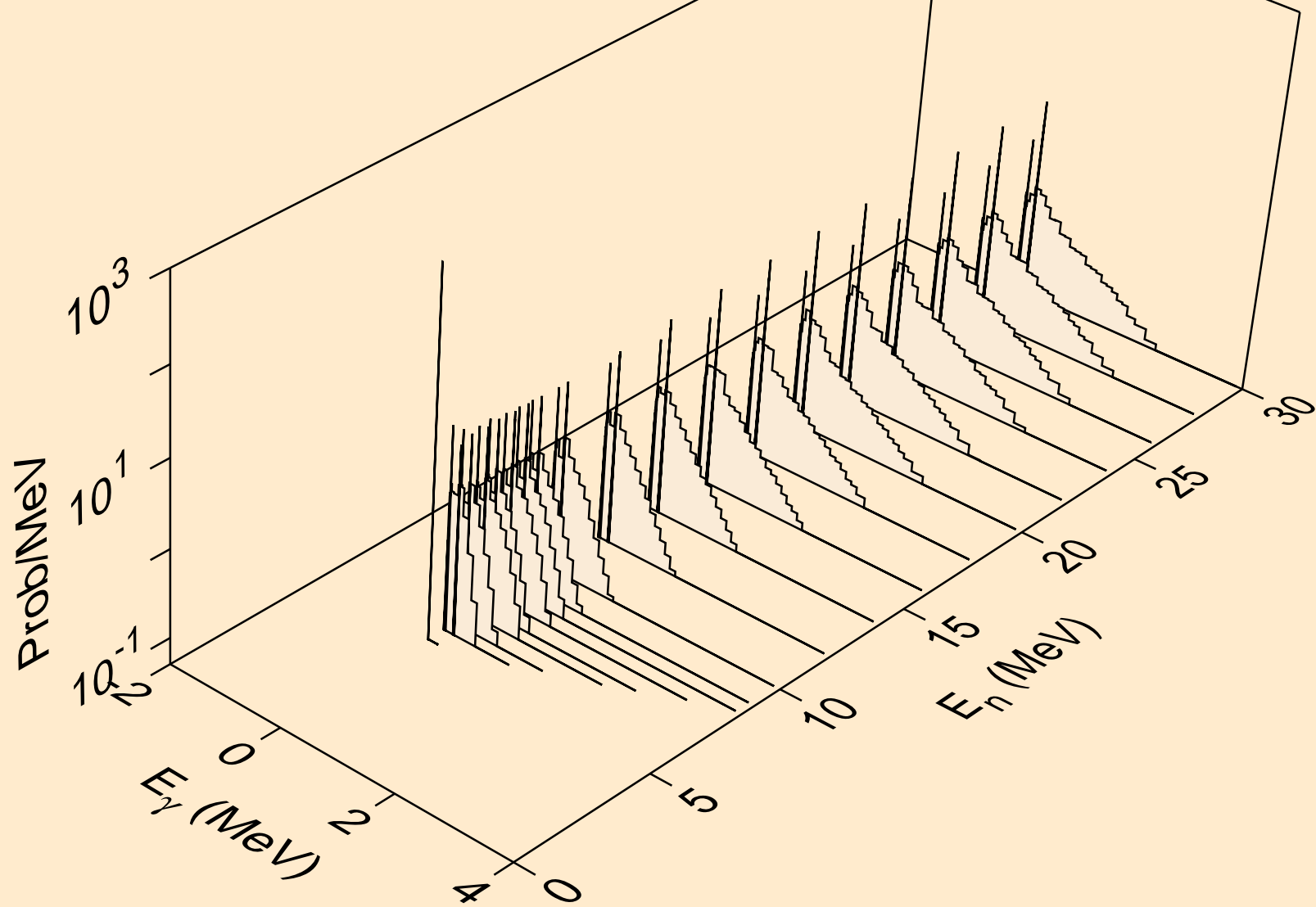

CM237 NEUTRON ACER TENDL-2023 LIBRARY; T=0.K  
Photon emission for (n,t)

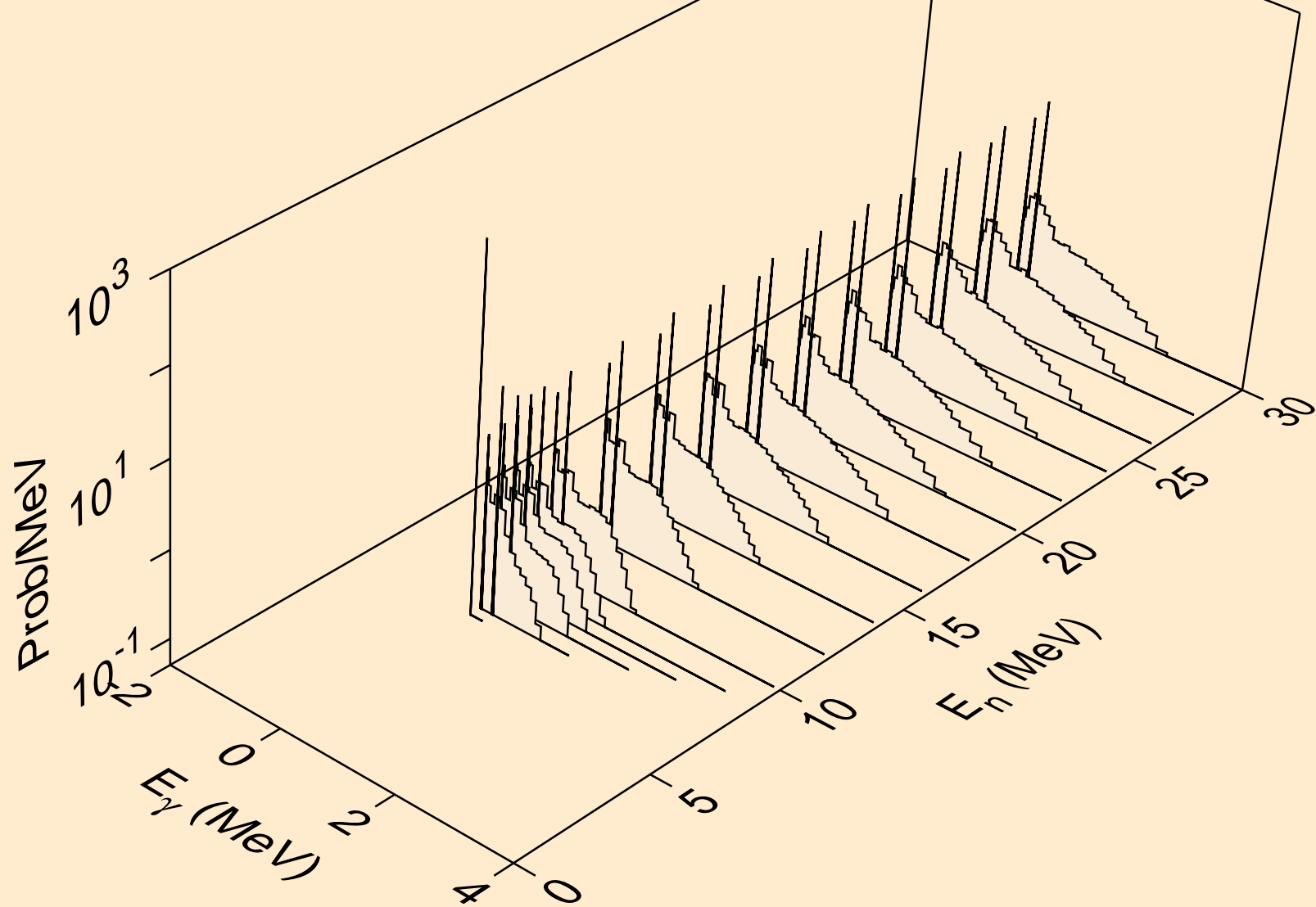

CM237 NEUTRON ACER TENDL-2023 LIBRARY; T=0.K  
Photon emission for (n,he3)

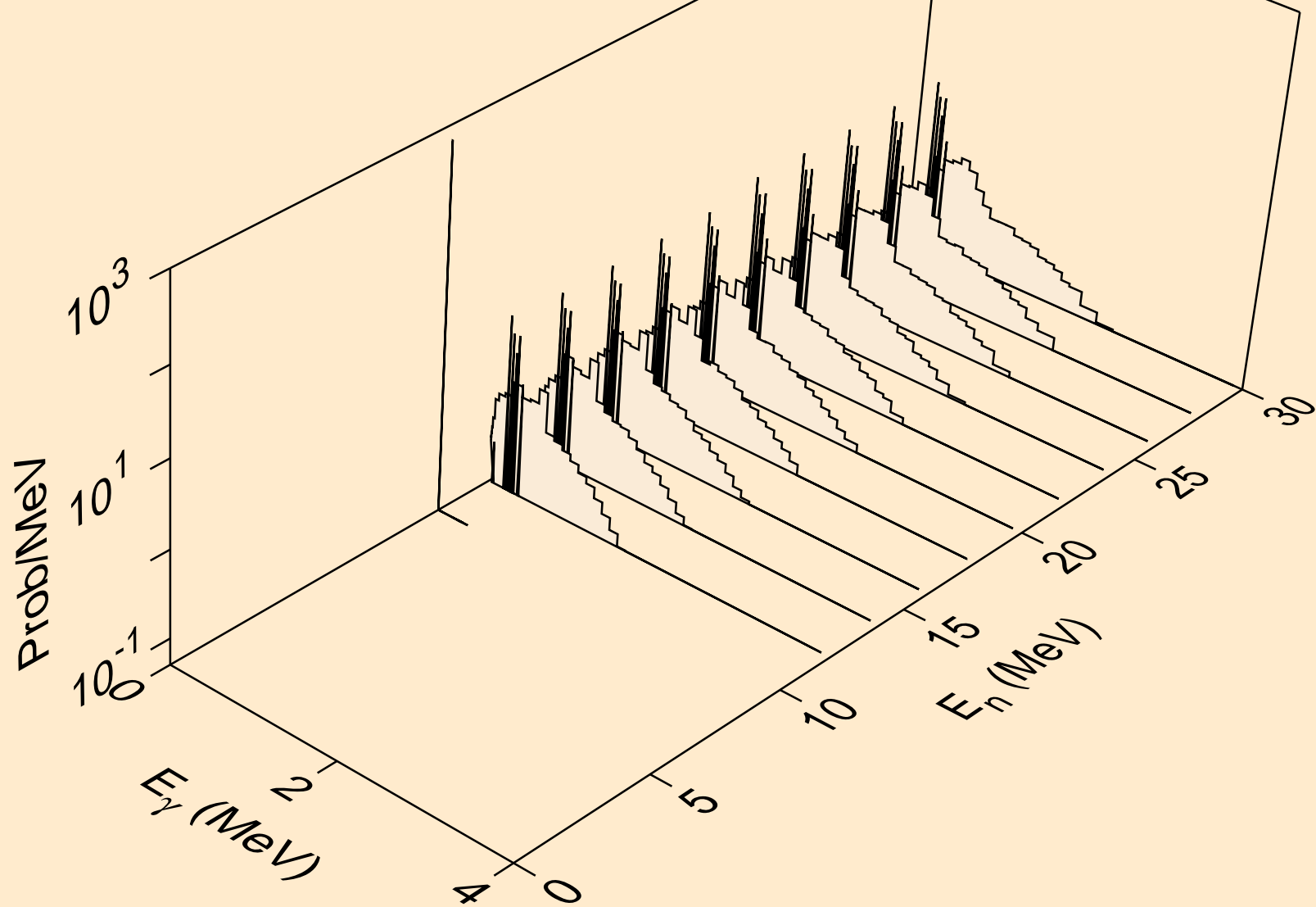

CM237 NEUTRON ACER TENDL-2023 LIBRARY; T=0.K  
Photon emission for (n,a)

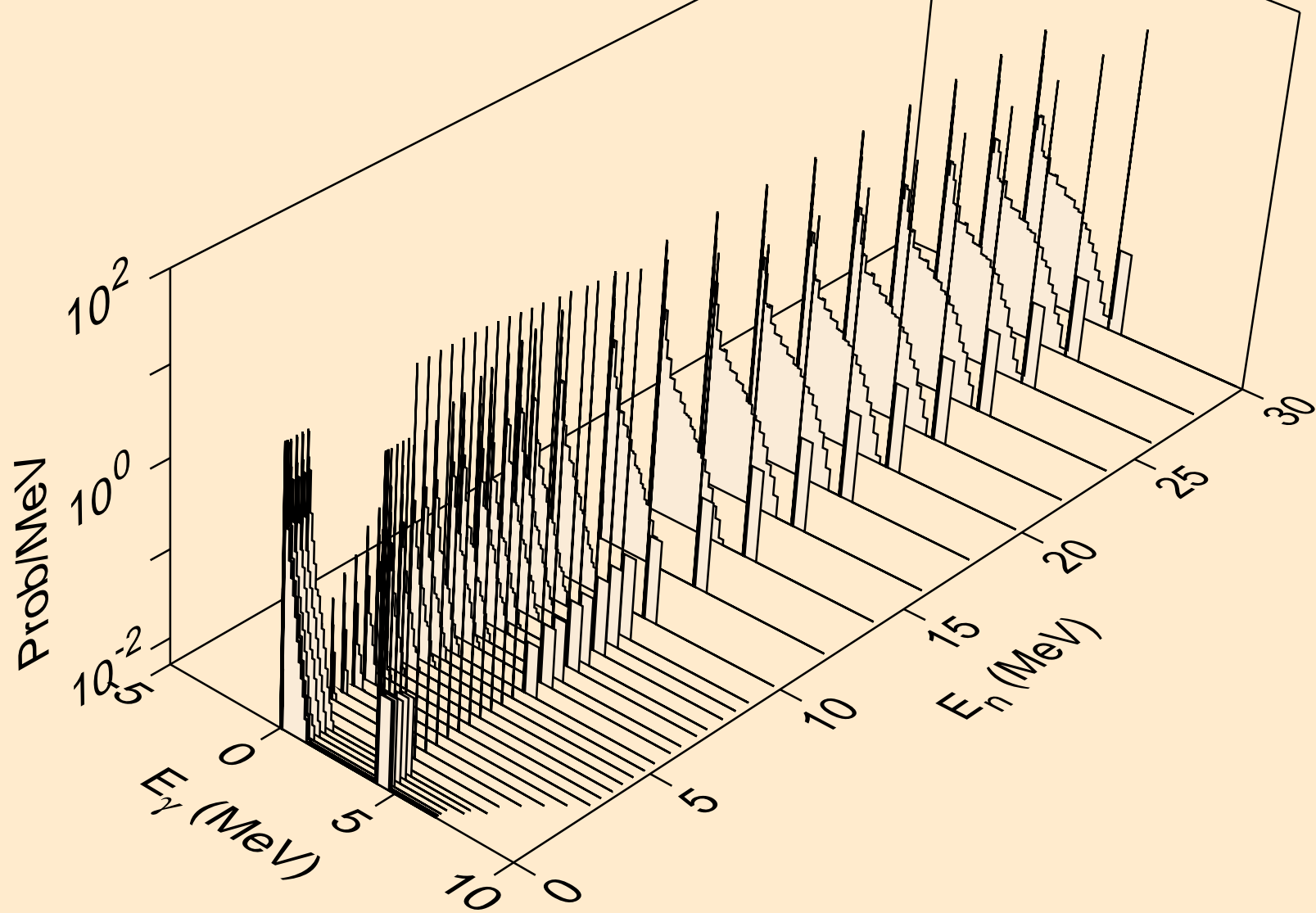

CM237 NEUTRON ACER TENDL-2023 LIBRARY; T=0.K  
Photon emission for (n,2a)

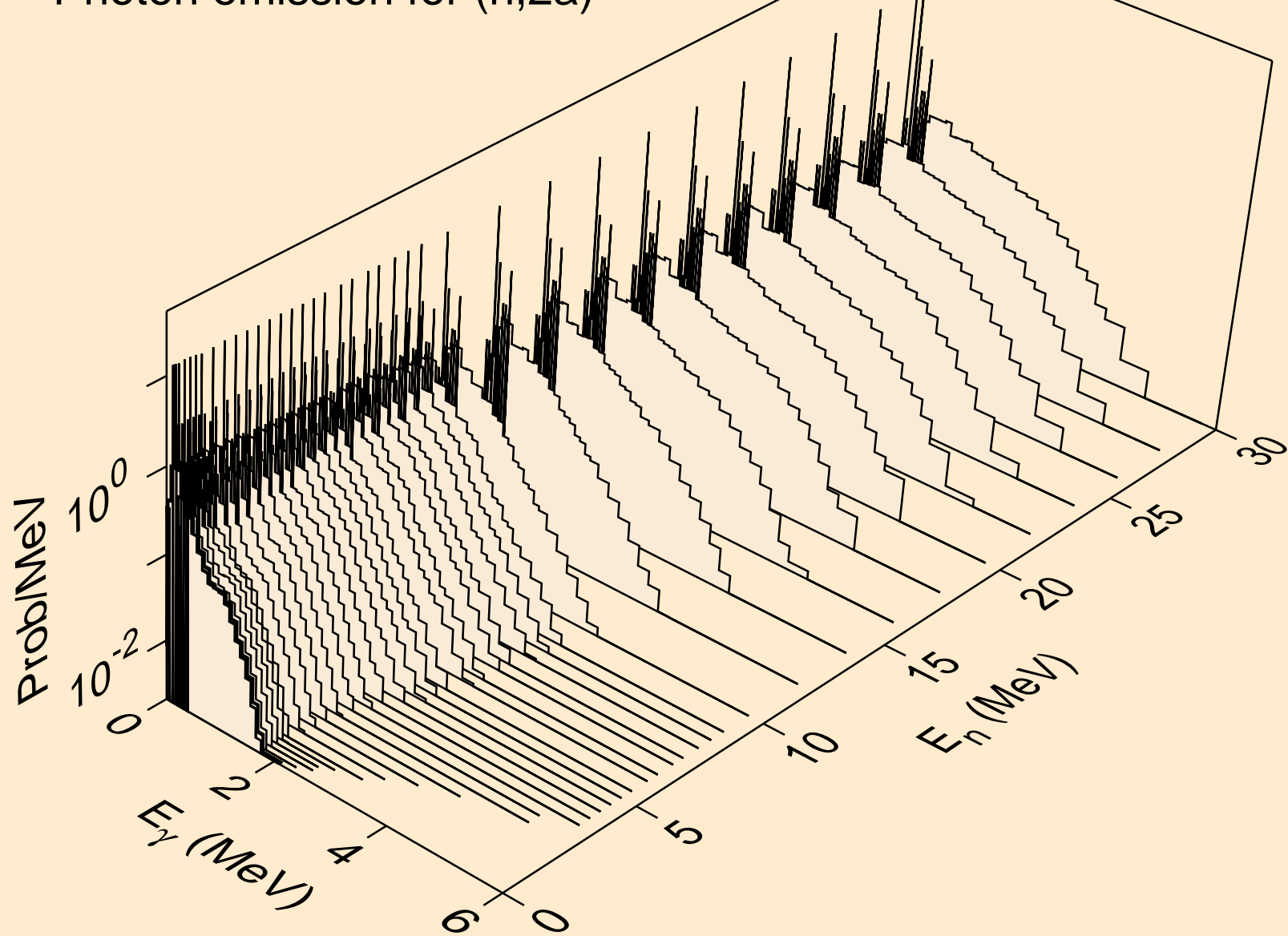

CM237 NEUTRON ACER TENDL-2023 LIBRARY; T=0.K  
Photon emission for (n,2p)

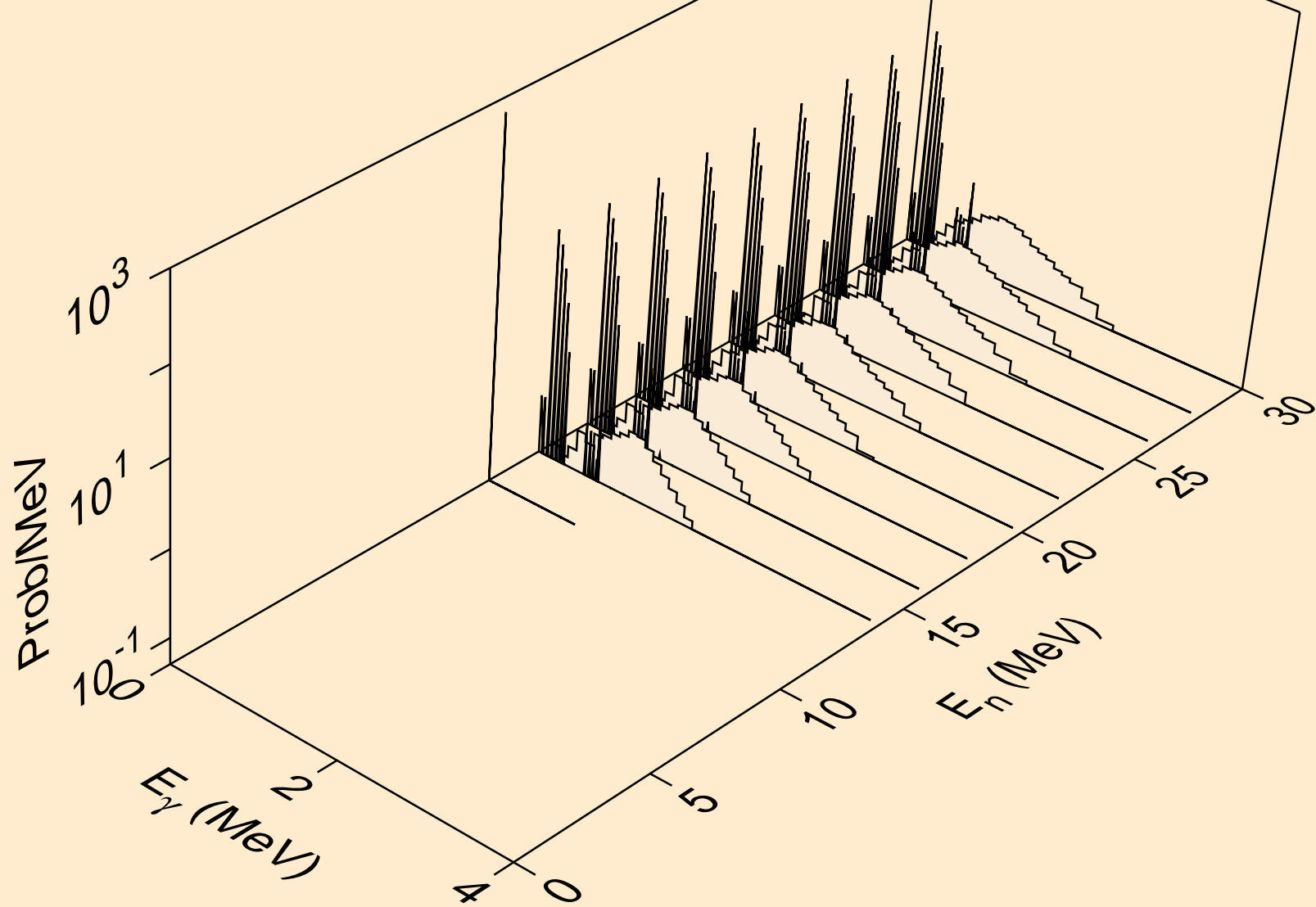

CM237 NEUTRON ACER TENDL-2023 LIBRARY; T=0.K  
Photon emission for (n,p $\alpha$ )

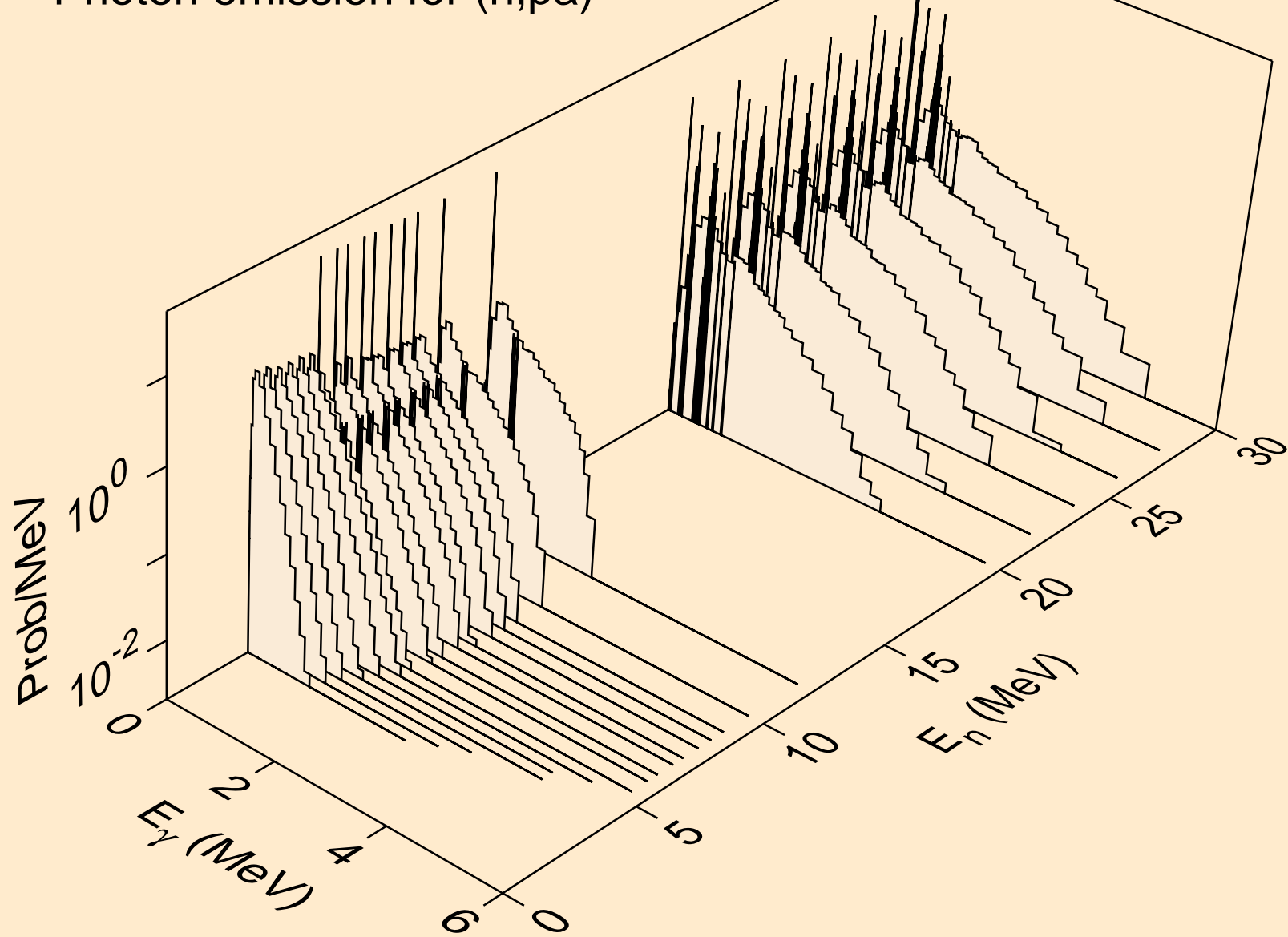

CM237 NEUTRON ACER TENDL-2023 LIBRARY; T=0.K  
Photon emission for (n,pd)

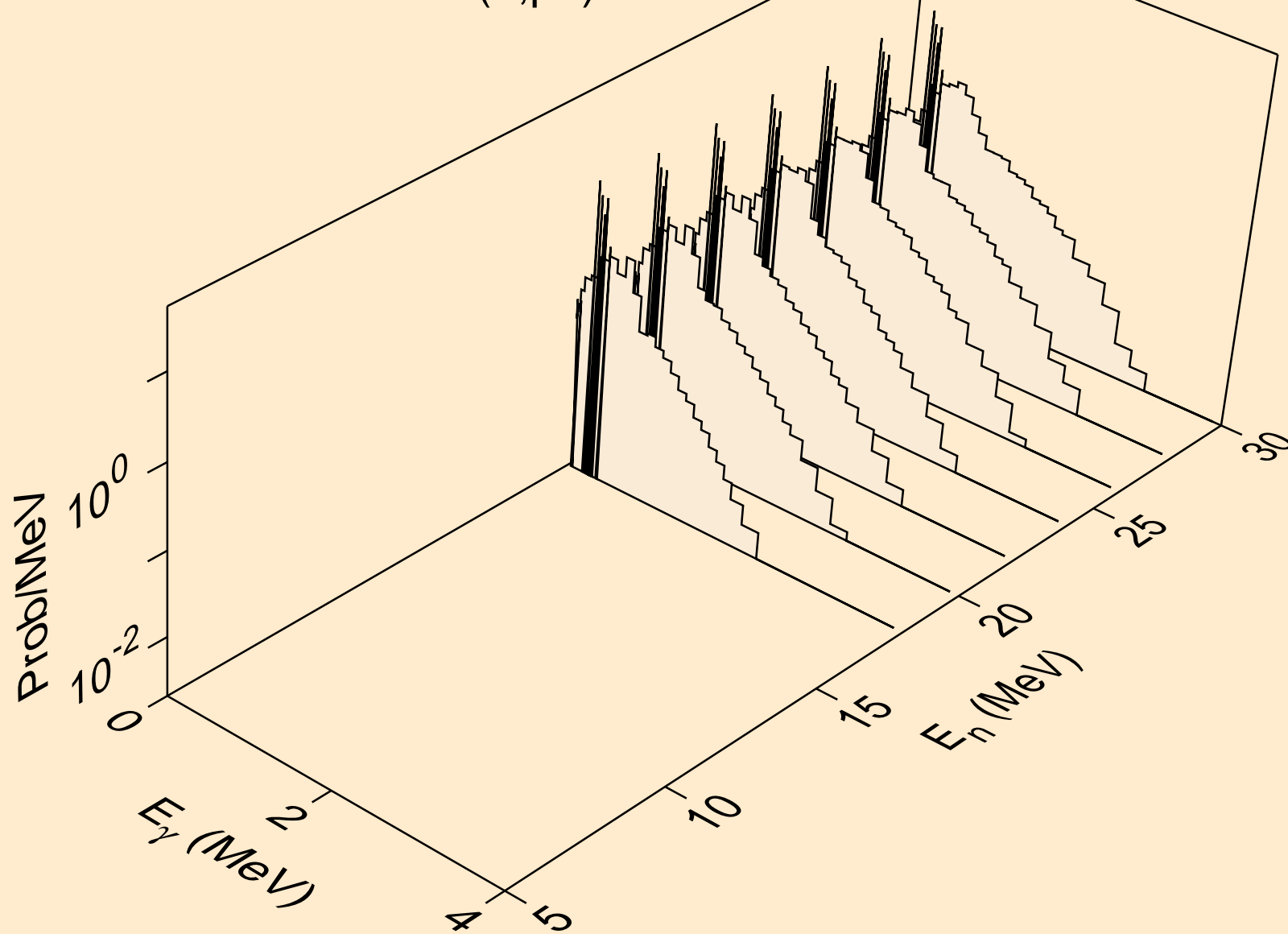

CM237 NEUTRON ACER TENDL-2023 LIBRARY; T=0.K  
thermal capture photon spectrum

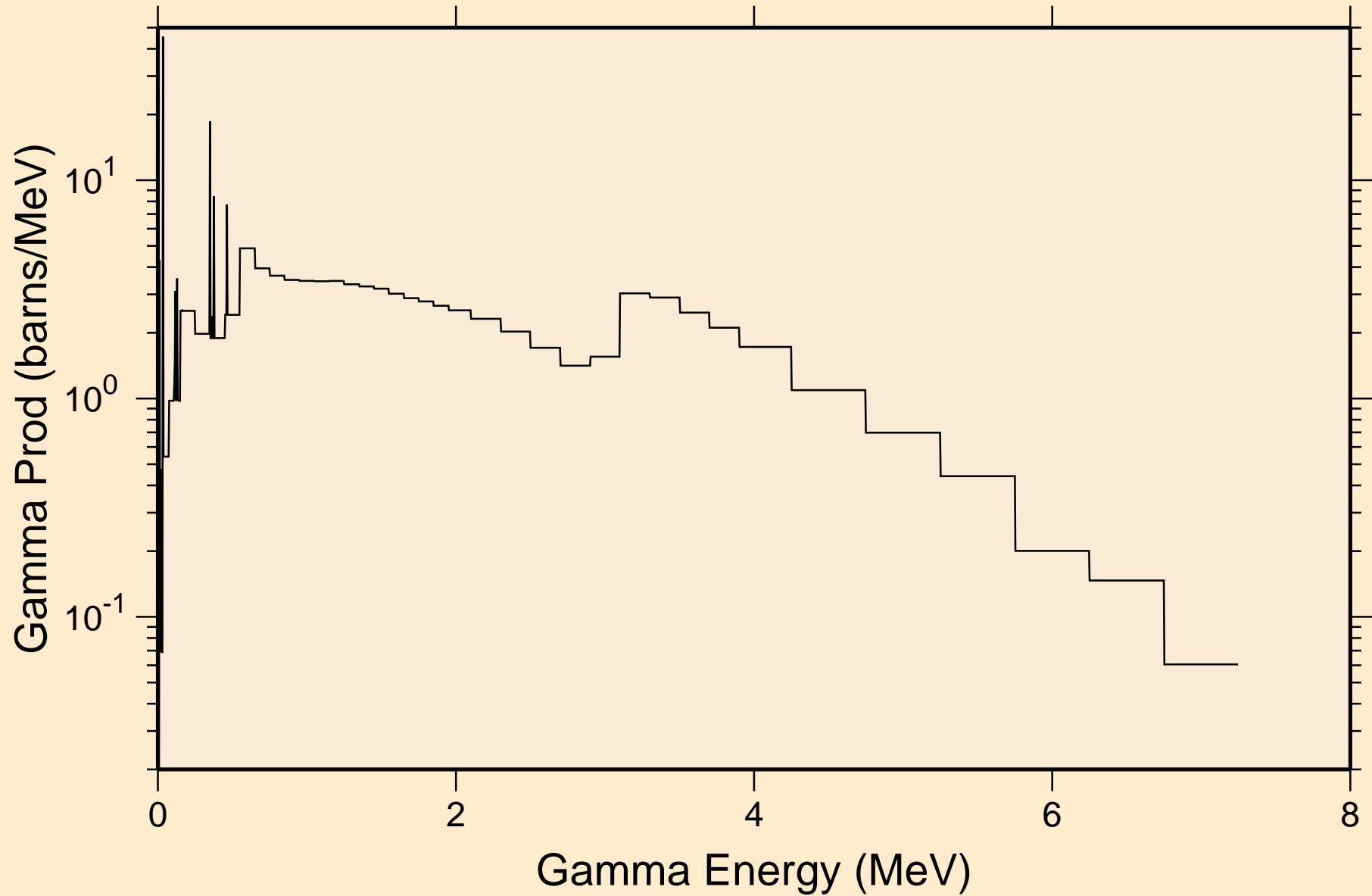

CM237 NEUTRON ACER TENDL-2023 LIBRARY; T=0.K  
14 MeV photon spectrum

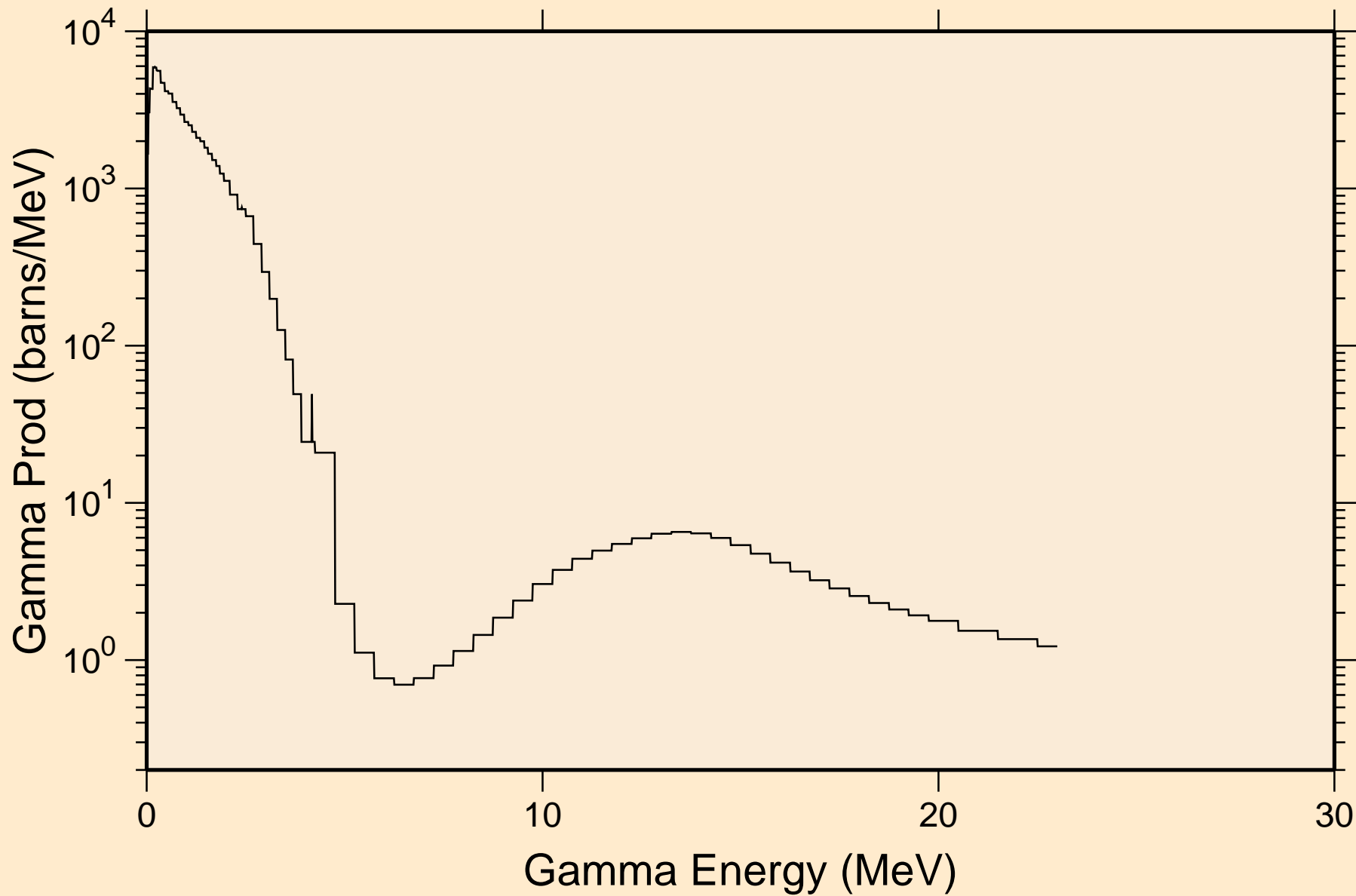

# CM237 NEUTRON ACER TENDL-2023 LIBRARY; T=0.K

## Particle heating contributions

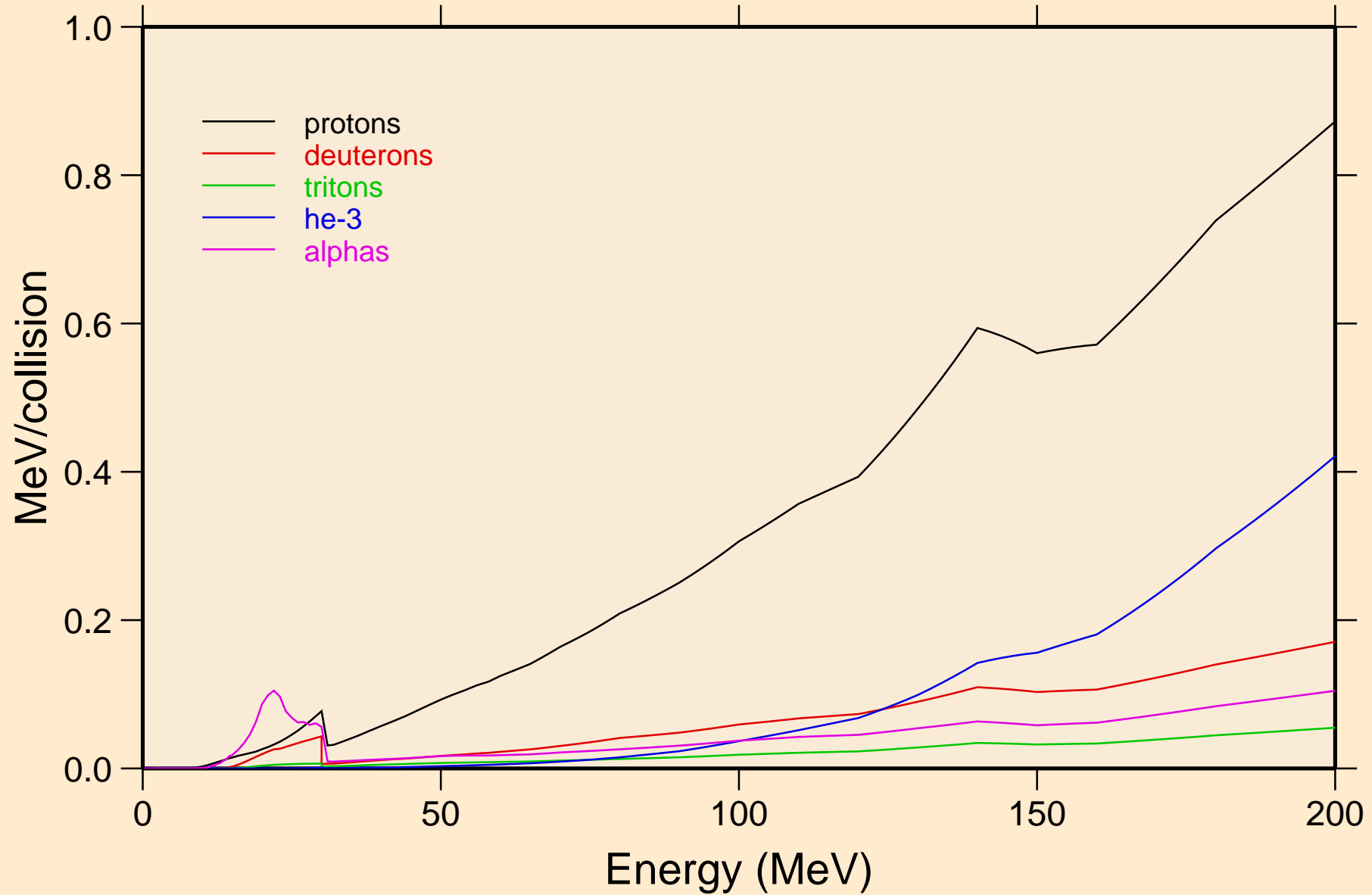

# CM237 NEUTRON ACER TENDL-2023 LIBRARY; T=0.K

## Recoil Heating

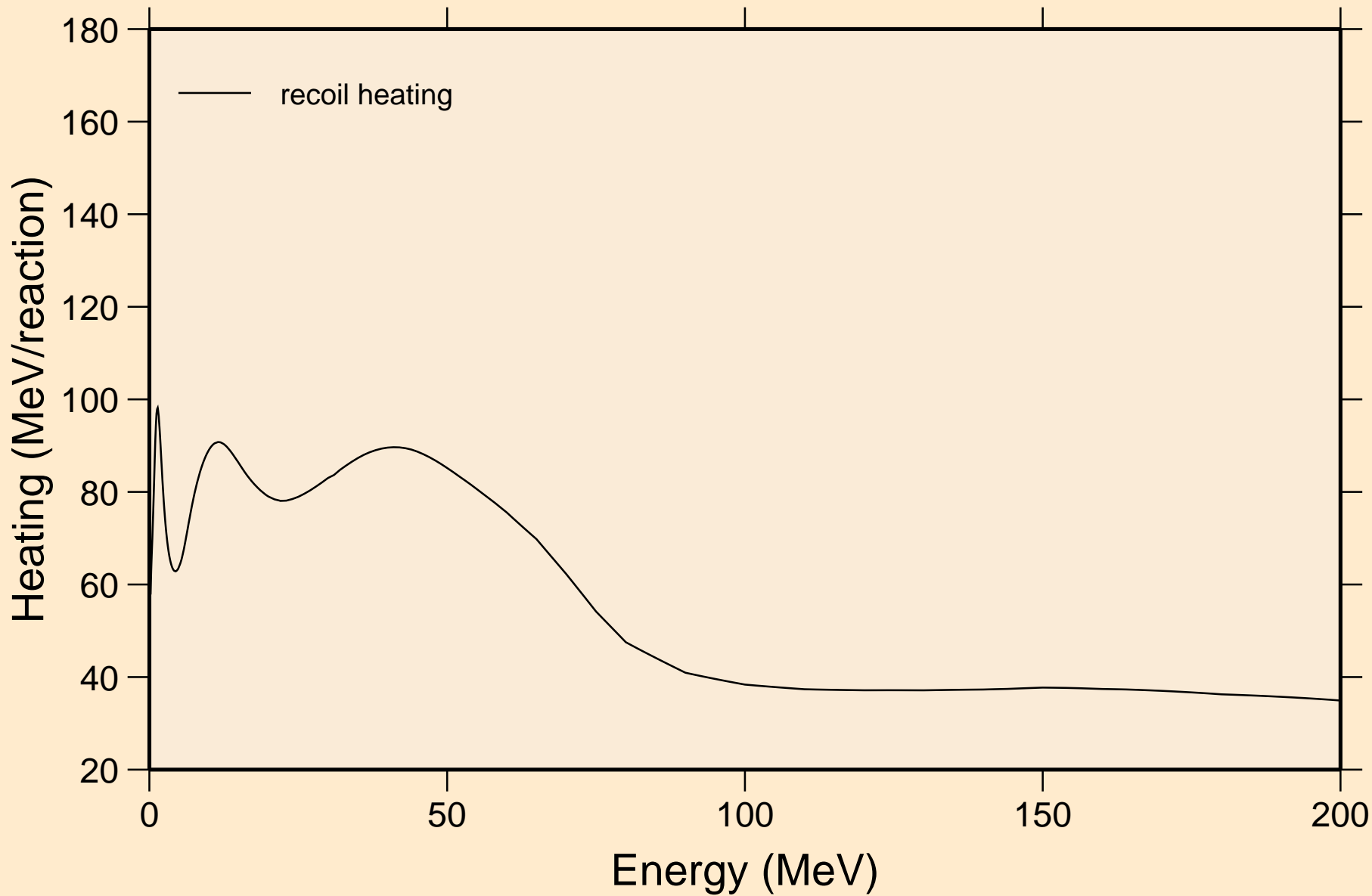

# CM237 NEUTRON ACER TENDL-2023 LIBRARY; T=0.K

## Particle production cross sections

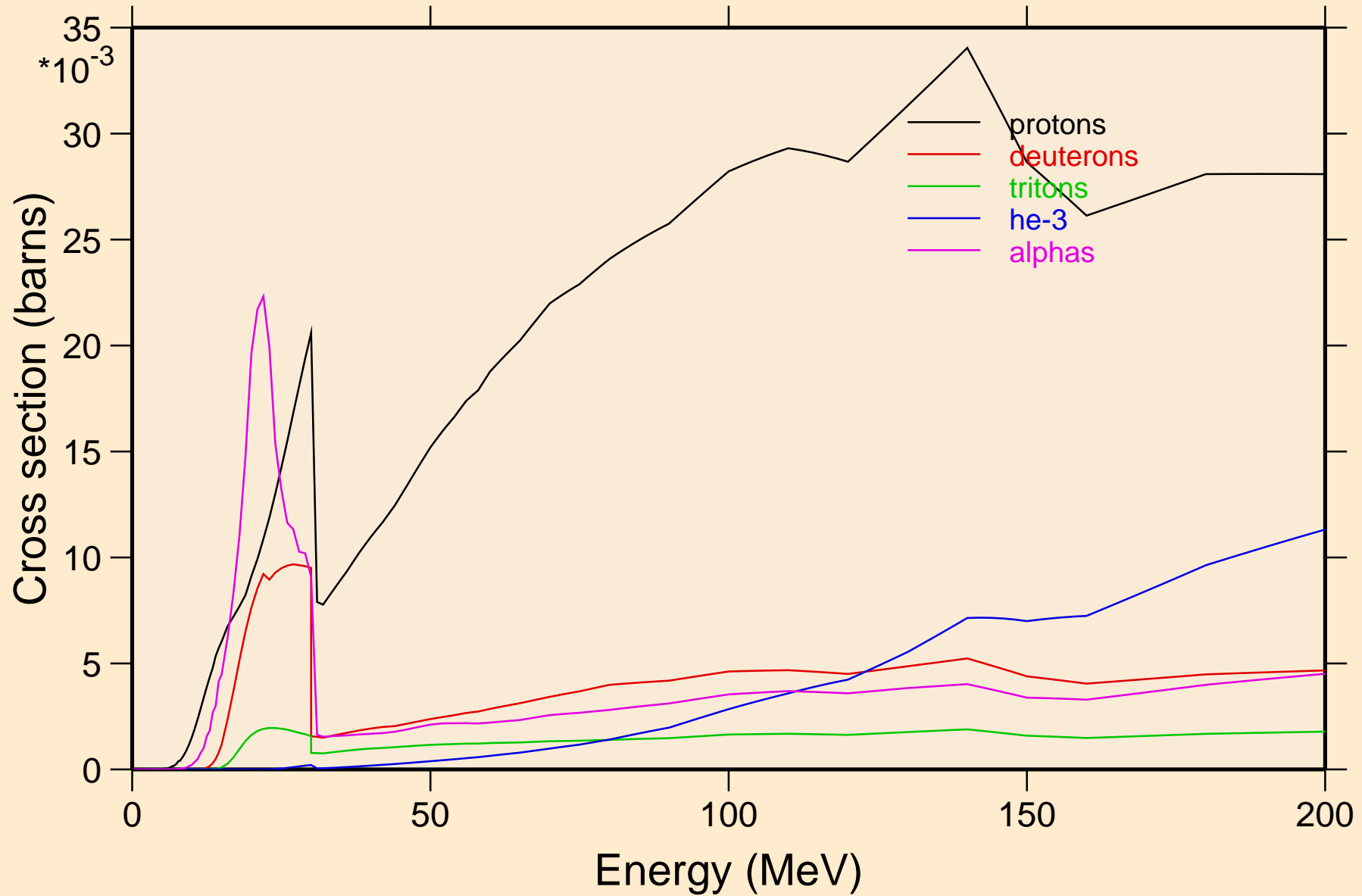

CM237 NEUTRON ACER TENDL-2023 LIBRARY; T=0.K  
protons from (n,x)

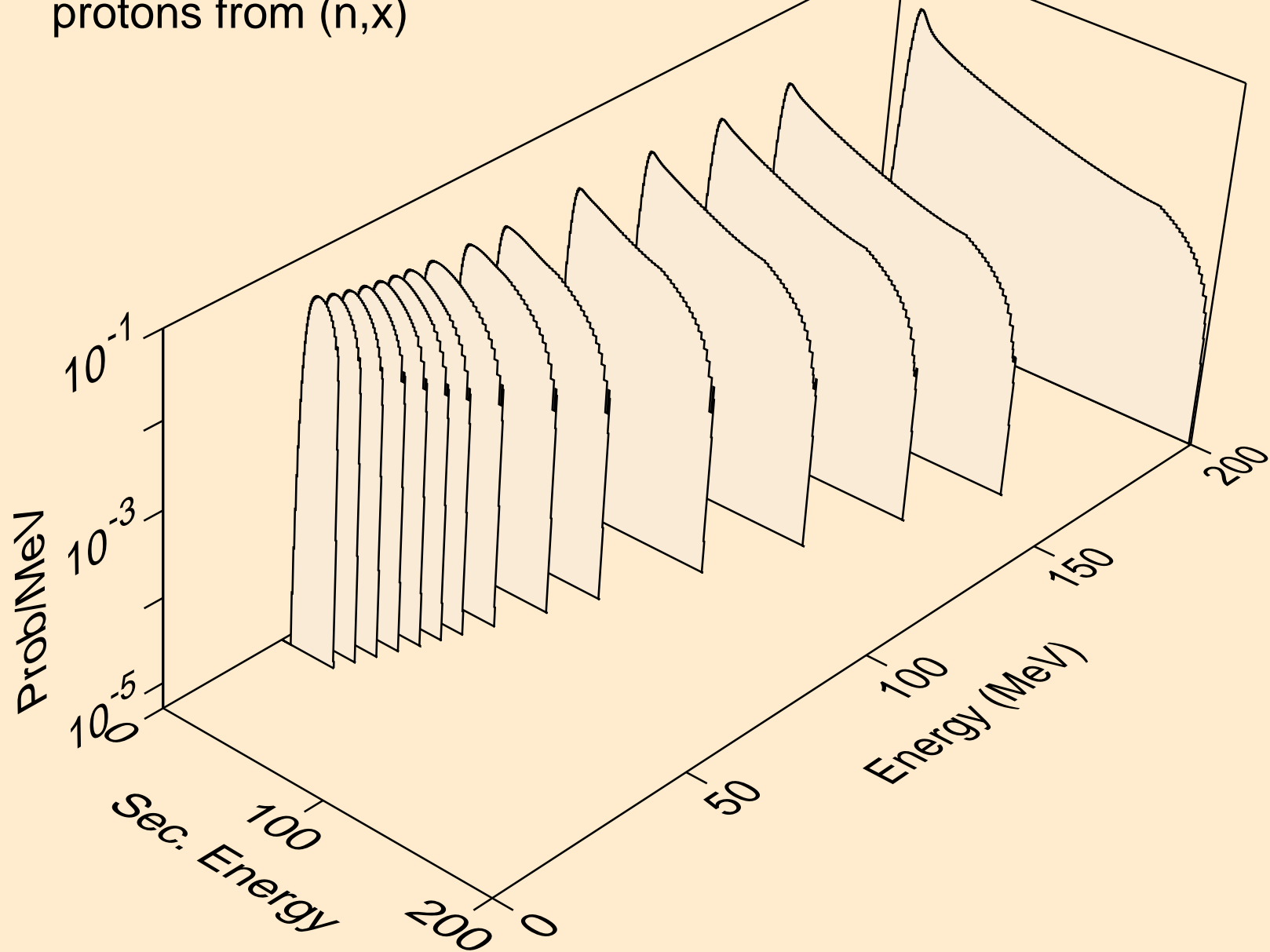

CM237 NEUTRON ACER TENDL-2023 LIBRARY; T=0.K  
protons from (n,n\*)p

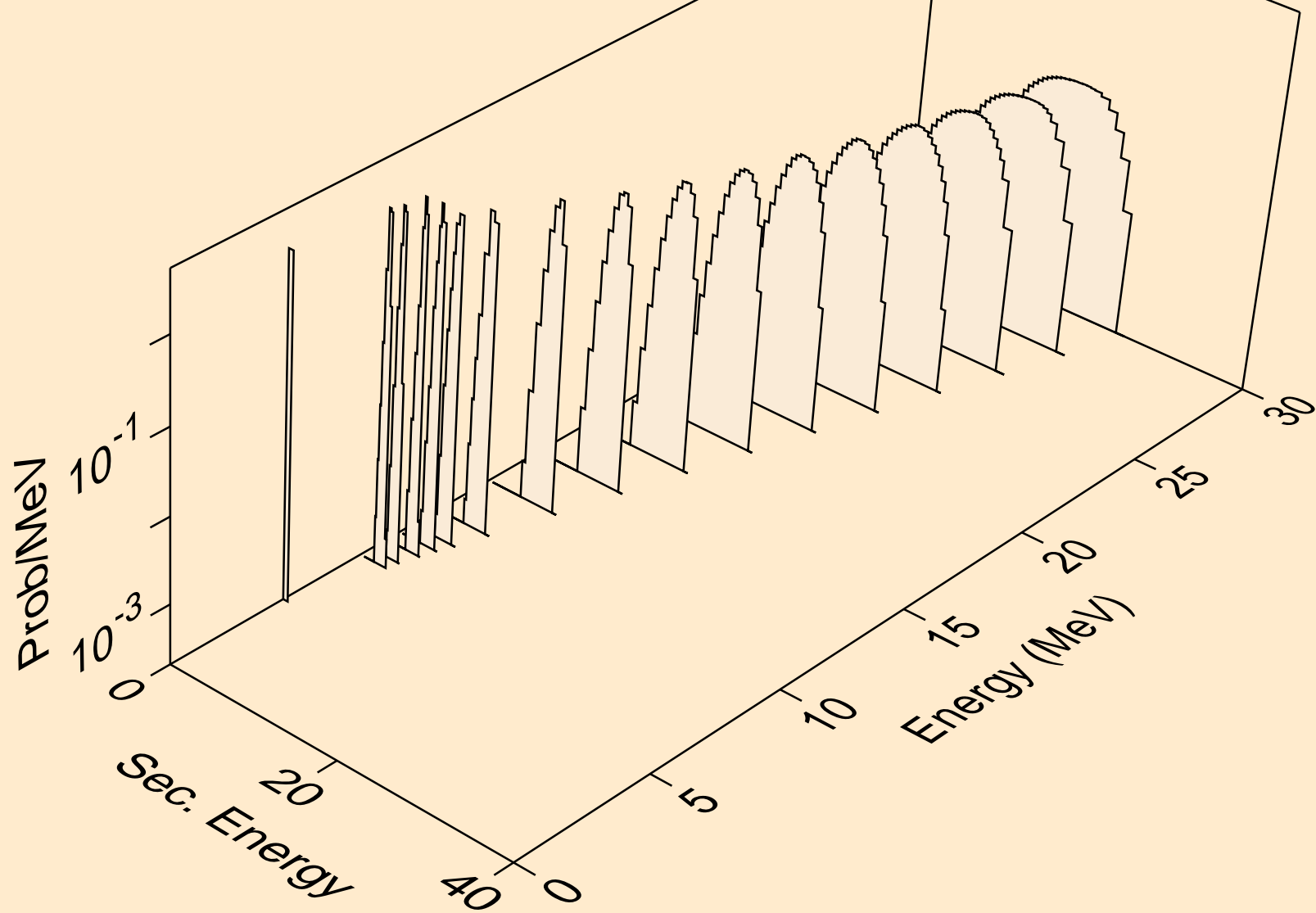

CM237 NEUTRON ACER TENDL-2023 LIBRARY; T=0.K  
protons from (n,2np)

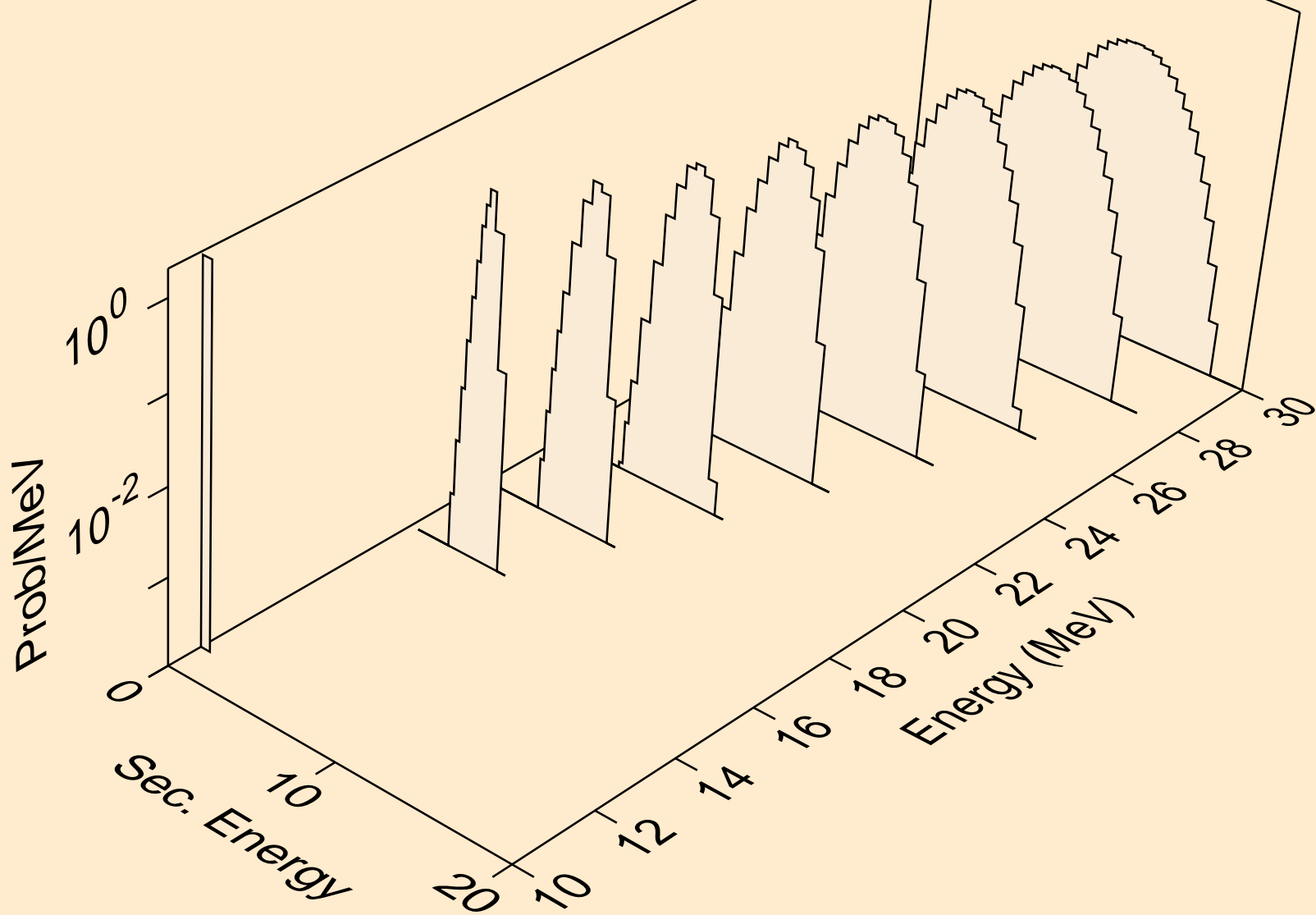

CM237 NEUTRON ACER TENDL-2023 LIBRARY; T=0.K  
protons from (n,n2p)

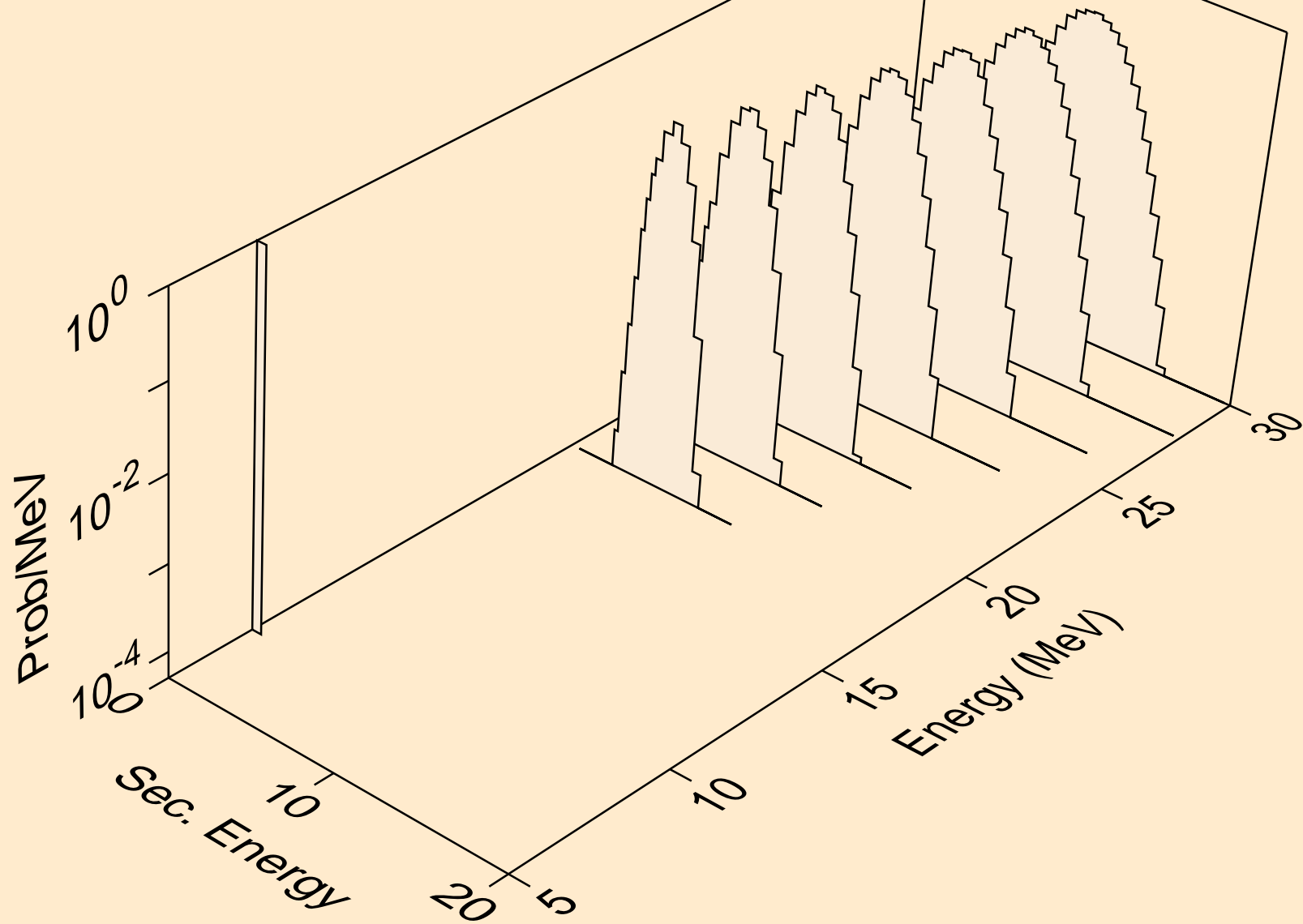

CM237 NEUTRON ACER TENDL-2023 LIBRARY; T=0.K  
protons from (n,npa)

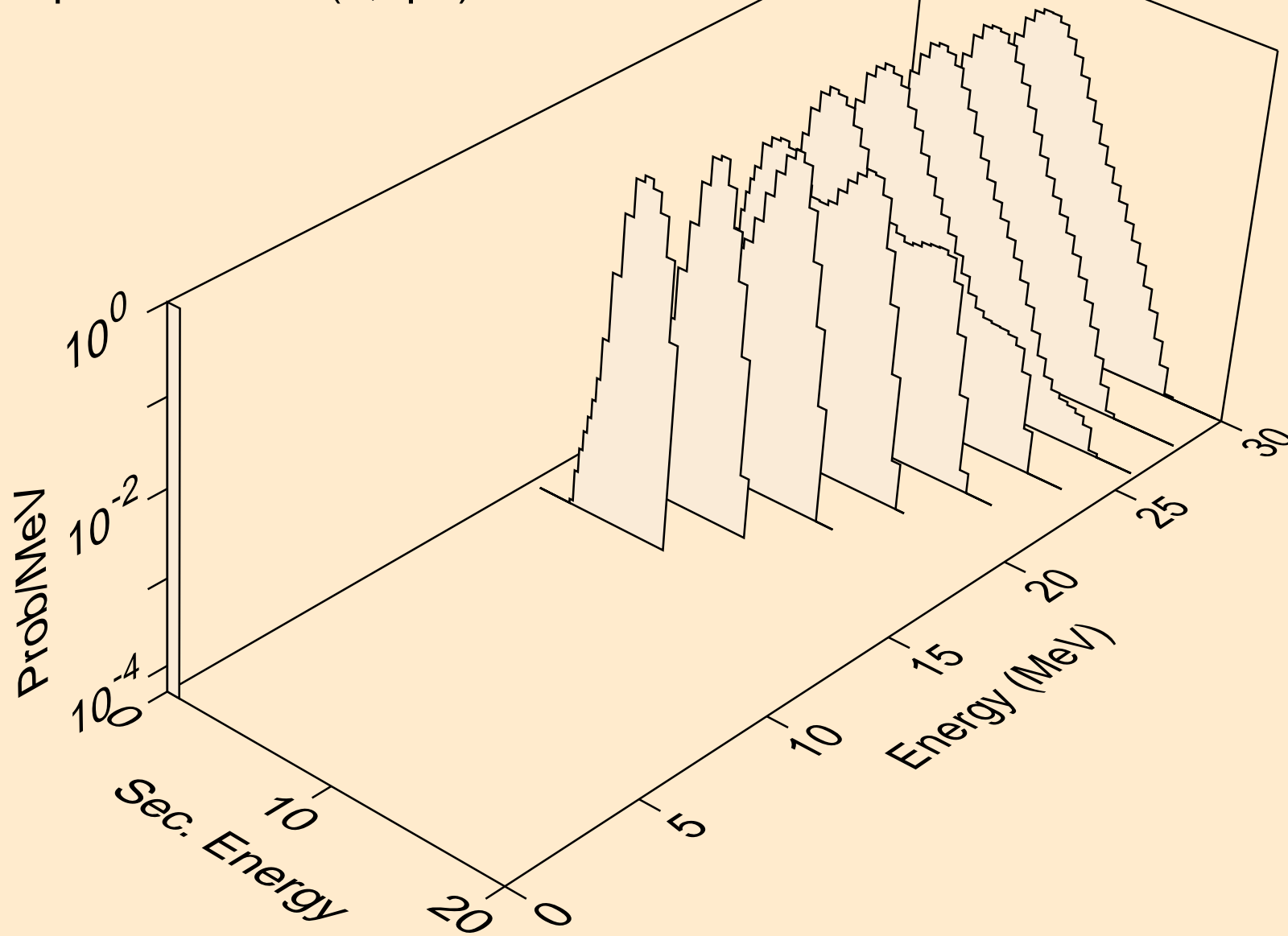

CM237 NEUTRON ACER TENDL-2023 LIBRARY; T=0.K  
protons from (n,p)

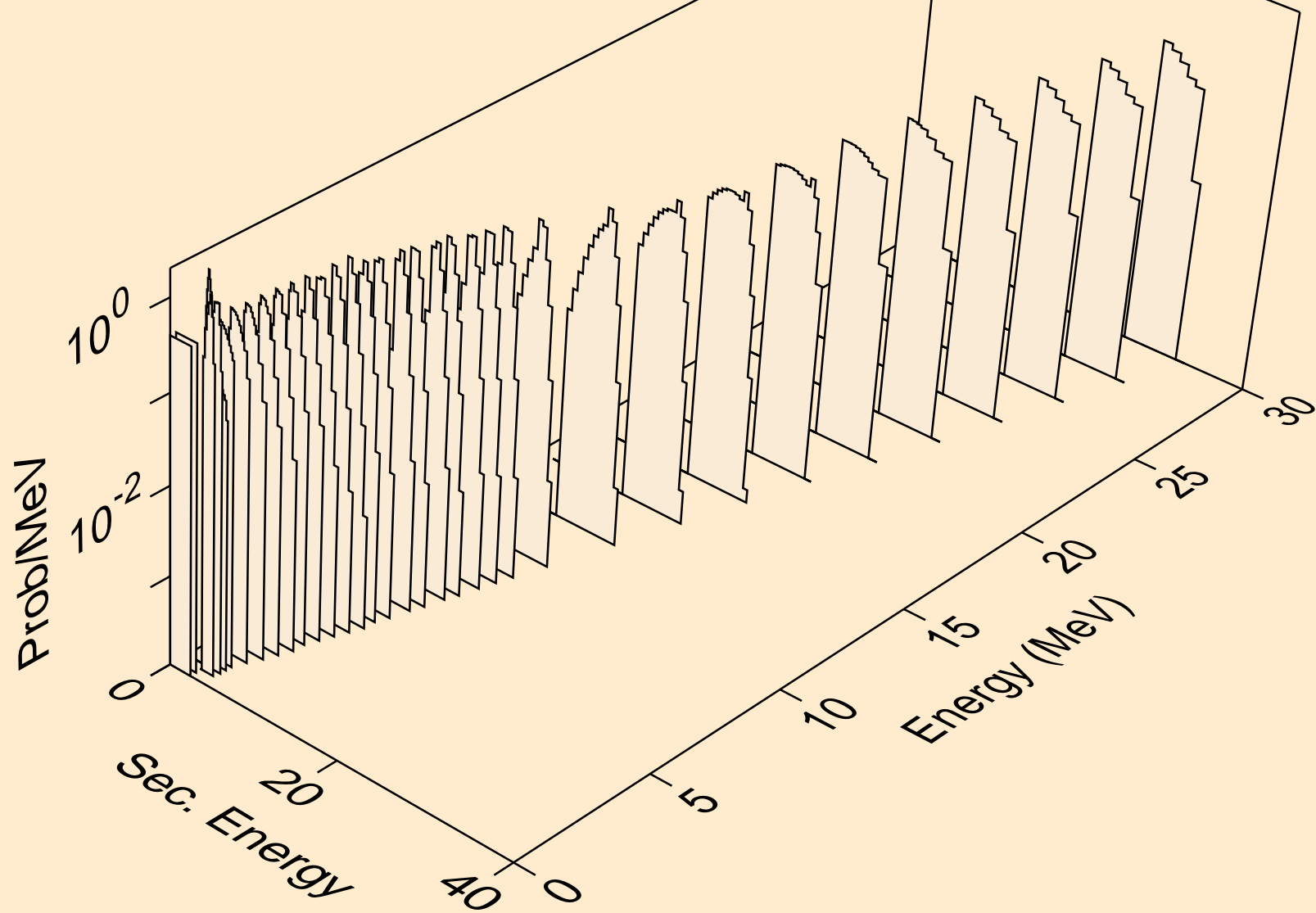

CM237 NEUTRON ACER TENDL-2023 LIBRARY; T=0.K  
protons from (n,2p)

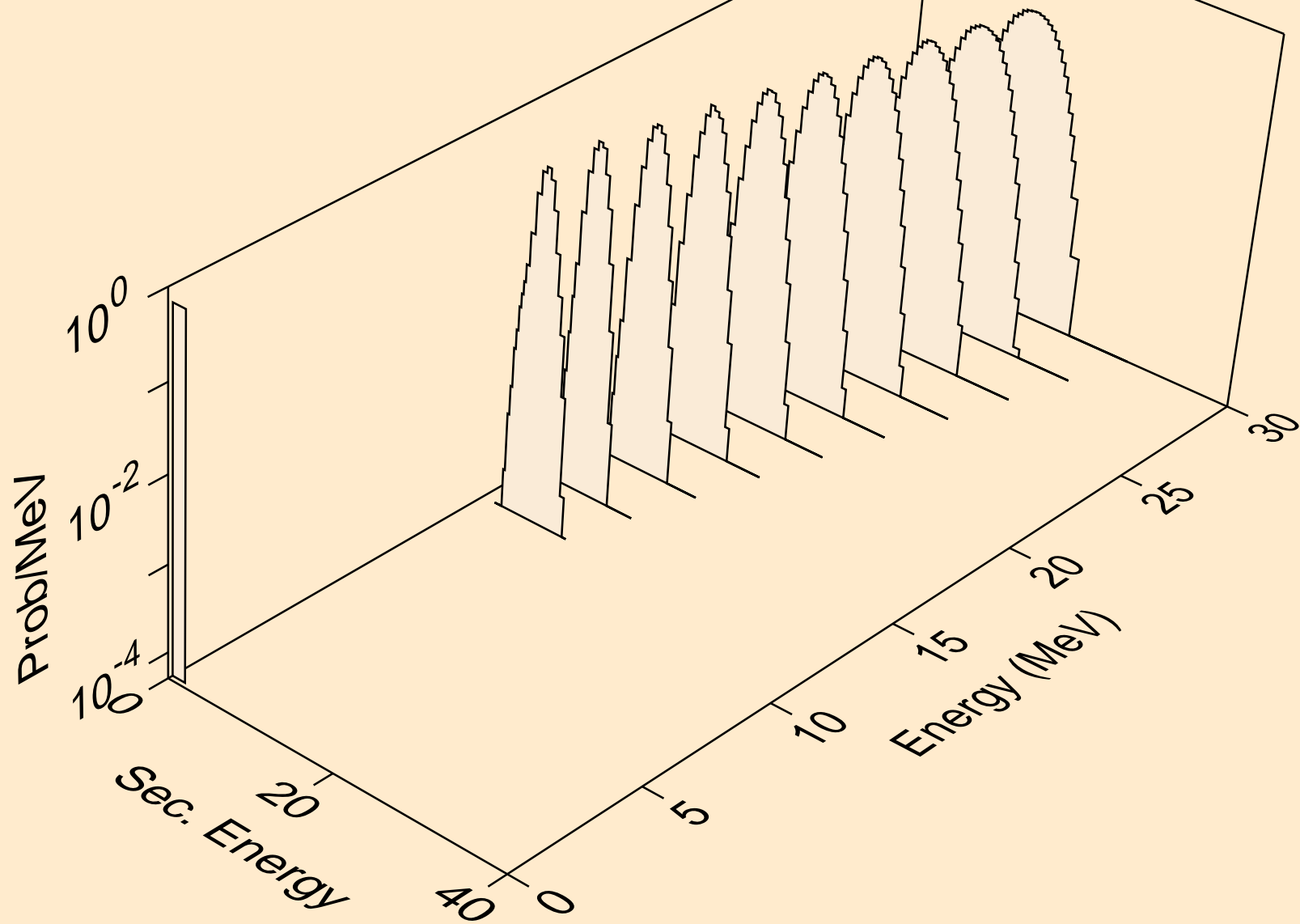

CM237 NEUTRON ACER TENDL-2023 LIBRARY; T=0.K  
protons from (n,p)

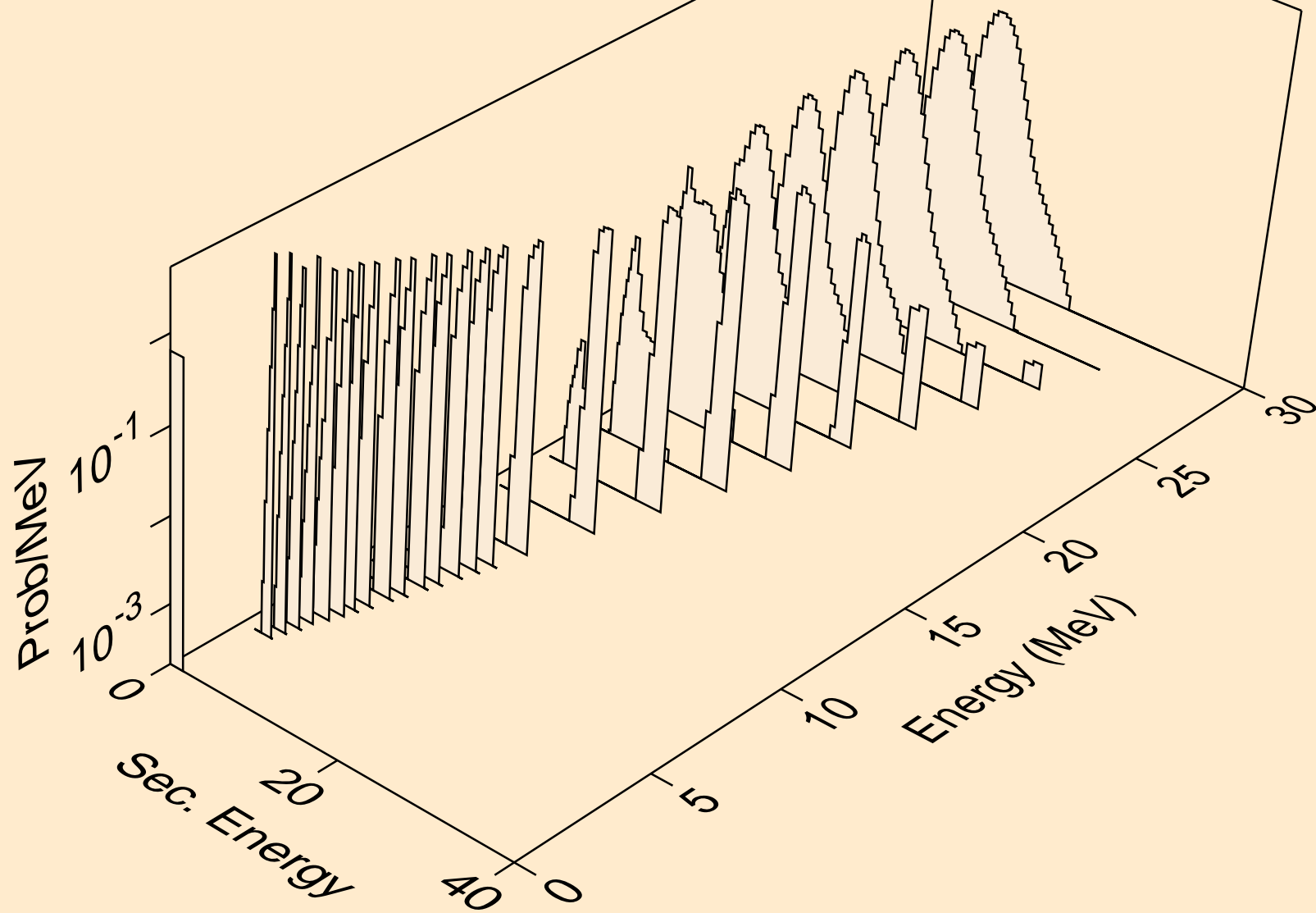

CM237 NEUTRON ACER TENDL-2023 LIBRARY; T=0.K  
protons from (n,pd)

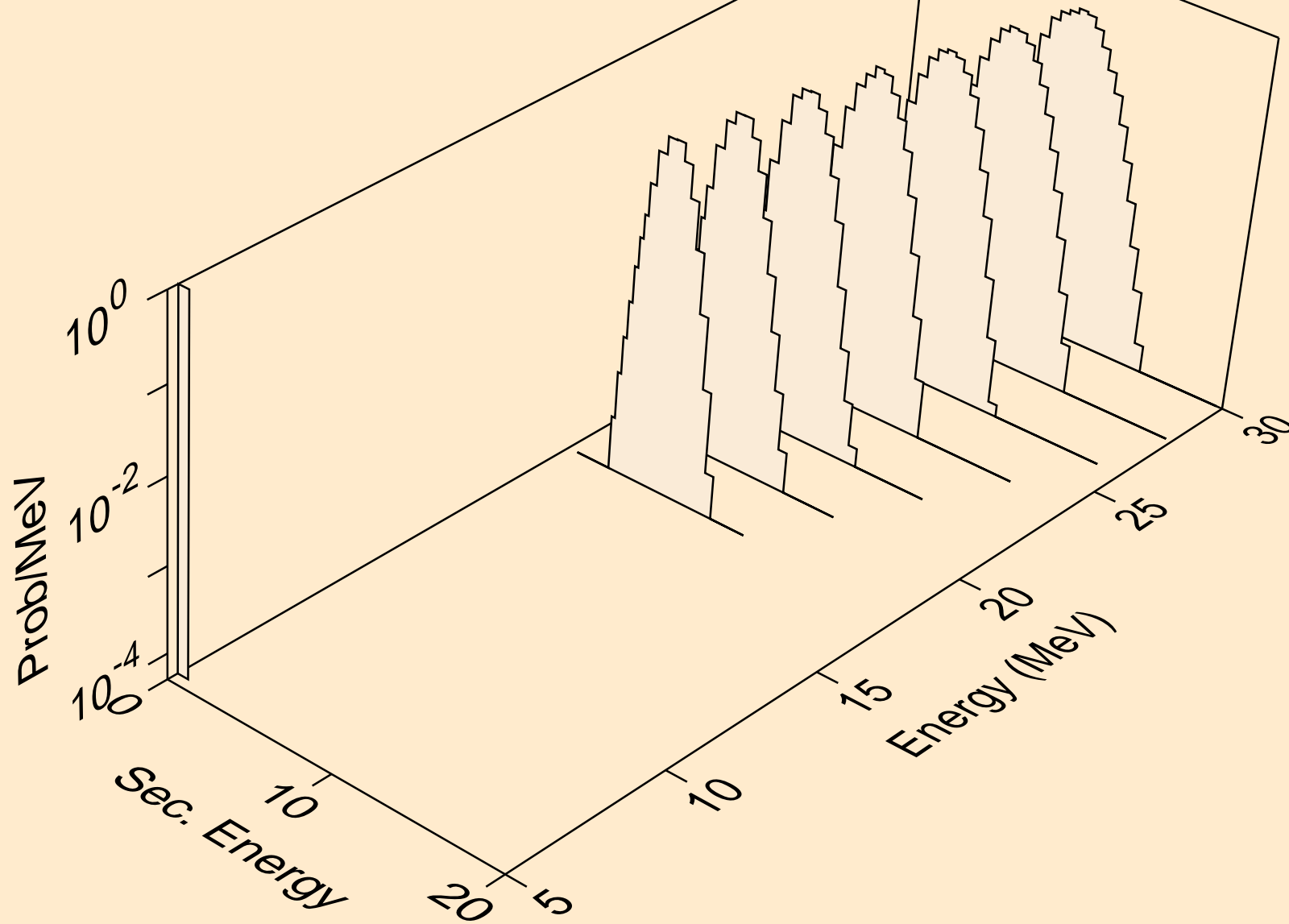

CM237 NEUTRON ACER TENDL-2023 LIBRARY; T=0.K  
deuterons from (n,x)

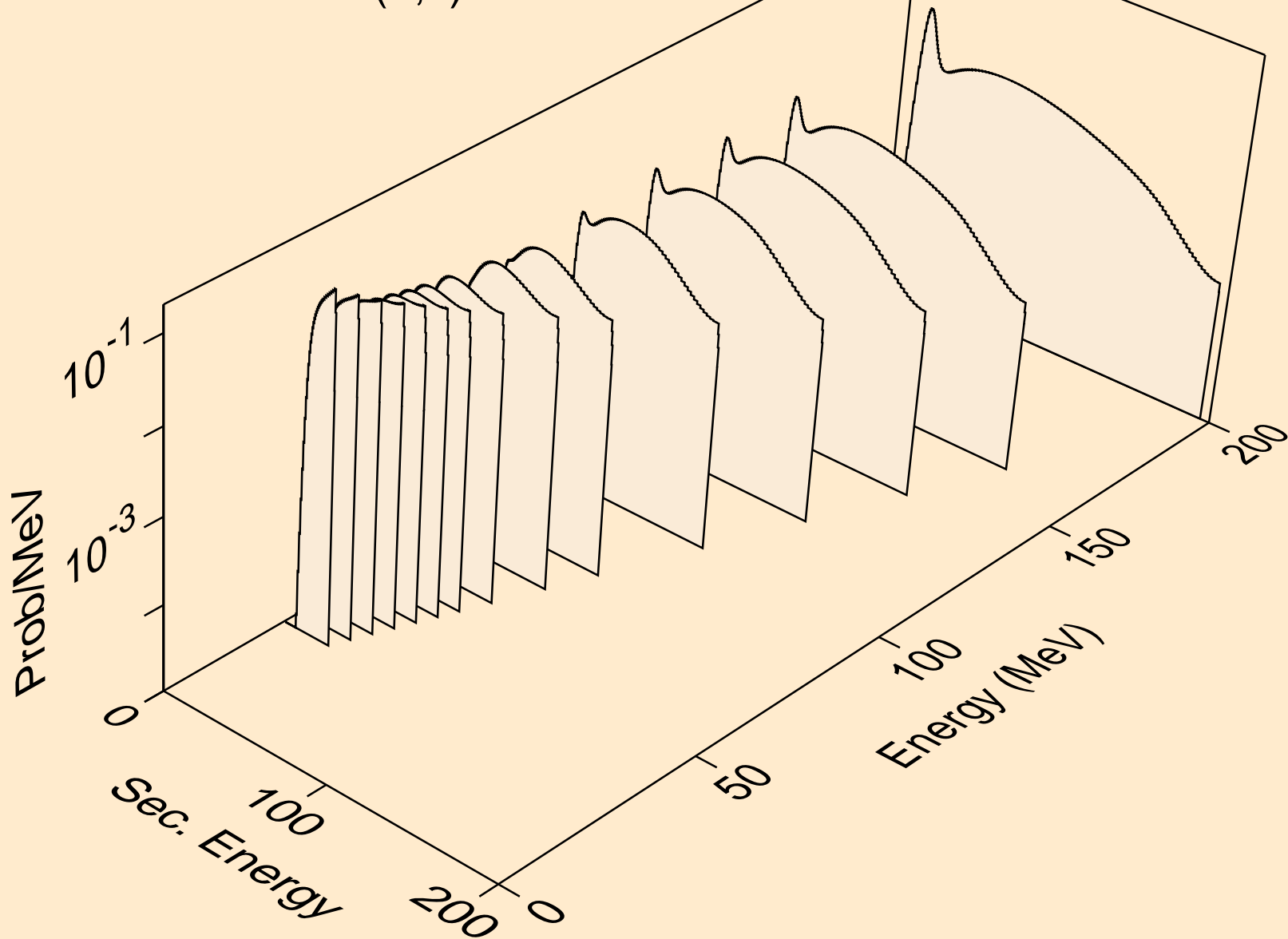

CM237 NEUTRON ACER TENDL-2023 LIBRARY; T=0.K  
deuterons from (n,n\*)d

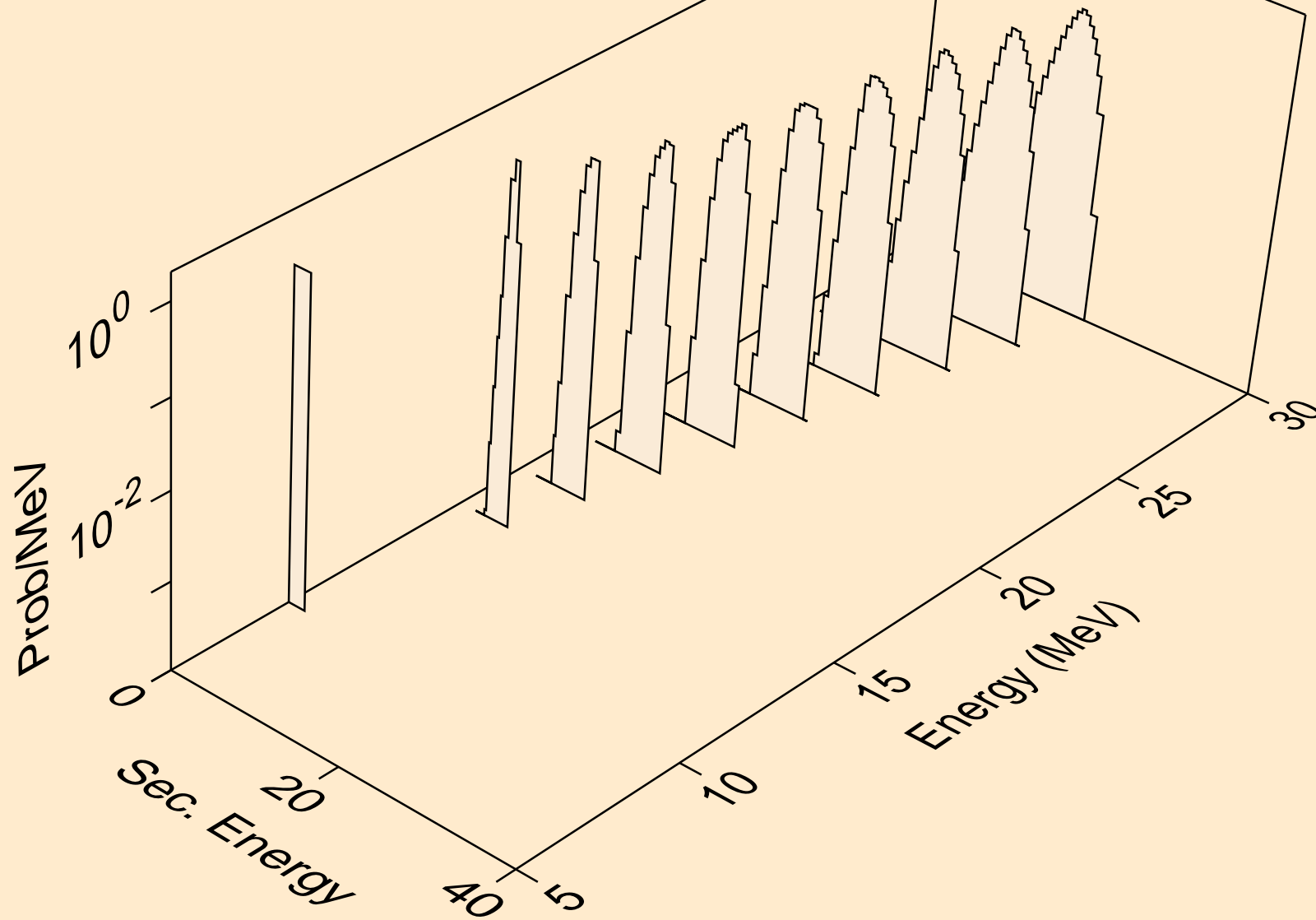

CM237 NEUTRON ACER TENDL-2023 LIBRARY; T=0.K  
deuterons from (n,d)

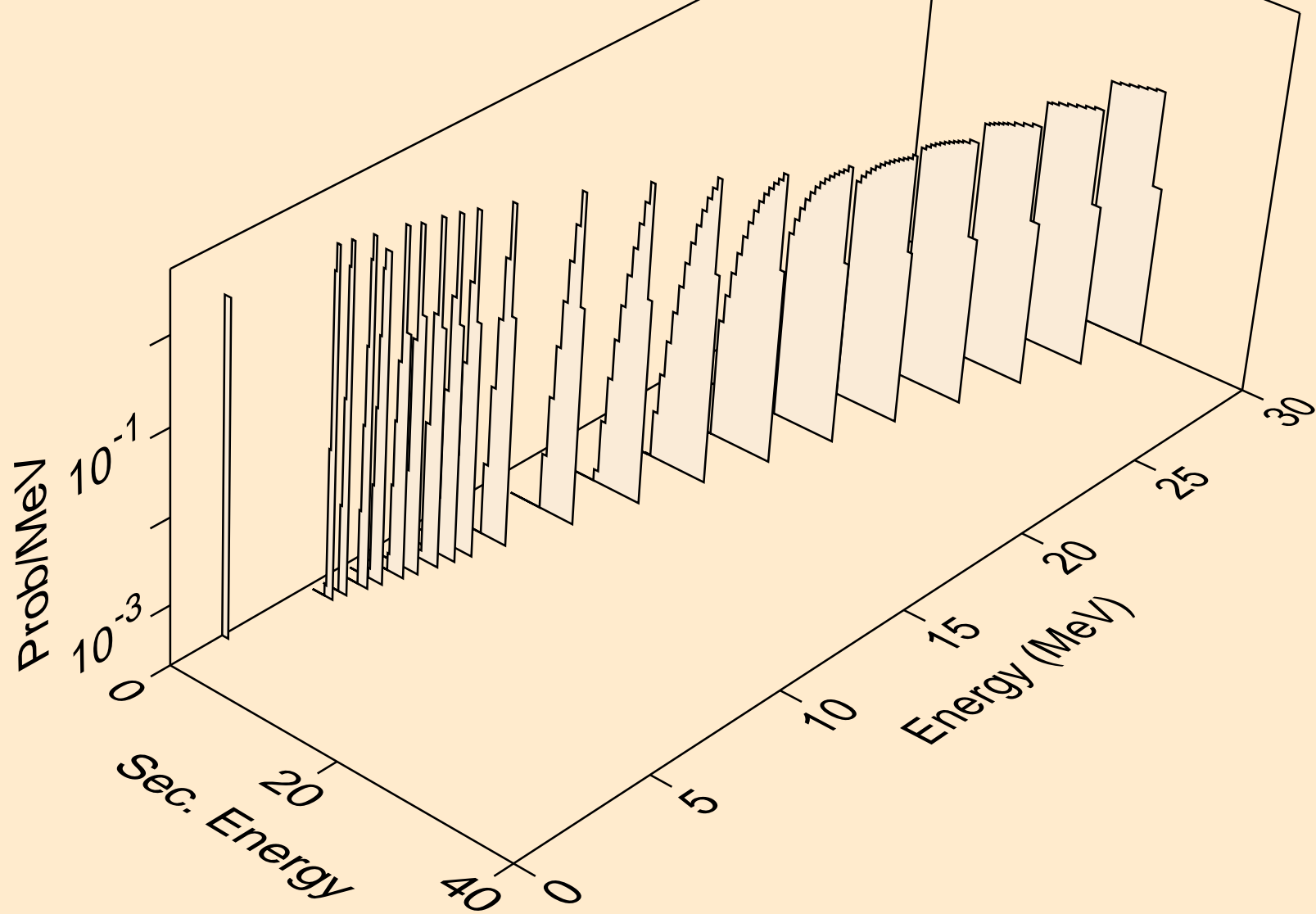

CM237 NEUTRON ACER TENDL-2023 LIBRARY; T=0.K  
deuterons from (n,pd)

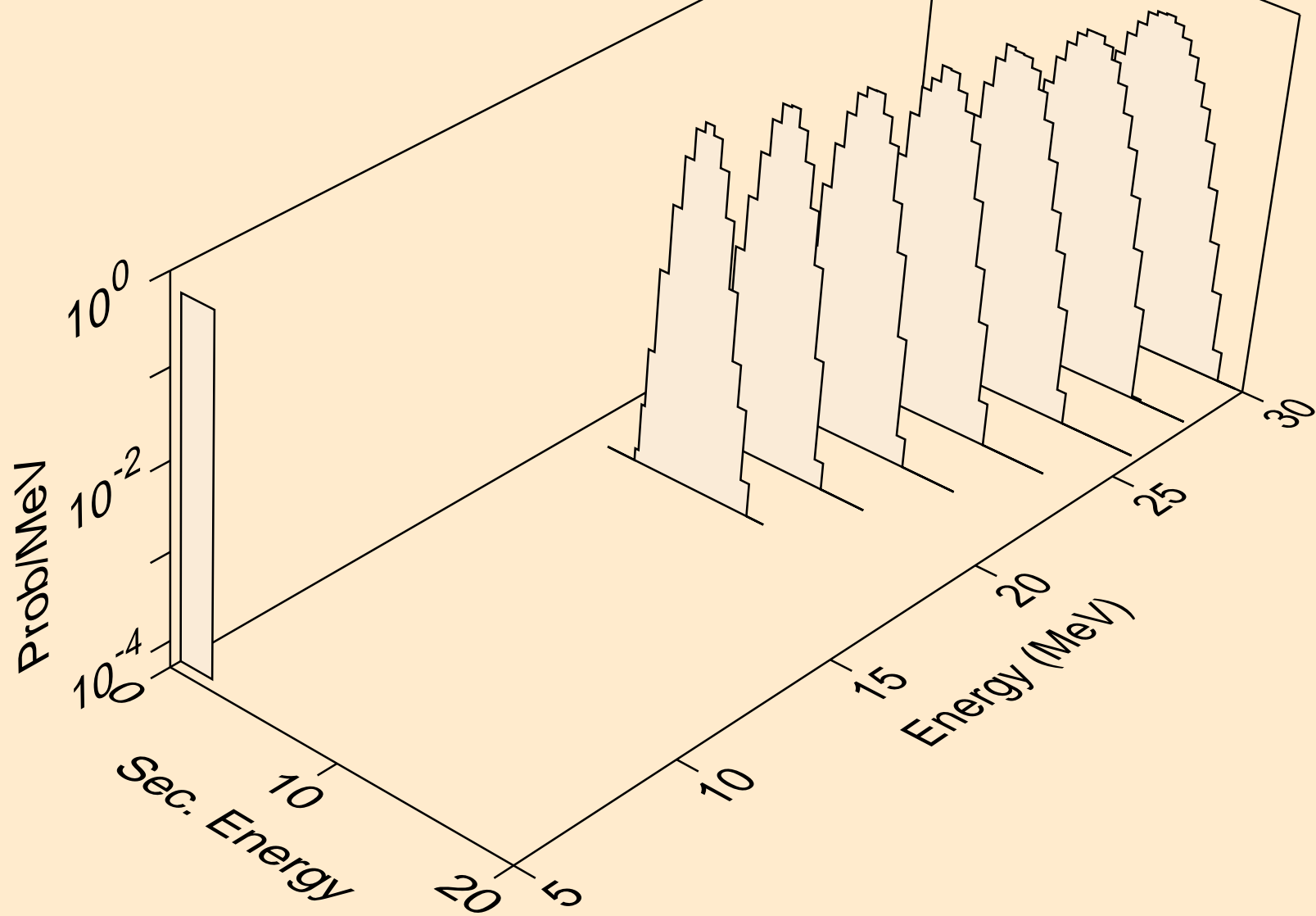

CM237 NEUTRON ACER TENDL-2023 LIBRARY; T=0.K  
tritons from (n,x)

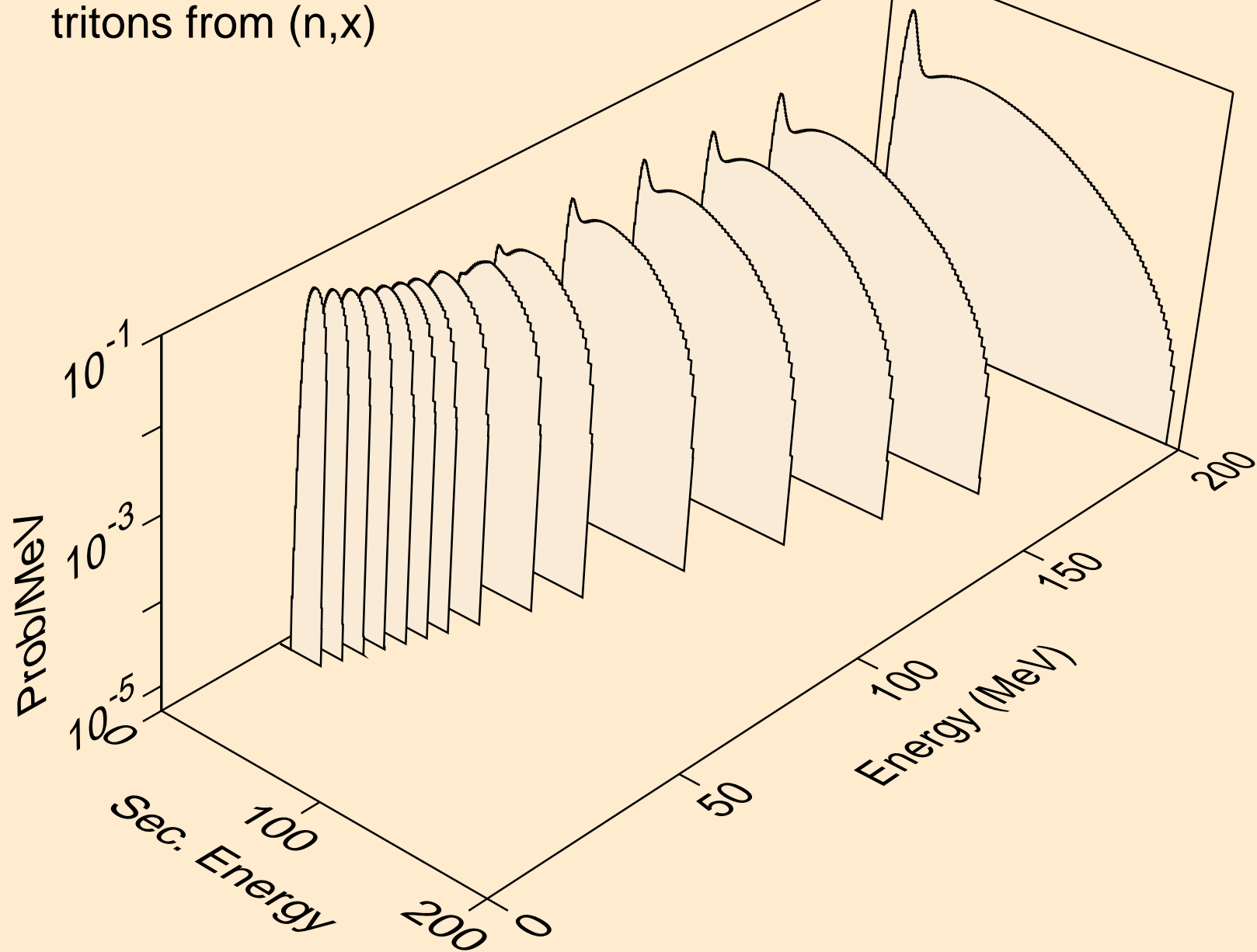

CM237 NEUTRON ACER TENDL-2023 LIBRARY; T=0.K  
tritons from (n,n\*)t

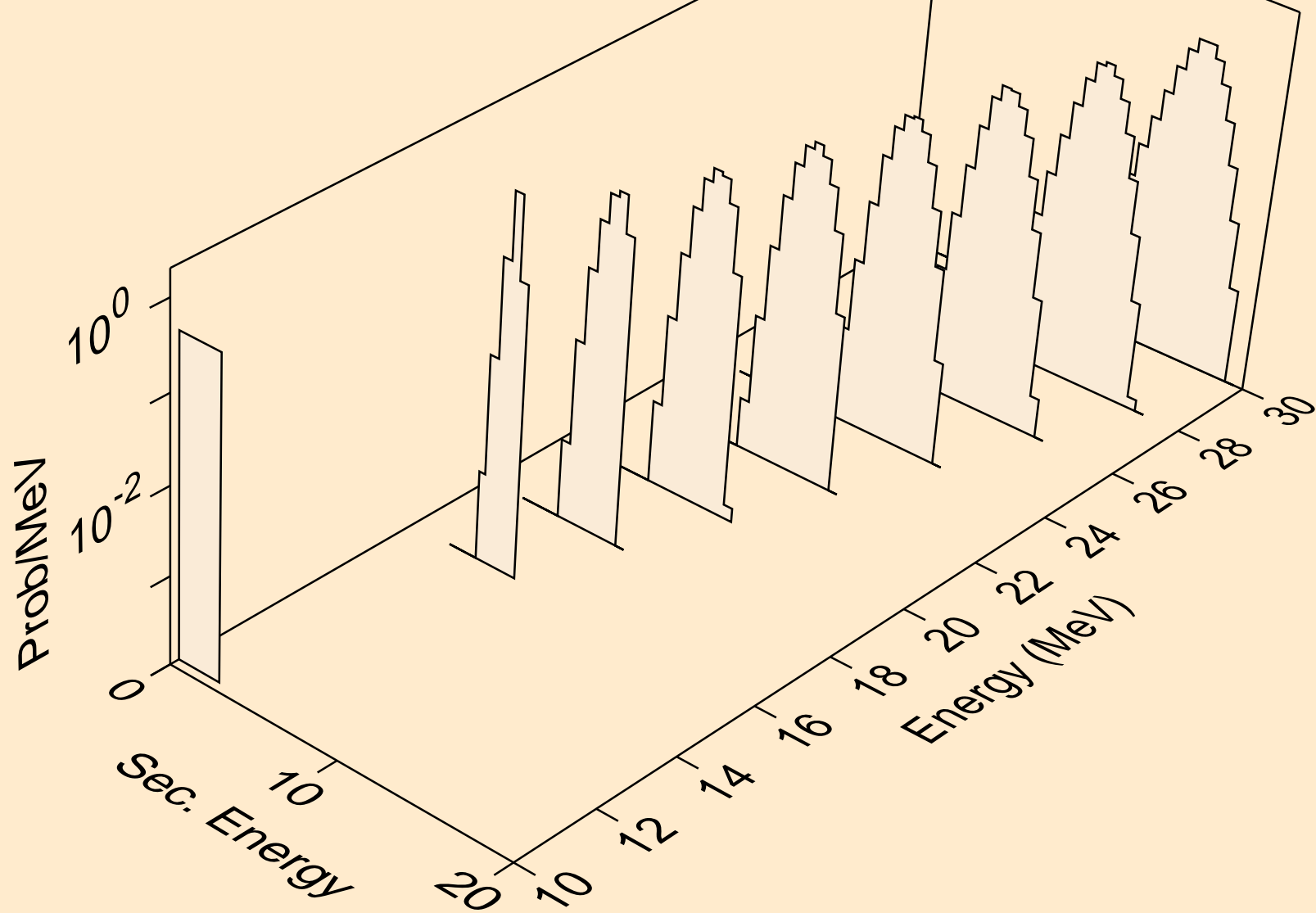

CM237 NEUTRON ACER TENDL-2023 LIBRARY; T=0.K  
tritons from (n,t)

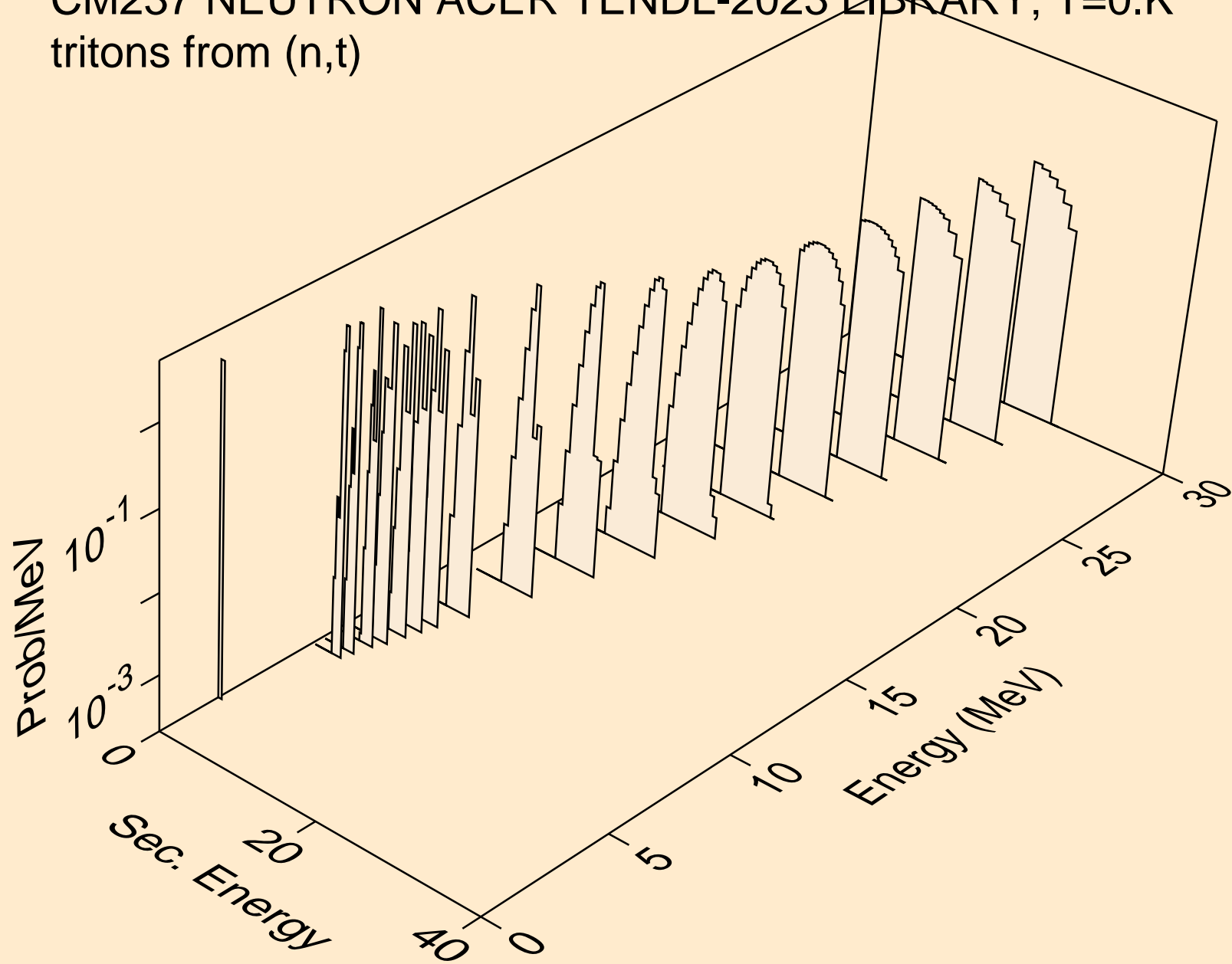

CM237 NEUTRON ACER TENDL-2023 LIBRARY; T=0.K  
he3s from (n,x)

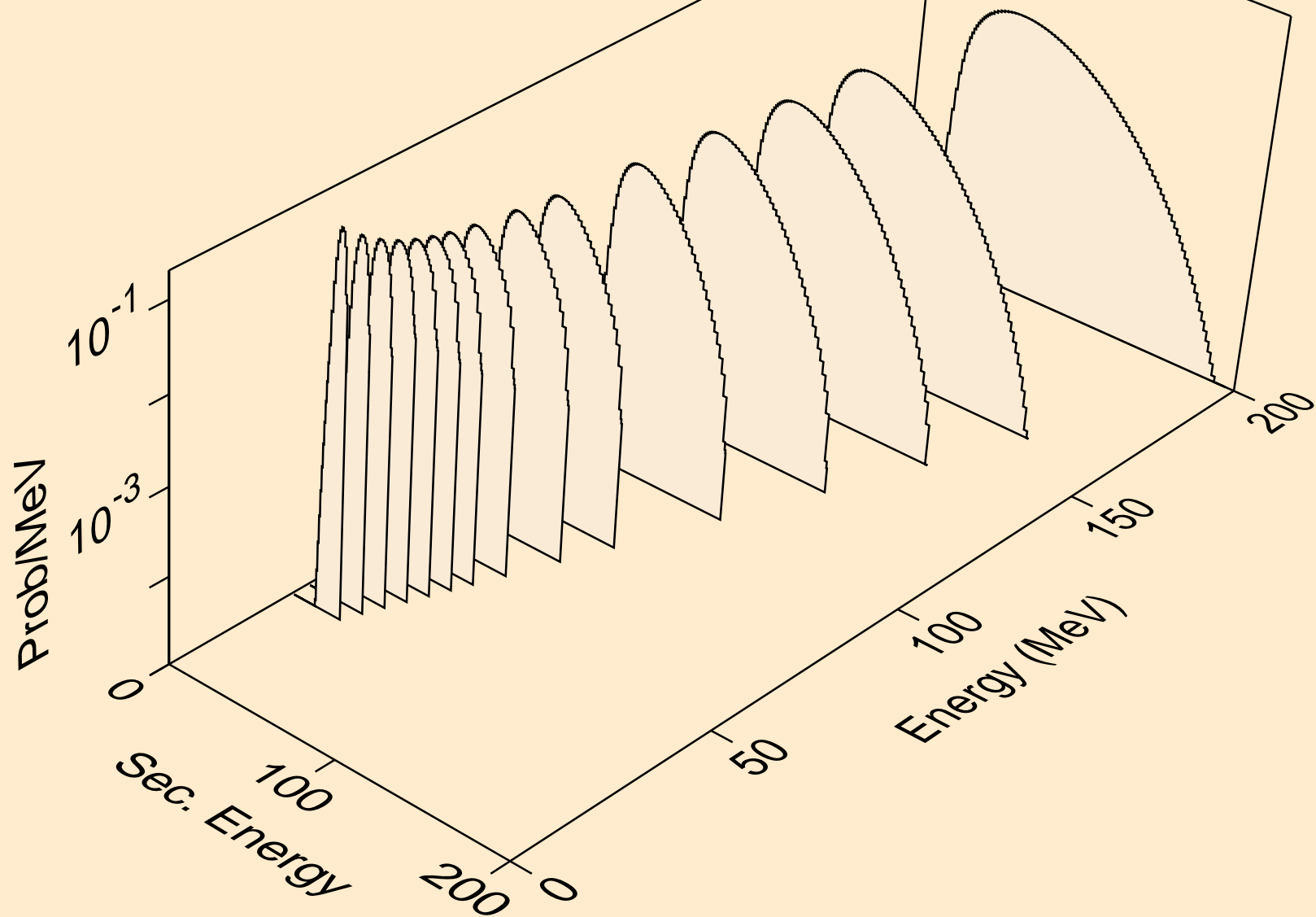

CM237 NEUTRON ACER TENDL-2023 LIBRARY; T=0.K  
he3s from (n,n\*)he3

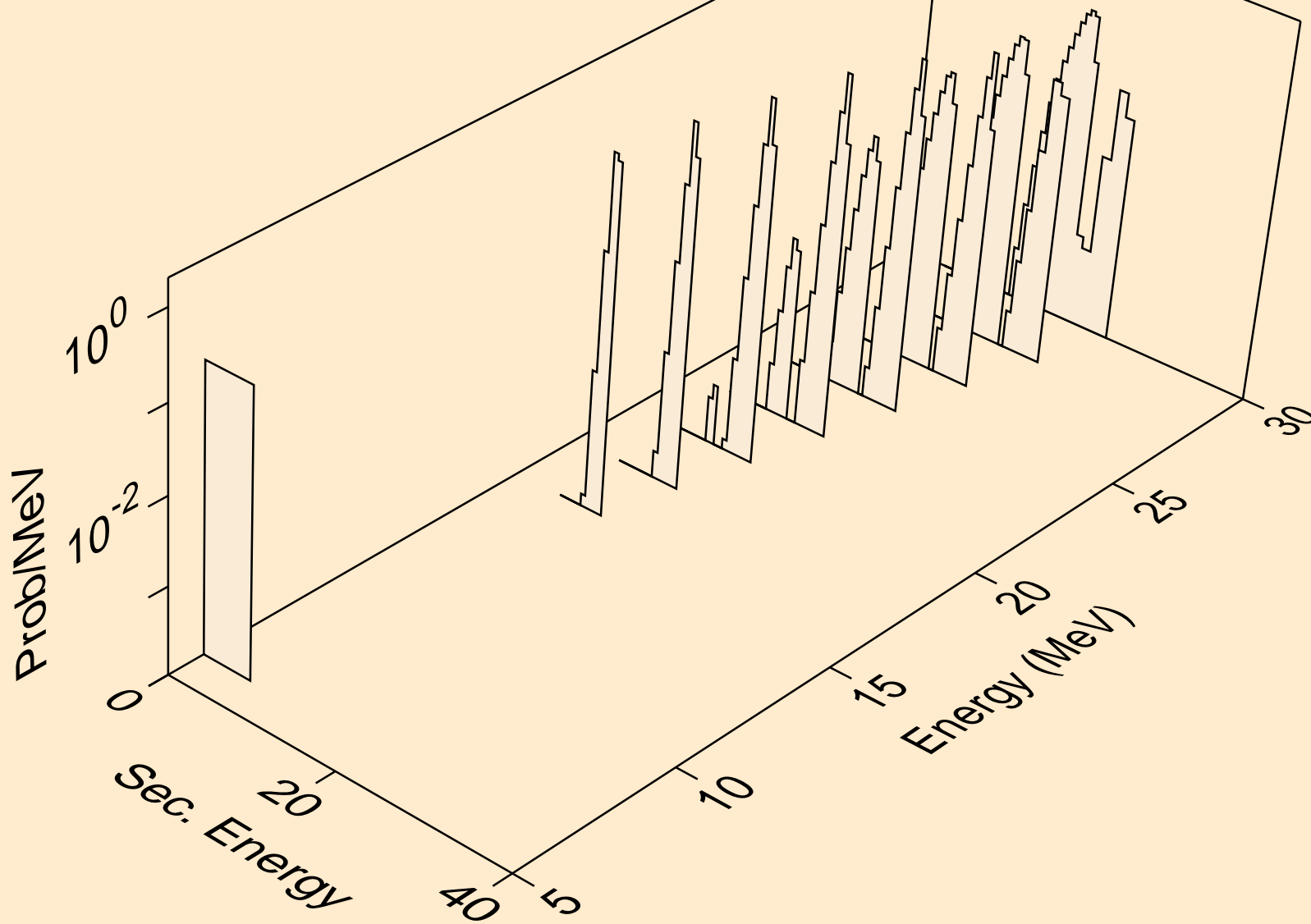

CM237 NEUTRON ACER TENDL-2023 LIBRARY; T=0.K  
he3s from (n,he3)

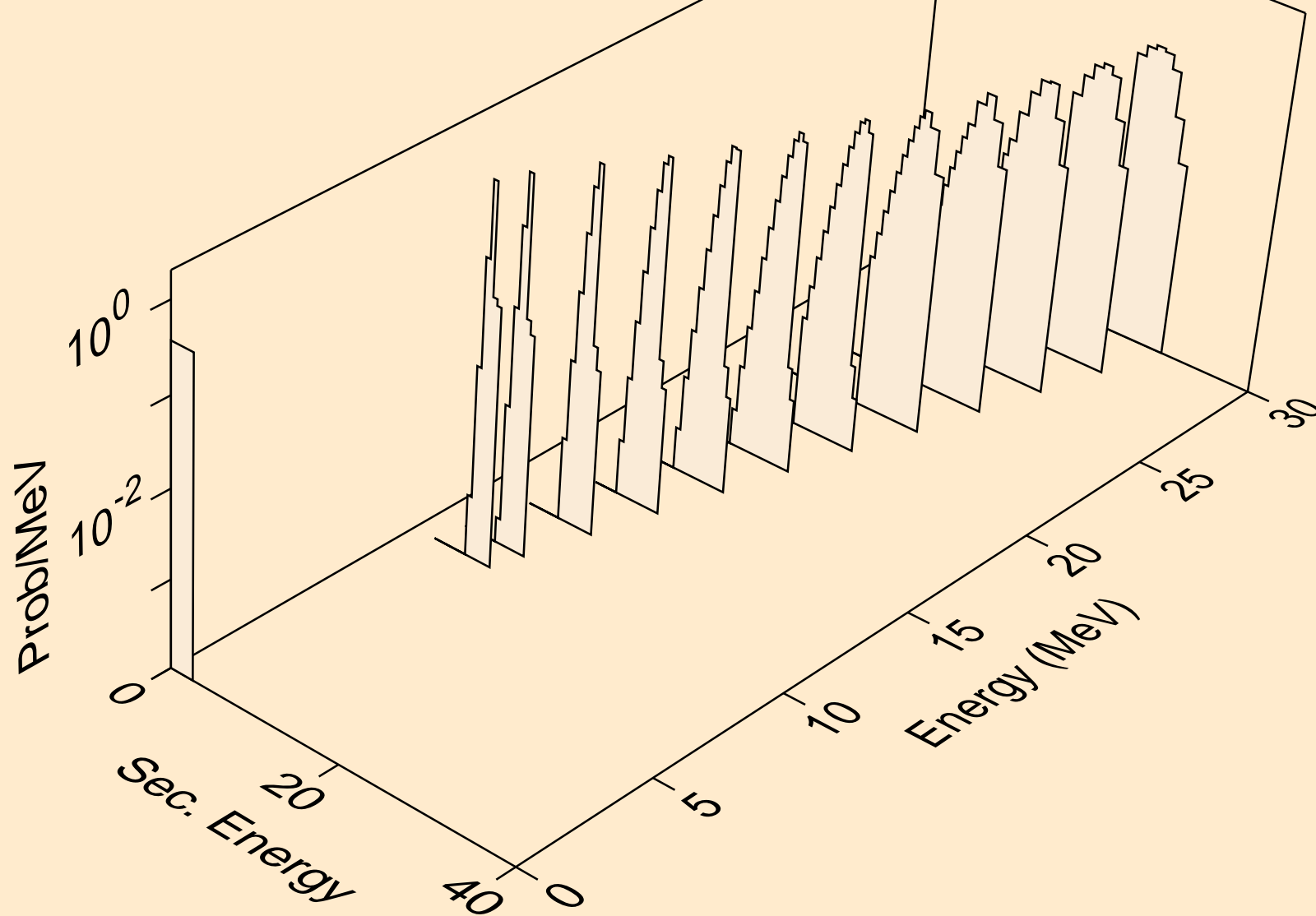

CM237 NEUTRON ACER TENDL-2023 LIBRARY; T=0.K  
alphas from (n,x)

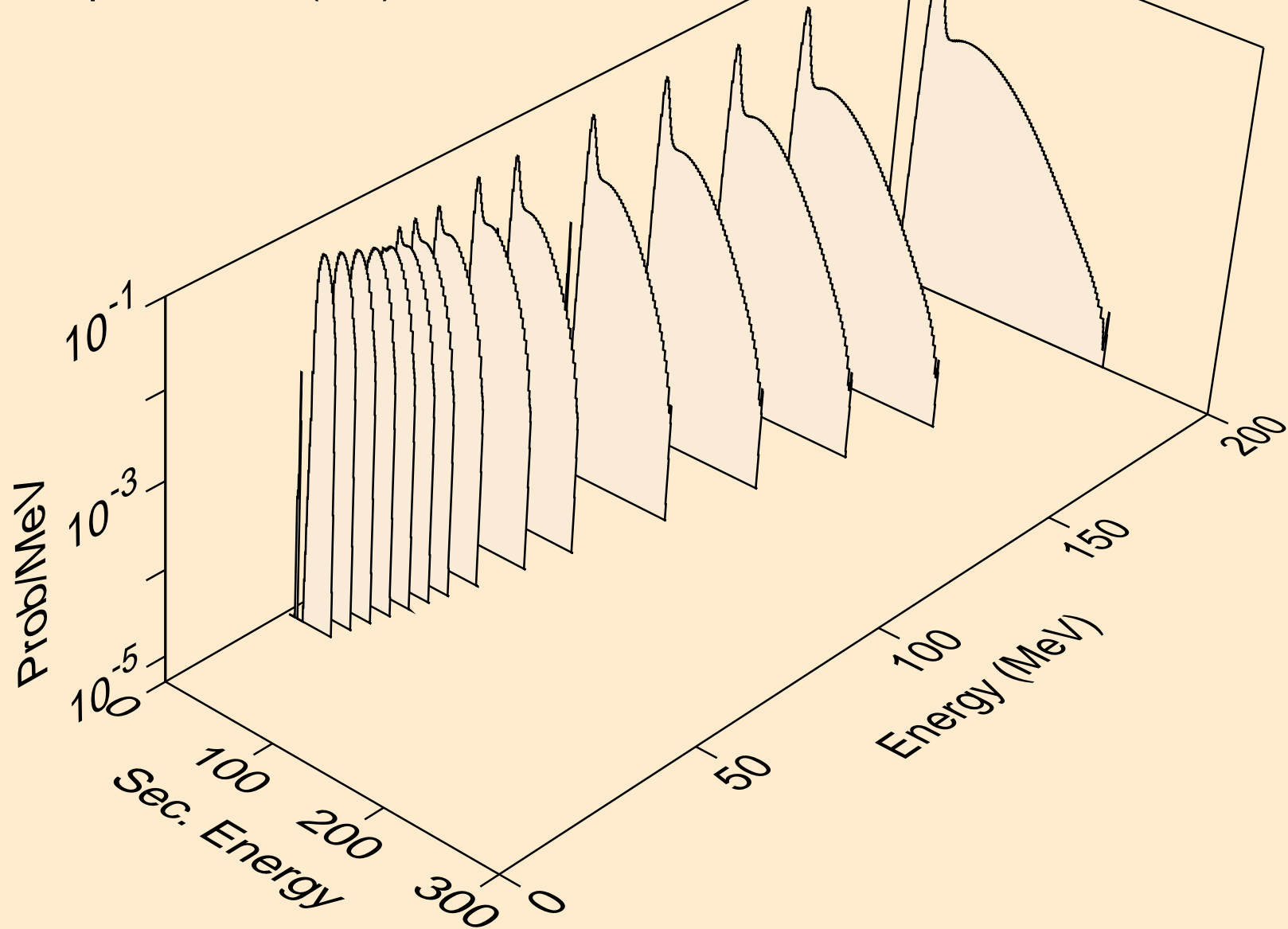

CM237 NEUTRON ACER TENDL-2023 LIBRARY; T=0.K  
alphas from (n,n\*)a

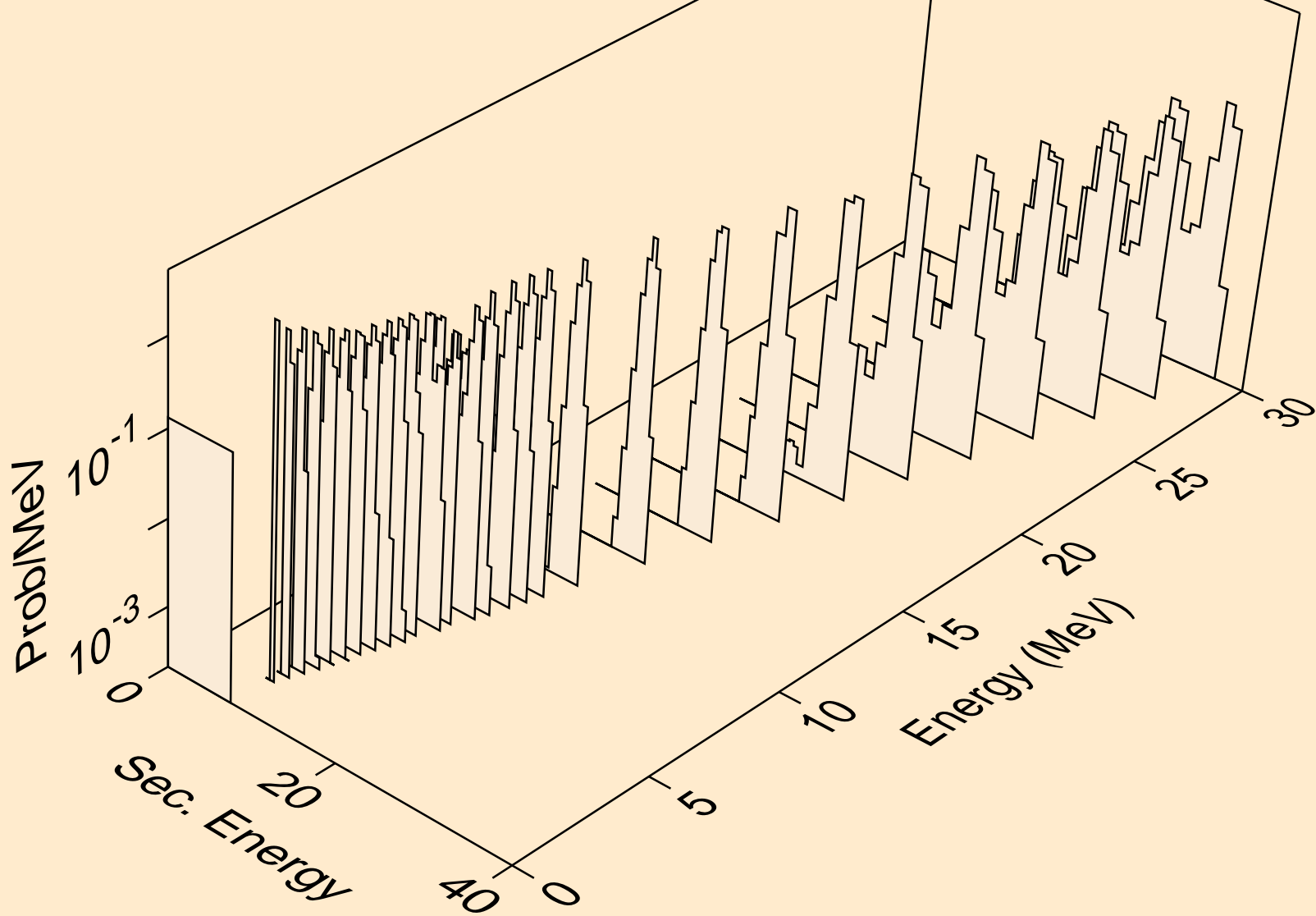

CM237 NEUTRON ACER TENDL-2023 LIBRARY; T=0.K  
alphas from (n,2n)a

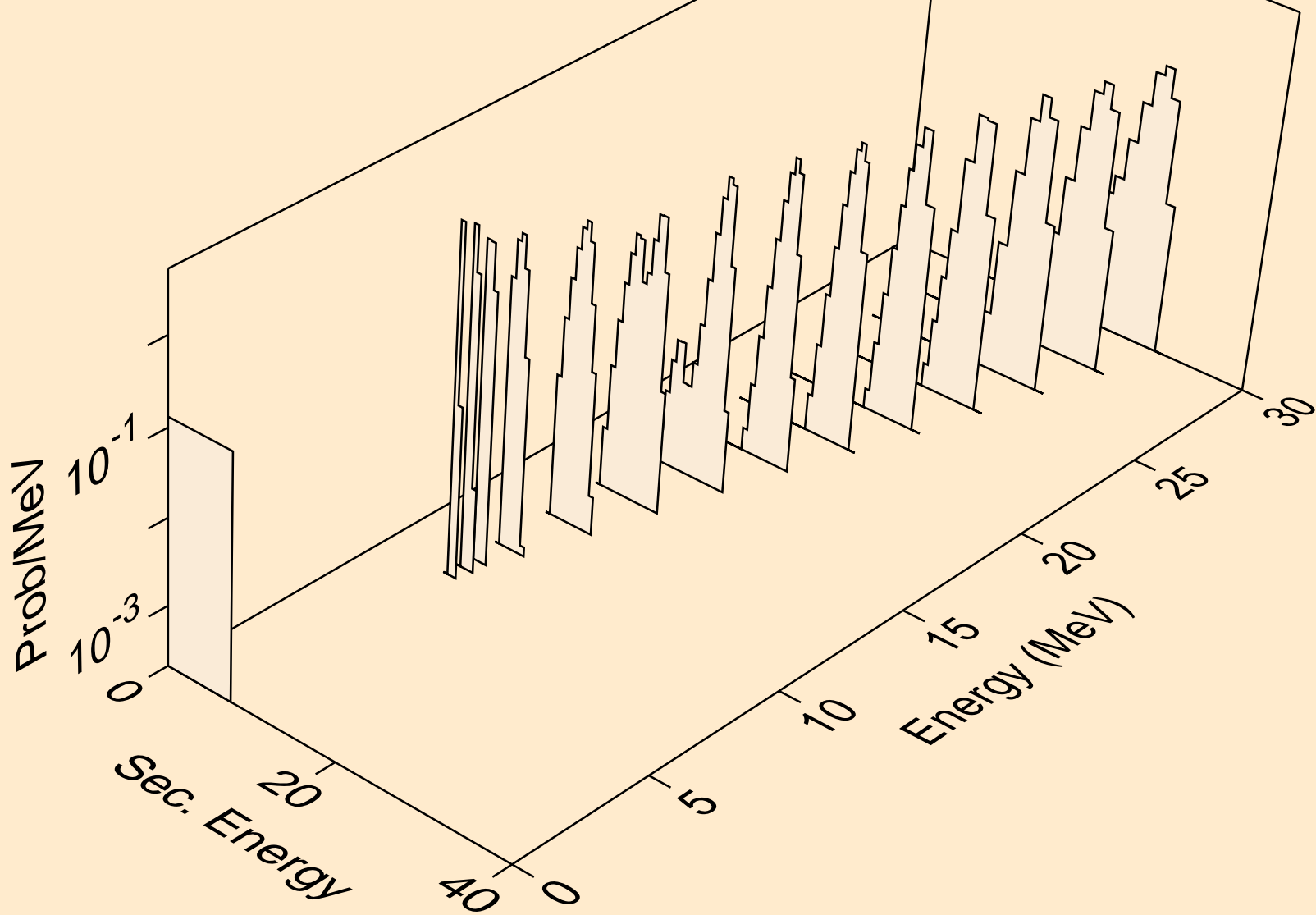

CM237 NEUTRON ACER TENDL-2023 LIBRARY; T=0.K  
alphas from (n,3n)a

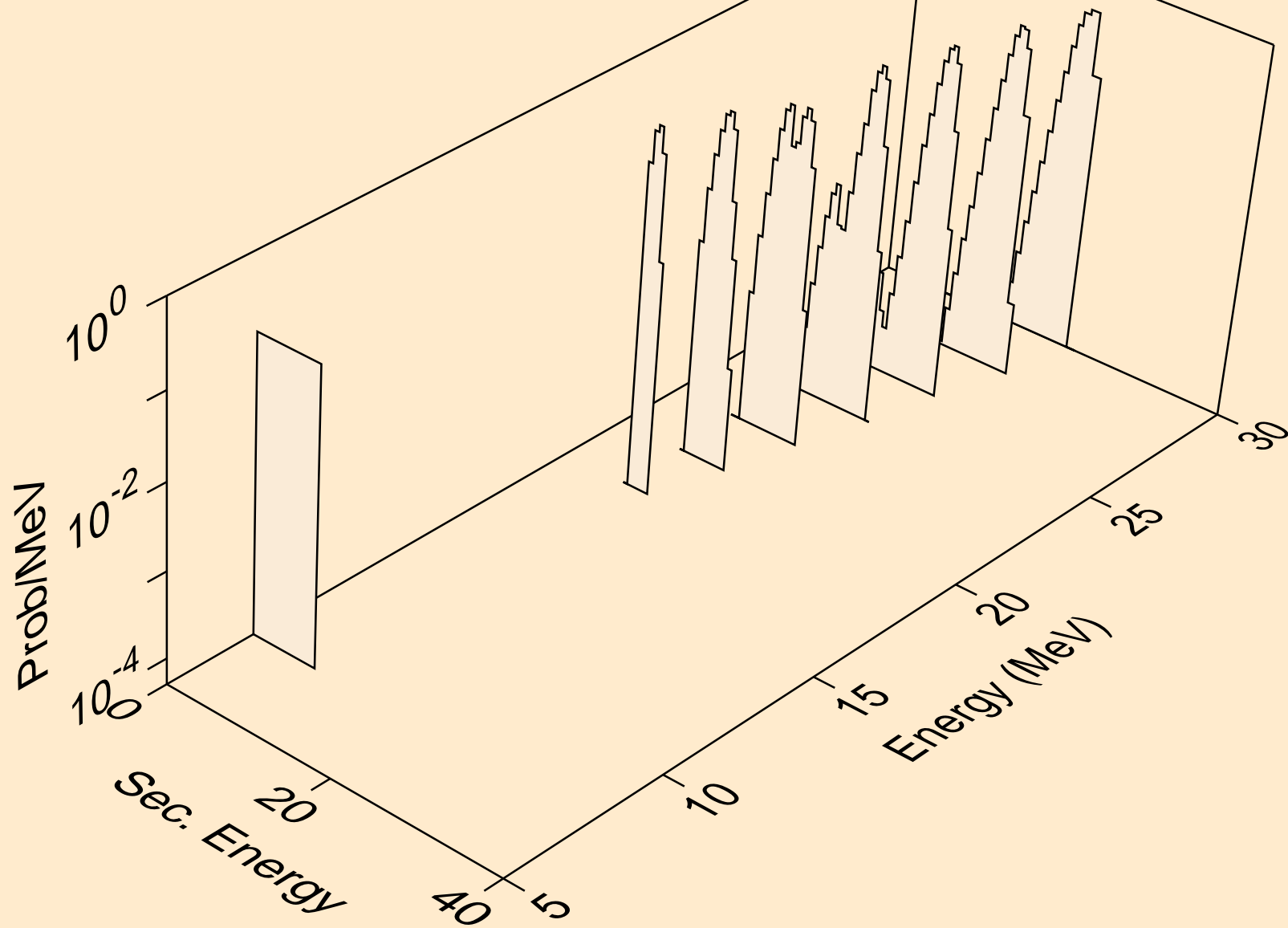

CM237 NEUTRON ACER TENDL-2023 LIBRARY; T=0.K  
alphas from (n,n\*)2a

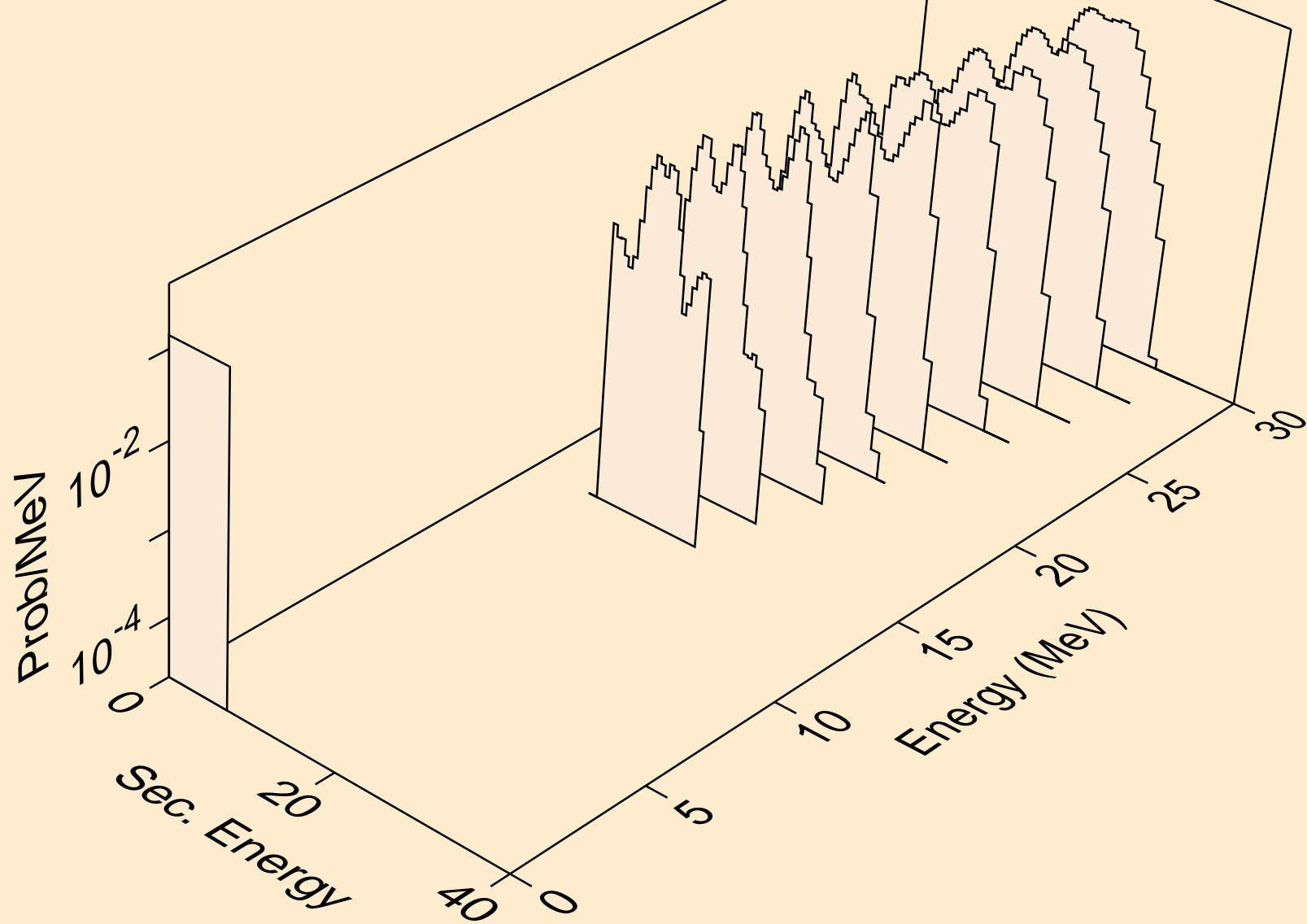

CM237 NEUTRON ACER TENDL-2023 LIBRARY; T=0.K  
alphas from (n,npa)

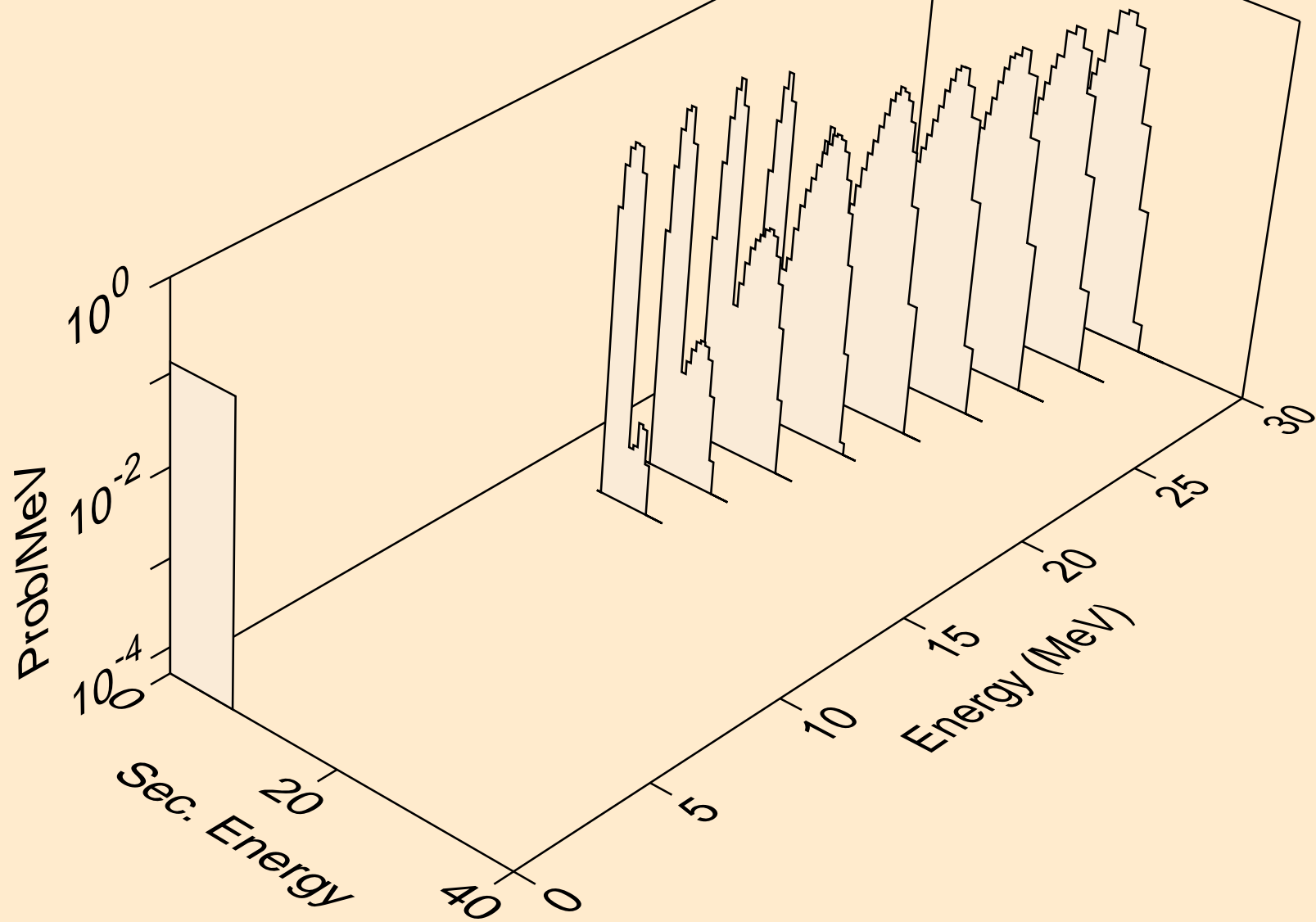

CM237 NEUTRON ACER TENDL-2023 LIBRARY; T=0.K  
alphas from (n,a)

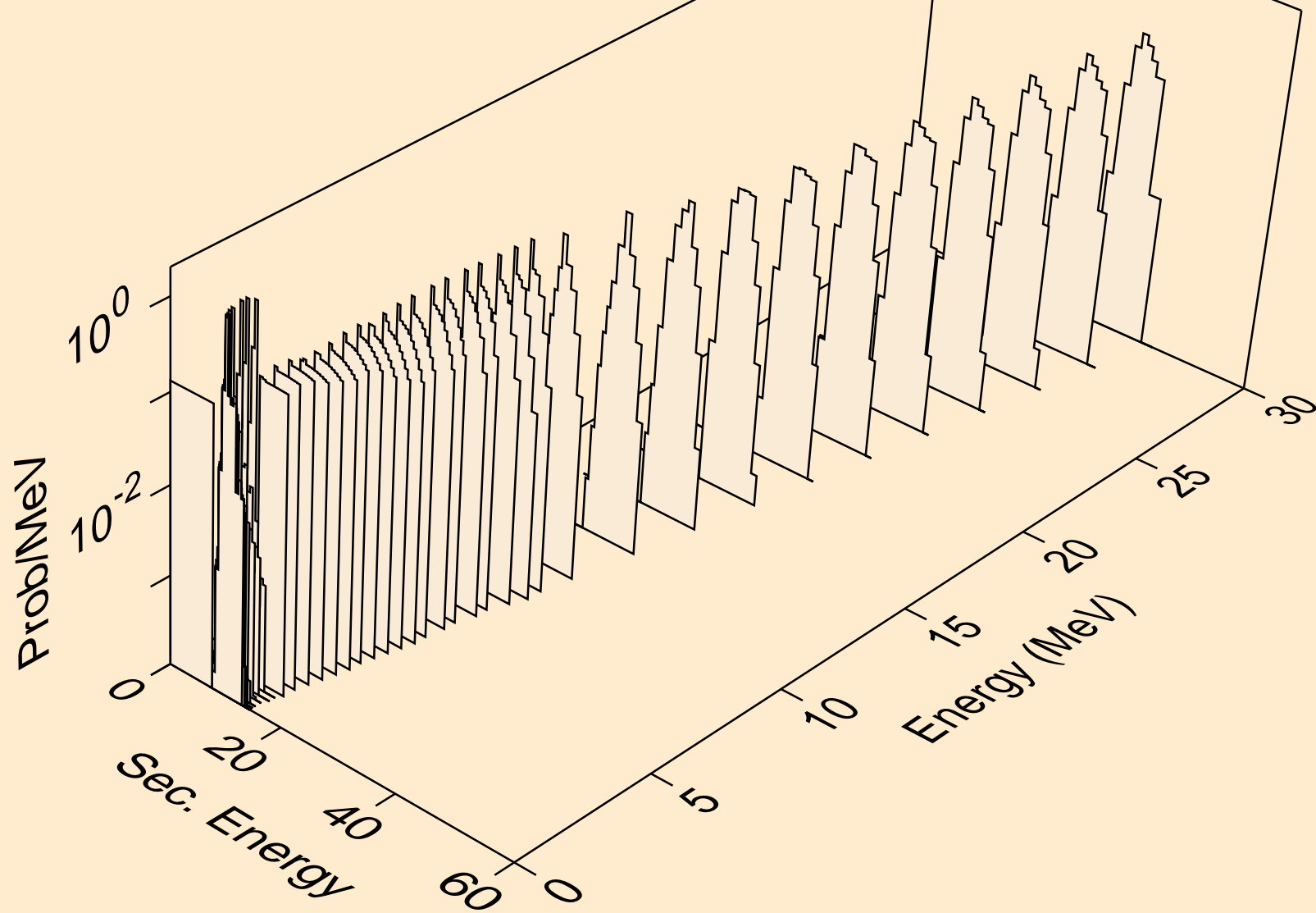

CM237 NEUTRON ACER TENDL-2023 LIBRARY; T=0.K  
alphas from (n,2a)

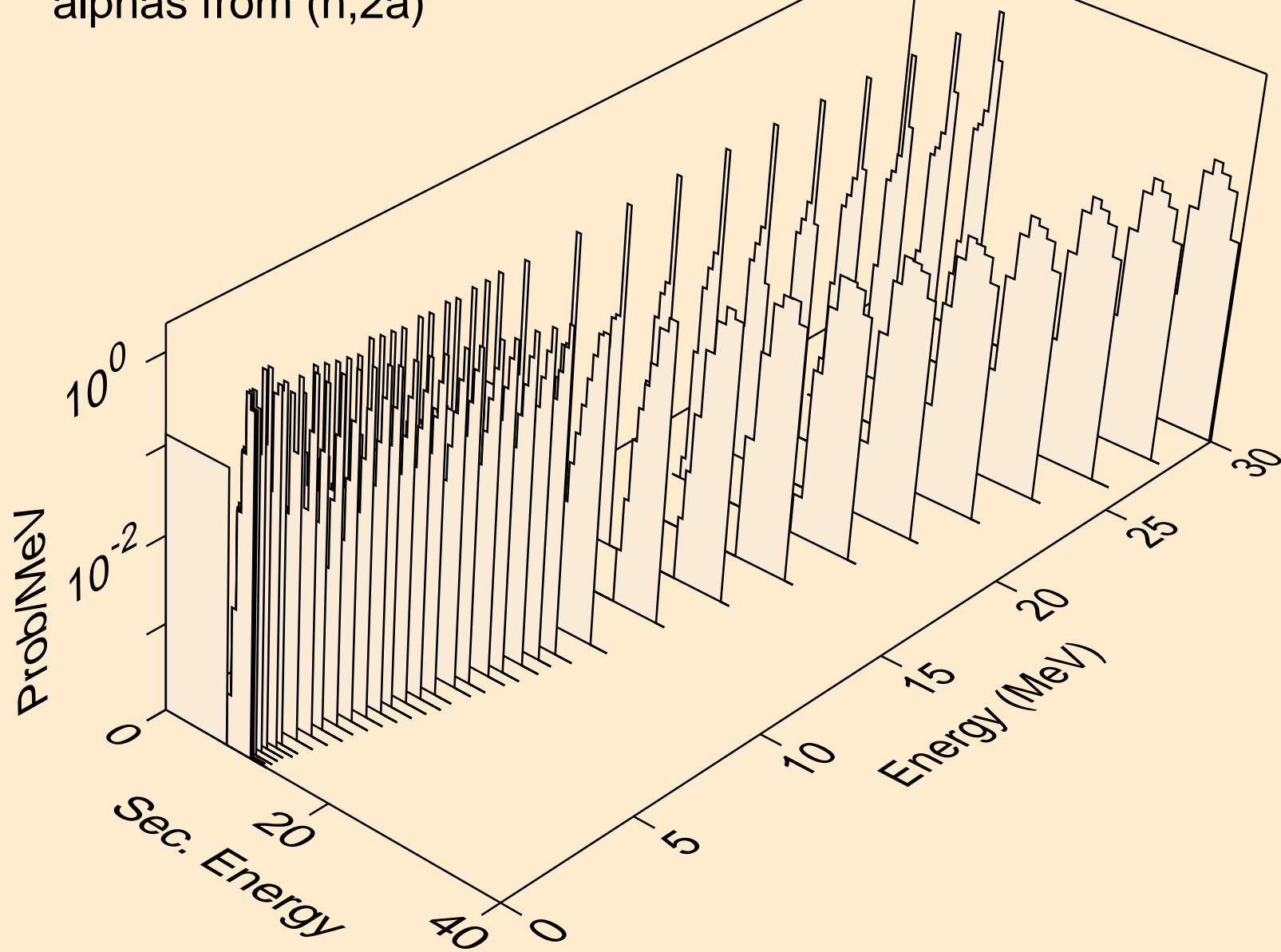

CM237 NEUTRON ACER TENDL-2023 LIBRARY; T=0.K  
alphas from (n,pa)

