

DB258 NEUTRON ACER TENDL-2023 LIBRARY; T=0.K

Principal cross sections

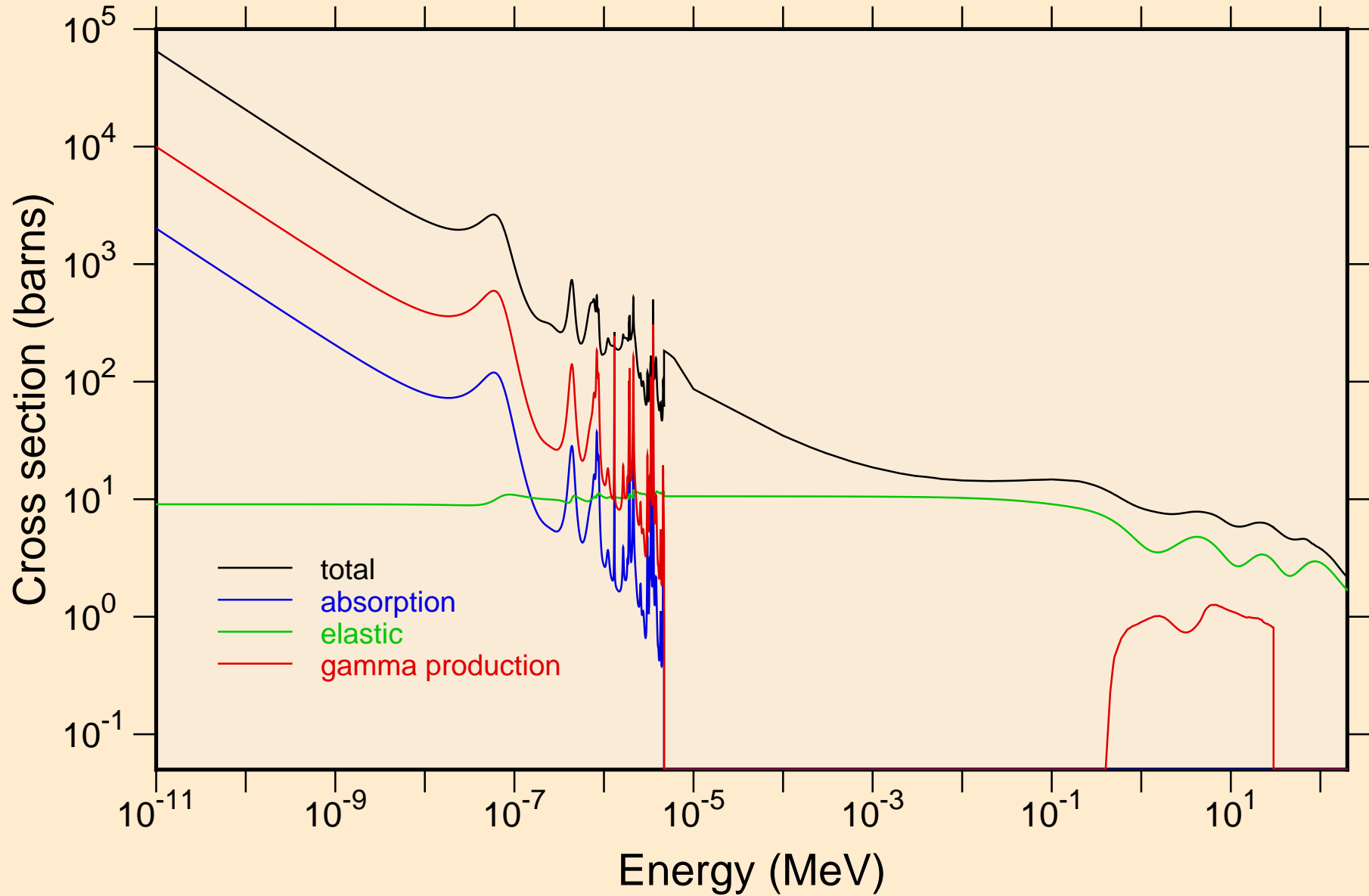

DB258 NEUTRON ACER TENDL-2023 LIBRARY; T=0.K
resonance total cross section

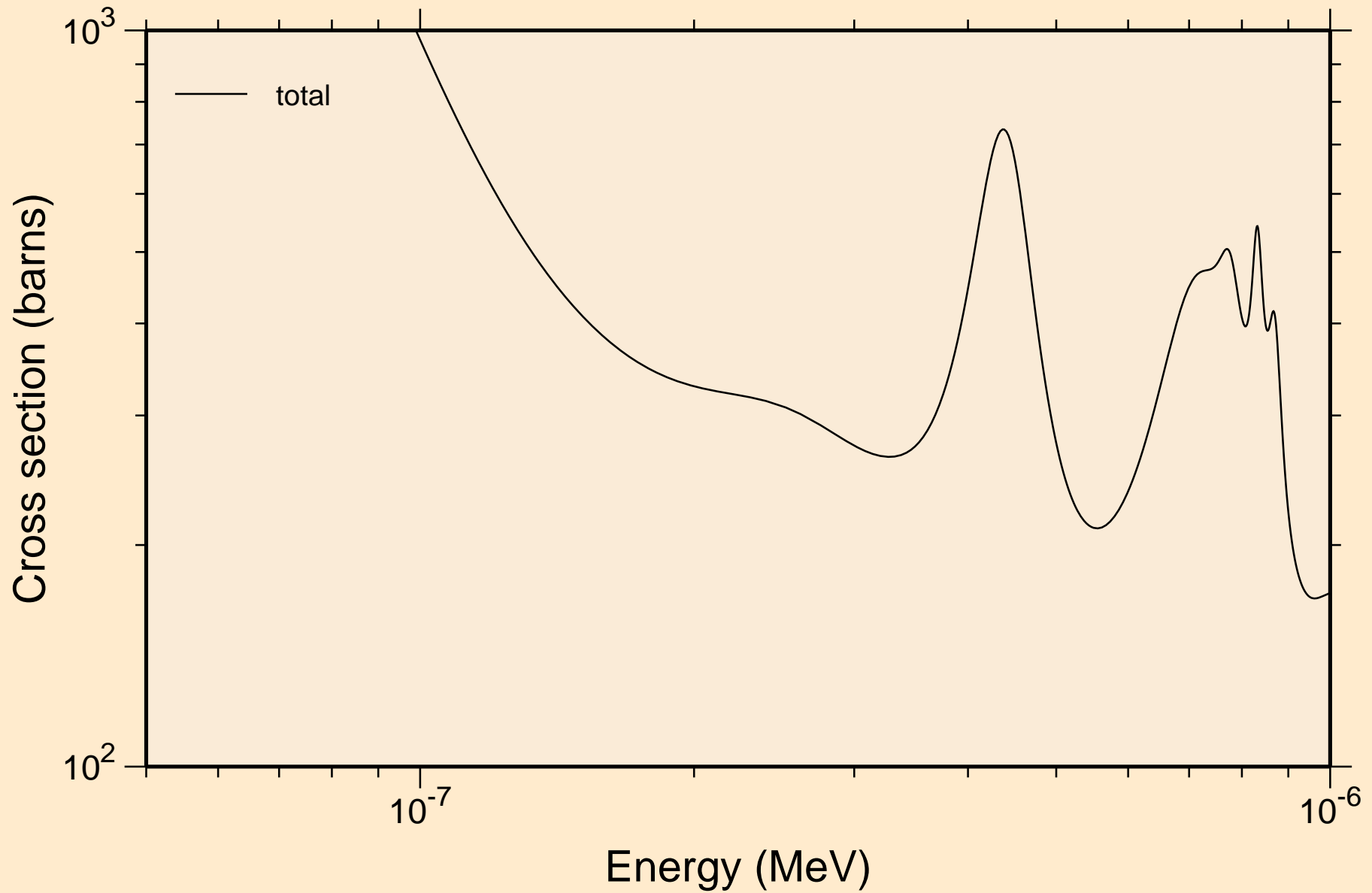

DB258 NEUTRON ACER TENDL-2023 LIBRARY; T=0.K
resonance total cross section

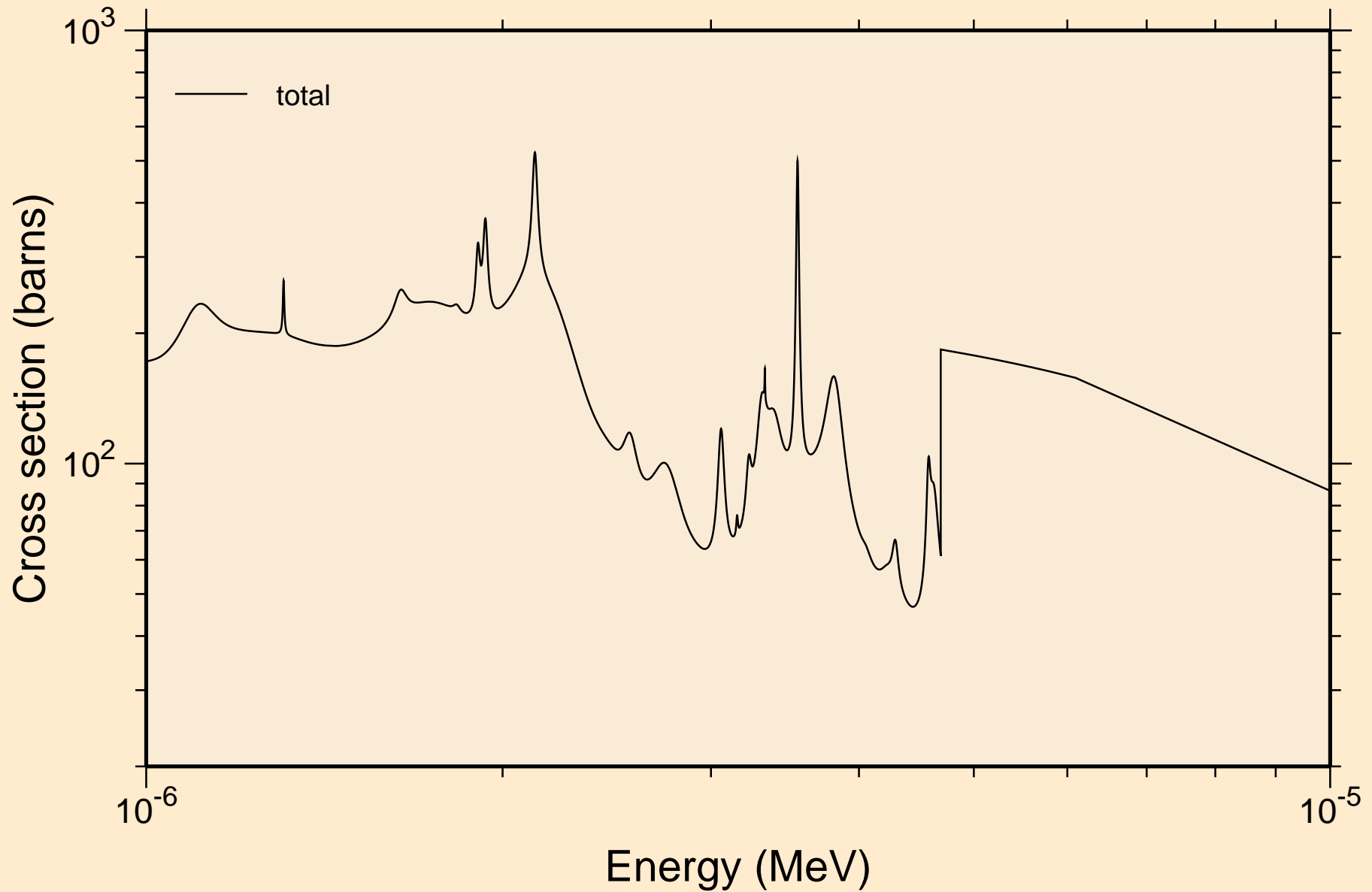

DB258 NEUTRON ACER TENDL-2023 LIBRARY; T=0.K
resonance total cross section

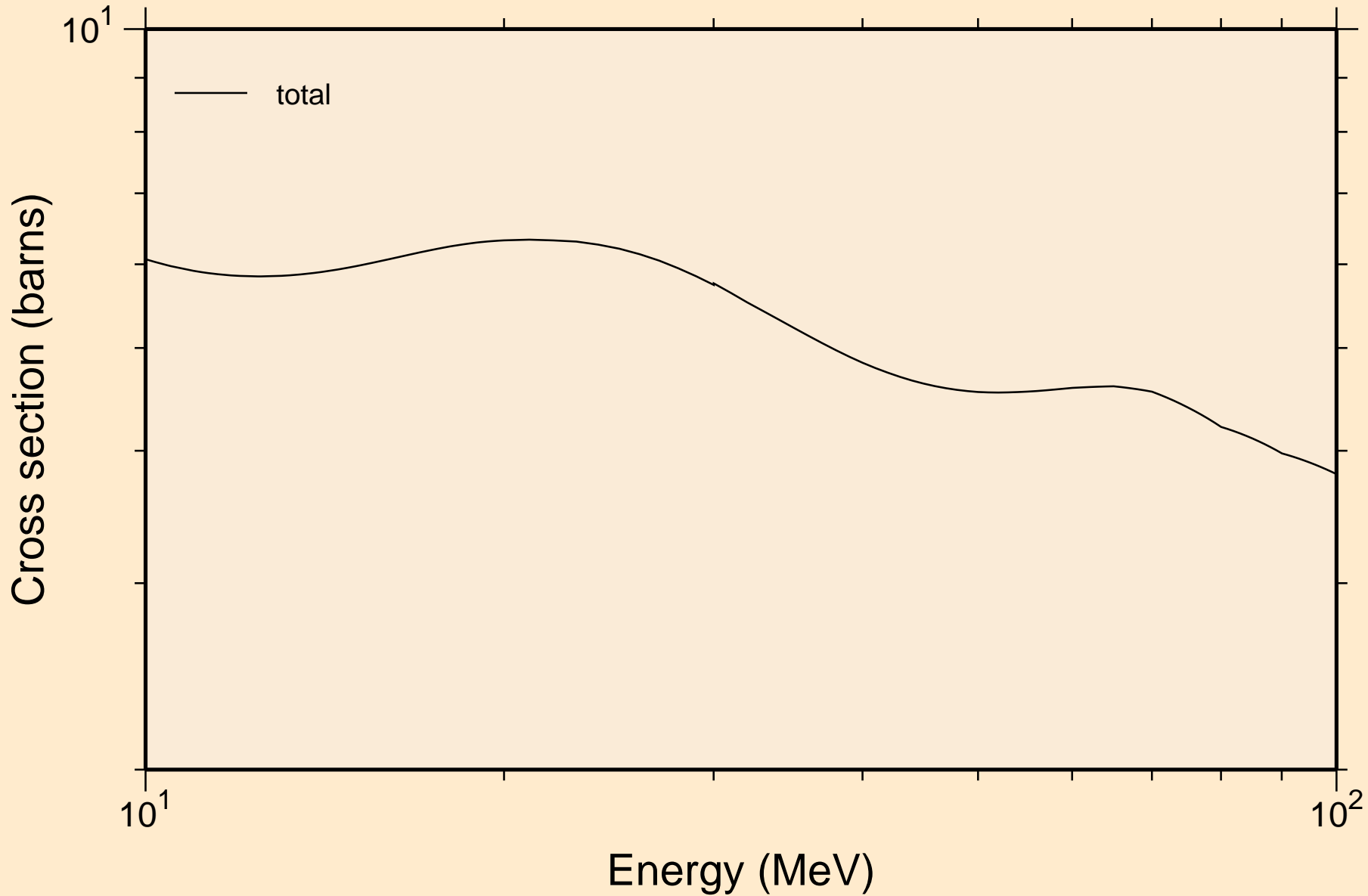

DB258 NEUTRON ACER TENDL-2023 LIBRARY; T=0.K
resonance absorption cross sections

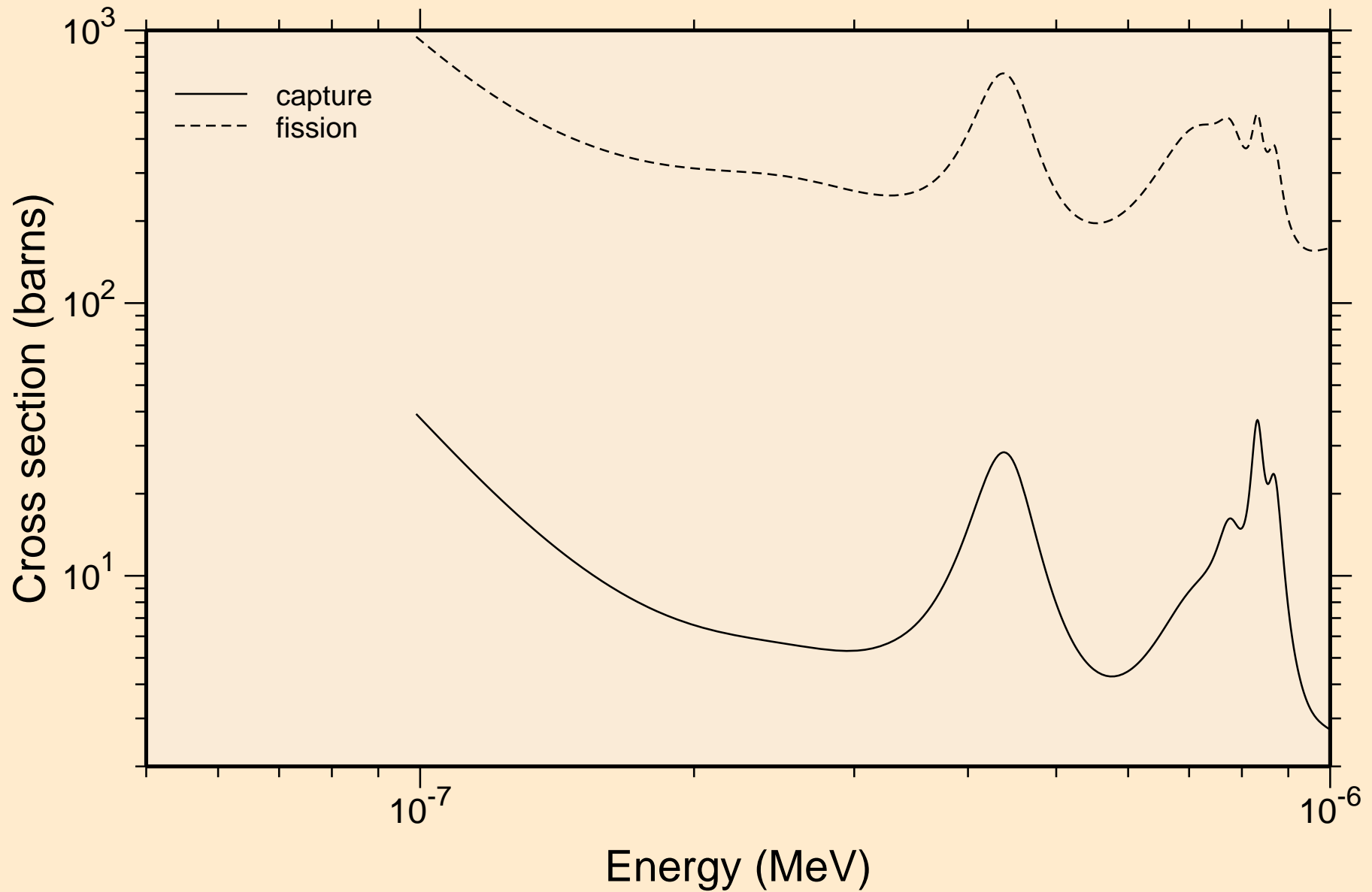

DB258 NEUTRON ACER TENDL-2023 LIBRARY; T=0.K
resonance absorption cross sections

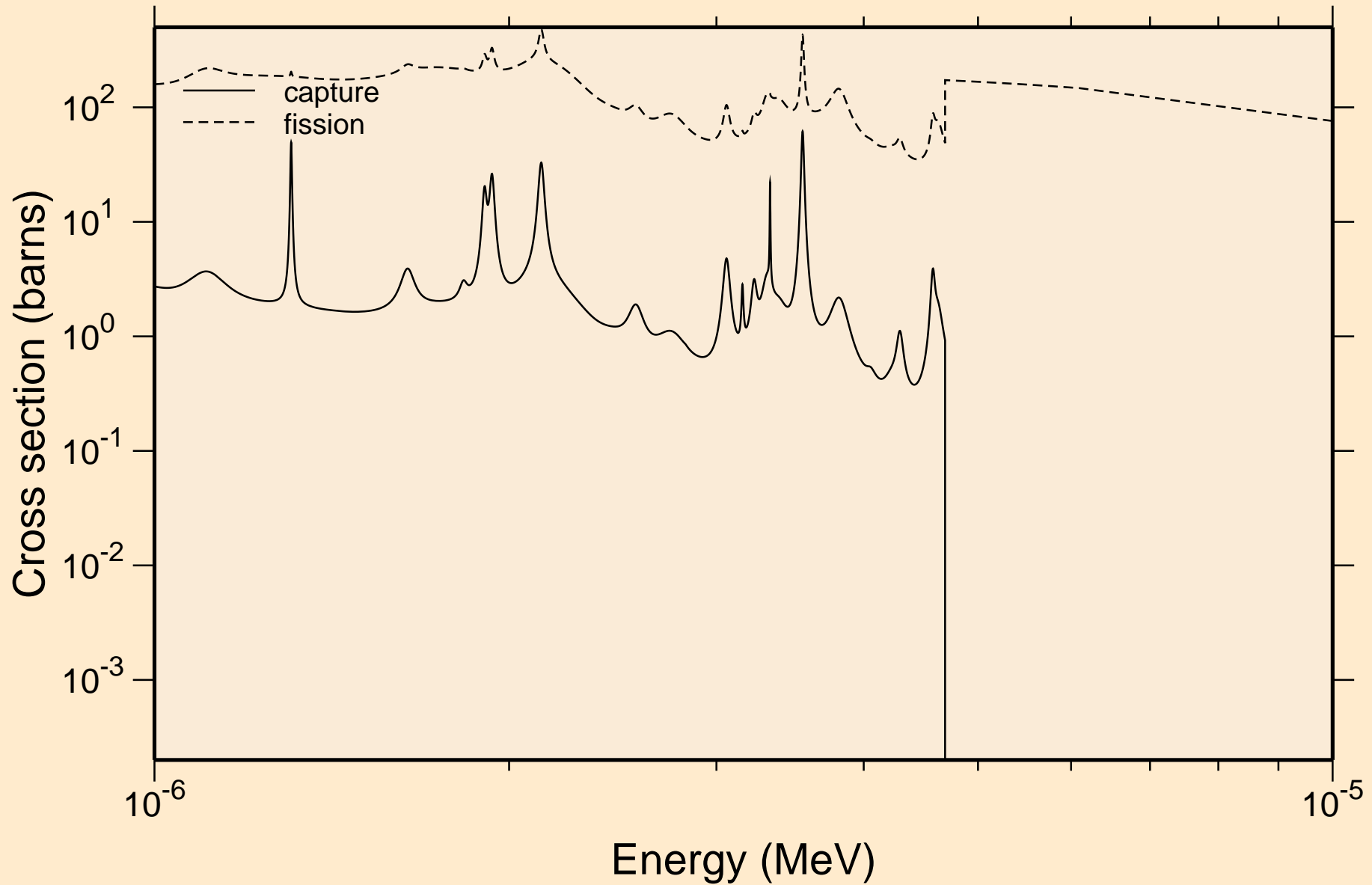

DB258 NEUTRON ACER TENDL-2023 LIBRARY; T=0.K
resonance absorption cross sections

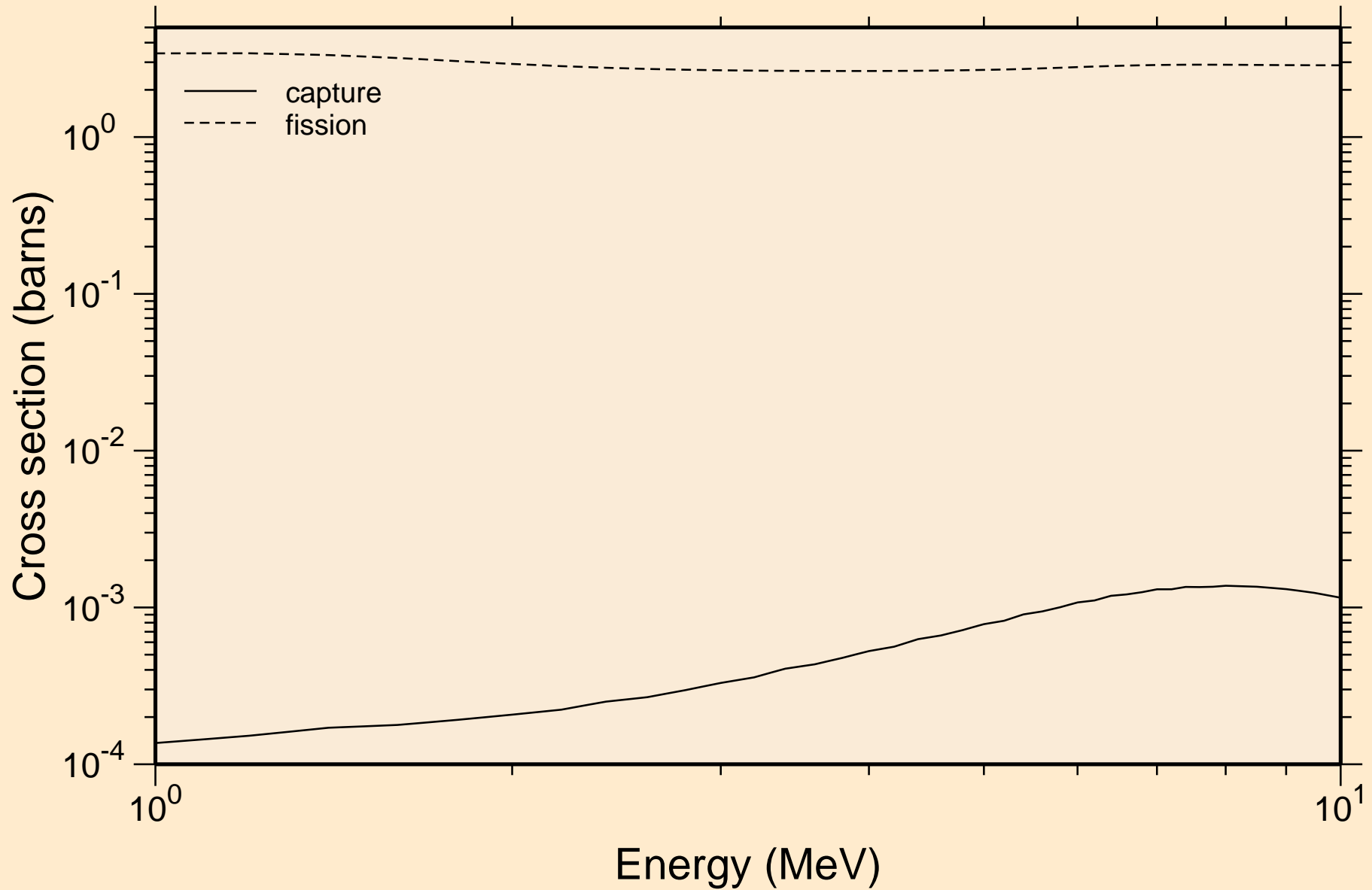

DB258 NEUTRON ACER TENDL-2023 LIBRARY; T=0.K

Heating

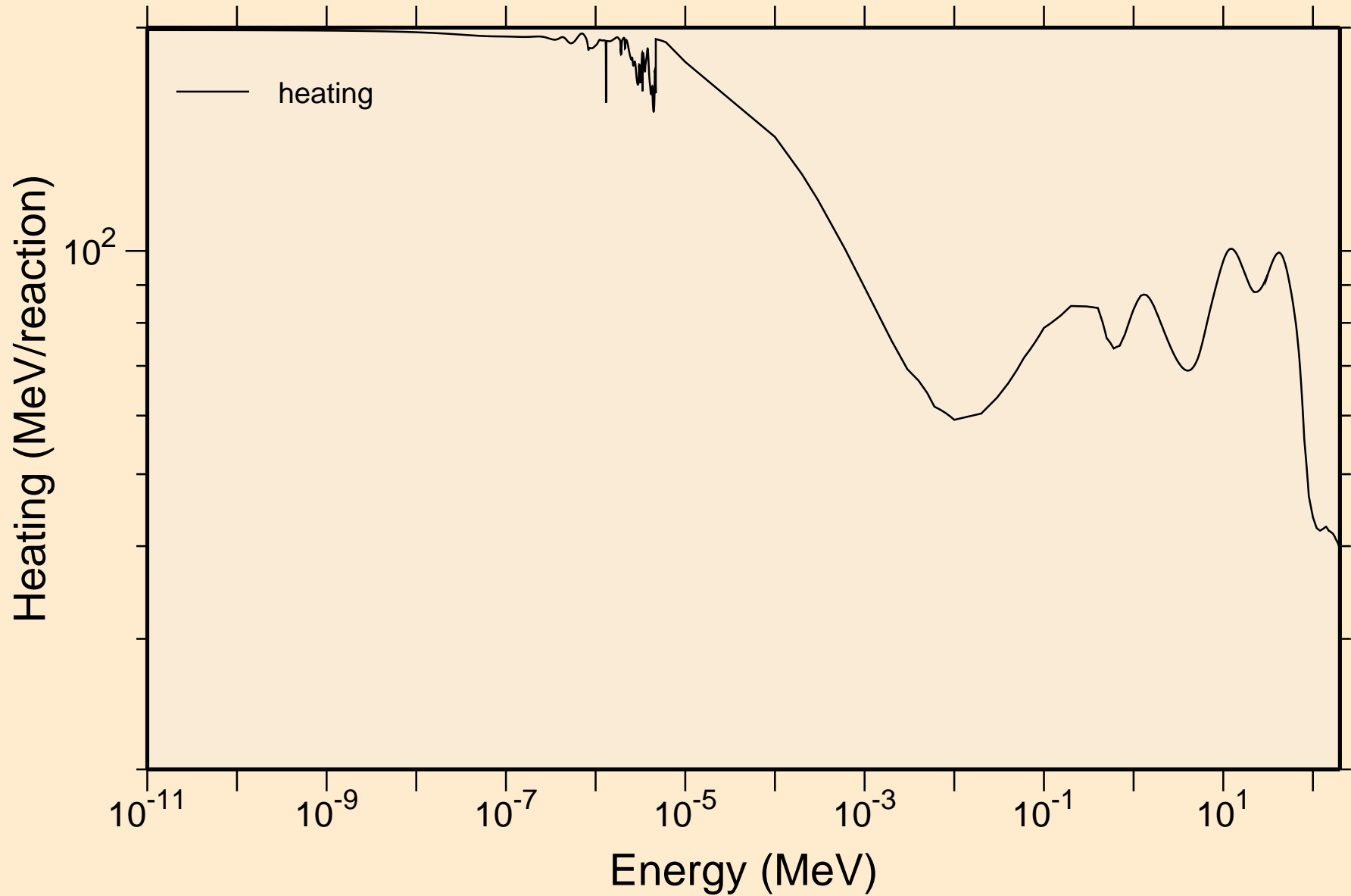

DB258 NEUTRON ACER TENDL-2023 LIBRARY; T=0.K
Damage

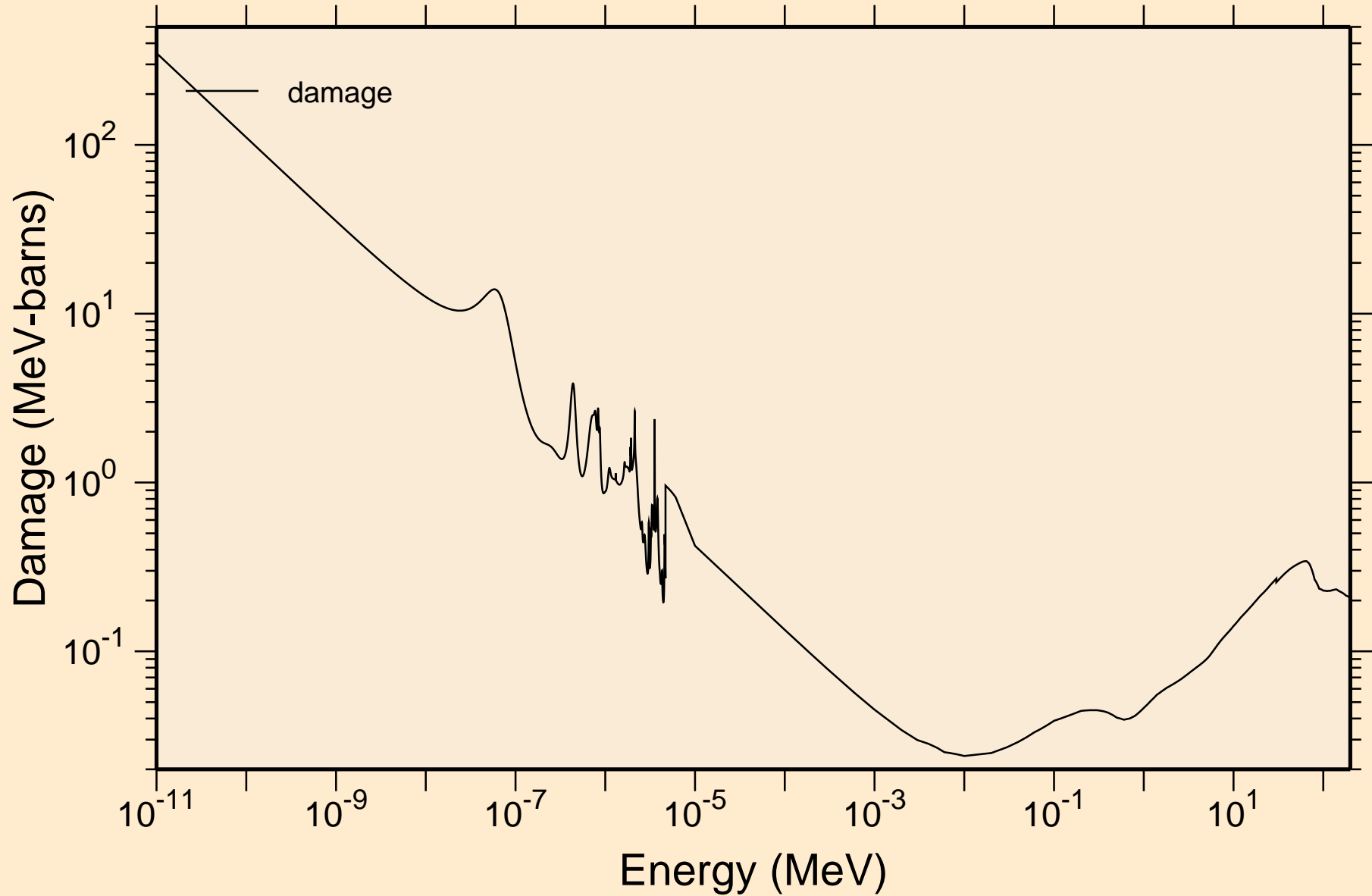

DB258 NEUTRON ACER TENDL-2023 LIBRARY; T=0.K

Non-threshold reactions

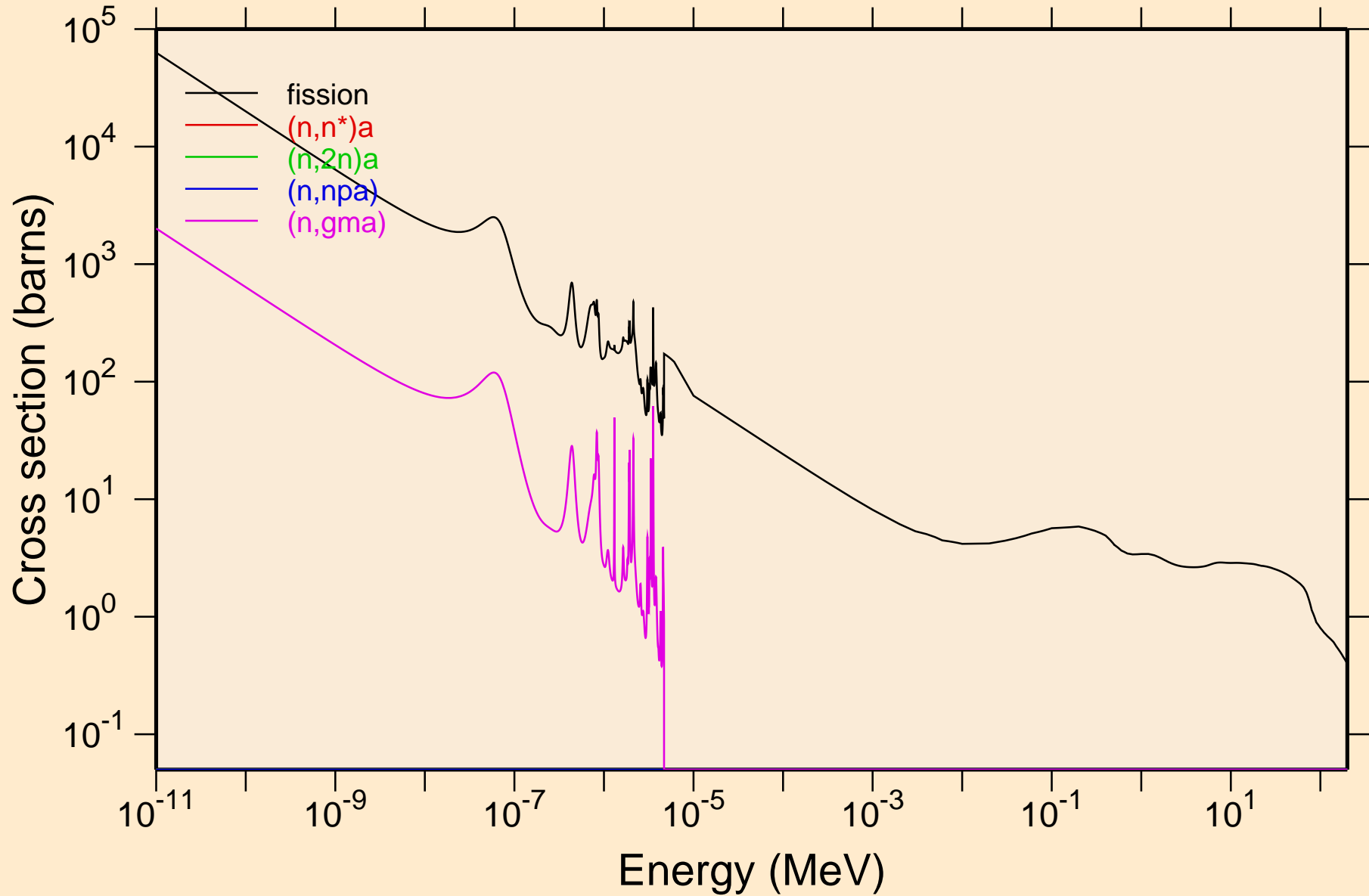

DB258 NEUTRON ACER TENDL-2023 LIBRARY; T=0.K
Non-threshold reactions

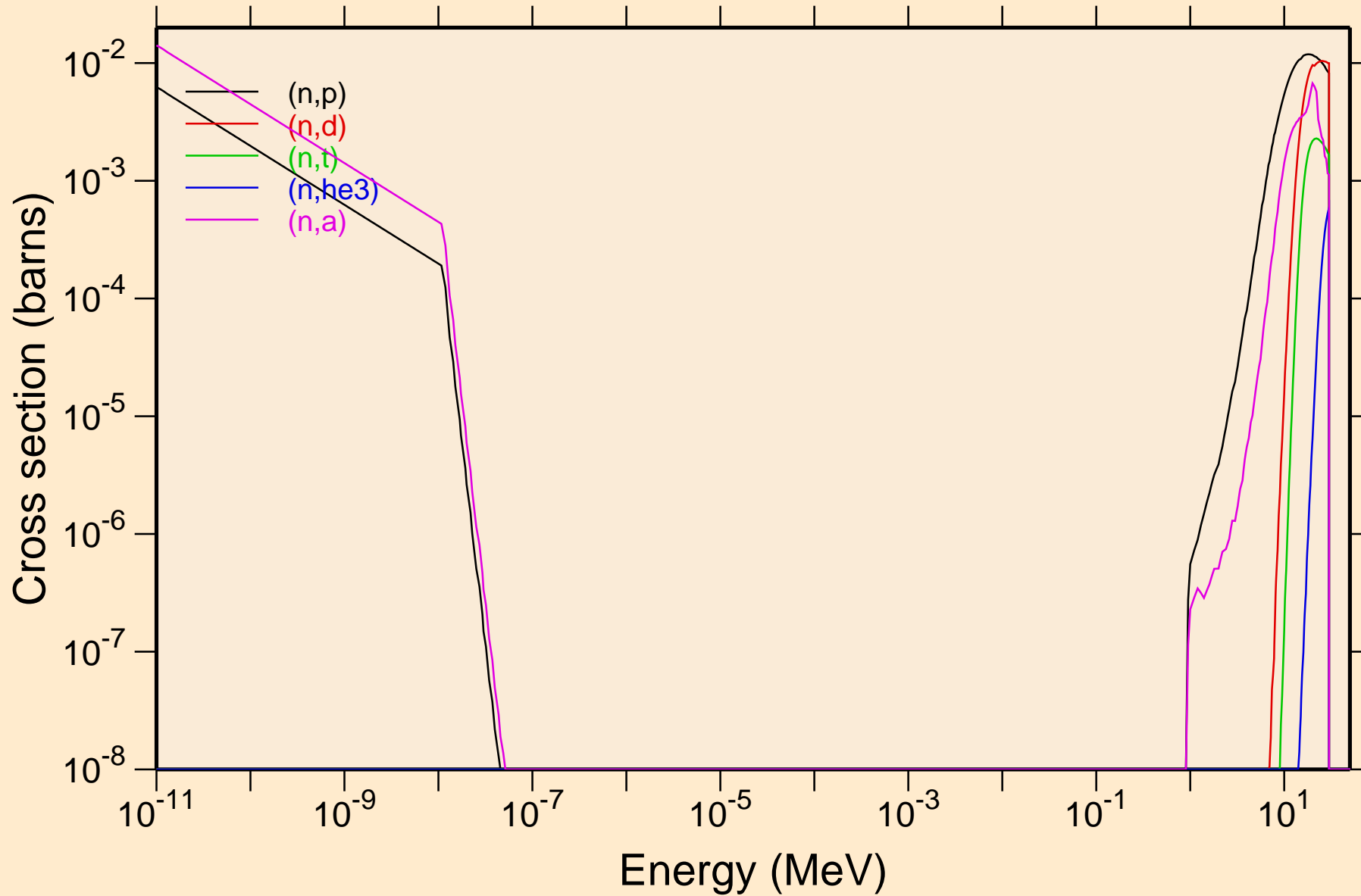

DB258 NEUTRON ACER TENDL-2023 LIBRARY; T=0.K
Non-threshold reactions

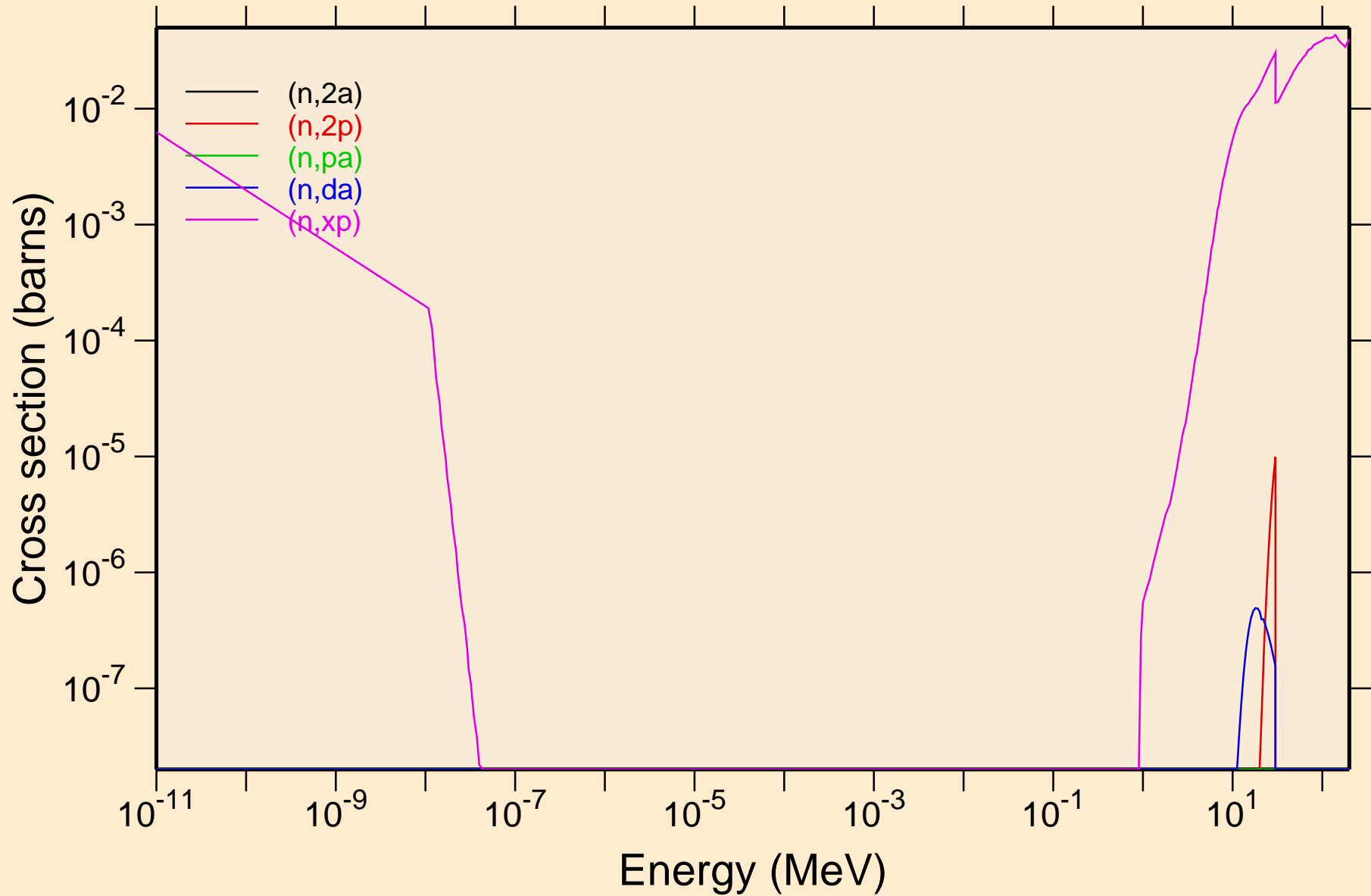

DB258 NEUTRON ACER TENDL-2023 LIBRARY; T=0.K
Non-threshold reactions

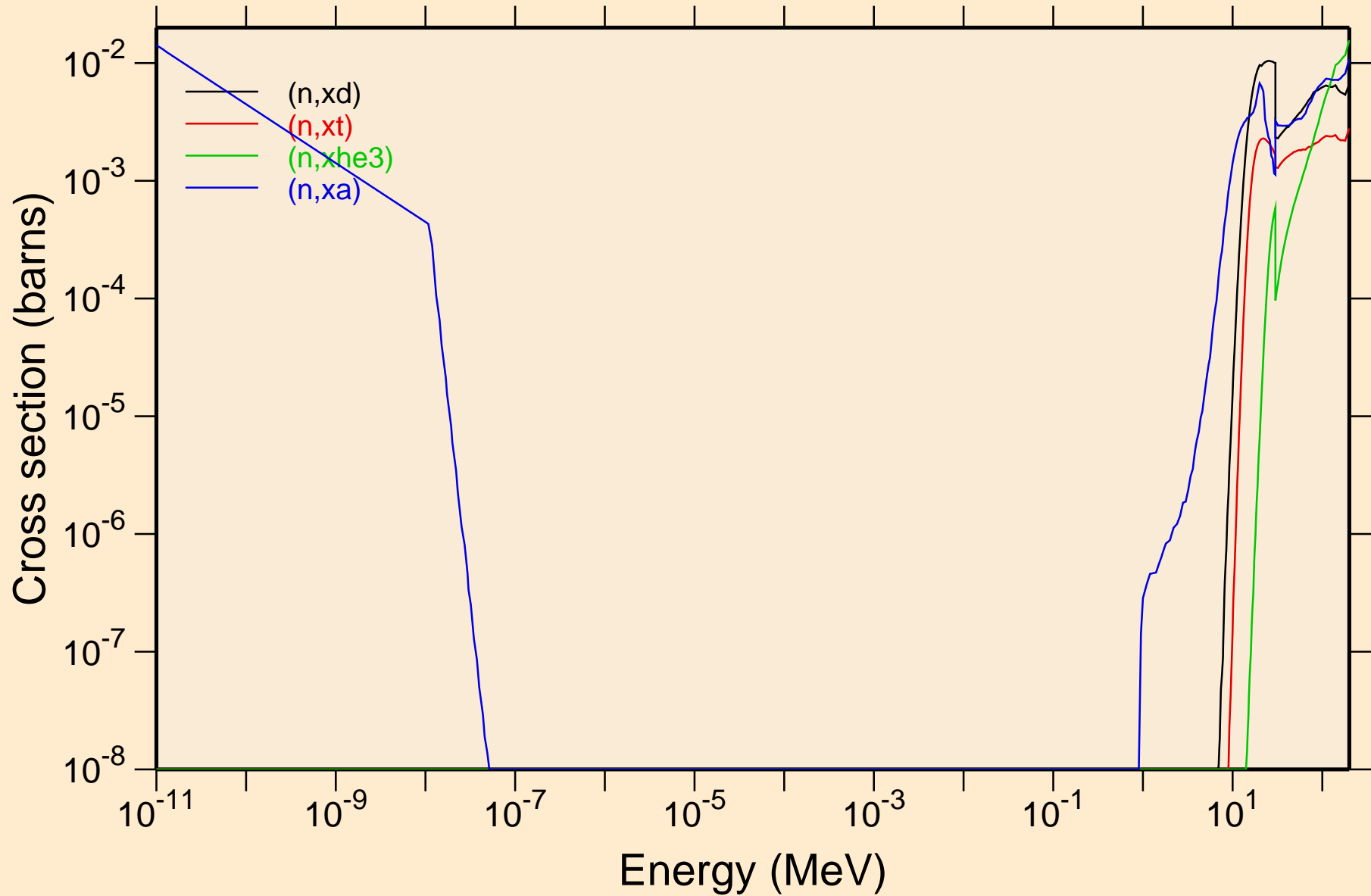

DB258 NEUTRON ACER TENDL-2023 LIBRARY; T=0.K

Principal cross sections

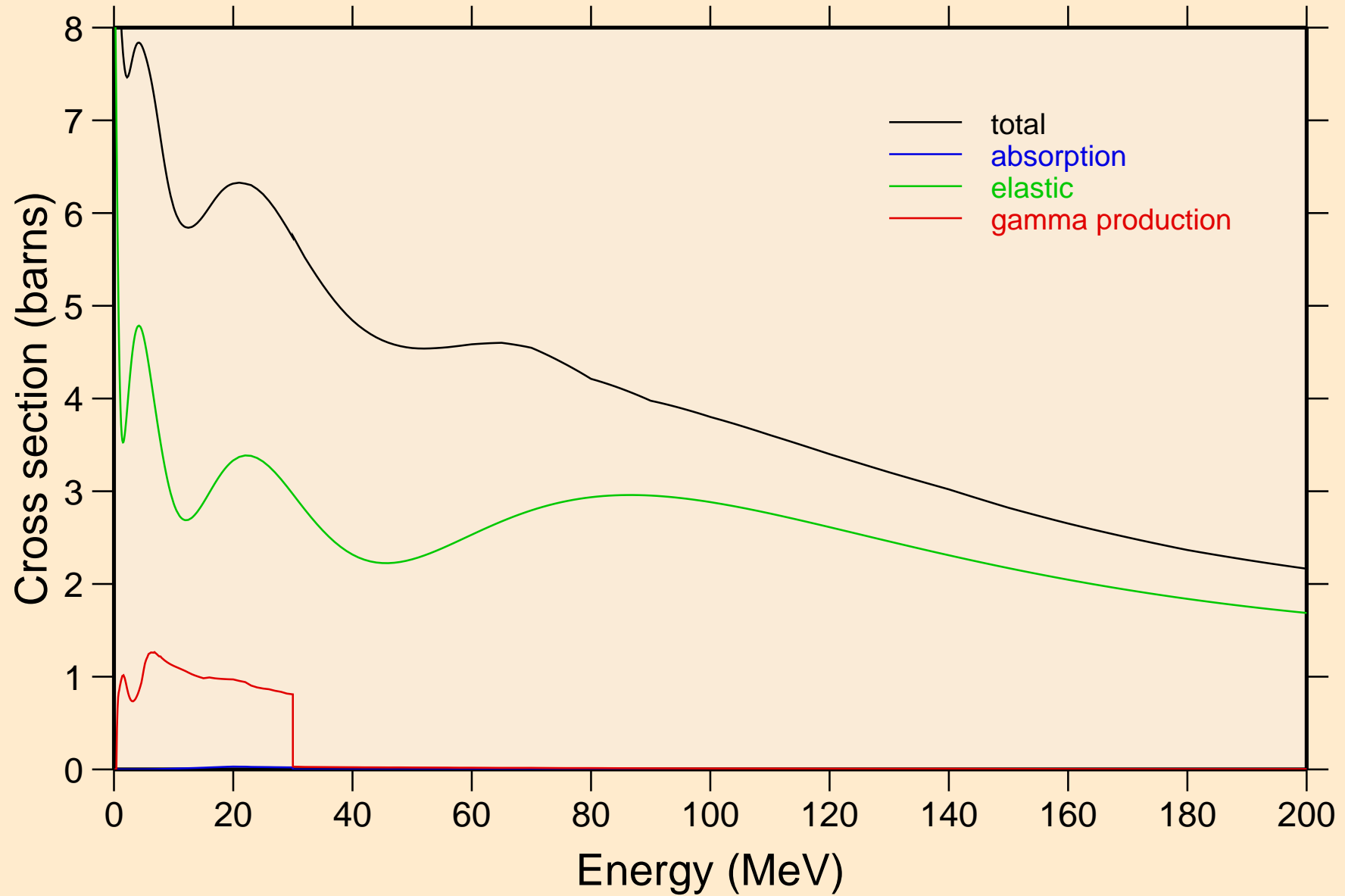

DB258 NEUTRON ACER TENDL-2023 LIBRARY; T=0.K

Heating

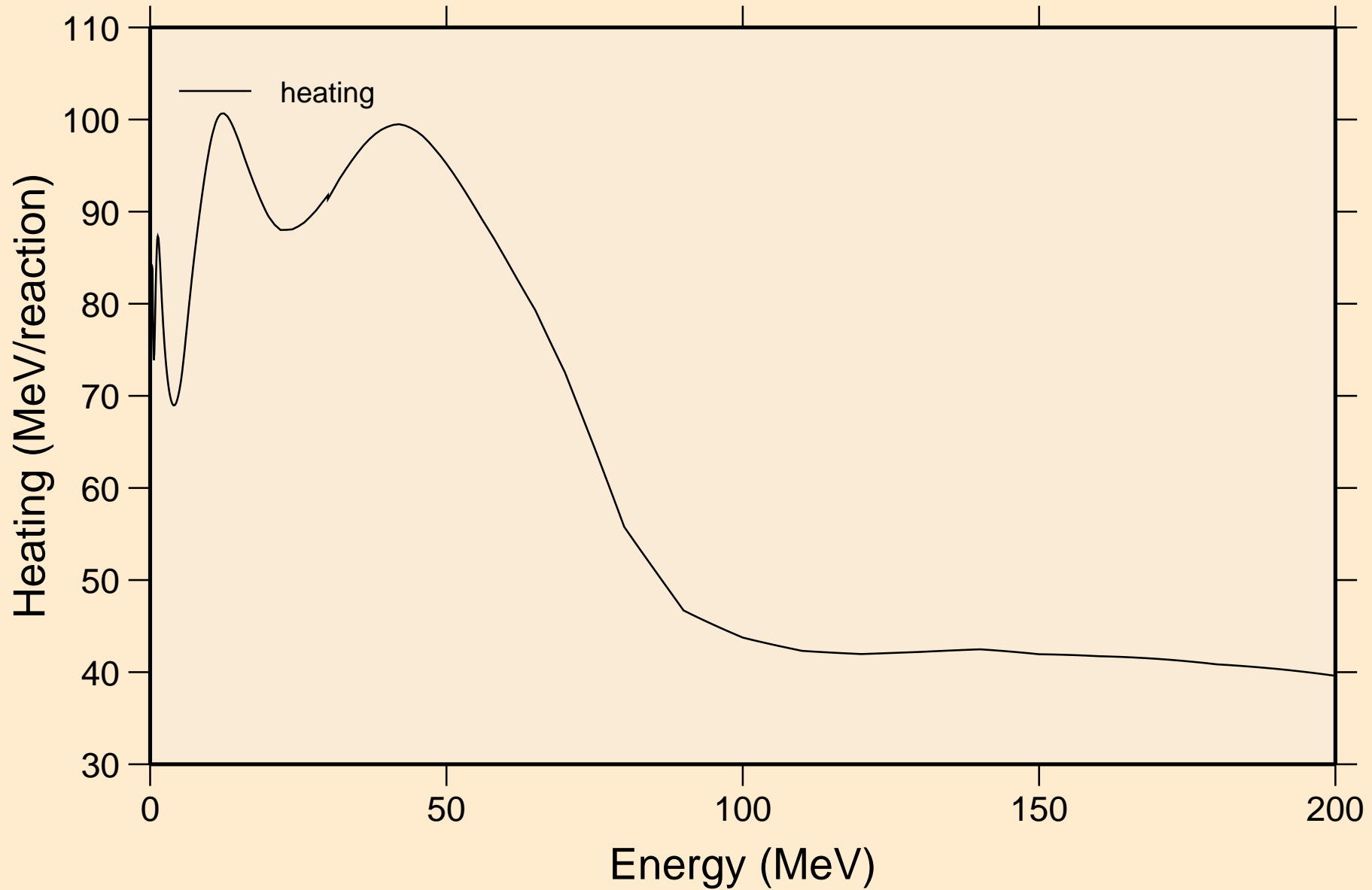

DB258 NEUTRON ACER TENDL-2023 LIBRARY; T=0.K
Damage

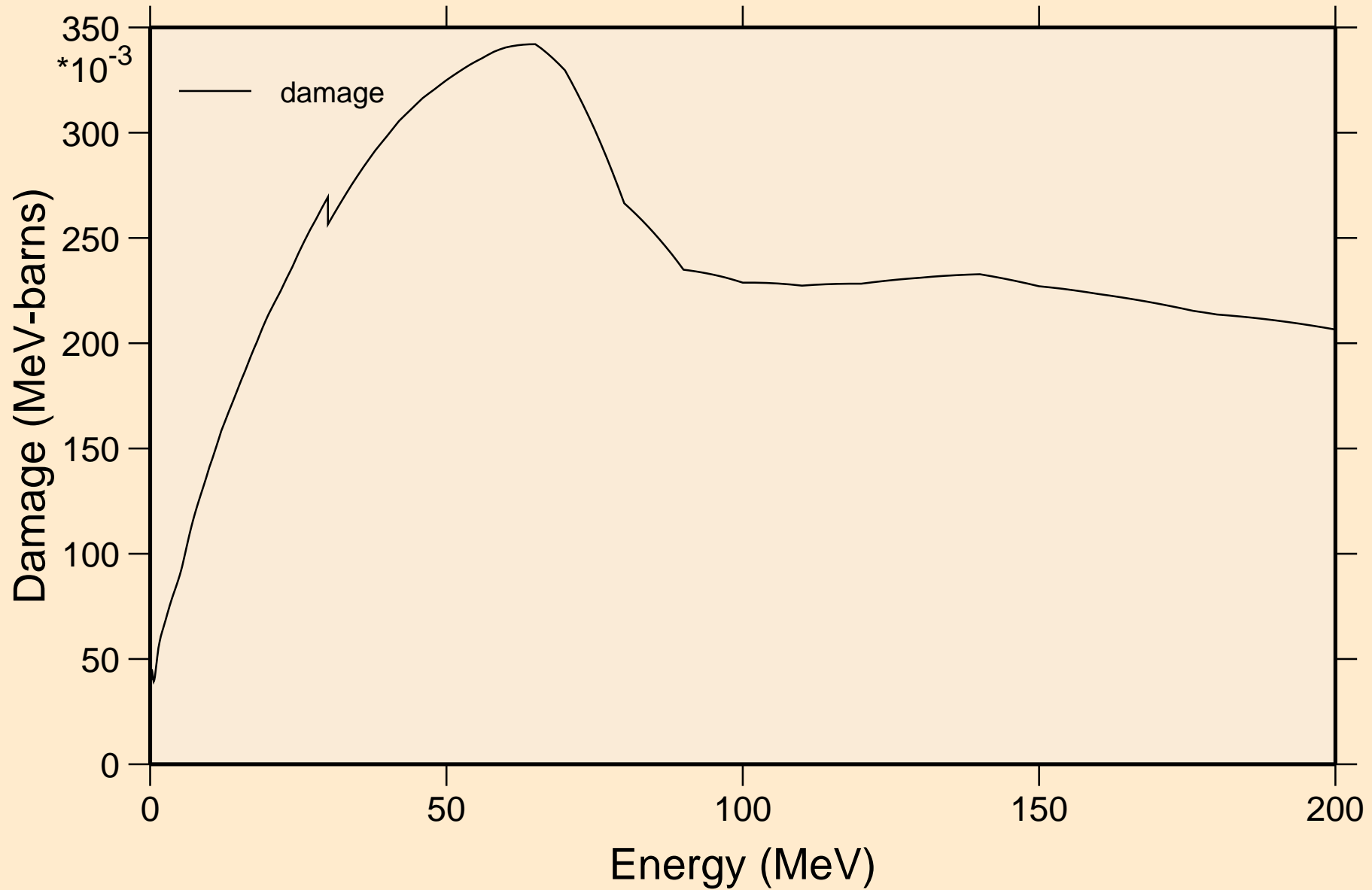

DB258 NEUTRON ACER TENDL-2023 LIBRARY; T=0.K

Non-threshold reactions

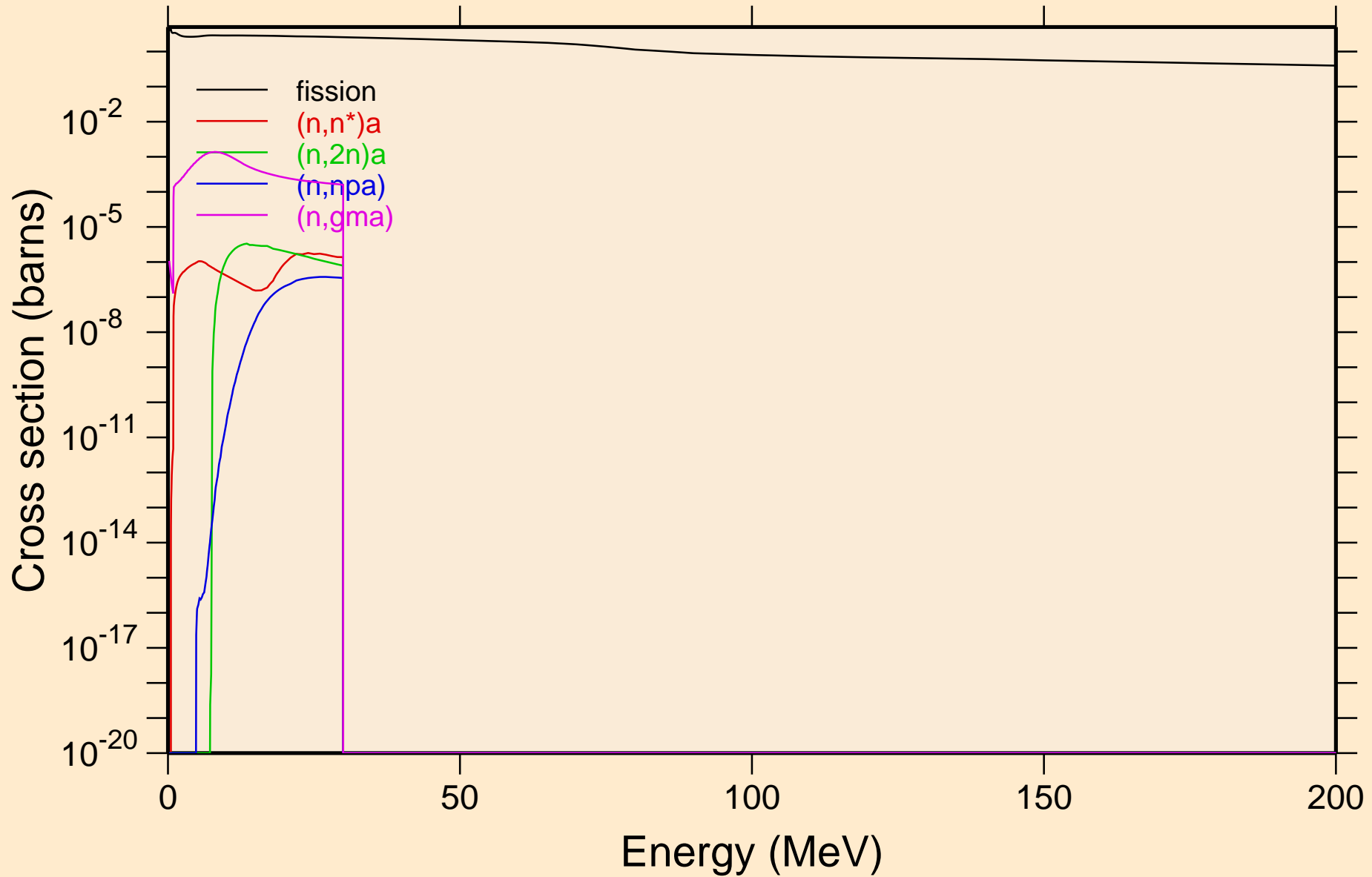

DB258 NEUTRON ACER TENDL-2023 LIBRARY; T=0.K

Non-threshold reactions

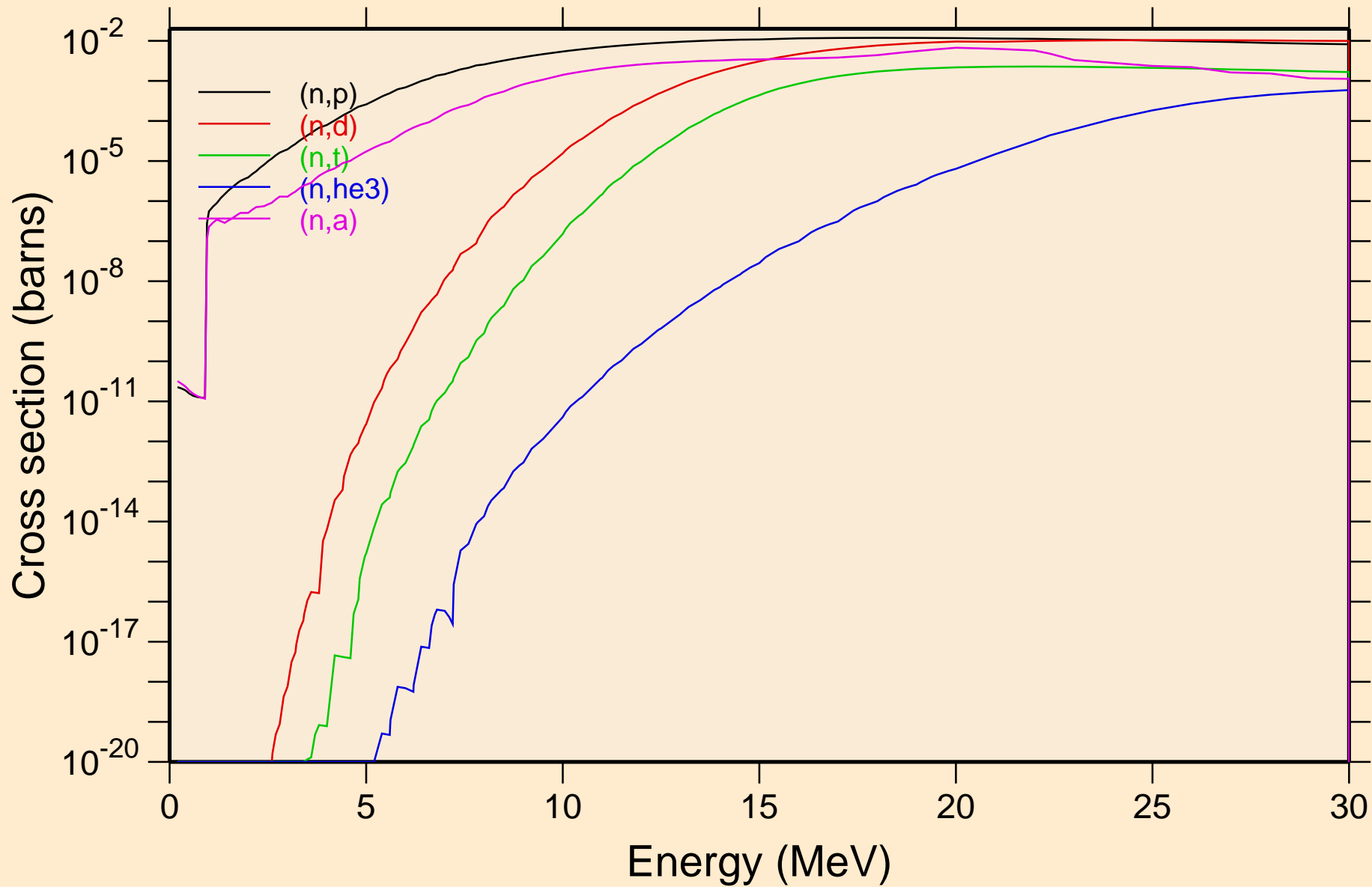

DB258 NEUTRON ACER TENDL-2023 LIBRARY; T=0.K
Non-threshold reactions

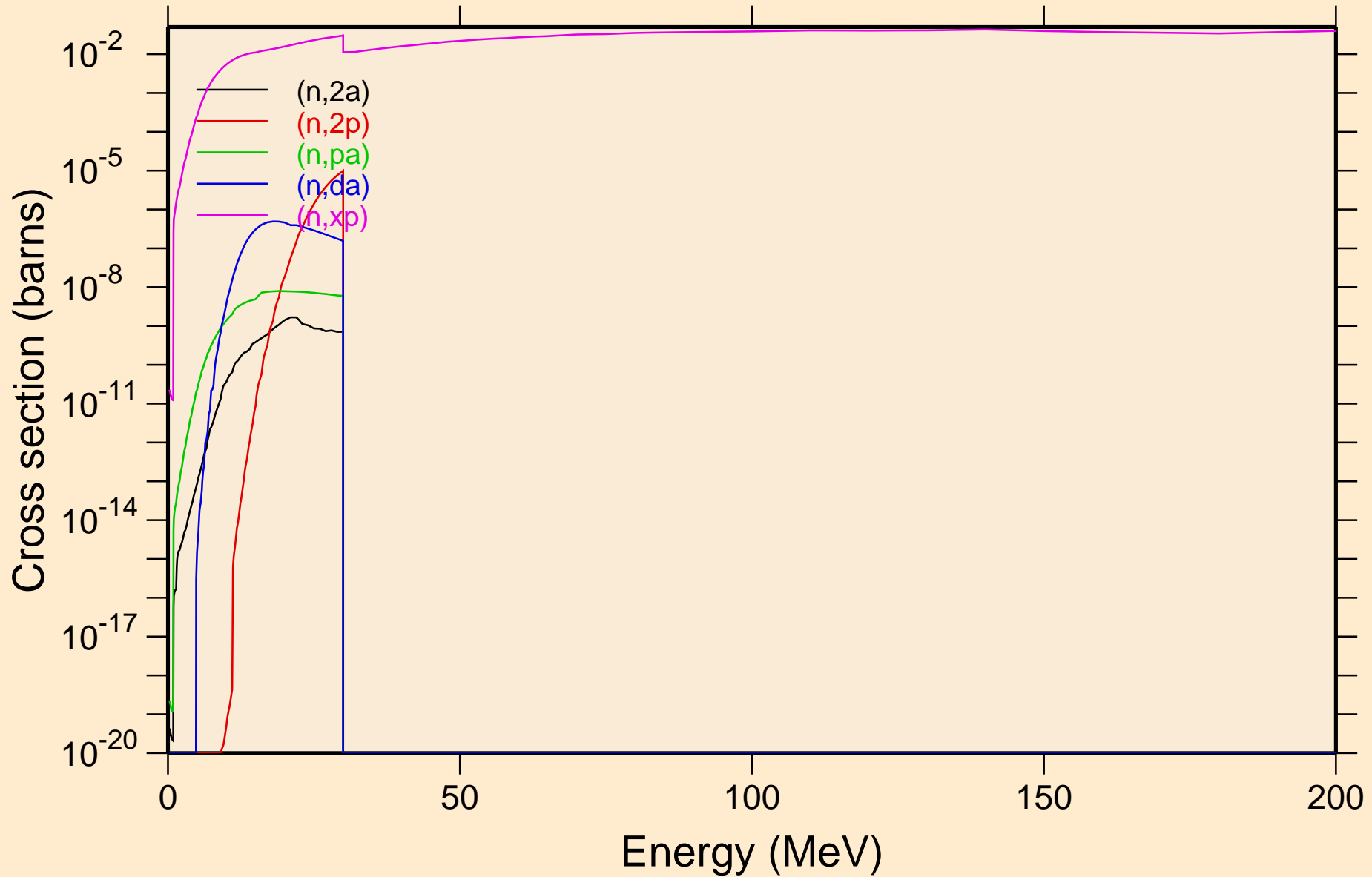

DB258 NEUTRON ACER TENDL-2023 LIBRARY; T=0.K
Non-threshold reactions

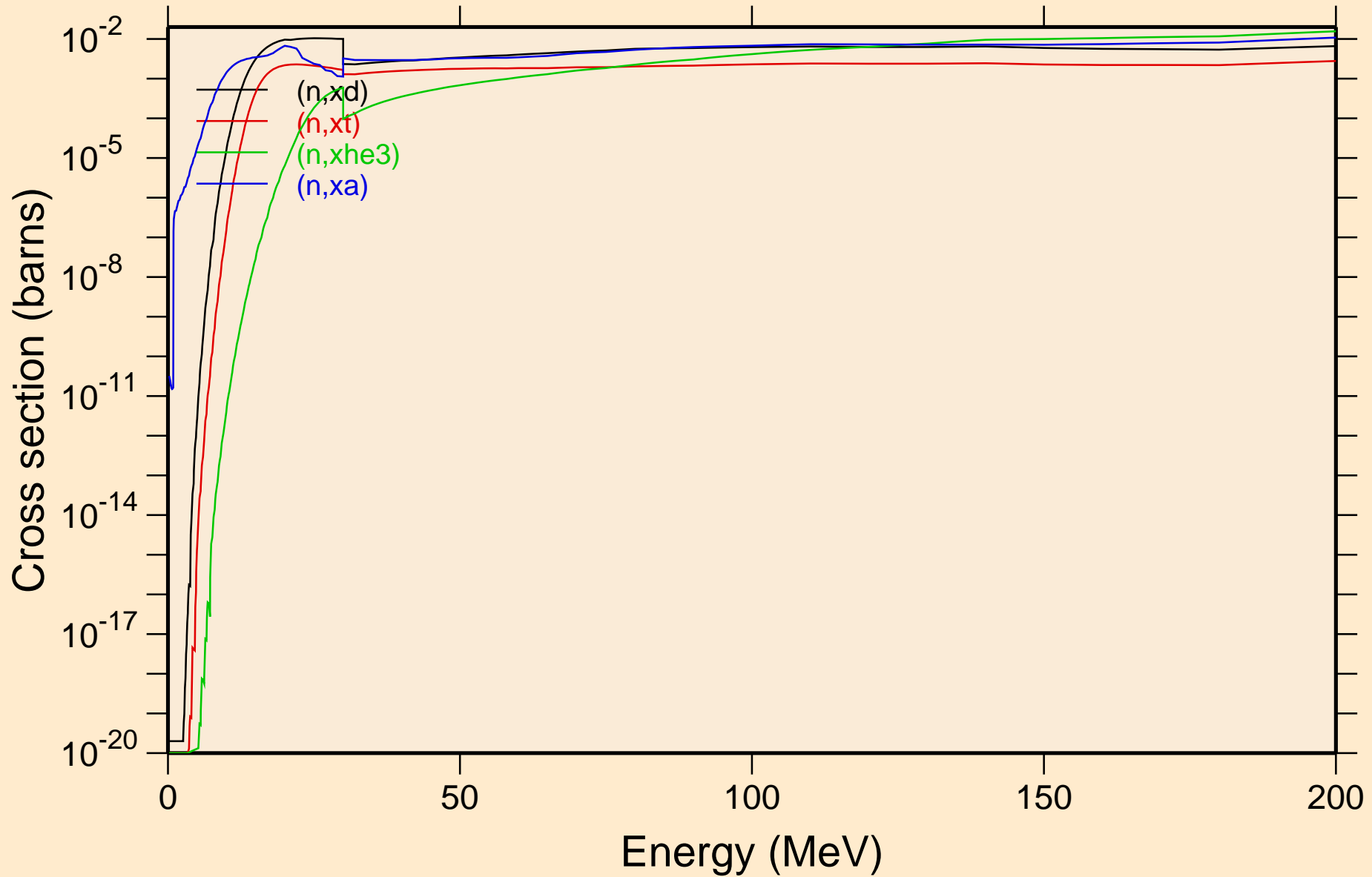

DB258 NEUTRON ACER TENDL-2023 LIBRARY; T=0.K
Inelastic levels

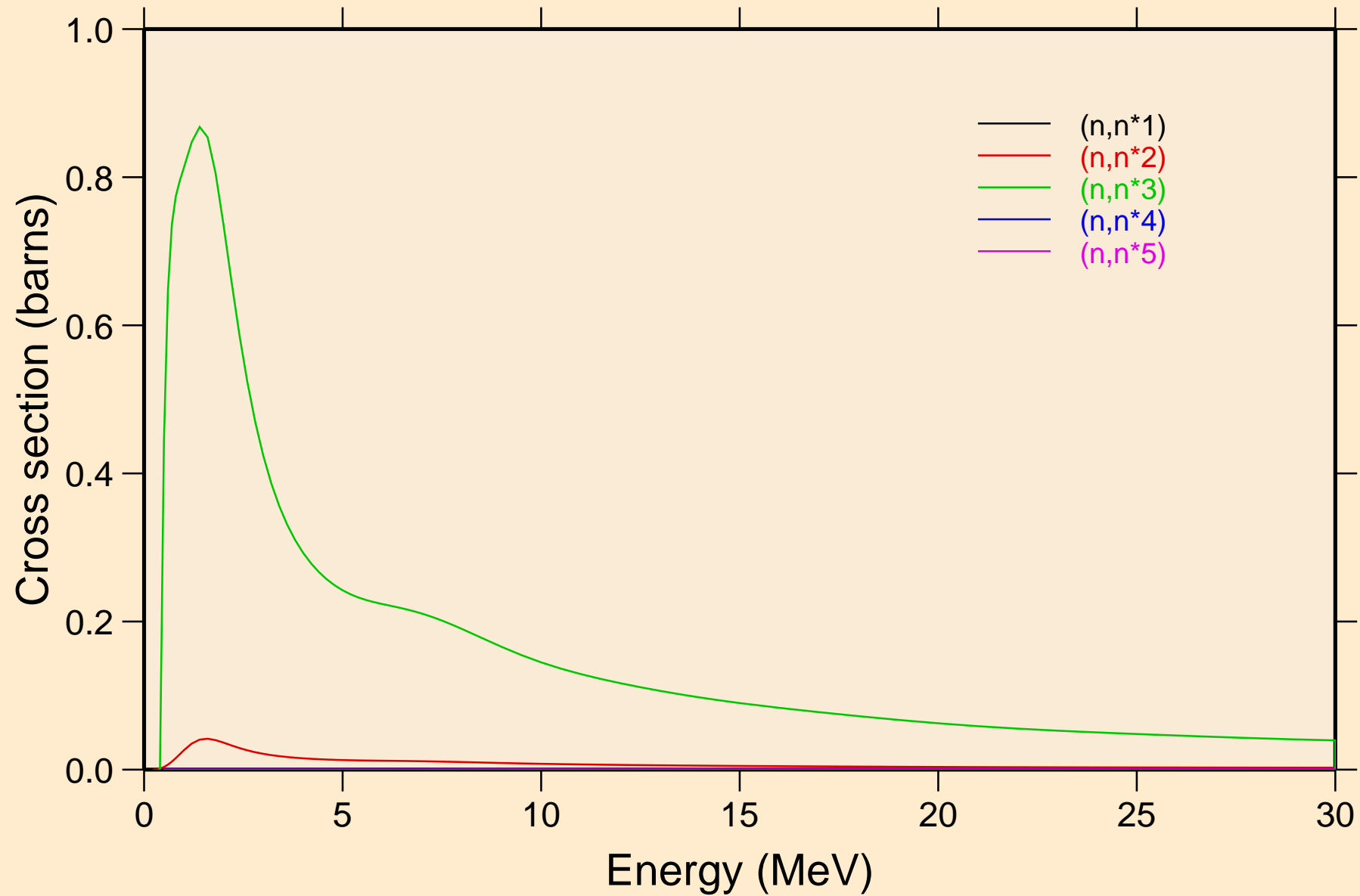

DB258 NEUTRON ACER TENDL-2023 LIBRARY; T=0.K
Inelastic levels

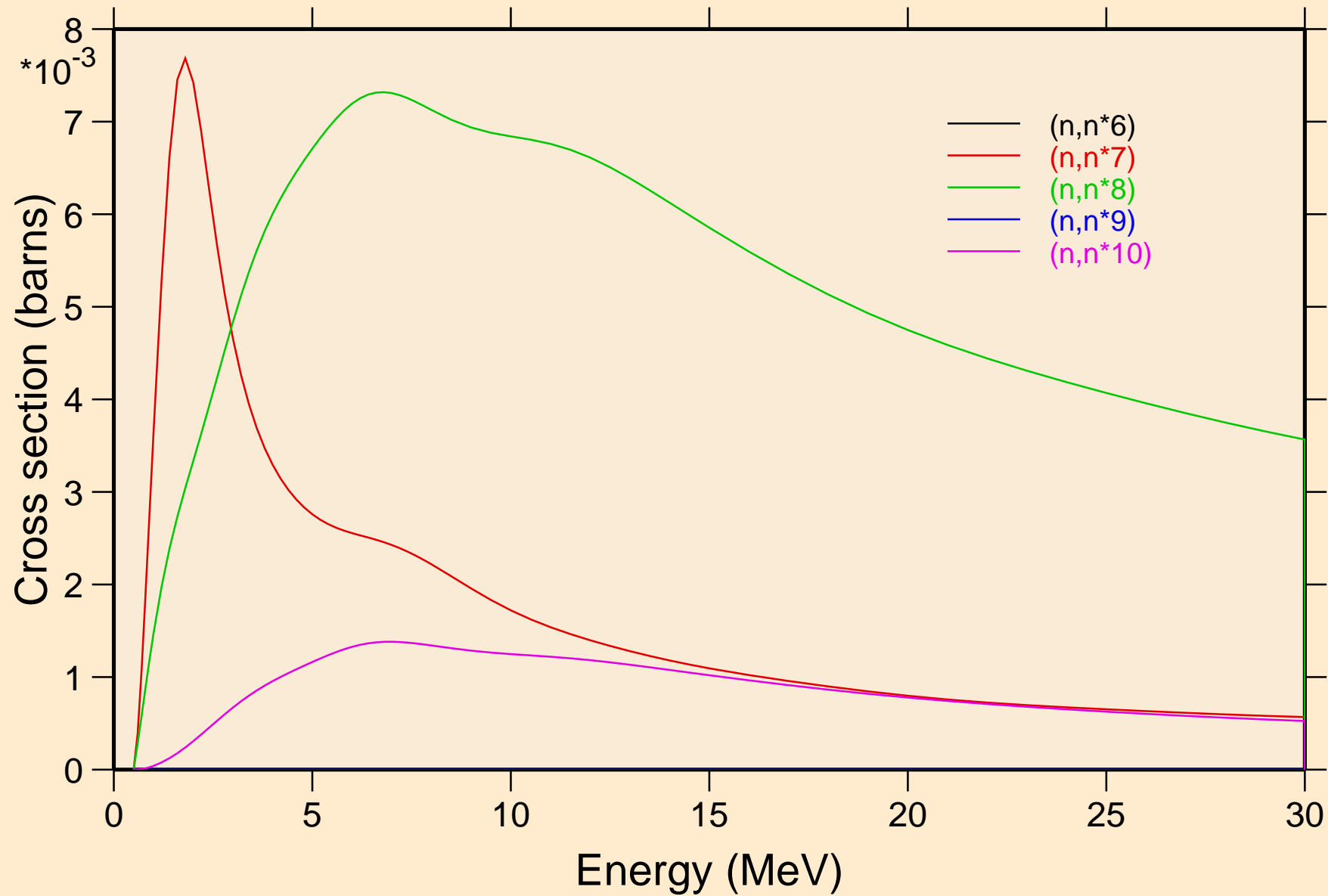

DB258 NEUTRON ACER TENDL-2023 LIBRARY; T=0.K
Inelastic levels

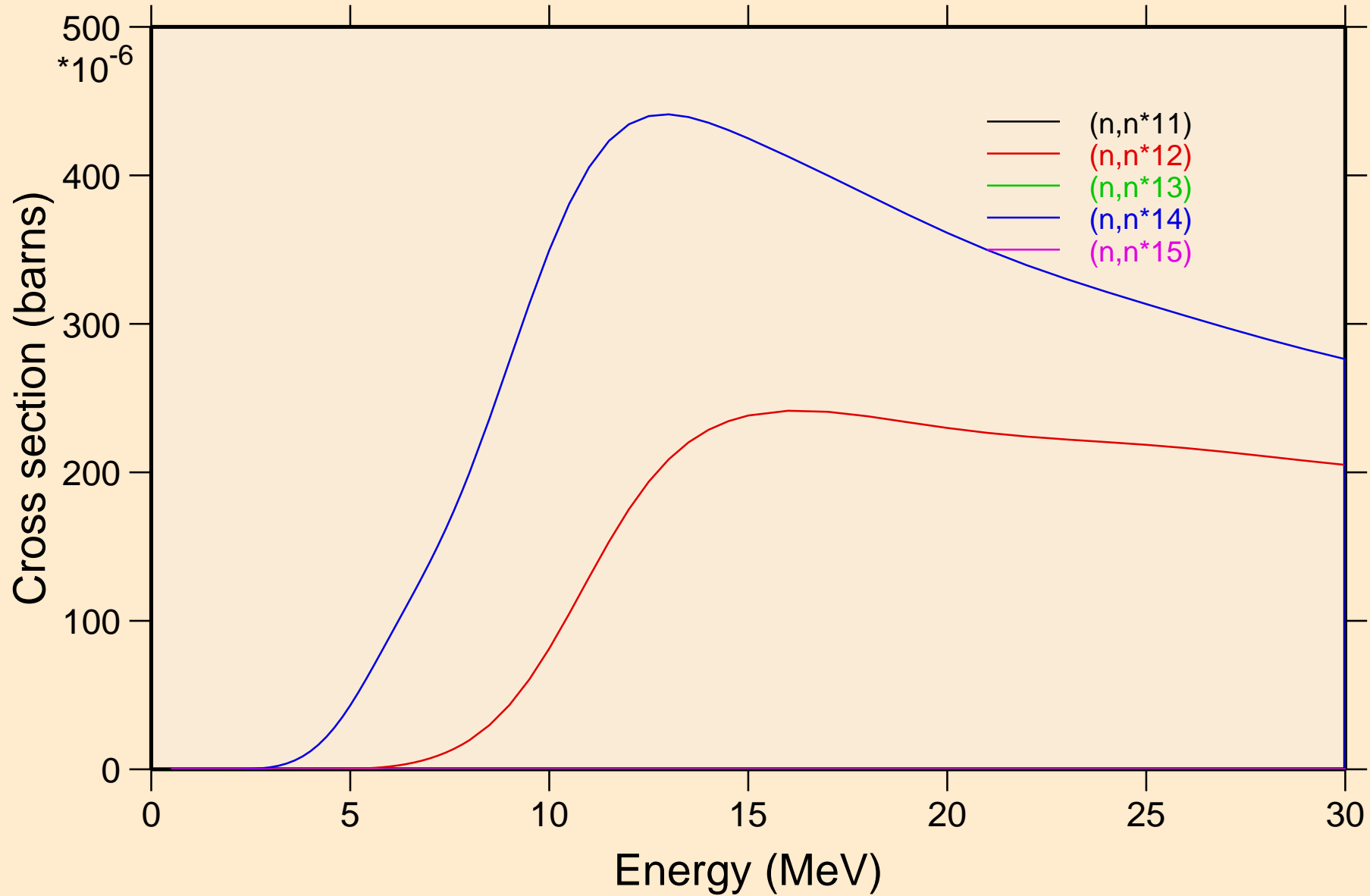

DB258 NEUTRON ACER TENDL-2023 LIBRARY; T=0.K
Inelastic levels

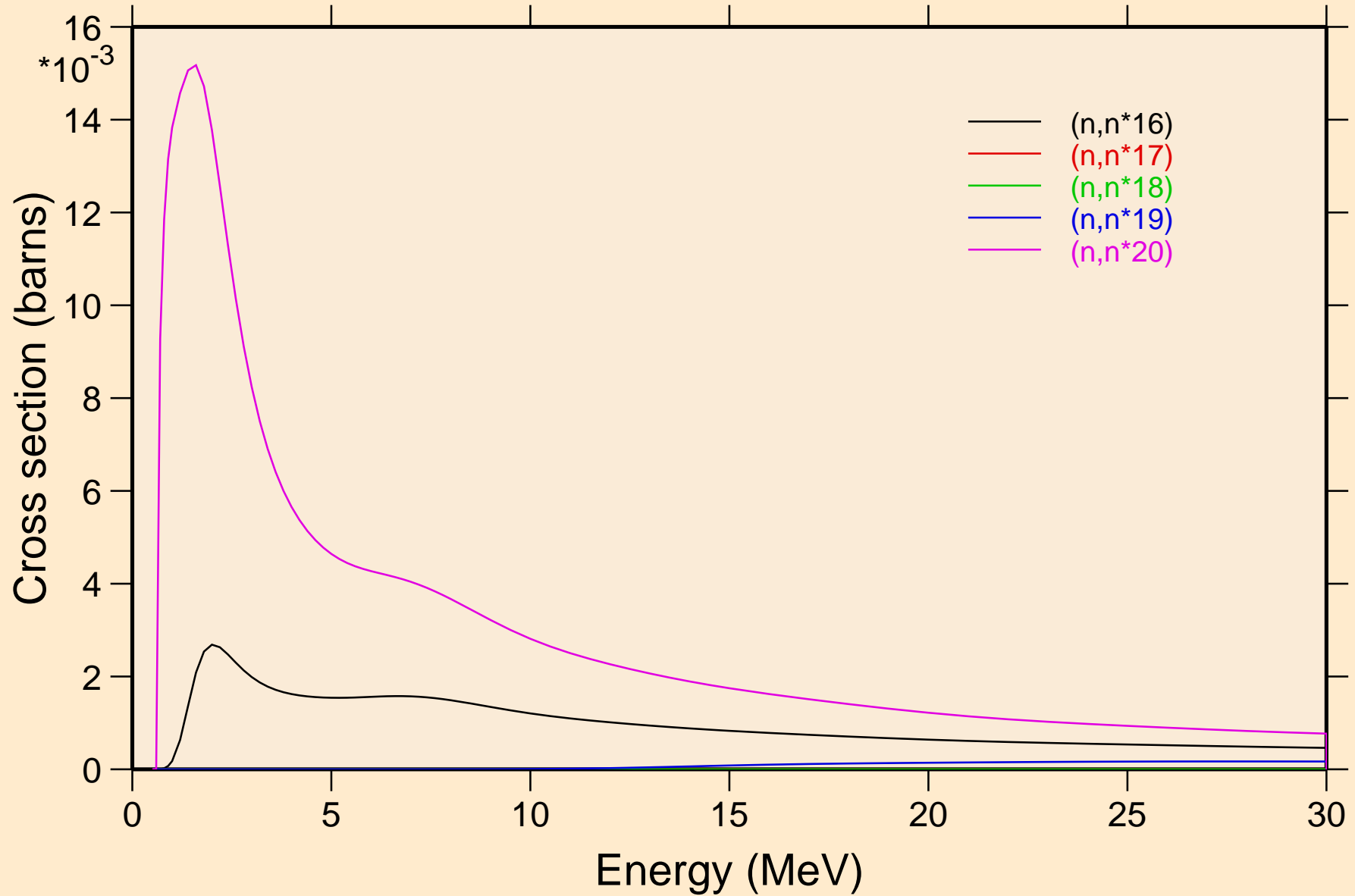

DB258 NEUTRON ACER TENDL-2023 LIBRARY; T=0.K

Threshold reactions

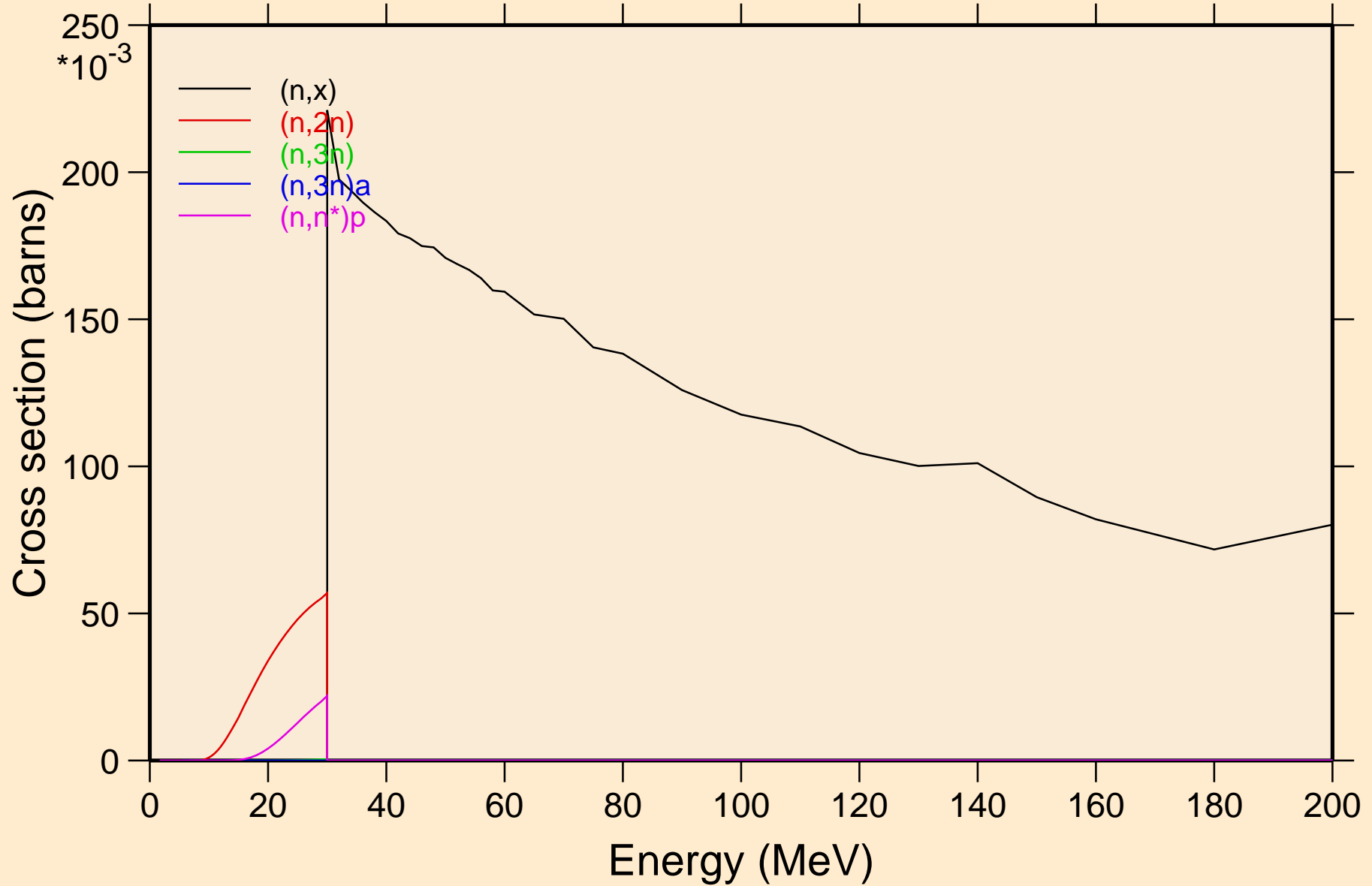

DB258 NEUTRON ACER TENDL-2023 LIBRARY; T=0.K
Threshold reactions

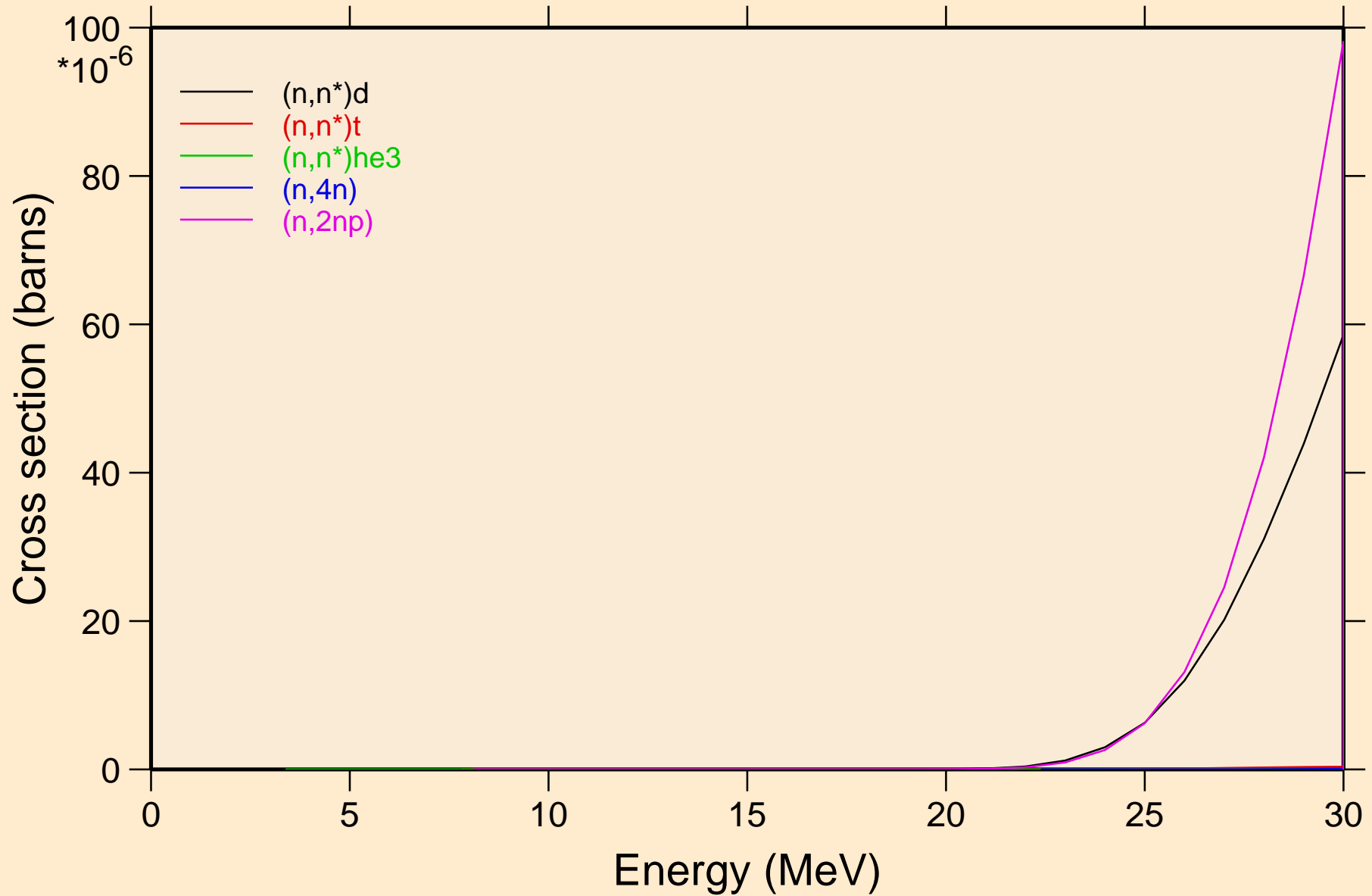

DB258 NEUTRON ACER TENDL-2023 LIBRARY; T=0.K
Threshold reactions

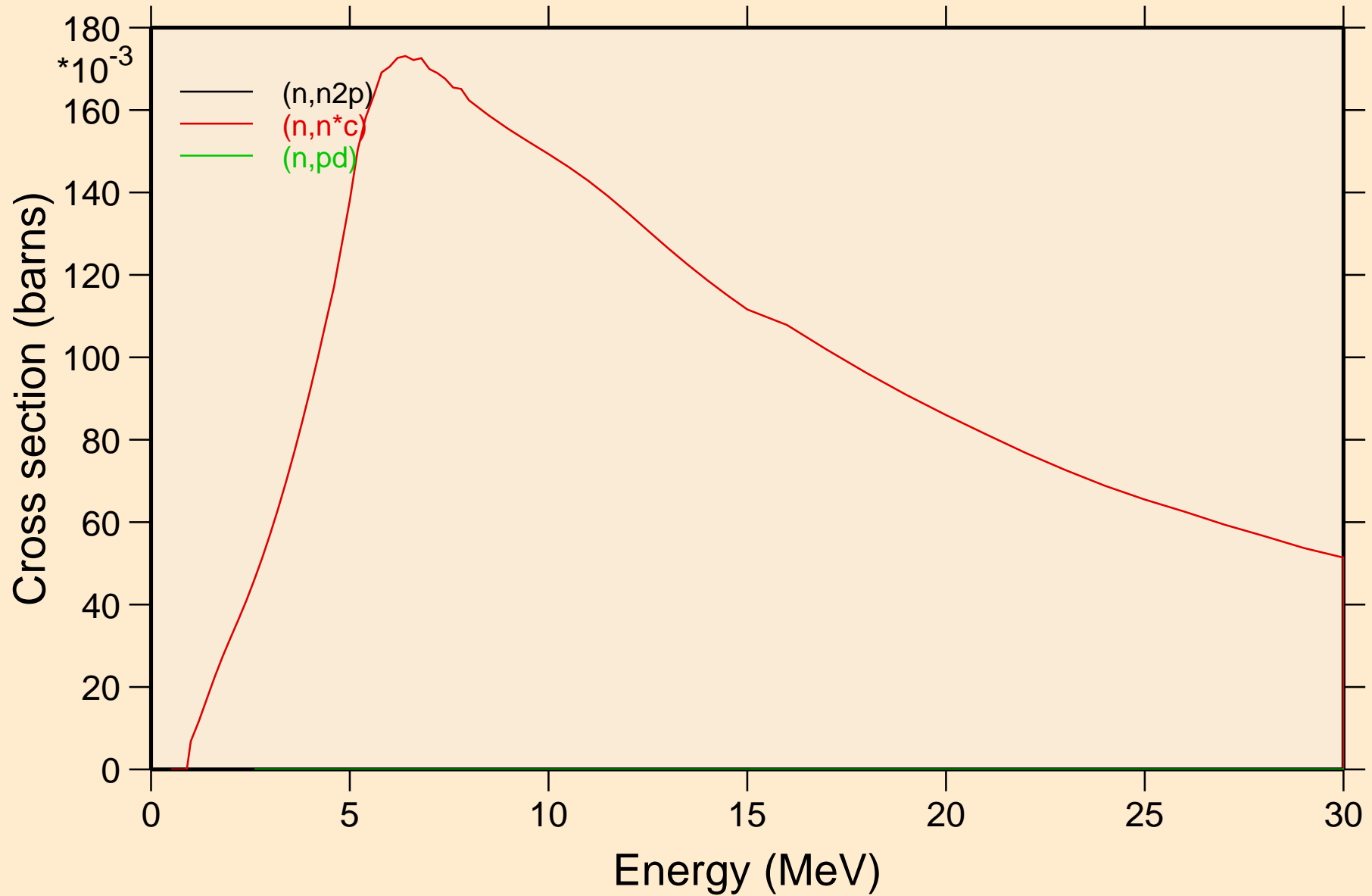

DB258 NEUTRON ACER TENDL-2023 LIBRARY; T=0.K
angular distribution for elastic

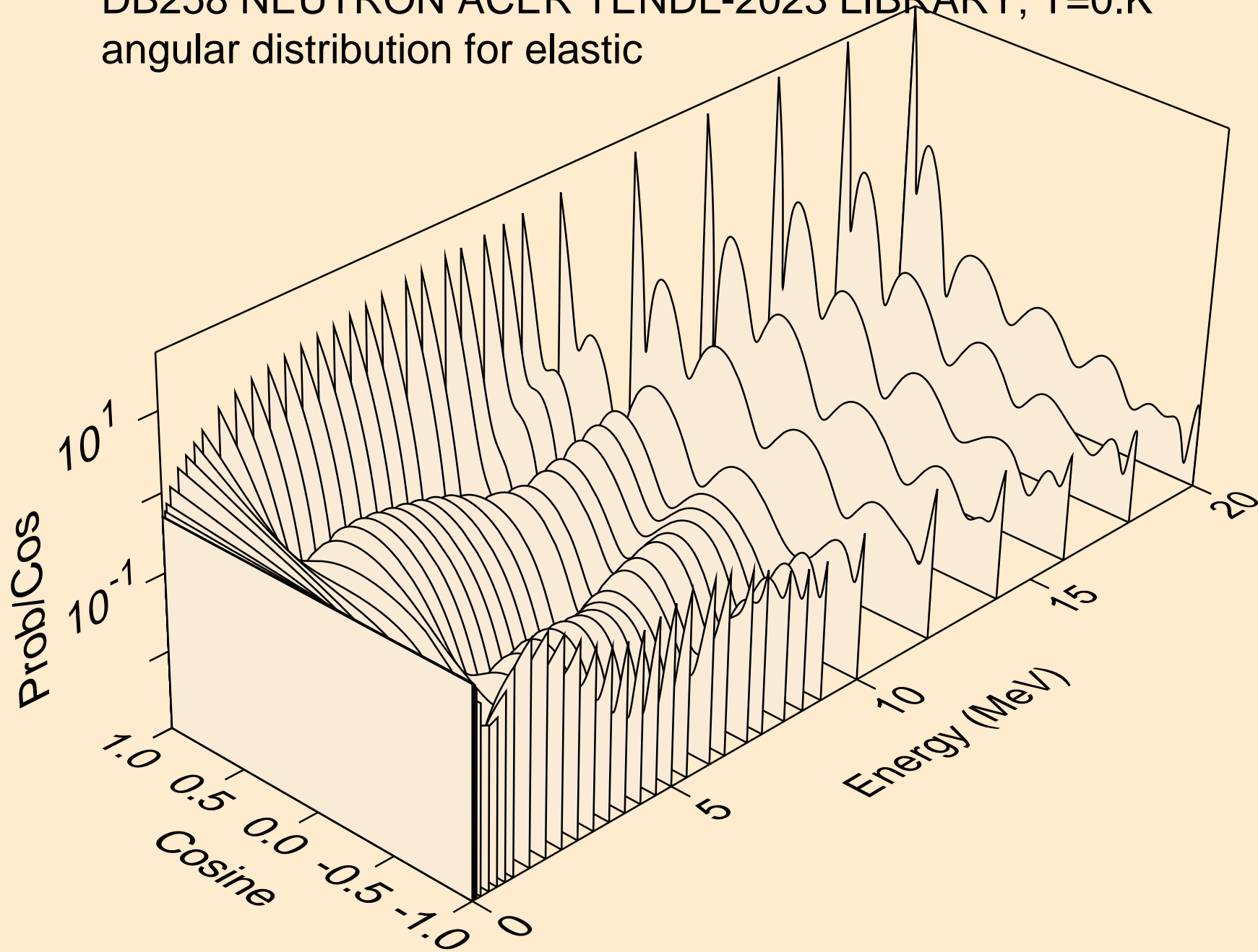

DB258 NEUTRON ACER TENDL-2023 LIBRARY; T=0.K
angular distribution for elastic

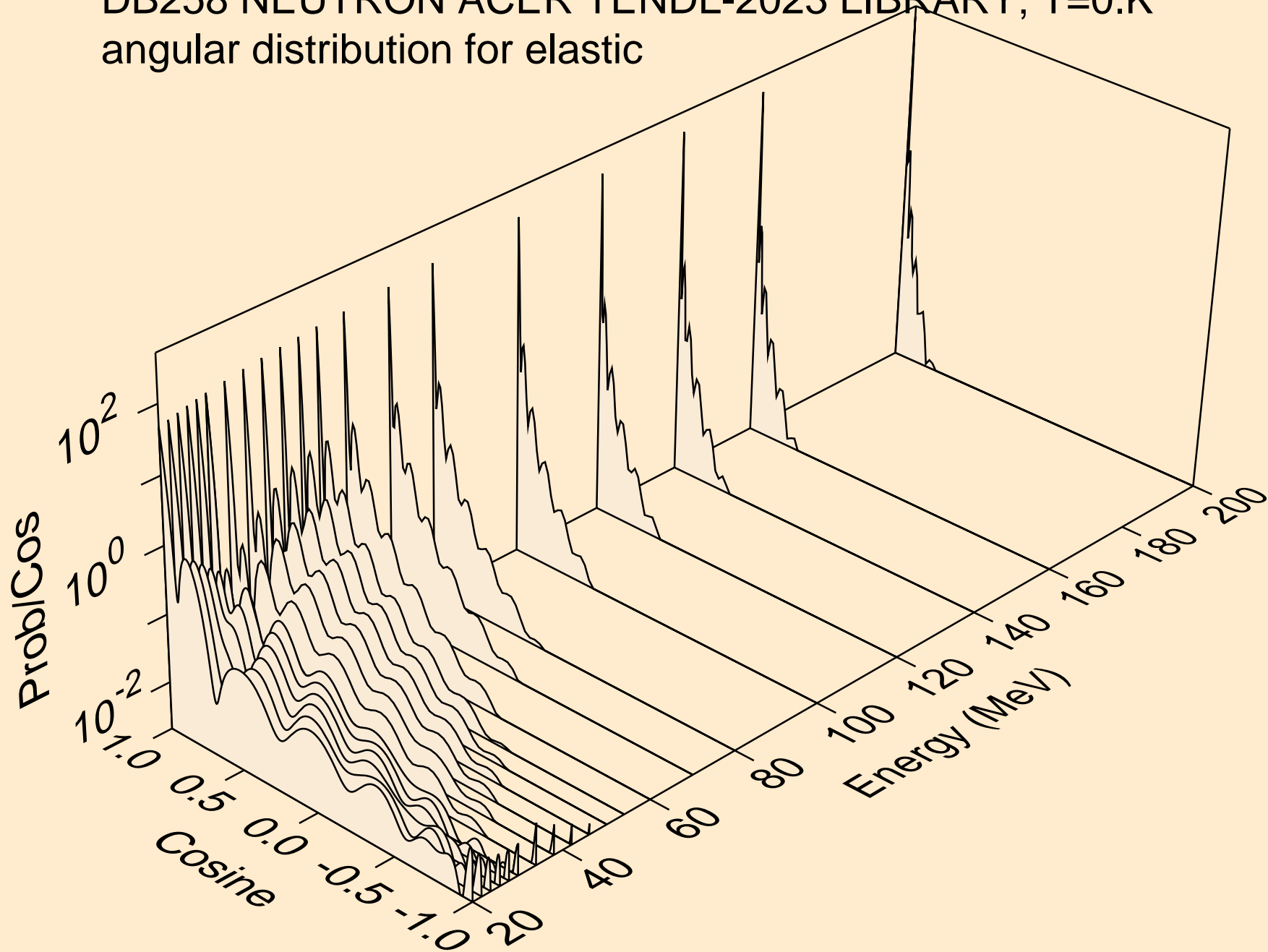

DB258 NEUTRON ACER TENDL-2023 LIBRARY; T=0.K
angular distribution for (n,n*1)

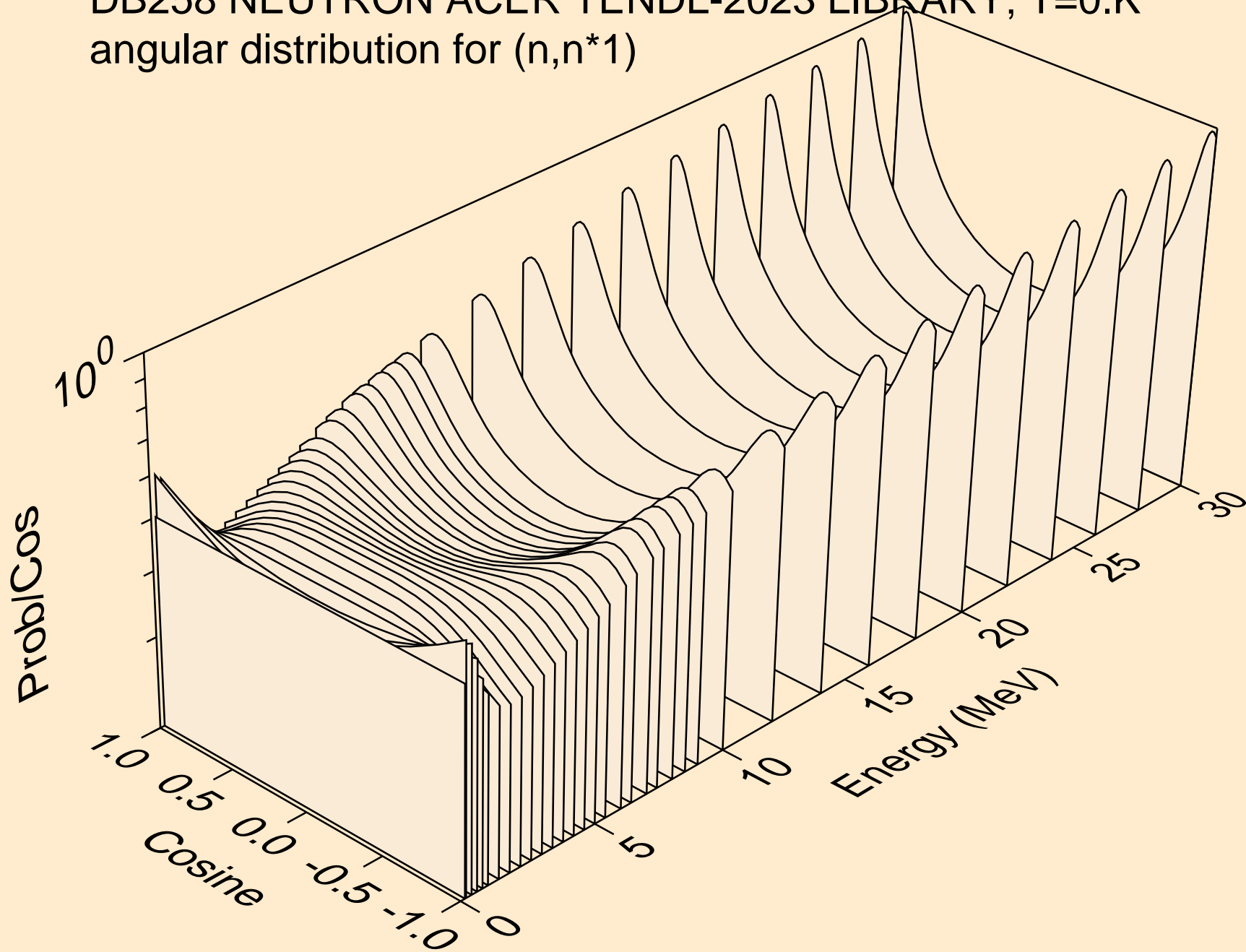

DB258 NEUTRON ACER TENDL-2023 LIBRARY; T=0.K
angular distribution for (n,n*2)

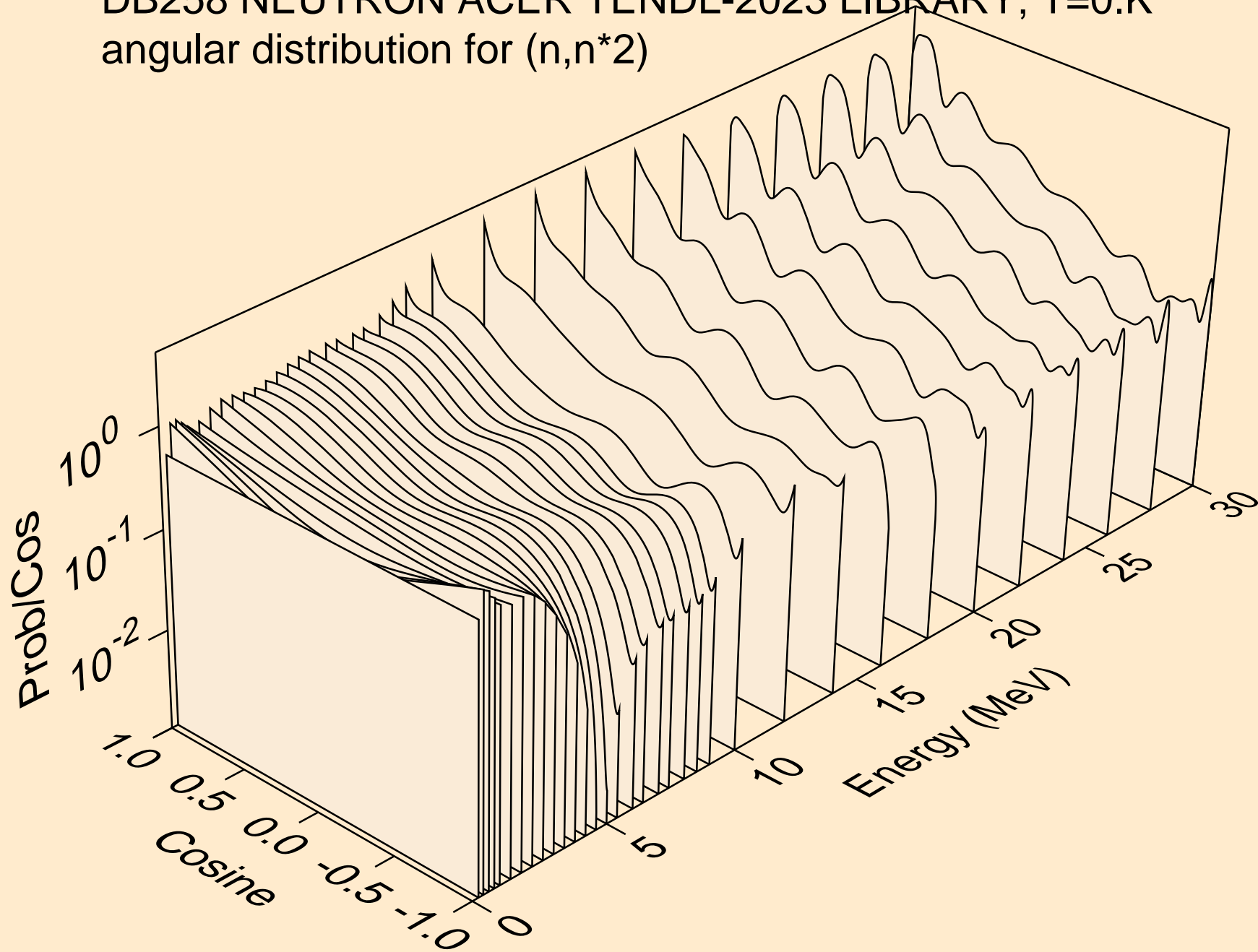

DB258 NEUTRON ACER TENDL-2023 LIBRARY; T=0.K
angular distribution for (n,n*3)

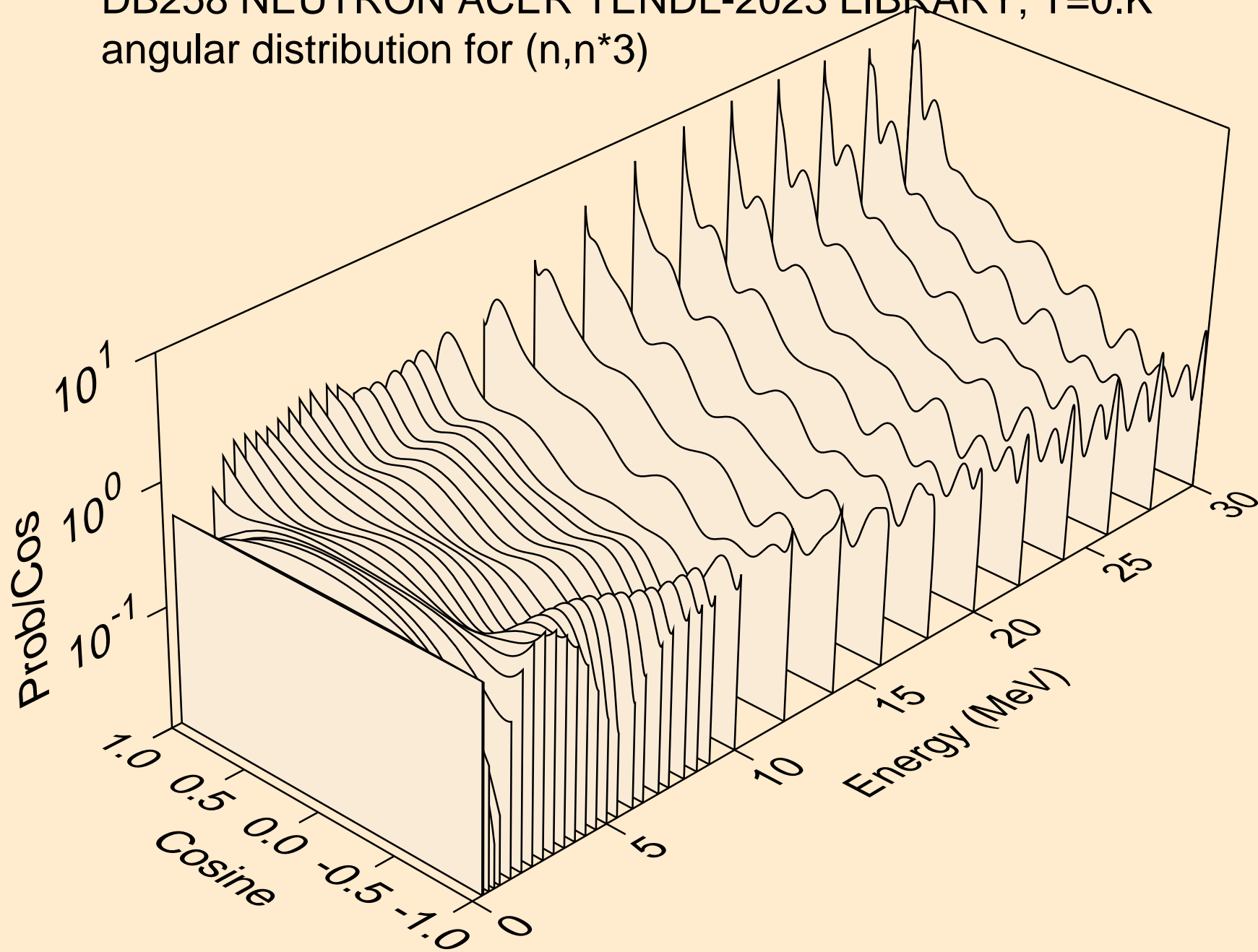

DB258 NEUTRON ACER TENDL-2023 LIBRARY; T=0.K
angular distribution for (n,n*4)

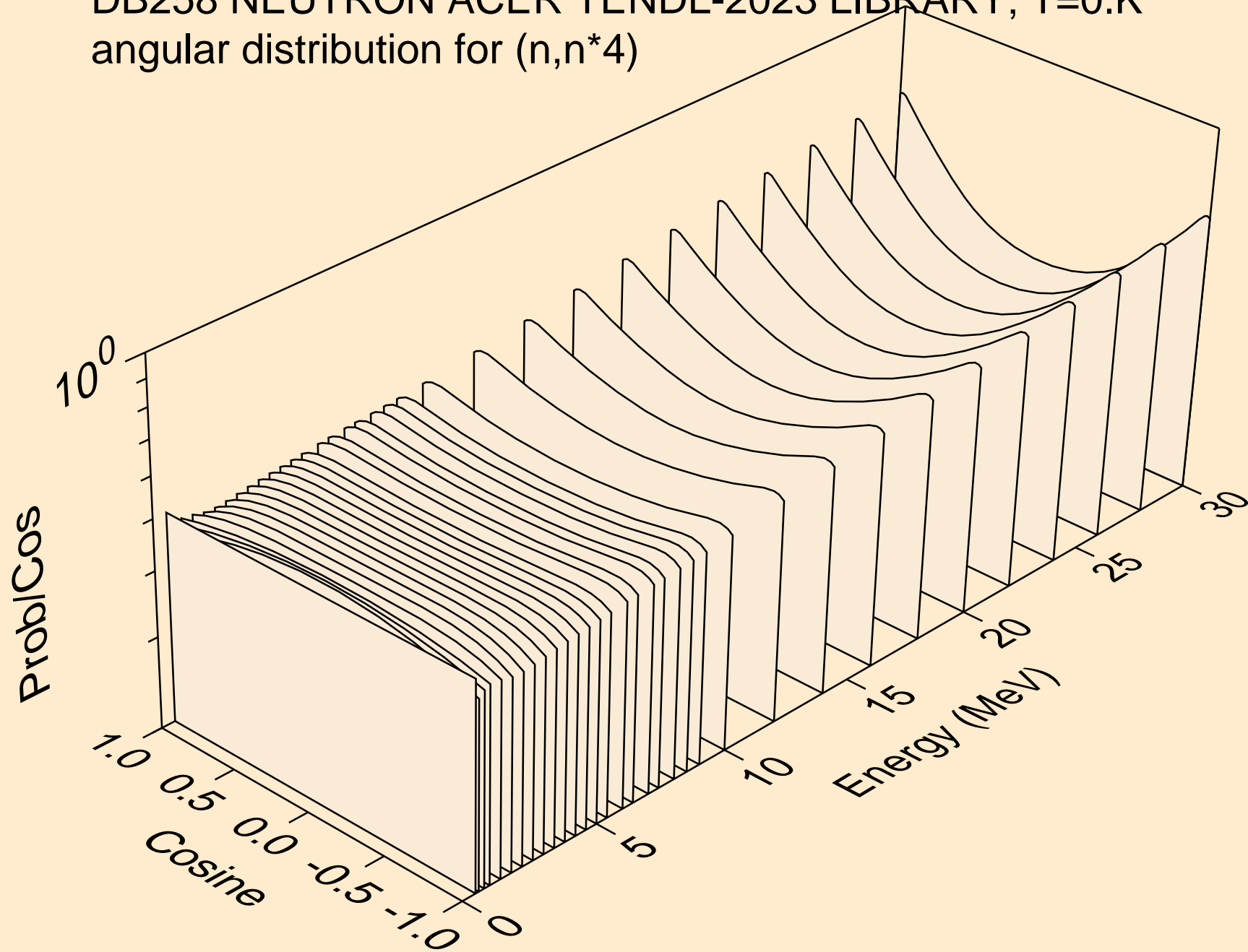

DB258 NEUTRON ACER TENDL-2023 LIBRARY; T=0.K
angular distribution for (n,n*5)

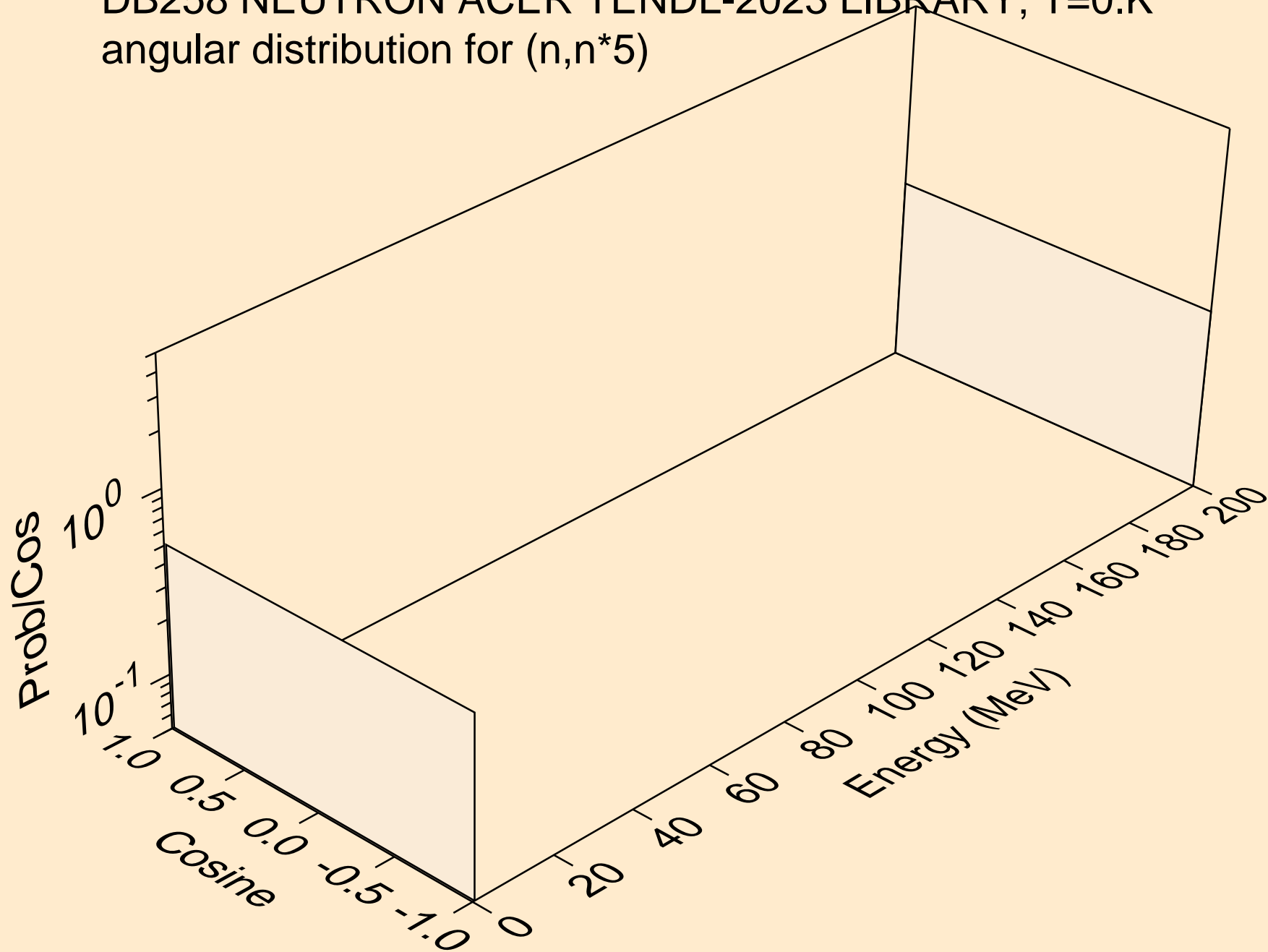

DB258 NEUTRON ACER TENDL-2023 LIBRARY; T=0.K
angular distribution for (n,n*6)

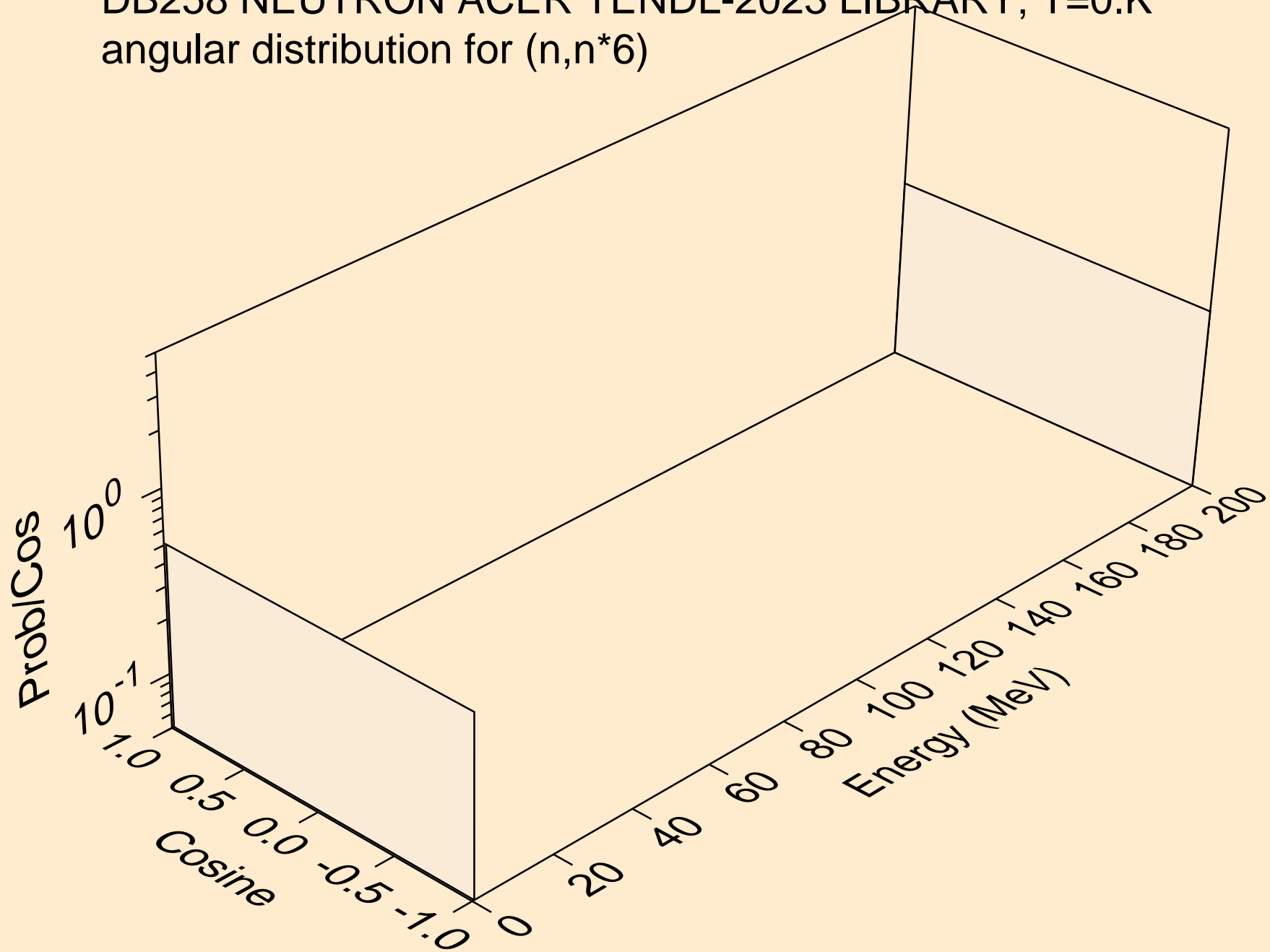

DB258 NEUTRON ACER TENDL-2023 LIBRARY; T=0.K
angular distribution for (n,n*7)

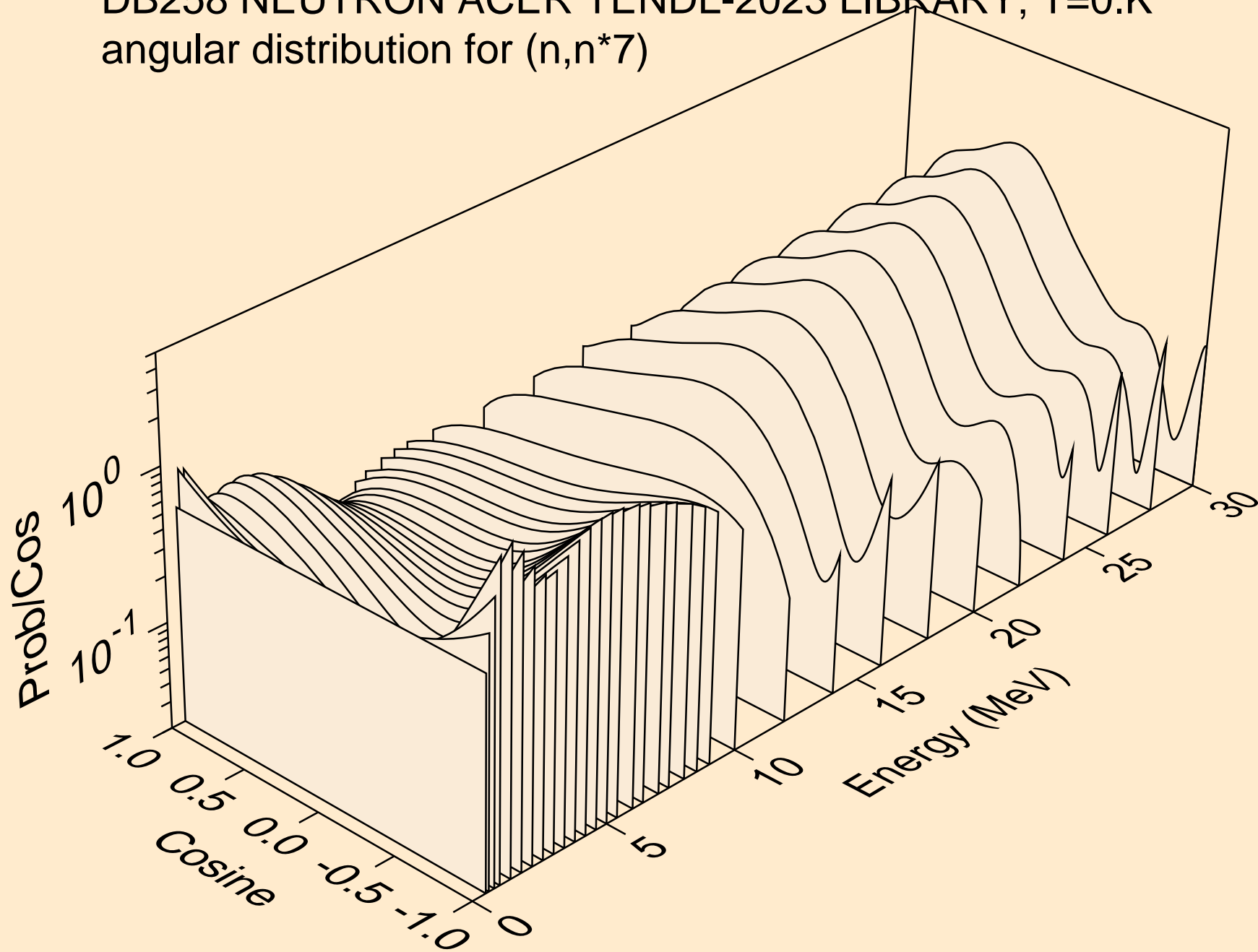

DB258 NEUTRON ACER TENDL-2023 LIBRARY; T=0.K
angular distribution for (n,n*8)

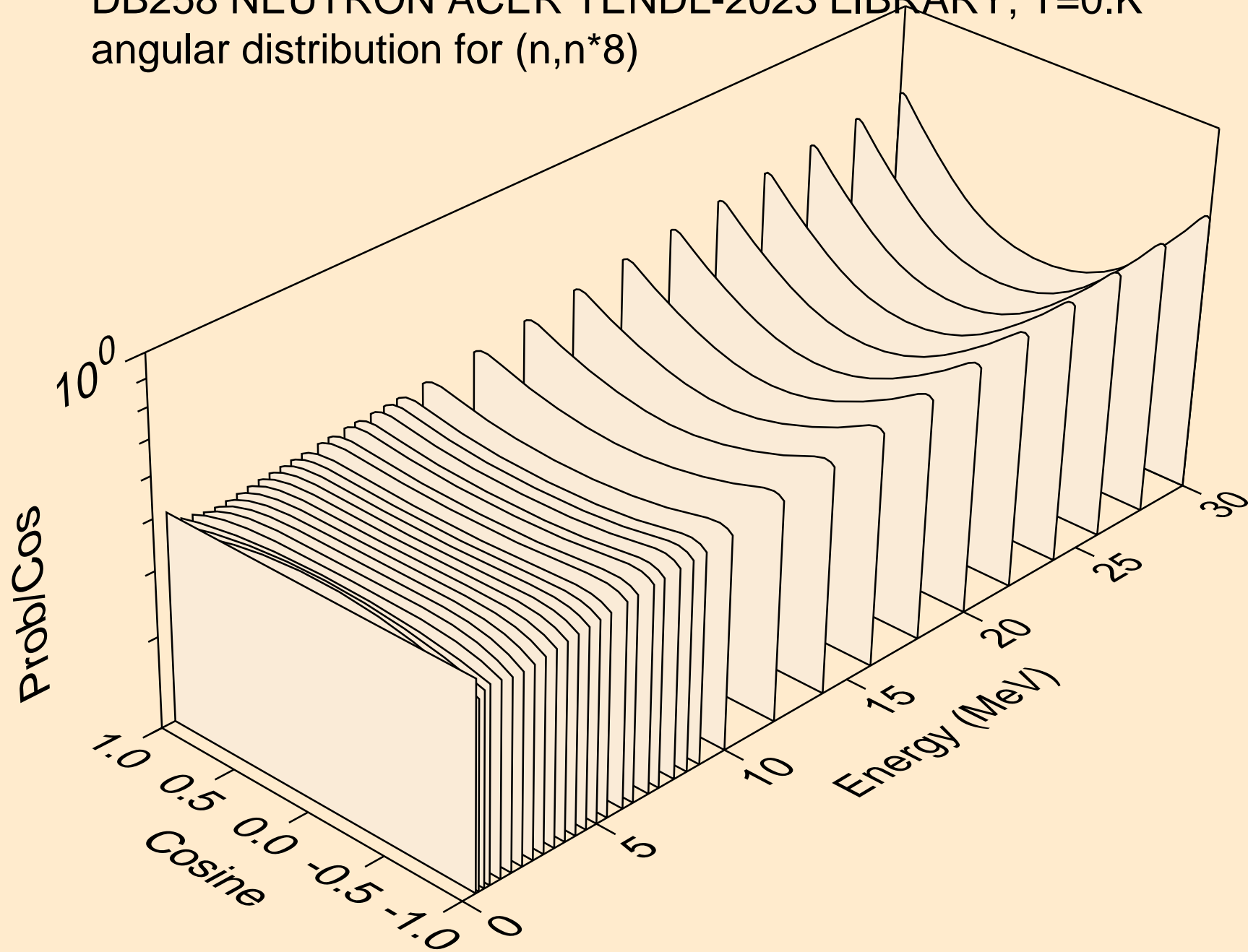

DB258 NEUTRON ACER TENDL-2023 LIBRARY; T=0.K
angular distribution for (n,n*9)

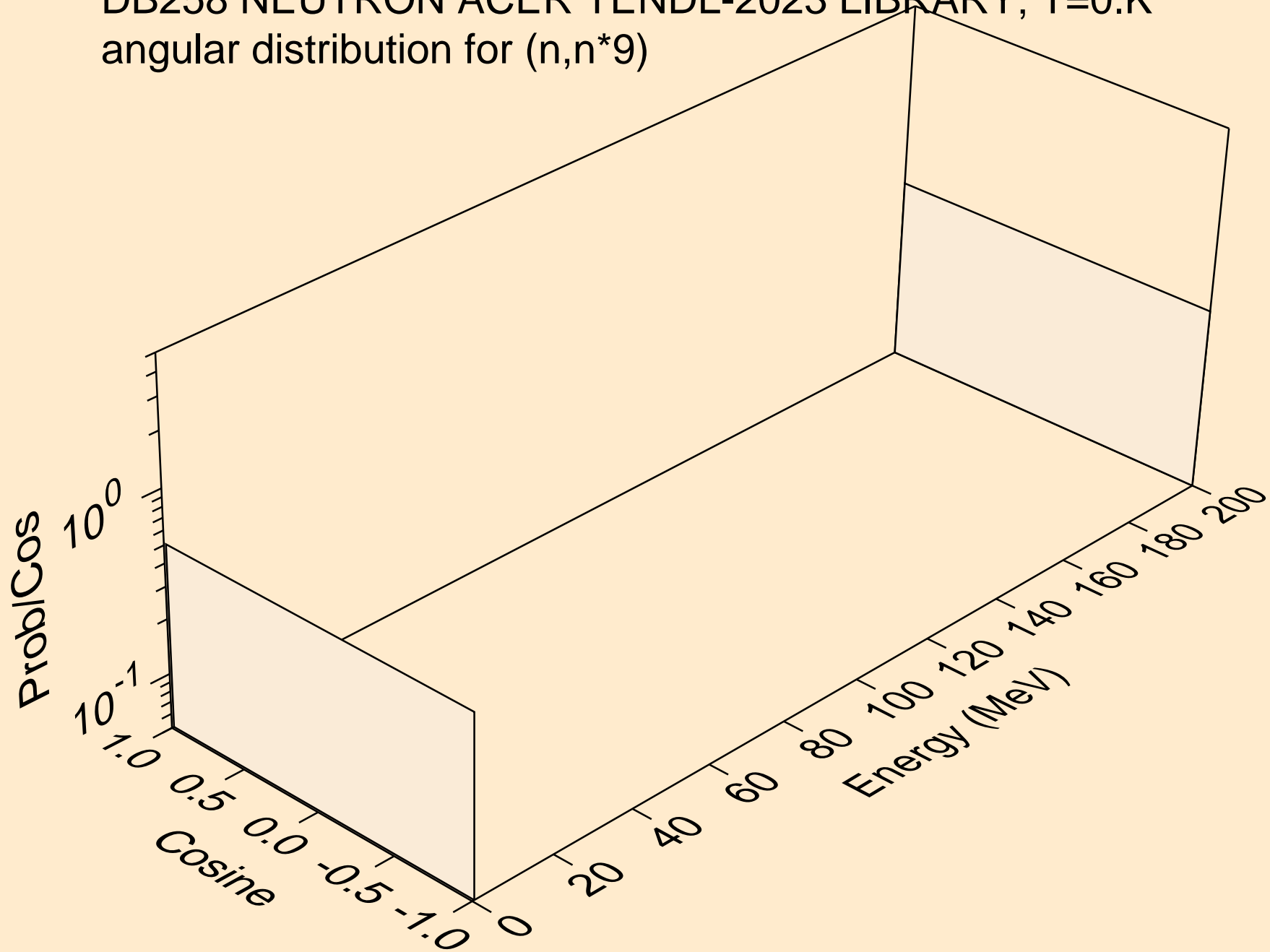

DB258 NEUTRON ACER TENDL-2023 LIBRARY; T=0.K
angular distribution for (n,n*10)

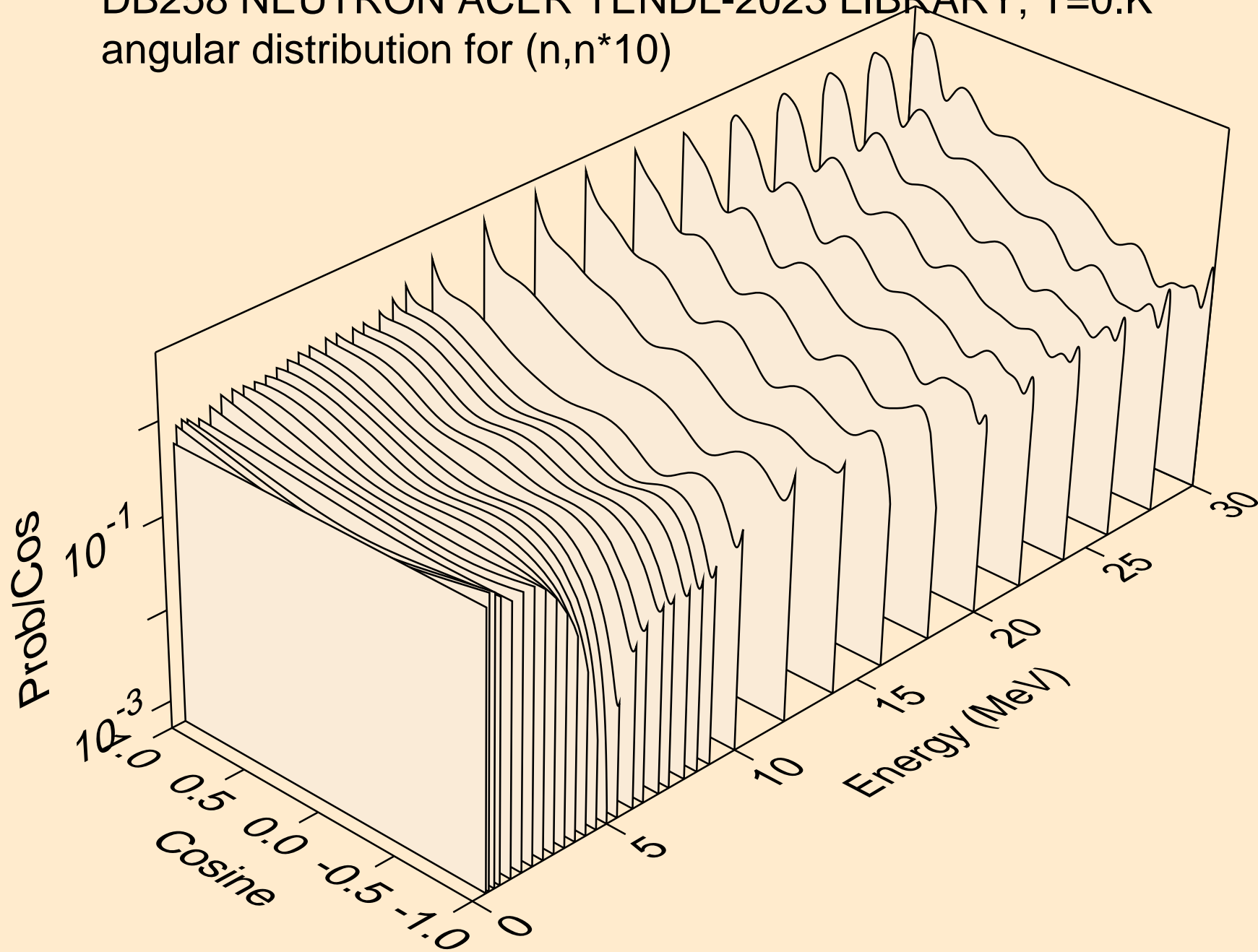

DB258 NEUTRON ACER TENDL-2023 LIBRARY; T=0.K
angular distribution for (n,n*11)

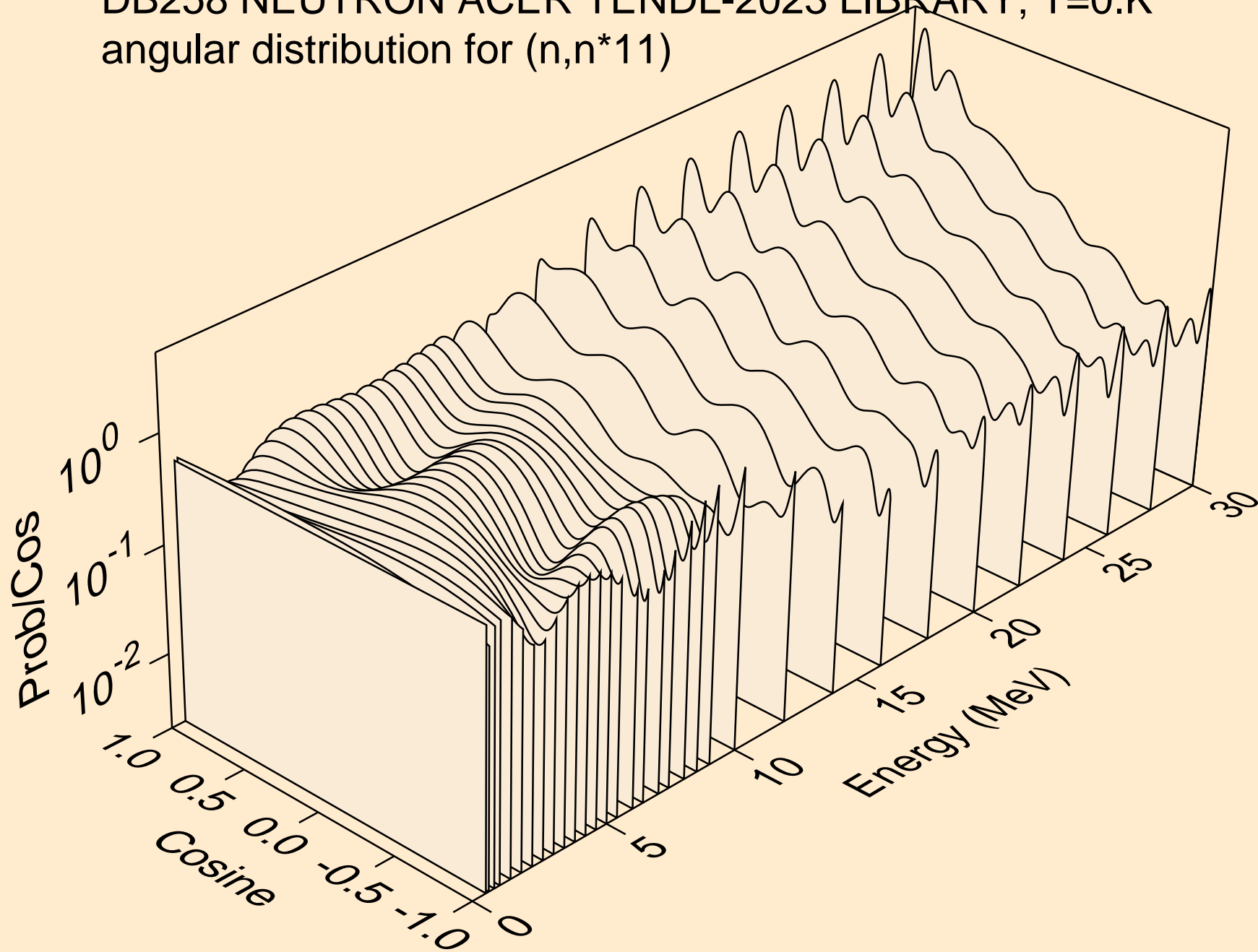

DB258 NEUTRON ACER TENDL-2023 LIBRARY; T=0.K
angular distribution for (n,n*12)

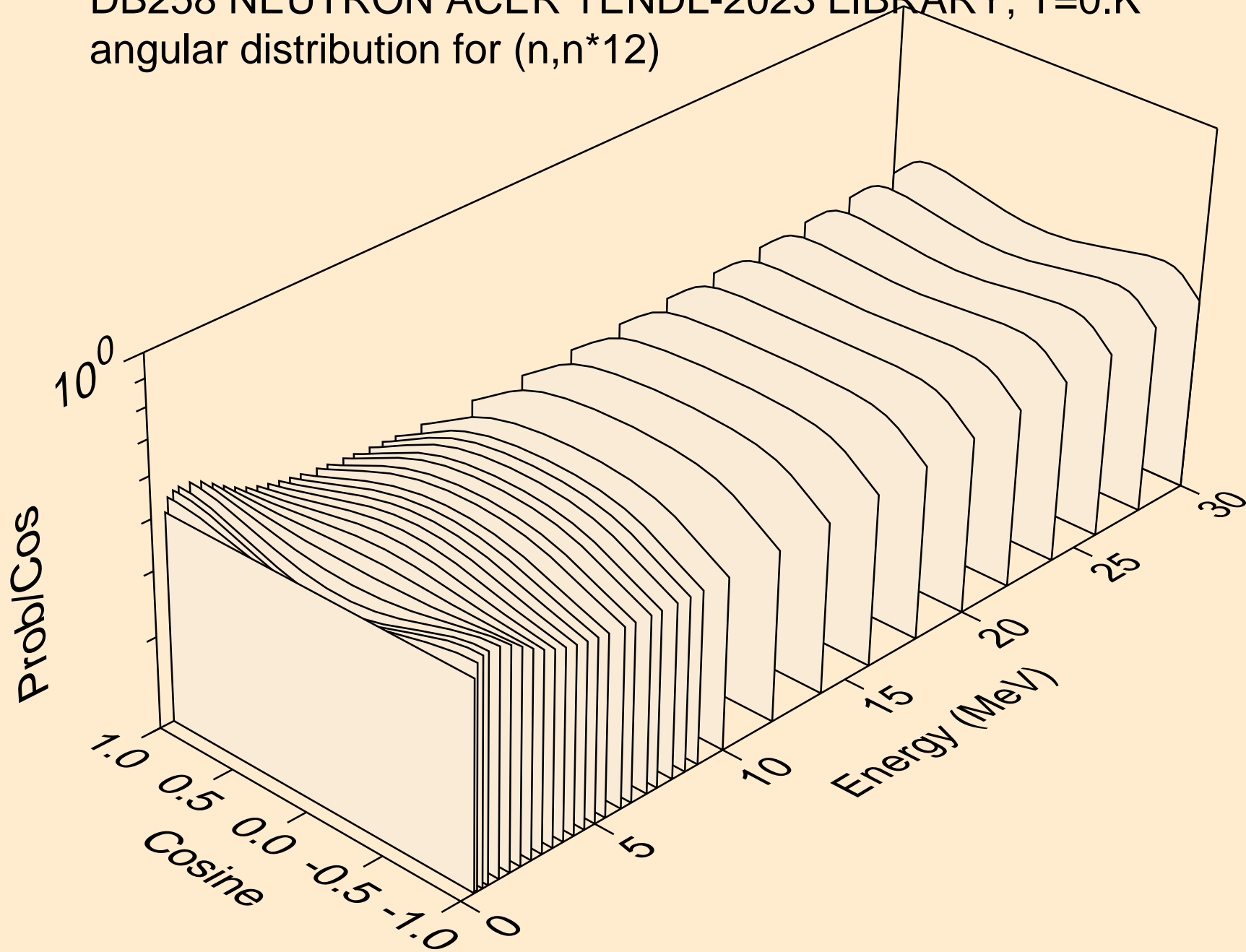

DB258 NEUTRON ACER TENDL-2023 LIBRARY; T=0.K
angular distribution for (n,n*13)

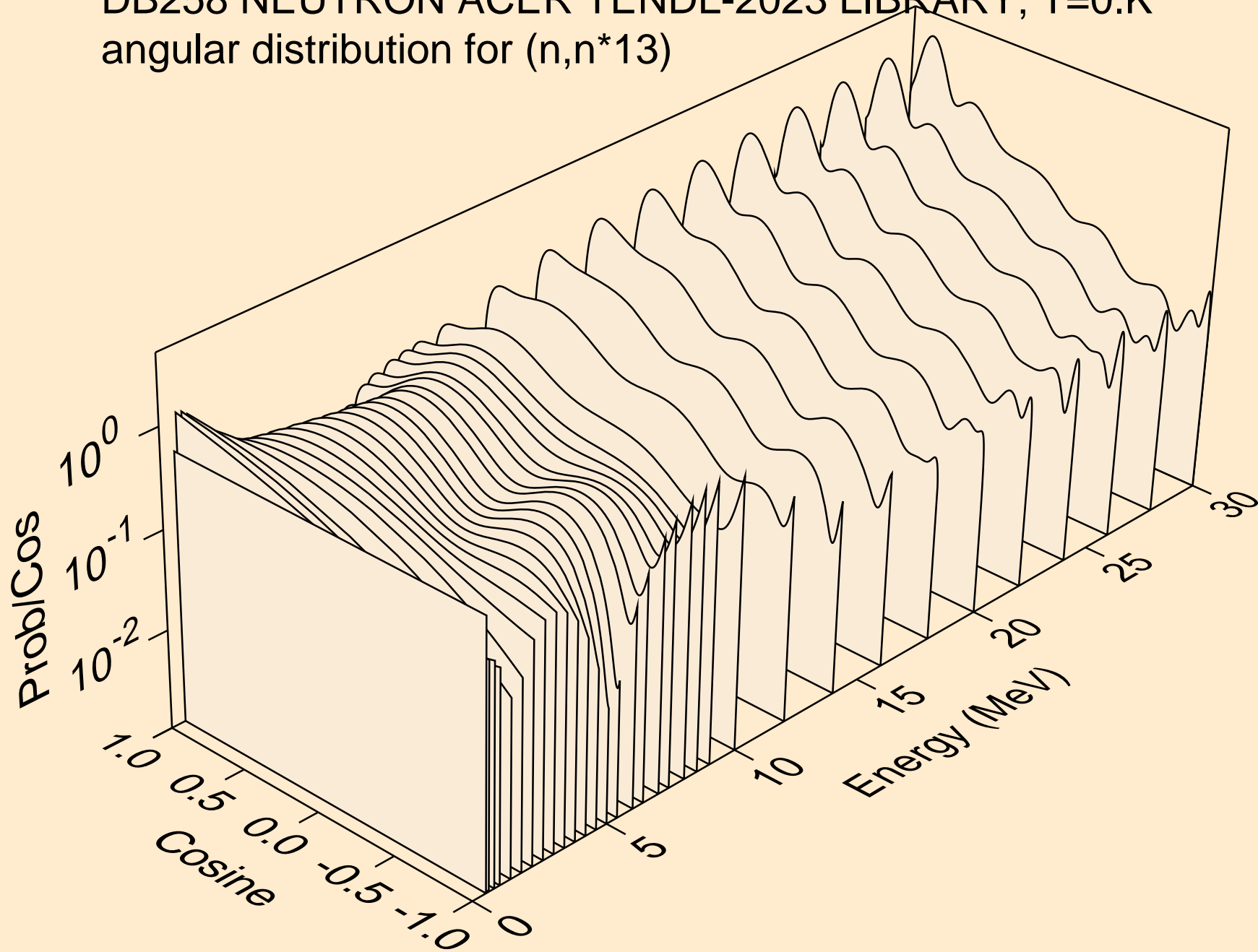

DB258 NEUTRON ACER TENDL-2023 LIBRARY; T=0.K
angular distribution for (n,n*14)

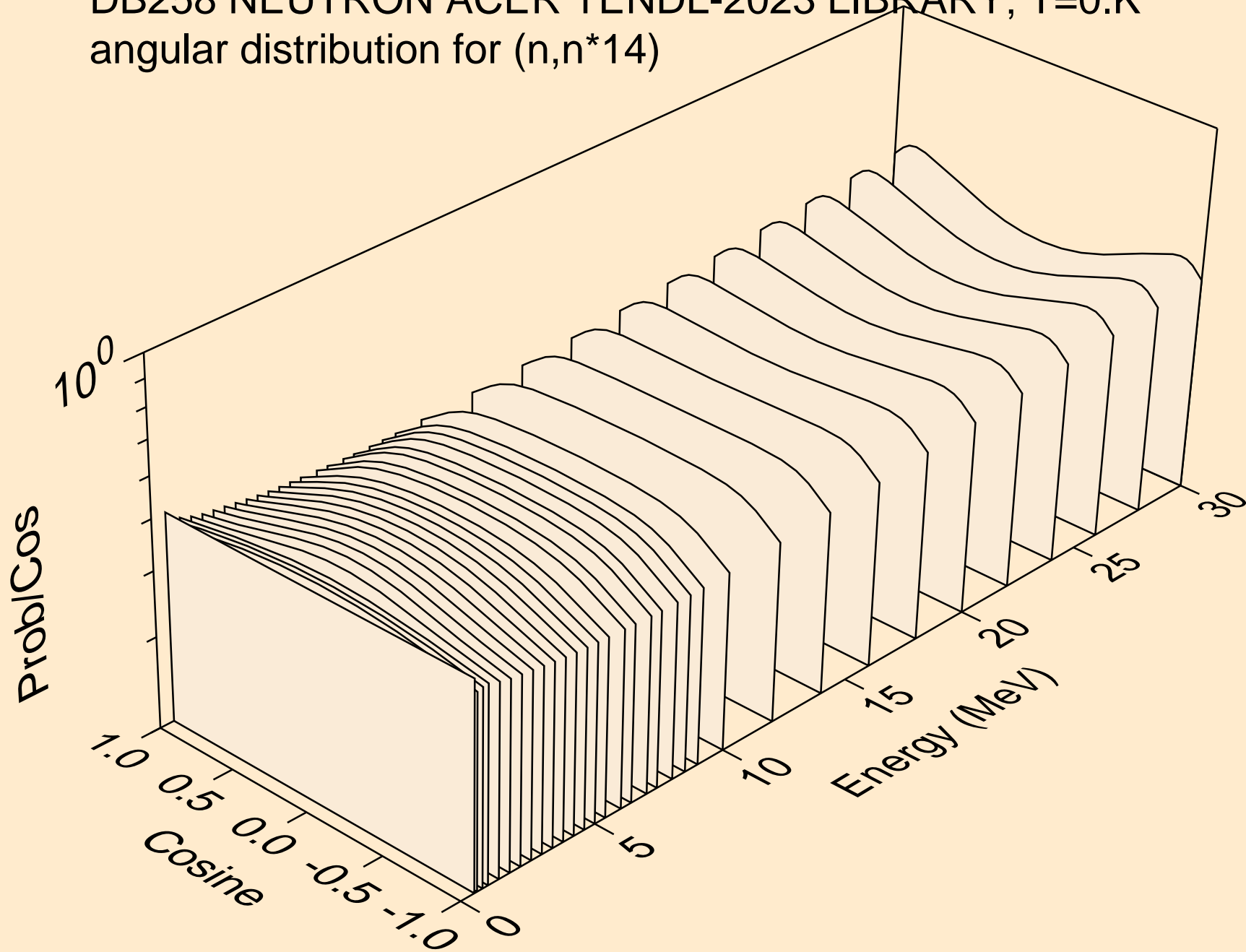

DB258 NEUTRON ACER TENDL-2023 LIBRARY; T=0.K
angular distribution for (n,n*15)

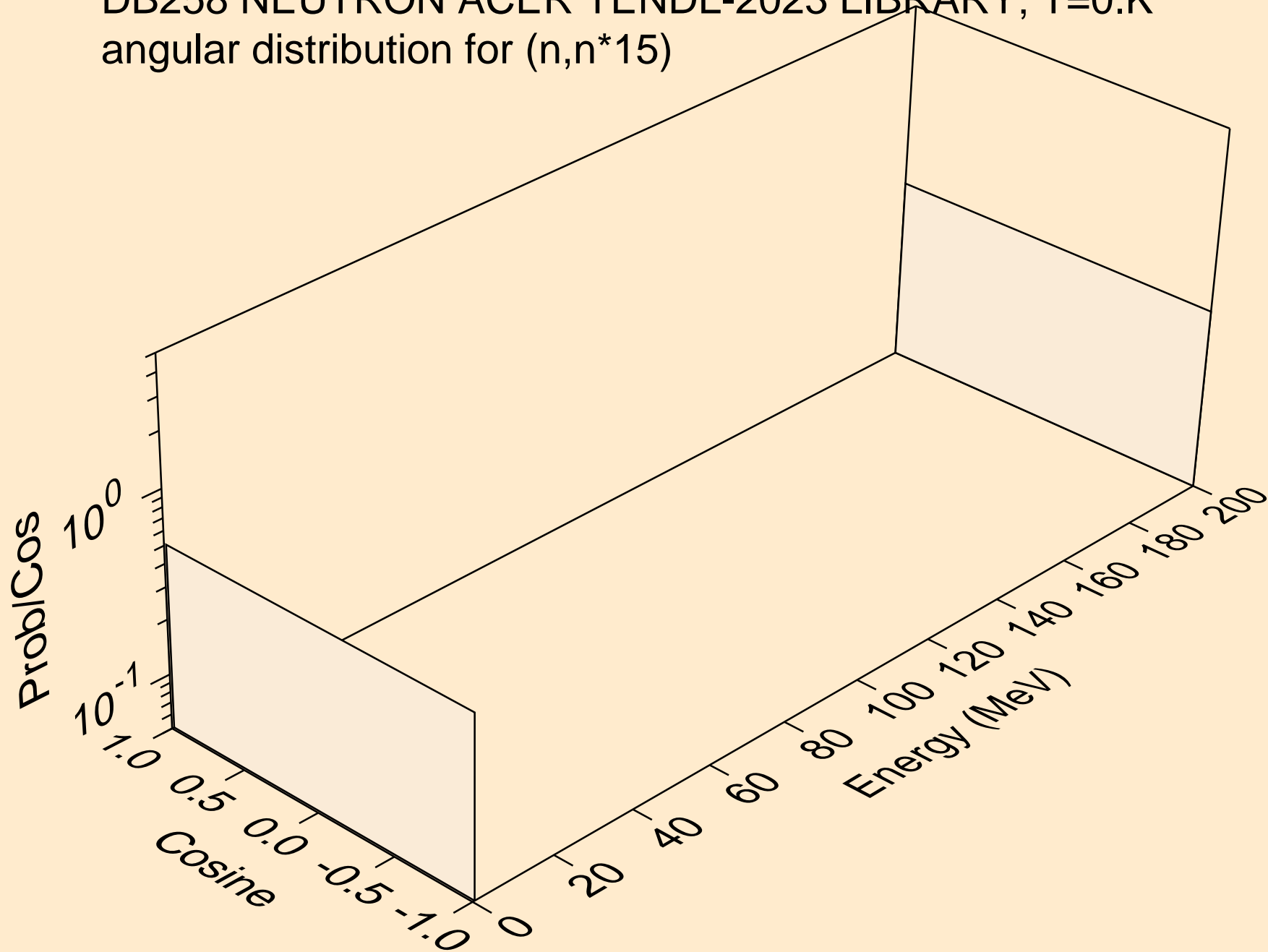

DB258 NEUTRON ACER TENDL-2023 LIBRARY; T=0.K
angular distribution for (n,n*16)

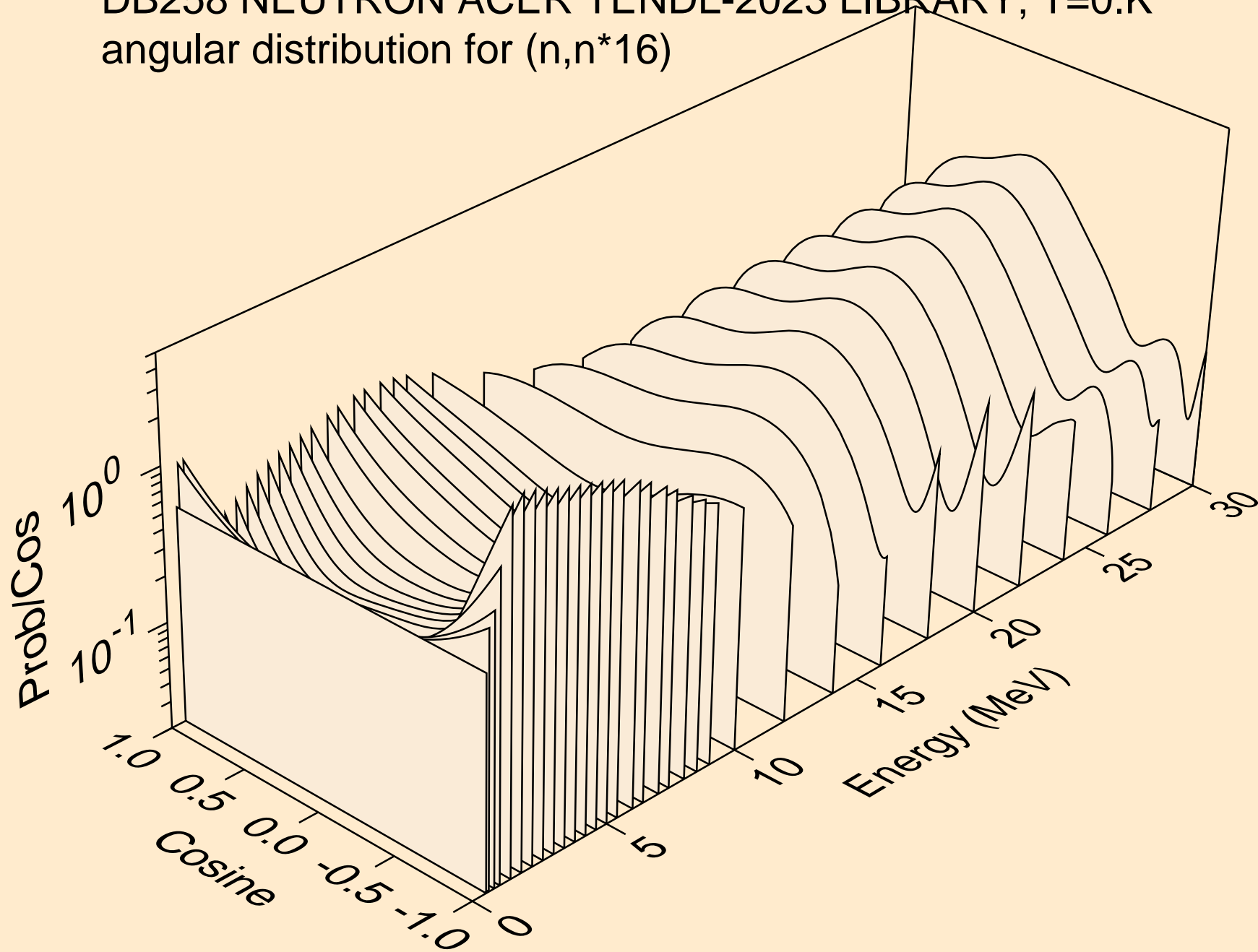

DB258 NEUTRON ACER TENDL-2023 LIBRARY; T=0.K
angular distribution for (n,n*17)

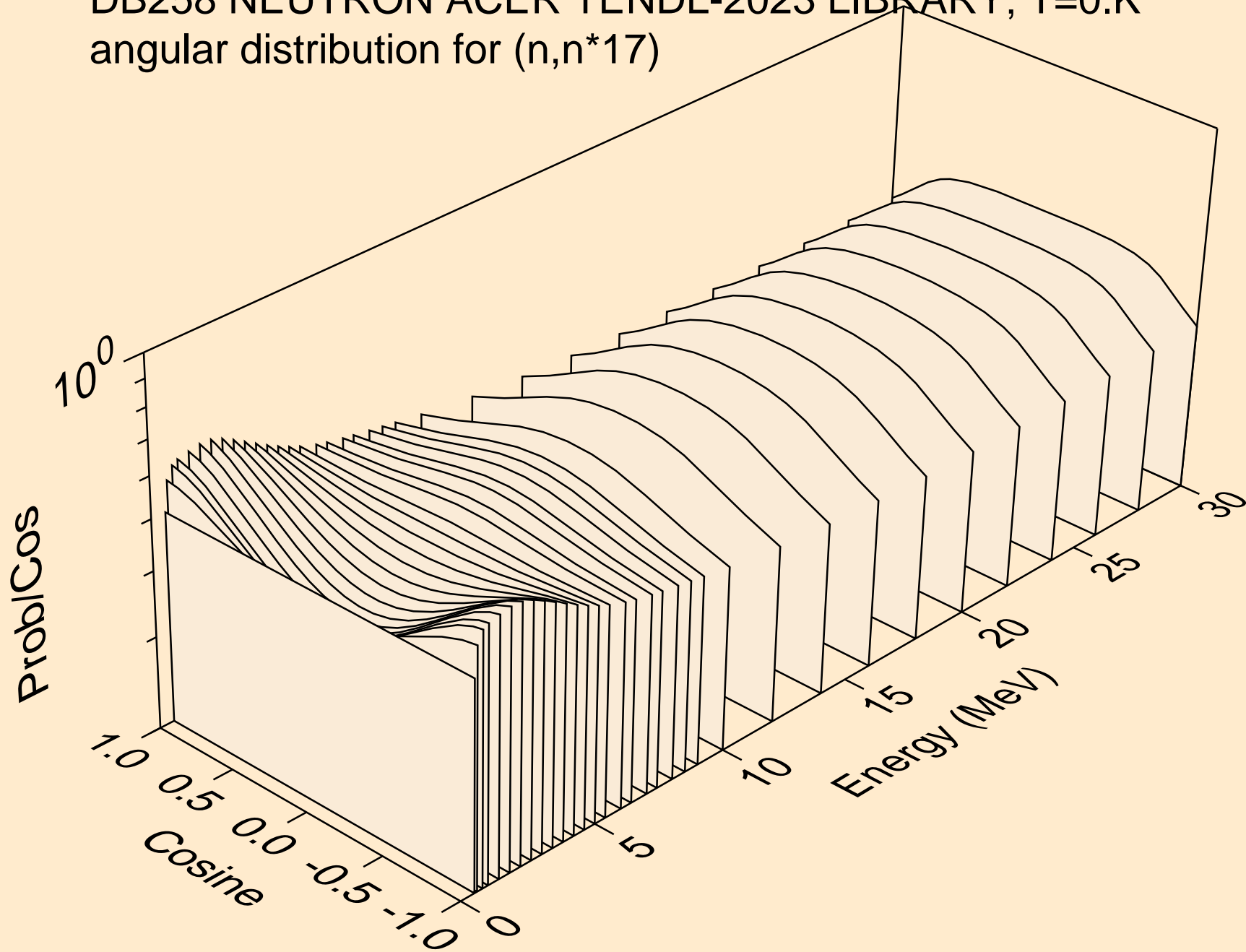

DB258 NEUTRON ACER TENDL-2023 LIBRARY; T=0.K
angular distribution for (n,n*18)

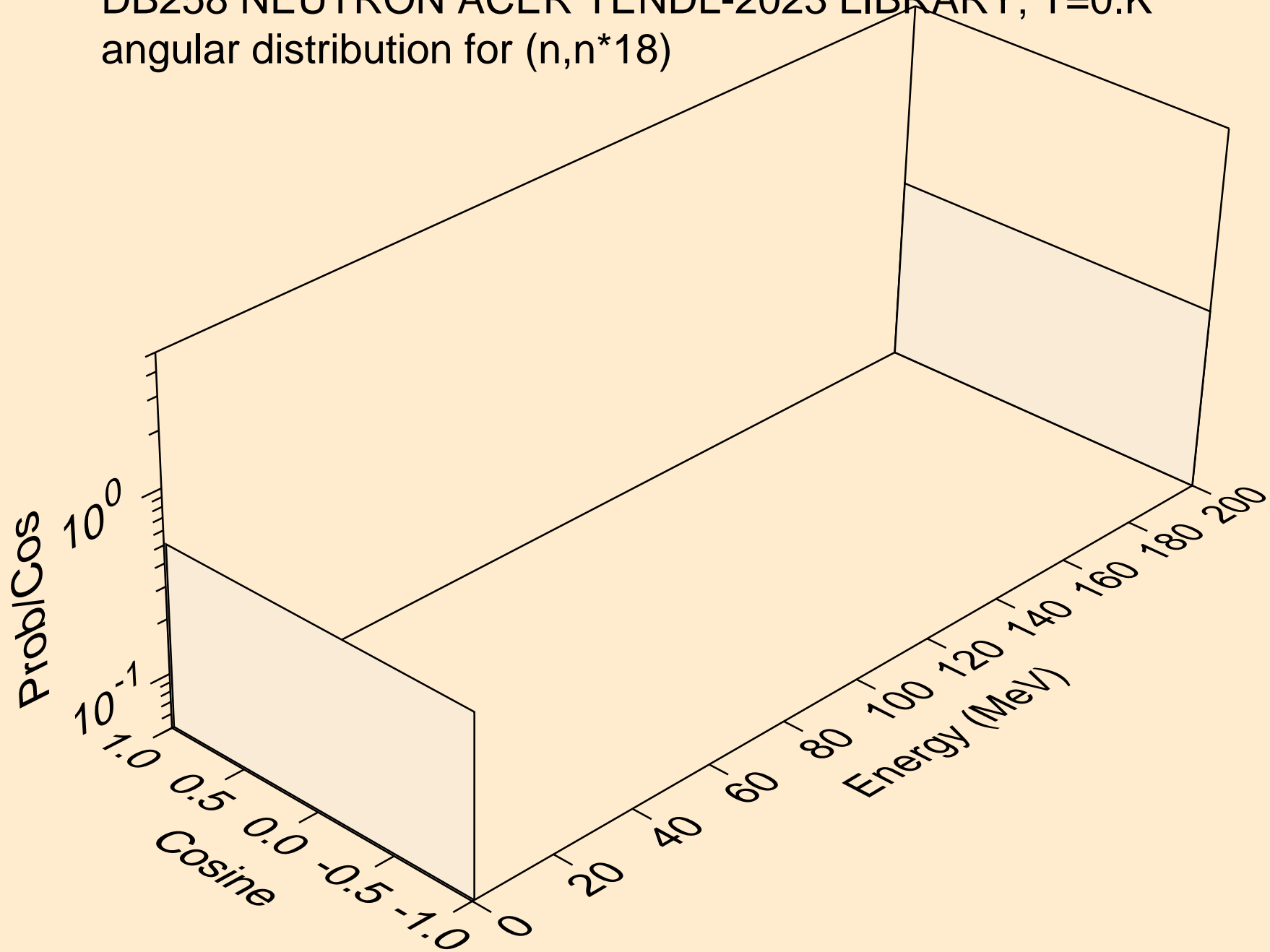

DB258 NEUTRON ACER TENDL-2023 LIBRARY; T=0.K
angular distribution for (n,n*19)

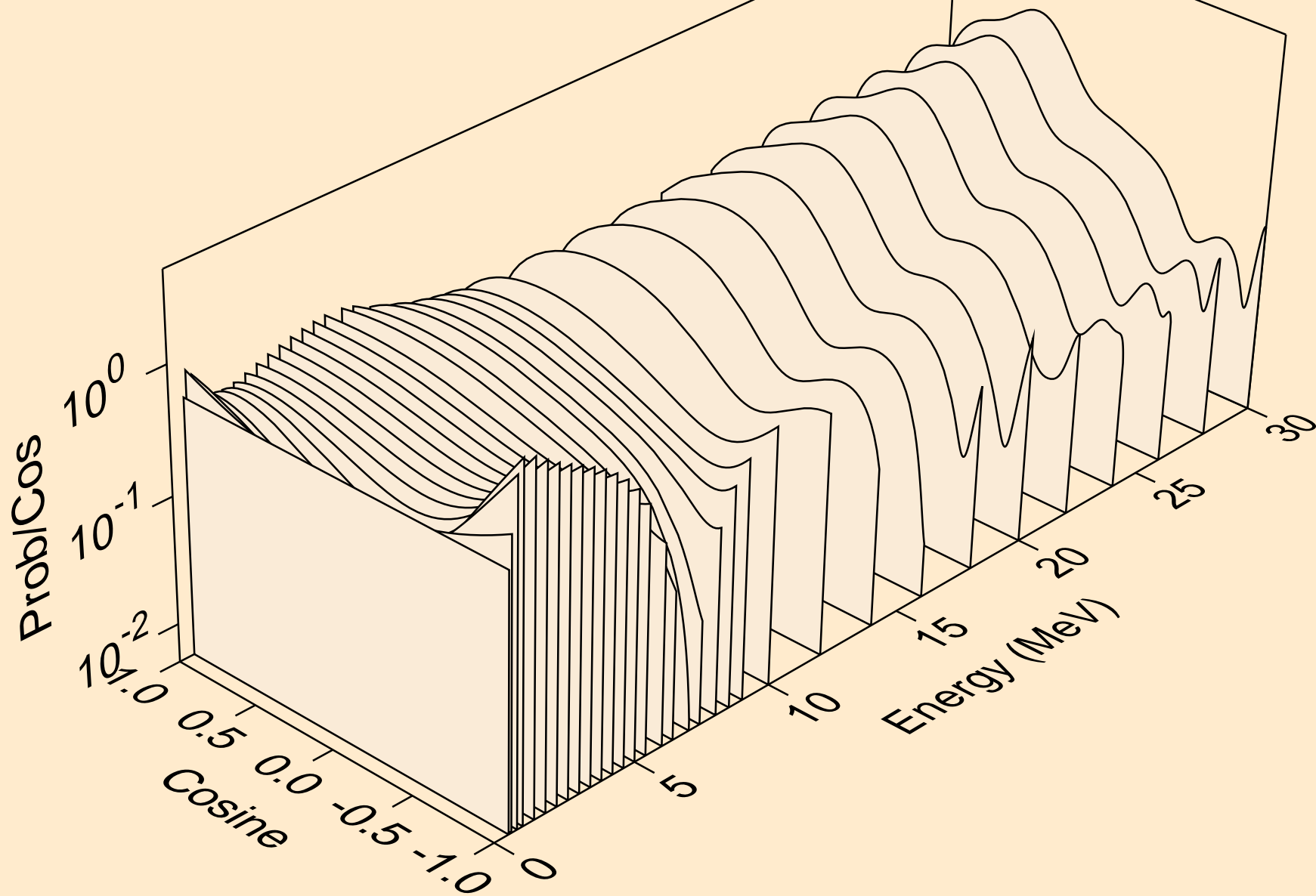

DB258 NEUTRON ACER TENDL-2023 LIBRARY; T=0.K
angular distribution for (n,n*20)

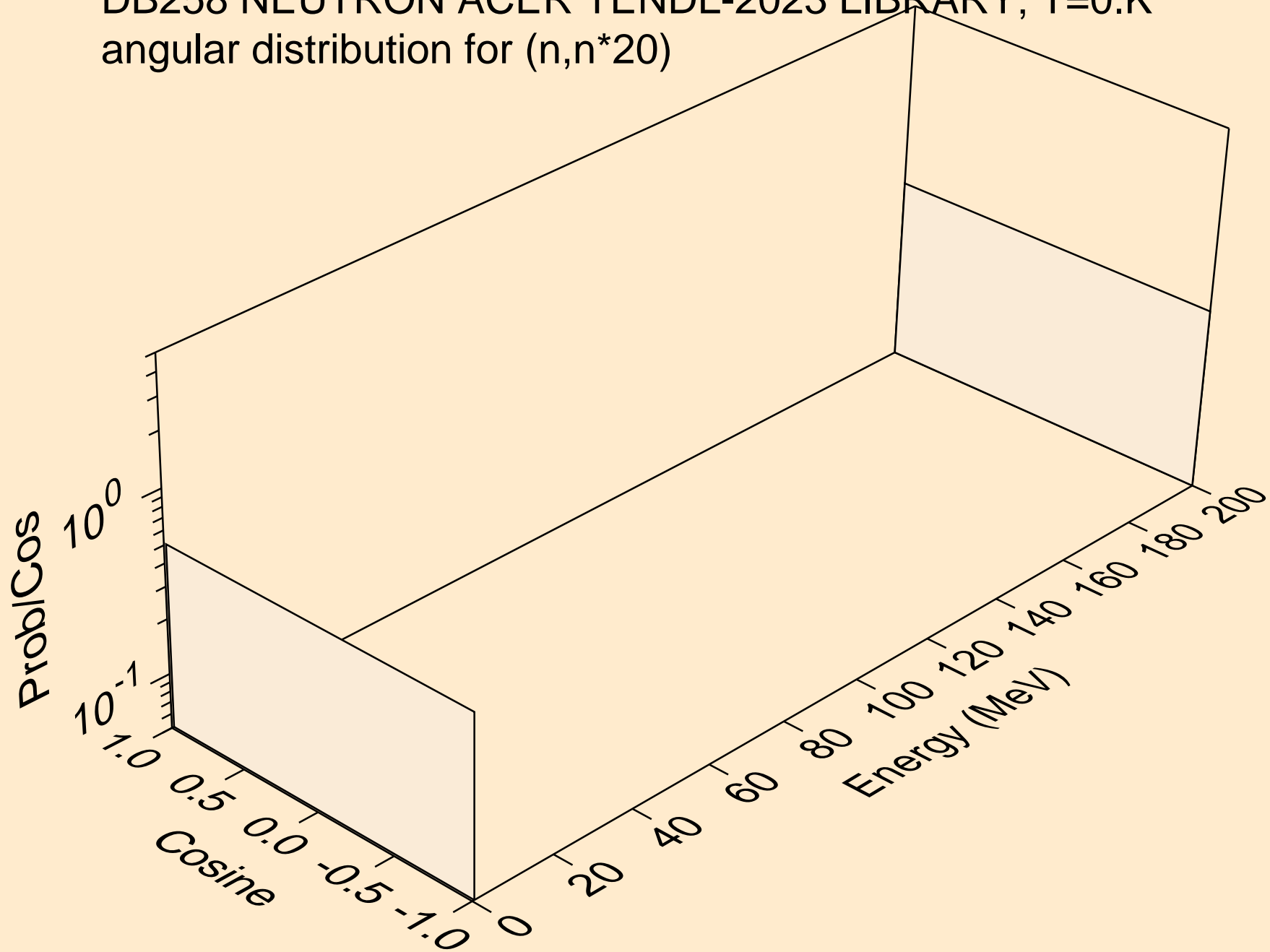

DB258 NEUTRON ACER TENDL-2023 LIBRARY; T=0.K

Total fission nubar

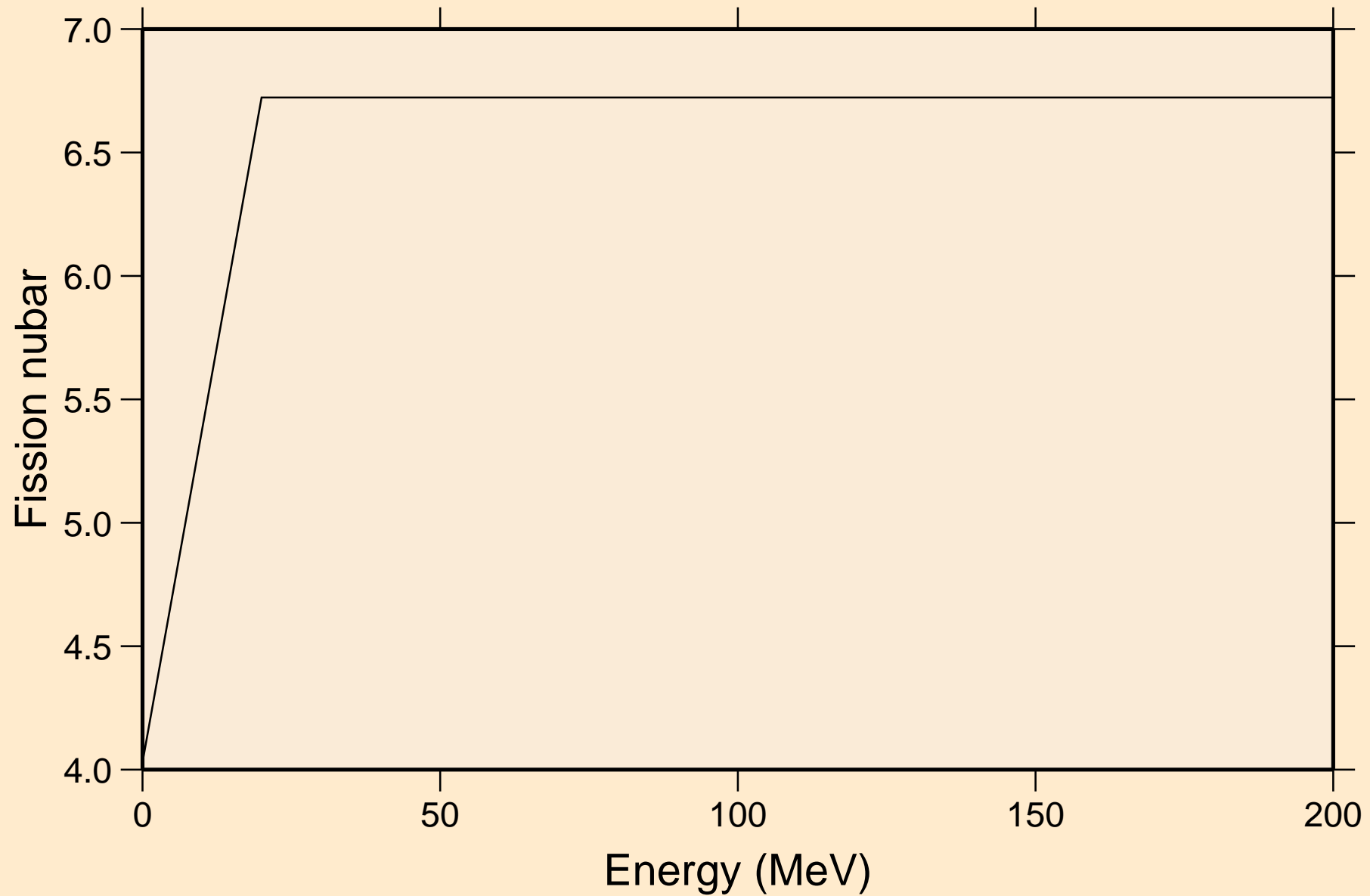

DB258 NEUTRON ACER TENDL-2023 LIBRARY; T=0.K
Neutron emission for (n,x)

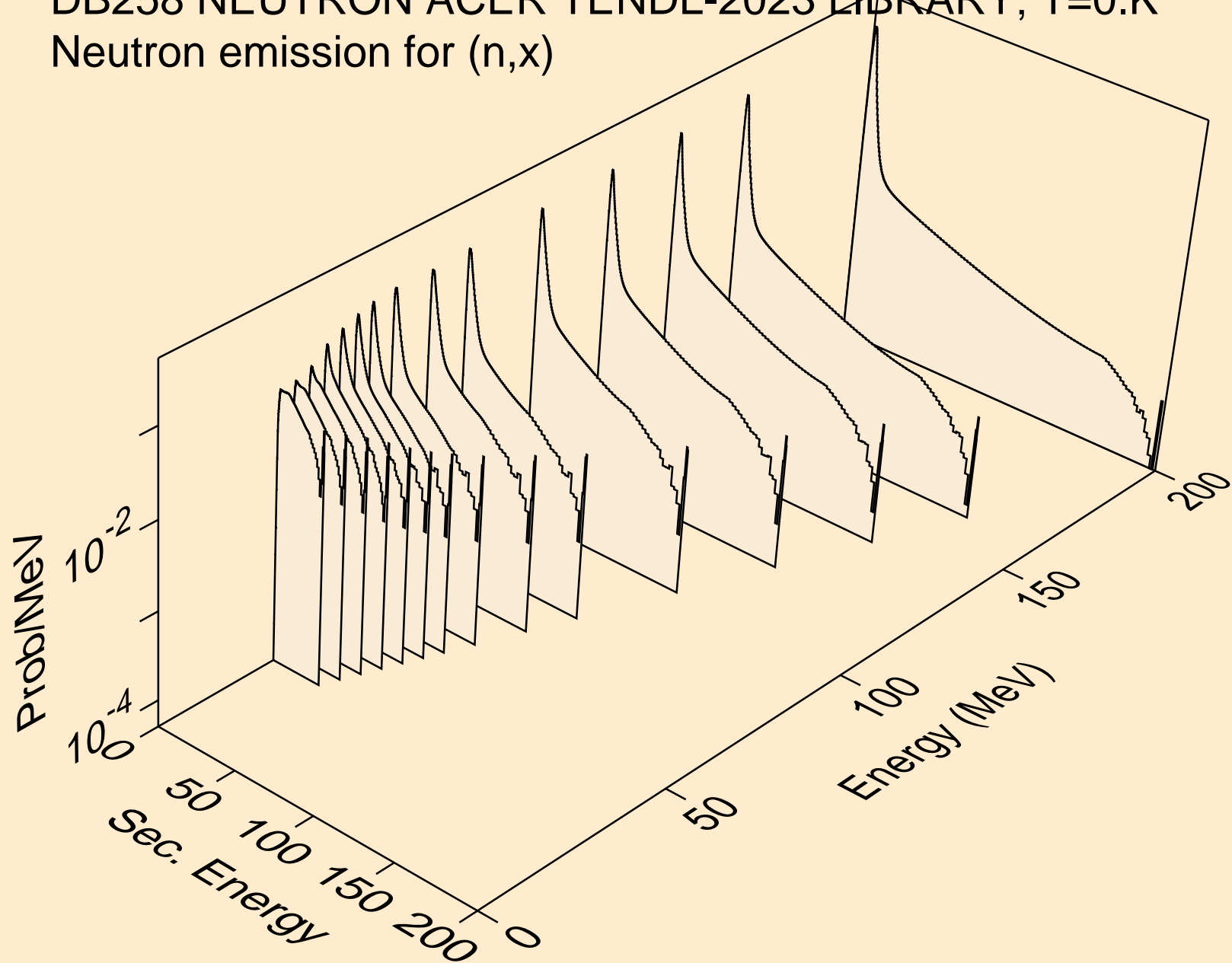

DB258 NEUTRON ACER TENDL-2023 LIBRARY; T=0.K
Neutron emission for (n,2n)

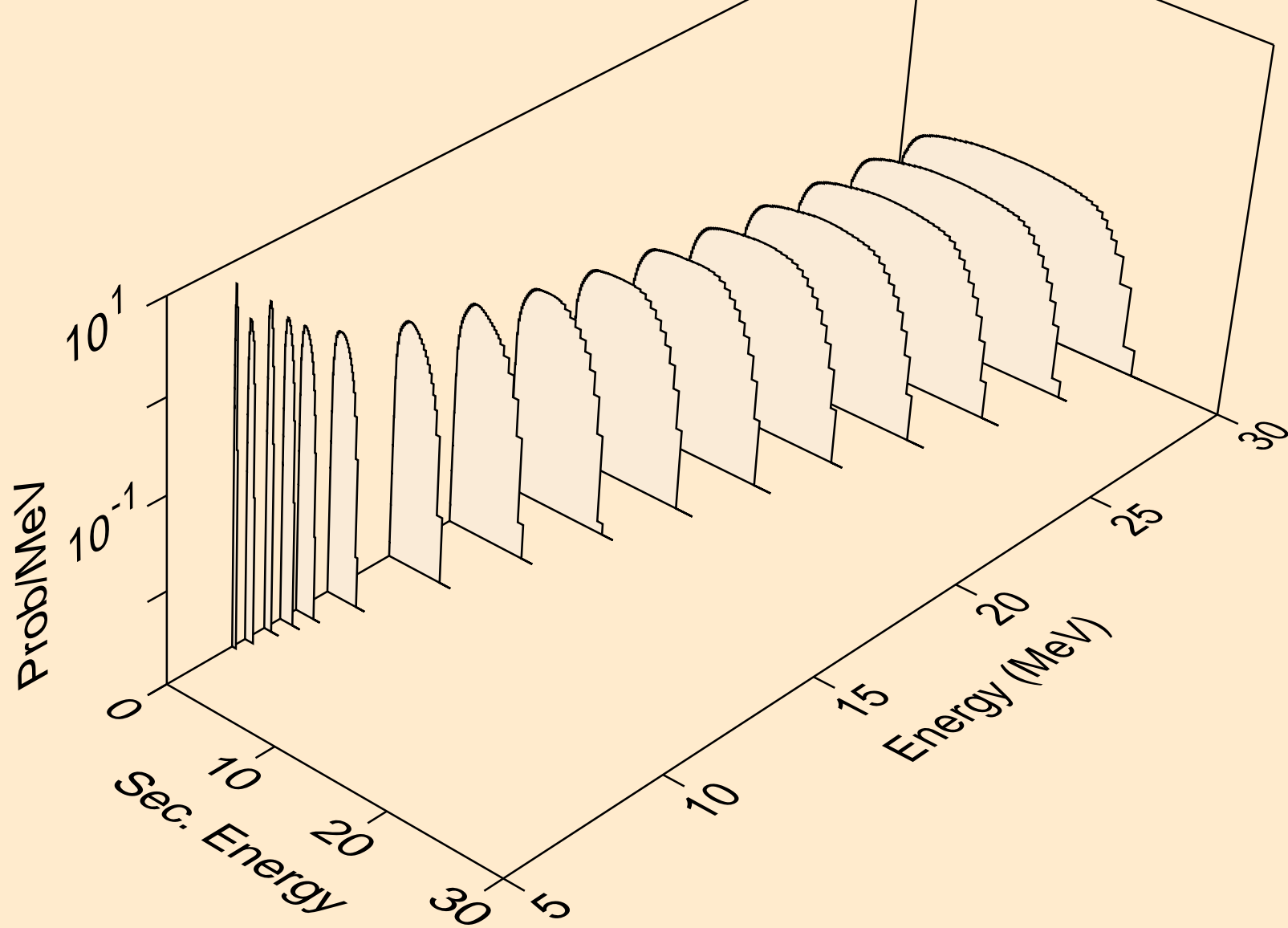

DB258 NEUTRON ACER TENDL-2023 LIBRARY; T=0.K
Neutron emission for (n,3n)

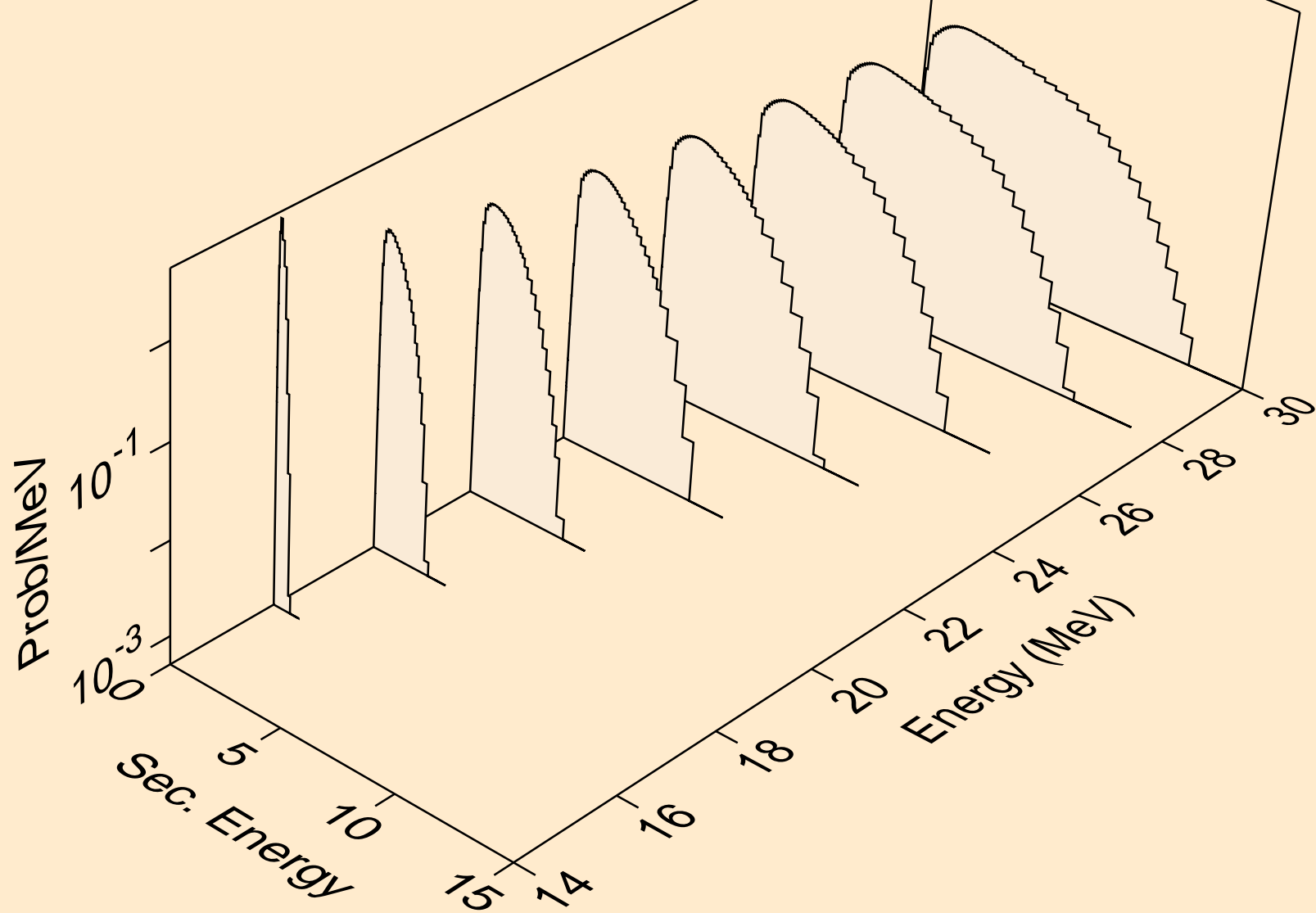

DB258 NEUTRON ACER TENDL-2023 LIBRARY; T=0.K
Neutron emission for fission

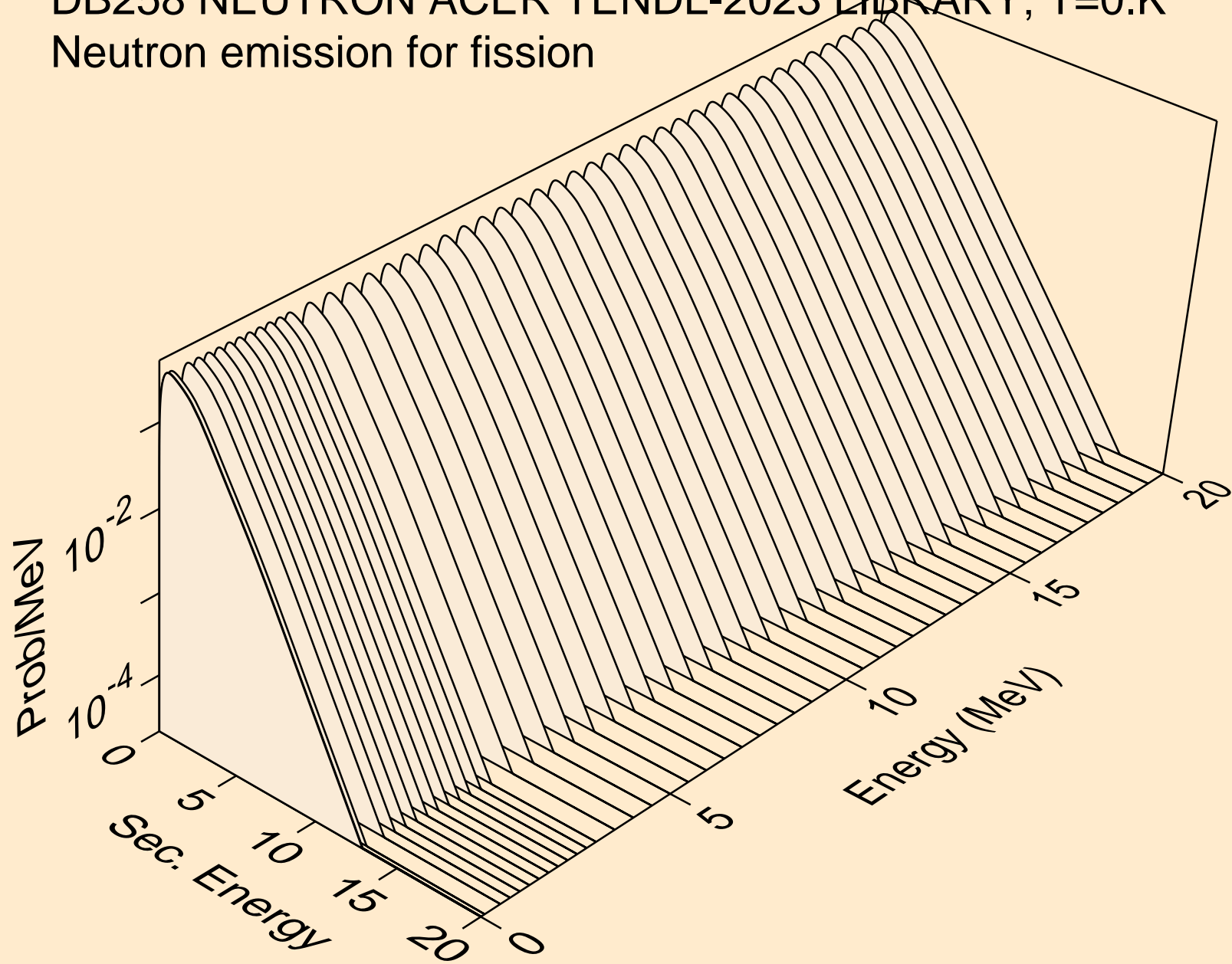

DB258 NEUTRON ACER TENDL-2023 LIBRARY; T=0.K
Neutron emission for (n,n*)a

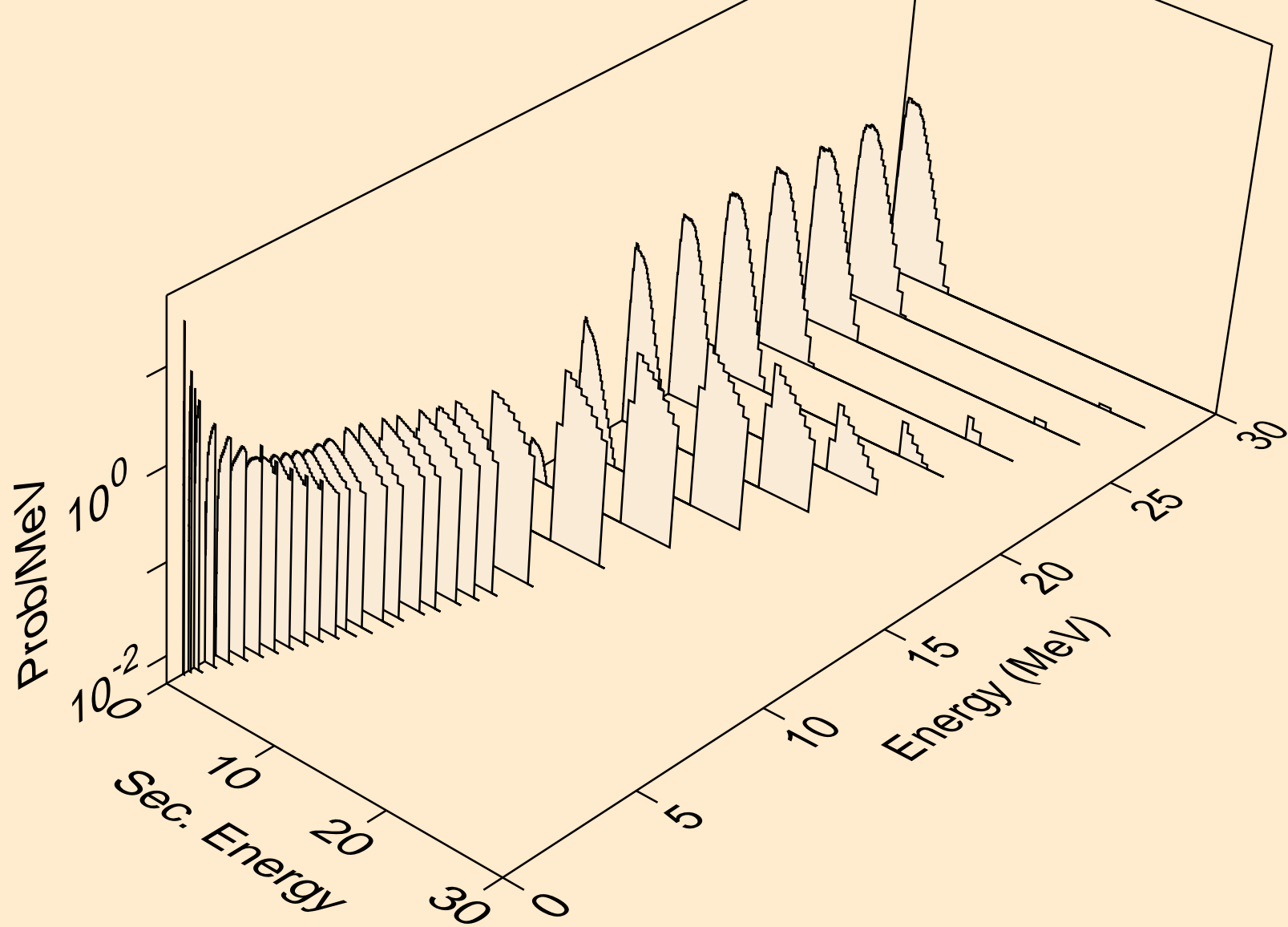

DB258 NEUTRON ACER TENDL-2023 LIBRARY; T=0.K
Neutron emission for (n,2n)a

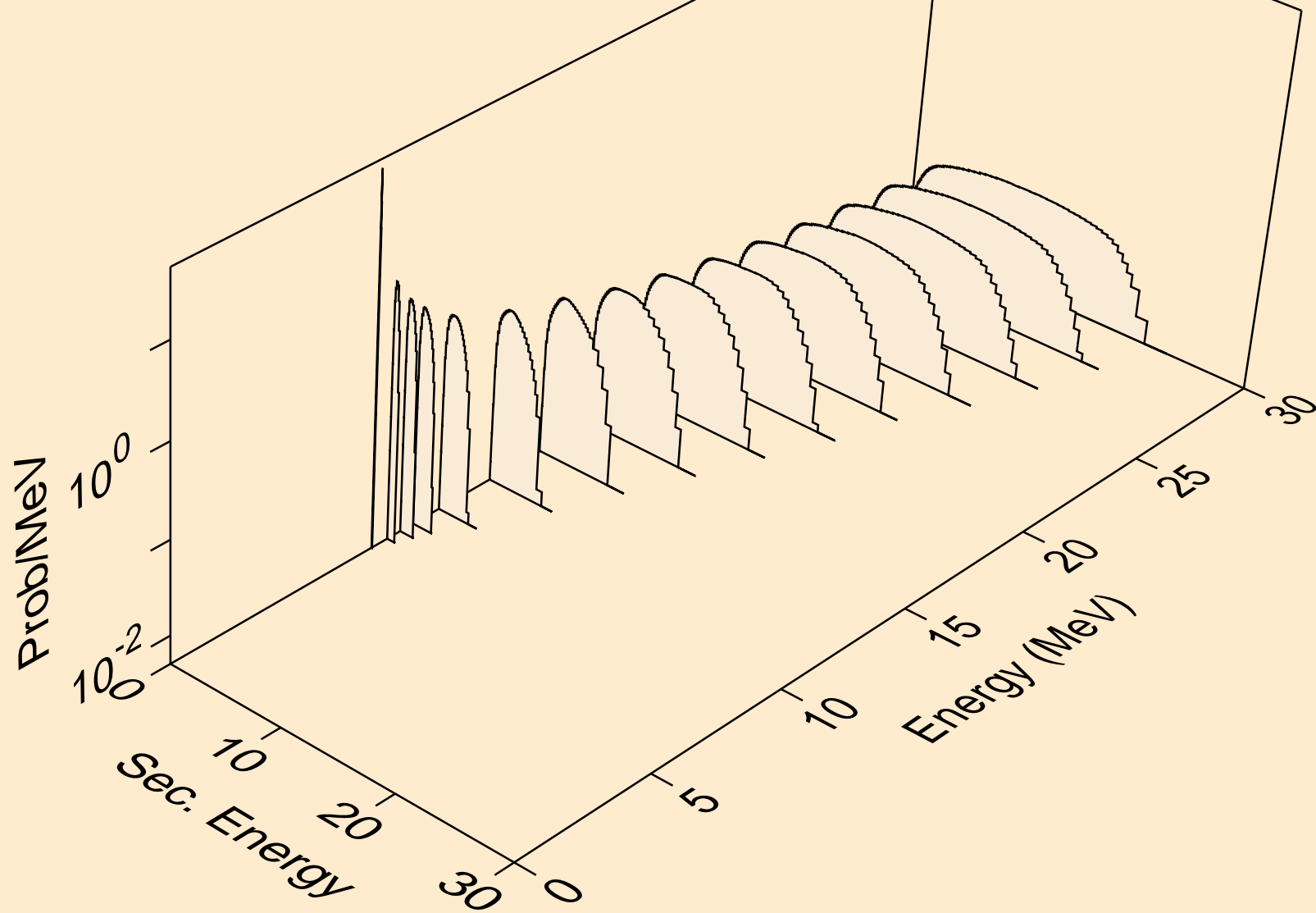

DB258 NEUTRON ACER TENDL-2023 LIBRARY; T=0.K
Neutron emission for (n,3n)a

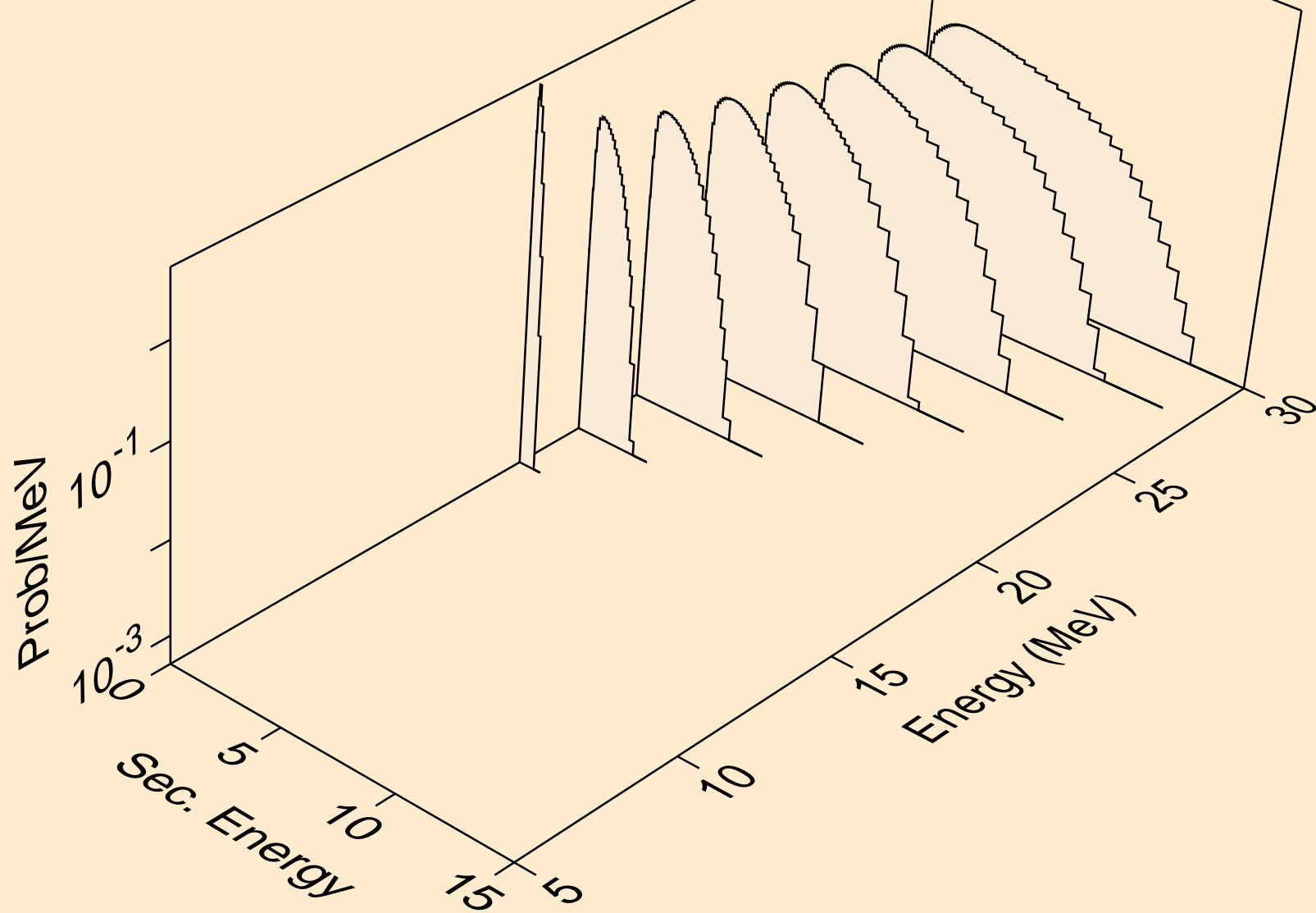

DB258 NEUTRON ACER TENDL-2023 LIBRARY; T=0.K
Neutron emission for (n,n*)p

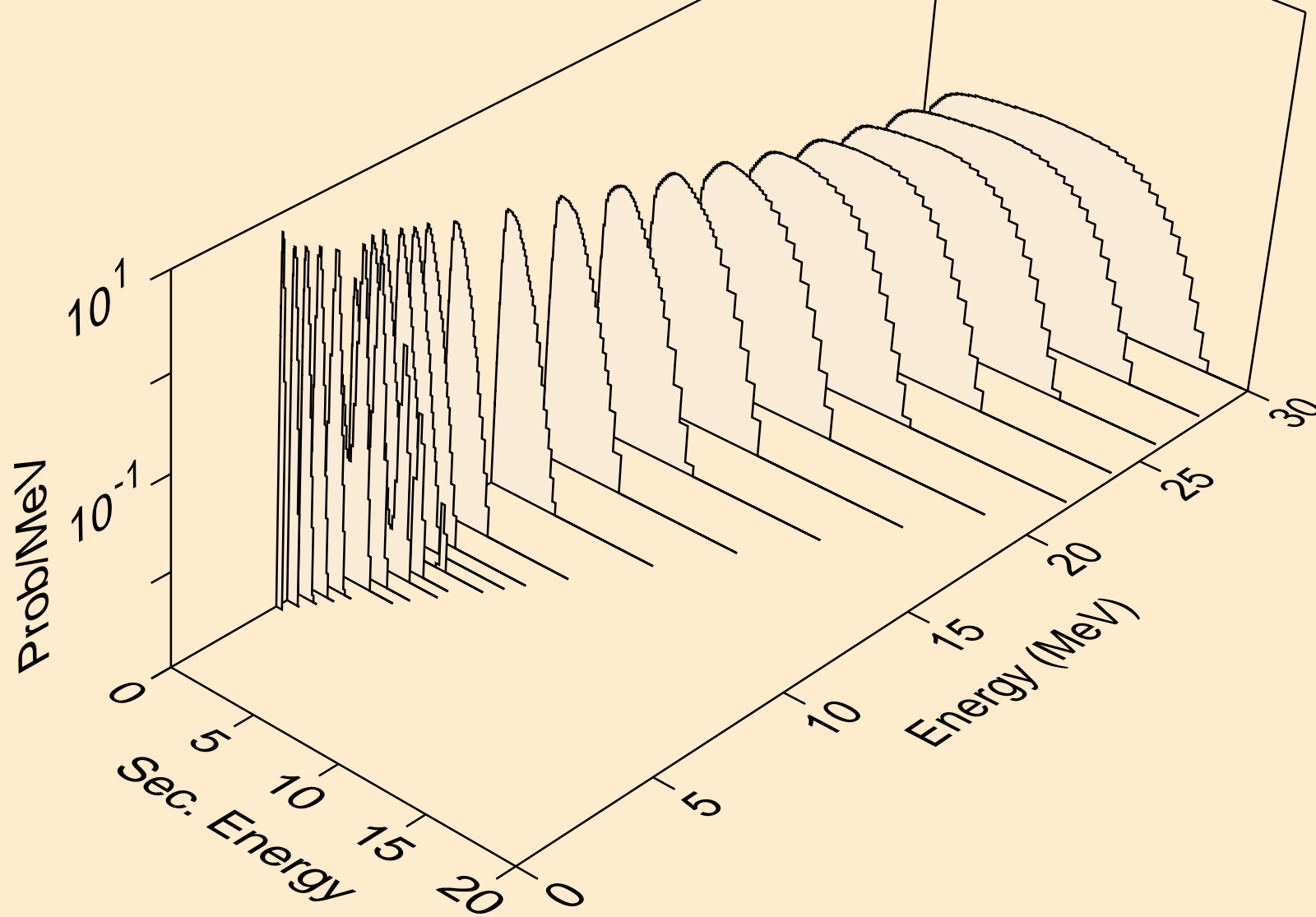

DB258 NEUTRON ACER TENDL-2023 LIBRARY; T=0.K
Neutron emission for (n,n*)d

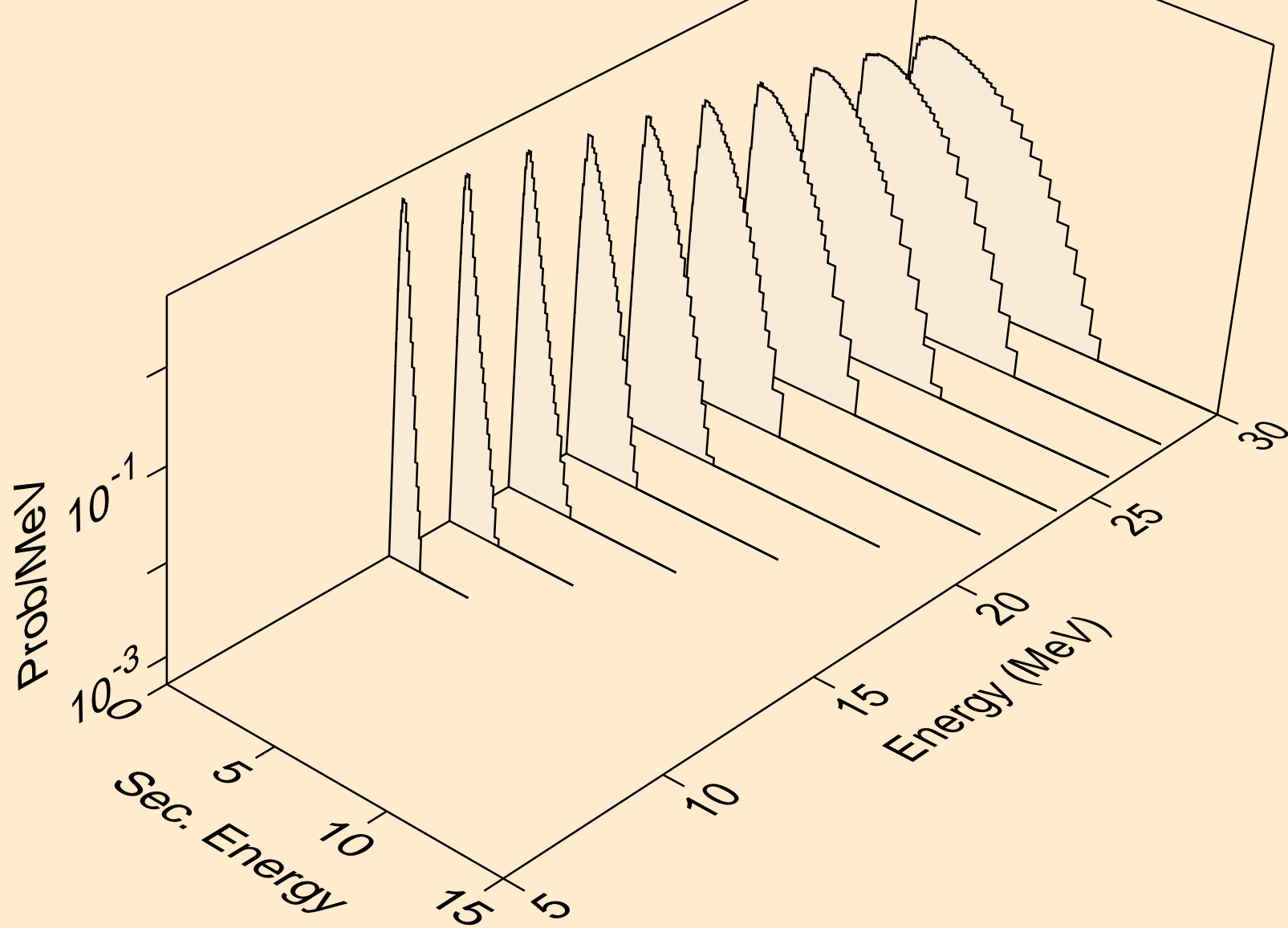

DB258 NEUTRON ACER TENDL-2023 LIBRARY; T=0.K
Neutron emission for (n,n*)t

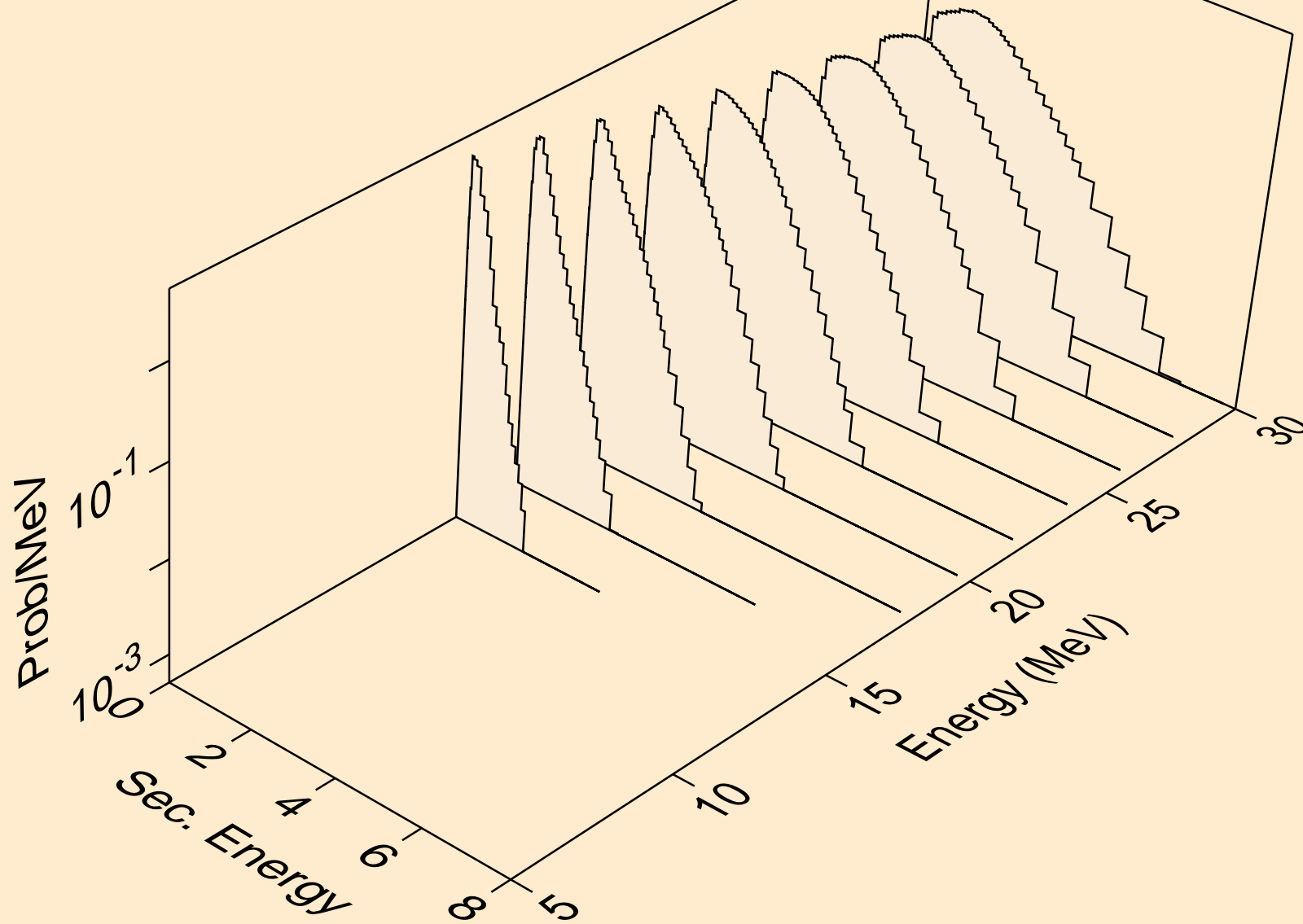

DB258 NEUTRON ACER TENDL-2023 LIBRARY; T=0.K
Neutron emission for (n,n*)he3

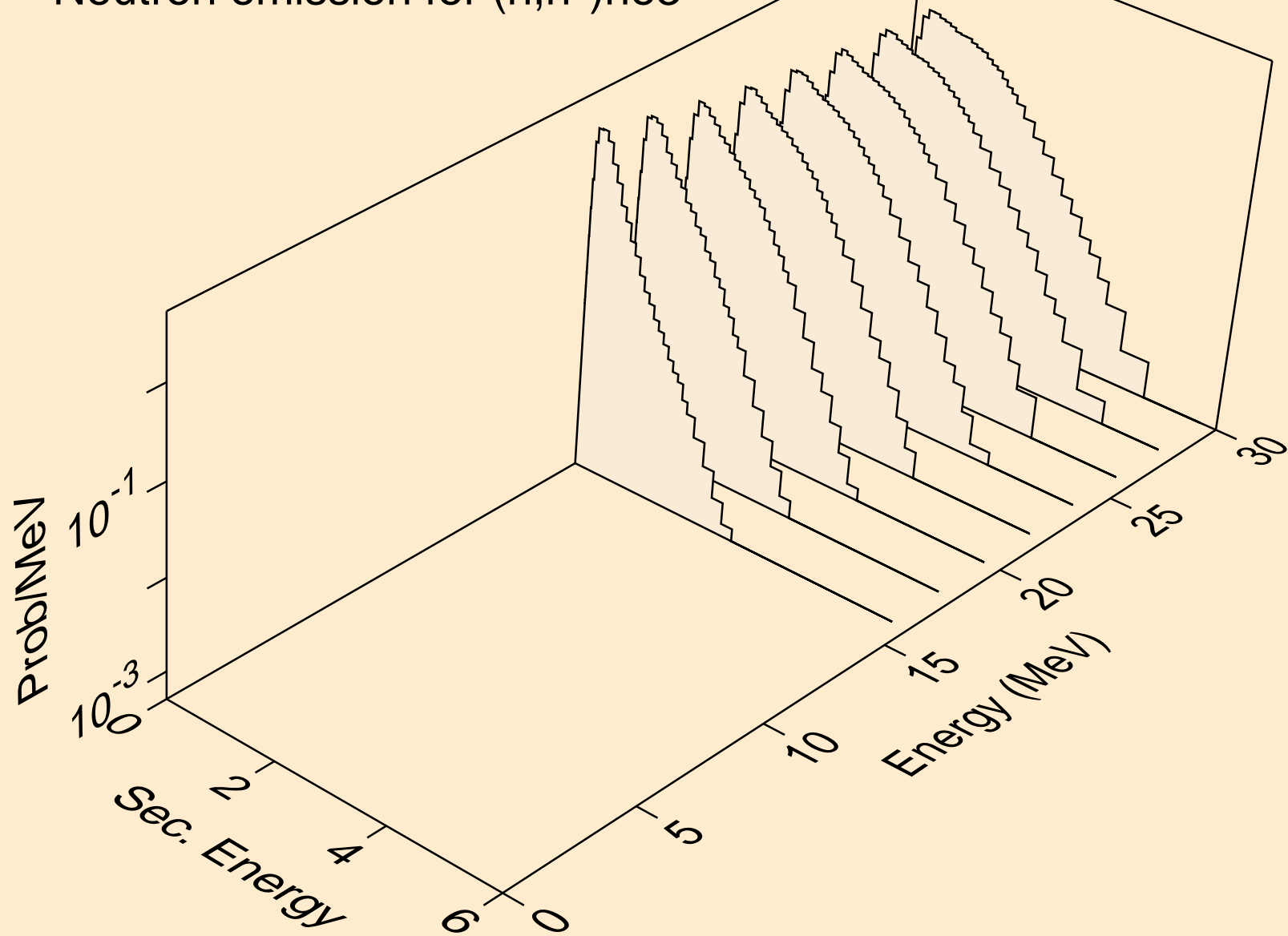

DB258 NEUTRON ACER TENDL-2023 LIBRARY; T=0.K
Neutron emission for (n,4n)

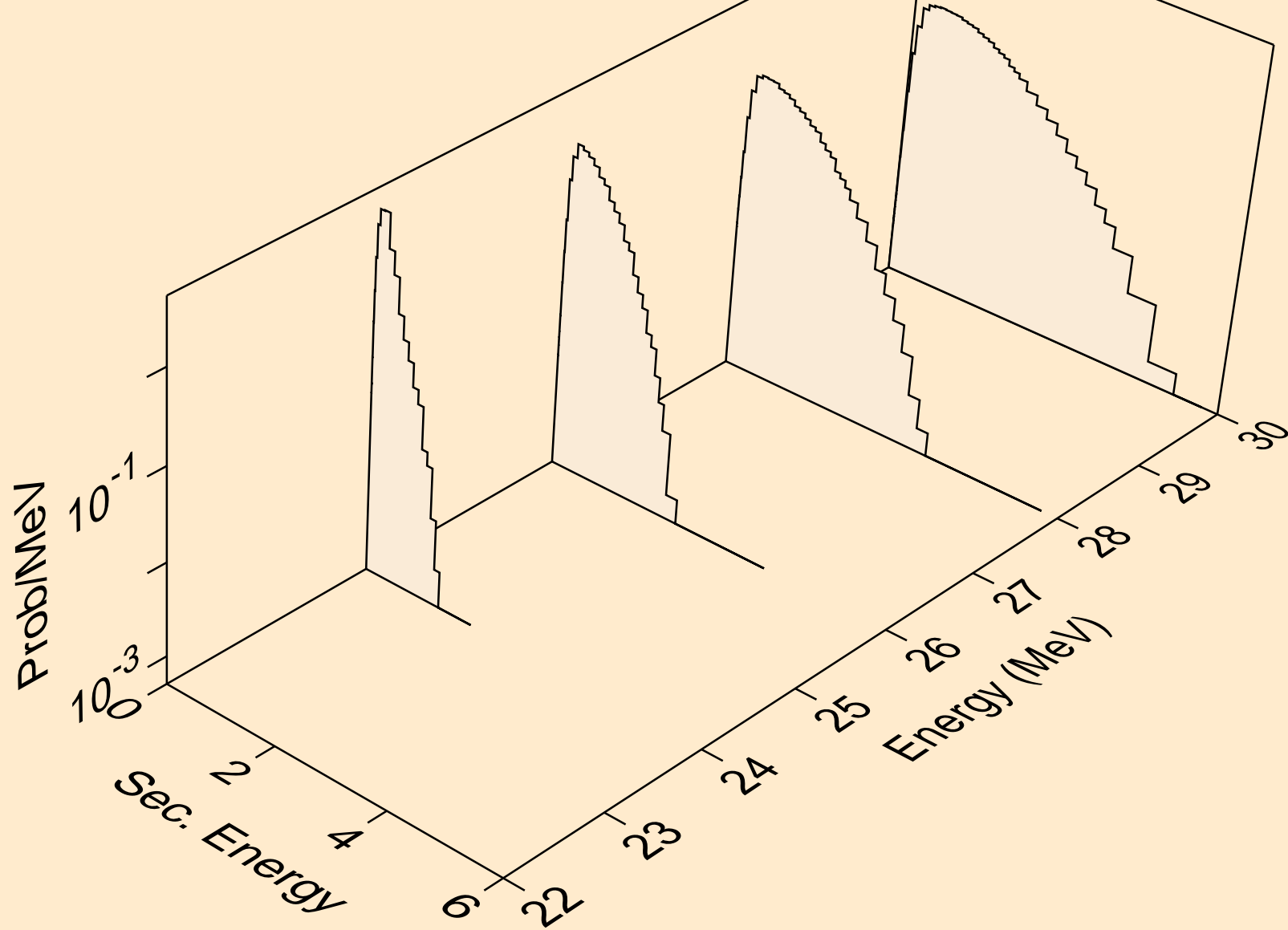

DB258 NEUTRON ACER TENDL-2023 LIBRARY; T=0.K
Neutron emission for (n,2np)

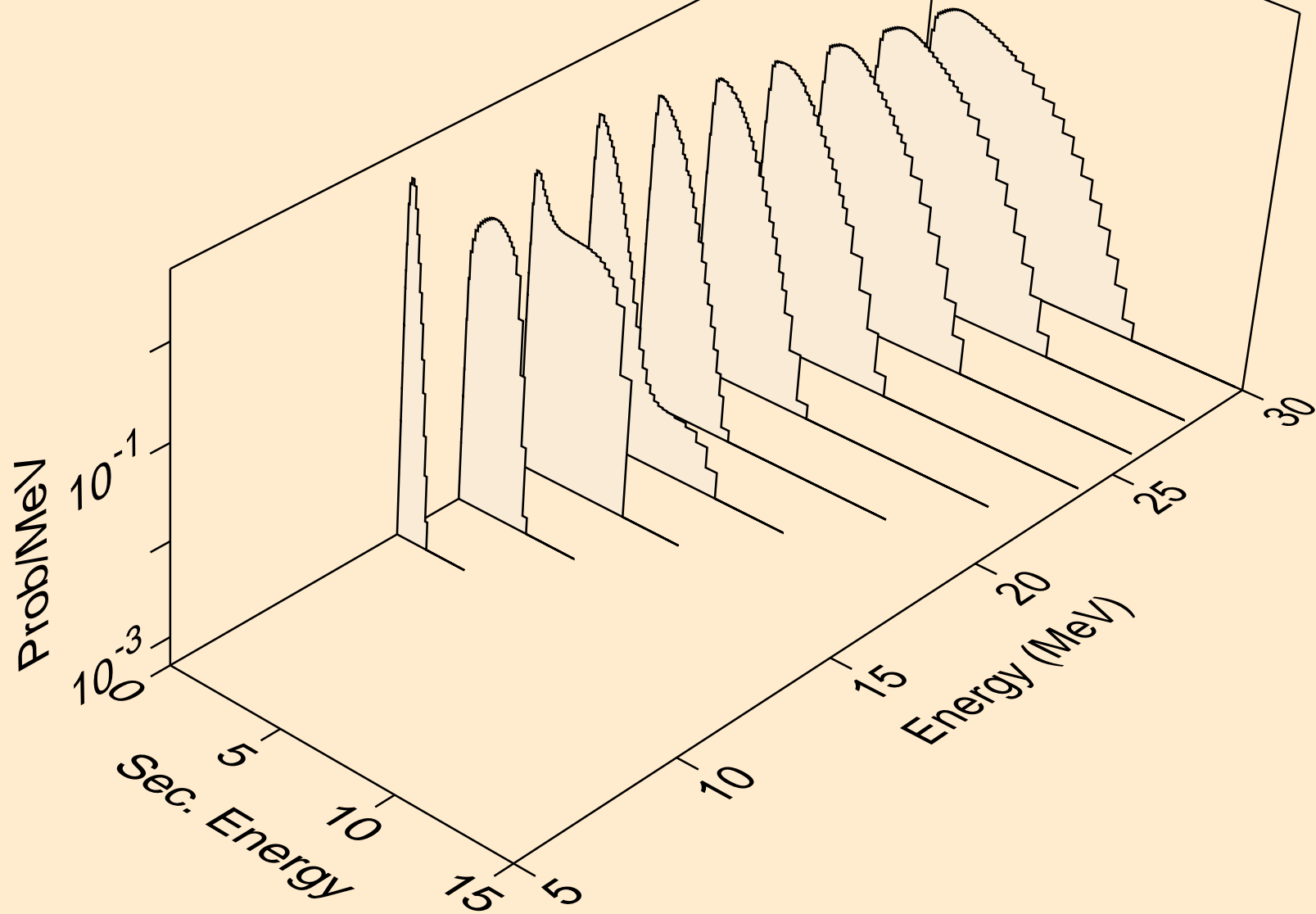

DB258 NEUTRON ACER TENDL-2023 LIBRARY; T=0.K
Neutron emission for (n,n2p)

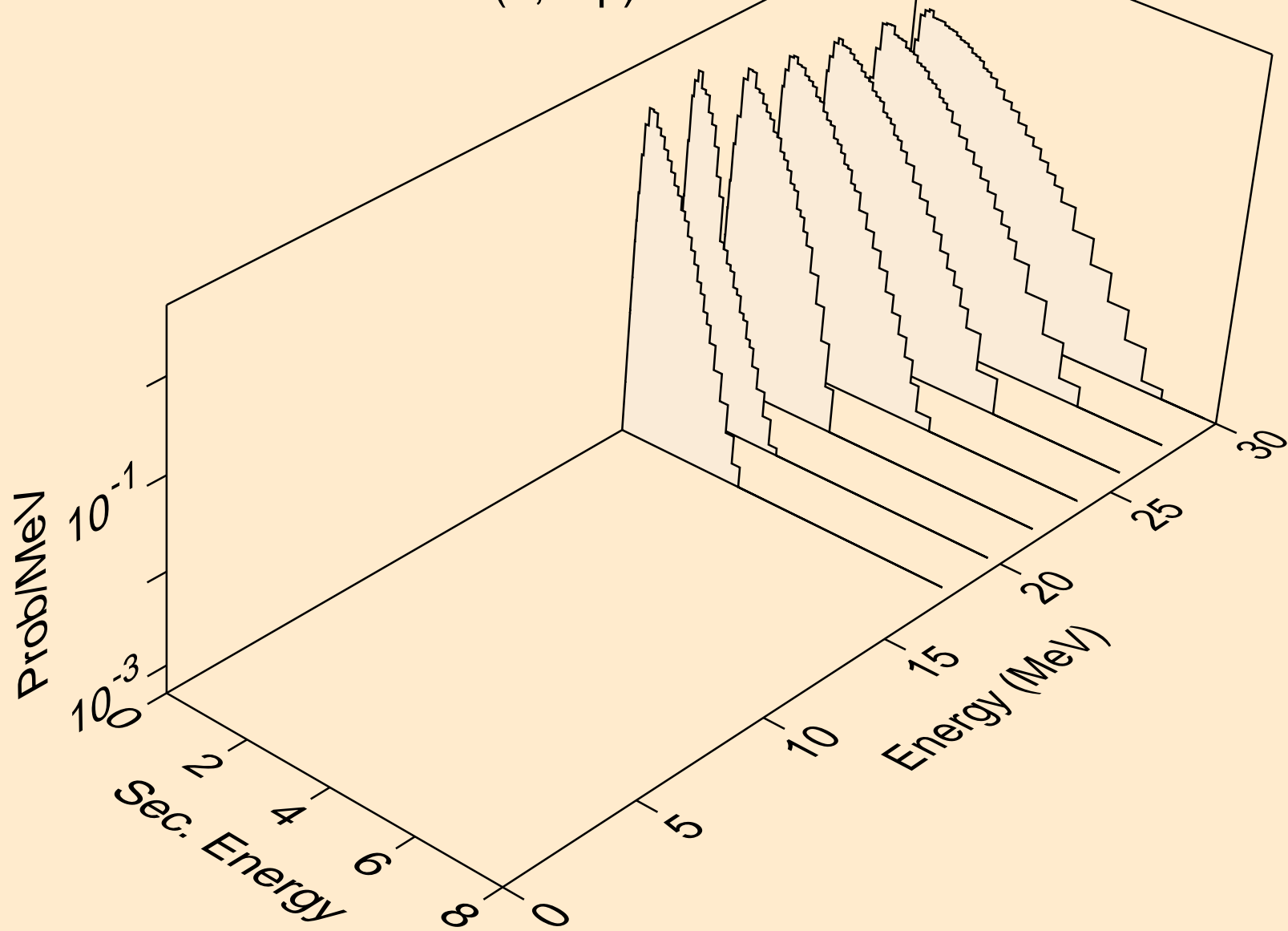

DB258 NEUTRON ACER TENDL-2023 LIBRARY; T=0.K
Neutron emission for (n,npa)

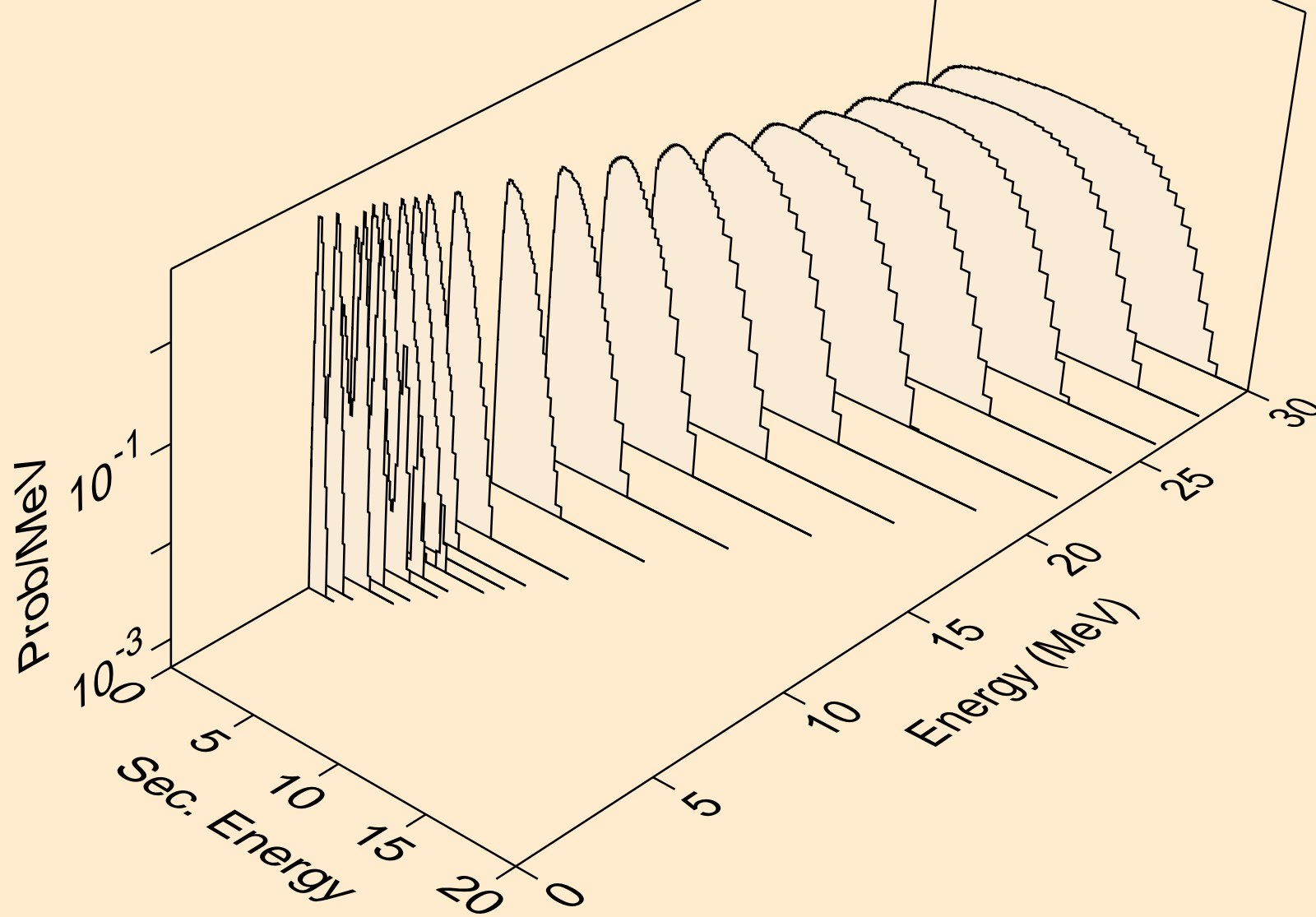

DB258 NEUTRON ACER TENDL-2023 LIBRARY; T=0.K
Neutron emission for (n,n*c)

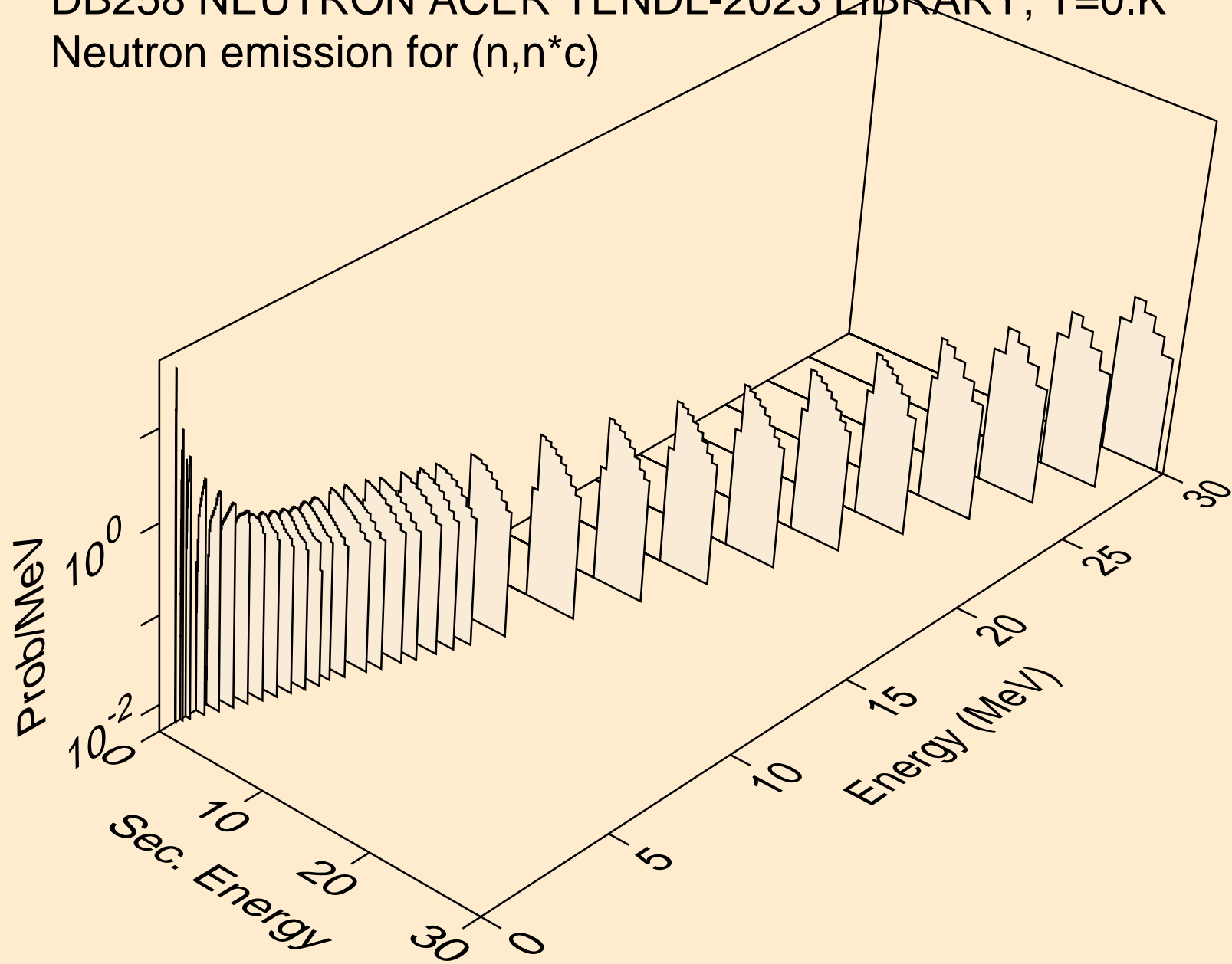

DB258 NEUTRON ACER TENDL-2023 LIBRARY; T=0.K

Delayed nubar

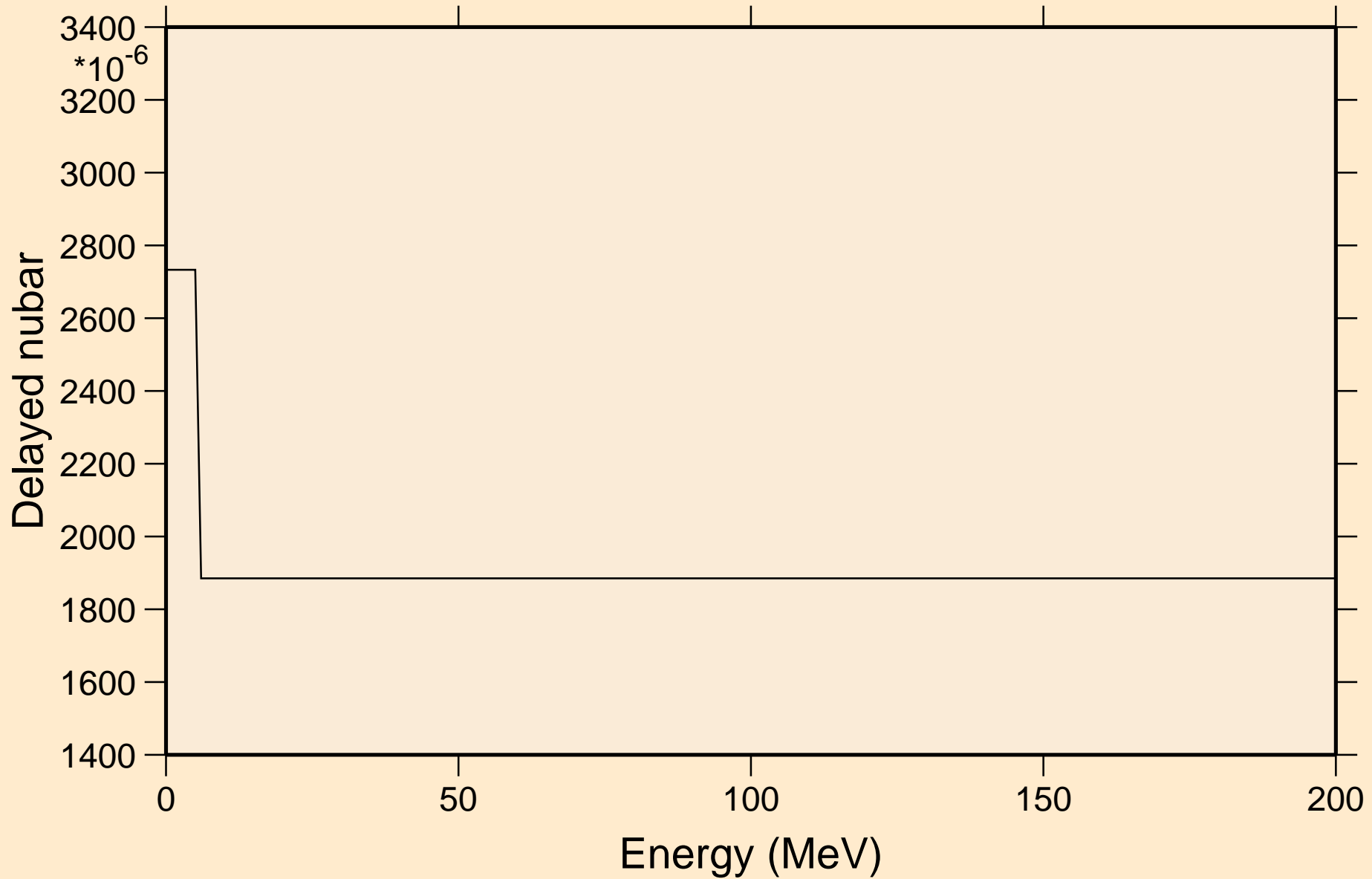

DB258 NEUTRON ACER TENDL-2023 LIBRARY; T=0.K

Delayed neutron spectra

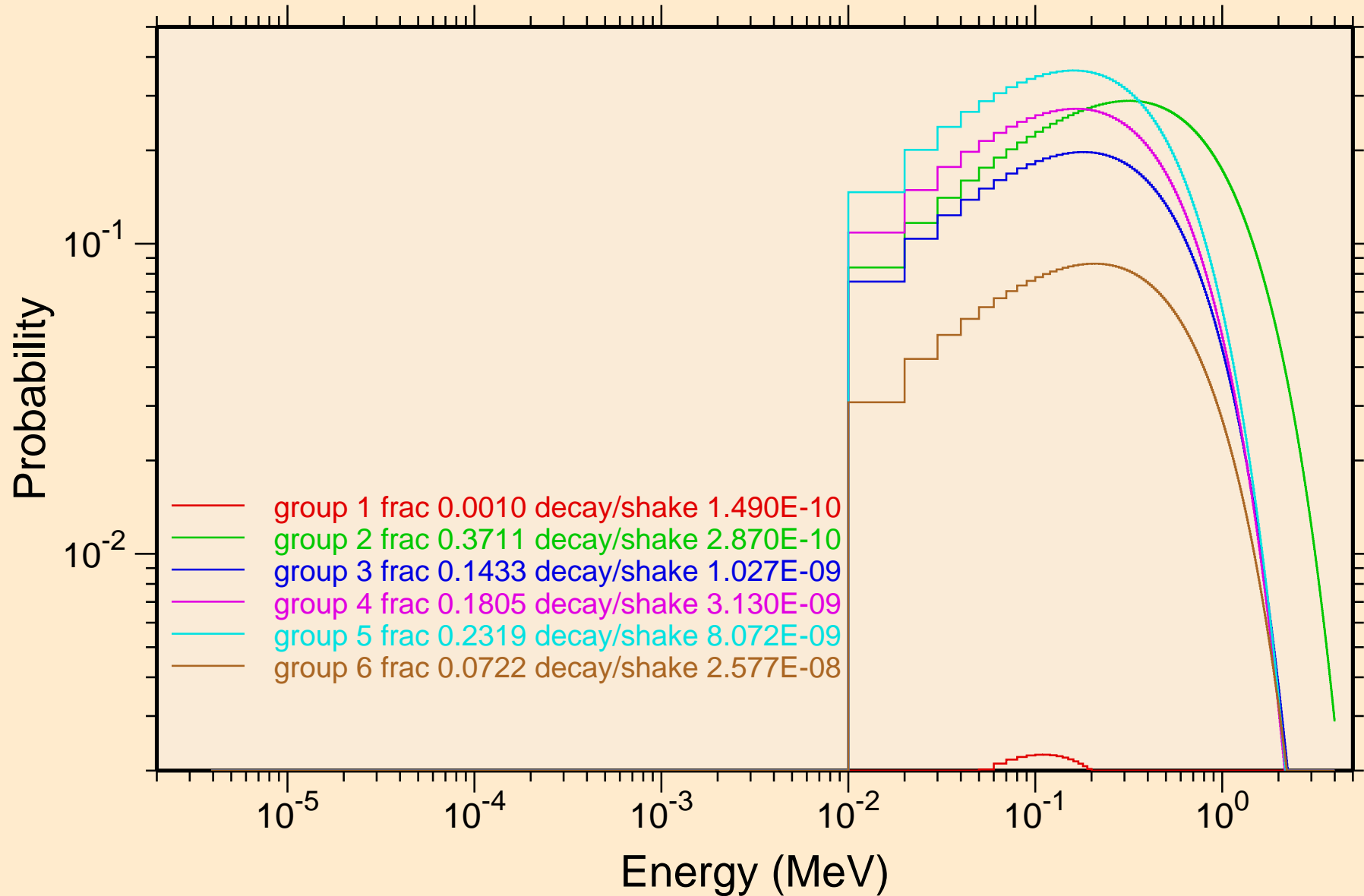

DB258 NEUTRON ACER TENDL-2023 LIBRARY; T=0.K
Photon emission for (n,x)

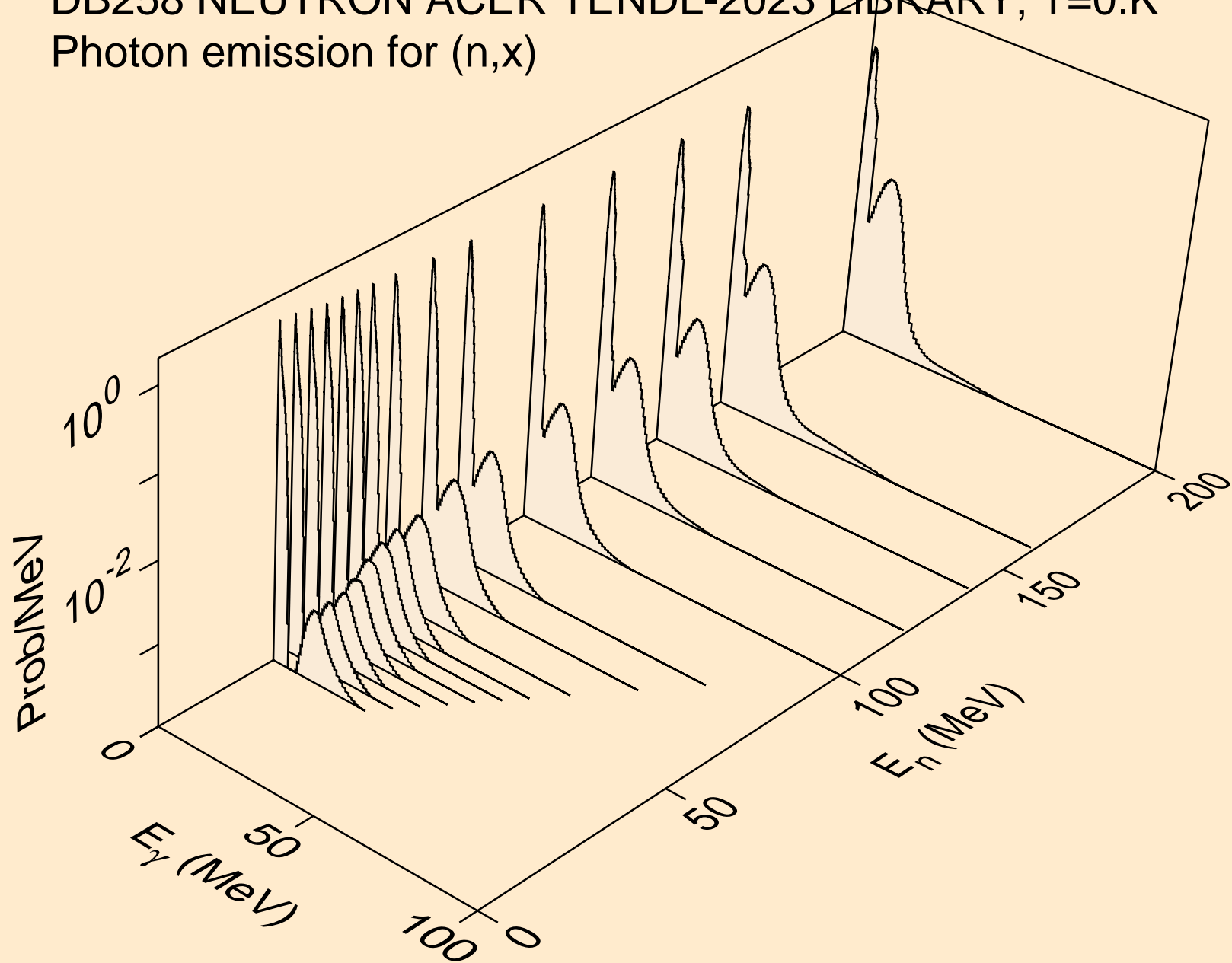

DB258 NEUTRON ACER TENDL-2023 LIBRARY; T=0.K
Photon emission for (n,2n)

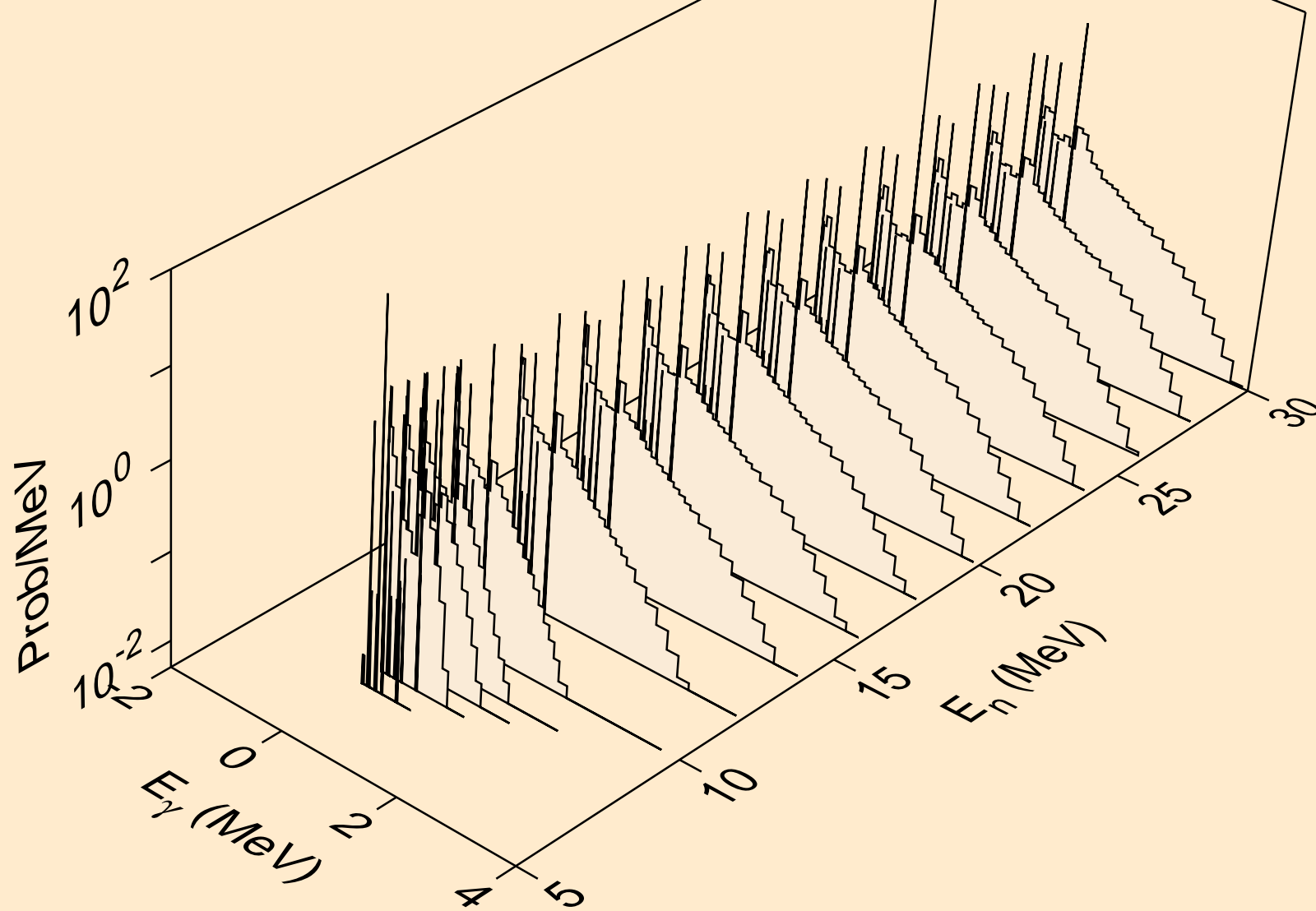

DB258 NEUTRON ACER TENDL-2023 LIBRARY; T=0.K
Photon emission for (n,3n)

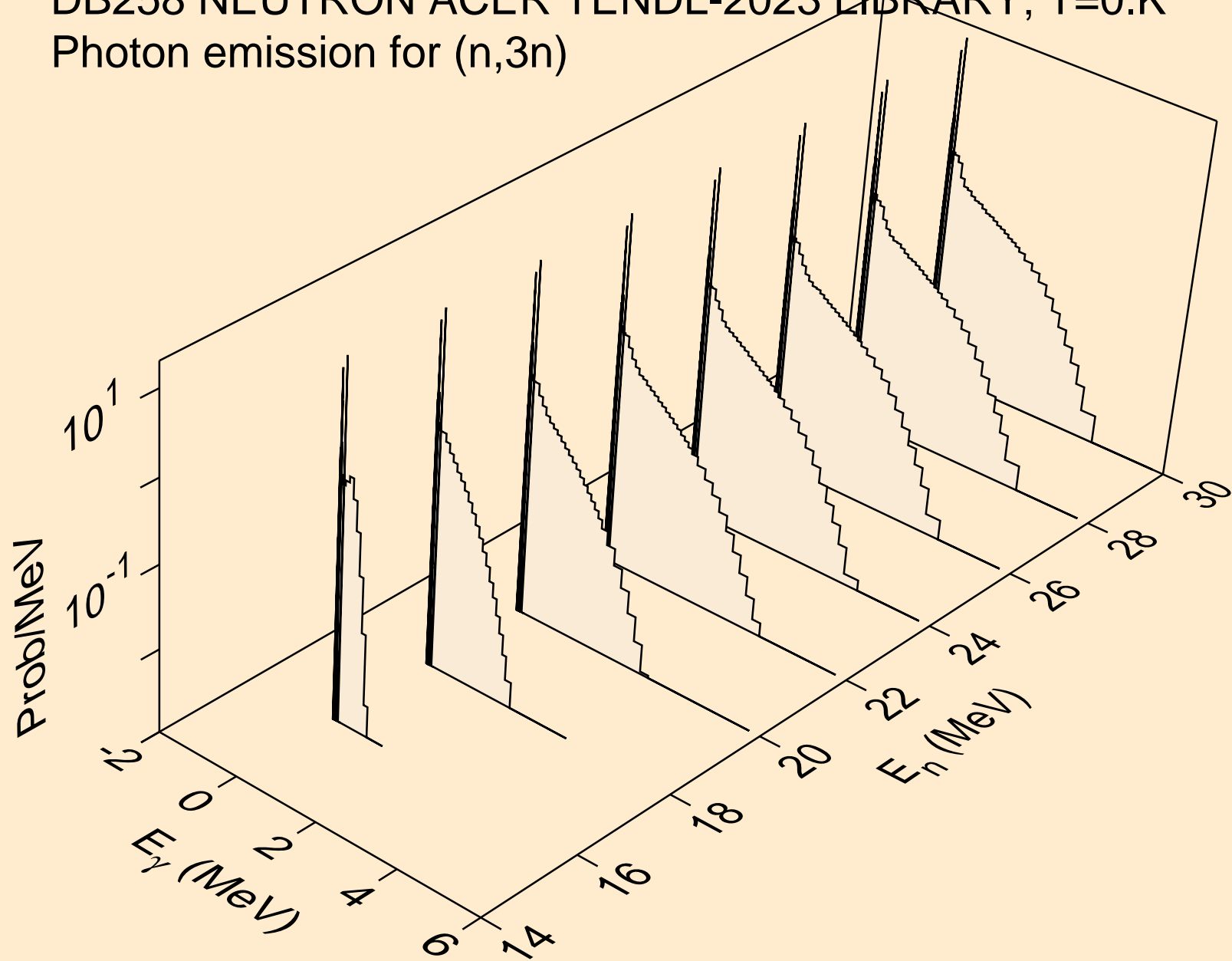

DB258 NEUTRON ACER TENDL-2023 LIBRARY; T=0.K
Photon emission for (n,n*)a

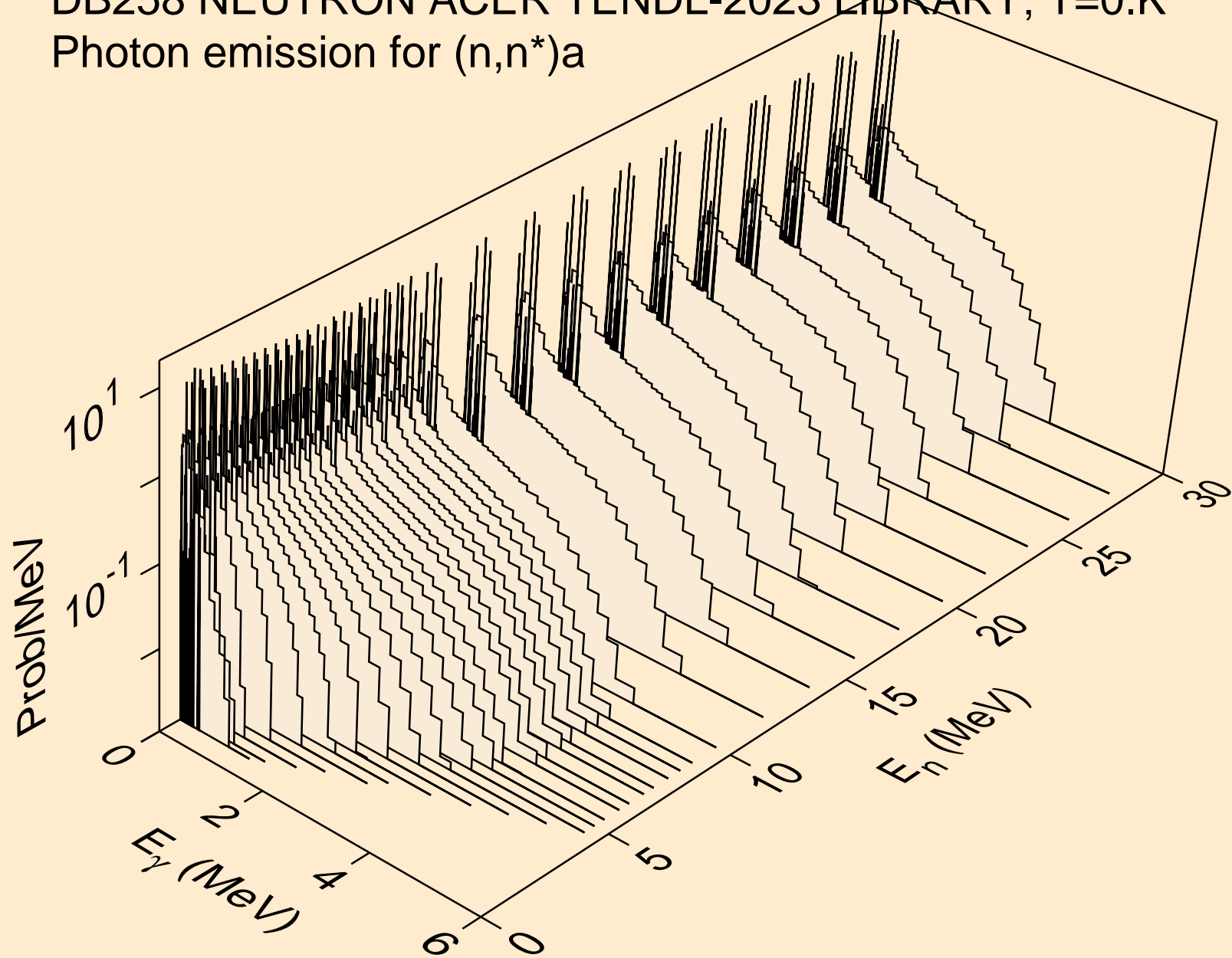

DB258 NEUTRON ACER TENDL-2023 LIBRARY; T=0.K
Photon emission for (n,2n)a

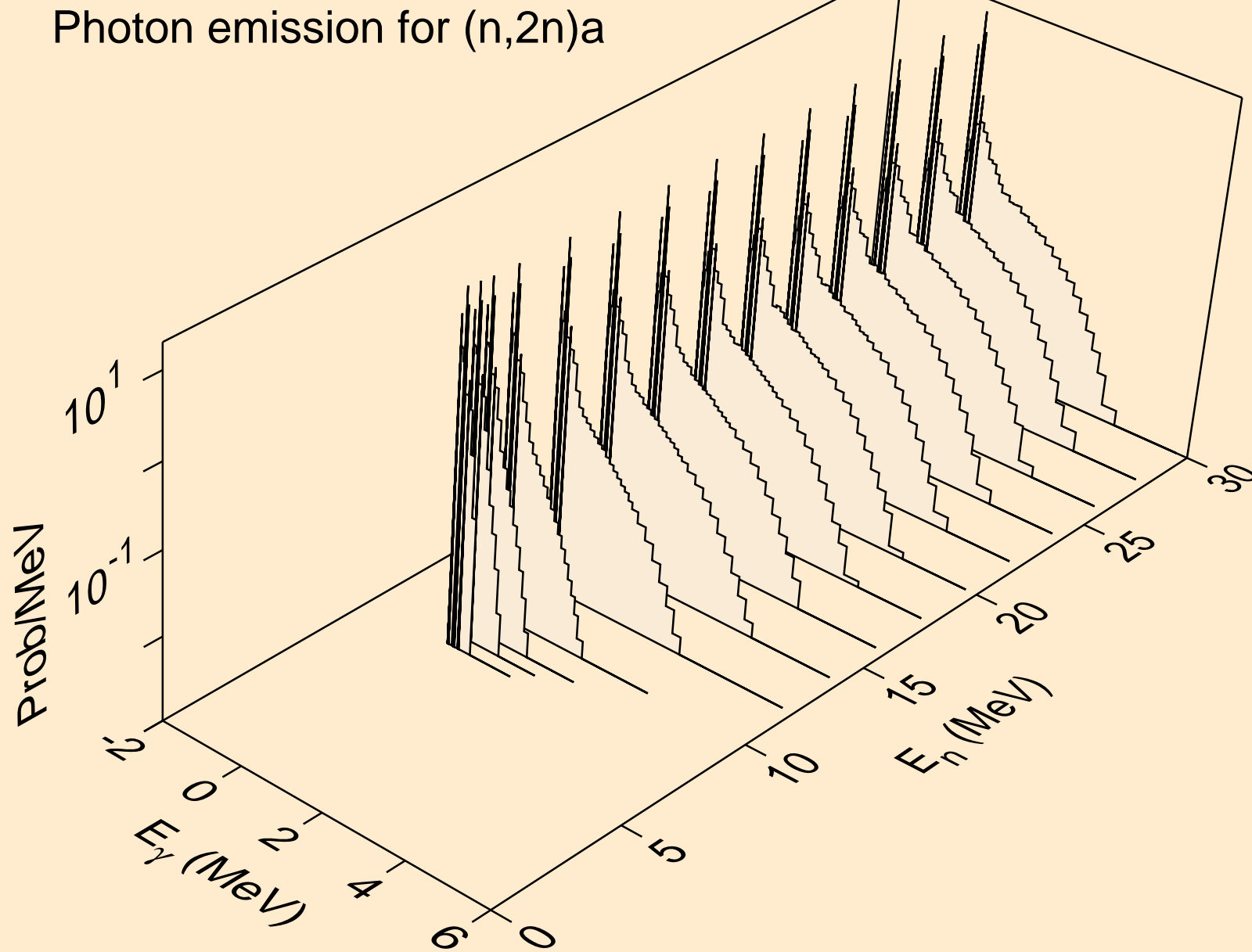

DB258 NEUTRON ACER TENDL-2023 LIBRARY; T=0.K
Photon emission for (n,3n)a

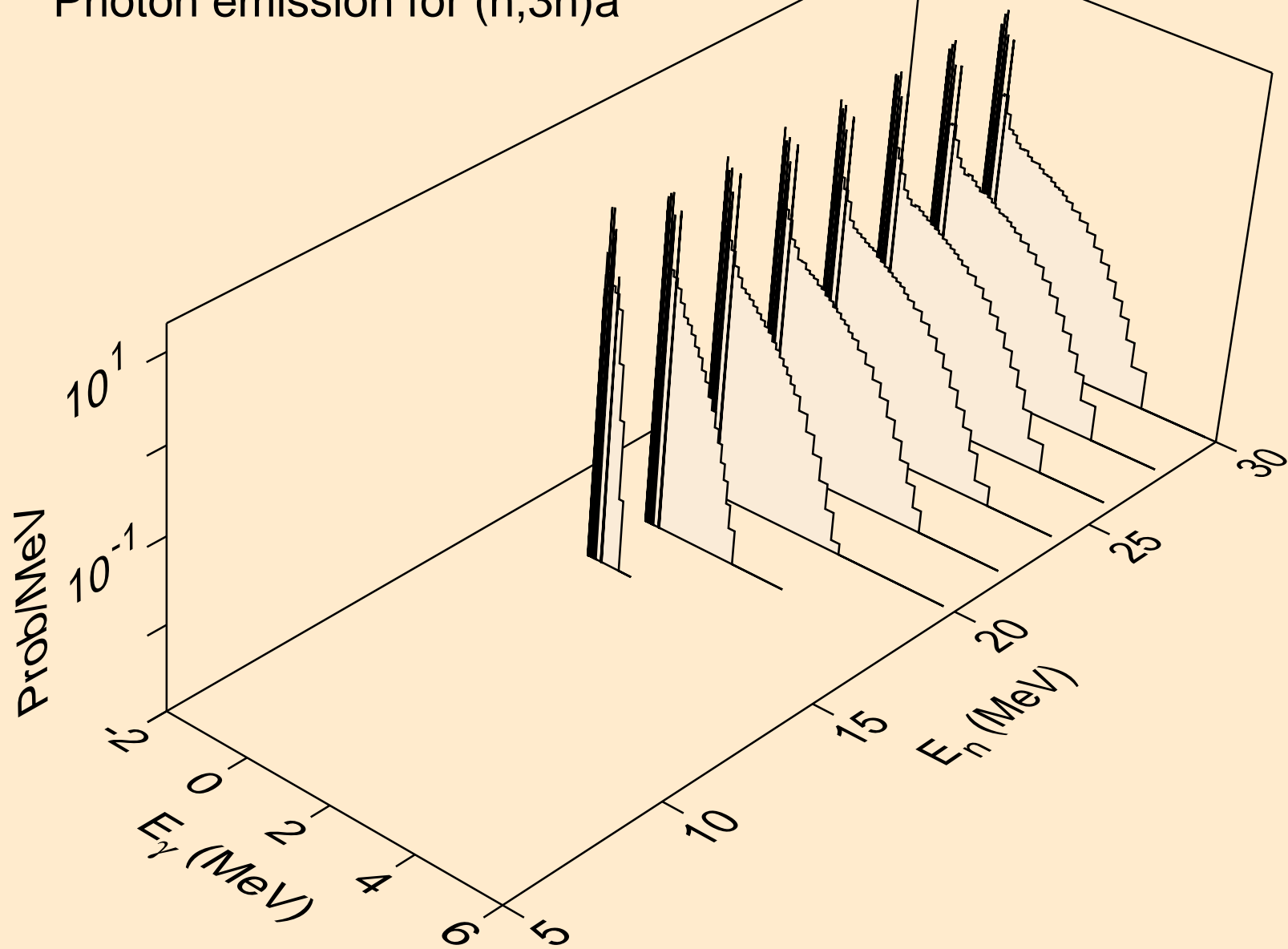

DB258 NEUTRON ACER TENDL-2023 LIBRARY; T=0.K
Photon emission for (n,n*)p

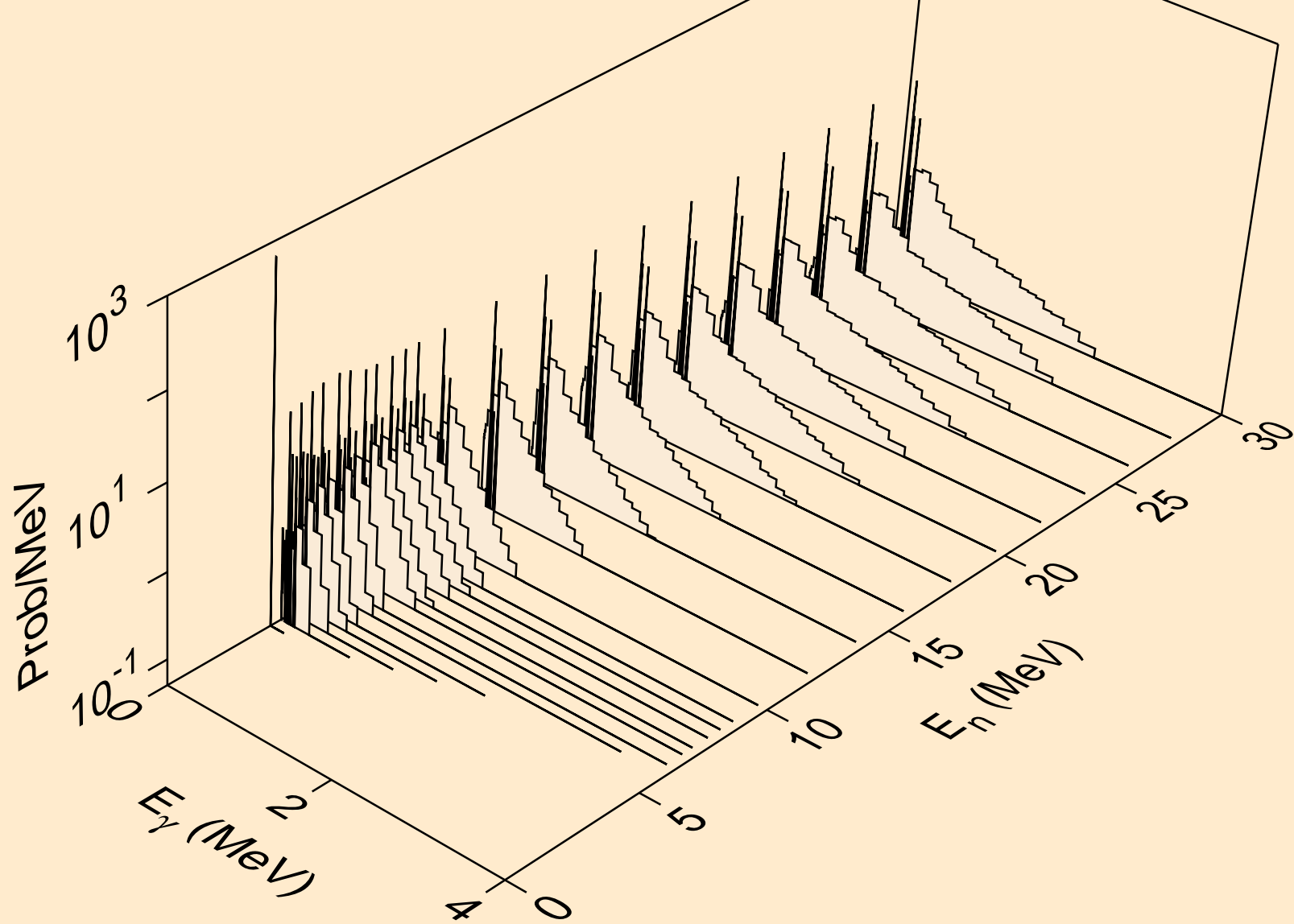

DB258 NEUTRON ACER TENDL-2023 LIBRARY; T=0.K
Photon emission for (n,n*)d

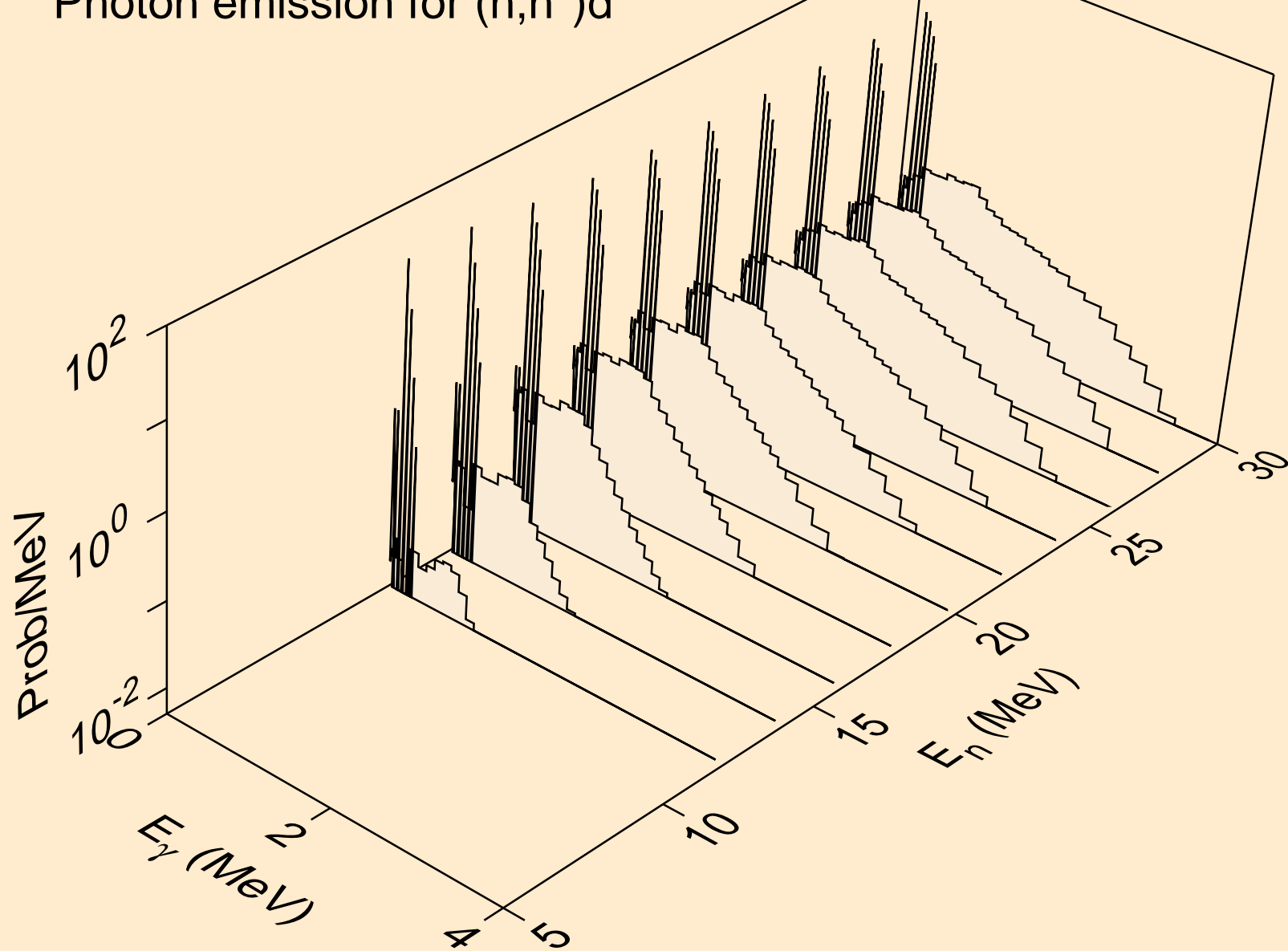

DB258 NEUTRON ACER TENDL-2023 LIBRARY; T=0.K
Photon emission for (n,n*)t

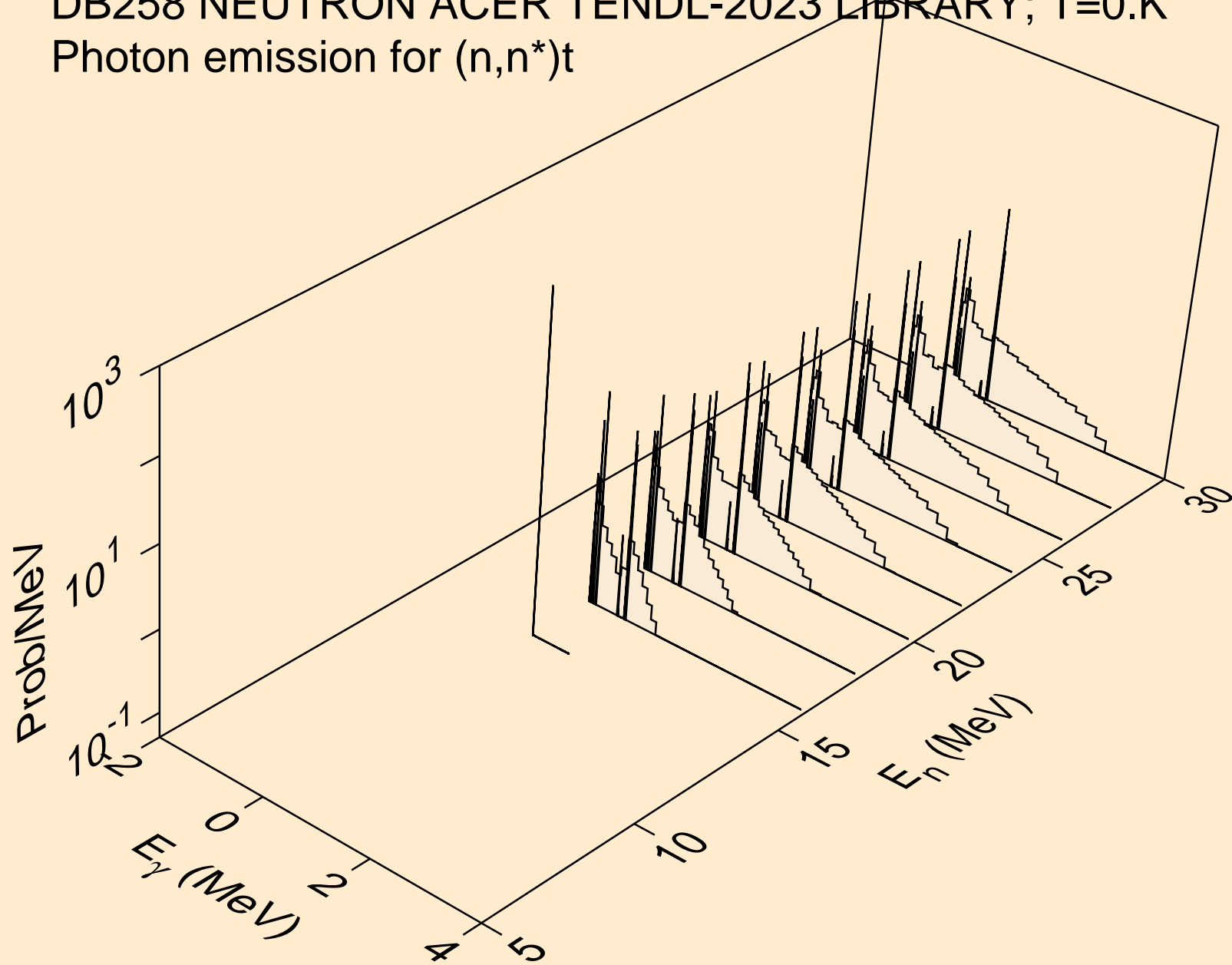

DB258 NEUTRON ACER TENDL-2023 LIBRARY; T=0.K
Photon emission for (n,n*)he3

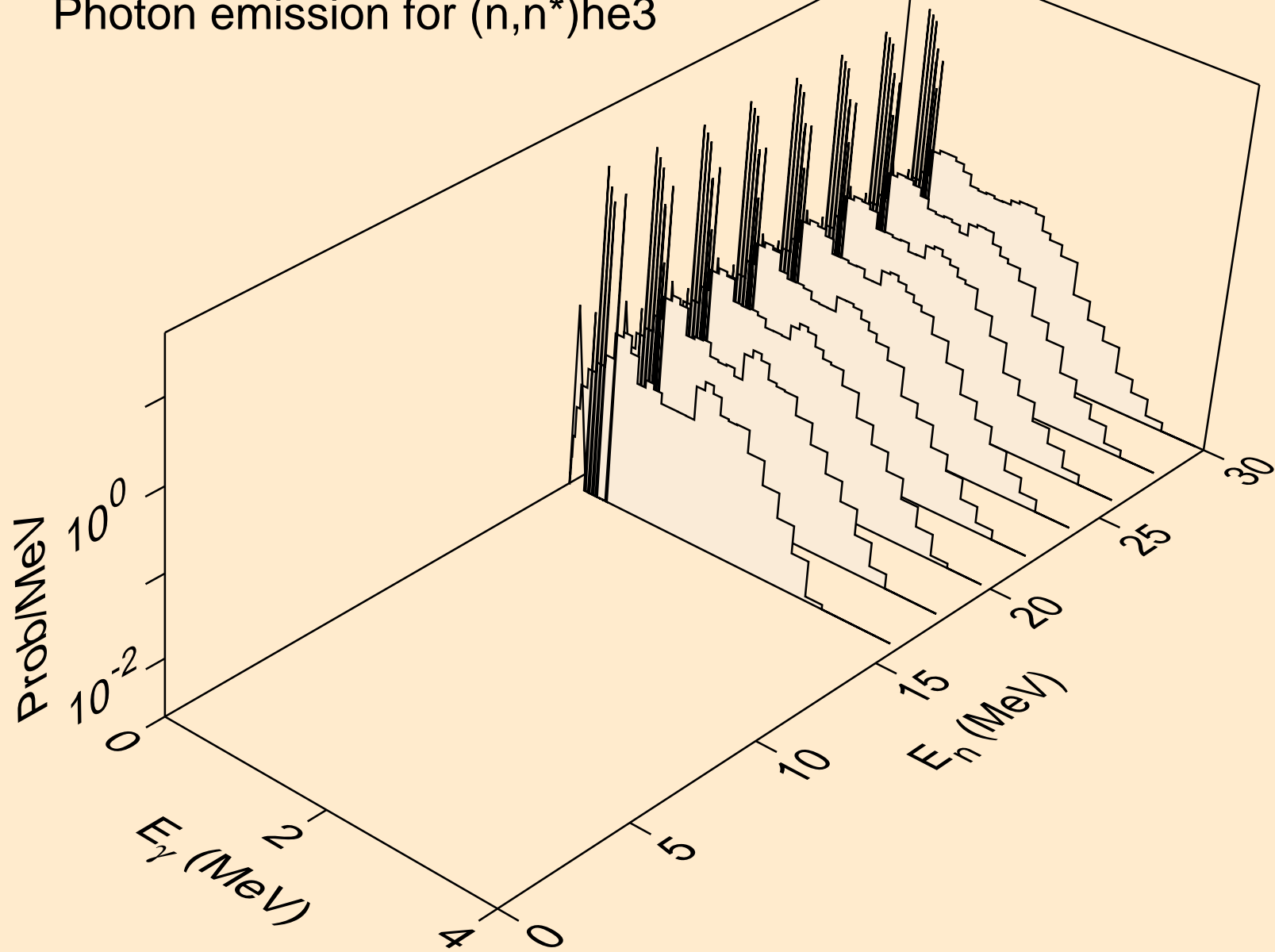

DB258 NEUTRON ACER TENDL-2023 LIBRARY; T=0.K
Photon emission for (n,4n)

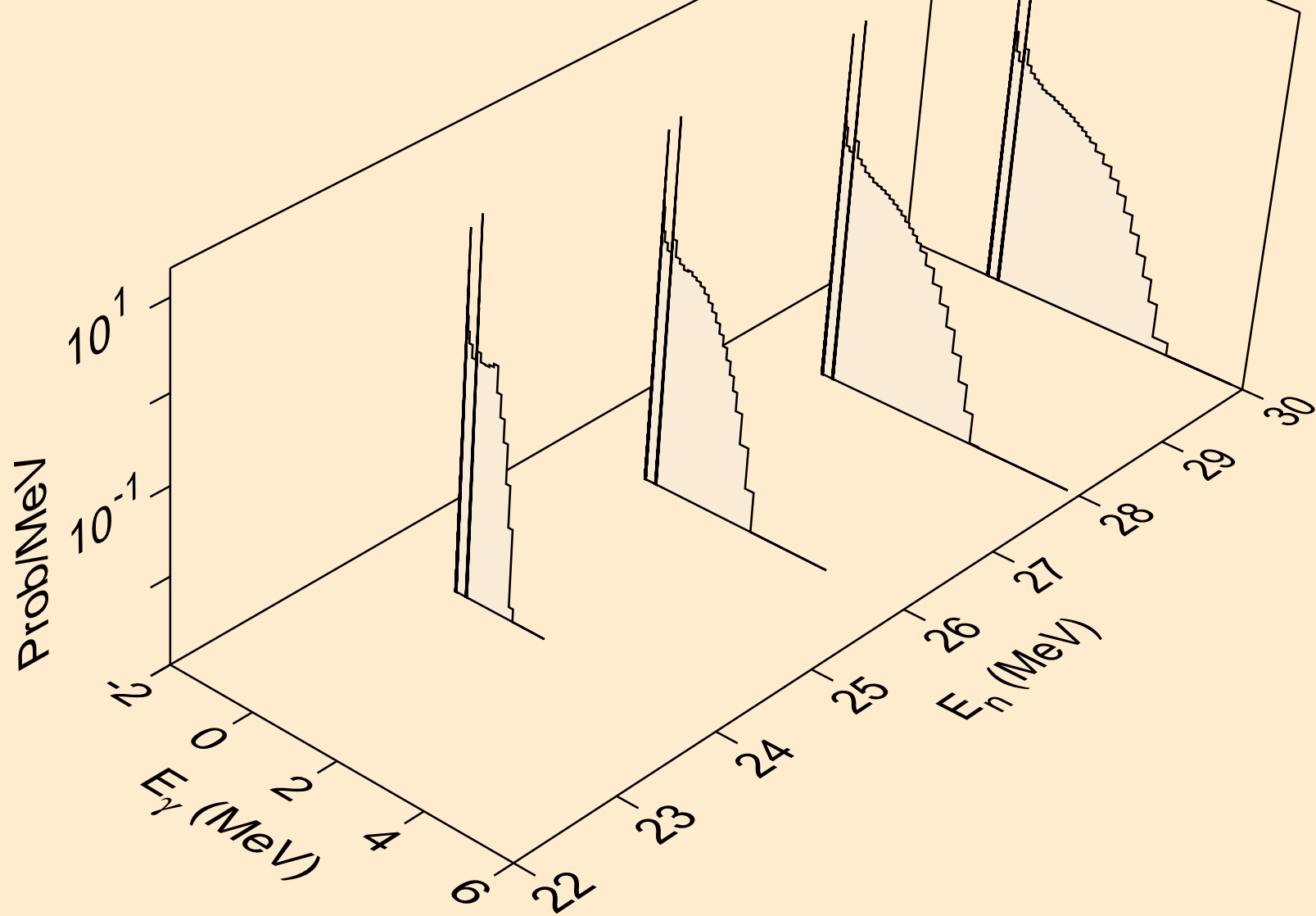

DB258 NEUTRON ACER TENDL-2023 LIBRARY; T=0.K
Photon emission for (n,2np)

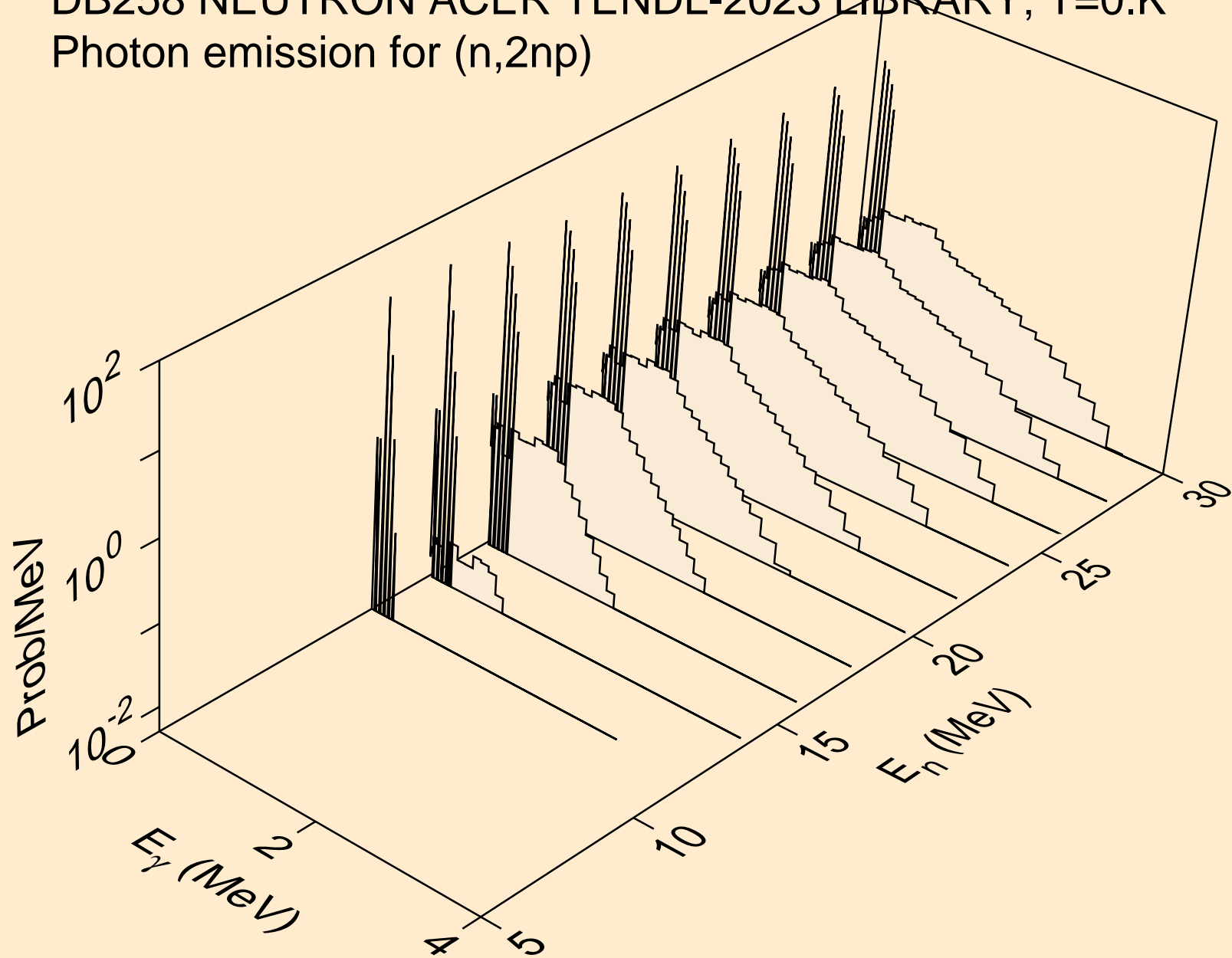

DB258 NEUTRON ACER TENDL-2023 LIBRARY; T=0.K
Photon emission for (n,n2p)

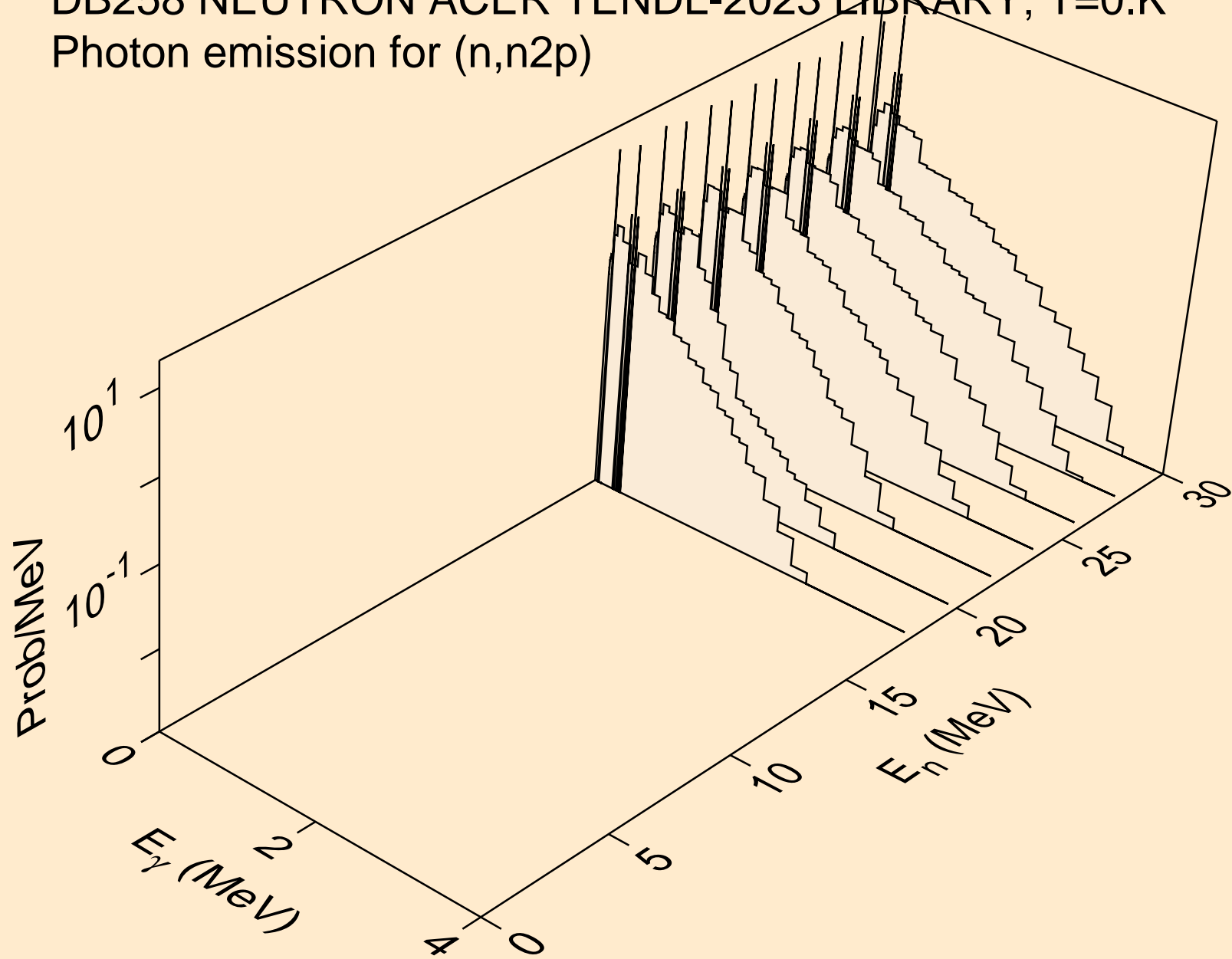

DB258 NEUTRON ACER TENDL-2023 LIBRARY; T=0.K
Photon emission for (n,npa)

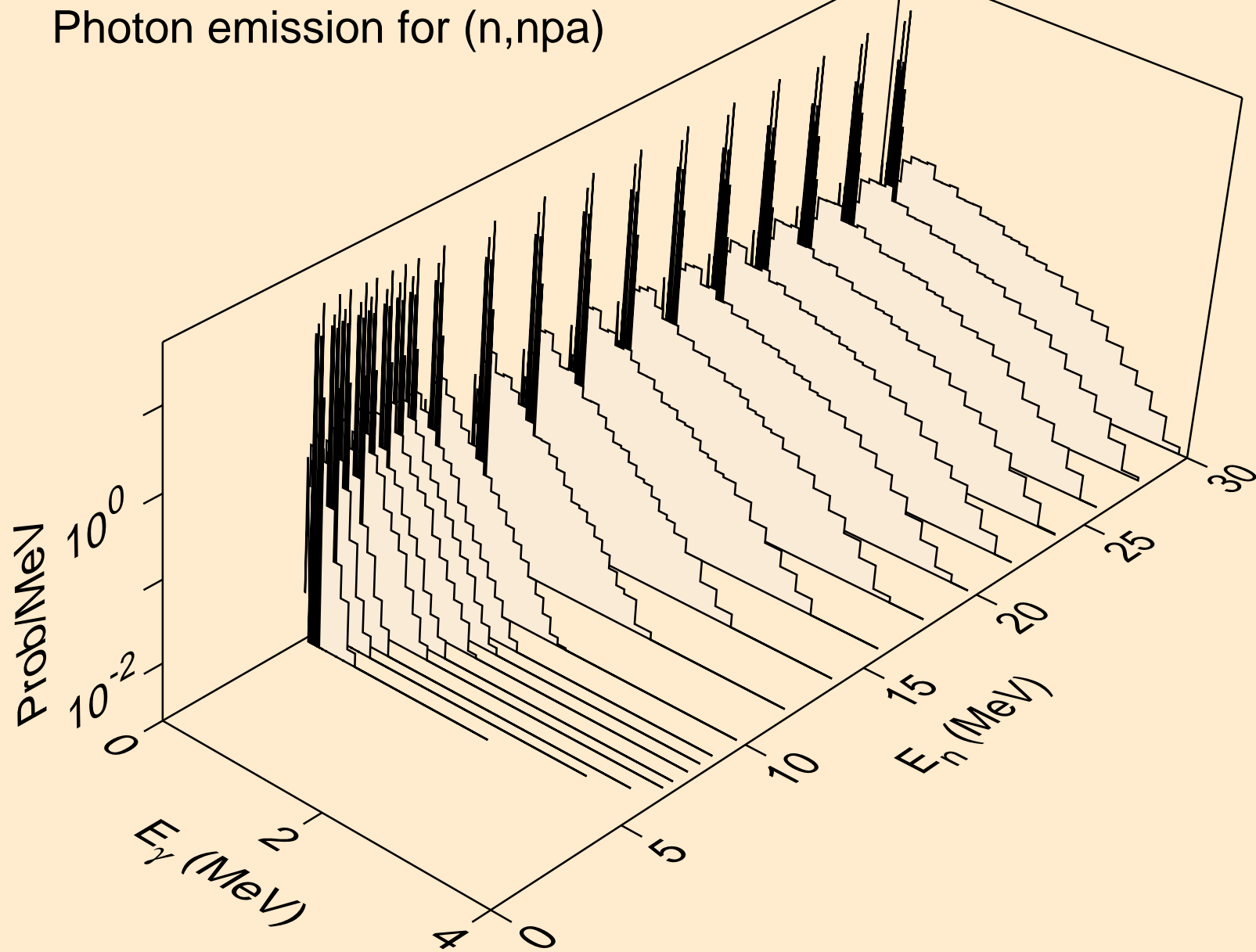

DB258 NEUTRON ACER TENDL-2023 LIBRARY; T=0.K
Photon emission for (n,n*c)

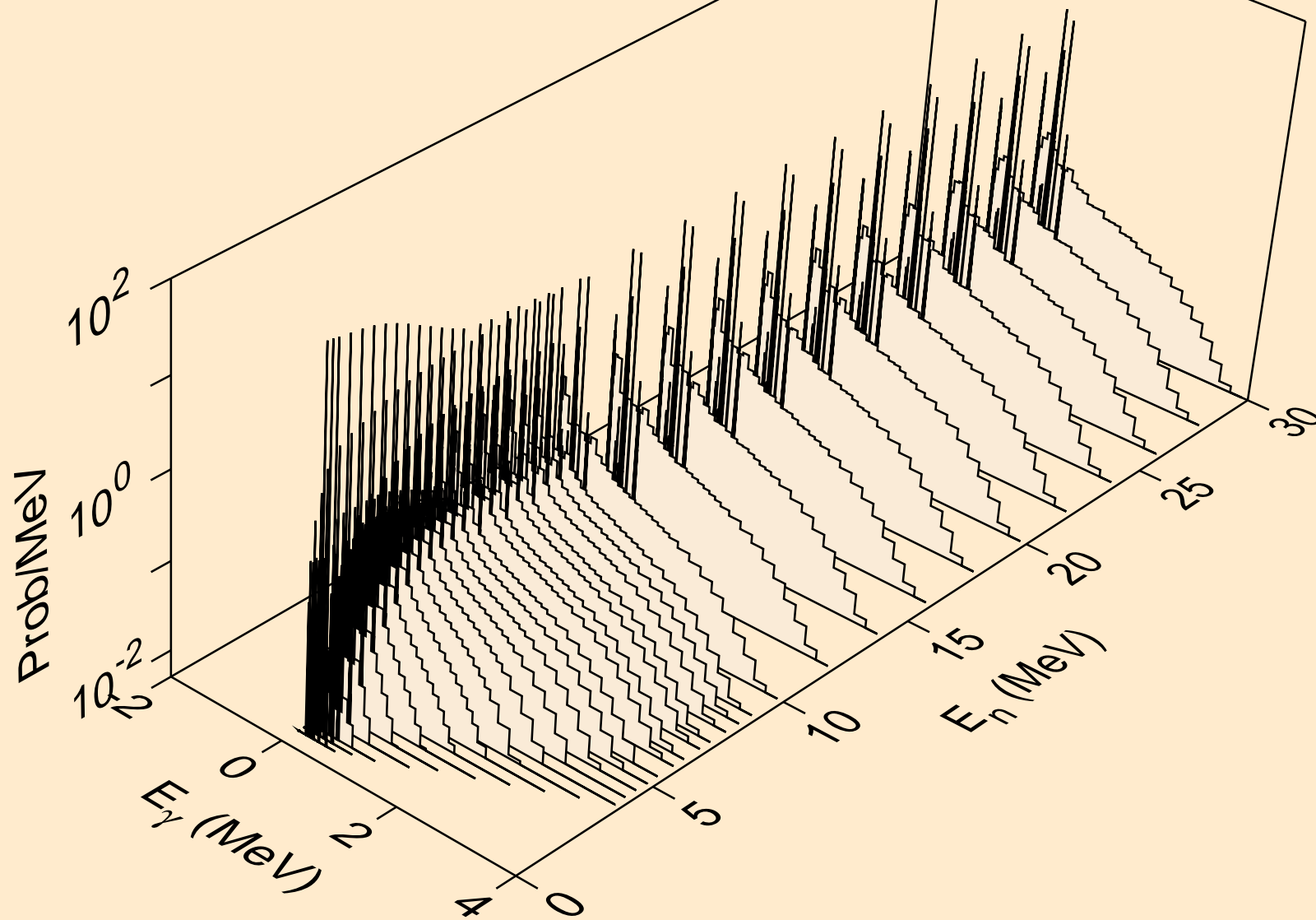

DB258 NEUTRON ACER TENDL-2023 LIBRARY; T=0.K
Photon emission for (n,gma)

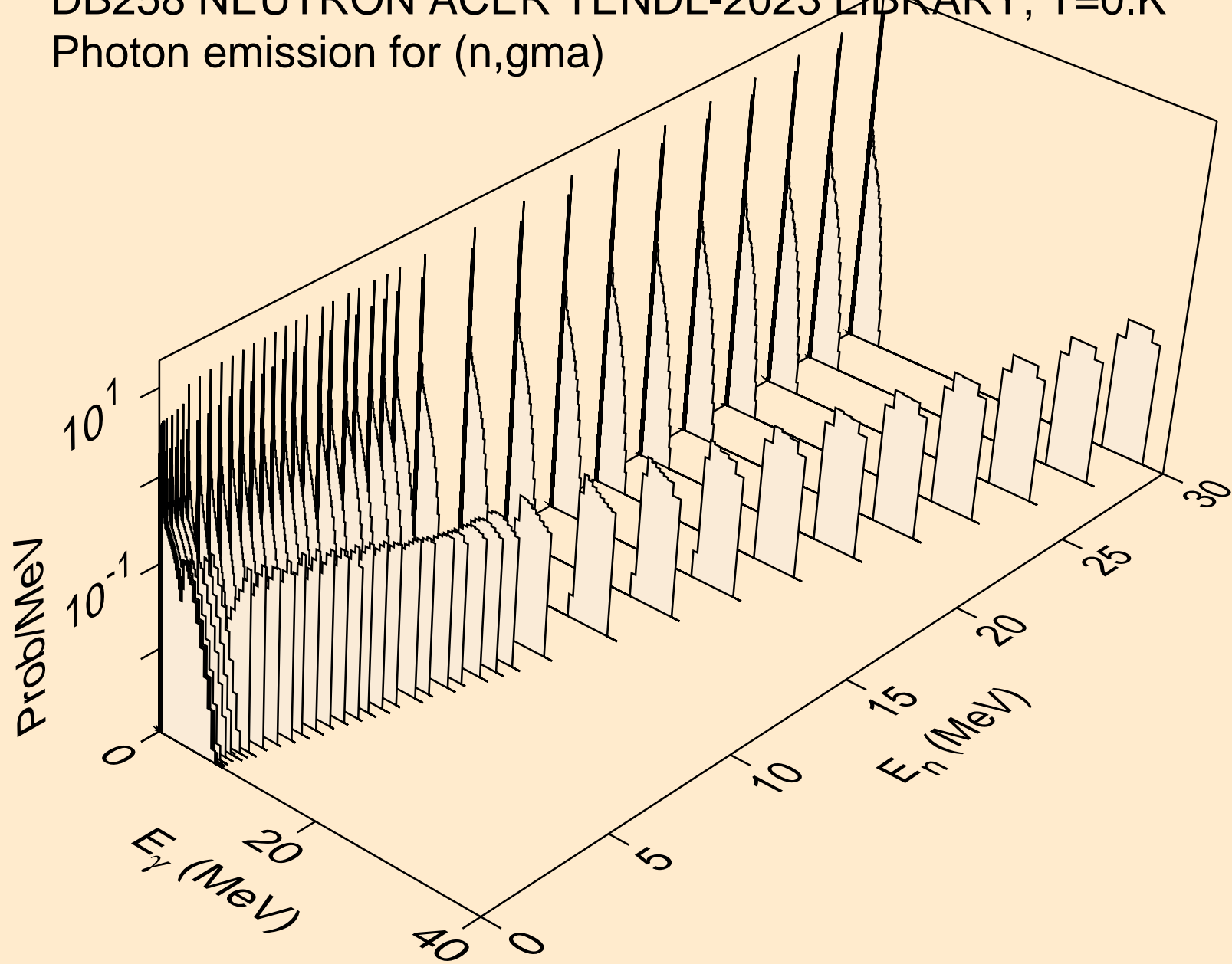

DB258 NEUTRON ACER TENDL-2023 LIBRARY; T=0.K
Photon emission for (n,p)

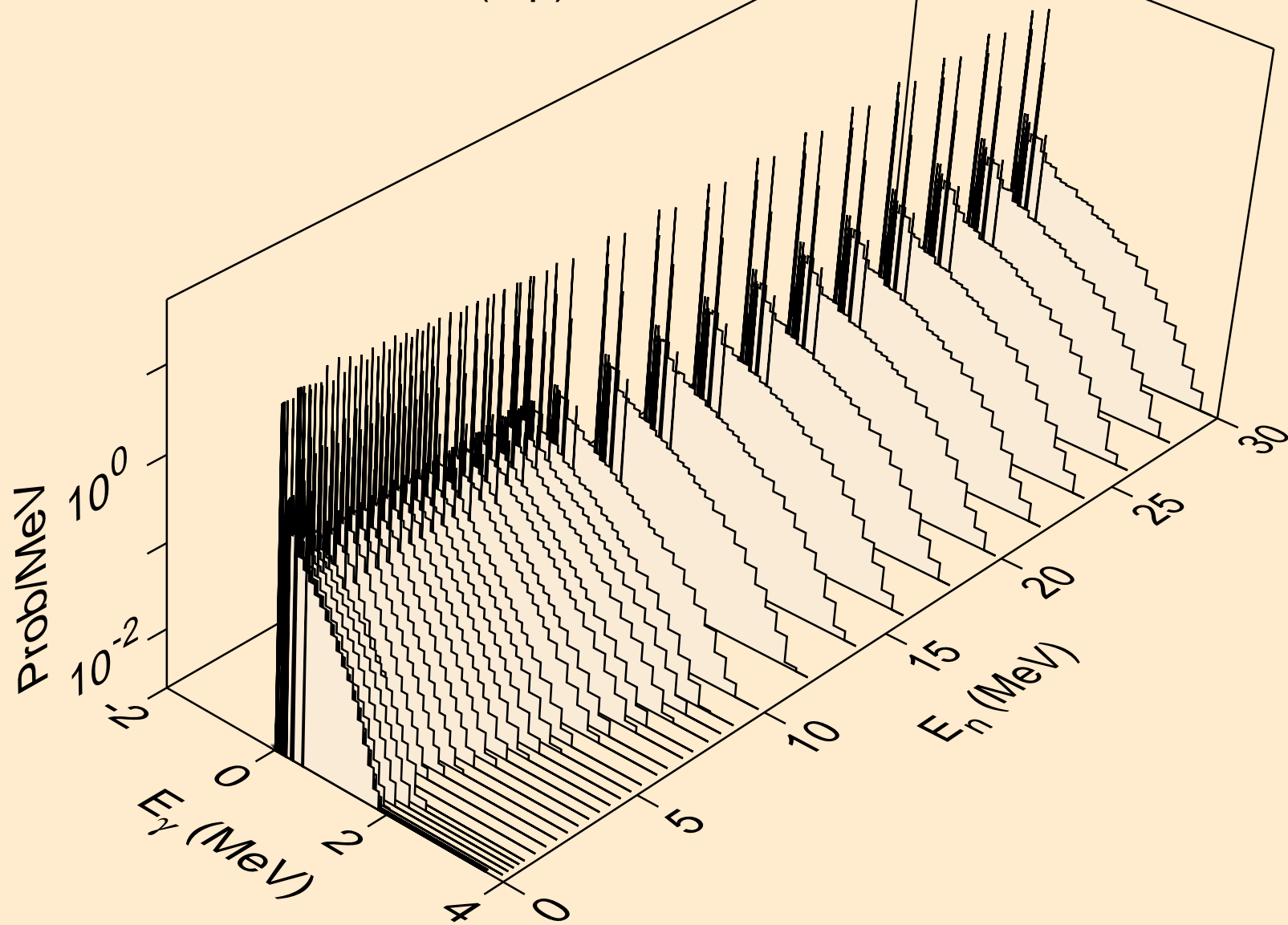

DB258 NEUTRON ACER TENDL-2023 LIBRARY; T=0.K
Photon emission for (n,d)

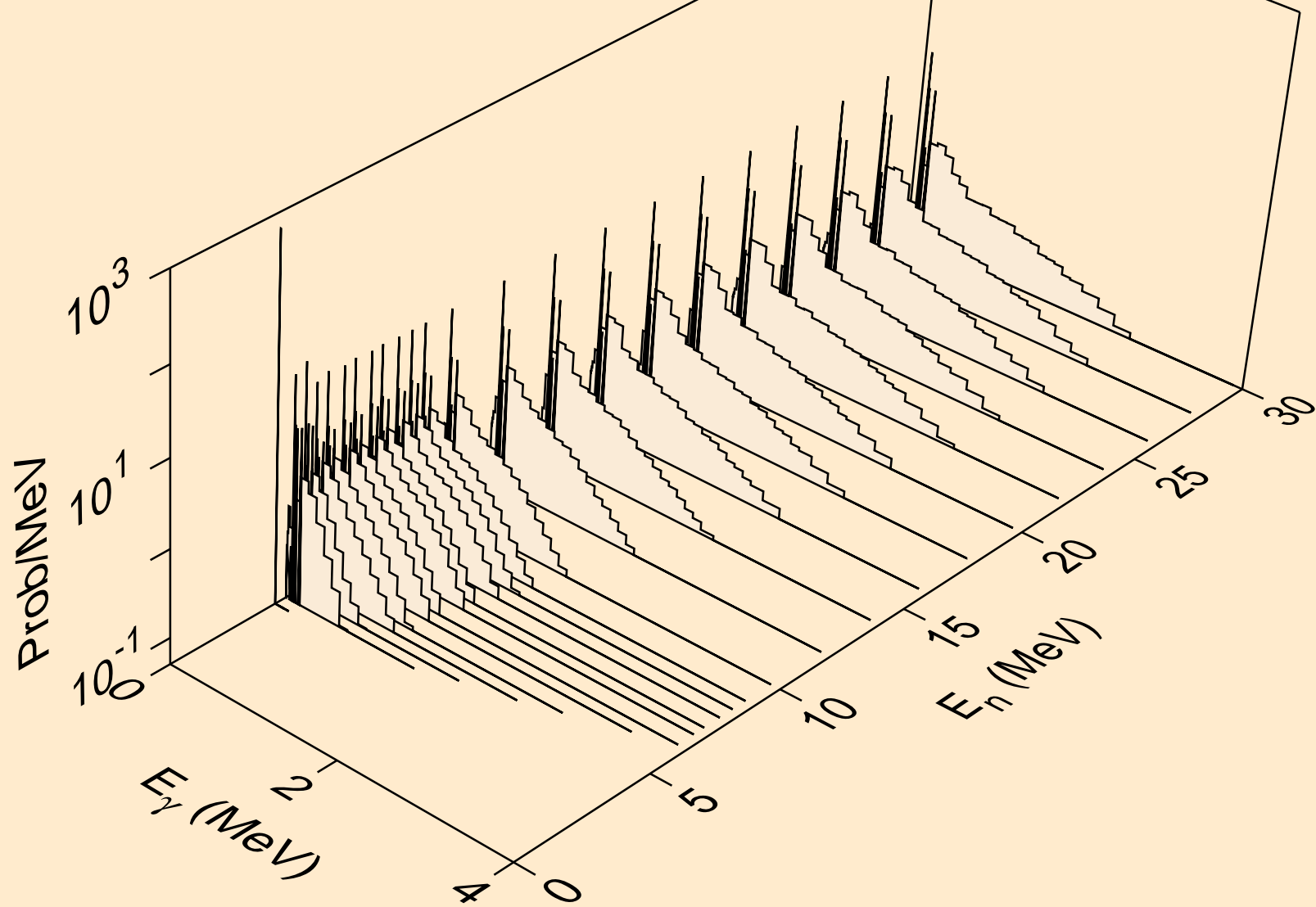

DB258 NEUTRON ACER TENDL-2023 LIBRARY; T=0.K
Photon emission for (n,t)

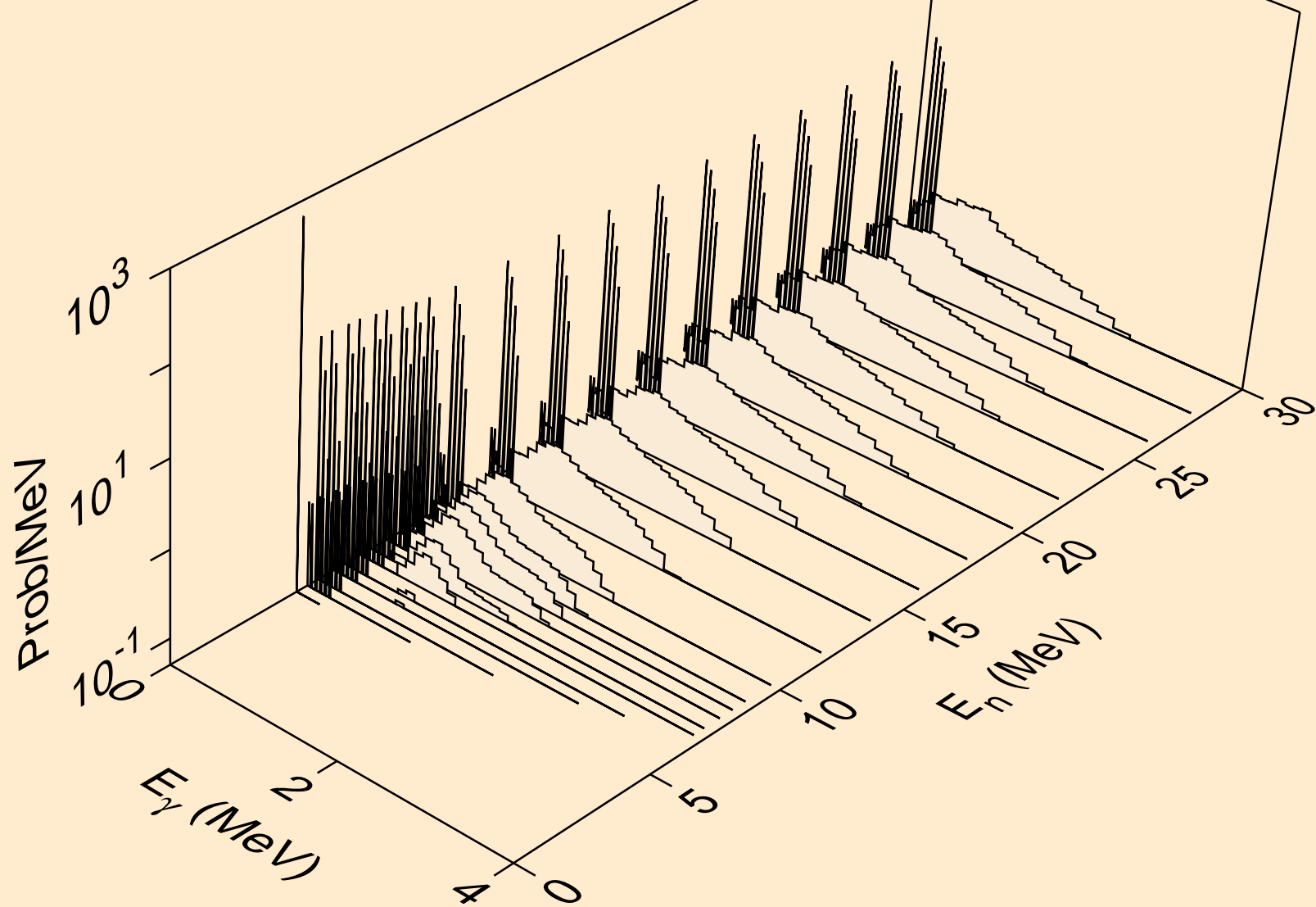

DB258 NEUTRON ACER TENDL-2023 LIBRARY; T=0.K
Photon emission for (n,he3)

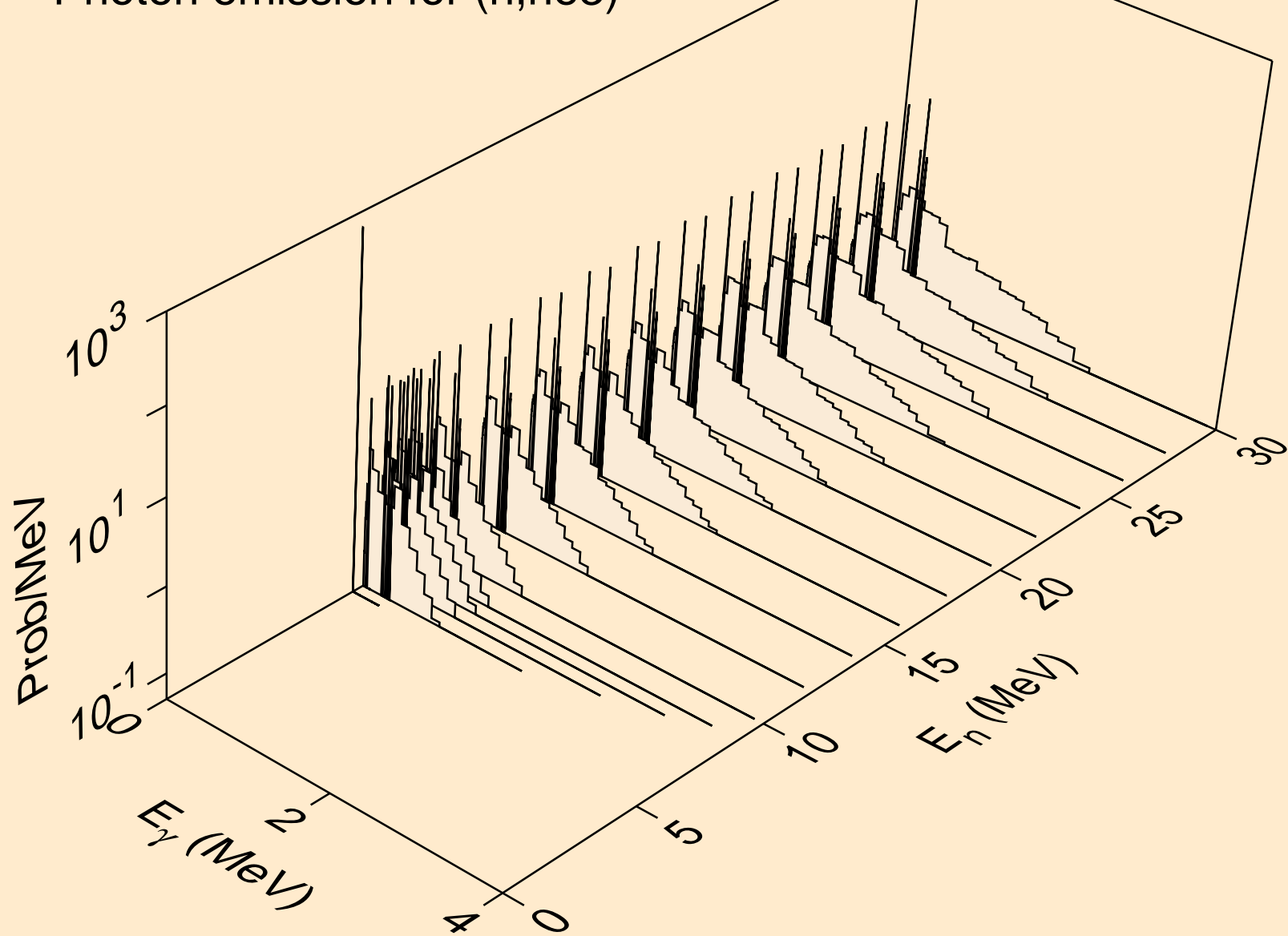

DB258 NEUTRON ACER TENDL-2023 LIBRARY; T=0.K
Photon emission for (n,a)

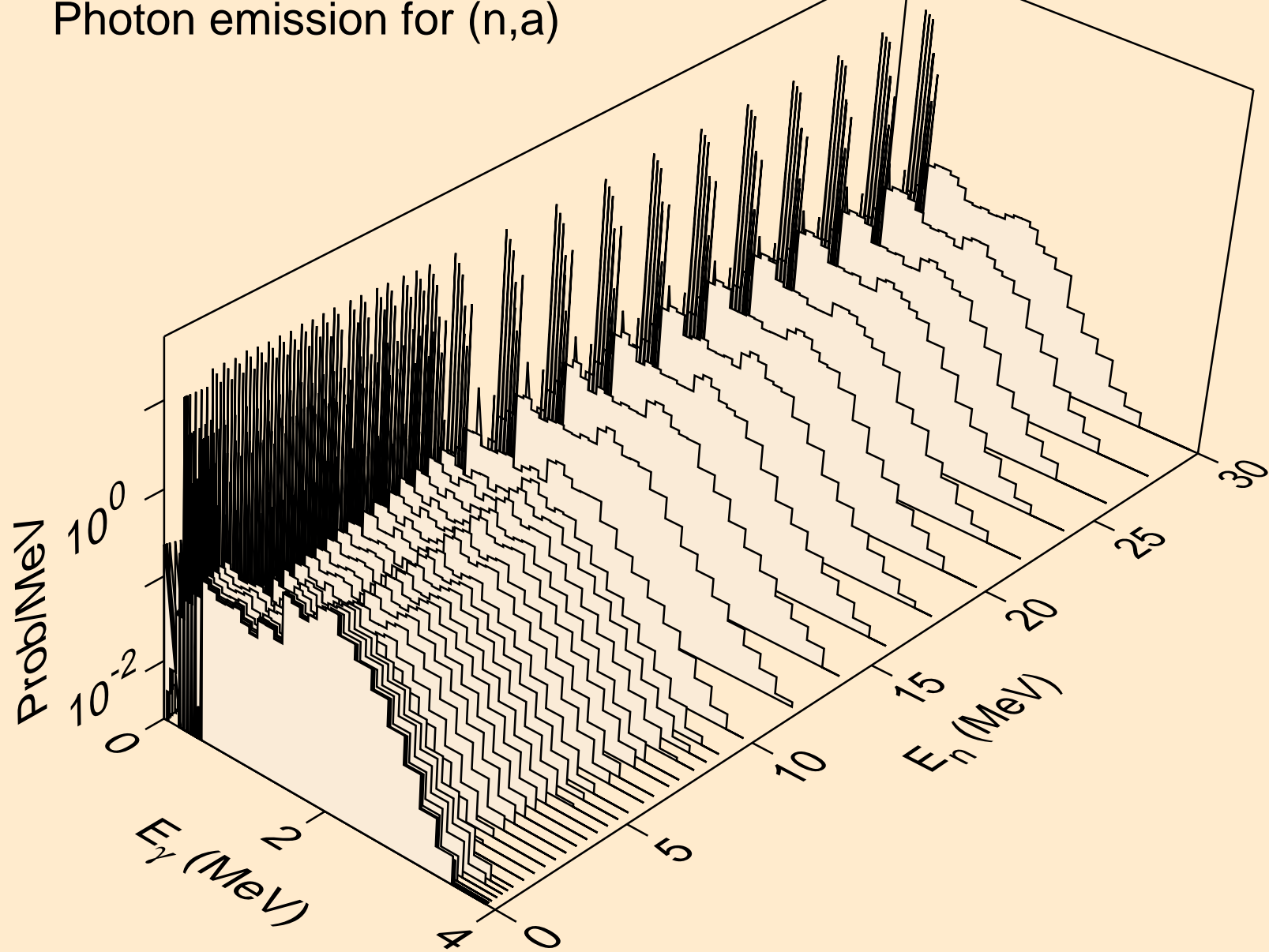

DB258 NEUTRON ACER TENDL-2023 LIBRARY; T=0.K
Photon emission for (n,2a)

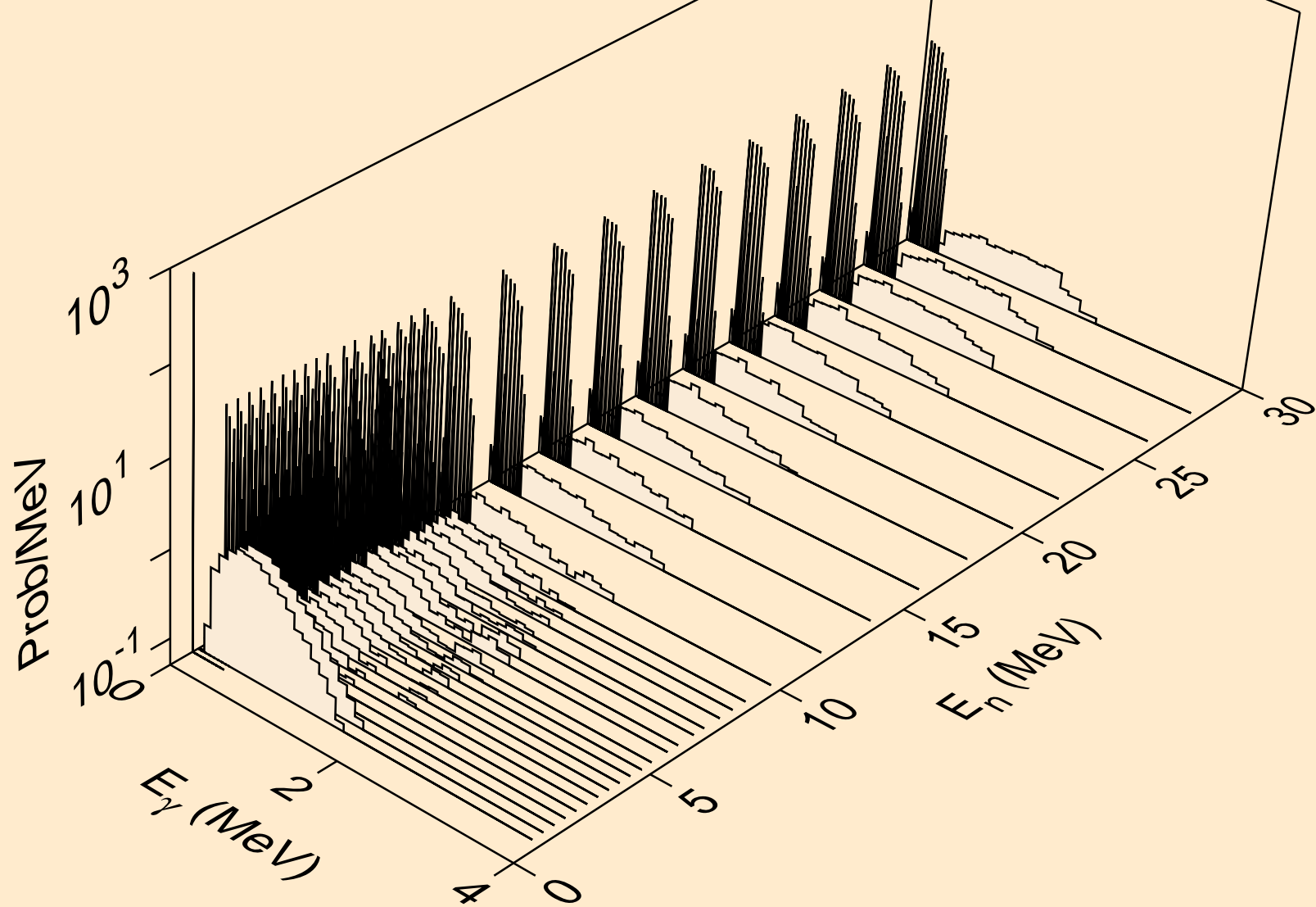

DB258 NEUTRON ACER TENDL-2023 LIBRARY; T=0.K
Photon emission for (n,2p)

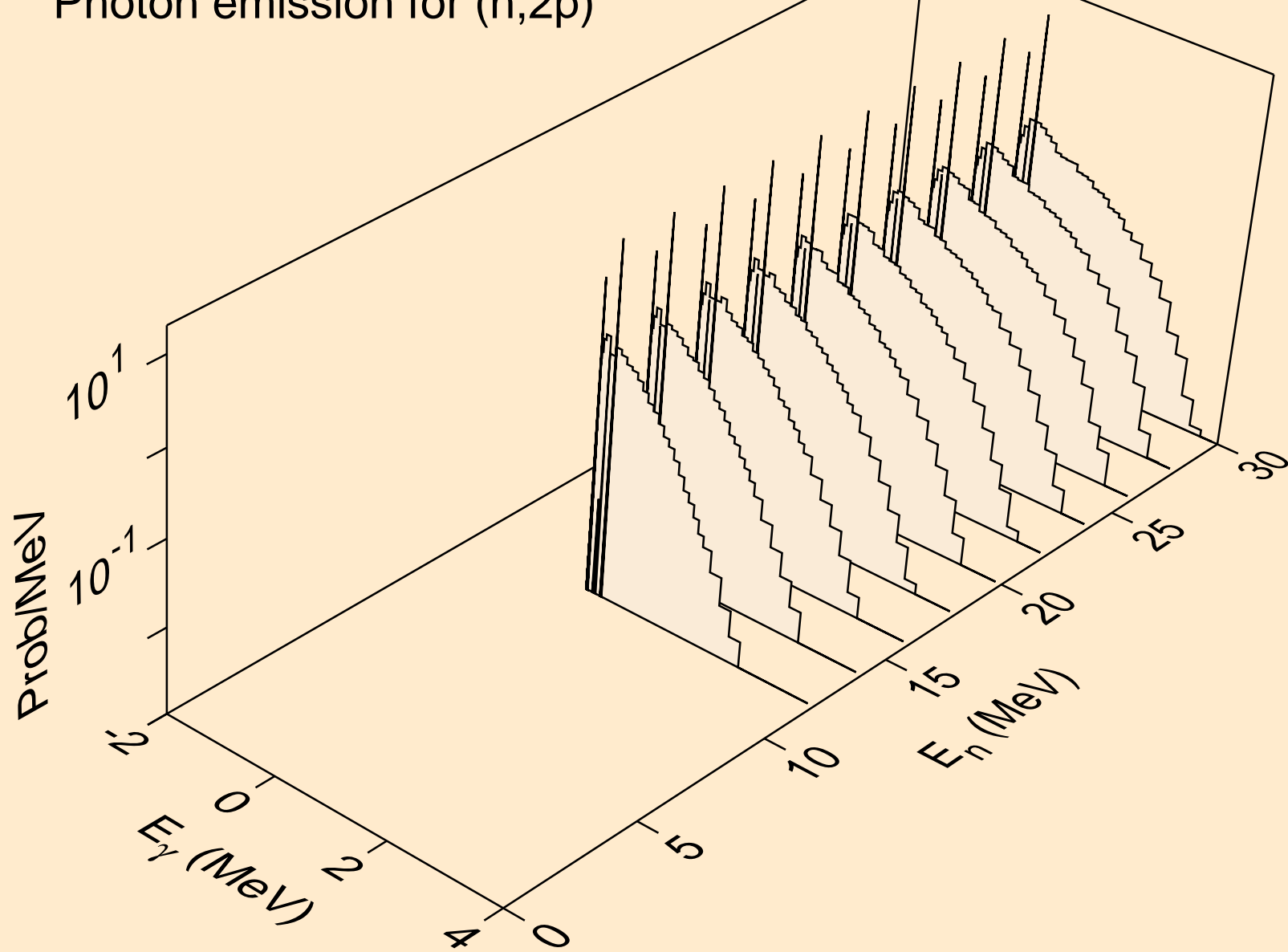

DB258 NEUTRON ACER TENDL-2023 LIBRARY; T=0.K
Photon emission for (n,p α)

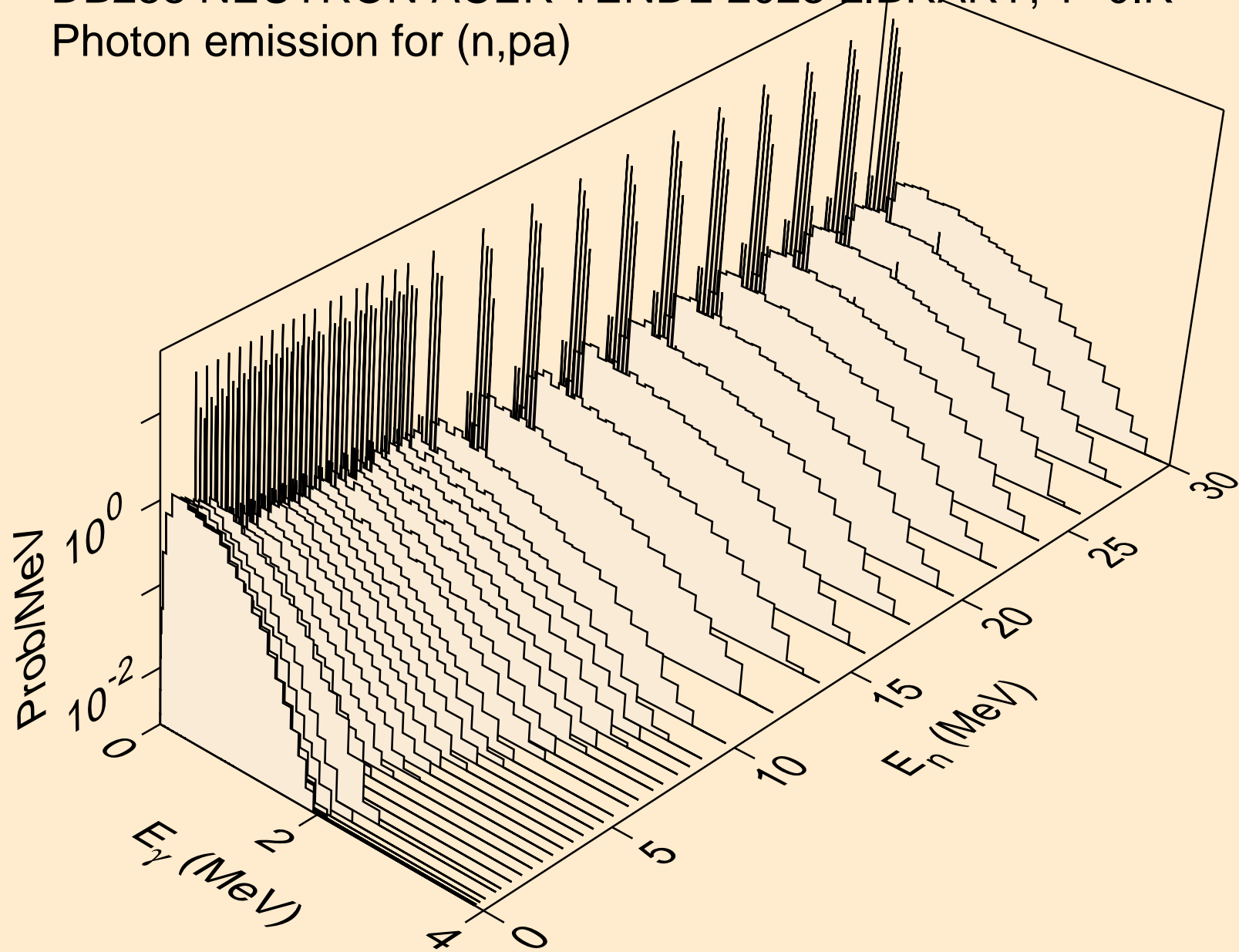

DB258 NEUTRON ACER TENDL-2023 LIBRARY; T=0.K
Photon emission for (n,pd)

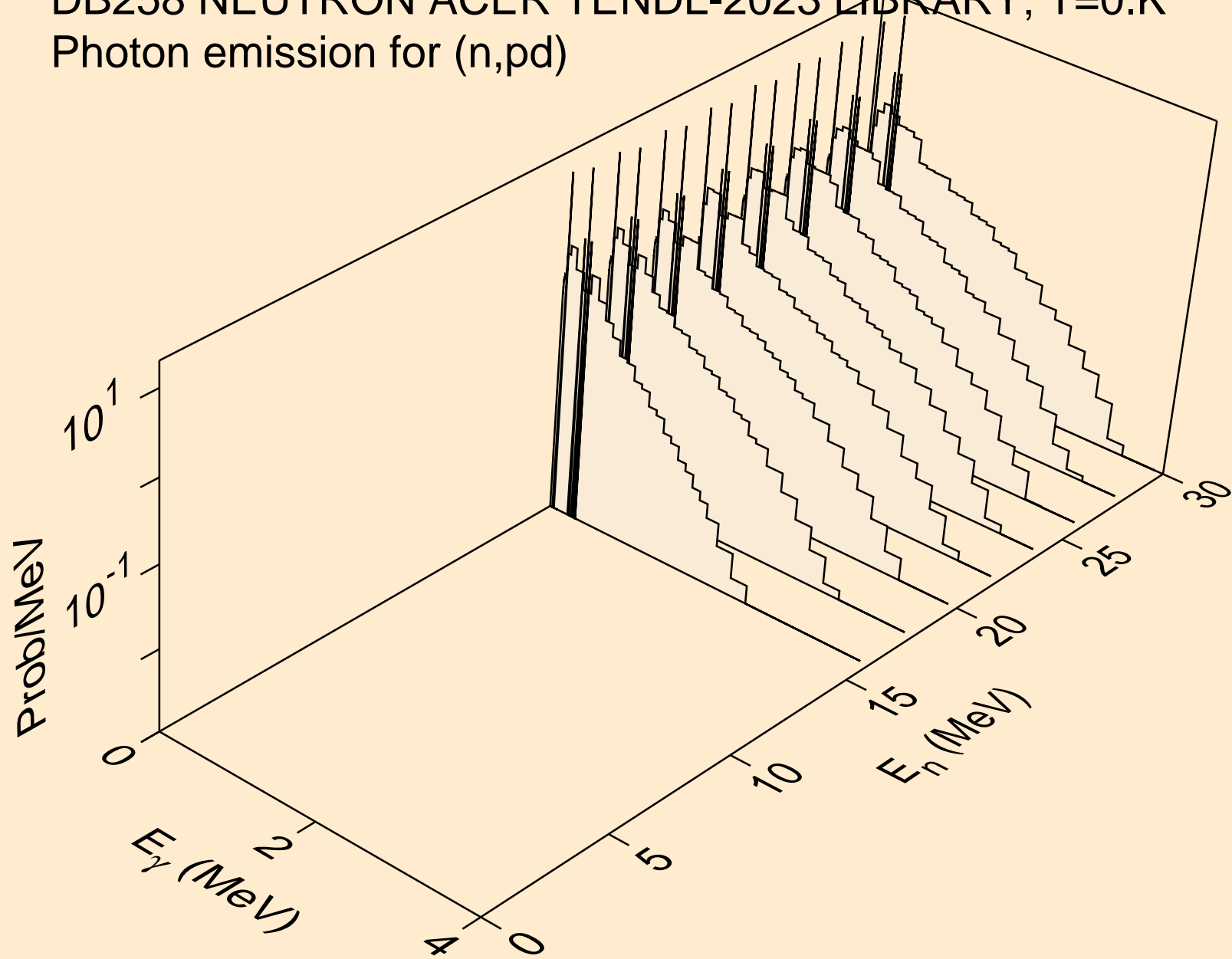

DB258 NEUTRON ACER TENDL-2023 LIBRARY; T=0.K
Photon emission for (n,da)

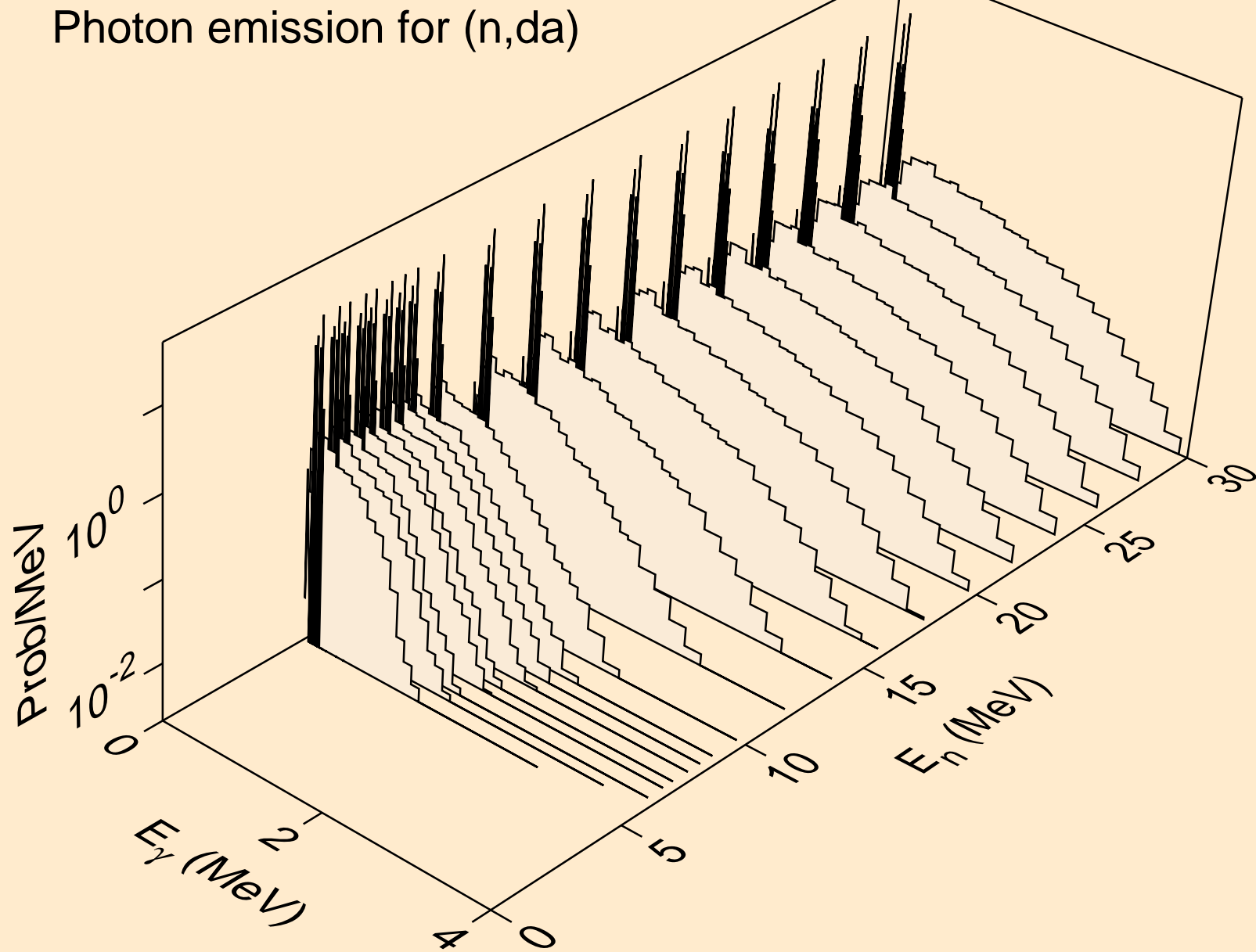

DB258 NEUTRON ACER TENDL-2023 LIBRARY; T=0.K
thermal capture photon spectrum

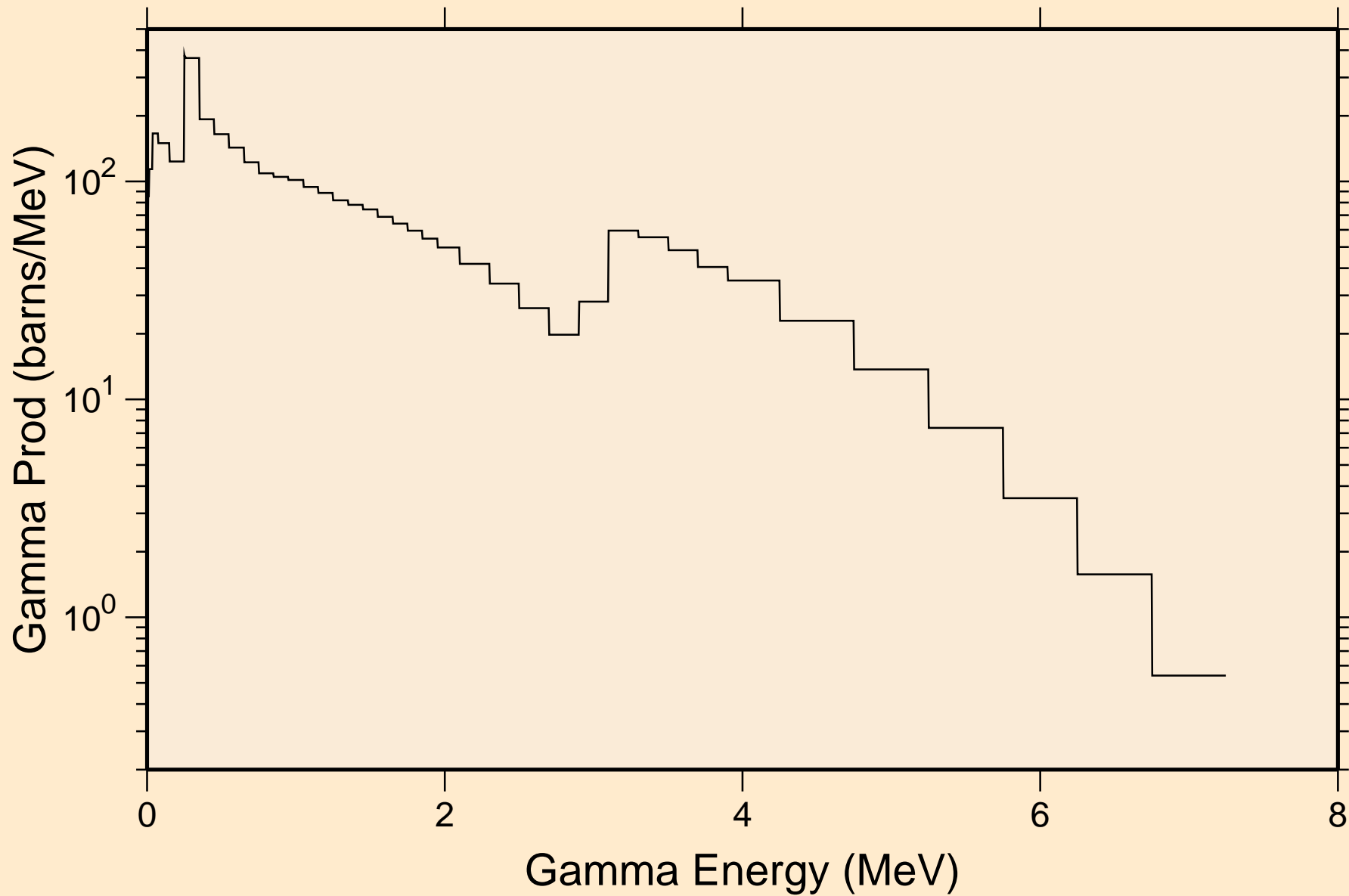

DB258 NEUTRON ACER TENDL-2023 LIBRARY; T=0.K
14 MeV photon spectrum

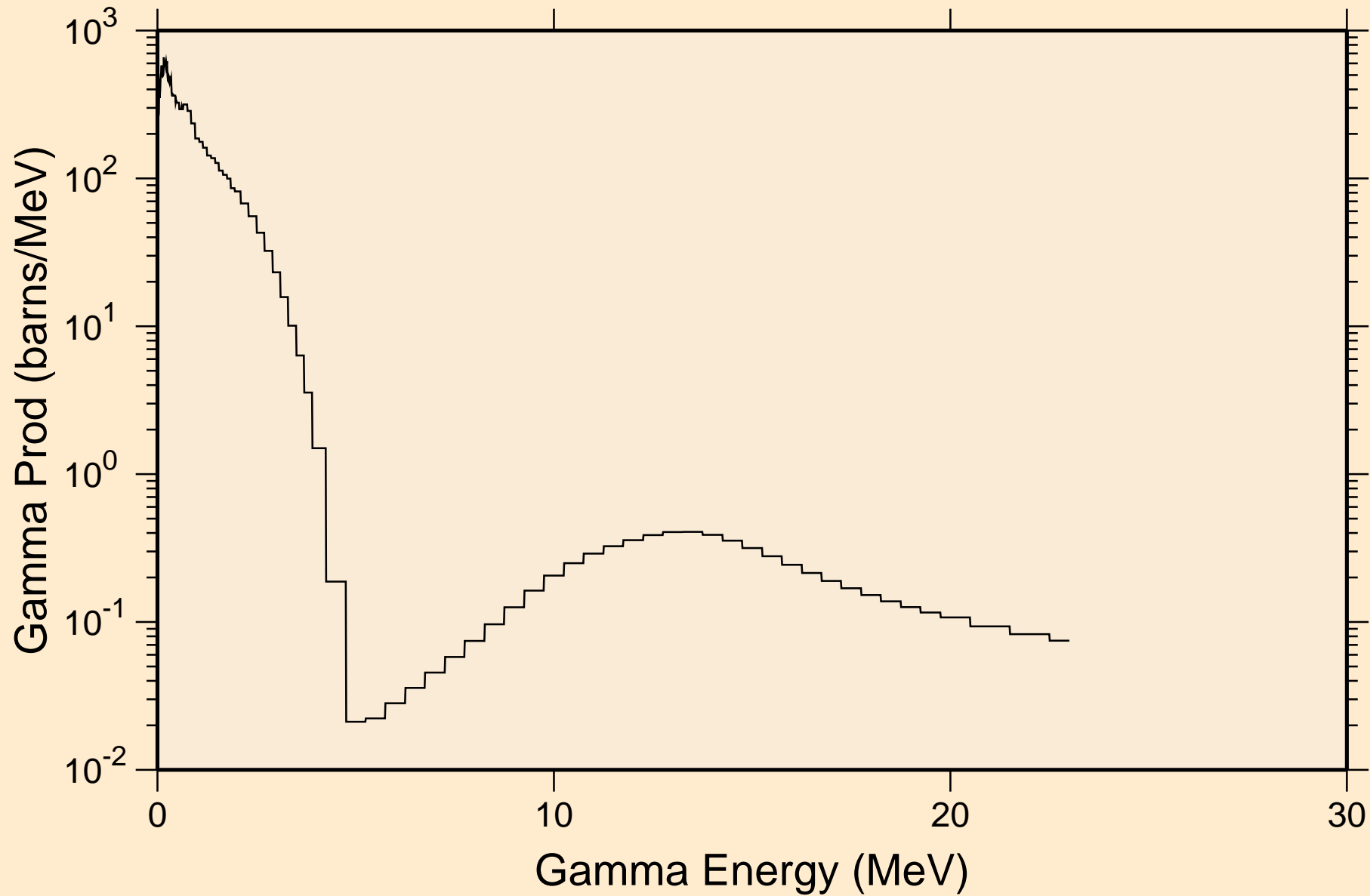

DB258 NEUTRON ACER TENDL-2023 LIBRARY; T=0.K

Particle heating contributions

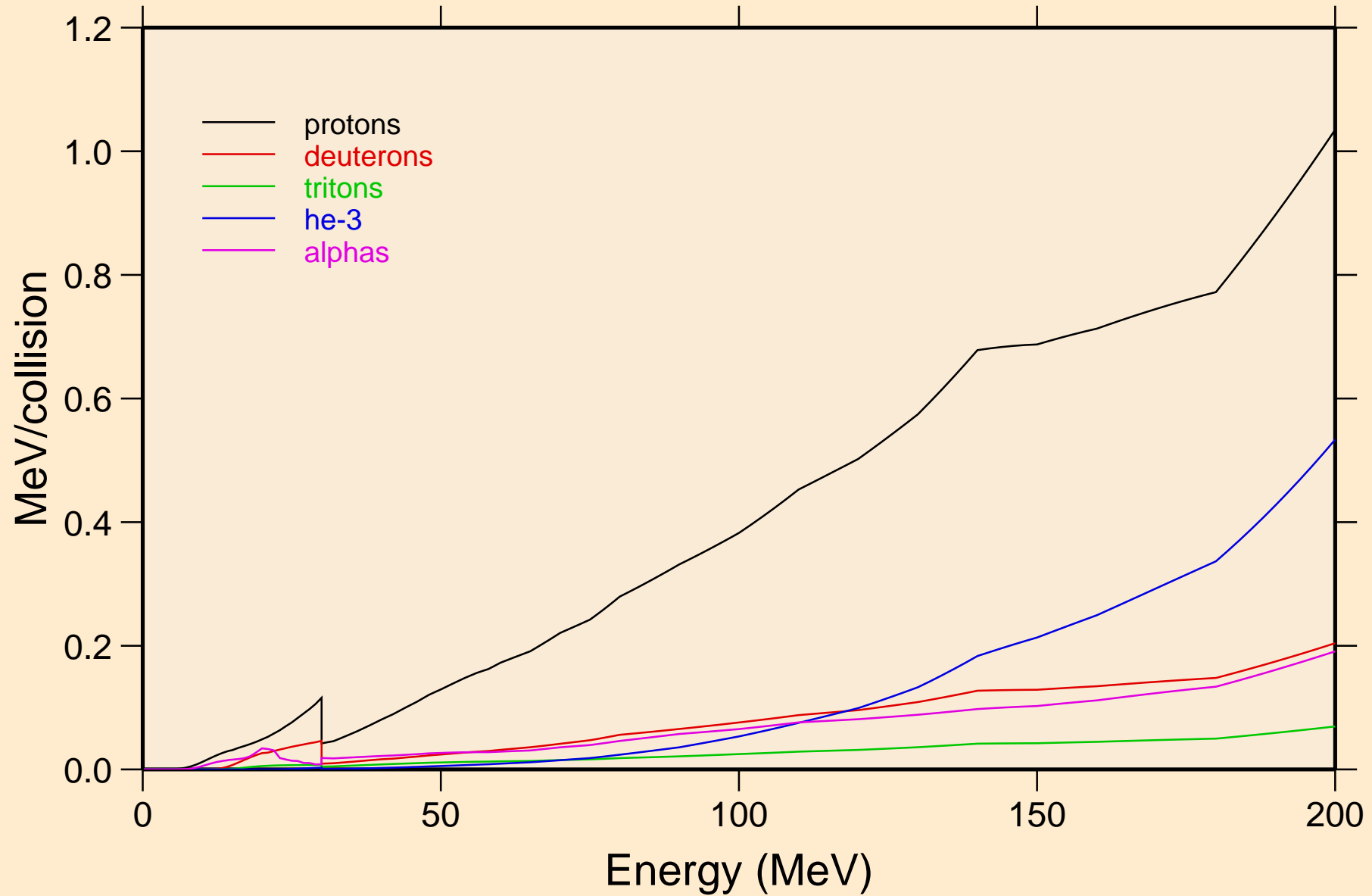

DB258 NEUTRON ACER TENDL-2023 LIBRARY; T=0.K
Recoil Heating

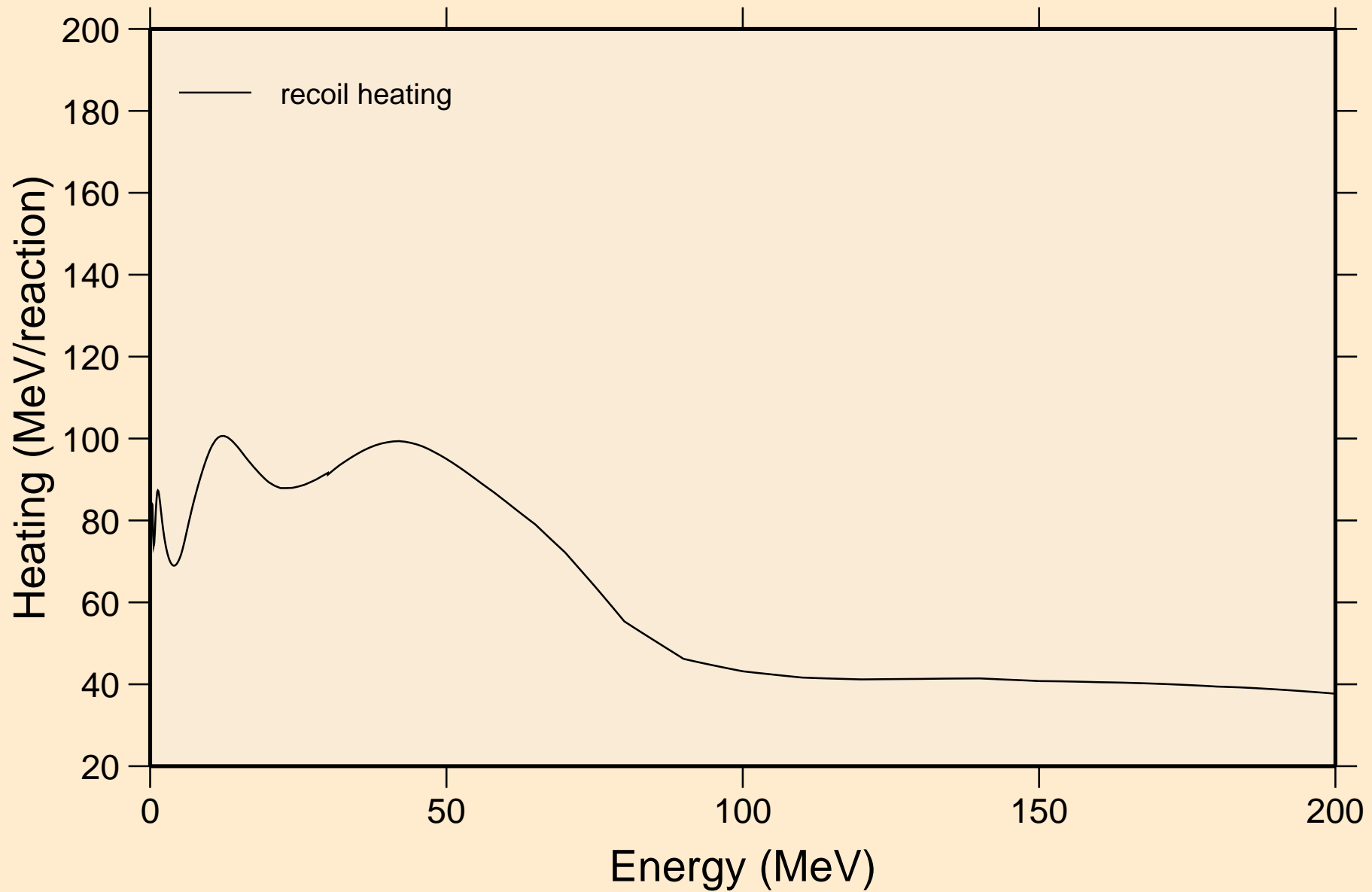

DB258 NEUTRON ACER TENDL-2023 LIBRARY; T=0.K

Particle production cross sections

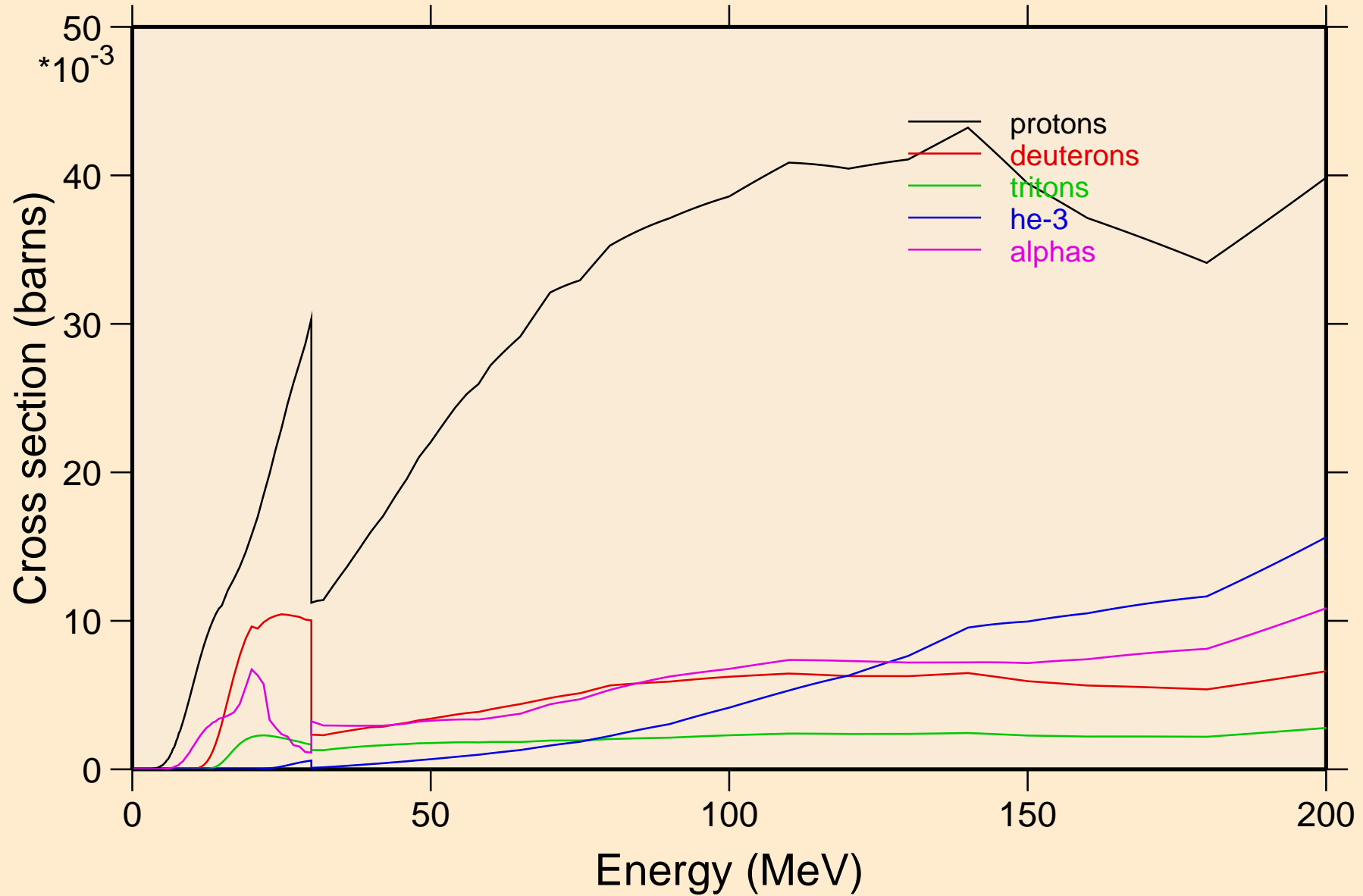

DB258 NEUTRON ACER TENDL-2023 LIBRARY; T=0.K
protons from (n,x)

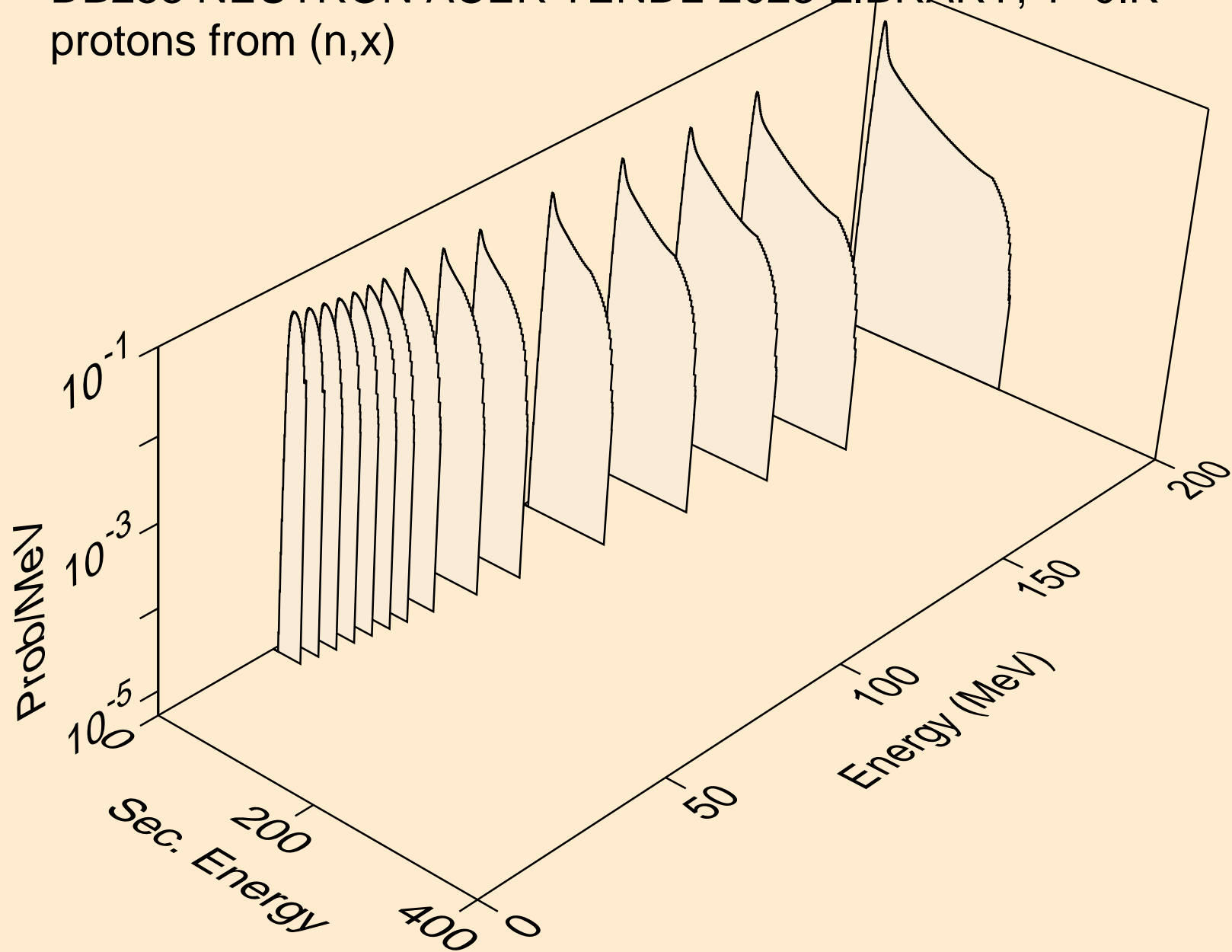

DB258 NEUTRON ACER TENDL-2023 LIBRARY; T=0.K
protons from (n,n*)p

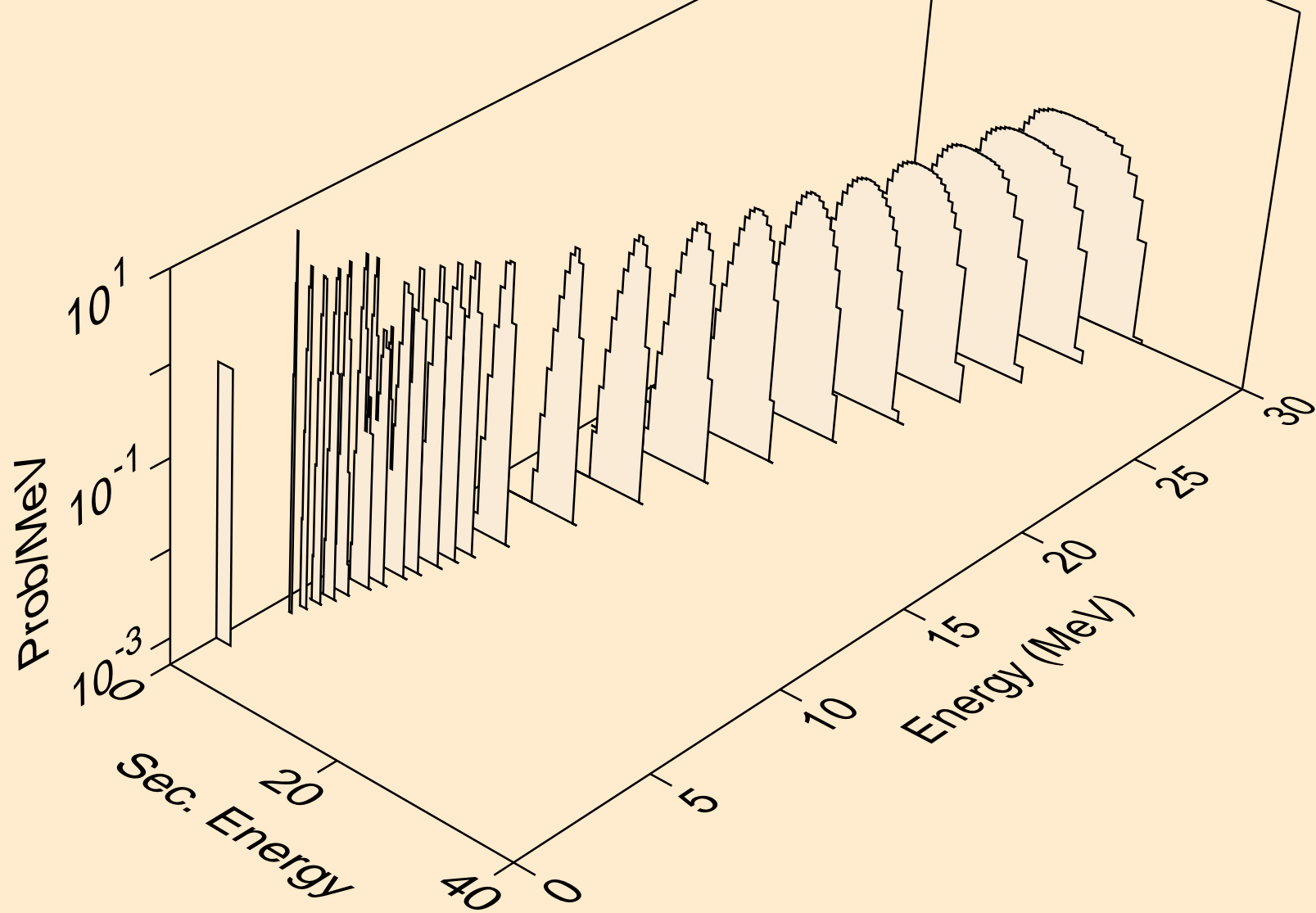

DB258 NEUTRON ACER TENDL-2023 LIBRARY; T=0.K
protons from (n,2np)

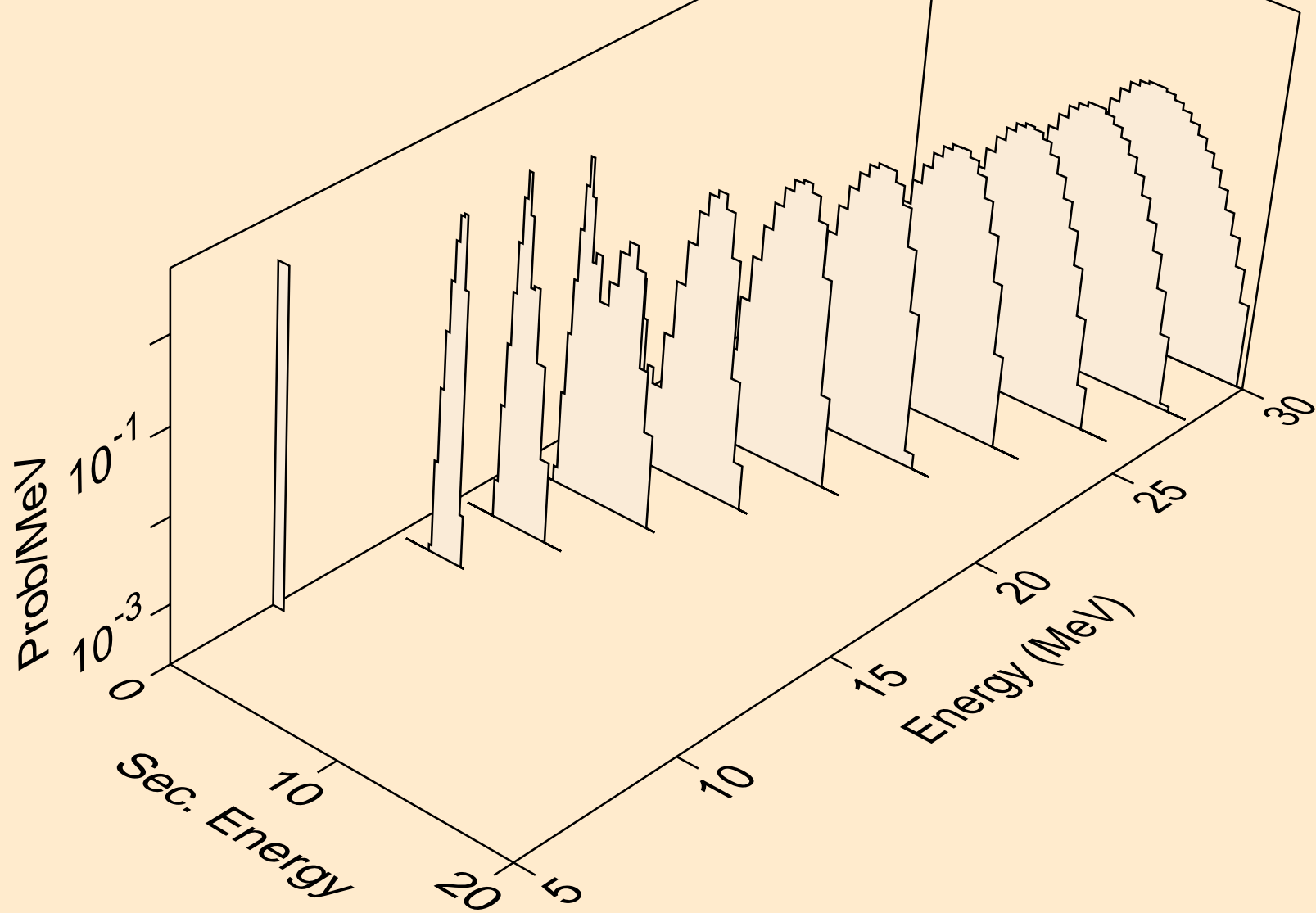

DB258 NEUTRON ACER TENDL-2023 LIBRARY; T=0.K
protons from (n,n2p)

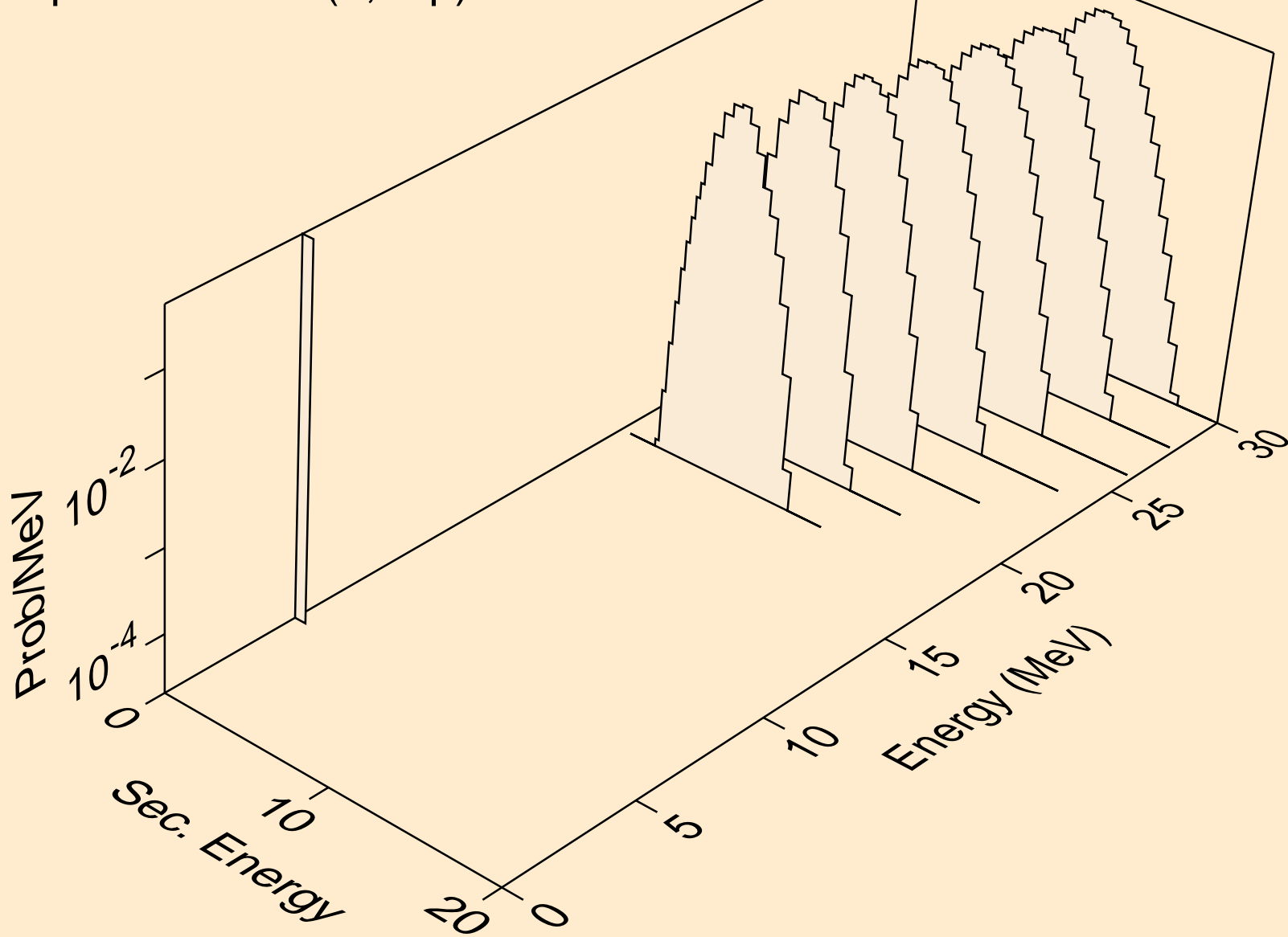

DB258 NEUTRON ACER TENDL-2023 LIBRARY; T=0.K
protons from (n,npa)

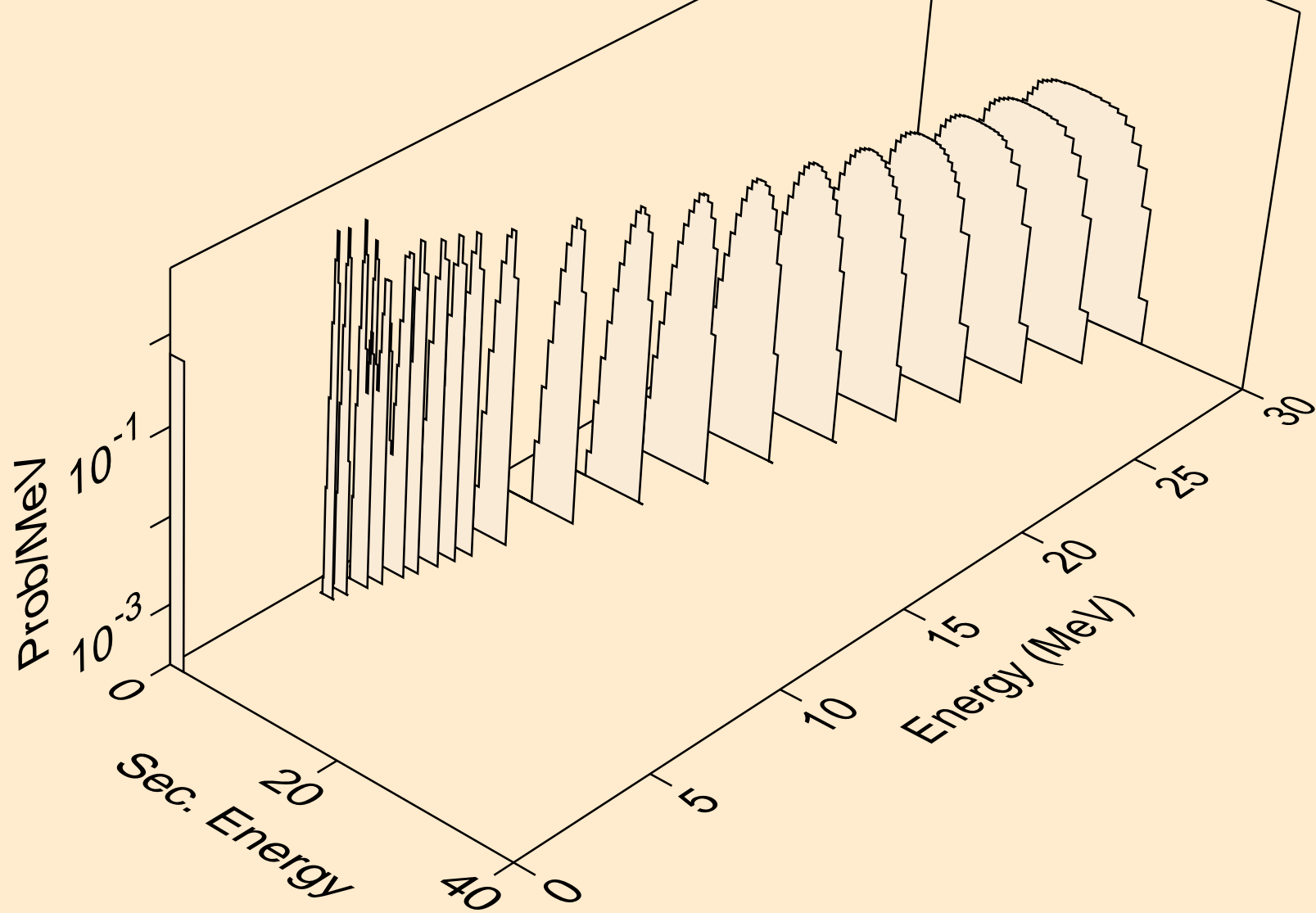

DB258 NEUTRON ACER TENDL-2023 LIBRARY; T=0.K
protons from (n,p)

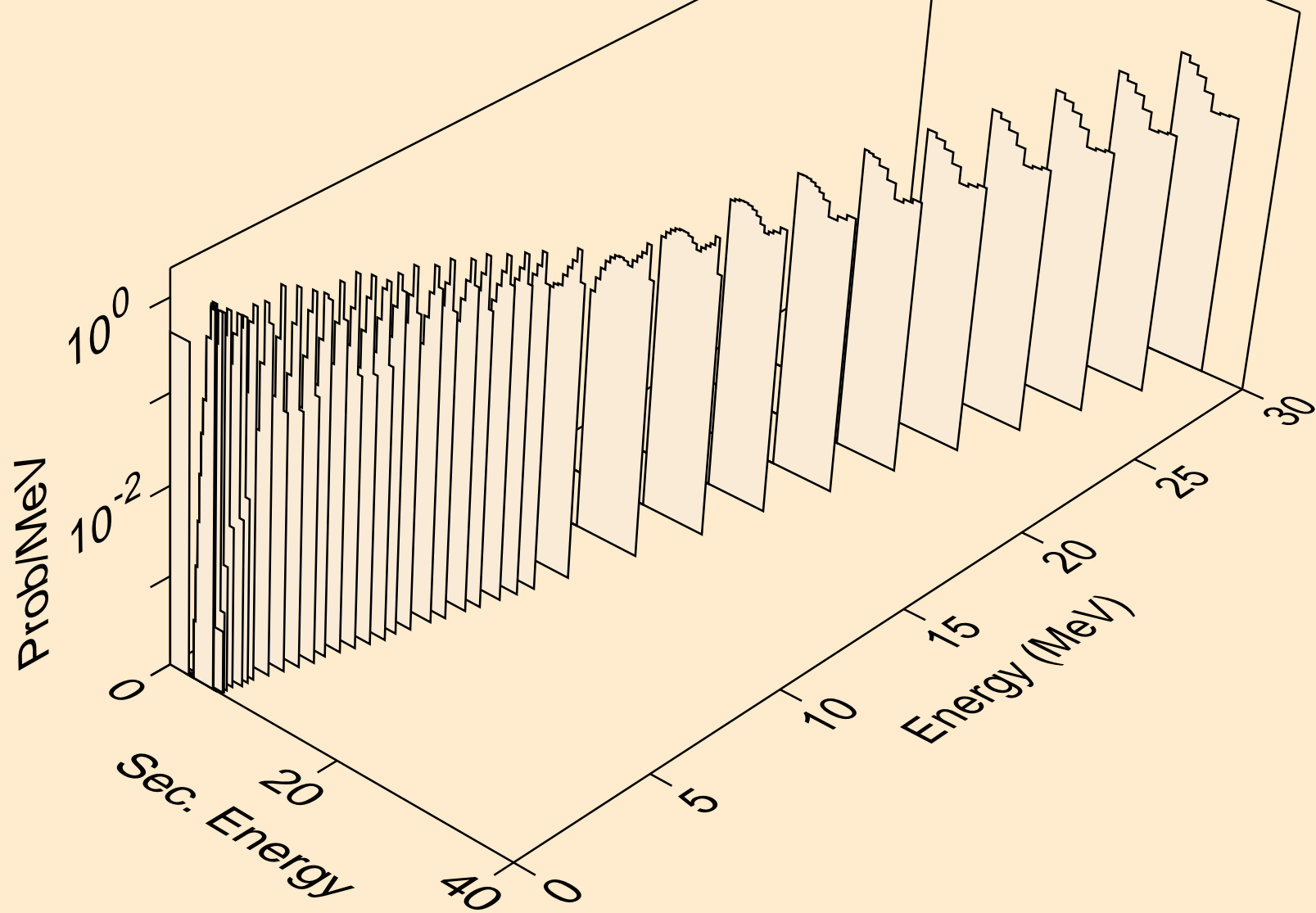

DB258 NEUTRON ACER TENDL-2023 LIBRARY; T=0.K
protons from (n,2p)

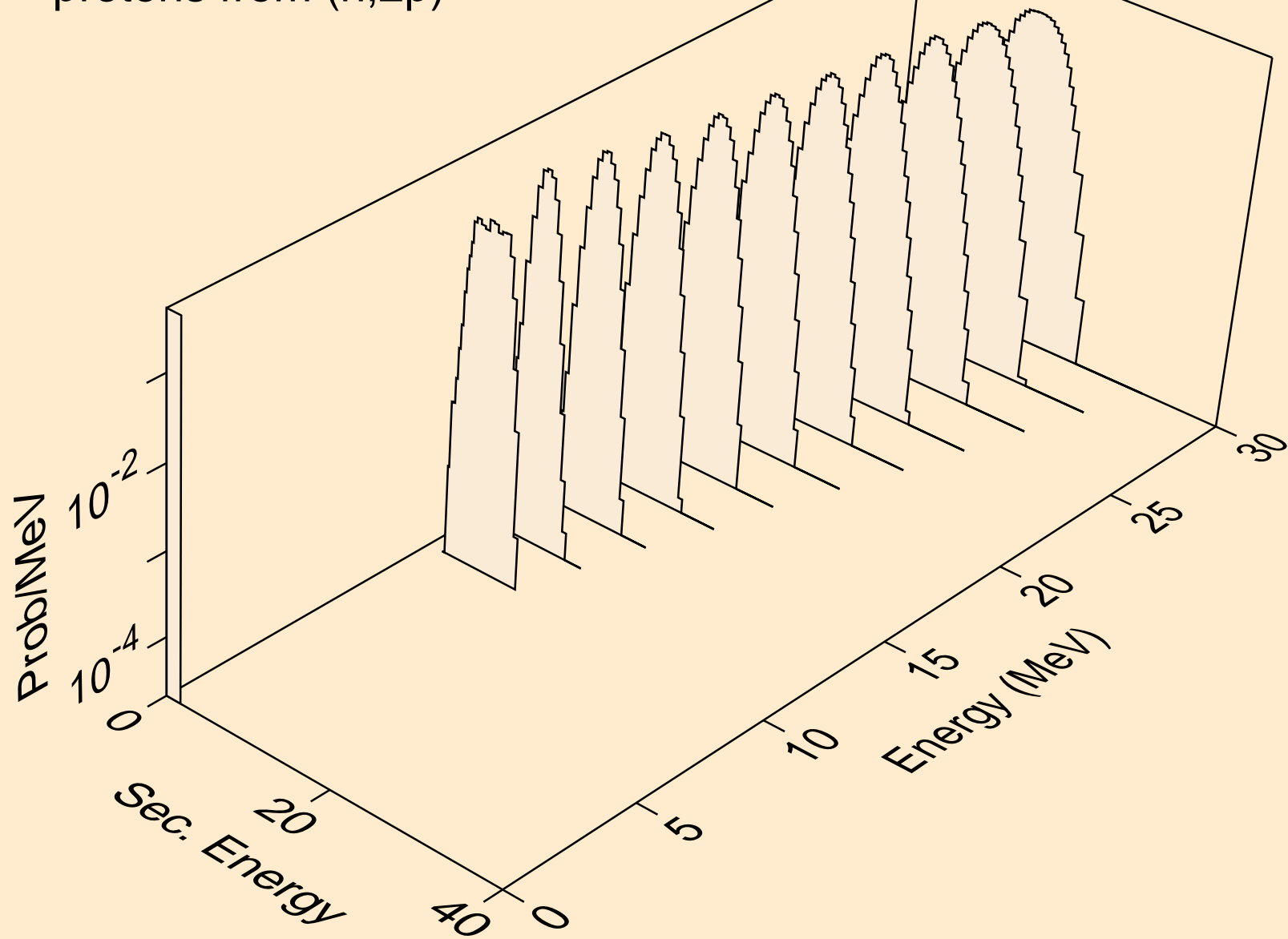

DB258 NEUTRON ACER TENDL-2023 LIBRARY; T=0.K
protons from (n,p)

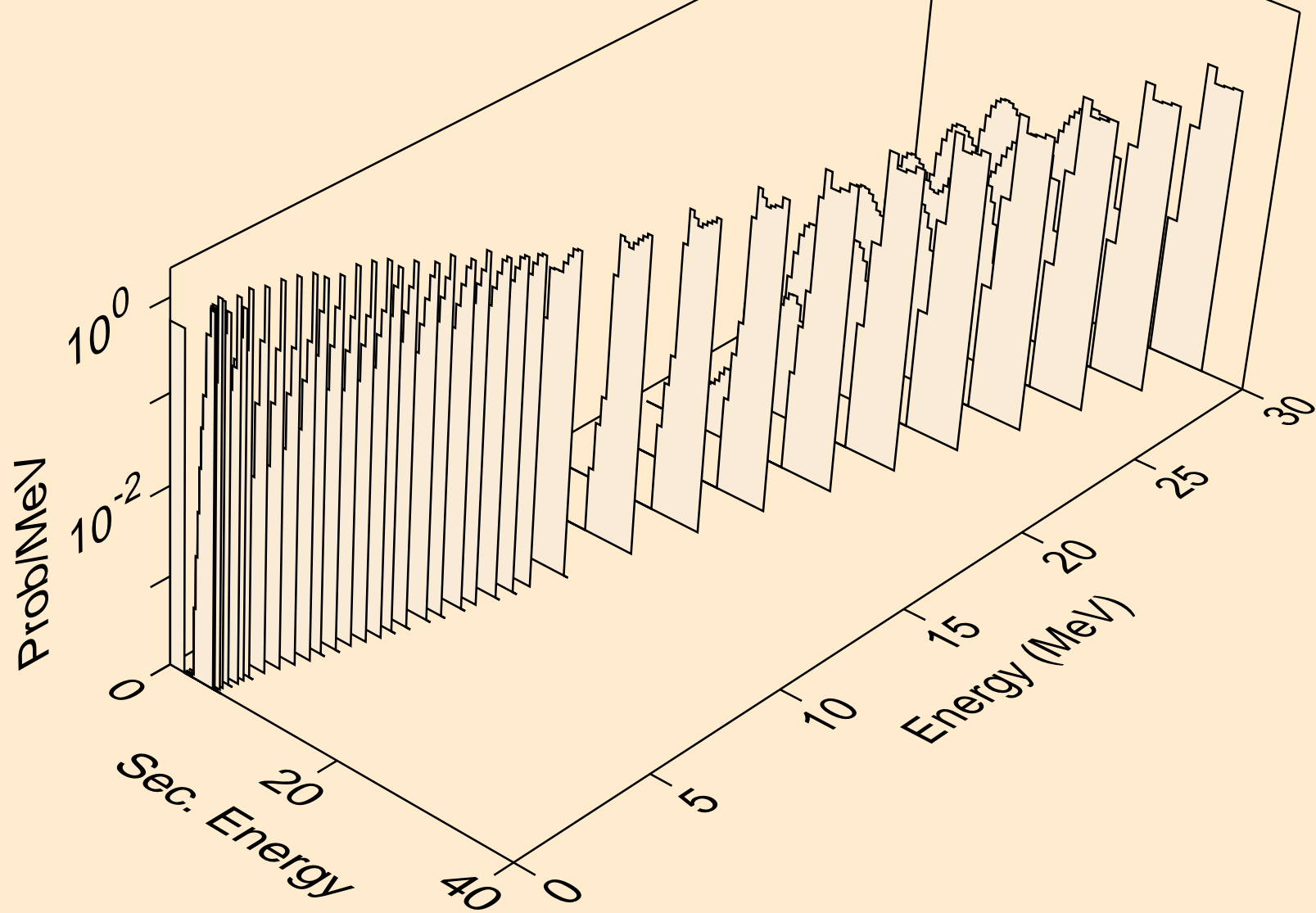

DB258 NEUTRON ACER TENDL-2023 LIBRARY; T=0.K
protons from (n,pd)

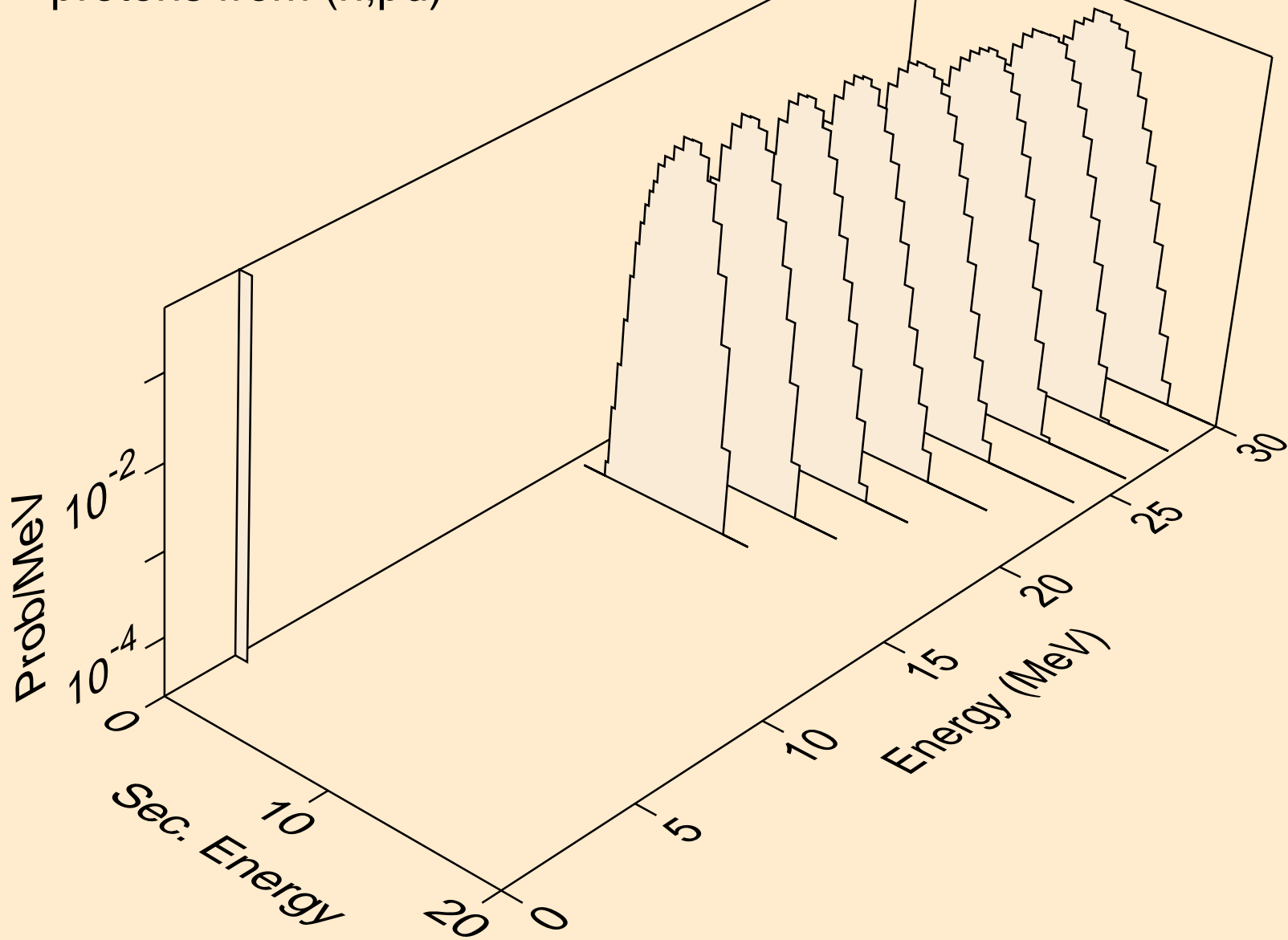

DB258 NEUTRON ACER TENDL-2023 LIBRARY; T=0.K
deuterons from (n,x)

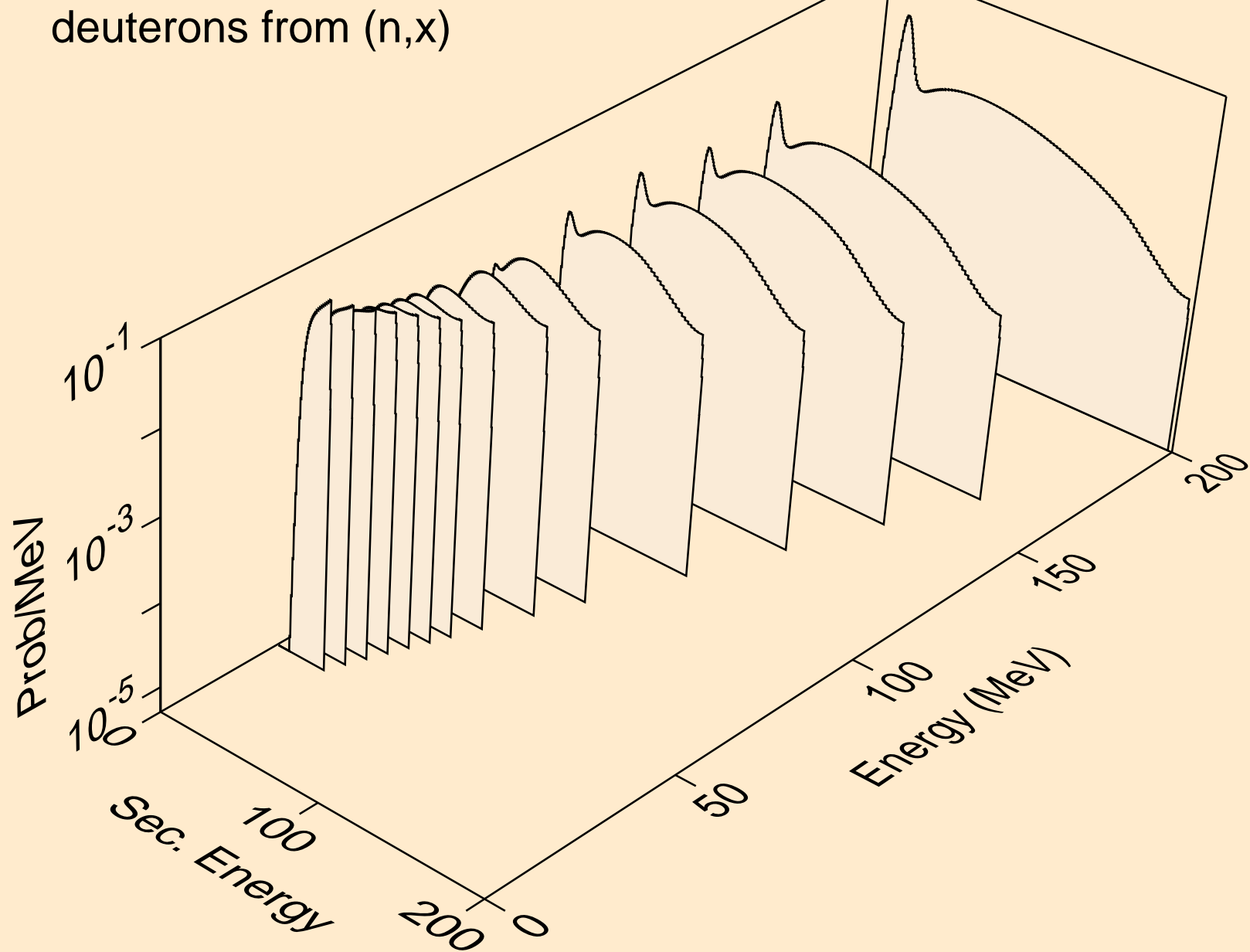

DB258 NEUTRON ACER TENDL-2023 LIBRARY; T=0.K
deuterons from (n,n*)d

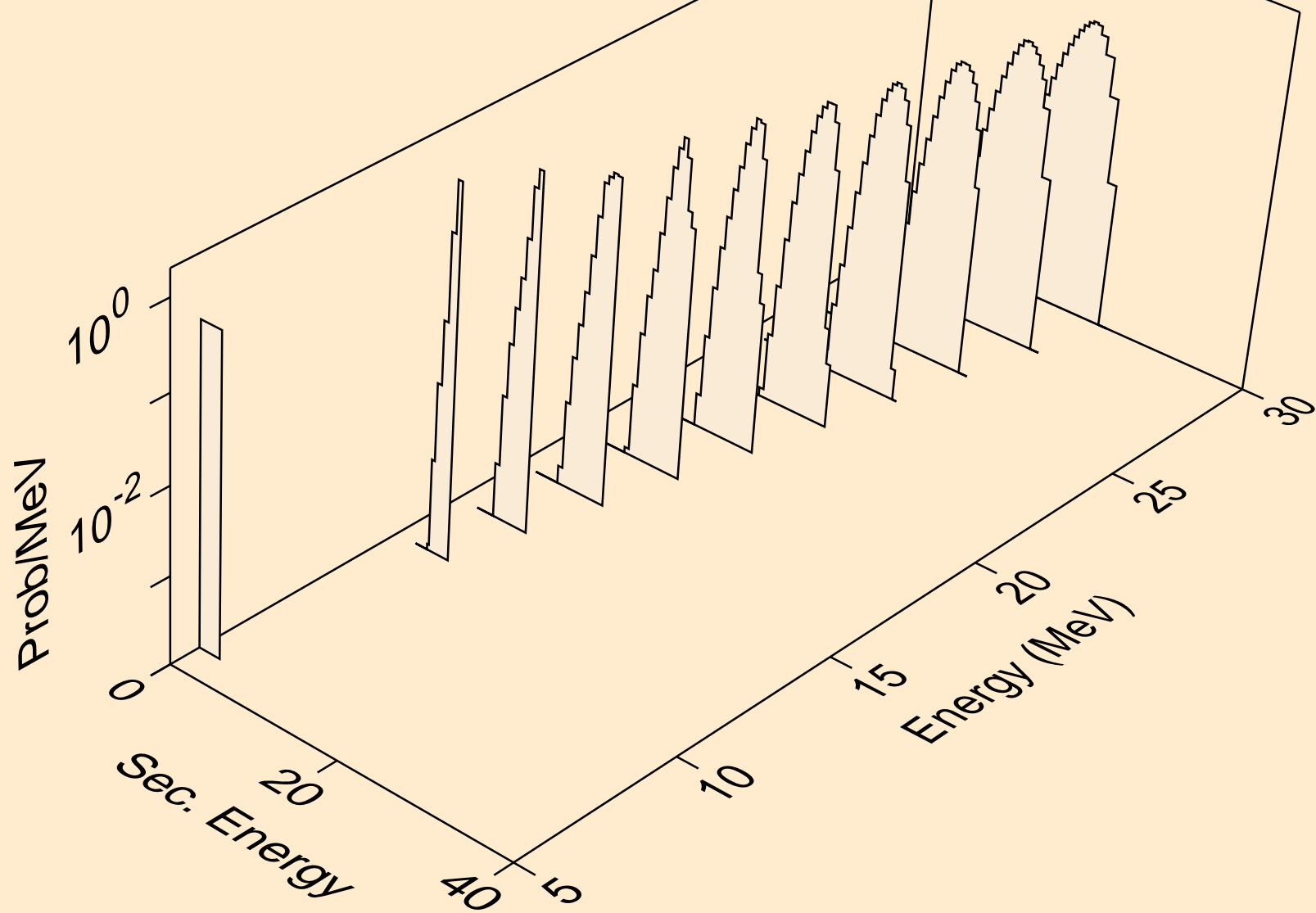

DB258 NEUTRON ACER TENDL-2023 LIBRARY; T=0.K
deuterons from (n,d)

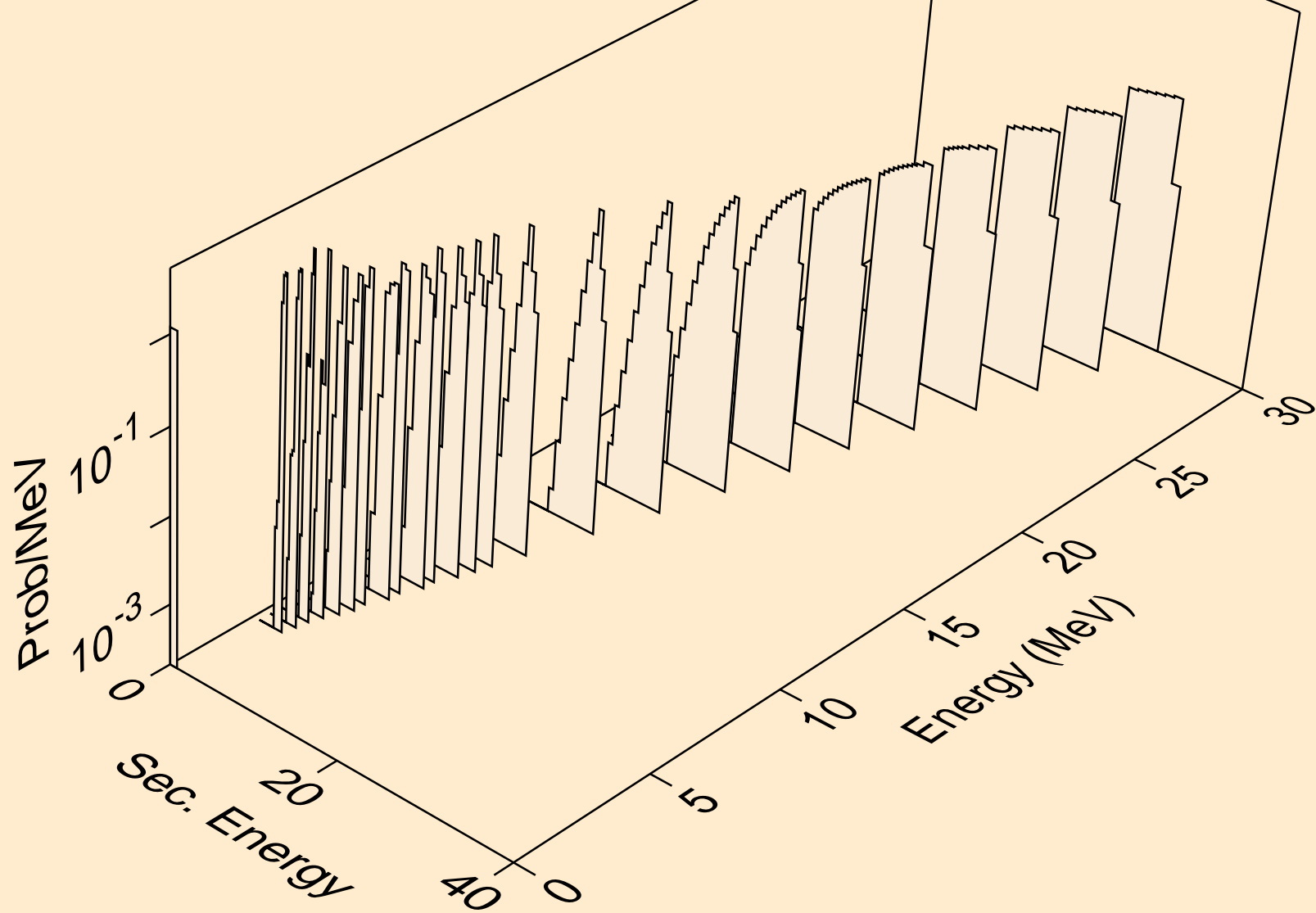

DB258 NEUTRON ACER TENDL-2023 LIBRARY; T=0.K
deuterons from (n,pd)

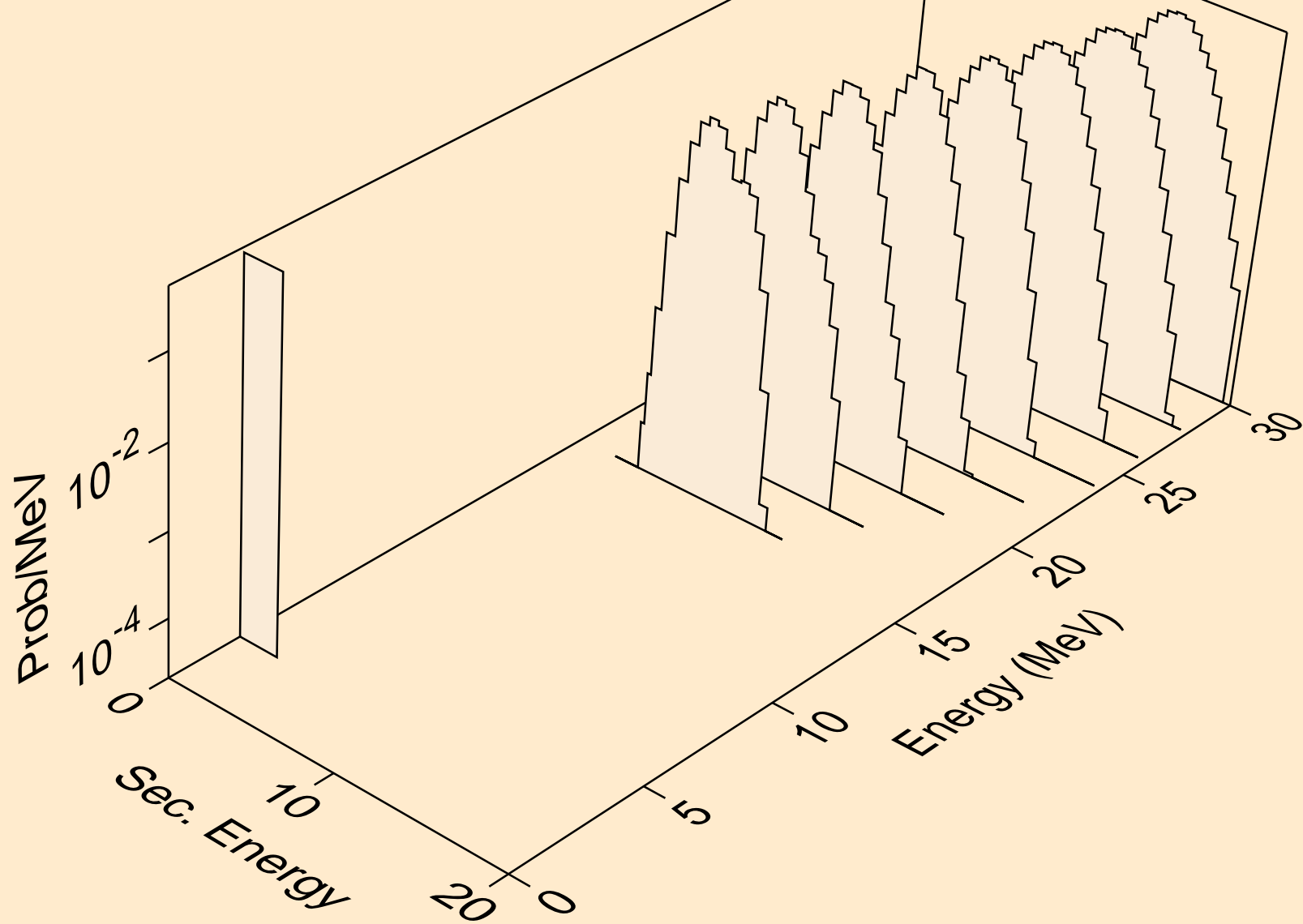

DB258 NEUTRON ACER TENDL-2023 LIBRARY; T=0.K
deuterons from (n,da)

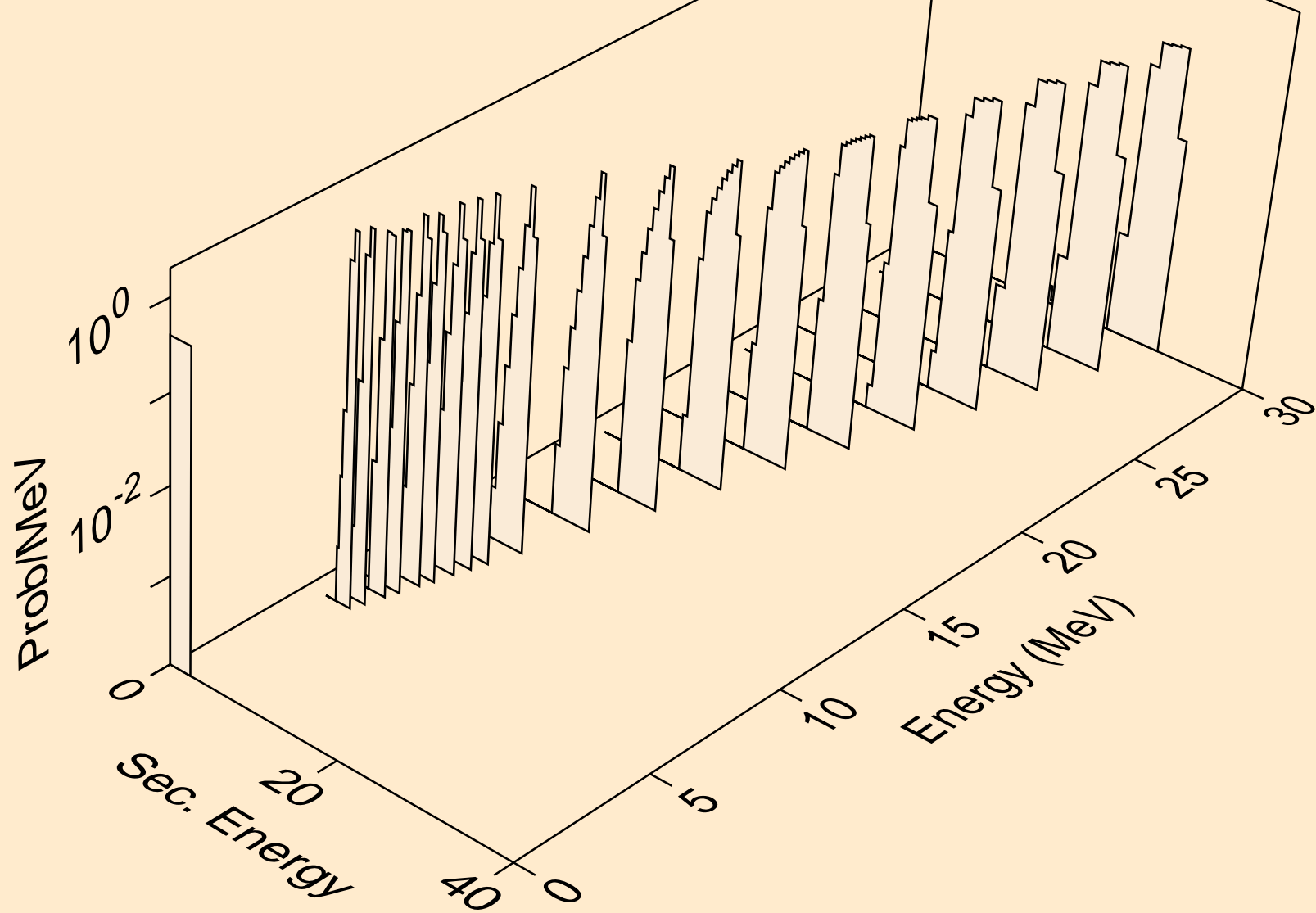

DB258 NEUTRON ACER TENDL-2023 LIBRARY; T=0.K
tritons from (n,x)

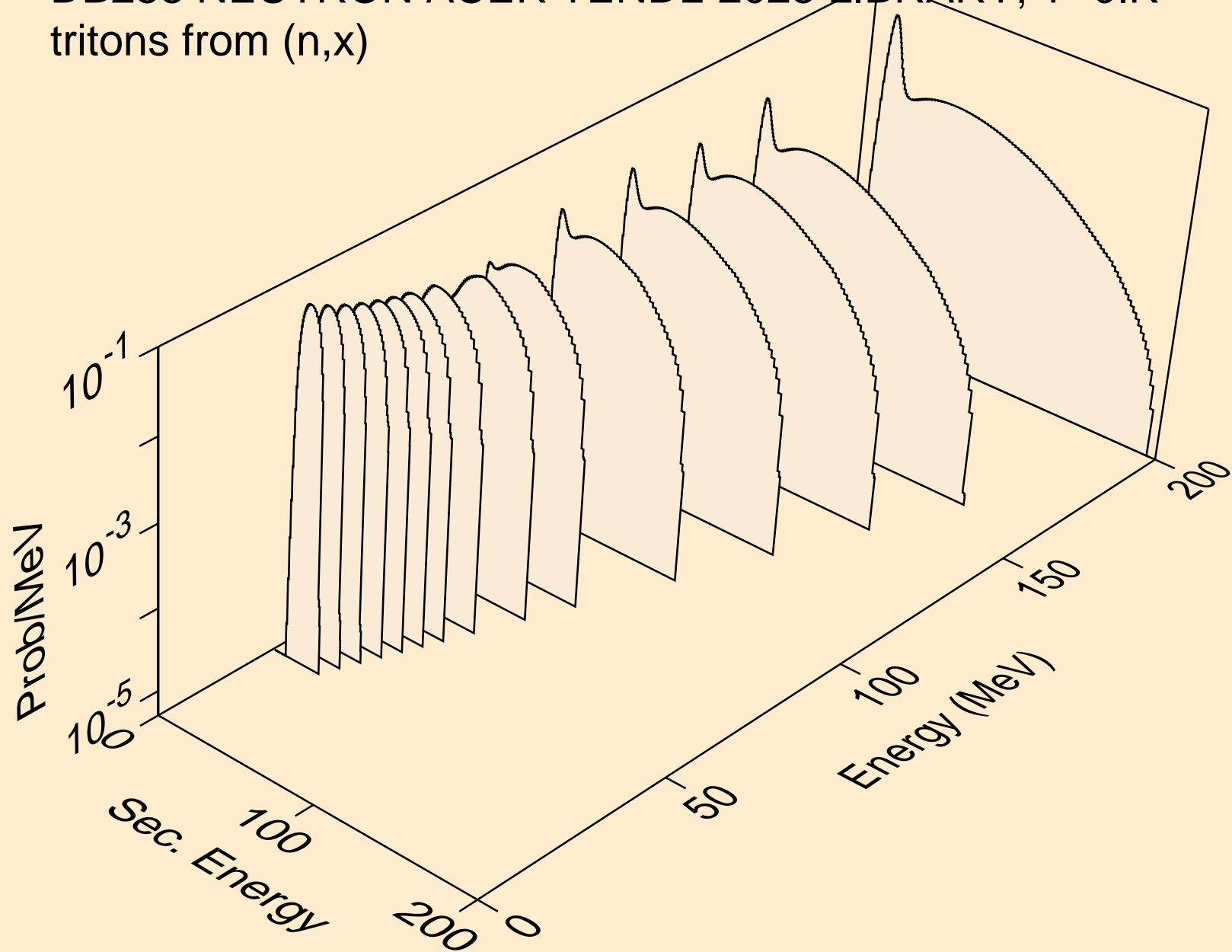

DB258 NEUTRON ACER TENDL-2023 LIBRARY; T=0.K
tritons from (n,n*)t

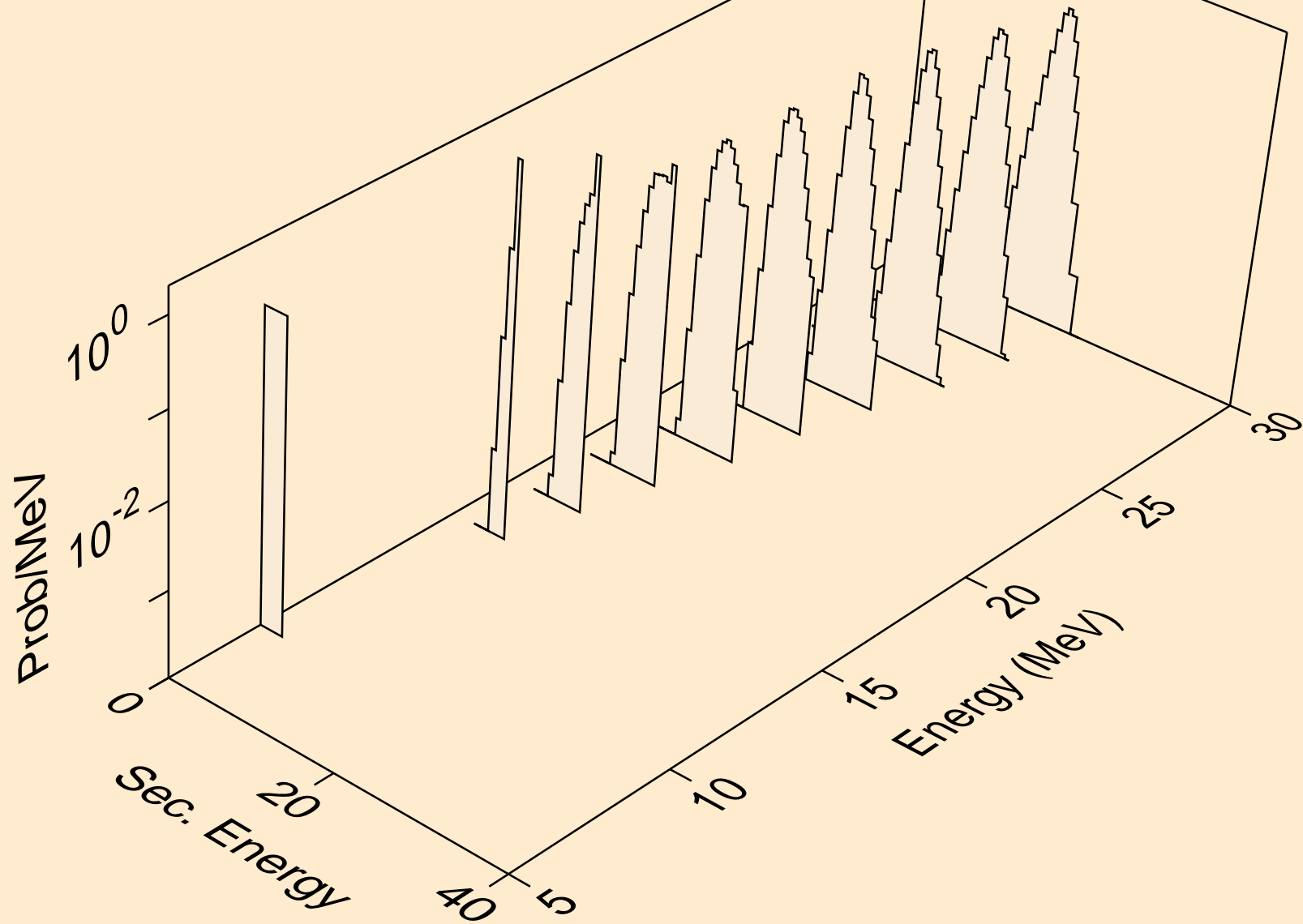

DB258 NEUTRON ACER TENDL-2023 LIBRARY; T=0.K
tritons from (n,t)

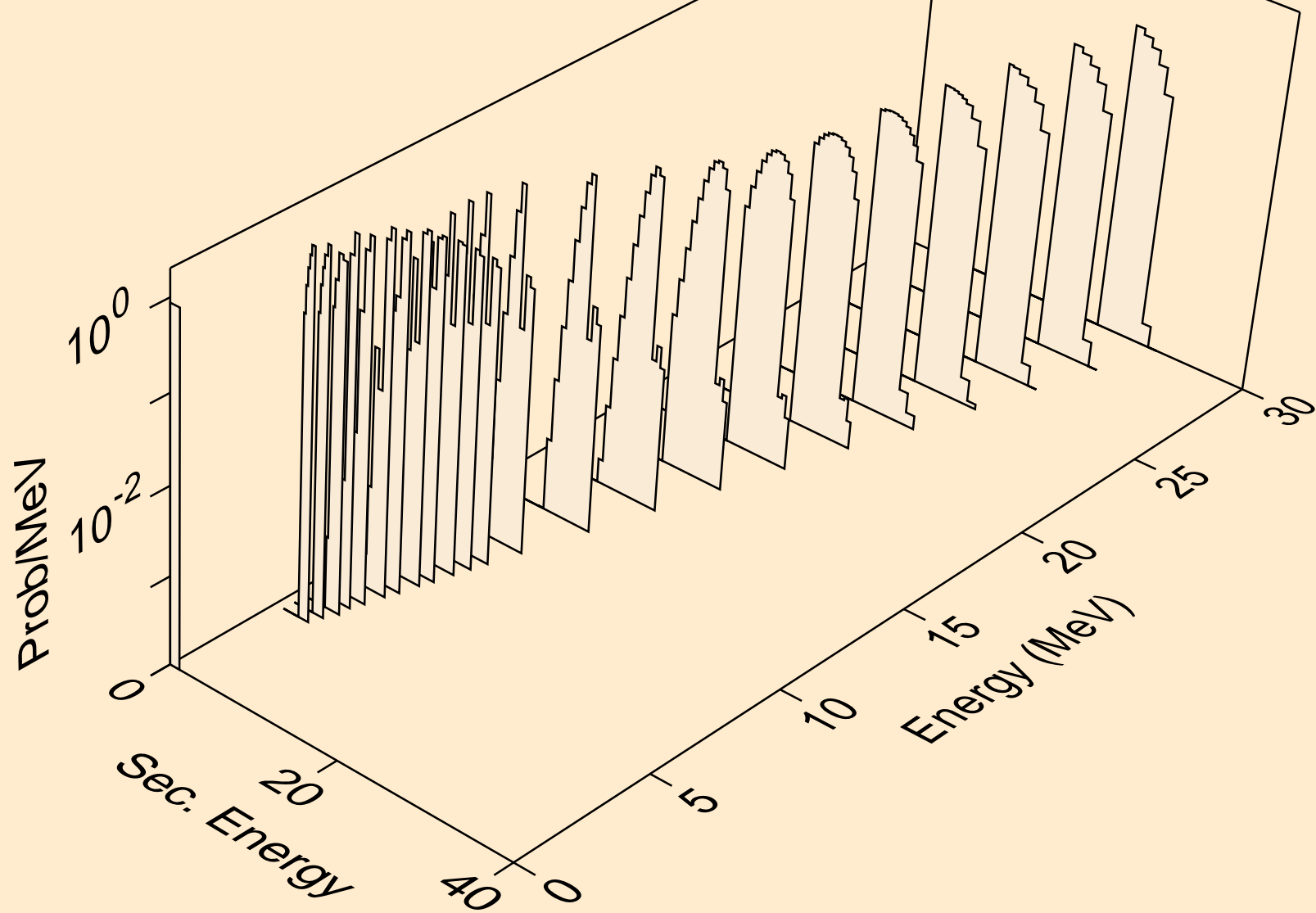

DB258 NEUTRON ACER TENDL-2023 LIBRARY; T=0.K
he3s from (n,x)

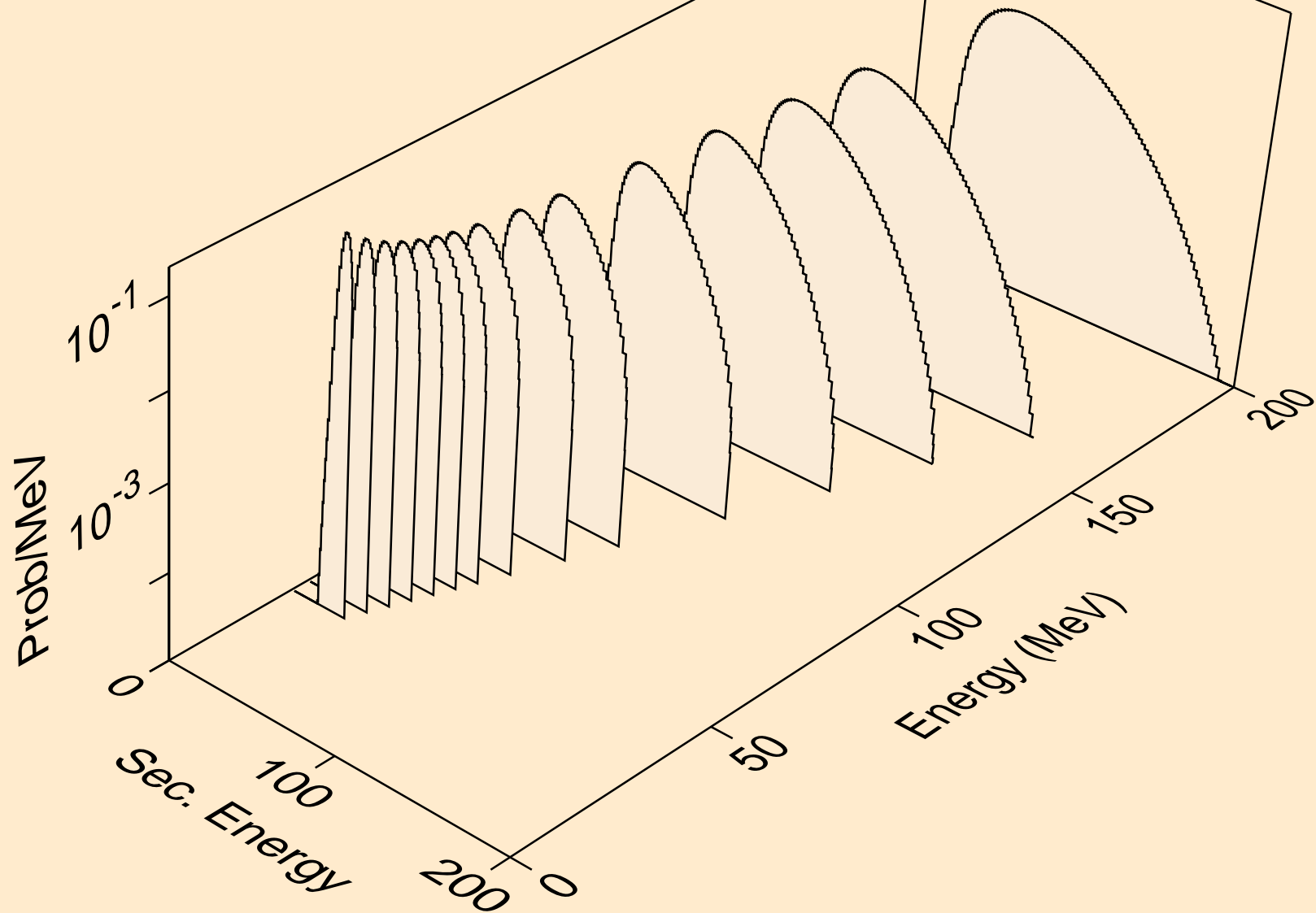

DB258 NEUTRON ACER TENDL-2023 LIBRARY; T=0.K
he3s from (n,n*)he3

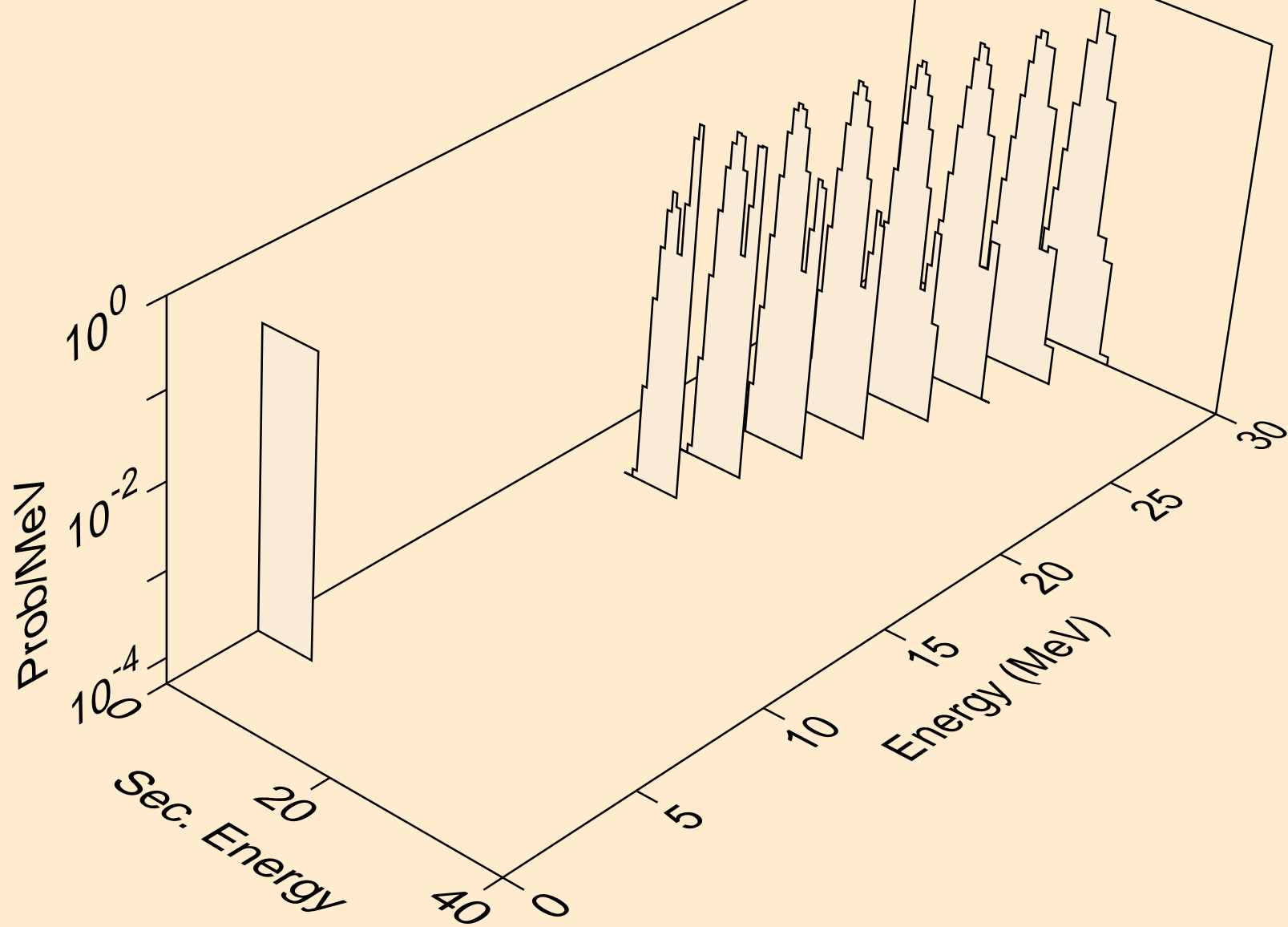

DB258 NEUTRON ACER TENDL-2023 LIBRARY; T=0.K
he3s from (n,he3)

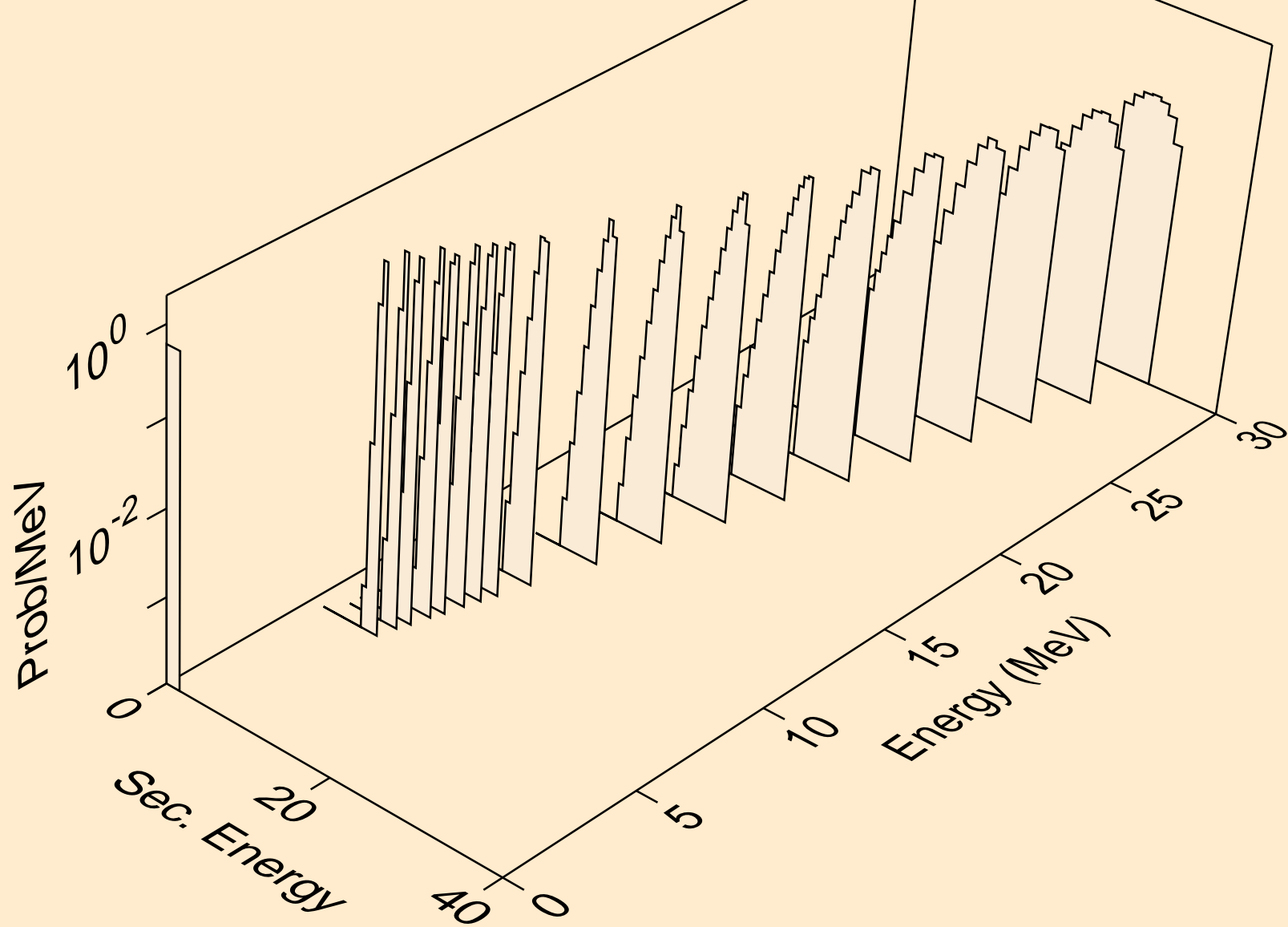

DB258 NEUTRON ACER TENDL-2023 LIBRARY; T=0.K
alphas from (n,x)

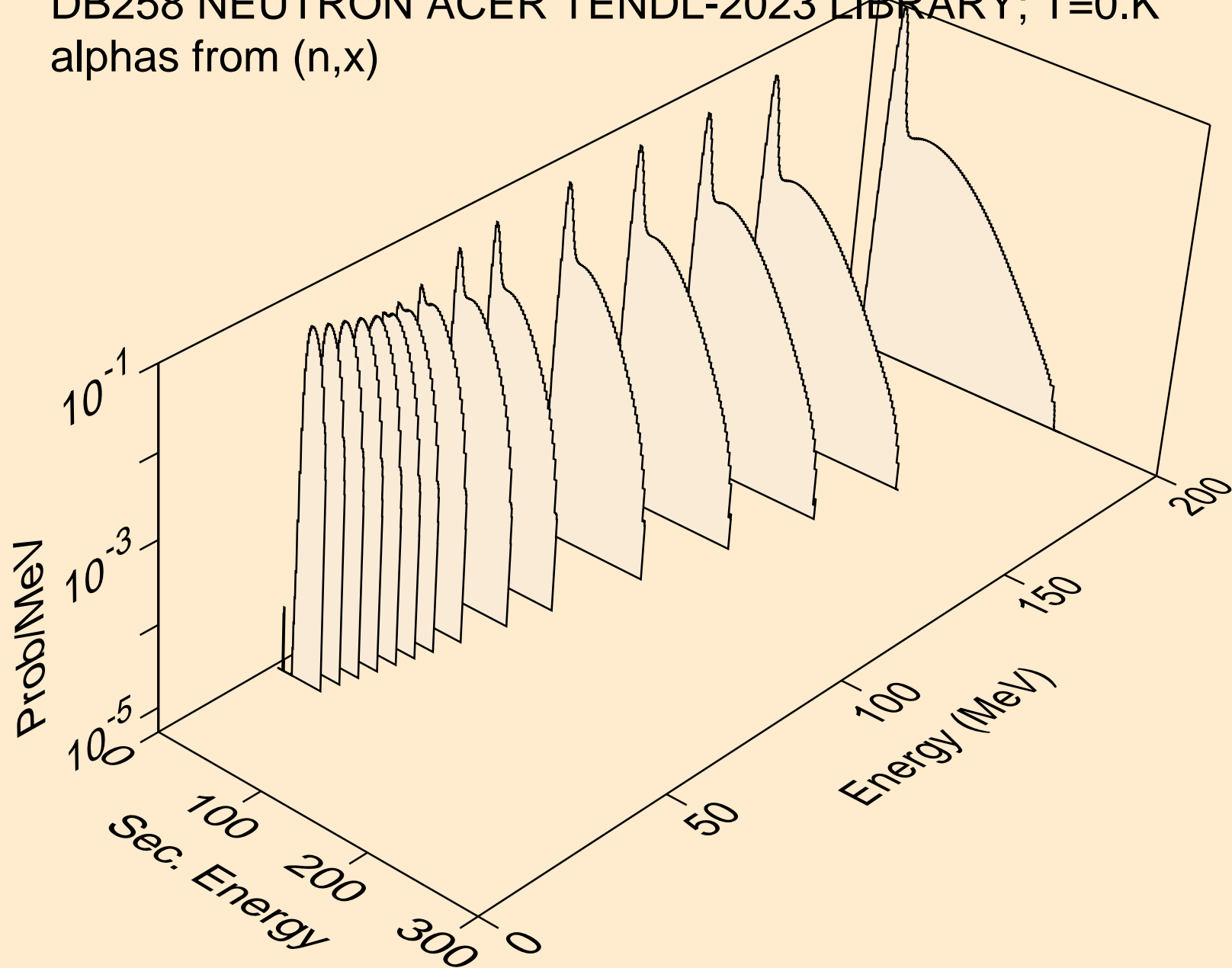

DB258 NEUTRON ACER TENDL-2023 LIBRARY; T=0.K
alphas from (n,n*)a

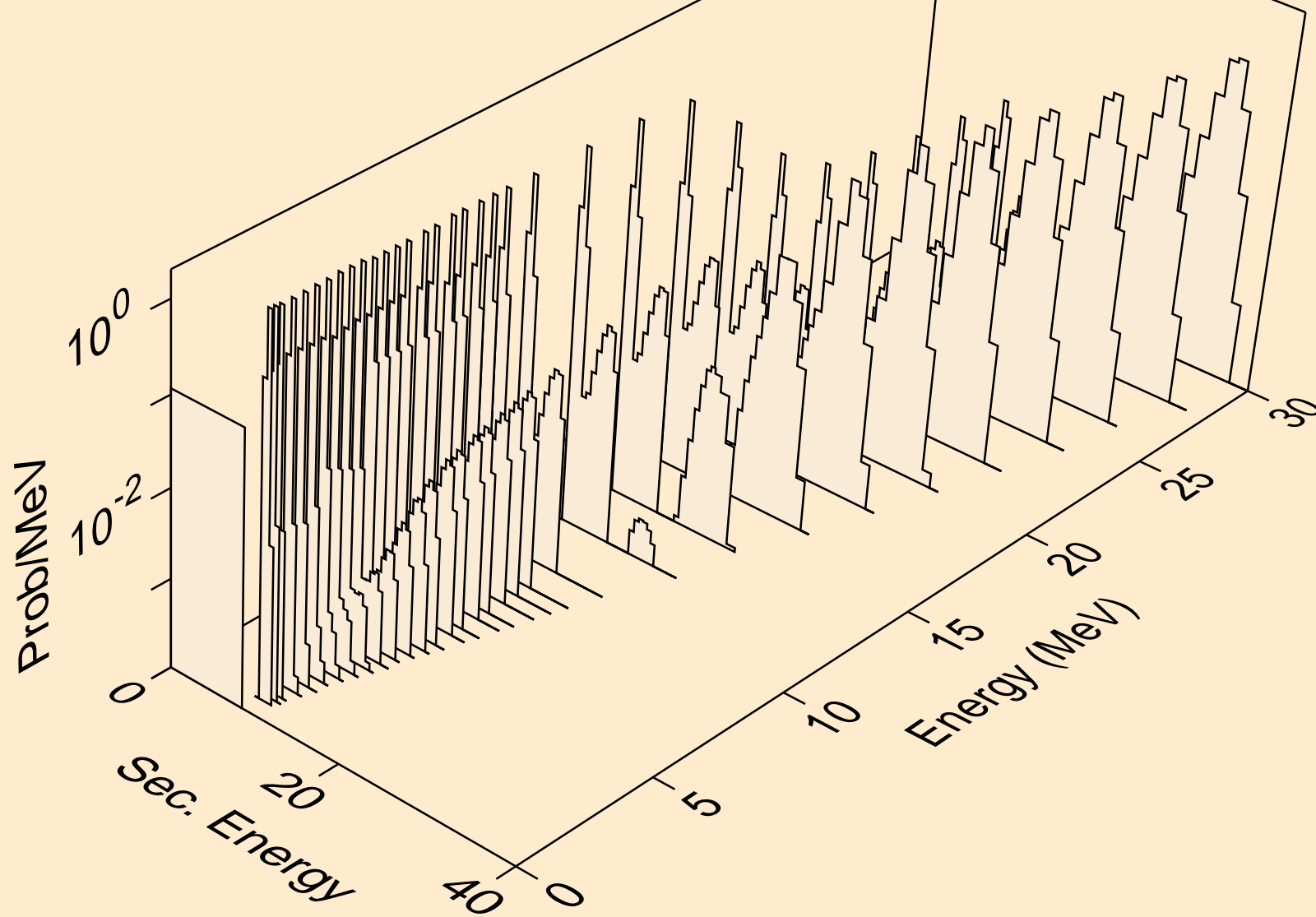

DB258 NEUTRON ACER TENDL-2023 LIBRARY; T=0.K
alphas from (n,2n)a

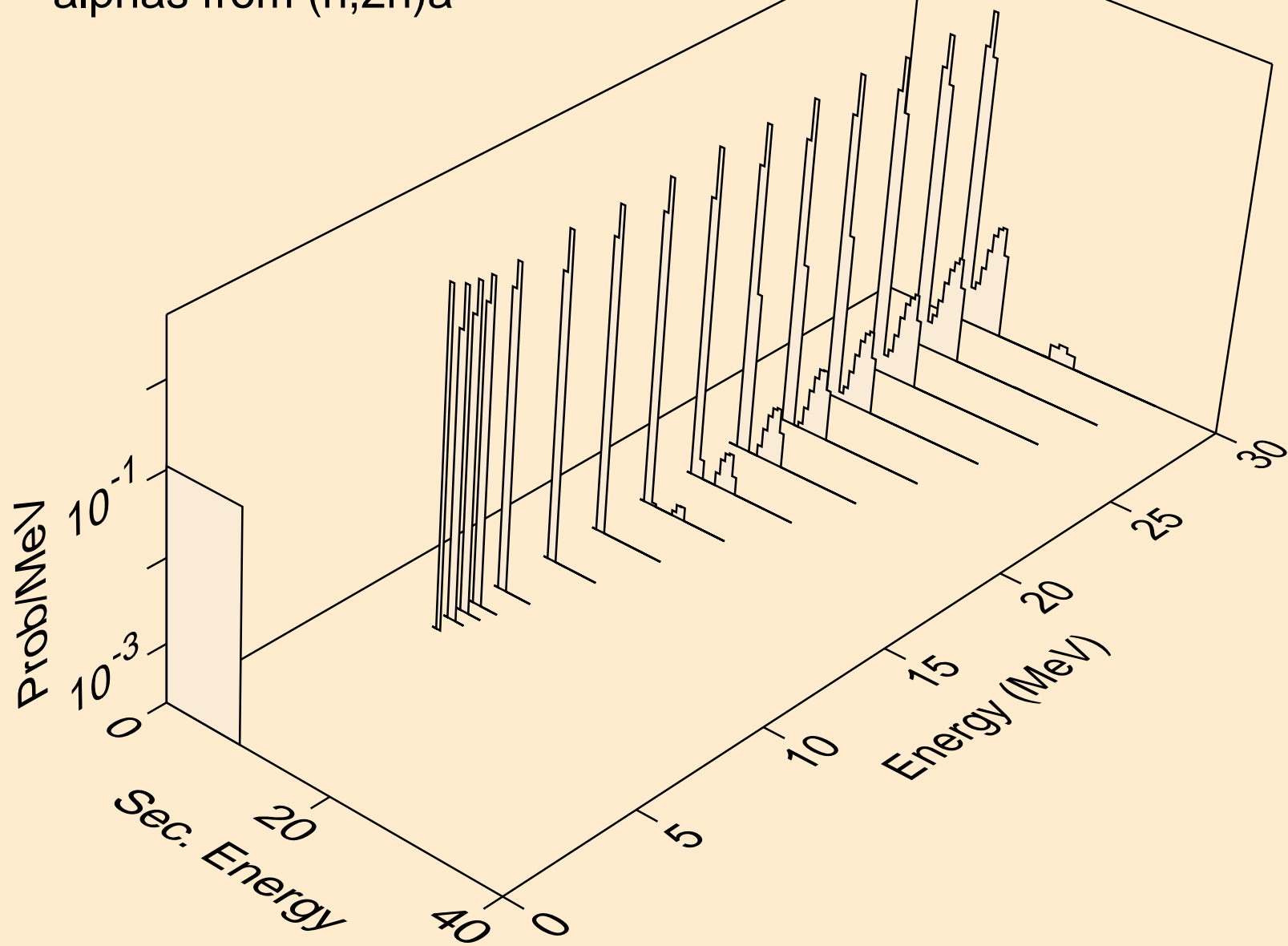

DB258 NEUTRON ACER TENDL-2023 LIBRARY; T=0.K
alphas from (n,3n)a

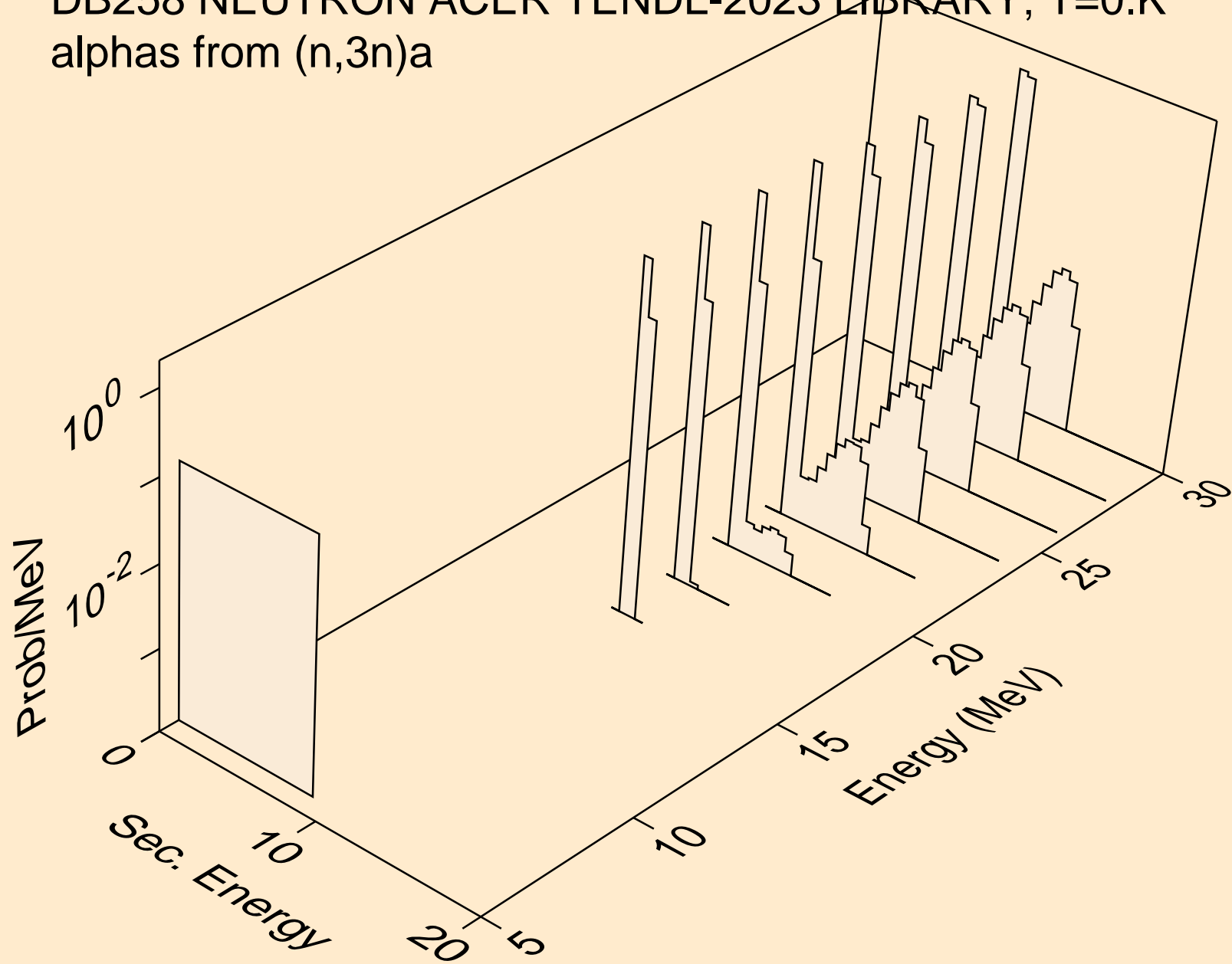

DB258 NEUTRON ACER TENDL-2023 LIBRARY; T=0.K
alphas from (n,npa)

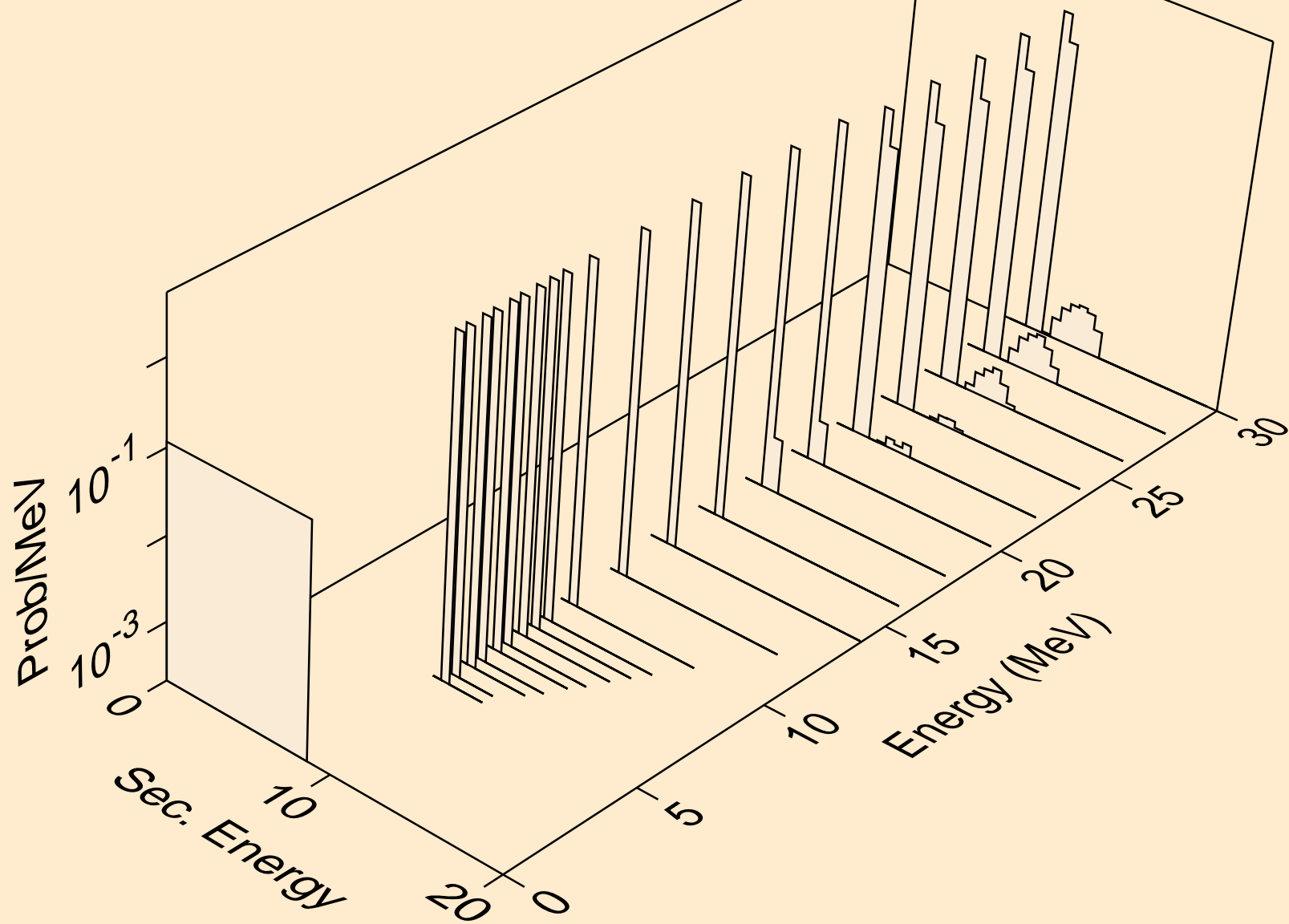

DB258 NEUTRON ACER TENDL-2023 LIBRARY; T=0.K
alphas from (n,a)

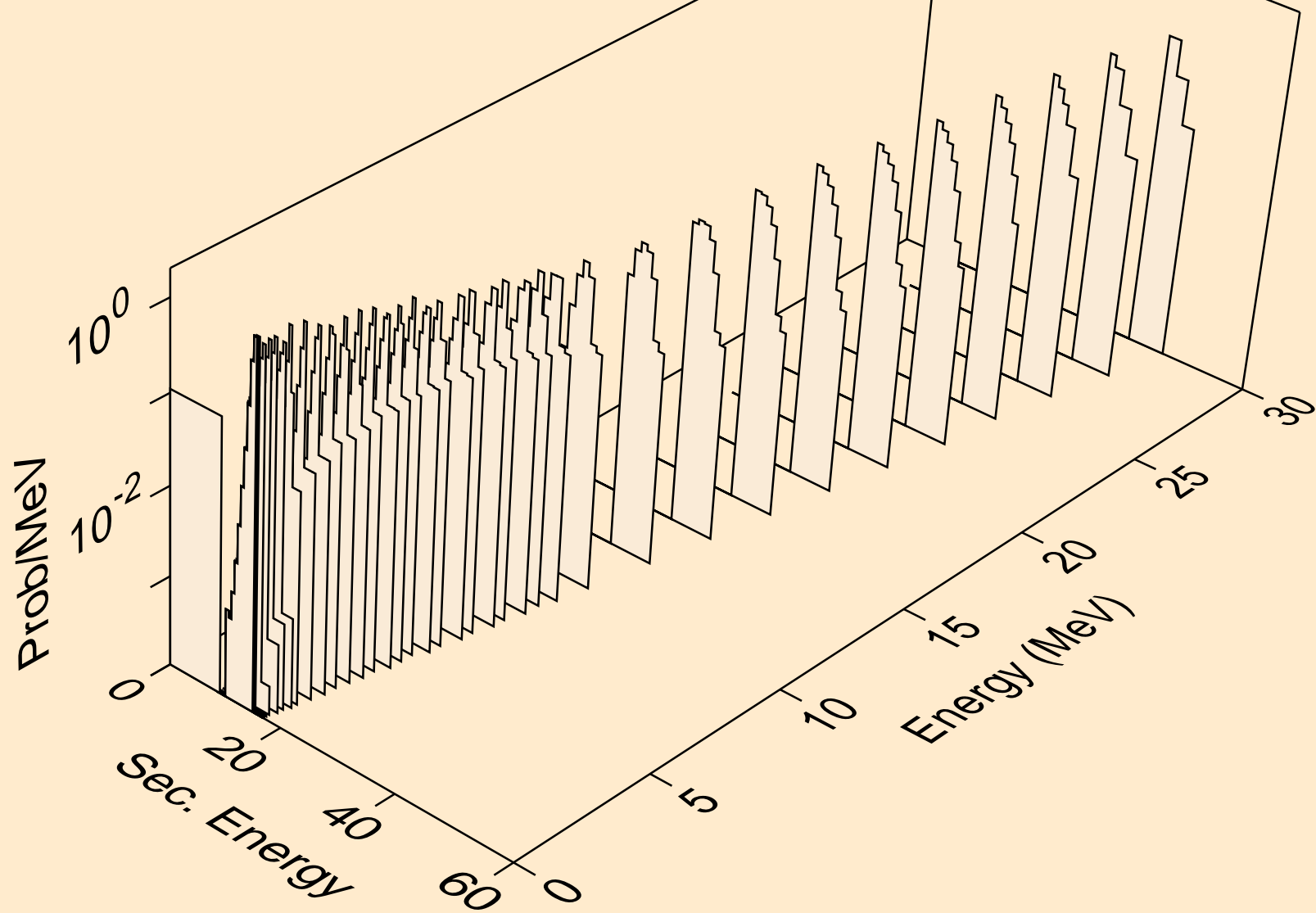

DB258 NEUTRON ACER TENDL-2023 LIBRARY; T=0.K
alphas from (n,2a)

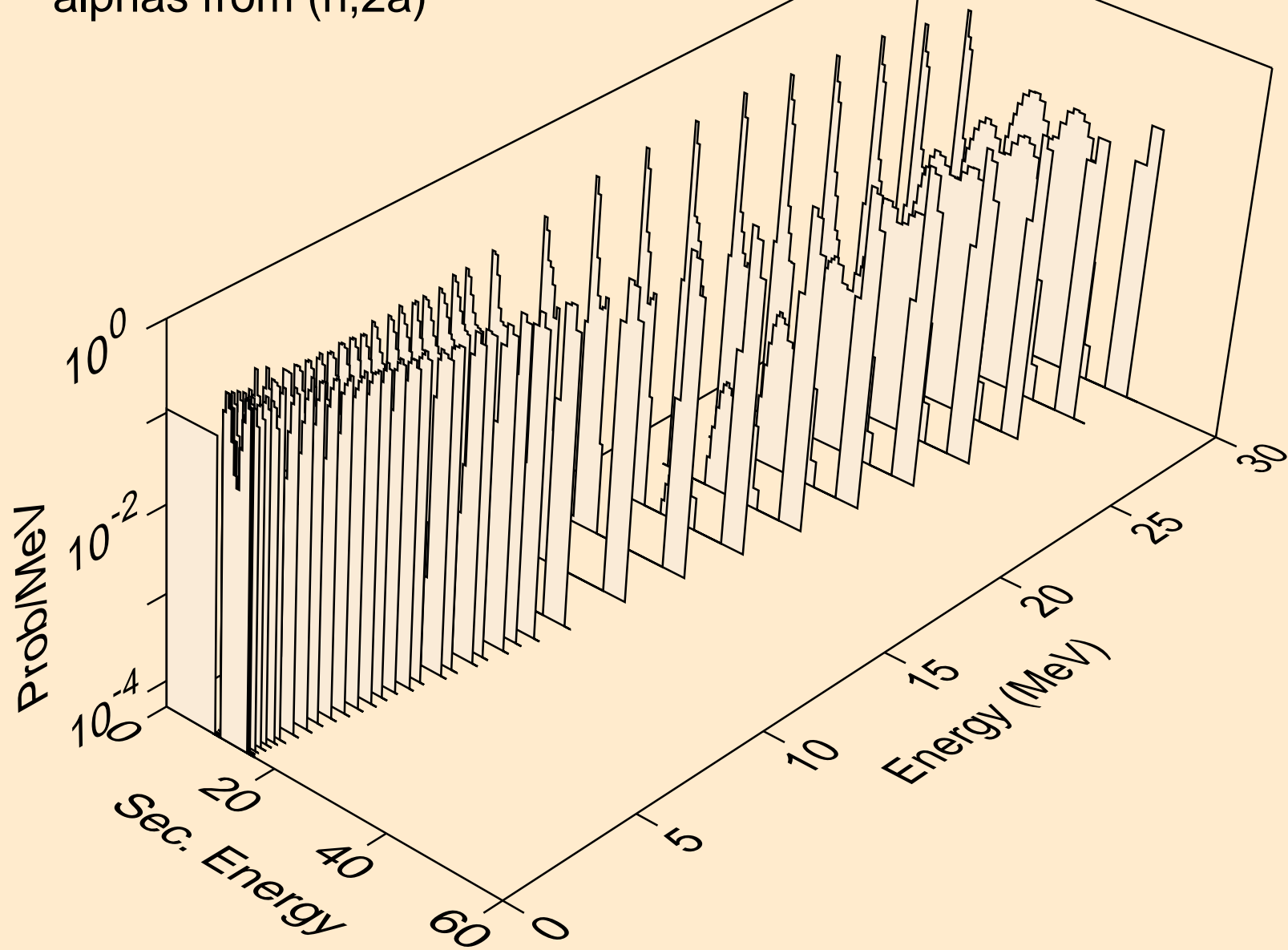

DB258 NEUTRON ACER TENDL-2023 LIBRARY; T=0.K
alphas from (n,pa)

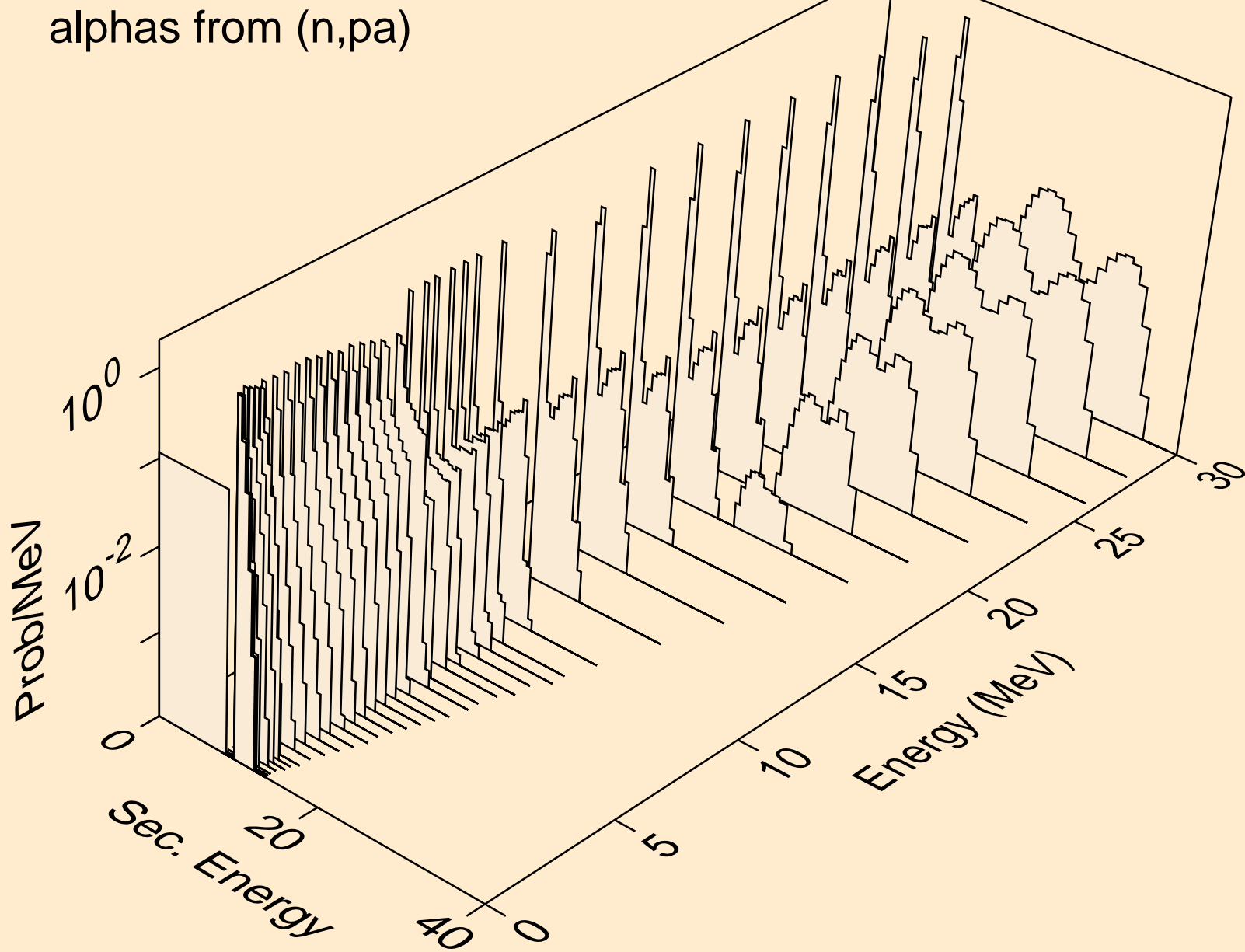

DB258 NEUTRON ACER TENDL-2023 LIBRARY; T=0.K
alphas from (n,da)

