

# DB268 NEUTRON ACER TENDL-2023 LIBRARY; T=0.K

## Principal cross sections

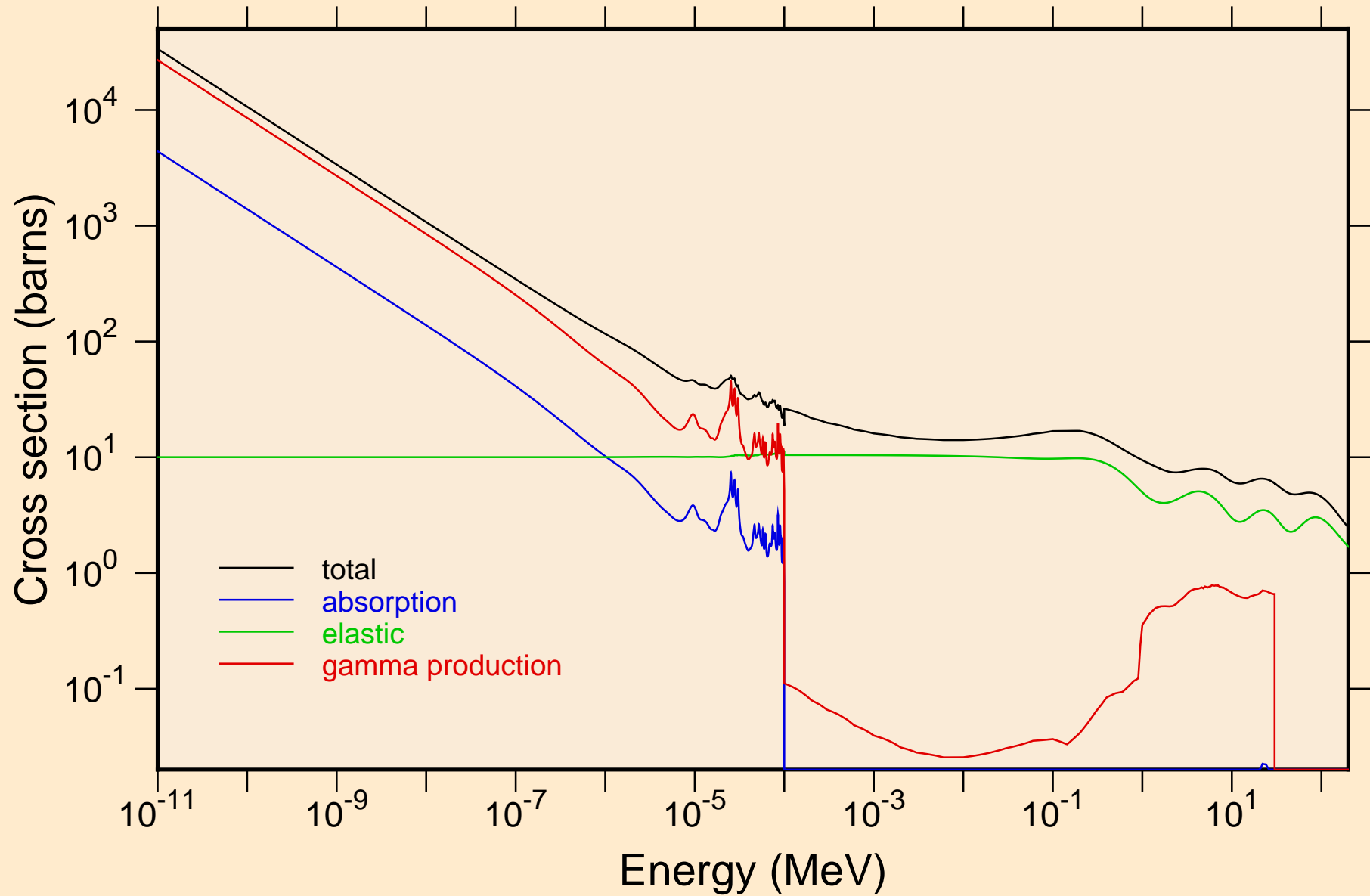

# DB268 NEUTRON ACER TENDL-2023 LIBRARY; T=0.K

## Heating

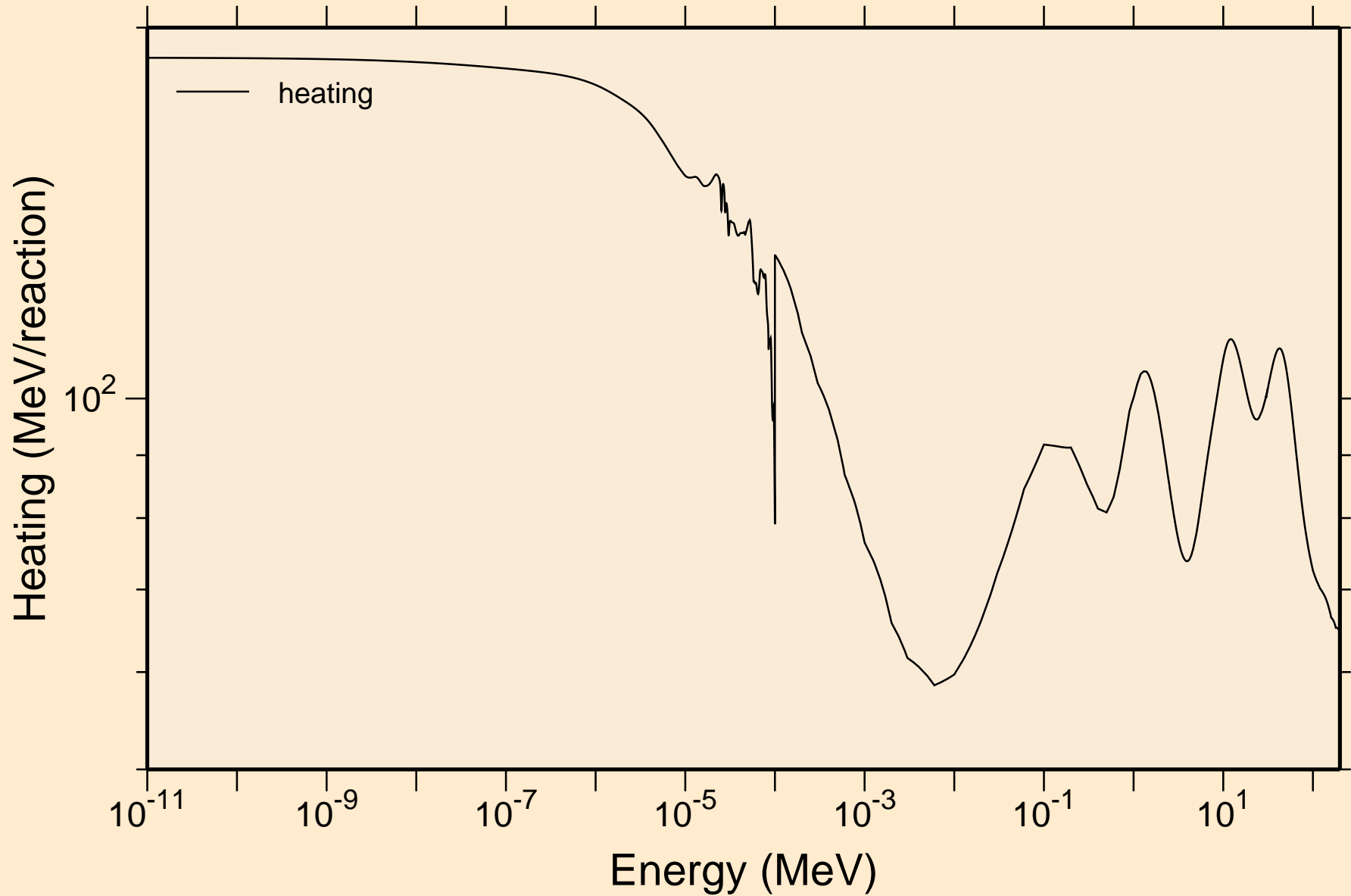

DB268 NEUTRON ACER TENDL-2023 LIBRARY; T=0.K  
Damage

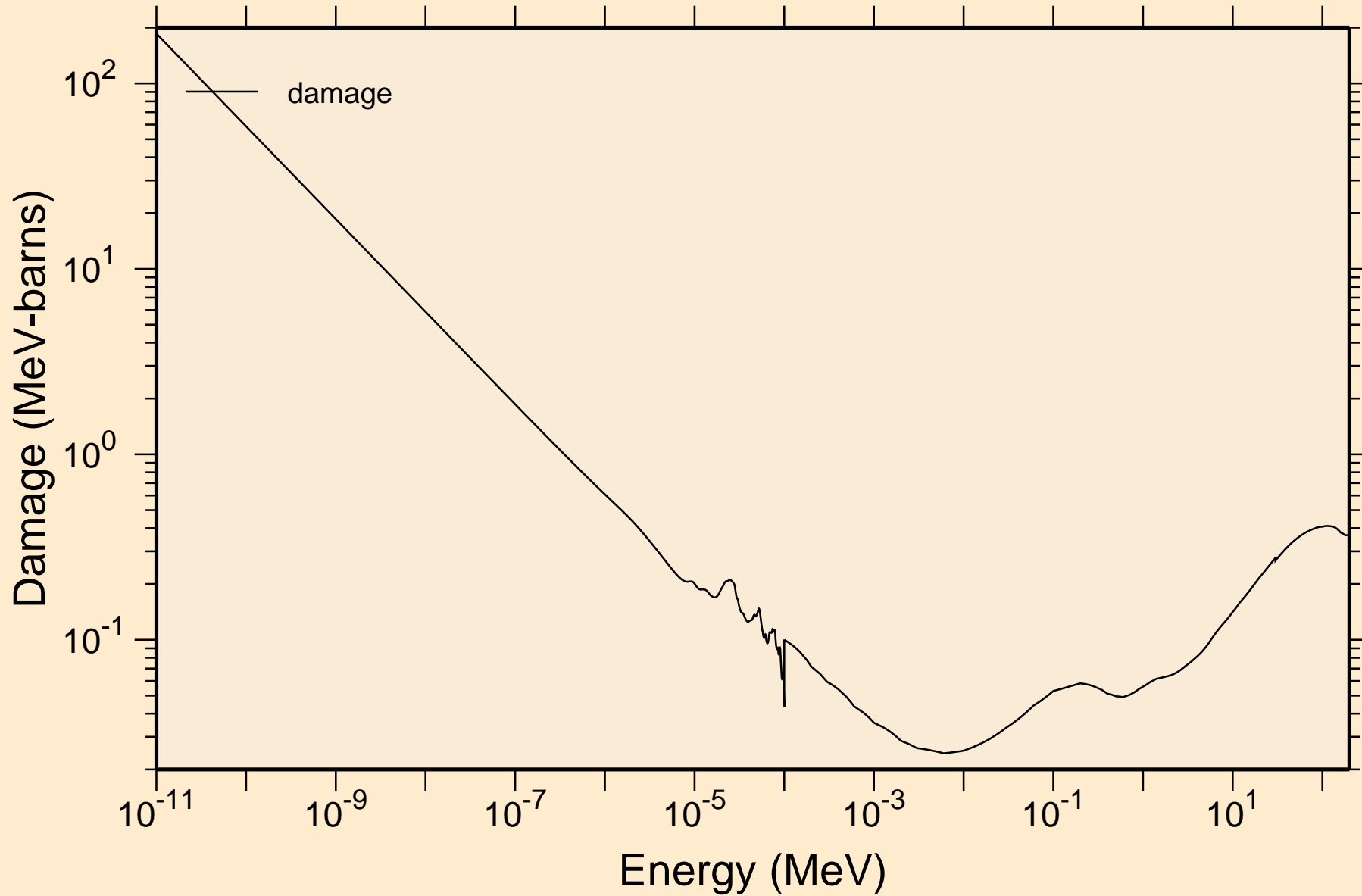

DB268 NEUTRON ACER TENDL-2023 LIBRARY; T=0.K  
Non-threshold reactions

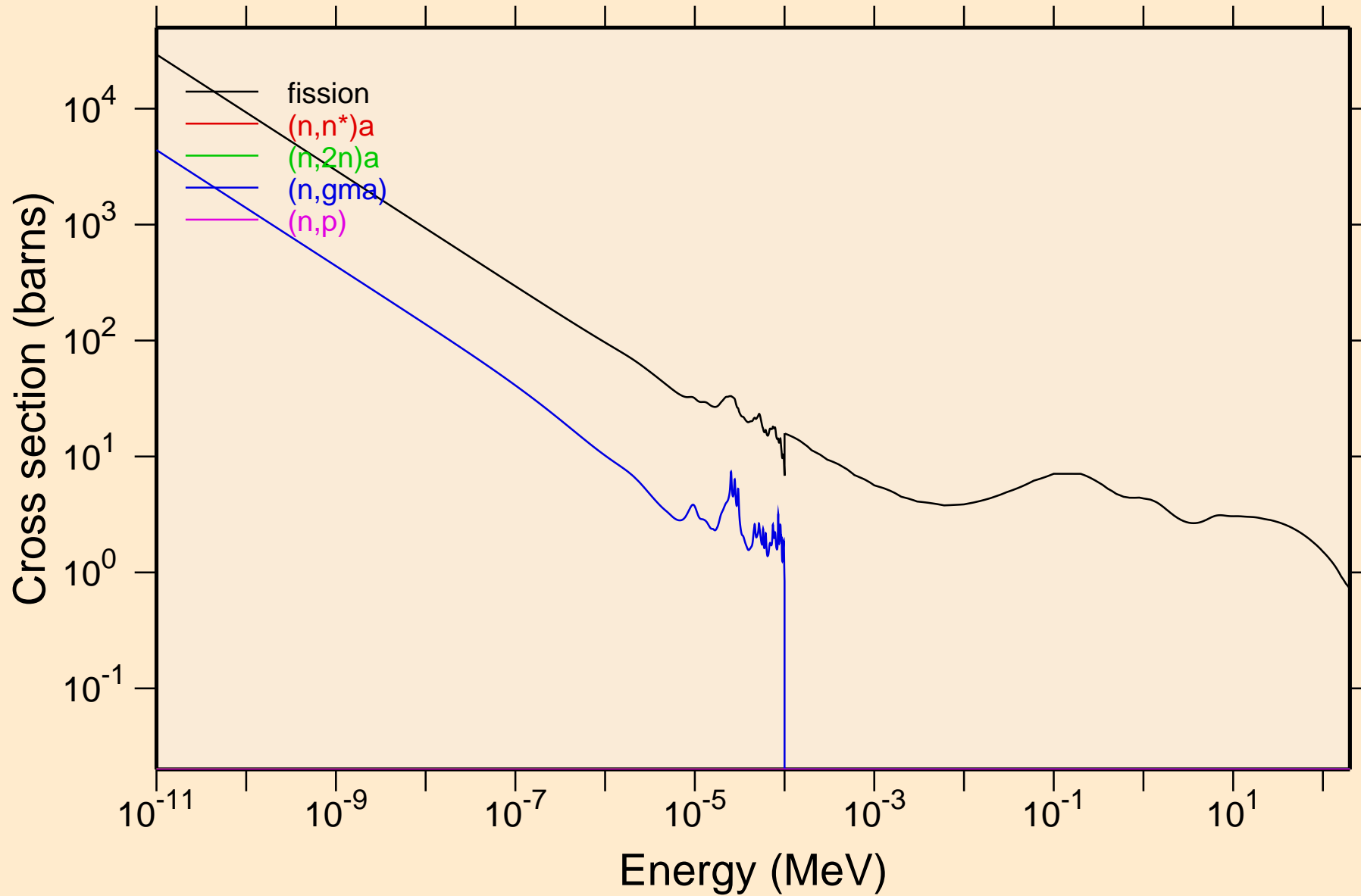

DB268 NEUTRON ACER TENDL-2023 LIBRARY; T=0.K  
Non-threshold reactions

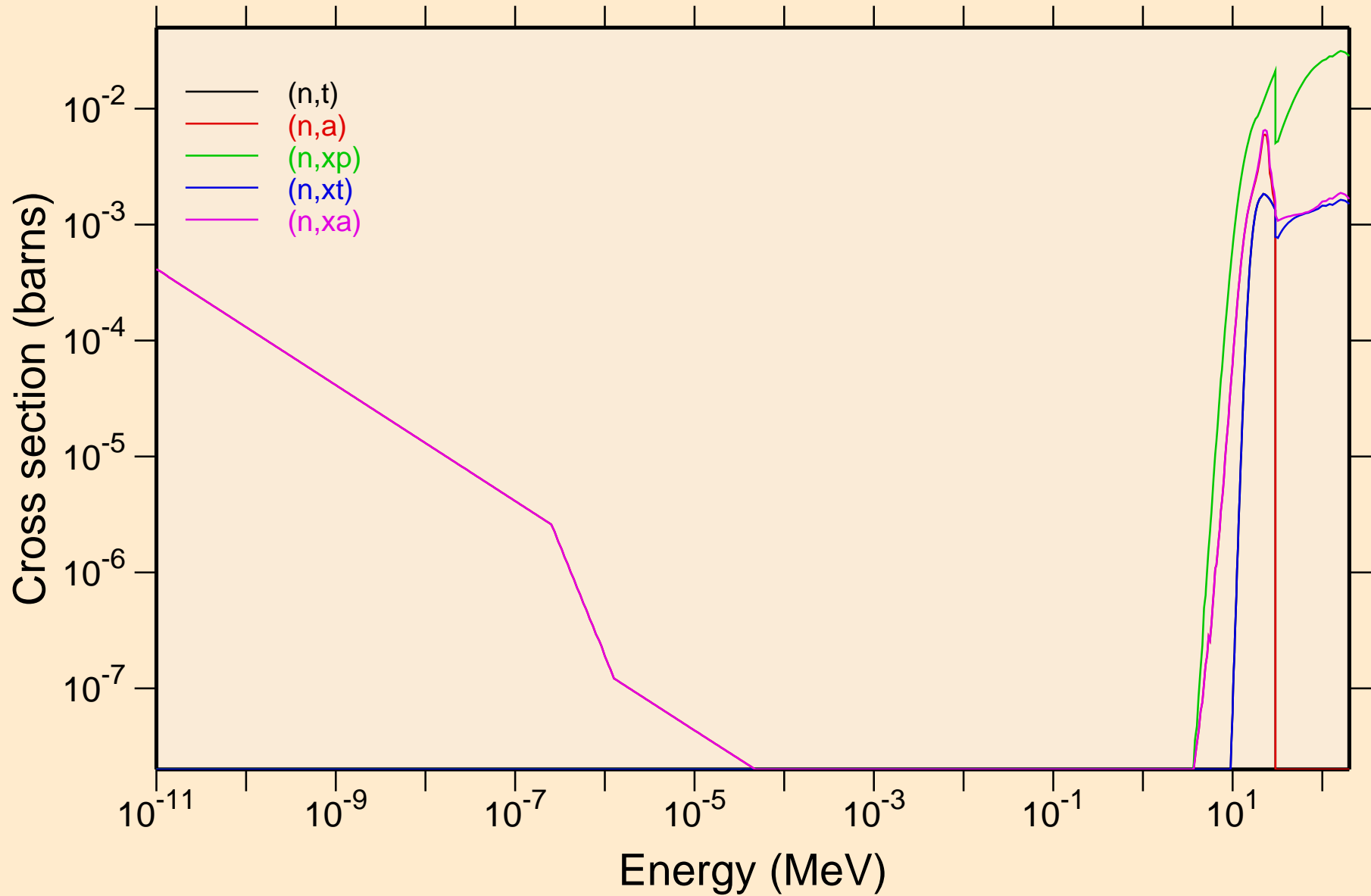

# DB268 NEUTRON ACER TENDL-2023 LIBRARY; T=0.K

## Principal cross sections

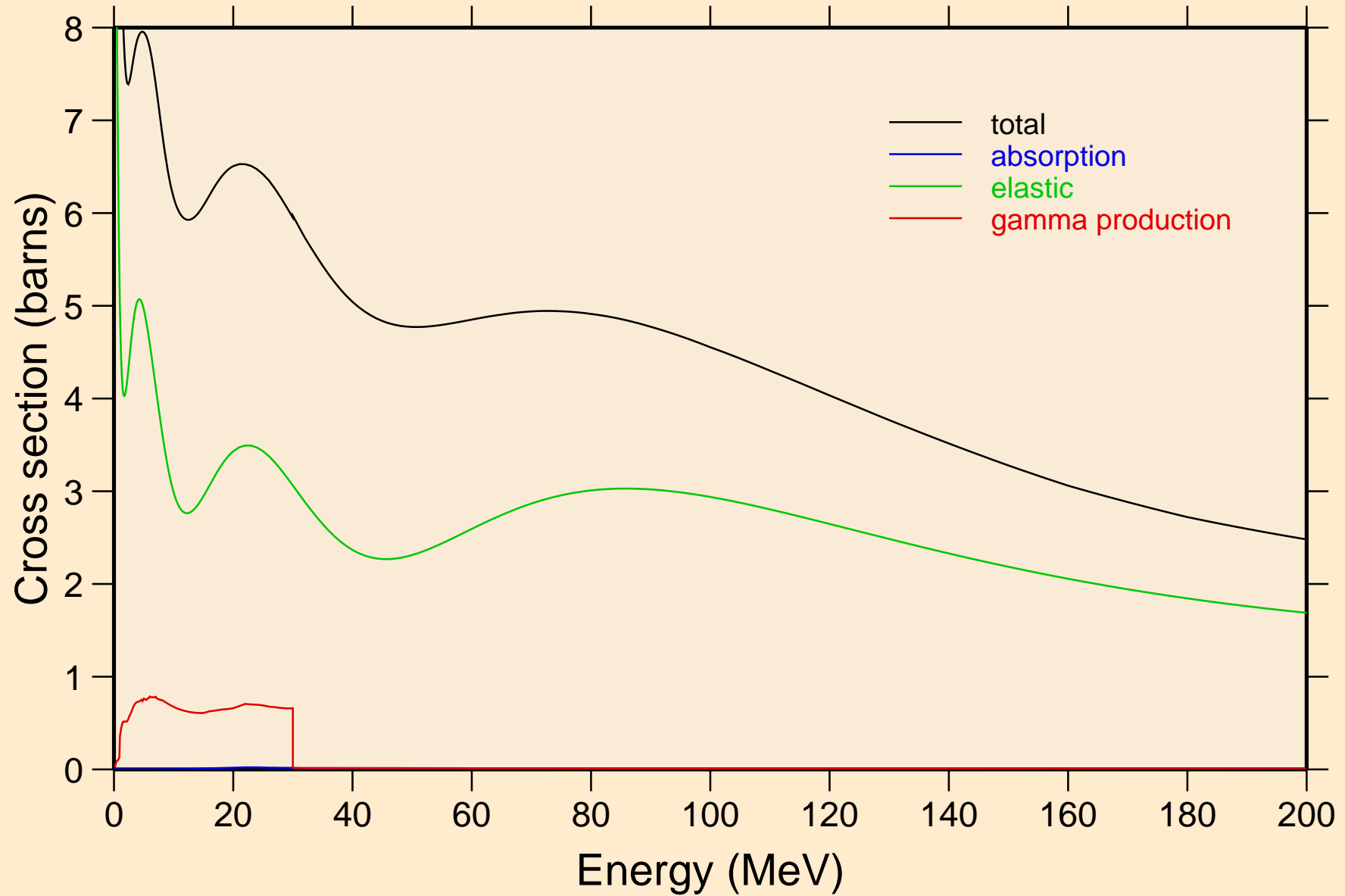

# DB268 NEUTRON ACER TENDL-2023 LIBRARY; T=0.K

## Heating

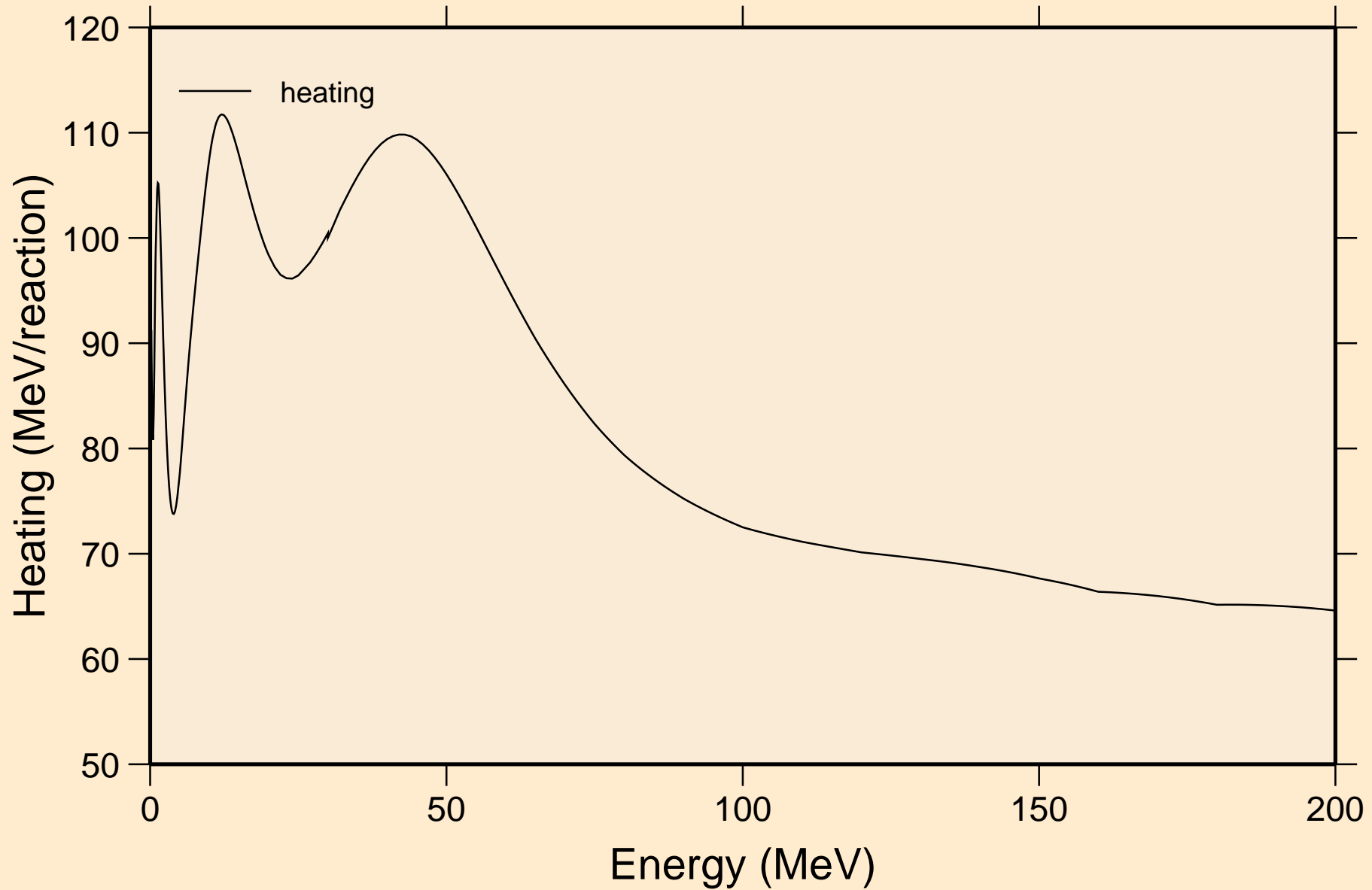

DB268 NEUTRON ACER TENDL-2023 LIBRARY; T=0.K  
Damage

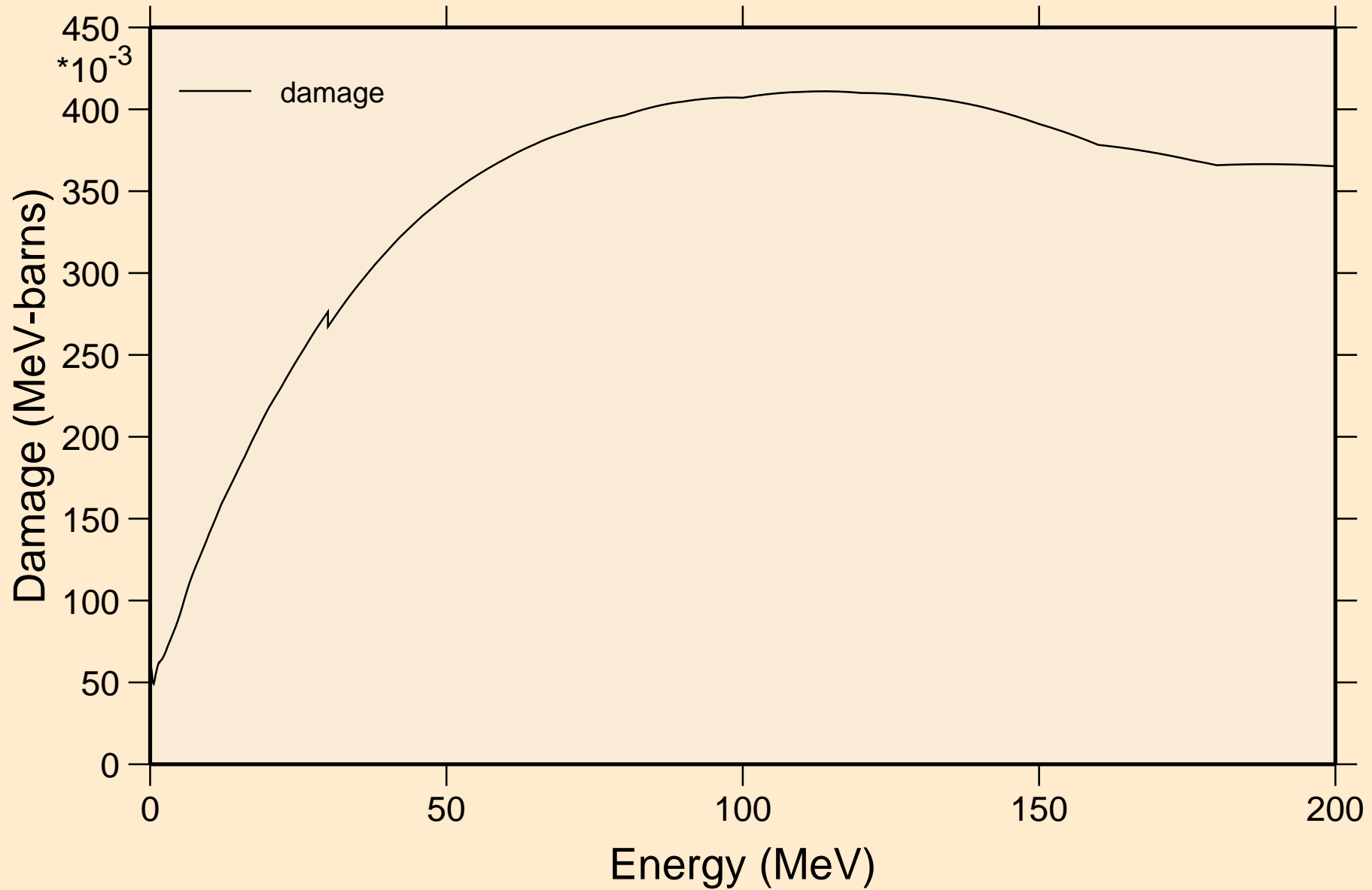

DB268 NEUTRON ACER TENDL-2023 LIBRARY; T=0.K  
Non-threshold reactions

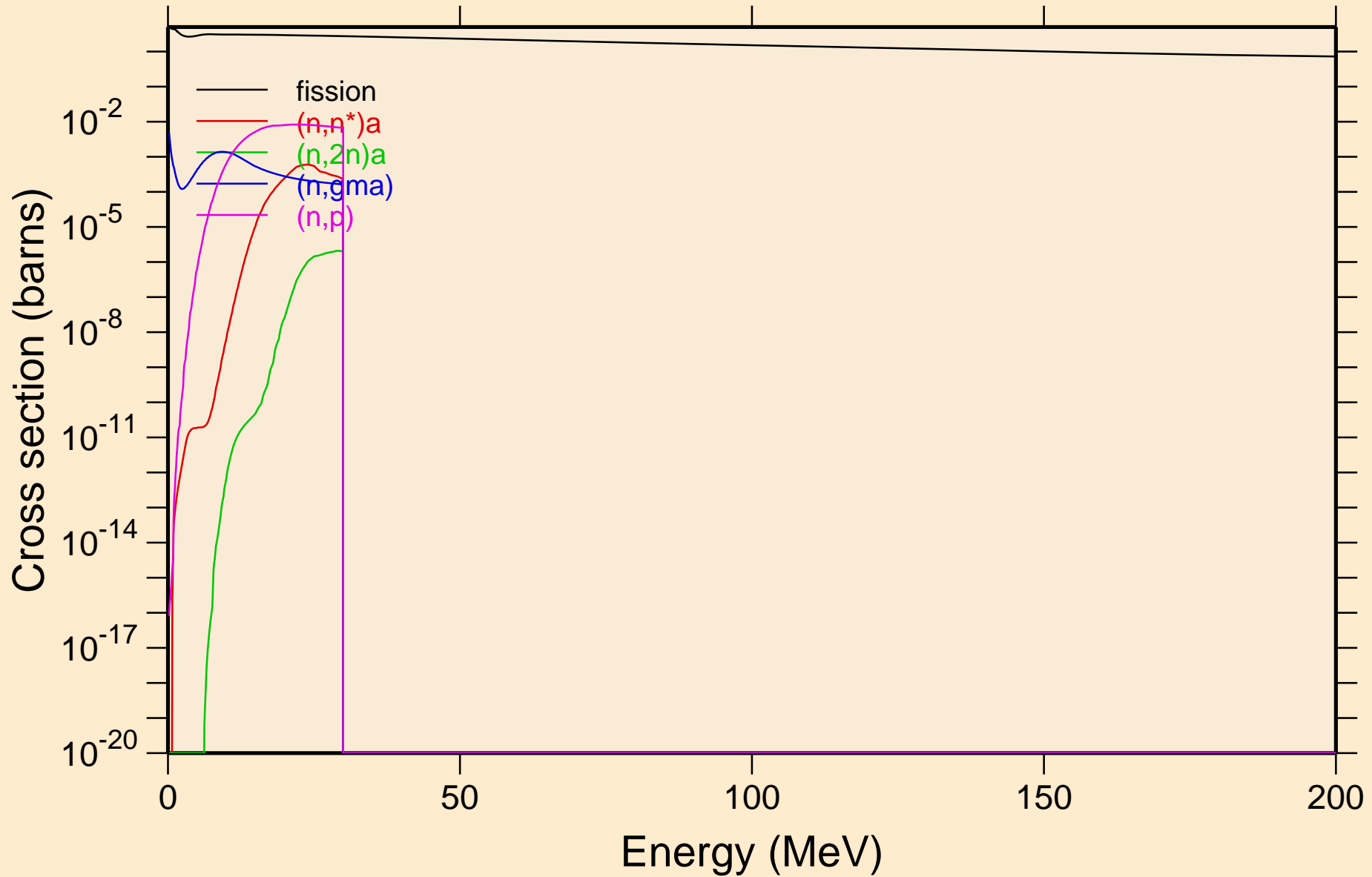

DB268 NEUTRON ACER TENDL-2023 LIBRARY; T=0.K  
Non-threshold reactions

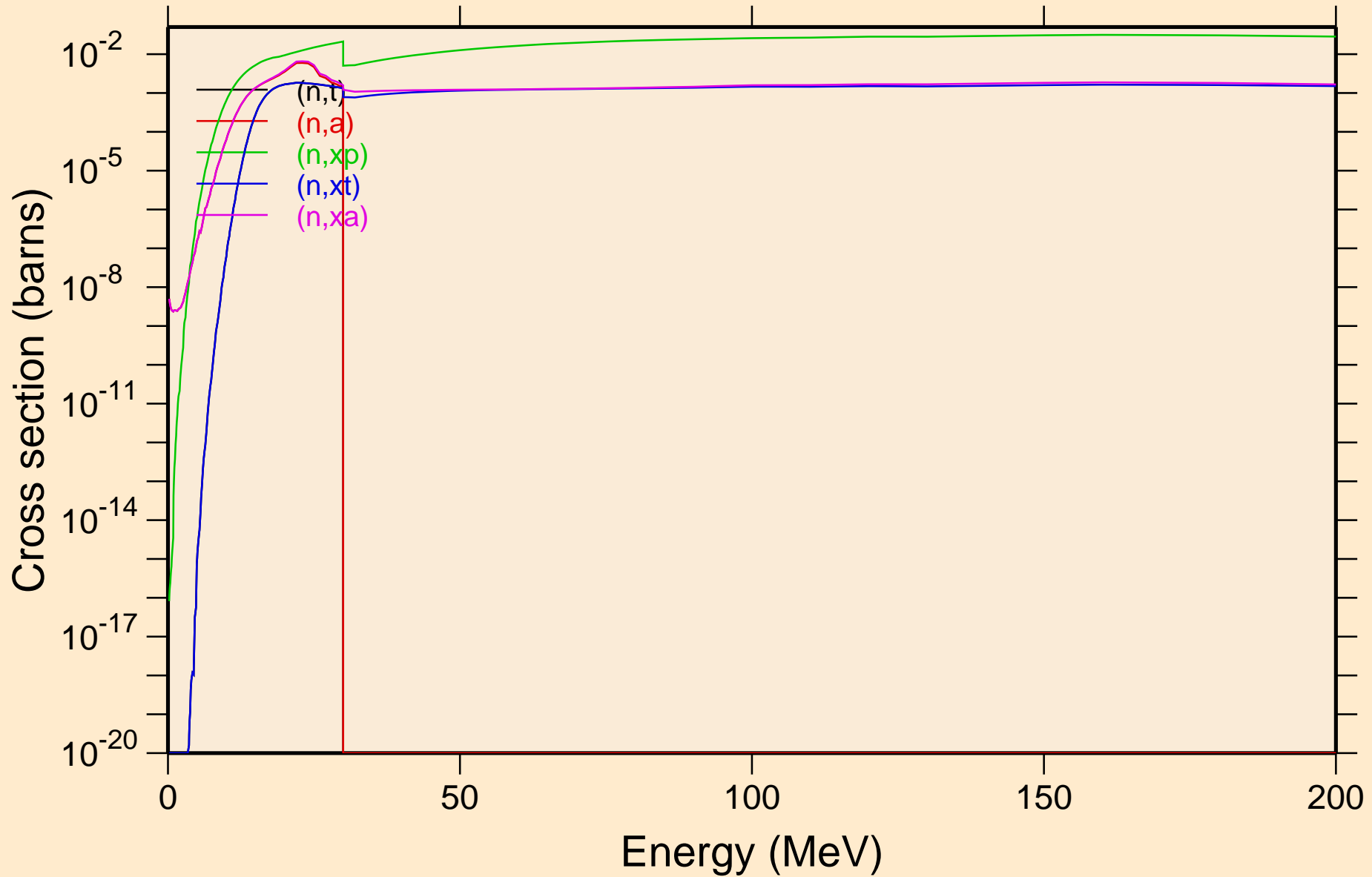

DB268 NEUTRON ACER TENDL-2023 LIBRARY; T=0.K  
Inelastic levels

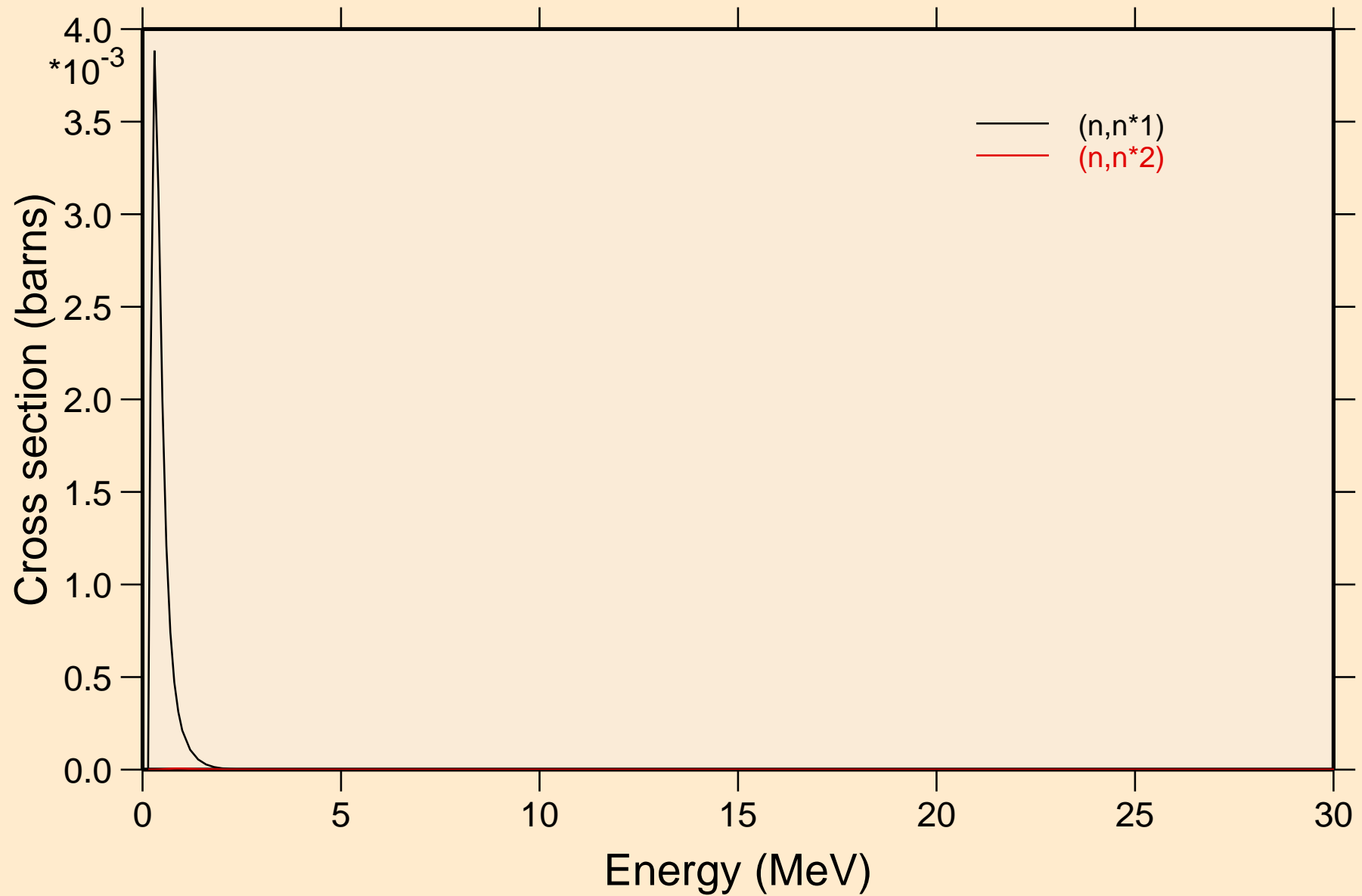

DB268 NEUTRON ACER TENDL-2023 LIBRARY; T=0.K  
Threshold reactions

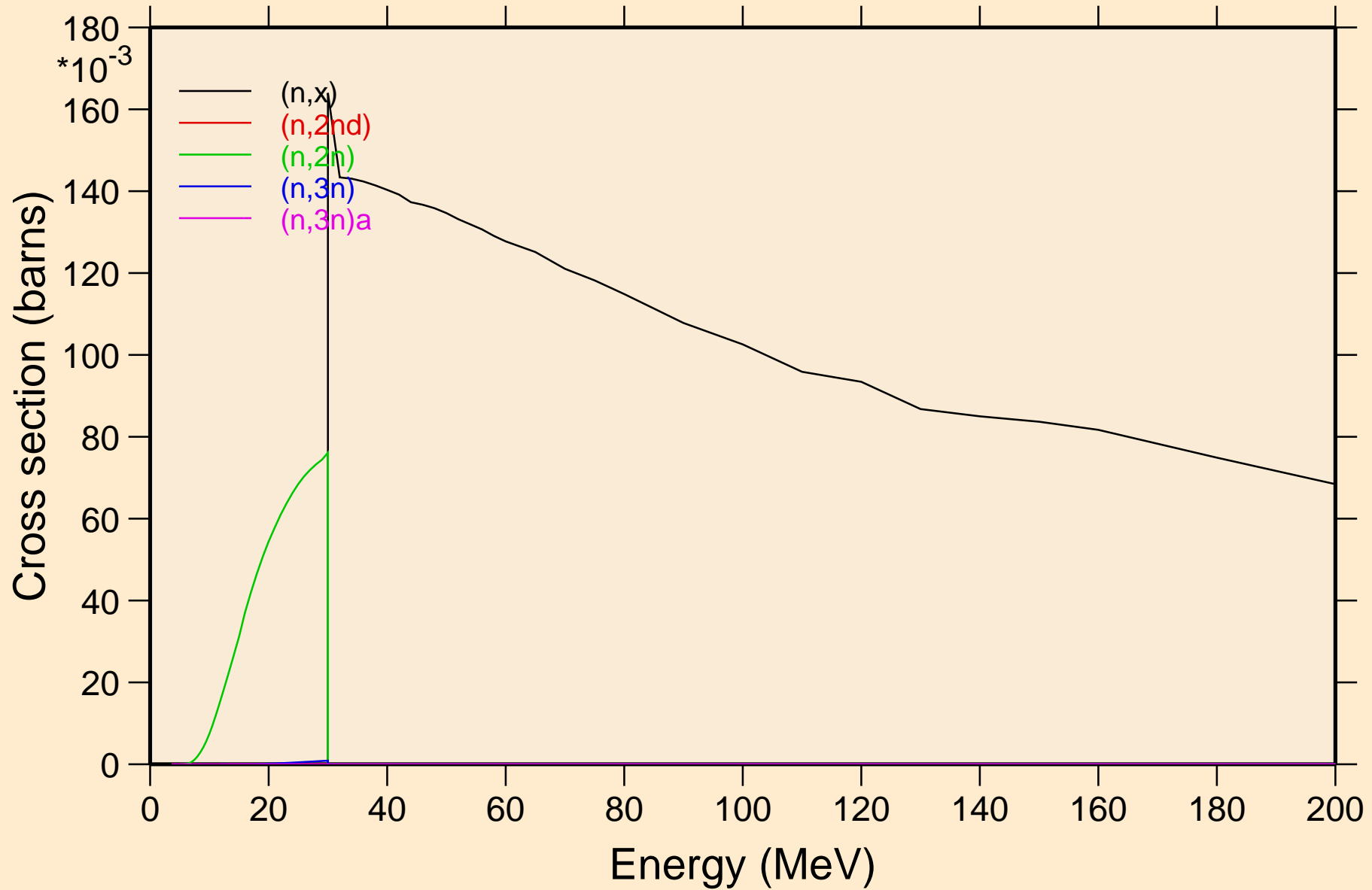

DB268 NEUTRON ACER TENDL-2023 LIBRARY; T=0.K  
Threshold reactions

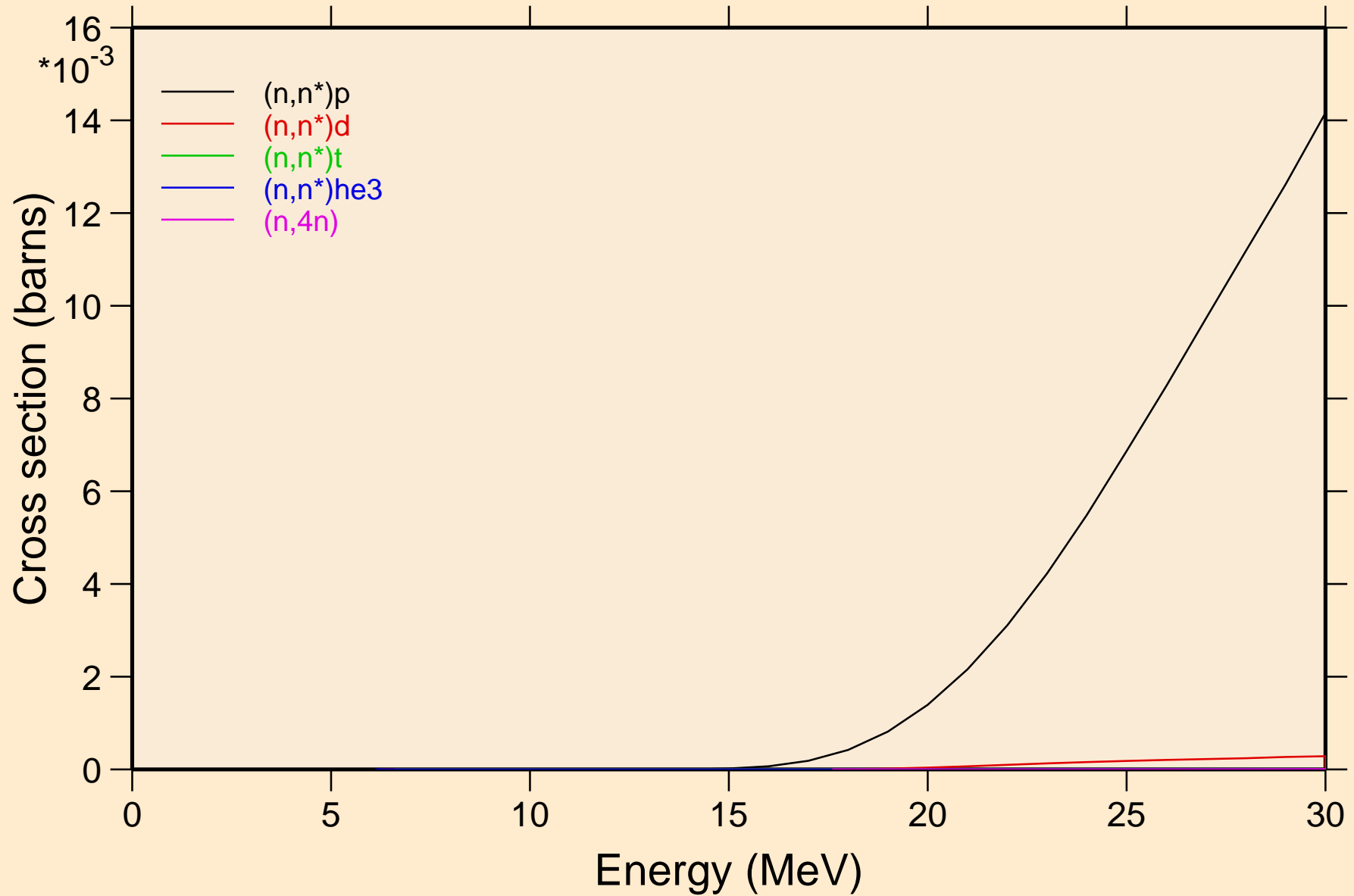

# DB268 NEUTRON ACER TENDL-2023 LIBRARY; T=0.K

## Threshold reactions

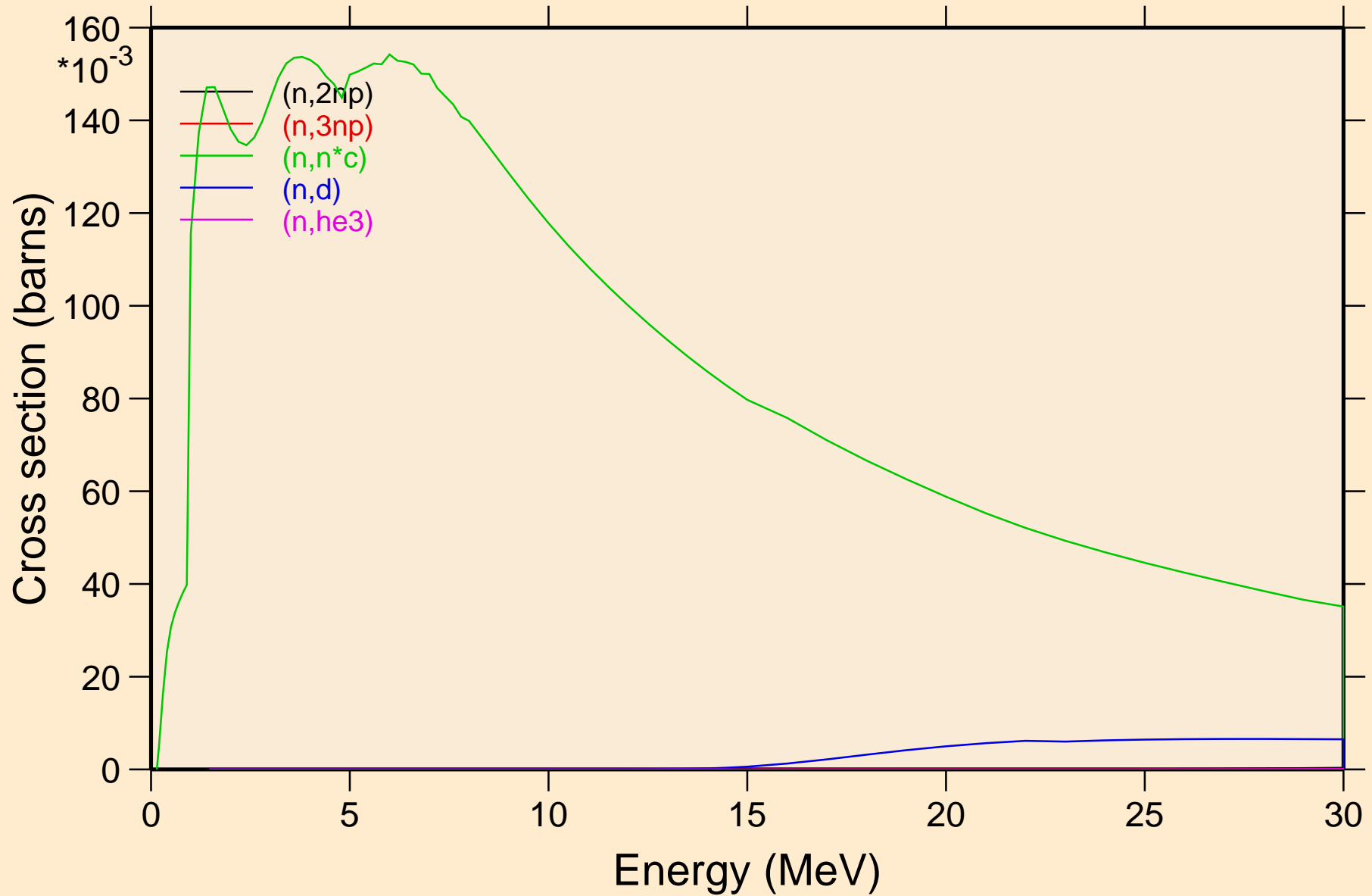

DB268 NEUTRON ACER TENDL-2023 LIBRARY; T=0.K  
Threshold reactions

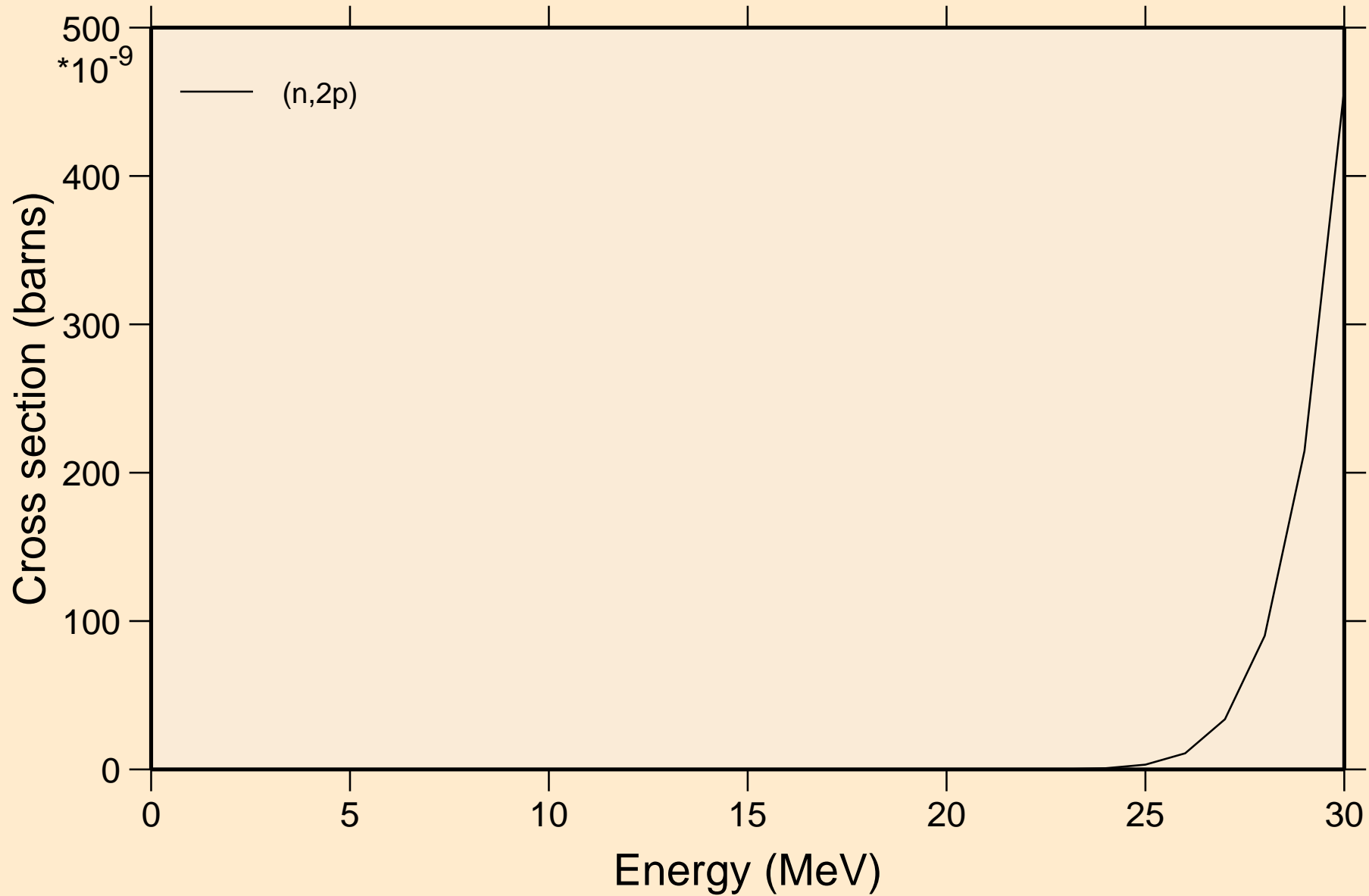

DB268 NEUTRON ACER TENDL-2023 LIBRARY; T=0.K  
Threshold reactions

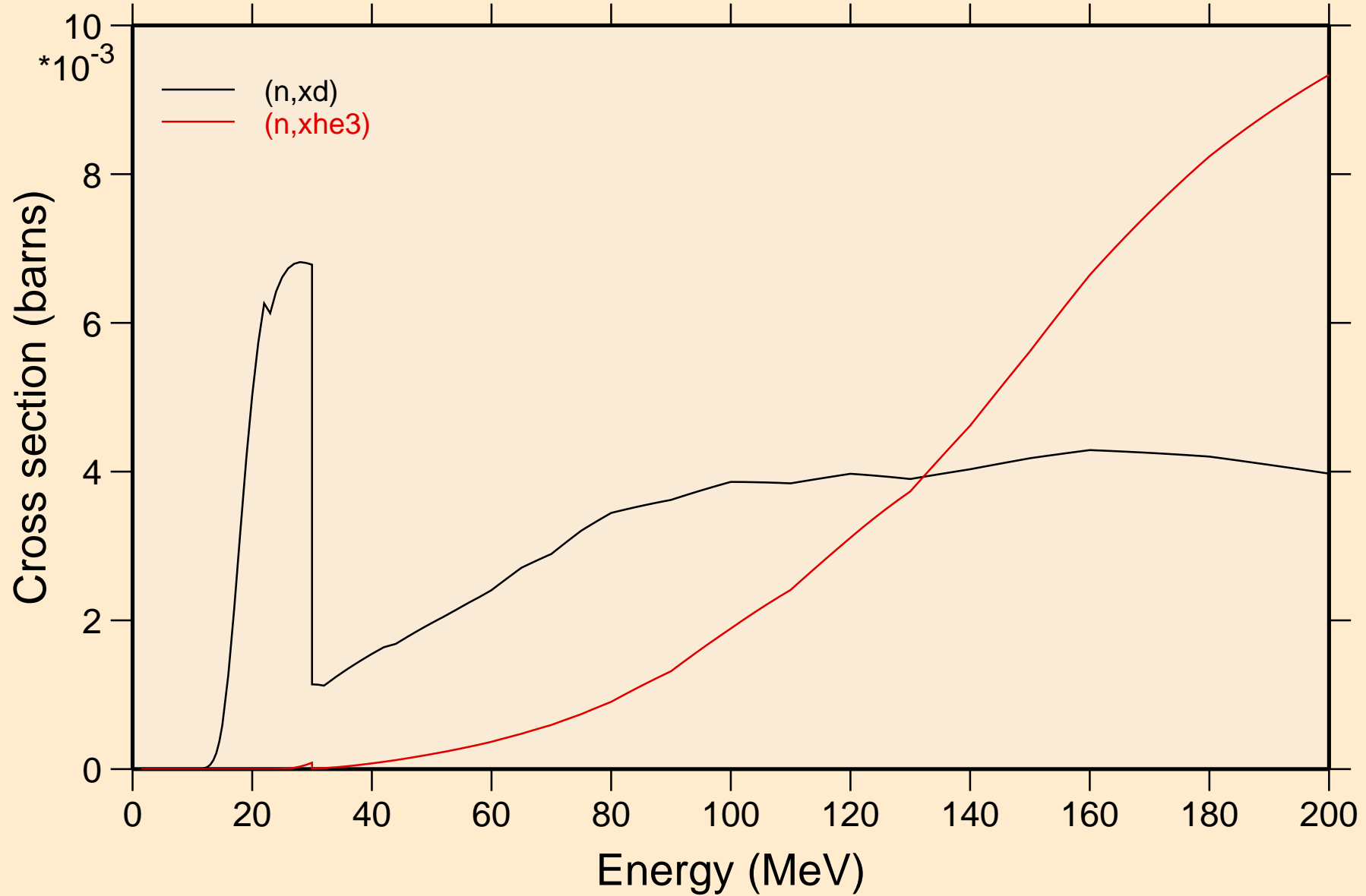

DB268 NEUTRON ACER TENDL-2023 LIBRARY; T=0.K  
angular distribution for elastic

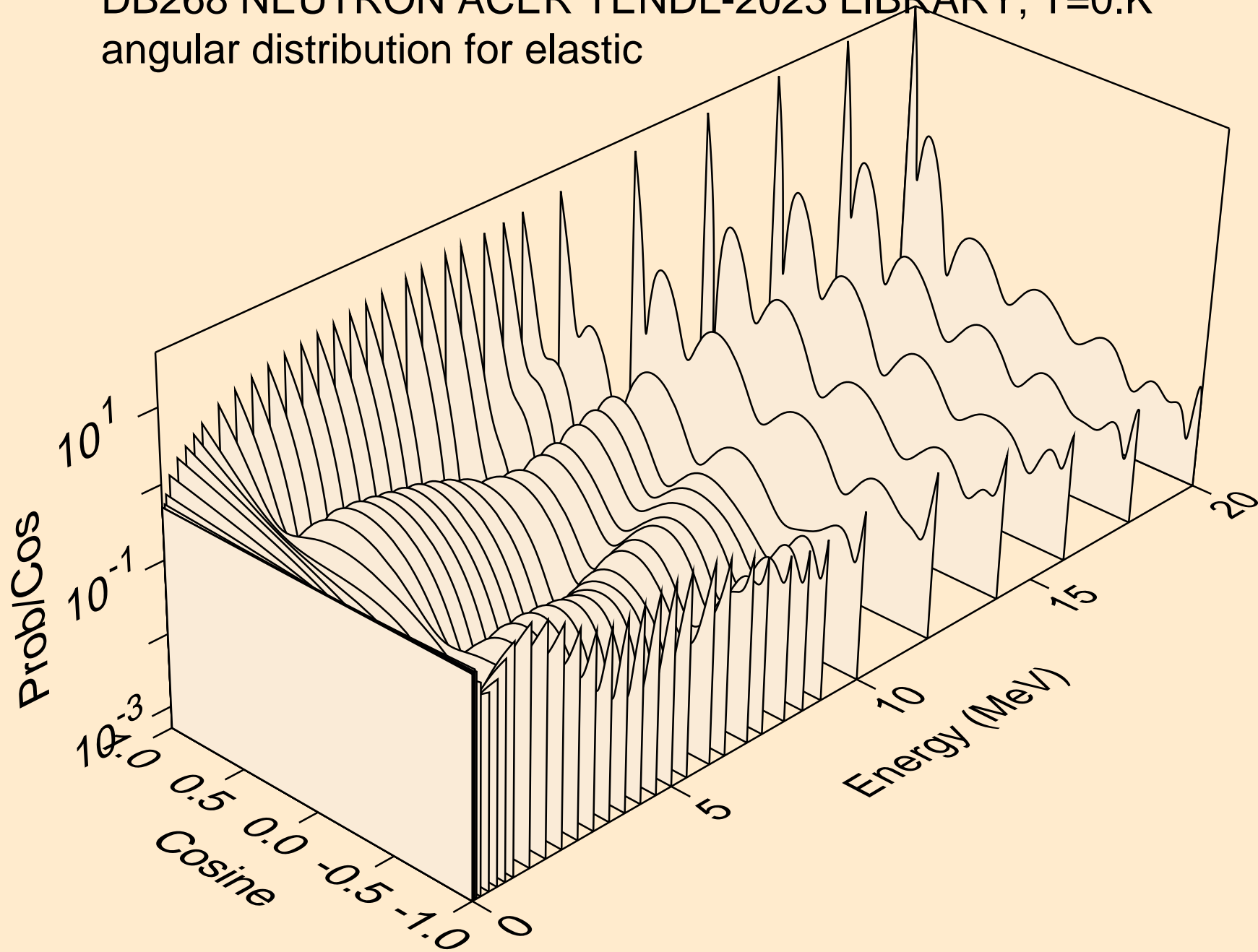

DB268 NEUTRON ACER TENDL-2023 LIBRARY; T=0.K  
angular distribution for elastic

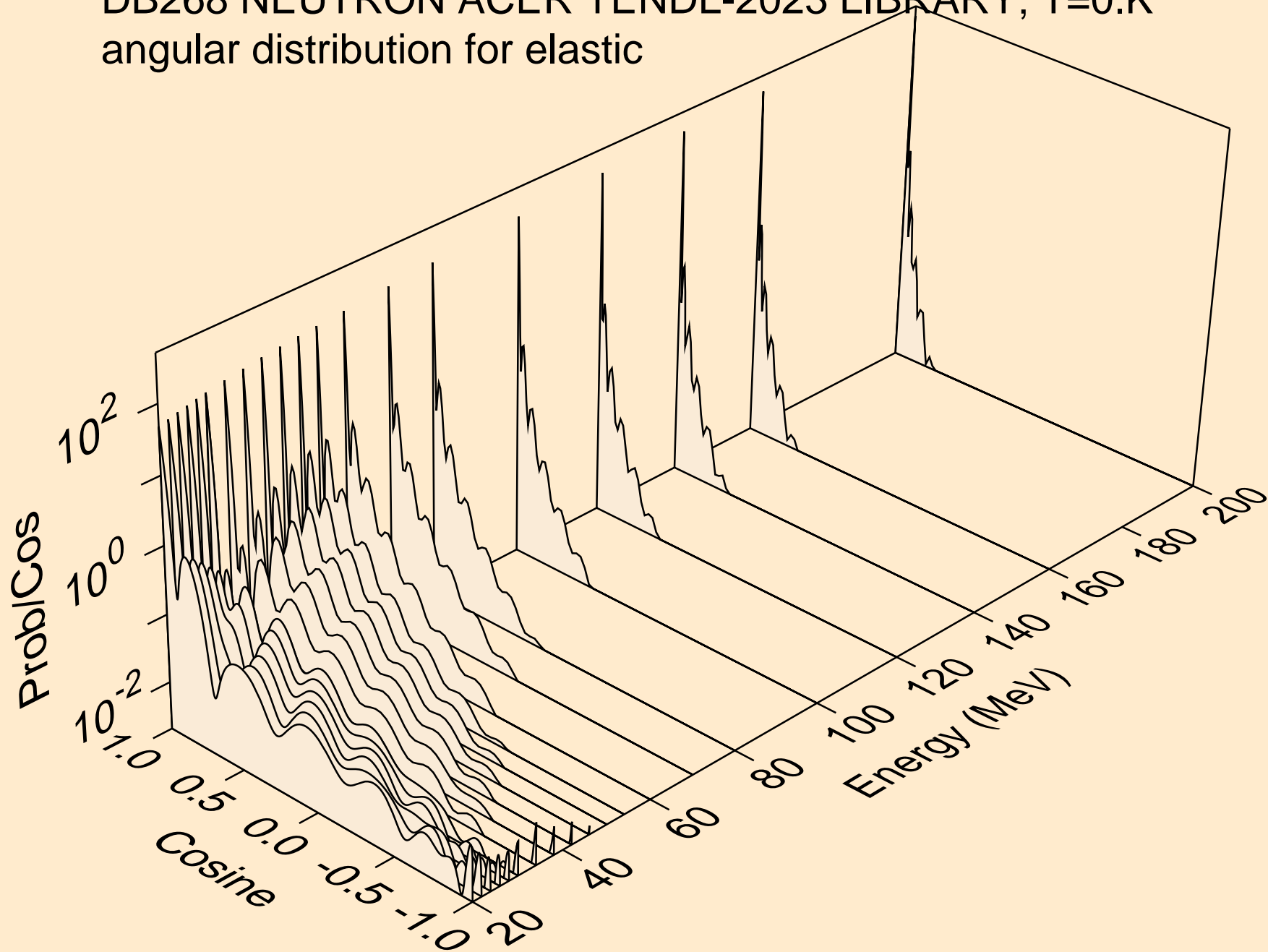

DB268 NEUTRON ACER TENDL-2023 LIBRARY; T=0.K  
angular distribution for (n,n\*1)

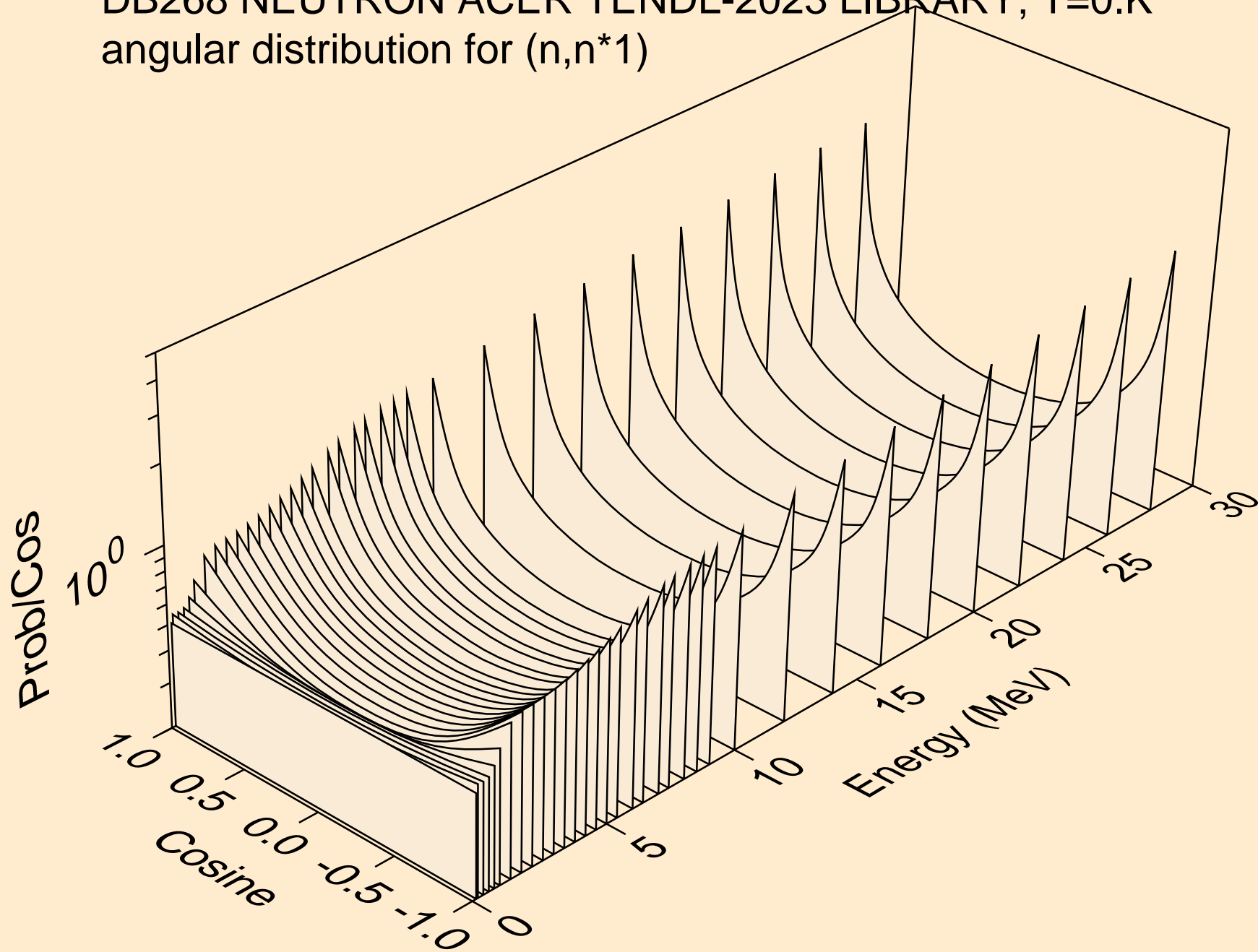

DB268 NEUTRON ACER TENDL-2023 LIBRARY; T=0.K  
angular distribution for (n,n\*2)

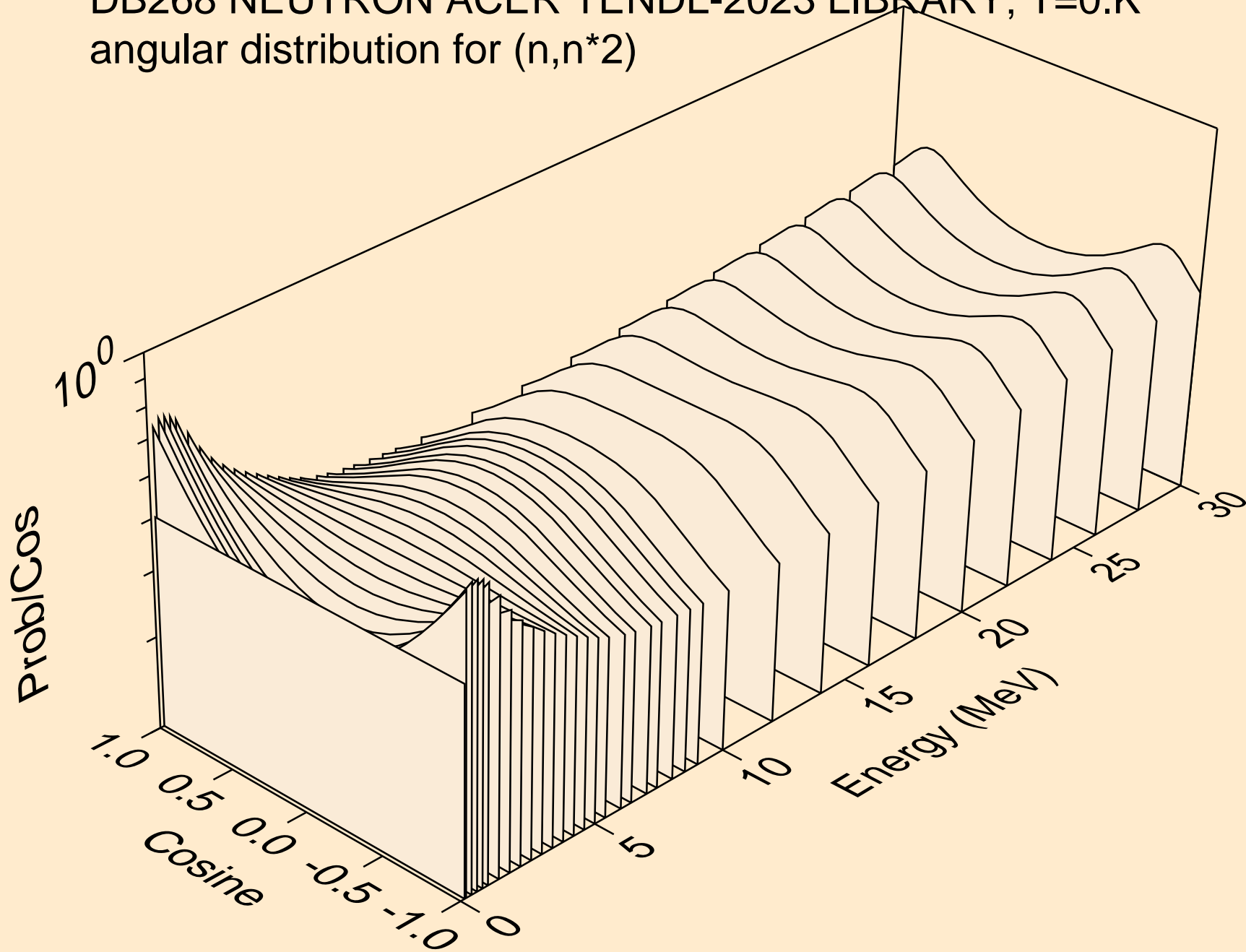

DB268 NEUTRON ACER TENDL-2023 LIBRARY; T=0.K

Total fission nubar

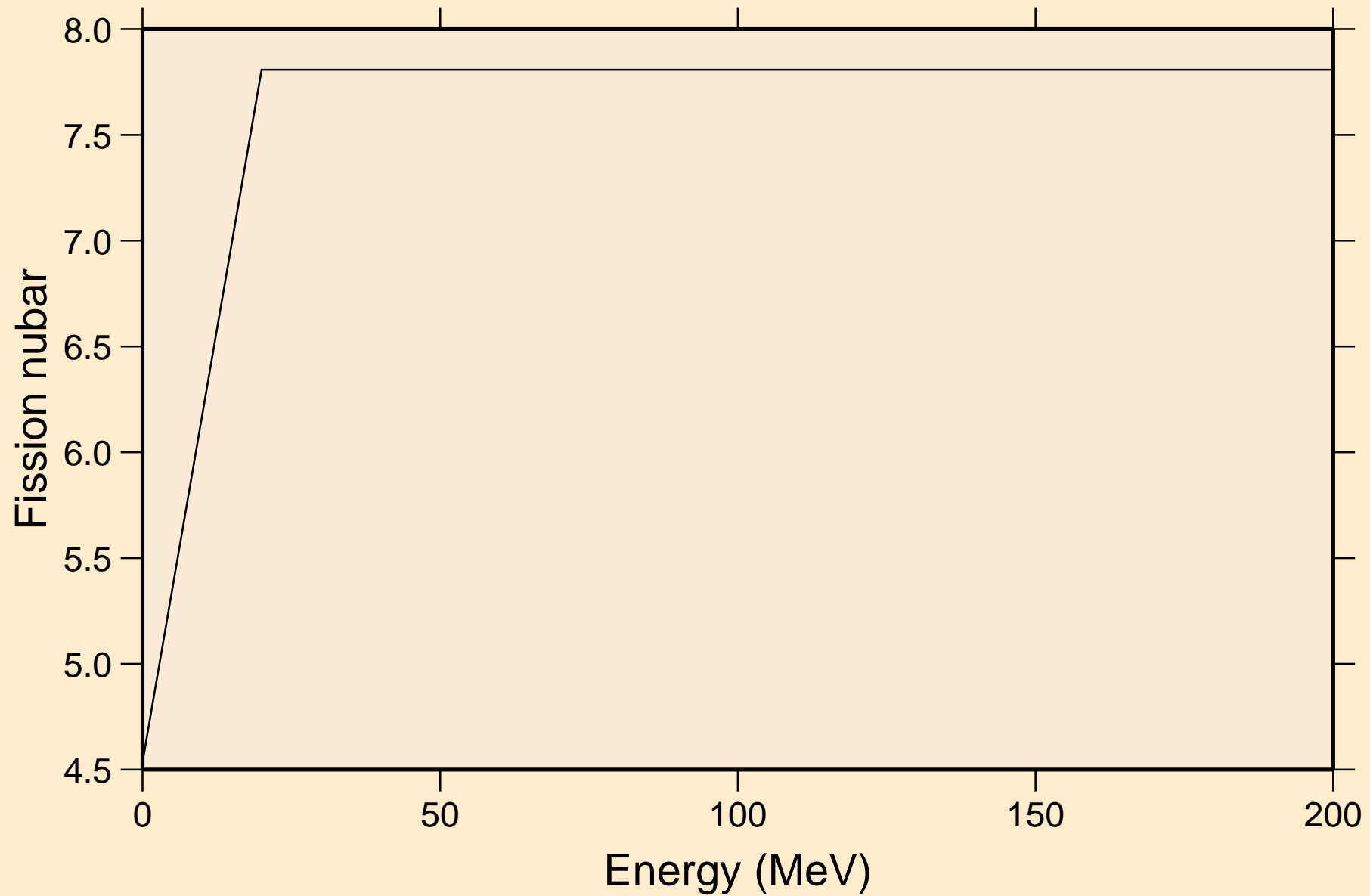

DB268 NEUTRON ACER TENDL-2023 LIBRARY; T=0.K  
Neutron emission for (n,x)

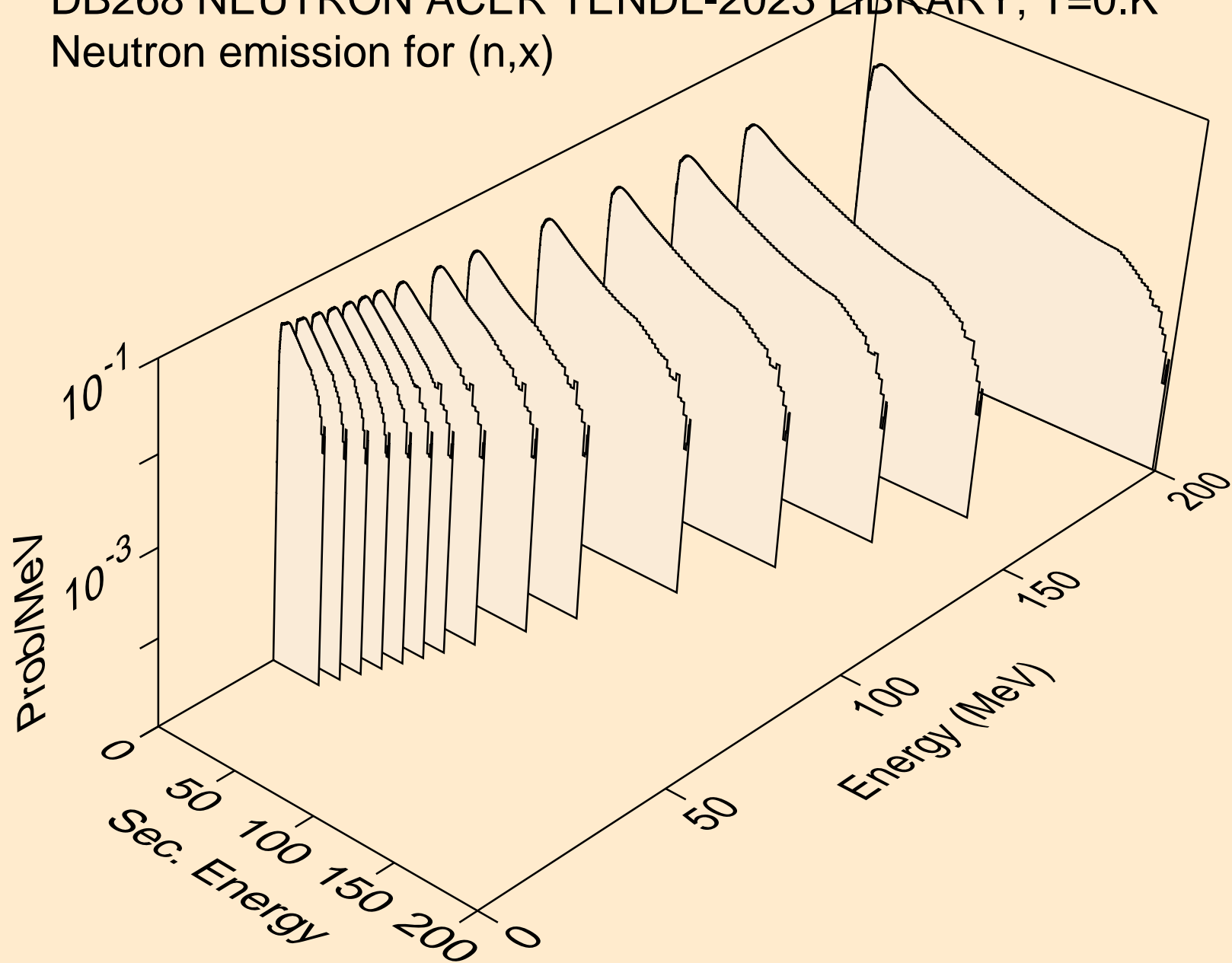

DB268 NEUTRON ACER TENDL-2023 LIBRARY; T=0.K  
Neutron emission for (n,2nd)

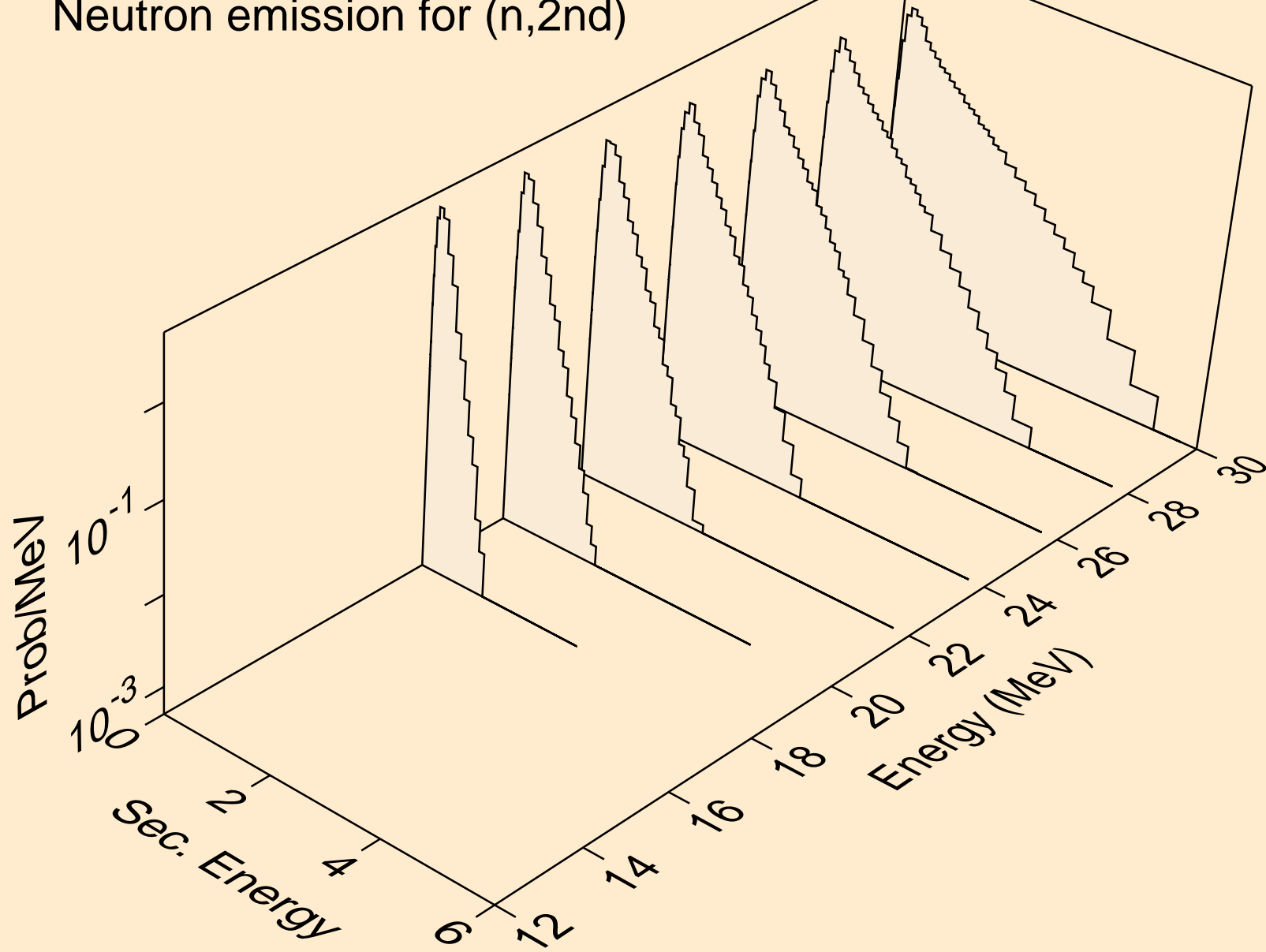

DB268 NEUTRON ACER TENDL-2023 LIBRARY; T=0.K  
Neutron emission for (n,2n)

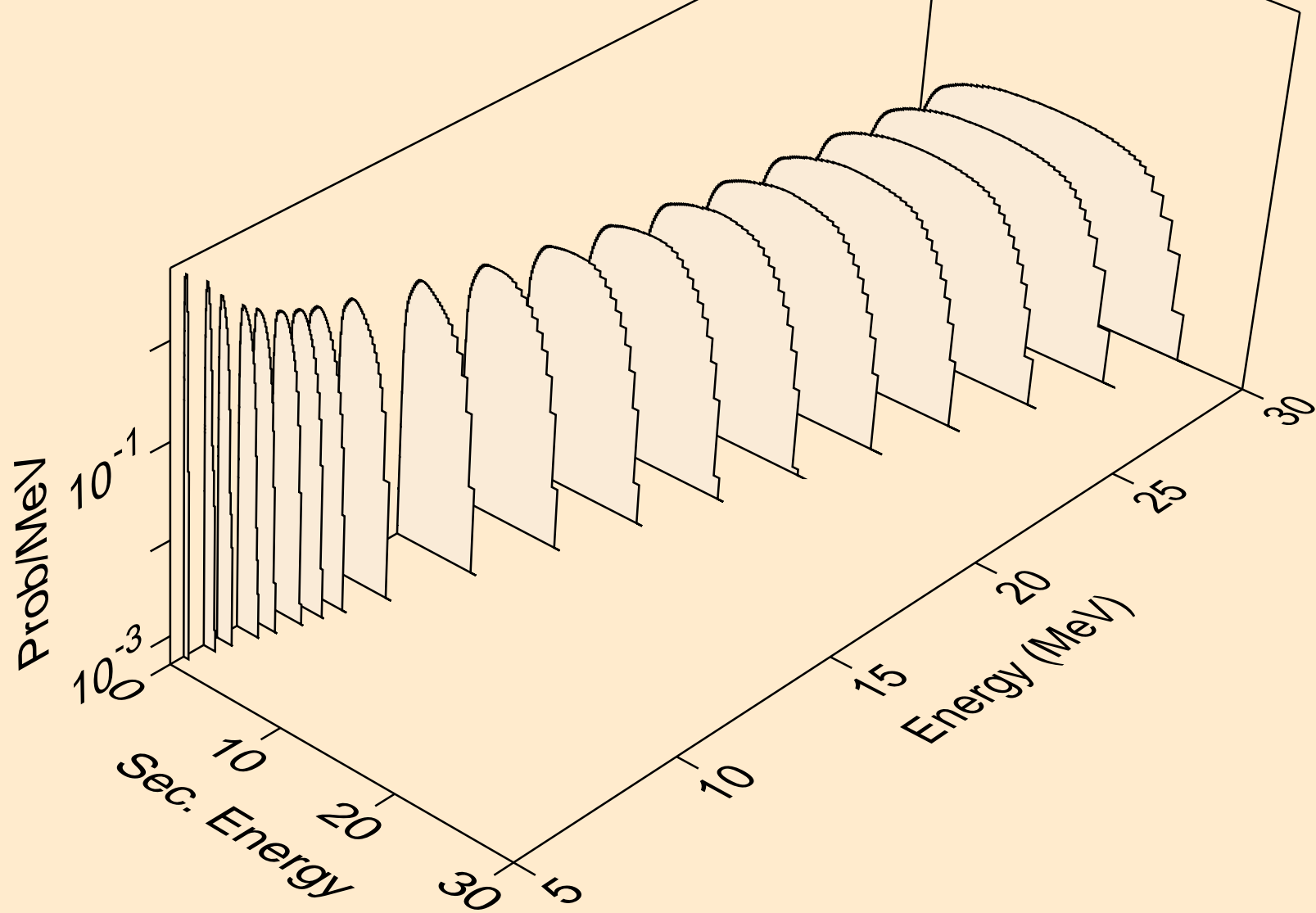

DB268 NEUTRON ACER TENDL-2023 LIBRARY; T=0.K  
Neutron emission for (n,3n)

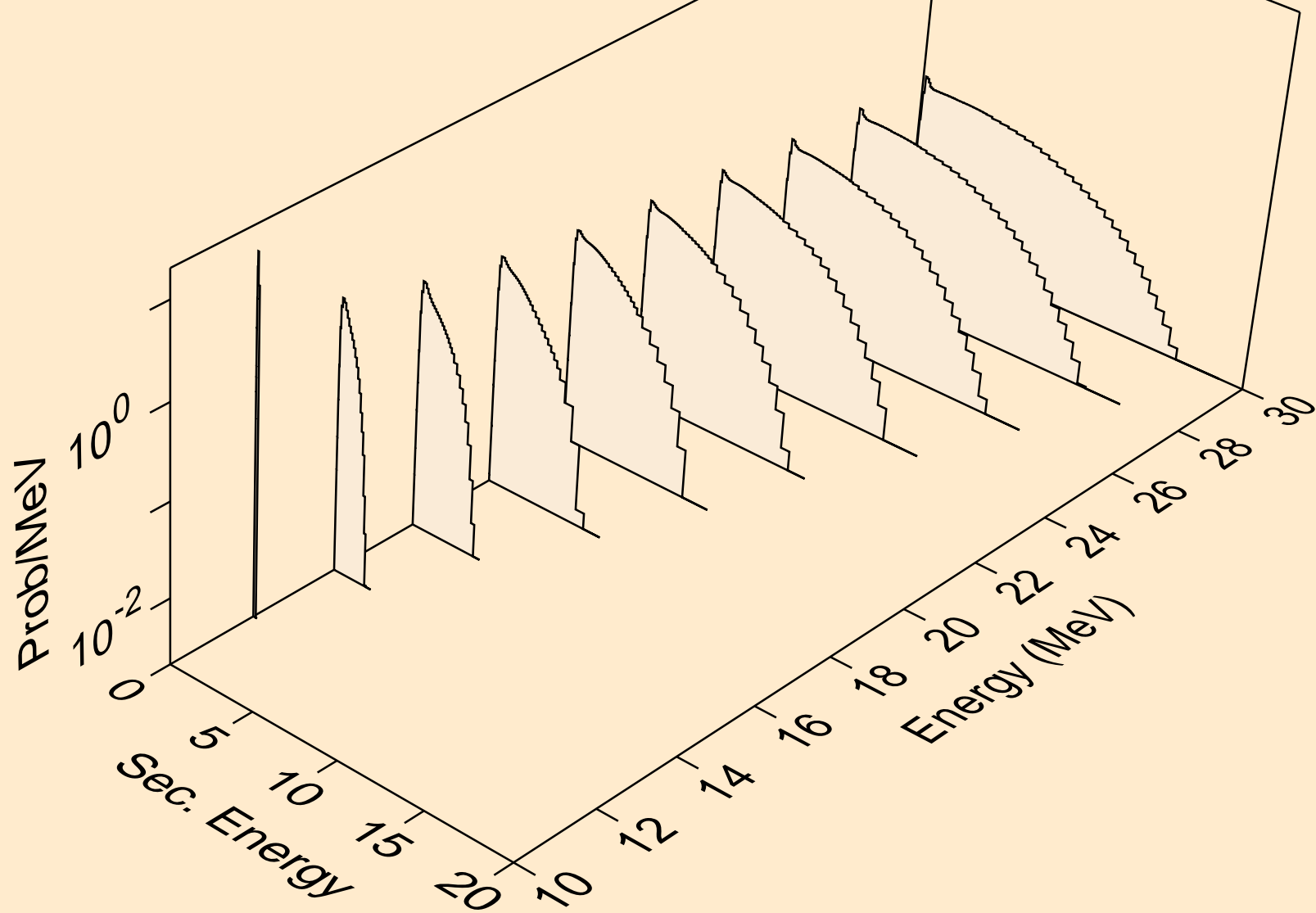

DB268 NEUTRON ACER TENDL-2023 LIBRARY; T=0.K  
Neutron emission for fission

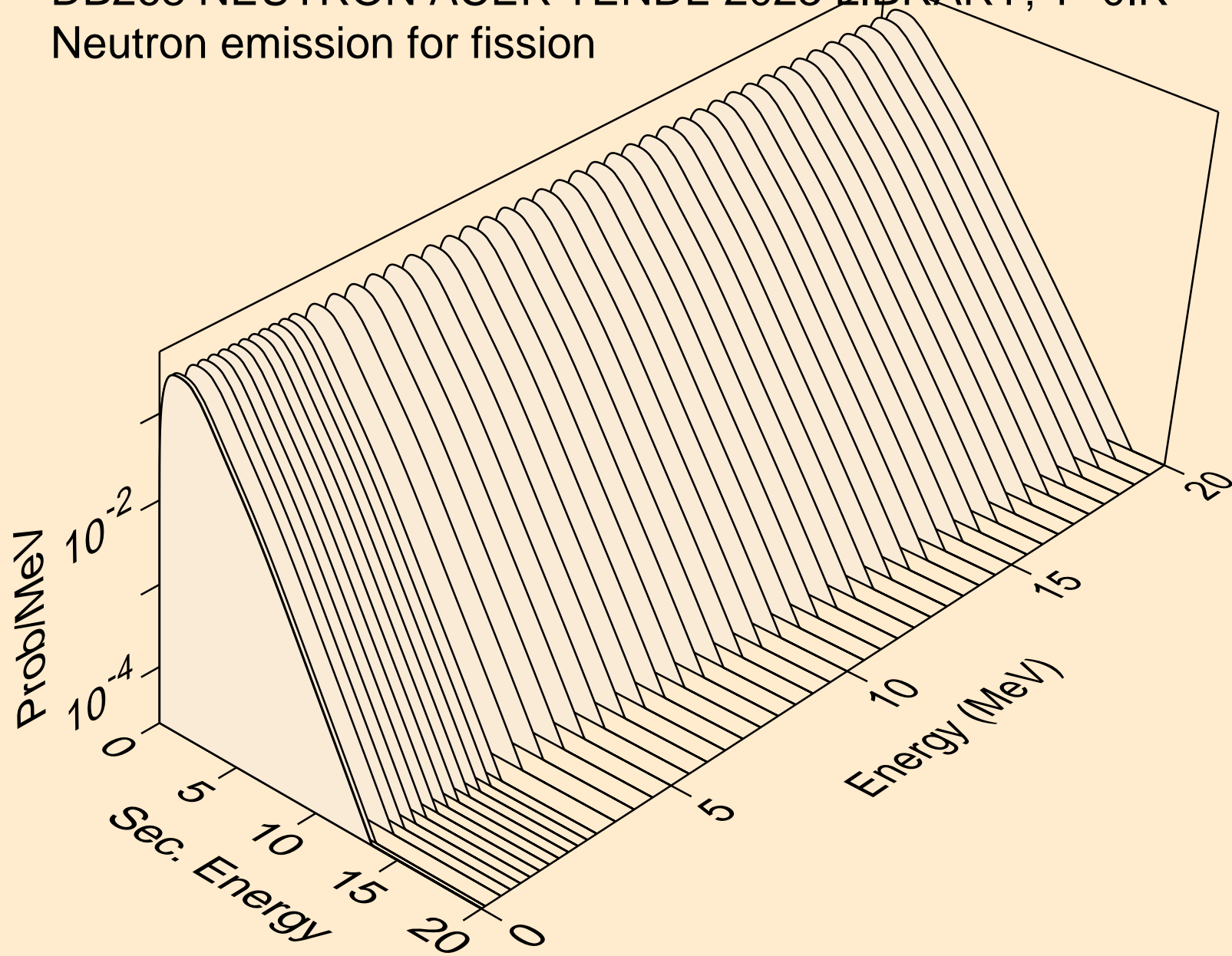

DB268 NEUTRON ACER TENDL-2023 LIBRARY; T=0.K  
Neutron emission for (n,n\*)a

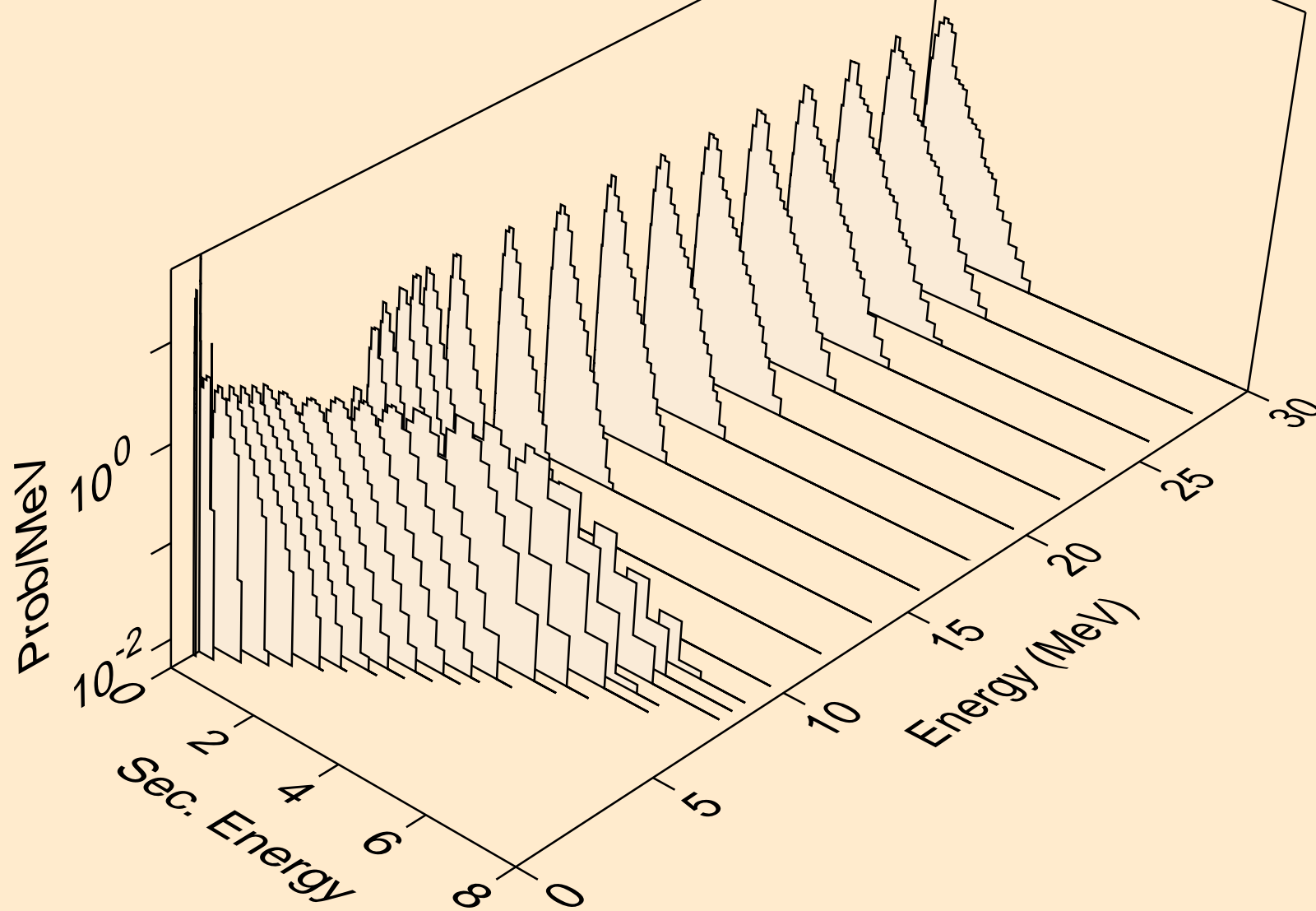

DB268 NEUTRON ACER TENDL-2023 LIBRARY; T=0.K  
Neutron emission for (n,2n)a

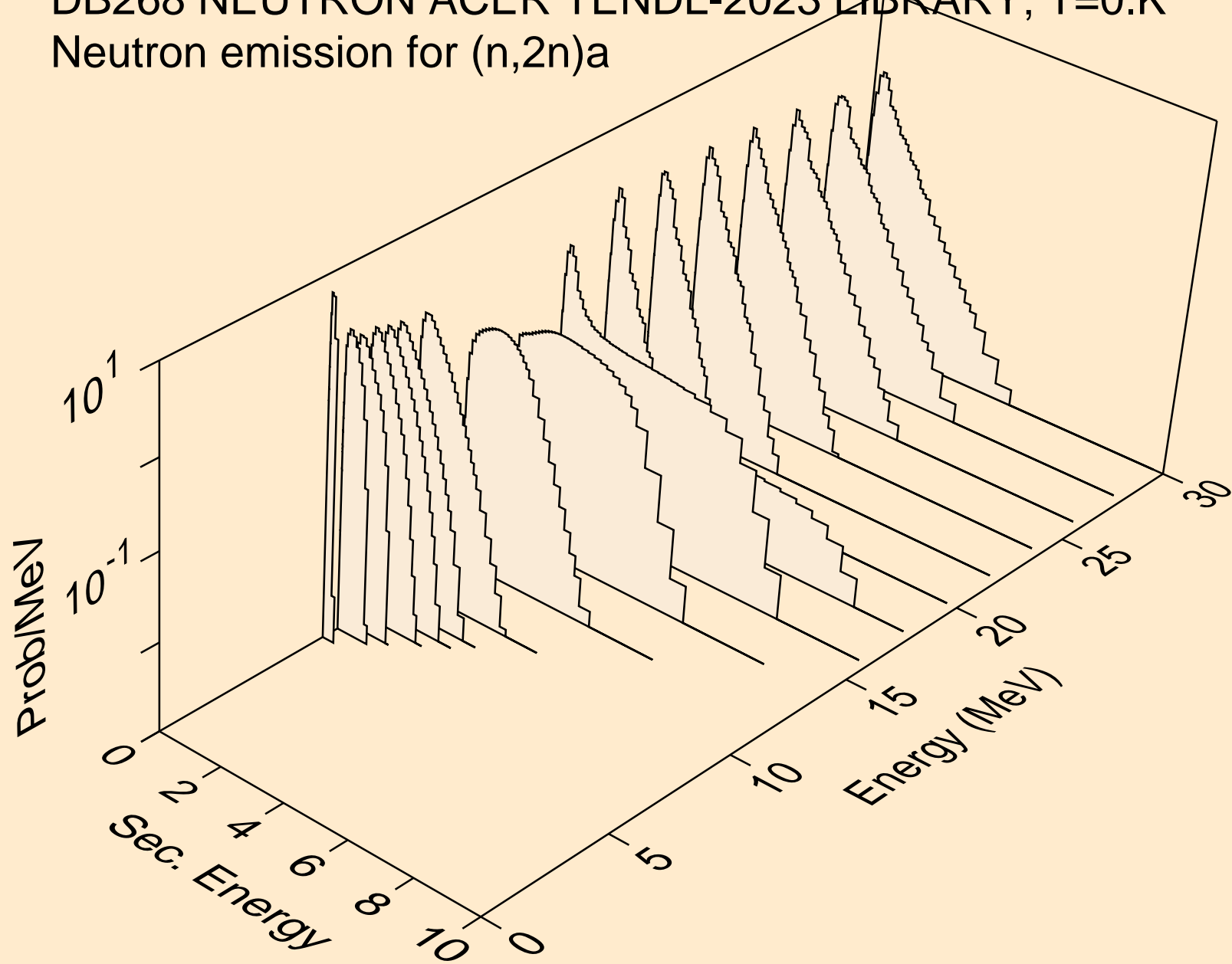

DB268 NEUTRON ACER TENDL-2023 LIBRARY; T=0.K  
Neutron emission for (n,3n)a

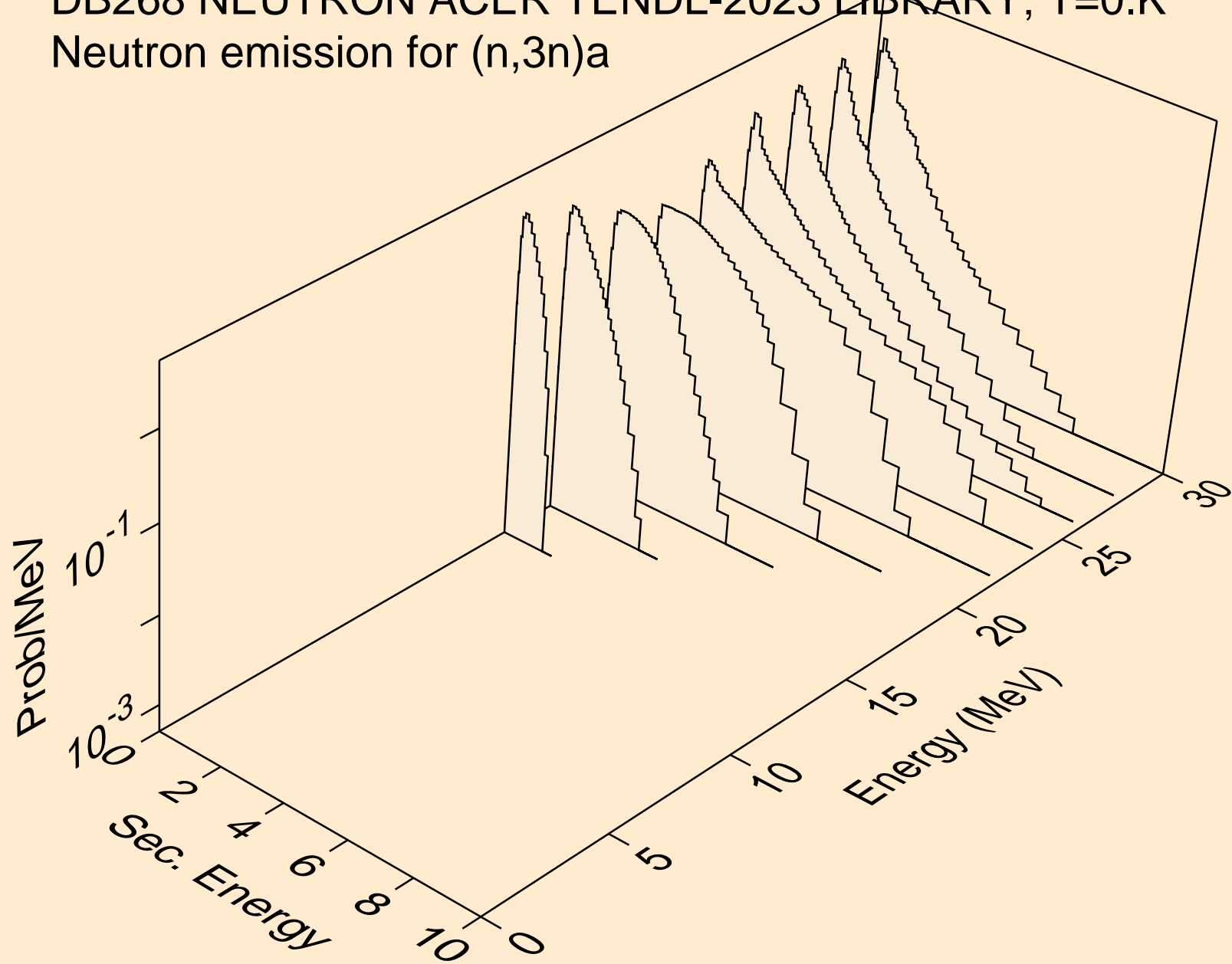

DB268 NEUTRON ACER TENDL-2023 LIBRARY; T=0.K  
Neutron emission for (n,n\*)p

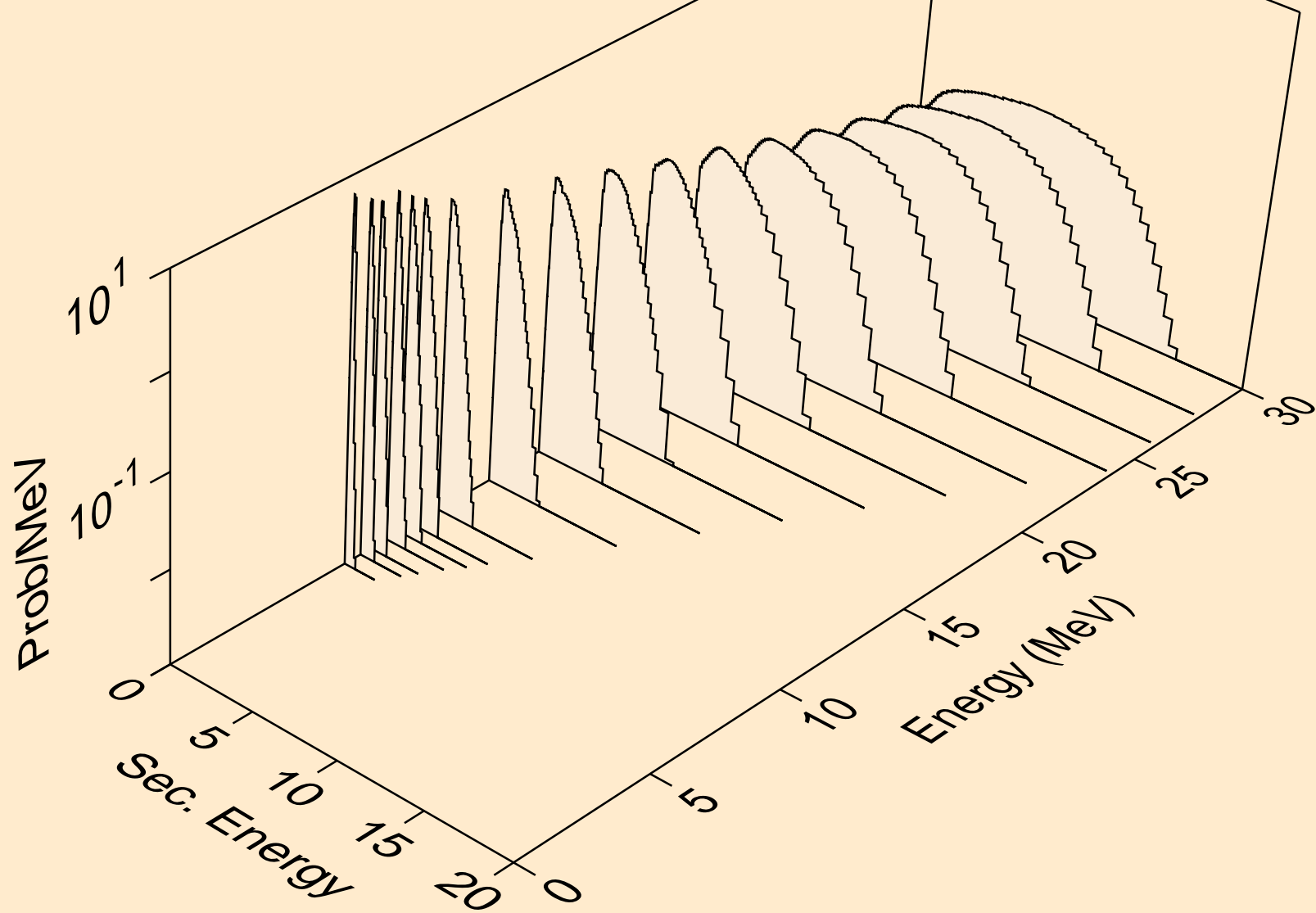

DB268 NEUTRON ACER TENDL-2023 LIBRARY; T=0.K  
Neutron emission for (n,n\*)d

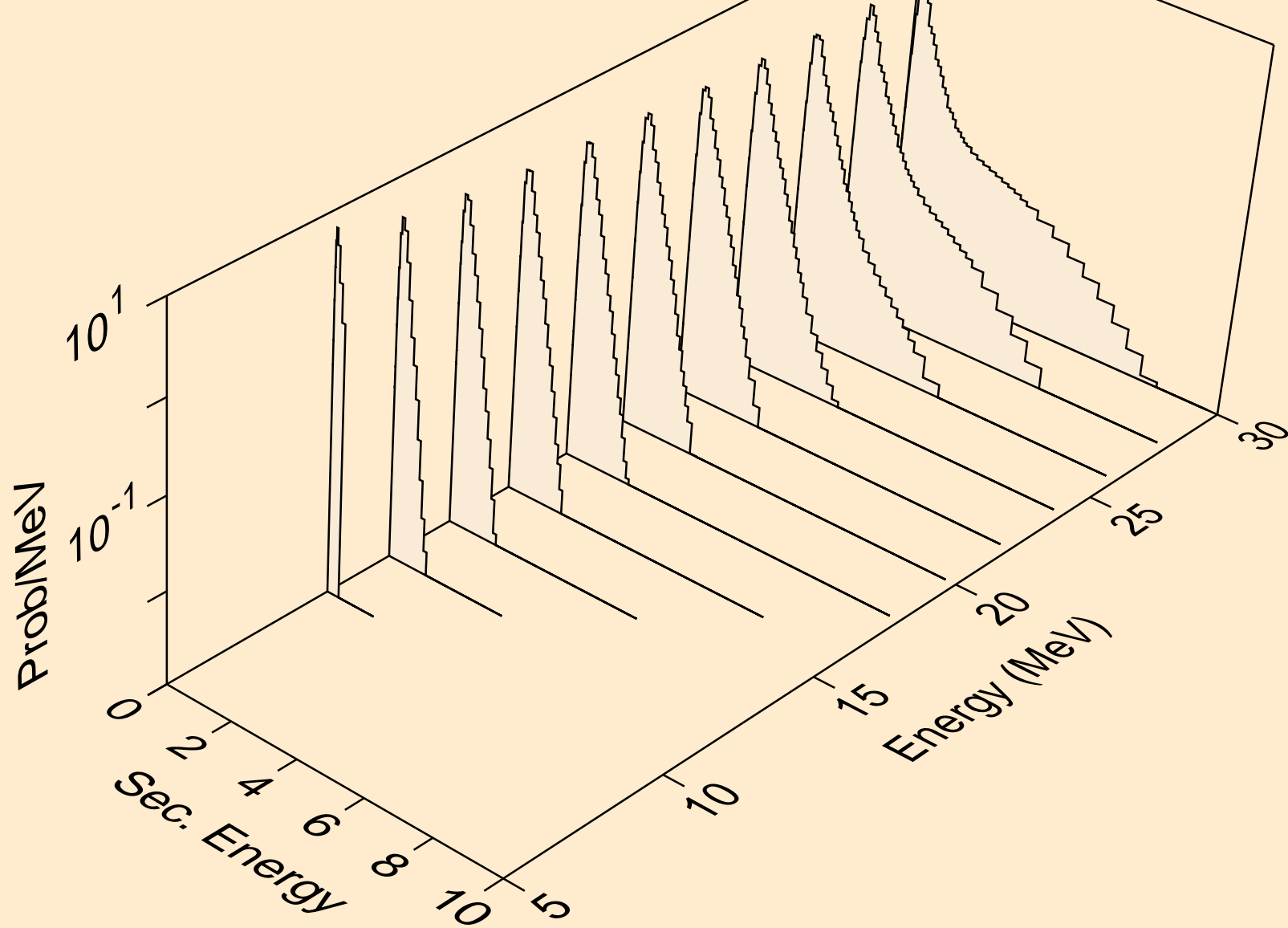

DB268 NEUTRON ACER TENDL-2023 LIBRARY; T=0.K  
Neutron emission for (n,n\*)t

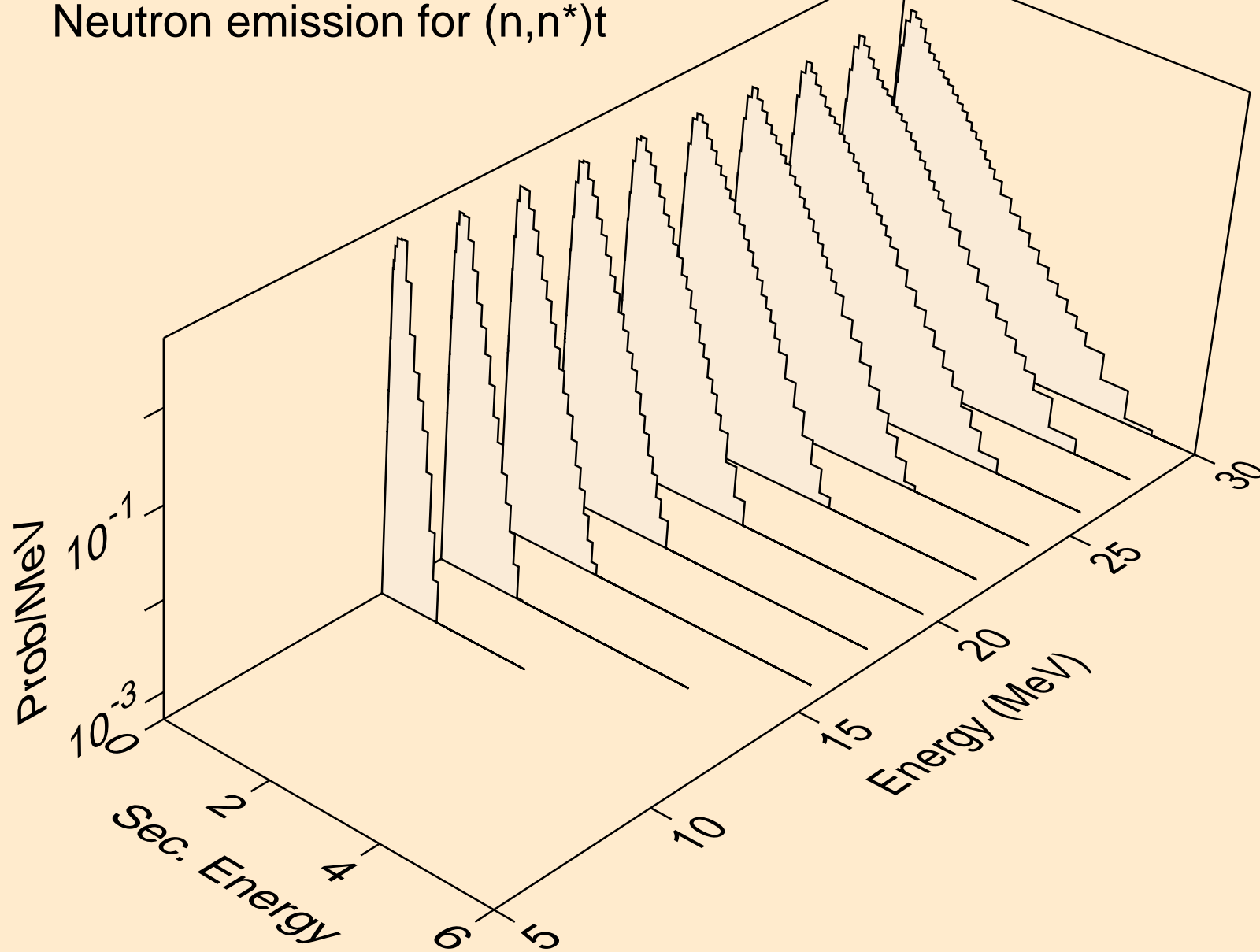

DB268 NEUTRON ACER TENDL-2023 LIBRARY; T=0.K  
Neutron emission for (n,n\*)he3

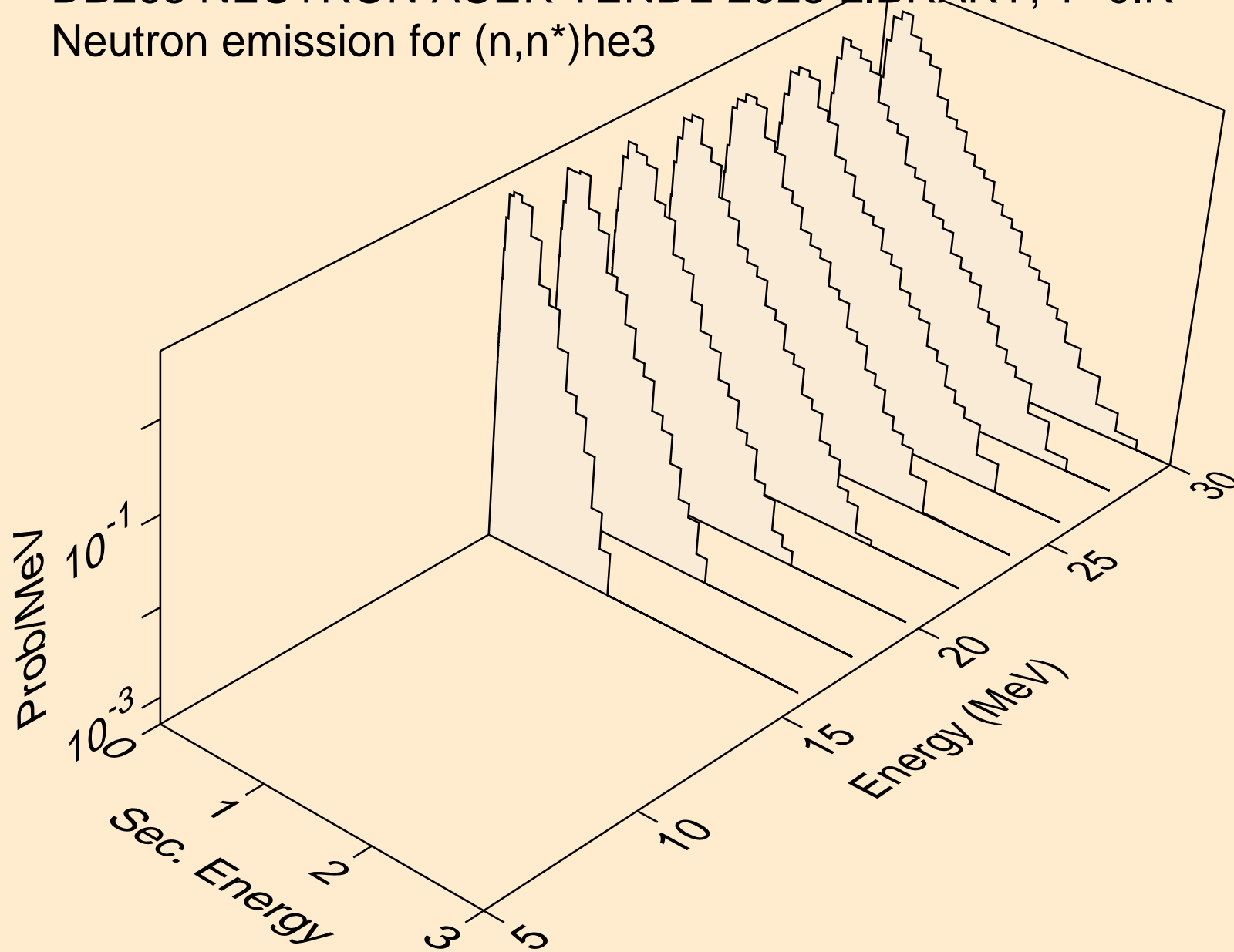

DB268 NEUTRON ACER TENDL-2023 LIBRARY; T=0.K  
Neutron emission for (n,4n)

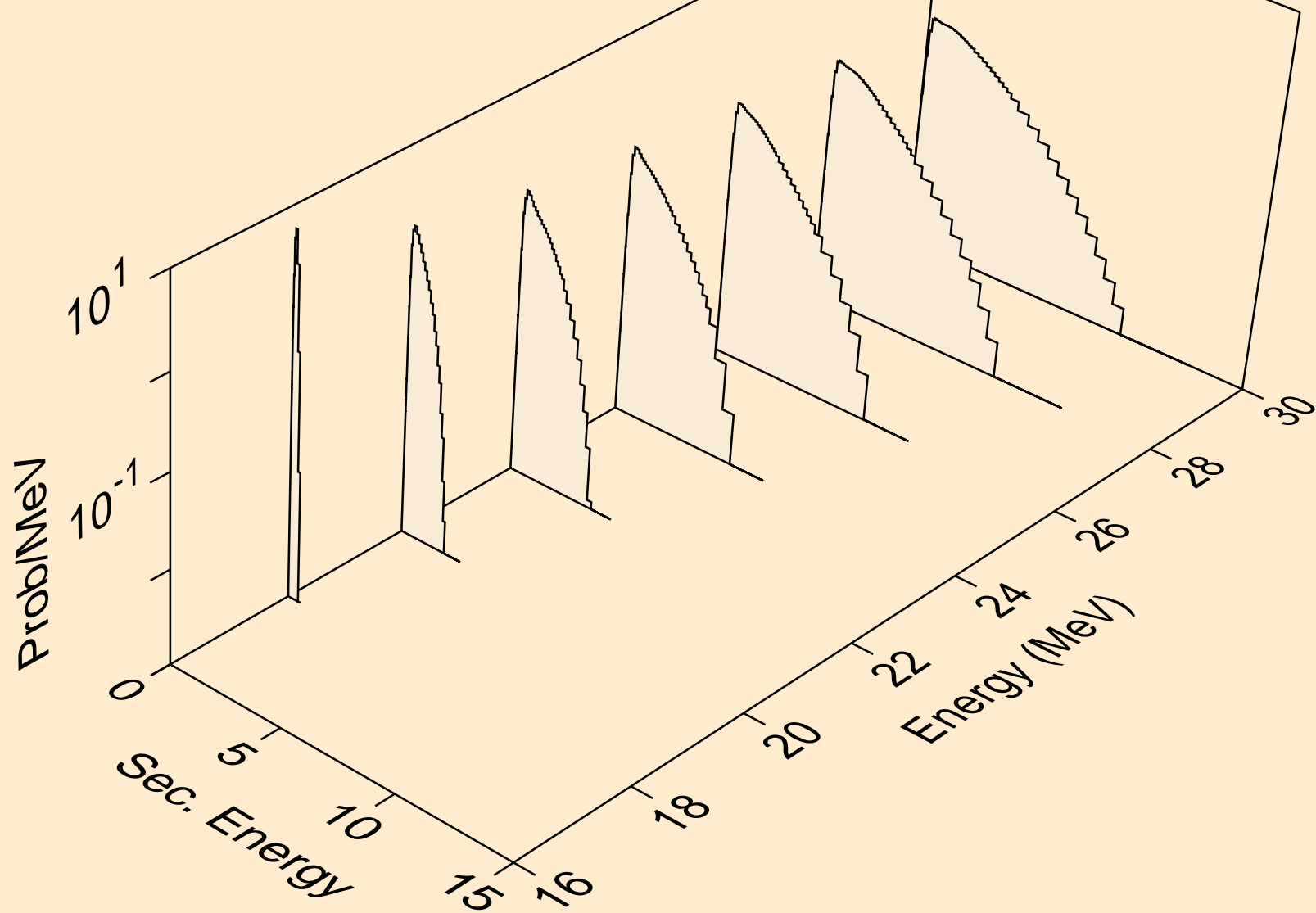

DB268 NEUTRON ACER TENDL-2023 LIBRARY; T=0.K  
Neutron emission for (n,2np)

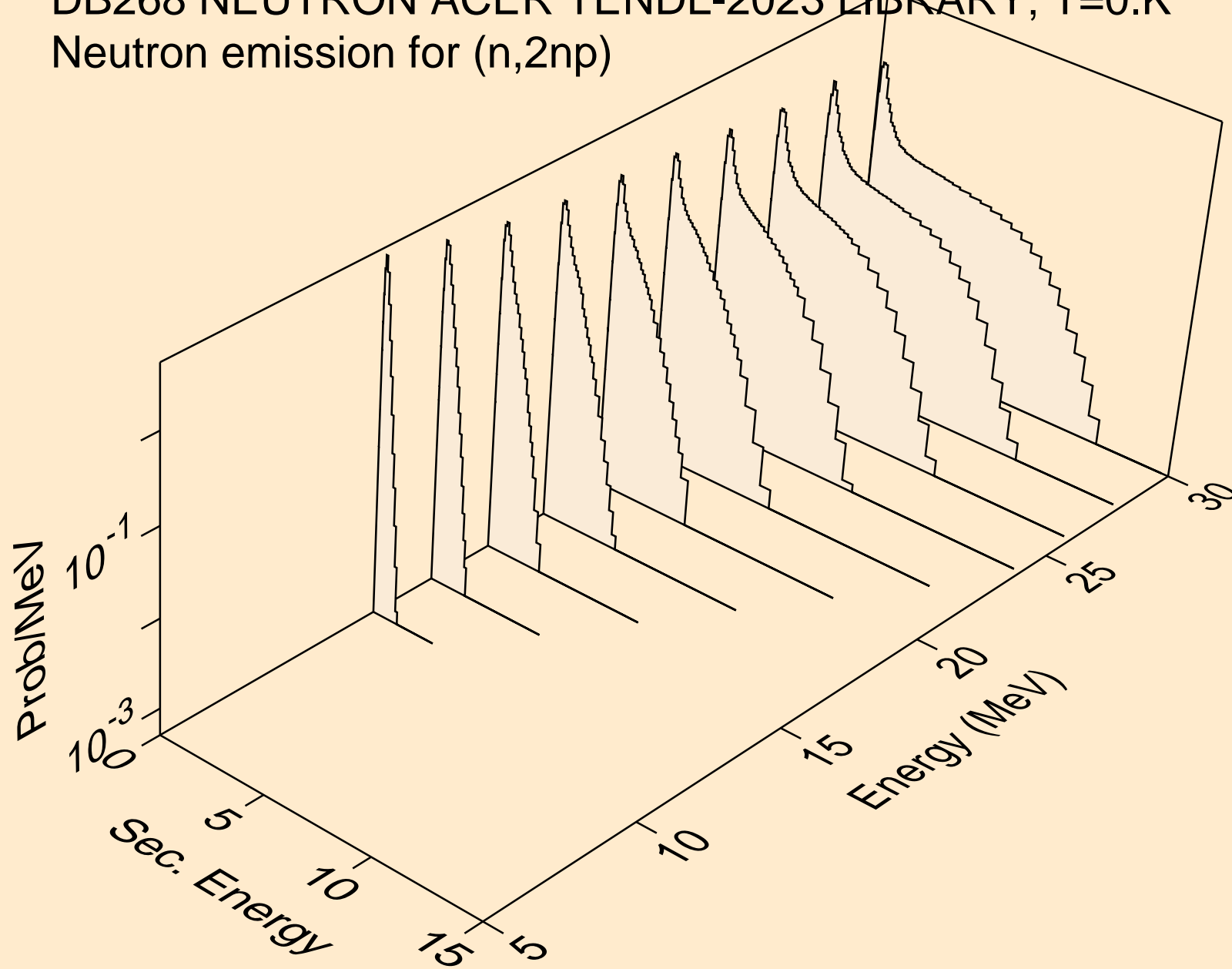

DB268 NEUTRON ACER TENDL-2023 LIBRARY; T=0.K  
Neutron emission for (n,3np)

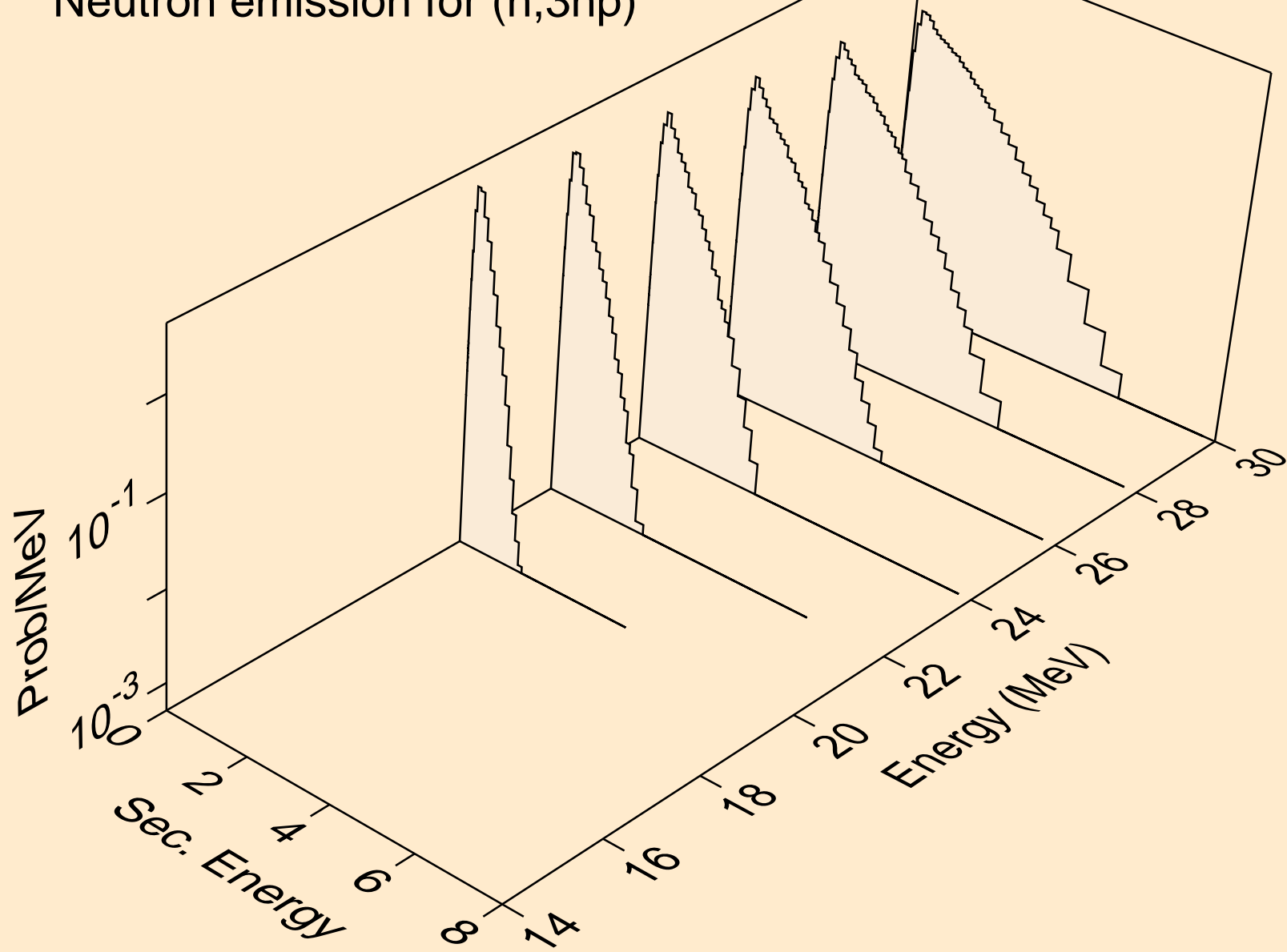

DB268 NEUTRON ACER TENDL-2023 LIBRARY; T=0.K  
Neutron emission for (n,n\*c)

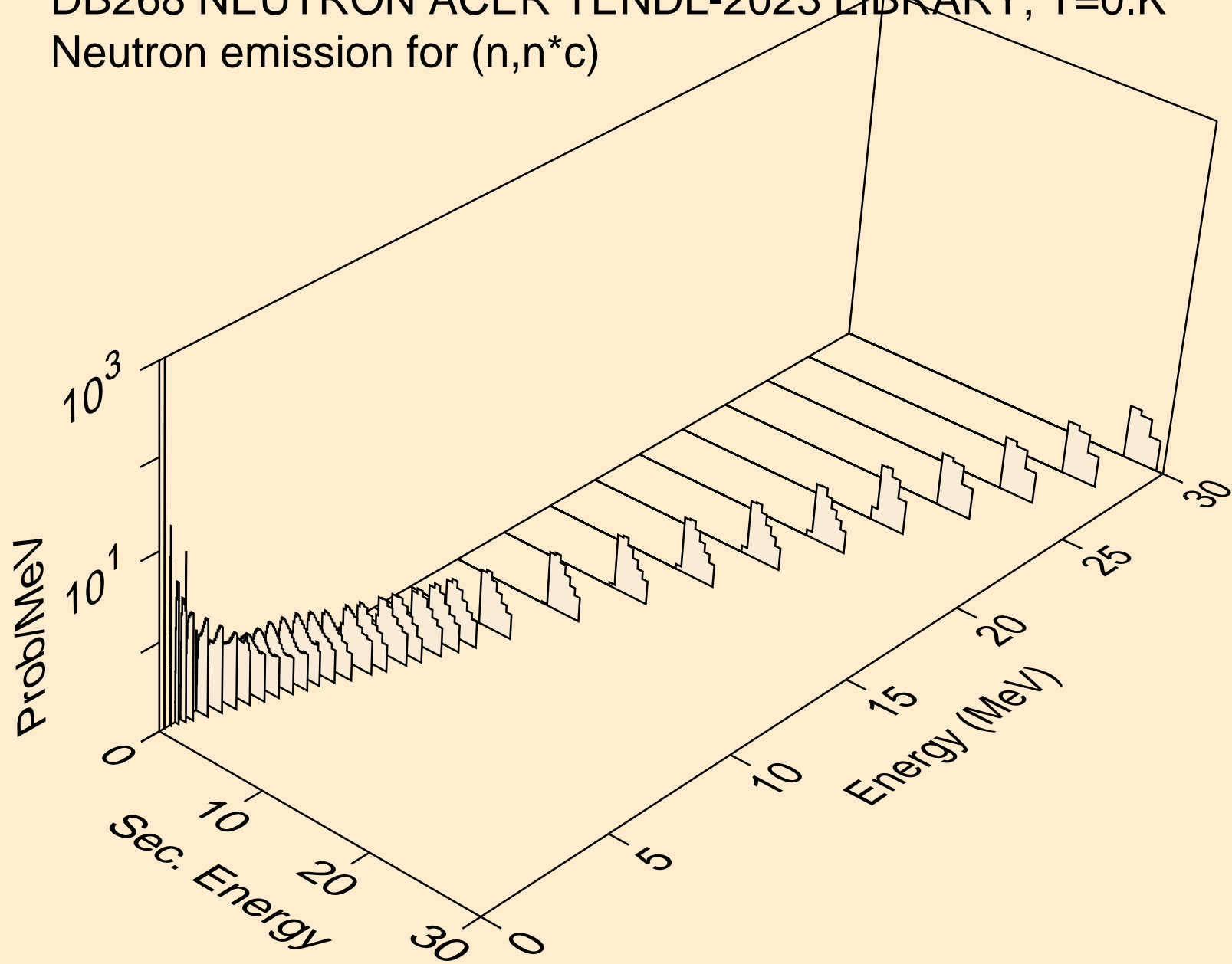

# DB268 NEUTRON ACER TENDL-2023 LIBRARY; T=0.K

## Delayed nubar

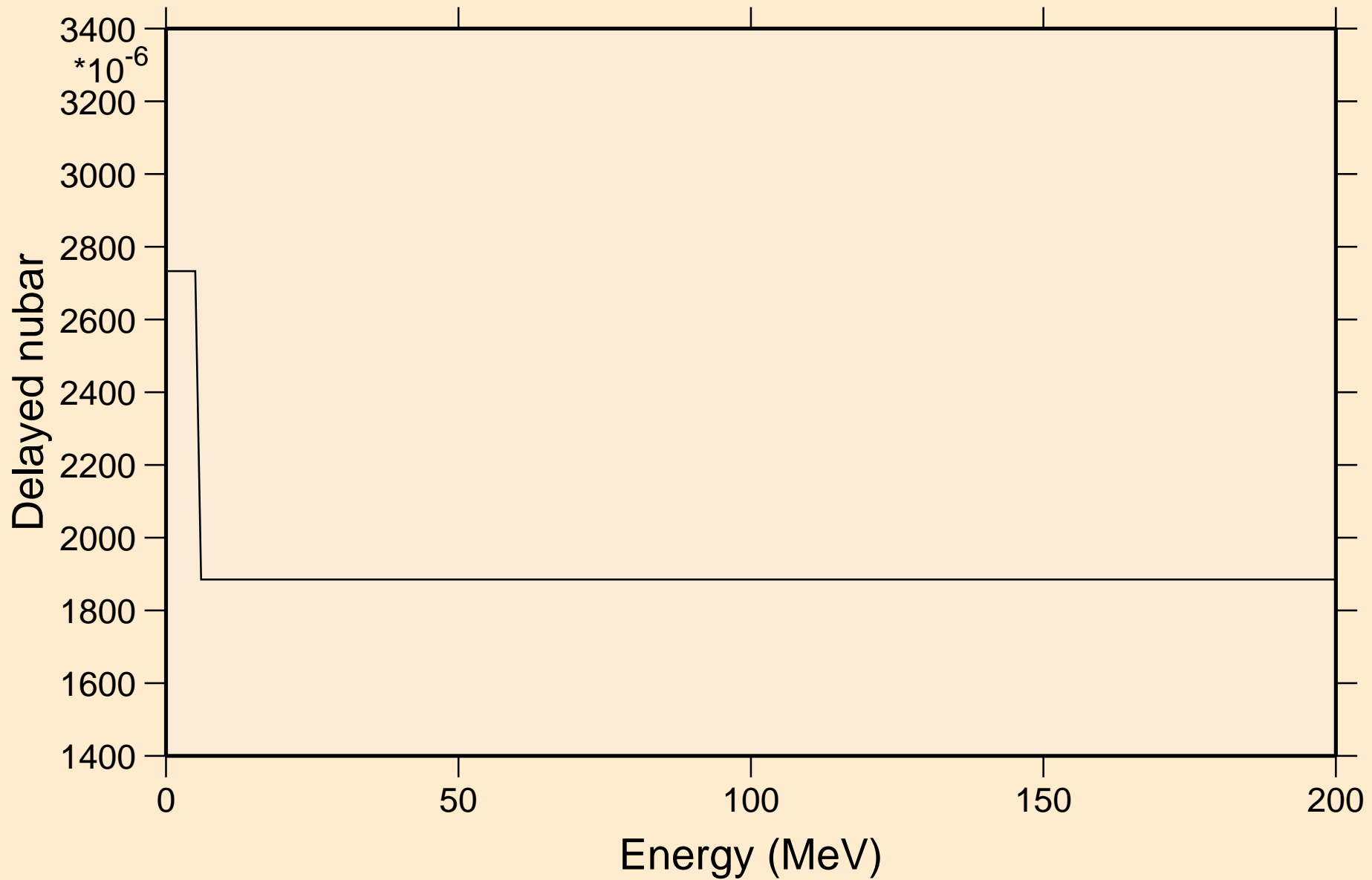

# DB268 NEUTRON ACER TENDL-2023 LIBRARY; T=0.K

## Delayed neutron spectra

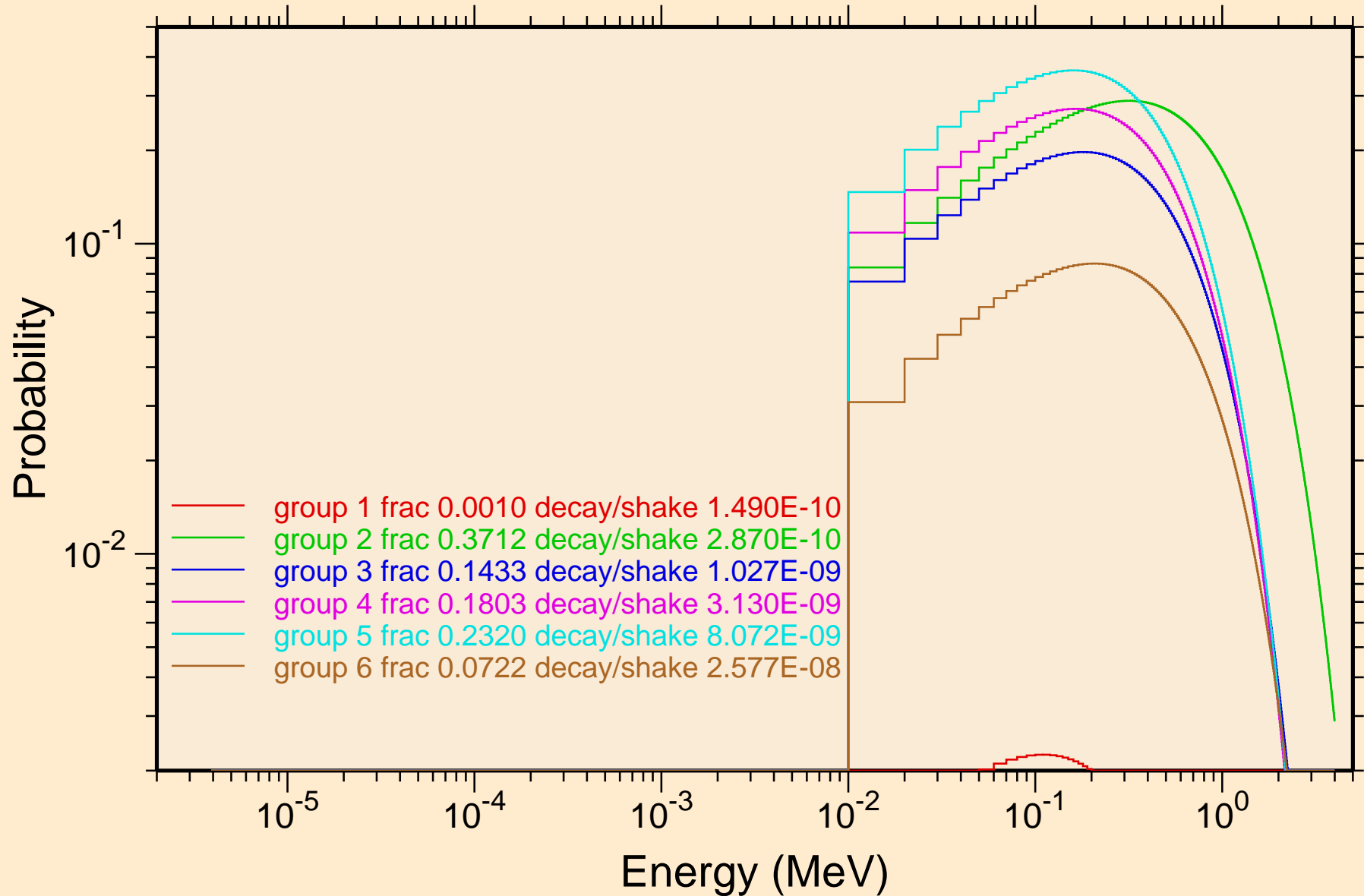

DB268 NEUTRON ACER TENDL-2023 LIBRARY; T=0.K  
Photon emission for (n,x)

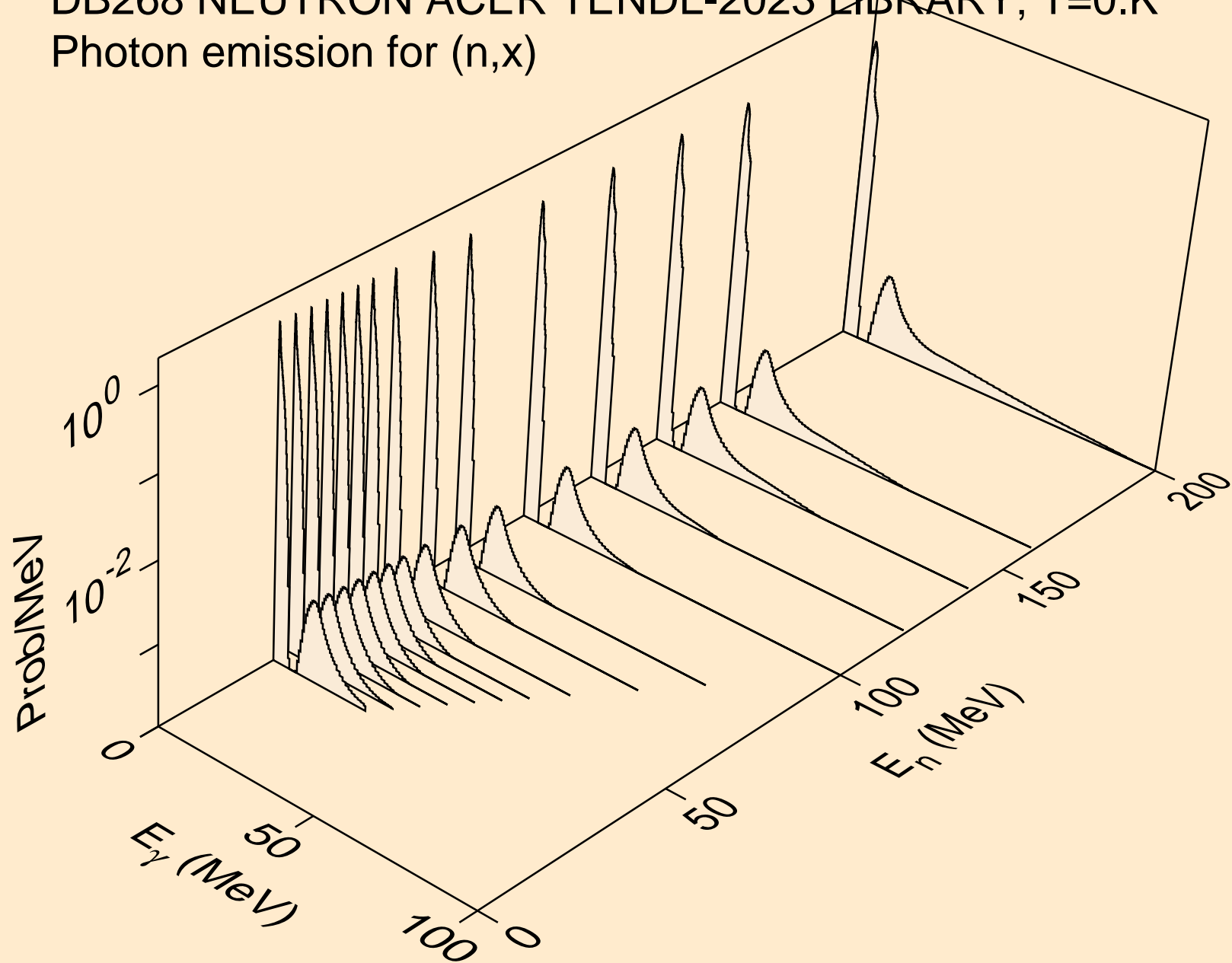

DB268 NEUTRON ACER TENDL-2023 LIBRARY; T=0.K  
Photon emission for (n,2nd)

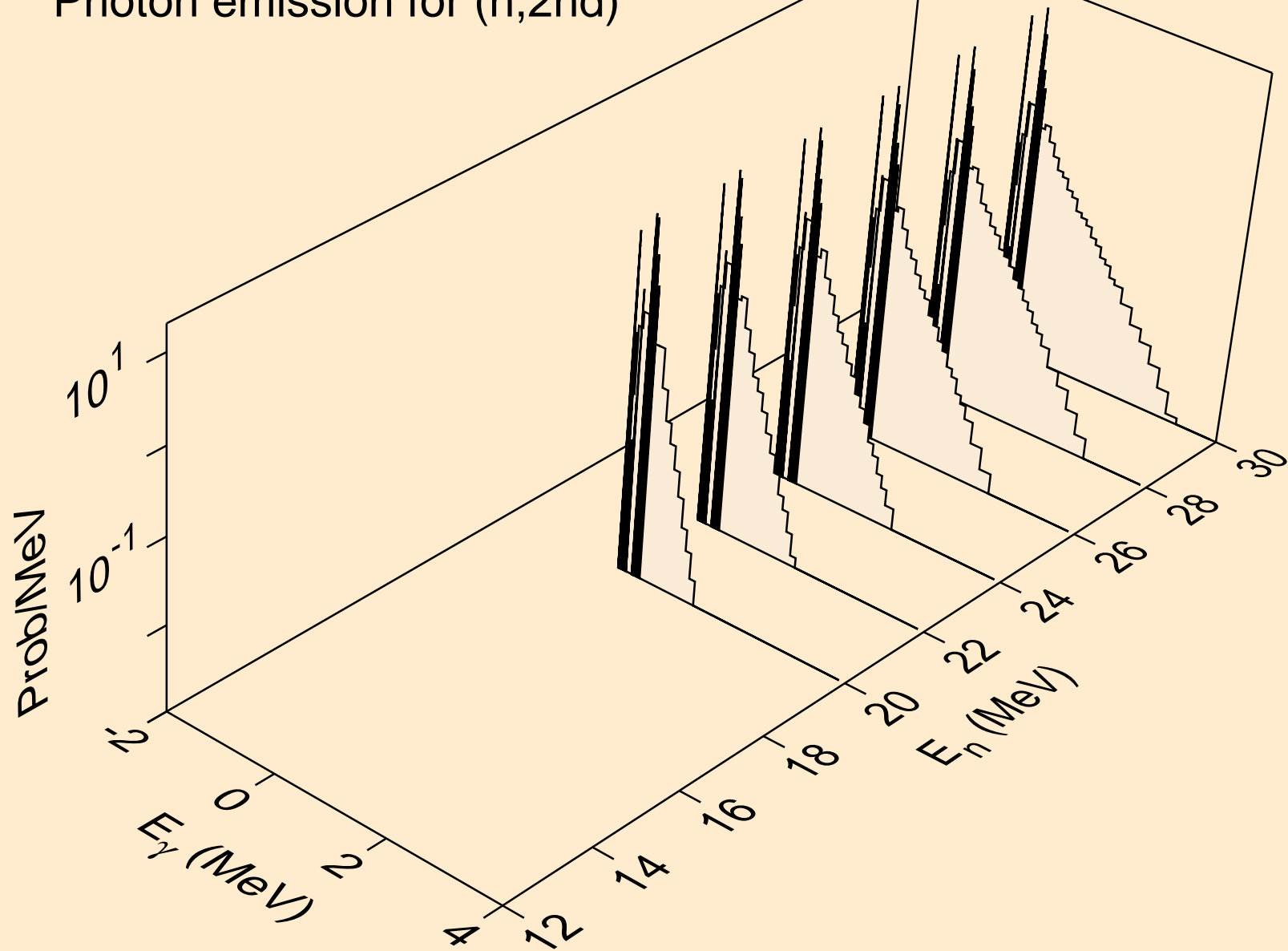

DB268 NEUTRON ACER TENDL-2023 LIBRARY; T=0.K  
Photon emission for (n,2n)

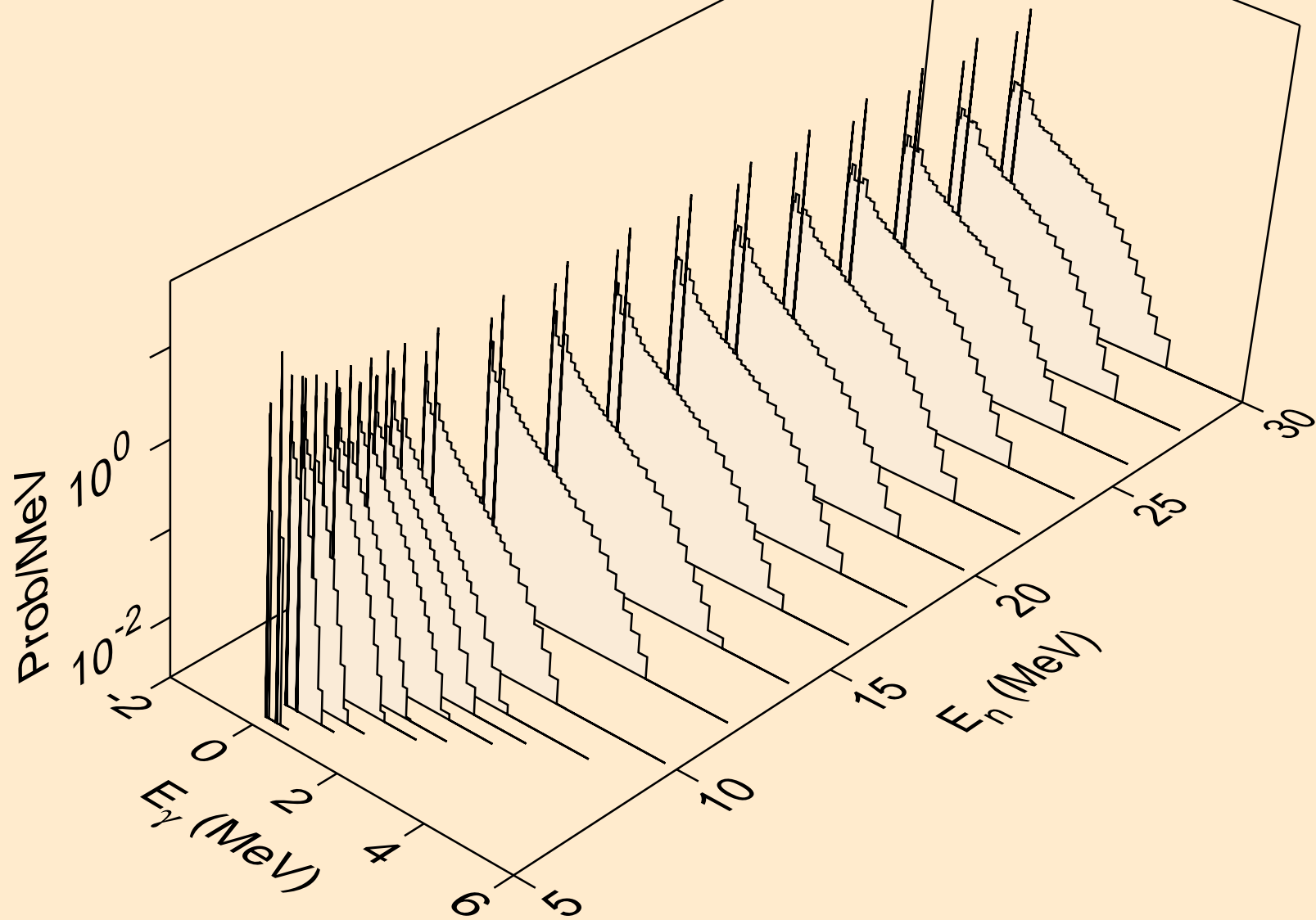

DB268 NEUTRON ACER TENDL-2023 LIBRARY; T=0.K  
Photon emission for (n,3n)

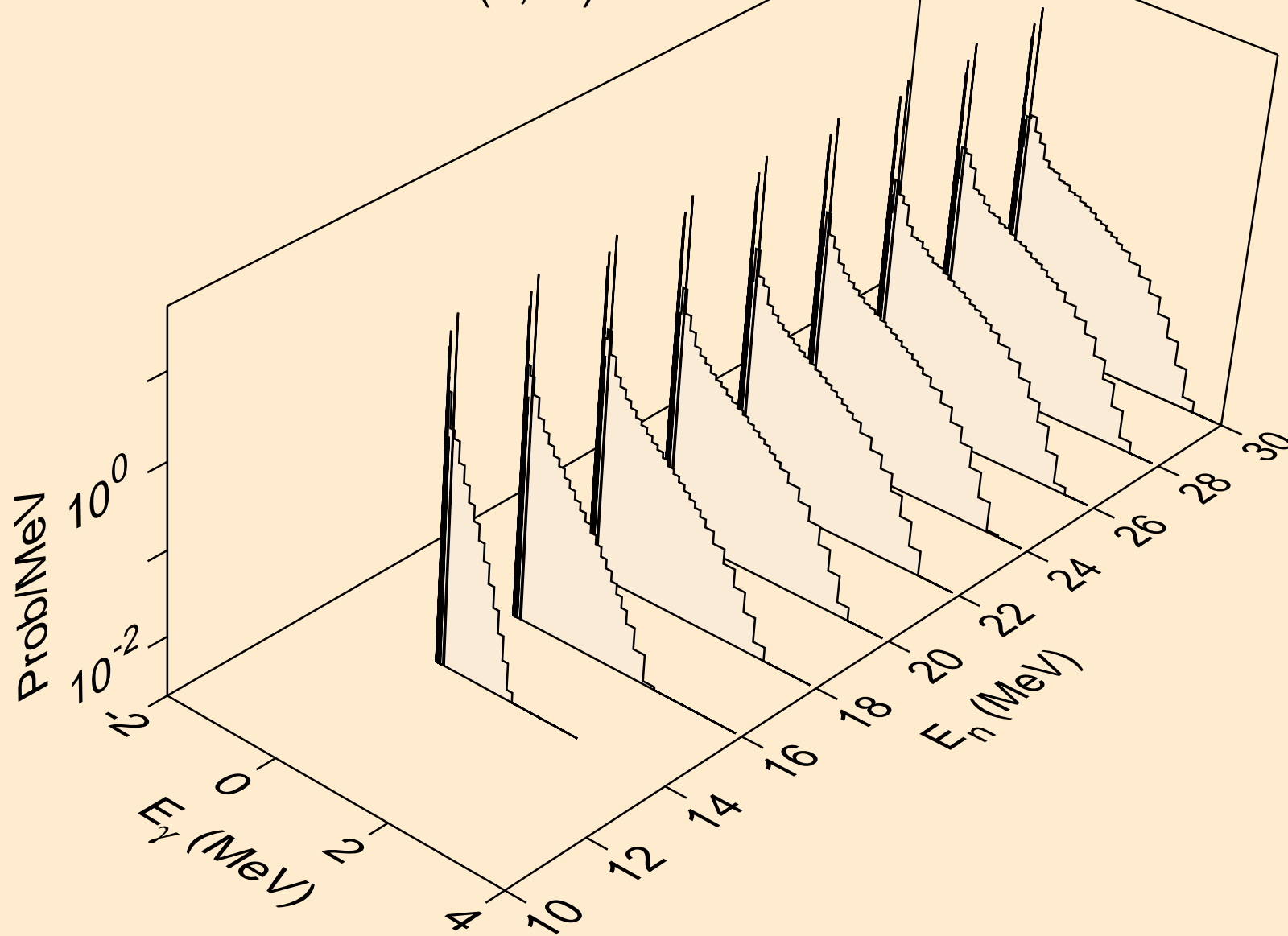

DB268 NEUTRON ACER TENDL-2023 LIBRARY; T=0.K  
Photon emission for (n,n\*)a

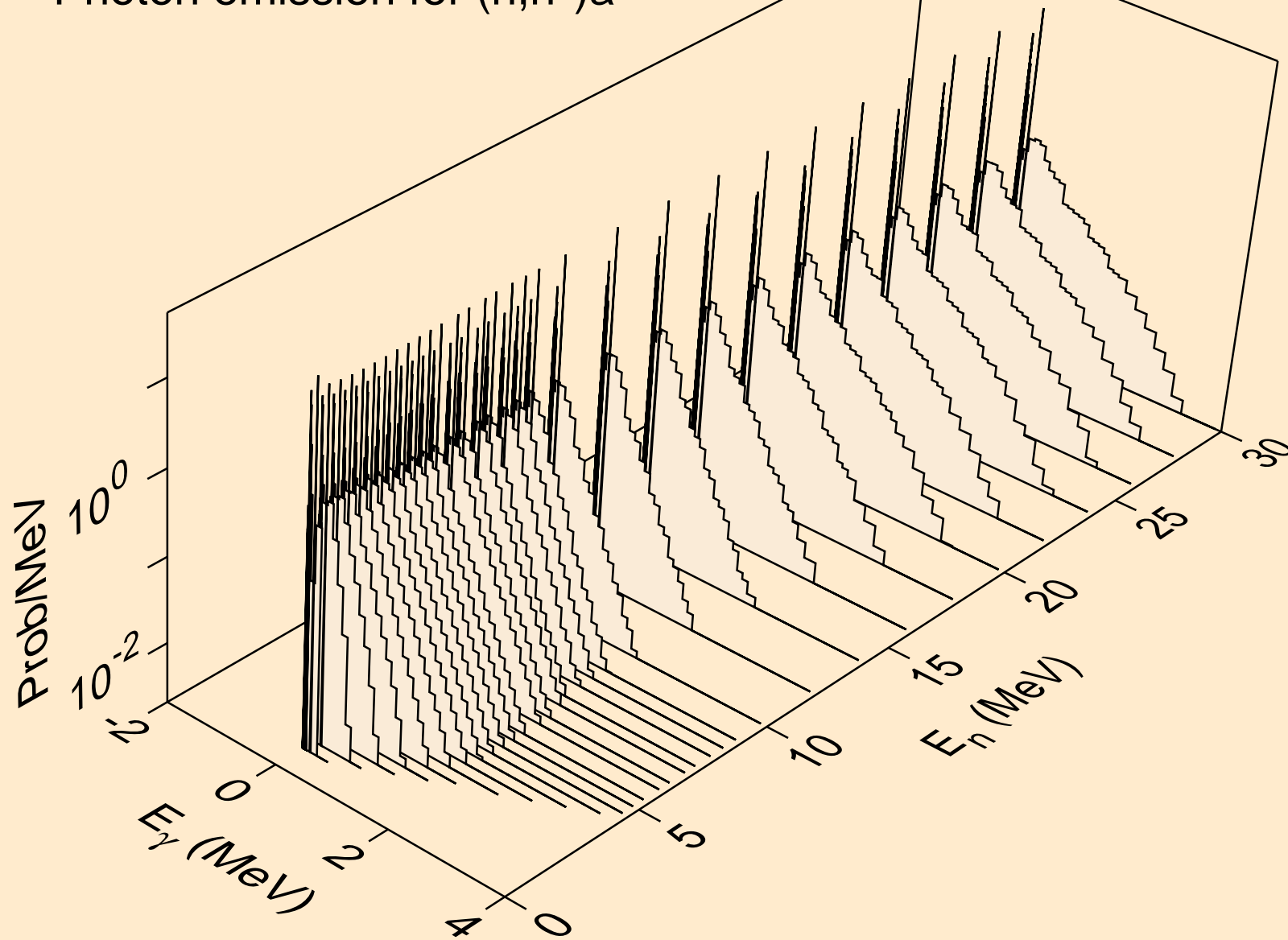

DB268 NEUTRON ACER TENDL-2023 LIBRARY; T=0.K  
Photon emission for (n,2n)a

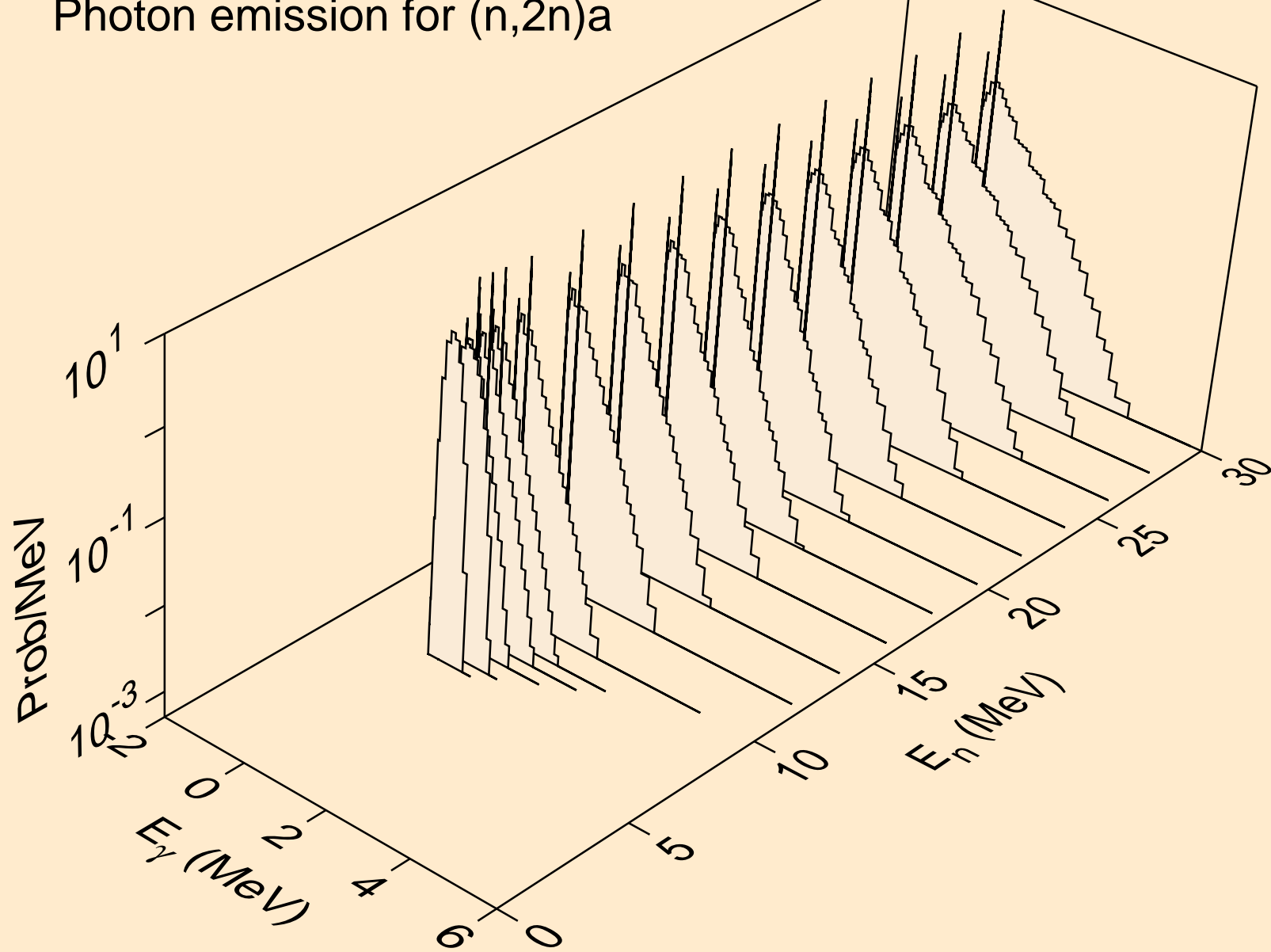

DB268 NEUTRON ACER TENDL-2023 LIBRARY; T=0.K  
Photon emission for (n,3n)a

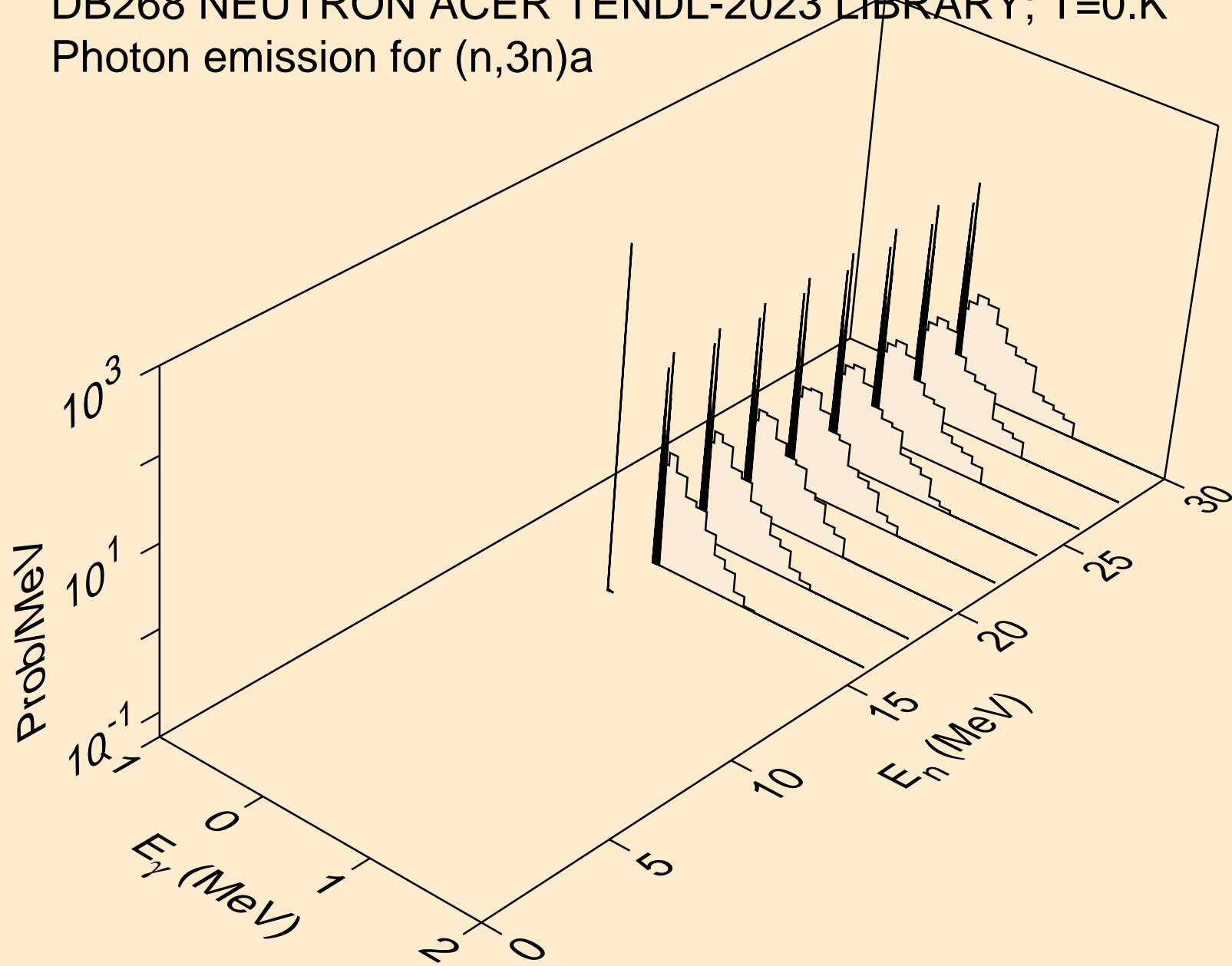

DB268 NEUTRON ACER TENDL-2023 LIBRARY; T=0.K  
Photon emission for (n,n\*)p

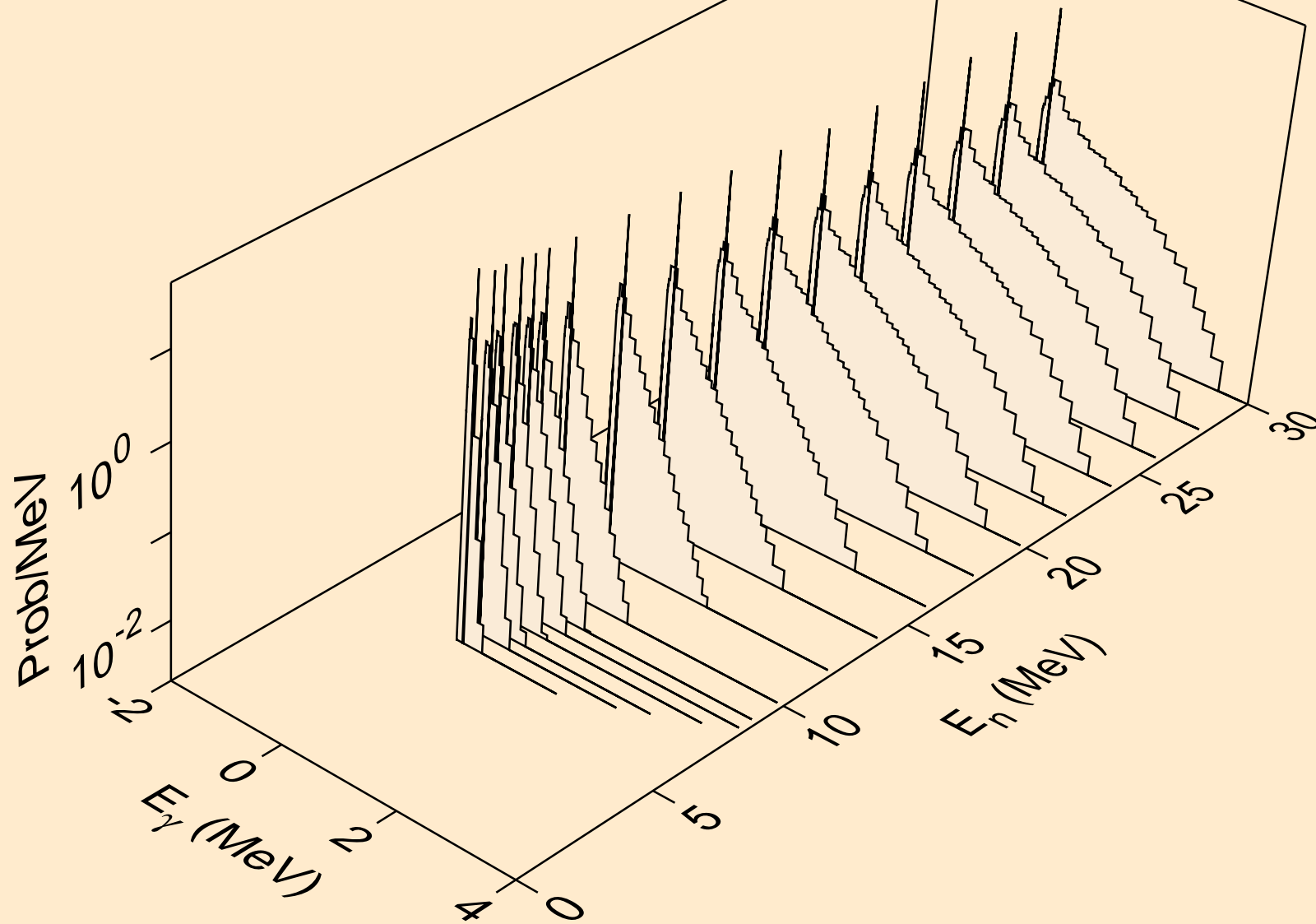

DB268 NEUTRON ACER TENDL-2023 LIBRARY; T=0.K  
Photon emission for (n,n\*)d

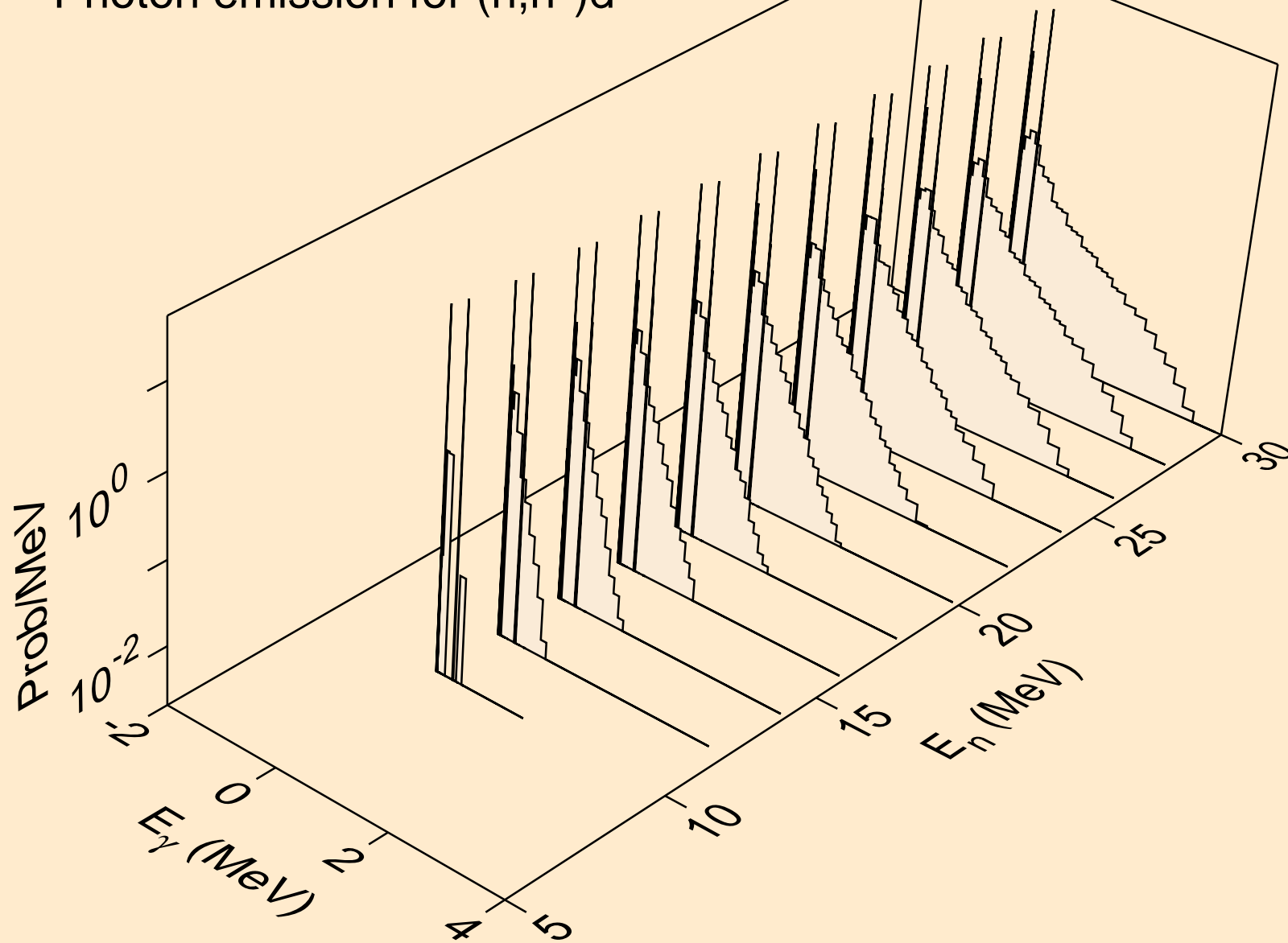

DB268 NEUTRON ACER TENDL-2023 LIBRARY; T=0.K  
Photon emission for (n,n\*)t

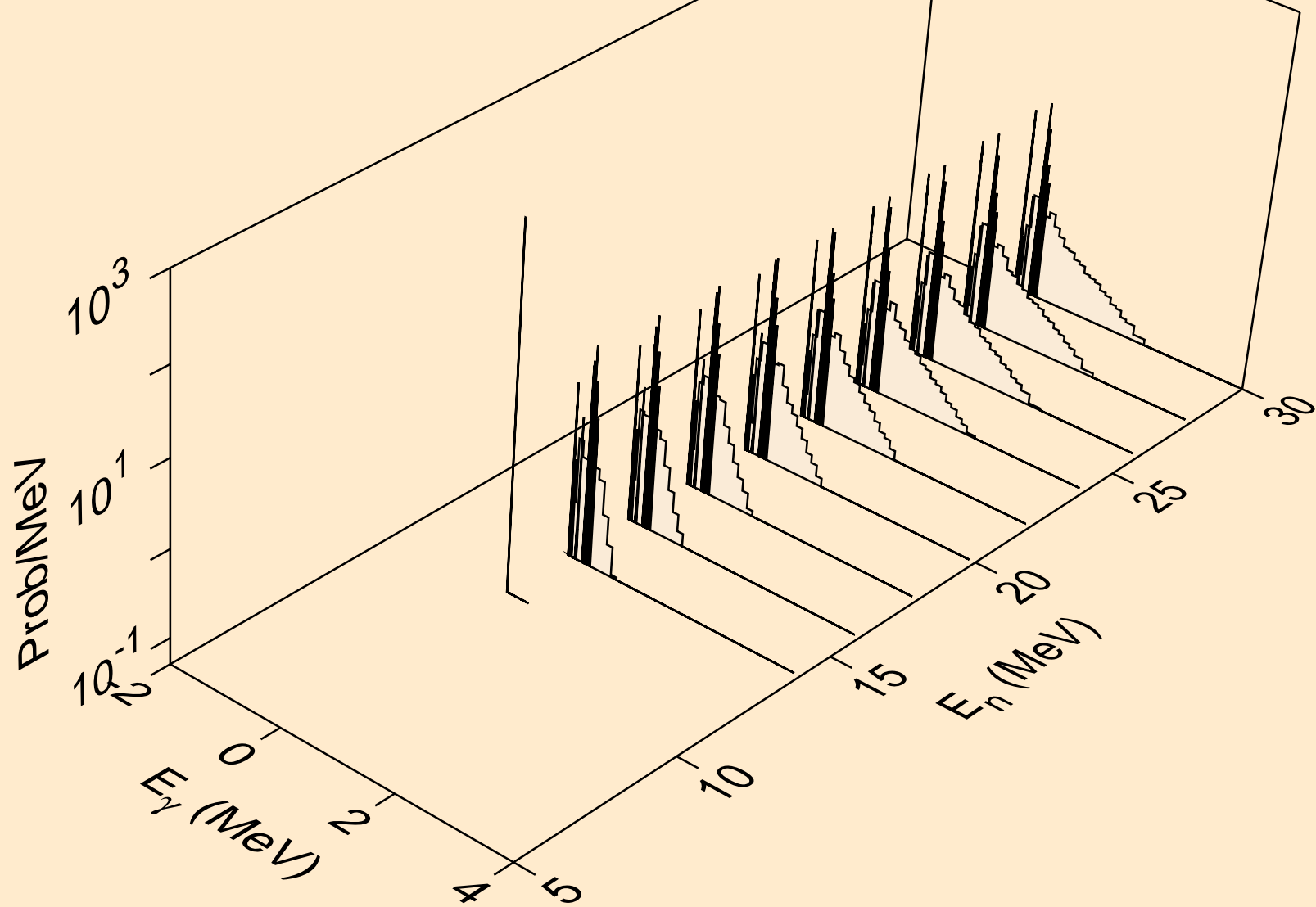

DB268 NEUTRON ACER TENDL-2023 LIBRARY; T=0.K  
Photon emission for (n,n\*)he3

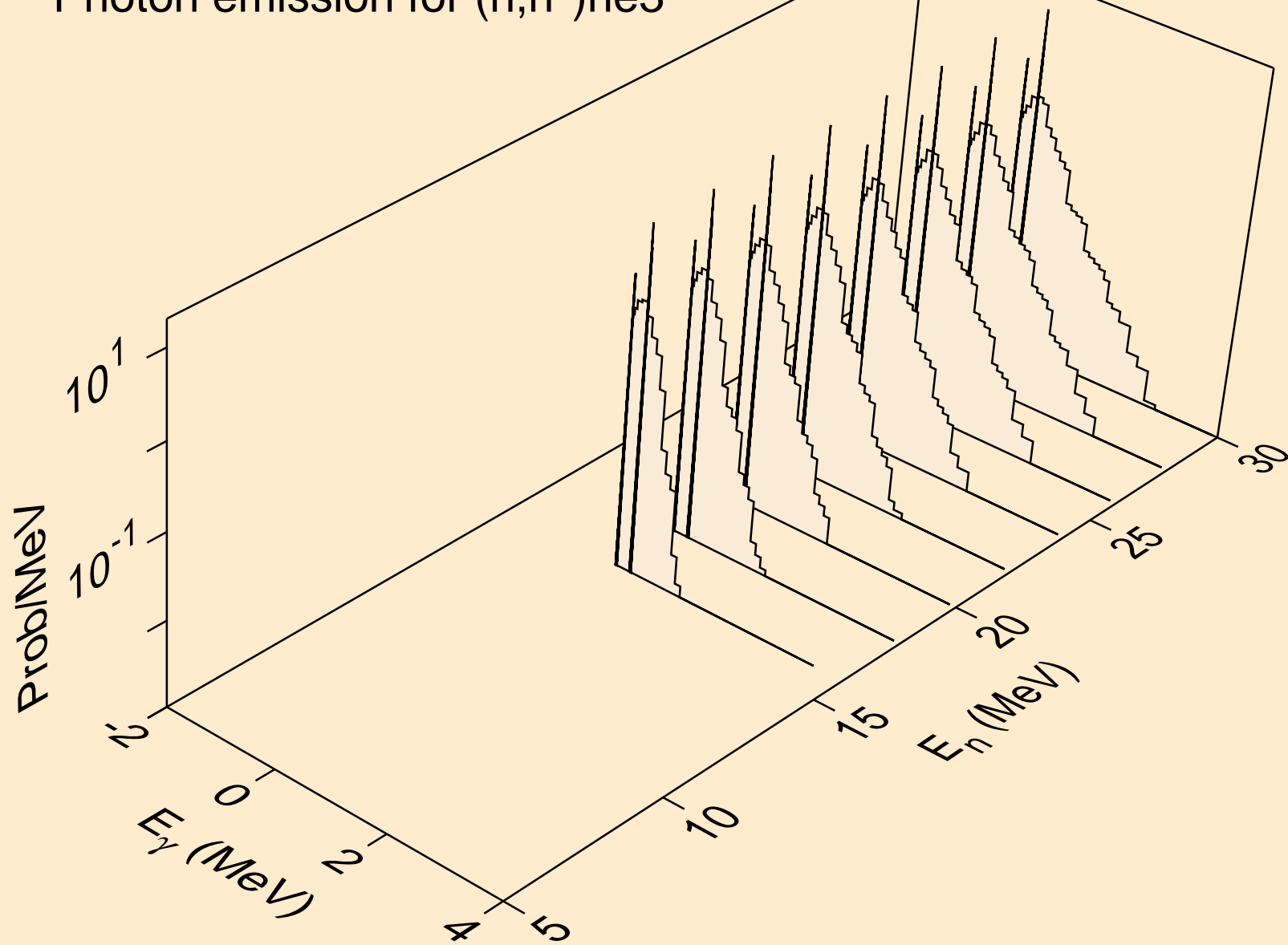

DB268 NEUTRON ACER TENDL-2023 LIBRARY; T=0.K  
Photon emission for (n,4n)

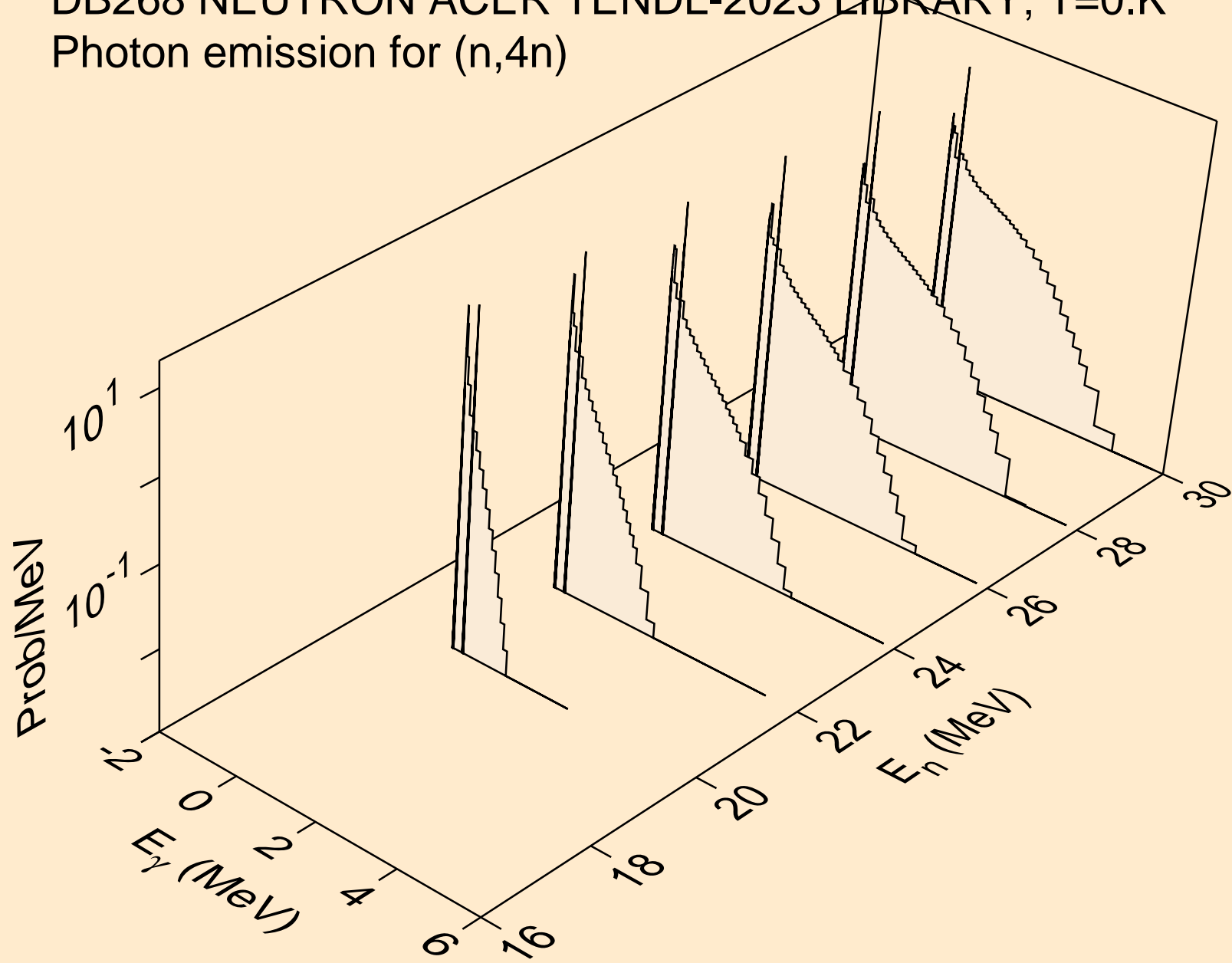

DB268 NEUTRON ACER TENDL-2023 LIBRARY; T=0.K  
Photon emission for (n,2np)

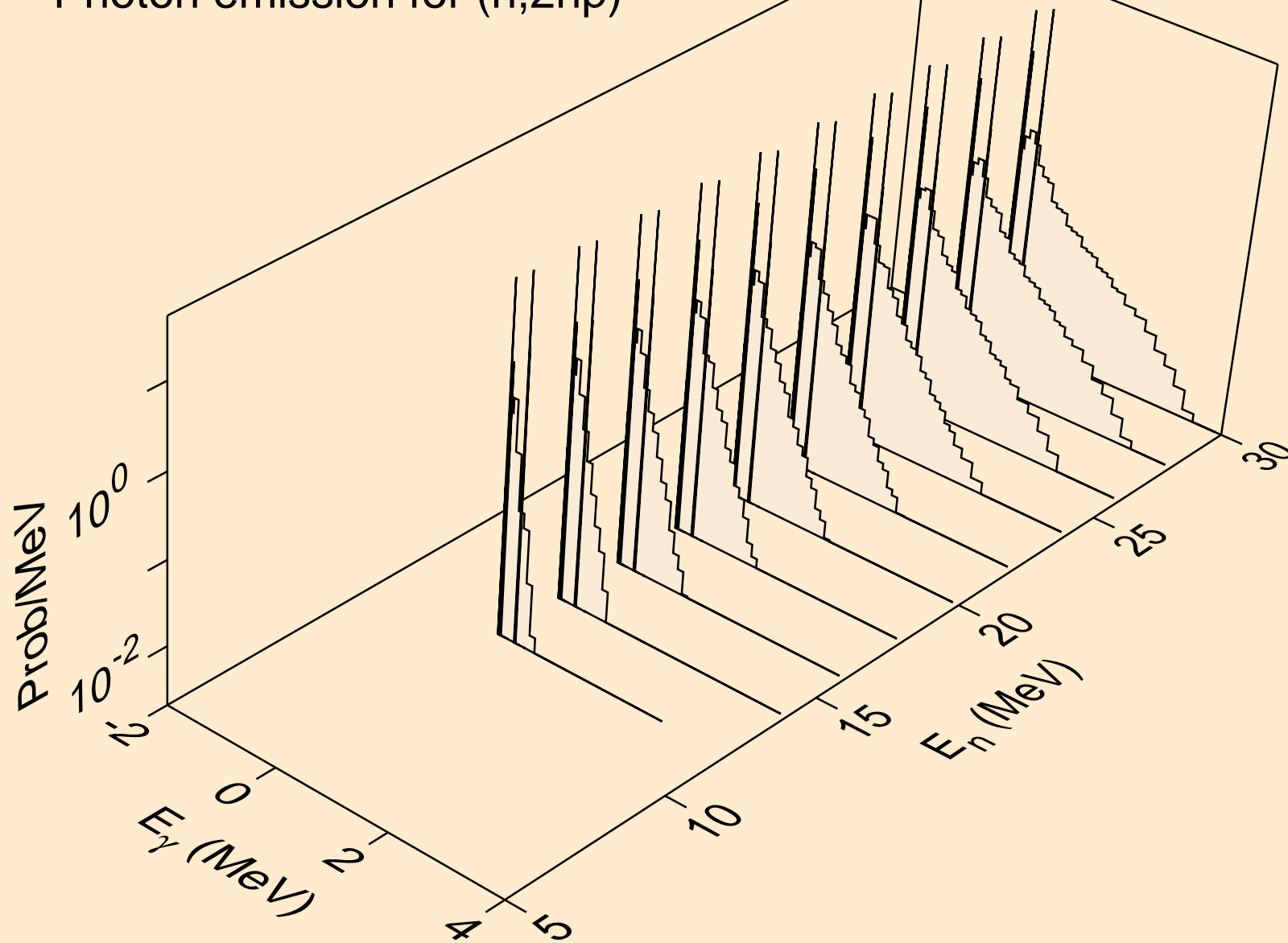

DB268 NEUTRON ACER TENDL-2023 LIBRARY; T=0.K  
Photon emission for (n,3np)

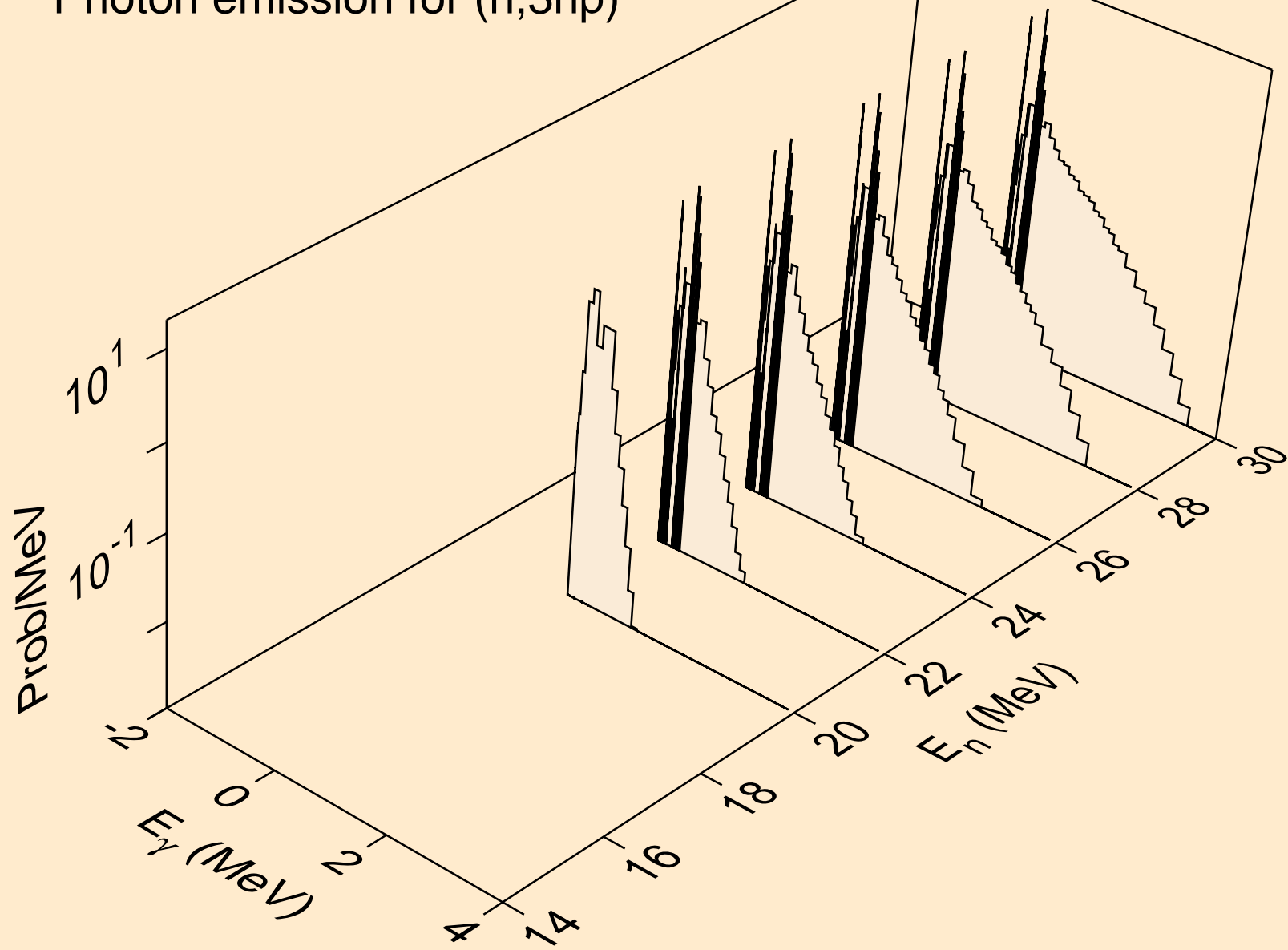

DB268 NEUTRON ACER TENDL-2023 LIBRARY; T=0.K  
Photon emission for (n,n\*c)

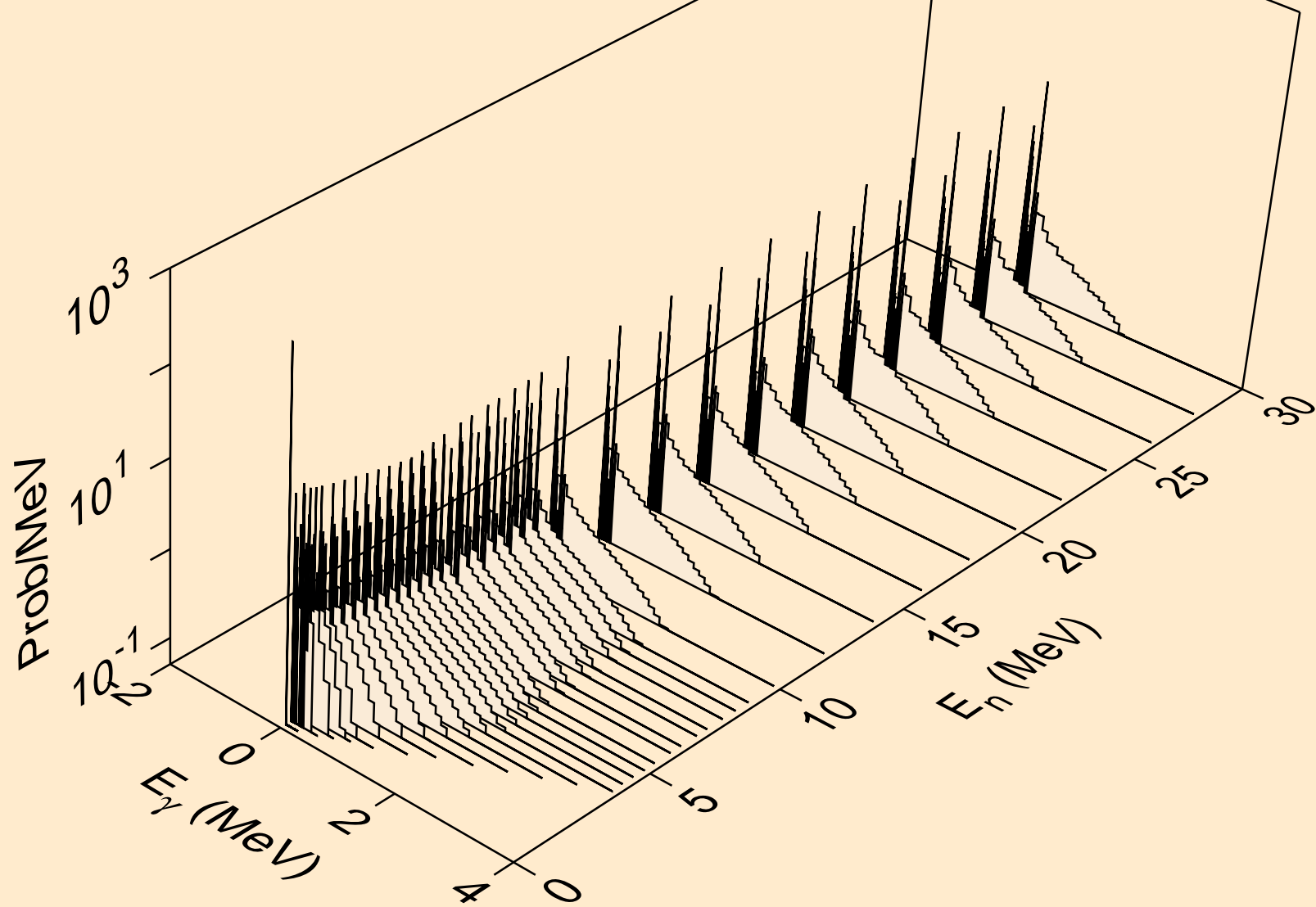

DB268 NEUTRON ACER TENDL-2023 LIBRARY; T=0.K  
Photon emission for (n,gma)

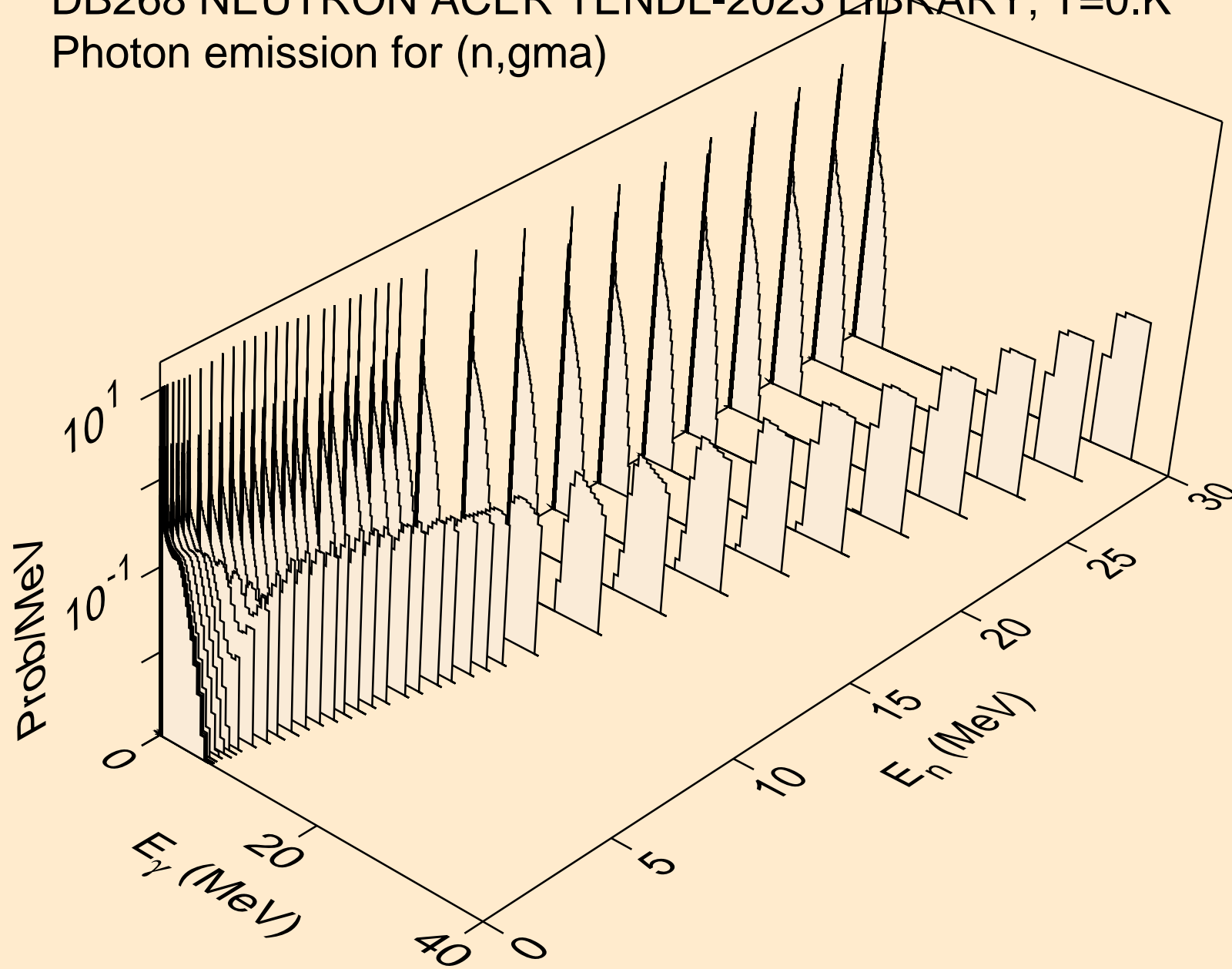

DB268 NEUTRON ACER TENDL-2023 LIBRARY; T=0.K  
Photon emission for (n,p)

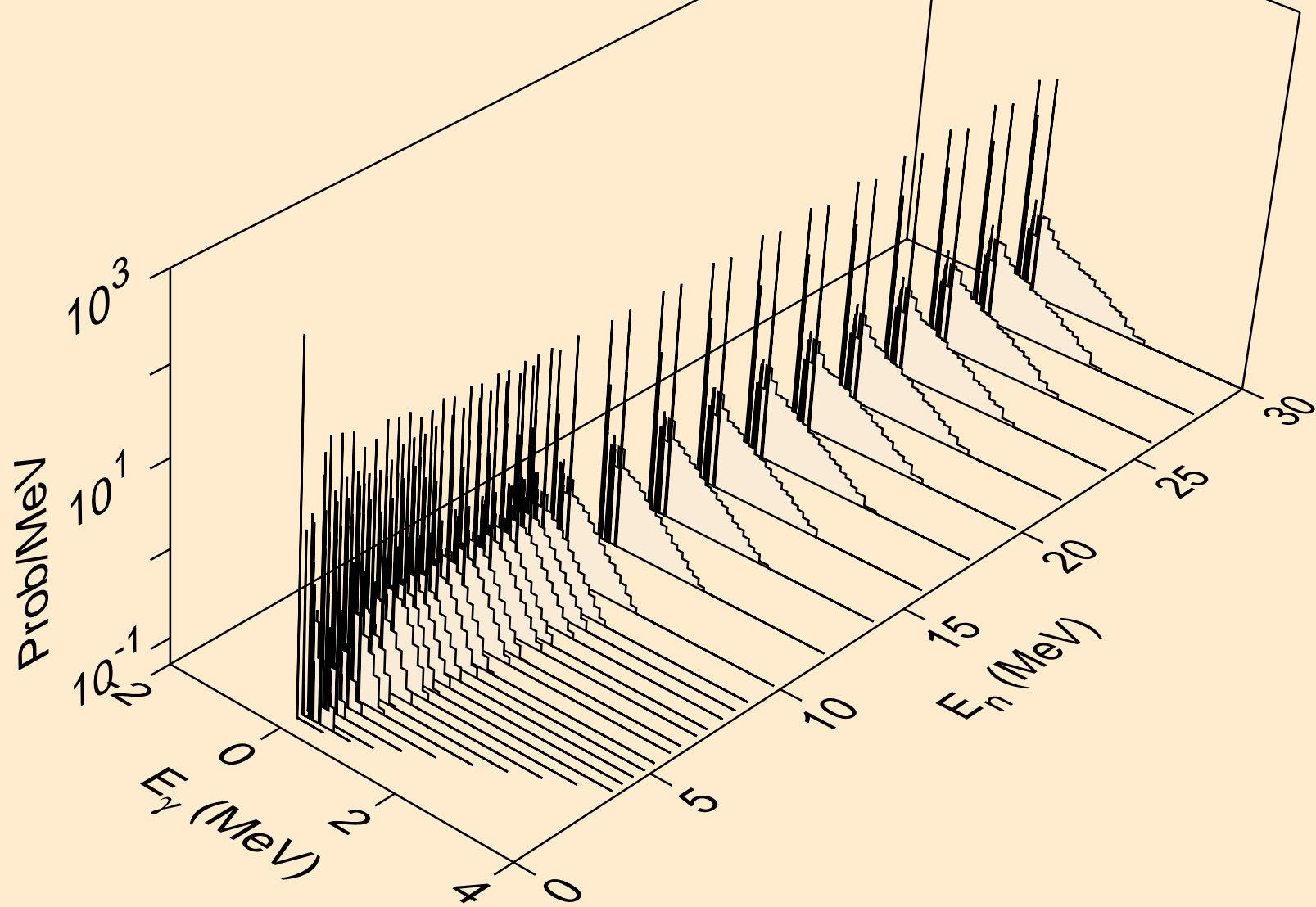

DB268 NEUTRON ACER TENDL-2023 LIBRARY; T=0.K  
Photon emission for (n,d)

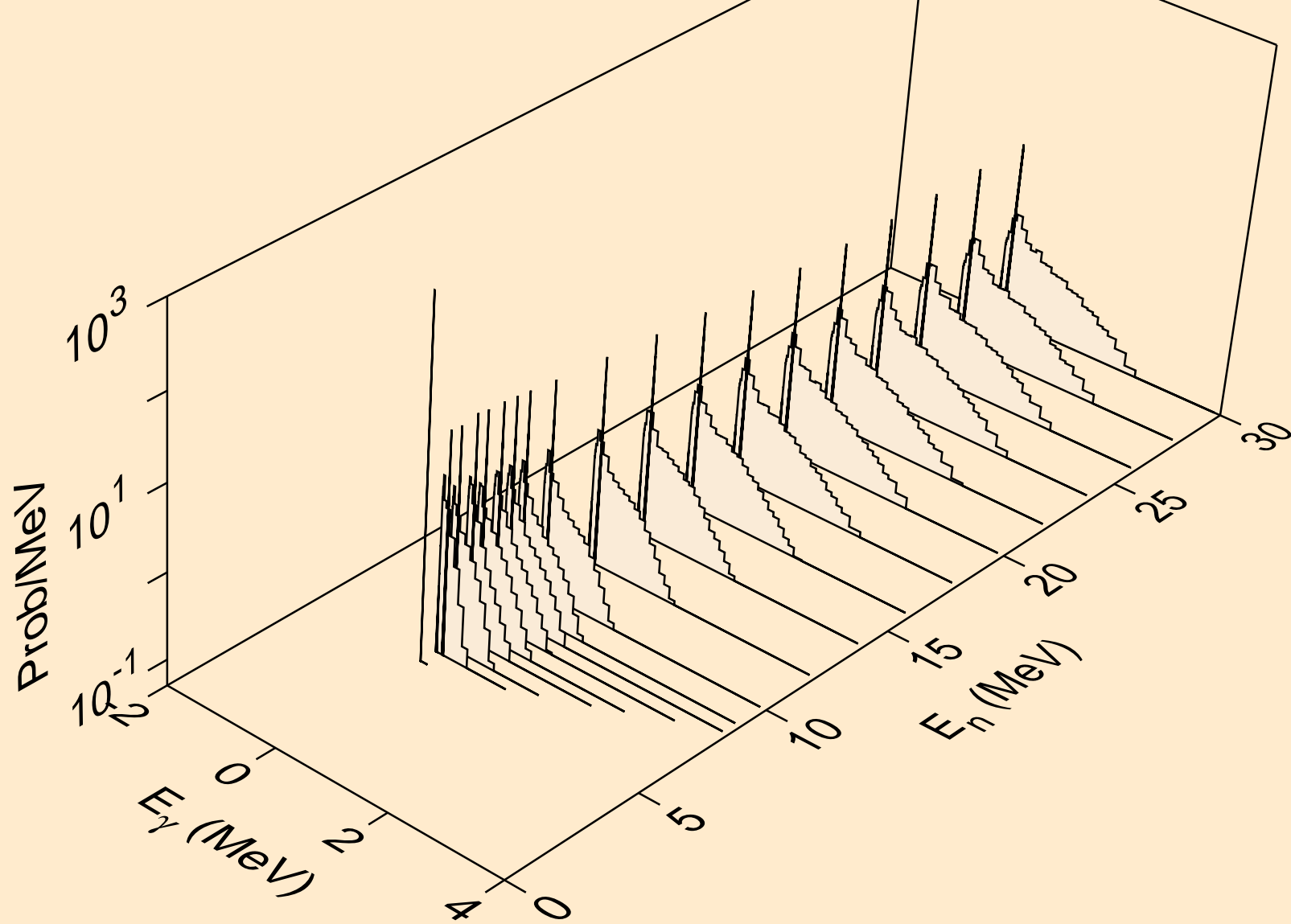

DB268 NEUTRON ACER TENDL-2023 LIBRARY; T=0.K  
Photon emission for (n,t)

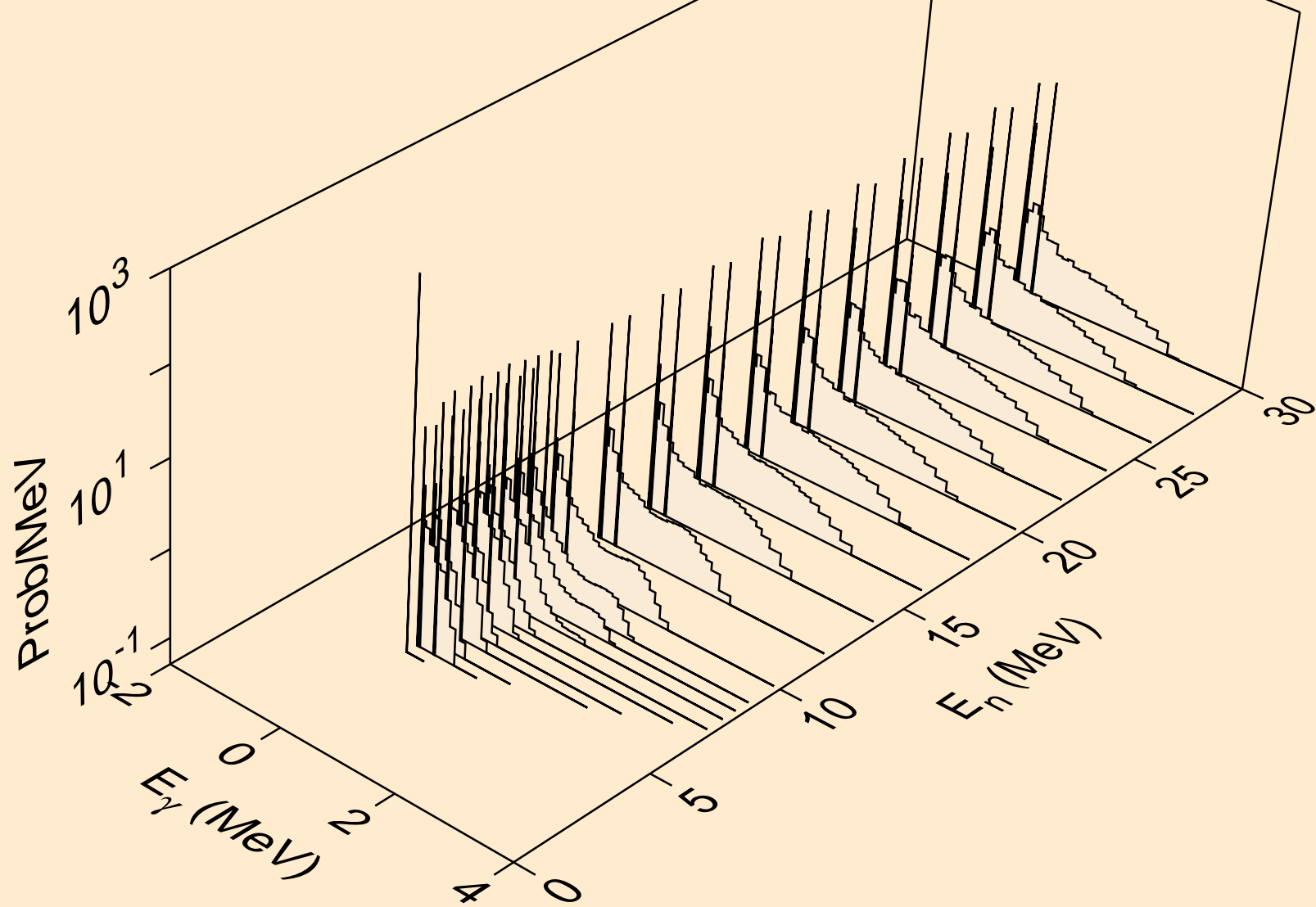

DB268 NEUTRON ACER TENDL-2023 LIBRARY; T=0.K  
Photon emission for (n,he3)

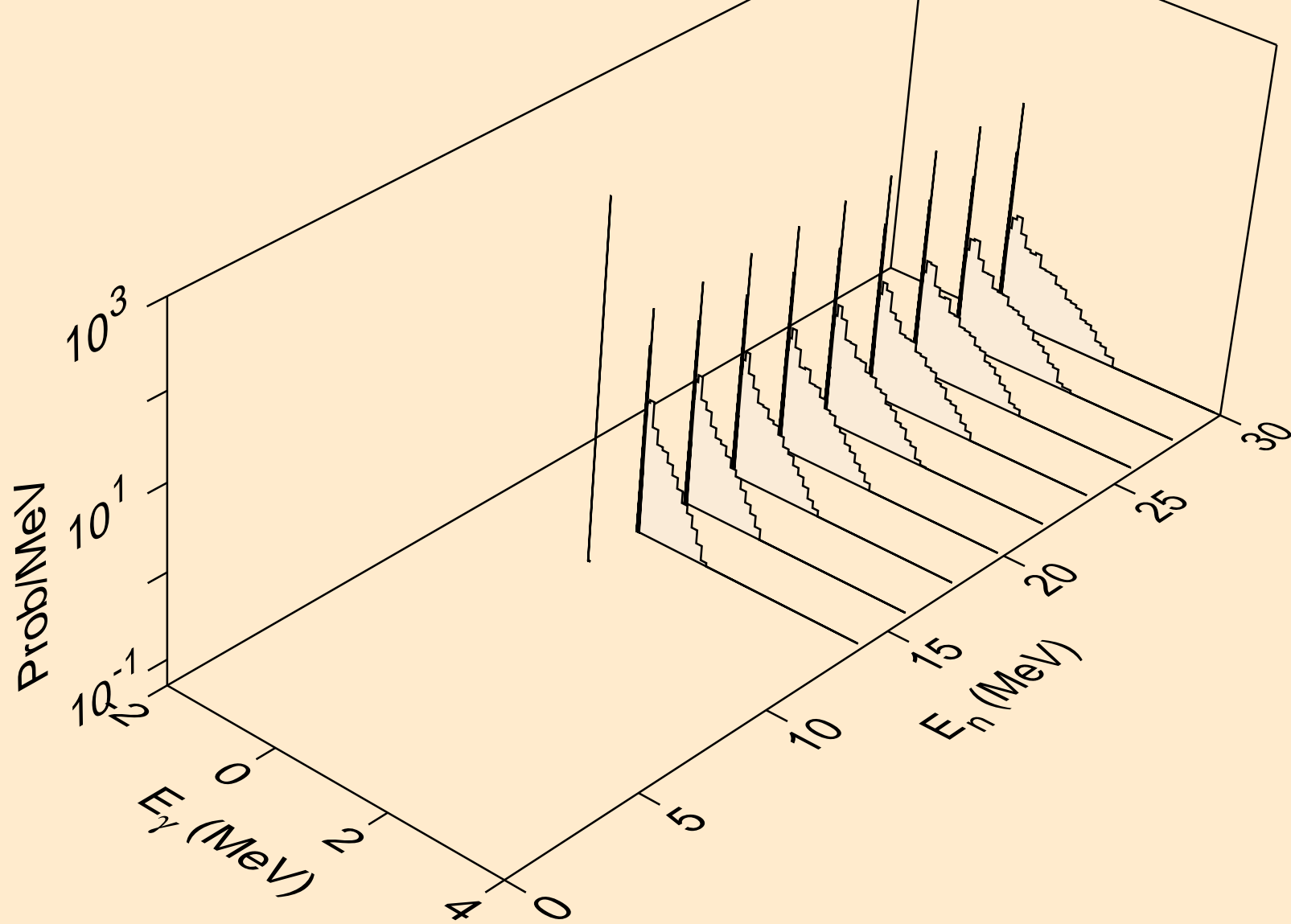

DB268 NEUTRON ACER TENDL-2023 LIBRARY; T=0.K  
Photon emission for (n,a)

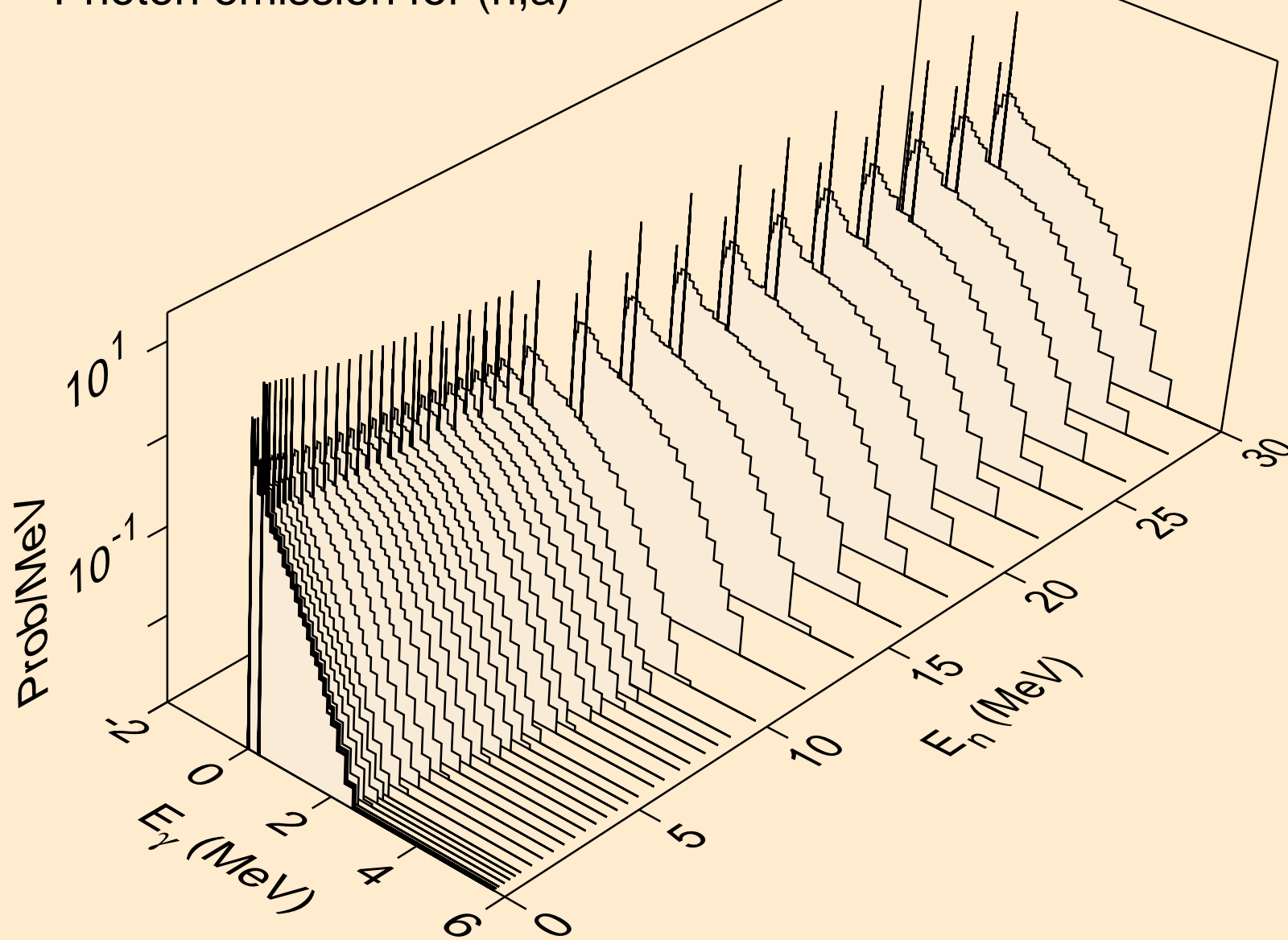

DB268 NEUTRON ACER TENDL-2023 LIBRARY; T=0.K  
Photon emission for (n,2p)

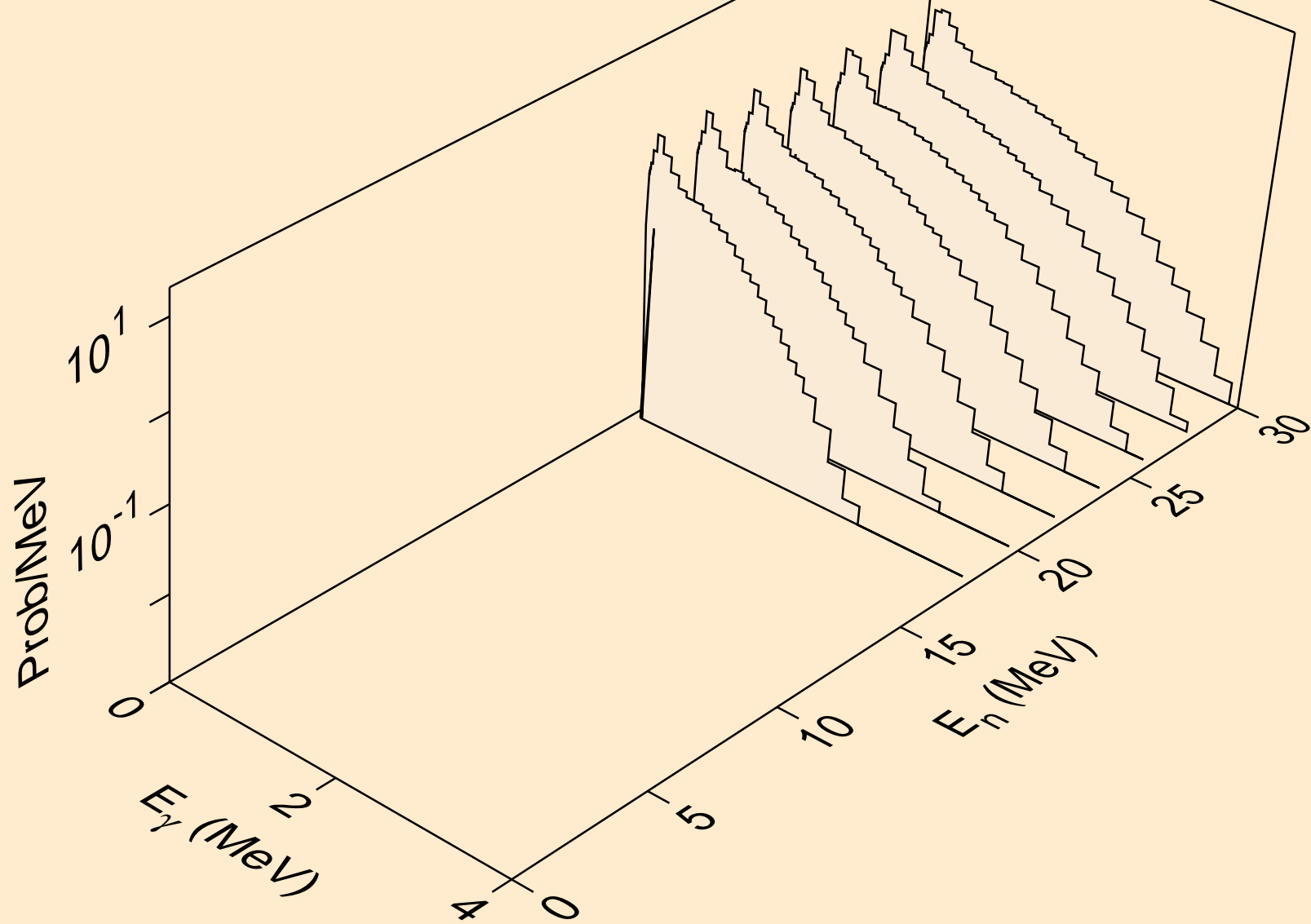

DB268 NEUTRON ACER TENDL-2023 LIBRARY; T=0.K  
thermal capture photon spectrum

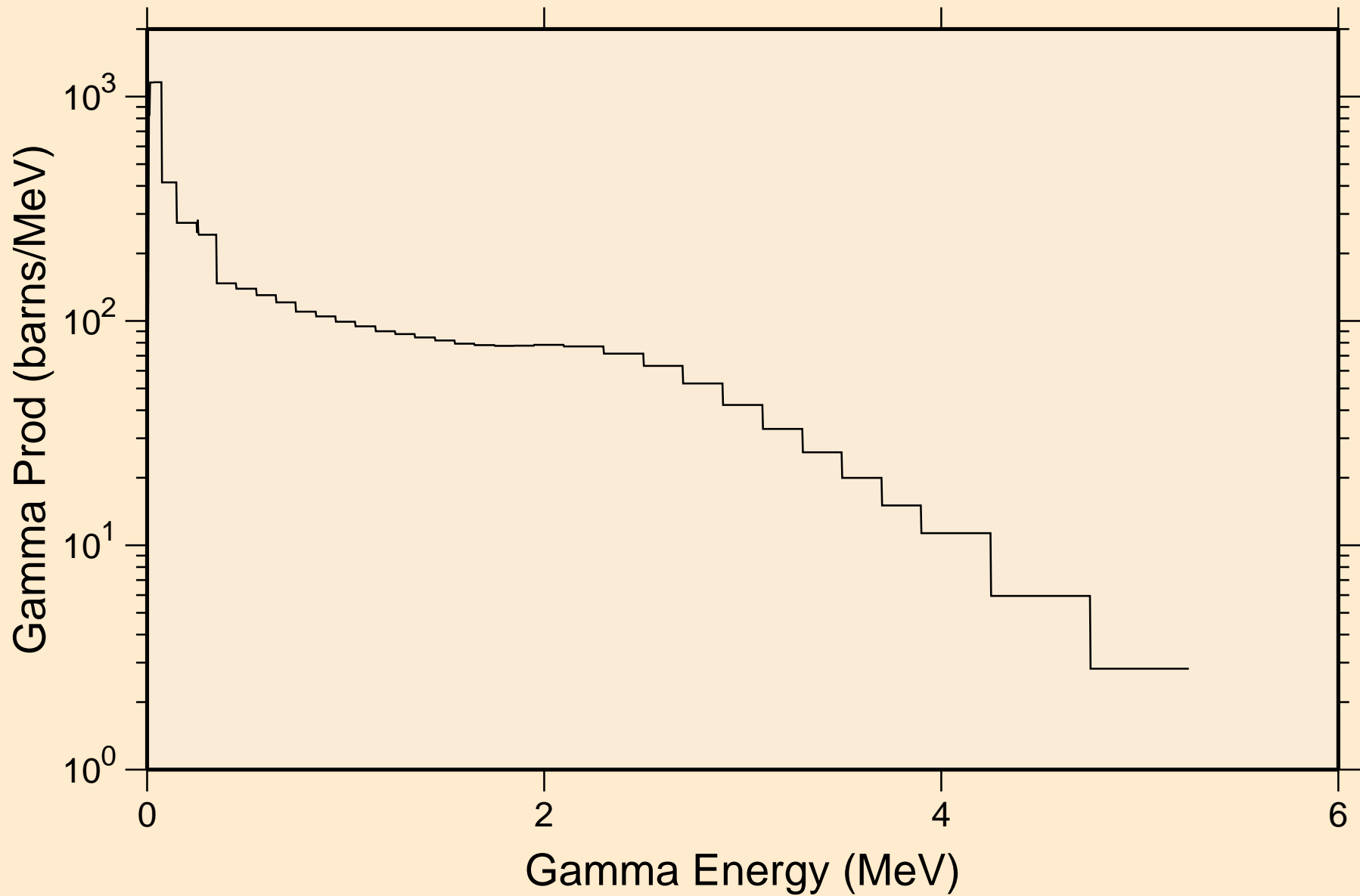

DB268 NEUTRON ACER TENDL-2023 LIBRARY; T=0.K  
14 MeV photon spectrum

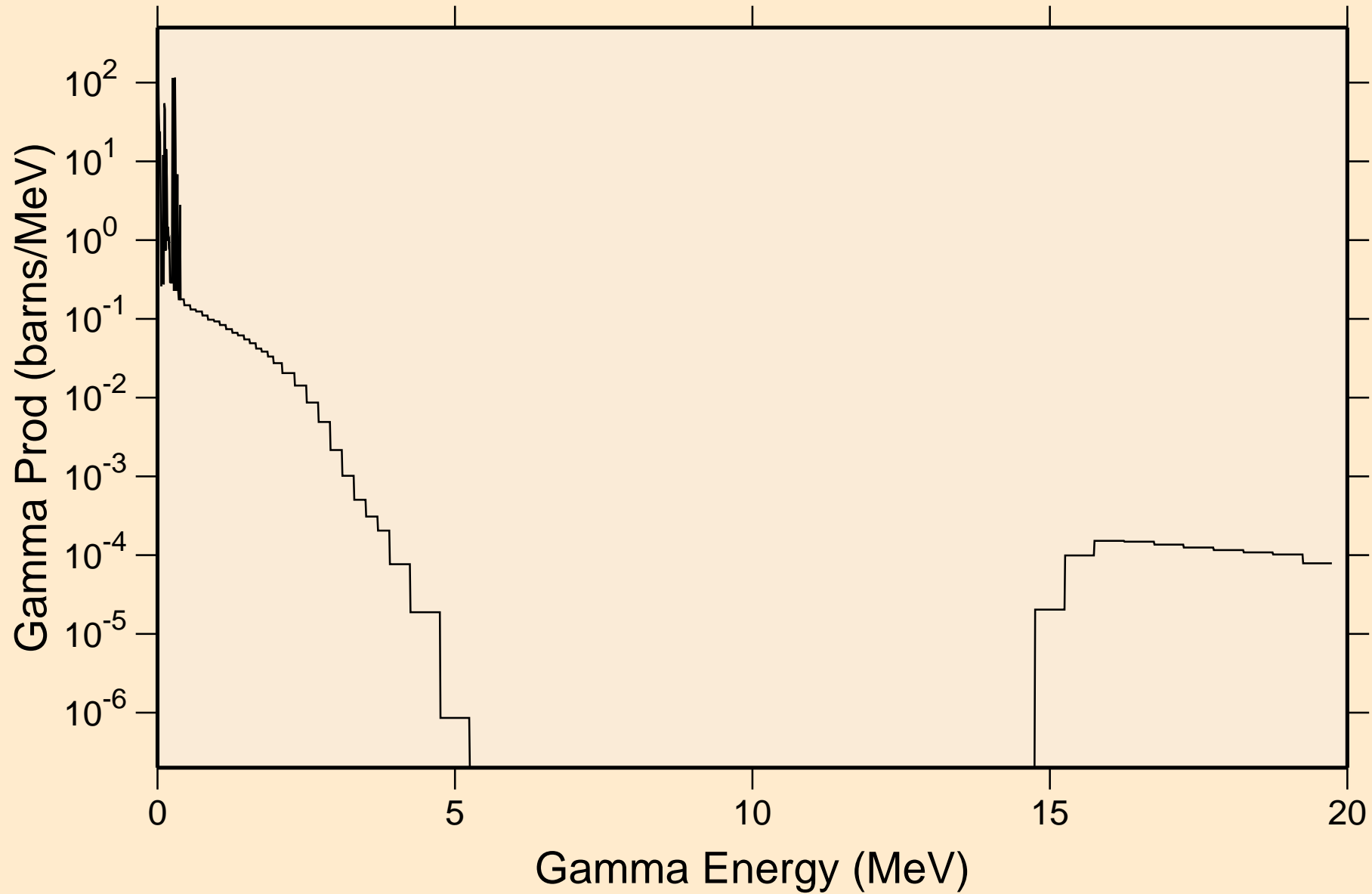

# DB268 NEUTRON ACER TENDL-2023 LIBRARY; T=0.K

## Particle heating contributions

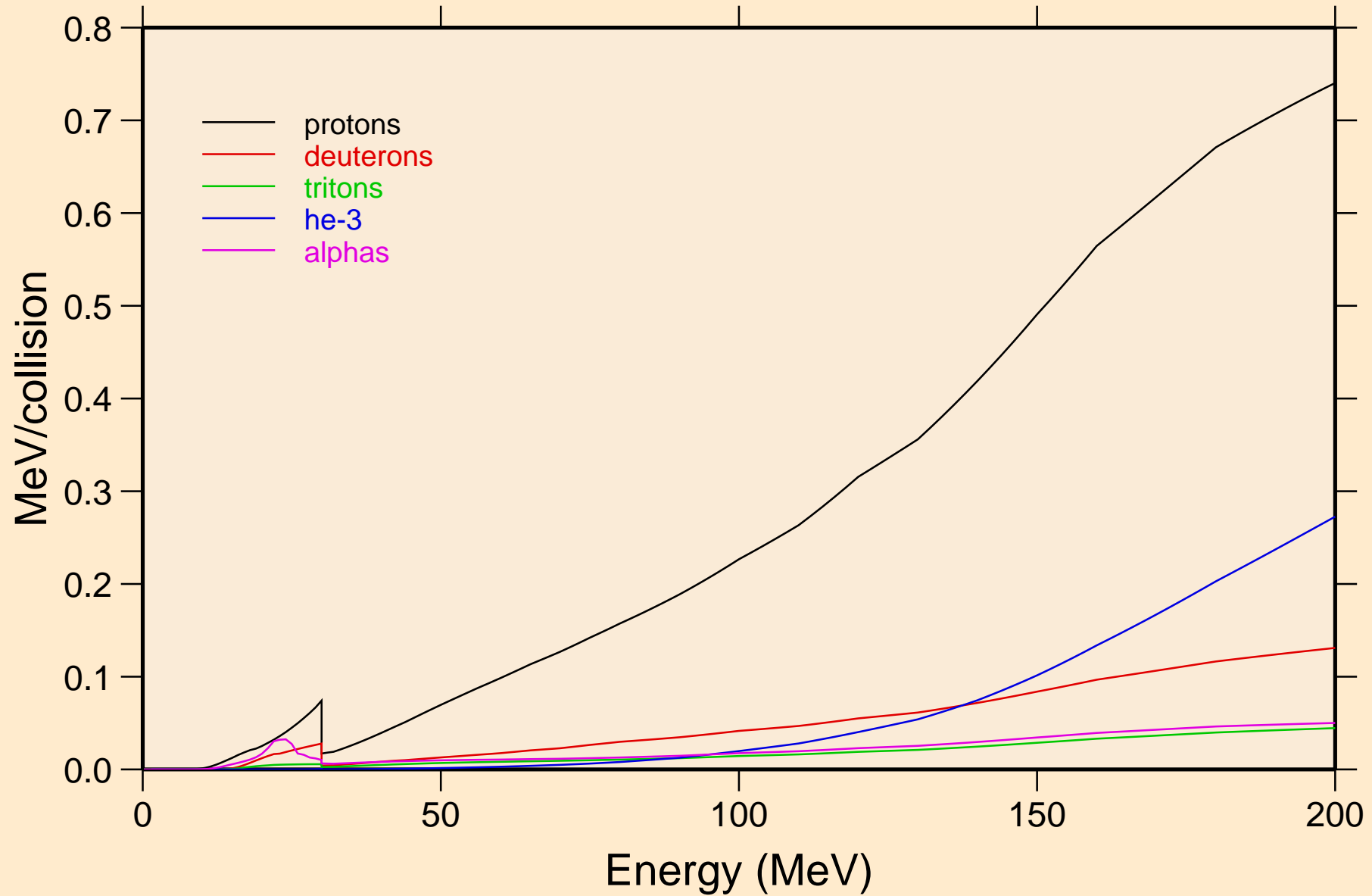

DB268 NEUTRON ACER TENDL-2023 LIBRARY; T=0.K  
Recoil Heating

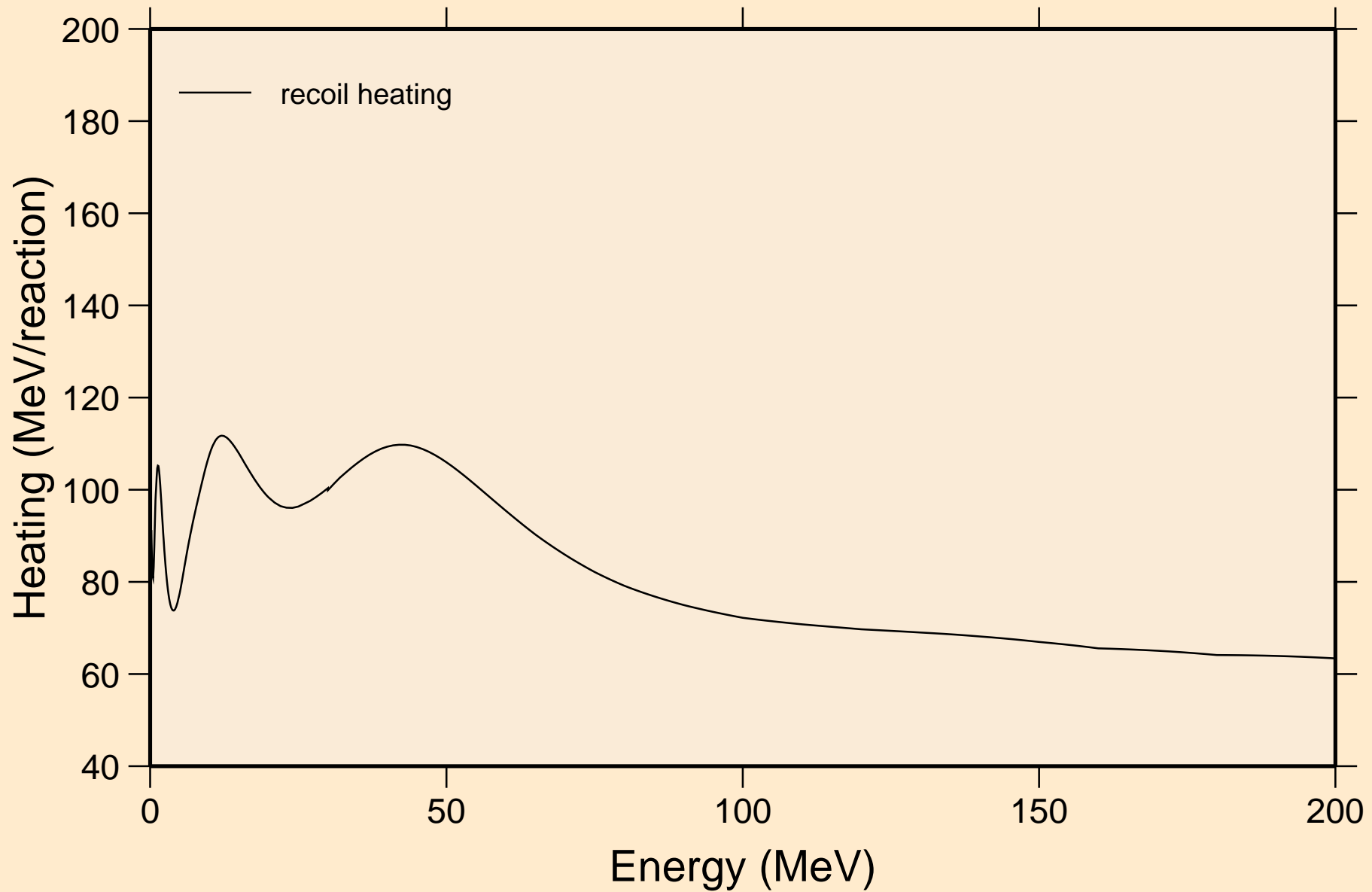

# DB268 NEUTRON ACER TENDL-2023 LIBRARY; T=0.K

## Particle production cross sections

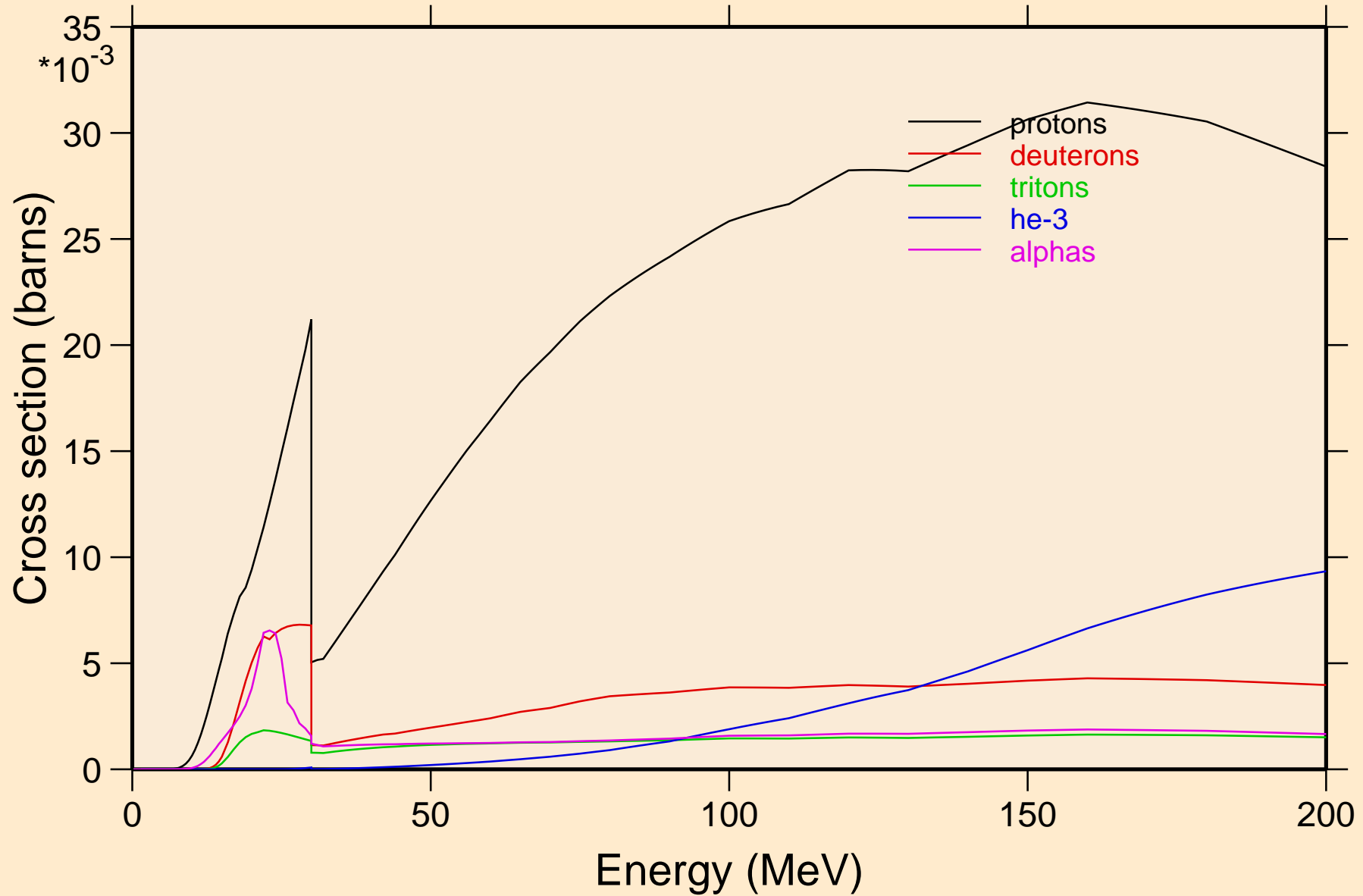

DB268 NEUTRON ACER TENDL-2023 LIBRARY; T=0.K  
protons from (n,x)

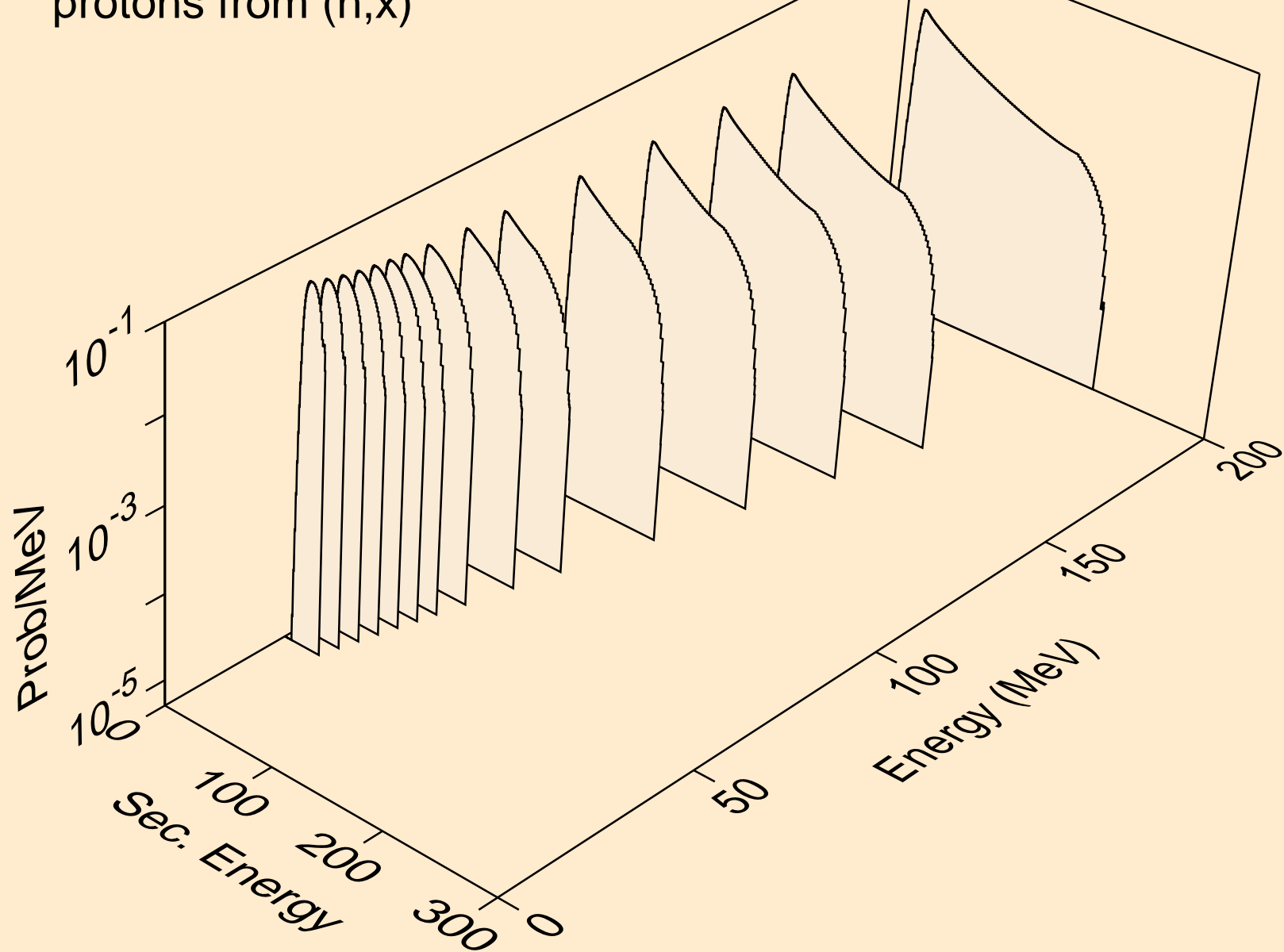

DB268 NEUTRON ACER TENDL-2023 LIBRARY; T=0.K  
protons from (n,n\*)p

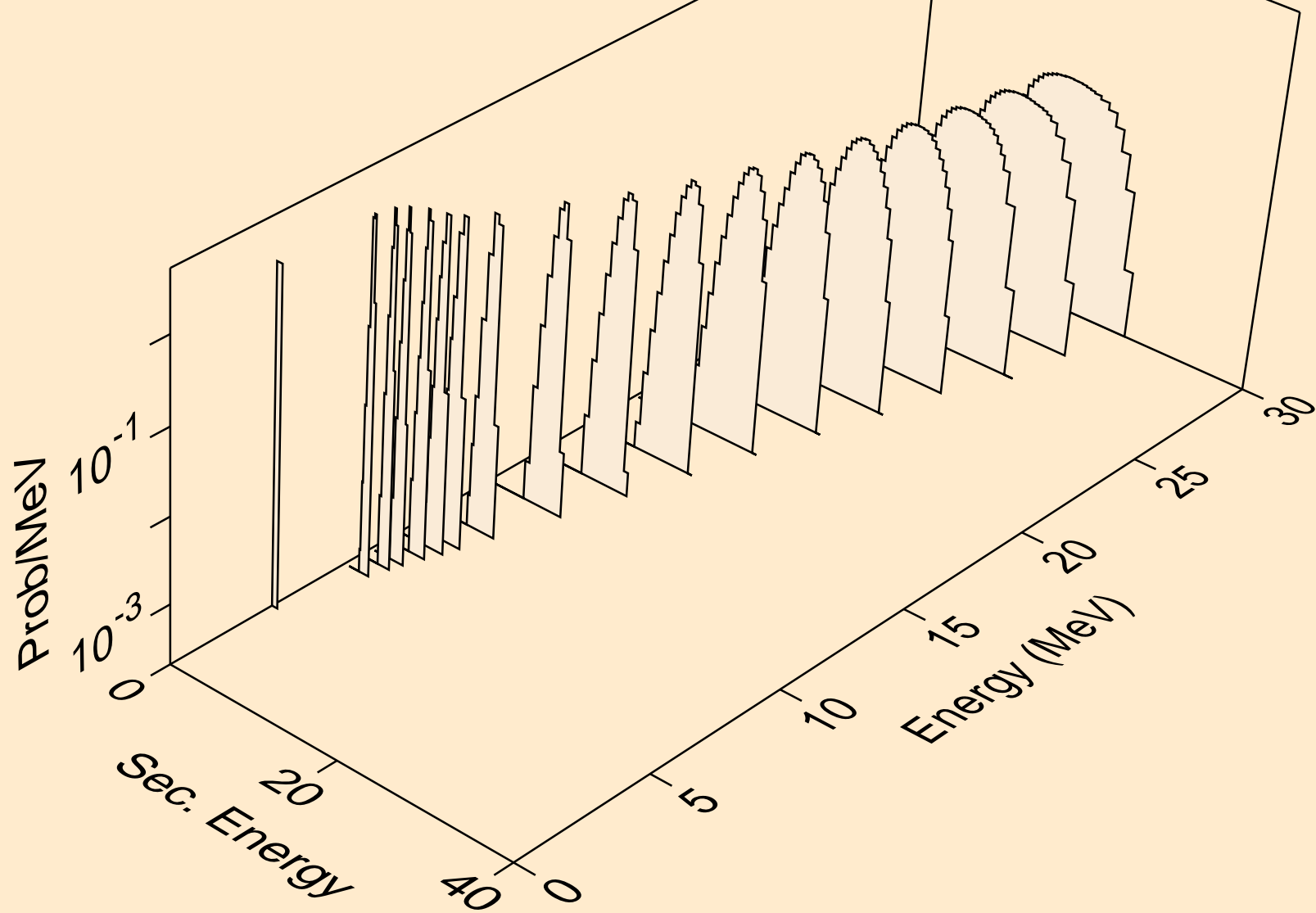

DB268 NEUTRON ACER TENDL-2023 LIBRARY; T=0.K  
protons from (n,2np)

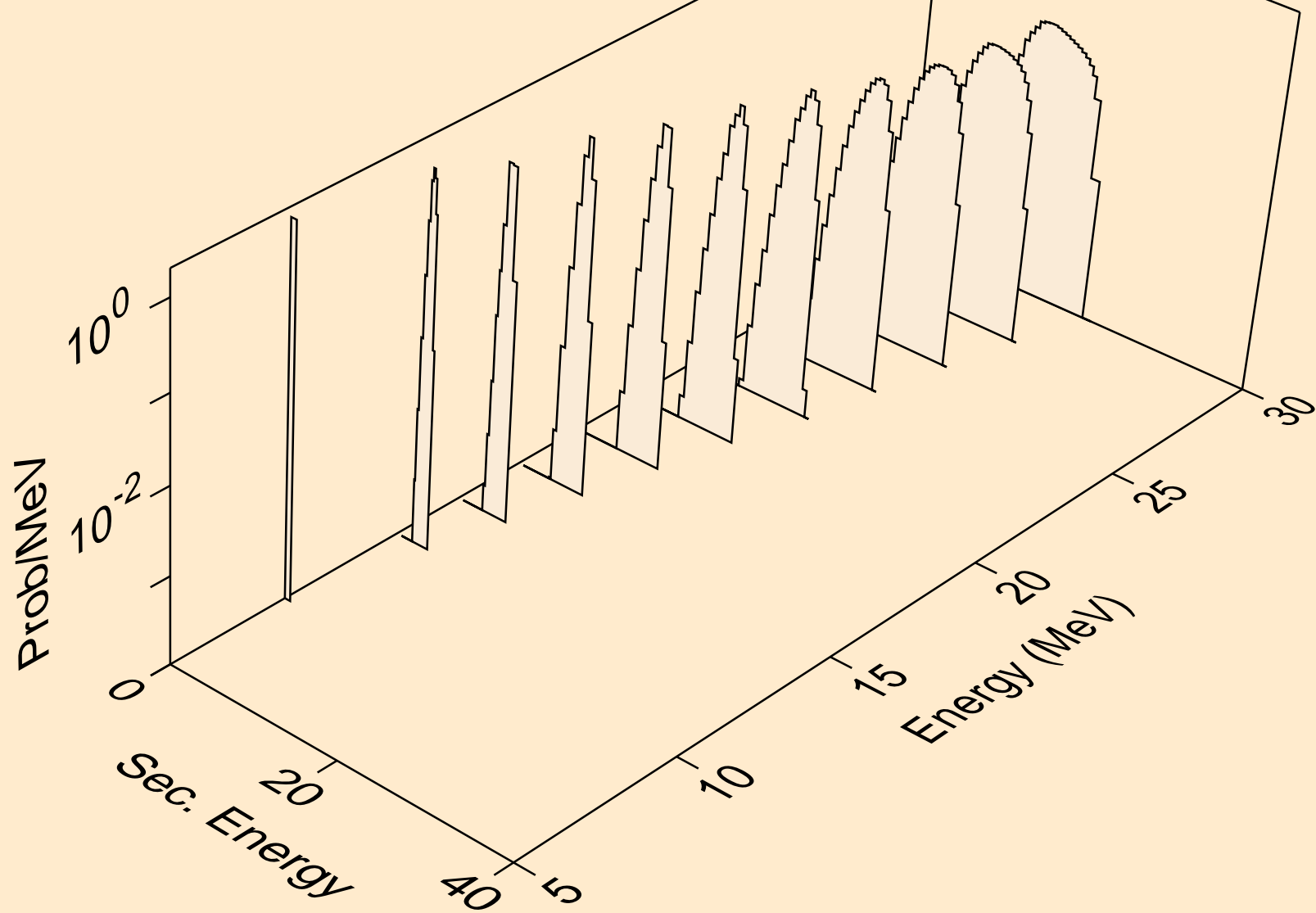

DB268 NEUTRON ACER TENDL-2023 LIBRARY; T=0.K  
protons from (n,3np)

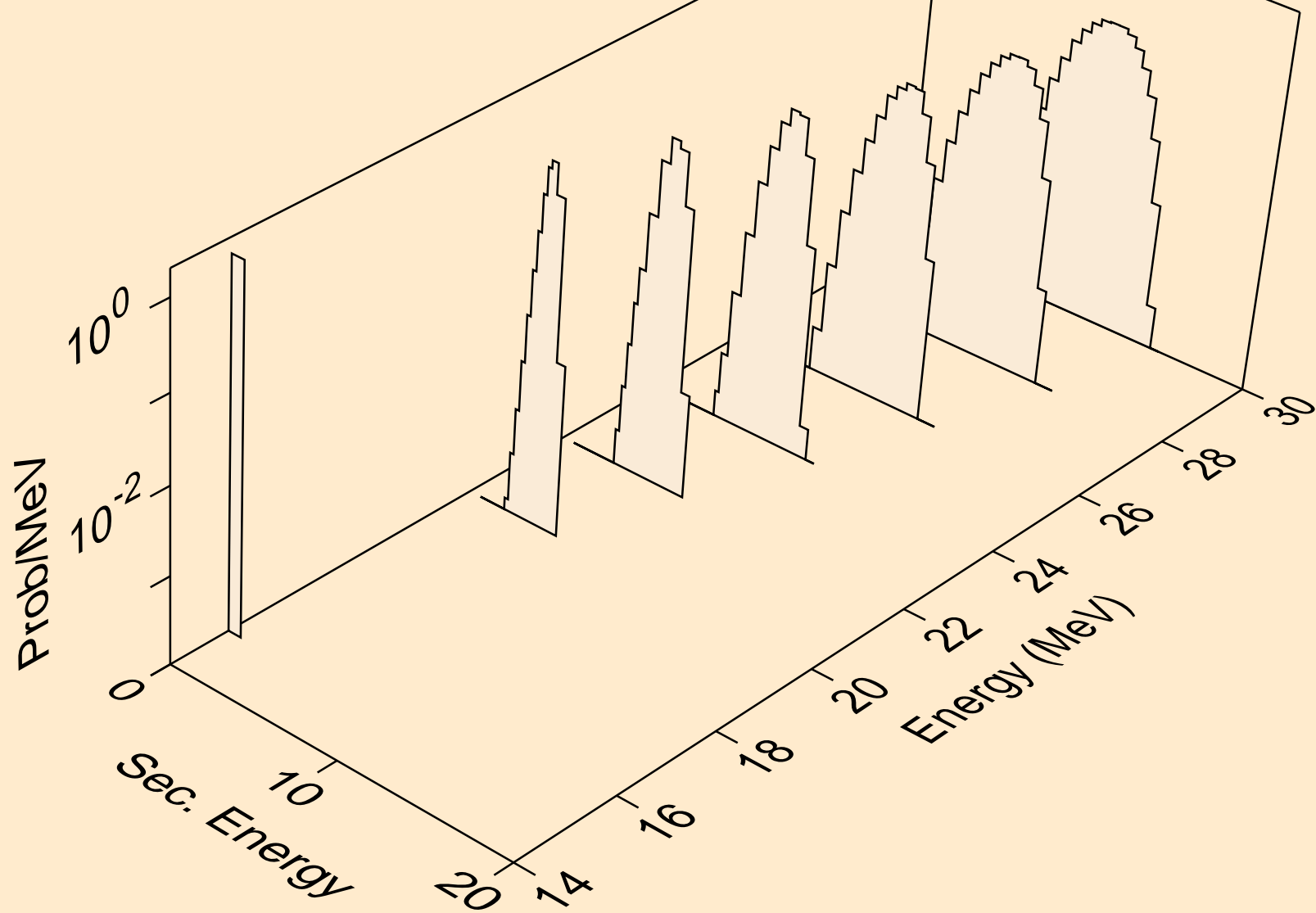

DB268 NEUTRON ACER TENDL-2023 LIBRARY; T=0.K  
protons from (n,p)

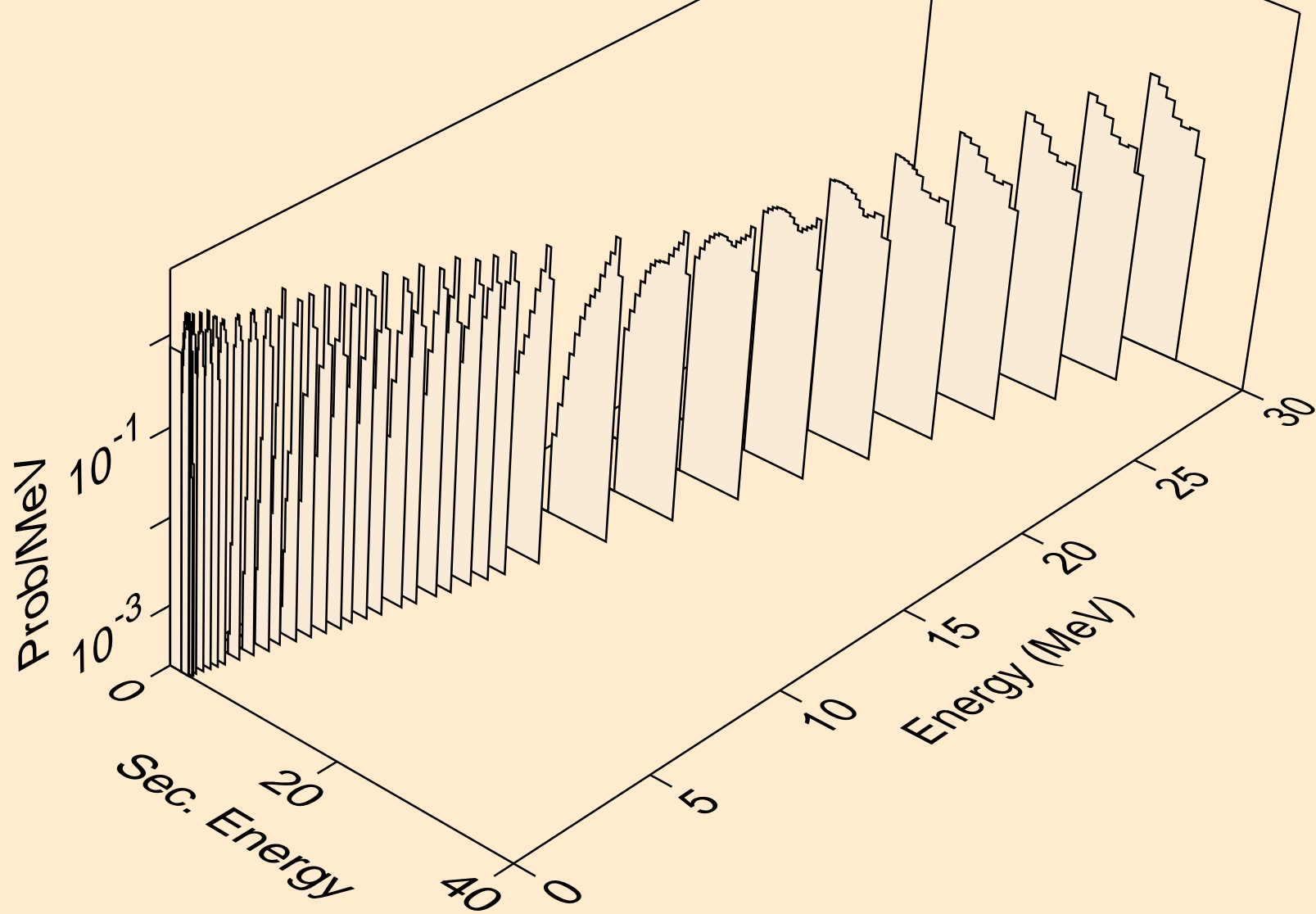

DB268 NEUTRON ACER TENDL-2023 LIBRARY; T=0.K  
protons from (n,2p)

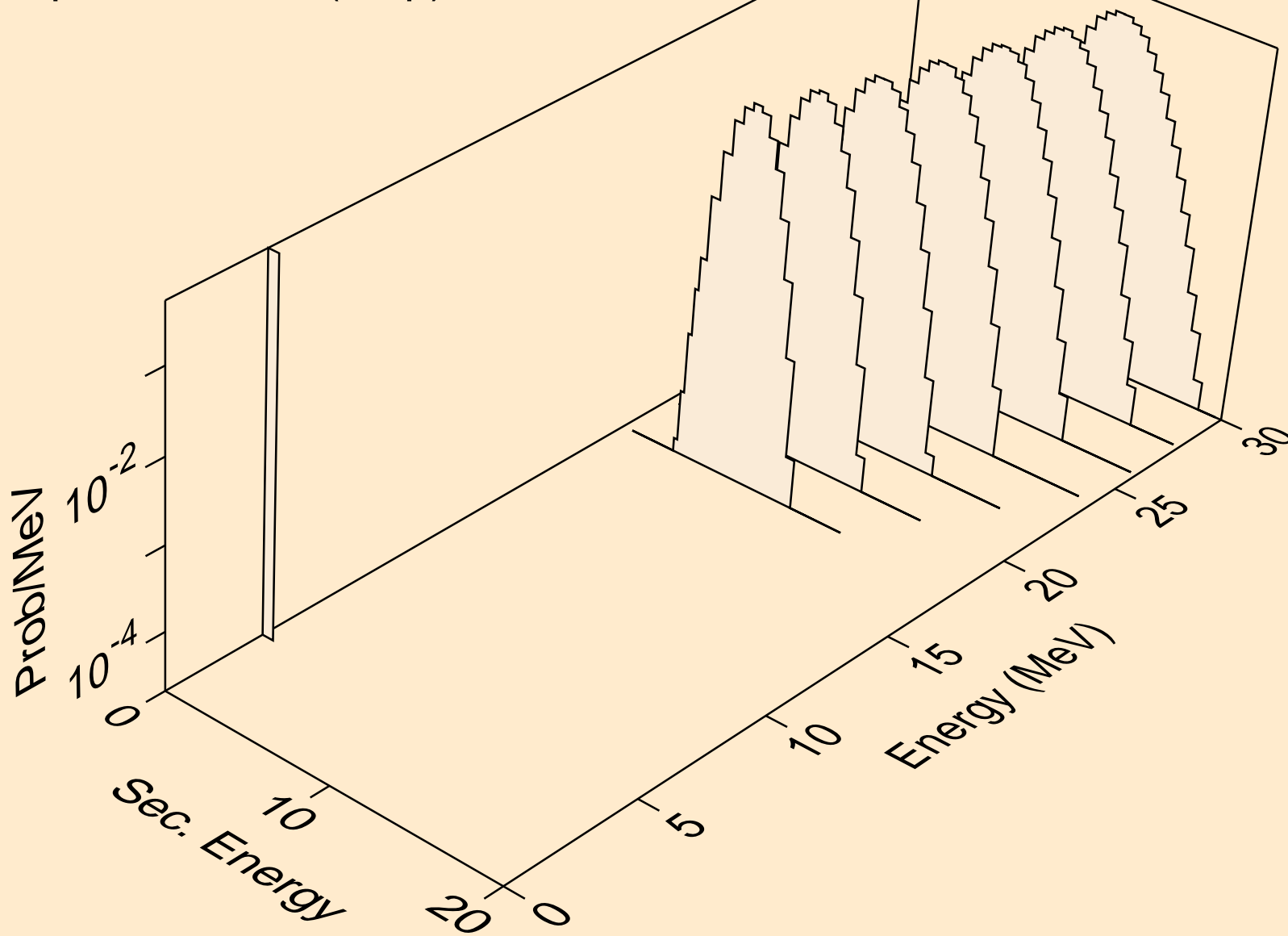

DB268 NEUTRON ACER TENDL-2023 LIBRARY; T=0.K  
deuterons from (n,x)

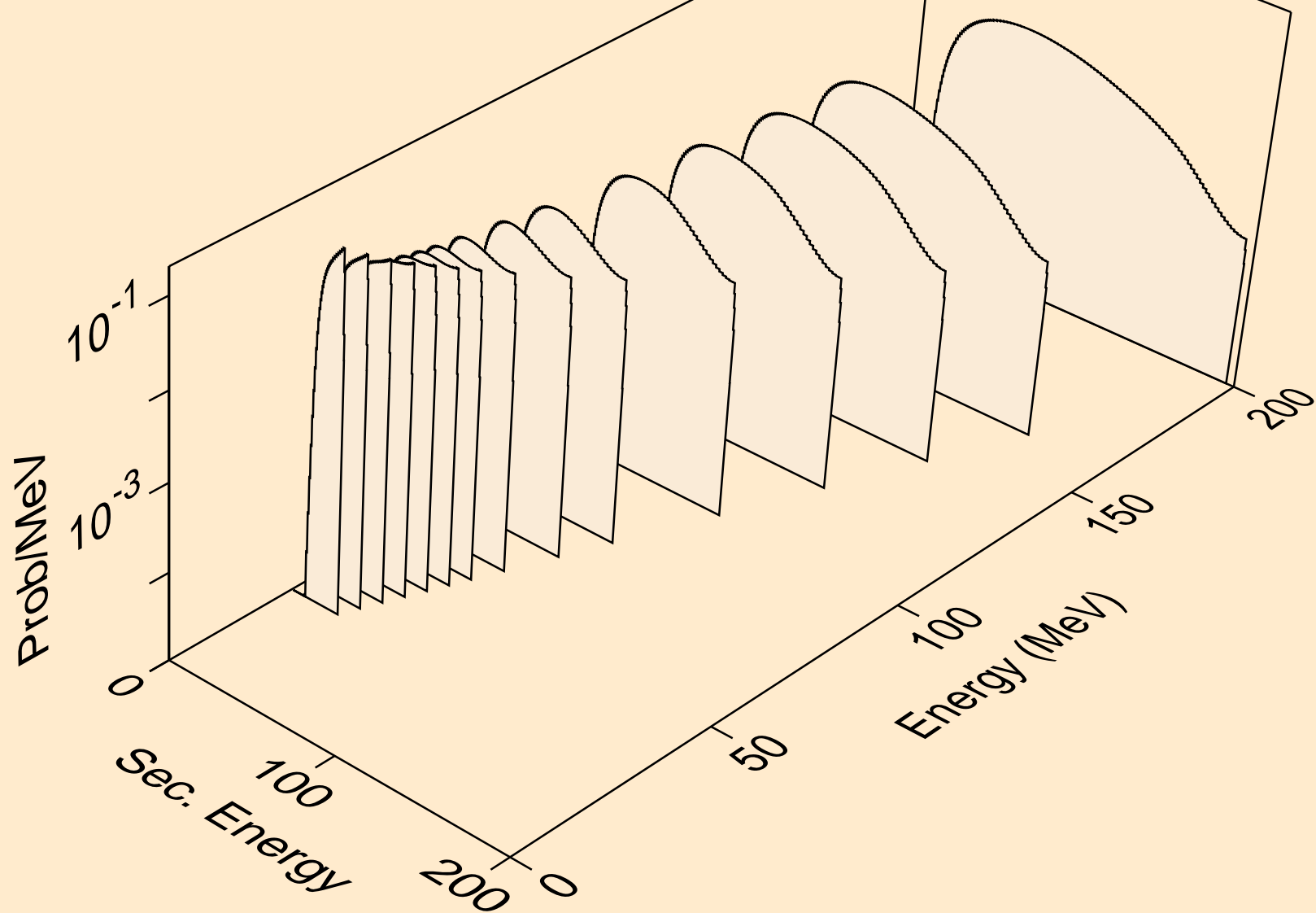

DB268 NEUTRON ACER TENDL-2023 LIBRARY; T=0.K  
deuterons from (n,2nd)

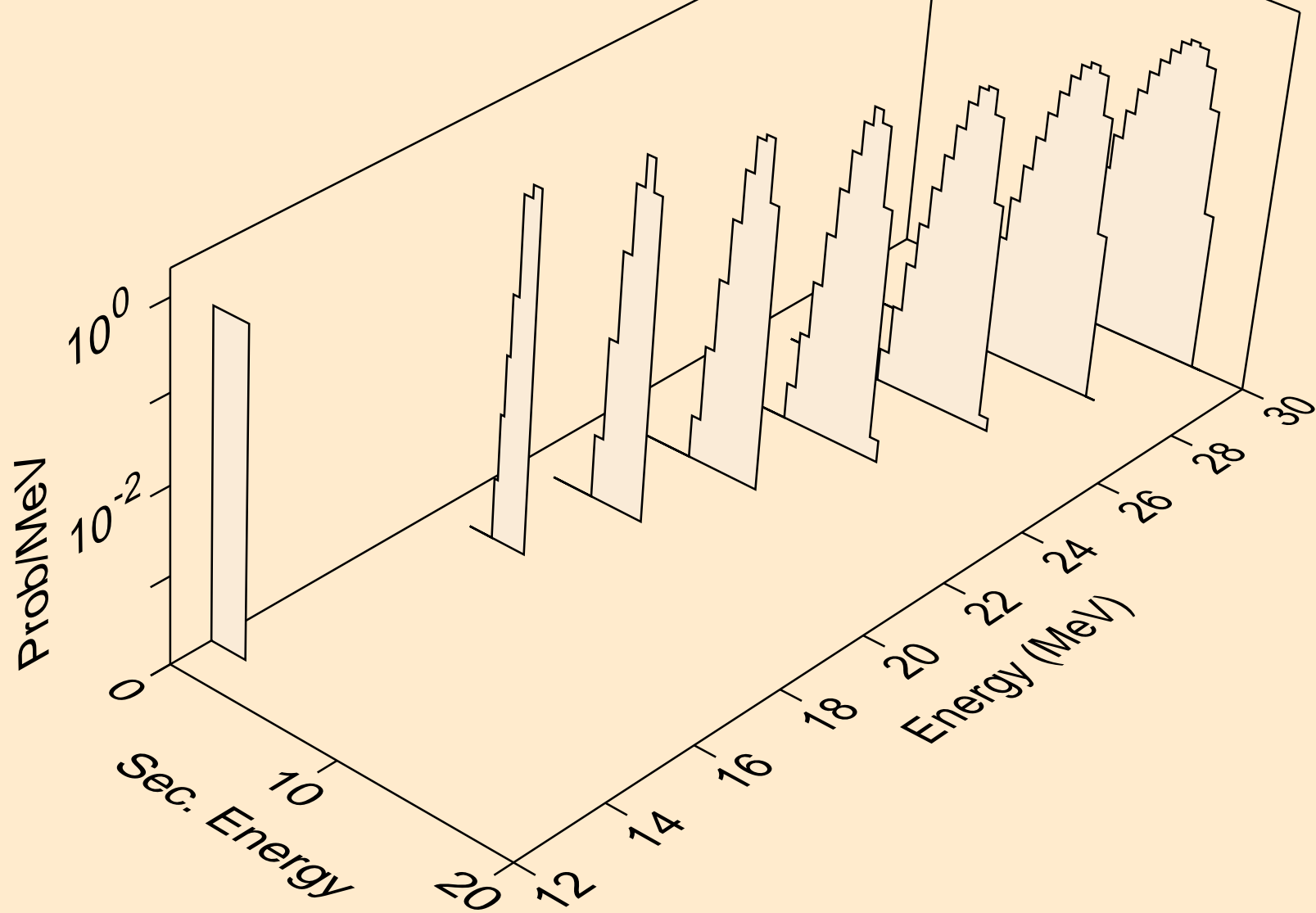

DB268 NEUTRON ACER TENDL-2023 LIBRARY; T=0.K  
deuterons from (n,n\*)d

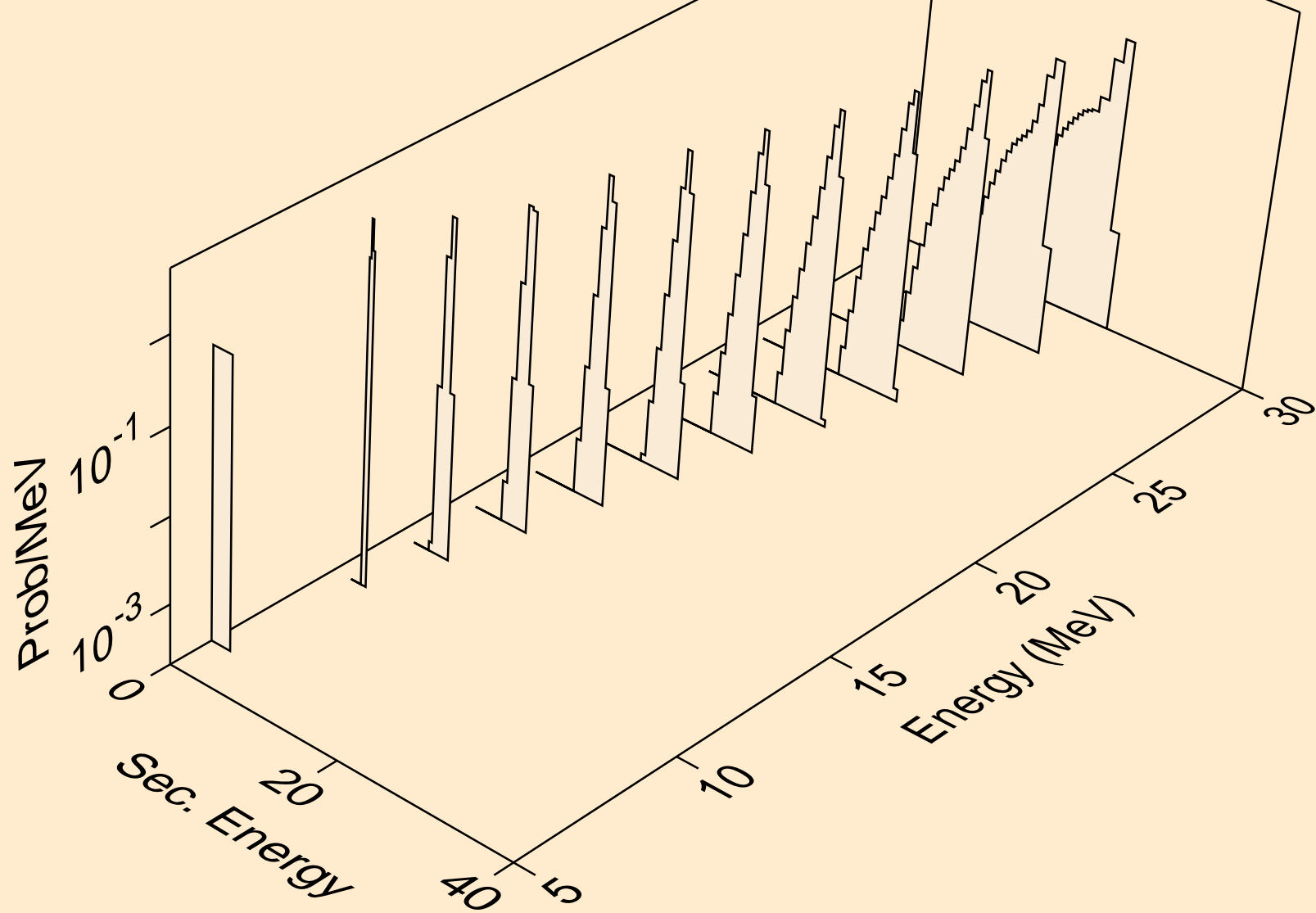

DB268 NEUTRON ACER TENDL-2023 LIBRARY; T=0.K  
deuterons from (n,d)

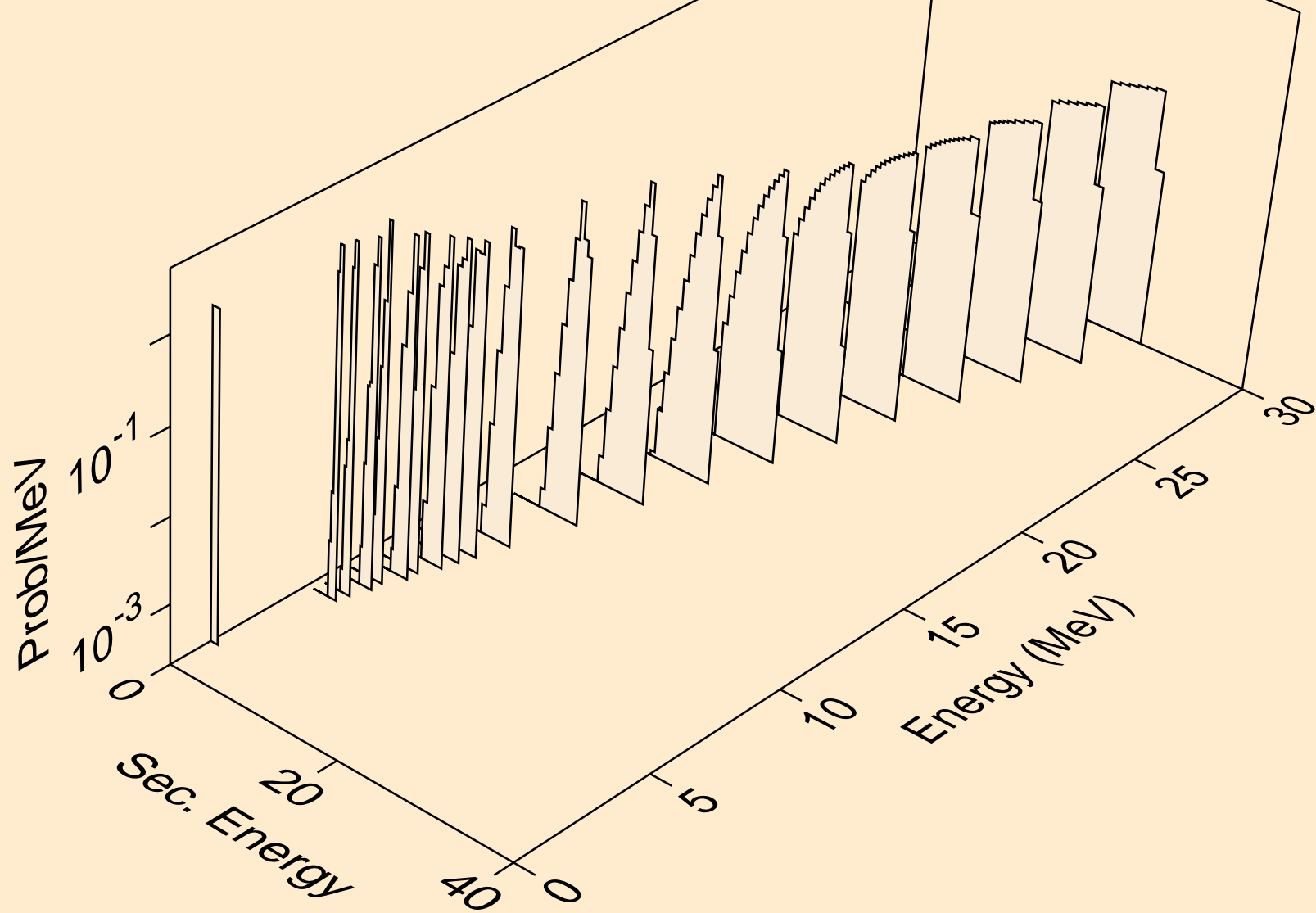

DB268 NEUTRON ACER TENDL-2023 LIBRARY; T=0.K  
tritons from (n,x)

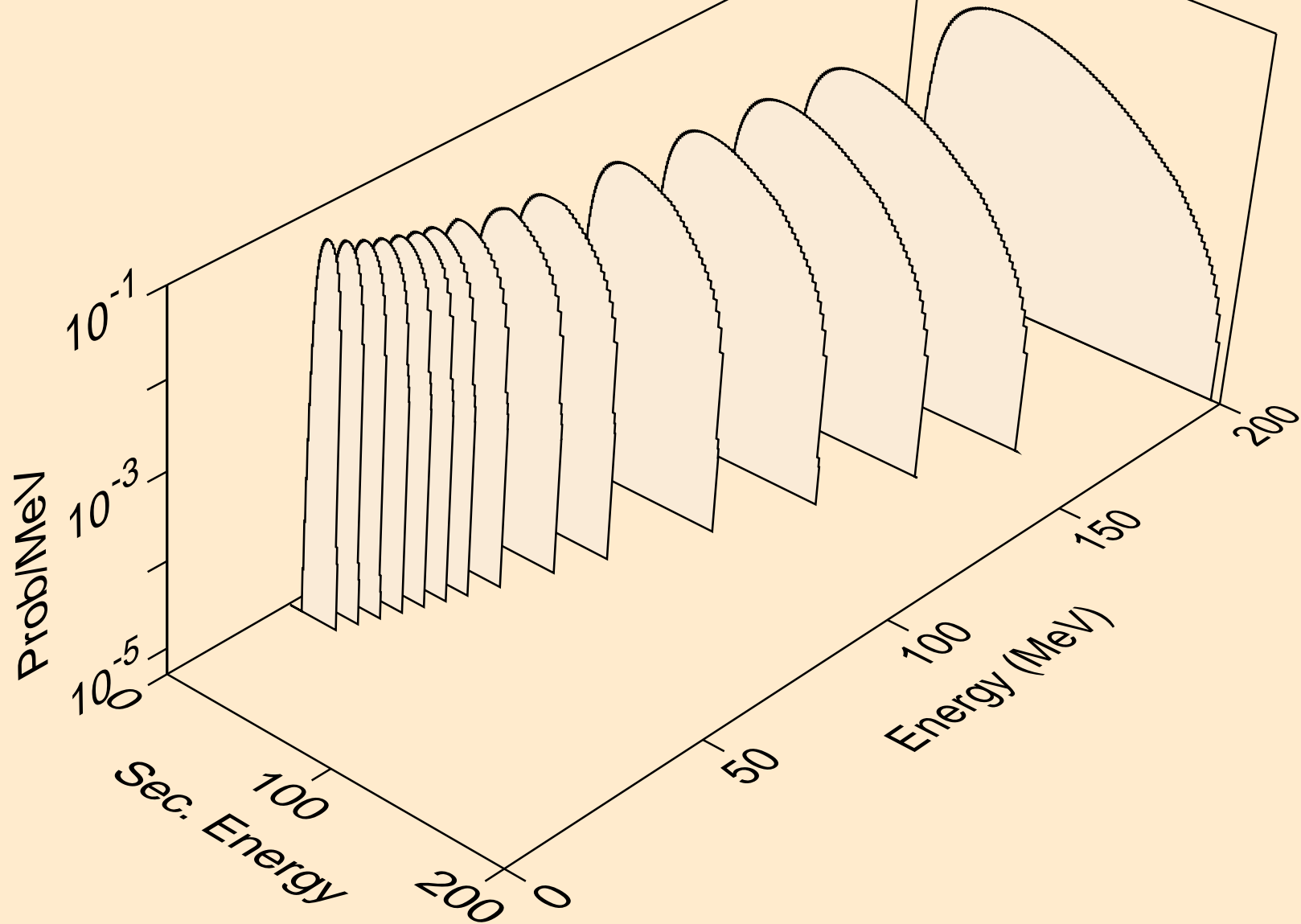

DB268 NEUTRON ACER TENDL-2023 LIBRARY; T=0.K  
tritons from (n,n\*)t

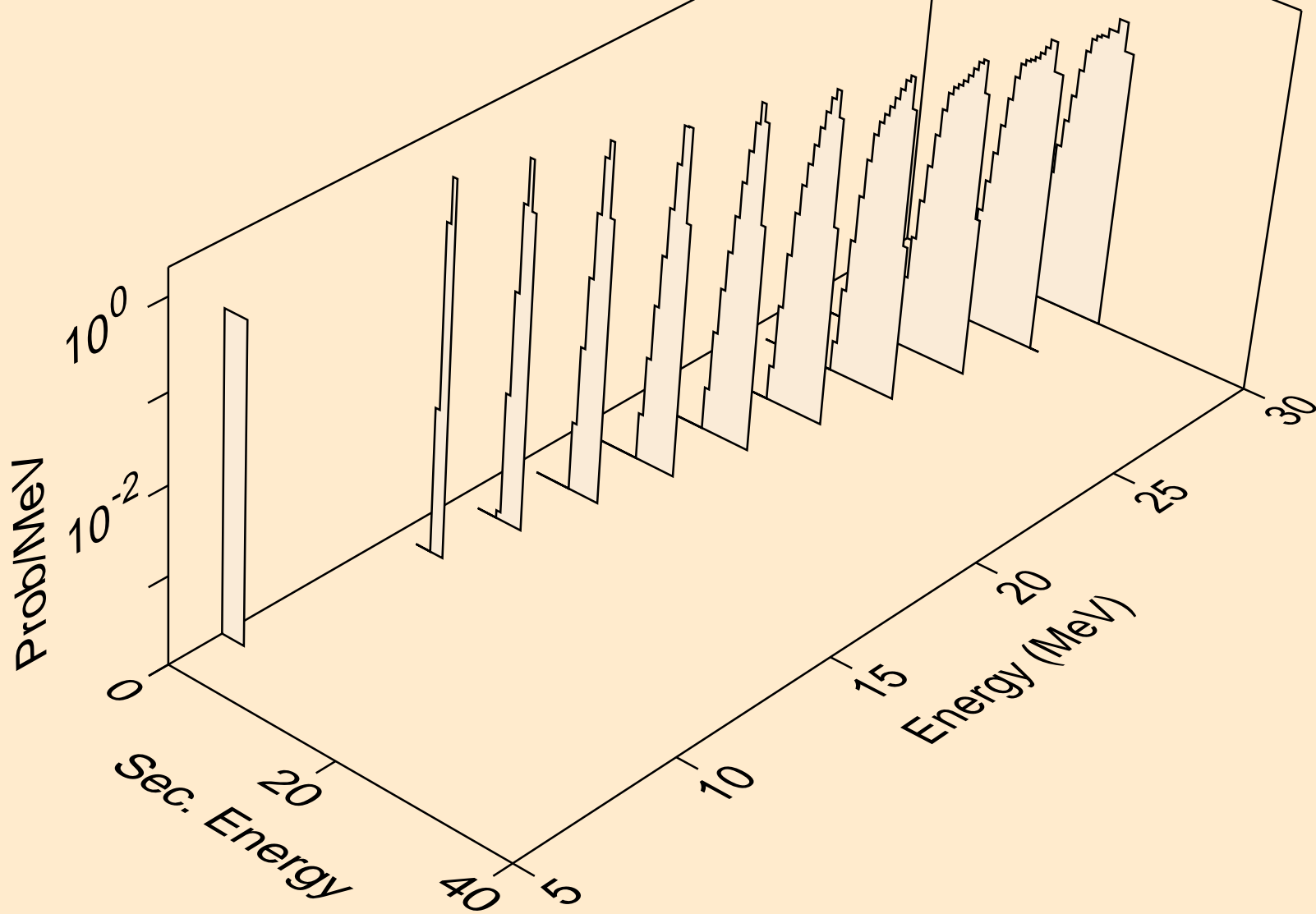

DB268 NEUTRON ACER TENDL-2023 LIBRARY; T=0.K  
tritons from (n,t)

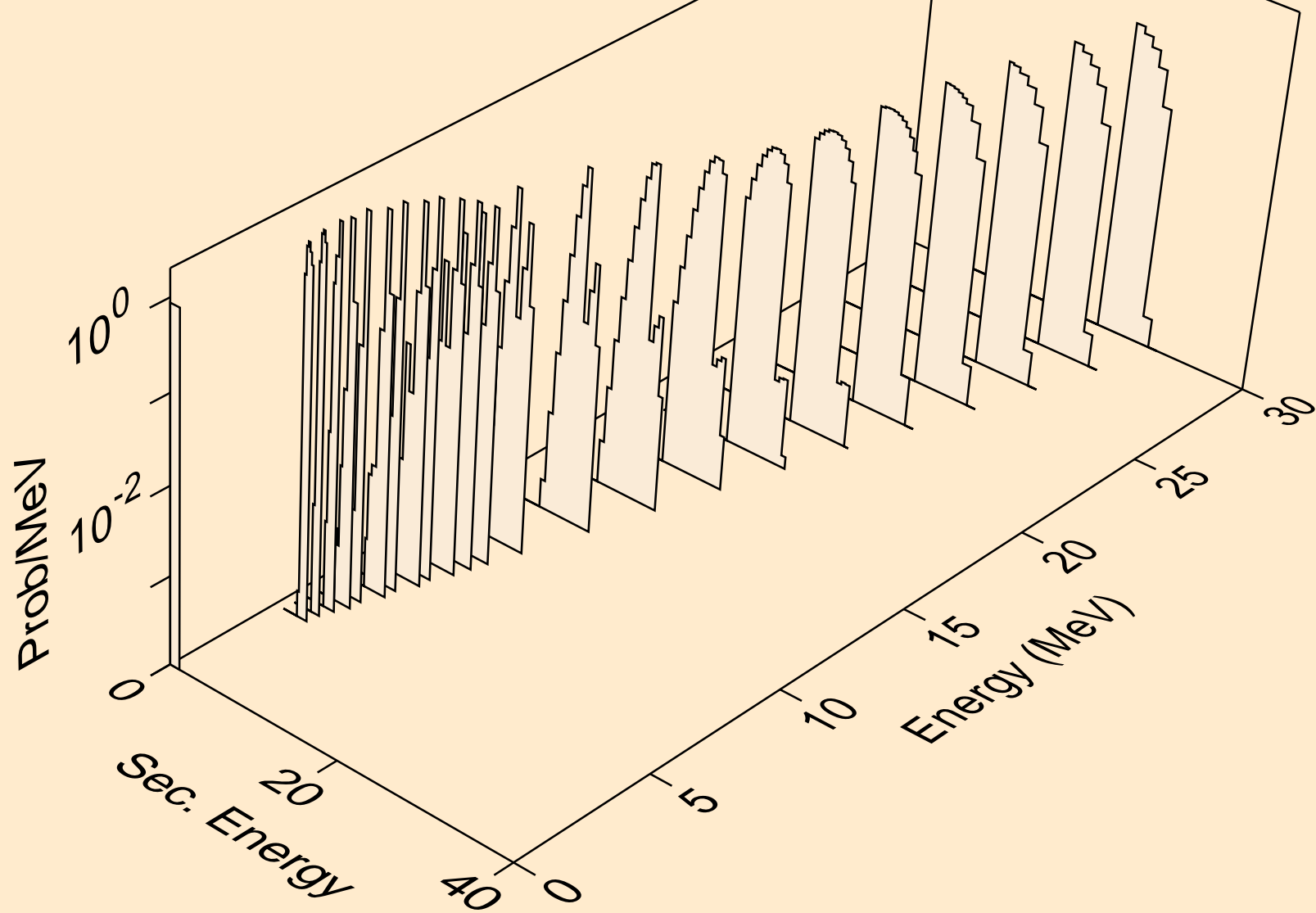

DB268 NEUTRON ACER TENDL-2023 LIBRARY; T=0.K  
he3s from (n,x)

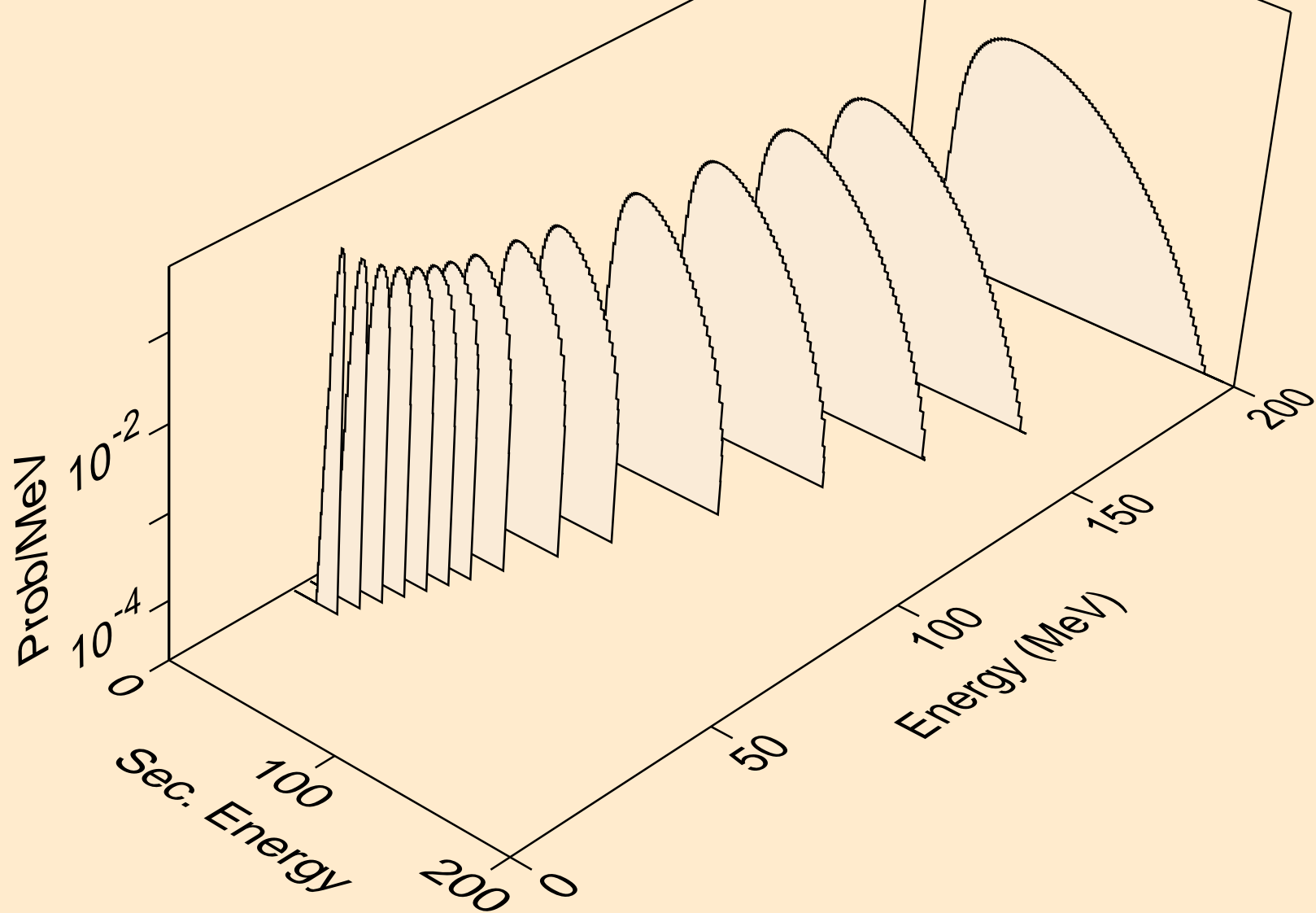

DB268 NEUTRON ACER TENDL-2023 LIBRARY; T=0.K  
he3s from (n,n\*)he3

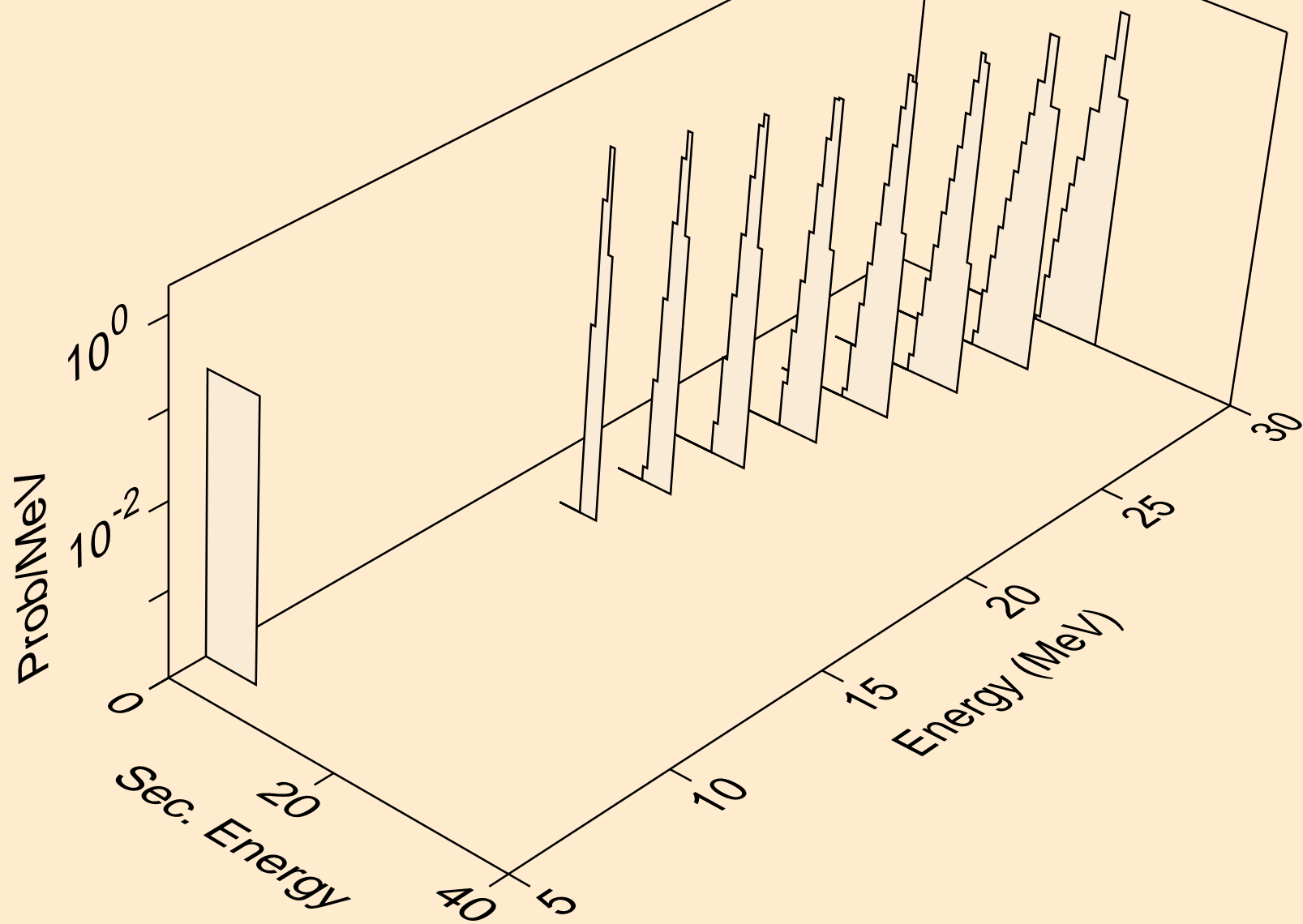

DB268 NEUTRON ACER TENDL-2023 LIBRARY; T=0.K  
he3s from (n,he3)

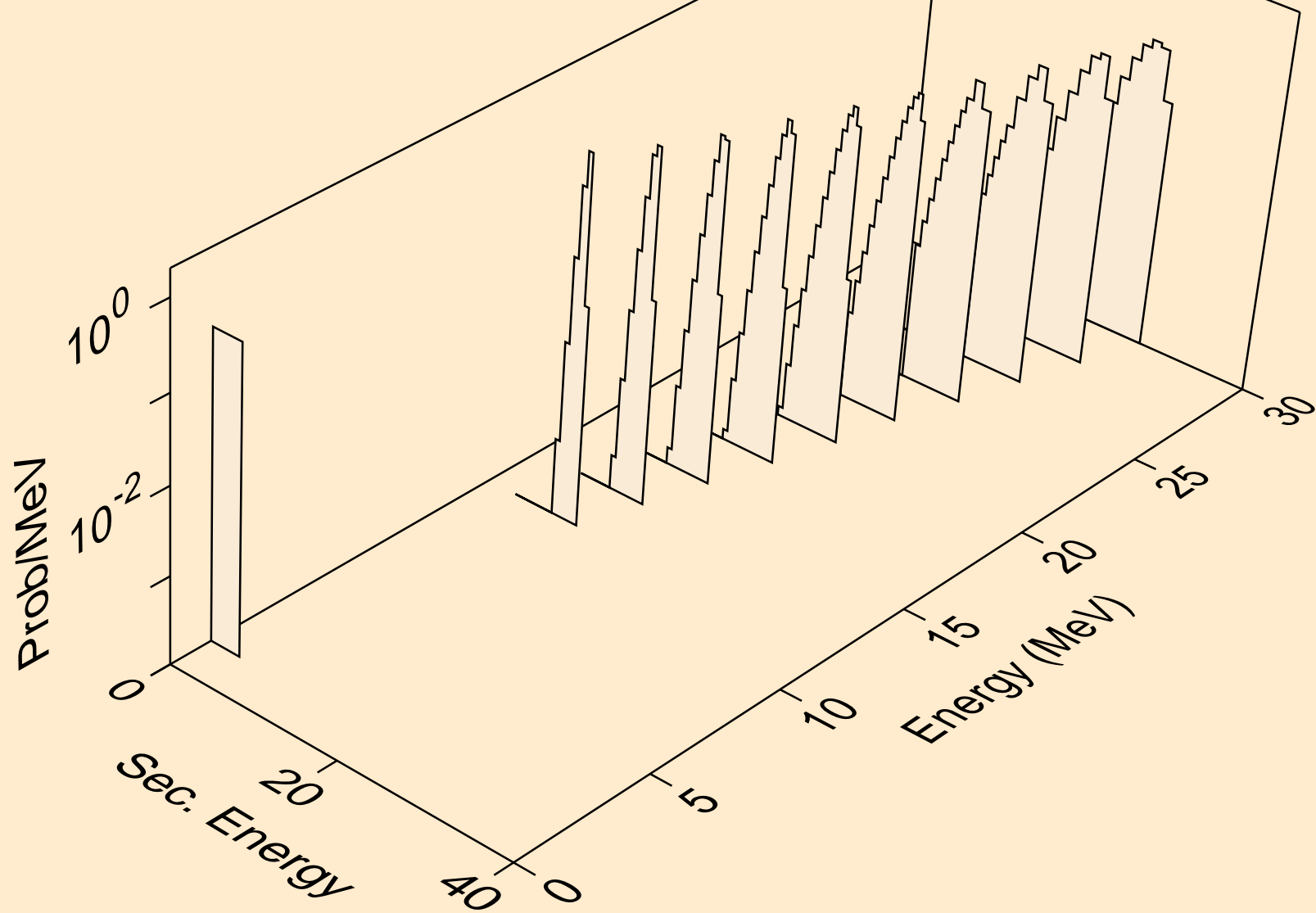

DB268 NEUTRON ACER TENDL-2023 LIBRARY; T=0.K  
alphas from (n,x)

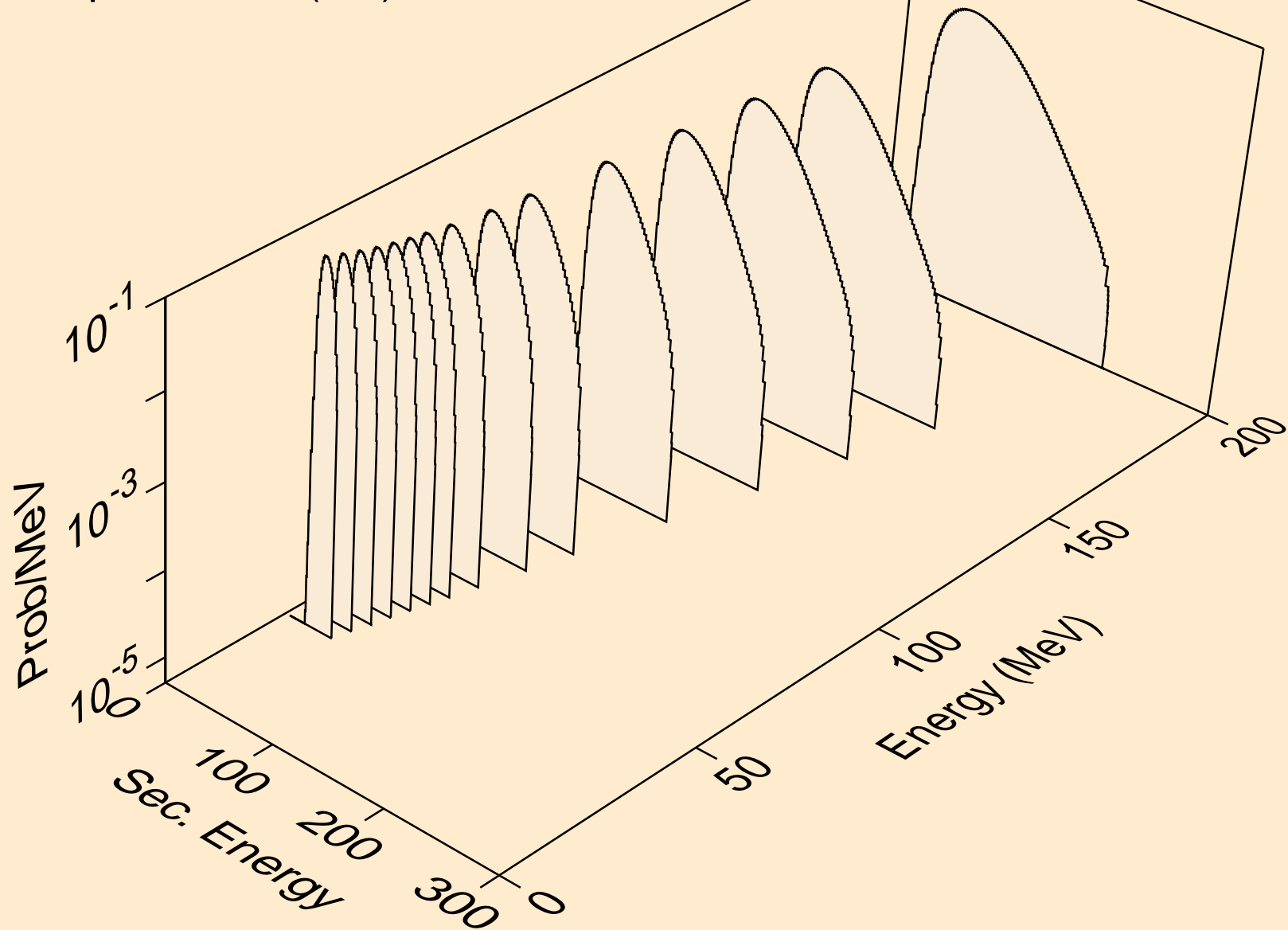

DB268 NEUTRON ACER TENDL-2023 LIBRARY; T=0.K  
alphas from (n,n\*)a

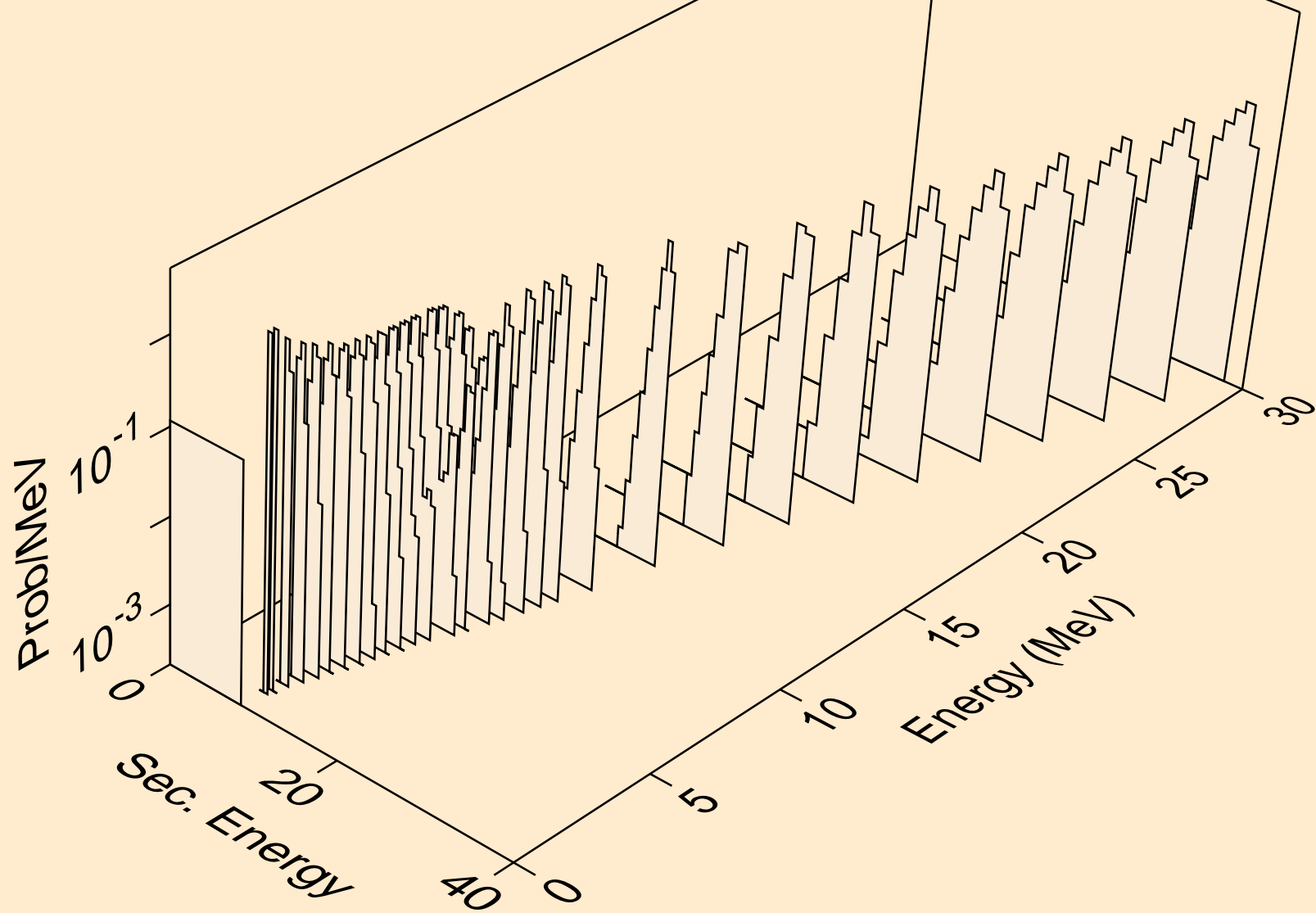

DB268 NEUTRON ACER TENDL-2023 LIBRARY; T=0.K  
alphas from (n,2n)a

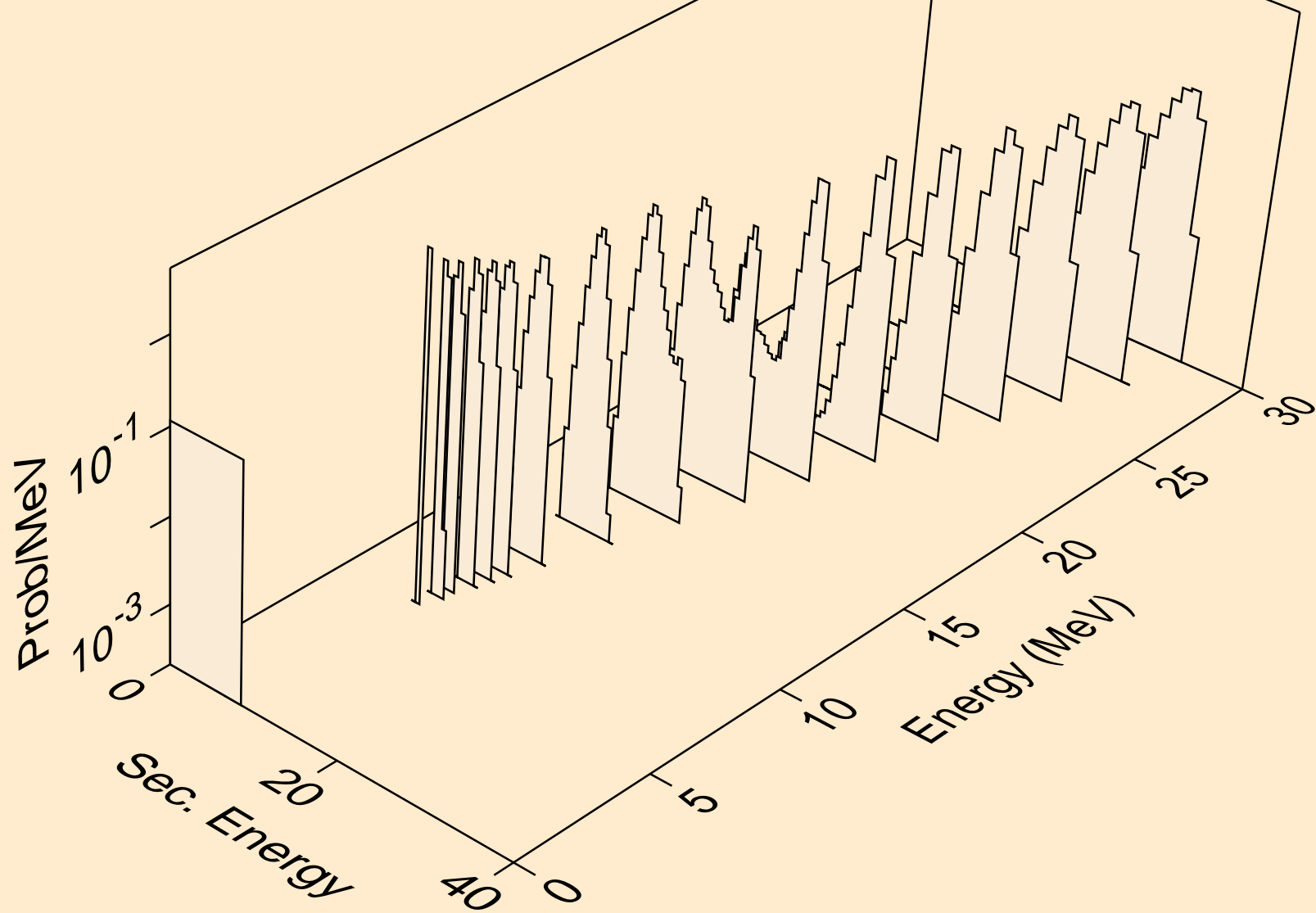

DB268 NEUTRON ACER TENDL-2023 LIBRARY; T=0.K  
alphas from (n,3n)a

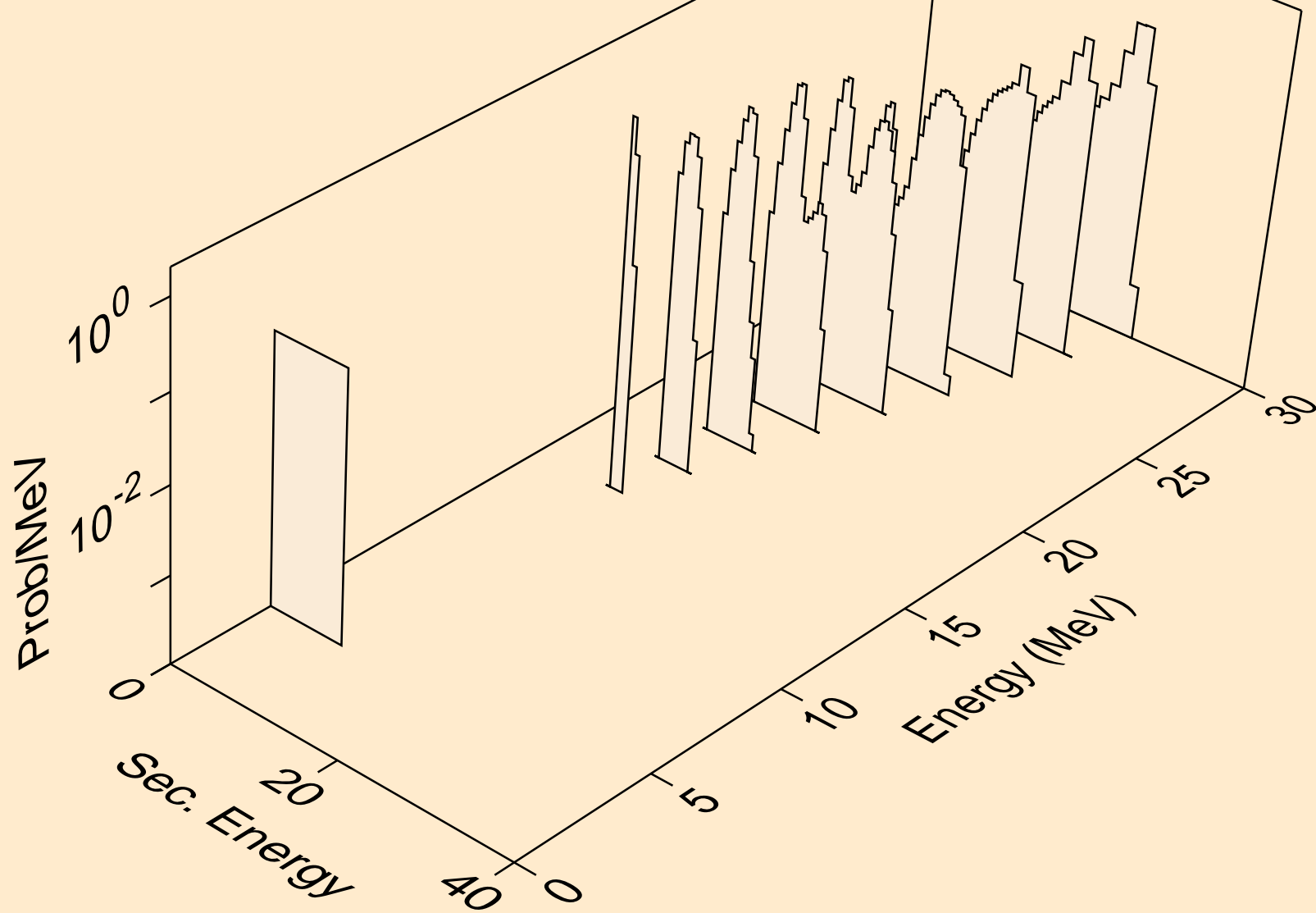

DB268 NEUTRON ACER TENDL-2023 LIBRARY; T=0.K  
alphas from (n,a)

