

ER149 NEUTRON ACER TENDL-2023 LIBRARY; T=0.K

Principal cross sections

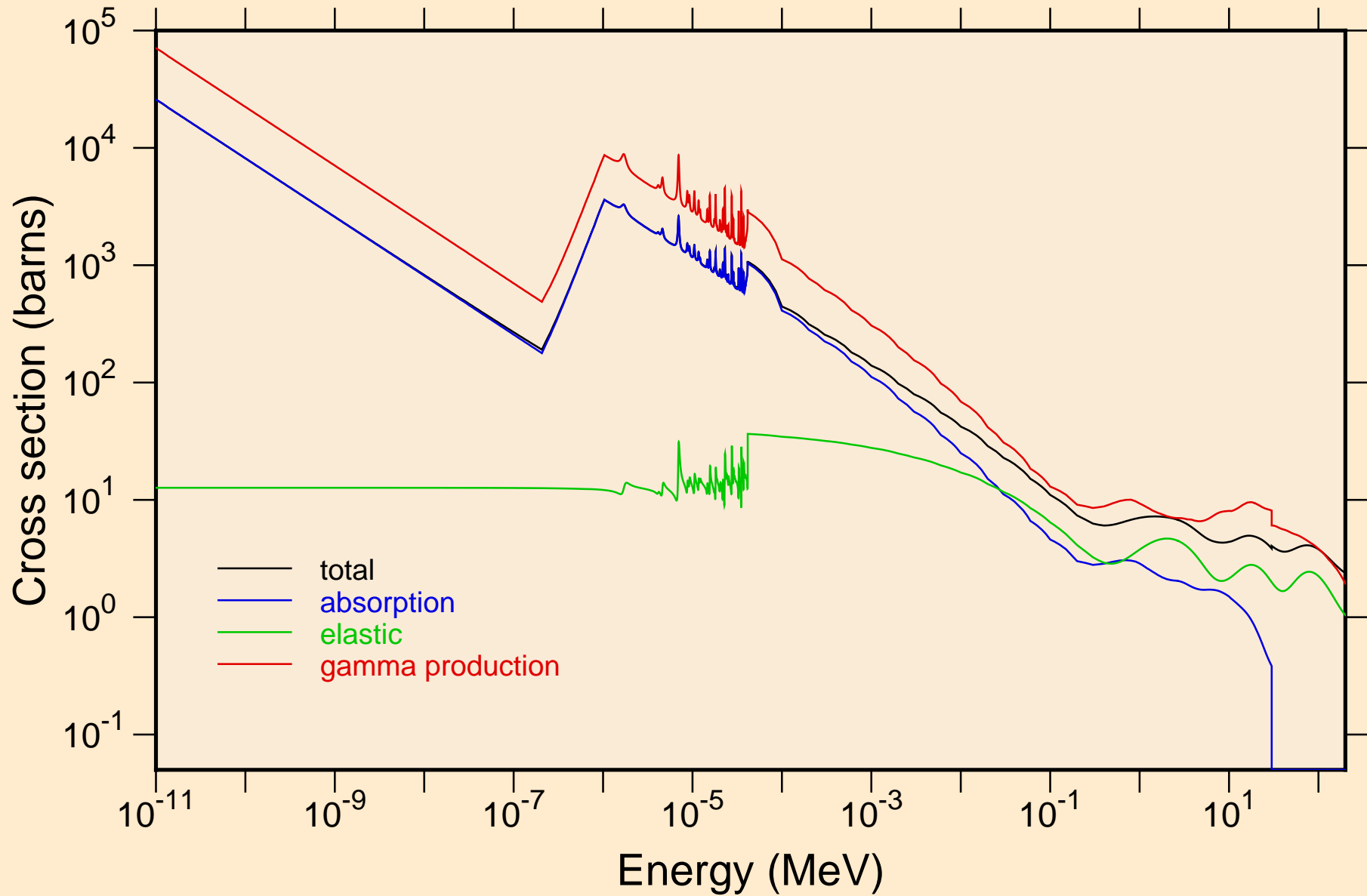

ER149 NEUTRON ACER TENDL-2023 LIBRARY; T=0.K
resonance total cross section

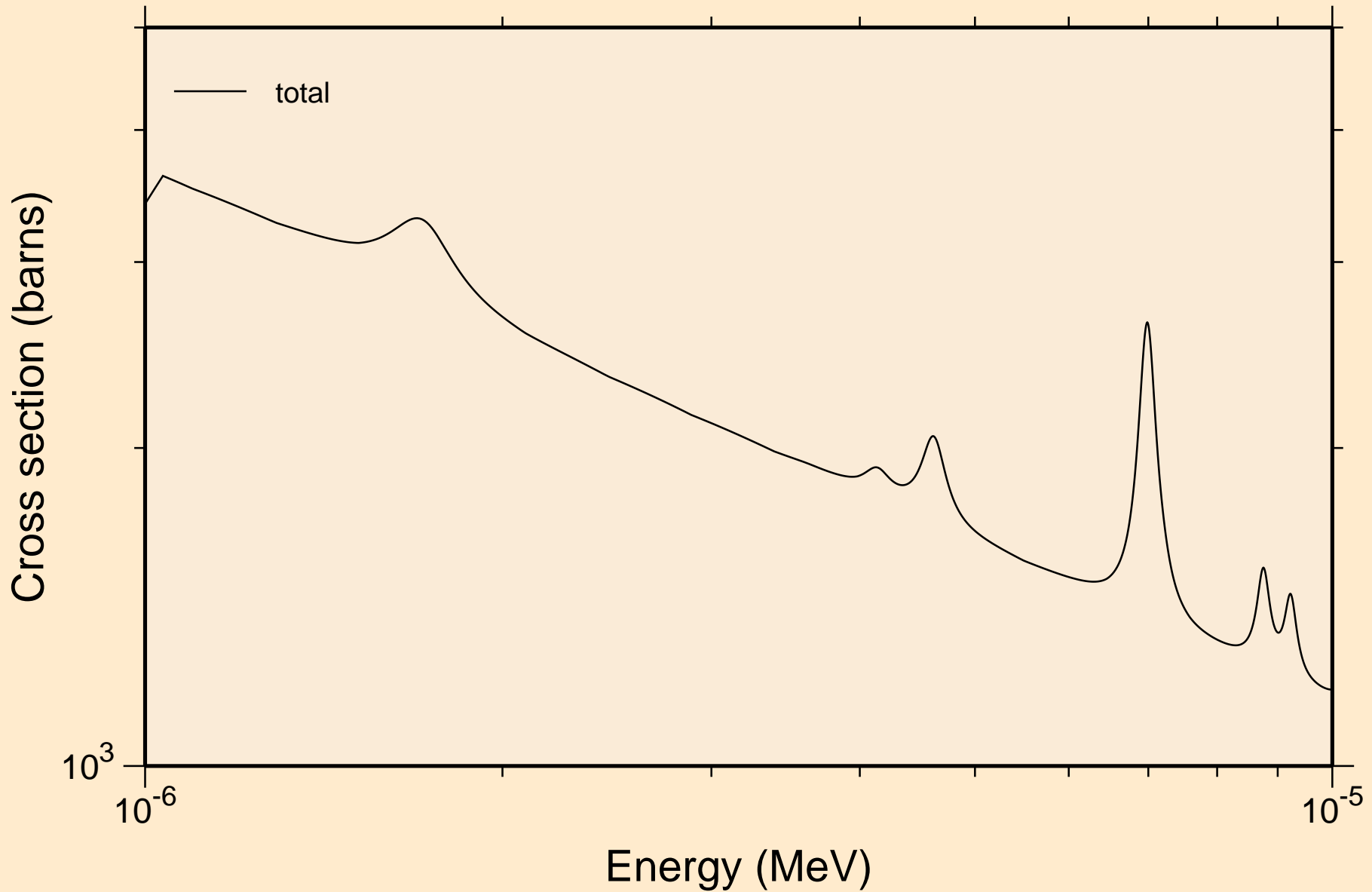

ER149 NEUTRON ACER TENDL-2023 LIBRARY; T=0.K
resonance total cross section

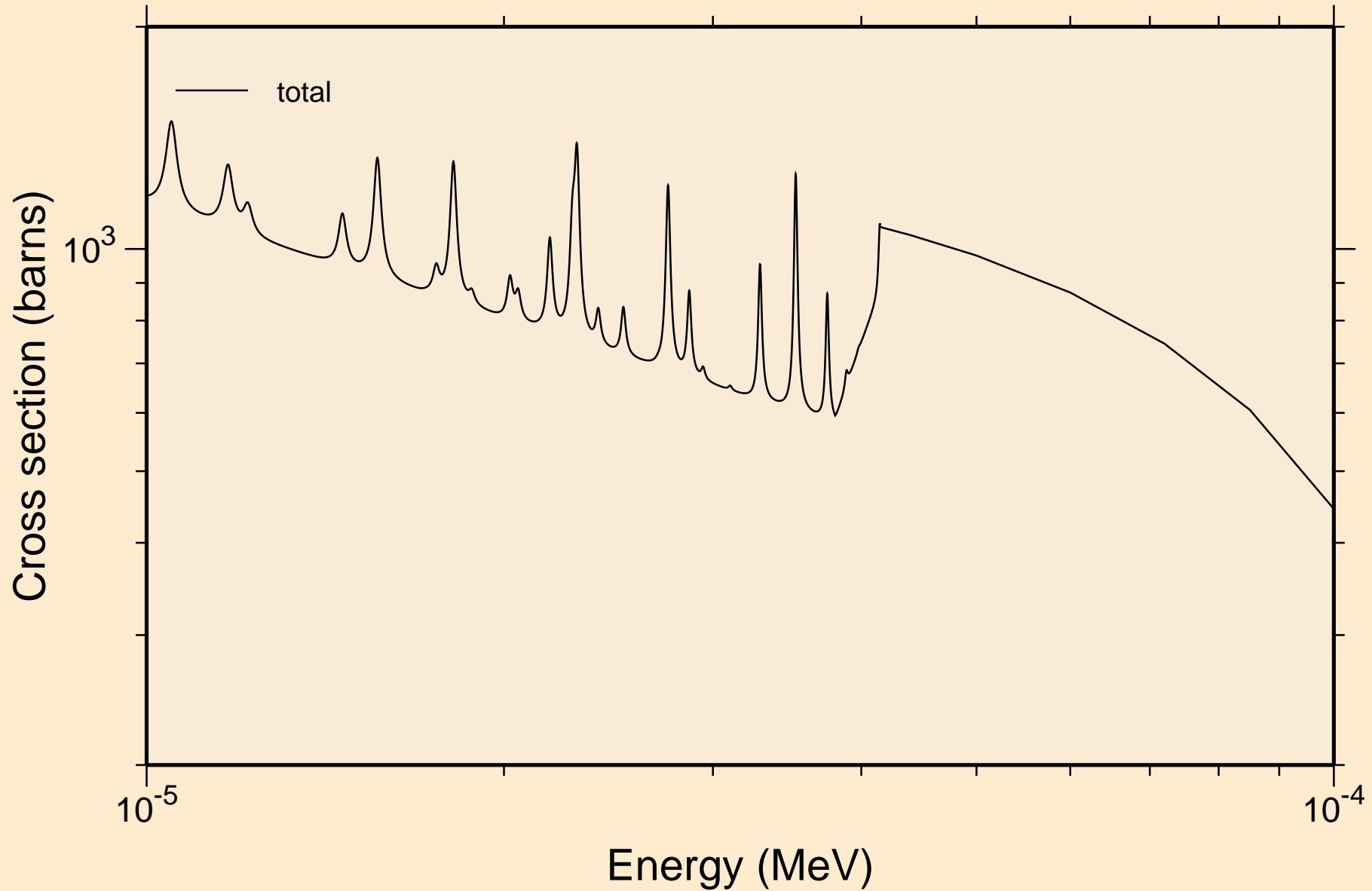

ER149 NEUTRON ACER TENDL-2023 LIBRARY; T=0.K
resonance total cross section

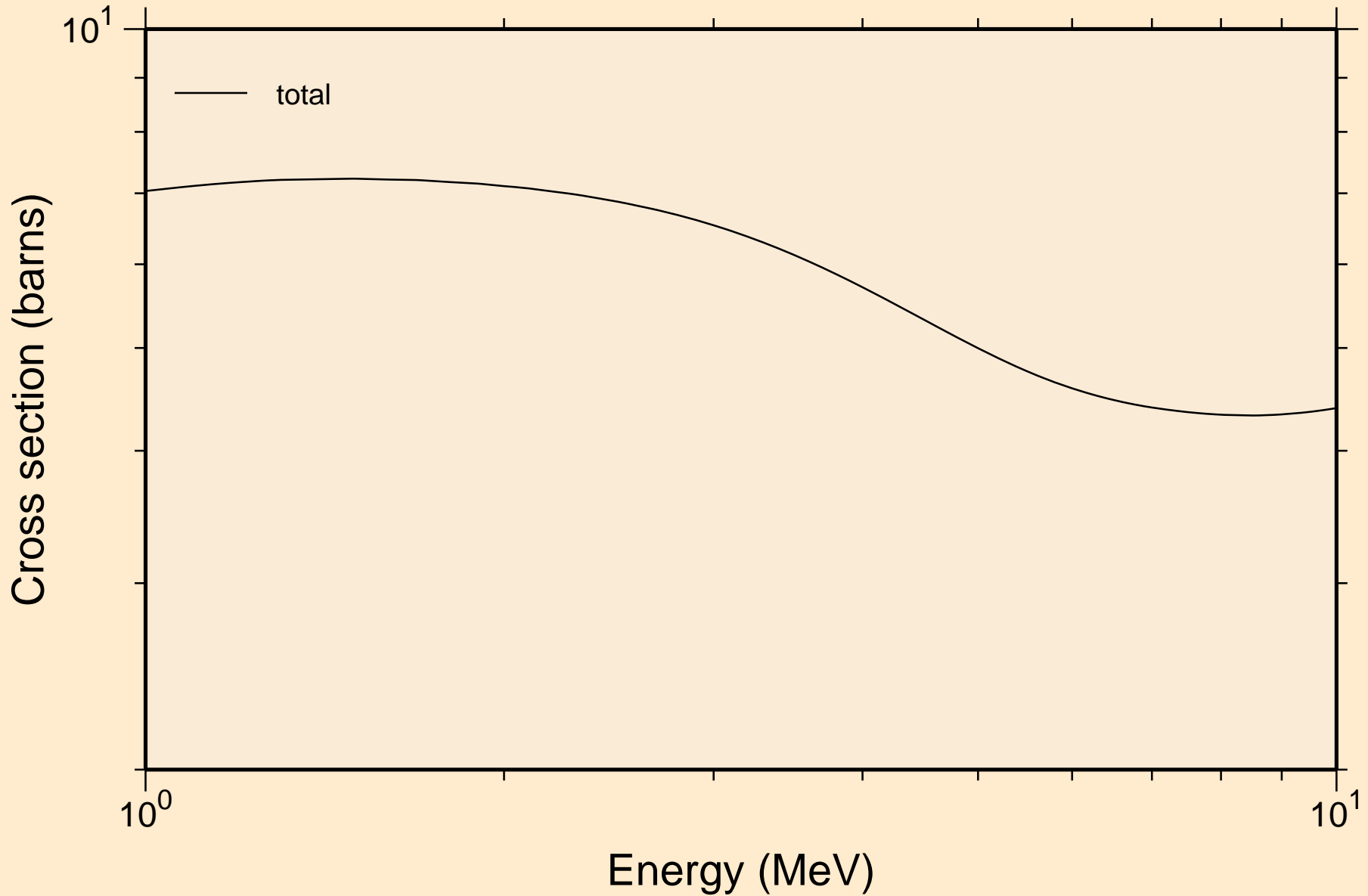

ER149 NEUTRON ACER TENDL-2023 LIBRARY; T=0.K
resonance absorption cross sections

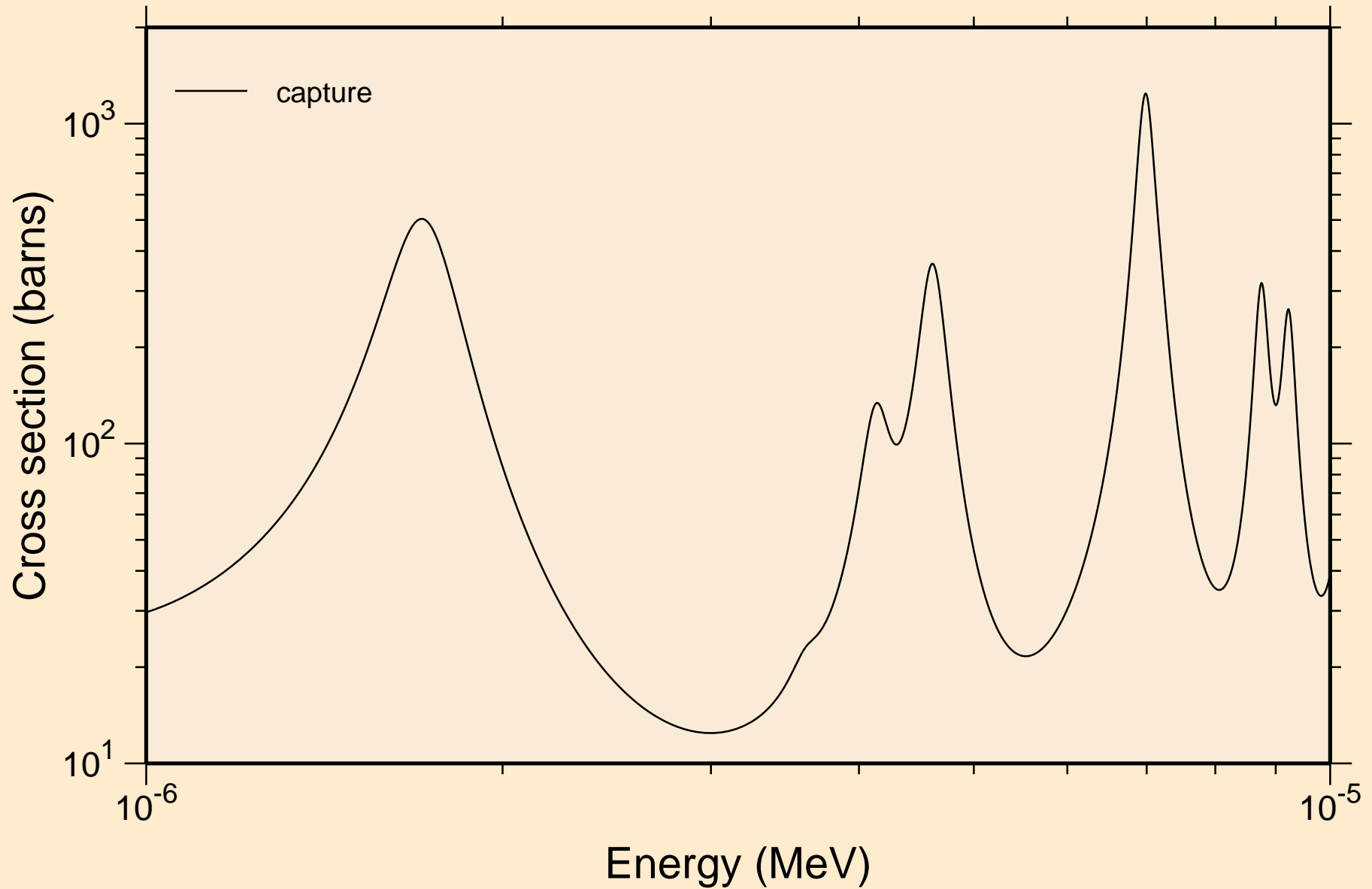

ER149 NEUTRON ACER TENDL-2023 LIBRARY; T=0.K
resonance absorption cross sections

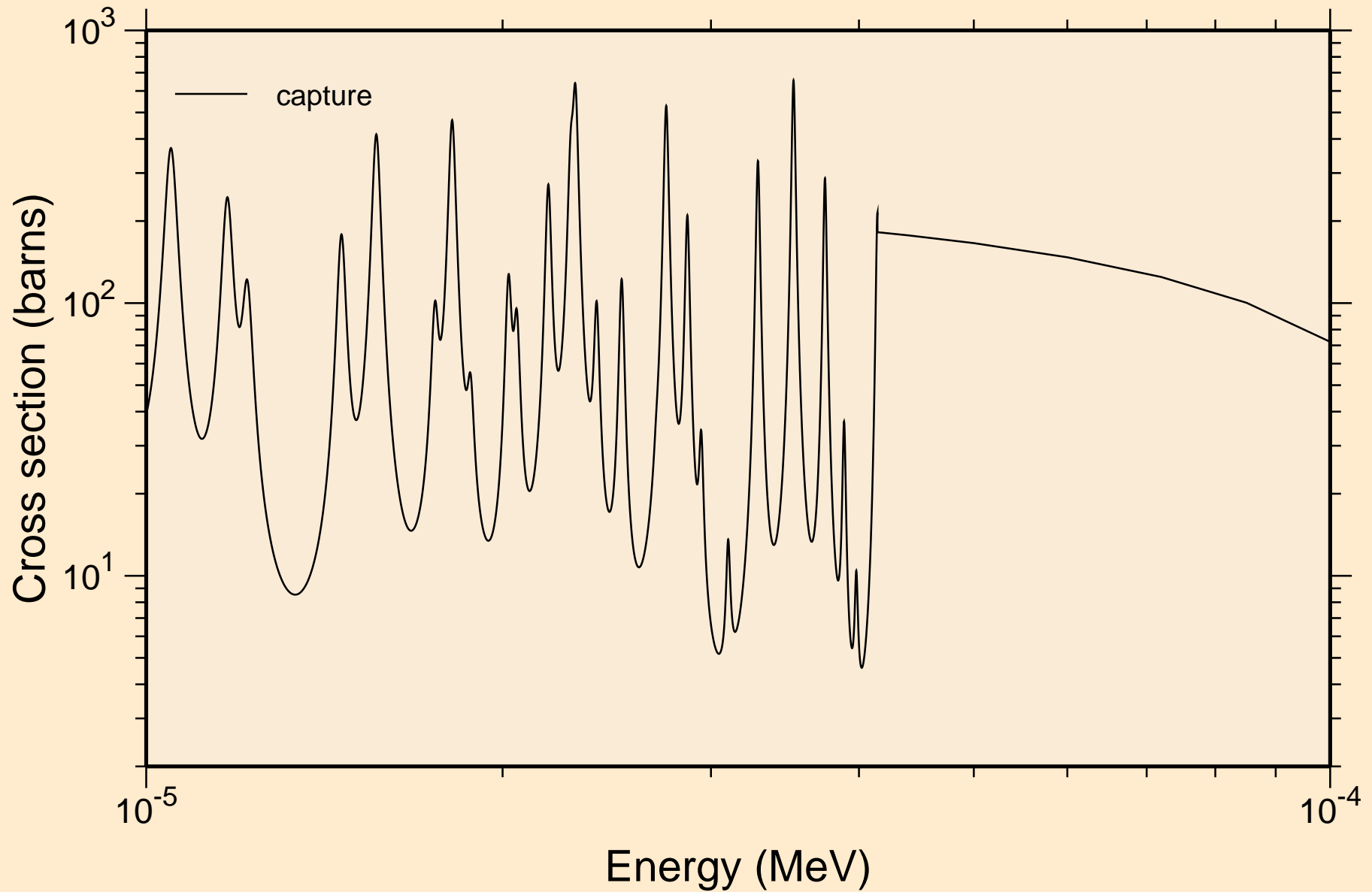

ER149 NEUTRON ACER TENDL-2023 LIBRARY; T=0.K
resonance absorption cross sections

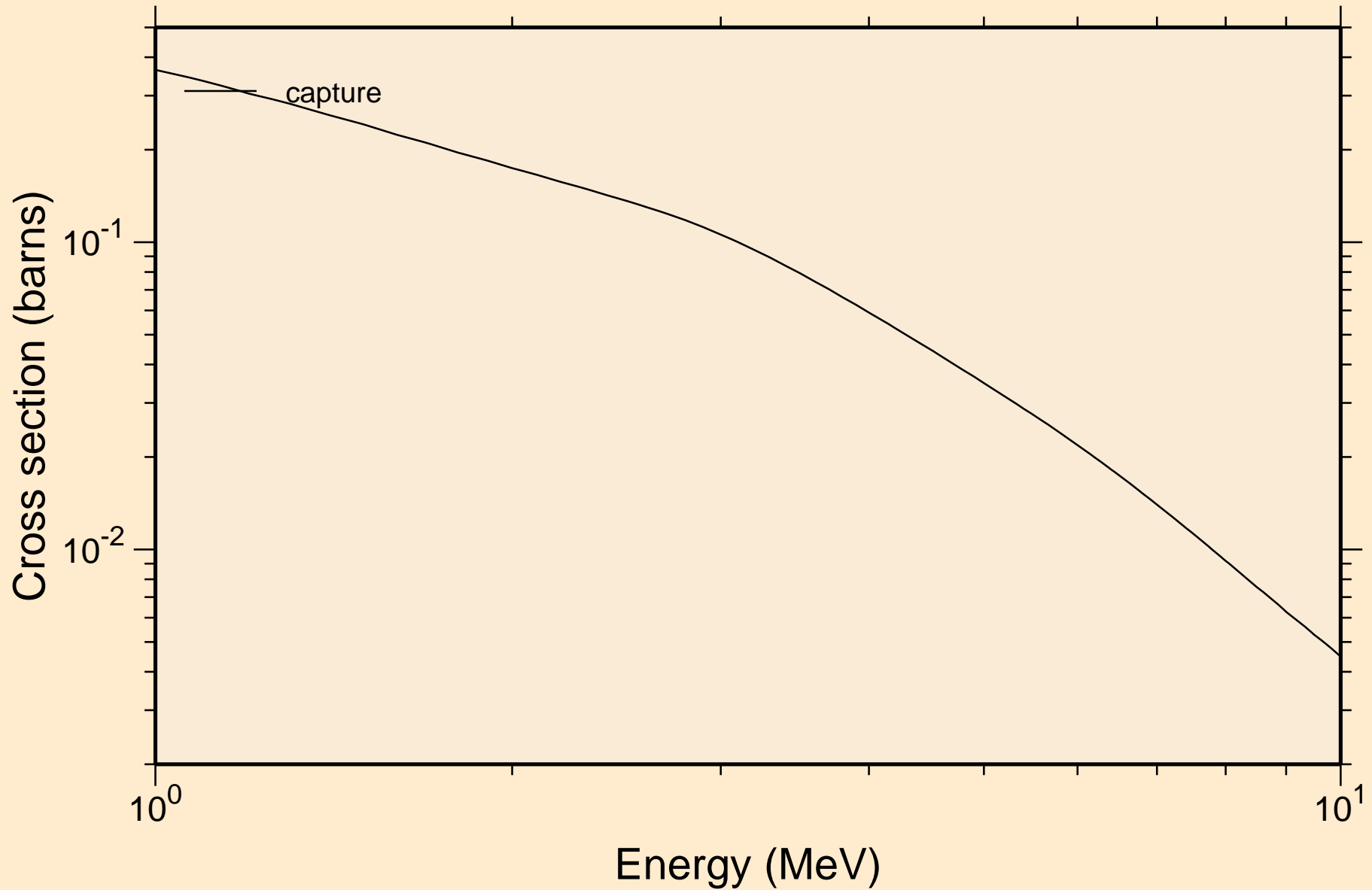

ER149 NEUTRON ACER TENDL-2023 LIBRARY; T=0.K

Heating

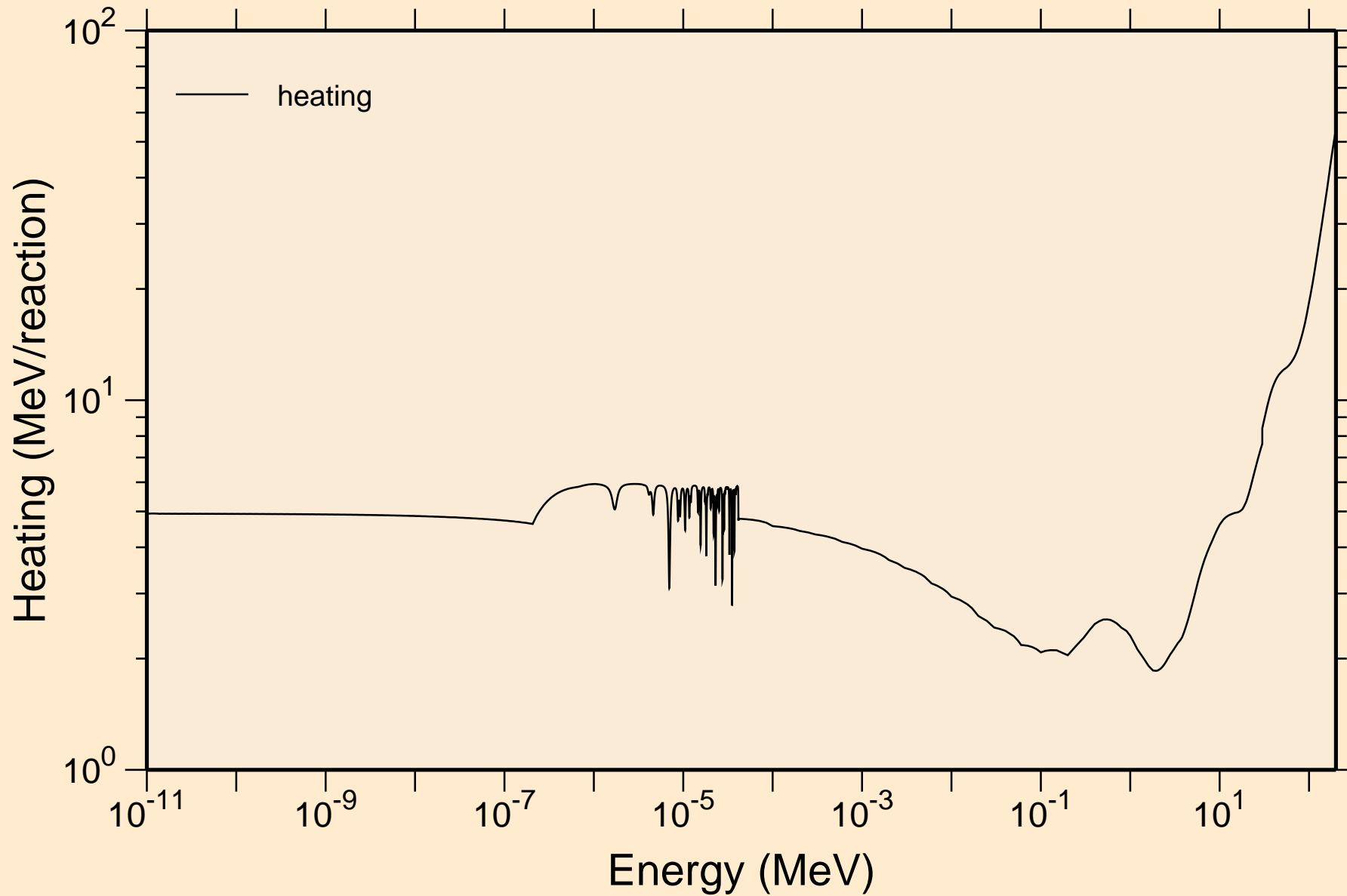

ER149 NEUTRON ACER TENDL-2023 LIBRARY; T=0.K
Damage

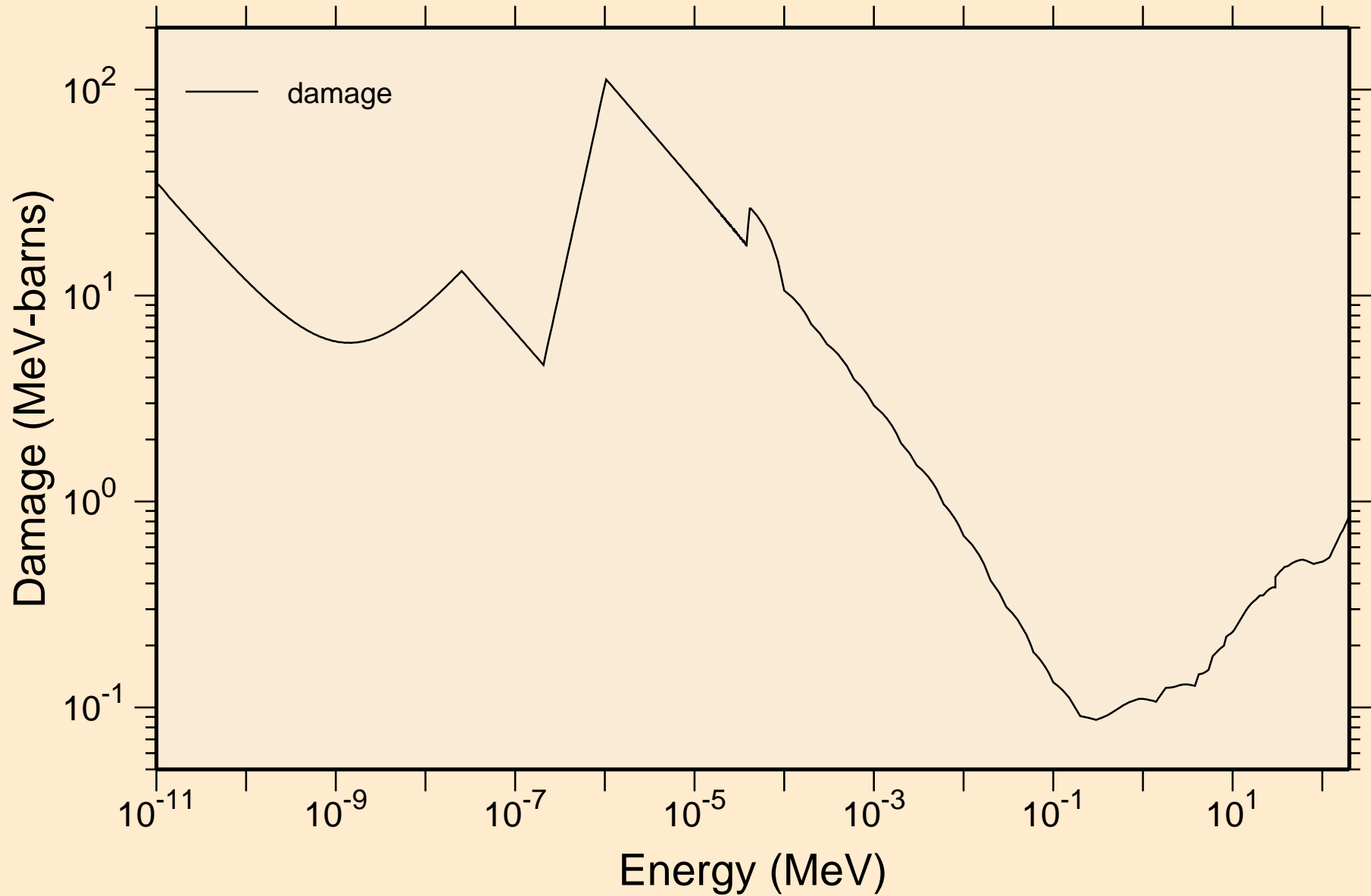

ER149 NEUTRON ACER TENDL-2023 LIBRARY; T=0.K
Non-threshold reactions

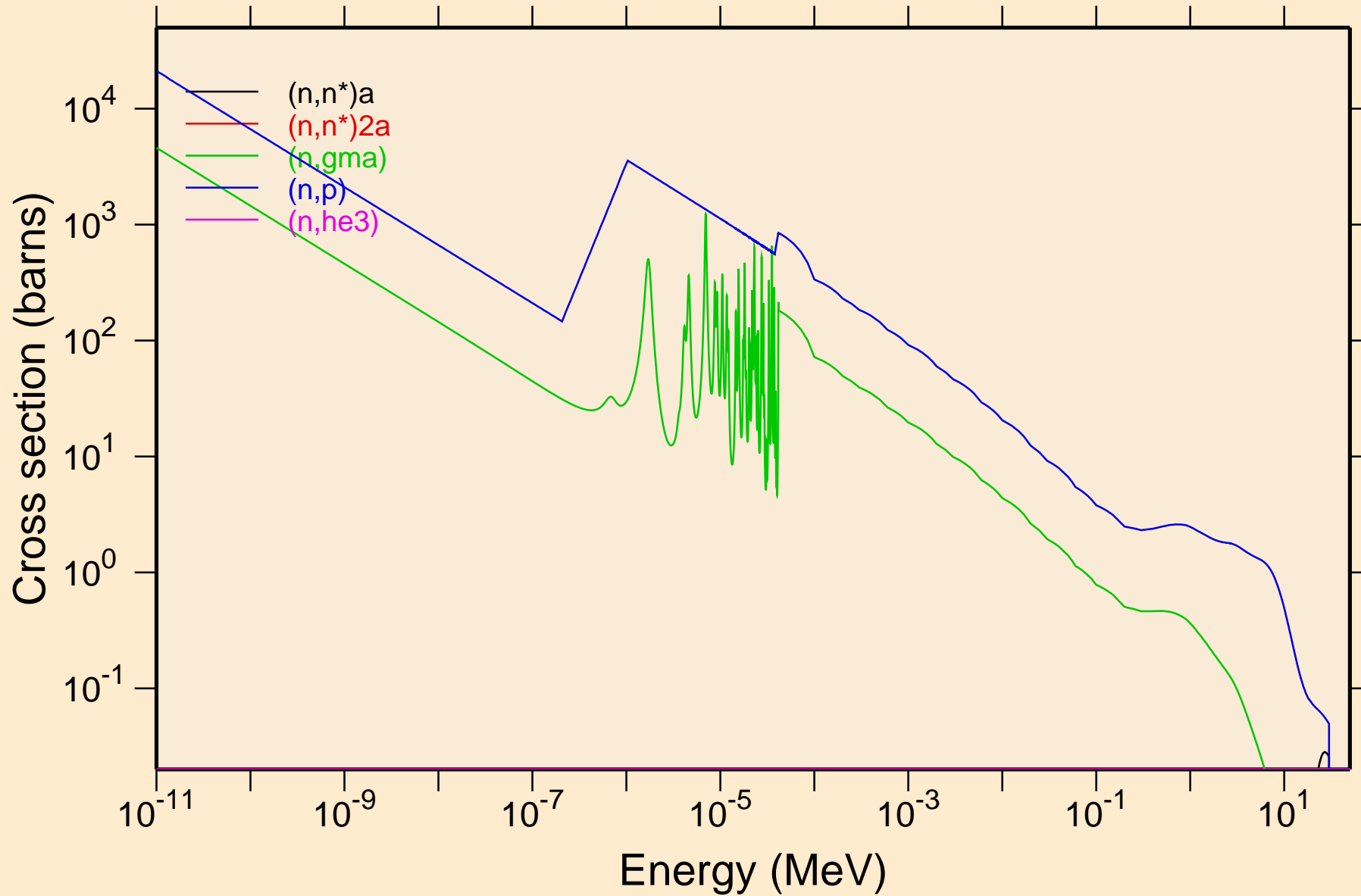

ER149 NEUTRON ACER TENDL-2023 LIBRARY; T=0.K

Non-threshold reactions

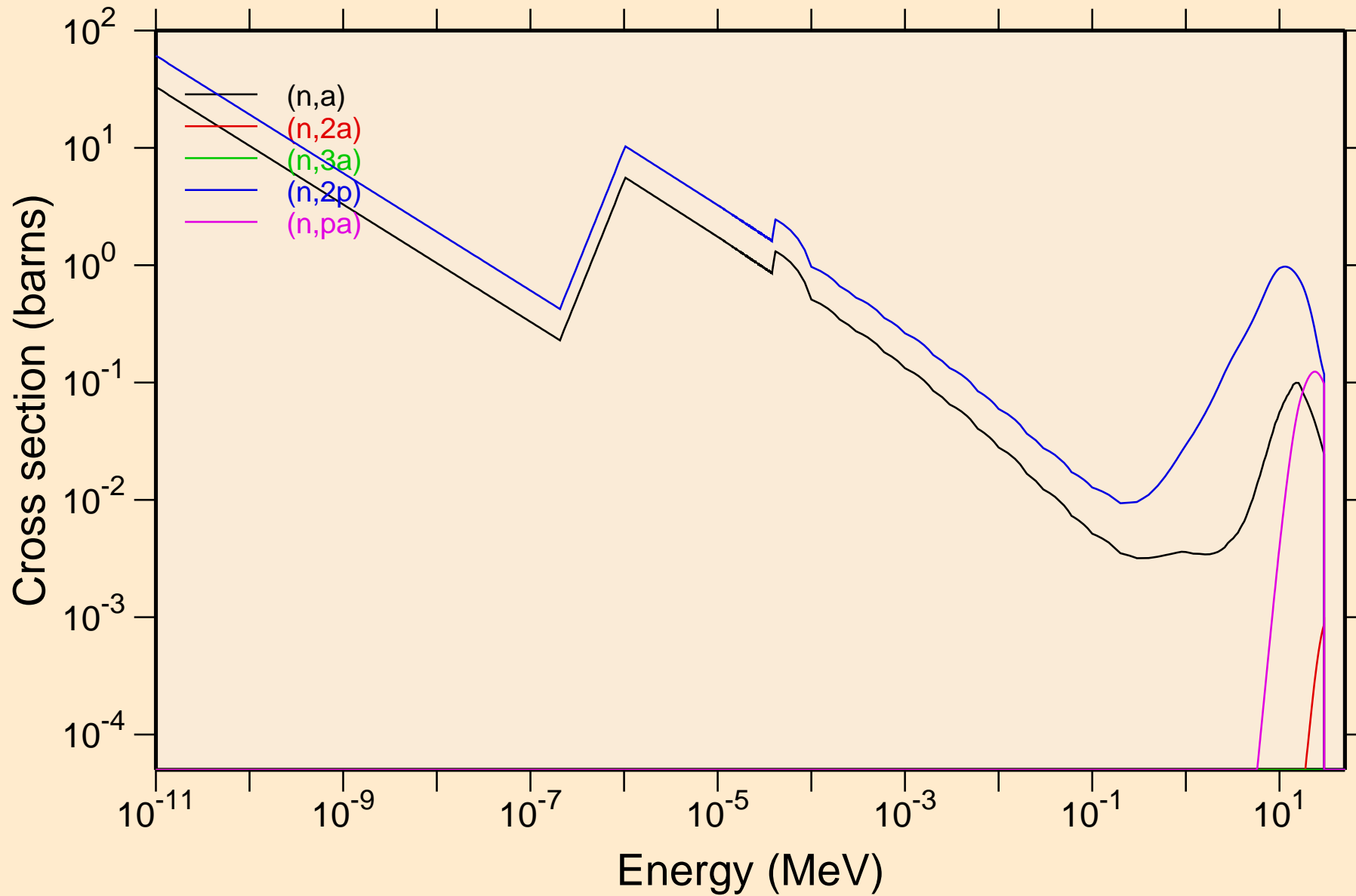

ER149 NEUTRON ACER TENDL-2023 LIBRARY; T=0.K

Non-threshold reactions

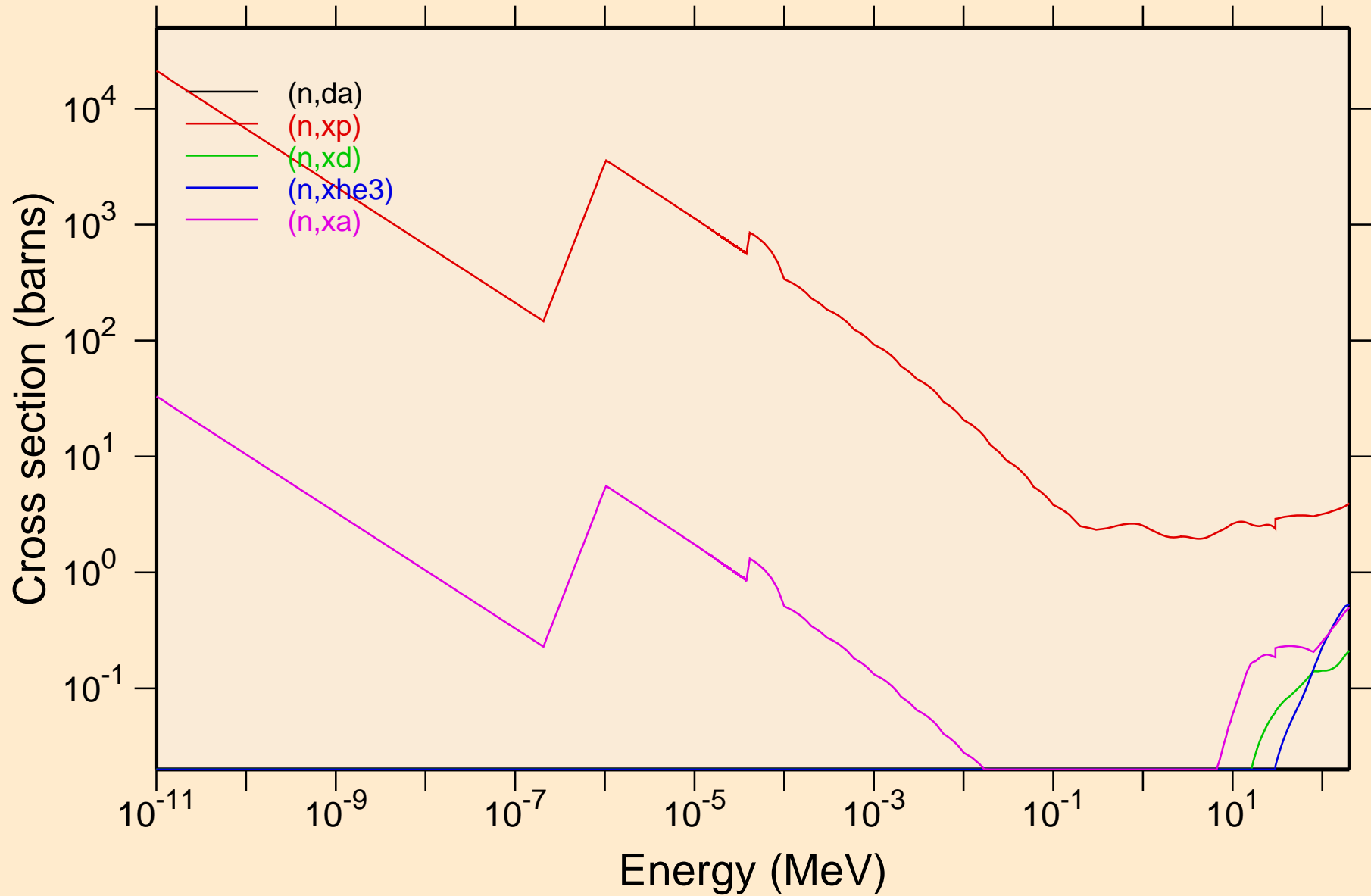

ER149 NEUTRON ACER TENDL-2023 LIBRARY; T=0.K
Principal cross sections

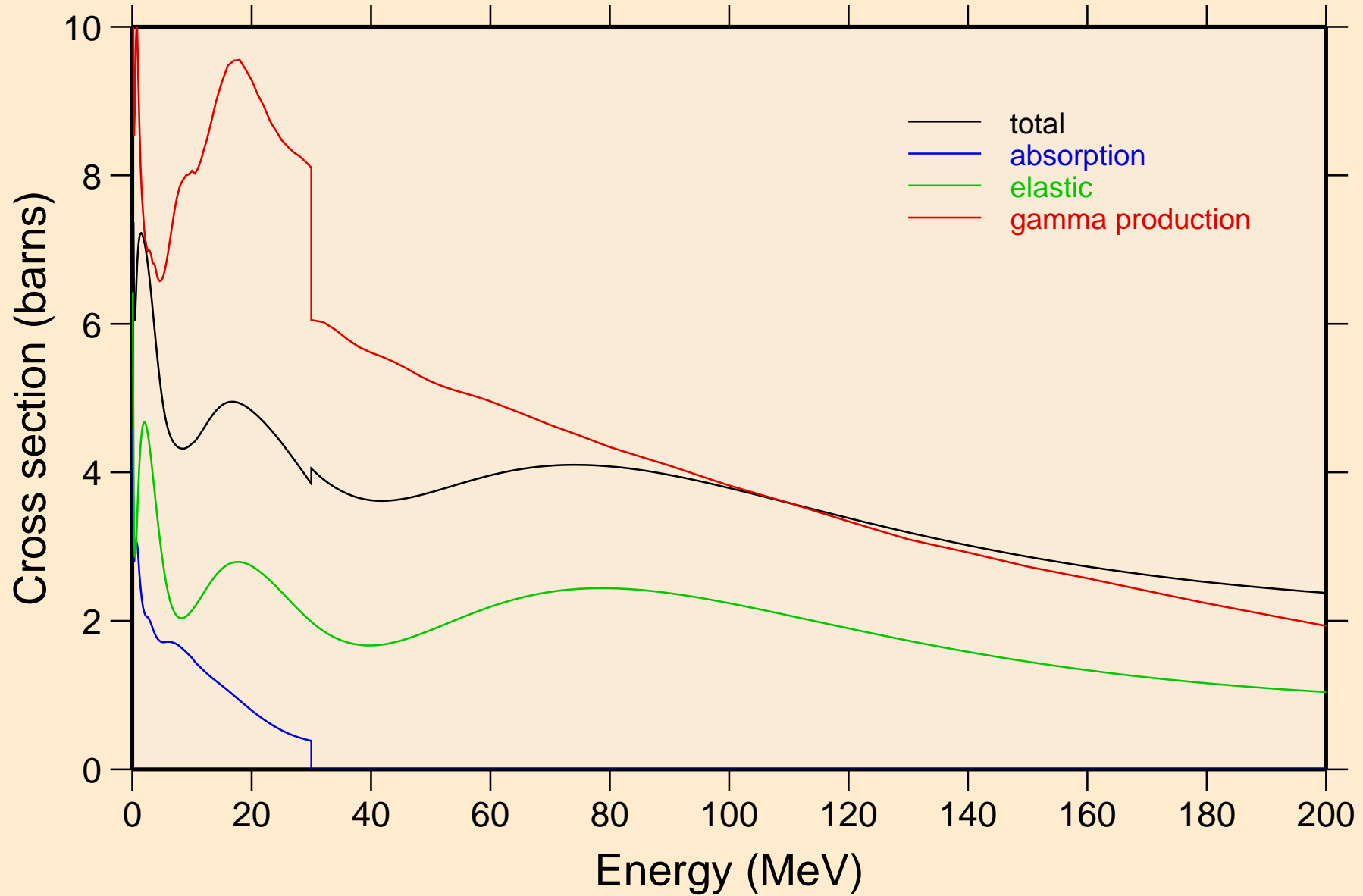

ER149 NEUTRON ACER TENDL-2023 LIBRARY; T=0.K

Heating

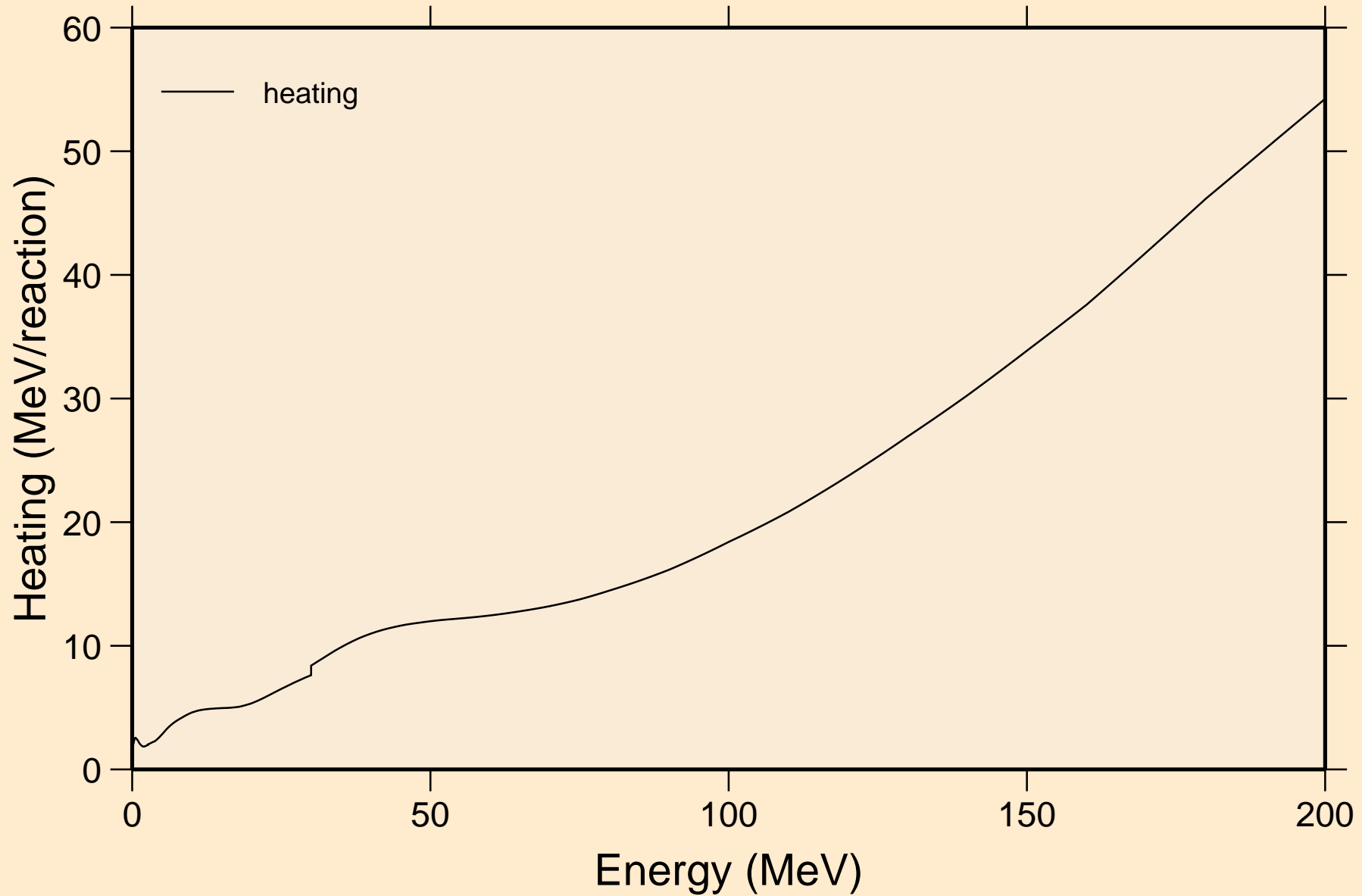

ER149 NEUTRON ACER TENDL-2023 LIBRARY; T=0.K
Damage

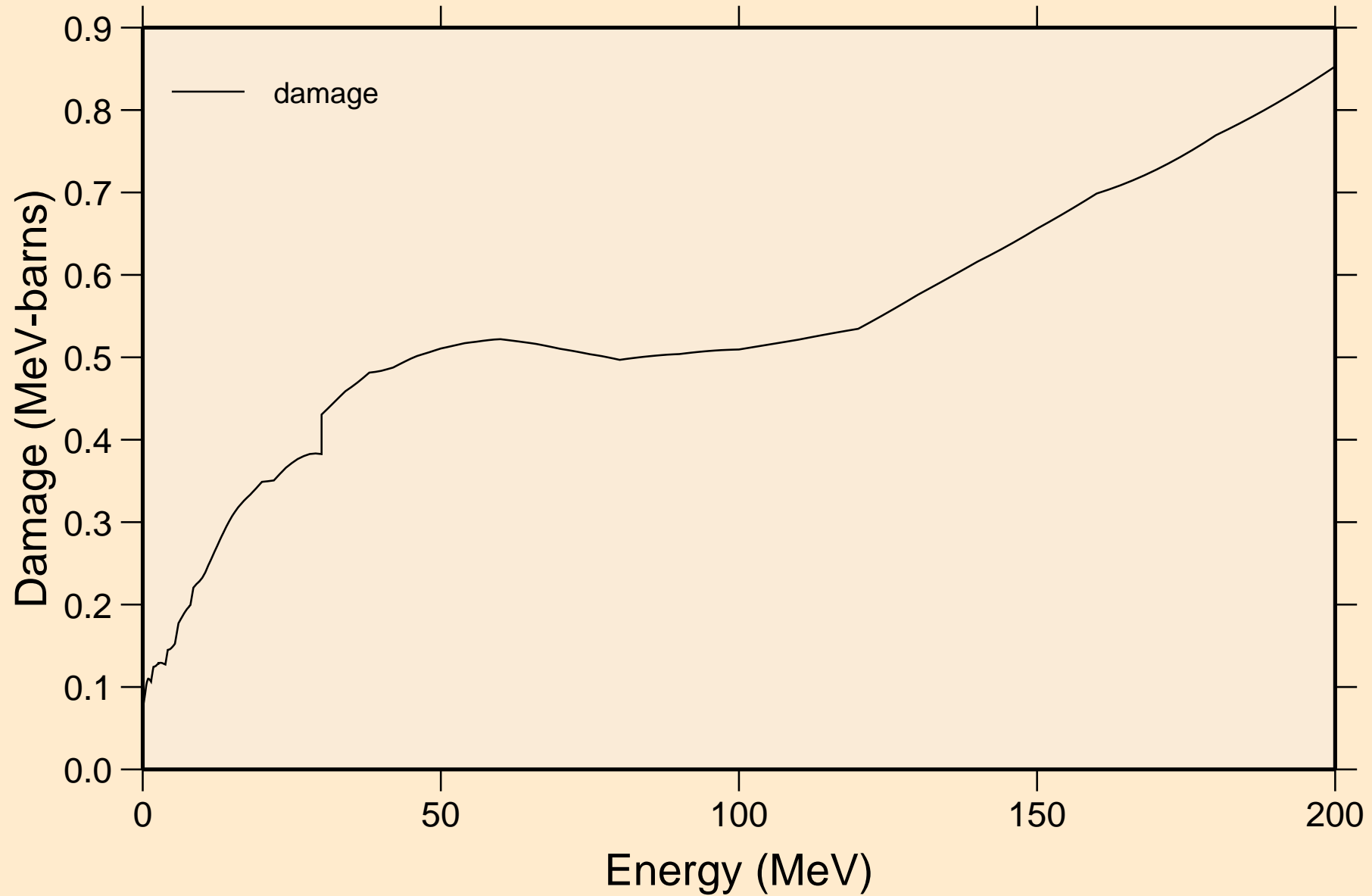

ER149 NEUTRON ACER TENDL-2023 LIBRARY; T=0.K

Non-threshold reactions

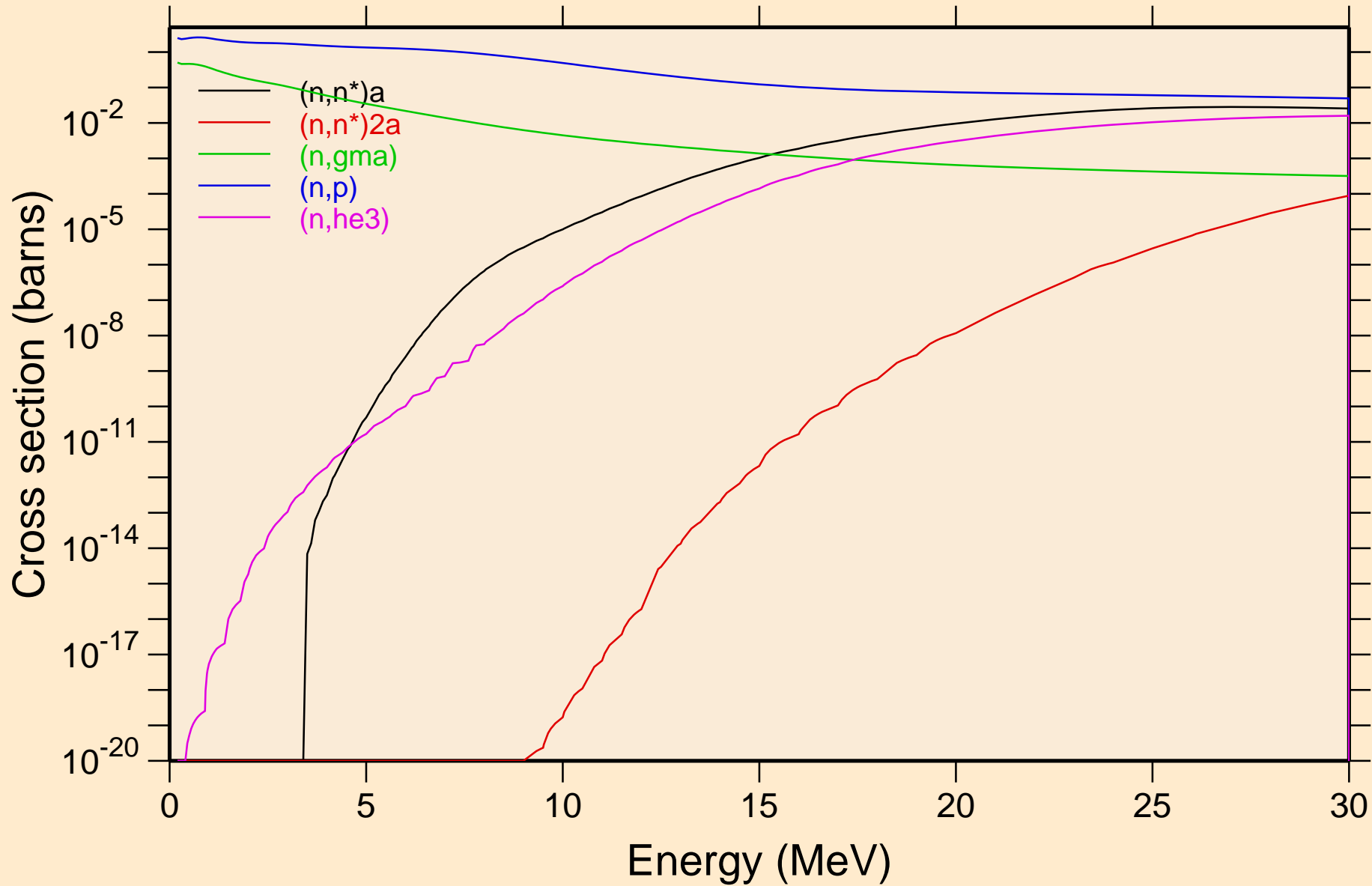

ER149 NEUTRON ACER TENDL-2023 LIBRARY; T=0.K

Non-threshold reactions

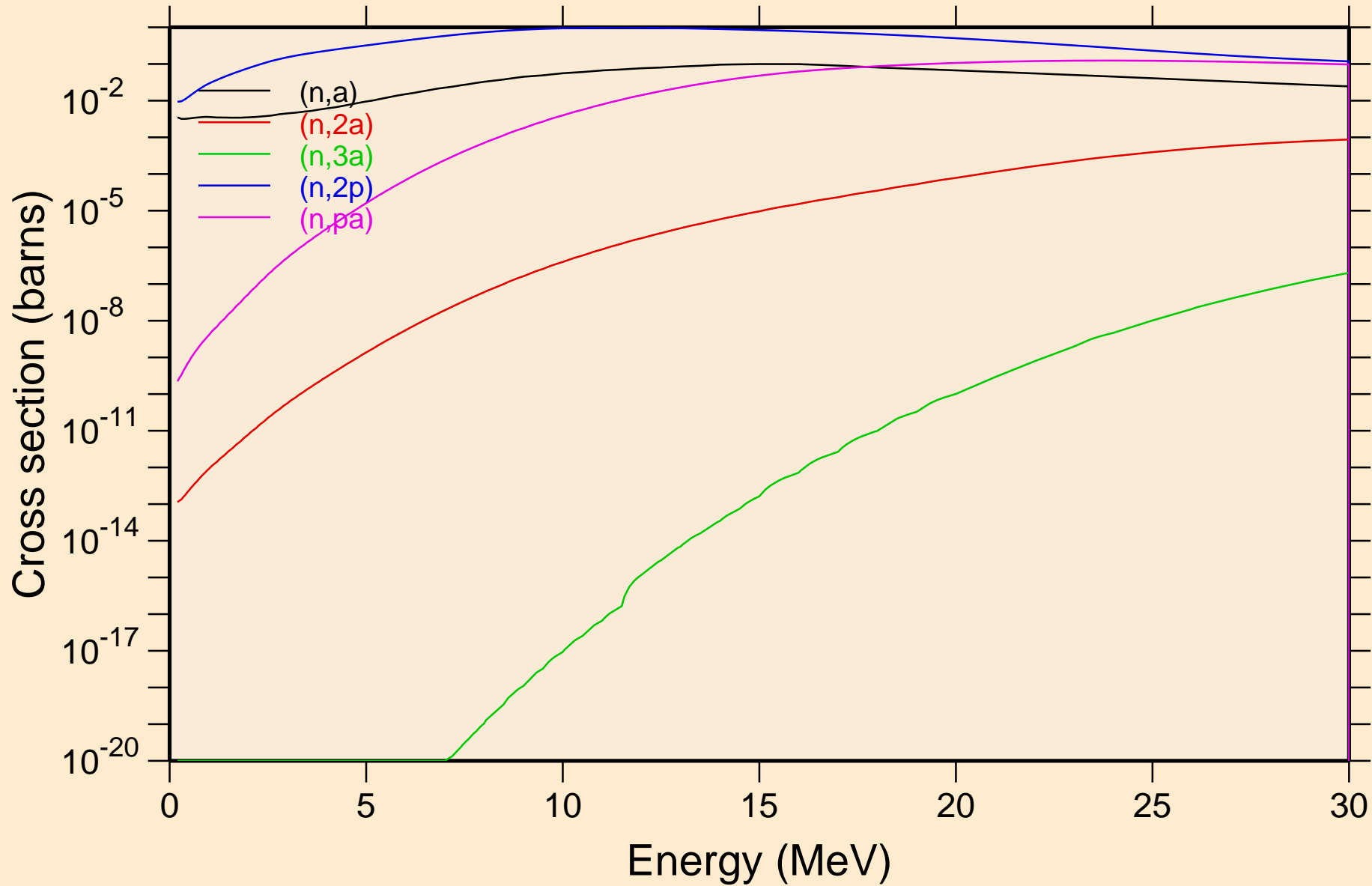

ER149 NEUTRON ACER TENDL-2023 LIBRARY; T=0.K
Non-threshold reactions

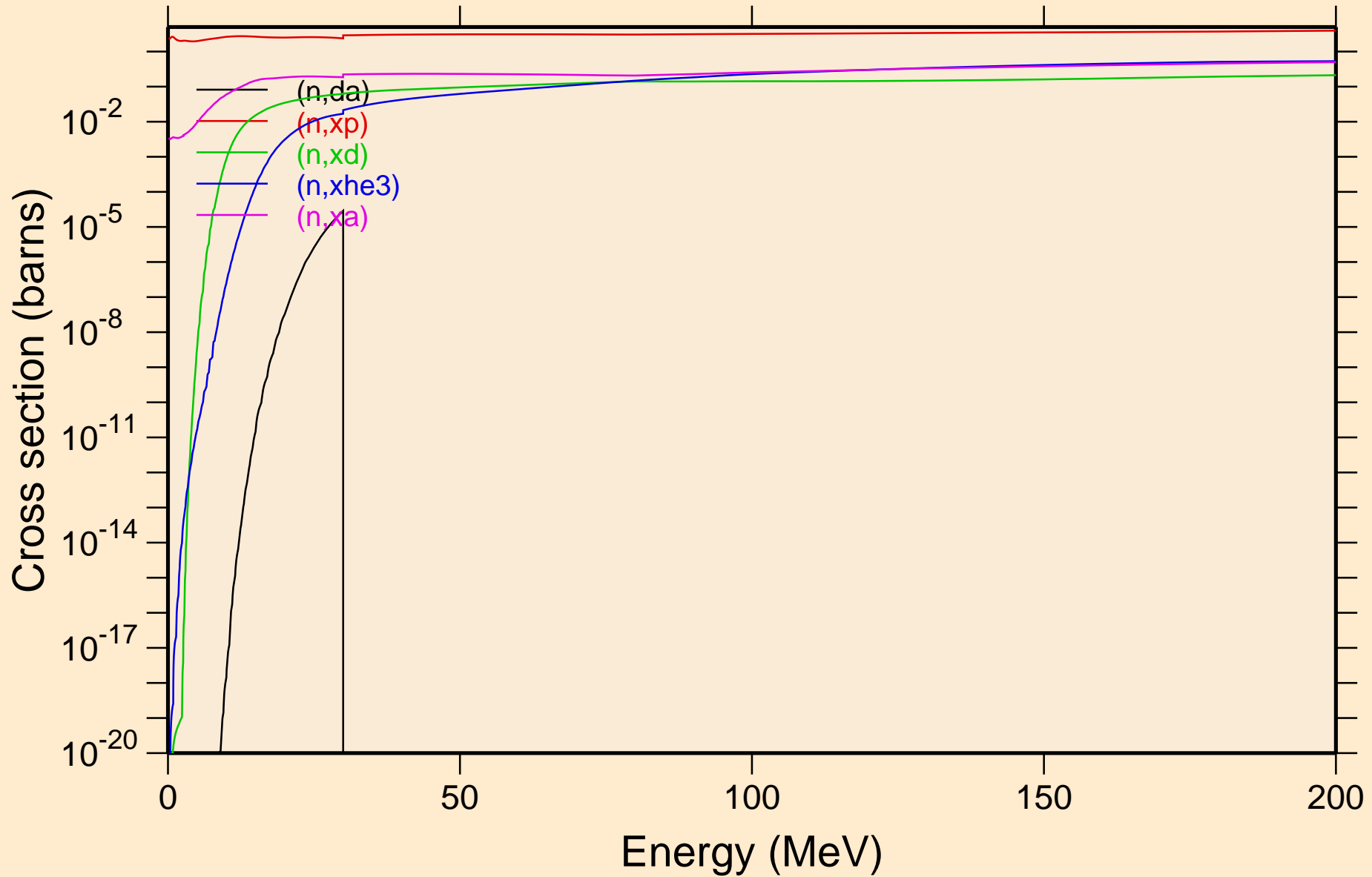

ER149 NEUTRON ACER TENDL-2023 LIBRARY; T=0.K

Inelastic levels

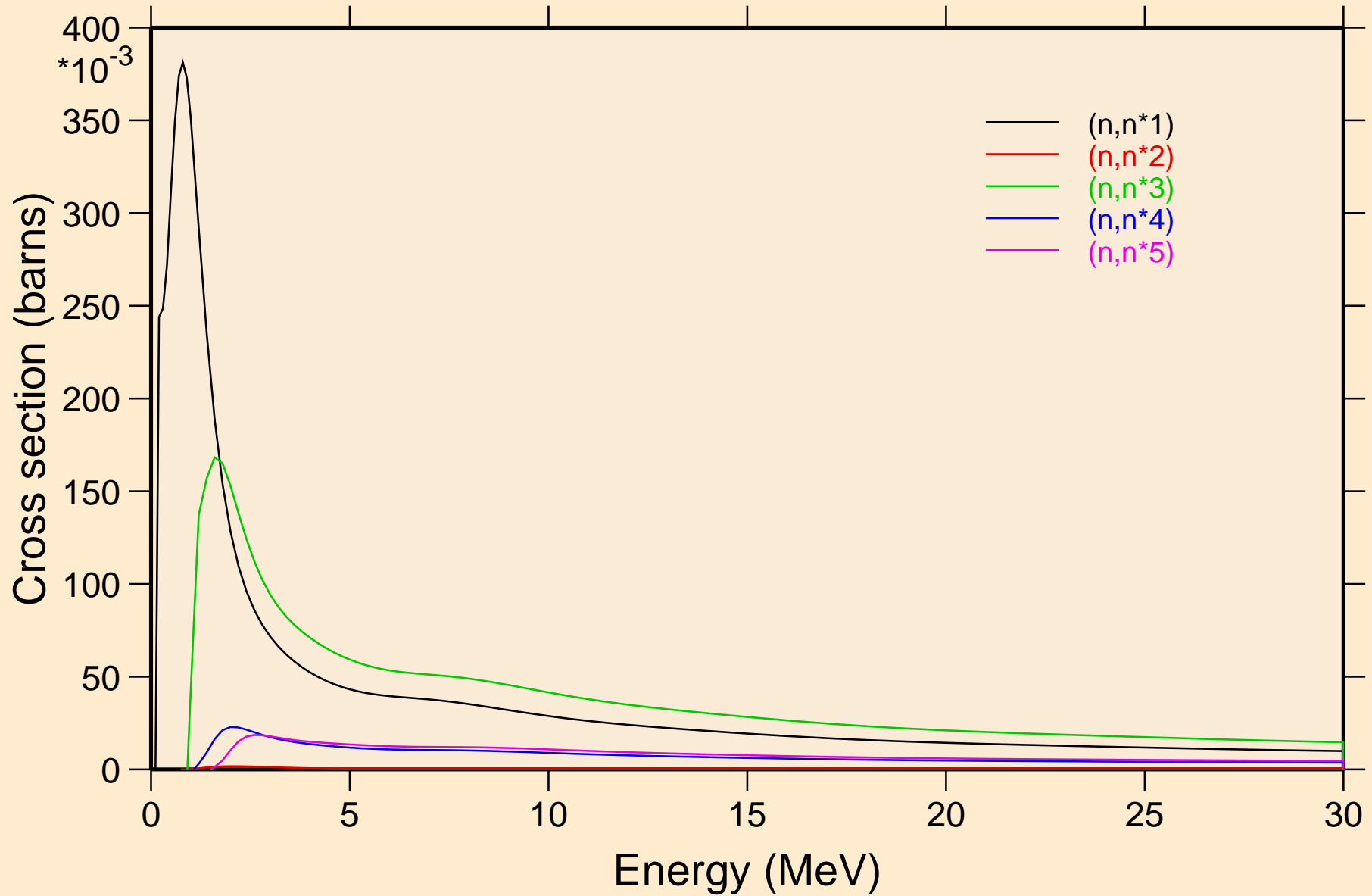

ER149 NEUTRON ACER TENDL-2023 LIBRARY; T=0.K

Threshold reactions

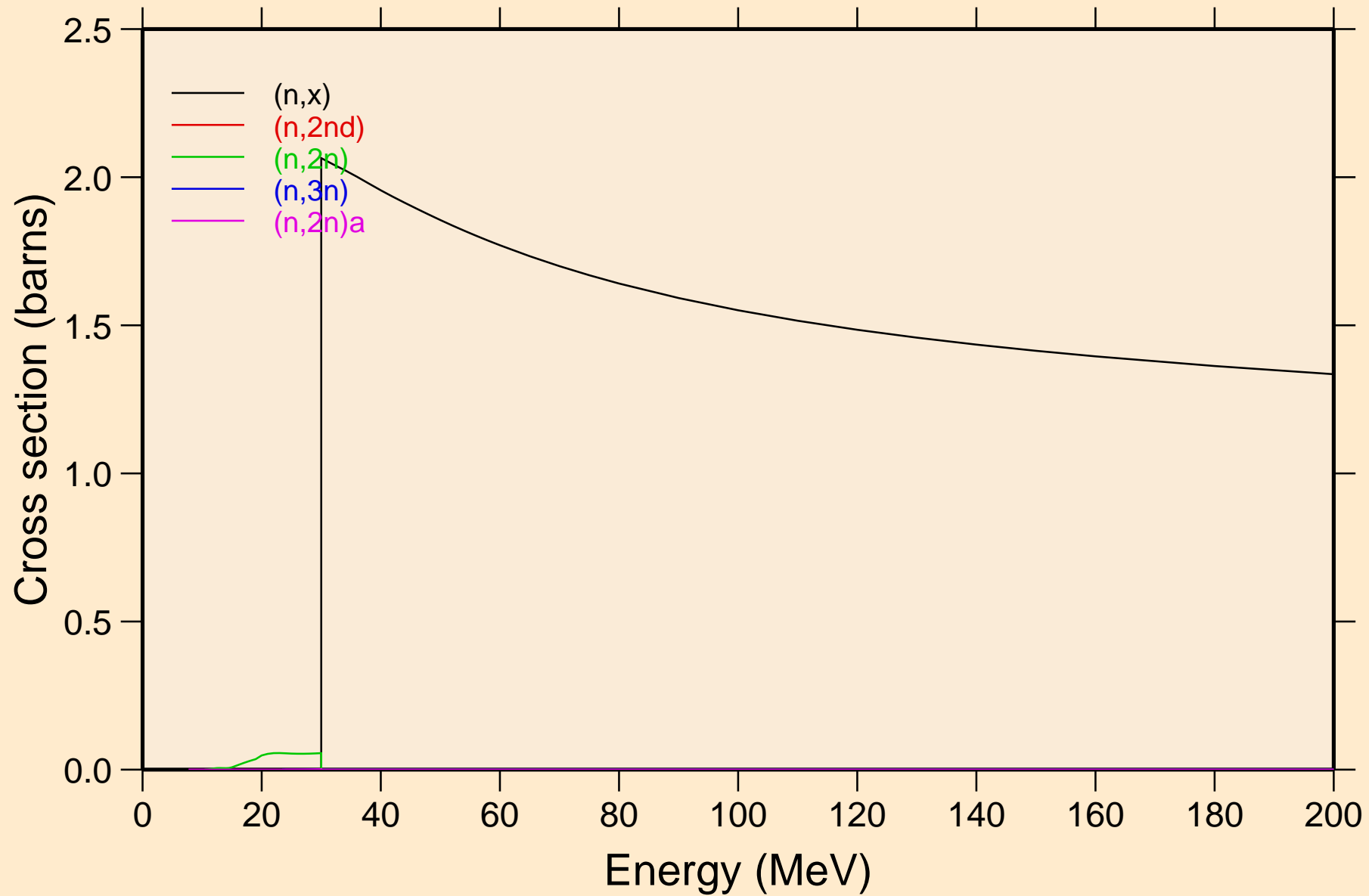

ER149 NEUTRON ACER TENDL-2023 LIBRARY; T=0.K
Threshold reactions

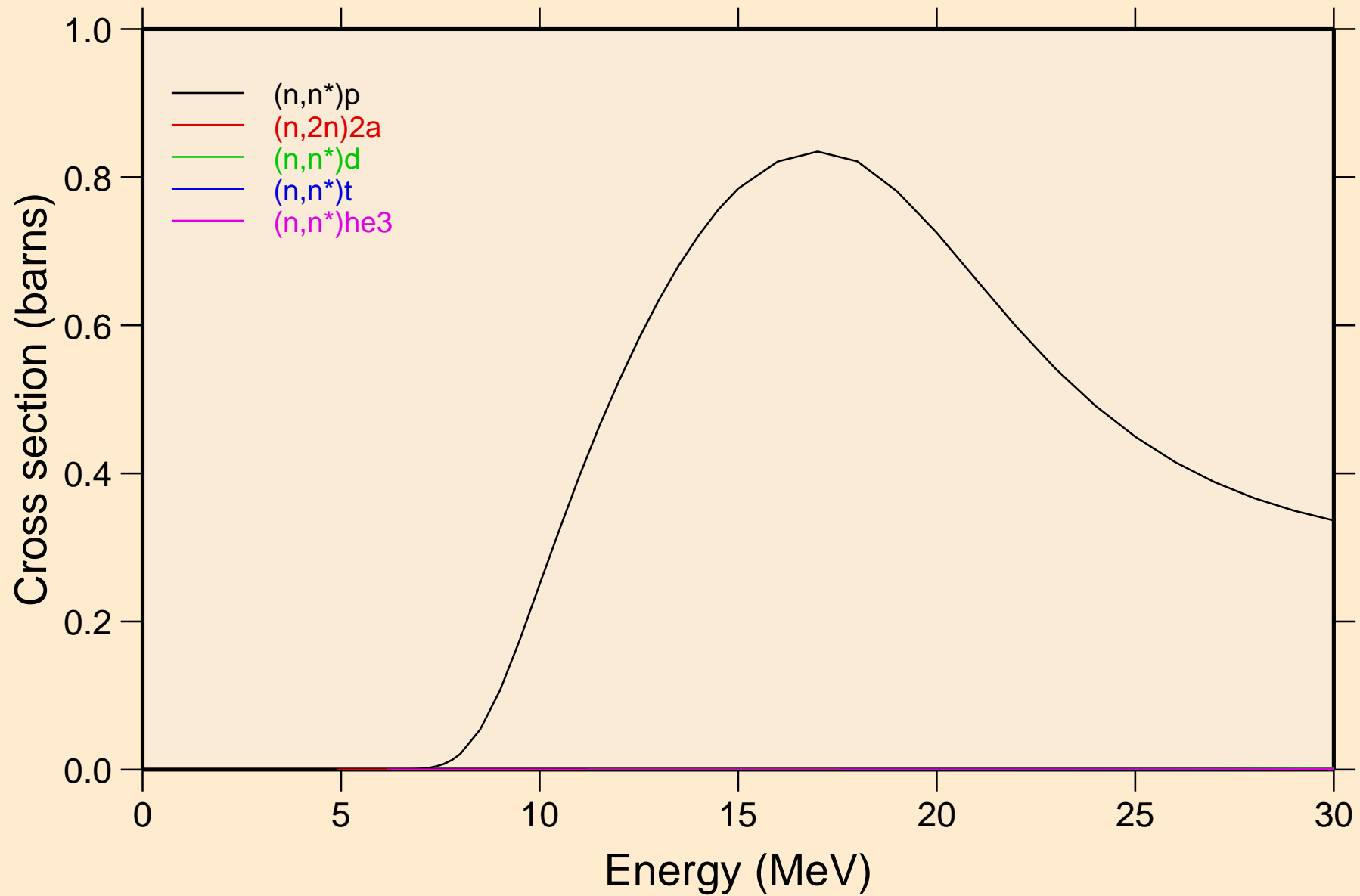

ER149 NEUTRON ACER TENDL-2023 LIBRARY; T=0.K

Threshold reactions

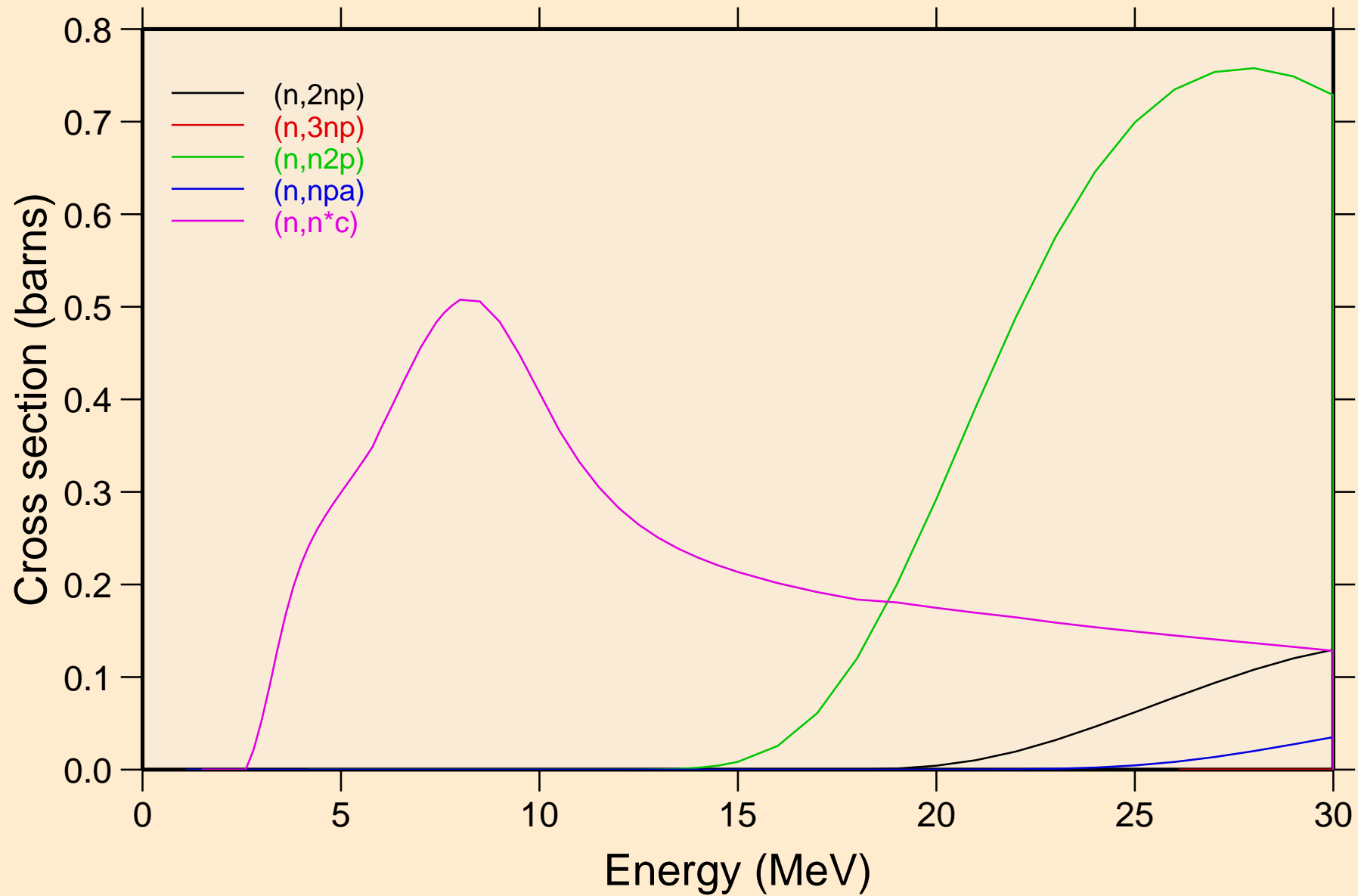

ER149 NEUTRON ACER TENDL-2023 LIBRARY; T=0.K
Threshold reactions

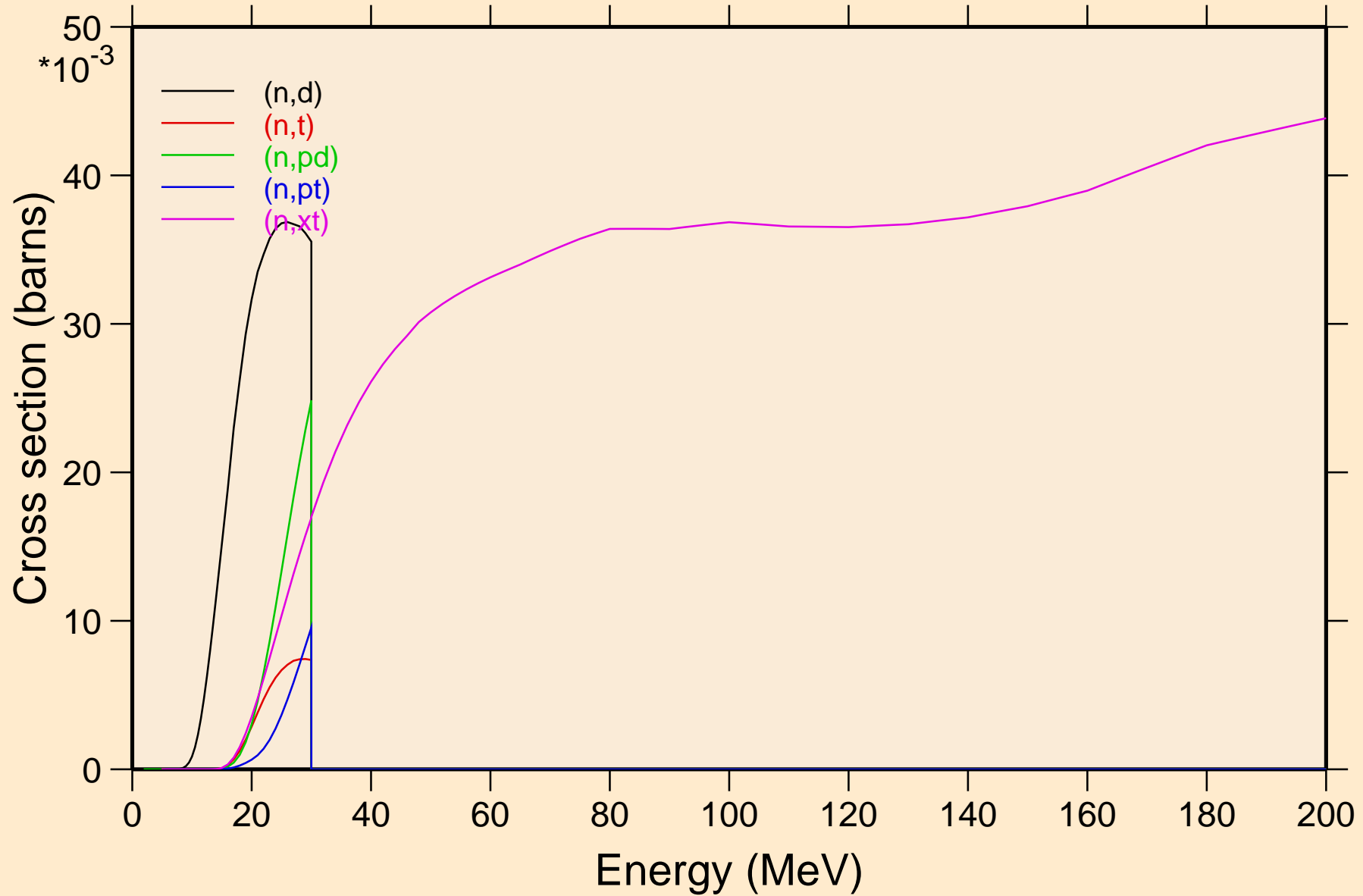

ER149 NEUTRON ACER TENDL-2023 LIBRARY; T=0.K
angular distribution for elastic

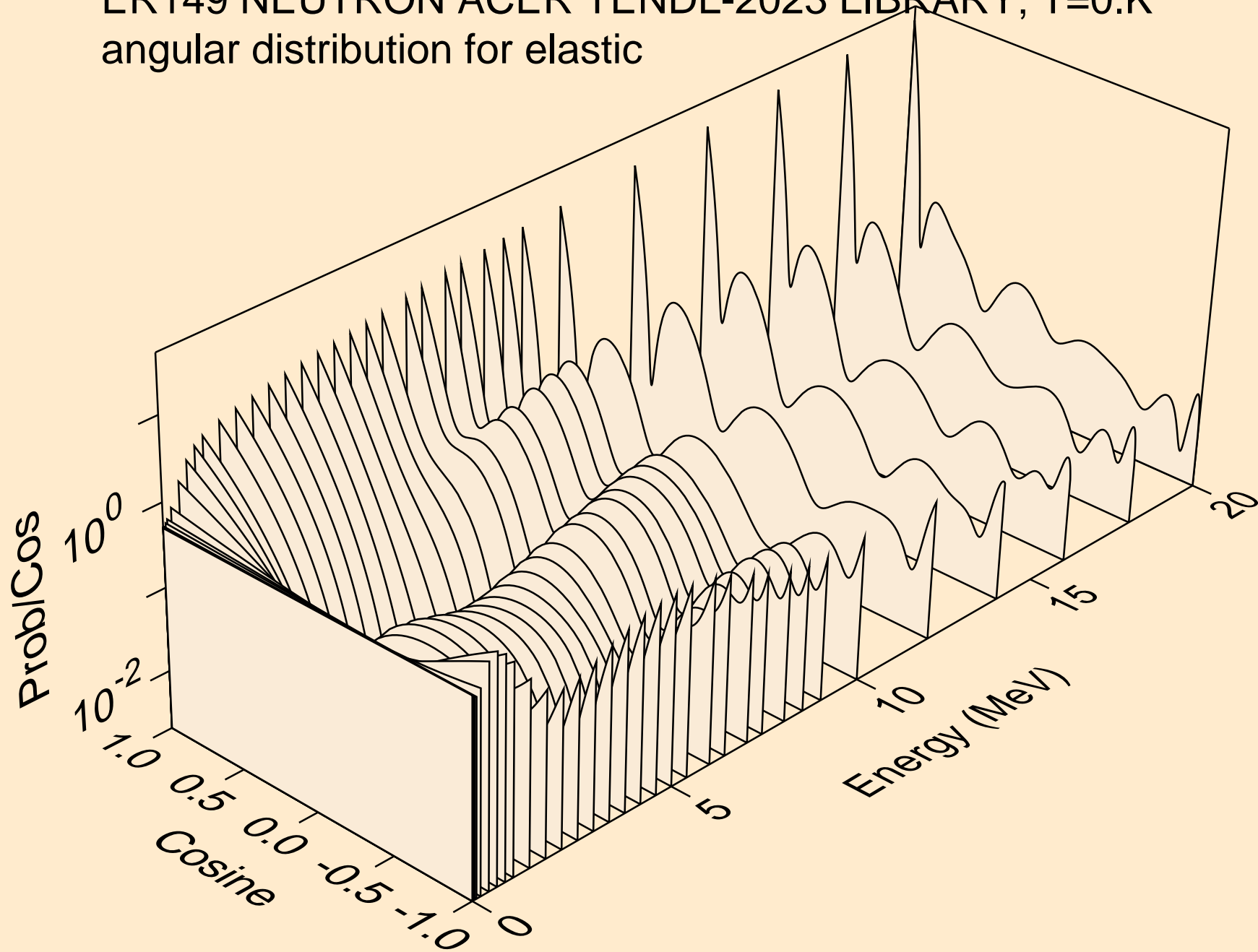

ER149 NEUTRON ACER TENDL-2023 LIBRARY; T=0.K
angular distribution for elastic

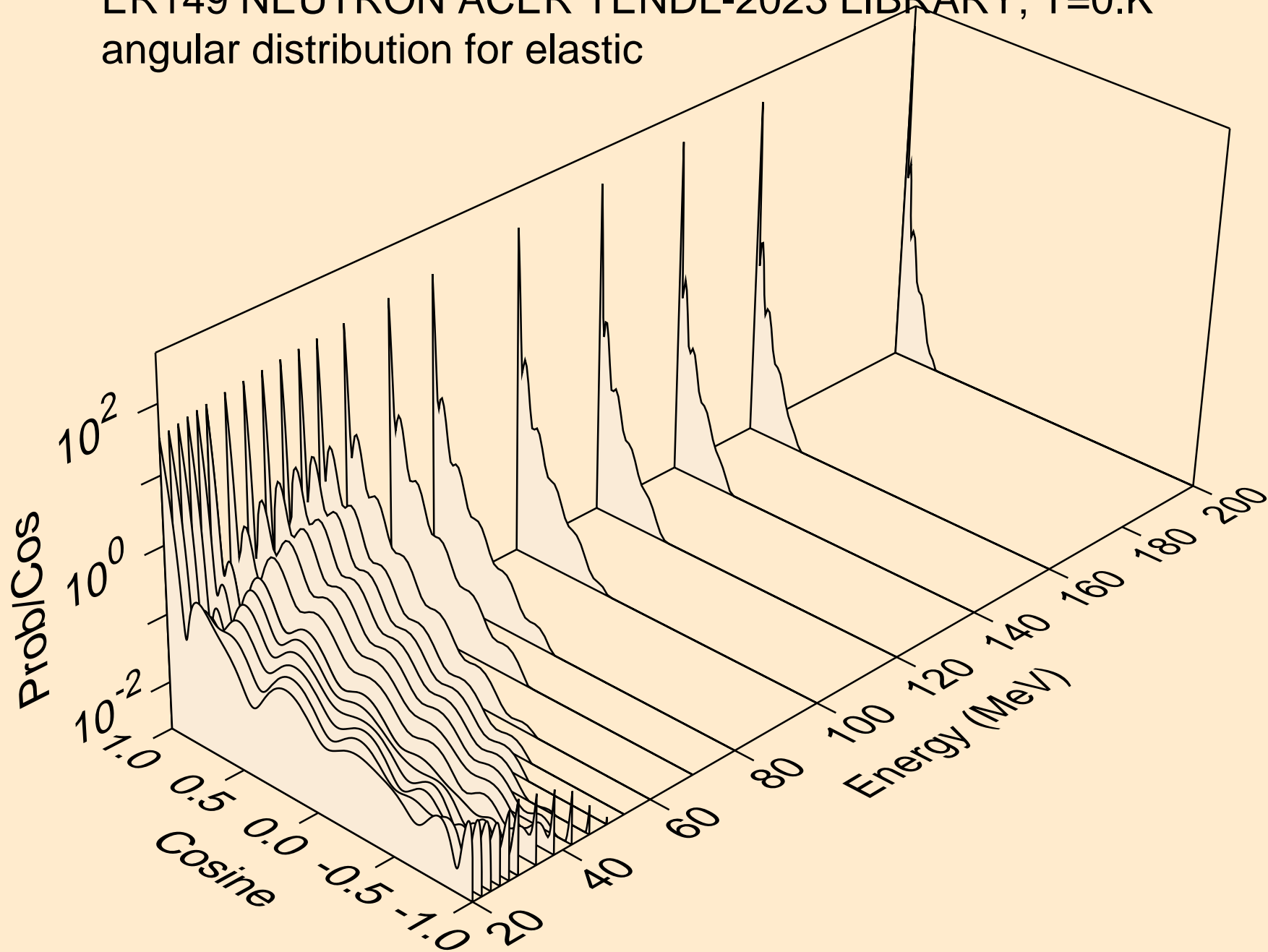

ER149 NEUTRON ACER TENDL-2023 LIBRARY; T=0.K
angular distribution for (n,n*1)

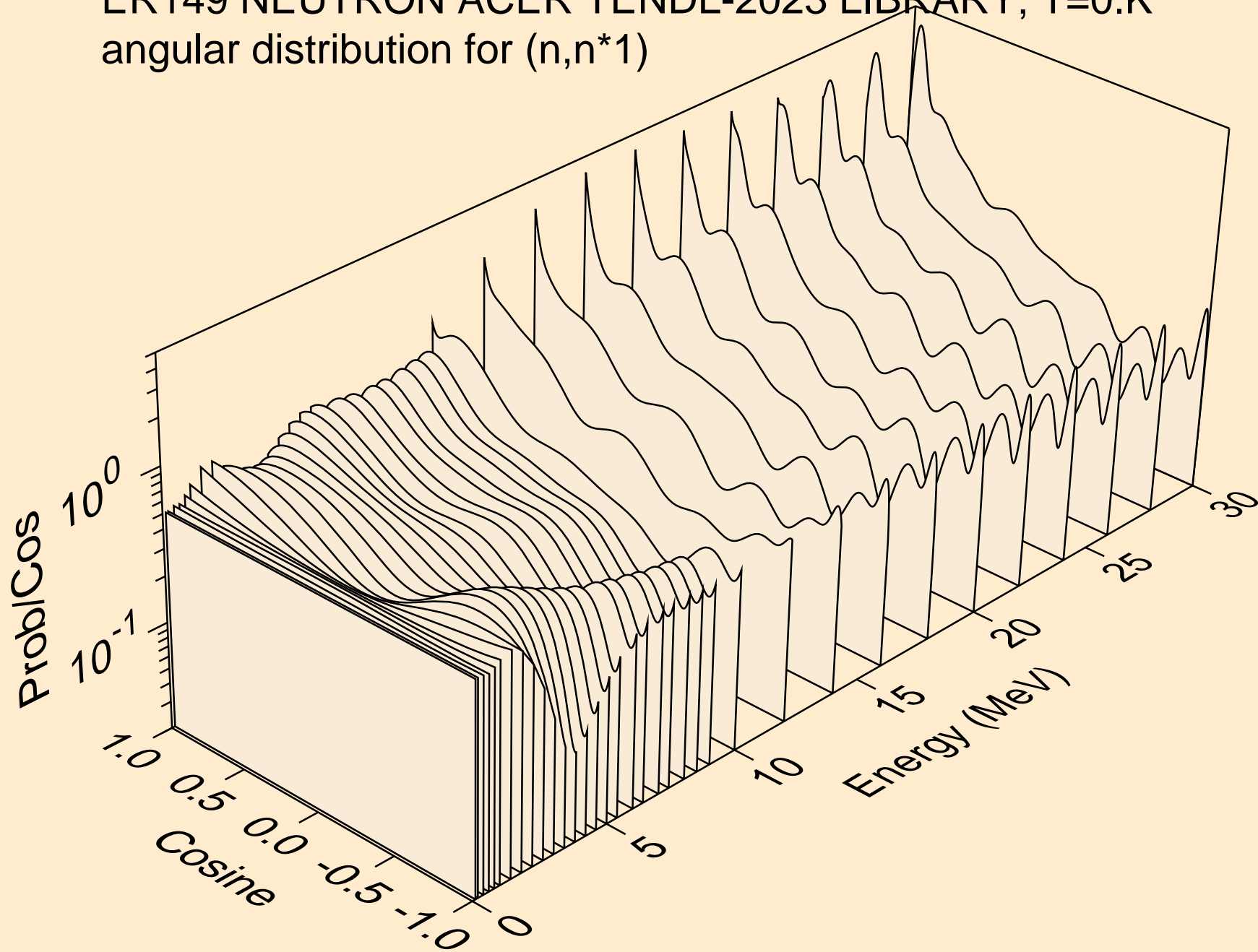

ER149 NEUTRON ACER TENDL-2023 LIBRARY; T=0.K
angular distribution for (n,n*2)

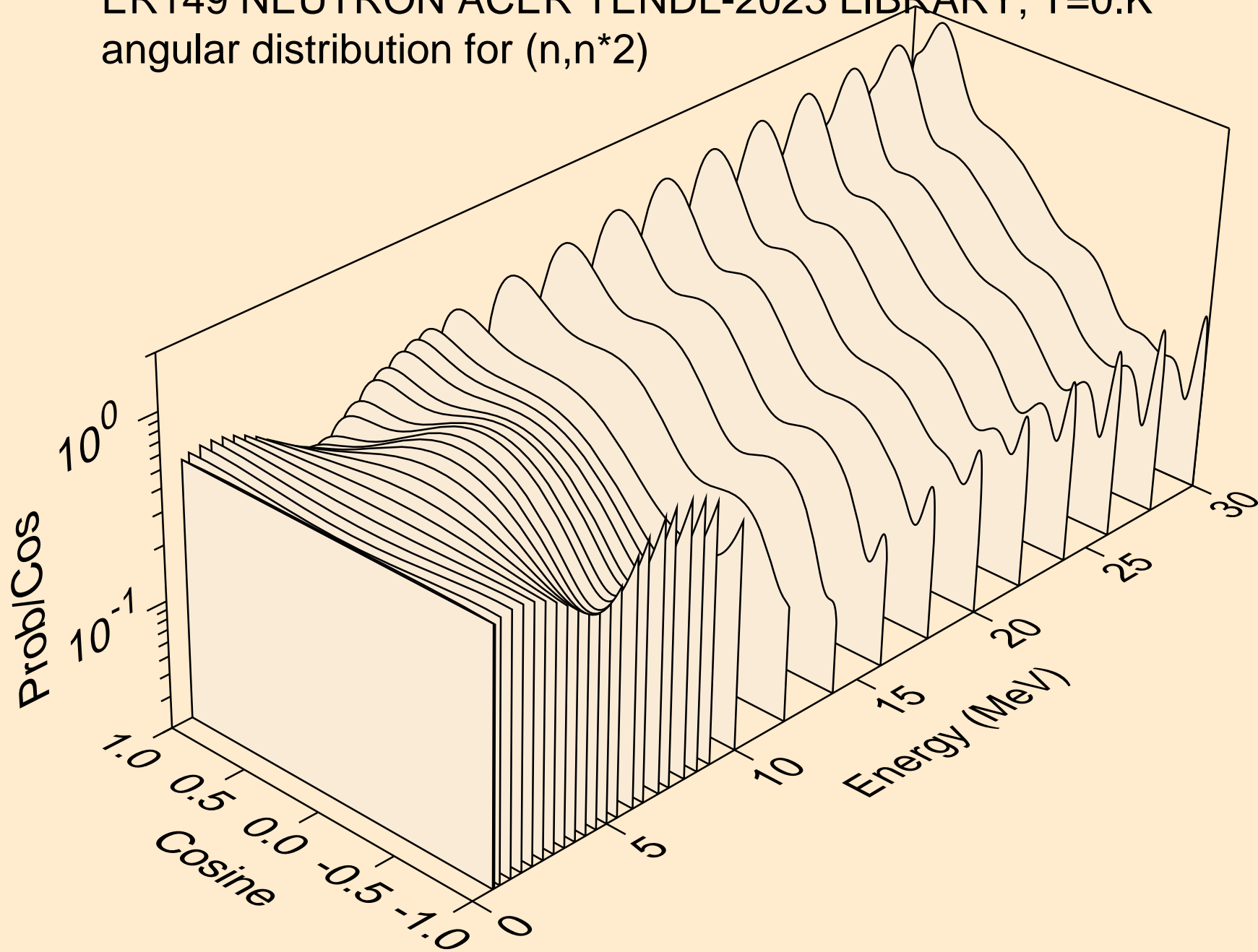

ER149 NEUTRON ACER TENDL-2023 LIBRARY; T=0.K
angular distribution for (n,n*3)

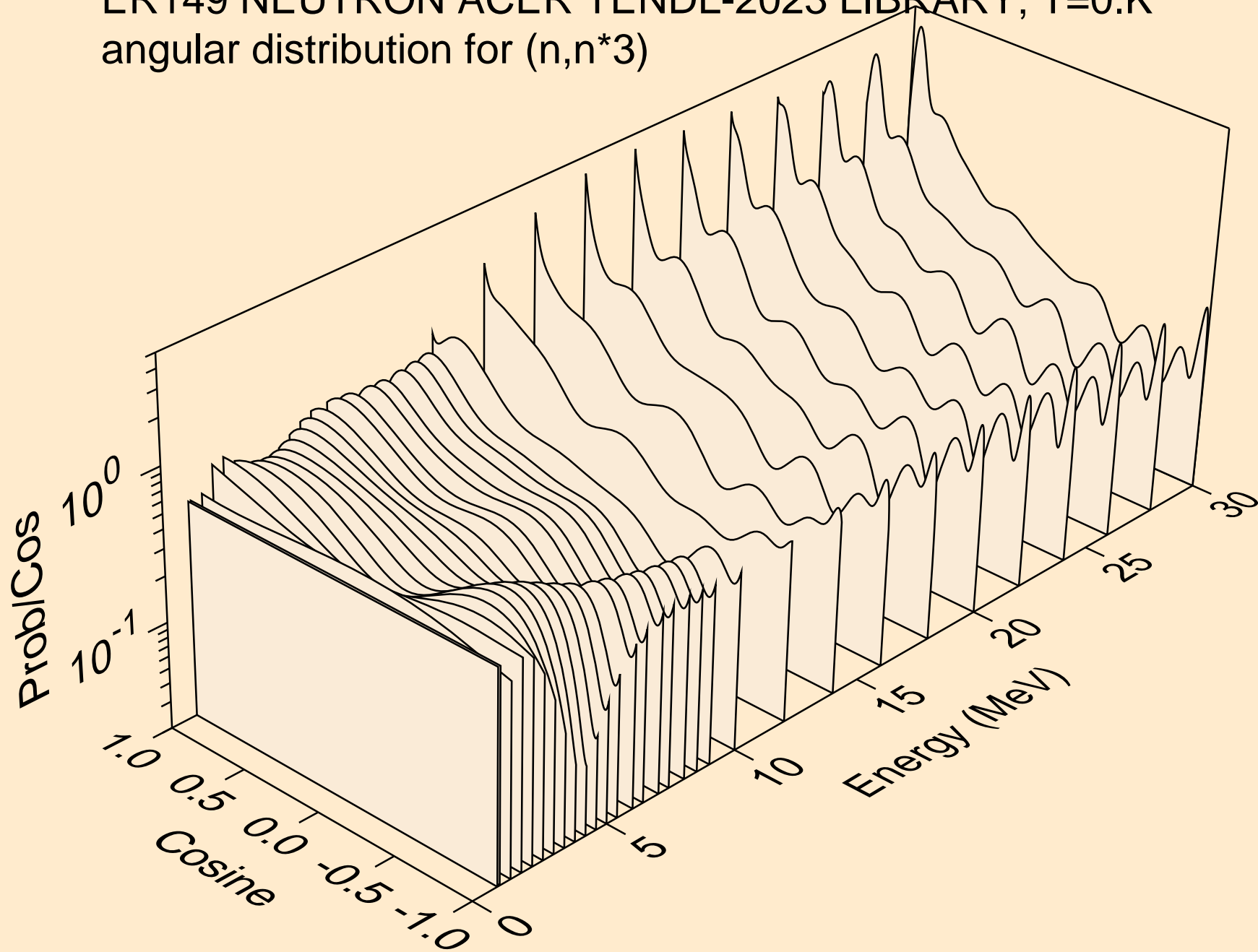

ER149 NEUTRON ACER TENDL-2023 LIBRARY; T=0.K
angular distribution for (n,n*4)

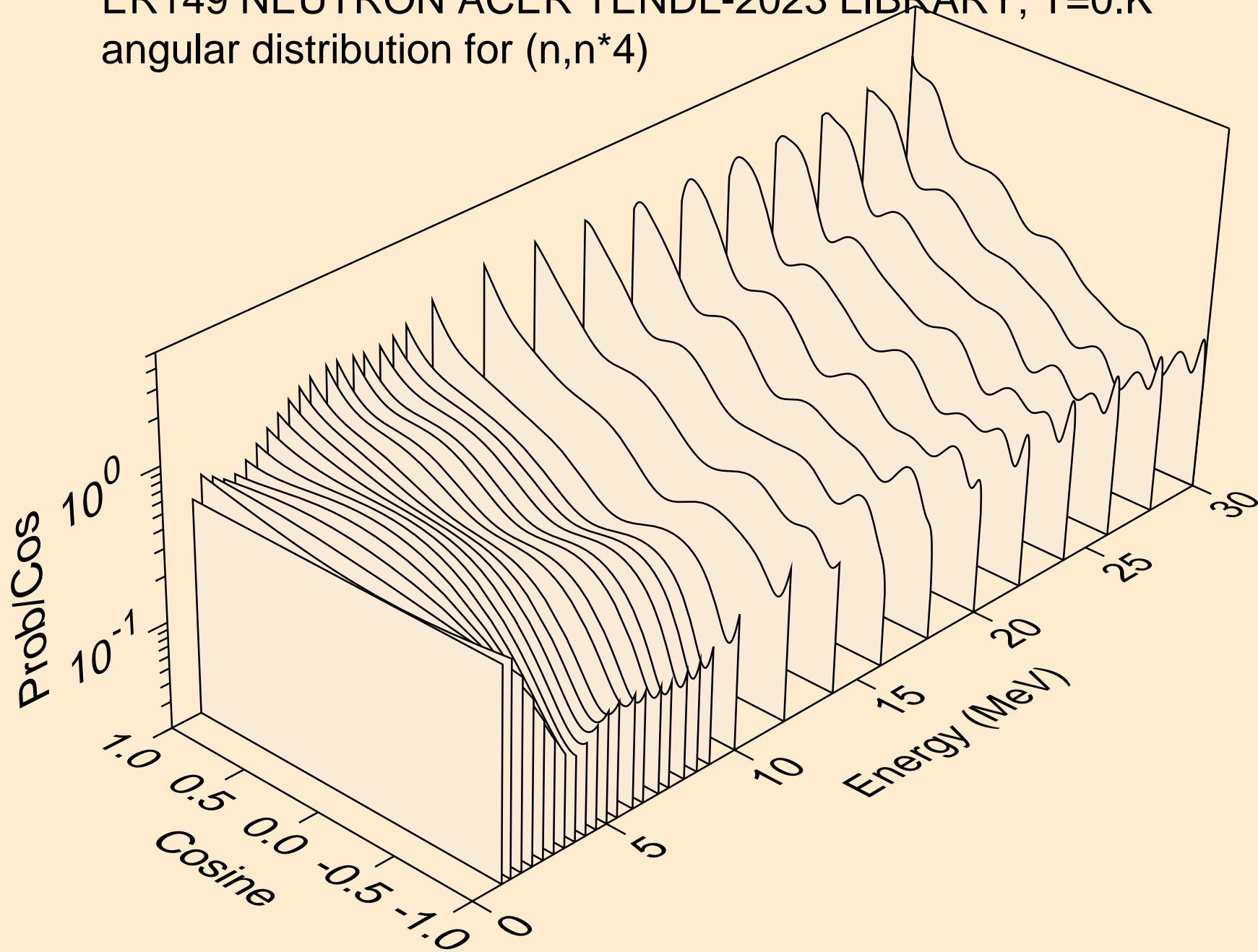

ER149 NEUTRON ACER TENDL-2023 LIBRARY; T=0.K
angular distribution for (n,n*5)

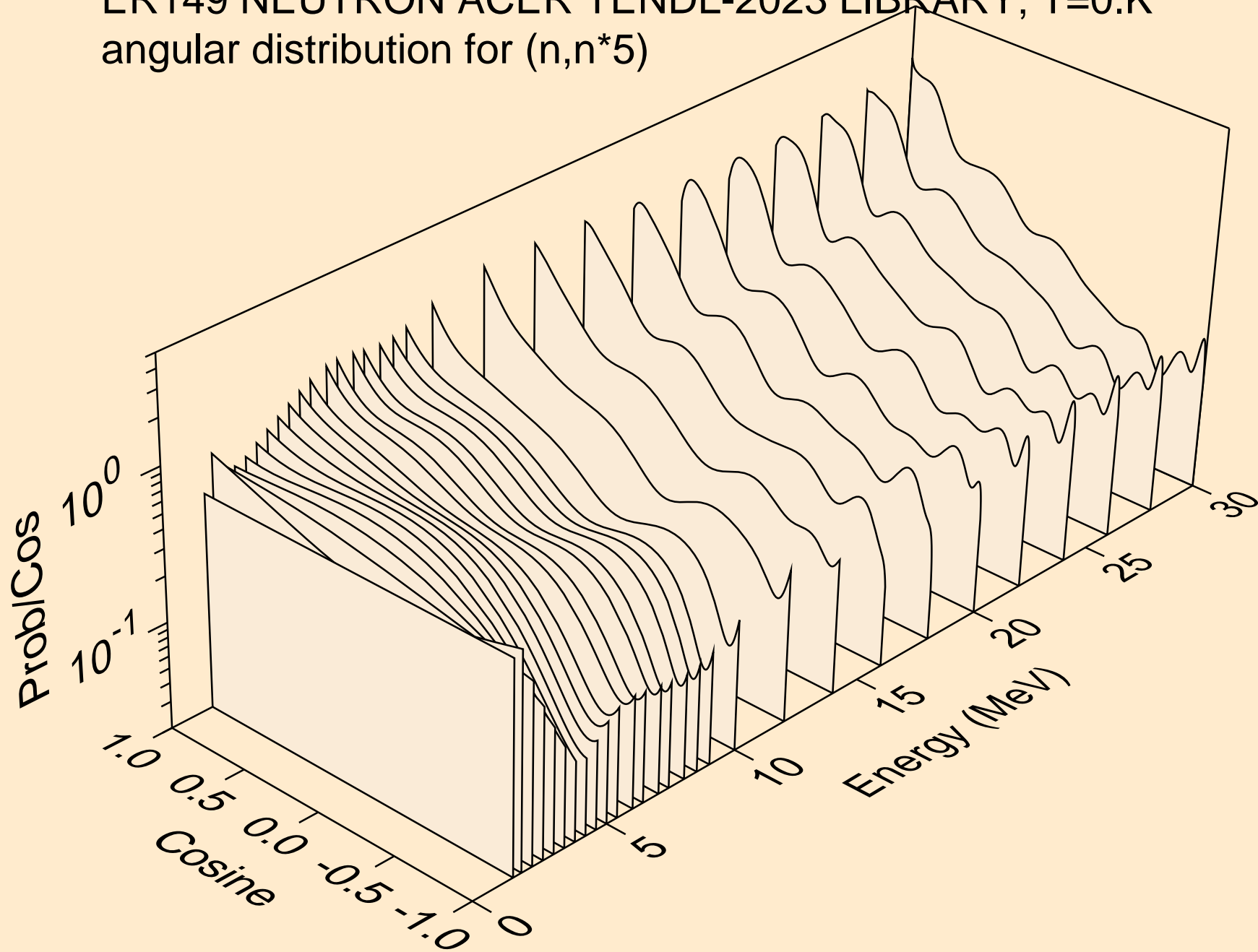

ER149 NEUTRON ACER TENDL-2023 LIBRARY; T=0.K
Neutron emission for (n,x)

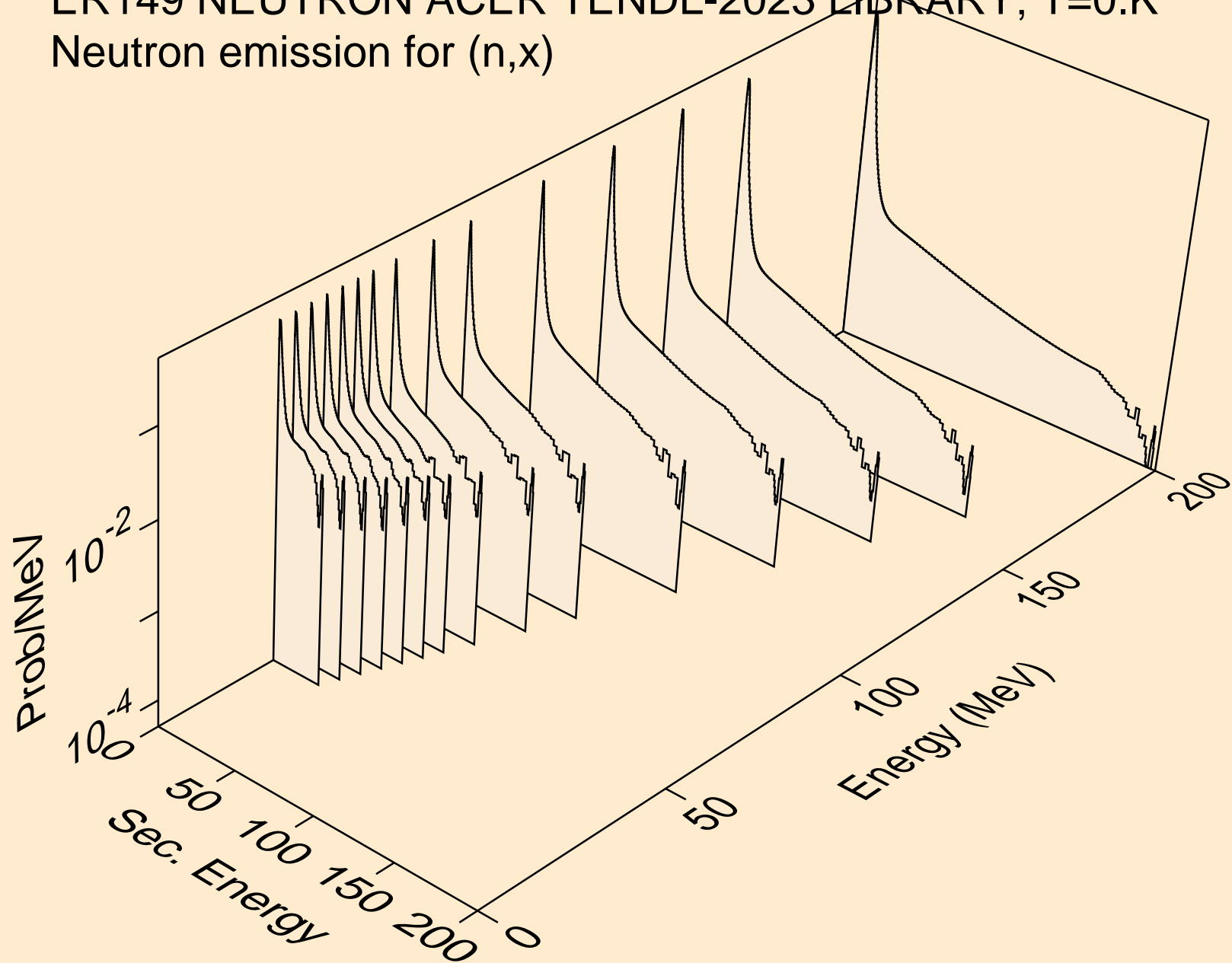

ER149 NEUTRON ACER TENDL-2023 LIBRARY; T=0.K
Neutron emission for (n,2nd)

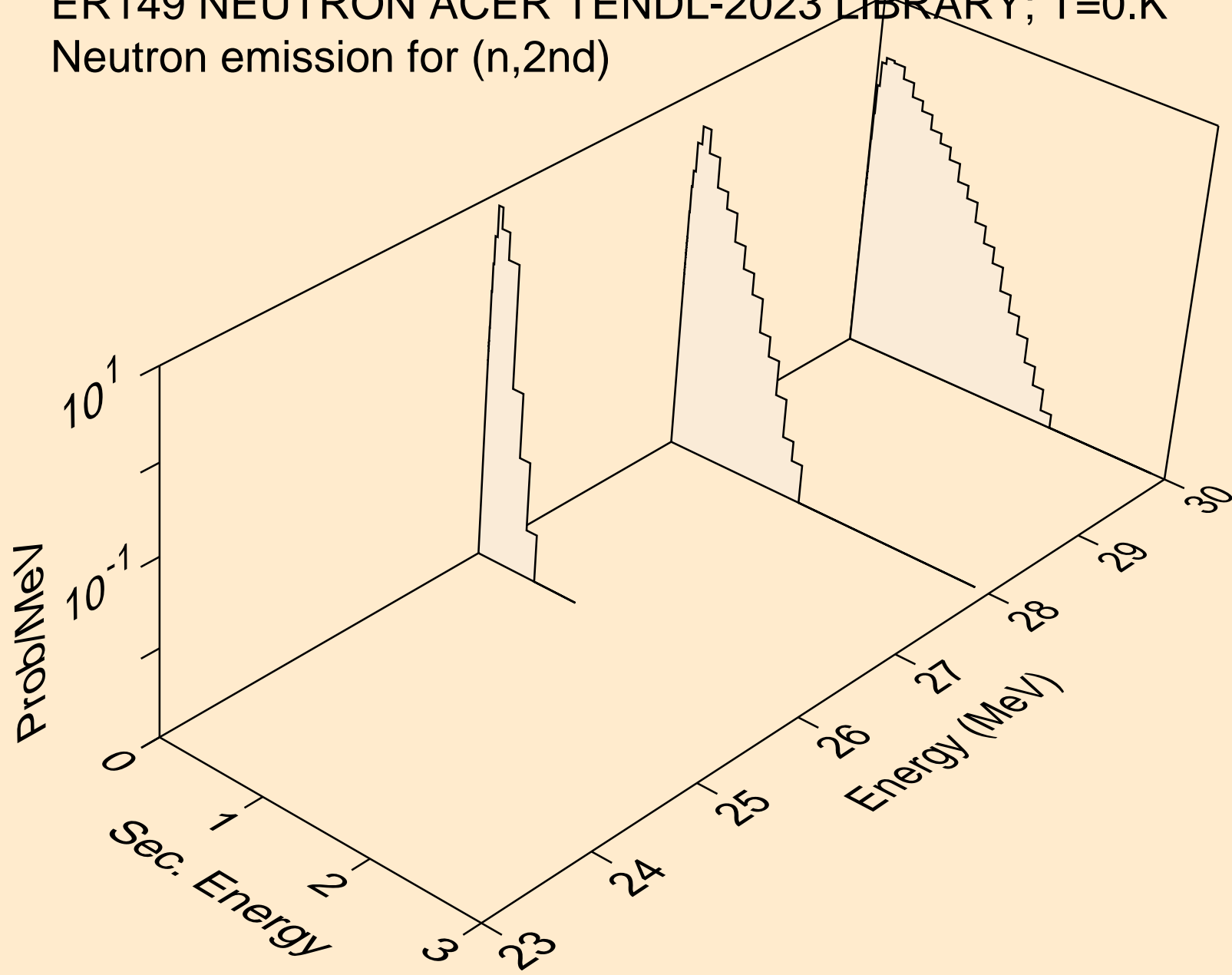

ER149 NEUTRON ACER TENDL-2023 LIBRARY; T=0.K
Neutron emission for (n,2n)

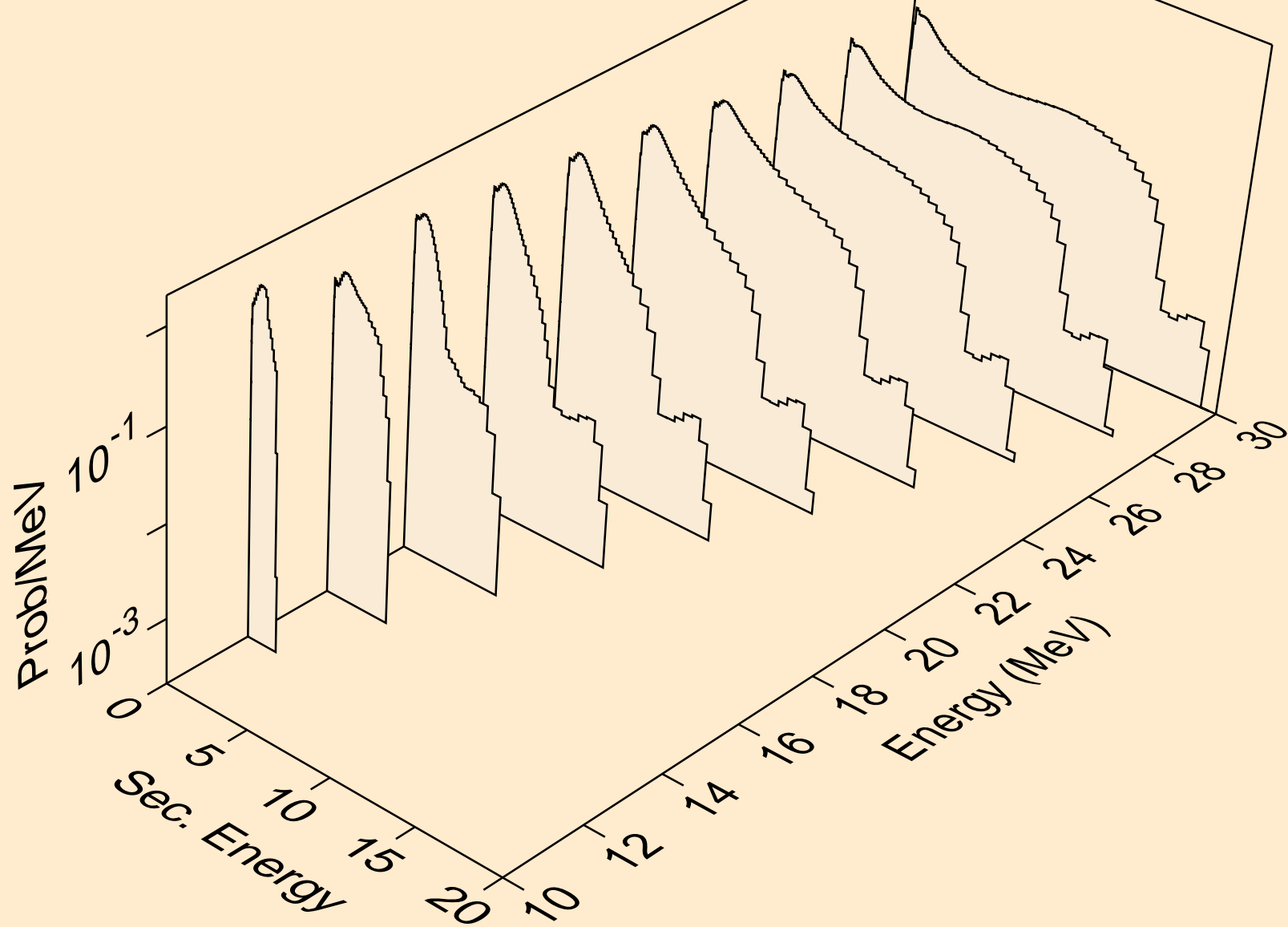

ER149 NEUTRON ACER TENDL-2023 LIBRARY; T=0.K
Neutron emission for (n,3n)

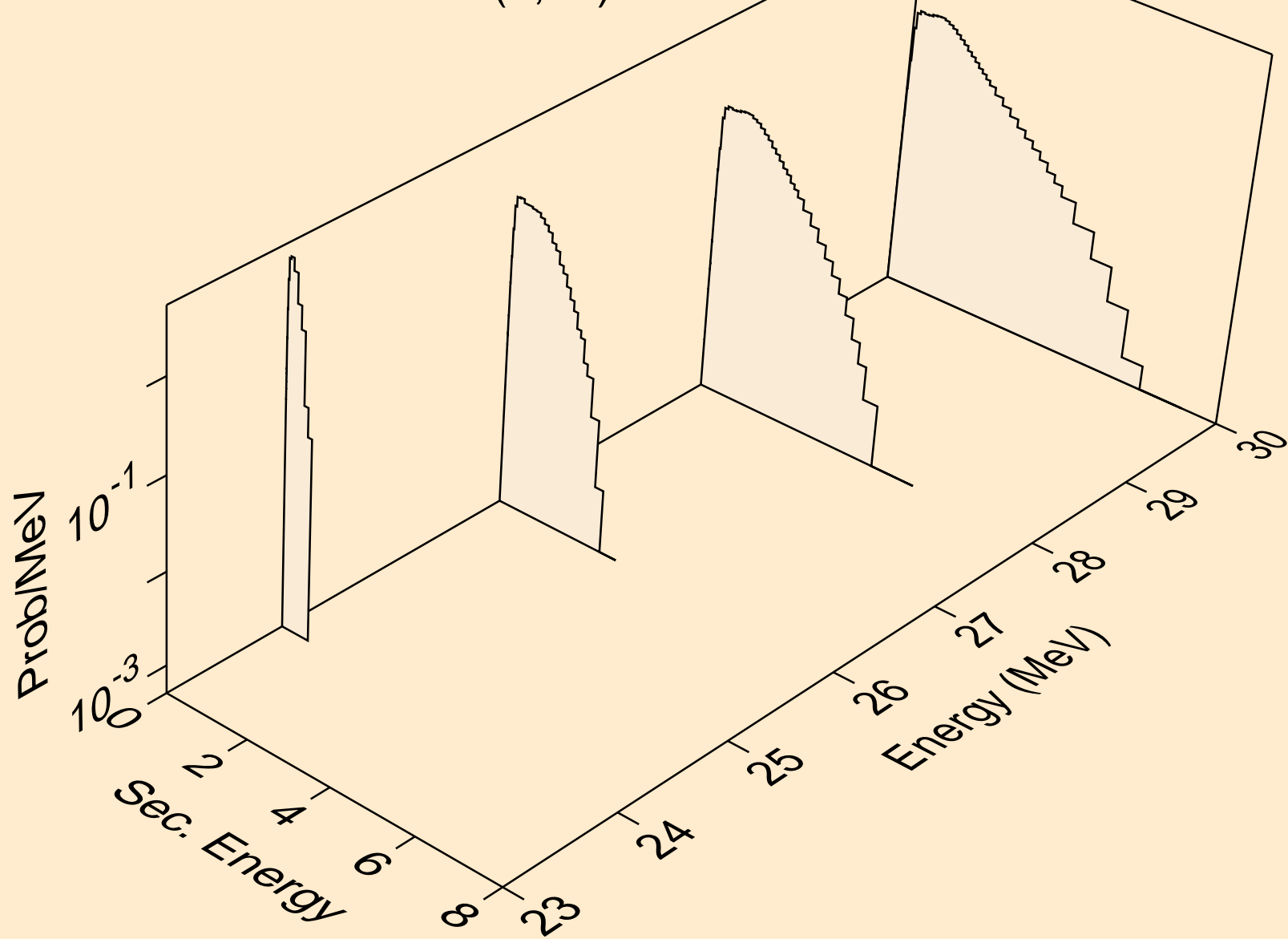

ER149 NEUTRON ACER TENDL-2023 LIBRARY; T=0.K
Neutron emission for (n,n*)a

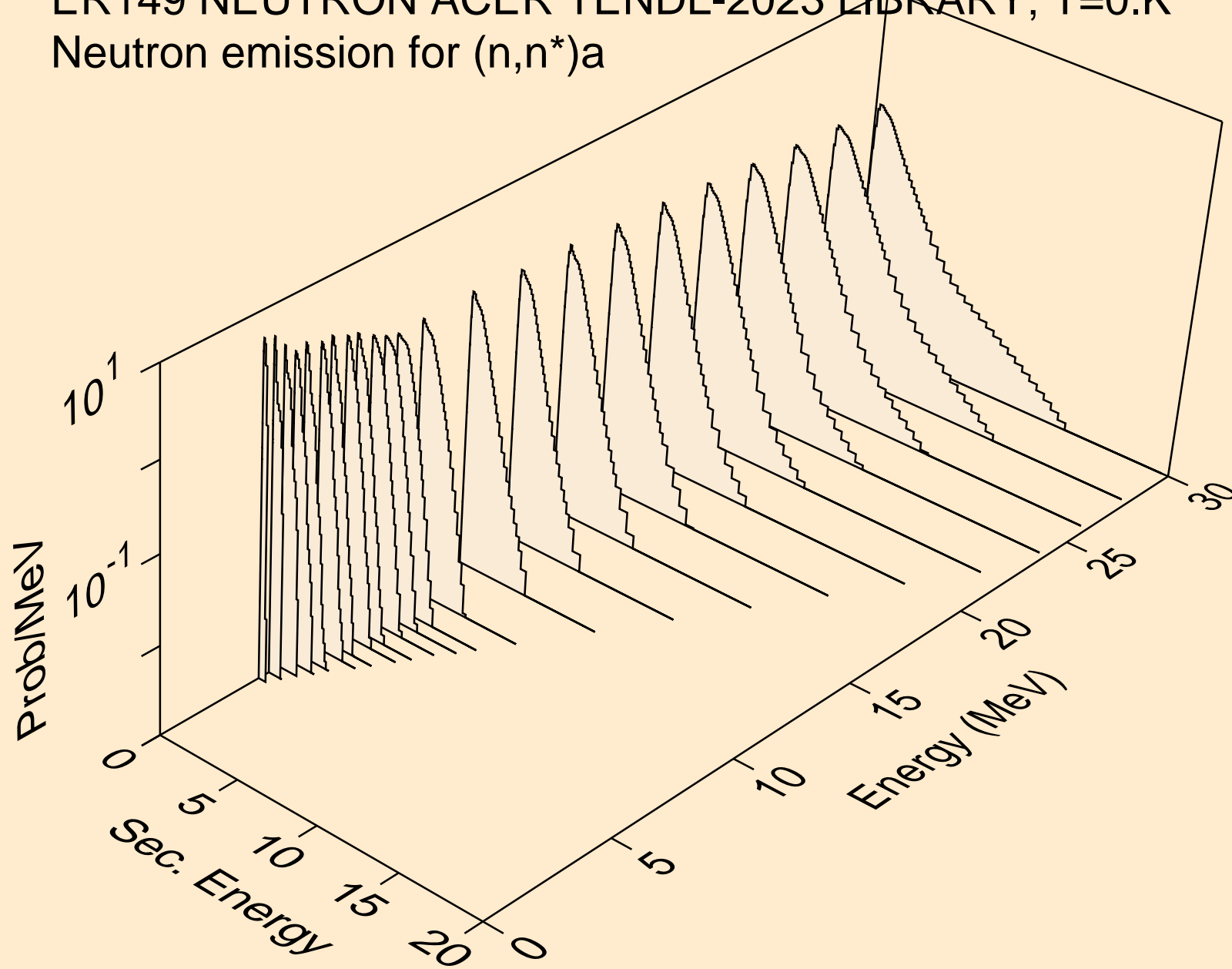

ER149 NEUTRON ACER TENDL-2023 LIBRARY; T=0.K
Neutron emission for (n,2n)a

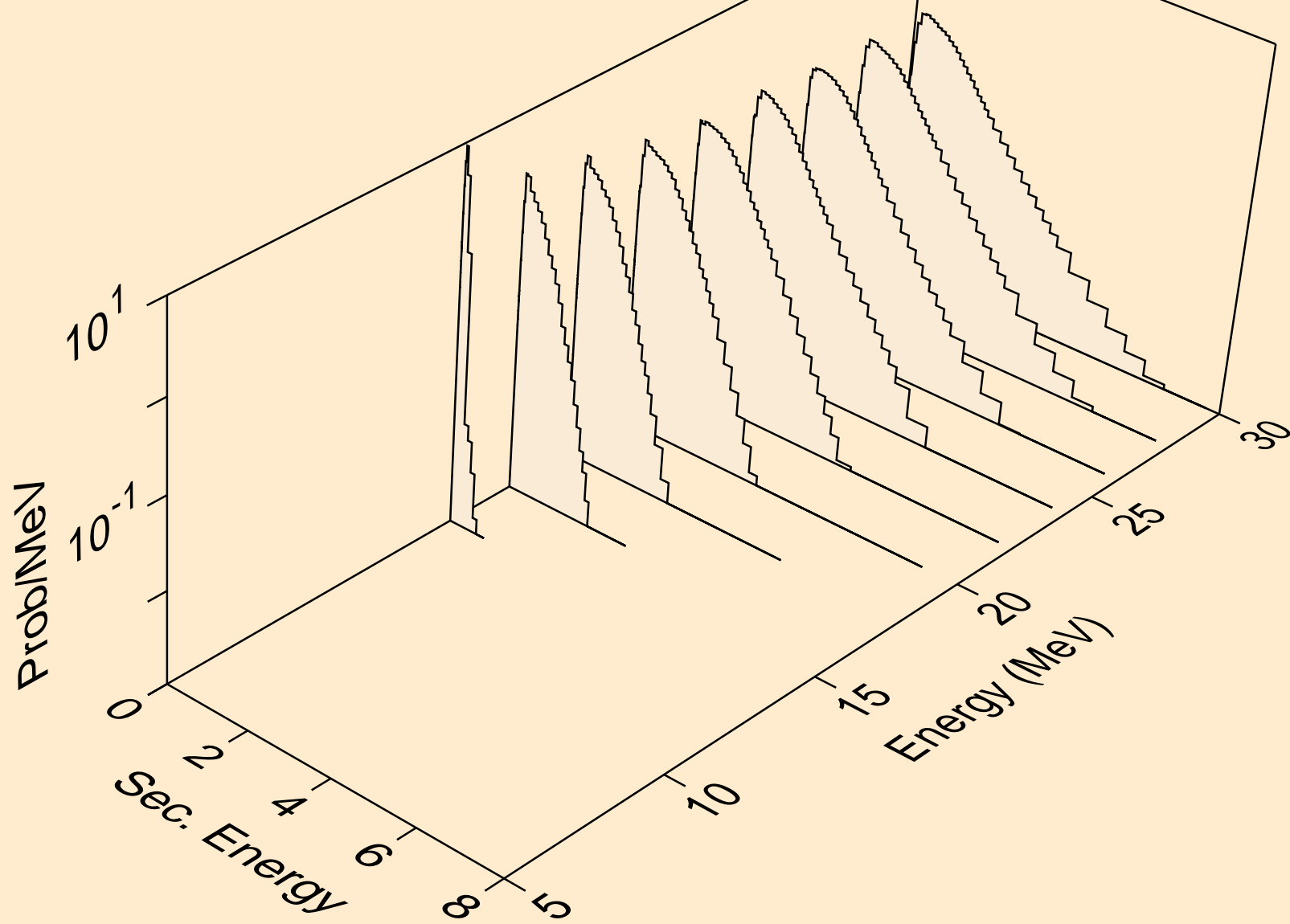

ER149 NEUTRON ACER TENDL-2023 LIBRARY; T=0.K
Neutron emission for (n,n*)p

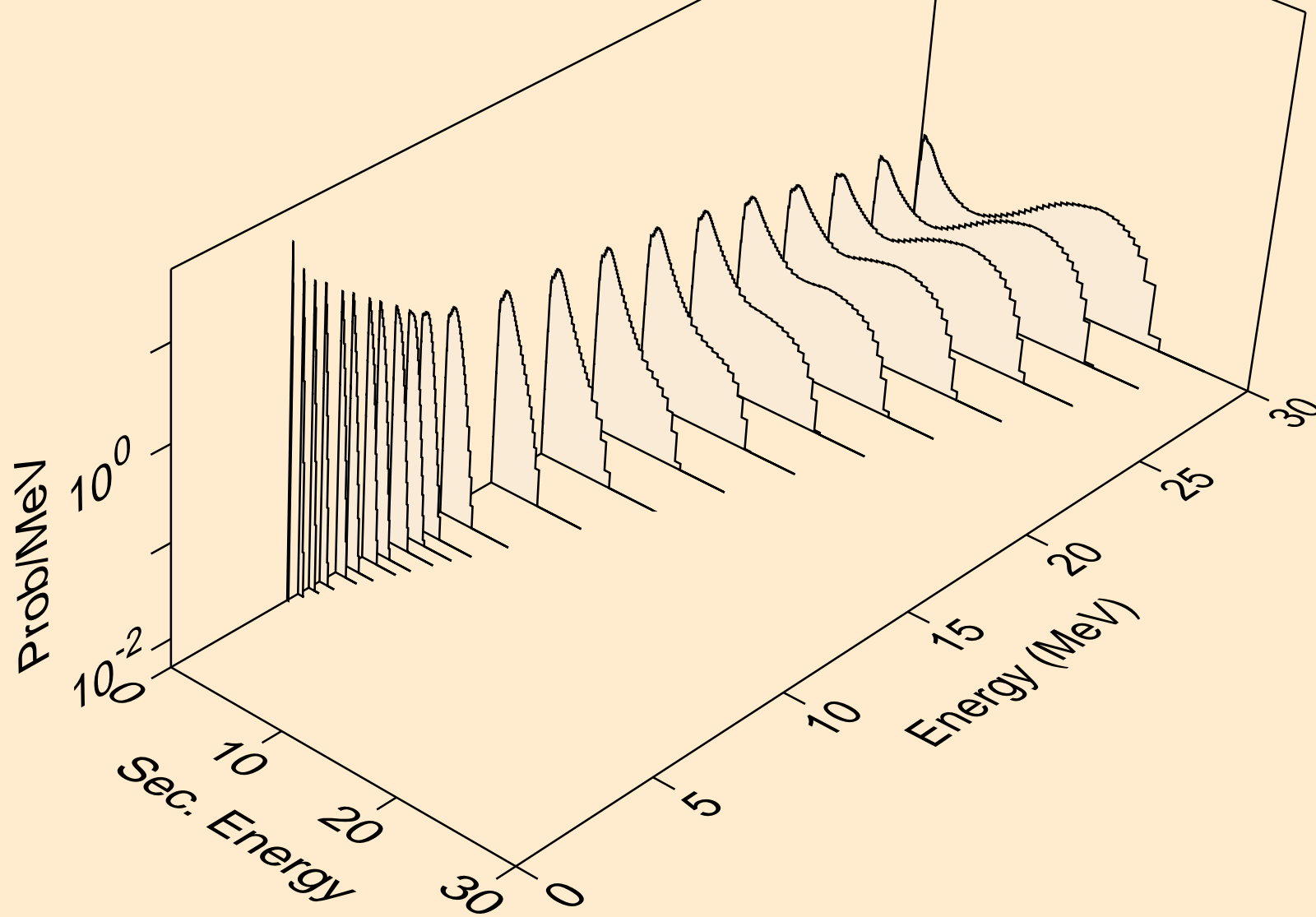

ER149 NEUTRON ACER TENDL-2023 LIBRARY; T=0.K
Neutron emission for (n,n*)2a

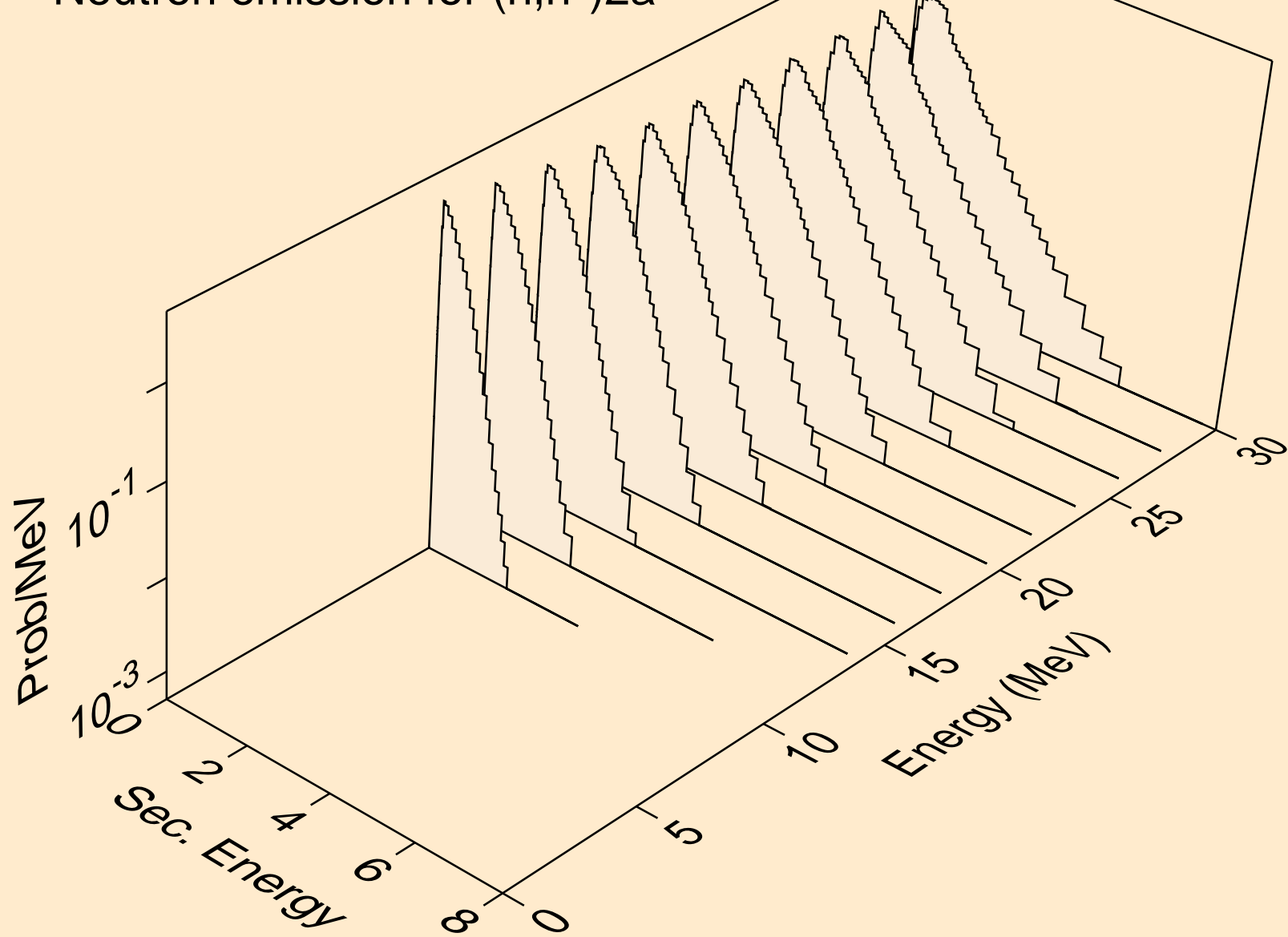

ER149 NEUTRON ACER TENDL-2023 LIBRARY; T=0.K
Neutron emission for (n,2n)2a

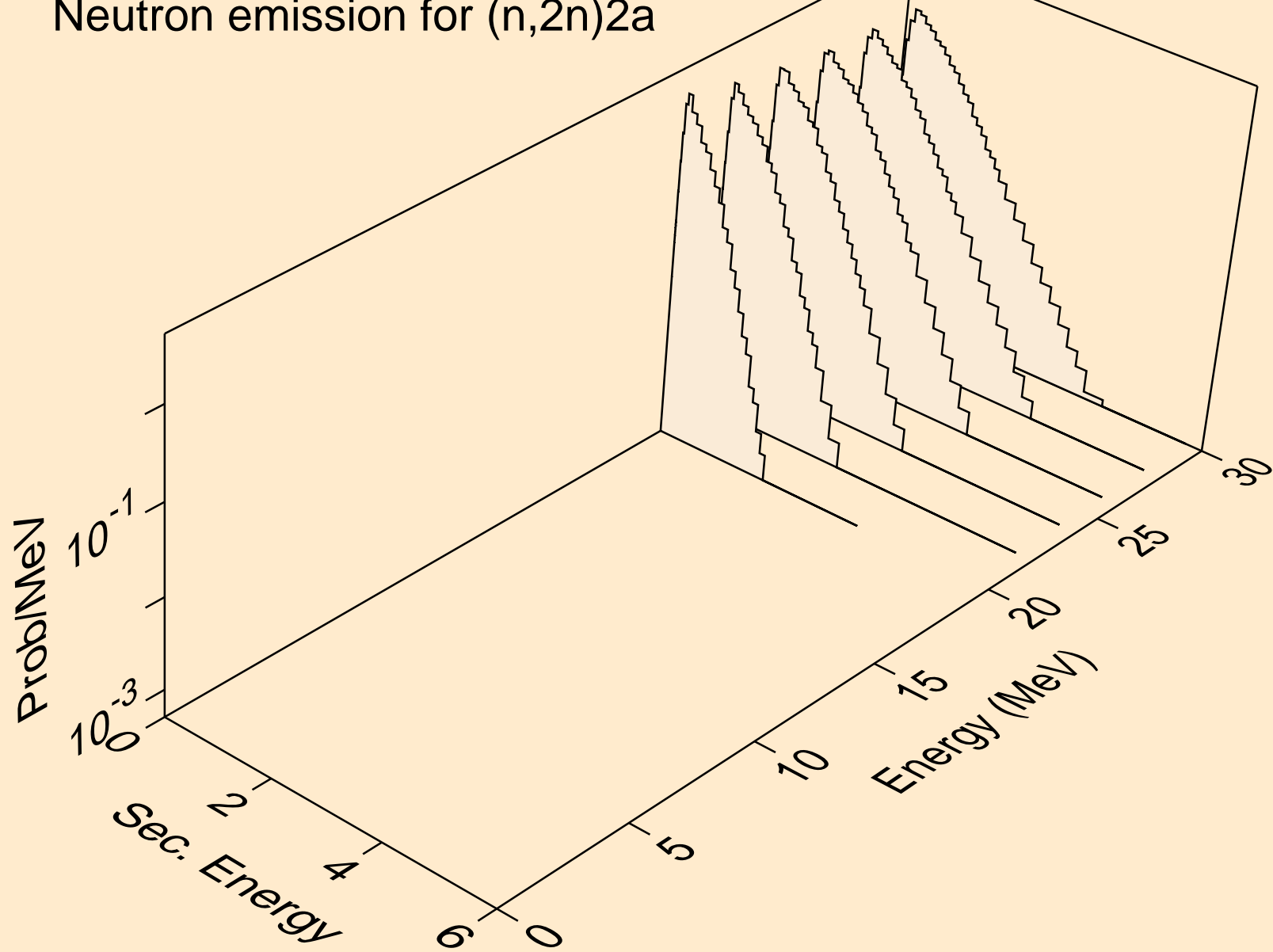

ER149 NEUTRON ACER TENDL-2023 LIBRARY; T=0.K
Neutron emission for (n,n*)d

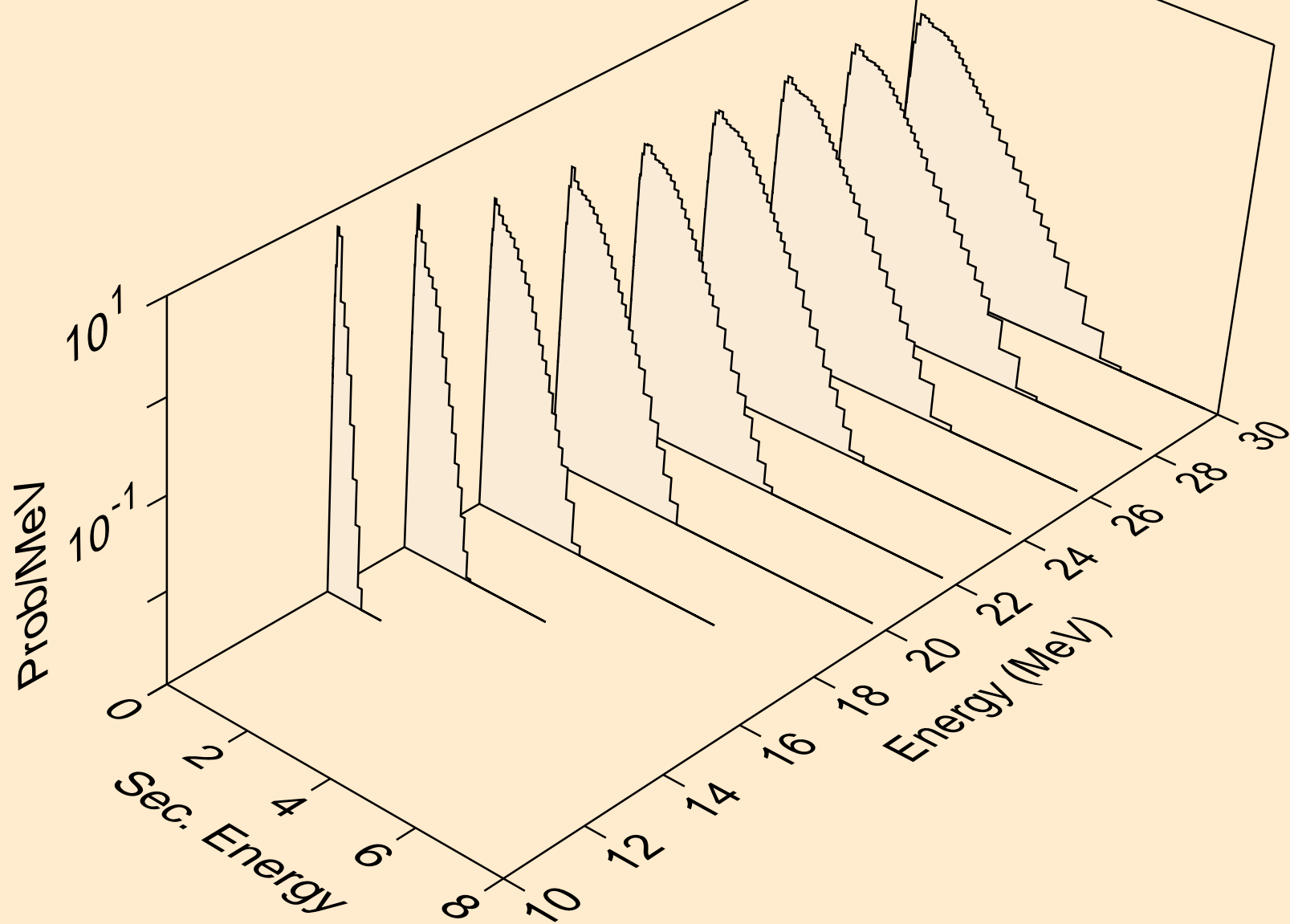

ER149 NEUTRON ACER TENDL-2023 LIBRARY; T=0.K
Neutron emission for (n,n*)t

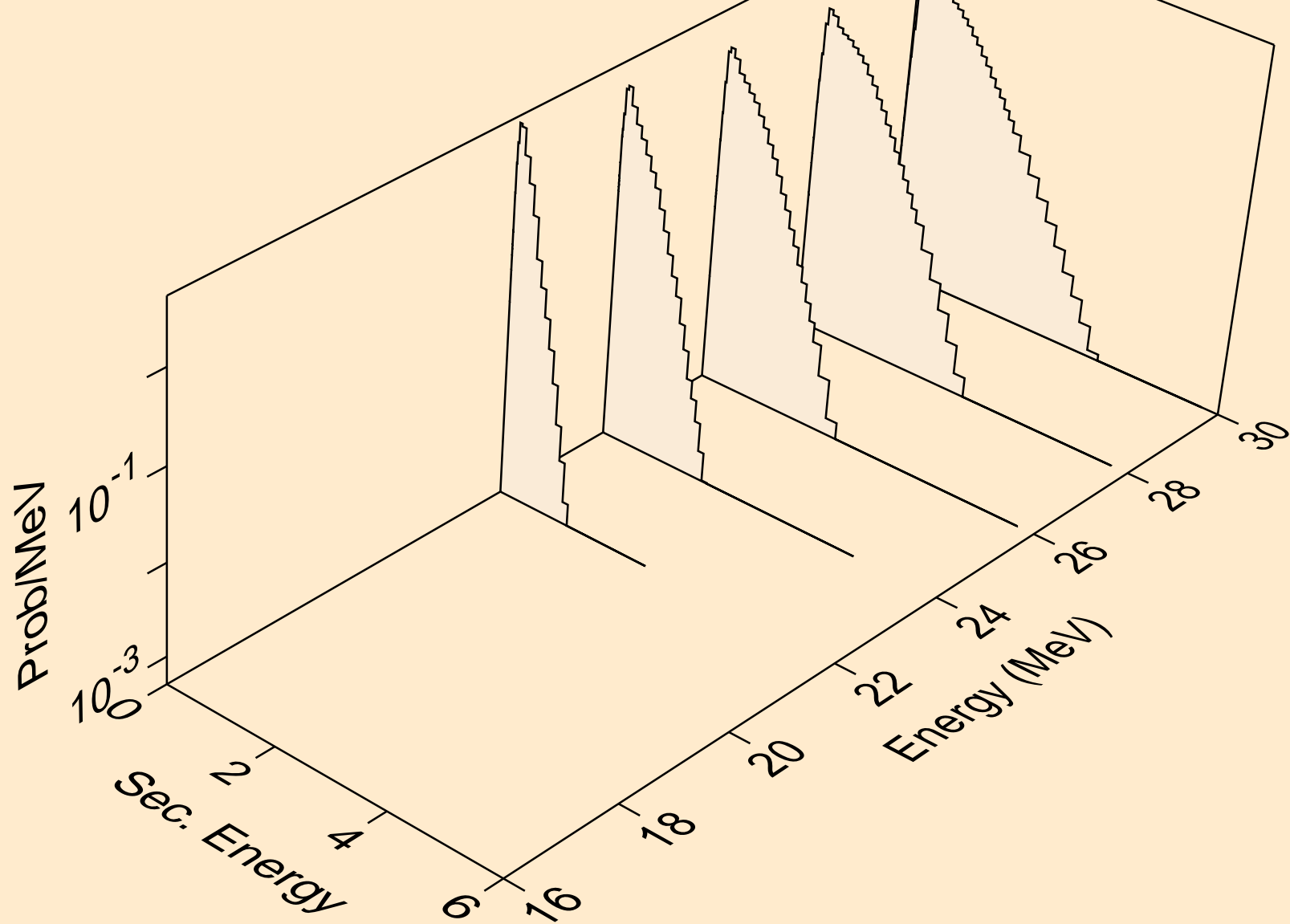

ER149 NEUTRON ACER TENDL-2023 LIBRARY; T=0.K
Neutron emission for (n,n*)he3

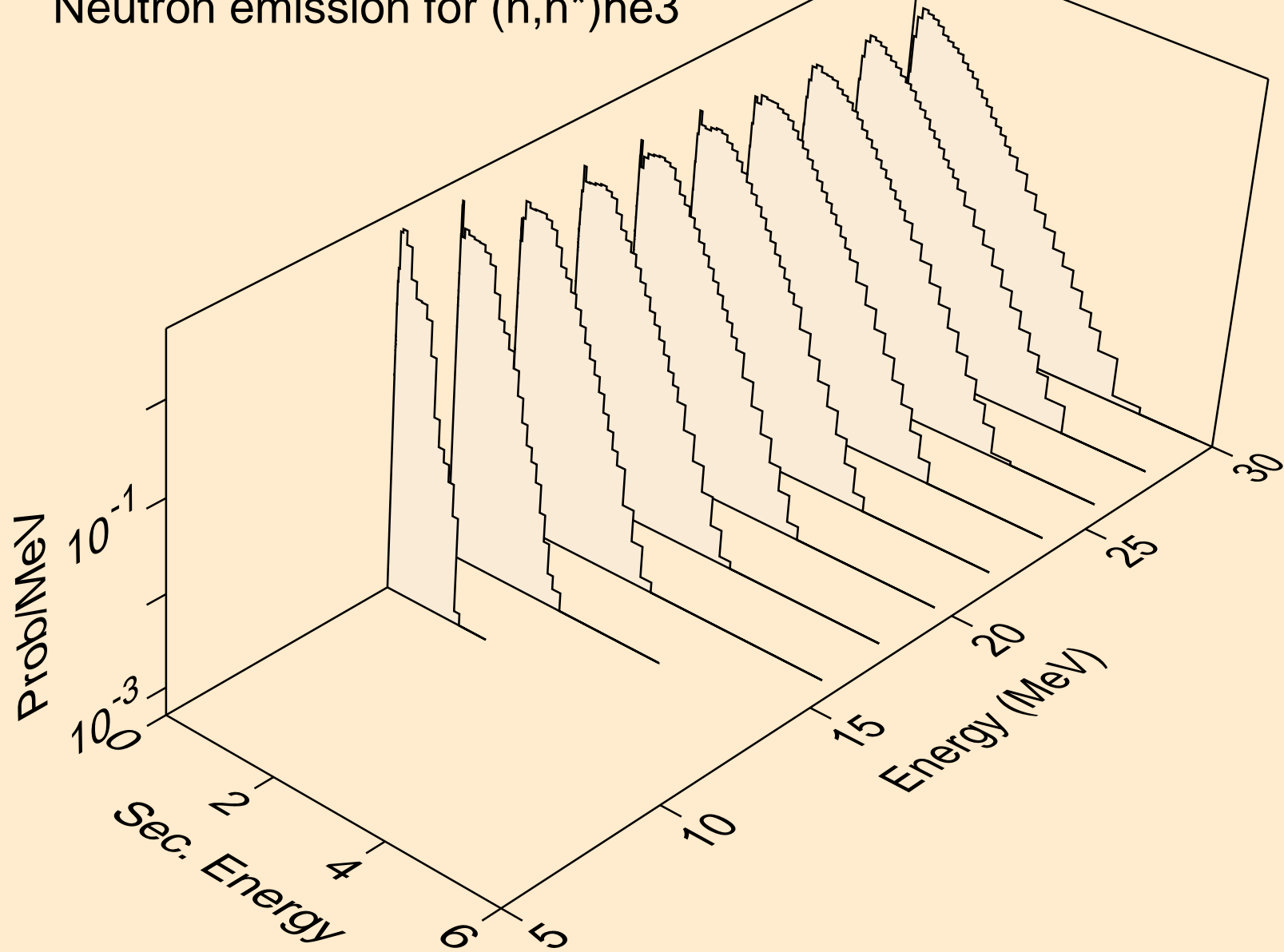

ER149 NEUTRON ACER TENDL-2023 LIBRARY; T=0.K
Neutron emission for (n,2np)

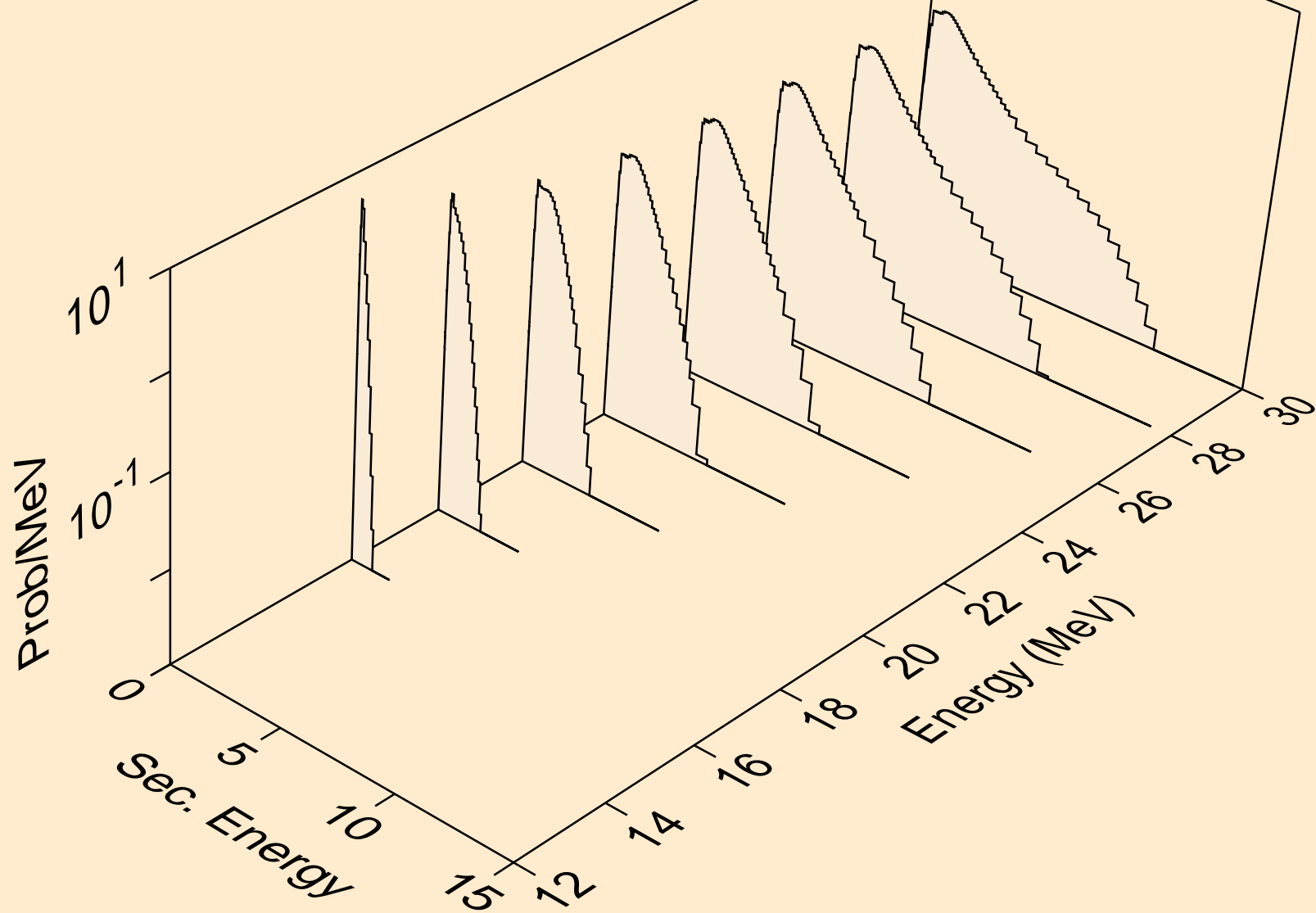

ER149 NEUTRON ACER TENDL-2023 LIBRARY; T=0.K
Neutron emission for (n,3np)

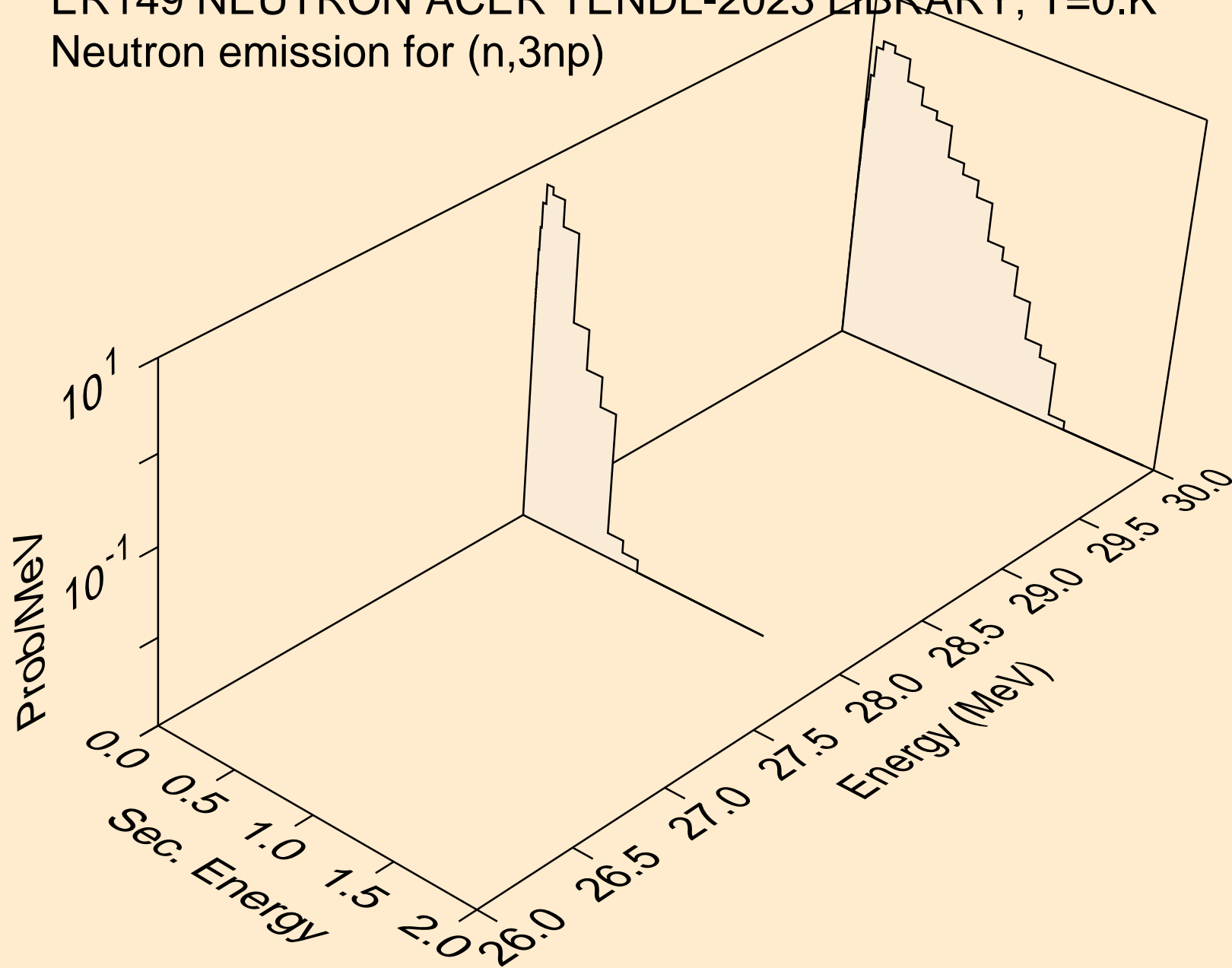

ER149 NEUTRON ACER TENDL-2023 LIBRARY; T=0.K
Neutron emission for (n,n2p)

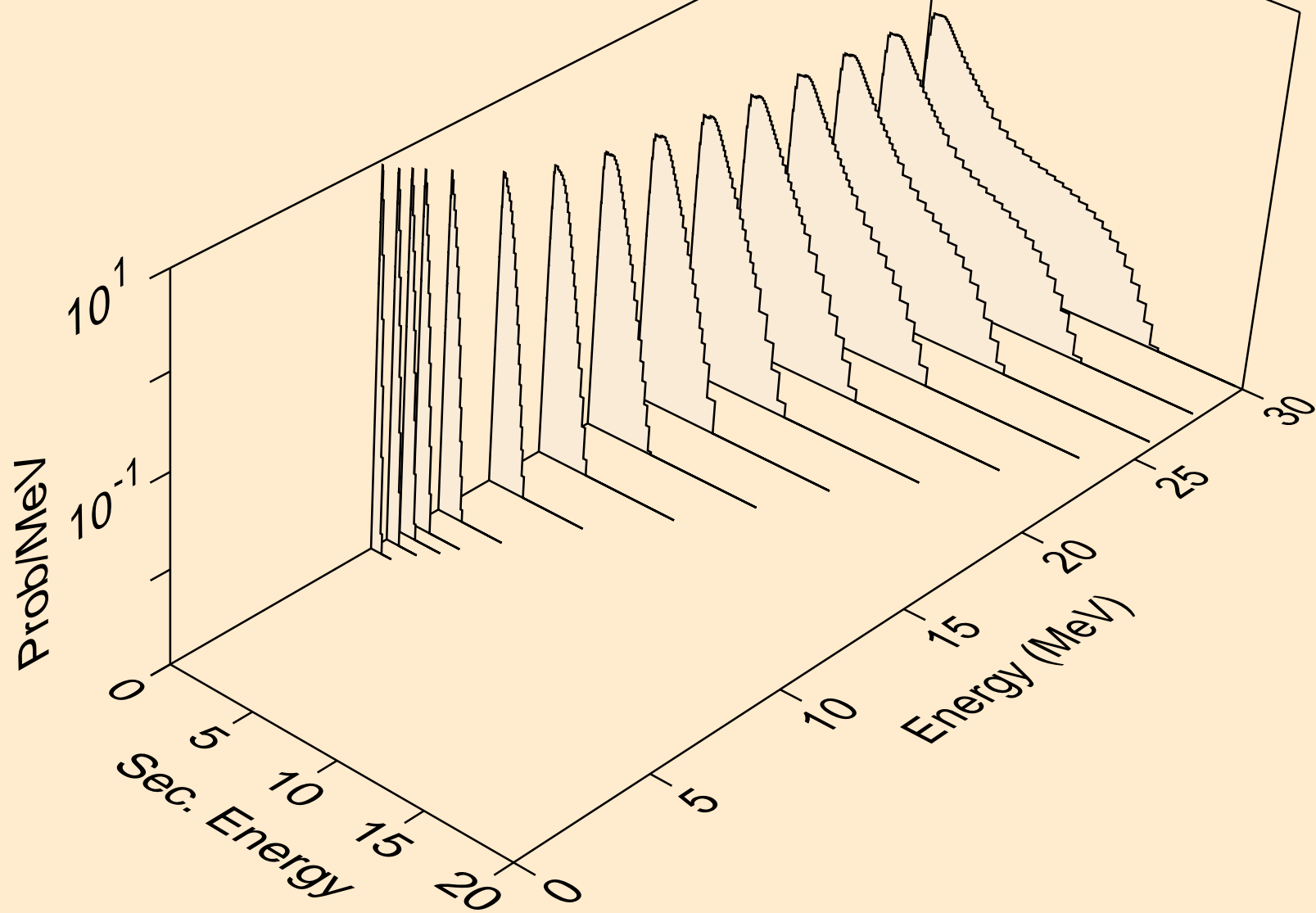

ER149 NEUTRON ACER TENDL-2023 LIBRARY; T=0.K
Neutron emission for (n,npa)

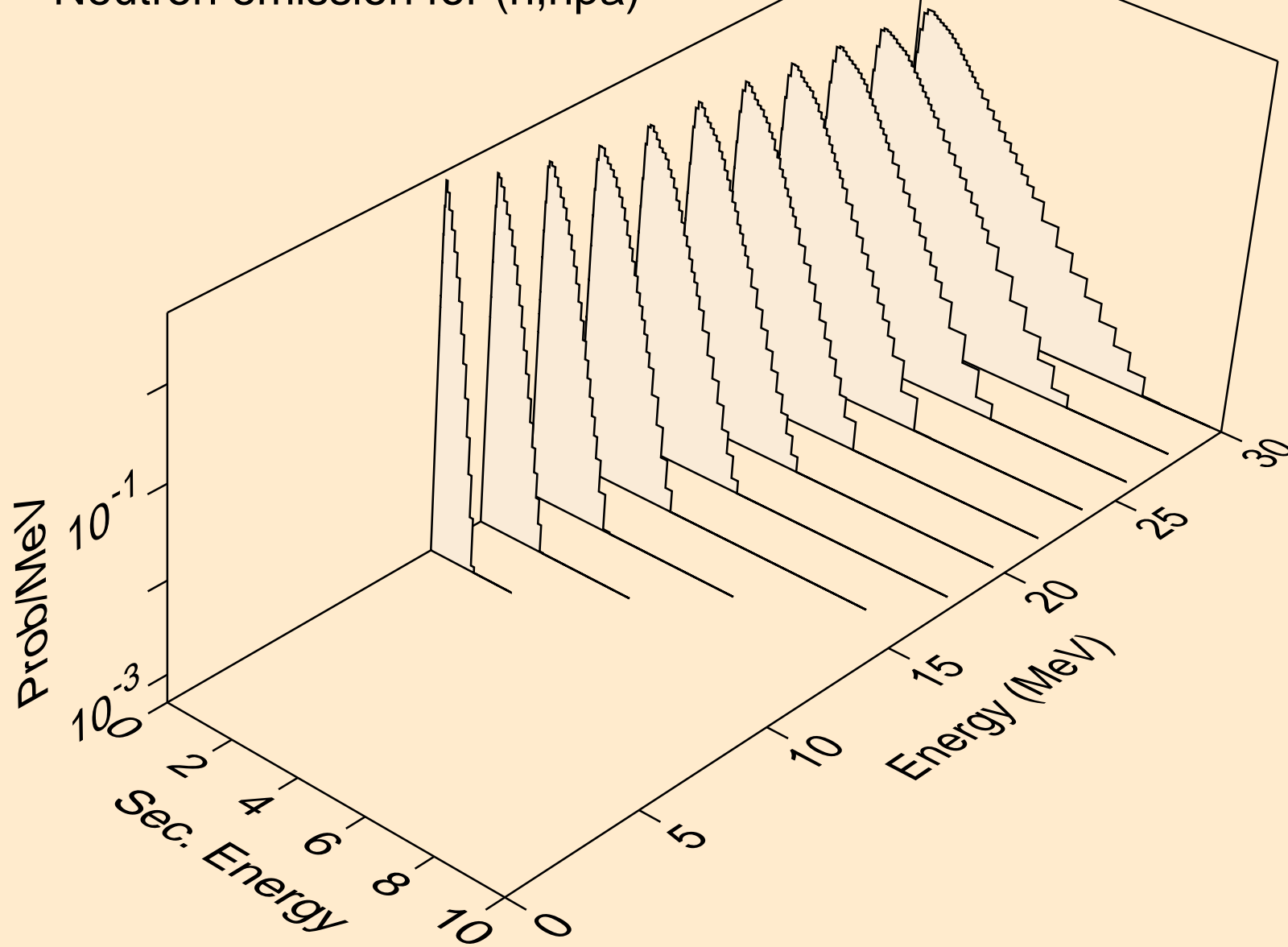

ER149 NEUTRON ACER TENDL-2023 LIBRARY; T=0.K
Neutron emission for (n,n*c)

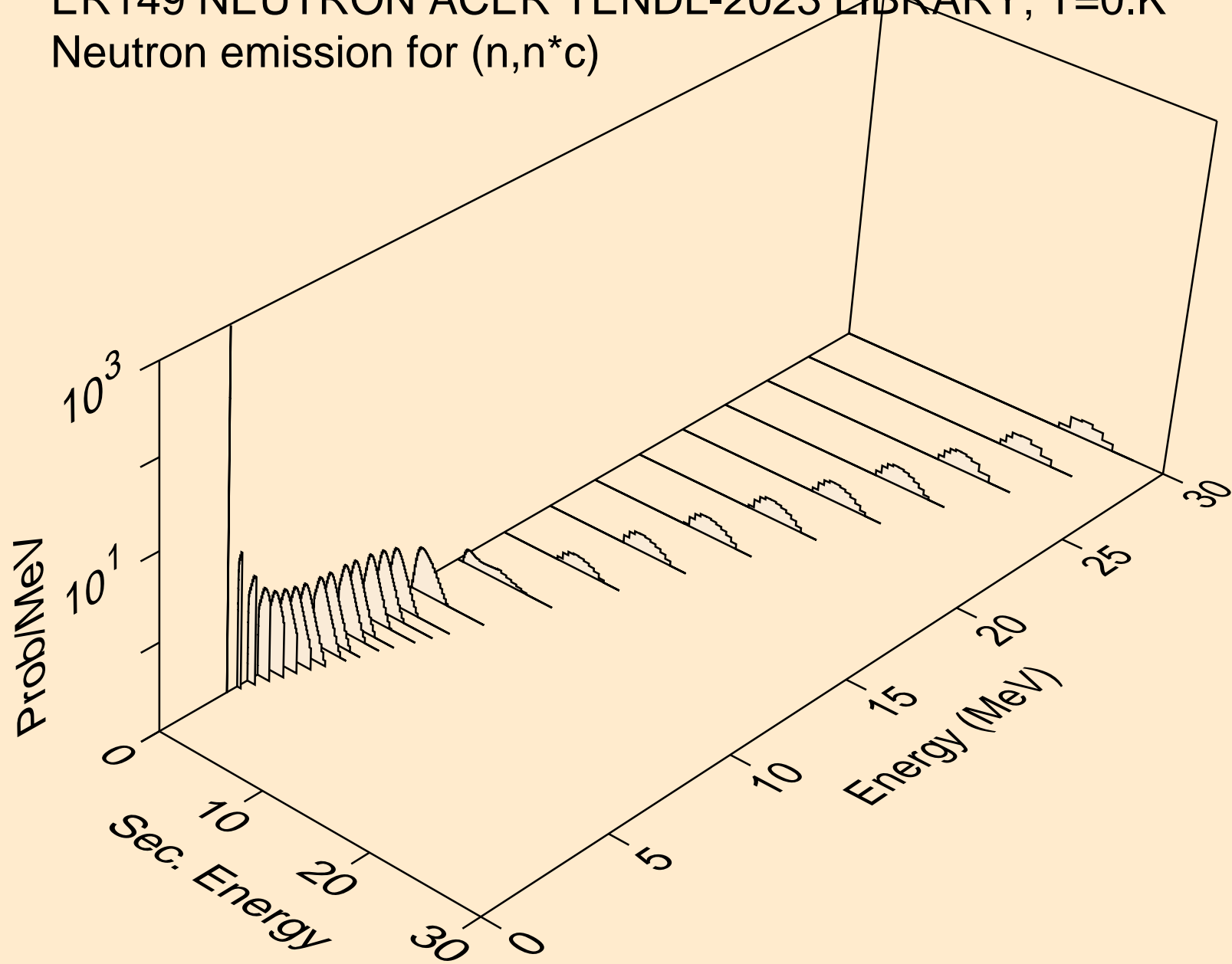

ER149 NEUTRON ACER TENDL-2023 LIBRARY; T=0.K
Photon emission for (n,x)

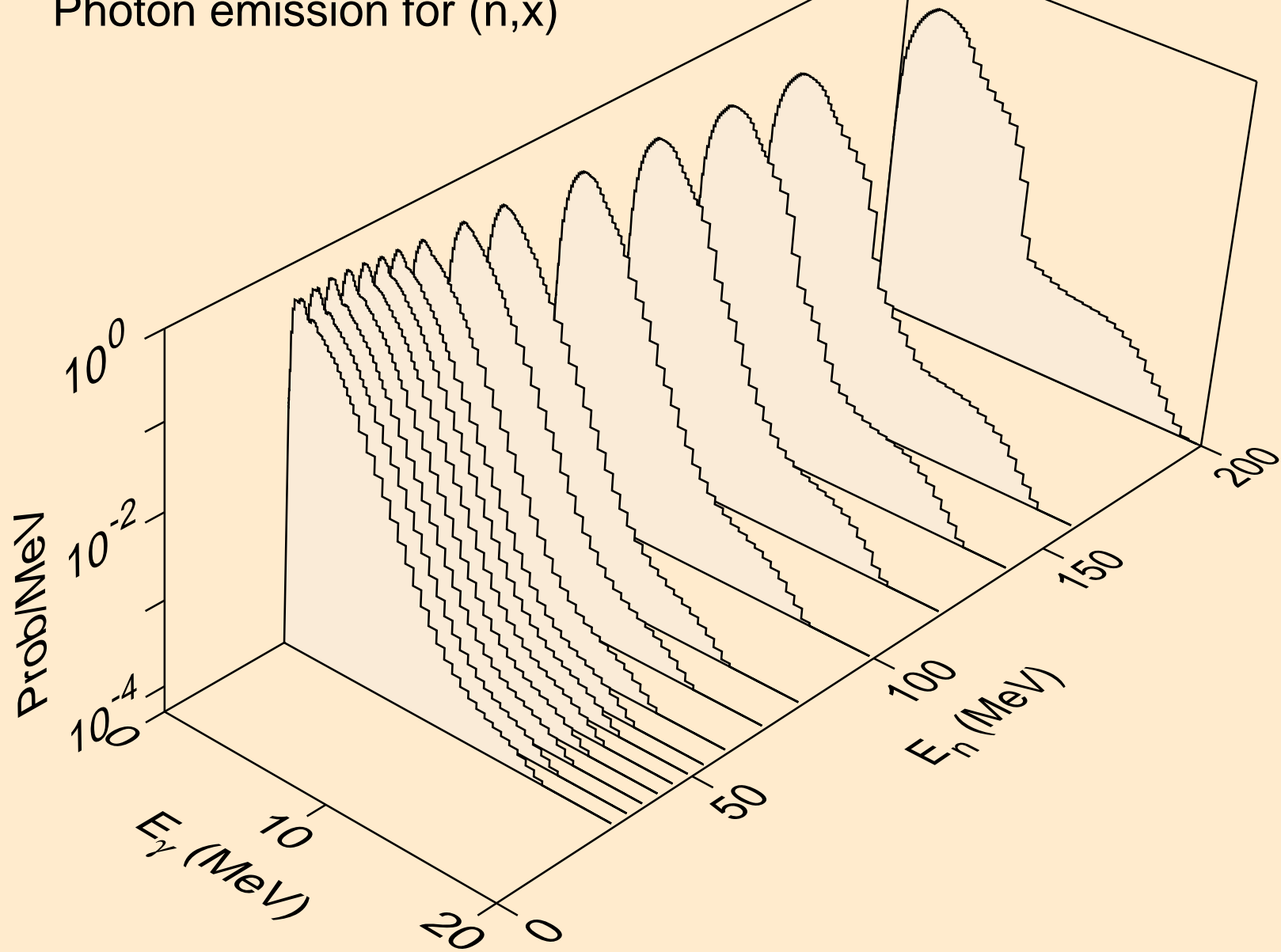

ER149 NEUTRON ACER TENDL-2023 LIBRARY; T=0.K
Photon emission for (n,2nd)

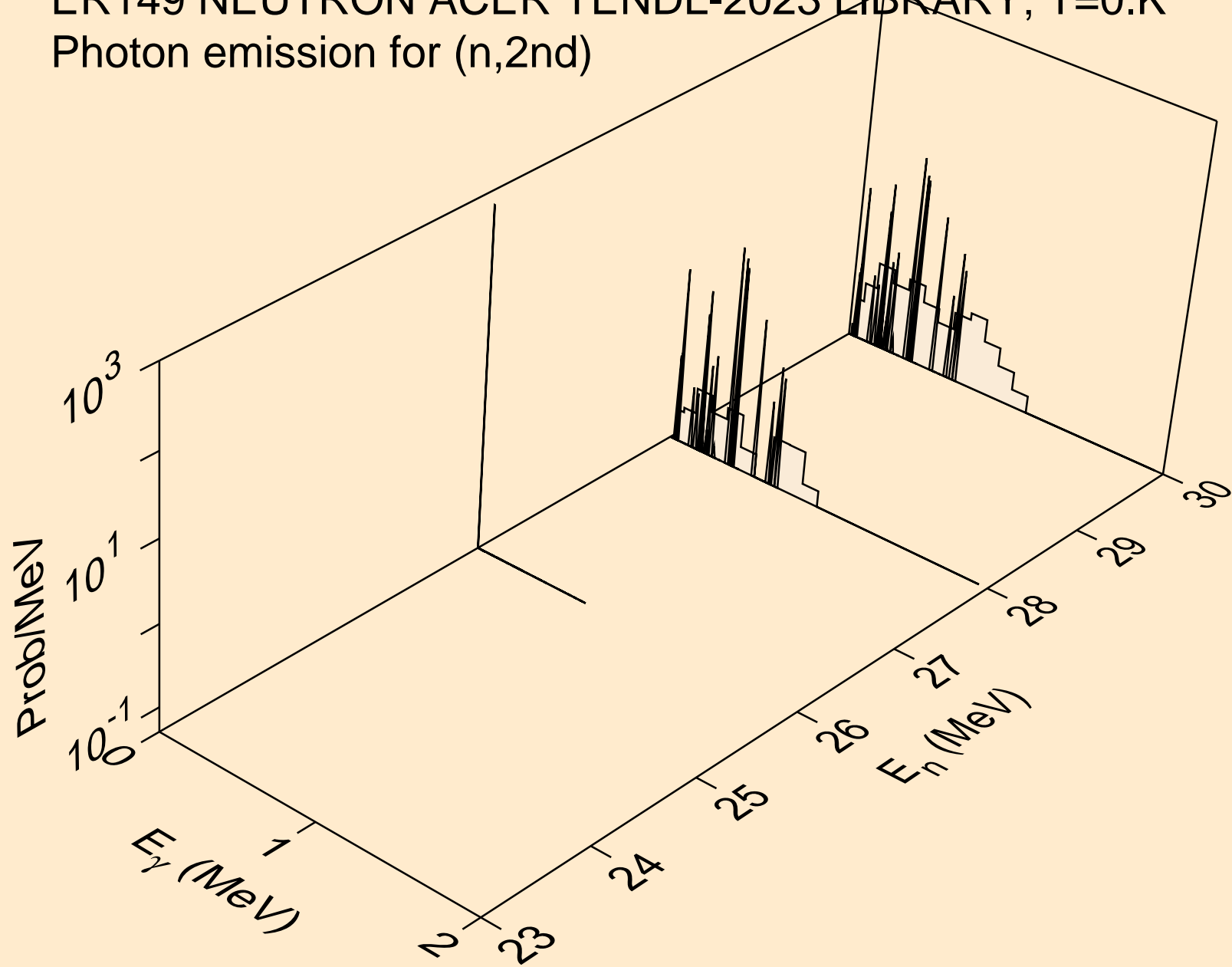

ER149 NEUTRON ACER TENDL-2023 LIBRARY; T=0.K
Photon emission for (n,2n)

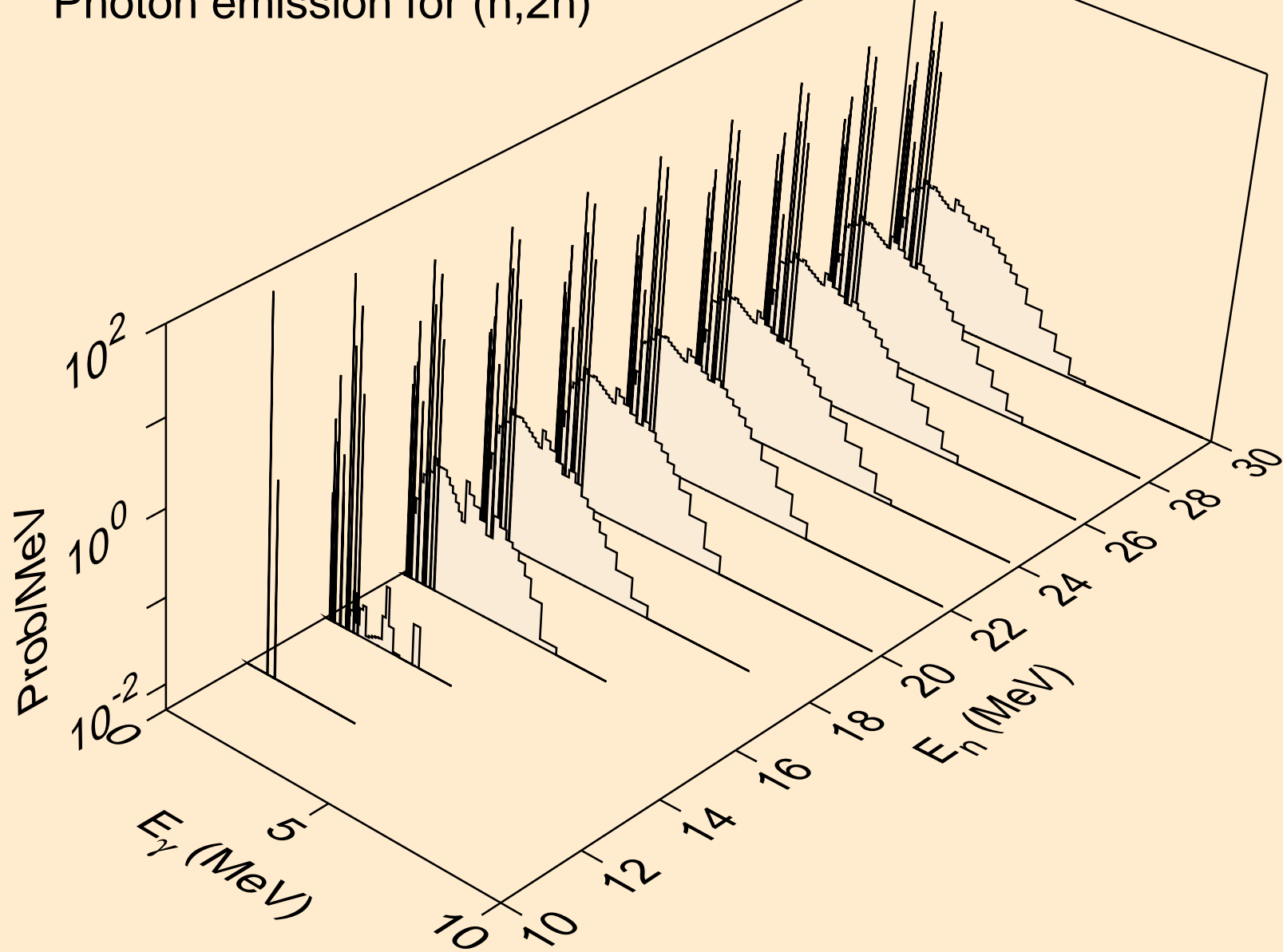

ER149 NEUTRON ACER TENDL-2023 LIBRARY; T=0.K
Photon emission for (n,3n)

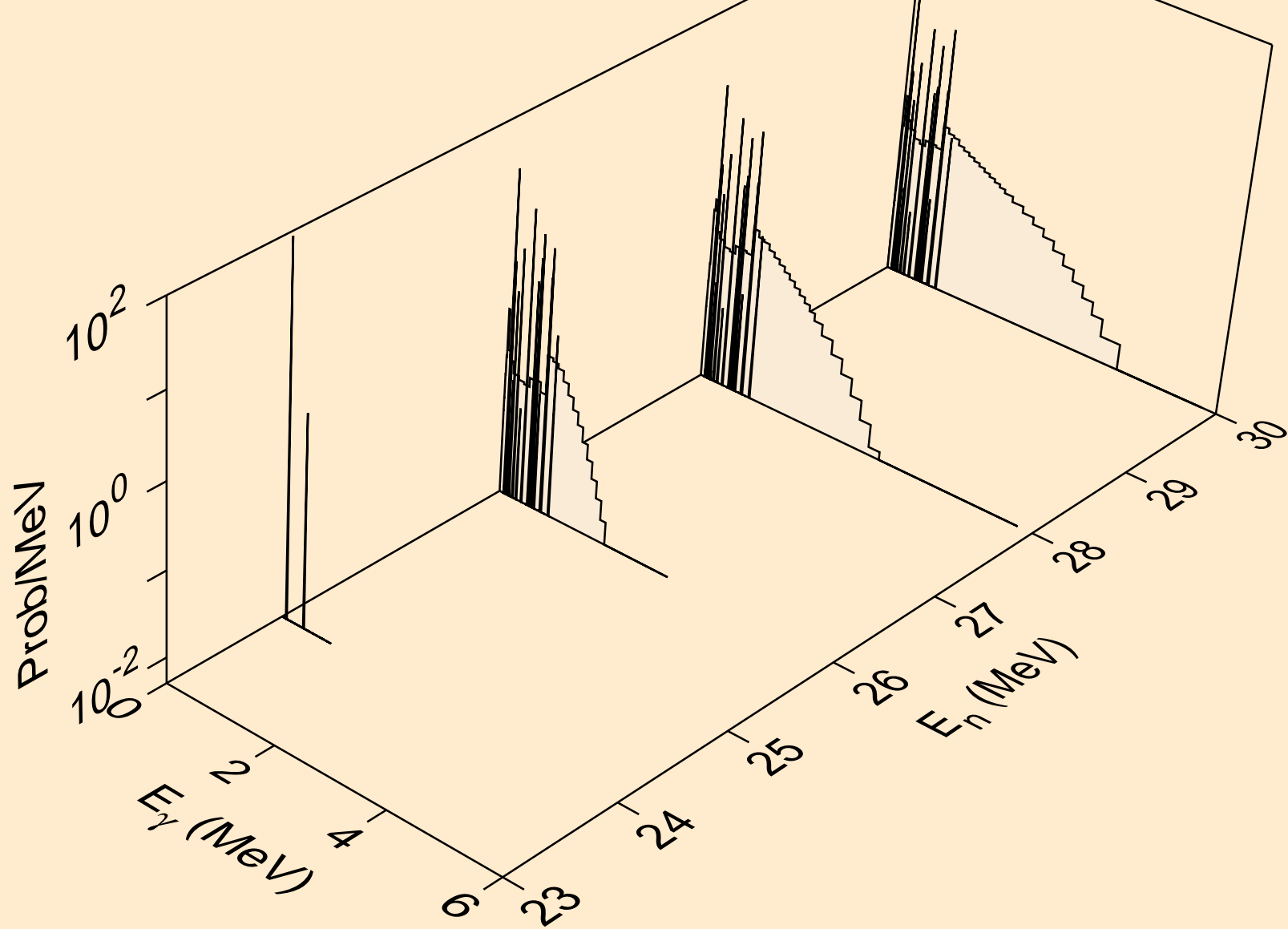

ER149 NEUTRON ACER TENDL-2023 LIBRARY; T=0.K
Photon emission for (n,n*)a

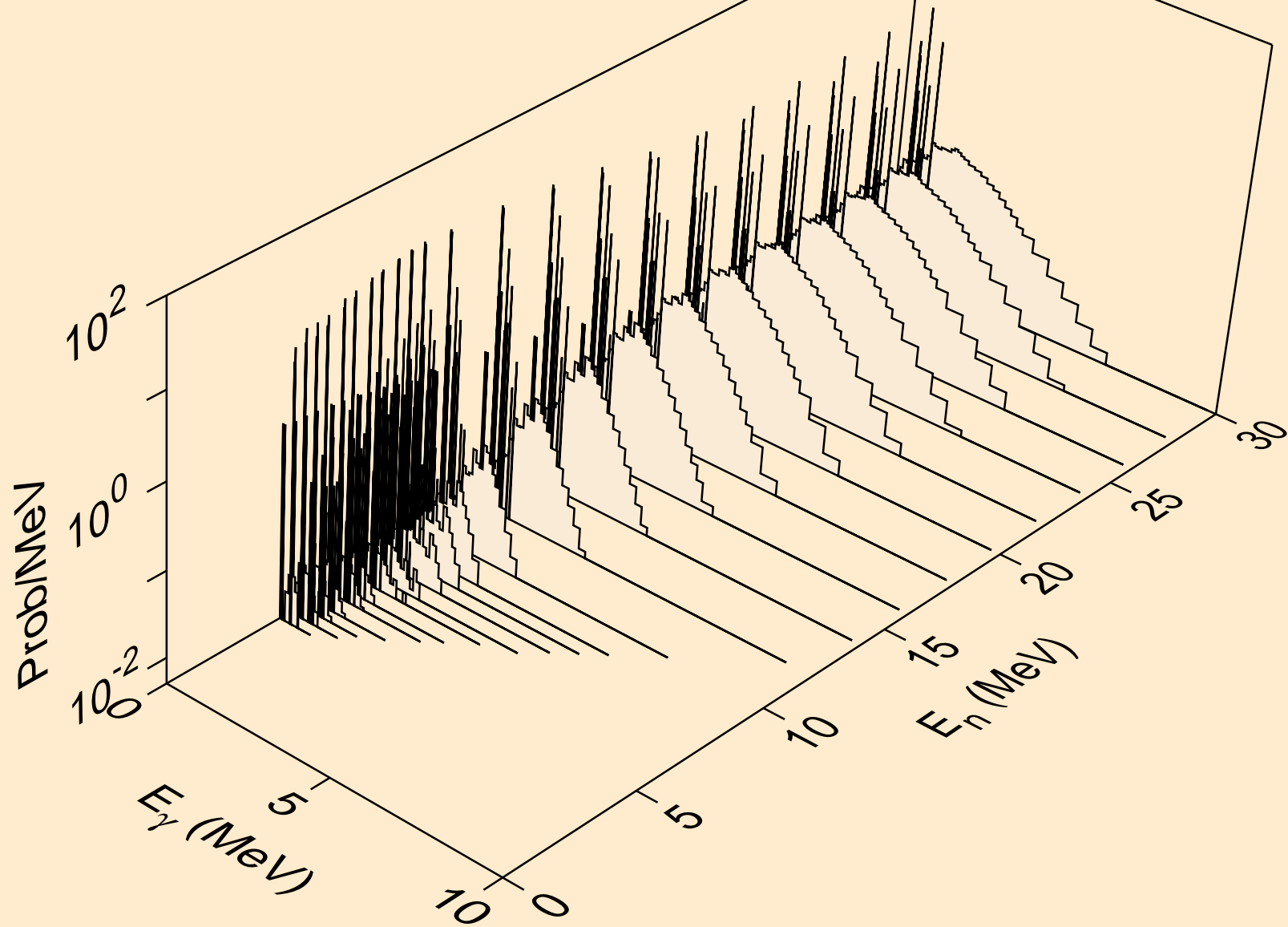

ER149 NEUTRON ACER TENDL-2023 LIBRARY; T=0.K
Photon emission for (n,2n)a

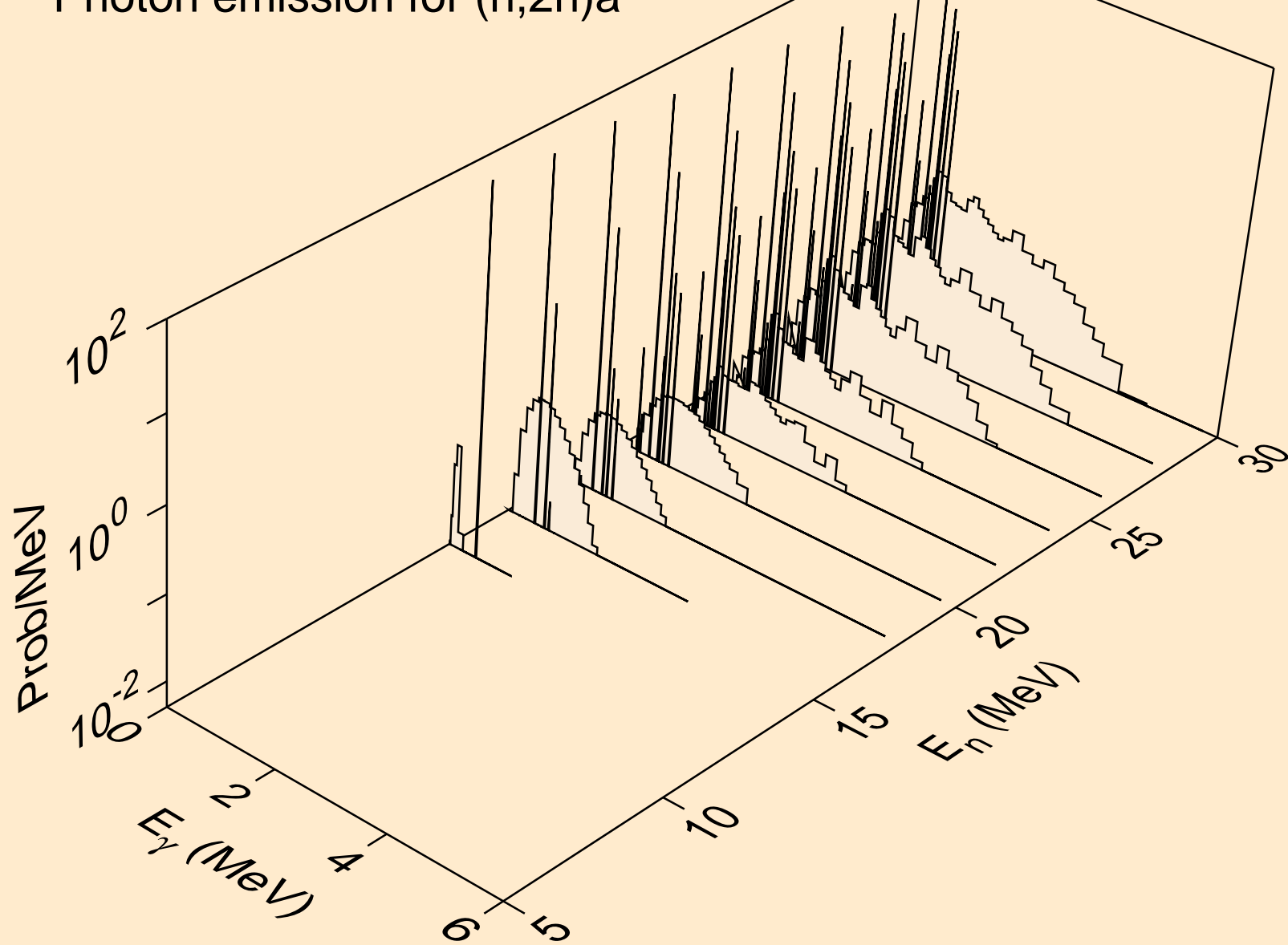

ER149 NEUTRON ACER TENDL-2023 LIBRARY; T=0.K
Photon emission for (n,n*)p

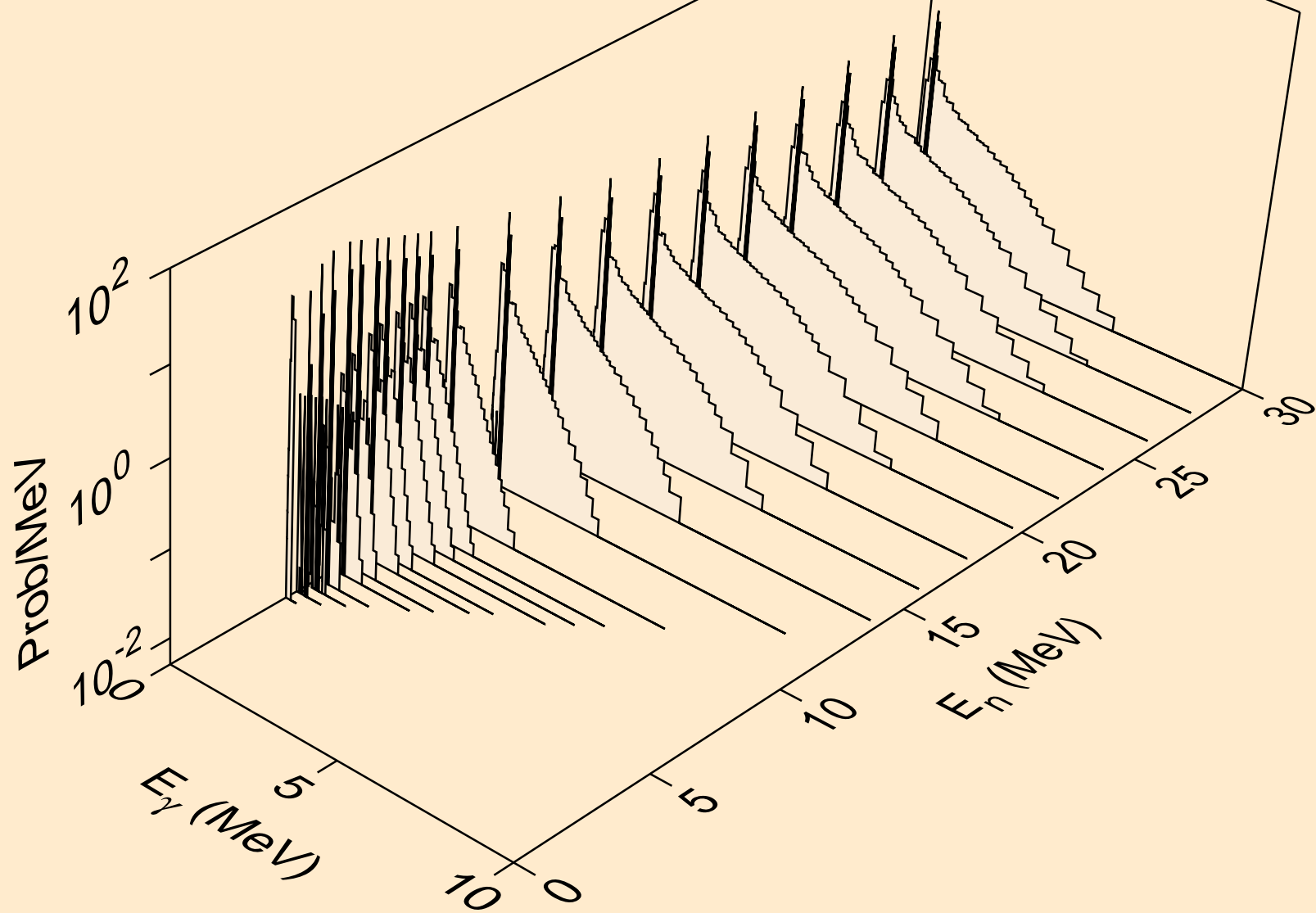

ER149 NEUTRON ACER TENDL-2023 LIBRARY; T=0.K
Photon emission for (n,n*)2a

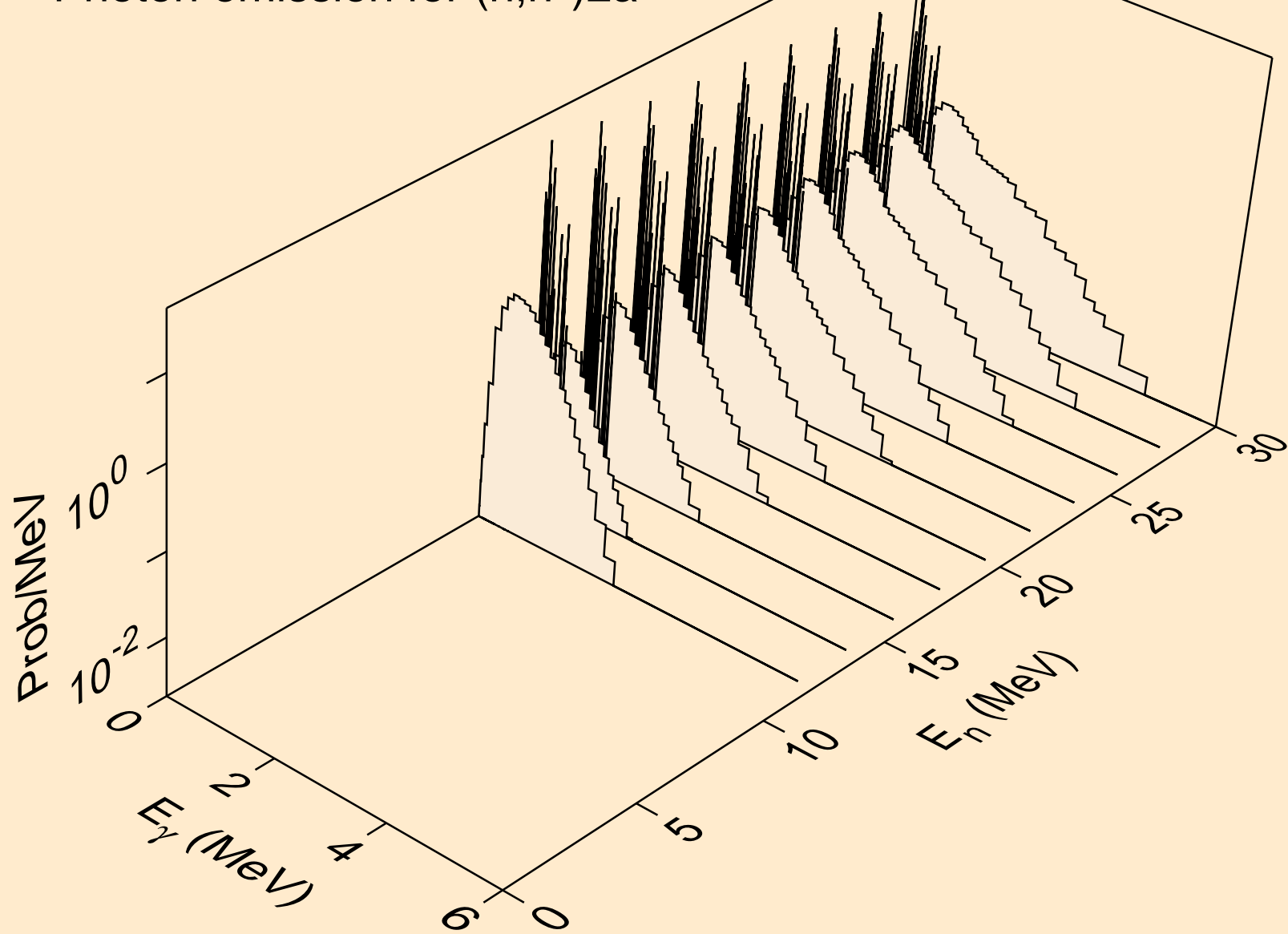

ER149 NEUTRON ACER TENDL-2023 LIBRARY; T=0.K
Photon emission for (n,2n)2a

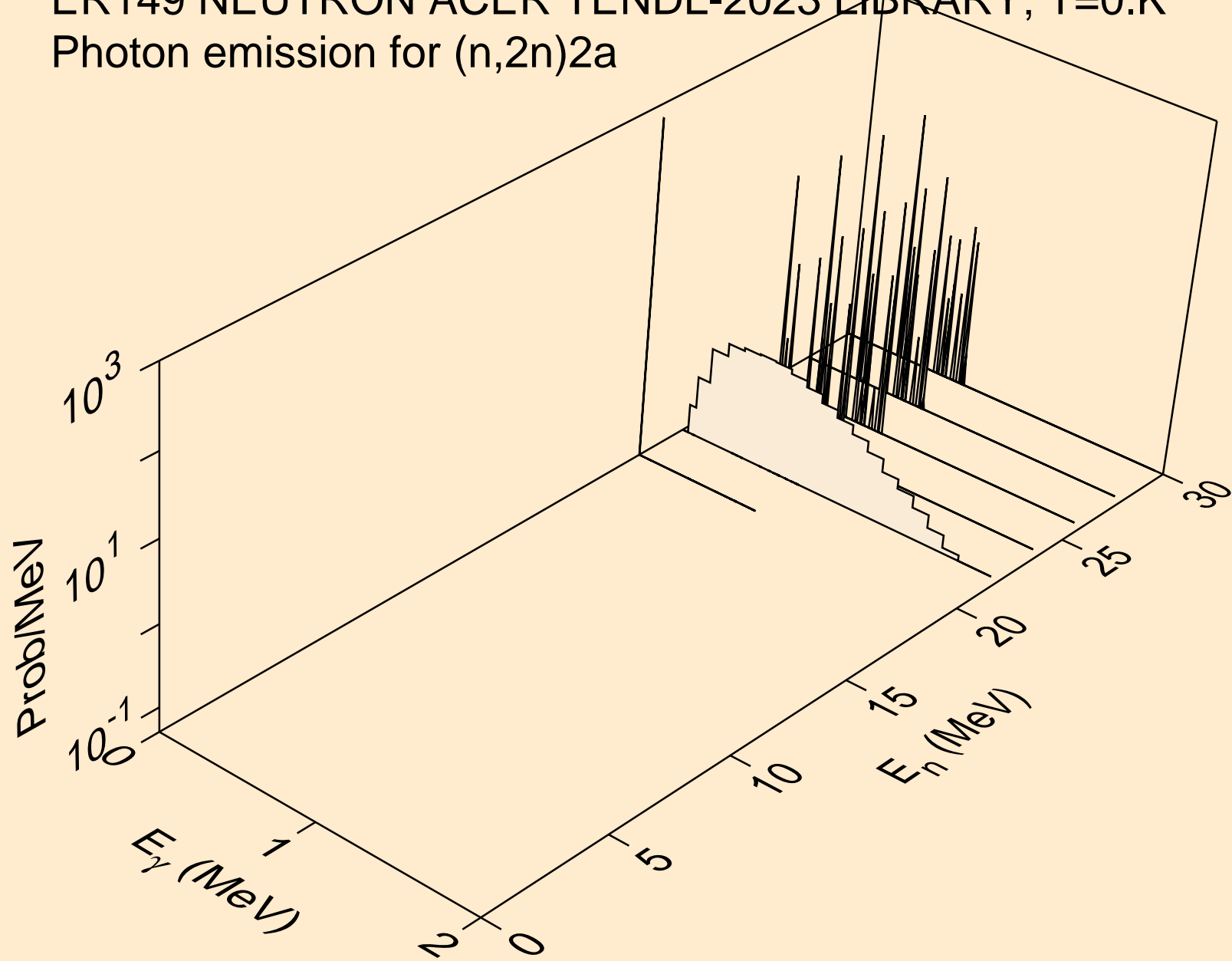

ER149 NEUTRON ACER TENDL-2023 LIBRARY; T=0.K
Photon emission for (n,n*)d

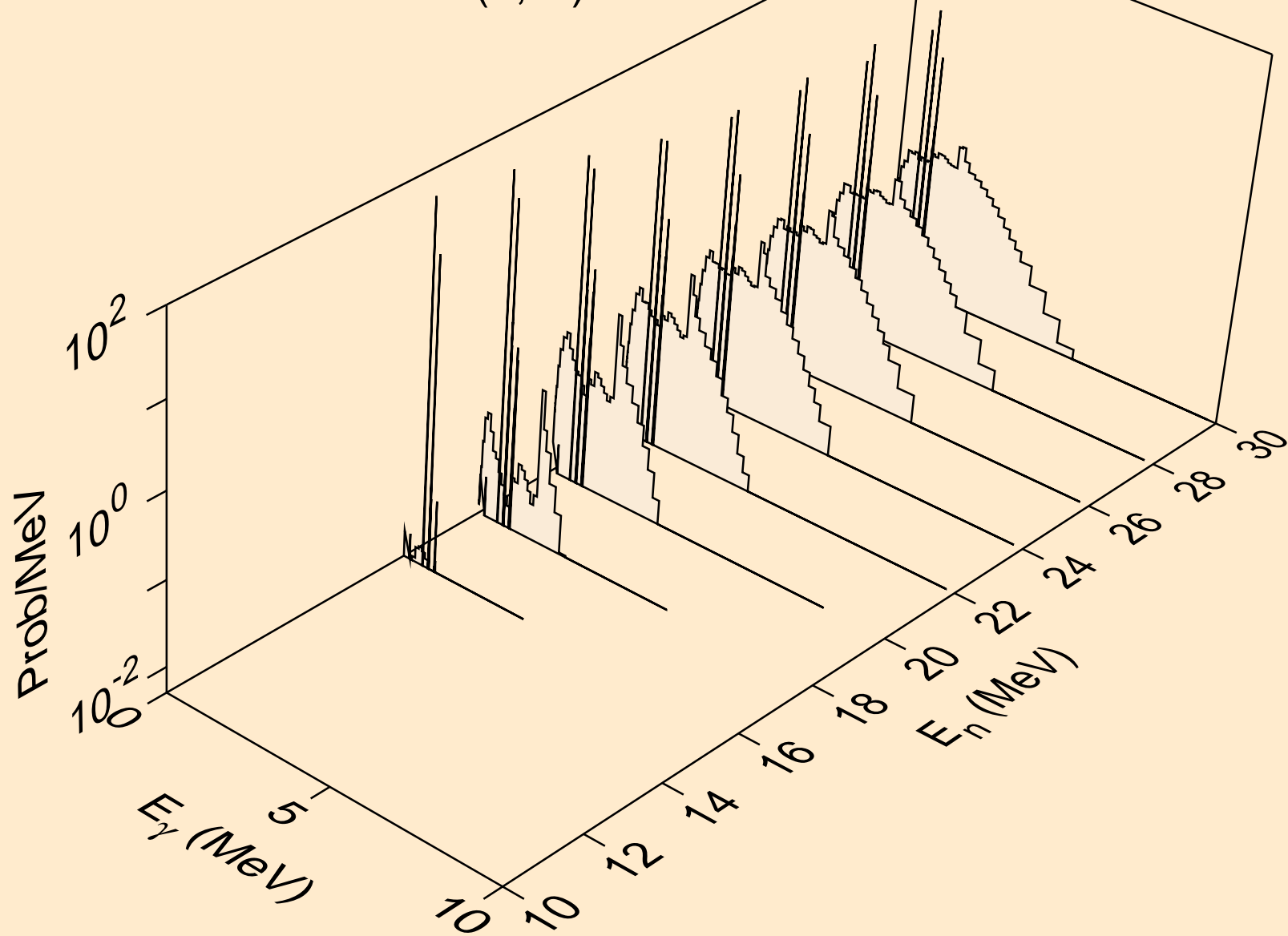

ER149 NEUTRON ACER TENDL-2023 LIBRARY; T=0.K
Photon emission for (n,n*)t

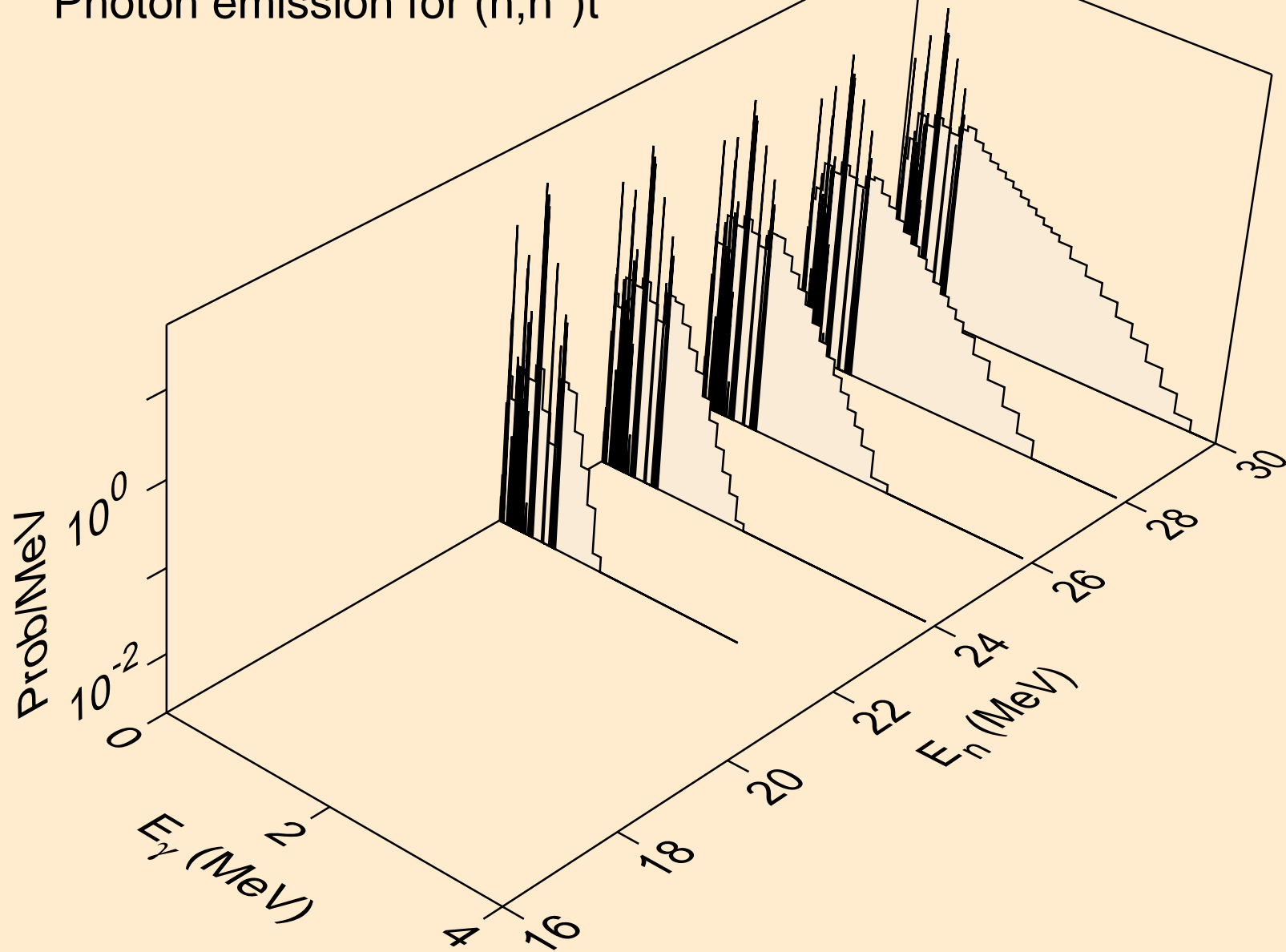

ER149 NEUTRON ACER TENDL-2023 LIBRARY; T=0.K
Photon emission for (n,n*)he3

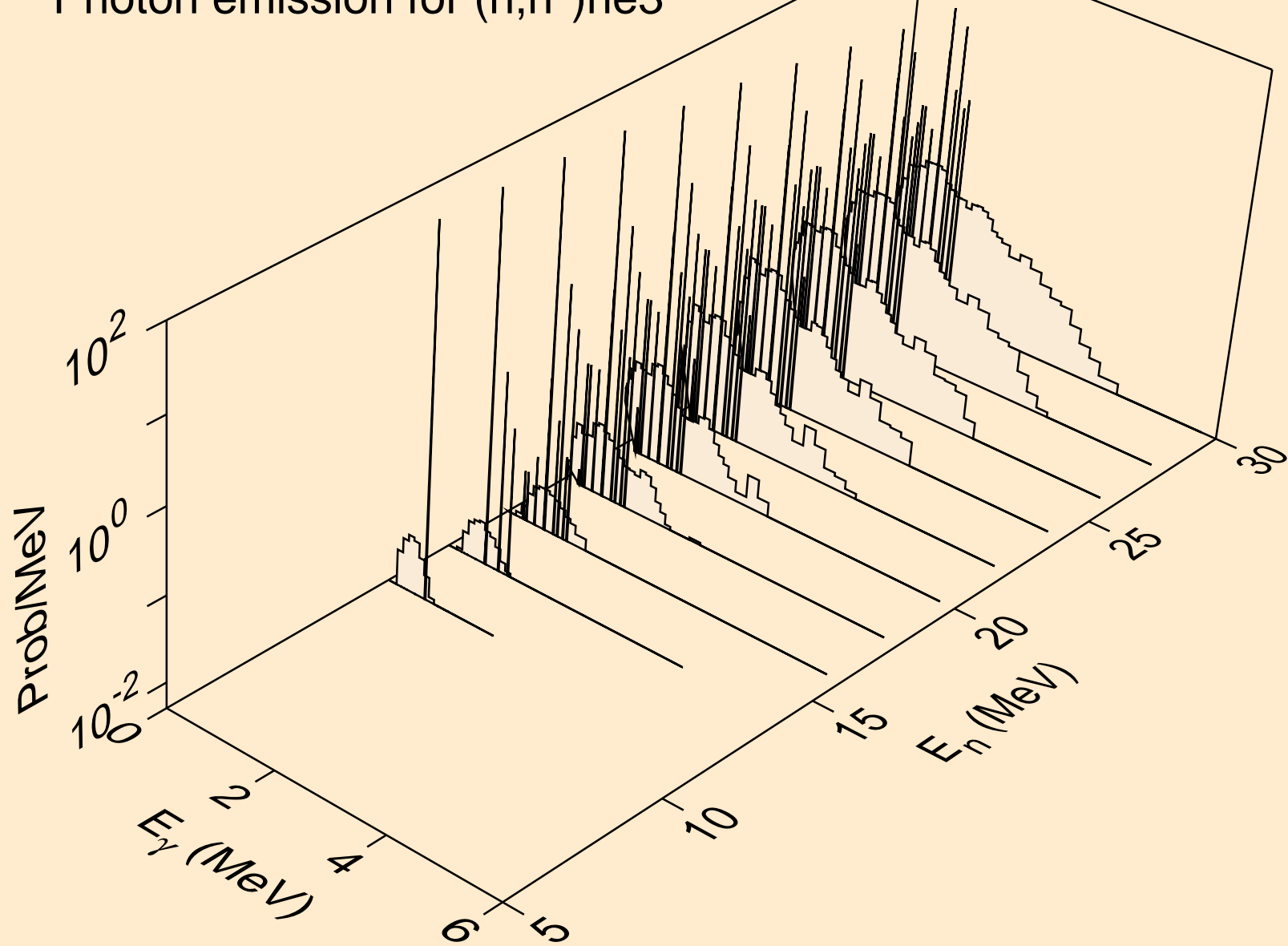

ER149 NEUTRON ACER TENDL-2023 LIBRARY; T=0.K
Photon emission for (n,2np)

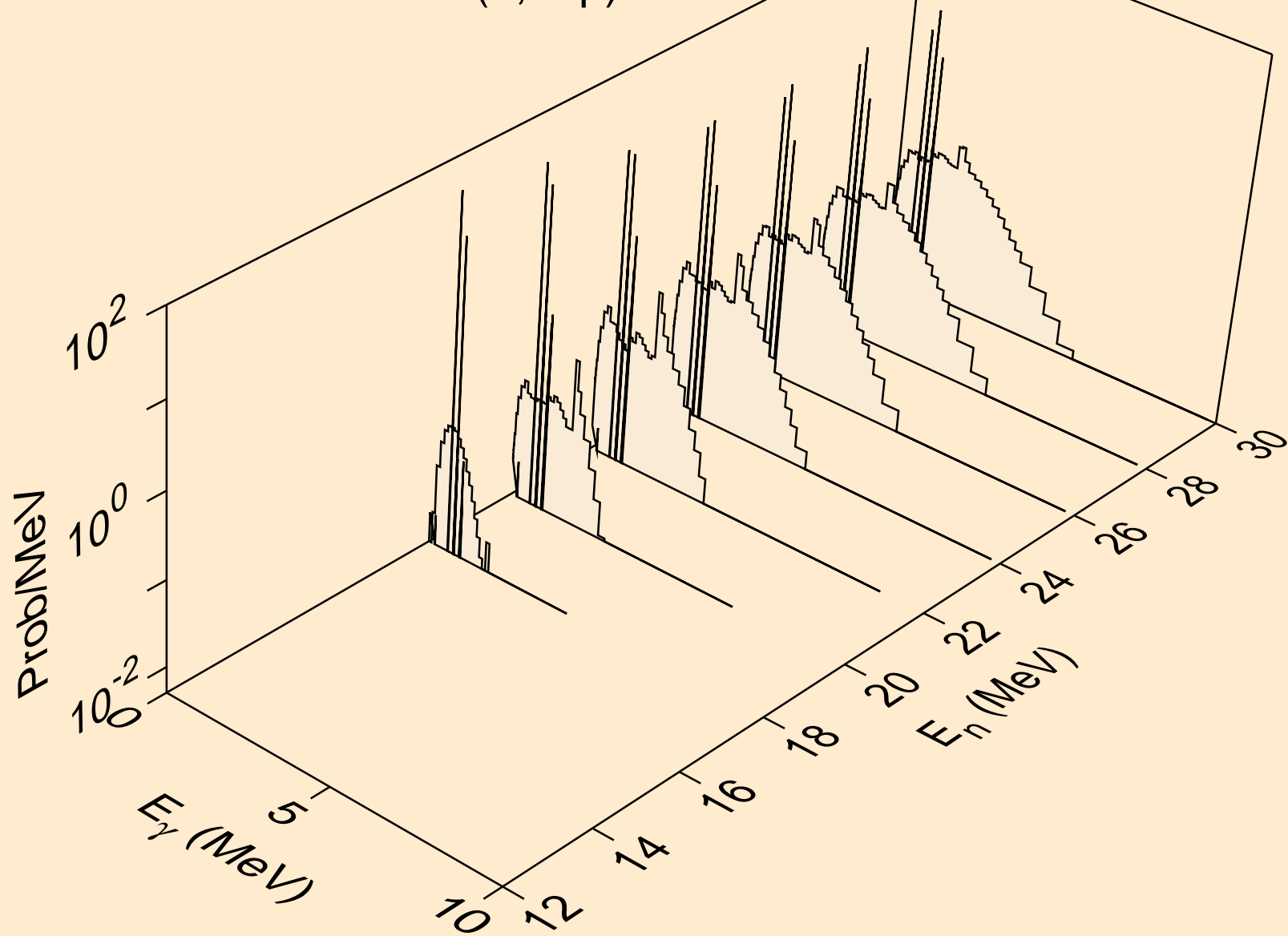

ER149 NEUTRON ACER TENDL-2023 LIBRARY; T=0.K
Photon emission for (n,3np)

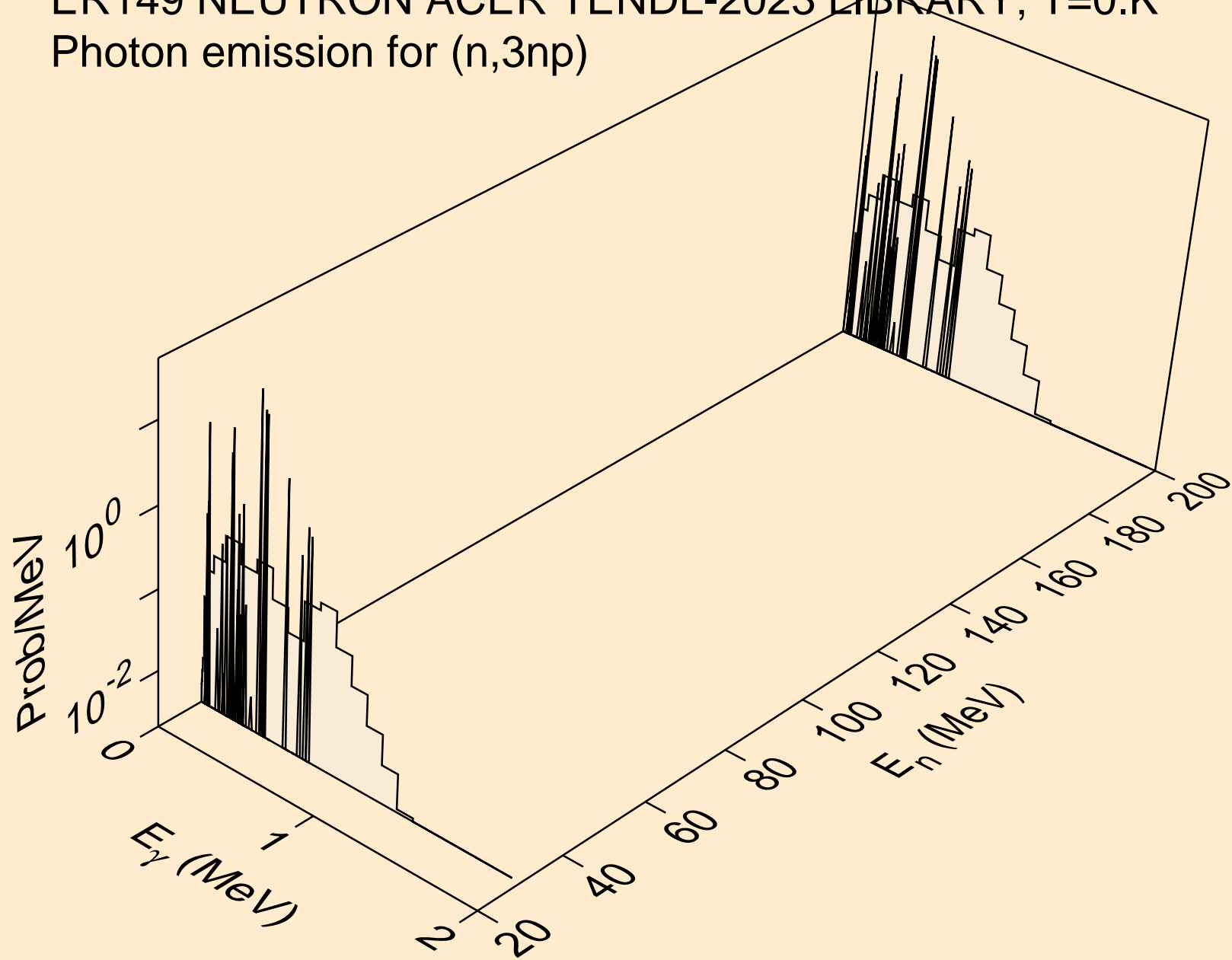

ER149 NEUTRON ACER TENDL-2023 LIBRARY; T=0.K
Photon emission for (n,n2p)

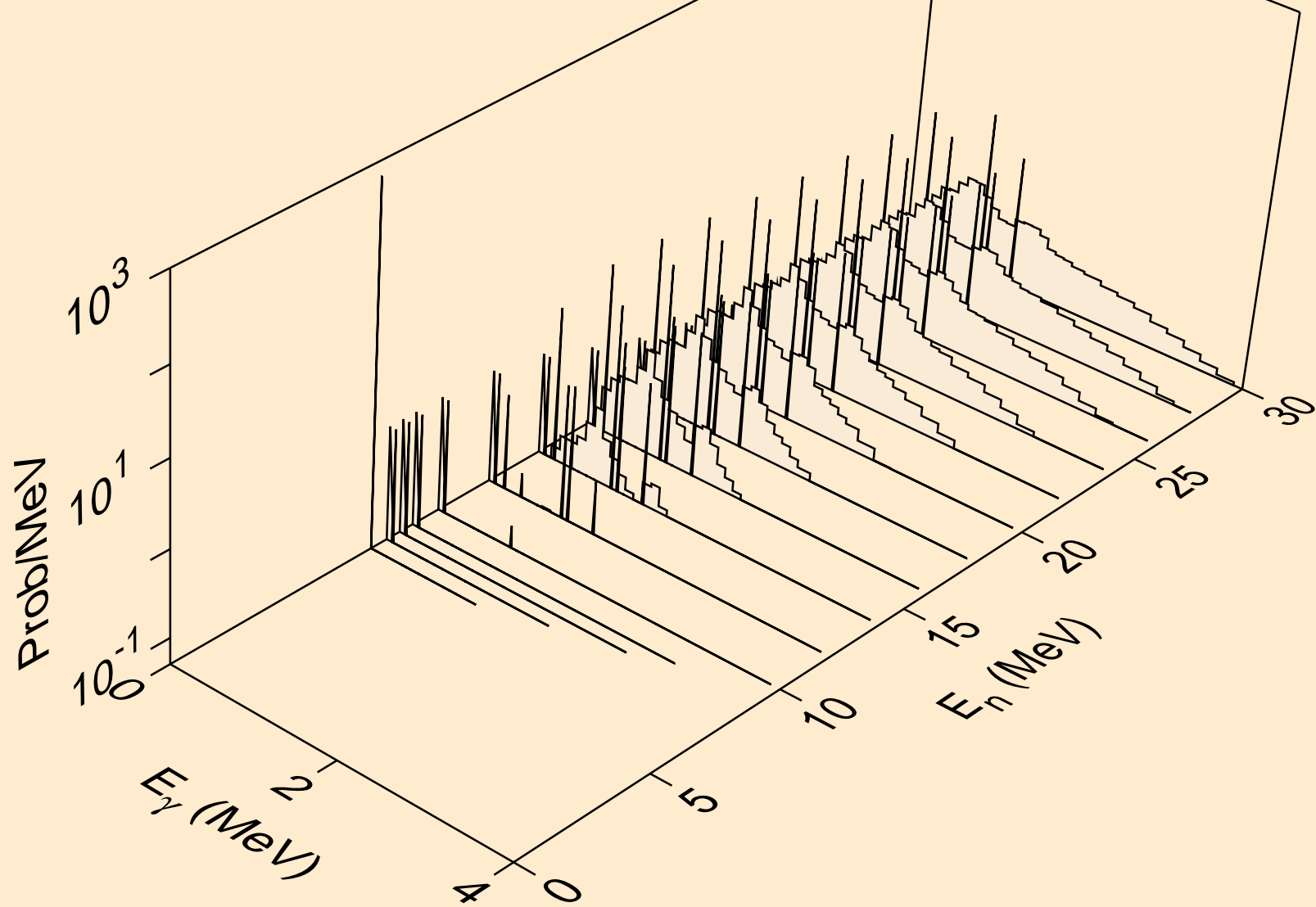

ER149 NEUTRON ACER TENDL-2023 LIBRARY; T=0.K
Photon emission for (n,npa)

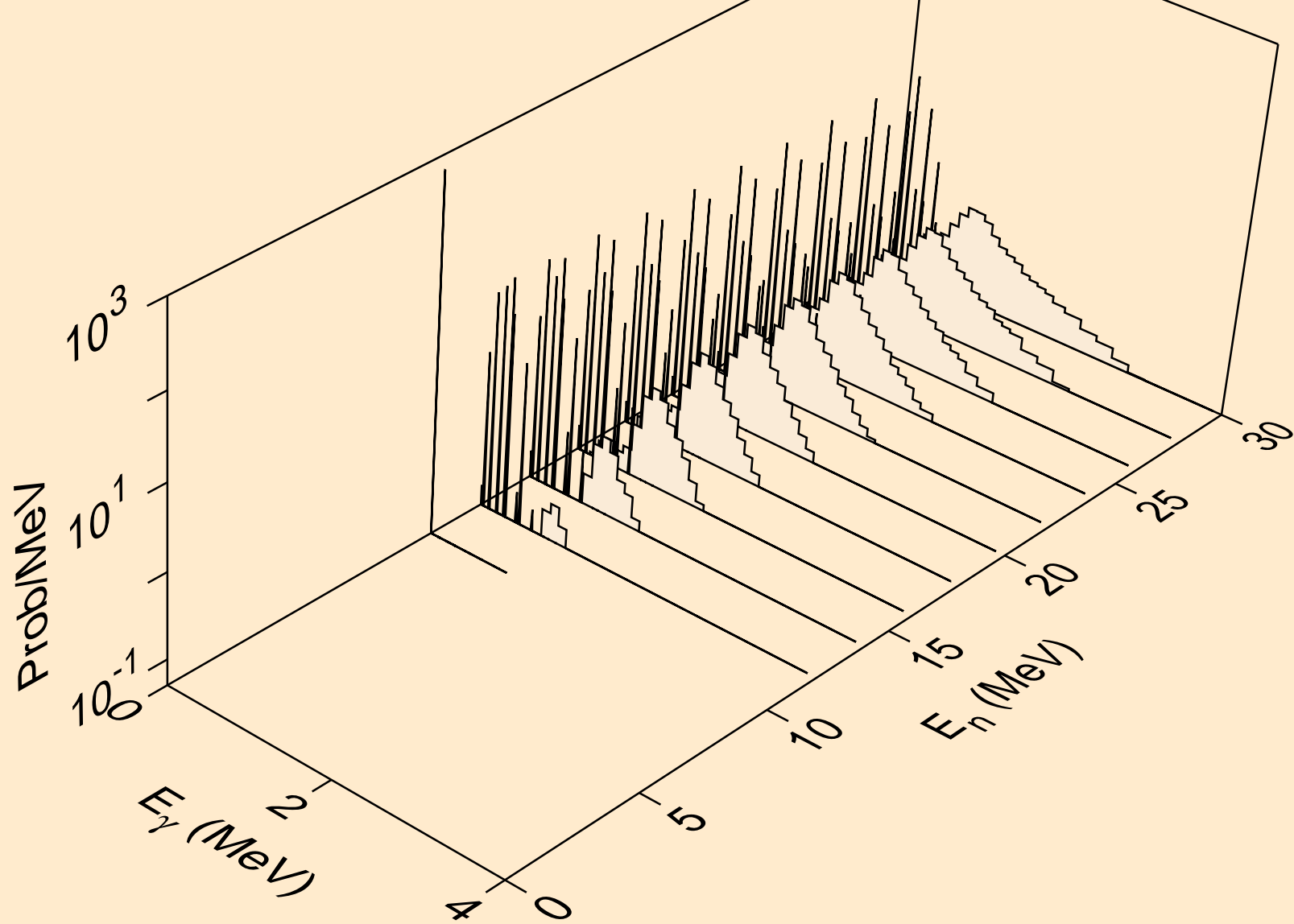

ER149 NEUTRON ACER TENDL-2023 LIBRARY; T=0.K
Photon emission for (n,n*c)

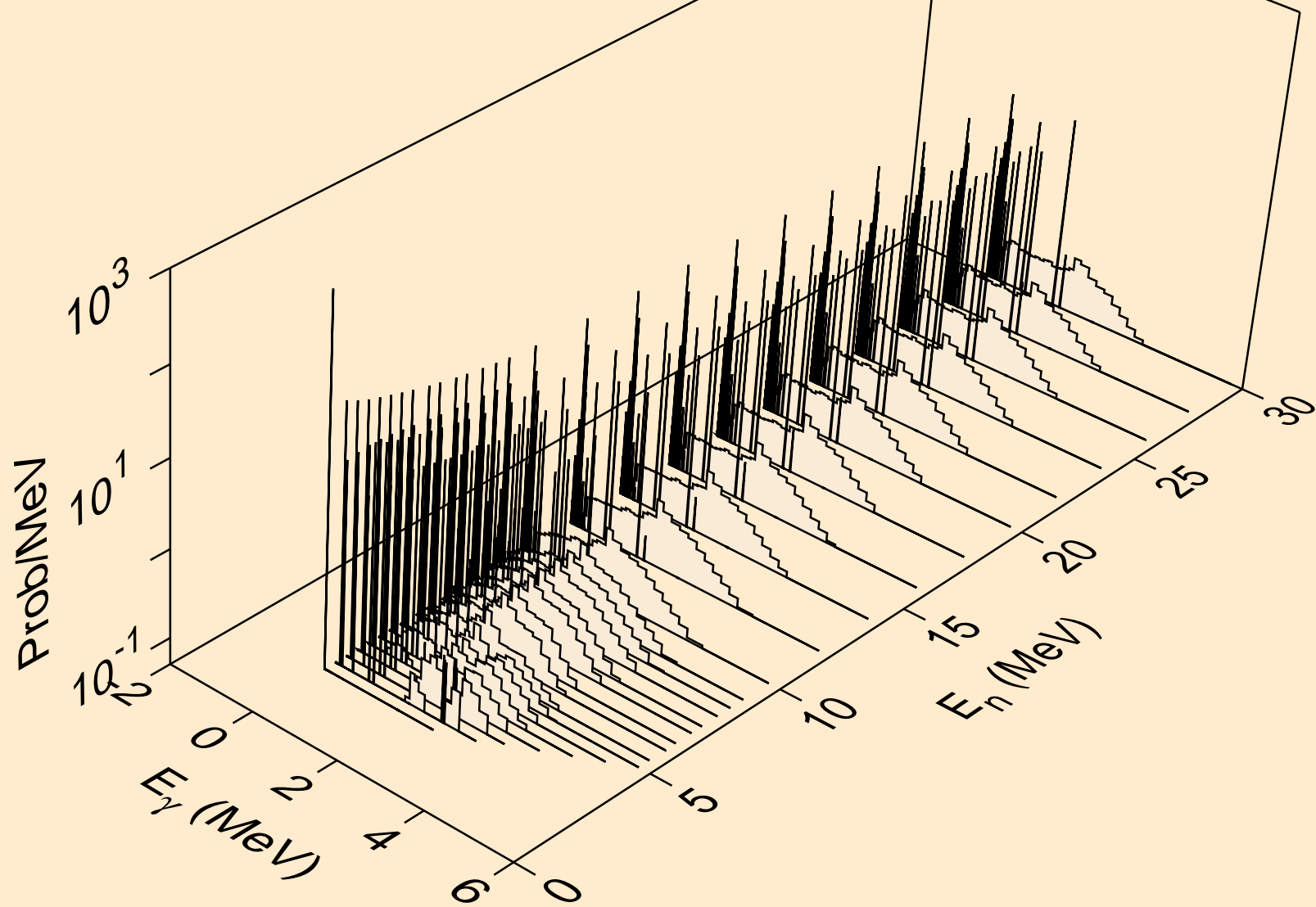

ER149 NEUTRON ACER TENDL-2023 LIBRARY; T=0.K
Photon emission for (n,gma)

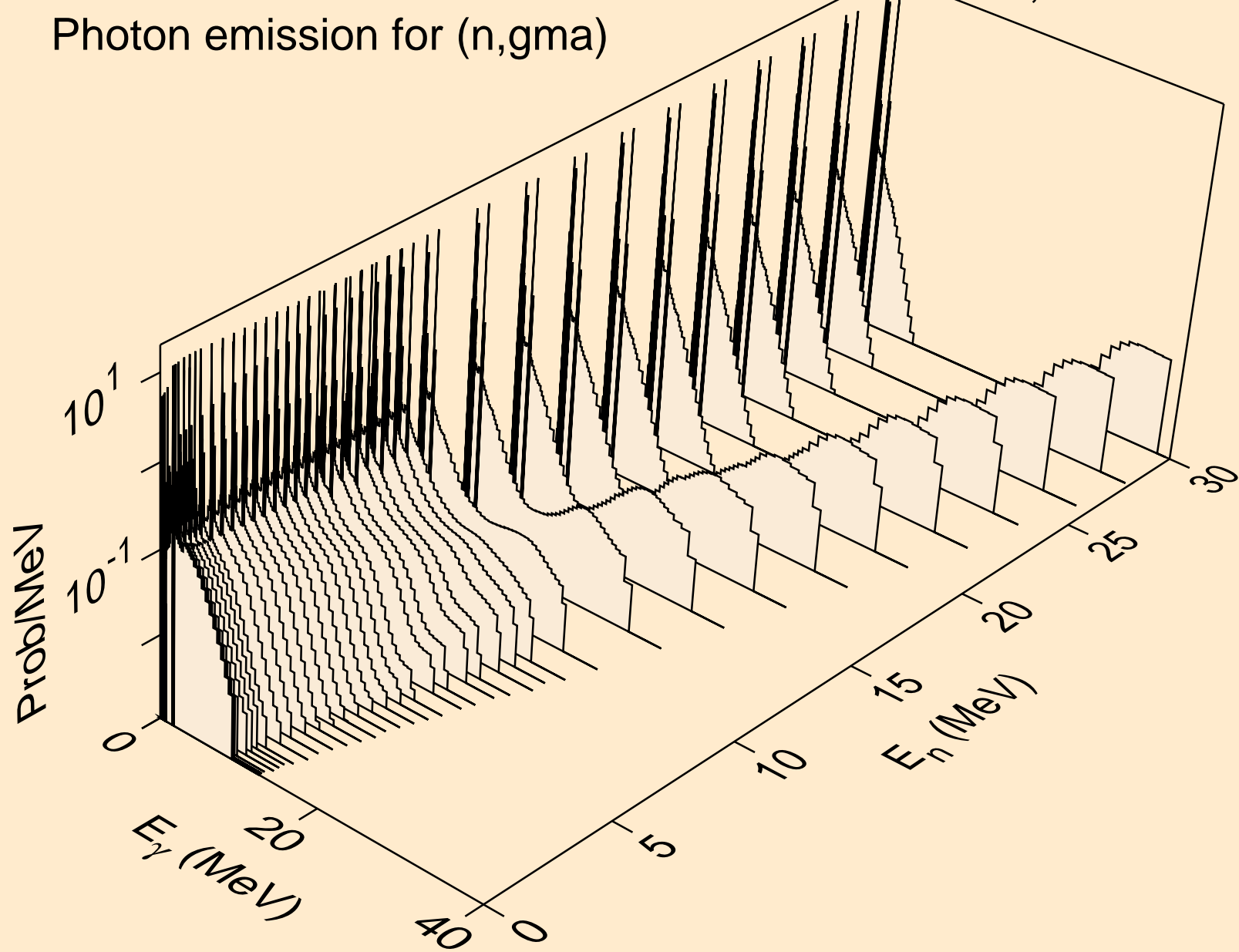

ER149 NEUTRON ACER TENDL-2023 LIBRARY; T=0.K
Photon emission for (n,p)

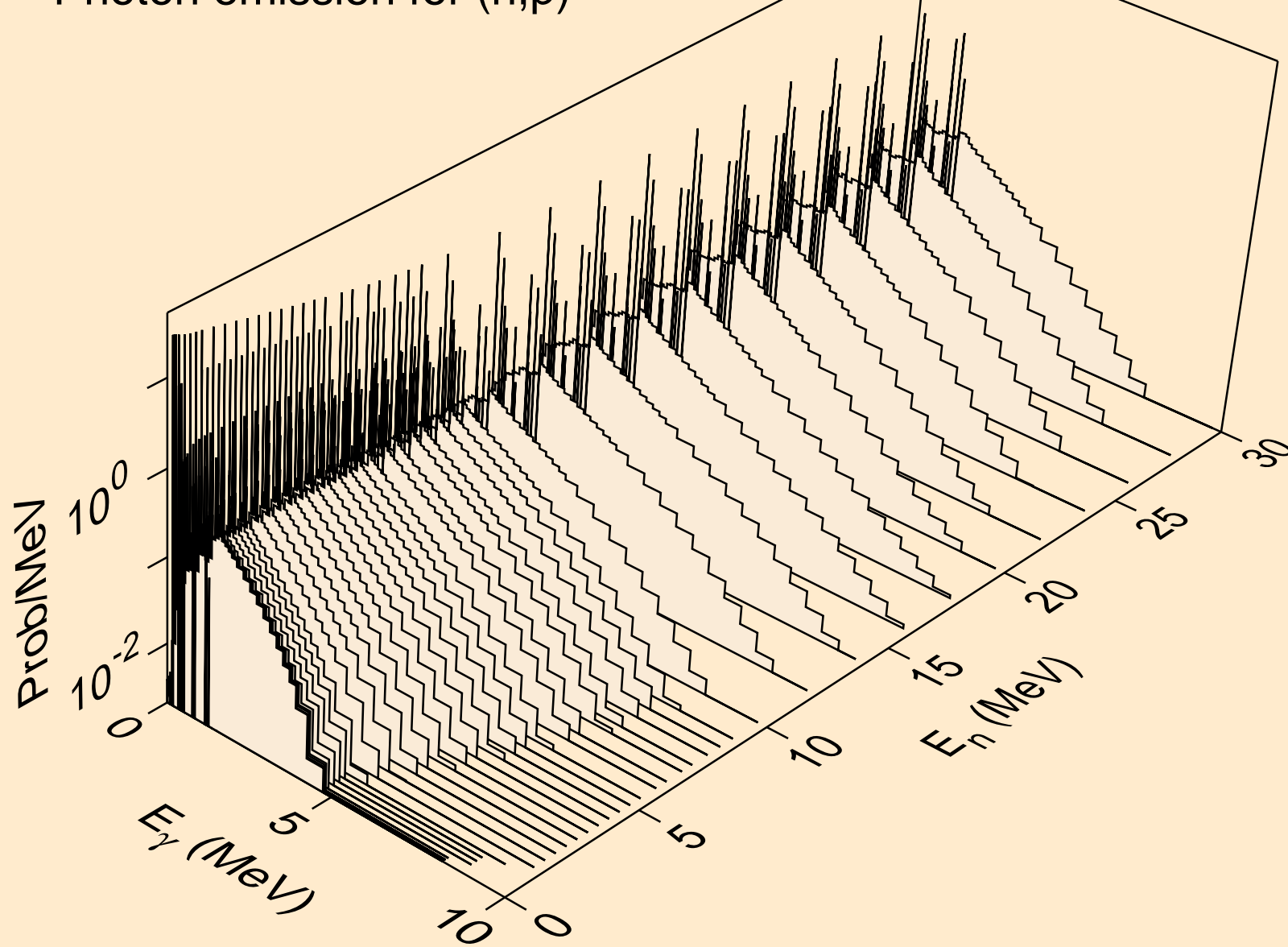

ER149 NEUTRON ACER TENDL-2023 LIBRARY; T=0.K
Photon emission for (n,d)

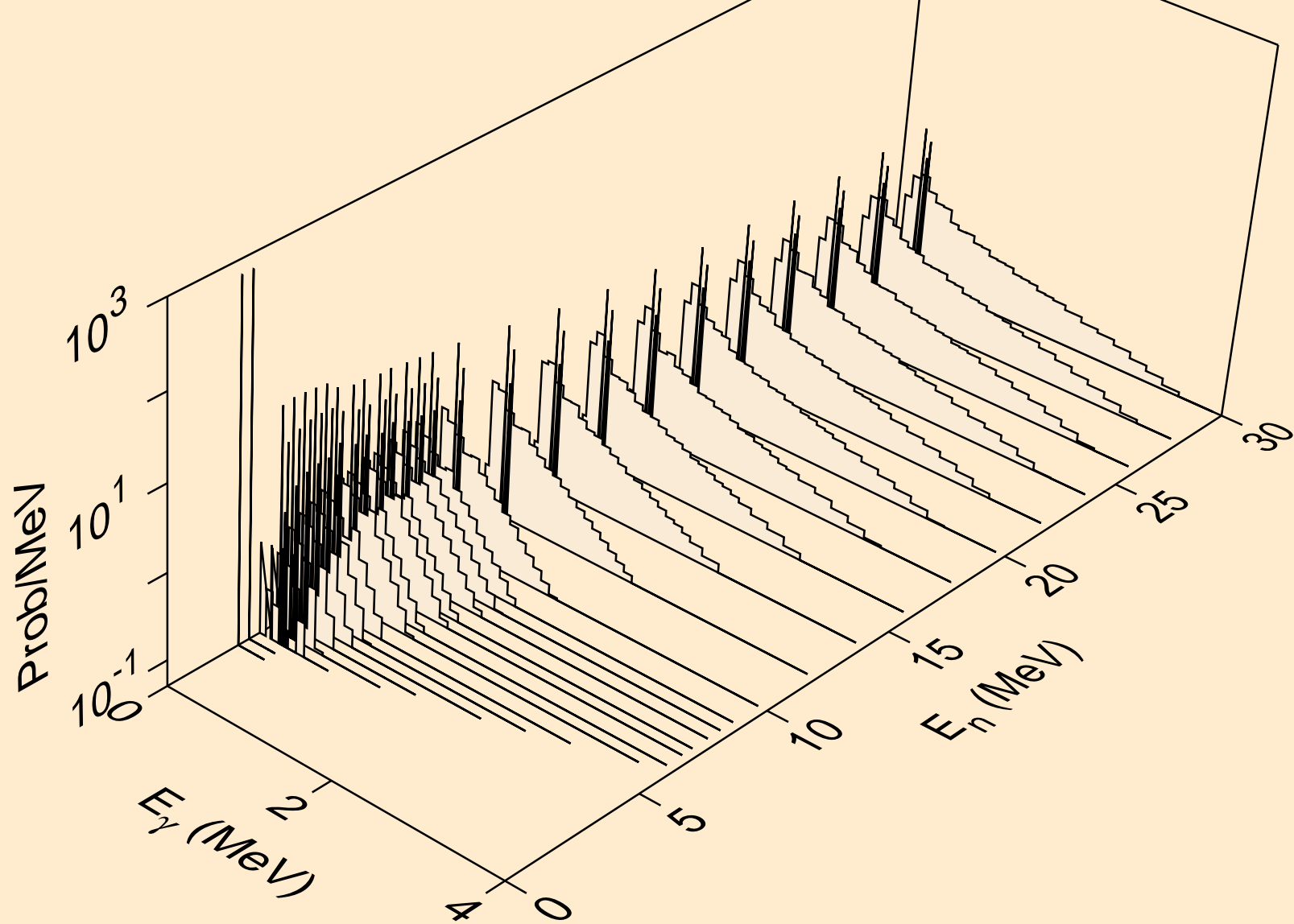

ER149 NEUTRON ACER TENDL-2023 LIBRARY; T=0.K
Photon emission for (n,t)

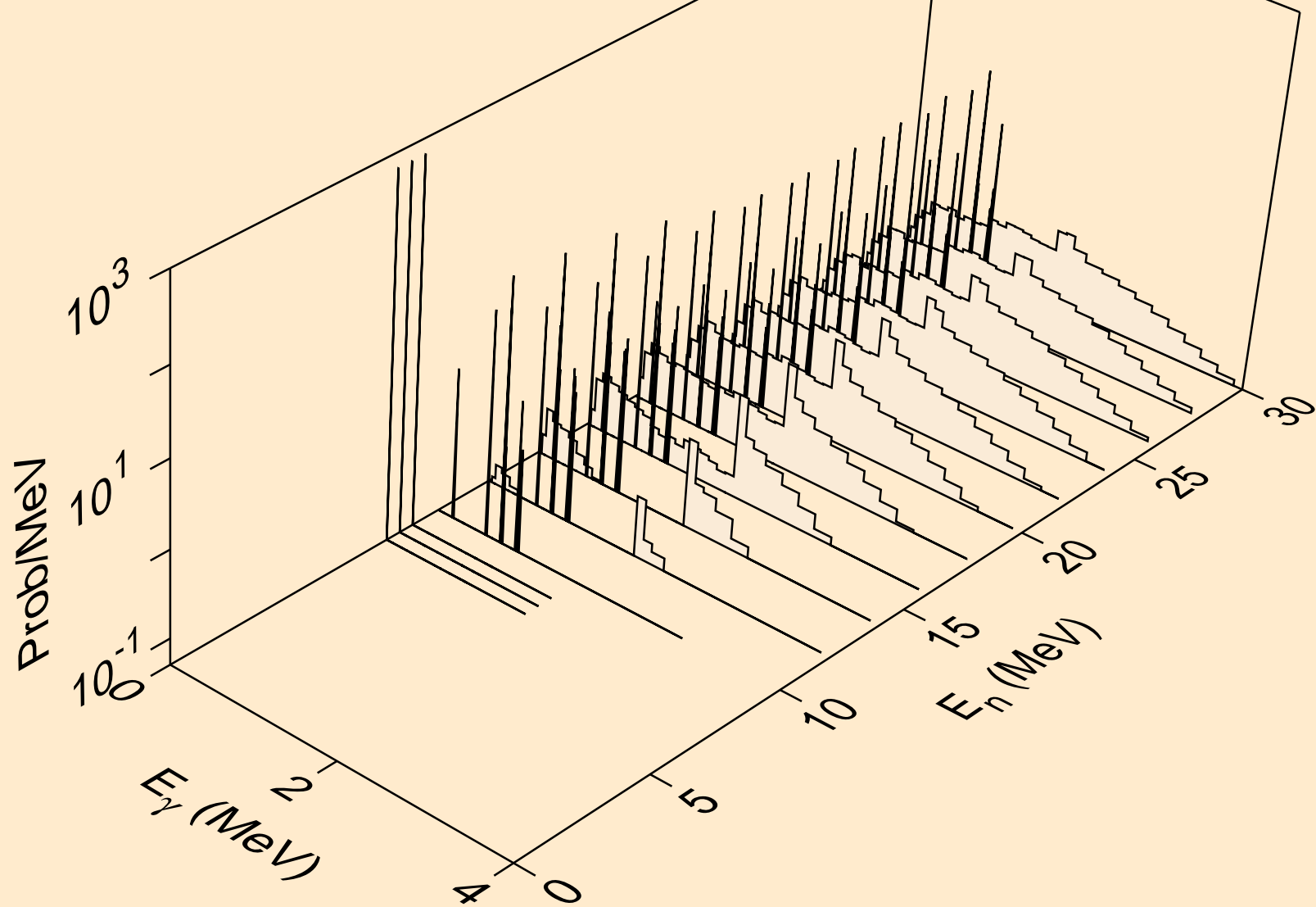

ER149 NEUTRON ACER TENDL-2023 LIBRARY; T=0.K
Photon emission for (n,he3)

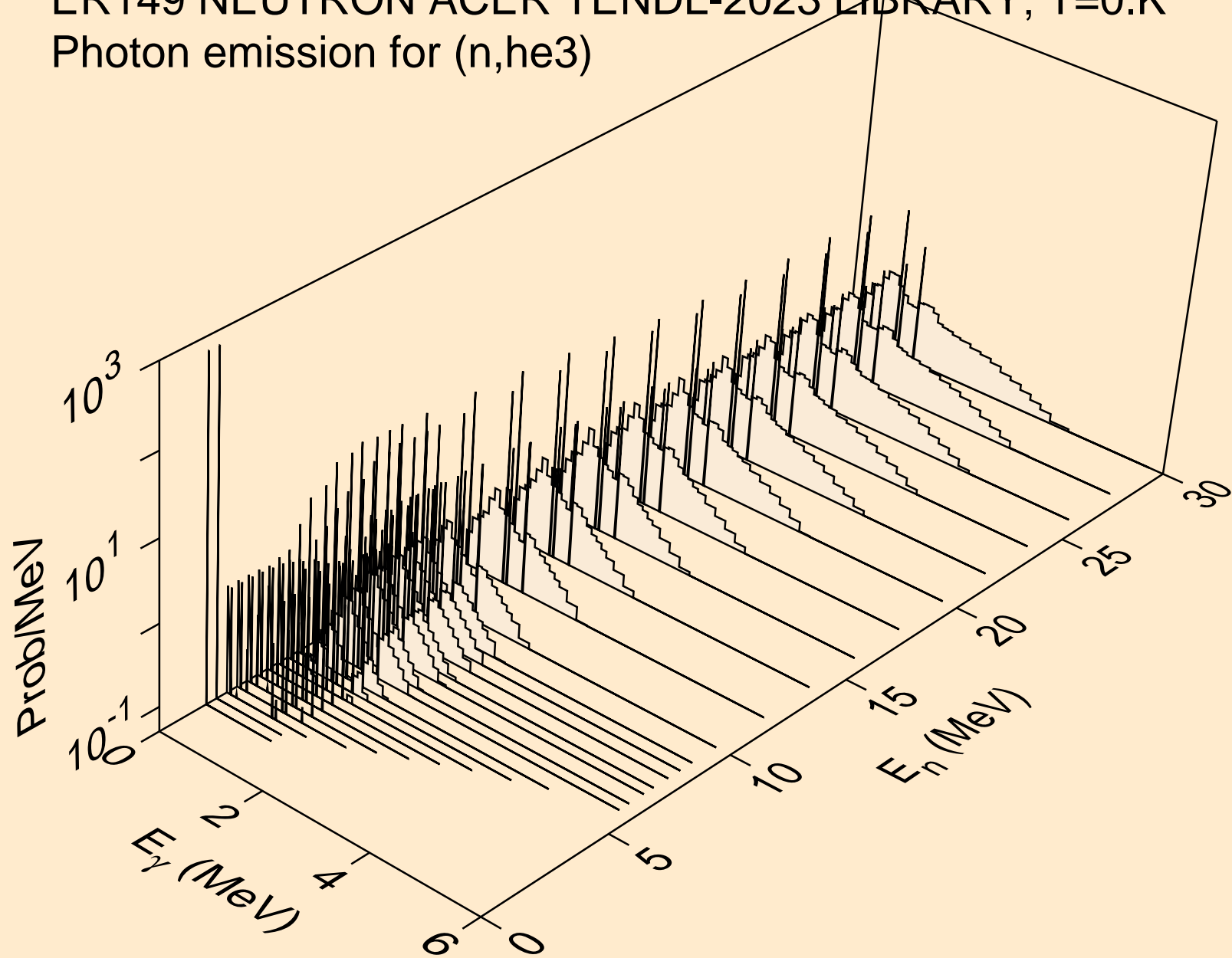

ER149 NEUTRON ACER TENDL-2023 LIBRARY; T=0.K
Photon emission for (n,a)

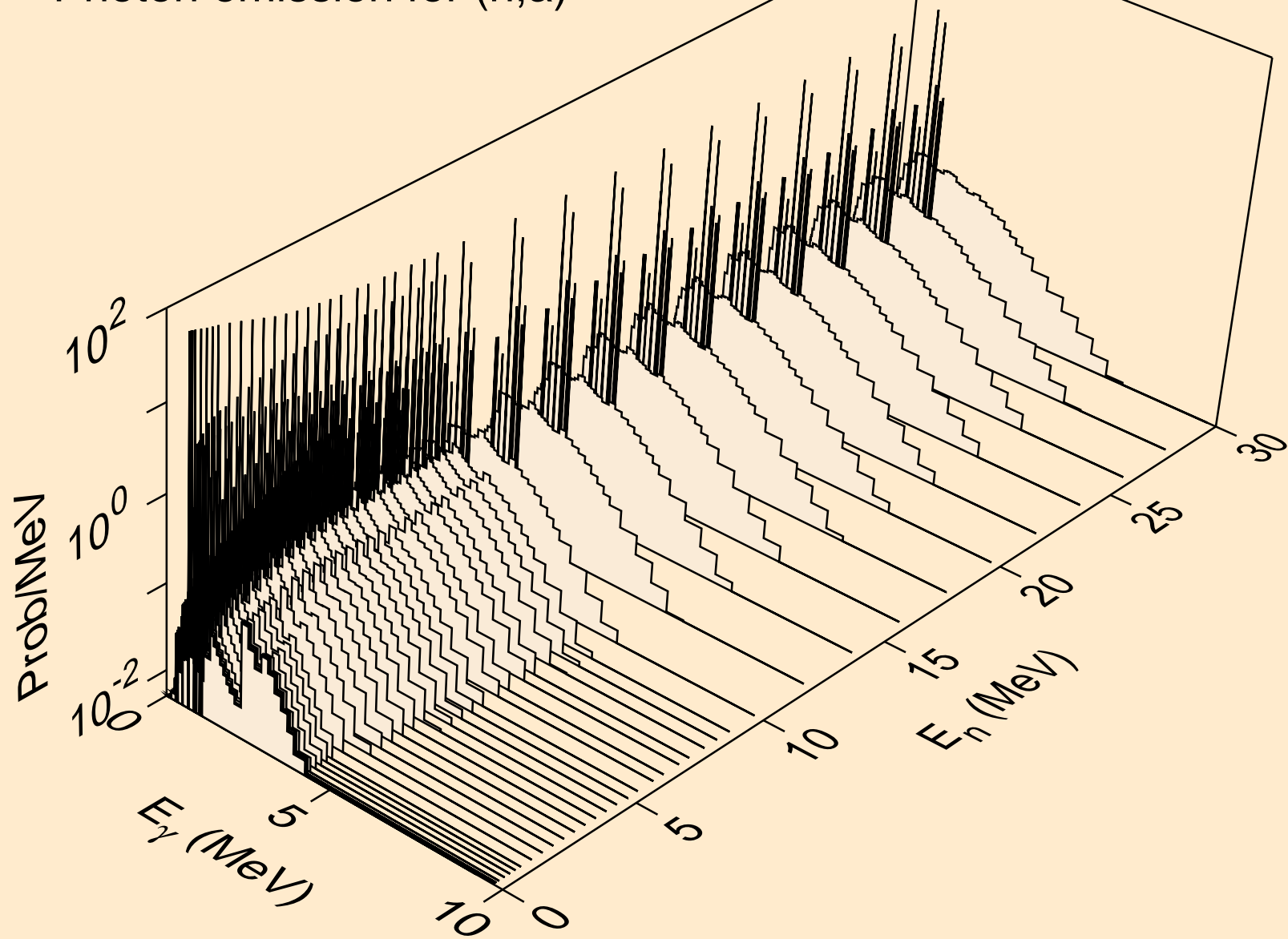

ER149 NEUTRON ACER TENDL-2023 LIBRARY; T=0.K
Photon emission for (n,2a)

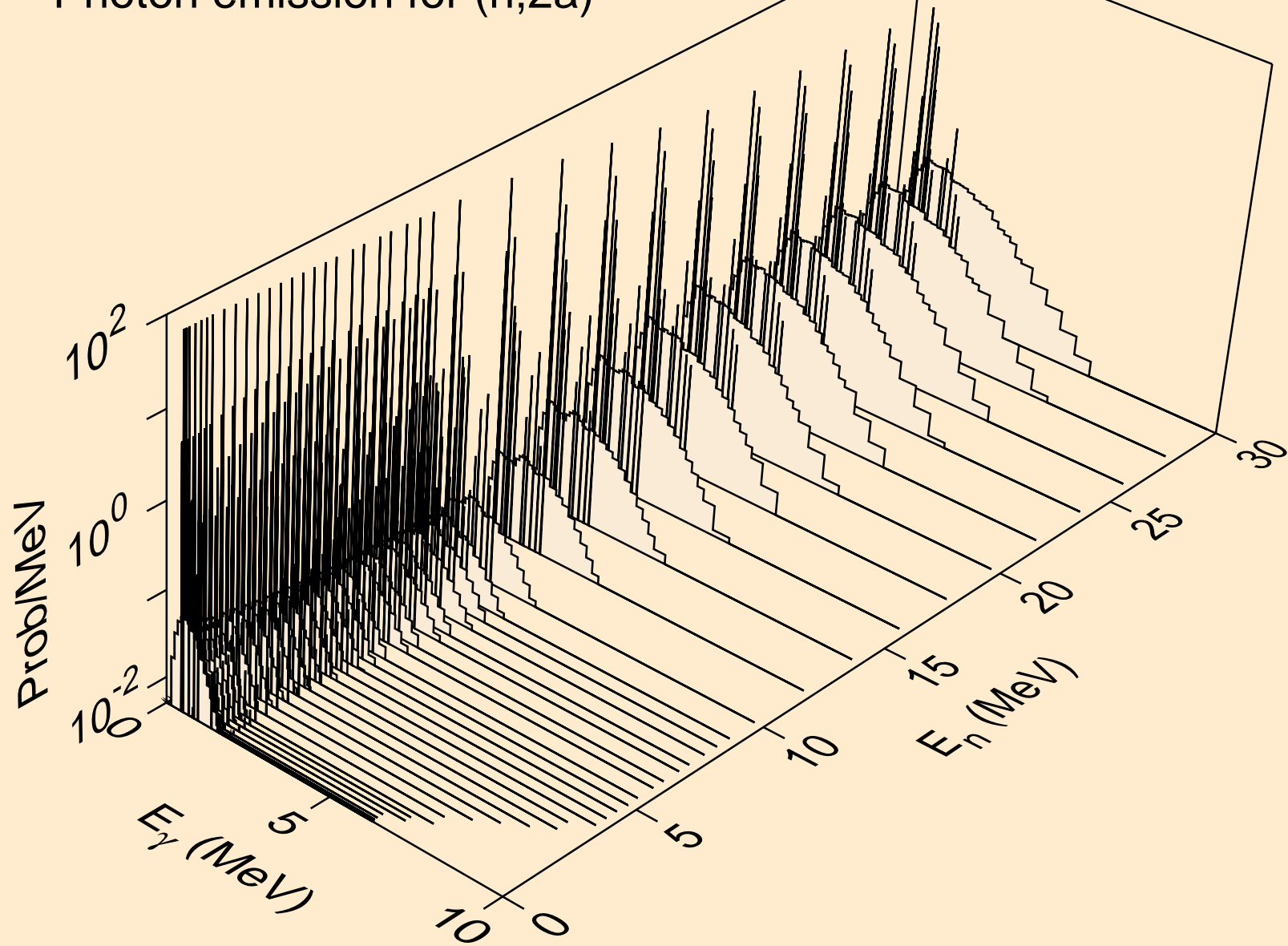

ER149 NEUTRON ACER TENDL-2023 LIBRARY; T=0.K
Photon emission for (n,3a)

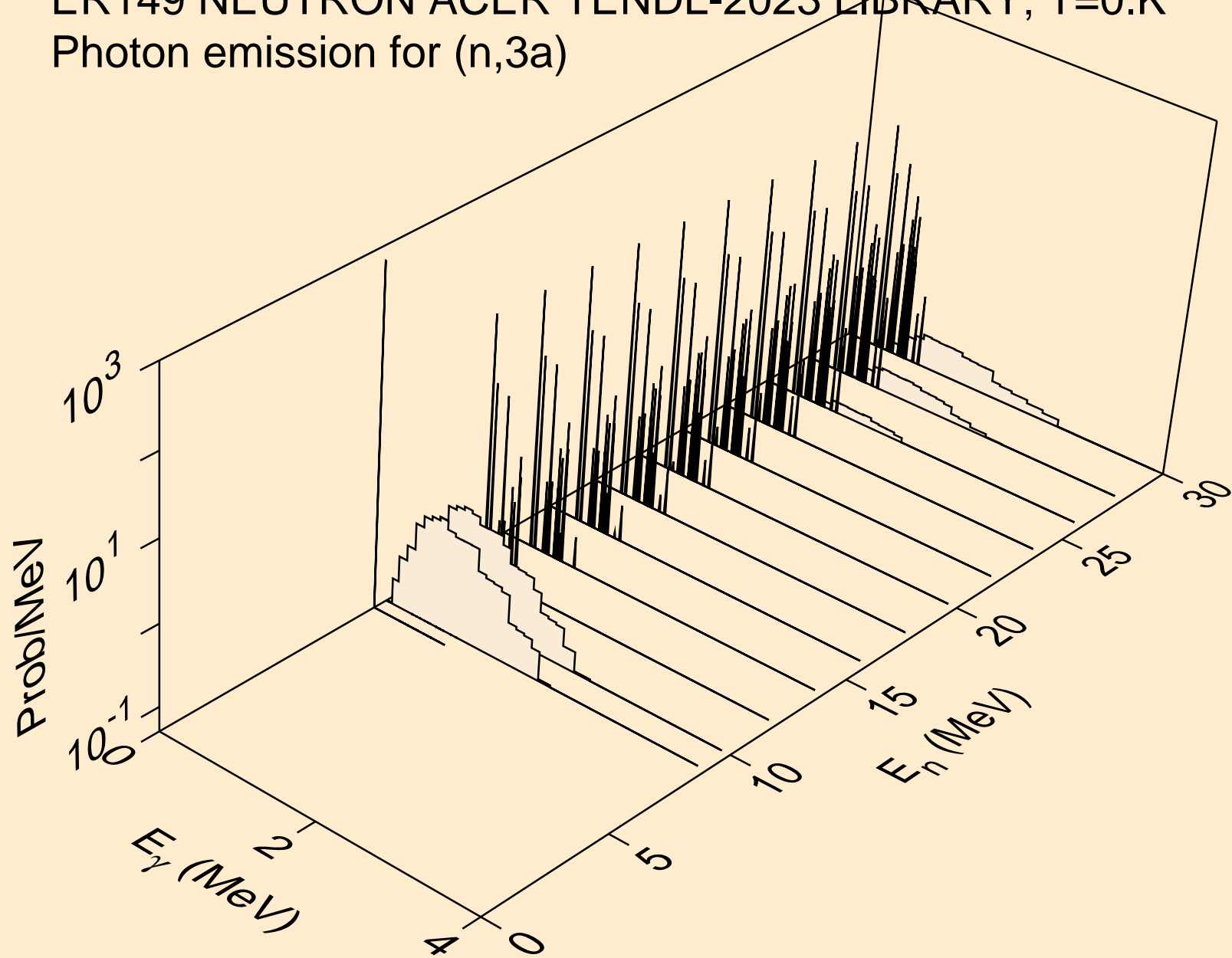

ER149 NEUTRON ACER TENDL-2023 LIBRARY; T=0.K
Photon emission for (n,2p)

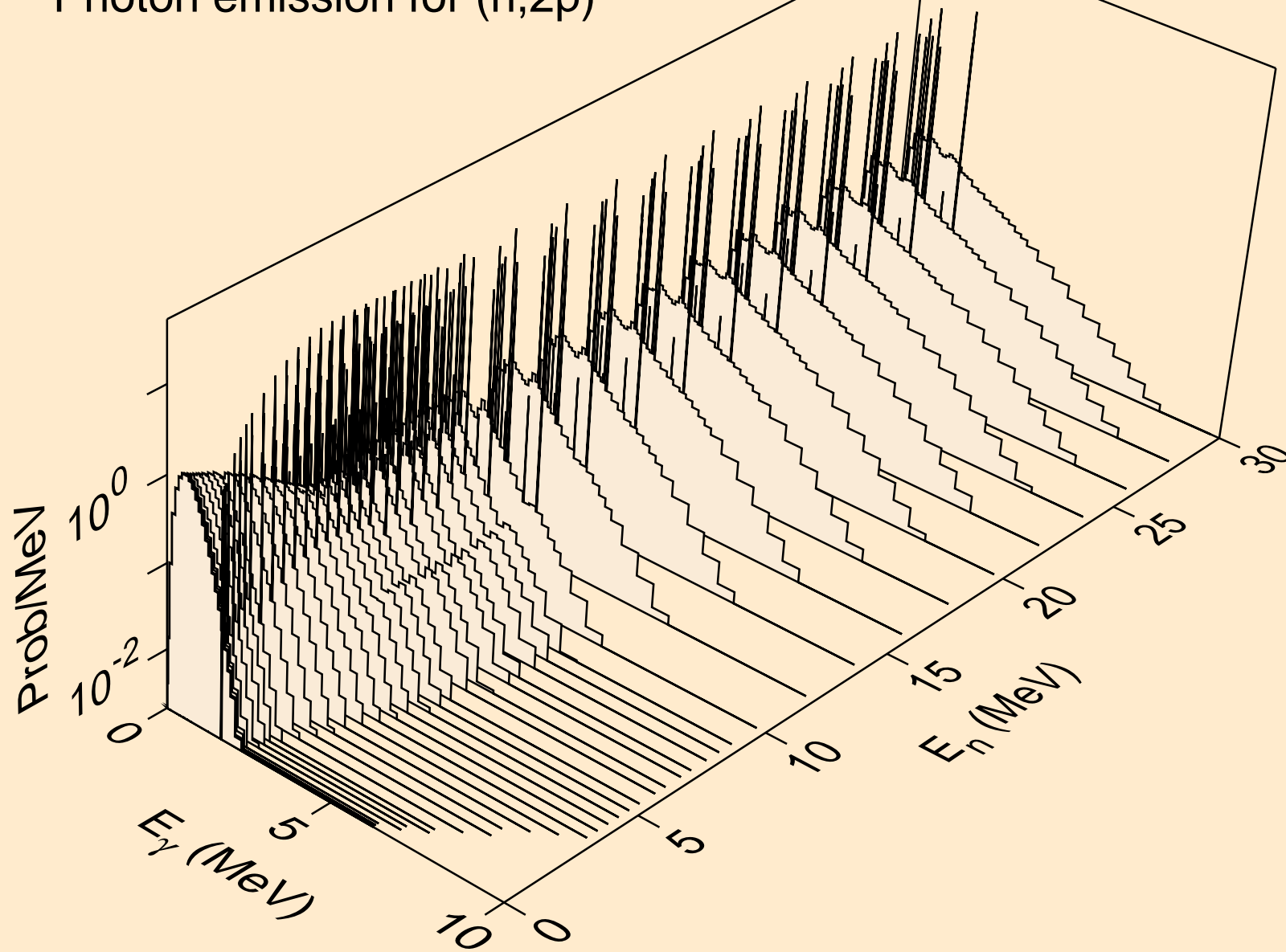

ER149 NEUTRON ACER TENDL-2023 LIBRARY; T=0.K
Photon emission for (n,p α)

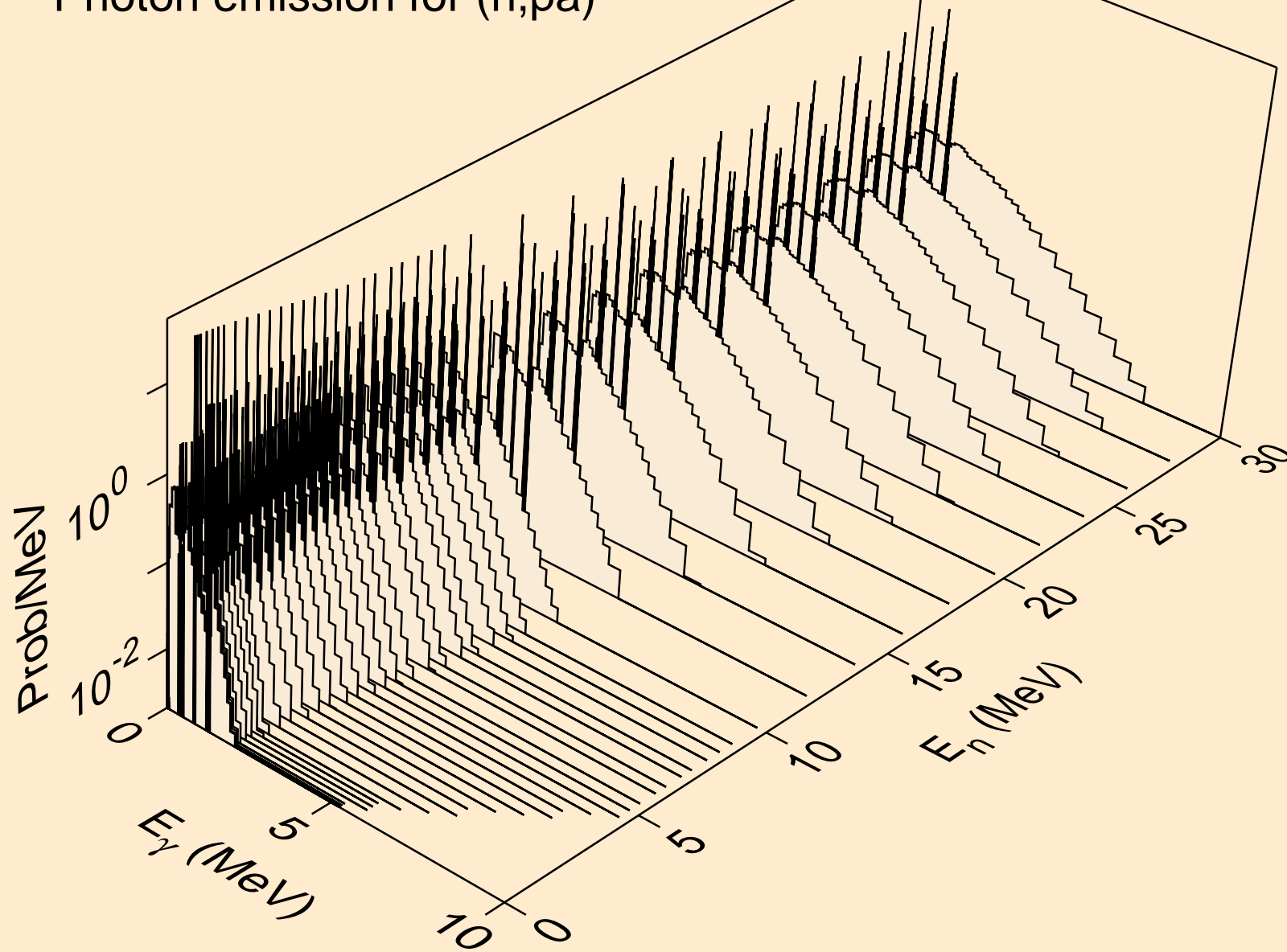

ER149 NEUTRON ACER TENDL-2023 LIBRARY; T=0.K
Photon emission for (n,pd)



ER149 NEUTRON ACER TENDL-2023 LIBRARY; T=0.K
Photon emission for (n,pt)

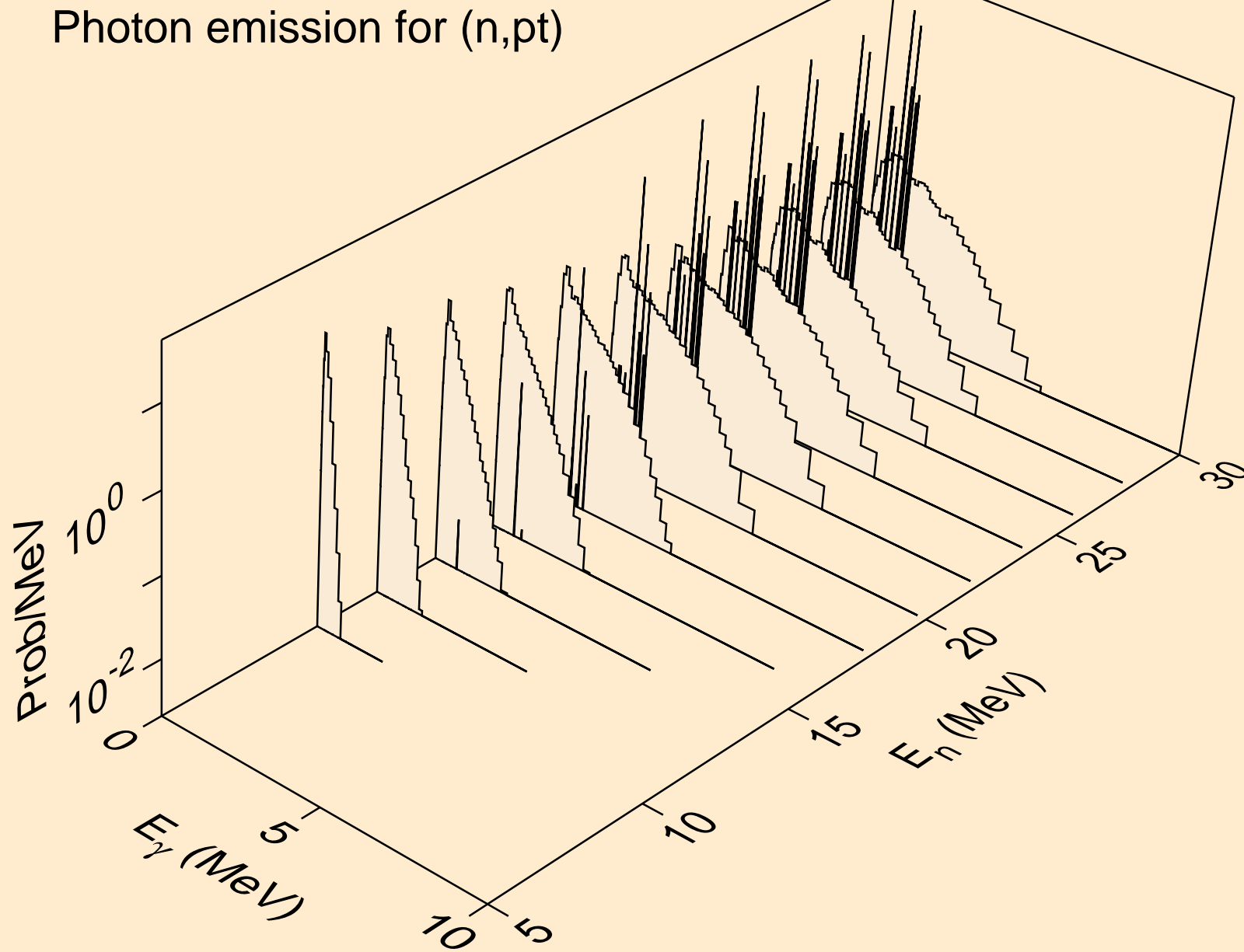

ER149 NEUTRON ACER TENDL-2023 LIBRARY; T=0.K
Photon emission for (n,da)

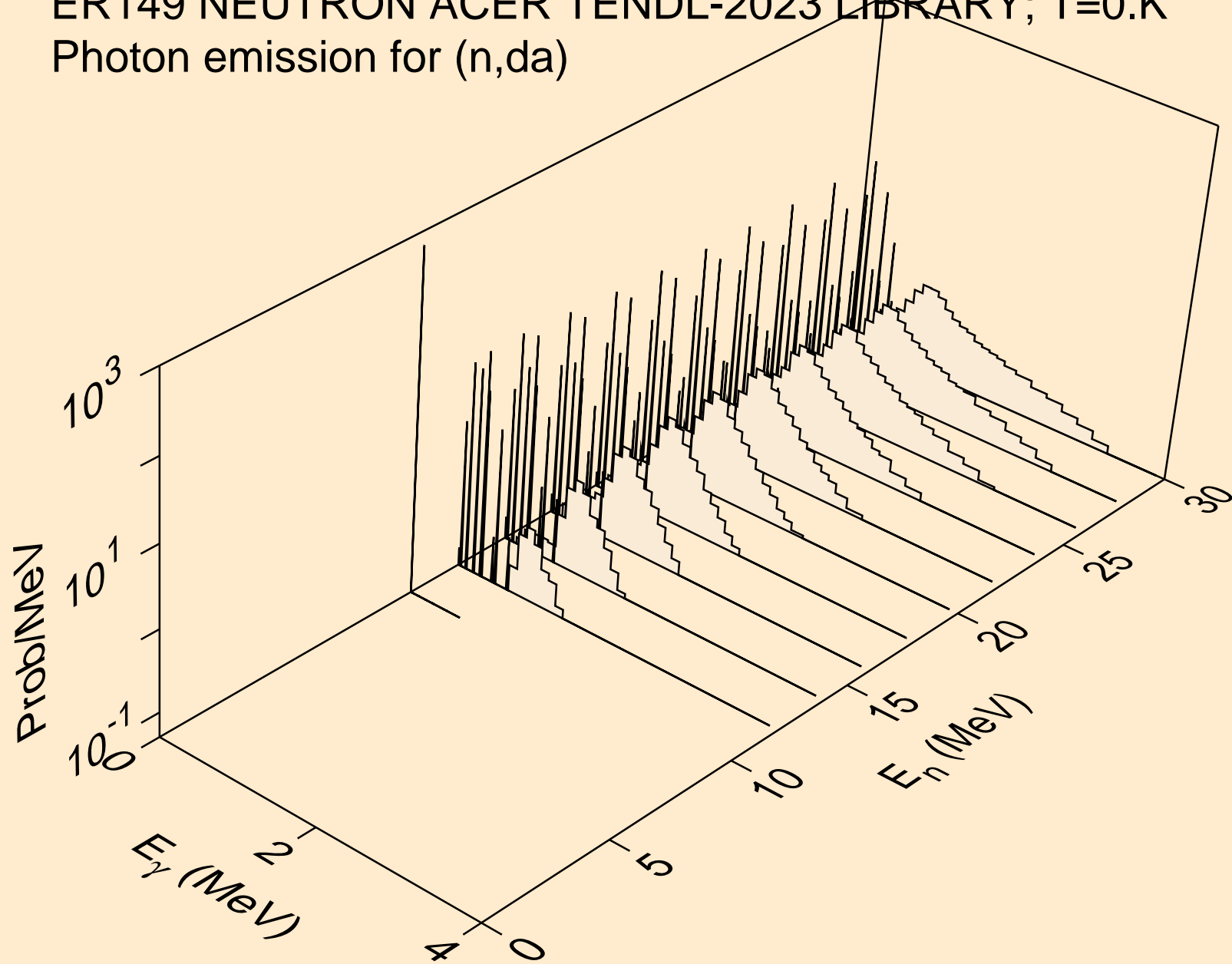

ER149 NEUTRON ACER TENDL-2023 LIBRARY; T=0.K
thermal capture photon spectrum

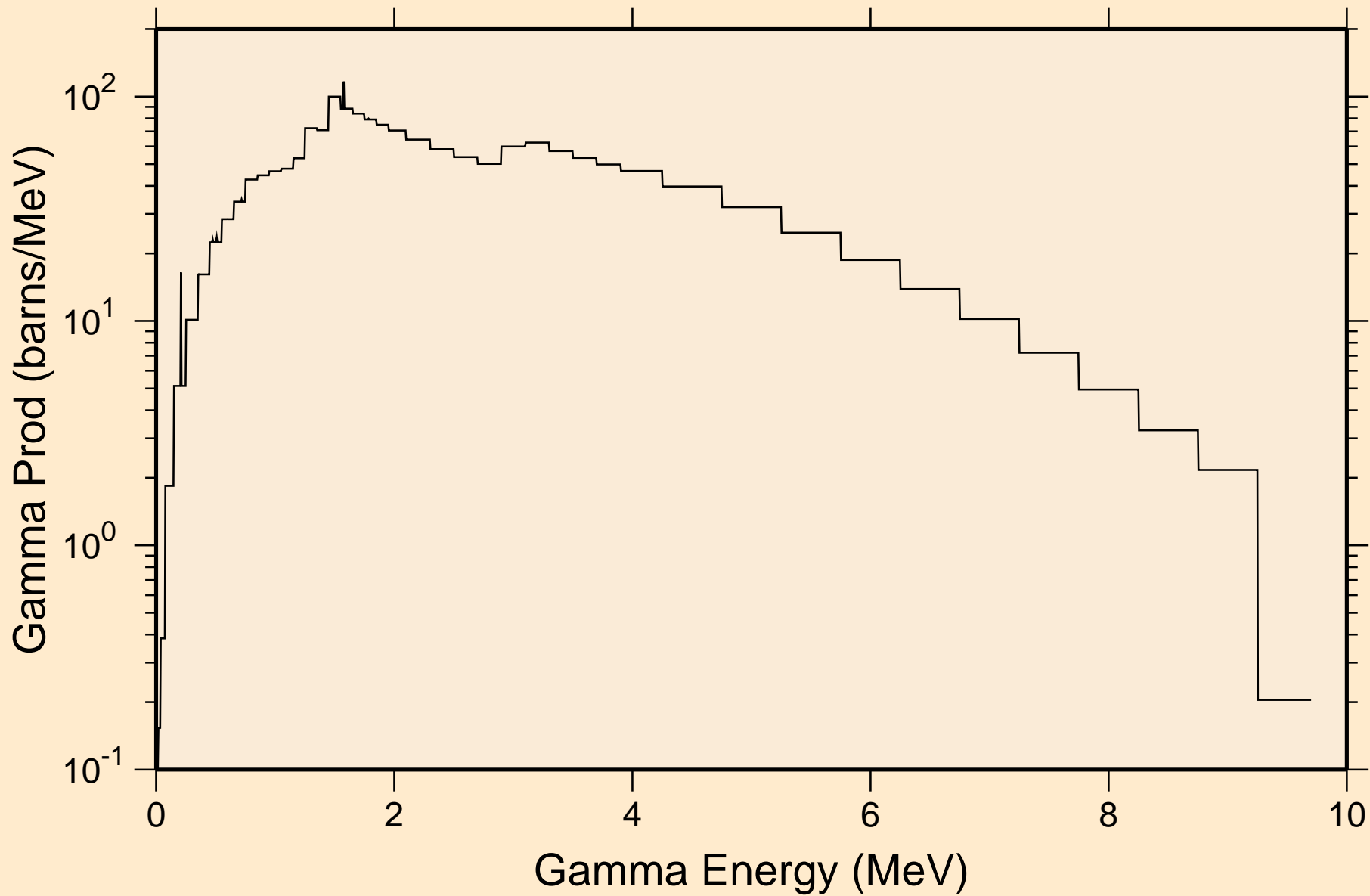

ER149 NEUTRON ACER TENDL-2023 LIBRARY; T=0.K
14 MeV photon spectrum

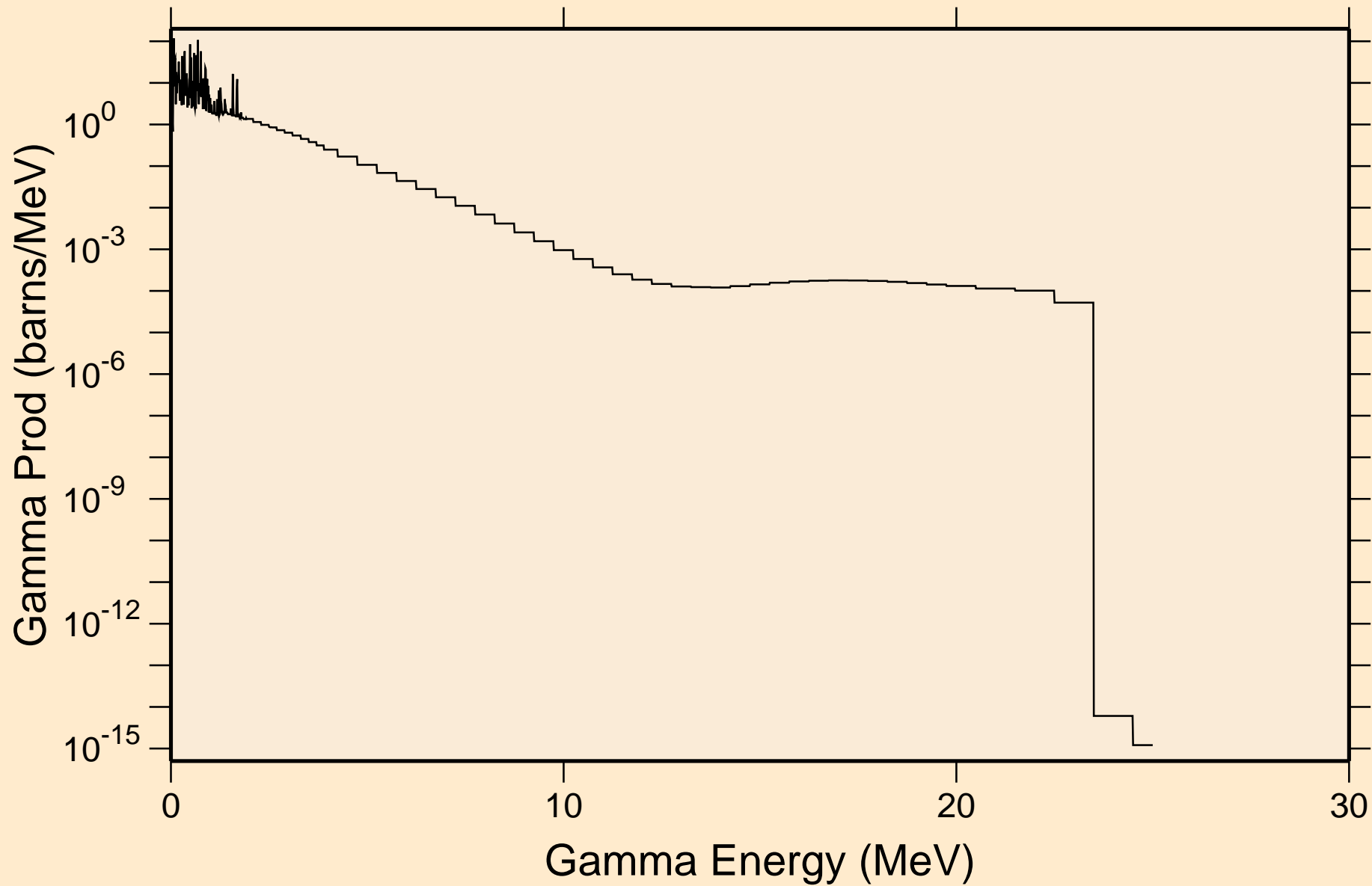

ER149 NEUTRON ACER TENDL-2023 LIBRARY; T=0.K

Particle heating contributions

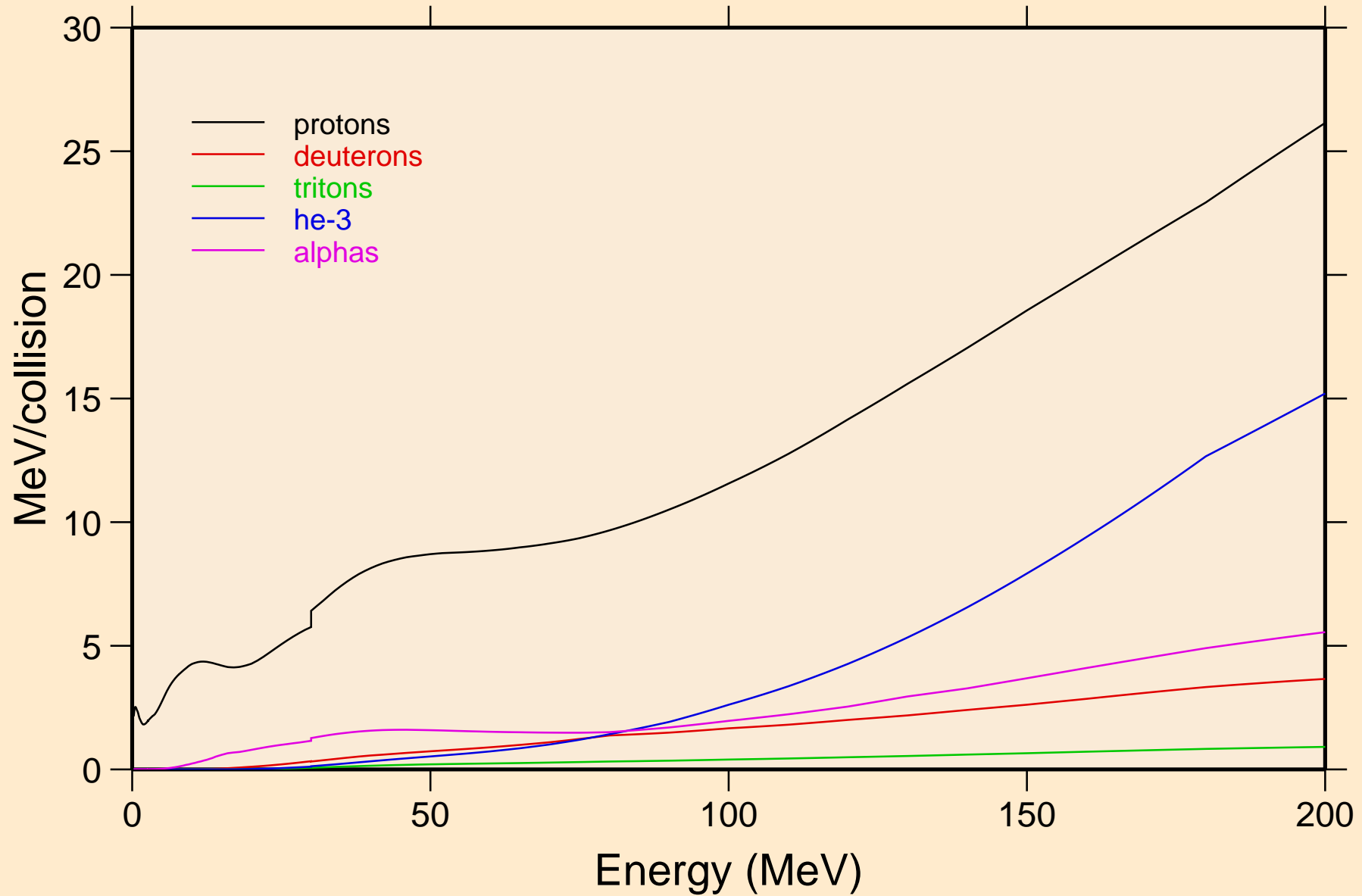

ER149 NEUTRON ACER TENDL-2023 LIBRARY; T=0.K
Recoil Heating

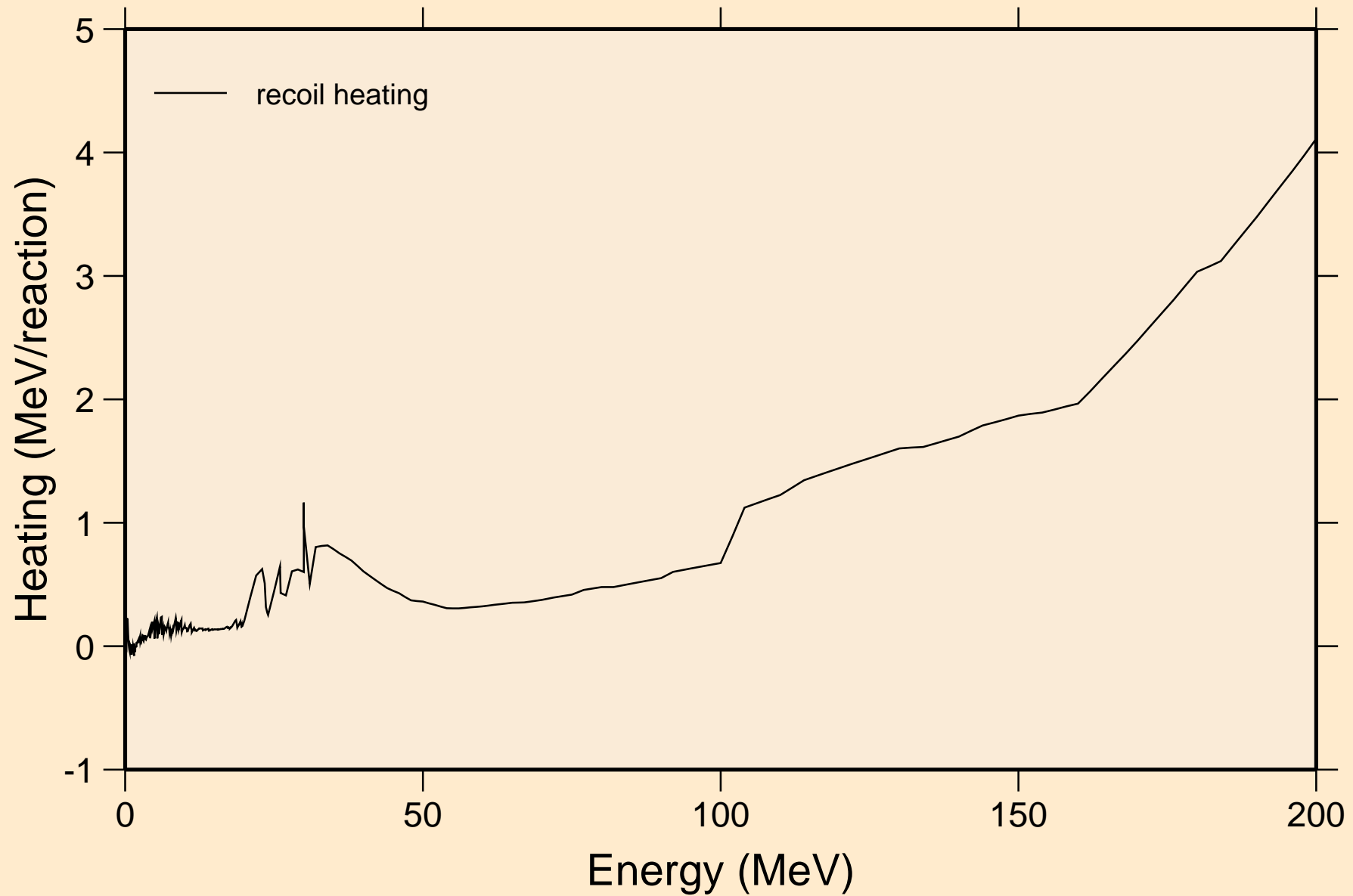

ER149 NEUTRON ACER TENDL-2023 LIBRARY; T=0.K

Particle production cross sections

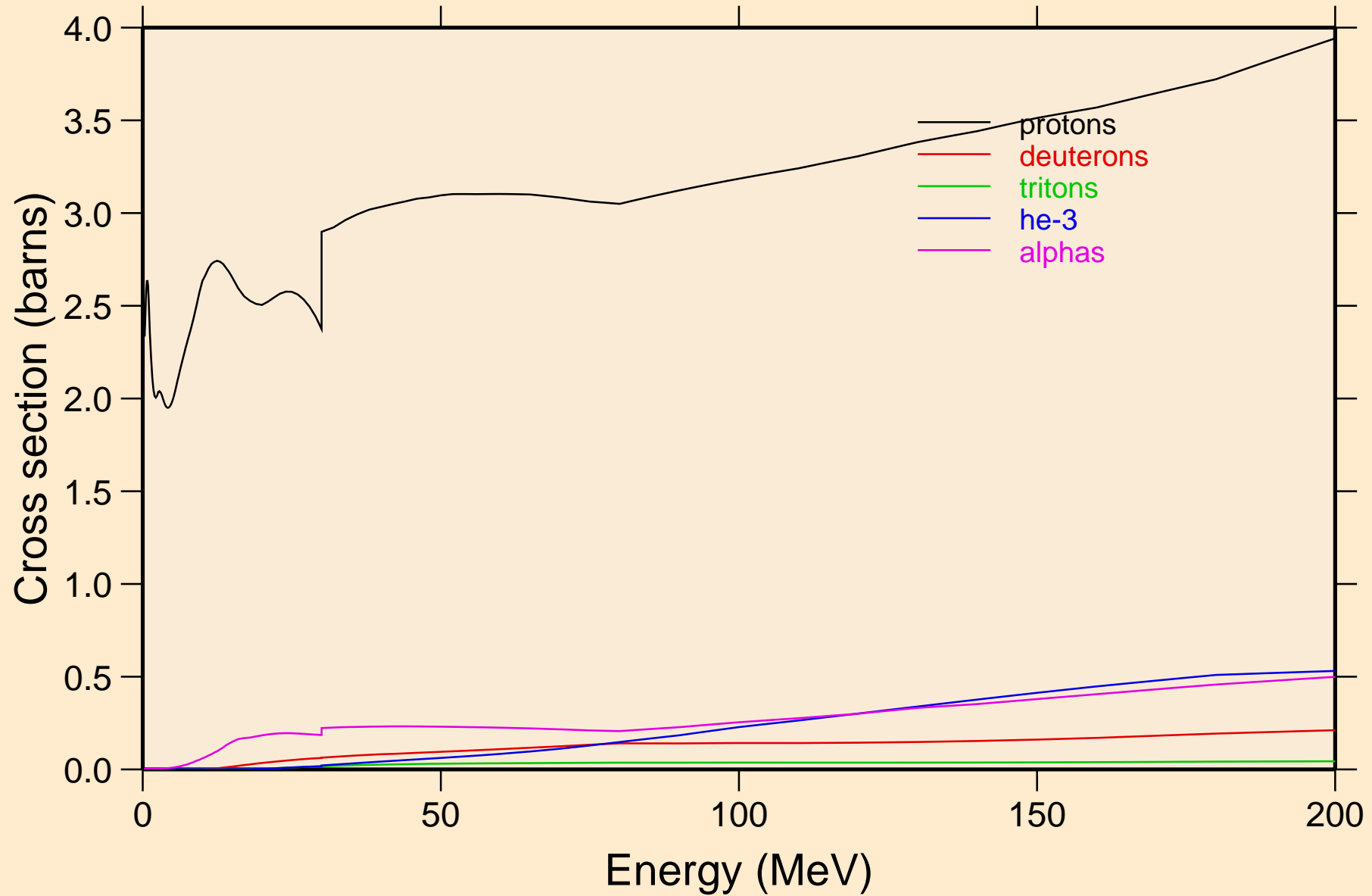

ER149 NEUTRON ACER TENDL-2023 LIBRARY; T=0.K
protons from (n,x)

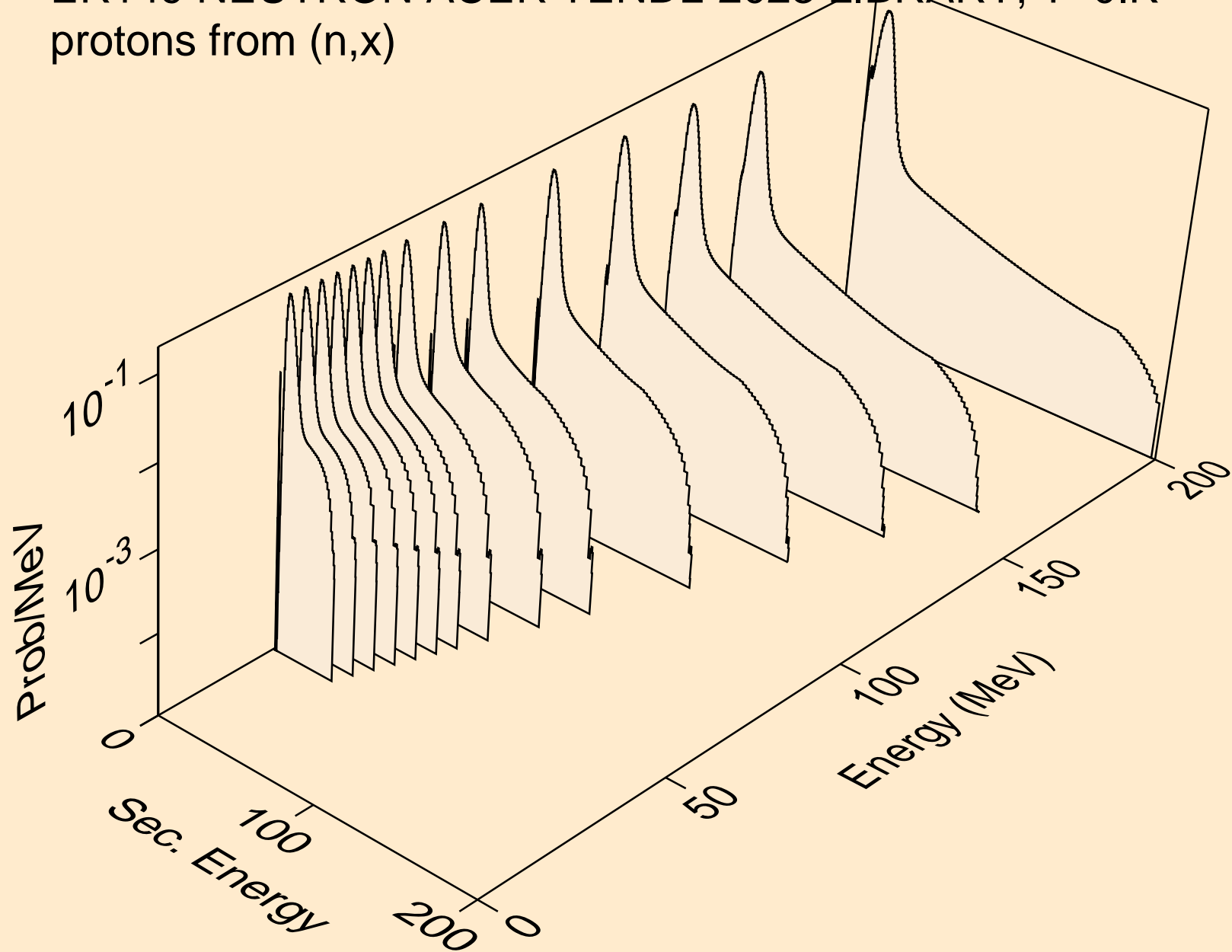

ER149 NEUTRON ACER TENDL-2023 LIBRARY; T=0.K
protons from (n,n*)p

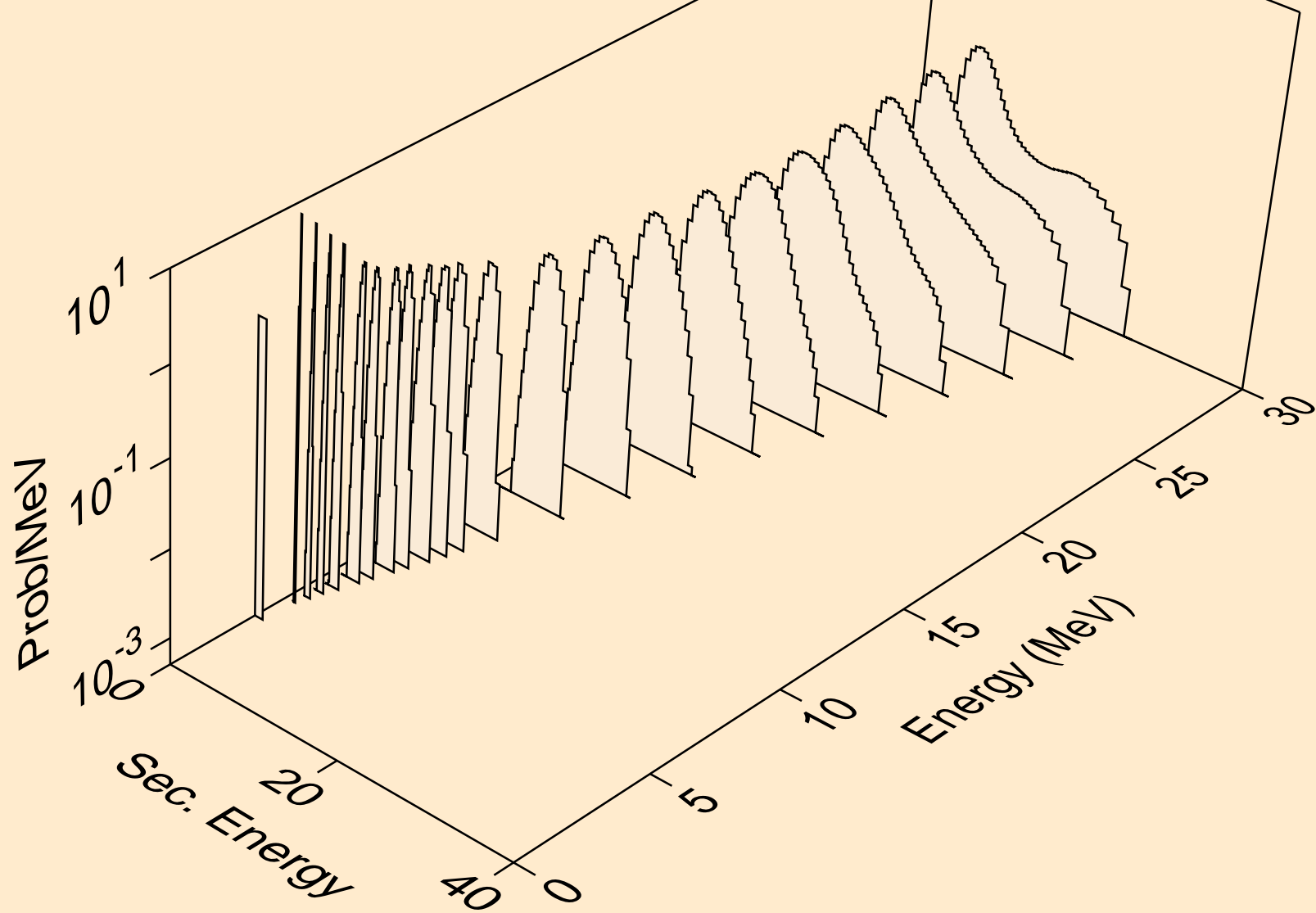

ER149 NEUTRON ACER TENDL-2023 LIBRARY; T=0.K
protons from (n,2np)

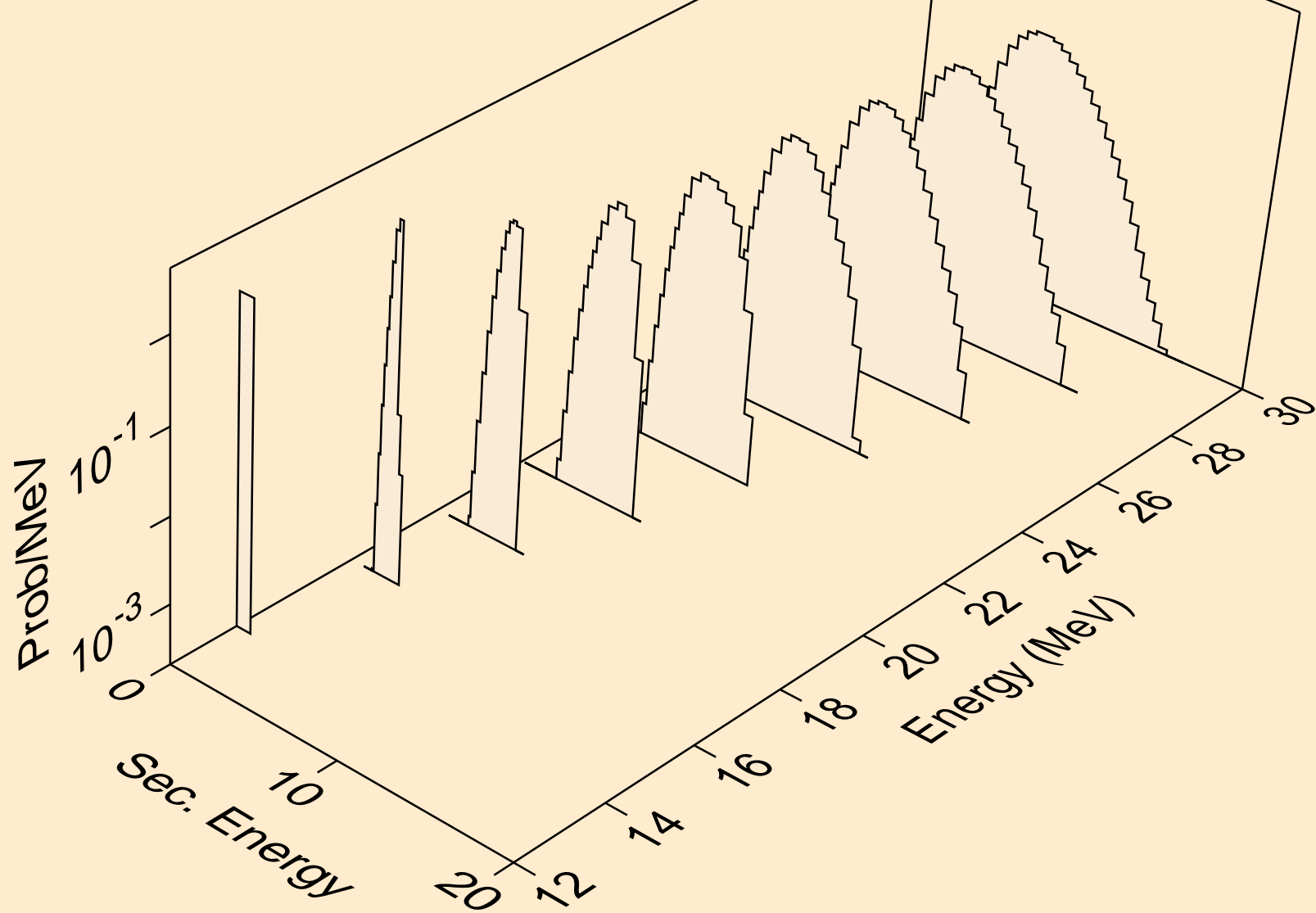

ER149 NEUTRON ACER TENDL-2023 LIBRARY; T=0.K
protons from (n,3np)

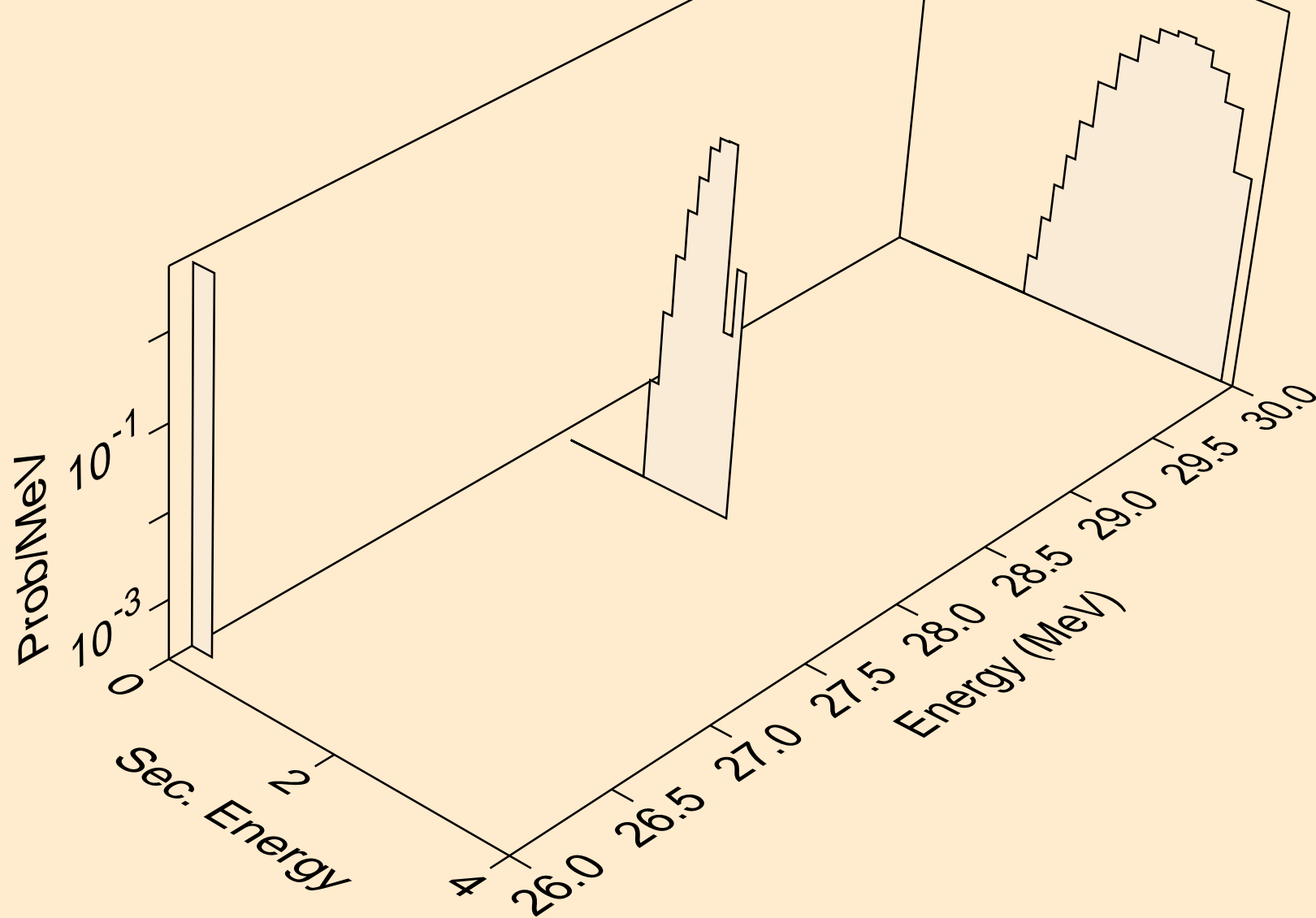

ER149 NEUTRON ACER TENDL-2023 LIBRARY; T=0.K
protons from (n,n2p)

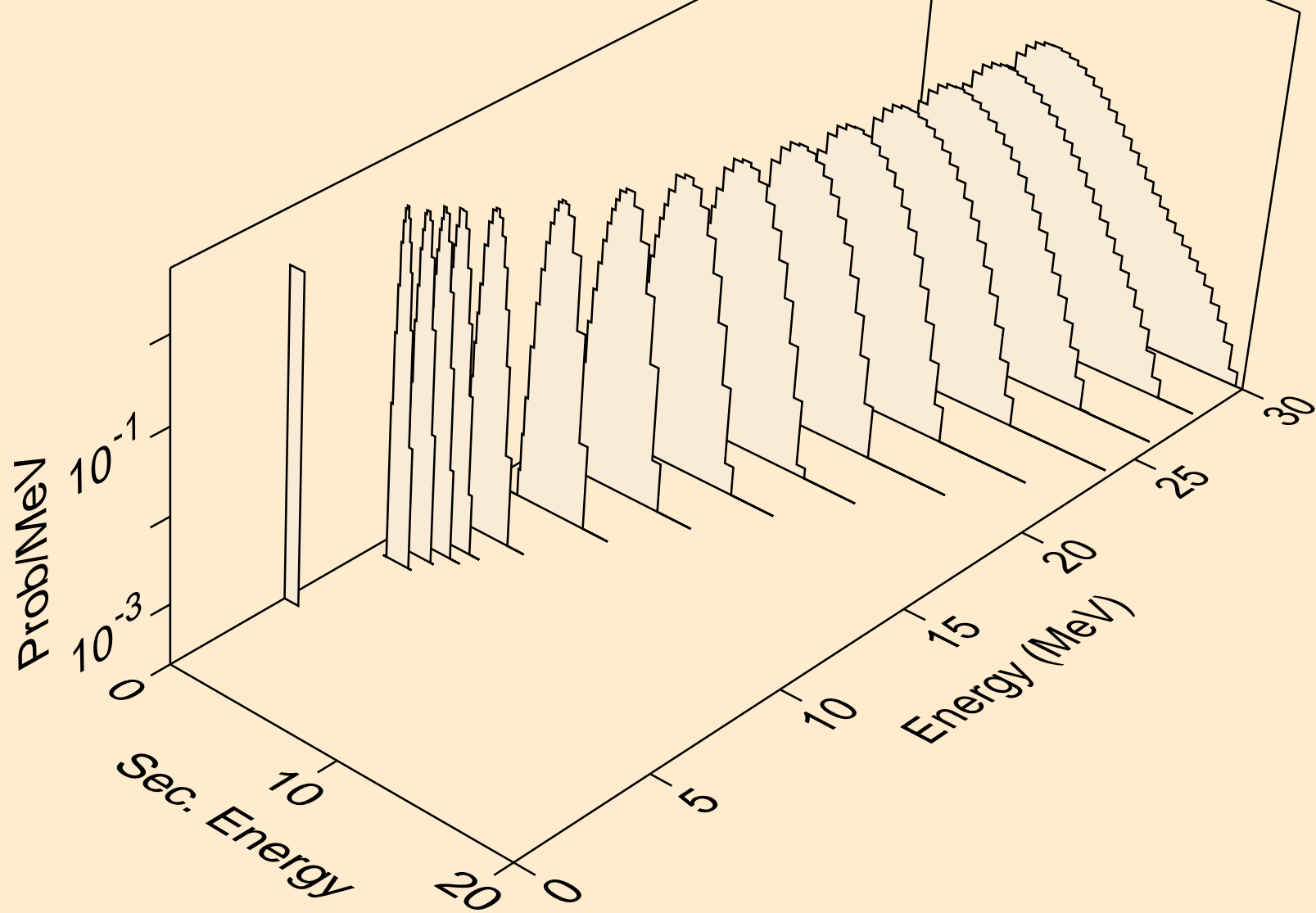

ER149 NEUTRON ACER TENDL-2023 LIBRARY; T=0.K
protons from (n,npa)

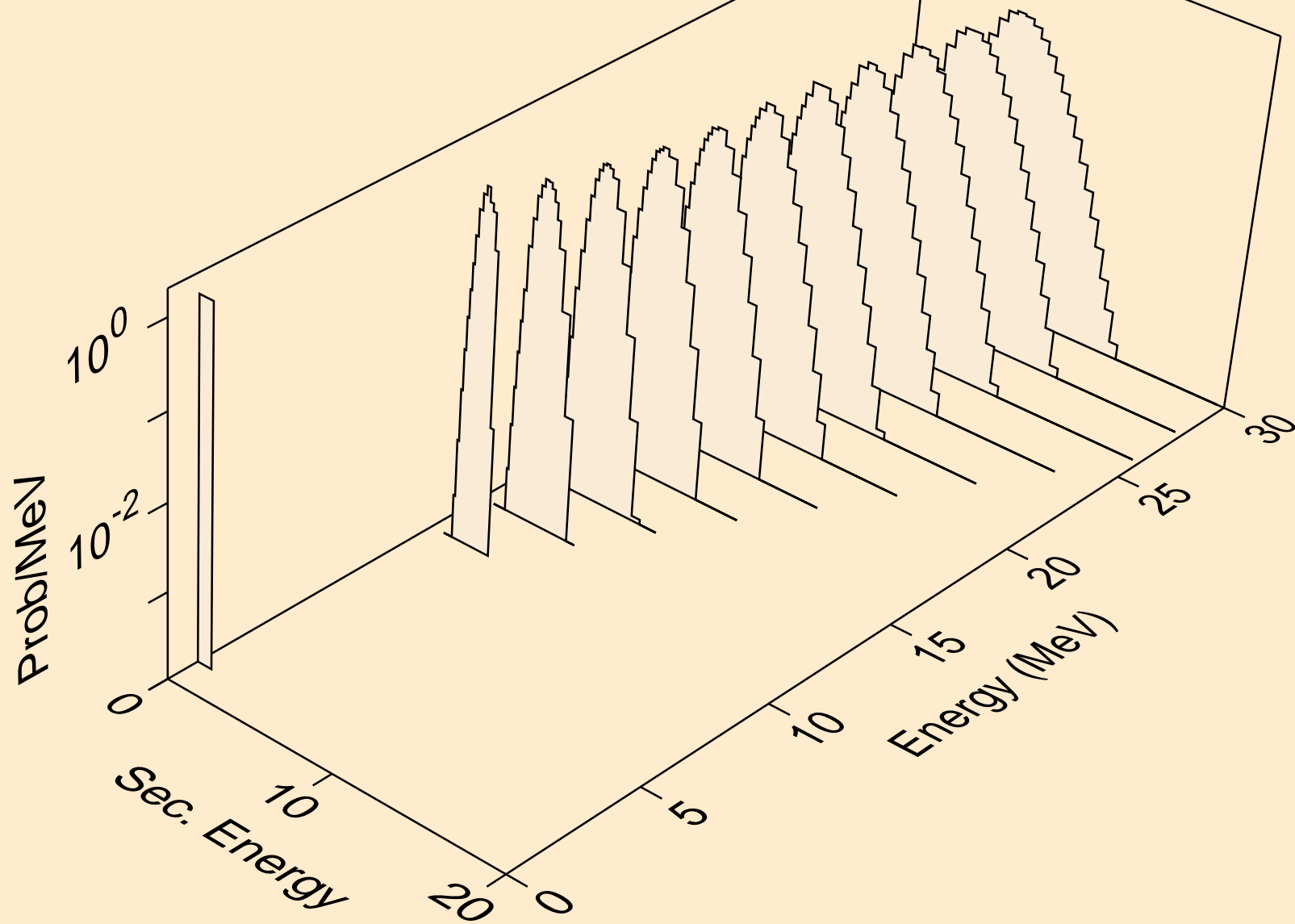

ER149 NEUTRON ACER TENDL-2023 LIBRARY; T=0.K
protons from (n,p)

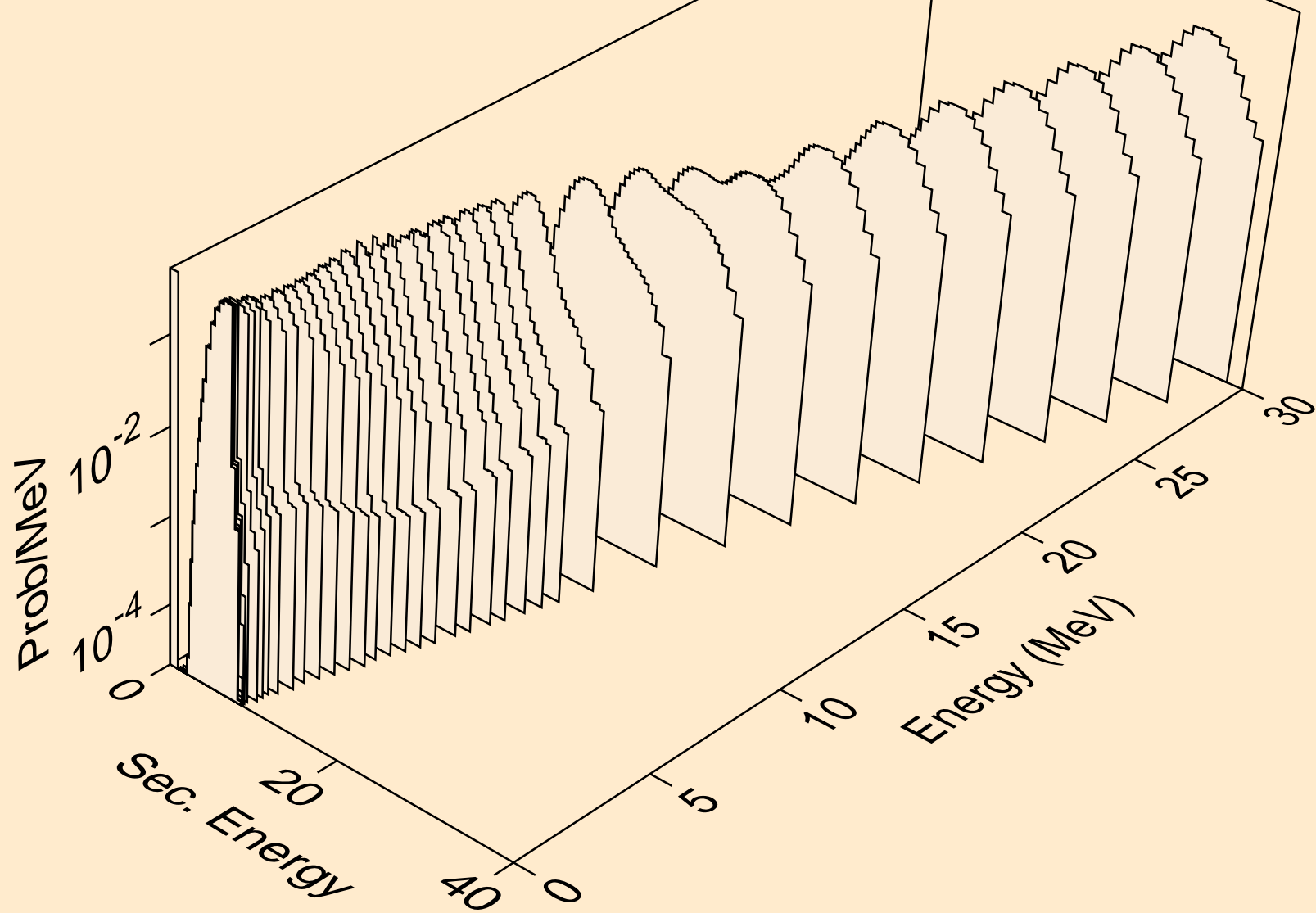

ER149 NEUTRON ACER TENDL-2023 LIBRARY; T=0.K
protons from (n,2p)

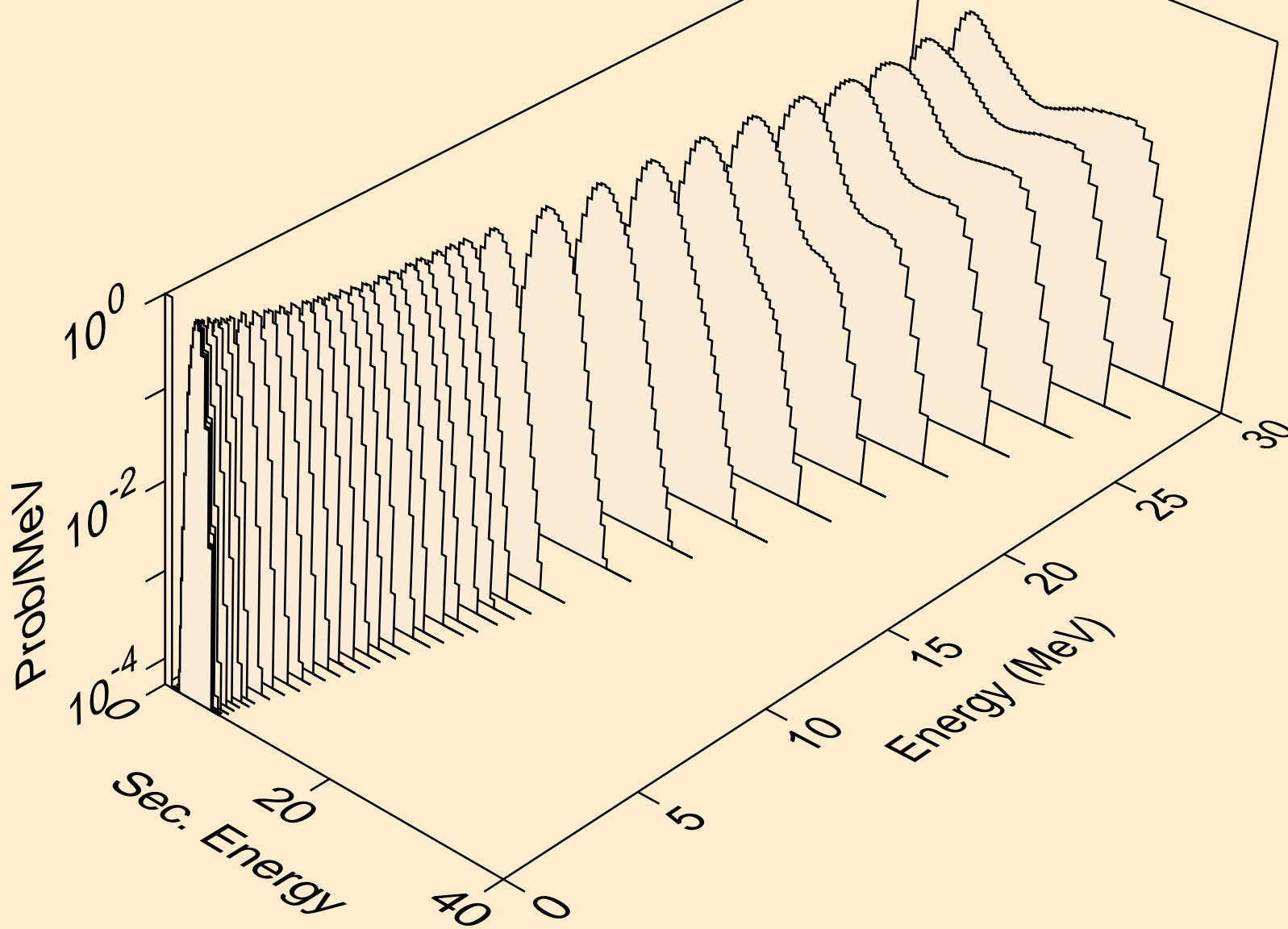

ER149 NEUTRON ACER TENDL-2023 LIBRARY; T=0.K
protons from (n,p)

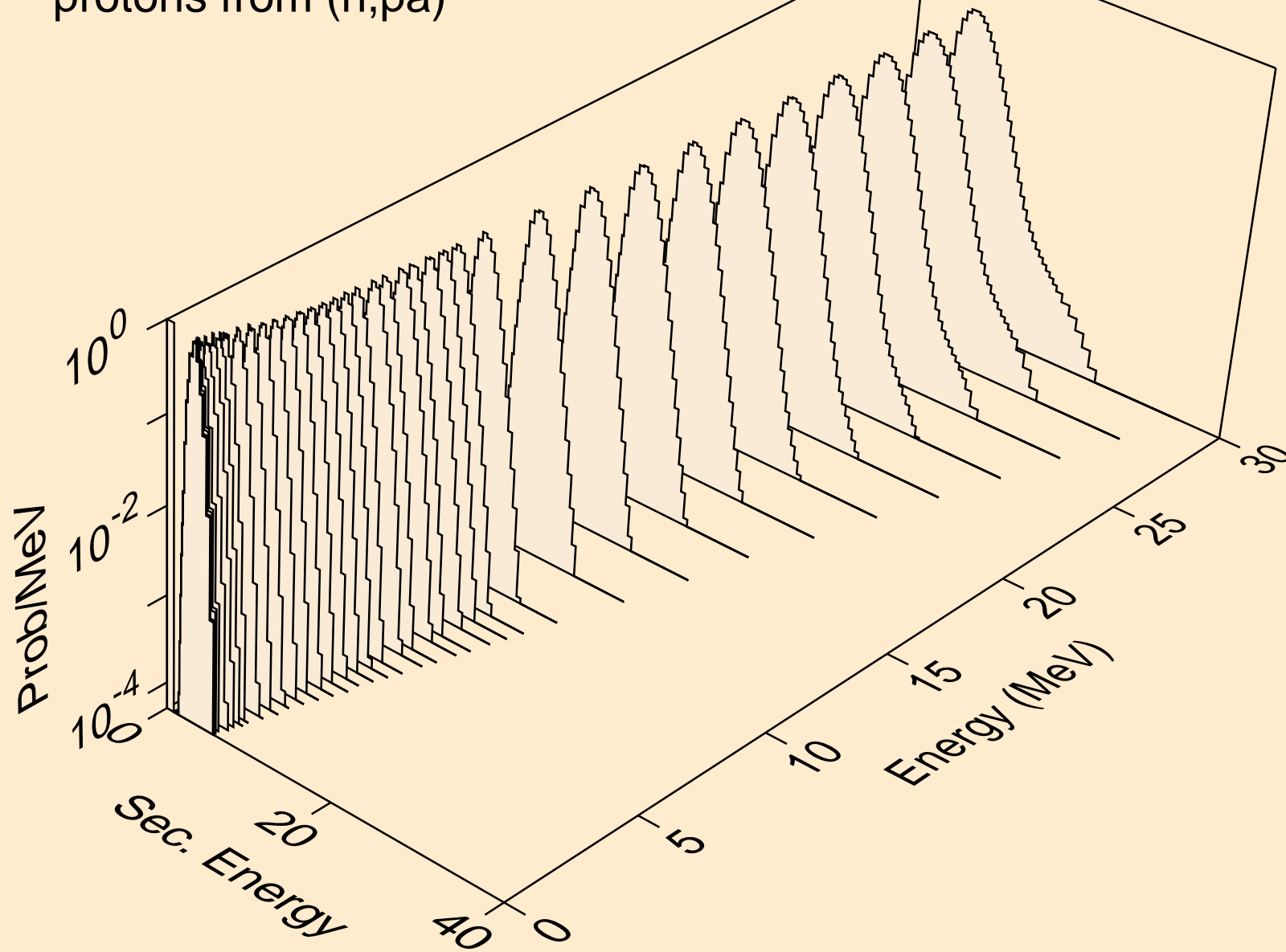

ER149 NEUTRON ACER TENDL-2023 LIBRARY; T=0.K
protons from (n,pd)

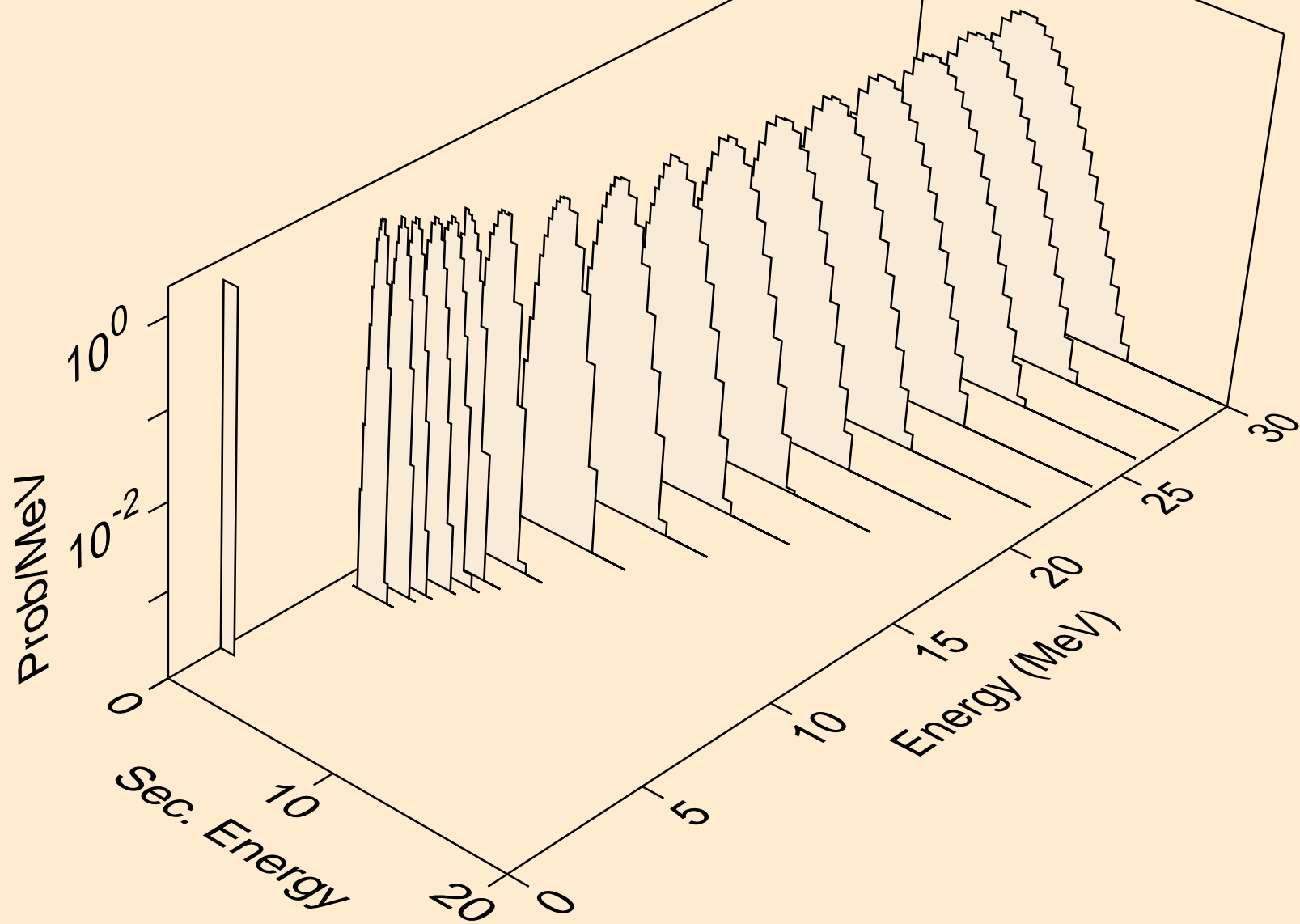

ER149 NEUTRON ACER TENDL-2023 LIBRARY; T=0.K
protons from (n,pt)

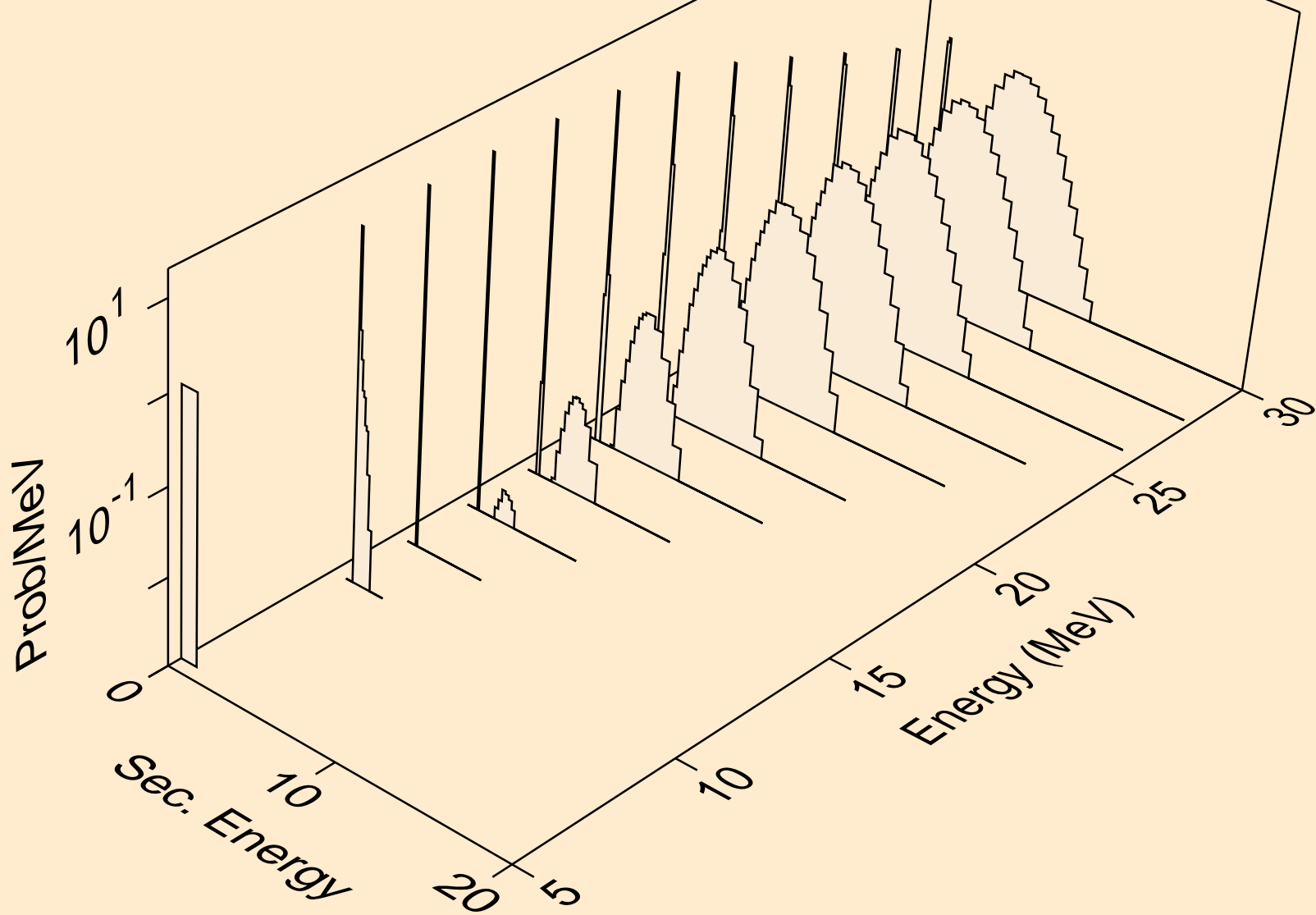

ER149 NEUTRON ACER TENDL-2023 LIBRARY; T=0.K
deuterons from (n,x)

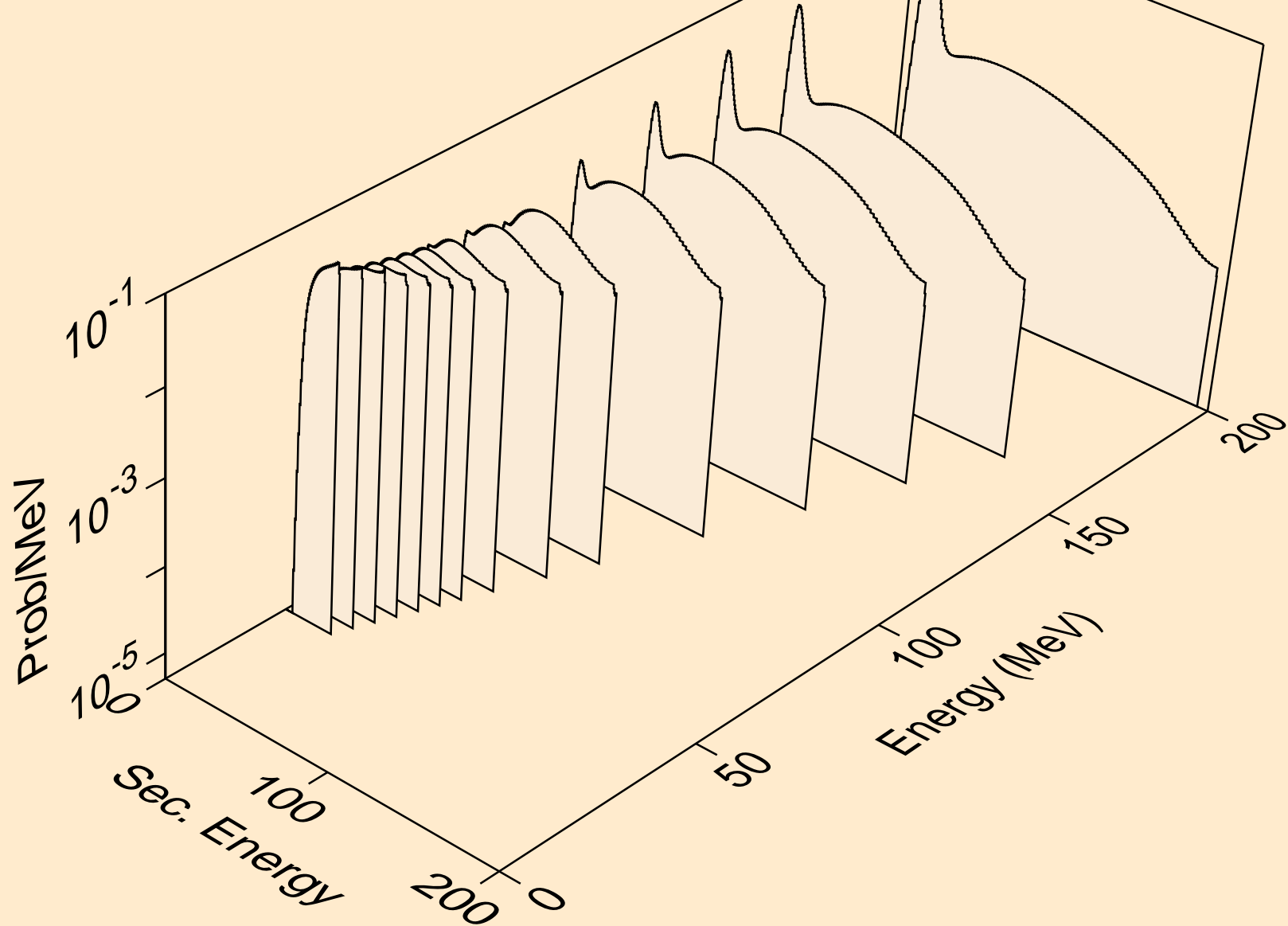

ER149 NEUTRON ACER TENDL-2023 LIBRARY; T=0.K
deuterons from (n,2nd)

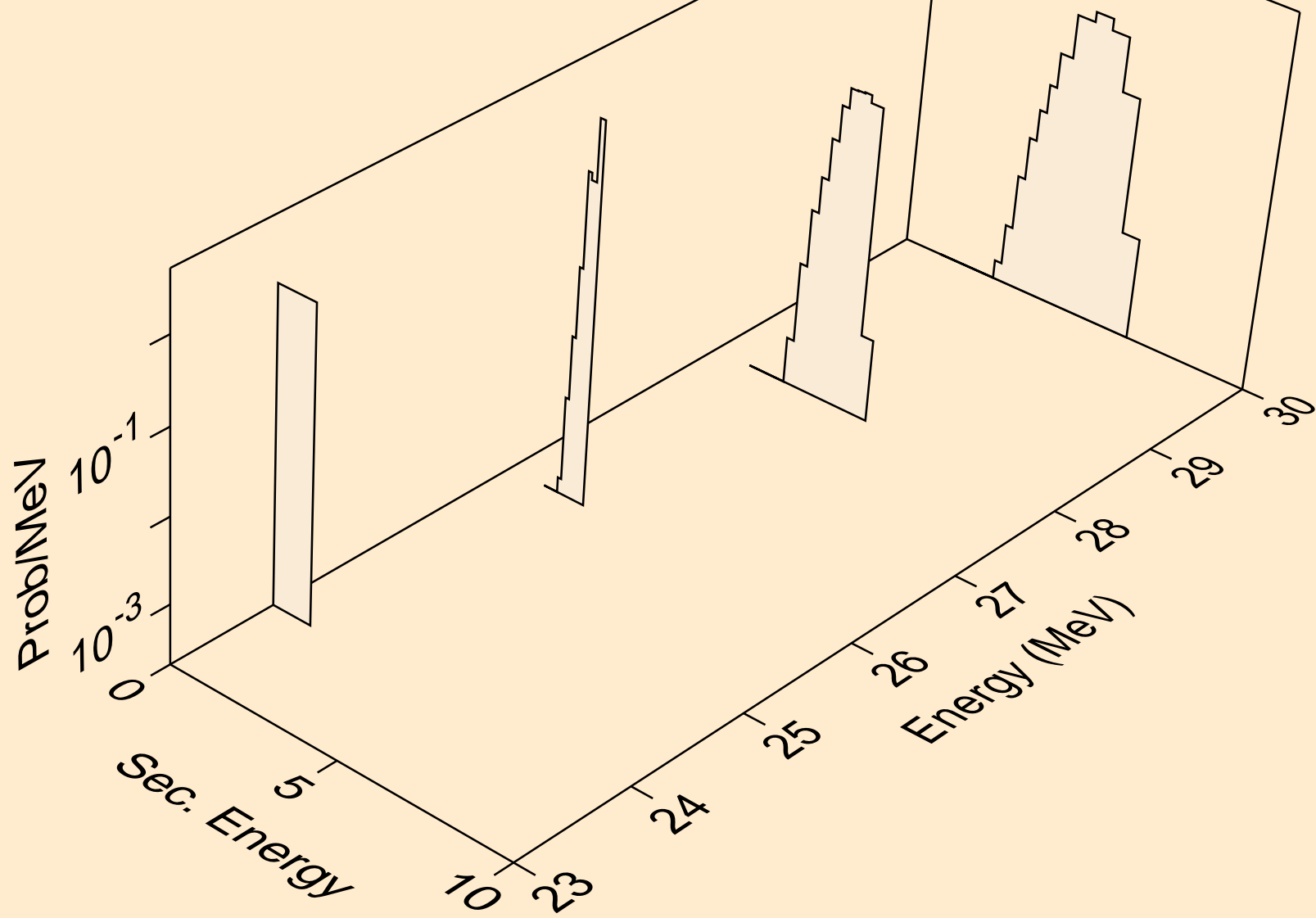

ER149 NEUTRON ACER TENDL-2023 LIBRARY; T=0.K
deuterons from (n,n*)d

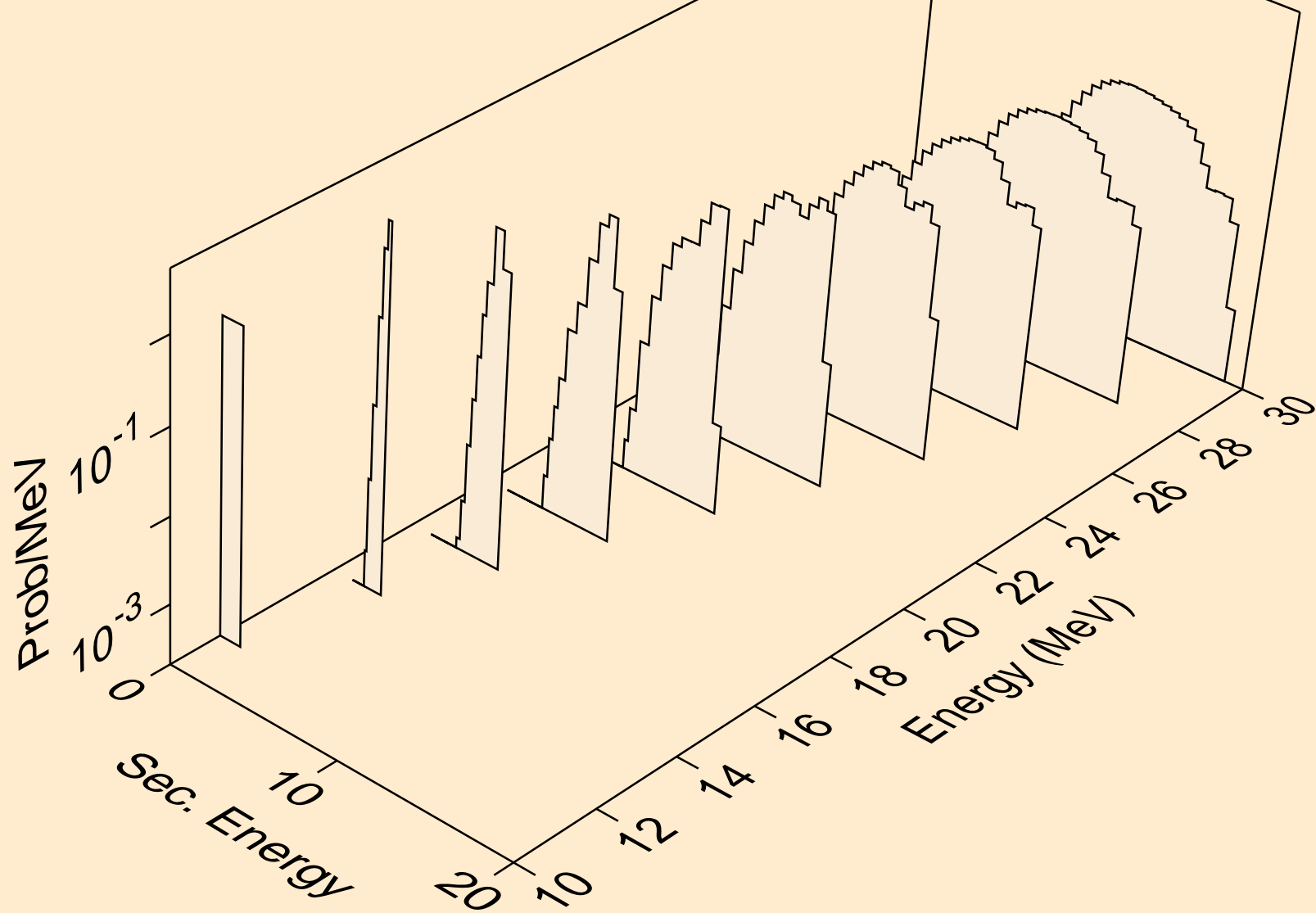

ER149 NEUTRON ACER TENDL-2023 LIBRARY; T=0.K
deuterons from (n,d)

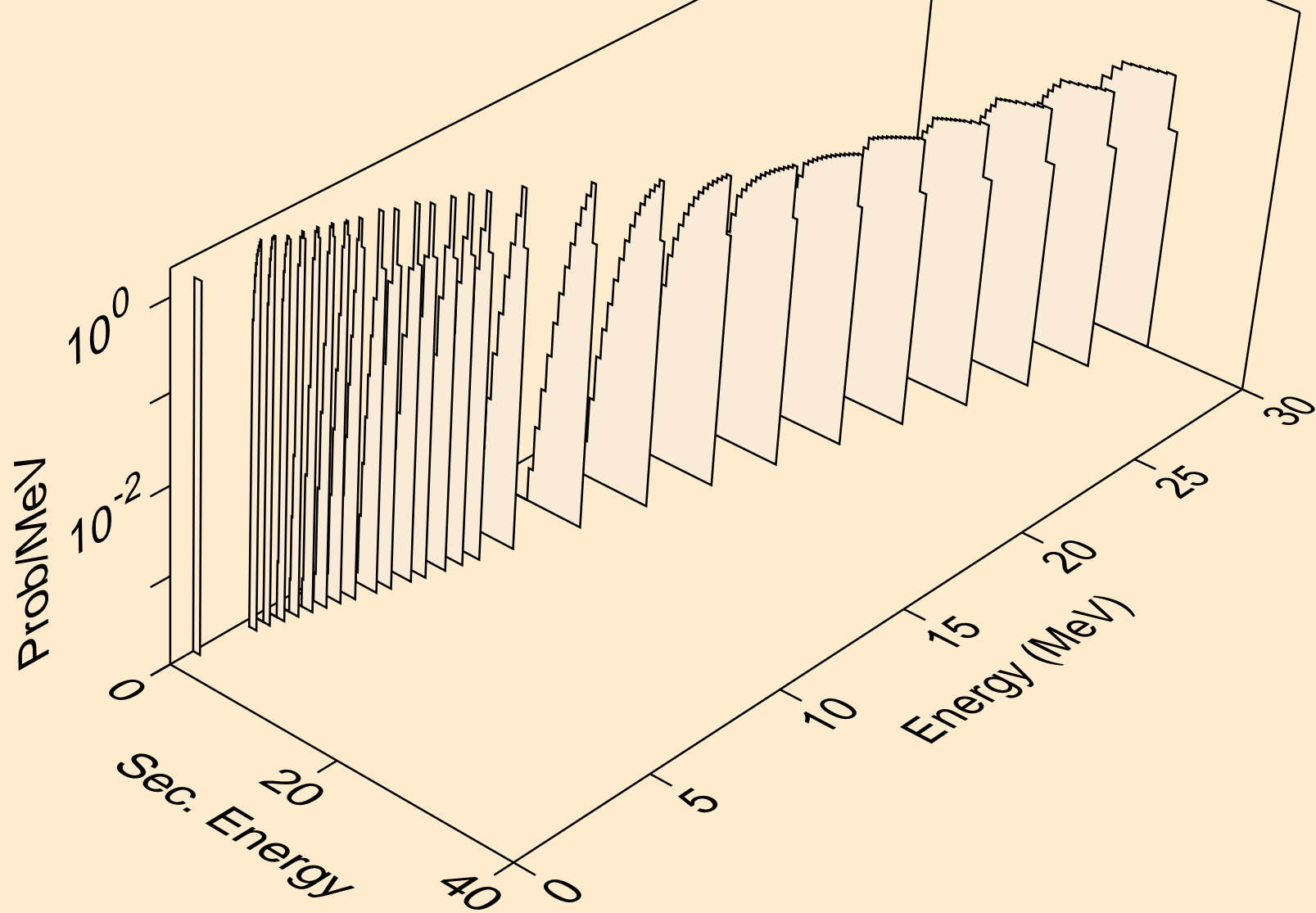

ER149 NEUTRON ACER TENDL-2023 LIBRARY; T=0.K
deuterons from (n,pd)

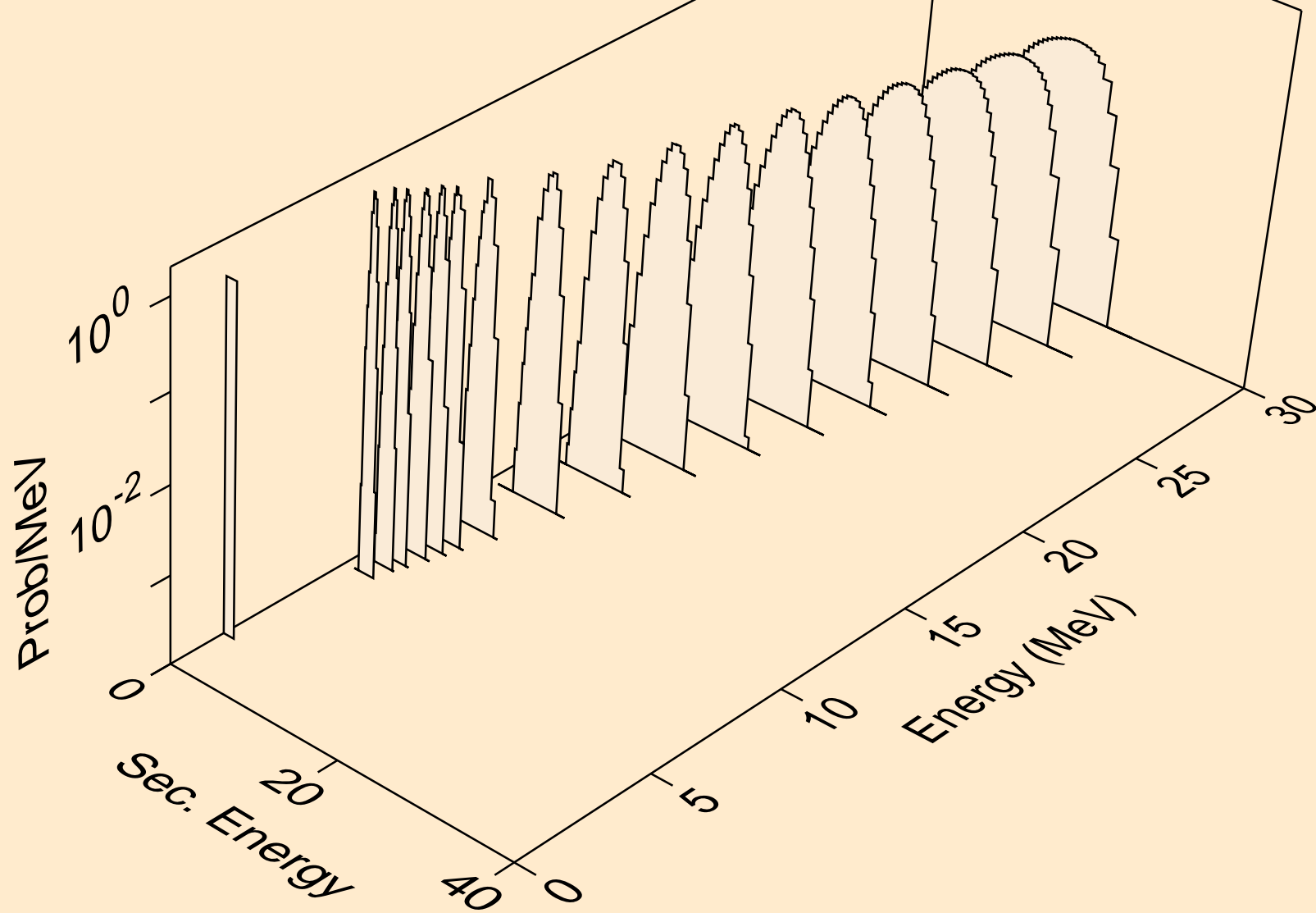

ER149 NEUTRON ACER TENDL-2023 LIBRARY; T=0.K
deuterons from (n,da)

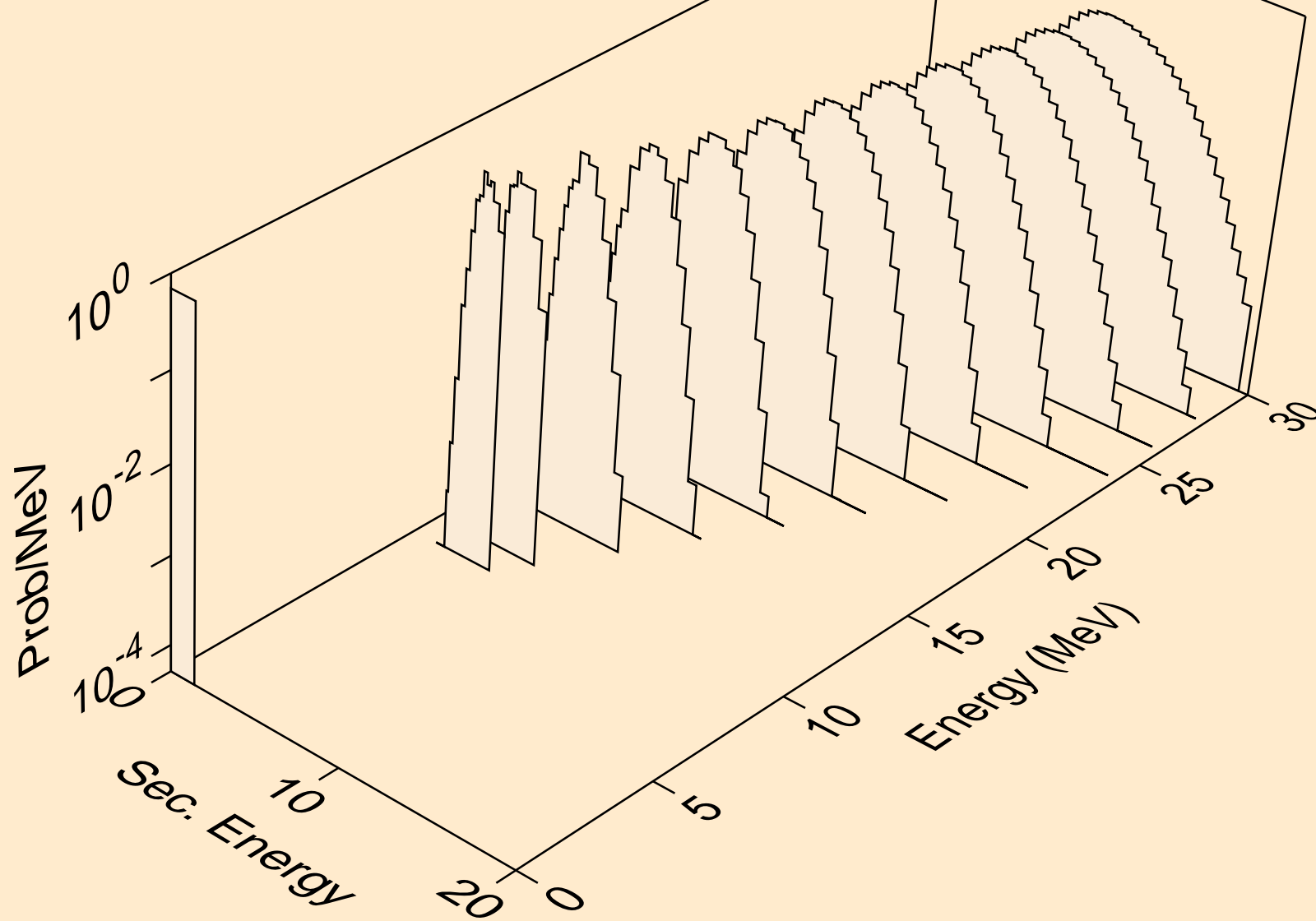

ER149 NEUTRON ACER TENDL-2023 LIBRARY; T=0.K
tritons from (n,x)

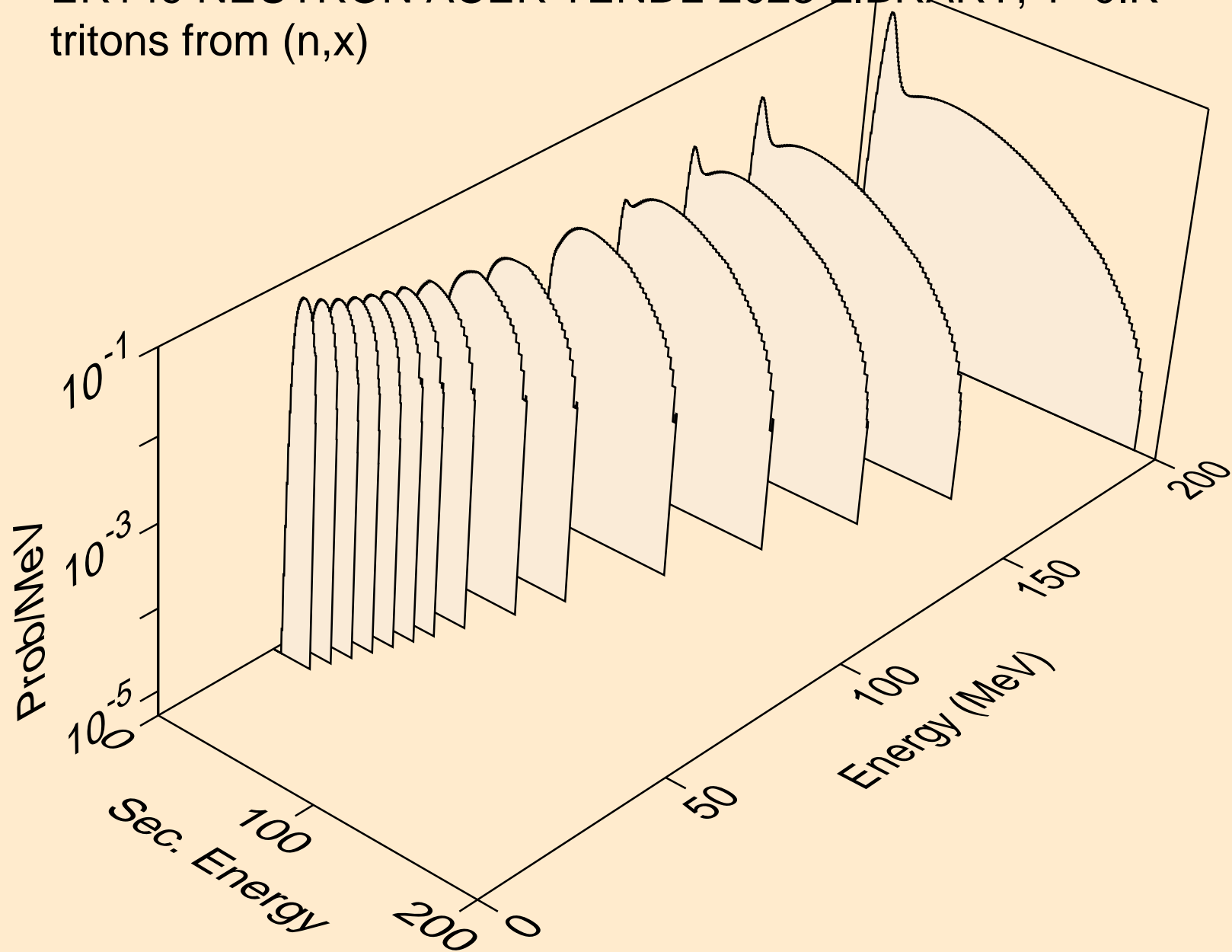

ER149 NEUTRON ACER TENDL-2023 LIBRARY; T=0.K
tritons from (n,n*)t

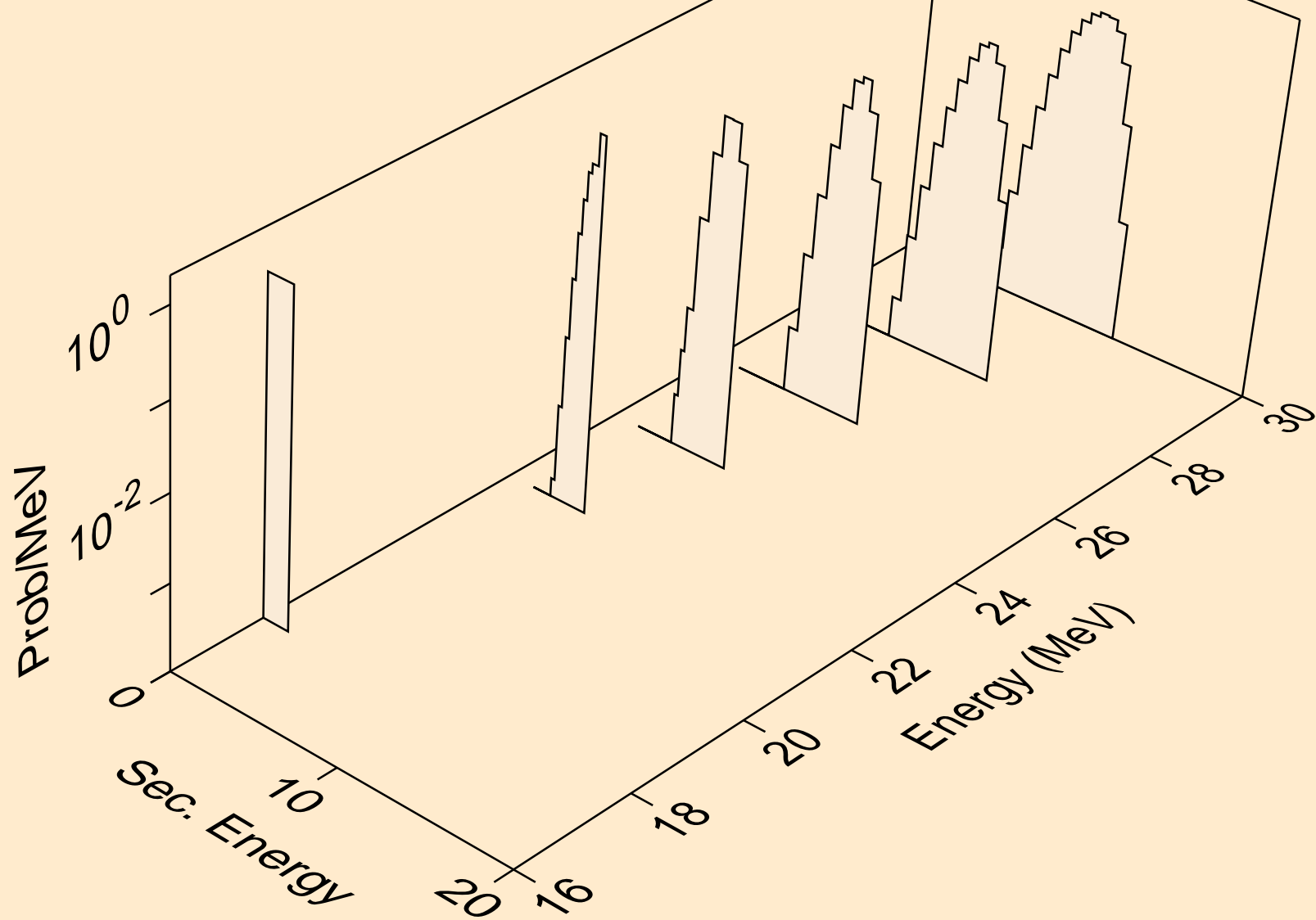

ER149 NEUTRON ACER TENDL-2023 LIBRARY; T=0.K
tritons from (n,t)

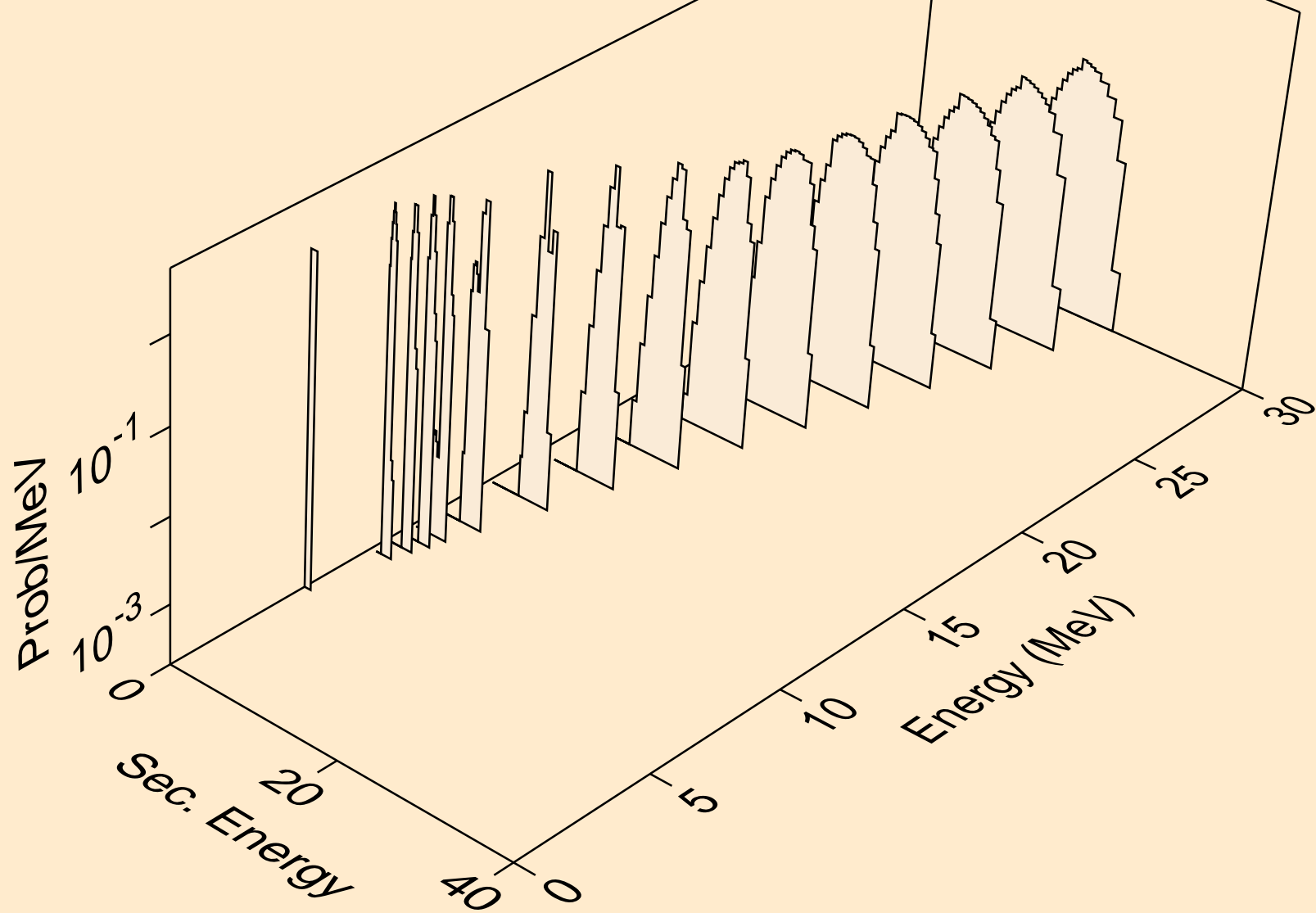

ER149 NEUTRON ACER TENDL-2023 LIBRARY; T=0.K
tritons from (n,pt)

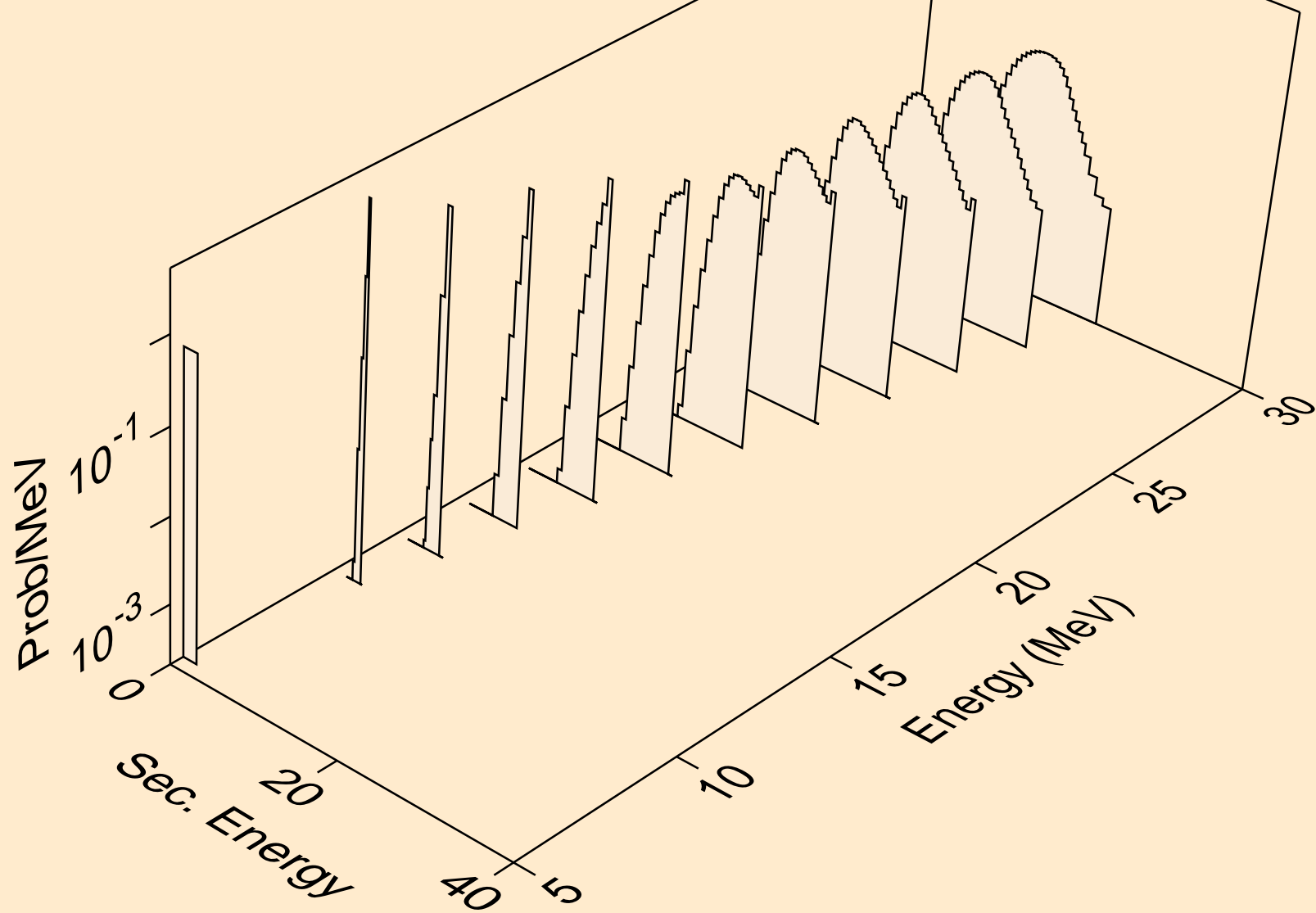

ER149 NEUTRON ACER TENDL-2023 LIBRARY; T=0.K
he3s from (n,x)

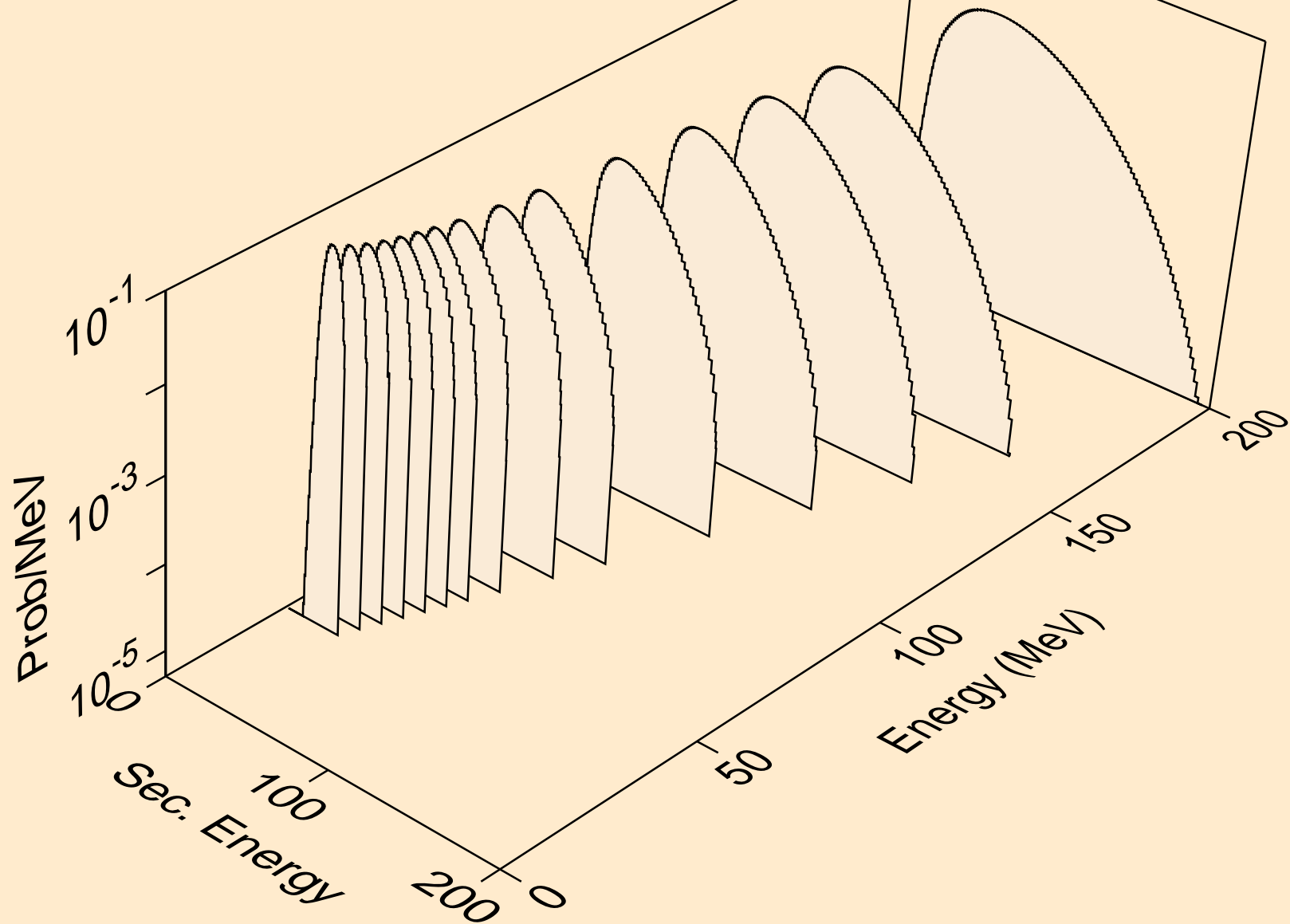

ER149 NEUTRON ACER TENDL-2023 LIBRARY; T=0.K
he3s from (n,n*)he3

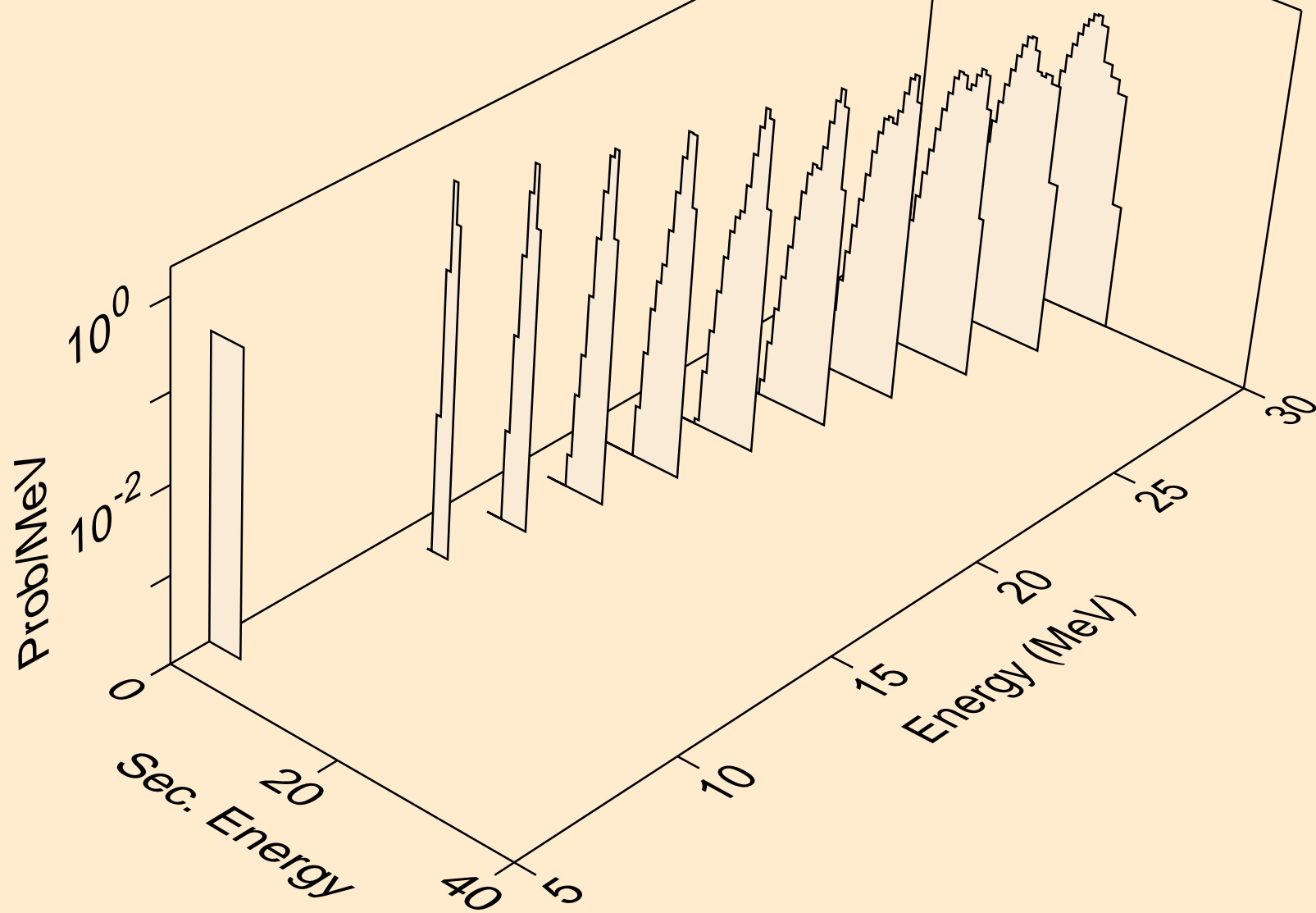

ER149 NEUTRON ACER TENDL-2023 LIBRARY; T=0.K
he3s from (n,he3)

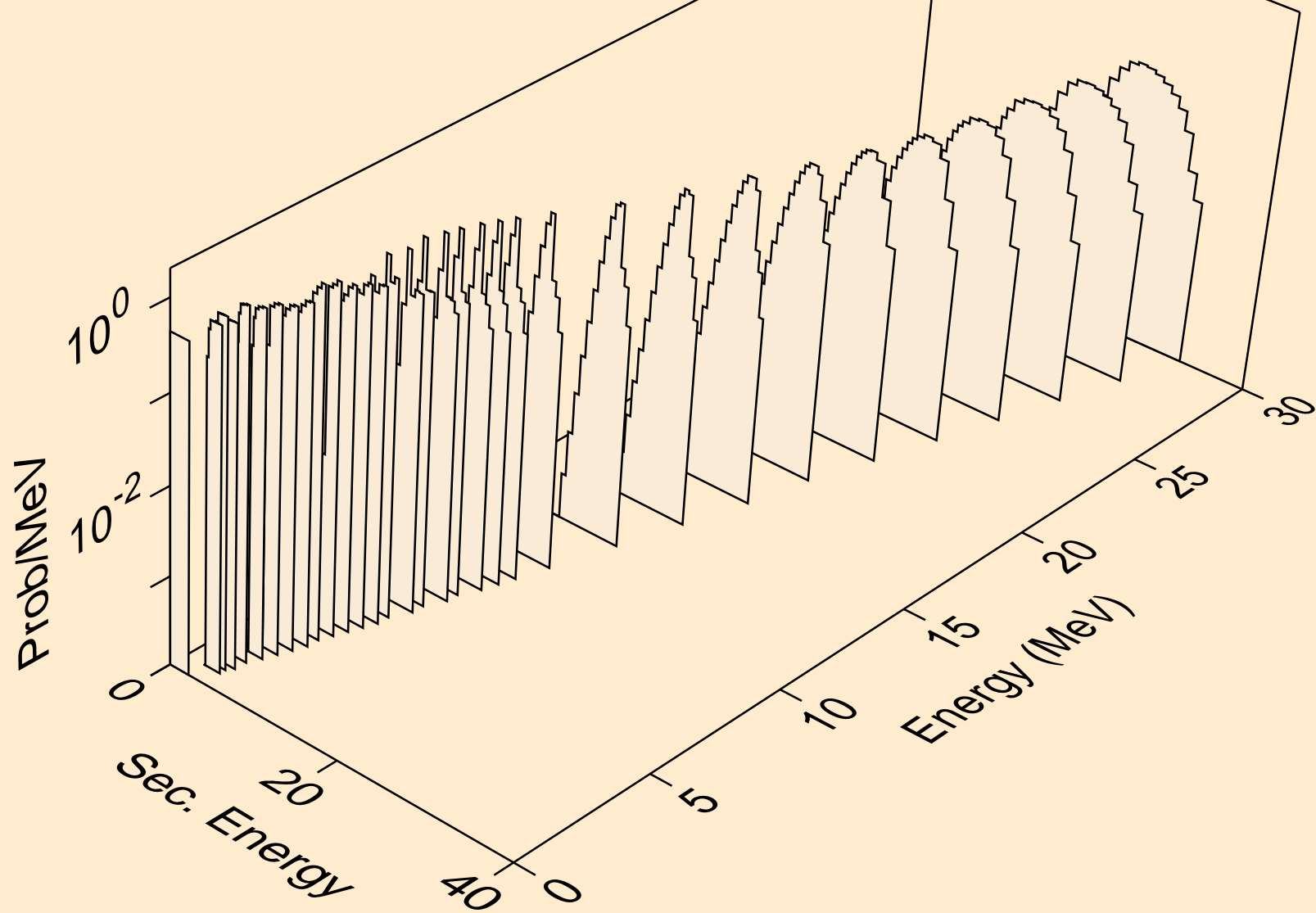

ER149 NEUTRON ACER TENDL-2023 LIBRARY; T=0.K
alphas from (n,x)

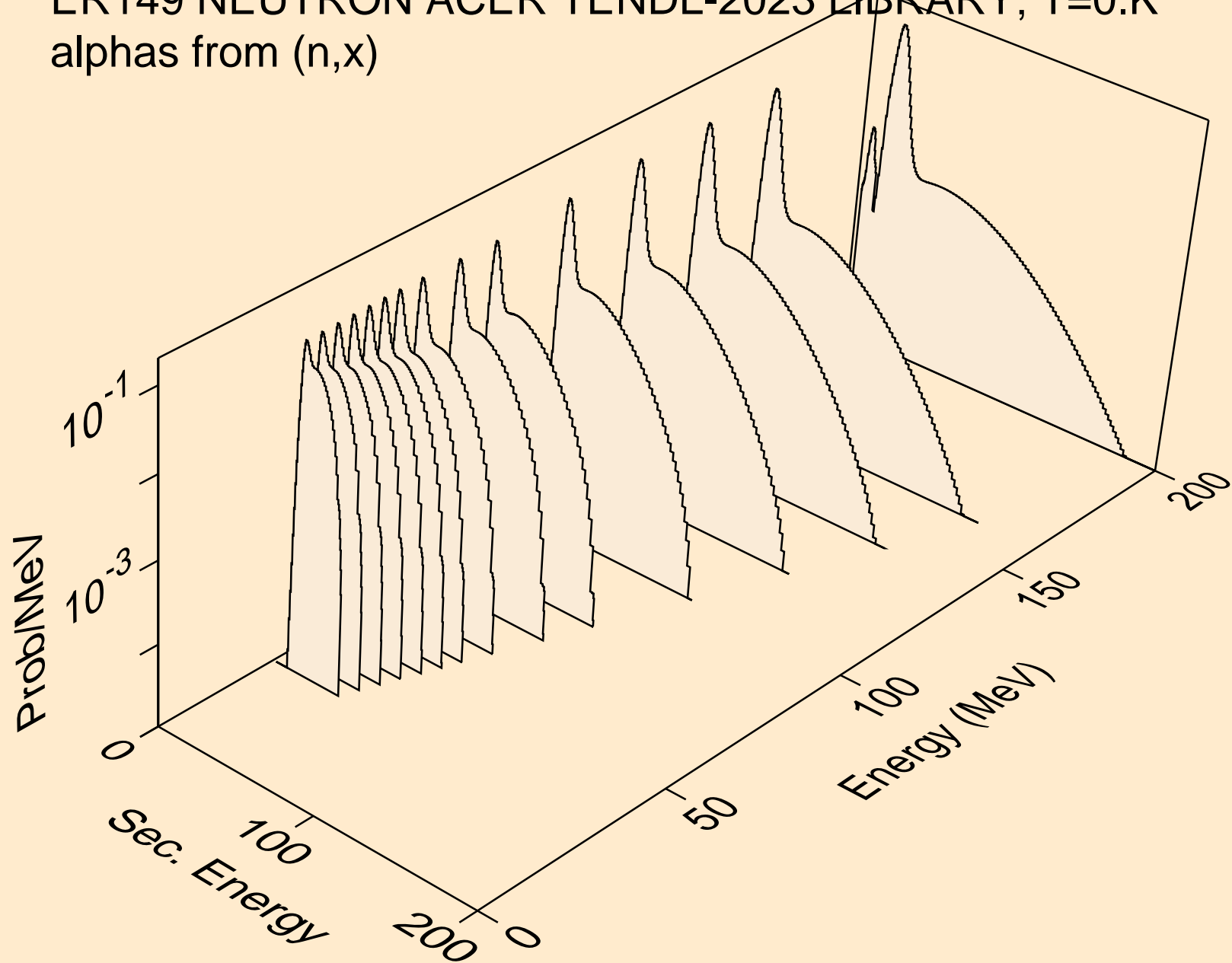

ER149 NEUTRON ACER TENDL-2023 LIBRARY; T=0.K
alphas from (n,n*)a

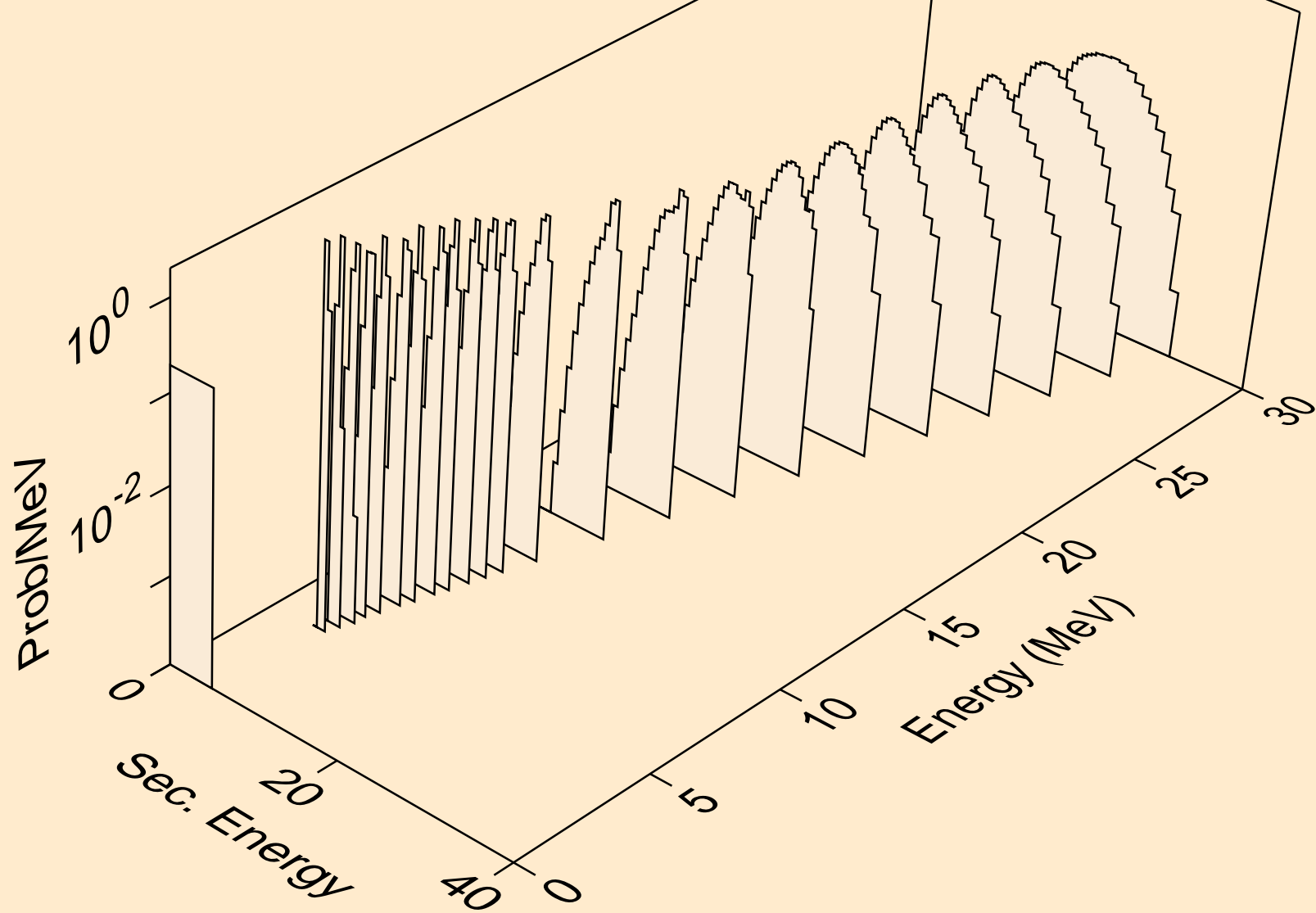

ER149 NEUTRON ACER TENDL-2023 LIBRARY; T=0.K
alphas from (n,2n)a

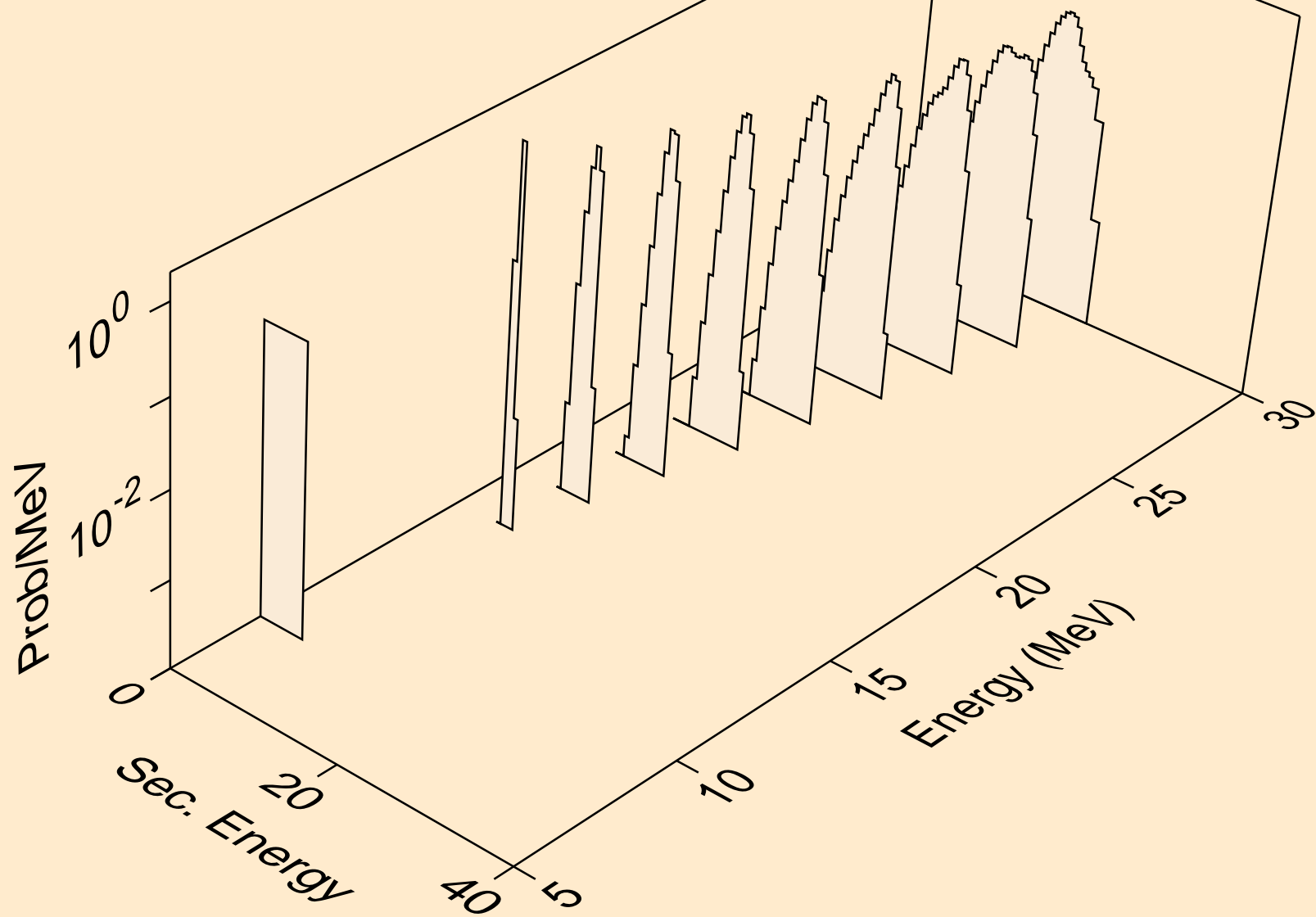

ER149 NEUTRON ACER TENDL-2023 LIBRARY; T=0.K
alphas from (n,n*)2a

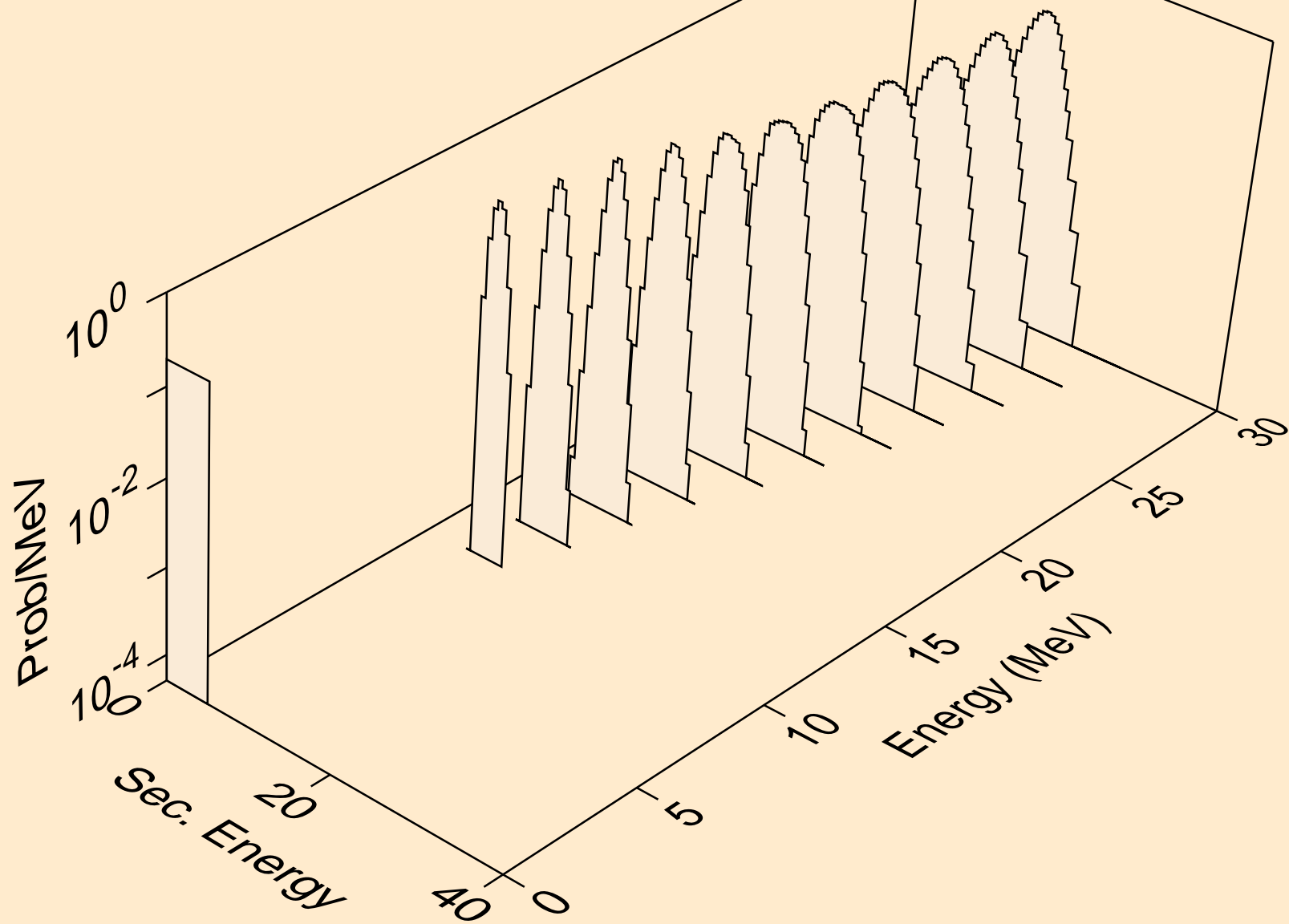

ER149 NEUTRON ACER TENDL-2023 LIBRARY; T=0.K
alphas from (n,2n)2a

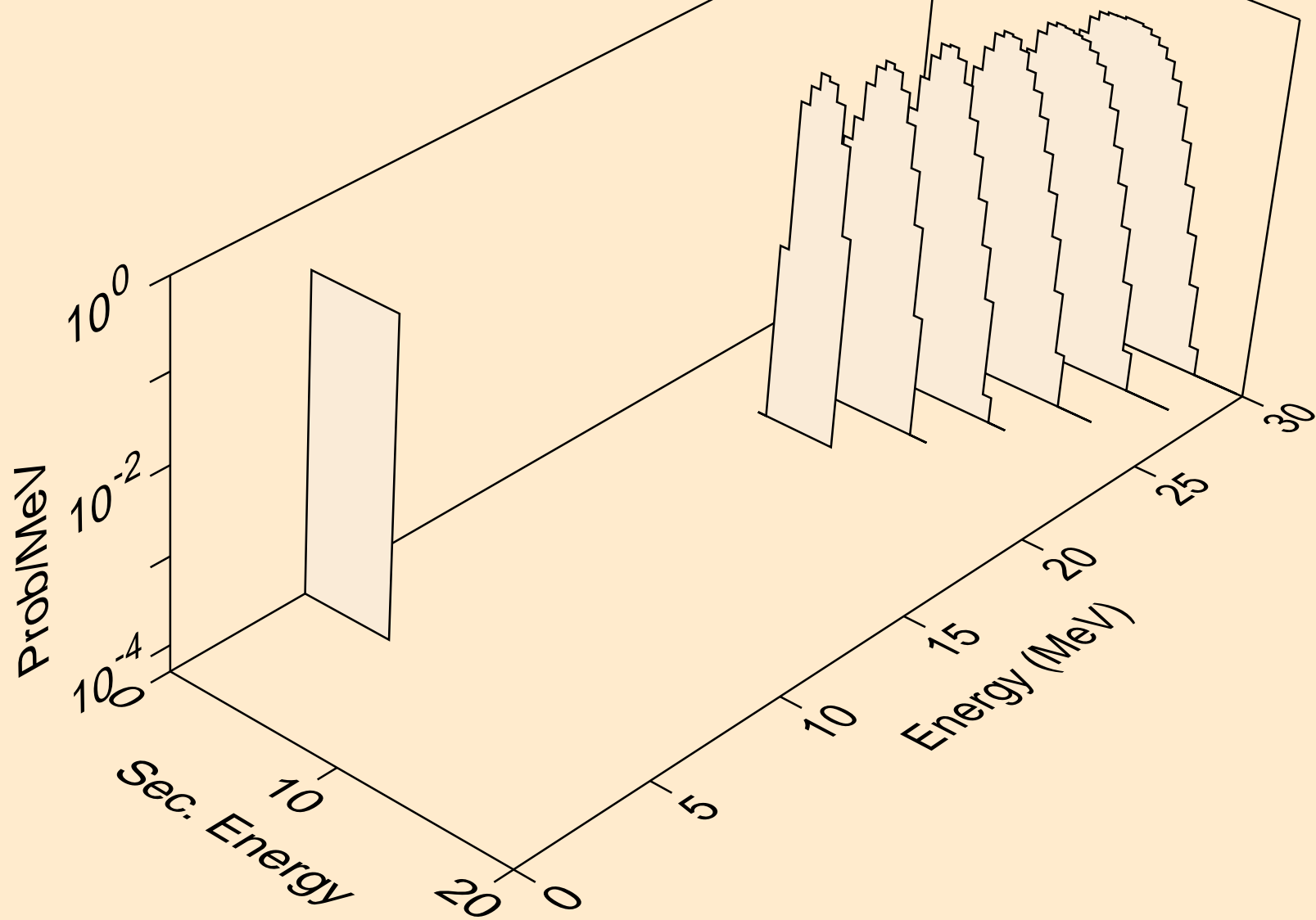

ER149 NEUTRON ACER TENDL-2023 LIBRARY; T=0.K
alphas from (n,npa)

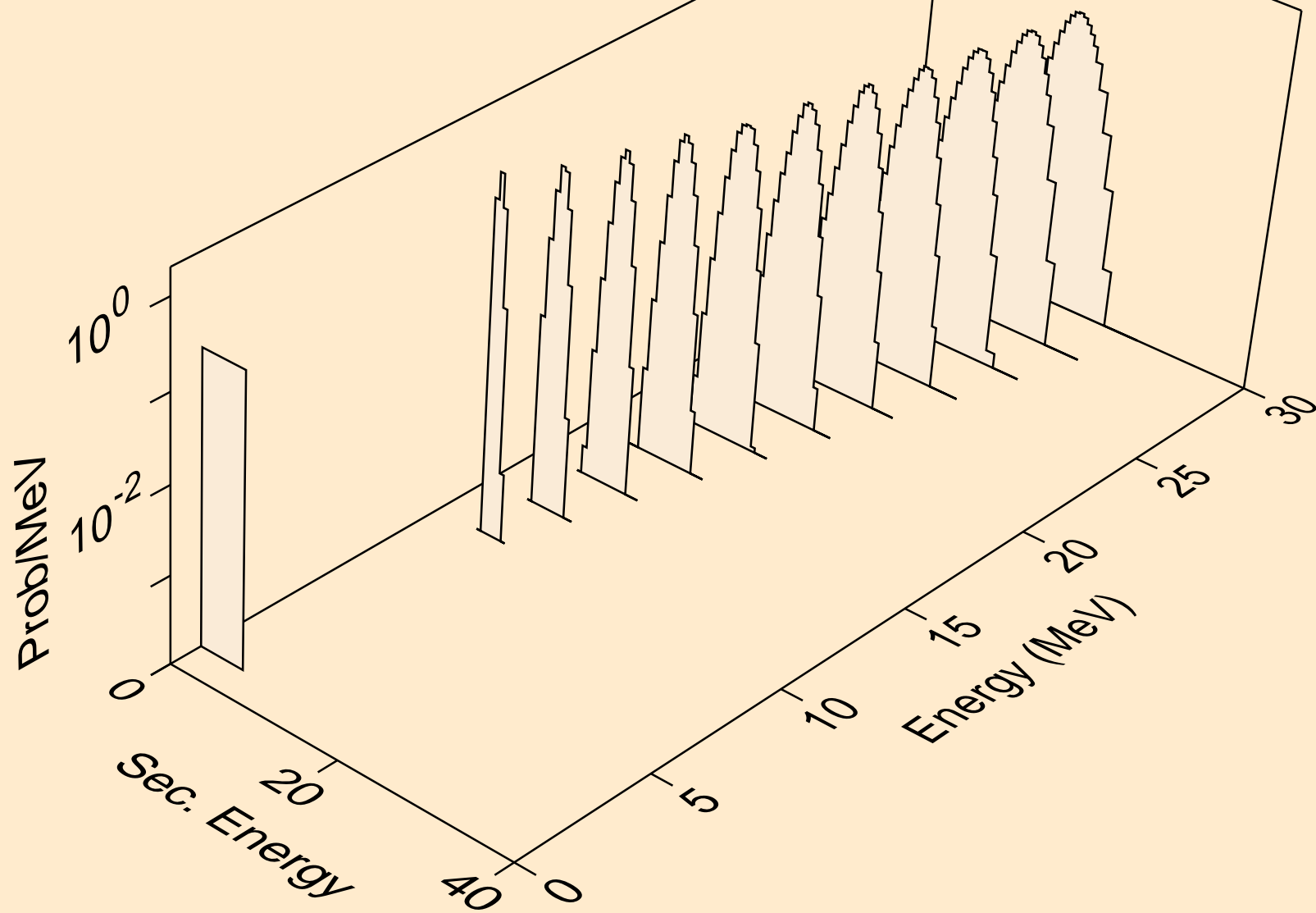

ER149 NEUTRON ACER TENDL-2023 LIBRARY; T=0.K
alphas from (n,a)

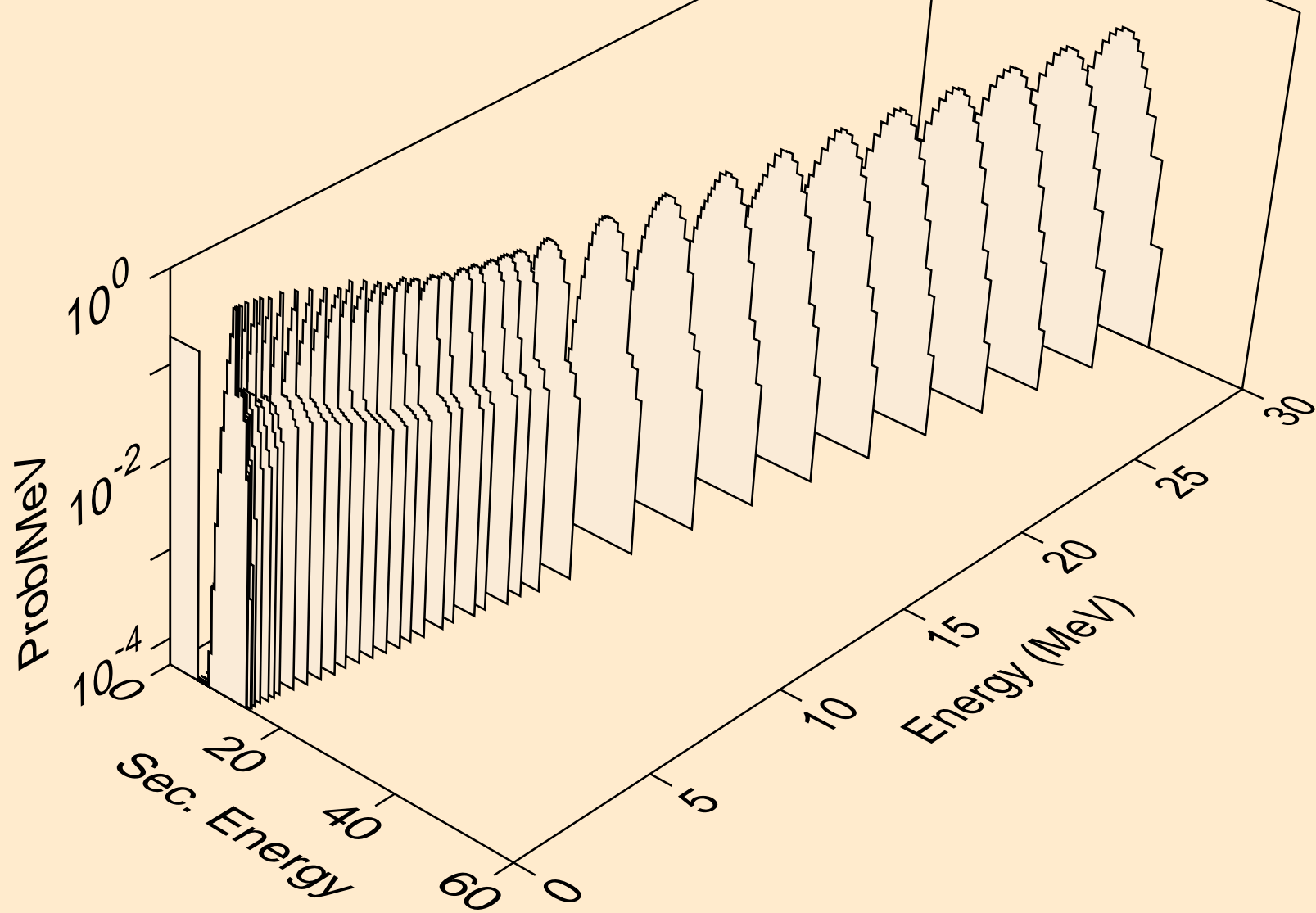

ER149 NEUTRON ACER TENDL-2023 LIBRARY; T=0.K
alphas from (n,2a)

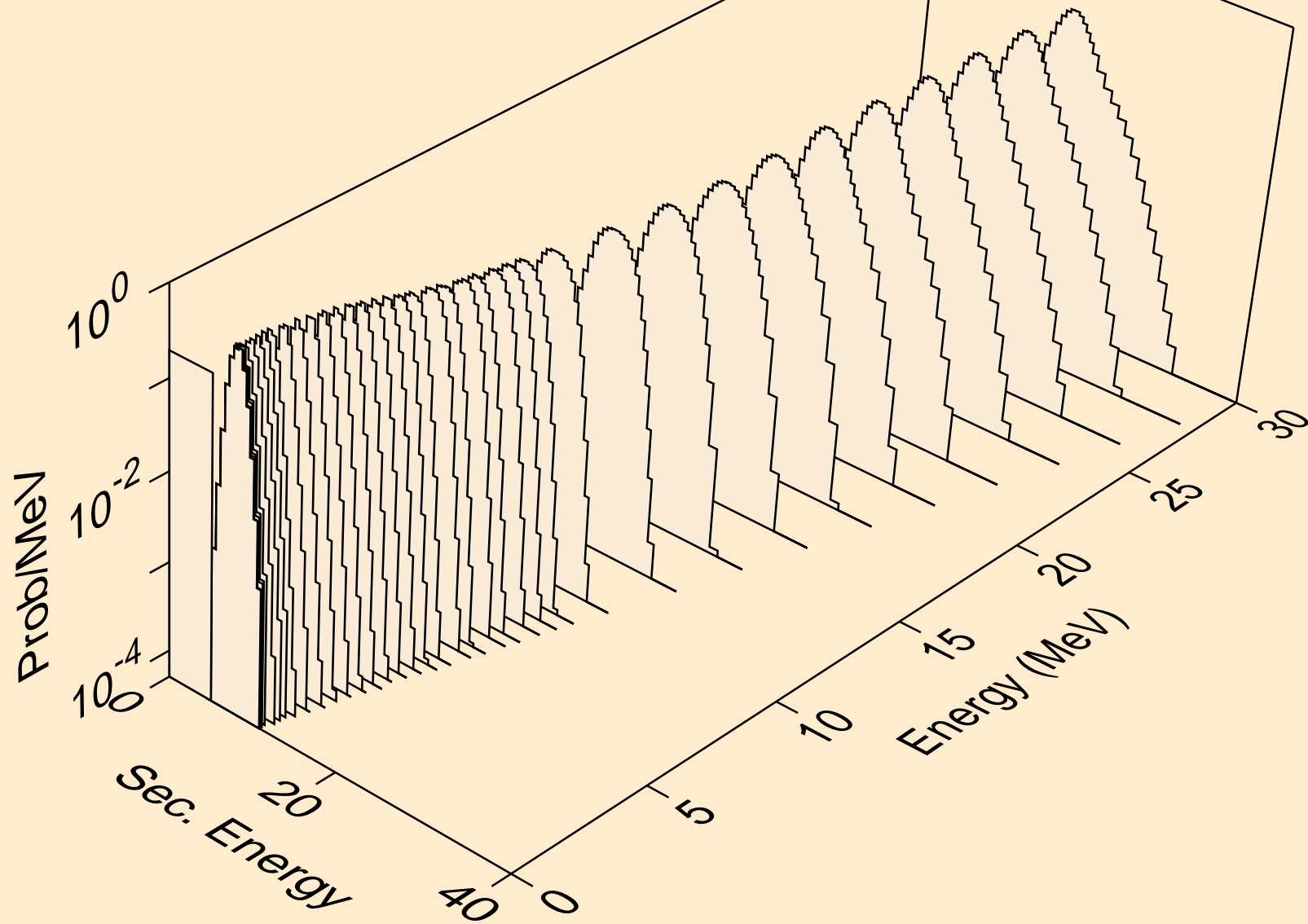

ER149 NEUTRON ACER TENDL-2023 LIBRARY; T=0.K
alphas from (n,3a)

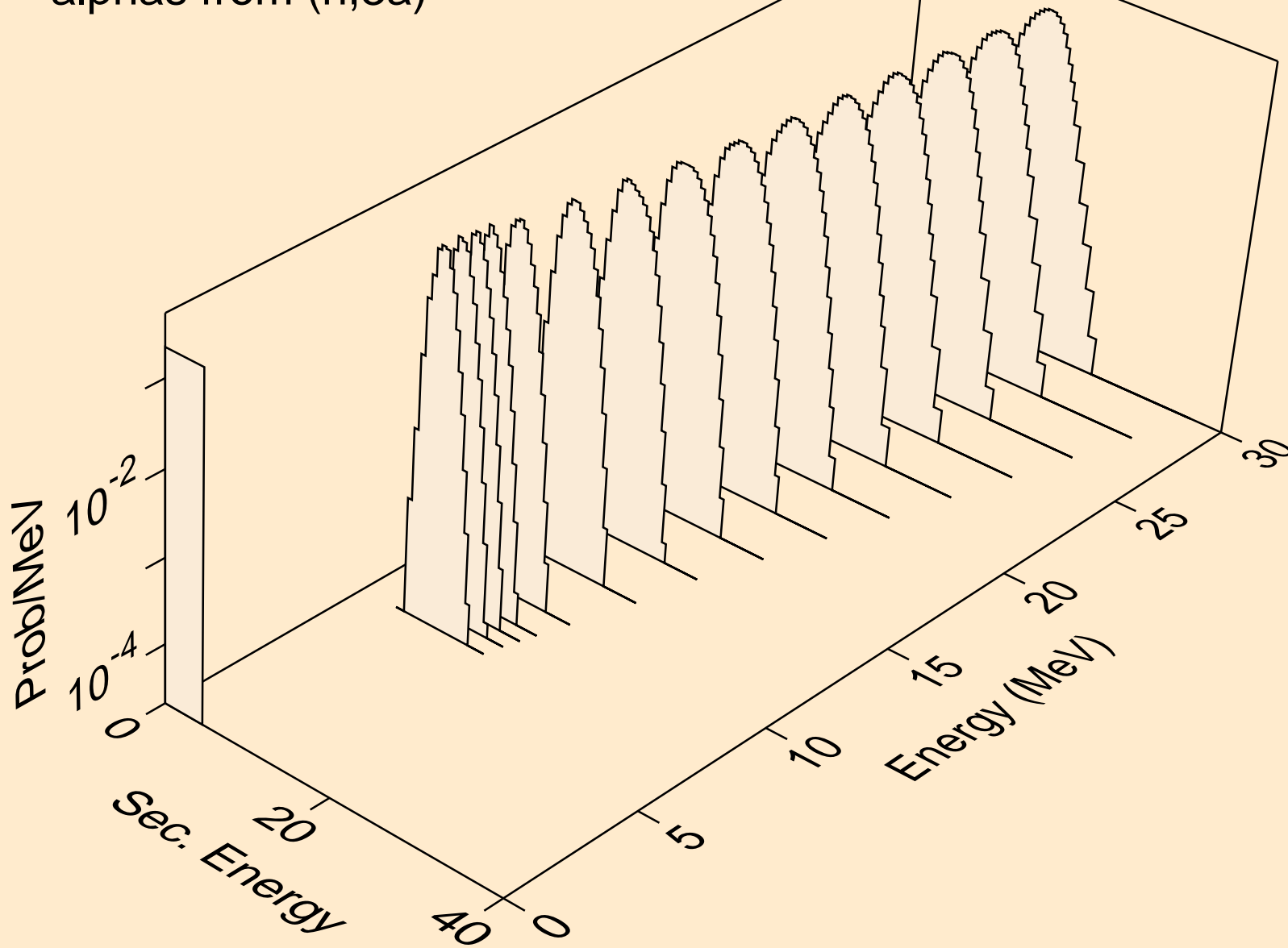

ER149 NEUTRON ACER TENDL-2023 LIBRARY; T=0.K
alphas from (n,pa)

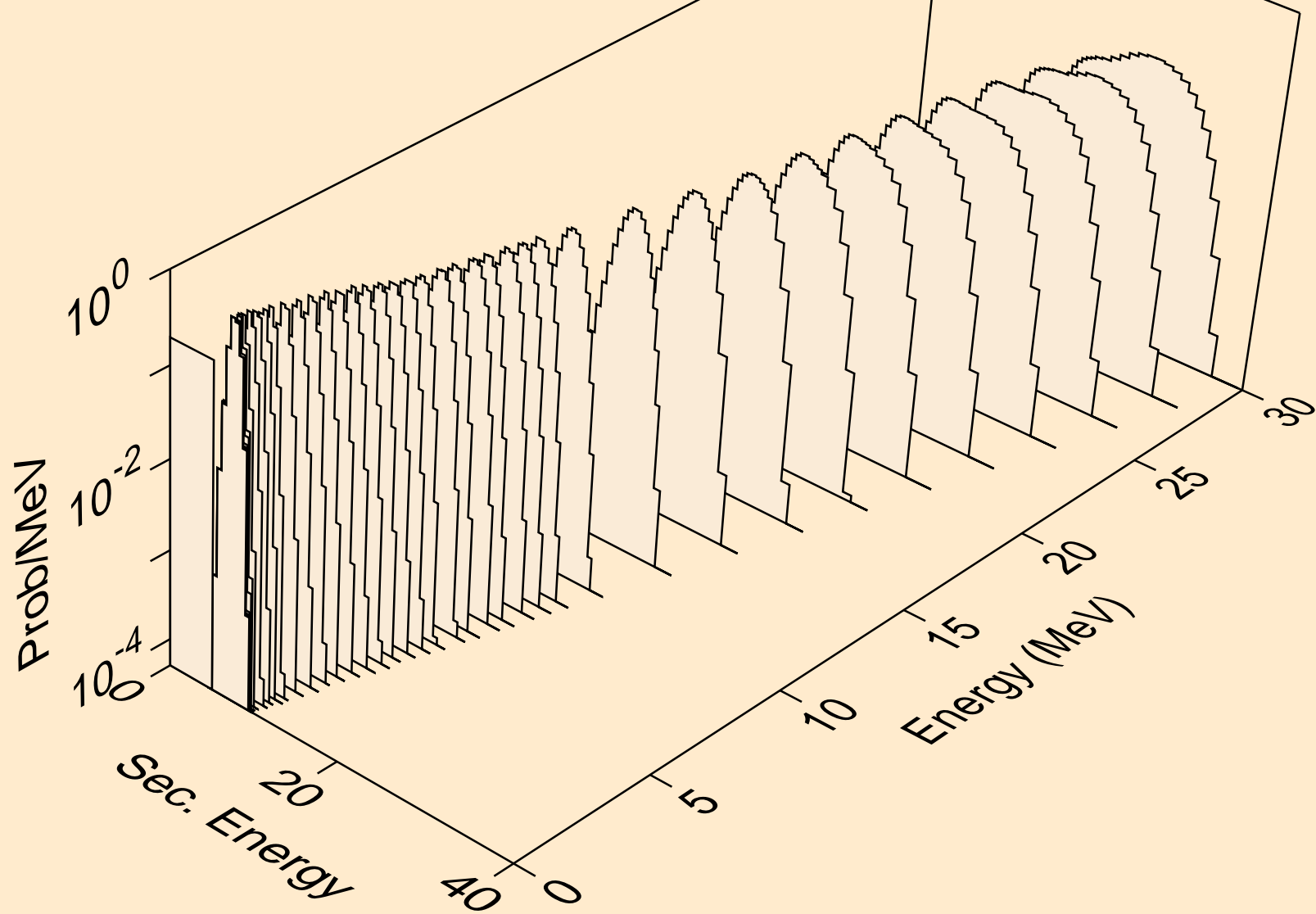

ER149 NEUTRON ACER TENDL-2023 LIBRARY; T=0.K
alphas from (n,da)

