

EU151 NEUTRON ACER TENDL-2023 LIBRARY; T=0.K

Principal cross sections

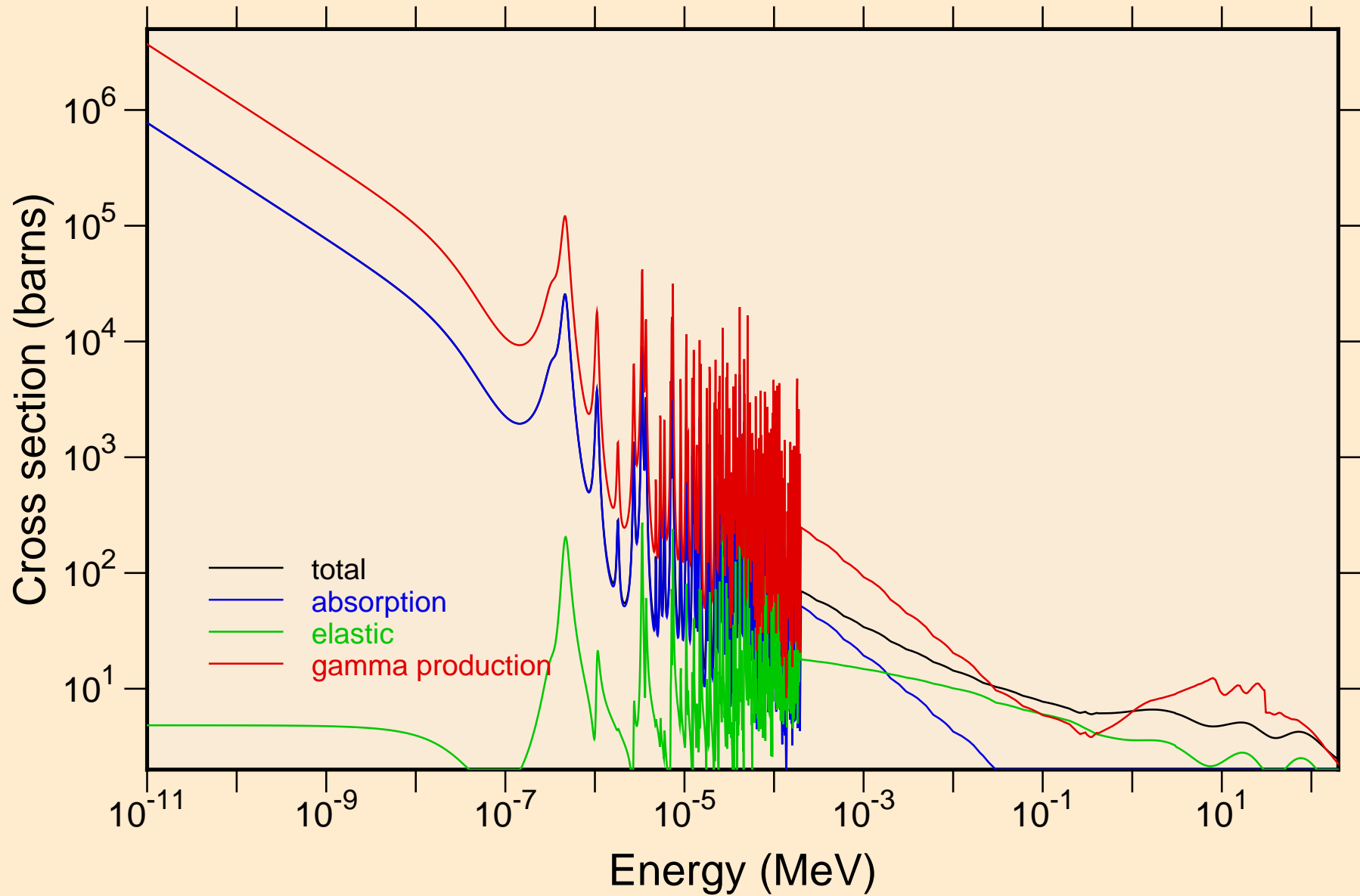

EU151 NEUTRON ACER TENDL-2023 LIBRARY; T=0.K
resonance total cross section

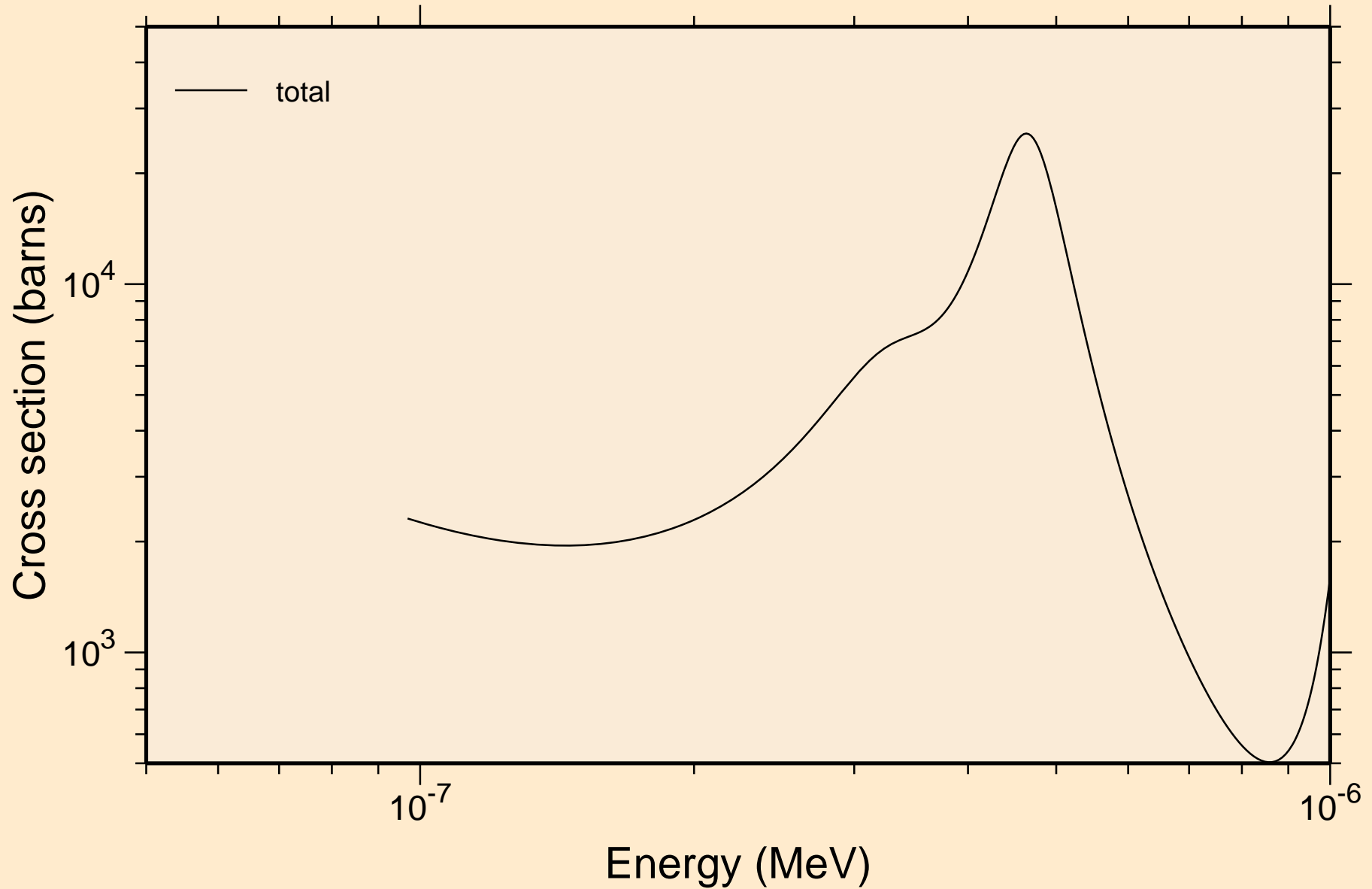

EU151 NEUTRON ACER TENDL-2023 LIBRARY; T=0.K
resonance total cross section

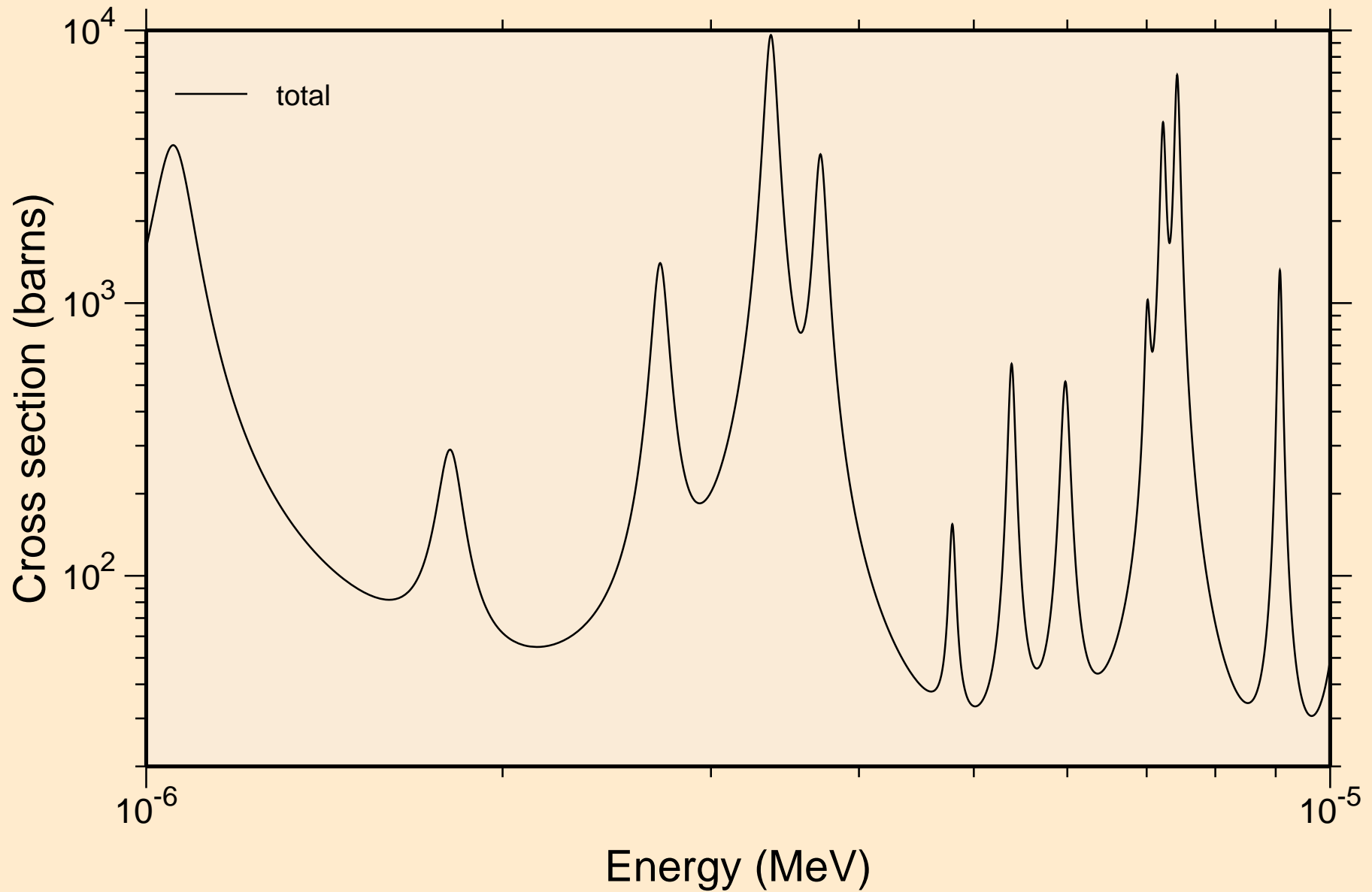

EU151 NEUTRON ACER TENDL-2023 LIBRARY; T=0.K
resonance total cross section

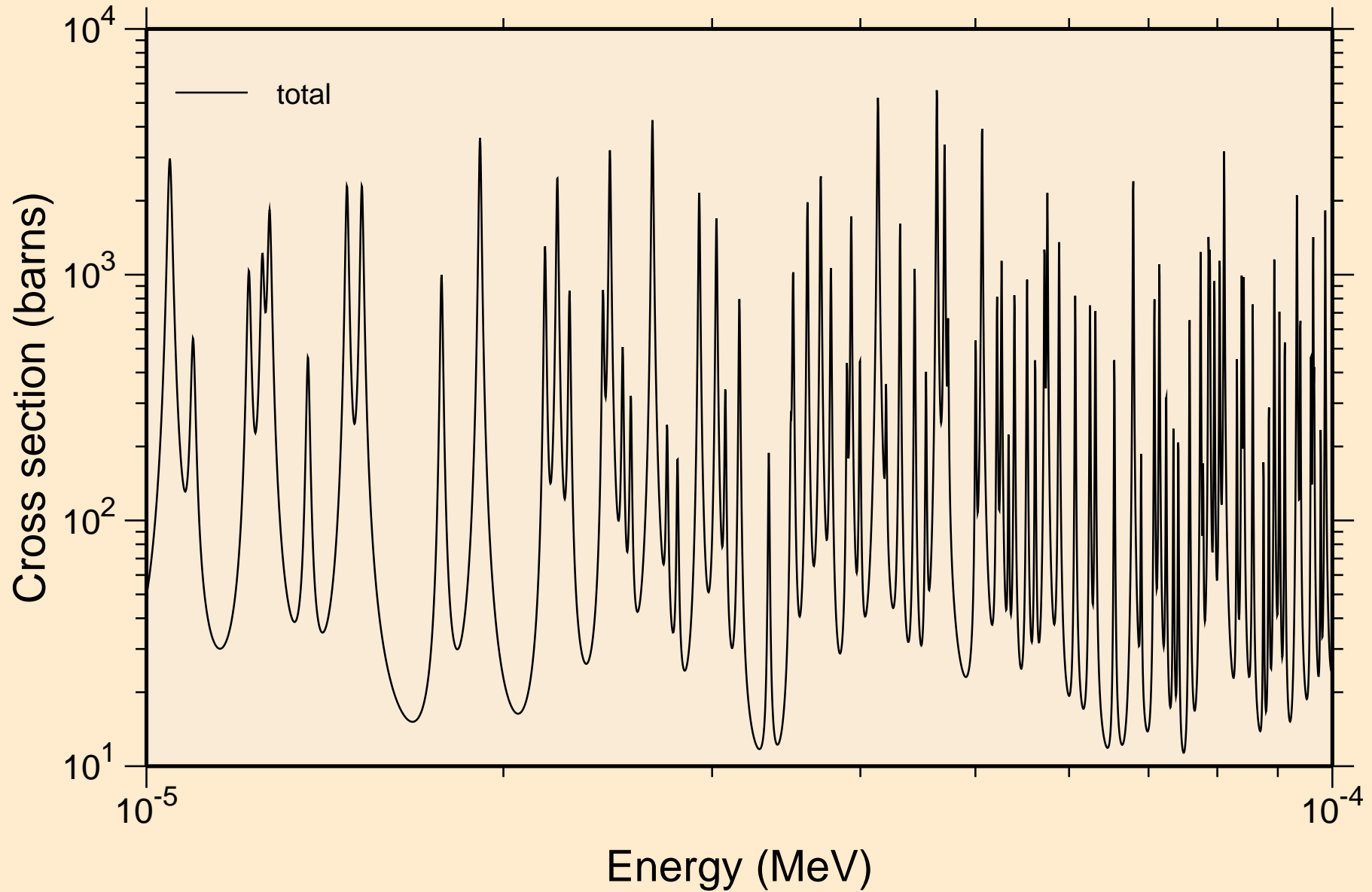

EU151 NEUTRON ACER TENDL-2023 LIBRARY; T=0.K
resonance total cross section

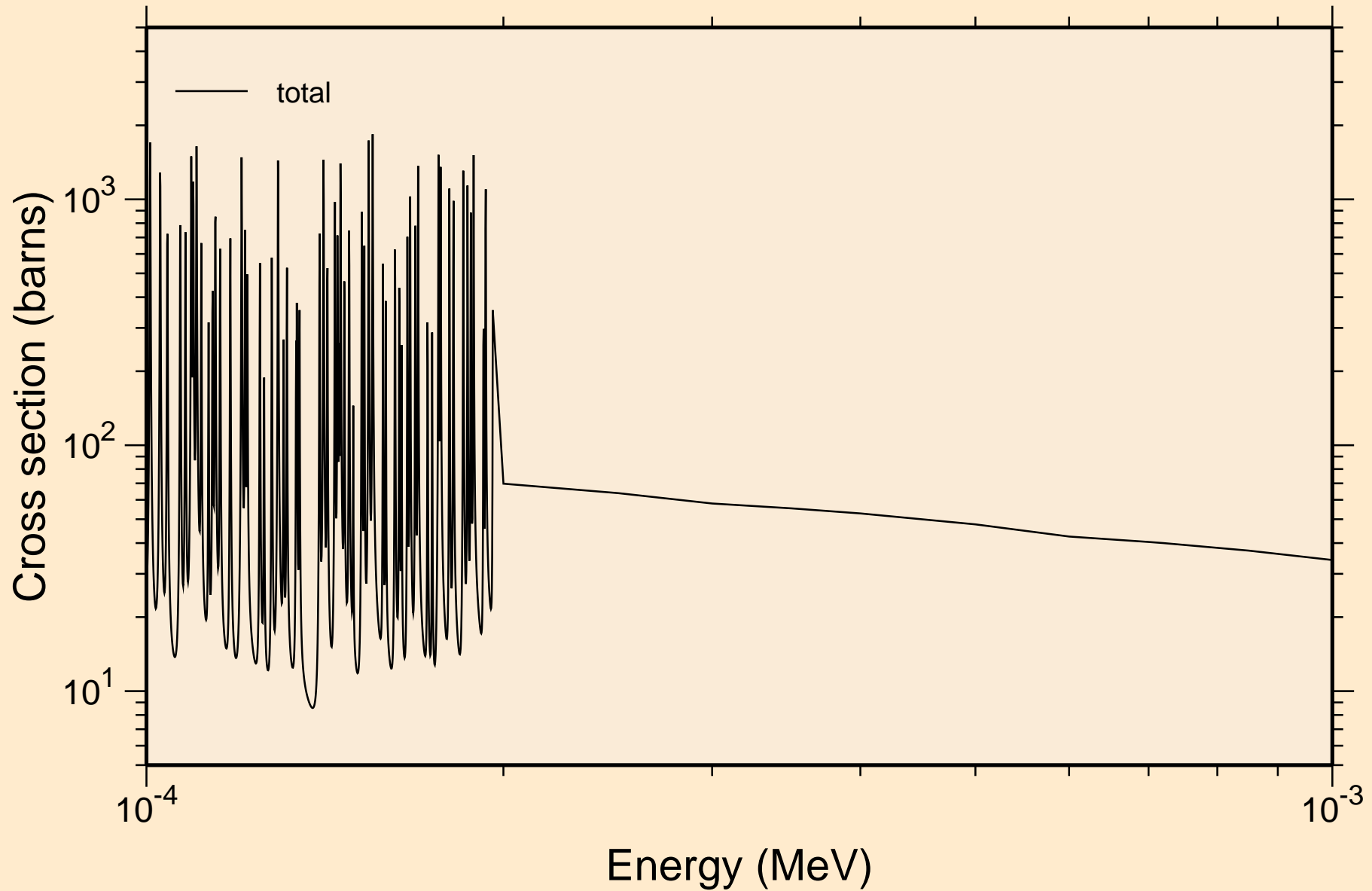

EU151 NEUTRON ACER TENDL-2023 LIBRARY; T=0.K
resonance total cross section

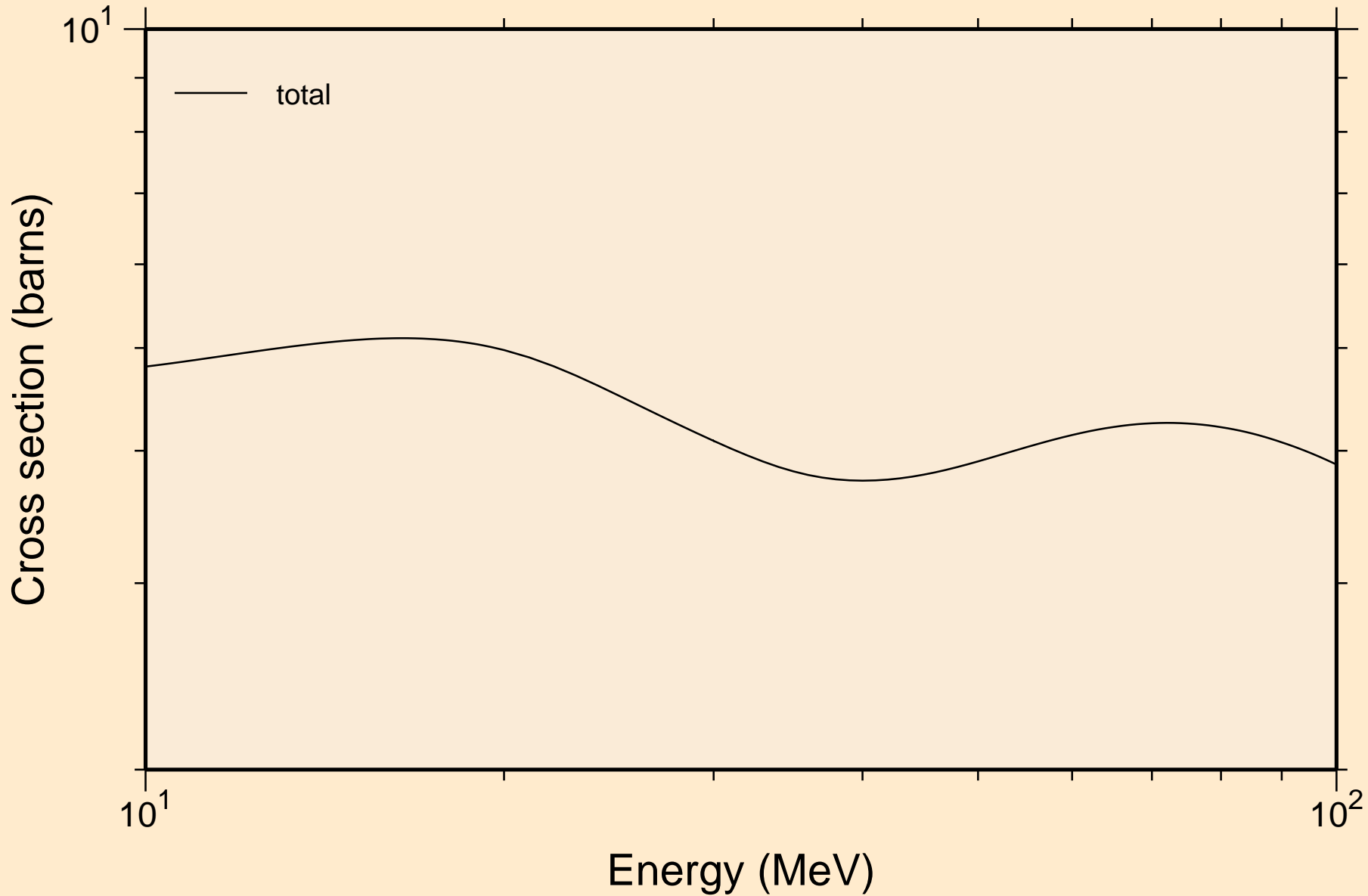

EU151 NEUTRON ACER TENDL-2023 LIBRARY; T=0.K
resonance absorption cross sections

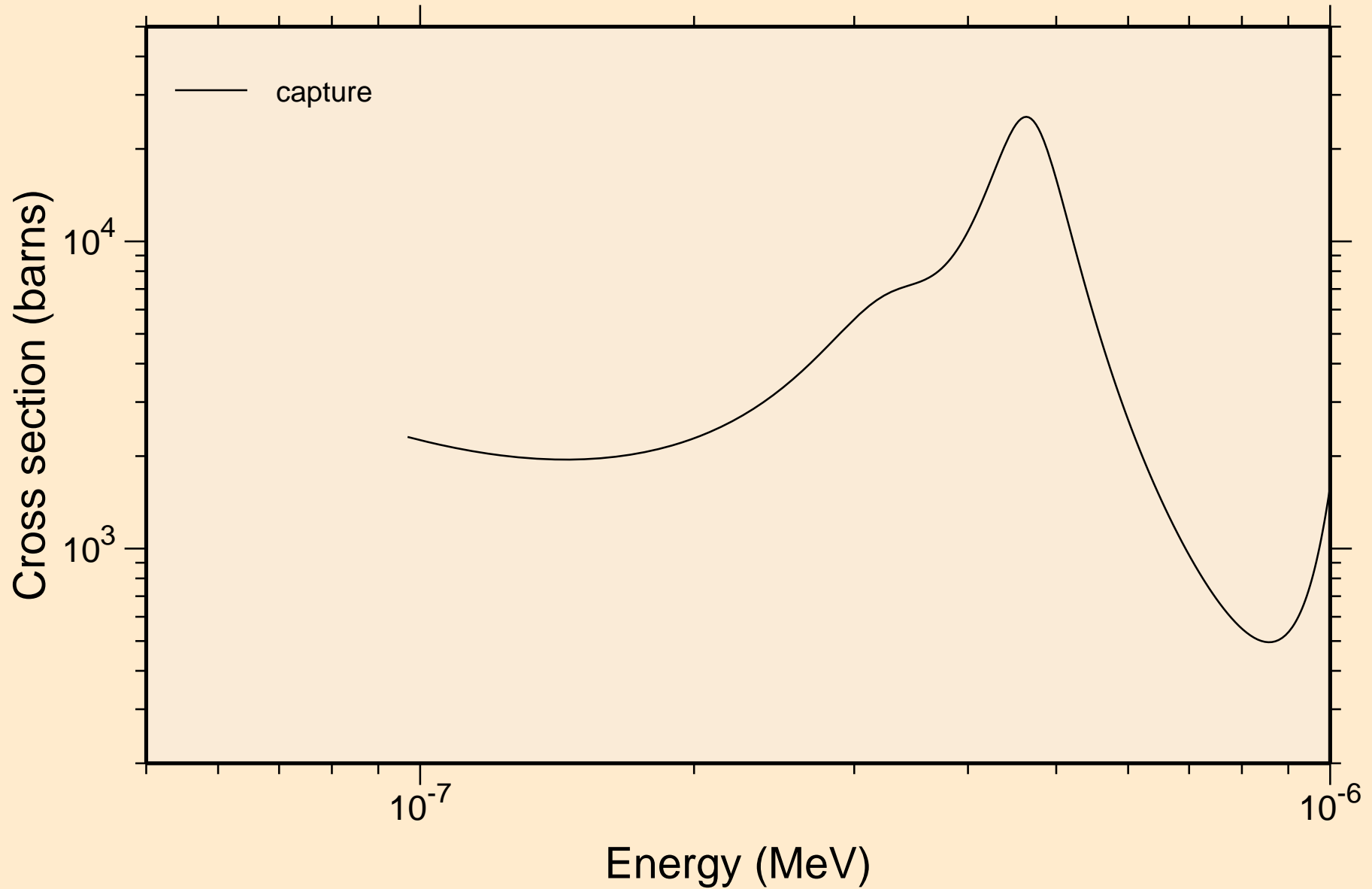

EU151 NEUTRON ACER TENDL-2023 LIBRARY; T=0.K
resonance absorption cross sections

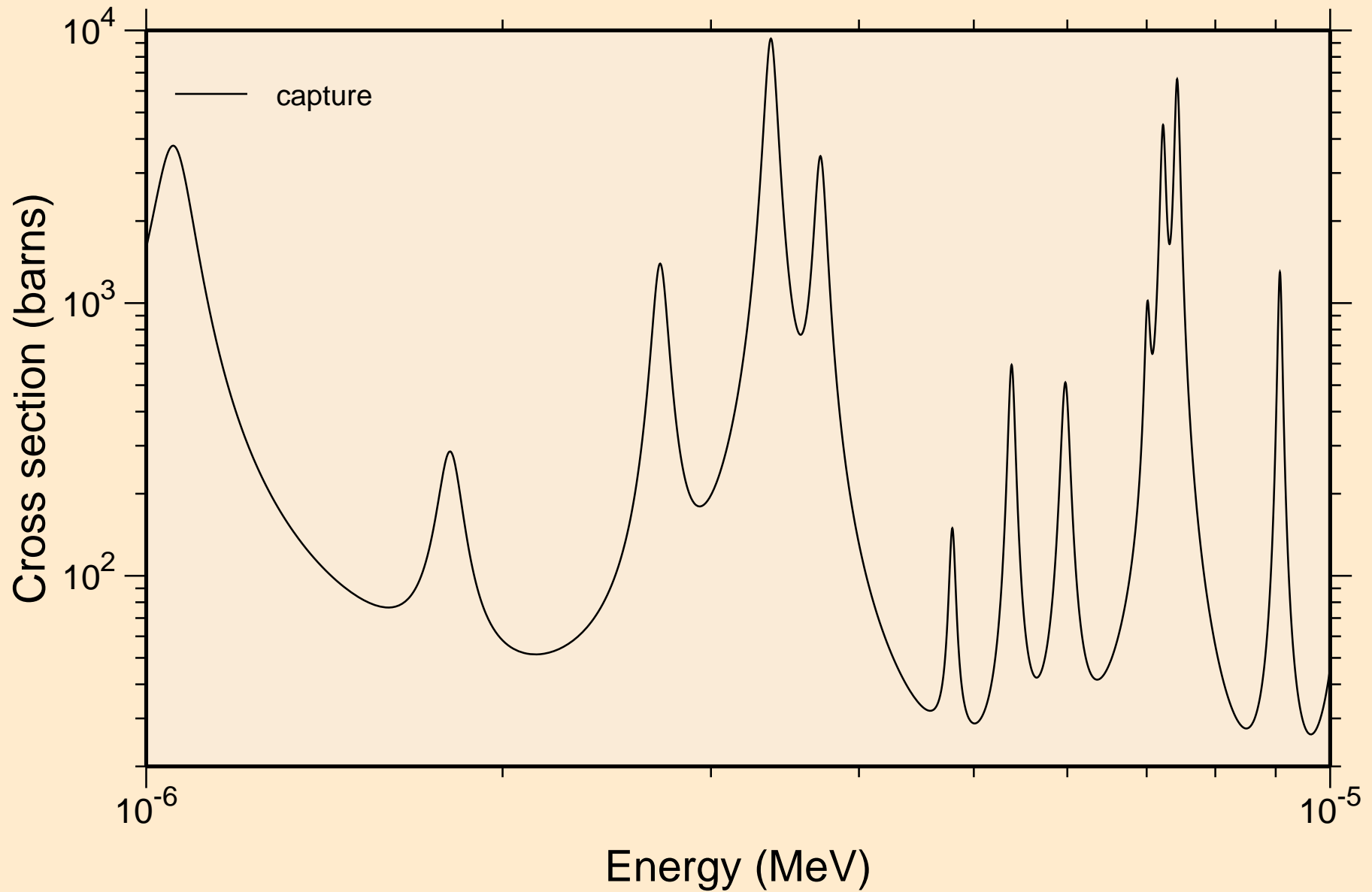

EU151 NEUTRON ACER TENDL-2023 LIBRARY; T=0.K
resonance absorption cross sections

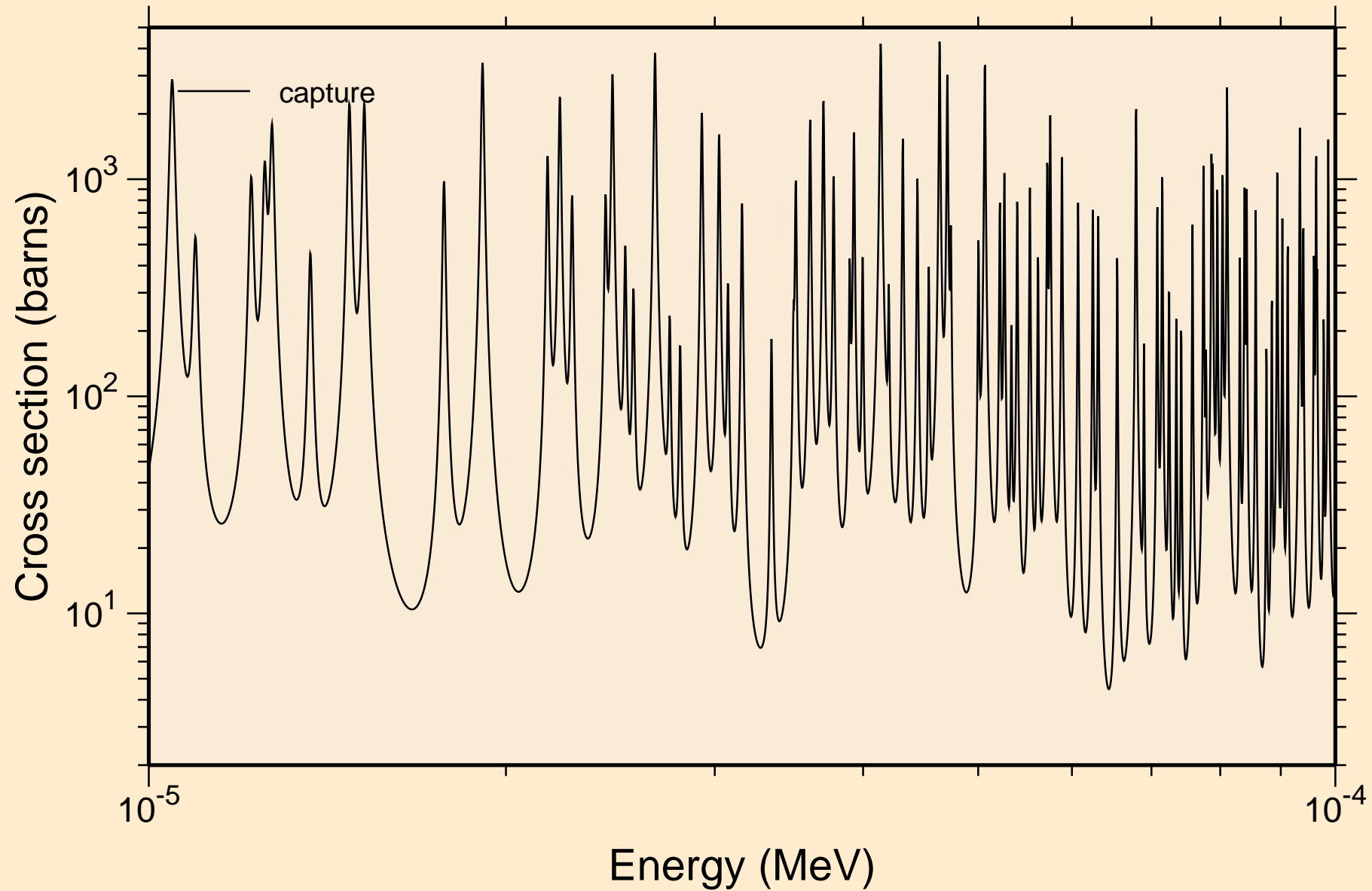

EU151 NEUTRON ACER TENDL-2023 LIBRARY; T=0.K
resonance absorption cross sections

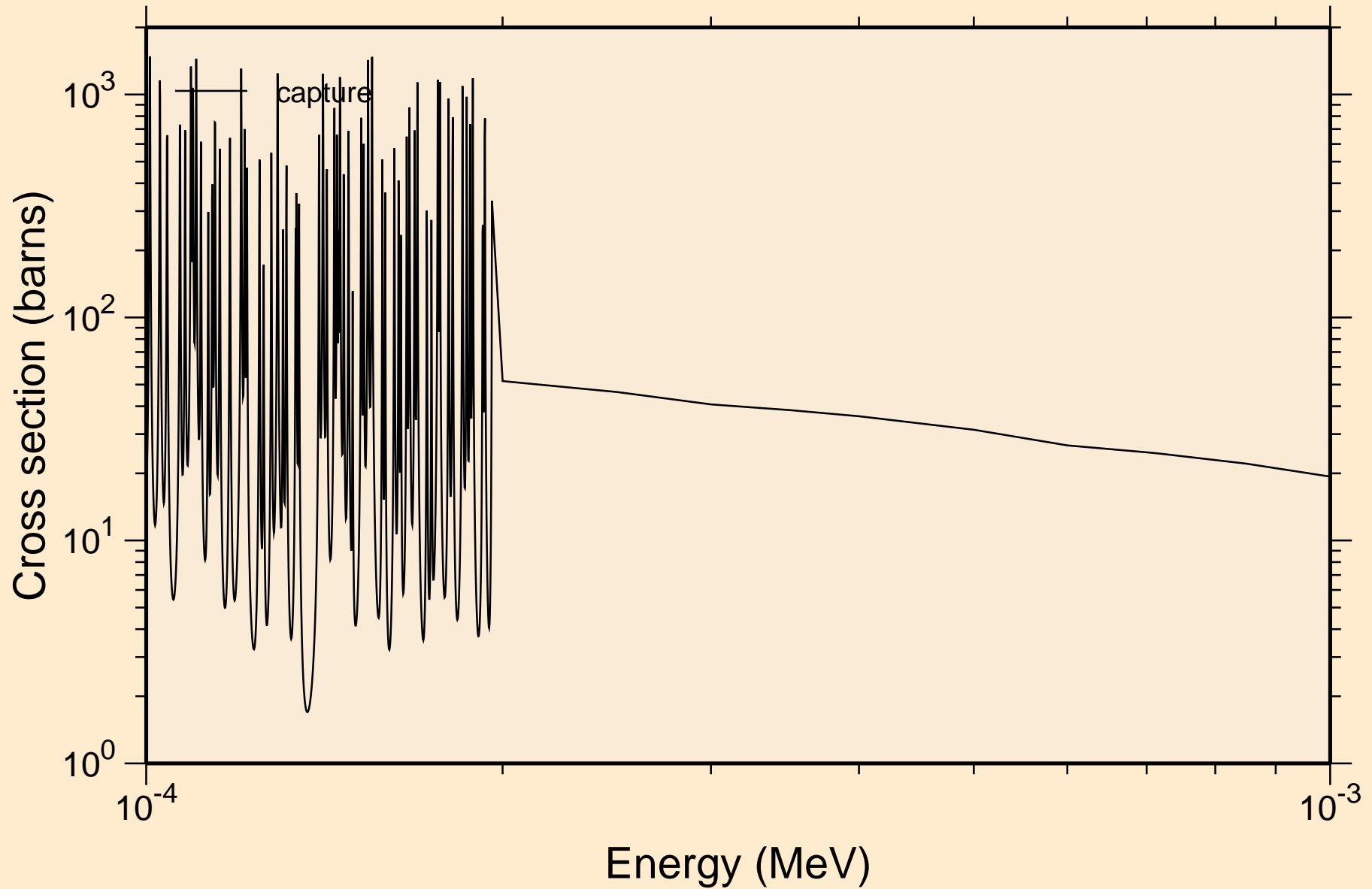

EU151 NEUTRON ACER TENDL-2023 LIBRARY; T=0.K
resonance absorption cross sections

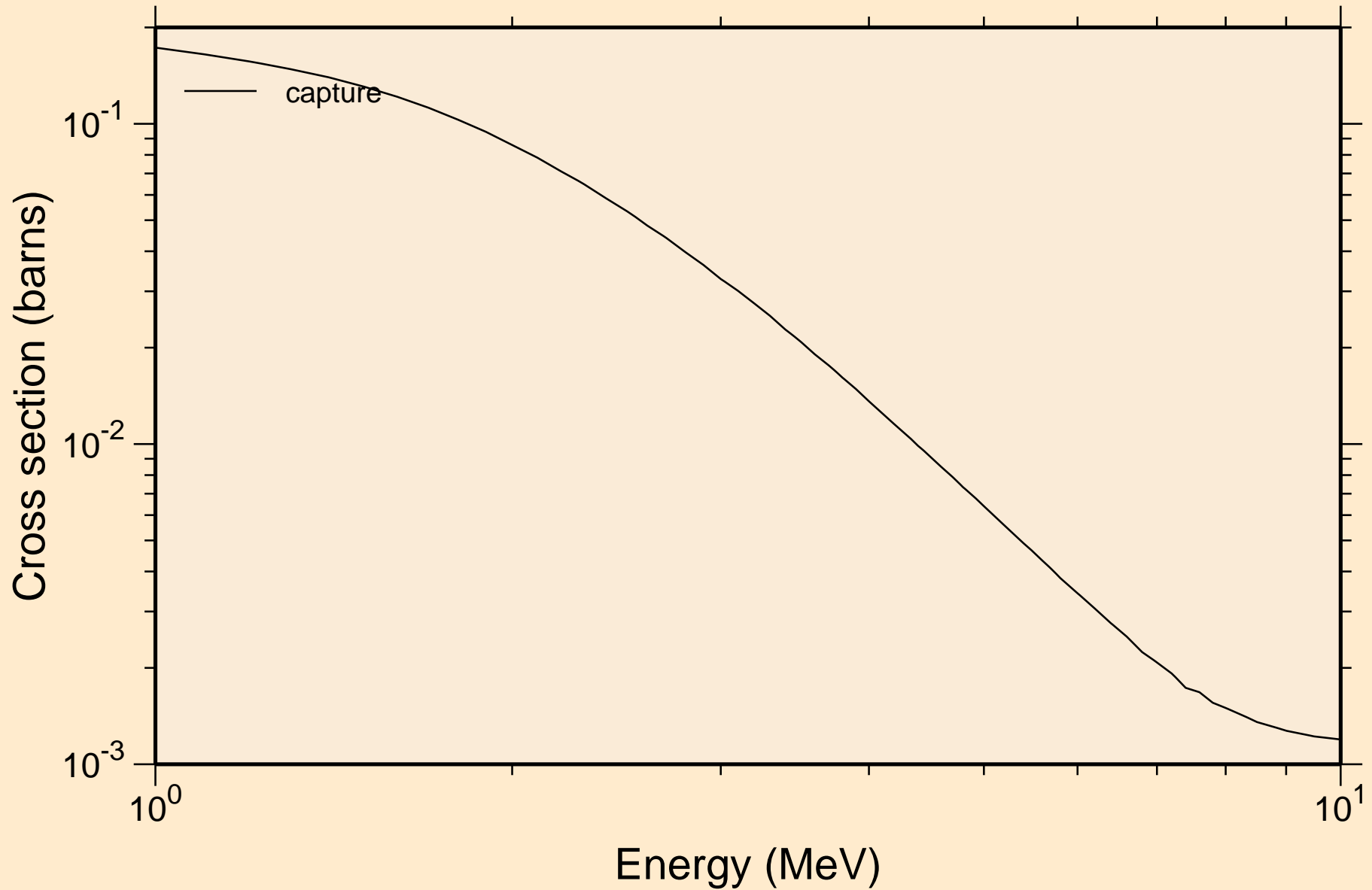

EU151 NEUTRON ACER TENDL-2023 LIBRARY; T=0.K

Heating

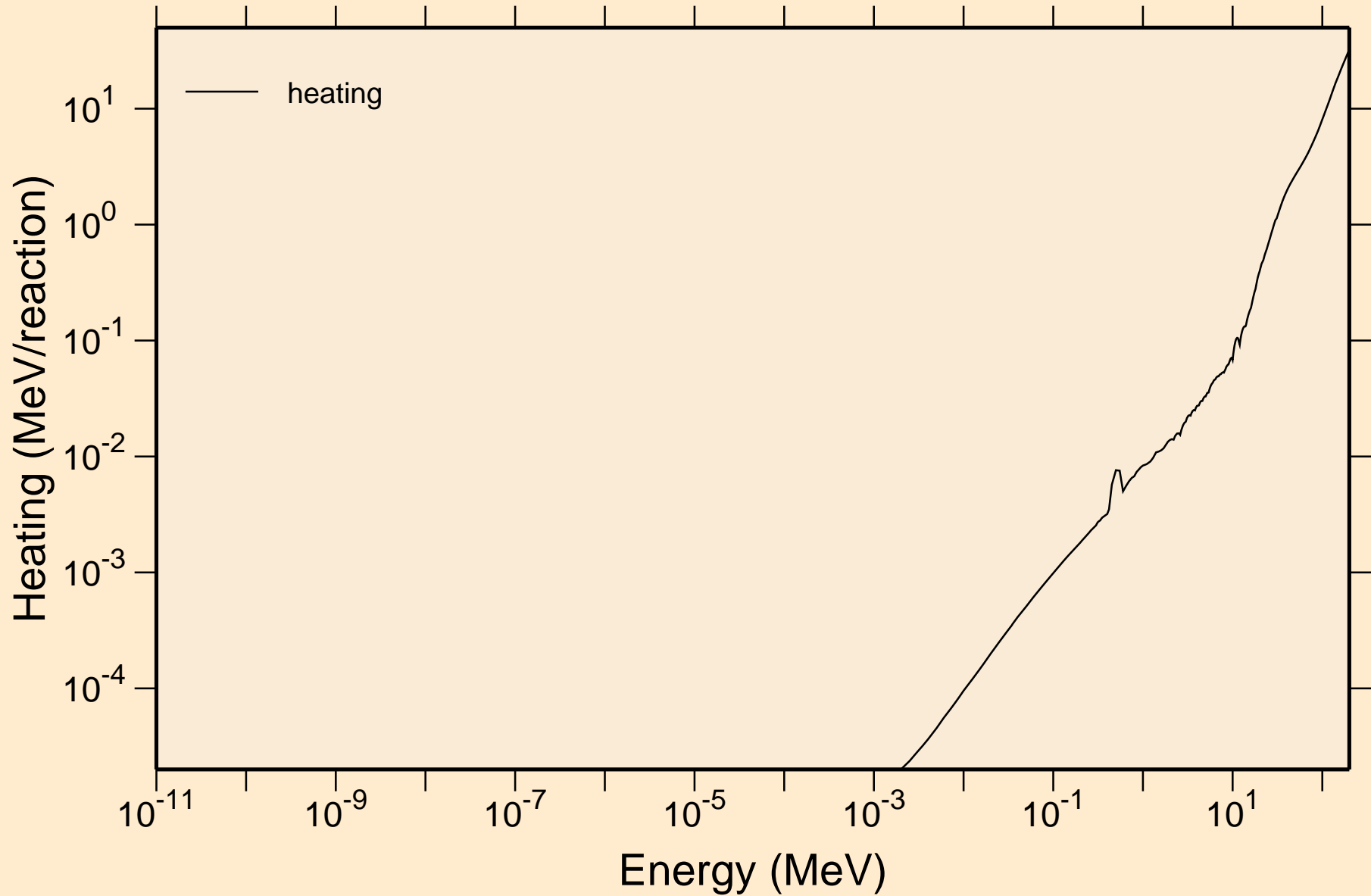

EU151 NEUTRON ACER TENDL-2023 LIBRARY; T=0.K

Damage

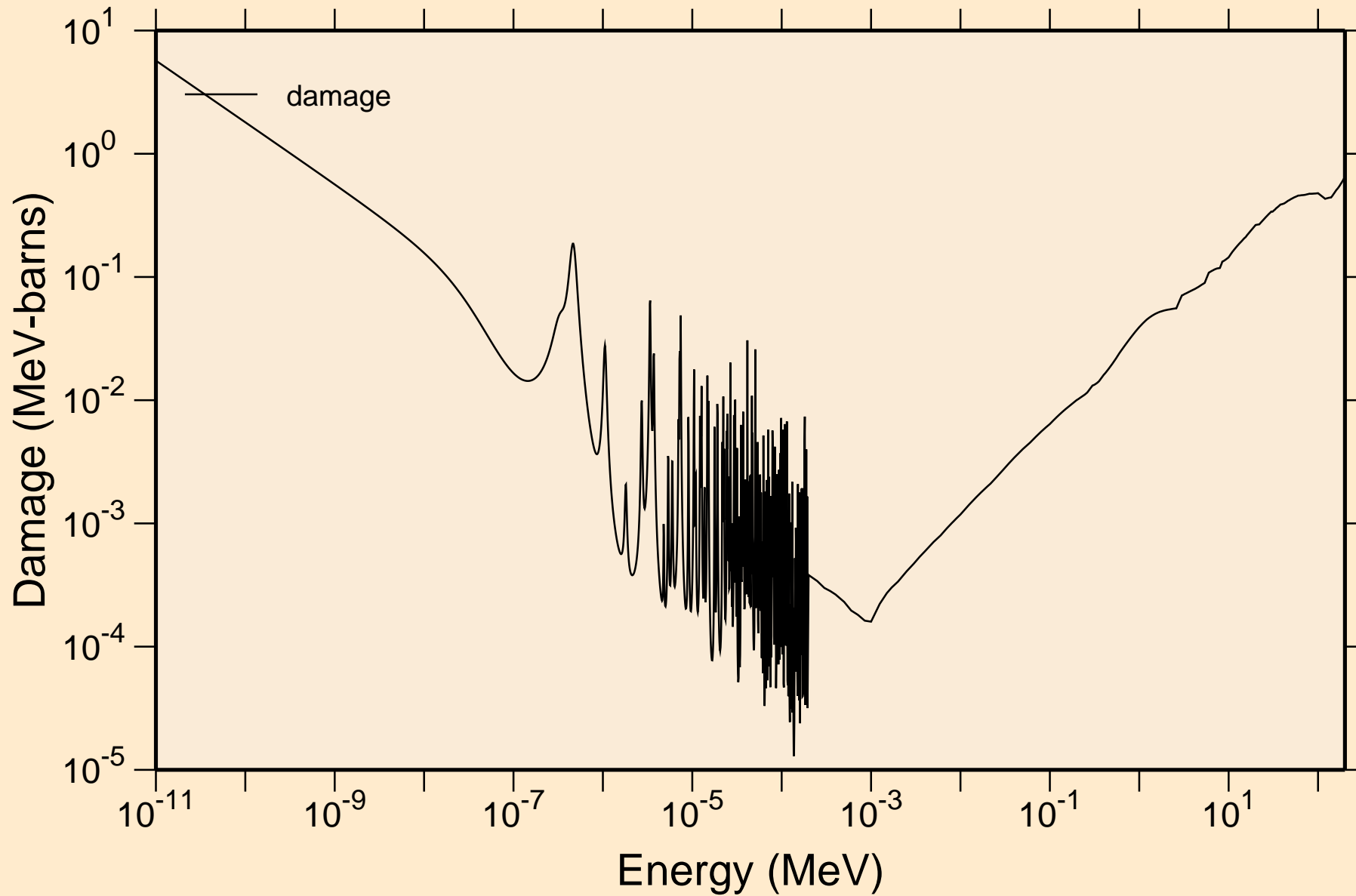

EU151 NEUTRON ACER TENDL-2023 LIBRARY; T=0.K

Non-threshold reactions

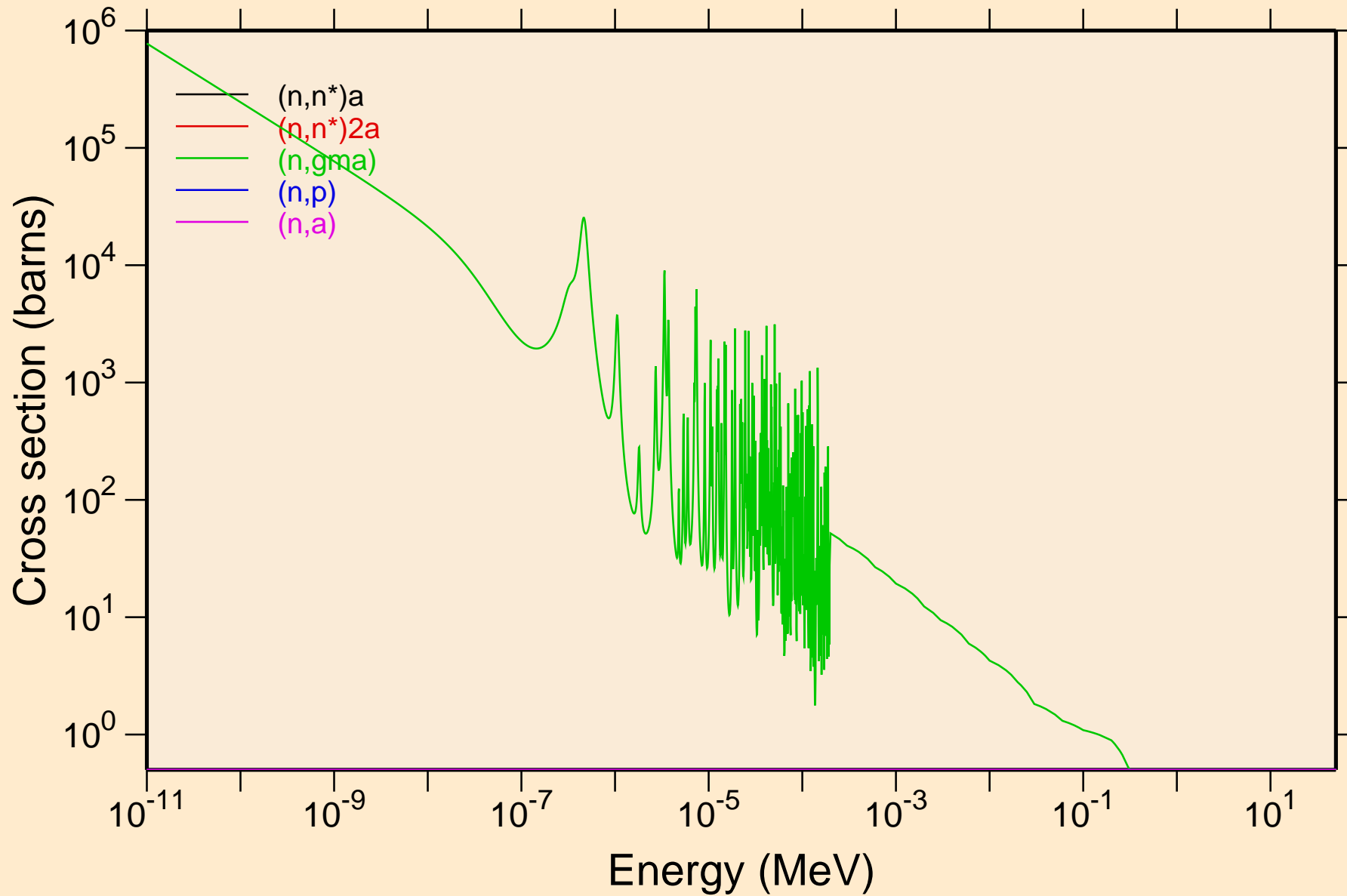

EU151 NEUTRON ACER TENDL-2023 LIBRARY; T=0.K

Non-threshold reactions

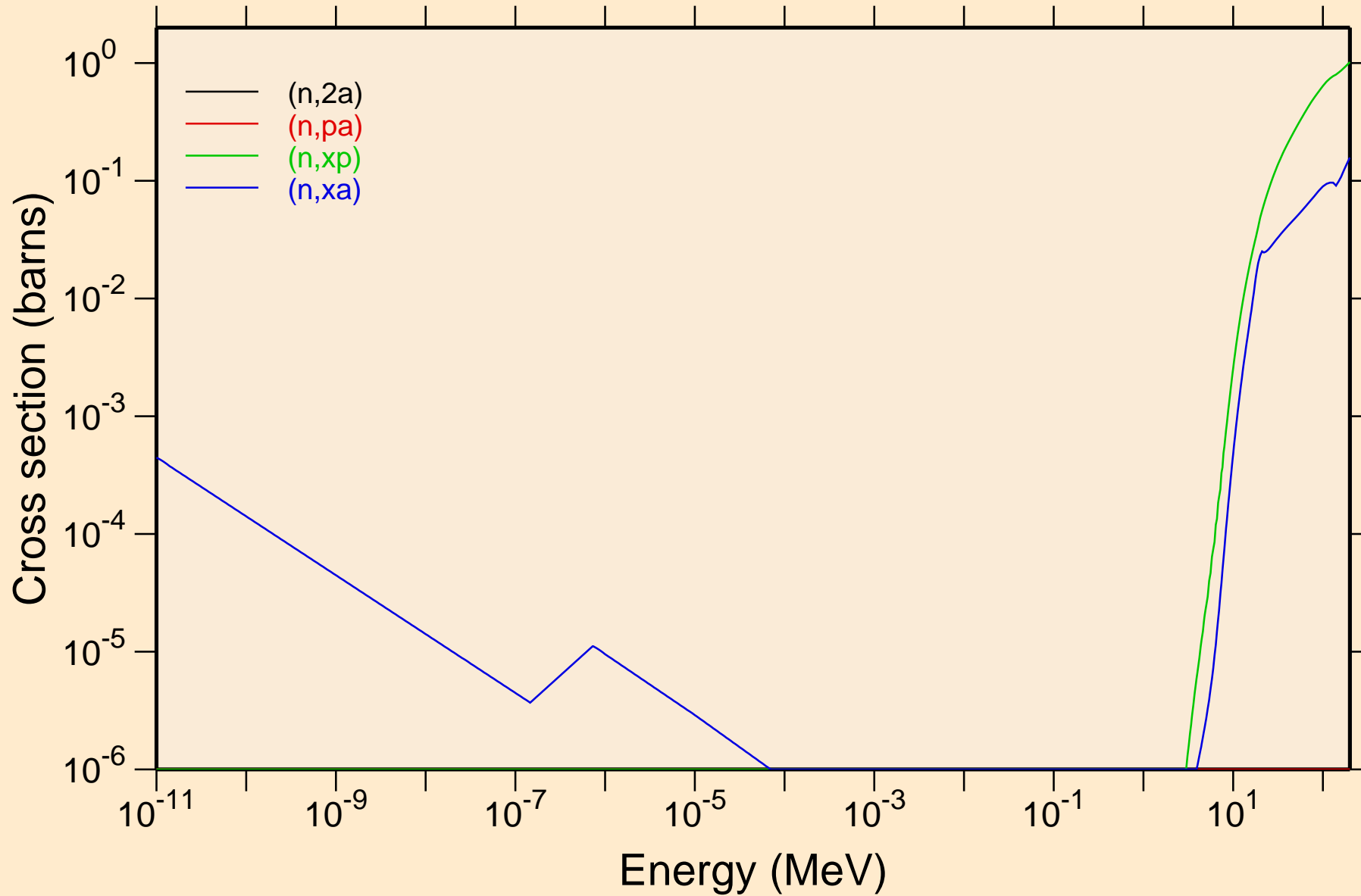

EU151 NEUTRON ACER TENDL-2023 LIBRARY; T=0.K

Principal cross sections

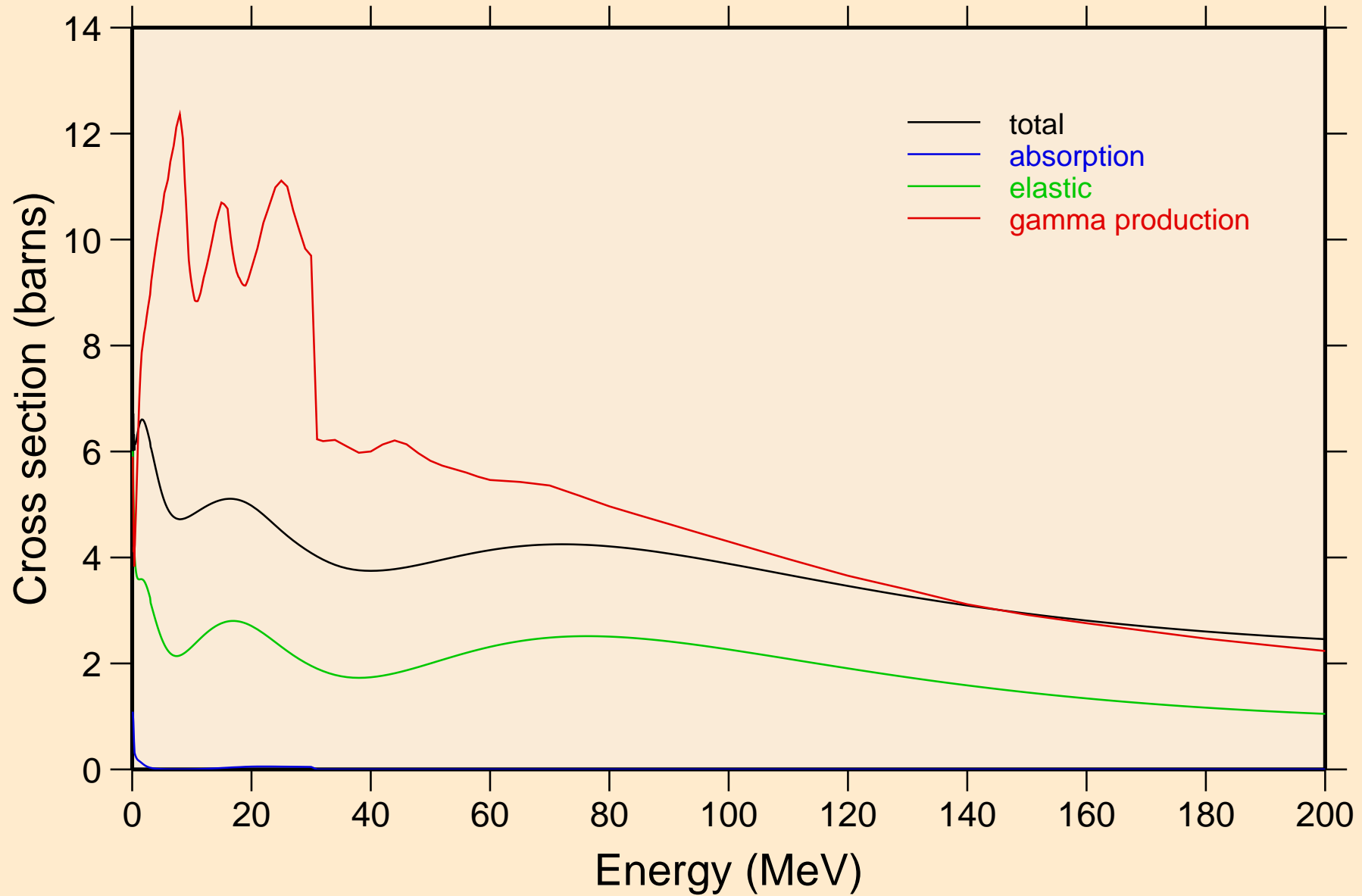

EU151 NEUTRON ACER TENDL-2023 LIBRARY; T=0.K

Heating

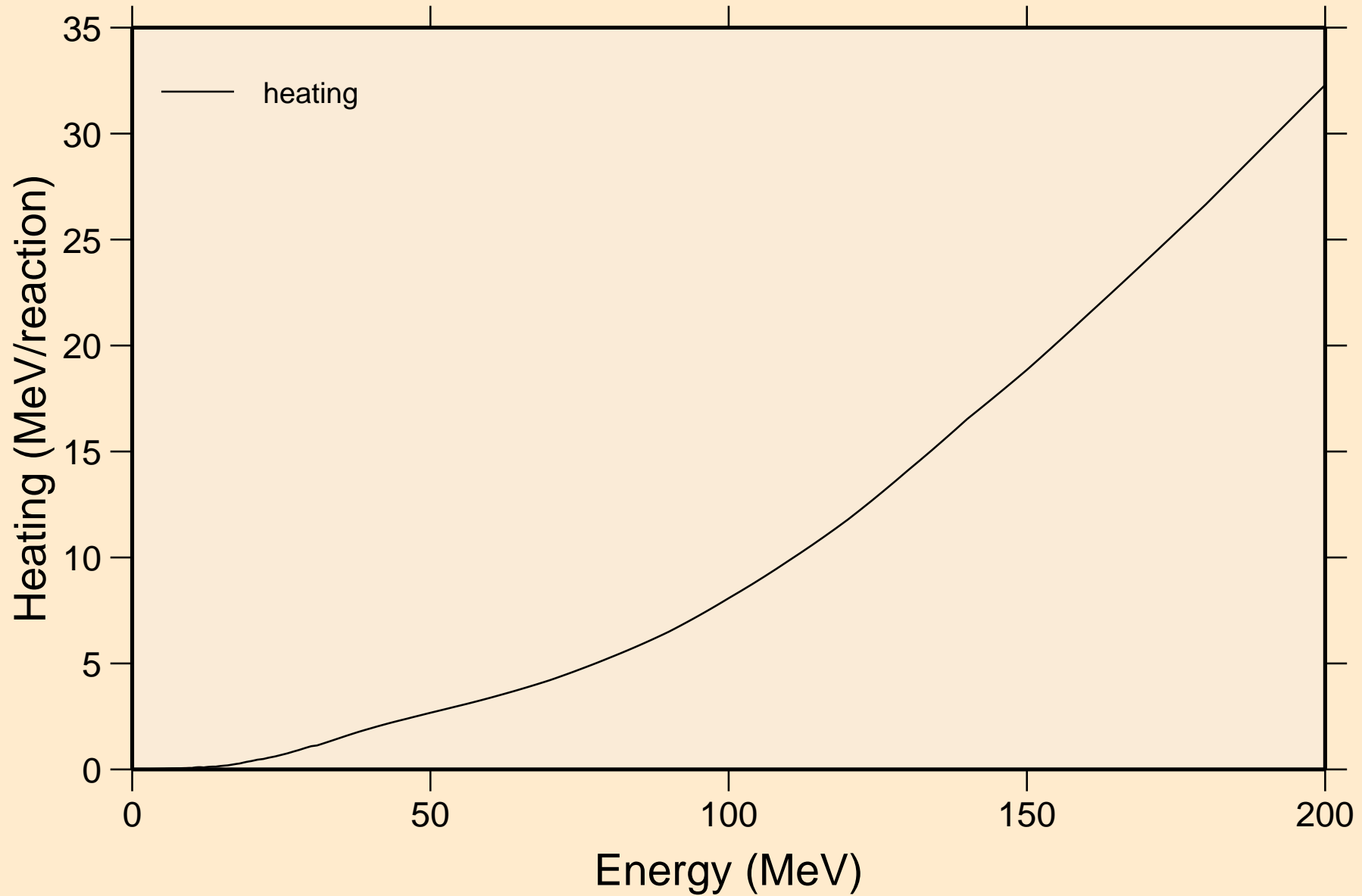

EU151 NEUTRON ACER TENDL-2023 LIBRARY; T=0.K

Damage

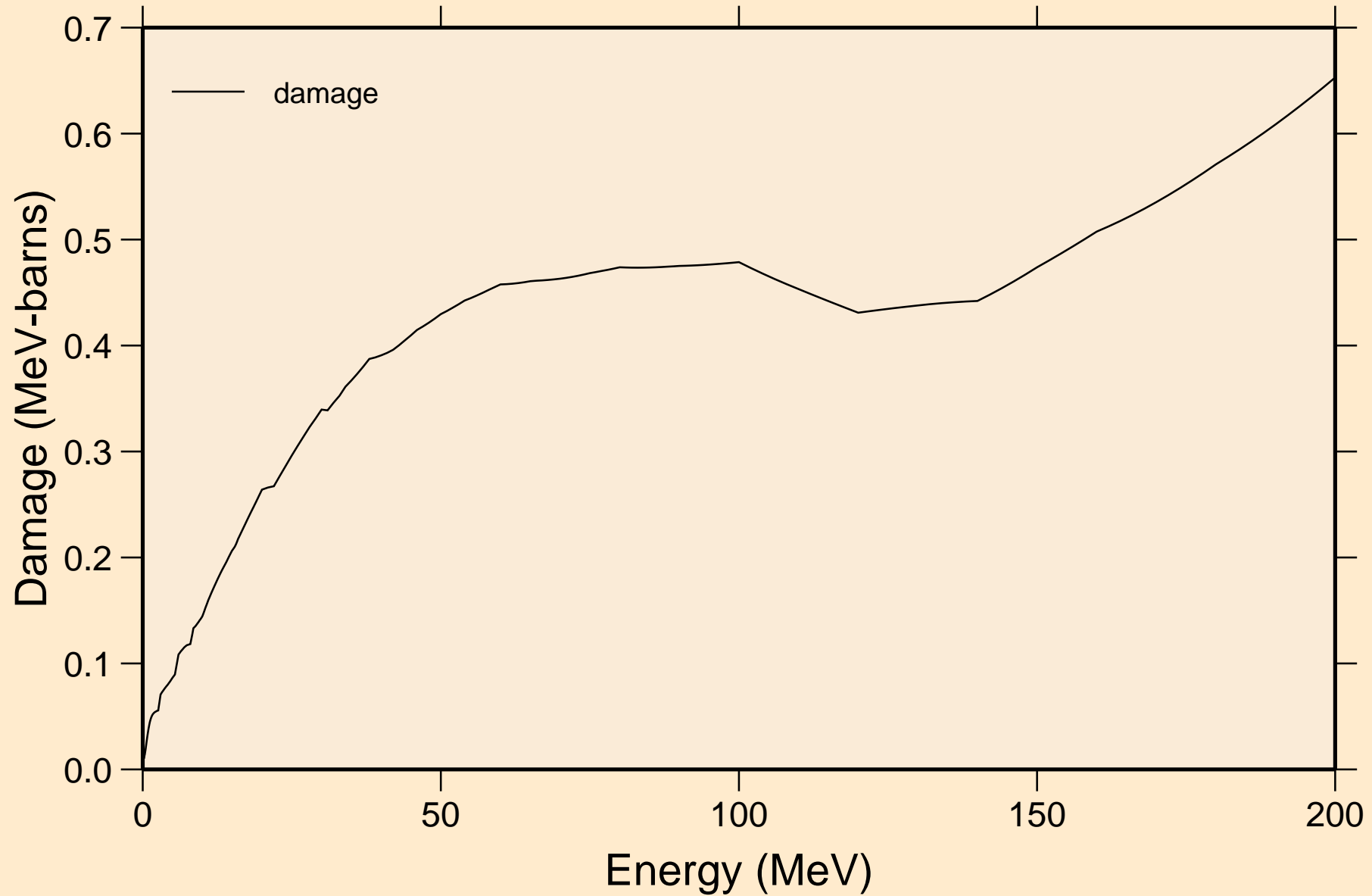

EU151 NEUTRON ACER TENDL-2023 LIBRARY; T=0.K

Non-threshold reactions

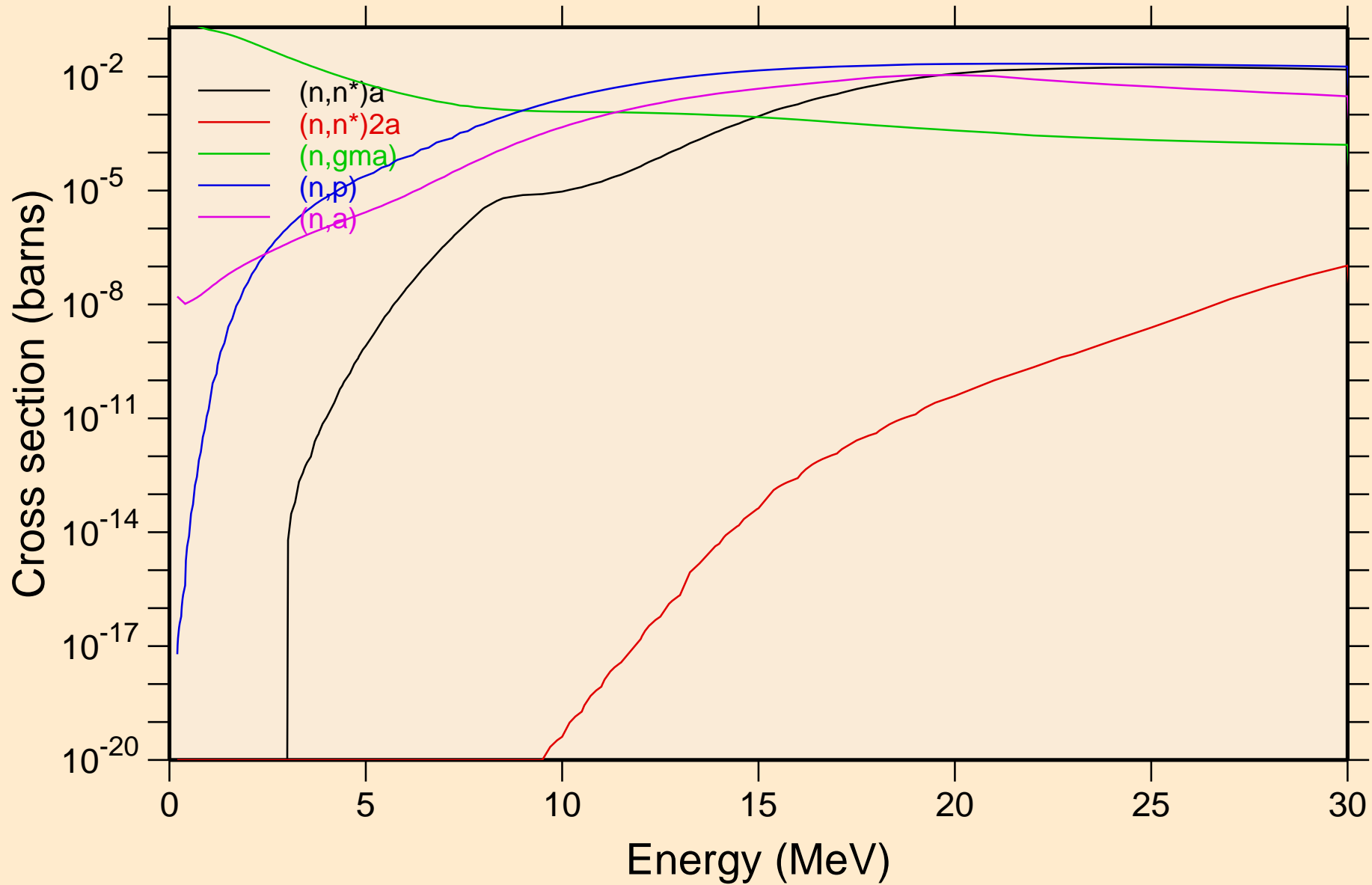

EU151 NEUTRON ACER TENDL-2023 LIBRARY; T=0.K
Non-threshold reactions

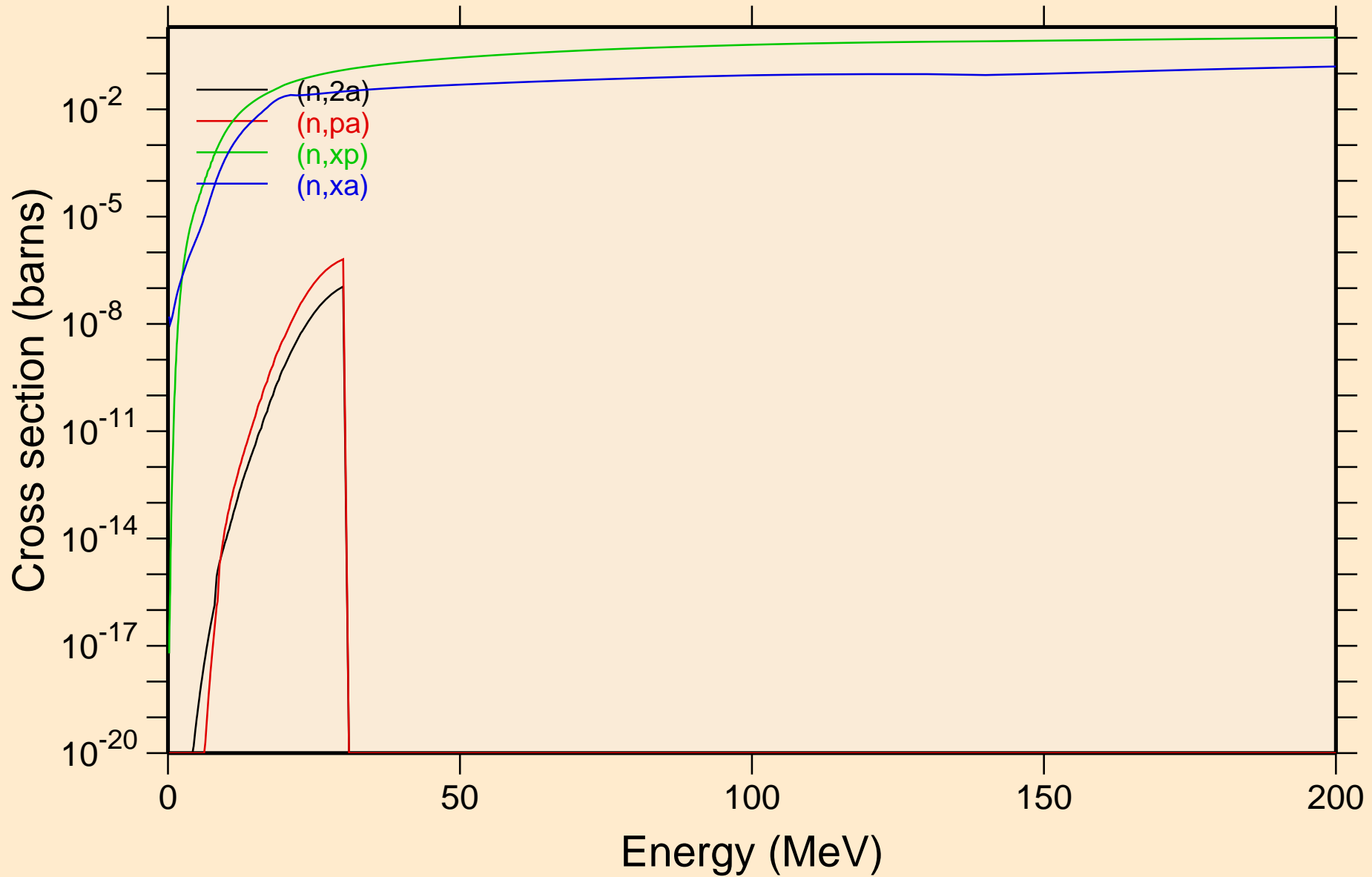

EU151 NEUTRON ACER TENDL-2023 LIBRARY; T=0.K
Inelastic levels

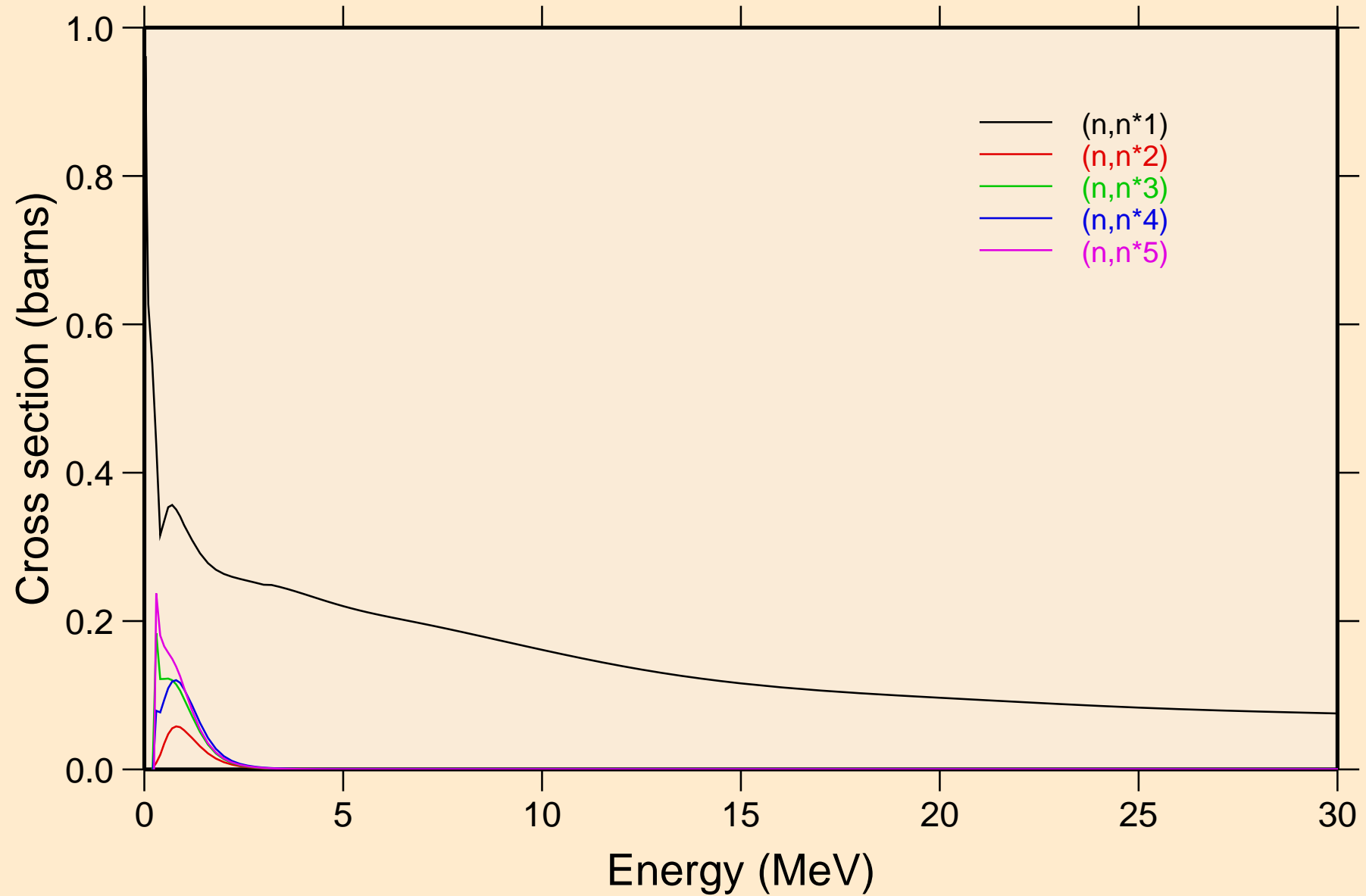

EU151 NEUTRON ACER TENDL-2023 LIBRARY; T=0.K

Inelastic levels

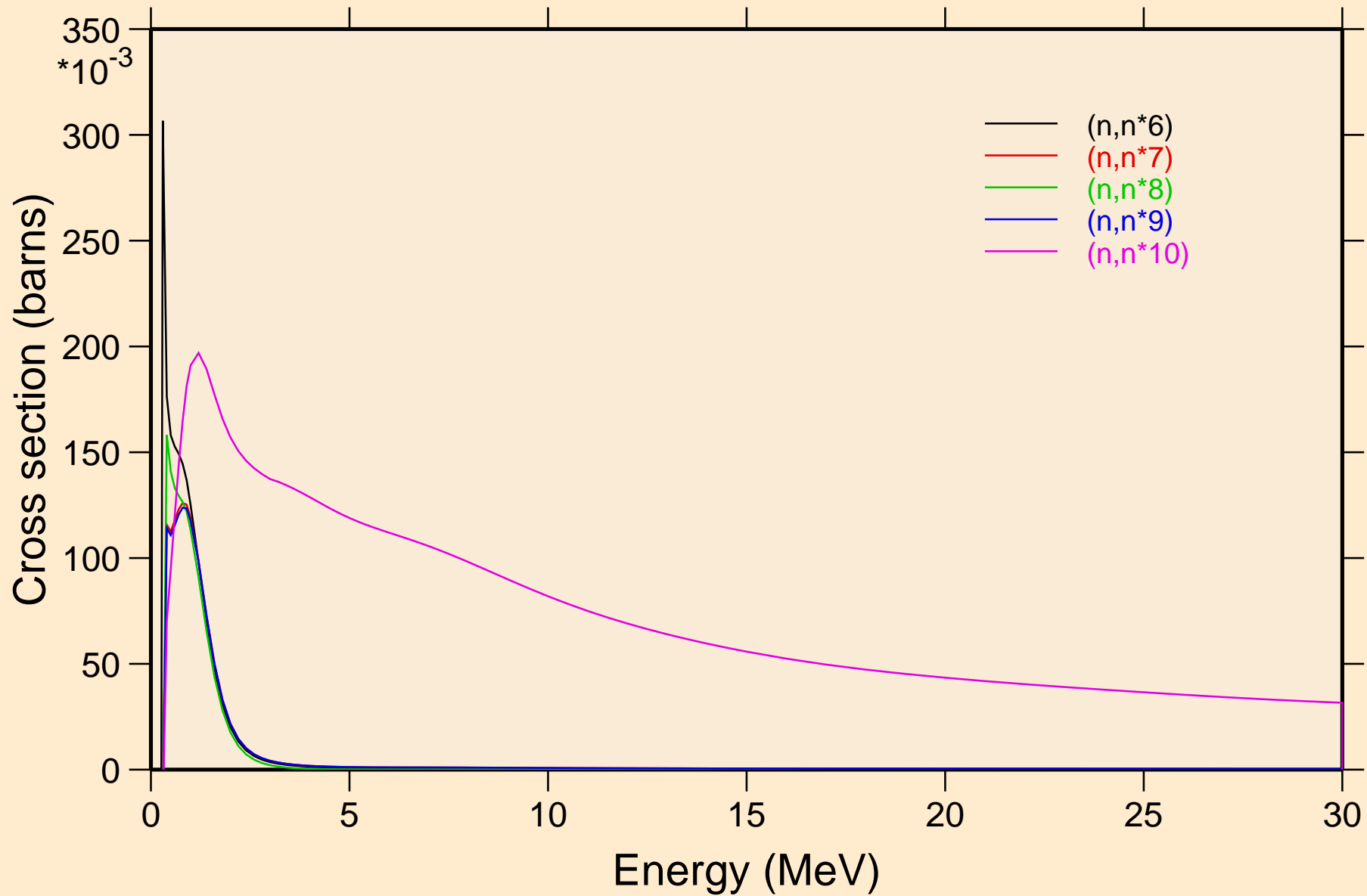

EU151 NEUTRON ACER TENDL-2023 LIBRARY; T=0.K

Inelastic levels

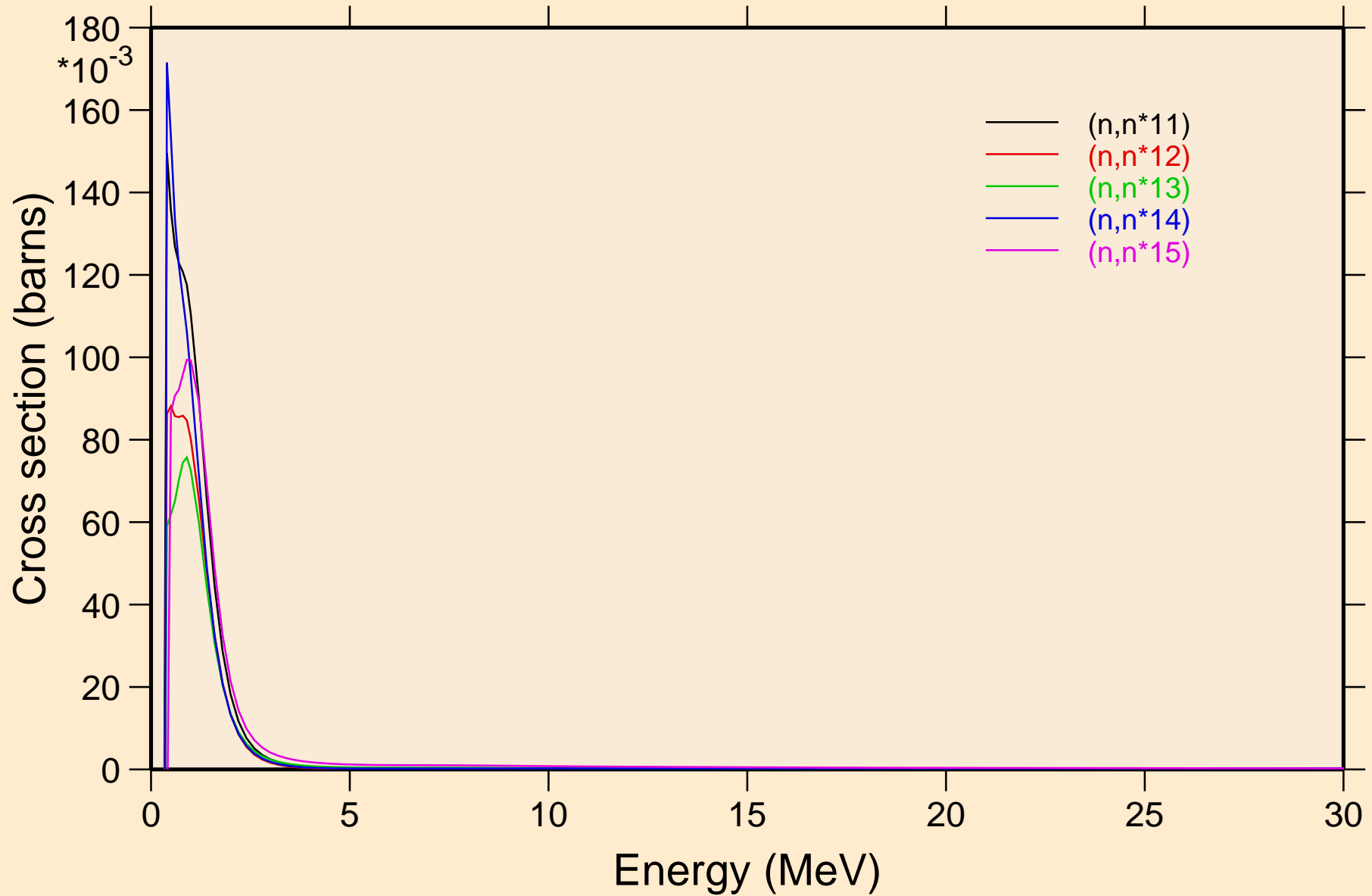

EU151 NEUTRON ACER TENDL-2023 LIBRARY; T=0.K

Threshold reactions

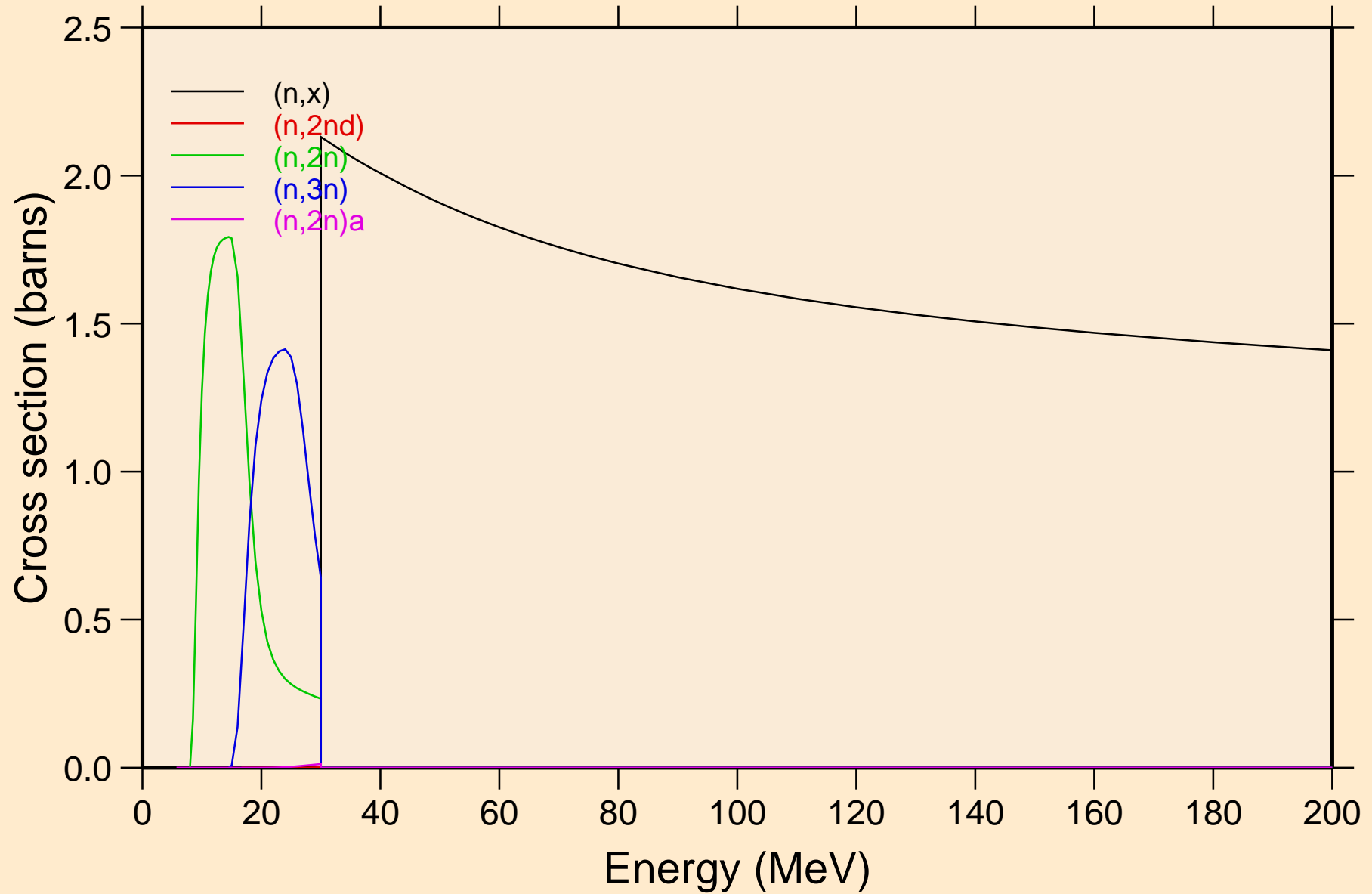

EU151 NEUTRON ACER TENDL-2023 LIBRARY; T=0.K

Threshold reactions

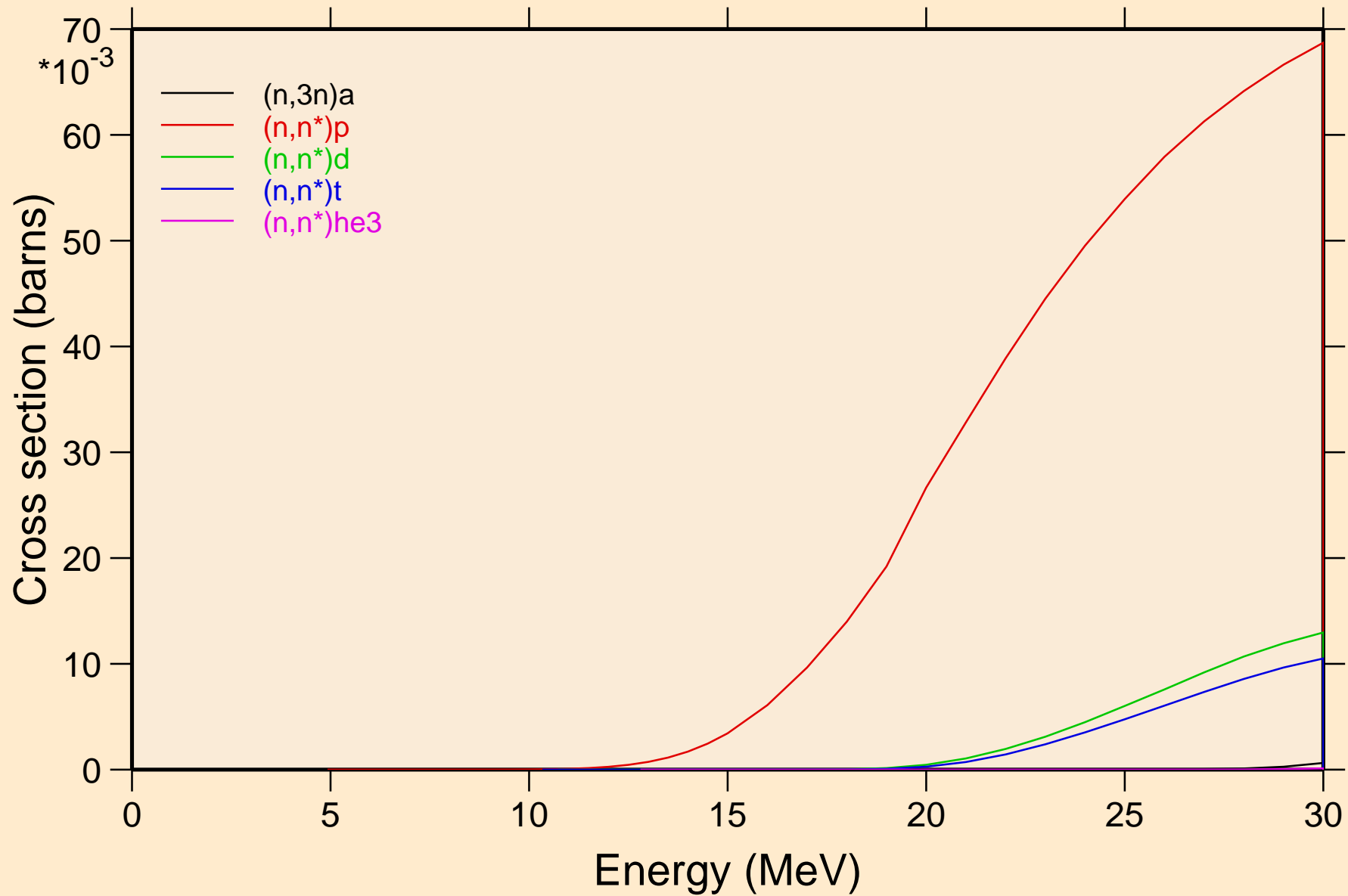

EU151 NEUTRON ACER TENDL-2023 LIBRARY; T=0.K
Threshold reactions

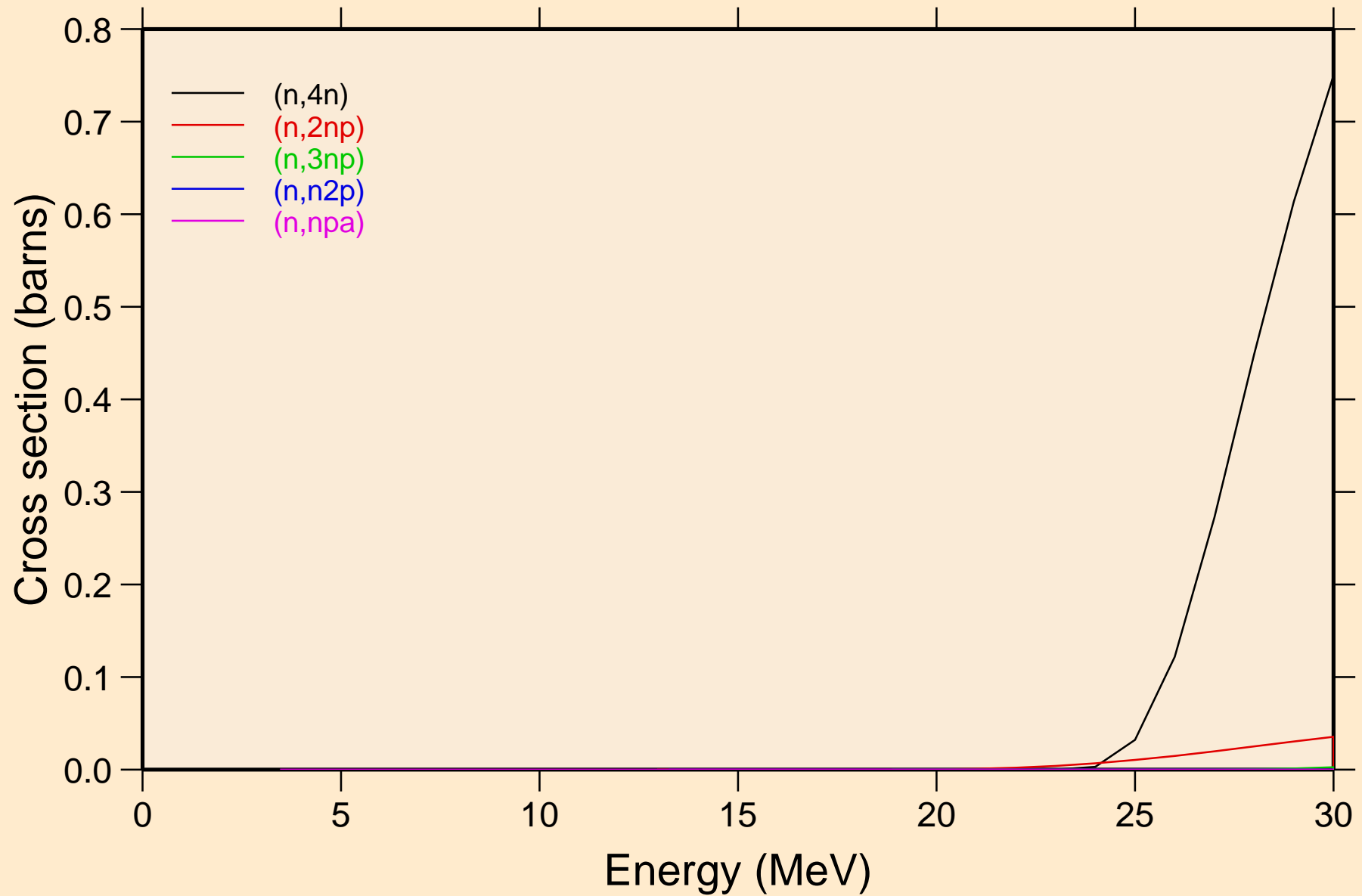

EU151 NEUTRON ACER TENDL-2023 LIBRARY; T=0.K

Threshold reactions

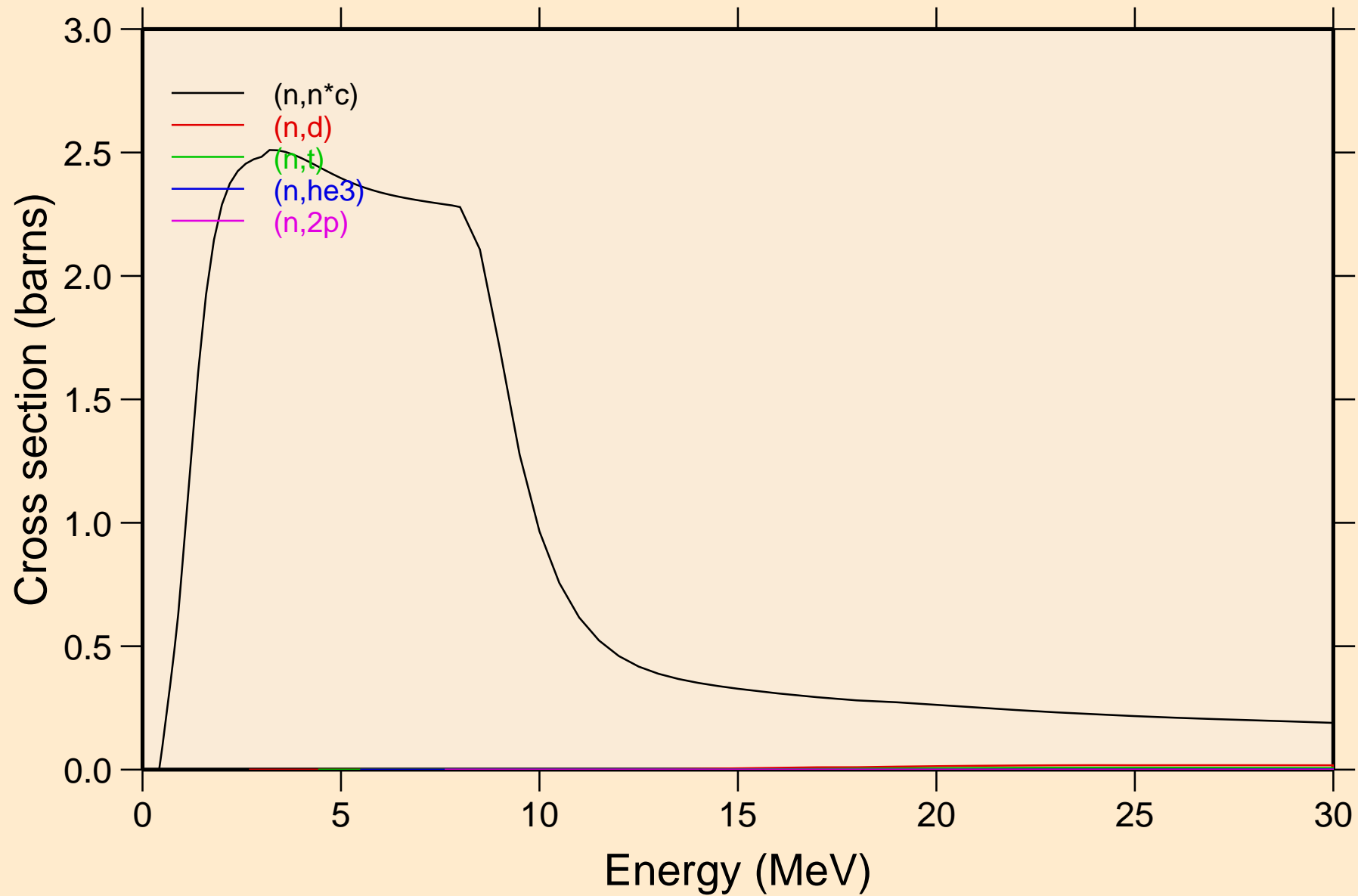

EU151 NEUTRON ACER TENDL-2023 LIBRARY; T=0.K

Threshold reactions

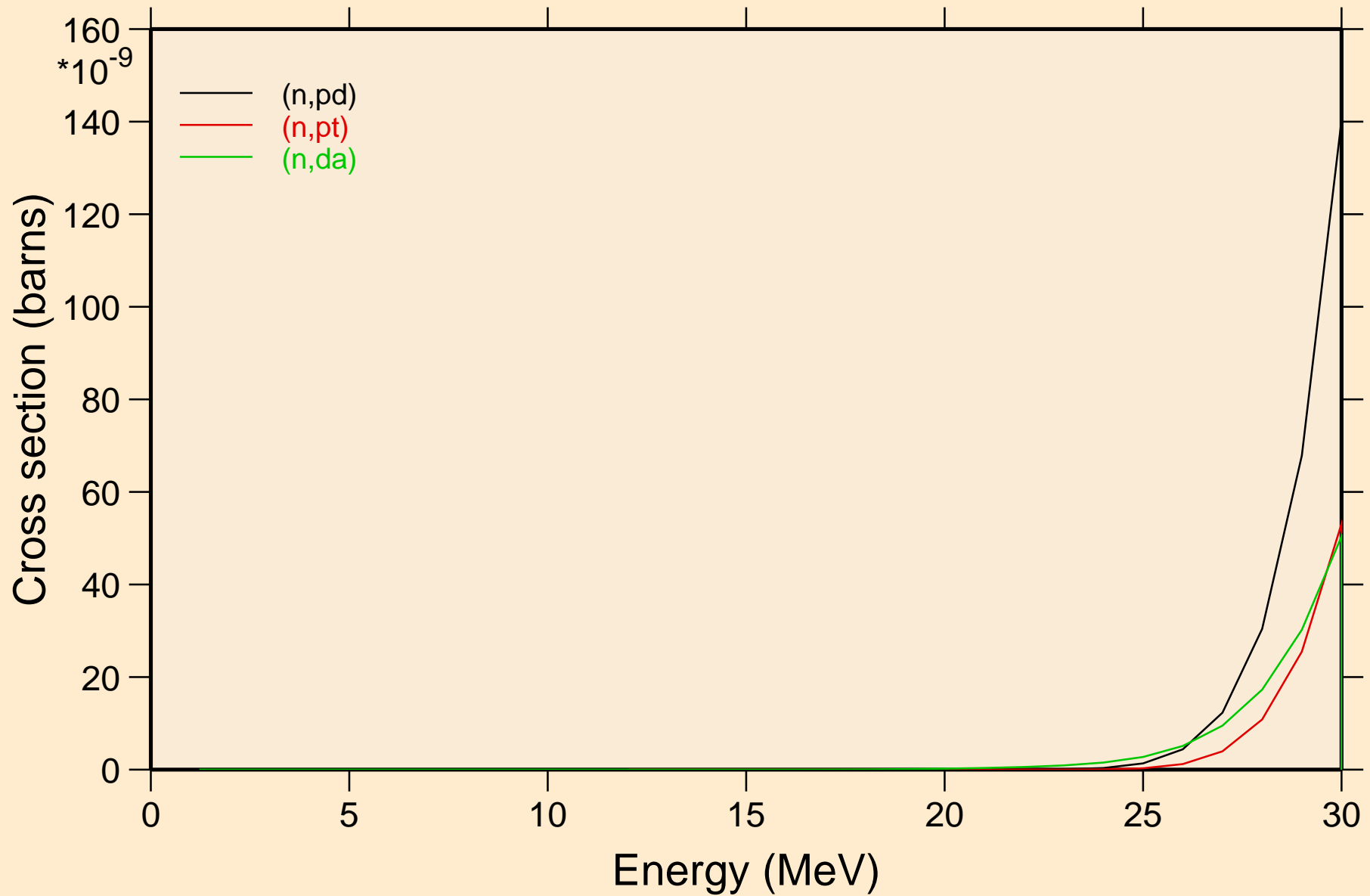

EU151 NEUTRON ACER TENDL-2023 LIBRARY; T=0.K

Threshold reactions

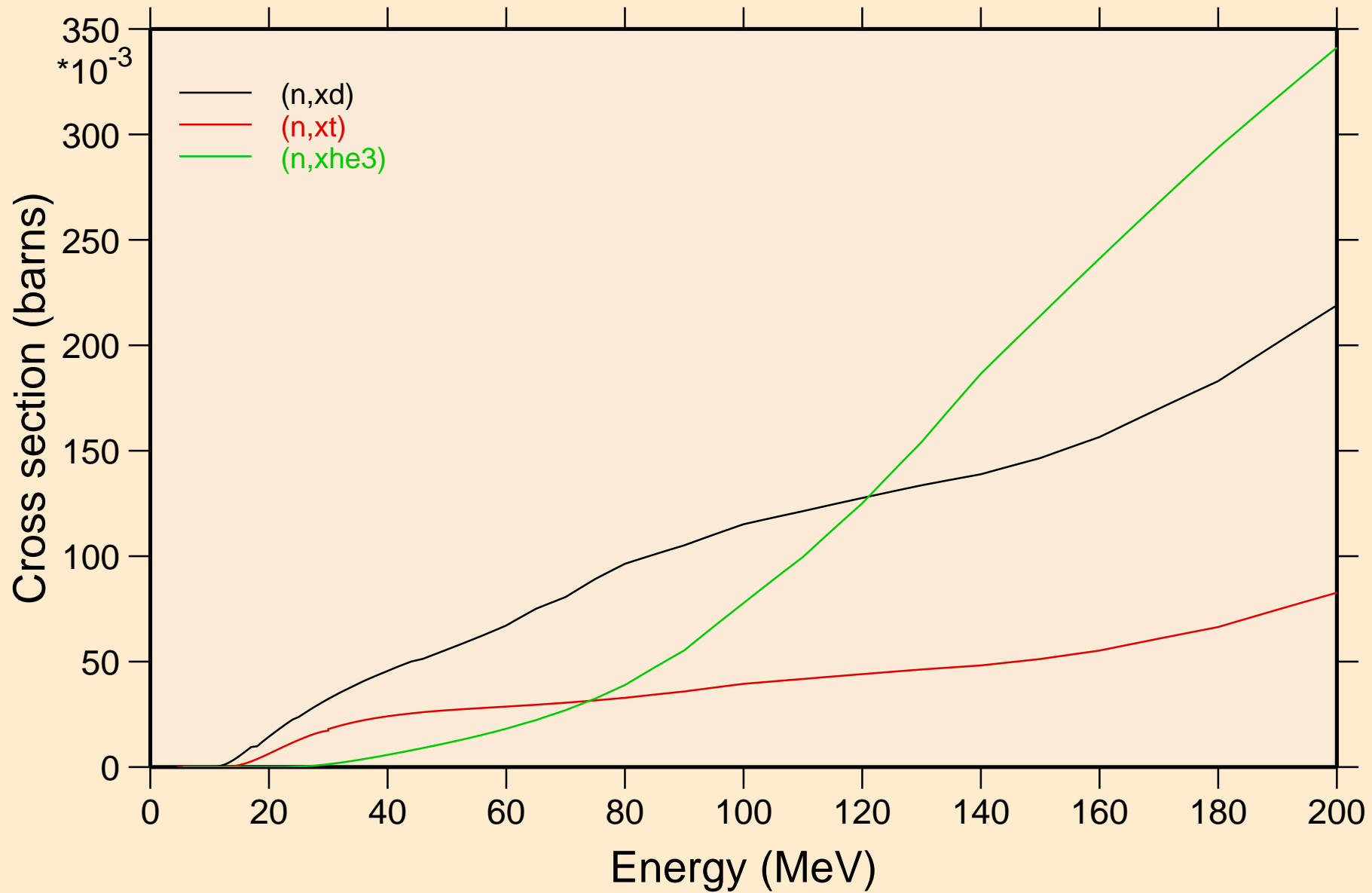

EU151 NEUTRON ACER TENDL-2023 LIBRARY; T=0.K
angular distribution for elastic

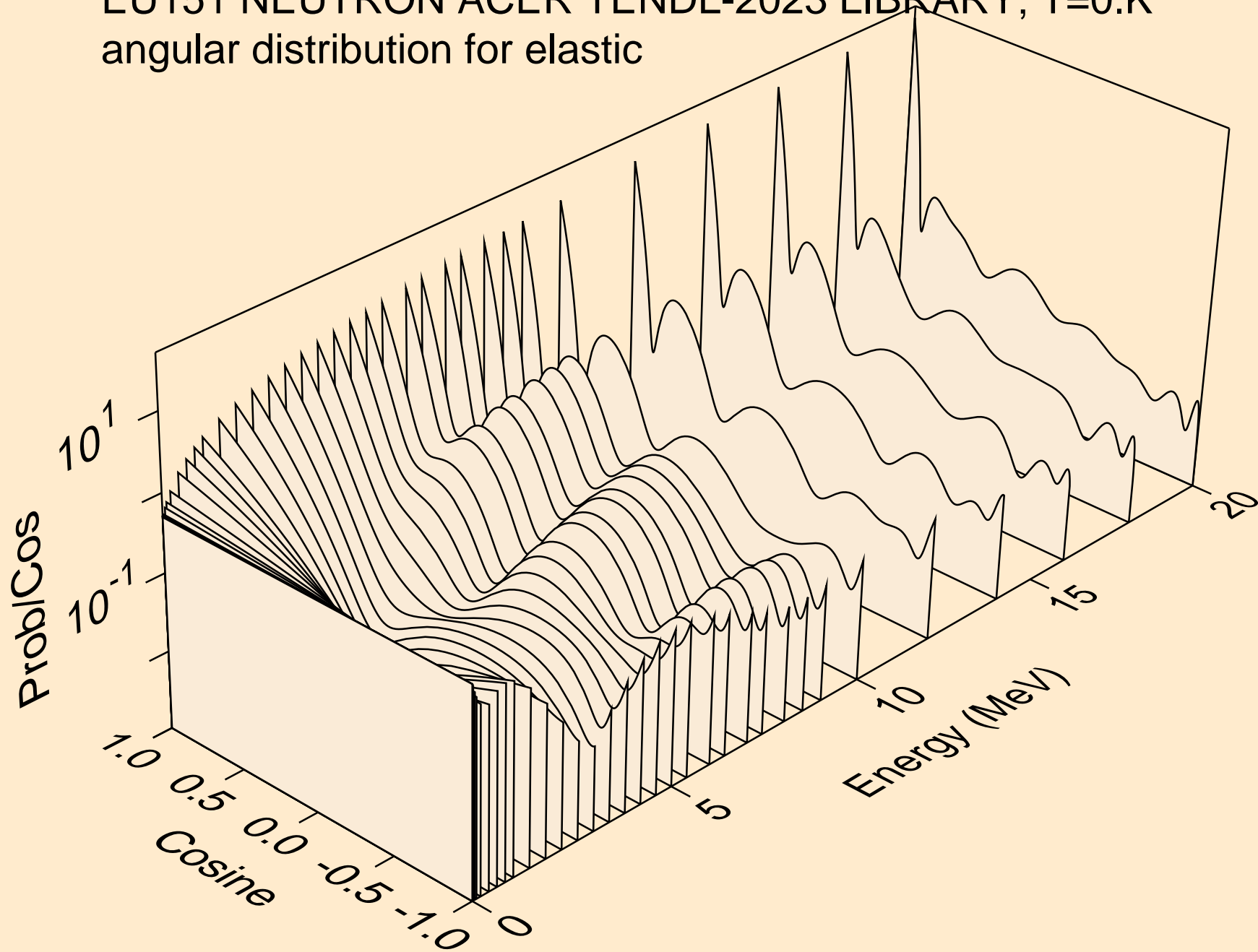

EU151 NEUTRON ACER TENDL-2023 LIBRARY; T=0.K
angular distribution for elastic

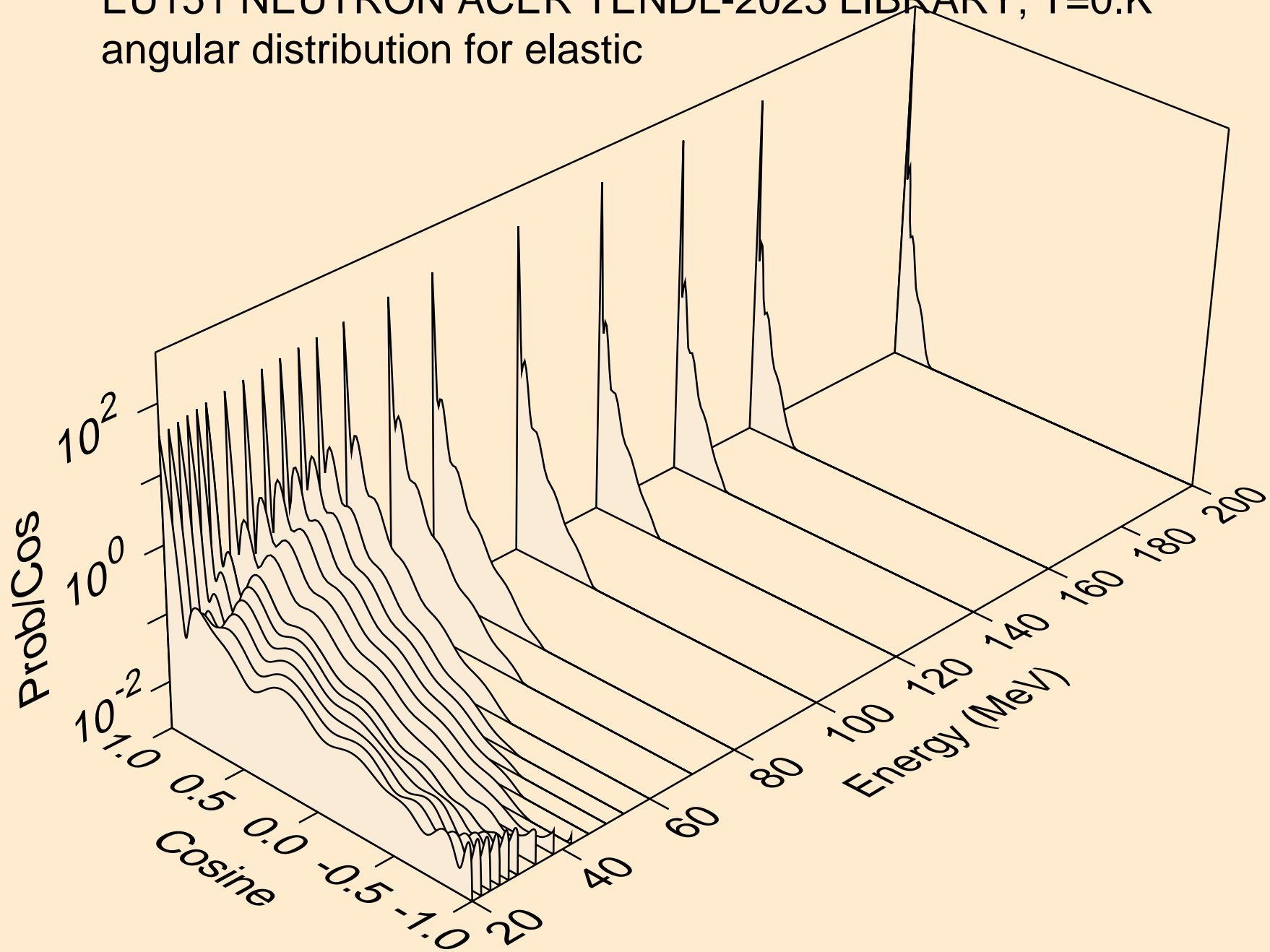

EU151 NEUTRON ACER TENDL-2023 LIBRARY; T=0.K
angular distribution for (n,n*1)

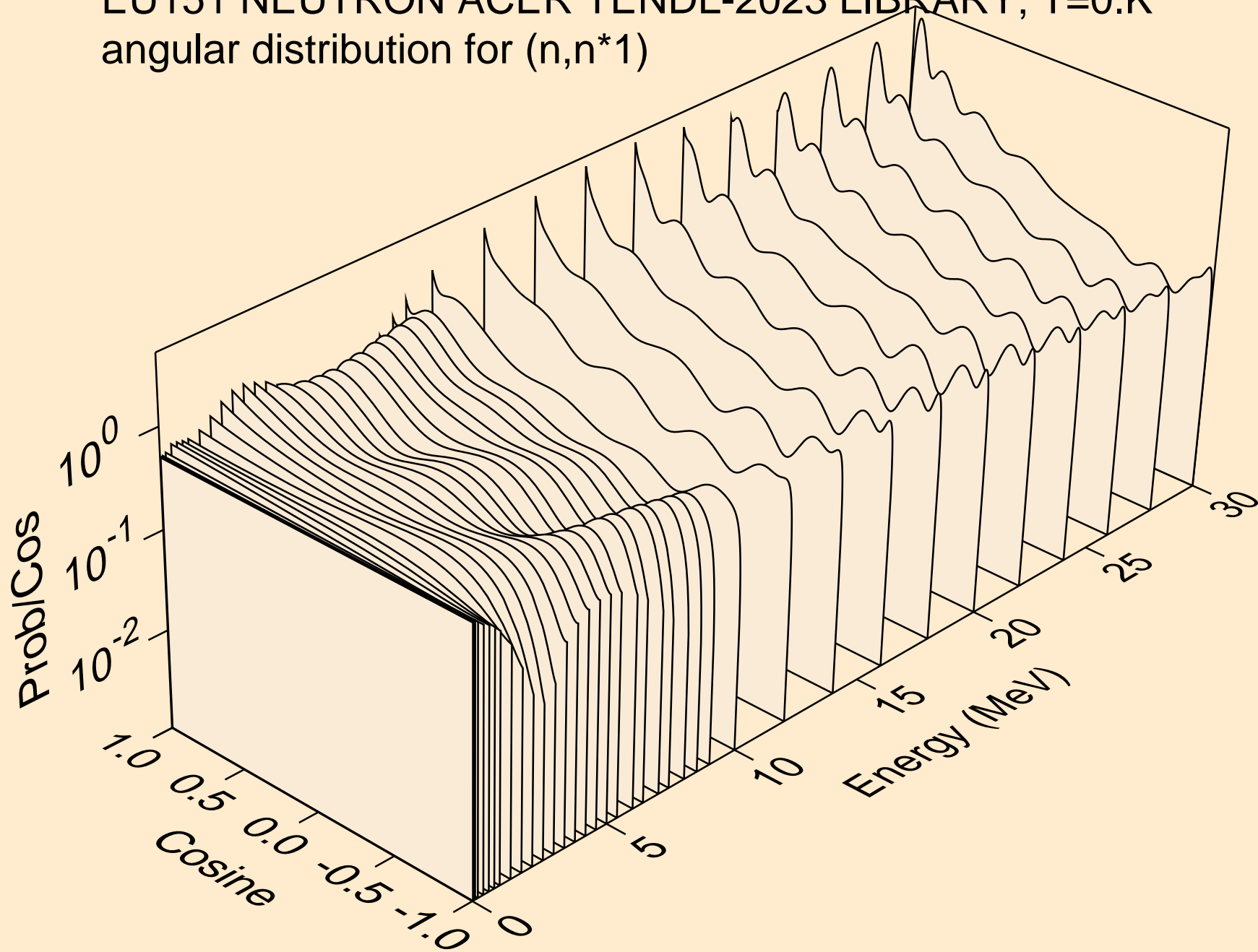

EU151 NEUTRON ACER TENDL-2023 LIBRARY; T=0.K
angular distribution for (n,n*2)

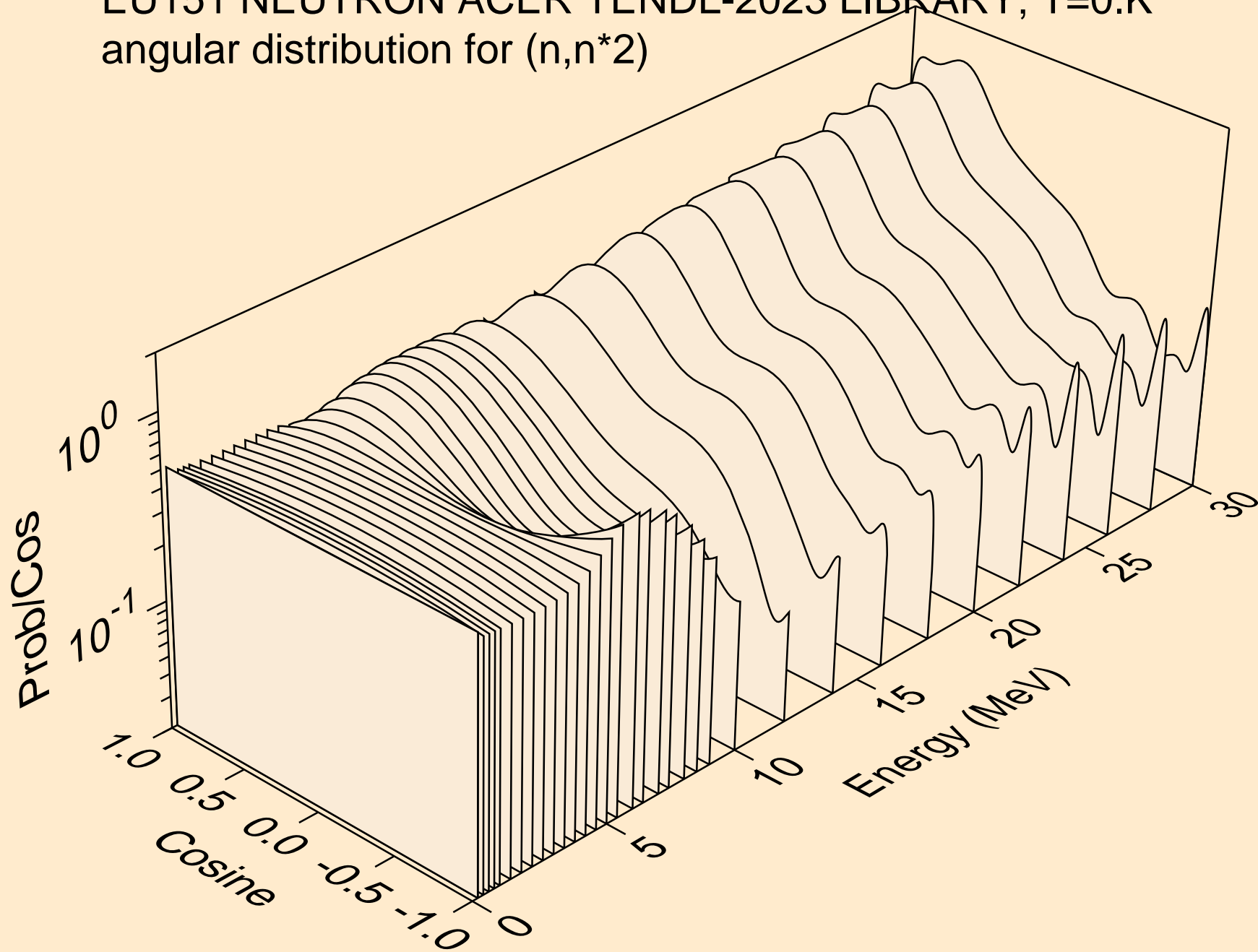

EU151 NEUTRON ACER TENDL-2023 LIBRARY; T=0.K
angular distribution for (n,n*3)

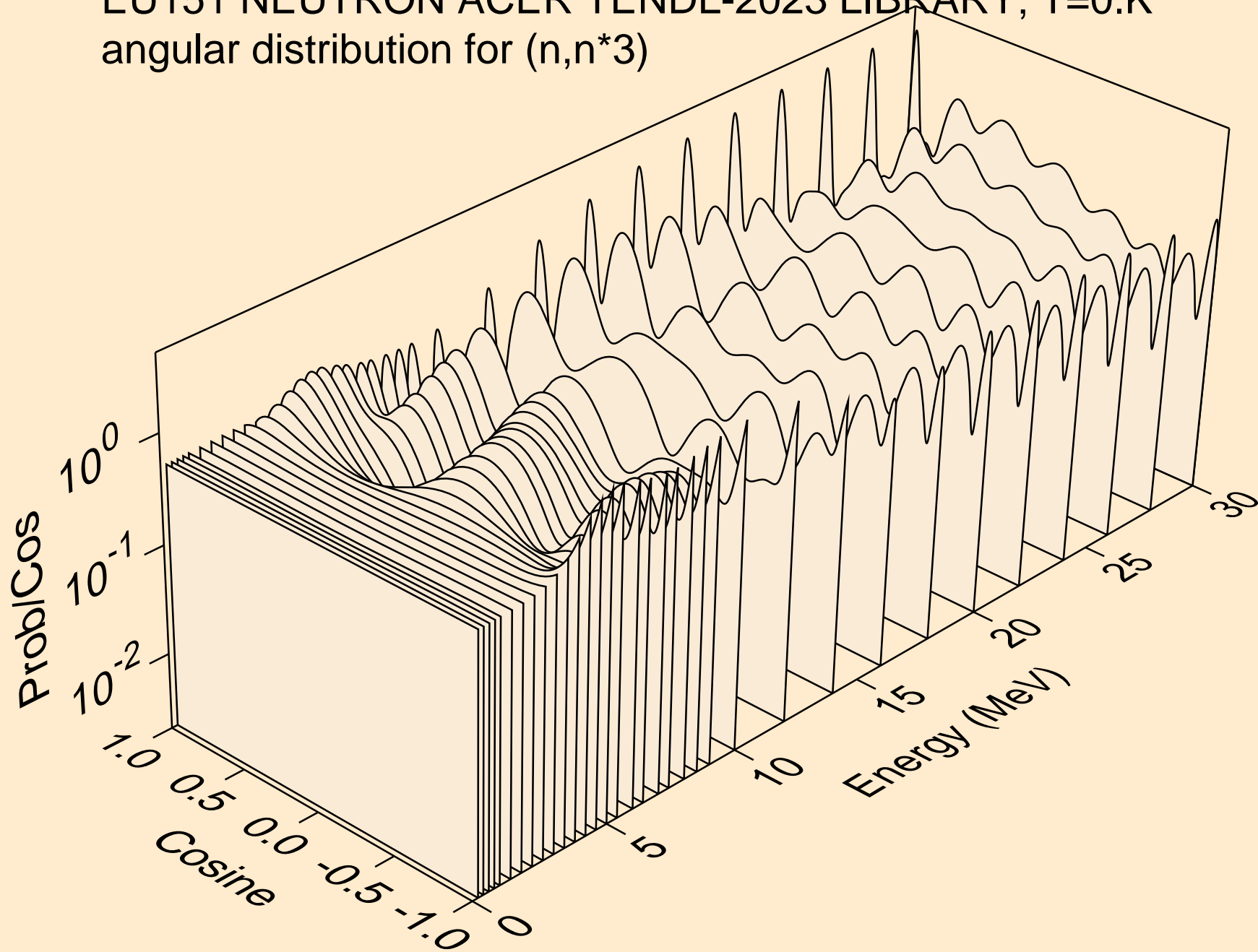

EU151 NEUTRON ACER TENDL-2023 LIBRARY; T=0.K
angular distribution for (n,n*4)

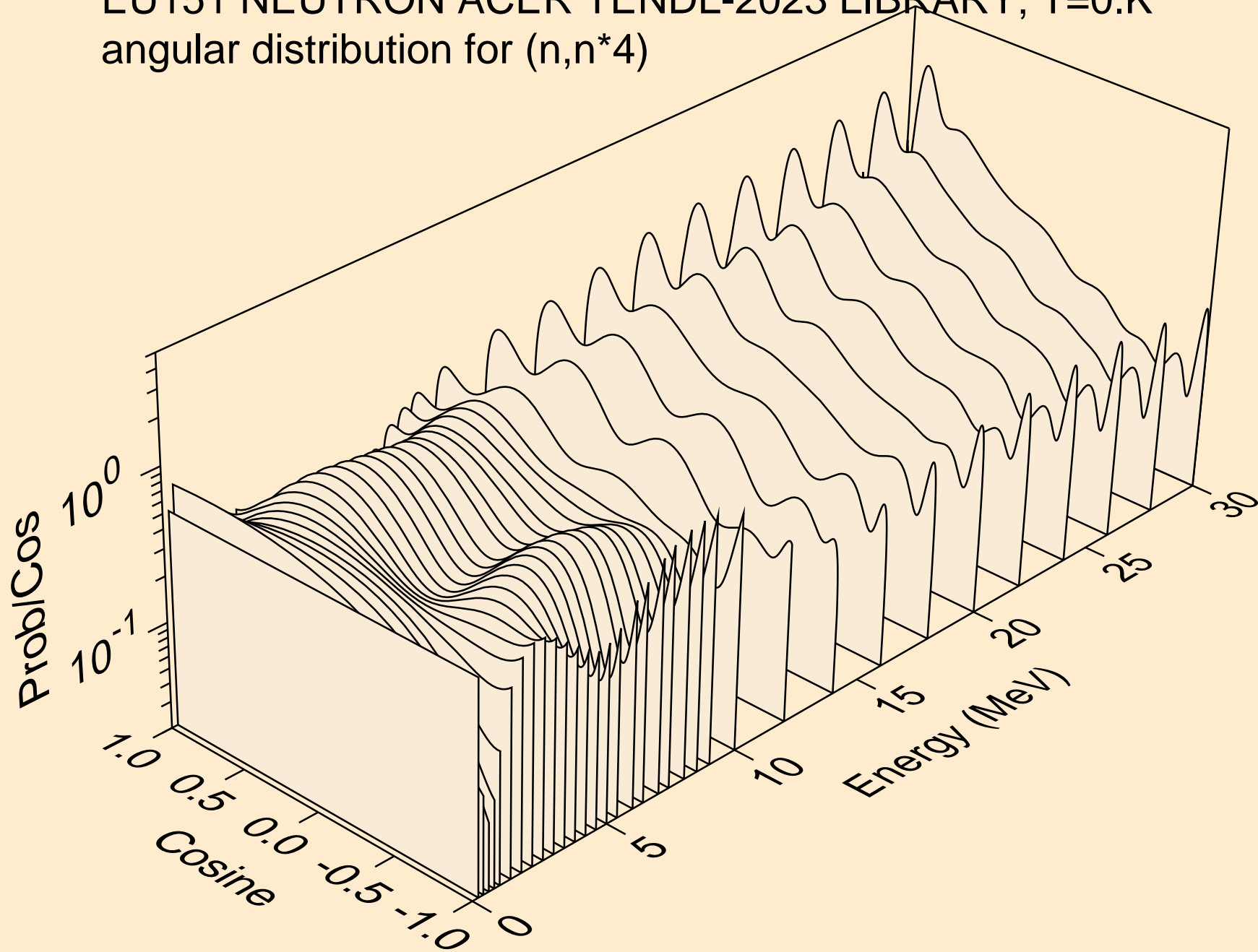

EU151 NEUTRON ACER TENDL-2023 LIBRARY; T=0.K
angular distribution for (n,n*5)

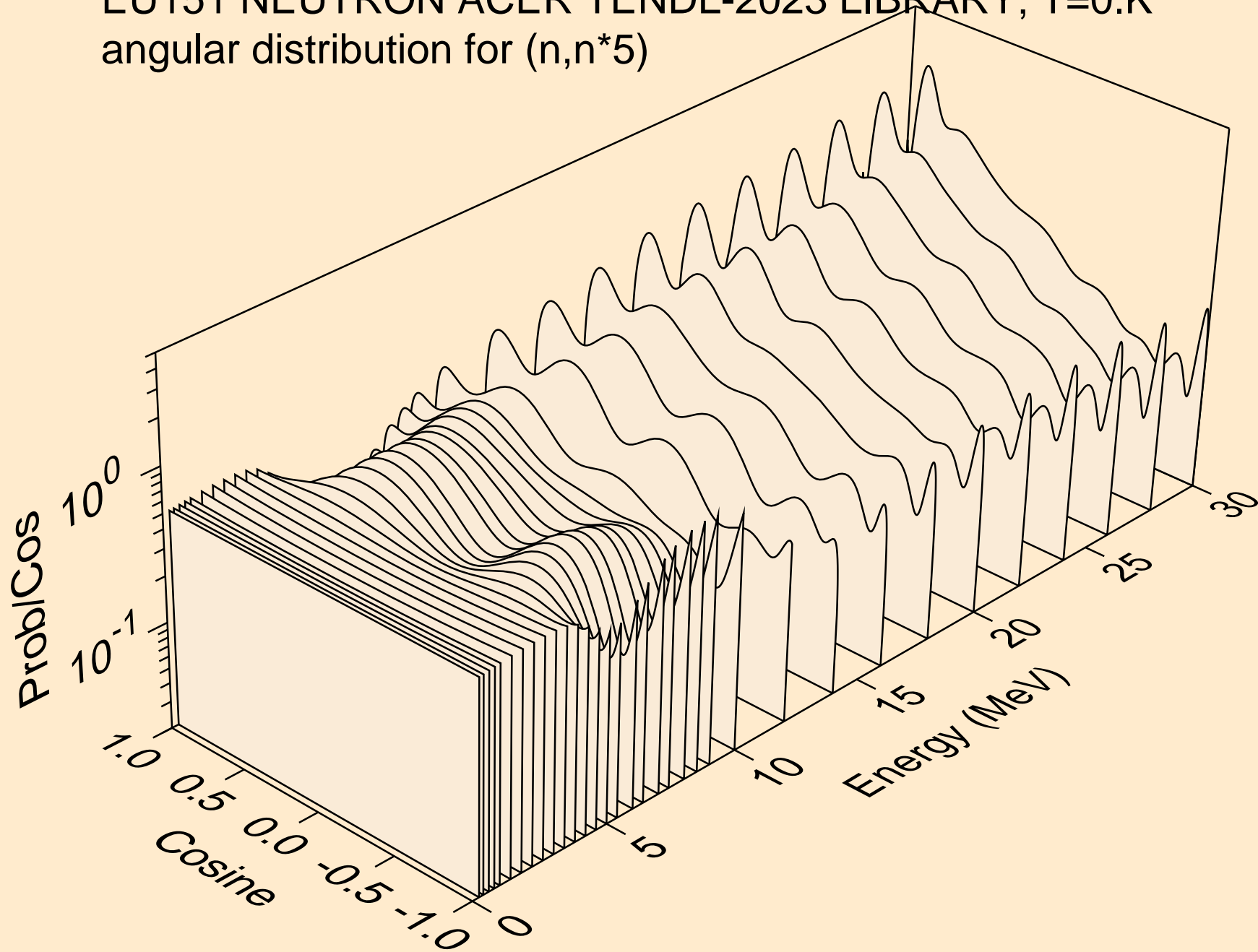

EU151 NEUTRON ACER TENDL-2023 LIBRARY; T=0.K
angular distribution for (n,n*6)

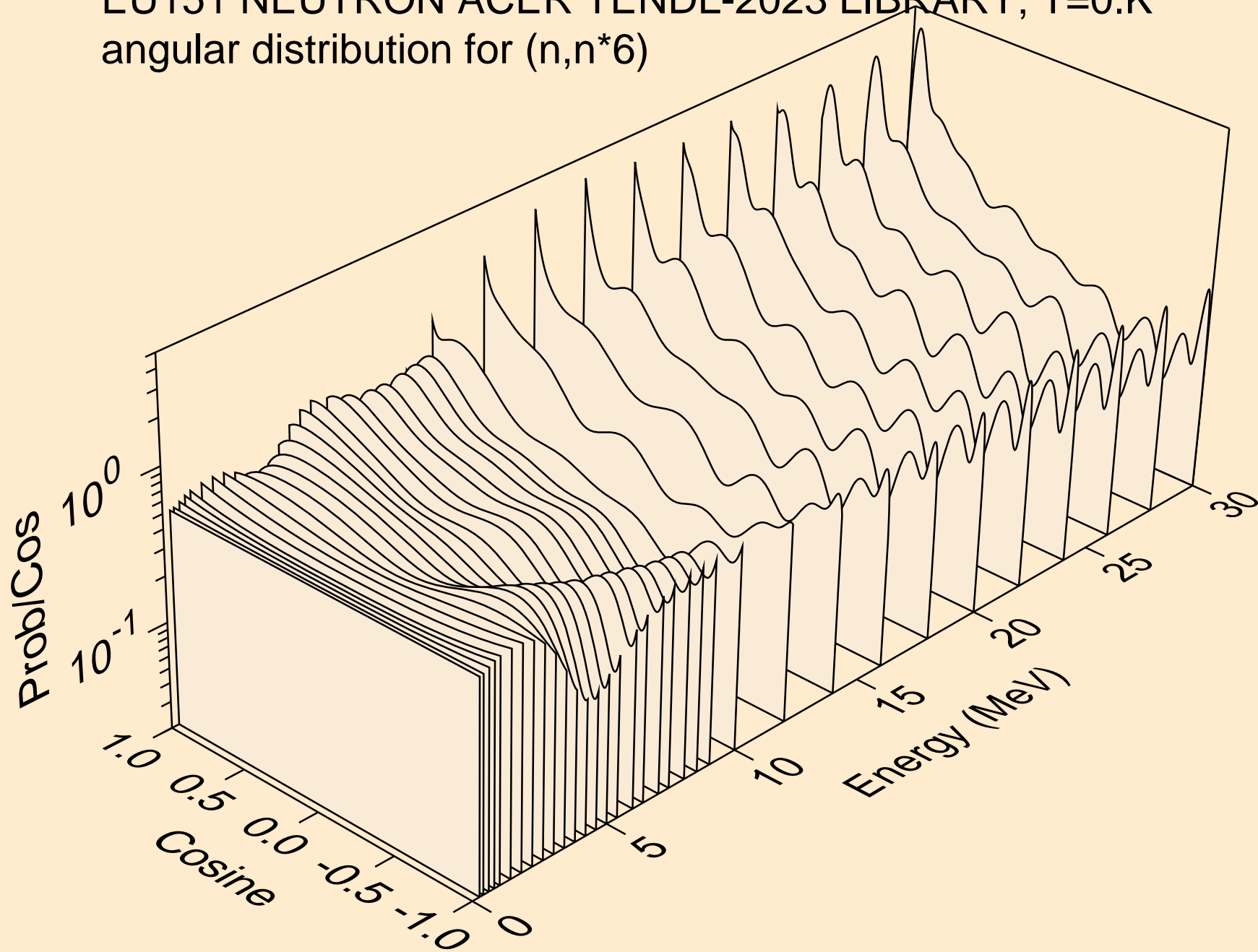

EU151 NEUTRON ACER TENDL-2023 LIBRARY; T=0.K
angular distribution for (n,n*7)

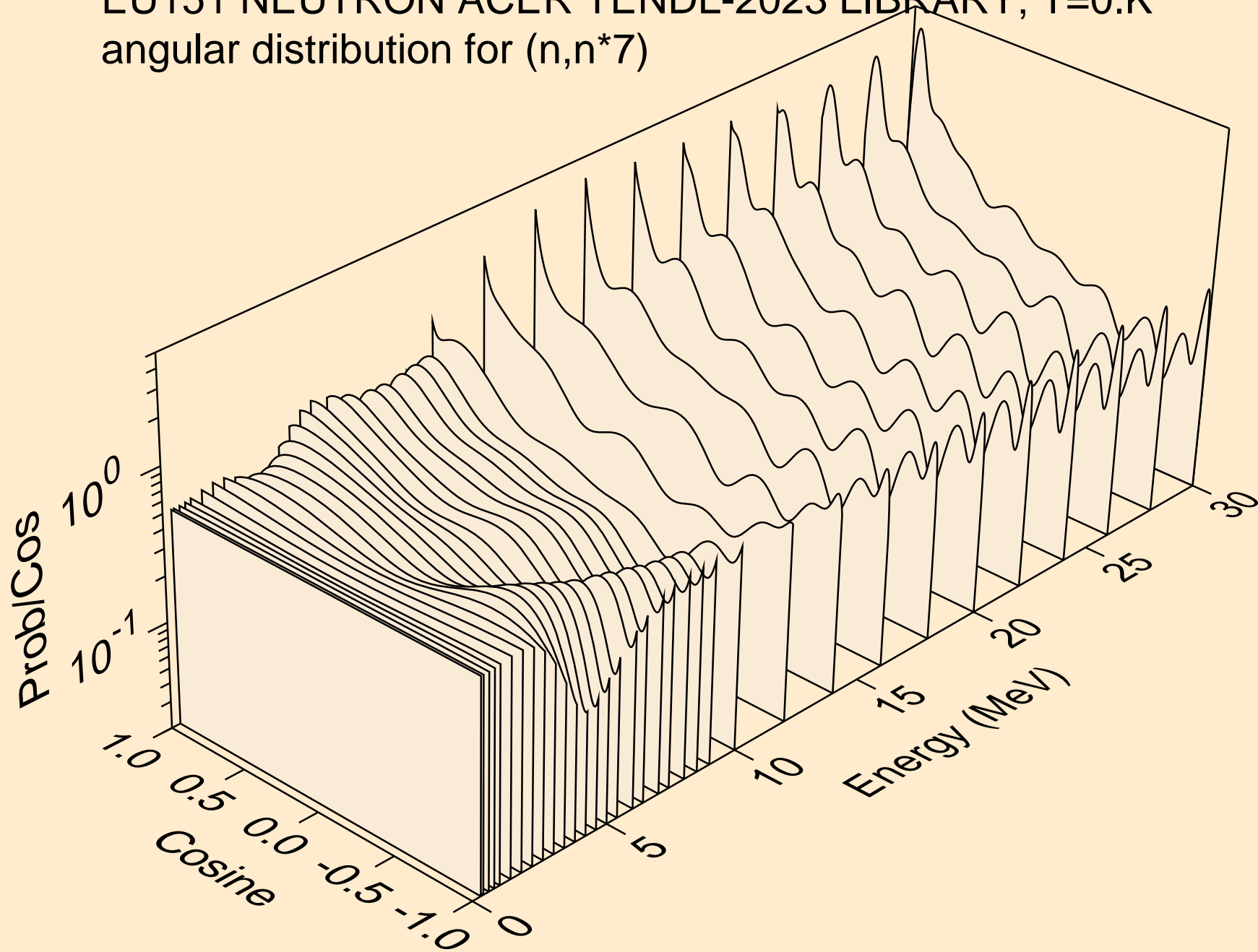

EU151 NEUTRON ACER TENDL-2023 LIBRARY; T=0.K
angular distribution for (n,n*8)

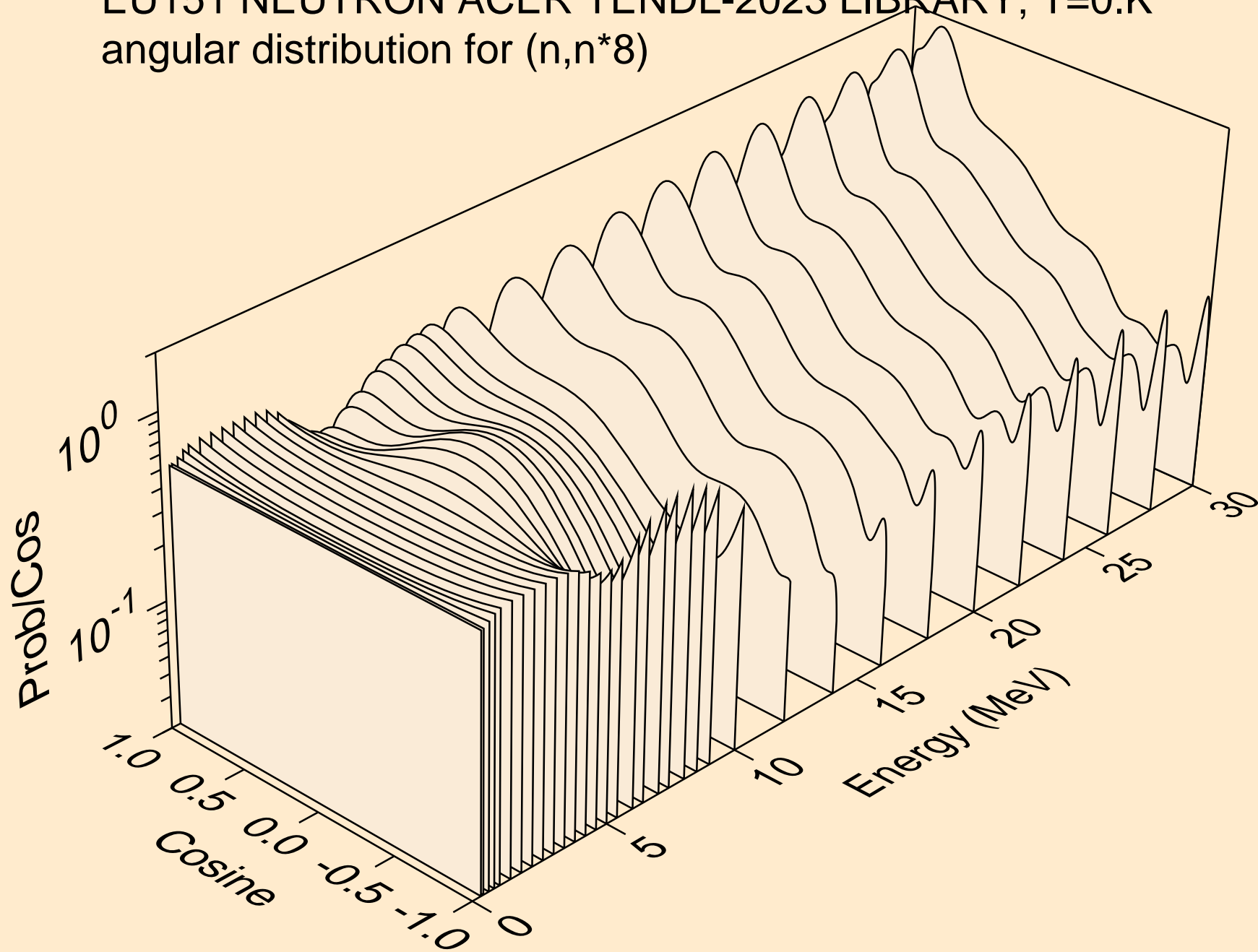

EU151 NEUTRON ACER TENDL-2023 LIBRARY; T=0.K
angular distribution for (n,n*9)

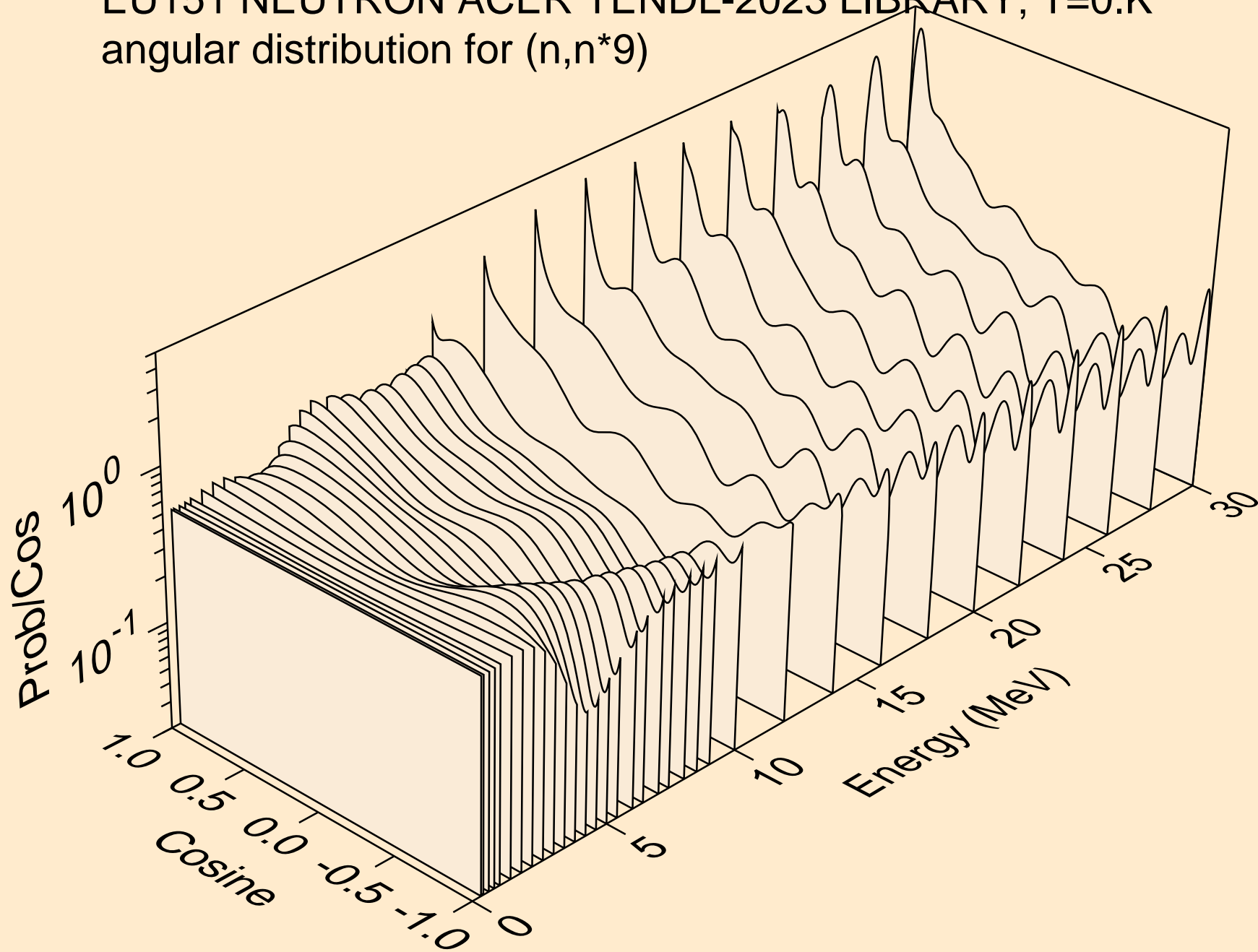

EU151 NEUTRON ACER TENDL-2023 LIBRARY; T=0.K
angular distribution for (n,n*10)

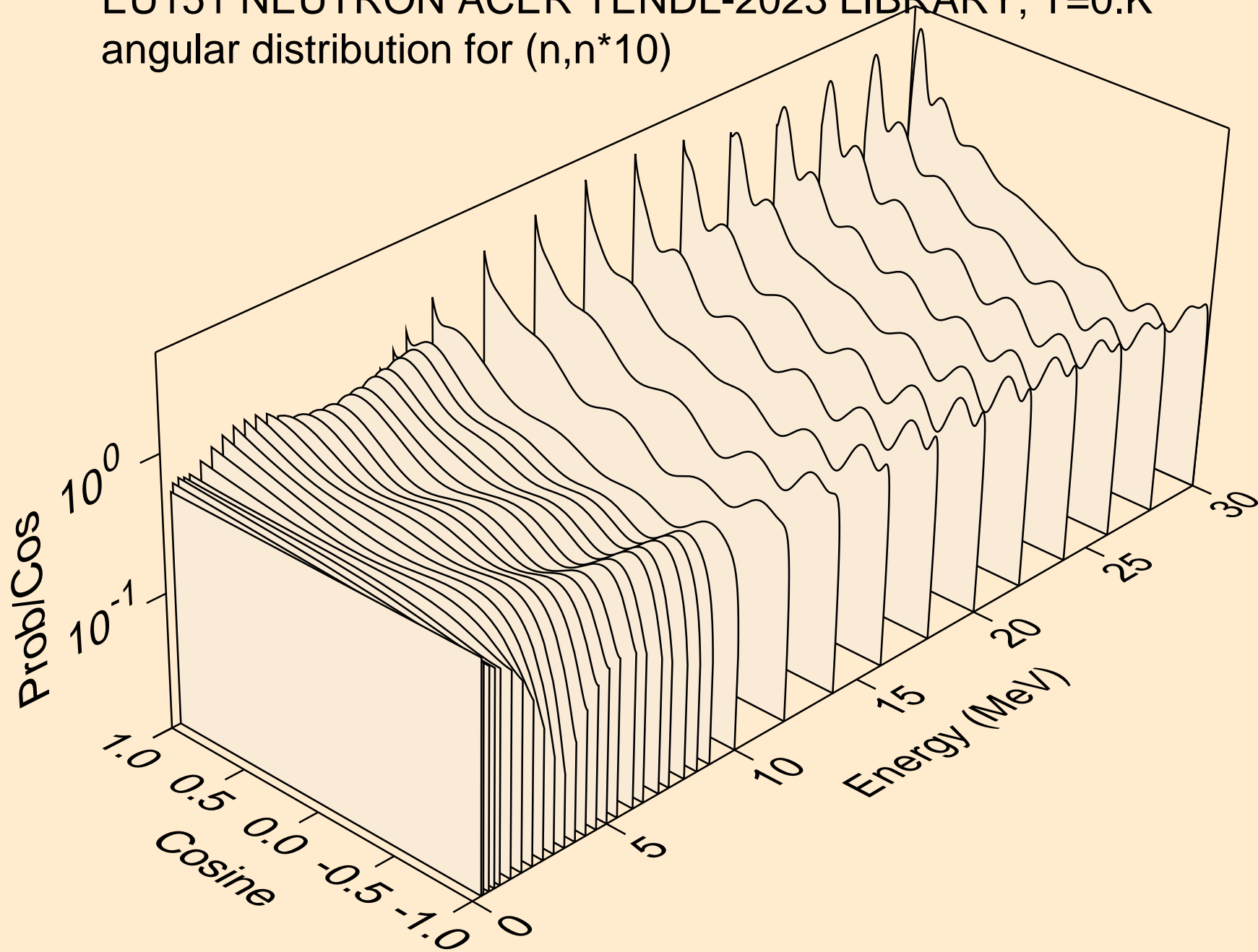

EU151 NEUTRON ACER TENDL-2023 LIBRARY; T=0.K
angular distribution for (n,n*11)

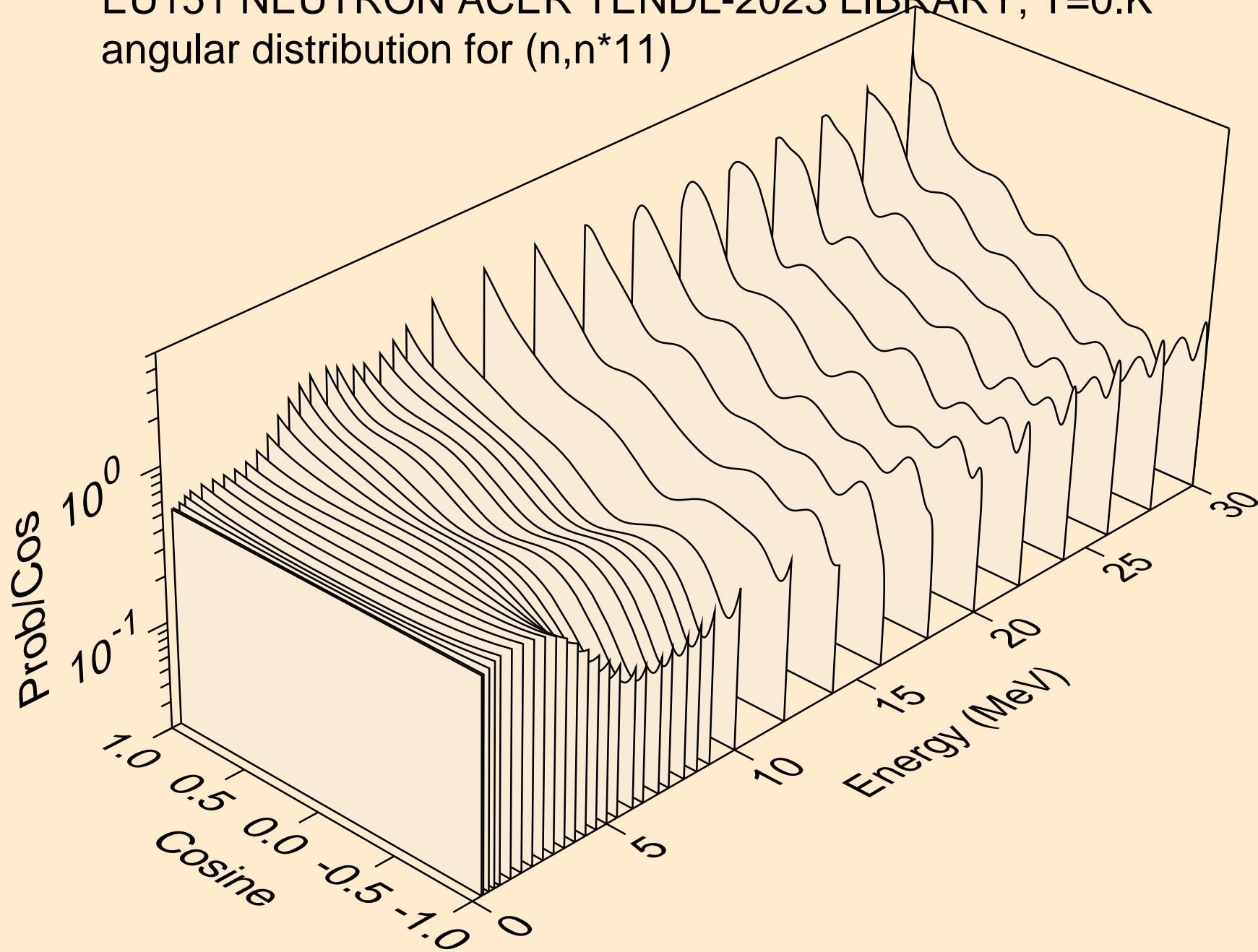

EU151 NEUTRON ACER TENDL-2023 LIBRARY; T=0.K
angular distribution for (n,n*12)

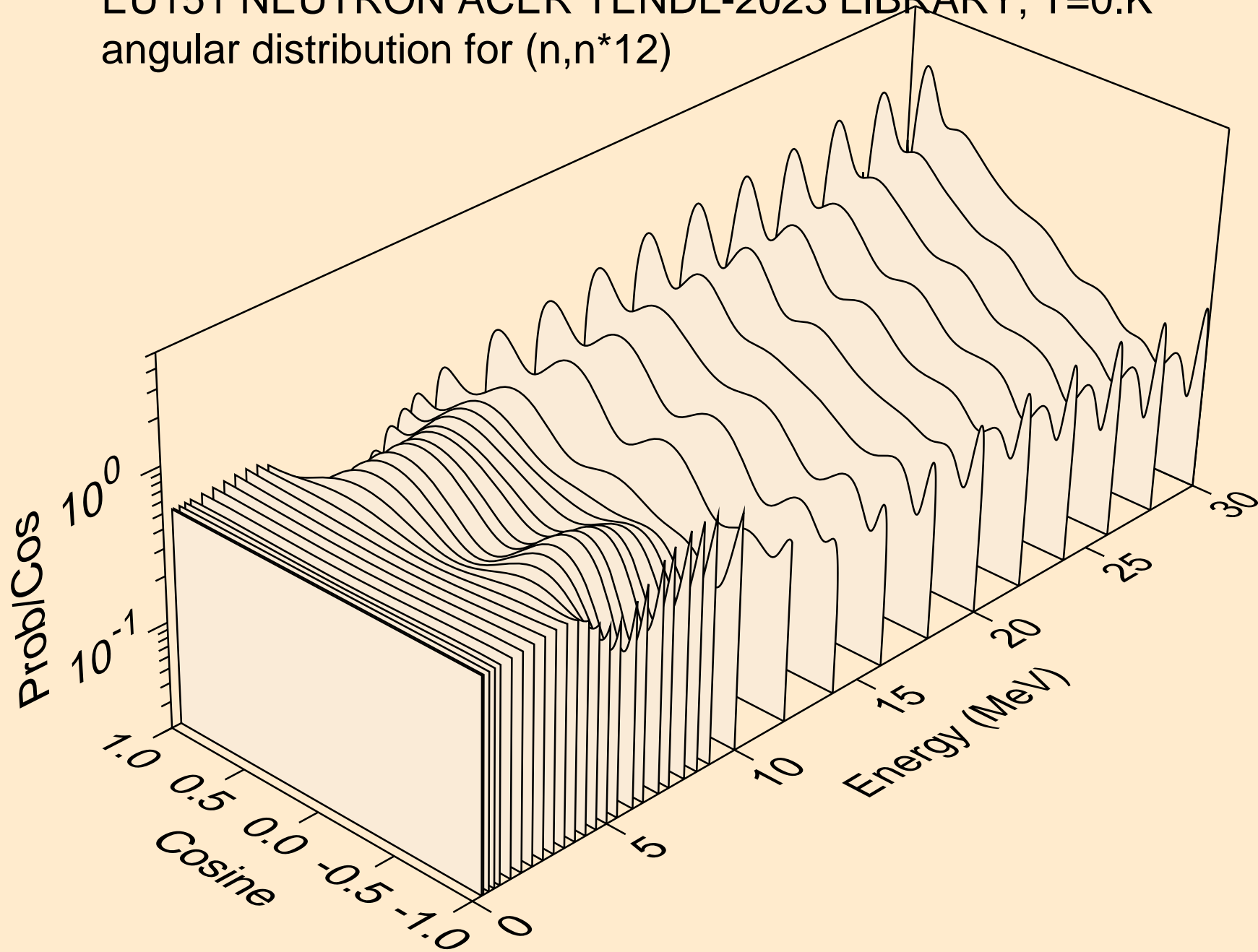

EU151 NEUTRON ACER TENDL-2023 LIBRARY; T=0.K
angular distribution for (n,n*13)

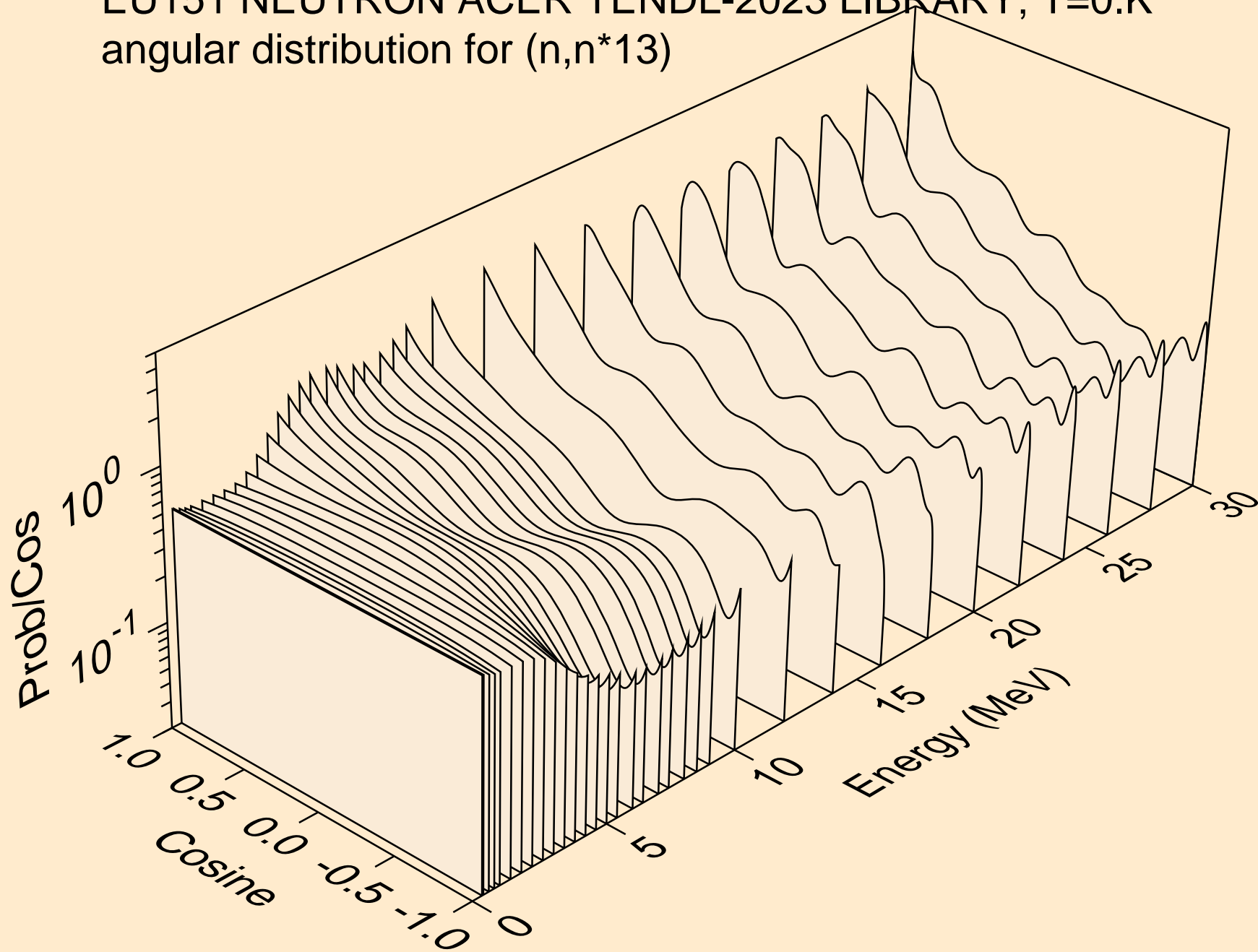

EU151 NEUTRON ACER TENDL-2023 LIBRARY; T=0.K
angular distribution for (n,n*14)

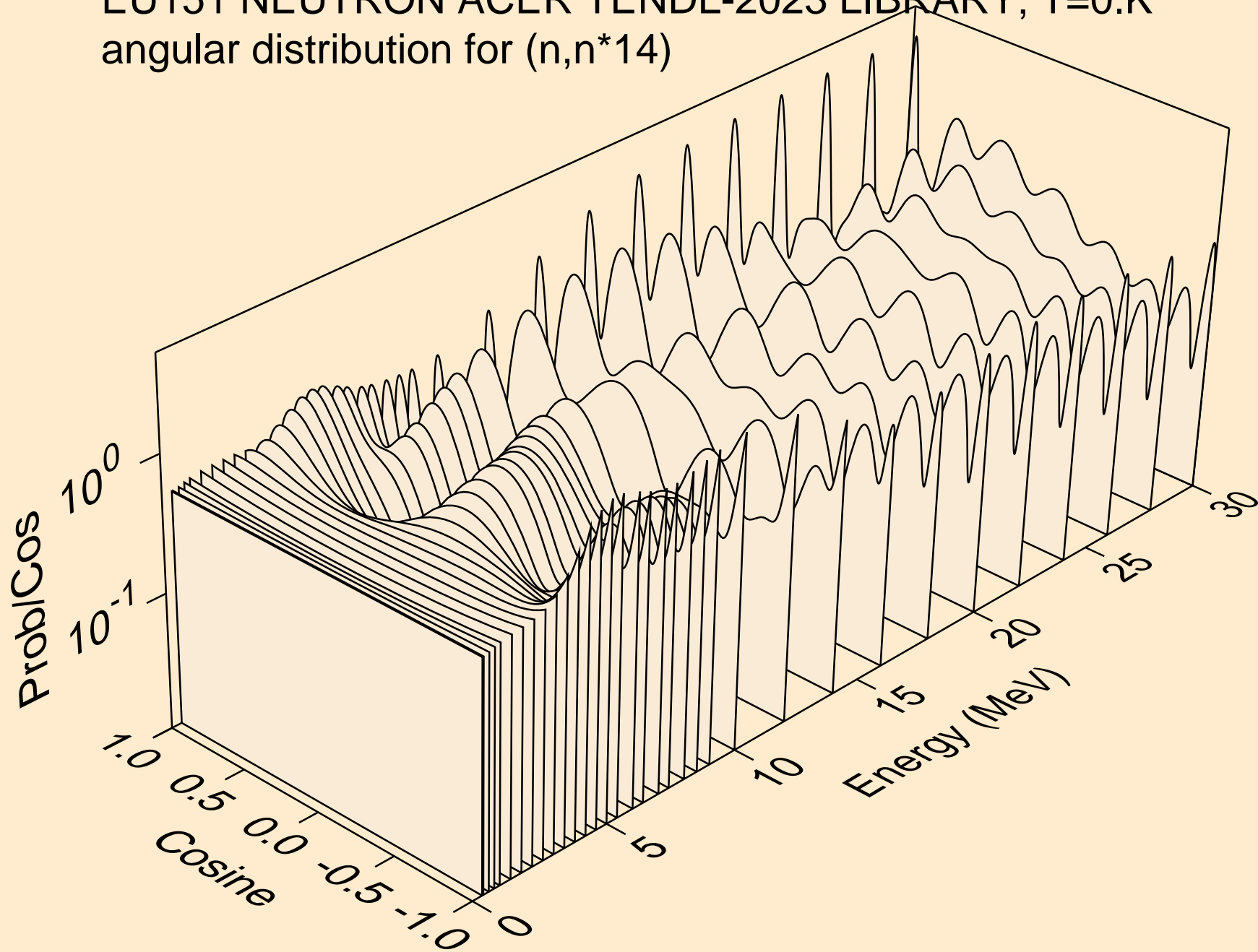

EU151 NEUTRON ACER TENDL-2023 LIBRARY; T=0.K
angular distribution for (n,n*15)

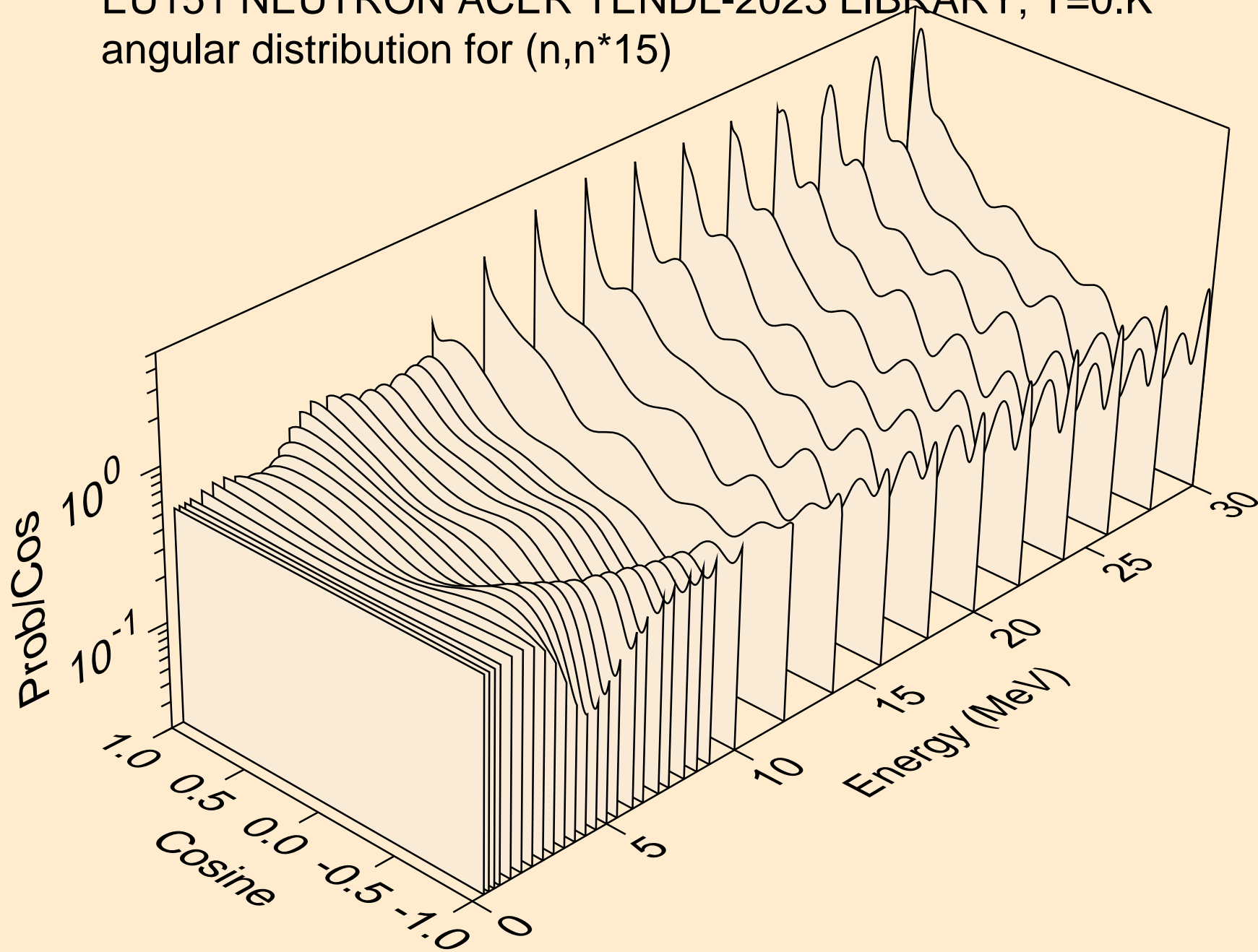

EU151 NEUTRON ACER TENDL-2023 LIBRARY; T=0.K
Neutron emission for (n,x)

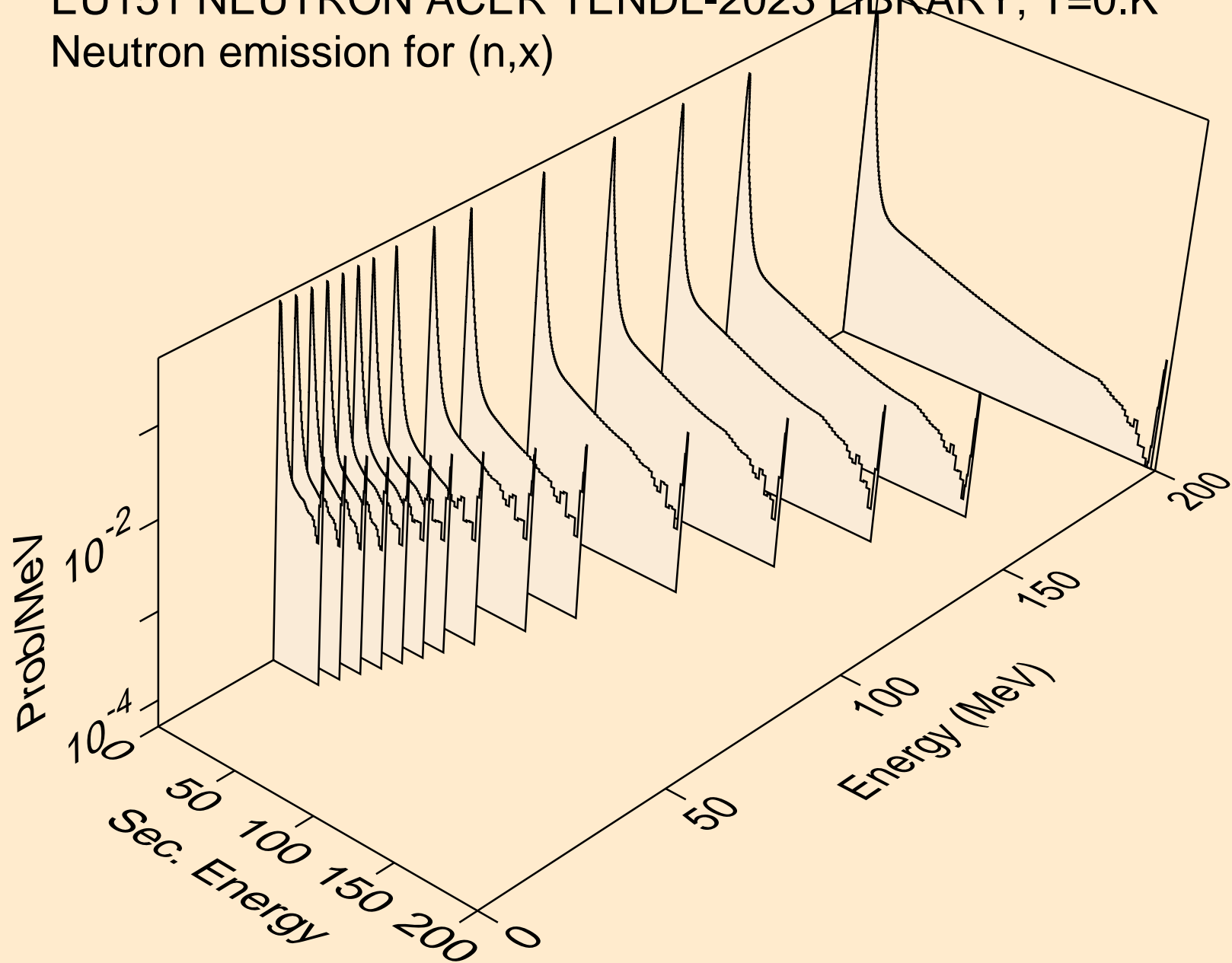

EU151 NEUTRON ACER TENDL-2023 LIBRARY; T=0.K
Neutron emission for (n,2nd)

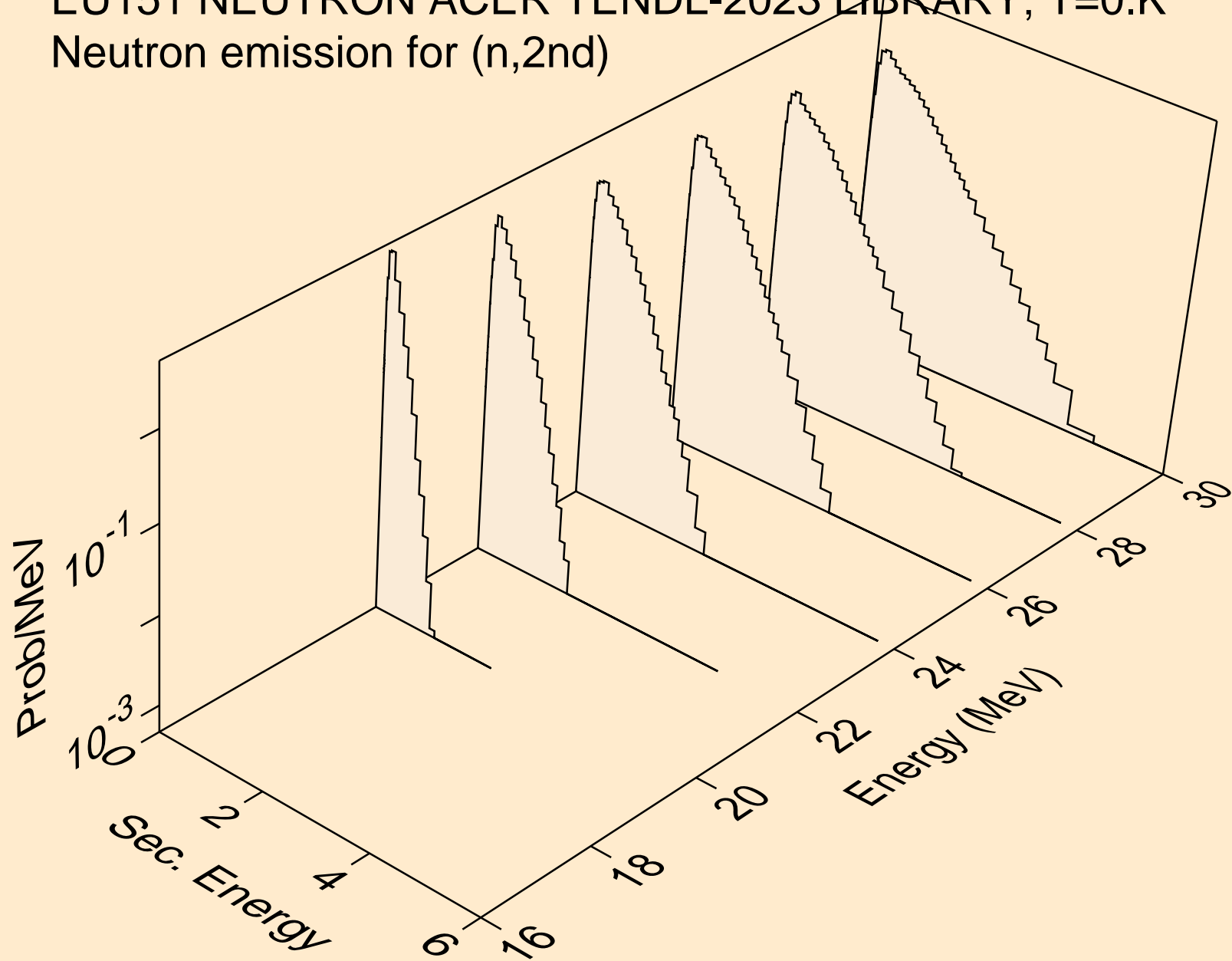

EU151 NEUTRON ACER TENDL-2023 LIBRARY; T=0.K
Neutron emission for (n,2n)

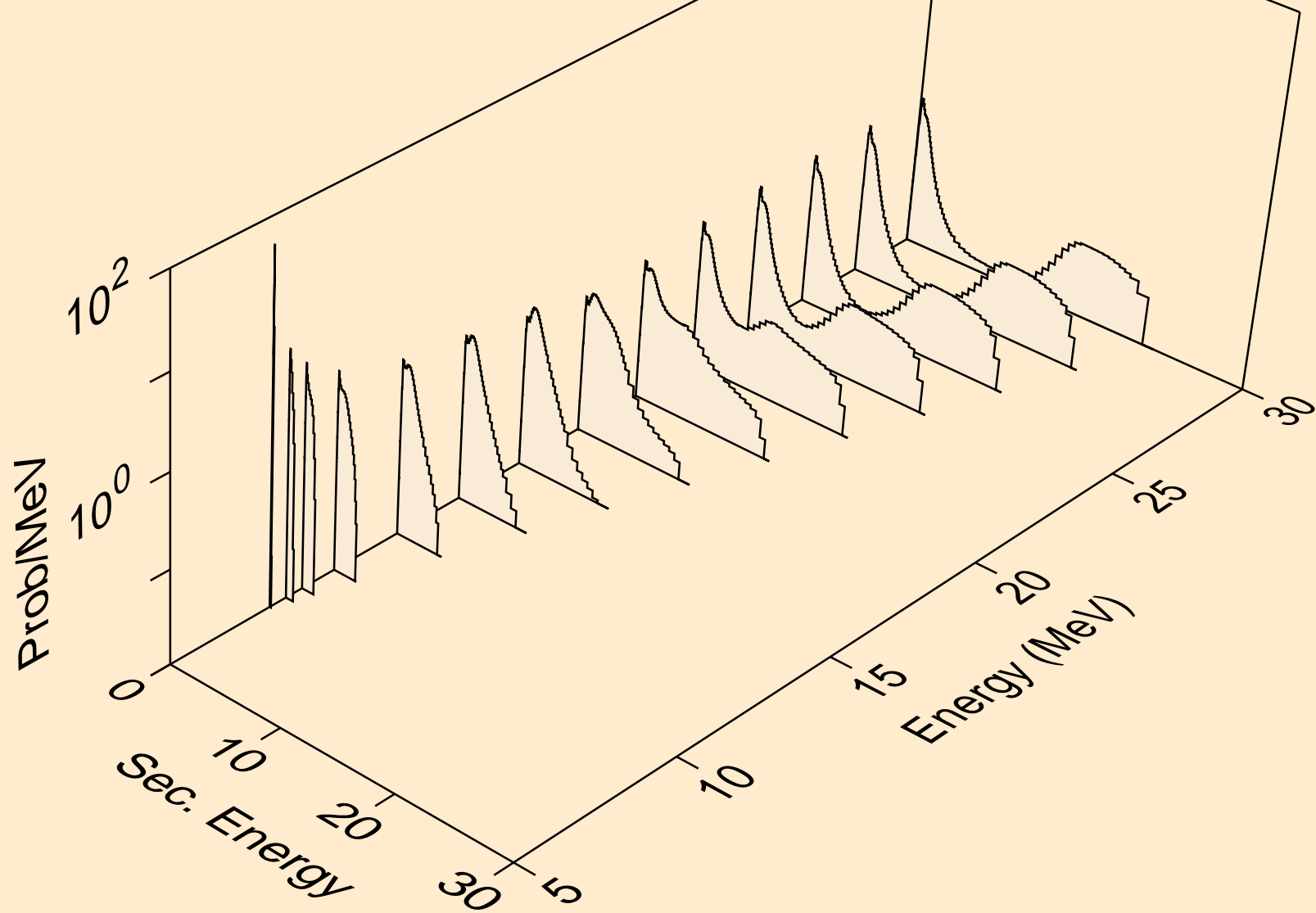

EU151 NEUTRON ACER TENDL-2023 LIBRARY; T=0.K
Neutron emission for (n,3n)

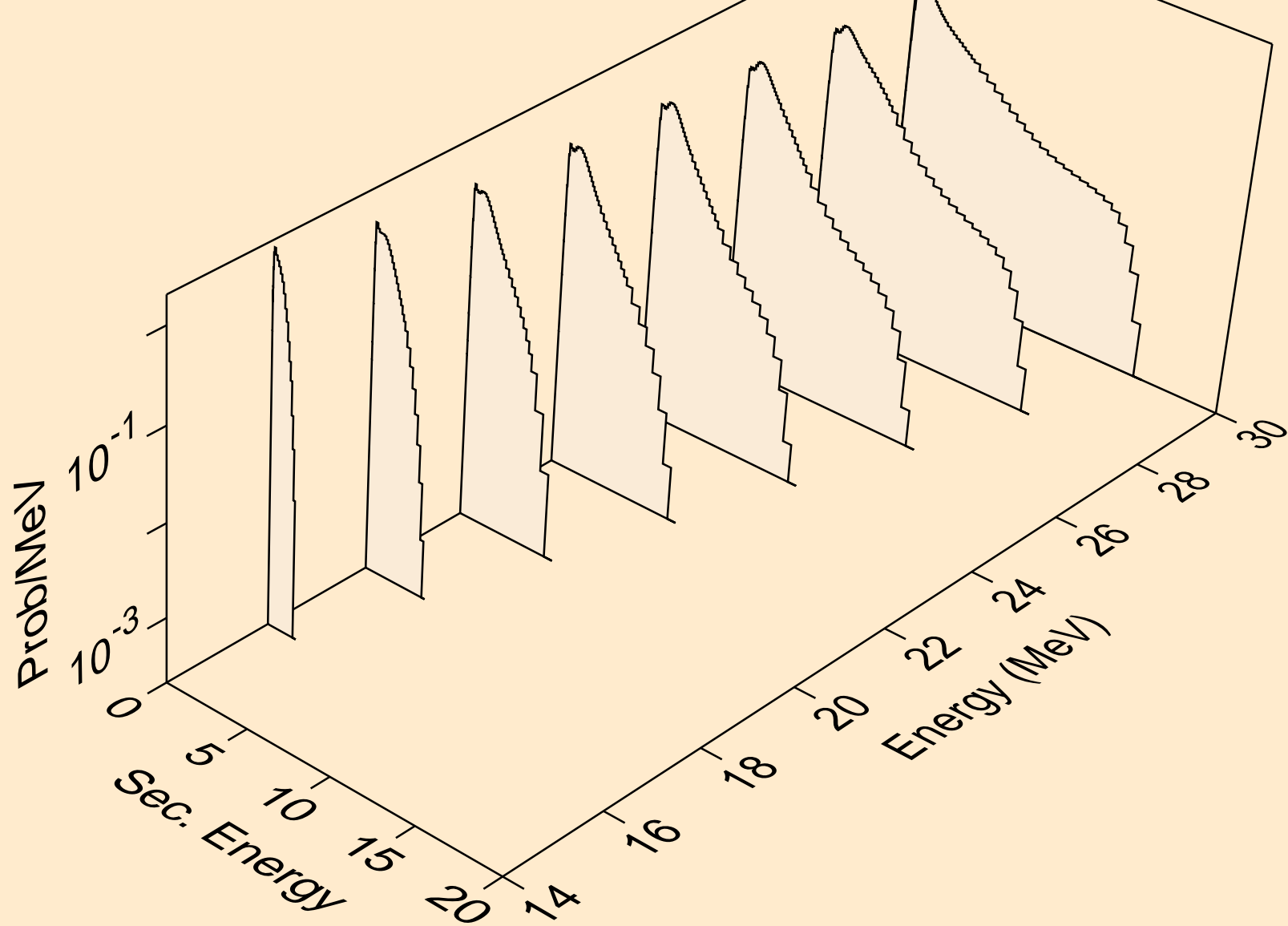

EU151 NEUTRON ACER TENDL-2023 LIBRARY; T=0.K
Neutron emission for (n,n*)a

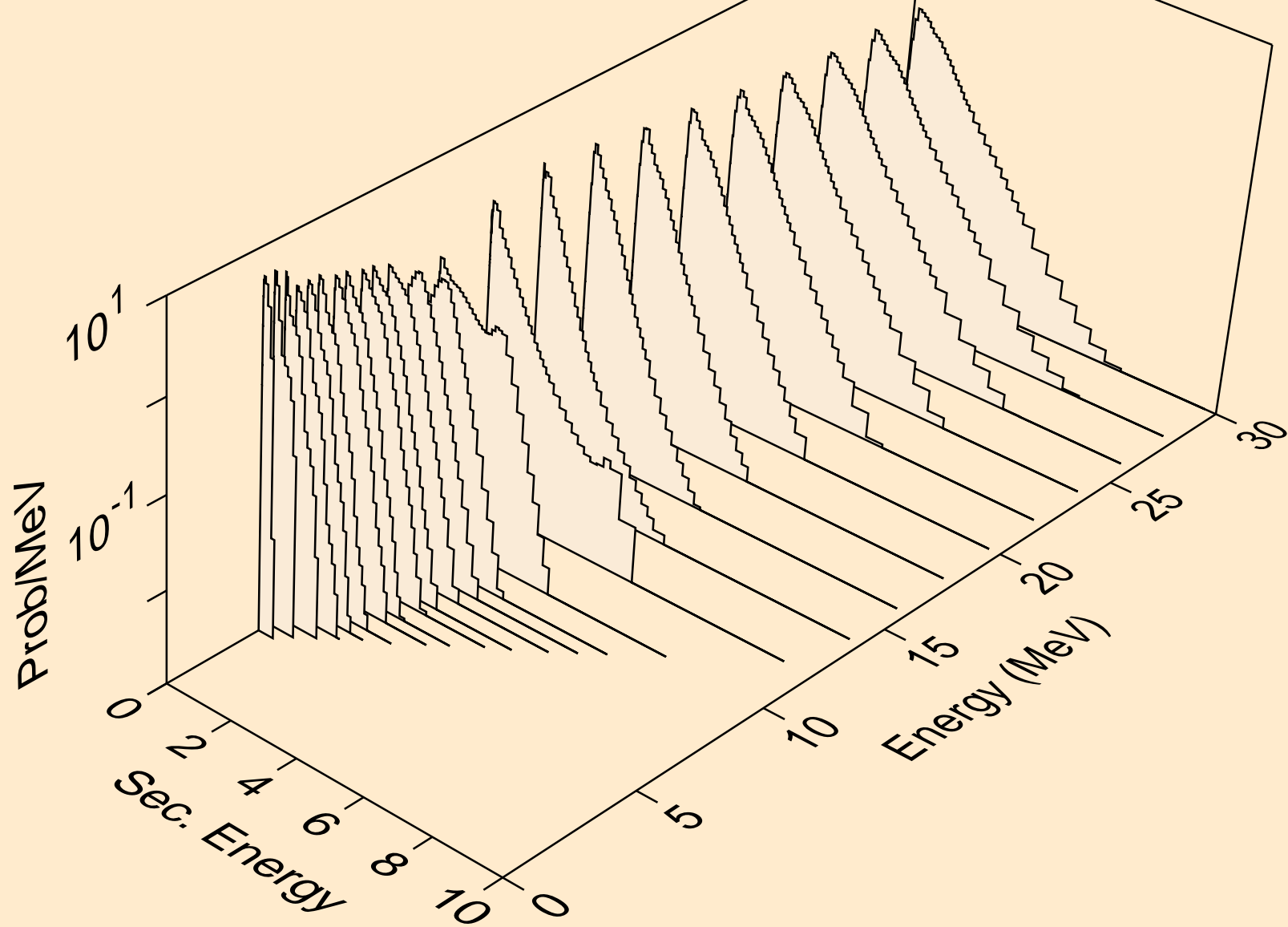

EU151 NEUTRON ACER TENDL-2023 LIBRARY; T=0.K
Neutron emission for (n,2n)a

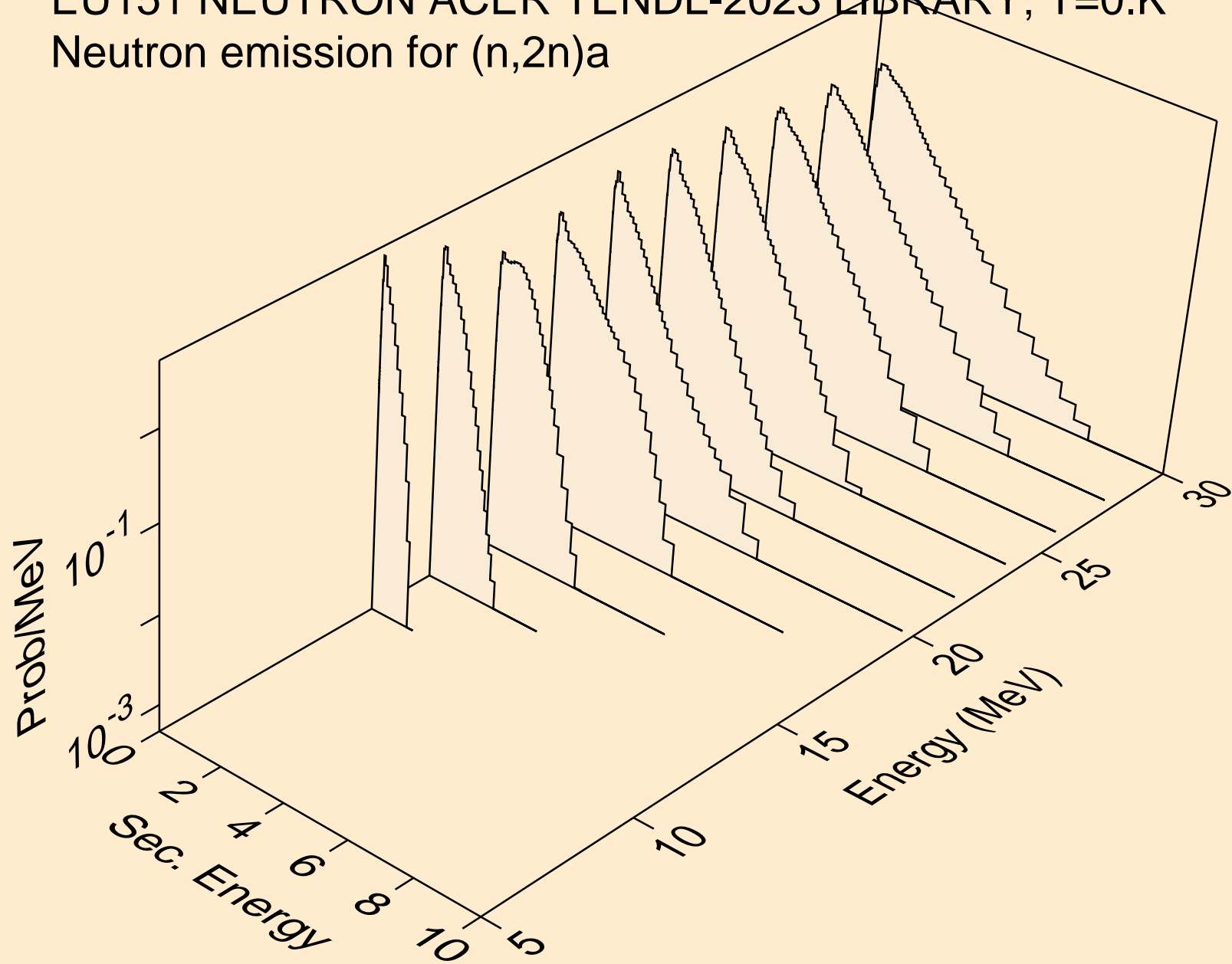

EU151 NEUTRON ACER TENDL-2023 LIBRARY; T=0.K
Neutron emission for (n,3n)a

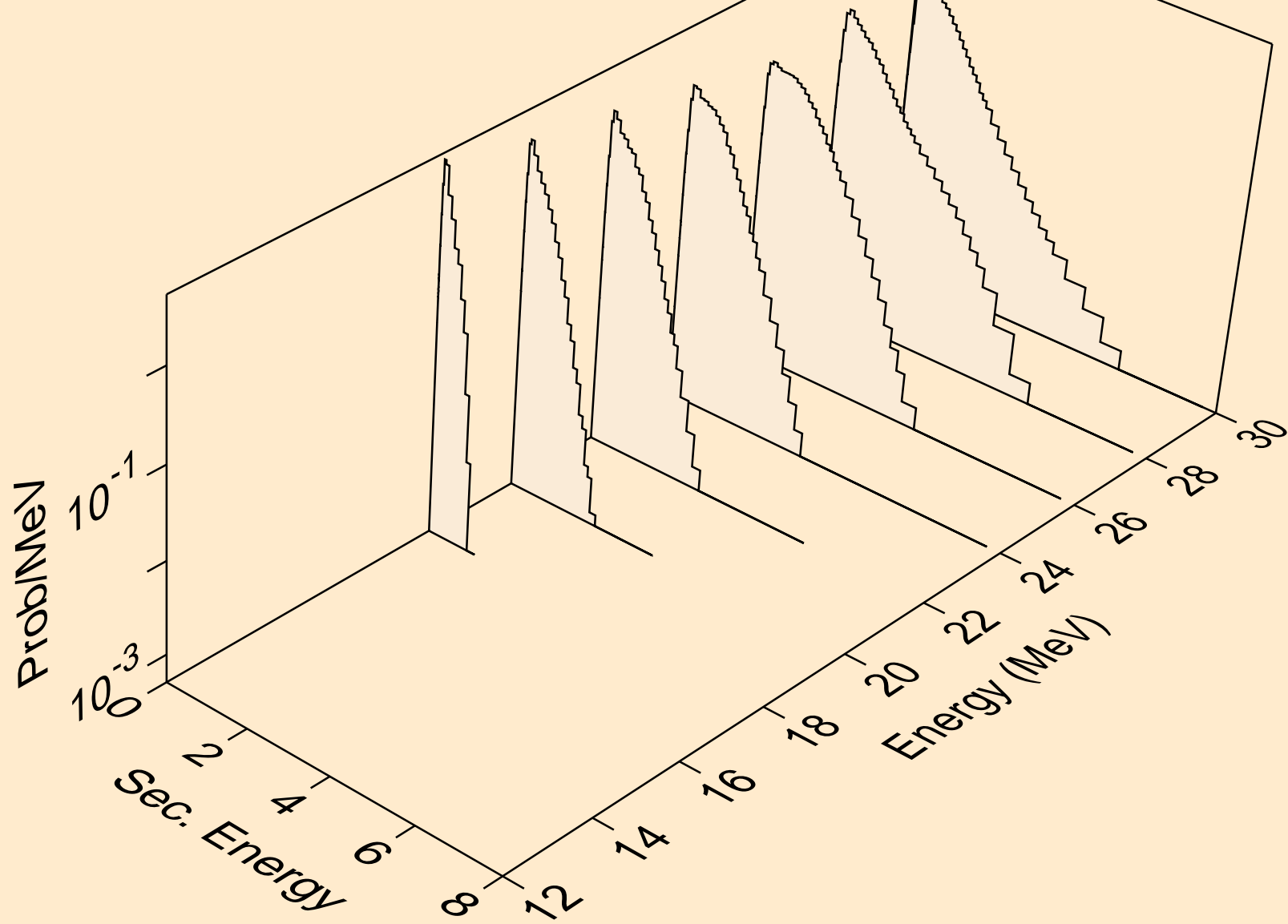

EU151 NEUTRON ACER TENDL-2023 LIBRARY; T=0.K
Neutron emission for (n,n*)p

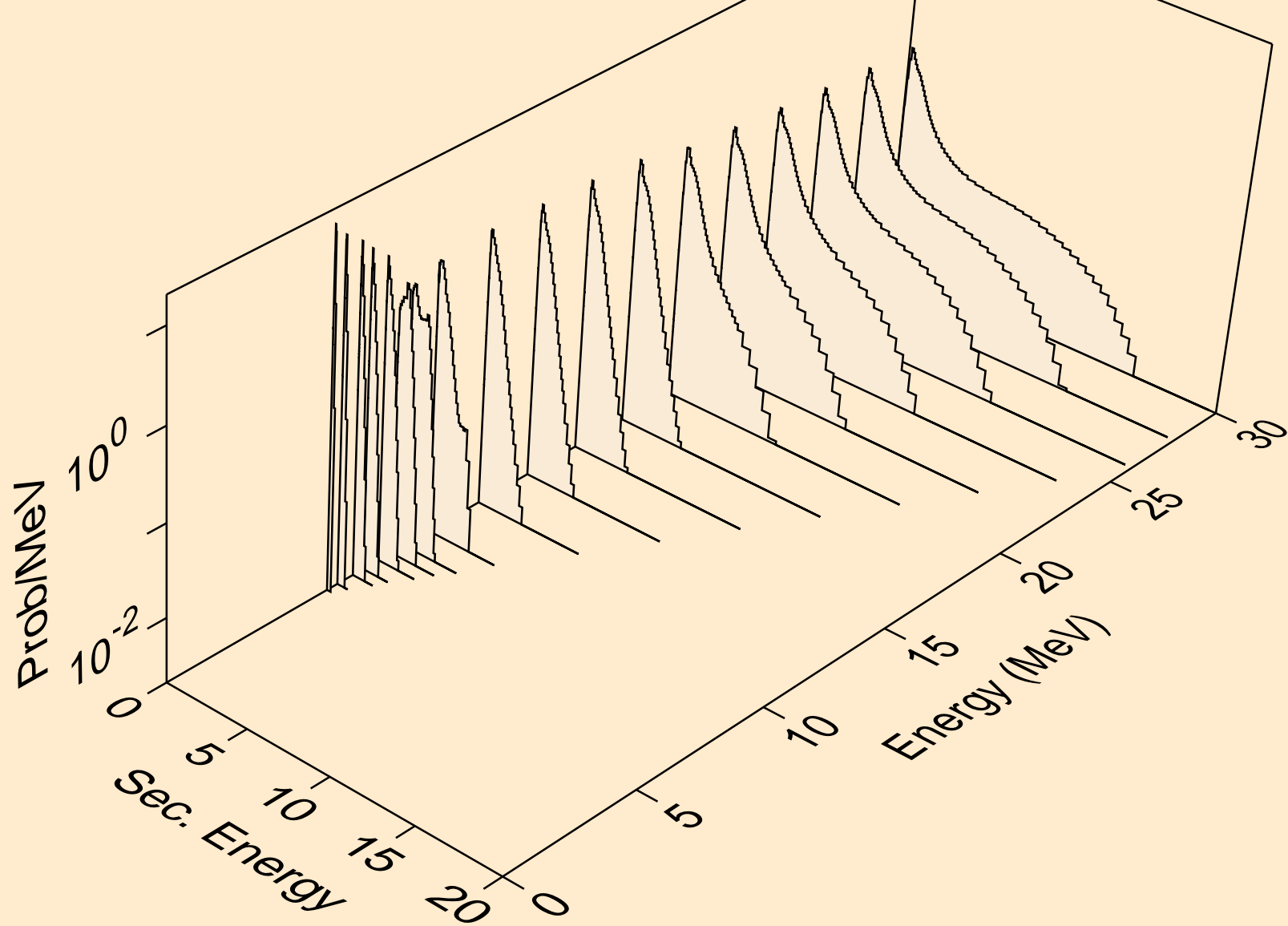

EU151 NEUTRON ACER TENDL-2023 LIBRARY; T=0.K
Neutron emission for (n,n*)2a

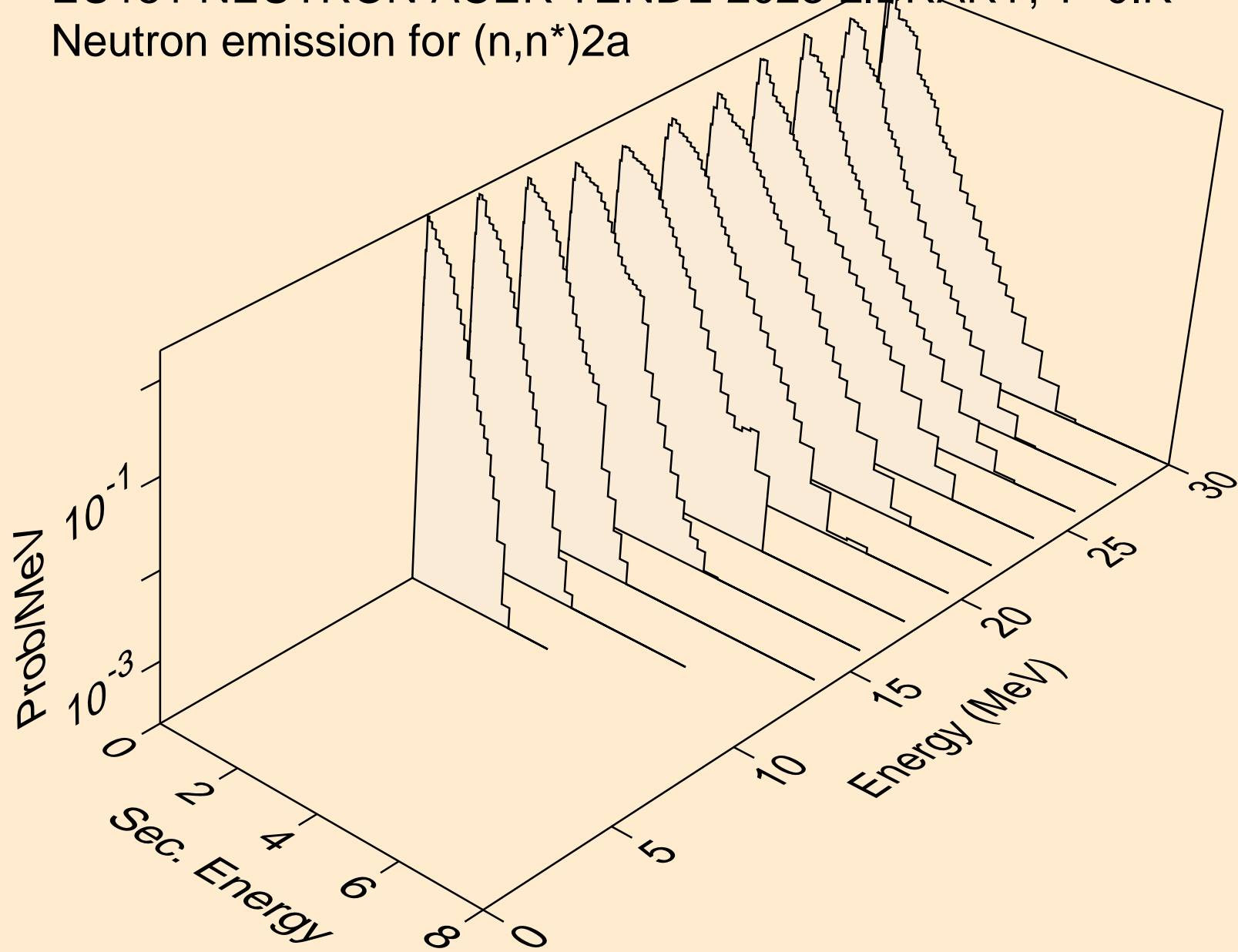

EU151 NEUTRON ACER TENDL-2023 LIBRARY; T=0.K
Neutron emission for (n,n*)d

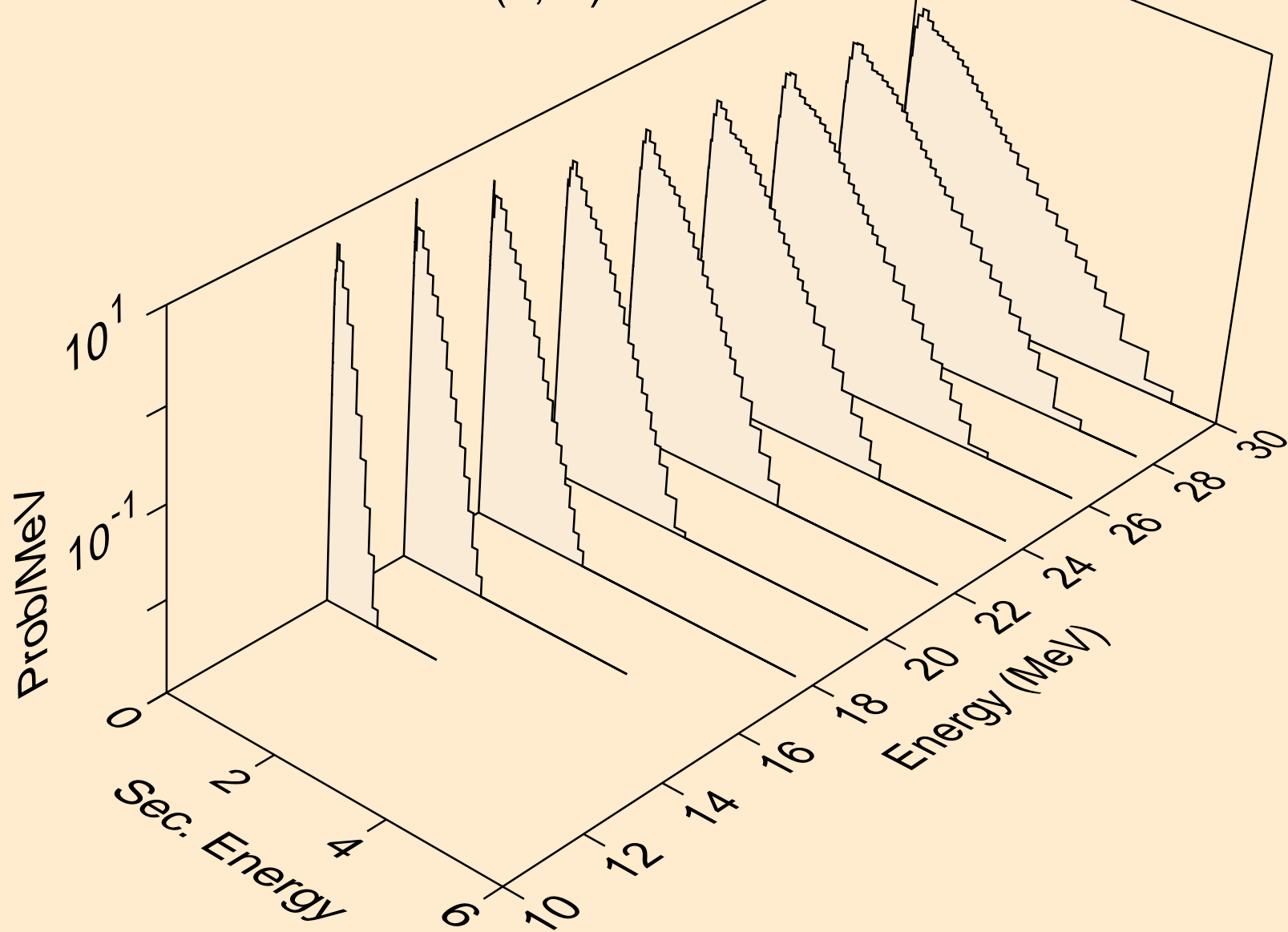

EU151 NEUTRON ACER TENDL-2023 LIBRARY; T=0.K
Neutron emission for (n,n*)t

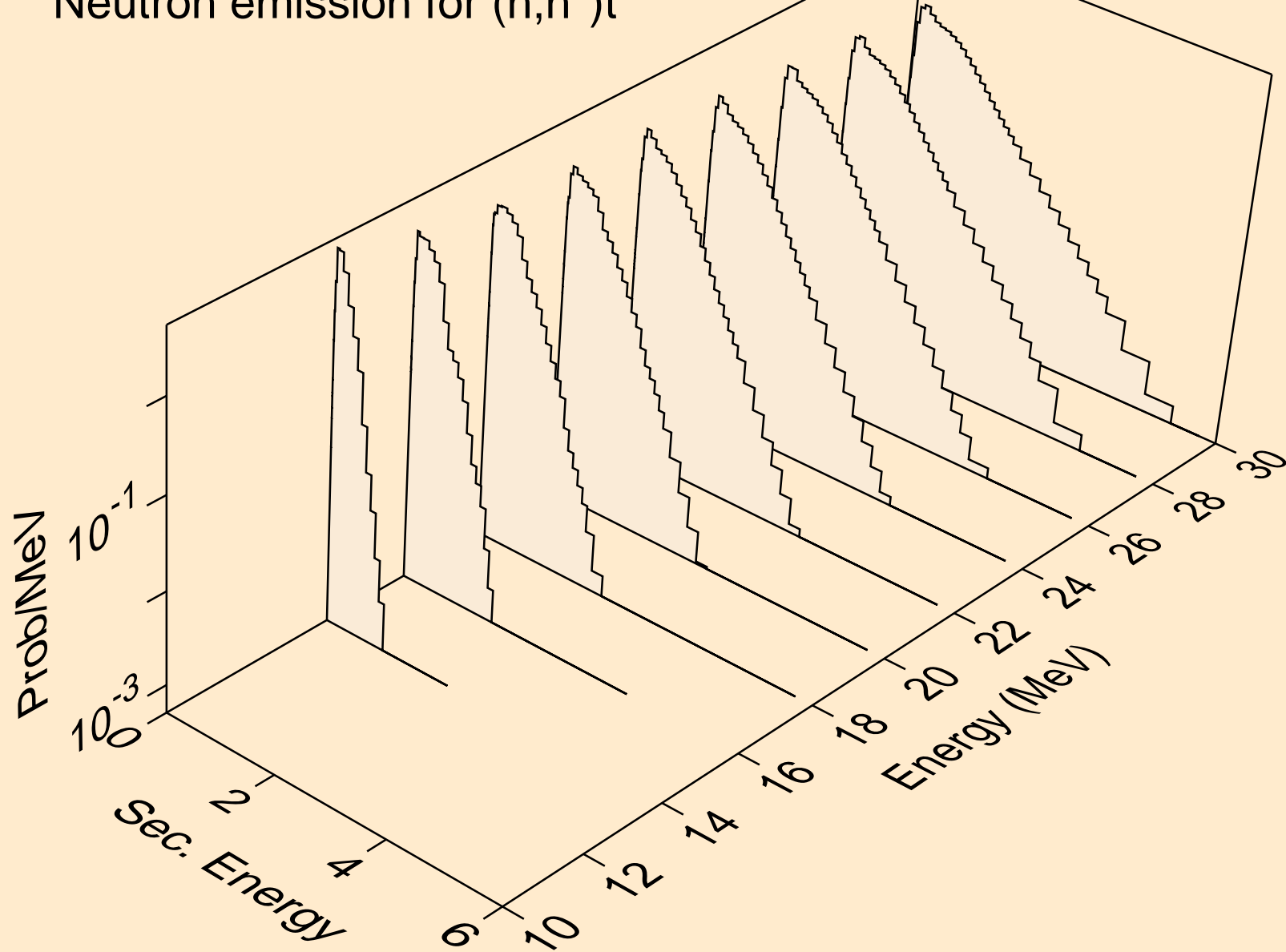

EU151 NEUTRON ACER TENDL-2023 LIBRARY; T=0.K
Neutron emission for (n,n*)he3

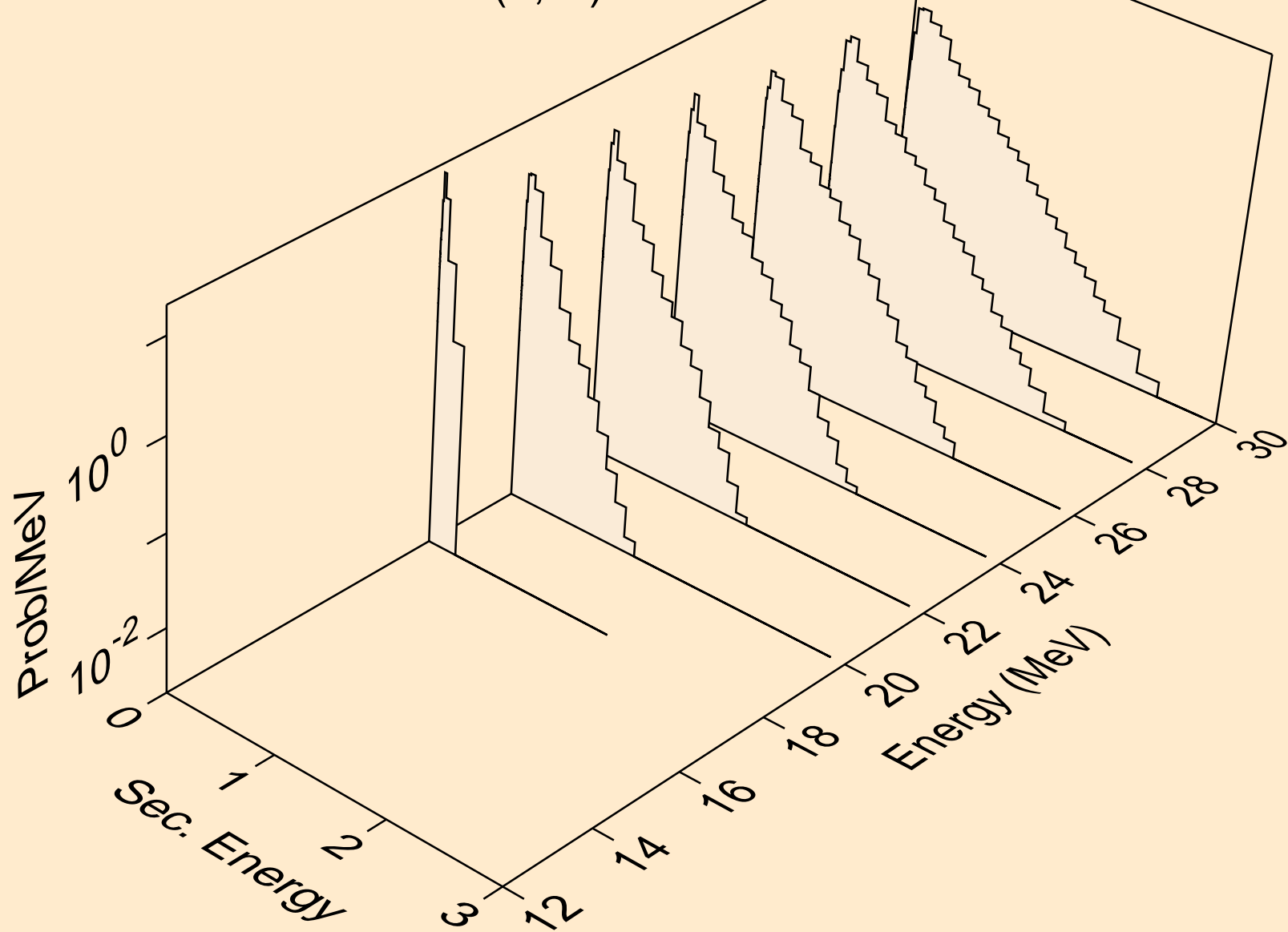

EU151 NEUTRON ACER TENDL-2023 LIBRARY; T=0.K
Neutron emission for (n,4n)

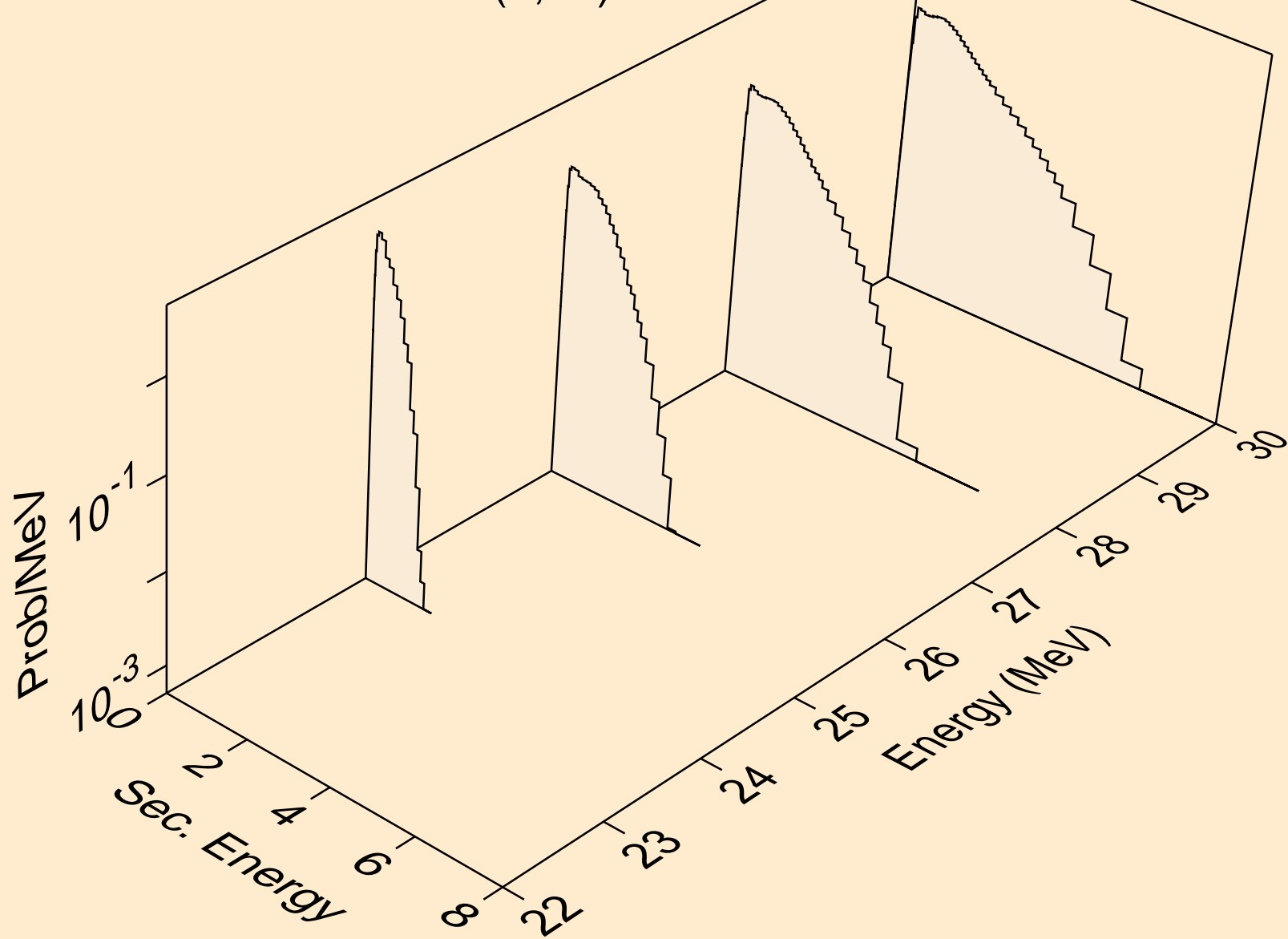

EU151 NEUTRON ACER TENDL-2023 LIBRARY; T=0.K
Neutron emission for (n,2np)

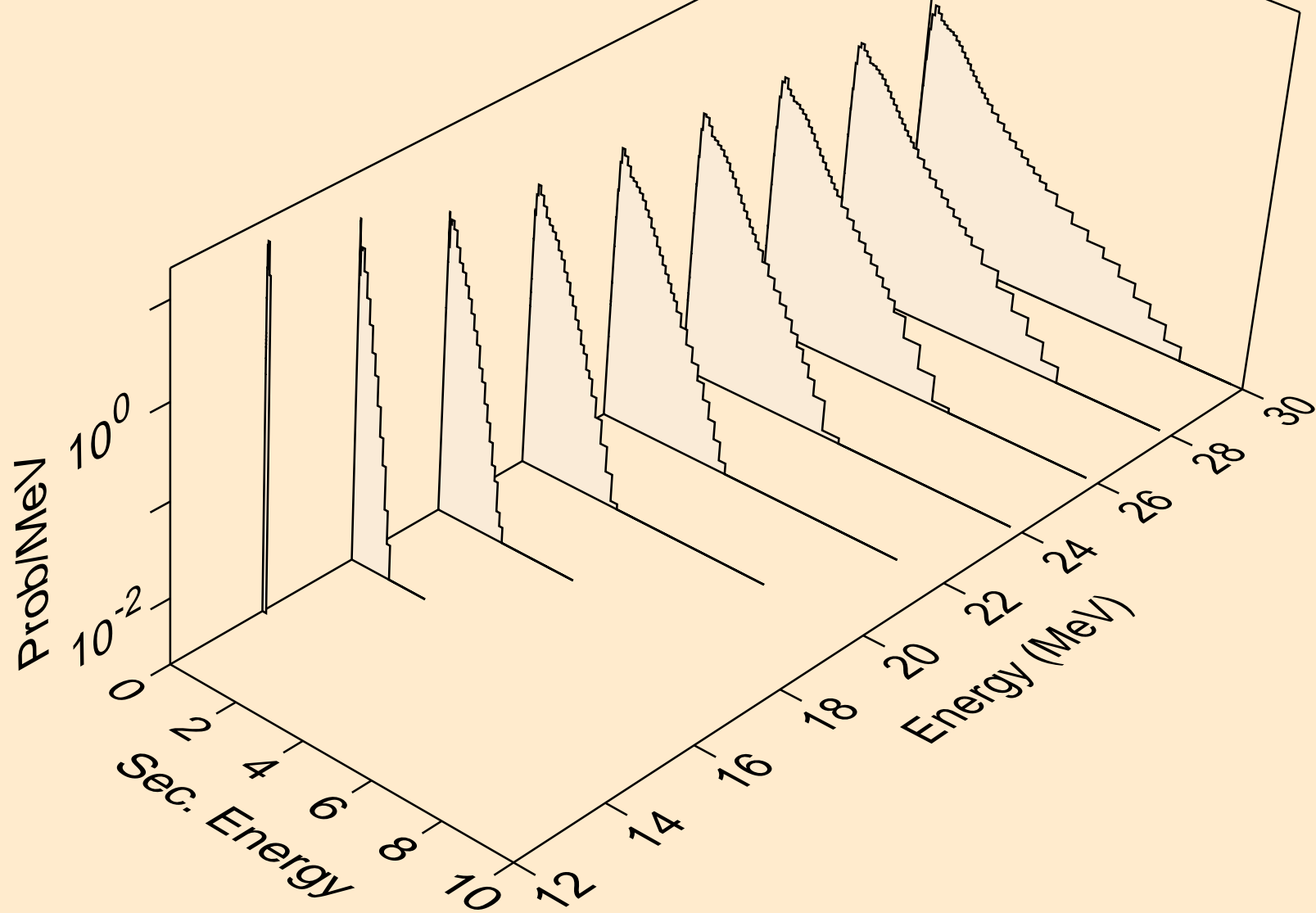

EU151 NEUTRON ACER TENDL-2023 LIBRARY; T=0.K
Neutron emission for (n,3np)

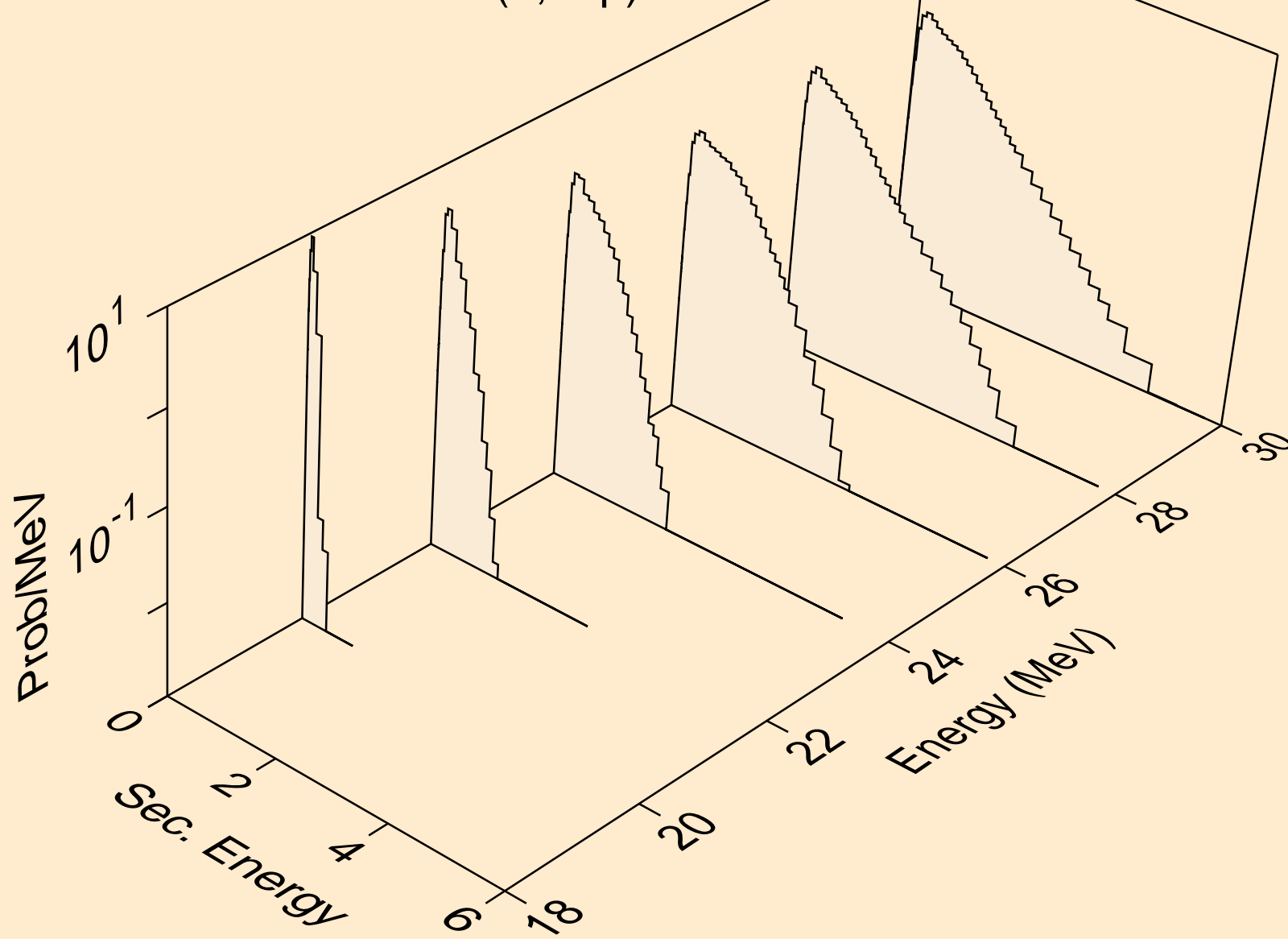

EU151 NEUTRON ACER TENDL-2023 LIBRARY; T=0.K
Neutron emission for (n,n2p)

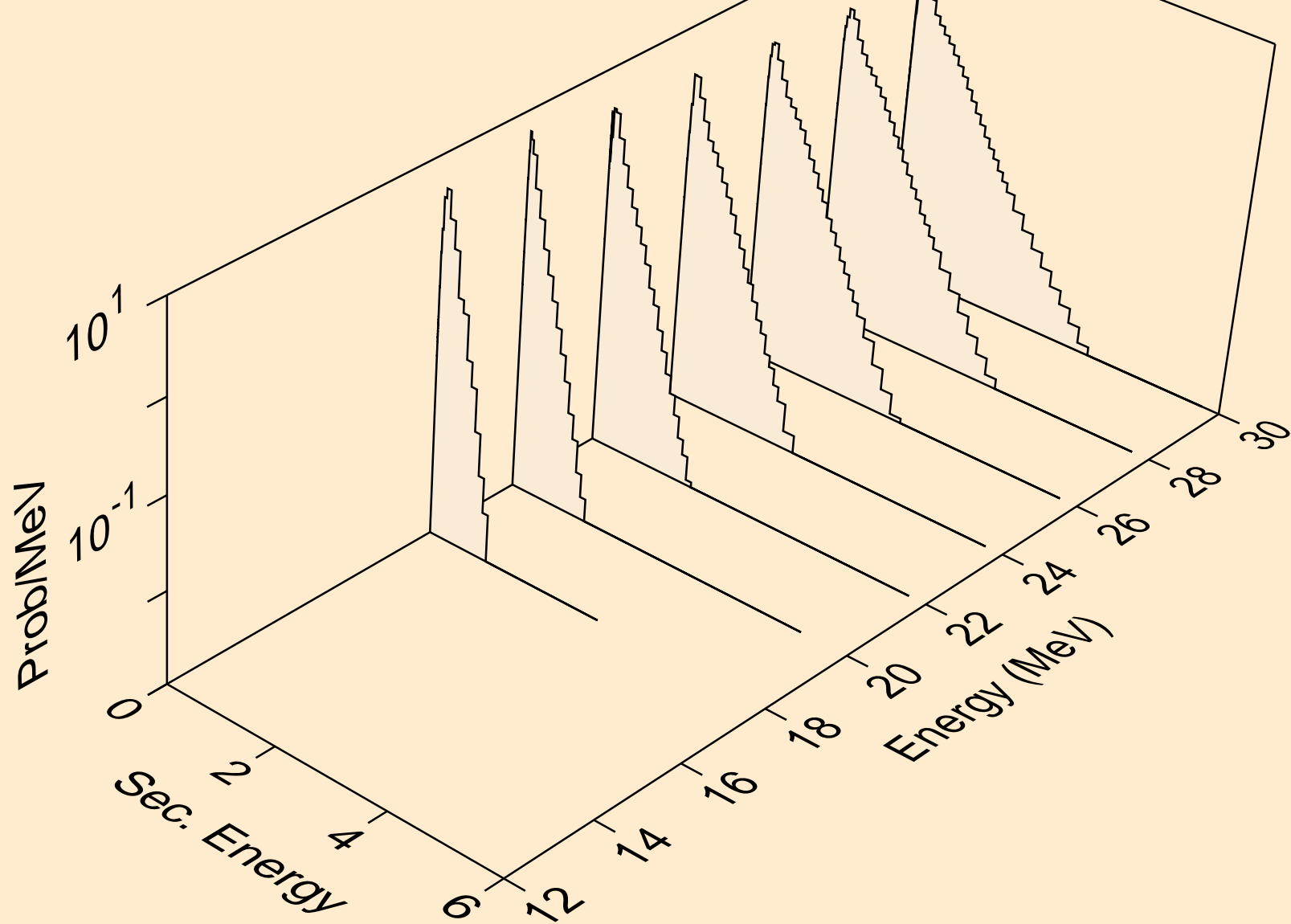

EU151 NEUTRON ACER TENDL-2023 LIBRARY; T=0.K
Neutron emission for (n,npa)

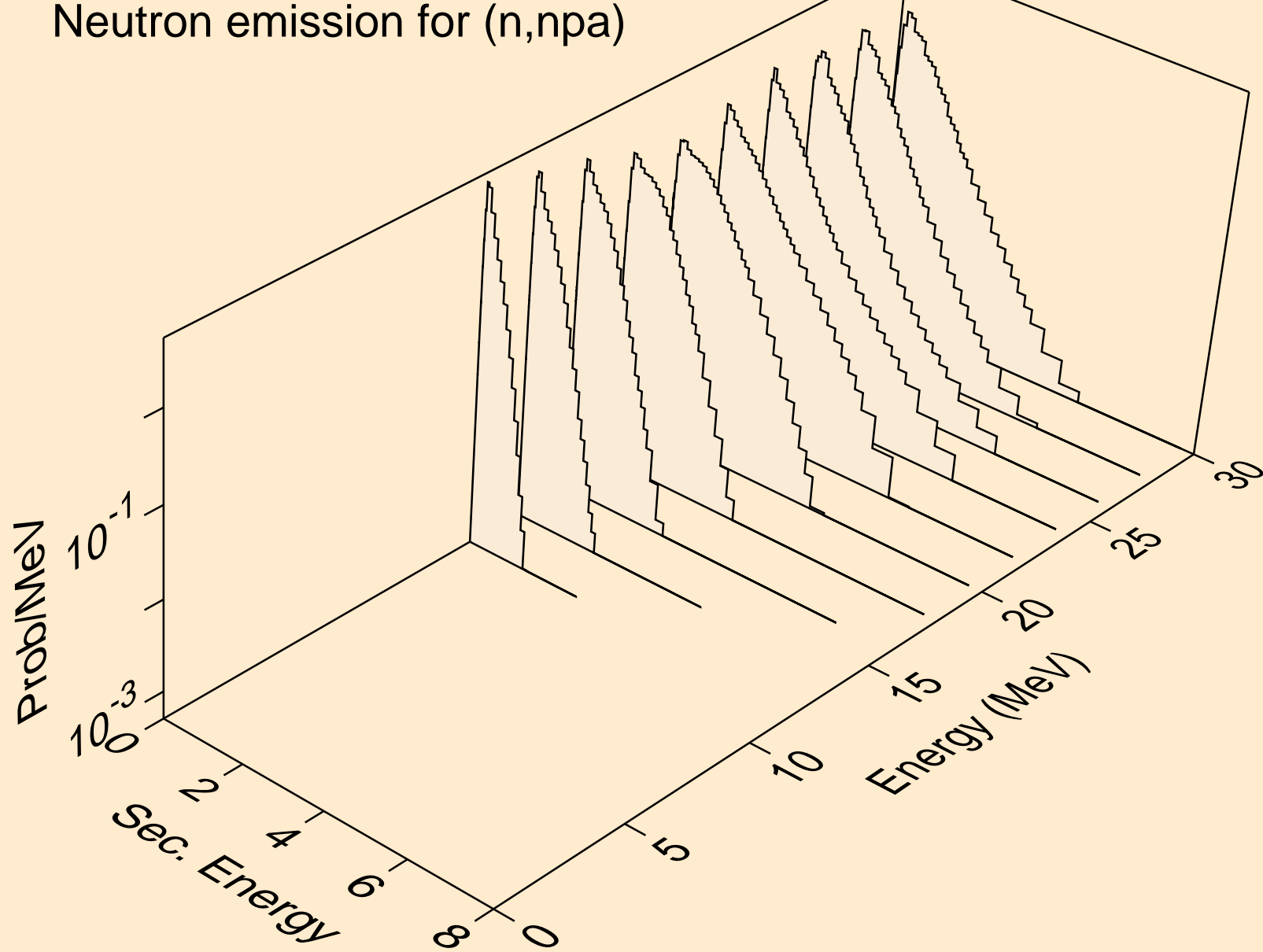

EU151 NEUTRON ACER TENDL-2023 LIBRARY; T=0.K
Neutron emission for (n,n*c)

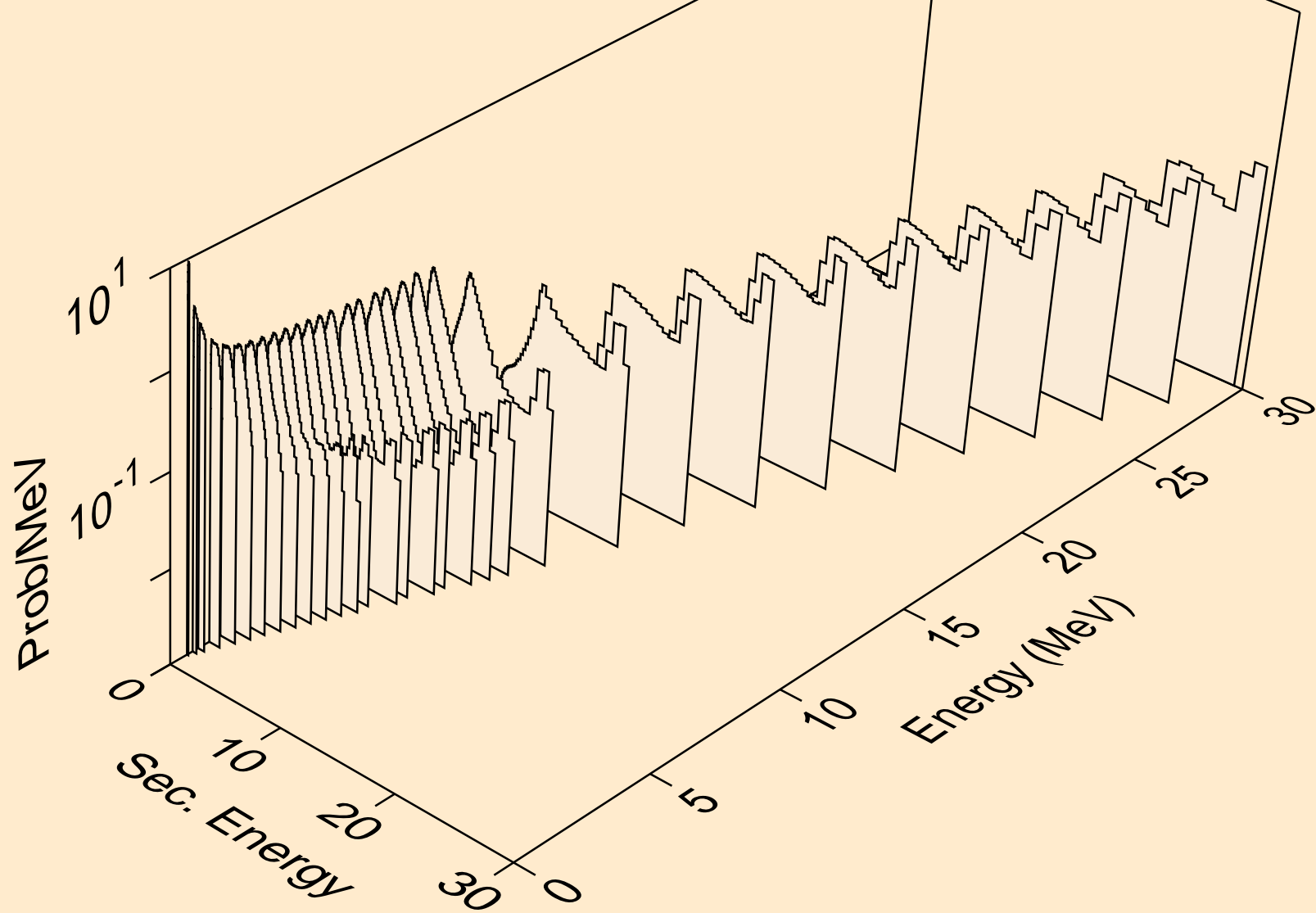

EU151 NEUTRON ACER TENDL-2023 LIBRARY; T=0.K
Photon emission for (n,x)

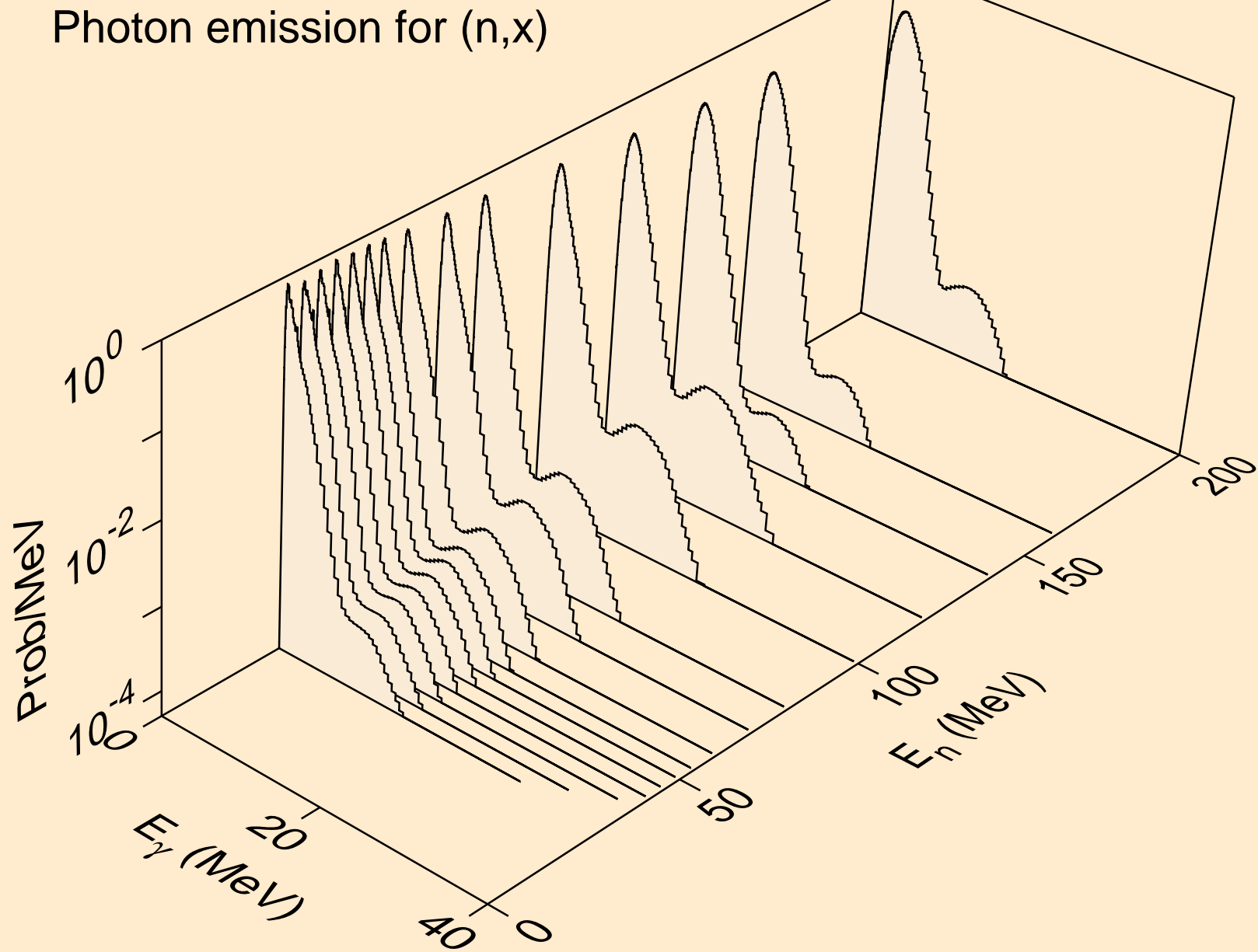

EU151 NEUTRON ACER TENDL-2023 LIBRARY; T=0.K
Photon emission for (n,2nd)

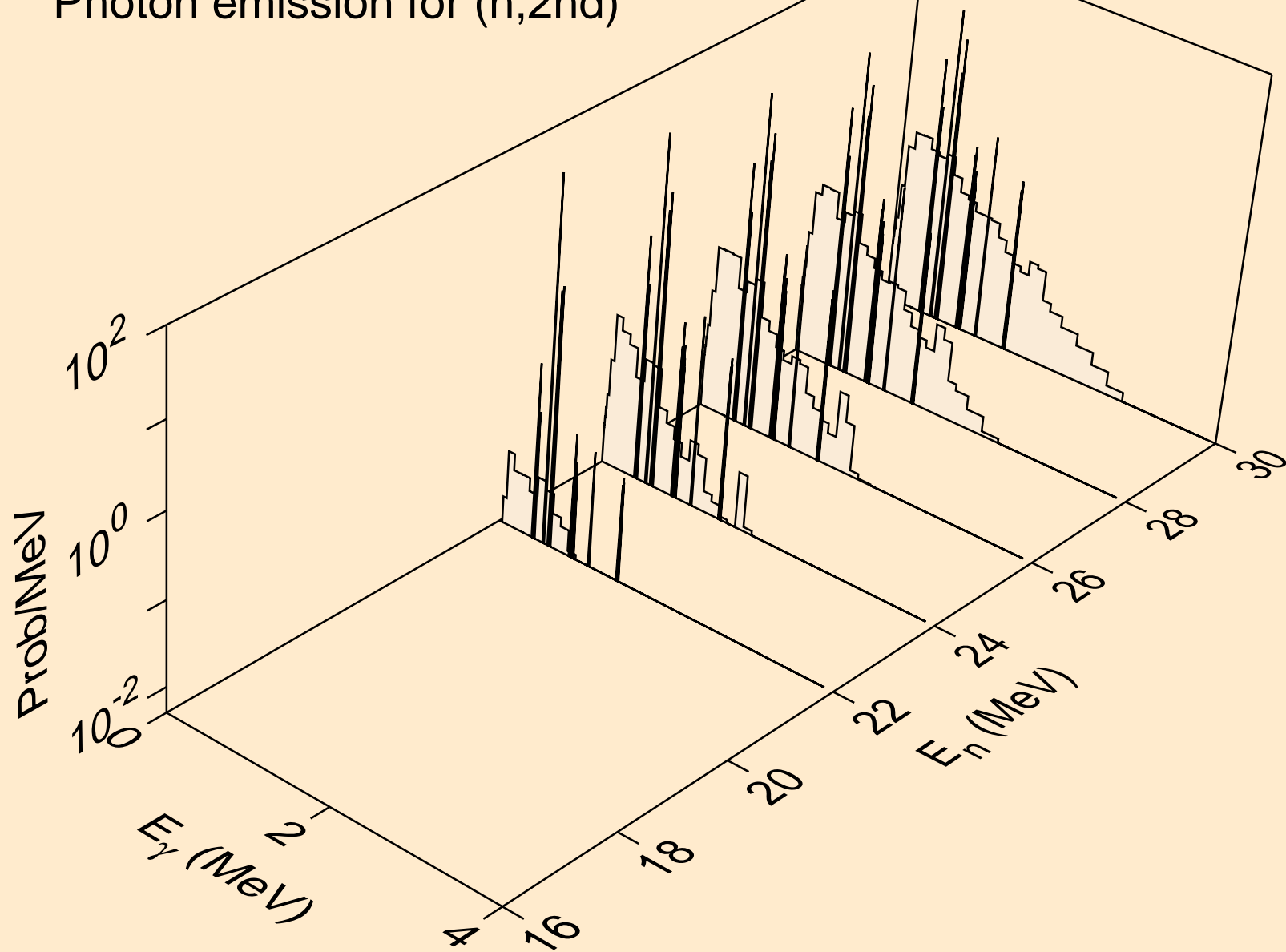

EU151 NEUTRON ACER TENDL-2023 LIBRARY; T=0.K
Photon emission for (n,2n)

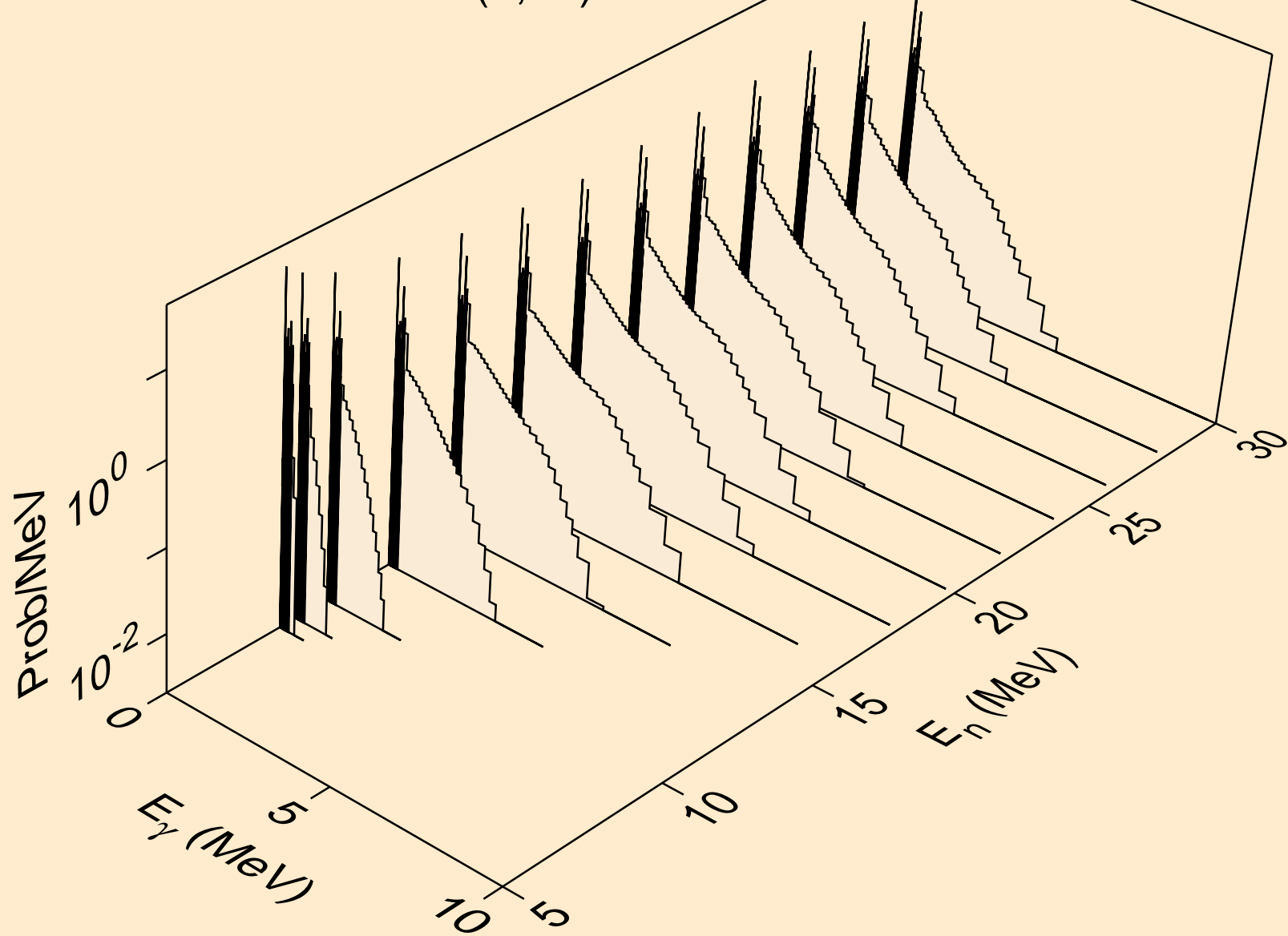

EU151 NEUTRON ACER TENDL-2023 LIBRARY; T=0.K
Photon emission for (n,3n)

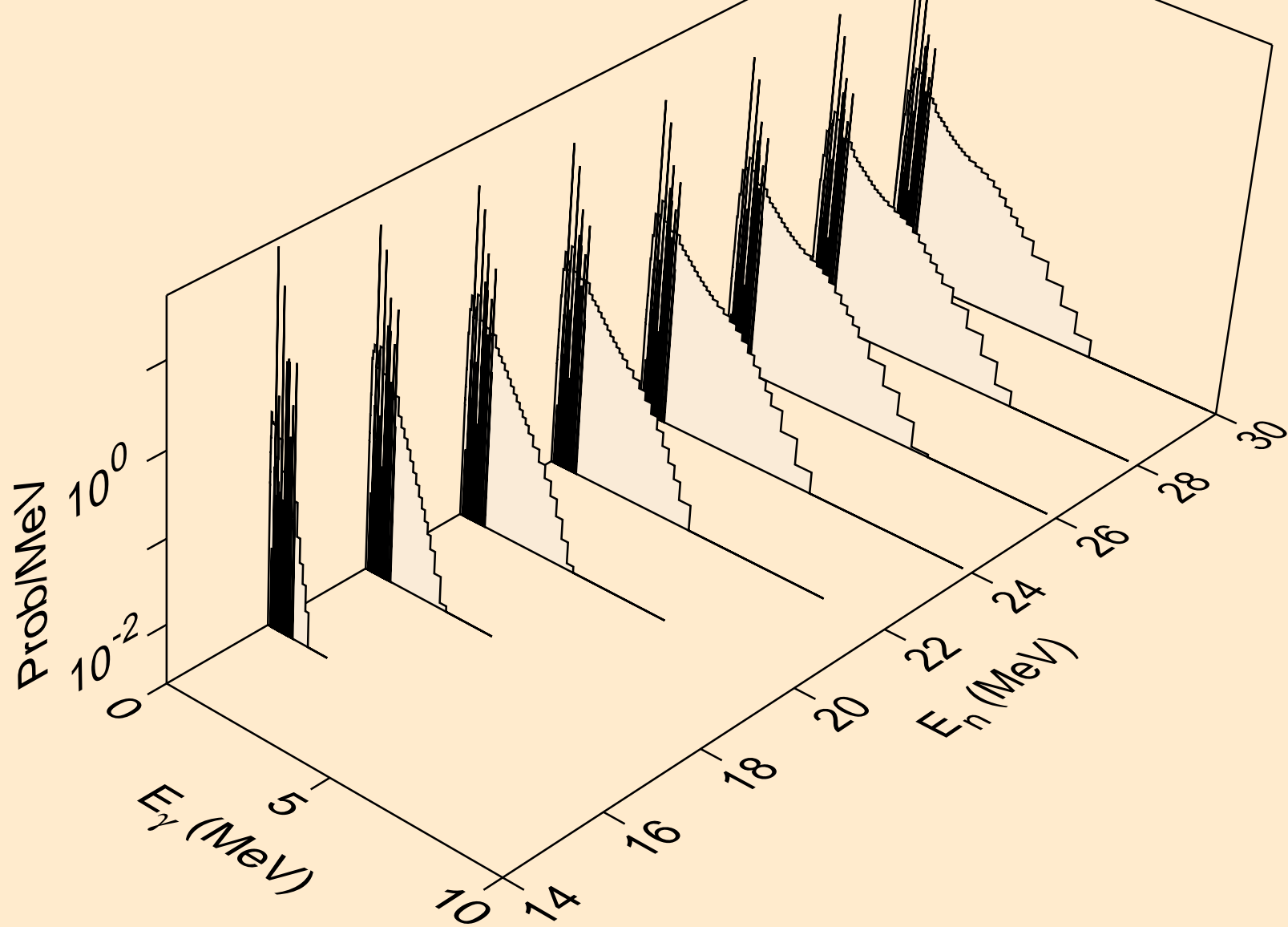

EU151 NEUTRON ACER TENDL-2023 LIBRARY; T=0.K
Photon emission for (n,n*)a

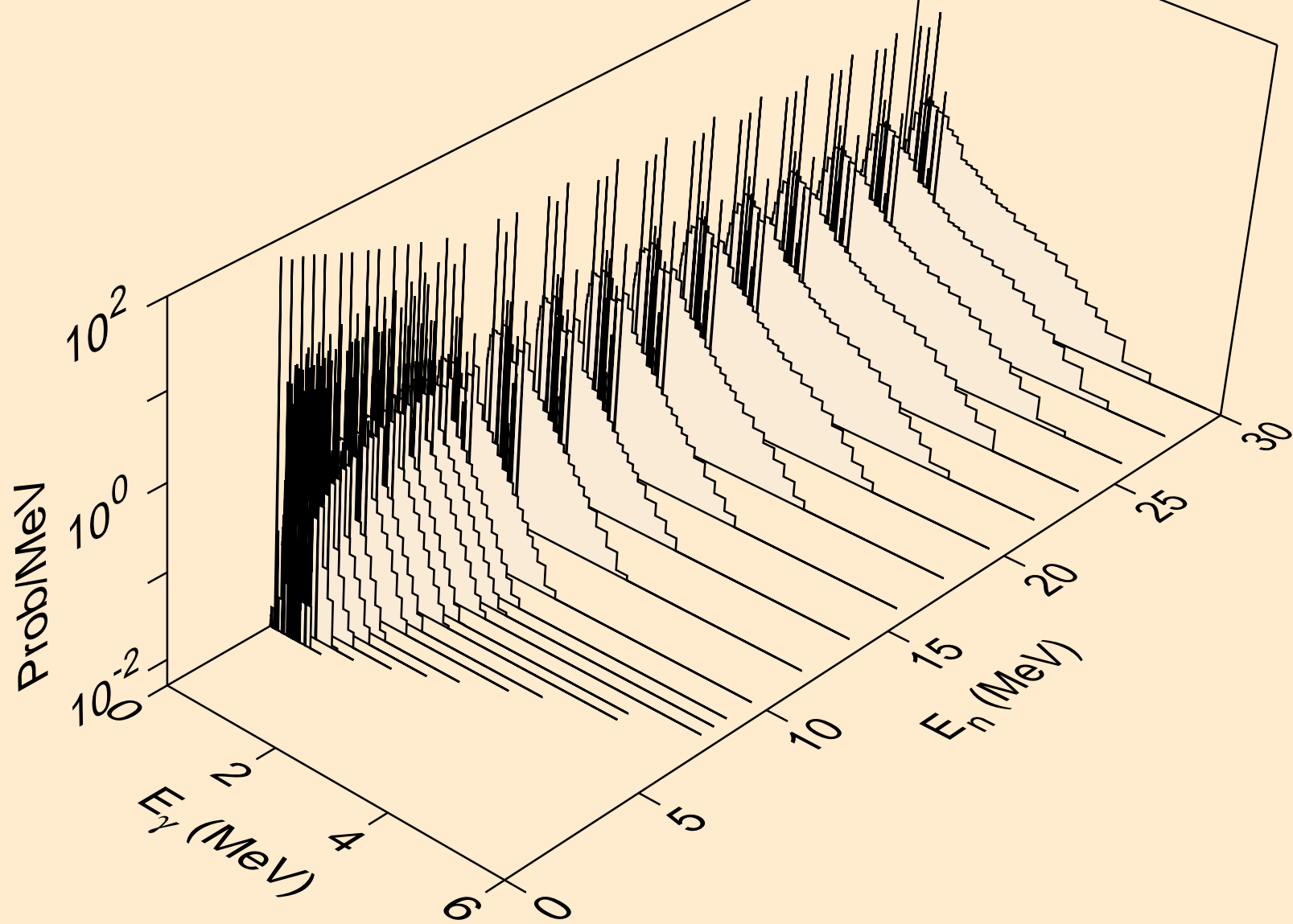

EU151 NEUTRON ACER TENDL-2023 LIBRARY; T=0.K
Photon emission for (n,2n)a

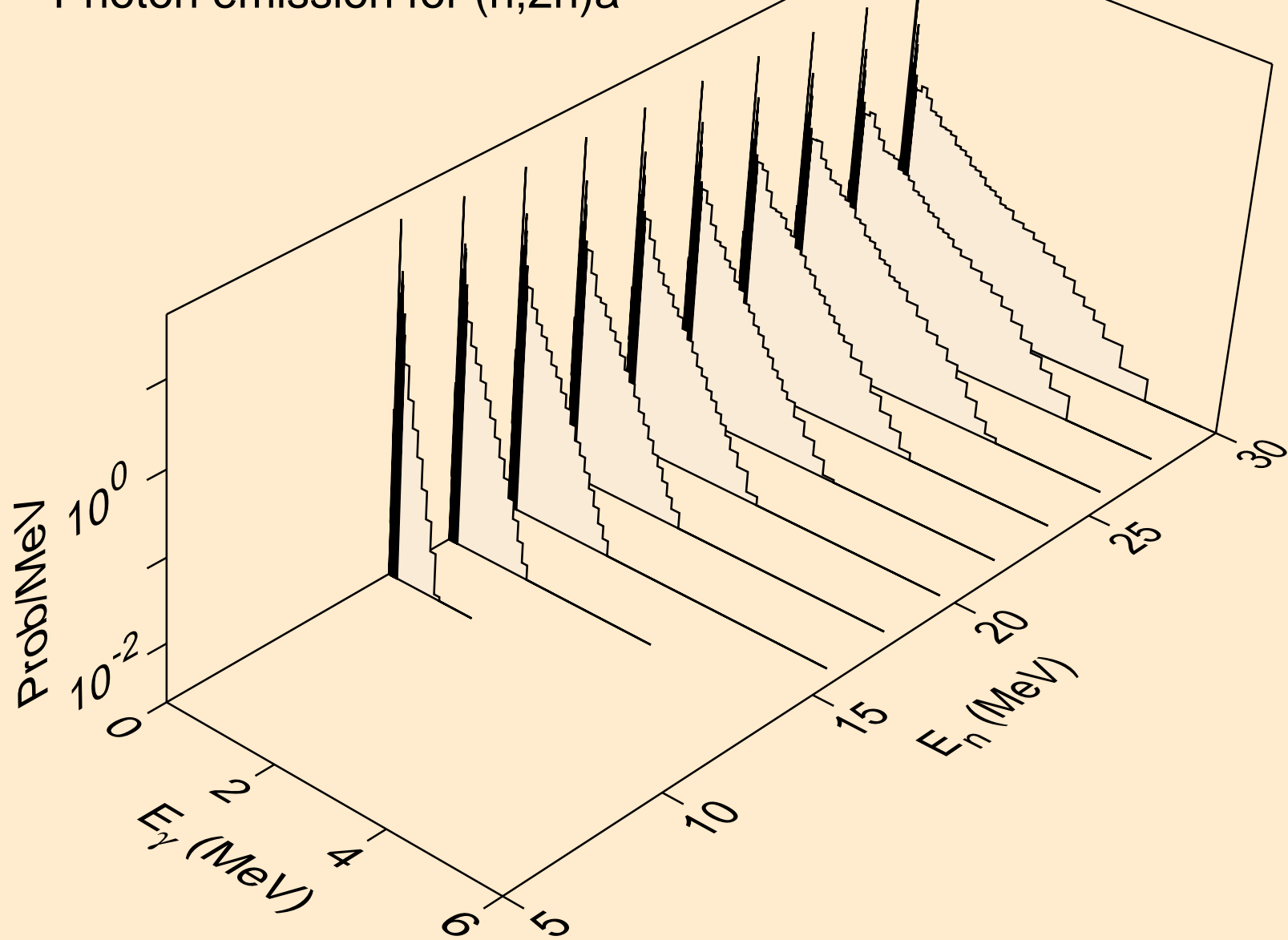

EU151 NEUTRON ACER TENDL-2023 LIBRARY; T=0.K
Photon emission for (n,3n)a

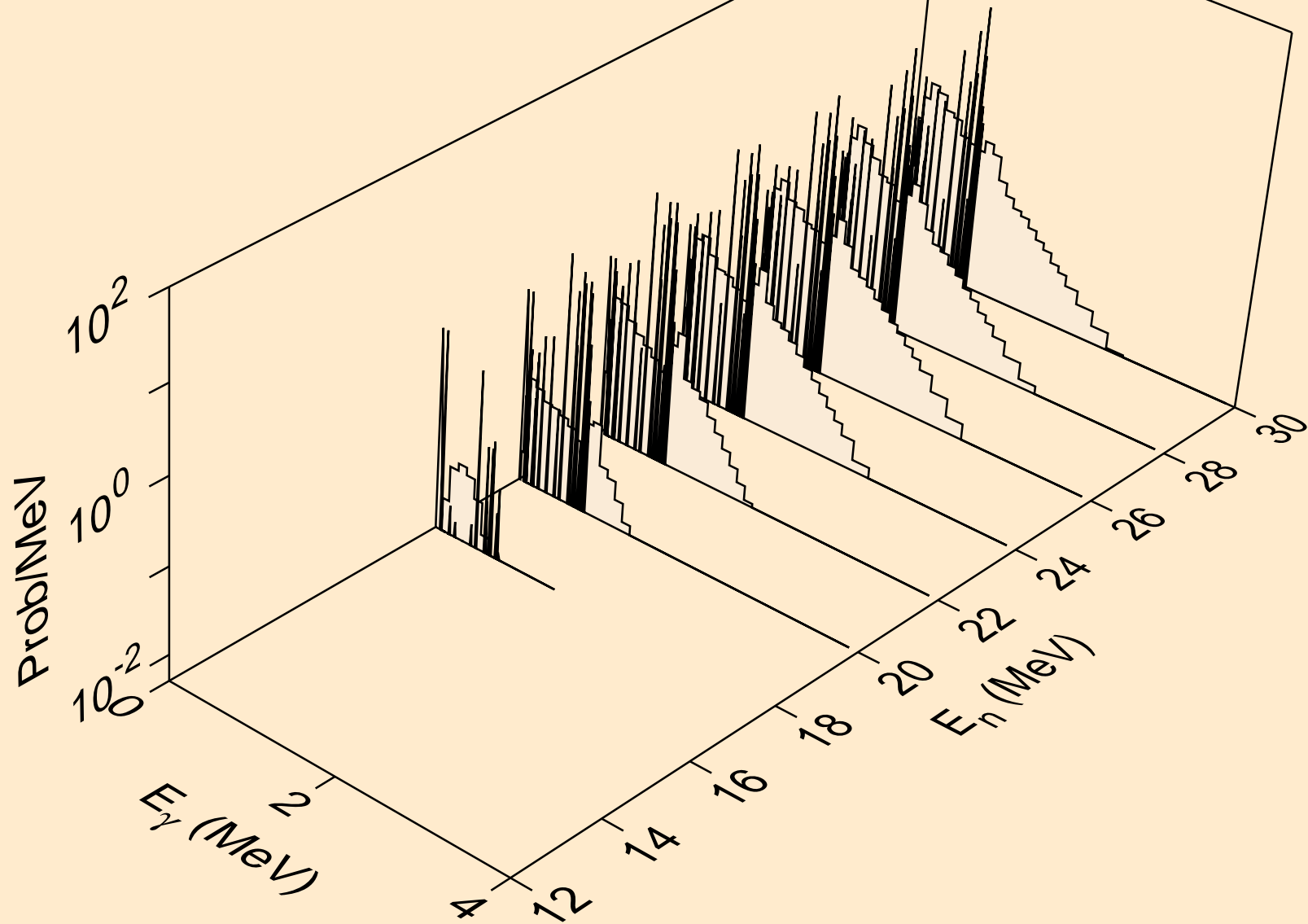

EU151 NEUTRON ACER TENDL-2023 LIBRARY; T=0.K
Photon emission for (n,n*)p

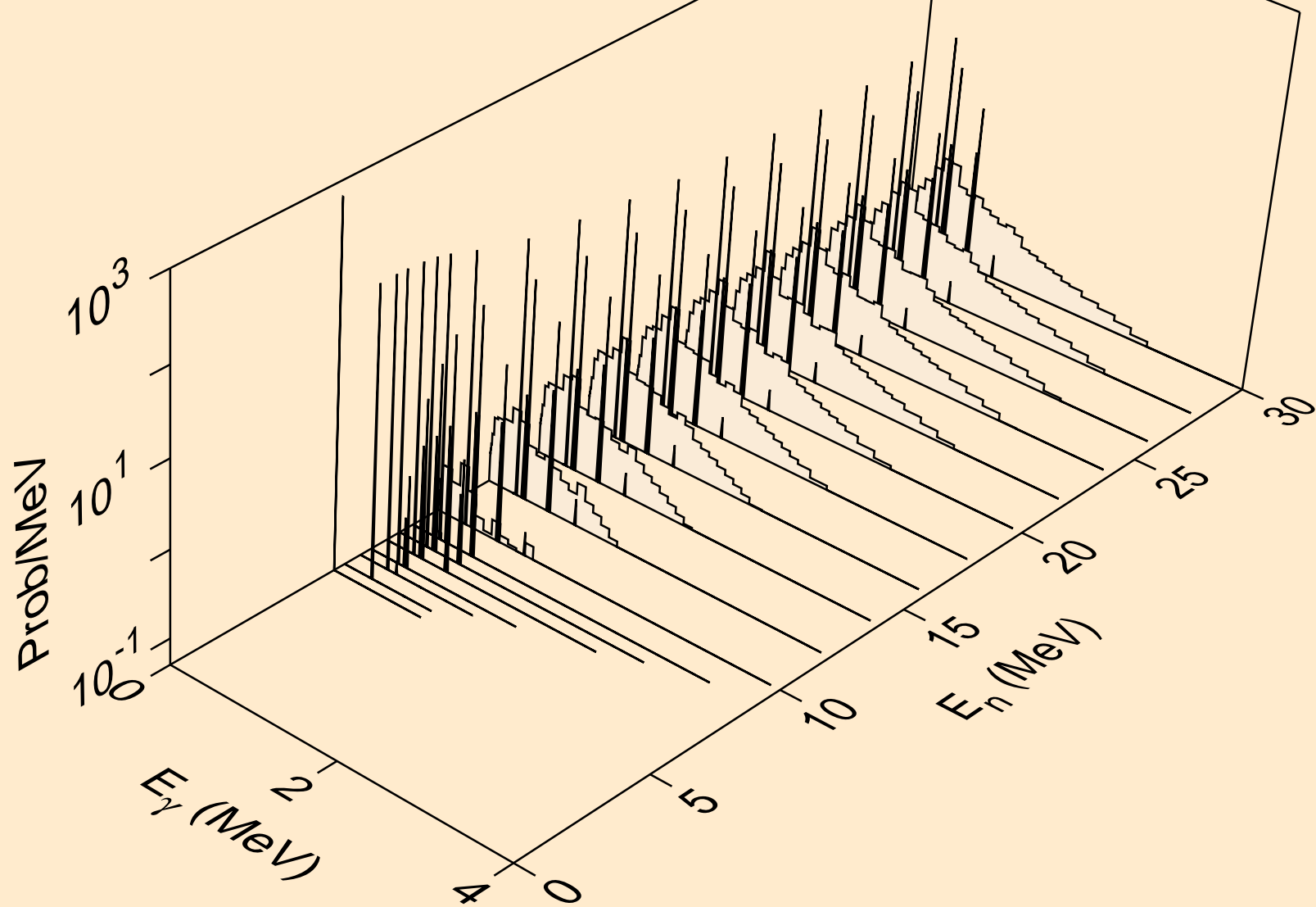

EU151 NEUTRON ACER TENDL-2023 LIBRARY; T=0.K
Photon emission for (n,n*)2a

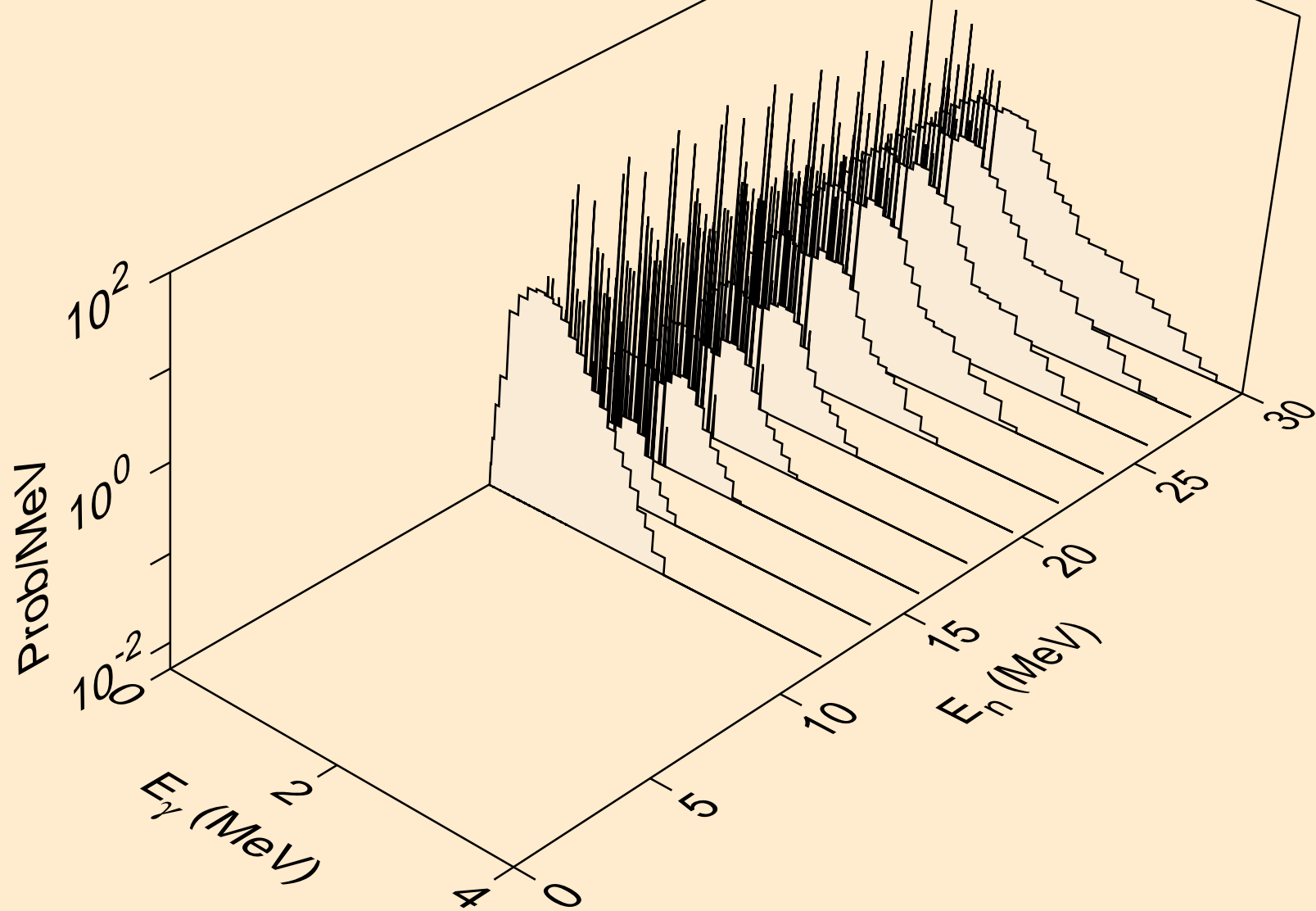

EU151 NEUTRON ACER TENDL-2023 LIBRARY; T=0.K
Photon emission for (n,n*)d

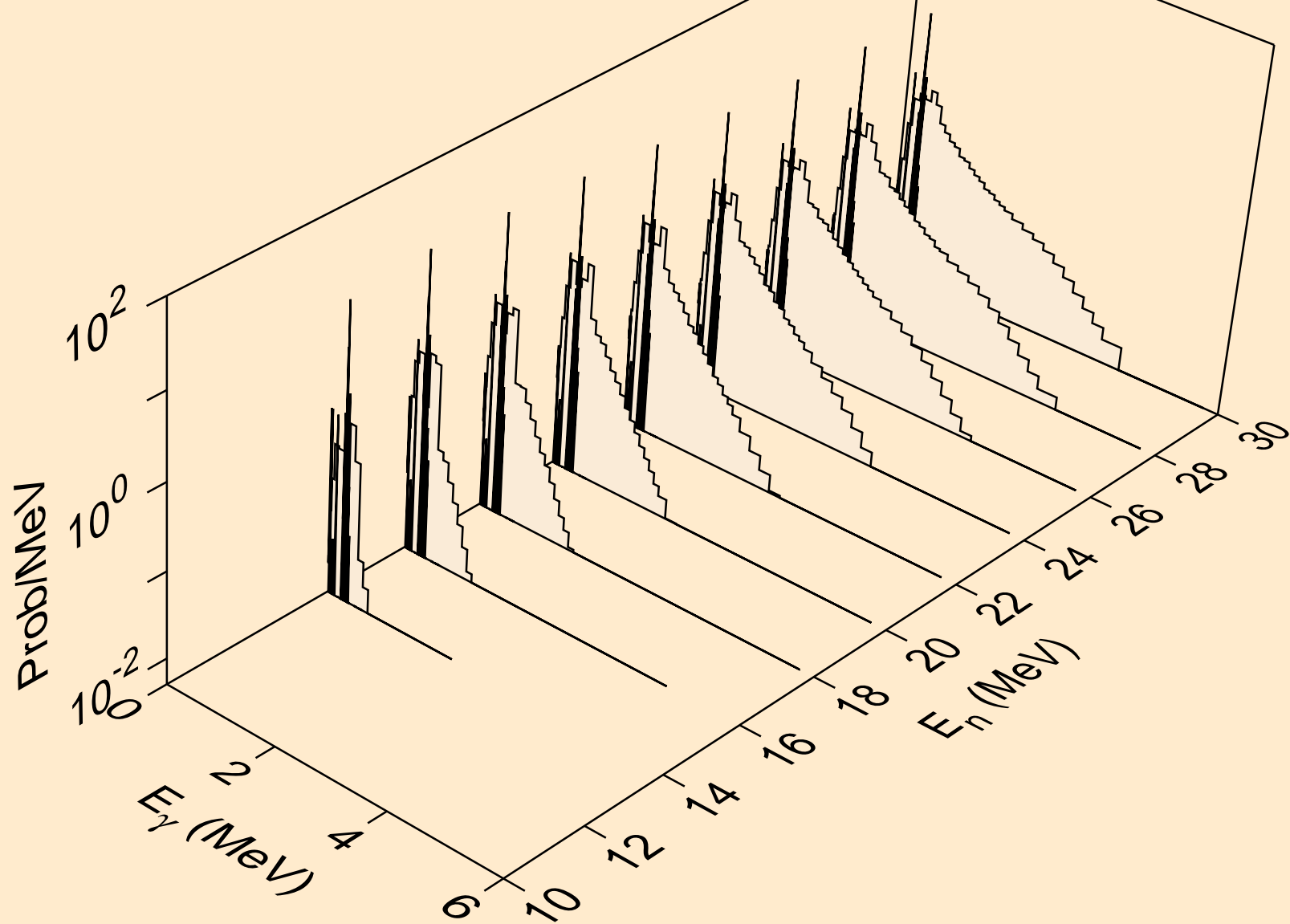

EU151 NEUTRON ACER TENDL-2023 LIBRARY; T=0.K
Photon emission for (n,n*)t

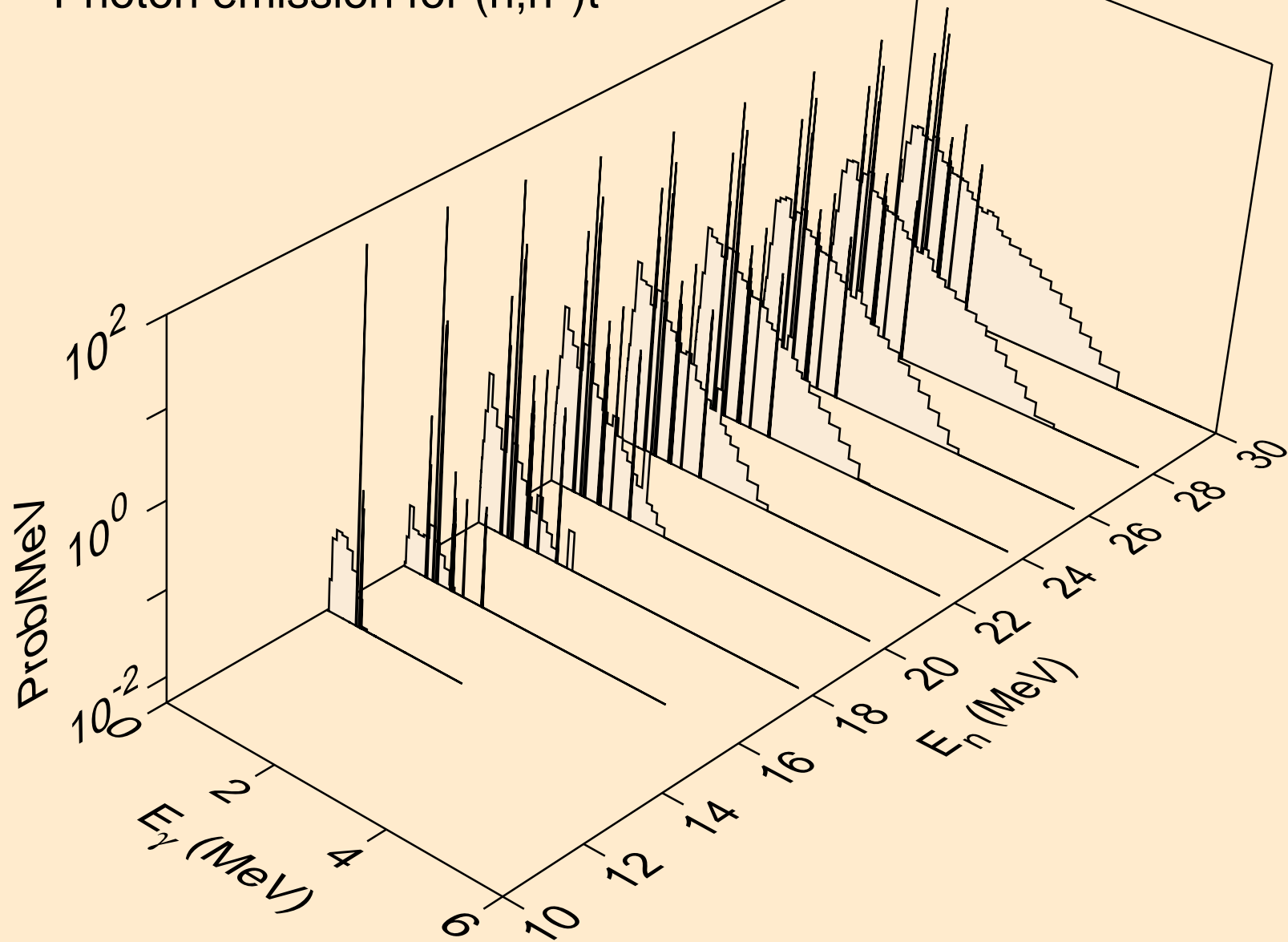

EU151 NEUTRON ACER TENDL-2023 LIBRARY; T=0.K
Photon emission for (n,n*)he3

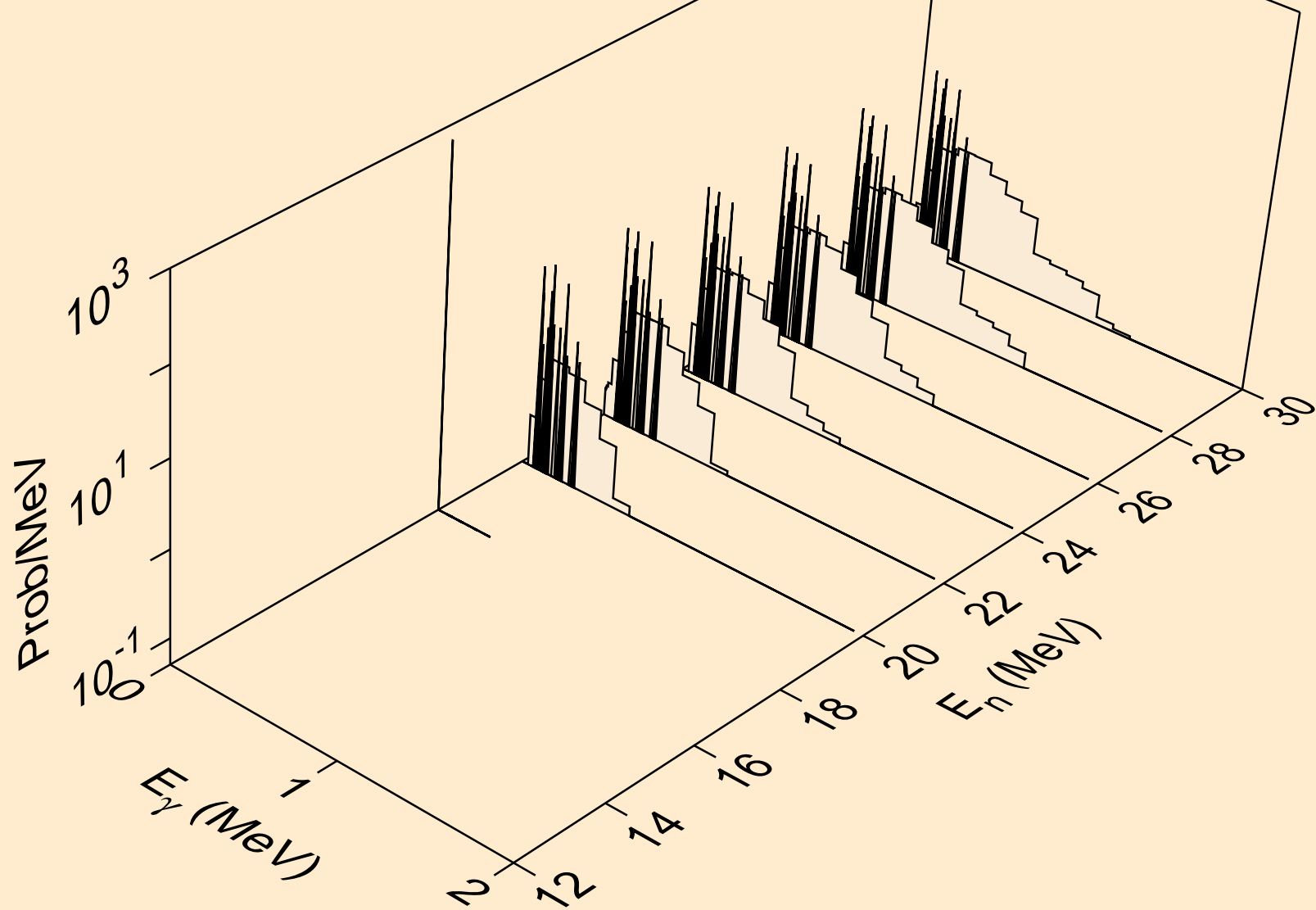

EU151 NEUTRON ACER TENDL-2023 LIBRARY; T=0.K
Photon emission for (n,4n)

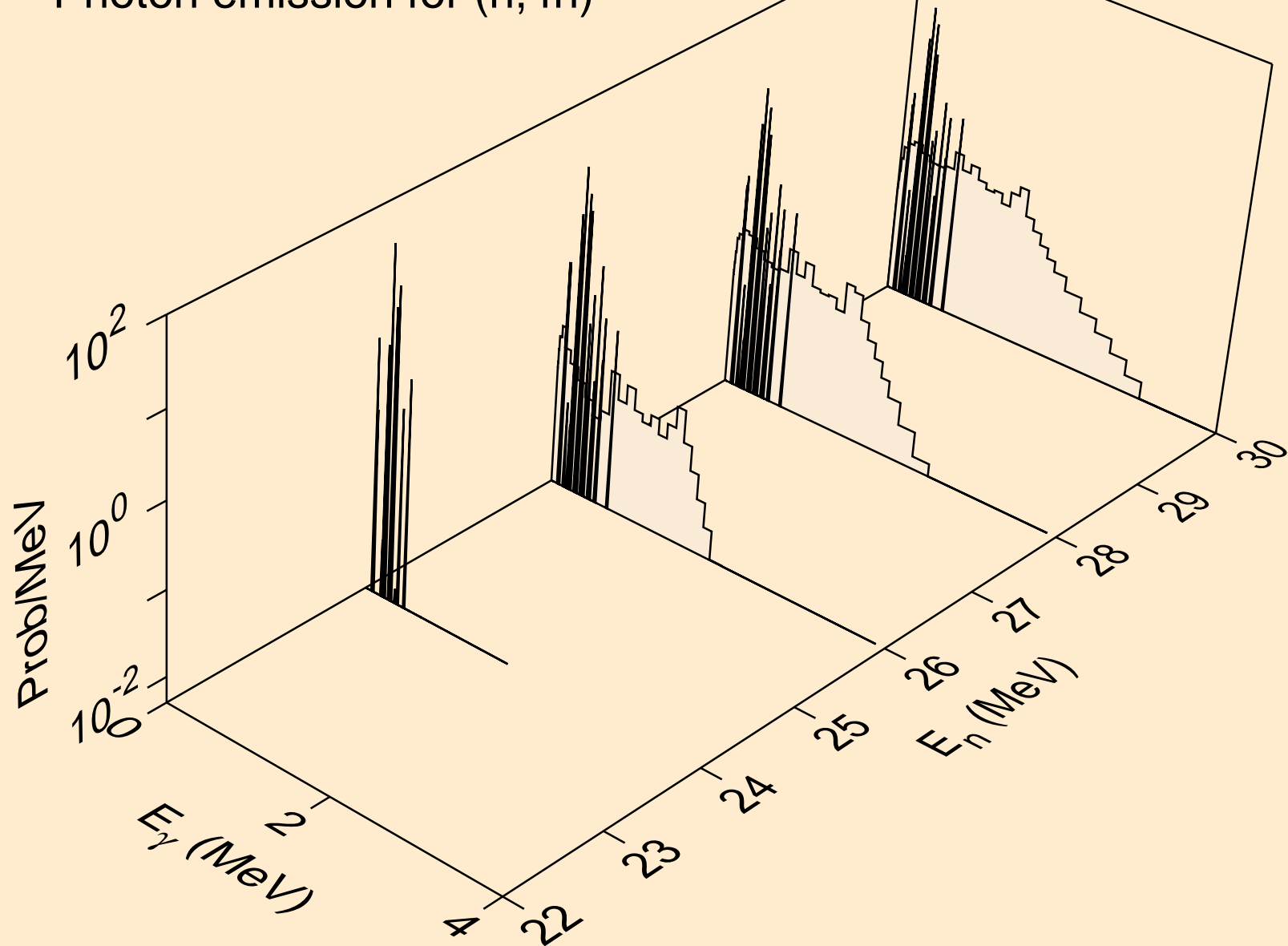

EU151 NEUTRON ACER TENDL-2023 LIBRARY; T=0.K
Photon emission for (n,2np)

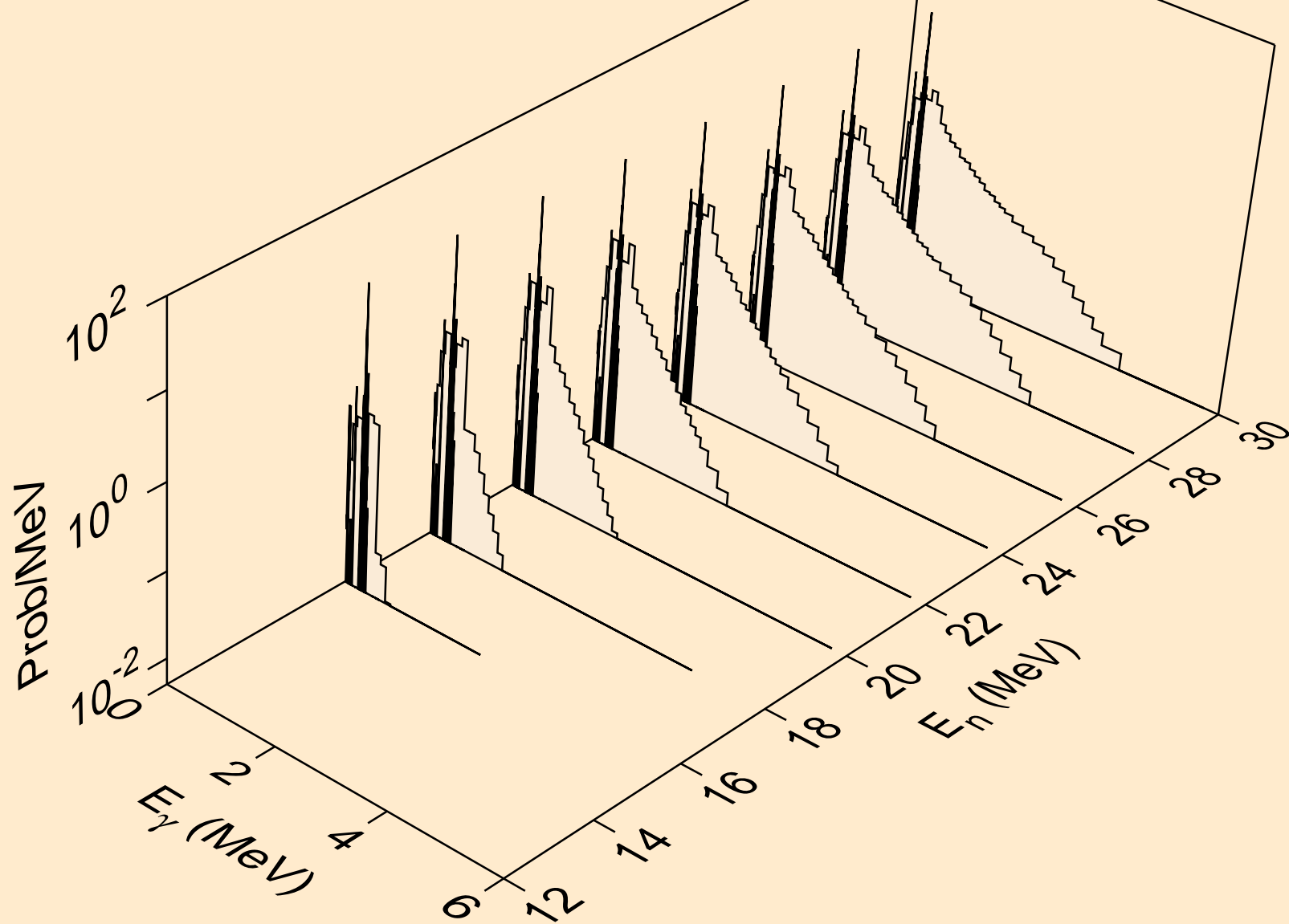

EU151 NEUTRON ACER TENDL-2023 LIBRARY; T=0.K
Photon emission for (n,3np)

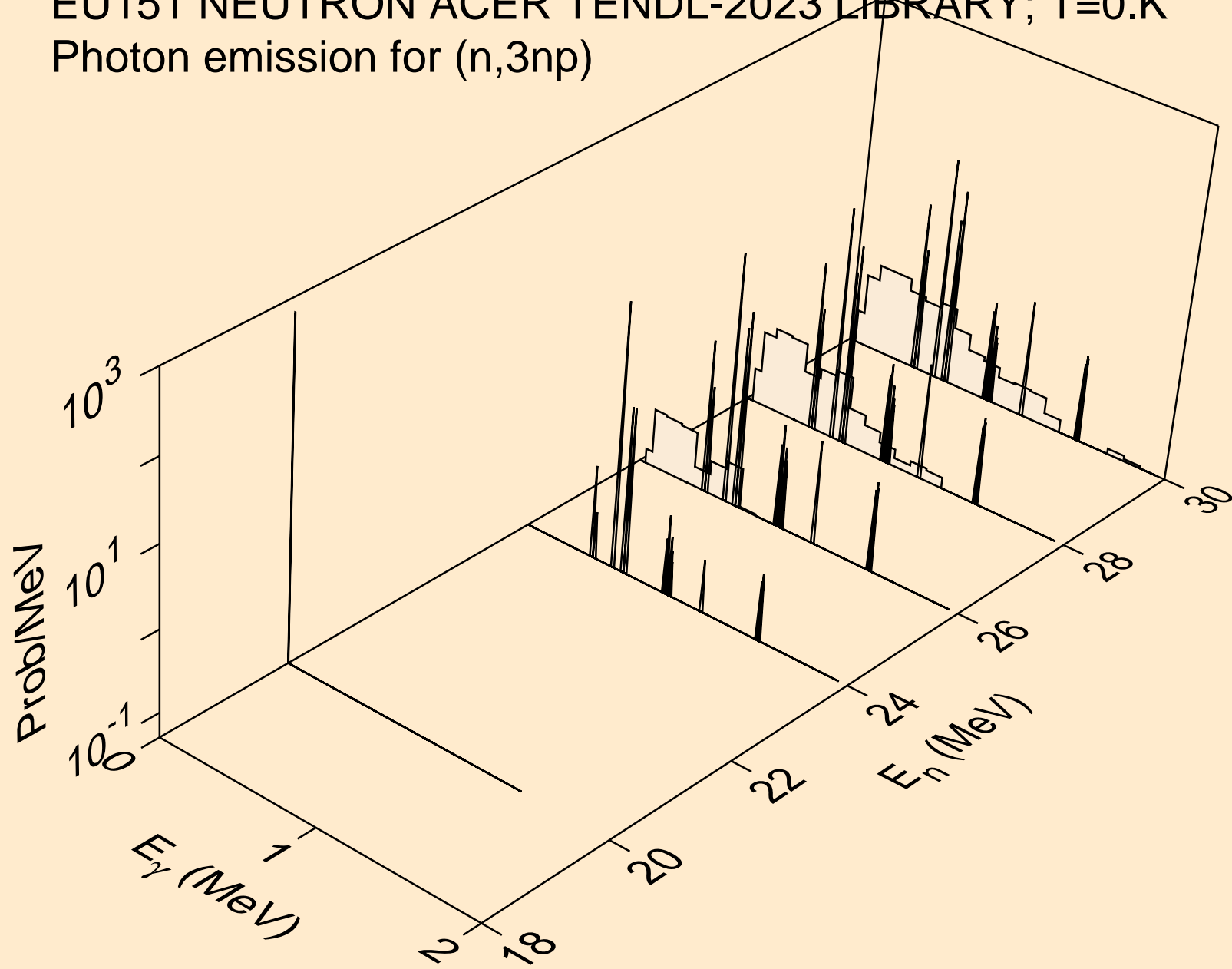

EU151 NEUTRON ACER TENDL-2023 LIBRARY; T=0.K
Photon emission for (n,n2p)

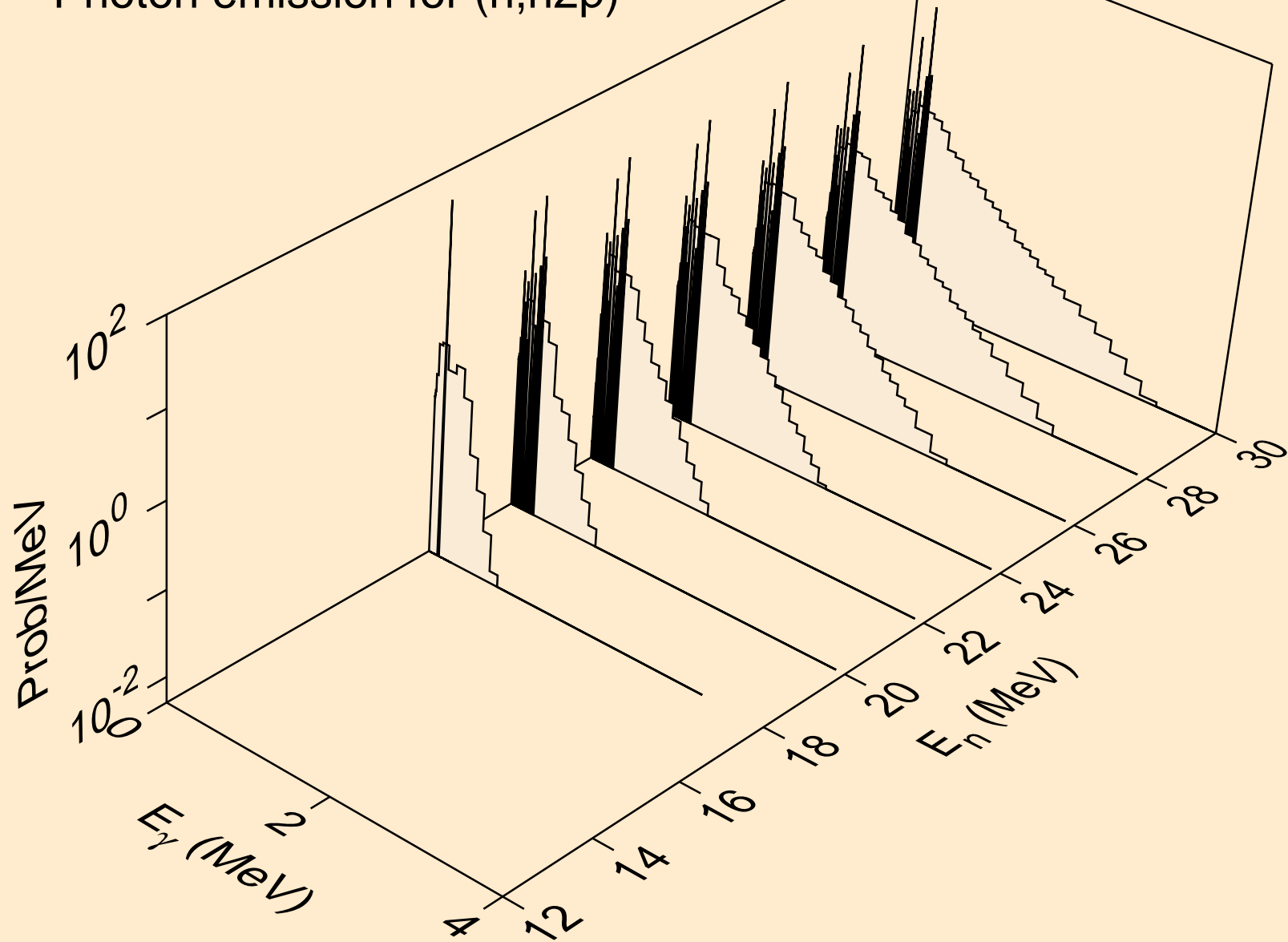

EU151 NEUTRON ACER TENDL-2023 LIBRARY; T=0.K
Photon emission for (n,npa)

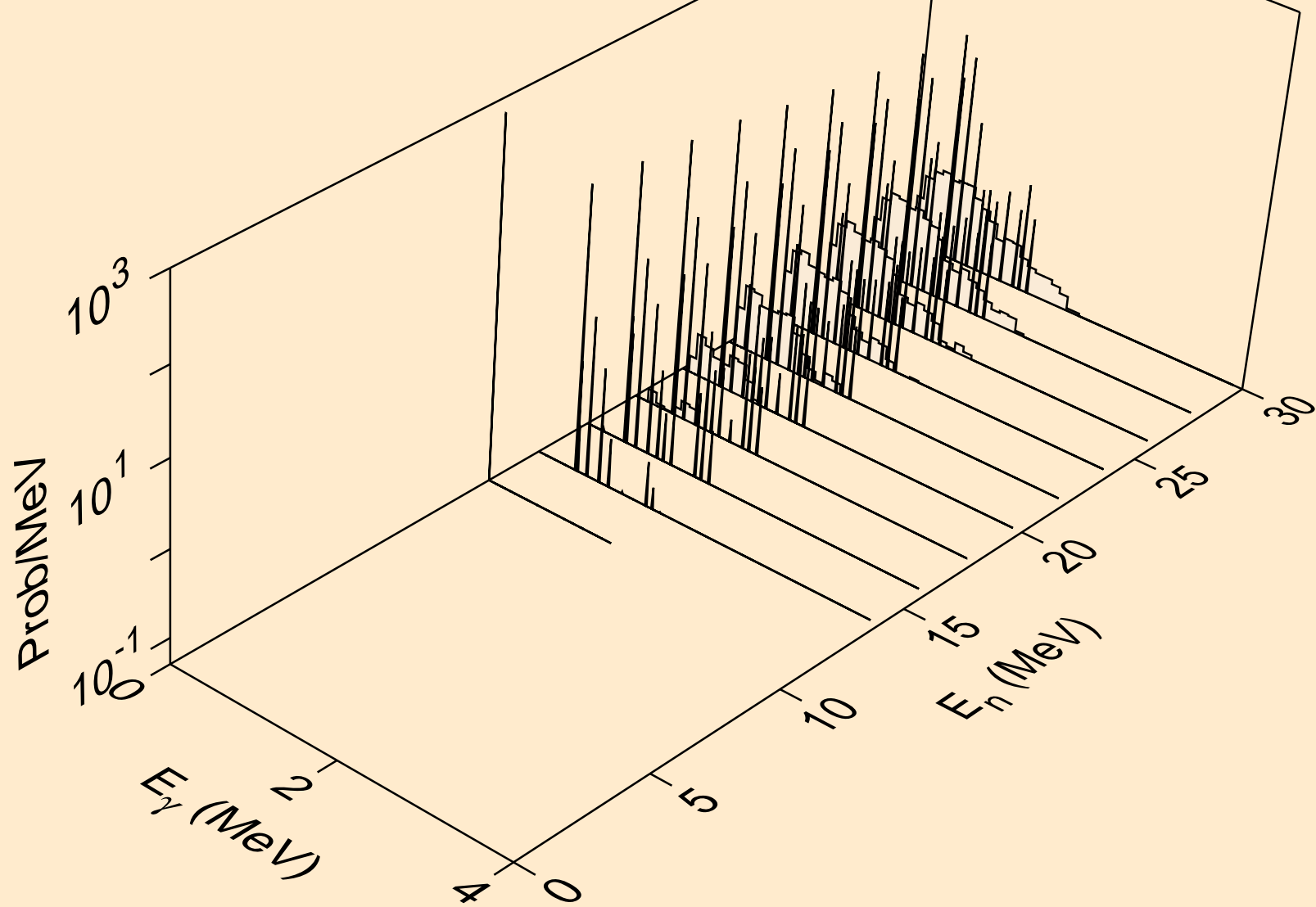

EU151 NEUTRON ACER TENDL-2023 LIBRARY; T=0.K
Photon emission for (n,n*c)

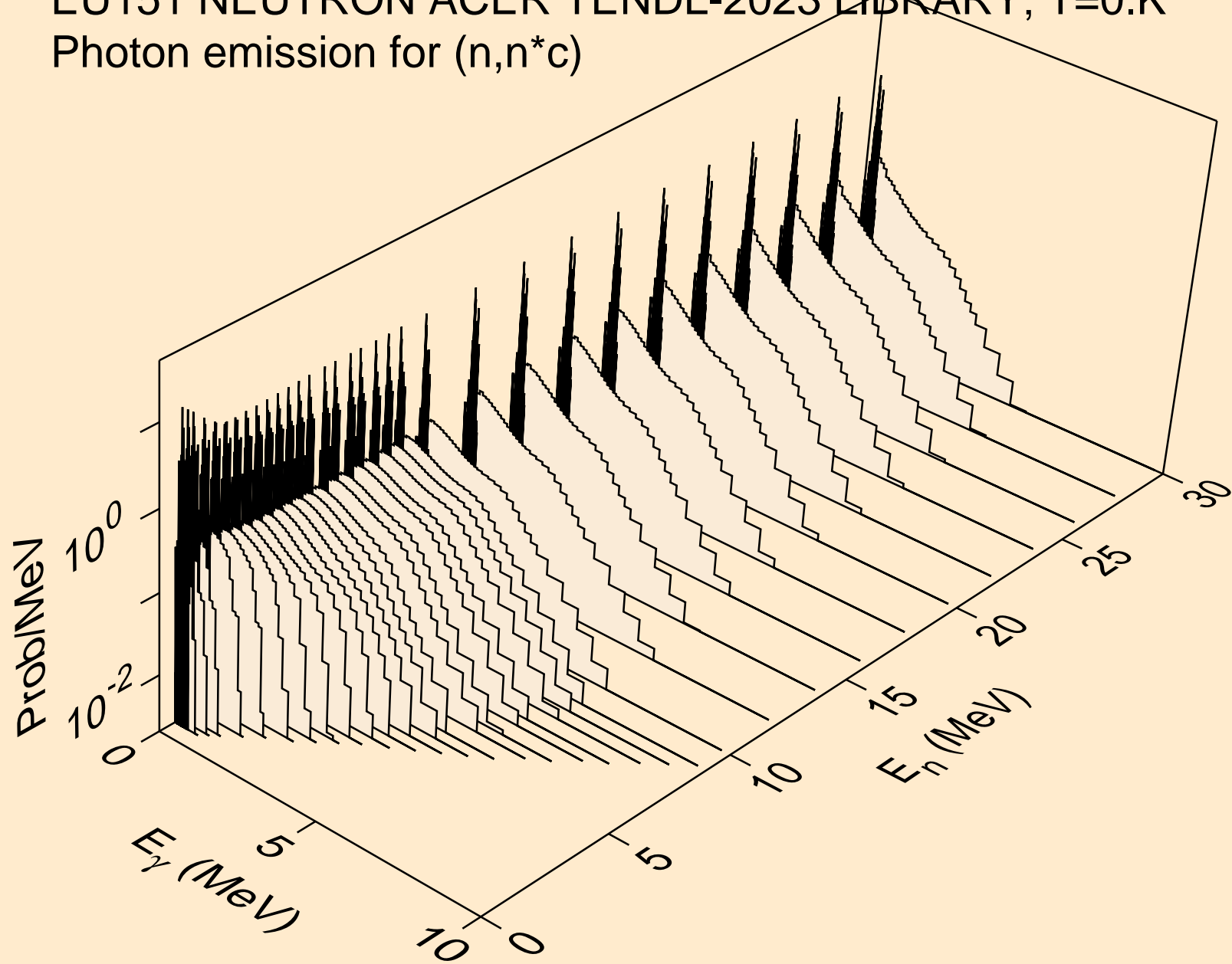

EU151 NEUTRON ACER TENDL-2023 LIBRARY; T=0.K
Photon emission for (n,gma)

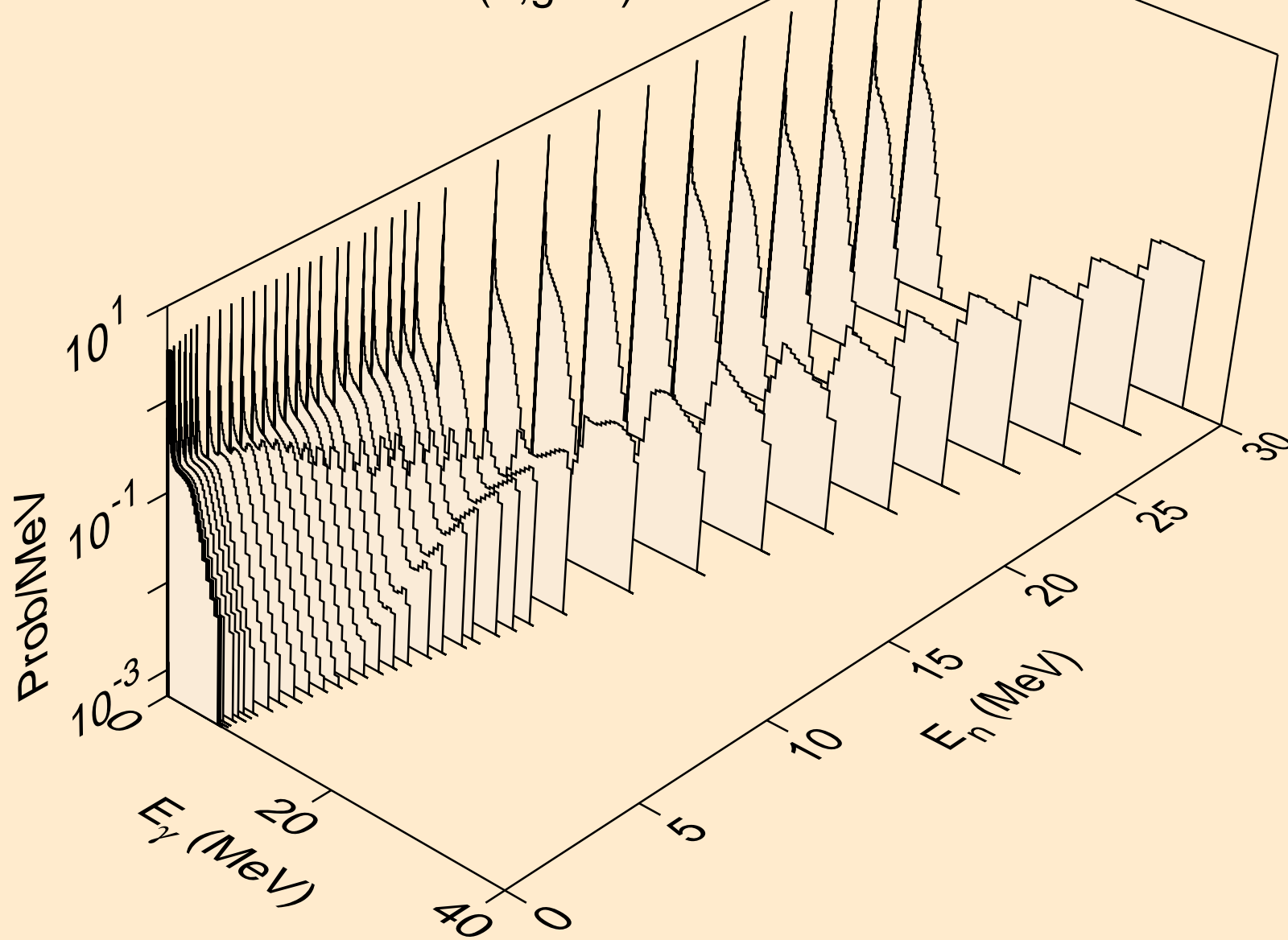

EU151 NEUTRON ACER TENDL-2023 LIBRARY; T=0.K
Photon emission for (n,p)

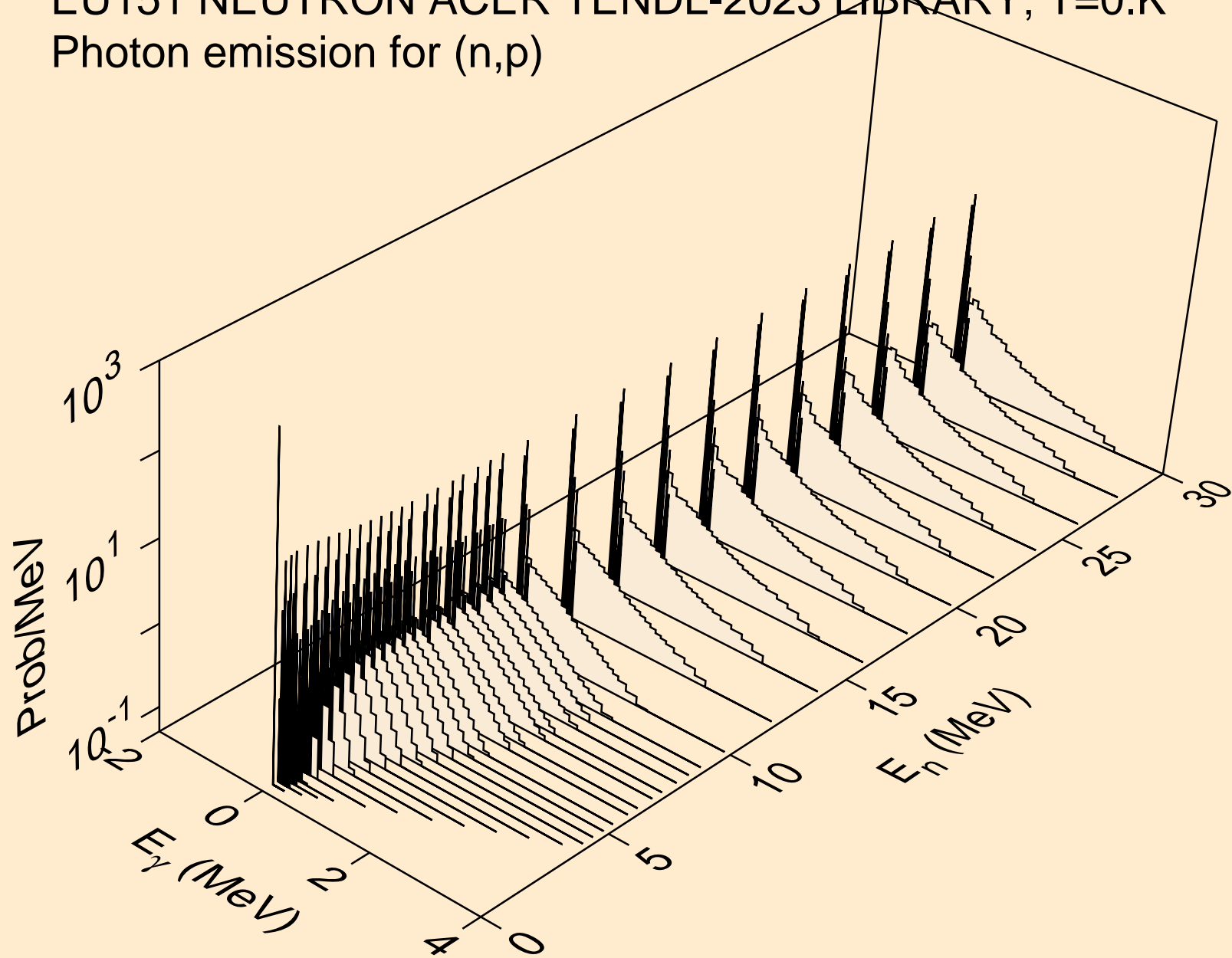

EU151 NEUTRON ACER TENDL-2023 LIBRARY; T=0.K
Photon emission for (n,d)

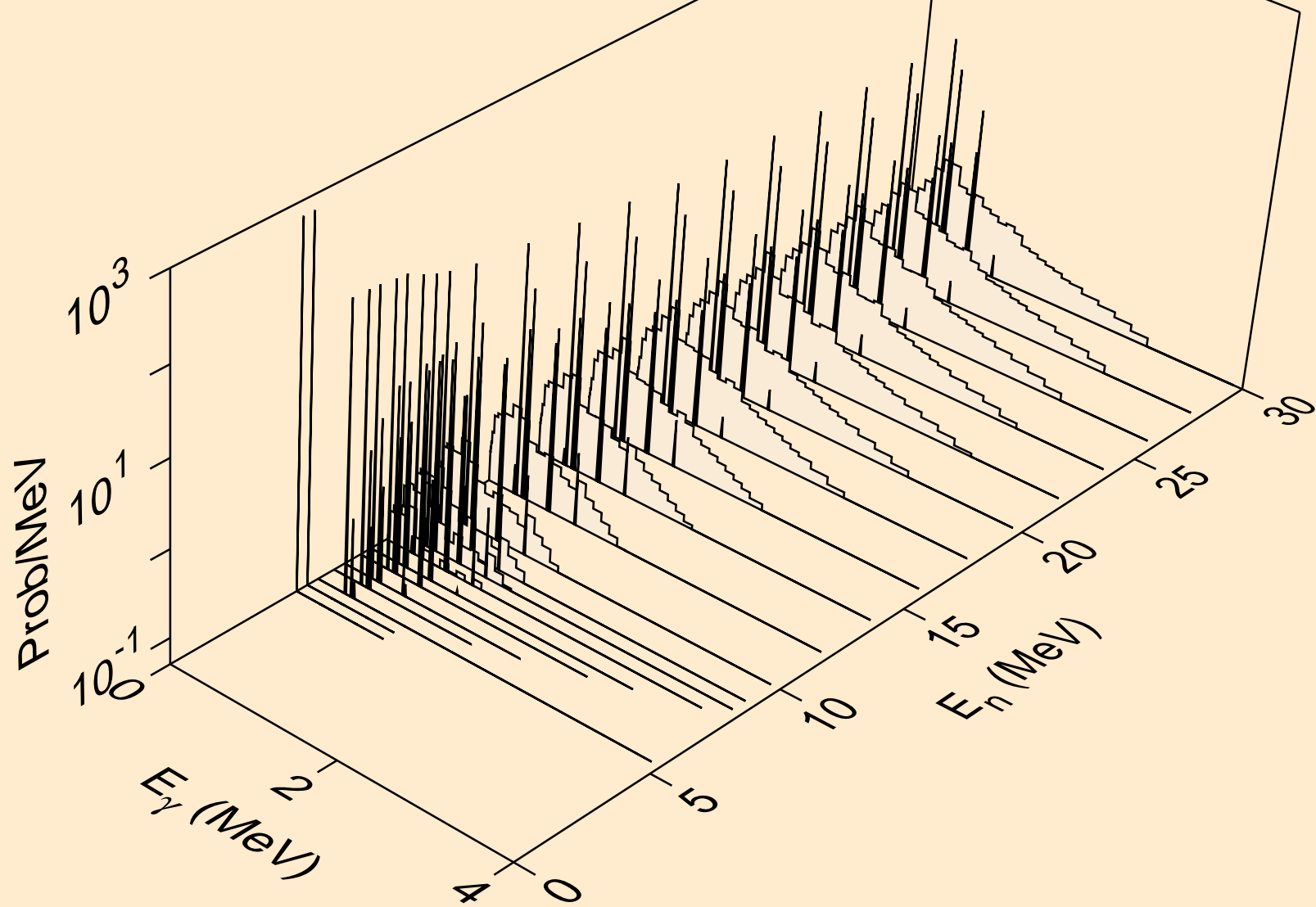

EU151 NEUTRON ACER TENDL-2023 LIBRARY; T=0.K
Photon emission for (n,t)

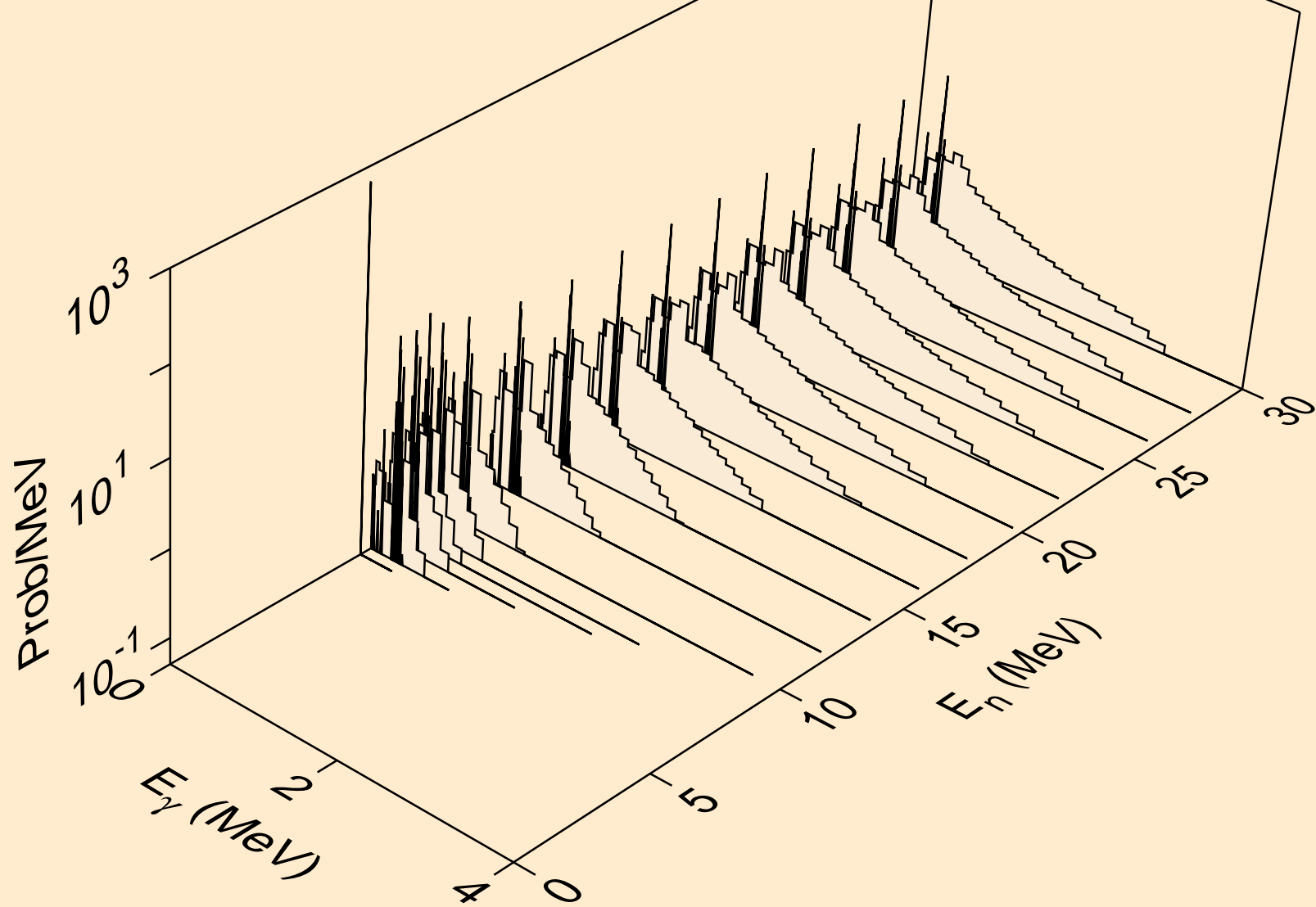

EU151 NEUTRON ACER TENDL-2023 LIBRARY; T=0.K
Photon emission for (n,he3)

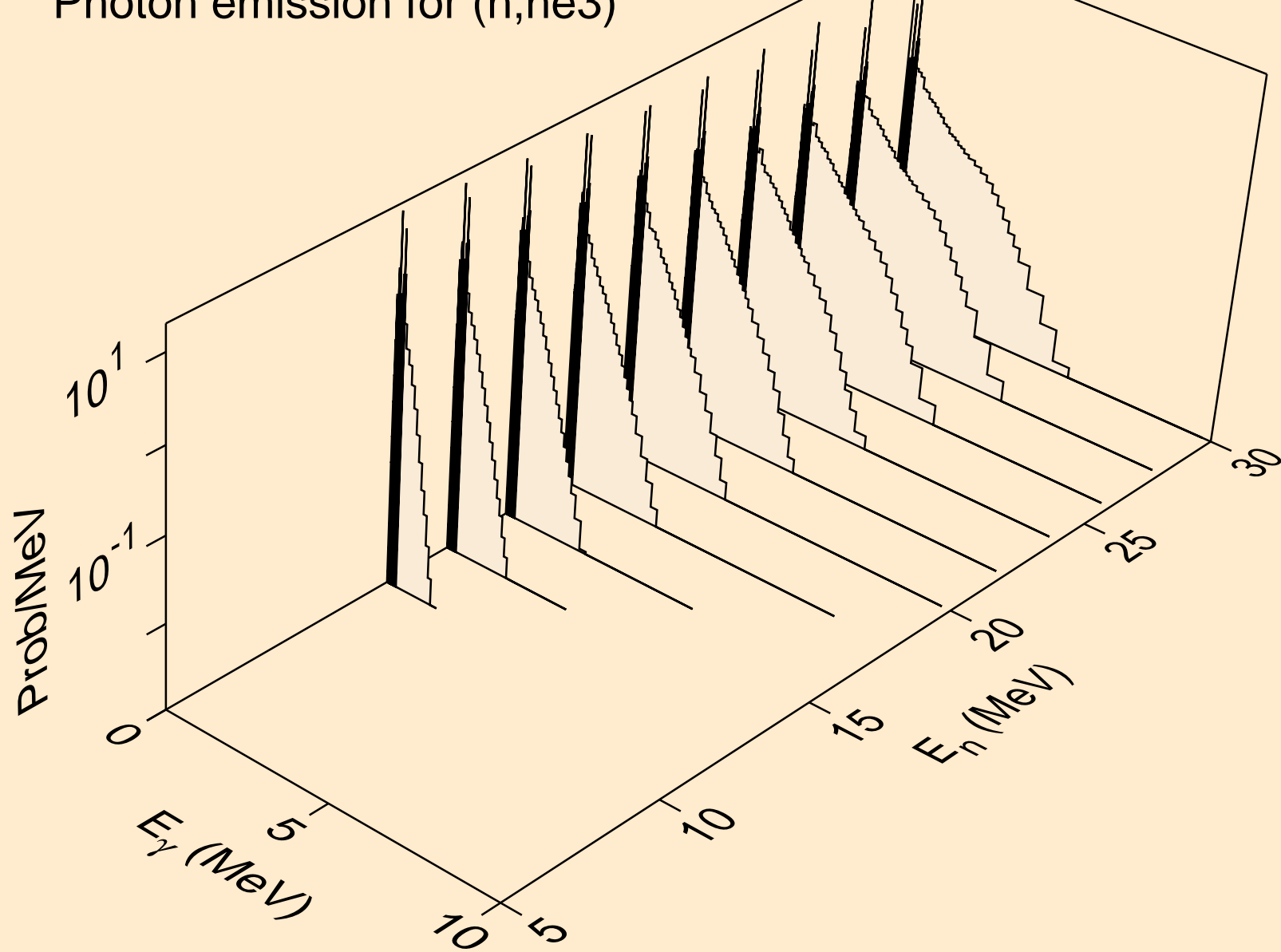

EU151 NEUTRON ACER TENDL-2023 LIBRARY; T=0.K
Photon emission for (n,a)

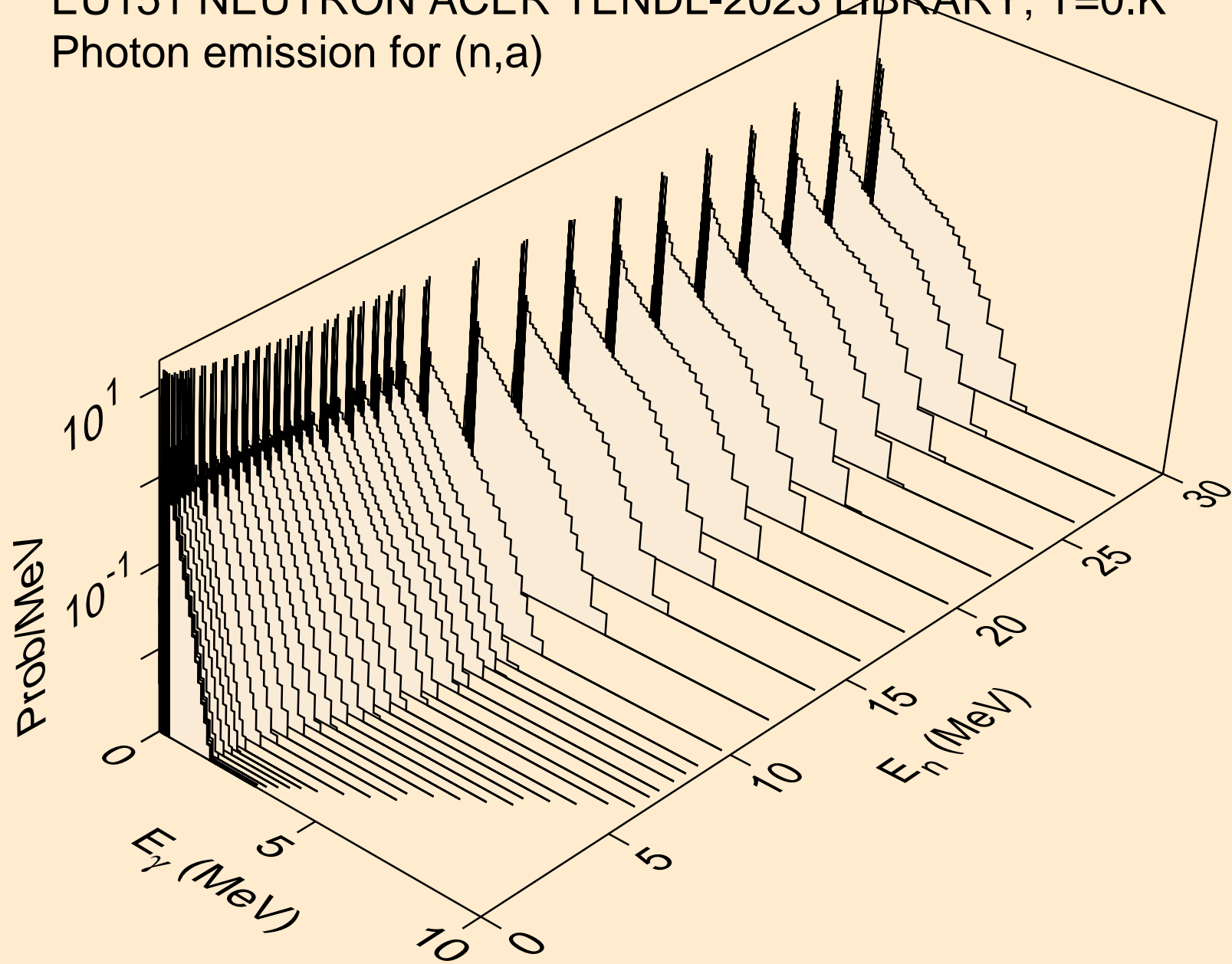

EU151 NEUTRON ACER TENDL-2023 LIBRARY; T=0.K
Photon emission for (n,2a)

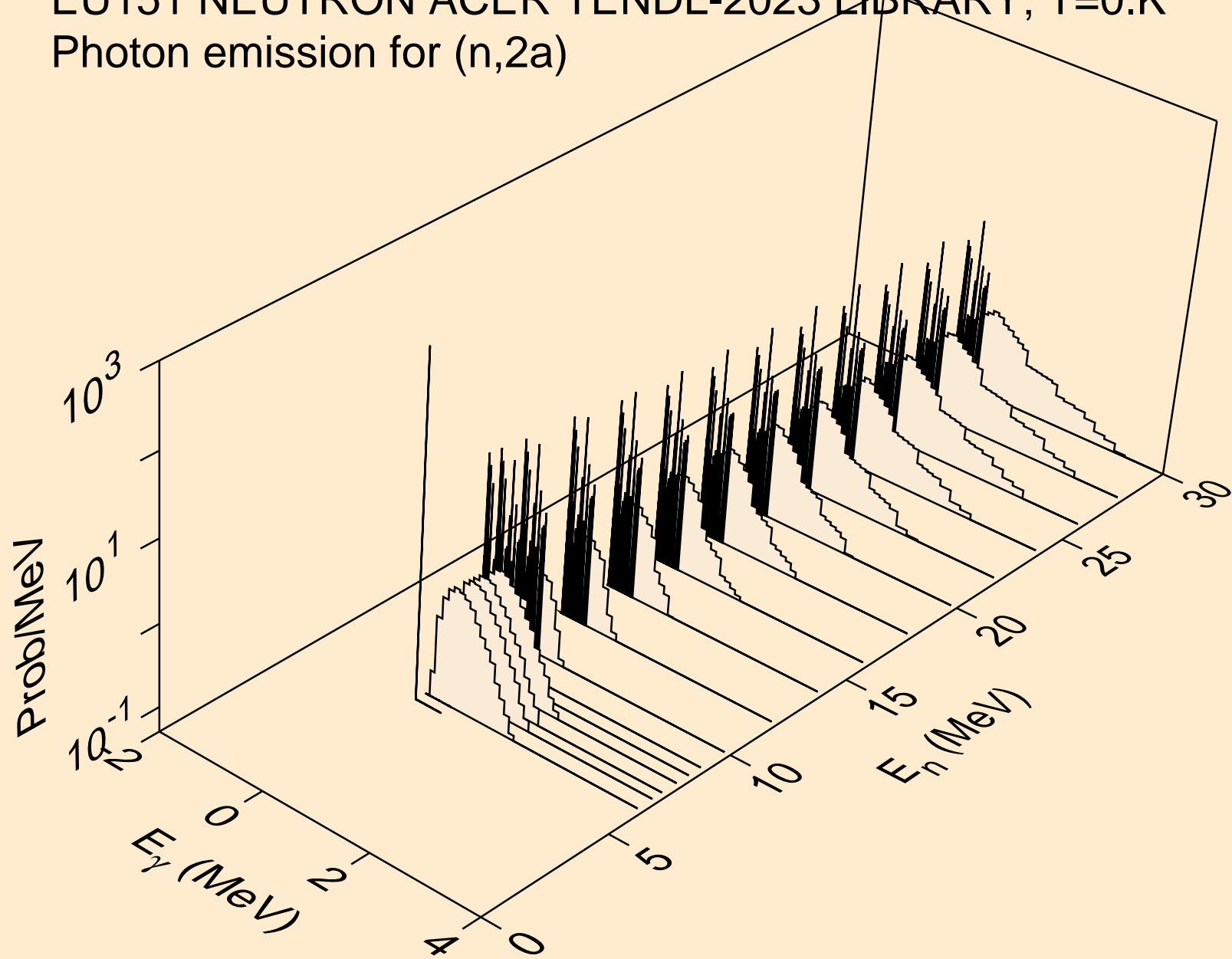

EU151 NEUTRON ACER TENDL-2023 LIBRARY; T=0.K
Photon emission for (n,2p)

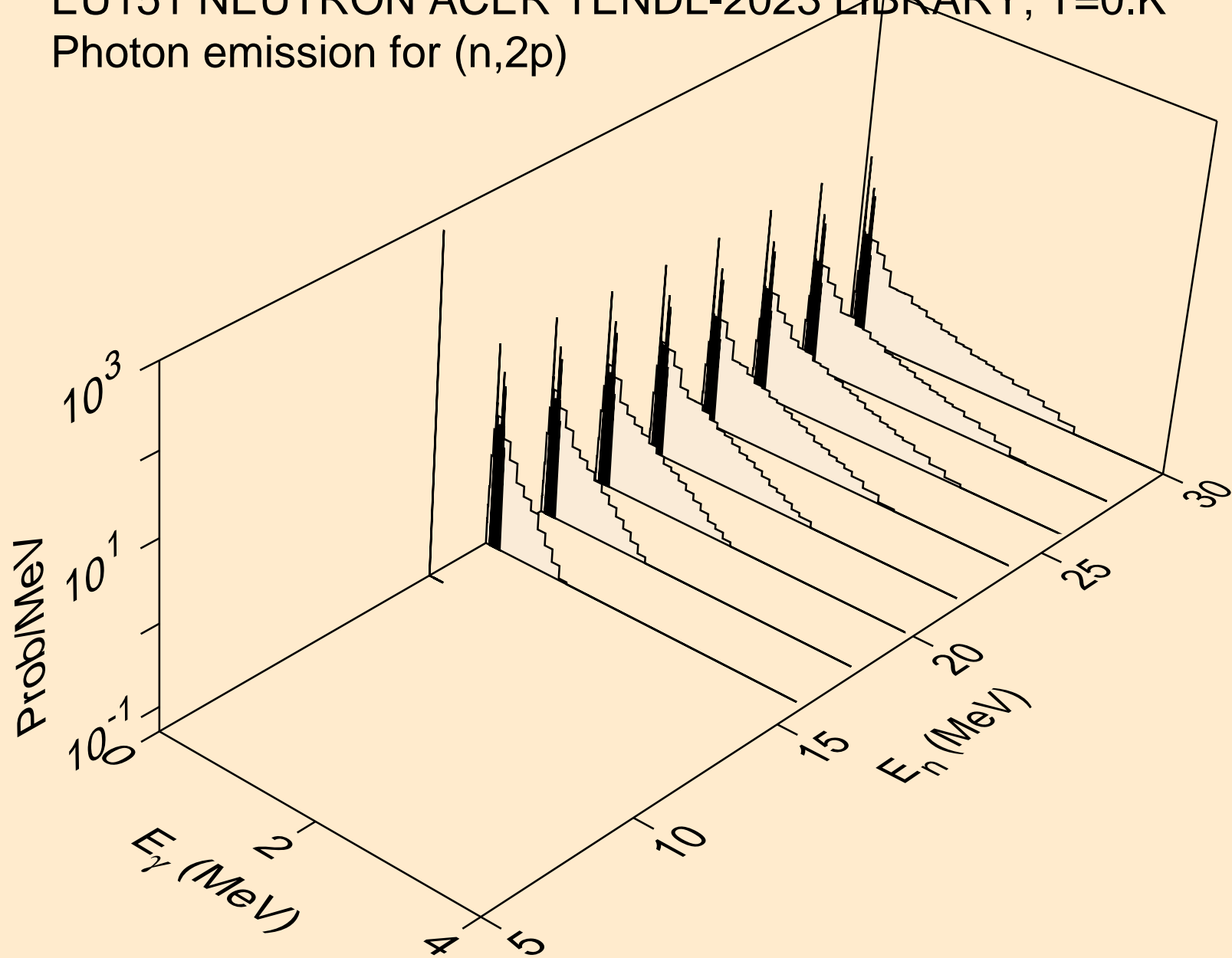

EU151 NEUTRON ACER TENDL-2023 LIBRARY; T=0.K
Photon emission for (n,p α)

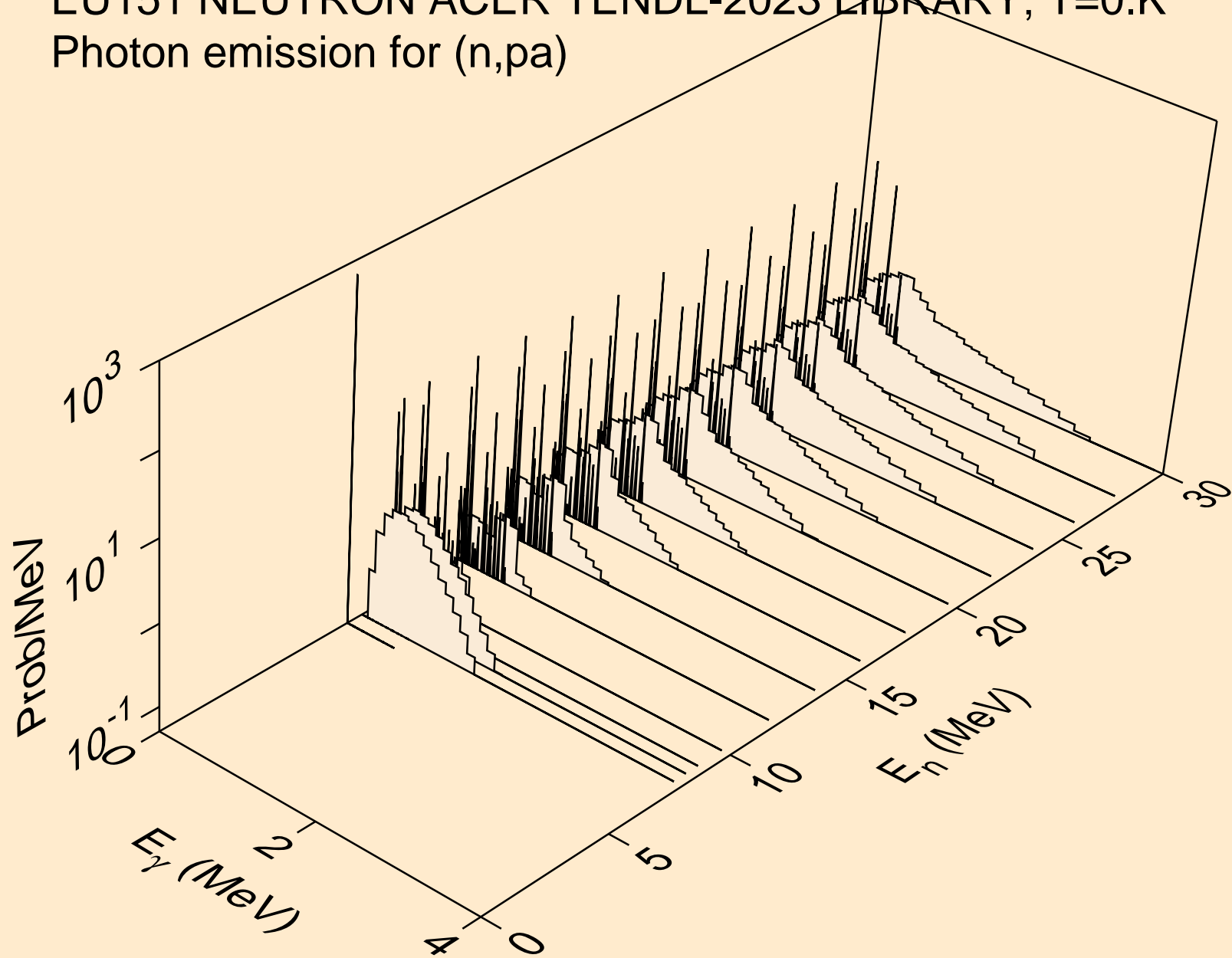

EU151 NEUTRON ACER TENDL-2023 LIBRARY; T=0.K
Photon emission for (n,pd)

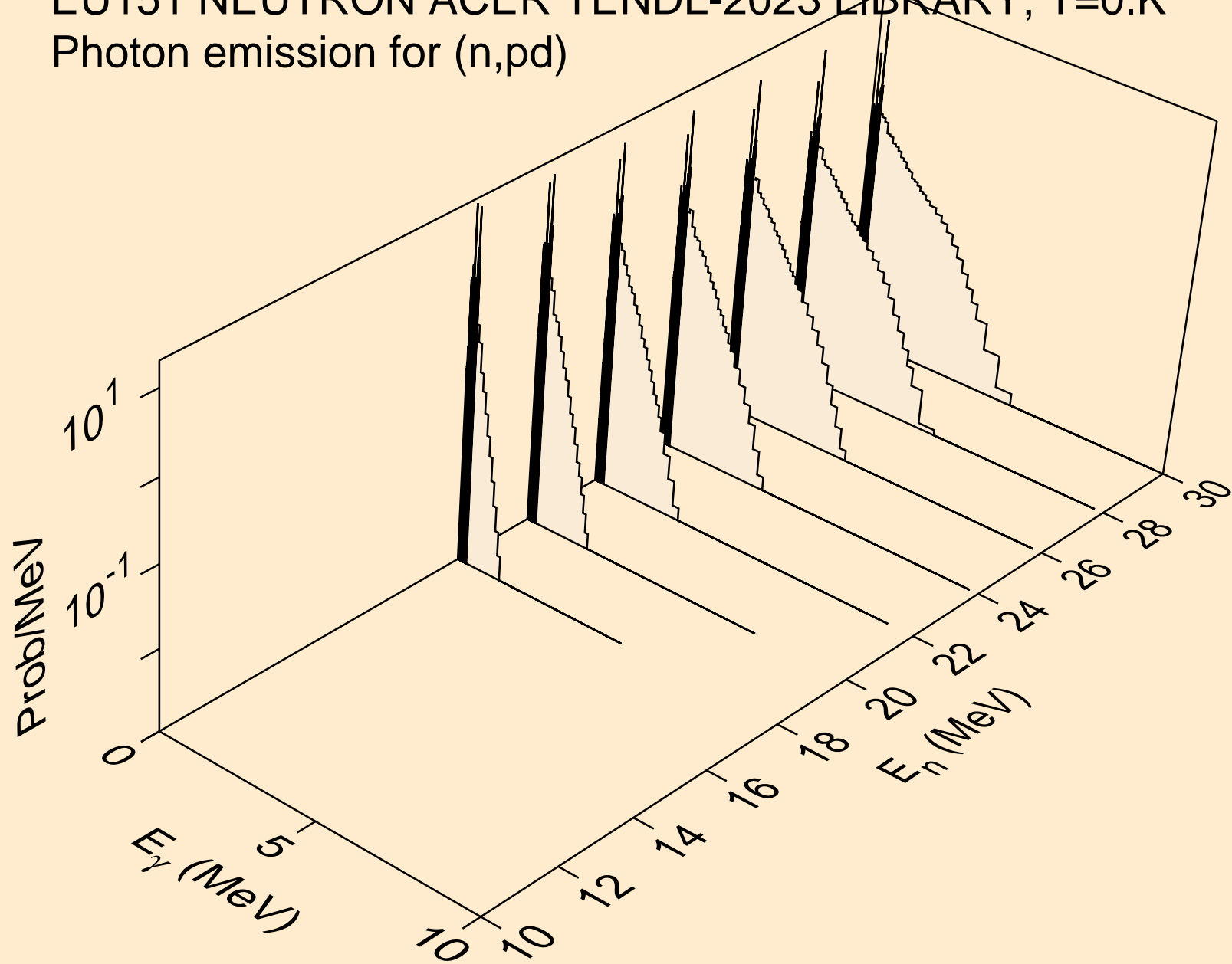

EU151 NEUTRON ACER TENDL-2023 LIBRARY; T=0.K
Photon emission for (n,pt)

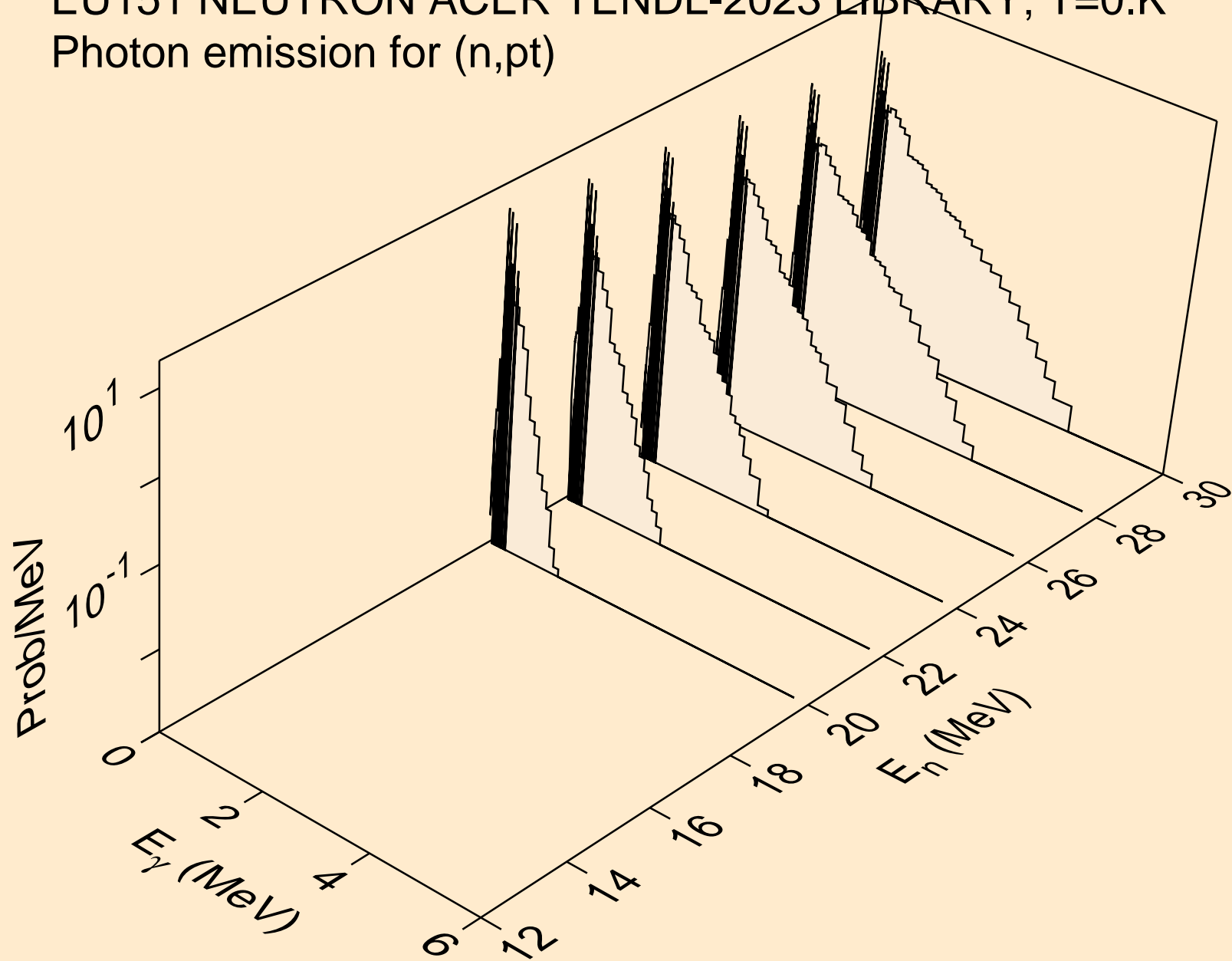

EU151 NEUTRON ACER TENDL-2023 LIBRARY; T=0.K
Photon emission for (n,da)

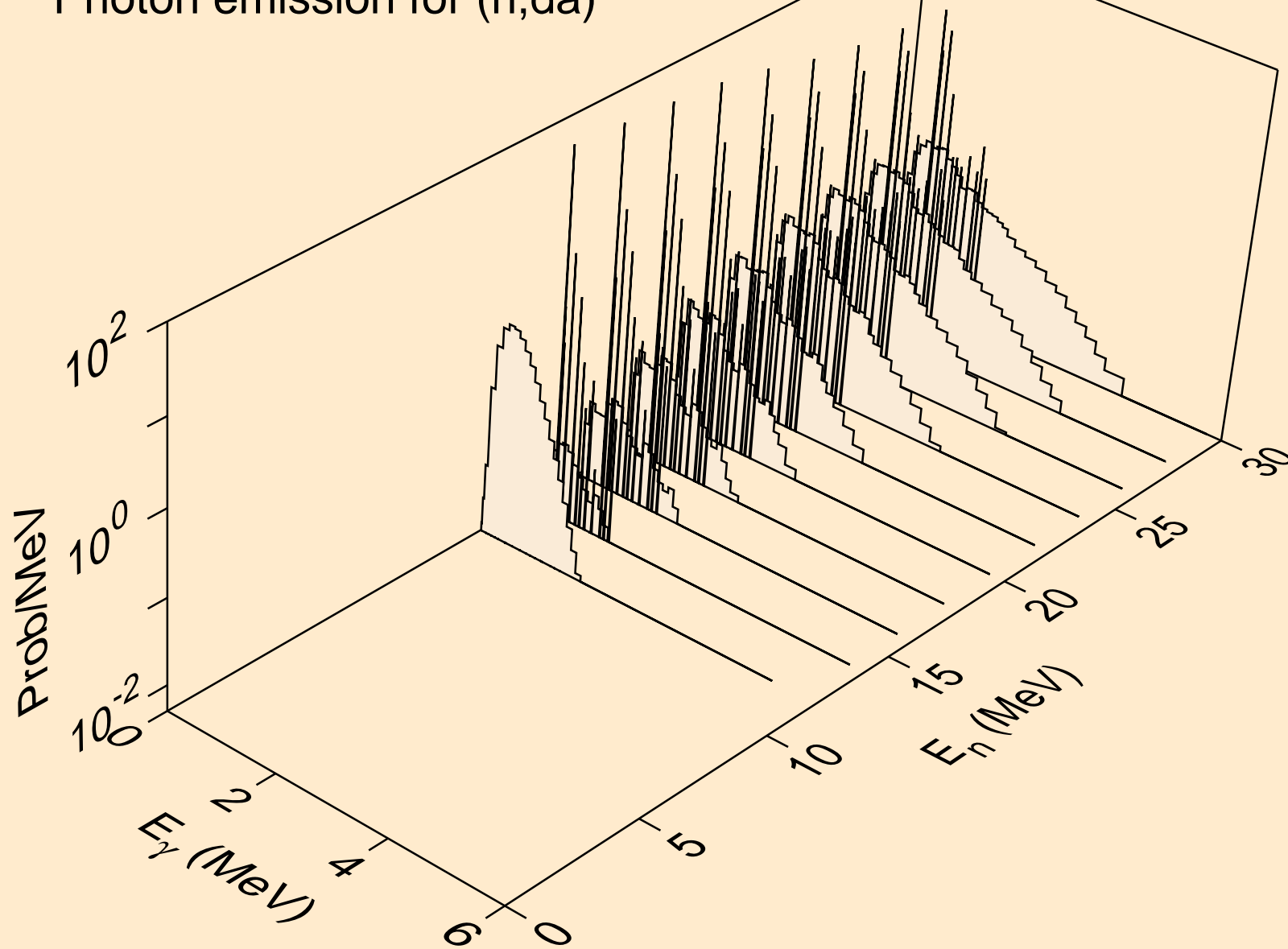

EU151 NEUTRON ACER TENDL-2023 LIBRARY; T=0.K
thermal capture photon spectrum

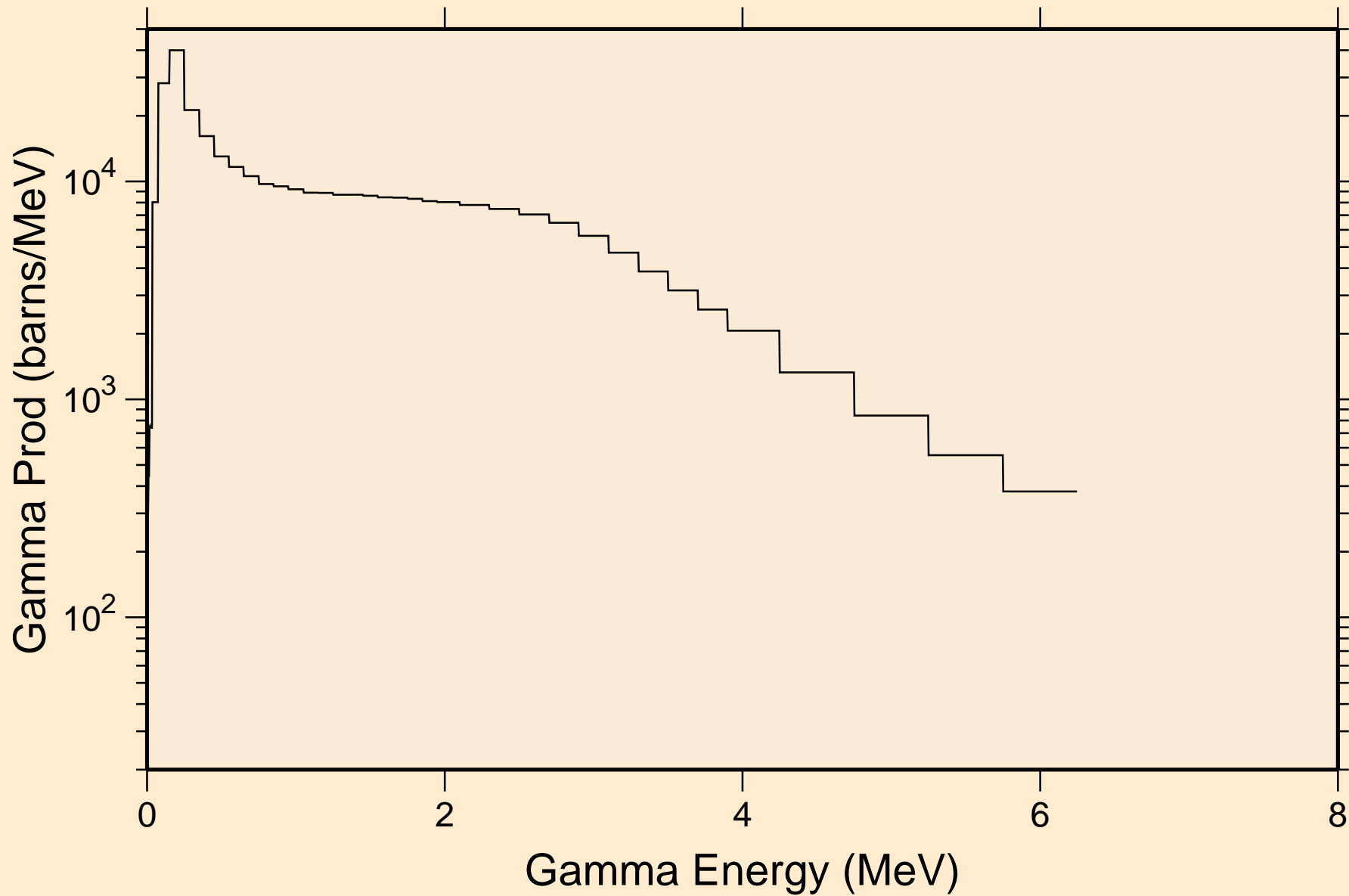

EU151 NEUTRON ACER TENDL-2023 LIBRARY; T=0.K
14 MeV photon spectrum

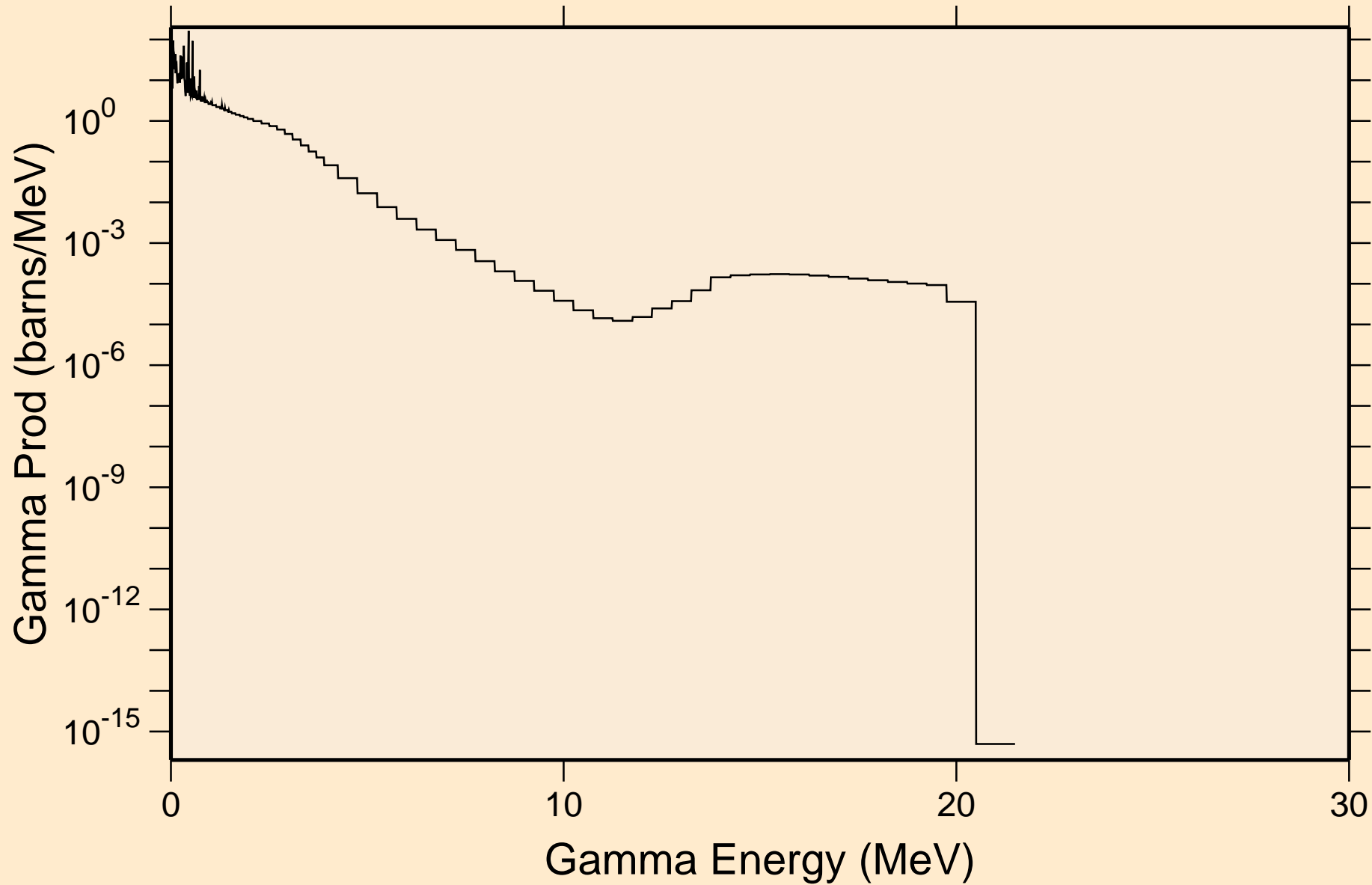

EU151 NEUTRON ACER TENDL-2023 LIBRARY; T=0.K

Particle heating contributions

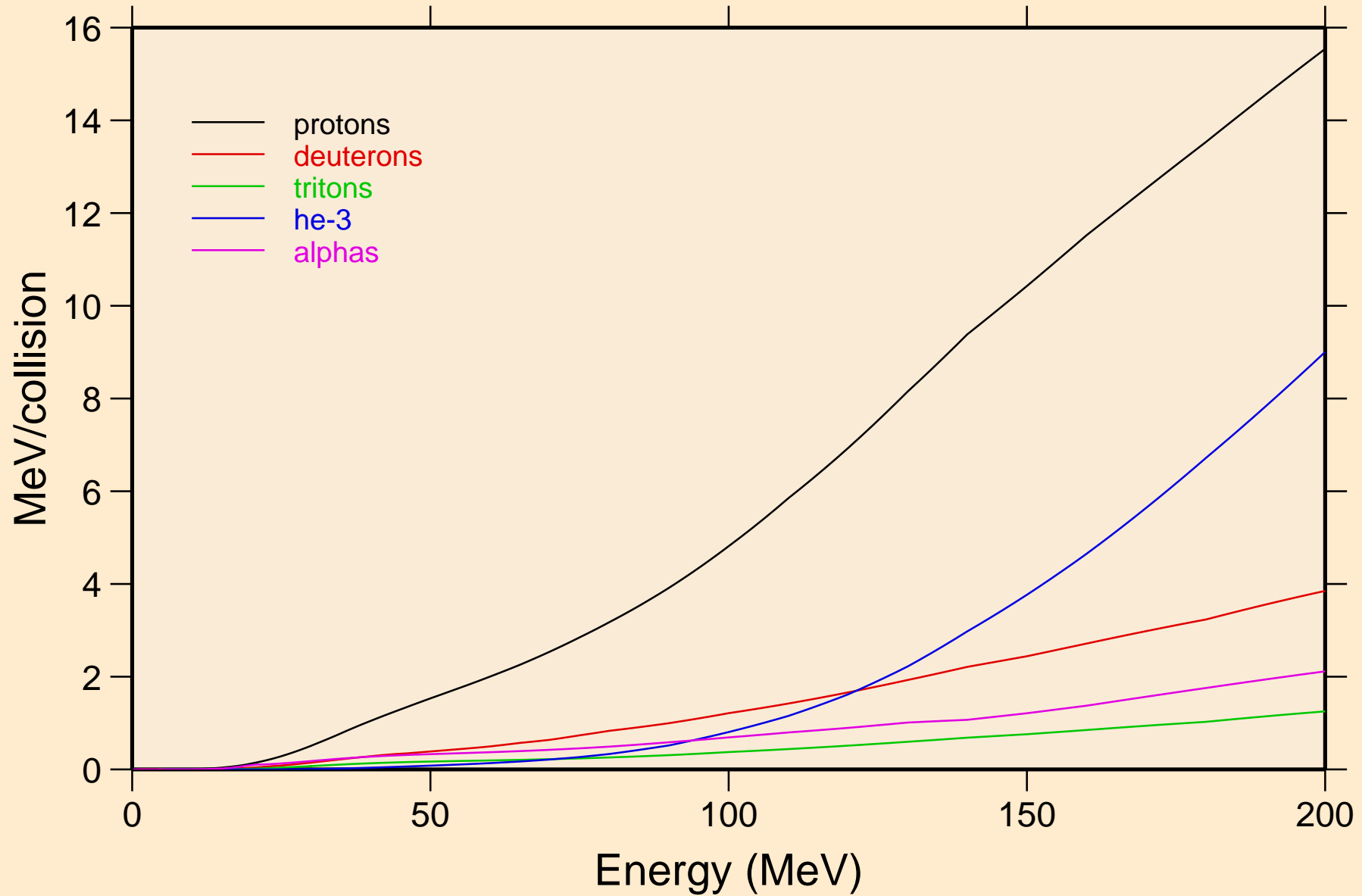

EU151 NEUTRON ACER TENDL-2023 LIBRARY; T=0.K
Recoil Heating

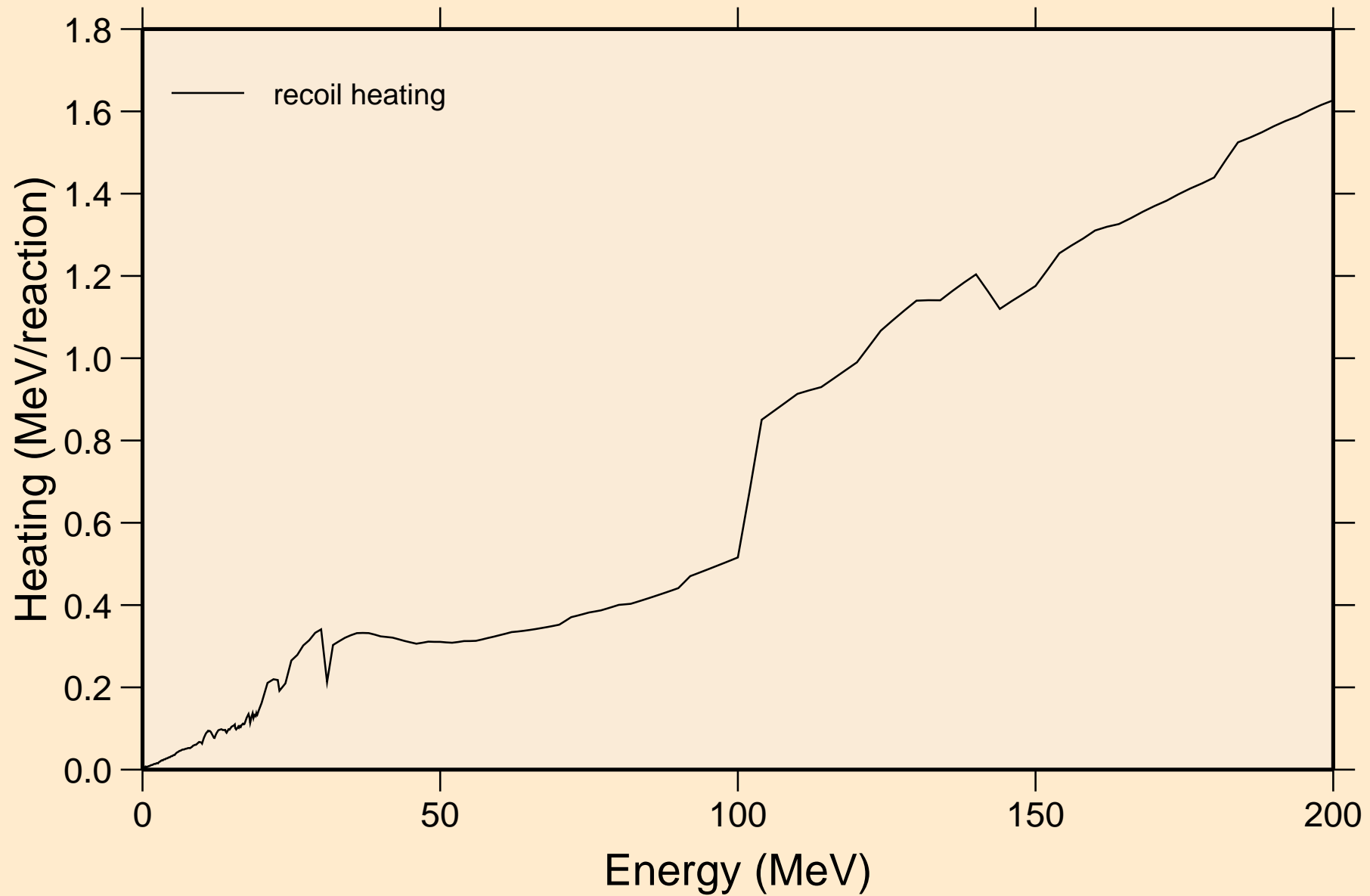

EU151 NEUTRON ACER TENDL-2023 LIBRARY; T=0.K

Particle production cross sections

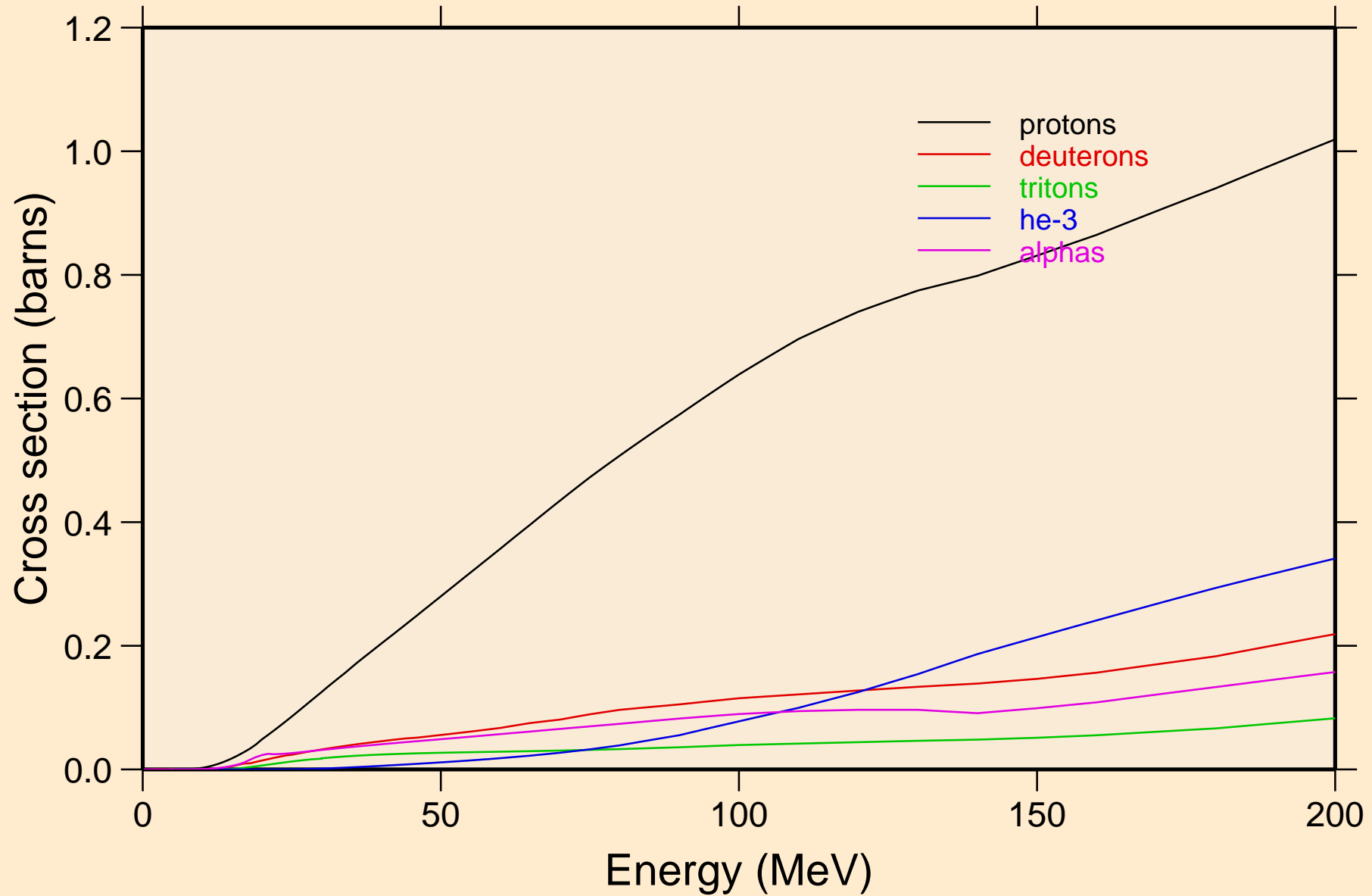

EU151 NEUTRON ACER TENDL-2023 LIBRARY; T=0.K
protons from (n,x)

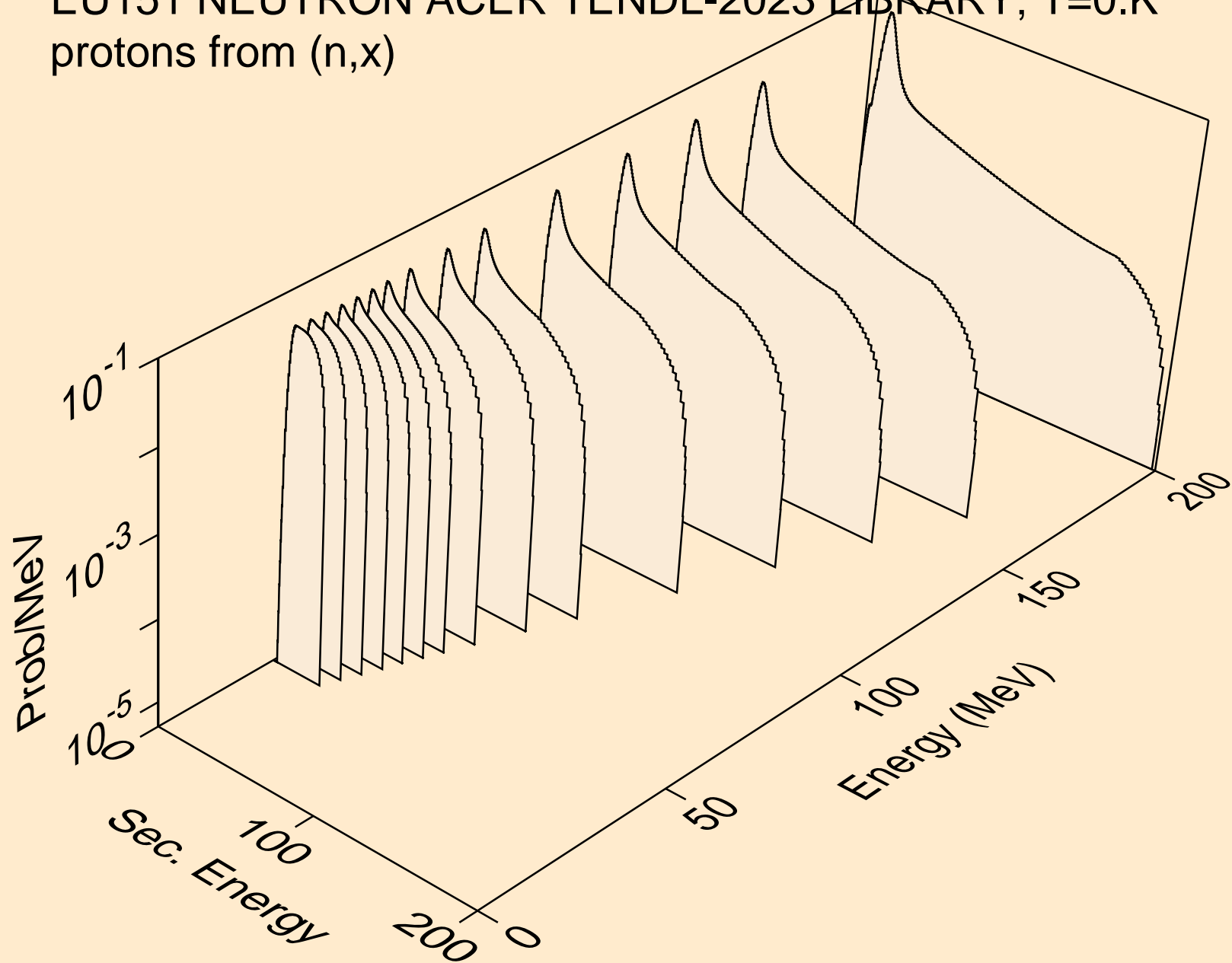

EU151 NEUTRON ACER TENDL-2023 LIBRARY; T=0.K
protons from (n,n*)p

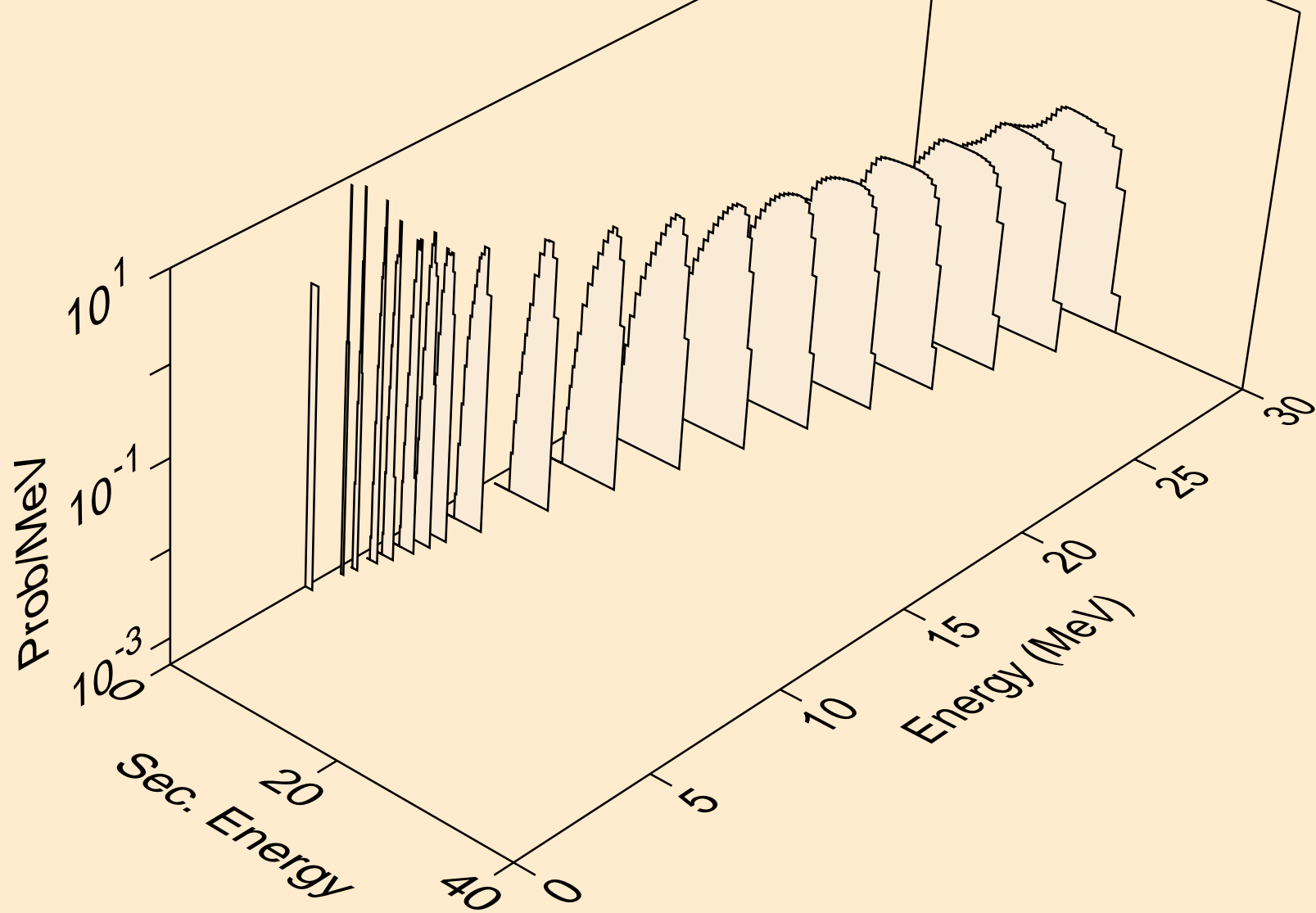

EU151 NEUTRON ACER TENDL-2023 LIBRARY; T=0.K
protons from (n,2np)

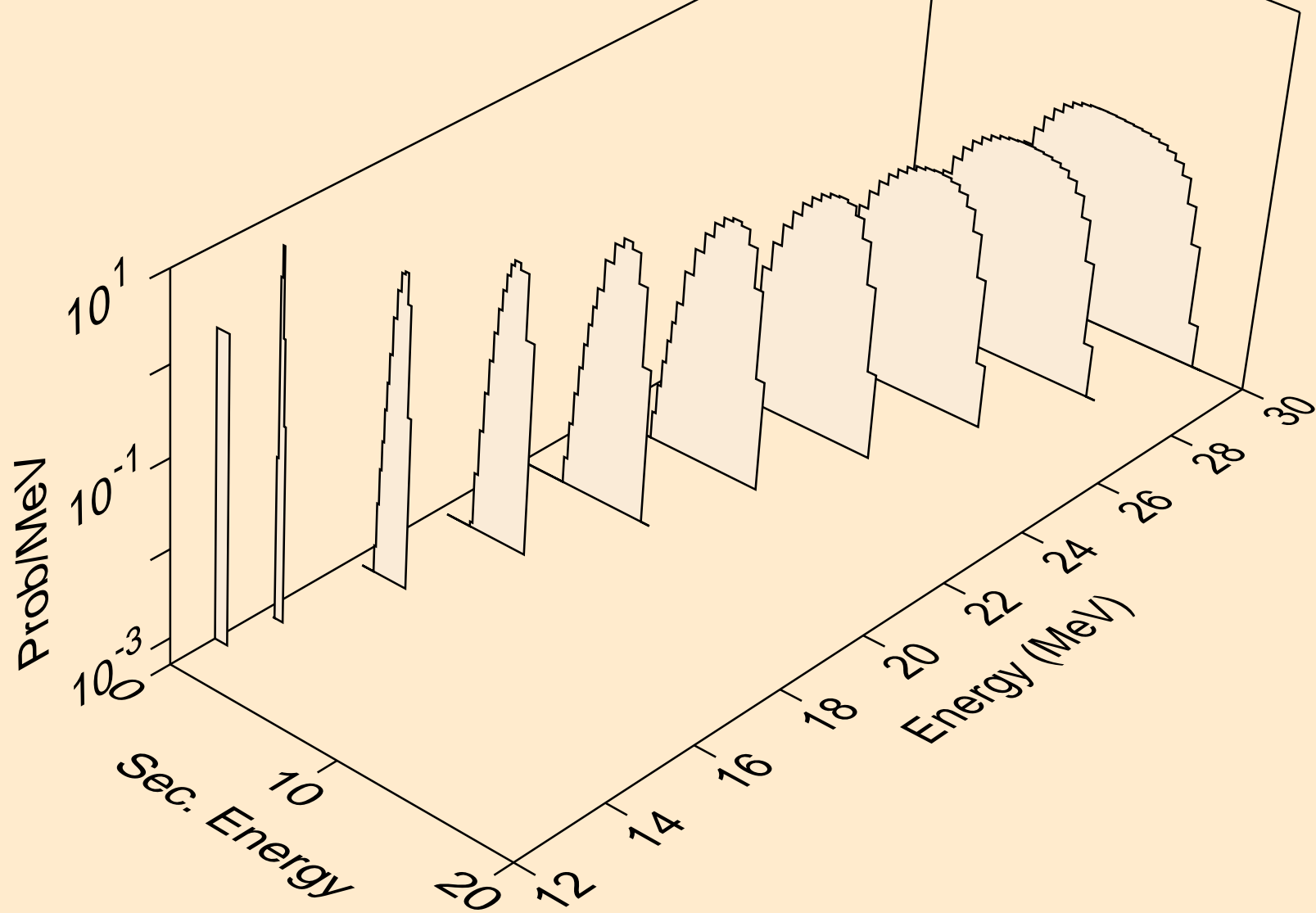

EU151 NEUTRON ACER TENDL-2023 LIBRARY; T=0.K
protons from (n,3np)

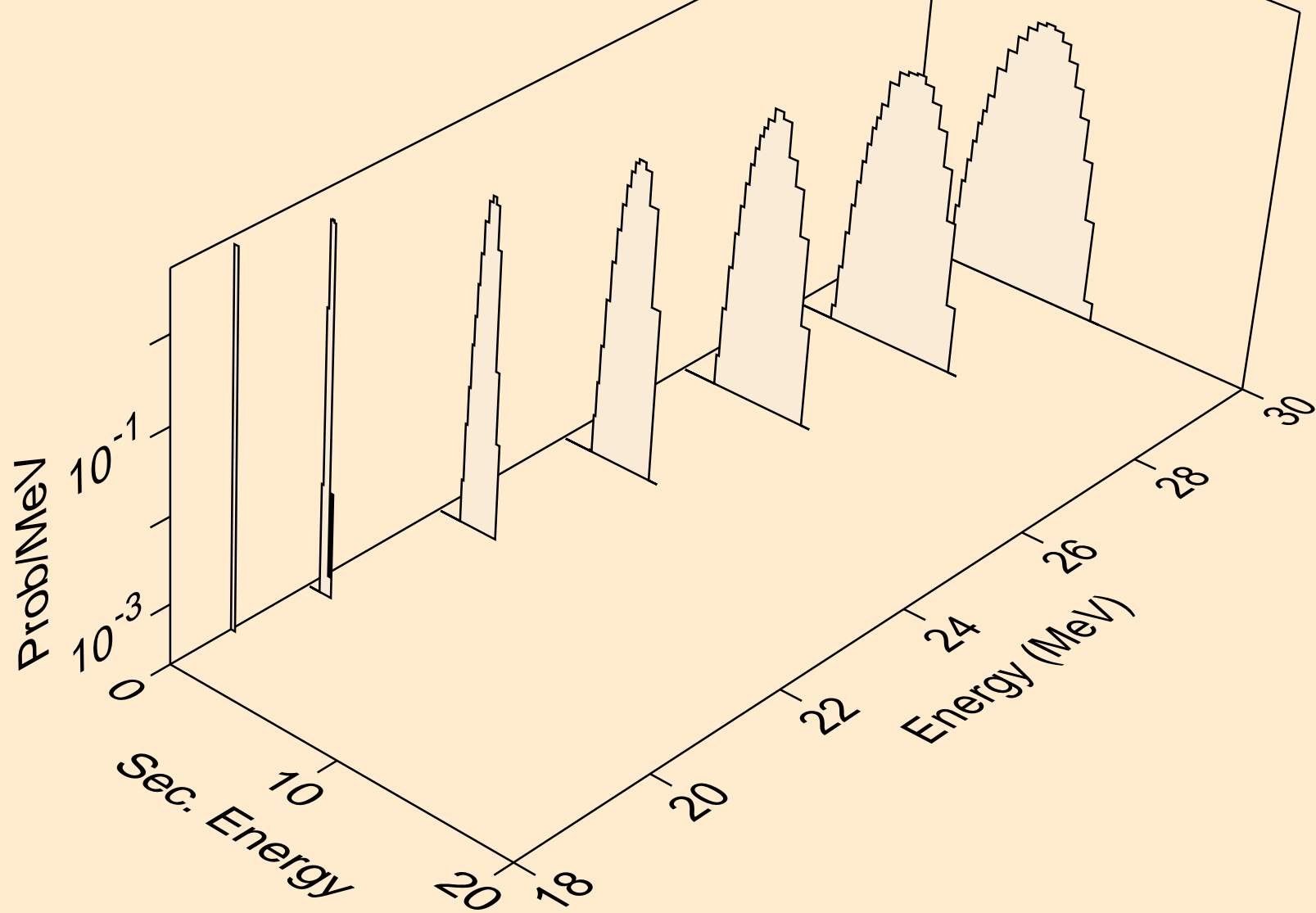

EU151 NEUTRON ACER TENDL-2023 LIBRARY; T=0.K
protons from (n,n2p)

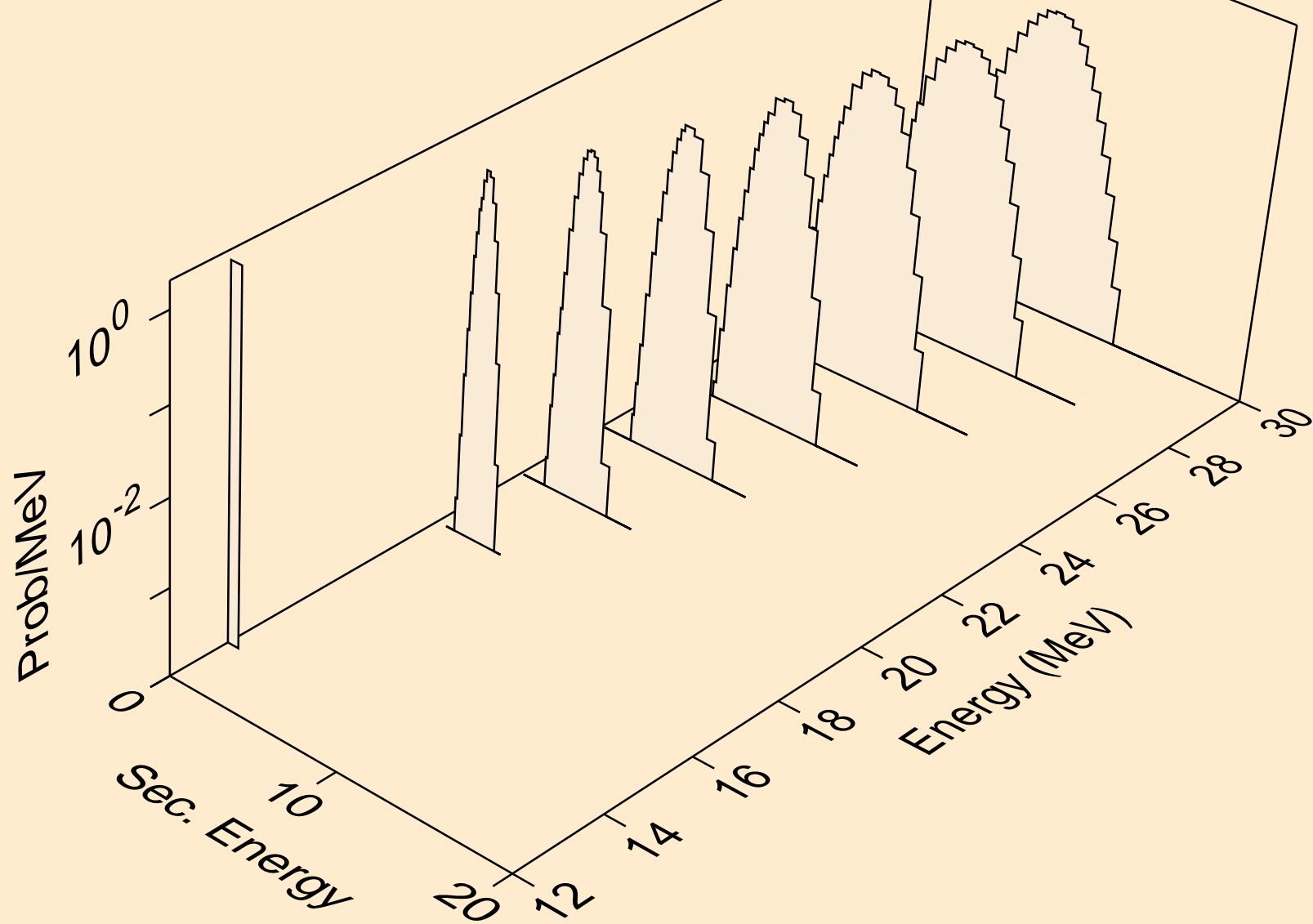

EU151 NEUTRON ACER TENDL-2023 LIBRARY; T=0.K
protons from (n,npa)

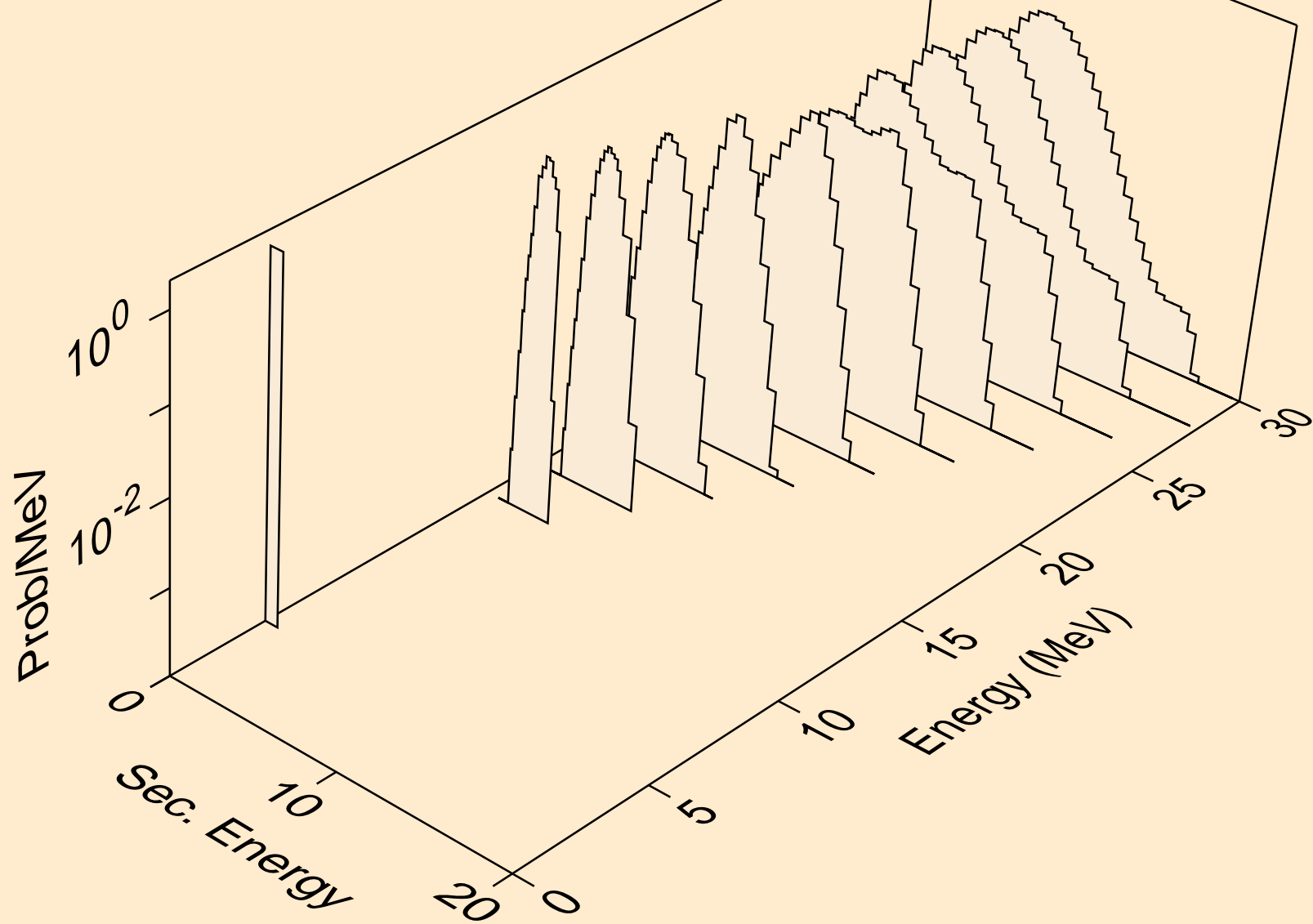

EU151 NEUTRON ACER TENDL-2023 LIBRARY; T=0.K
protons from (n,p)

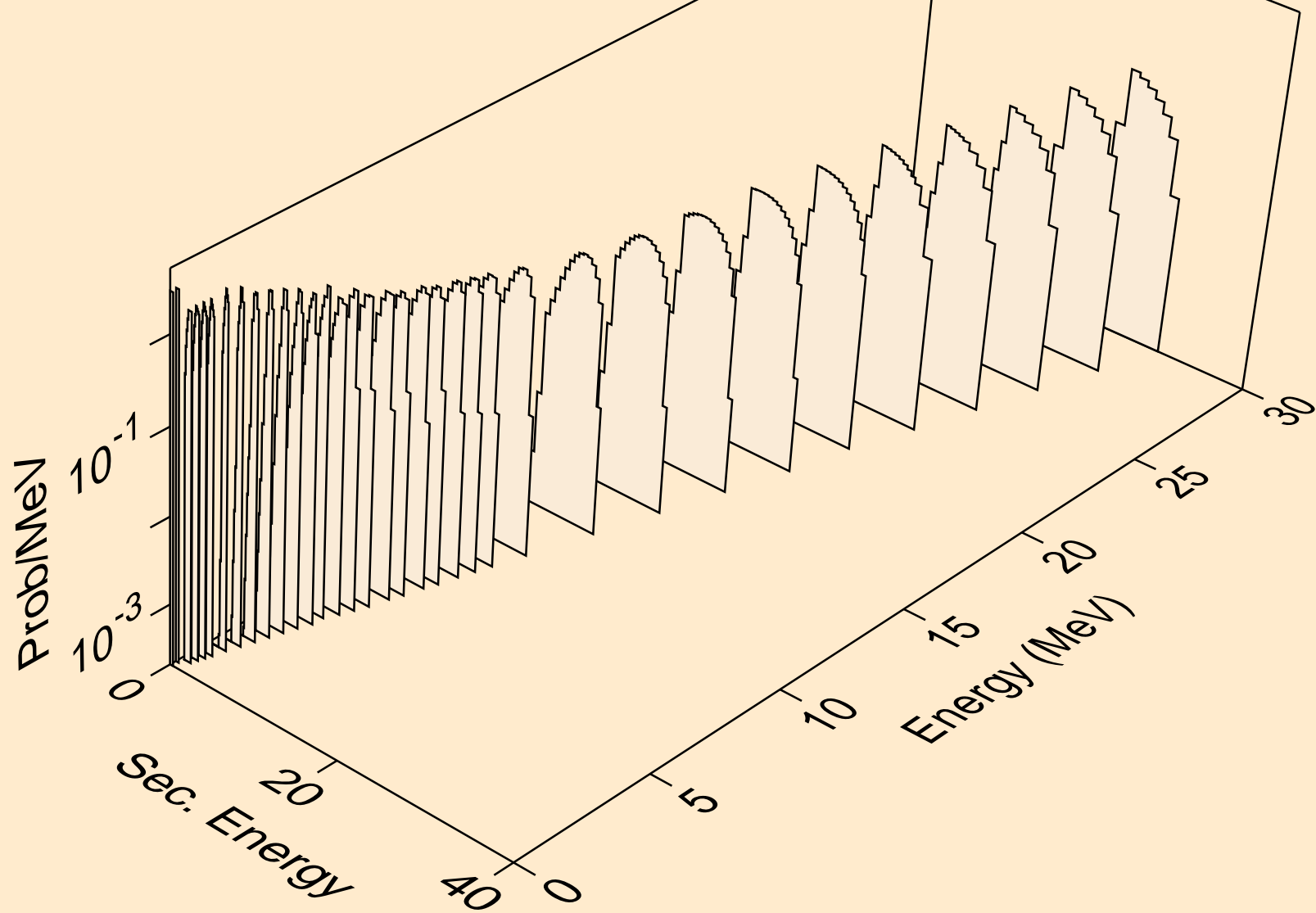

EU151 NEUTRON ACER TENDL-2023 LIBRARY; T=0.K
protons from (n,2p)

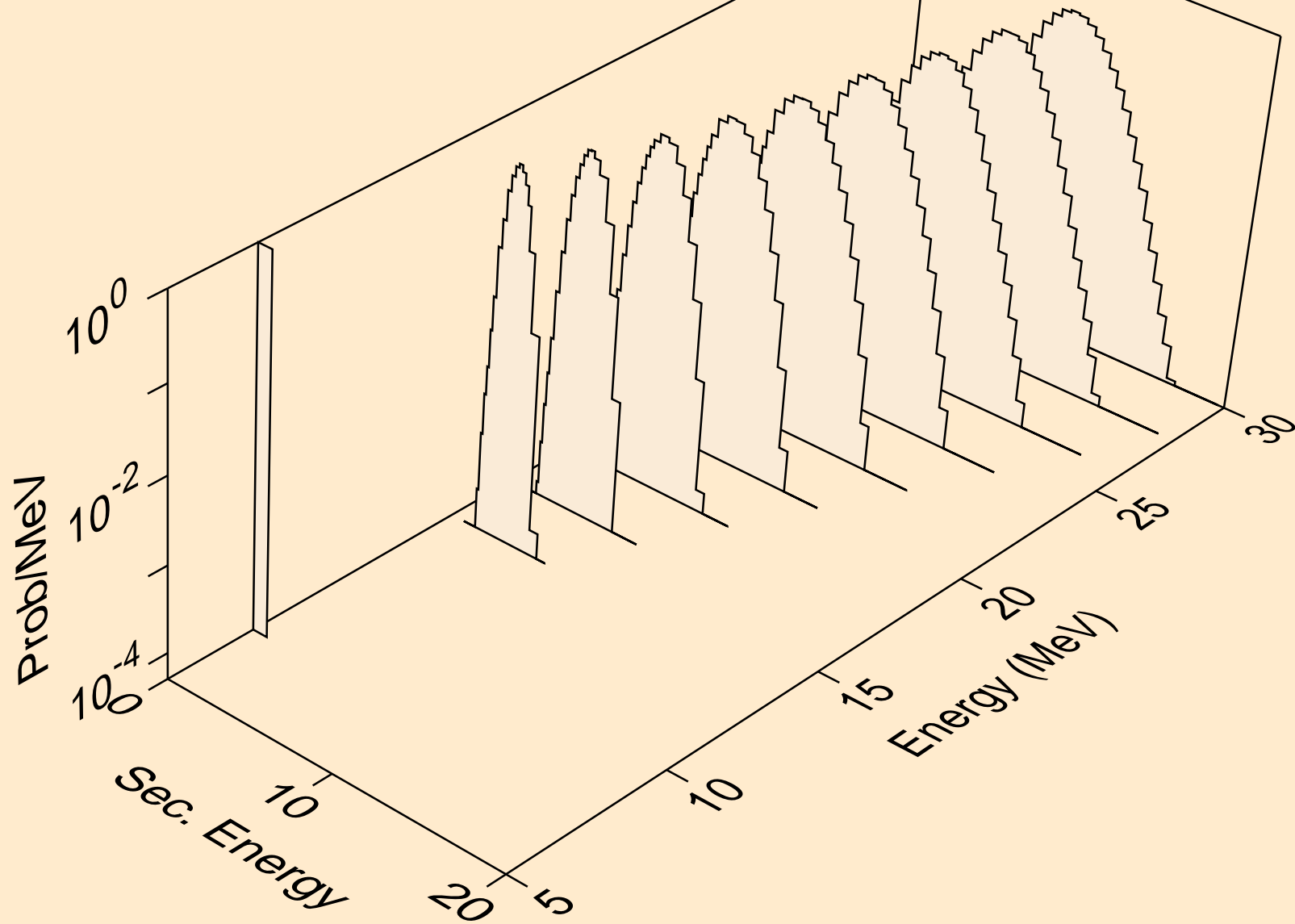

EU151 NEUTRON ACER TENDL-2023 LIBRARY; T=0.K
protons from (n,p)

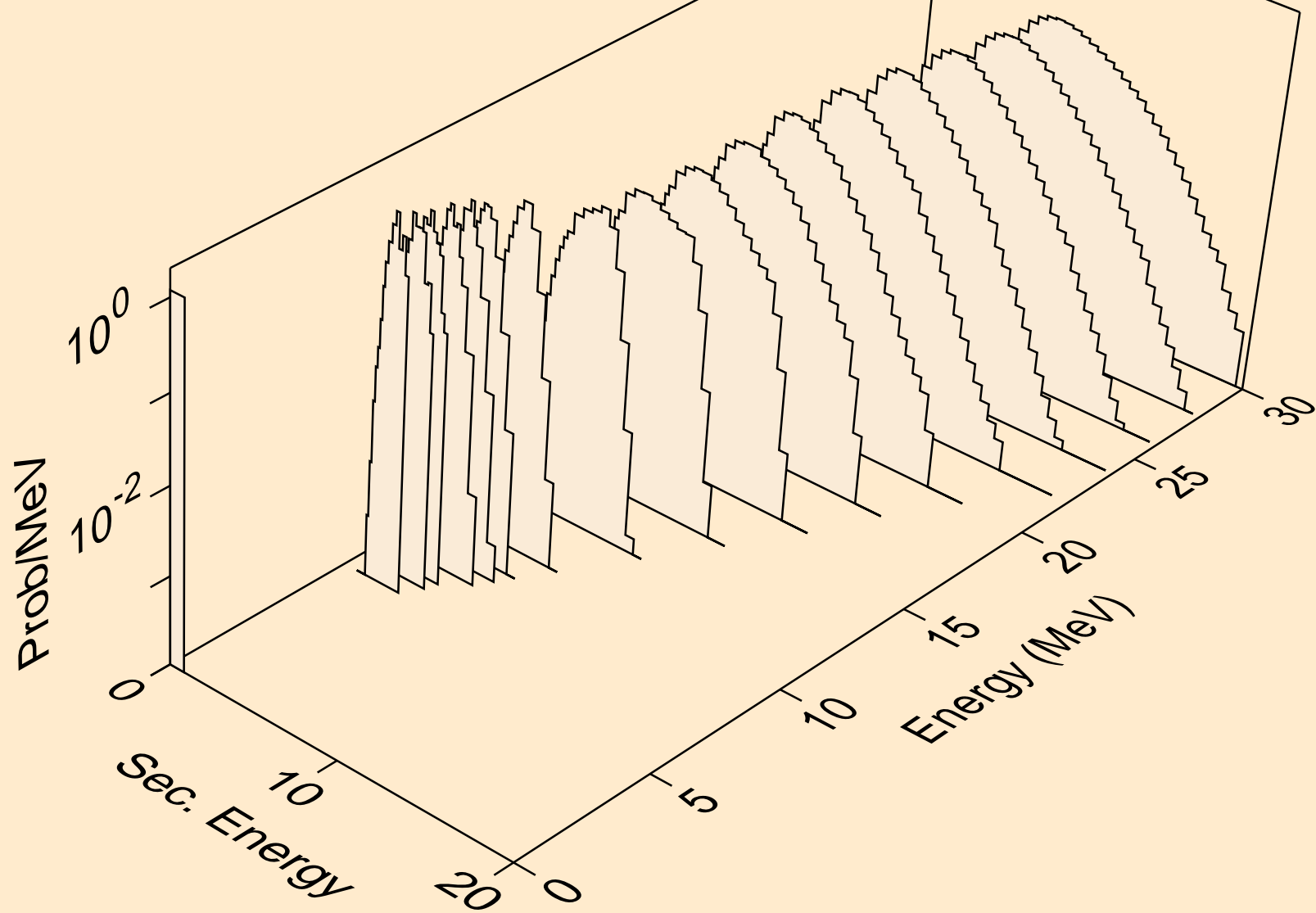

EU151 NEUTRON ACER TENDL-2023 LIBRARY; T=0.K
protons from (n,pd)

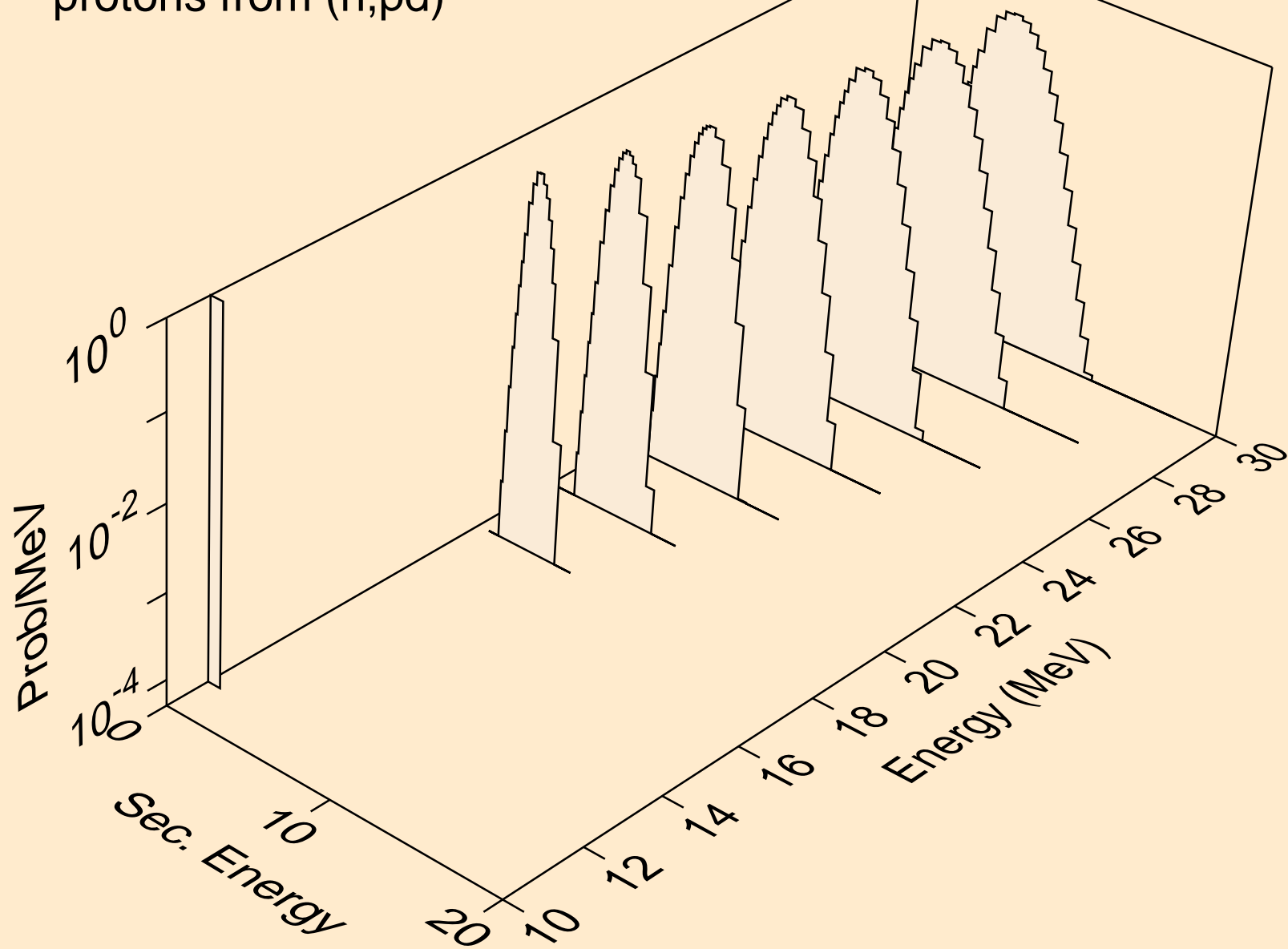

EU151 NEUTRON ACER TENDL-2023 LIBRARY; T=0.K
protons from (n,pt)

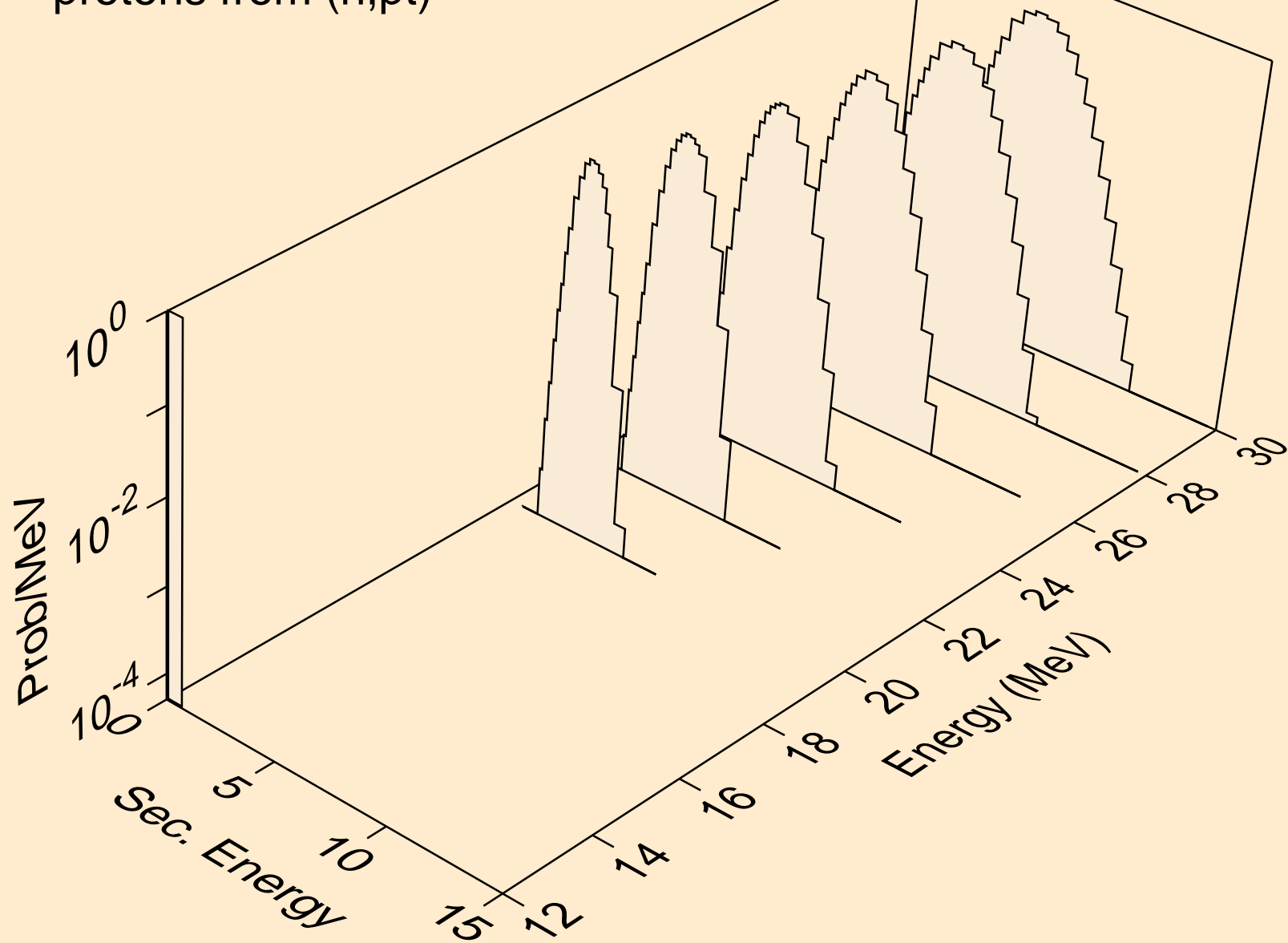

EU151 NEUTRON ACER TENDL-2023 LIBRARY; T=0.K
deuterons from (n,x)

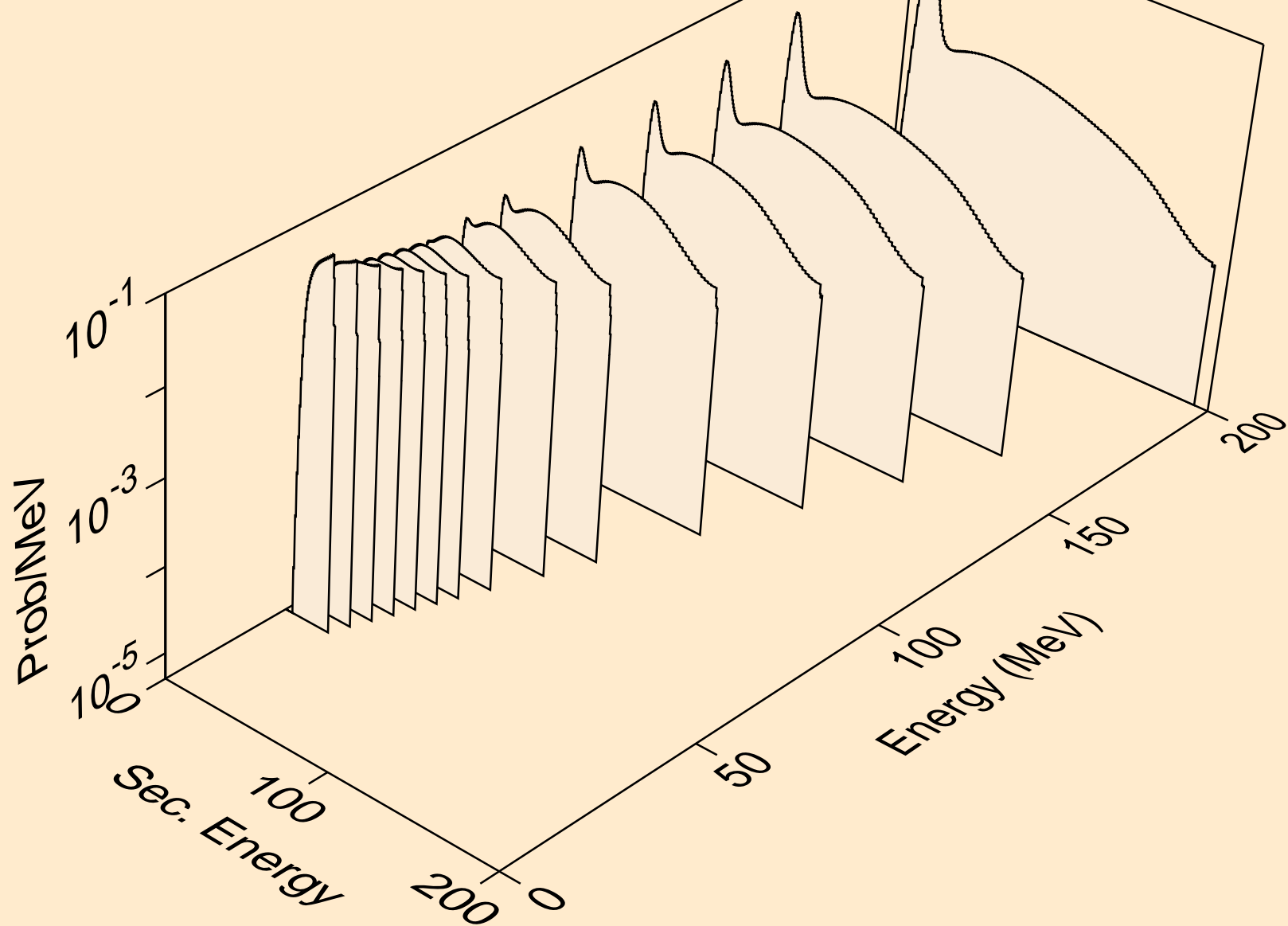

EU151 NEUTRON ACER TENDL-2023 LIBRARY; T=0.K
deuterons from (n,2nd)

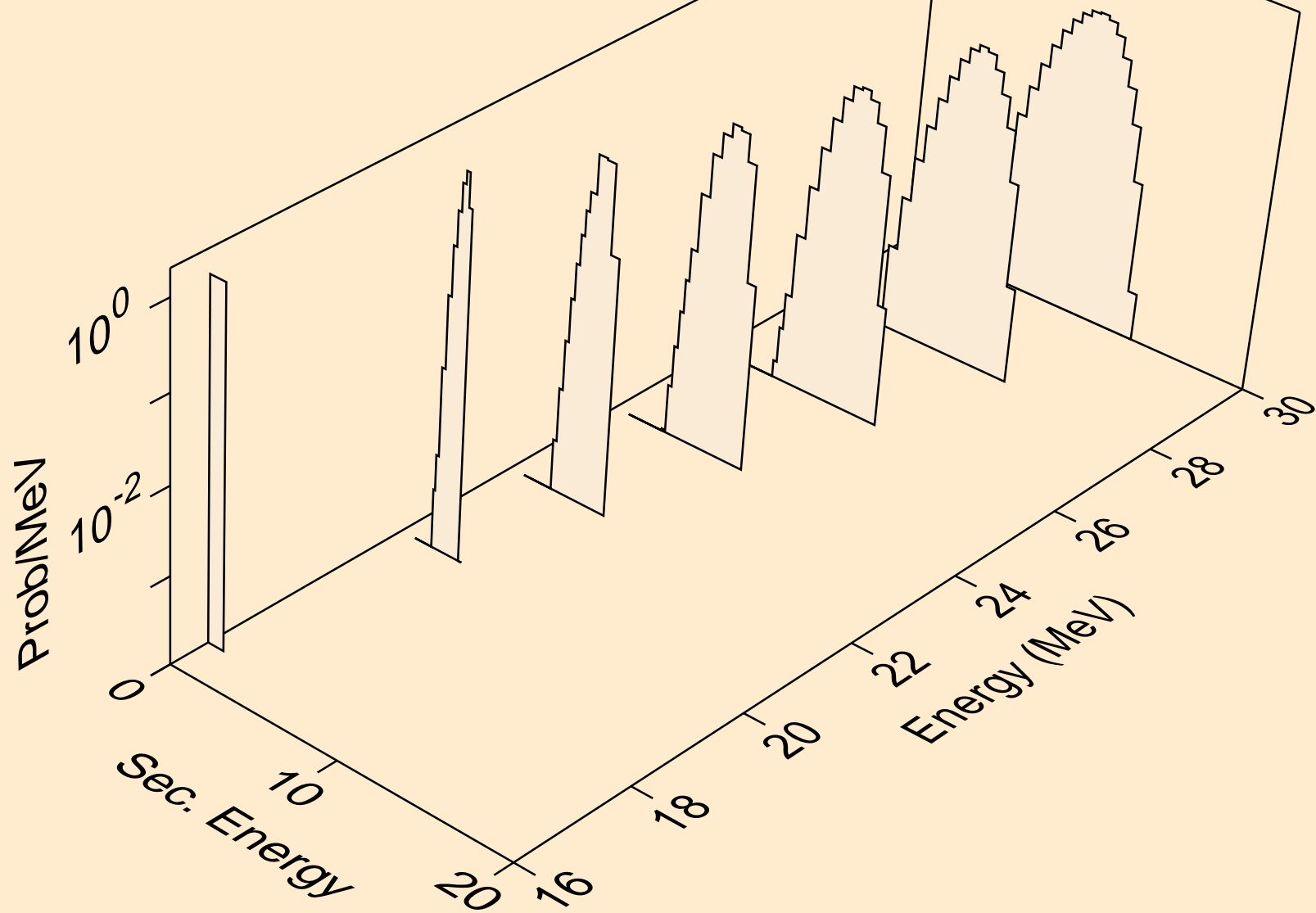

EU151 NEUTRON ACER TENDL-2023 LIBRARY; T=0.K
deuterons from (n,n*)d

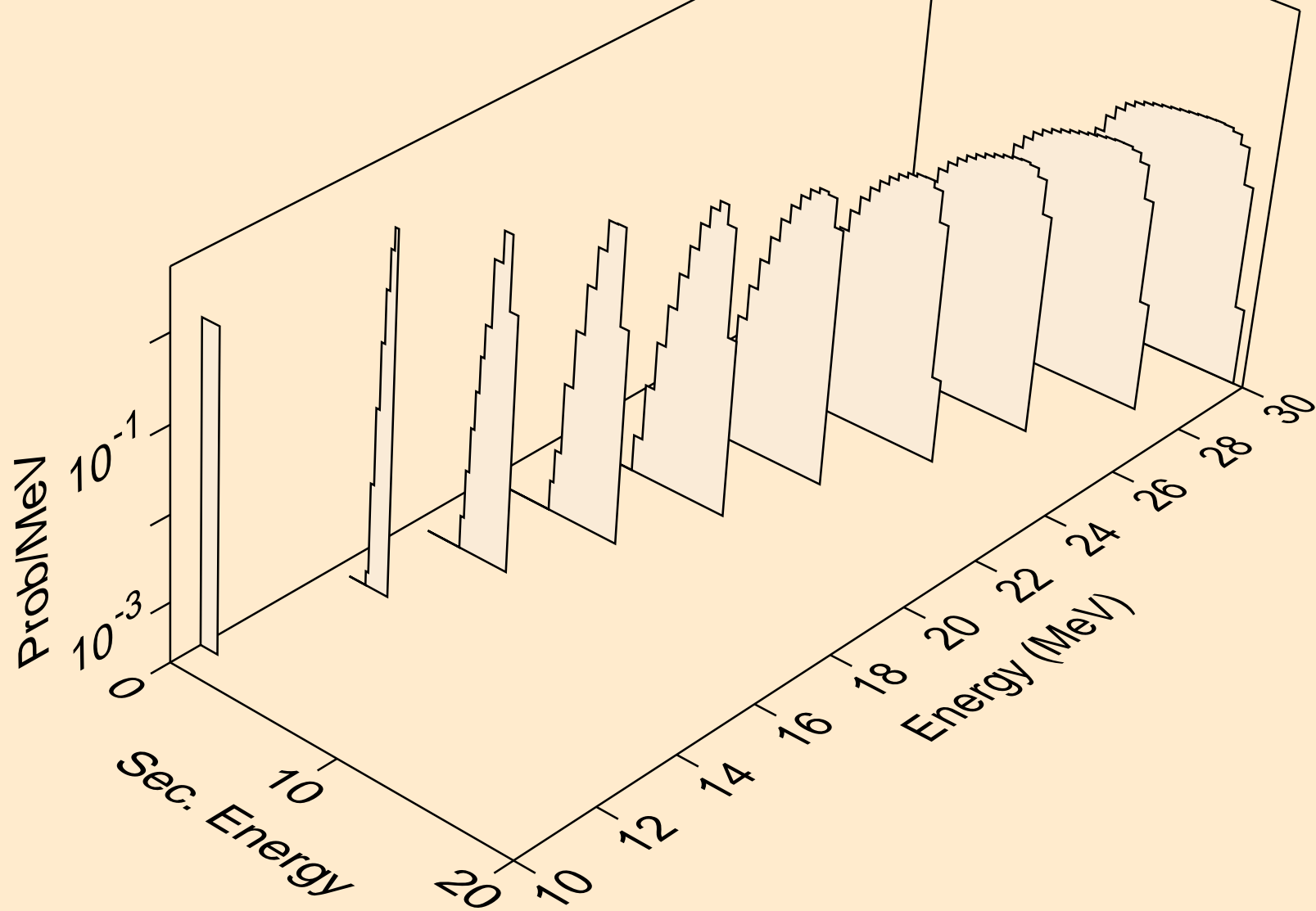

EU151 NEUTRON ACER TENDL-2023 LIBRARY; T=0.K
deuterons from (n,d)

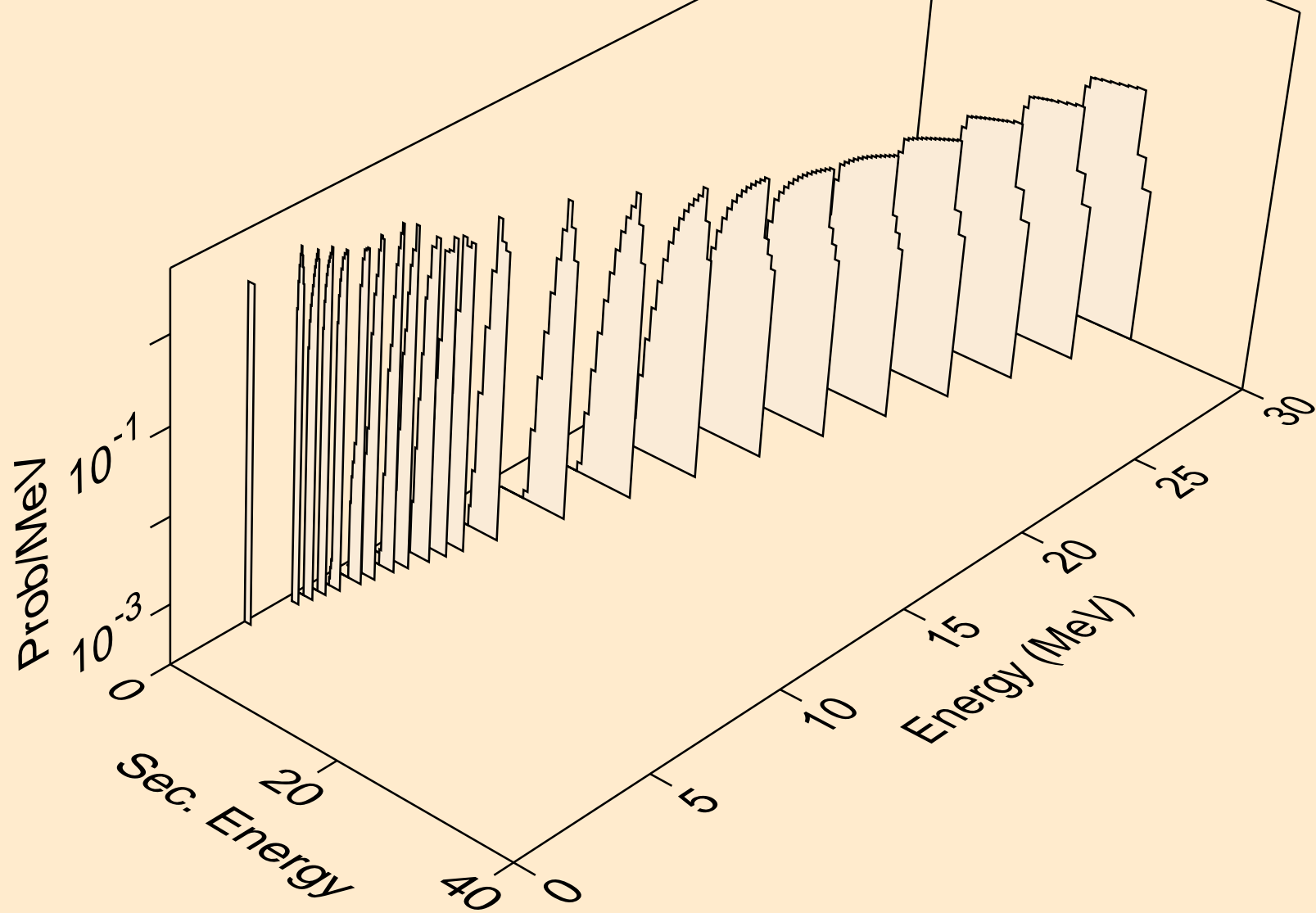

EU151 NEUTRON ACER TENDL-2023 LIBRARY; T=0.K
deuterons from (n,pd)

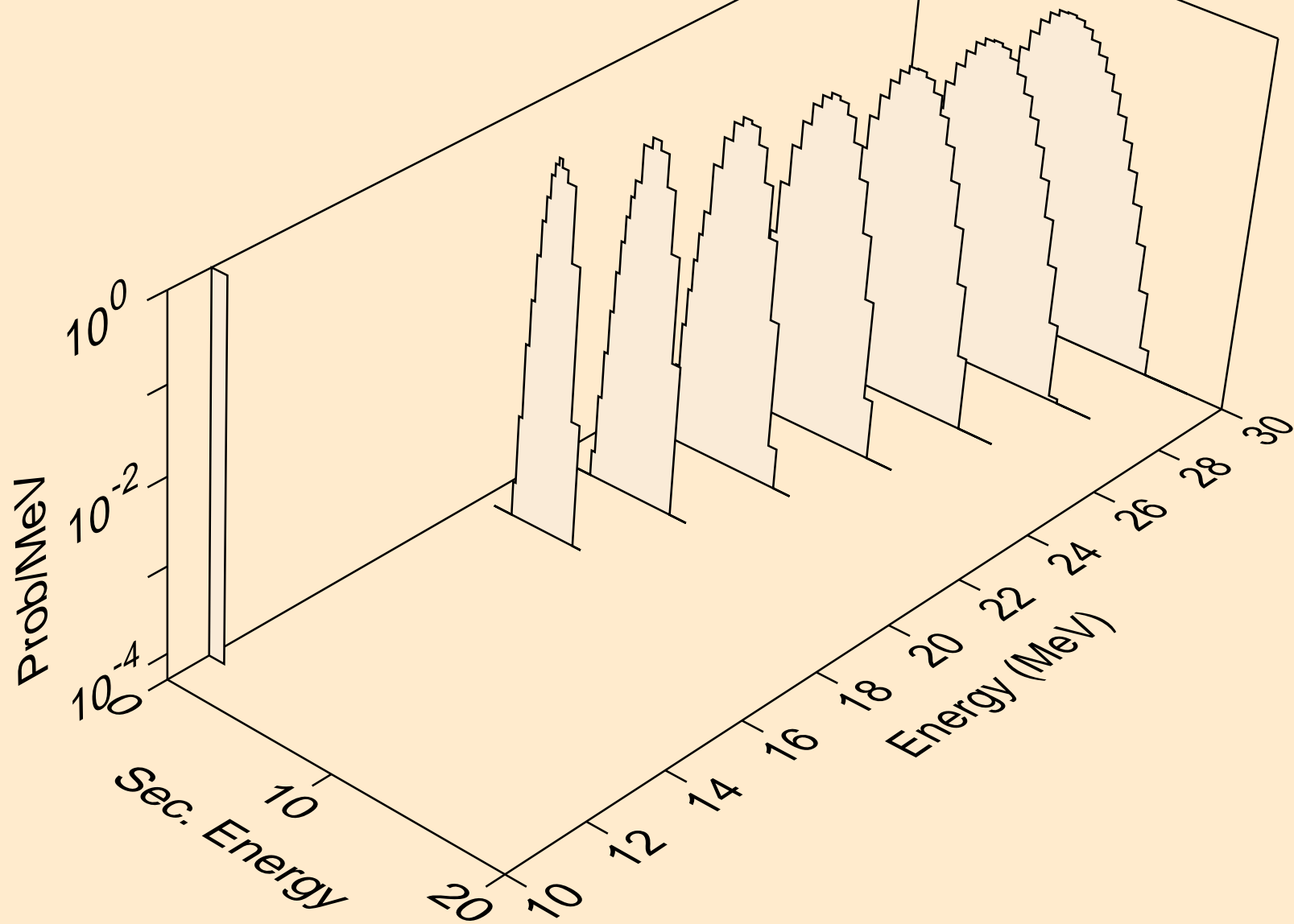

EU151 NEUTRON ACER TENDL-2023 LIBRARY; T=0.K
deuterons from (n,da)

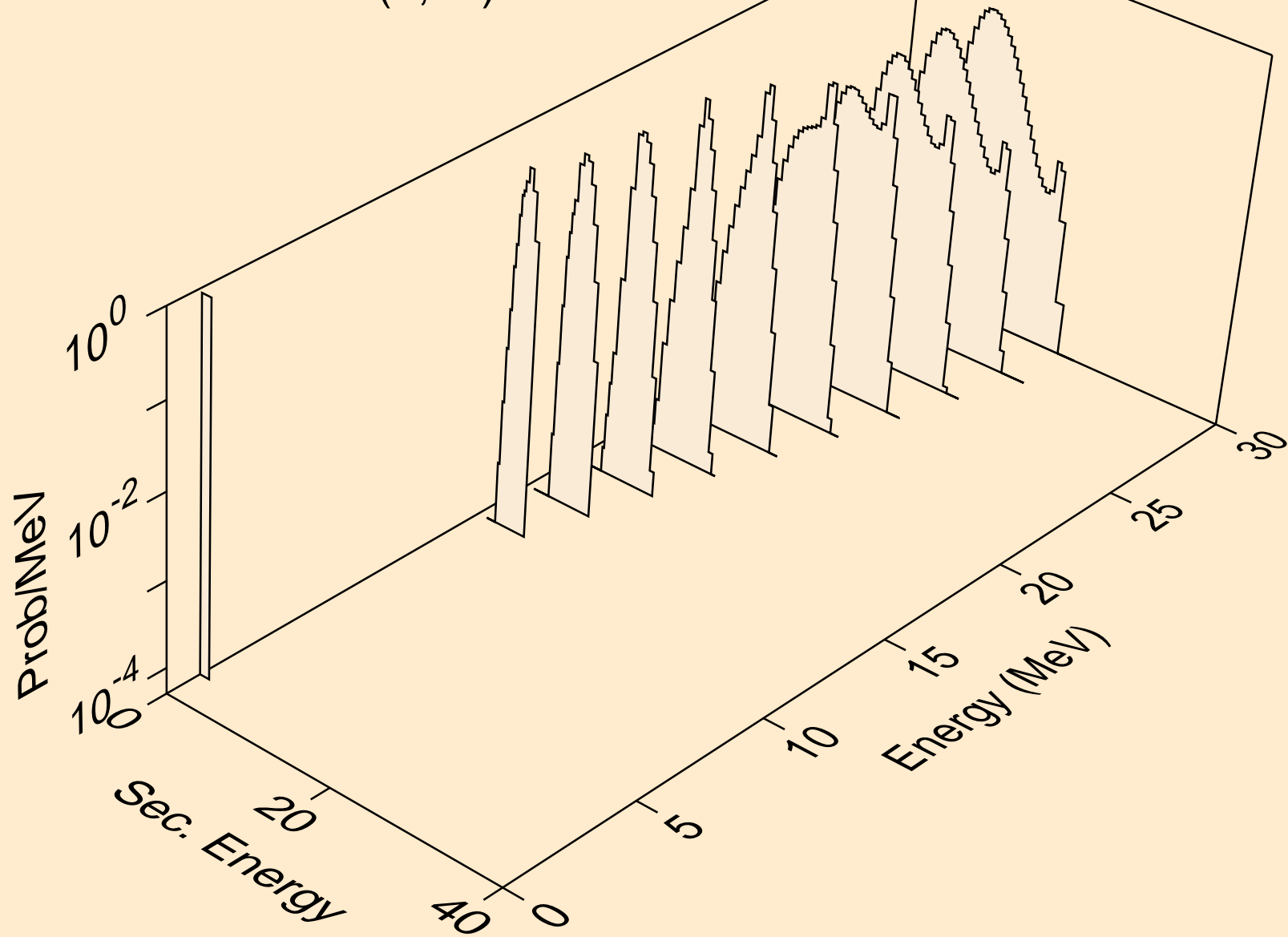

EU151 NEUTRON ACER TENDL-2023 LIBRARY; T=0.K
tritons from (n,x)

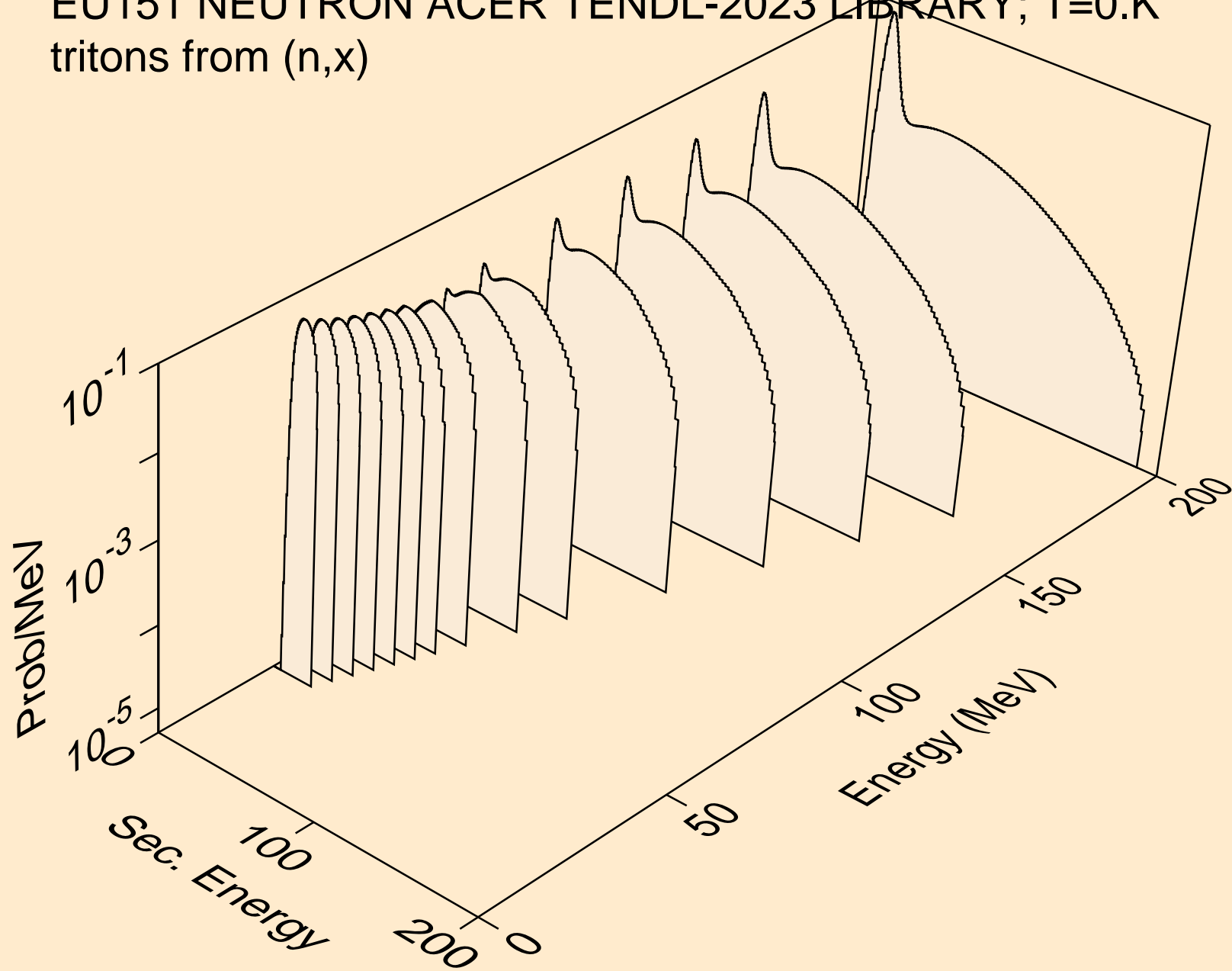

EU151 NEUTRON ACER TENDL-2023 LIBRARY; T=0.K
tritons from (n,n*)t

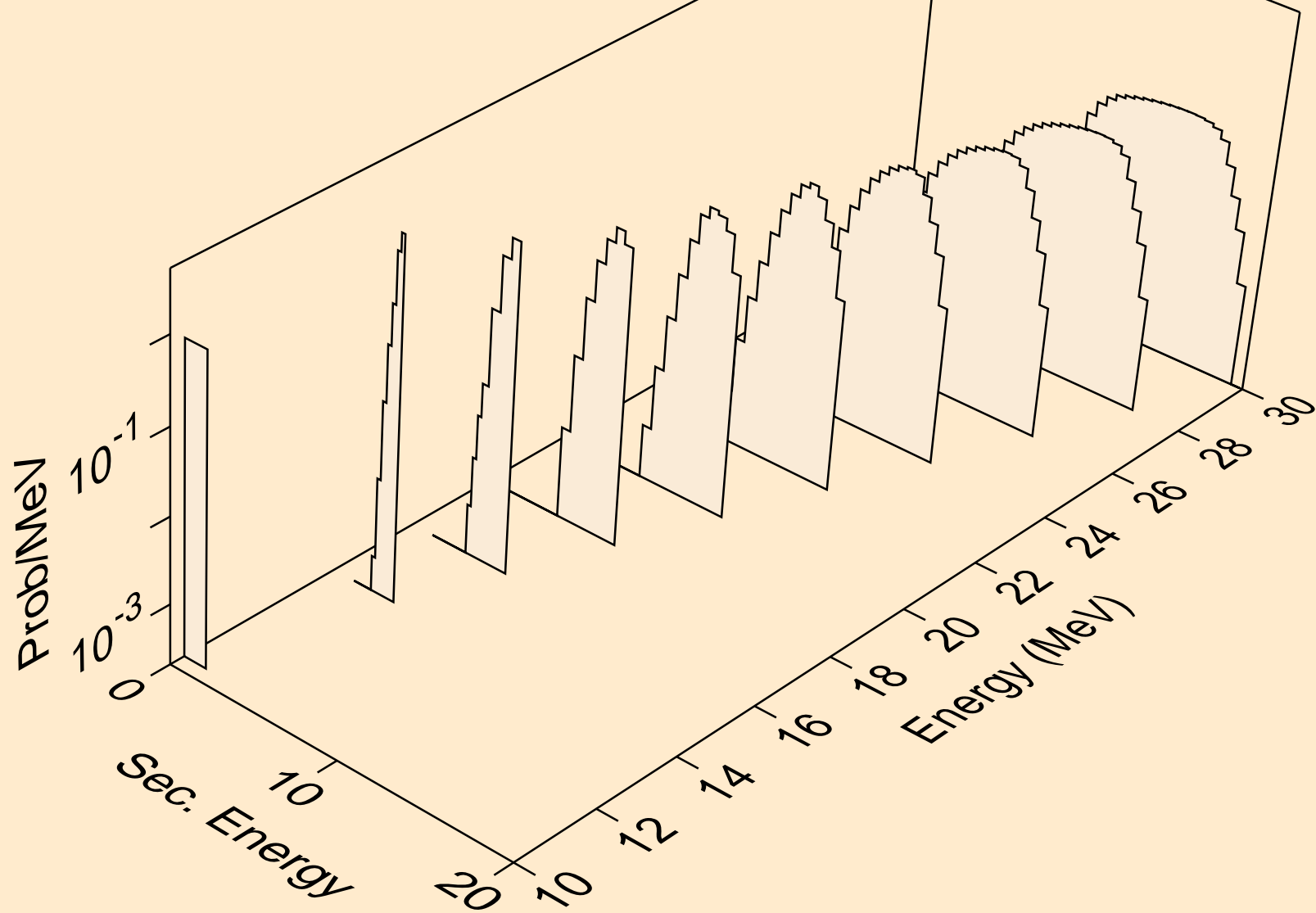

EU151 NEUTRON ACER TENDL-2023 LIBRARY; T=0.K
tritons from (n,t)

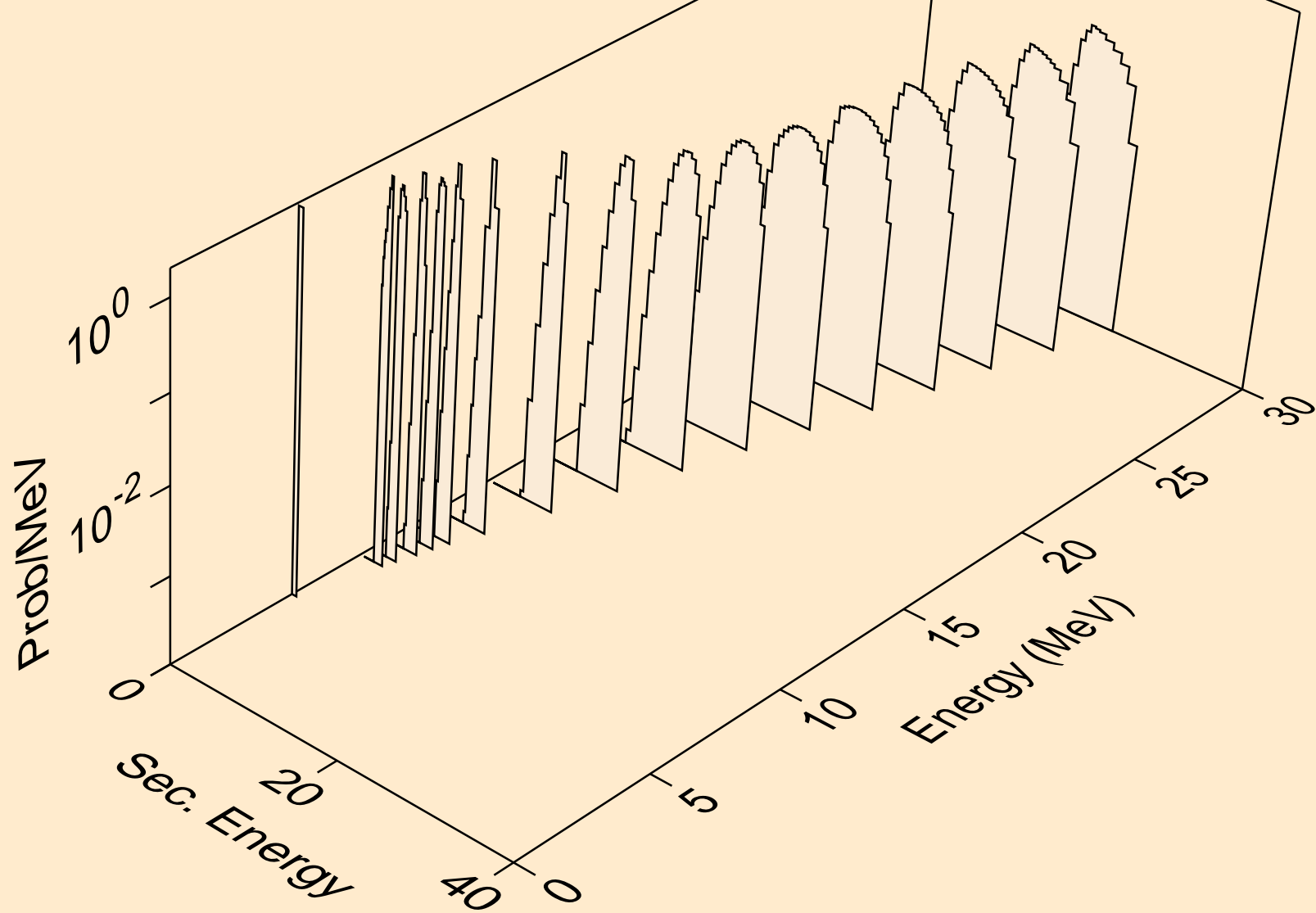

EU151 NEUTRON ACER TENDL-2023 LIBRARY; T=0.K
tritons from (n,pt)

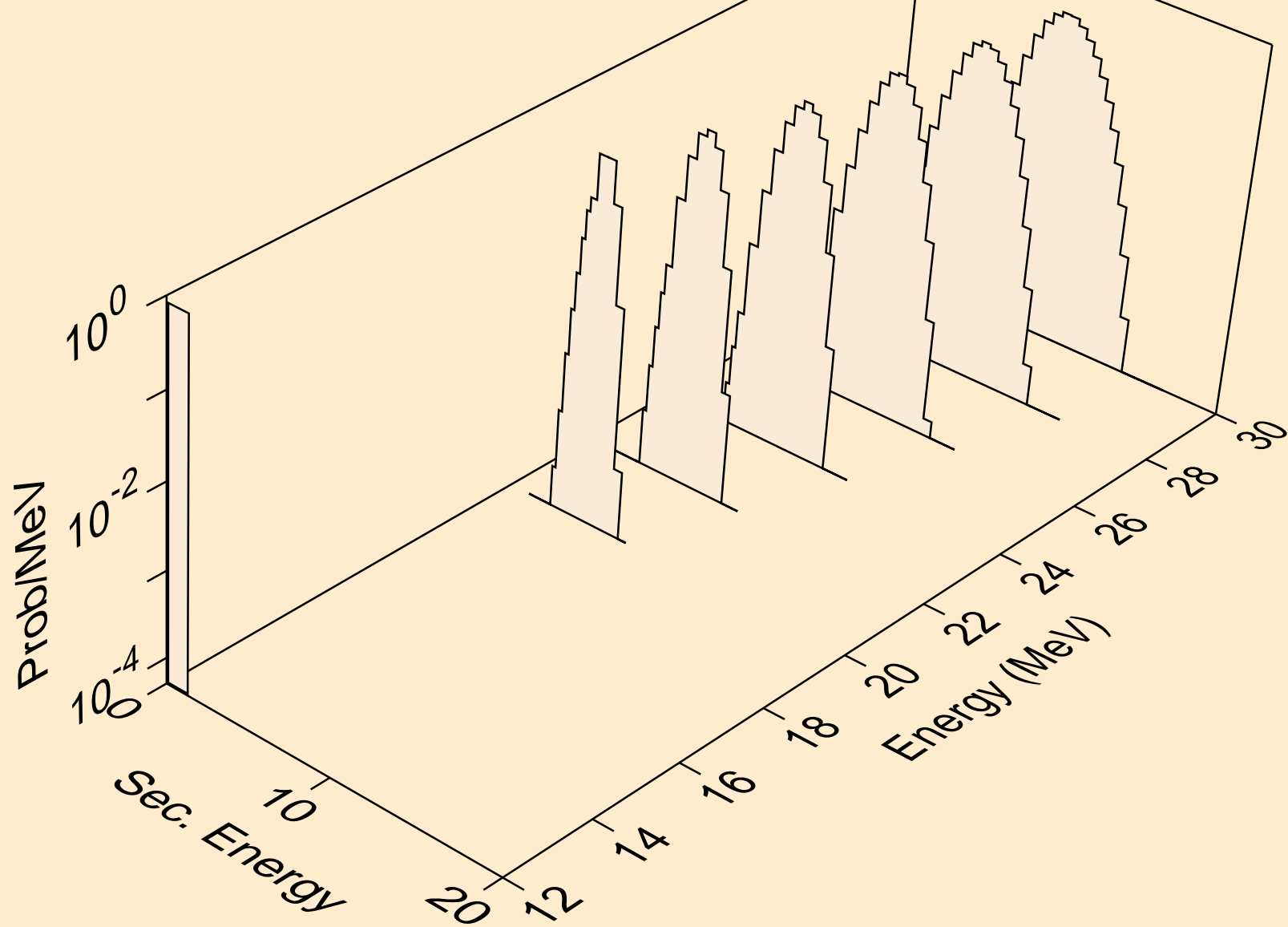

EU151 NEUTRON ACER TENDL-2023 LIBRARY; T=0.K
he3s from (n,x)

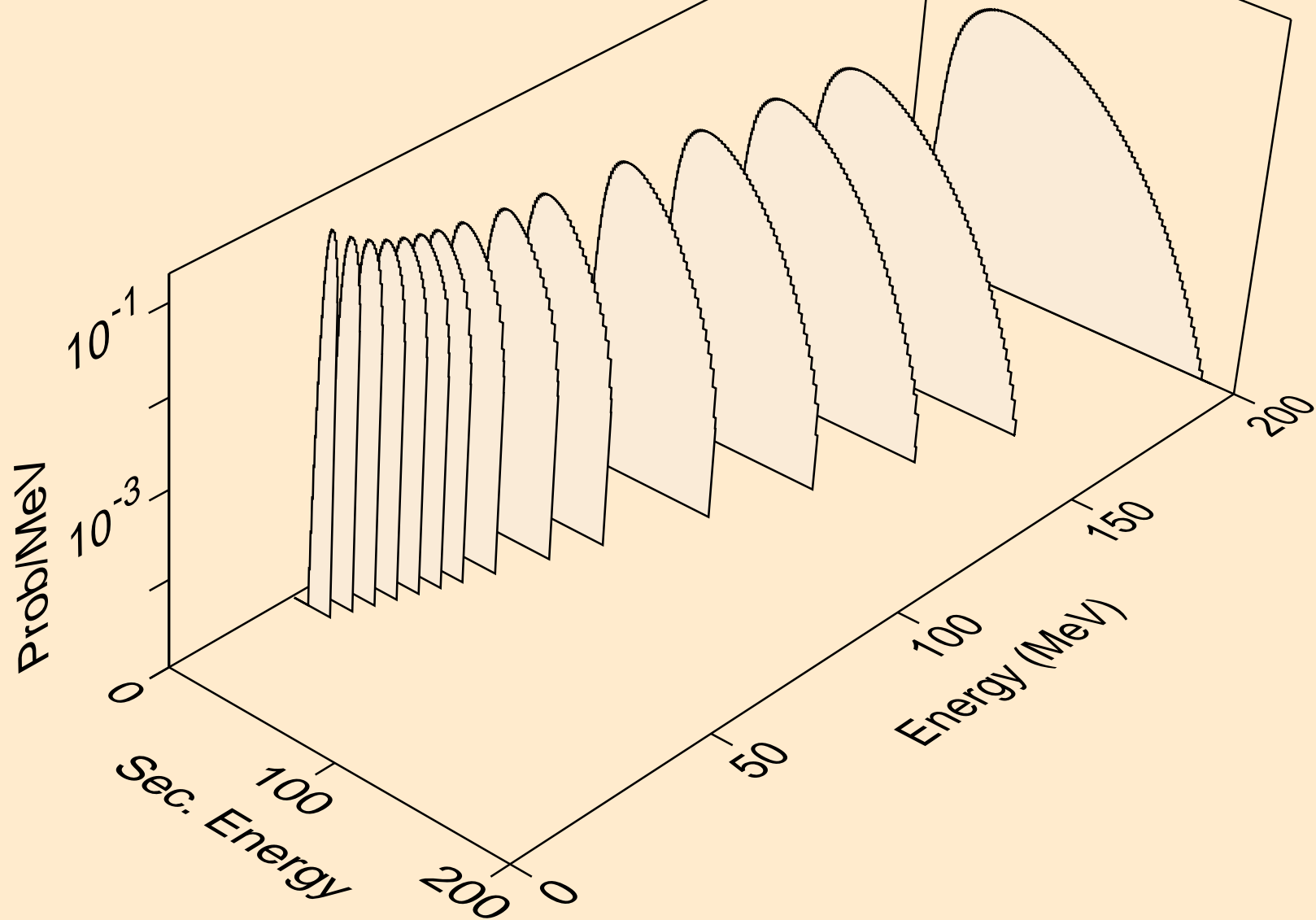

EU151 NEUTRON ACER TENDL-2023 LIBRARY; T=0.K
he3s from (n,n*)he3

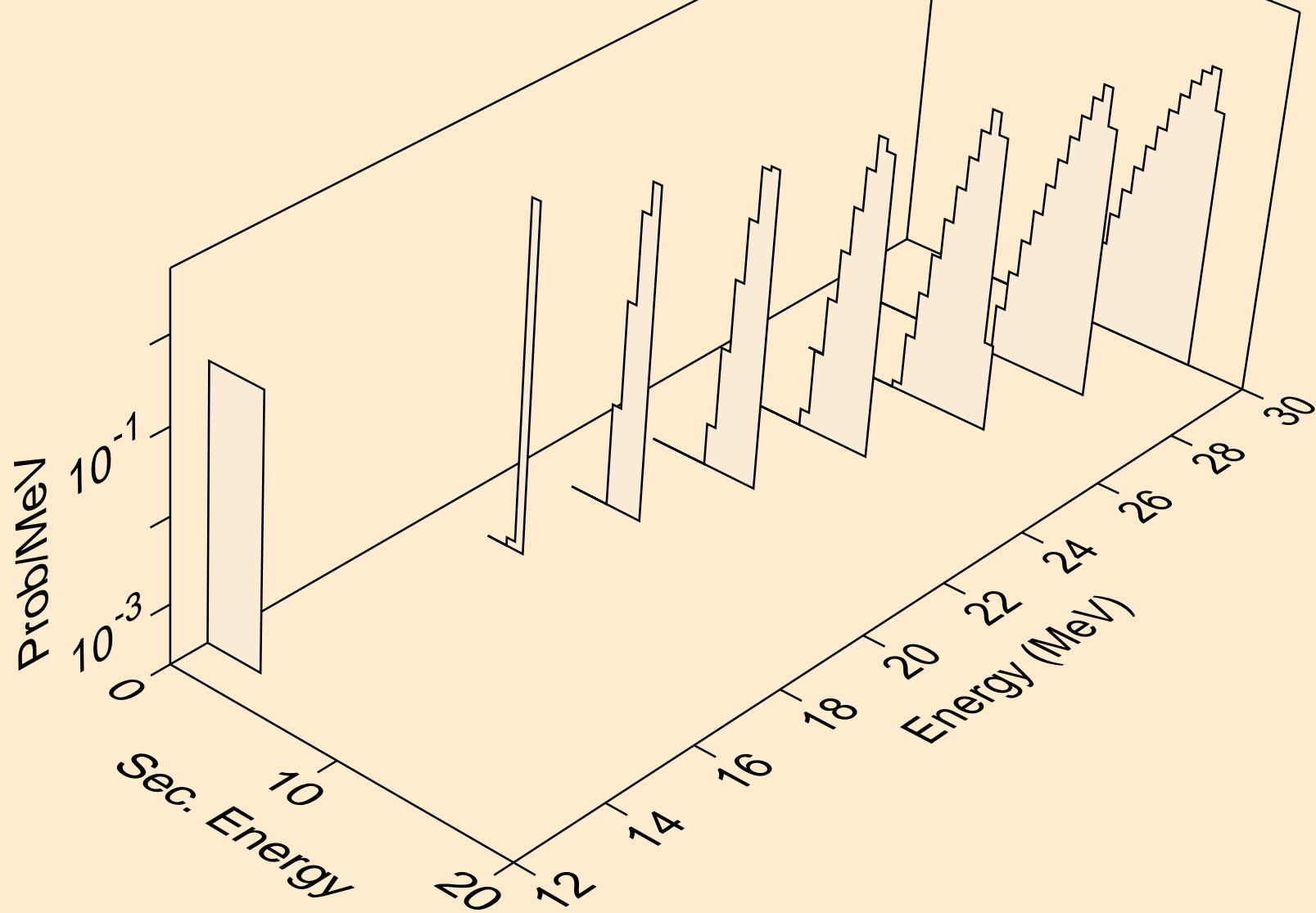

EU151 NEUTRON ACER TENDL-2023 LIBRARY; T=0.K
he3s from (n,he3)

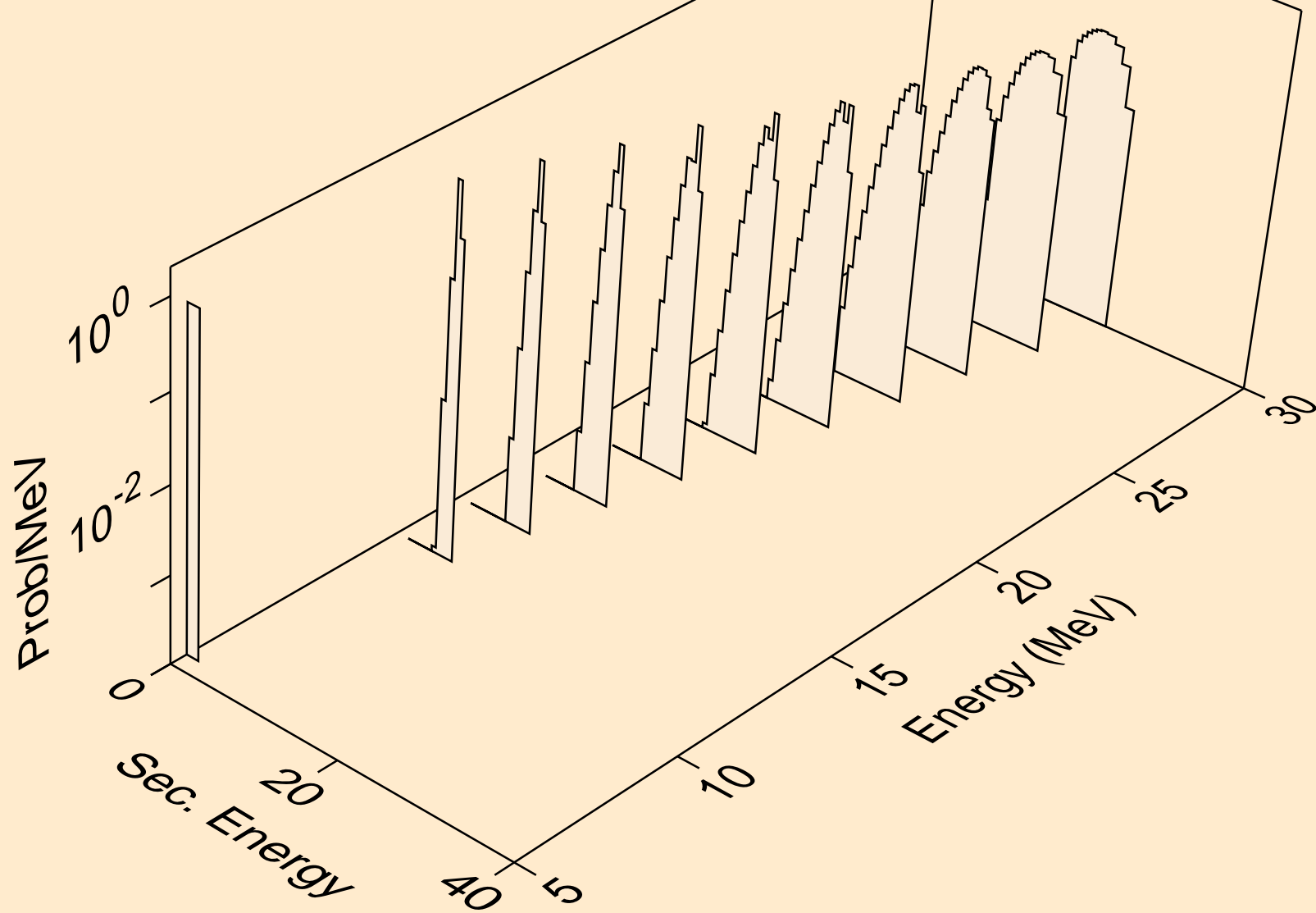

EU151 NEUTRON ACER TENDL-2023 LIBRARY; T=0.K
alphas from (n,x)

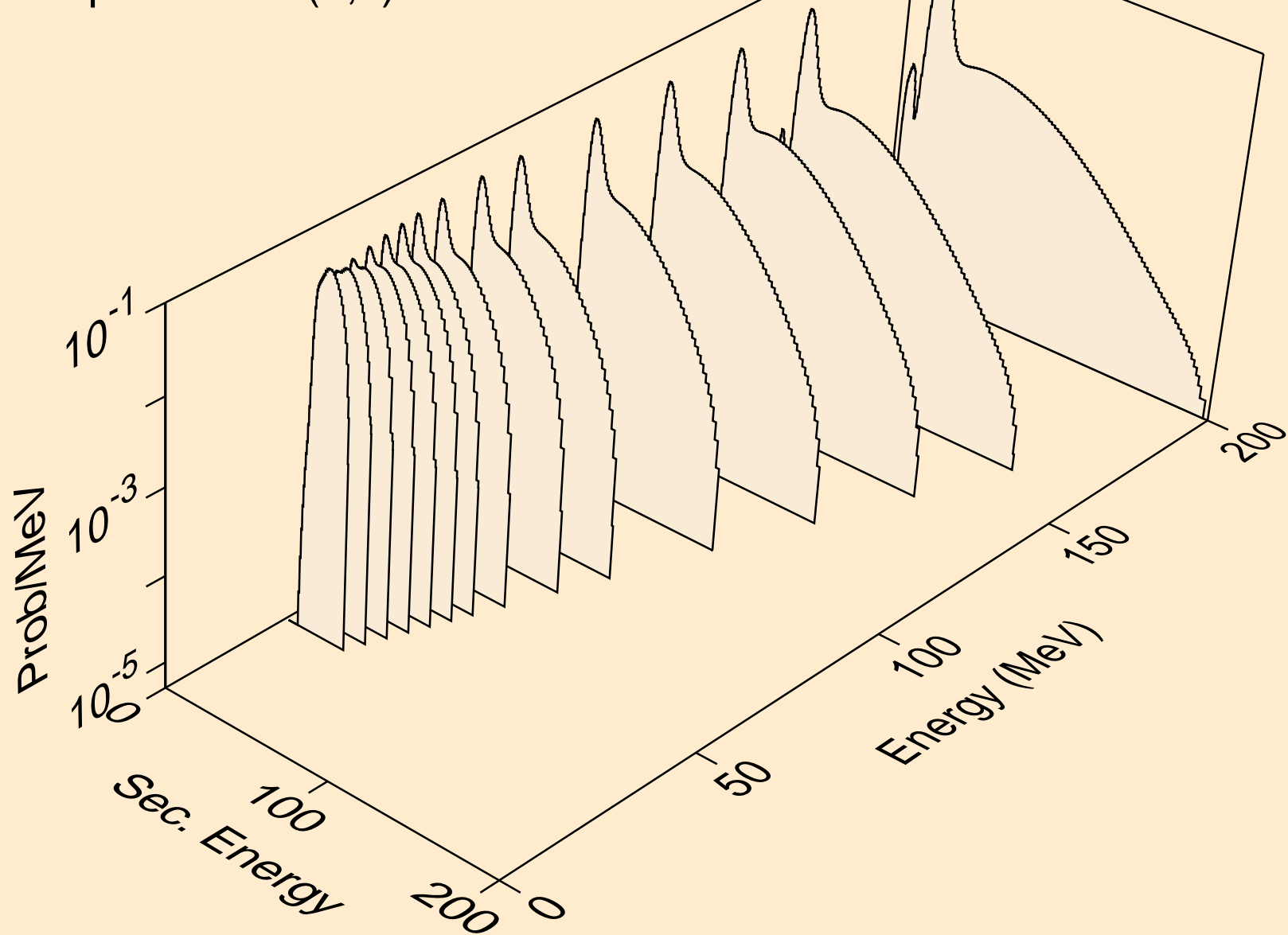

EU151 NEUTRON ACER TENDL-2023 LIBRARY; T=0.K
alphas from (n,n*)a

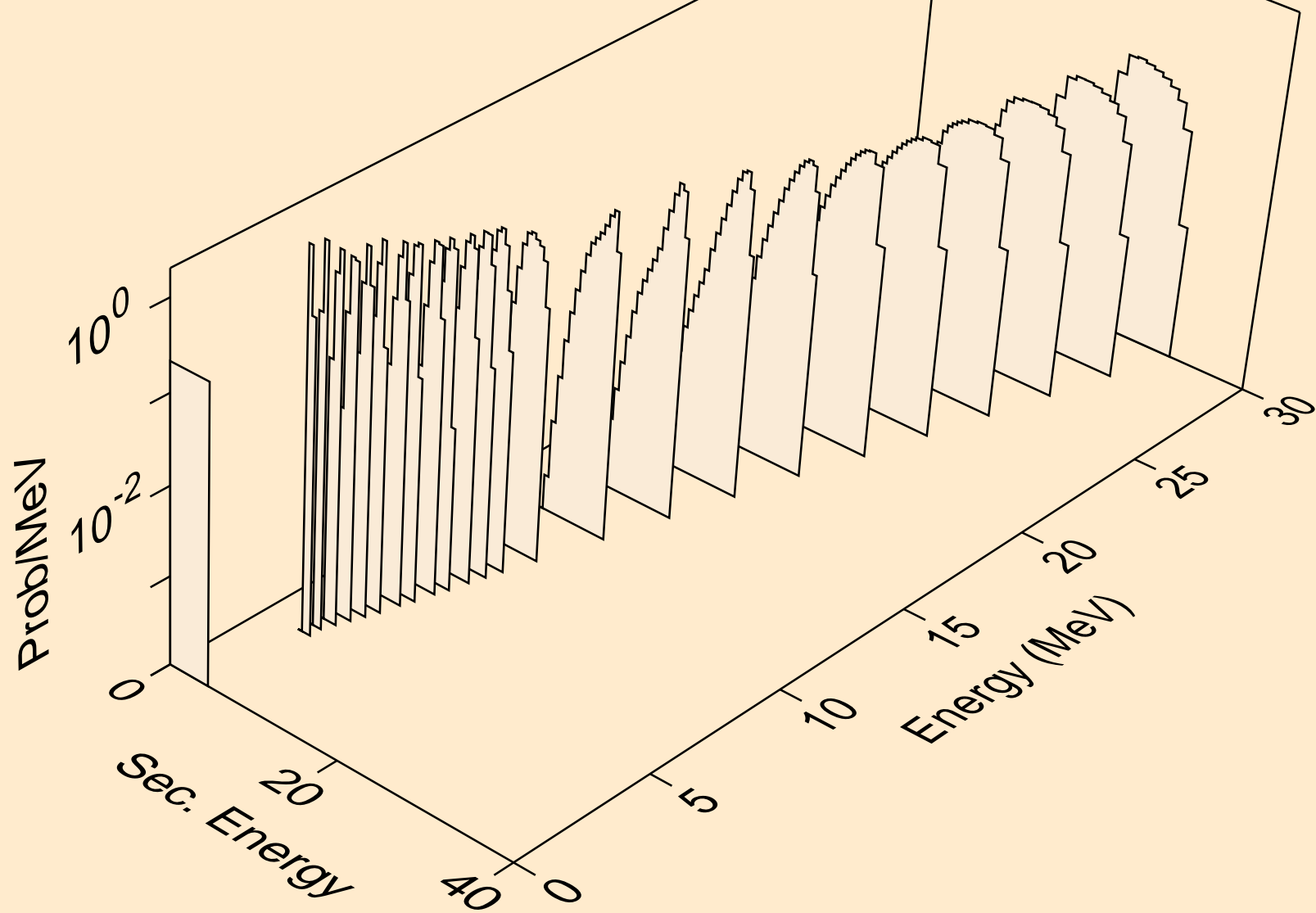

EU151 NEUTRON ACER TENDL-2023 LIBRARY; T=0.K
alphas from (n,2n)a

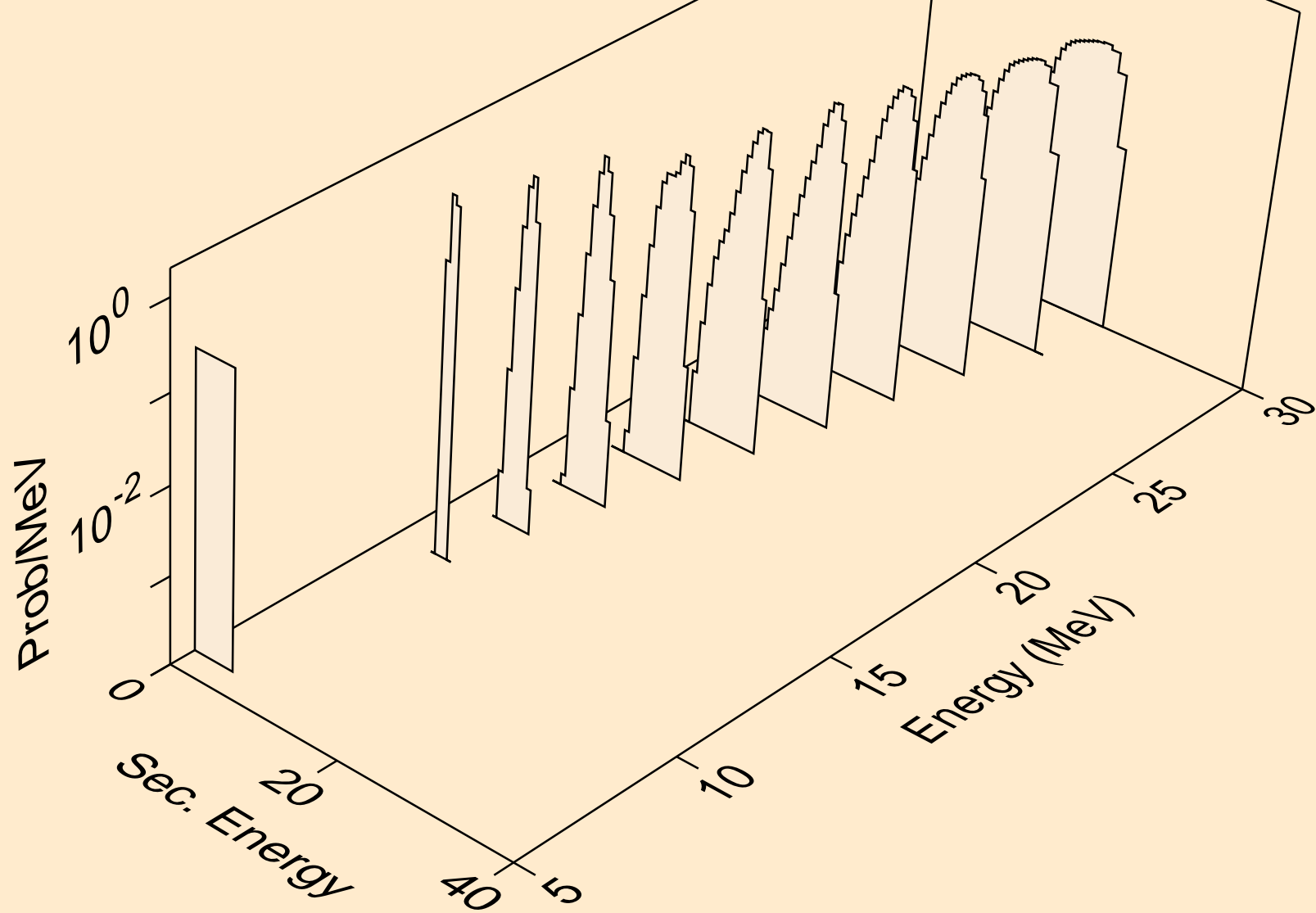

EU151 NEUTRON ACER TENDL-2023 LIBRARY; T=0.K
alphas from (n,3n)a

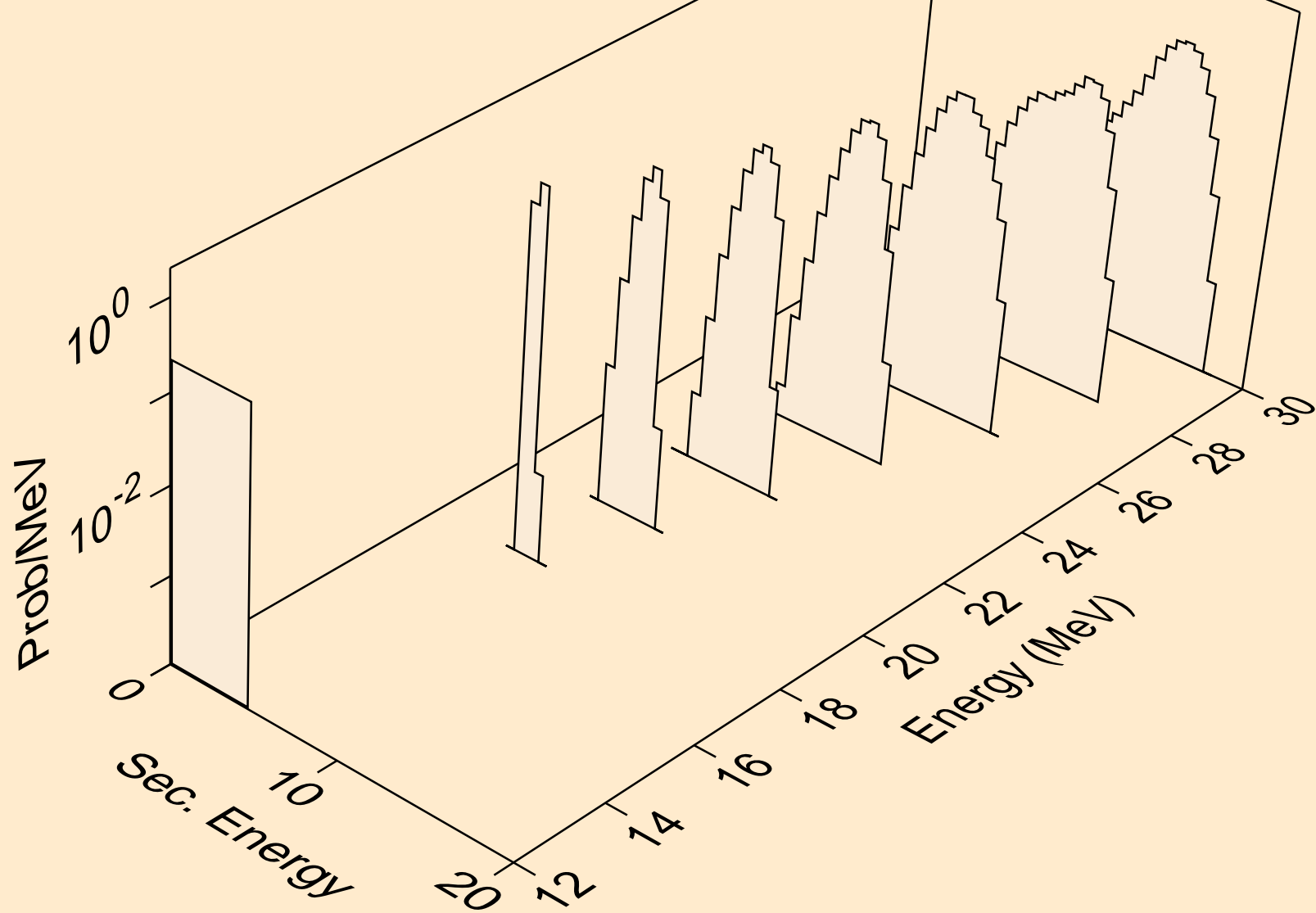

EU151 NEUTRON ACER TENDL-2023 LIBRARY; T=0.K
alphas from (n,n*)2a

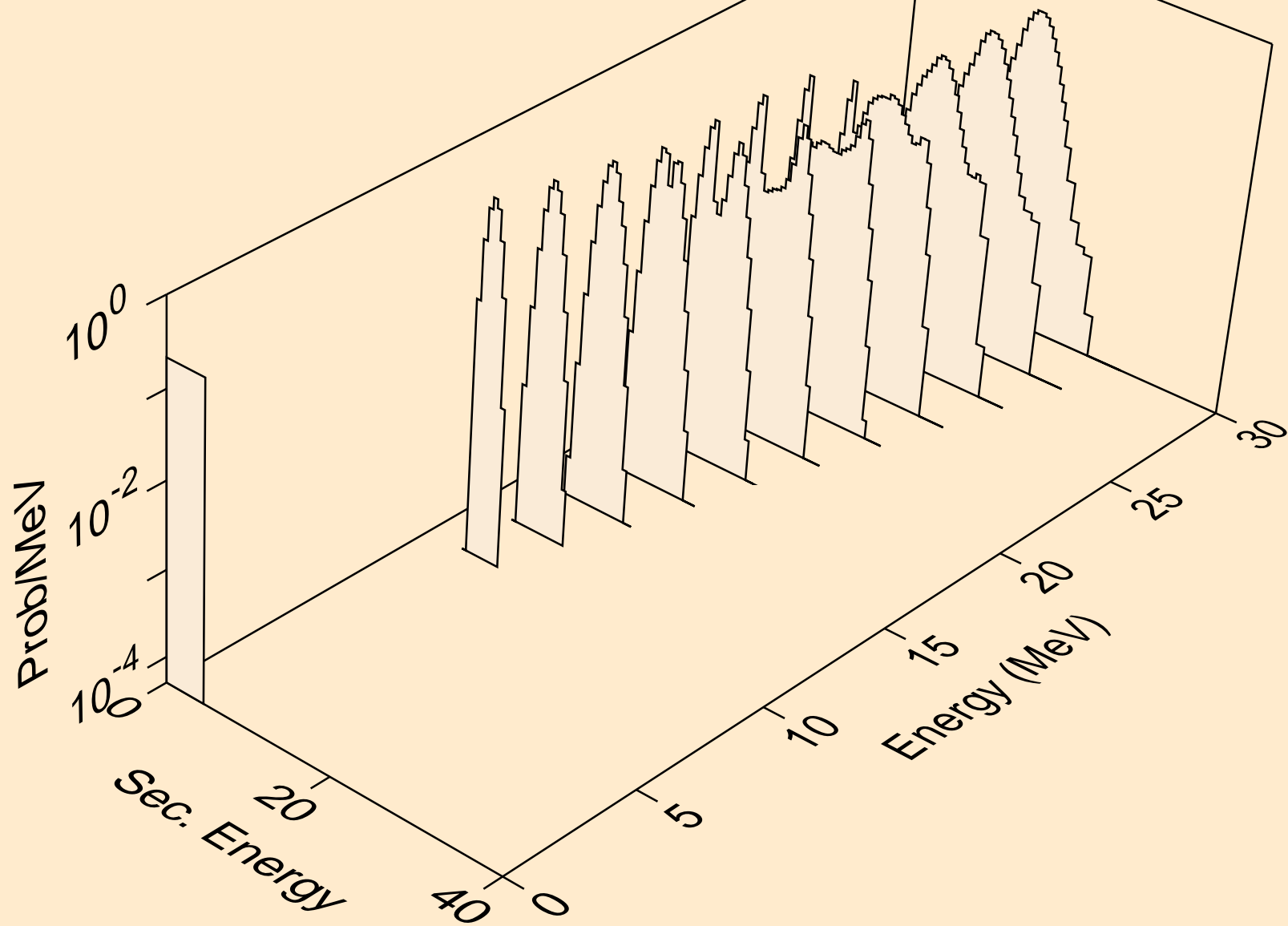

EU151 NEUTRON ACER TENDL-2023 LIBRARY; T=0.K
alphas from (n,npa)

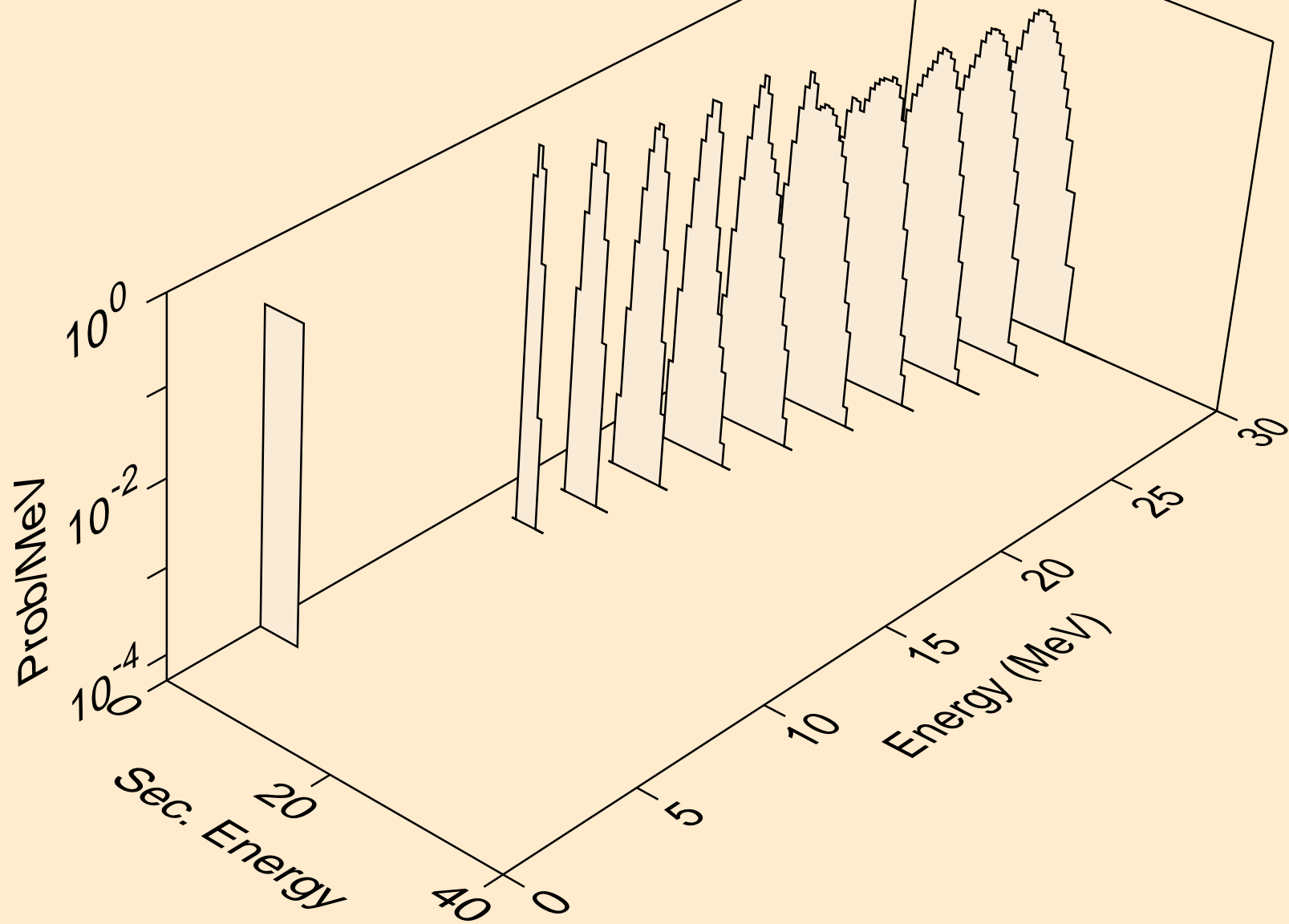

EU151 NEUTRON ACER TENDL-2023 LIBRARY; T=0.K
alphas from (n,a)

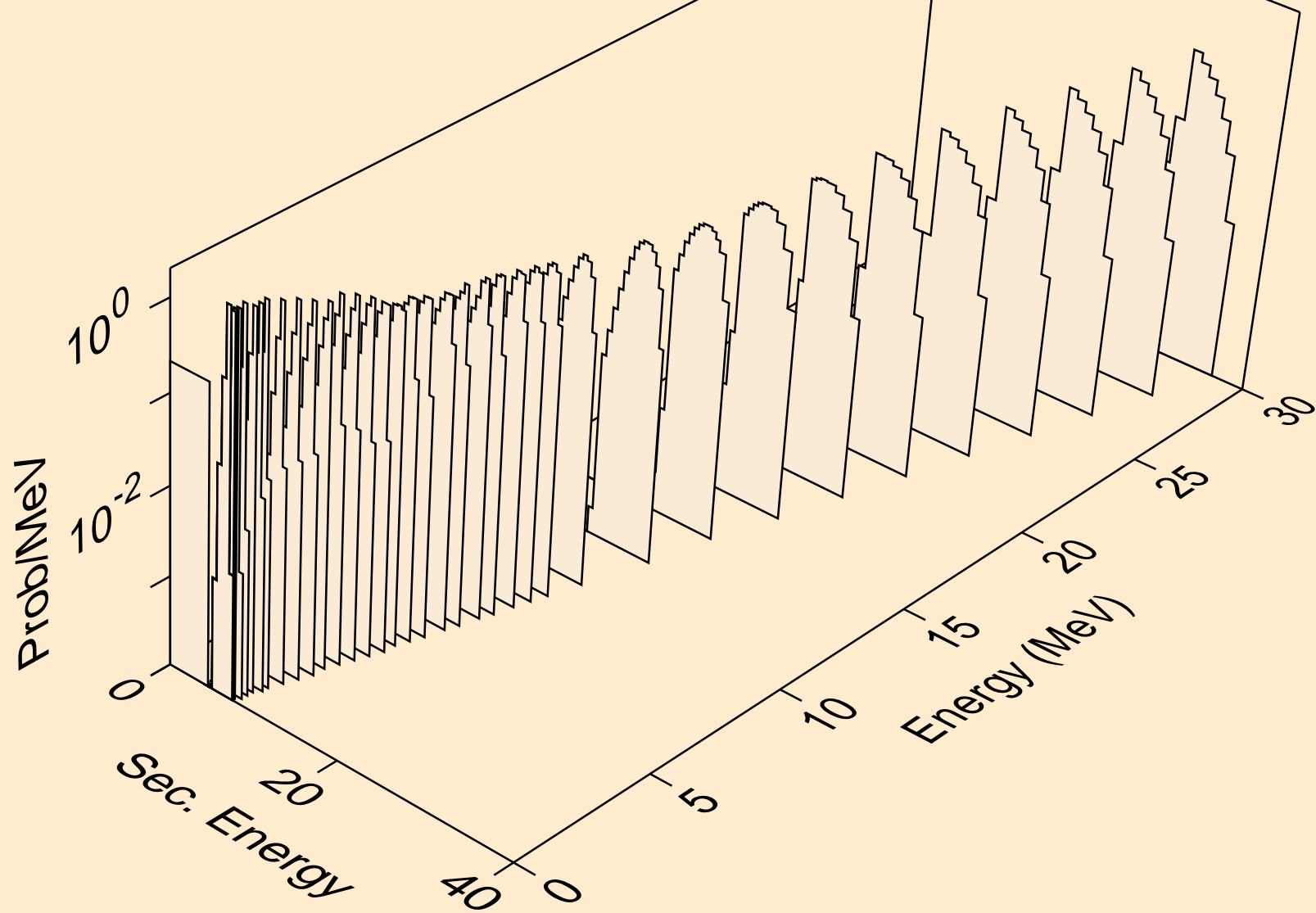

EU151 NEUTRON ACER TENDL-2023 LIBRARY; T=0.K
alphas from (n,2a)

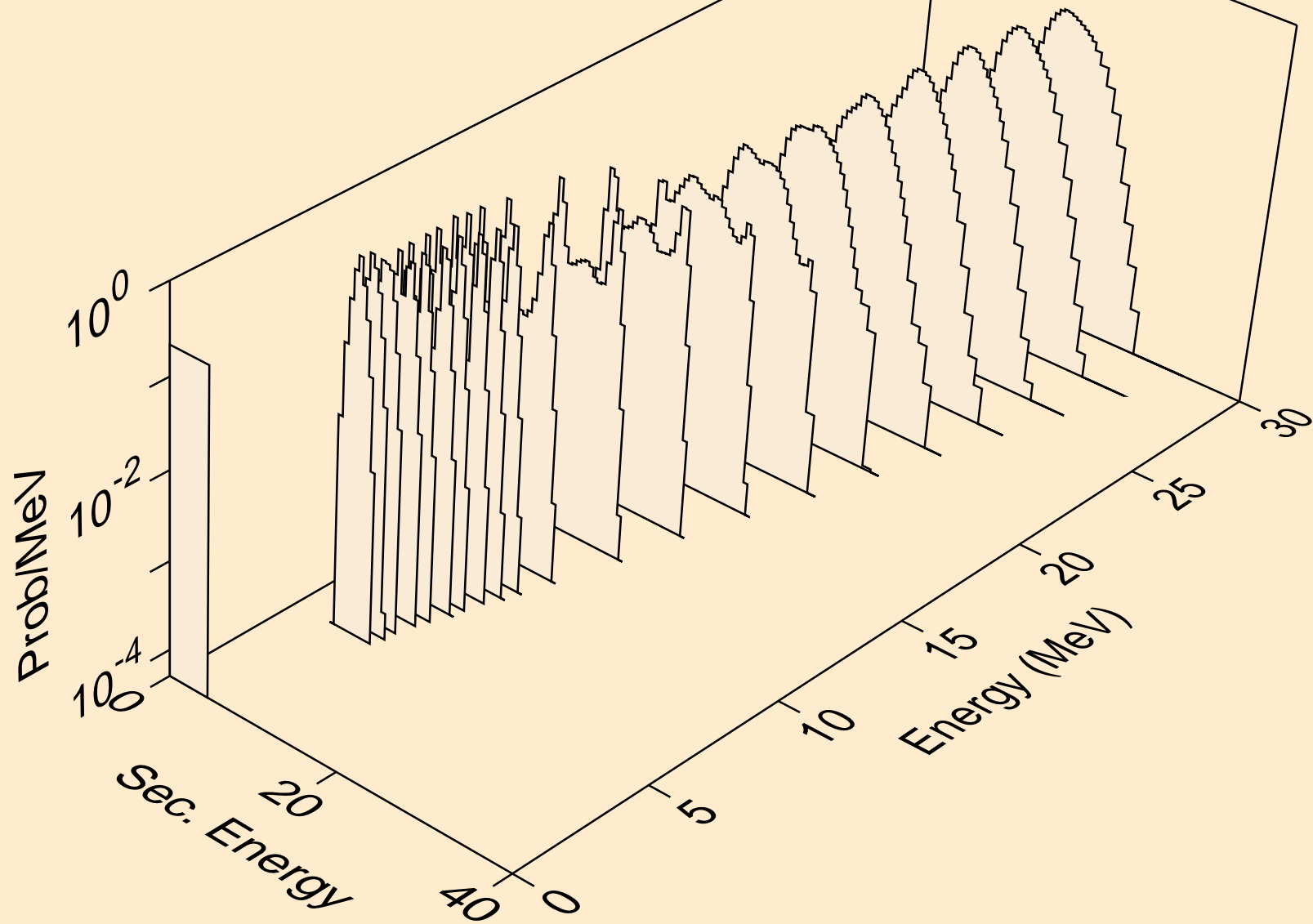

EU151 NEUTRON ACER TENDL-2023 LIBRARY; T=0.K
alphas from (n,pa)

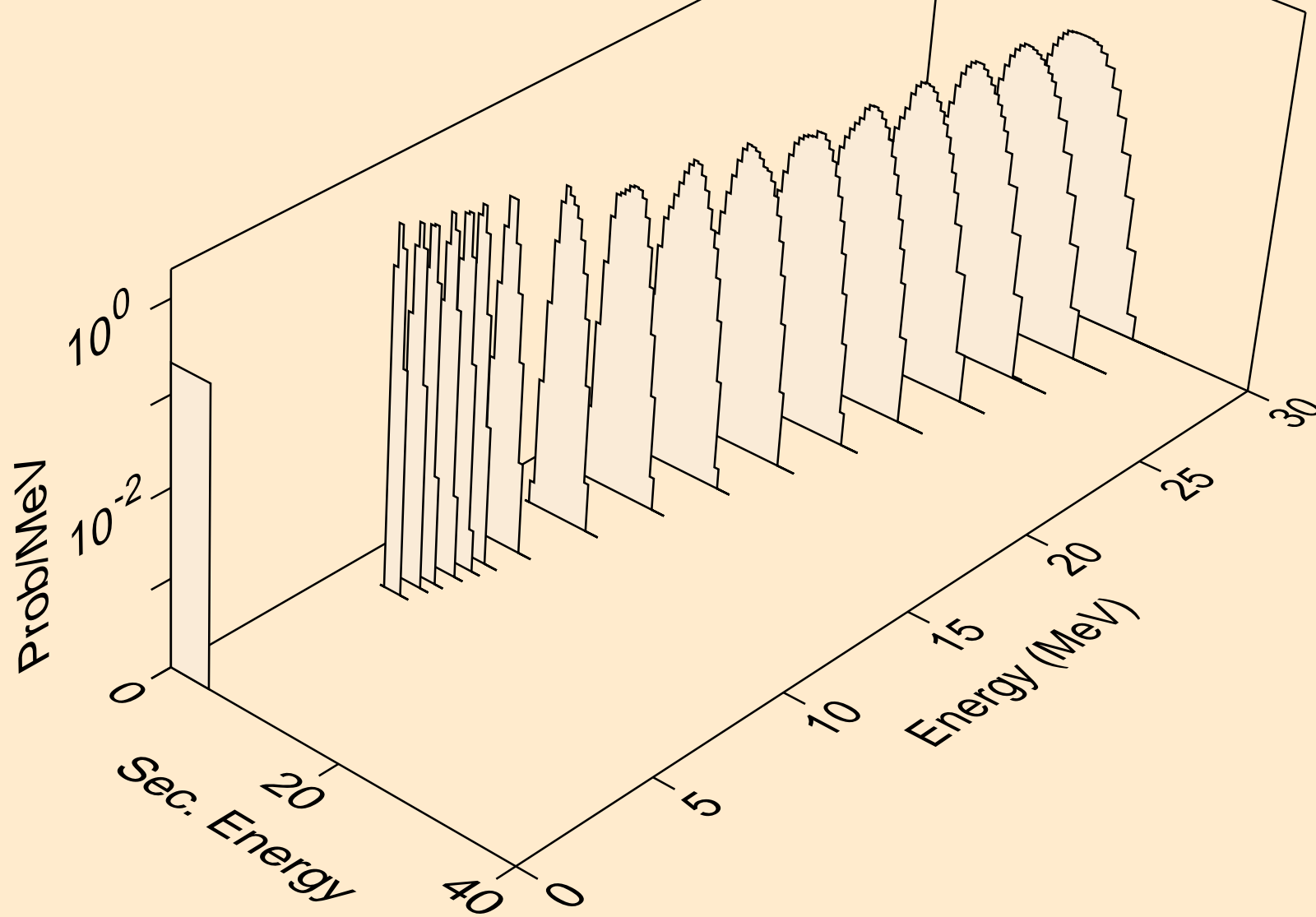

EU151 NEUTRON ACER TENDL-2023 LIBRARY; T=0.K
alphas from (n,da)

