

F018 NEUTRON ACER TENDL-2023 LIBRARY; T=0.K

Principal cross sections

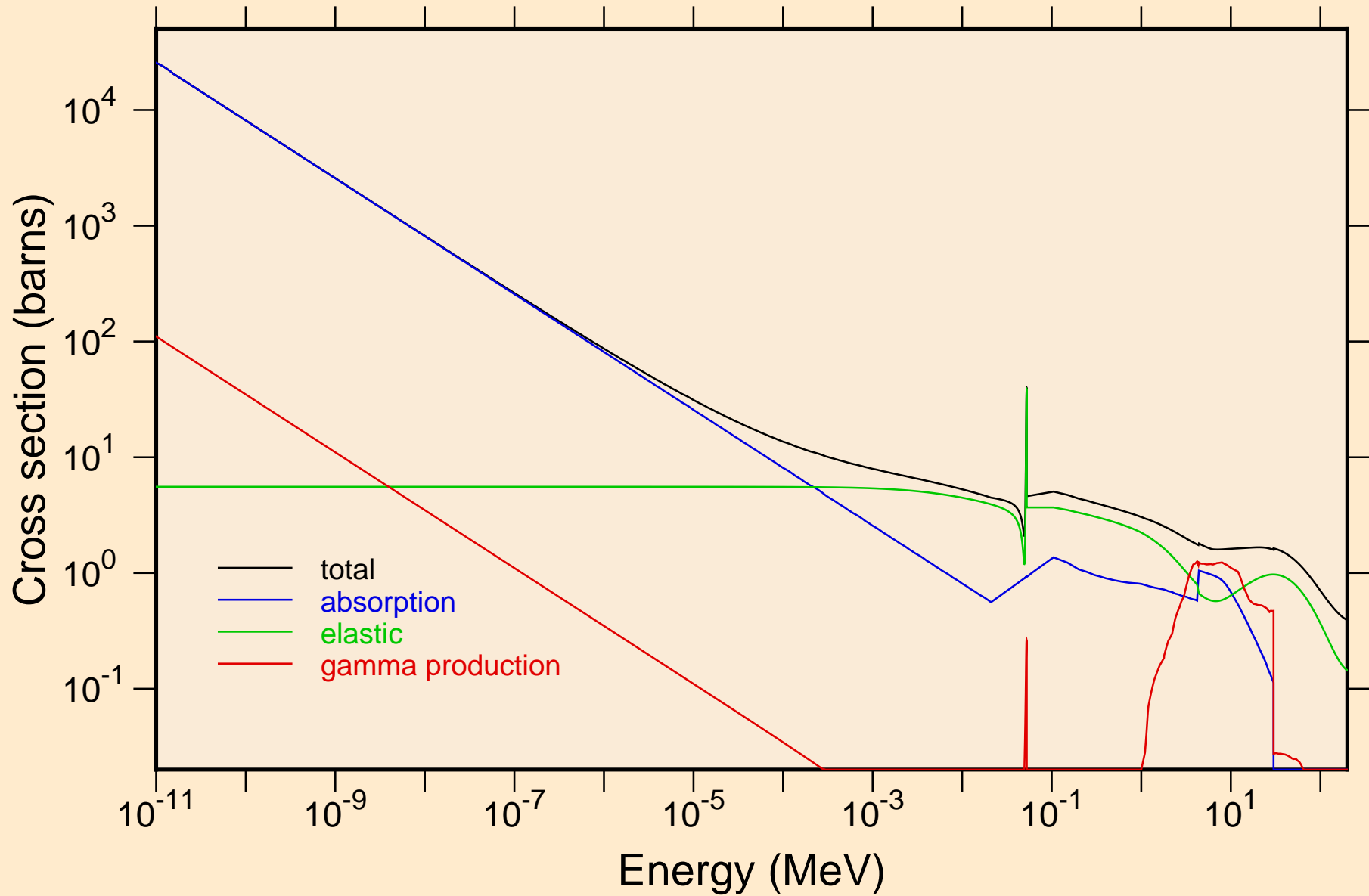

F018 NEUTRON ACER TENDL-2023 LIBRARY; T=0.K

Heating

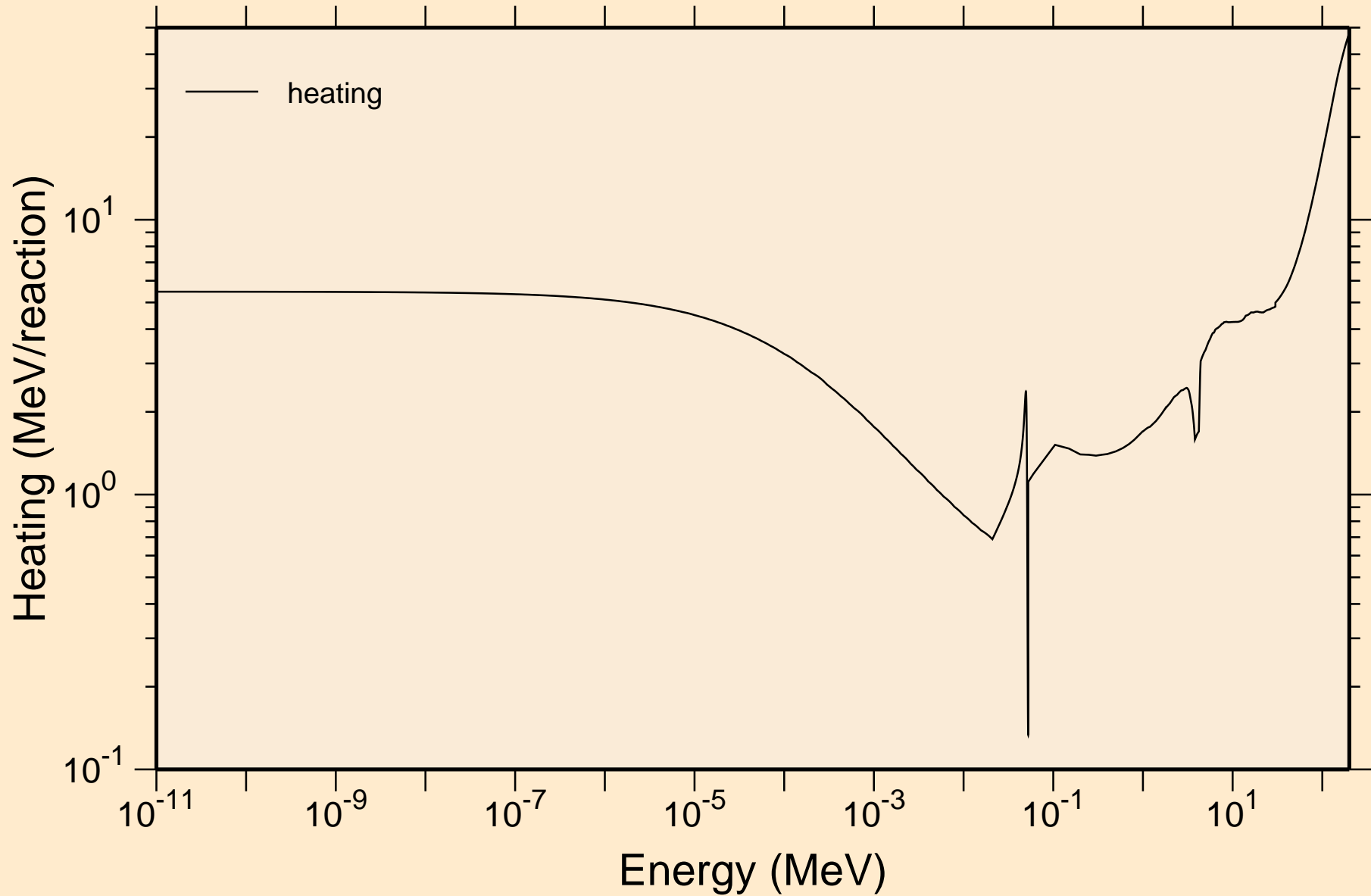

F018 NEUTRON ACER TENDL-2023 LIBRARY; T=0.K

Damage

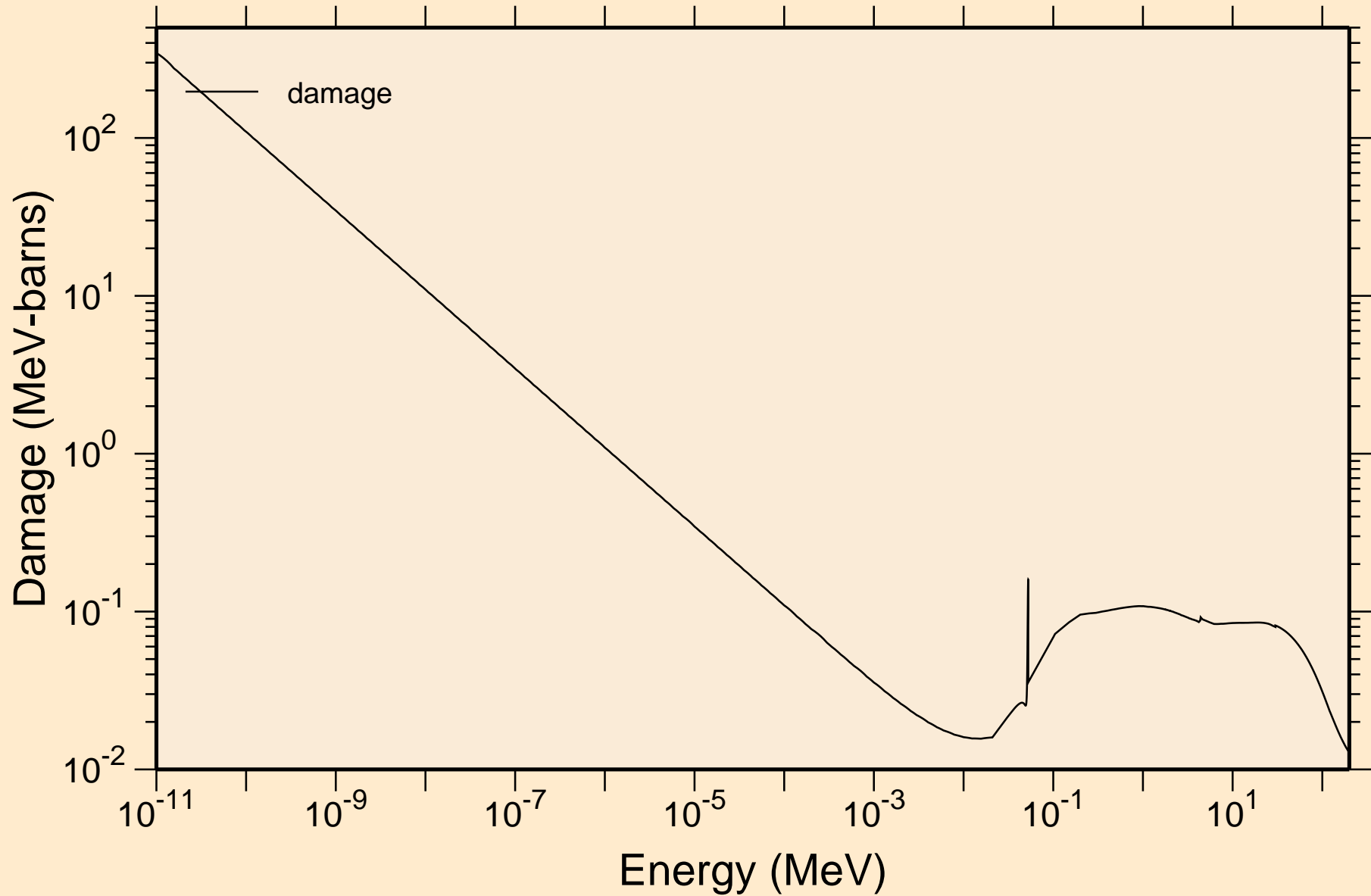

F018 NEUTRON ACER TENDL-2023 LIBRARY; T=0.K

Non-threshold reactions

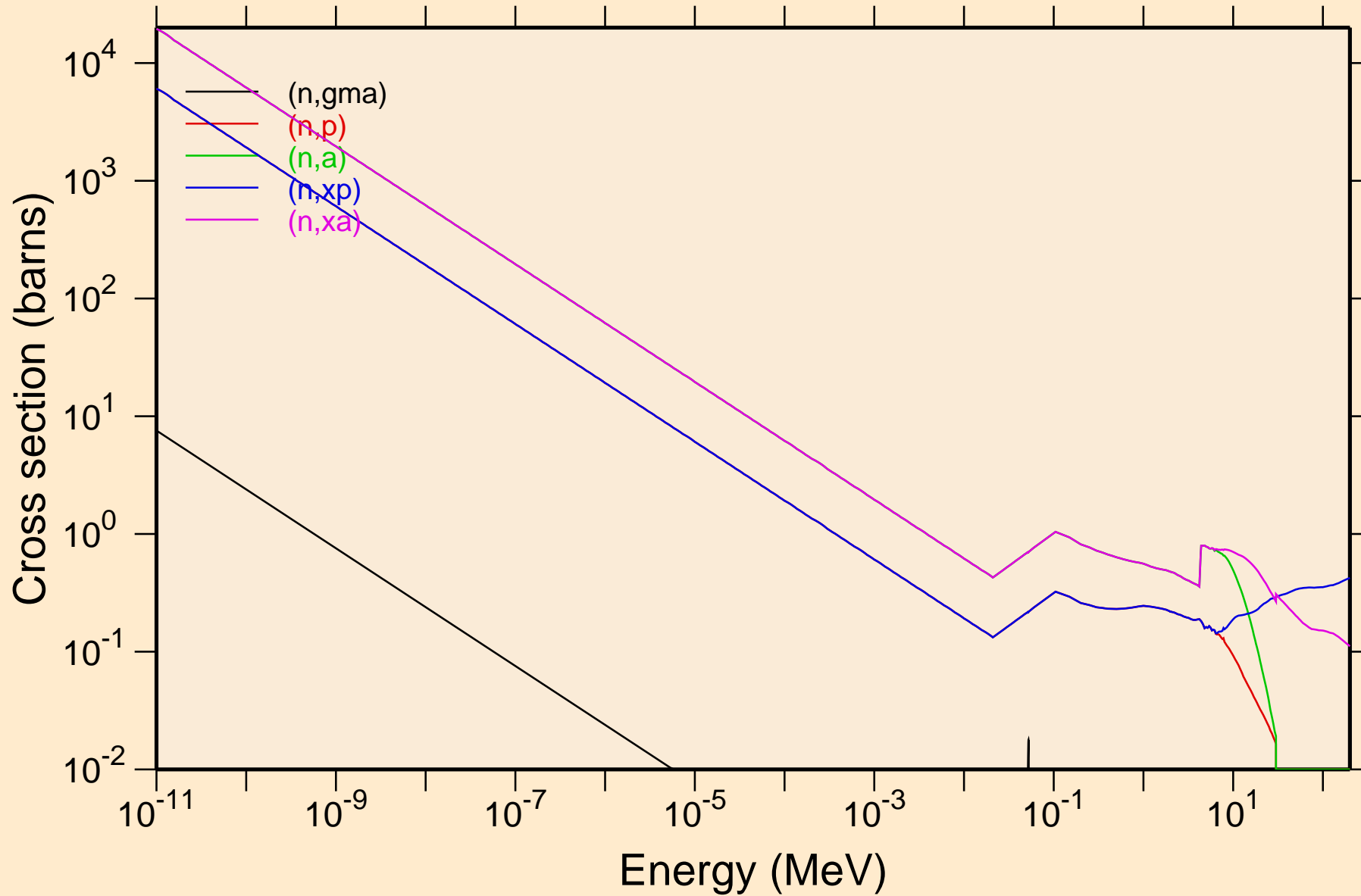

F018 NEUTRON ACER TENDL-2023 LIBRARY; T=0.K

Principal cross sections

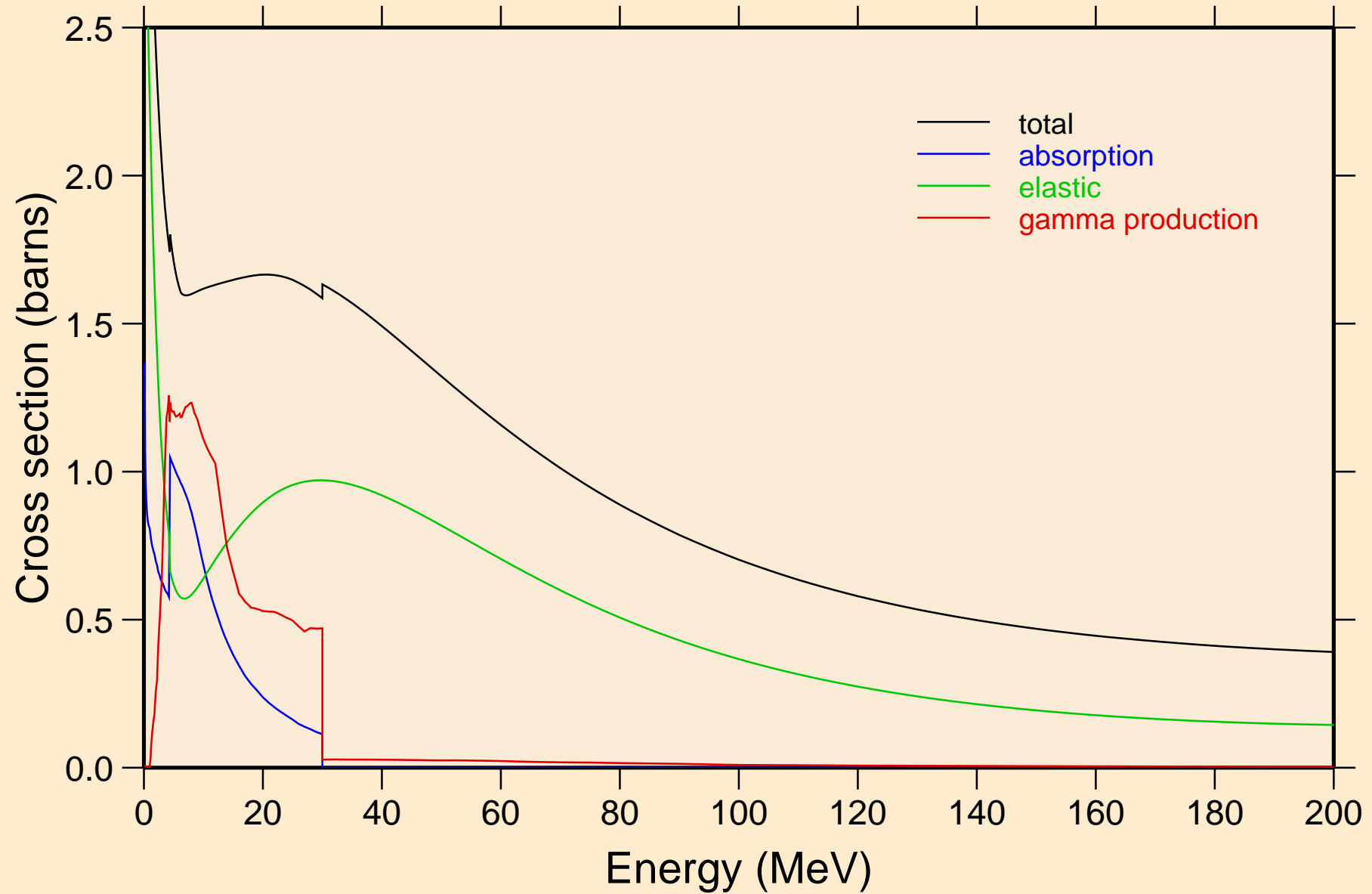

F018 NEUTRON ACER TENDL-2023 LIBRARY; T=0.K

Heating

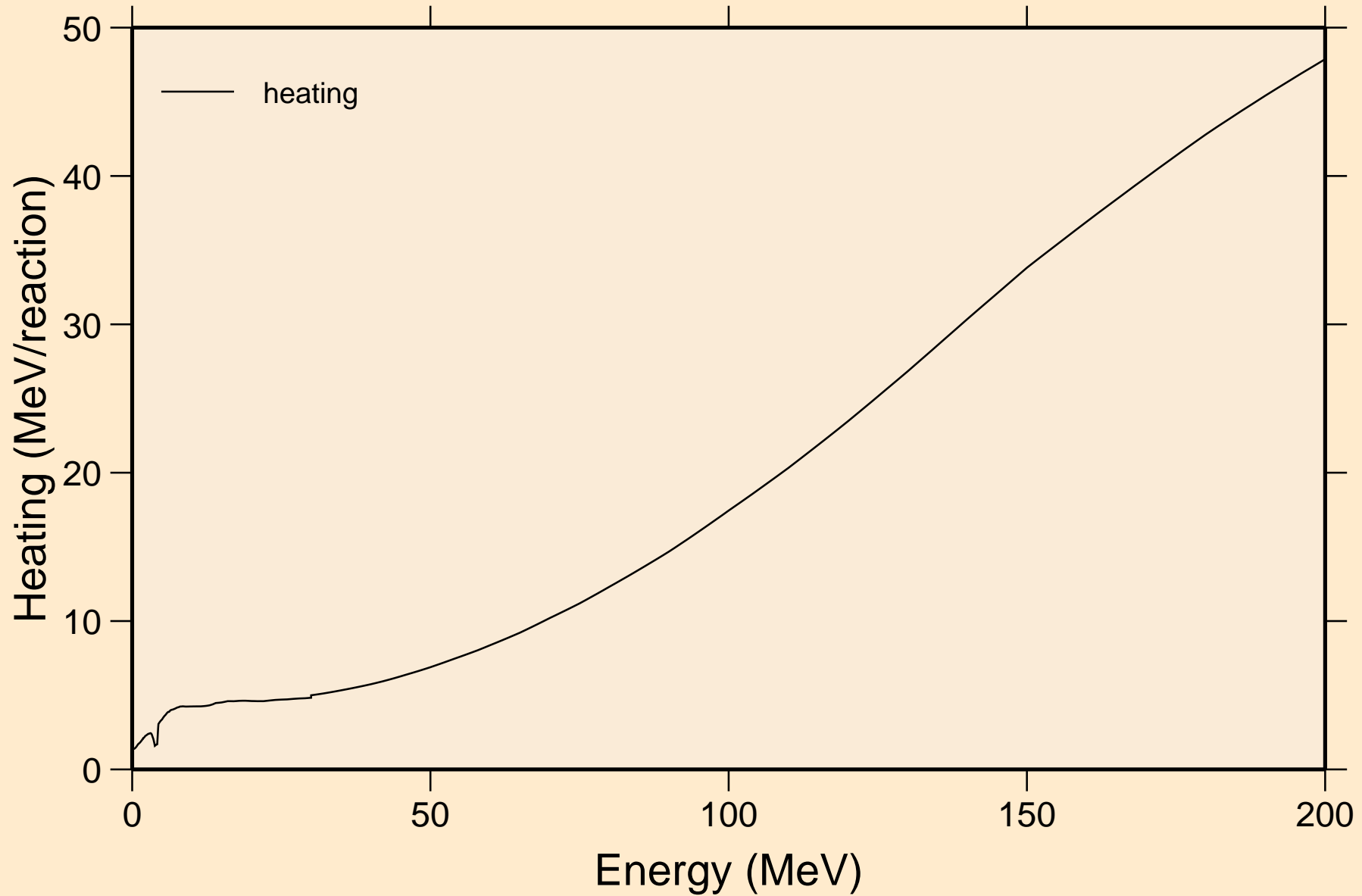

F018 NEUTRON ACER TENDL-2023 LIBRARY; T=0.K

Damage

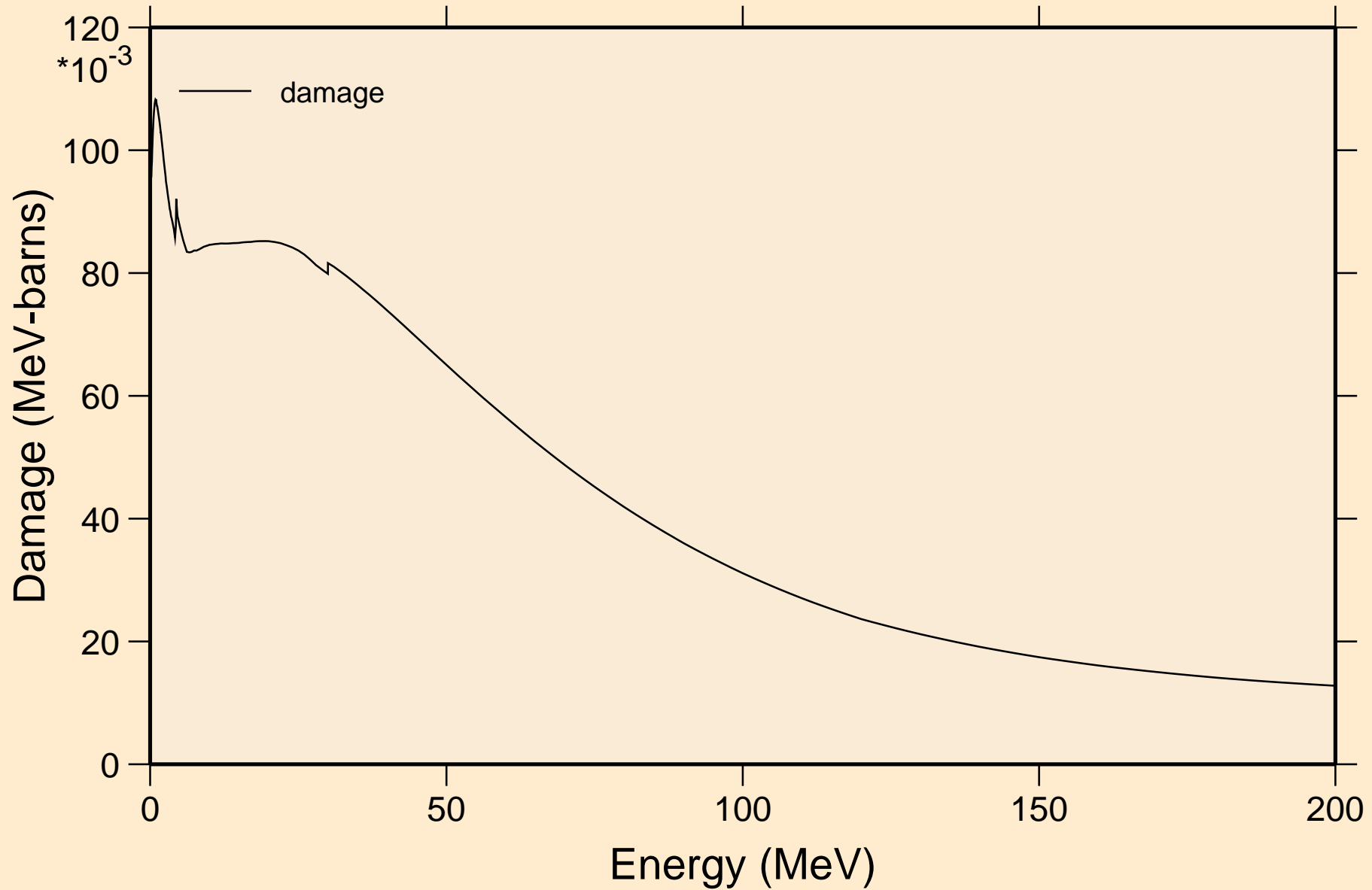

F018 NEUTRON ACER TENDL-2023 LIBRARY; T=0.K

Non-threshold reactions

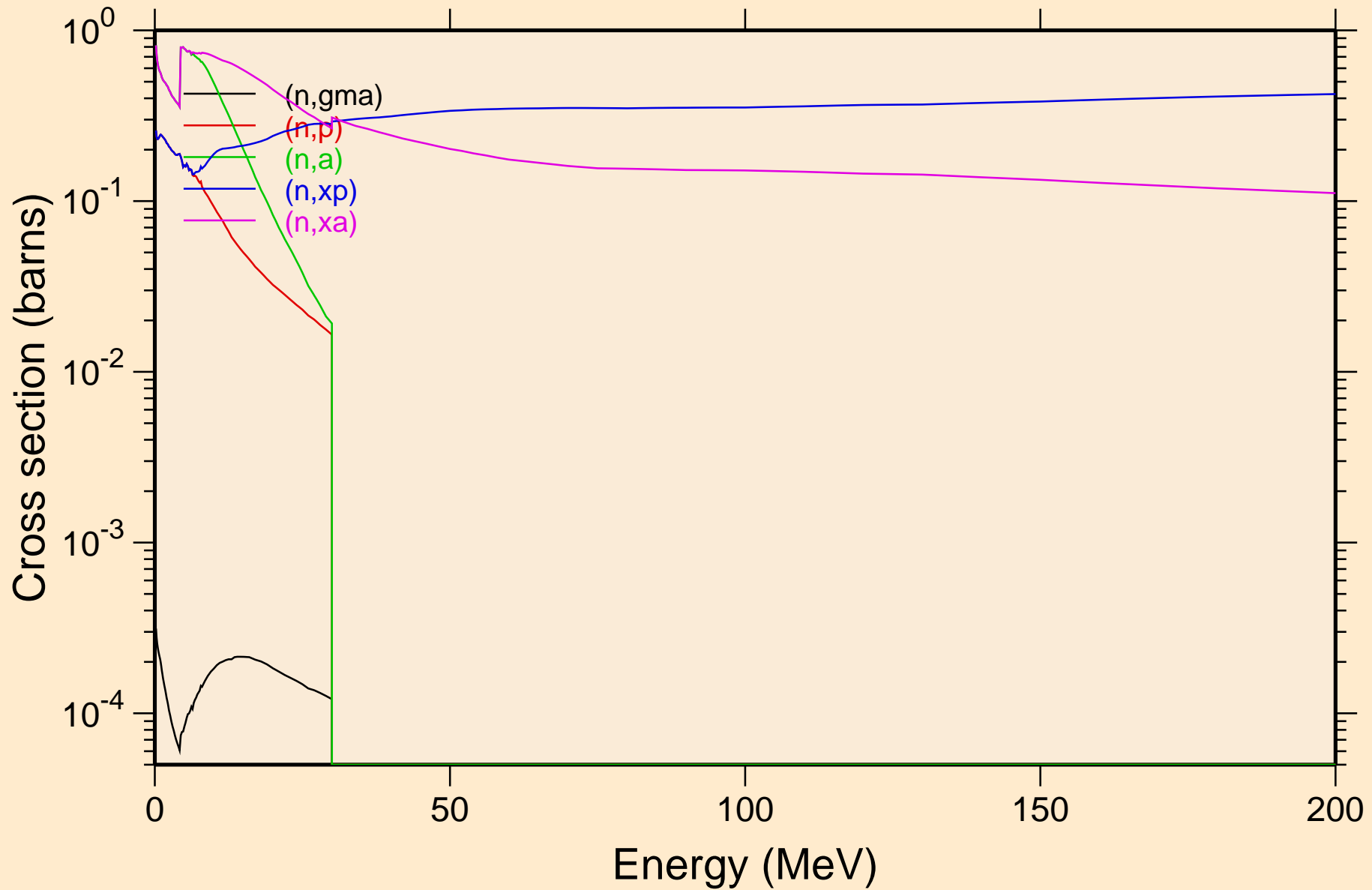

F018 NEUTRON ACER TENDL-2023 LIBRARY; T=0.K
Inelastic levels

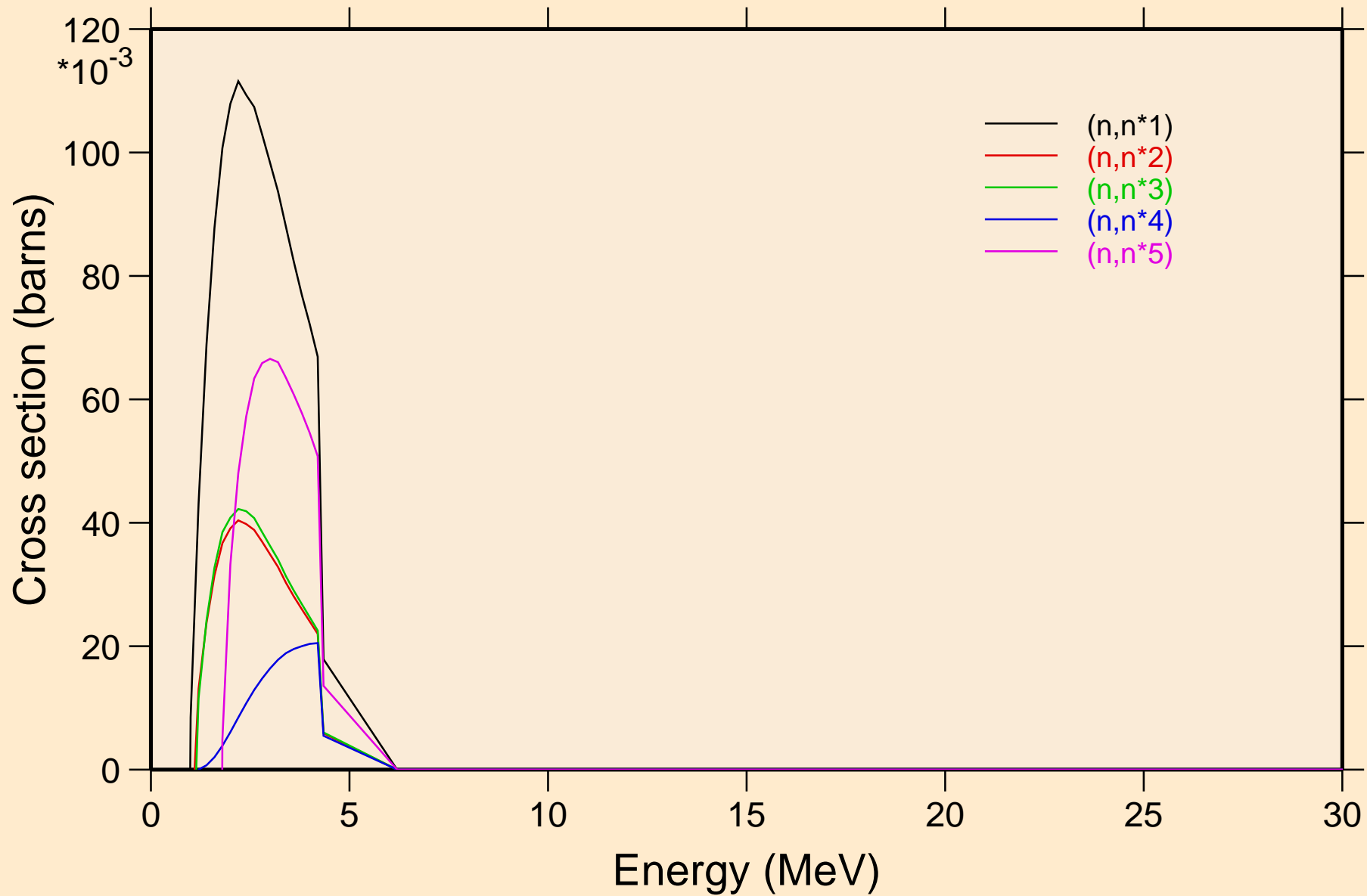

F018 NEUTRON ACER TENDL-2023 LIBRARY; T=0.K
Inelastic levels

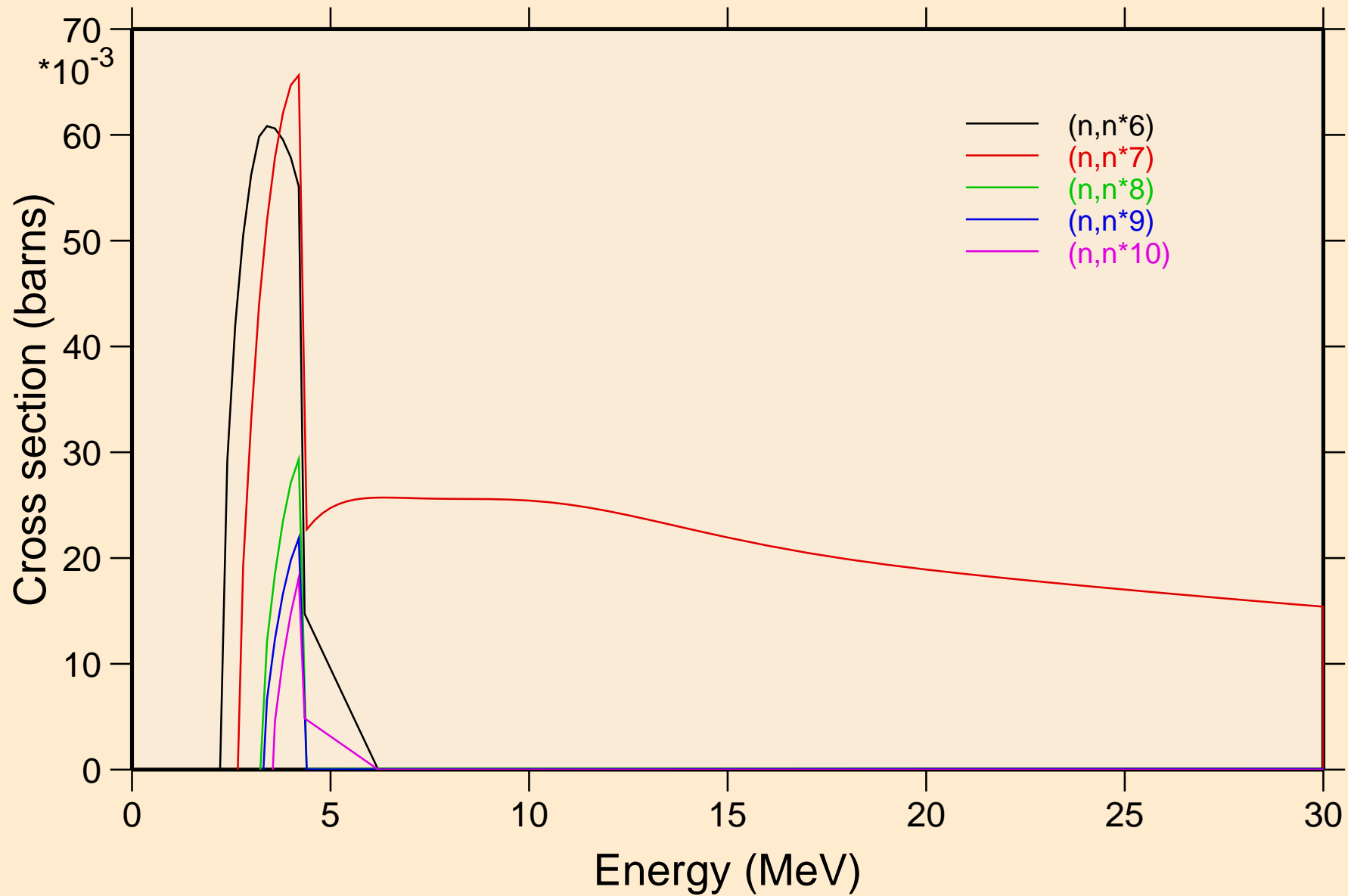

F018 NEUTRON ACER TENDL-2023 LIBRARY; T=0.K

Threshold reactions

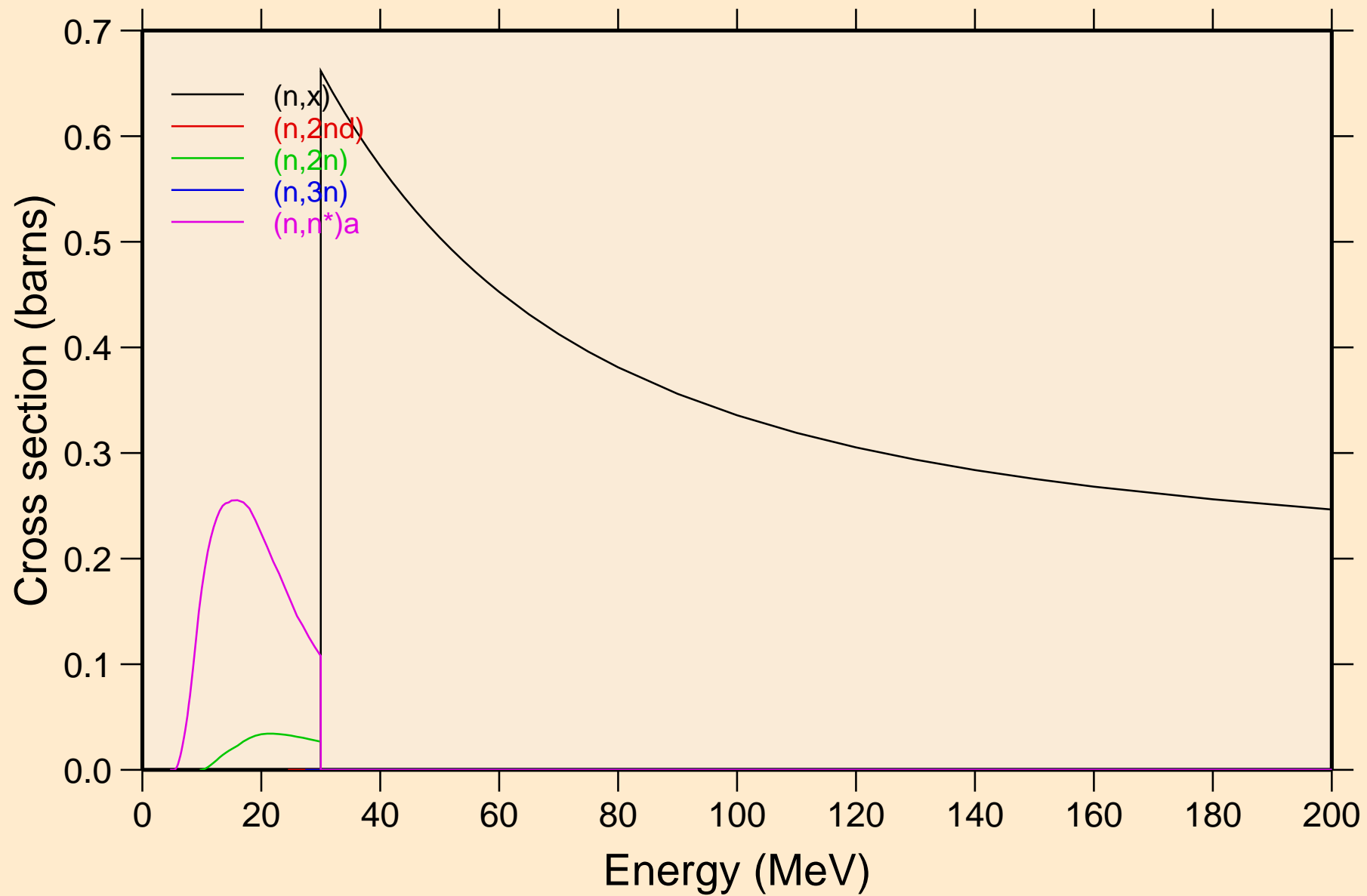

F018 NEUTRON ACER TENDL-2023 LIBRARY; T=0.K

Threshold reactions

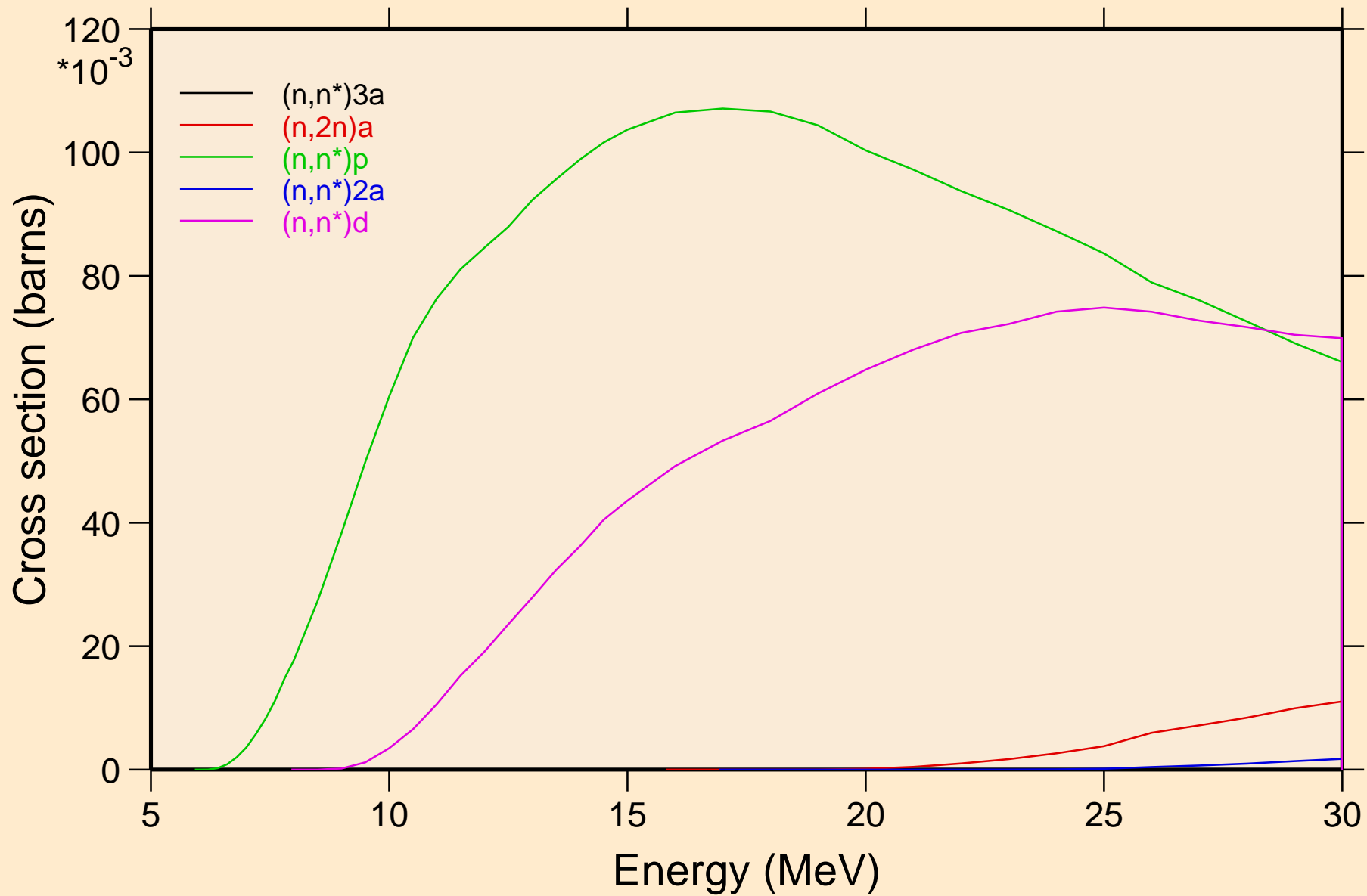

F018 NEUTRON ACER TENDL-2023 LIBRARY; T=0.K

Threshold reactions

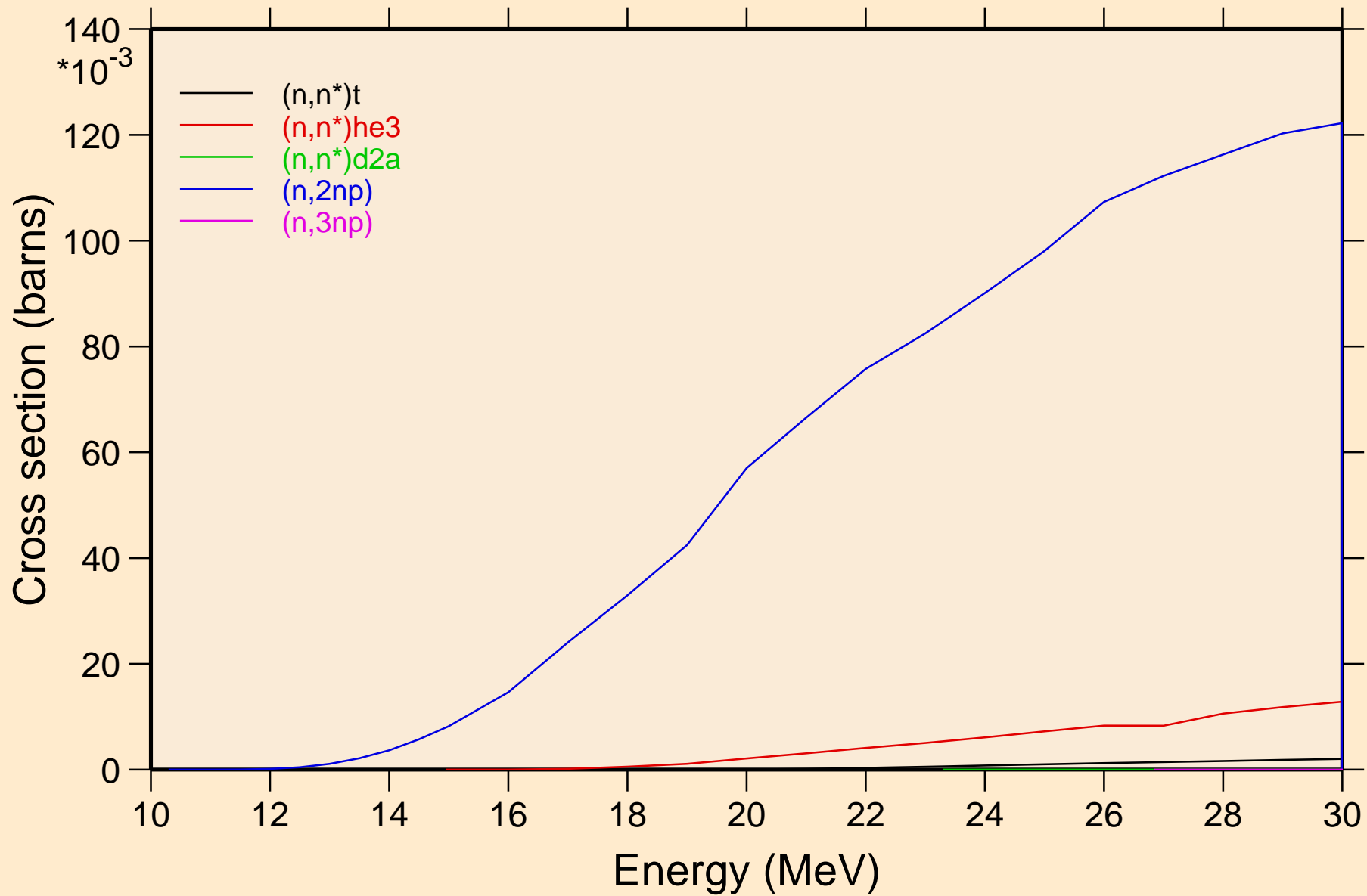

F018 NEUTRON ACER TENDL-2023 LIBRARY; T=0.K

Threshold reactions

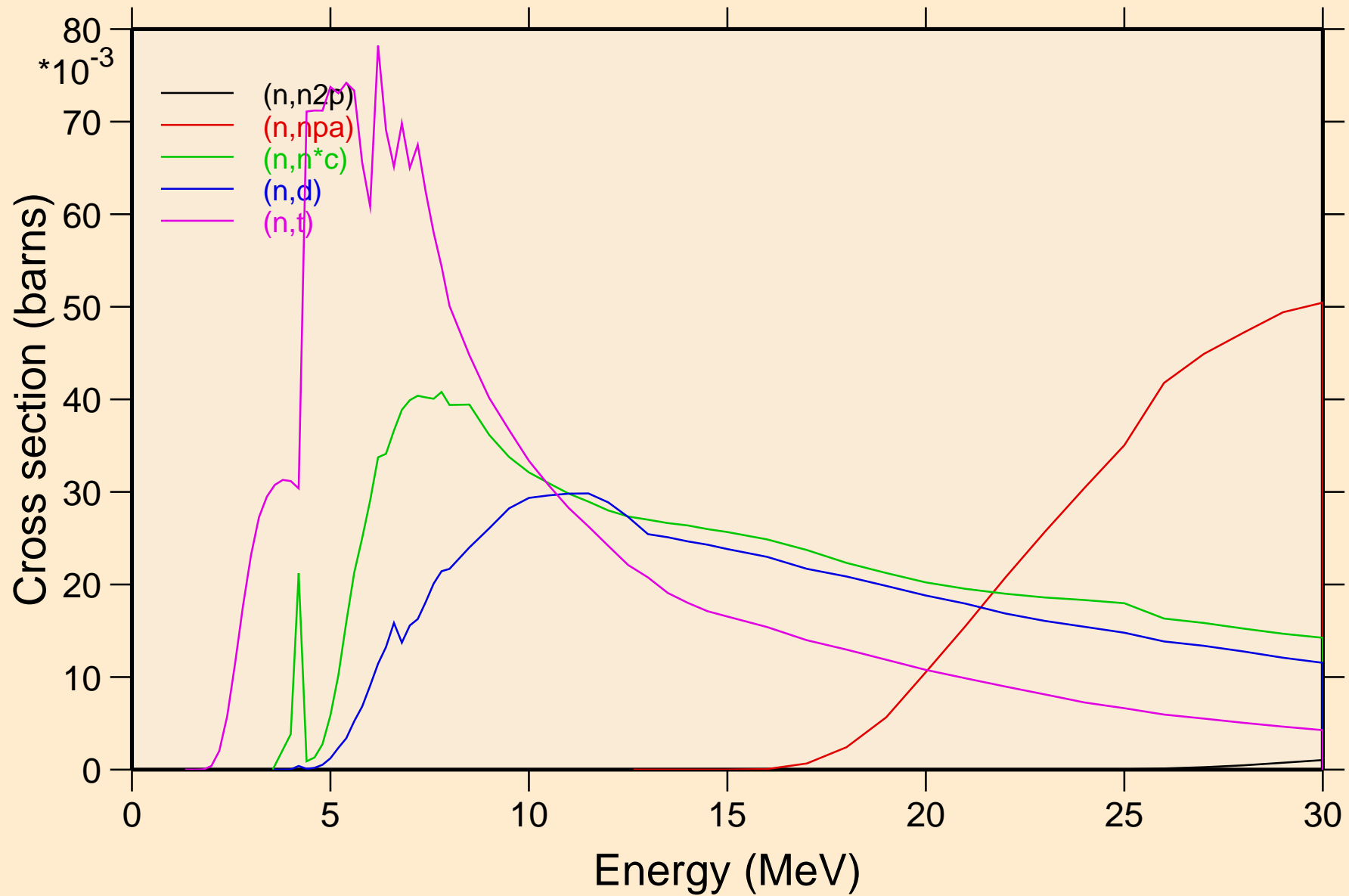

F018 NEUTRON ACER TENDL-2023 LIBRARY; T=0.K
Threshold reactions

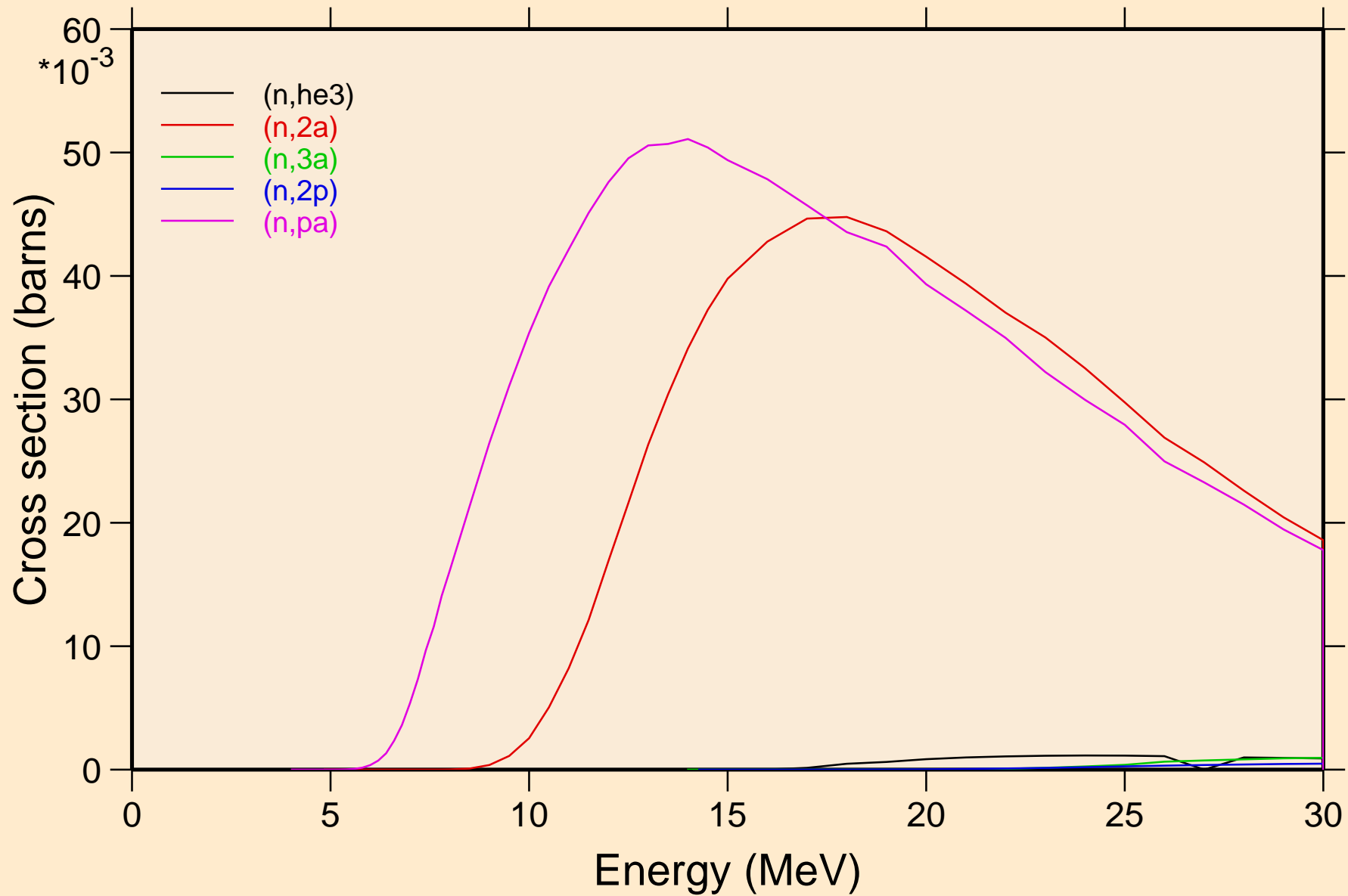

F018 NEUTRON ACER TENDL-2023 LIBRARY; T=0.K

Threshold reactions

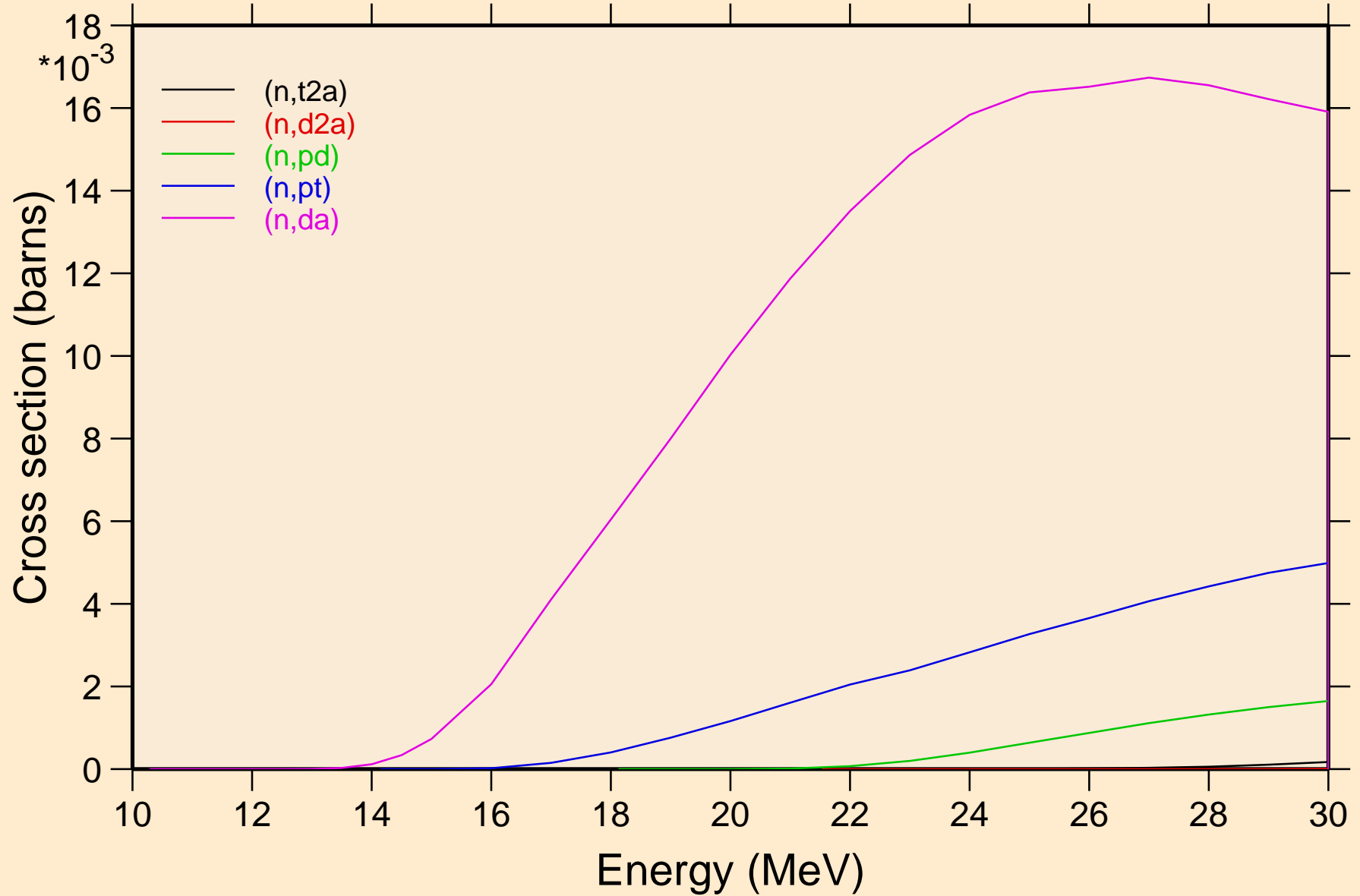

F018 NEUTRON ACER TENDL-2023 LIBRARY; T=0.K

Threshold reactions

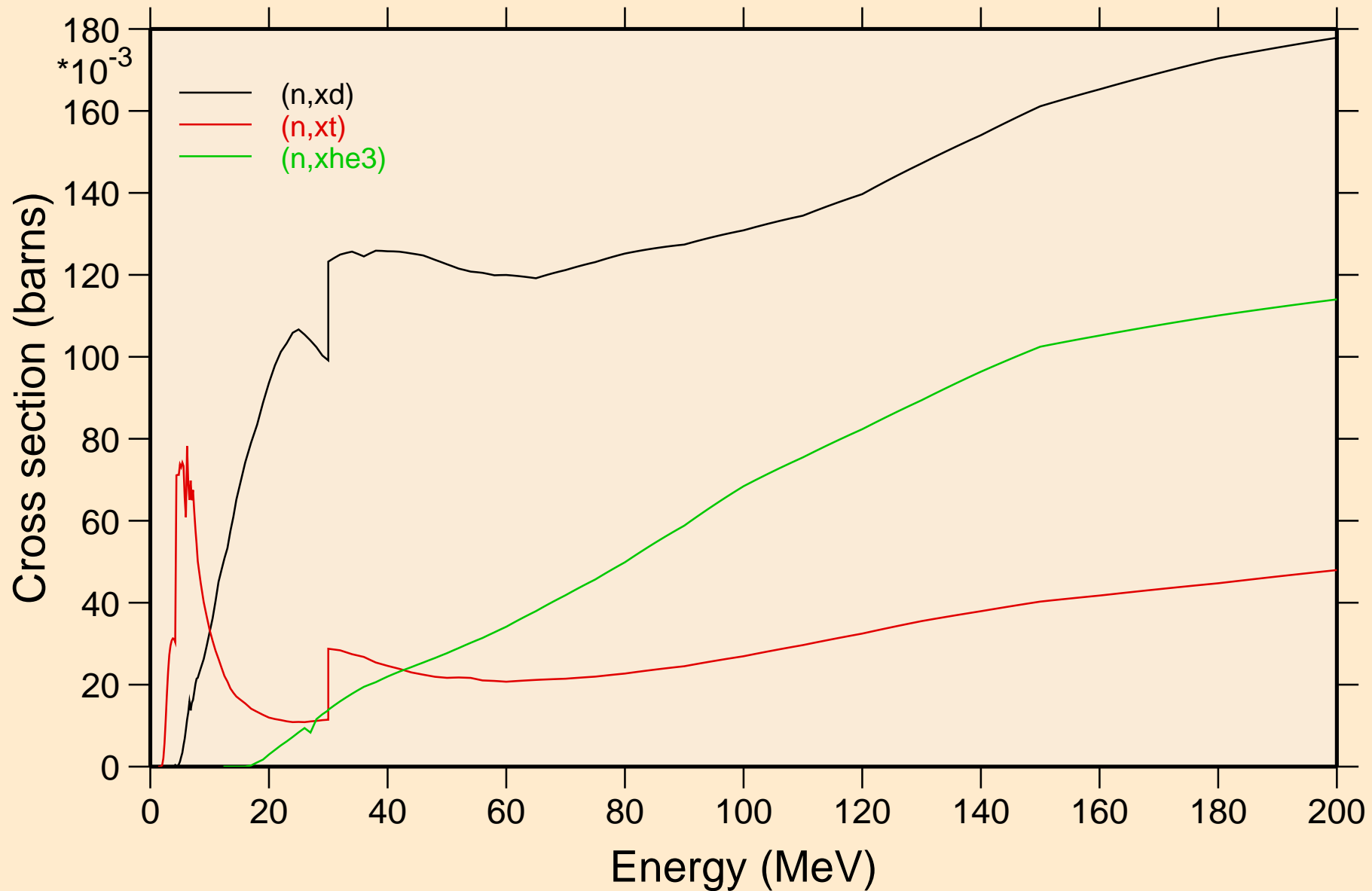

F018 NEUTRON ACER TENDL-2023 LIBRARY; T=0.K
angular distribution for elastic

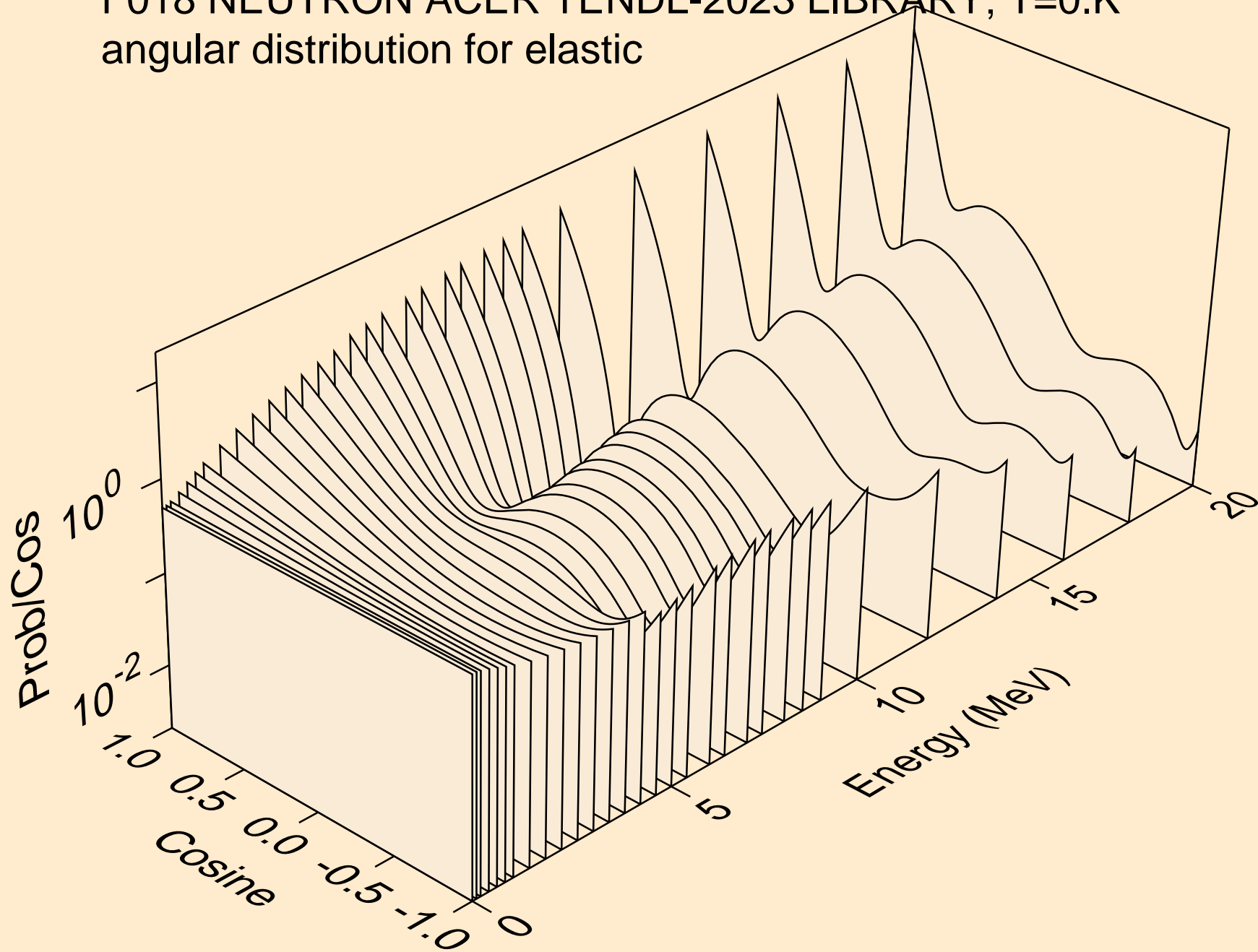

F018 NEUTRON ACER TENDL-2023 LIBRARY; T=0.K
angular distribution for elastic

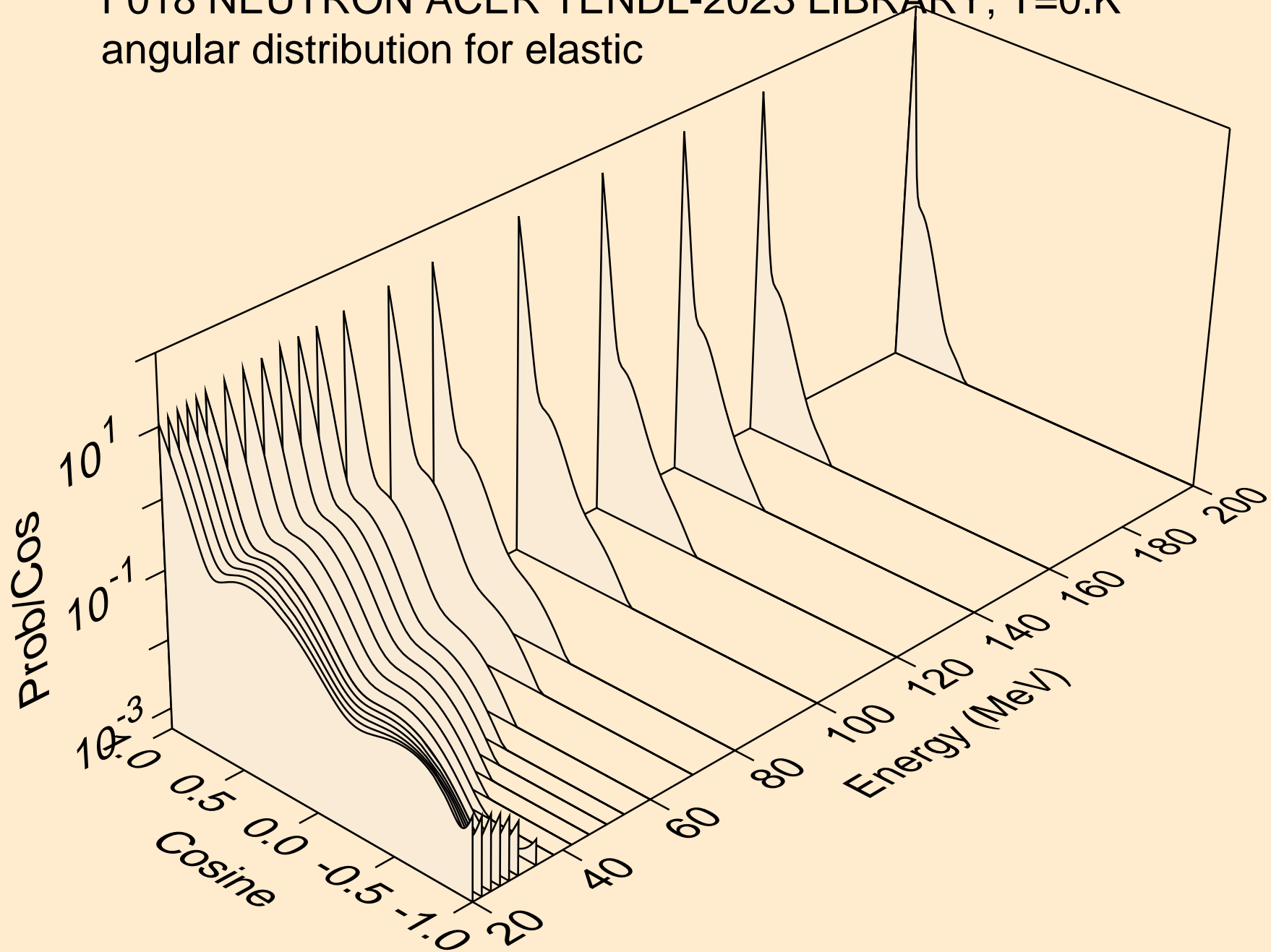

F018 NEUTRON ACER TENDL-2023 LIBRARY; T=0.K
angular distribution for (n,n*1)

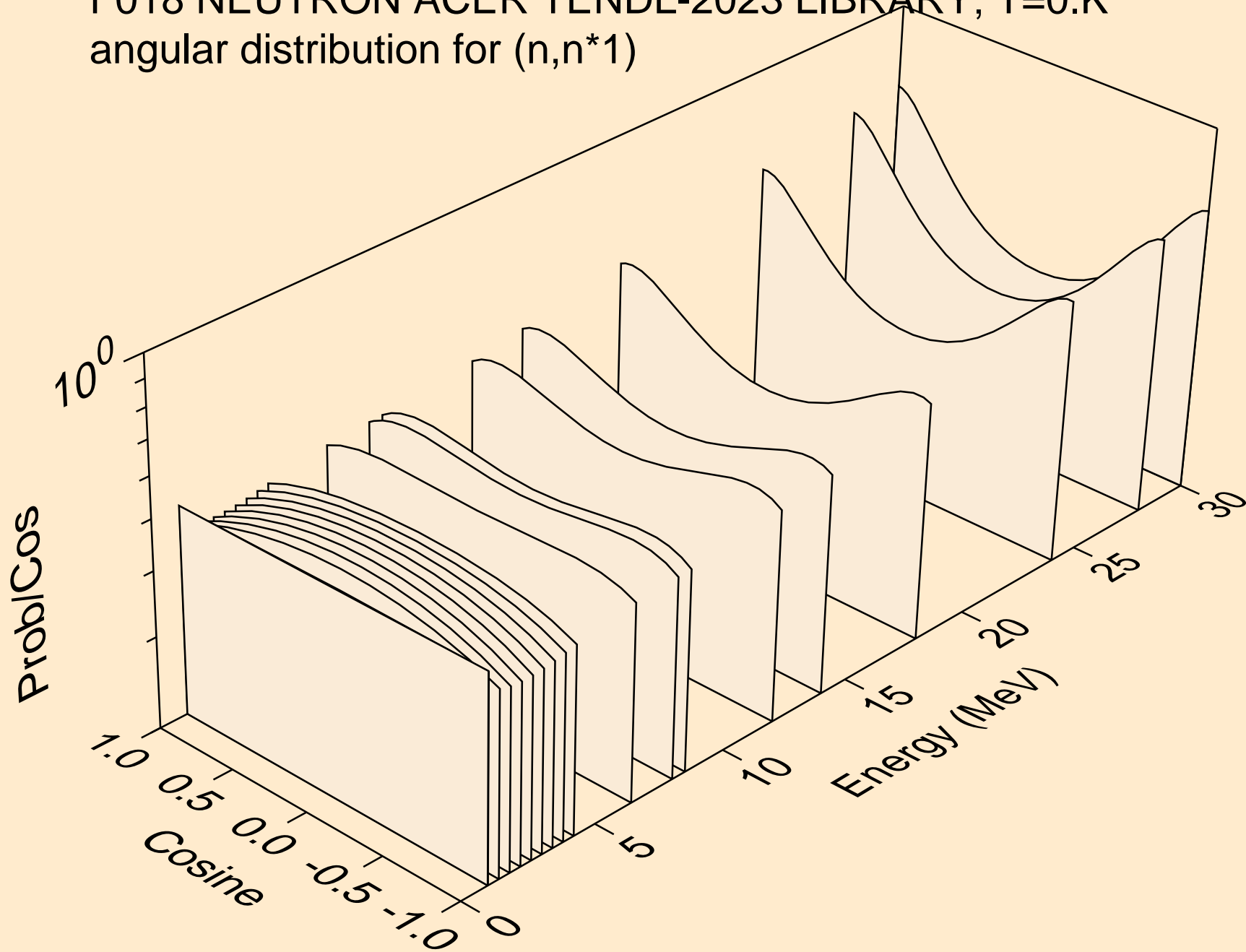

F018 NEUTRON ACER TENDL-2023 LIBRARY; T=0.K
angular distribution for (n,n*2)

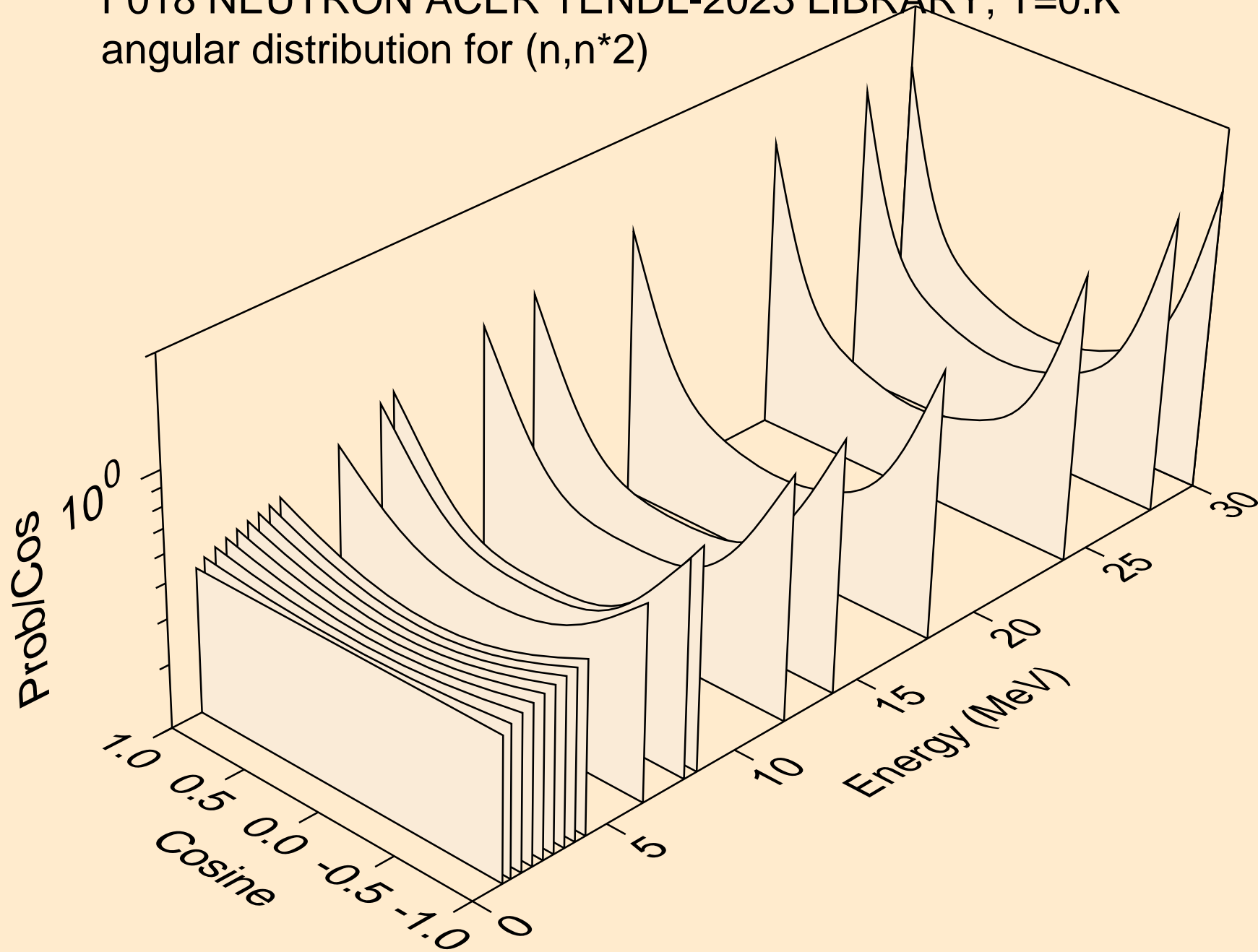

F018 NEUTRON ACER TENDL-2023 LIBRARY; T=0.K
angular distribution for (n,n*3)

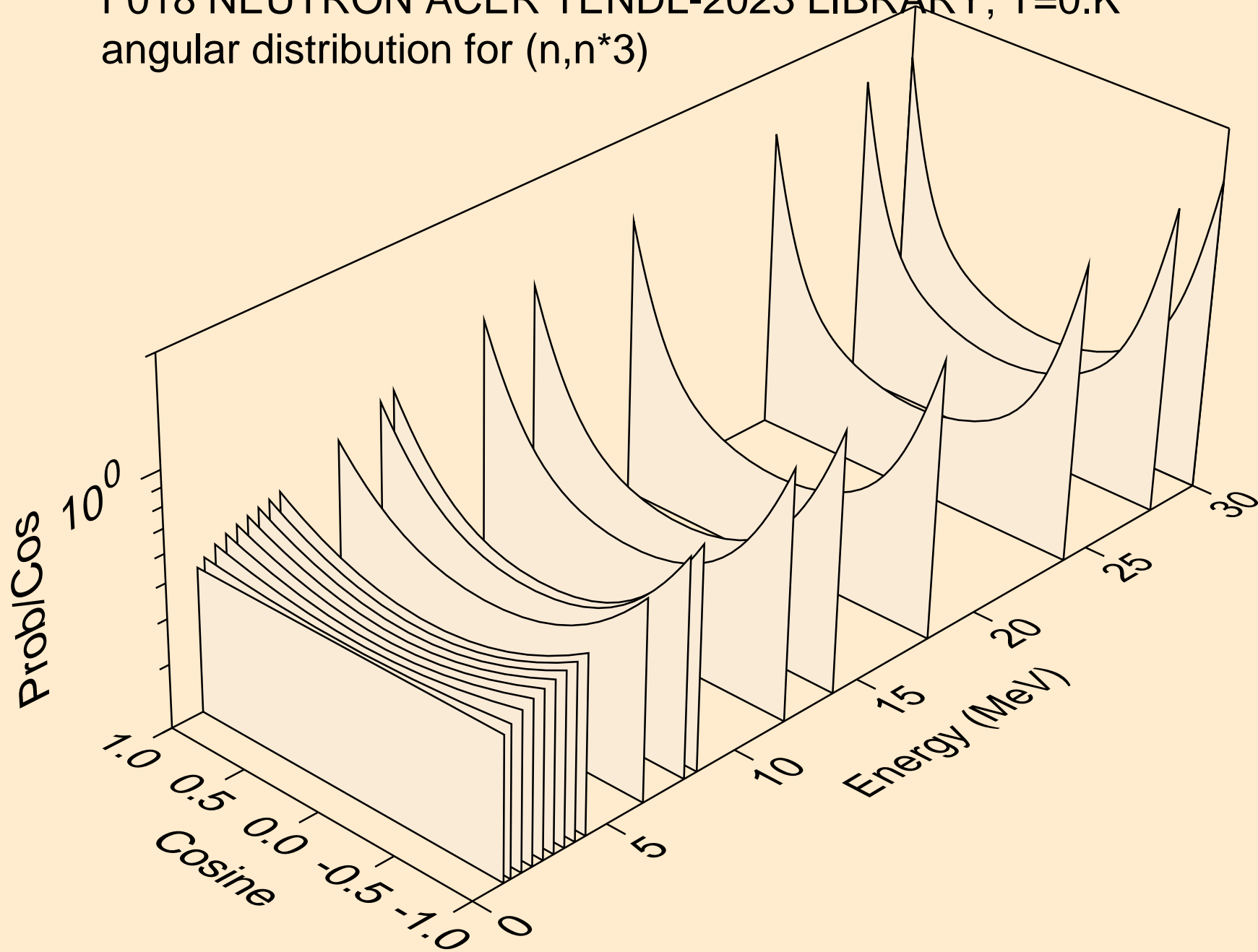

F018 NEUTRON ACER TENDL-2023 LIBRARY; T=0.K
angular distribution for (n,n*4)

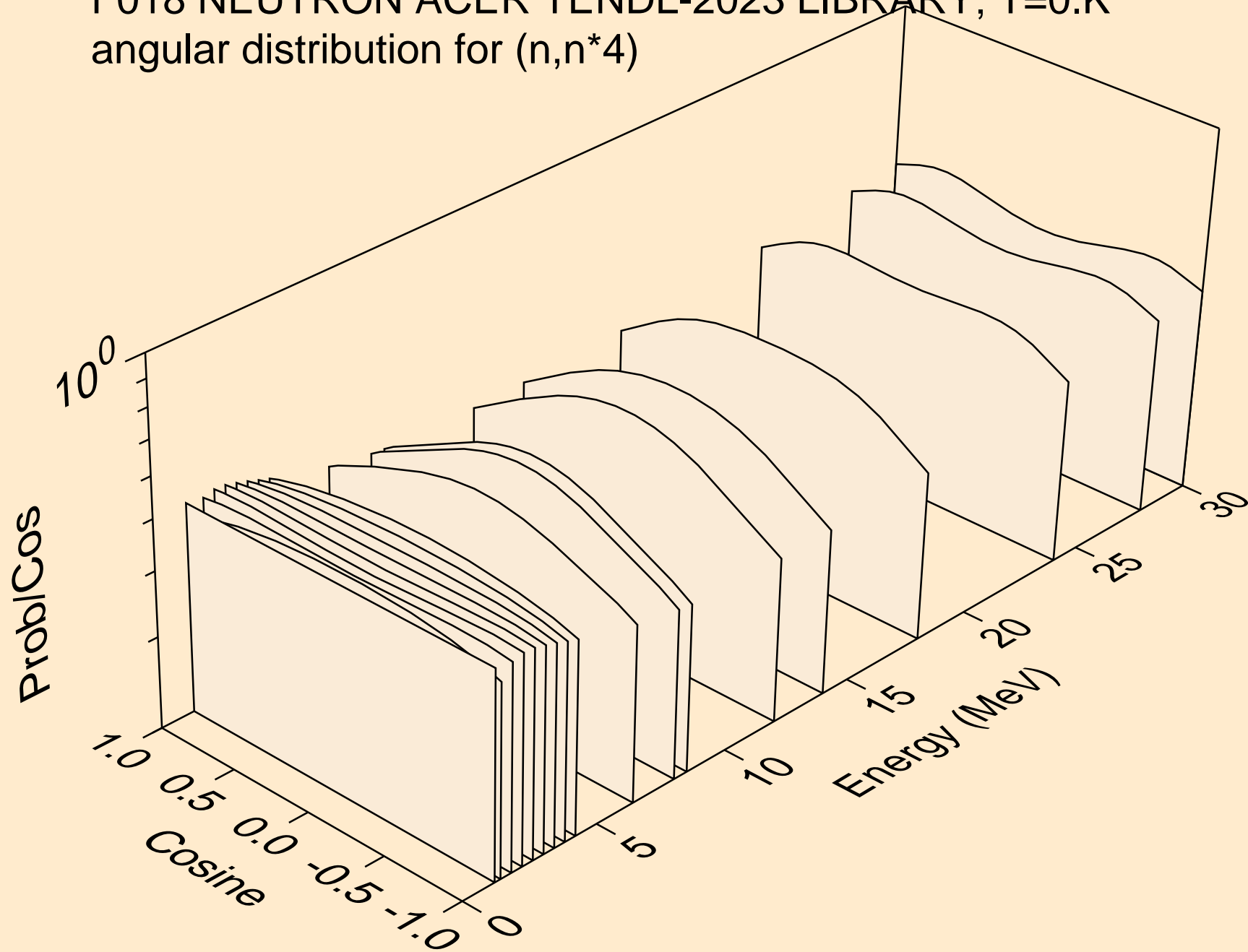

F018 NEUTRON ACER TENDL-2023 LIBRARY; T=0.K
angular distribution for (n,n*5)

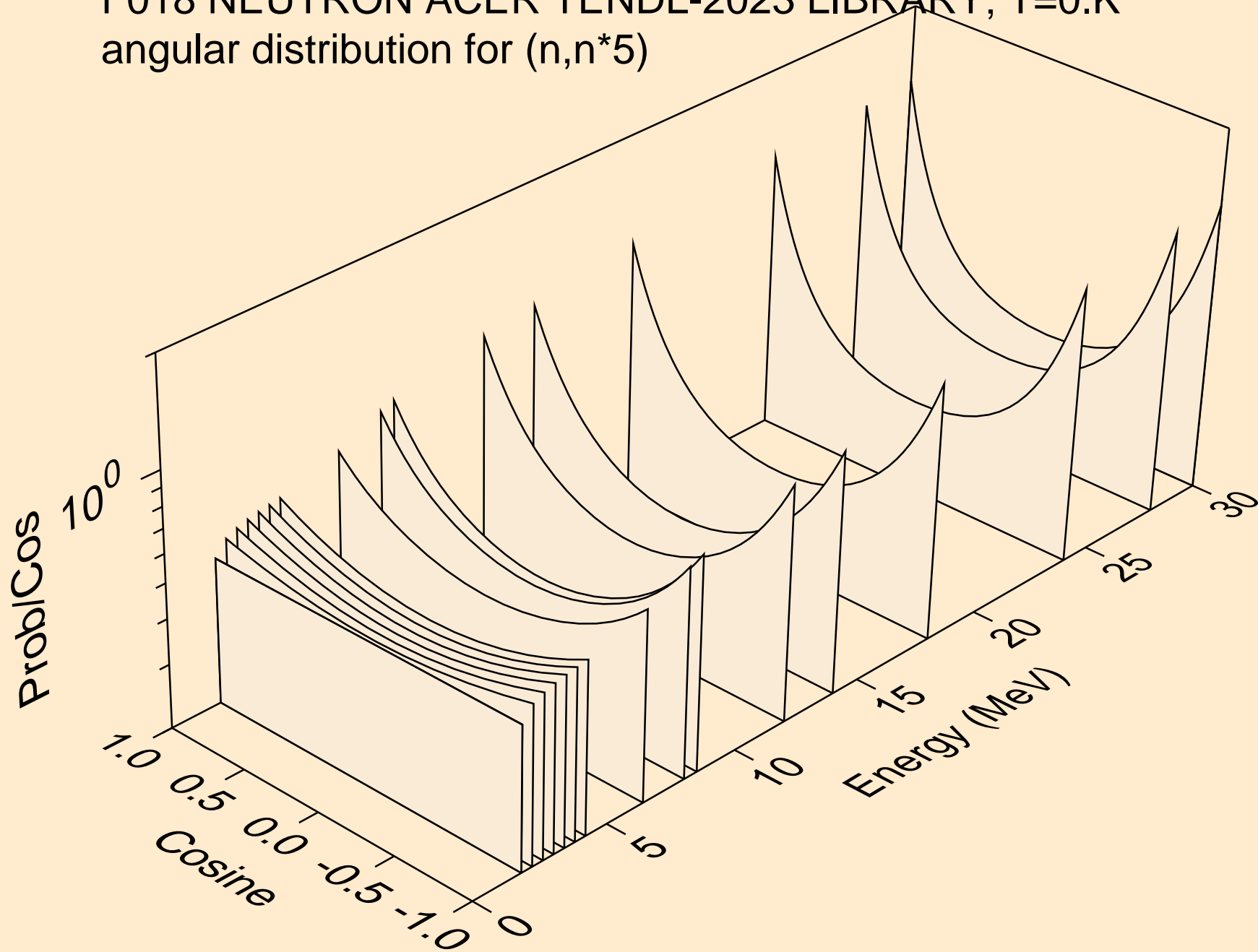

F018 NEUTRON ACER TENDL-2023 LIBRARY; T=0.K
angular distribution for (n,n*6)

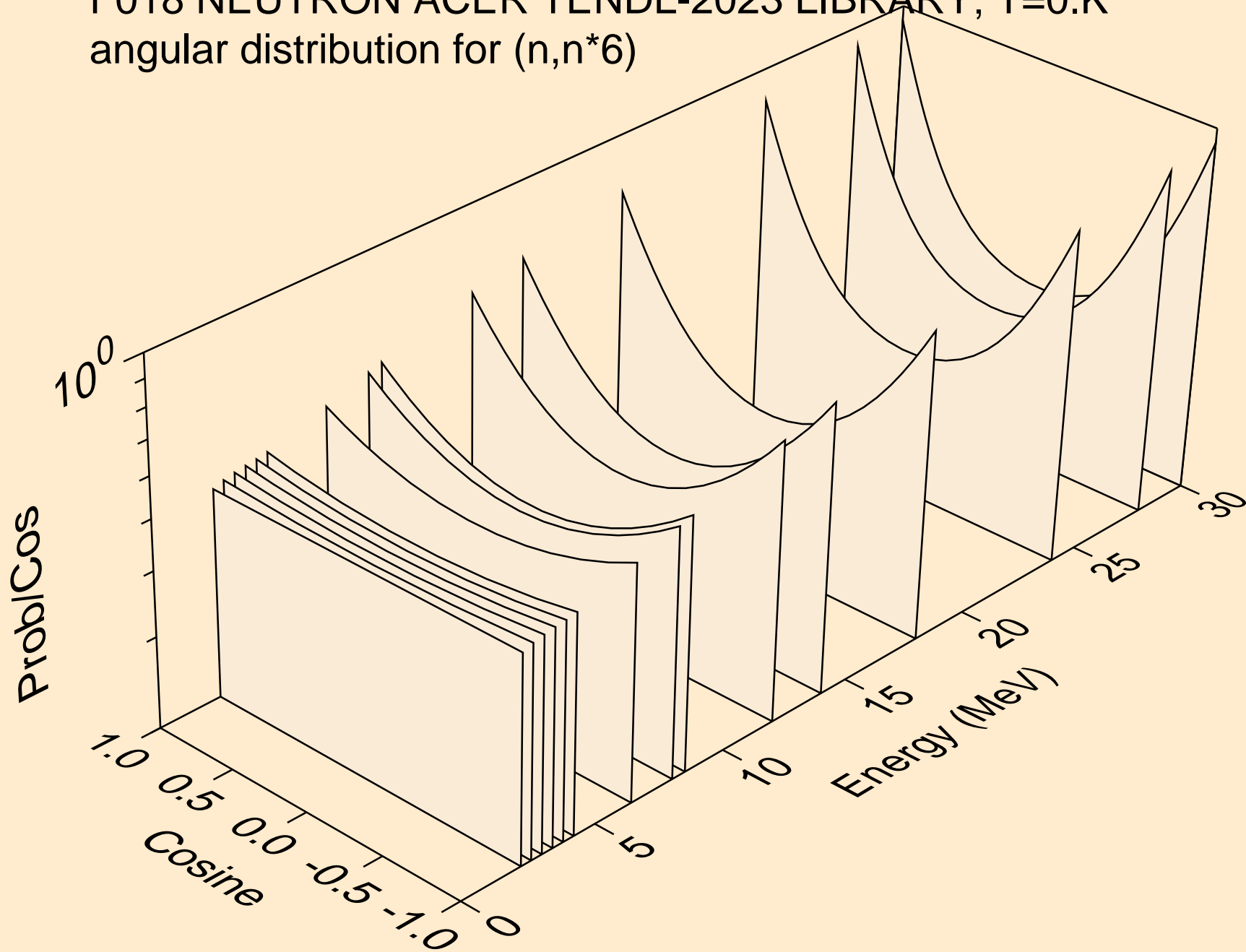

F018 NEUTRON ACER TENDL-2023 LIBRARY; T=0.K
angular distribution for (n,n*7)

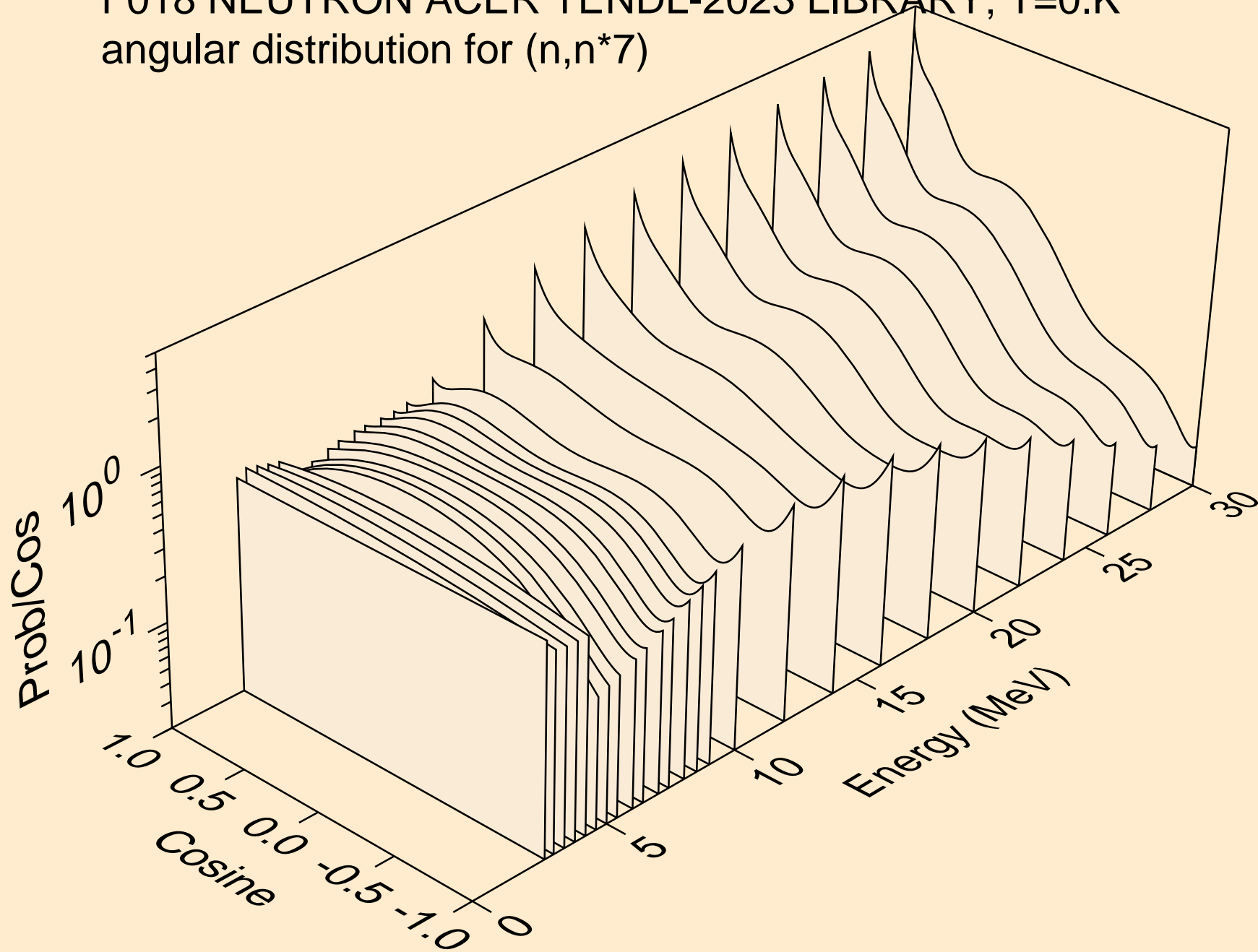

F018 NEUTRON ACER TENDL-2023 LIBRARY; T=0.K
angular distribution for (n,n*8)

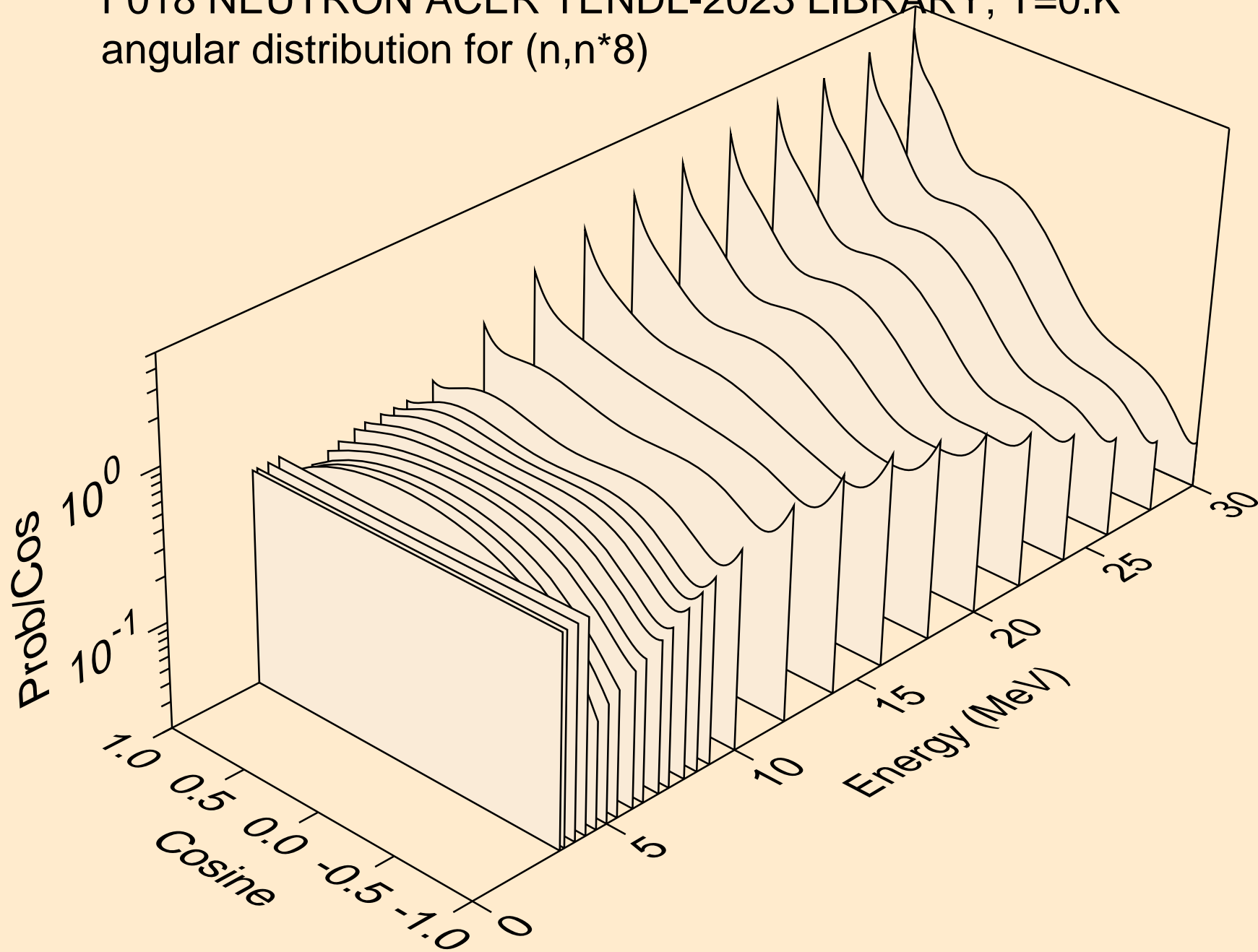

F018 NEUTRON ACER TENDL-2023 LIBRARY; T=0.K
angular distribution for (n,n*9)

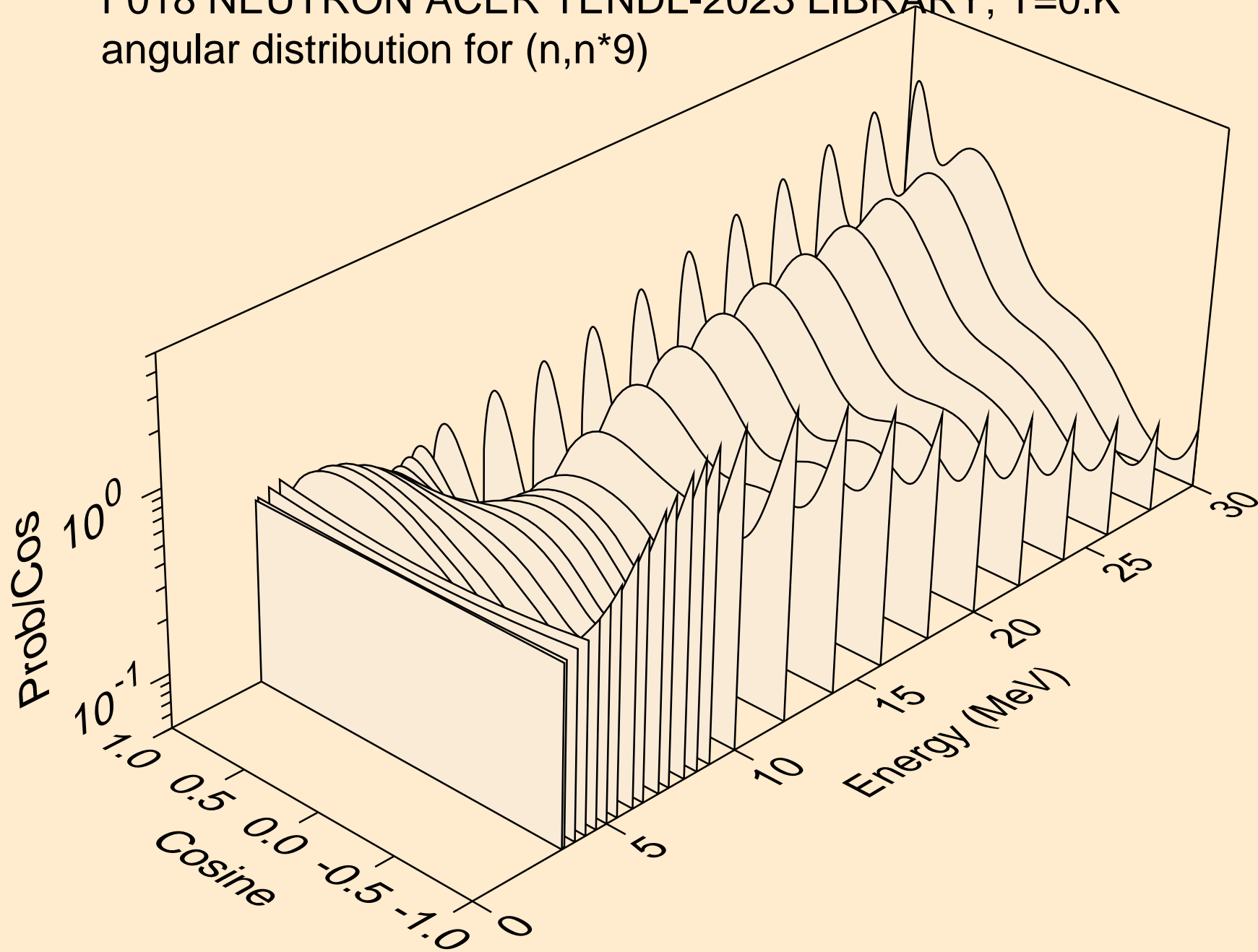

F018 NEUTRON ACER TENDL-2023 LIBRARY; T=0.K
angular distribution for (n,n*10)

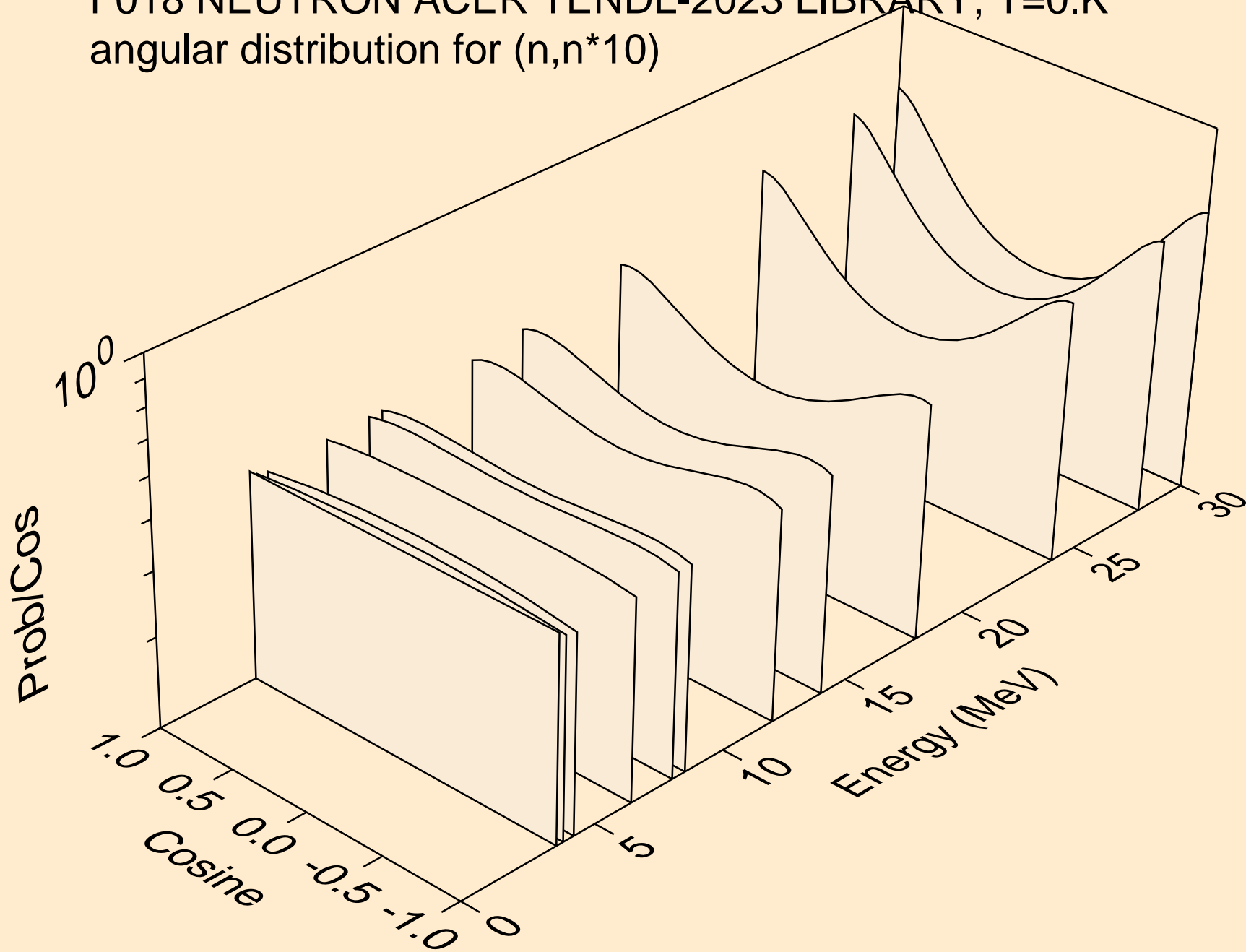

F018 NEUTRON ACER TENDL-2023 LIBRARY; T=0.K
Neutron emission for (n,x)

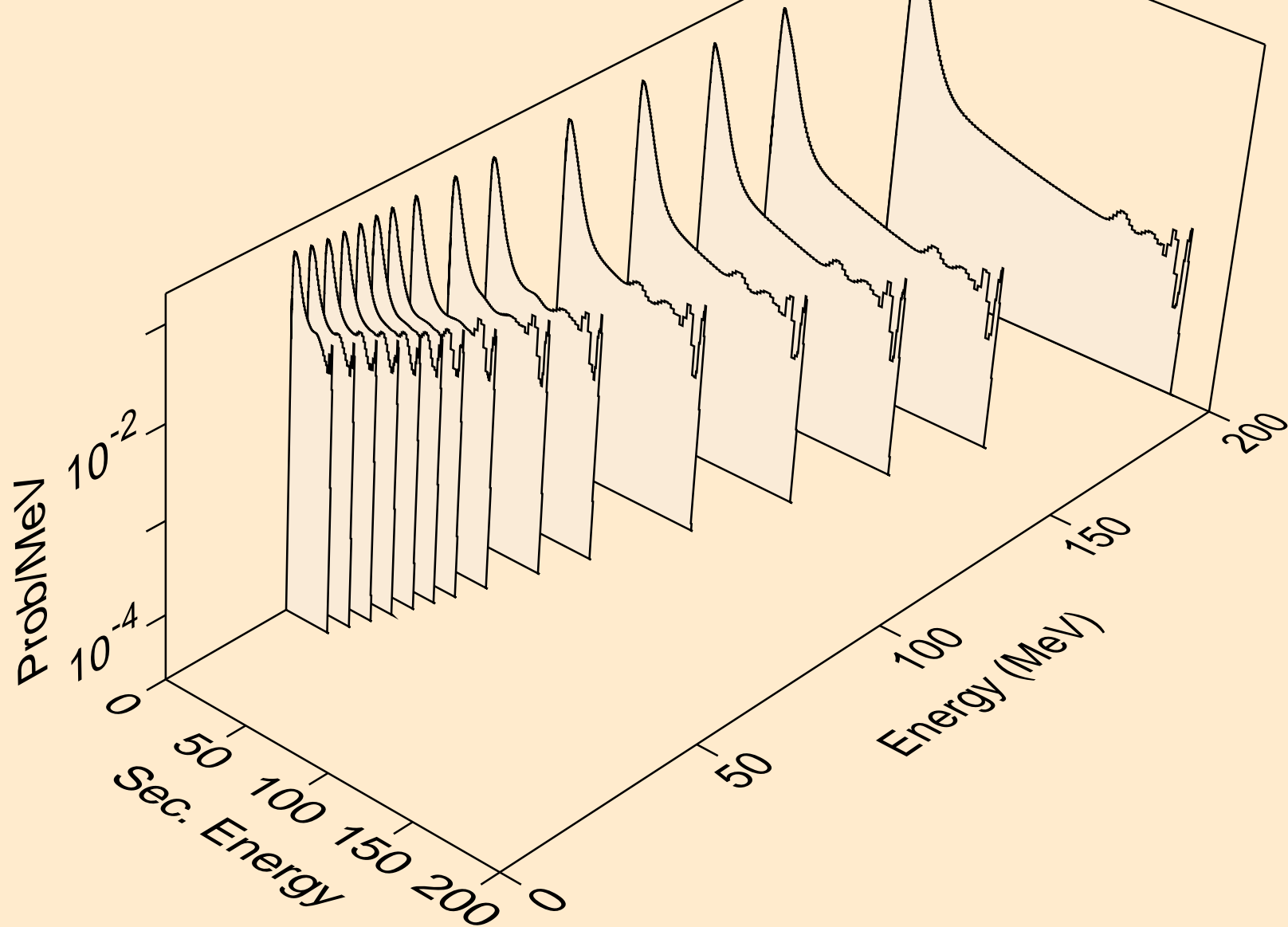

F018 NEUTRON ACER TENDL-2023 LIBRARY; T=0.K
Neutron emission for (n,2nd)

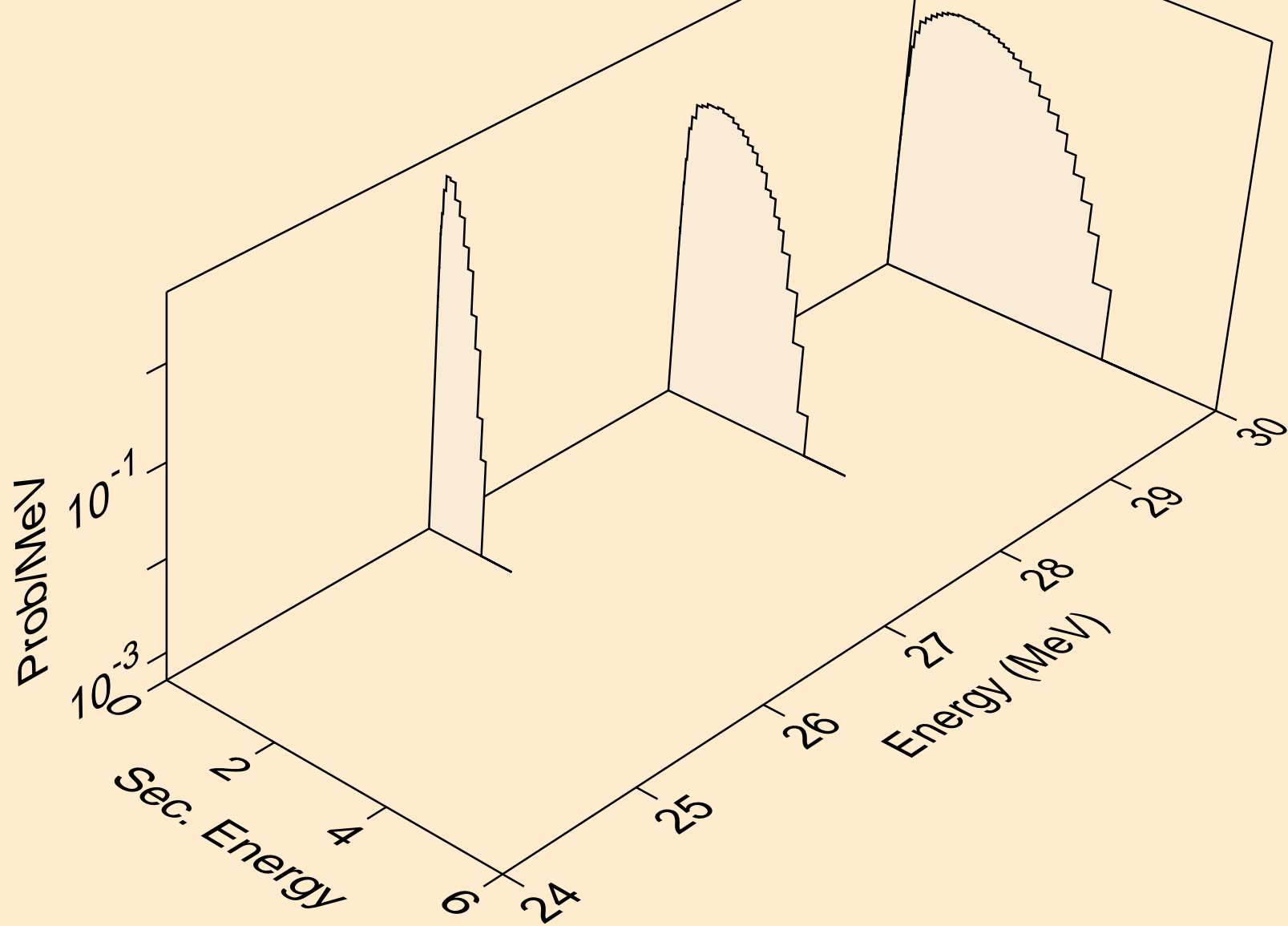

F018 NEUTRON ACER TENDL-2023 LIBRARY; T=0.K
Neutron emission for (n,2n)

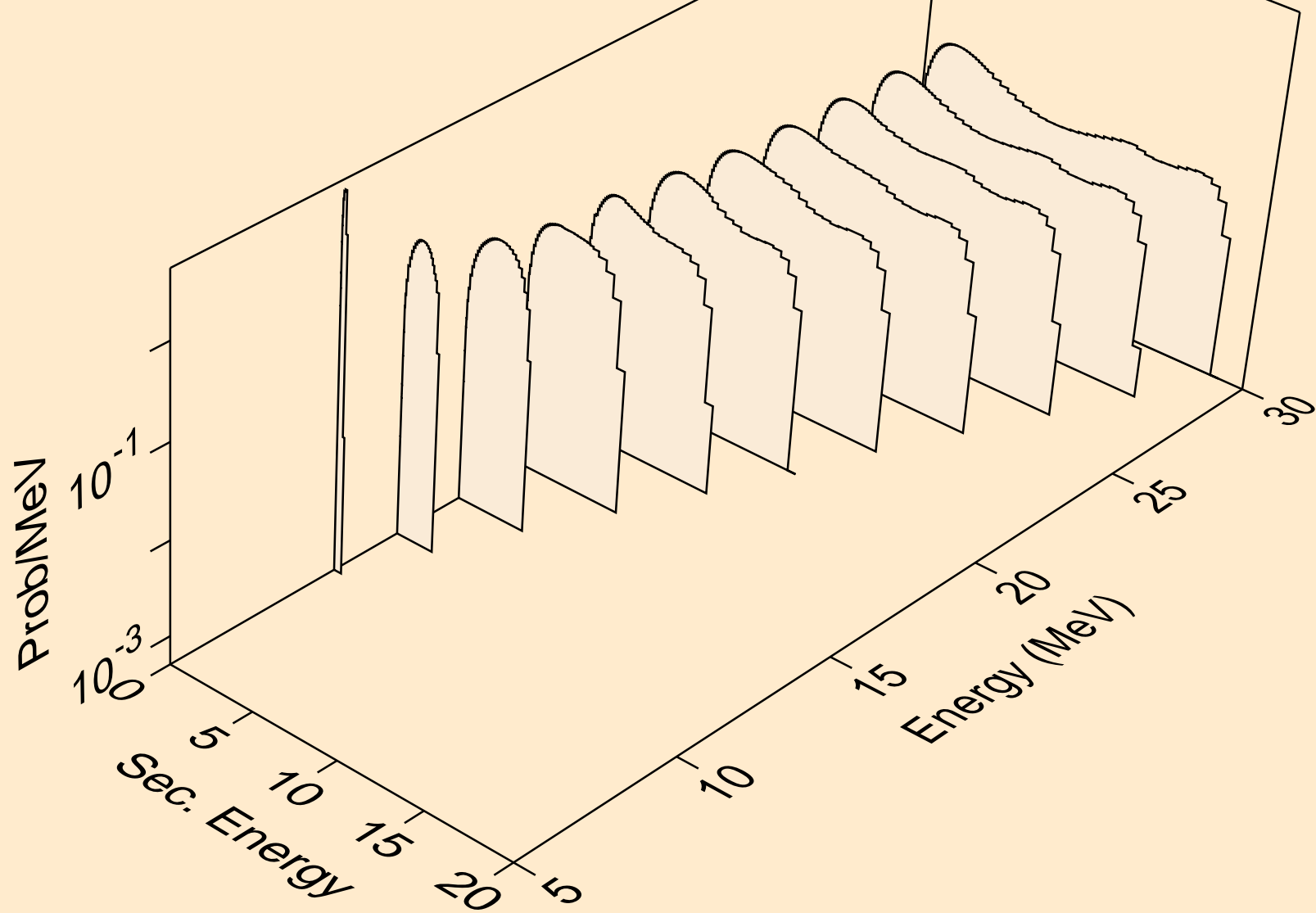

F018 NEUTRON ACER TENDL-2023 LIBRARY; T=0.K
Neutron emission for (n,3n)

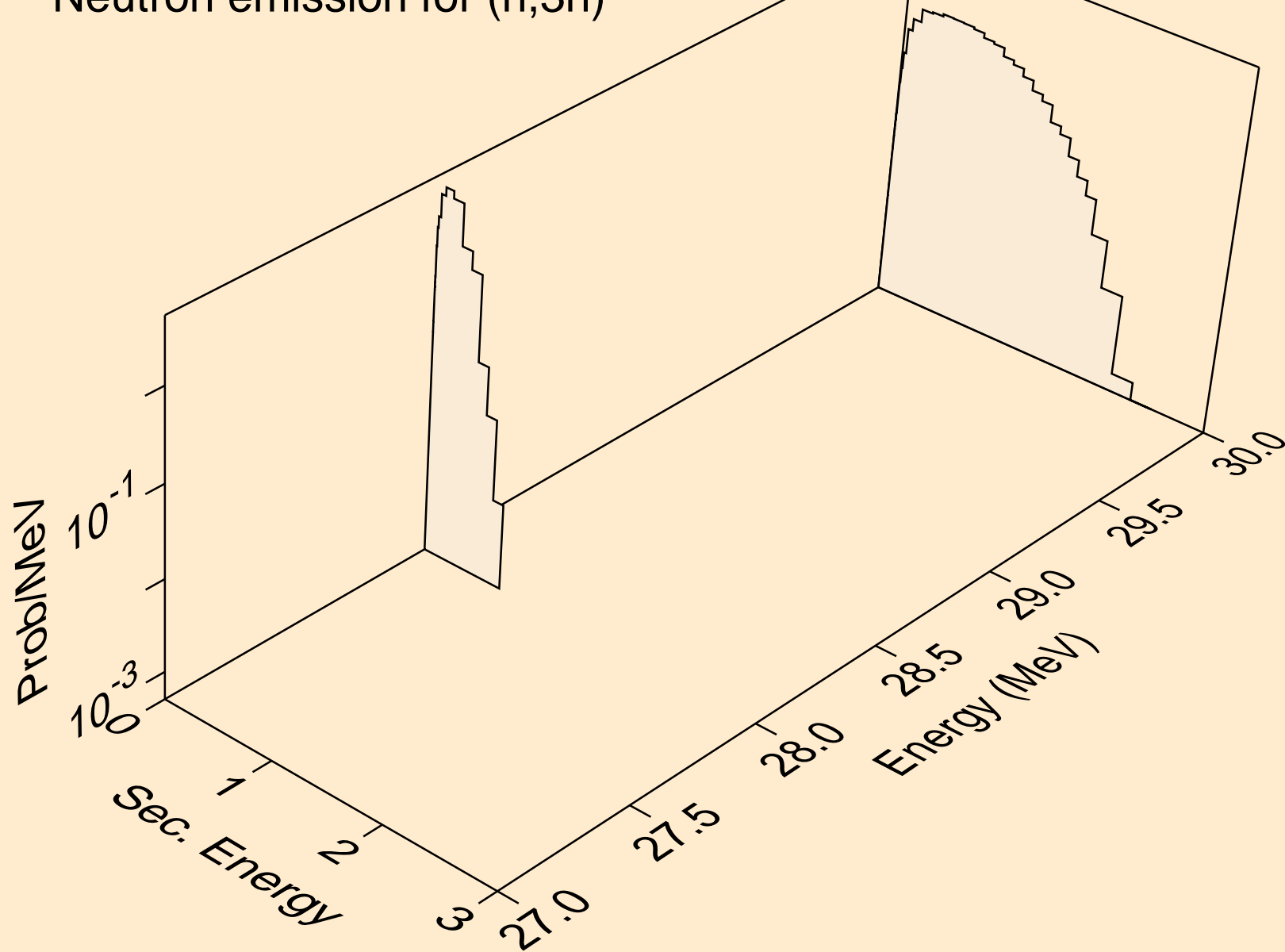

F018 NEUTRON ACER TENDL-2023 LIBRARY; T=0.K
Neutron emission for (n,n*)a

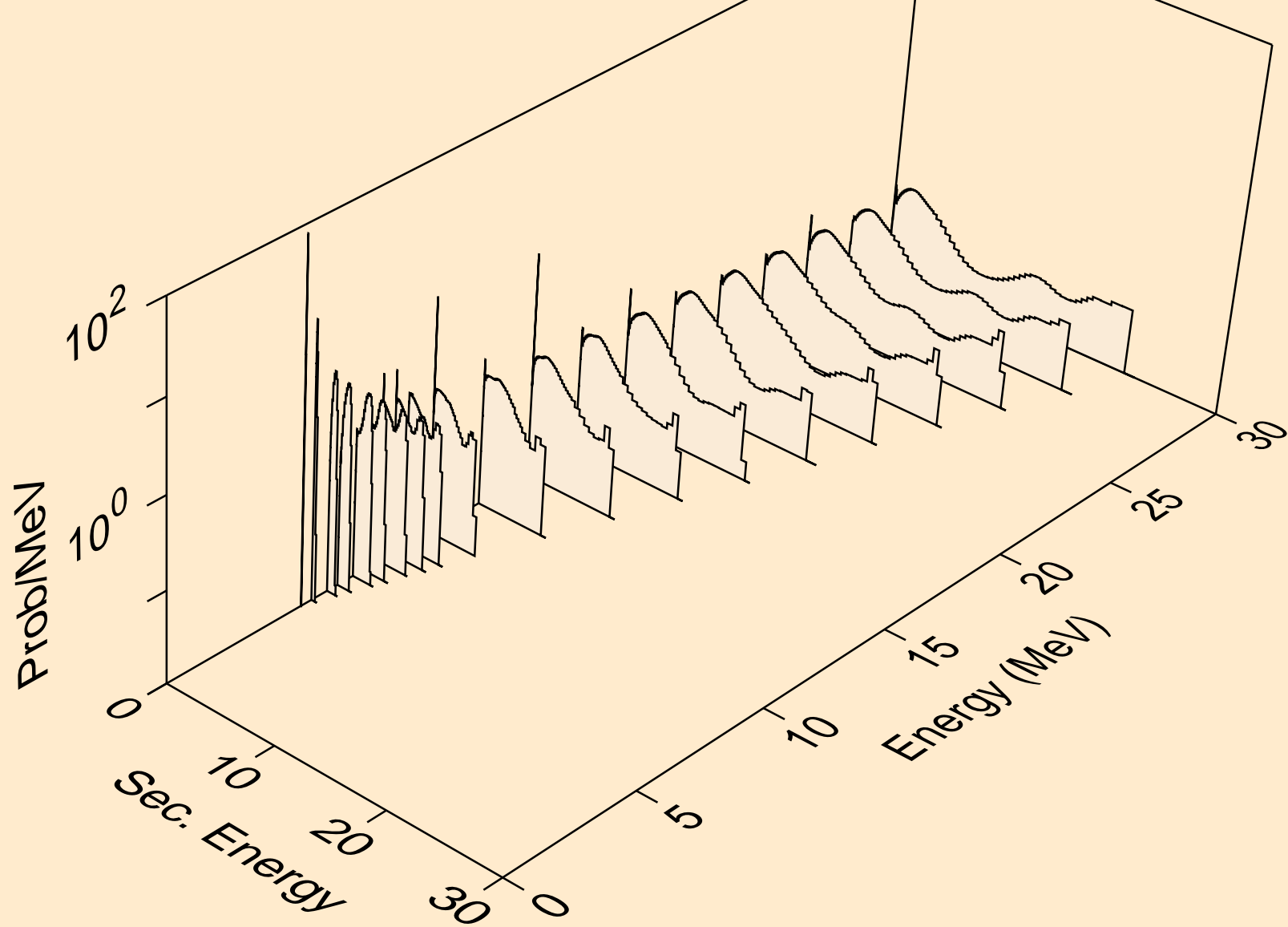

F018 NEUTRON ACER TENDL-2023 LIBRARY; T=0.K
Neutron emission for (n,n*)3a

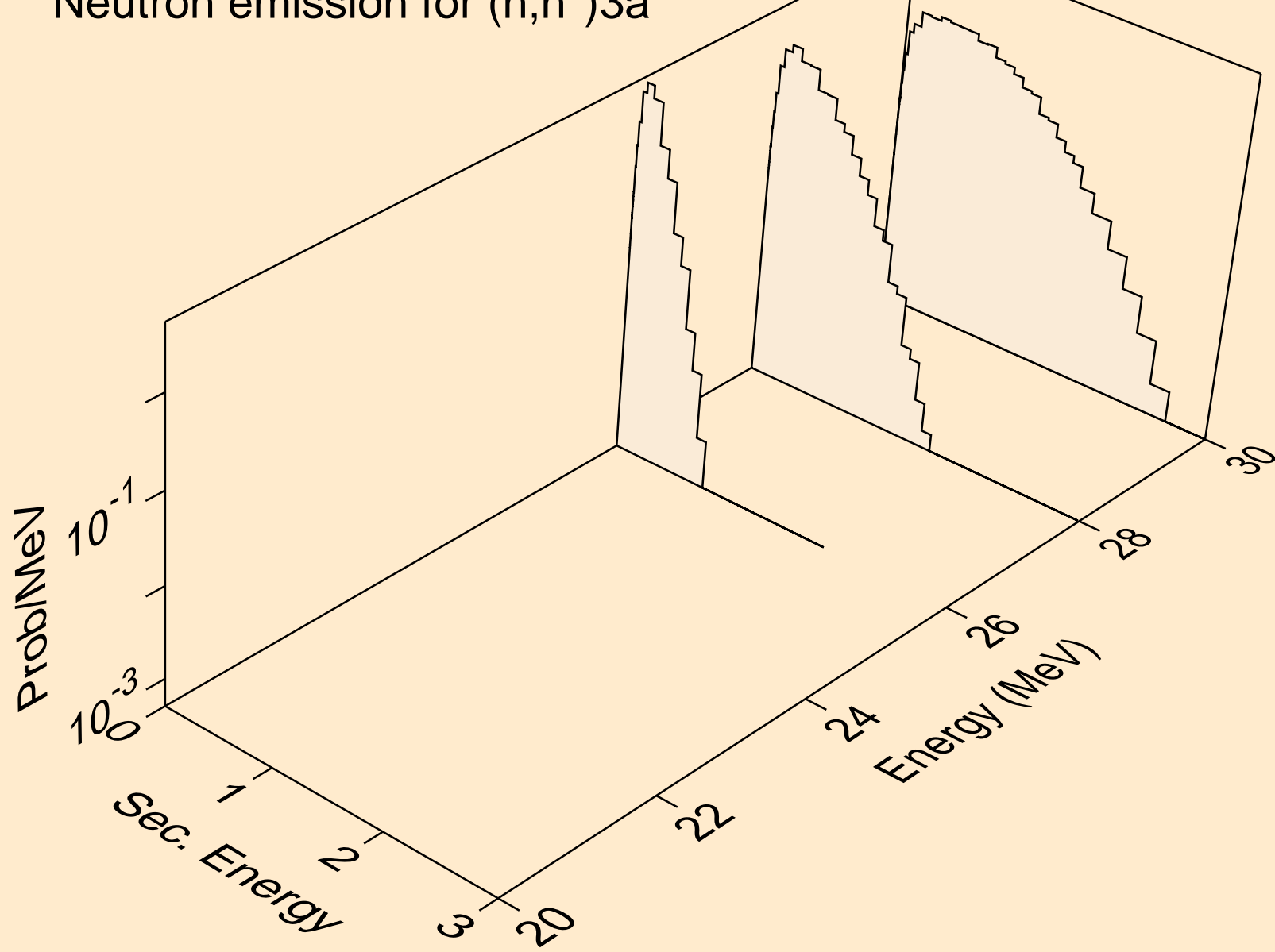

F018 NEUTRON ACER TENDL-2023 LIBRARY; T=0.K
Neutron emission for (n,2n)a

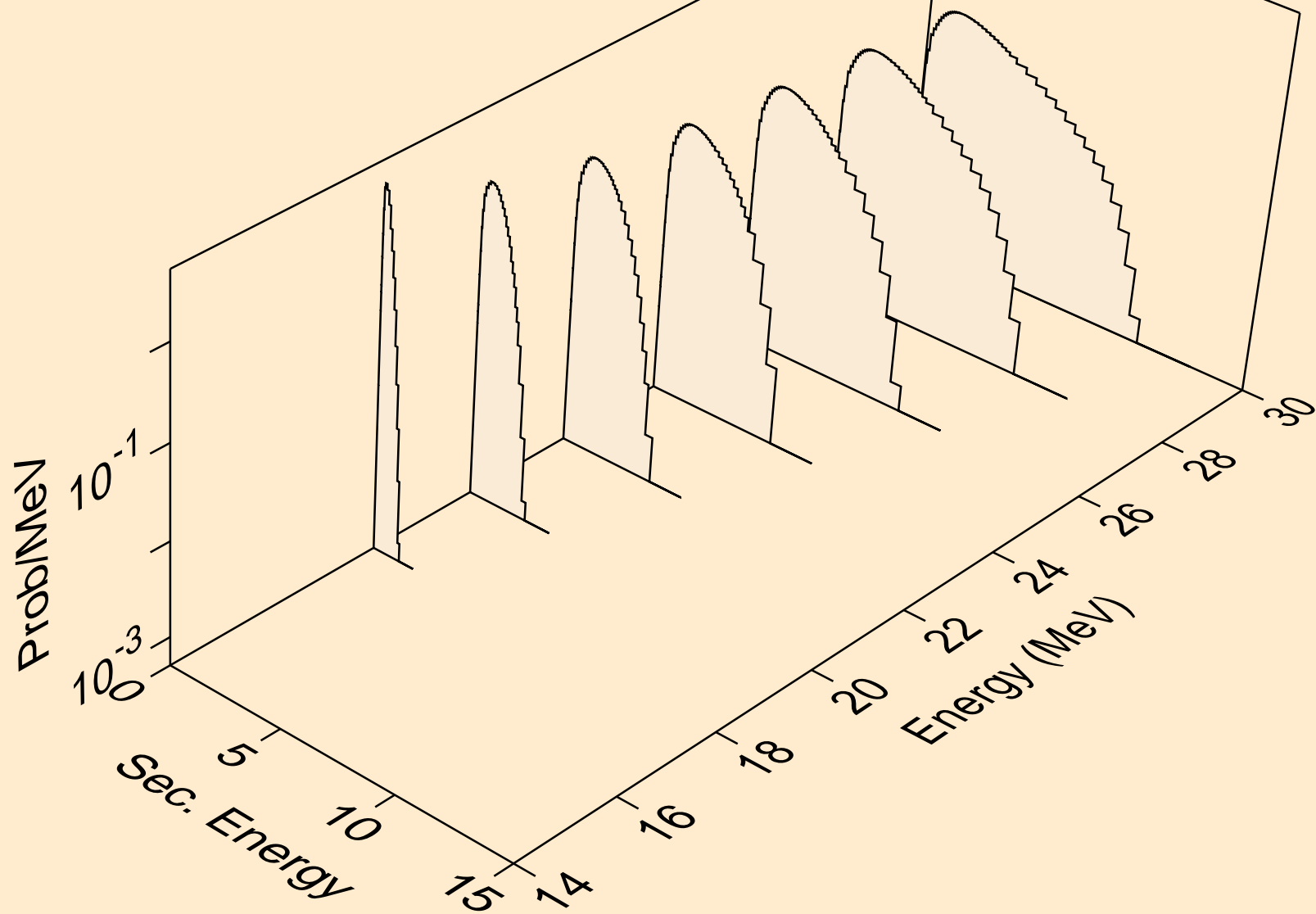

F018 NEUTRON ACER TENDL-2023 LIBRARY; T=0.K
Neutron emission for (n,n*)p

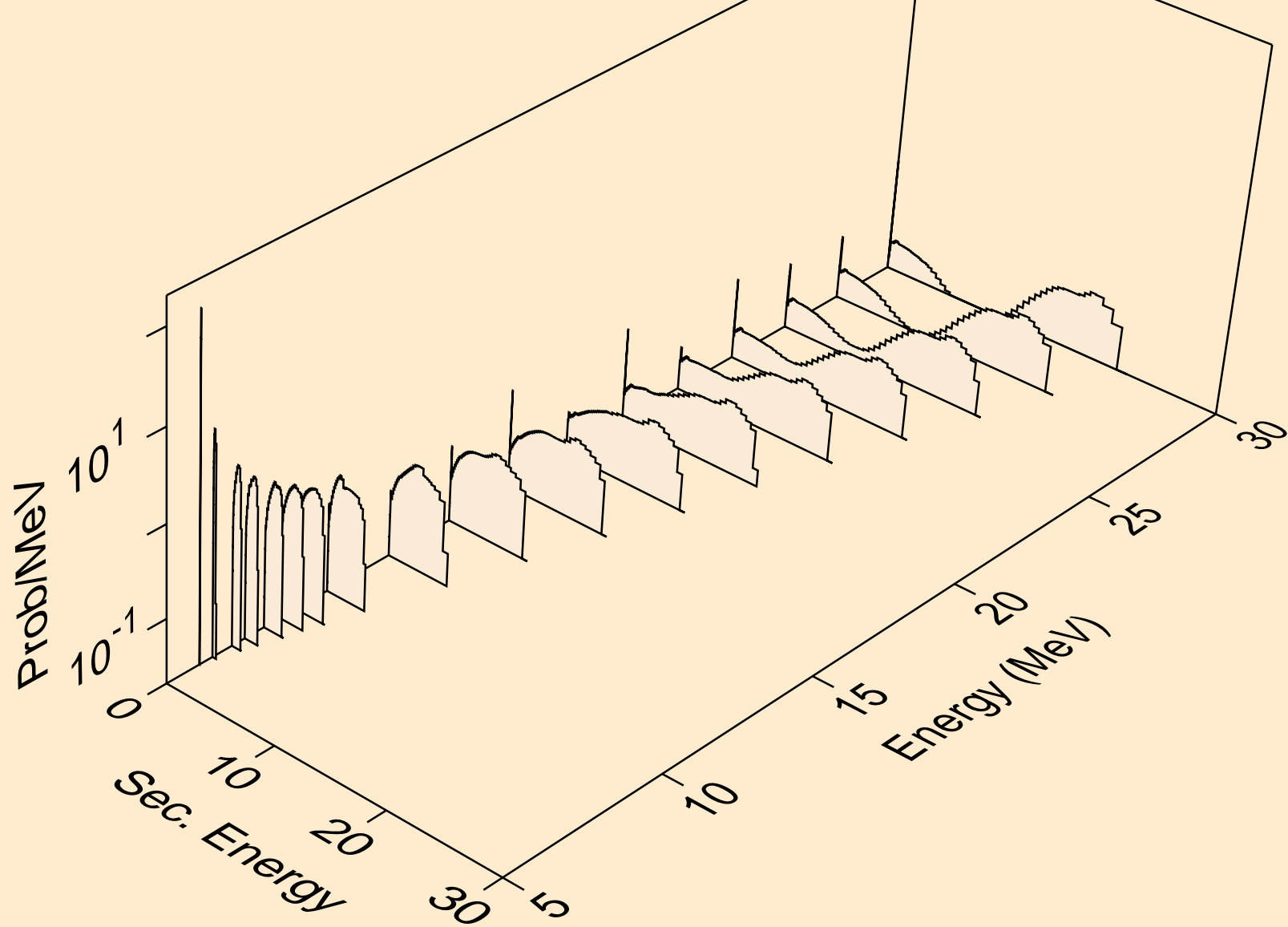

F018 NEUTRON ACER TENDL-2023 LIBRARY; T=0.K
Neutron emission for (n,n*)2a

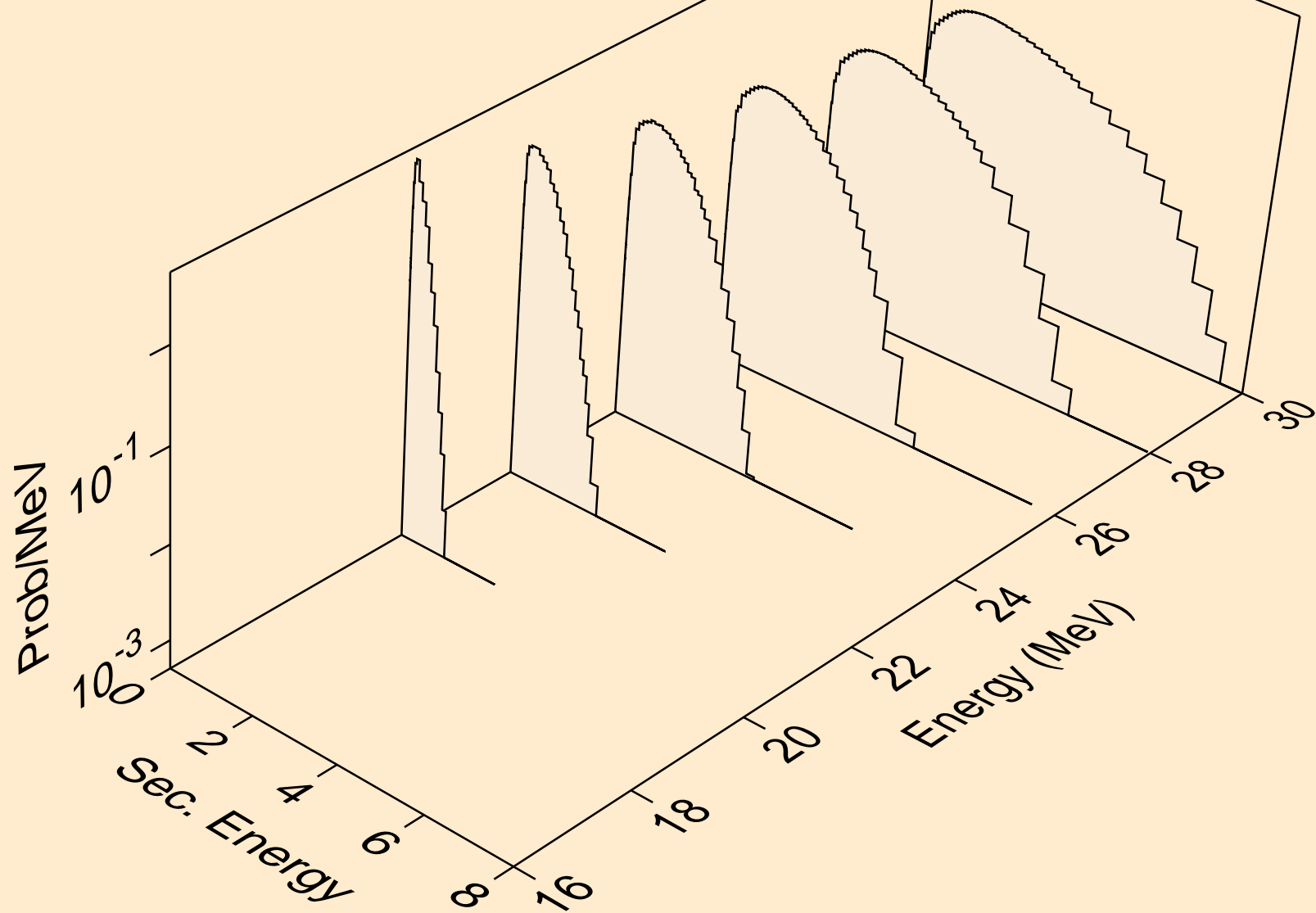

F018 NEUTRON ACER TENDL-2023 LIBRARY; T=0.K
Neutron emission for (n,n*)d

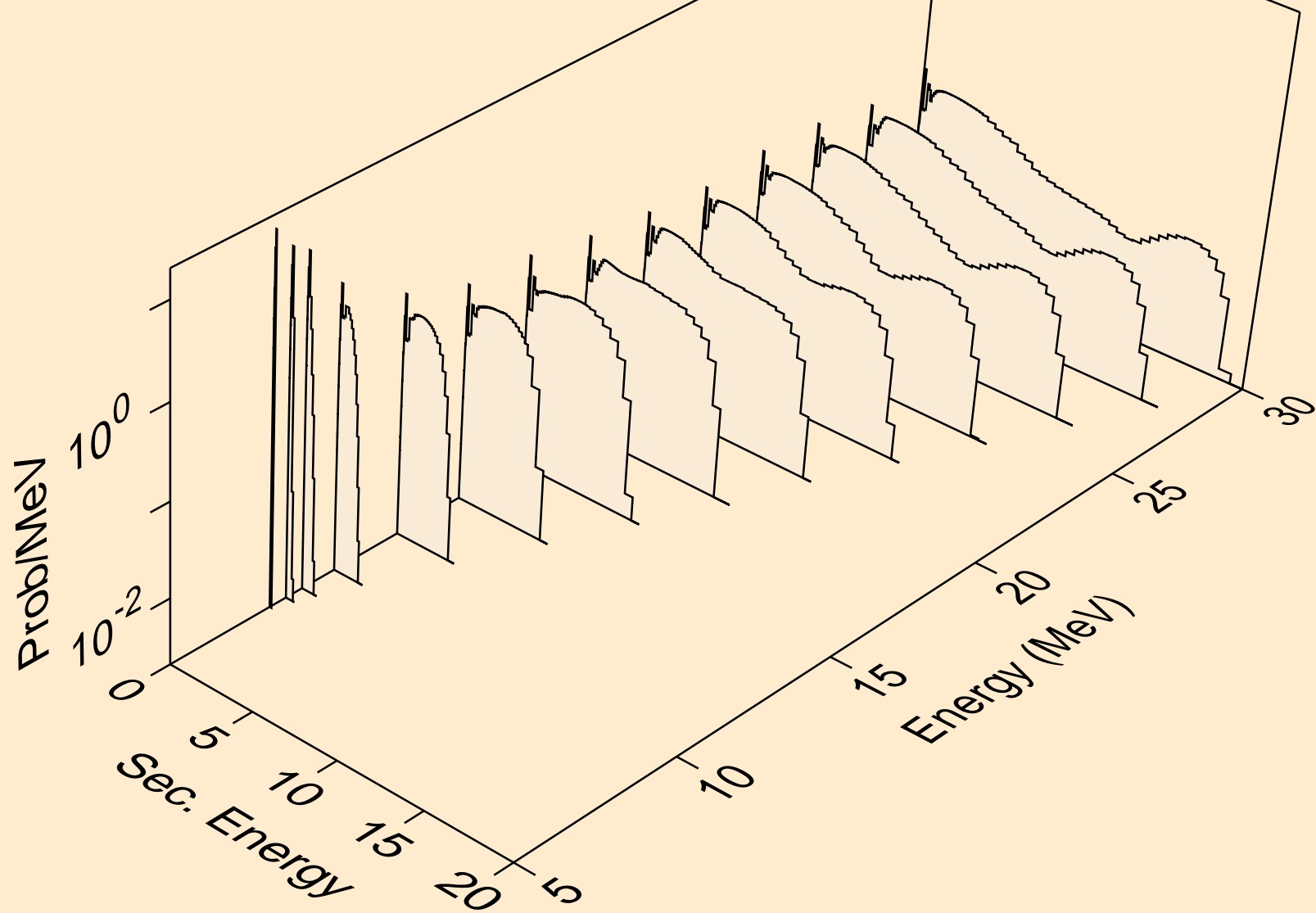

F018 NEUTRON ACER TENDL-2023 LIBRARY; T=0.K
Neutron emission for (n,n*)t

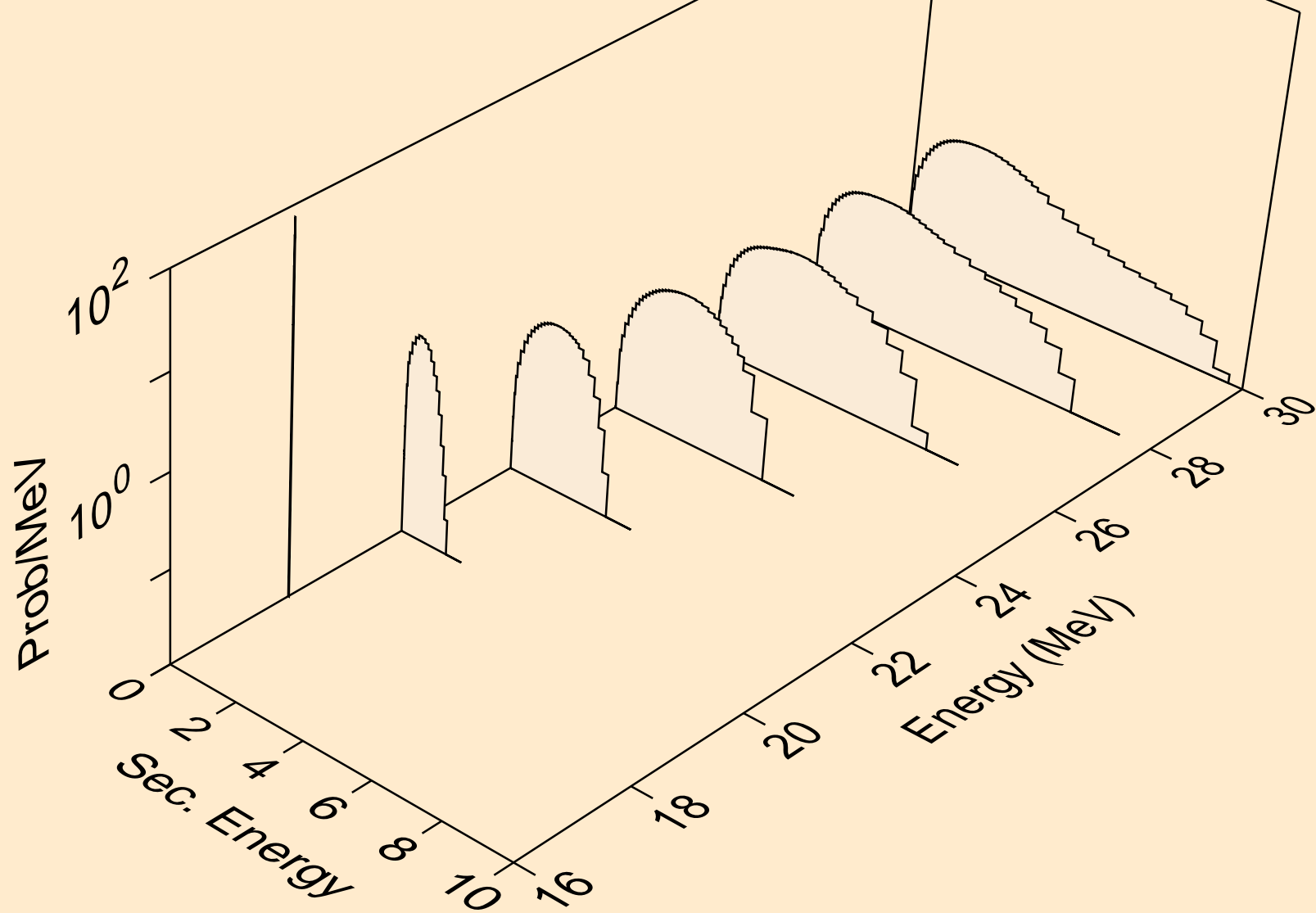

F018 NEUTRON ACER TENDL-2023 LIBRARY; T=0.K
Neutron emission for (n,n*)he3

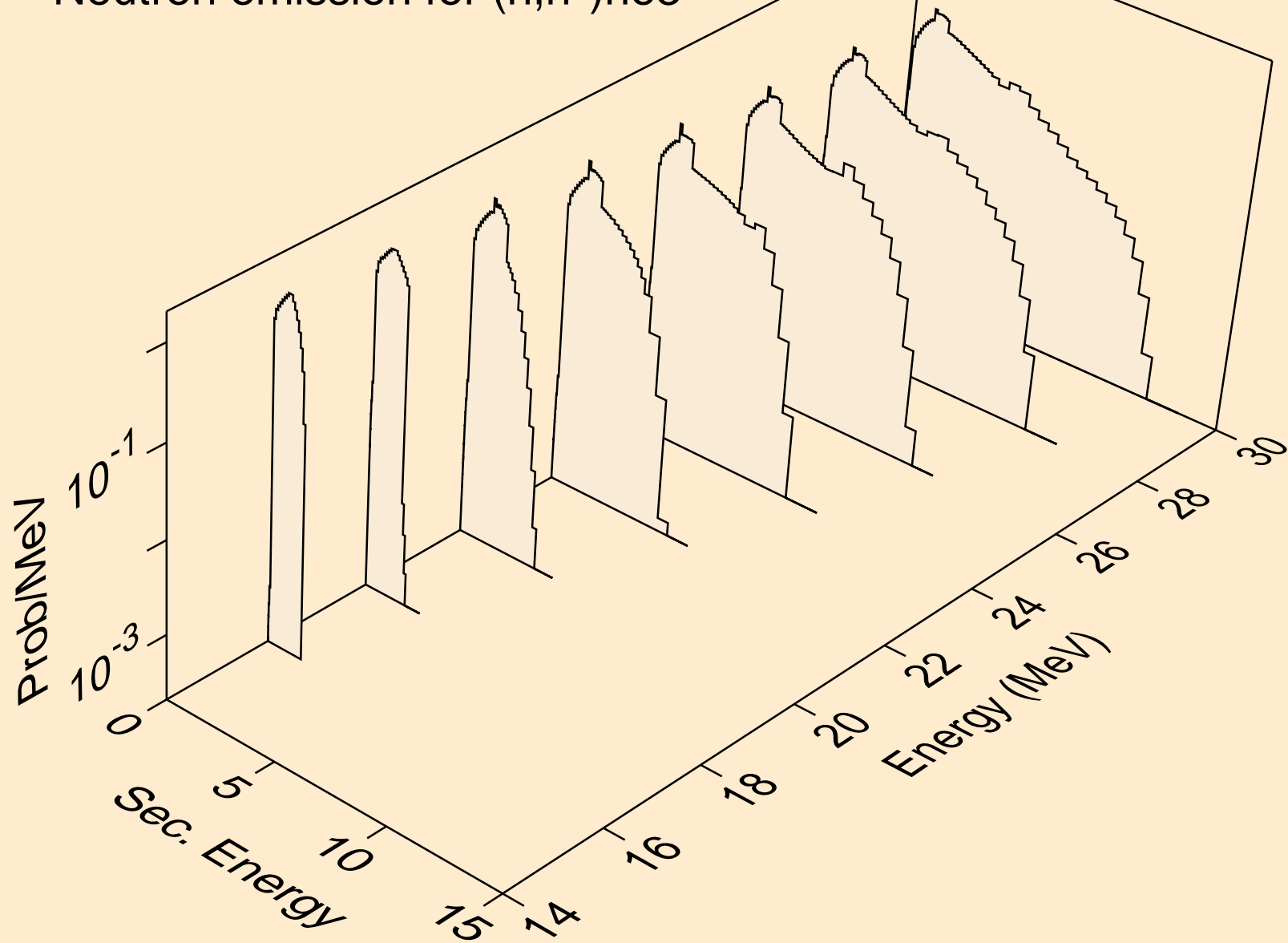

F018 NEUTRON ACER TENDL-2023 LIBRARY; T=0.K
Neutron emission for (n,n*)d2a

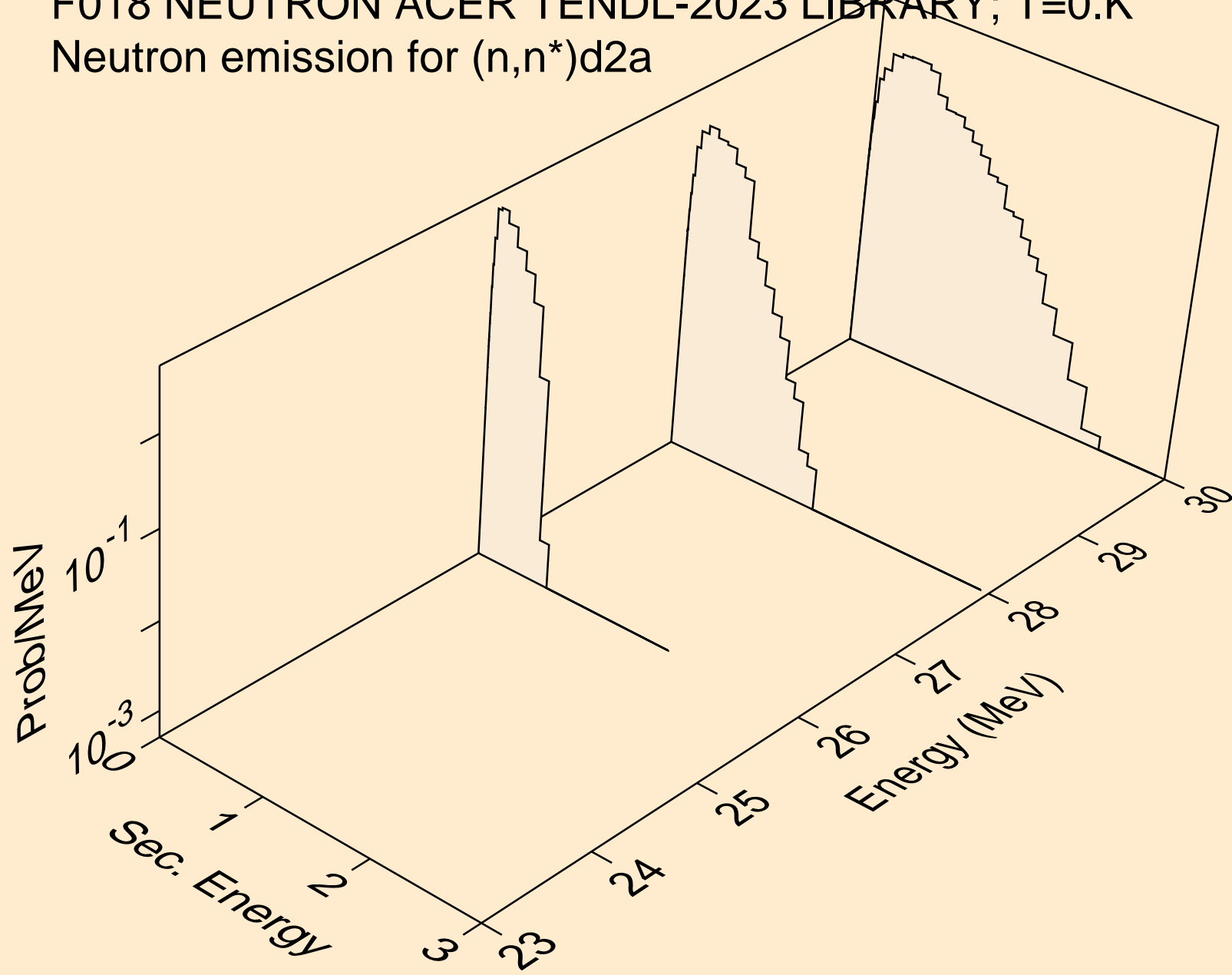

F018 NEUTRON ACER TENDL-2023 LIBRARY; T=0.K
Neutron emission for (n,2np)

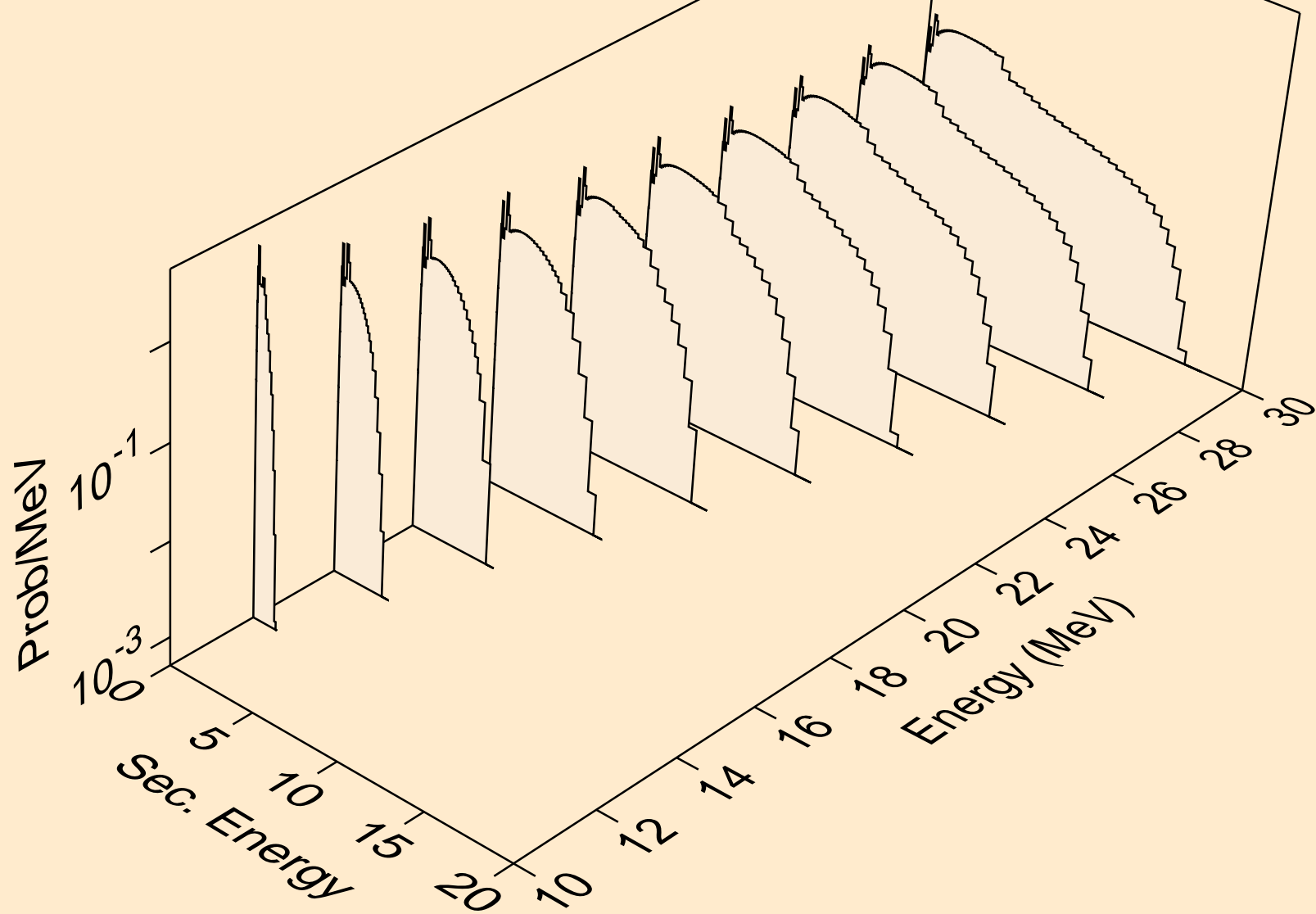

F018 NEUTRON ACER TENDL-2023 LIBRARY; T=0.K
Neutron emission for (n,3np)

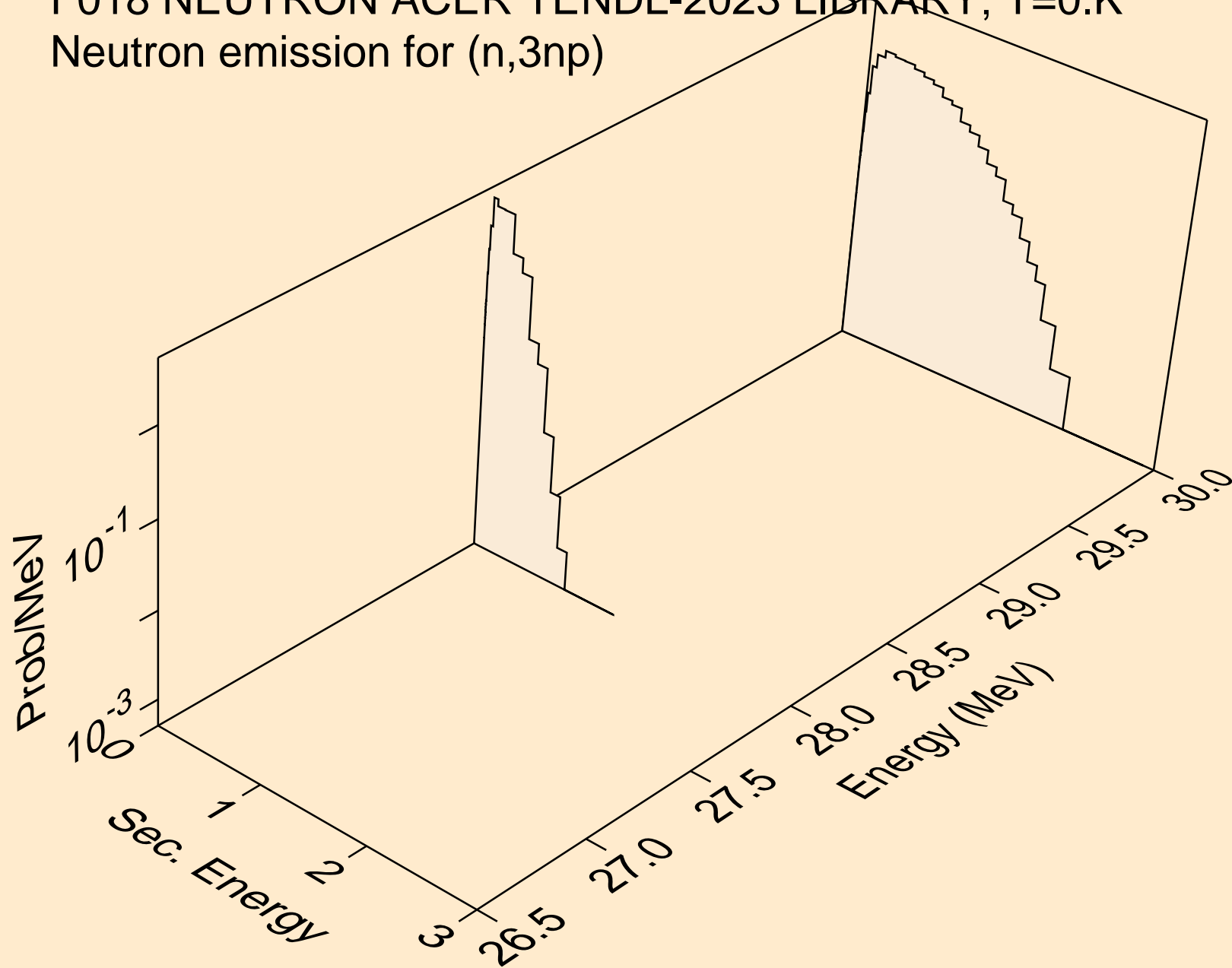

F018 NEUTRON ACER TENDL-2023 LIBRARY; T=0.K
Neutron emission for (n,n2p)

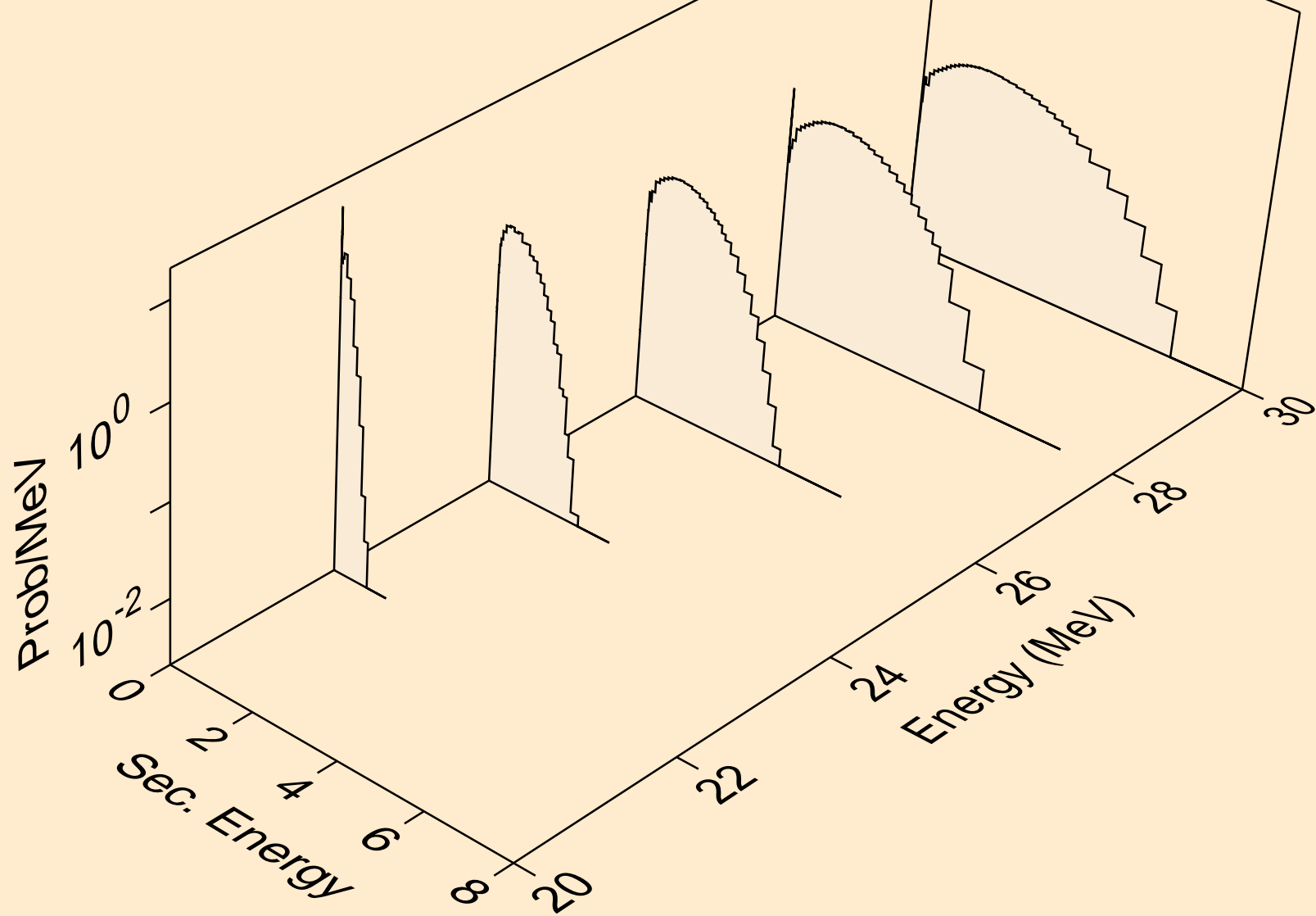

F018 NEUTRON ACER TENDL-2023 LIBRARY; T=0.K
Neutron emission for (n,npa)

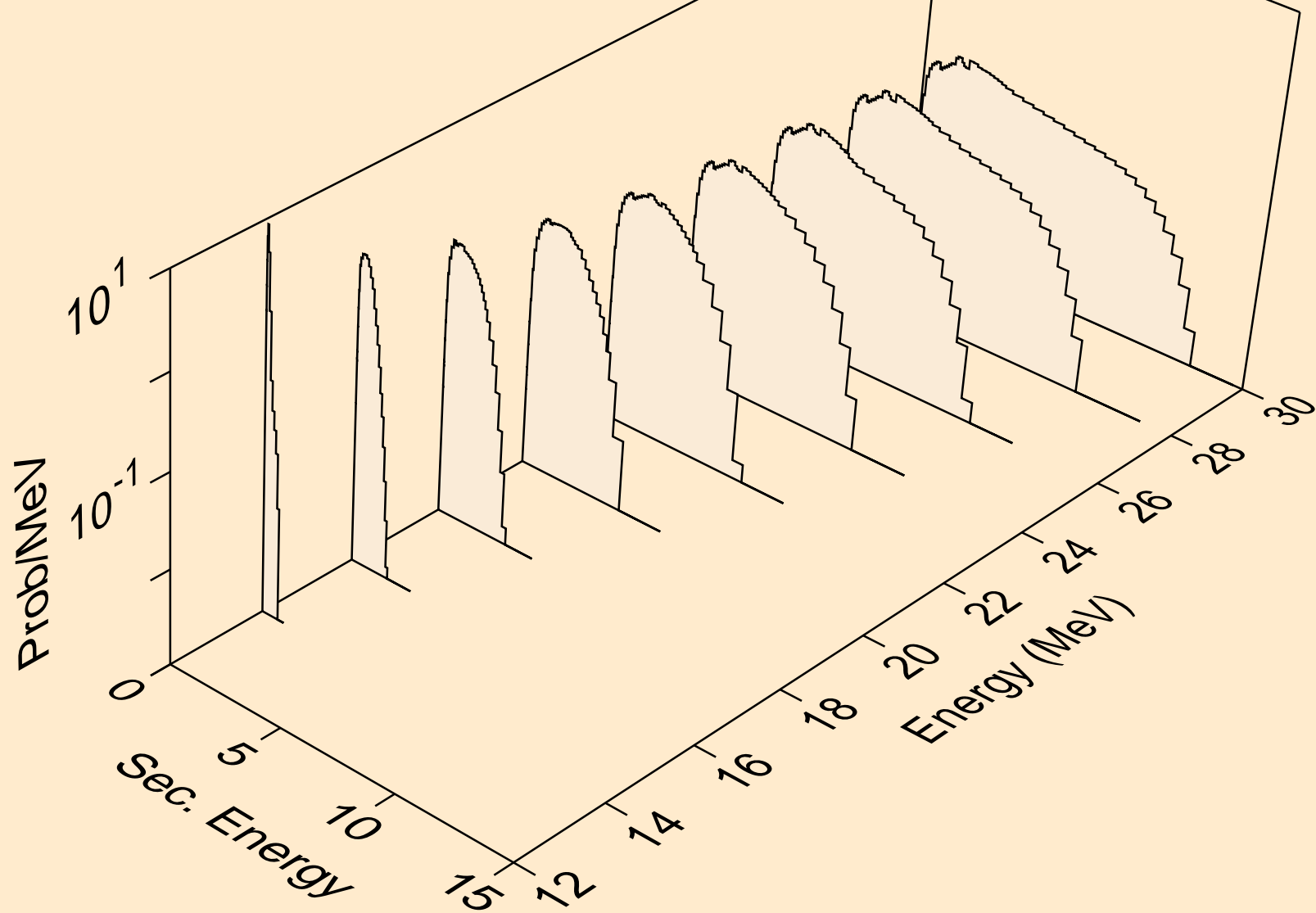

F018 NEUTRON ACER TENDL-2023 LIBRARY; T=0.K
Neutron emission for (n,n*c)

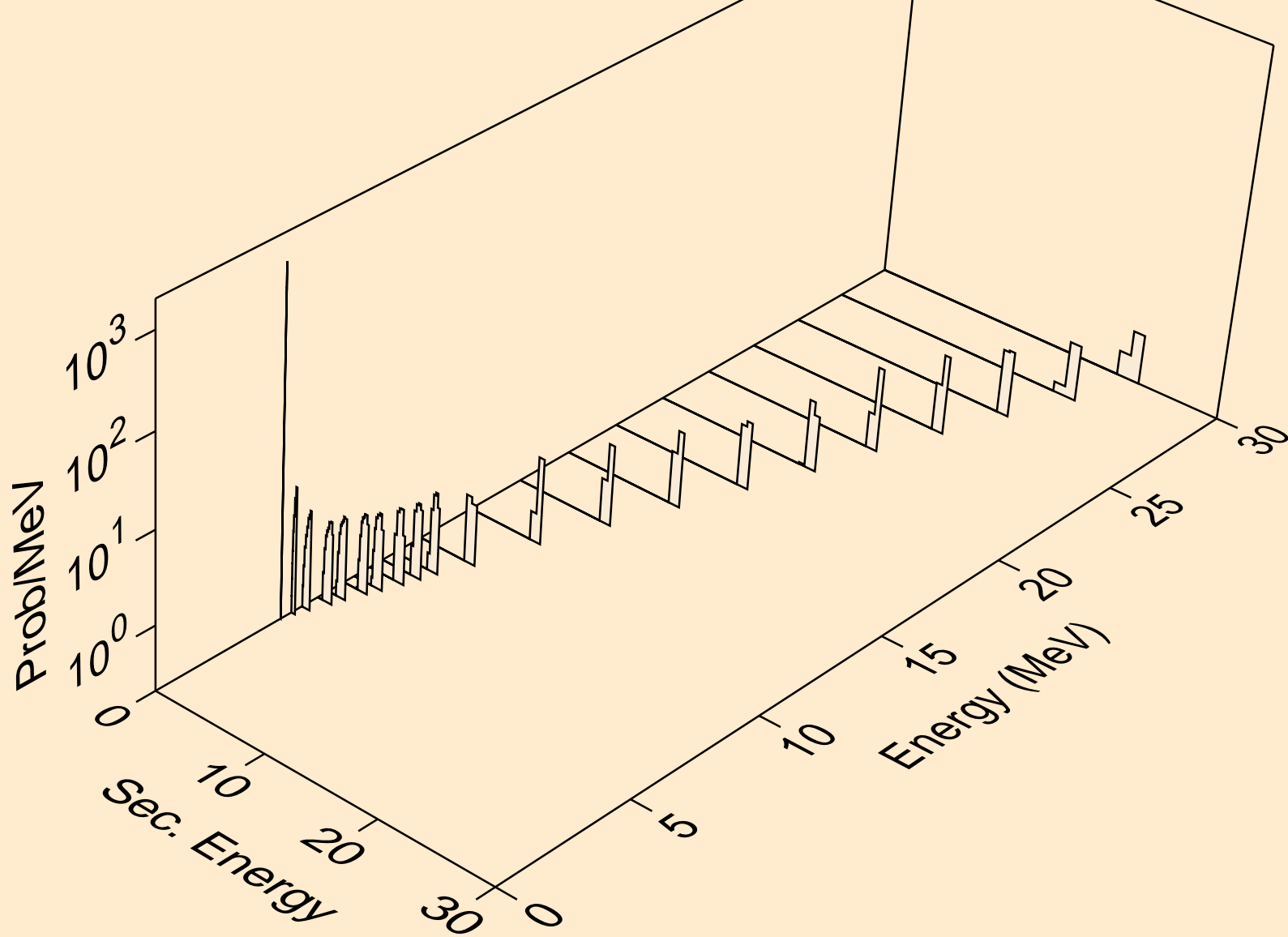

F018 NEUTRON ACER TENDL-2023 LIBRARY; T=0.K
Photon emission for (n,x)

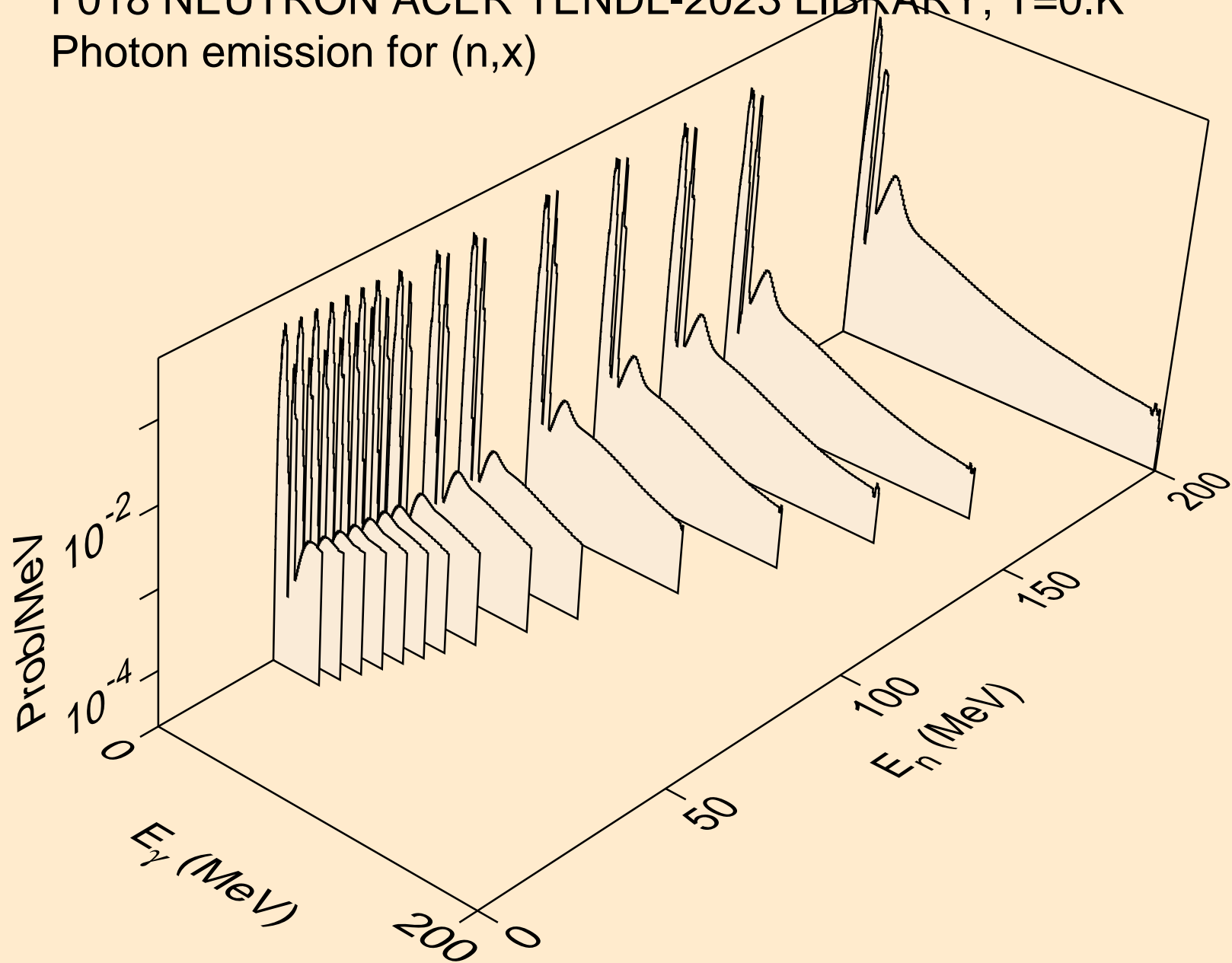

F018 NEUTRON ACER TENDL-2023 LIBRARY; T=0.K
Photon emission for (n,2nd)

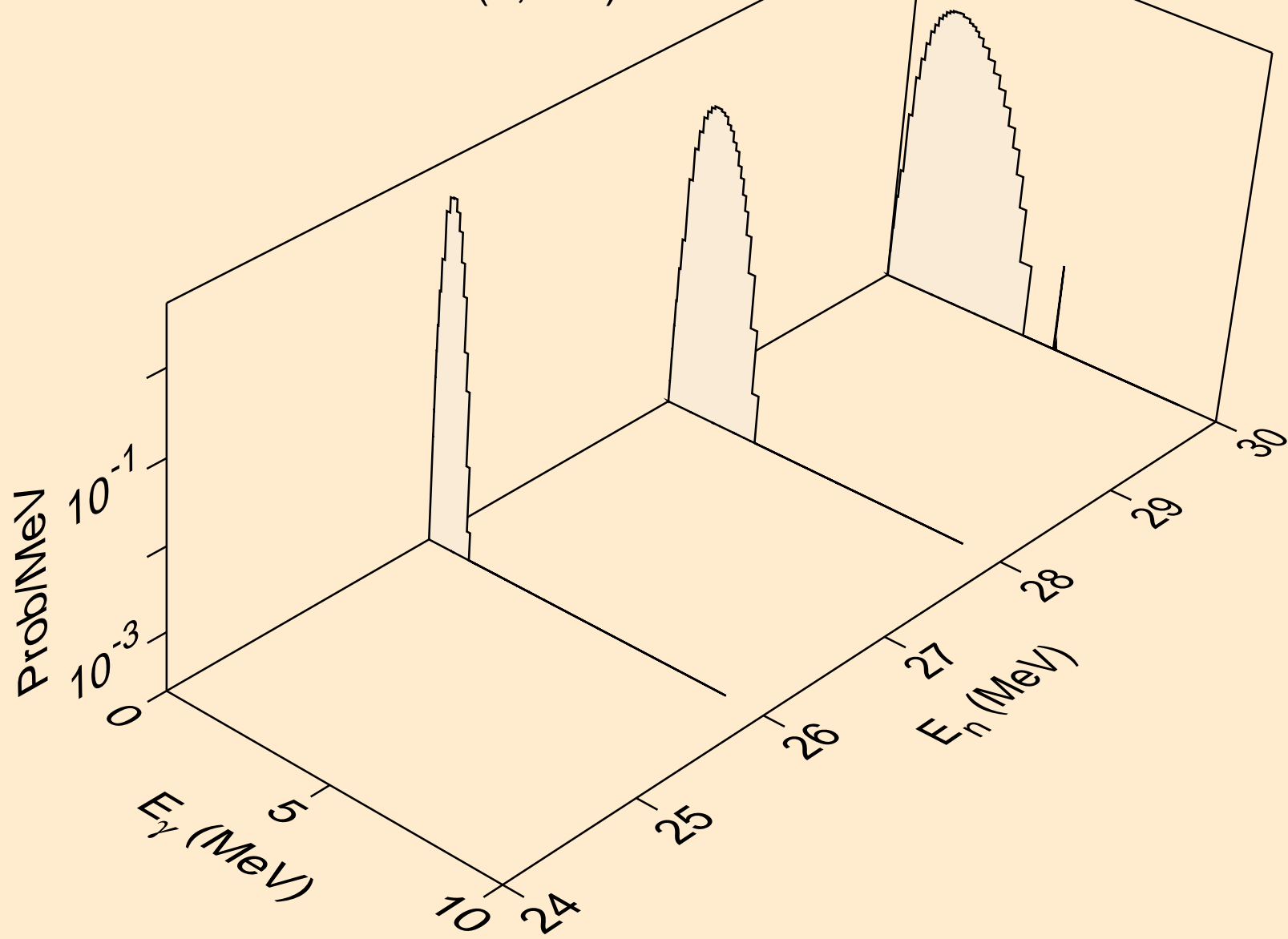

F018 NEUTRON ACER TENDL-2023 LIBRARY; T=0.K
Photon emission for (n,2n)

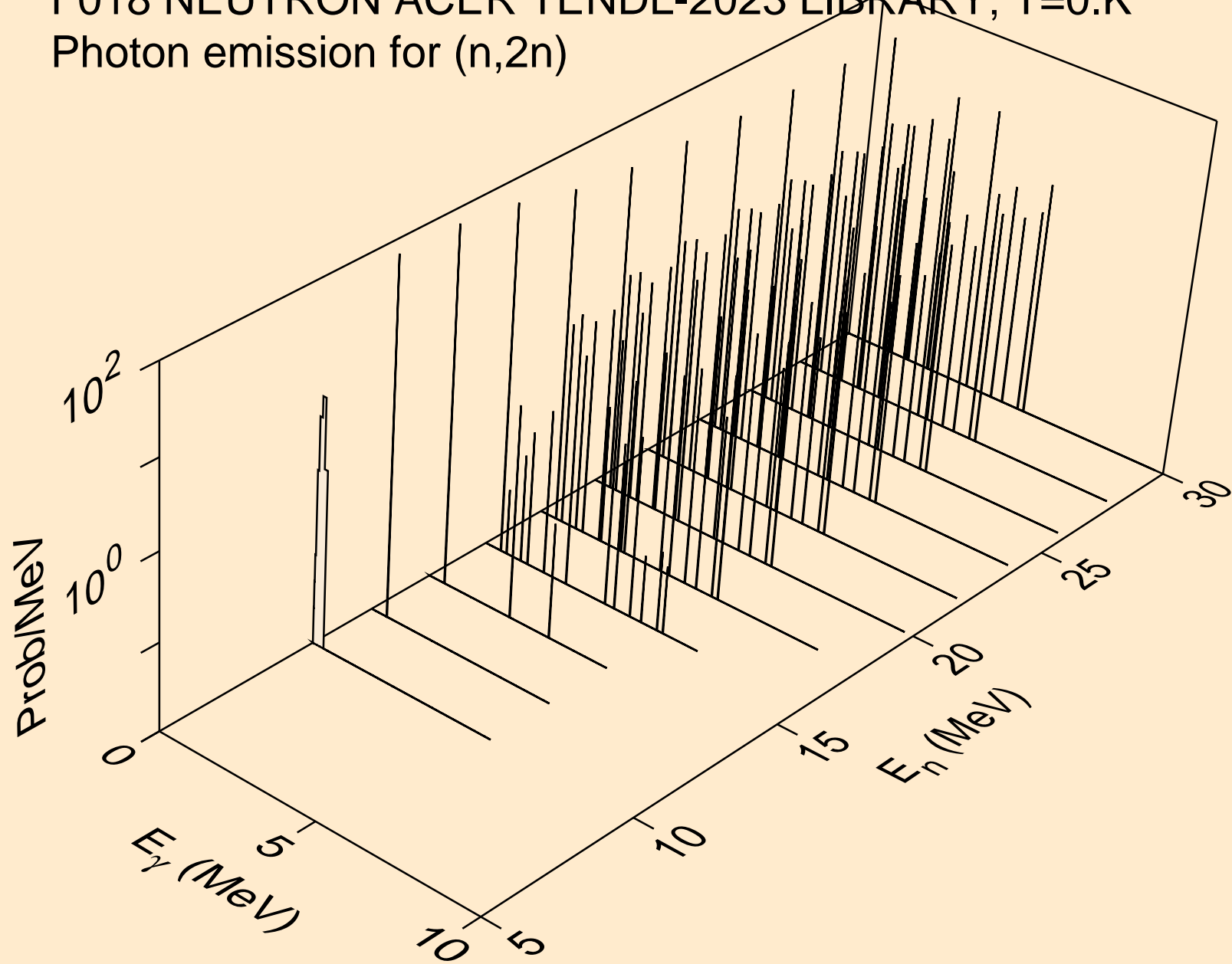

F018 NEUTRON ACER TENDL-2023 LIBRARY; T=0.K
Photon emission for (n,3n)

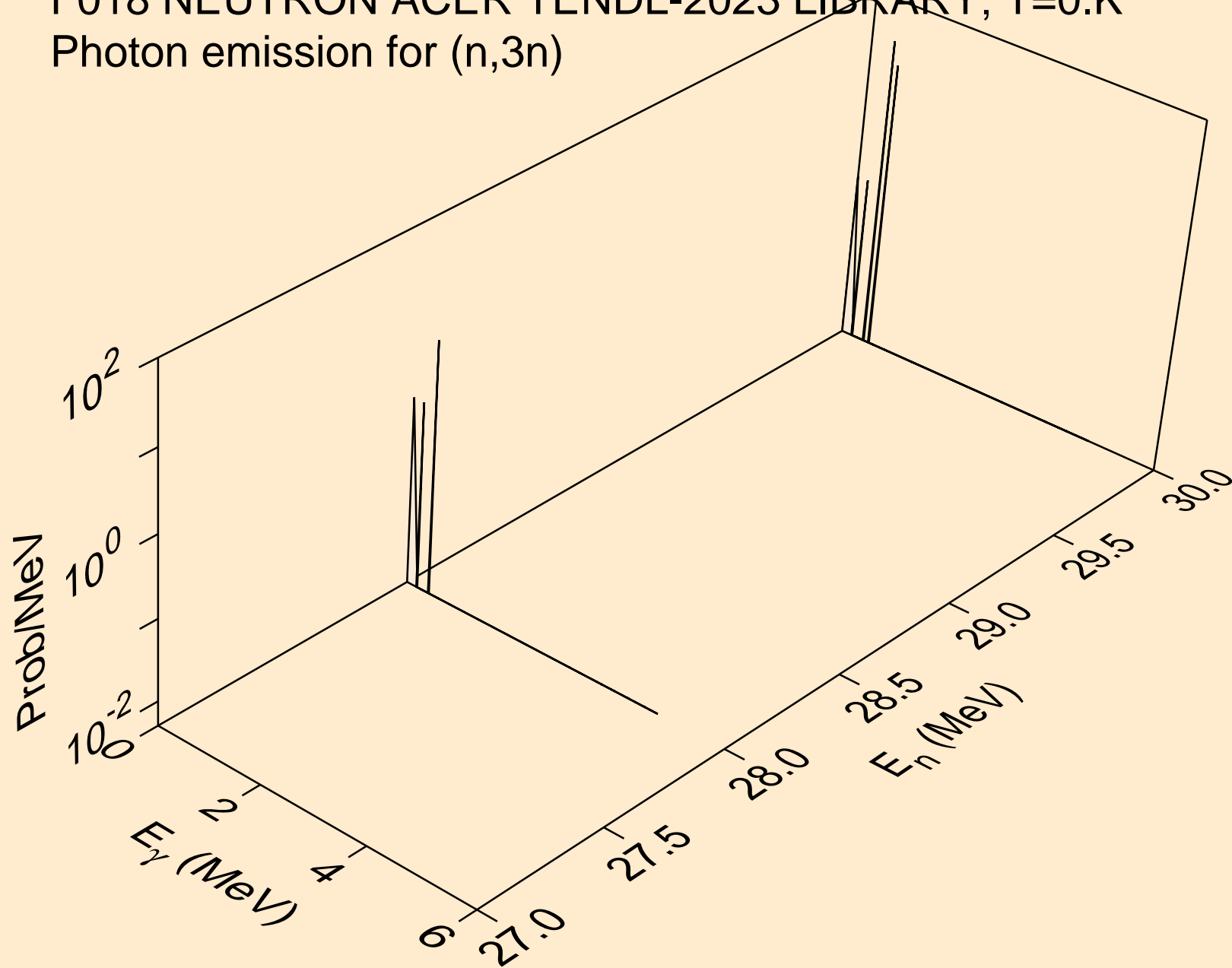

F018 NEUTRON ACER TENDL-2023 LIBRARY; T=0.K
Photon emission for (n,n*)a

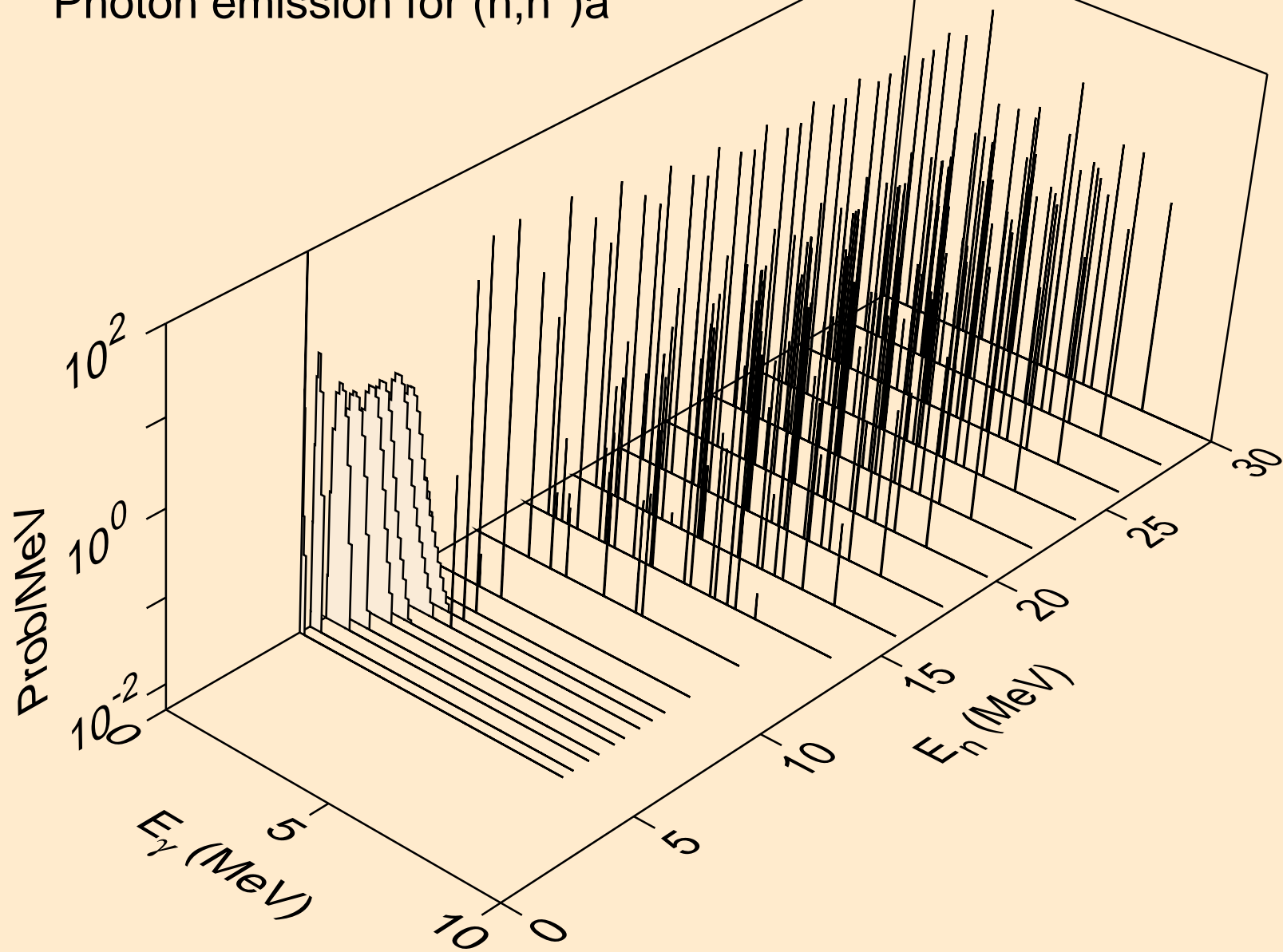

F018 NEUTRON ACER TENDL-2023 LIBRARY; T=0.K
Photon emission for (n,n*)3a

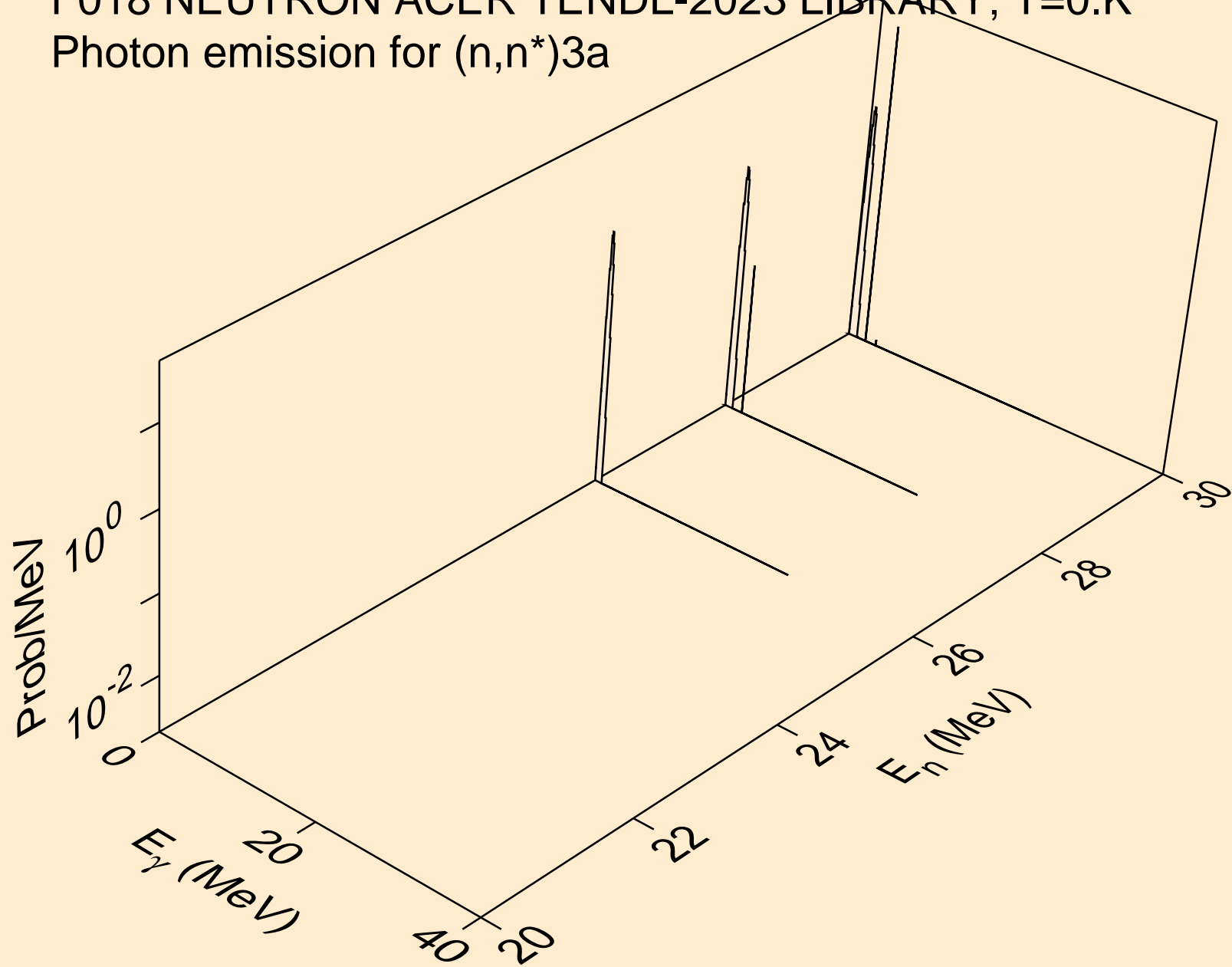

F018 NEUTRON ACER TENDL-2023 LIBRARY; T=0.K
Photon emission for (n,2n)a

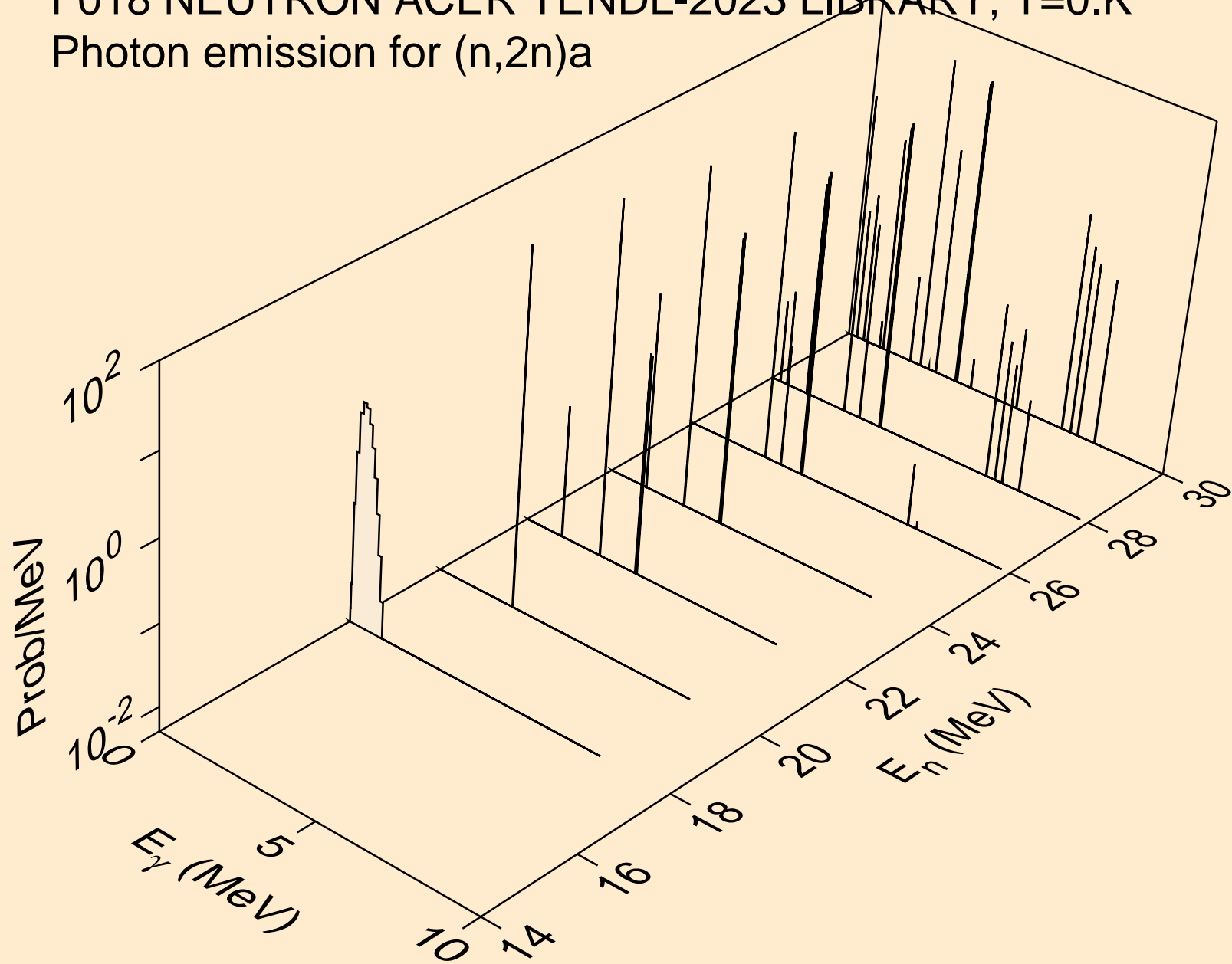

F018 NEUTRON ACER TENDL-2023 LIBRARY; T=0.K
Photon emission for (n,n*)p

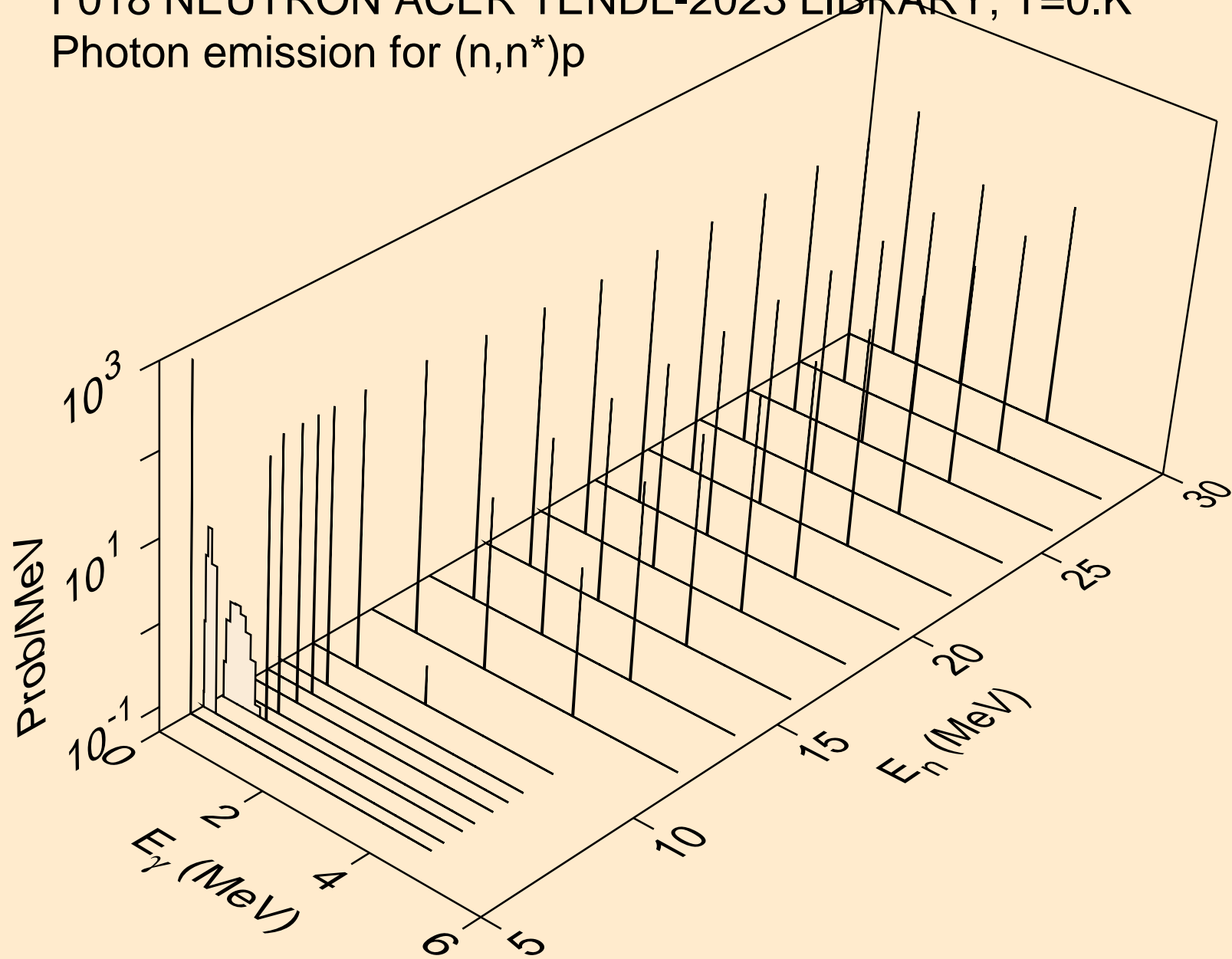

F018 NEUTRON ACER TENDL-2023 LIBRARY; T=0.K
Photon emission for (n,n*)2a

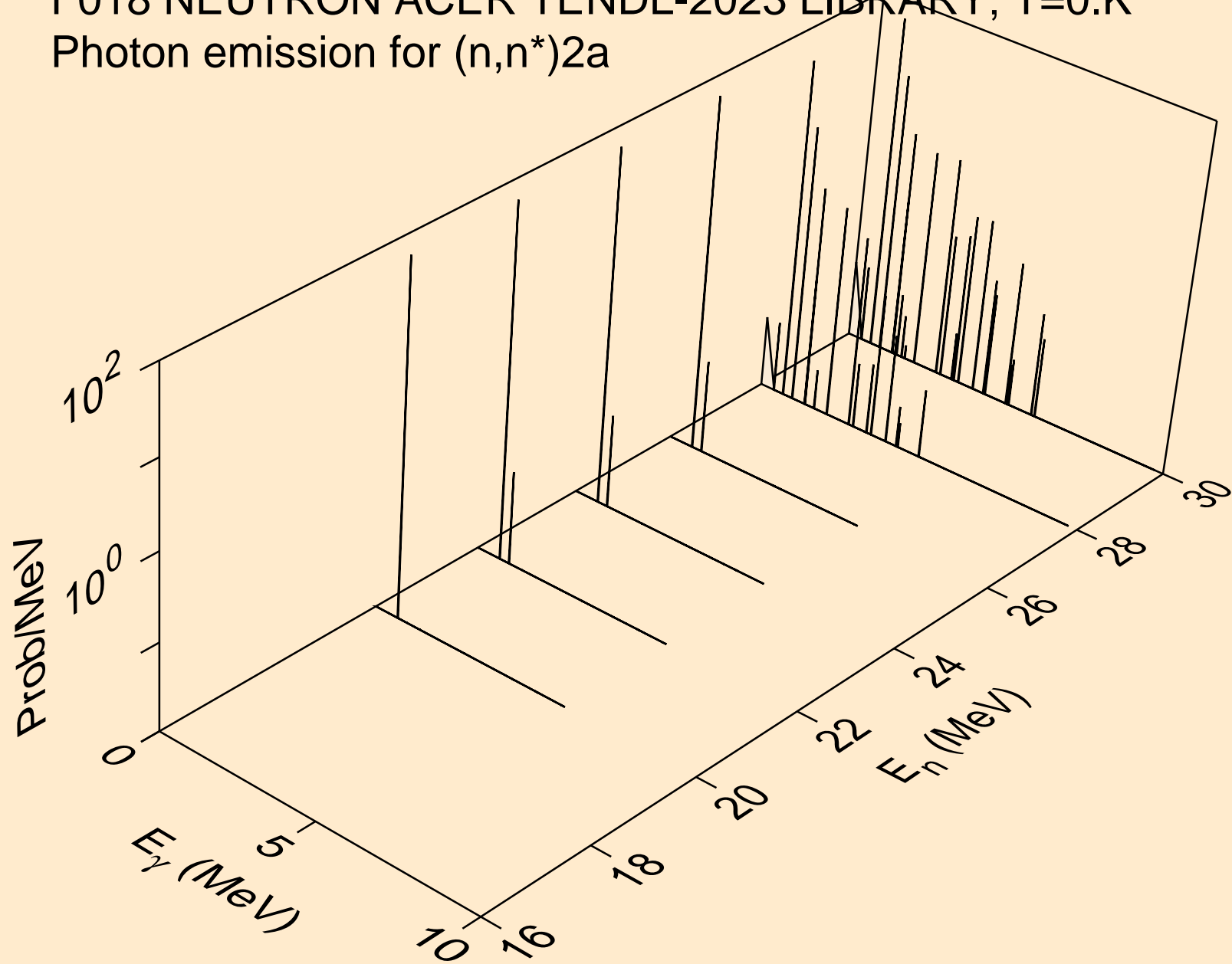

F018 NEUTRON ACER TENDL-2023 LIBRARY; T=0.K
Photon emission for (n,n*)d

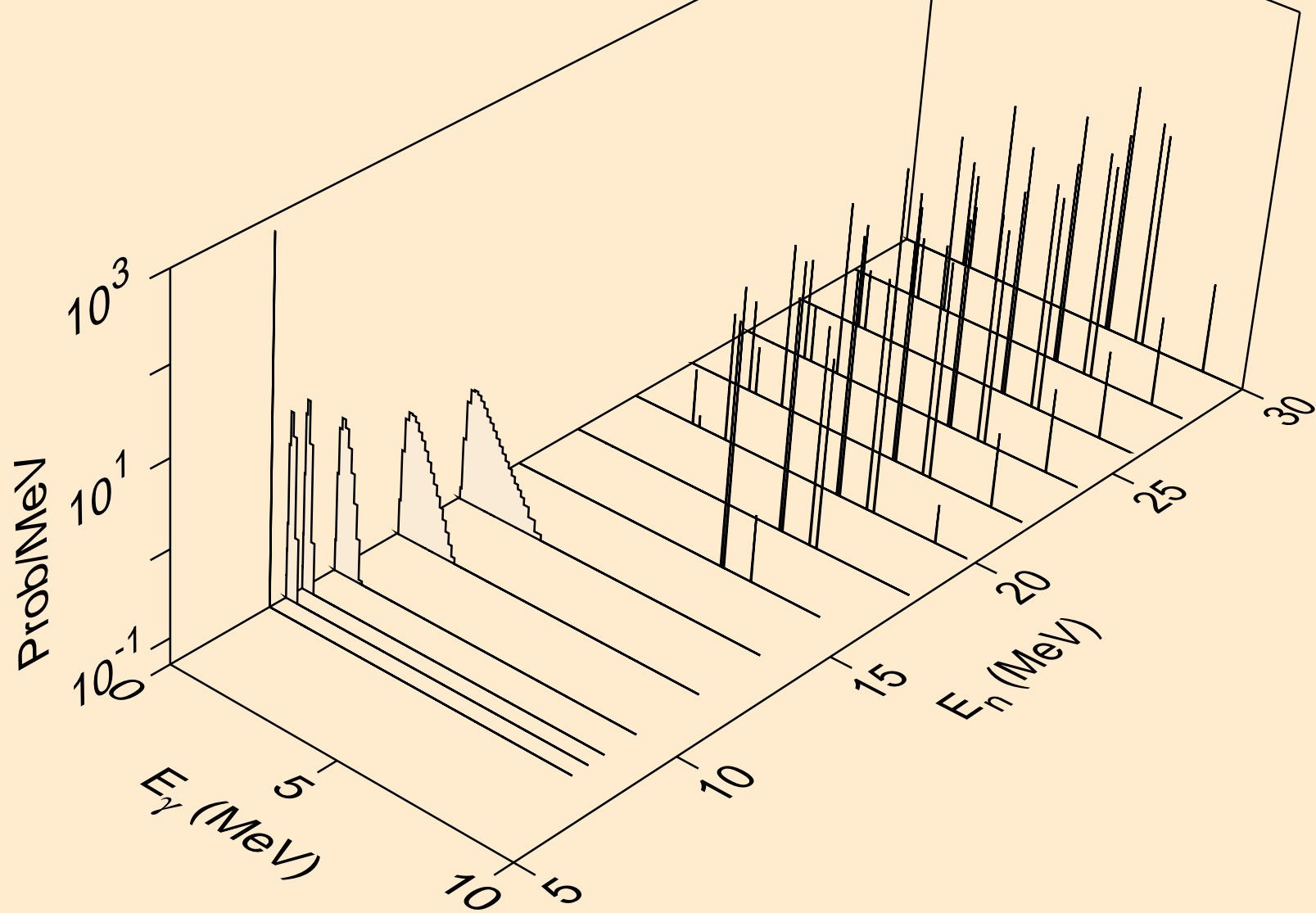

F018 NEUTRON ACER TENDL-2023 LIBRARY; T=0.K
Photon emission for (n,n*)t

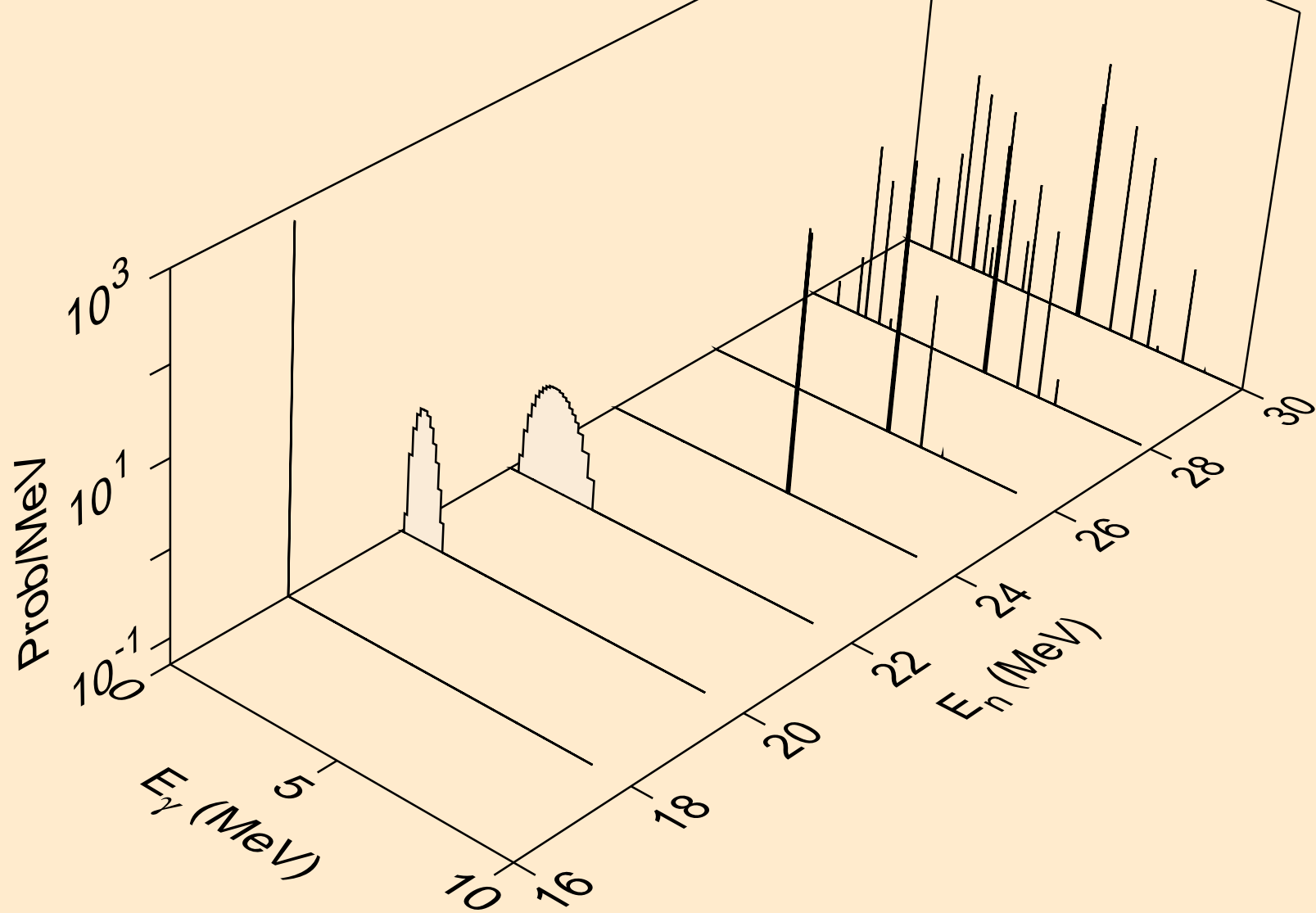

F018 NEUTRON ACER TENDL-2023 LIBRARY; T=0.K
Photon emission for (n,n*)he3

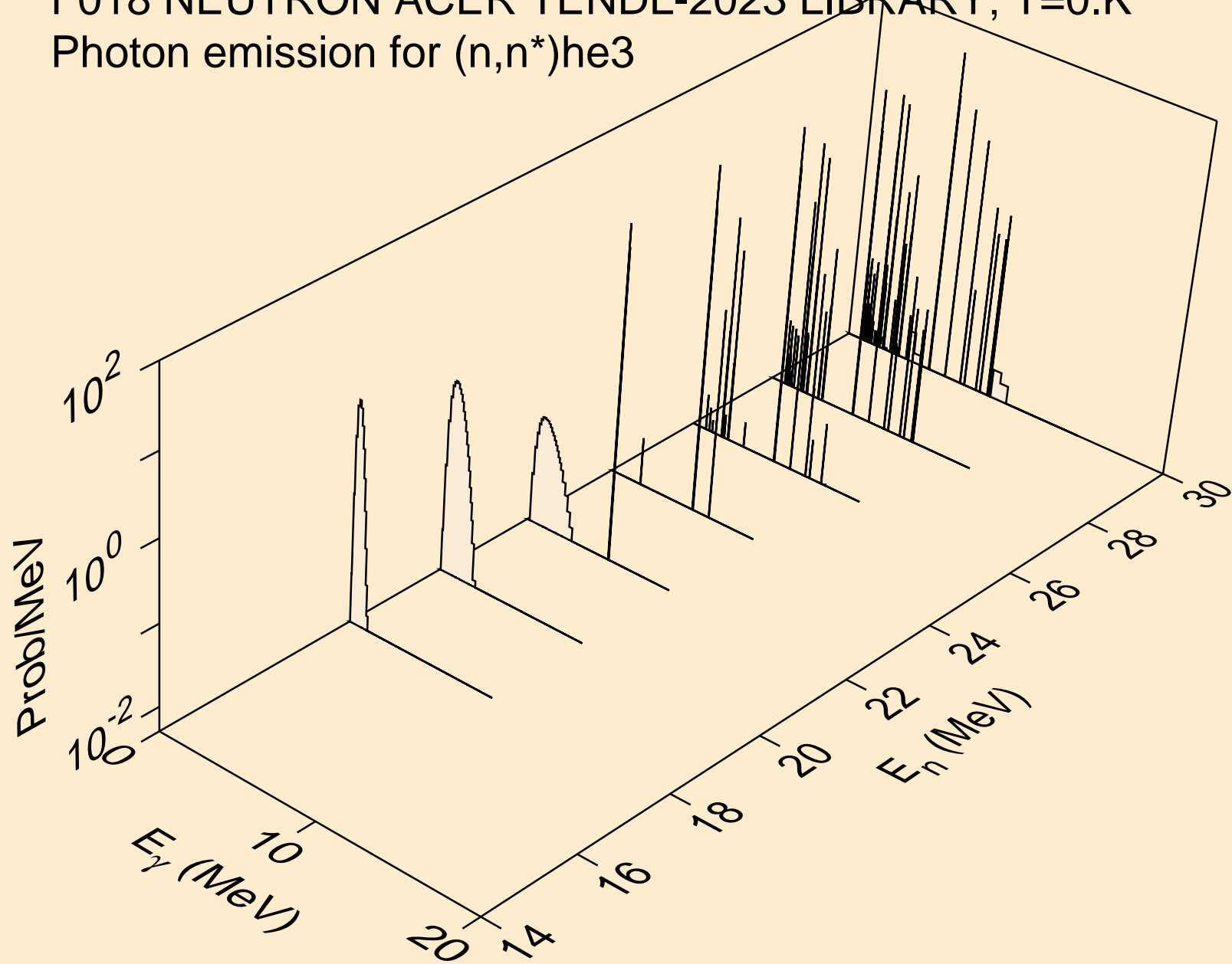

F018 NEUTRON ACER TENDL-2023 LIBRARY; T=0.K
Photon emission for (n,n*)d2a

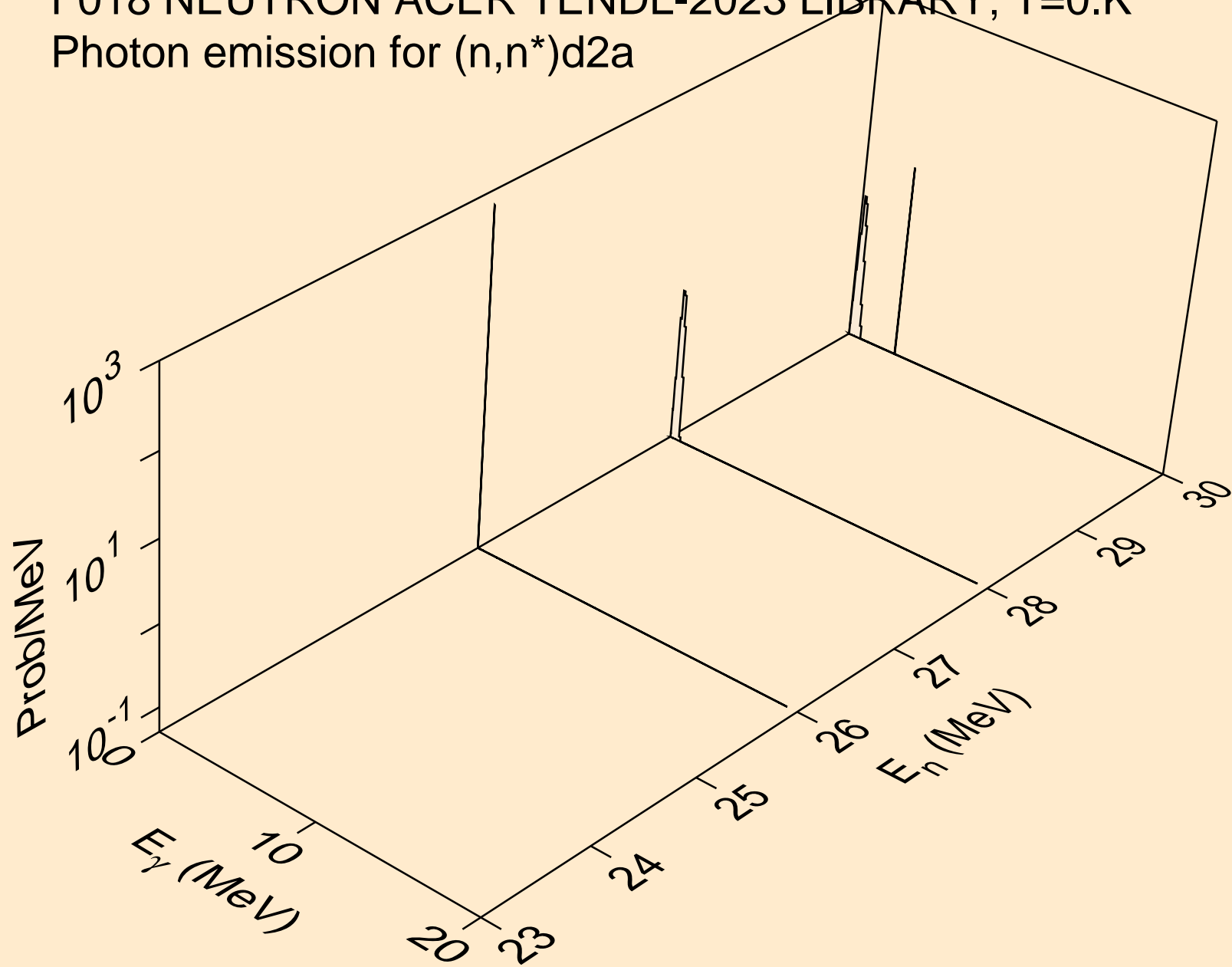

F018 NEUTRON ACER TENDL-2023 LIBRARY; T=0.K
Photon emission for (n,2np)

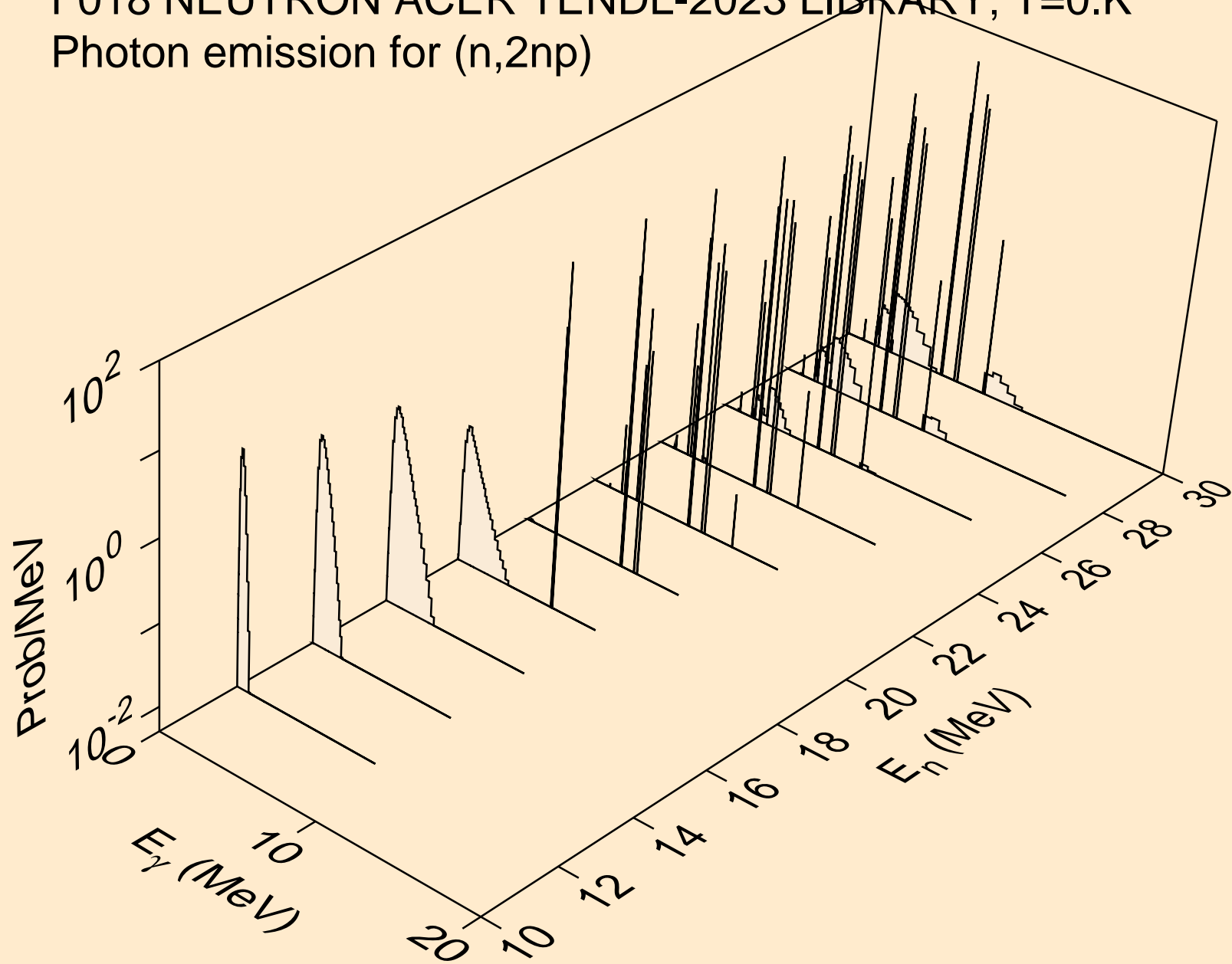

F018 NEUTRON ACER TENDL-2023 LIBRARY; T=0.K
Photon emission for (n,3np)

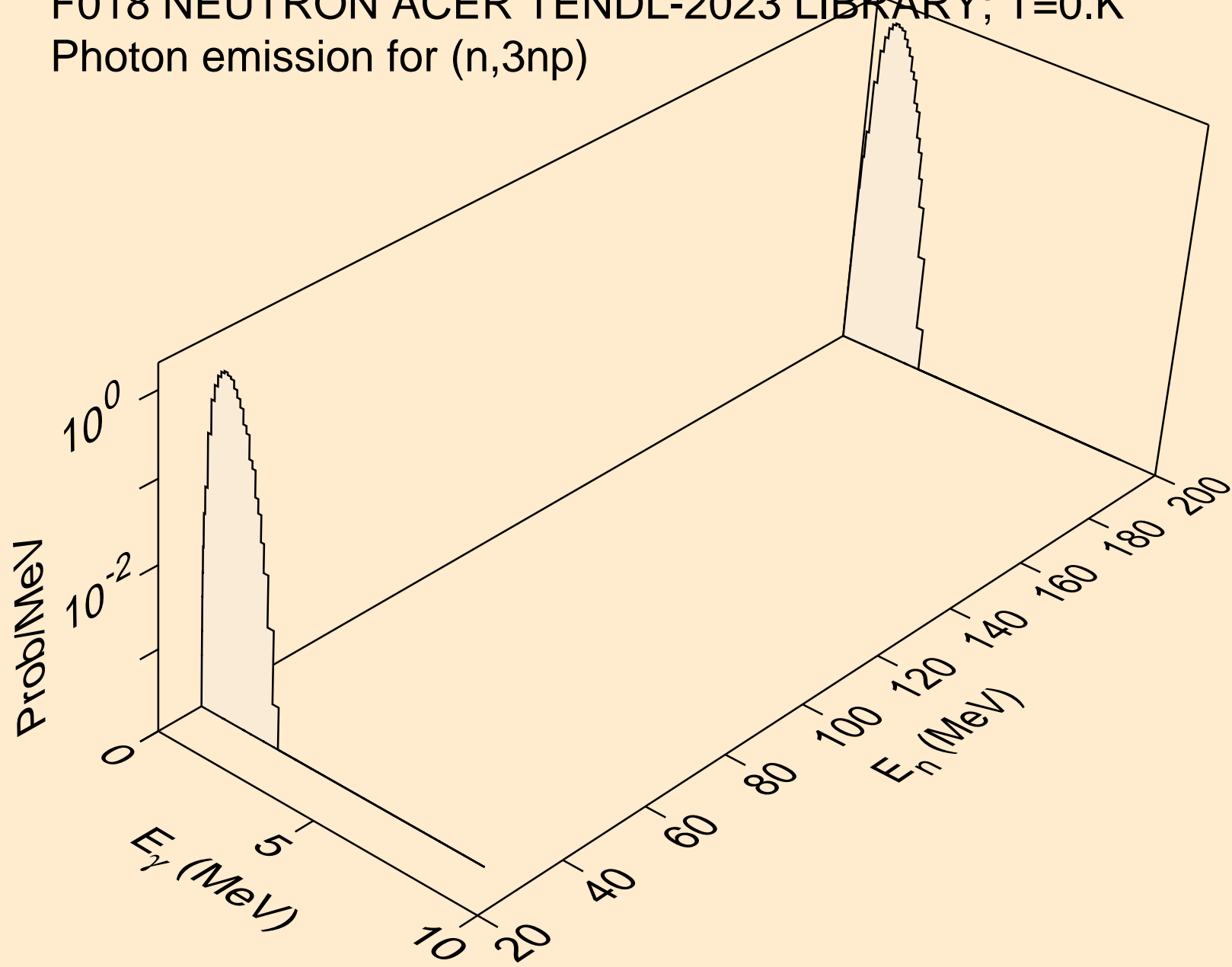

F018 NEUTRON ACER TENDL-2023 LIBRARY; T=0.K
Photon emission for (n,n2p)

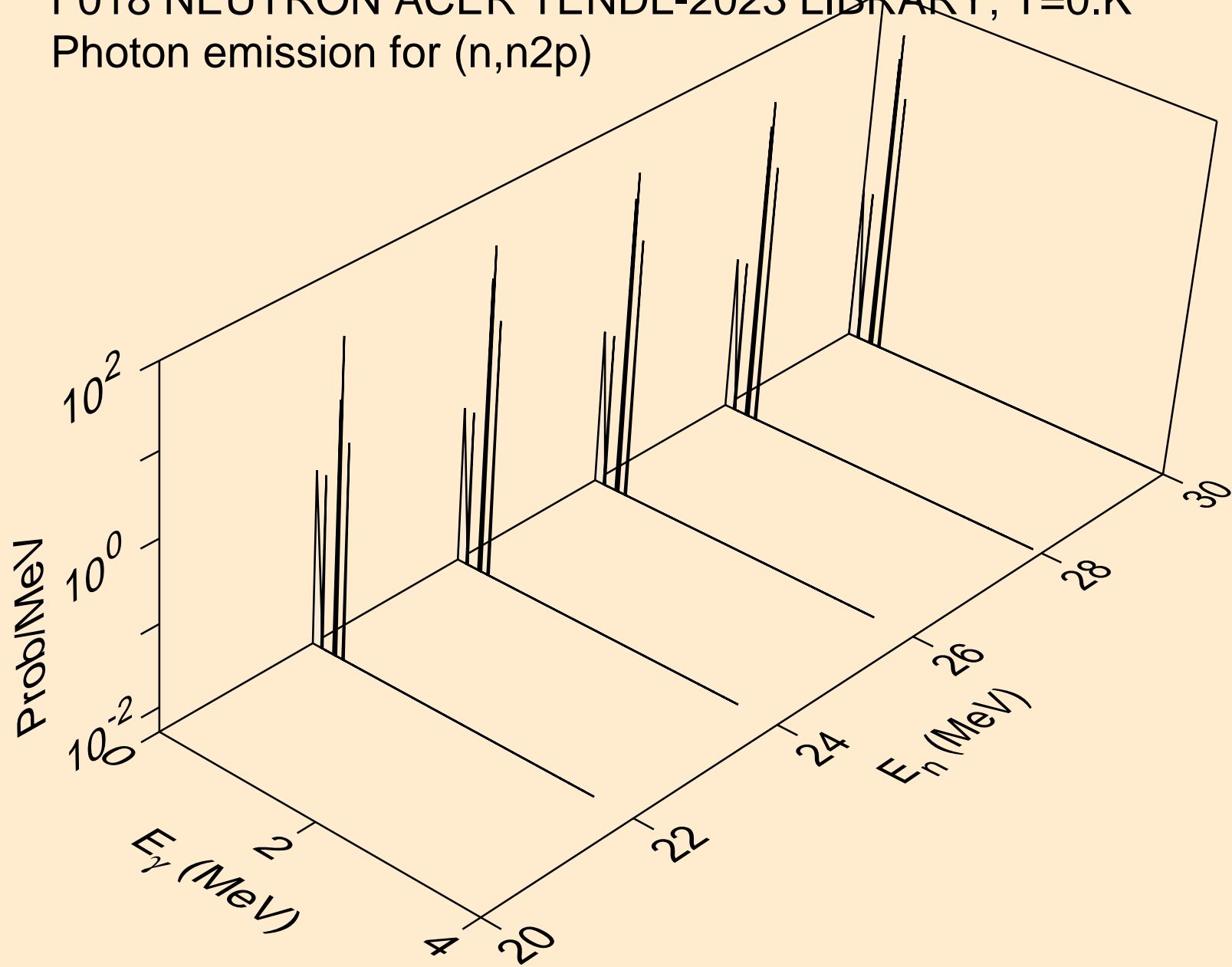

F018 NEUTRON ACER TENDL-2023 LIBRARY; T=0.K
Photon emission for (n,npa)

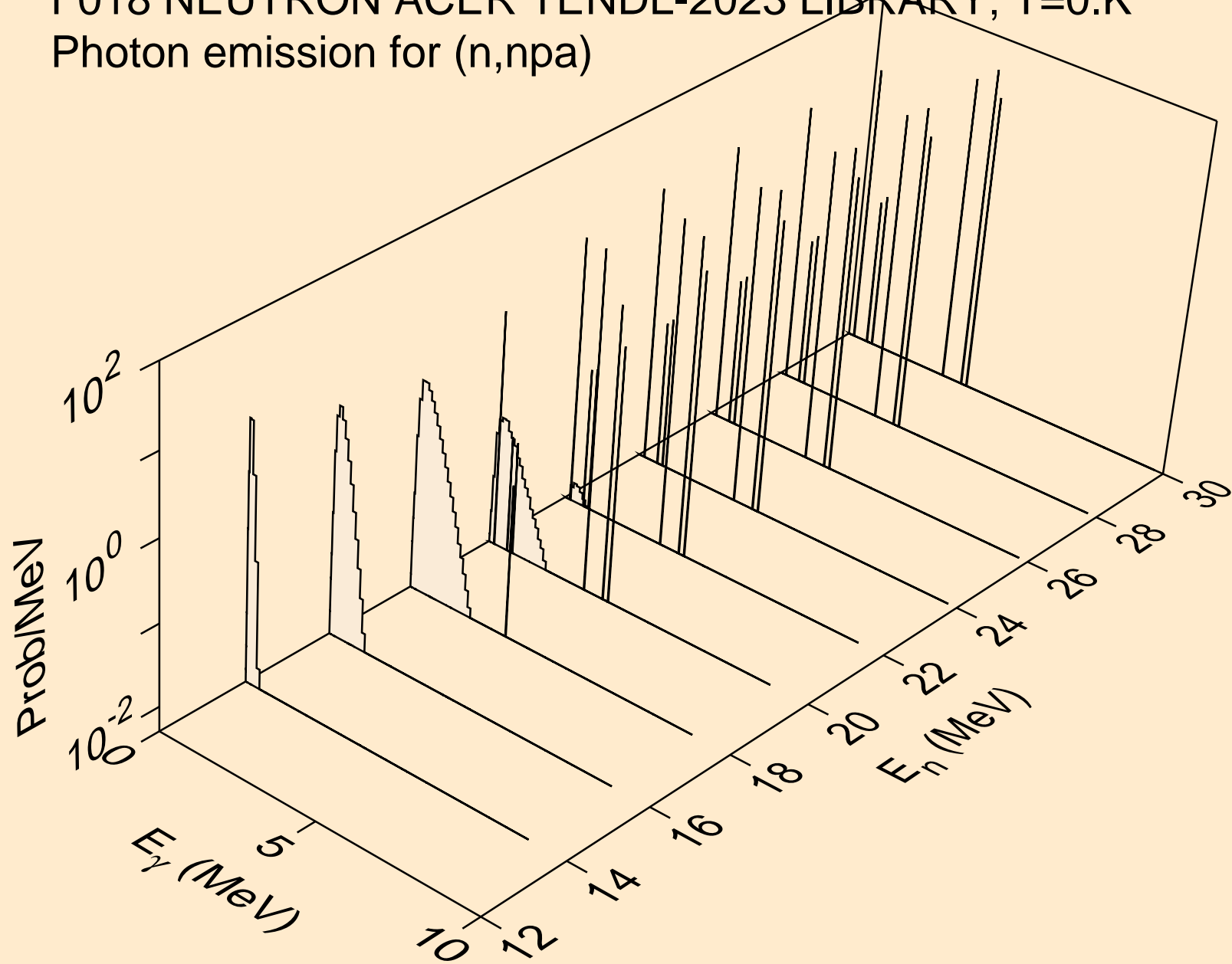

F018 NEUTRON ACER TENDL-2023 LIBRARY; T=0.K
Photon emission for (n,n*c)

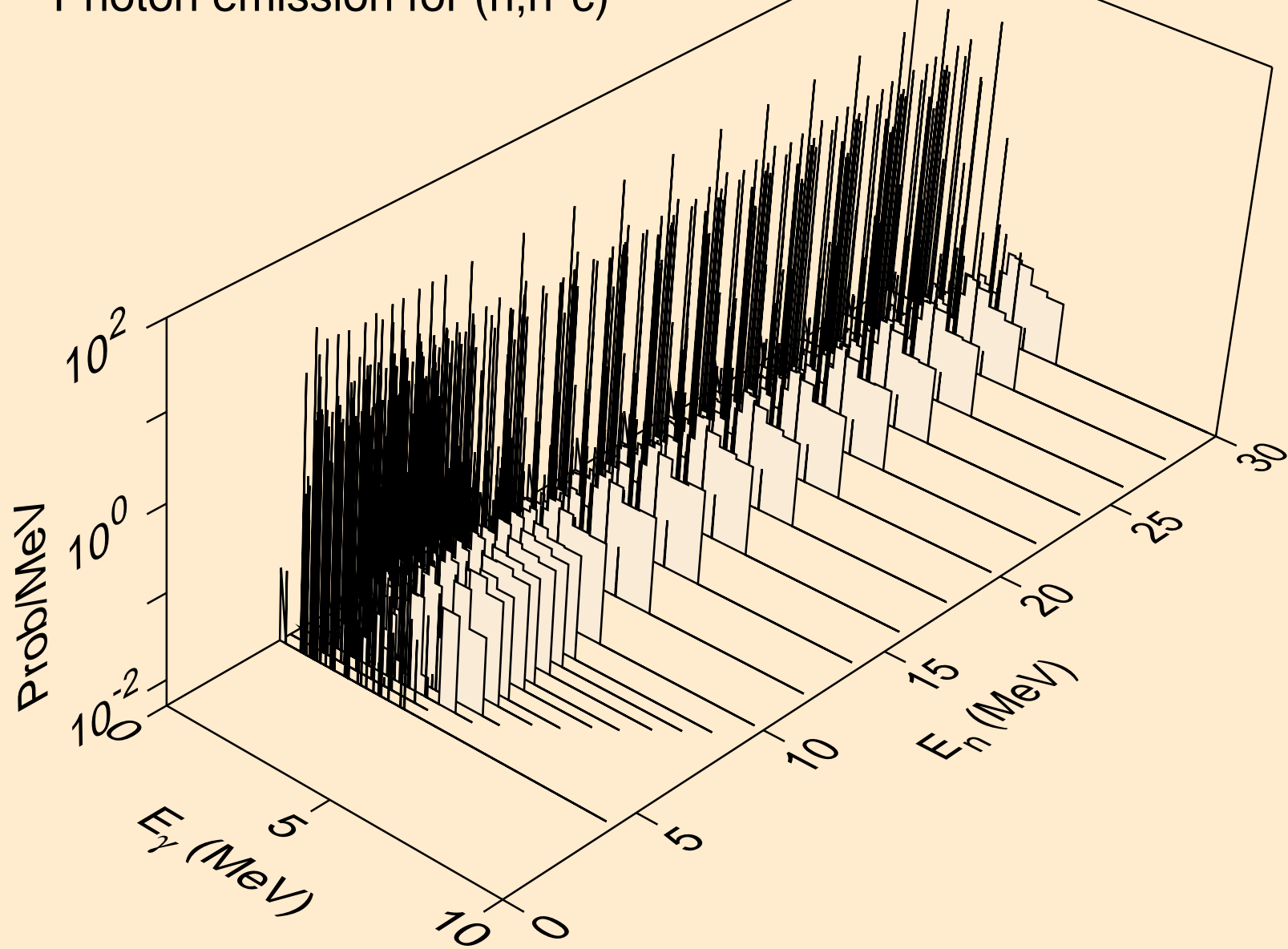

F018 NEUTRON ACER TENDL-2023 LIBRARY; T=0.K
Photon emission for (n,gma)

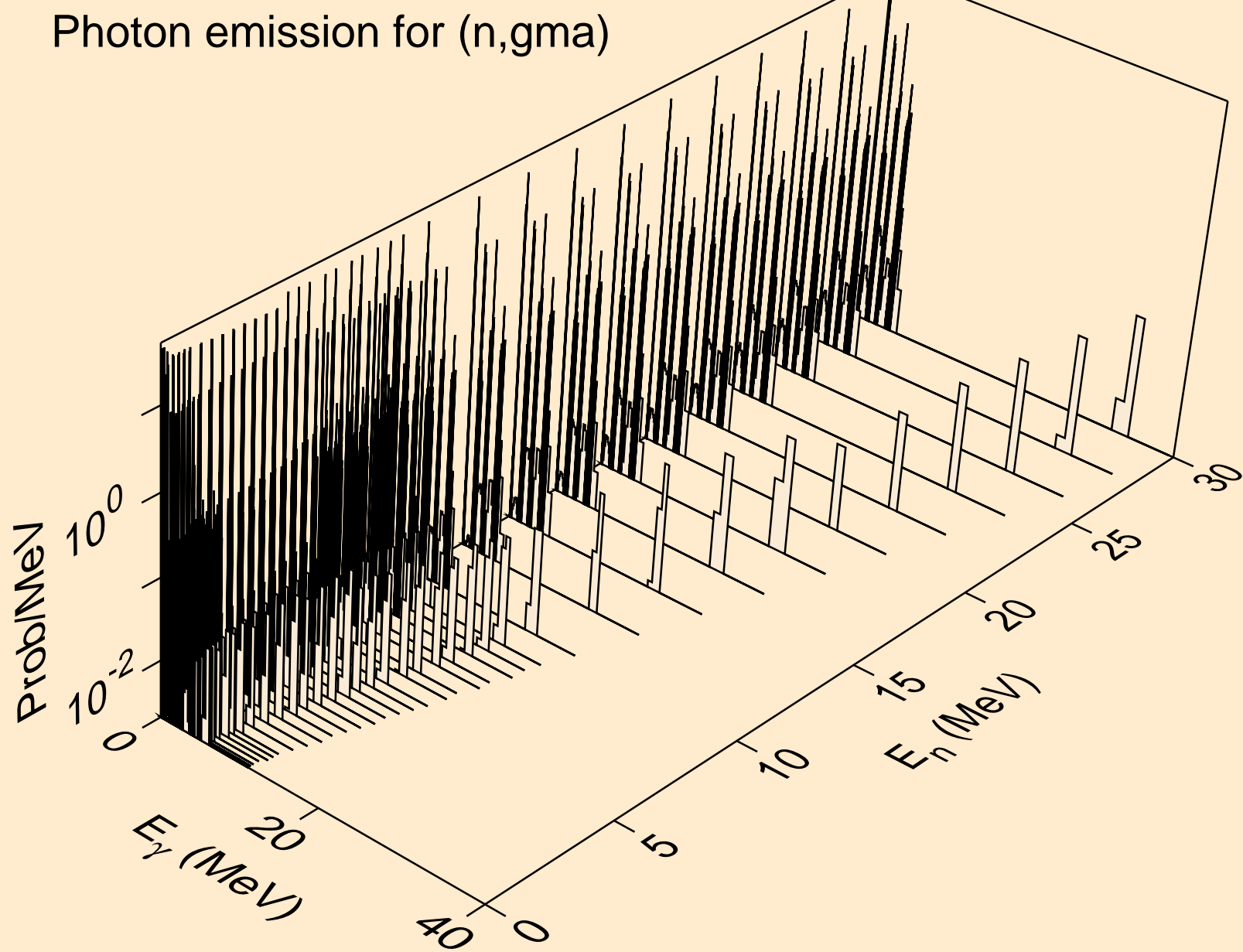

F018 NEUTRON ACER TENDL-2023 LIBRARY; T=0.K
Photon emission for (n,p)

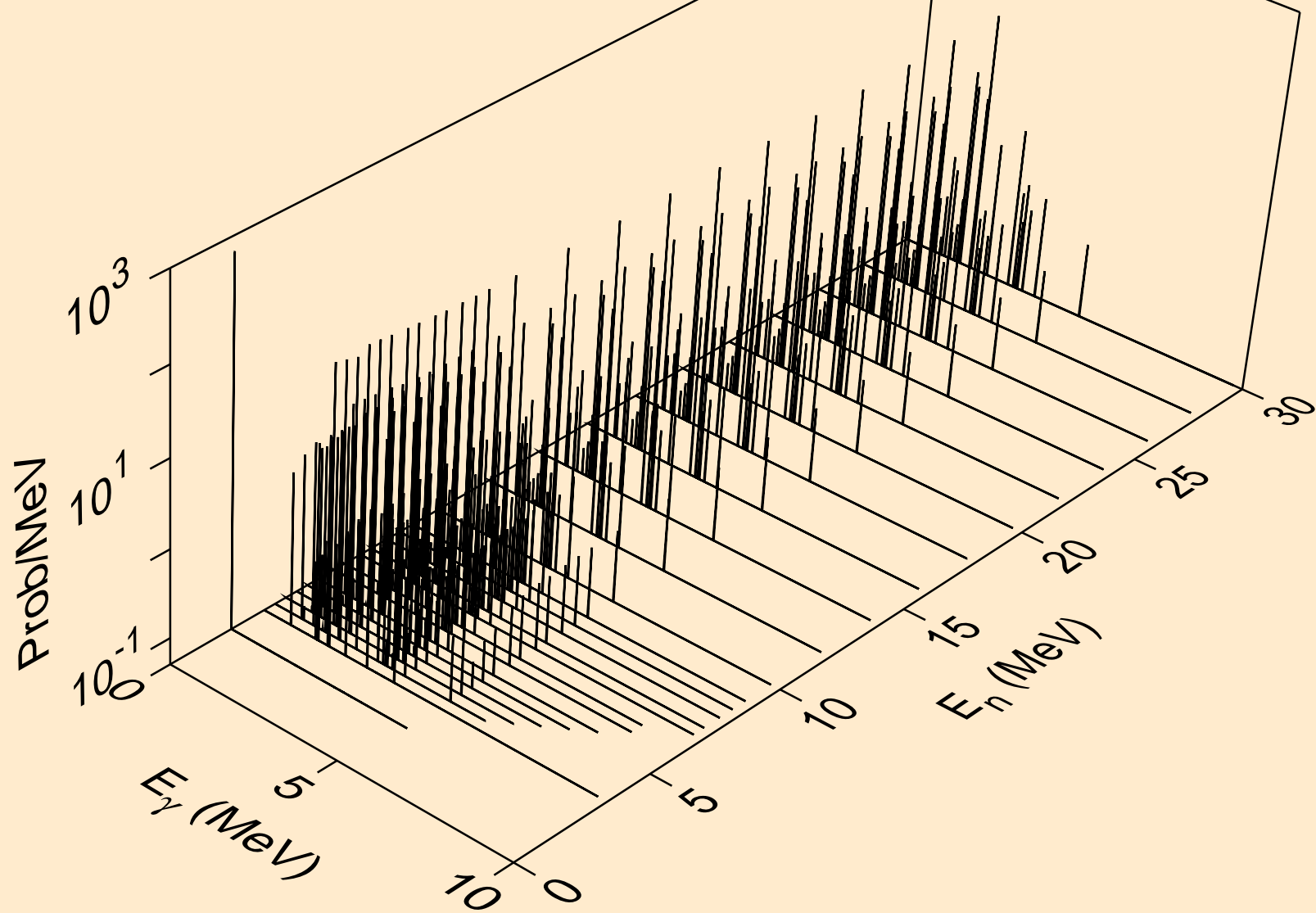

F018 NEUTRON ACER TENDL-2023 LIBRARY; T=0.K
Photon emission for (n,d)

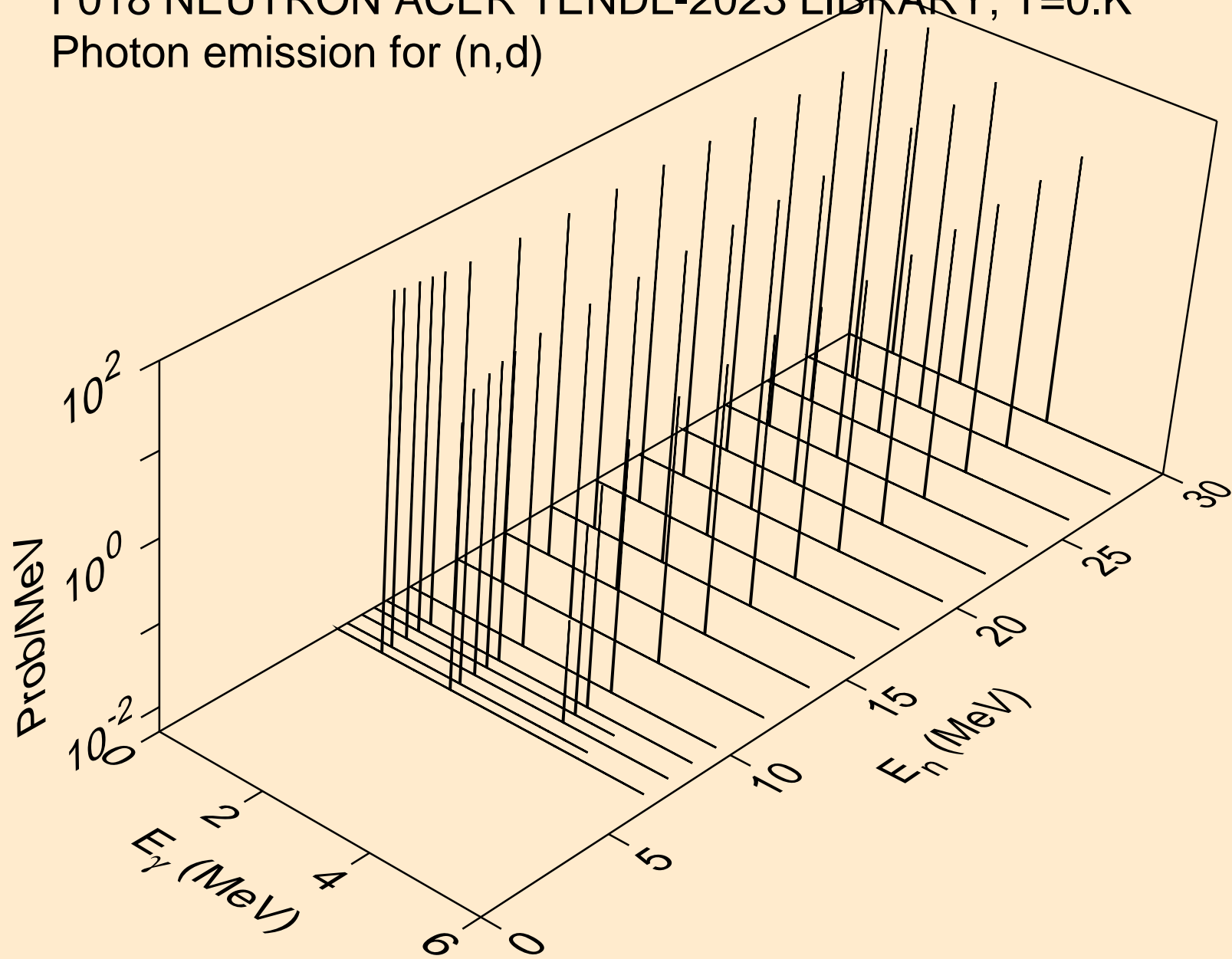

F018 NEUTRON ACER TENDL-2023 LIBRARY; T=0.K
Photon emission for (n,t)

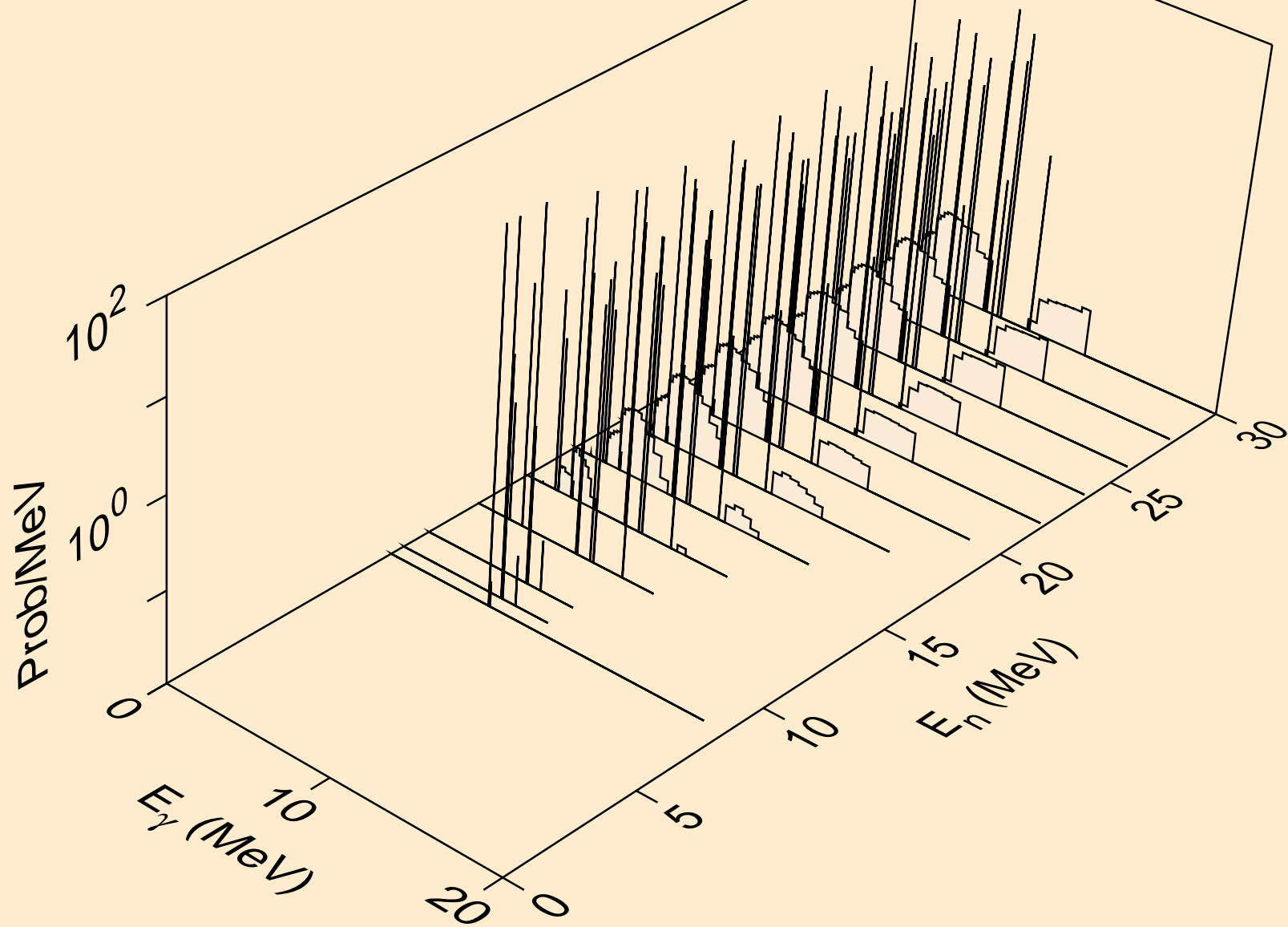

F018 NEUTRON ACER TENDL-2023 LIBRARY; T=0.K
Photon emission for (n,he3)

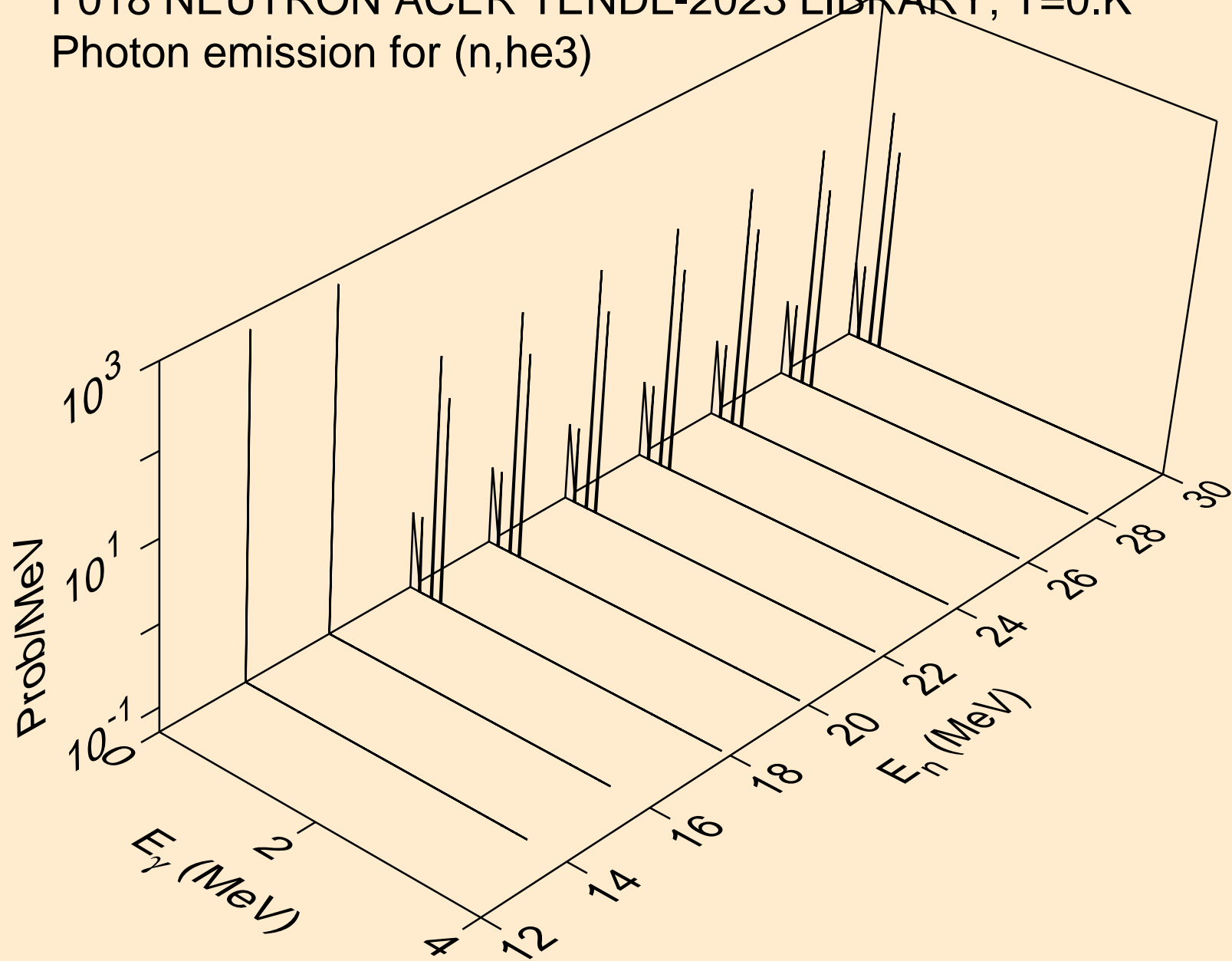

F018 NEUTRON ACER TENDL-2023 LIBRARY; T=0.K
Photon emission for (n,a)

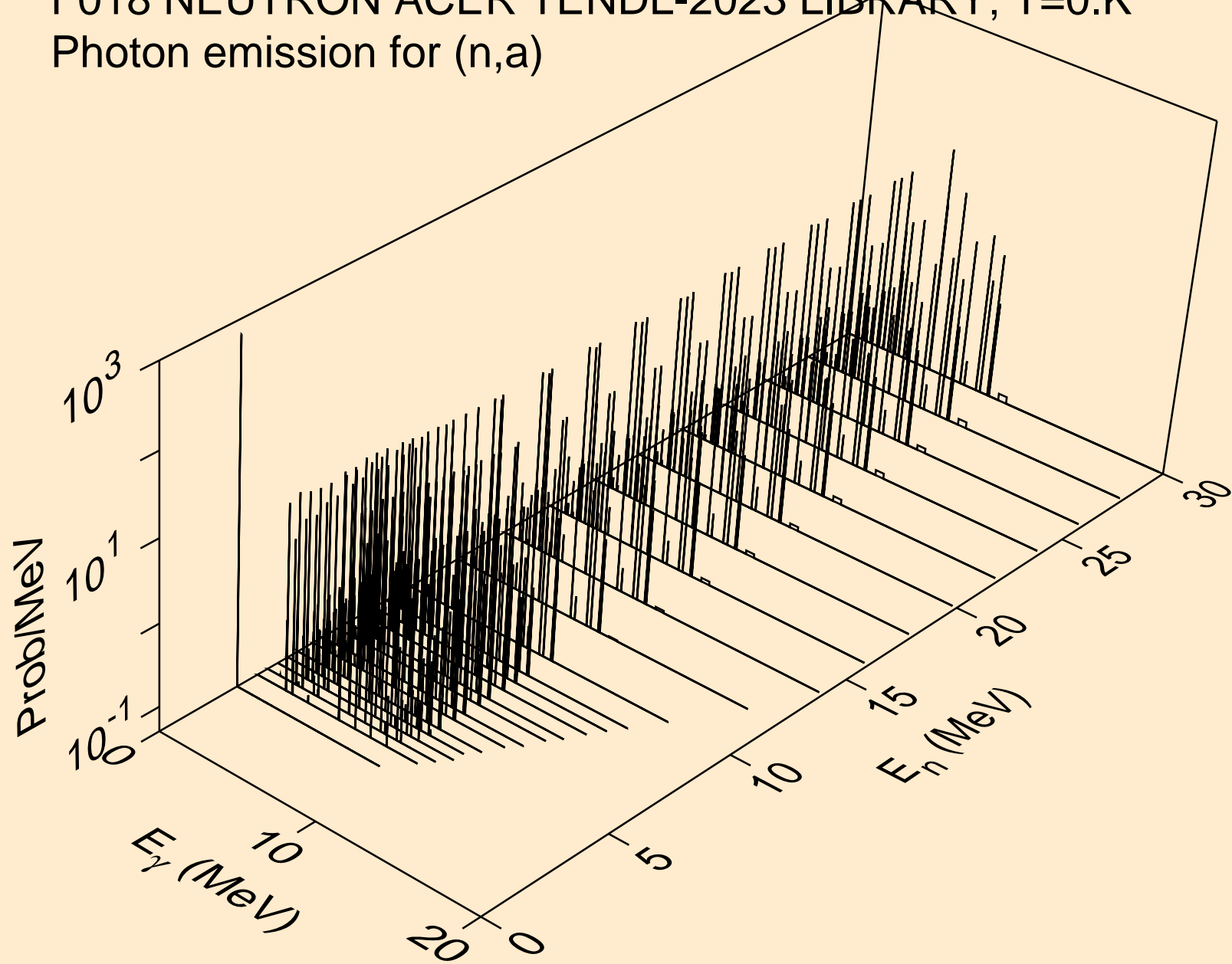

F018 NEUTRON ACER TENDL-2023 LIBRARY; T=0.K
Photon emission for (n,2a)

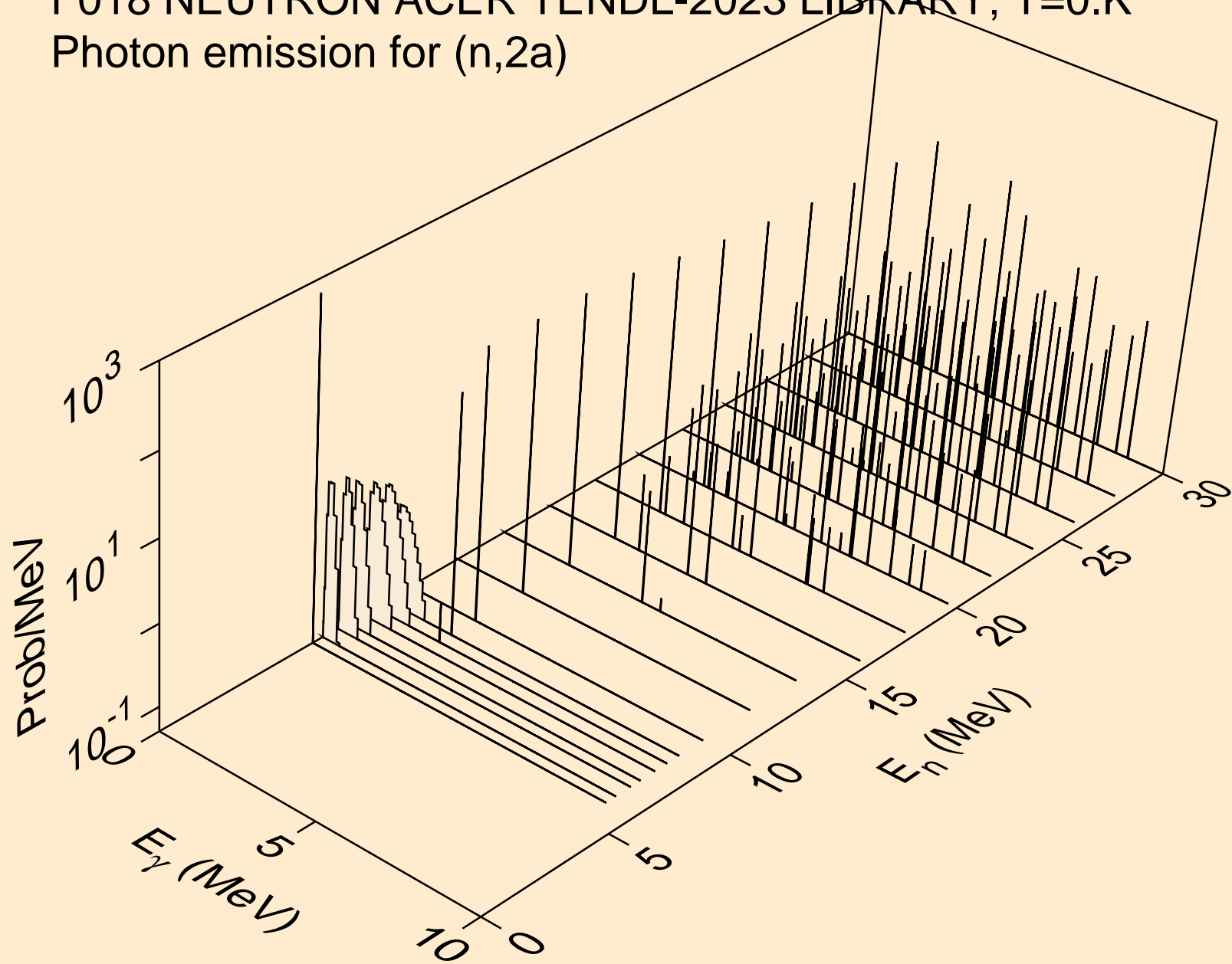

F018 NEUTRON ACER TENDL-2023 LIBRARY; T=0.K
Photon emission for (n,3a)

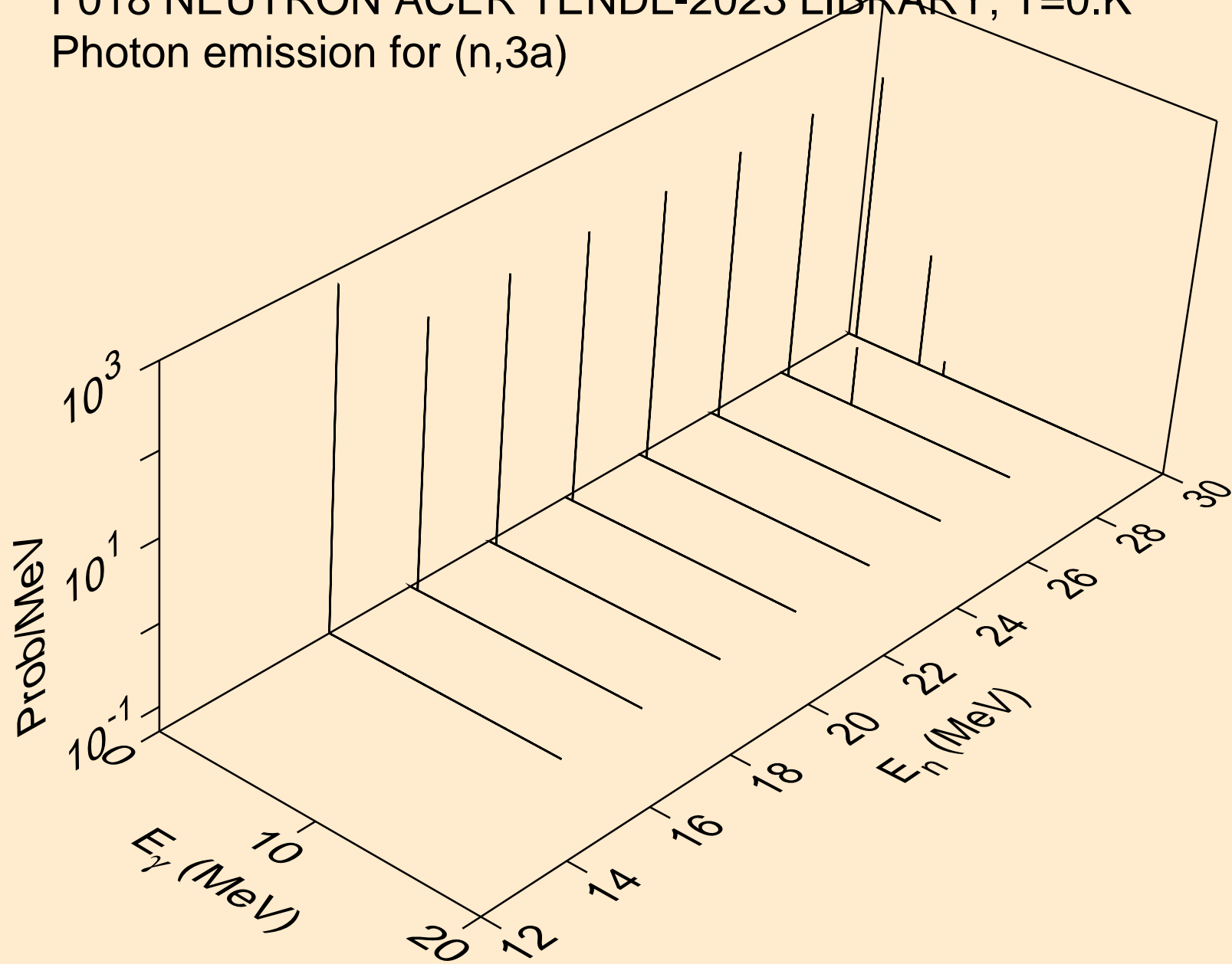

F018 NEUTRON ACER TENDL-2023 LIBRARY; T=0.K
Photon emission for (n,2p)

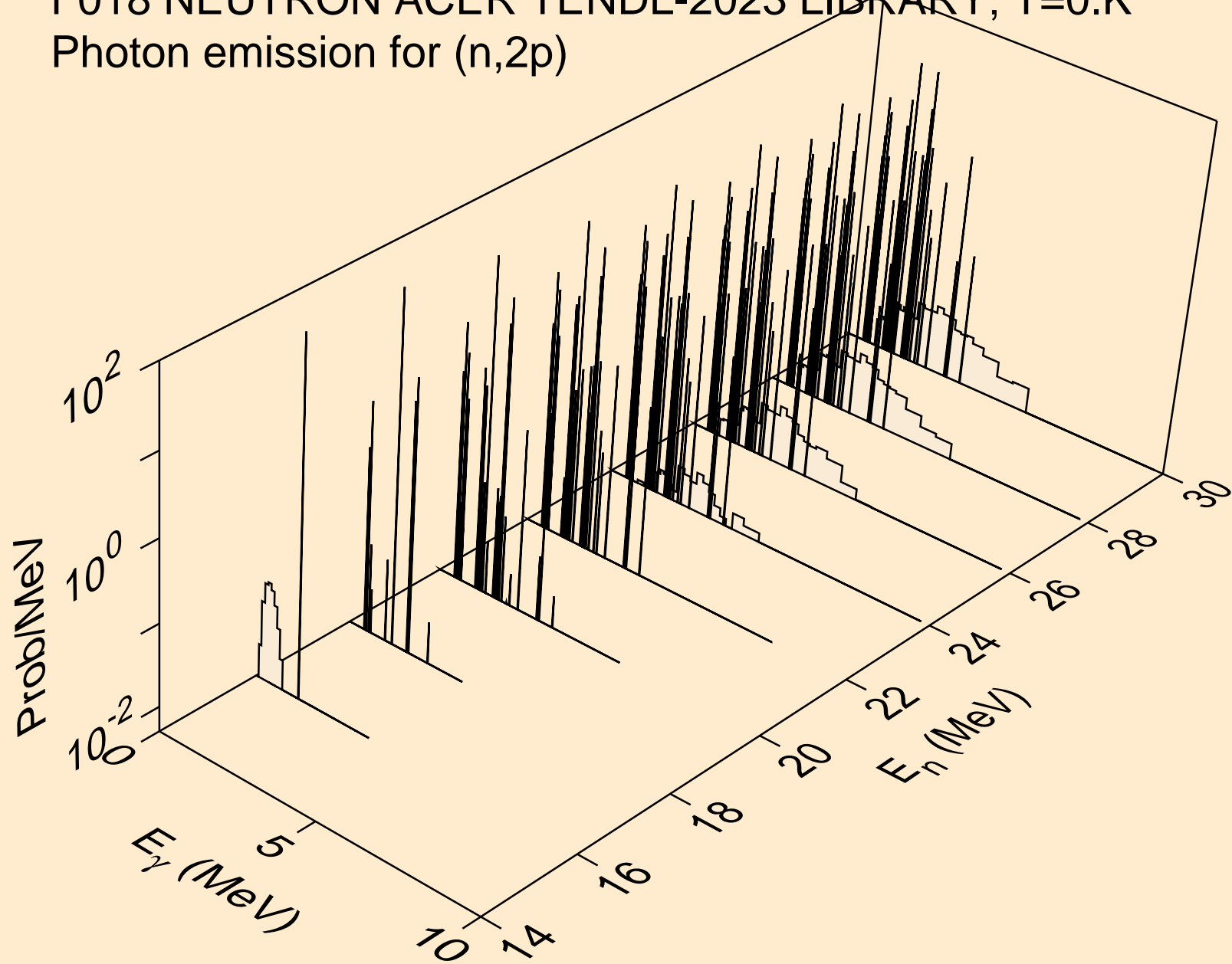

F018 NEUTRON ACER TENDL-2023 LIBRARY; T=0.K
Photon emission for (n,p)

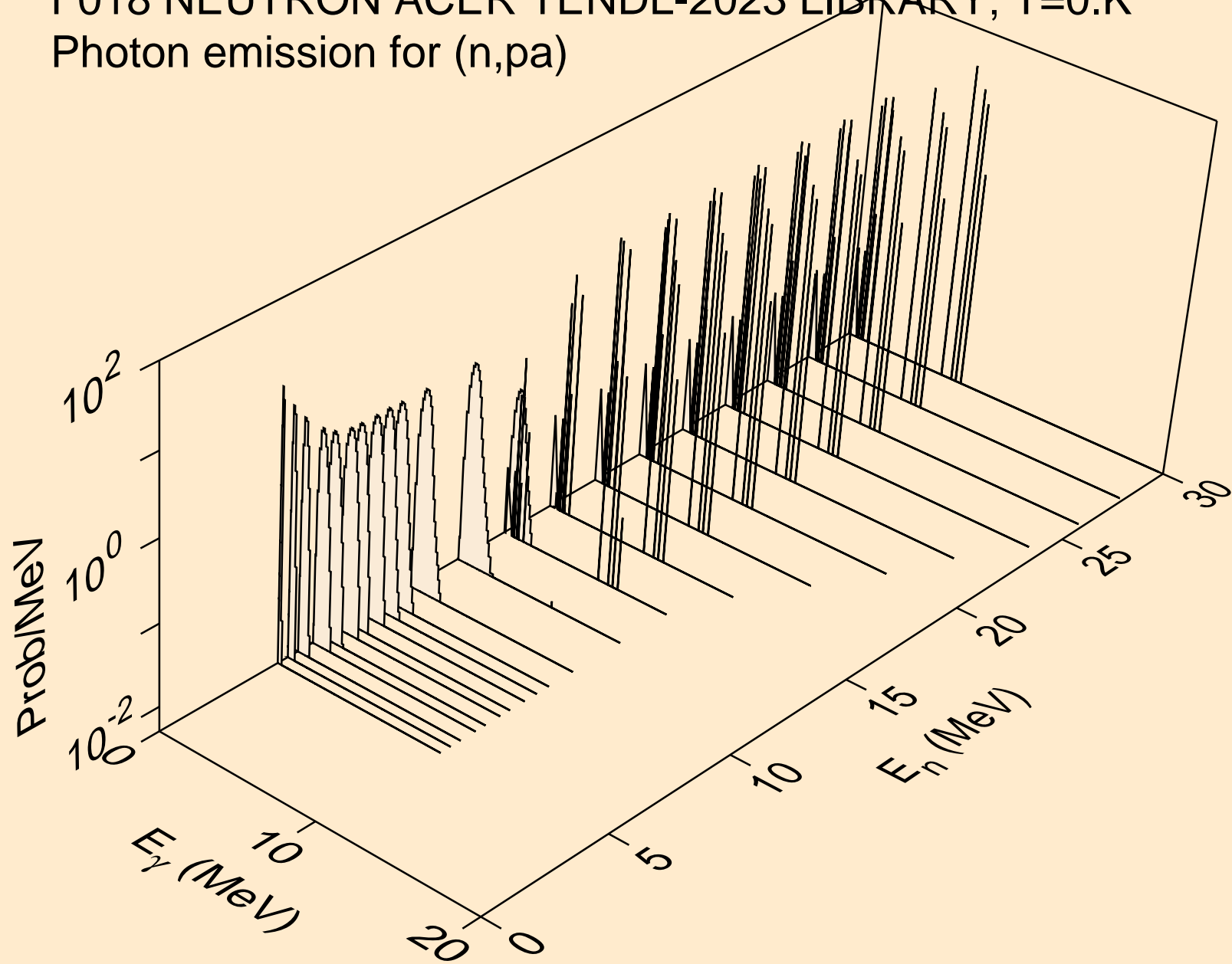

F018 NEUTRON ACER TENDL-2023 LIBRARY; T=0.K
Photon emission for (n,t2a)

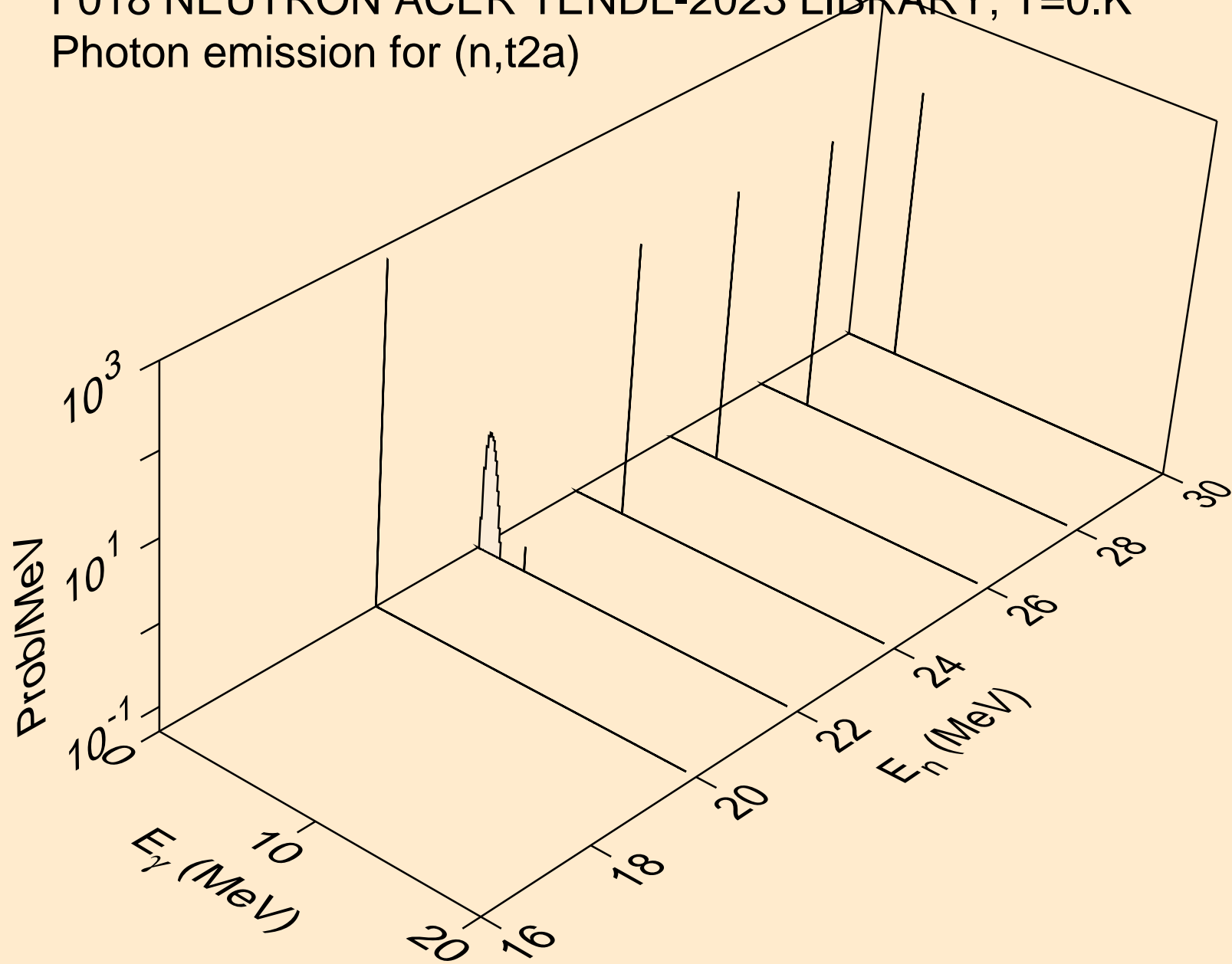

F018 NEUTRON ACER TENDL-2023 LIBRARY; T=0.K
Photon emission for (n,d2a)

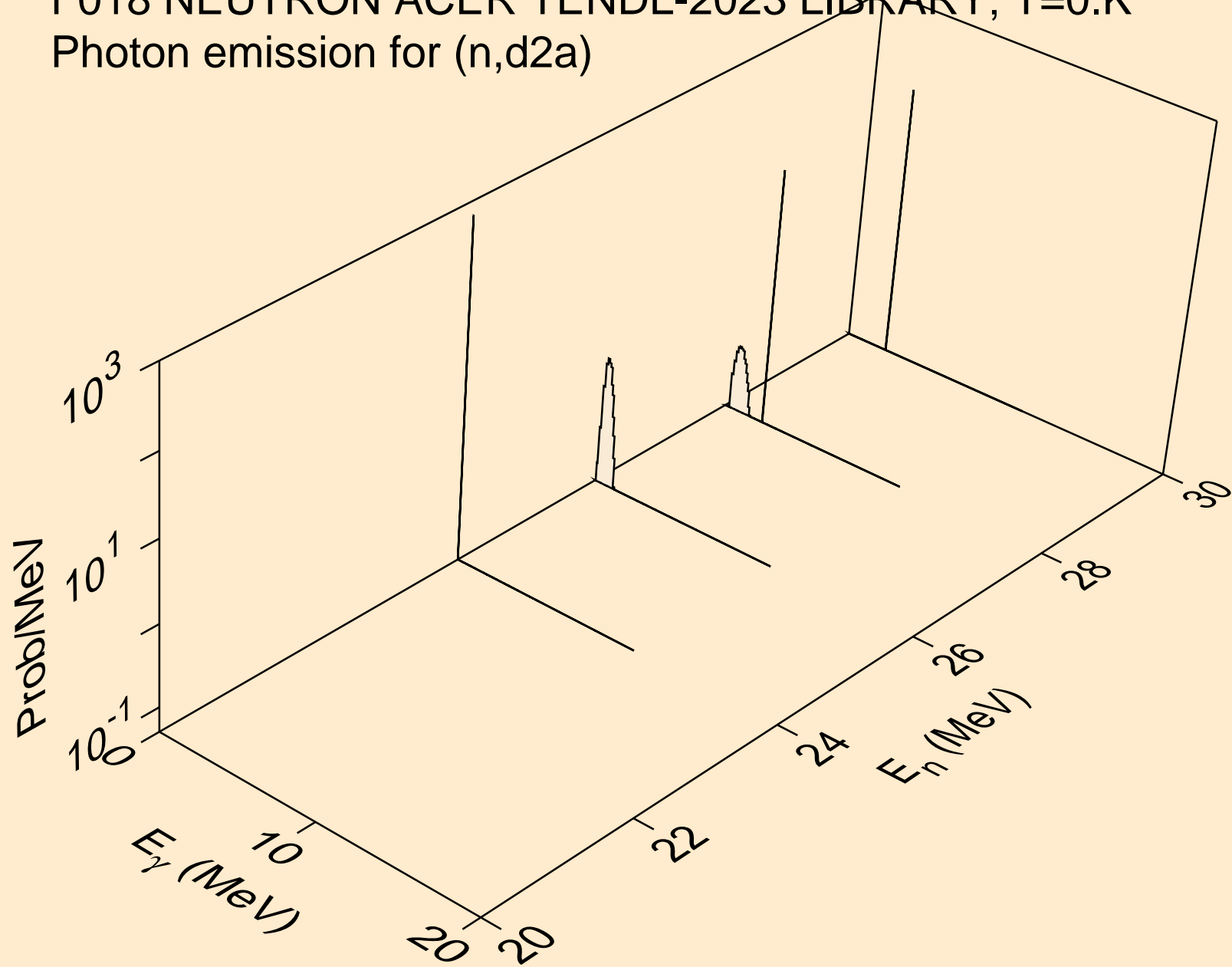

F018 NEUTRON ACER TENDL-2023 LIBRARY; T=0.K
Photon emission for (n,pd)

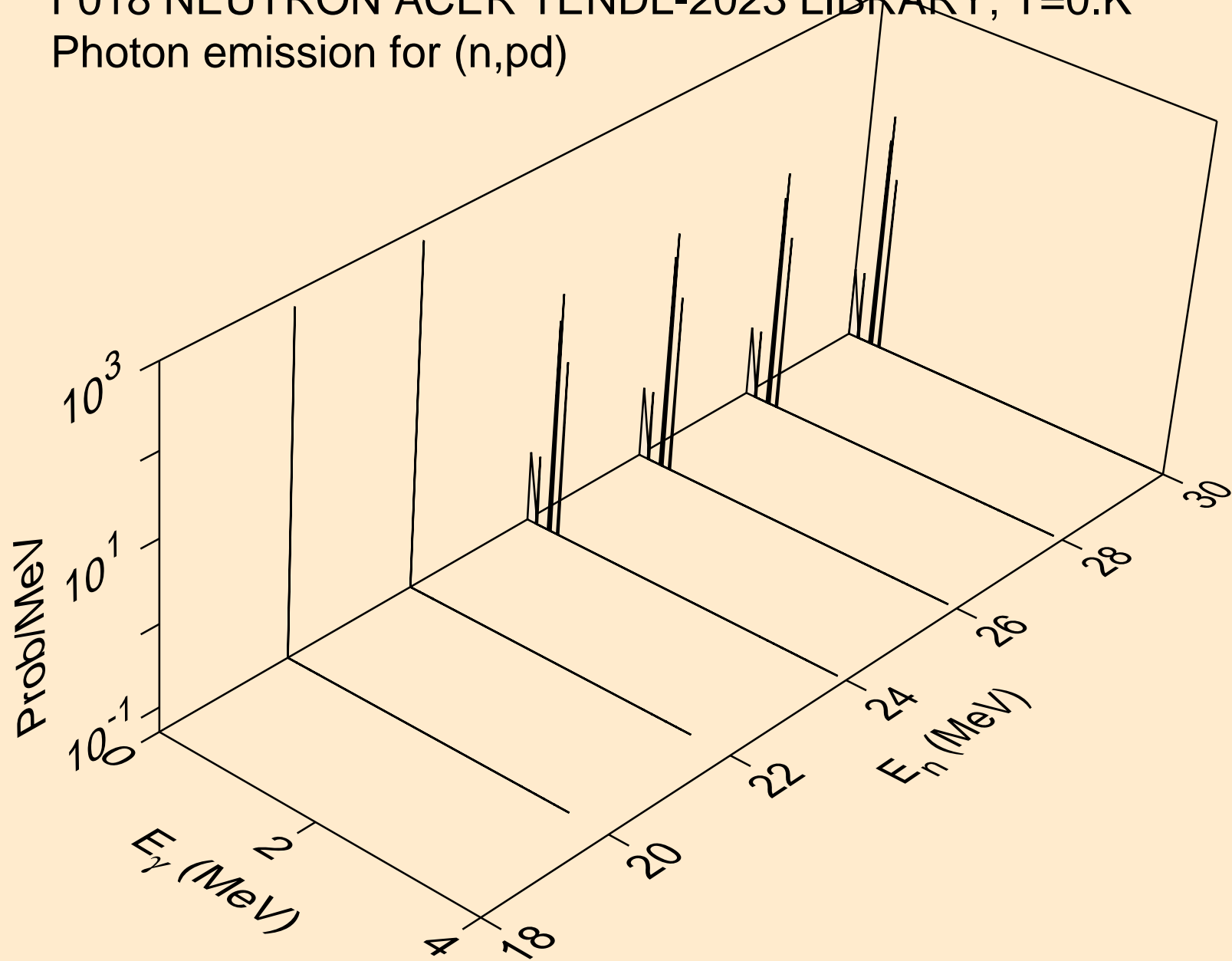

F018 NEUTRON ACER TENDL-2023 LIBRARY; T=0.K
Photon emission for (n,pt)

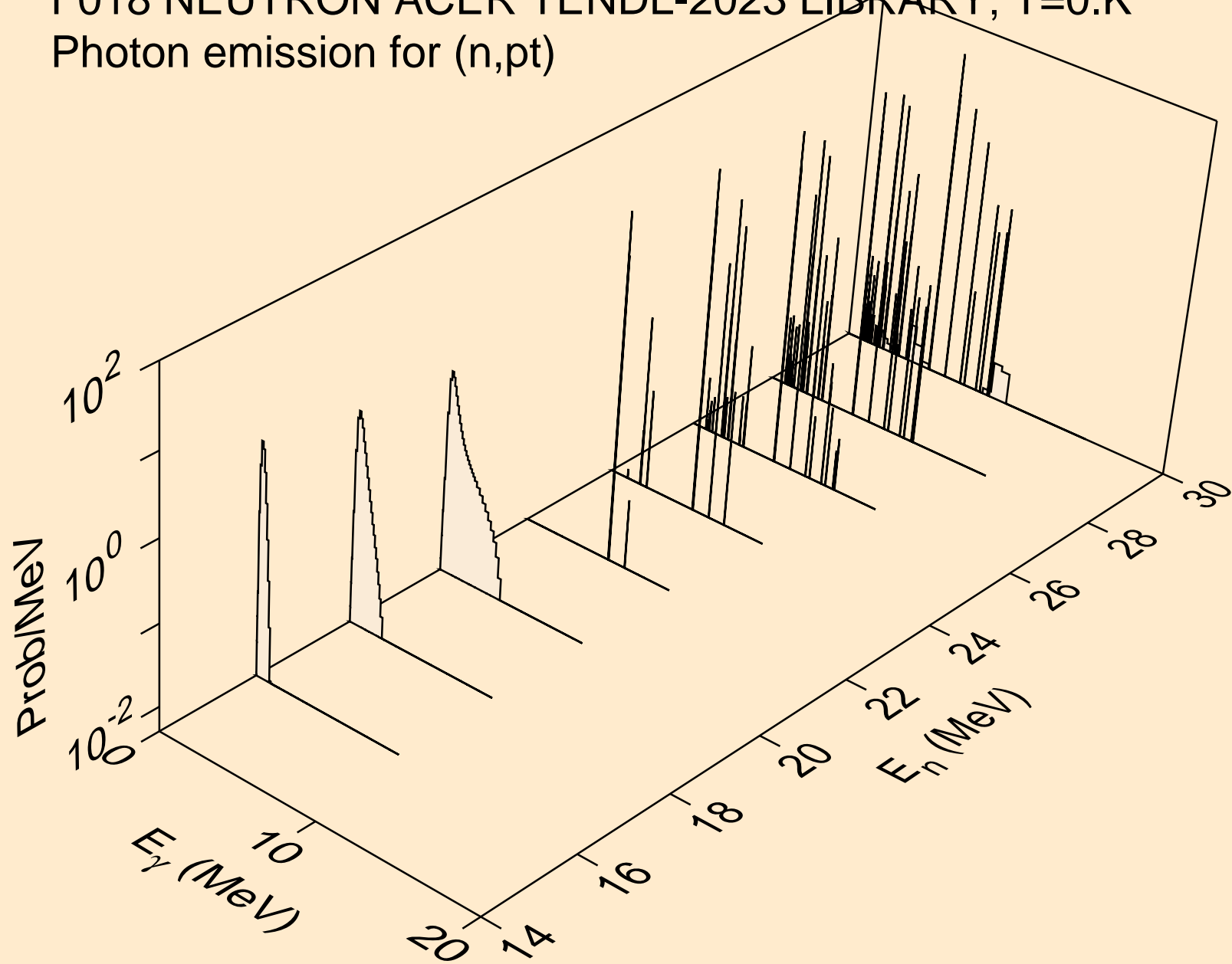

F018 NEUTRON ACER TENDL-2023 LIBRARY; T=0.K
Photon emission for (n,da)

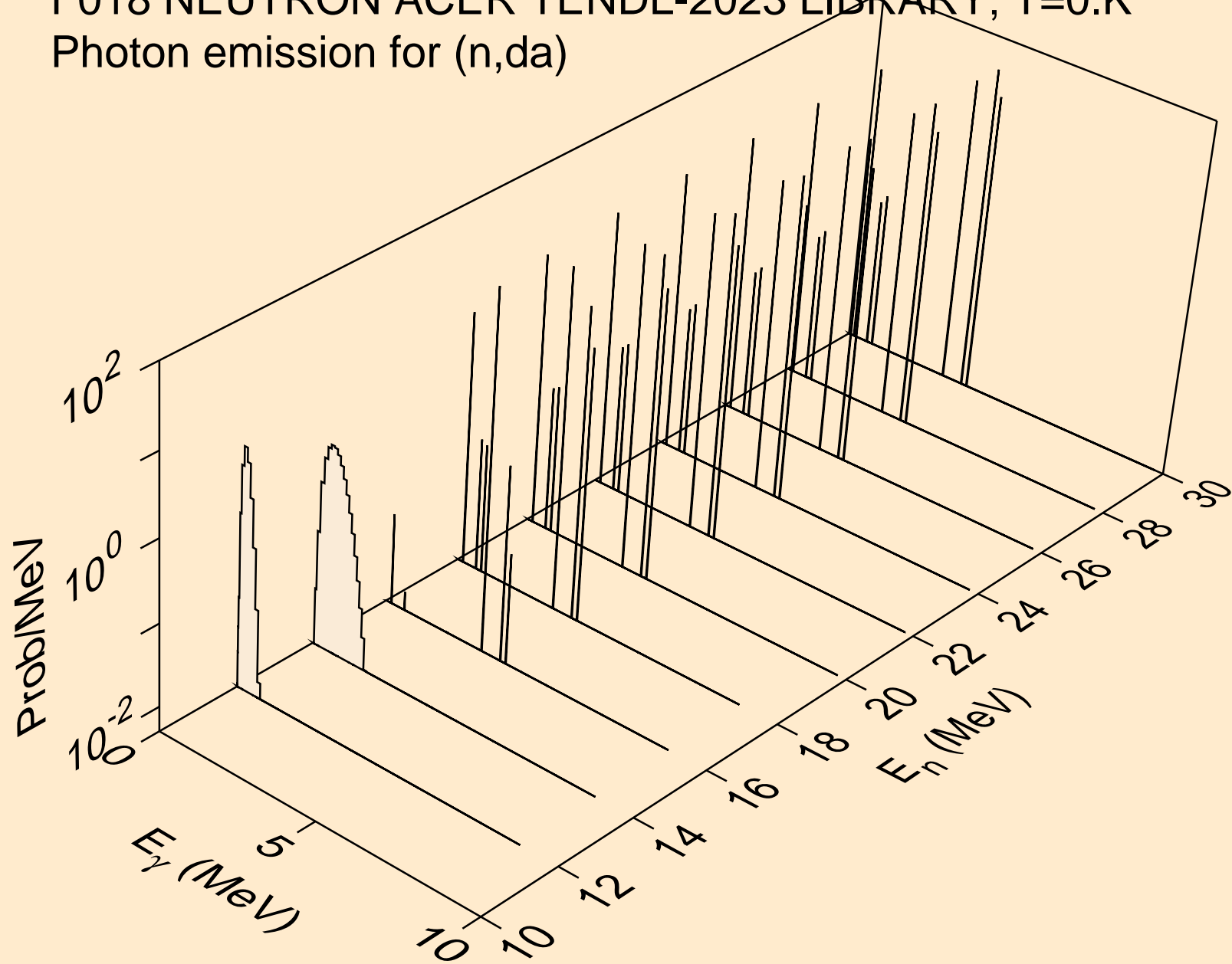

F018 NEUTRON ACER TENDL-2023 LIBRARY; T=0.K
thermal capture photon spectrum

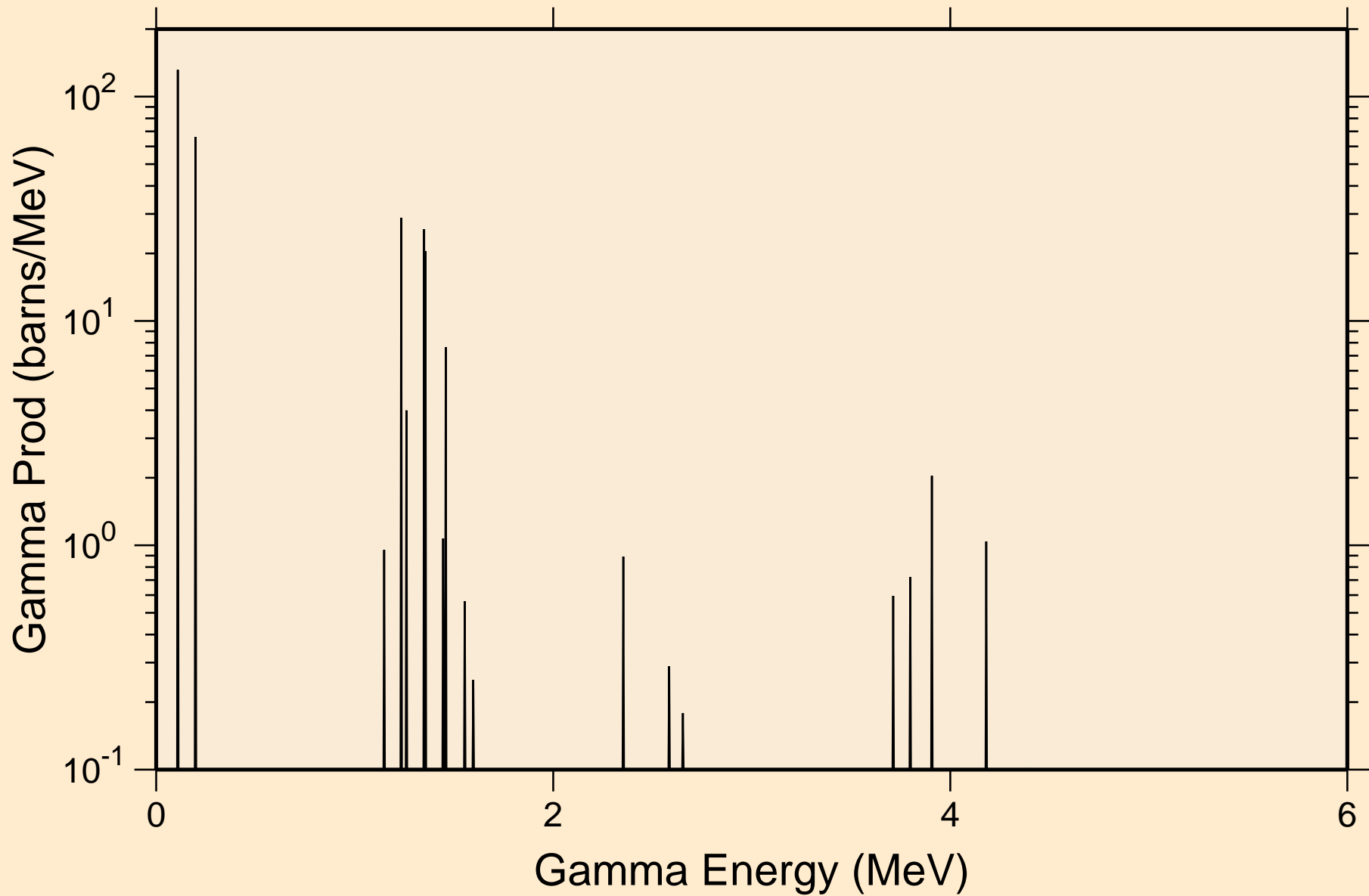

F018 NEUTRON ACER TENDL-2023 LIBRARY; T=0.K
14 MeV photon spectrum

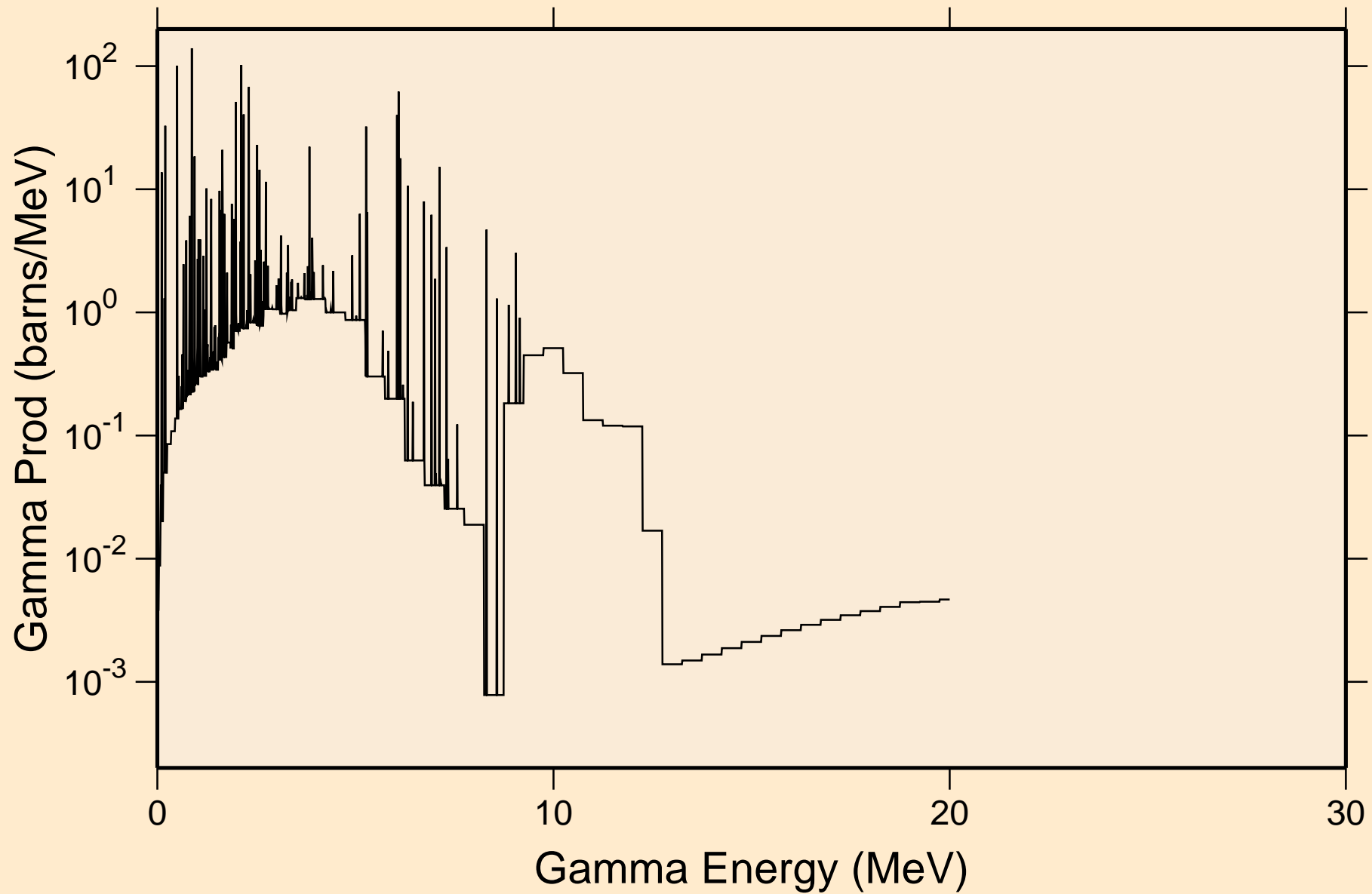

F018 NEUTRON ACER TENDL-2023 LIBRARY; T=0.K
Particle heating contributions

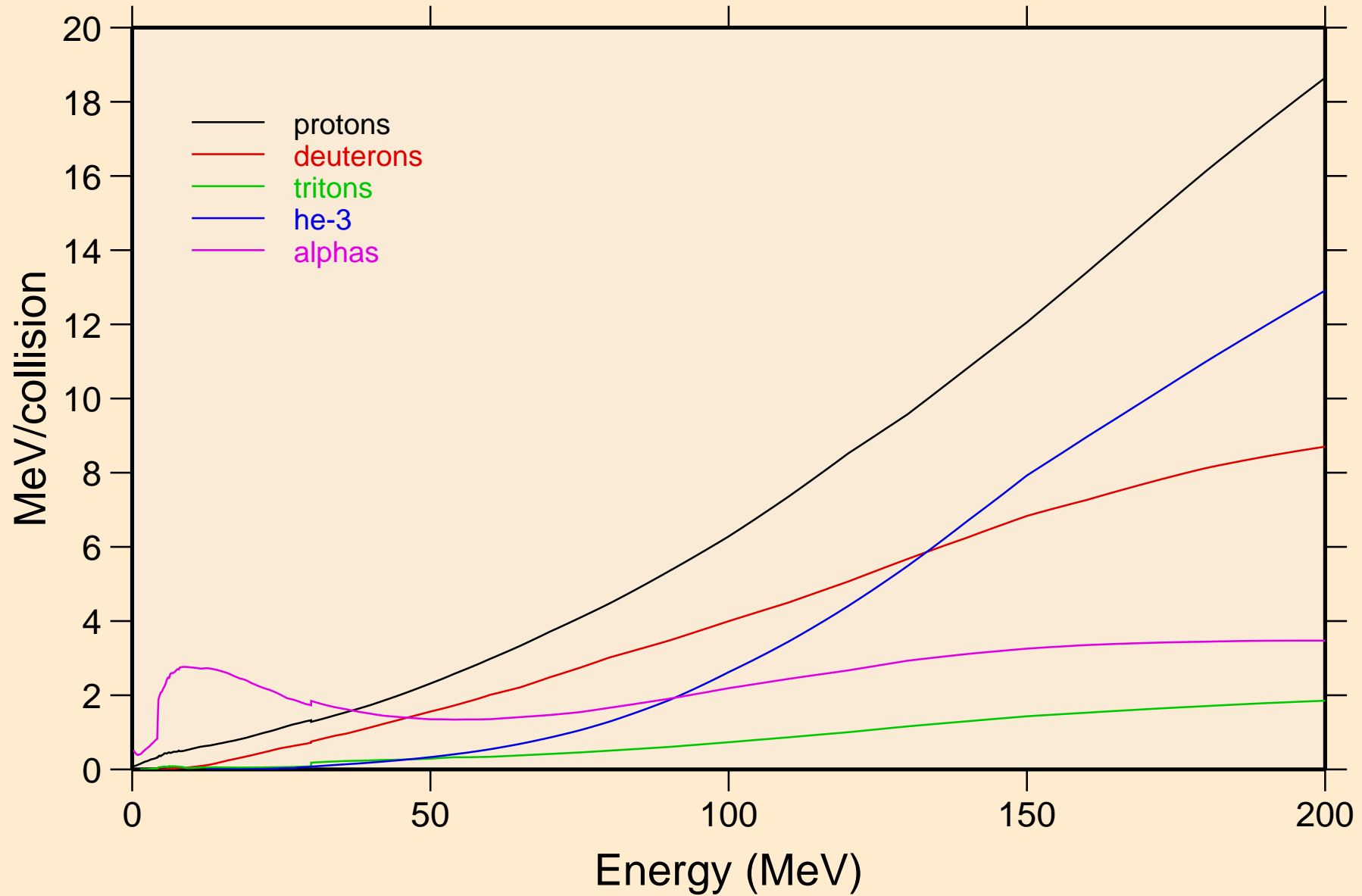

F018 NEUTRON ACER TENDL-2023 LIBRARY; T=0.K

Recoil Heating

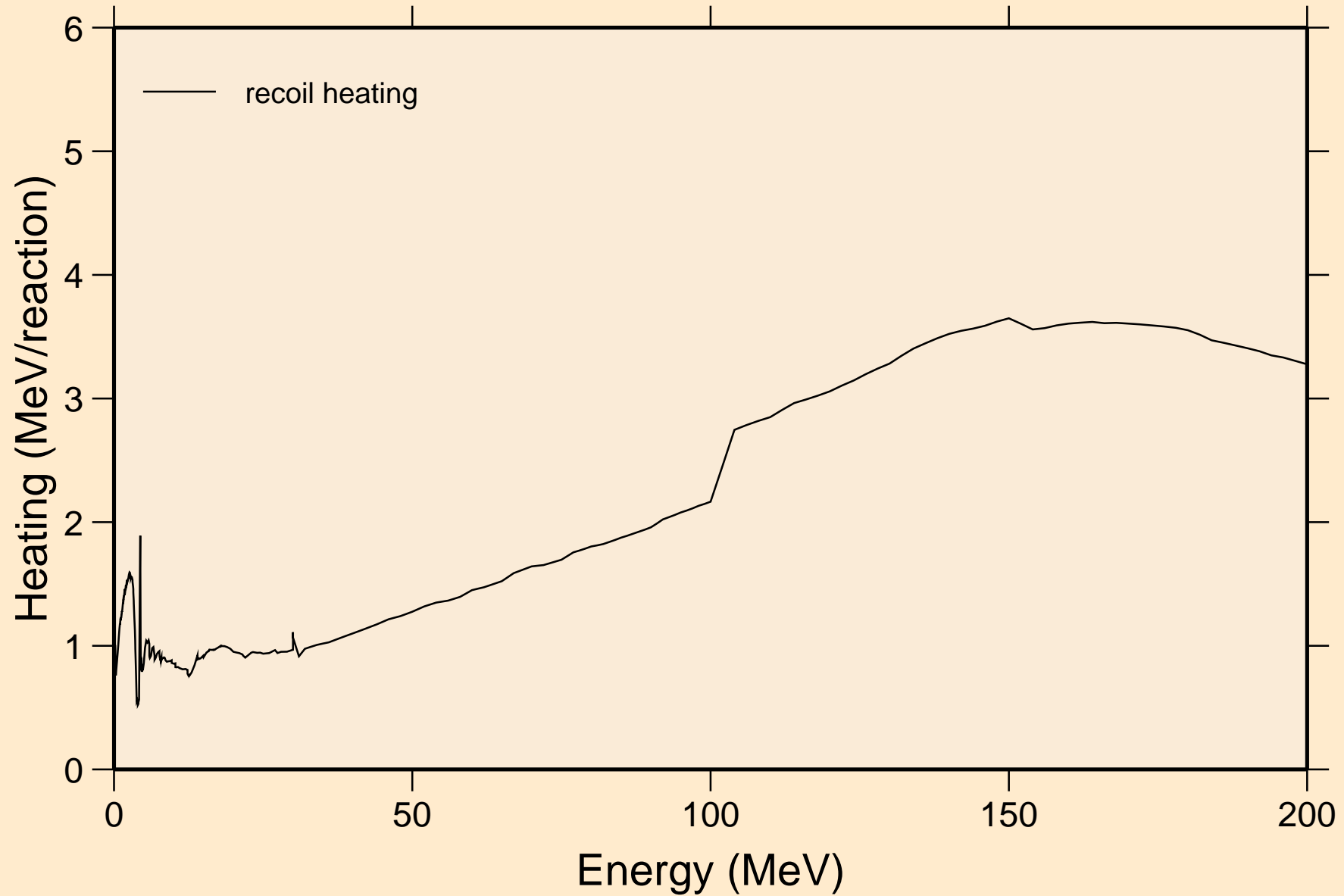

F018 NEUTRON ACER TENDL-2023 LIBRARY; T=0.K

Particle production cross sections

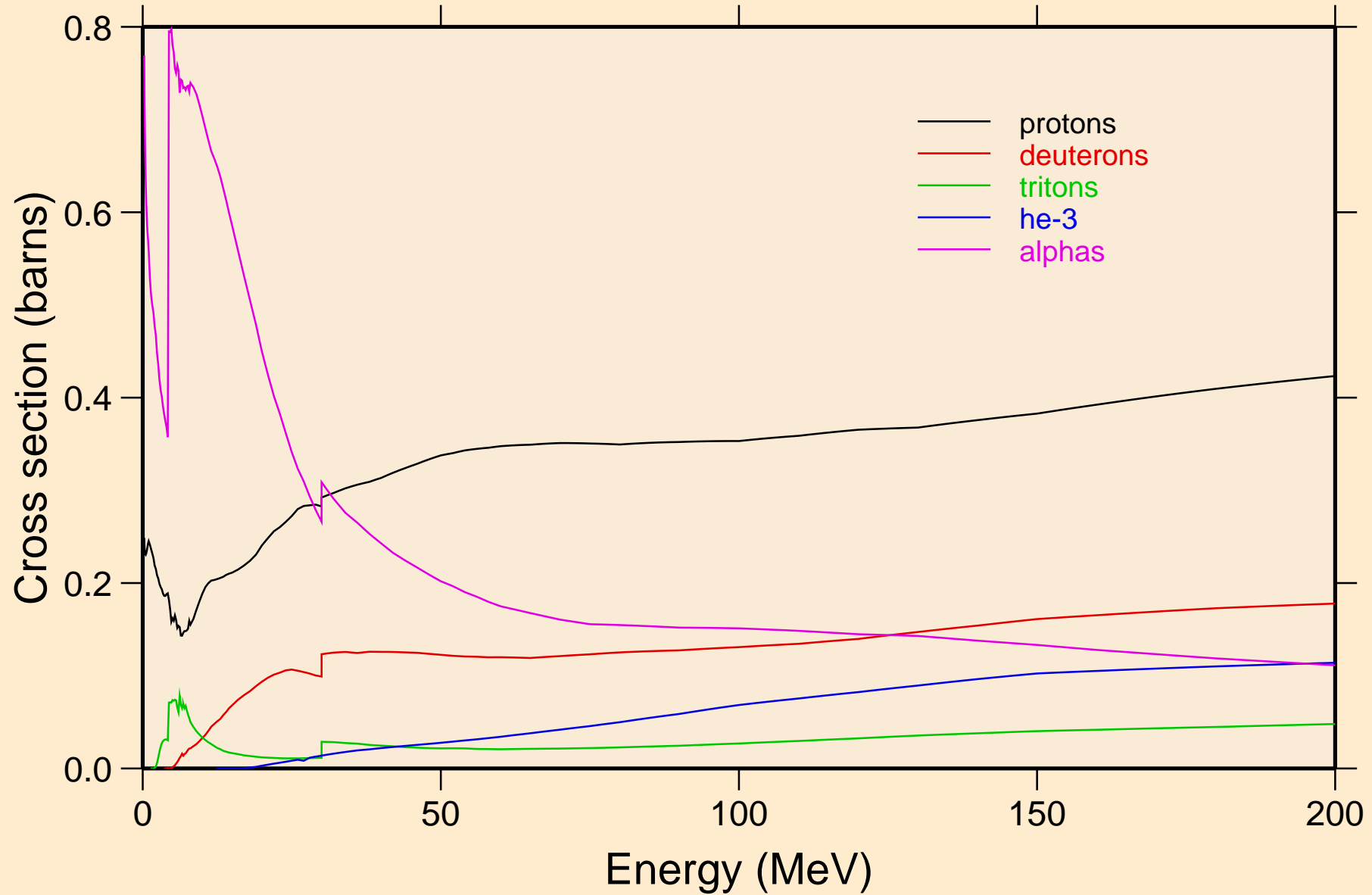

F018 NEUTRON ACER TENDL-2023 LIBRARY; T=0.K
protons from (n,x)

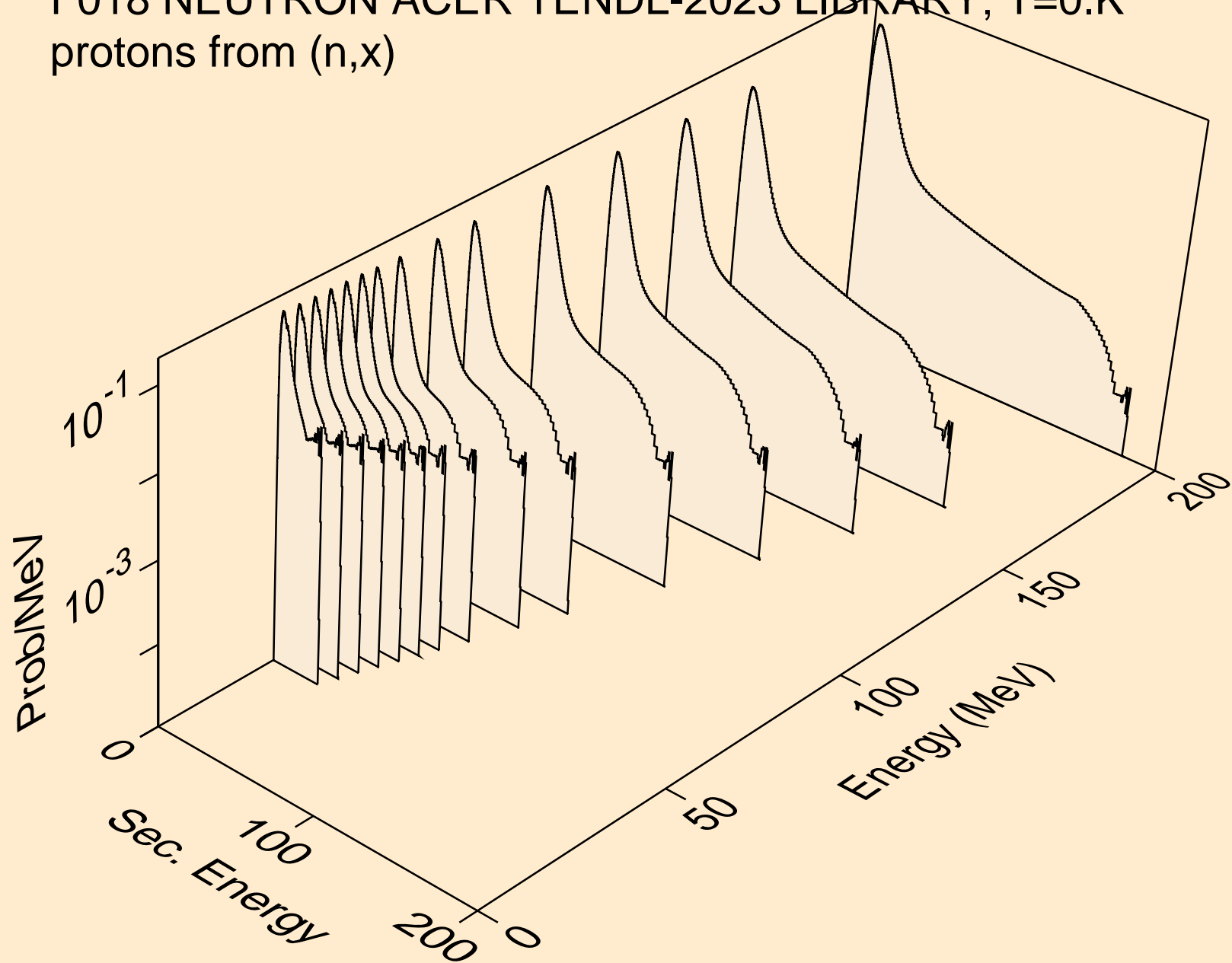

F018 NEUTRON ACER TENDL-2023 LIBRARY; T=0.K
protons from (n,n*)p

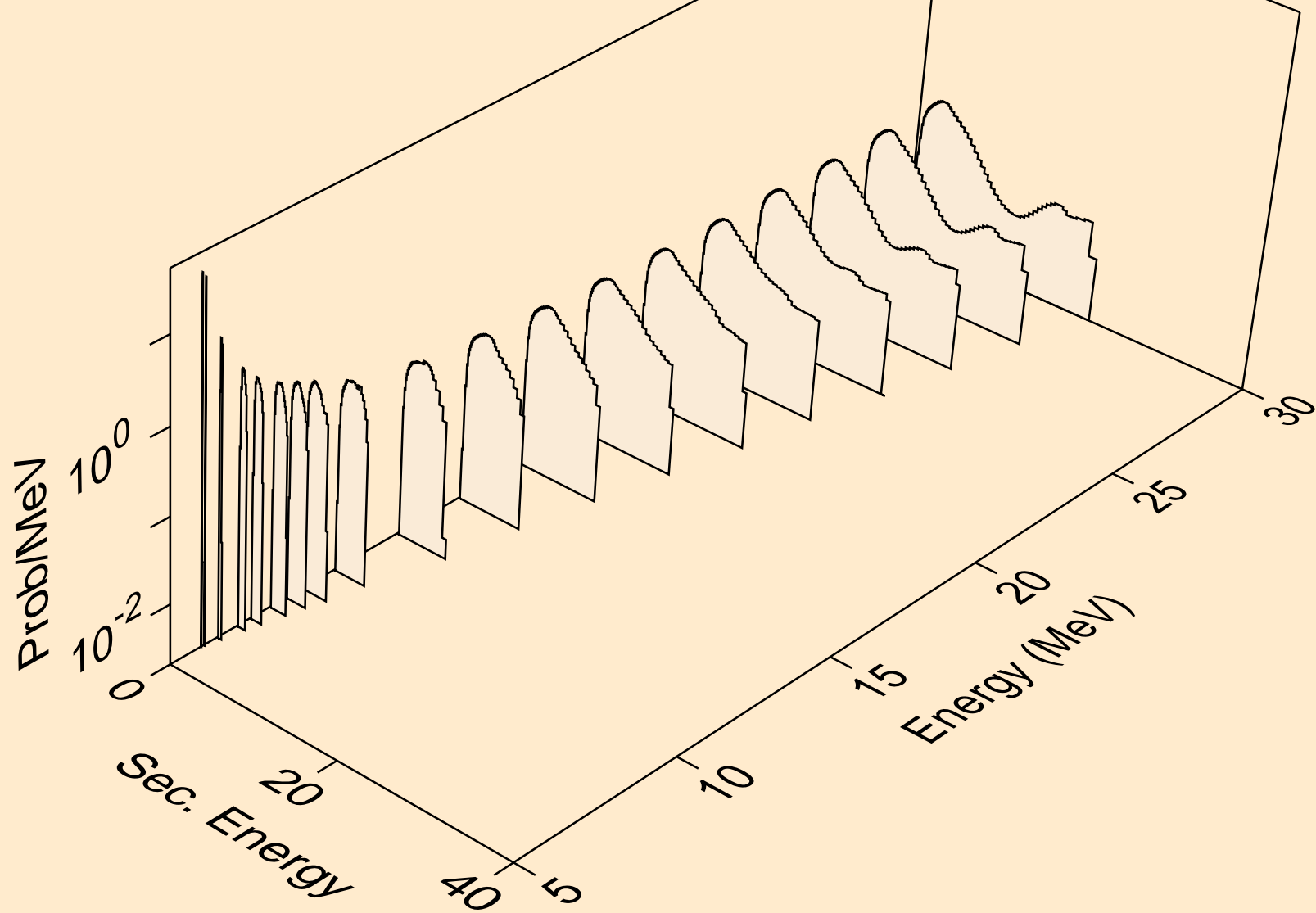

F018 NEUTRON ACER TENDL-2023 LIBRARY; T=0.K
protons from (n,2np)

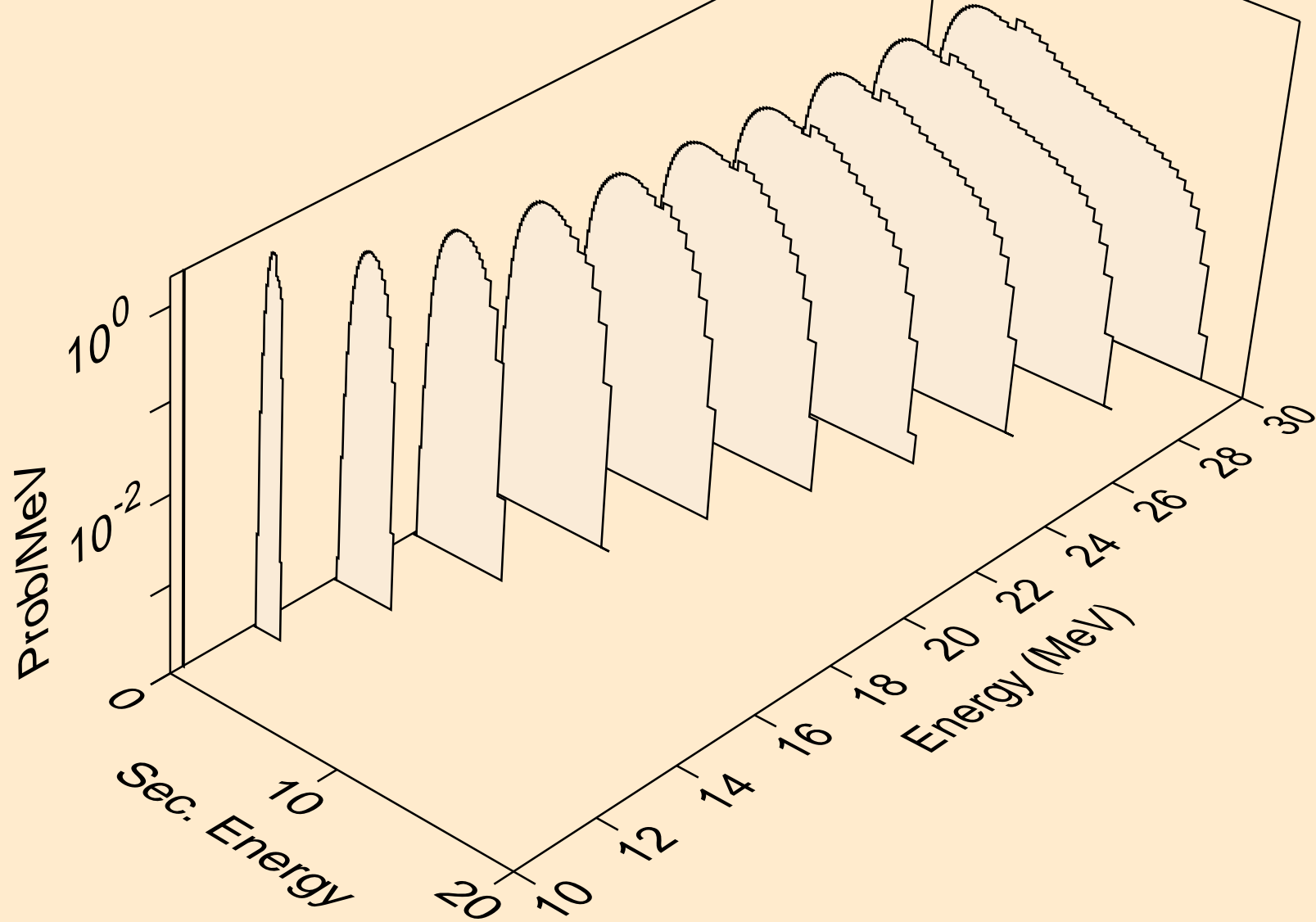

F018 NEUTRON ACER TENDL-2023 LIBRARY; T=0.K
protons from (n,3np)

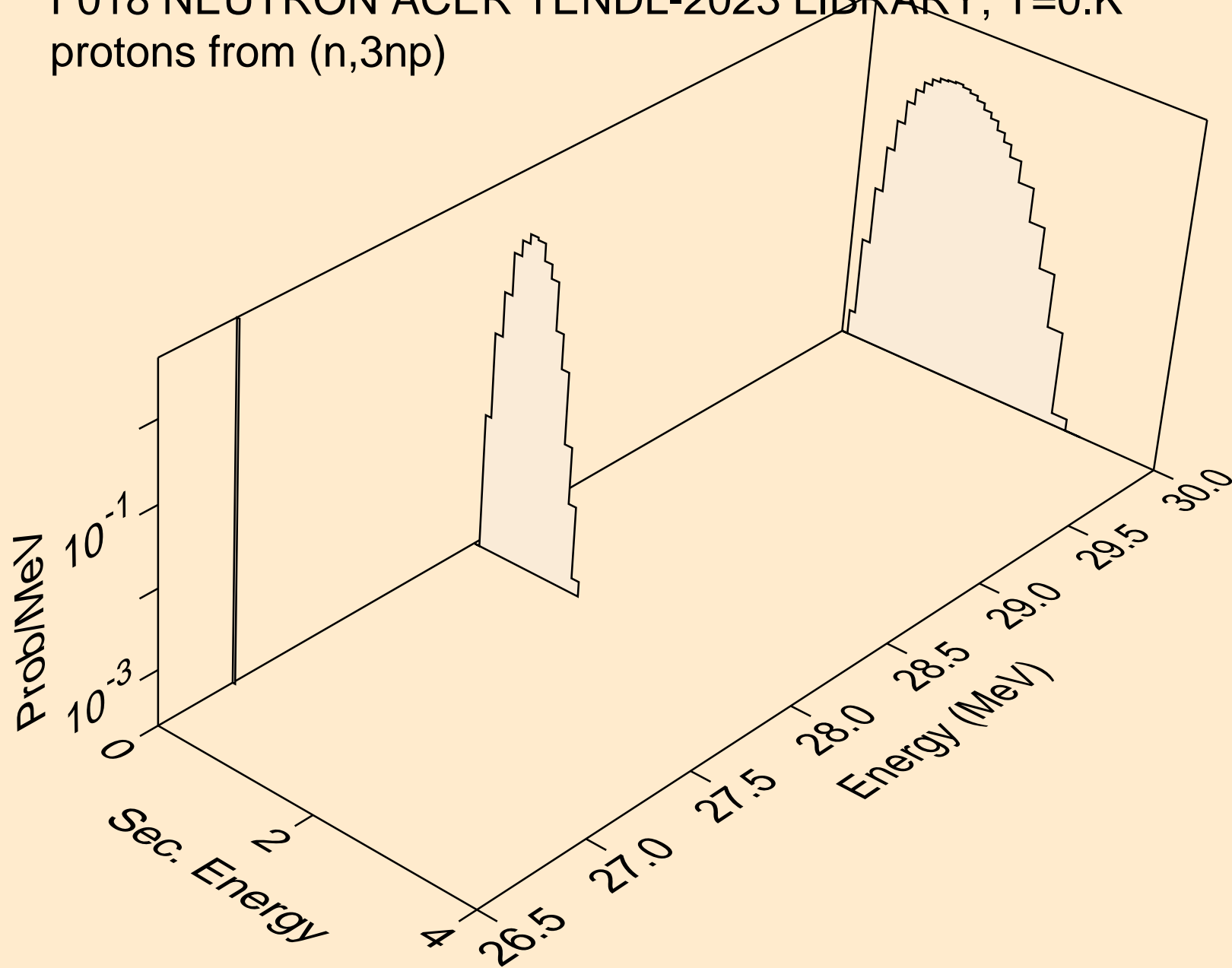

F018 NEUTRON ACER TENDL-2023 LIBRARY; T=0.K
protons from (n,n2p)

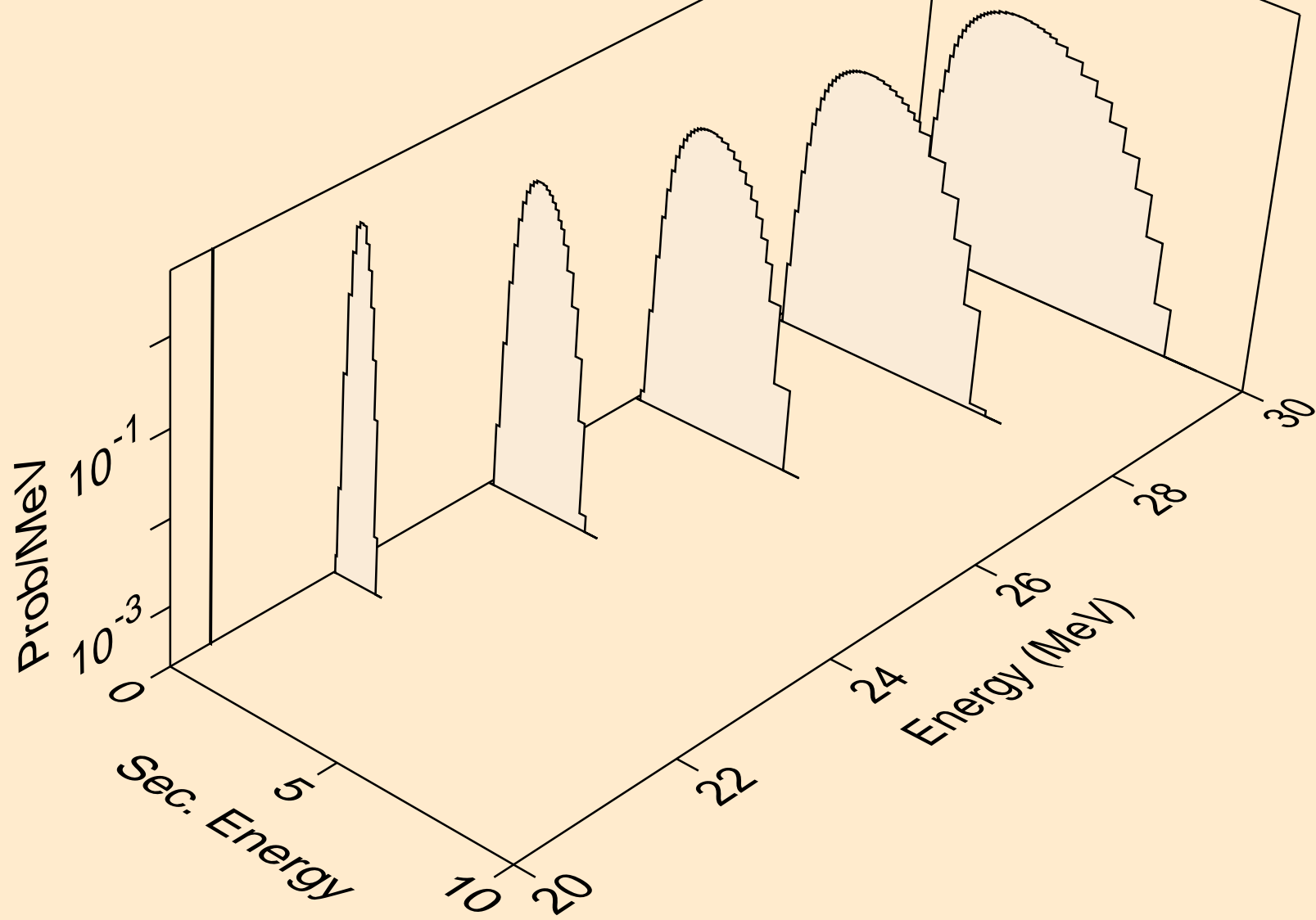

F018 NEUTRON ACER TENDL-2023 LIBRARY; T=0.K
protons from (n,npa)

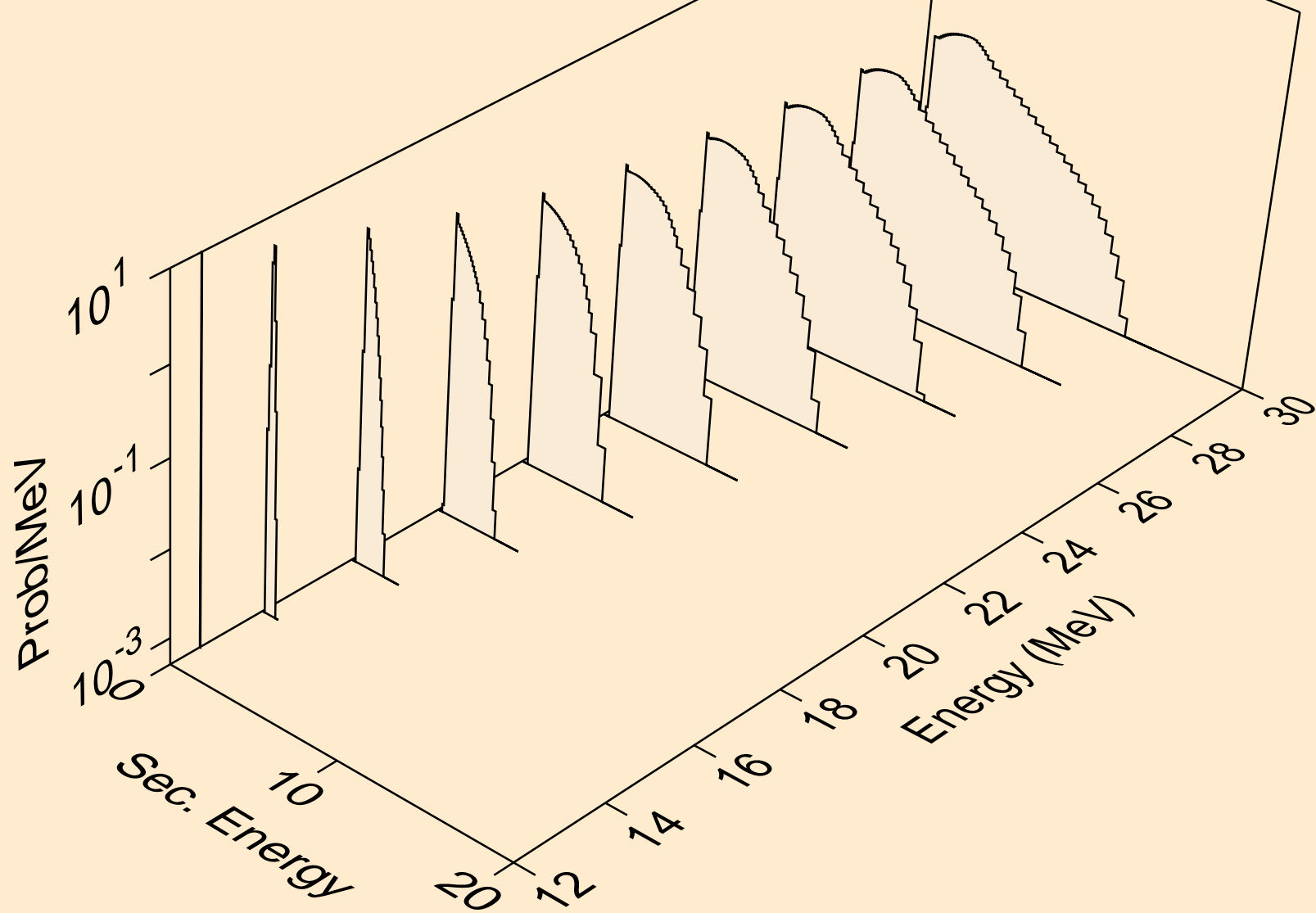

F018 NEUTRON ACER TENDL-2023 LIBRARY; T=0.K
protons from (n,p)

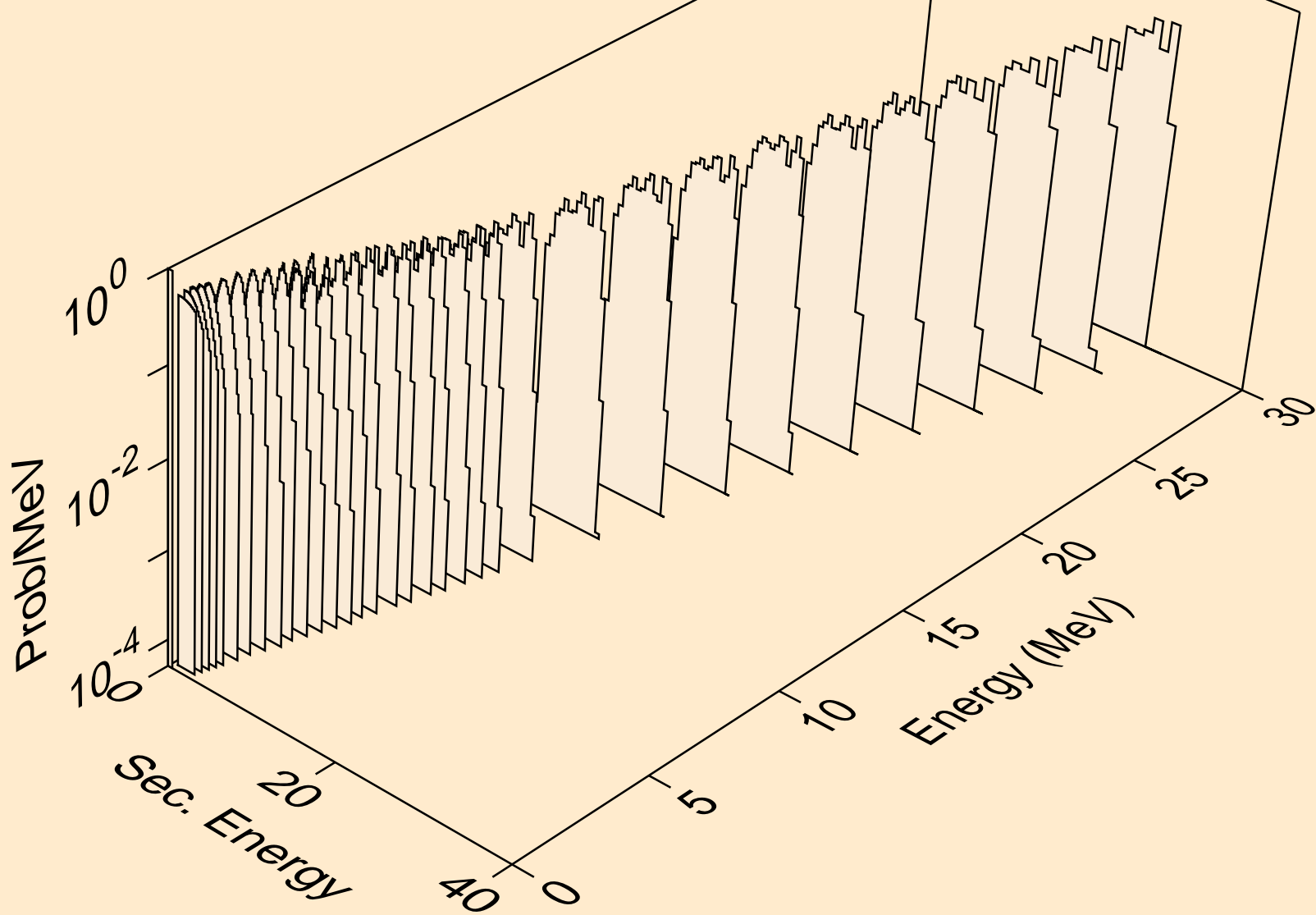

F018 NEUTRON ACER TENDL-2023 LIBRARY; T=0.K
protons from (n,2p)

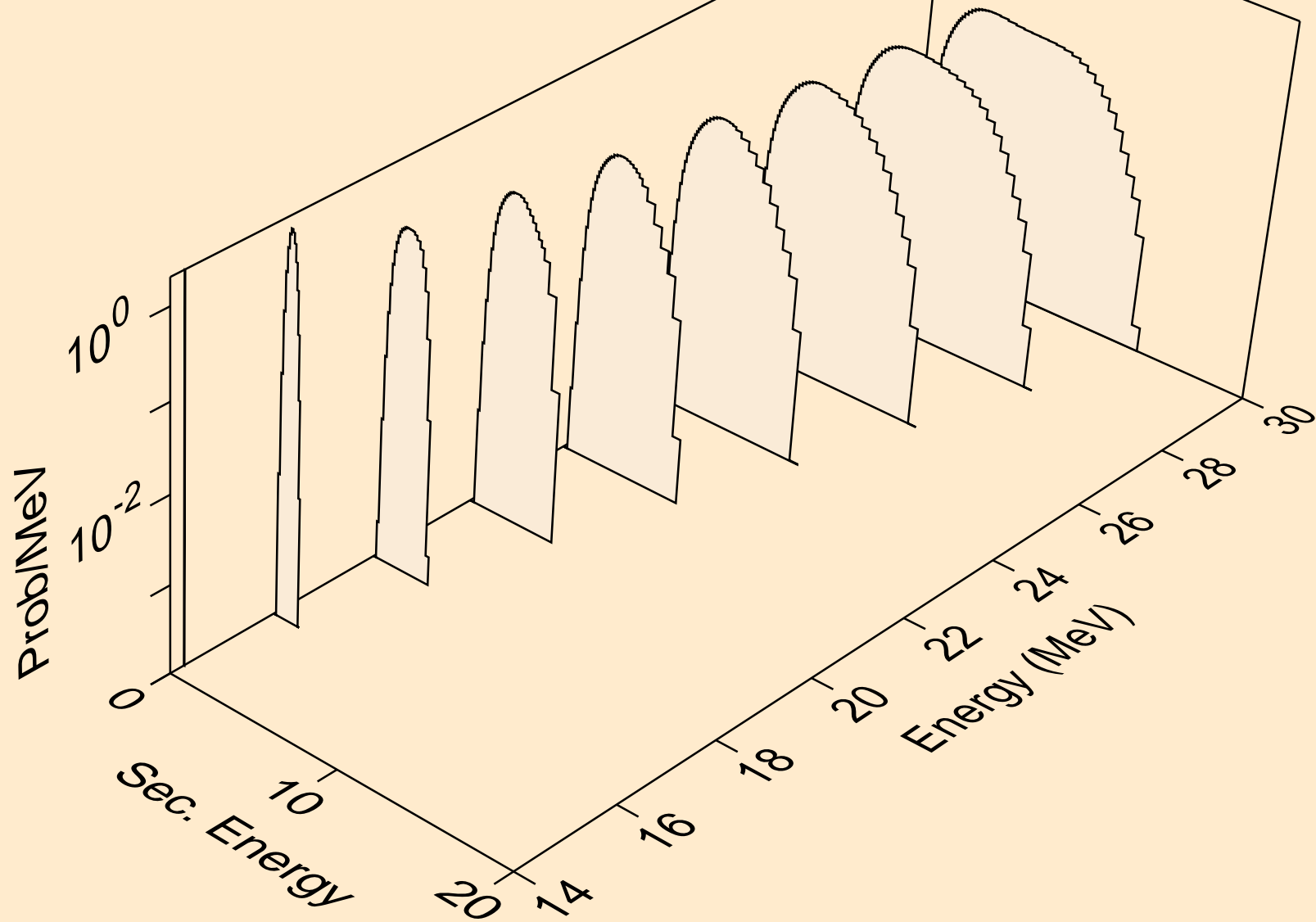

F018 NEUTRON ACER TENDL-2023 LIBRARY; T=0.K
protons from (n,p)

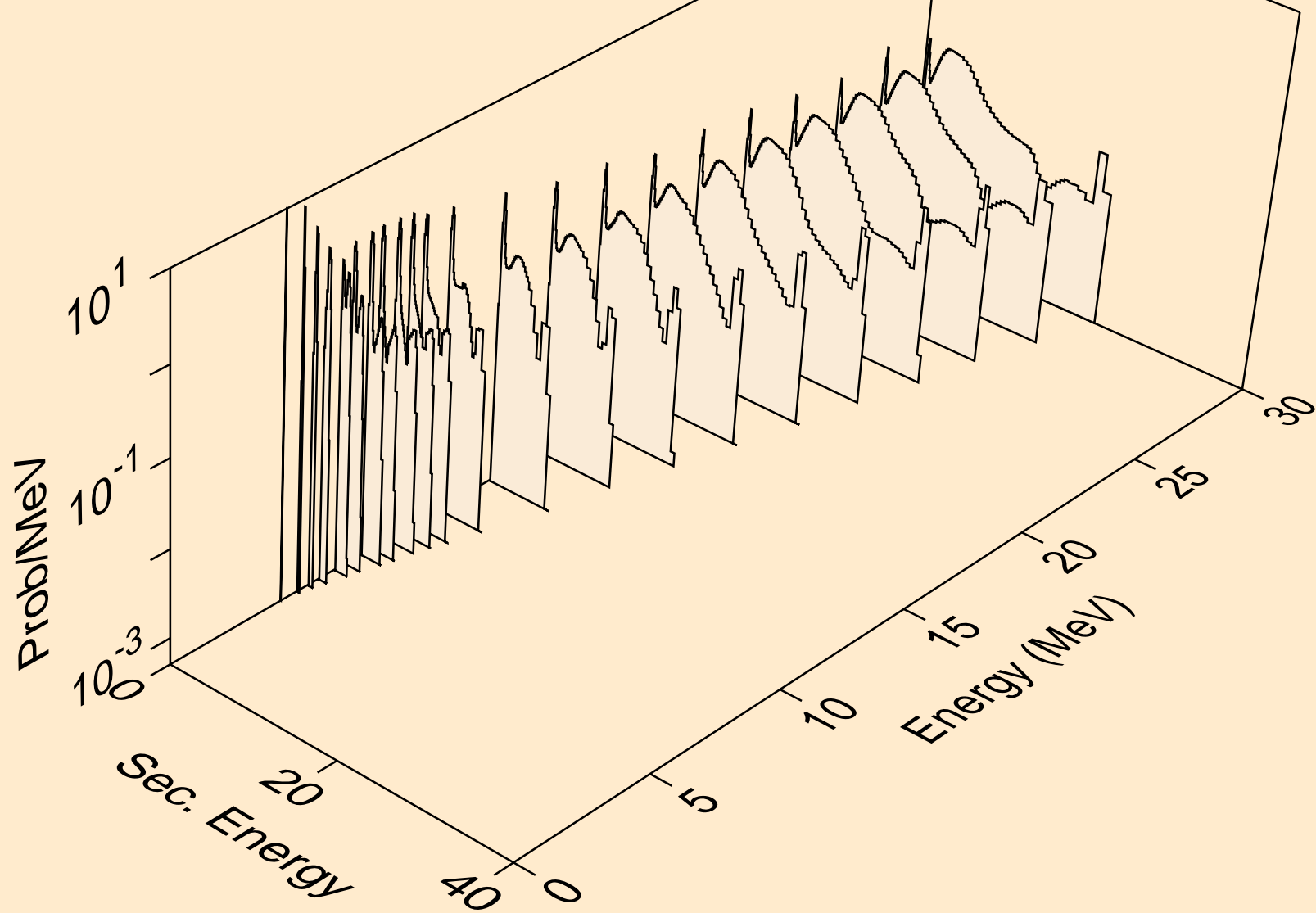

F018 NEUTRON ACER TENDL-2023 LIBRARY; T=0.K
protons from (n,pd)

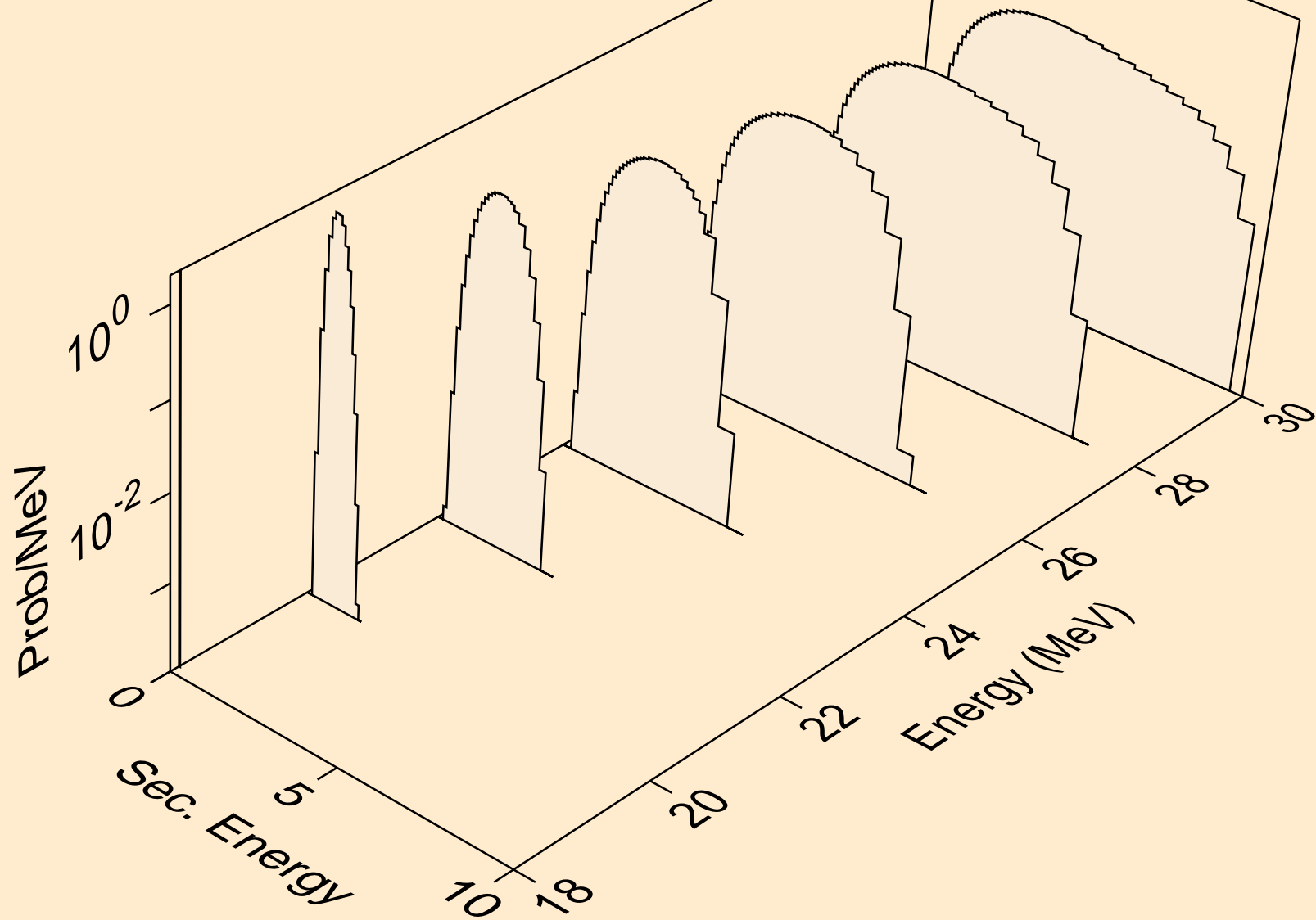

F018 NEUTRON ACER TENDL-2023 LIBRARY; T=0.K
protons from (n,pt)

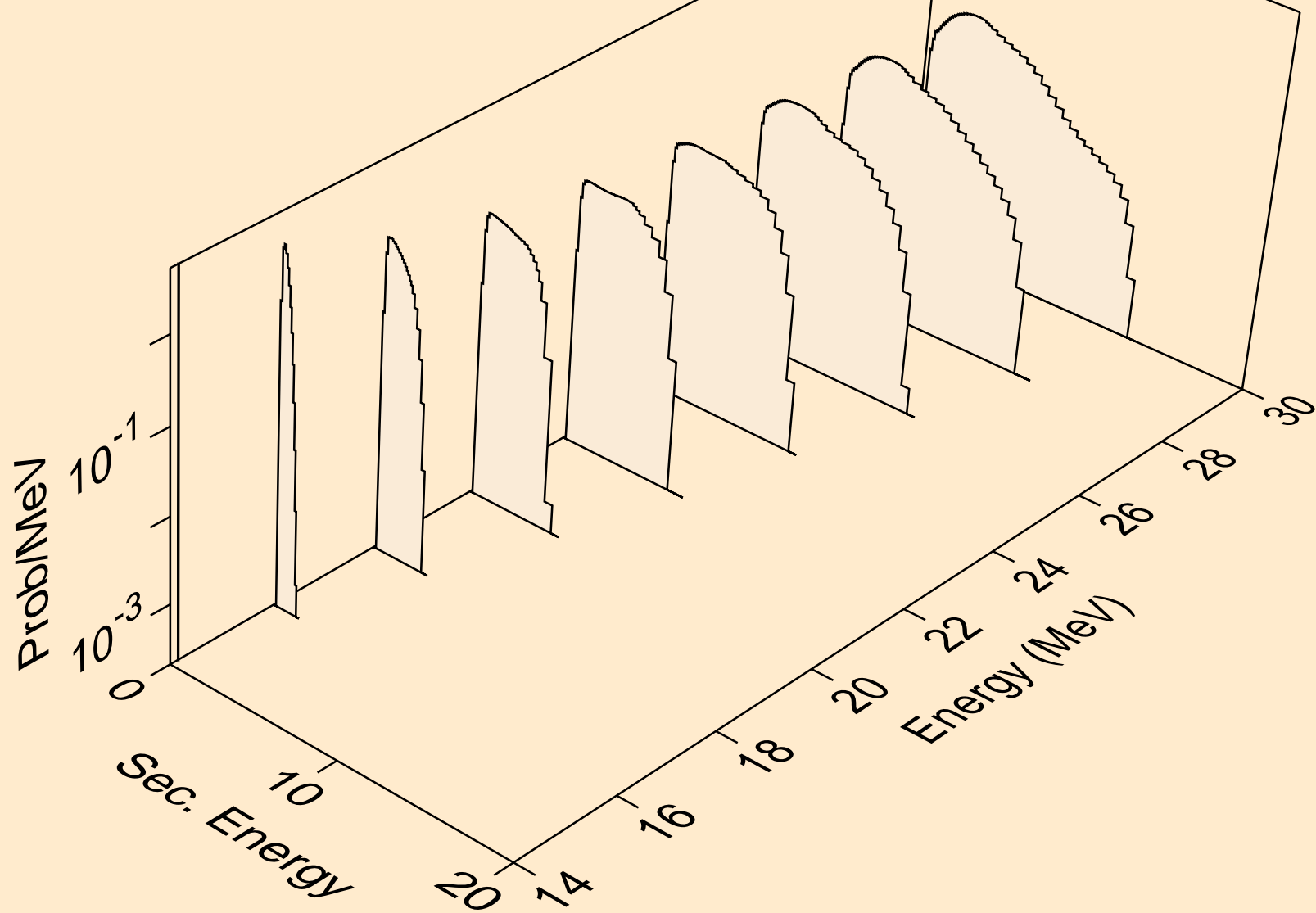

F018 NEUTRON ACER TENDL-2023 LIBRARY; T=0.K
deuterons from (n,x)

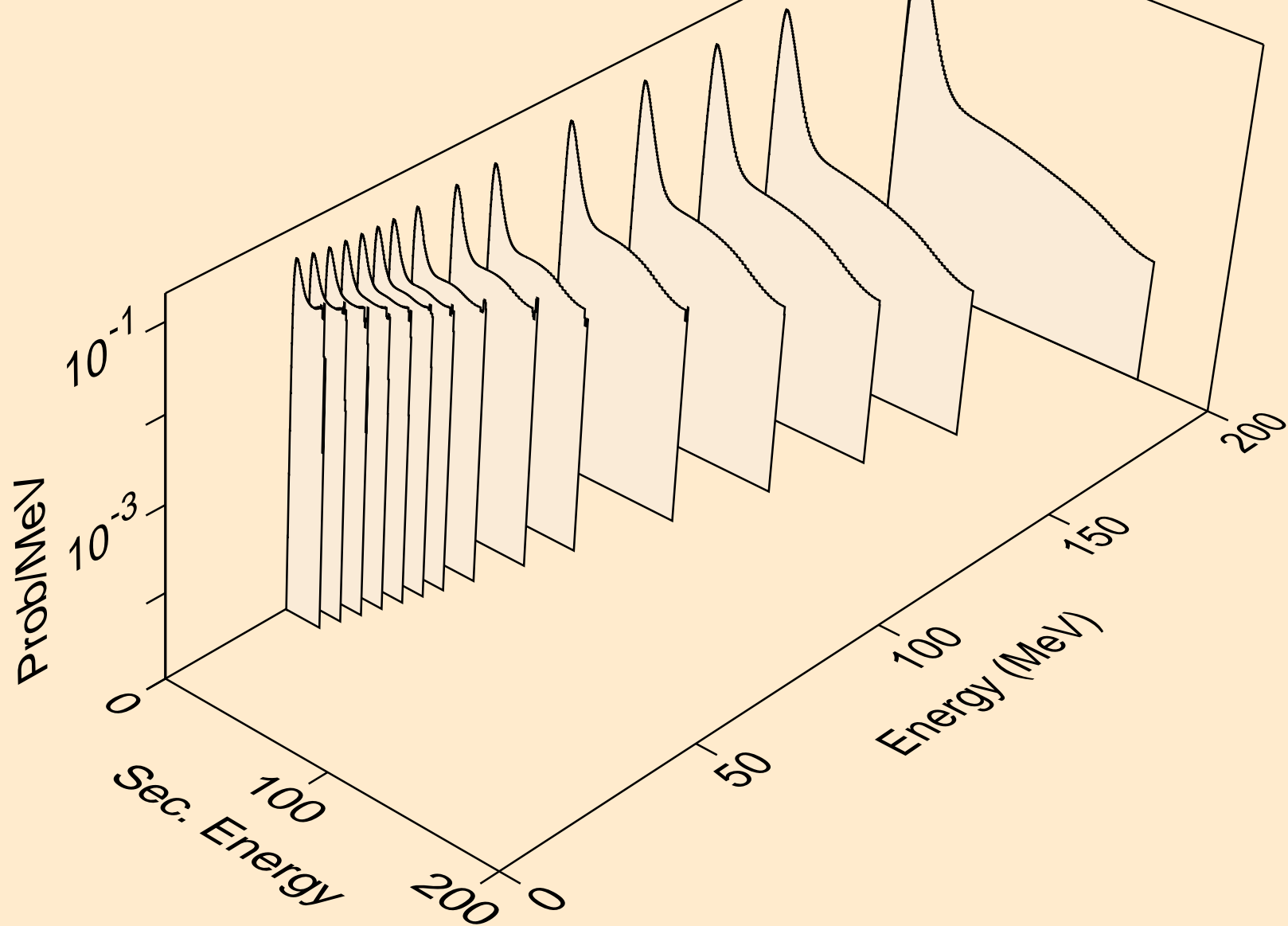

F018 NEUTRON ACER TENDL-2023 LIBRARY; T=0.K
deuterons from (n,2nd)

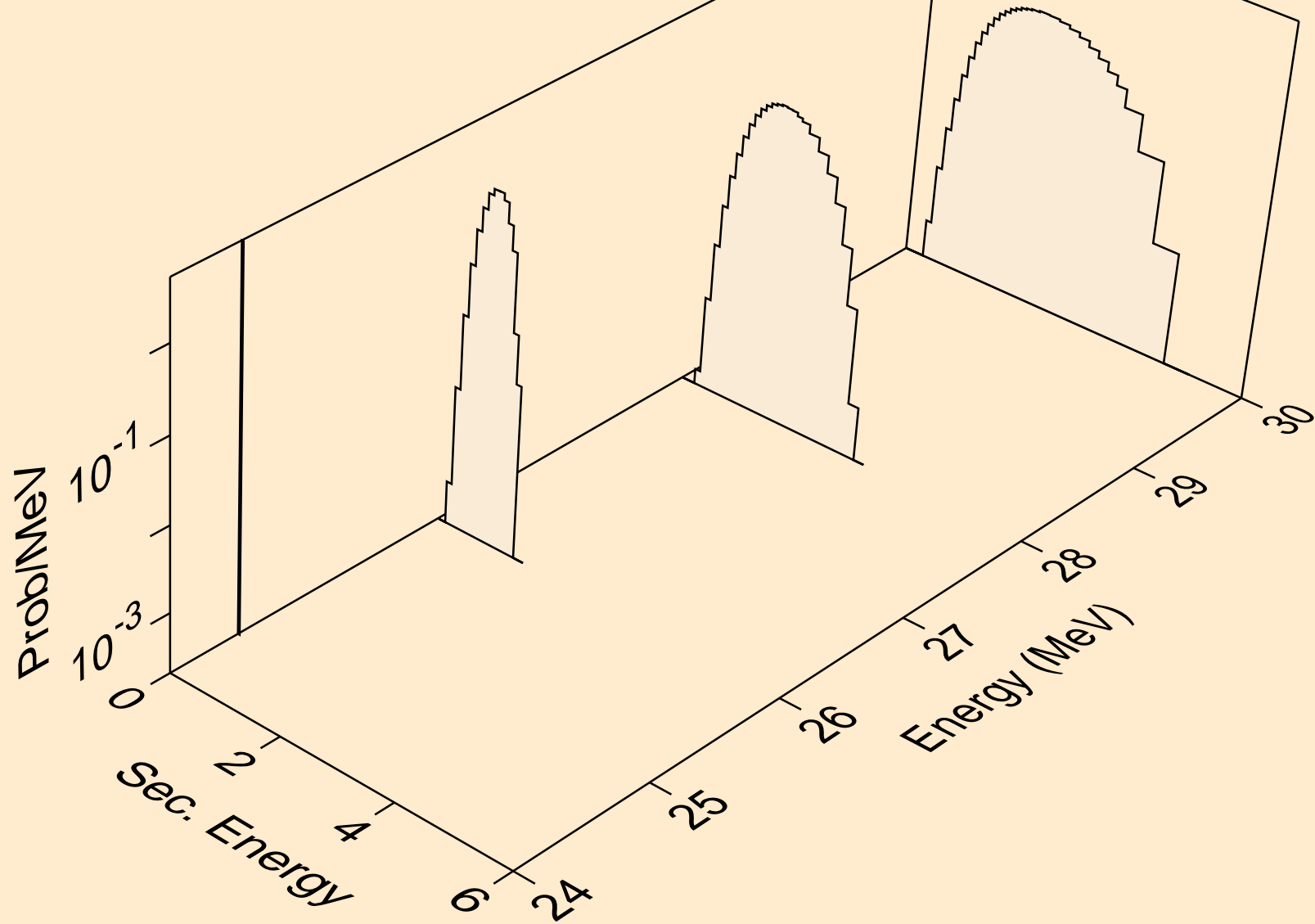

F018 NEUTRON ACER TENDL-2023 LIBRARY; T=0.K
deuterons from (n,n*)d

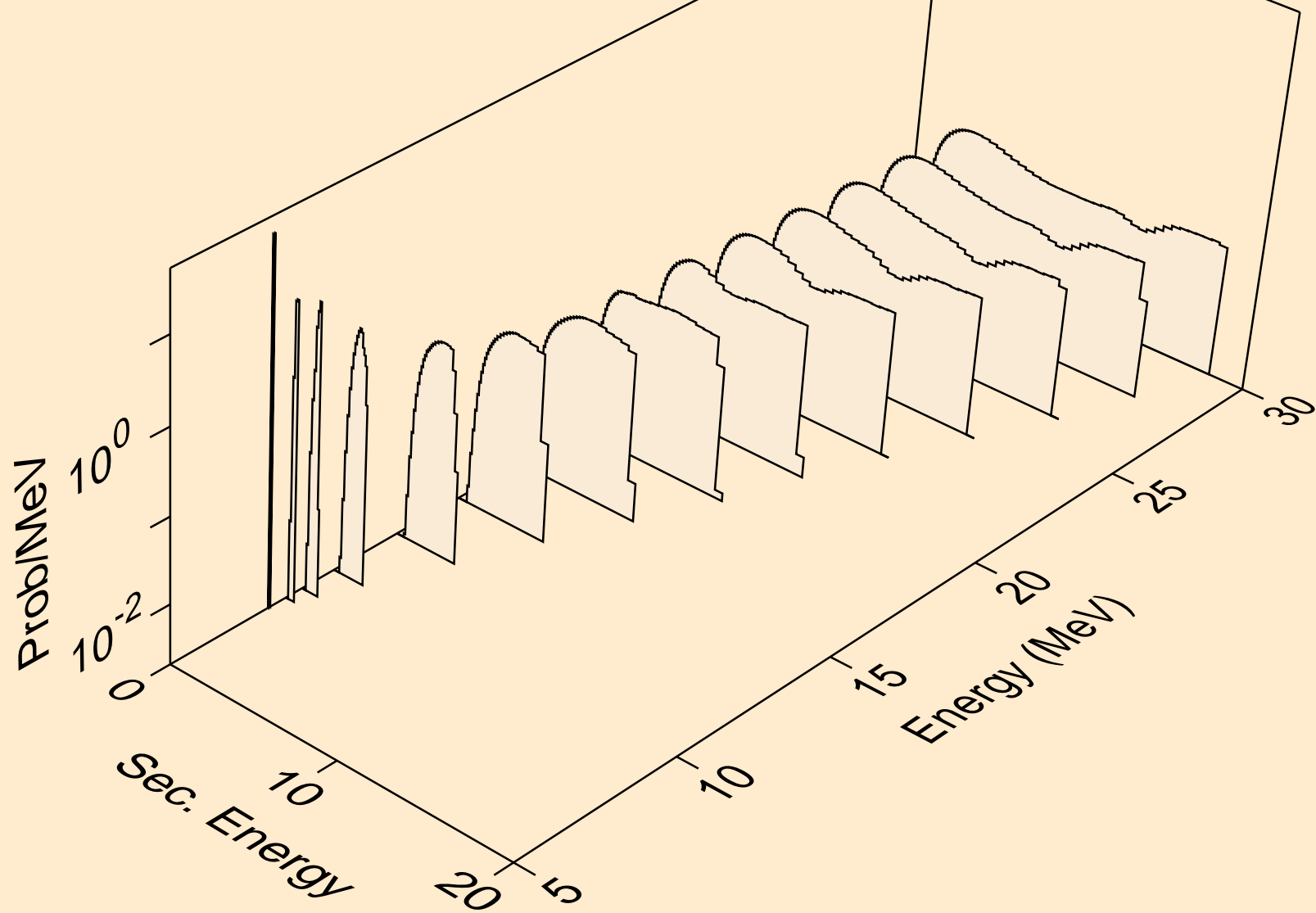

F018 NEUTRON ACER TENDL-2023 LIBRARY; T=0.K
deuterons from (n,n*)d2a

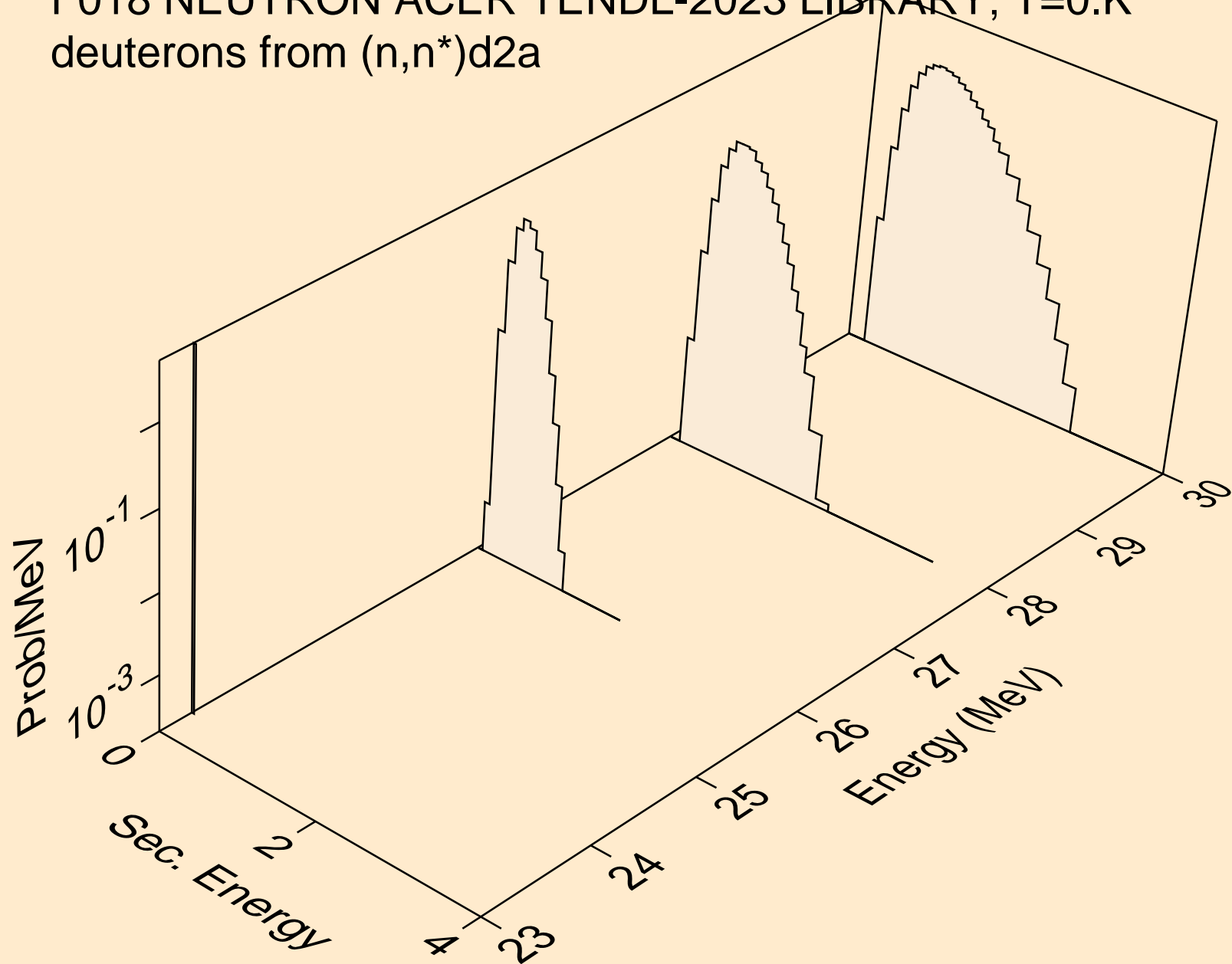

F018 NEUTRON ACER TENDL-2023 LIBRARY; T=0.K
deuterons from (n,d)

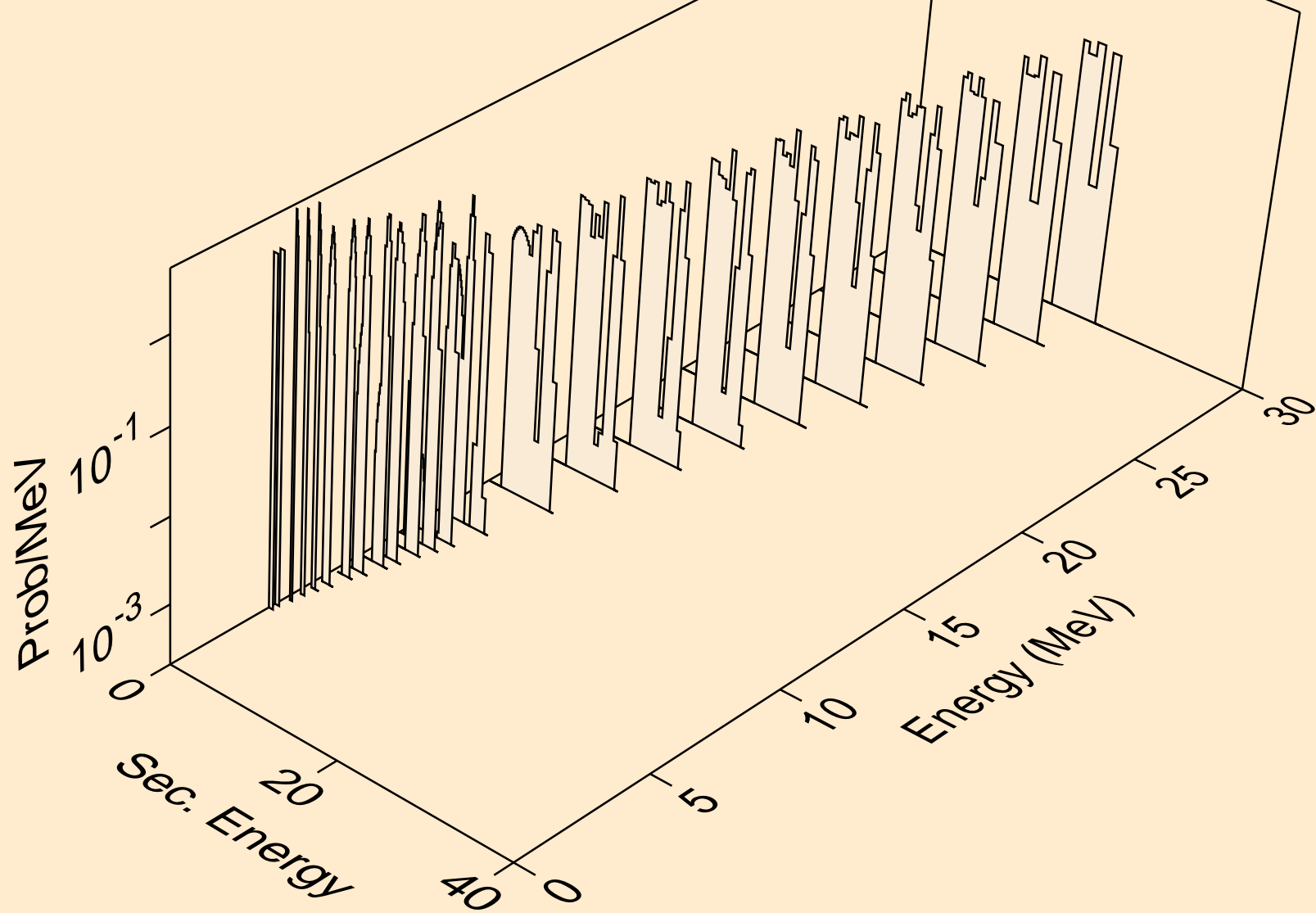

F018 NEUTRON ACER TENDL-2023 LIBRARY; T=0.K
deuterons from (n,d2a)

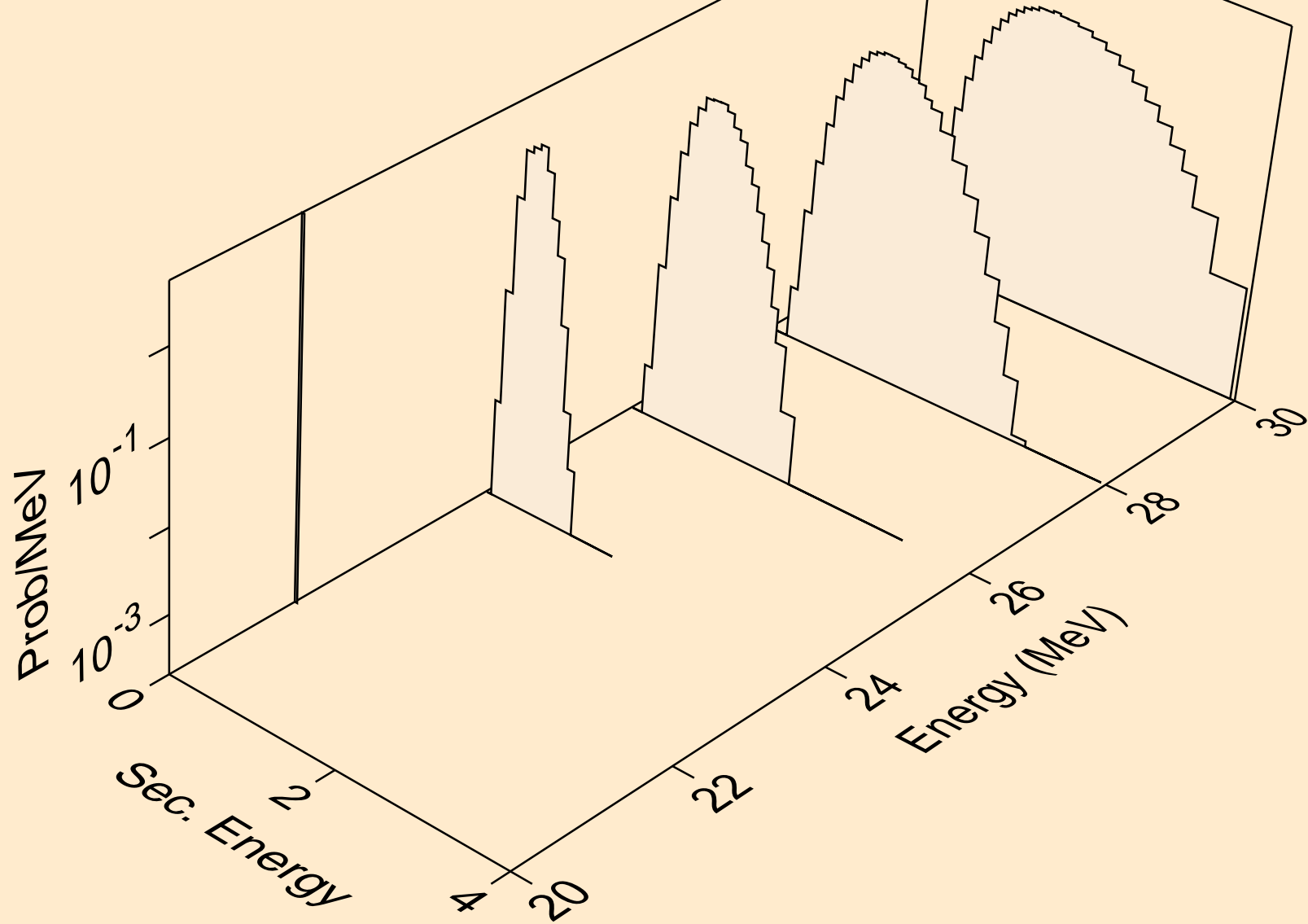

F018 NEUTRON ACER TENDL-2023 LIBRARY; T=0.K
deuterons from (n,pd)

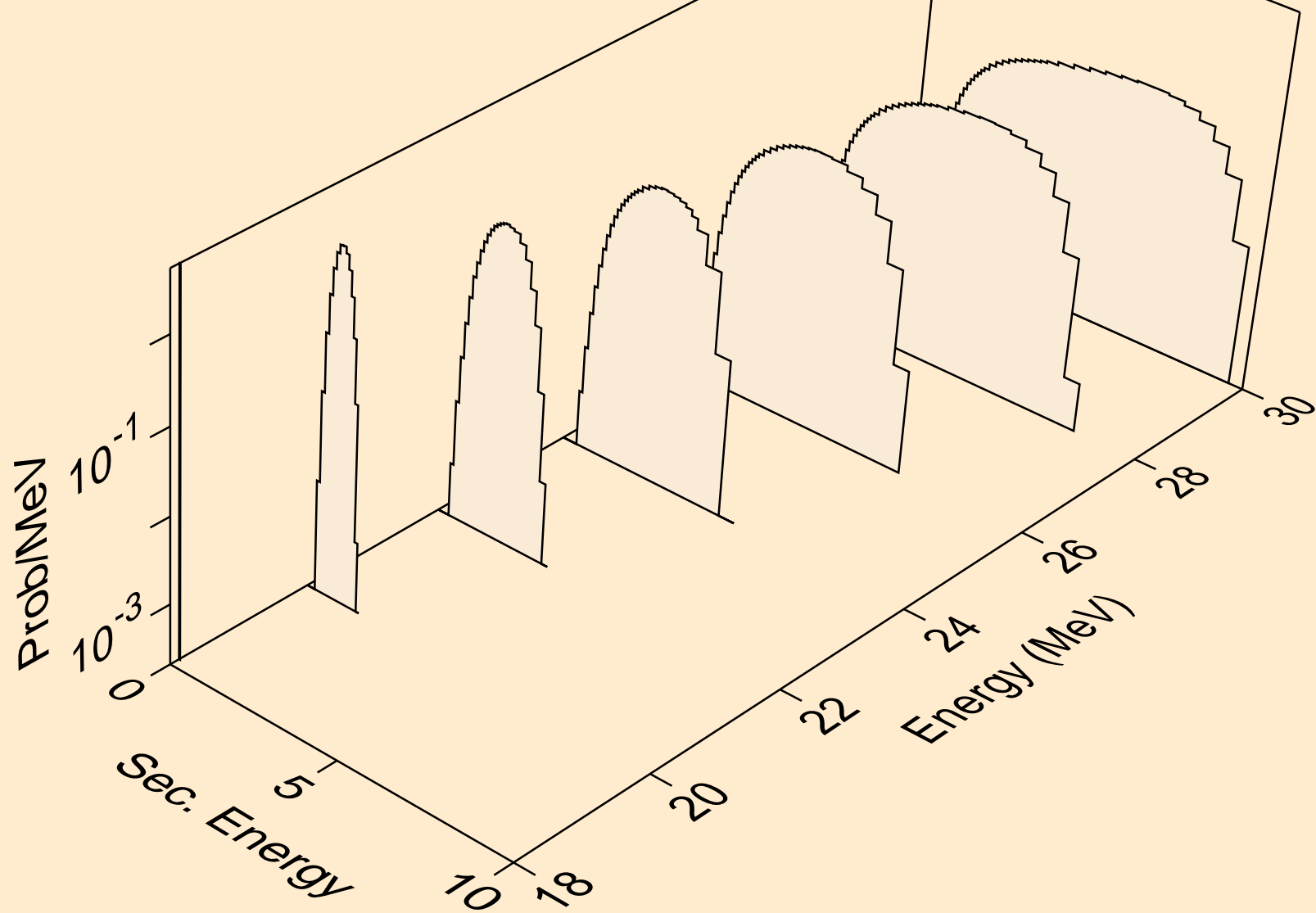

F018 NEUTRON ACER TENDL-2023 LIBRARY; T=0.K
deuterons from (n,da)

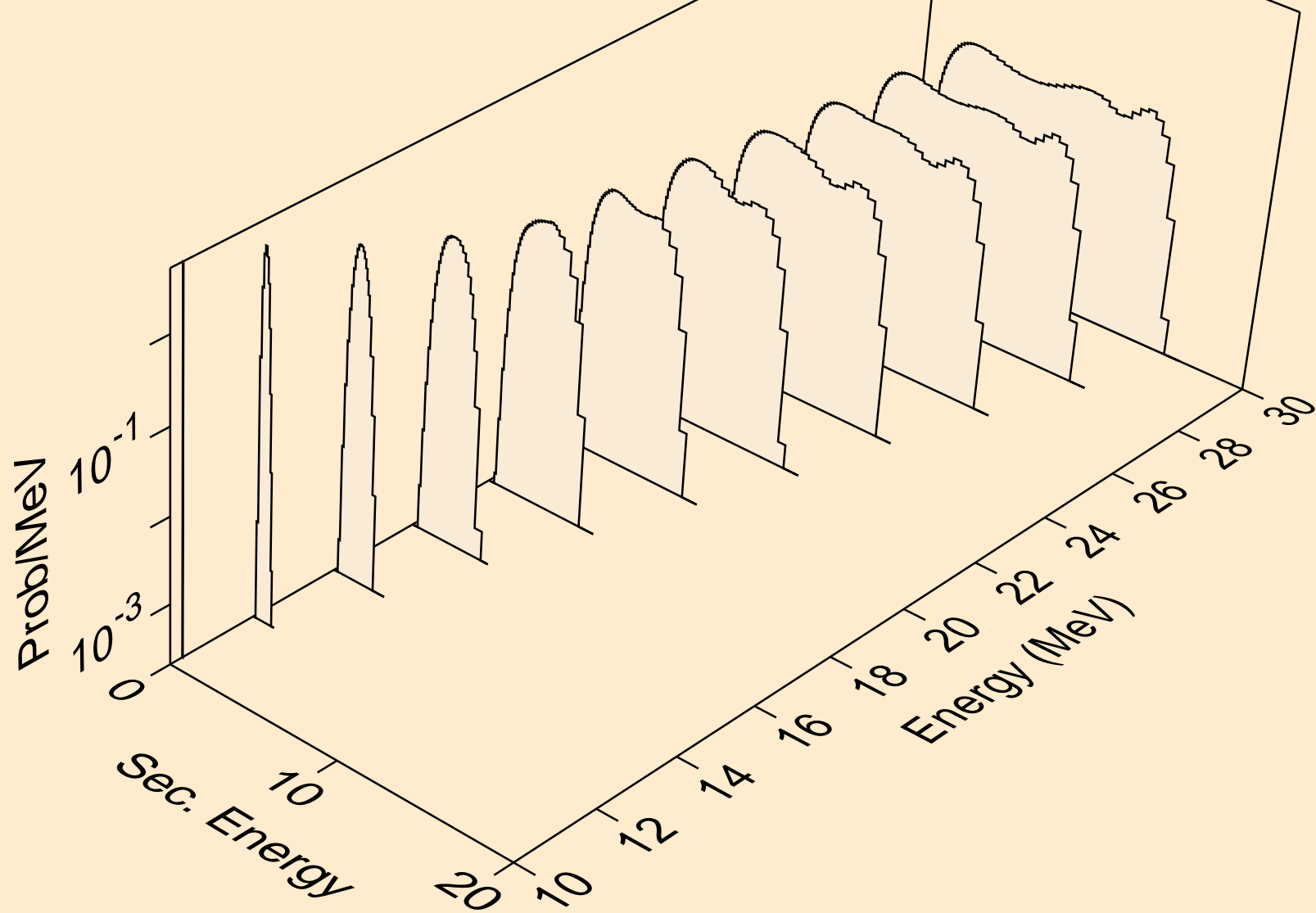

F018 NEUTRON ACER TENDL-2023 LIBRARY; T=0.K
tritons from (n,x)

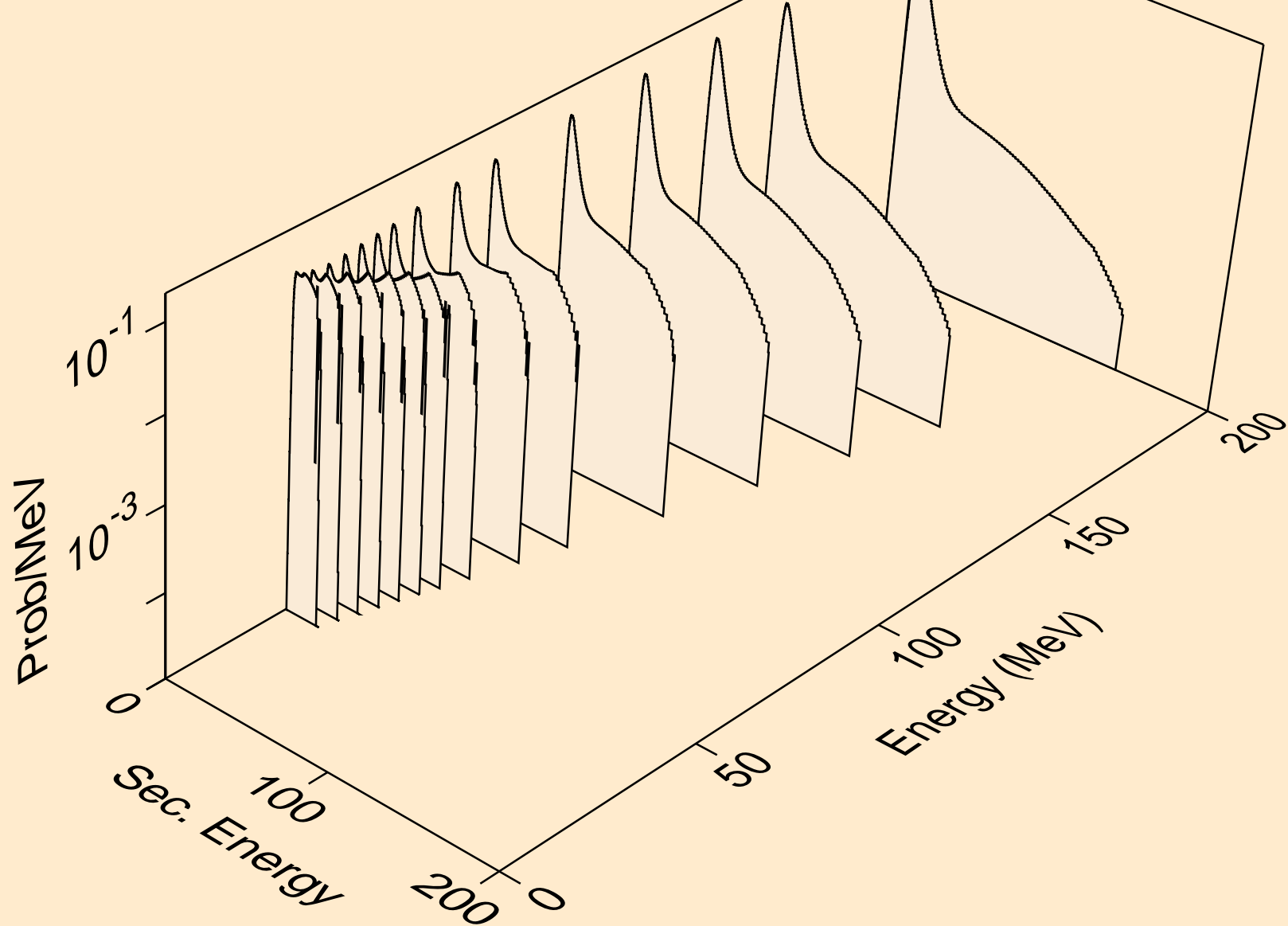

F018 NEUTRON ACER TENDL-2023 LIBRARY; T=0.K
tritons from (n,n*)t

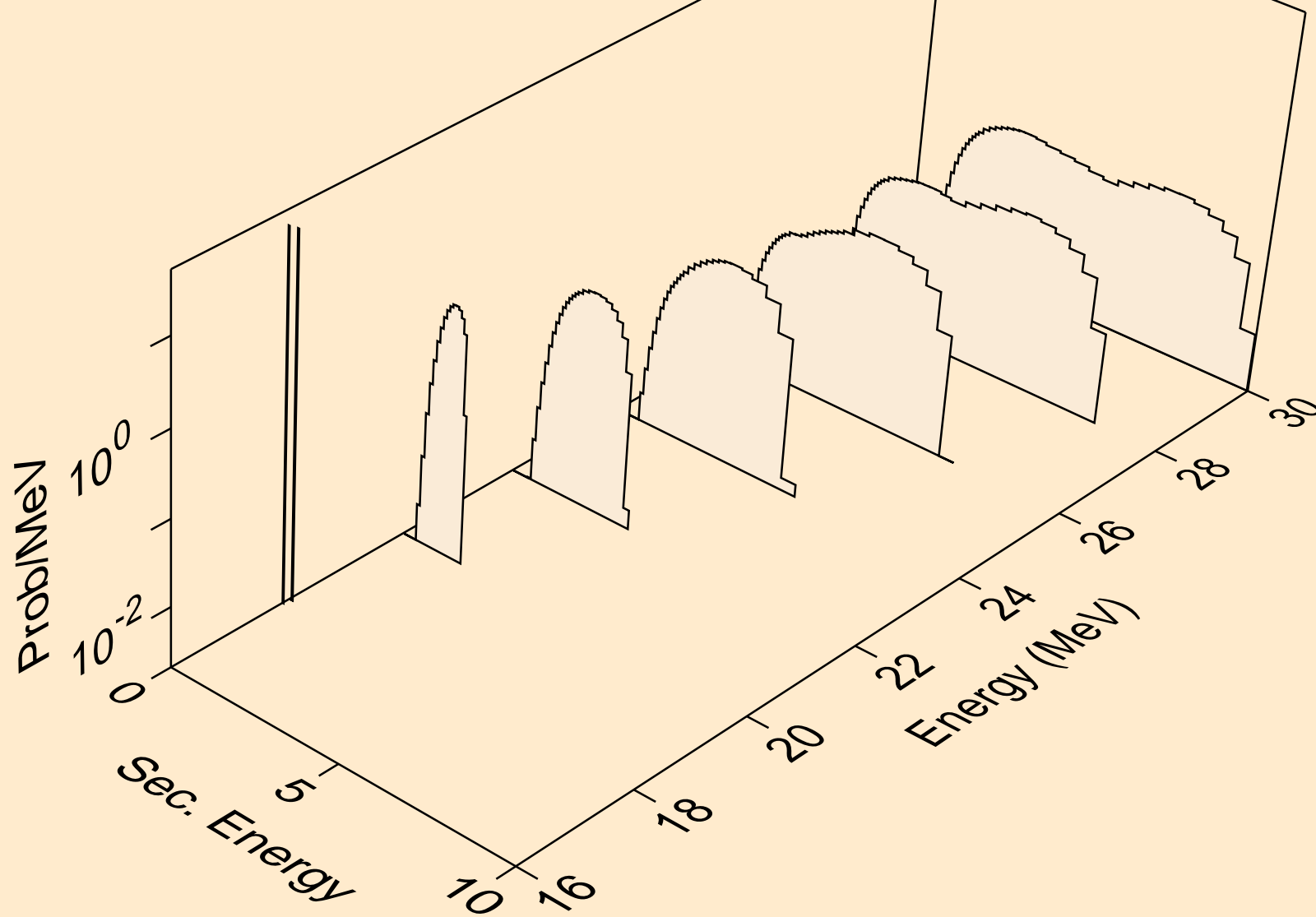

F018 NEUTRON ACER TENDL-2023 LIBRARY; T=0.K
tritons from (n,t)

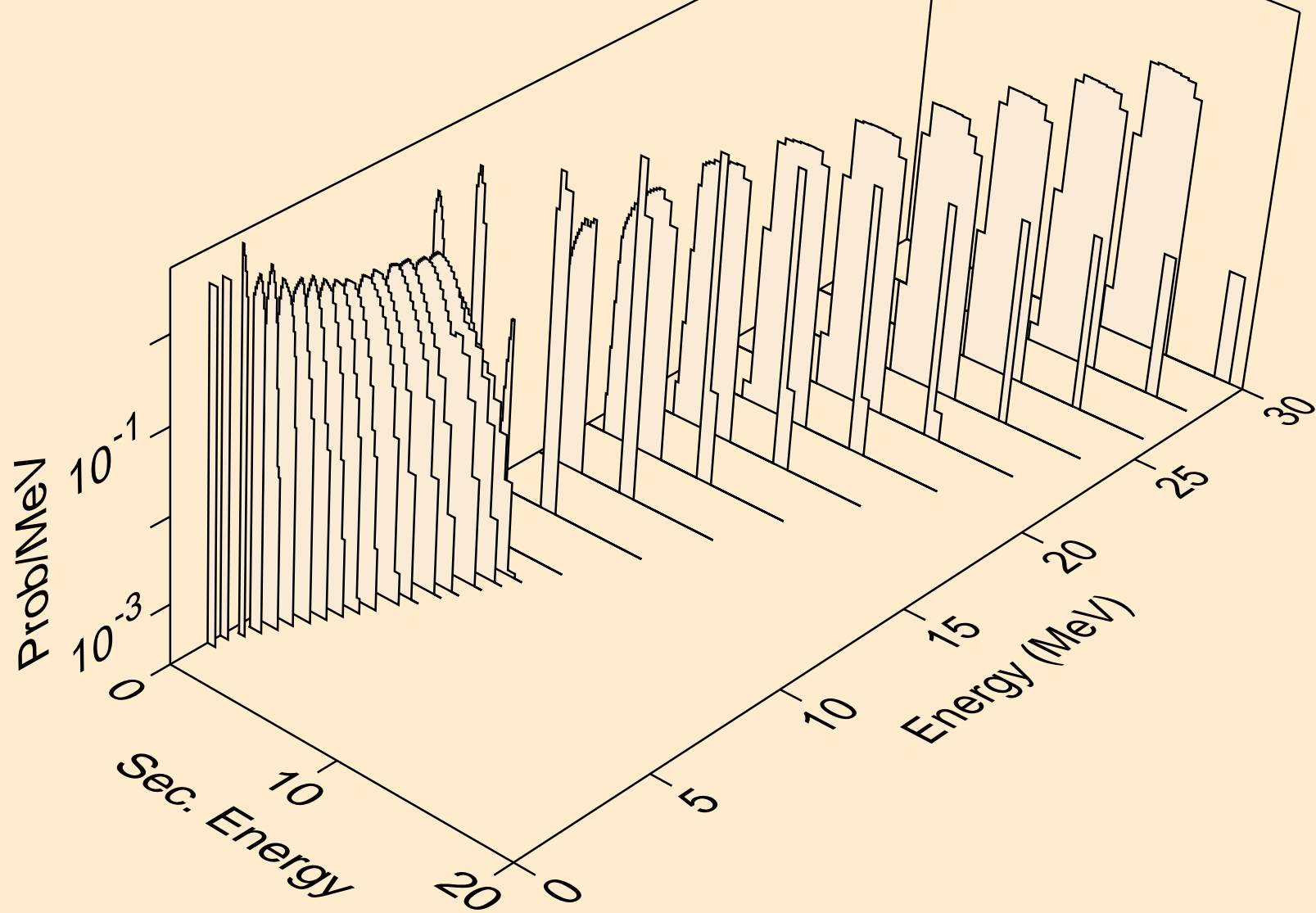

F018 NEUTRON ACER TENDL-2023 LIBRARY; T=0.K
tritons from (n,t2a)

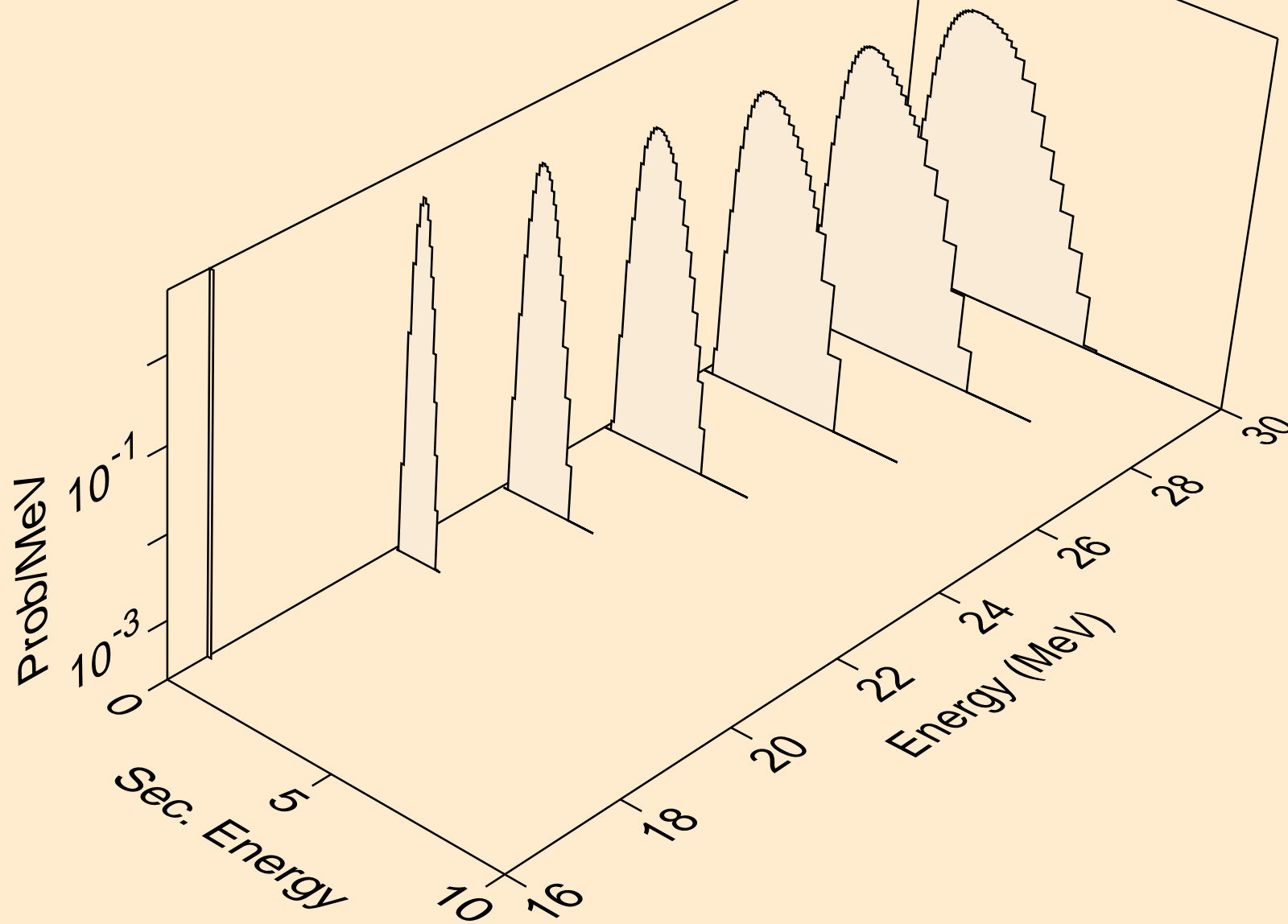

F018 NEUTRON ACER TENDL-2023 LIBRARY; T=0.K
tritons from (n,pt)

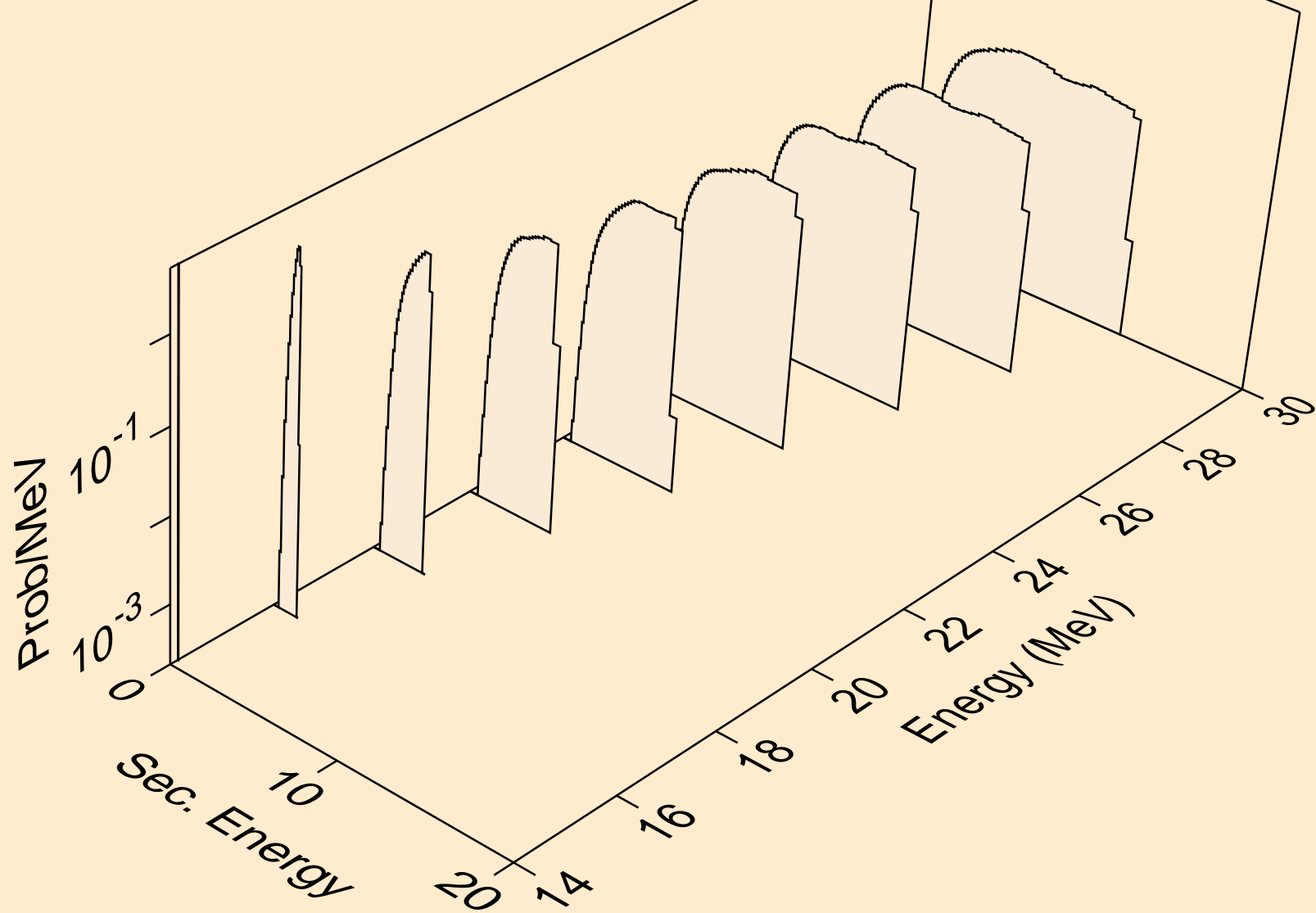

F018 NEUTRON ACER TENDL-2023 LIBRARY; T=0.K
he3s from (n,x)

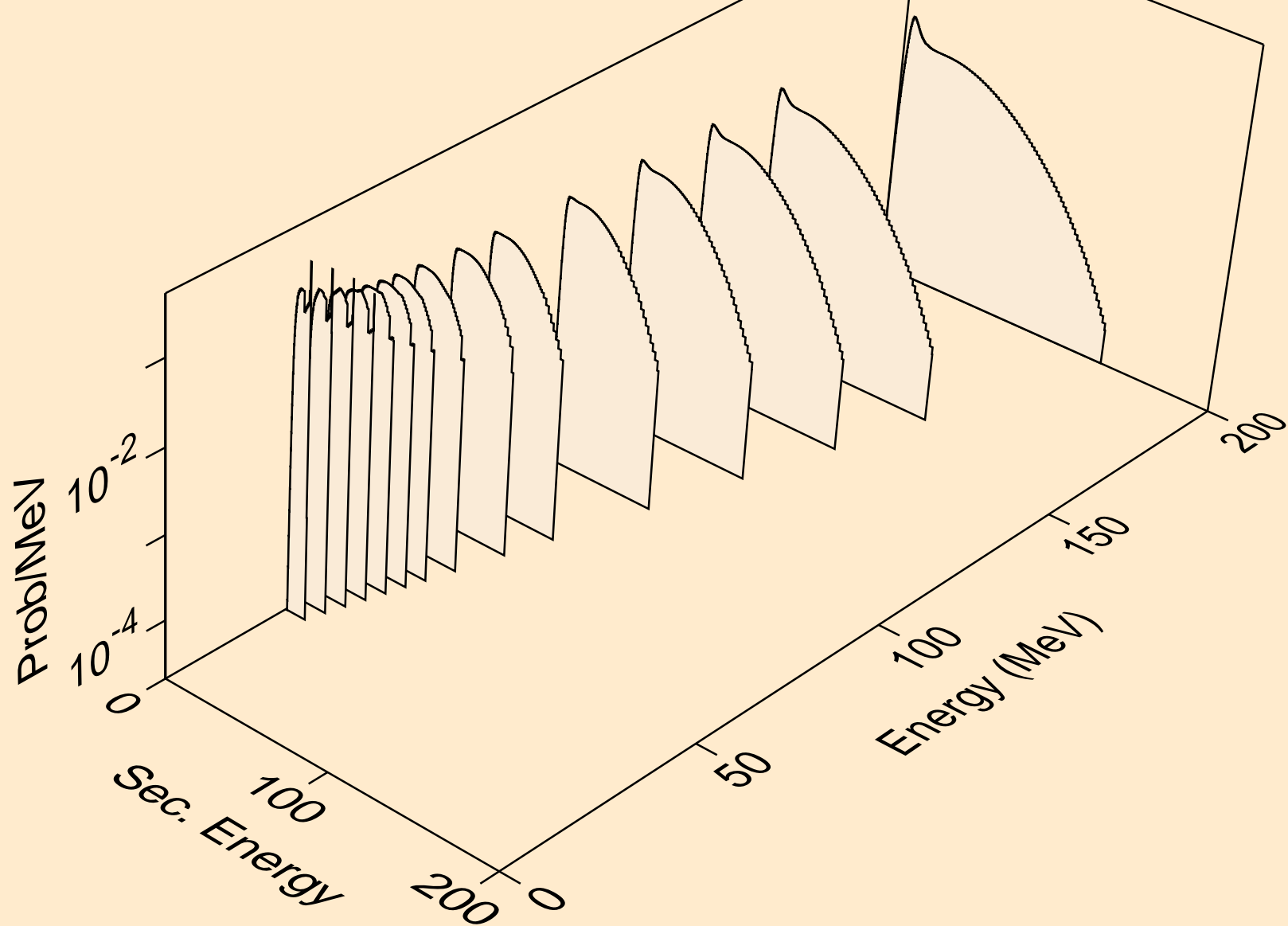

F018 NEUTRON ACER TENDL-2023 LIBRARY; T=0.K
he3s from (n,n*)he3

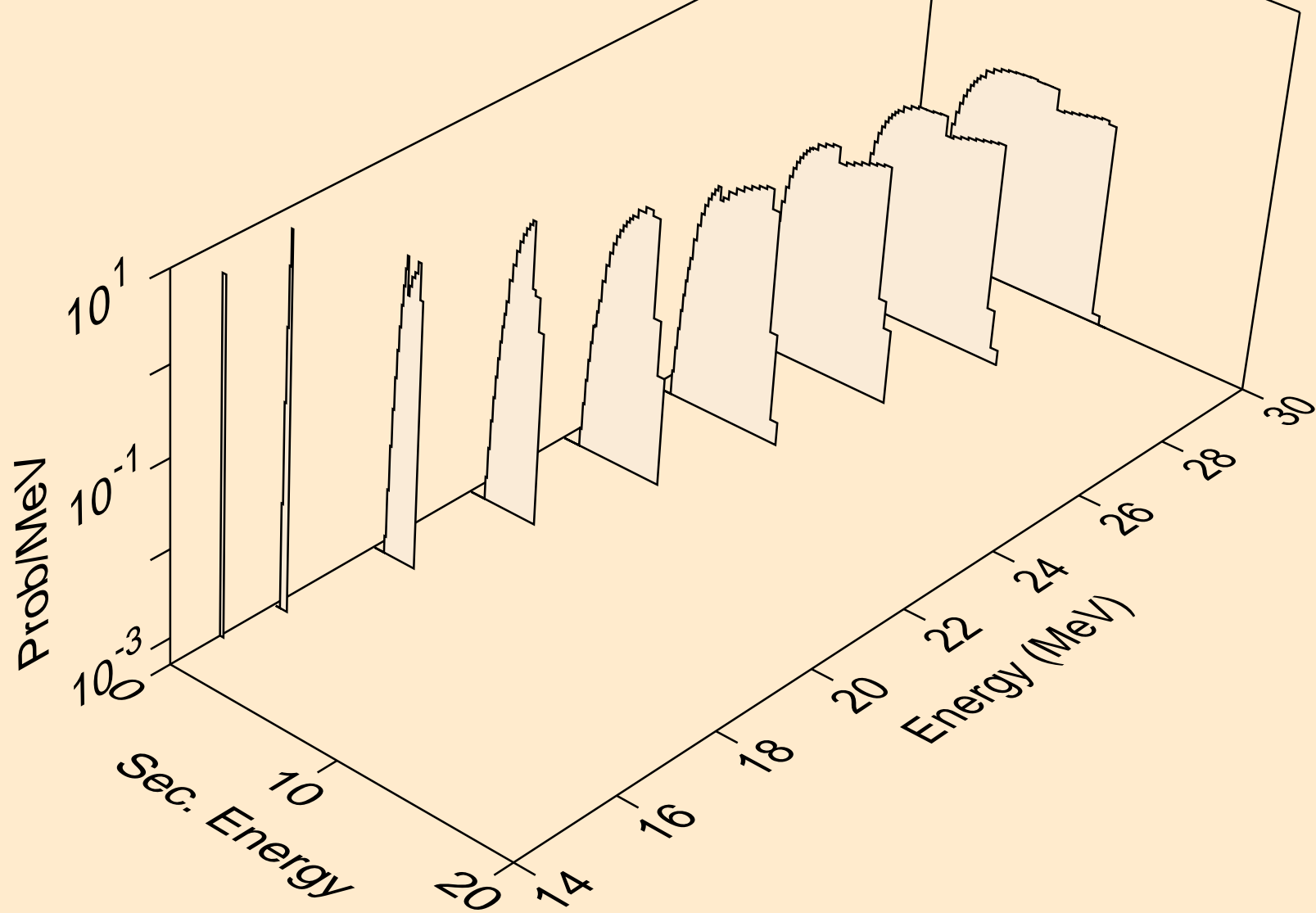

F018 NEUTRON ACER TENDL-2023 LIBRARY; T=0.K
he3s from (n,he3)

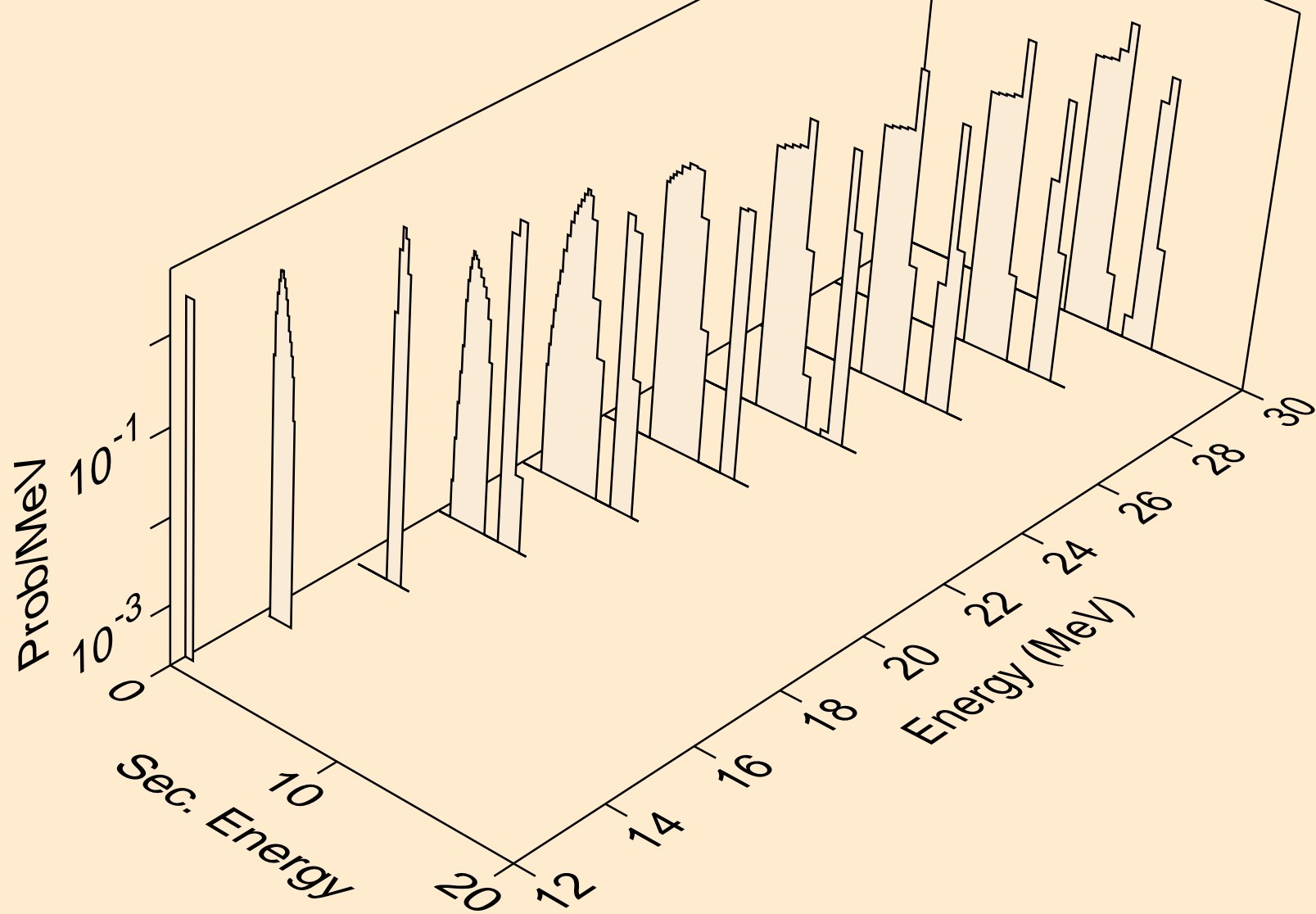

F018 NEUTRON ACER TENDL-2023 LIBRARY; T=0.K
alphas from (n,x)

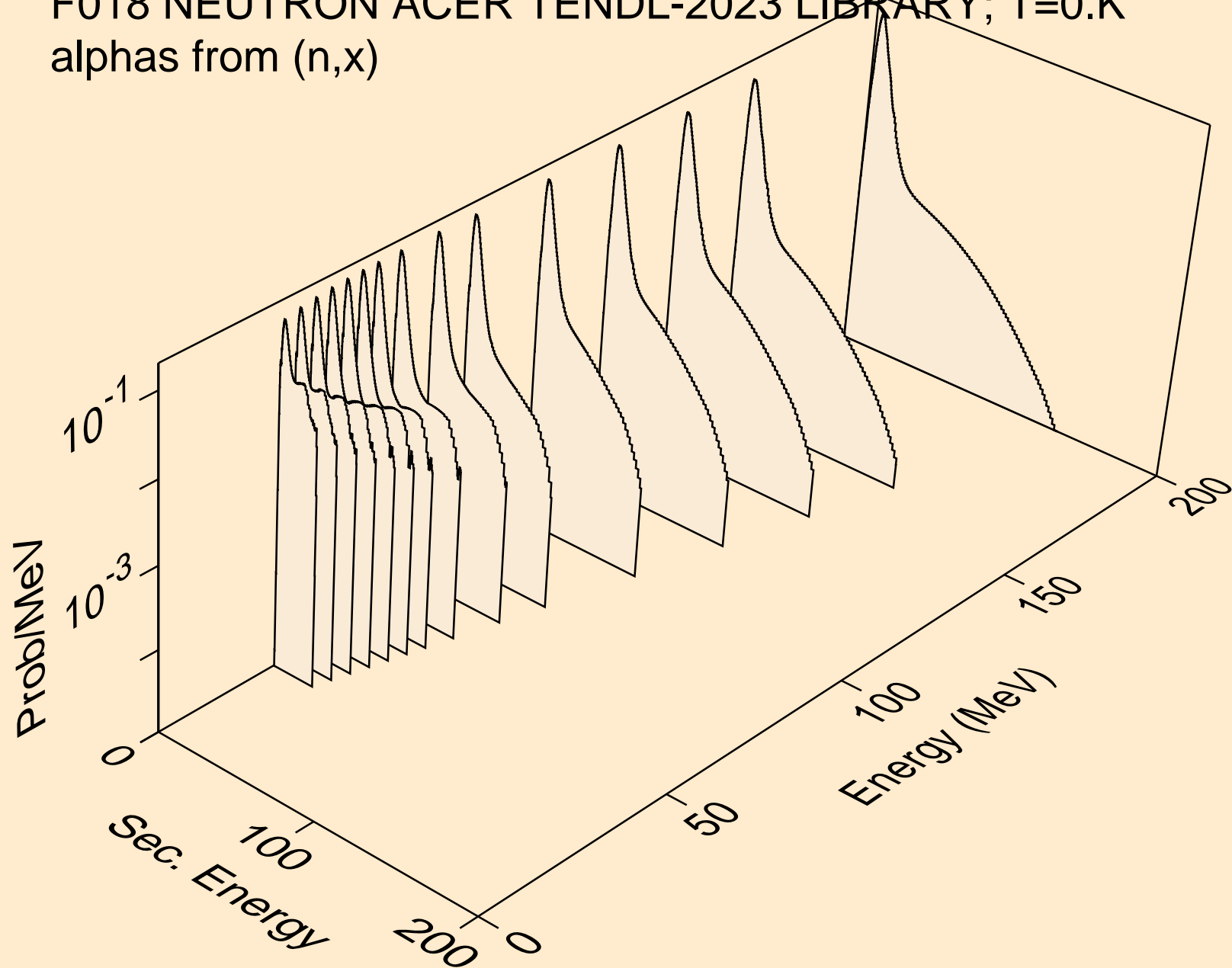

F018 NEUTRON ACER TENDL-2023 LIBRARY; T=0.K
alphas from (n,n*)a

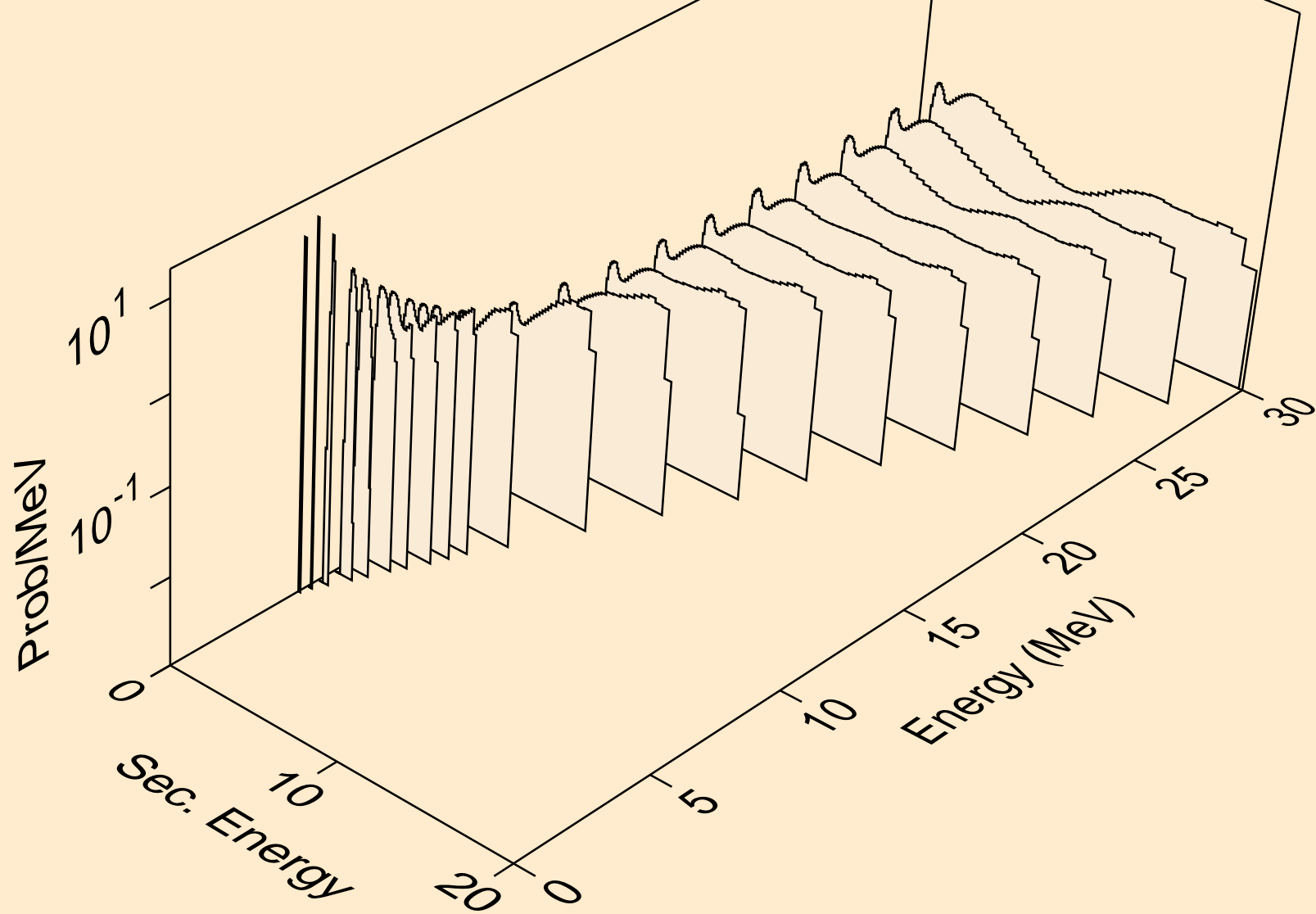

F018 NEUTRON ACER TENDL-2023 LIBRARY; T=0.K
alphas from (n,n*)3a

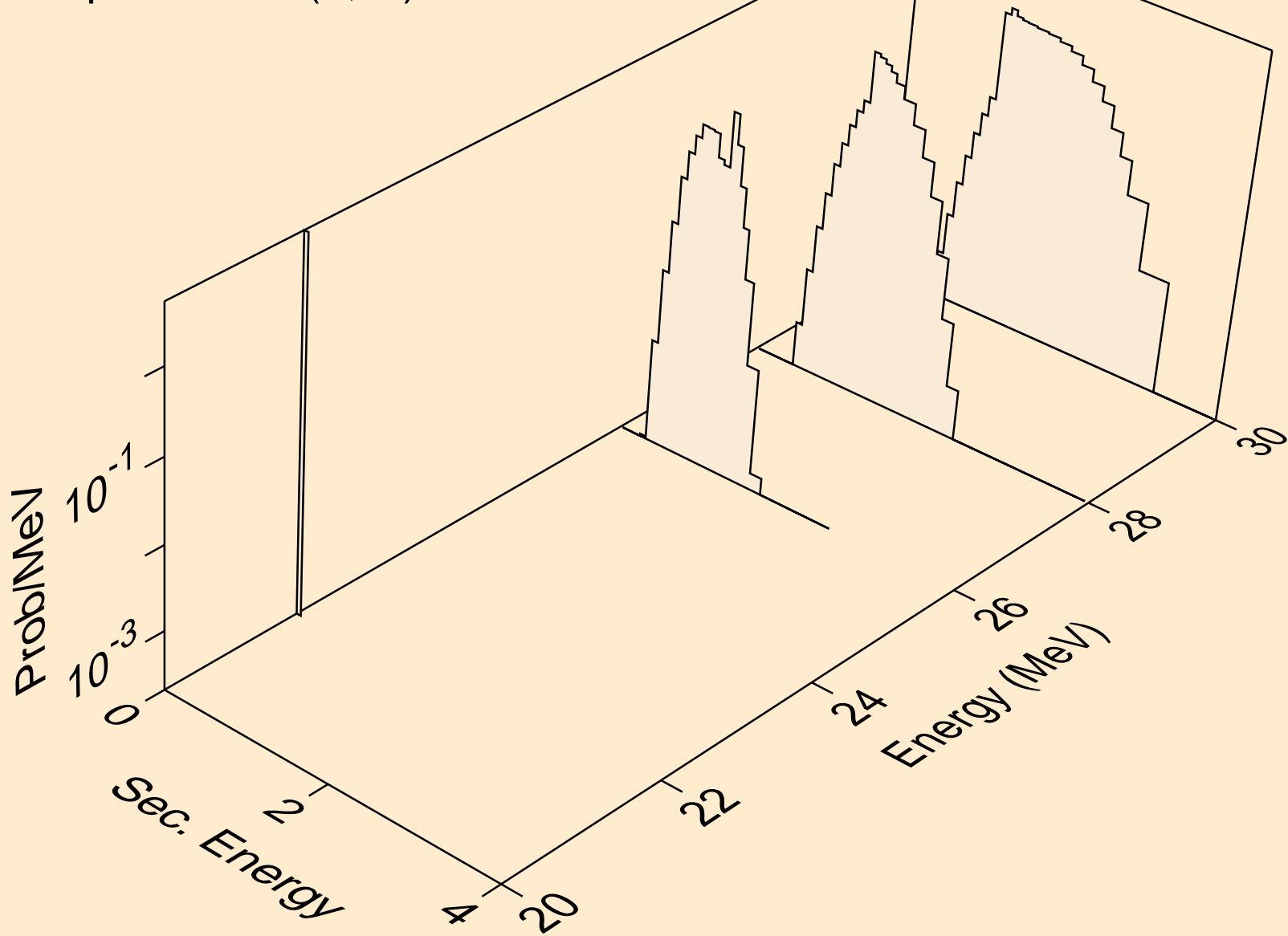

F018 NEUTRON ACER TENDL-2023 LIBRARY; T=0.K
alphas from (n,2n)a

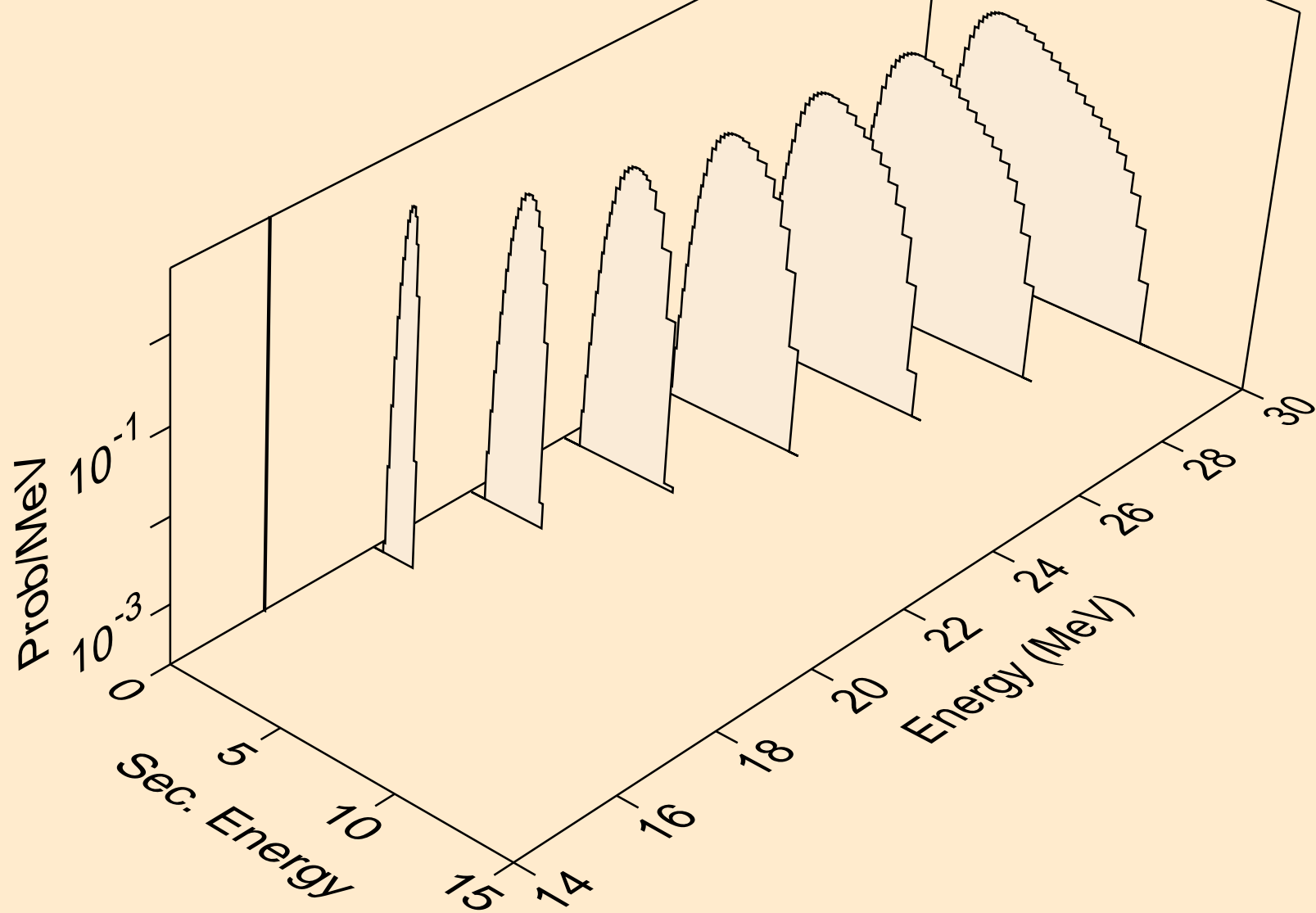

F018 NEUTRON ACER TENDL-2023 LIBRARY; T=0.K
alphas from (n,n*)2a

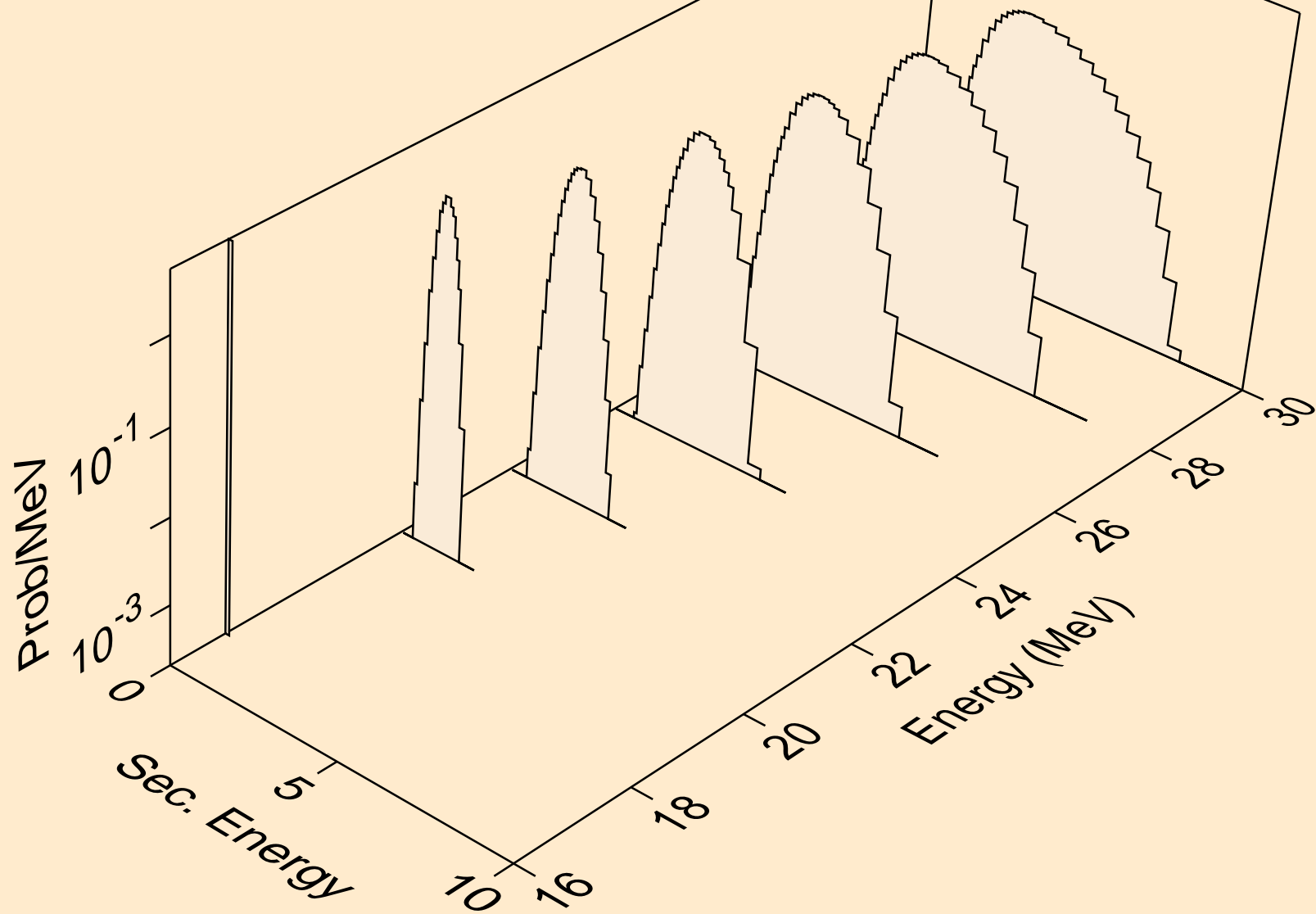

F018 NEUTRON ACER TENDL-2023 LIBRARY; T=0.K
alphas from (n,n*)d2a

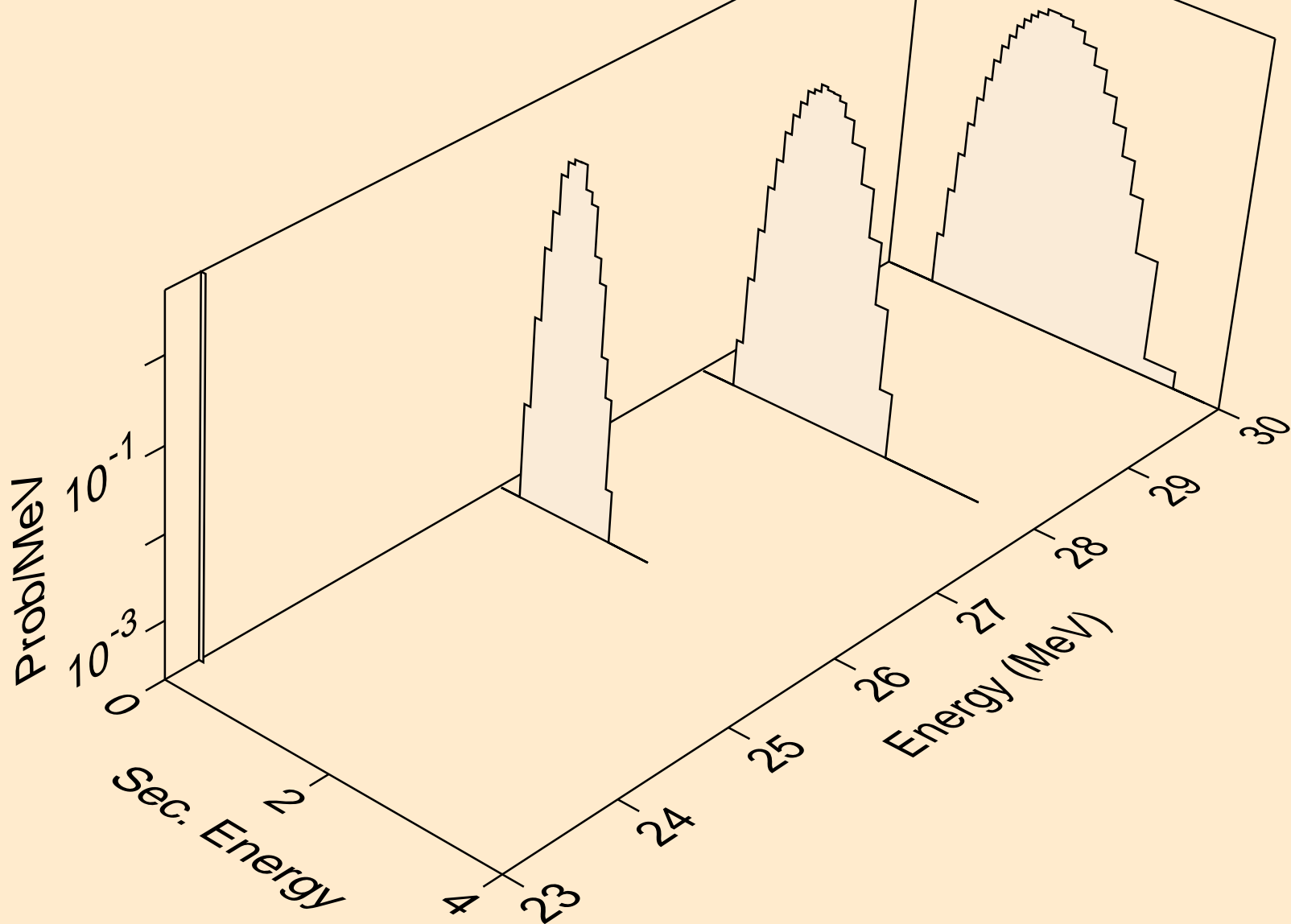

F018 NEUTRON ACER TENDL-2023 LIBRARY; T=0.K
alphas from (n,npa)

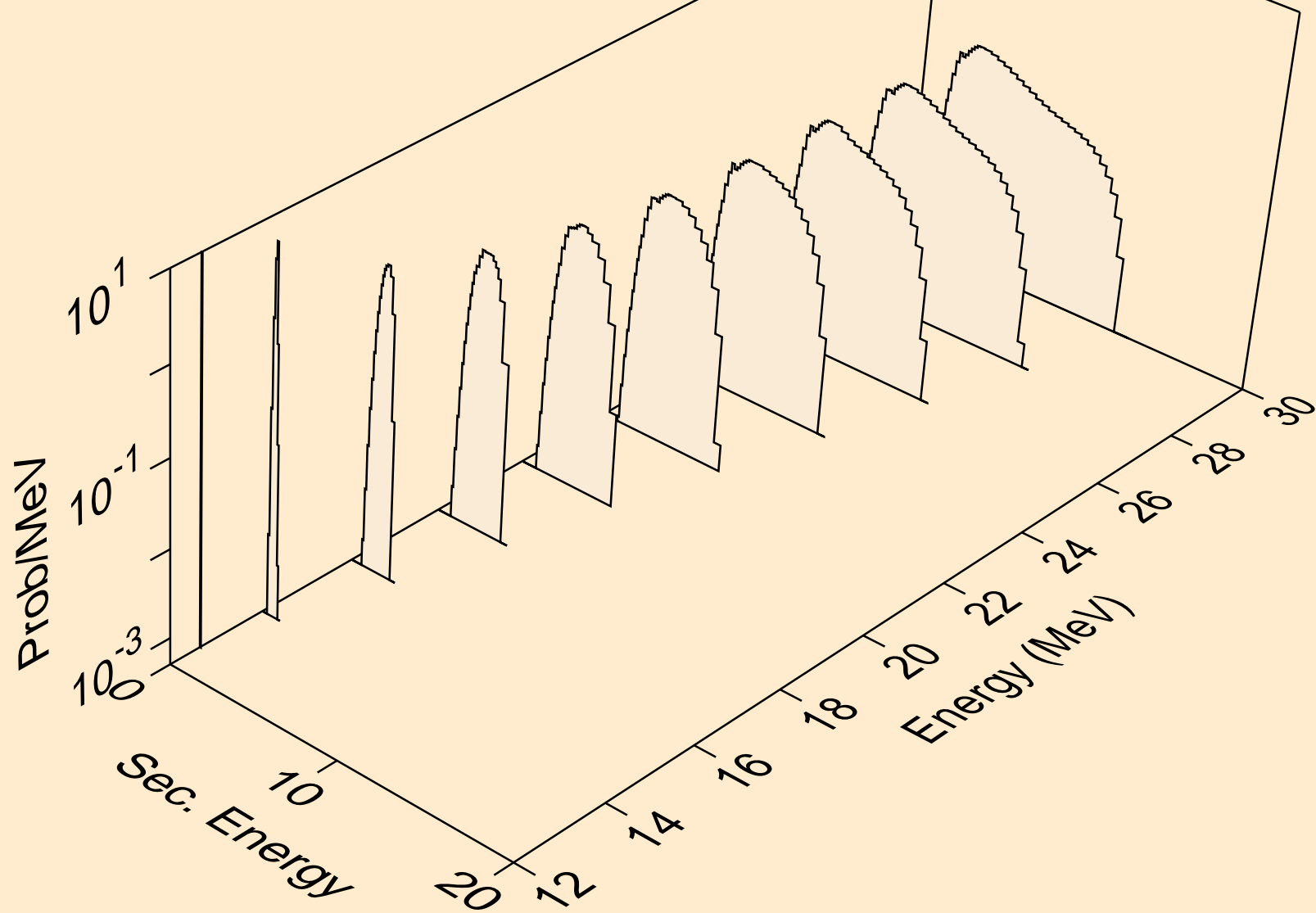

F018 NEUTRON ACER TENDL-2023 LIBRARY; T=0.K
alphas from (n,a)

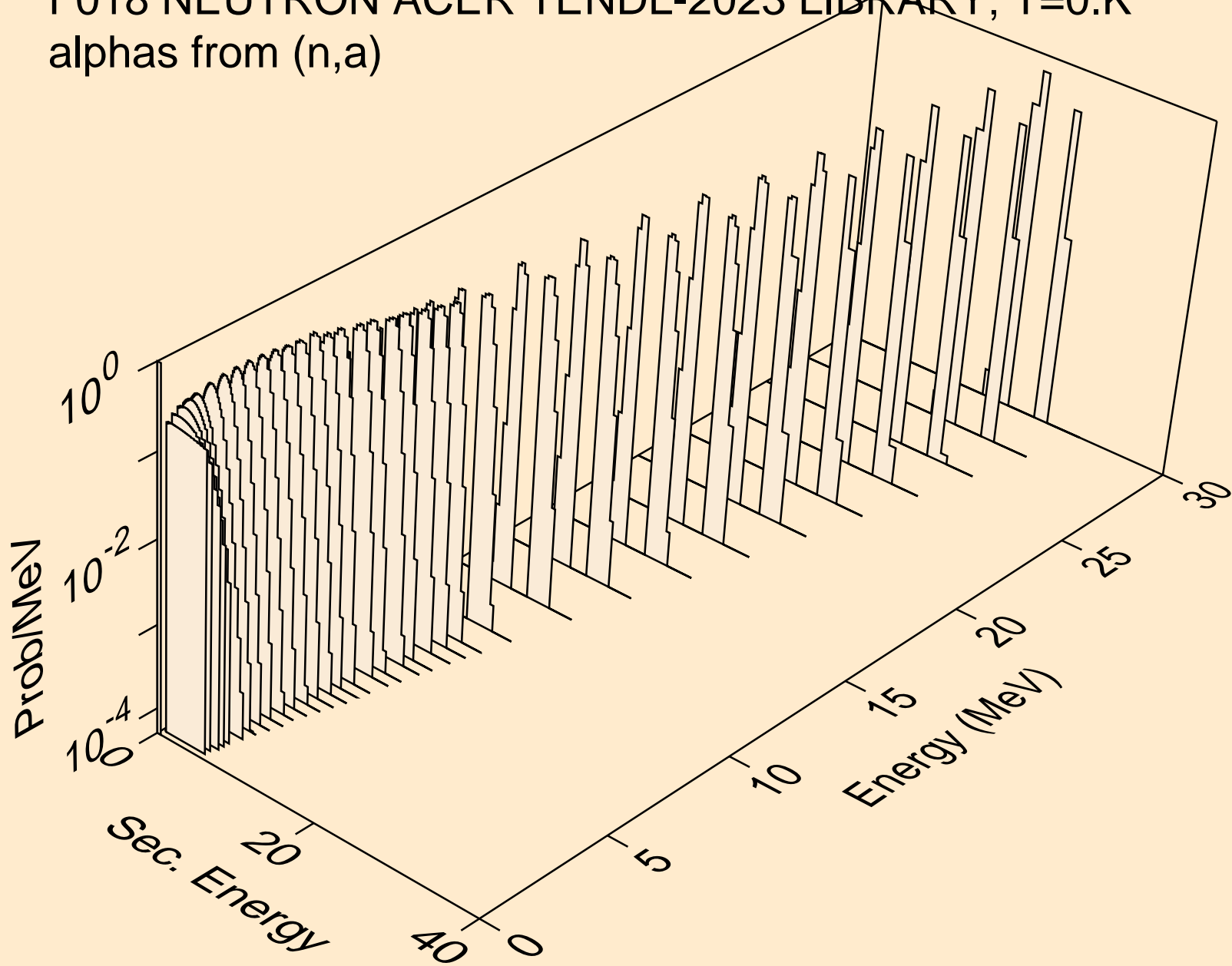

F018 NEUTRON ACER TENDL-2023 LIBRARY; T=0.K
alphas from (n,2a)

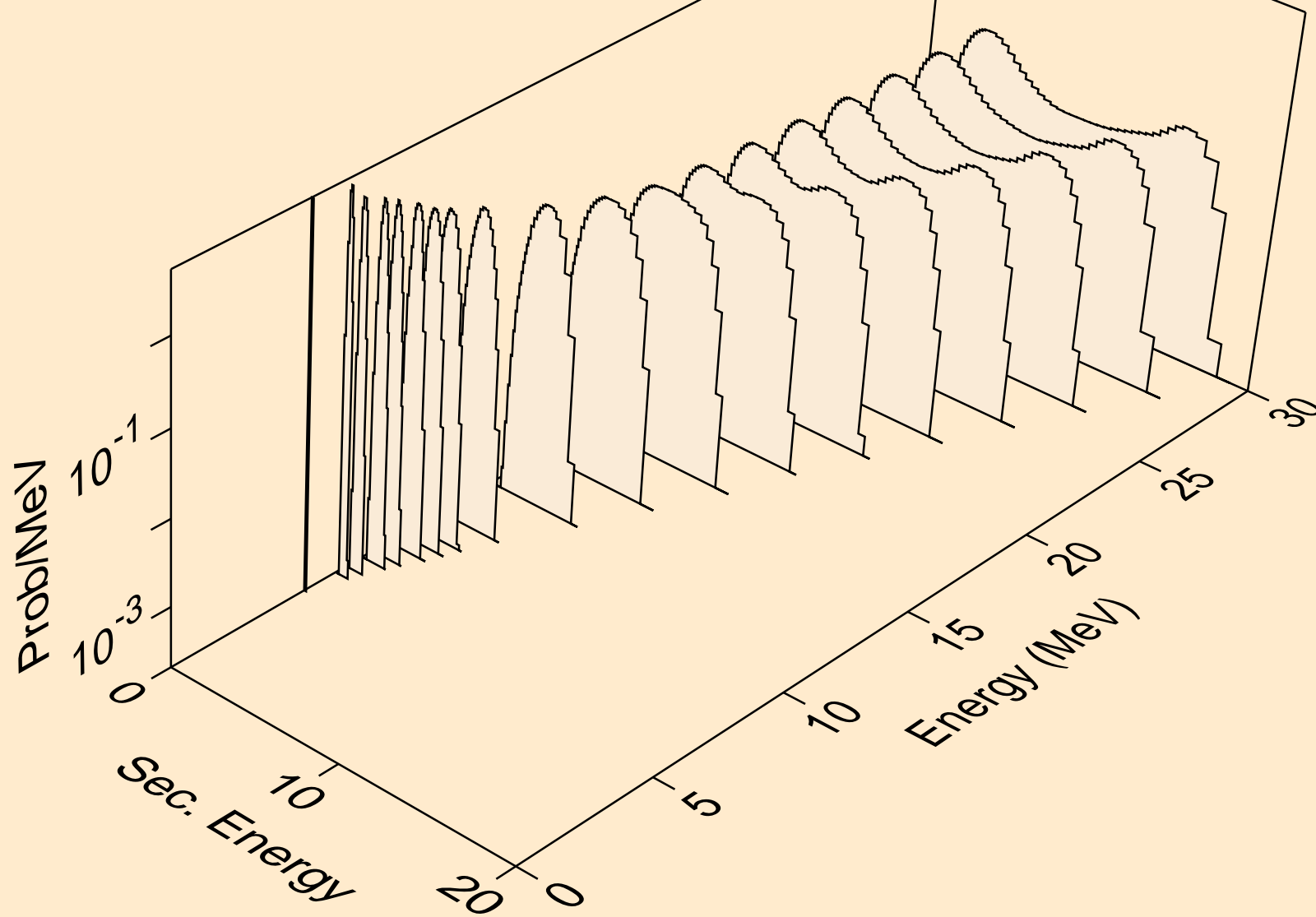

F018 NEUTRON ACER TENDL-2023 LIBRARY; T=0.K
alphas from (n,3a)

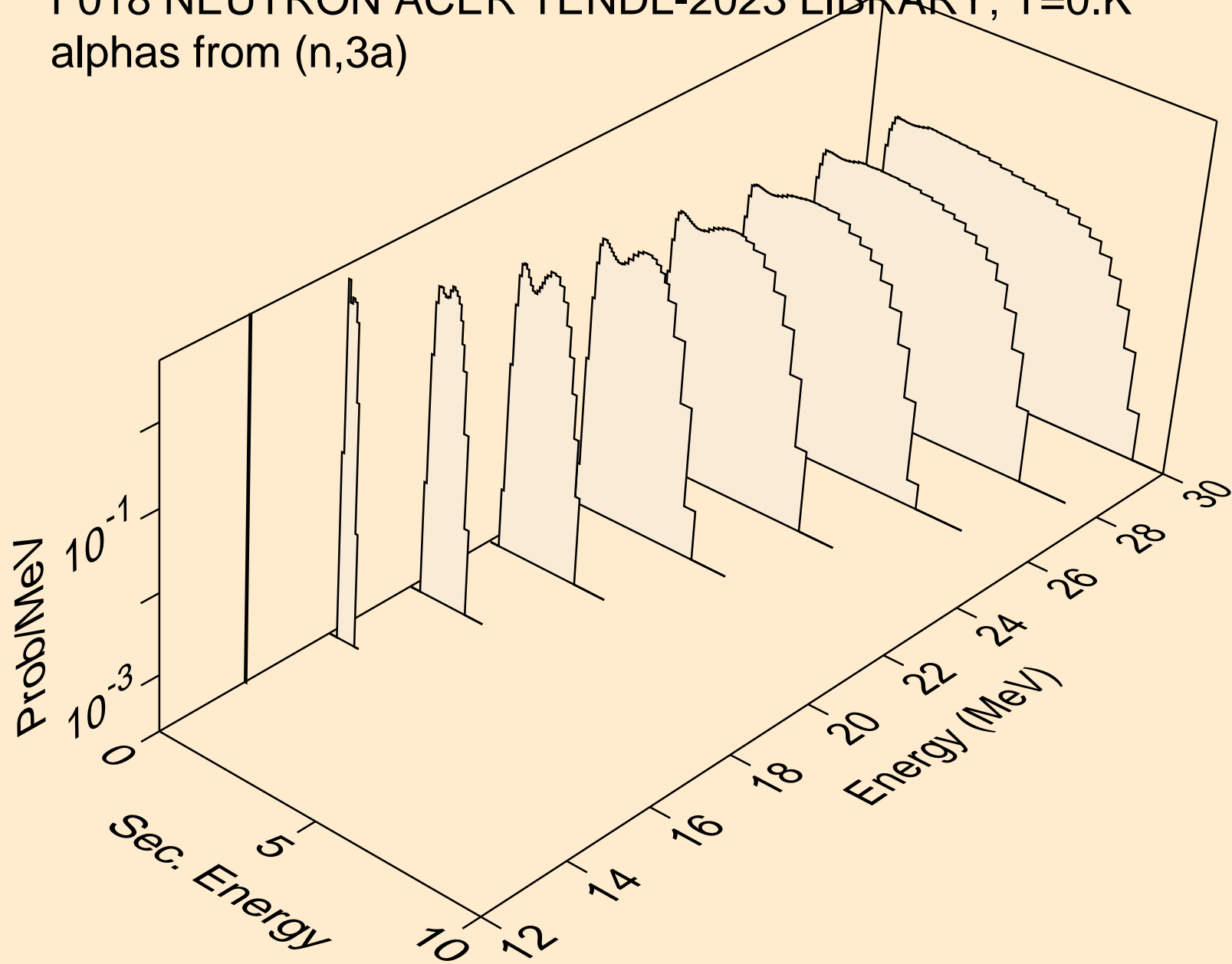

F018 NEUTRON ACER TENDL-2023 LIBRARY; T=0.K
alphas from (n,pa)

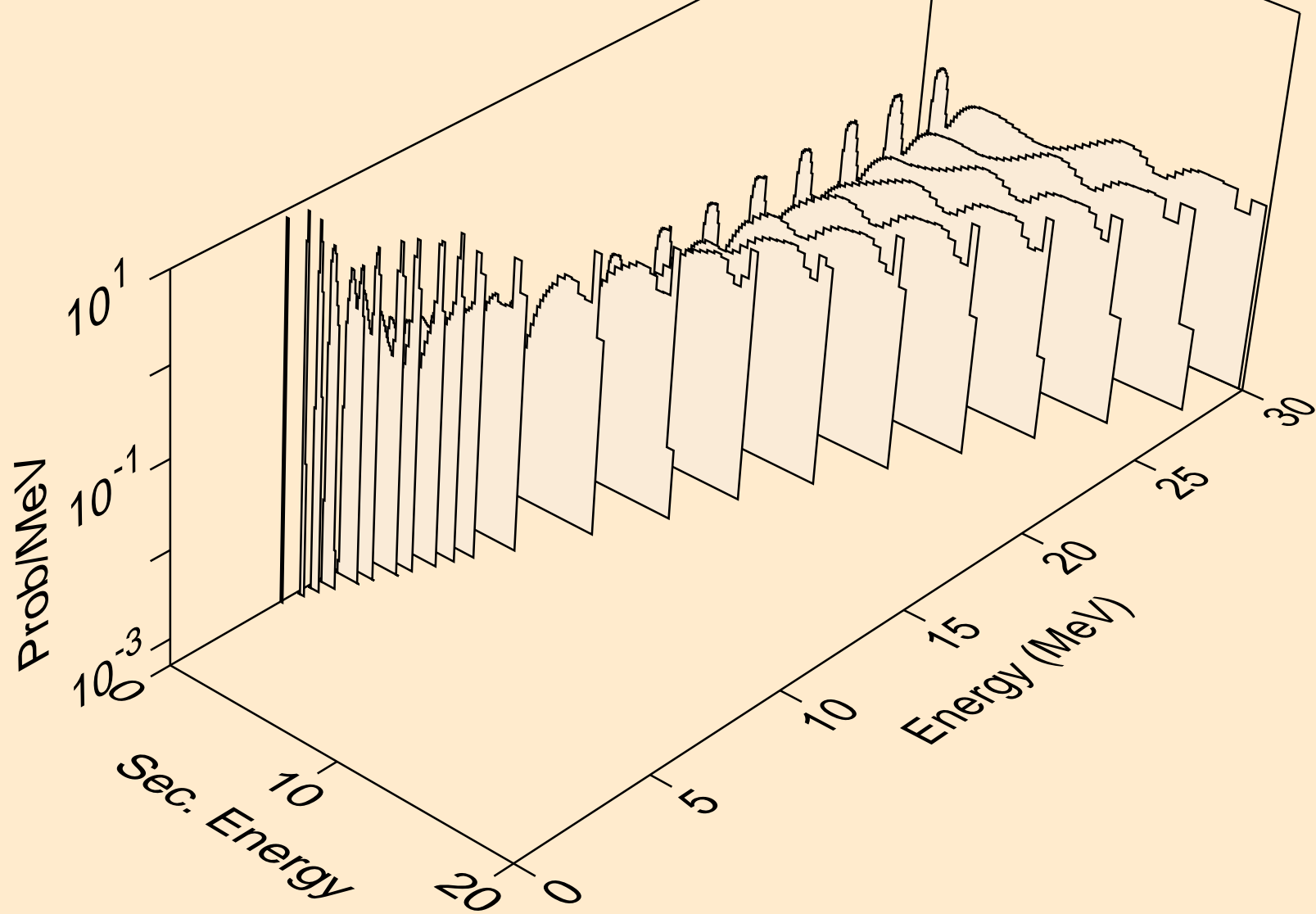

F018 NEUTRON ACER TENDL-2023 LIBRARY; T=0.K
alphas from (n,t2a)

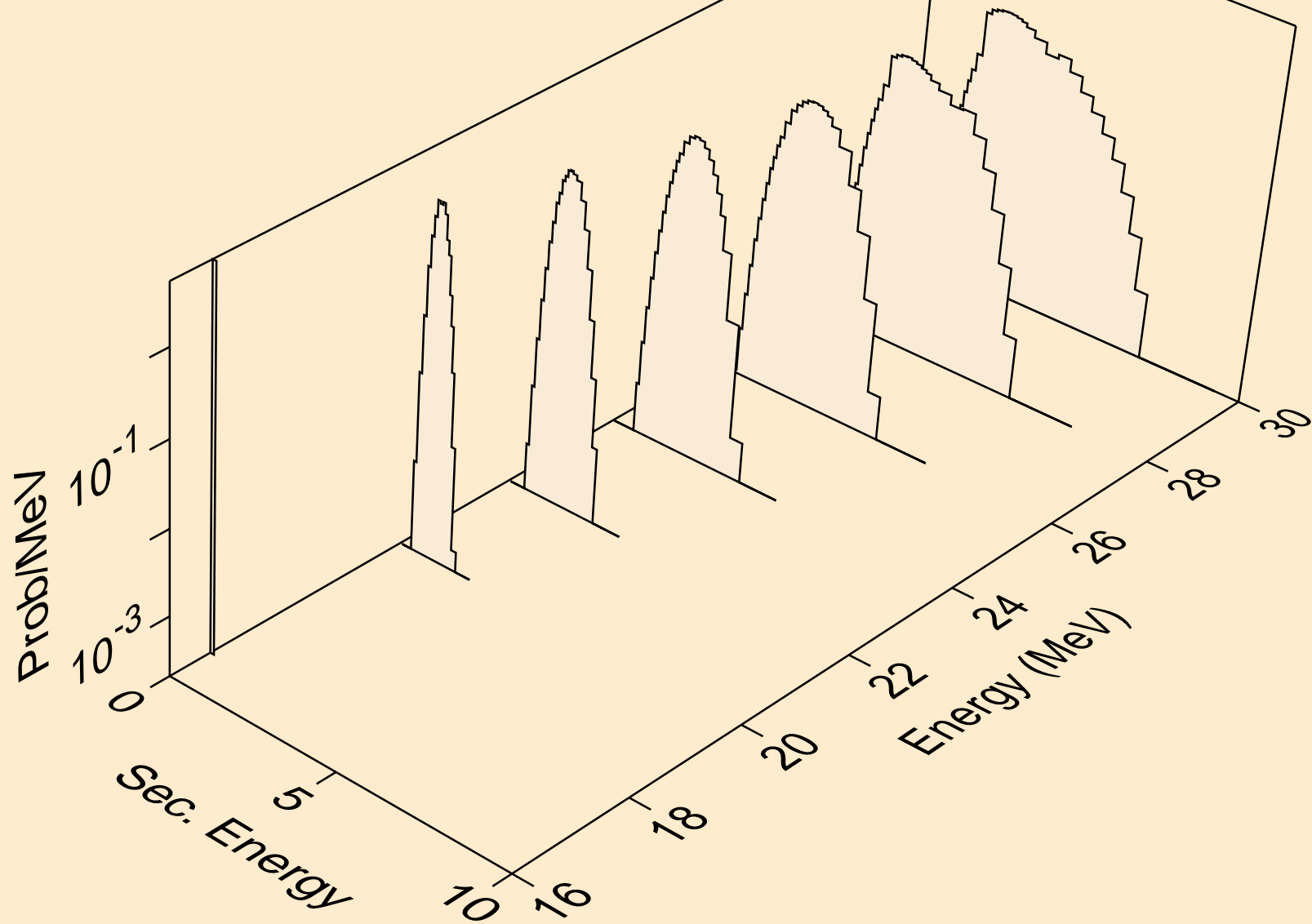

F018 NEUTRON ACER TENDL-2023 LIBRARY; T=0.K
alphas from (n,d2a)

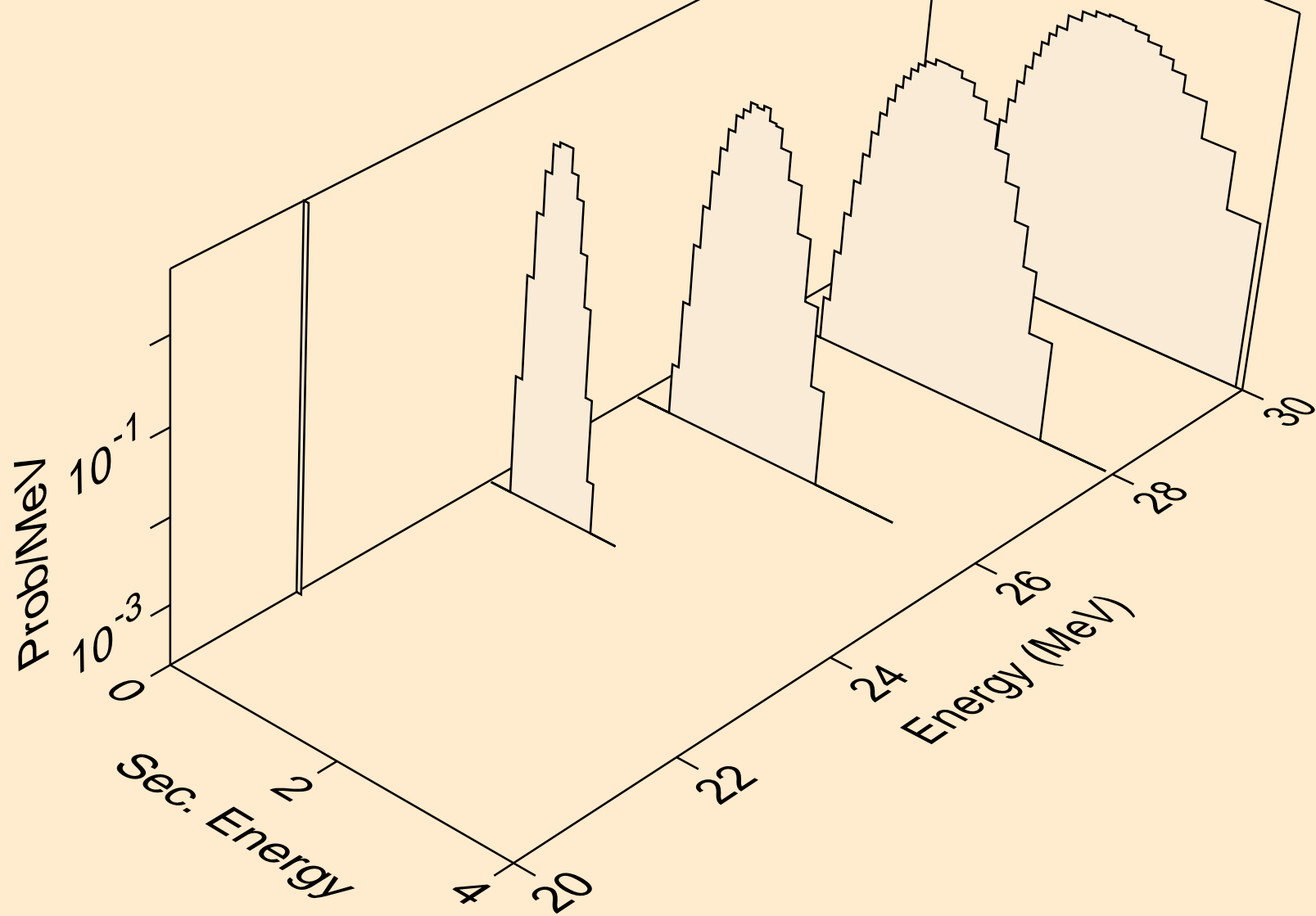

F018 NEUTRON ACER TENDL-2023 LIBRARY; T=0.K
alphas from (n,da)

