

FM246 NEUTRON ACER TENDL-2023 LIBRARY; T=0.K

Principal cross sections

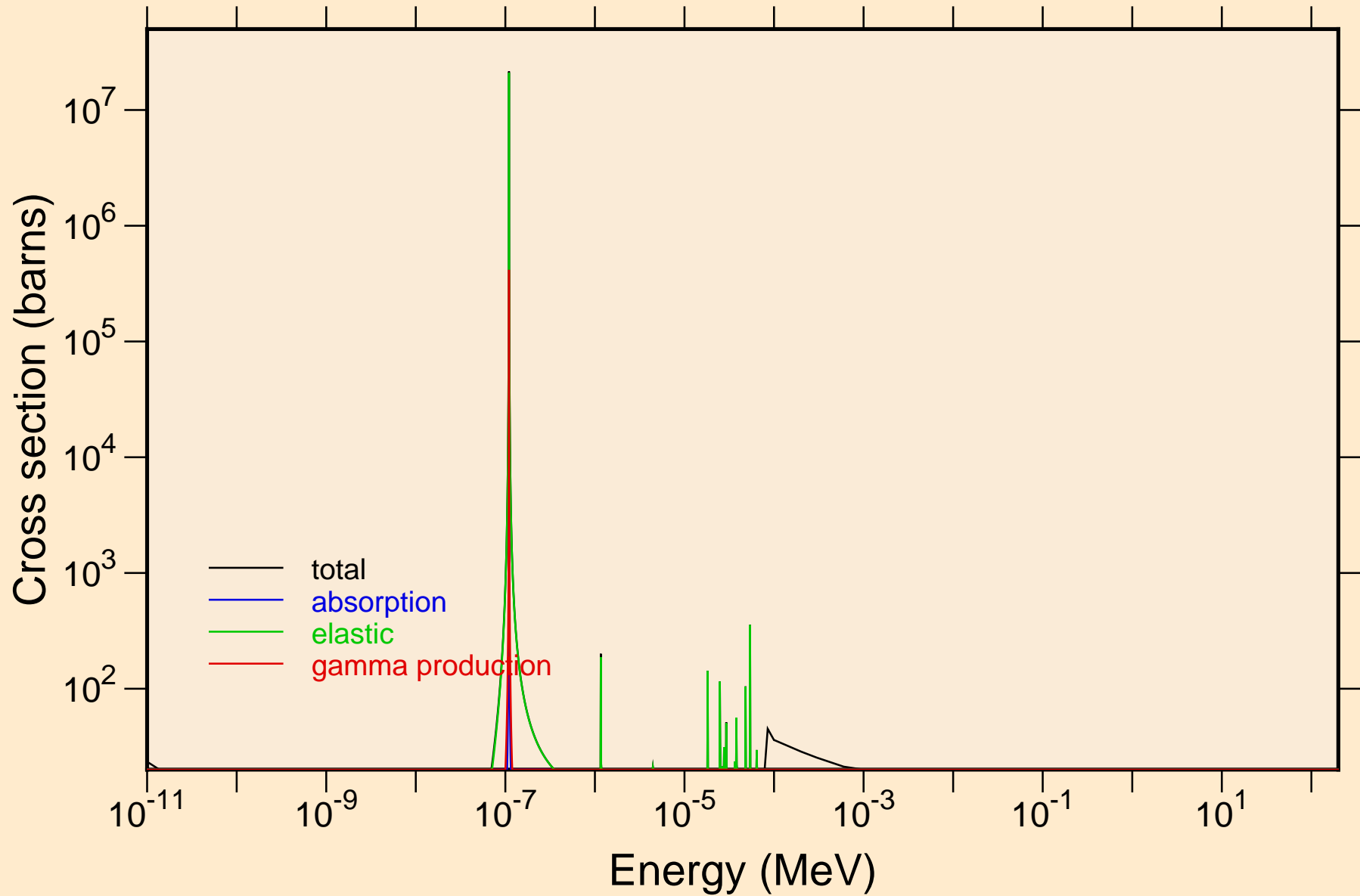

FM246 NEUTRON ACER TENDL-2023 LIBRARY; T=0.K
resonance total cross section

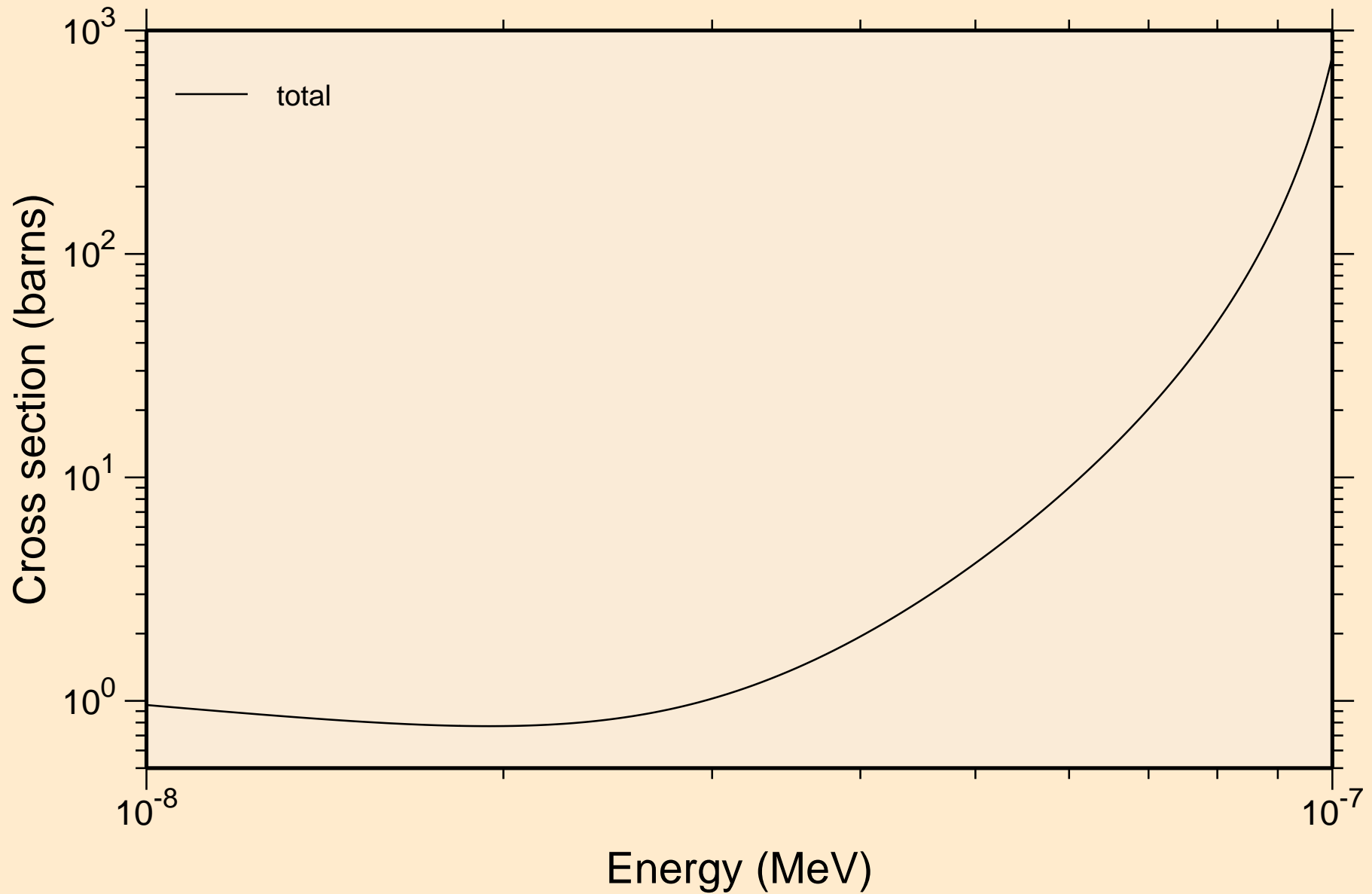

FM246 NEUTRON ACER TENDL-2023 LIBRARY; T=0.K
resonance total cross section

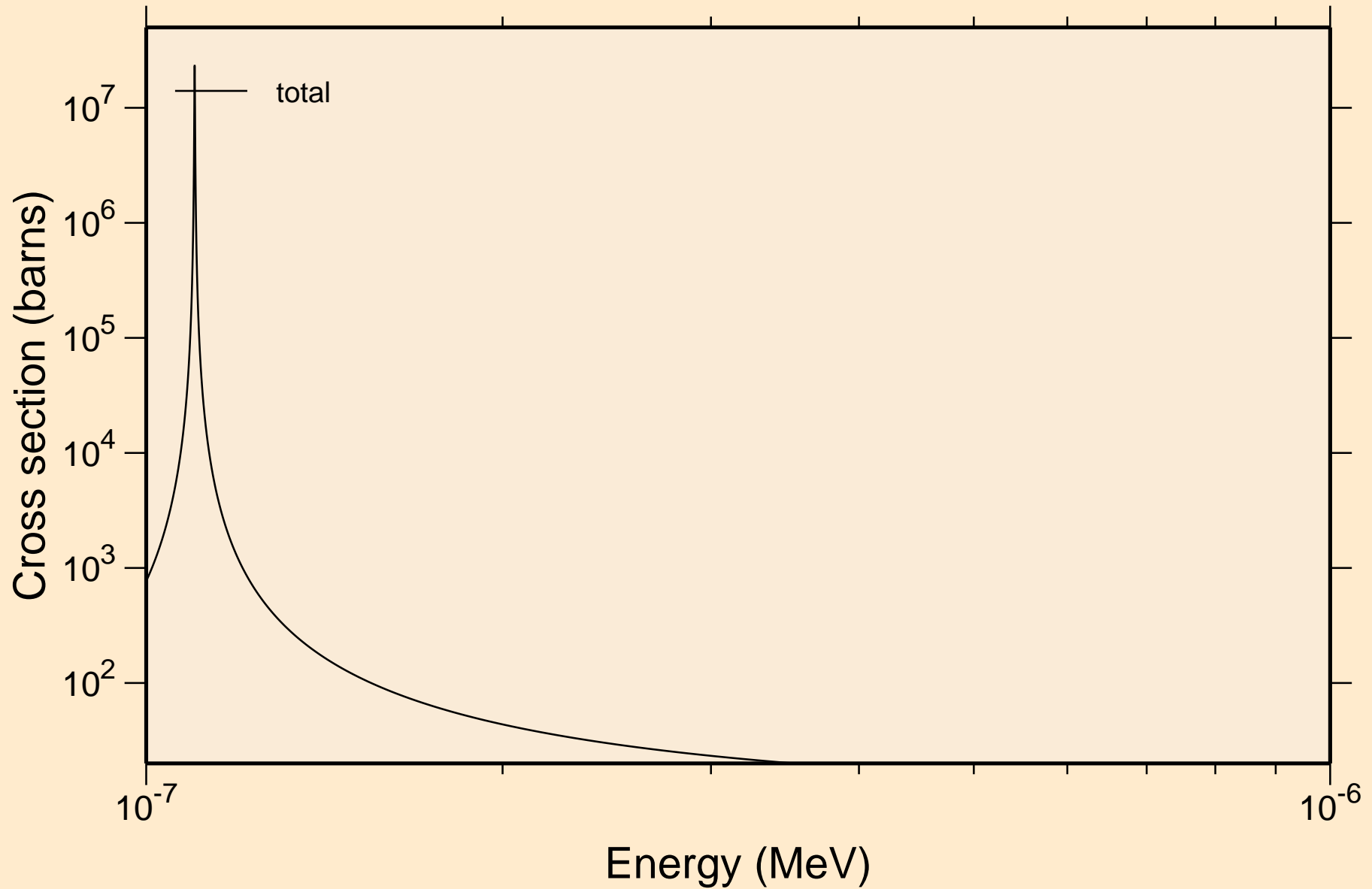

FM246 NEUTRON ACER TENDL-2023 LIBRARY; T=0.K
resonance total cross section

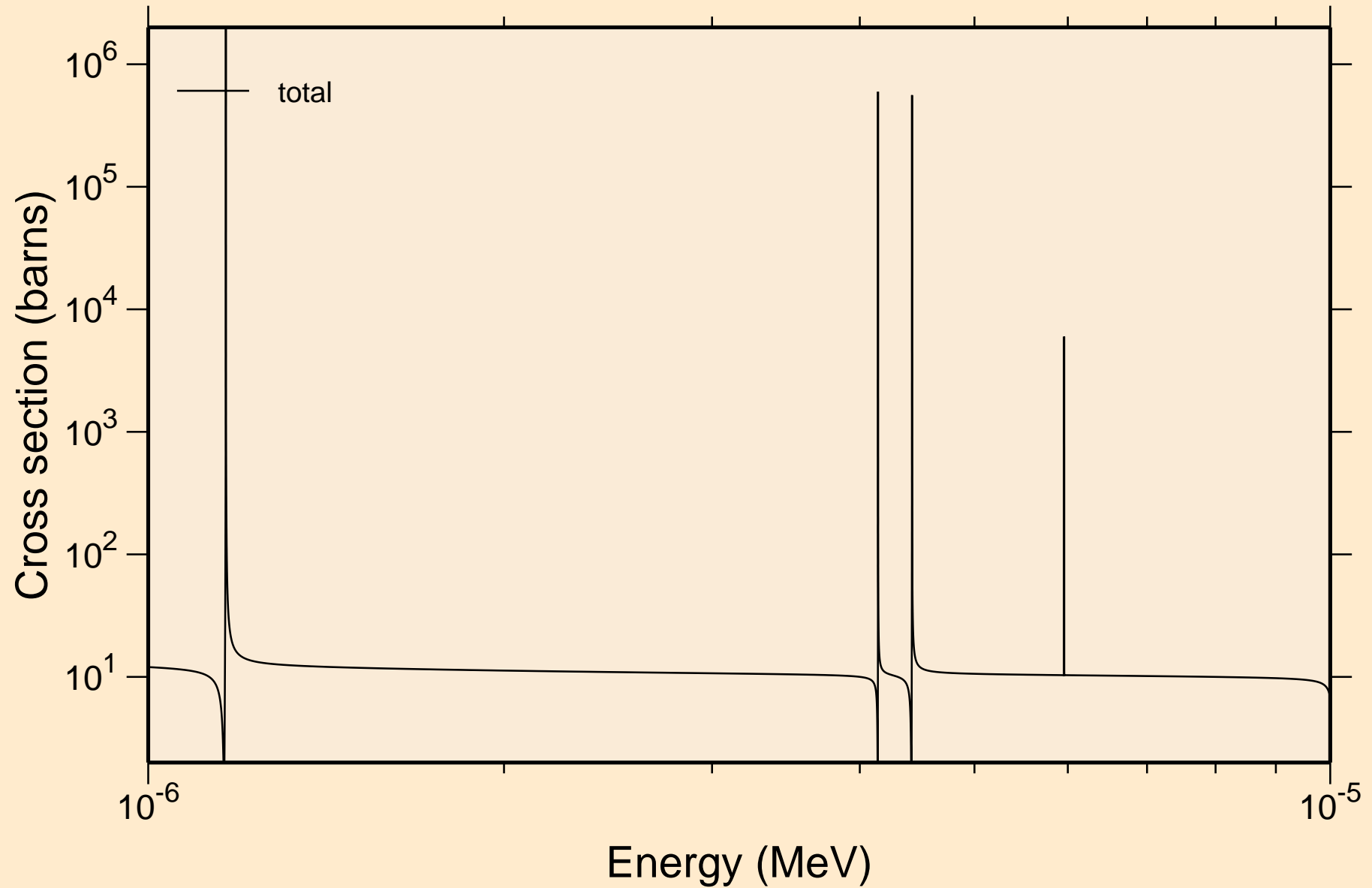

FM246 NEUTRON ACER TENDL-2023 LIBRARY; T=0.K
resonance total cross section

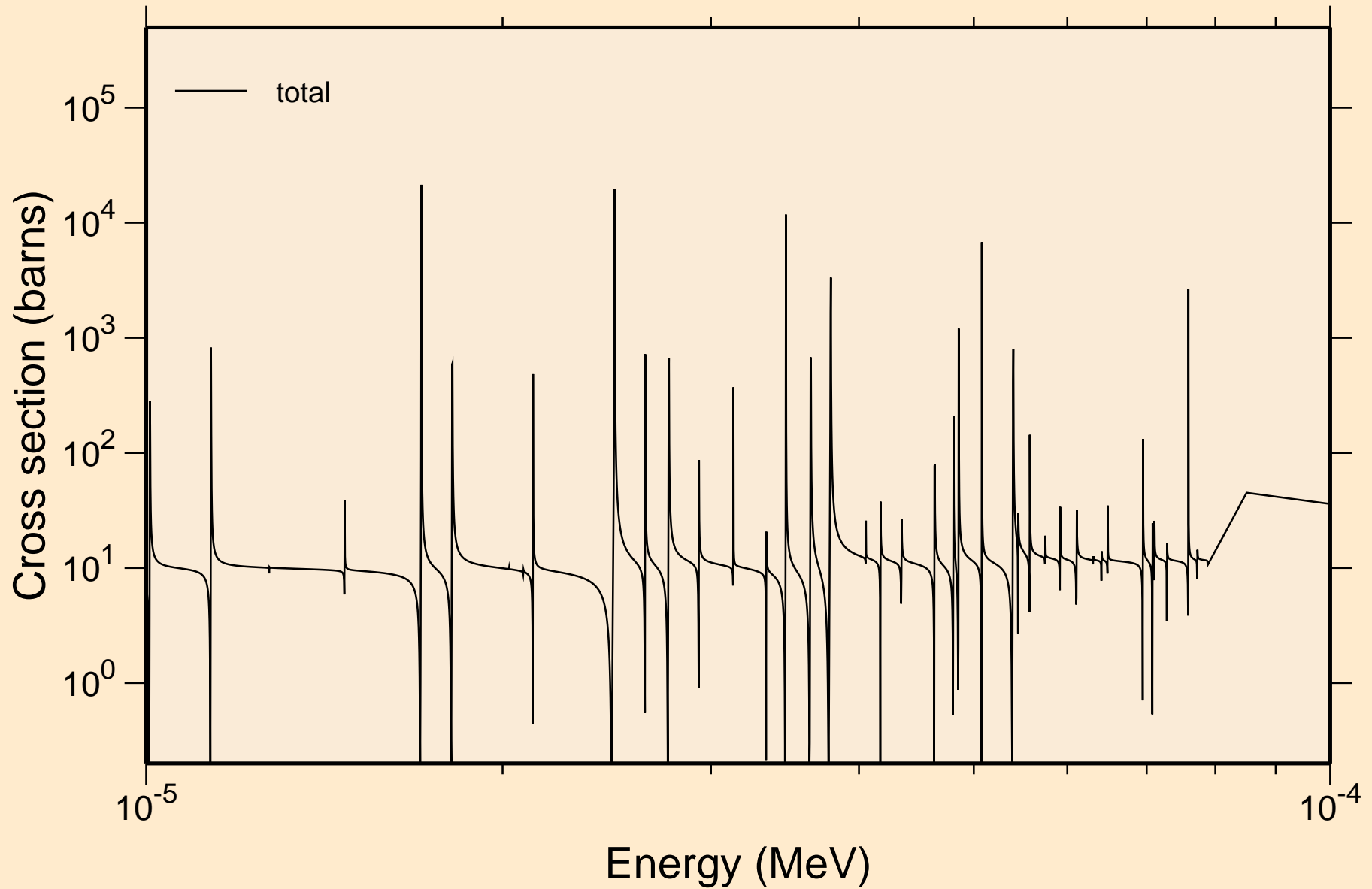

FM246 NEUTRON ACER TENDL-2023 LIBRARY; T=0.K
resonance total cross section

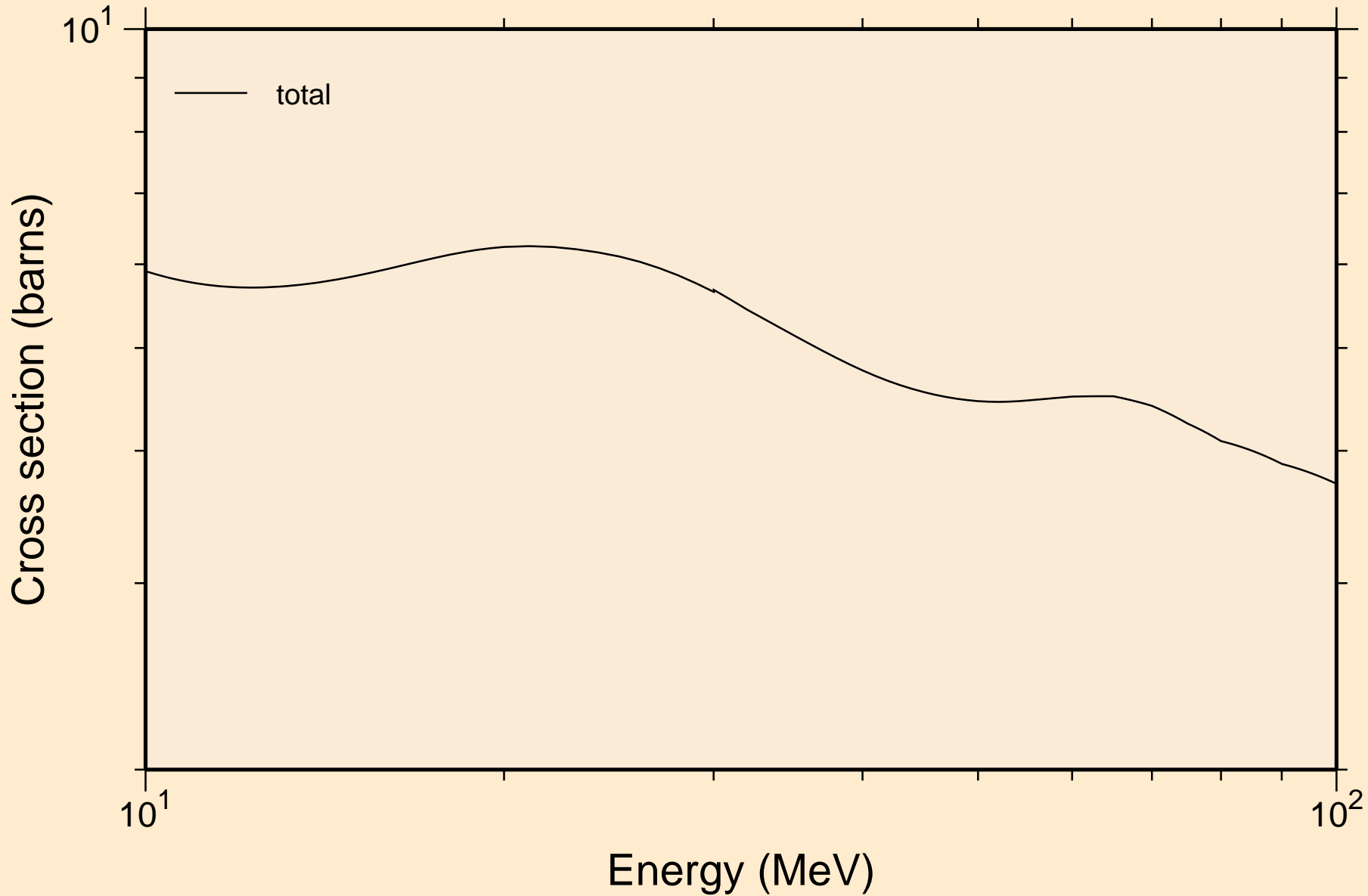

FM246 NEUTRON ACER TENDL-2023 LIBRARY; T=0.K
resonance absorption cross sections

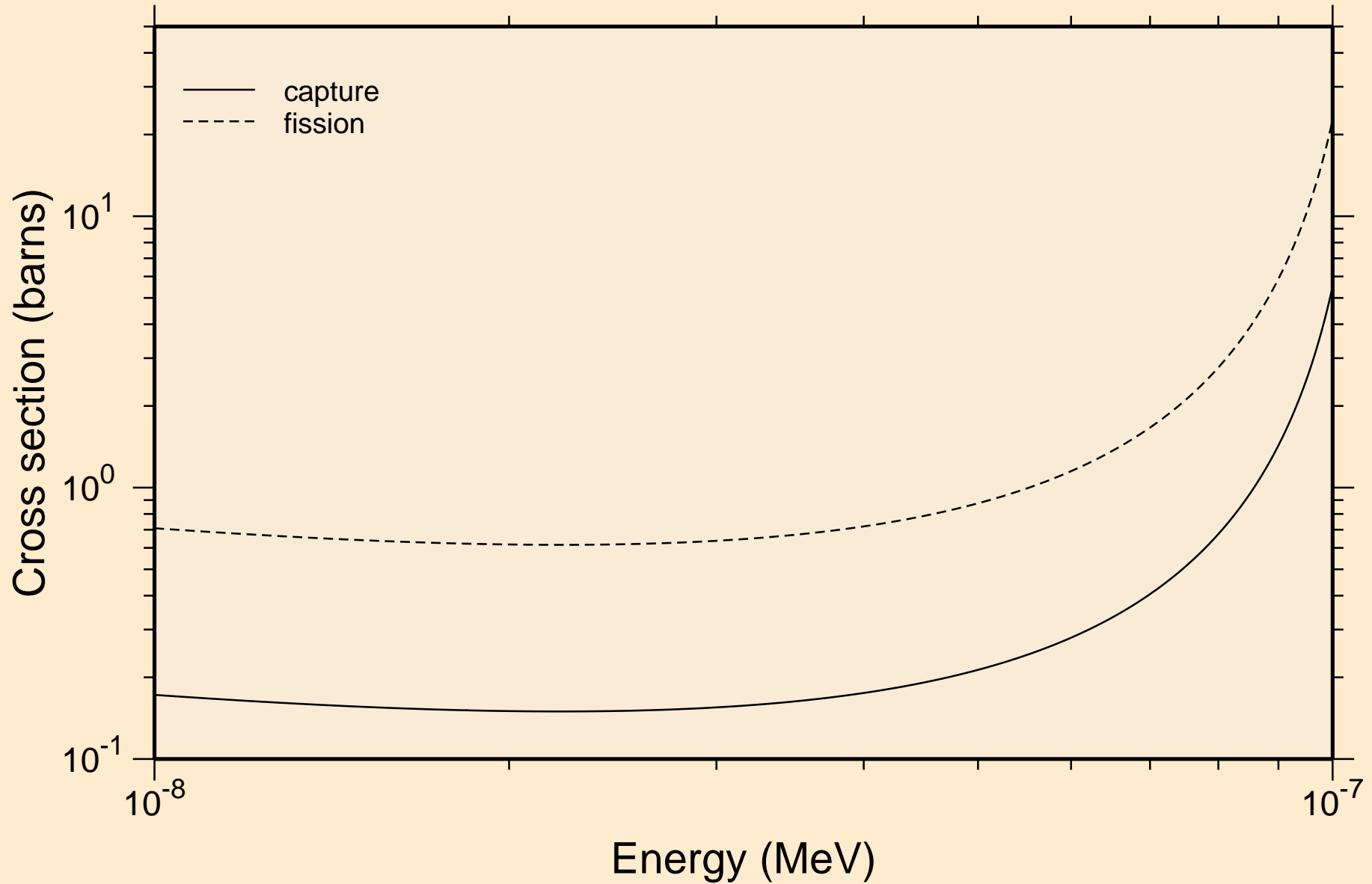

FM246 NEUTRON ACER TENDL-2023 LIBRARY; T=0.K
resonance absorption cross sections

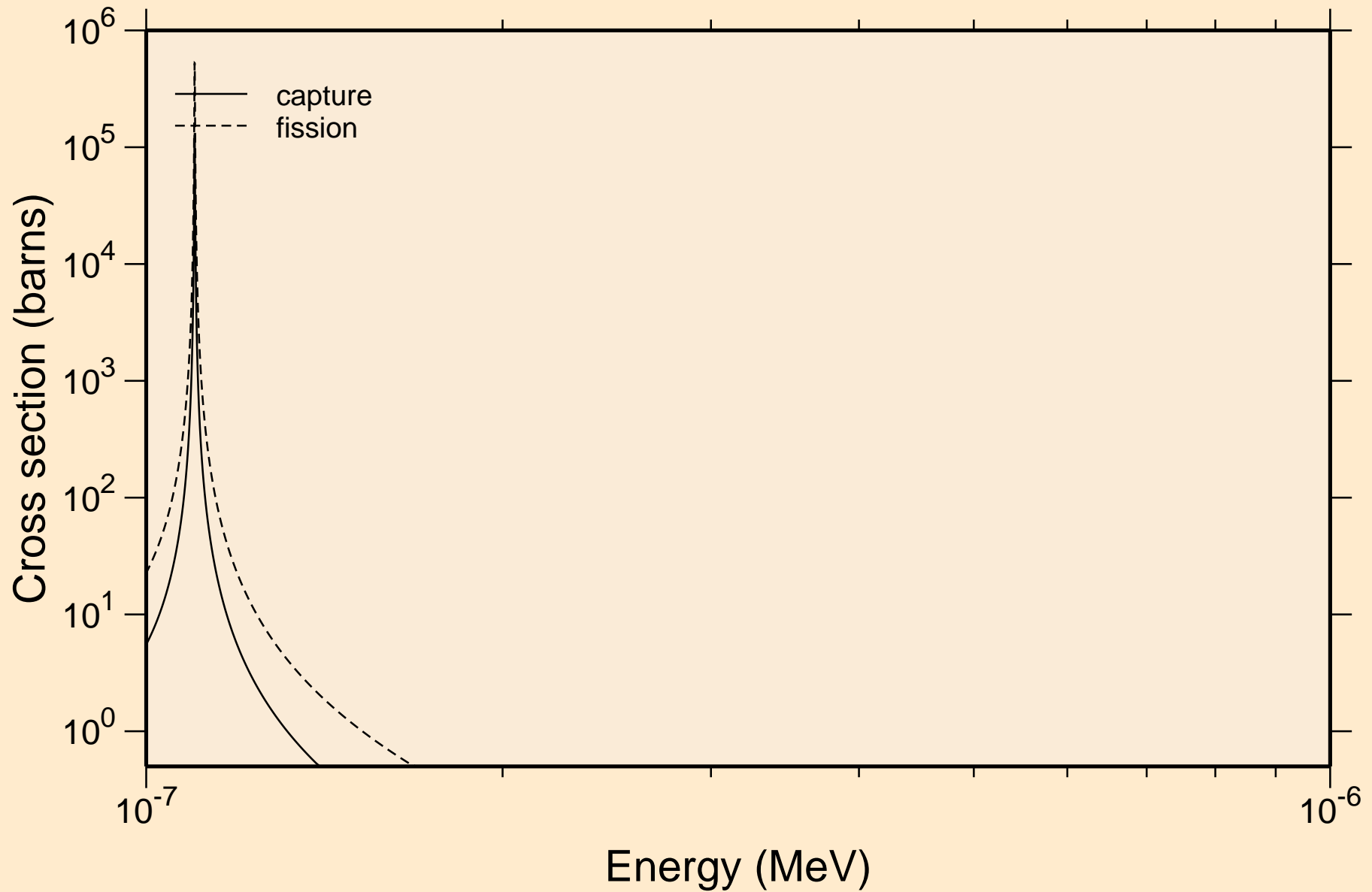

FM246 NEUTRON ACER TENDL-2023 LIBRARY; T=0.K
resonance absorption cross sections

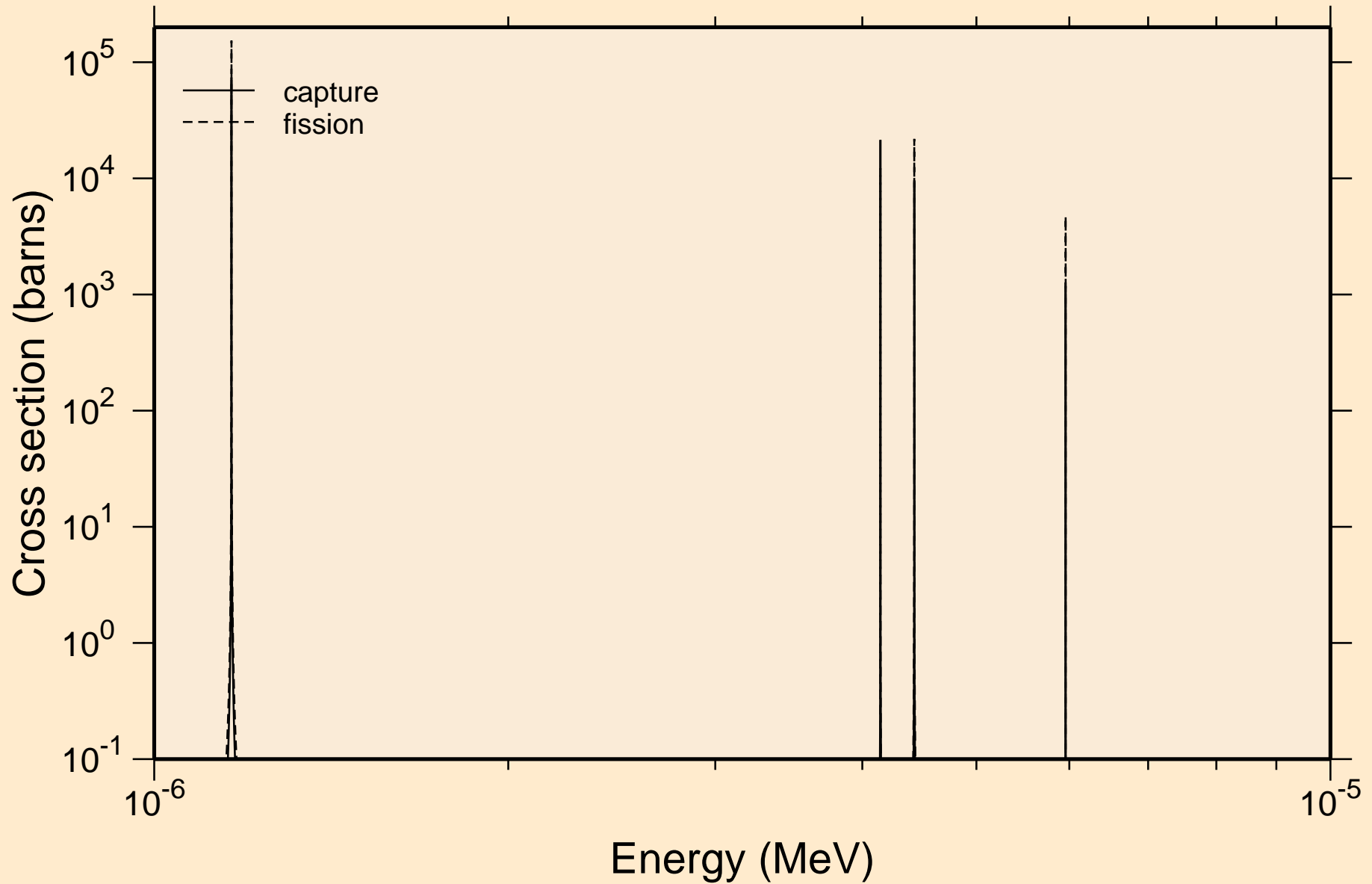

FM246 NEUTRON ACER TENDL-2023 LIBRARY; T=0.K

resonance absorption cross sections

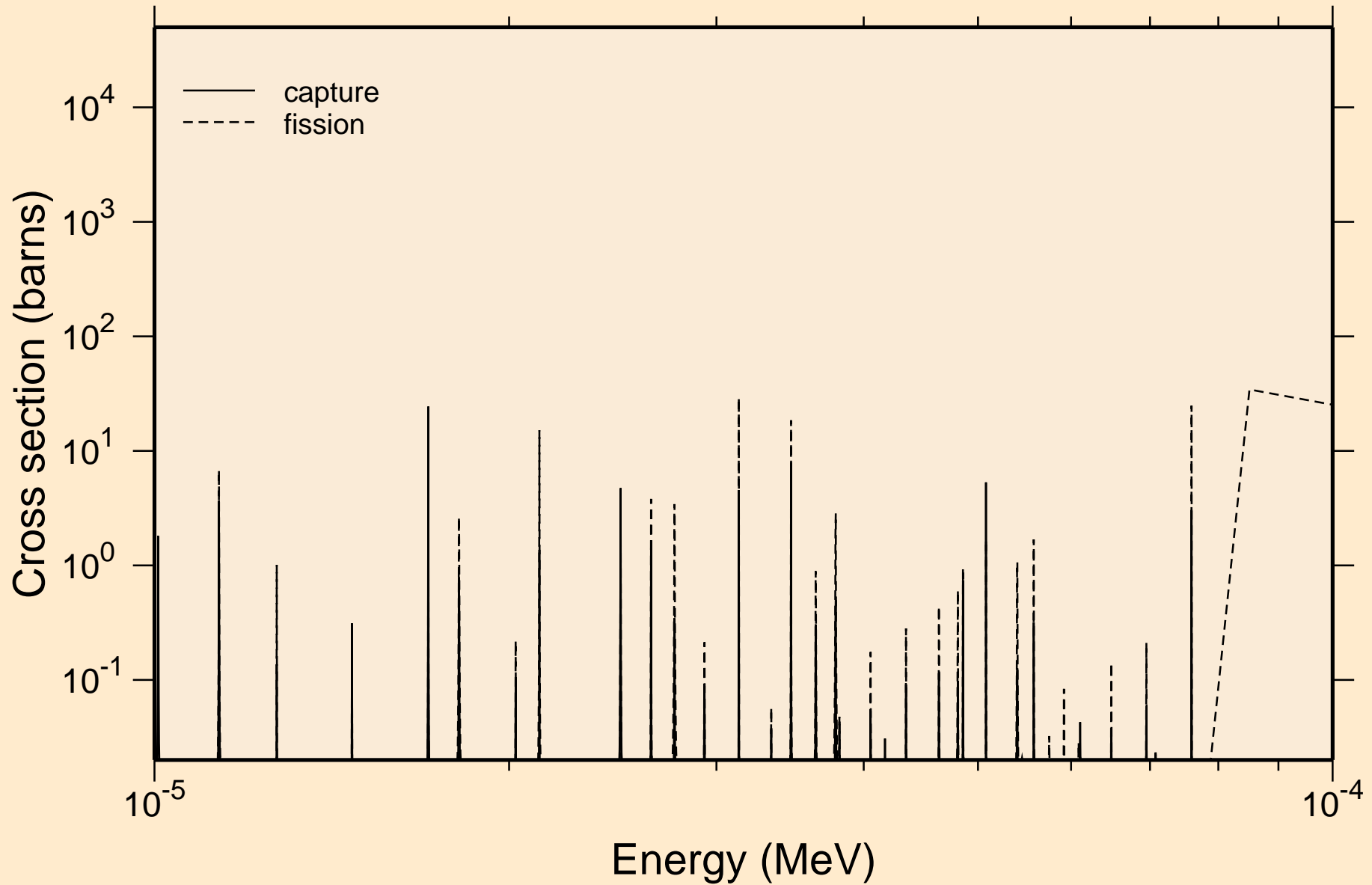

FM246 NEUTRON ACER TENDL-2023 LIBRARY; T=0.K
resonance absorption cross sections

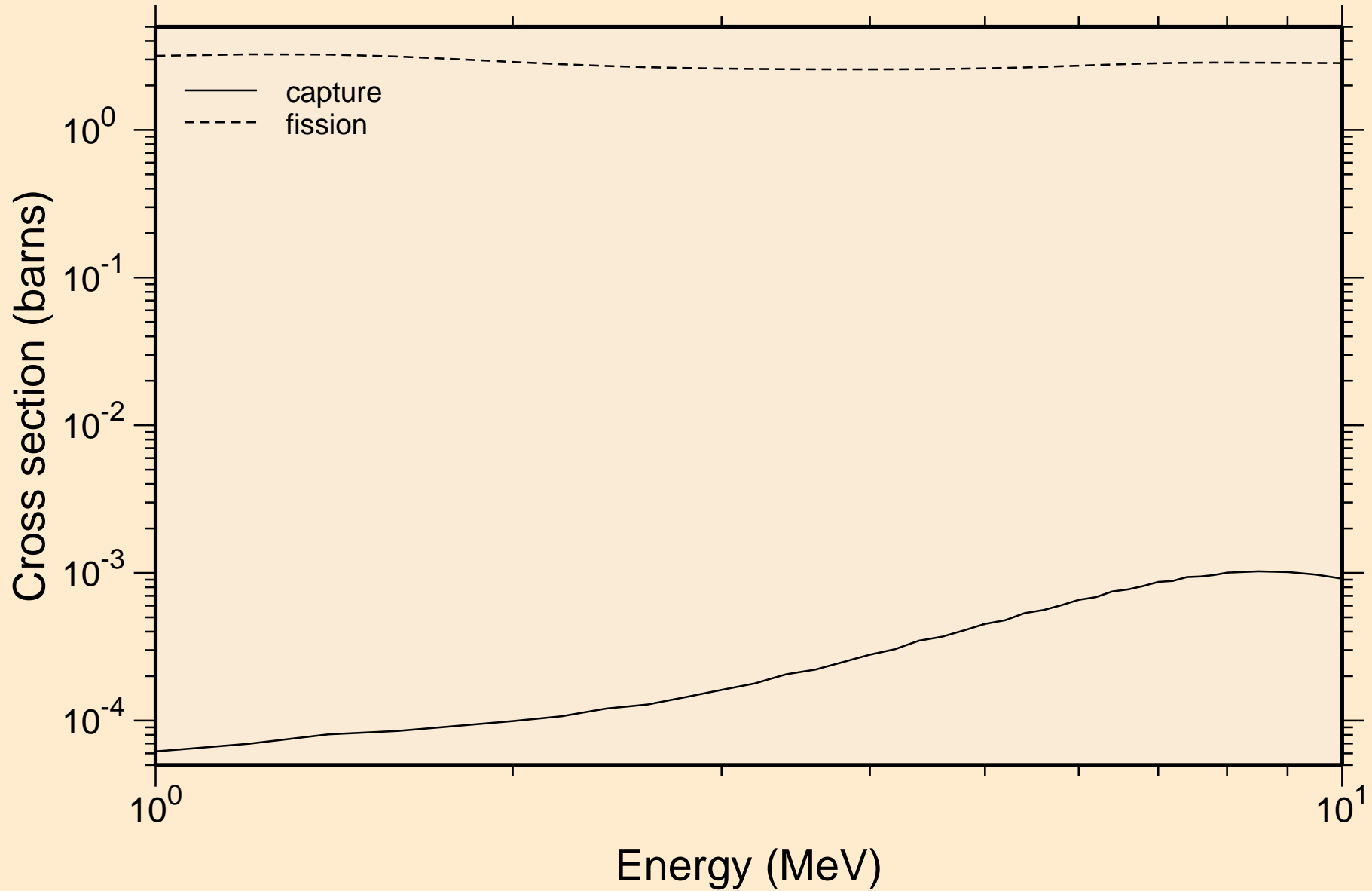

FM246 NEUTRON ACER TENDL-2023 LIBRARY; T=0.K
Heating

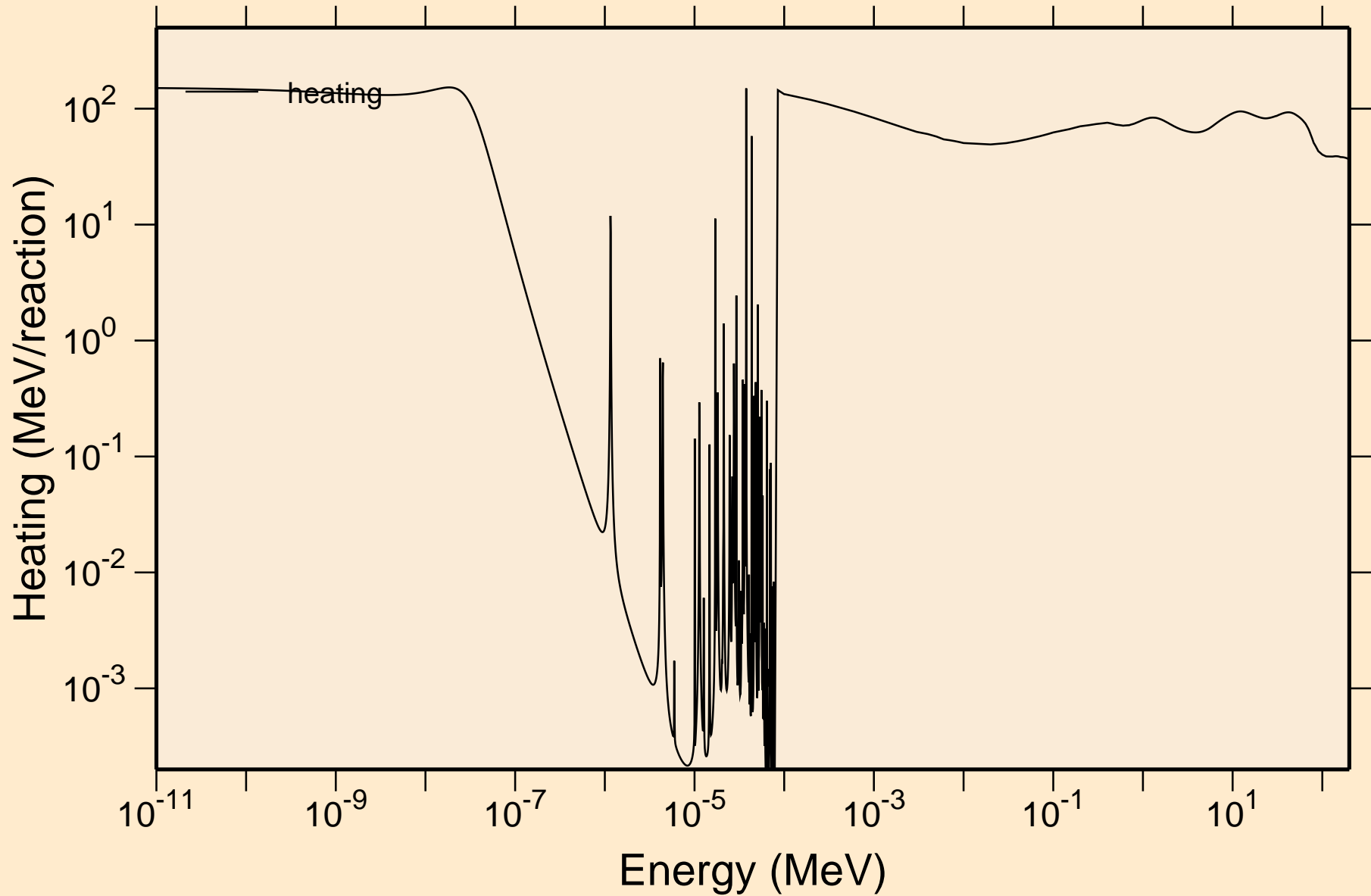

FM246 NEUTRON ACER TENDL-2023 LIBRARY; T=0.K
Damage

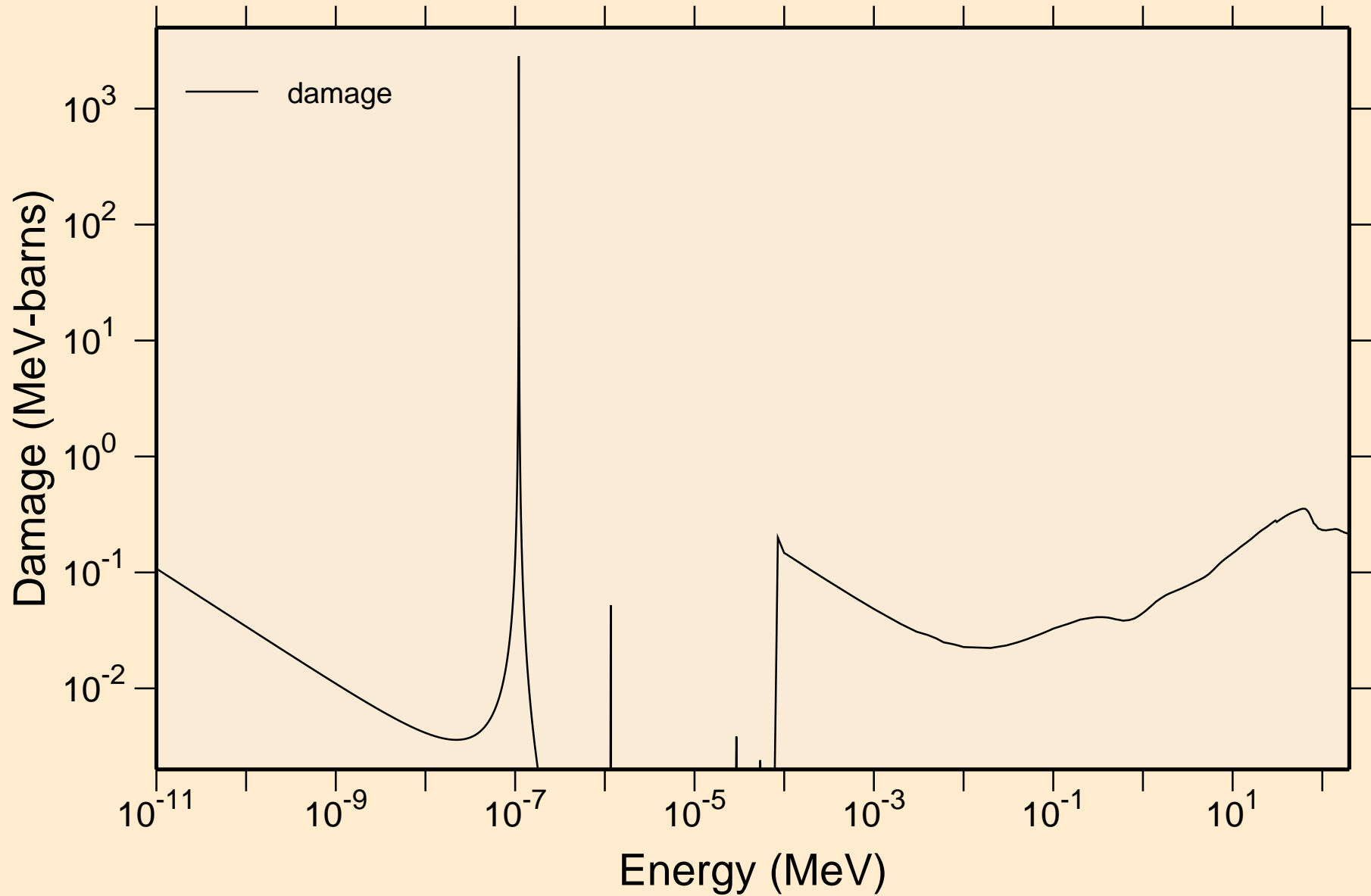

FM246 NEUTRON ACER TENDL-2023 LIBRARY; T=0.K

Non-threshold reactions

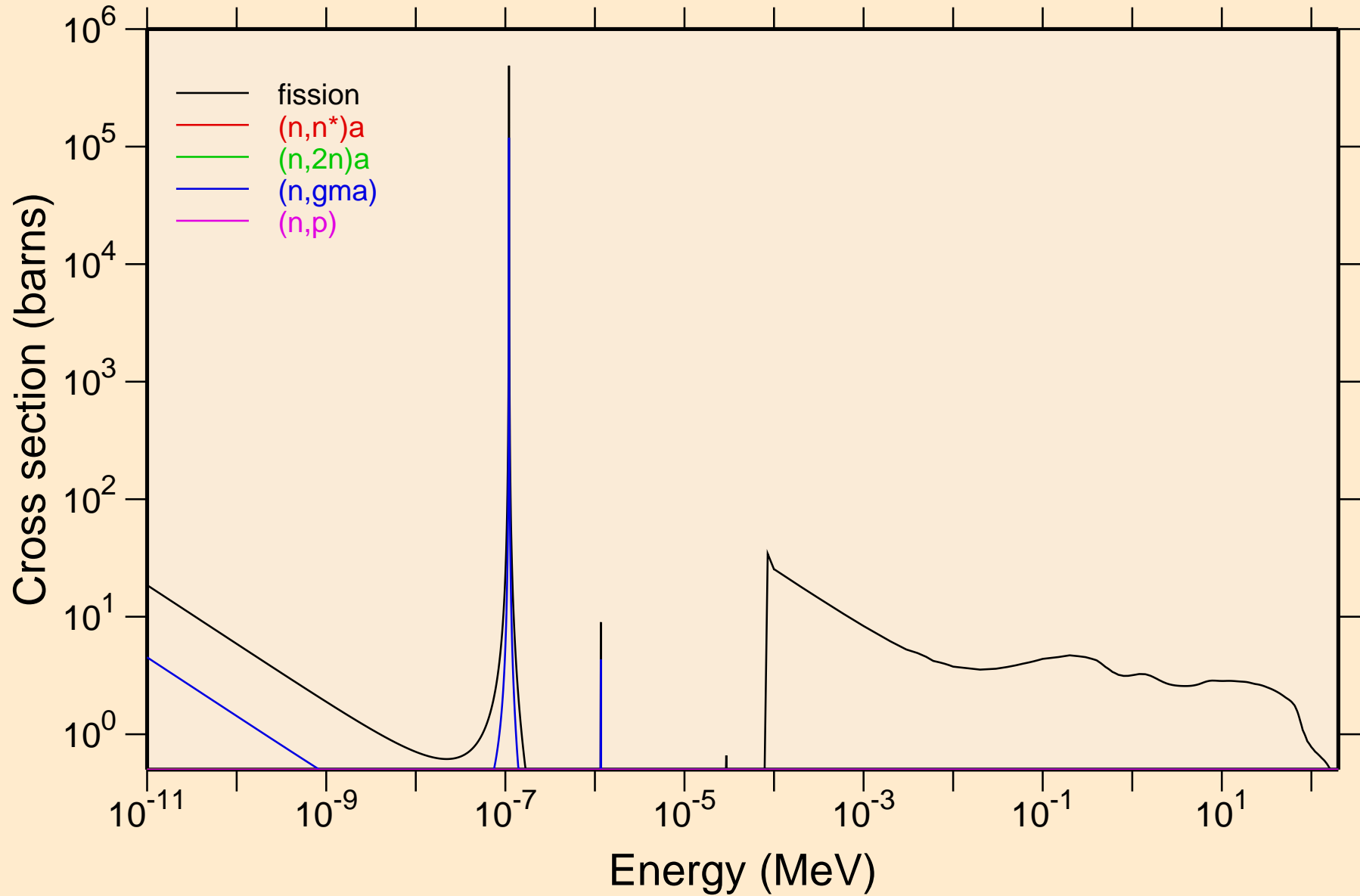

FM246 NEUTRON ACER TENDL-2023 LIBRARY; T=0.K

Non-threshold reactions

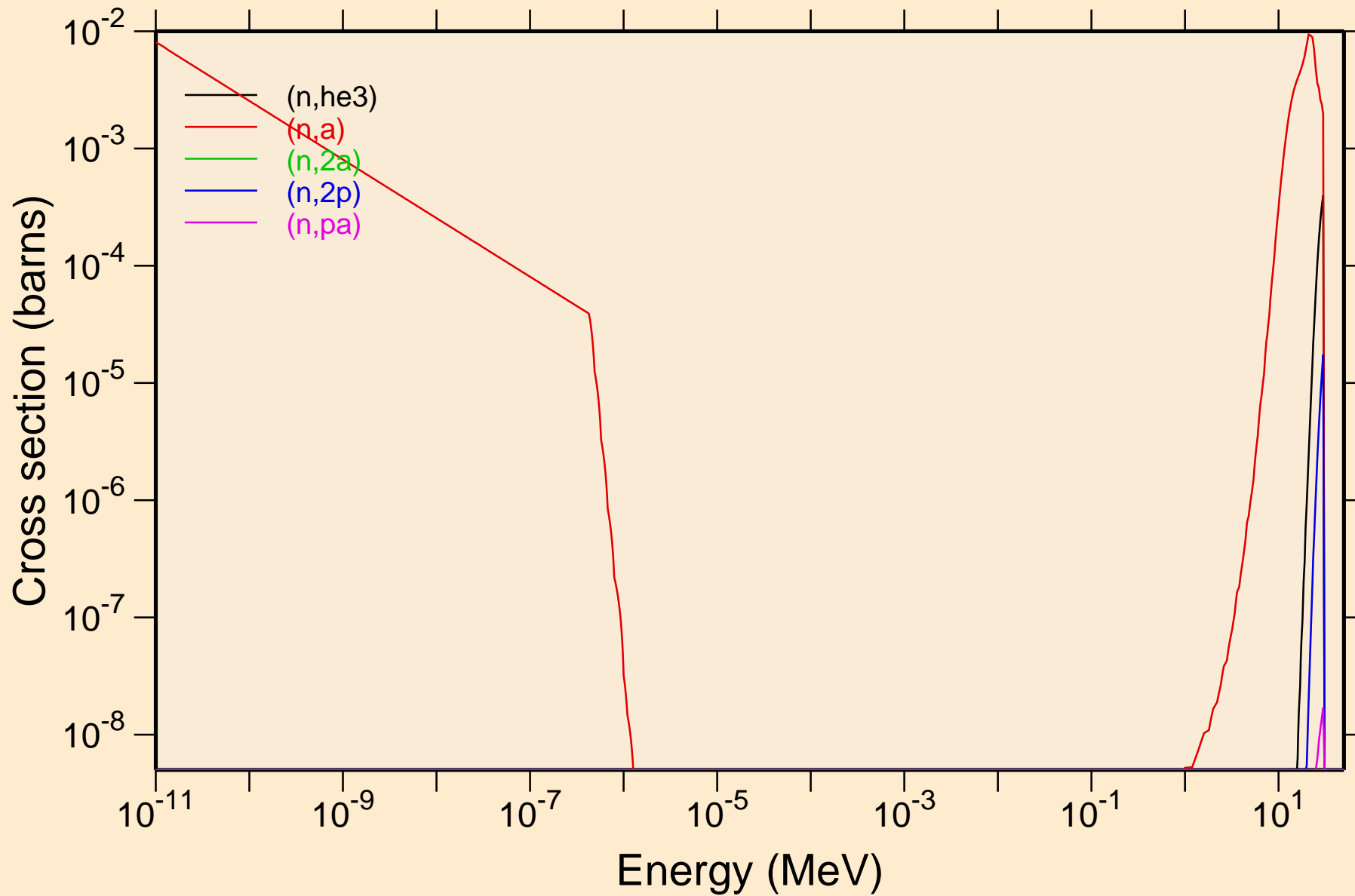

FM246 NEUTRON ACER TENDL-2023 LIBRARY; T=0.K
Non-threshold reactions

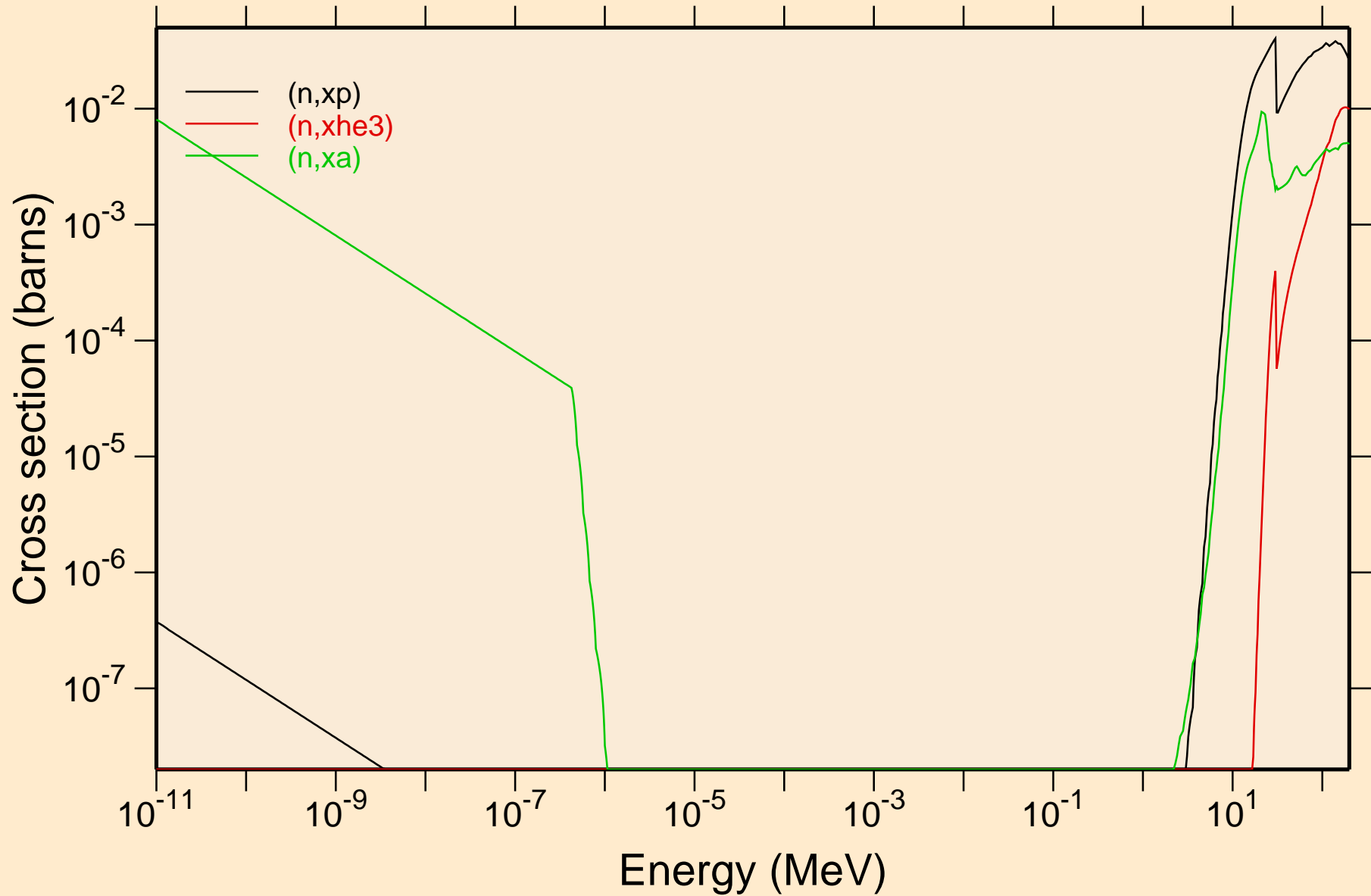

FM246 NEUTRON ACER TENDL-2023 LIBRARY; T=0.K

Principal cross sections

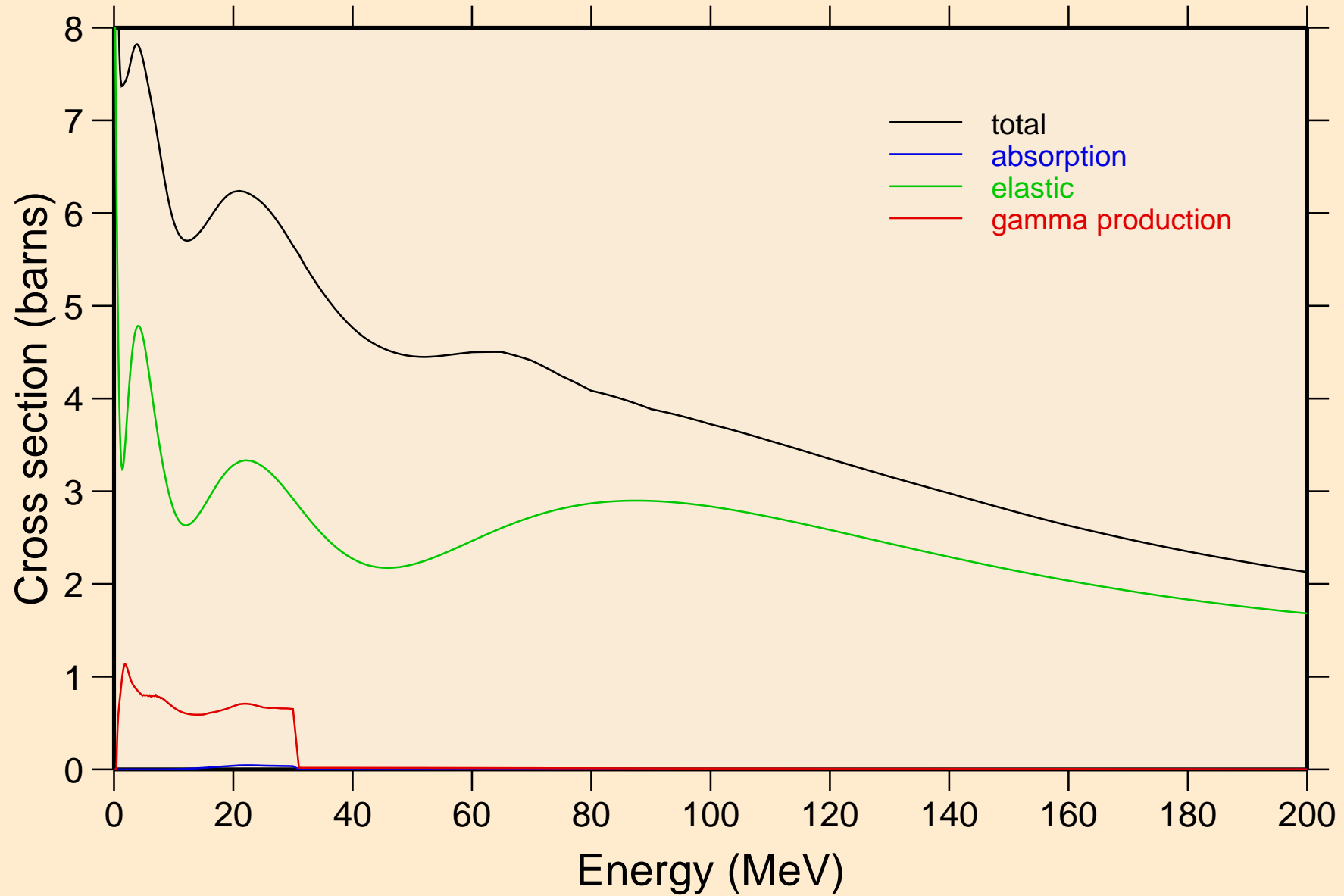

FM246 NEUTRON ACER TENDL-2023 LIBRARY; T=0.K
Heating

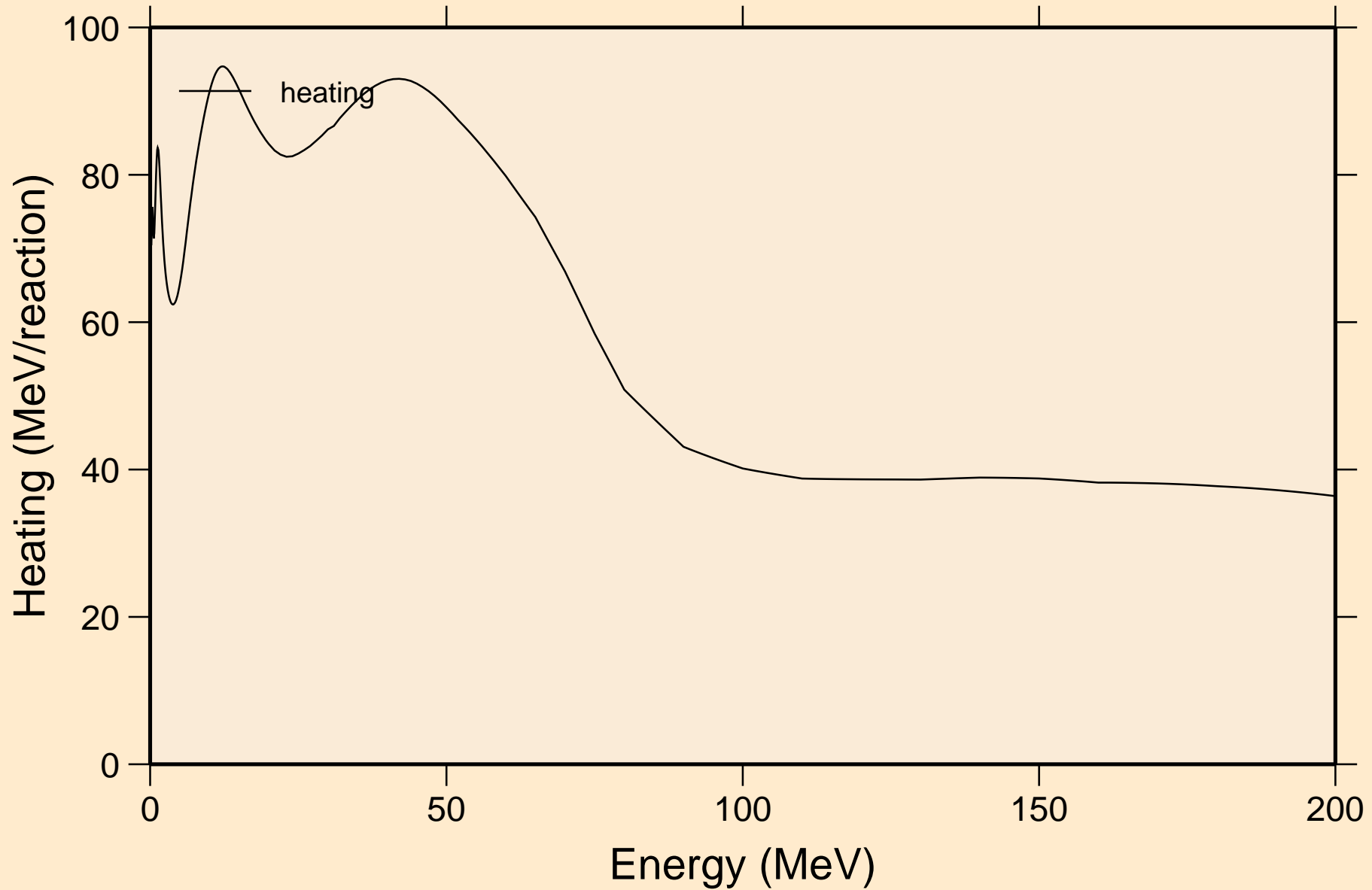

FM246 NEUTRON ACER TENDL-2023 LIBRARY; T=0.K

Damage

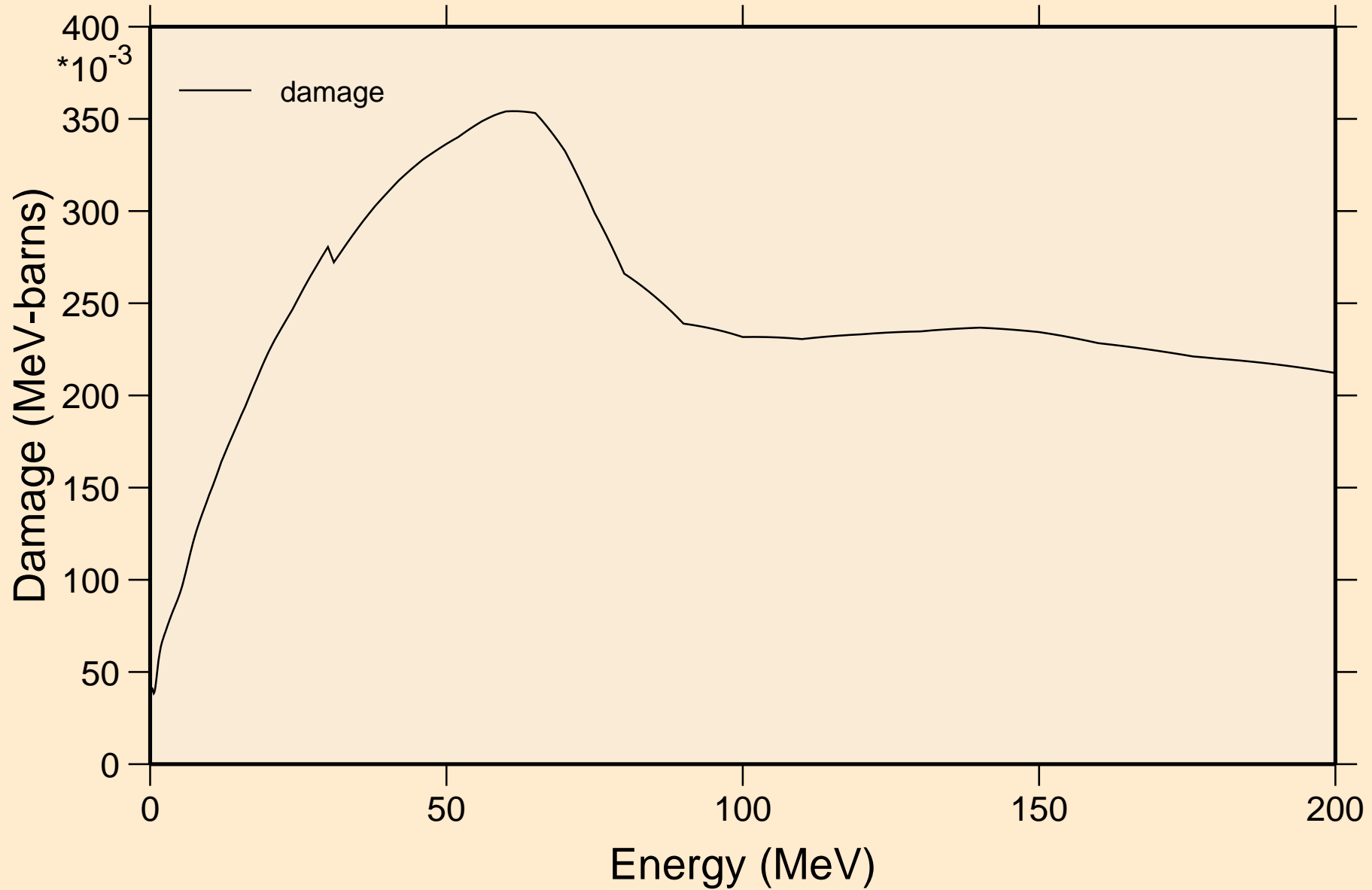

FM246 NEUTRON ACER TENDL-2023 LIBRARY; T=0.K

Non-threshold reactions

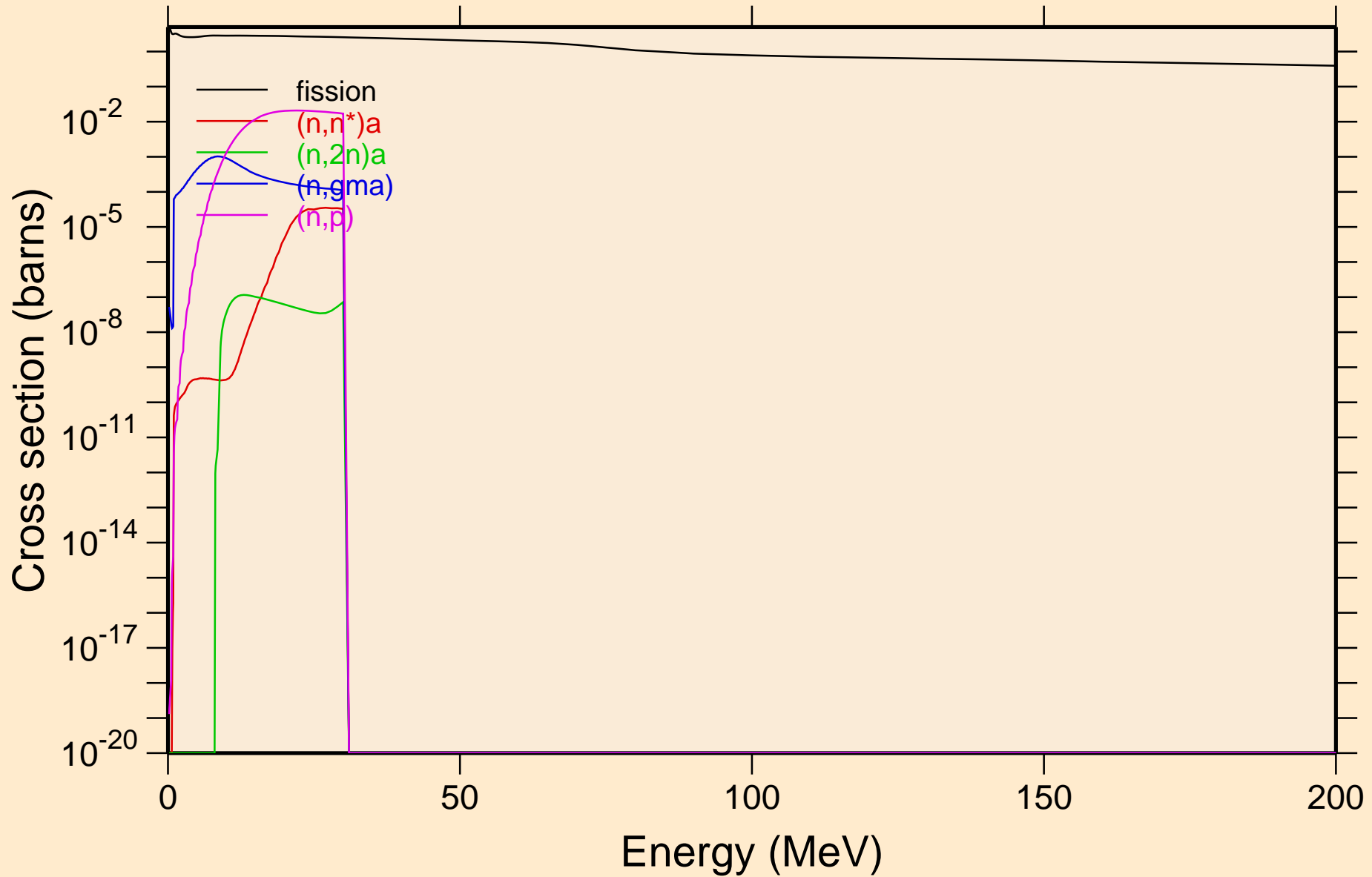

FM246 NEUTRON ACER TENDL-2023 LIBRARY; T=0.K

Non-threshold reactions

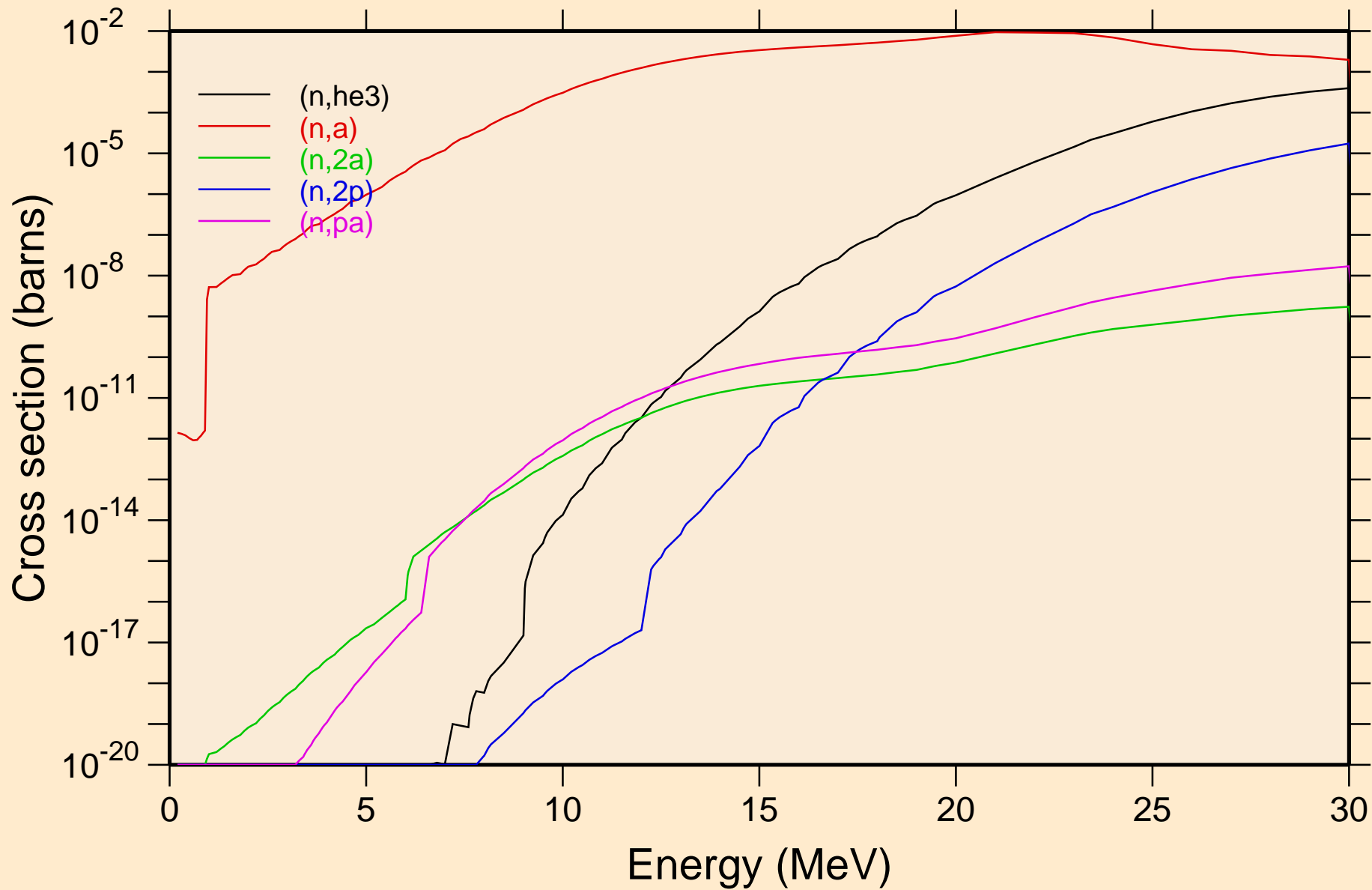

FM246 NEUTRON ACER TENDL-2023 LIBRARY; T=0.K
Non-threshold reactions

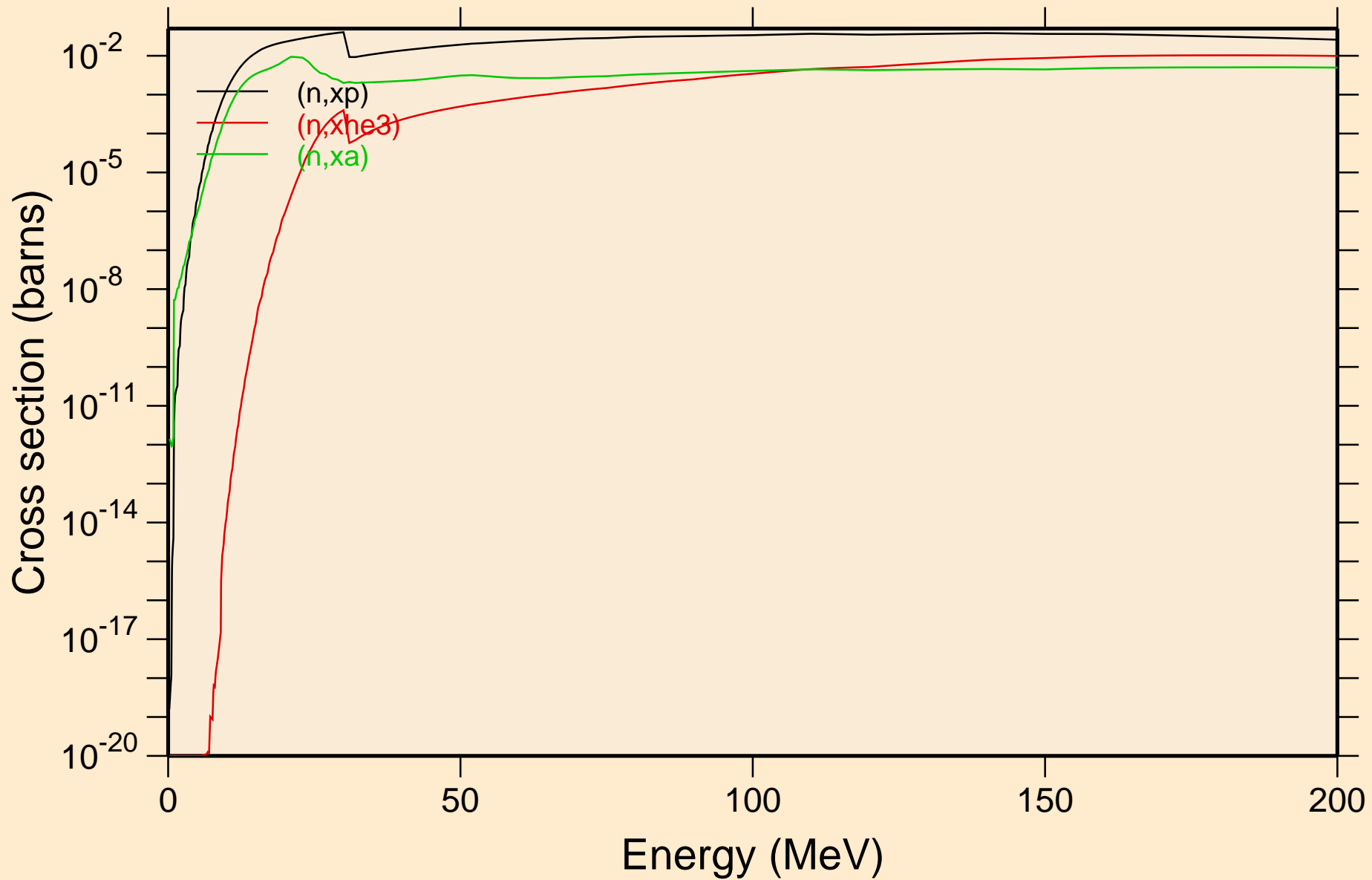

FM246 NEUTRON ACER TENDL-2023 LIBRARY; T=0.K
Inelastic levels

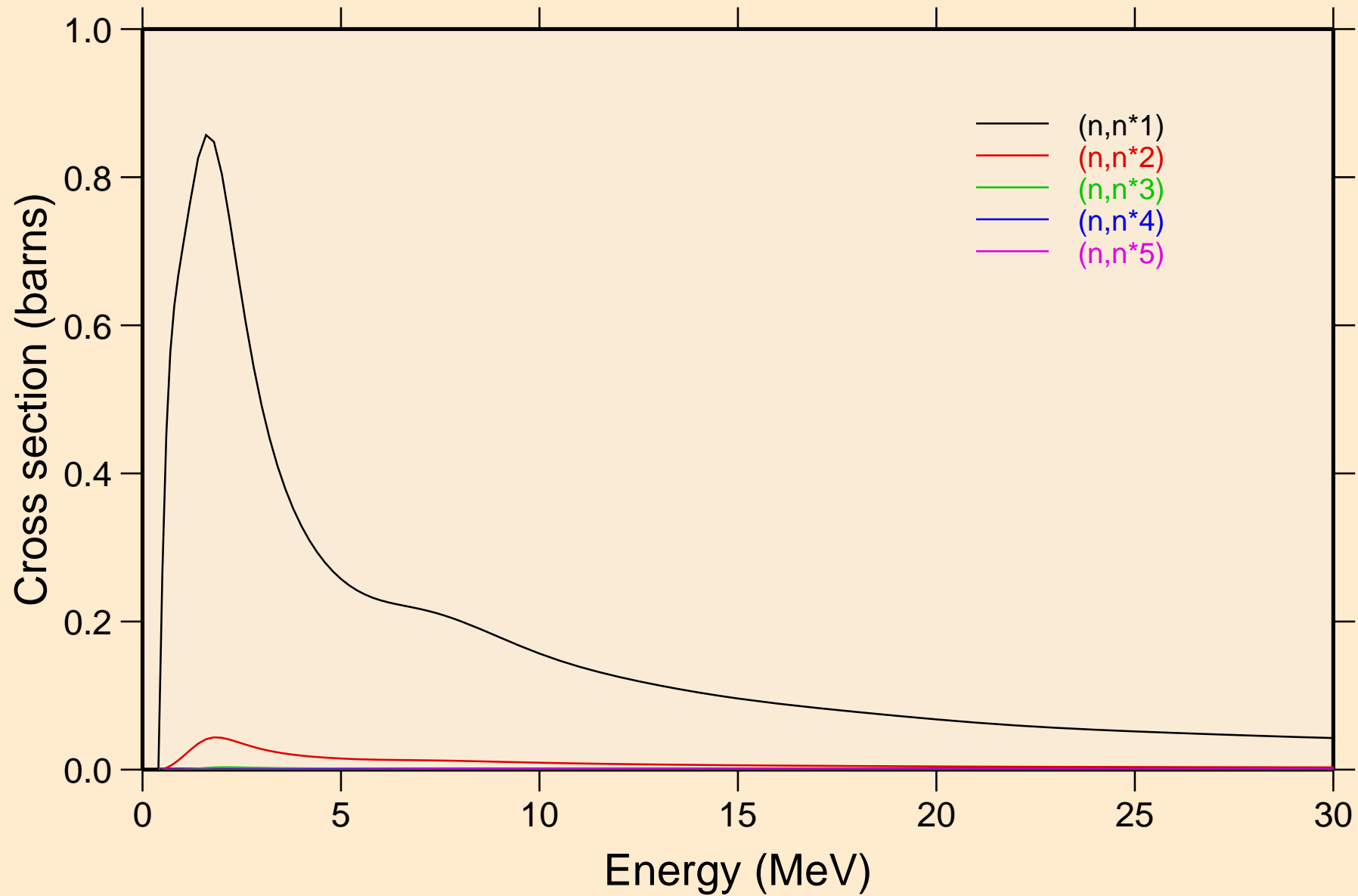

FM246 NEUTRON ACER TENDL-2023 LIBRARY; T=0.K
Inelastic levels

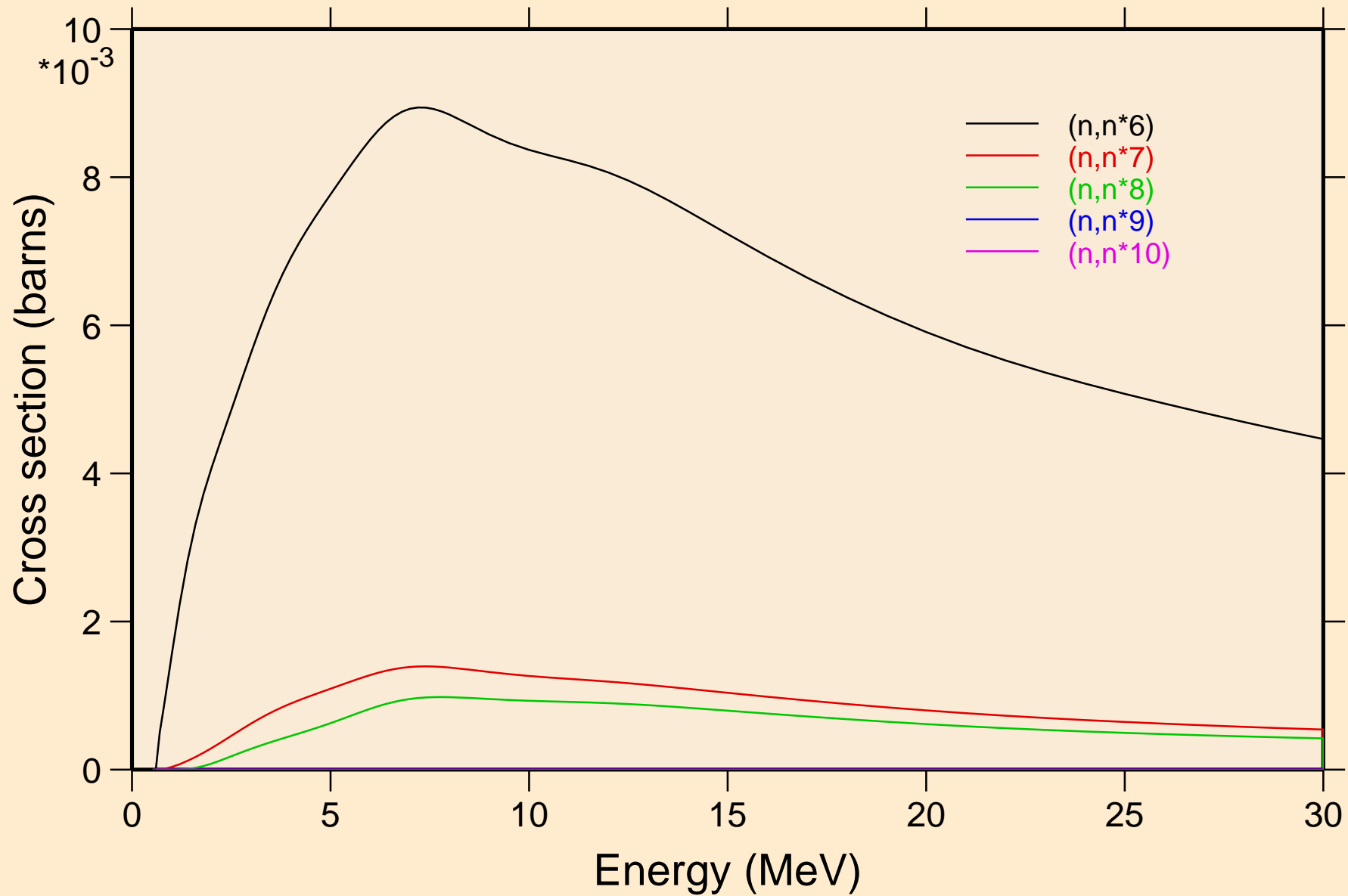

FM246 NEUTRON ACER TENDL-2023 LIBRARY; T=0.K
Inelastic levels

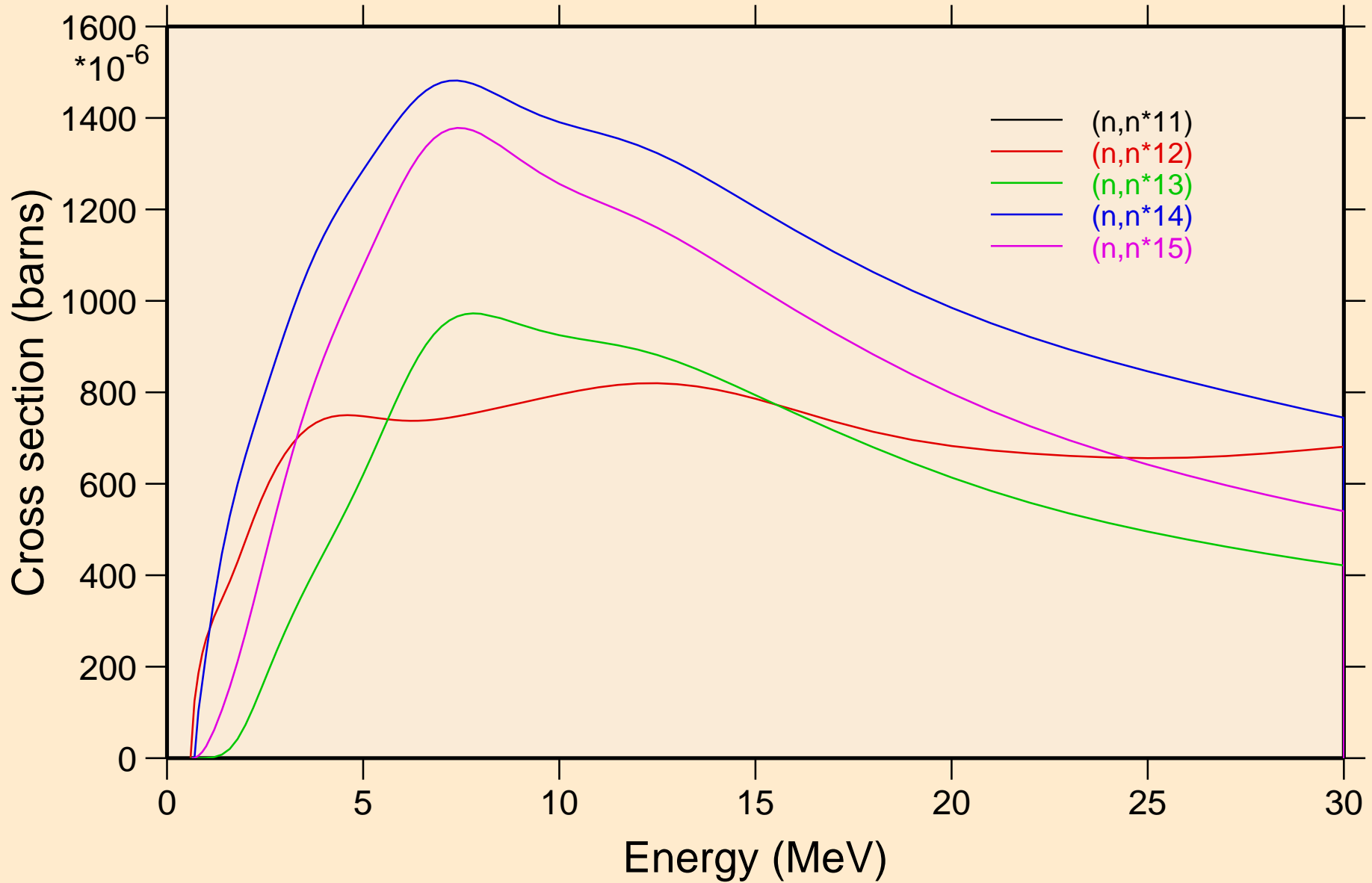

FM246 NEUTRON ACER TENDL-2023 LIBRARY; T=0.K
Inelastic levels

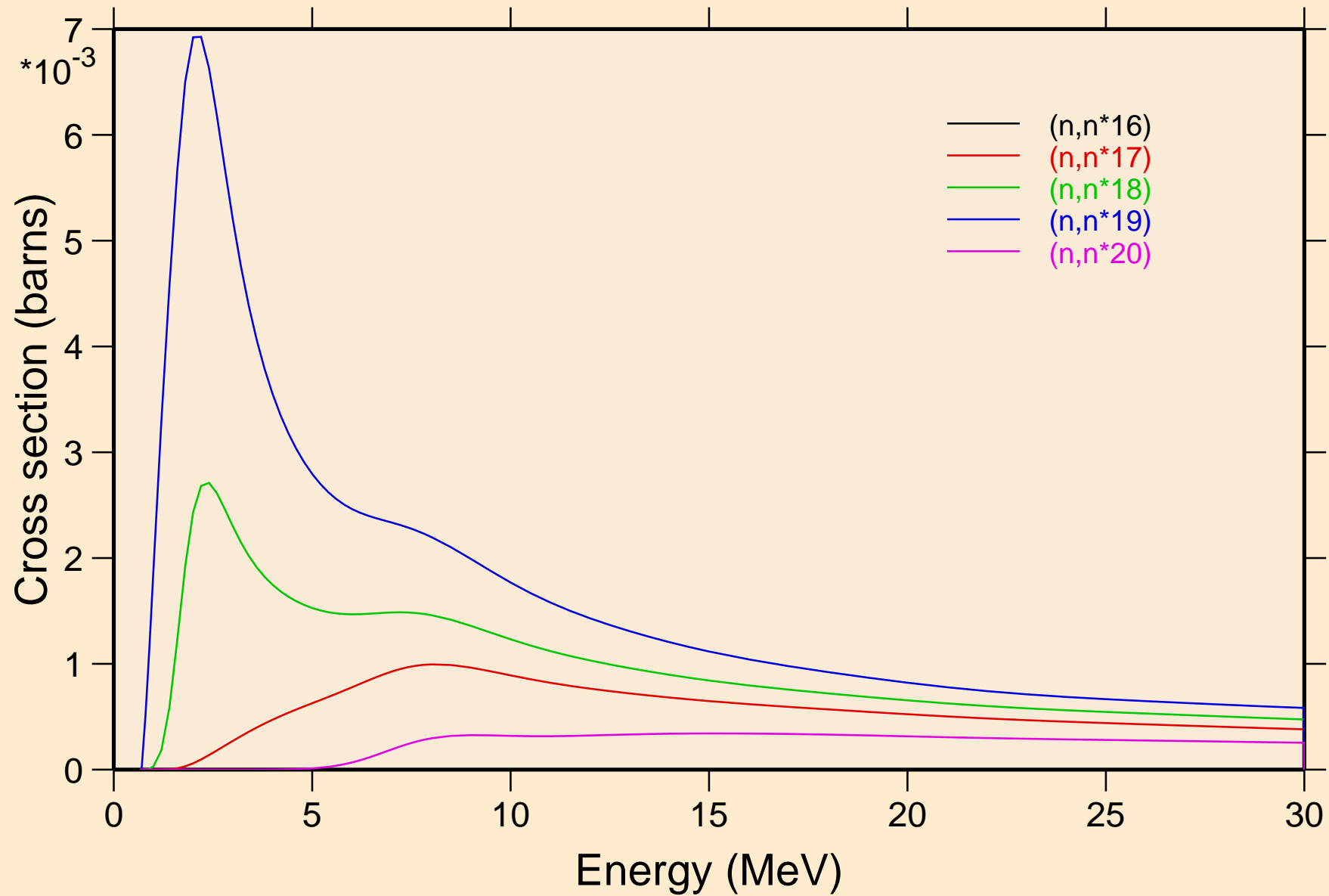

FM246 NEUTRON ACER TENDL-2023 LIBRARY; T=0.K
Inelastic levels

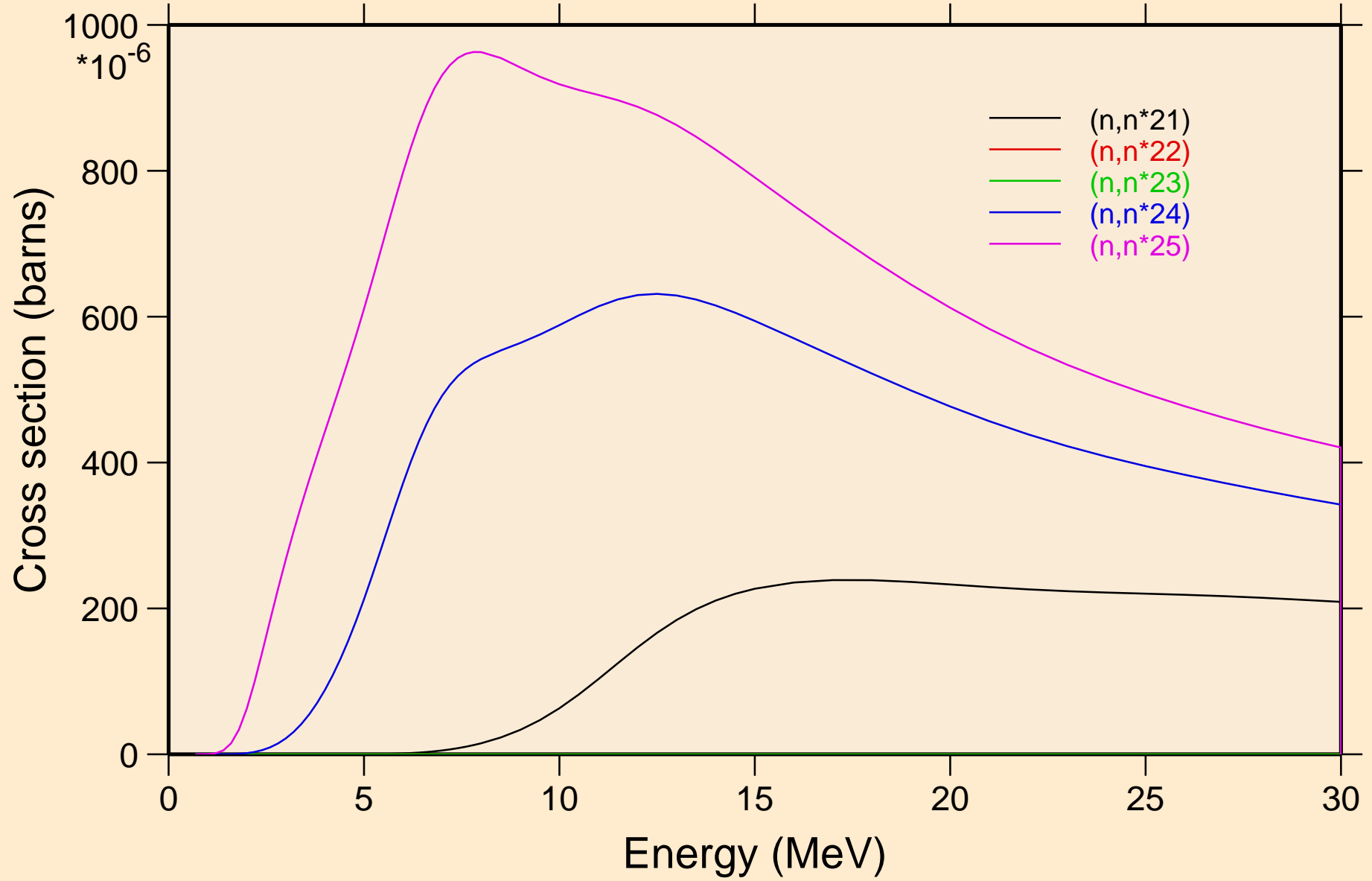

FM246 NEUTRON ACER TENDL-2023 LIBRARY; T=0.K
Inelastic levels

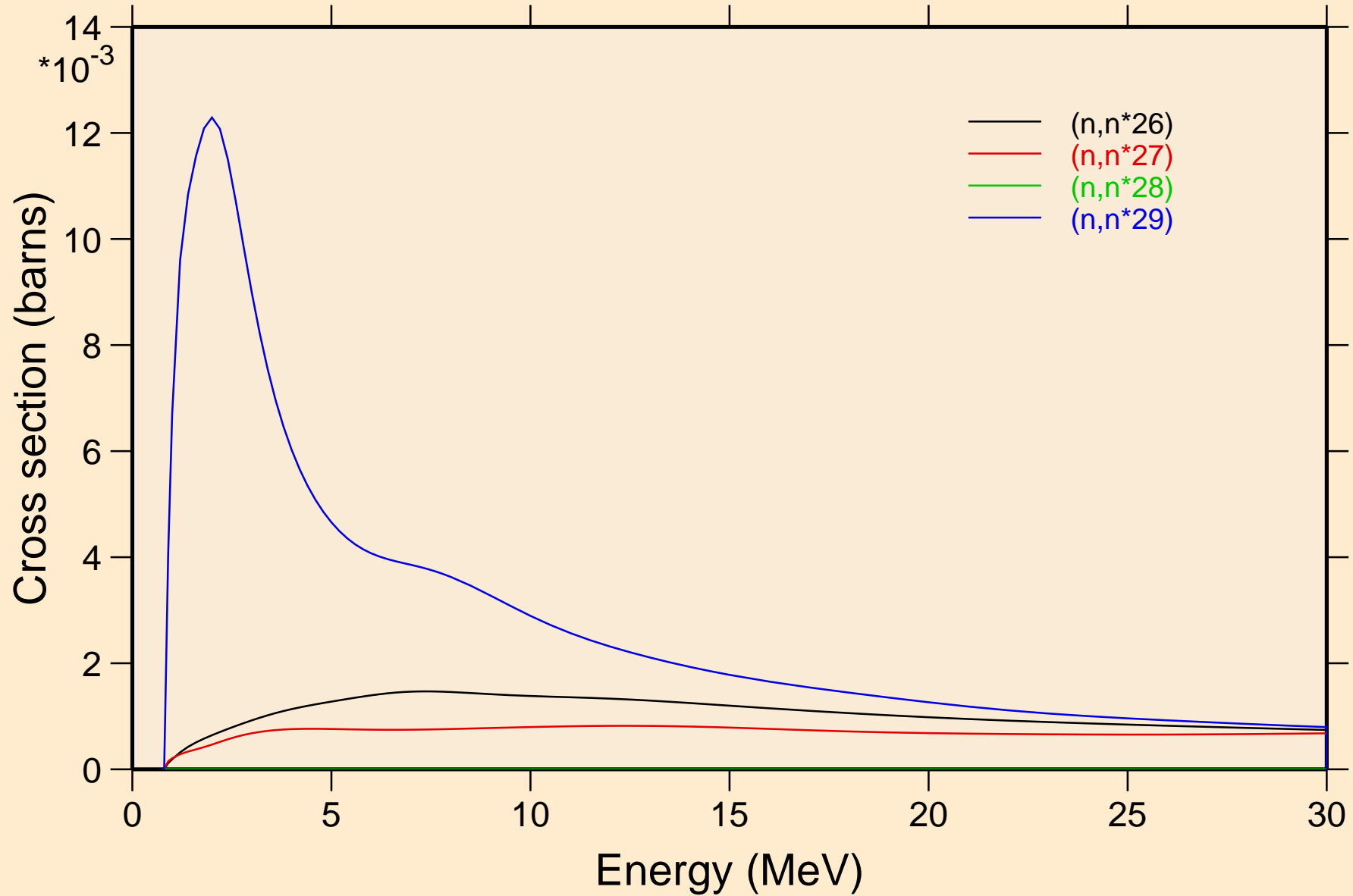

FM246 NEUTRON ACER TENDL-2023 LIBRARY; T=0.K

Threshold reactions

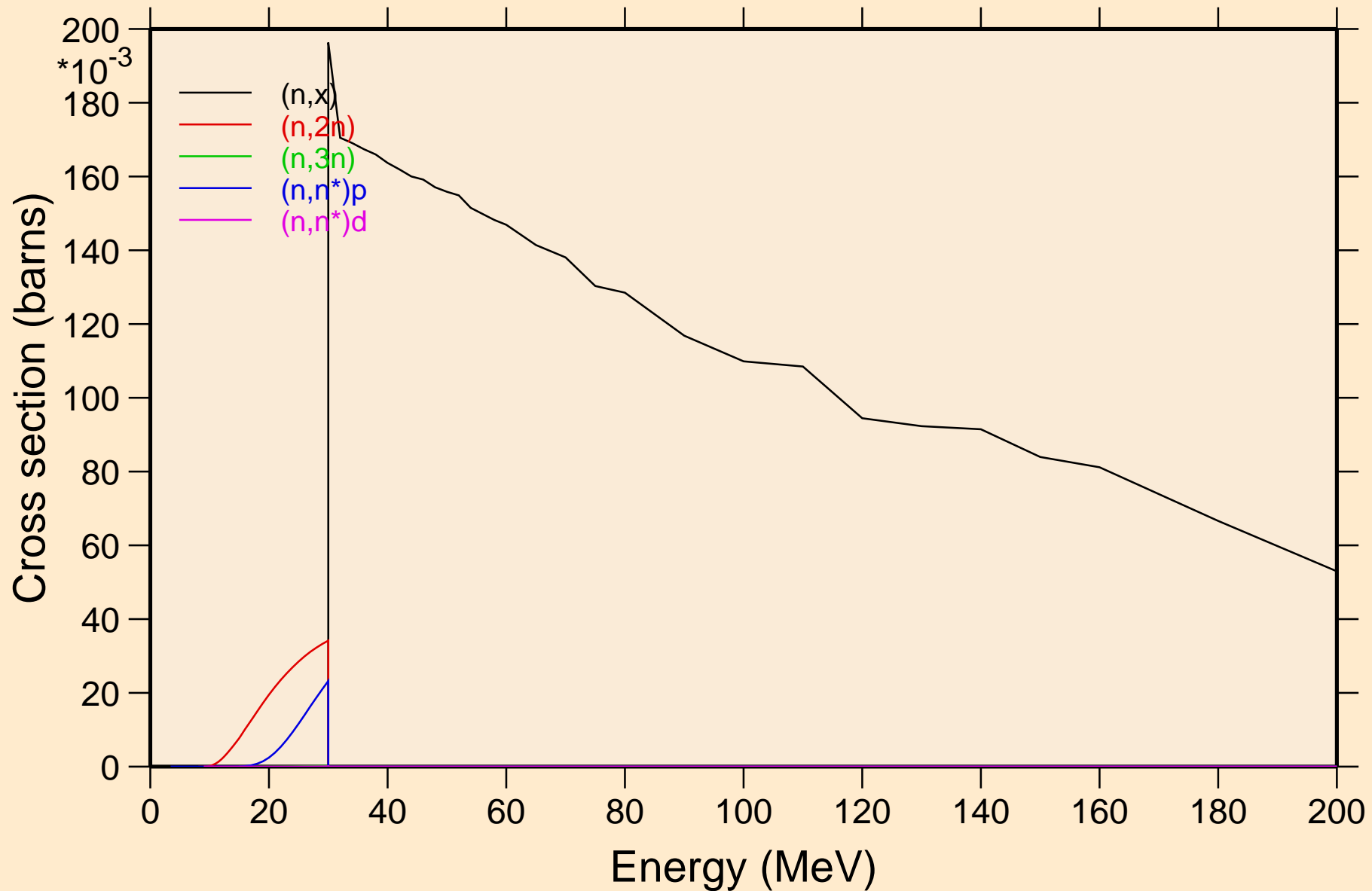

FM246 NEUTRON ACER TENDL-2023 LIBRARY; T=0.K

Threshold reactions

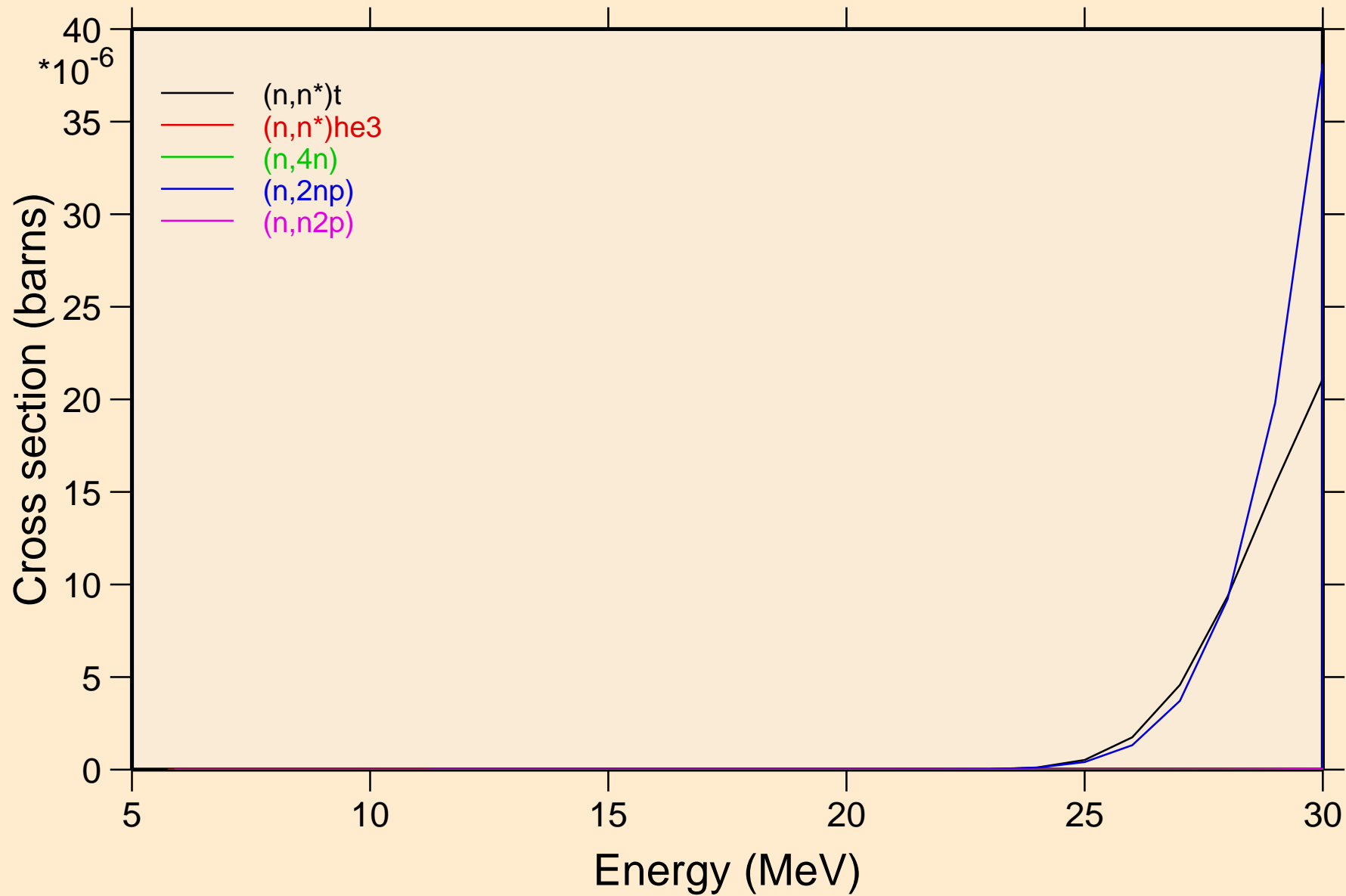

FM246 NEUTRON ACER TENDL-2023 LIBRARY; T=0.K

Threshold reactions

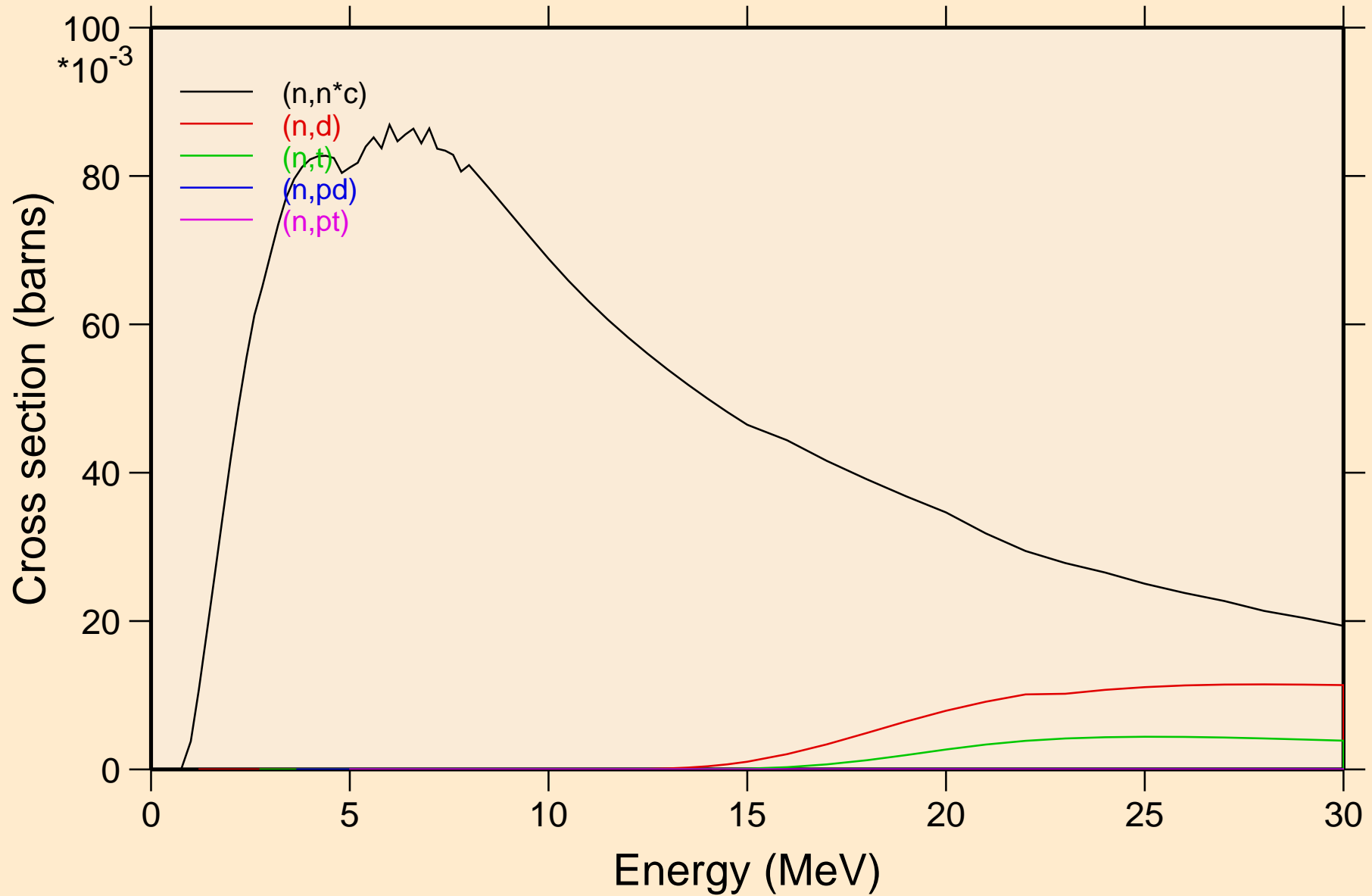

FM246 NEUTRON ACER TENDL-2023 LIBRARY; T=0.K

Threshold reactions

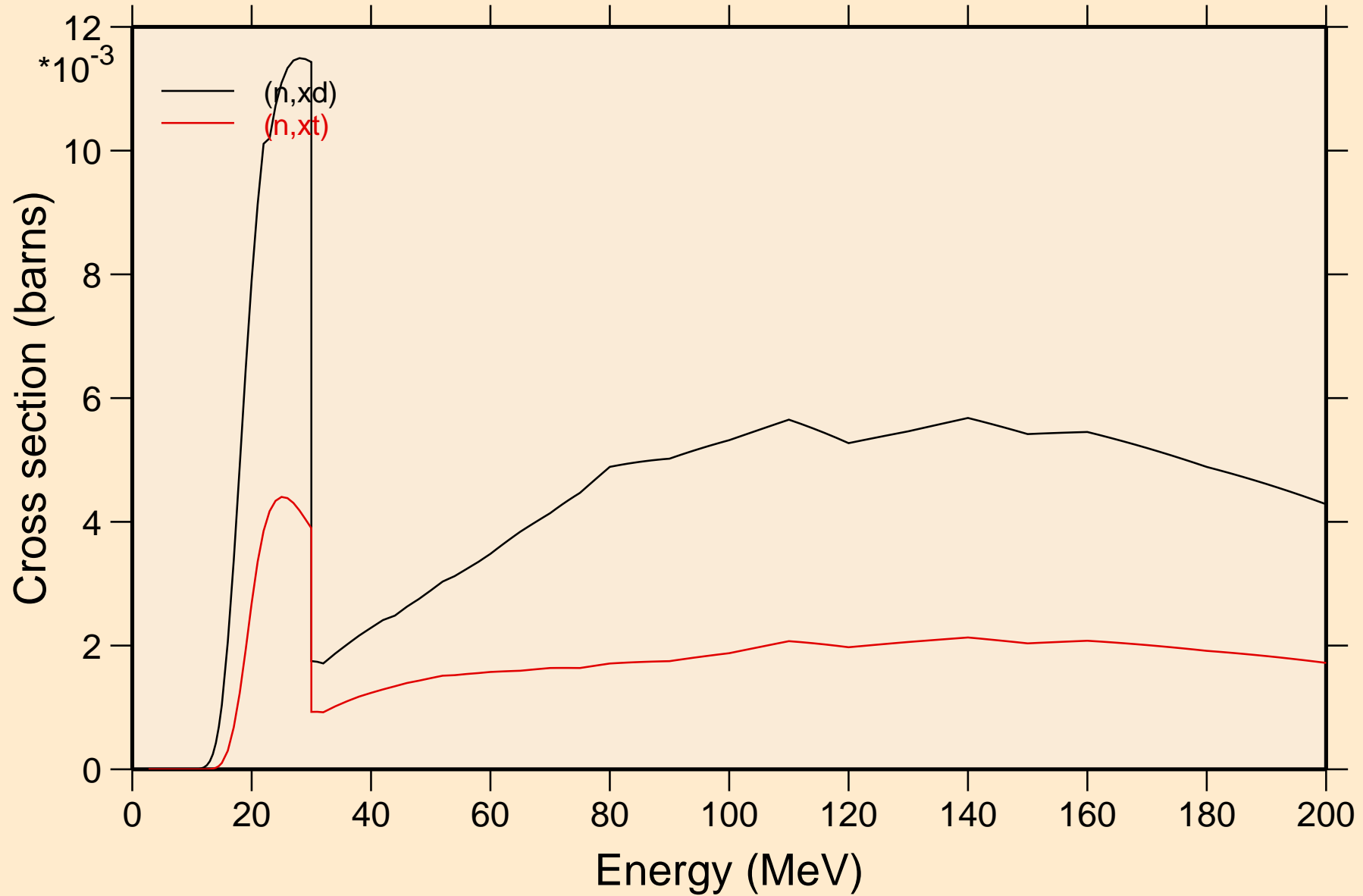

FM246 NEUTRON ACER TENDL-2023 LIBRARY; T=0.K
angular distribution for elastic

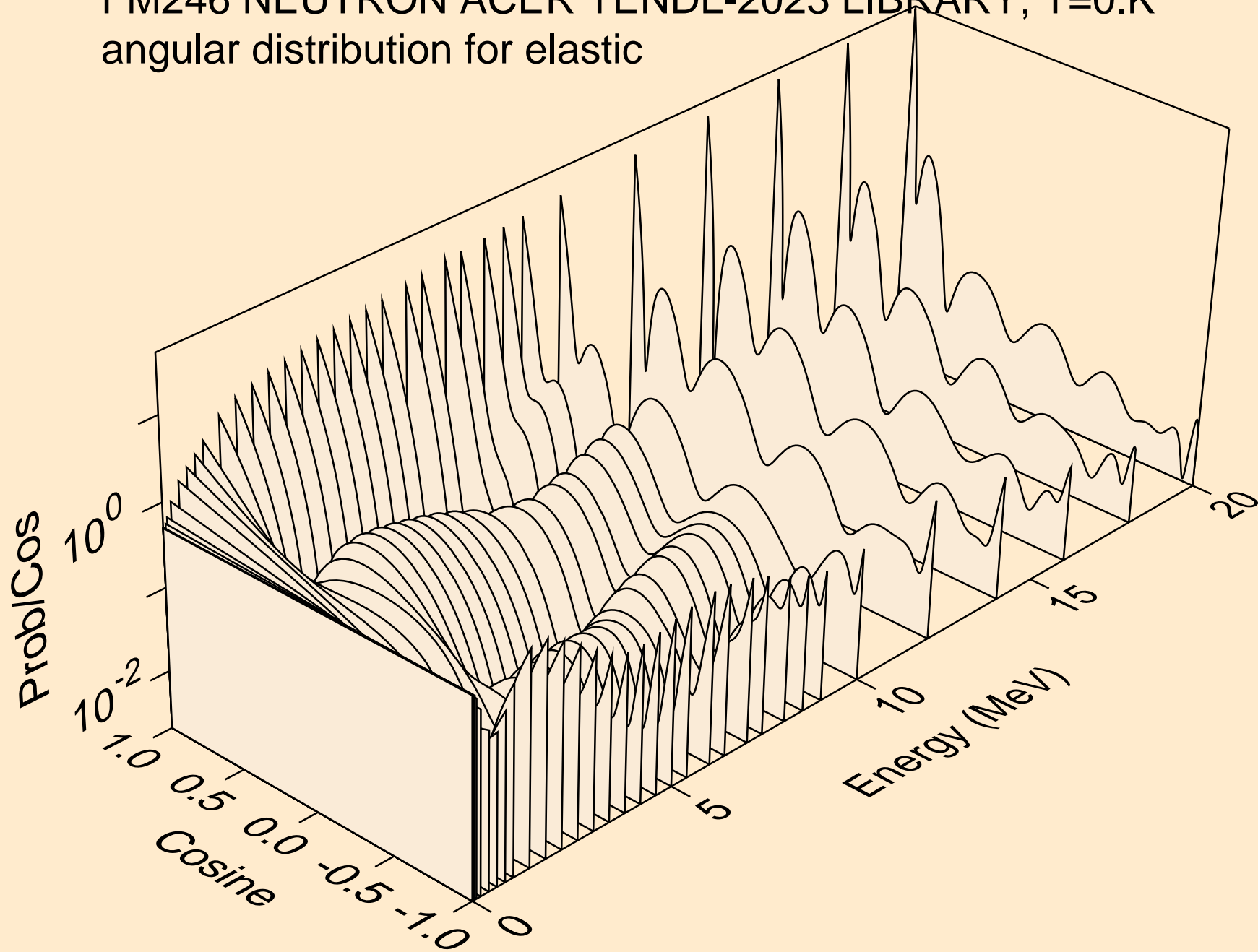

FM246 NEUTRON ACER TENDL-2023 LIBRARY; T=0.K
angular distribution for elastic

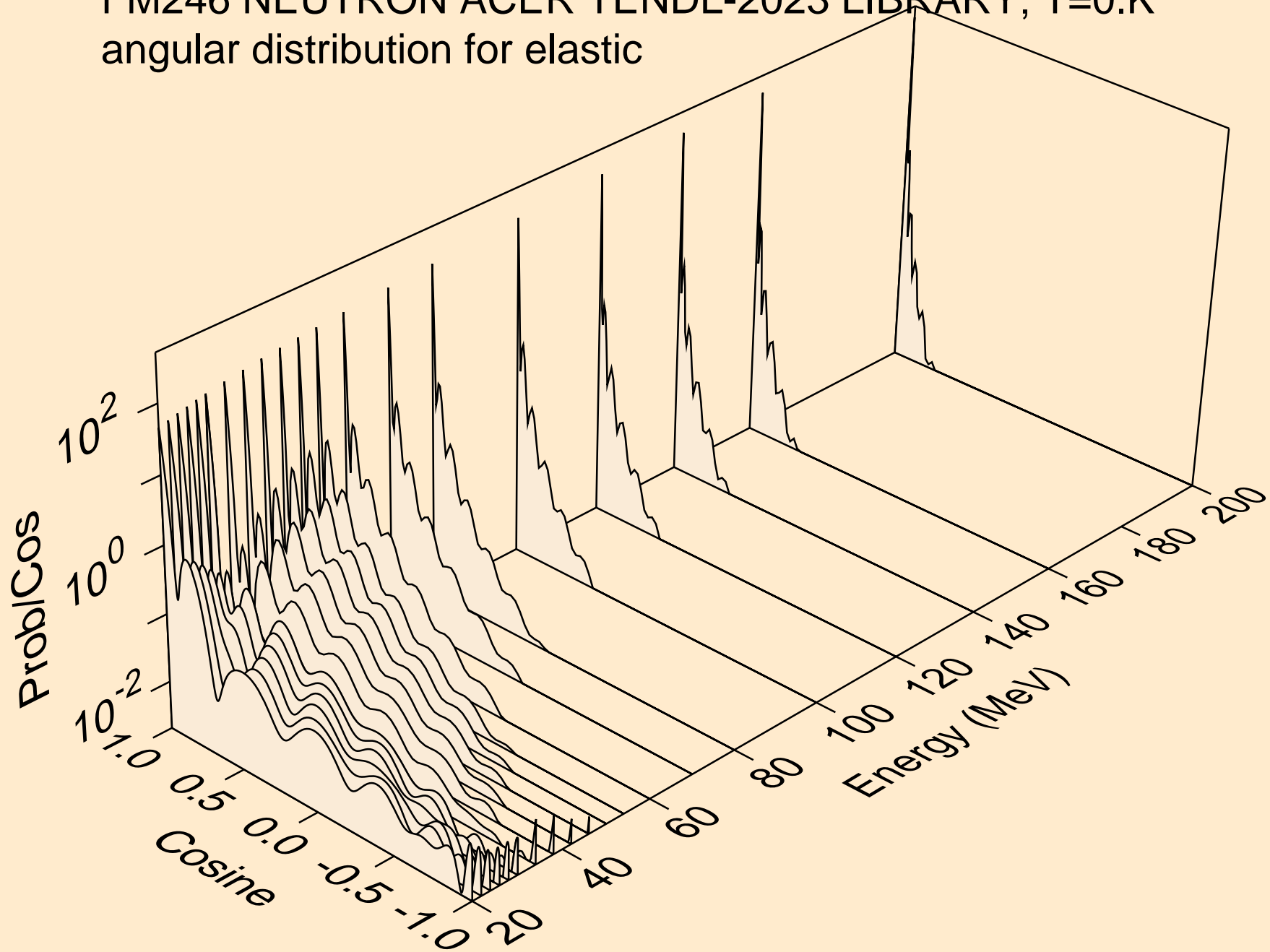

FM246 NEUTRON ACER TENDL-2023 LIBRARY; T=0.K
angular distribution for (n,n*1)

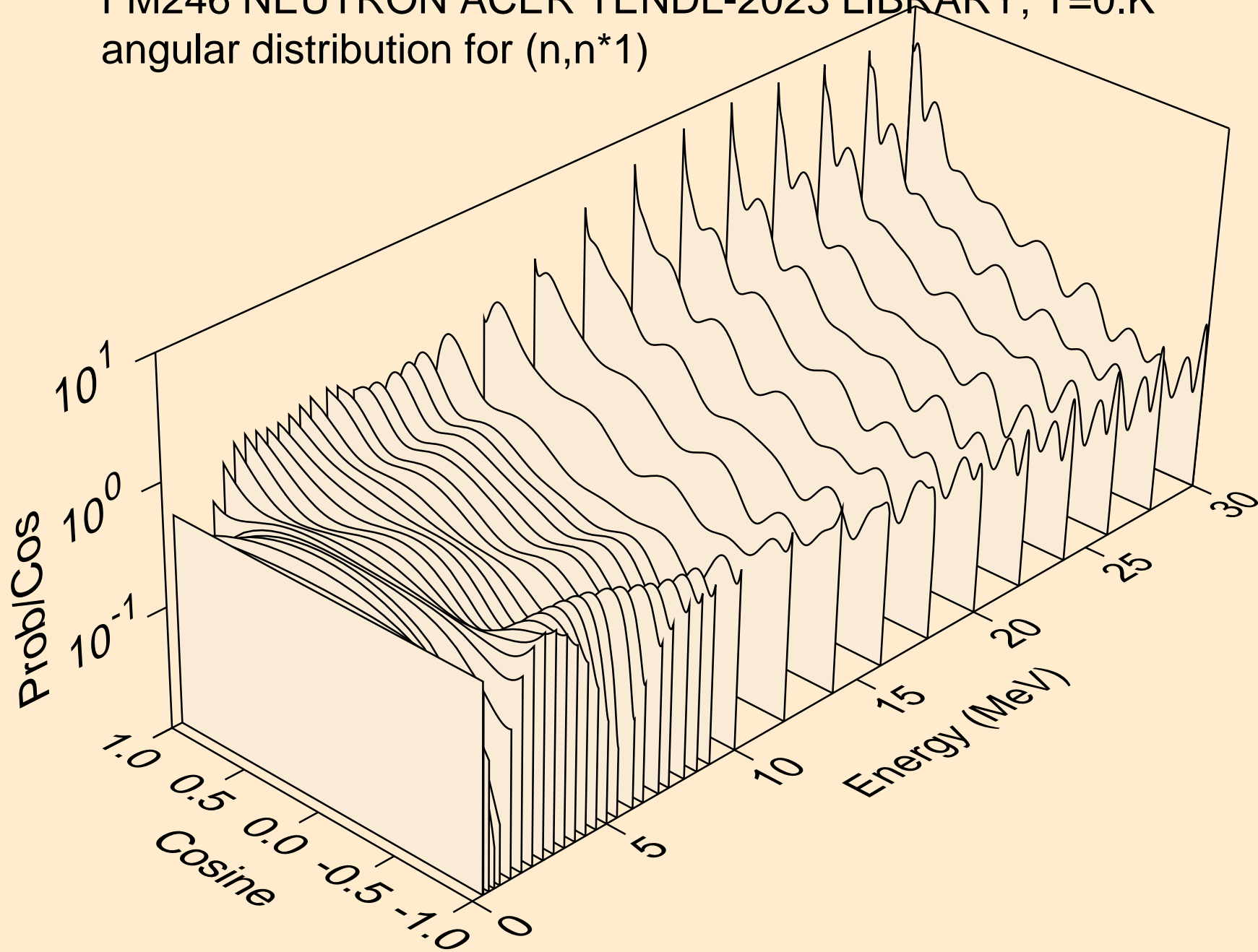

FM246 NEUTRON ACER TENDL-2023 LIBRARY; T=0.K
angular distribution for (n,n*2)

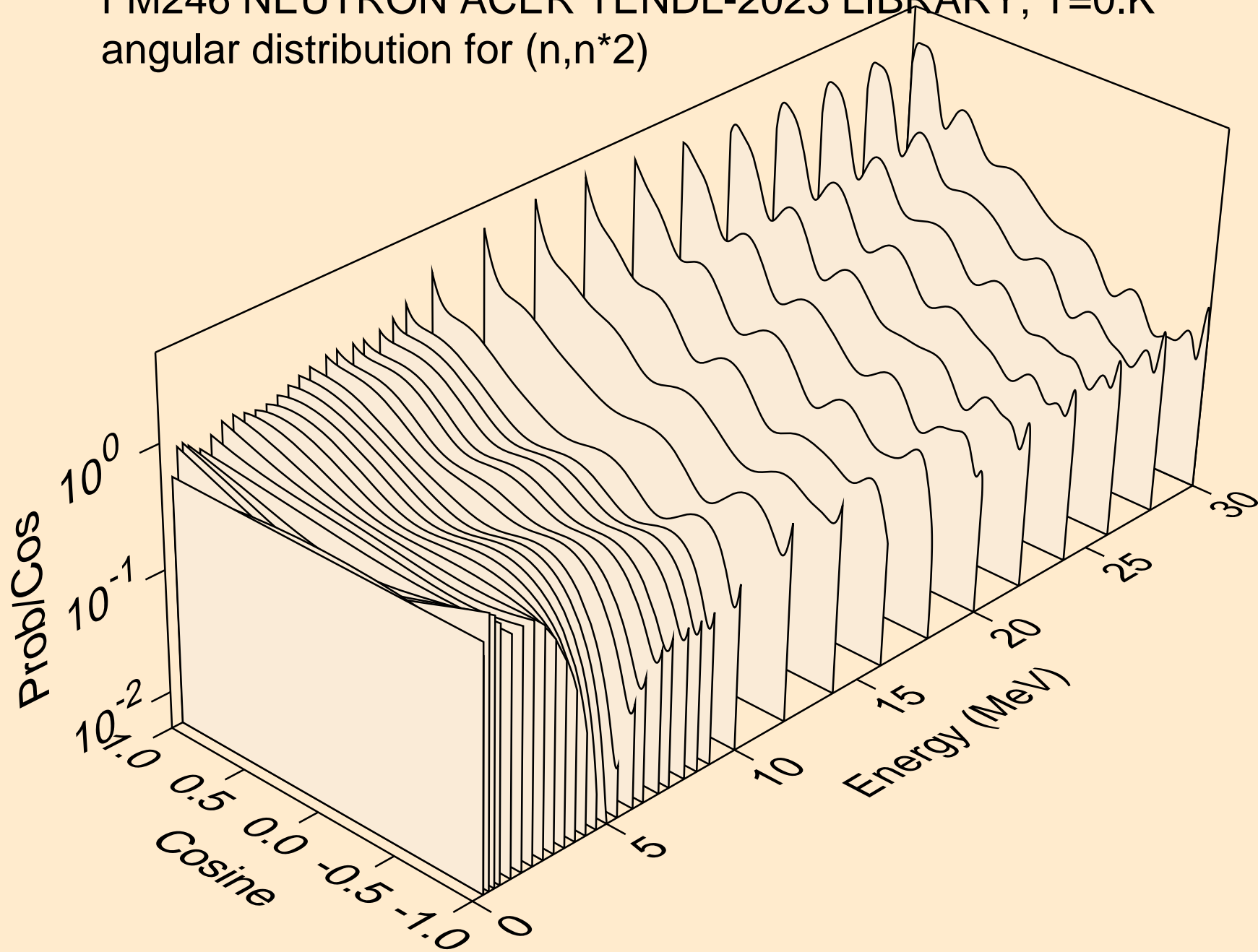

FM246 NEUTRON ACER TENDL-2023 LIBRARY; T=0.K
angular distribution for (n,n*3)

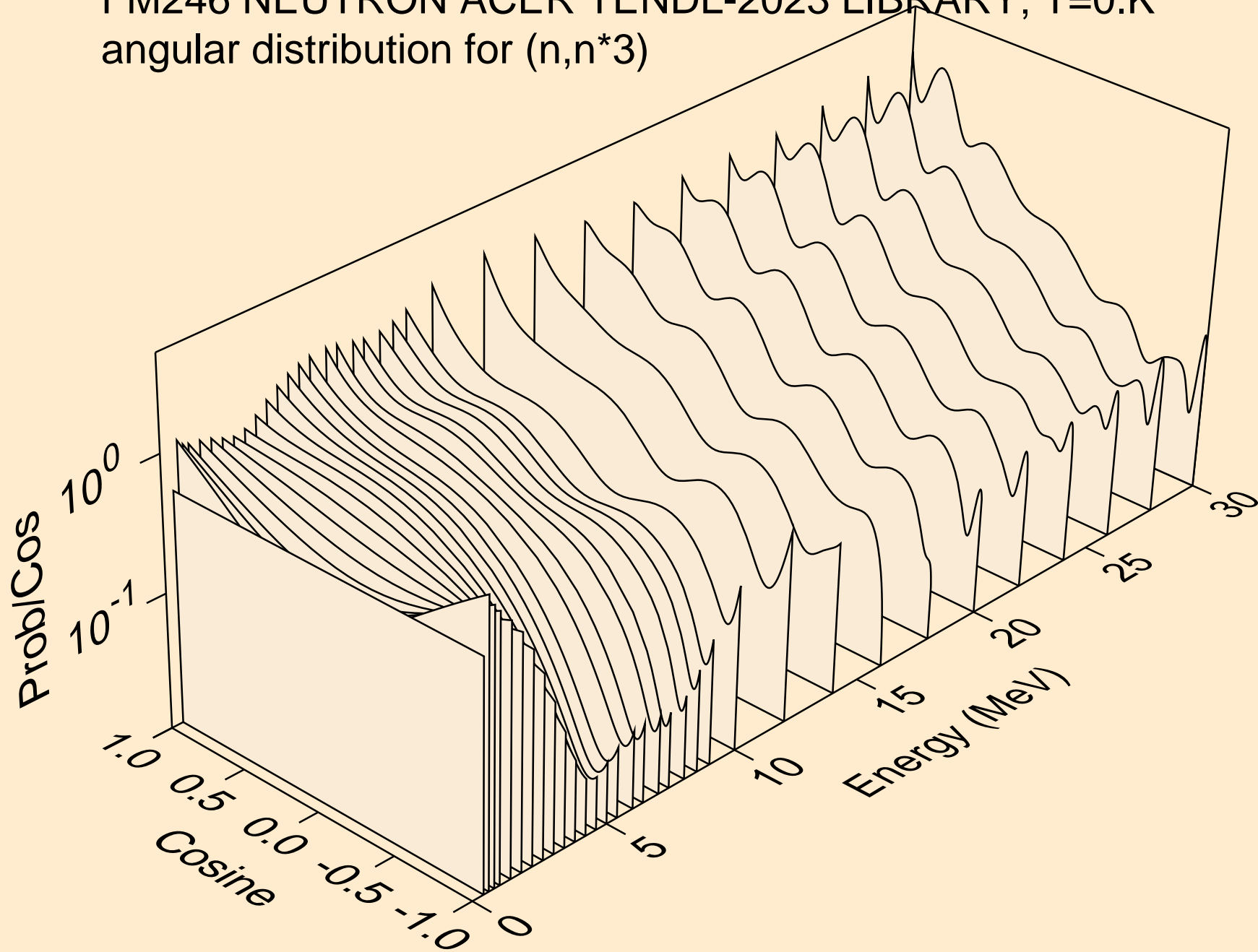

FM246 NEUTRON ACER TENDL-2023 LIBRARY; T=0.K
angular distribution for (n,n*4)

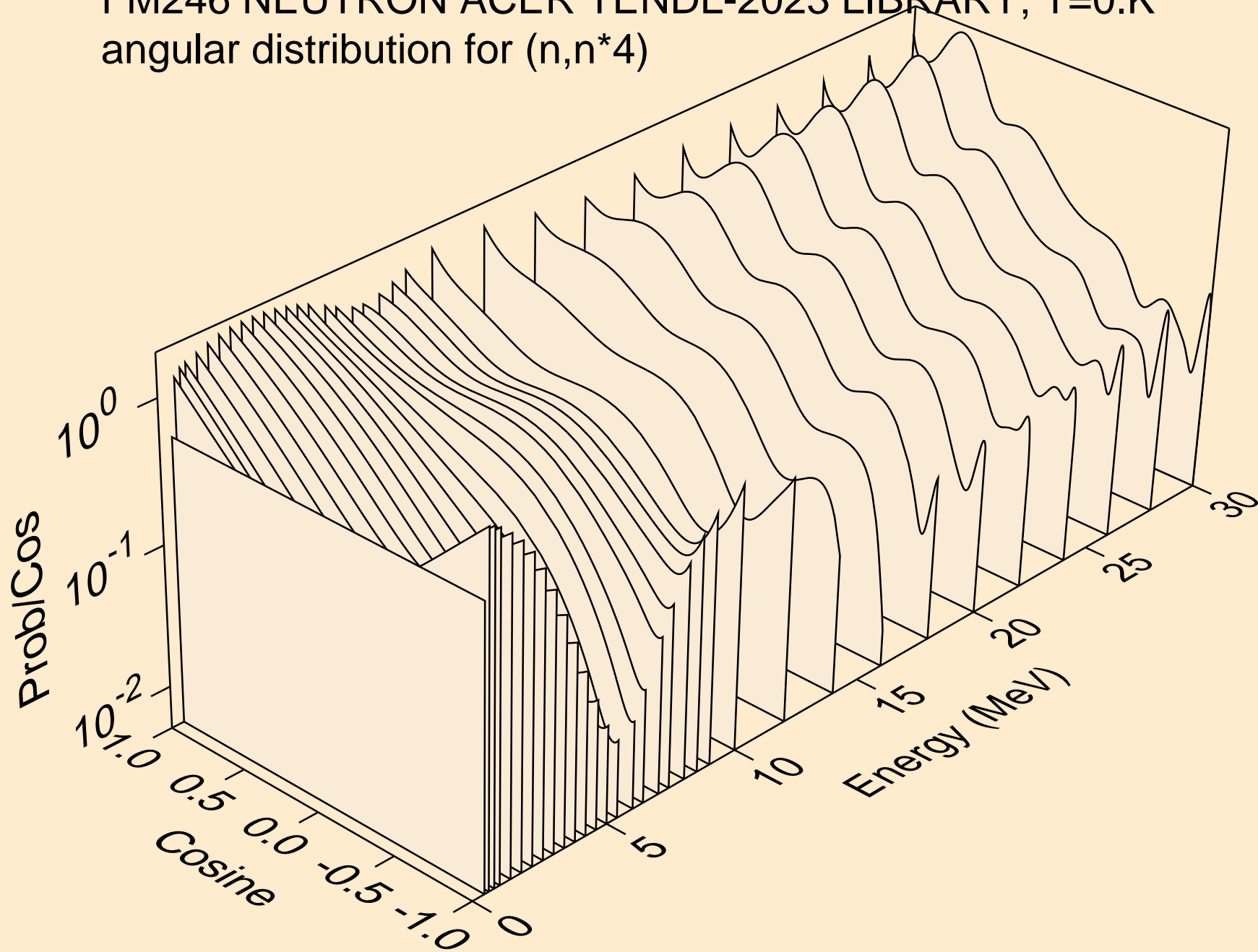

FM246 NEUTRON ACER TENDL-2023 LIBRARY; T=0.K
angular distribution for (n,n*5)

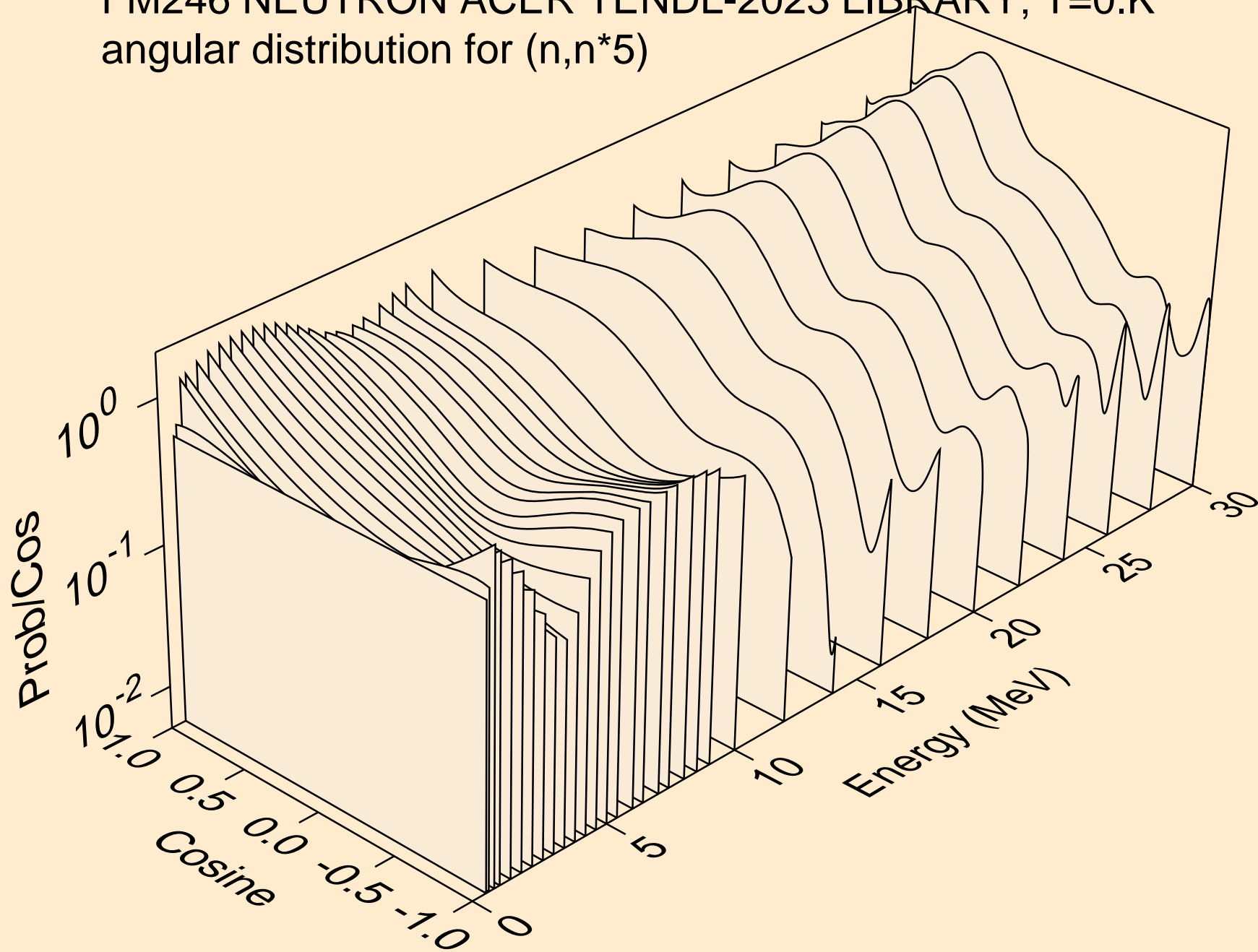

FM246 NEUTRON ACER TENDL-2023 LIBRARY; T=0.K
angular distribution for (n,n*6)

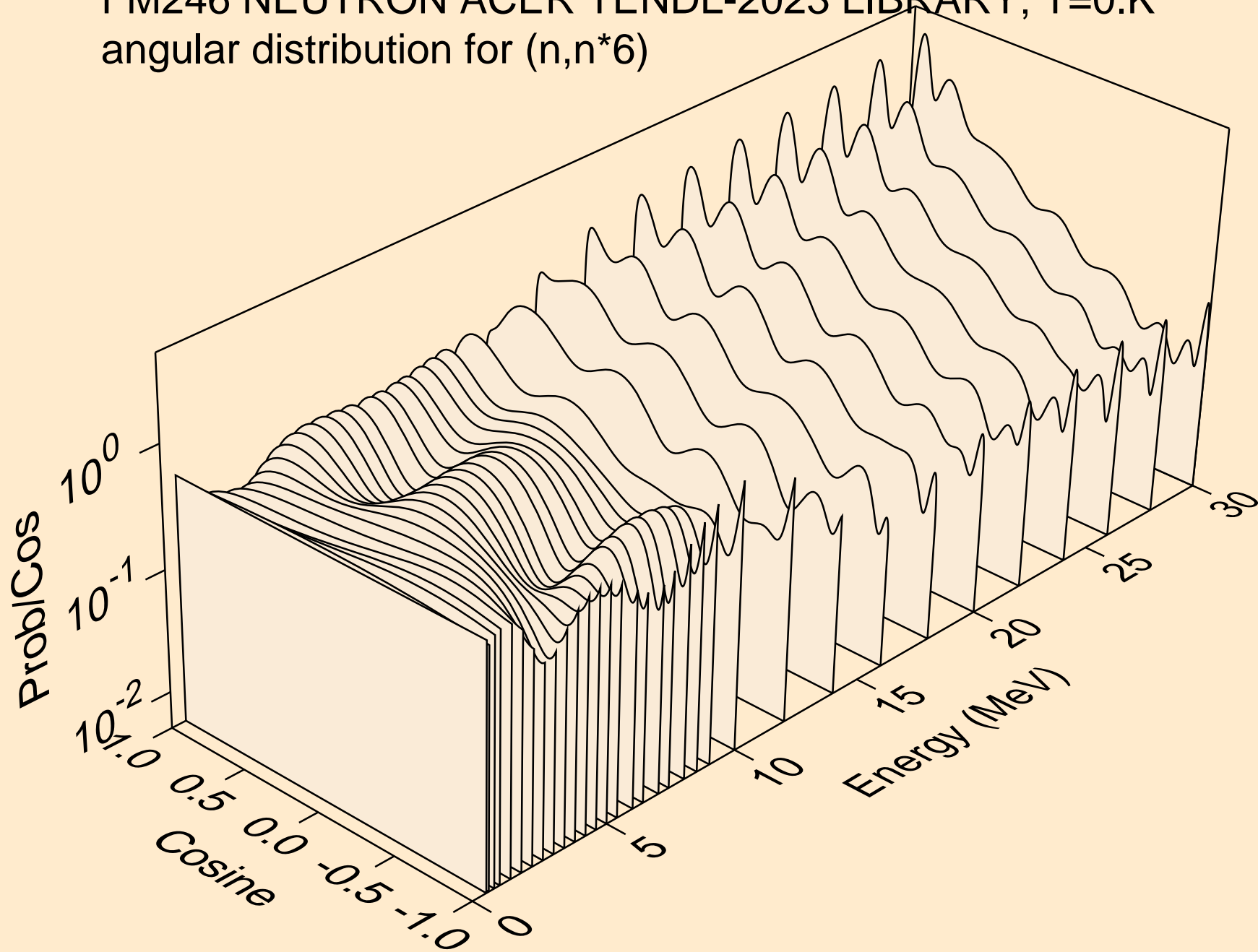

FM246 NEUTRON ACER TENDL-2023 LIBRARY; T=0.K
angular distribution for (n,n*7)

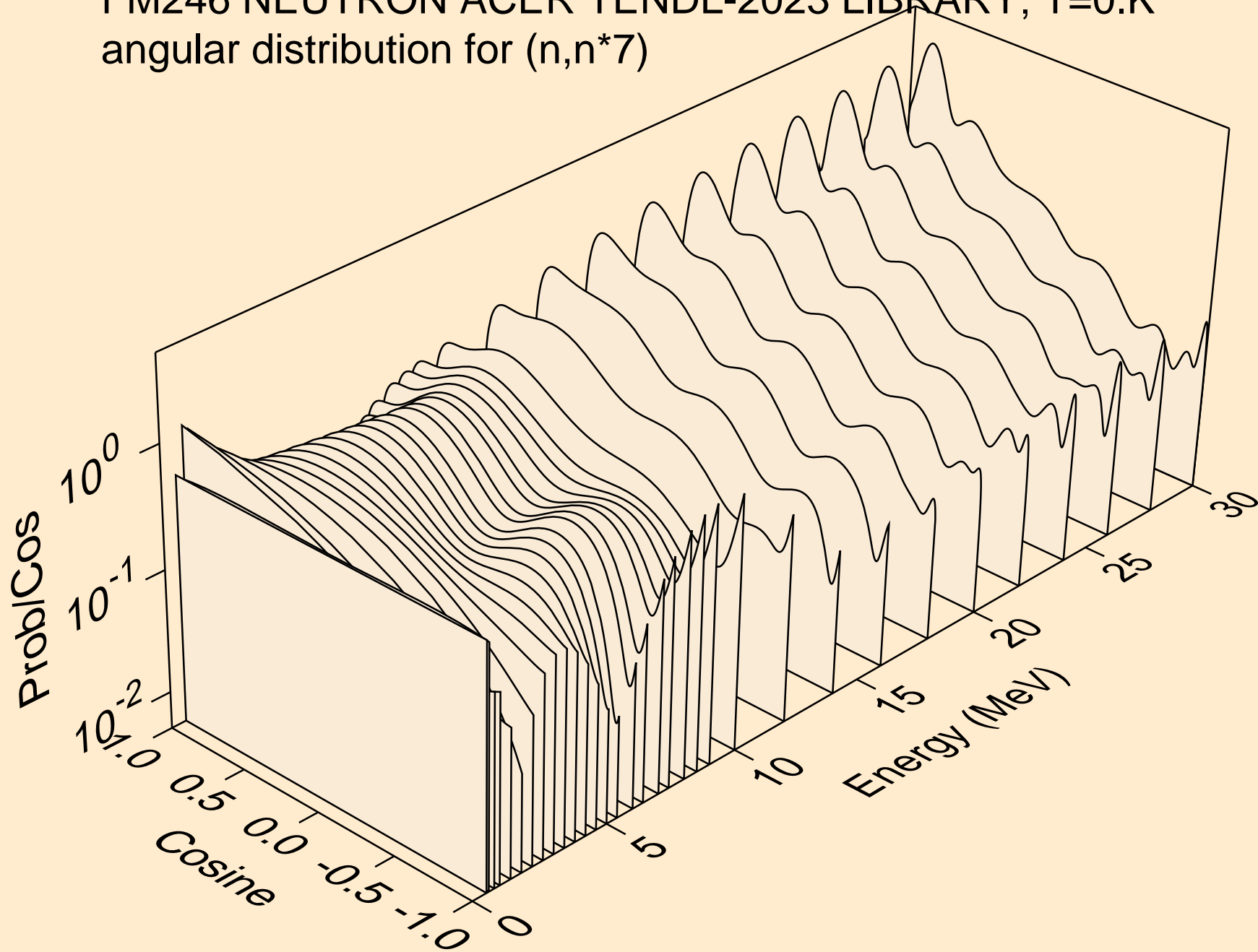

FM246 NEUTRON ACER TENDL-2023 LIBRARY; T=0.K
angular distribution for (n,n*8)

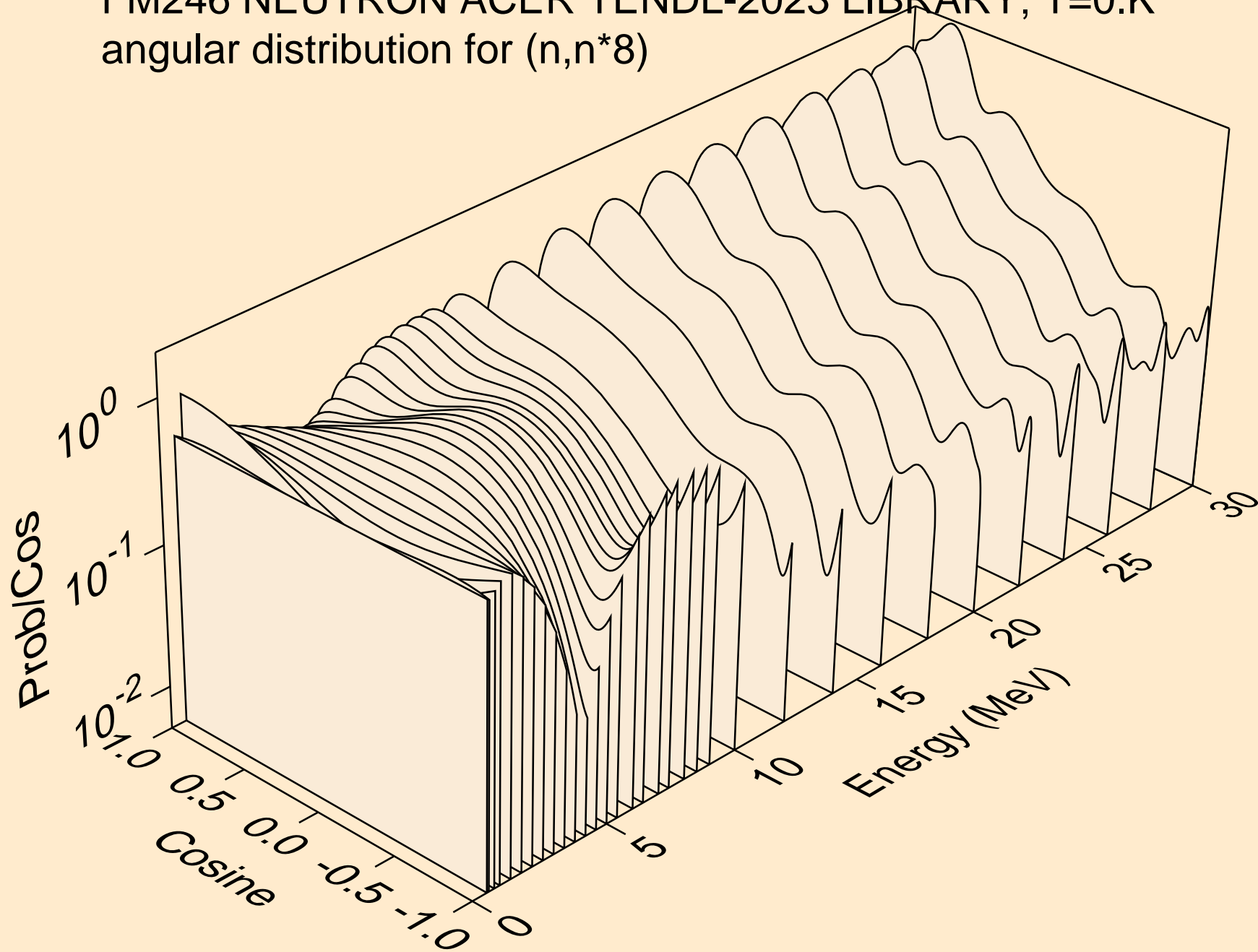

FM246 NEUTRON ACER TENDL-2023 LIBRARY; T=0.K
angular distribution for (n,n*9)

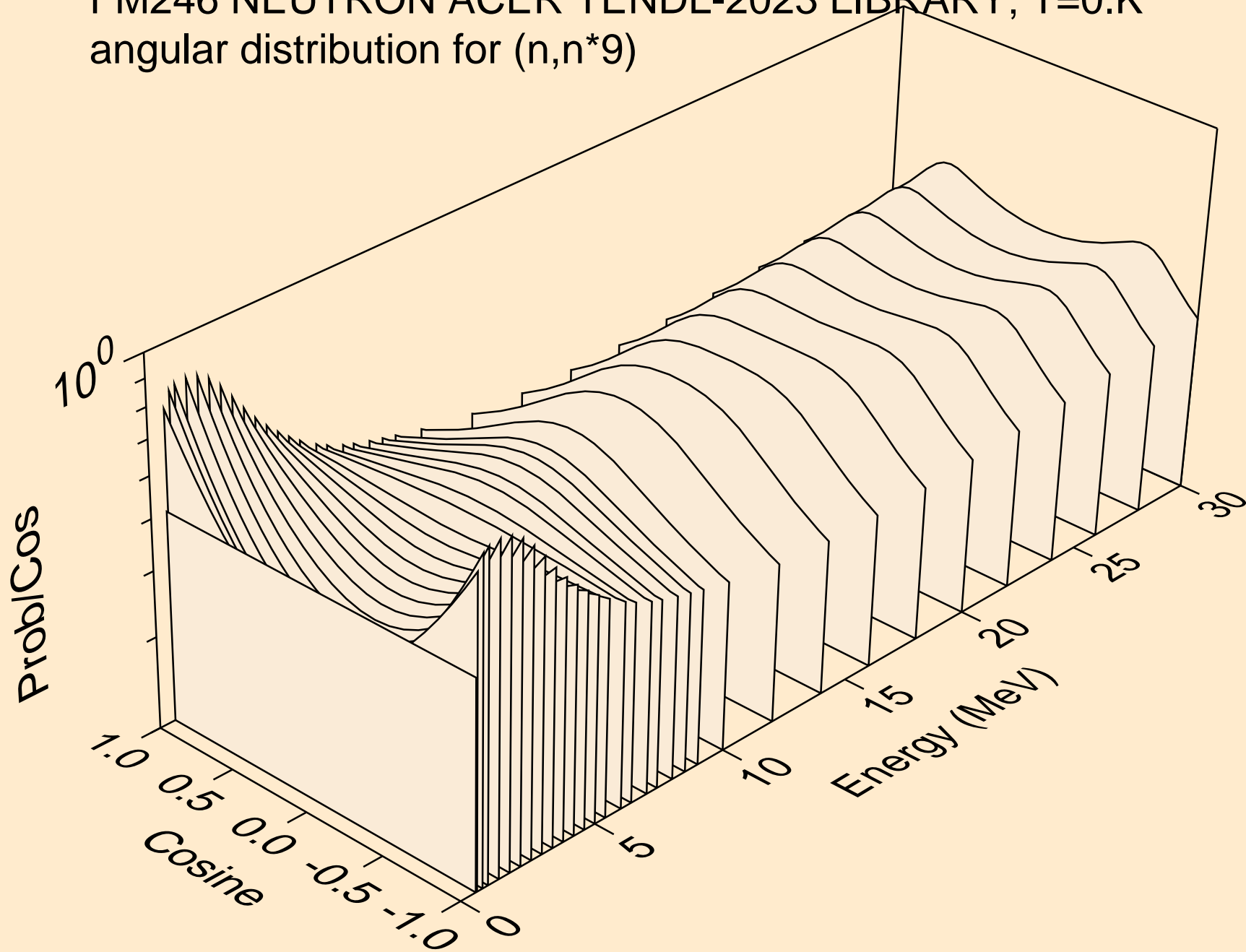

FM246 NEUTRON ACER TENDL-2023 LIBRARY; T=0.K
angular distribution for (n,n*10)

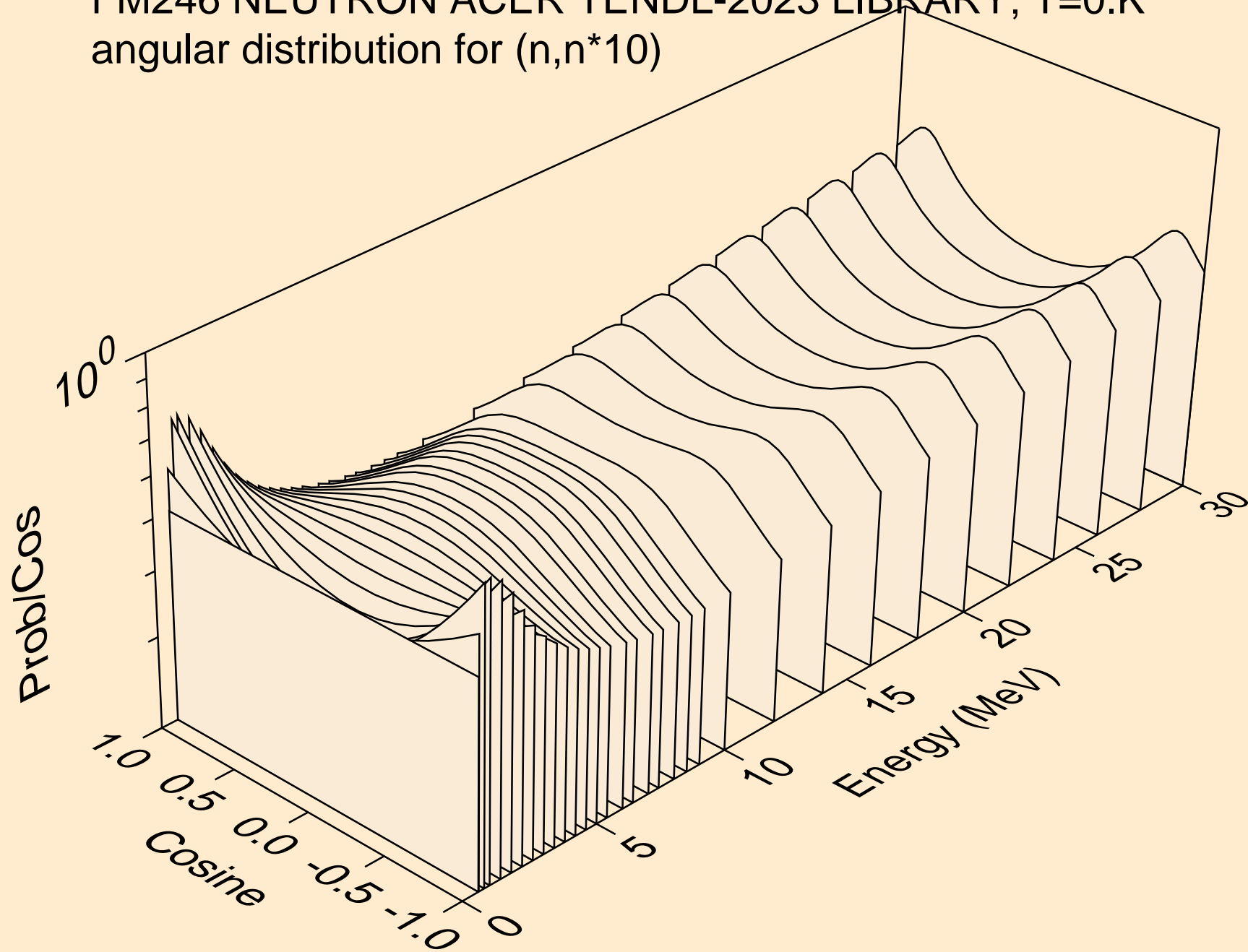

FM246 NEUTRON ACER TENDL-2023 LIBRARY; T=0.K
angular distribution for (n,n*11)

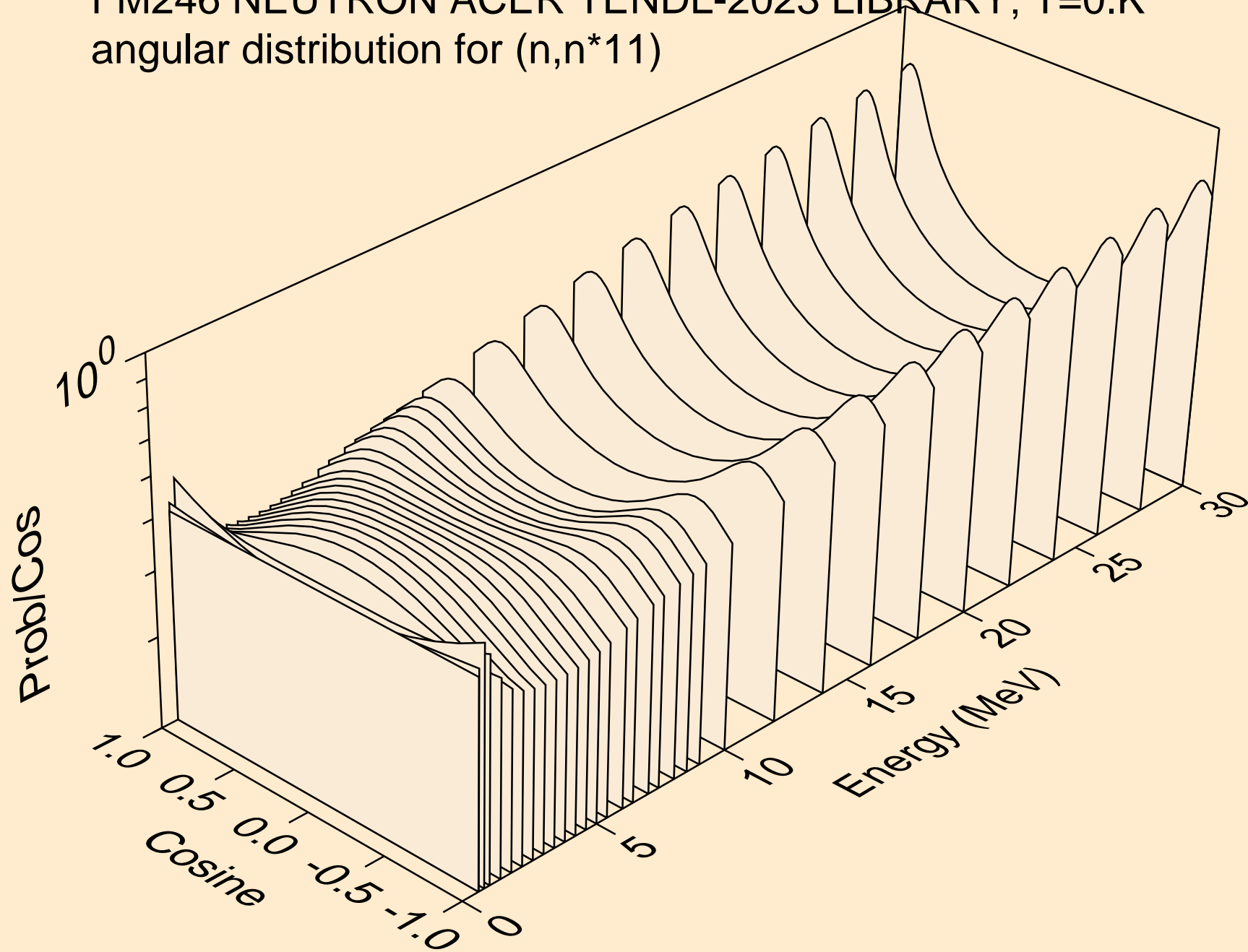

FM246 NEUTRON ACER TENDL-2023 LIBRARY; T=0.K
angular distribution for (n,n*12)

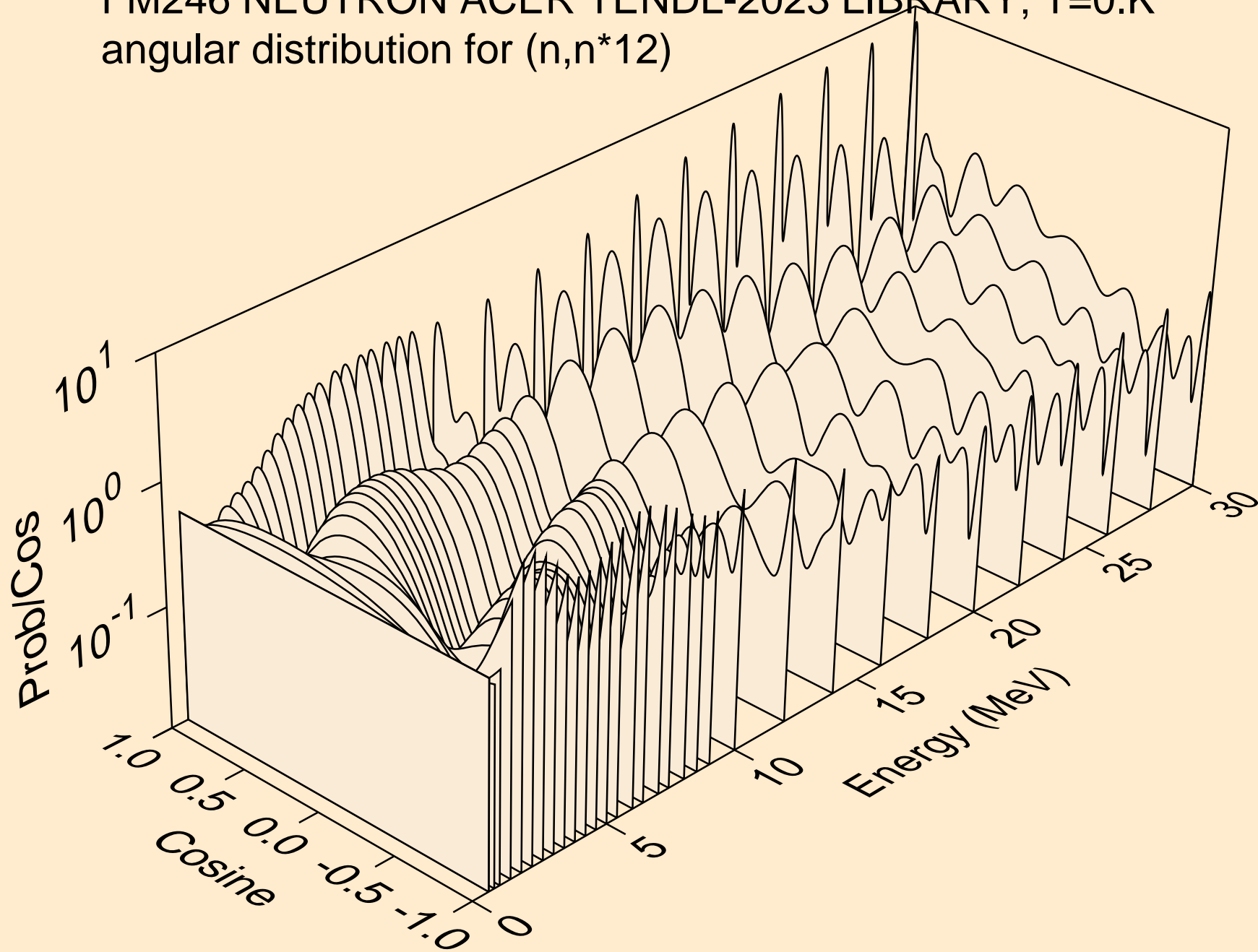

FM246 NEUTRON ACER TENDL-2023 LIBRARY; T=0.K
angular distribution for (n,n*13)

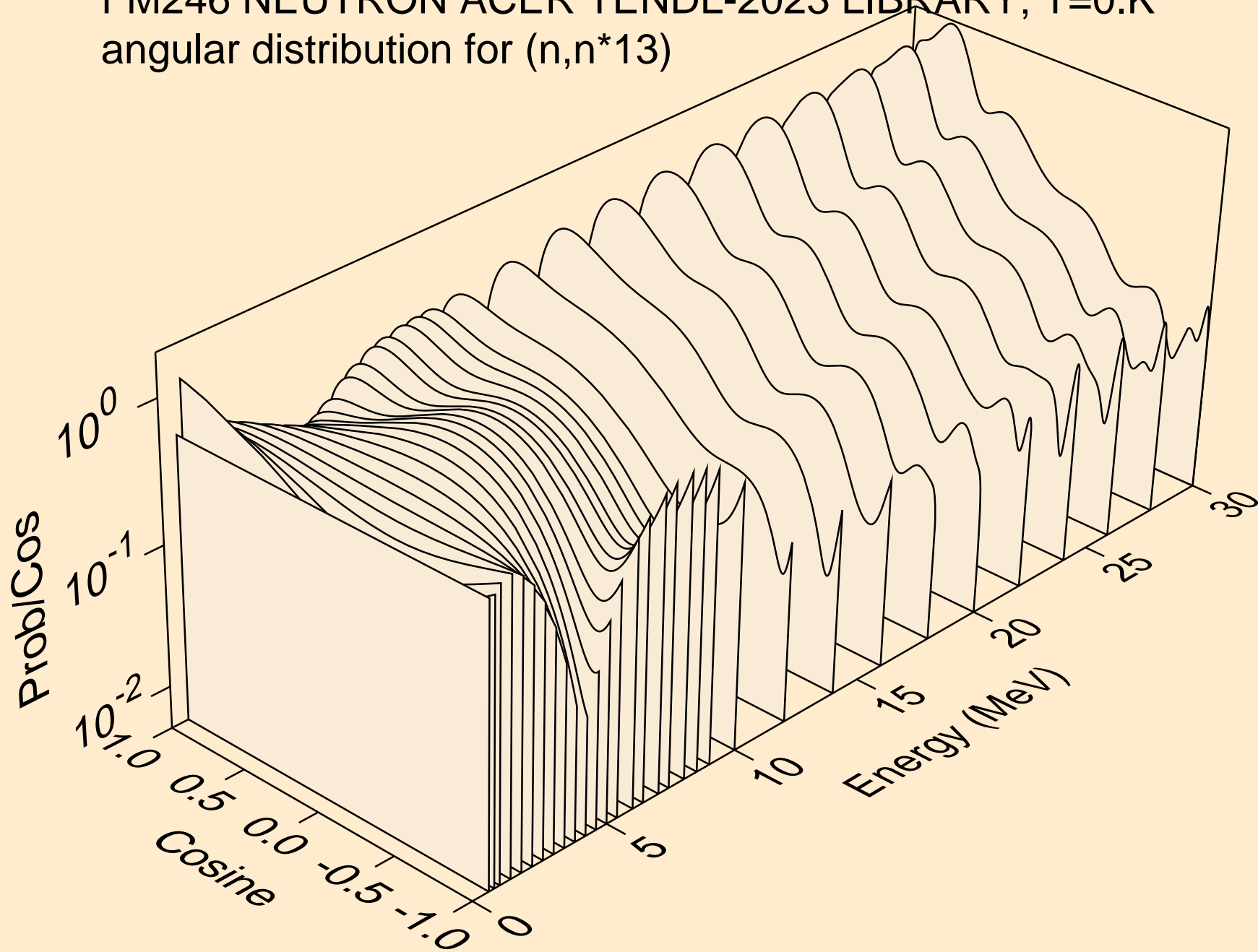

FM246 NEUTRON ACER TENDL-2023 LIBRARY; T=0.K
angular distribution for (n,n*14)

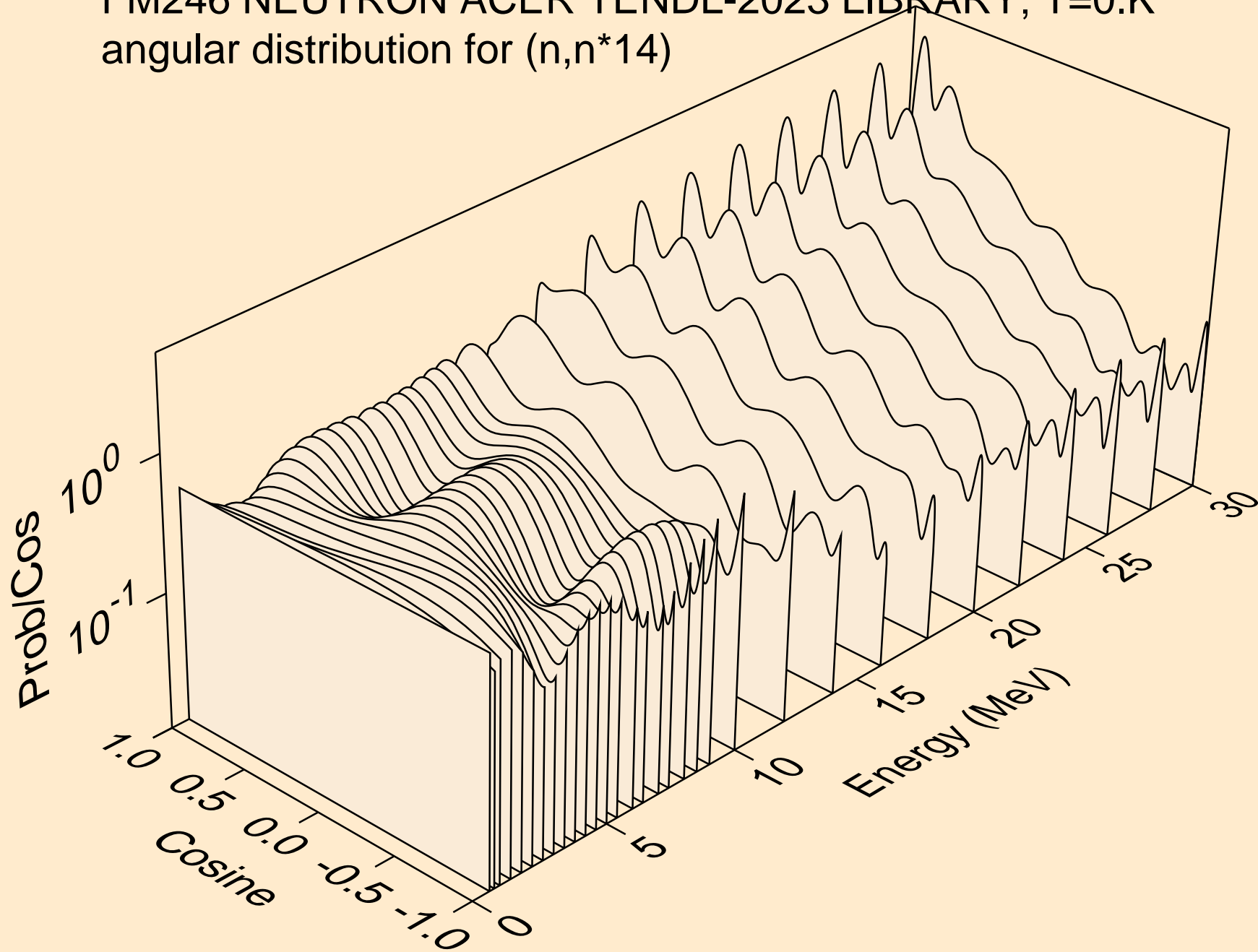

FM246 NEUTRON ACER TENDL-2023 LIBRARY; T=0.K
angular distribution for (n,n*15)

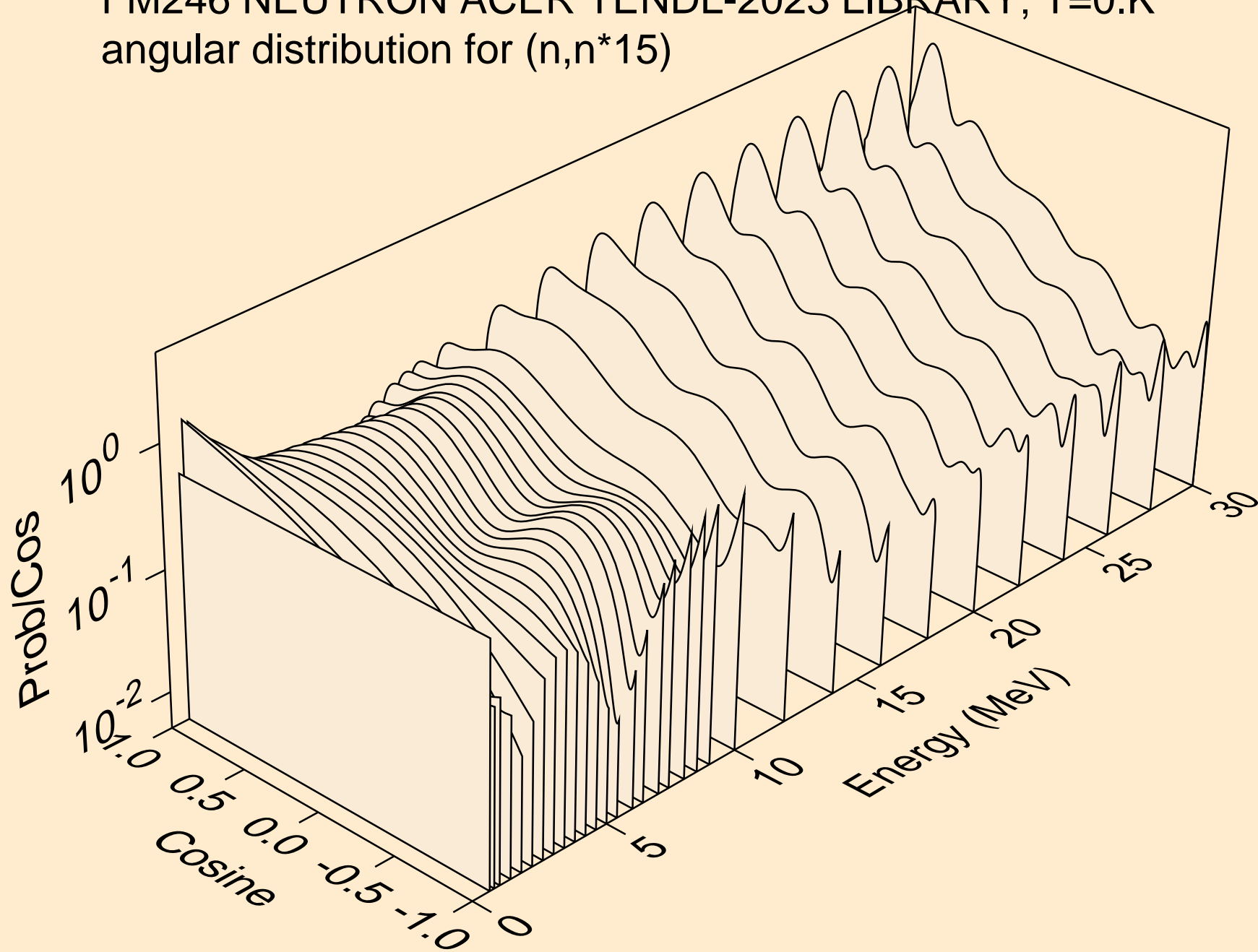

FM246 NEUTRON ACER TENDL-2023 LIBRARY; T=0.K
angular distribution for (n,n*16)

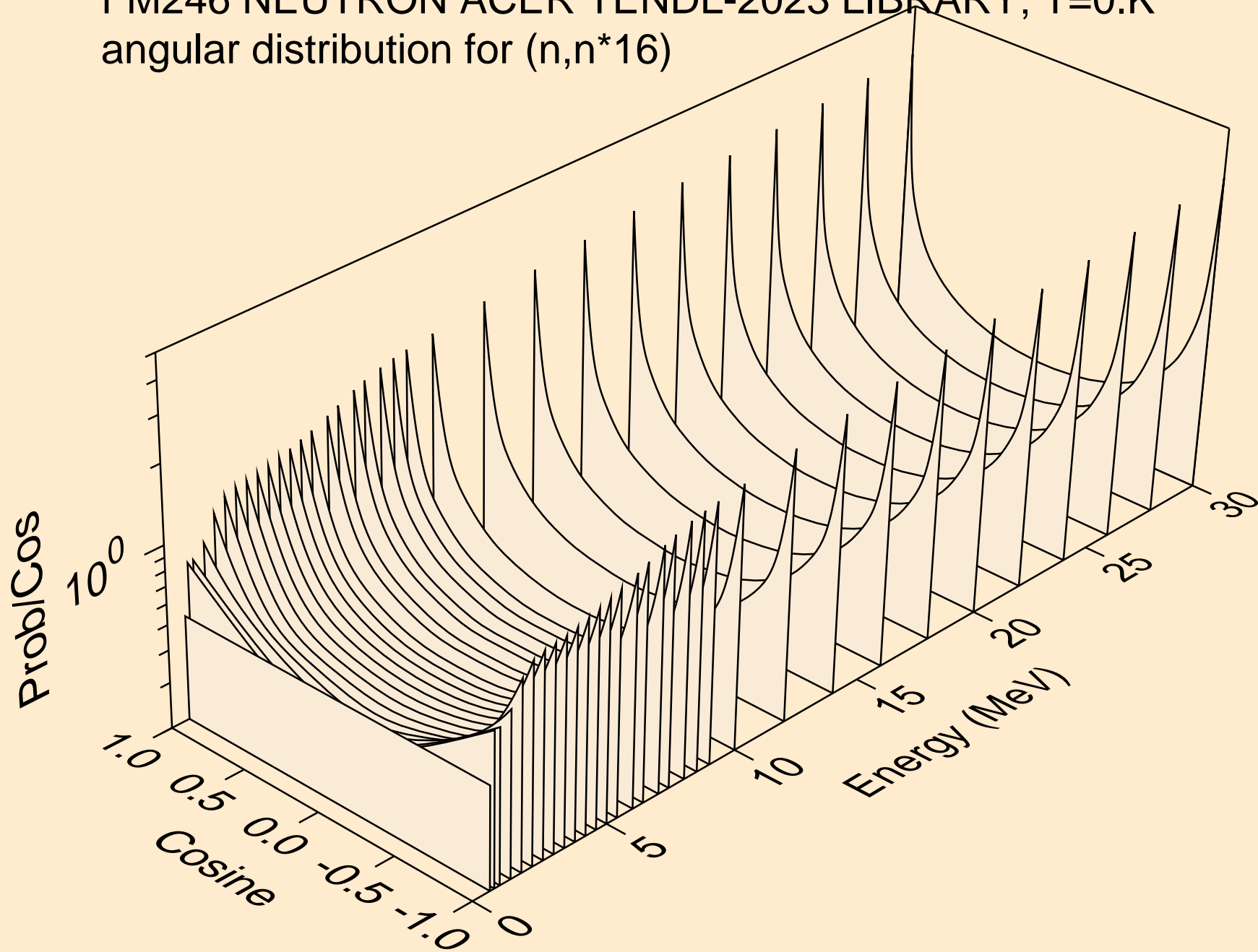

FM246 NEUTRON ACER TENDL-2023 LIBRARY; T=0.K
angular distribution for (n,n*17)

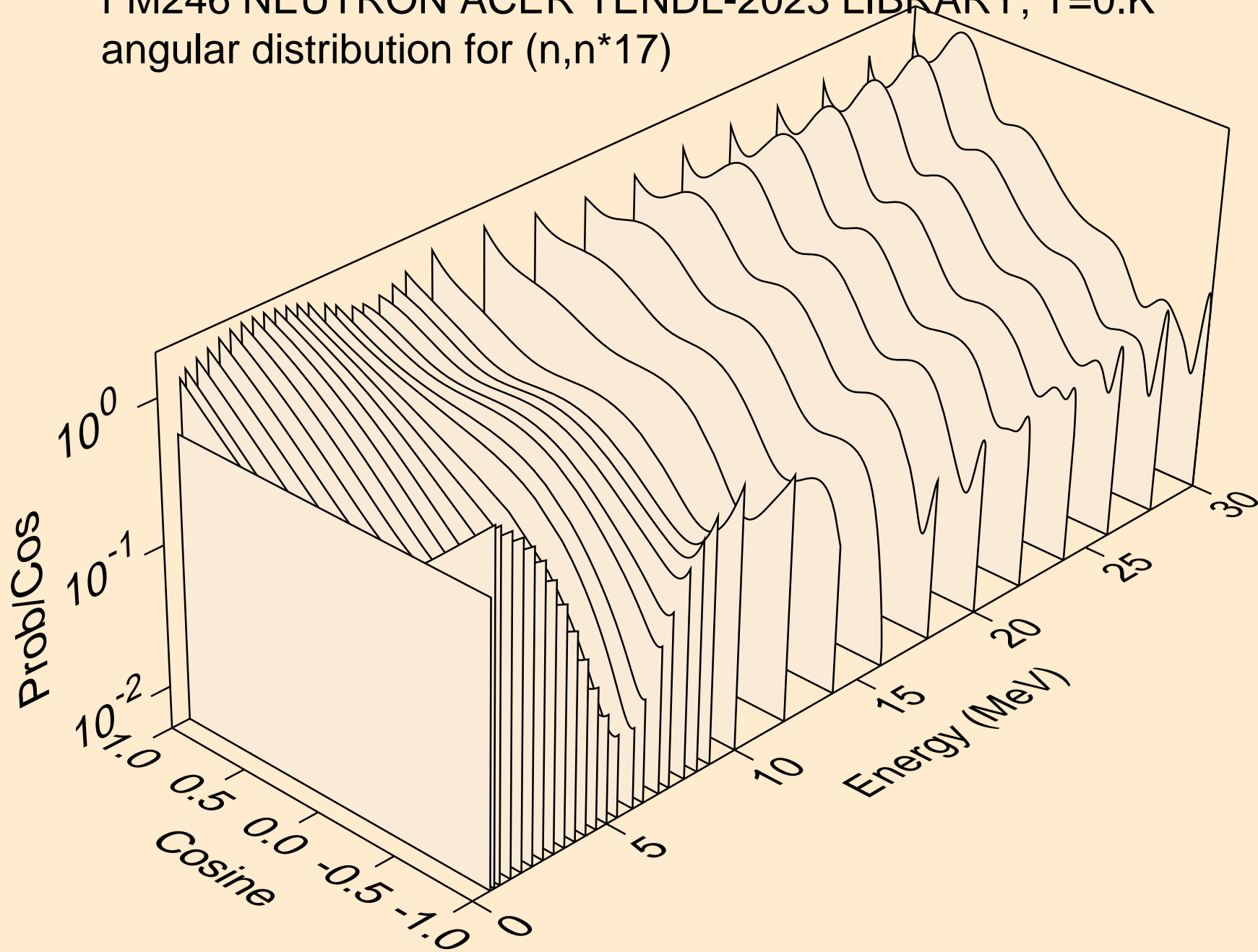

FM246 NEUTRON ACER TENDL-2023 LIBRARY; T=0.K
angular distribution for (n,n*18)

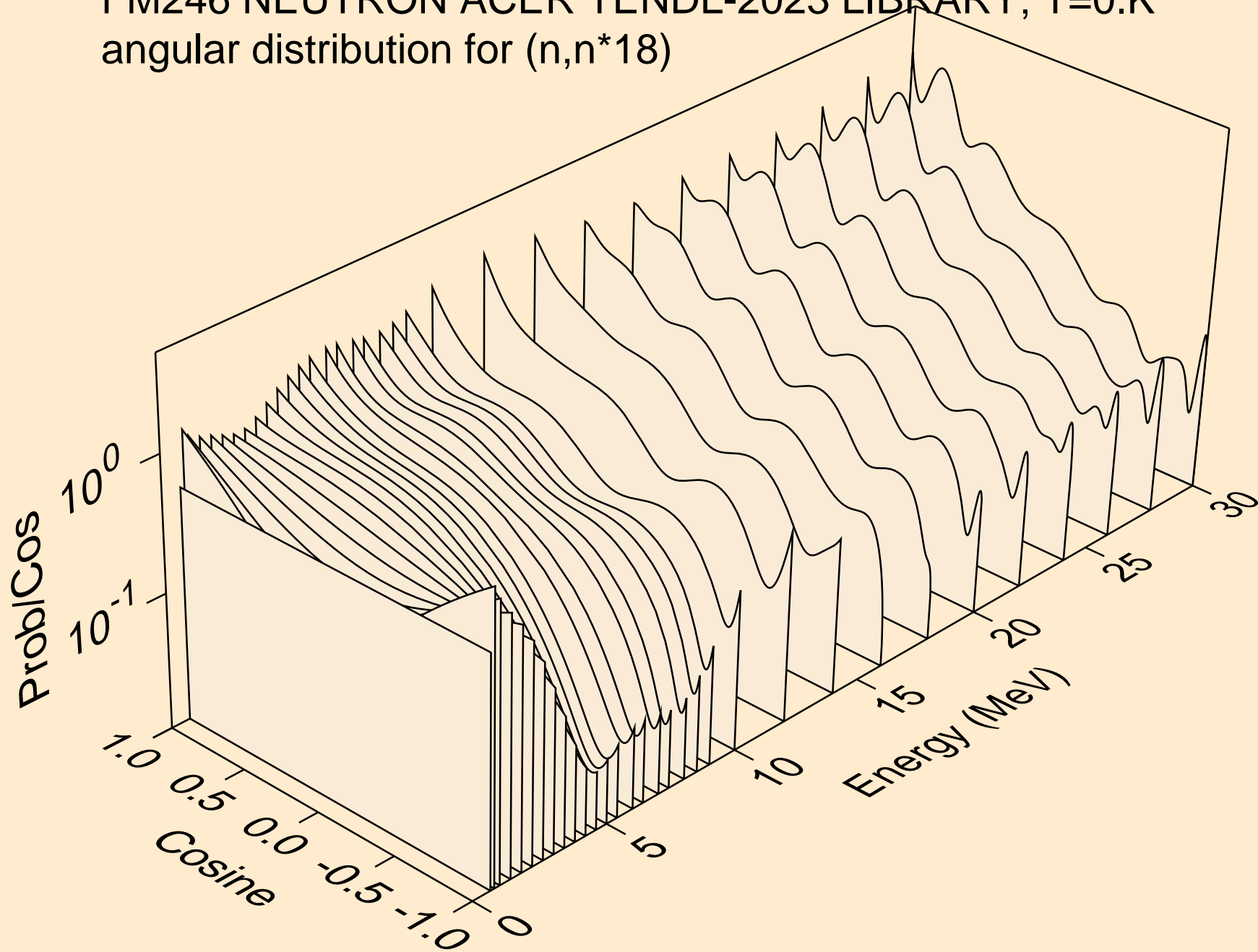

FM246 NEUTRON ACER TENDL-2023 LIBRARY; T=0.K
angular distribution for (n,n*19)

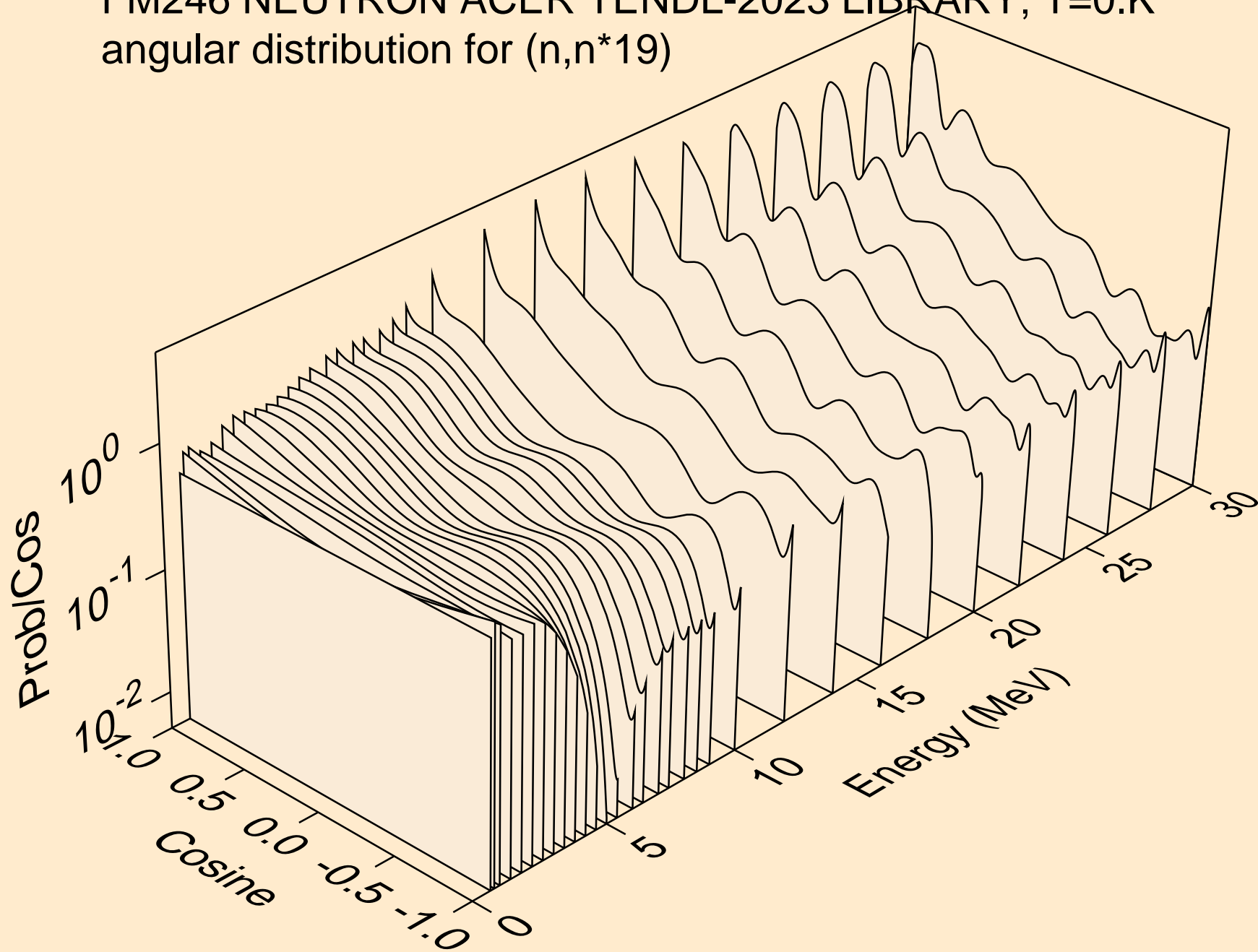

FM246 NEUTRON ACER TENDL-2023 LIBRARY; T=0.K
angular distribution for (n,n*20)

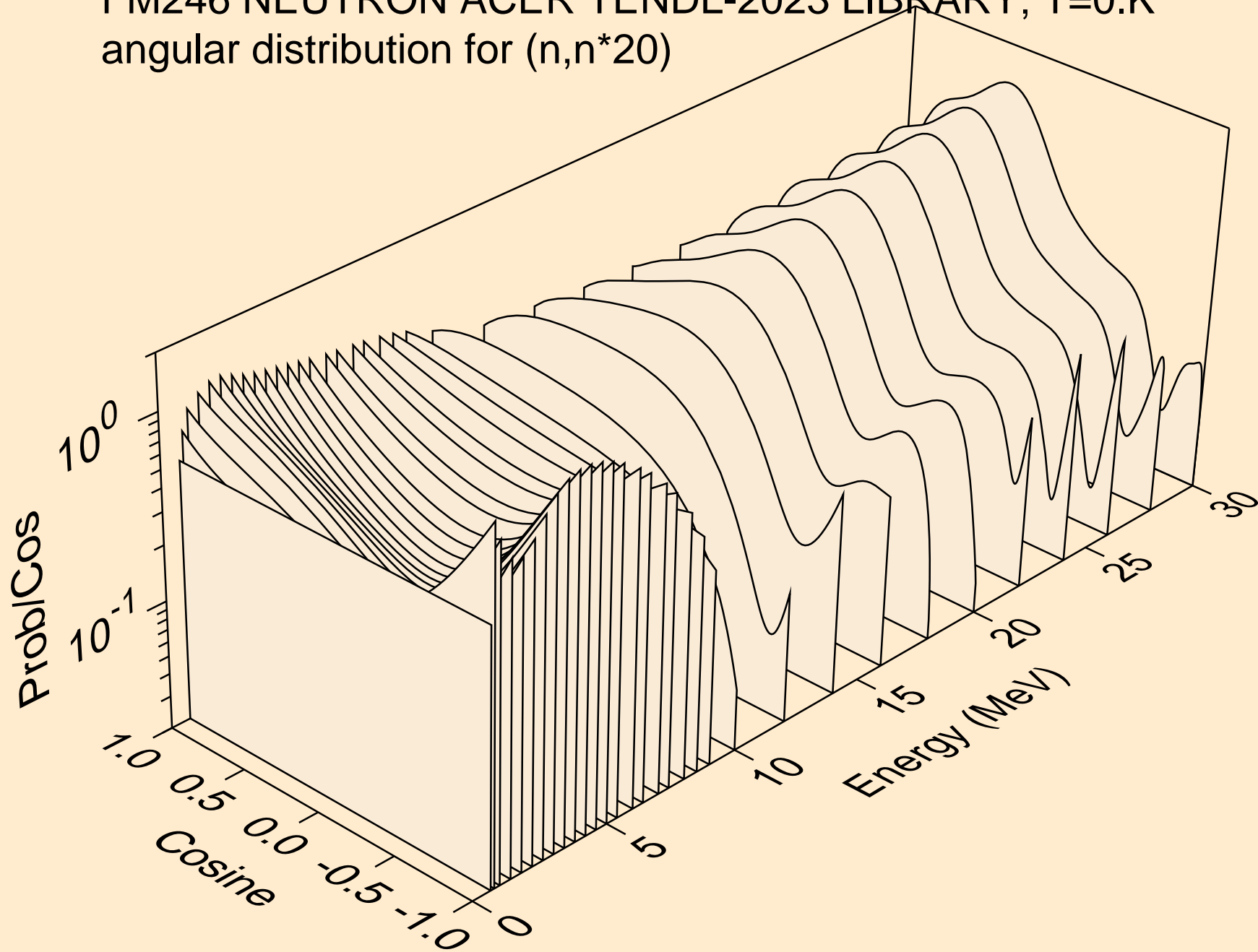

FM246 NEUTRON ACER TENDL-2023 LIBRARY; T=0.K
angular distribution for (n,n*21)

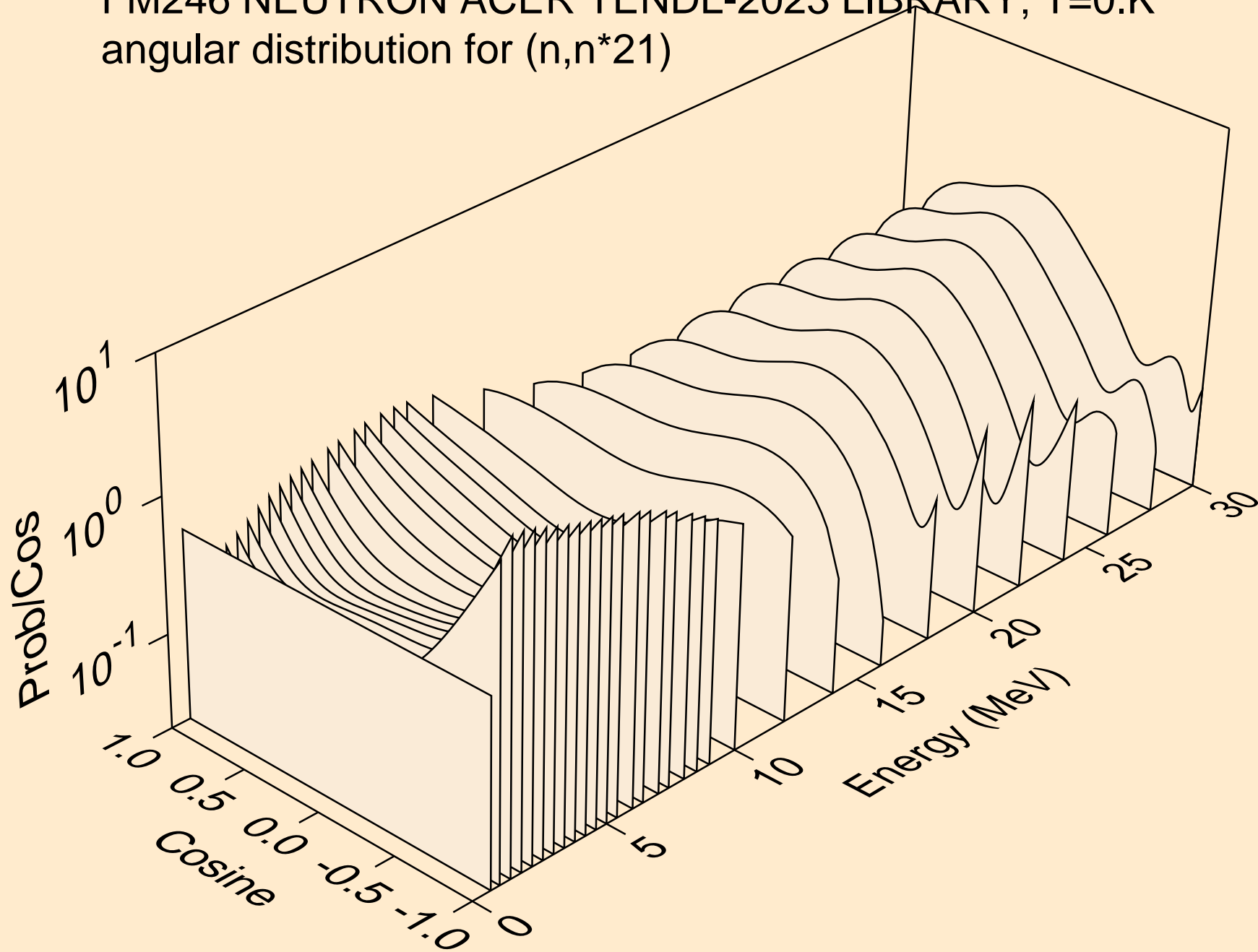

FM246 NEUTRON ACER TENDL-2023 LIBRARY; T=0.K
angular distribution for (n,n*22)

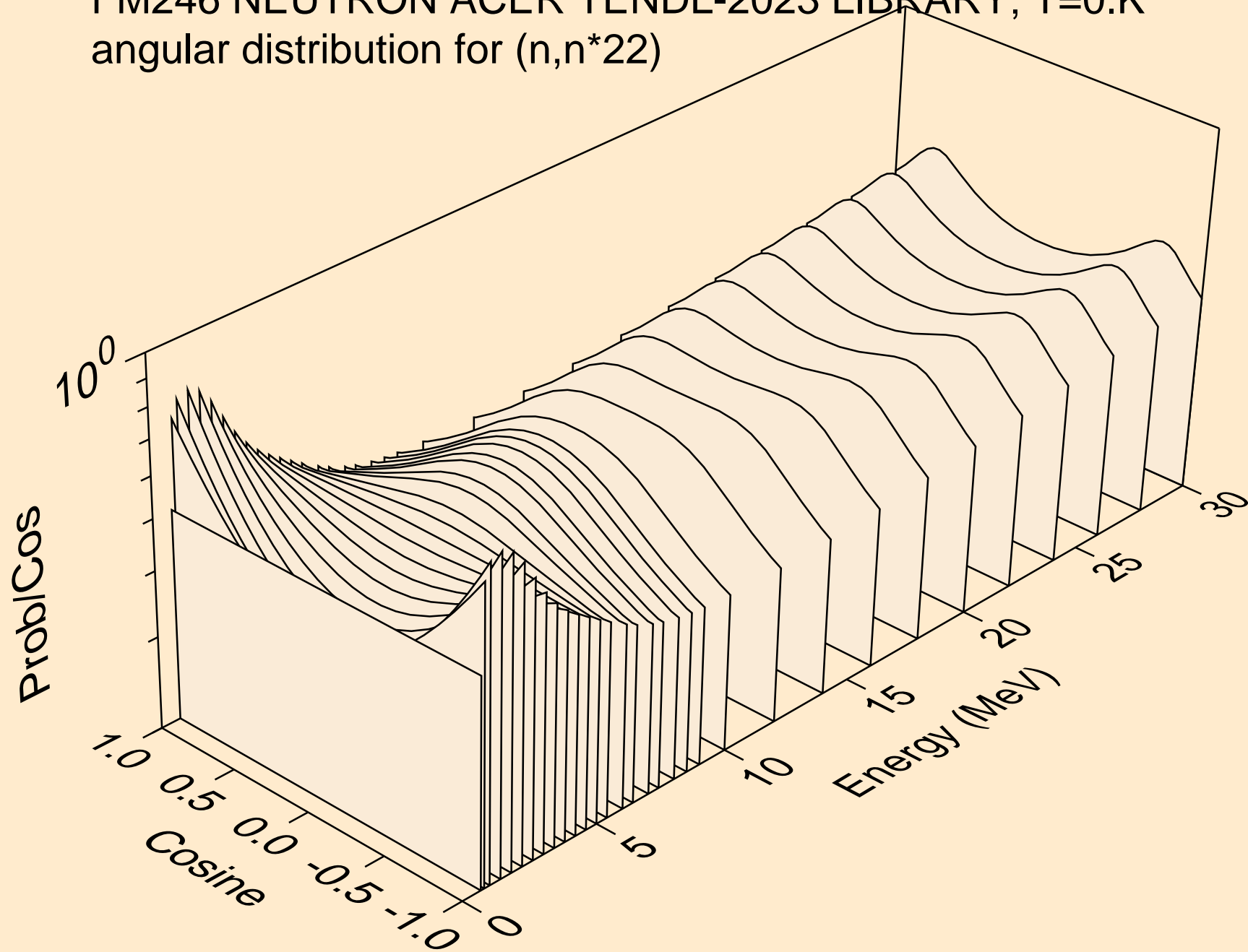

FM246 NEUTRON ACER TENDL-2023 LIBRARY; T=0.K
angular distribution for (n,n*23)

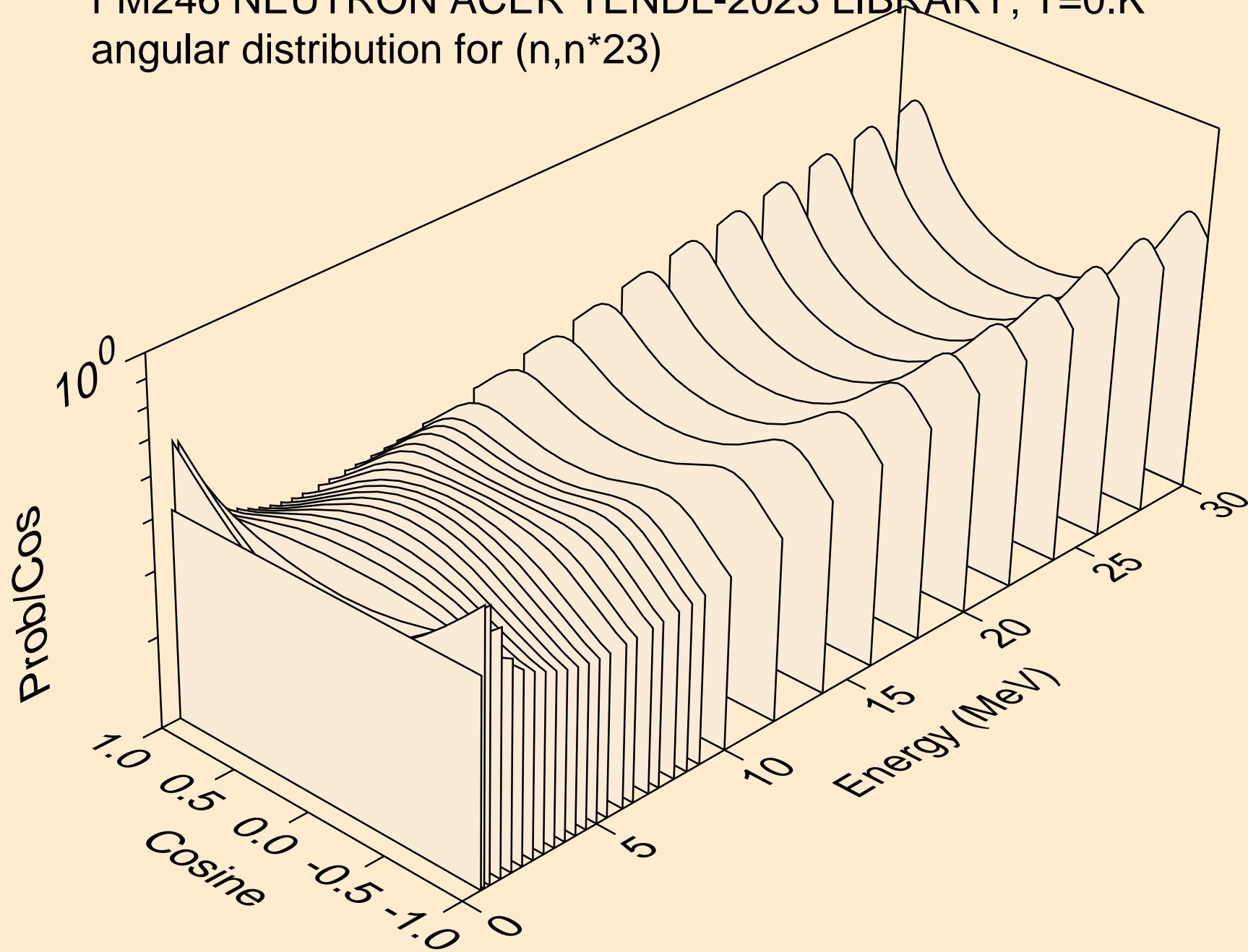

FM246 NEUTRON ACER TENDL-2023 LIBRARY; T=0.K
angular distribution for (n,n*24)

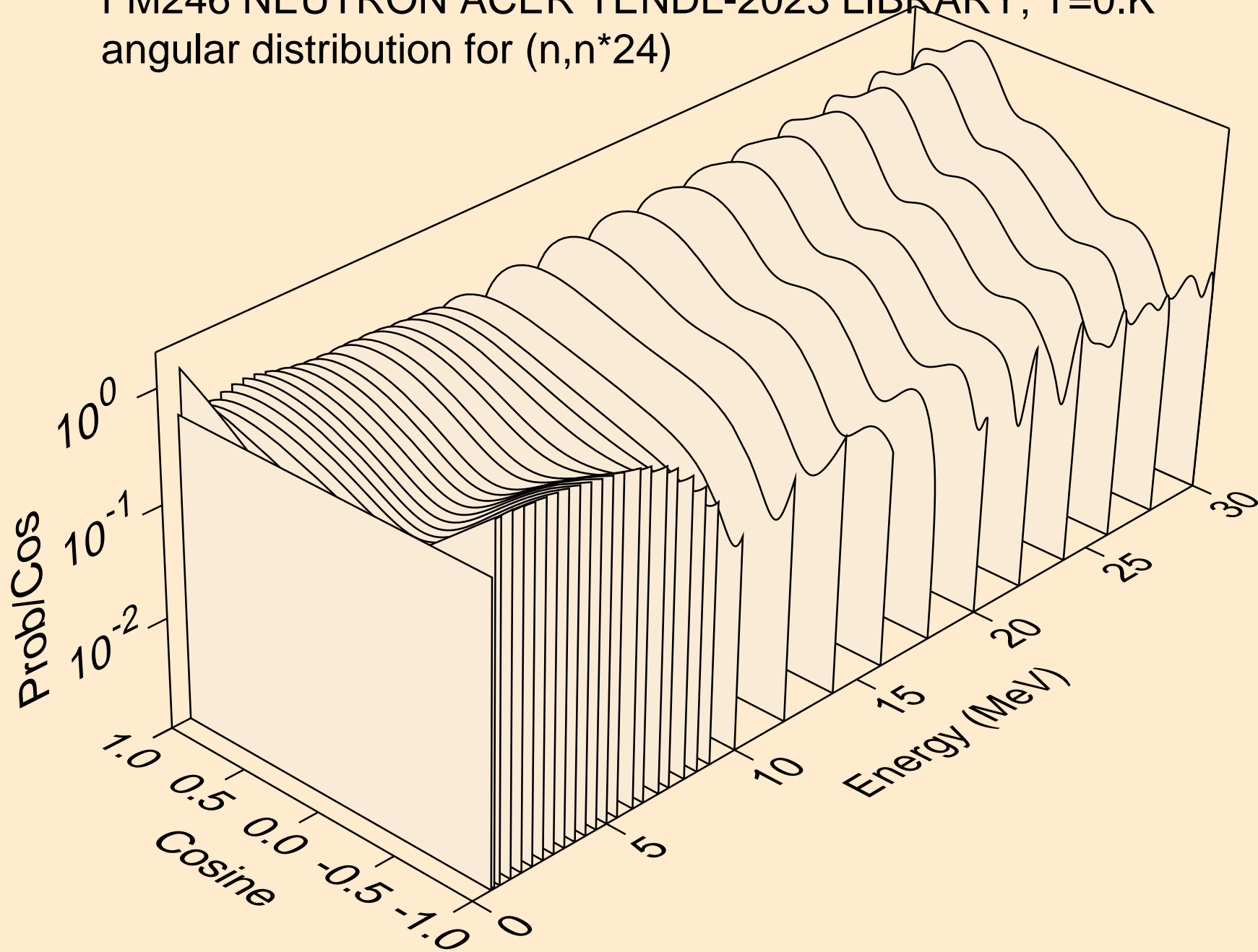

FM246 NEUTRON ACER TENDL-2023 LIBRARY; T=0.K
angular distribution for (n,n*25)

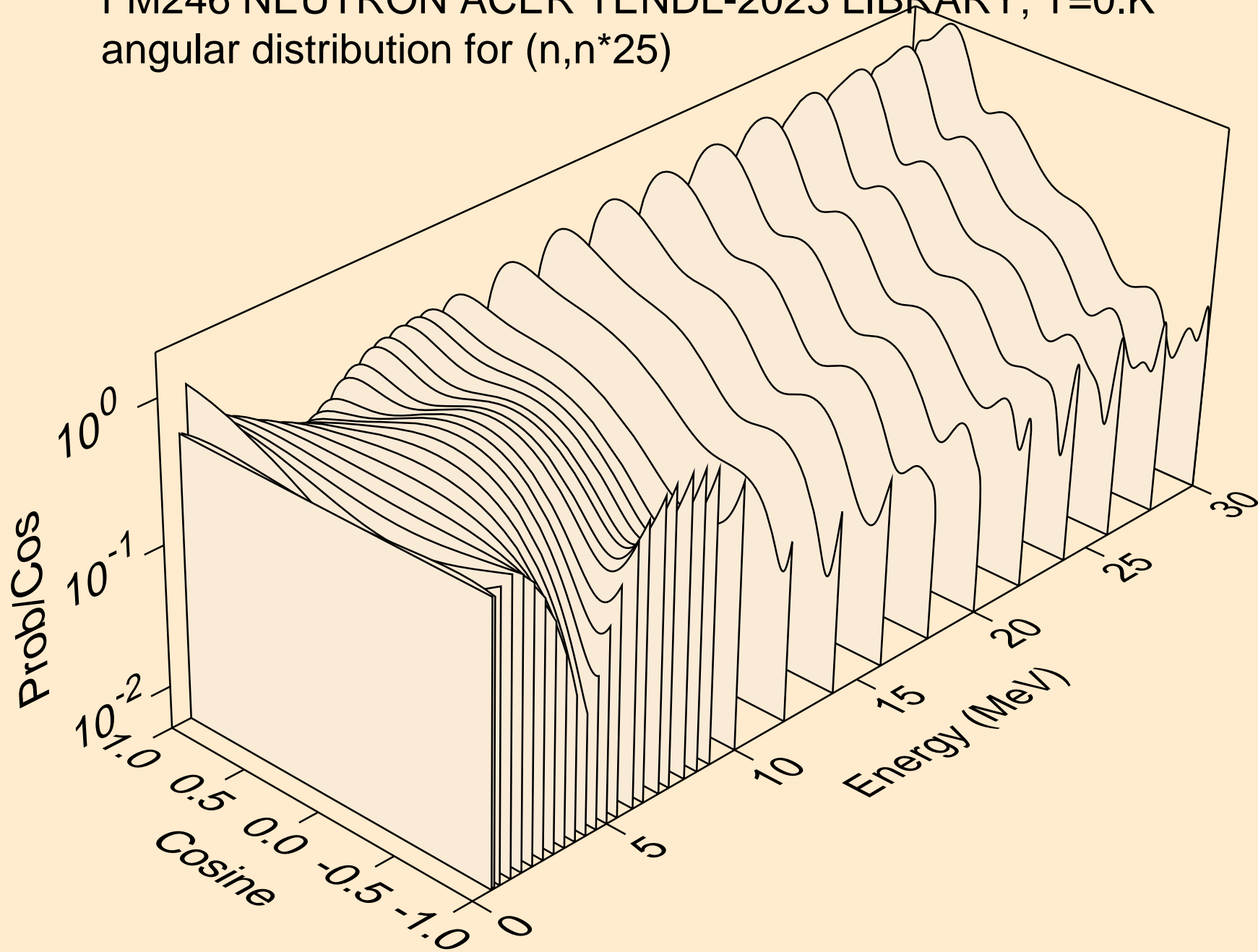

FM246 NEUTRON ACER TENDL-2023 LIBRARY; T=0.K
angular distribution for (n,n*26)

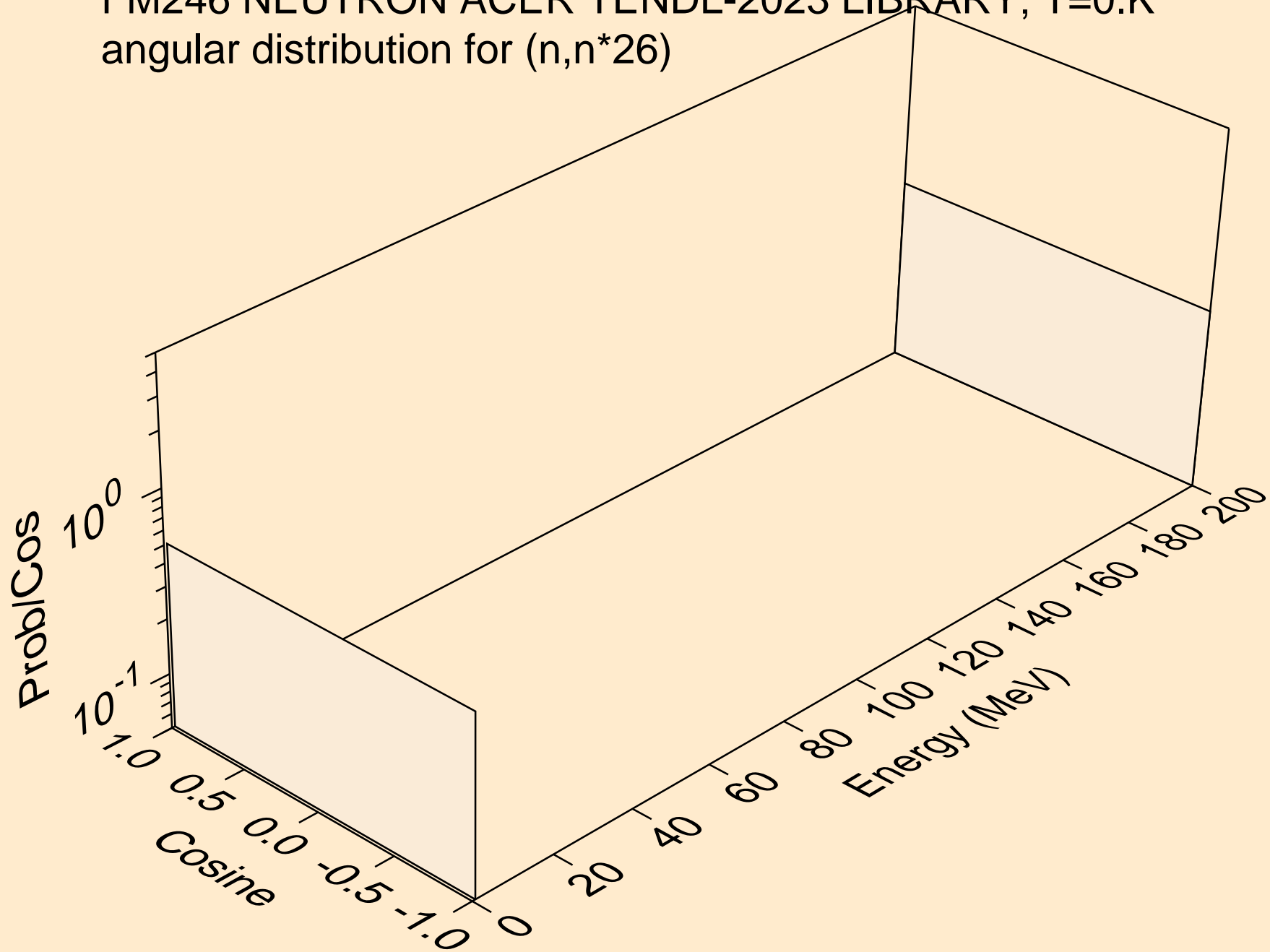

FM246 NEUTRON ACER TENDL-2023 LIBRARY; T=0.K
angular distribution for (n,n*27)

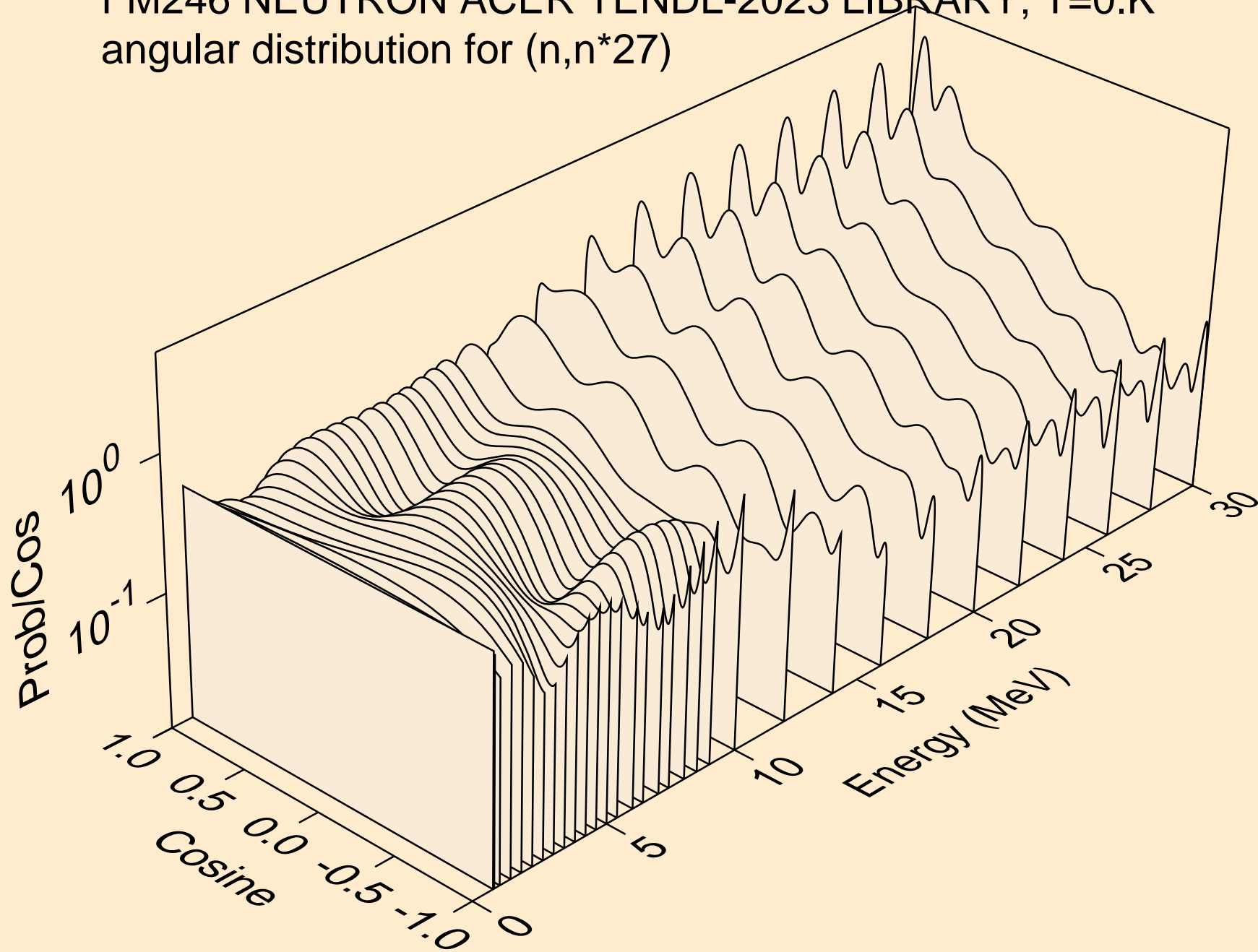

FM246 NEUTRON ACER TENDL-2023 LIBRARY; T=0.K
angular distribution for (n,n*28)

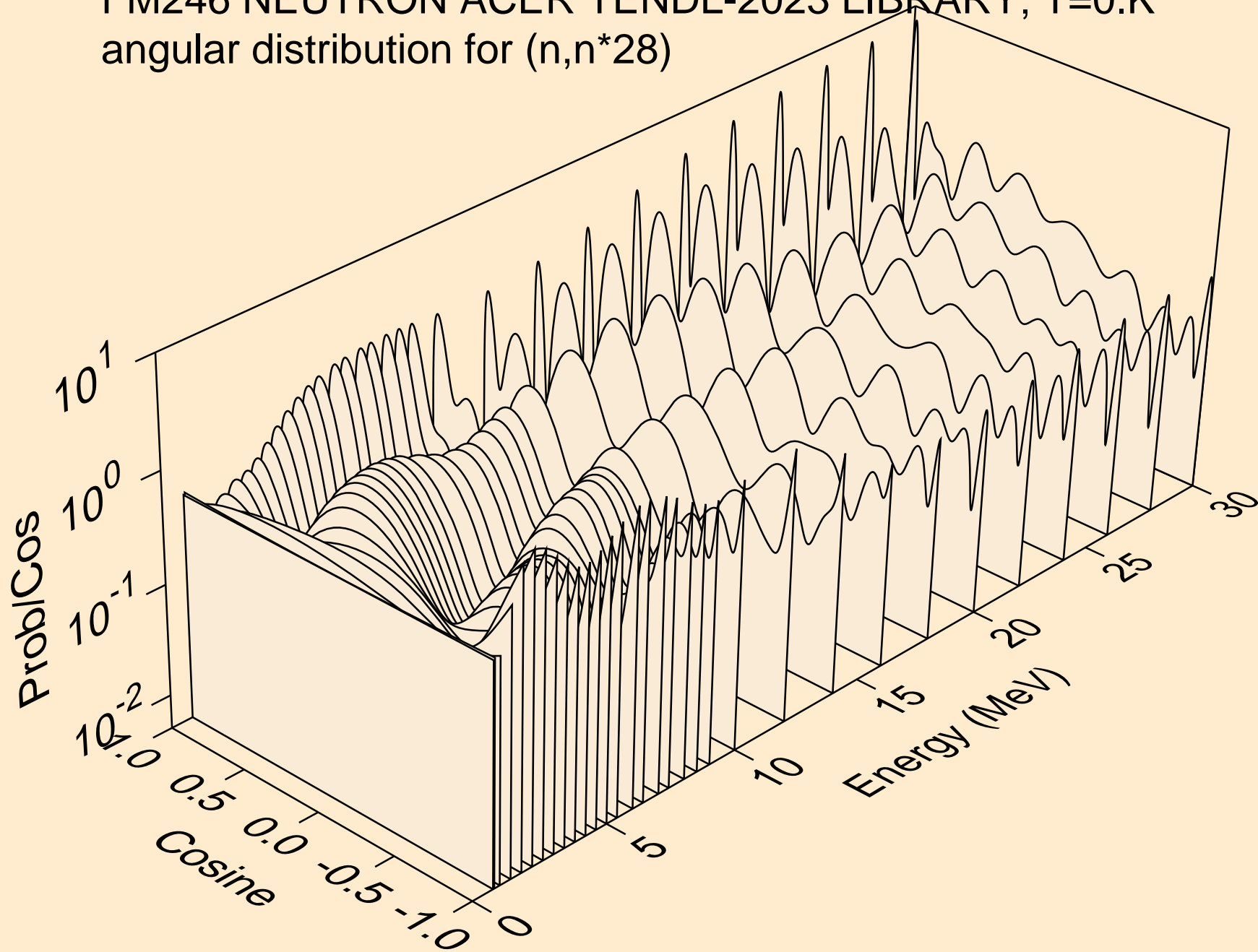

FM246 NEUTRON ACER TENDL-2023 LIBRARY; T=0.K
angular distribution for (n,n*29)

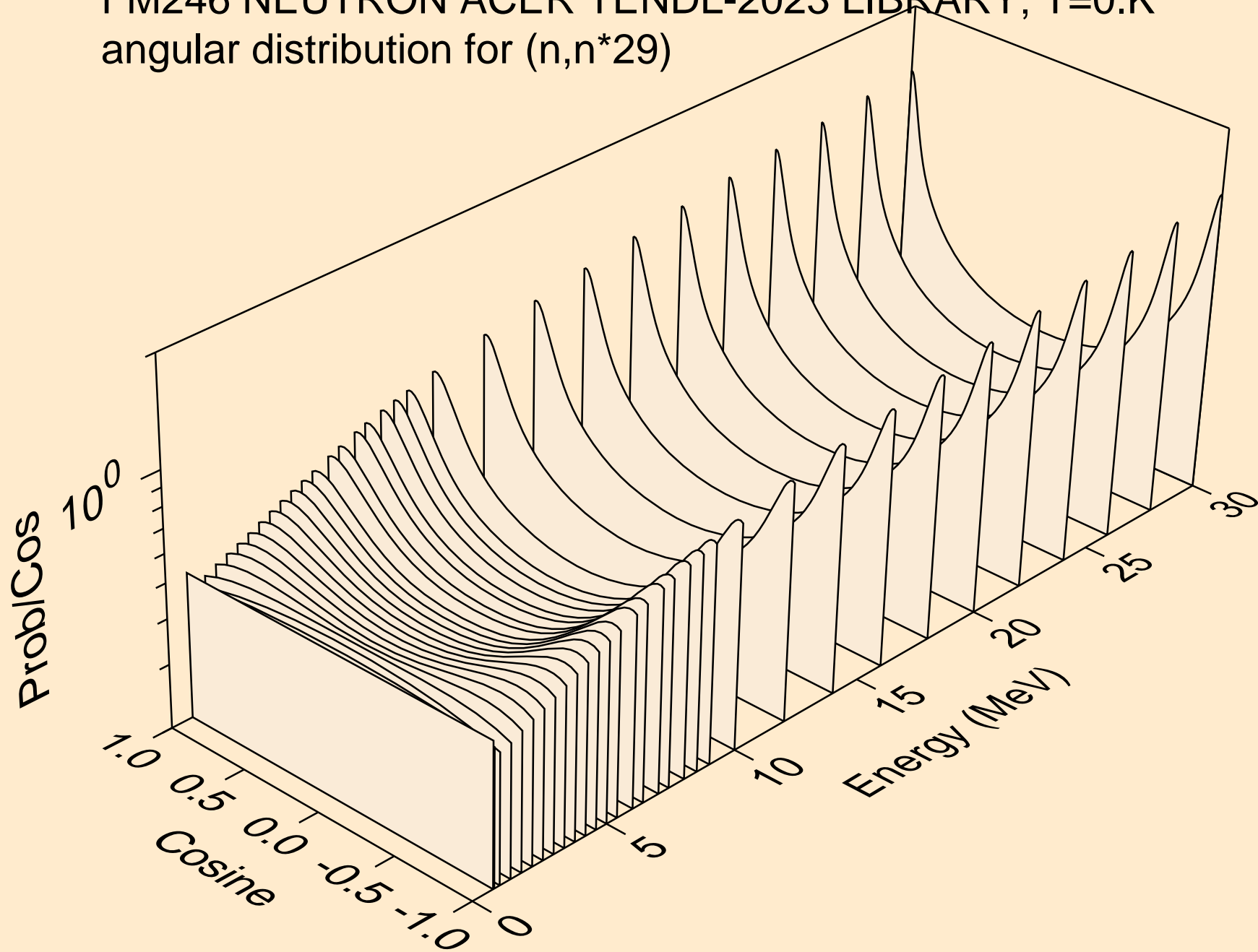

FM246 NEUTRON ACER TENDL-2023 LIBRARY; T=0.K
Total fission nubar

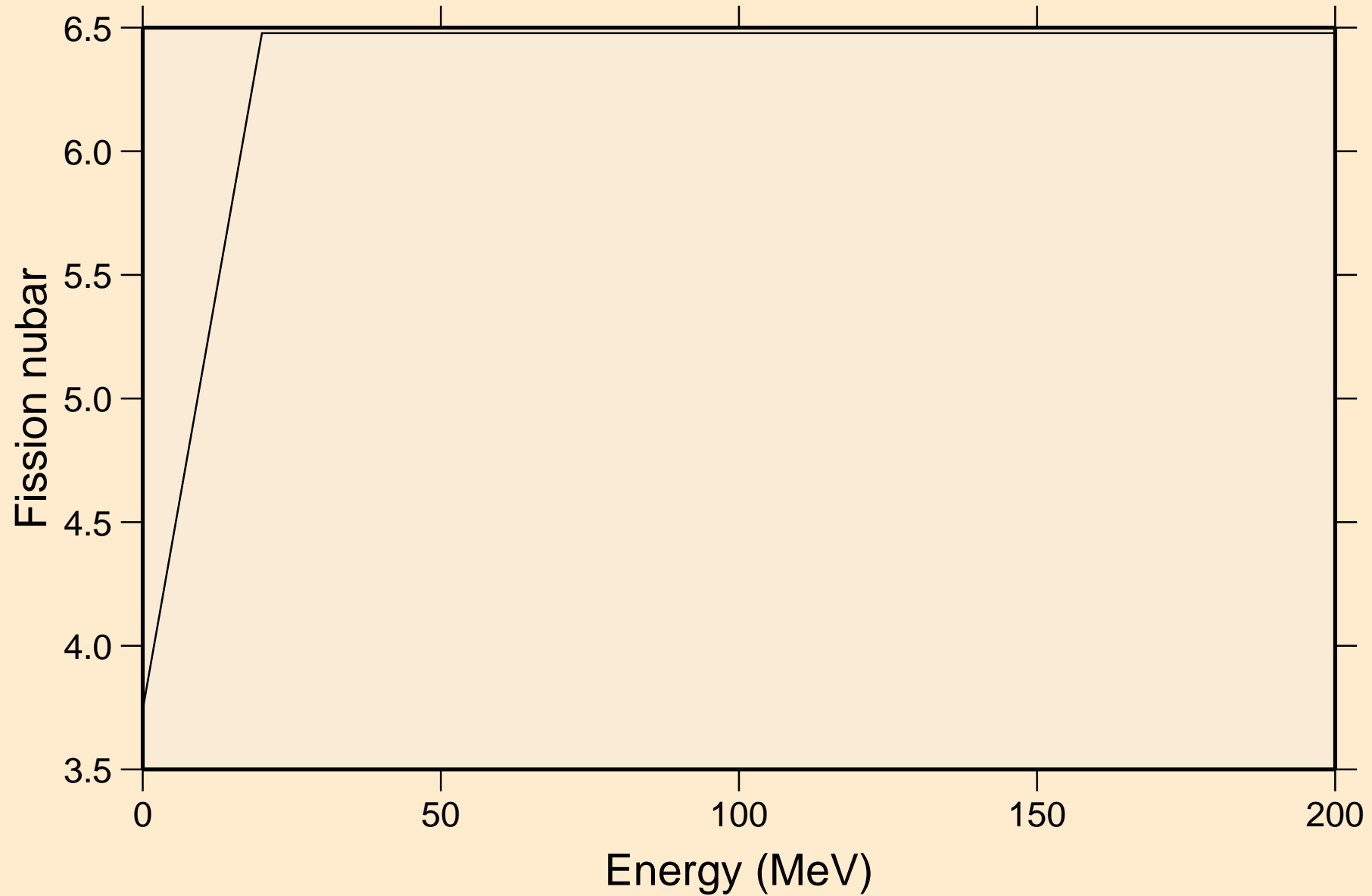

FM246 NEUTRON ACER TENDL-2023 LIBRARY; T=0.K
Neutron emission for (n,x)

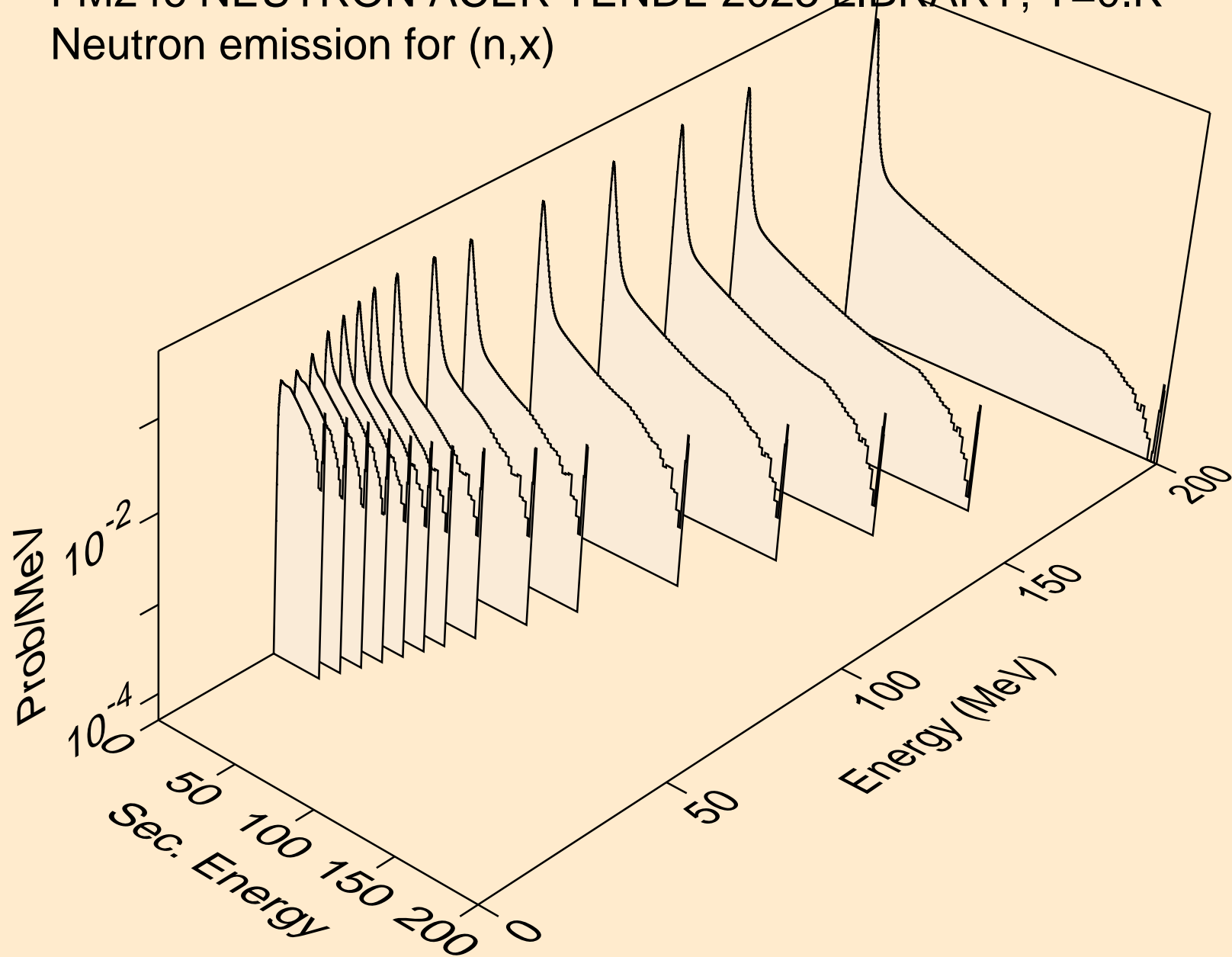

FM246 NEUTRON ACER TENDL-2023 LIBRARY; T=0.K
Neutron emission for (n,2n)

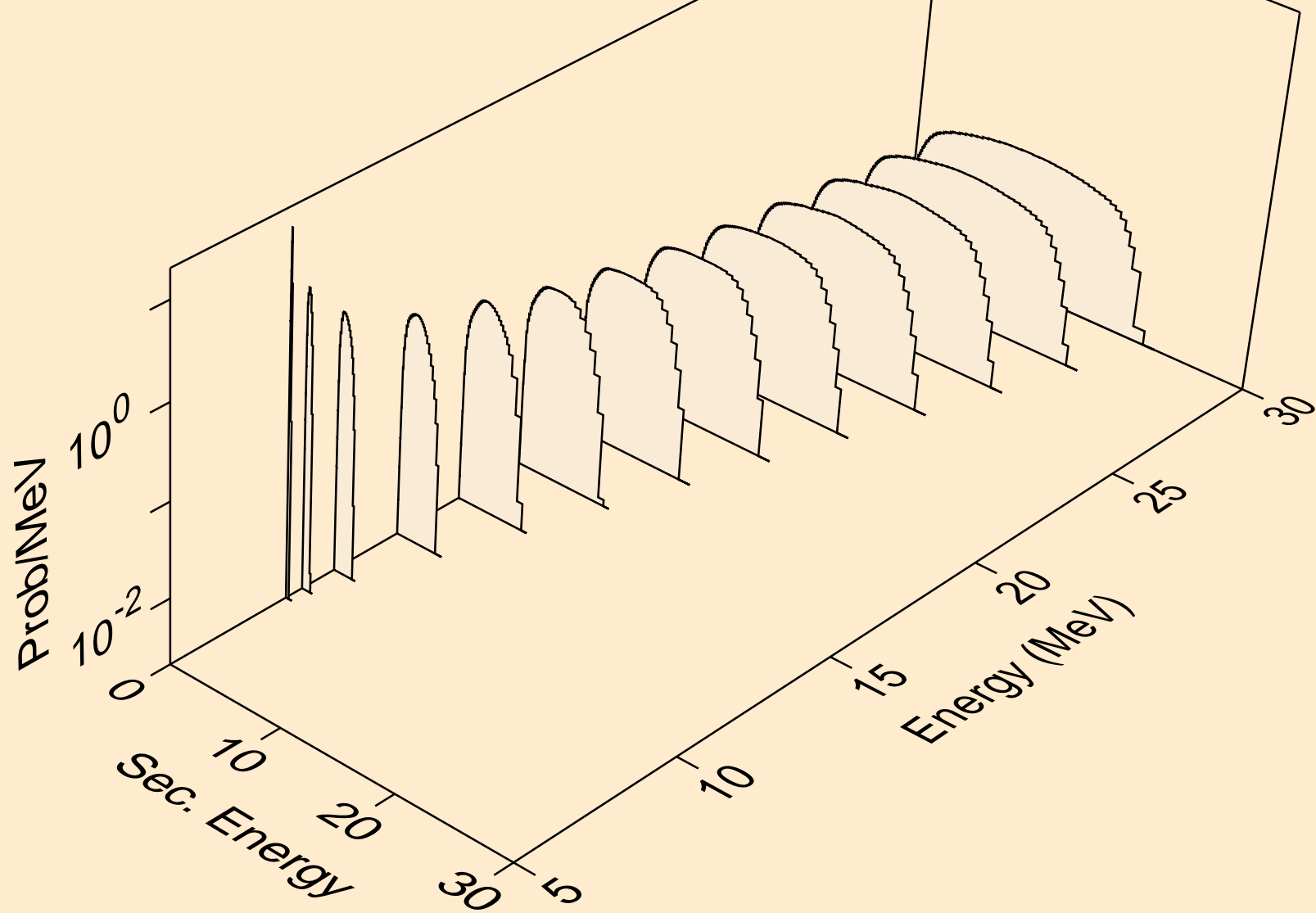

FM246 NEUTRON ACER TENDL-2023 LIBRARY; T=0.K
Neutron emission for (n,3n)

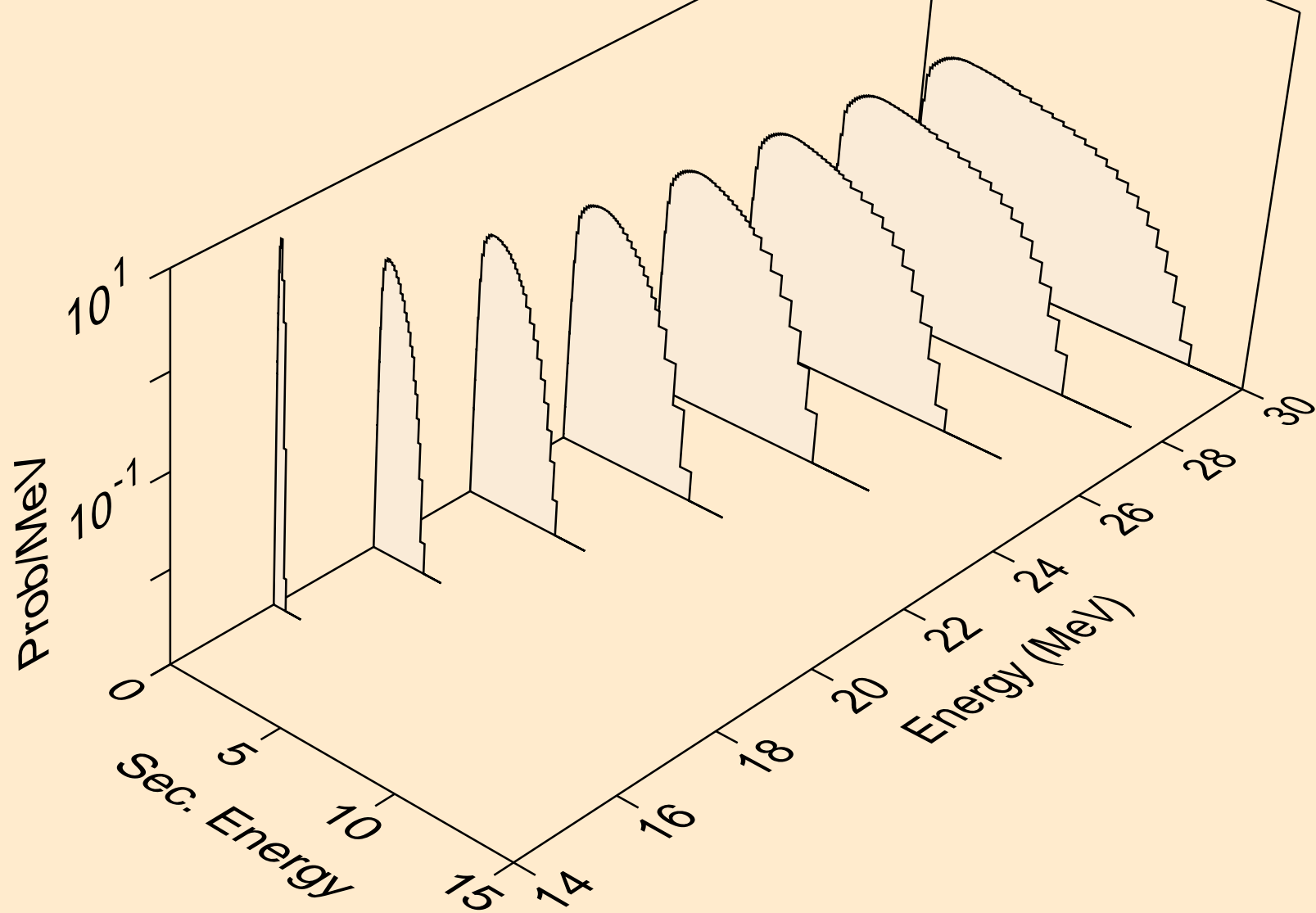

FM246 NEUTRON ACER TENDL-2023 LIBRARY; T=0.K
Neutron emission for fission

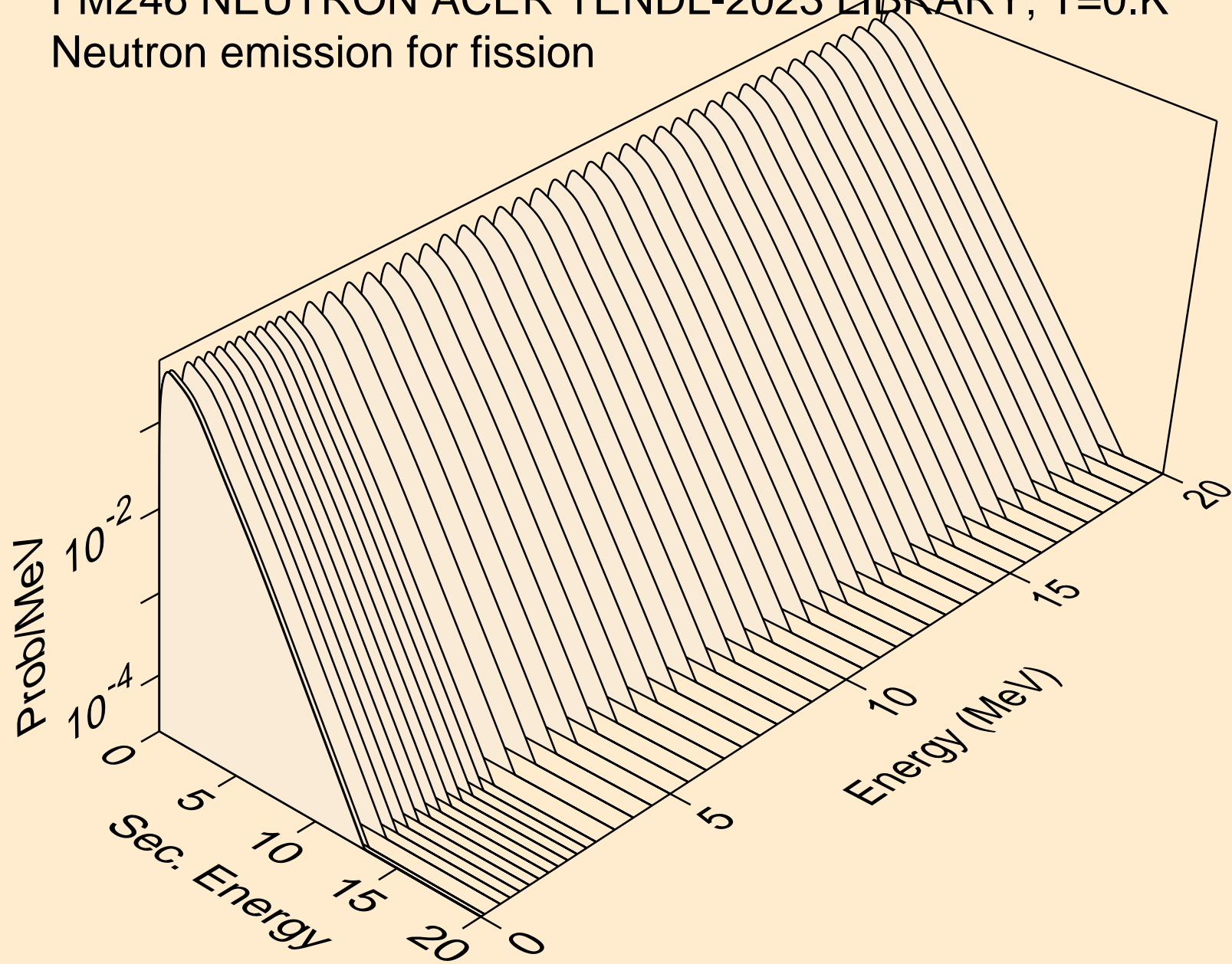

FM246 NEUTRON ACER TENDL-2023 LIBRARY; T=0.K
Neutron emission for (n,n*)a

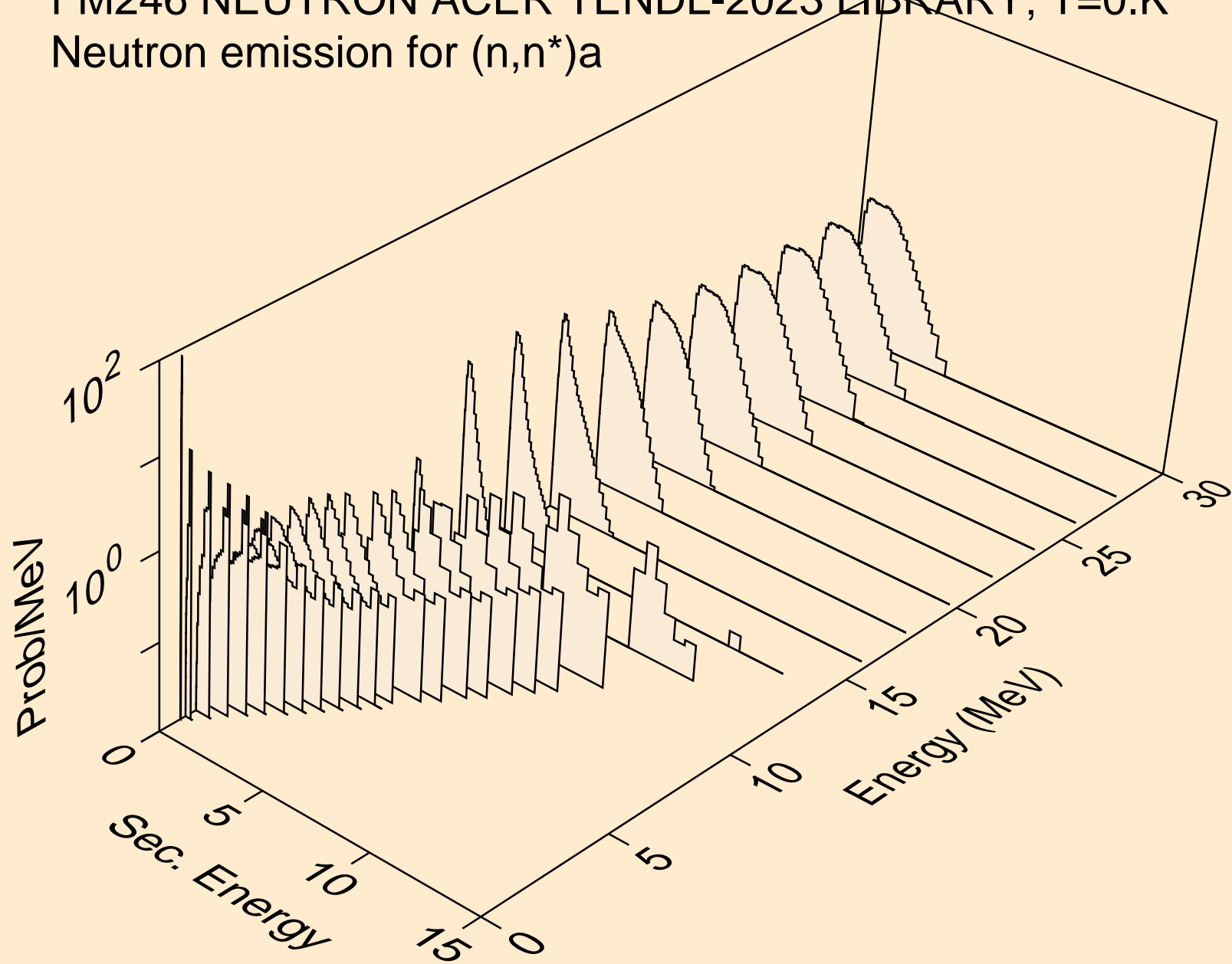

FM246 NEUTRON ACER TENDL-2023 LIBRARY; T=0.K
Neutron emission for (n,2n)a

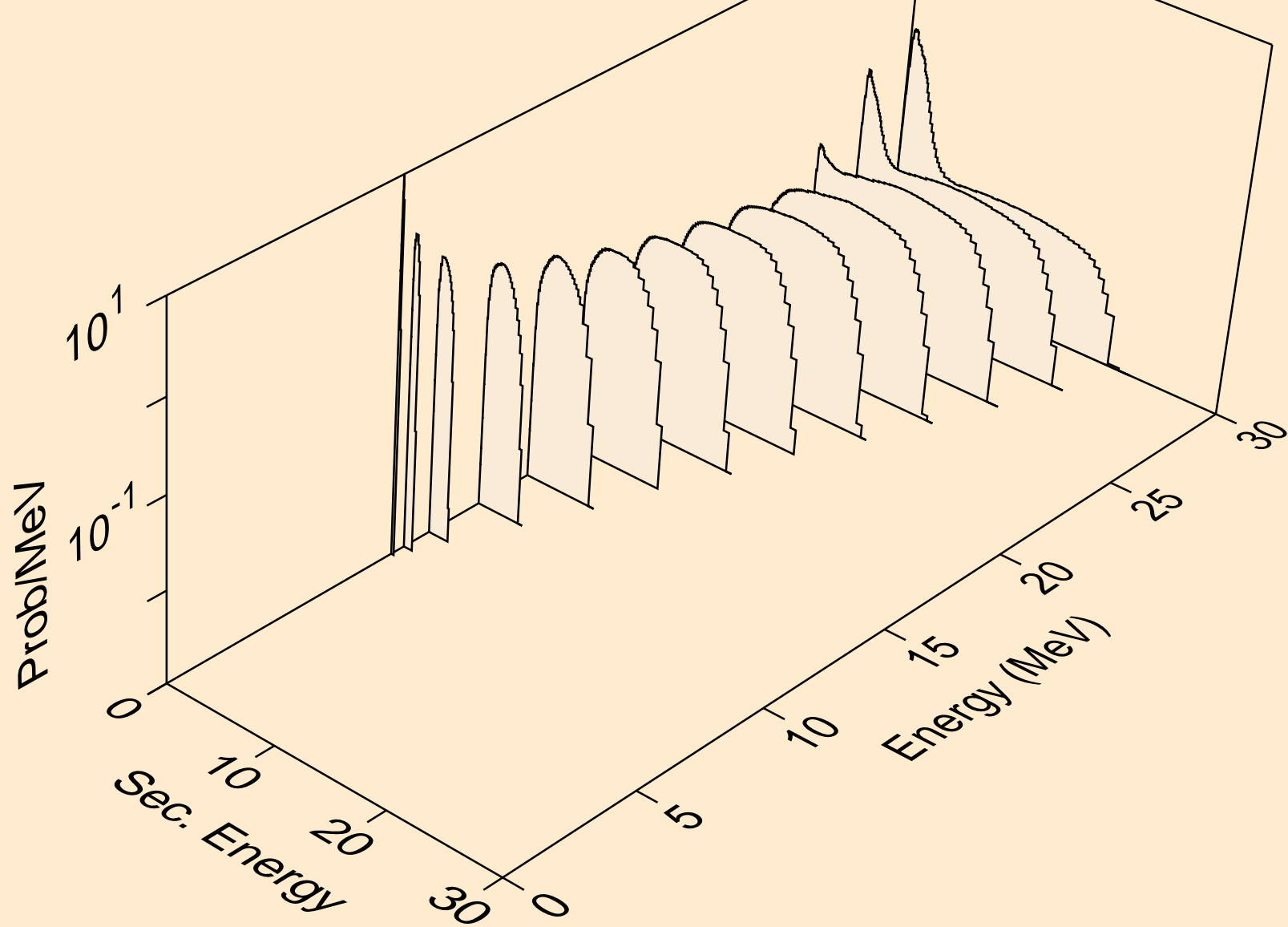

FM246 NEUTRON ACER TENDL-2023 LIBRARY; T=0.K
Neutron emission for (n,n*)p

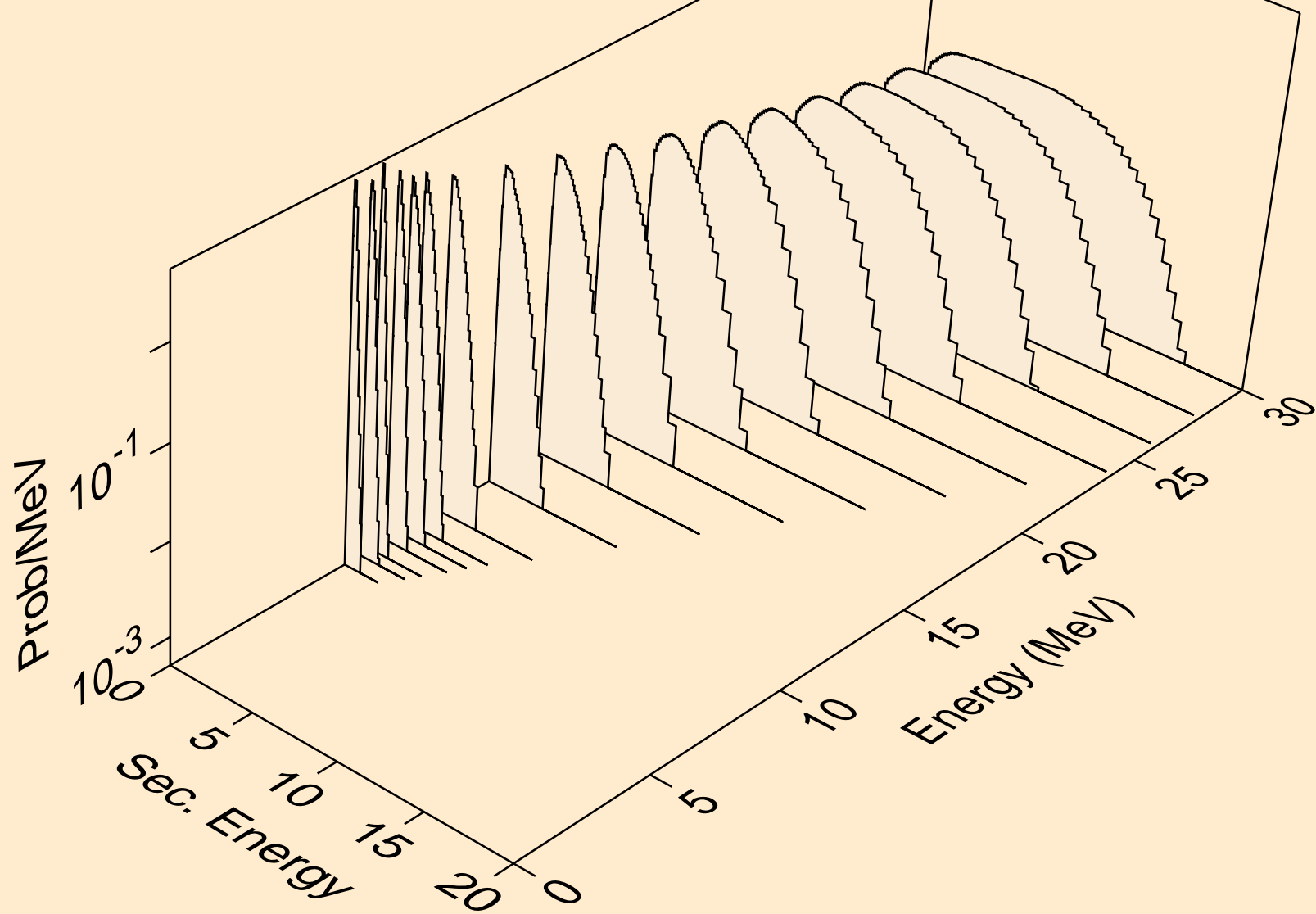

FM246 NEUTRON ACER TENDL-2023 LIBRARY; T=0.K
Neutron emission for (n,n*)d

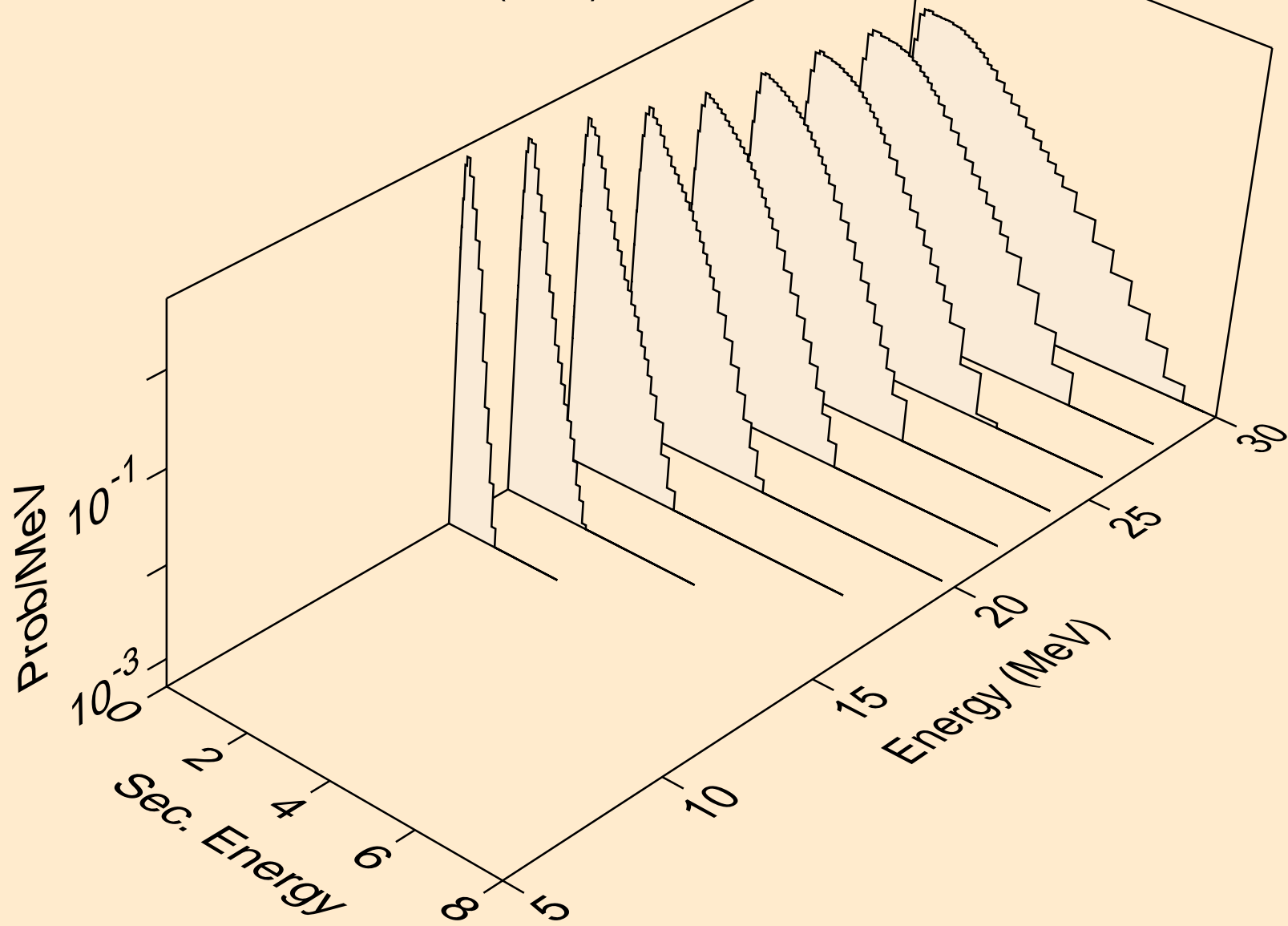

FM246 NEUTRON ACER TENDL-2023 LIBRARY; T=0.K
Neutron emission for (n,n*)t

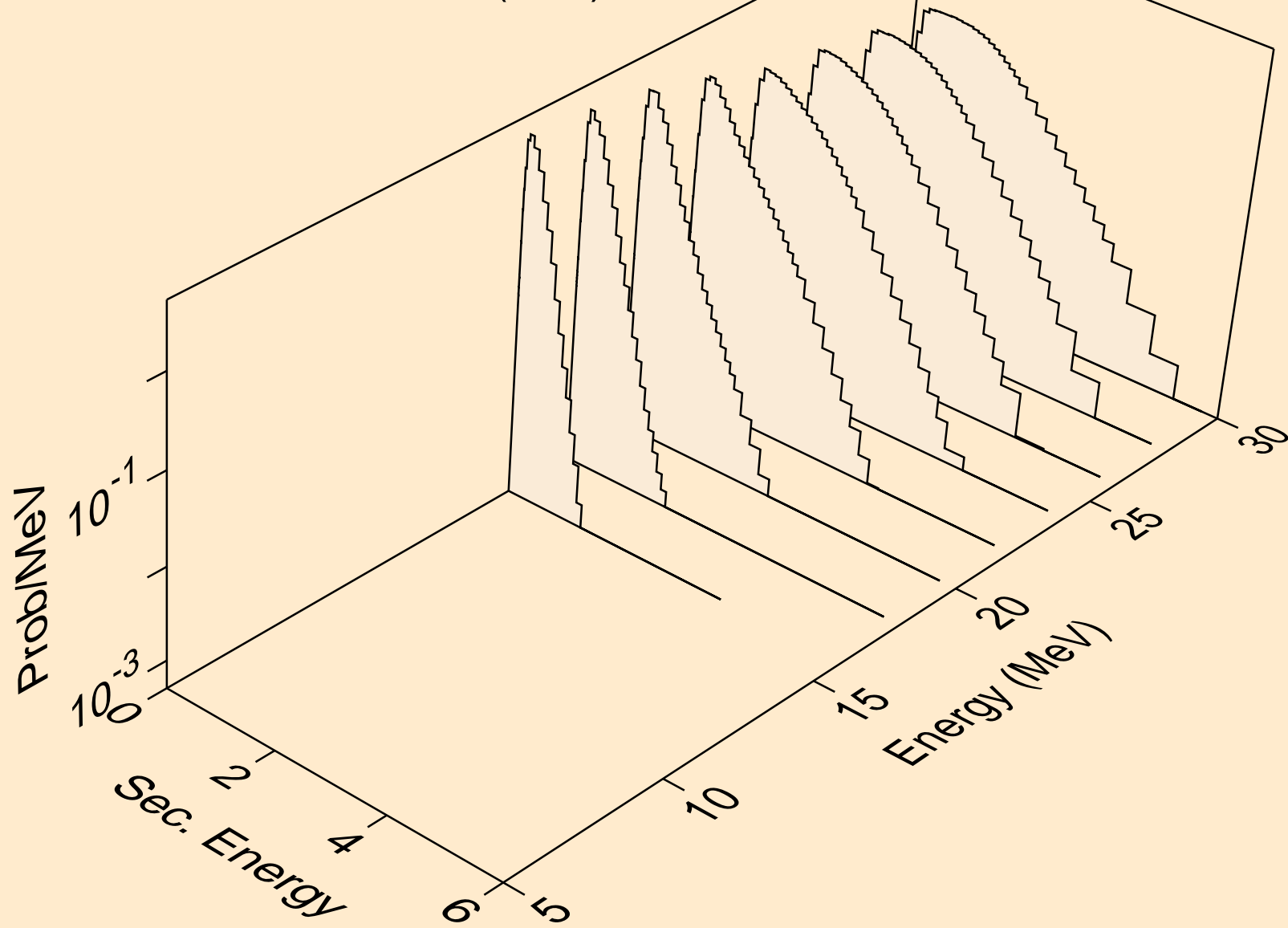

FM246 NEUTRON ACER TENDL-2023 LIBRARY; T=0.K
Neutron emission for (n,n*)he3

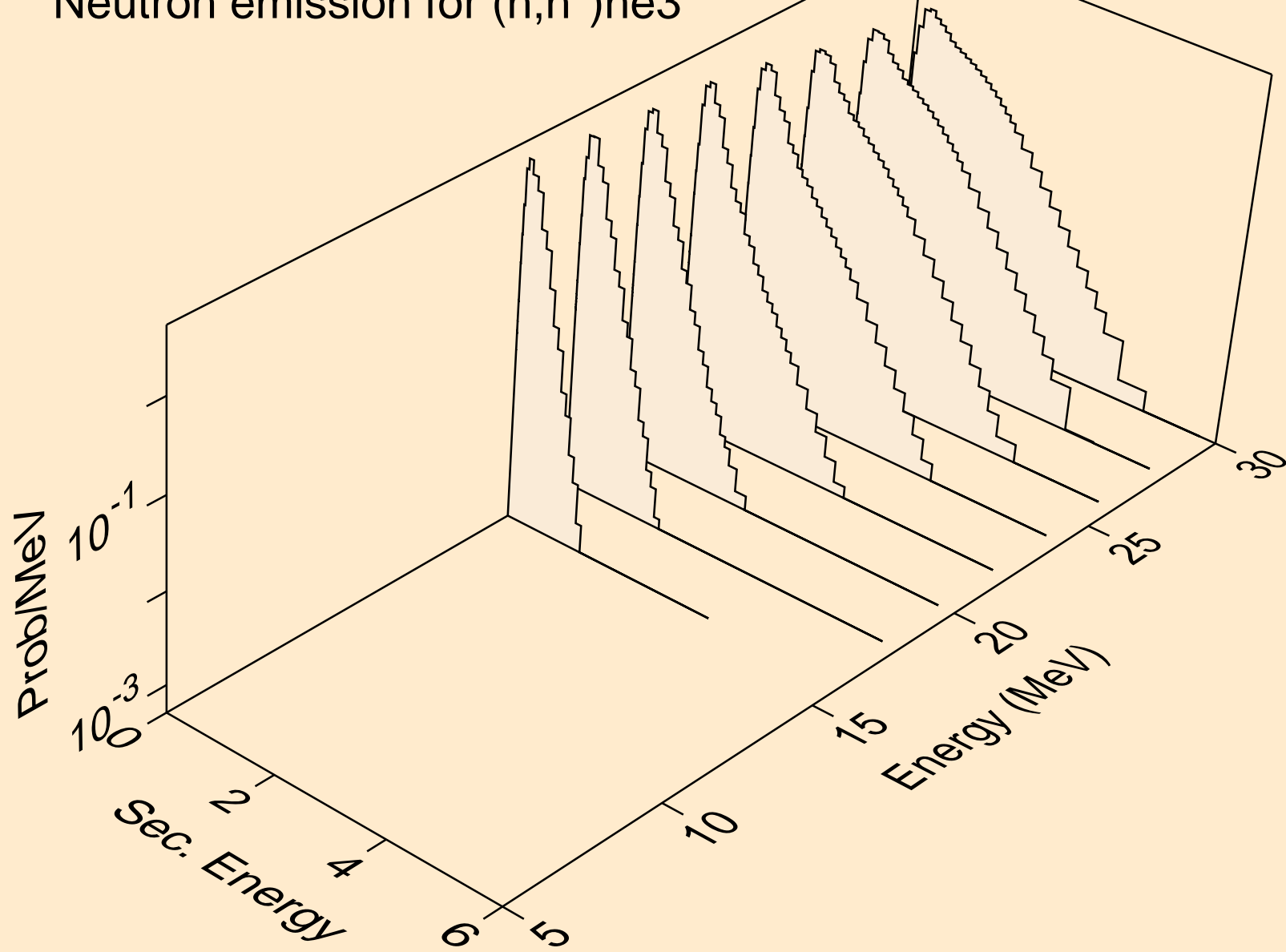

FM246 NEUTRON ACER TENDL-2023 LIBRARY; T=0.K
Neutron emission for (n,4n)

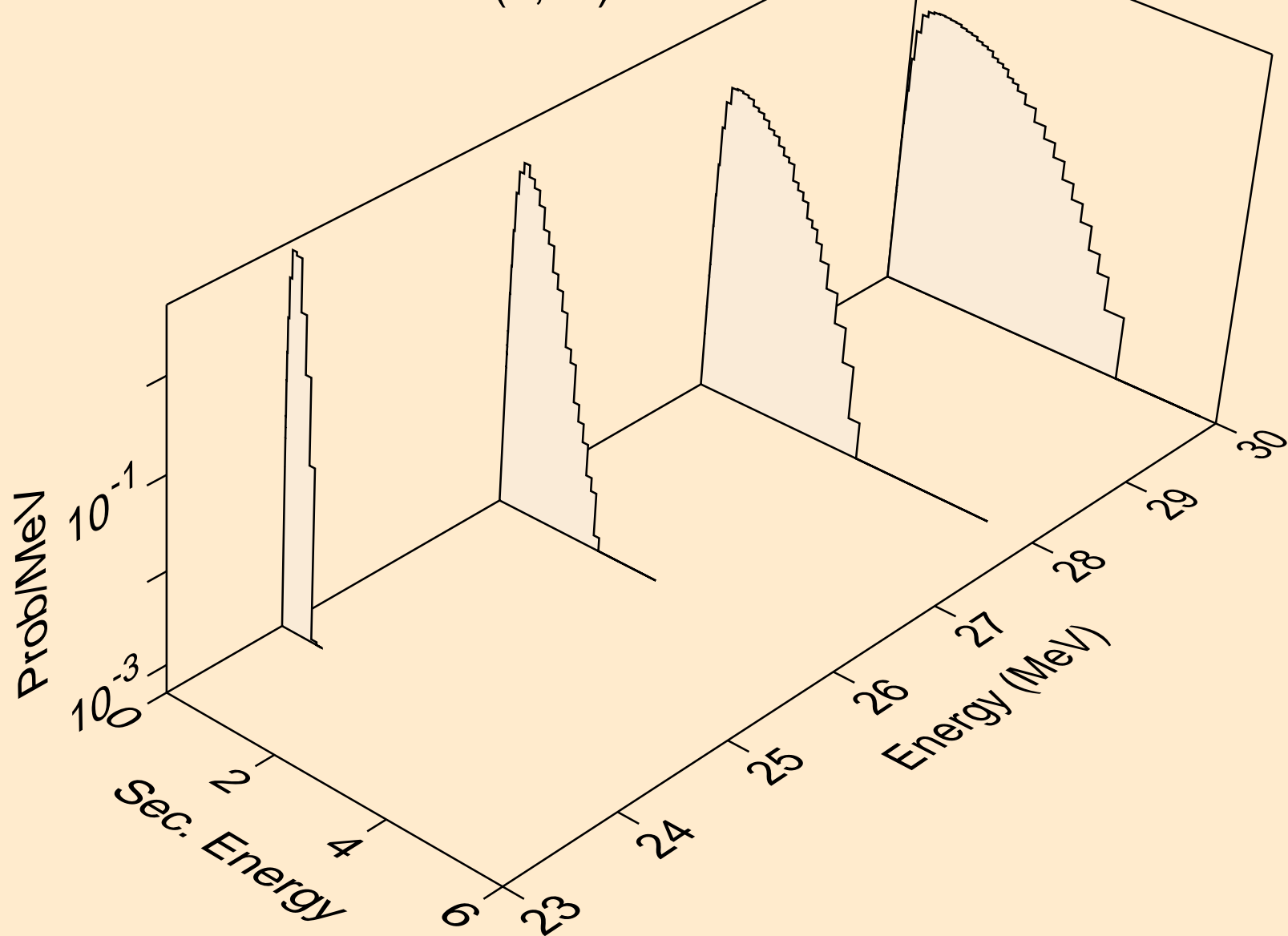

FM246 NEUTRON ACER TENDL-2023 LIBRARY; T=0.K
Neutron emission for (n,2np)

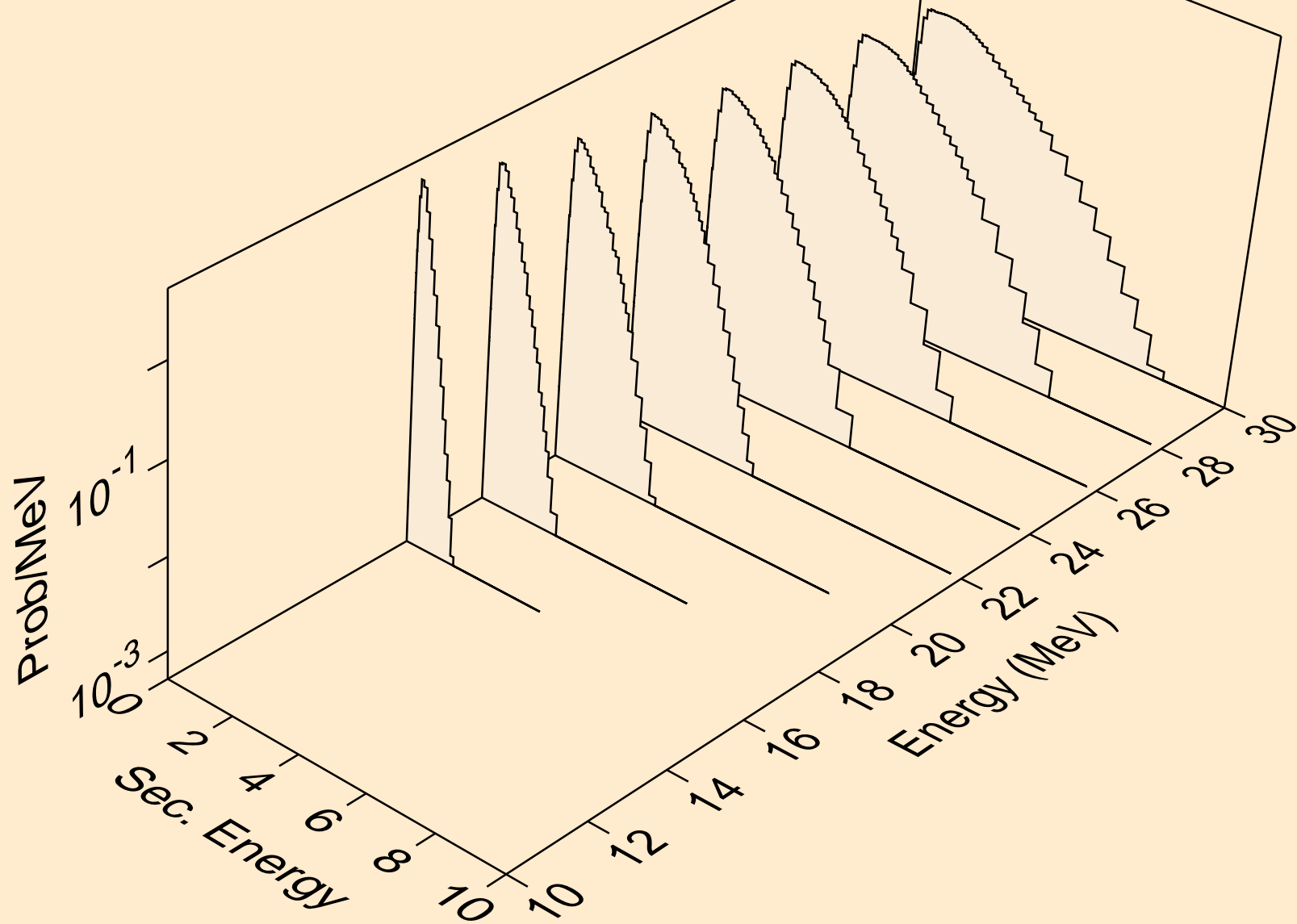

FM246 NEUTRON ACER TENDL-2023 LIBRARY; T=0.K
Neutron emission for (n,n2p)

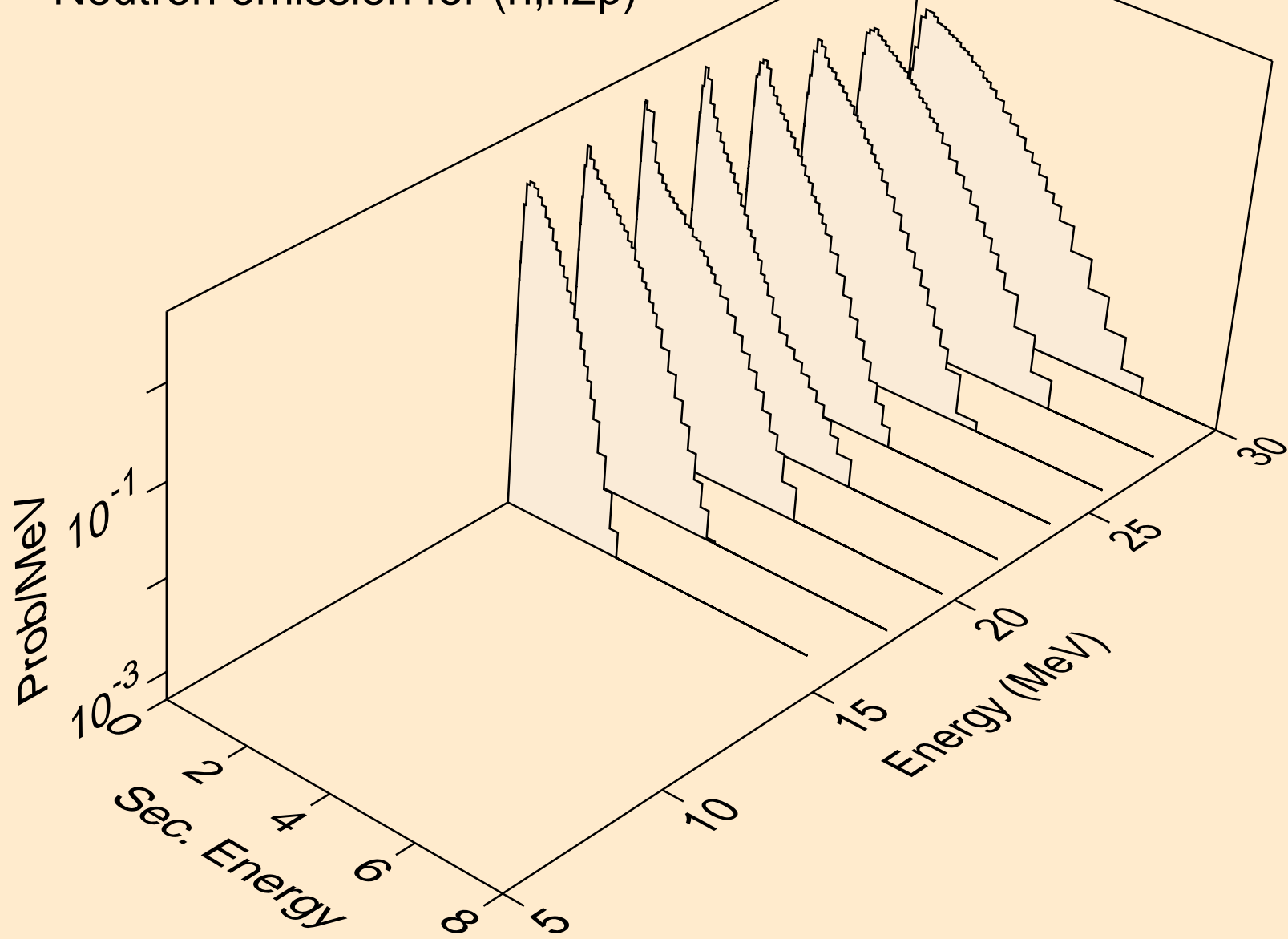

FM246 NEUTRON ACER TENDL-2023 LIBRARY; T=0.K
Neutron emission for (n,n*c)

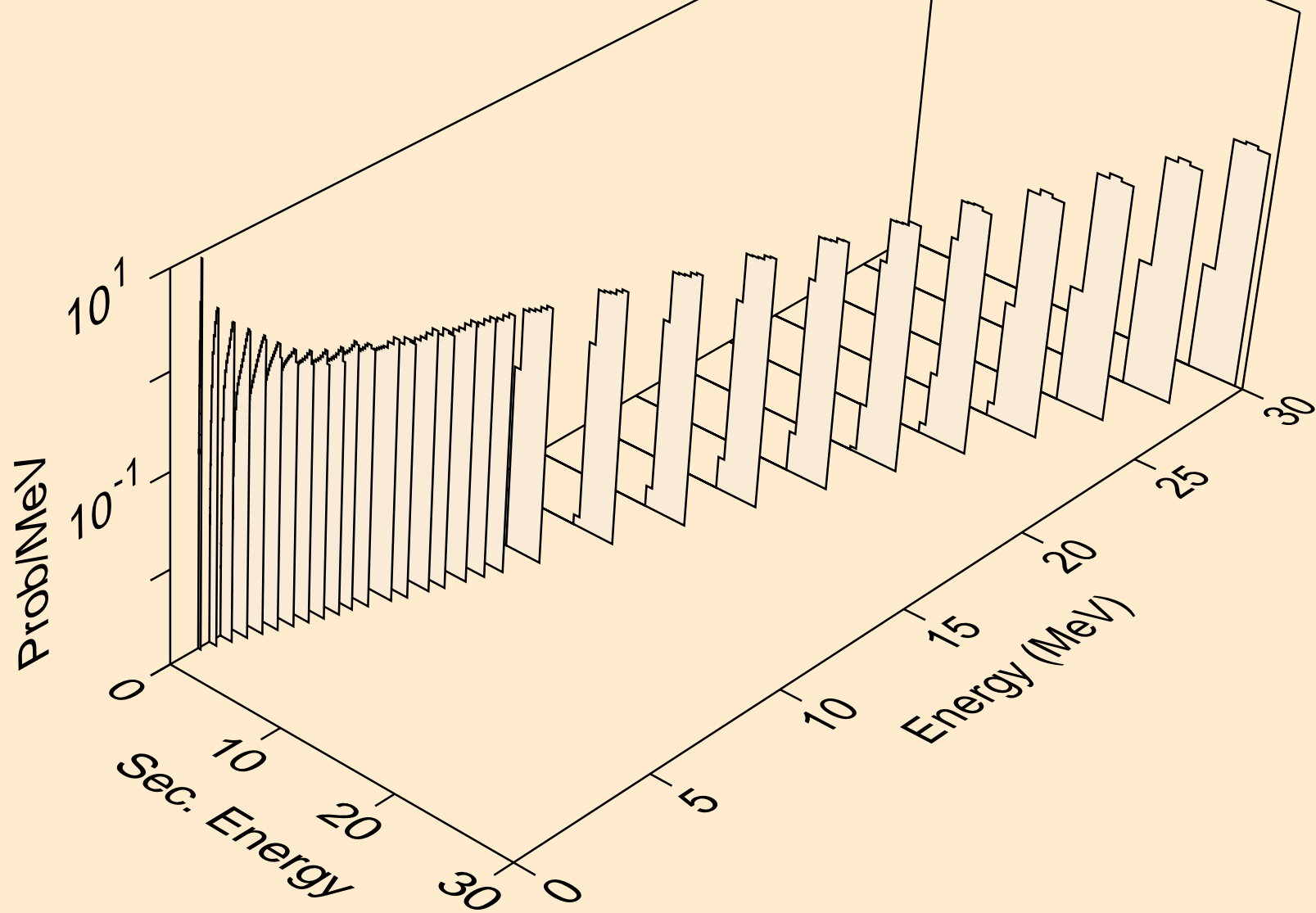

FM246 NEUTRON ACER TENDL-2023 LIBRARY; T=0.K

Delayed nubar

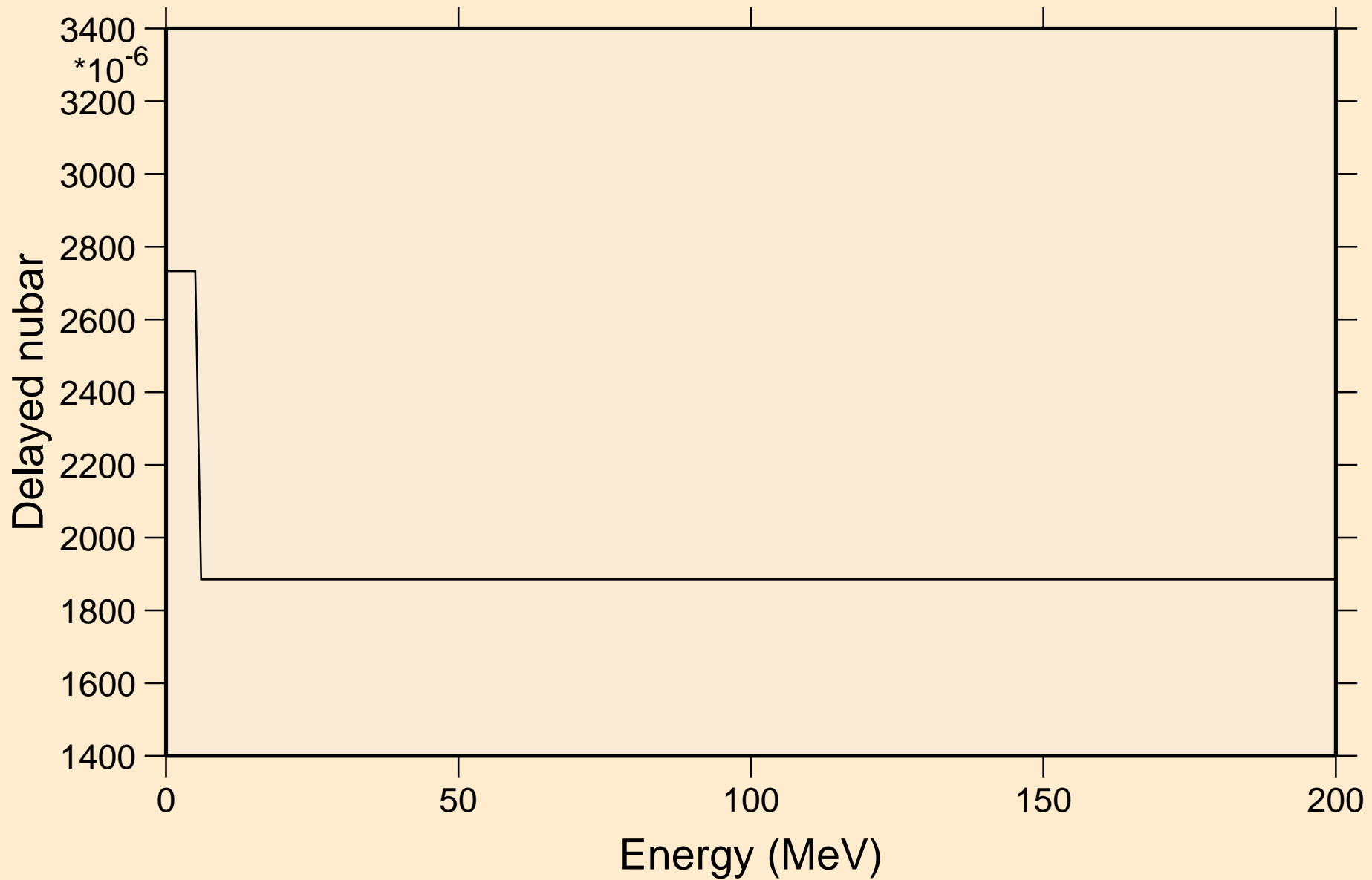

FM246 NEUTRON ACER TENDL-2023 LIBRARY; T=0.K

Delayed neutron spectra

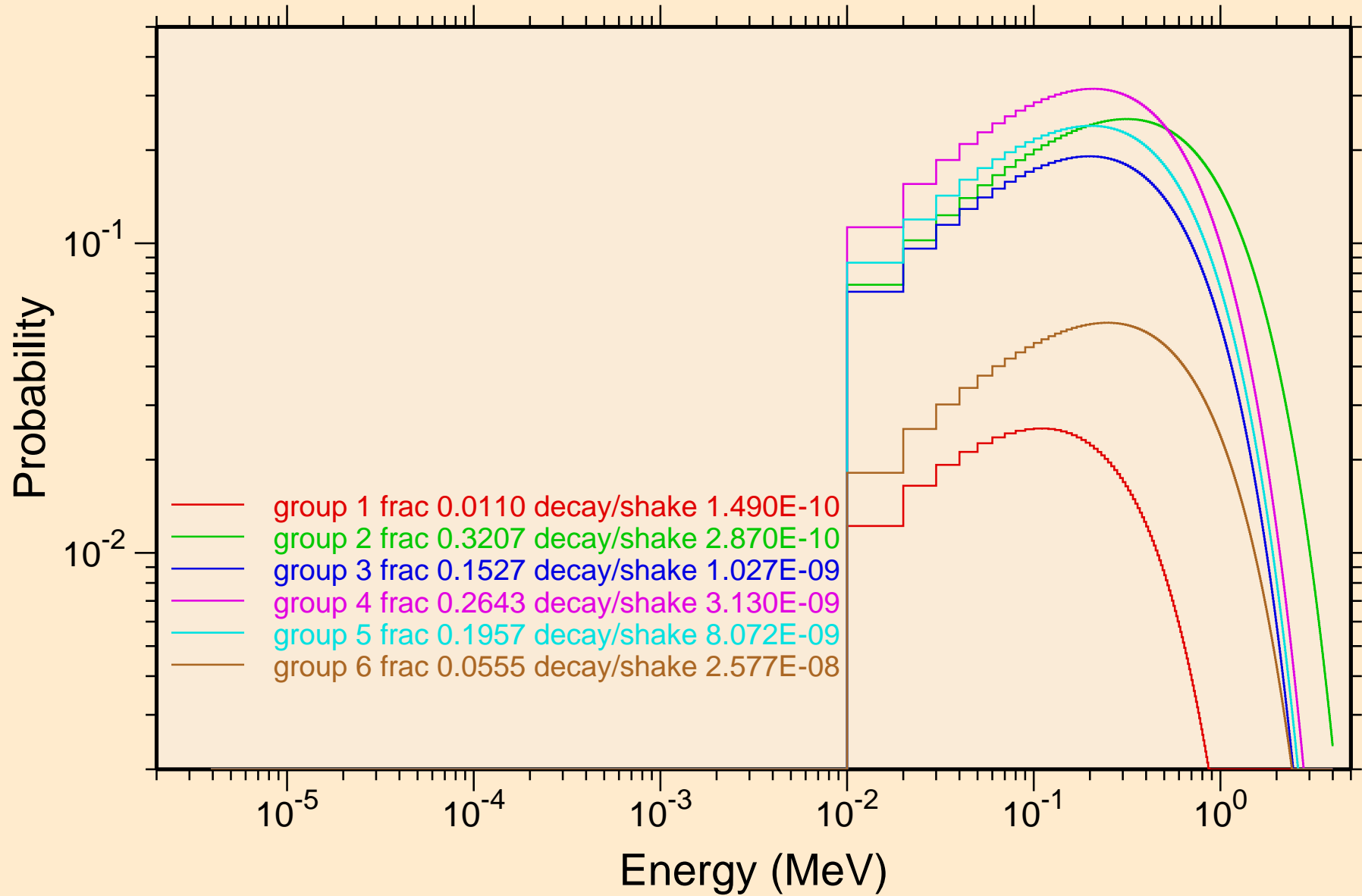

FM246 NEUTRON ACER TENDL-2023 LIBRARY; T=0.K
Photon emission for (n,x)

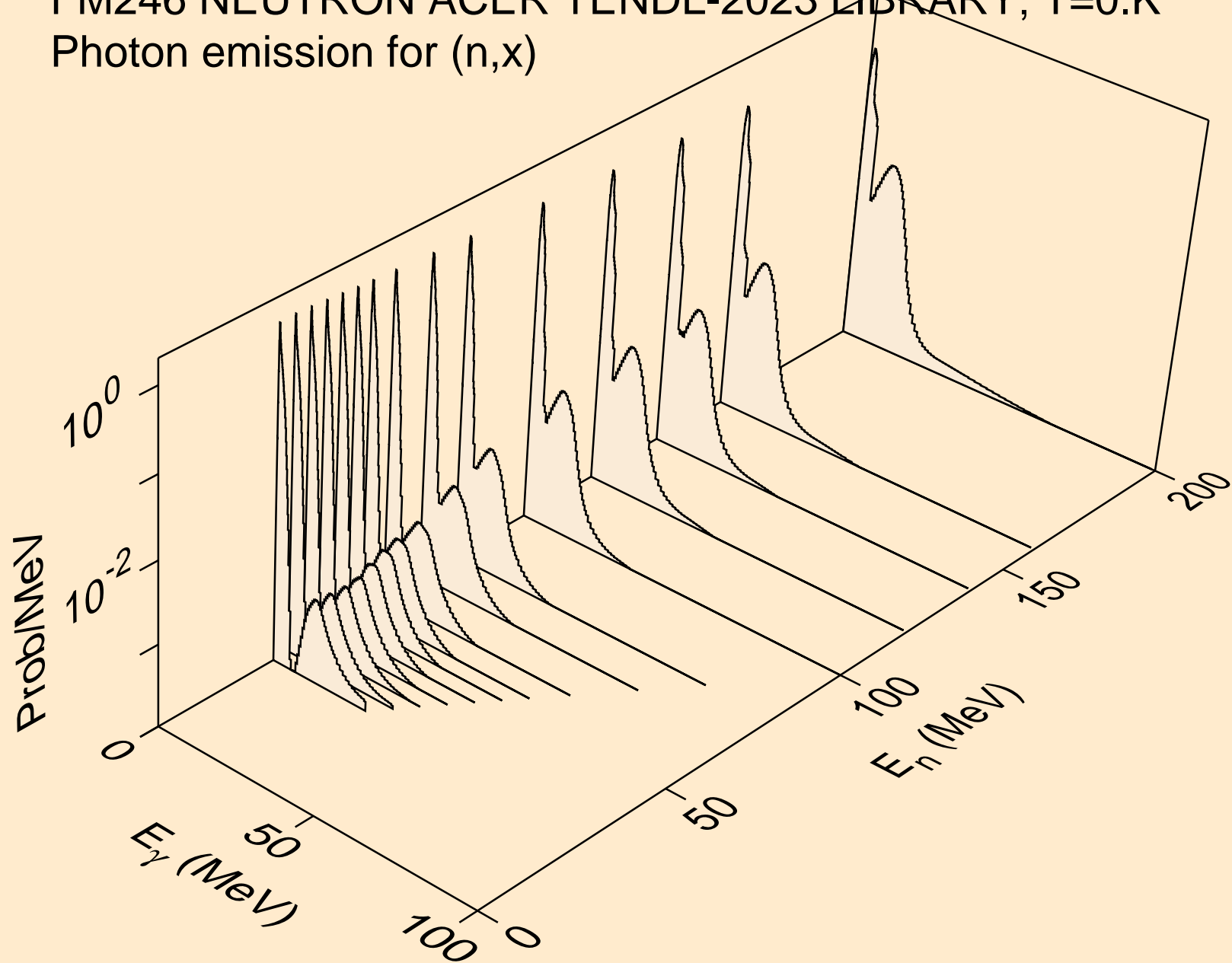

FM246 NEUTRON ACER TENDL-2023 LIBRARY; T=0.K
Photon emission for (n,2n)

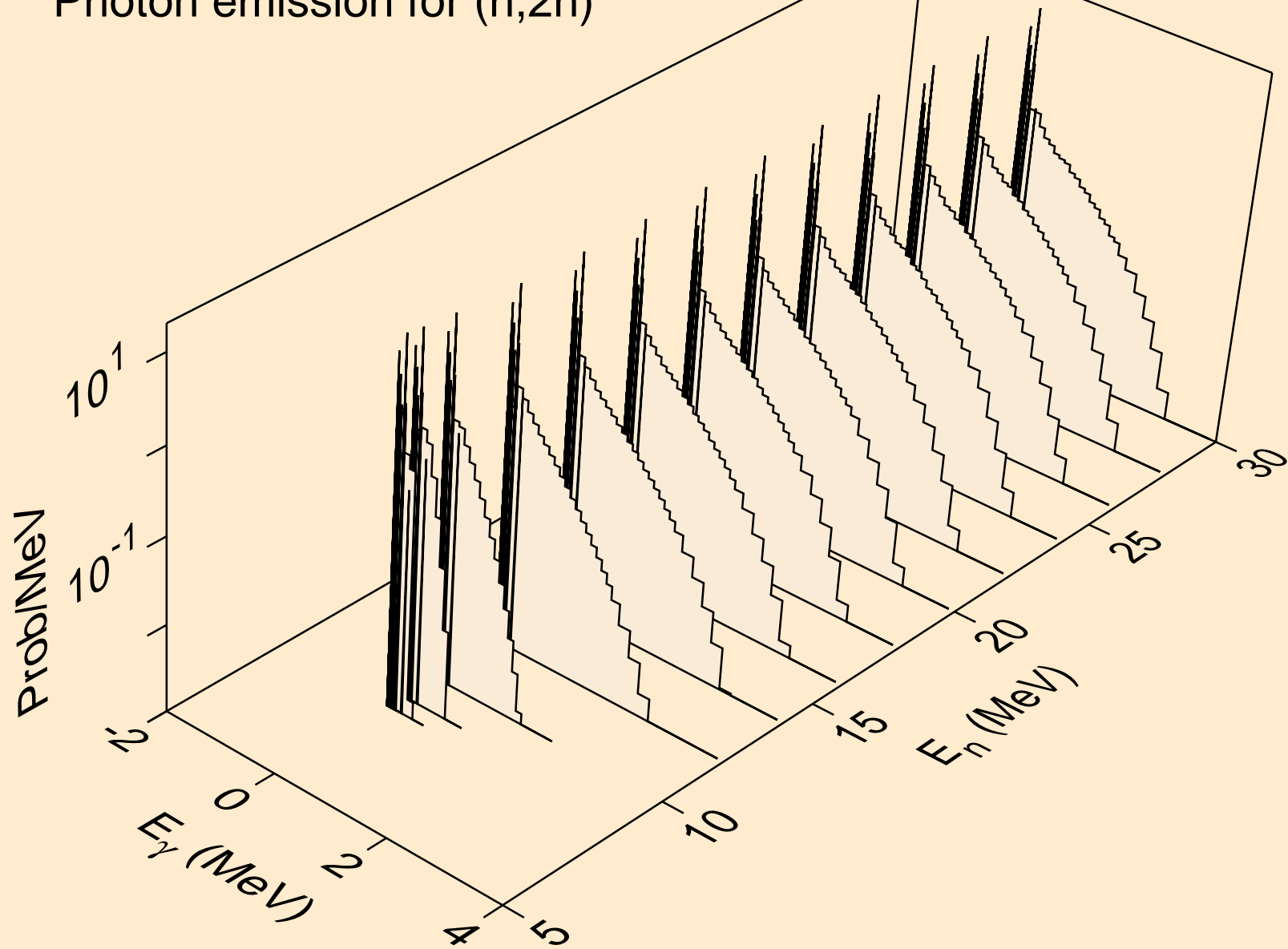

FM246 NEUTRON ACER TENDL-2023 LIBRARY; T=0.K
Photon emission for (n,3n)

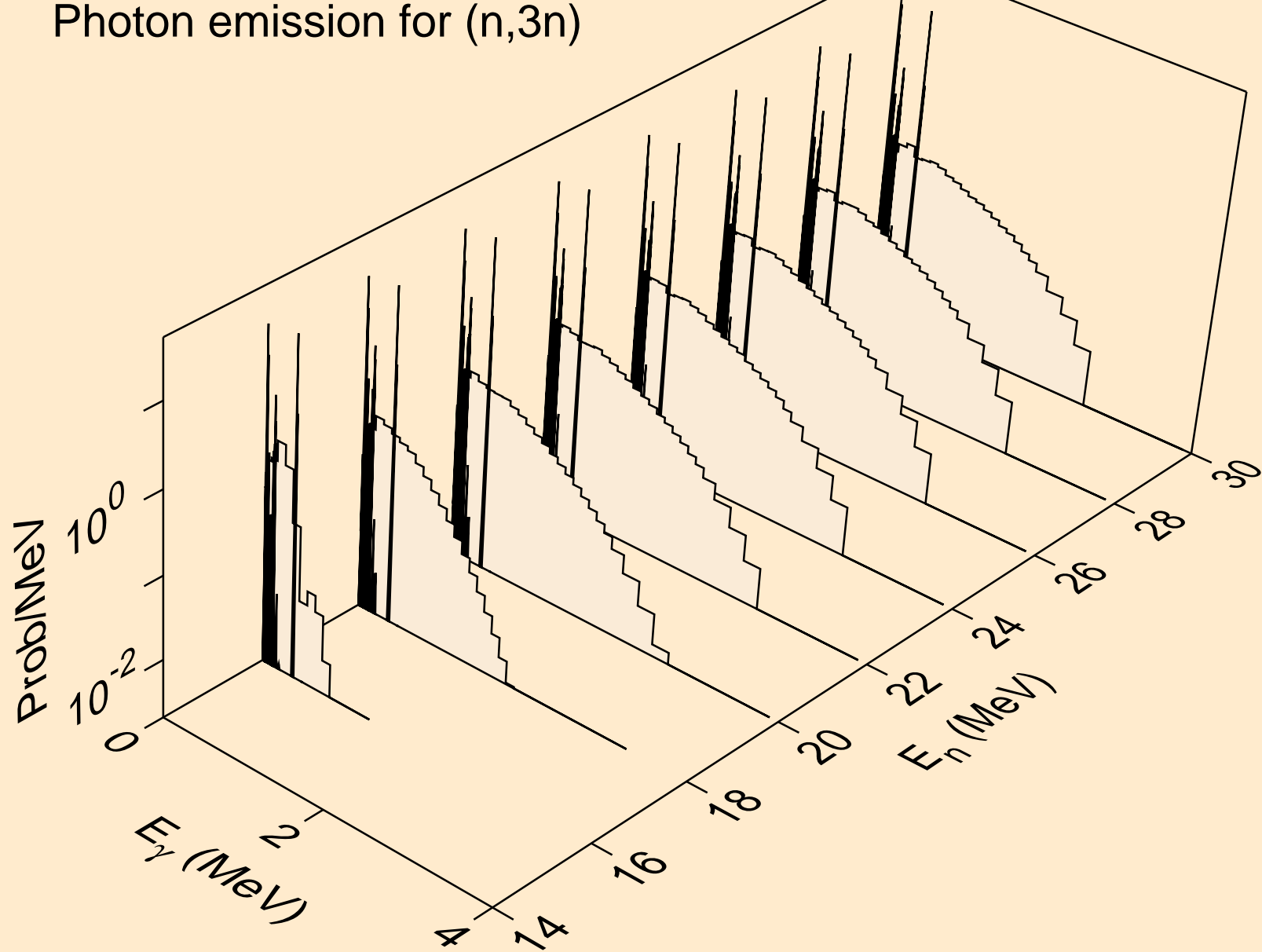

FM246 NEUTRON ACER TENDL-2023 LIBRARY; T=0.K
Photon emission for (n,n*)a

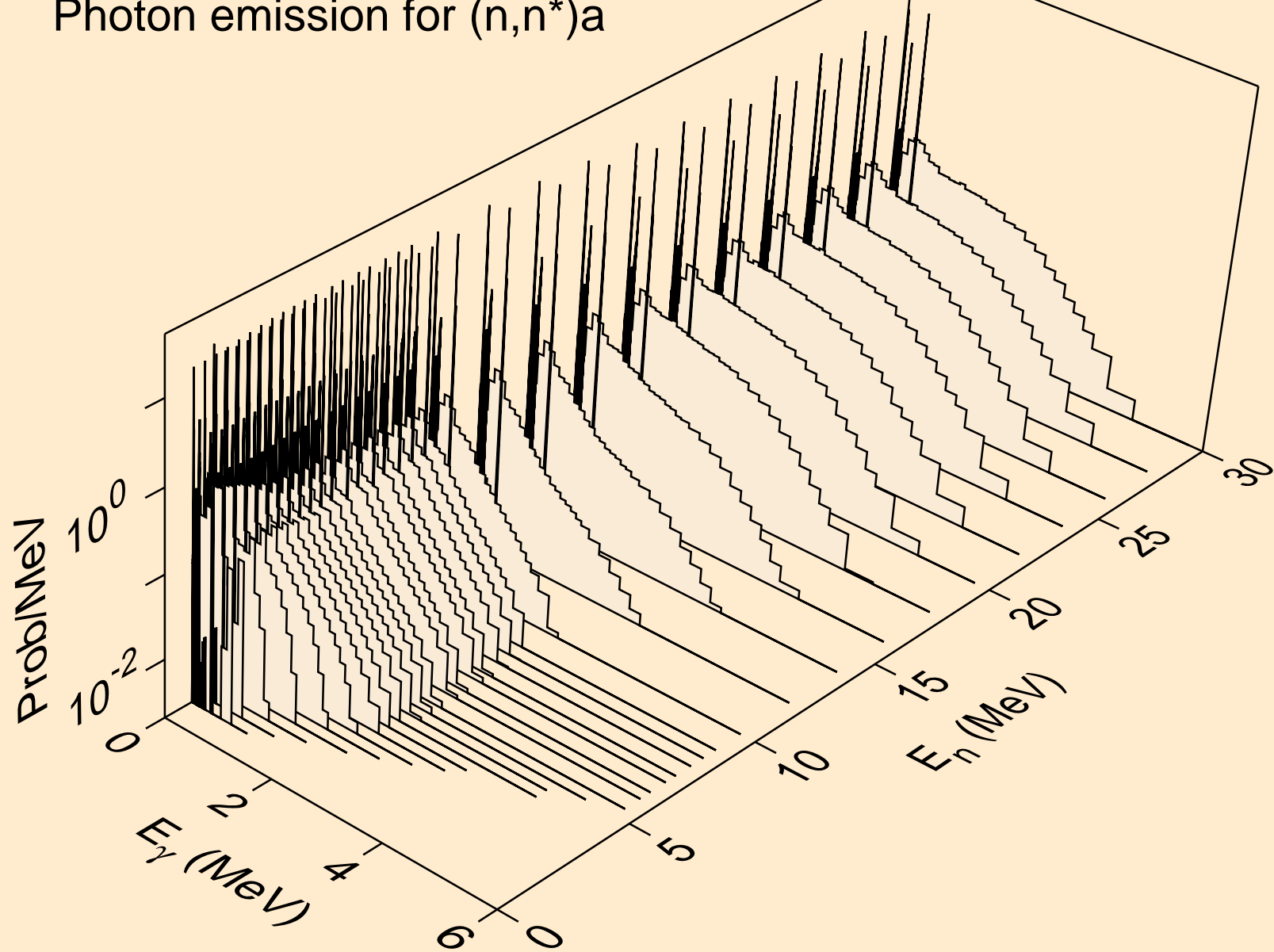

FM246 NEUTRON ACER TENDL-2023 LIBRARY; T=0.K
Photon emission for (n,2n)a

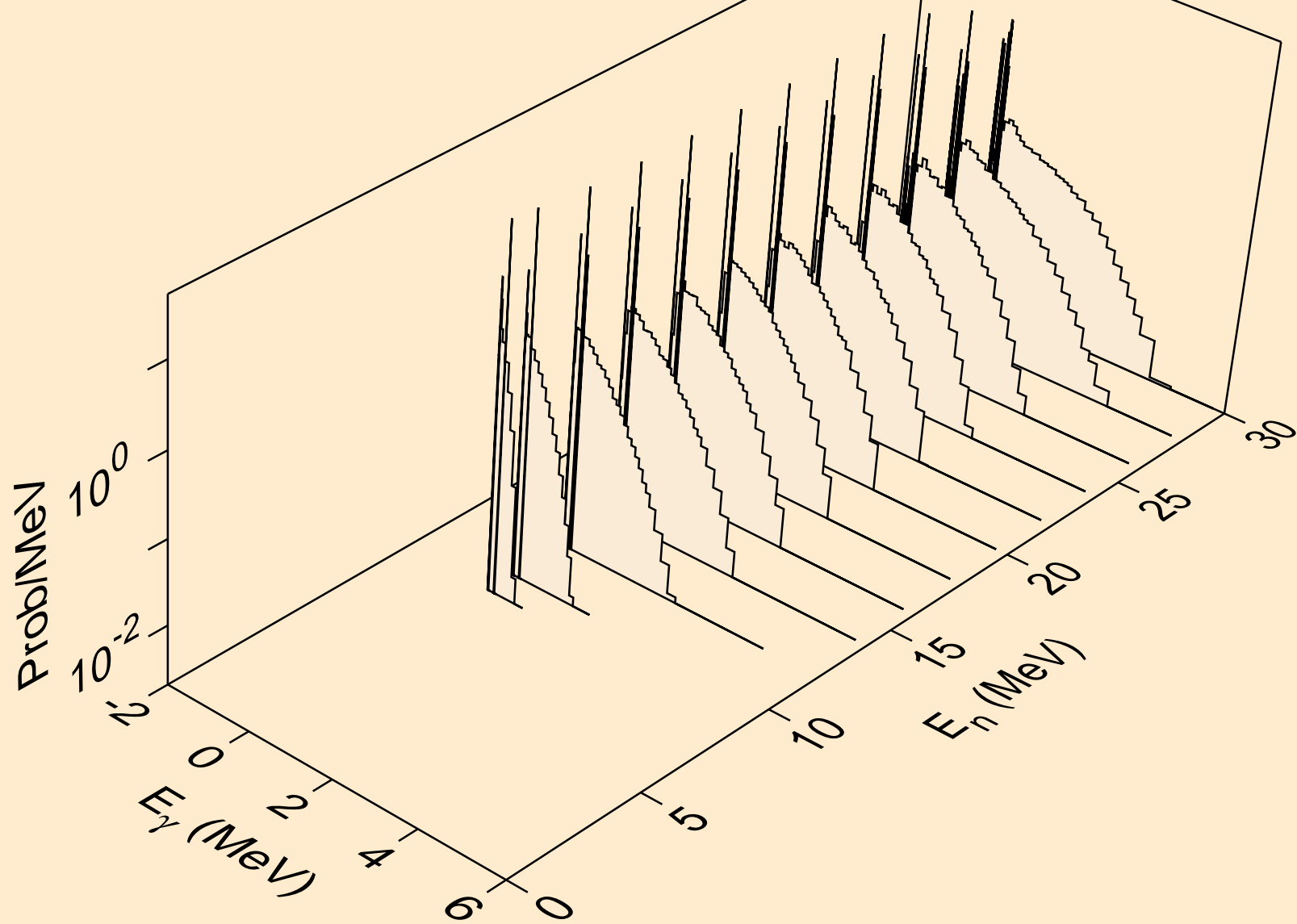

FM246 NEUTRON ACER TENDL-2023 LIBRARY; T=0.K
Photon emission for (n,n*)p

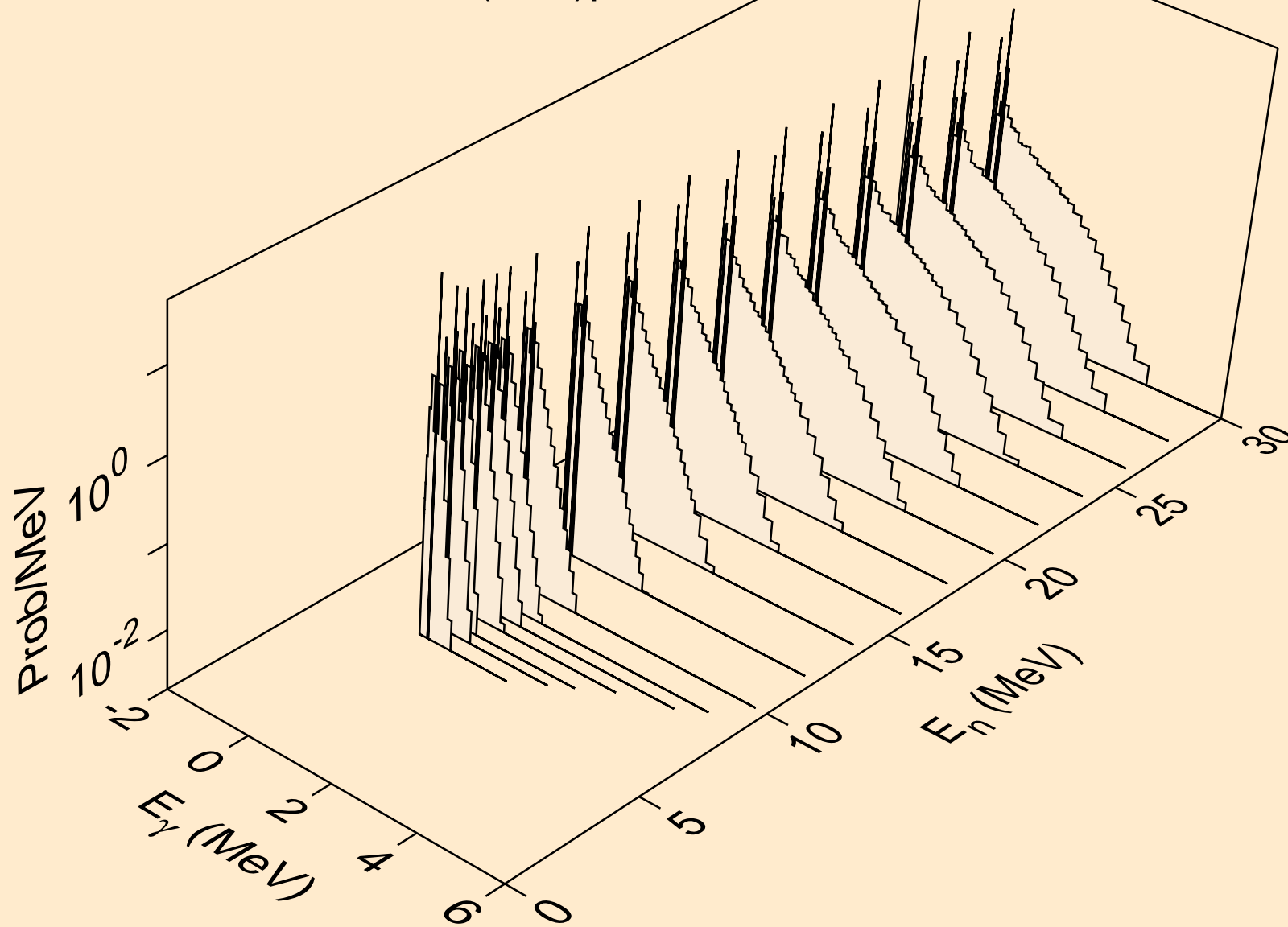

FM246 NEUTRON ACER TENDL-2023 LIBRARY; T=0.K
Photon emission for (n,n*)d

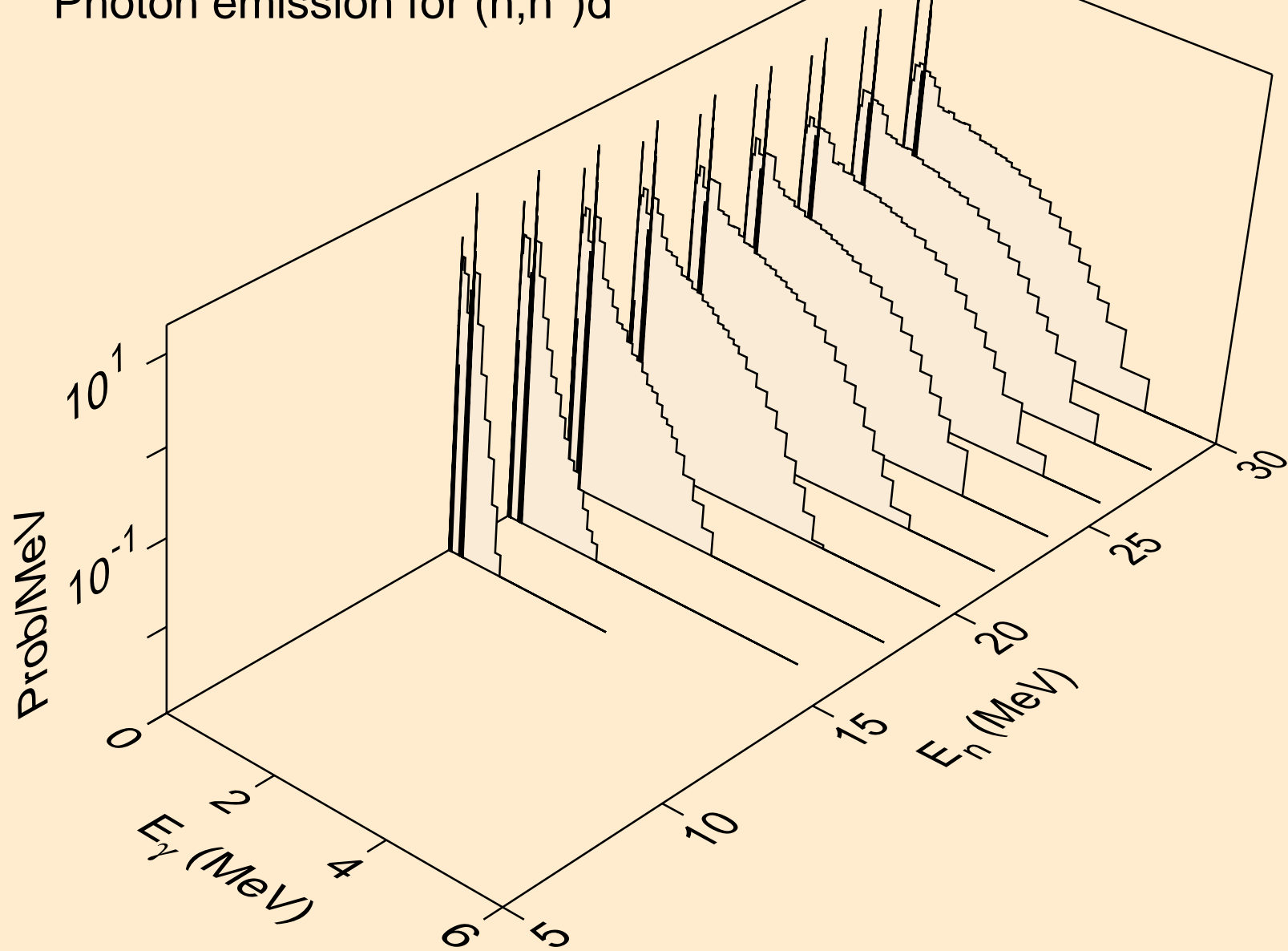

FM246 NEUTRON ACER TENDL-2023 LIBRARY; T=0.K
Photon emission for (n,n*)t

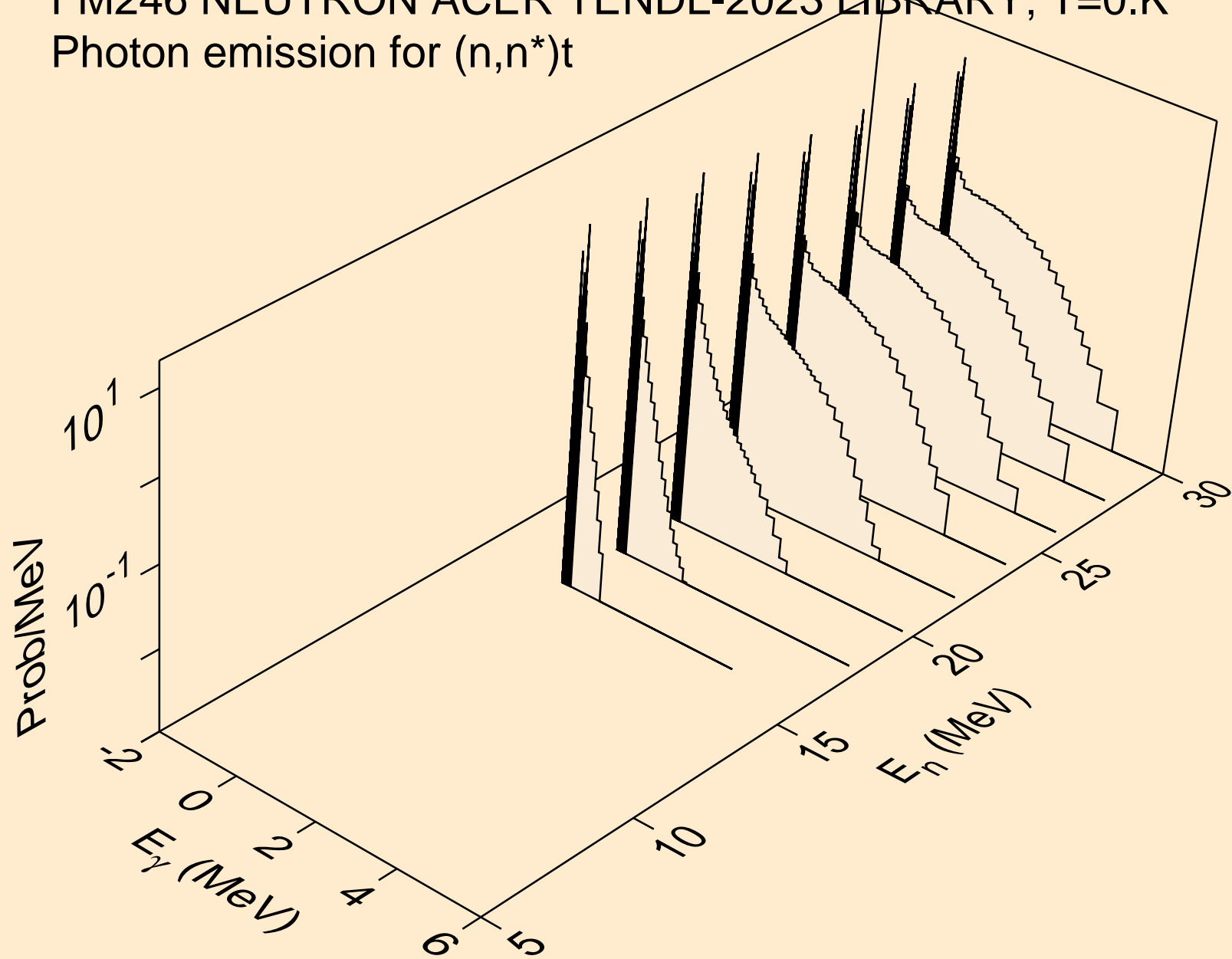

FM246 NEUTRON ACER TENDL-2023 LIBRARY; T=0.K
Photon emission for (n,n*)he3

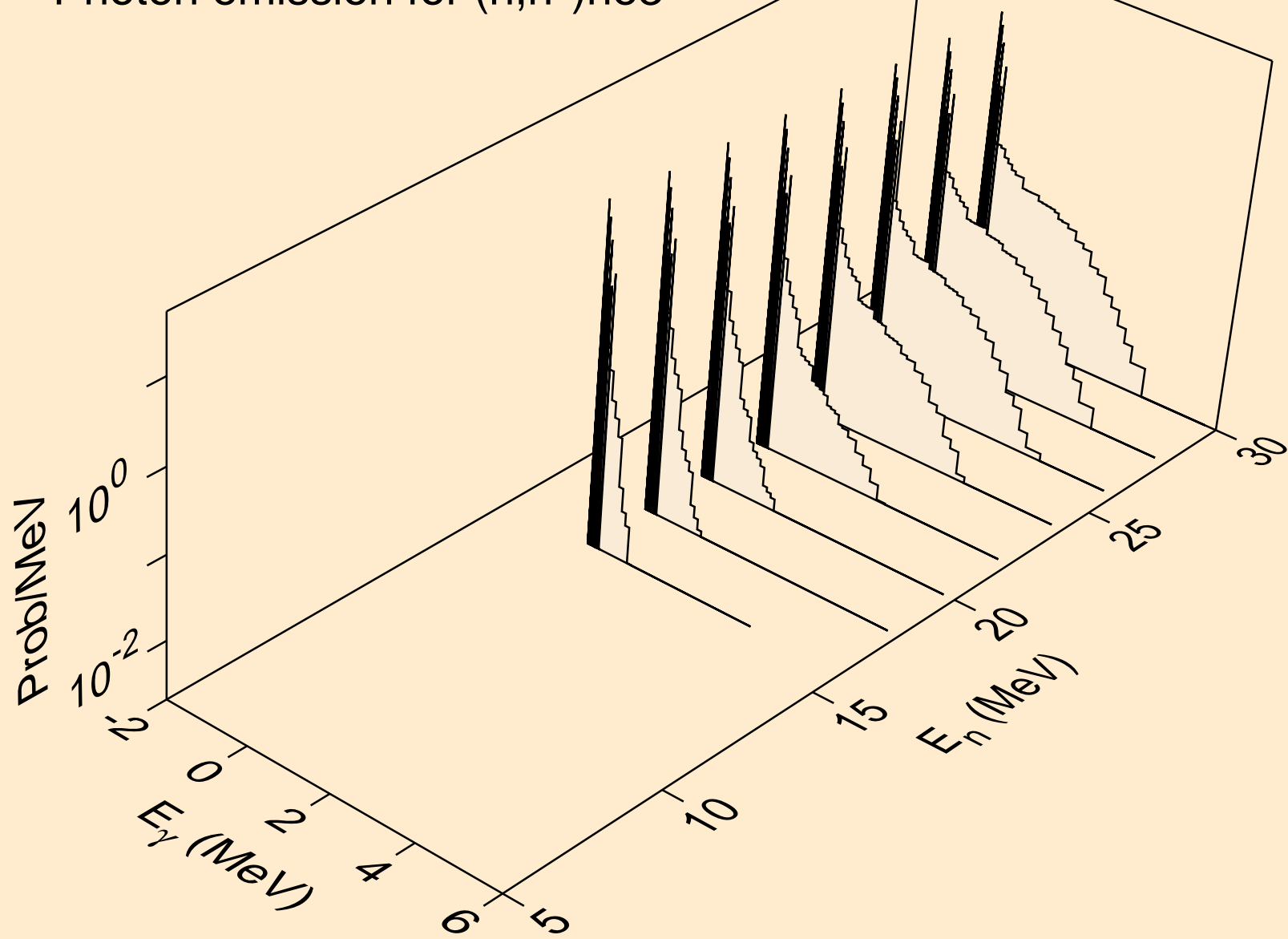

FM246 NEUTRON ACER TENDL-2023 LIBRARY; T=0.K
Photon emission for (n,4n)

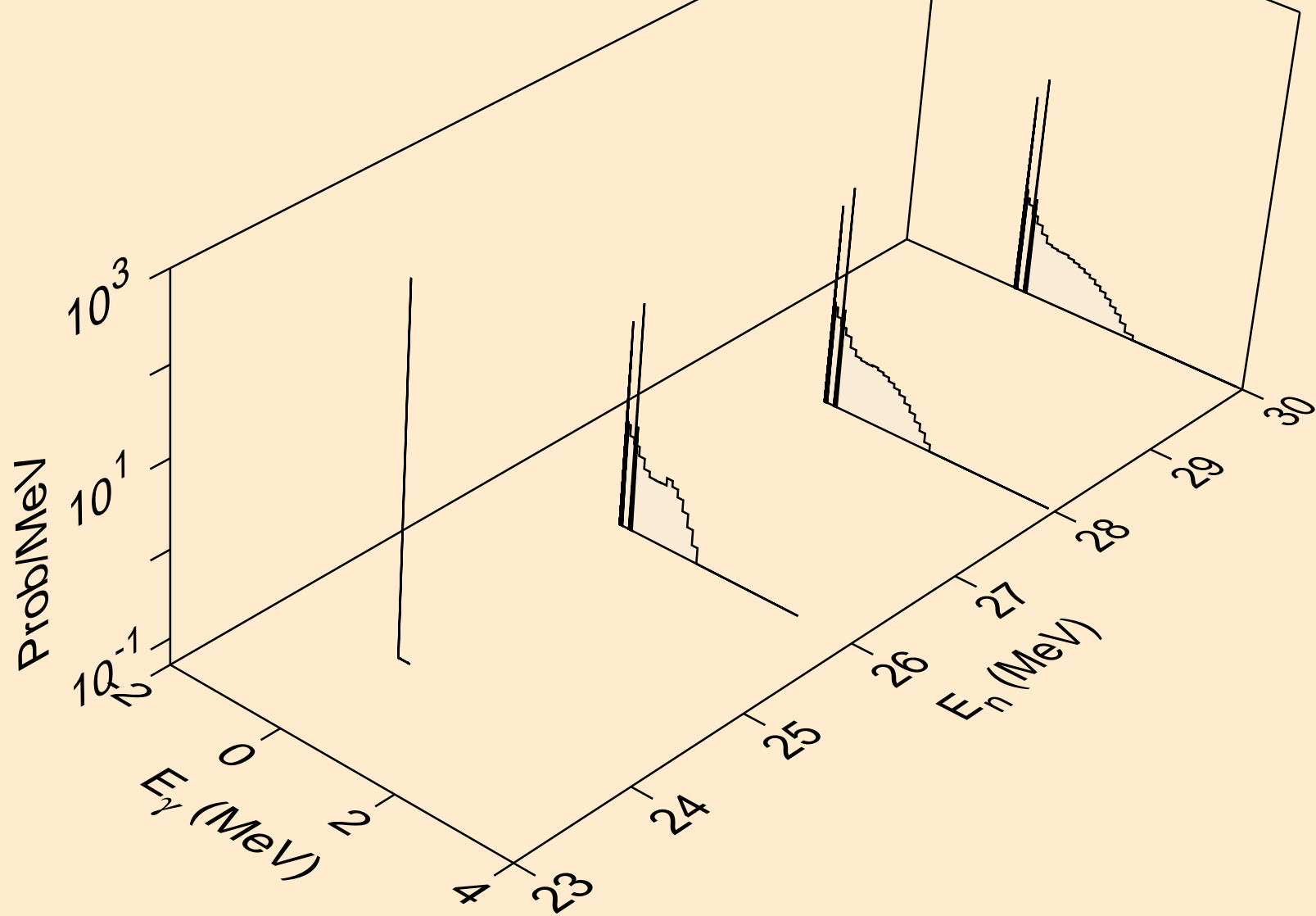

FM246 NEUTRON ACER TENDL-2023 LIBRARY; T=0.K
Photon emission for (n,2np)

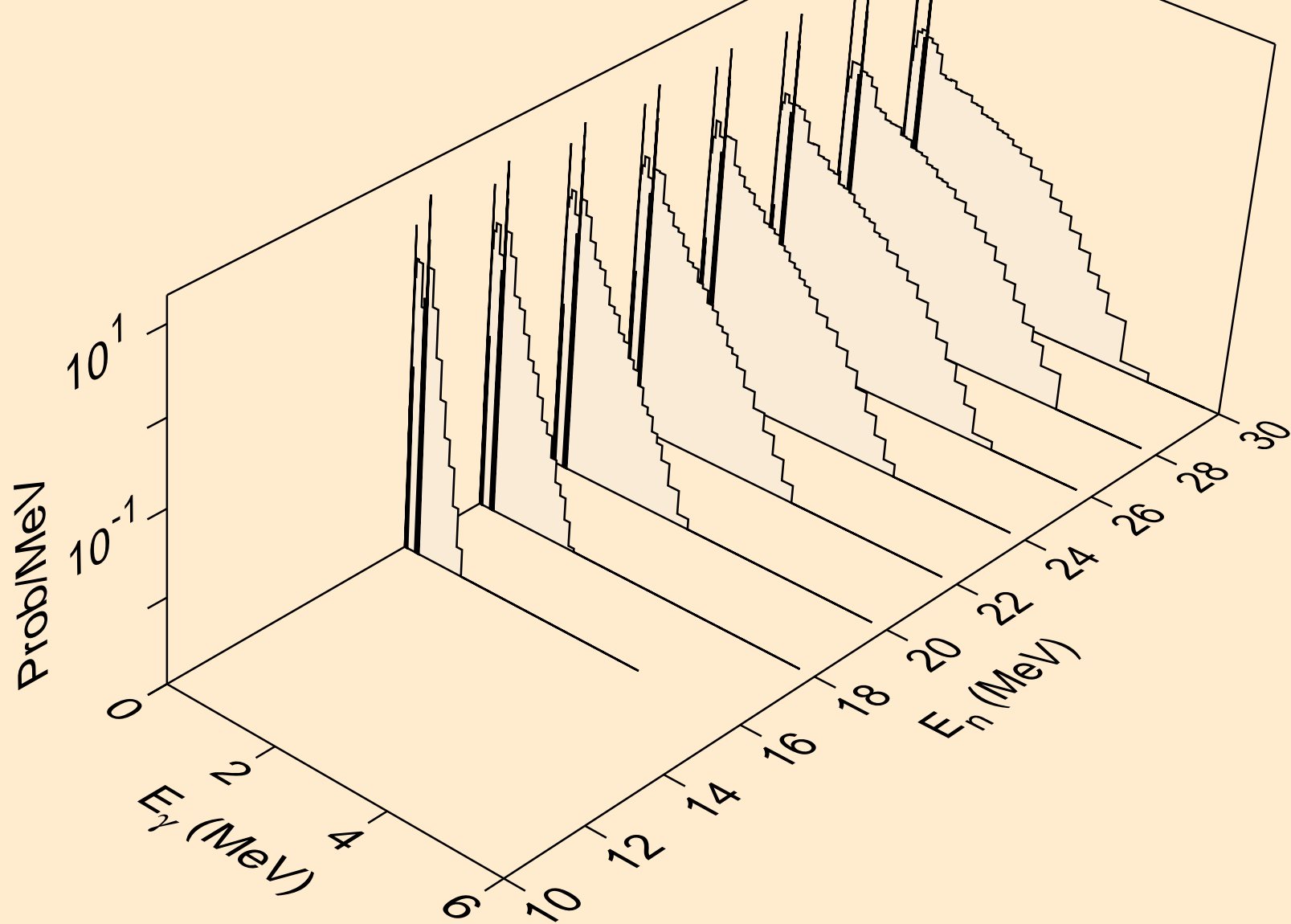

FM246 NEUTRON ACER TENDL-2023 LIBRARY; T=0.K
Photon emission for (n,n2p)

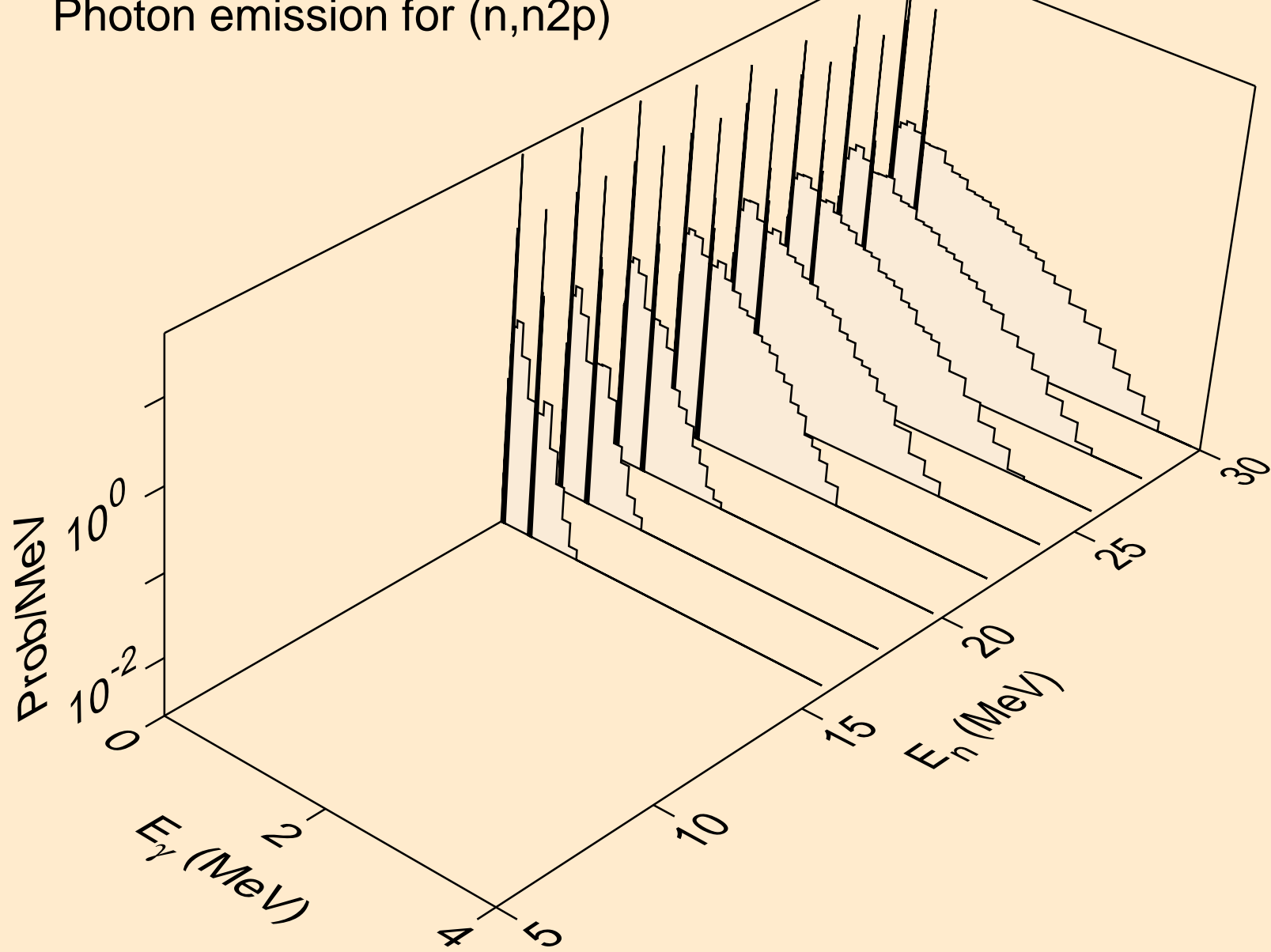

FM246 NEUTRON ACER TENDL-2023 LIBRARY; T=0.K
Photon emission for (n,n*c)

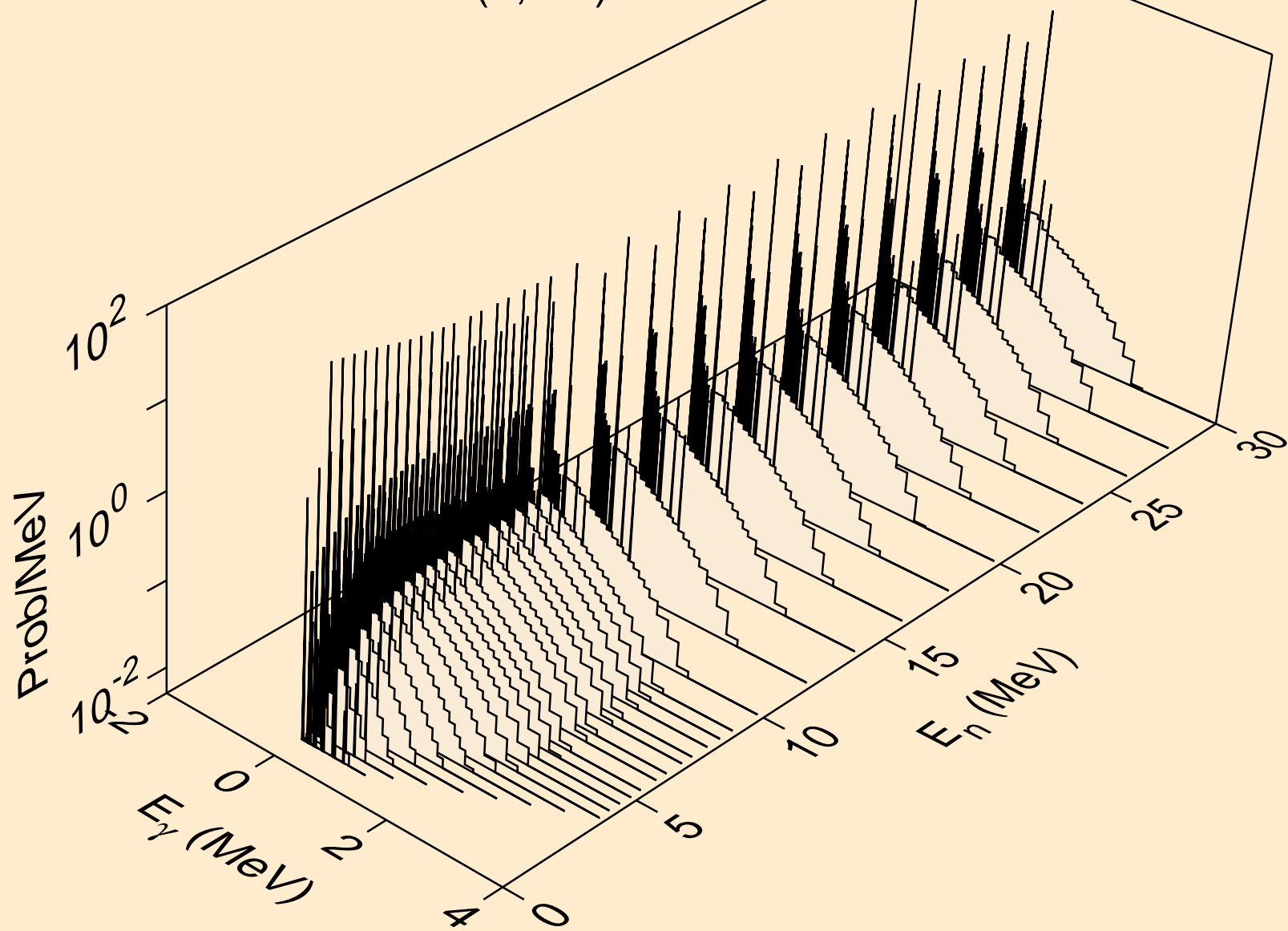

FM246 NEUTRON ACER TENDL-2023 LIBRARY; T=0.K
Photon emission for (n,gma)

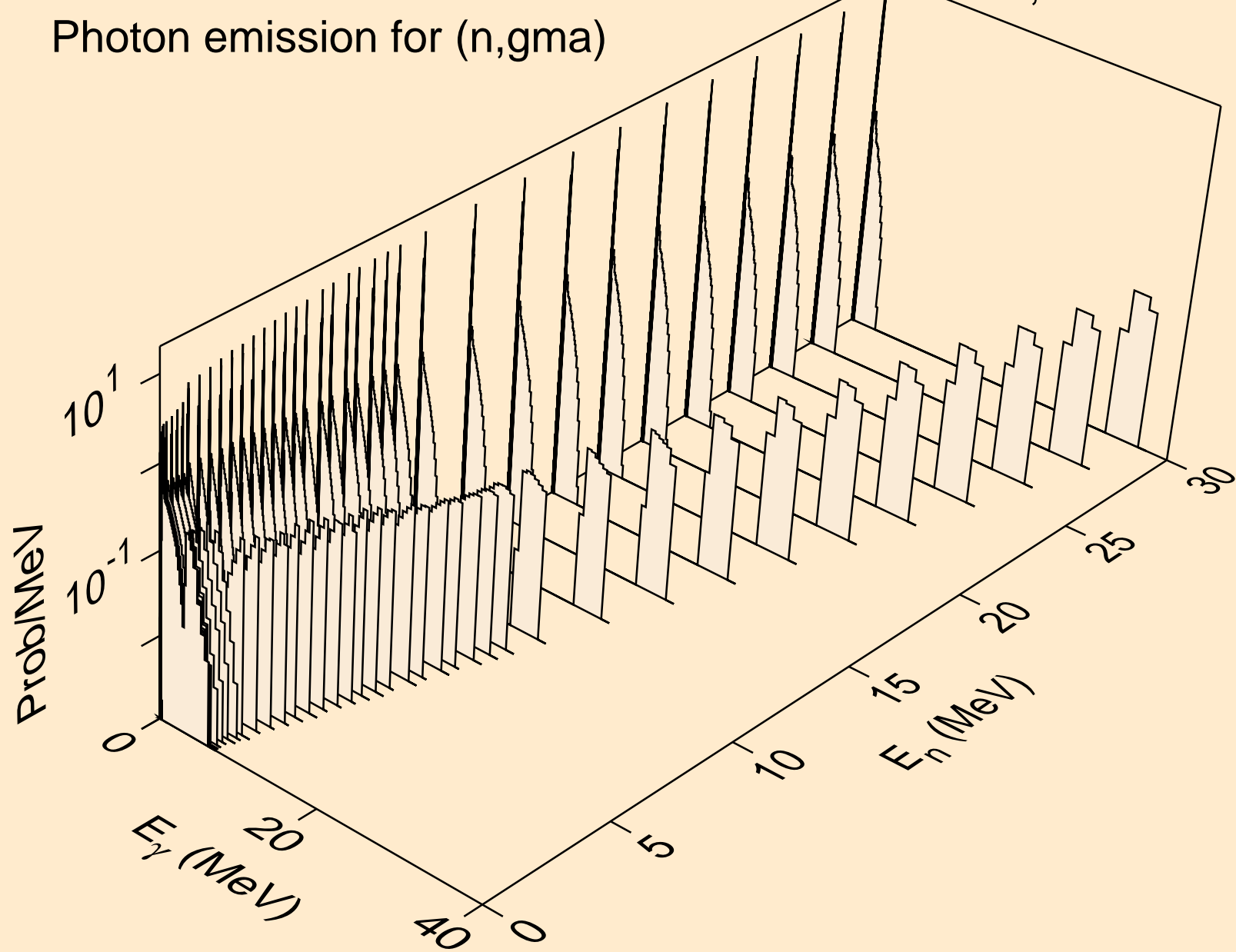

FM246 NEUTRON ACER TENDL-2023 LIBRARY; T=0.K
Photon emission for (n,p)

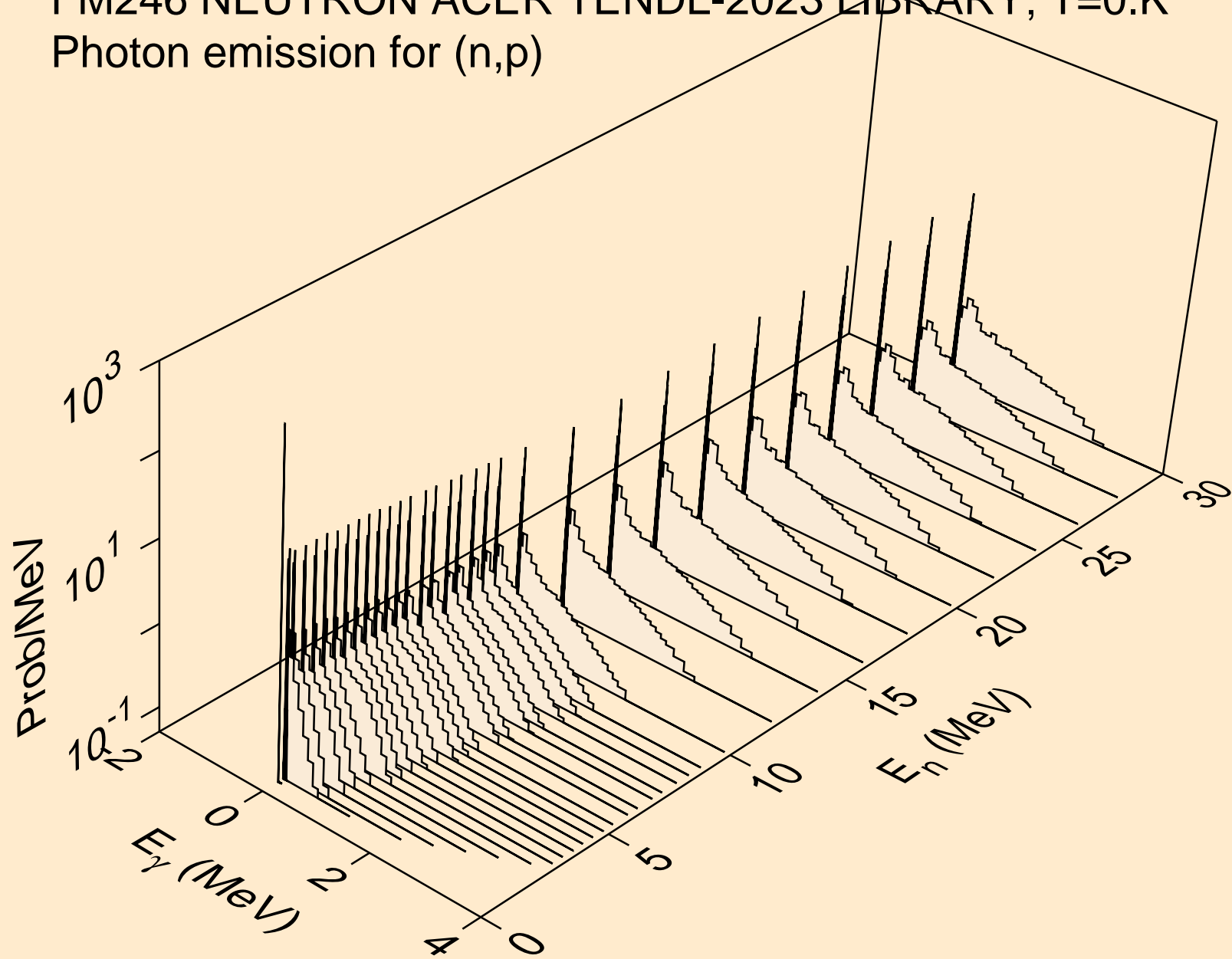

FM246 NEUTRON ACER TENDL-2023 LIBRARY; T=0.K
Photon emission for (n,d)

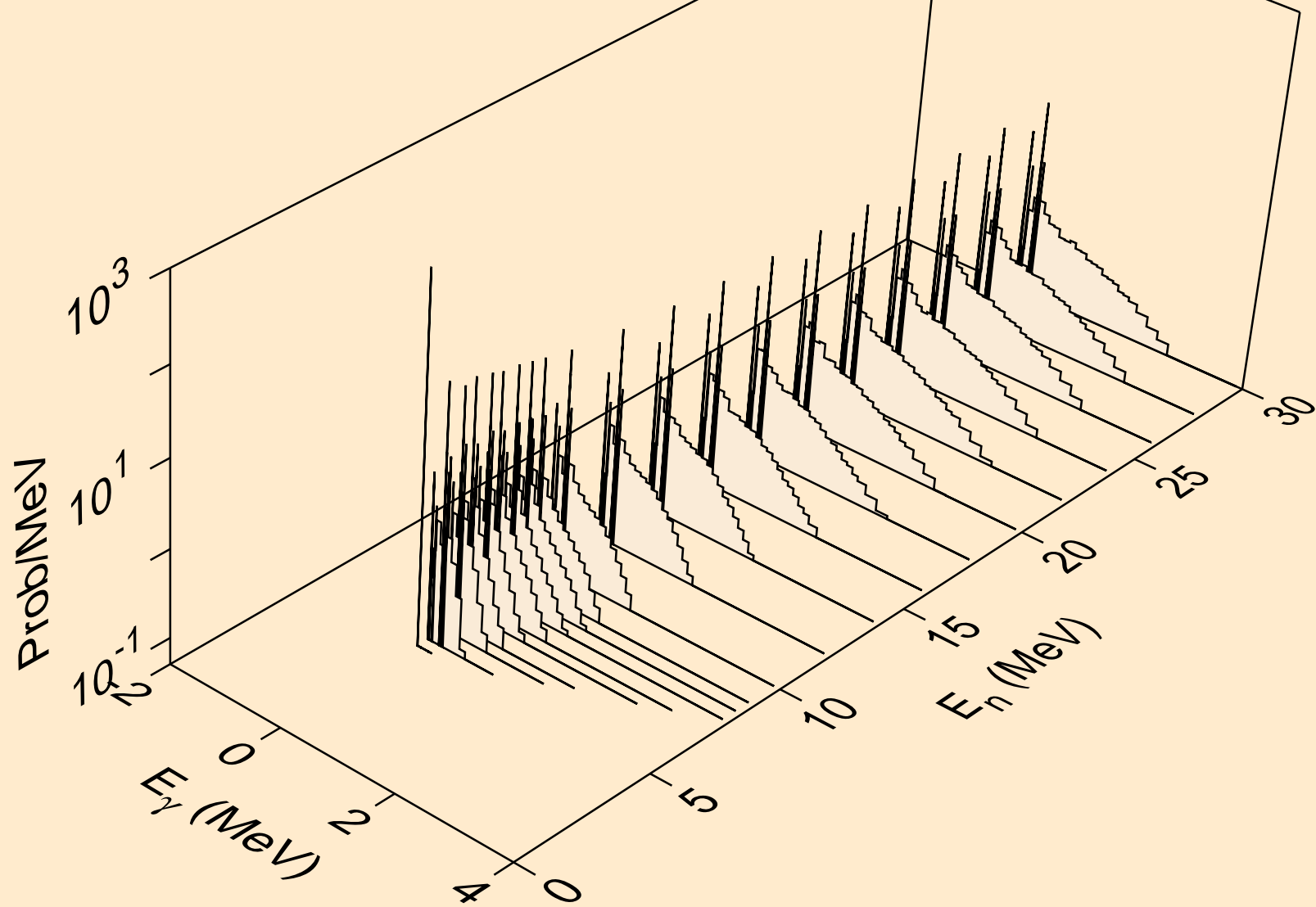

FM246 NEUTRON ACER TENDL-2023 LIBRARY; T=0.K
Photon emission for (n,t)

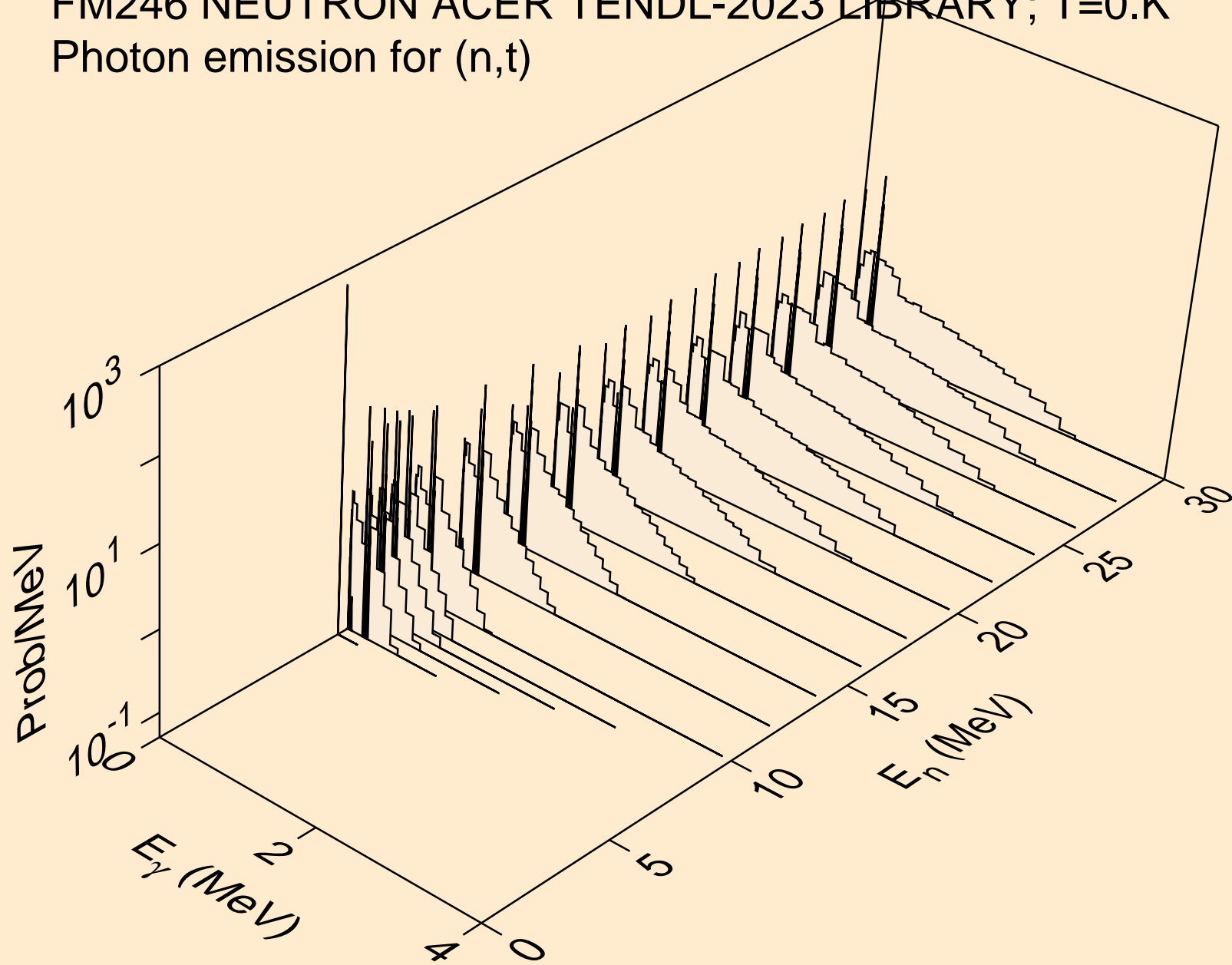

FM246 NEUTRON ACER TENDL-2023 LIBRARY; T=0.K
Photon emission for (n,he3)

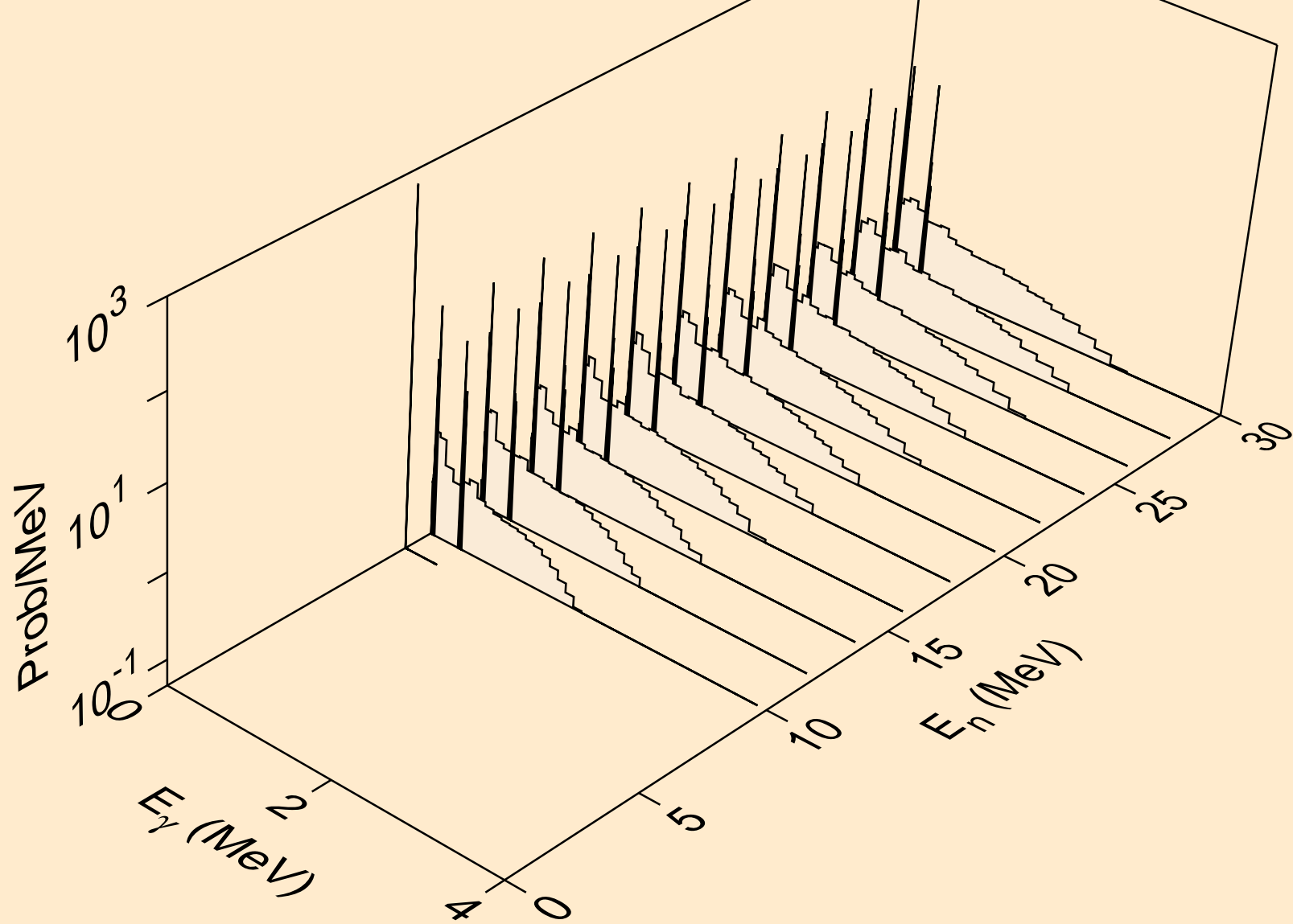

FM246 NEUTRON ACER TENDL-2023 LIBRARY; T=0.K
Photon emission for (n,a)

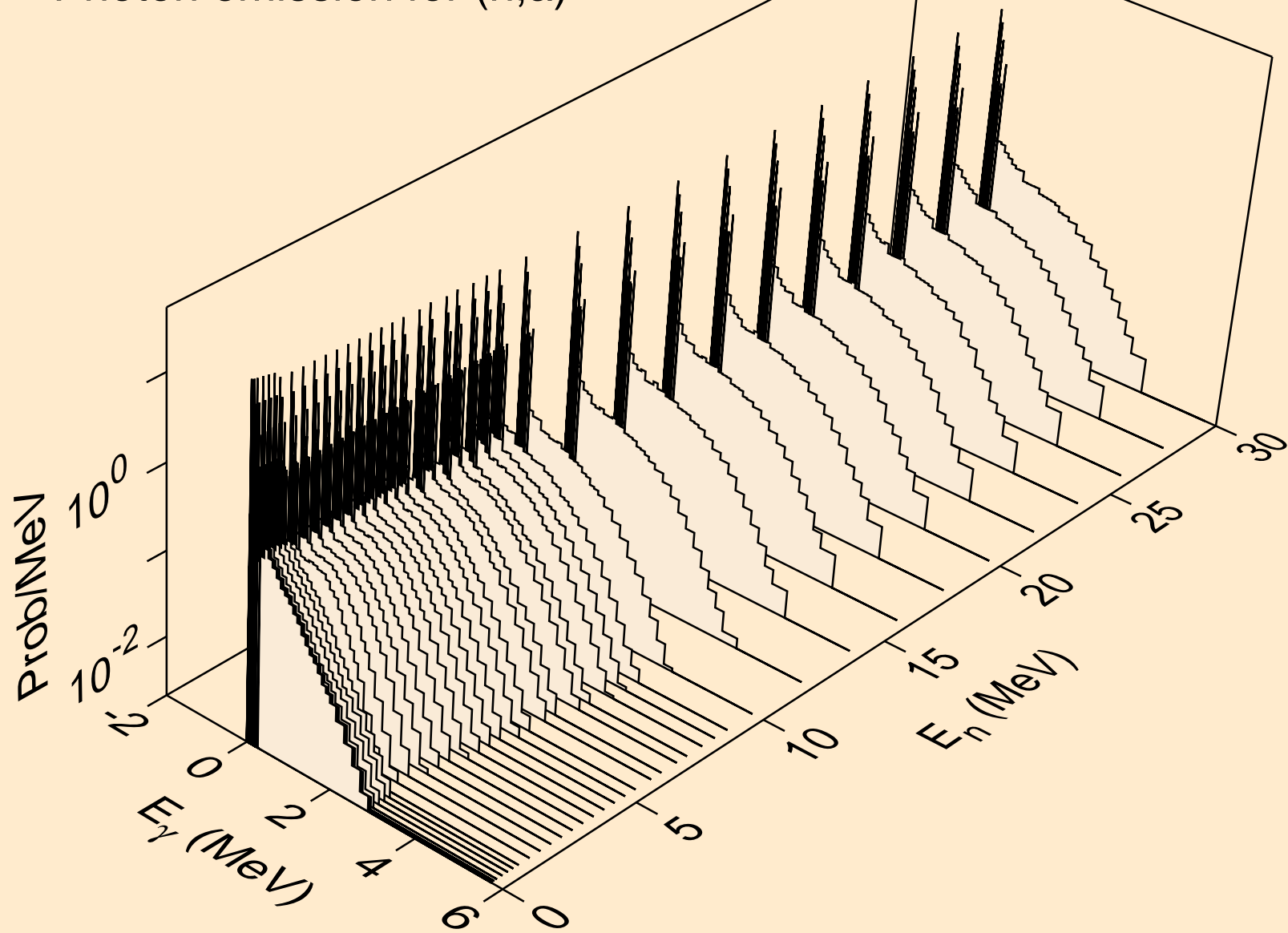

FM246 NEUTRON ACER TENDL-2023 LIBRARY; T=0.K
Photon emission for (n,2a)

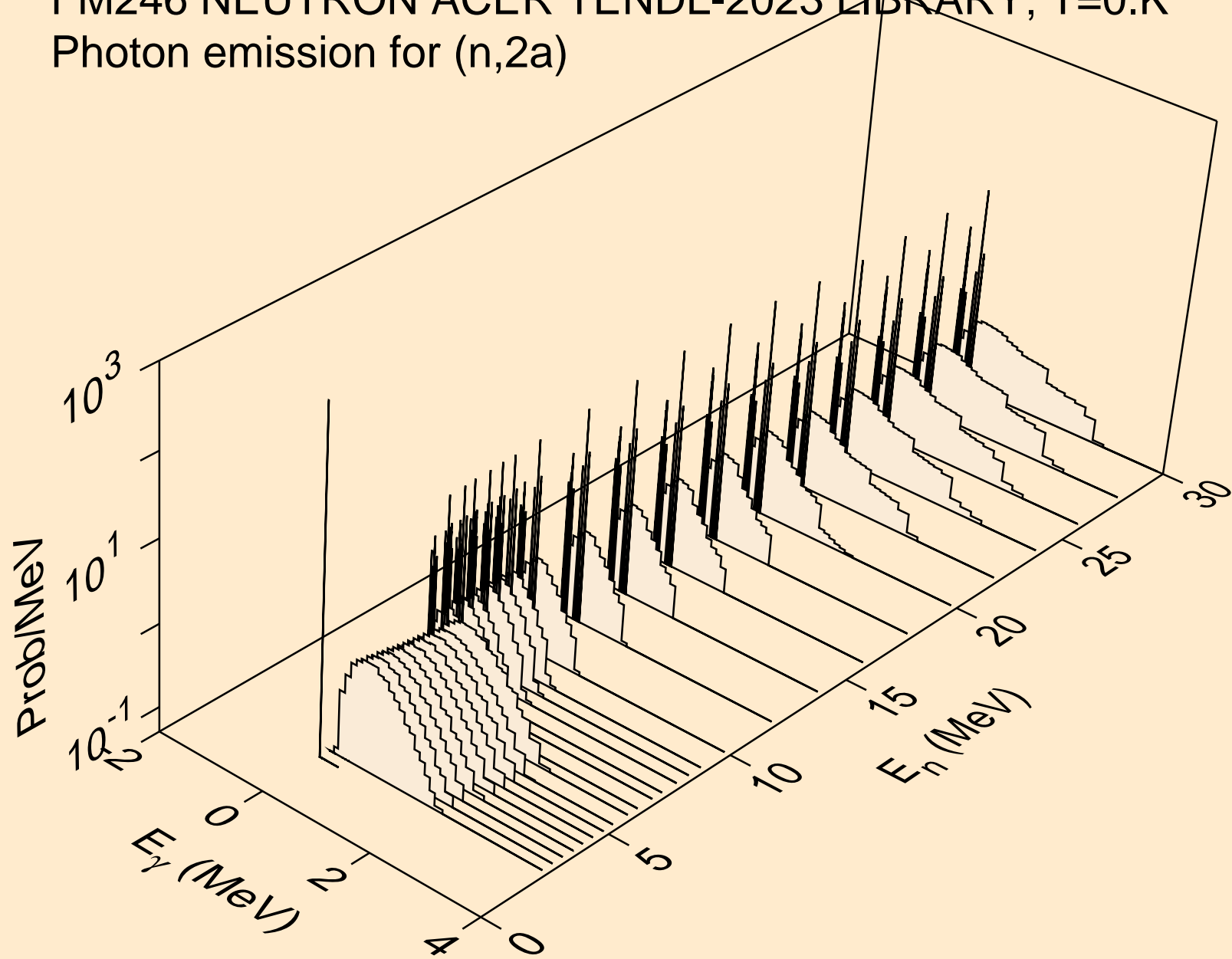

FM246 NEUTRON ACER TENDL-2023 LIBRARY; T=0.K
Photon emission for (n,2p)

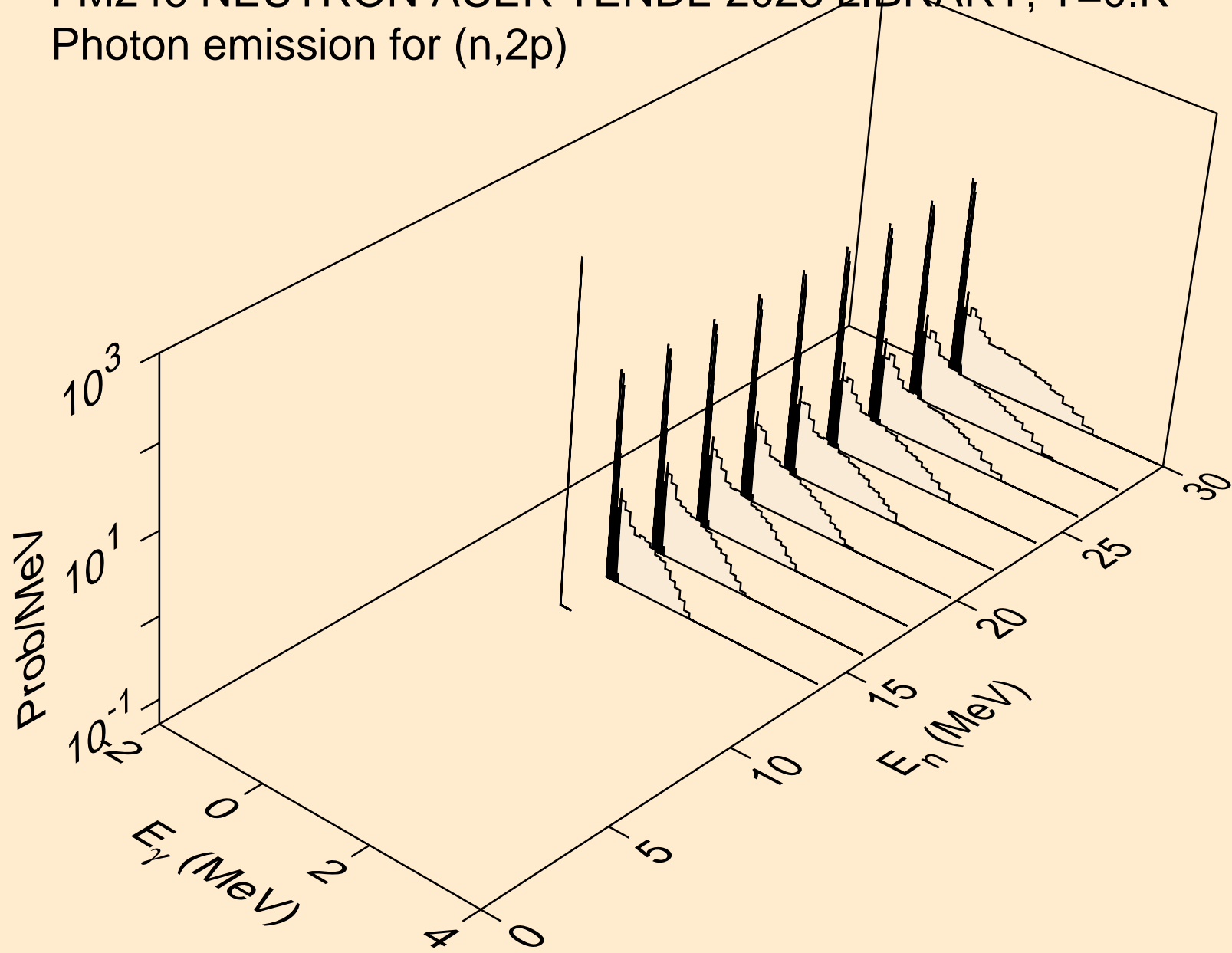

FM246 NEUTRON ACER TENDL-2023 LIBRARY; T=0.K
Photon emission for (n,p α)

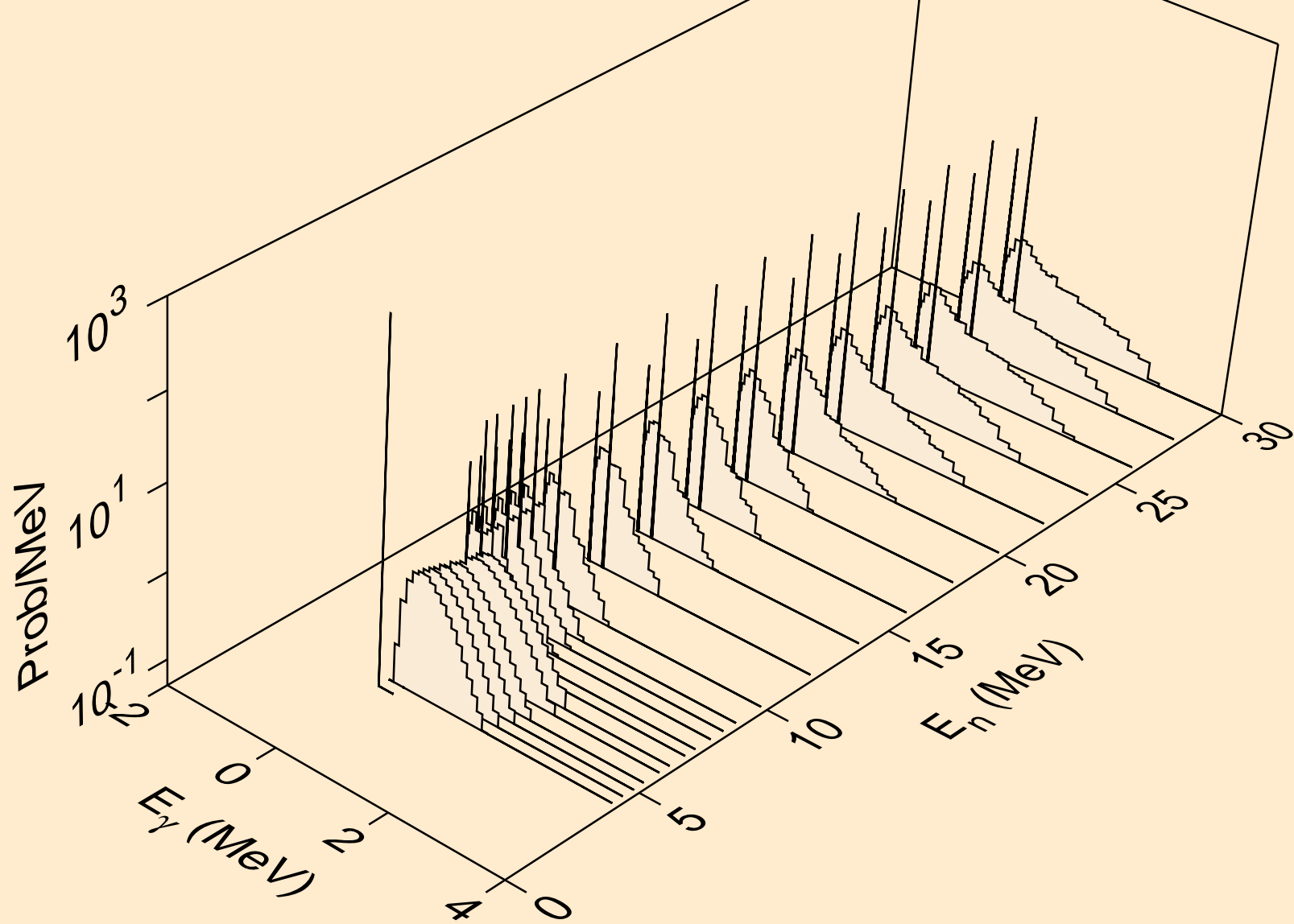

FM246 NEUTRON ACER TENDL-2023 LIBRARY; T=0.K
Photon emission for (n,pd)

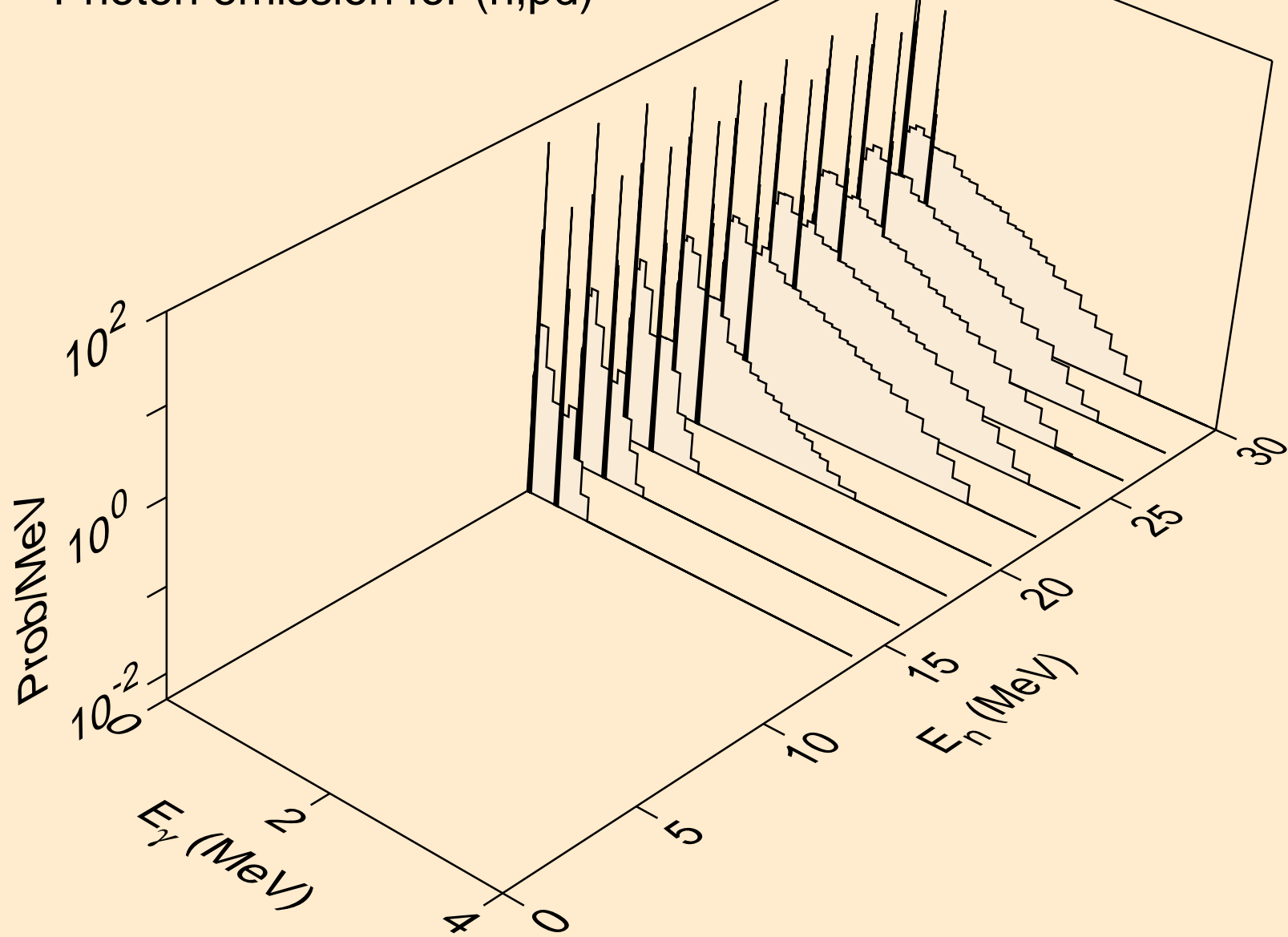

FM246 NEUTRON ACER TENDL-2023 LIBRARY; T=0.K
Photon emission for (n,pt)

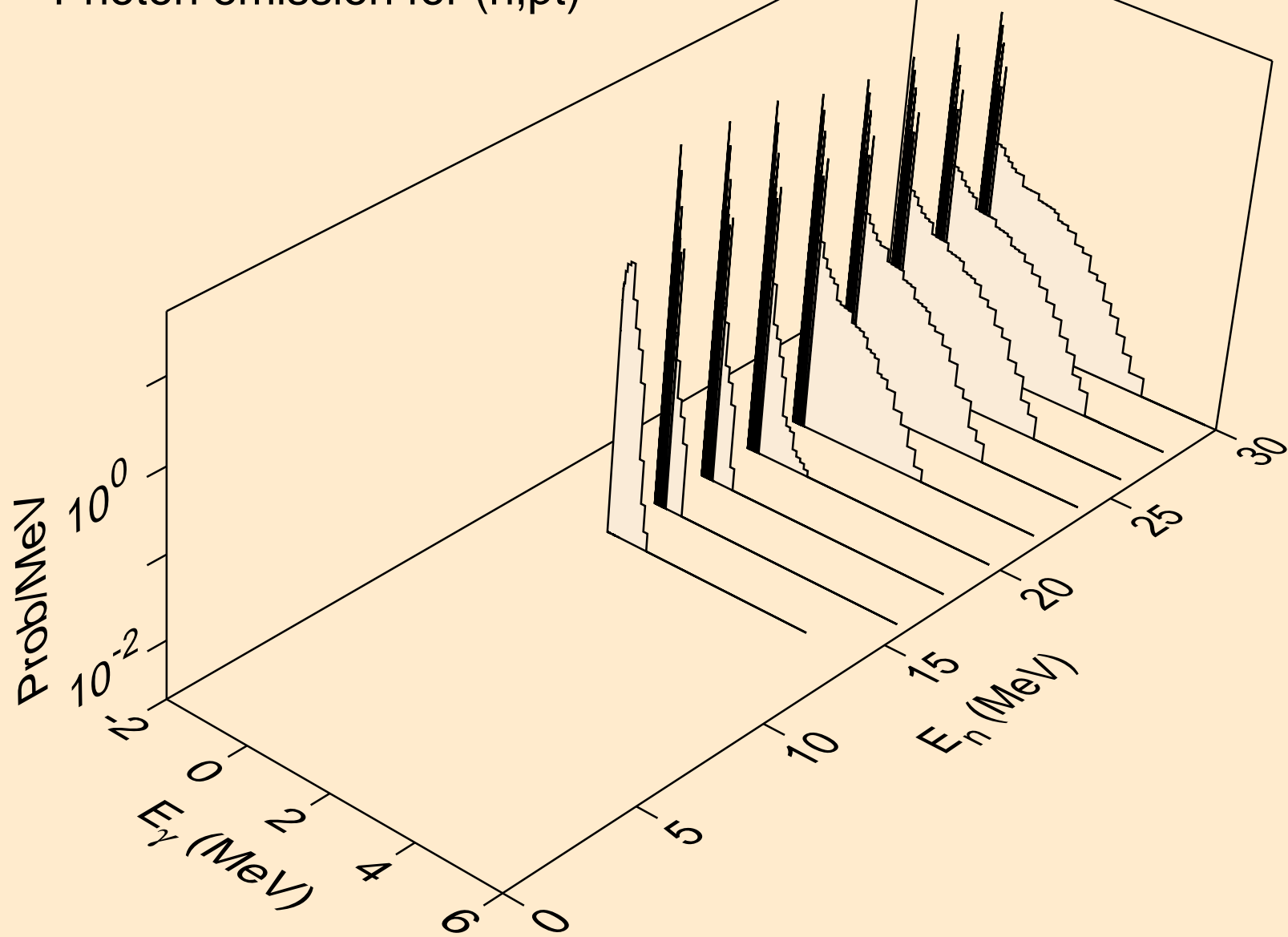

FM246 NEUTRON ACER TENDL-2023 LIBRARY; T=0.K
thermal capture photon spectrum

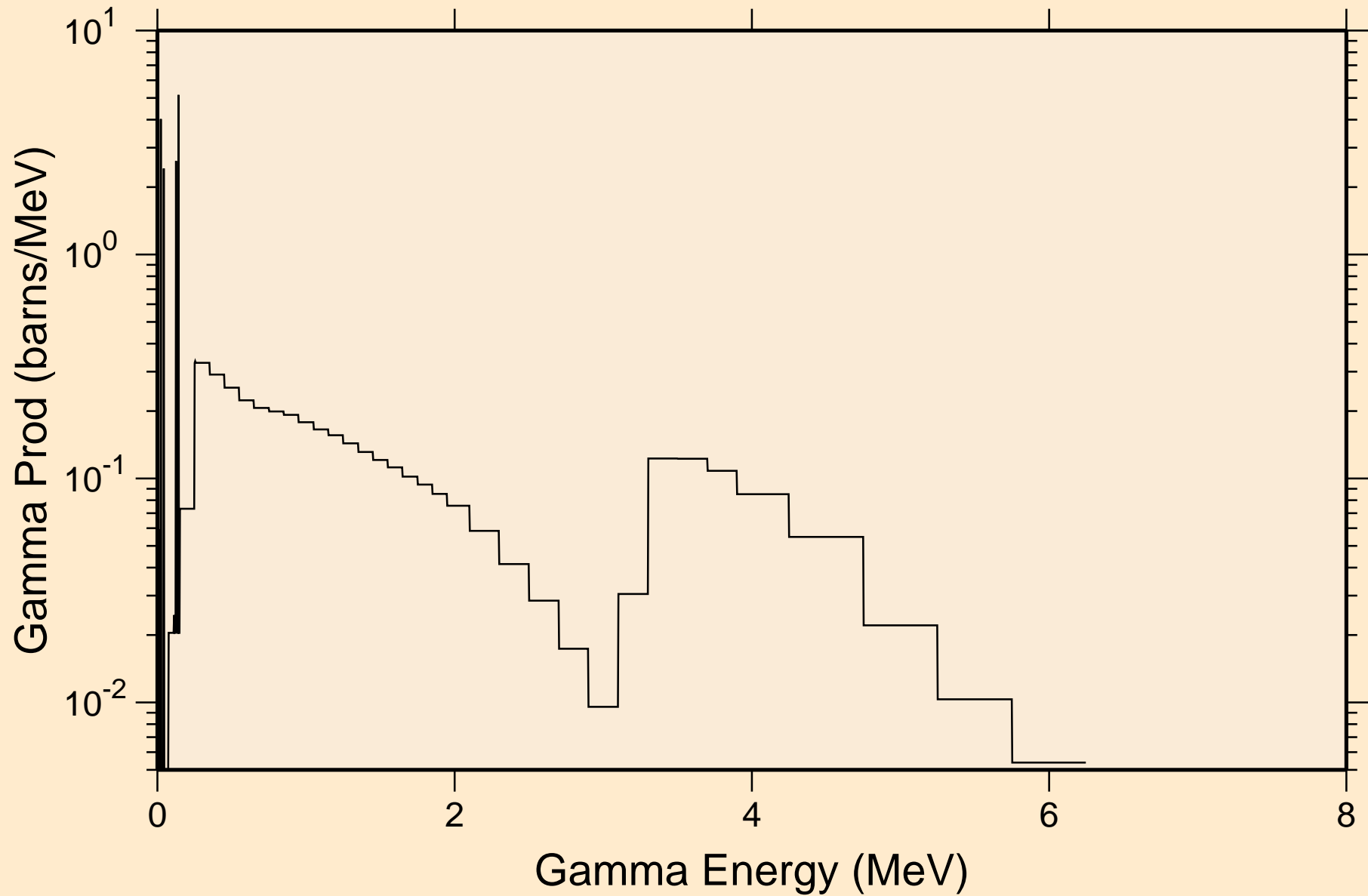

FM246 NEUTRON ACER TENDL-2023 LIBRARY; T=0.K
14 MeV photon spectrum

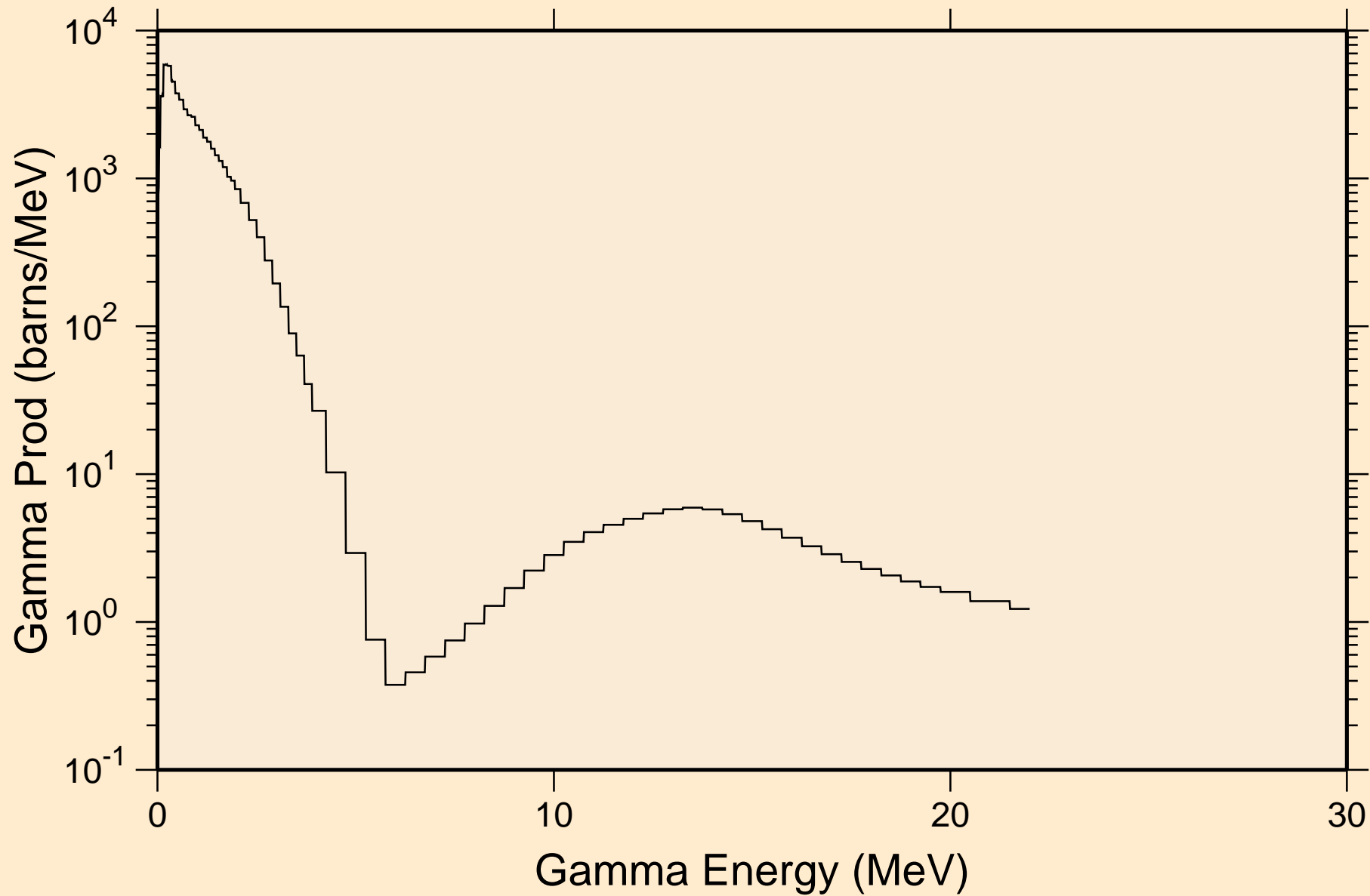

FM246 NEUTRON ACER TENDL-2023 LIBRARY; T=0.K

Particle heating contributions

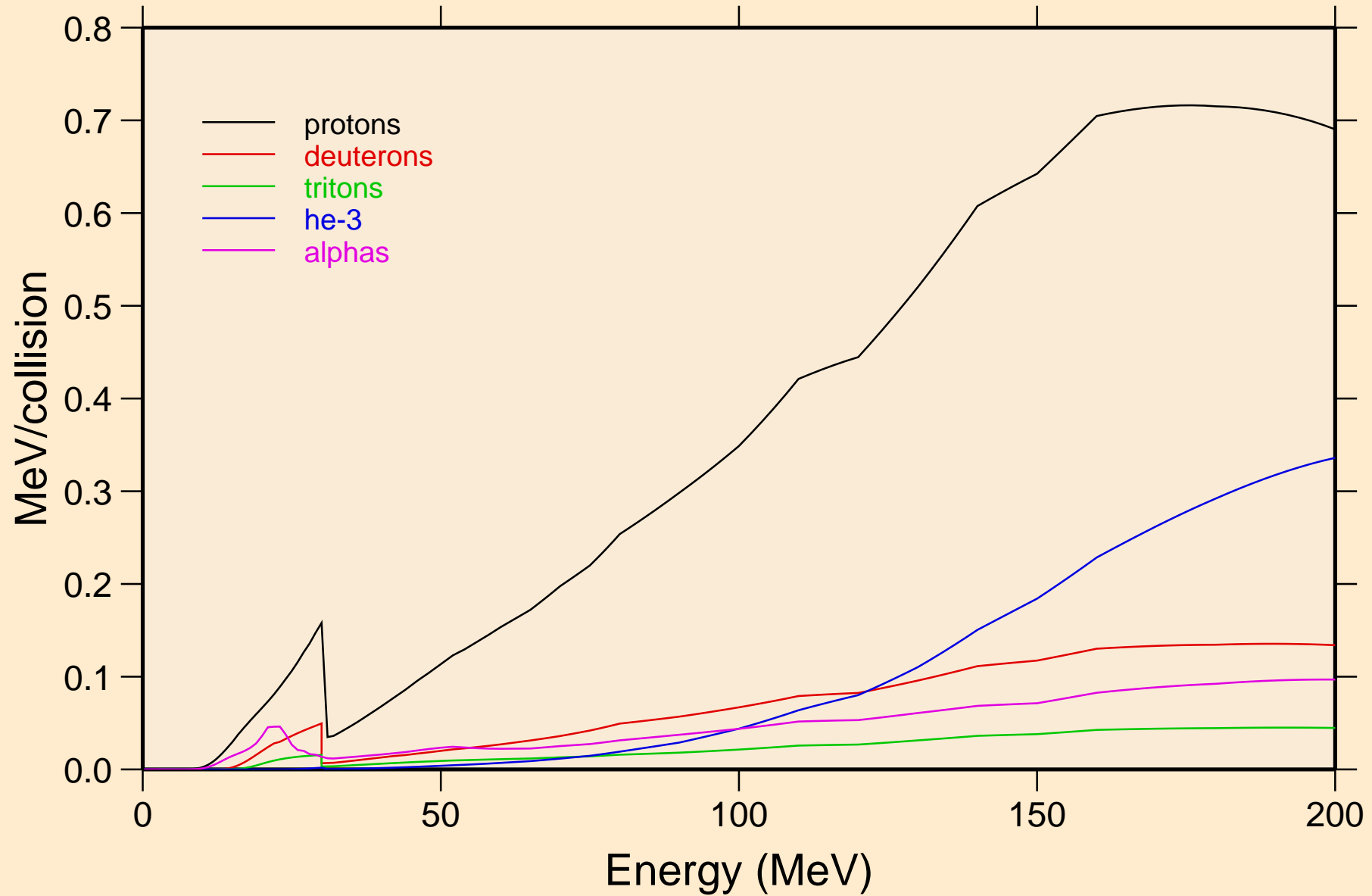

FM246 NEUTRON ACER TENDL-2023 LIBRARY; T=0.K
Recoil Heating

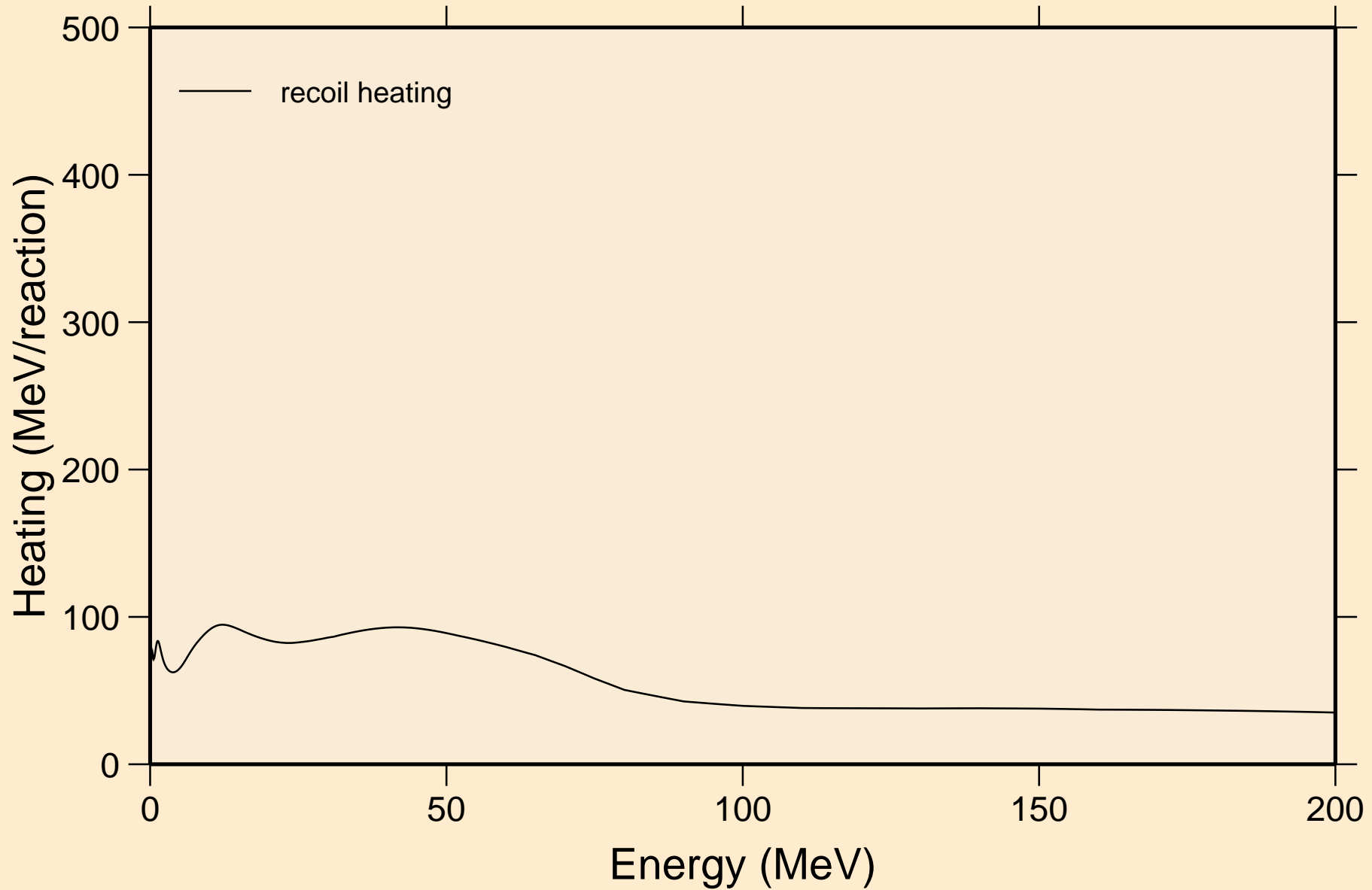

FM246 NEUTRON ACER TENDL-2023 LIBRARY; T=0.K

Particle production cross sections

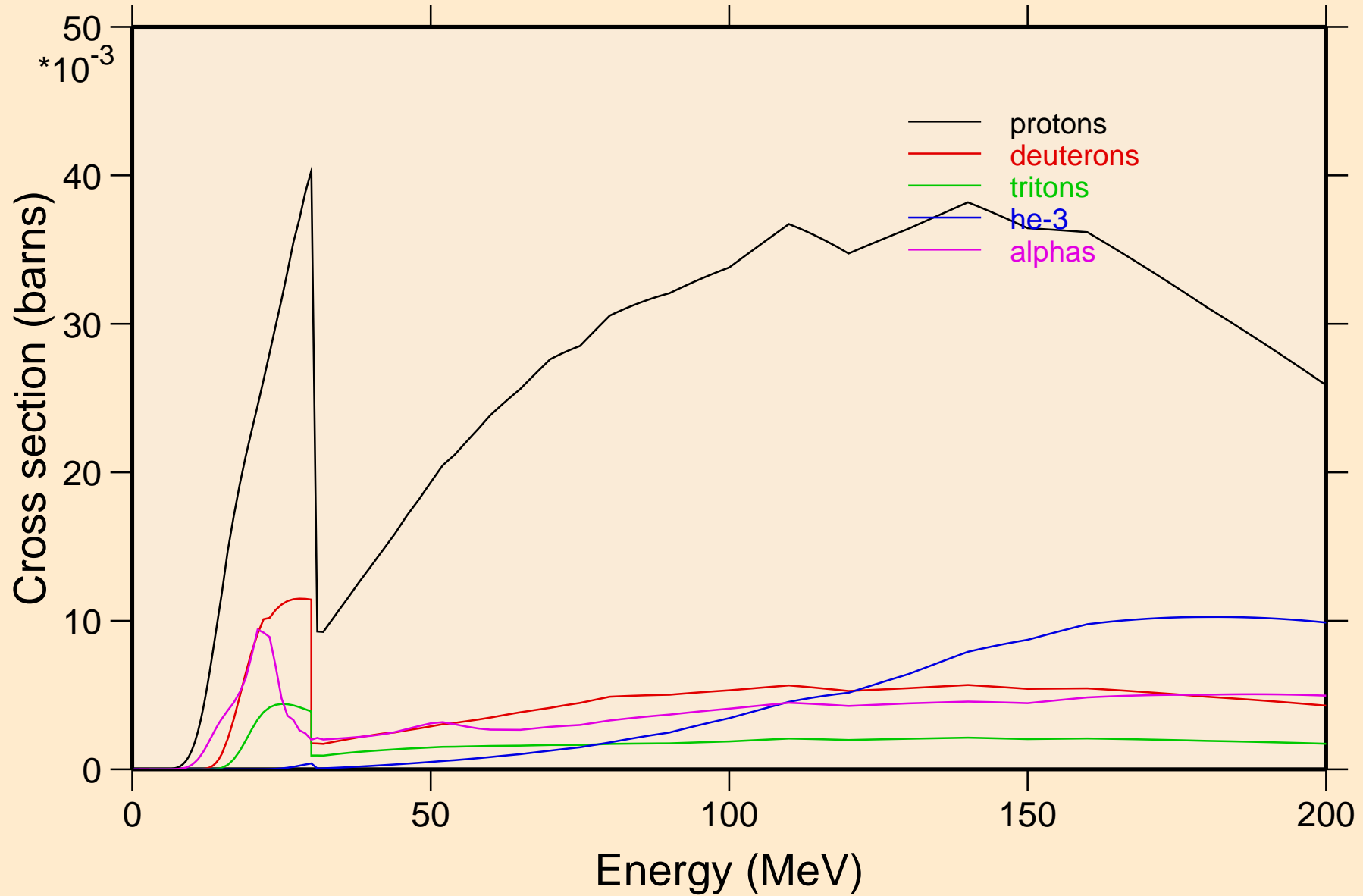

FM246 NEUTRON ACER TENDL-2023 LIBRARY; T=0.K
protons from (n,x)

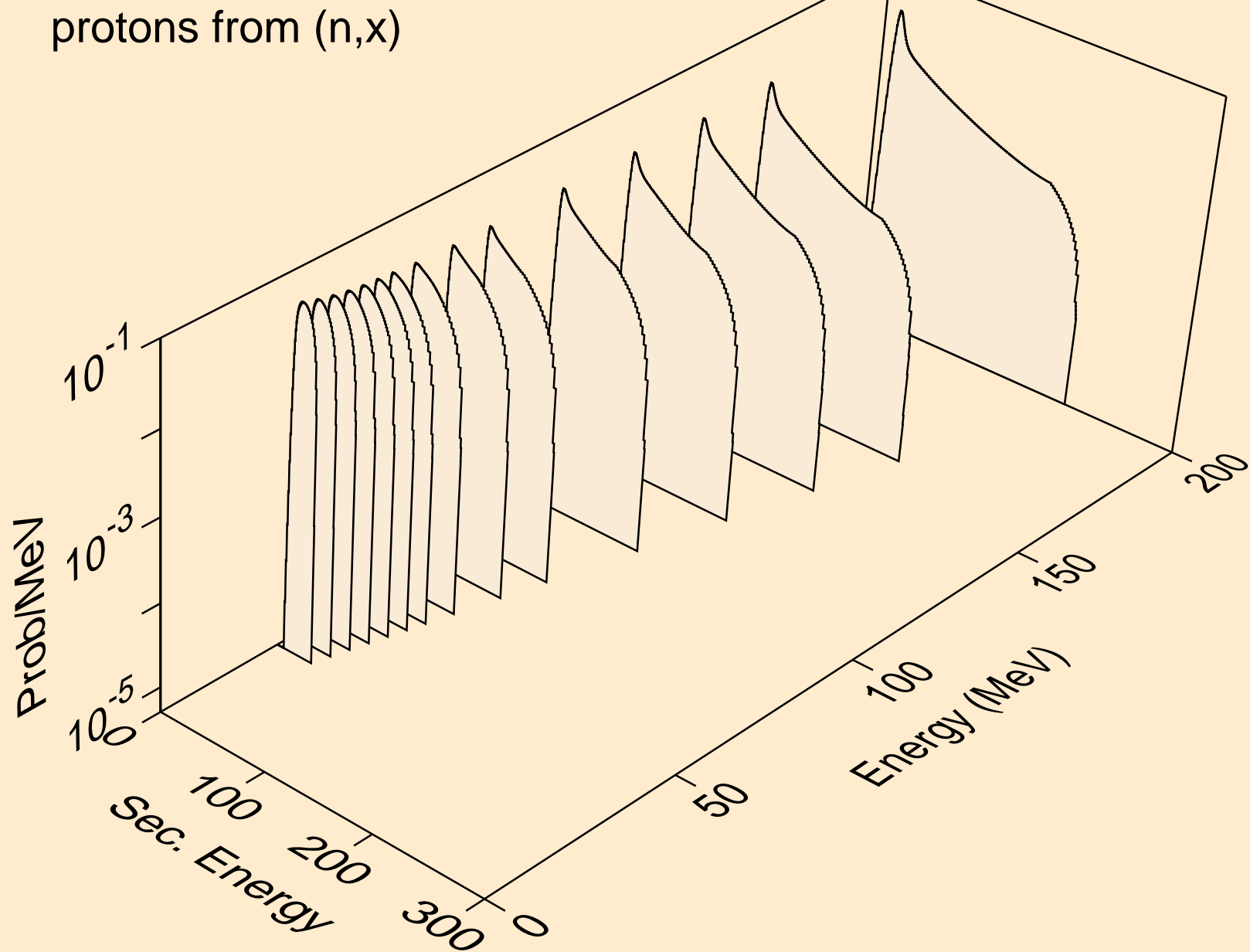

FM246 NEUTRON ACER TENDL-2023 LIBRARY; T=0.K
protons from (n,n*)p

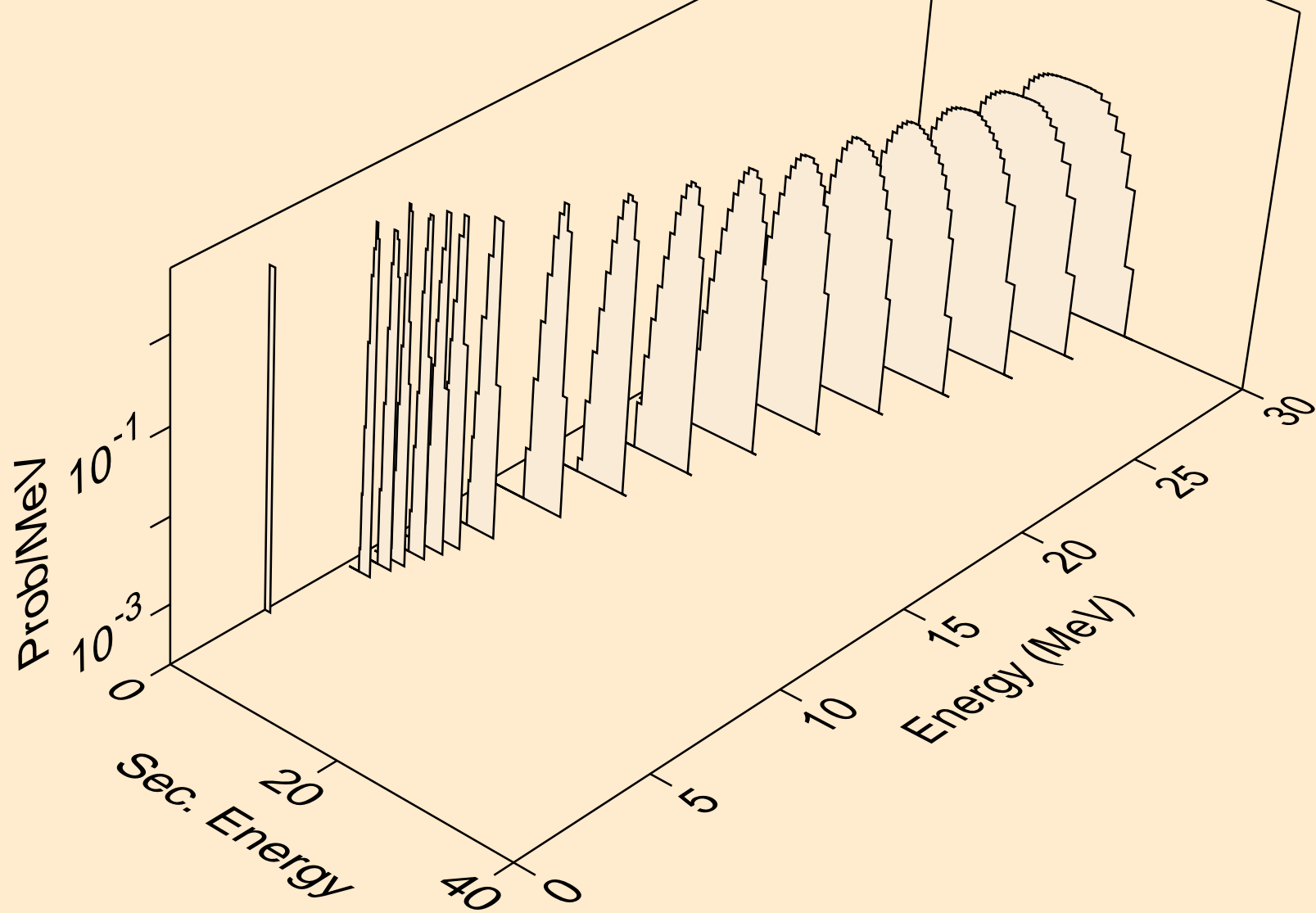

FM246 NEUTRON ACER TENDL-2023 LIBRARY; T=0.K
protons from (n,2np)

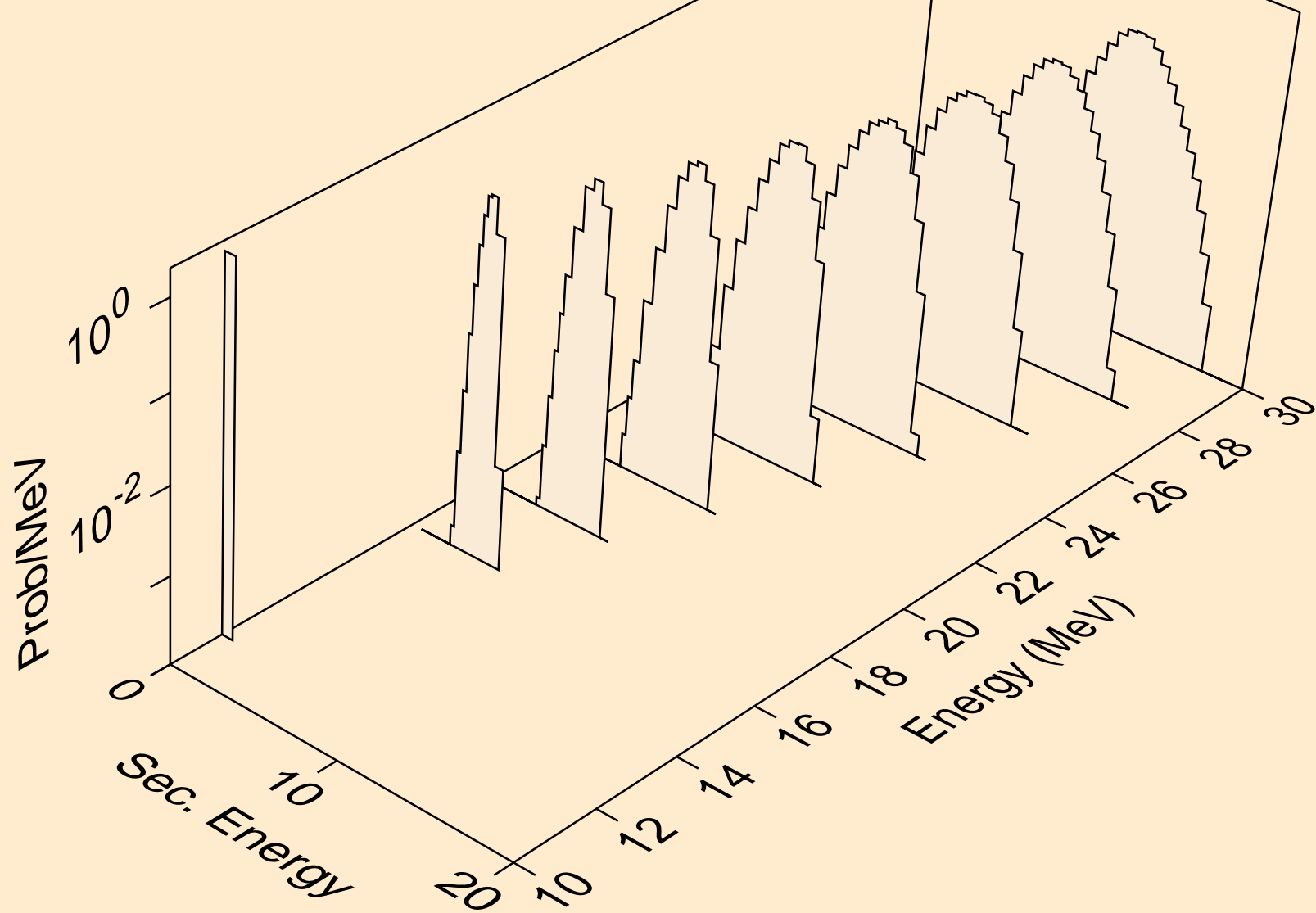

FM246 NEUTRON ACER TENDL-2023 LIBRARY; T=0.K
protons from (n,n2p)

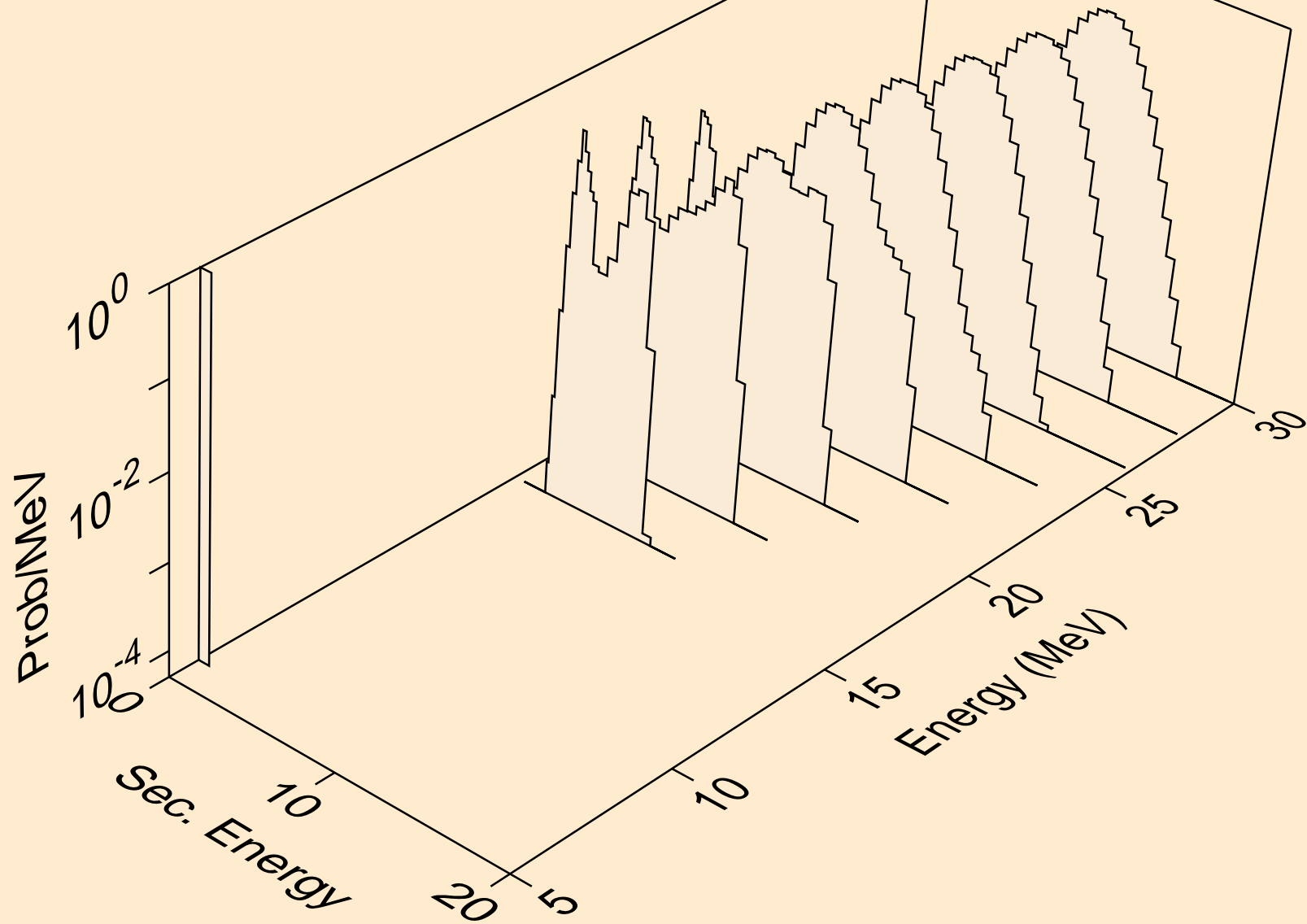

FM246 NEUTRON ACER TENDL-2023 LIBRARY; T=0.K
protons from (n,p)

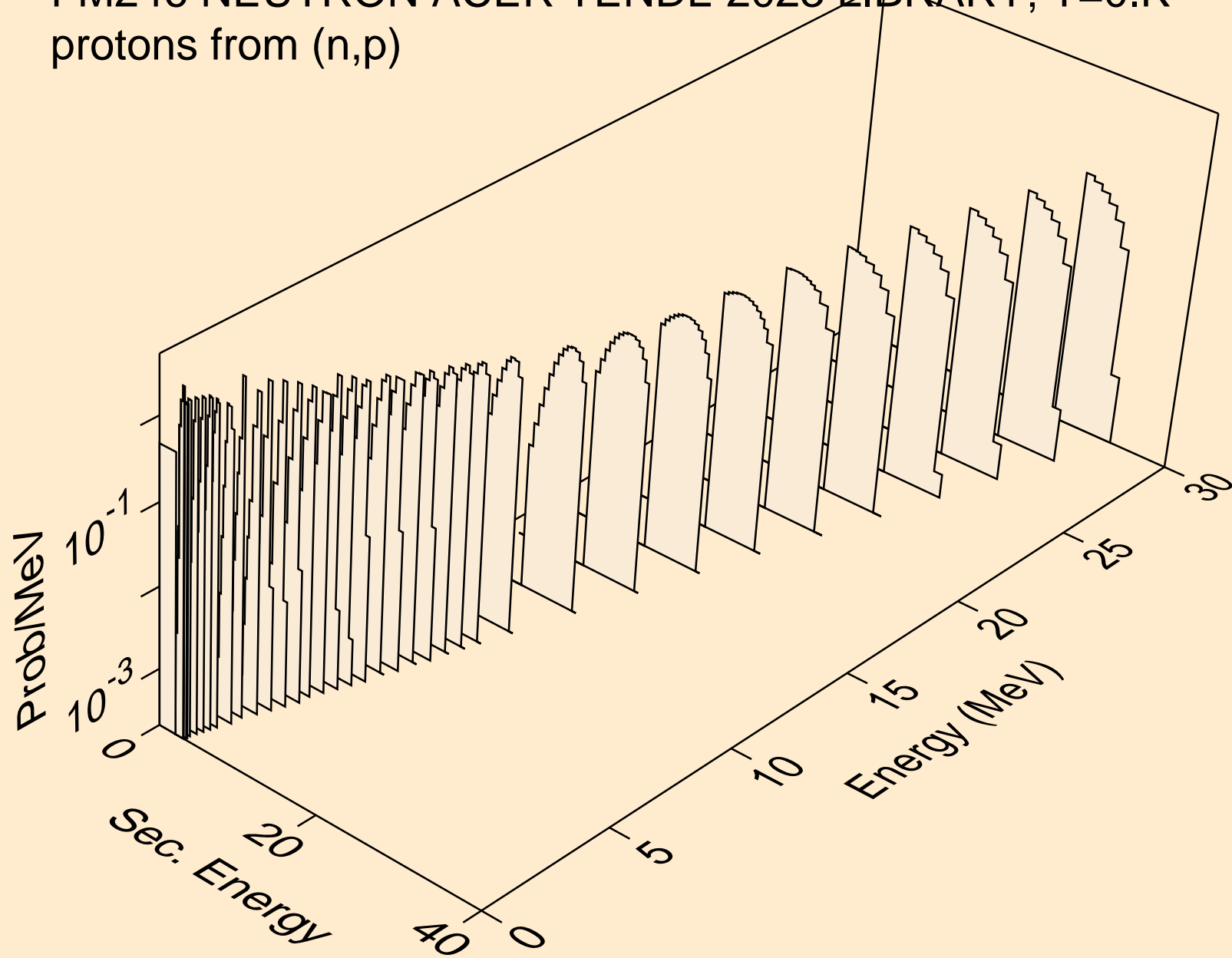

FM246 NEUTRON ACER TENDL-2023 LIBRARY; T=0.K
protons from (n,2p)

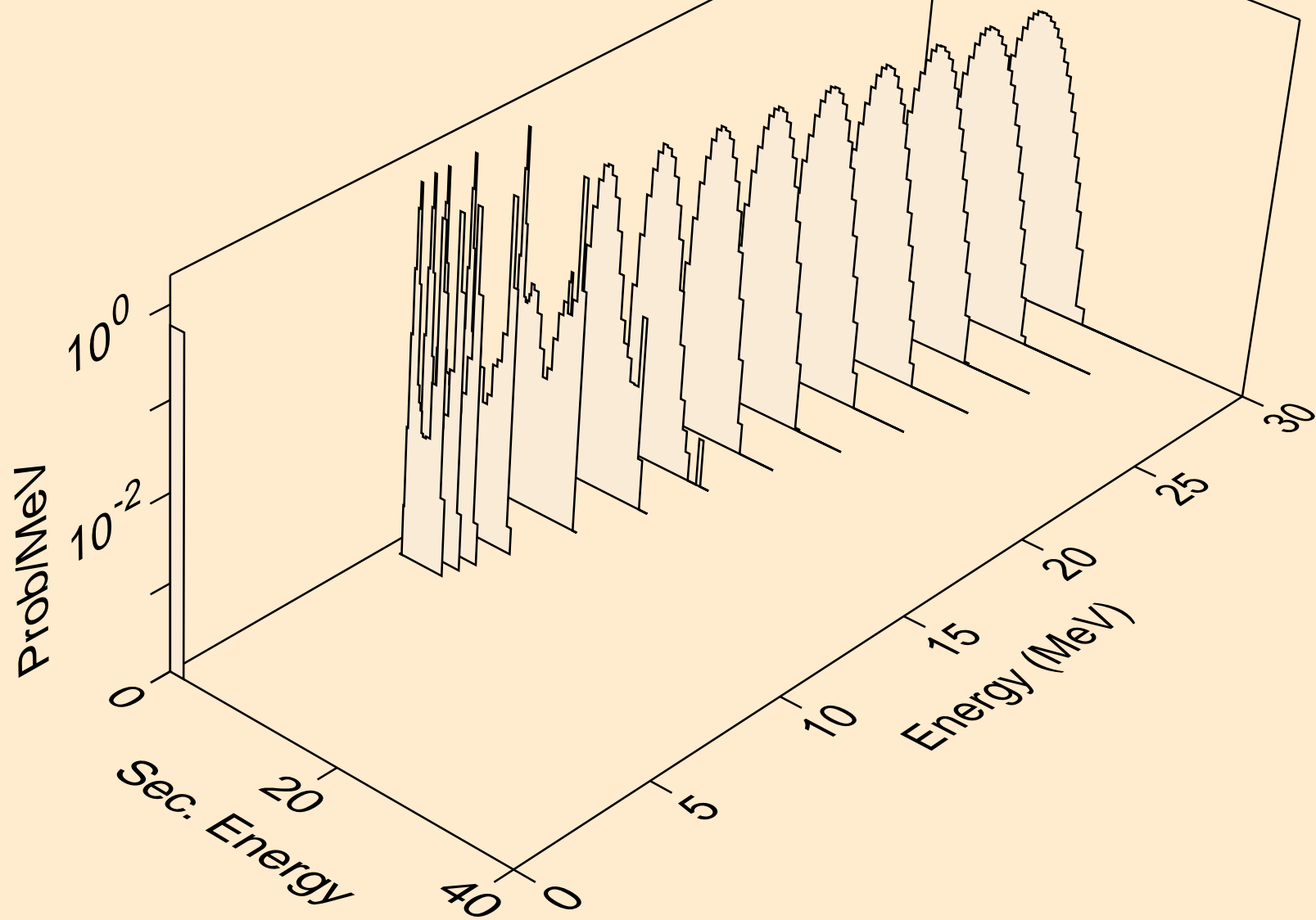

FM246 NEUTRON ACER TENDL-2023 LIBRARY; T=0.K
protons from (n,p)

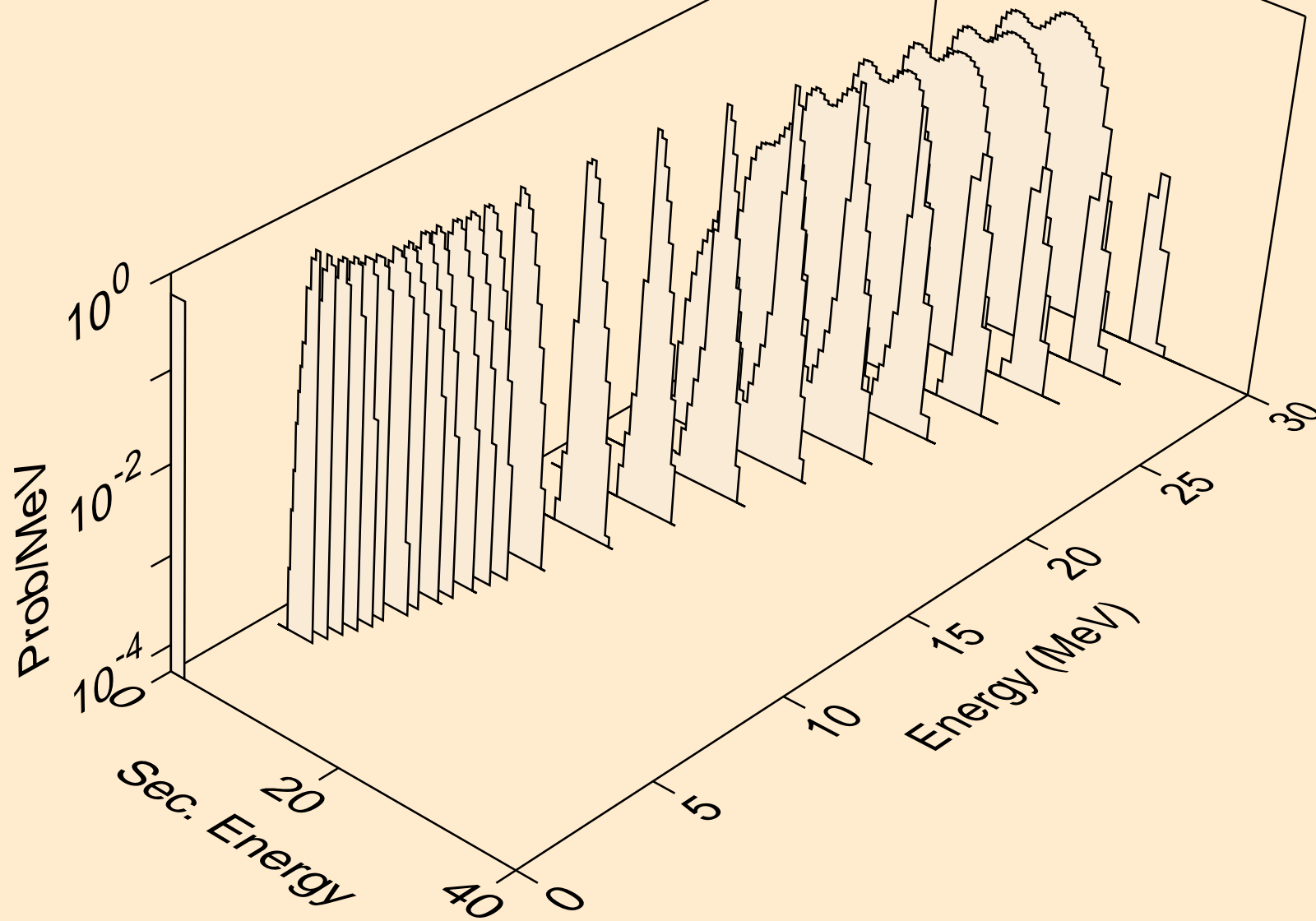

FM246 NEUTRON ACER TENDL-2023 LIBRARY; T=0.K
protons from (n,pd)

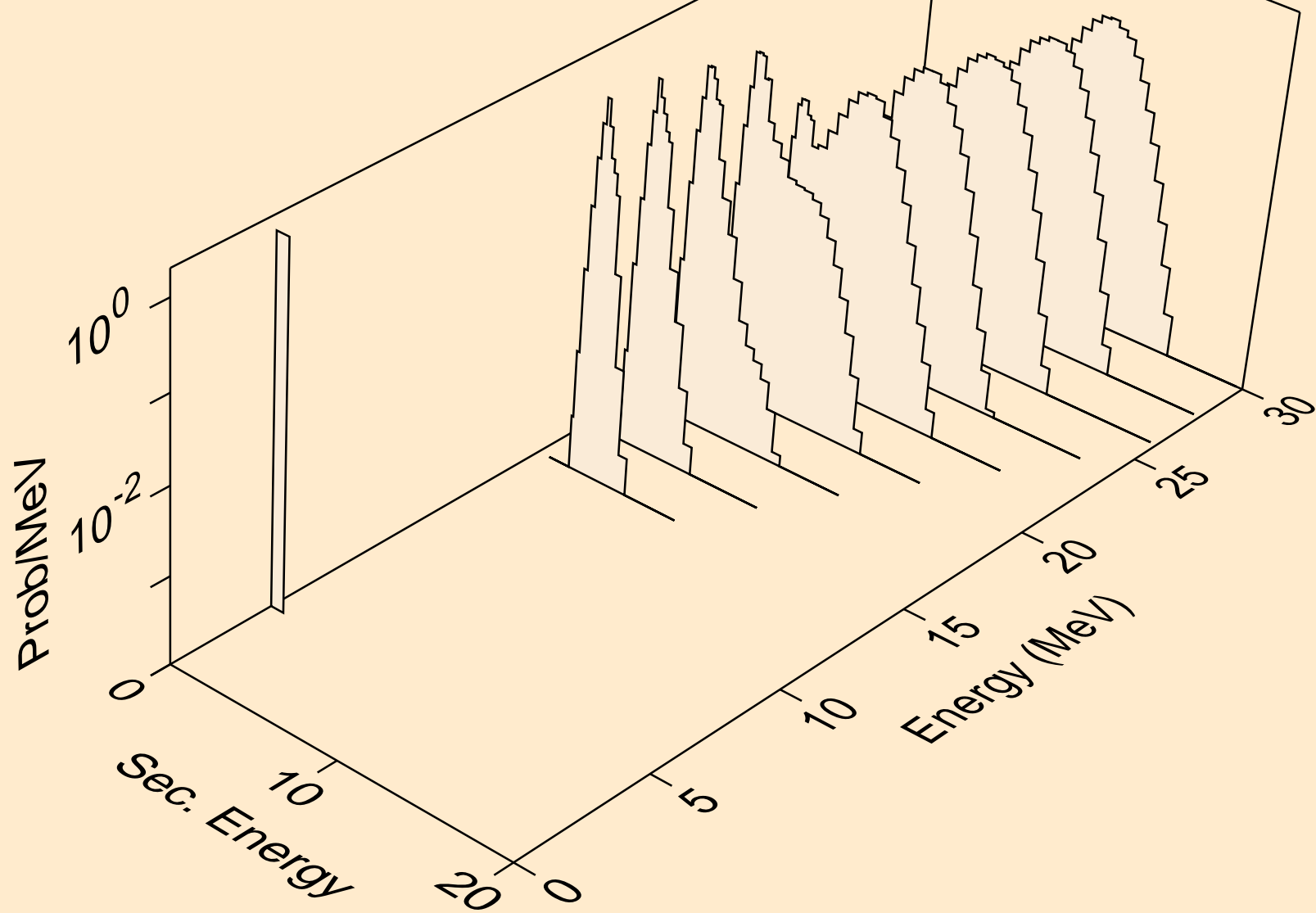

FM246 NEUTRON ACER TENDL-2023 LIBRARY; T=0.K
protons from (n,pt)

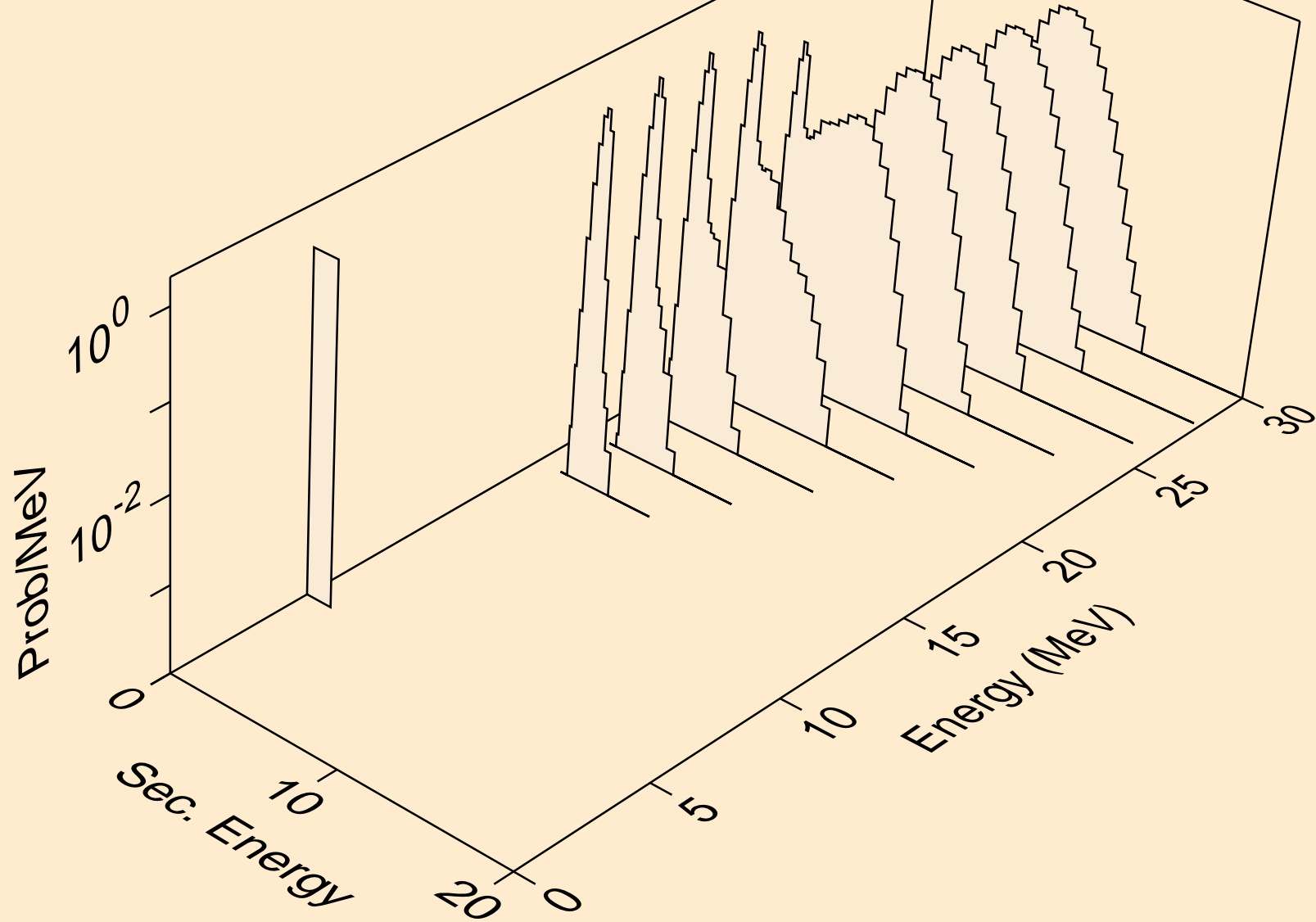

FM246 NEUTRON ACER TENDL-2023 LIBRARY; T=0.K
deuterons from (n,x)

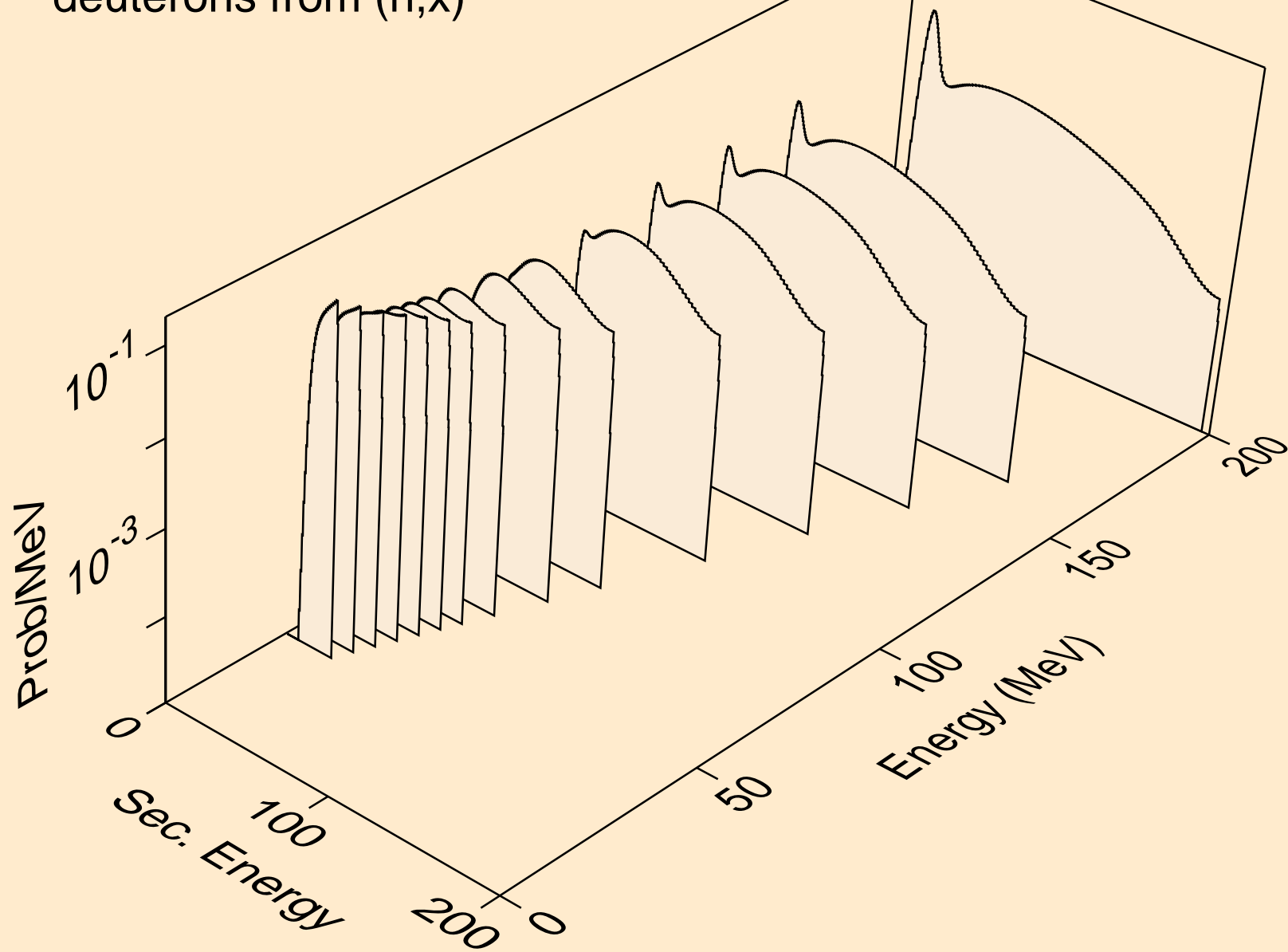

FM246 NEUTRON ACER TENDL-2023 LIBRARY; T=0.K
deuterons from (n,n*)d

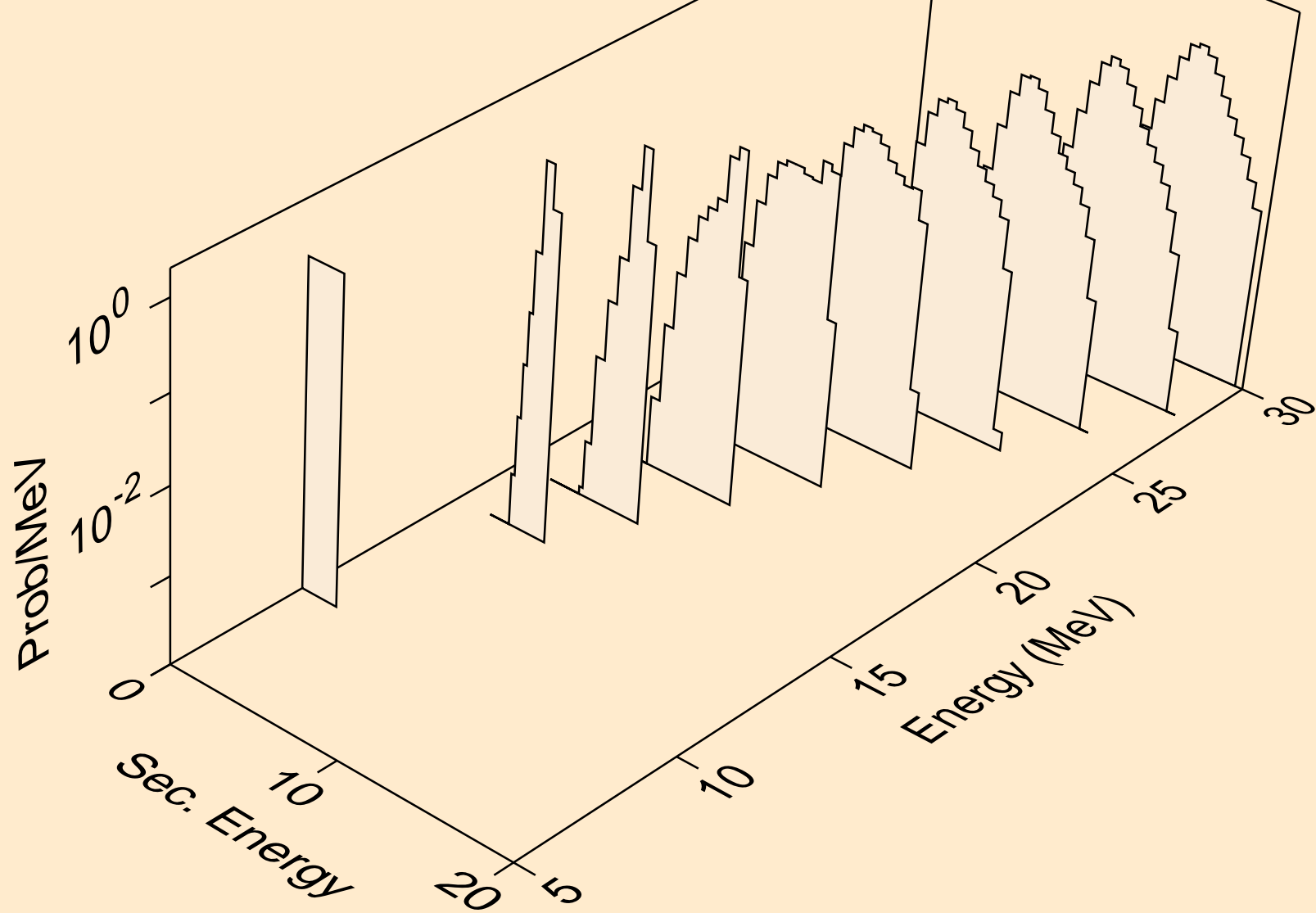

FM246 NEUTRON ACER TENDL-2023 LIBRARY; T=0.K
deuterons from (n,d)

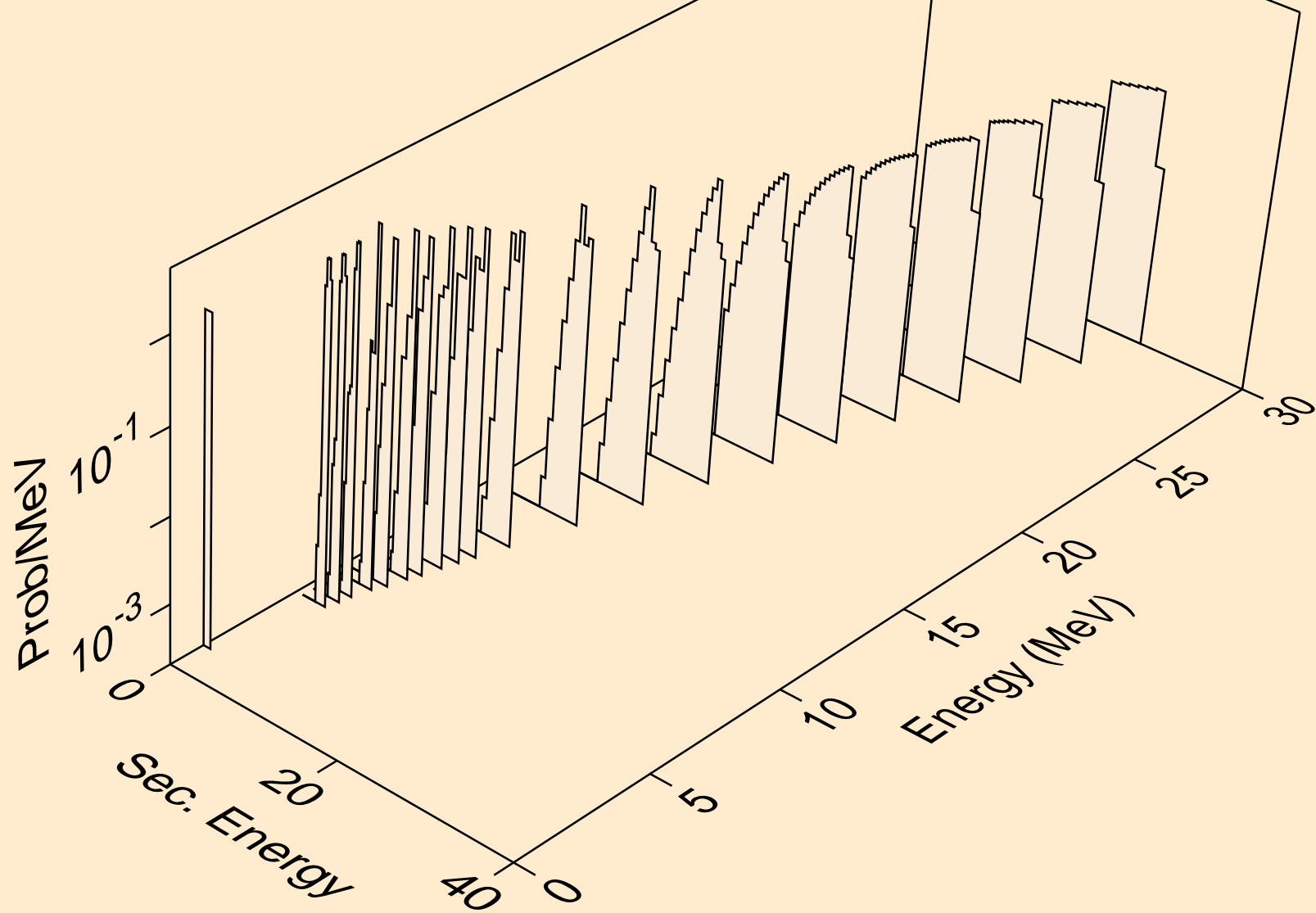

FM246 NEUTRON ACER TENDL-2023 LIBRARY; T=0.K
deuterons from (n,pd)

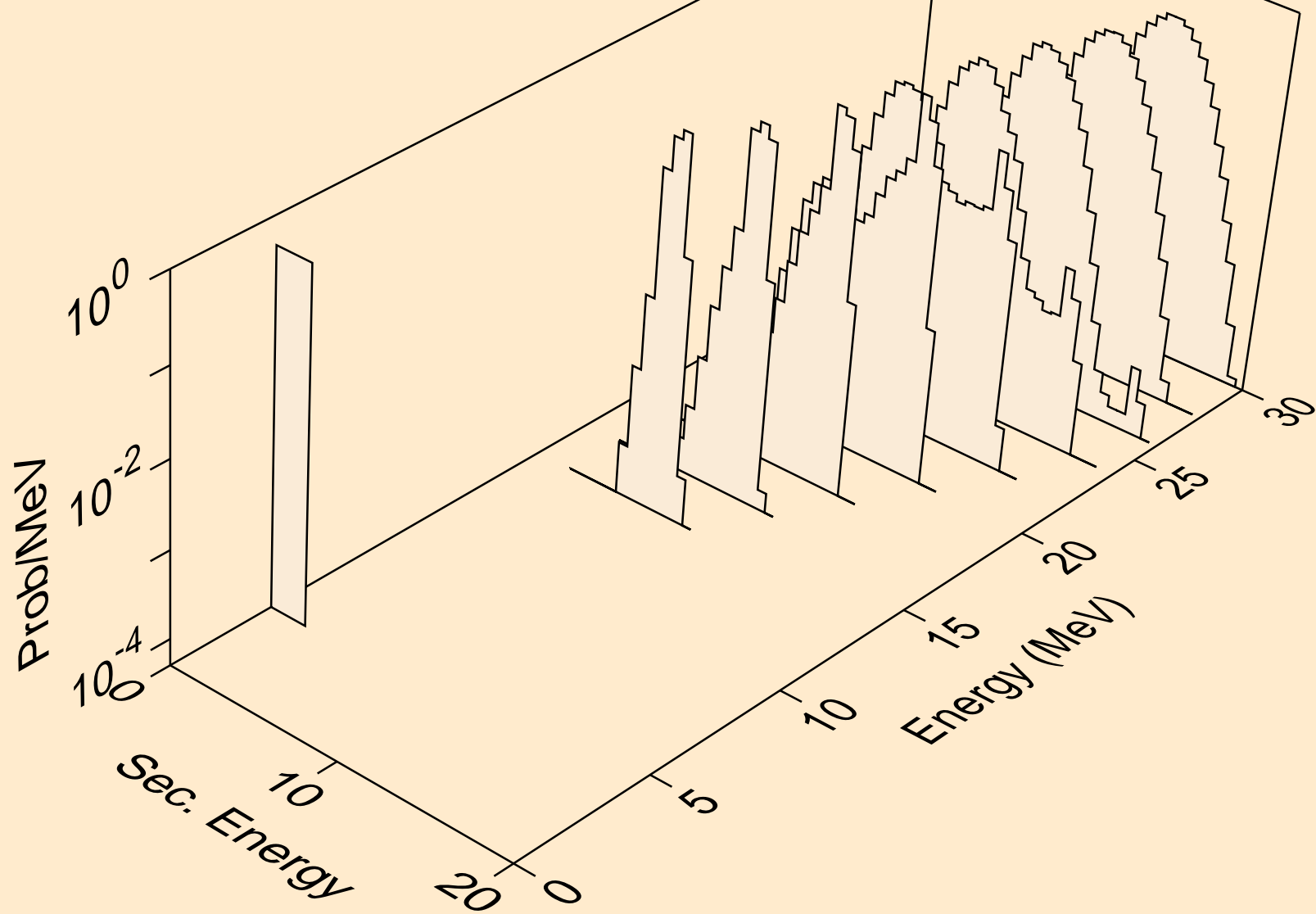

FM246 NEUTRON ACER TENDL-2023 LIBRARY; T=0.K
tritons from (n,x)

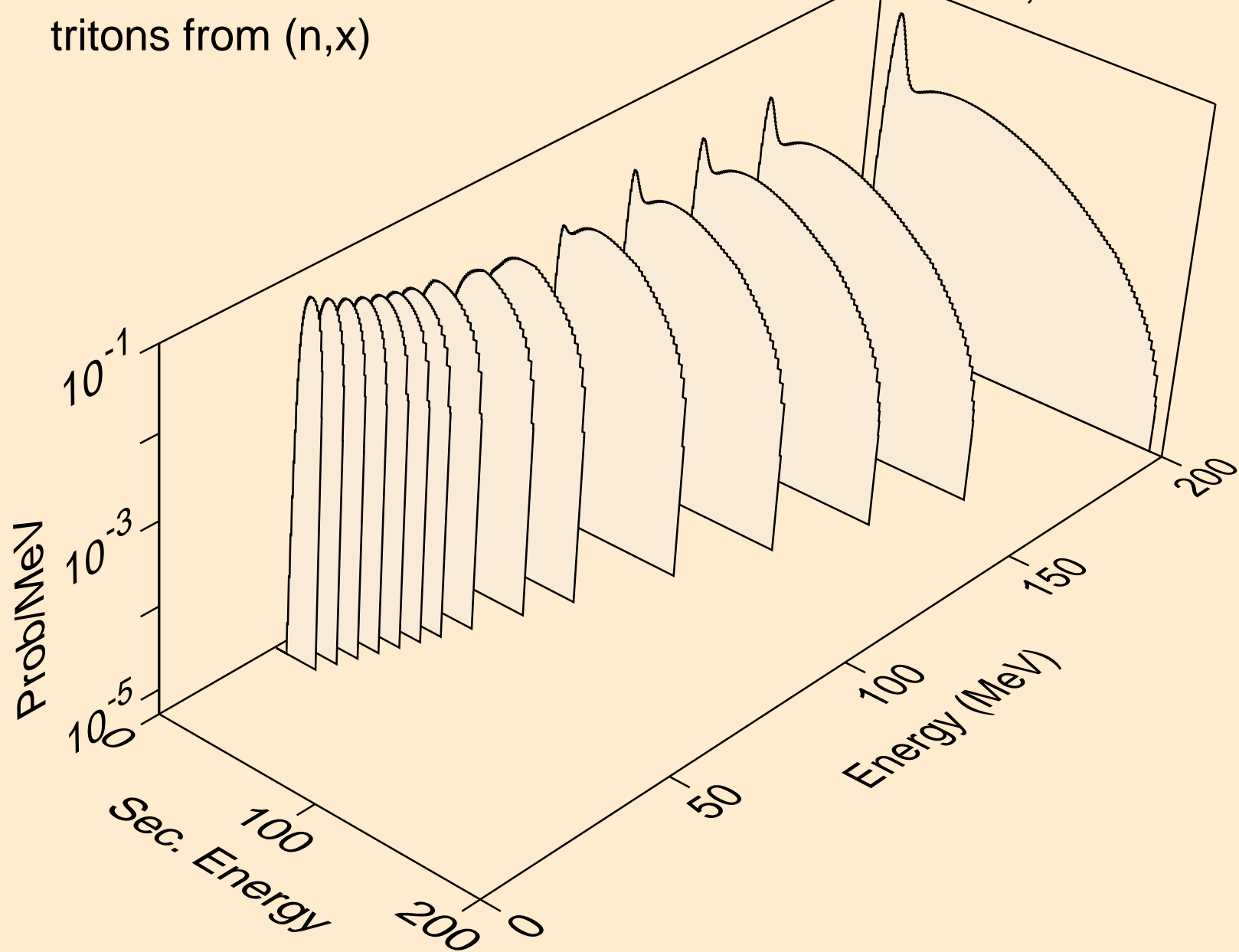

FM246 NEUTRON ACER TENDL-2023 LIBRARY; T=0.K
tritons from (n,n*)t

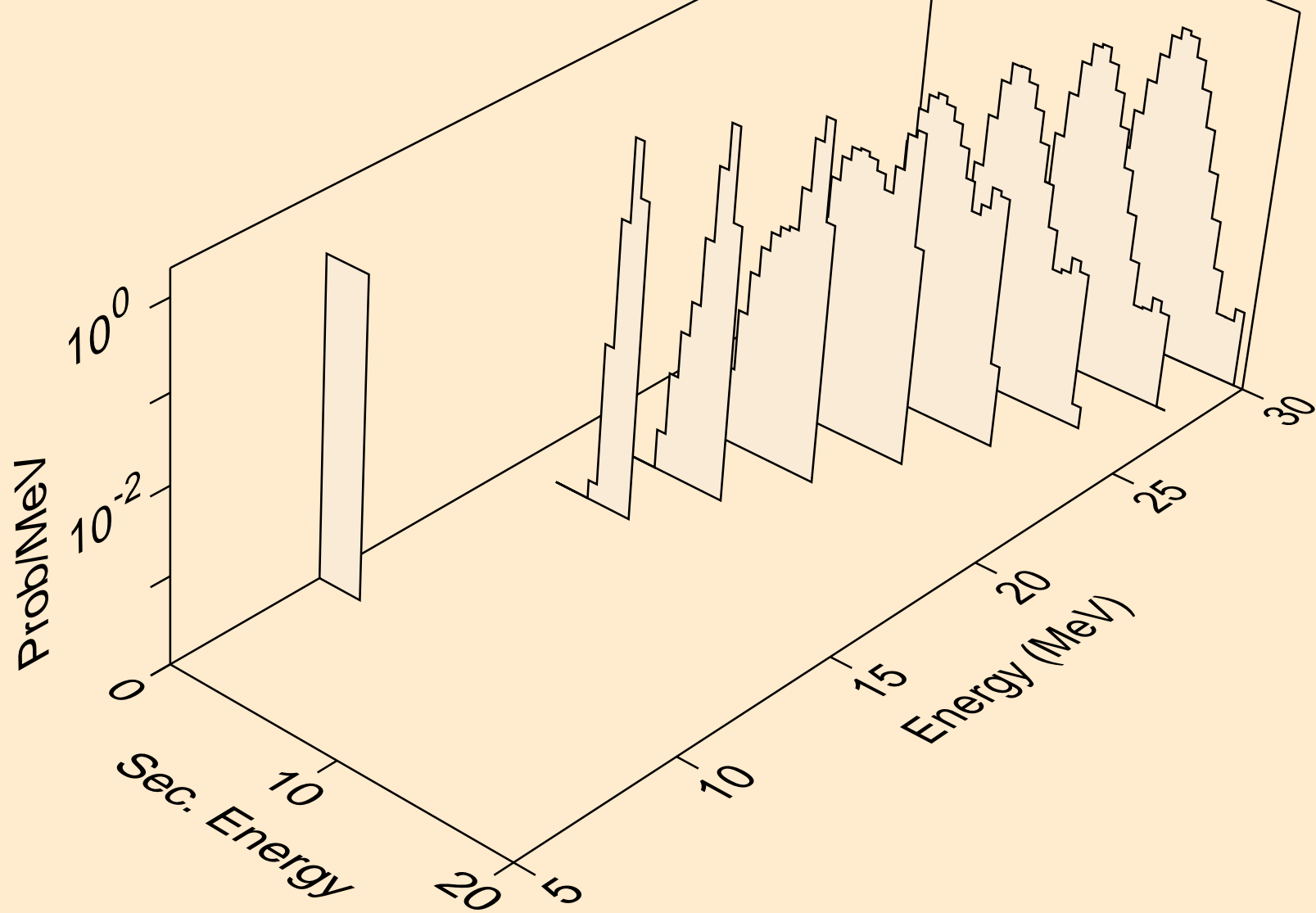

FM246 NEUTRON ACER TENDL-2023 LIBRARY; T=0.K
tritons from (n,t)

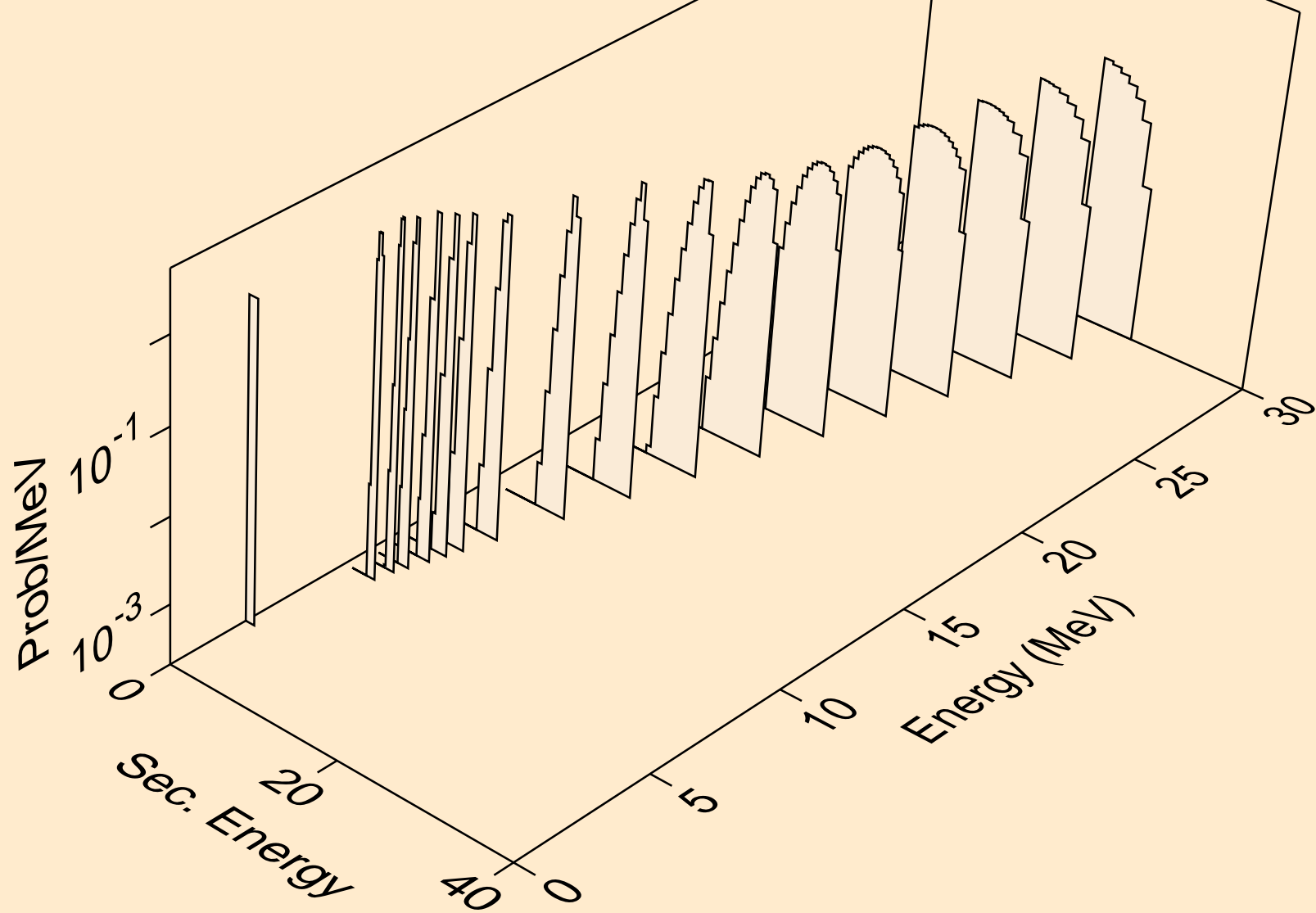

FM246 NEUTRON ACER TENDL-2023 LIBRARY; T=0.K
tritons from (n,pt)

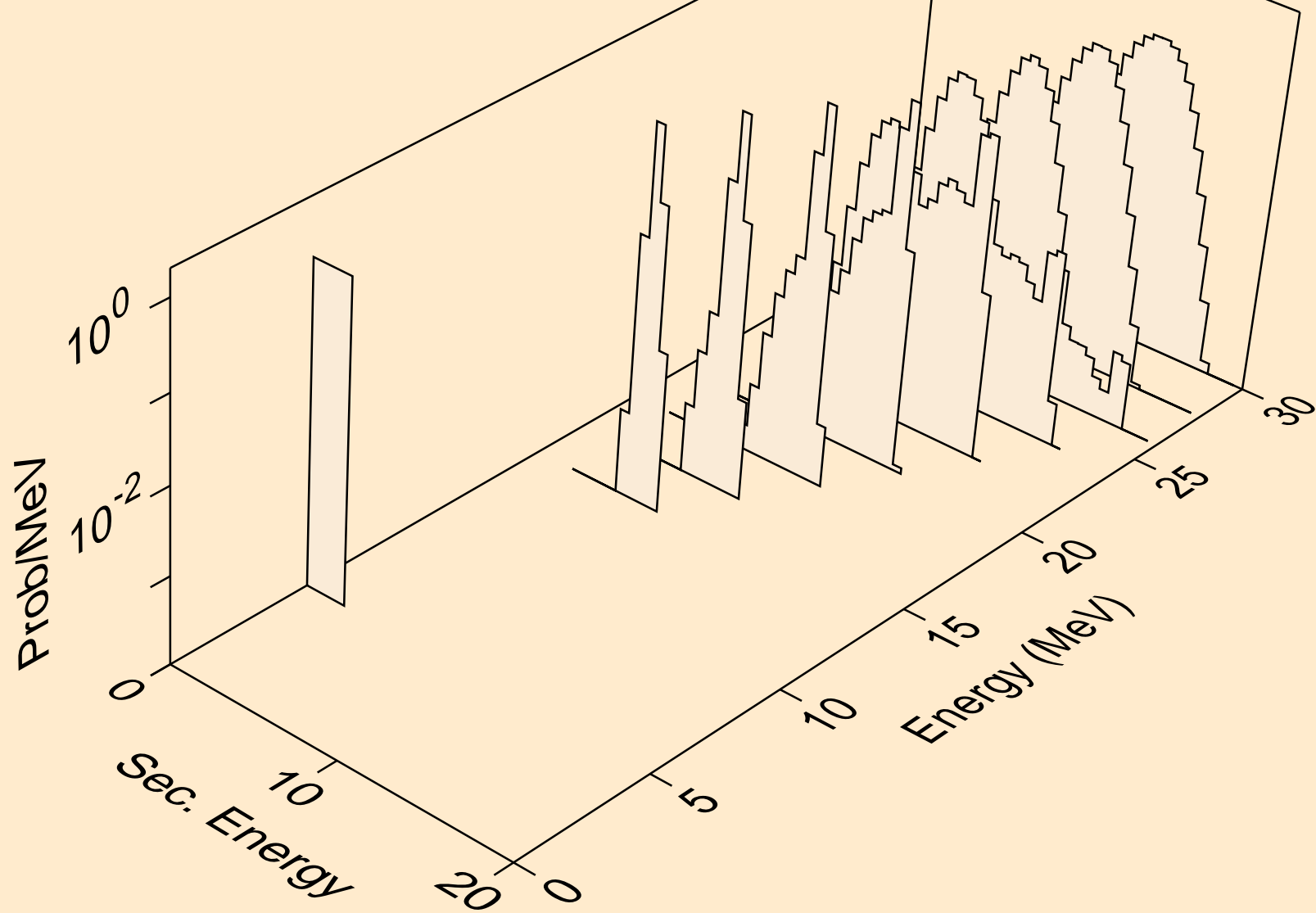

FM246 NEUTRON ACER TENDL-2023 LIBRARY; T=0.K
he3s from (n,x)

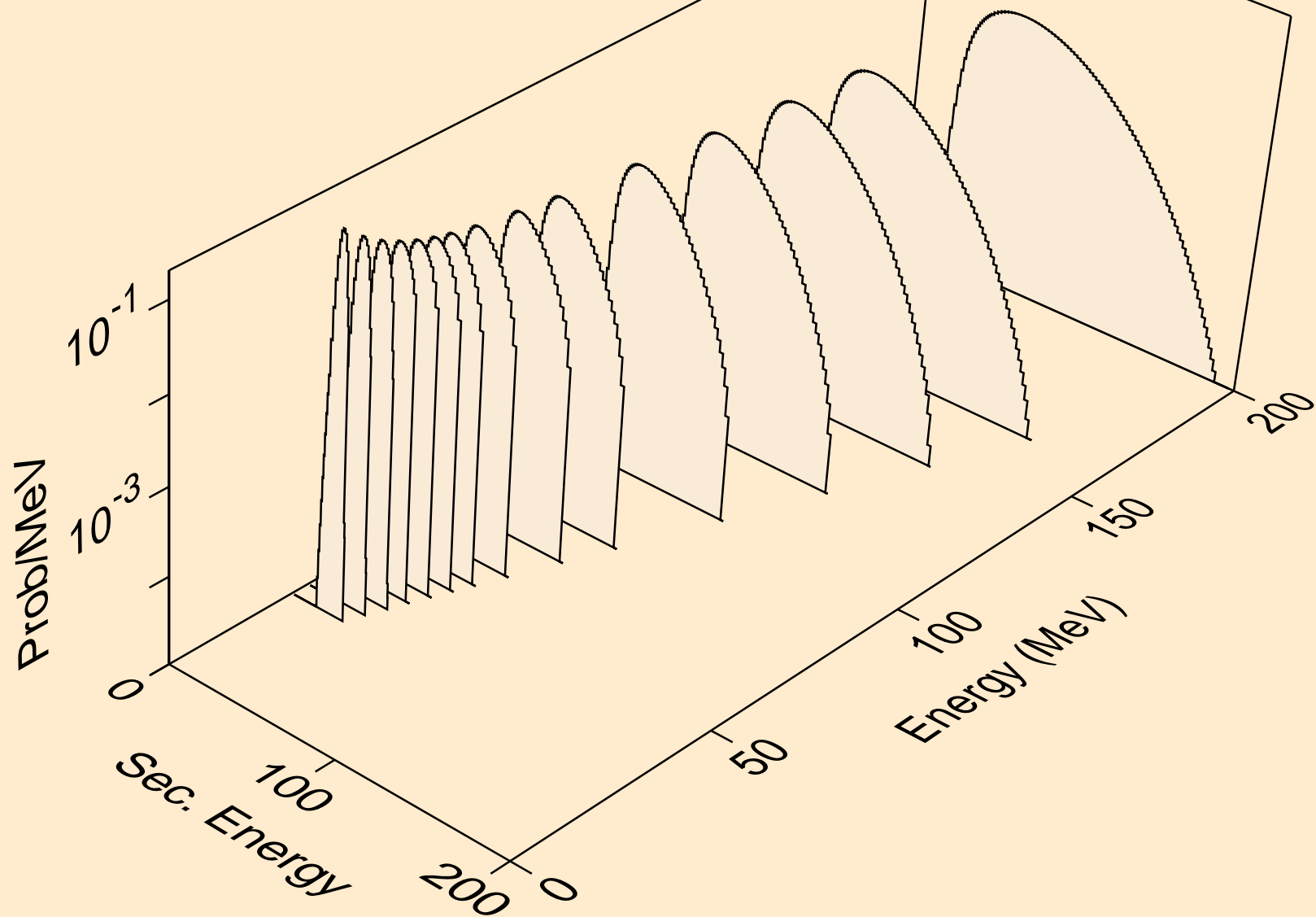

FM246 NEUTRON ACER TENDL-2023 LIBRARY; T=0.K
he3s from (n,n*)he3

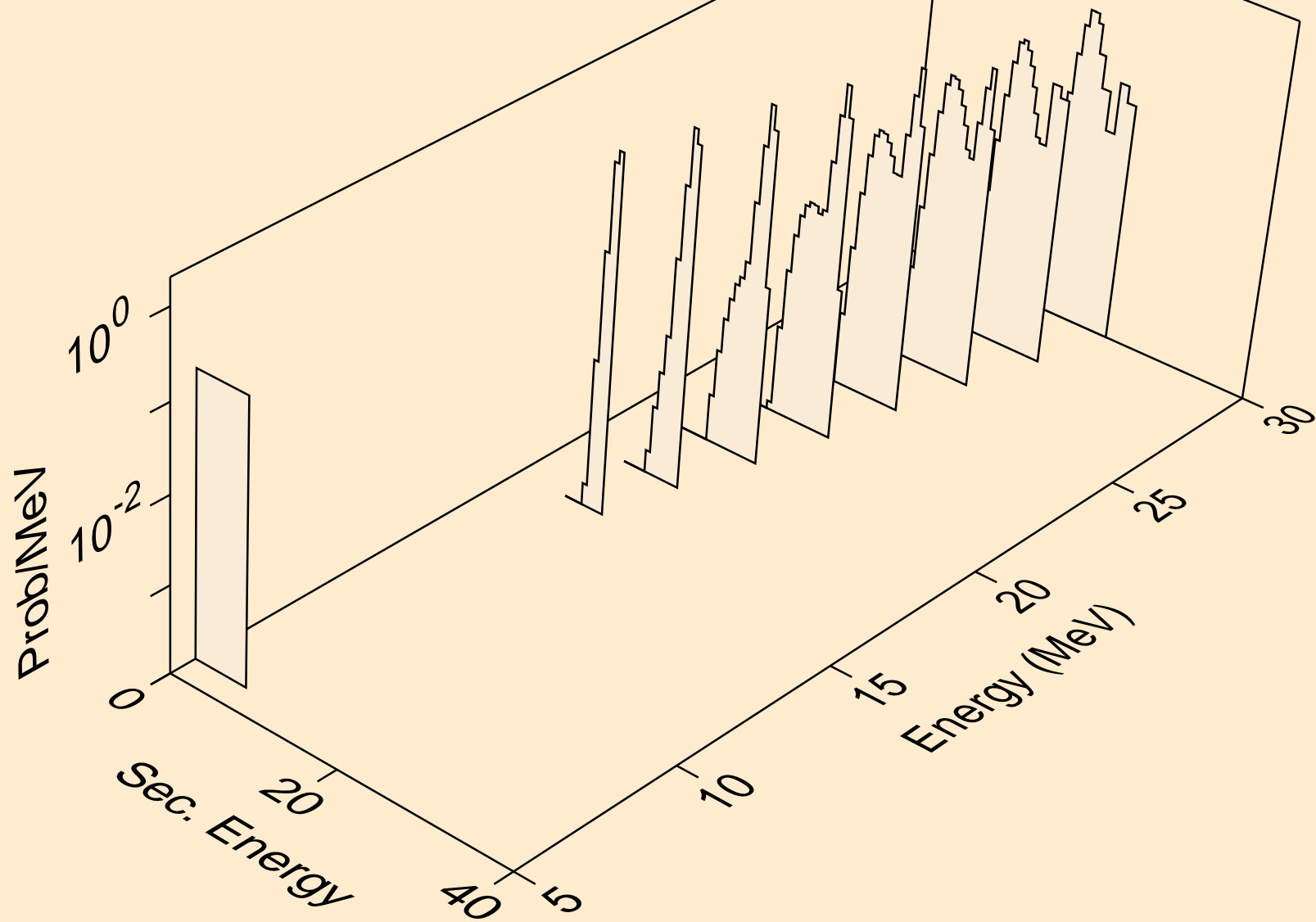

FM246 NEUTRON ACER TENDL-2023 LIBRARY; T=0.K
he3s from (n,he3)

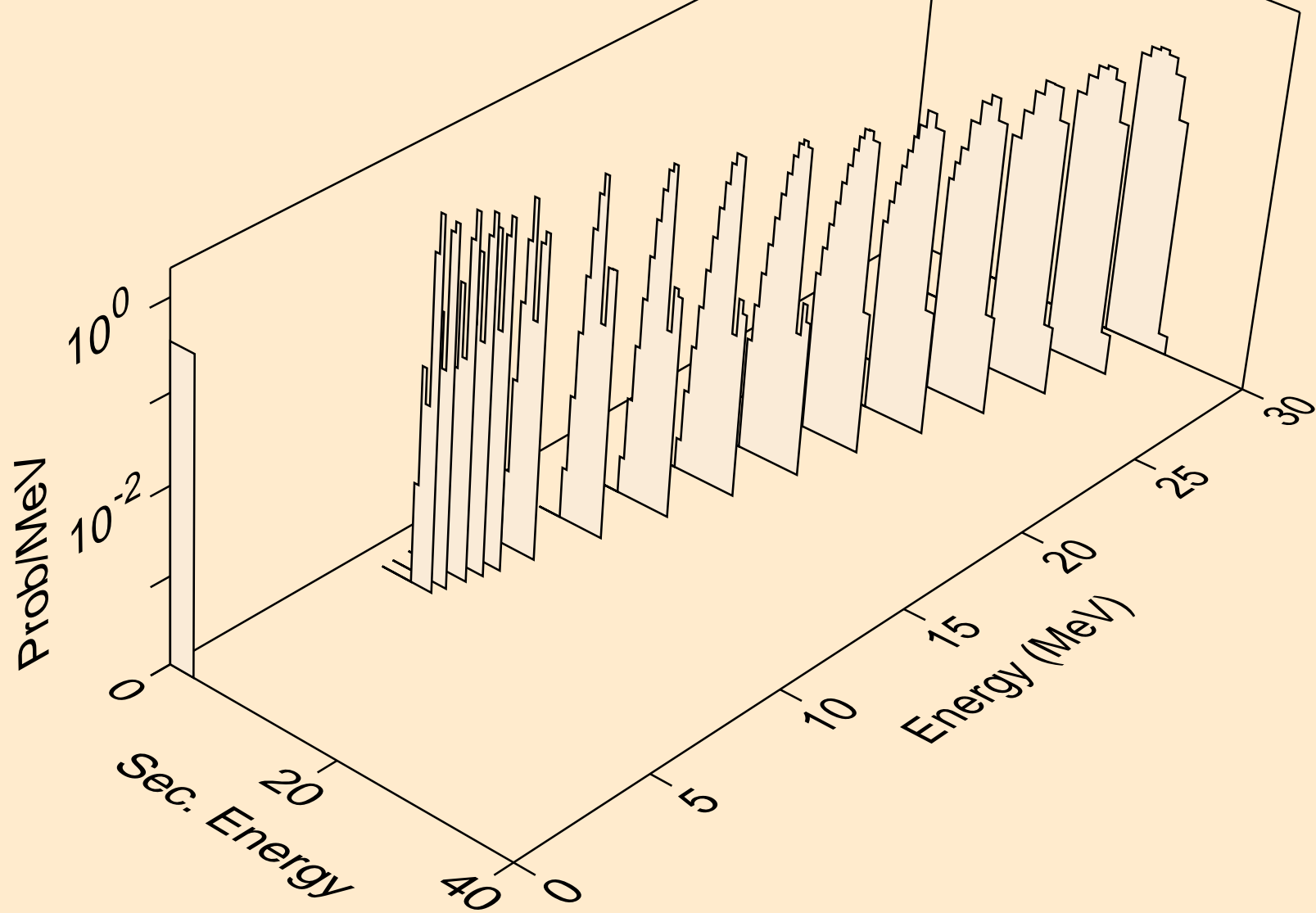

FM246 NEUTRON ACER TENDL-2023 LIBRARY; T=0.K
alphas from (n,x)

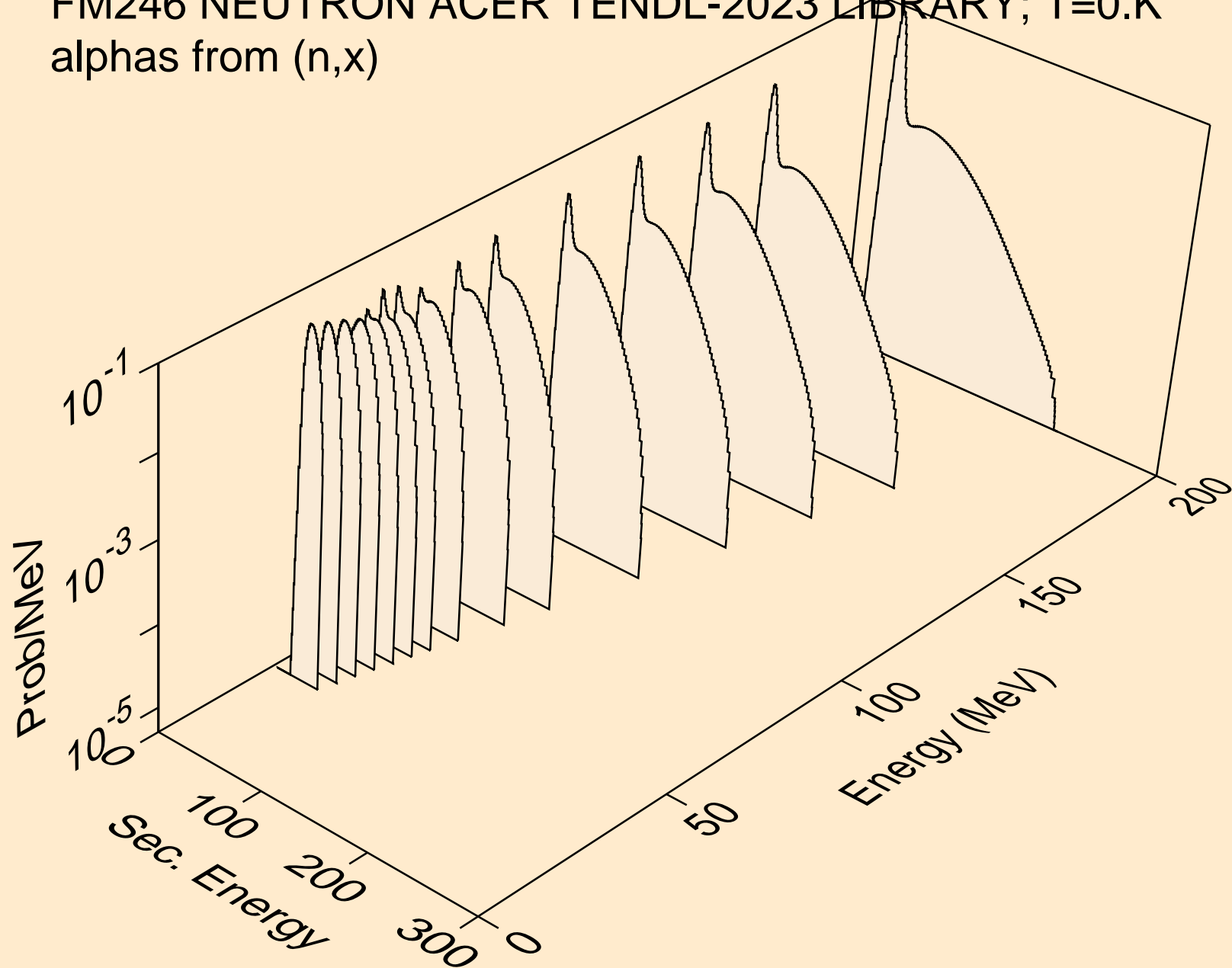

FM246 NEUTRON ACER TENDL-2023 LIBRARY; T=0.K
alphas from (n,n*)a

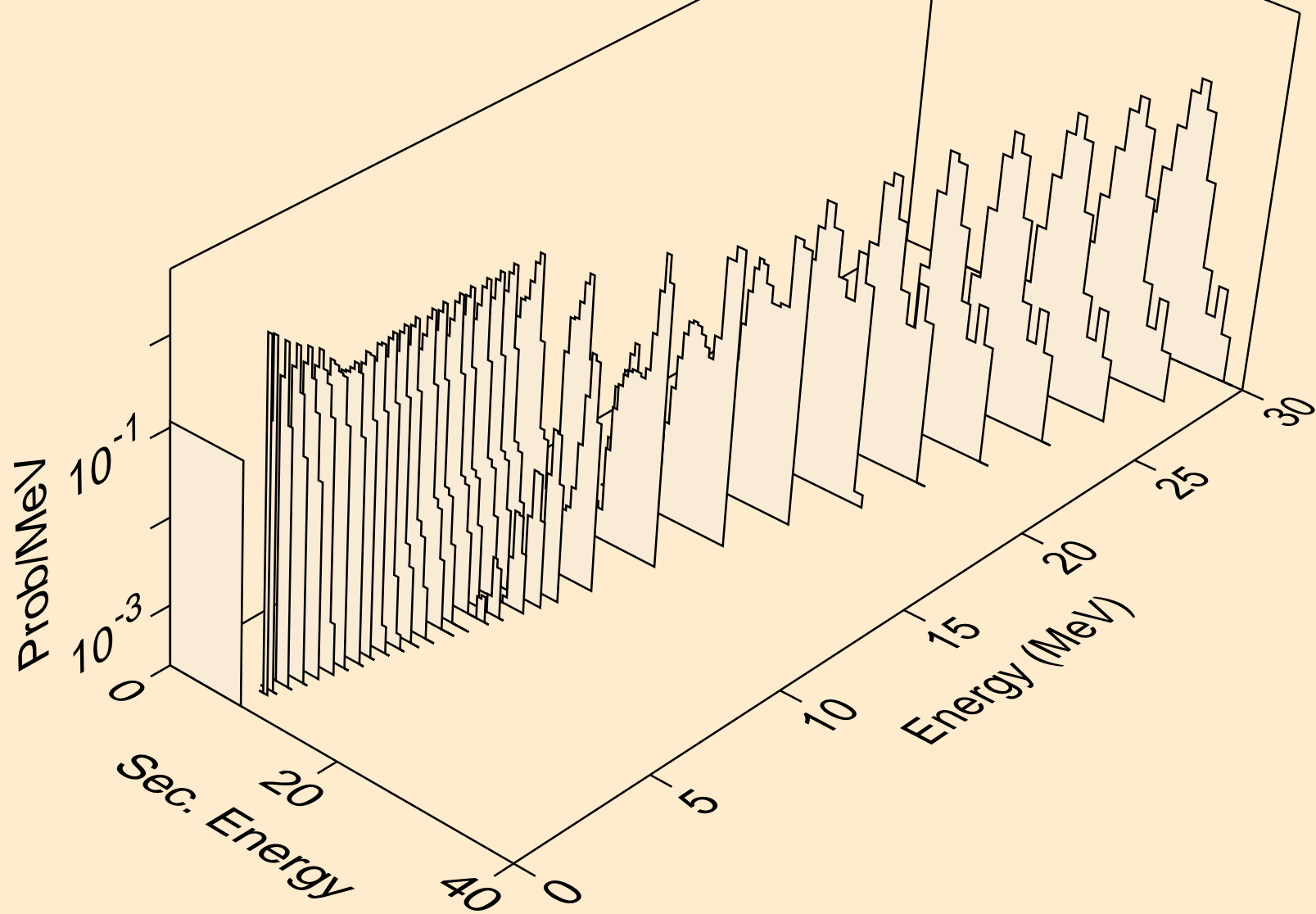

FM246 NEUTRON ACER TENDL-2023 LIBRARY; T=0.K
alphas from (n,2n)a

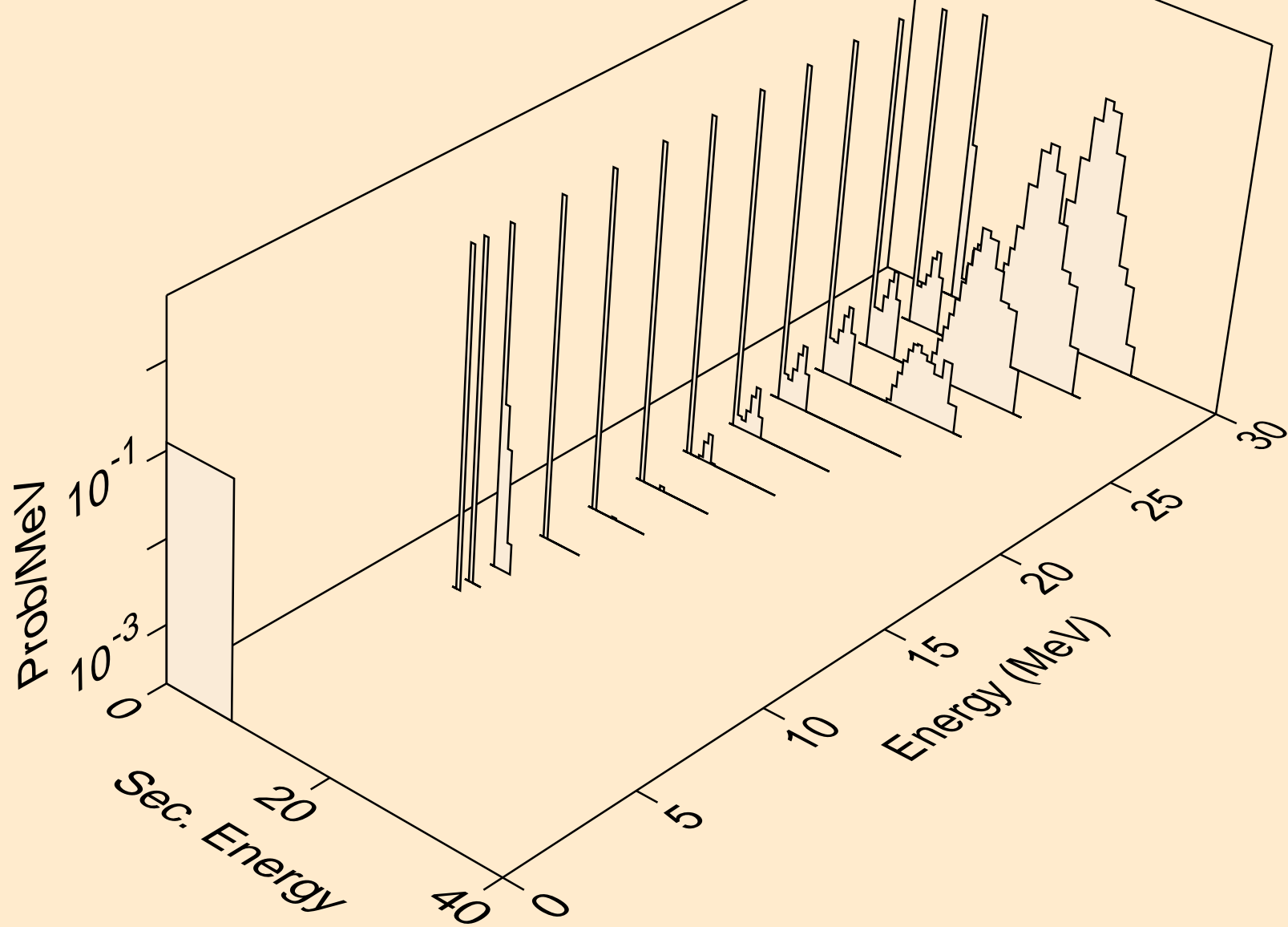

FM246 NEUTRON ACER TENDL-2023 LIBRARY; T=0.K
alphas from (n,a)

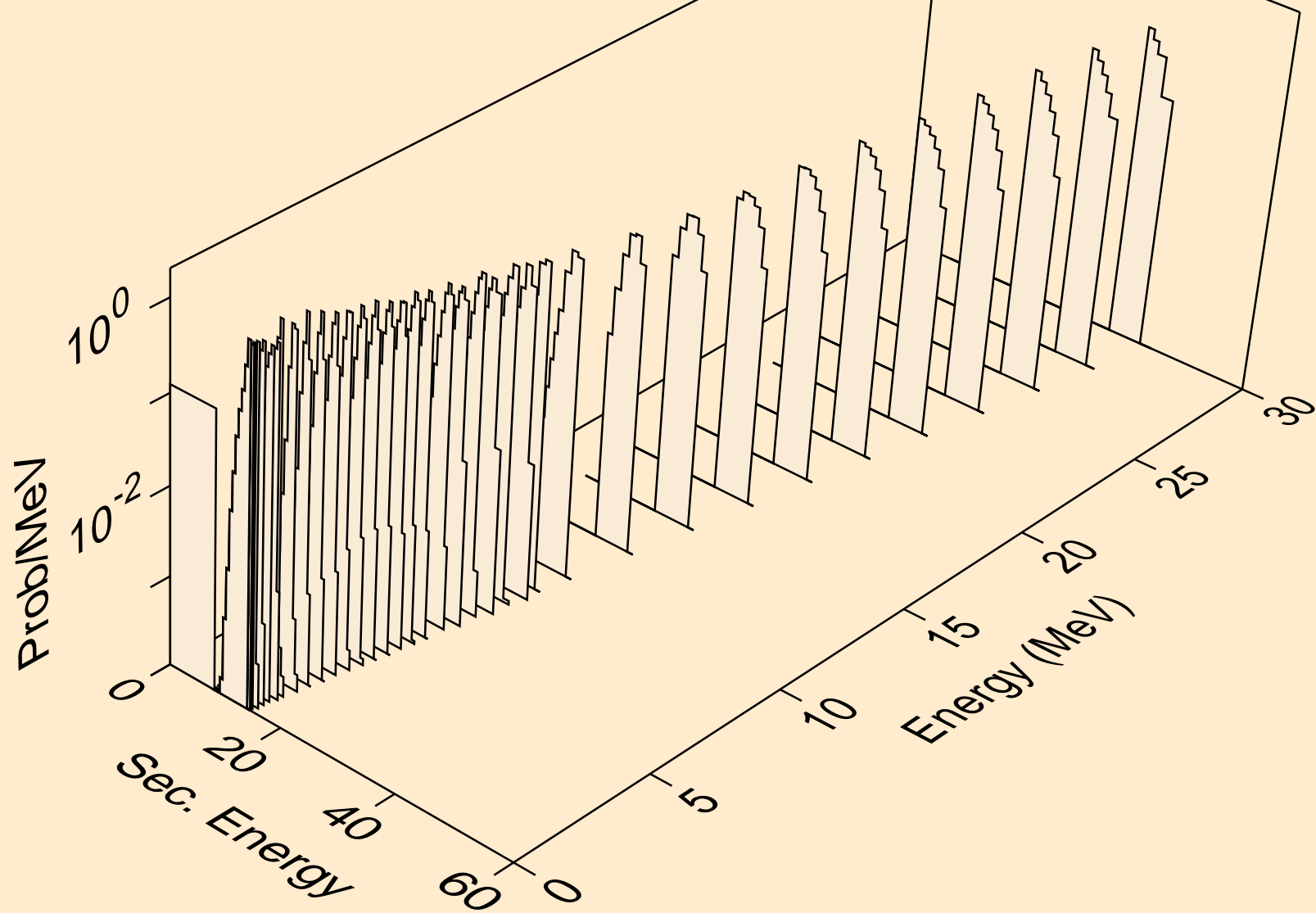

FM246 NEUTRON ACER TENDL-2023 LIBRARY; T=0.K
alphas from (n,2a)

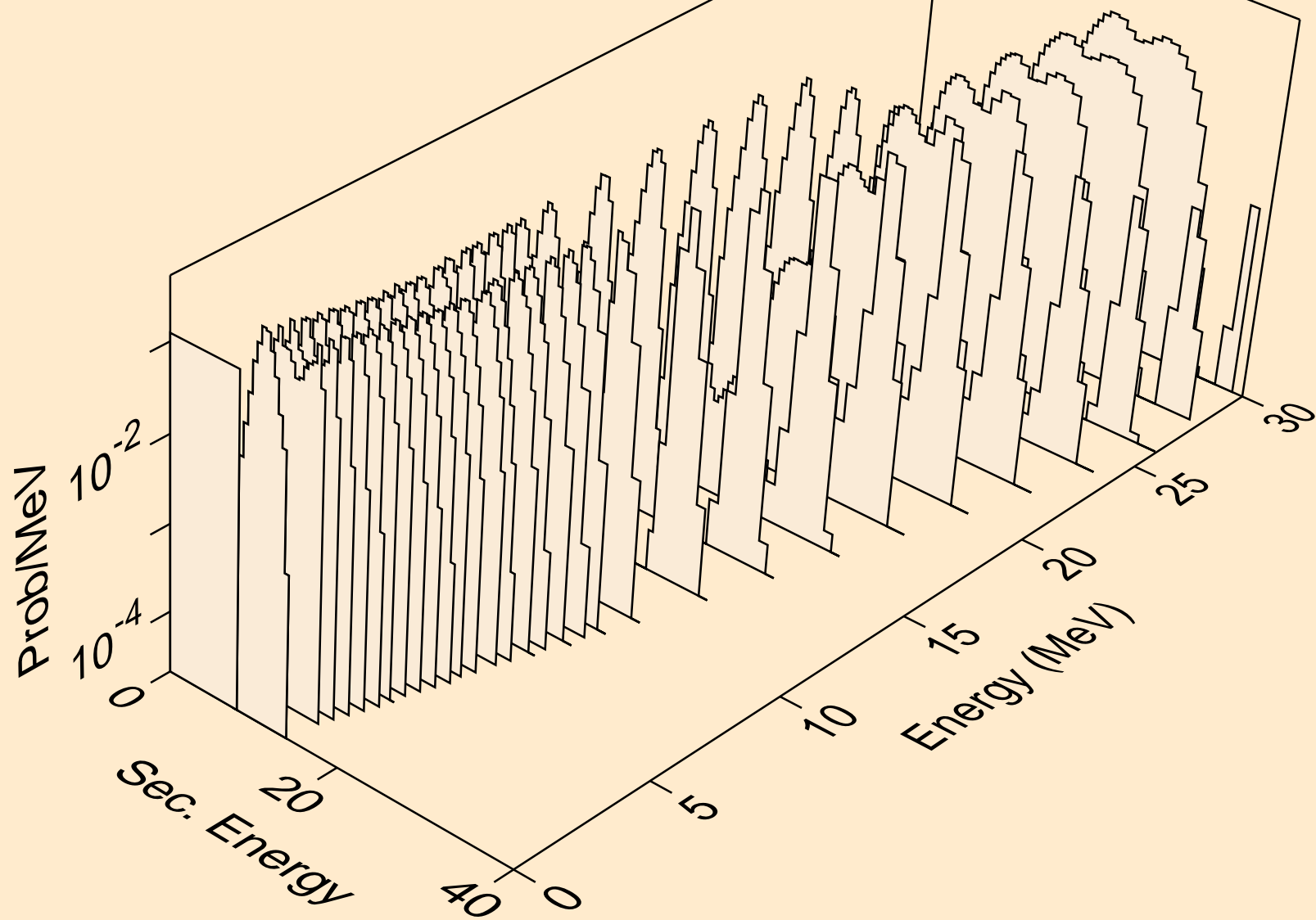

FM246 NEUTRON ACER TENDL-2023 LIBRARY; T=0.K
alphas from (n,pa)

