

# GD139M NEUTRON ACER TENDL-2023 LIBRARY; T=0.K

## Principal cross sections

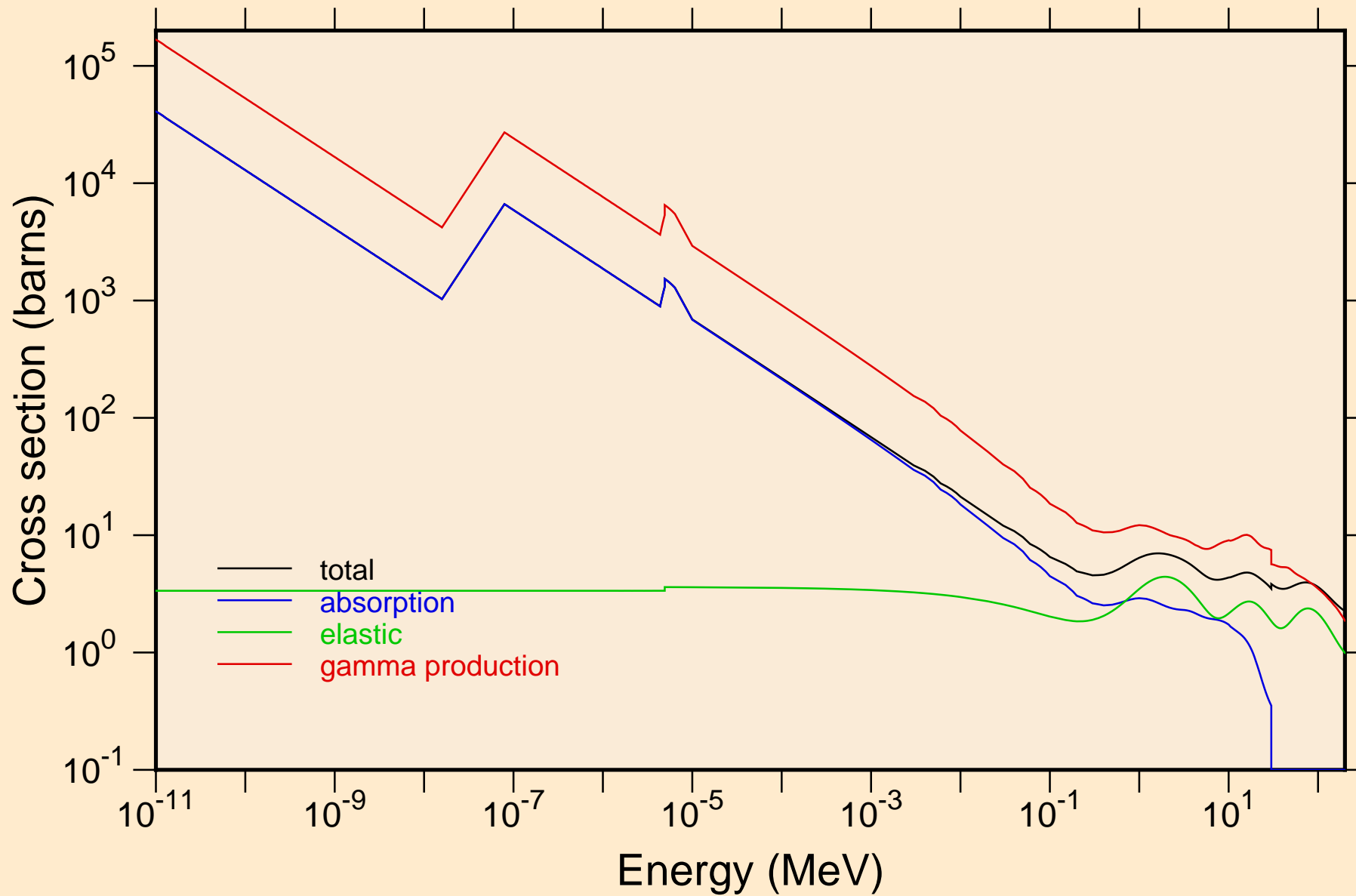

# GD139M NEUTRON ACER TENDL-2023 LIBRARY; T=0.K

## Heating

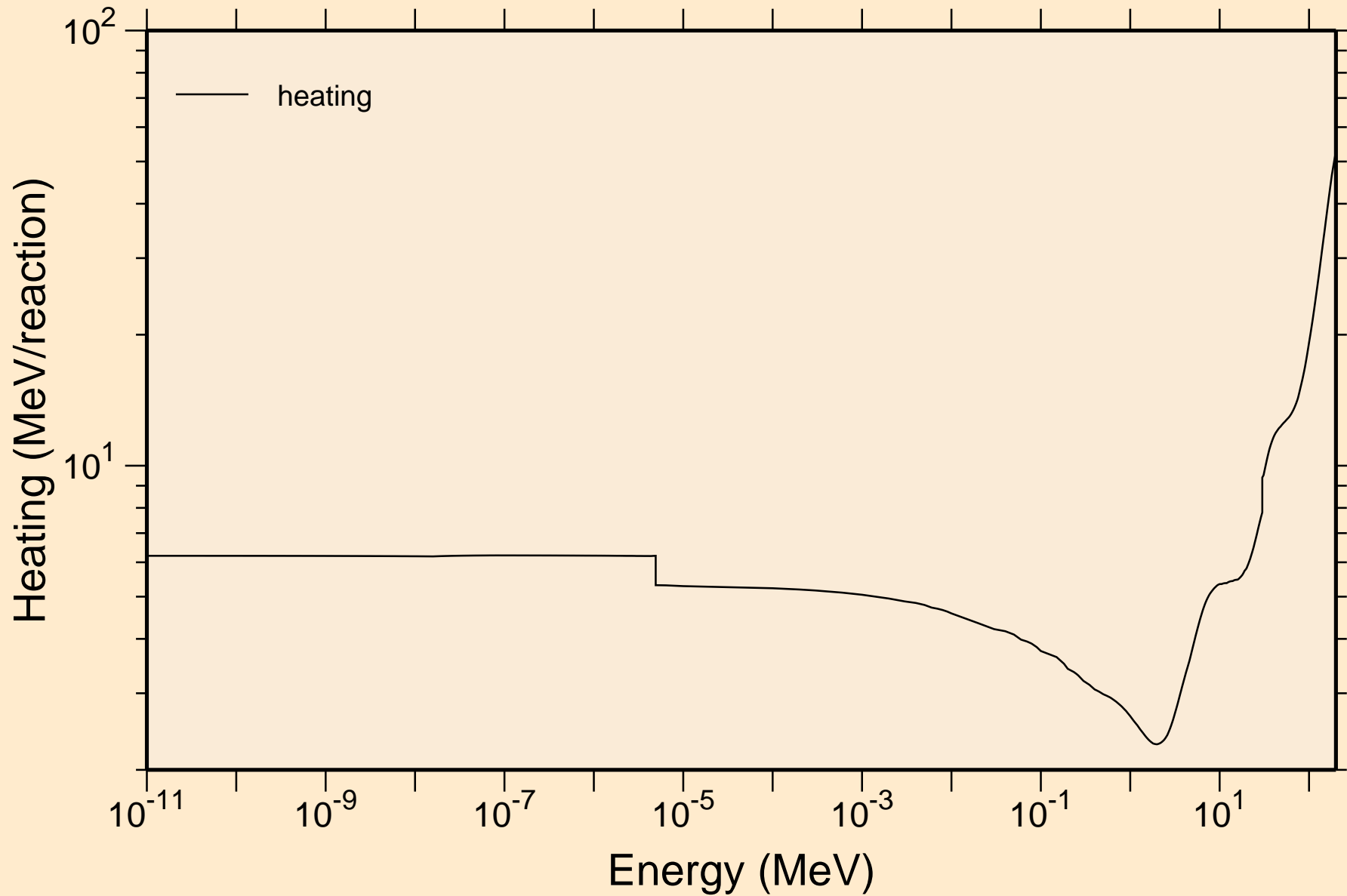

# GD139M NEUTRON ACER TENDL-2023 LIBRARY; T=0.K

## Damage

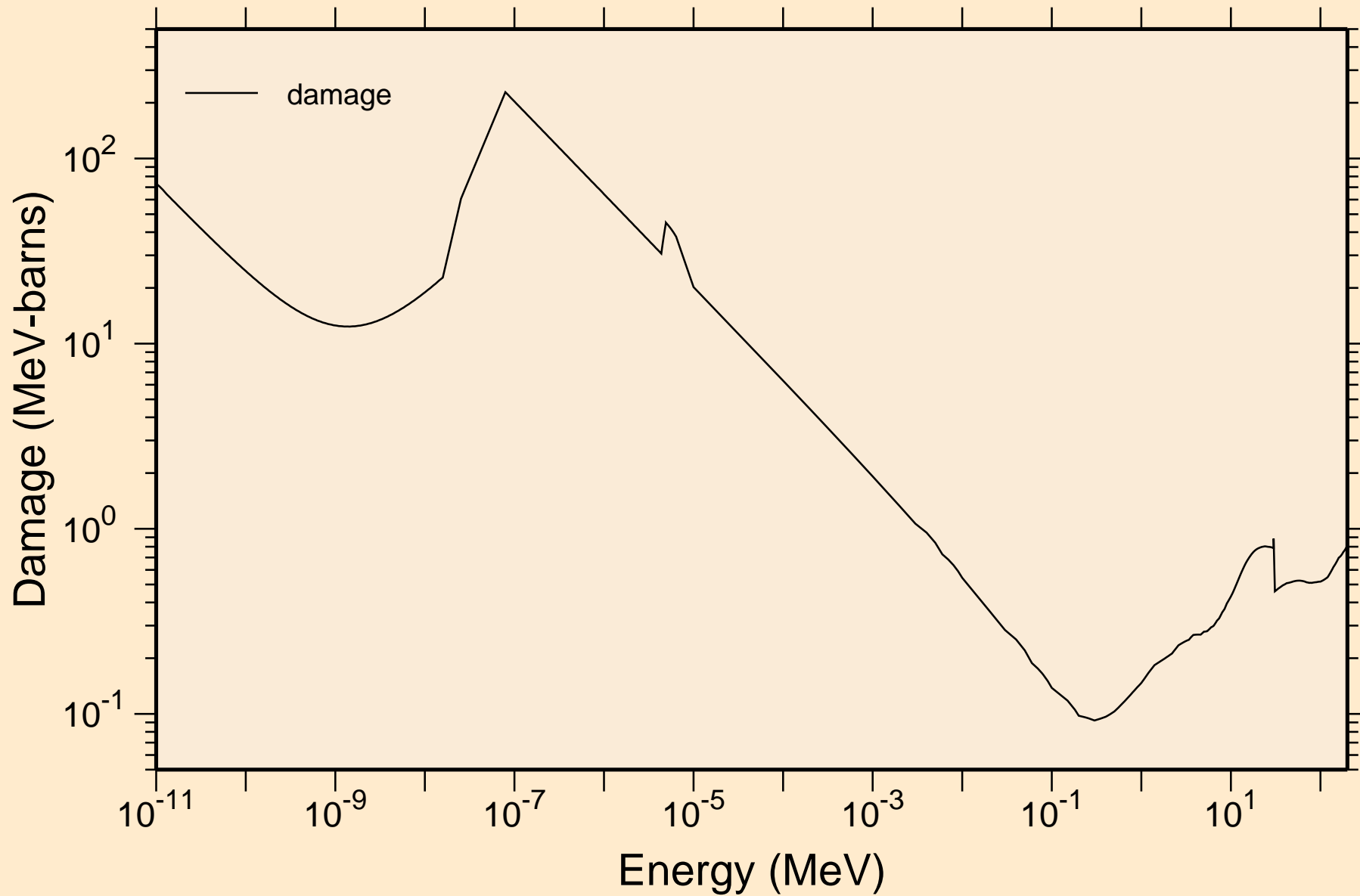

# GD139M NEUTRON ACER TENDL-2023 LIBRARY; T=0.K

## Non-threshold reactions

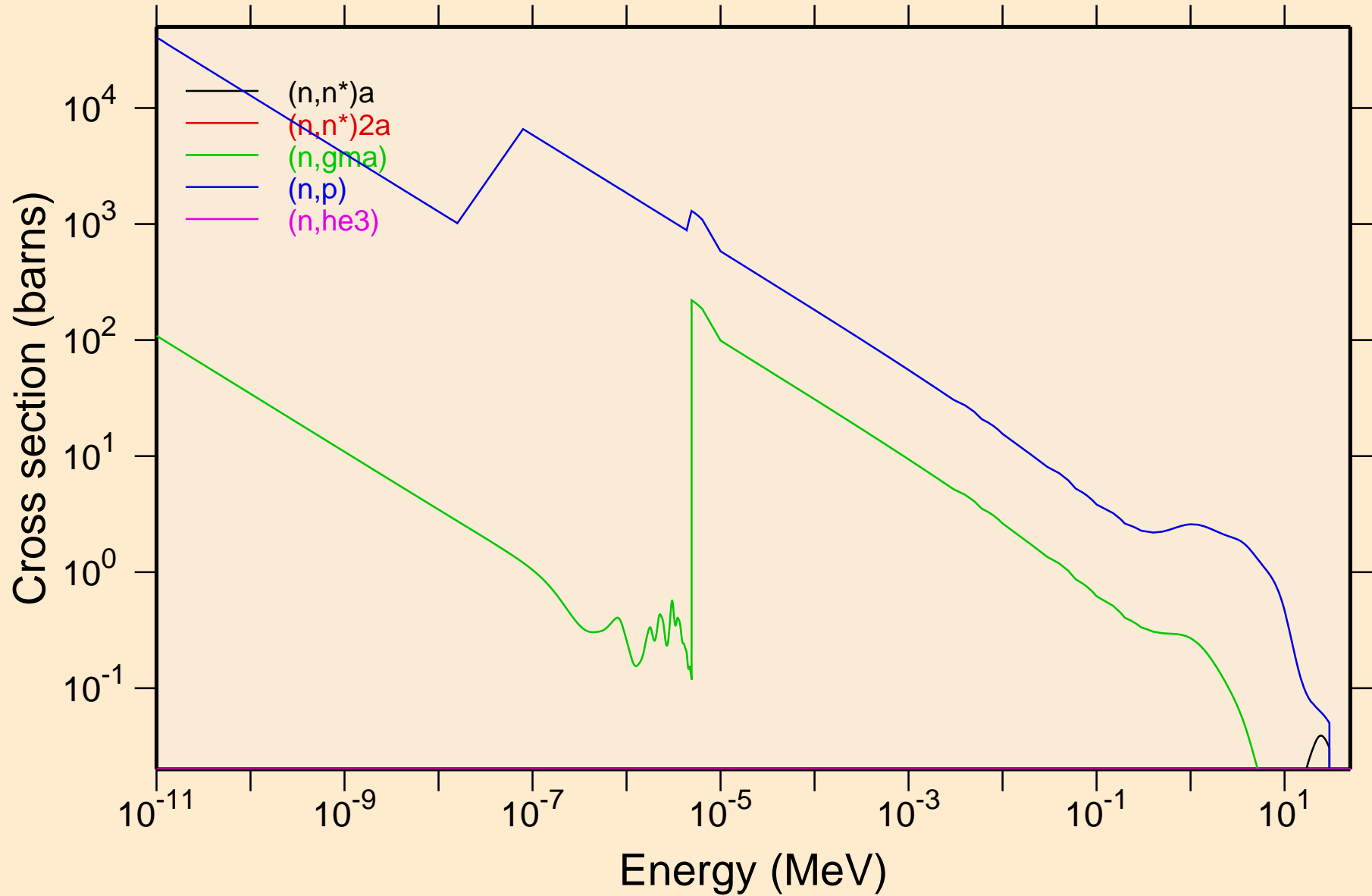

# GD139M NEUTRON ACER TENDL-2023 LIBRARY; T=0.K

## Non-threshold reactions

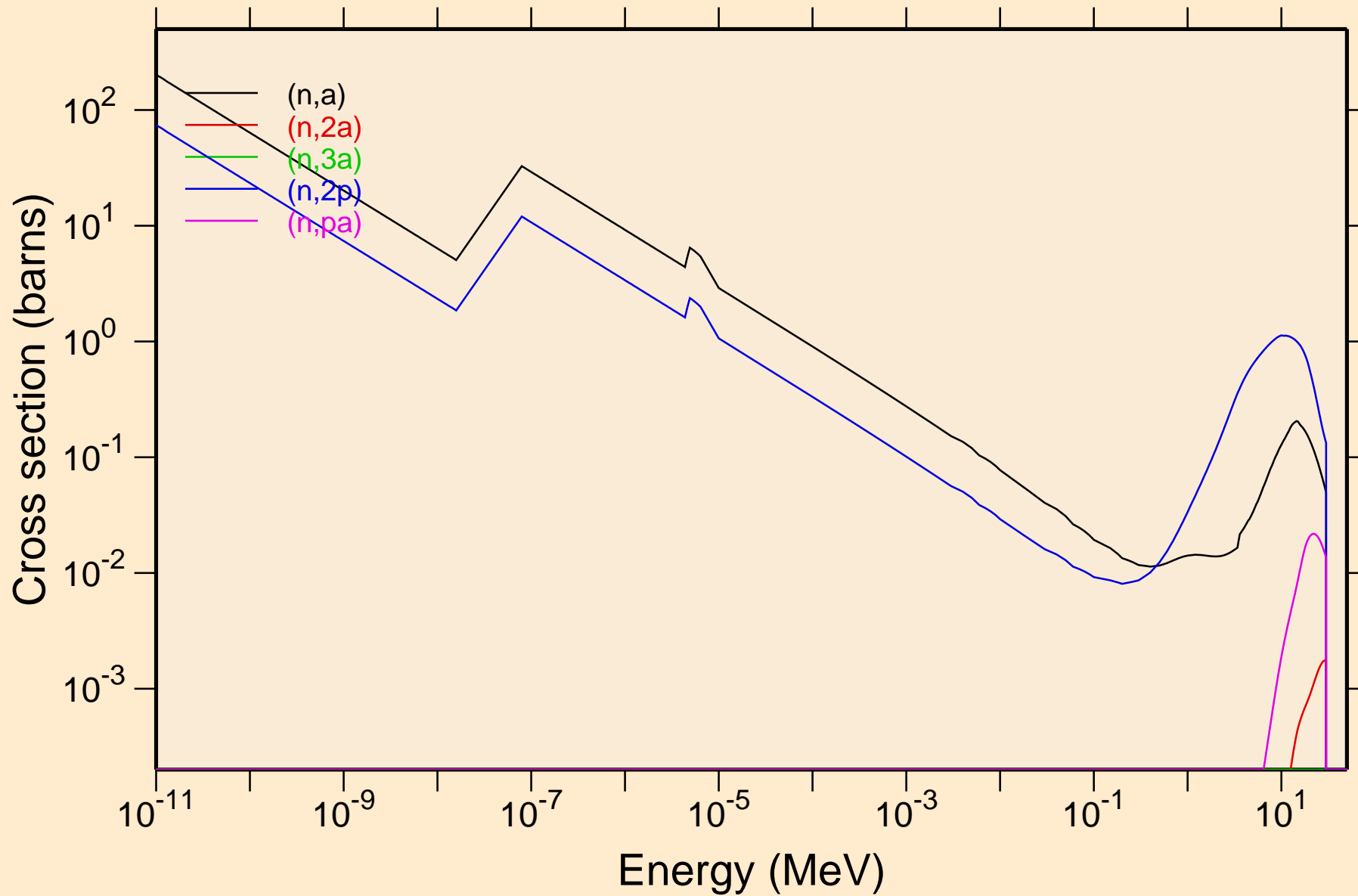

# GD139M NEUTRON ACER TENDL-2023 LIBRARY; T=0.K

## Non-threshold reactions

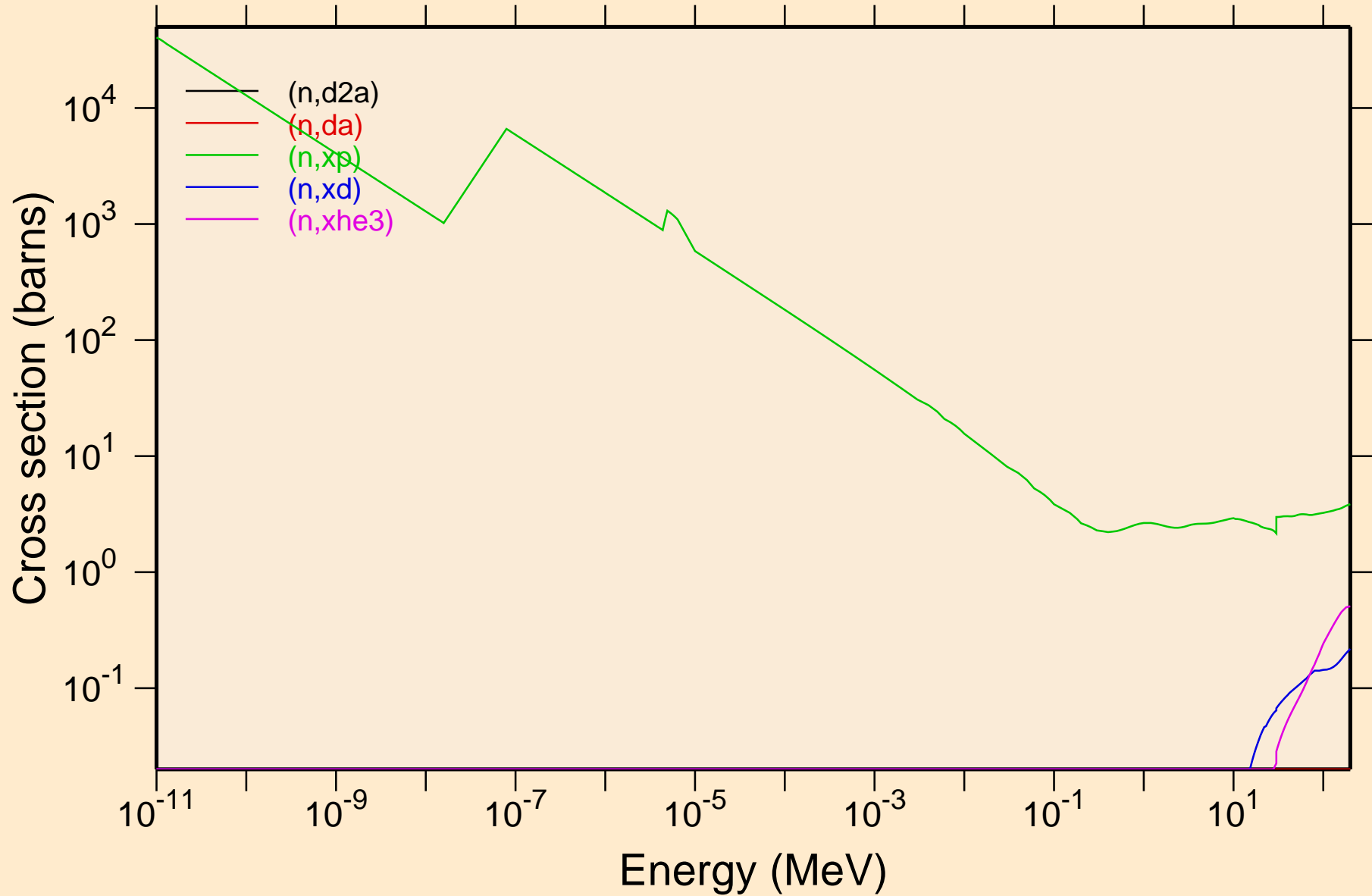

GD139M NEUTRON ACER TENDL-2023 LIBRARY; T=0.K  
Non-threshold reactions

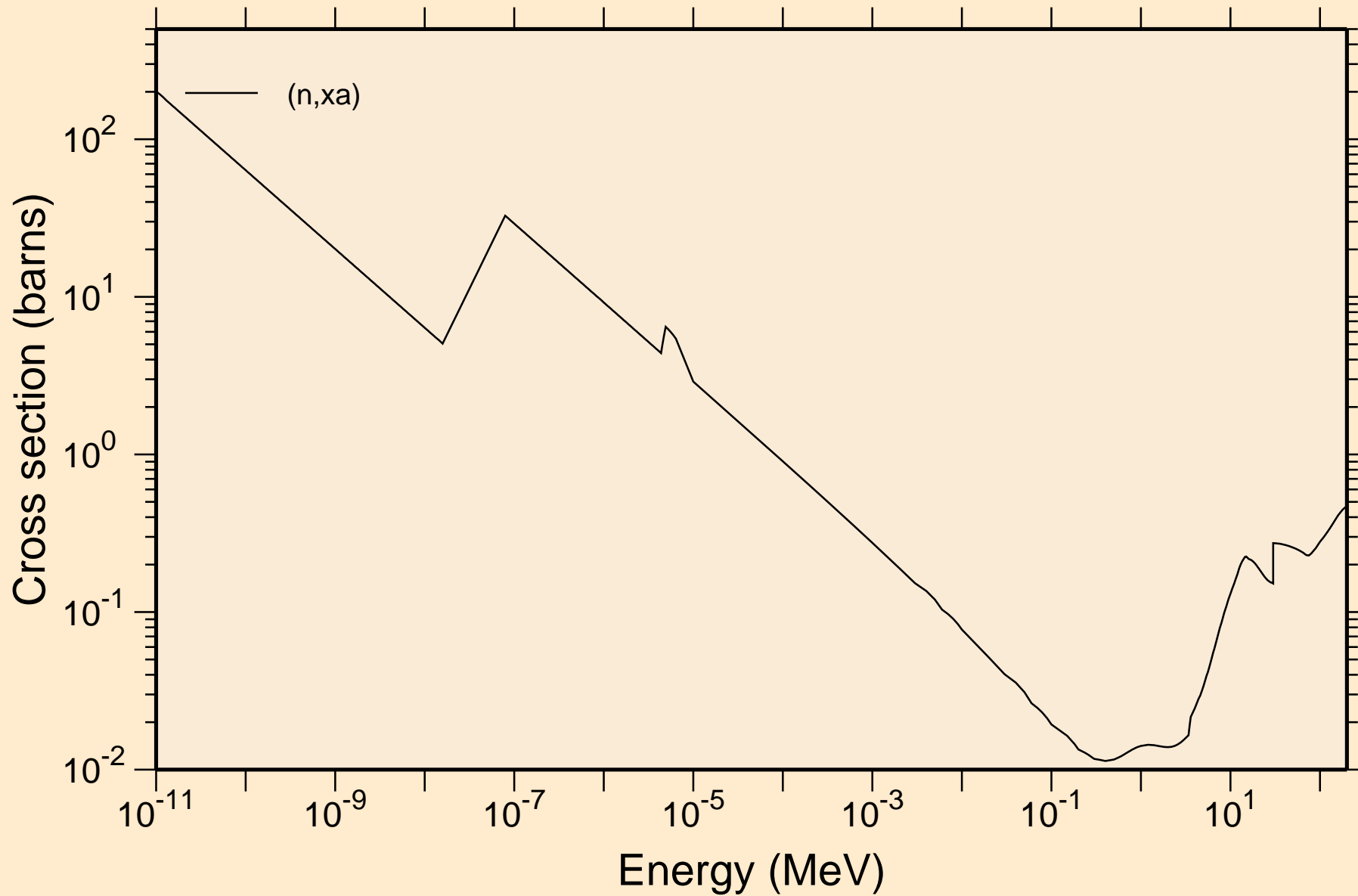

# GD139M NEUTRON ACER TENDL-2023 LIBRARY; T=0.K

## Principal cross sections

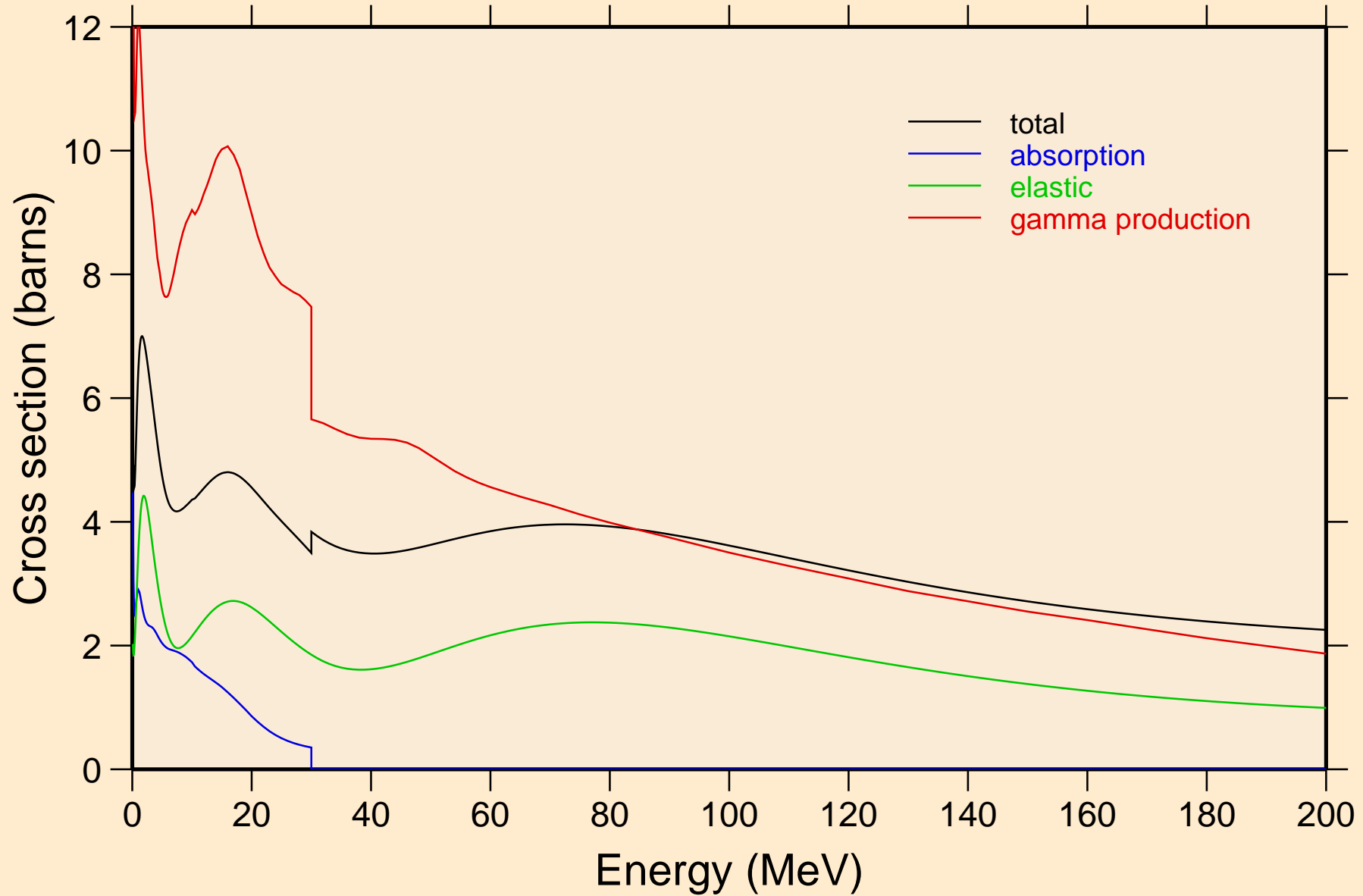

# GD139M NEUTRON ACER TENDL-2023 LIBRARY; T=0.K

## Heating

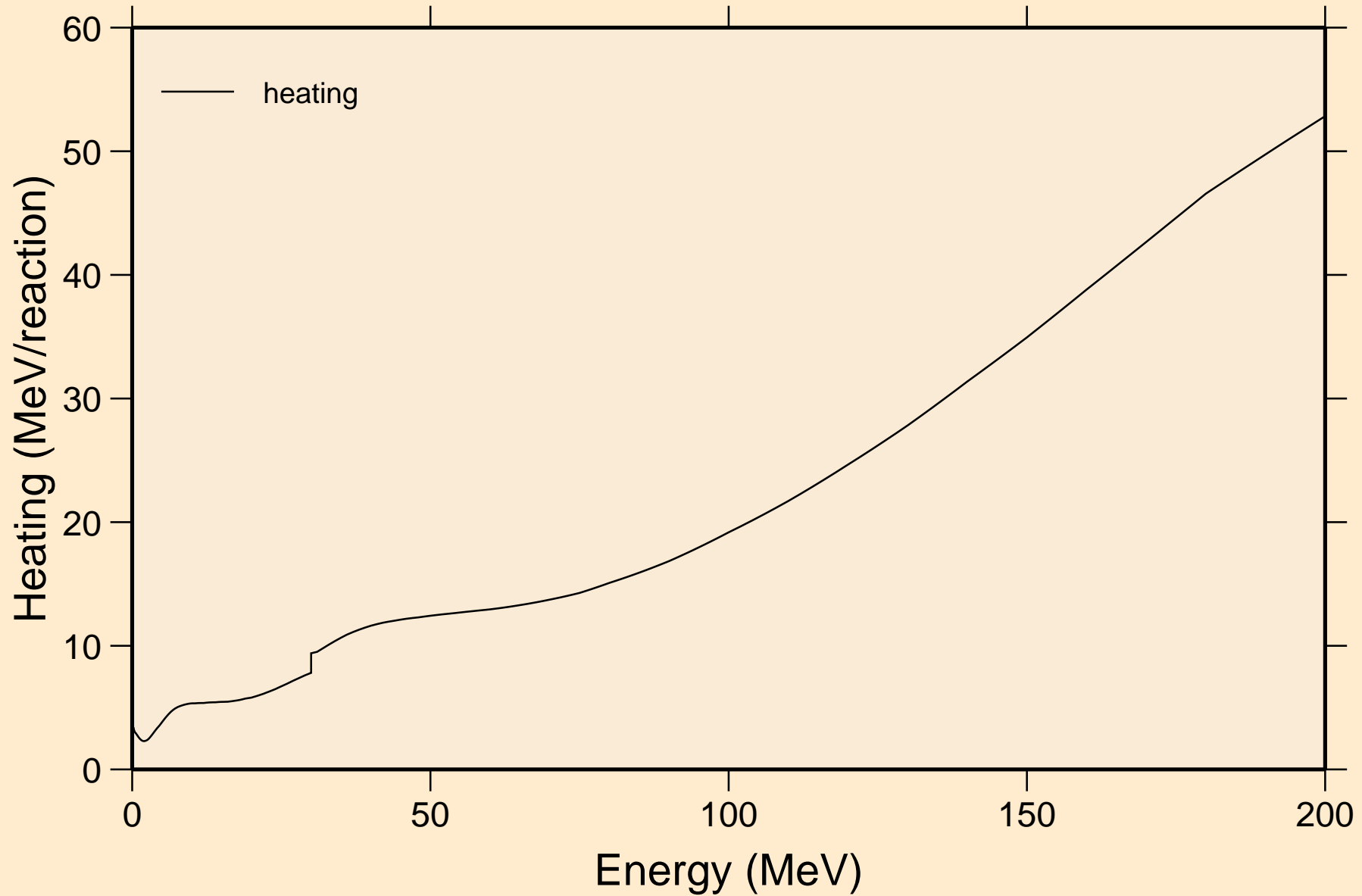

# GD139M NEUTRON ACER TENDL-2023 LIBRARY; T=0.K

## Damage

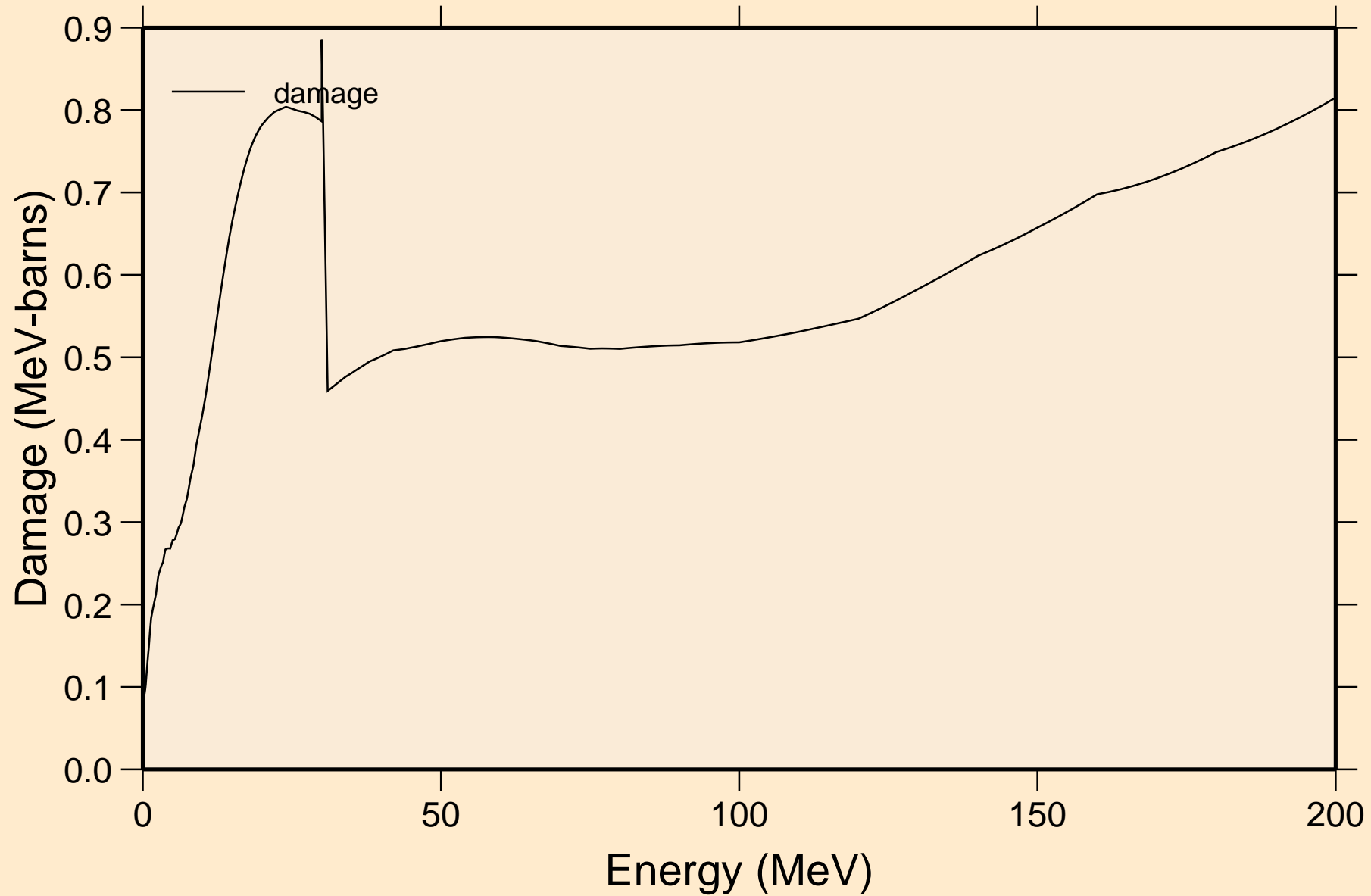

# GD139M NEUTRON ACER TENDL-2023 LIBRARY; T=0.K

## Non-threshold reactions

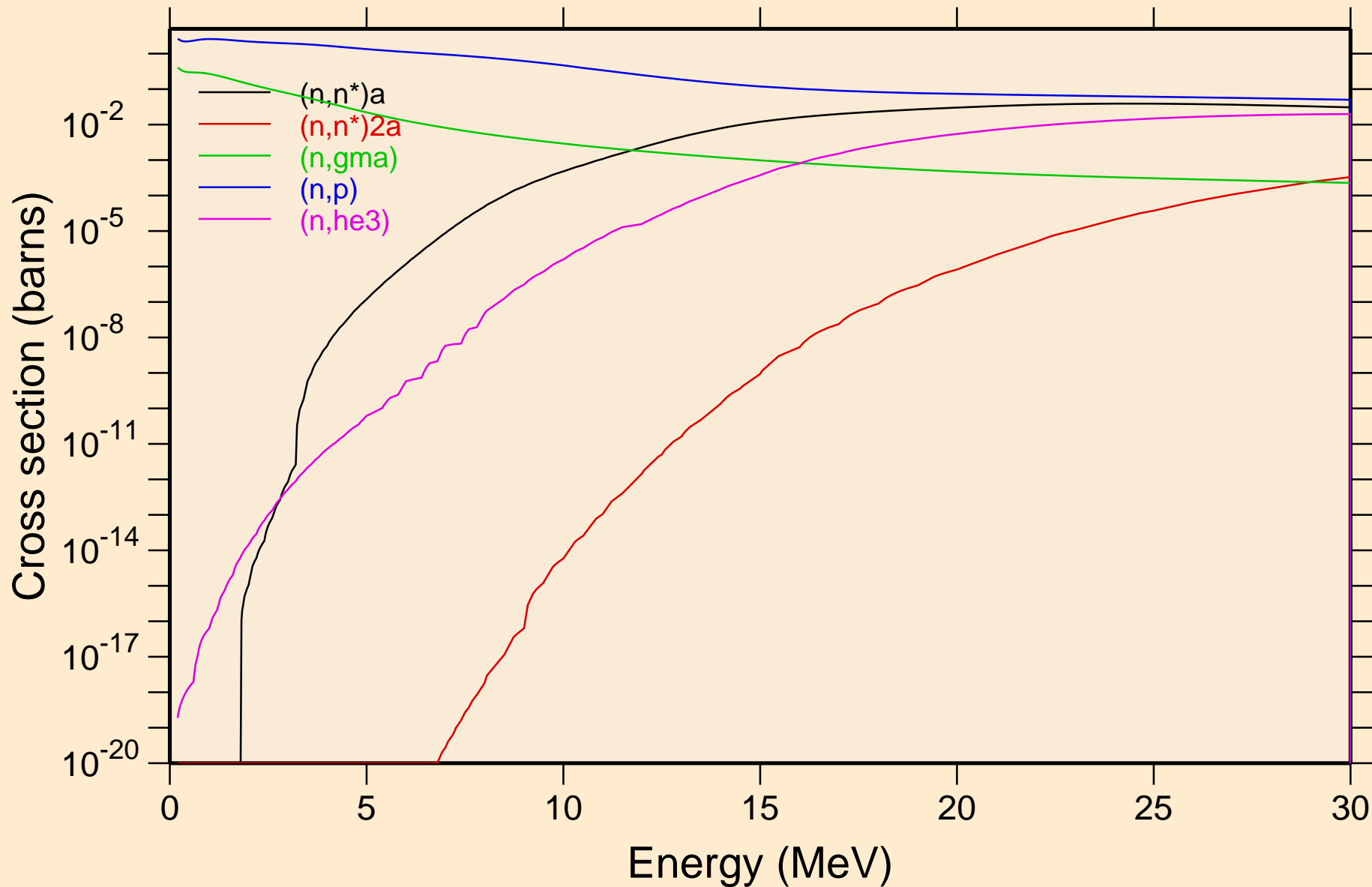

# GD139M NEUTRON ACER TENDL-2023 LIBRARY; T=0.K

## Non-threshold reactions

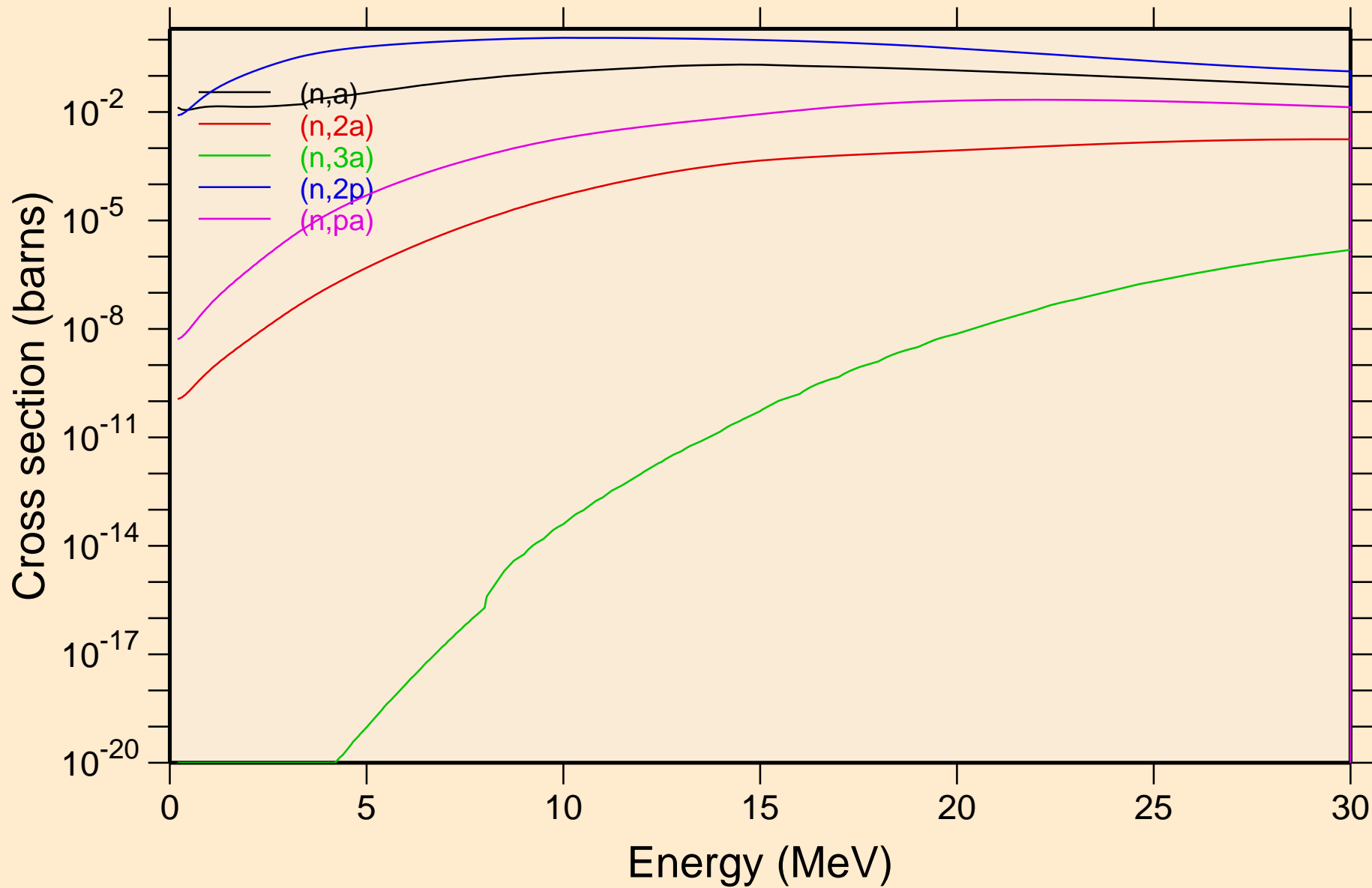

# GD139M NEUTRON ACER TENDL-2023 LIBRARY; T=0.K

## Non-threshold reactions

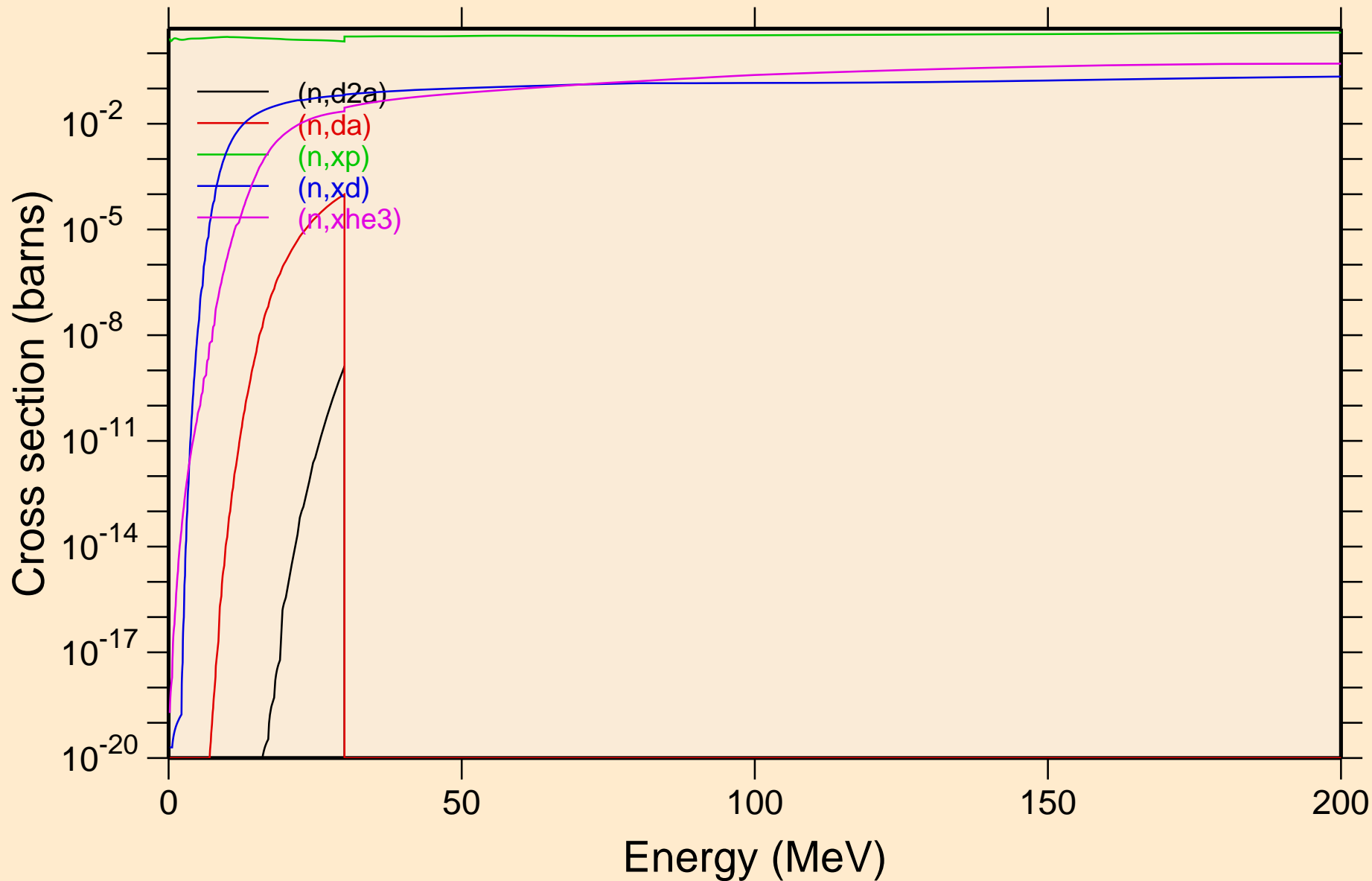

GD139M NEUTRON ACER TENDL-2023 LIBRARY; T=0.K  
Non-threshold reactions

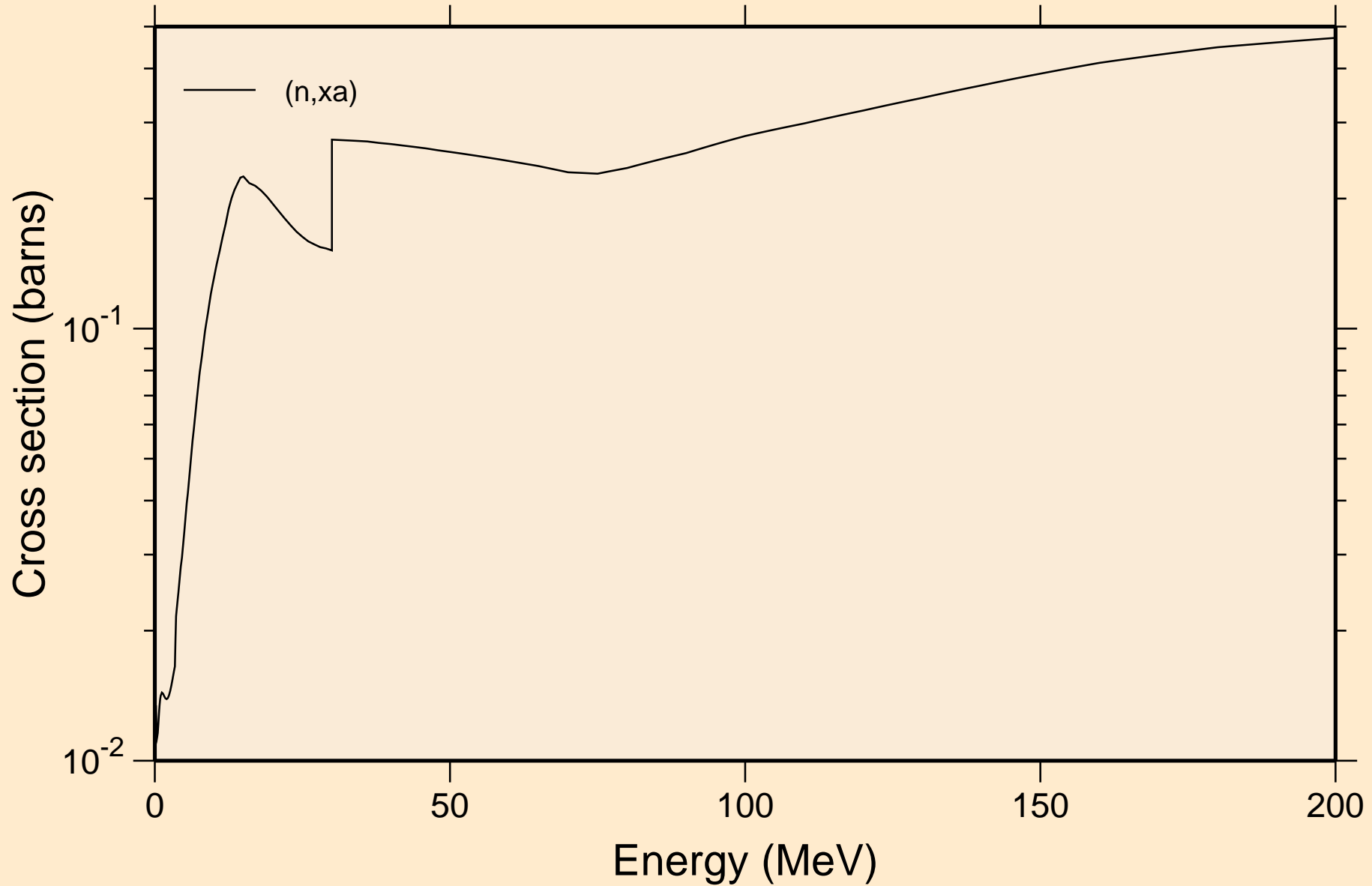

GD139M NEUTRON ACER TENDL-2023 LIBRARY; T=0.K  
Inelastic levels

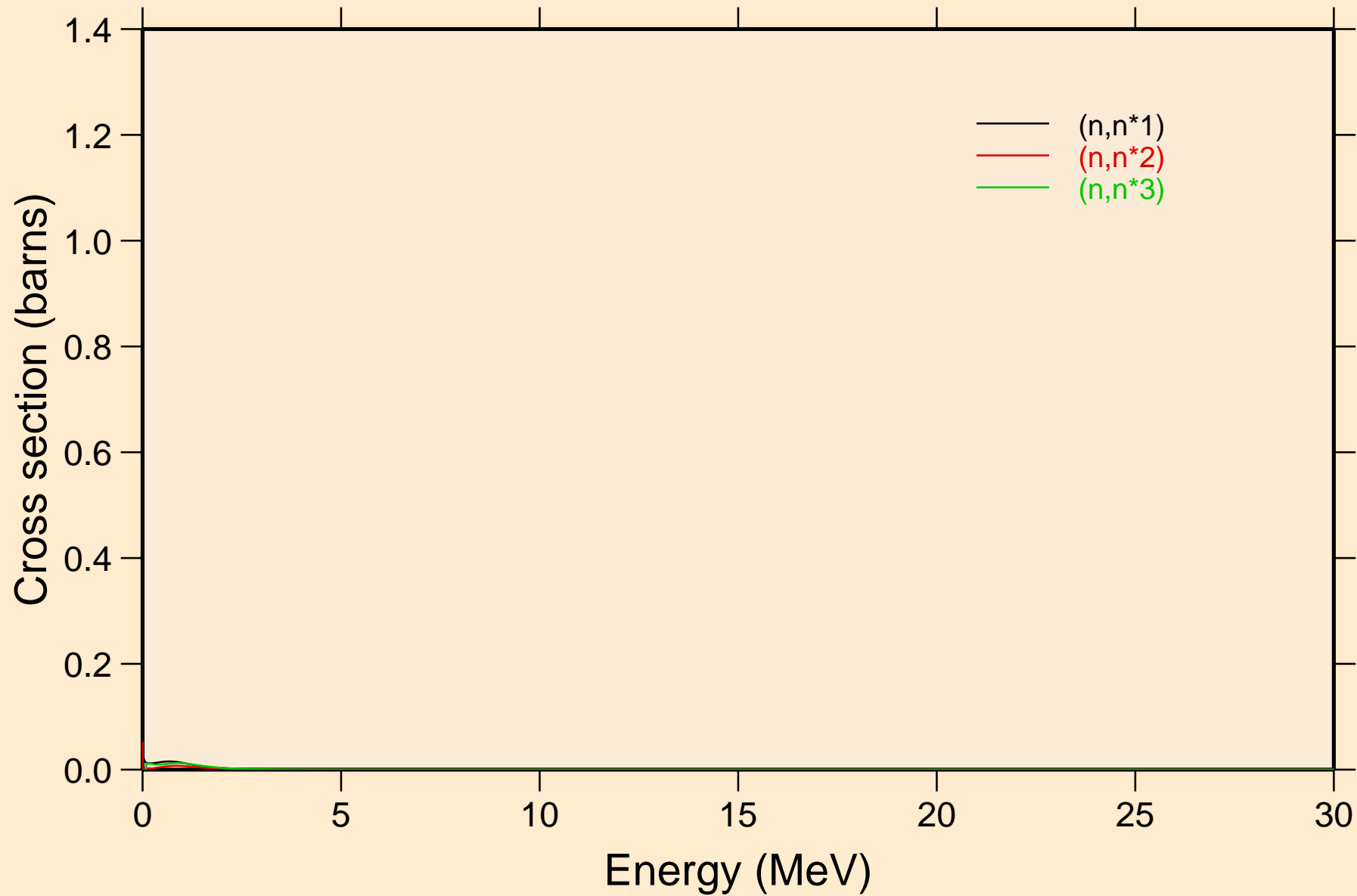

# GD139M NEUTRON ACER TENDL-2023 LIBRARY; T=0.K

## Threshold reactions

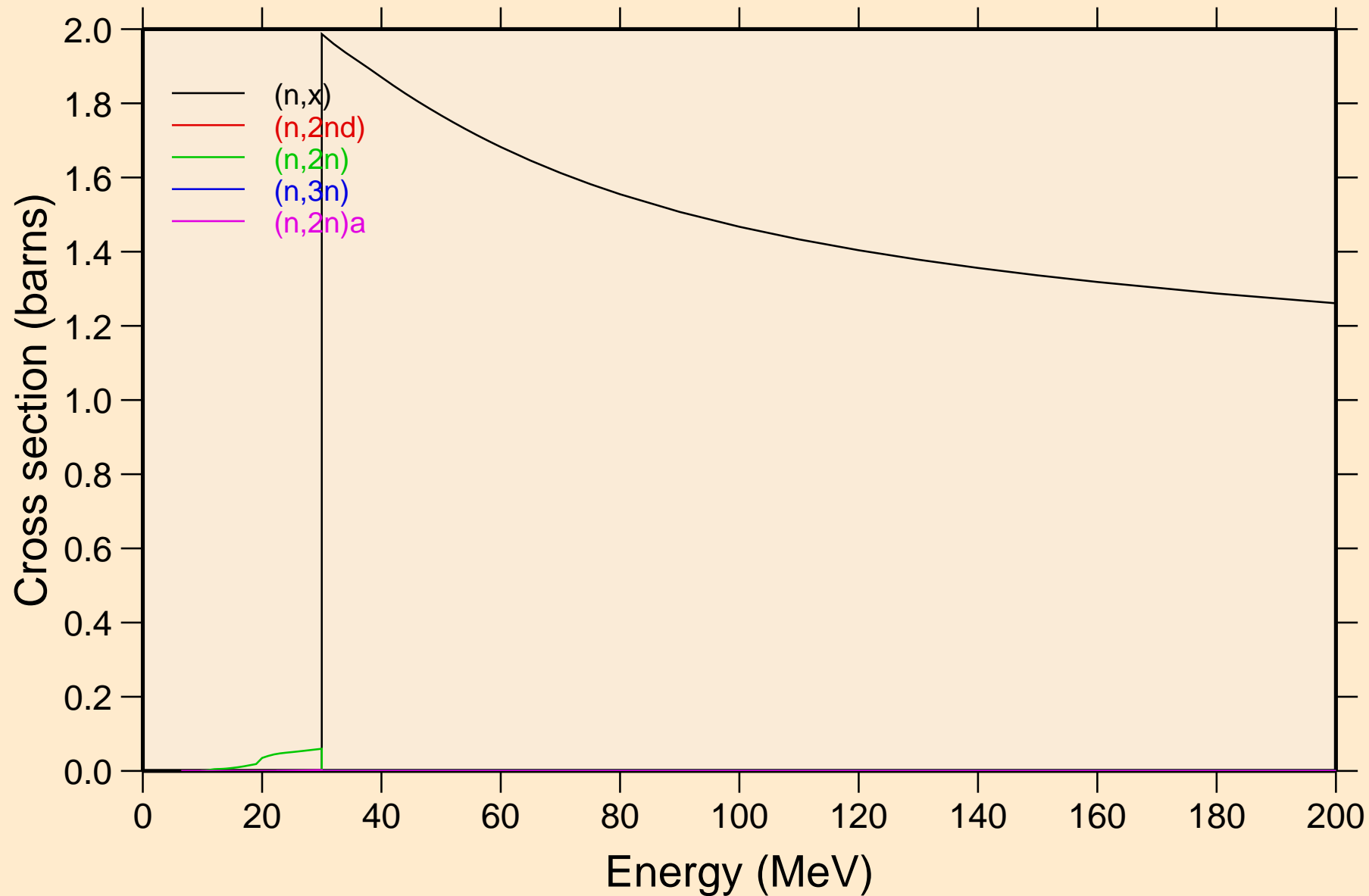

# GD139M NEUTRON ACER TENDL-2023 LIBRARY; T=0.K

## Threshold reactions

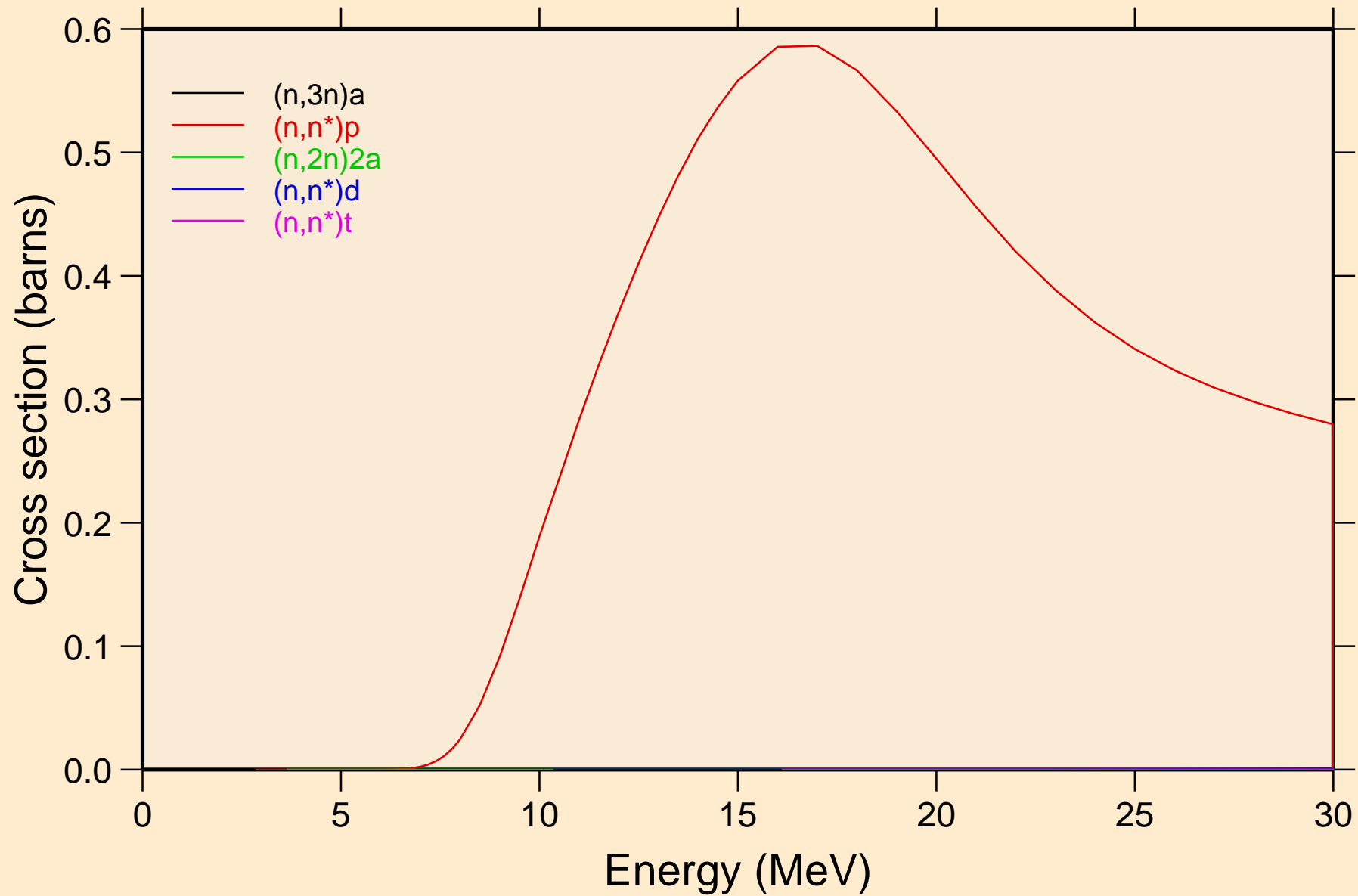

# GD139M NEUTRON ACER TENDL-2023 LIBRARY; T=0.K

## Threshold reactions

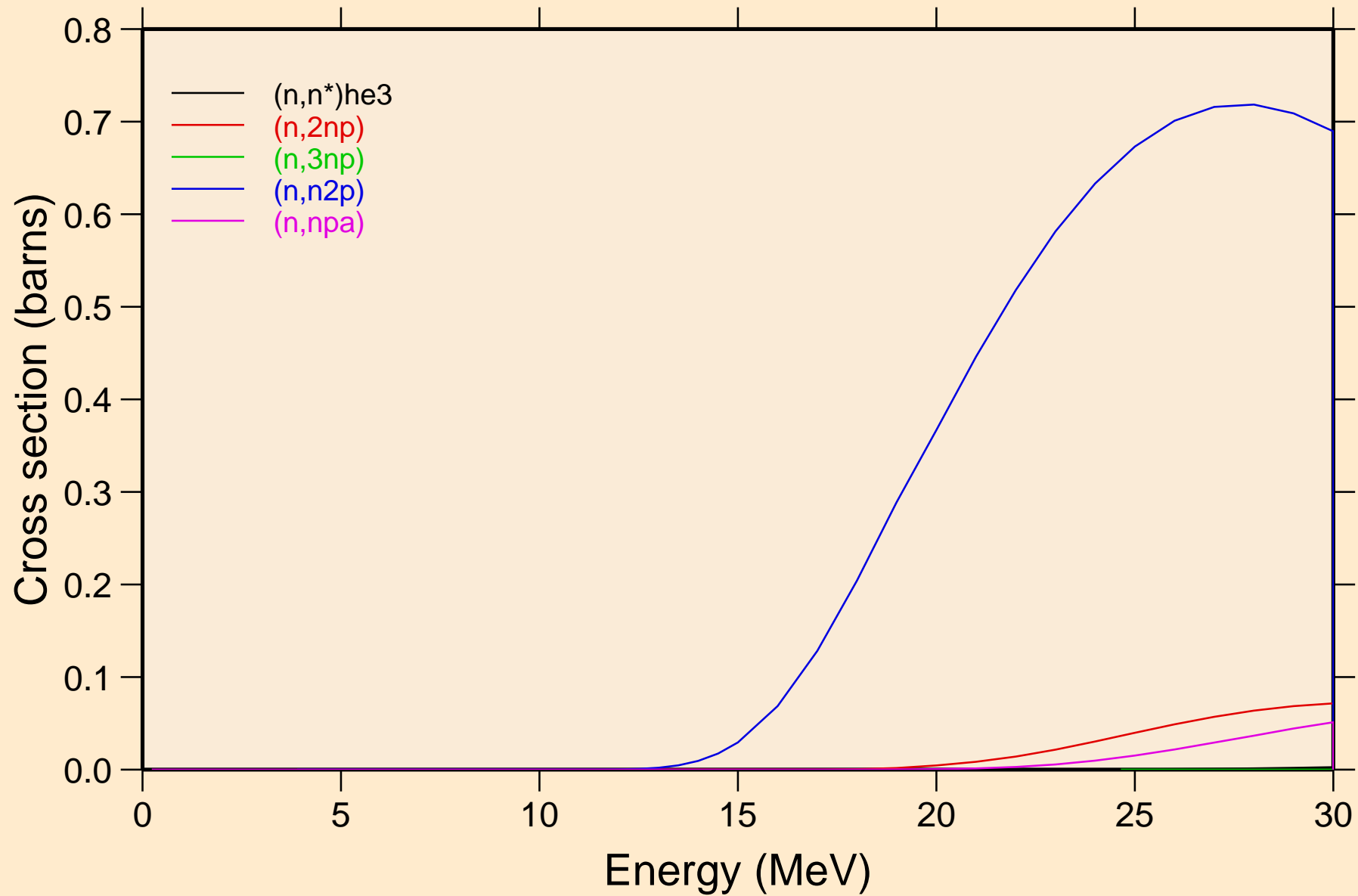

# GD139M NEUTRON ACER TENDL-2023 LIBRARY; T=0.K

## Threshold reactions

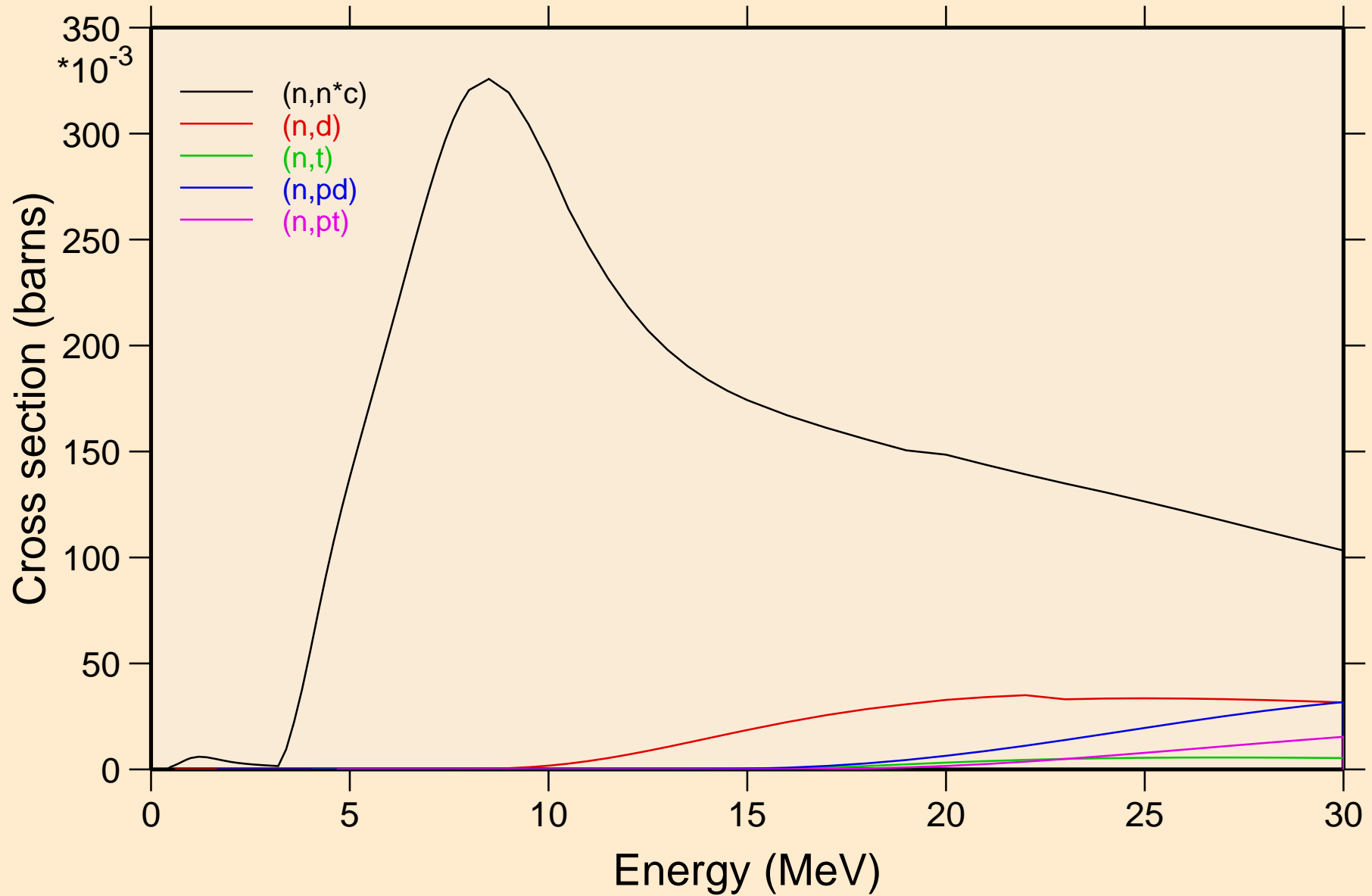

GD139M NEUTRON ACER TENDL-2023 LIBRARY; T=0.K  
Threshold reactions

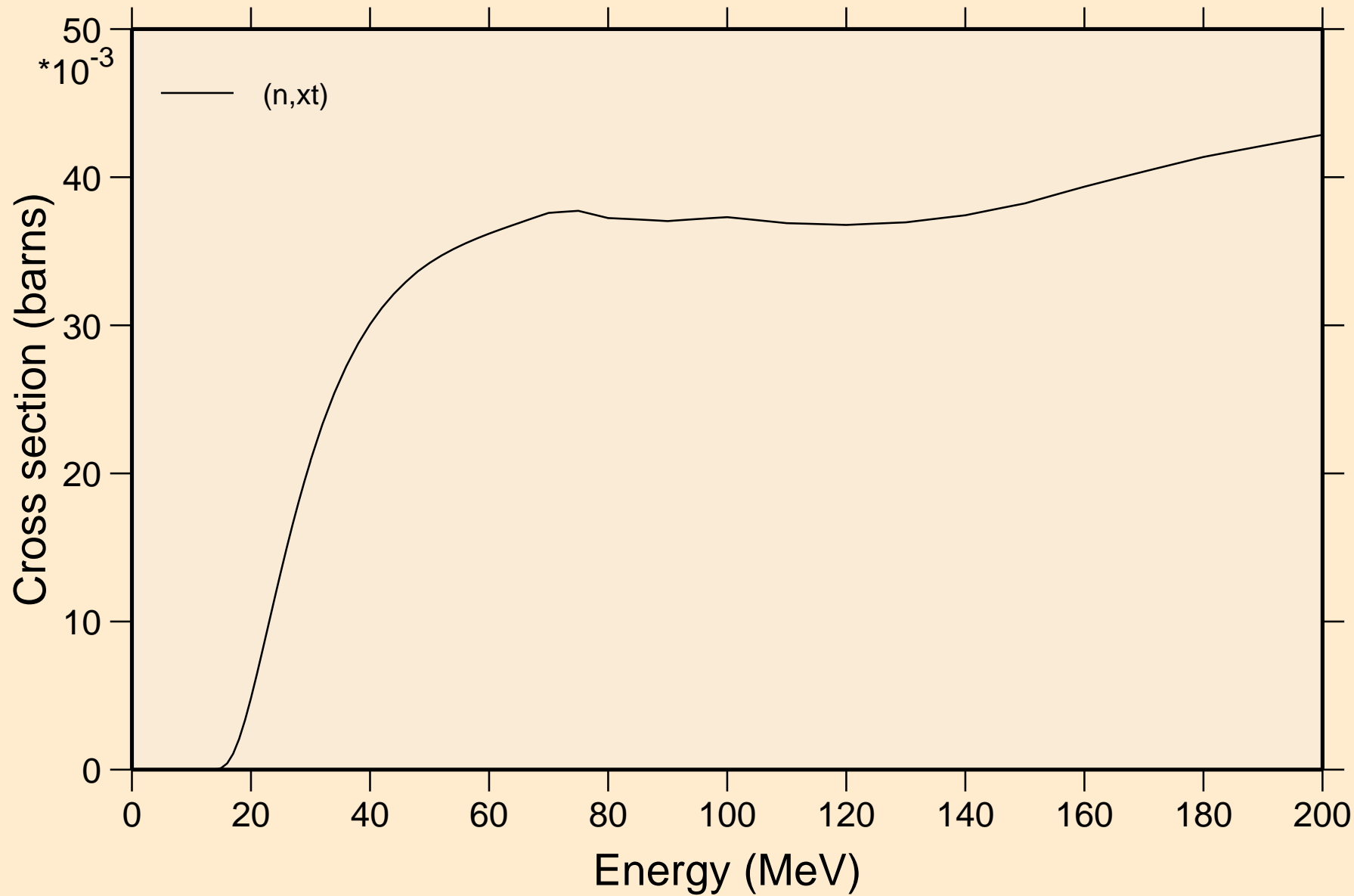

GD139M NEUTRON ACER TENDL-2023 LIBRARY; T=0.K  
angular distribution for elastic

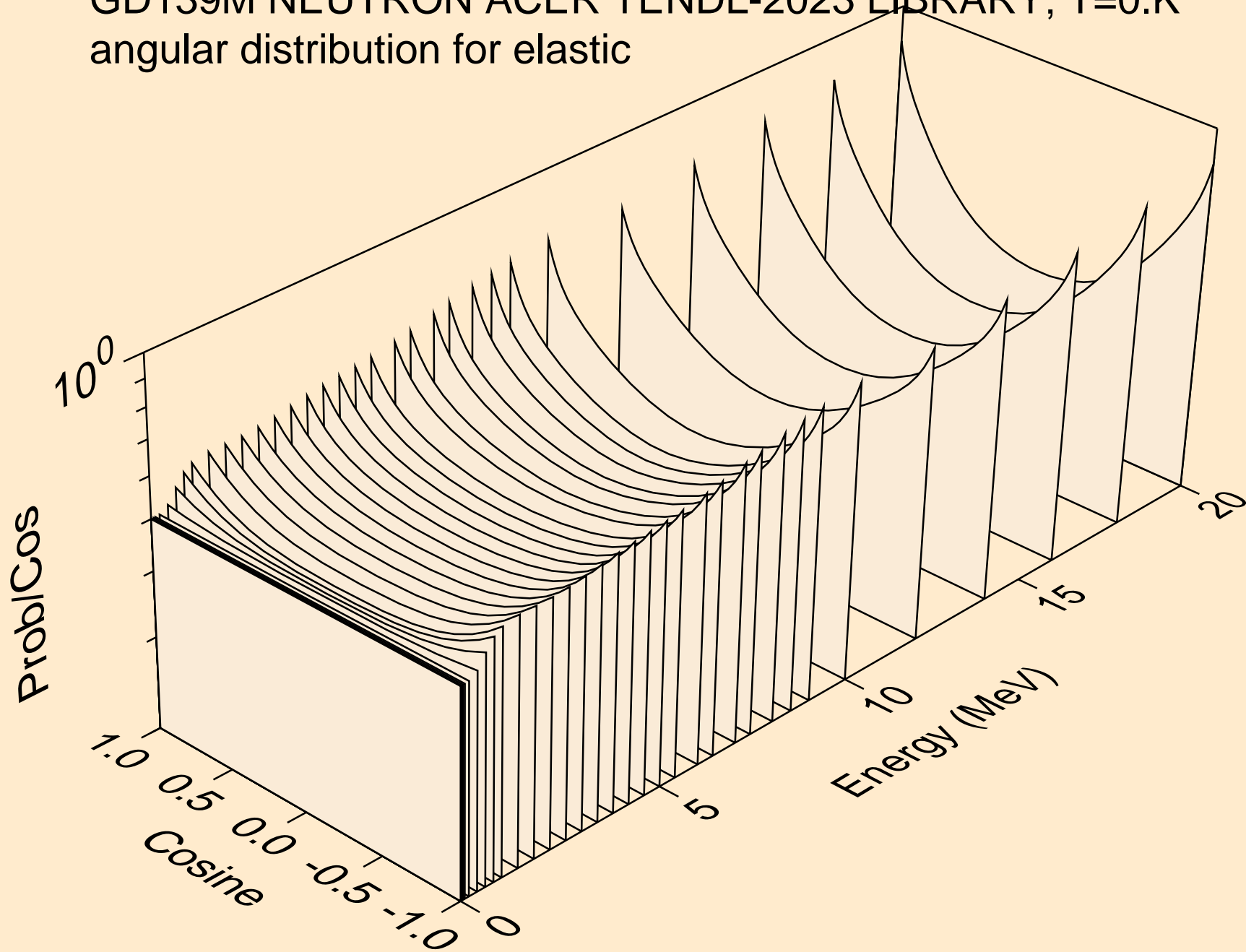

GD139M NEUTRON ACER TENDL-2023 LIBRARY; T=0.K  
angular distribution for elastic

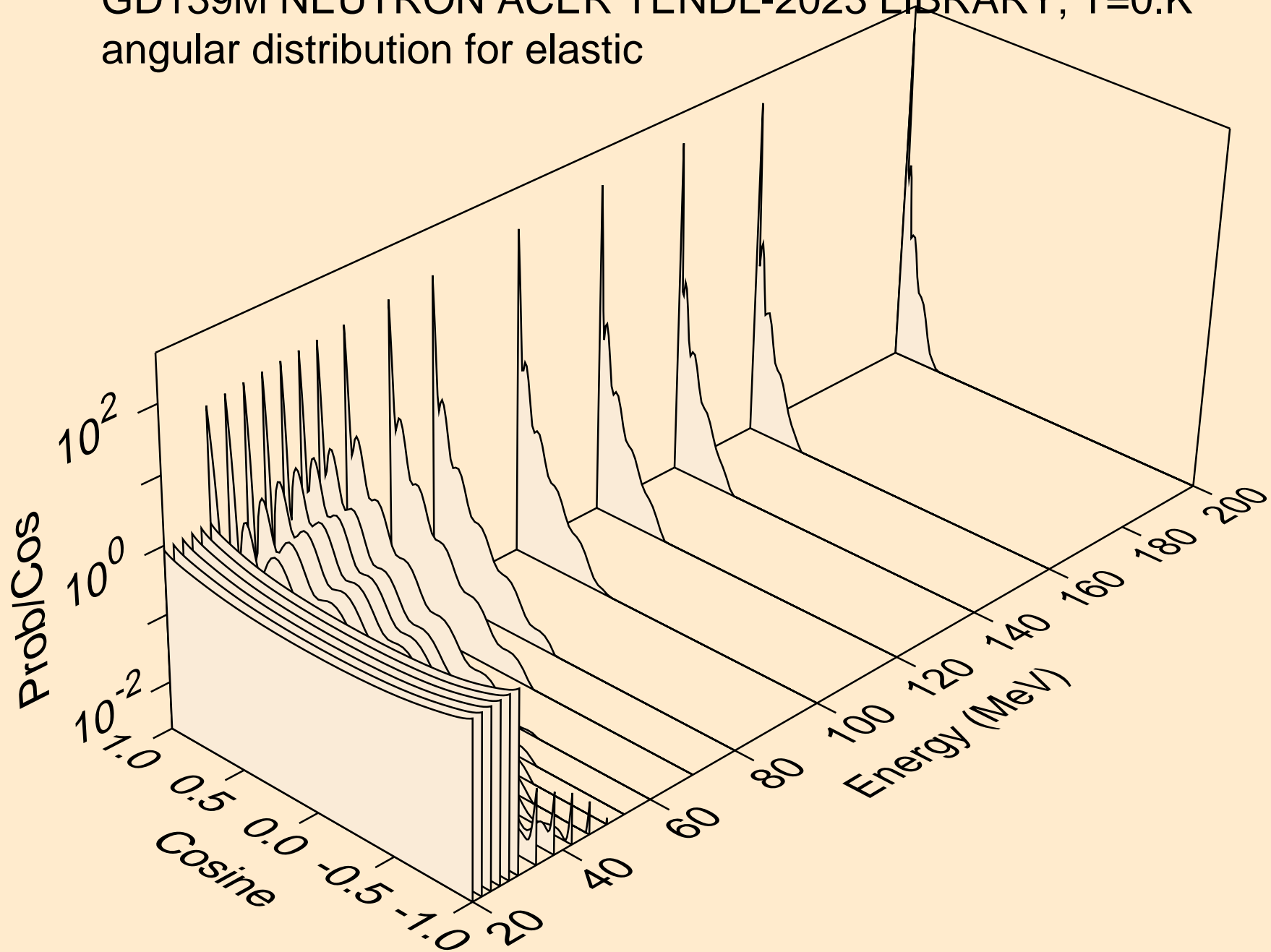

GD139M NEUTRON ACER TENDL-2023 LIBRARY; T=0.K  
angular distribution for (n,n\*1)

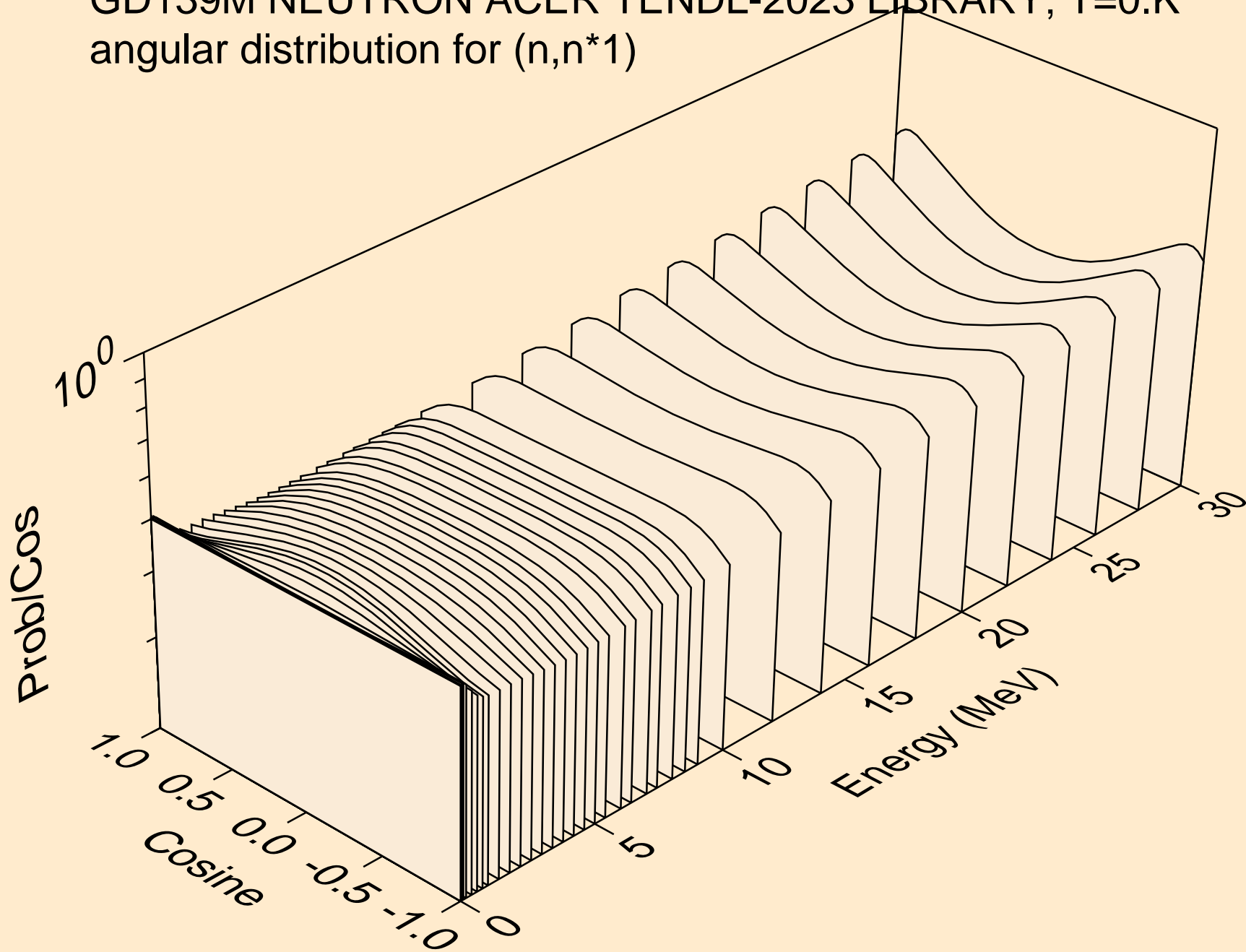

GD139M NEUTRON ACER TENDL-2023 LIBRARY; T=0.K  
angular distribution for (n,n\*2)

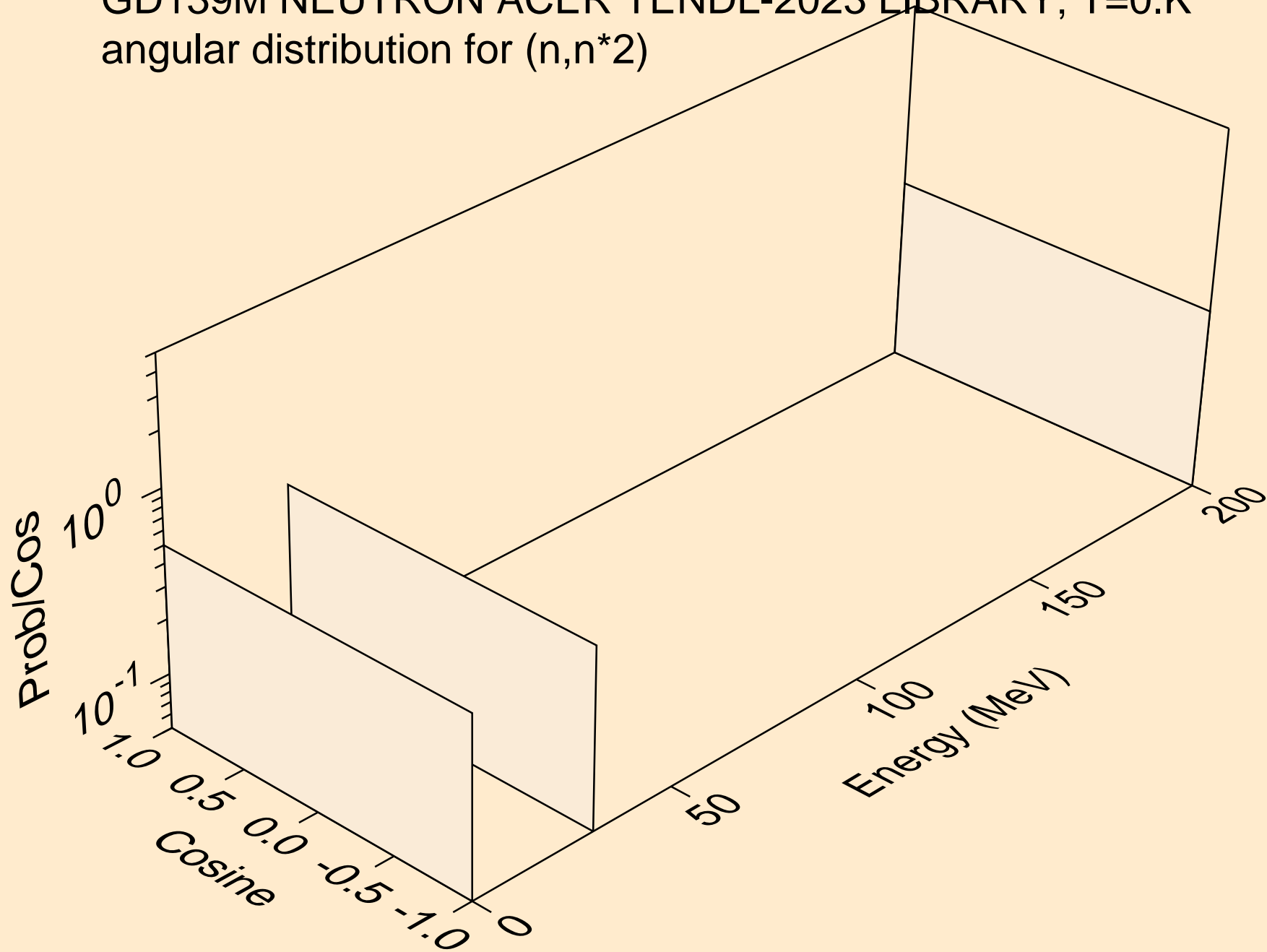

GD139M NEUTRON ACER TENDL-2023 LIBRARY; T=0.K  
angular distribution for (n,n\*3)

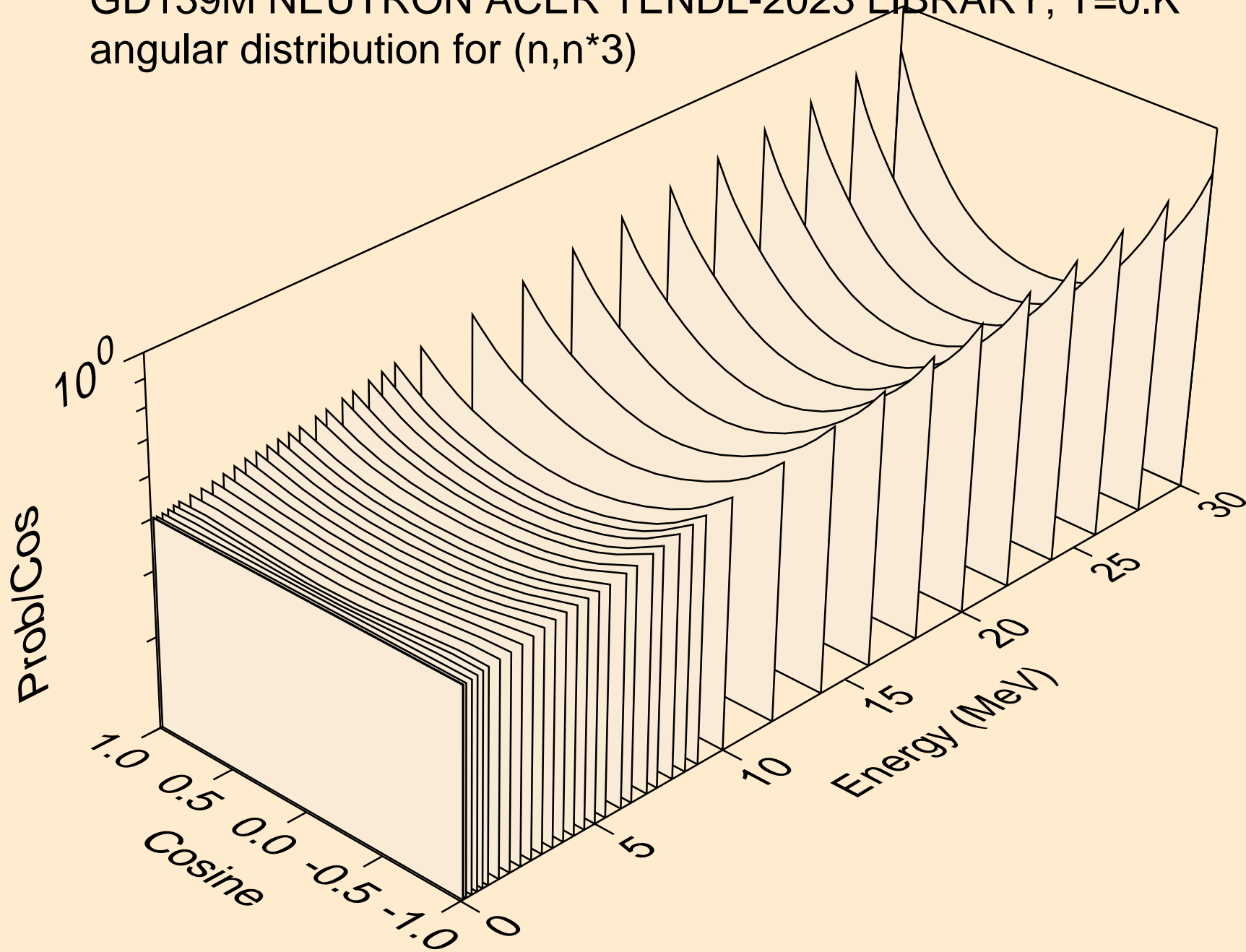

GD139M NEUTRON ACER TENDL-2023 LIBRARY; T=0.K  
Neutron emission for (n,x)

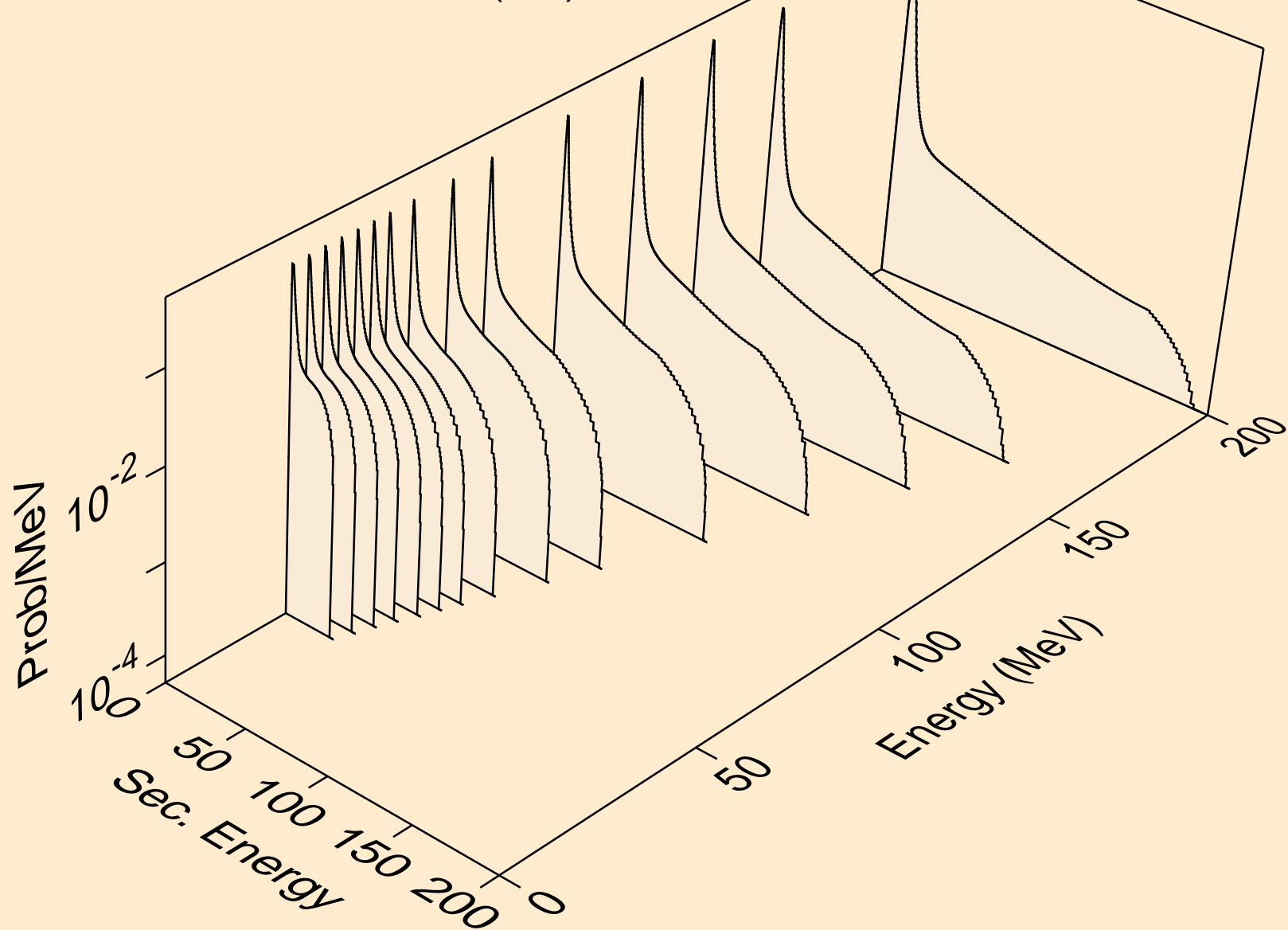

GD139M NEUTRON ACER TENDL-2023 LIBRARY; T=0.K  
Neutron emission for (n,2nd)

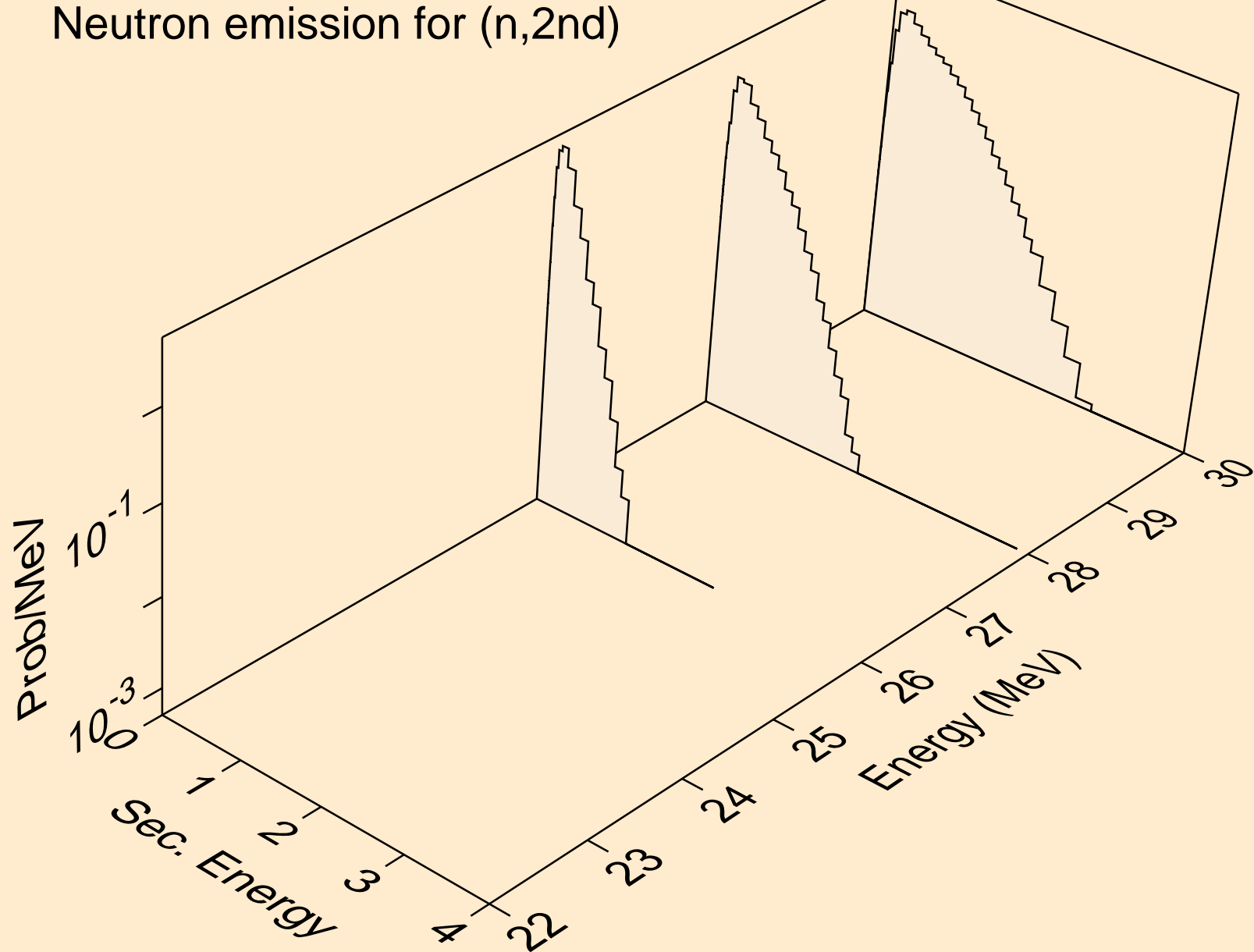

GD139M NEUTRON ACER TENDL-2023 LIBRARY; T=0.K  
Neutron emission for (n,2n)

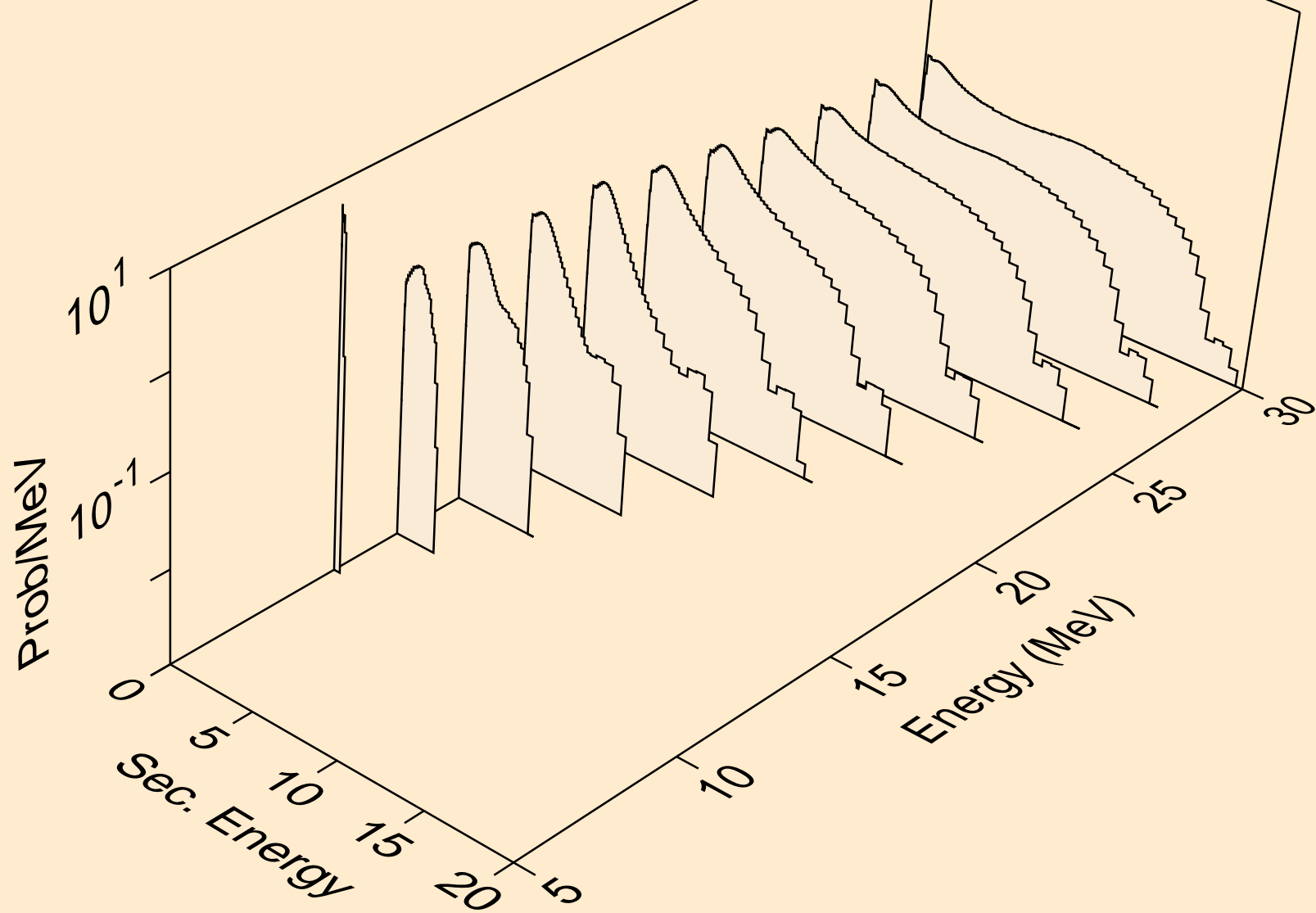

GD139M NEUTRON ACER TENDL-2023 LIBRARY; T=0.K  
Neutron emission for (n,3n)

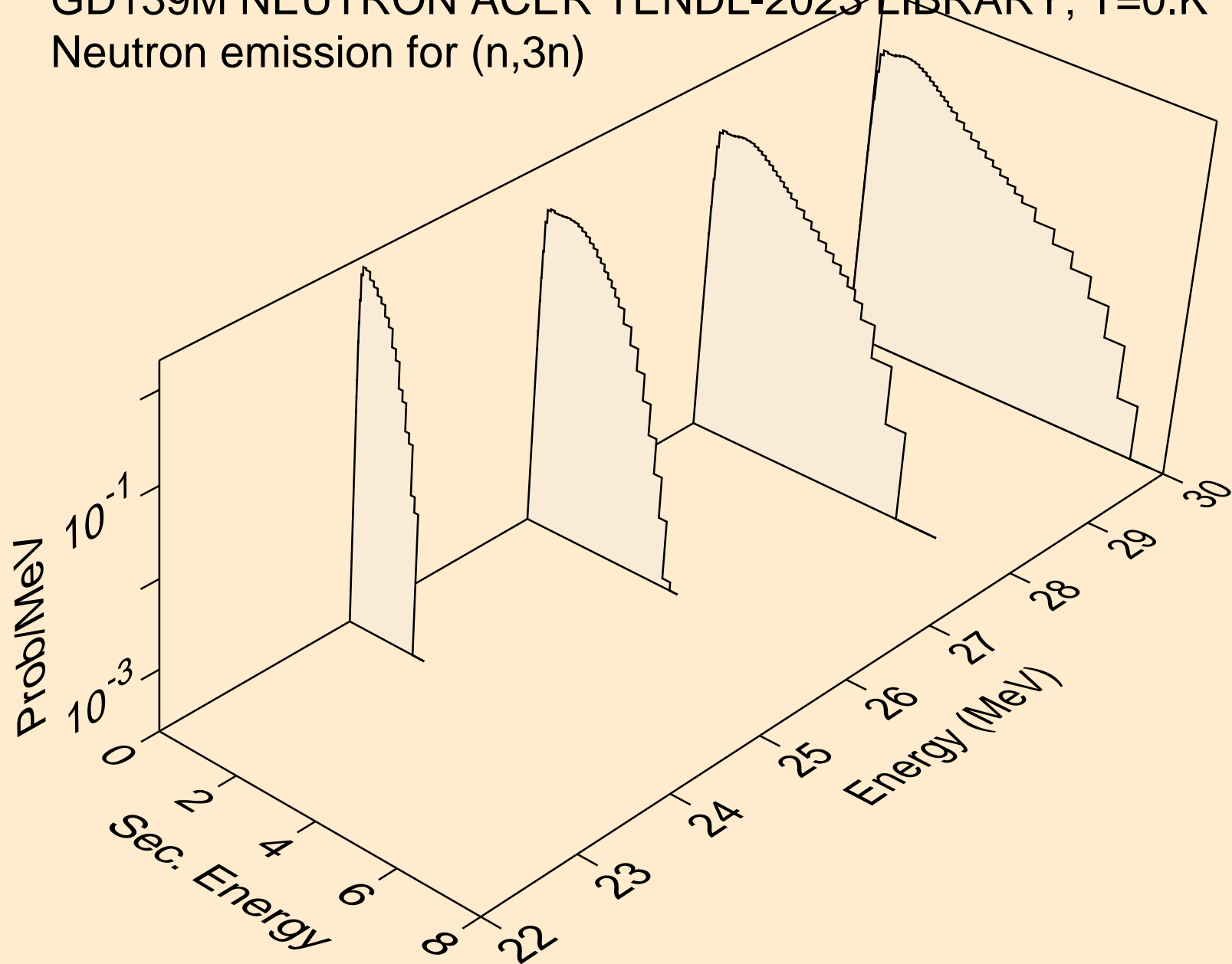

GD139M NEUTRON ACER TENDL-2023 LIBRARY; T=0.K  
Neutron emission for (n,n\*)a

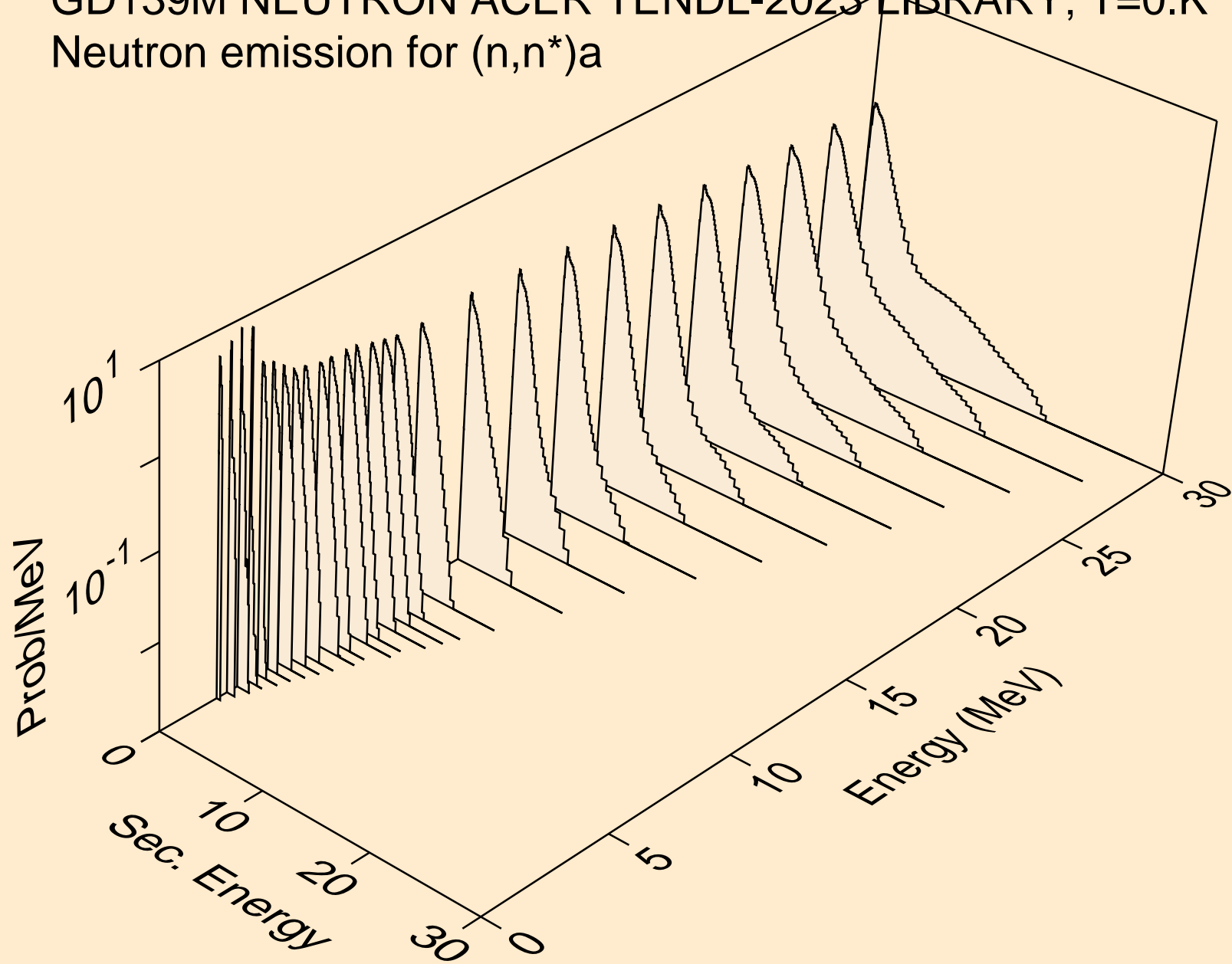

GD139M NEUTRON ACER TENDL-2023 LIBRARY; T=0.K  
Neutron emission for (n,2n)a

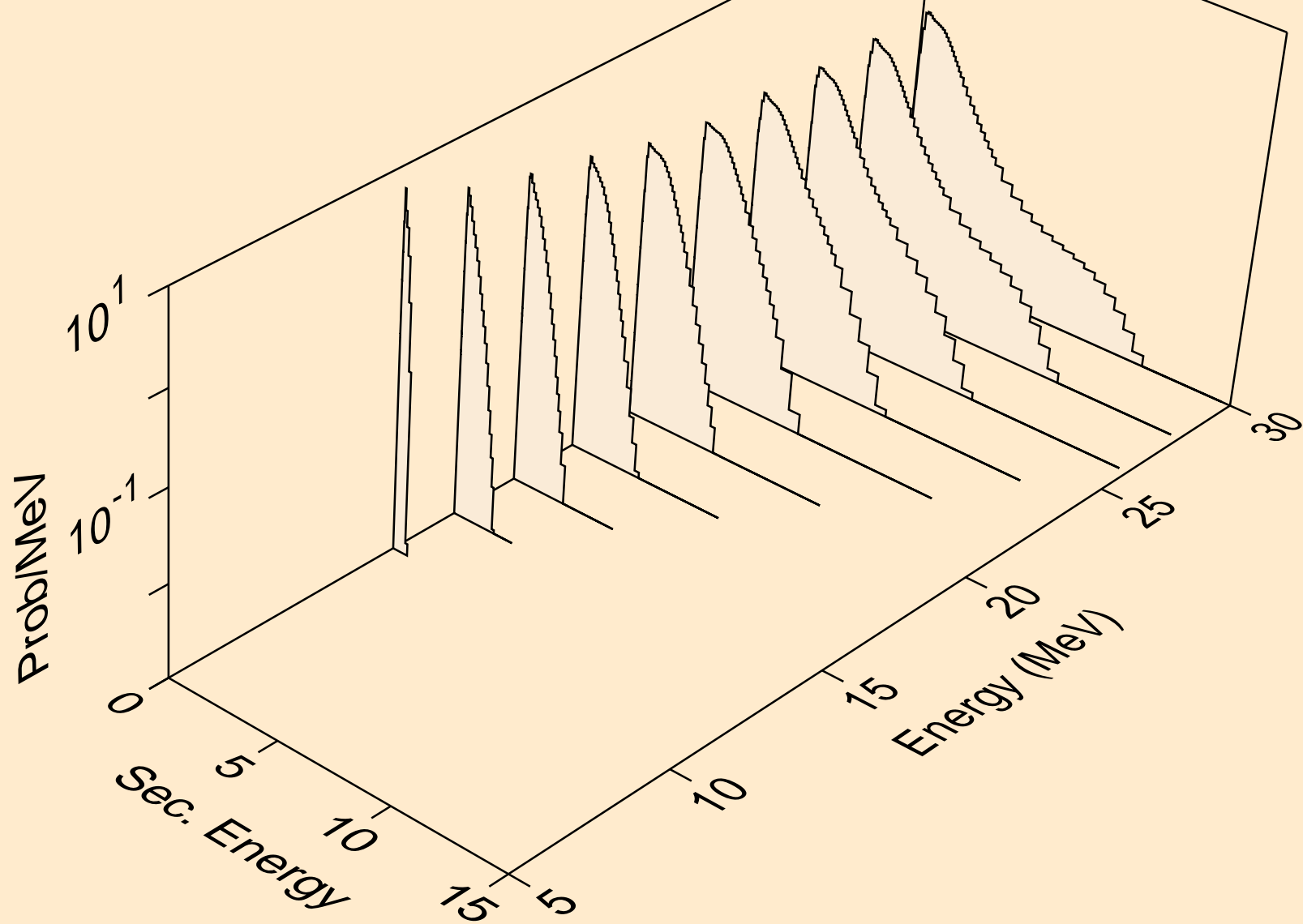

GD139M NEUTRON ACER TENDL-2023 LIBRARY; T=0.K  
Neutron emission for (n,3n)a

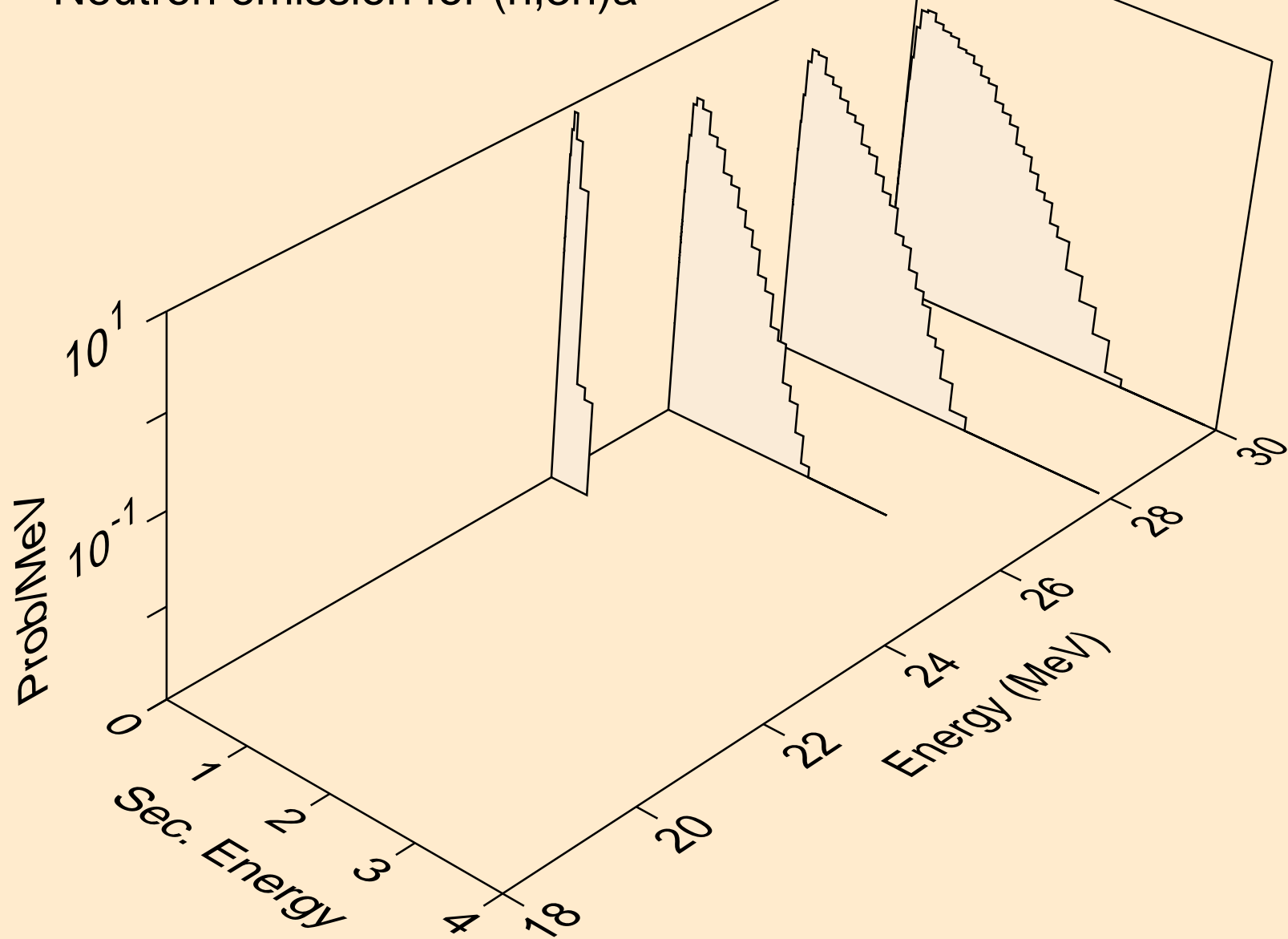

GD139M NEUTRON ACER TENDL-2023 LIBRARY; T=0.K  
Neutron emission for (n,n\*)p

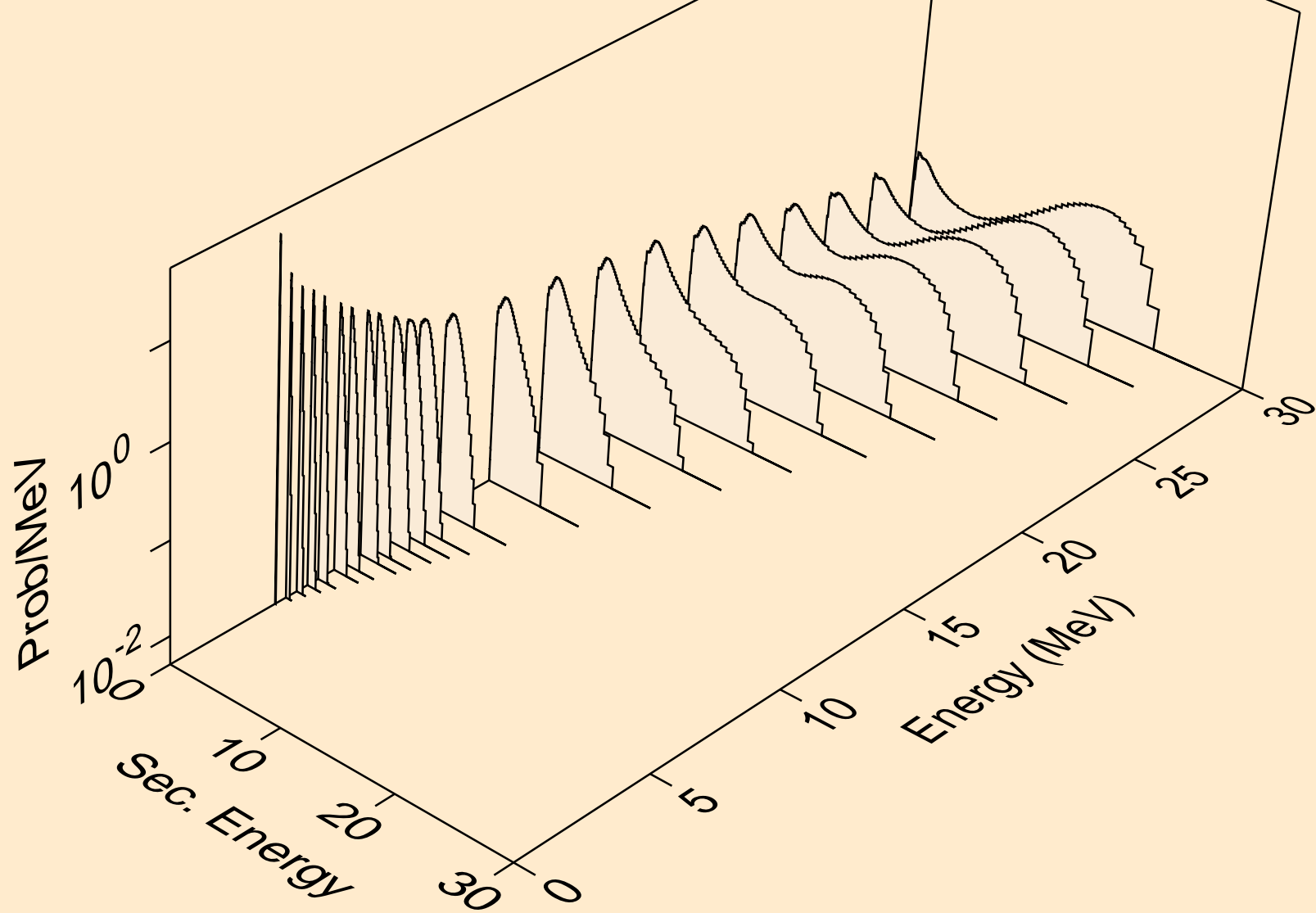

GD139M NEUTRON ACER TENDL-2023 LIBRARY; T=0.K  
Neutron emission for (n,n\*)2a

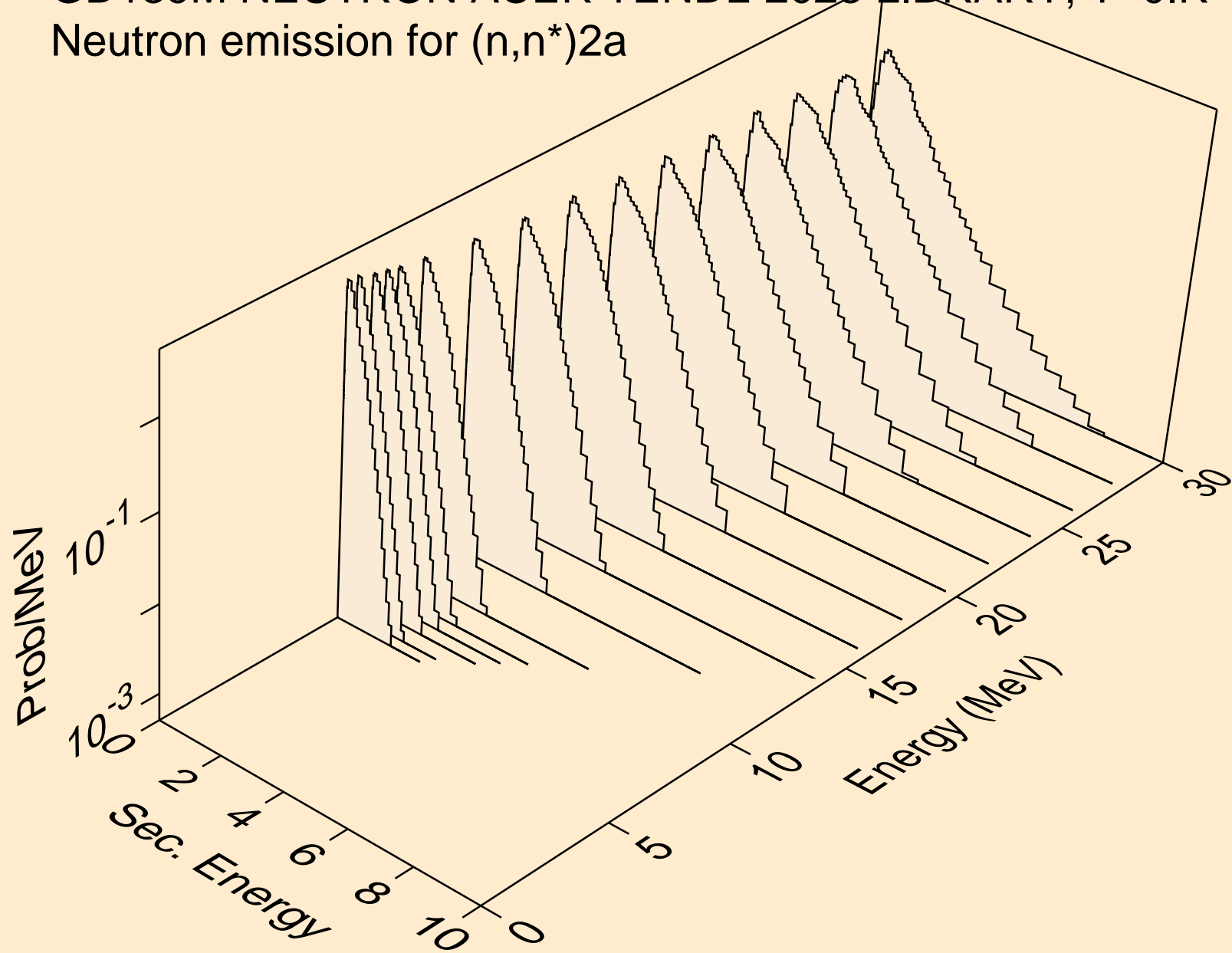

GD139M NEUTRON ACER TENDL-2023 LIBRARY; T=0.K  
Neutron emission for (n,2n)2a

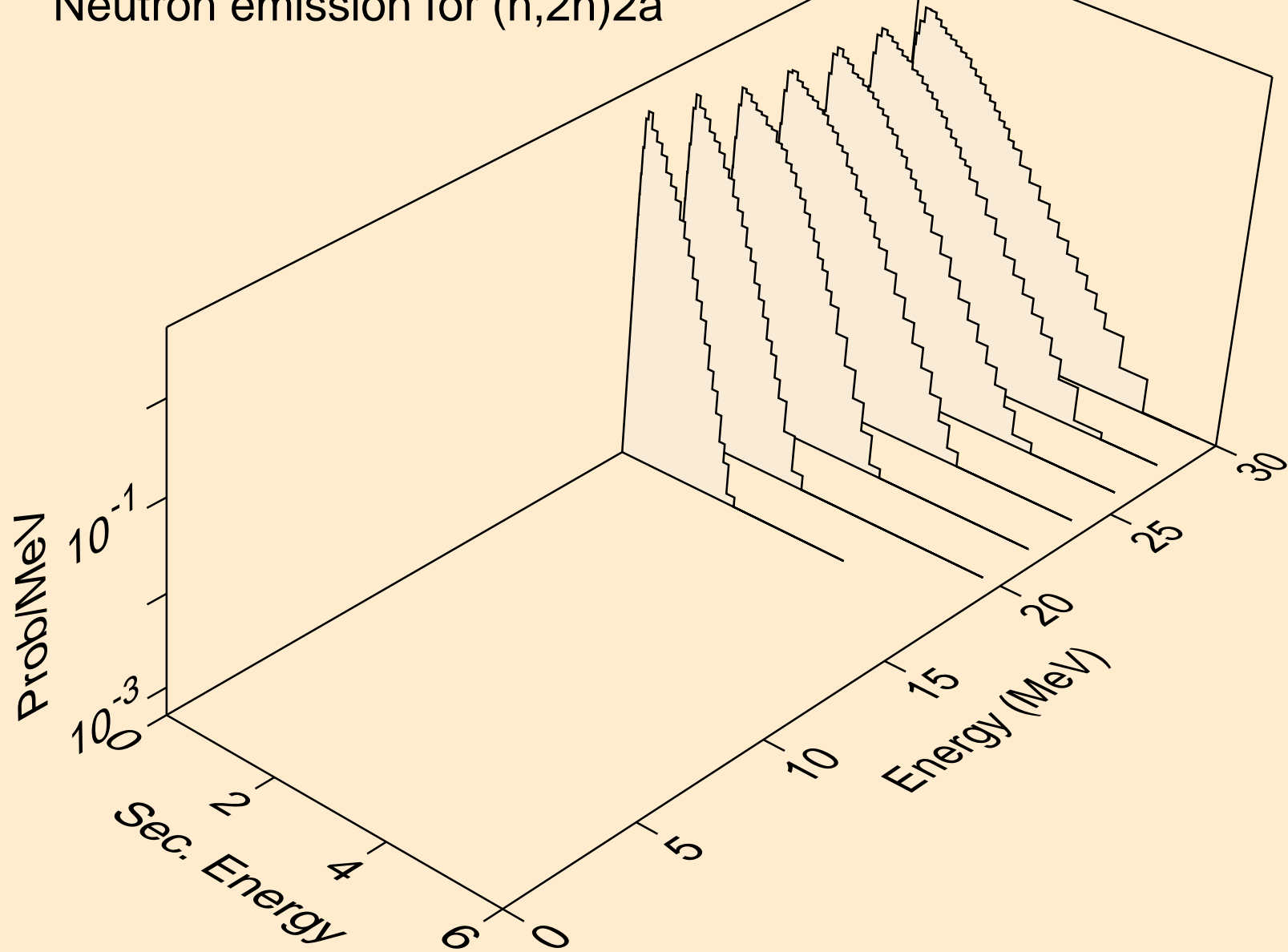

GD139M NEUTRON ACER TENDL-2023 LIBRARY; T=0.K  
Neutron emission for (n,n\*)d

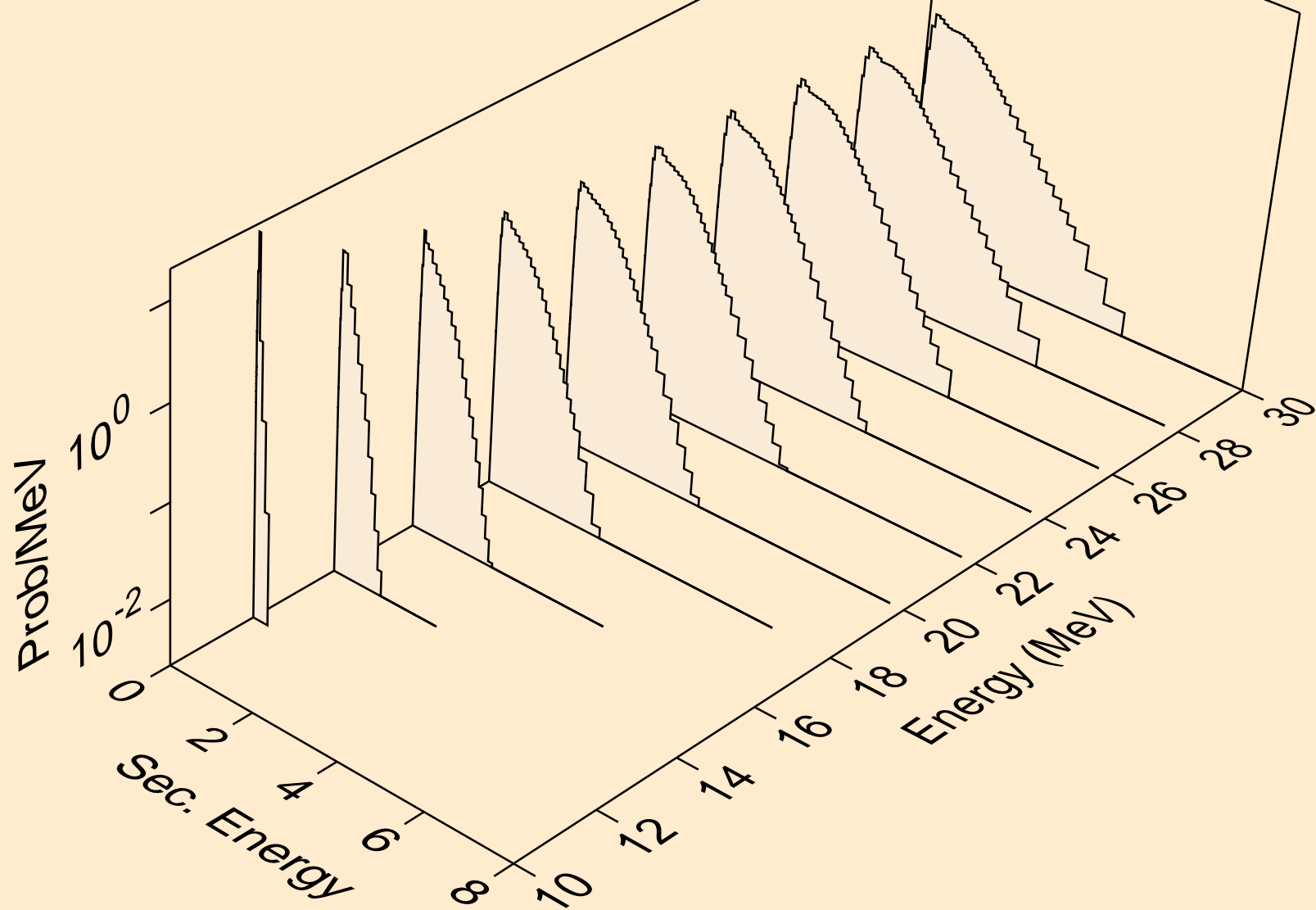

GD139M NEUTRON ACER TENDL-2023 LIBRARY; T=0.K  
Neutron emission for (n,n\*)t

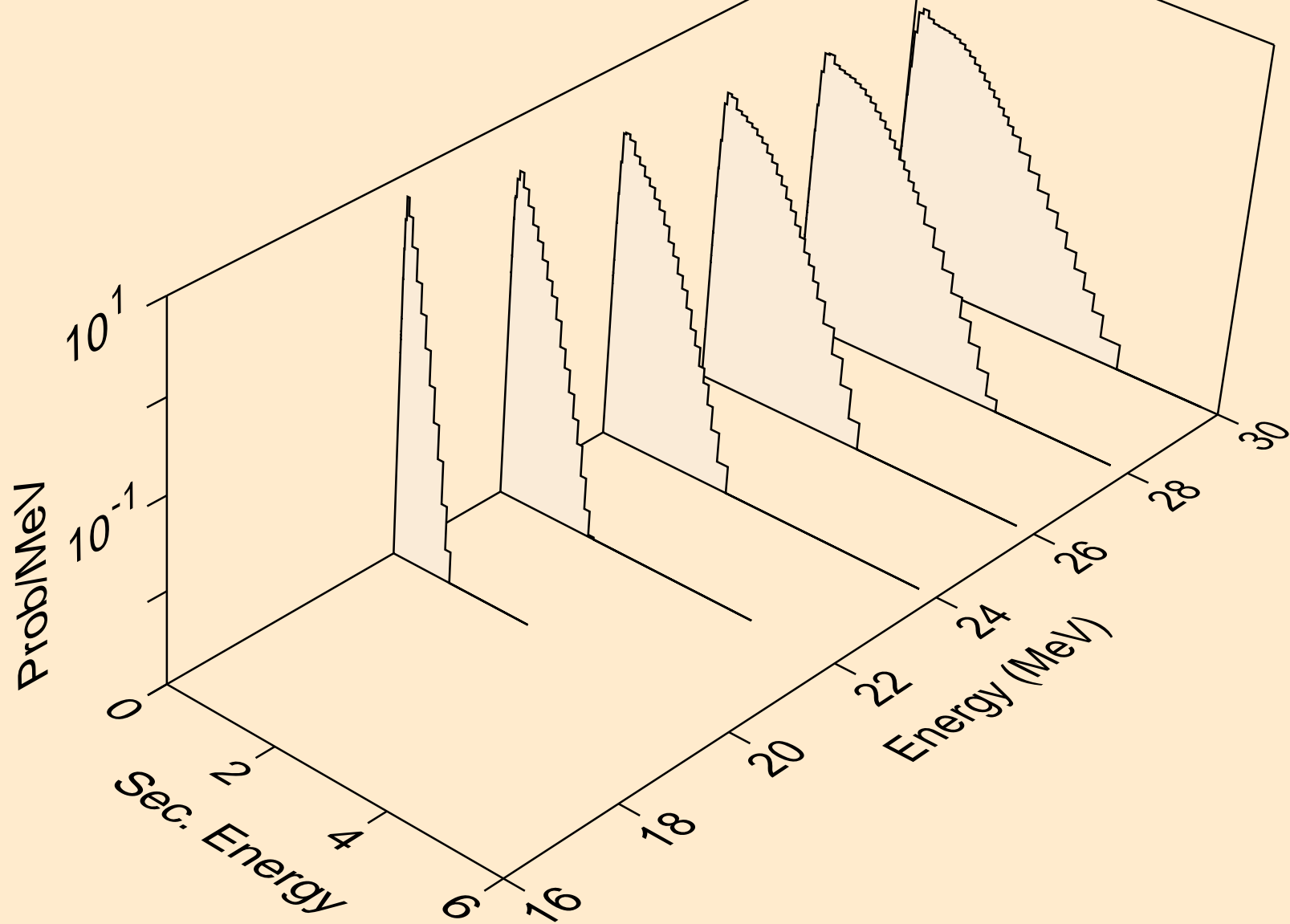

GD139M NEUTRON ACER TENDL-2023 LIBRARY; T=0.K  
Neutron emission for (n,n\*)he3

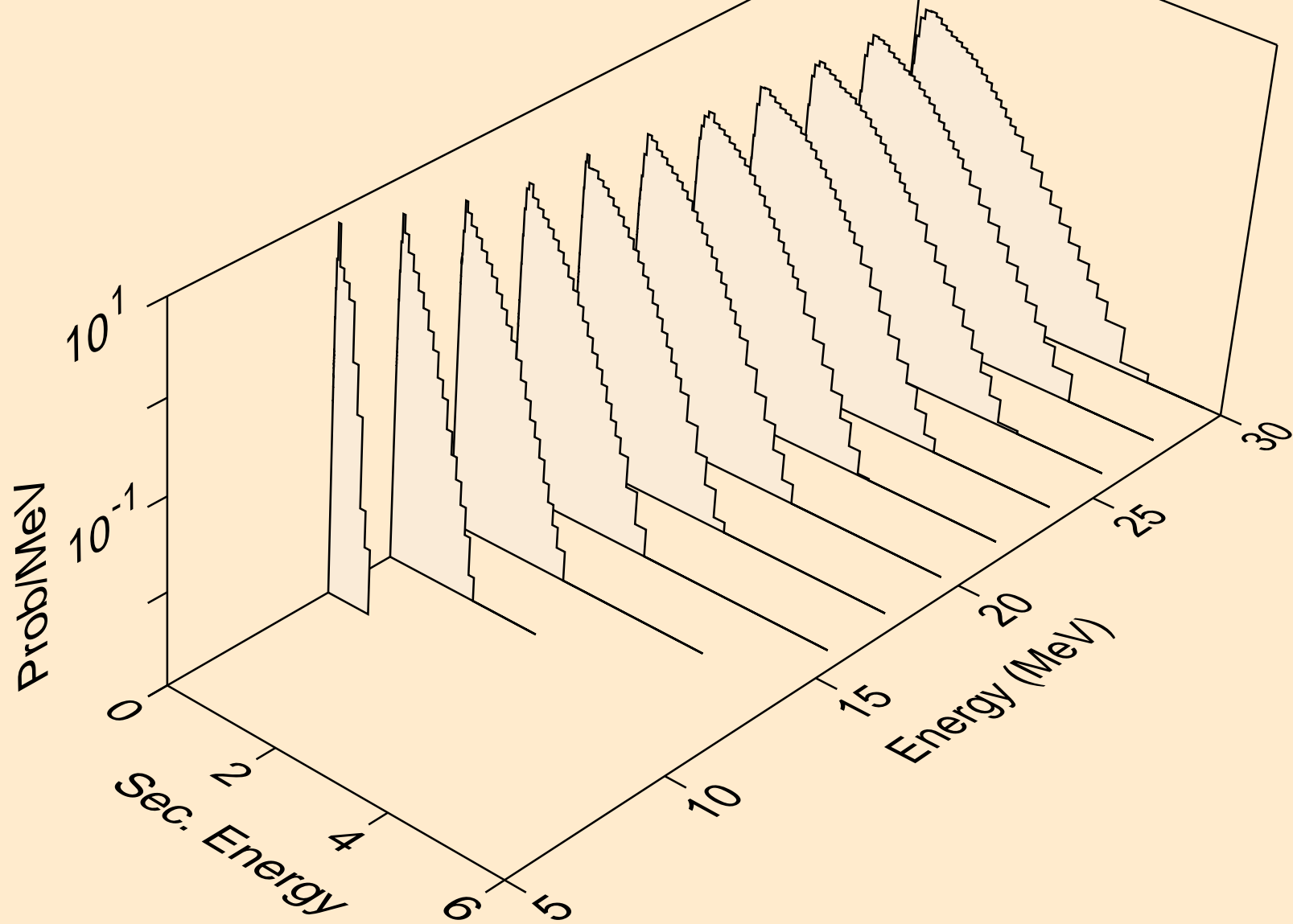

GD139M NEUTRON ACER TENDL-2023 LIBRARY; T=0.K  
Neutron emission for (n,2np)

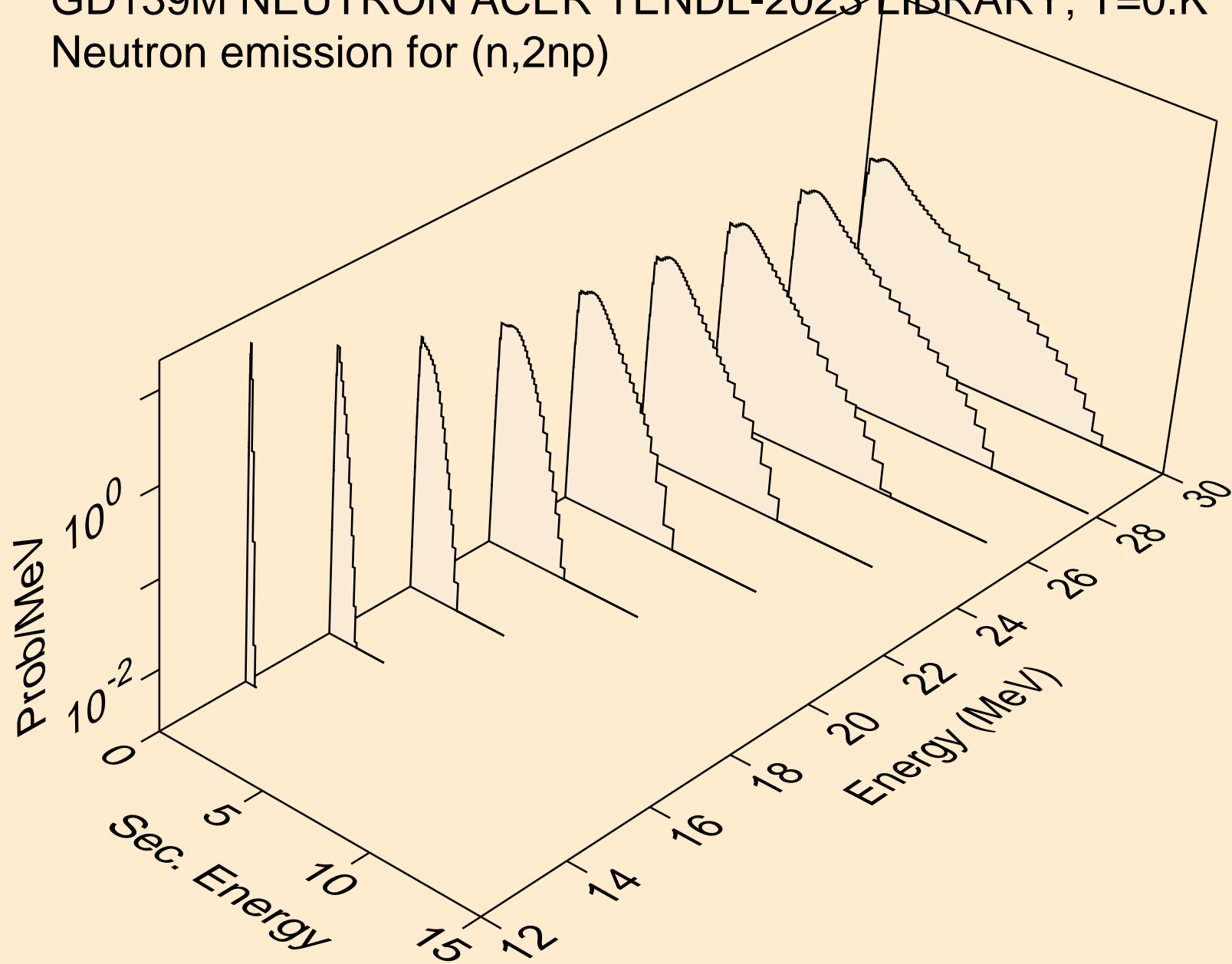

GD139M NEUTRON ACER TENDL-2023 LIBRARY; T=0.K  
Neutron emission for (n,3np)

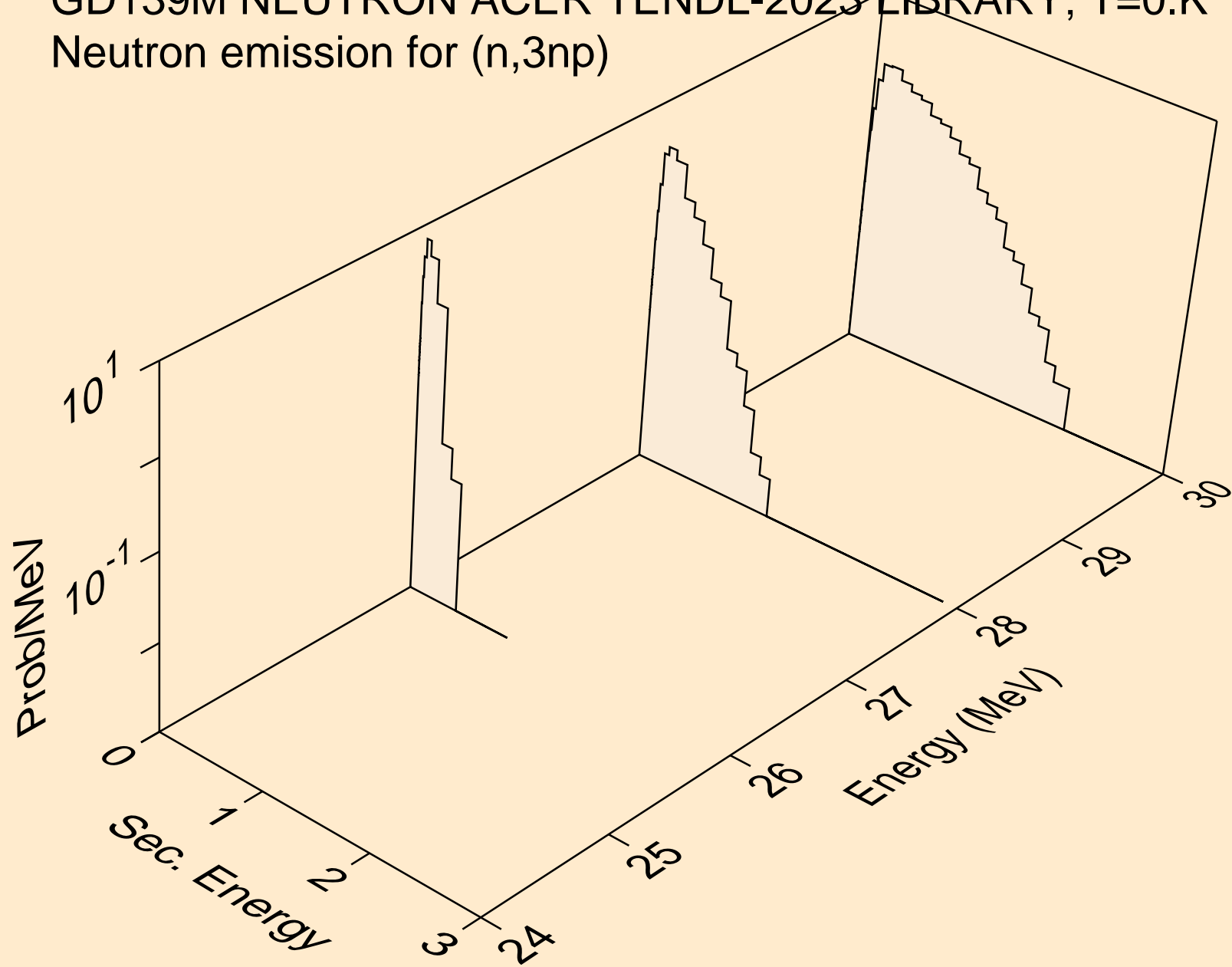

GD139M NEUTRON ACER TENDL-2023 LIBRARY; T=0.K  
Neutron emission for (n,n2p)

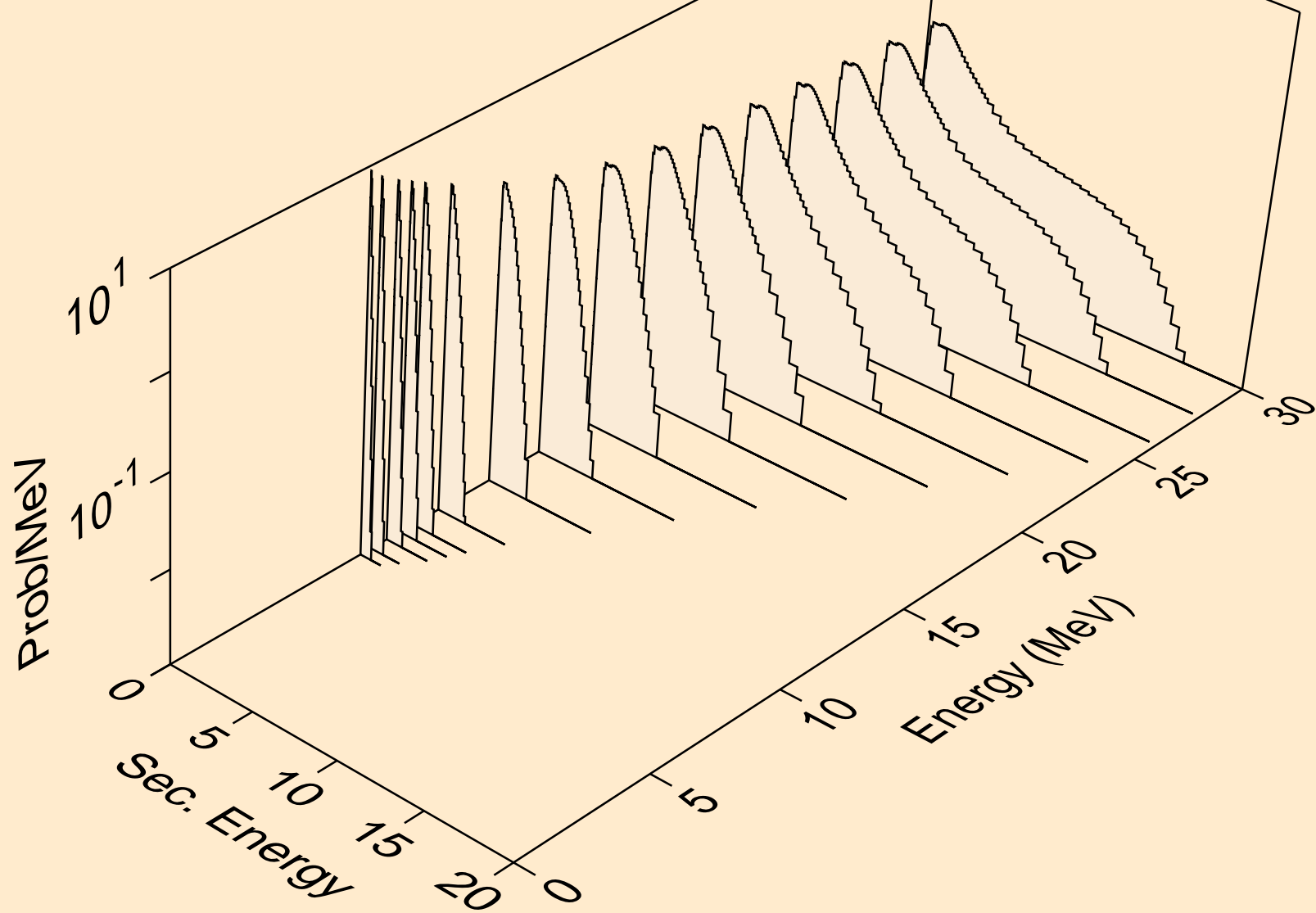

GD139M NEUTRON ACER TENDL-2023 LIBRARY; T=0.K  
Neutron emission for (n,npa)

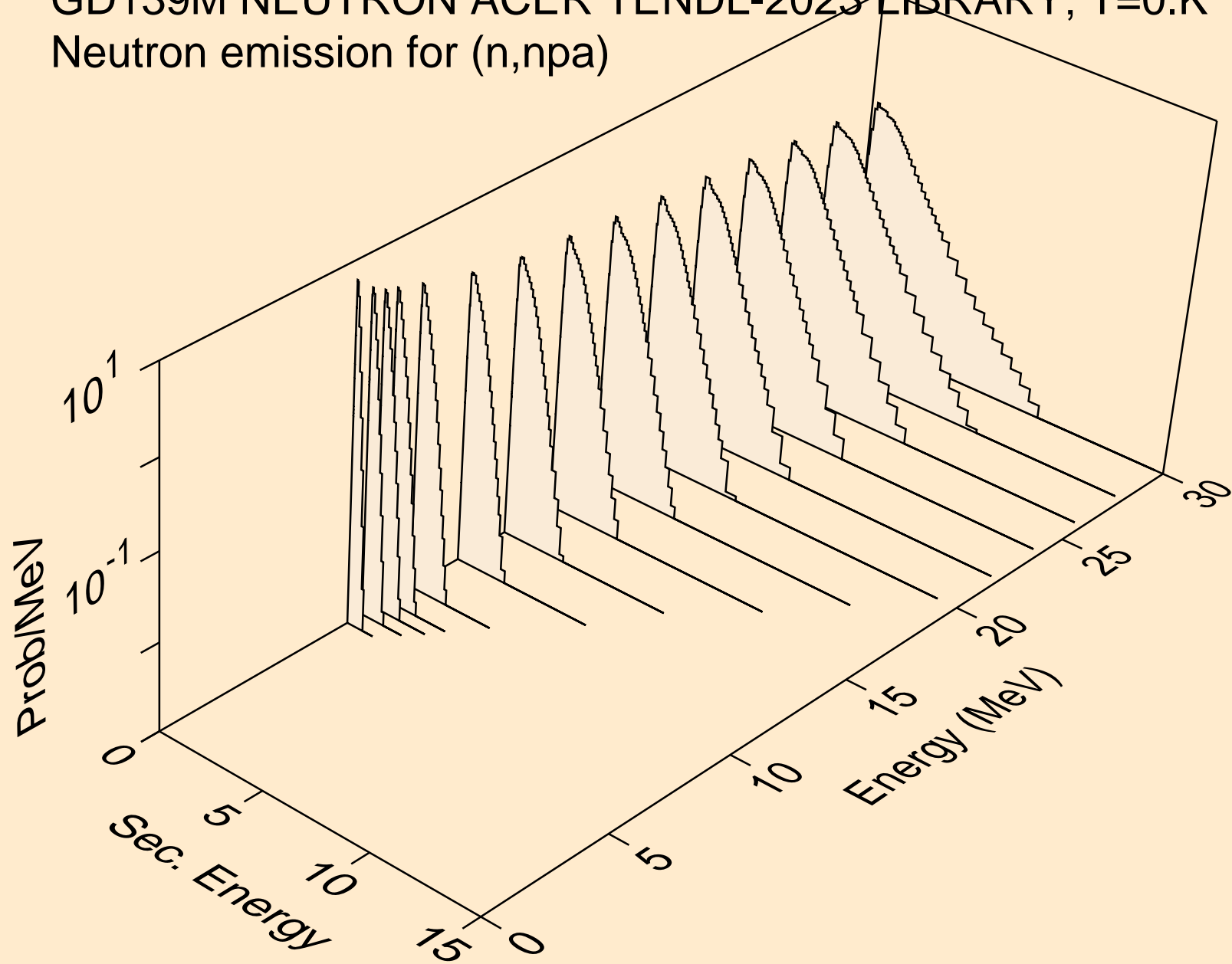

GD139M NEUTRON ACER TENDL-2023 LIBRARY; T=0.K  
Neutron emission for (n,n\*c)

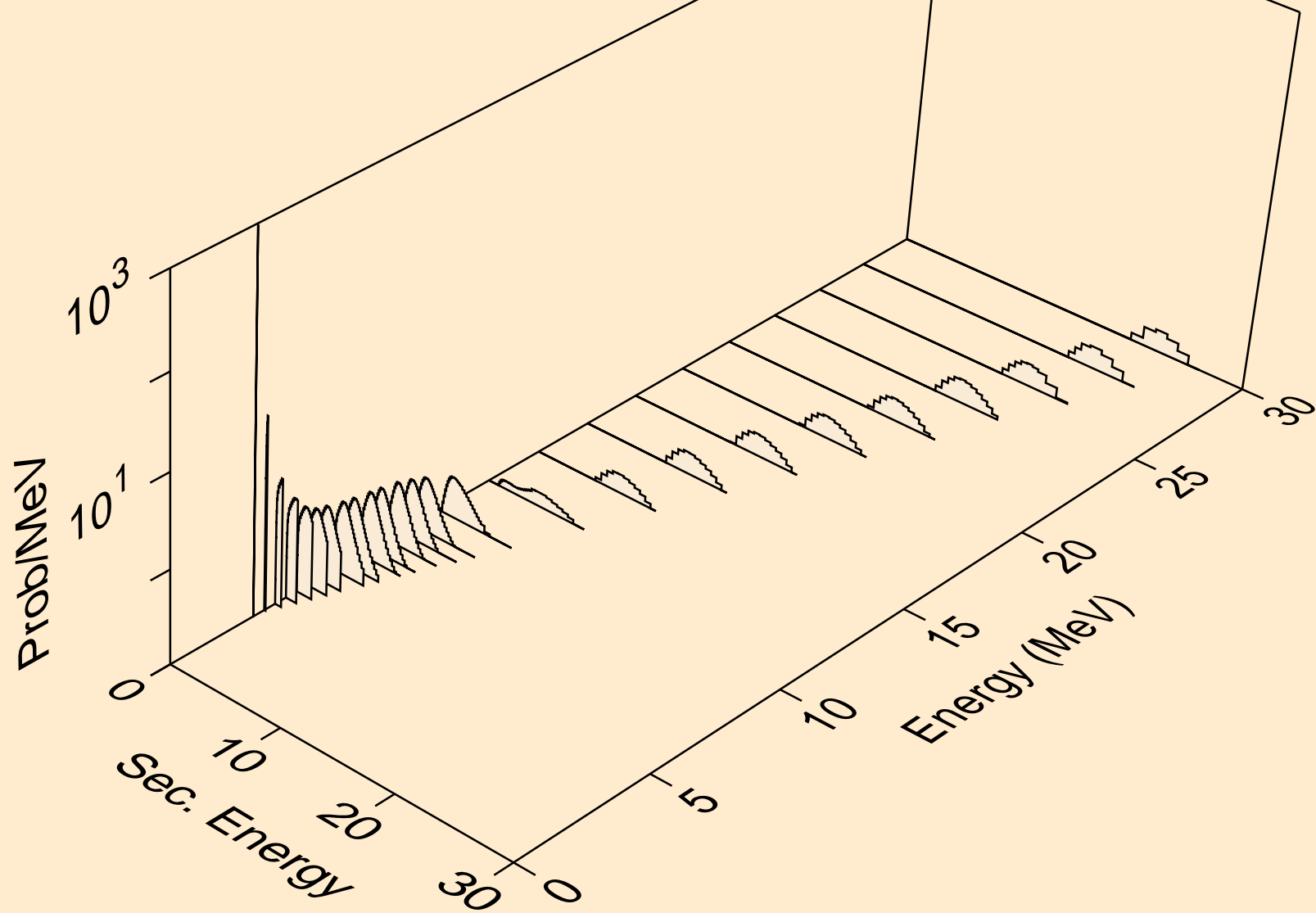

GD139M NEUTRON ACER TENDL-2023 LIBRARY; T=0.K  
Photon emission for (n,x)

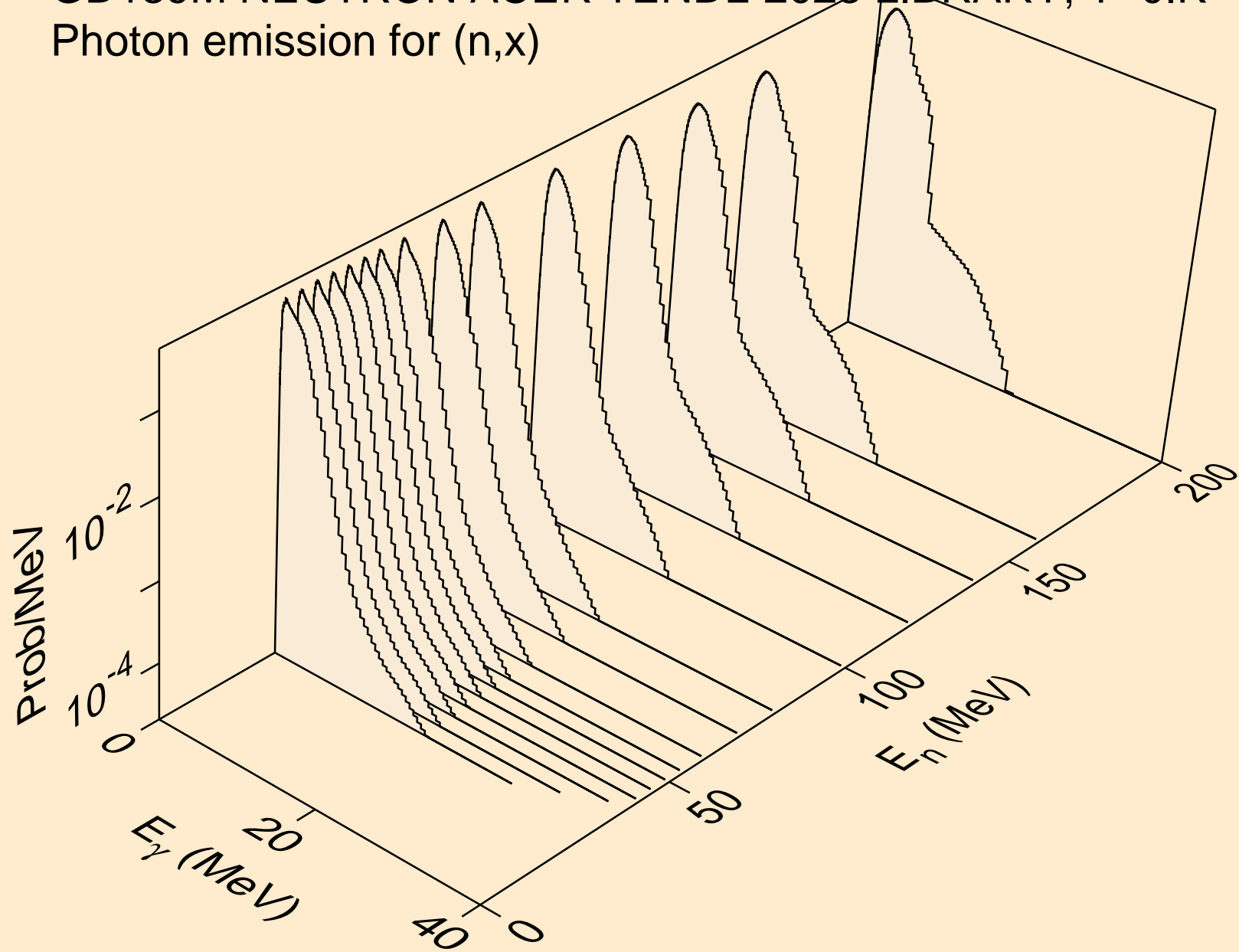

GD139M NEUTRON ACER TENDL-2023 LIBRARY; T=0.K  
Photon emission for (n,2nd)

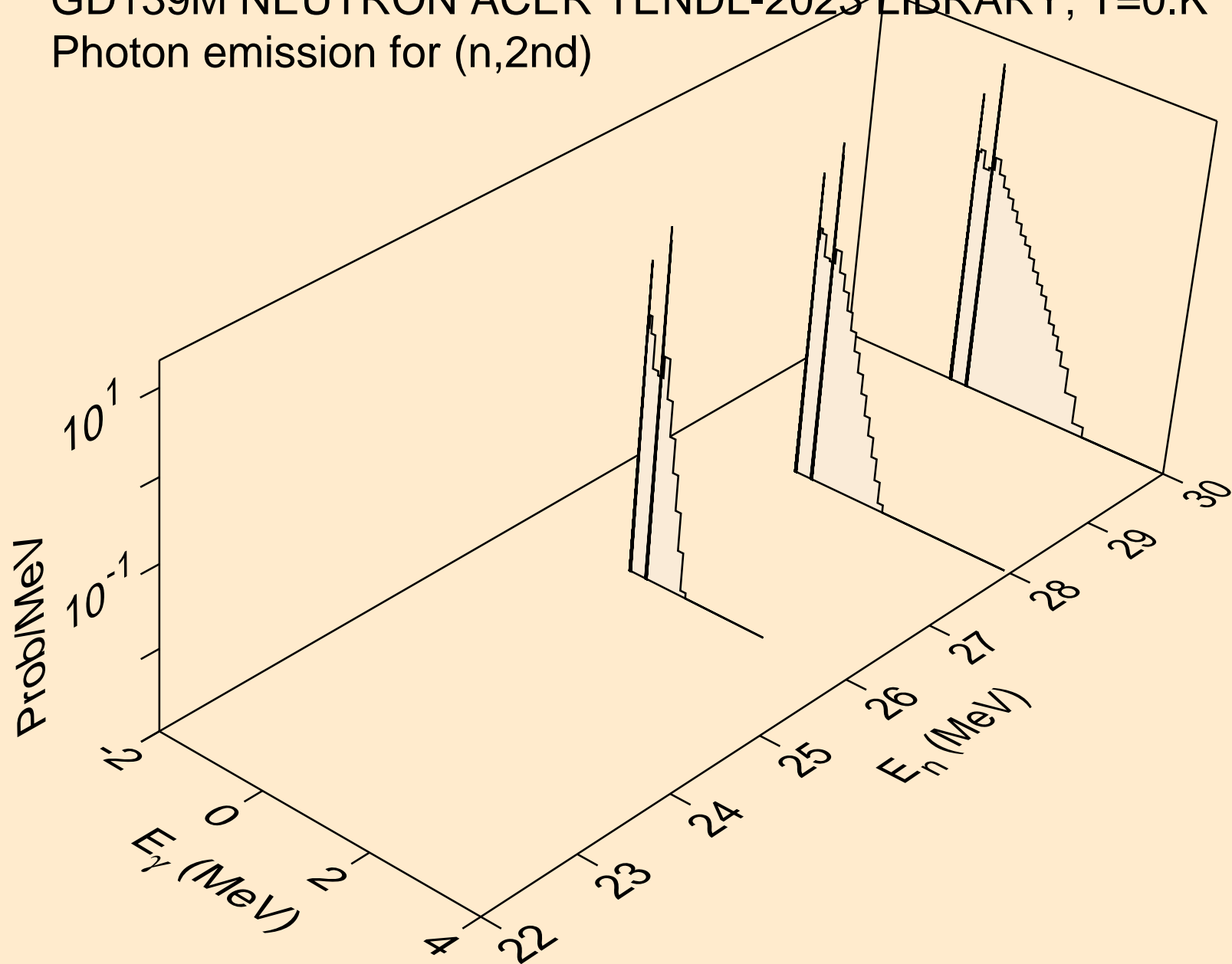

GD139M NEUTRON ACER TENDL-2023 LIBRARY; T=0.K  
Photon emission for (n,2n)

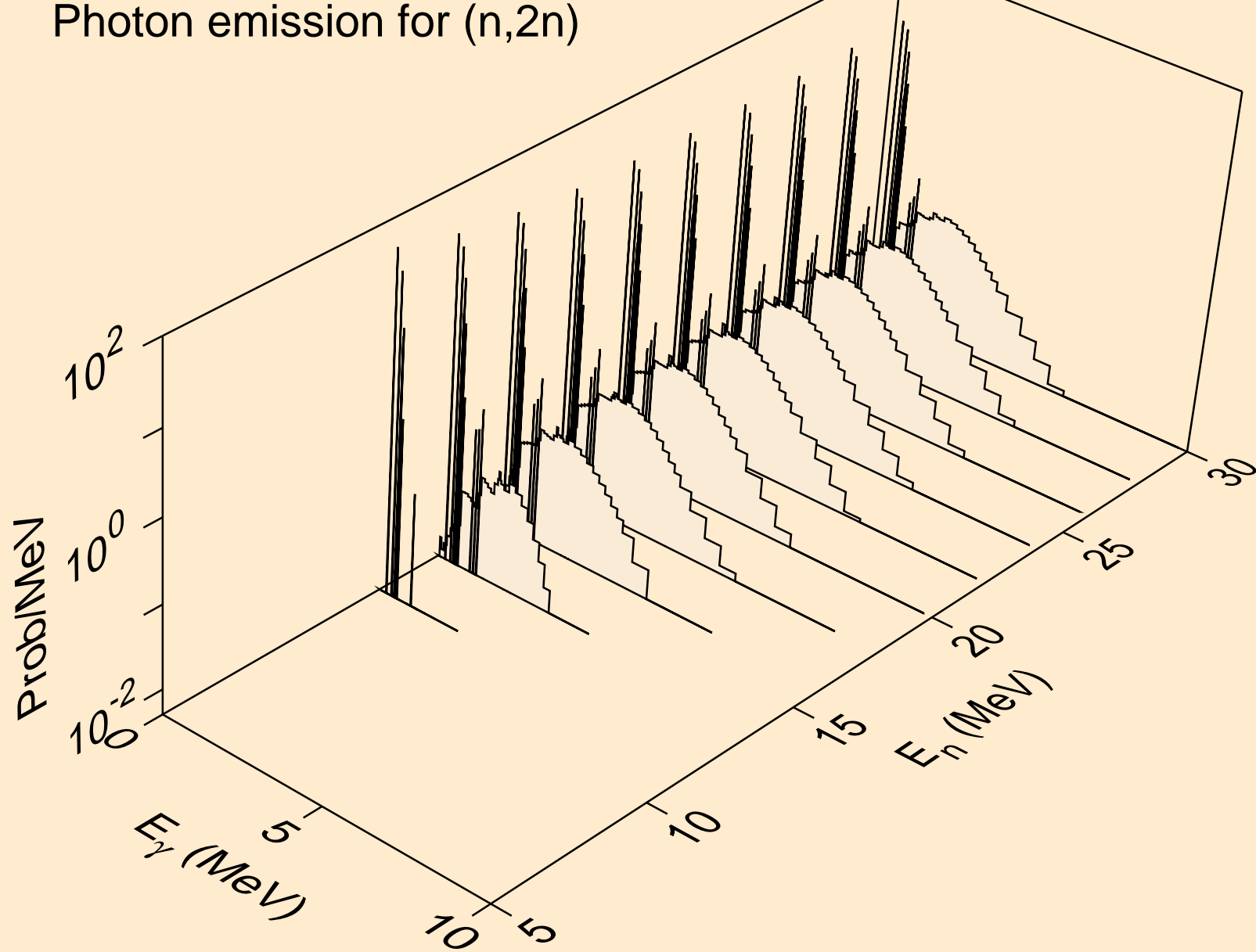

GD139M NEUTRON ACER TENDL-2023 LIBRARY; T=0.K  
Photon emission for (n,3n)

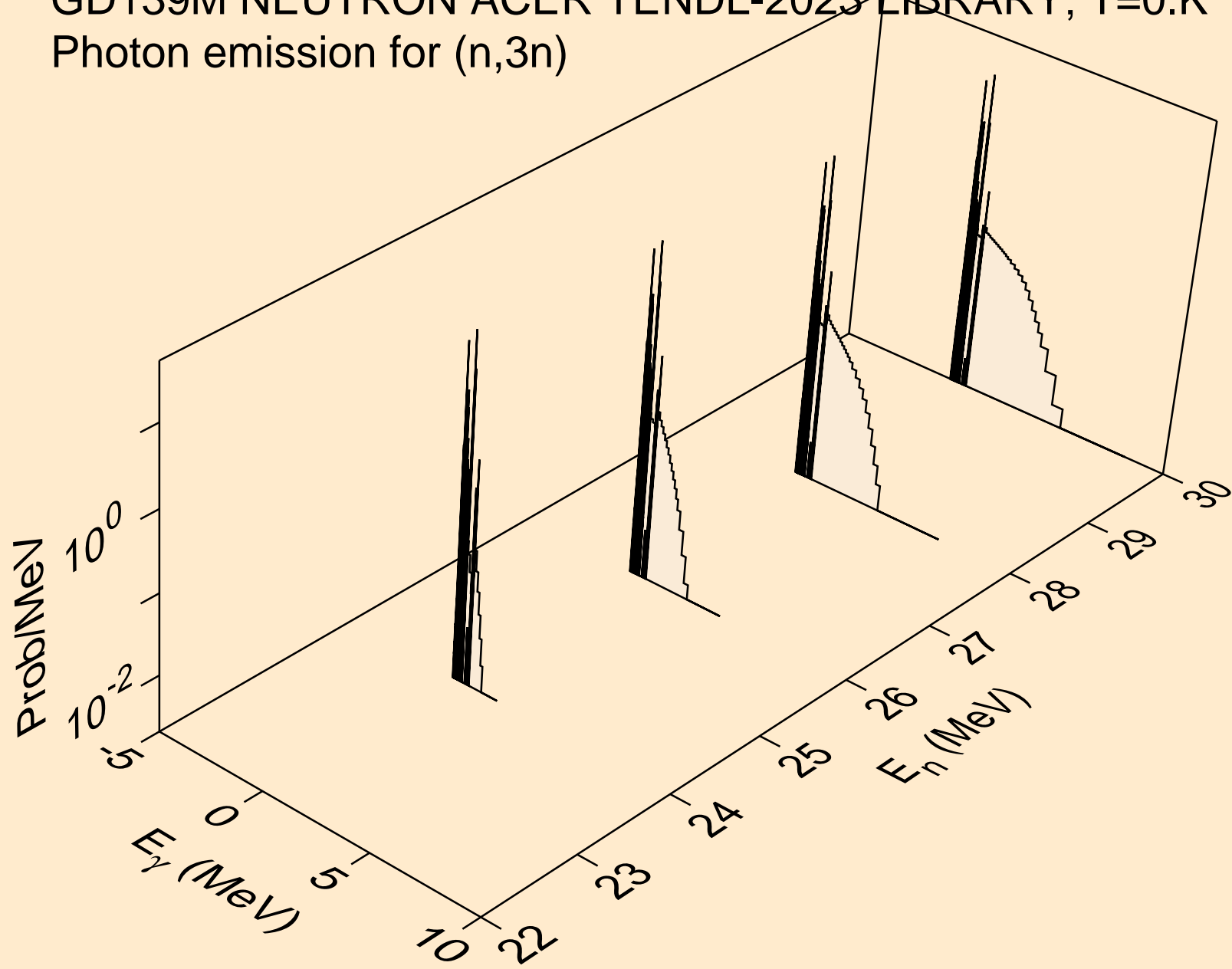

GD139M NEUTRON ACER TENDL-2023 LIBRARY; T=0.K  
Photon emission for (n,n\*)a

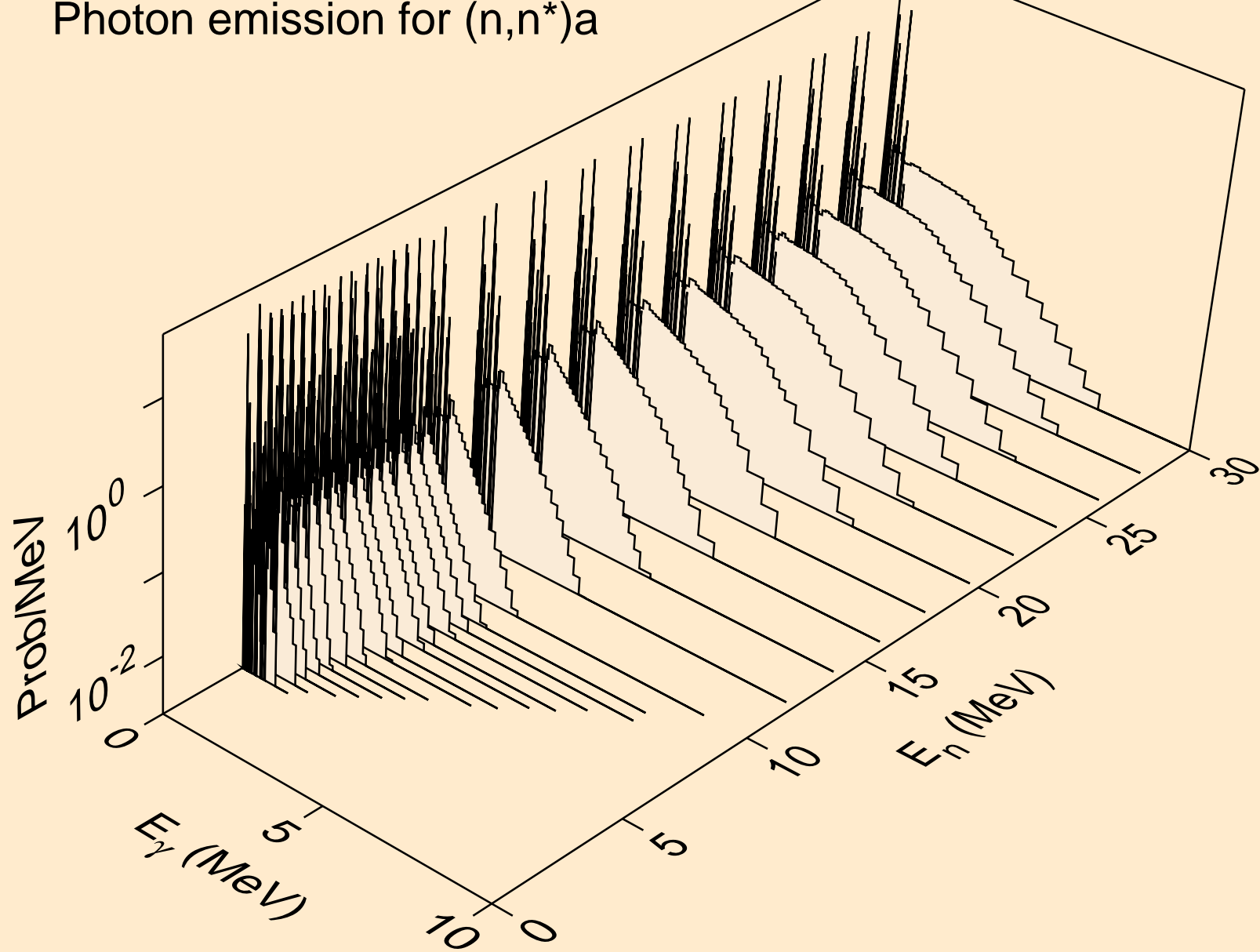

GD139M NEUTRON ACER TENDL-2023 LIBRARY; T=0.K  
Photon emission for (n,2n)a

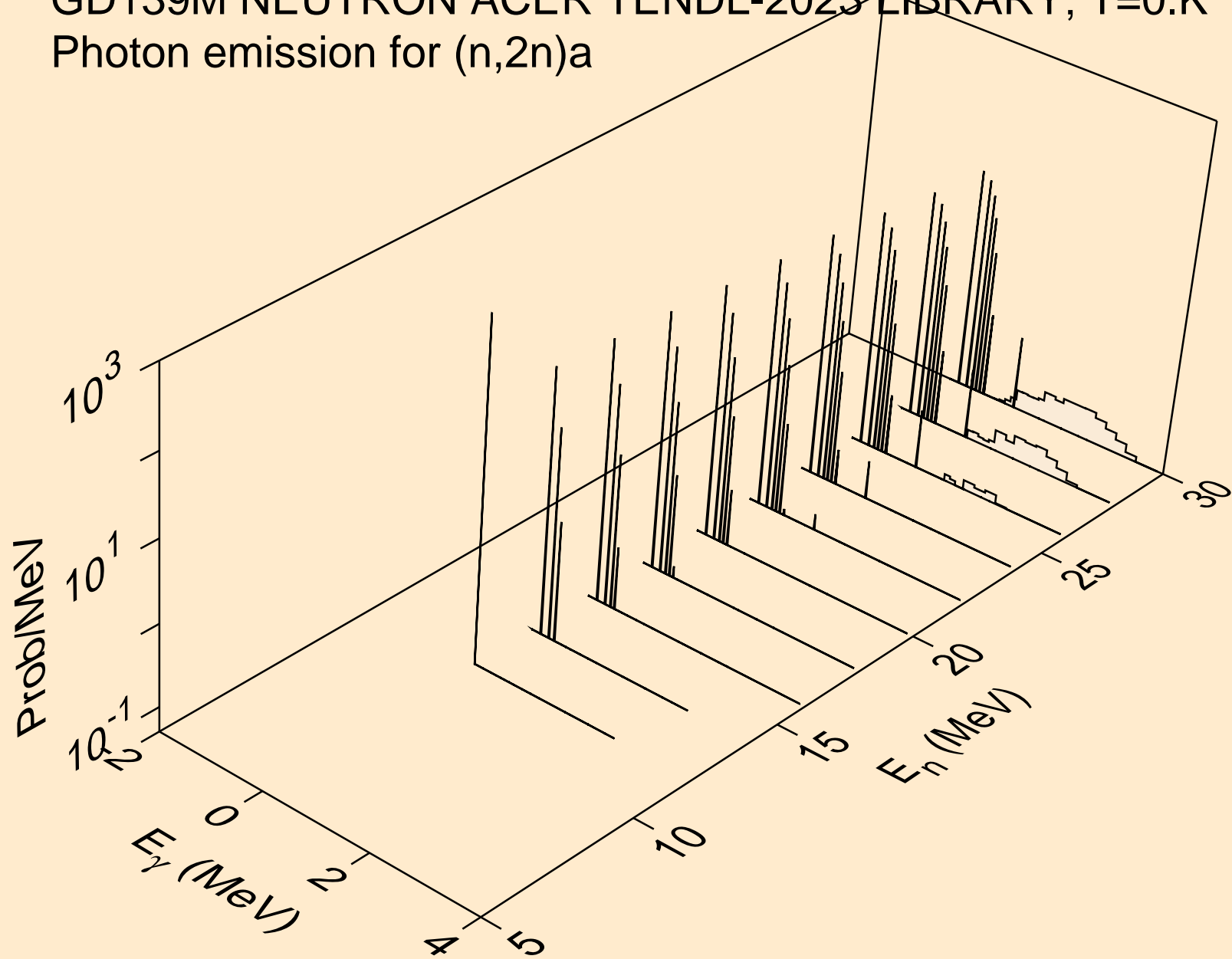

GD139M NEUTRON ACER TENDL-2023 LIBRARY; T=0.K  
Photon emission for (n,3n)a

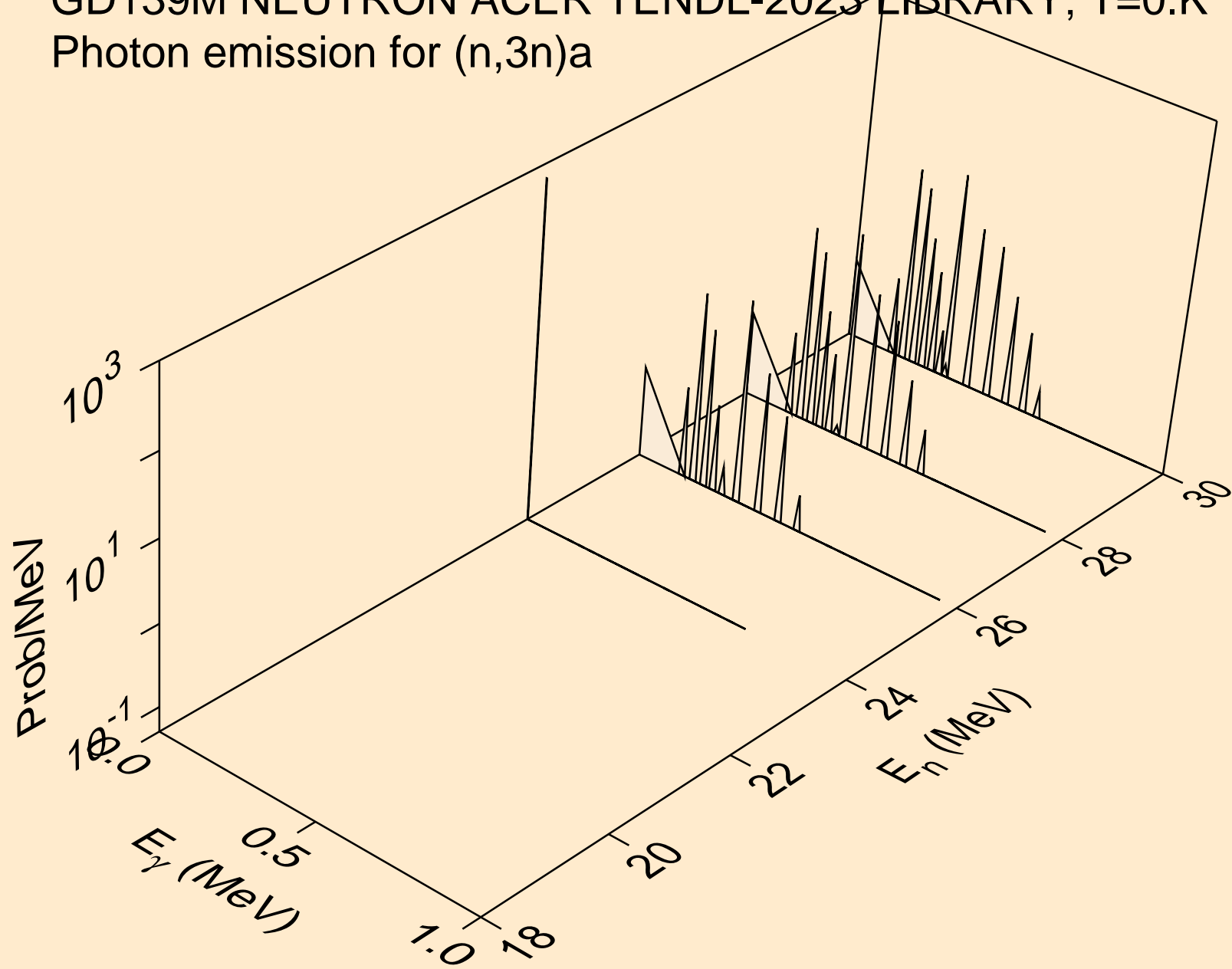

GD139M NEUTRON ACER TENDL-2023 LIBRARY; T=0.K  
Photon emission for (n,n\*)p

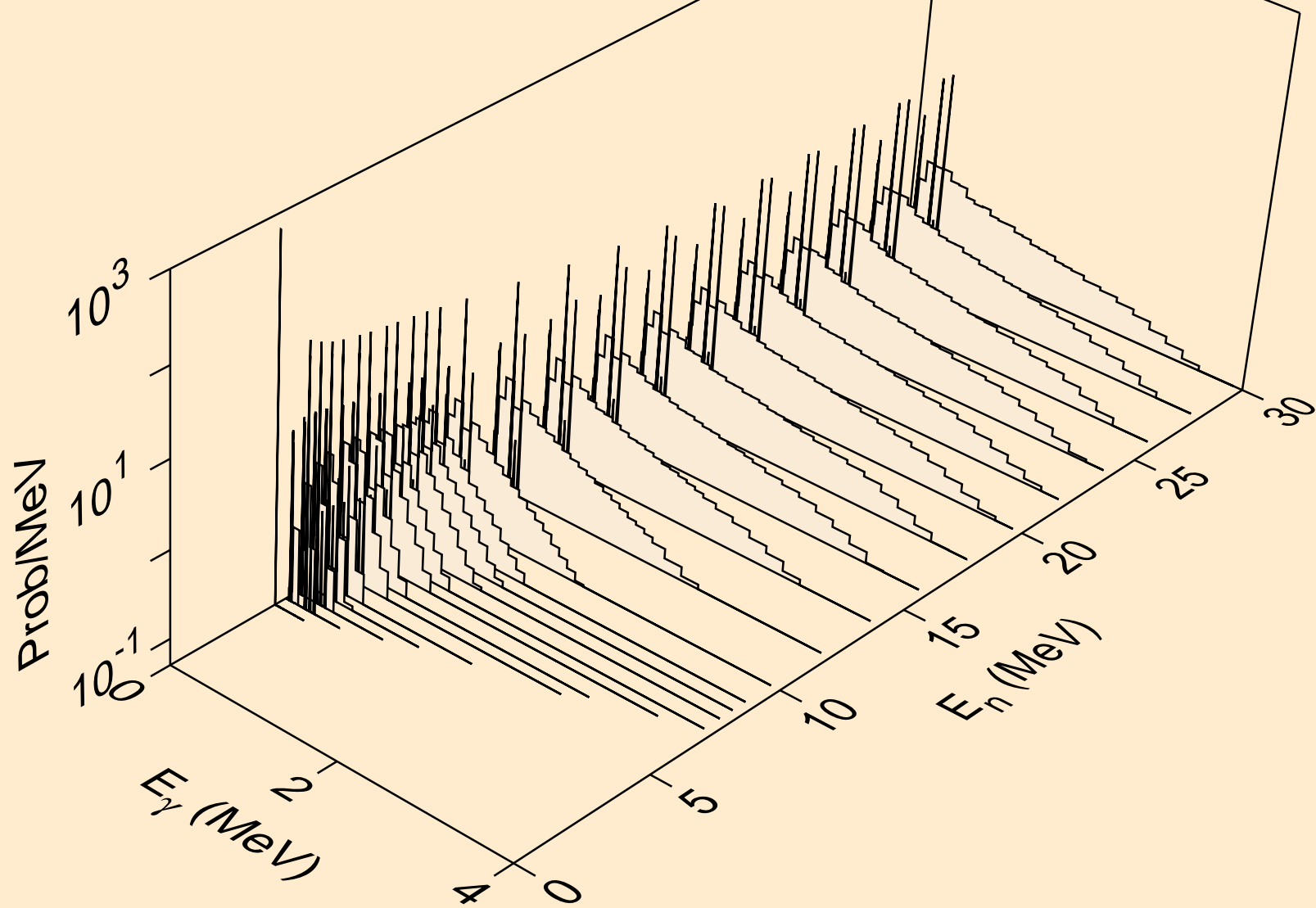

GD139M NEUTRON ACER TENDL-2023 LIBRARY; T=0.K  
Photon emission for (n,n\*)2a

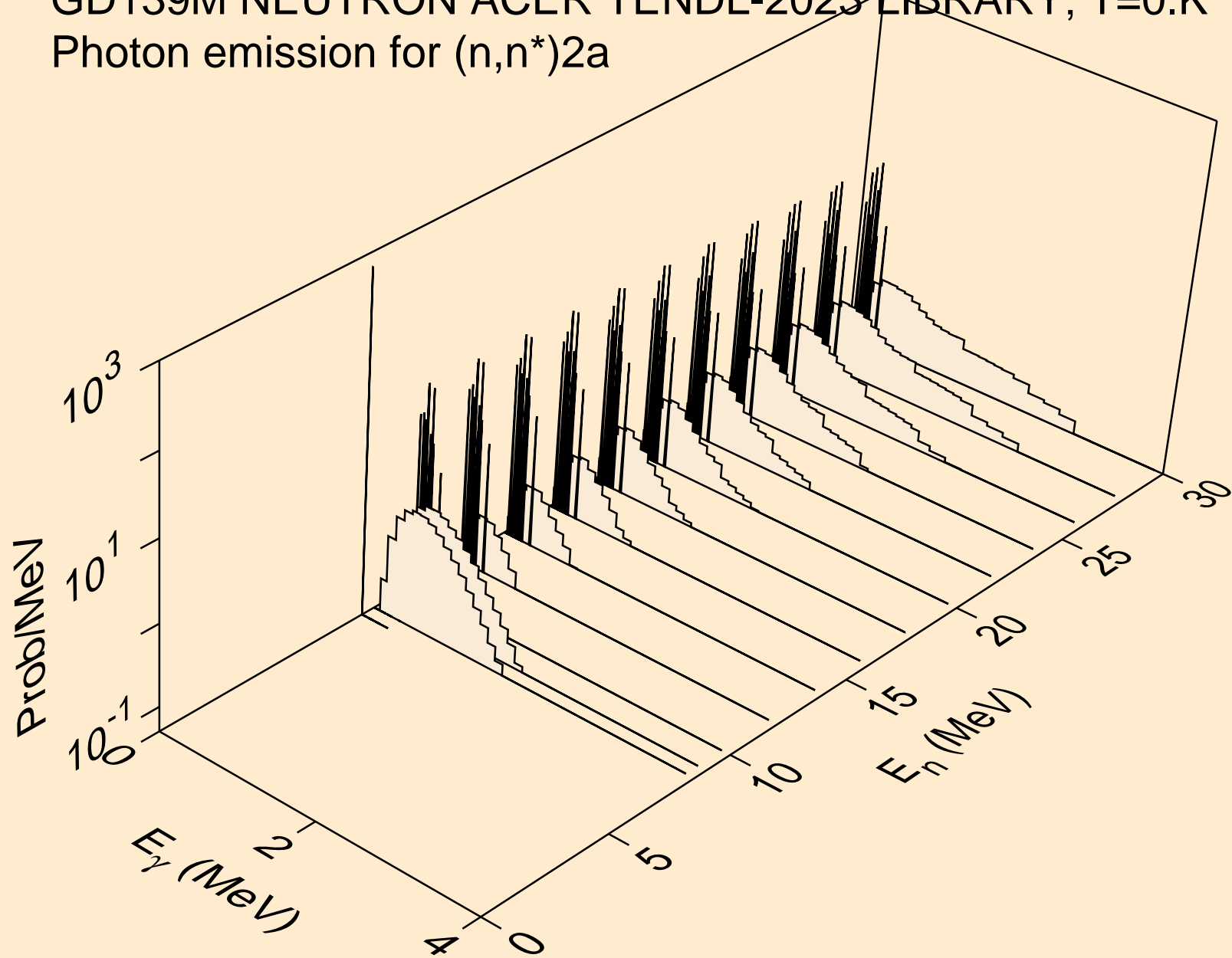

GD139M NEUTRON ACER TENDL-2023 LIBRARY; T=0.K  
Photon emission for (n,2n)2a

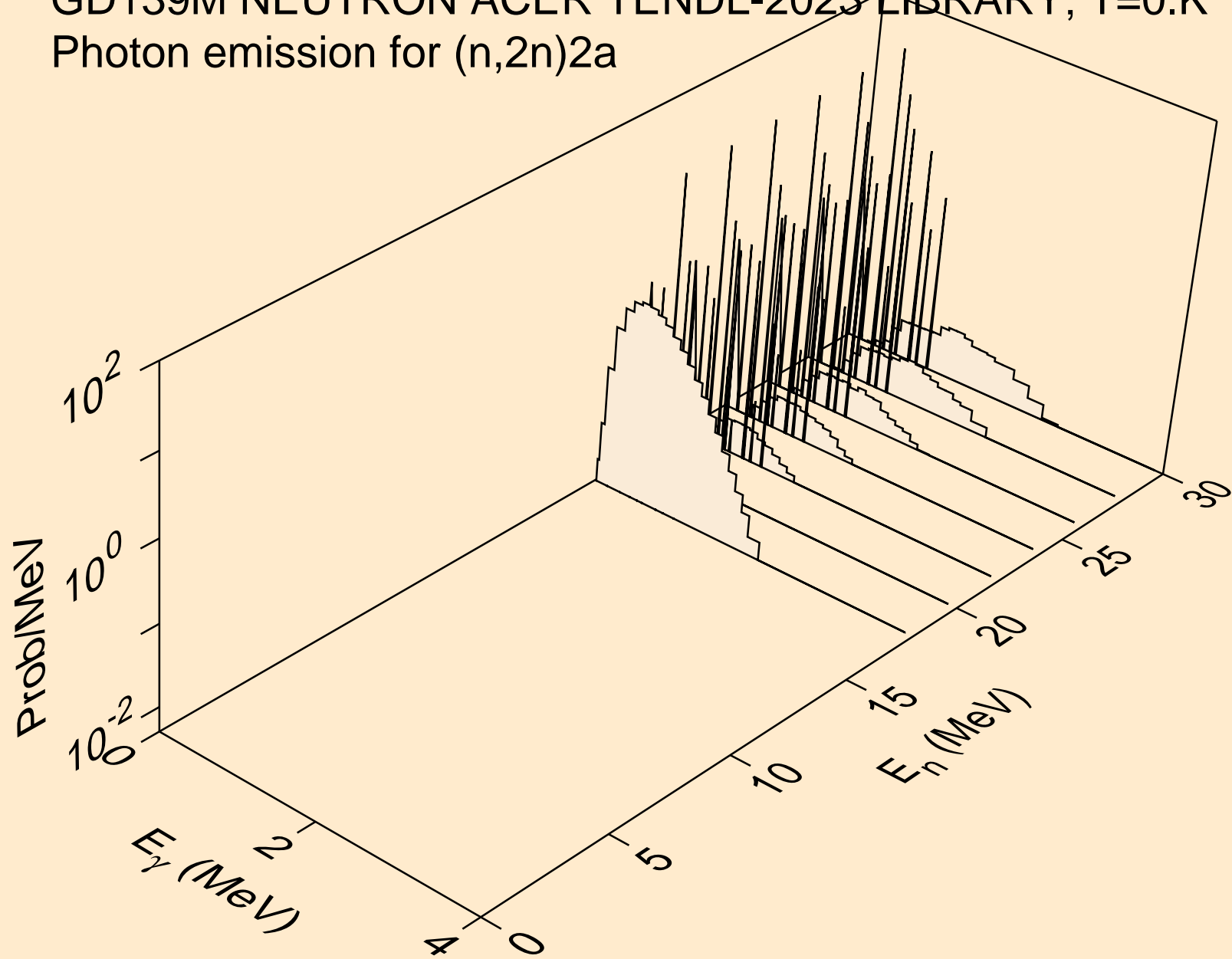

GD139M NEUTRON ACER TENDL-2023 LIBRARY; T=0.K  
Photon emission for (n,n\*)d

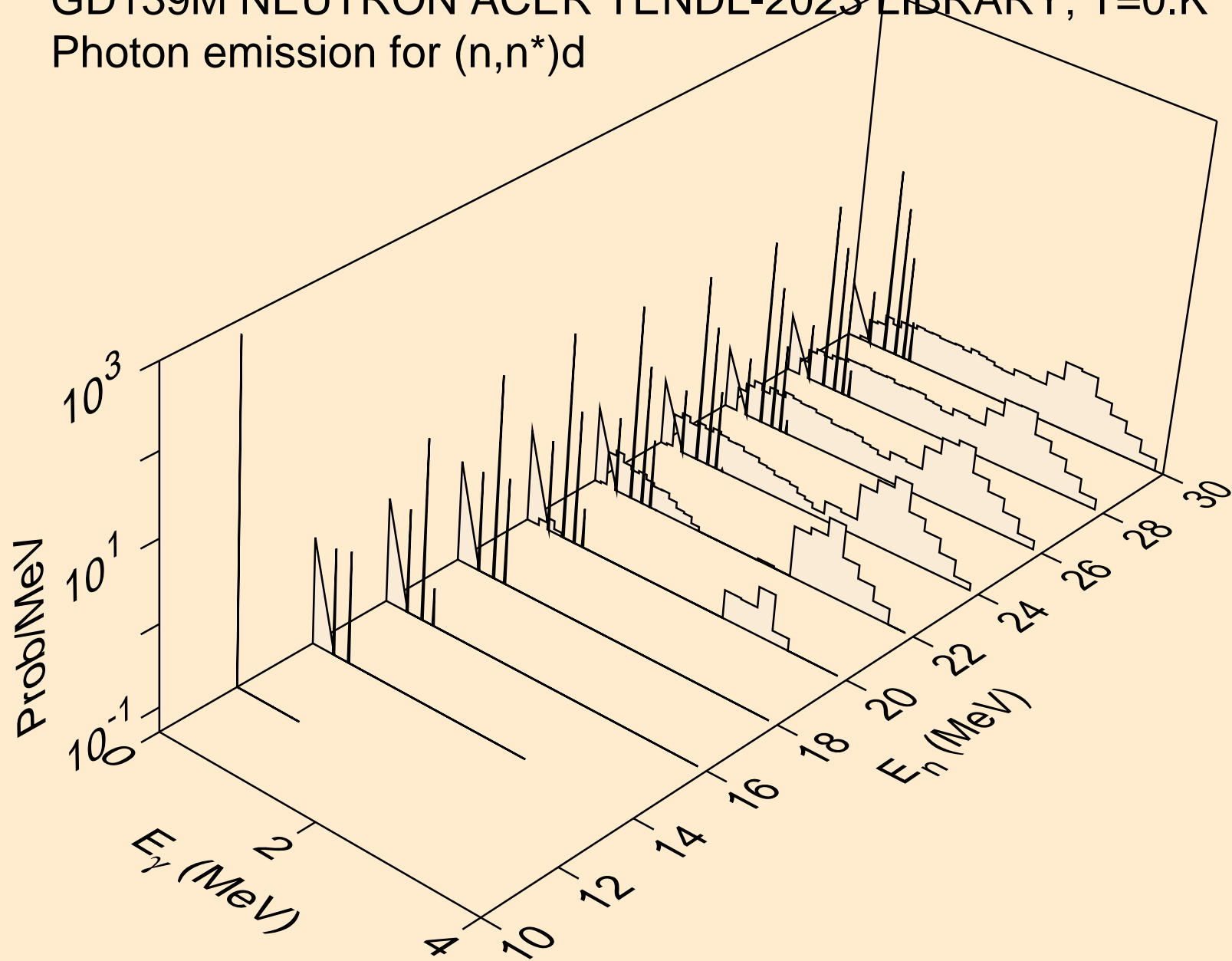

GD139M NEUTRON ACER TENDL-2023 LIBRARY; T=0.K  
Photon emission for (n,n\*)t

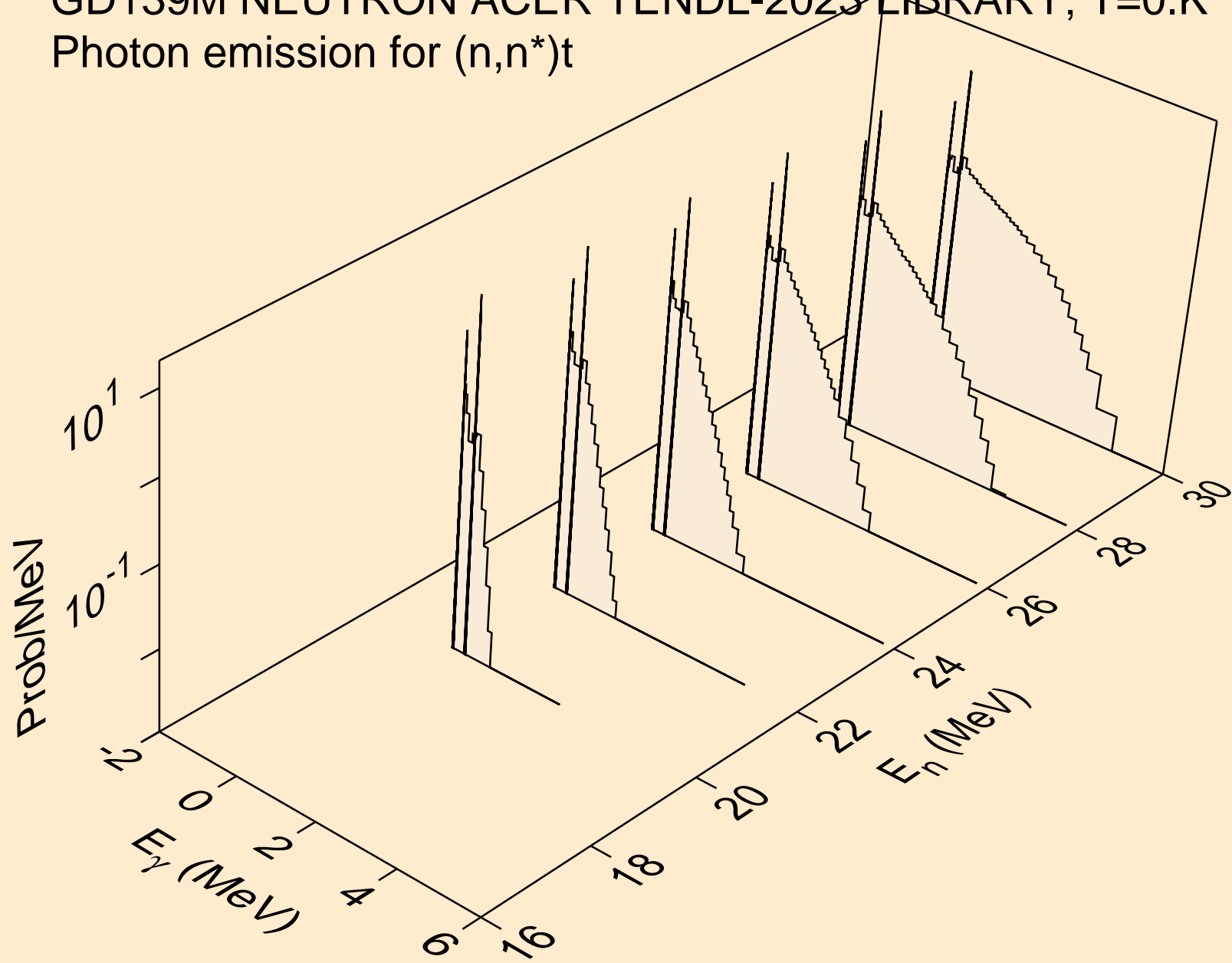

GD139M NEUTRON ACER TENDL-2023 LIBRARY; T=0.K  
Photon emission for (n,n\*)he3

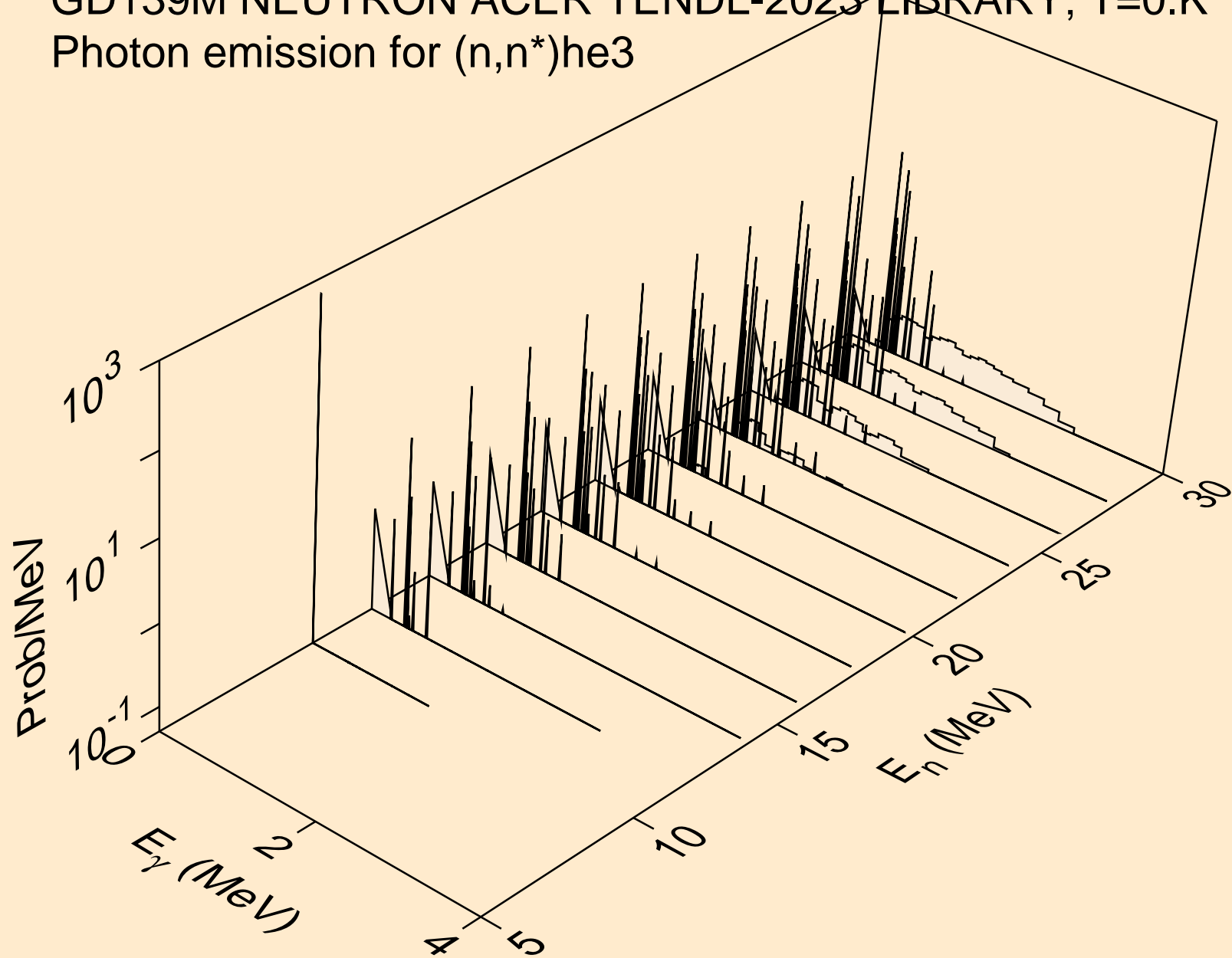

GD139M NEUTRON ACER TENDL-2023 LIBRARY; T=0.K  
Photon emission for (n,2np)

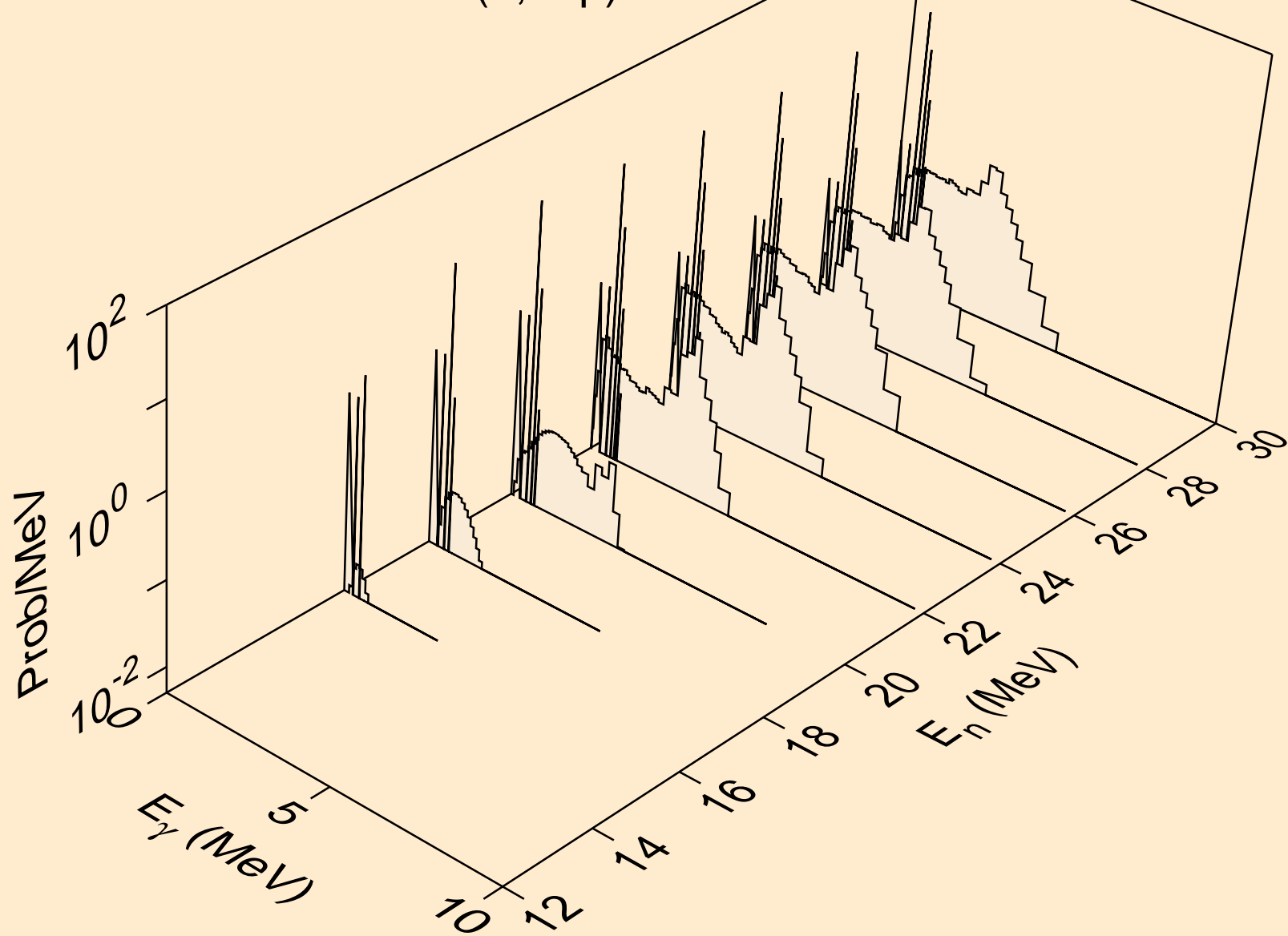

GD139M NEUTRON ACER TENDL-2023 LIBRARY; T=0.K  
Photon emission for (n,3np)

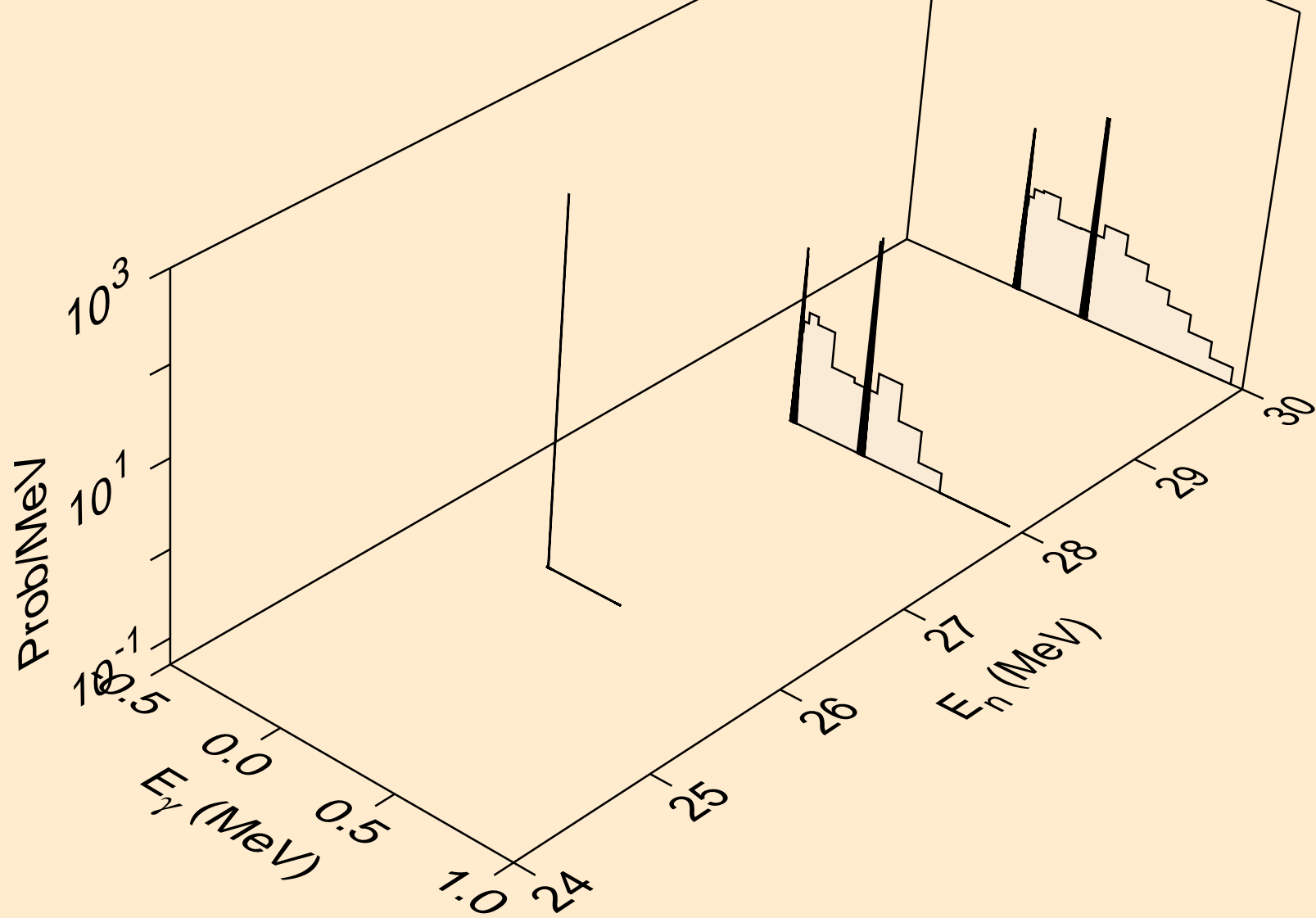

GD139M NEUTRON ACER TENDL-2023 LIBRARY; T=0.K  
Photon emission for (n,n2p)

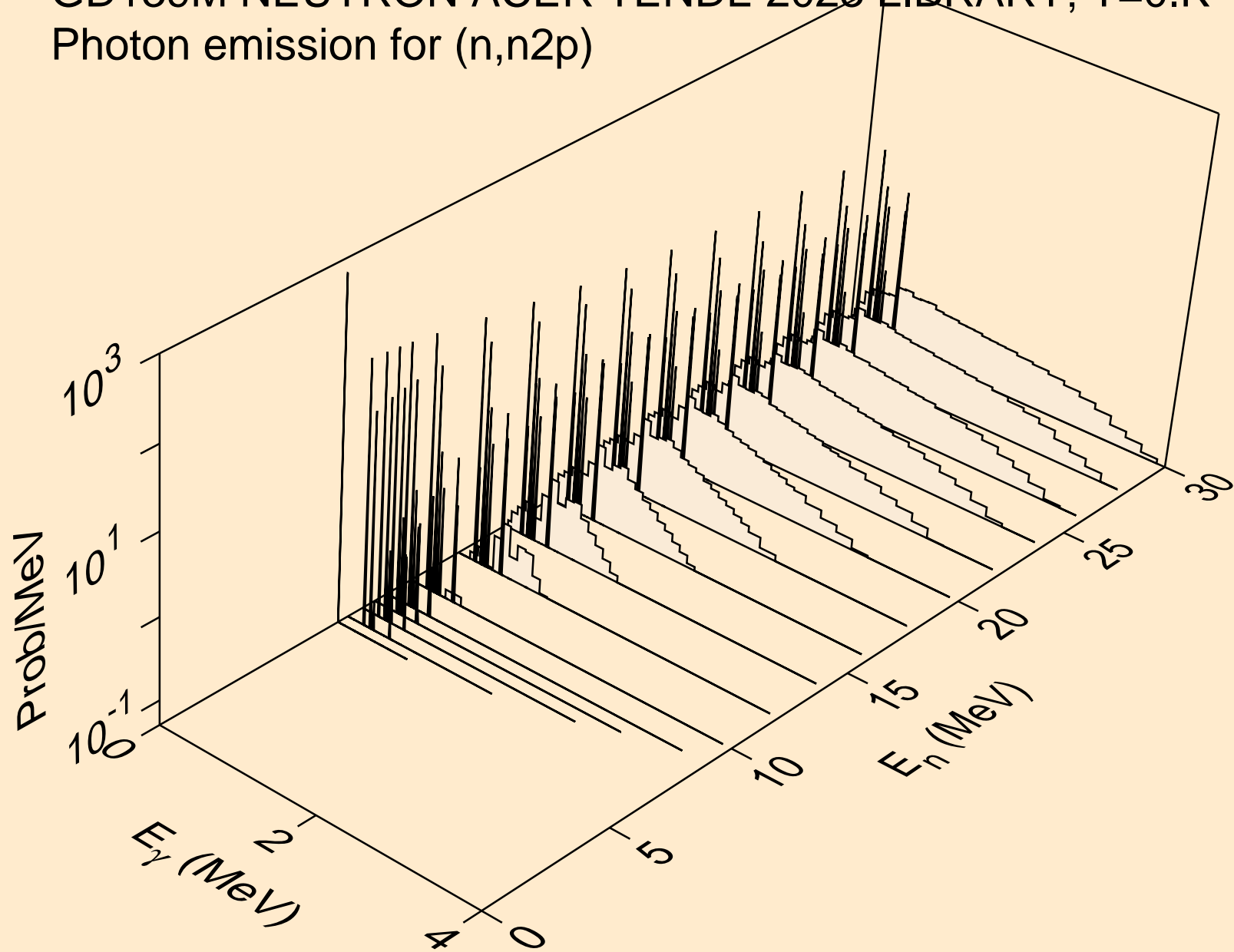

GD139M NEUTRON ACER TENDL-2023 LIBRARY; T=0.K  
Photon emission for (n,npa)

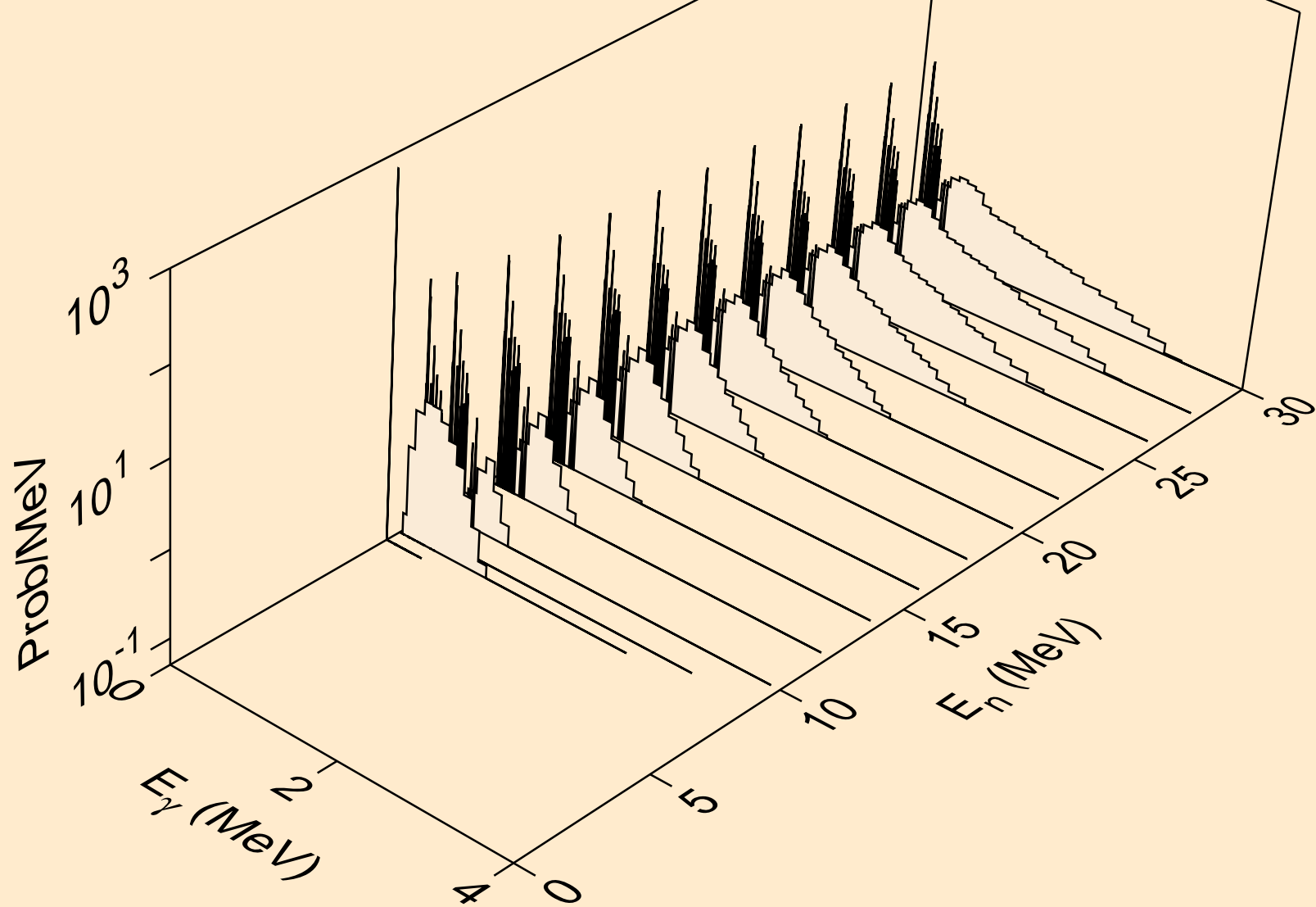

GD139M NEUTRON ACER TENDL-2023 LIBRARY; T=0.K  
Photon emission for (n,n\*1)

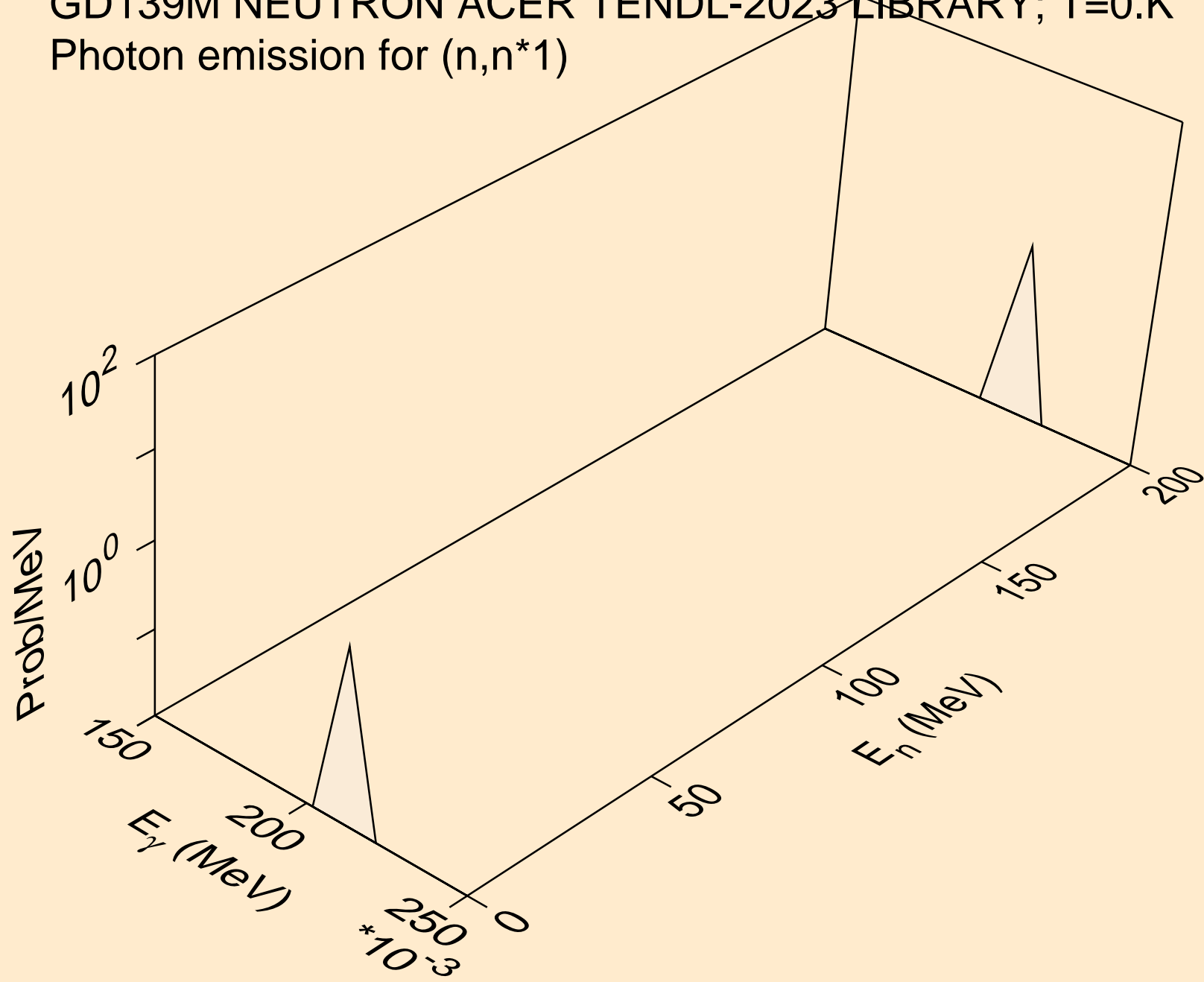

GD139M NEUTRON ACER TENDL-2023 LIBRARY; T=0.K  
Photon emission for (n,n\*3)

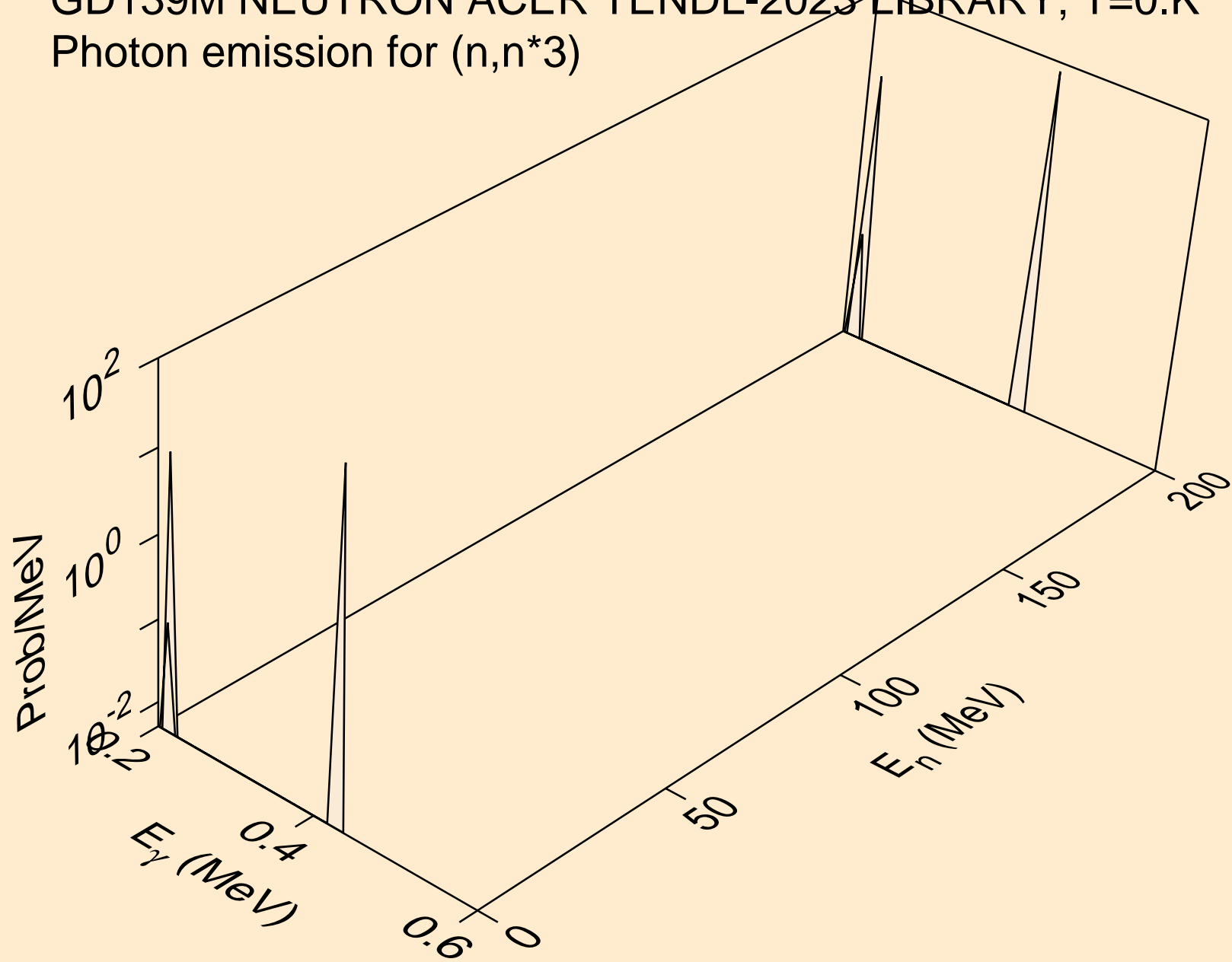

GD139M NEUTRON ACER TENDL-2023 LIBRARY; T=0.K  
Photon emission for (n,n\*c)

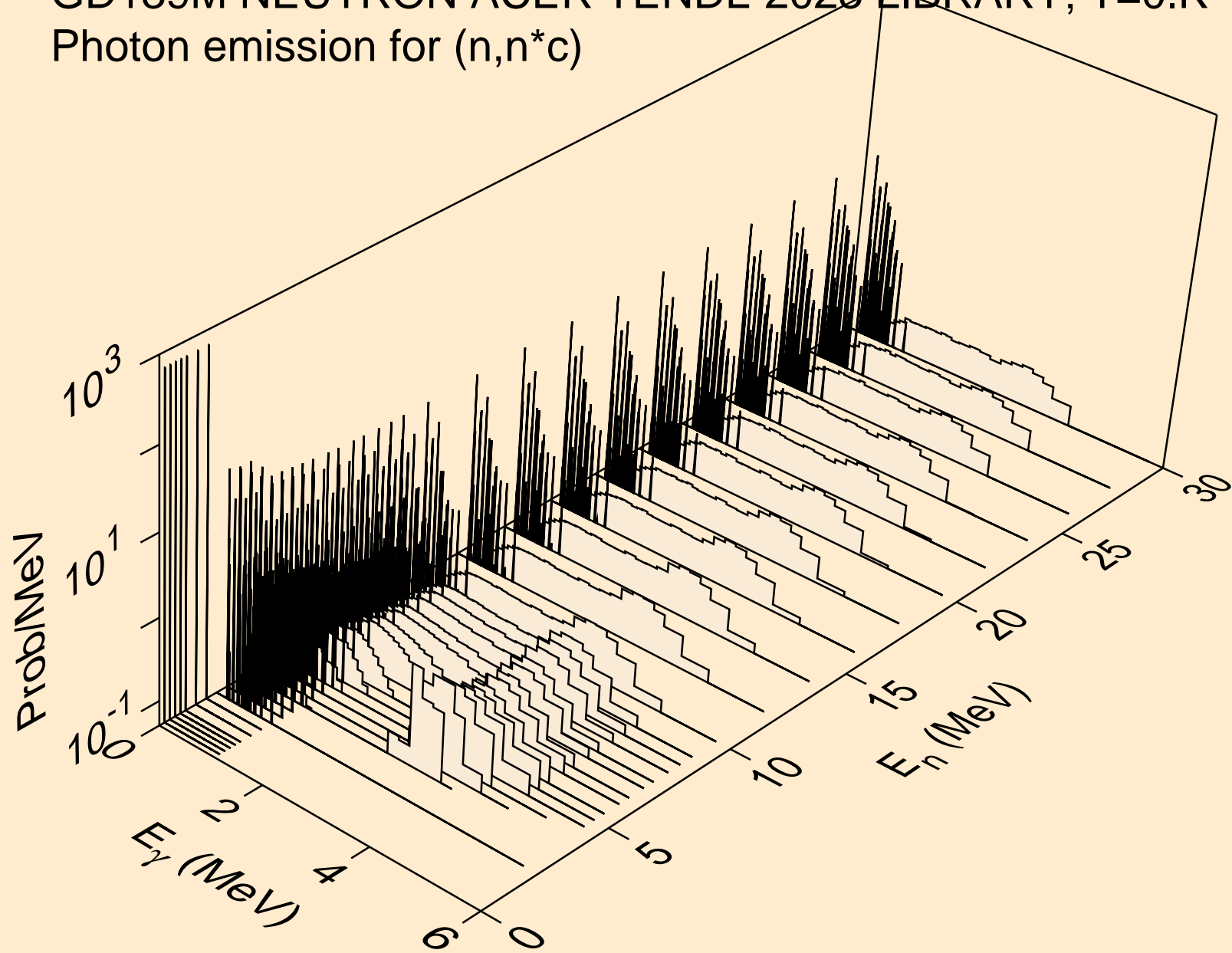

GD139M NEUTRON ACER TENDL-2023 LIBRARY; T=0.K  
Photon emission for (n,gma)

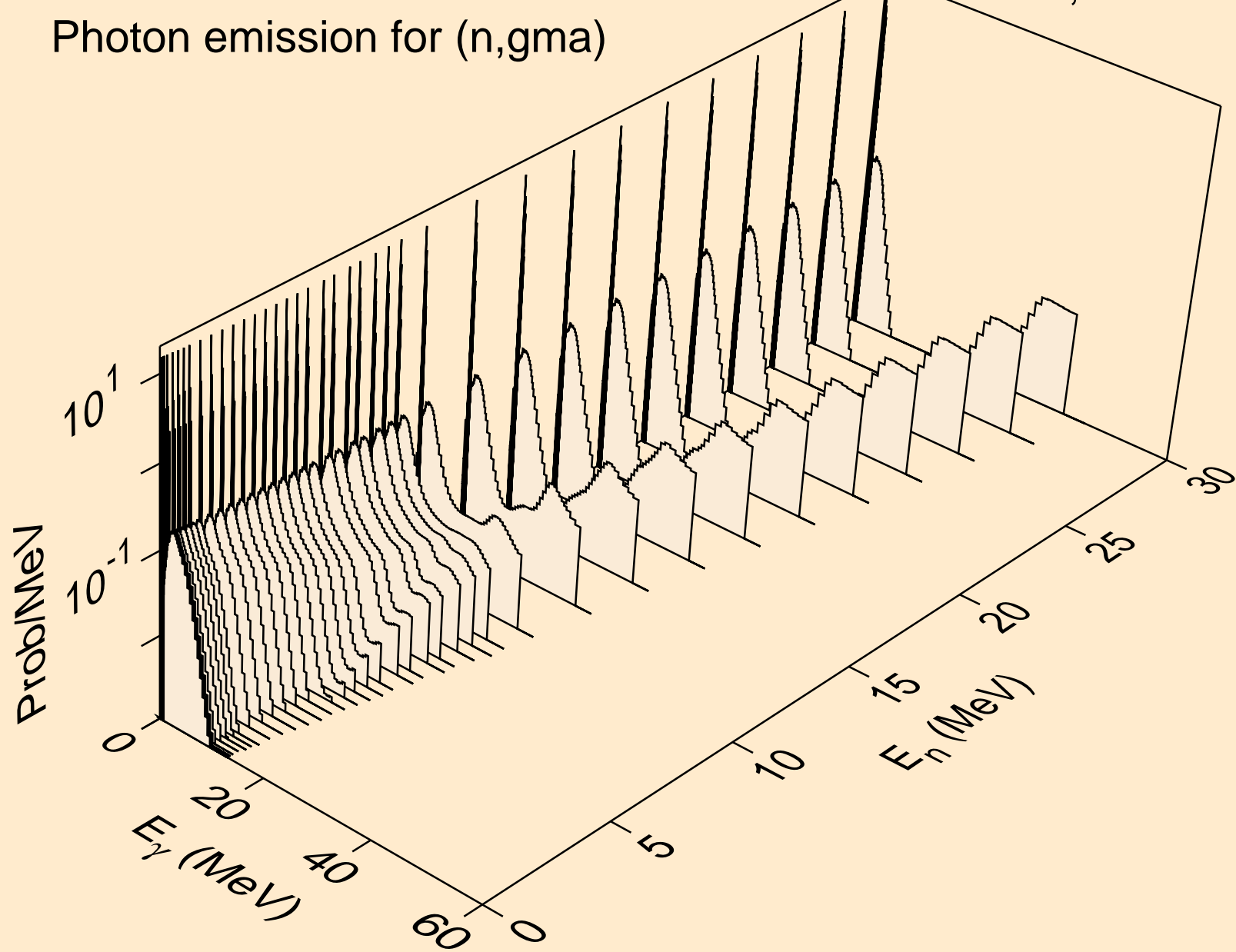

GD139M NEUTRON ACER TENDL-2023 LIBRARY; T=0.K  
Photon emission for (n,p)

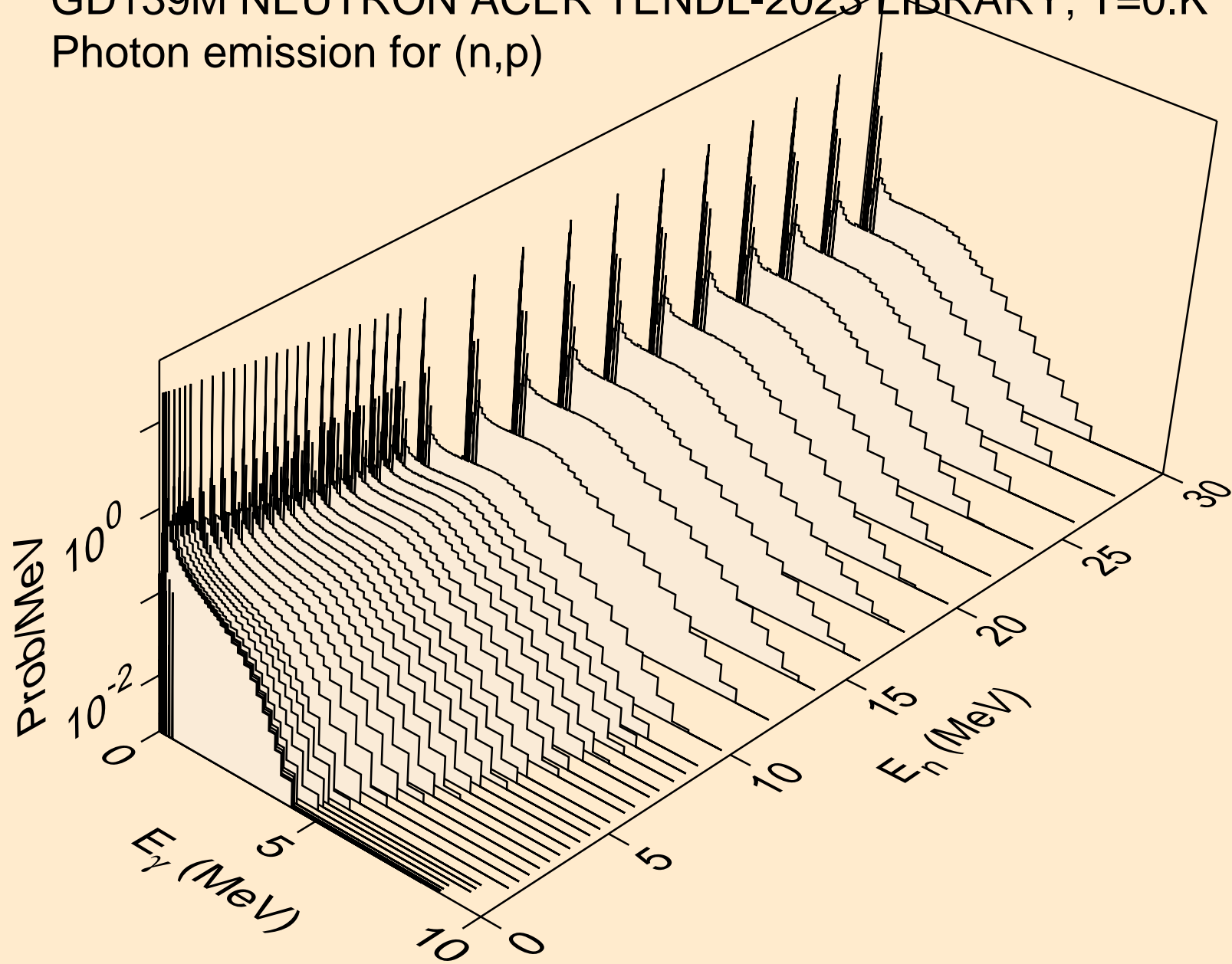

GD139M NEUTRON ACER TENDL-2023 LIBRARY; T=0.K  
Photon emission for (n,d)

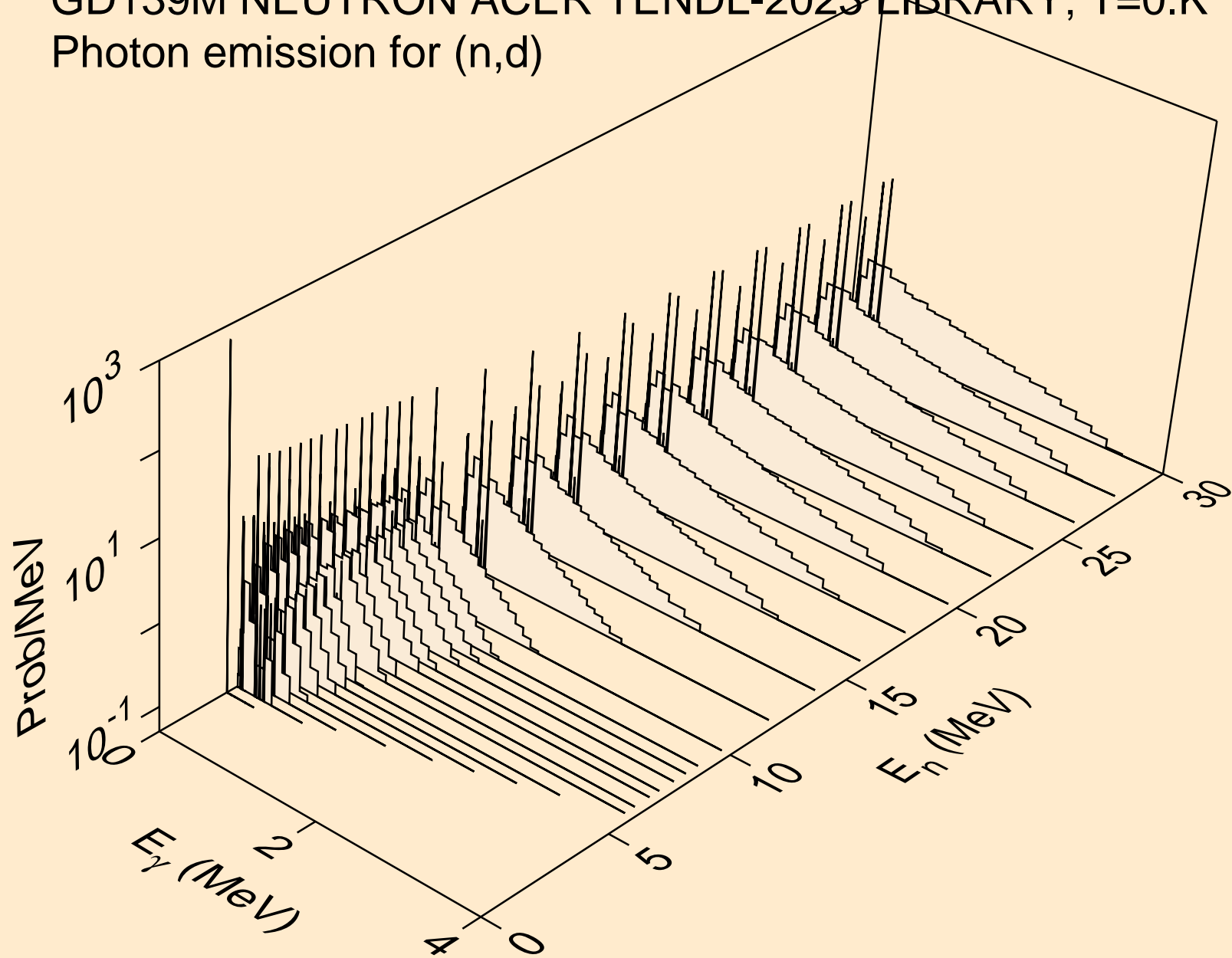

GD139M NEUTRON ACER TENDL-2023 LIBRARY; T=0.K  
Photon emission for (n,t)

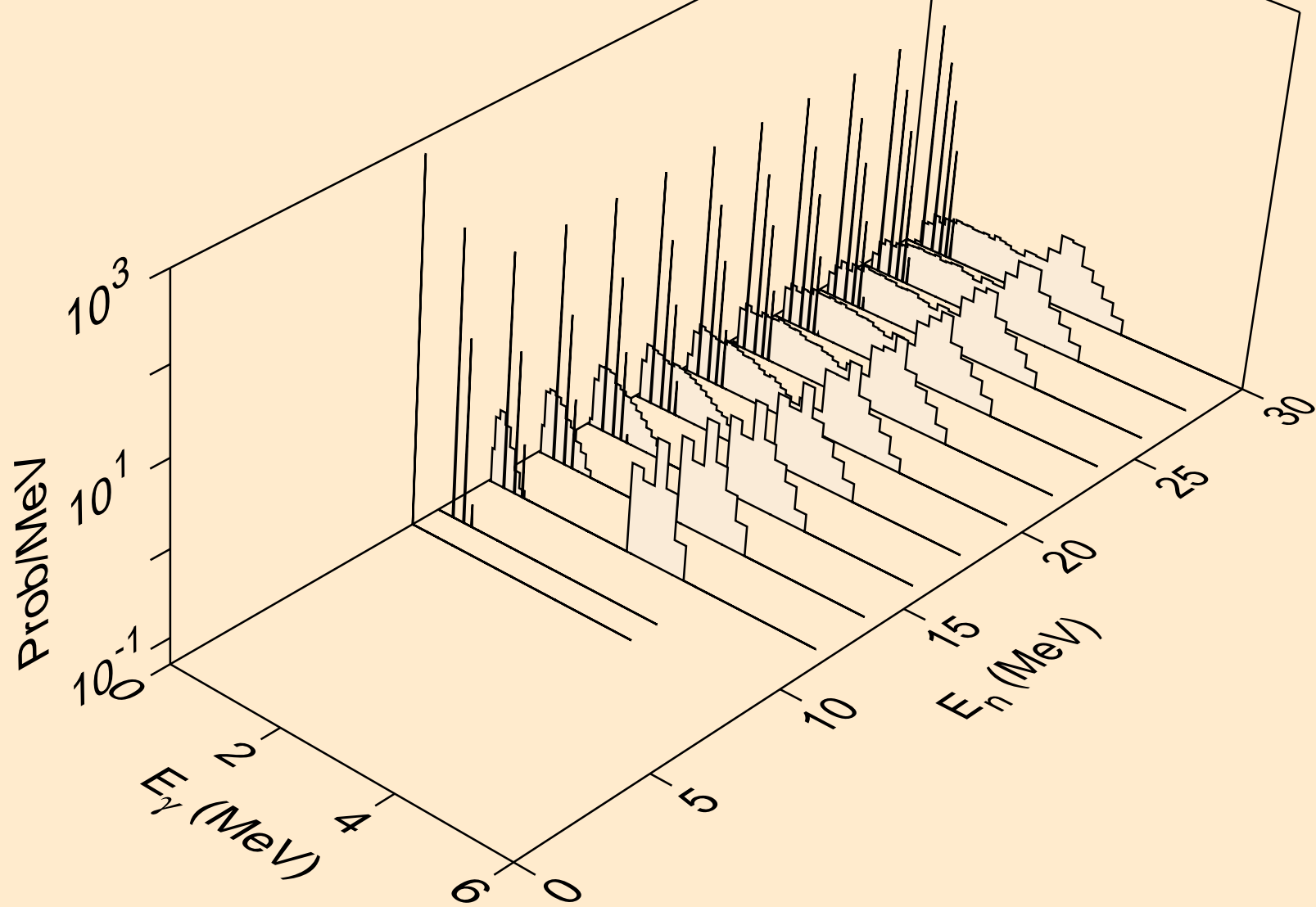

GD139M NEUTRON ACER TENDL-2023 LIBRARY; T=0.K  
Photon emission for (n,he3)

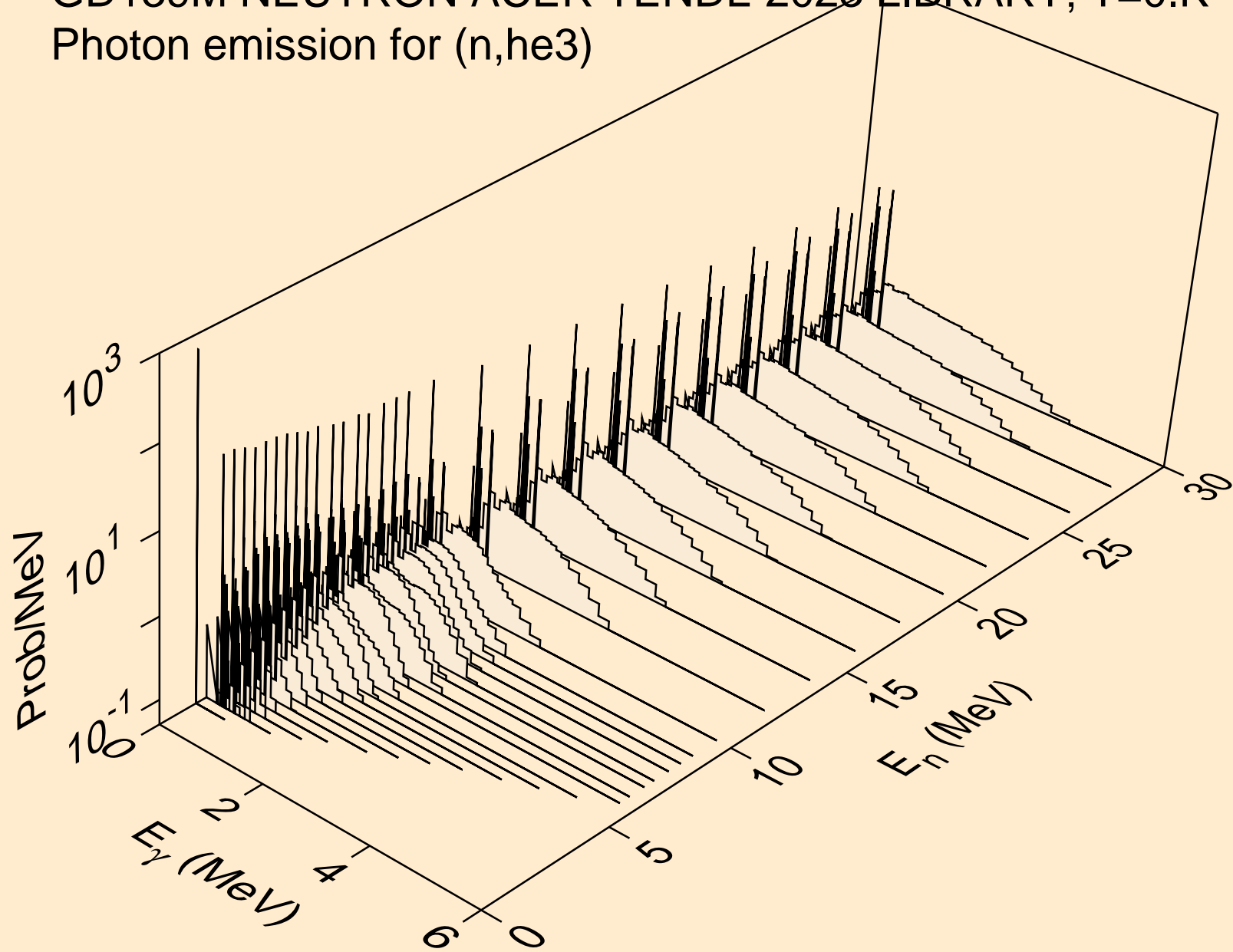

GD139M NEUTRON ACER TENDL-2023 LIBRARY; T=0.K  
Photon emission for (n,a)

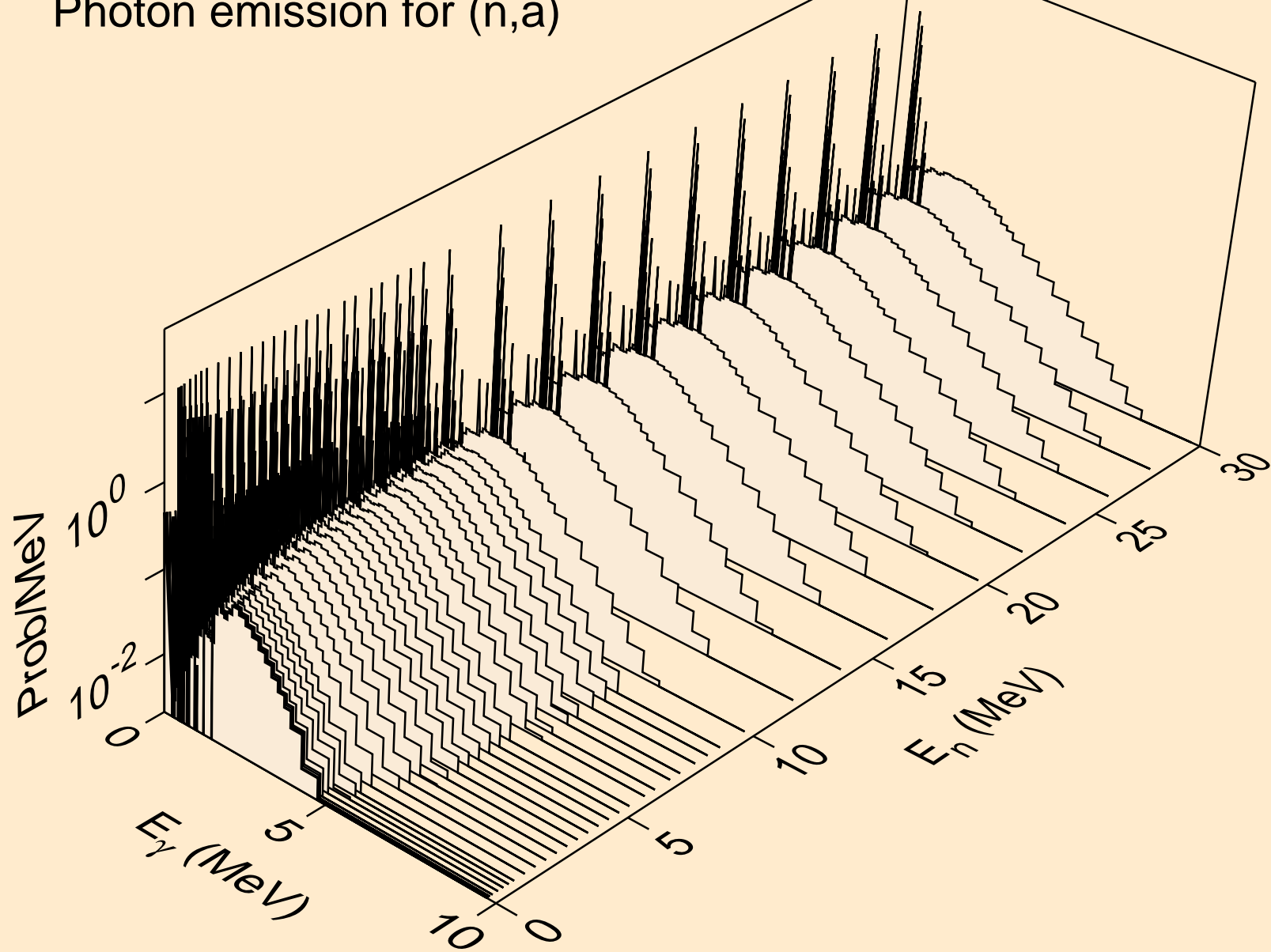

GD139M NEUTRON ACER TENDL-2023 LIBRARY; T=0.K  
Photon emission for (n,2a)

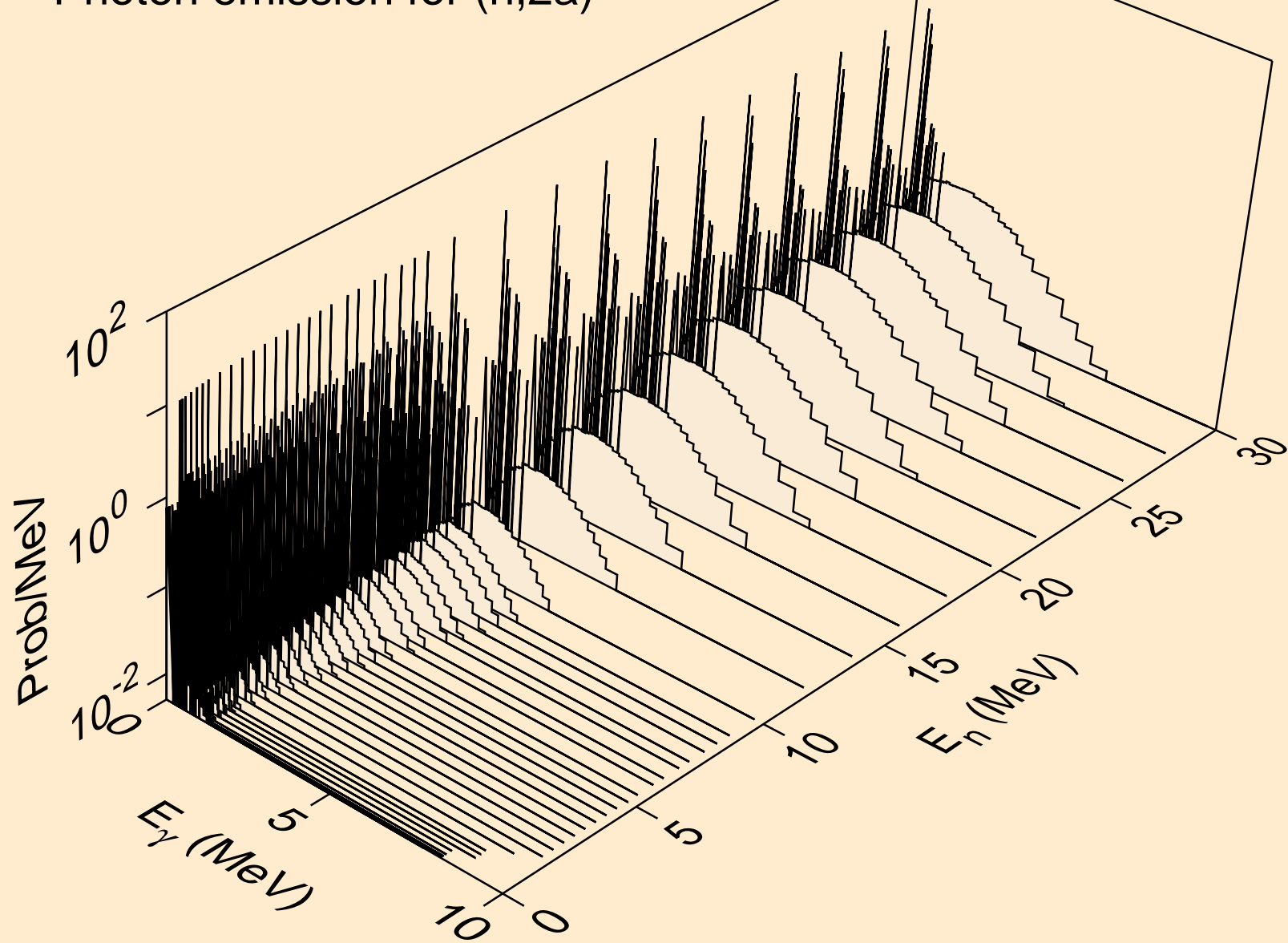

GD139M NEUTRON ACER TENDL-2023 LIBRARY; T=0.K  
Photon emission for (n,3a)

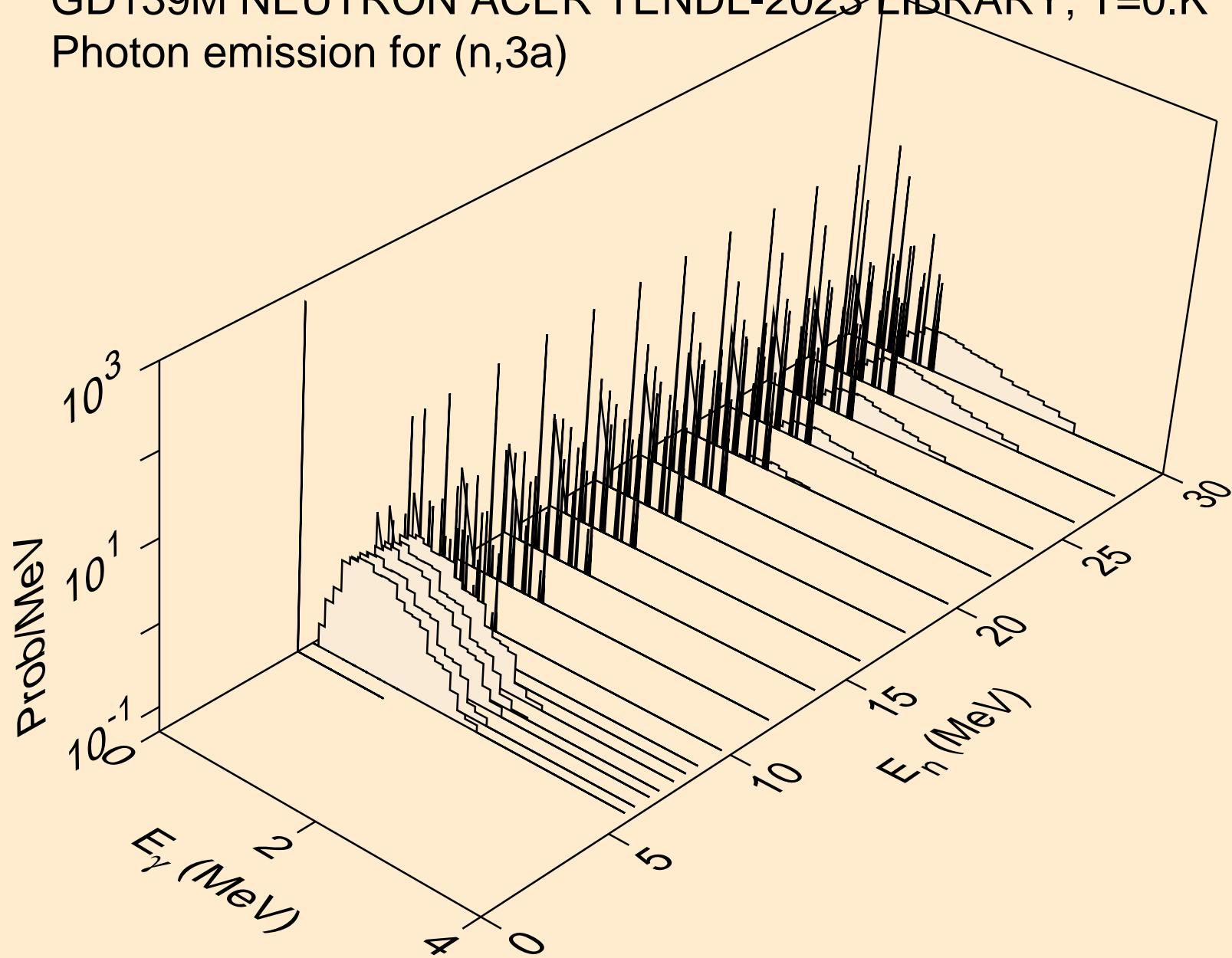

GD139M NEUTRON ACER TENDL-2023 LIBRARY; T=0.K  
Photon emission for (n,2p)

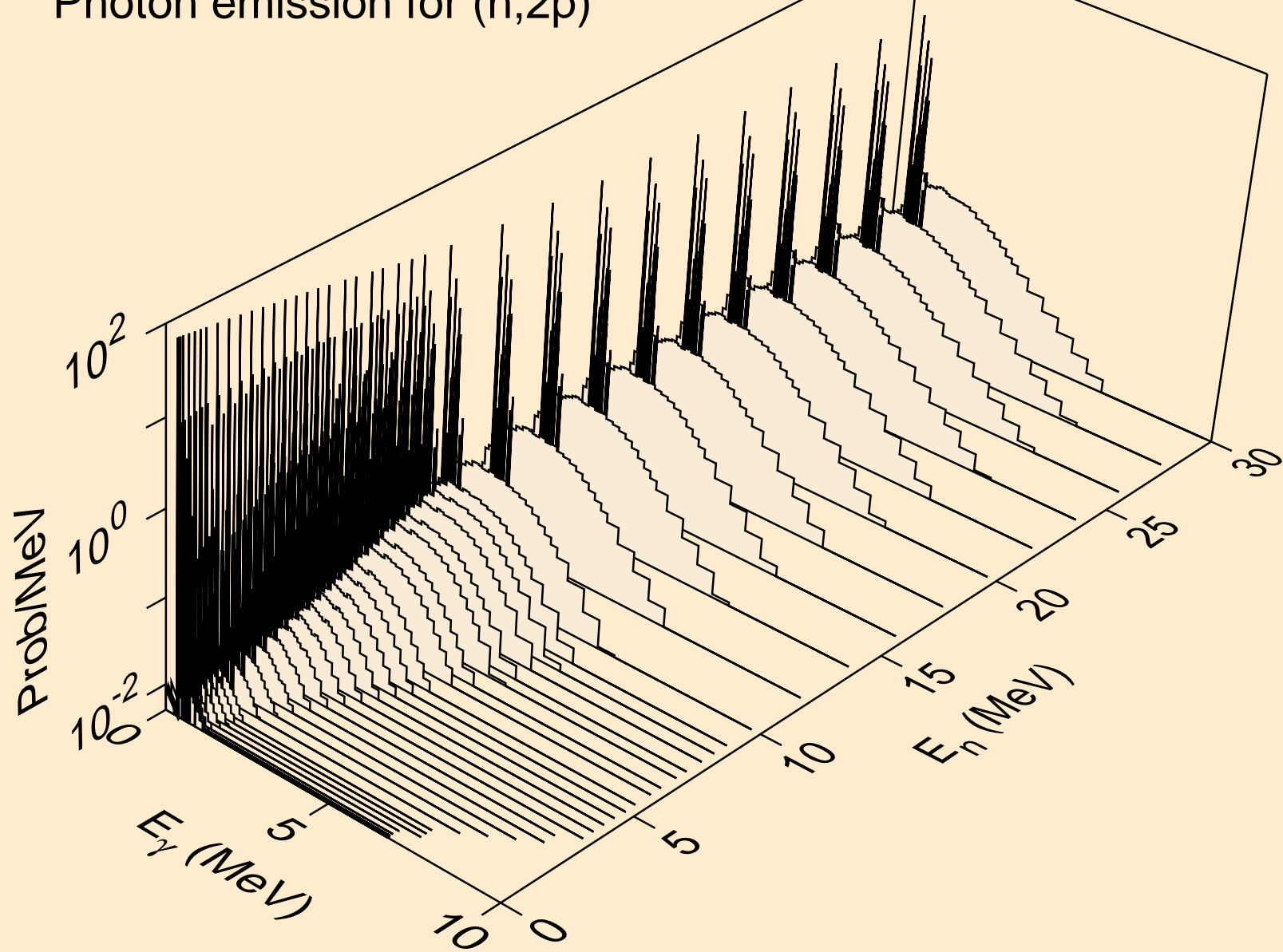

GD139M NEUTRON ACER TENDL-2023 LIBRARY; T=0.K  
Photon emission for (n,p $\alpha$ )

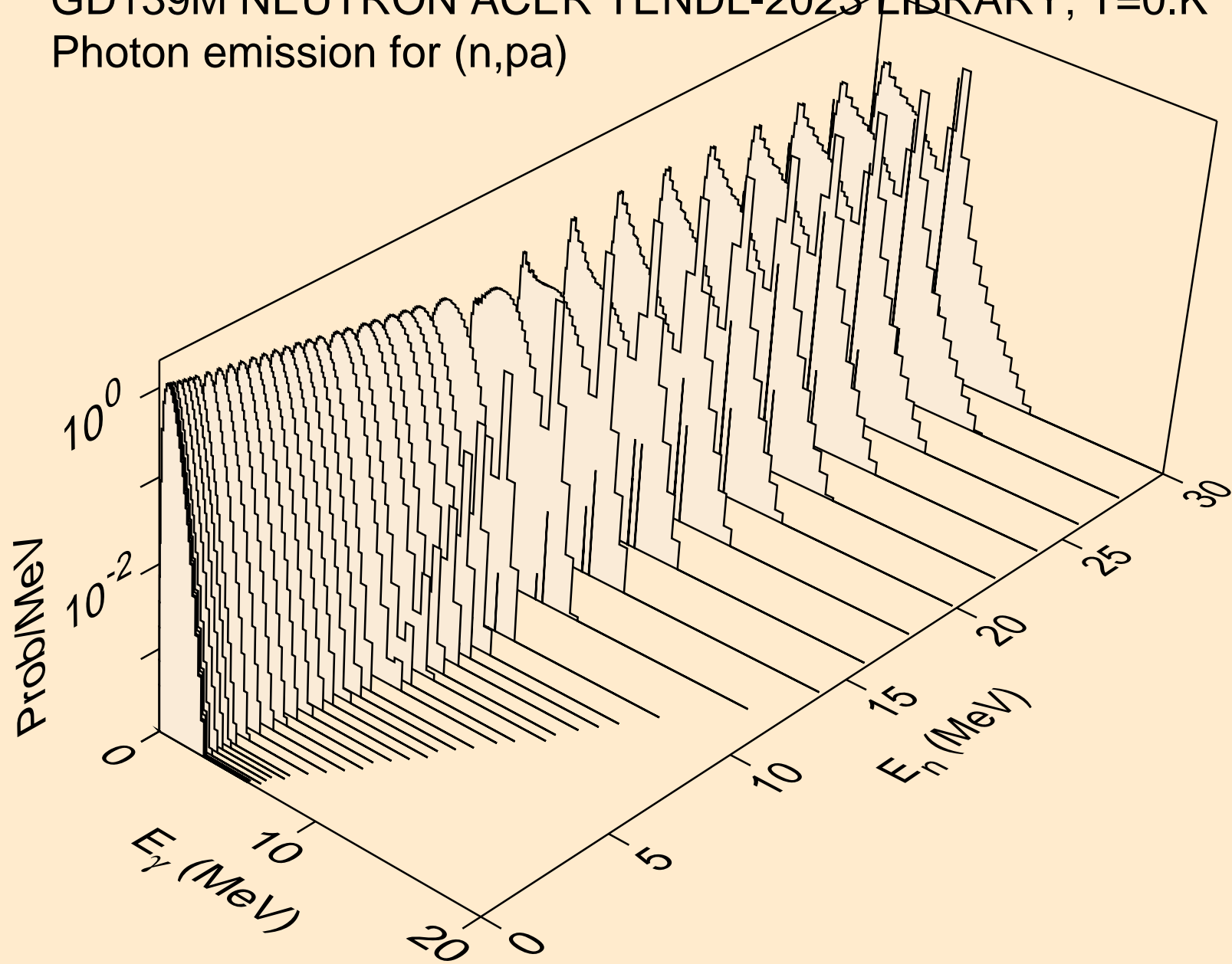

GD139M NEUTRON ACER TENDL-2023 LIBRARY; T=0.K  
Photon emission for (n,d2a)

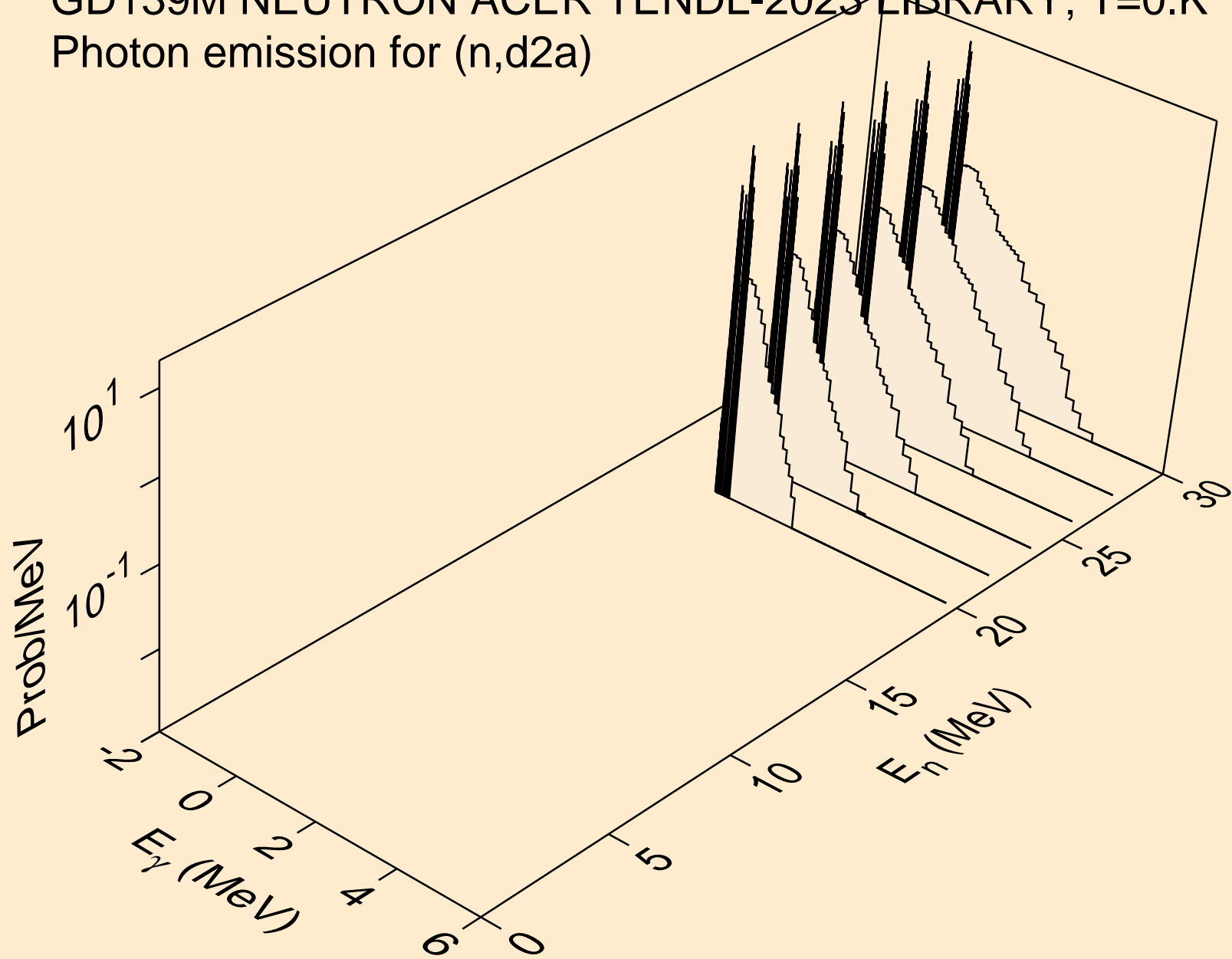

GD139M NEUTRON ACER TENDL-2023 LIBRARY; T=0.K  
Photon emission for (n,pd)

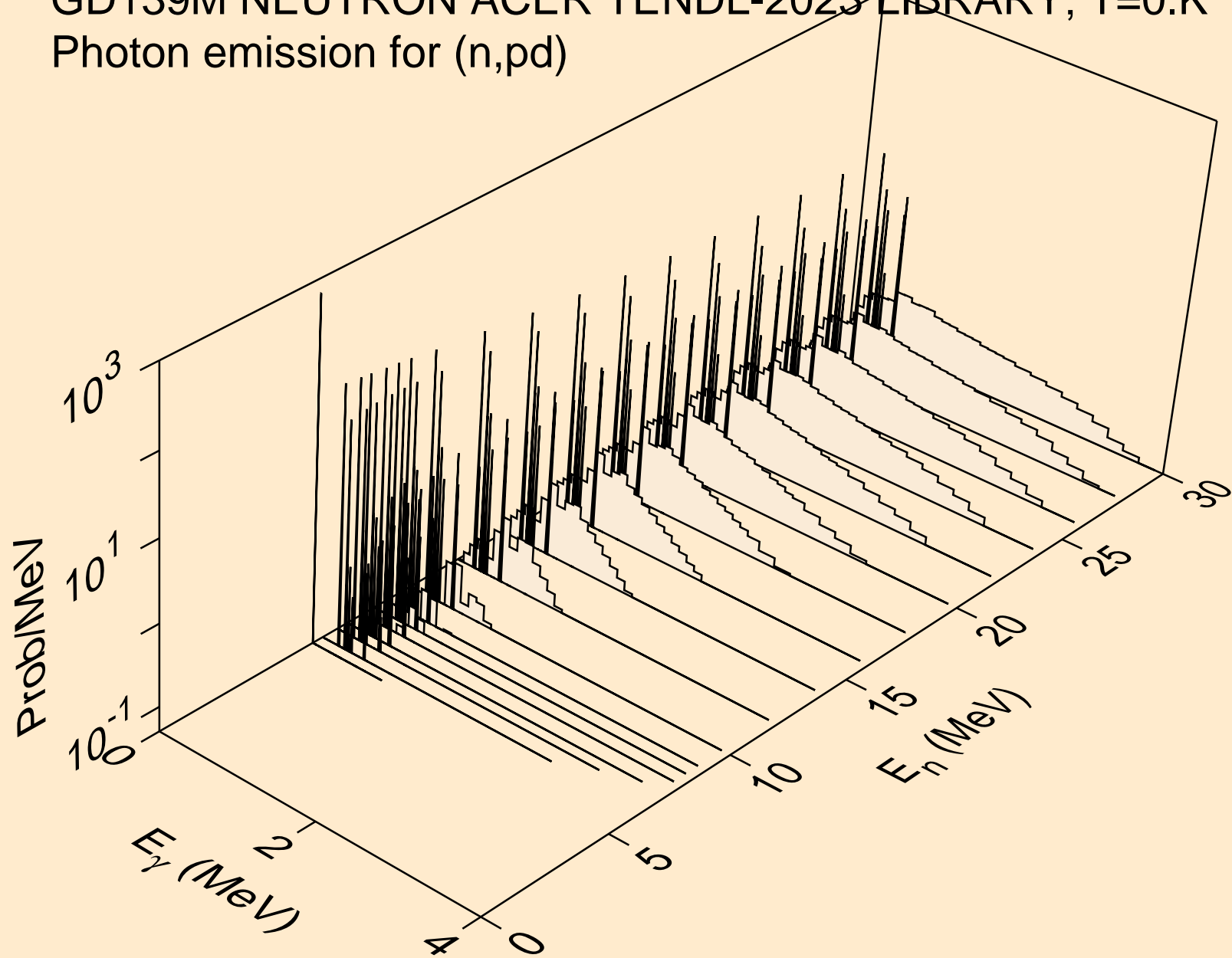

GD139M NEUTRON ACER TENDL-2023 LIBRARY; T=0.K  
Photon emission for (n,pt)

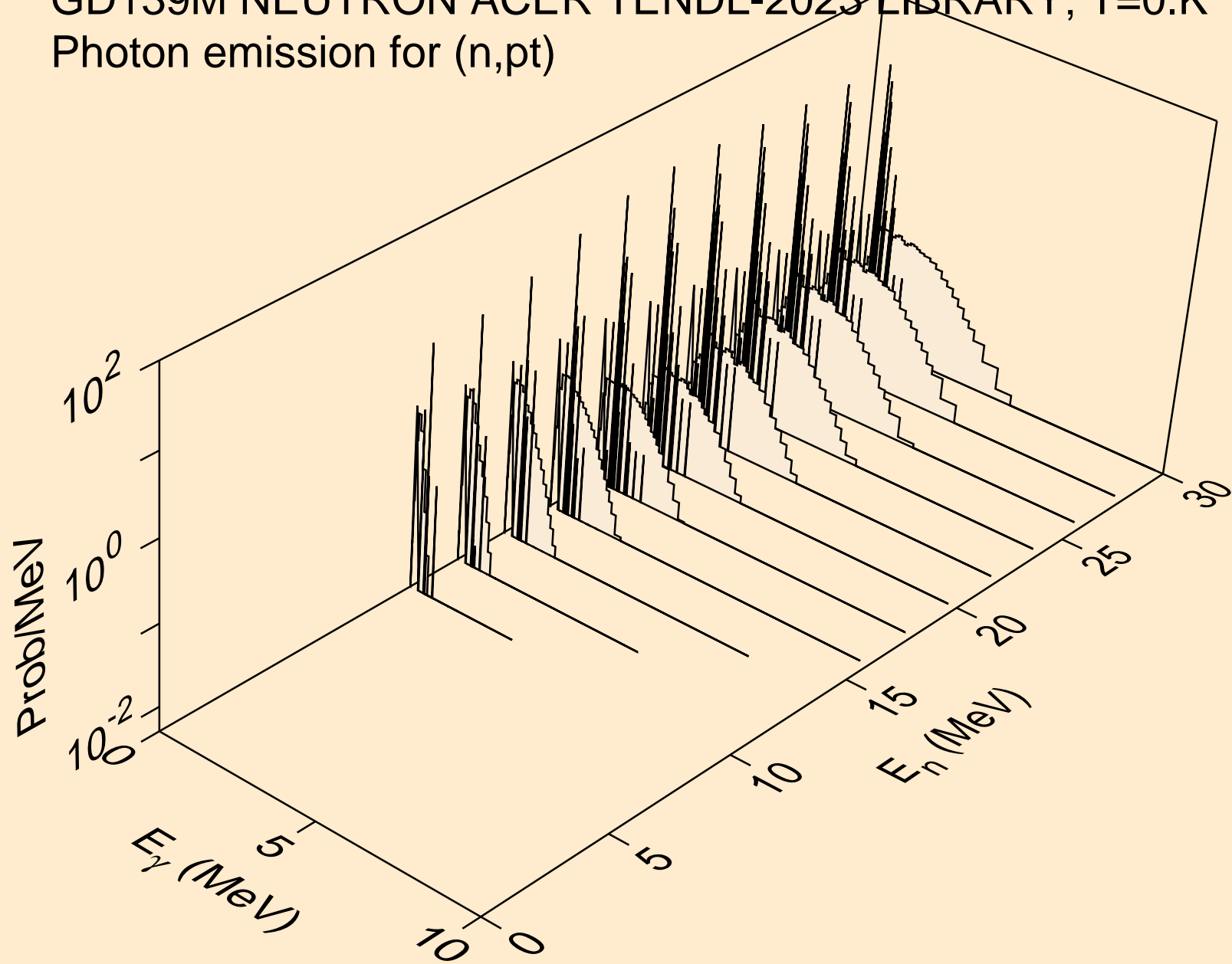

GD139M NEUTRON ACER TENDL-2023 LIBRARY; T=0.K  
Photon emission for (n,da)

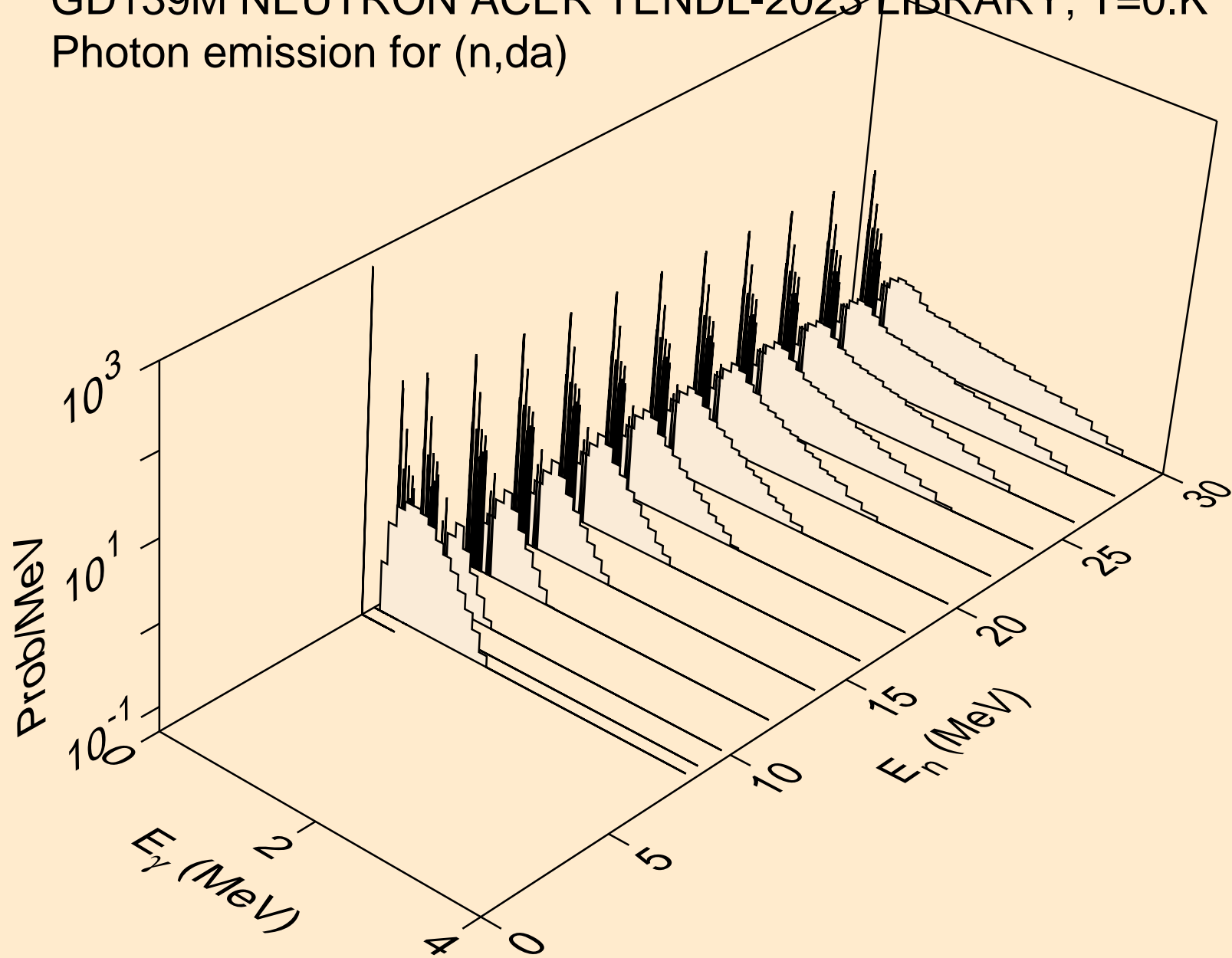

GD139M NEUTRON ACER TENDL-2023 LIBRARY; T=0.K  
thermal capture photon spectrum

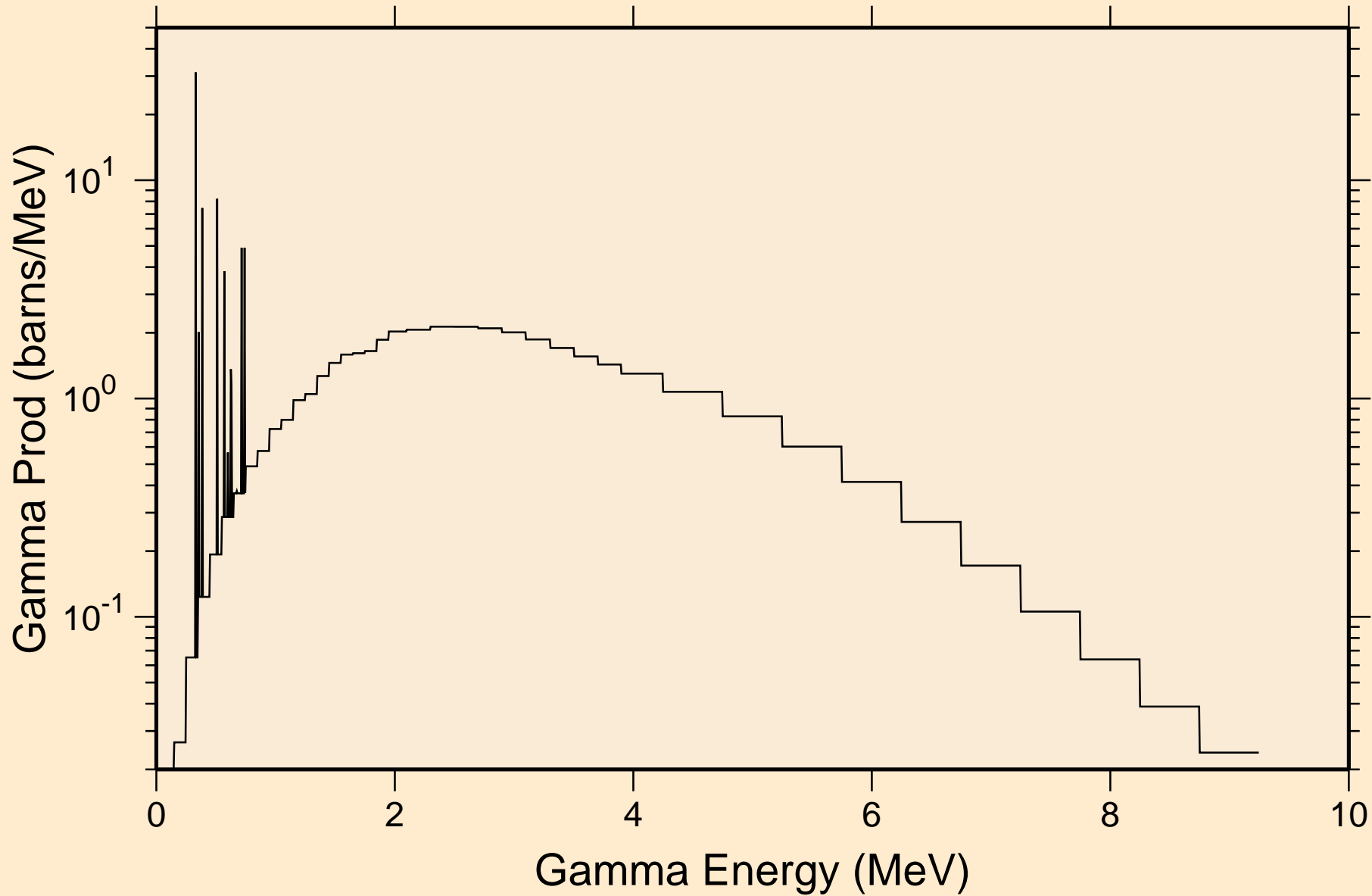

GD139M NEUTRON ACER TENDL-2023 LIBRARY; T=0.K  
14 MeV photon spectrum

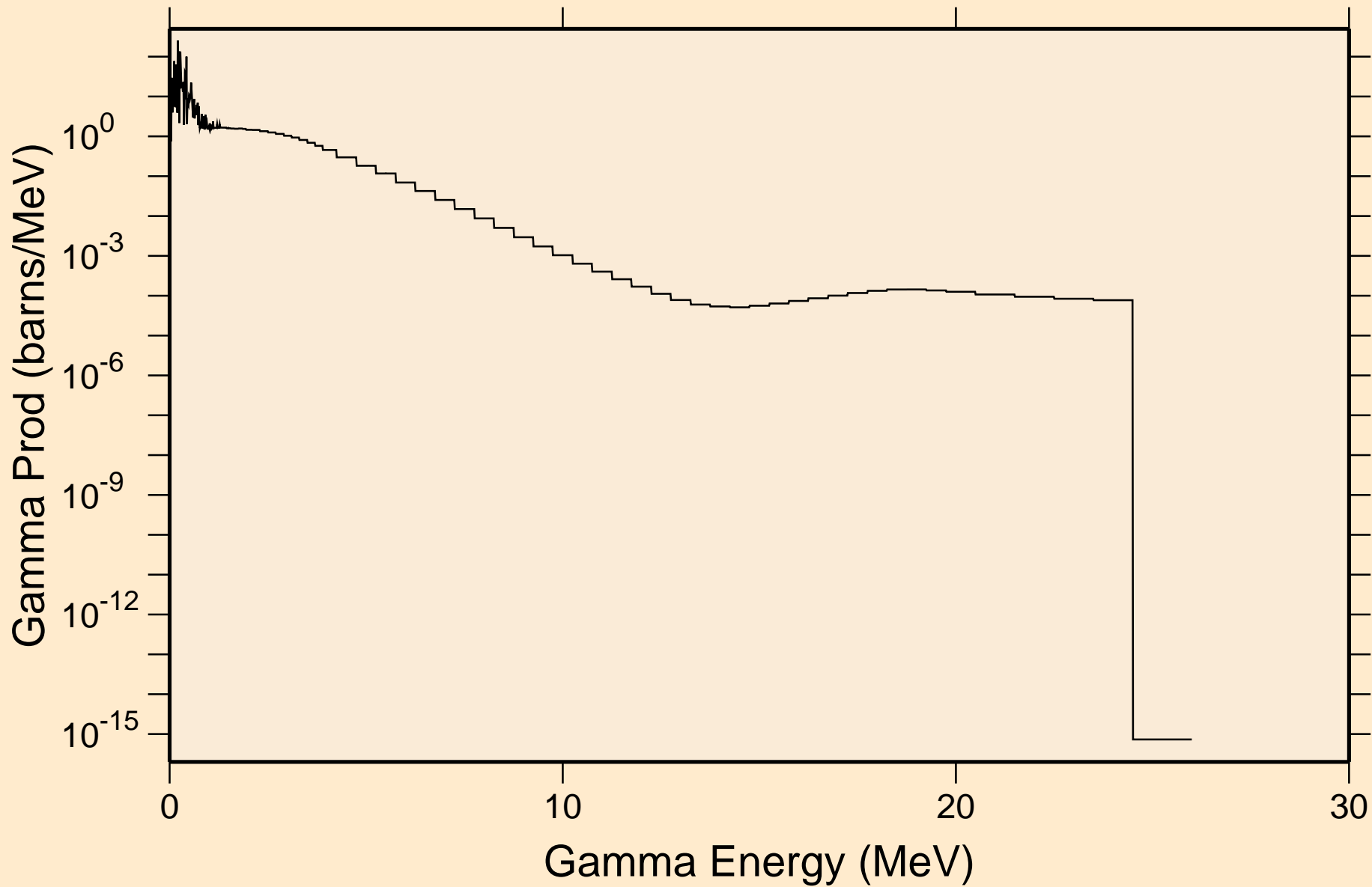

# GD139M NEUTRON ACER TENDL-2023 LIBRARY; T=0.K

## Particle heating contributions

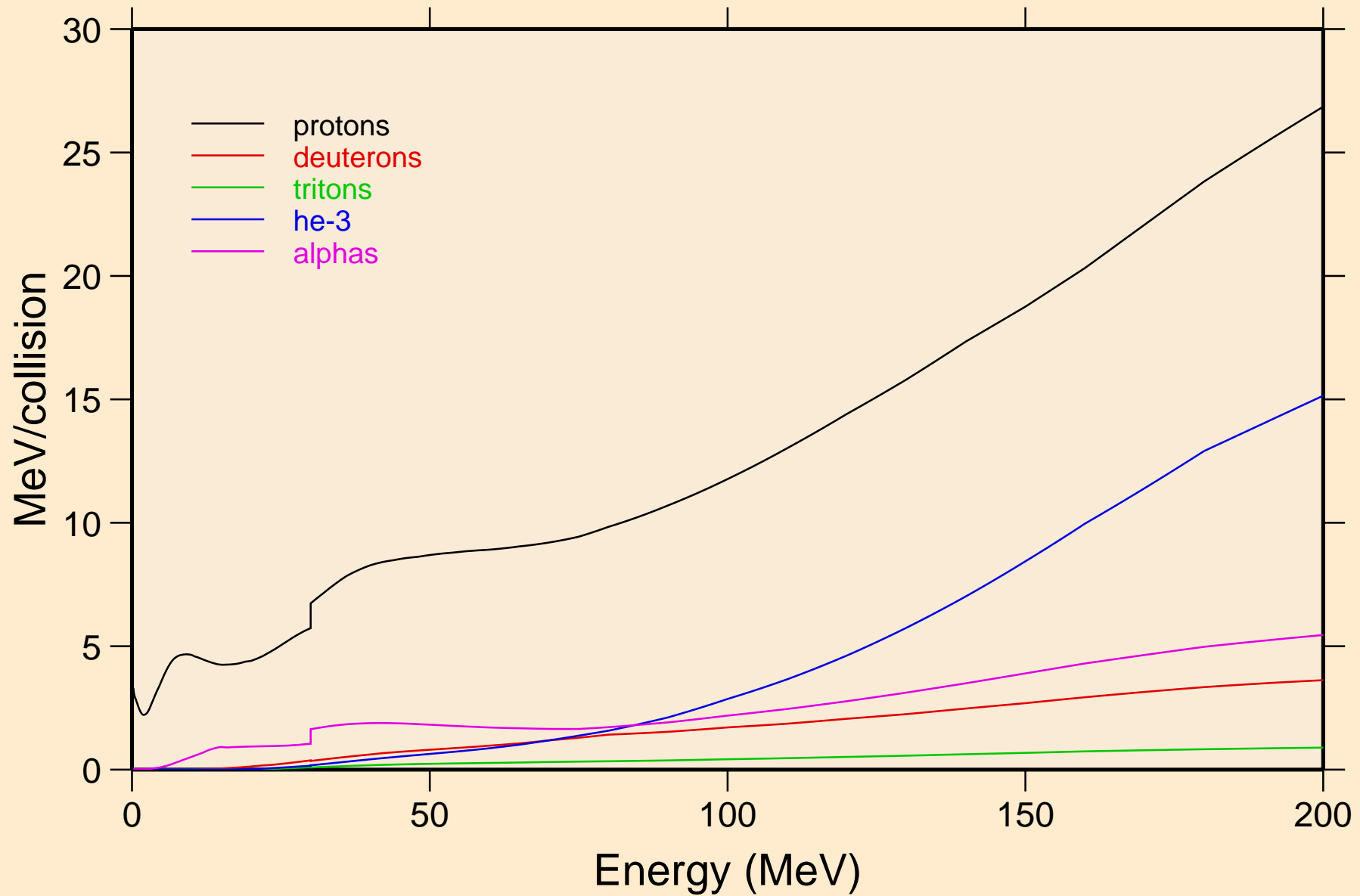

GD139M NEUTRON ACER TENDL-2023 LIBRARY; T=0.K  
Recoil Heating

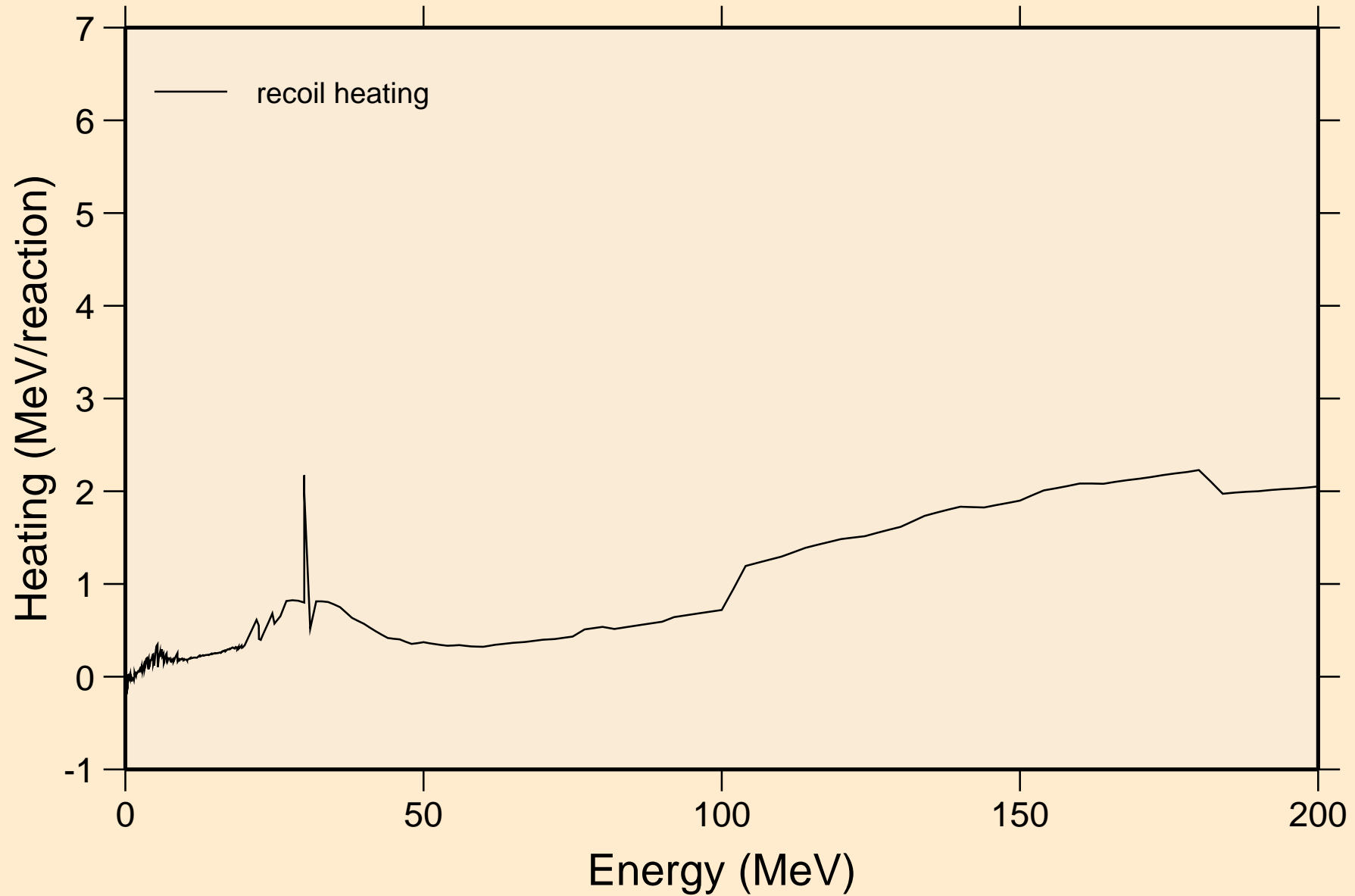

# GD139M NEUTRON ACER TENDL-2023 LIBRARY; T=0.K

## Particle production cross sections

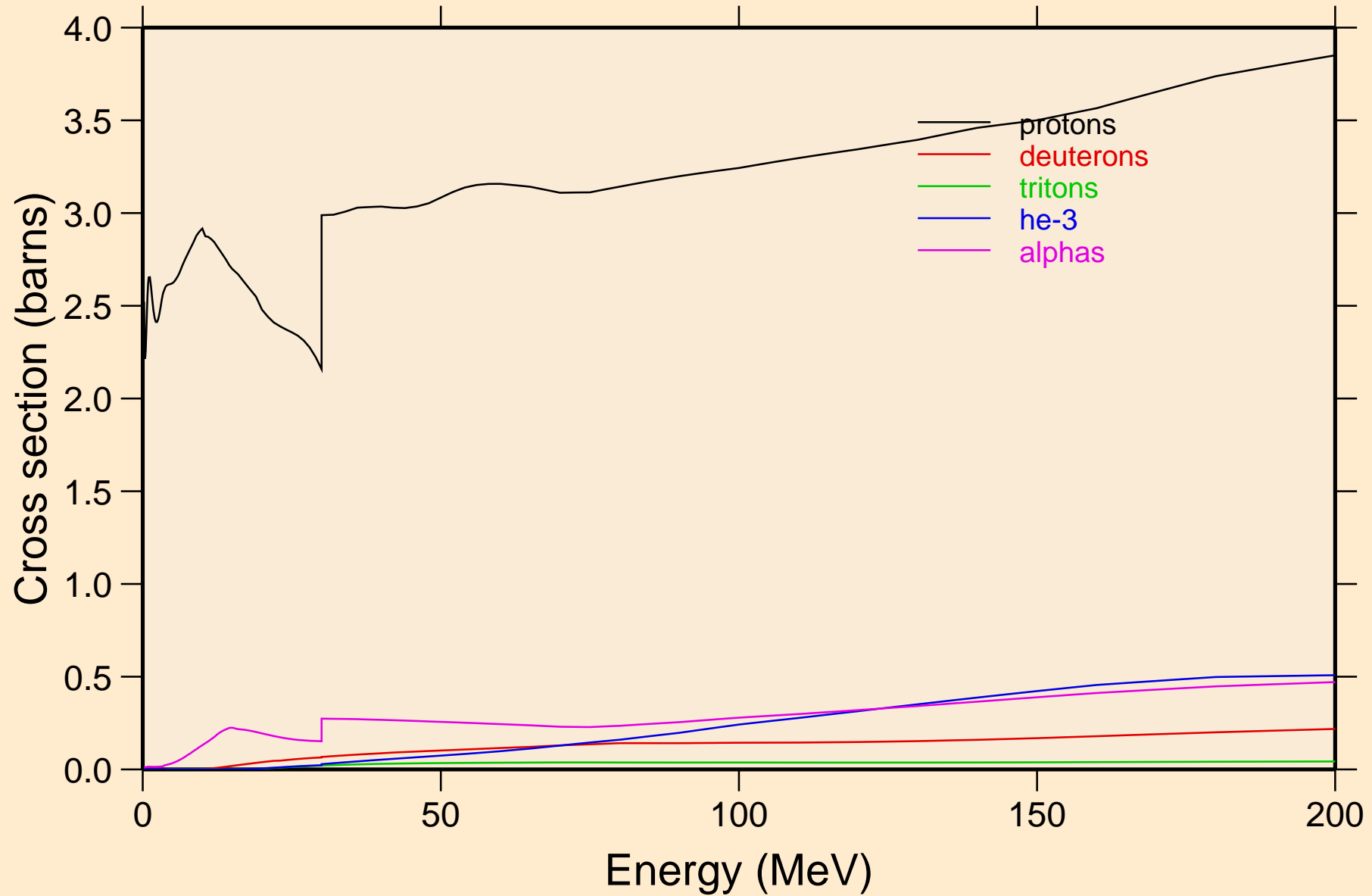

GD139M NEUTRON ACER TENDL-2023 LIBRARY; T=0.K  
protons from (n,x)

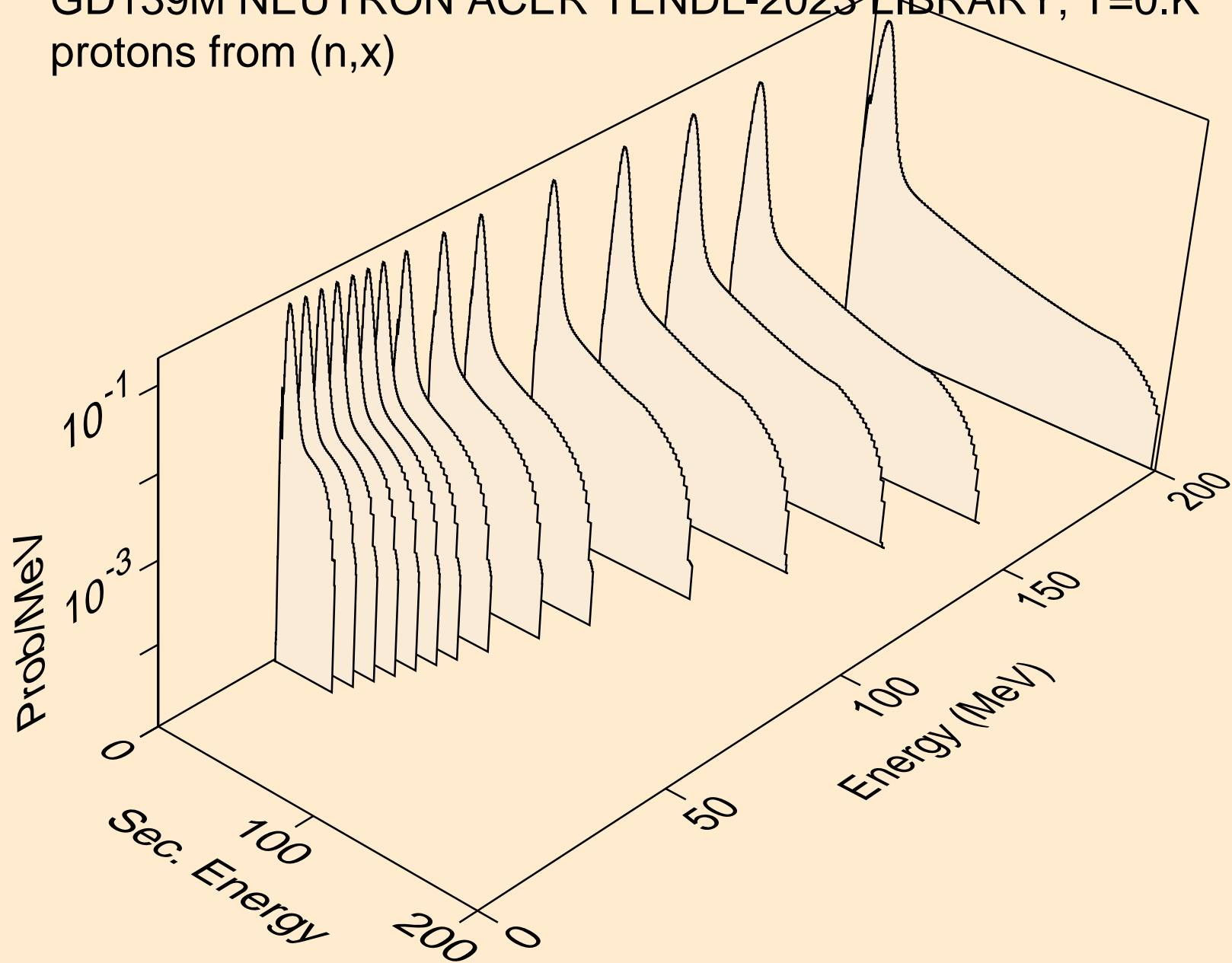

GD139M NEUTRON ACER TENDL-2023 LIBRARY; T=0.K  
protons from (n,n\*)p

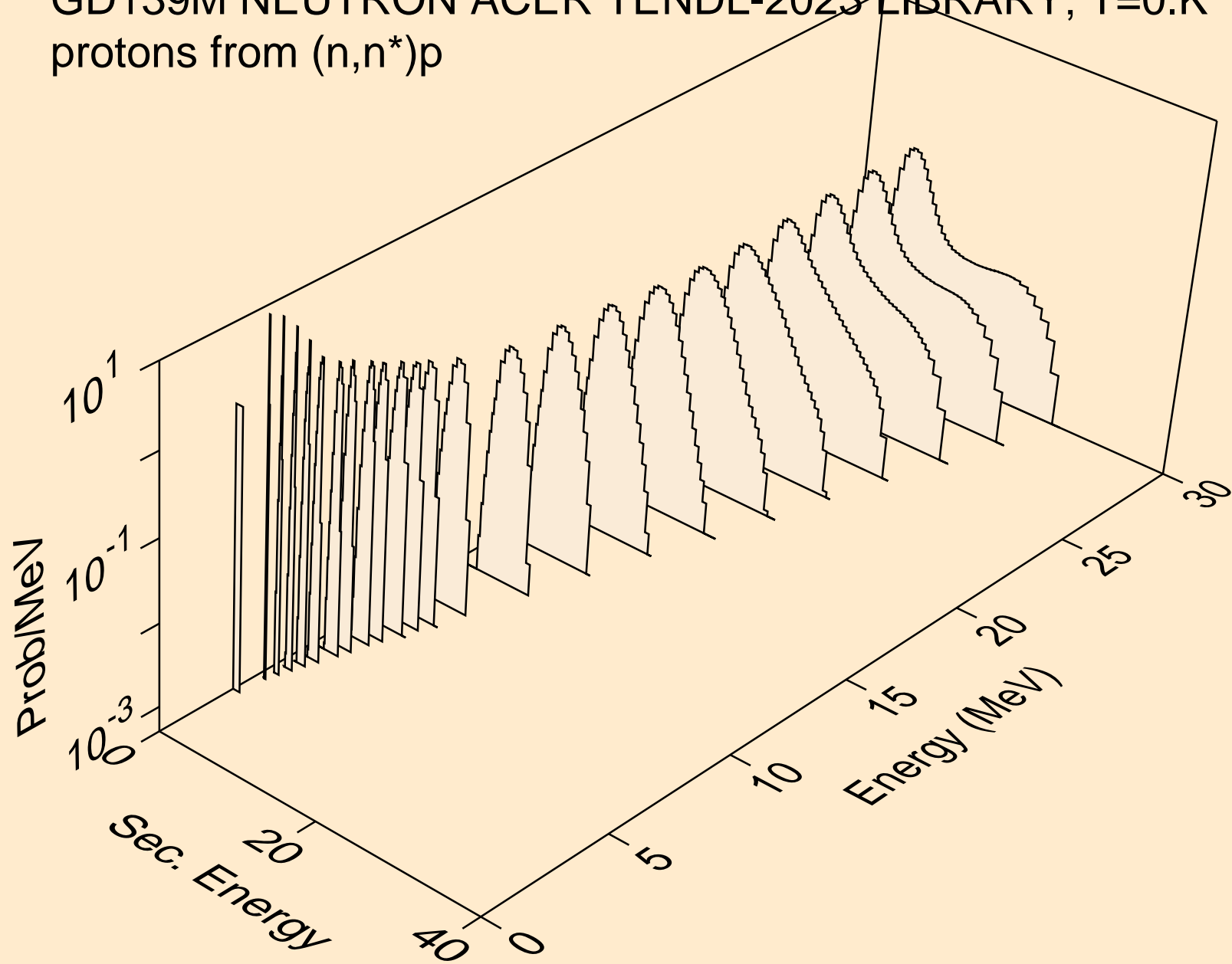

GD139M NEUTRON ACER TENDL-2023 LIBRARY; T=0.K  
protons from (n,2np)

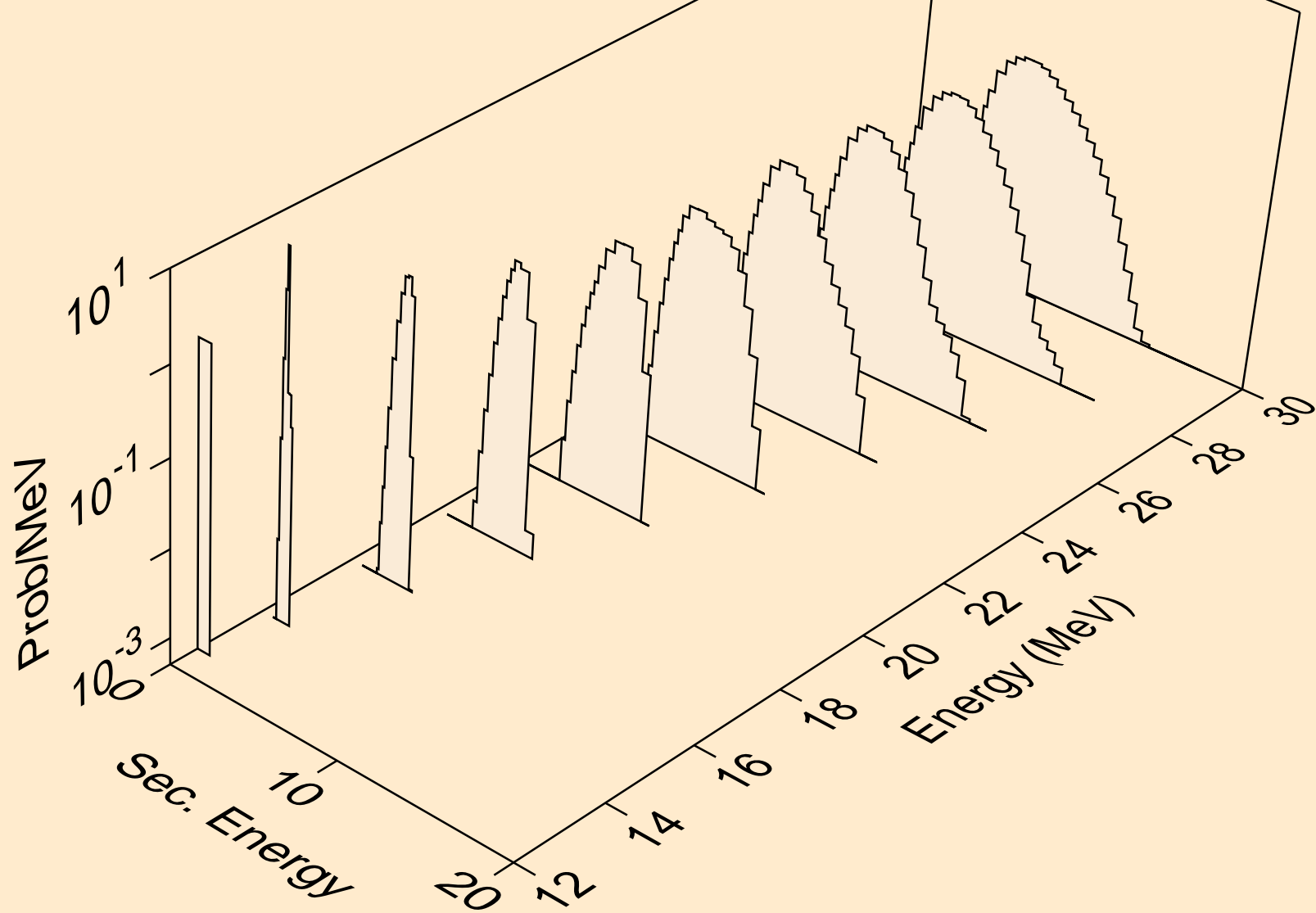

GD139M NEUTRON ACER TENDL-2023 LIBRARY; T=0.K  
protons from (n,3np)

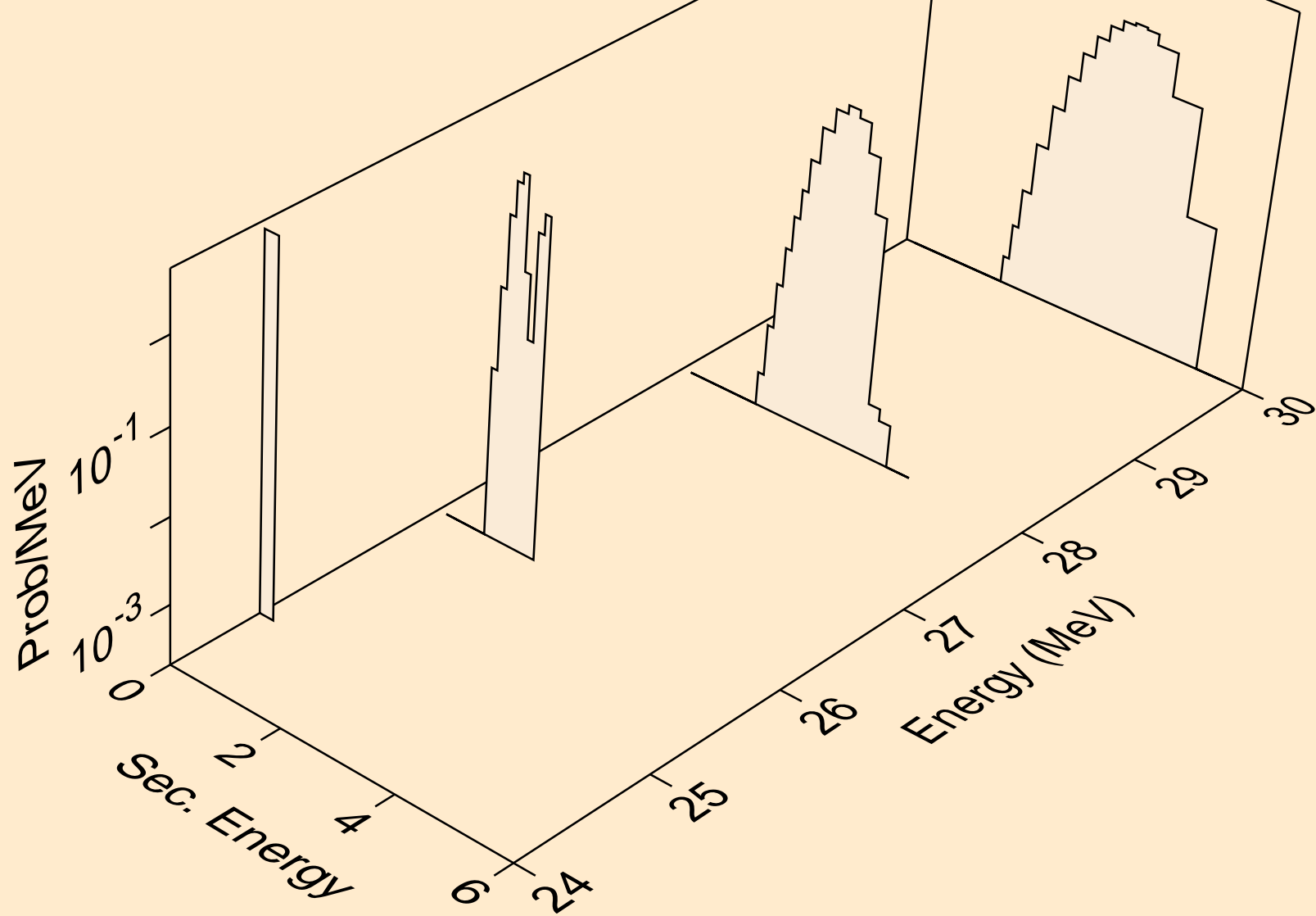

GD139M NEUTRON ACER TENDL-2023 LIBRARY; T=0.K  
protons from (n,n2p)

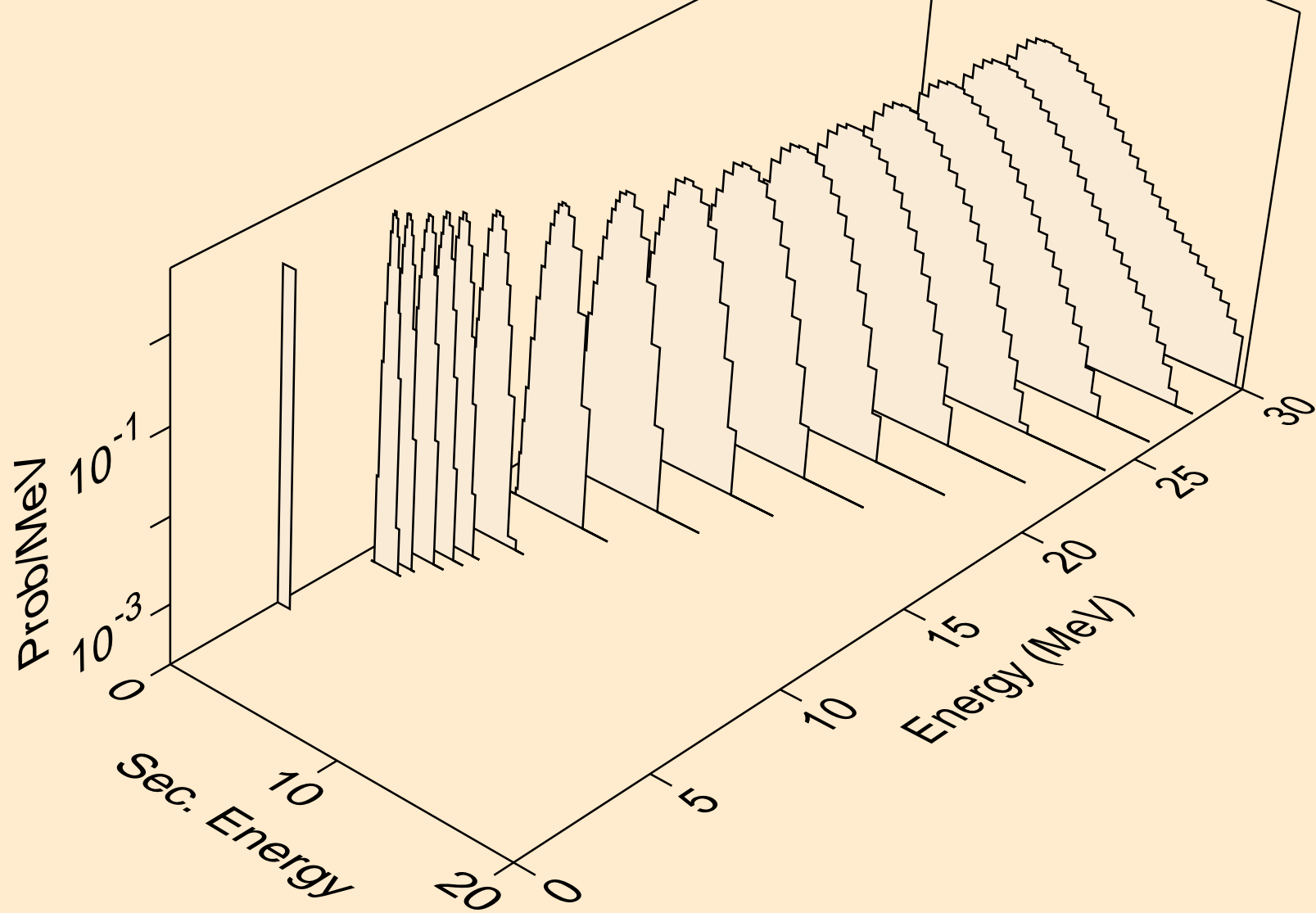

GD139M NEUTRON ACER TENDL-2023 LIBRARY; T=0.K  
protons from (n,npa)

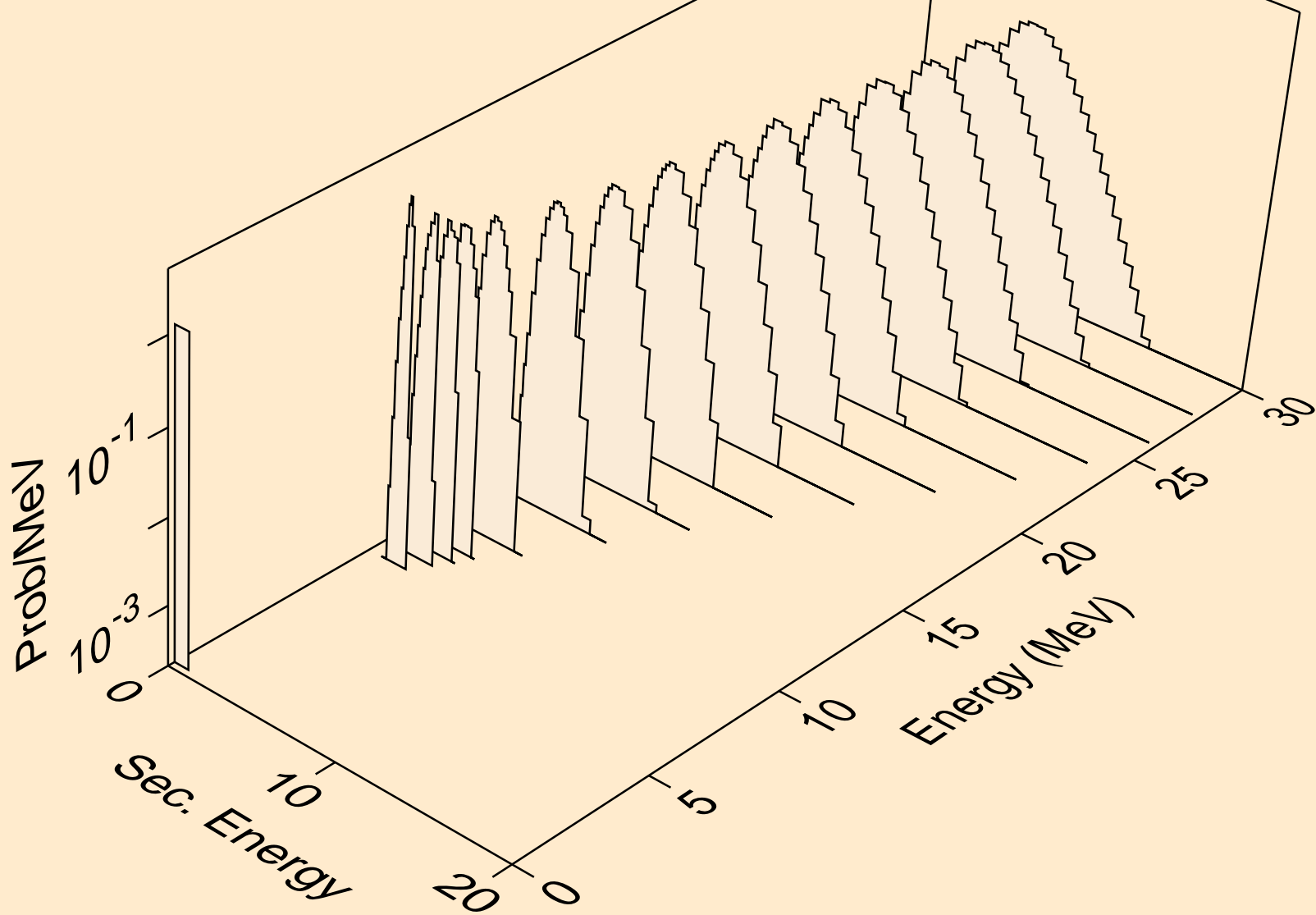

GD139M NEUTRON ACER TENDL-2023 LIBRARY; T=0.K  
protons from (n,p)

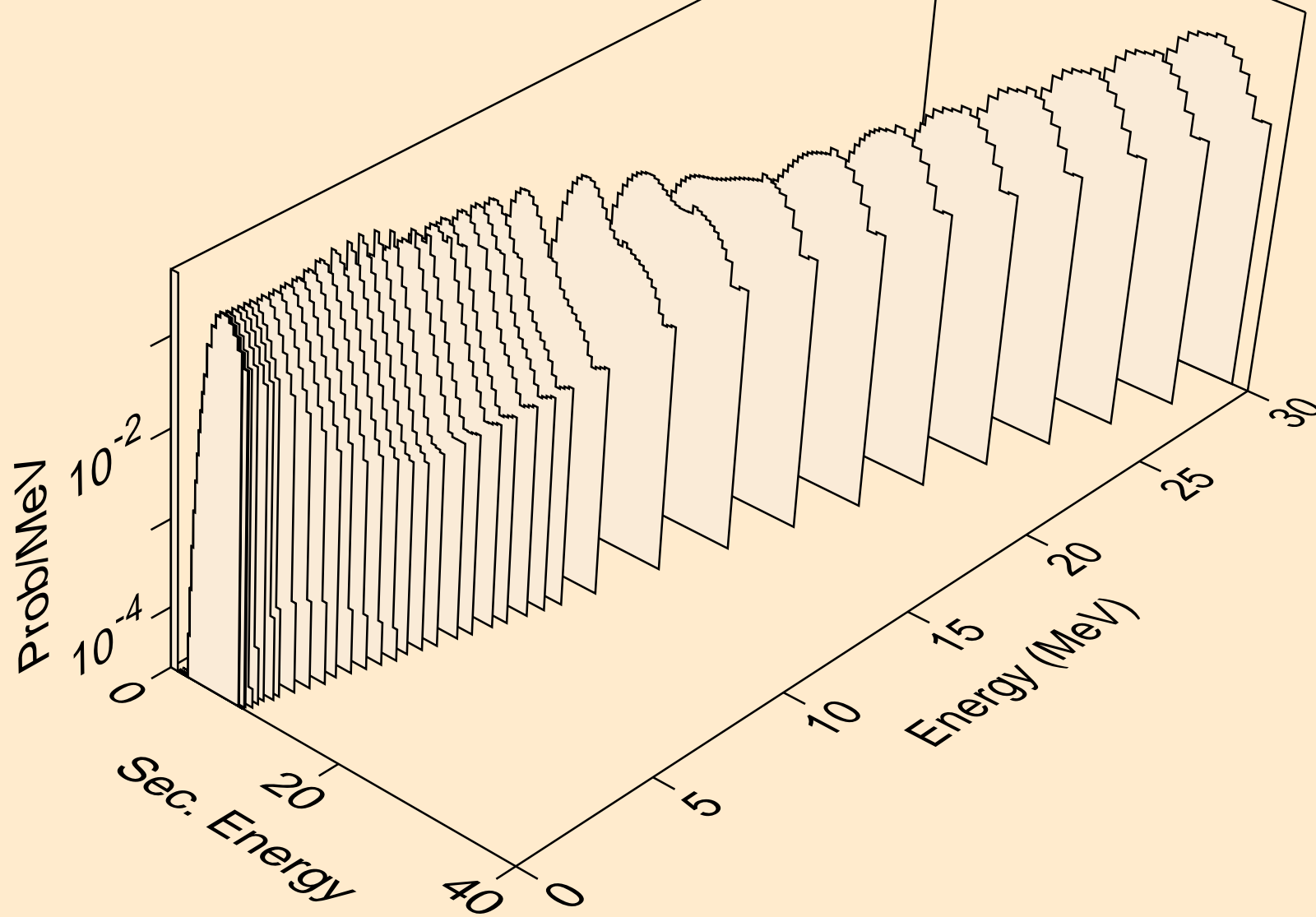

GD139M NEUTRON ACER TENDL-2023 LIBRARY; T=0.K  
protons from (n,2p)

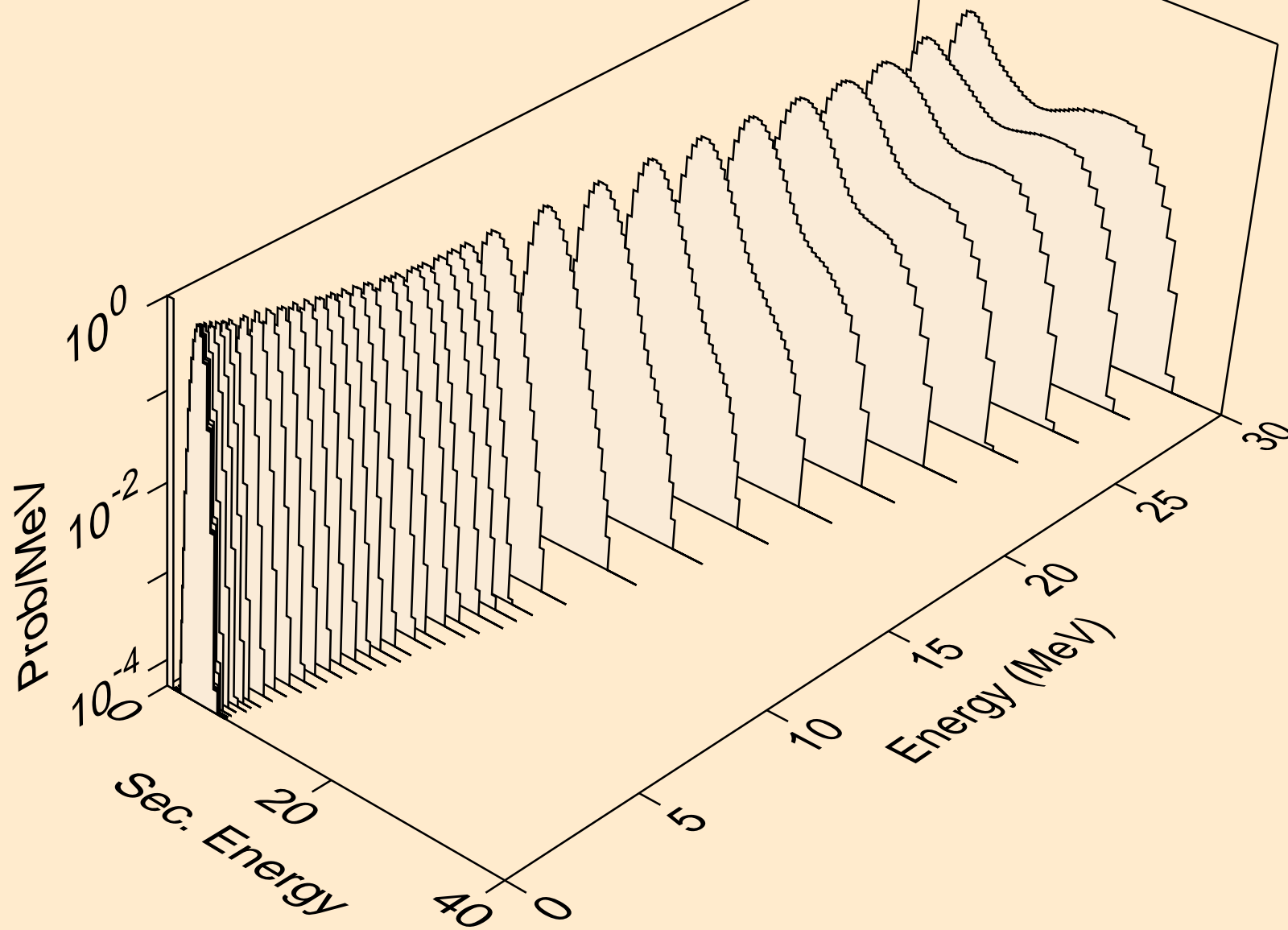

GD139M NEUTRON ACER TENDL-2023 LIBRARY; T=0.K  
protons from (n,p)

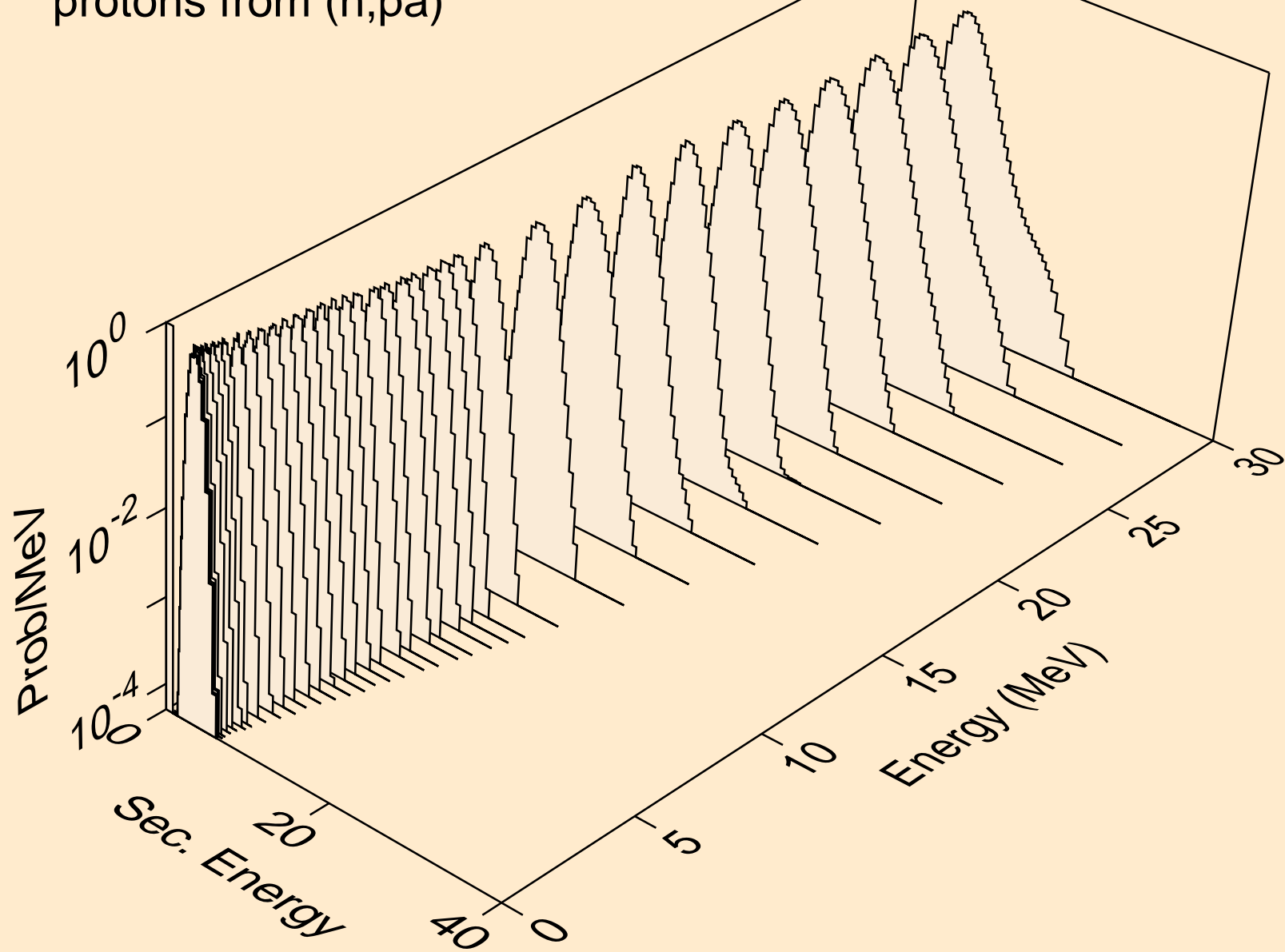

GD139M NEUTRON ACER TENDL-2023 LIBRARY; T=0.K  
protons from (n,pd)

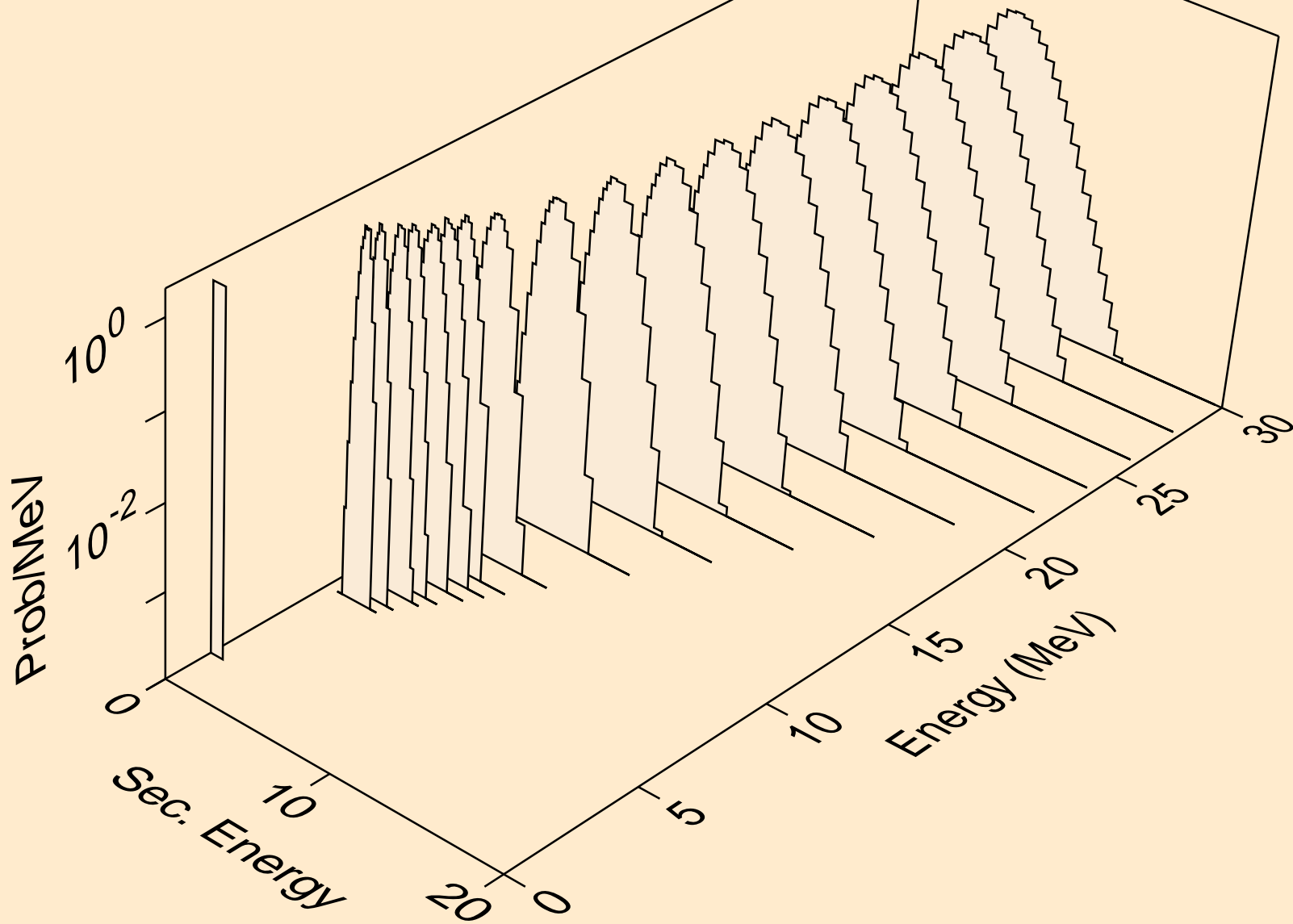

GD139M NEUTRON ACER TENDL-2023 LIBRARY; T=0.K  
protons from (n,pt)

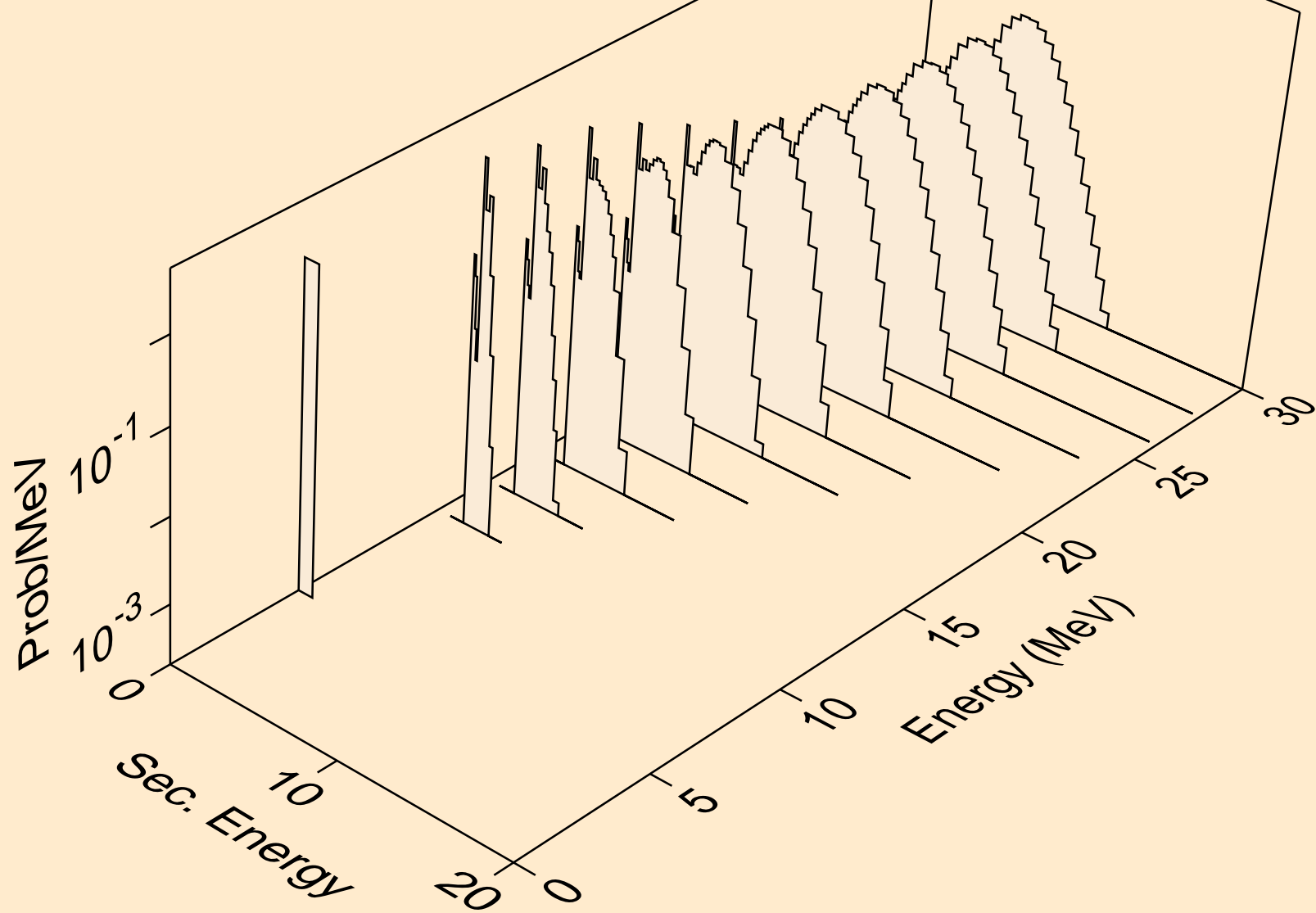

GD139M NEUTRON ACER TENDL-2023 LIBRARY; T=0.K  
deuterons from (n,x)

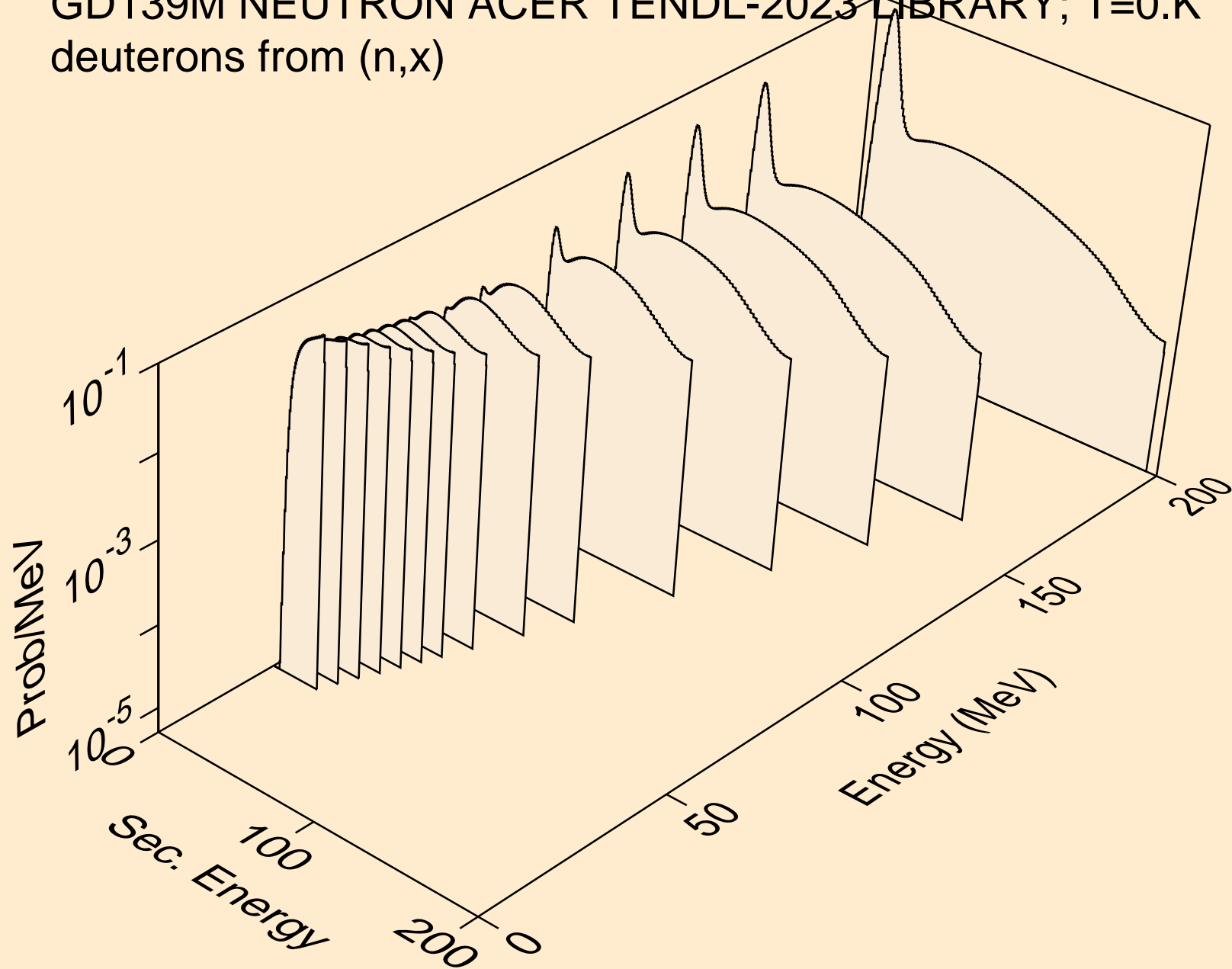

GD139M NEUTRON ACER TENDL-2023 LIBRARY; T=0.K  
deuterons from (n,2nd)

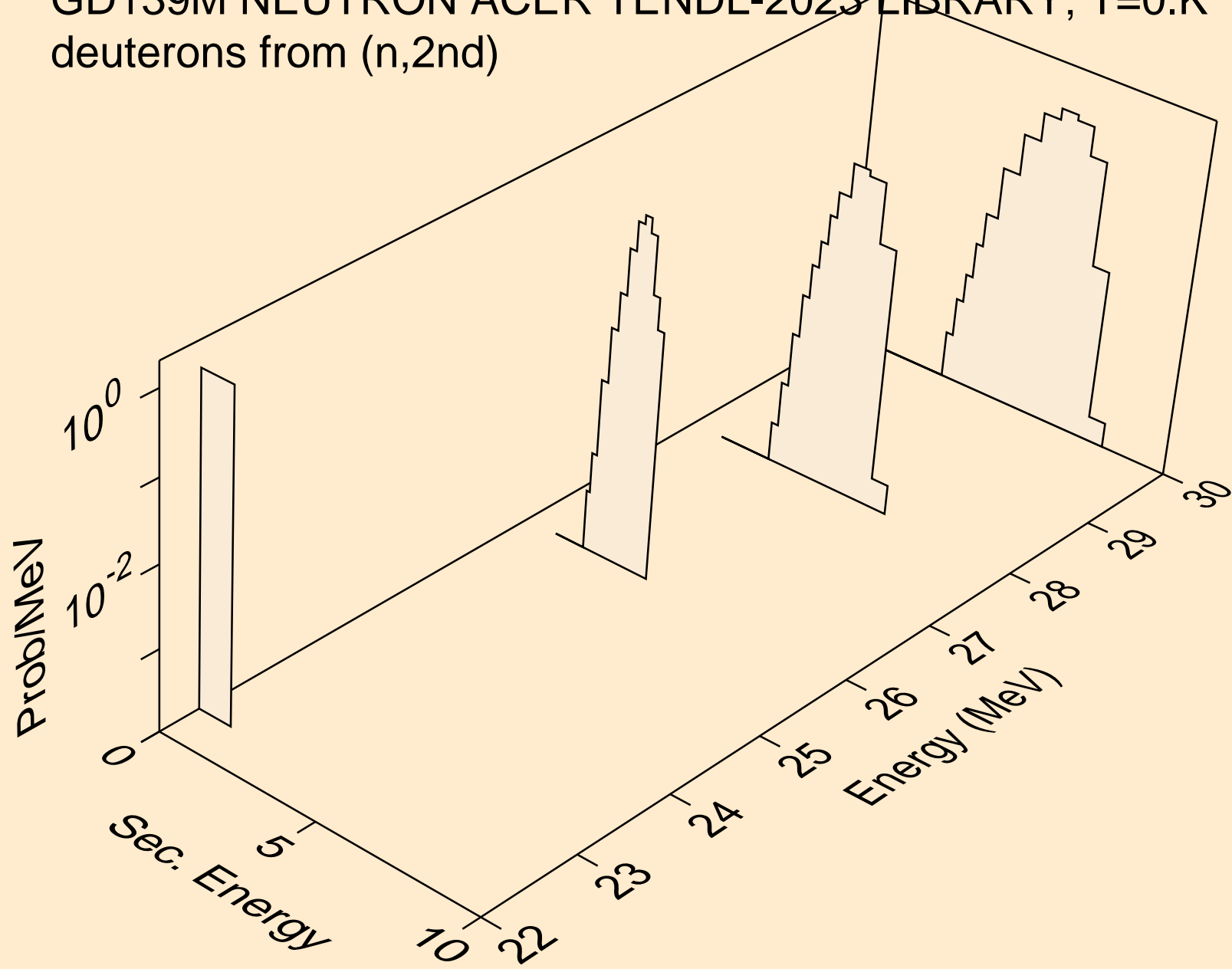

GD139M NEUTRON ACER TENDL-2023 LIBRARY; T=0.K  
deuterons from (n,n\*)d

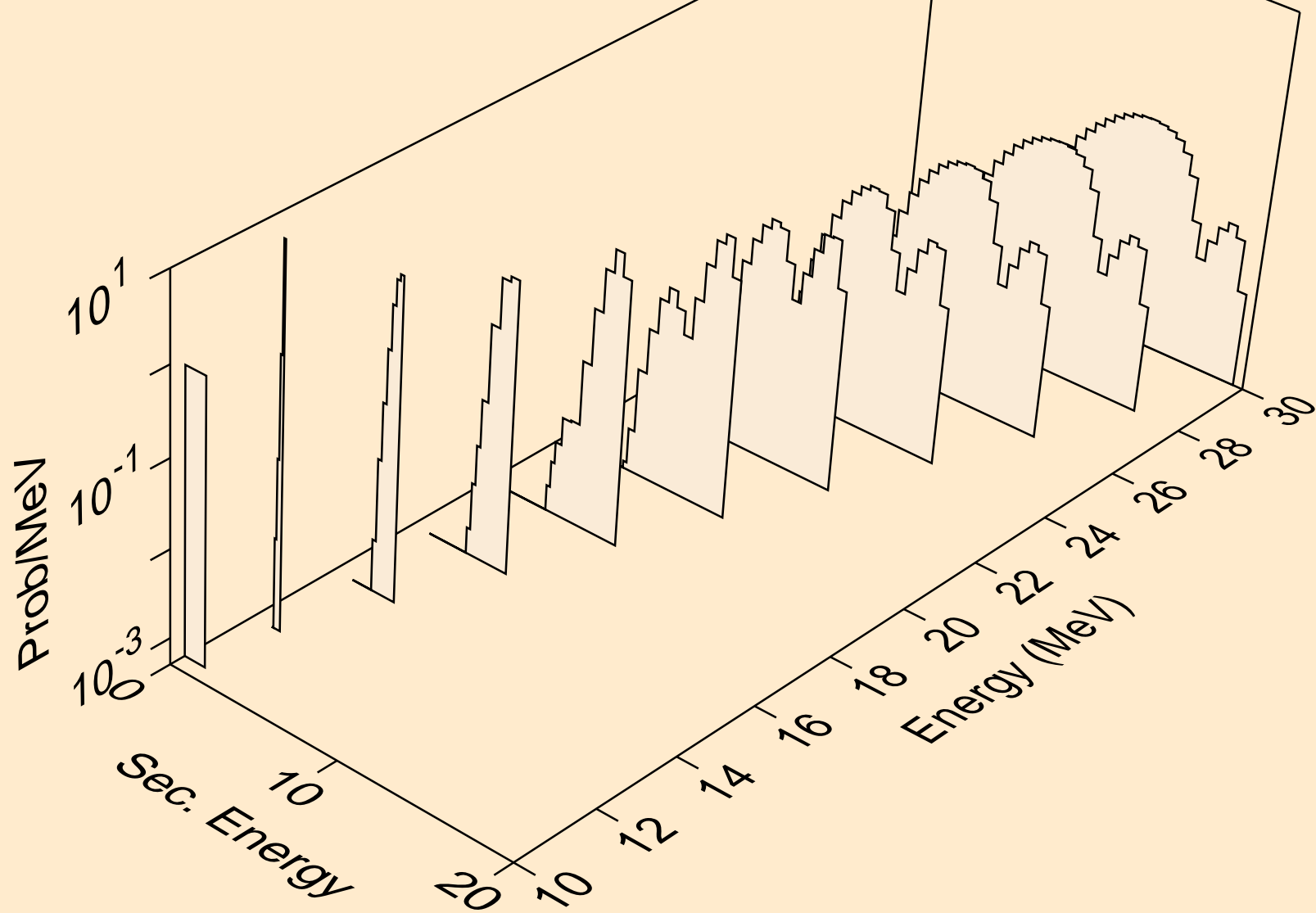

GD139M NEUTRON ACER TENDL-2023 LIBRARY; T=0.K  
deuterons from (n,d)

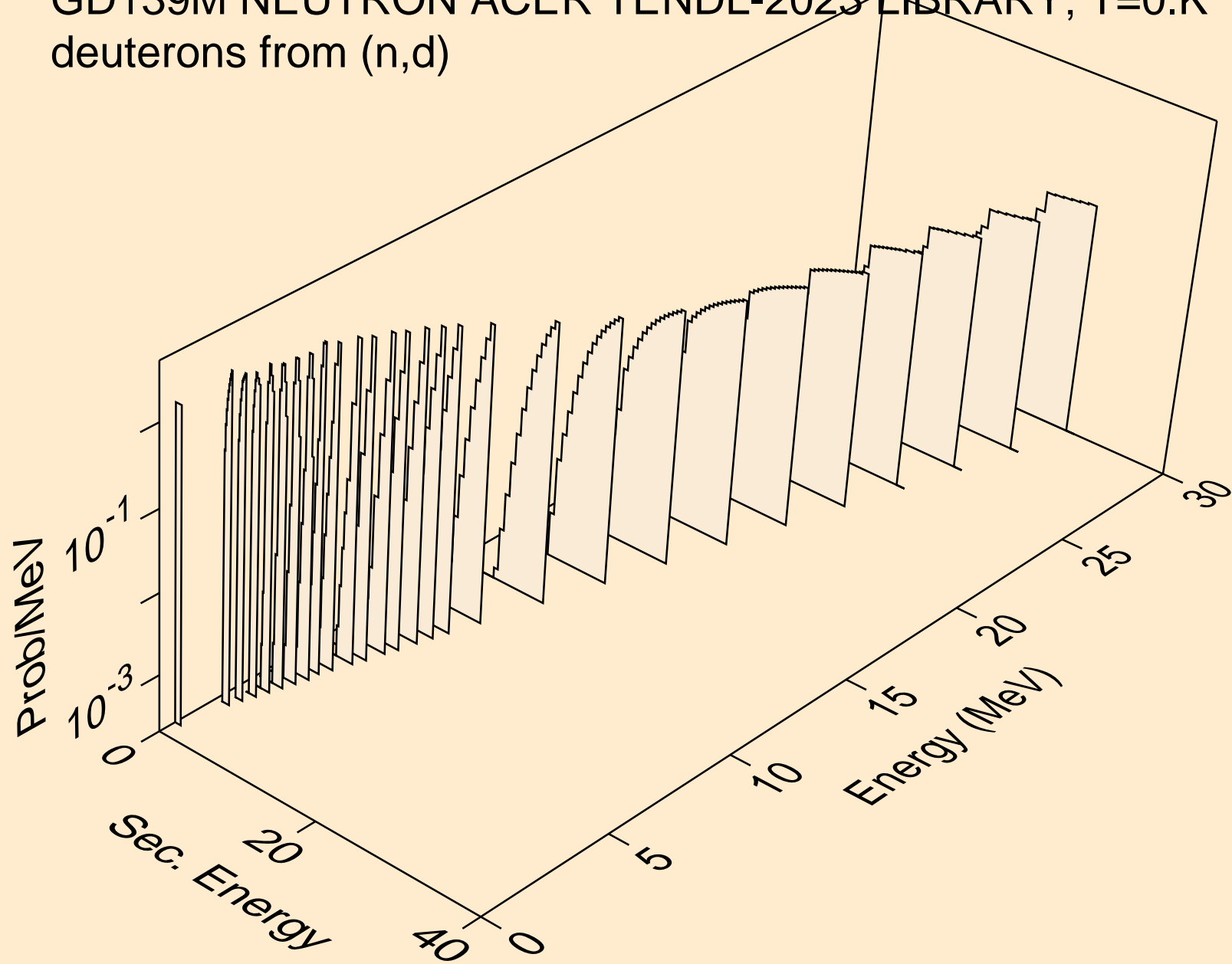

GD139M NEUTRON ACER TENDL-2023 LIBRARY; T=0.K  
deuterons from (n,d2a)

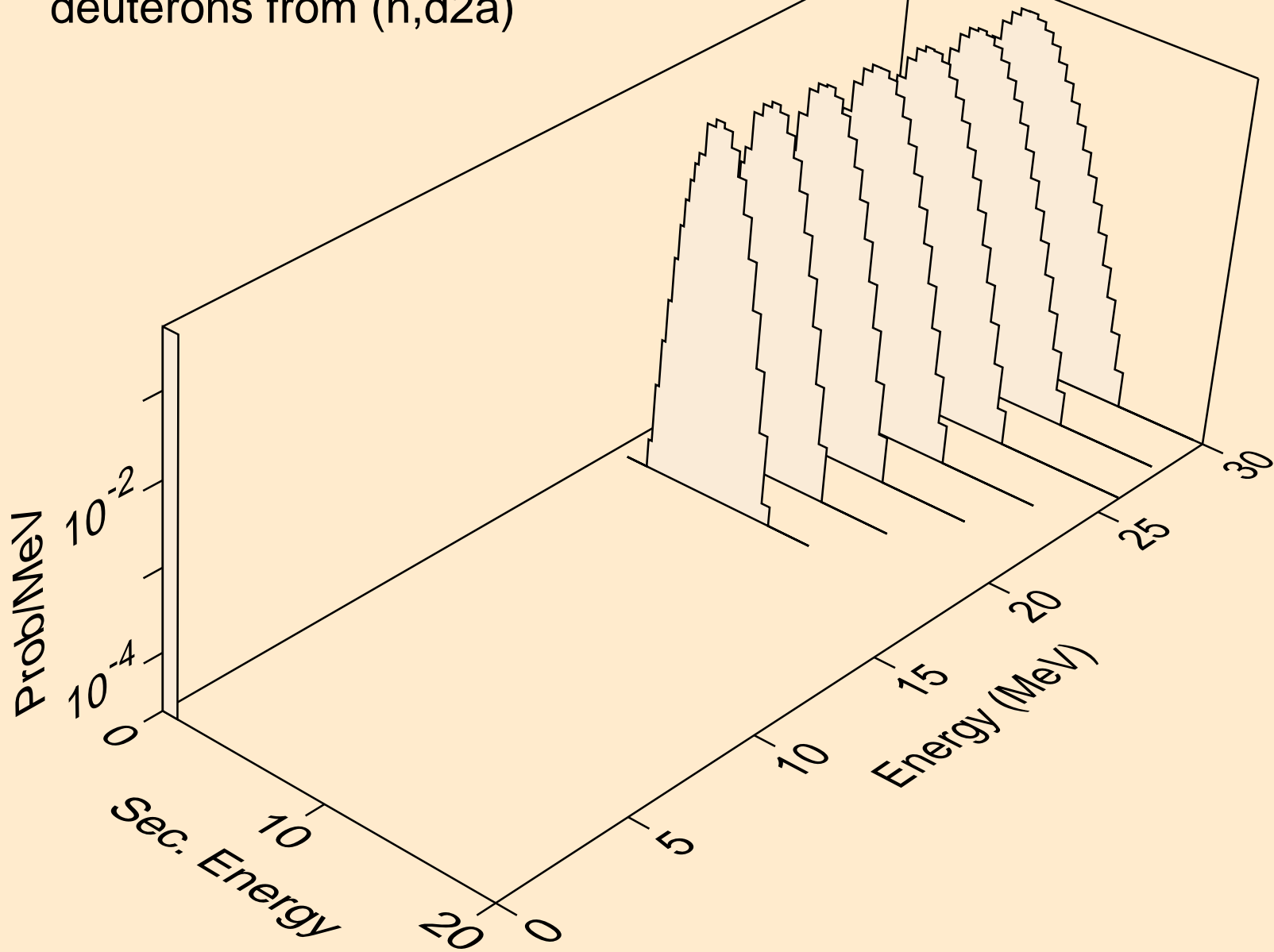

GD139M NEUTRON ACER TENDL-2023 LIBRARY; T=0.K  
deuterons from (n,pd)

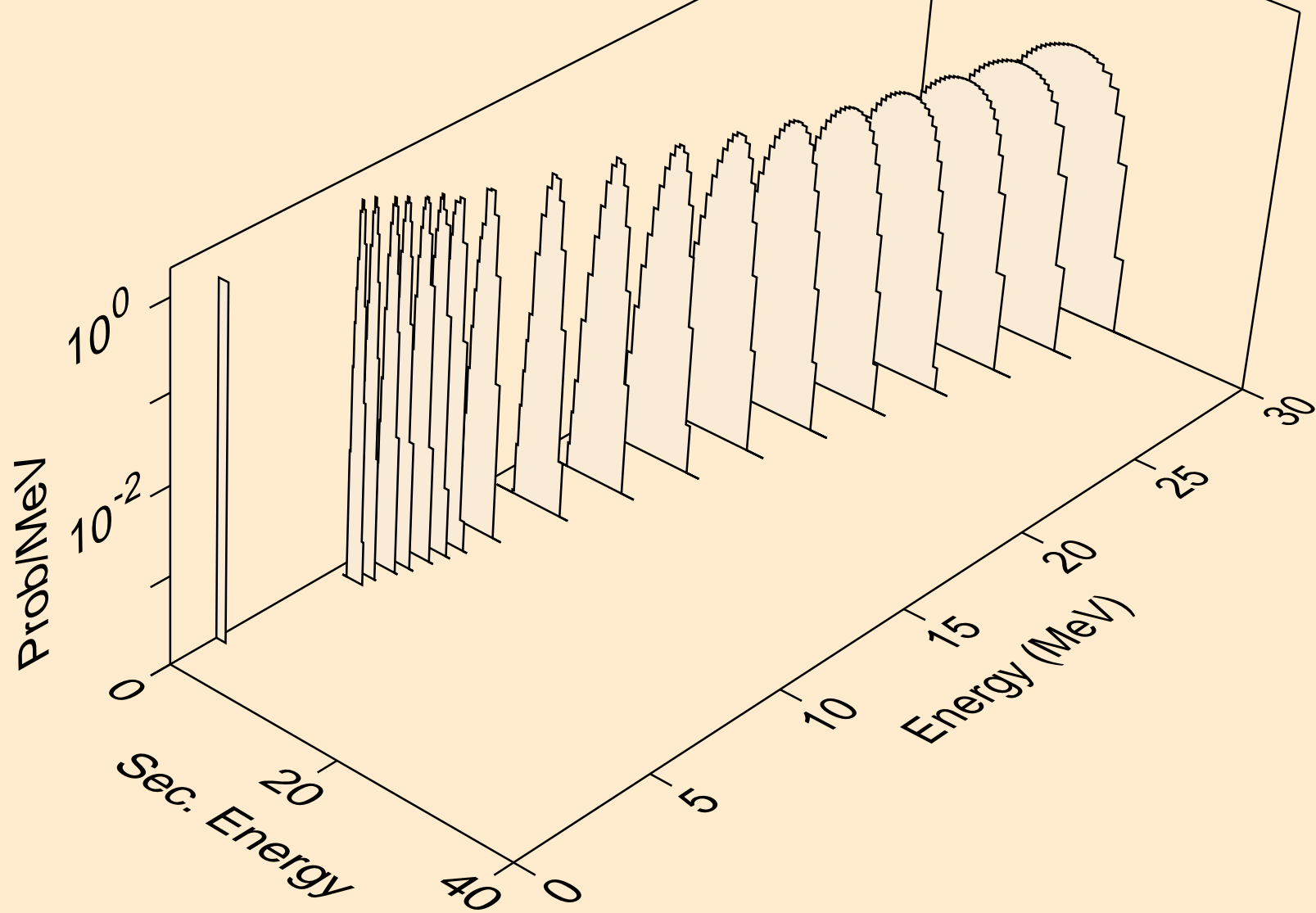

GD139M NEUTRON ACER TENDL-2023 LIBRARY; T=0.K  
deuterons from (n,da)

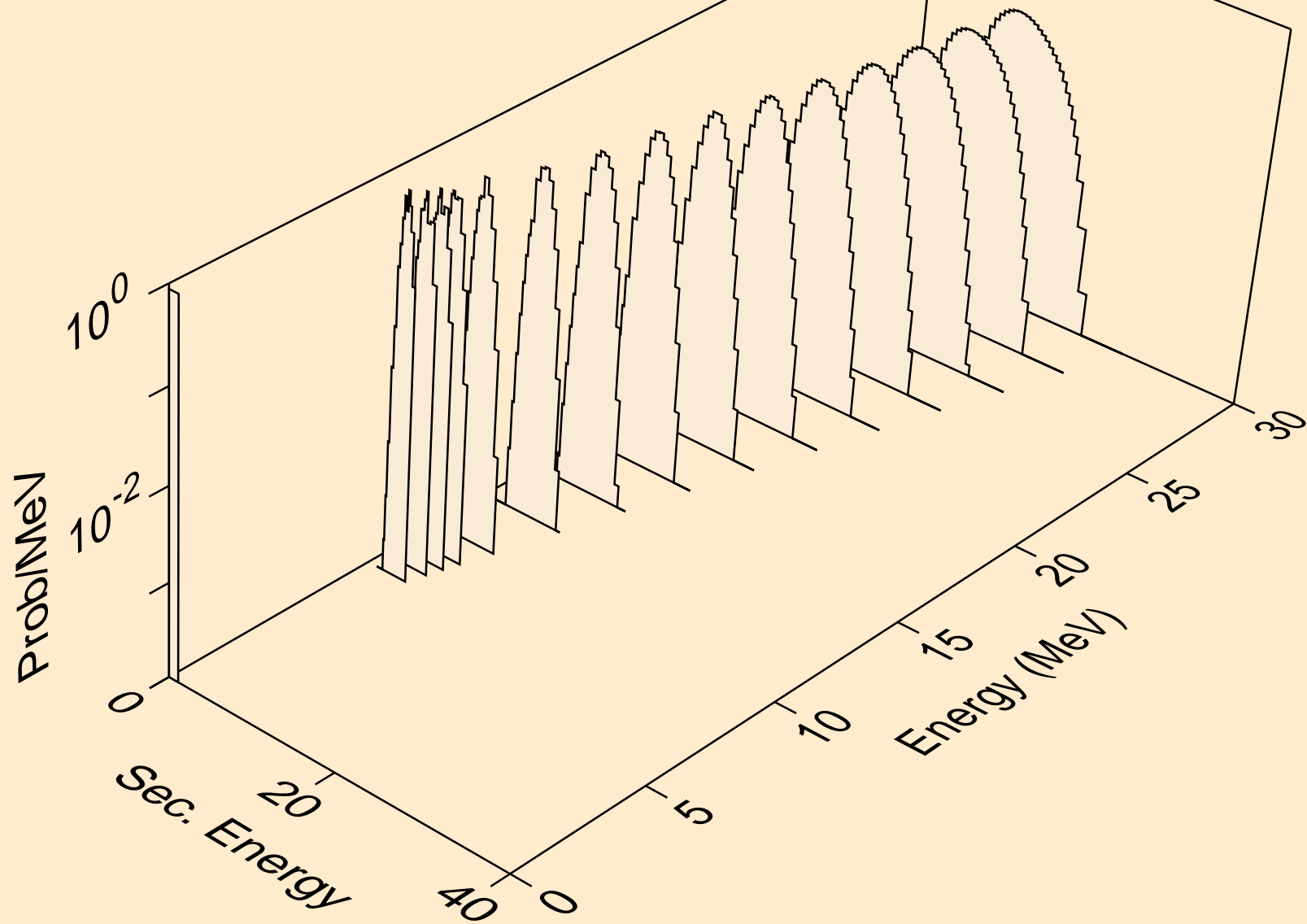

GD139M NEUTRON ACER TENDL-2023 LIBRARY; T=0.K  
tritons from (n,x)

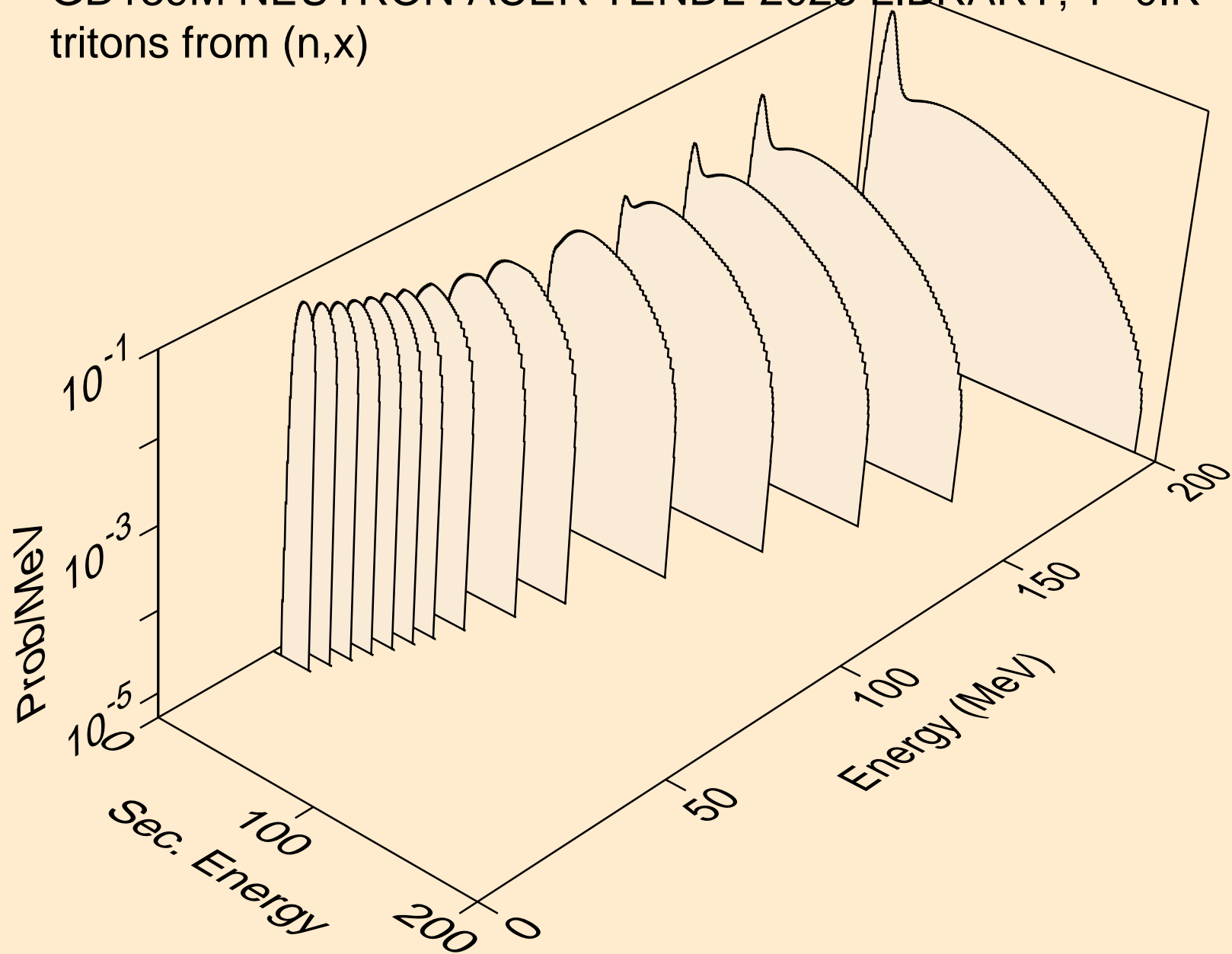

GD139M NEUTRON ACER TENDL-2023 LIBRARY; T=0.K  
tritons from (n,n\*)t

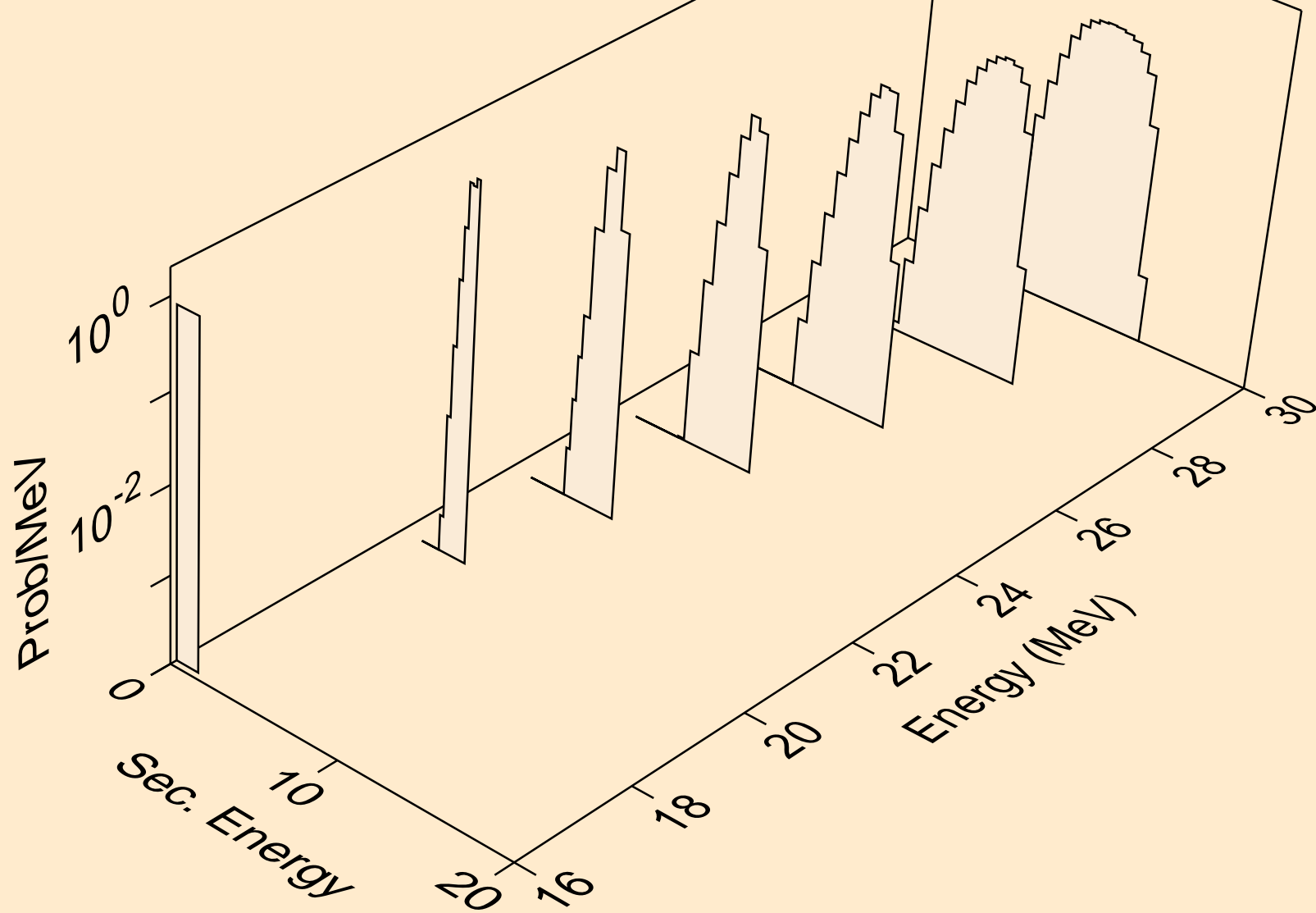

GD139M NEUTRON ACER TENDL-2023 LIBRARY; T=0.K  
tritons from (n,t)

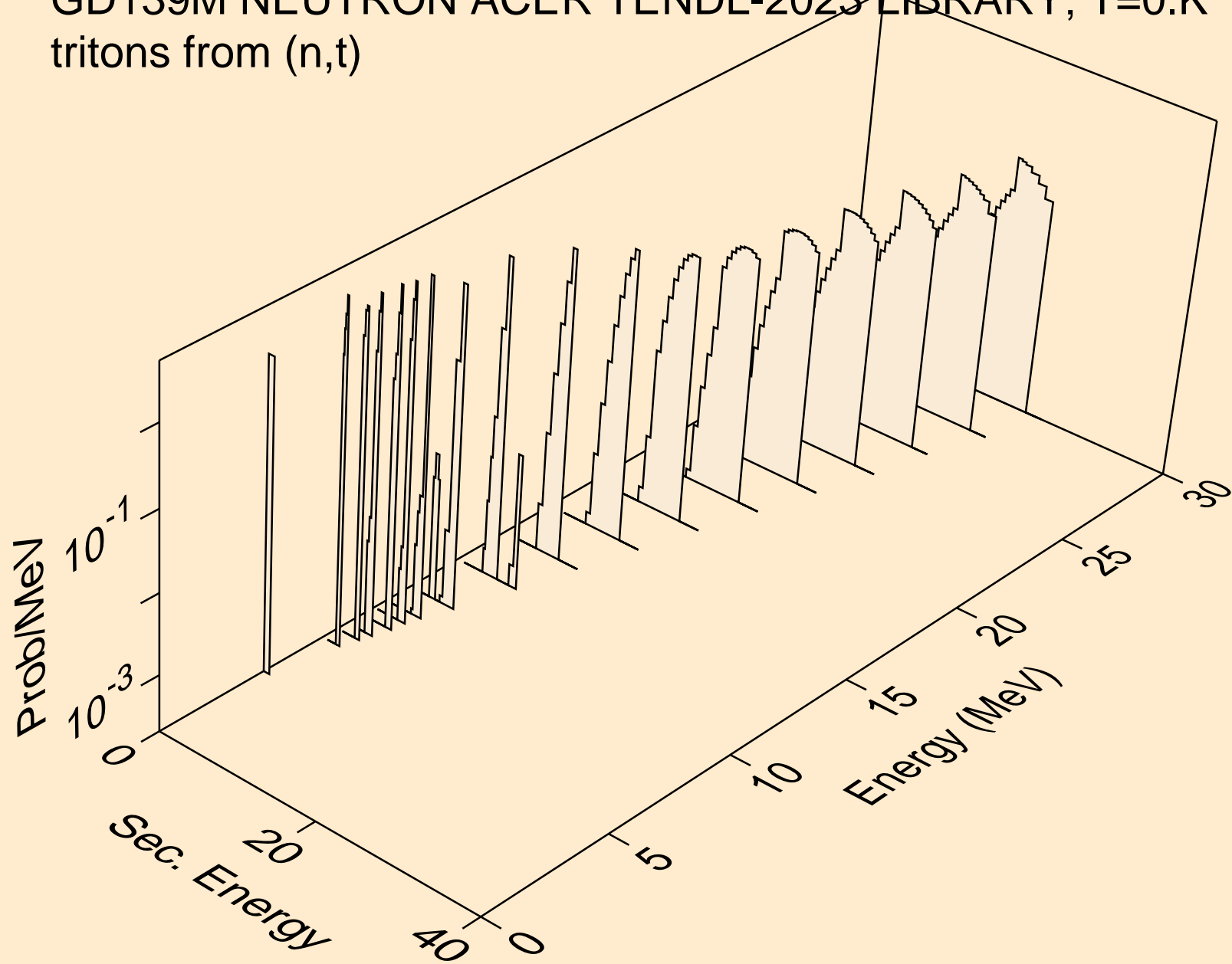

GD139M NEUTRON ACER TENDL-2023 LIBRARY; T=0.K  
tritons from (n,pt)

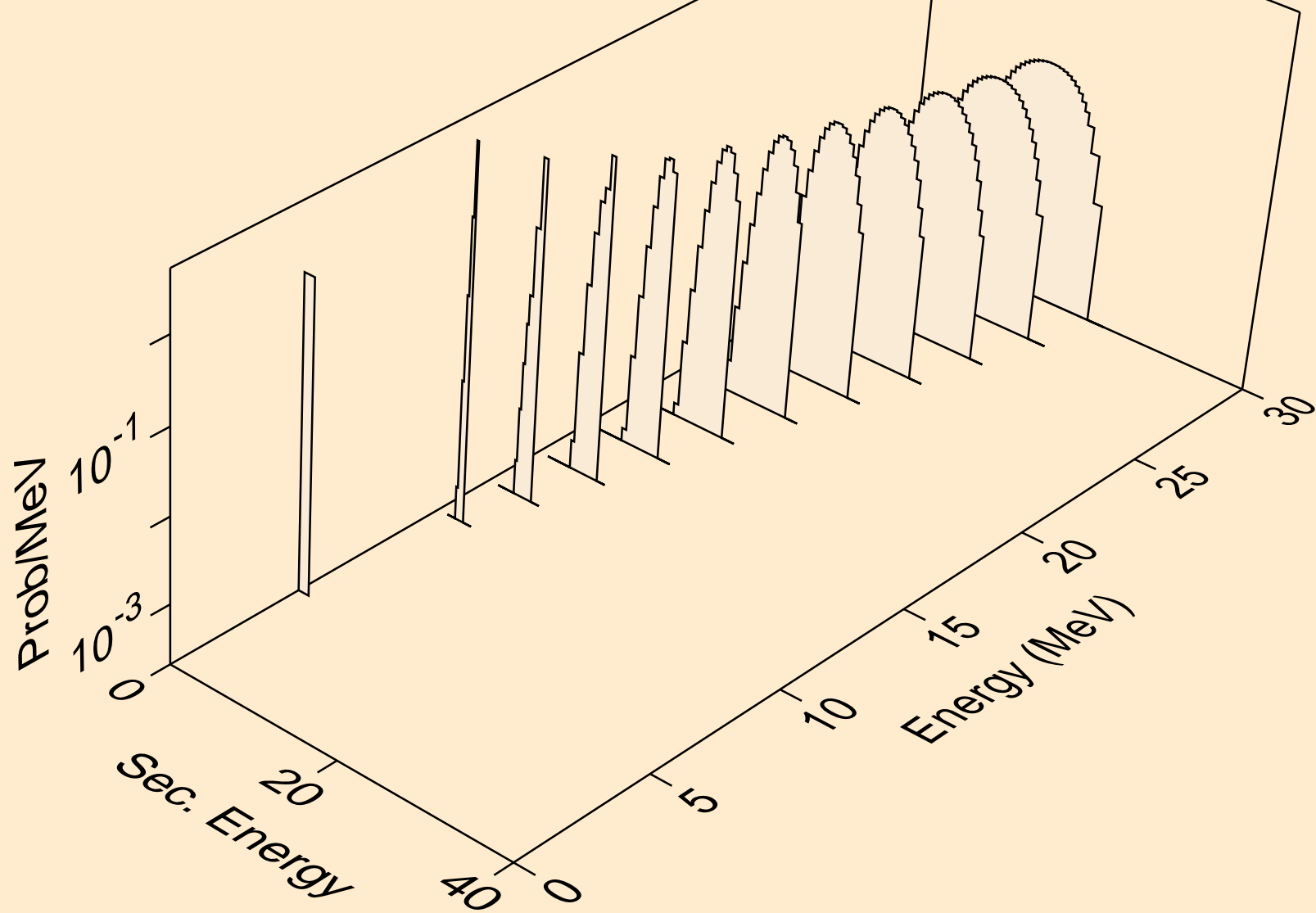

GD139M NEUTRON ACER TENDL-2023 LIBRARY; T=0.K  
he3s from (n,x)

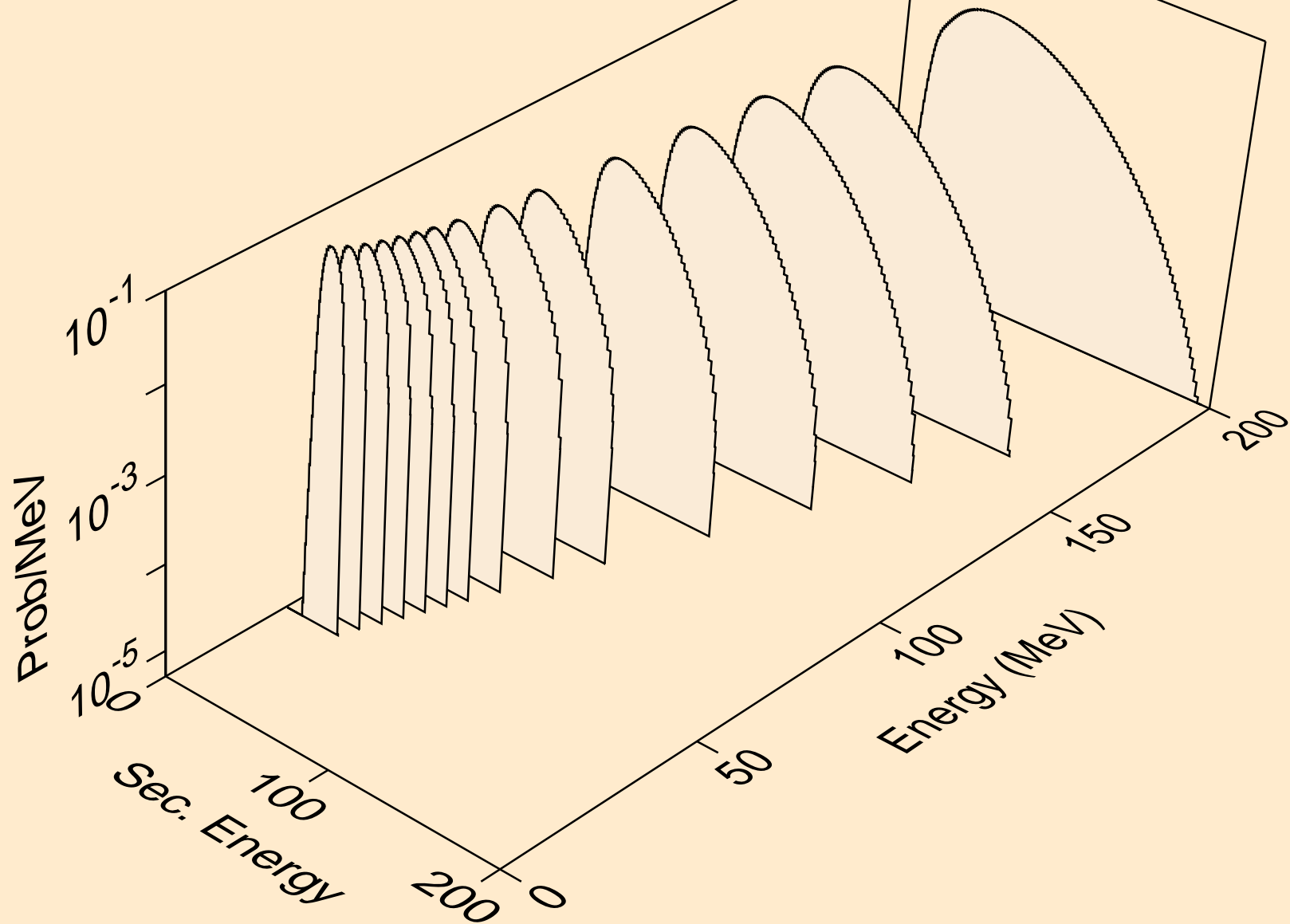

GD139M NEUTRON ACER TENDL-2023 LIBRARY; T=0.K  
he3s from (n,n\*)he3

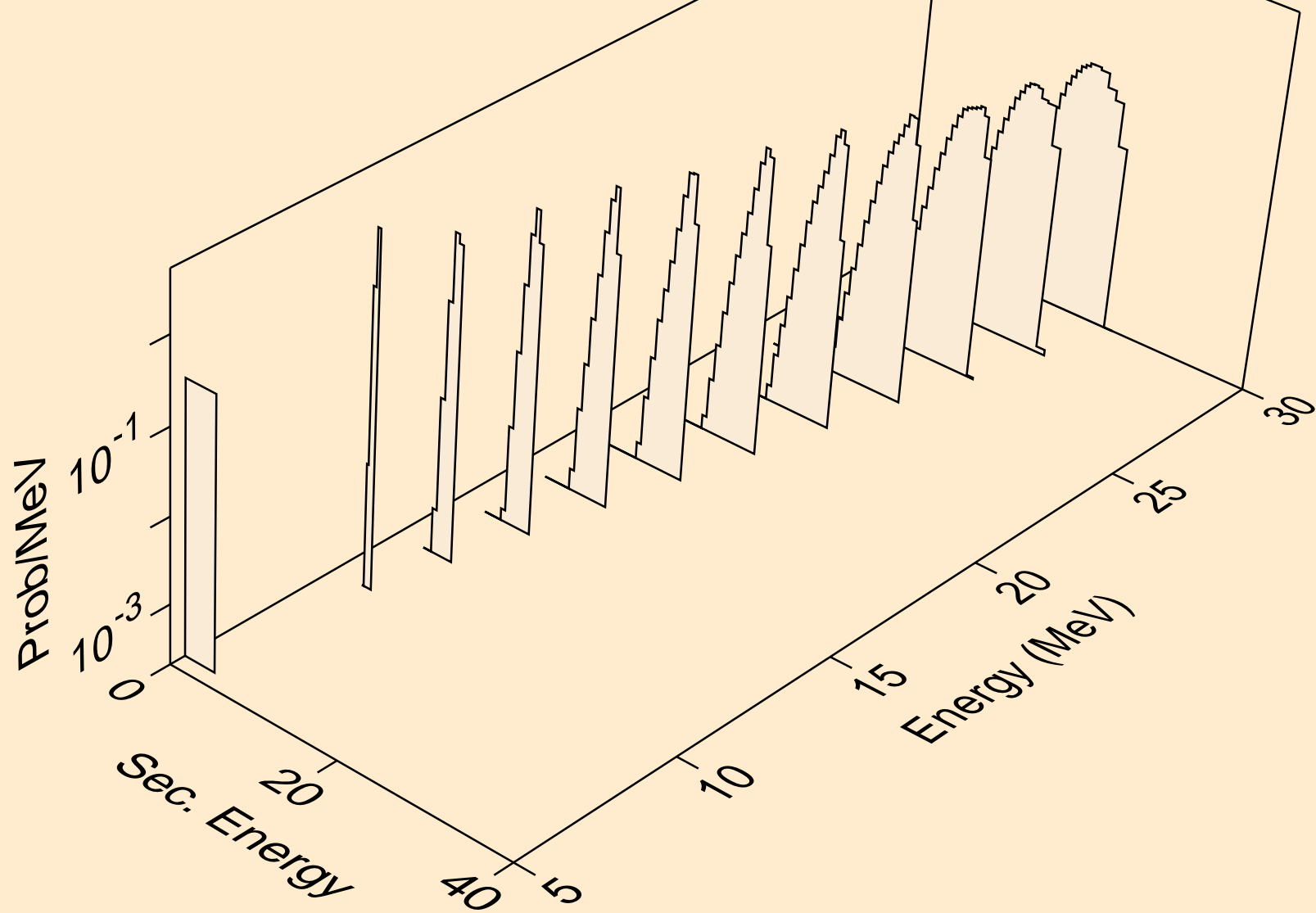

GD139M NEUTRON ACER TENDL-2023 LIBRARY; T=0.K  
he3s from (n,he3)

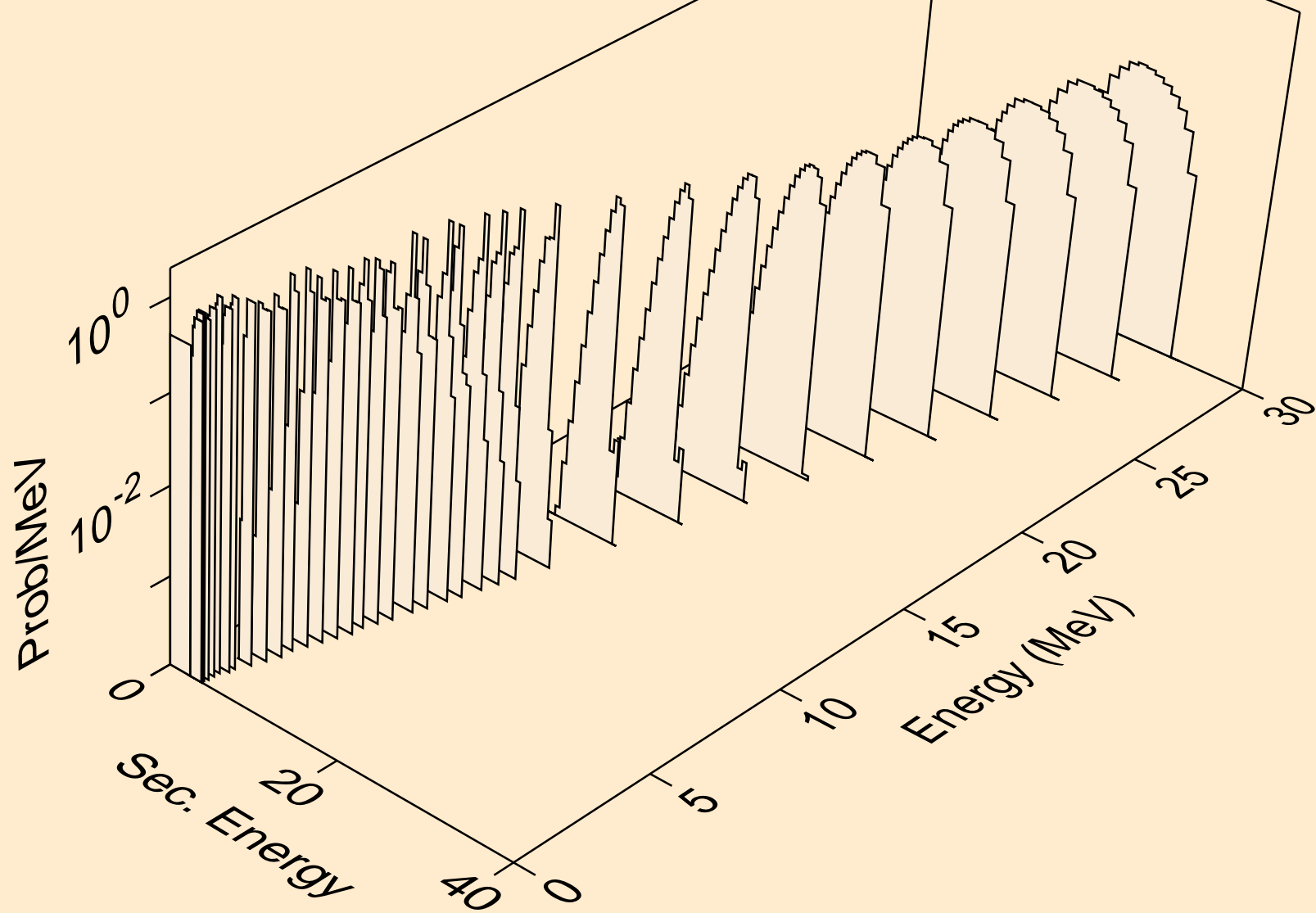

GD139M NEUTRON ACER TENDL-2023 LIBRARY; T=0.K  
alphas from (n,x)

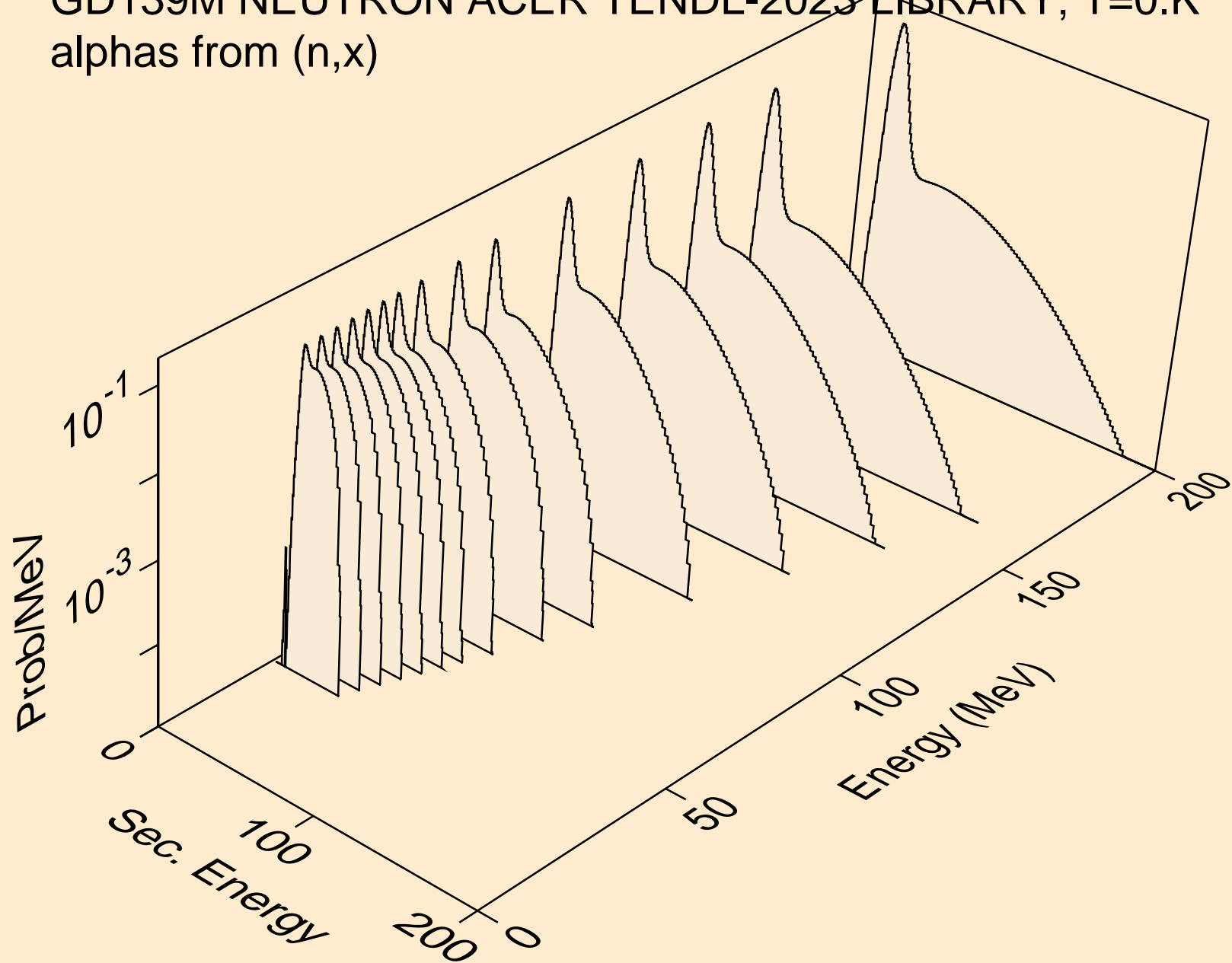

GD139M NEUTRON ACER TENDL-2023 LIBRARY; T=0.K  
alphas from (n,n\*)a

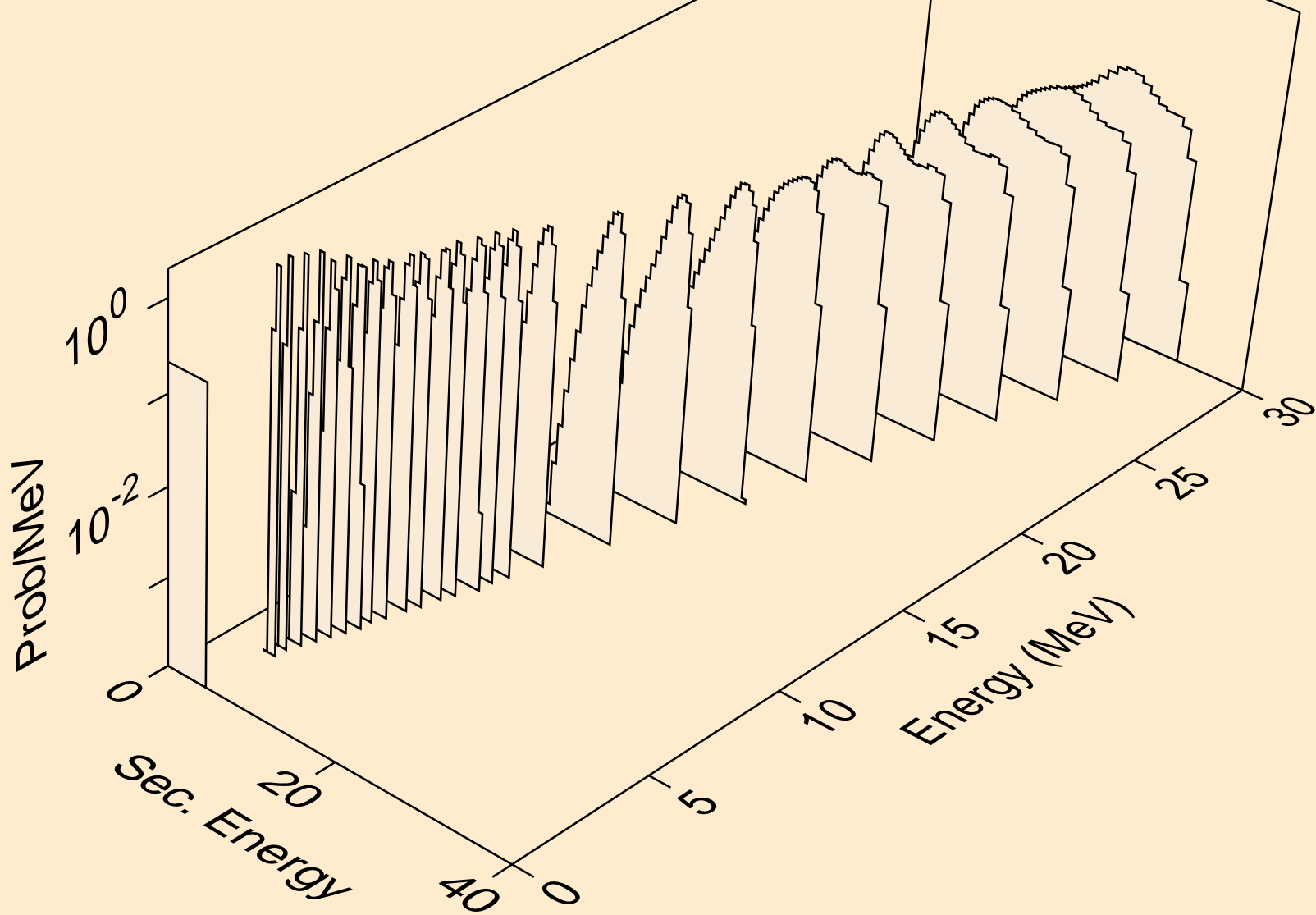

GD139M NEUTRON ACER TENDL-2023 LIBRARY; T=0.K  
alphas from (n,2n)a

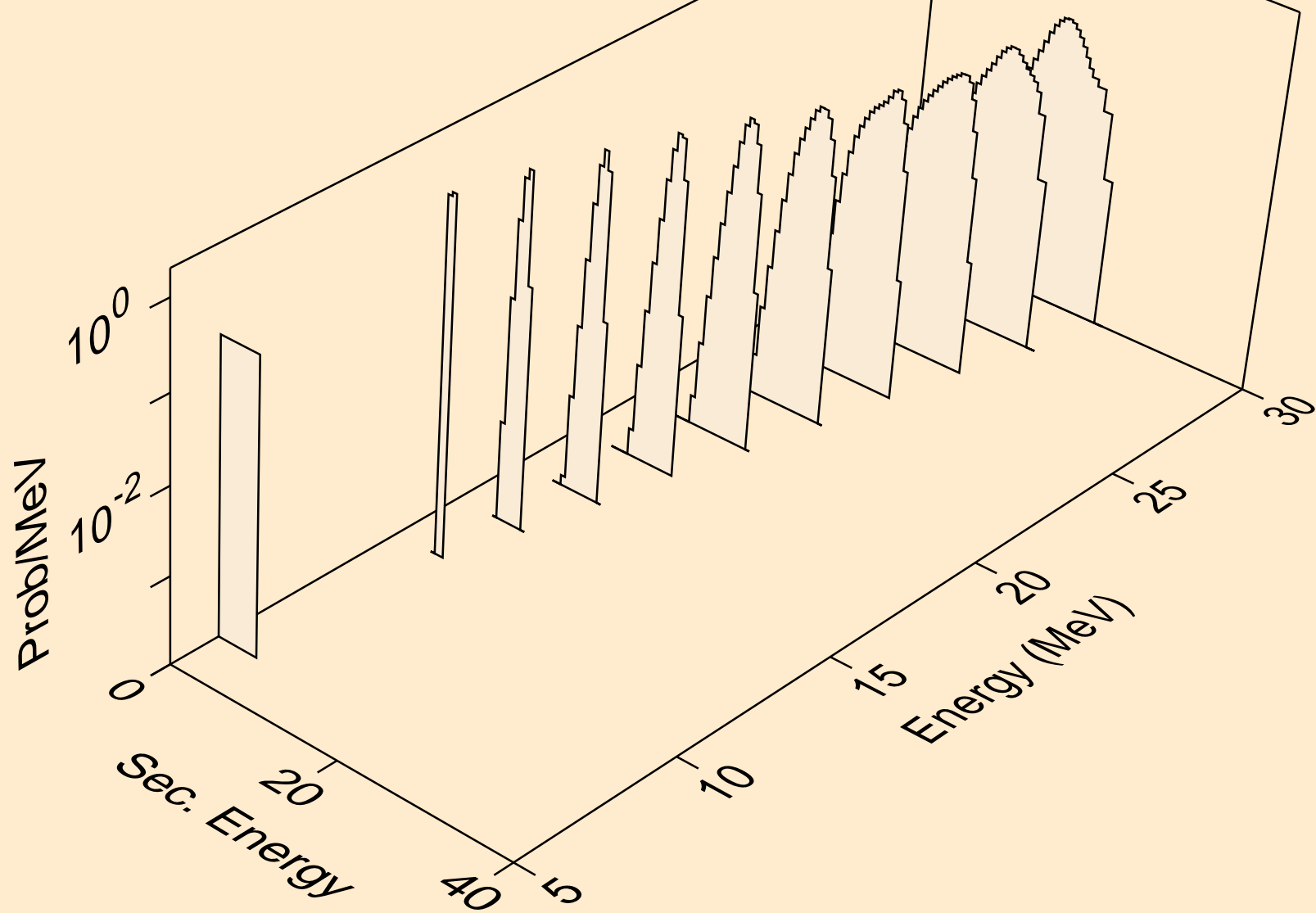

GD139M NEUTRON ACER TENDL-2023 LIBRARY; T=0.K  
alphas from (n,3n)a

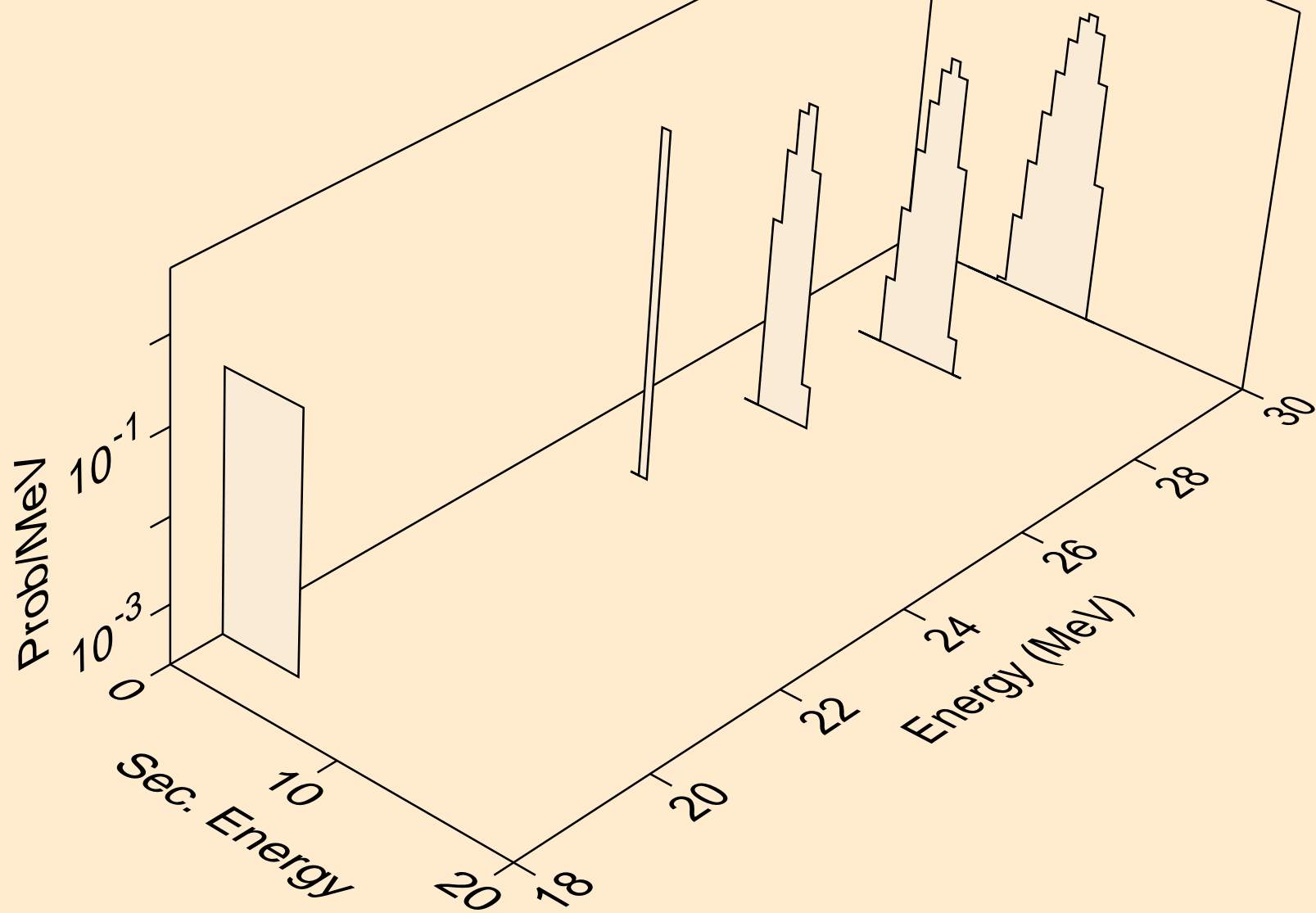

GD139M NEUTRON ACER TENDL-2023 LIBRARY; T=0.K  
alphas from (n,n\*)2a

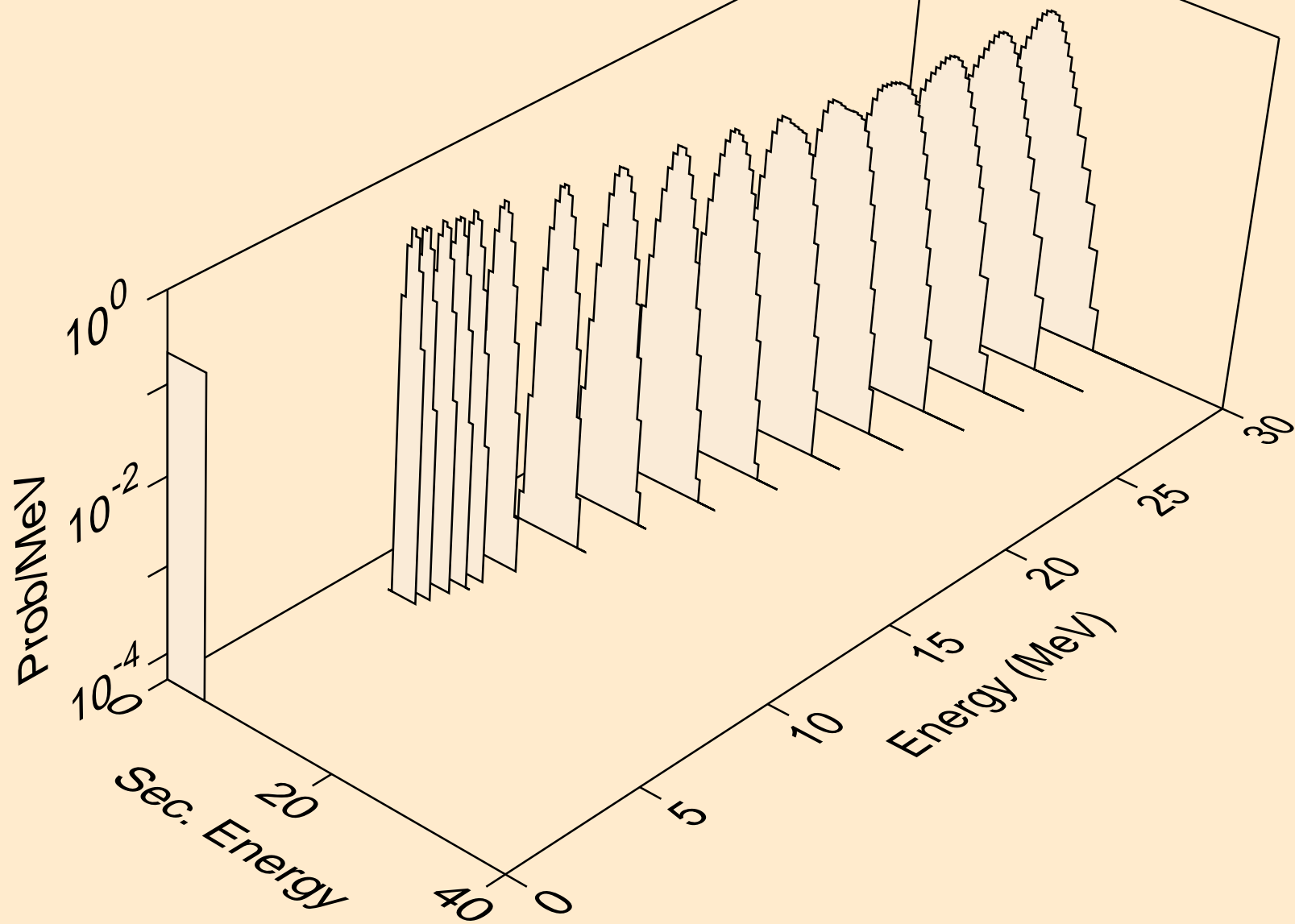

GD139M NEUTRON ACER TENDL-2023 LIBRARY; T=0.K  
alphas from (n,2n)2a

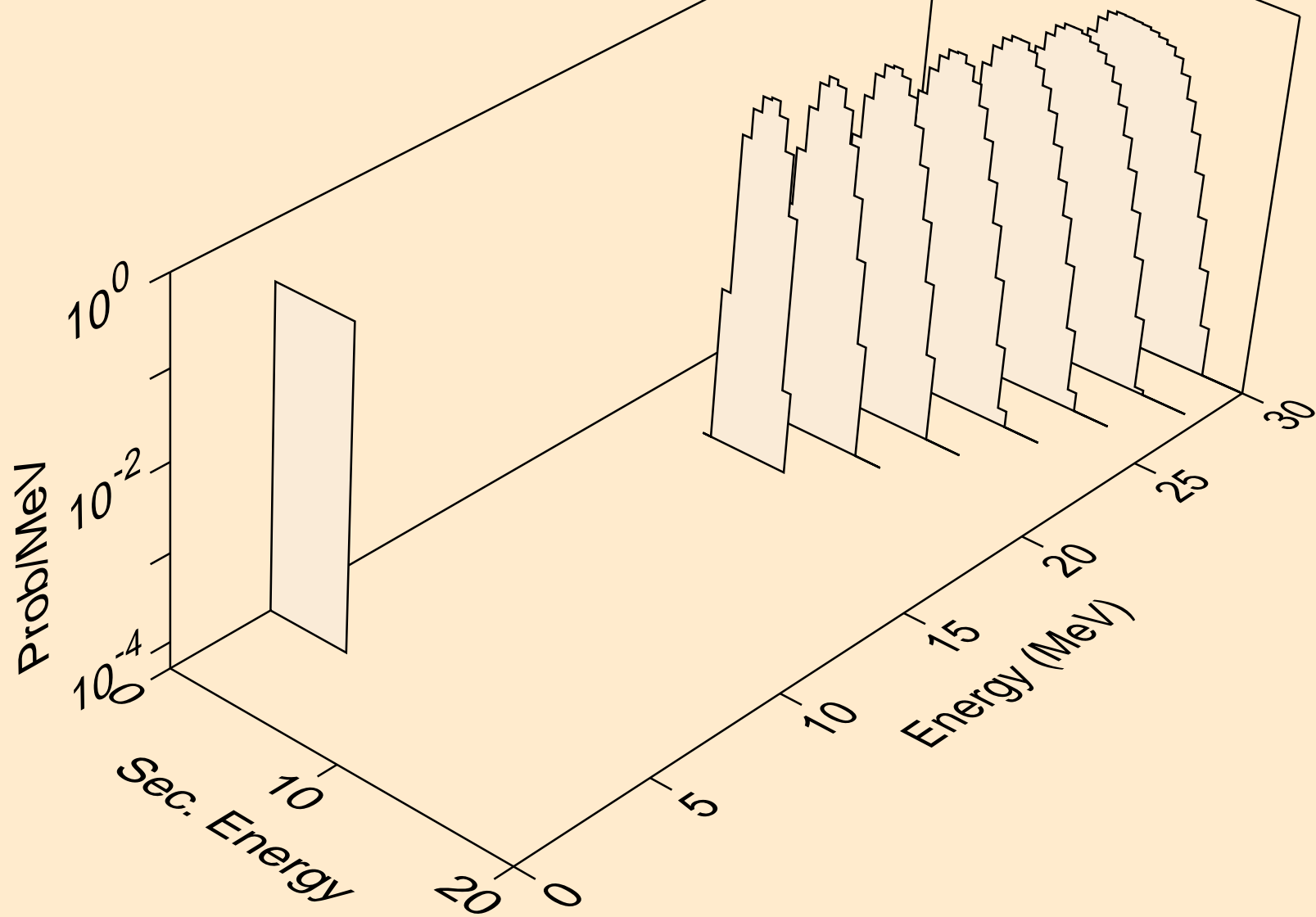

GD139M NEUTRON ACER TENDL-2023 LIBRARY; T=0.K  
alphas from (n,npa)

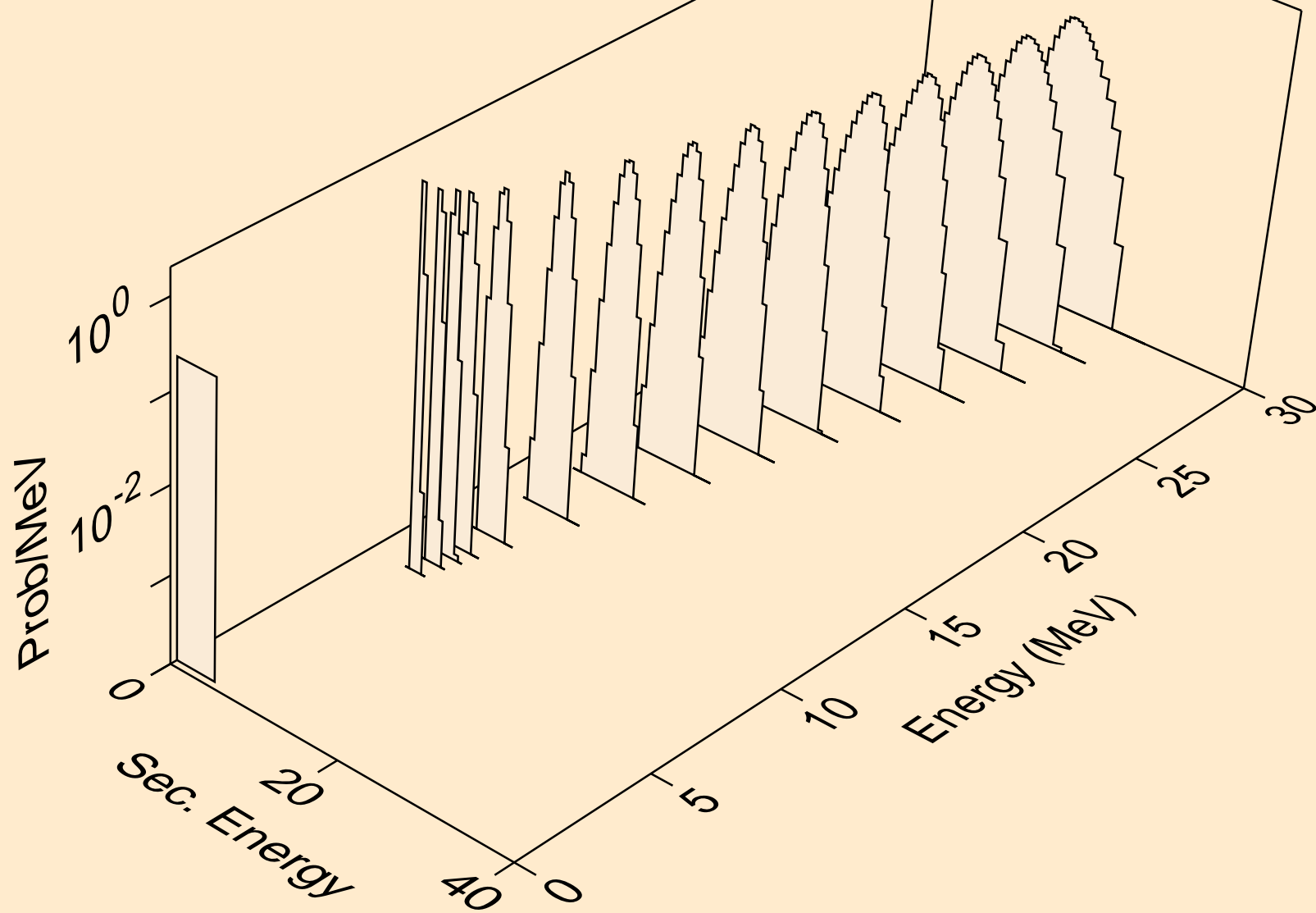

GD139M NEUTRON ACER TENDL-2023 LIBRARY; T=0.K  
alphas from (n,a)

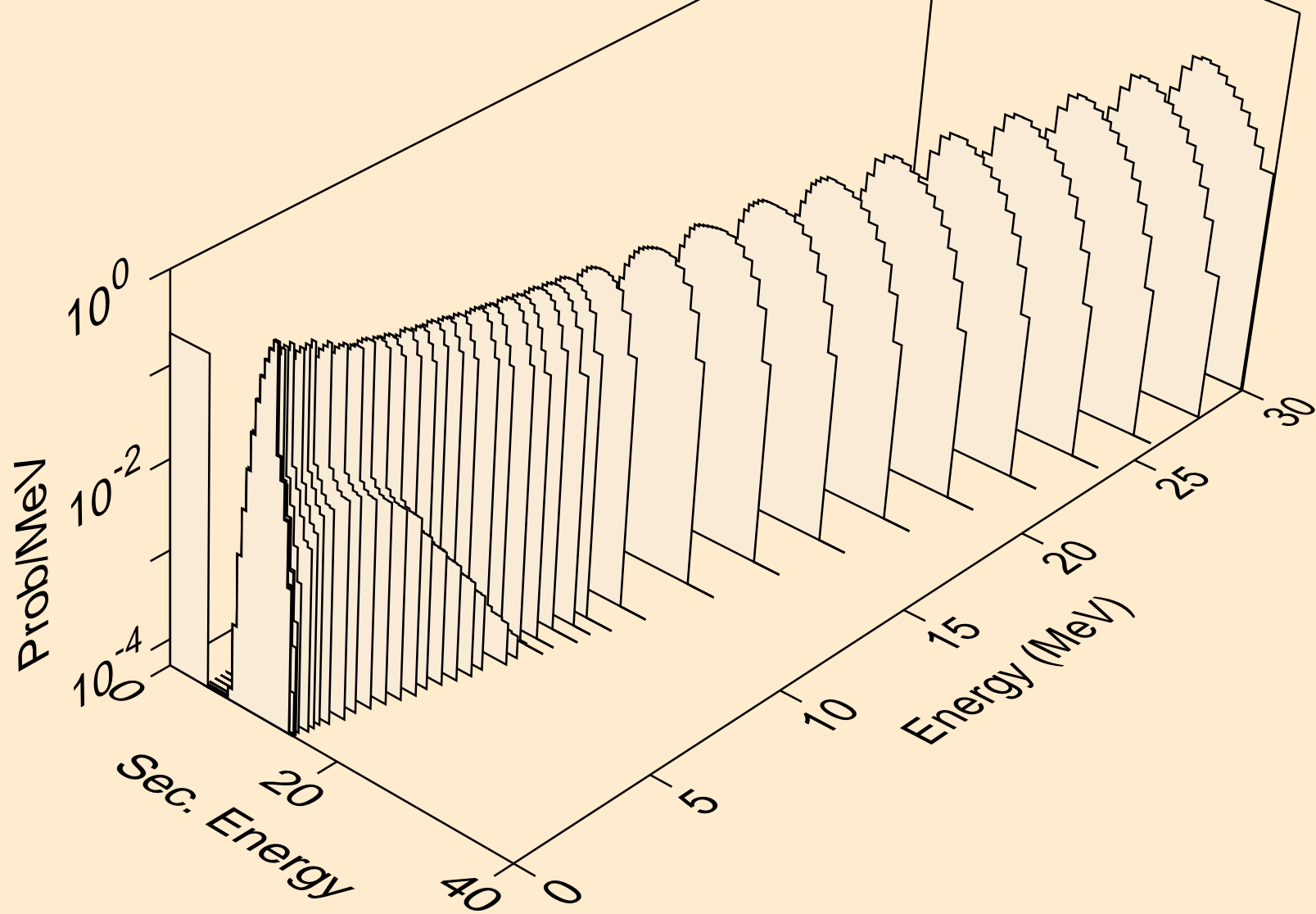

GD139M NEUTRON ACER TENDL-2023 LIBRARY; T=0.K  
alphas from (n,2a)

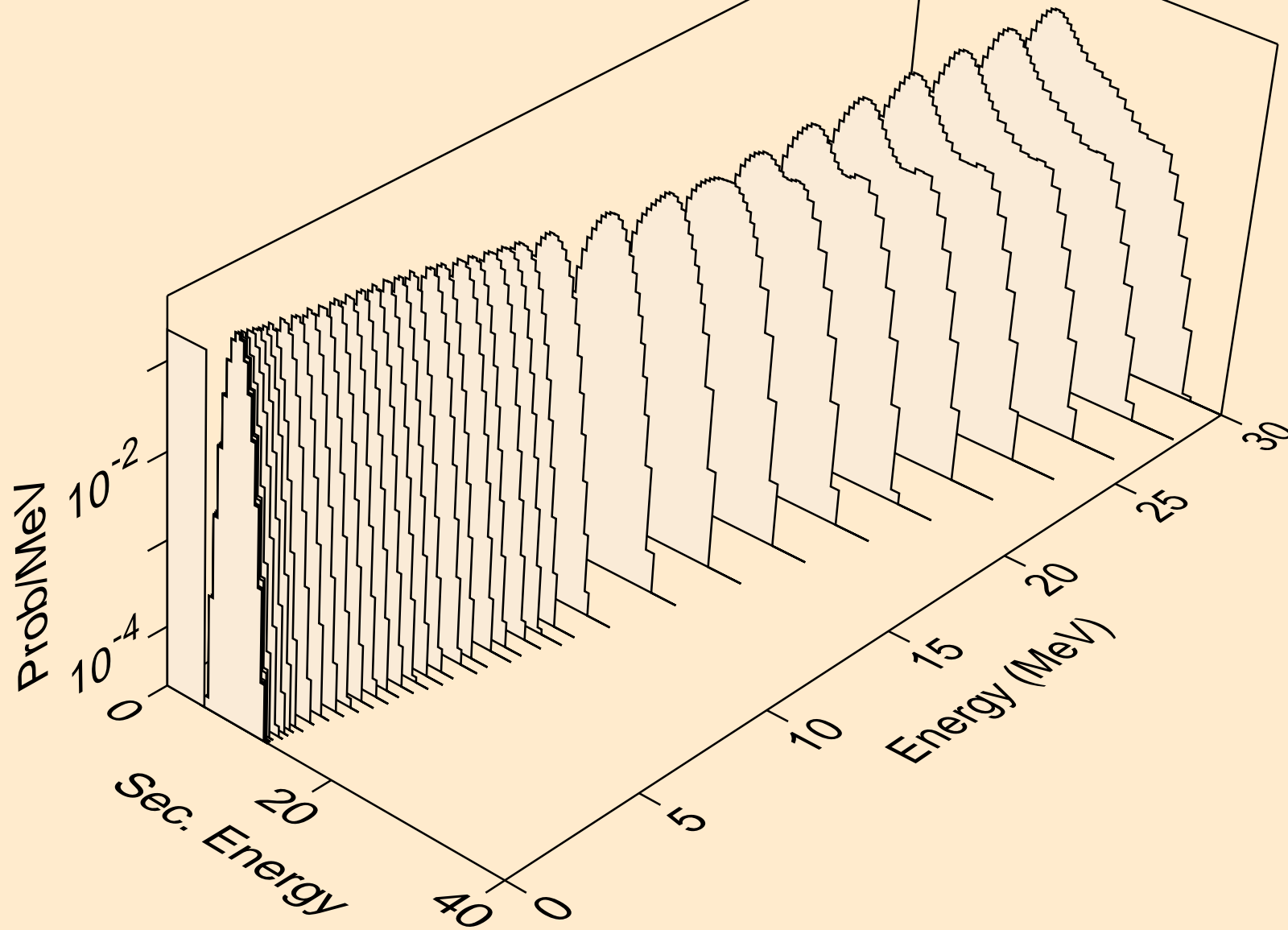

GD139M NEUTRON ACER TENDL-2023 LIBRARY; T=0.K  
alphas from (n,3a)

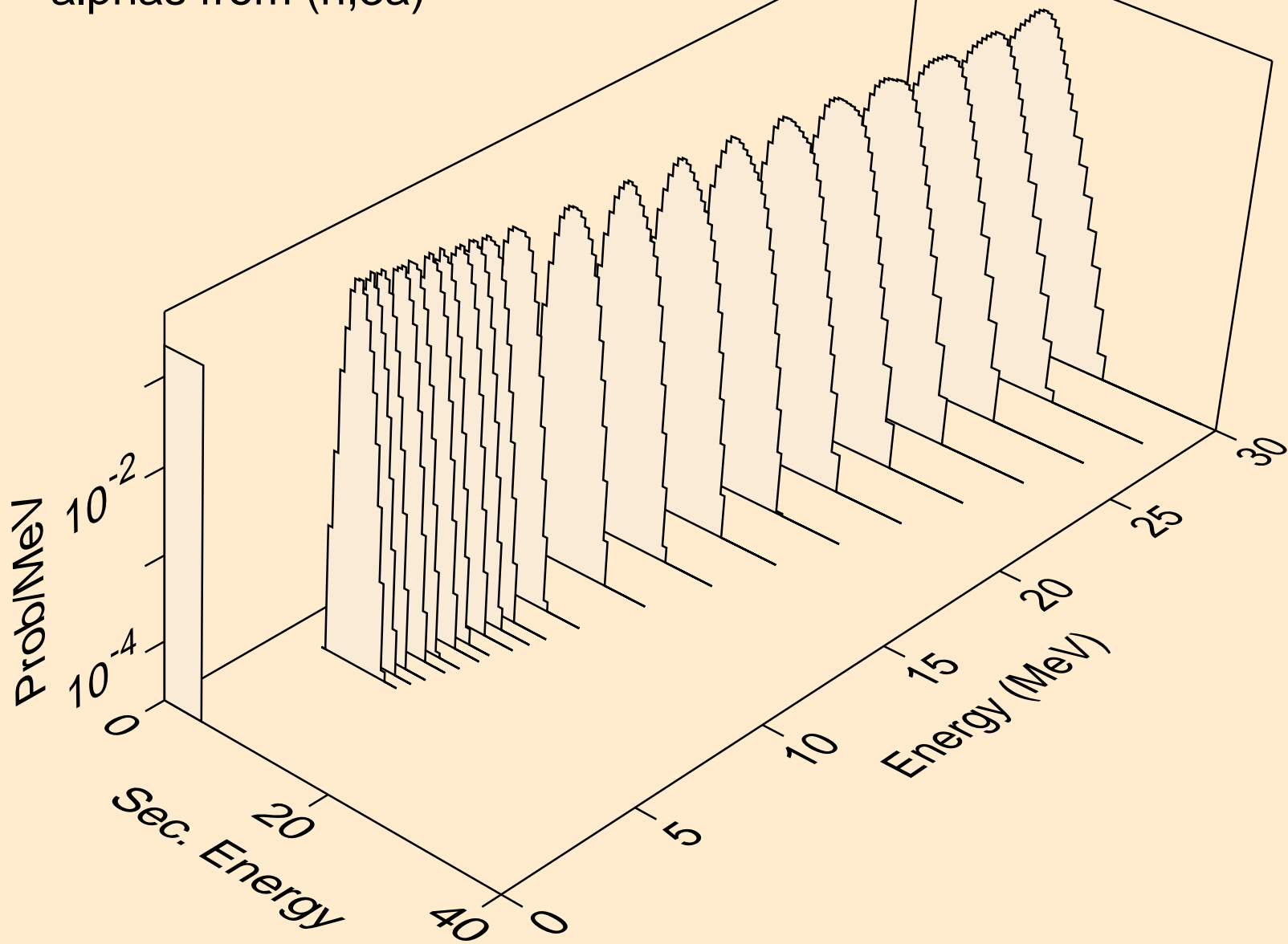

GD139M NEUTRON ACER TENDL-2023 LIBRARY; T=0.K  
alphas from (n,pa)

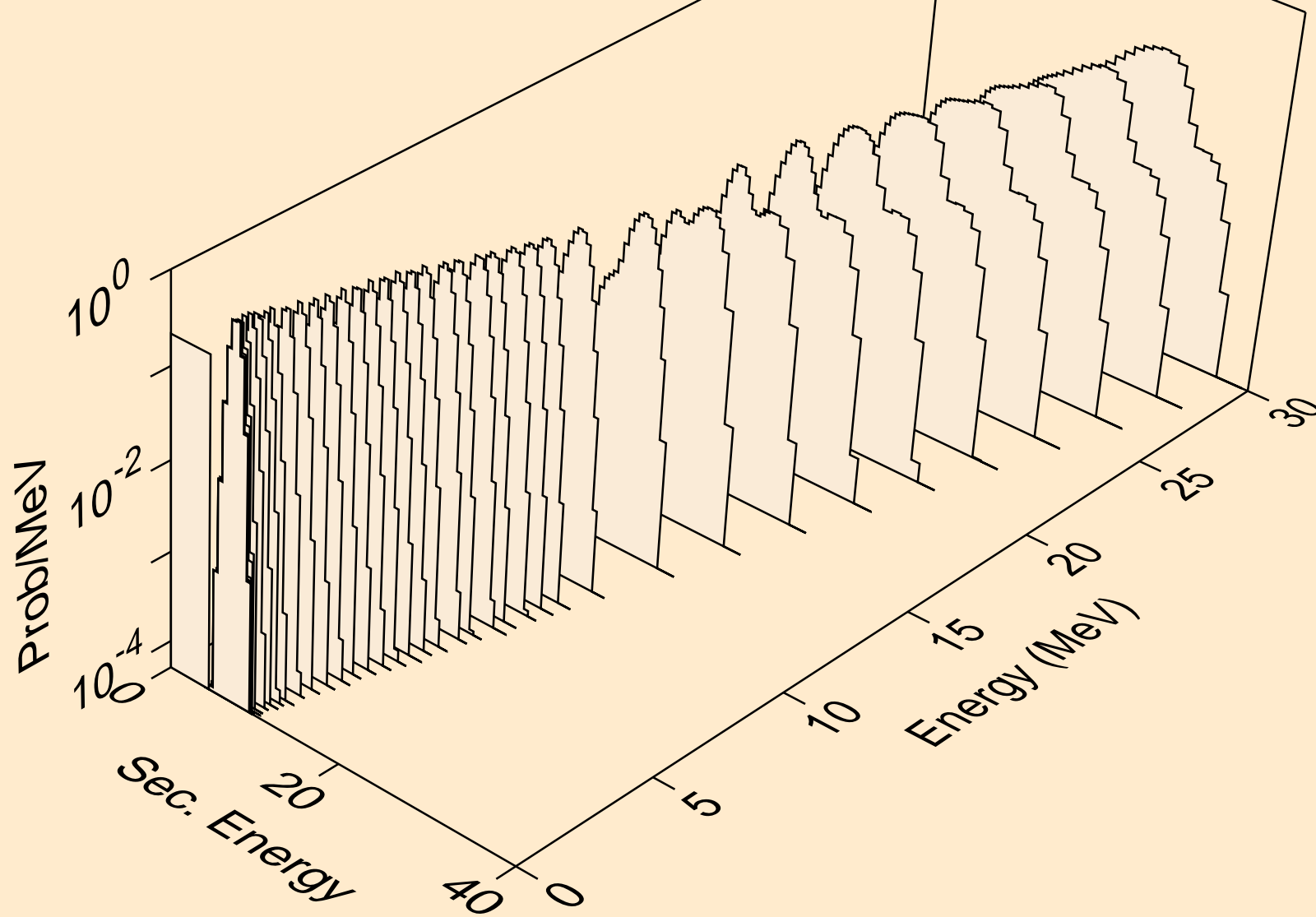

GD139M NEUTRON ACER TENDL-2023 LIBRARY; T=0.K  
alphas from (n,d2a)

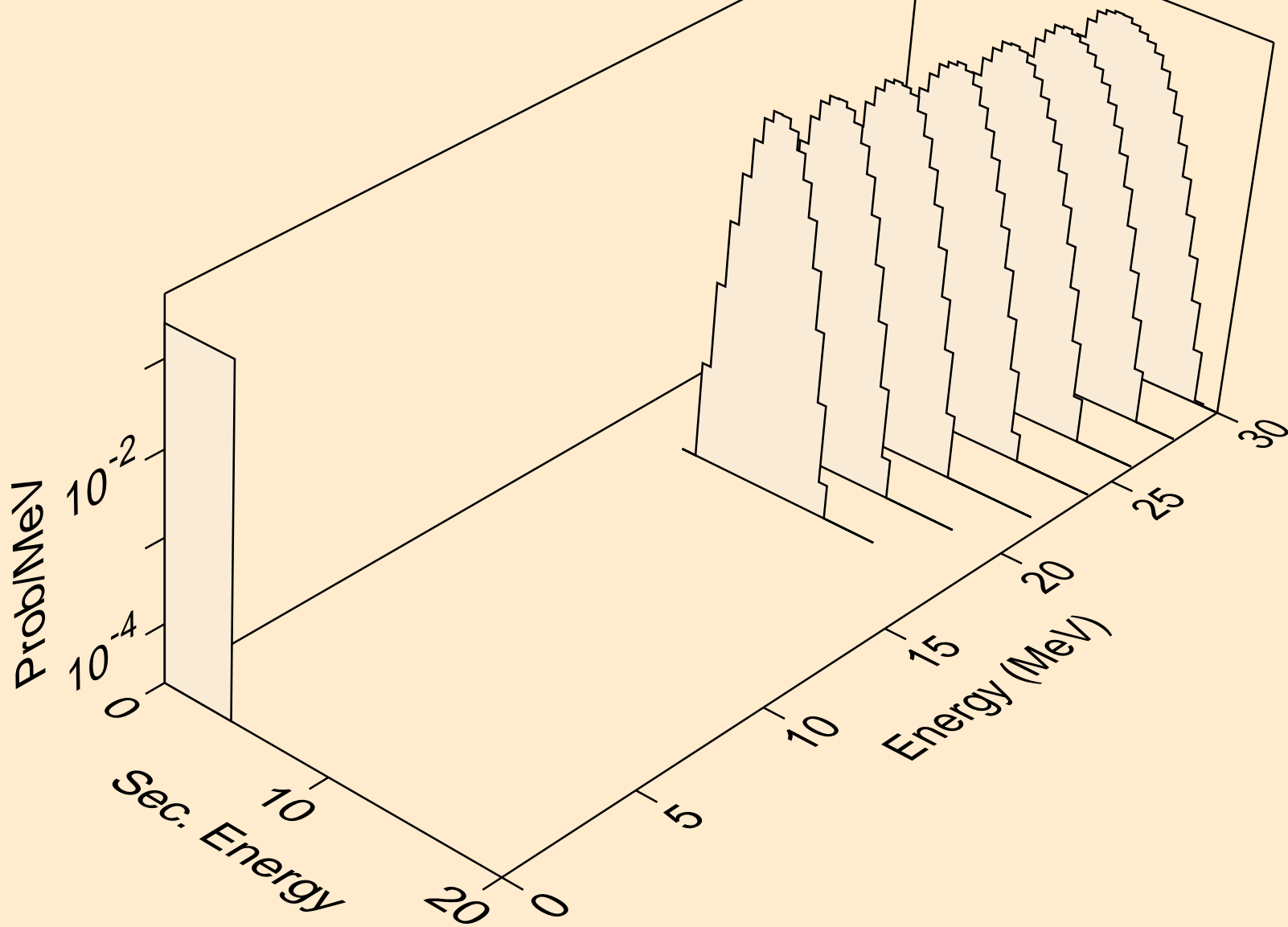

GD139M NEUTRON ACER TENDL-2023 LIBRARY; T=0.K  
alphas from (n,da)

