

# HO159 NEUTRON ACER TENDL-2023 LIBRARY; T=0.K

## Principal cross sections

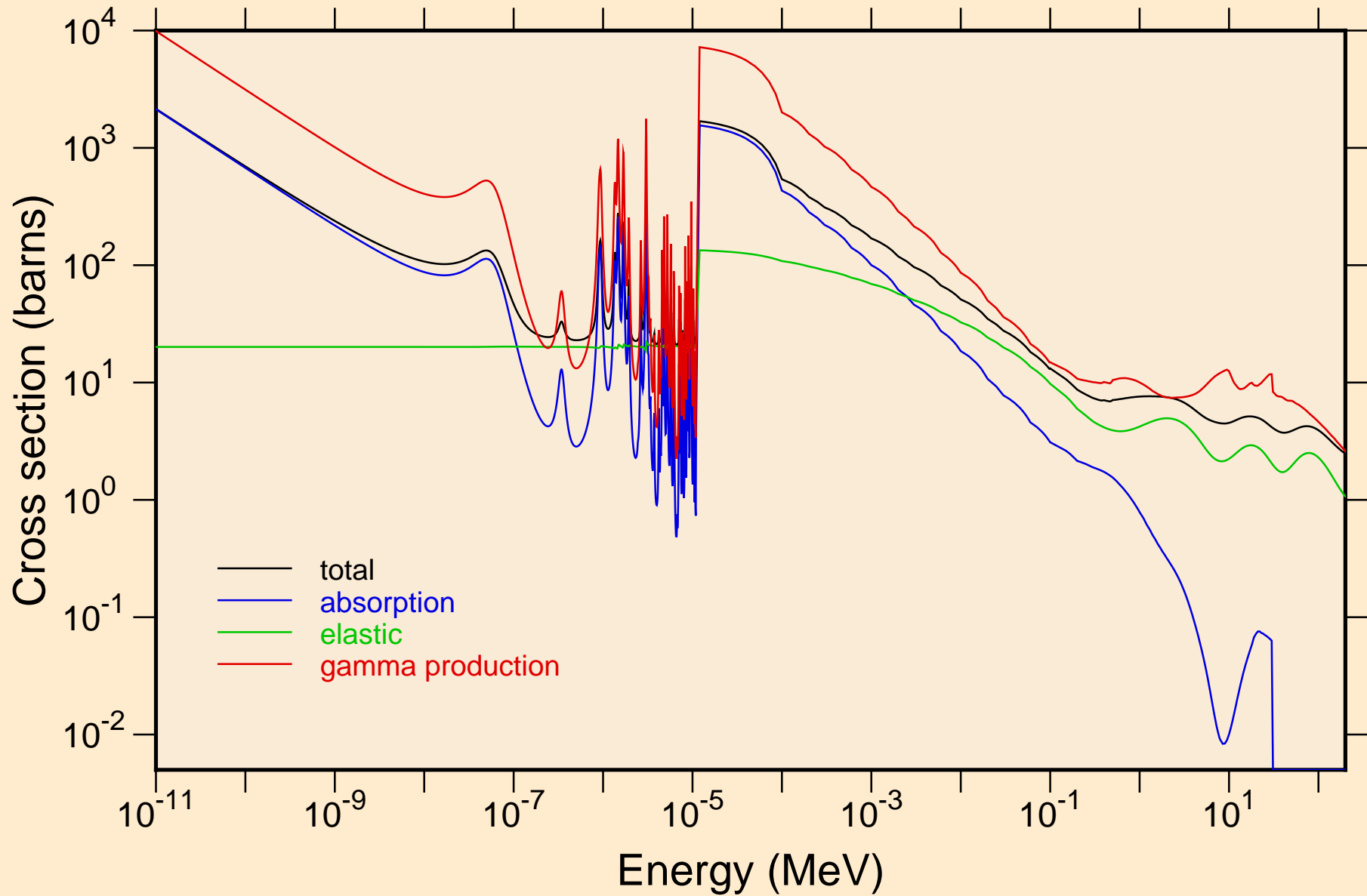

HO159 NEUTRON ACER TENDL-2023 LIBRARY; T=0.K  
resonance total cross section

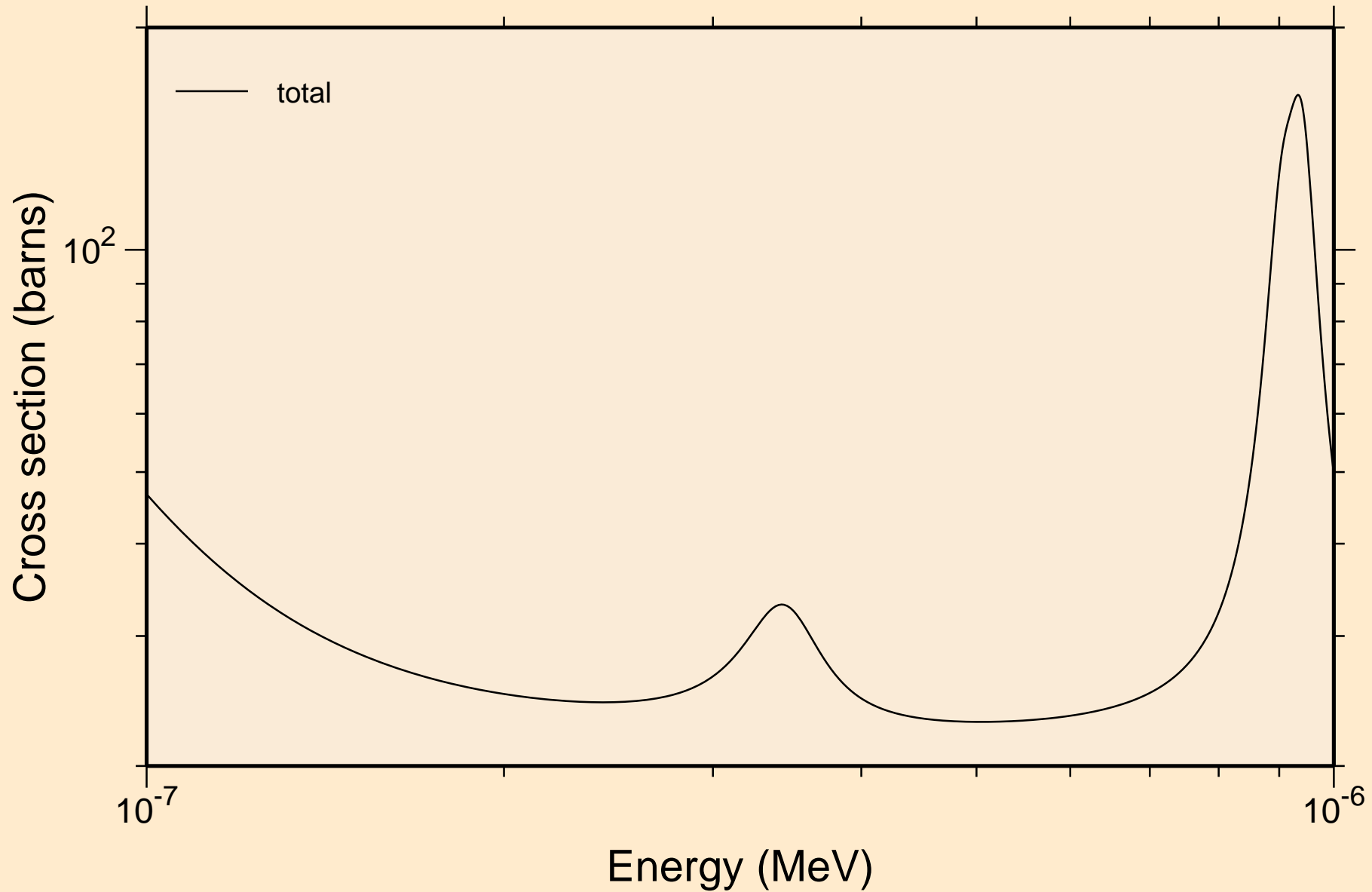

HO159 NEUTRON ACER TENDL-2023 LIBRARY; T=0.K  
resonance total cross section

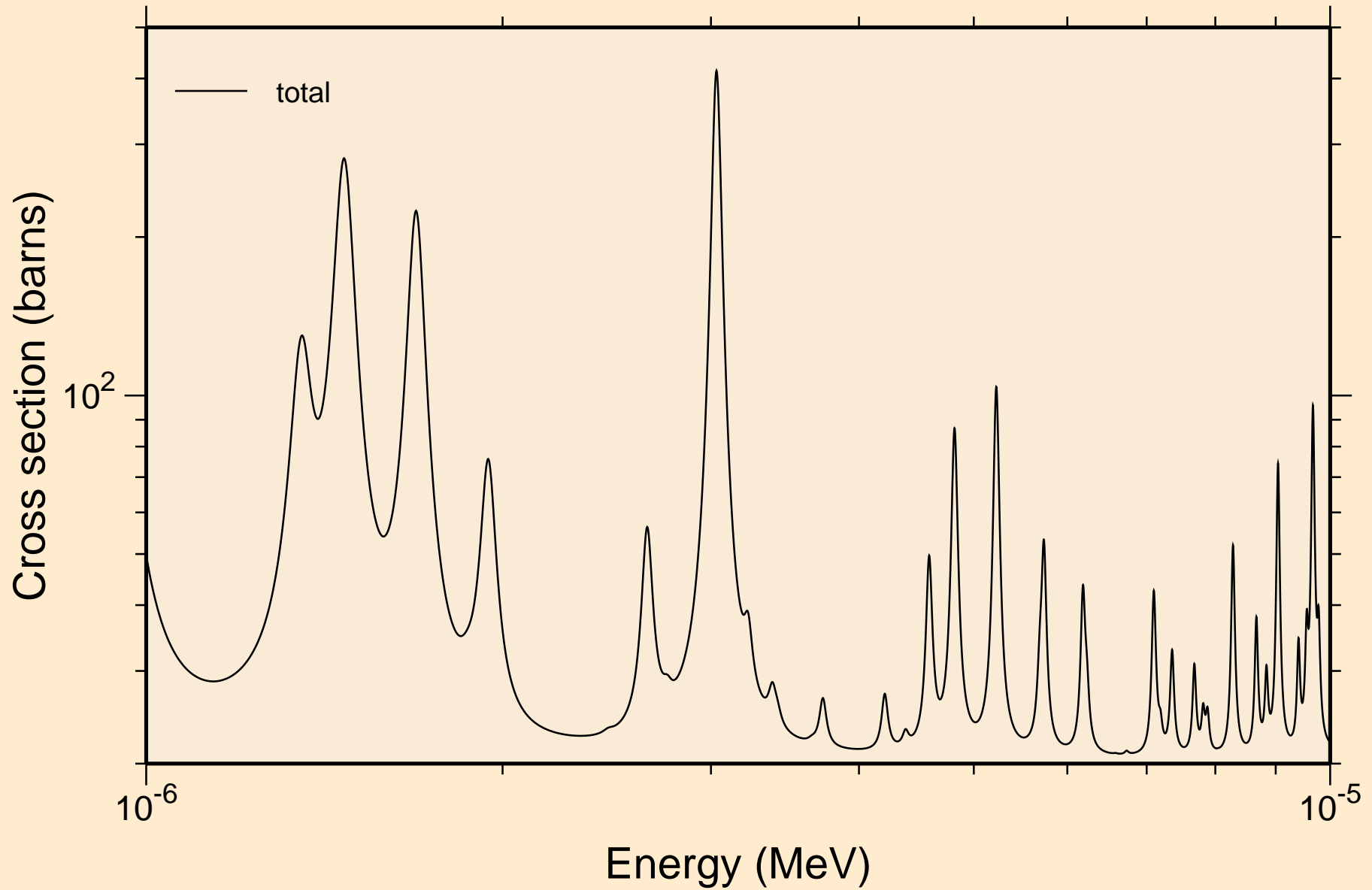

HO159 NEUTRON ACER TENDL-2023 LIBRARY; T=0.K  
resonance total cross section

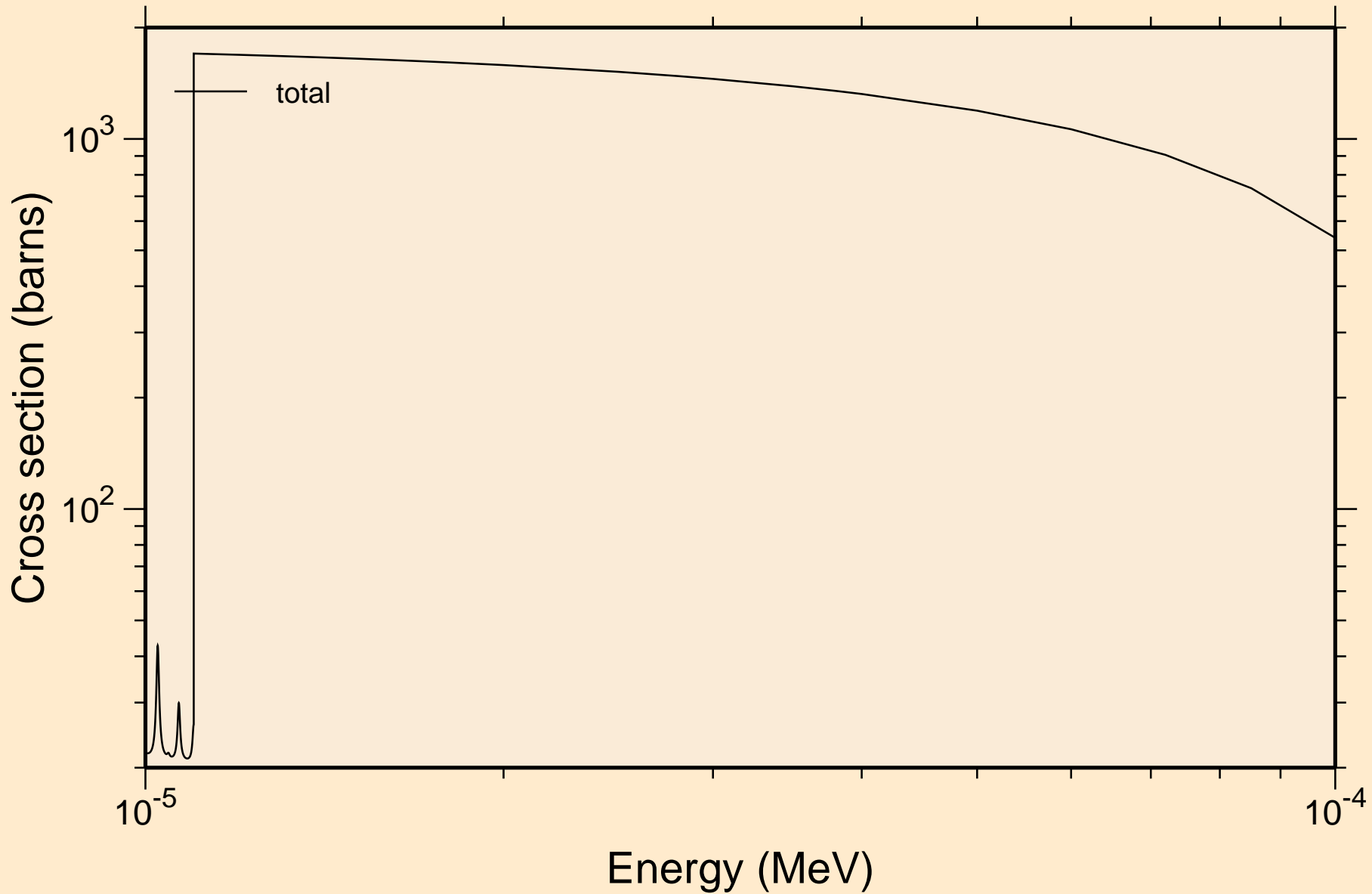

HO159 NEUTRON ACER TENDL-2023 LIBRARY; T=0.K  
resonance total cross section

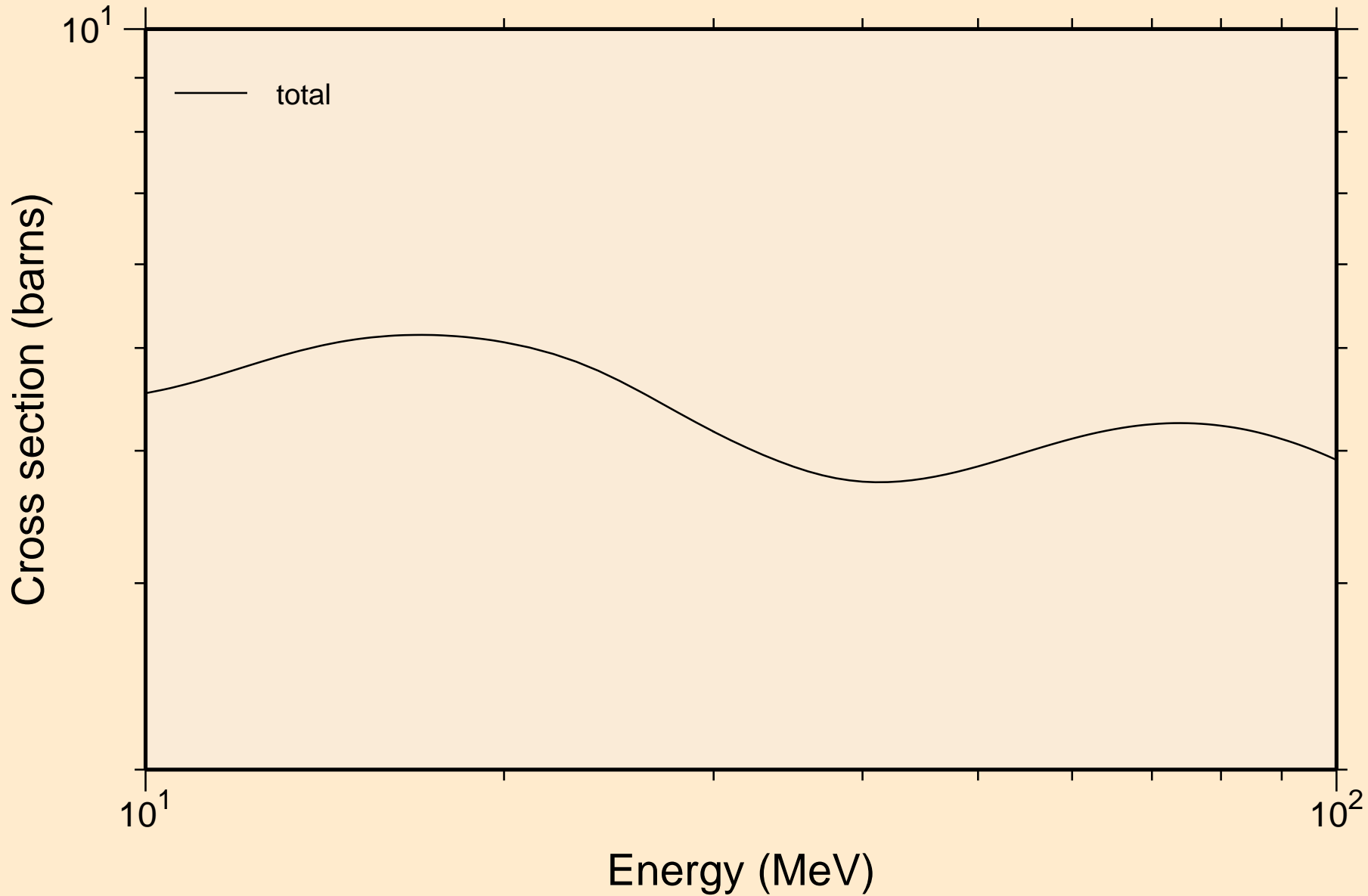

HO159 NEUTRON ACER TENDL-2023 LIBRARY; T=0.K  
resonance absorption cross sections

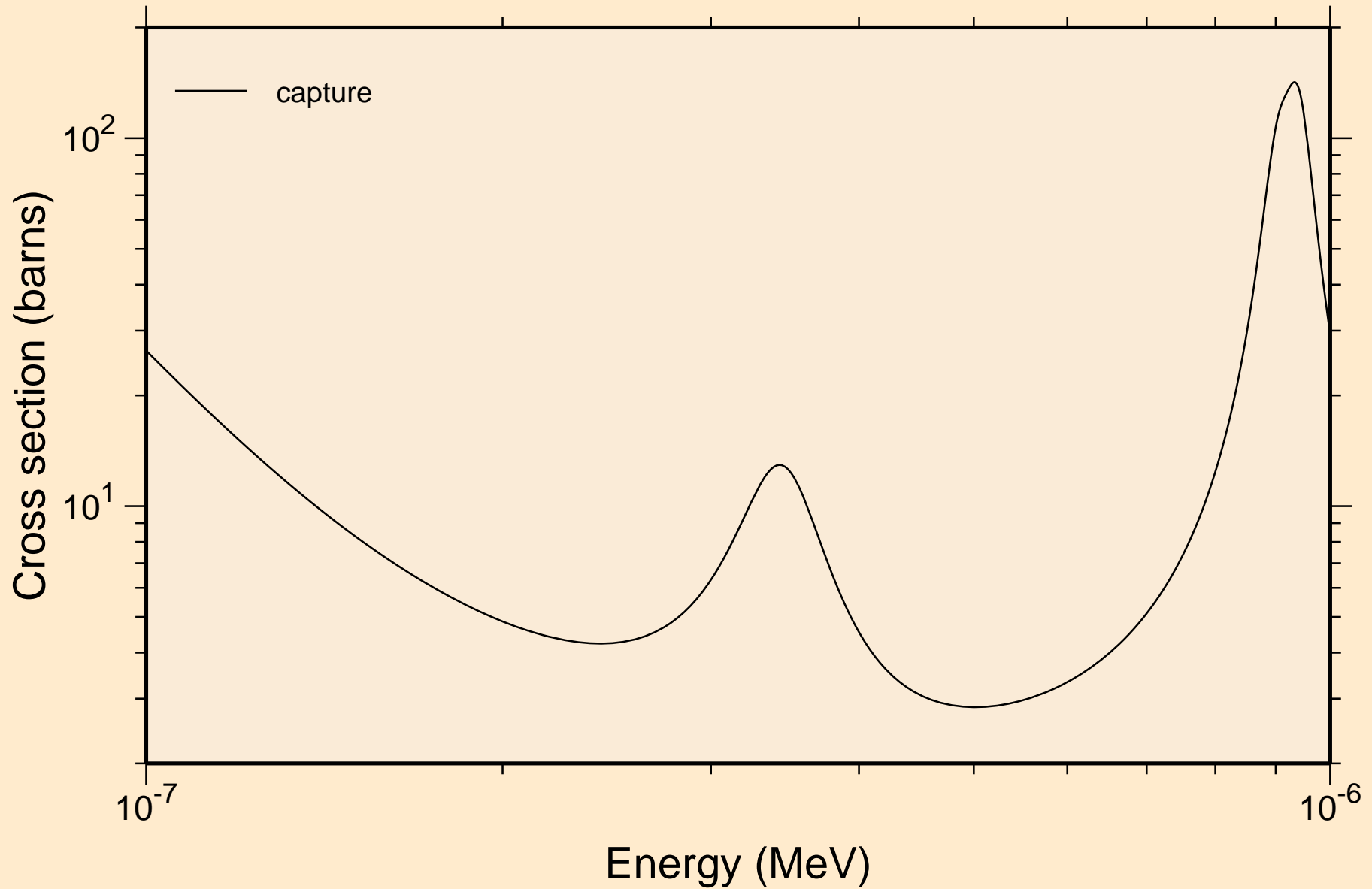

HO159 NEUTRON ACER TENDL-2023 LIBRARY; T=0.K  
resonance absorption cross sections

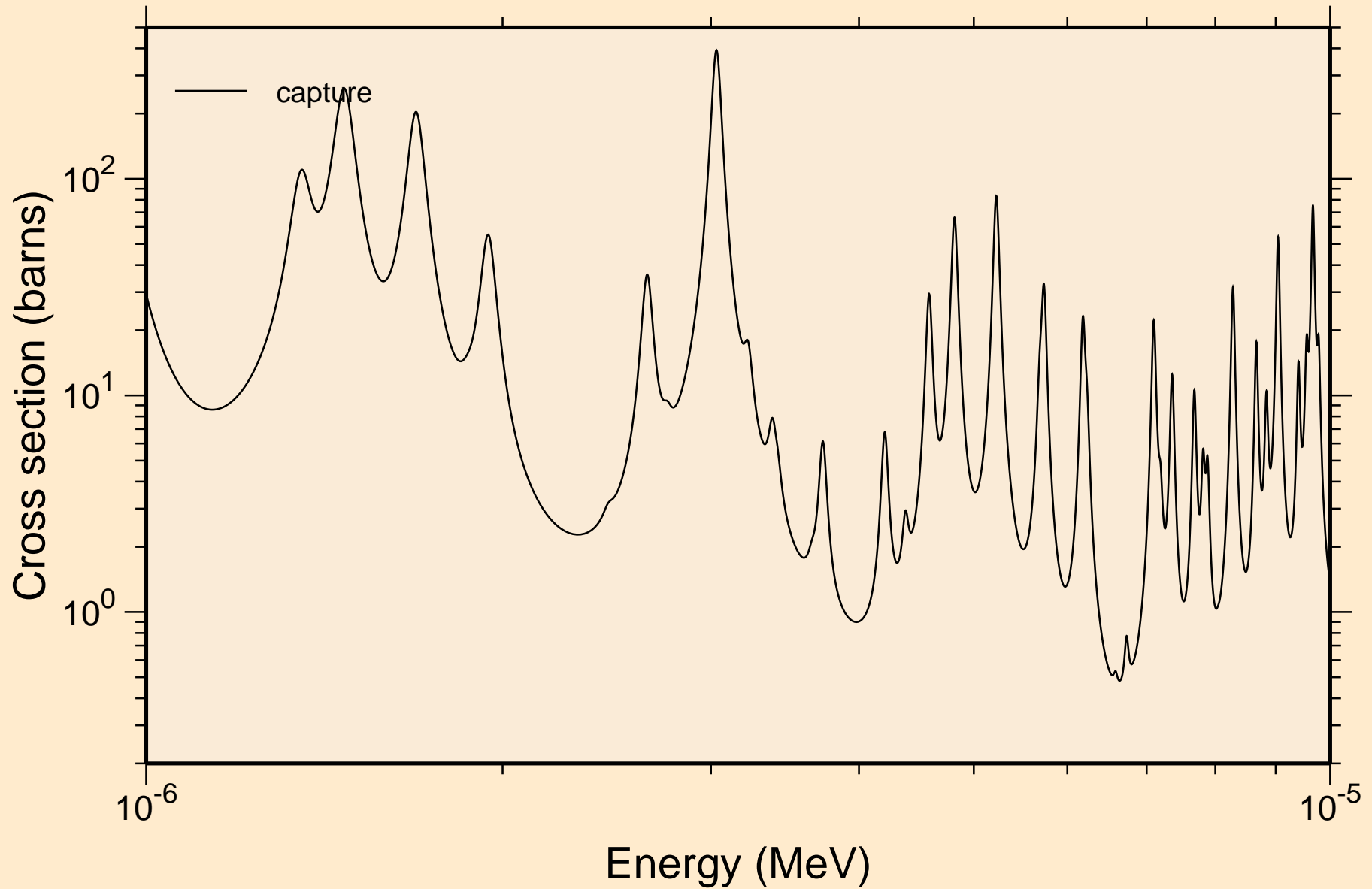

HO159 NEUTRON ACER TENDL-2023 LIBRARY; T=0.K  
resonance absorption cross sections

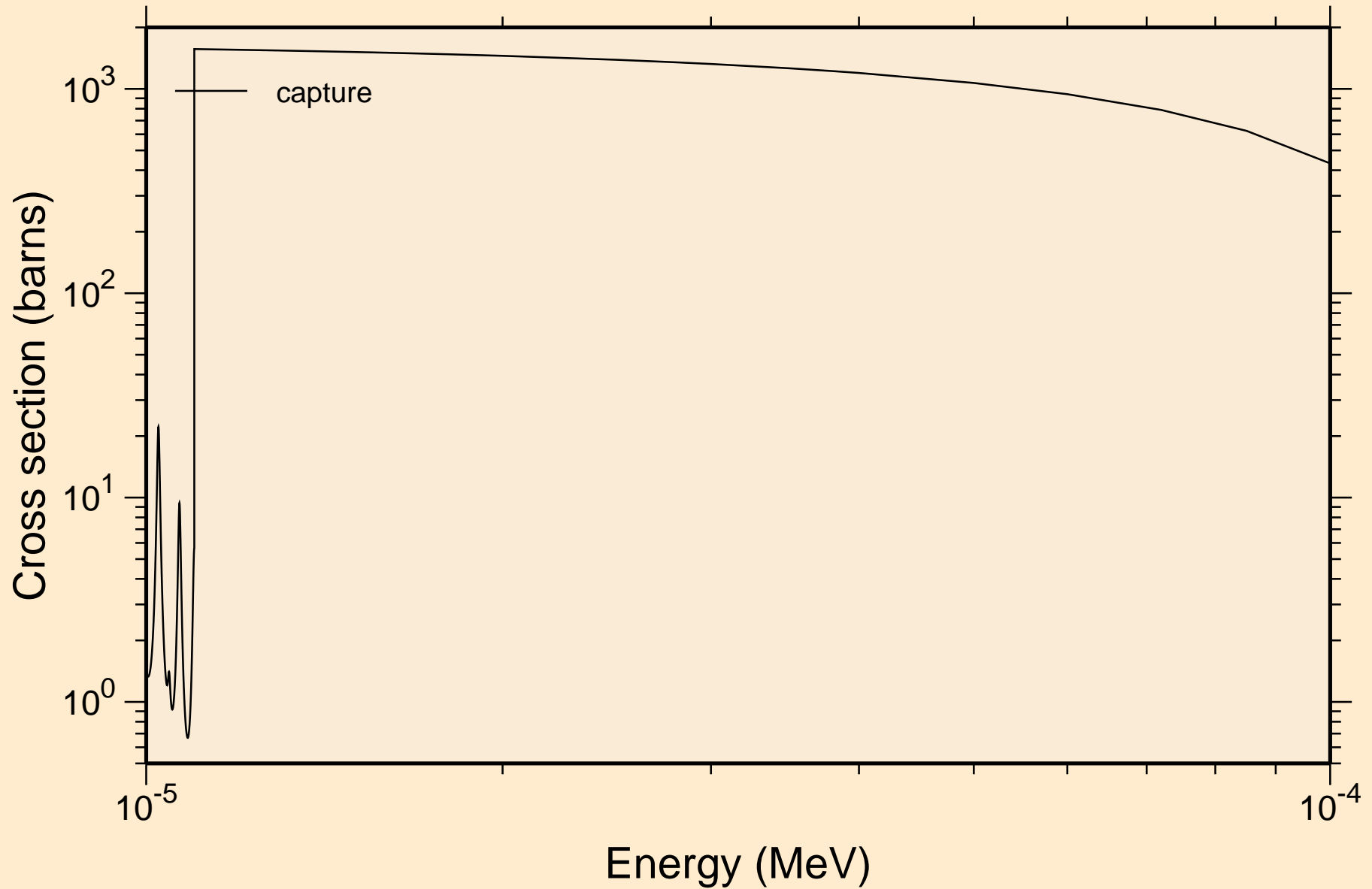

HO159 NEUTRON ACER TENDL-2023 LIBRARY; T=0.K  
resonance absorption cross sections

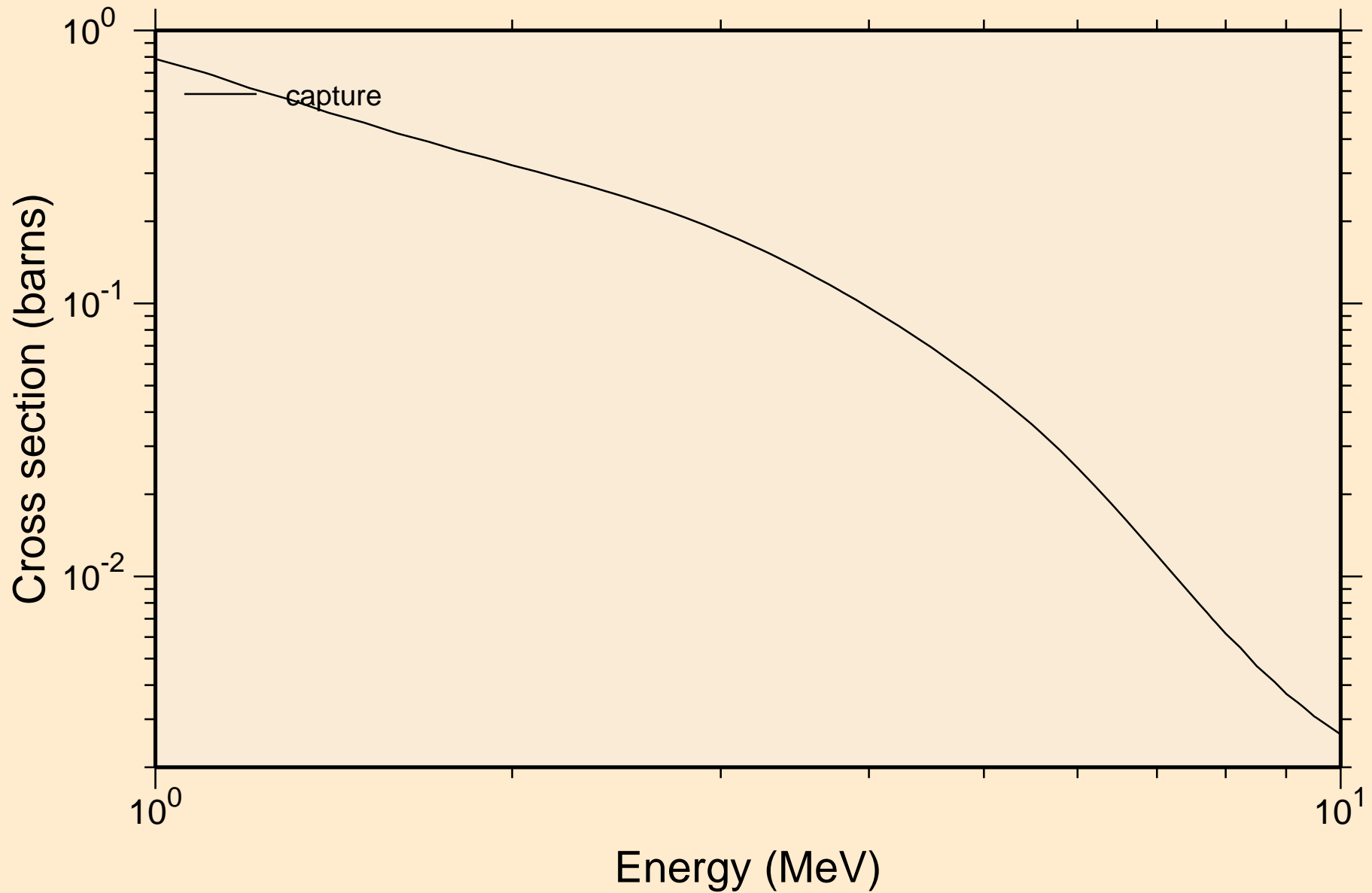

HO159 NEUTRON ACER TENDL-2023 LIBRARY; T=0.K  
Heating

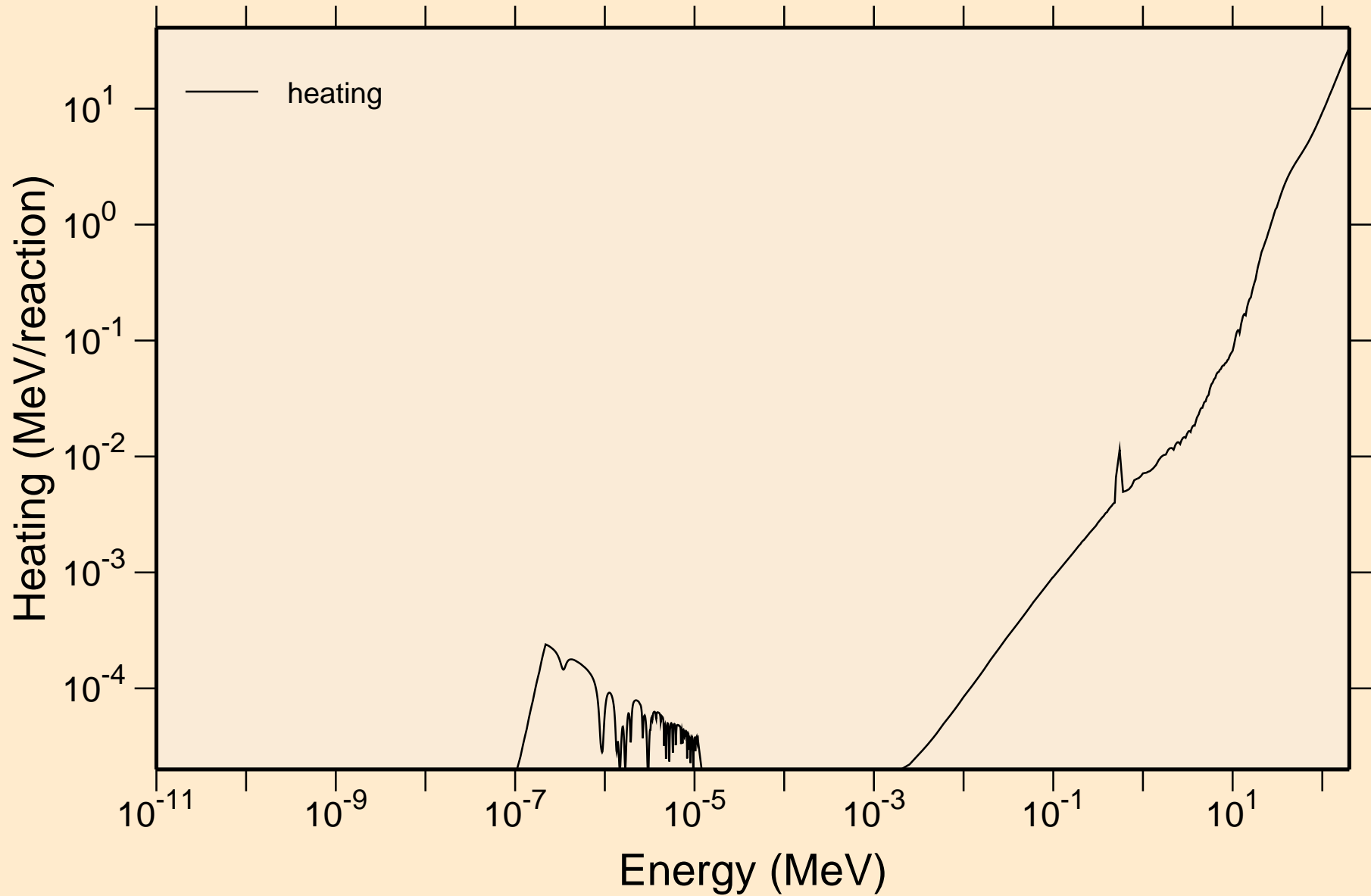

# HO159 NEUTRON ACER TENDL-2023 LIBRARY; T=0.K

## Damage

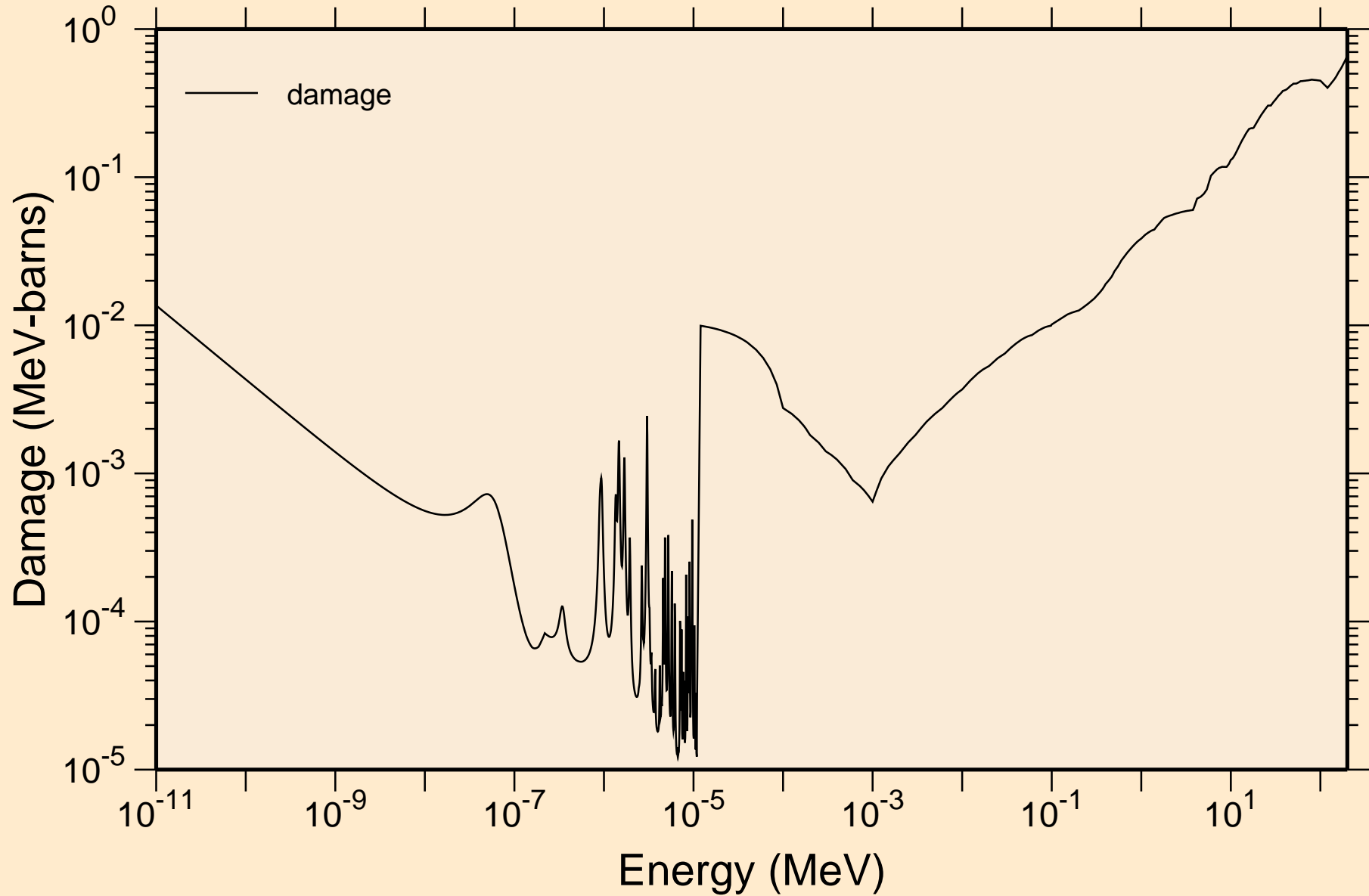

# HO159 NEUTRON ACER TENDL-2023 LIBRARY; T=0.K

## Non-threshold reactions

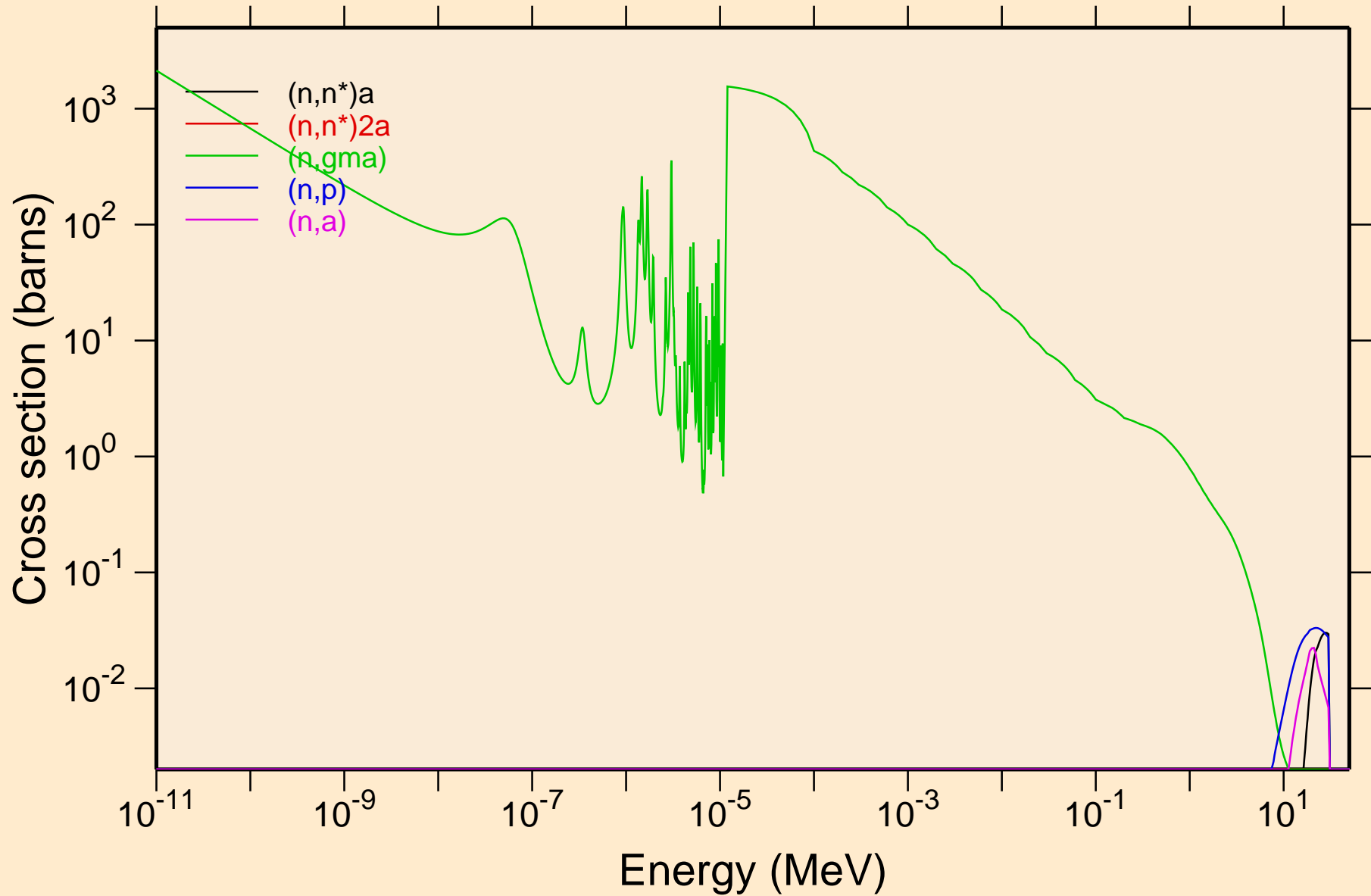

HO159 NEUTRON ACER TENDL-2023 LIBRARY; T=0.K  
Non-threshold reactions

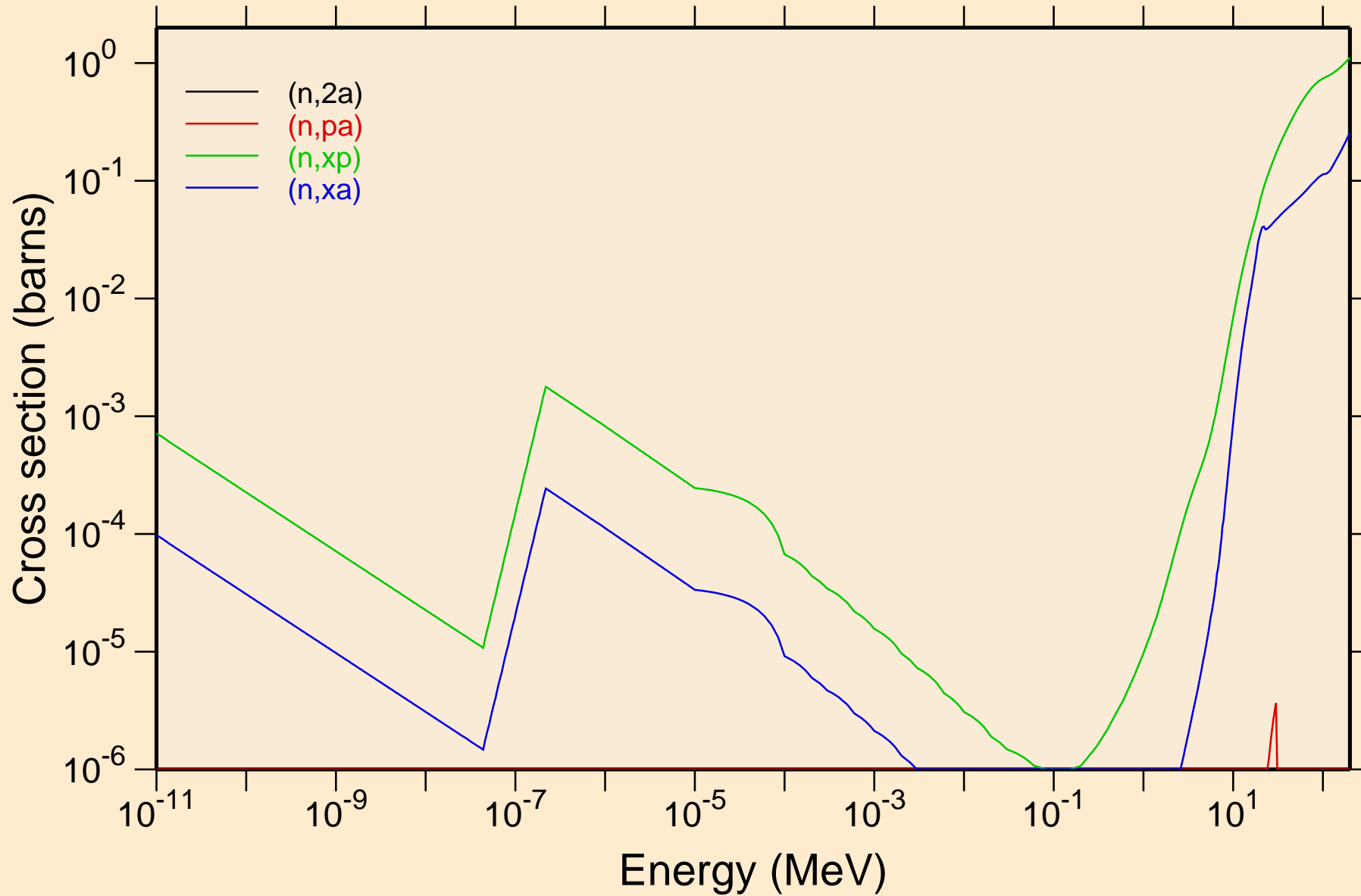

# HO159 NEUTRON ACER TENDL-2023 LIBRARY; T=0.K

## Principal cross sections

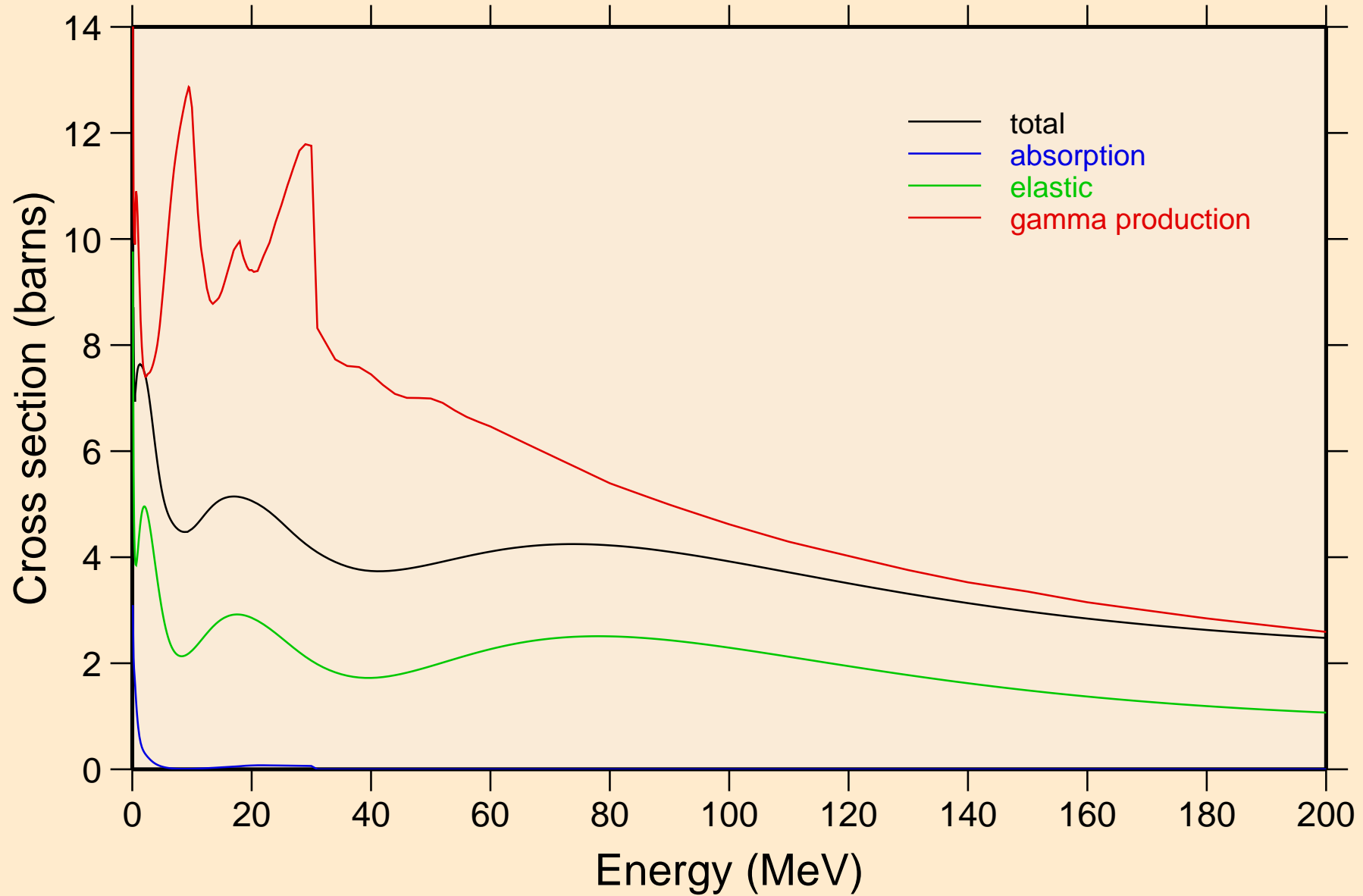

# HO159 NEUTRON ACER TENDL-2023 LIBRARY; T=0.K

## Heating

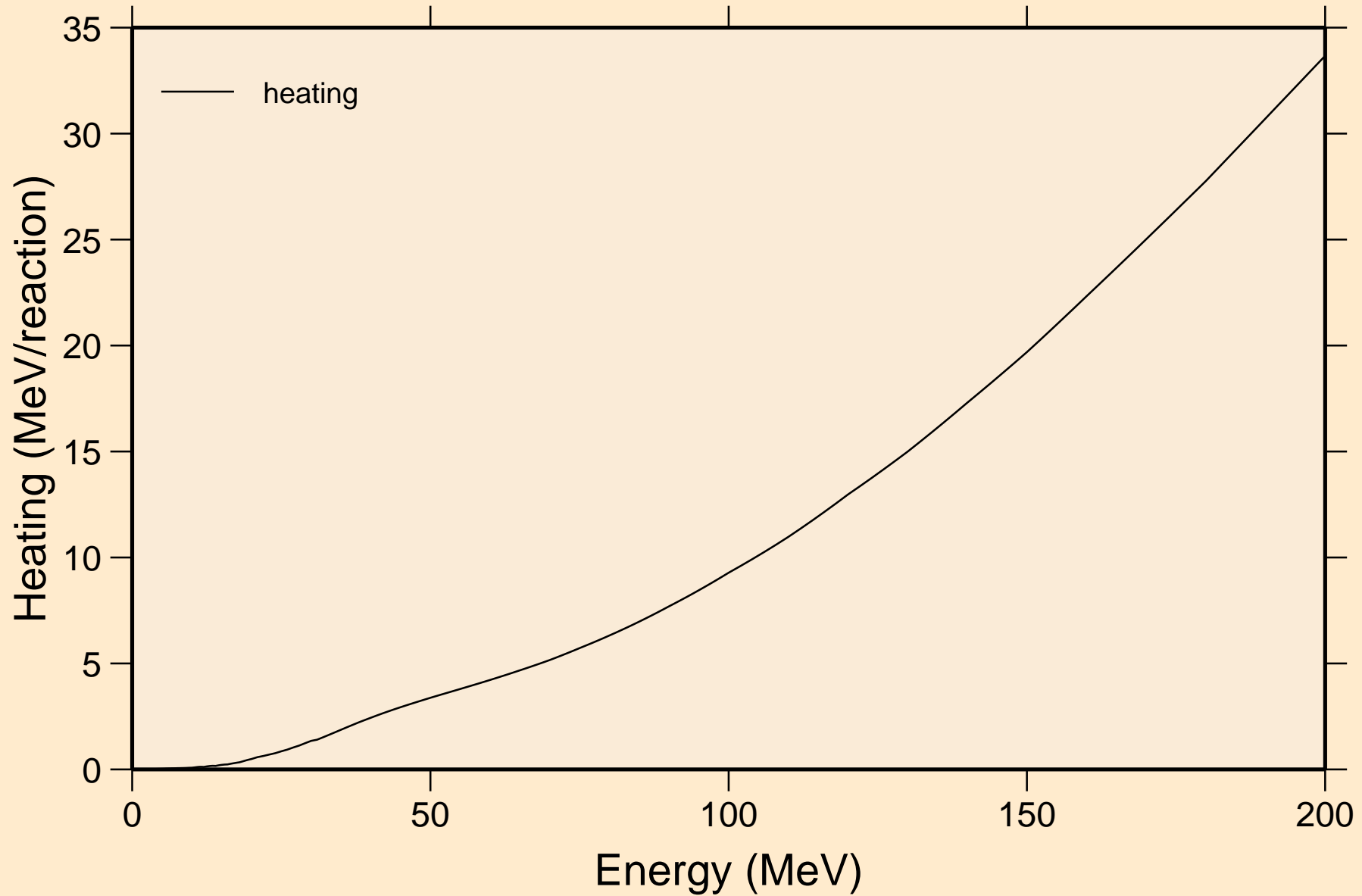

# HO159 NEUTRON ACER TENDL-2023 LIBRARY; T=0.K

## Damage

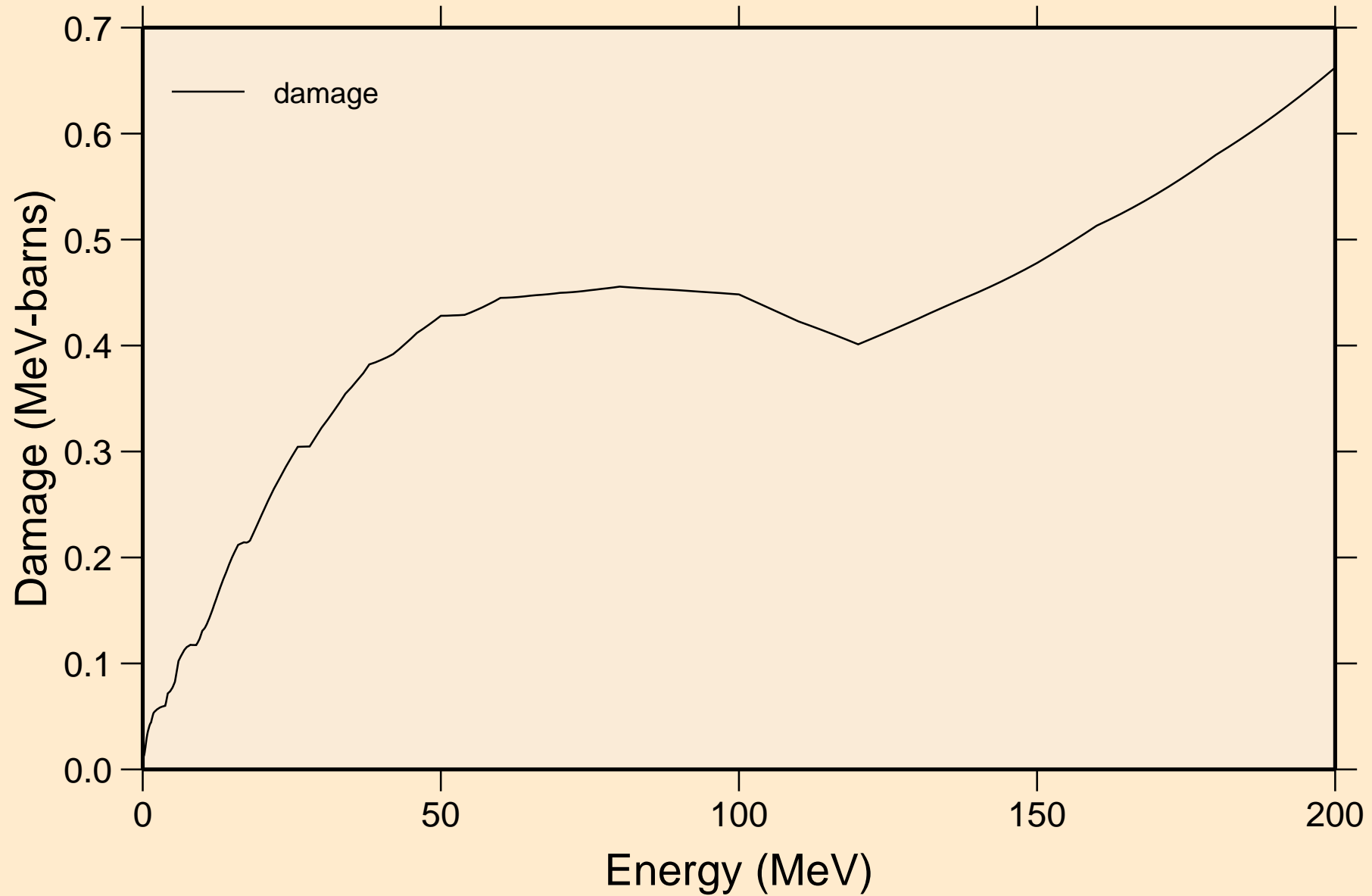

# HO159 NEUTRON ACER TENDL-2023 LIBRARY; T=0.K

## Non-threshold reactions

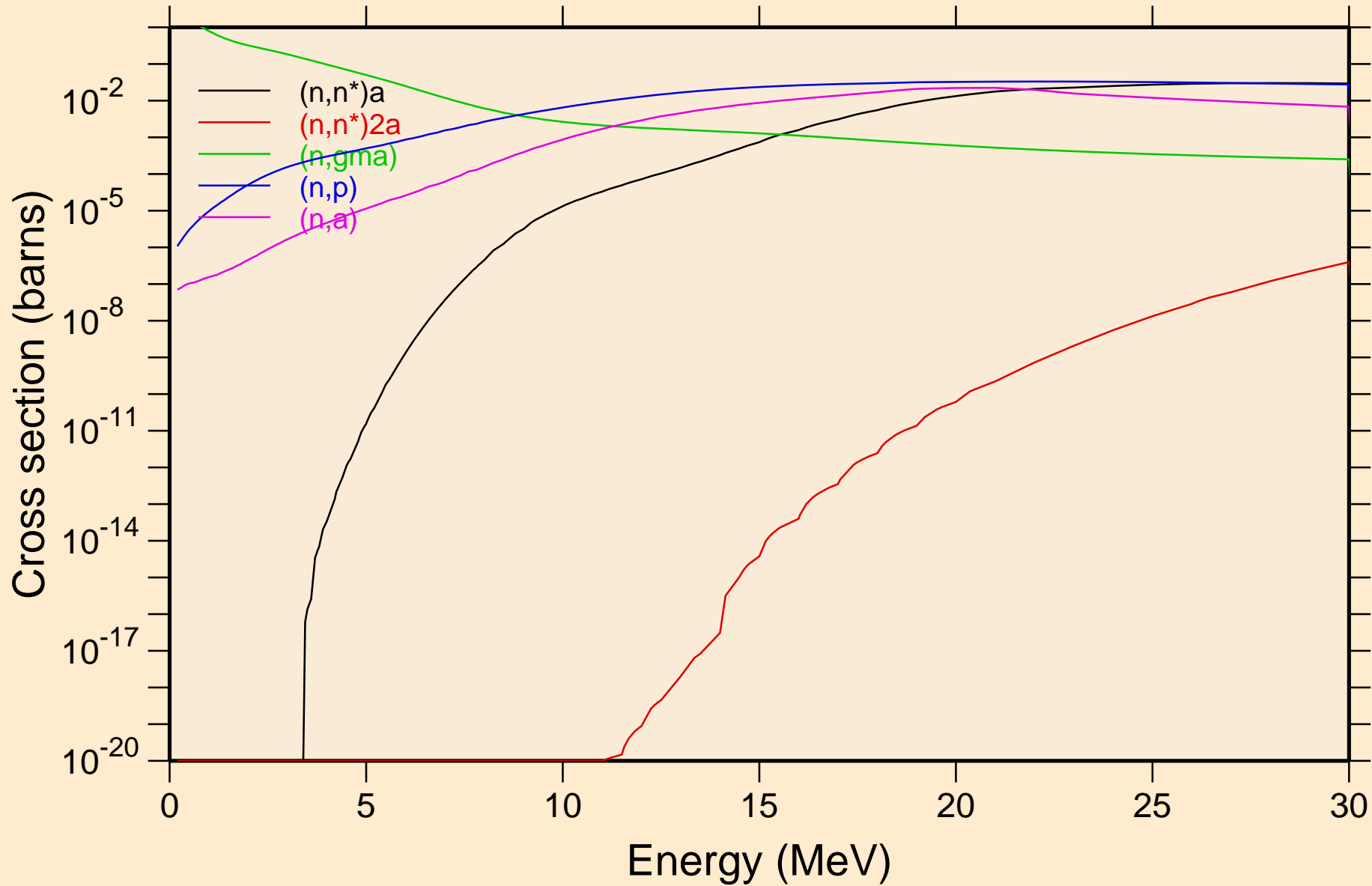

HO159 NEUTRON ACER TENDL-2023 LIBRARY; T=0.K  
Non-threshold reactions

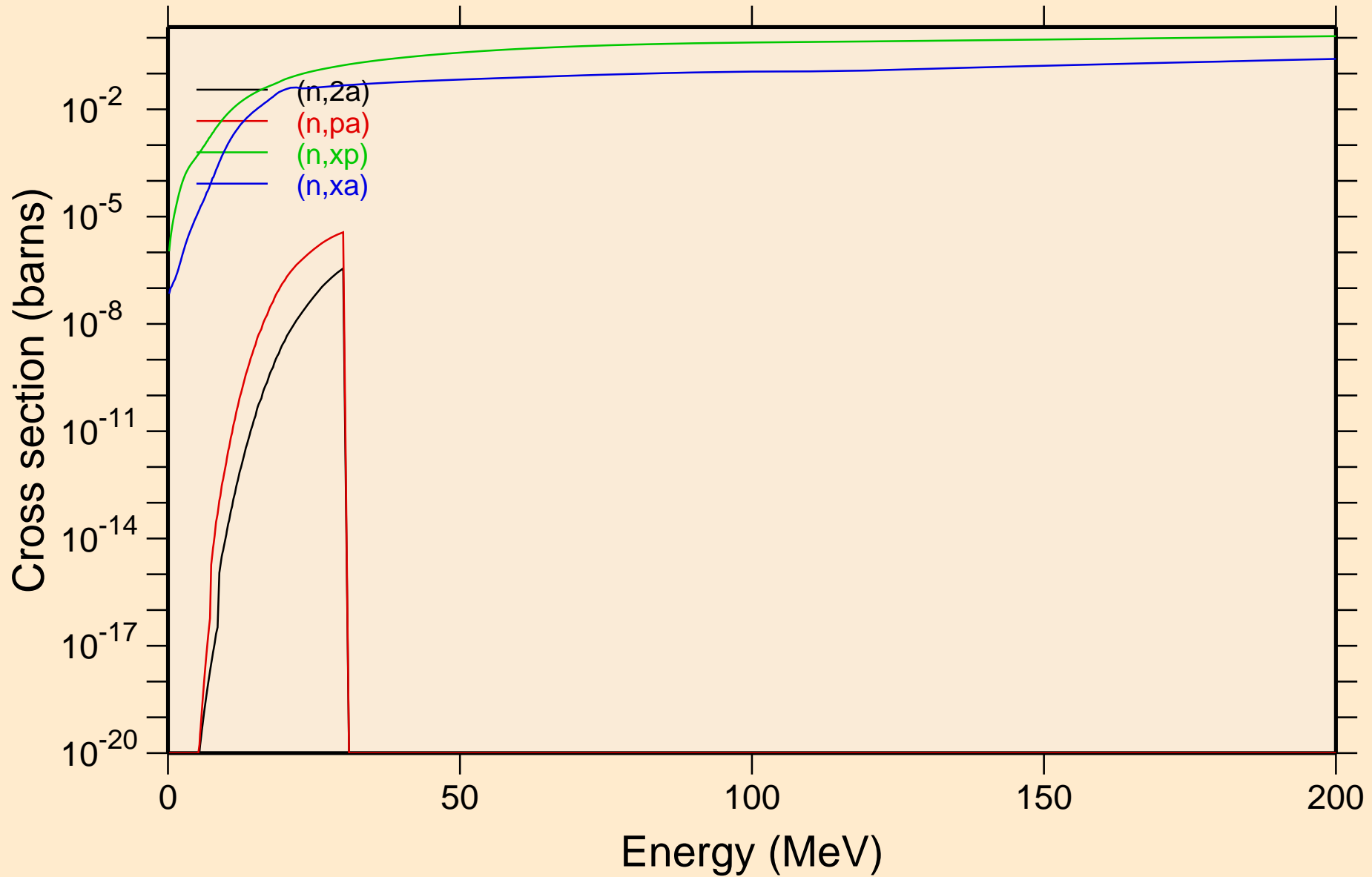

HO159 NEUTRON ACER TENDL-2023 LIBRARY; T=0.K  
Inelastic levels

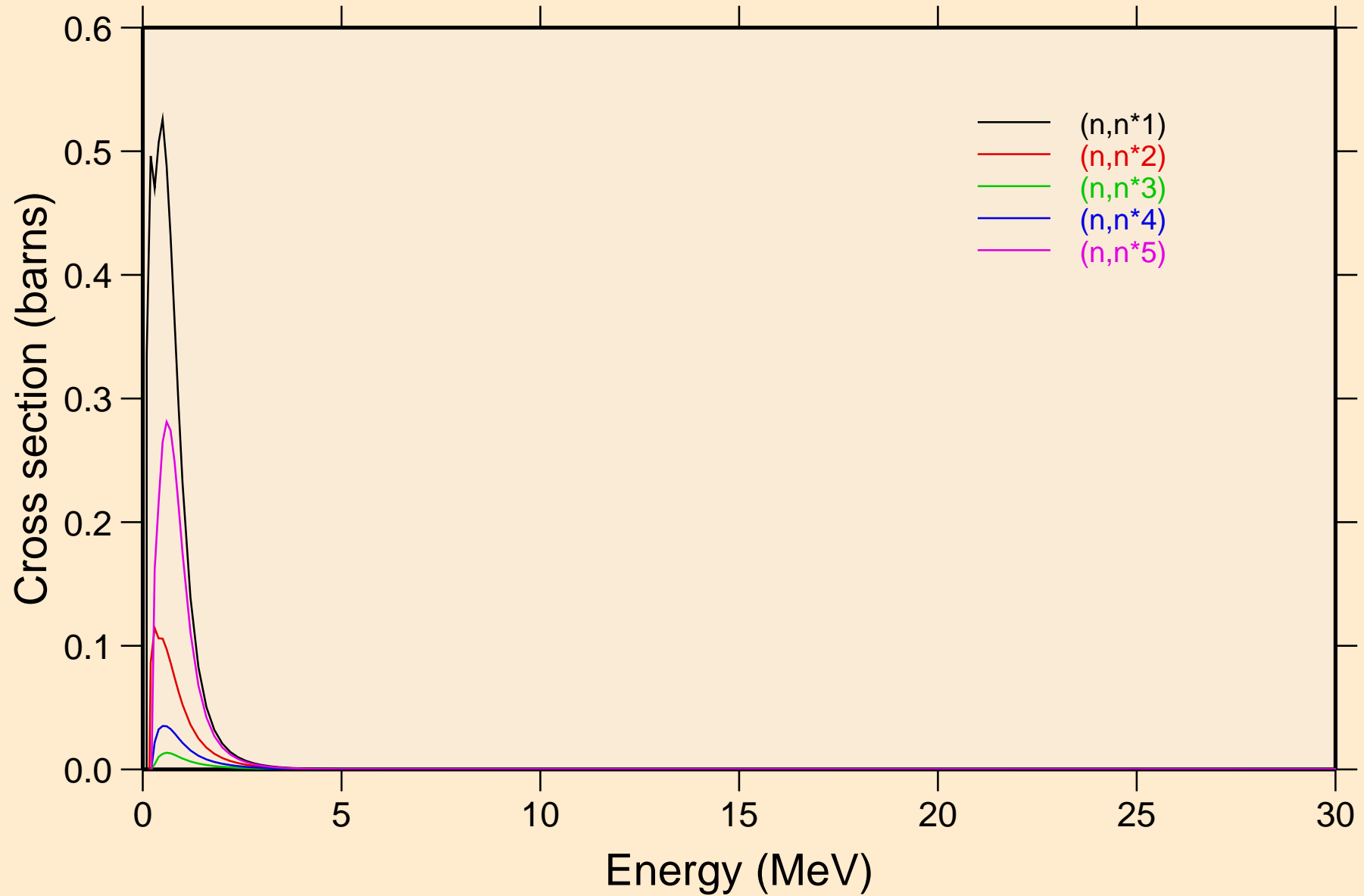

HO159 NEUTRON ACER TENDL-2023 LIBRARY; T=0.K  
Inelastic levels

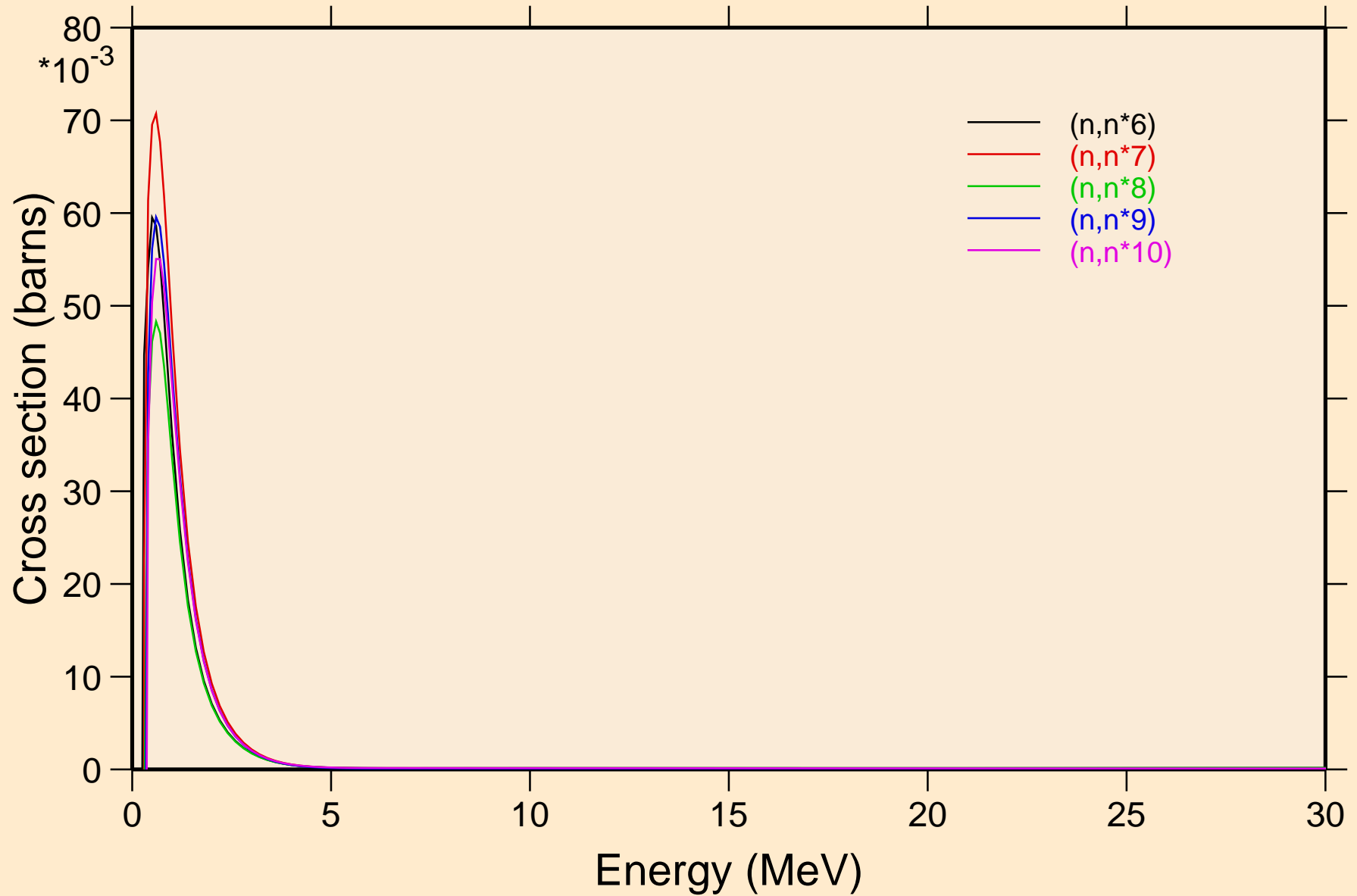

# HO159 NEUTRON ACER TENDL-2023 LIBRARY; T=0.K

## Inelastic levels

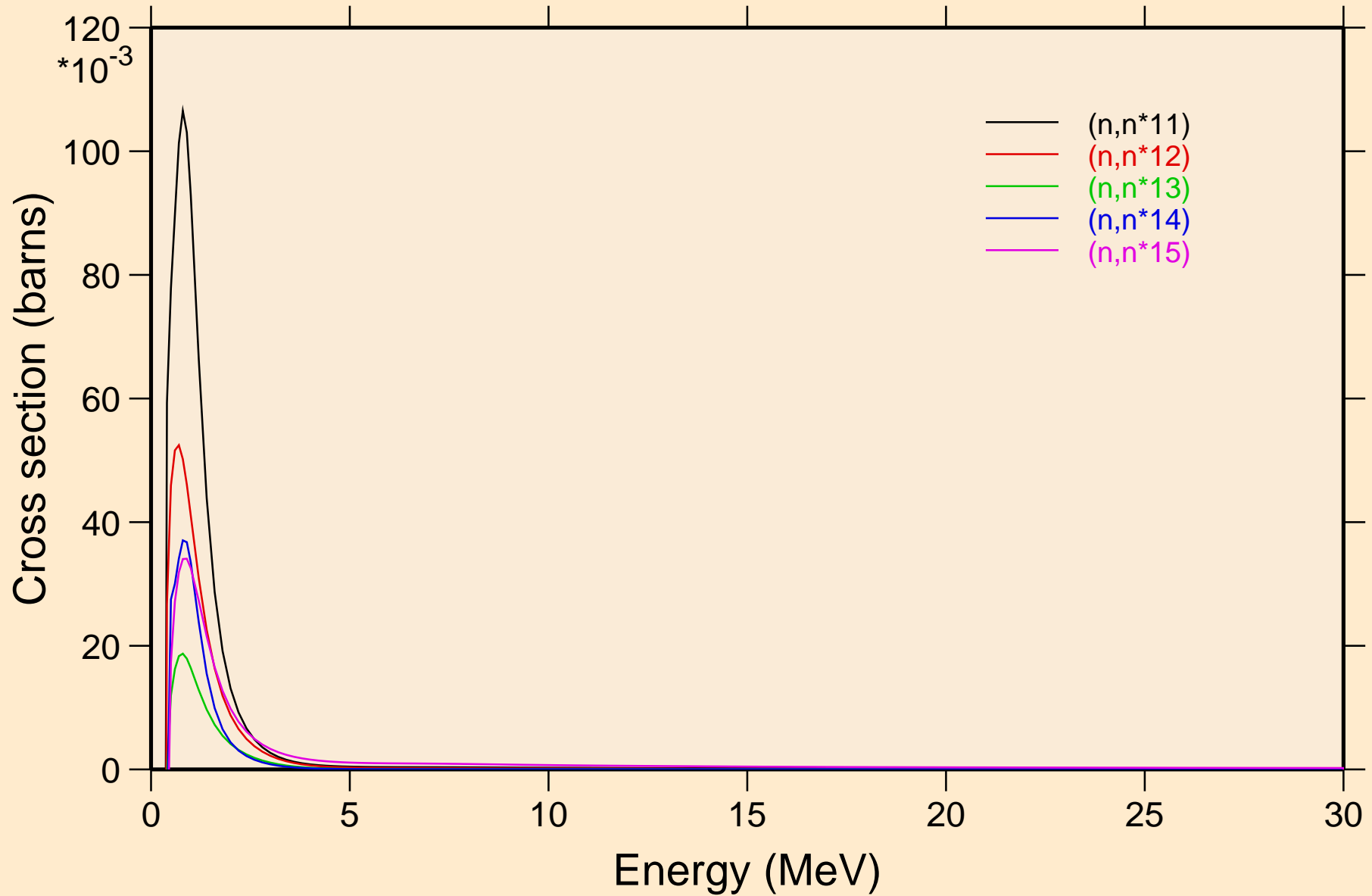

HO159 NEUTRON ACER TENDL-2023 LIBRARY; T=0.K  
Inelastic levels

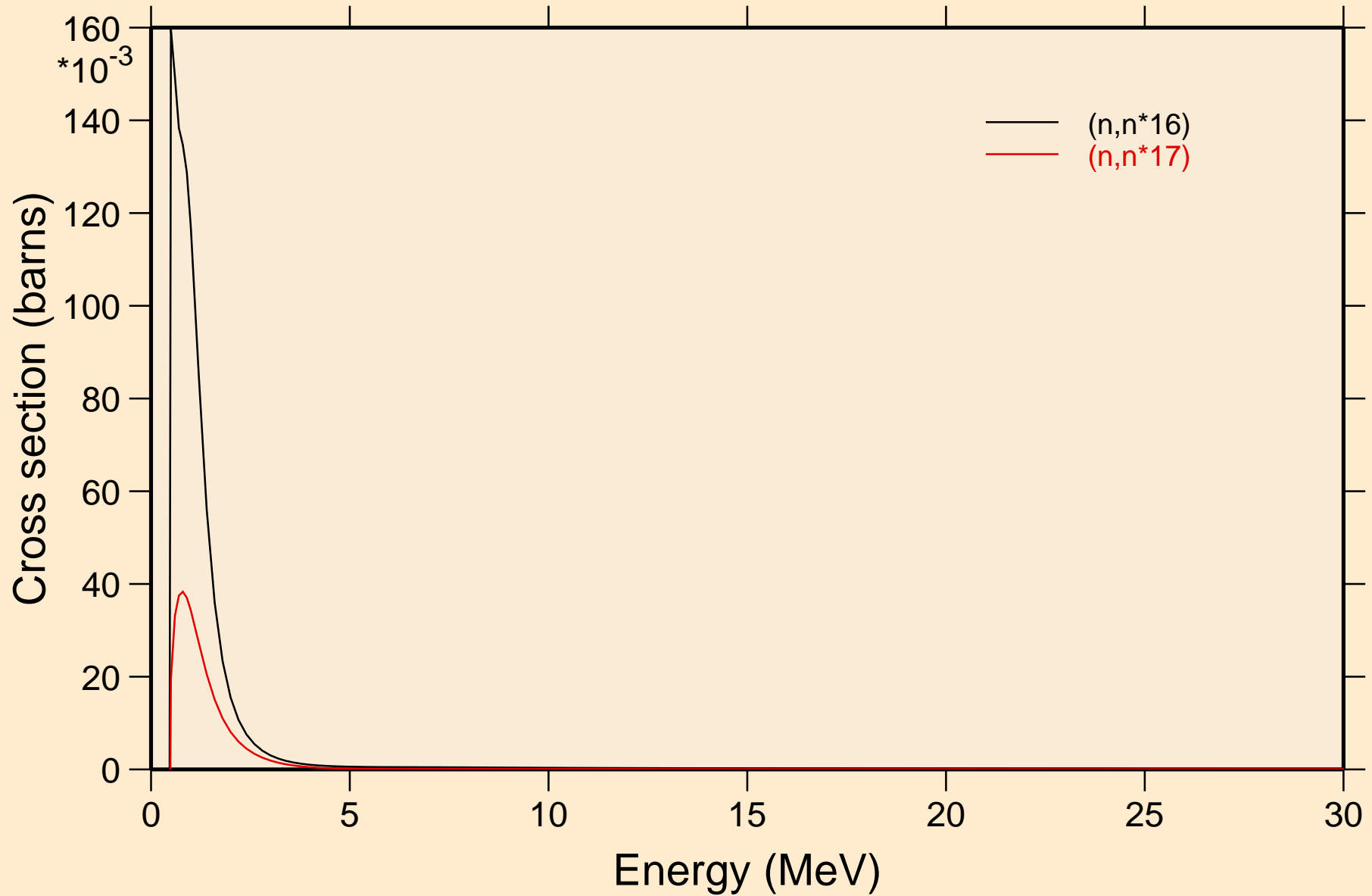

# HO159 NEUTRON ACER TENDL-2023 LIBRARY; T=0.K

## Threshold reactions

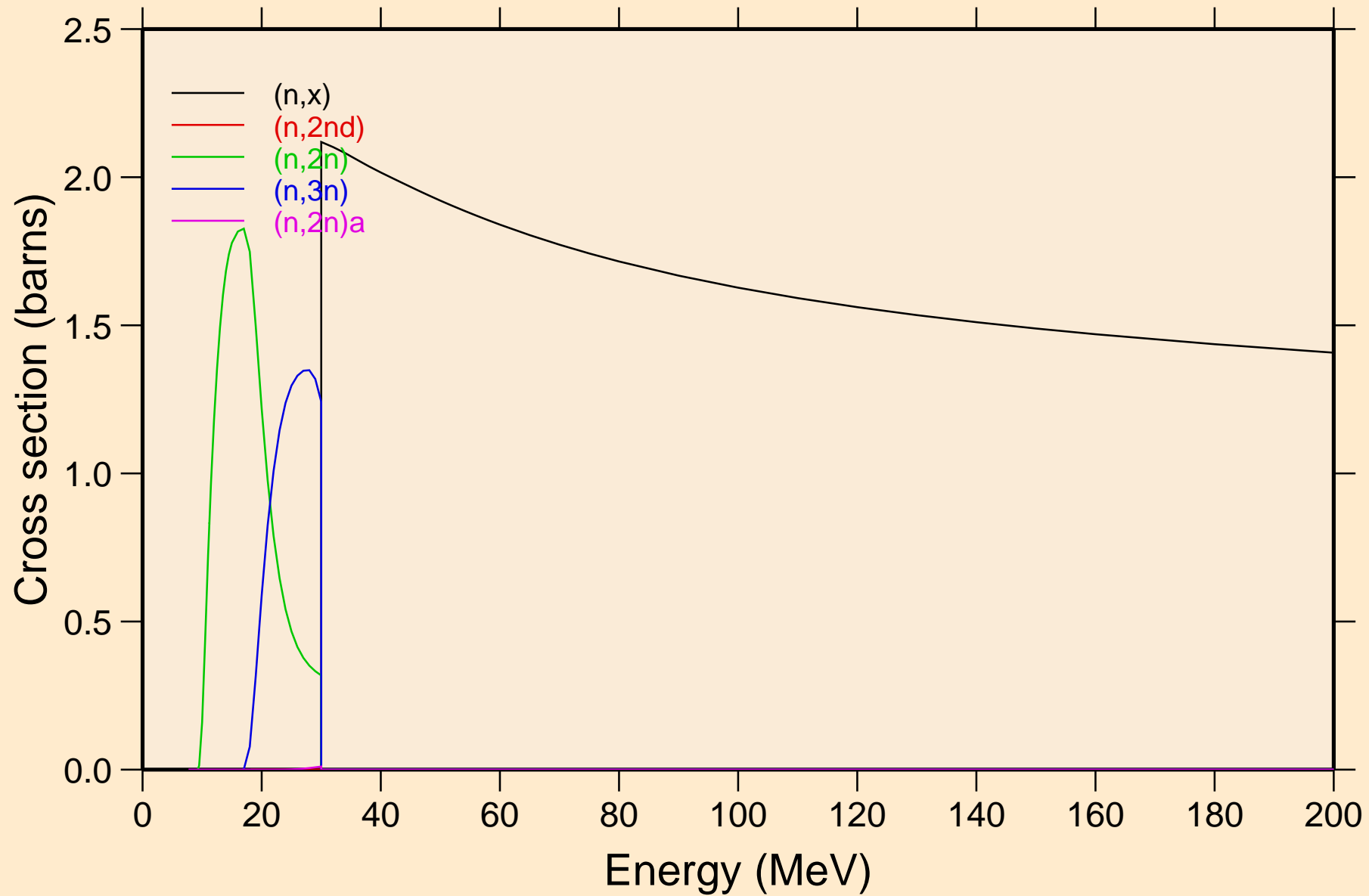

# HO159 NEUTRON ACER TENDL-2023 LIBRARY; T=0.K

## Threshold reactions

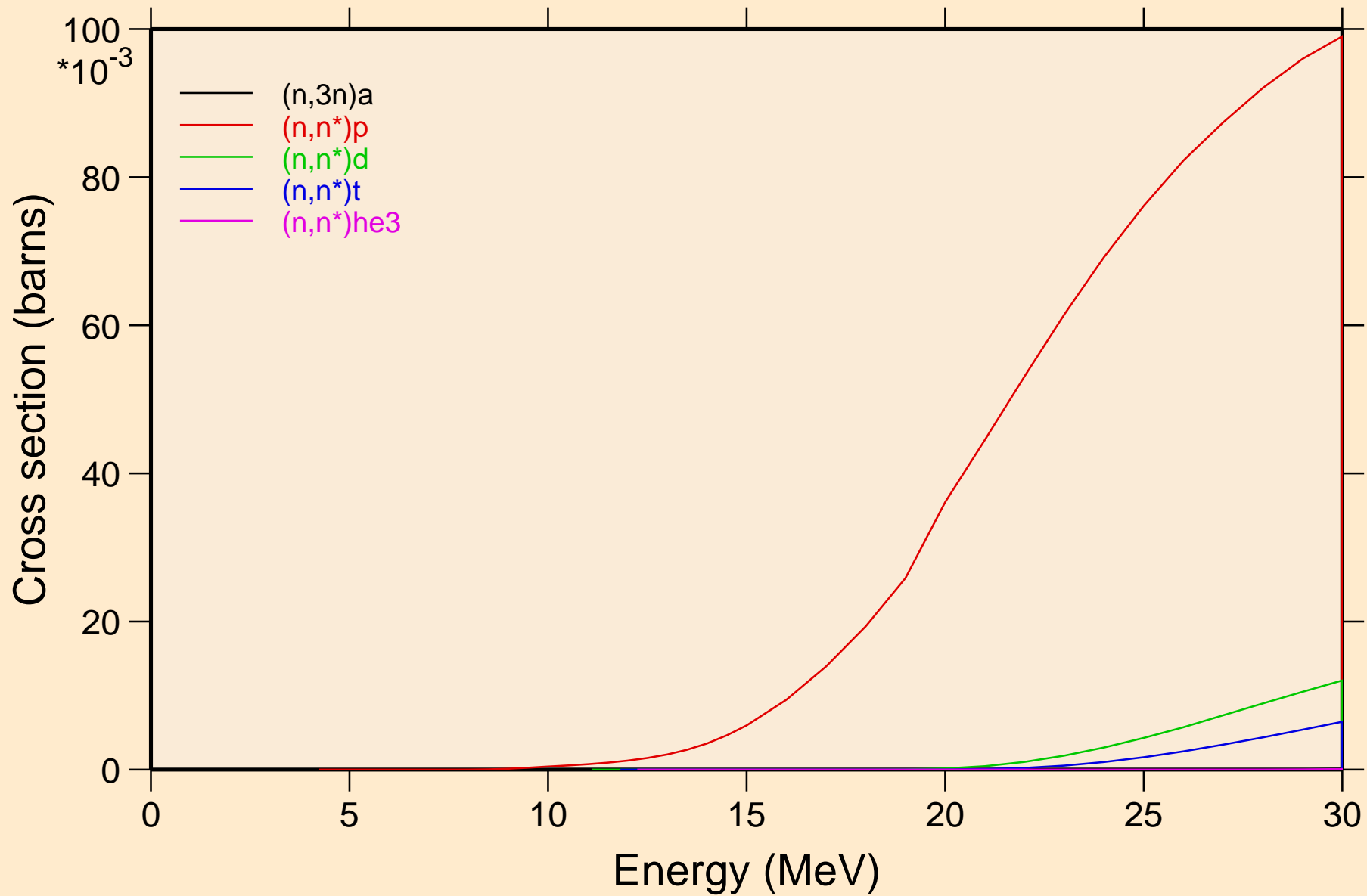

HO159 NEUTRON ACER TENDL-2023 LIBRARY; T=0.K  
Threshold reactions

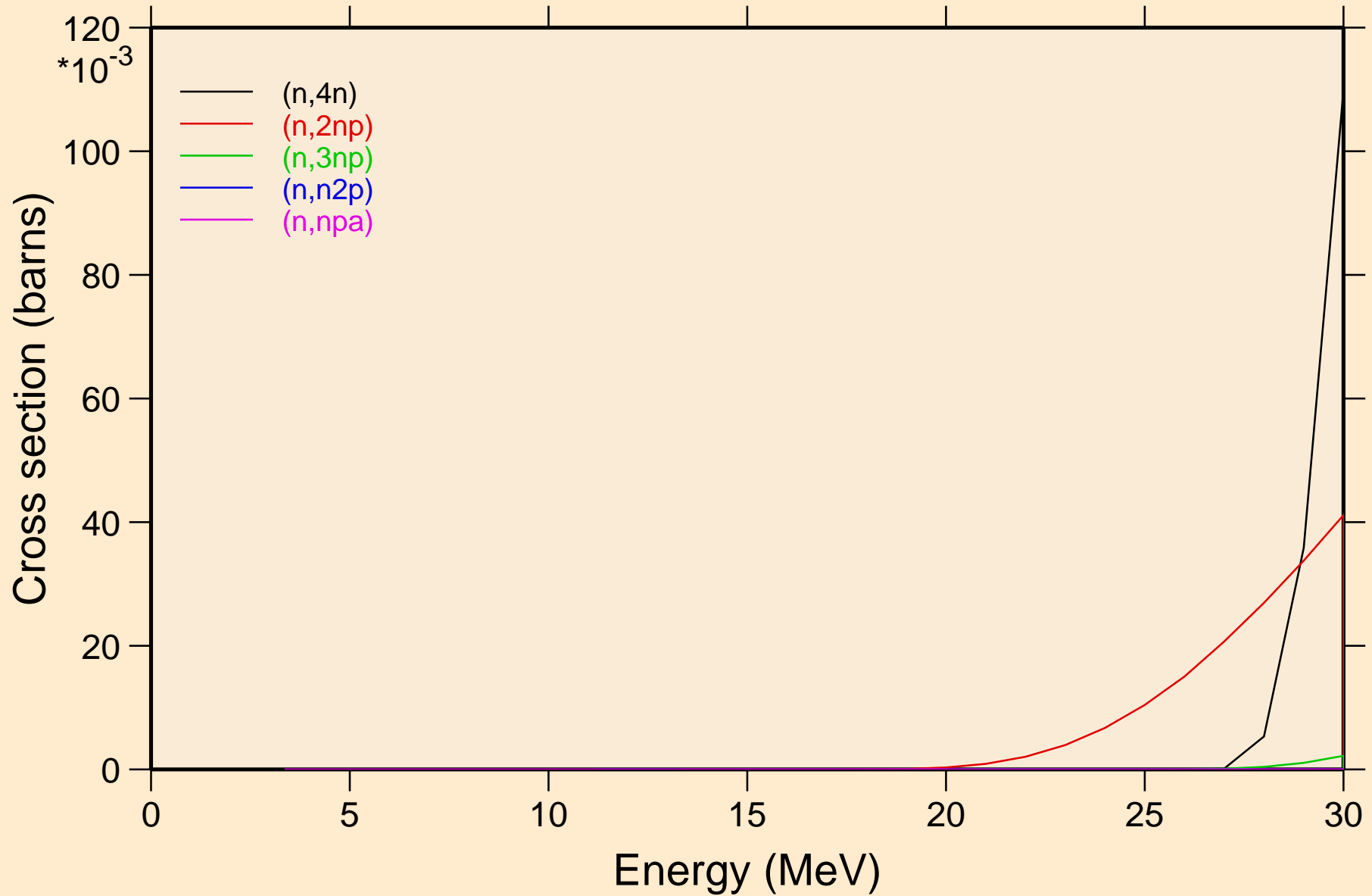

HO159 NEUTRON ACER TENDL-2023 LIBRARY; T=0.K  
Threshold reactions

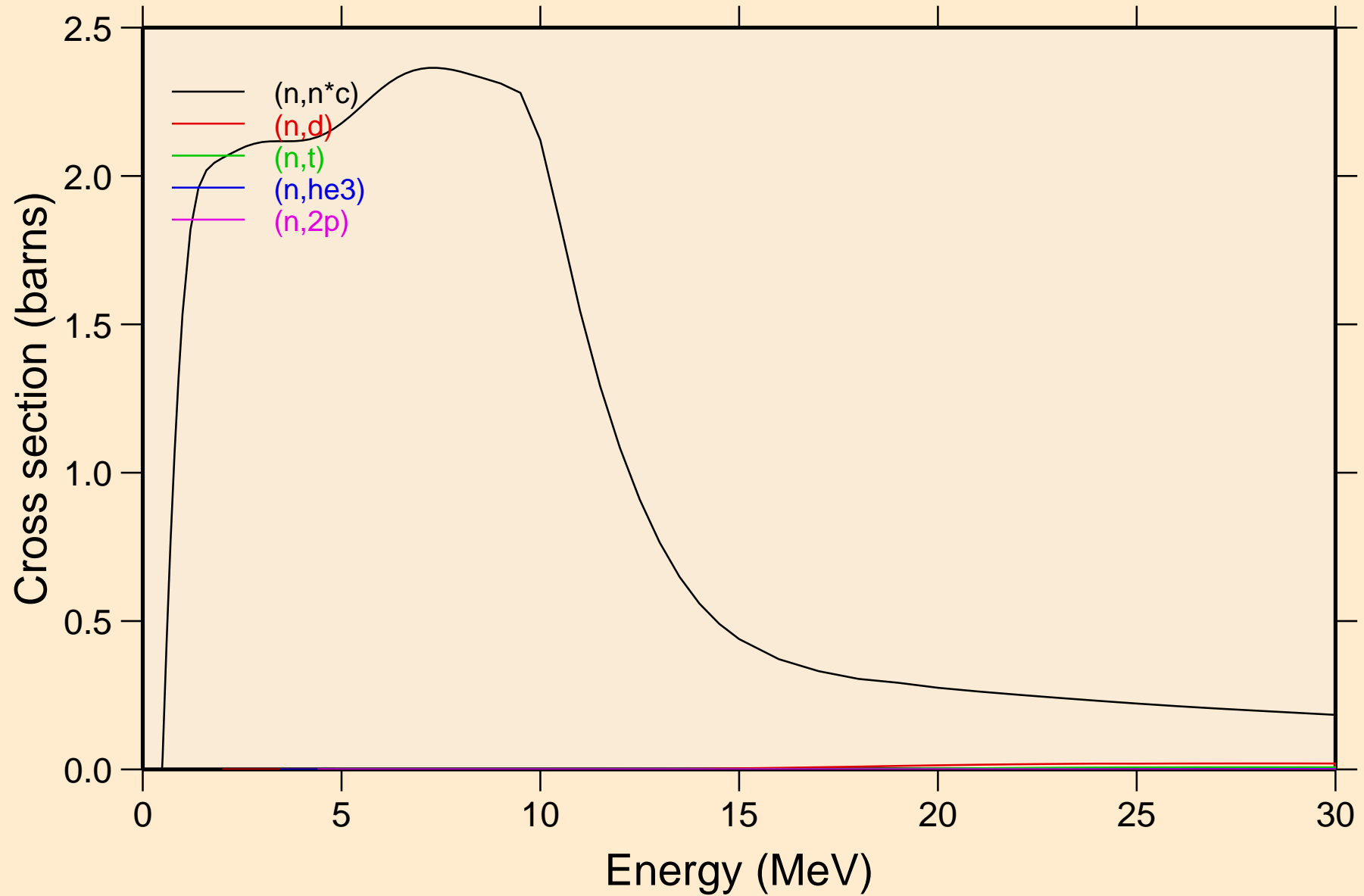

# HO159 NEUTRON ACER TENDL-2023 LIBRARY; T=0.K

## Threshold reactions

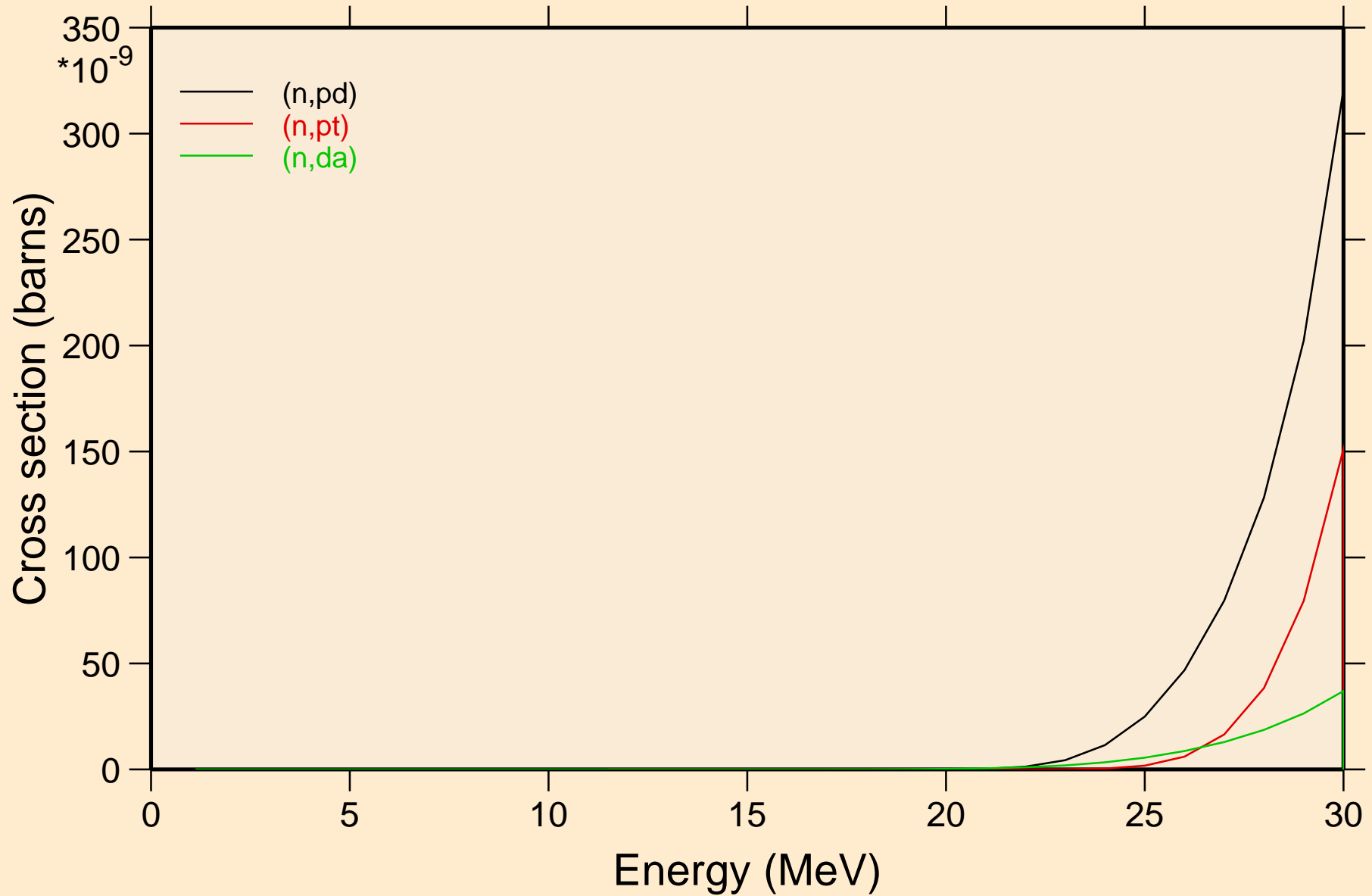

HO159 NEUTRON ACER TENDL-2023 LIBRARY; T=0.K  
Threshold reactions

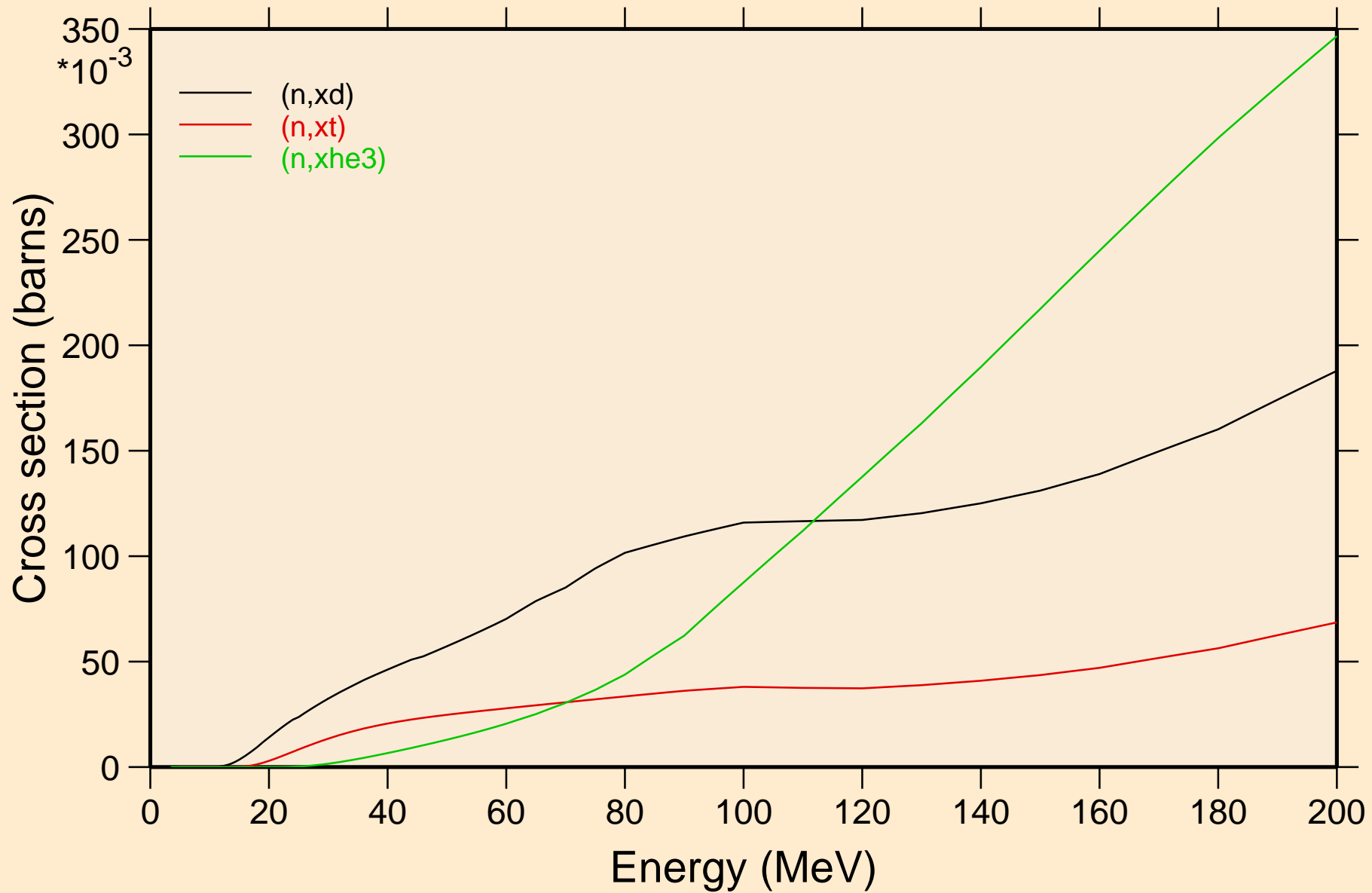

HO159 NEUTRON ACER TENDL-2023 LIBRARY; T=0.K  
angular distribution for elastic

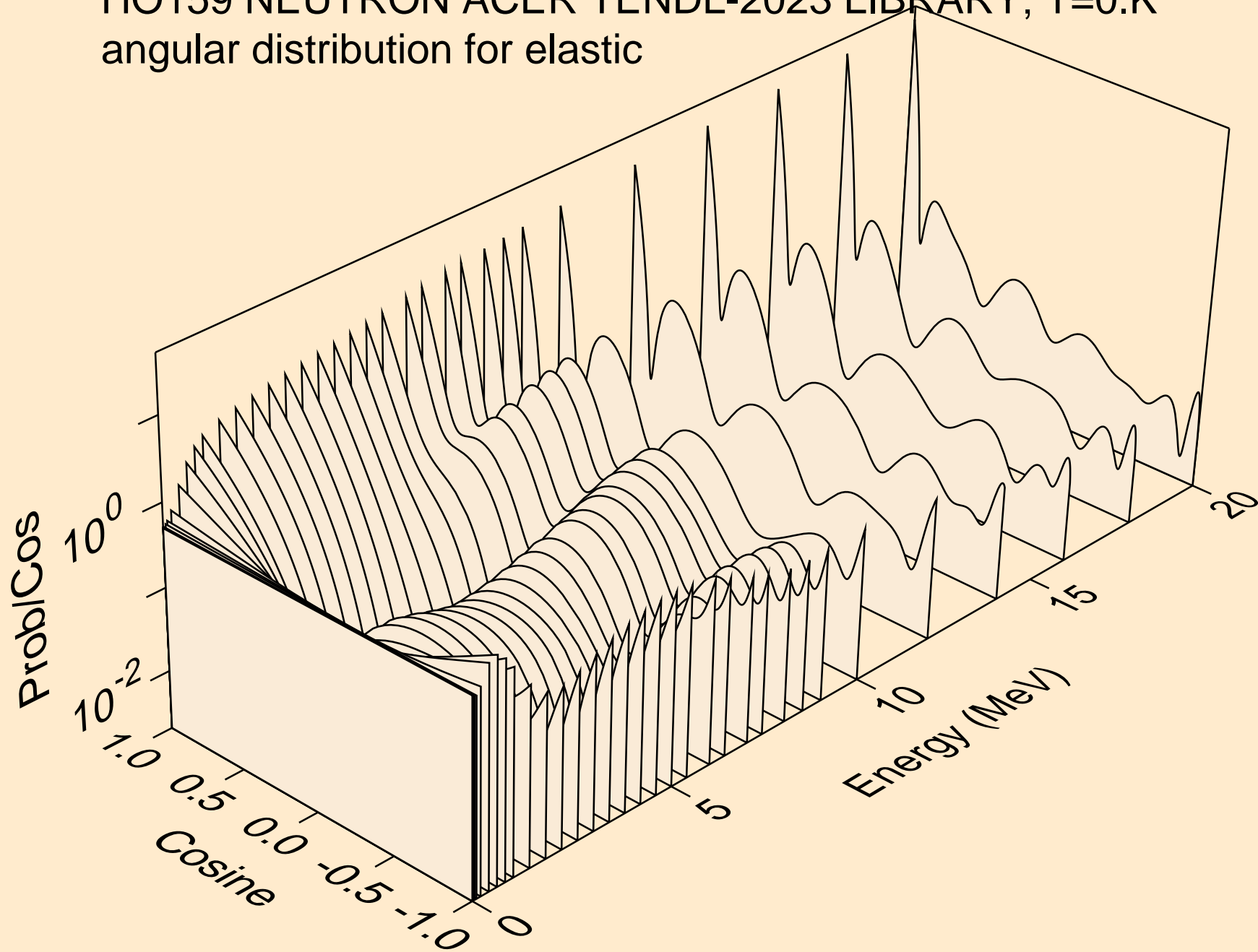

HO159 NEUTRON ACER TENDL-2023 LIBRARY; T=0.K  
angular distribution for elastic

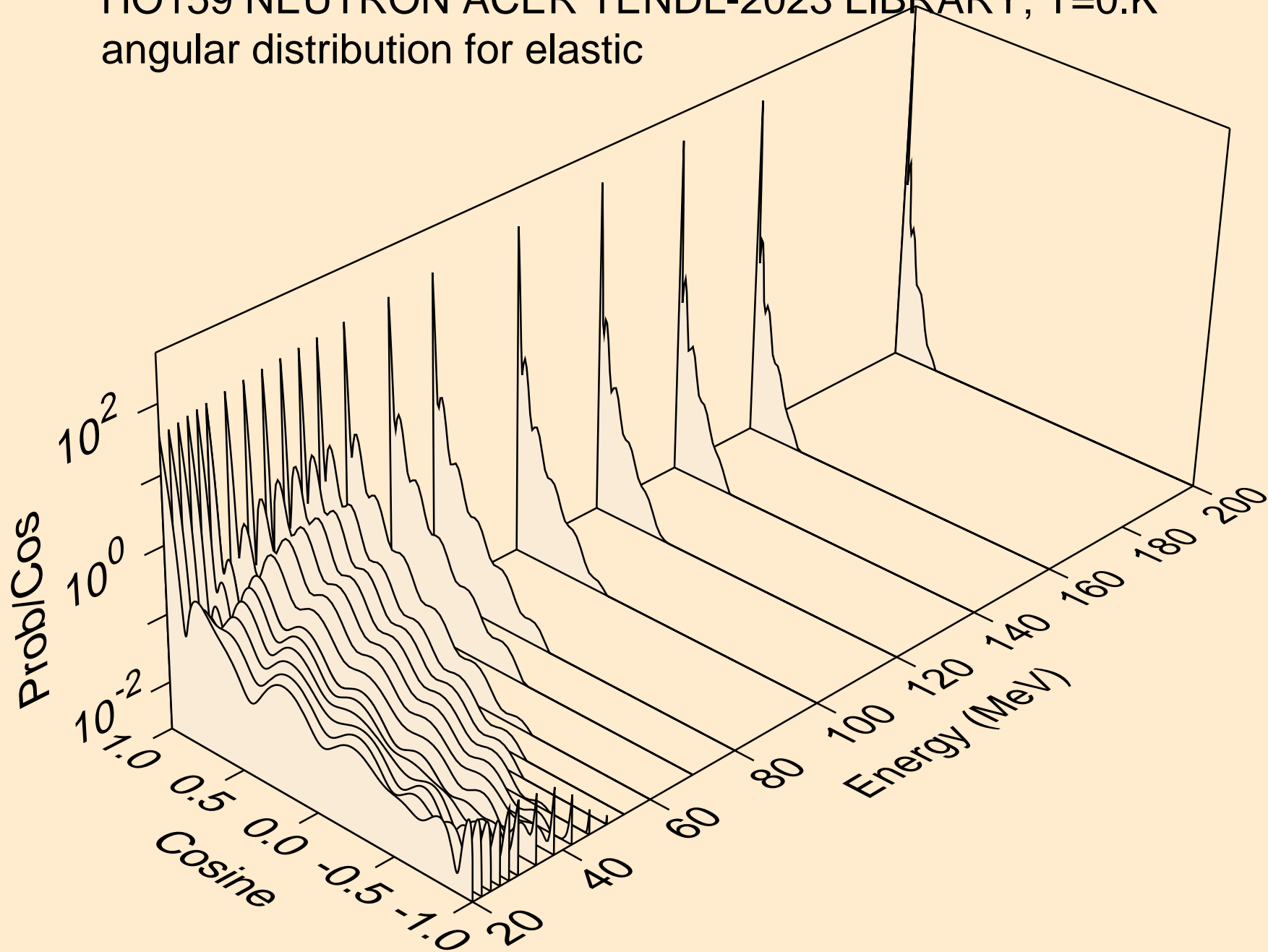

HO159 NEUTRON ACER TENDL-2023 LIBRARY; T=0.K  
angular distribution for (n,n\*1)

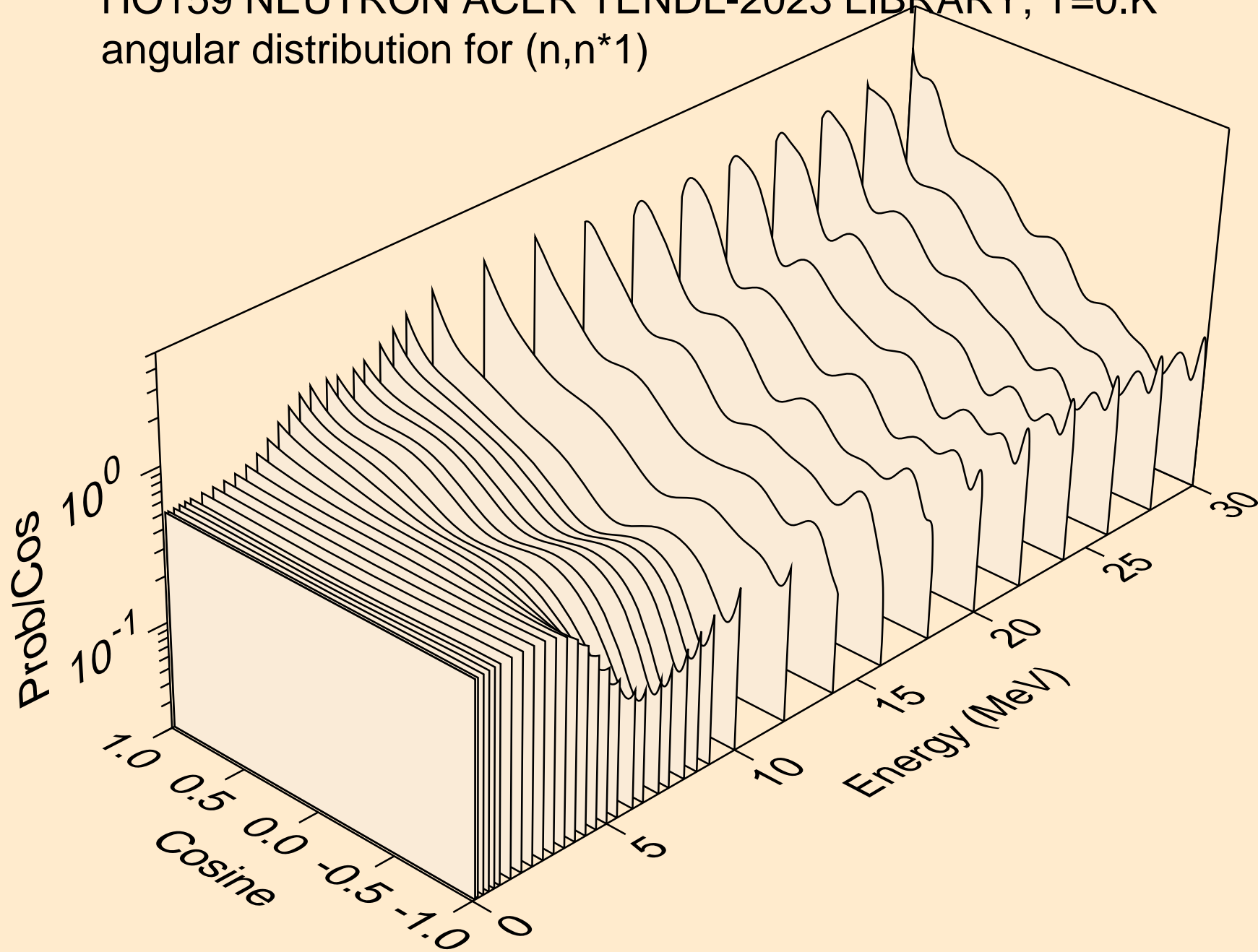

HO159 NEUTRON ACER TENDL-2023 LIBRARY; T=0.K  
angular distribution for (n,n\*2)

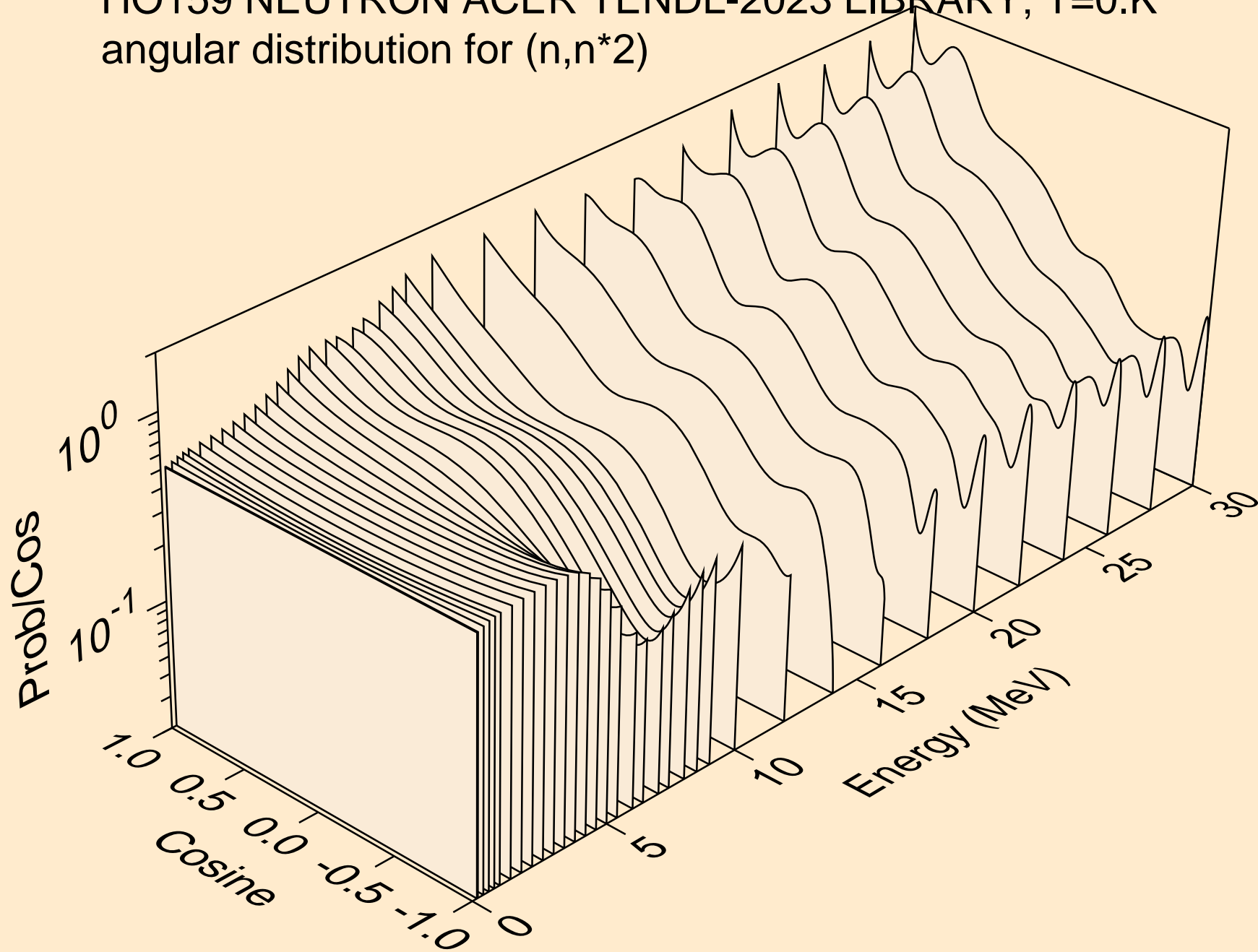

HO159 NEUTRON ACER TENDL-2023 LIBRARY; T=0.K  
angular distribution for (n,n\*3)

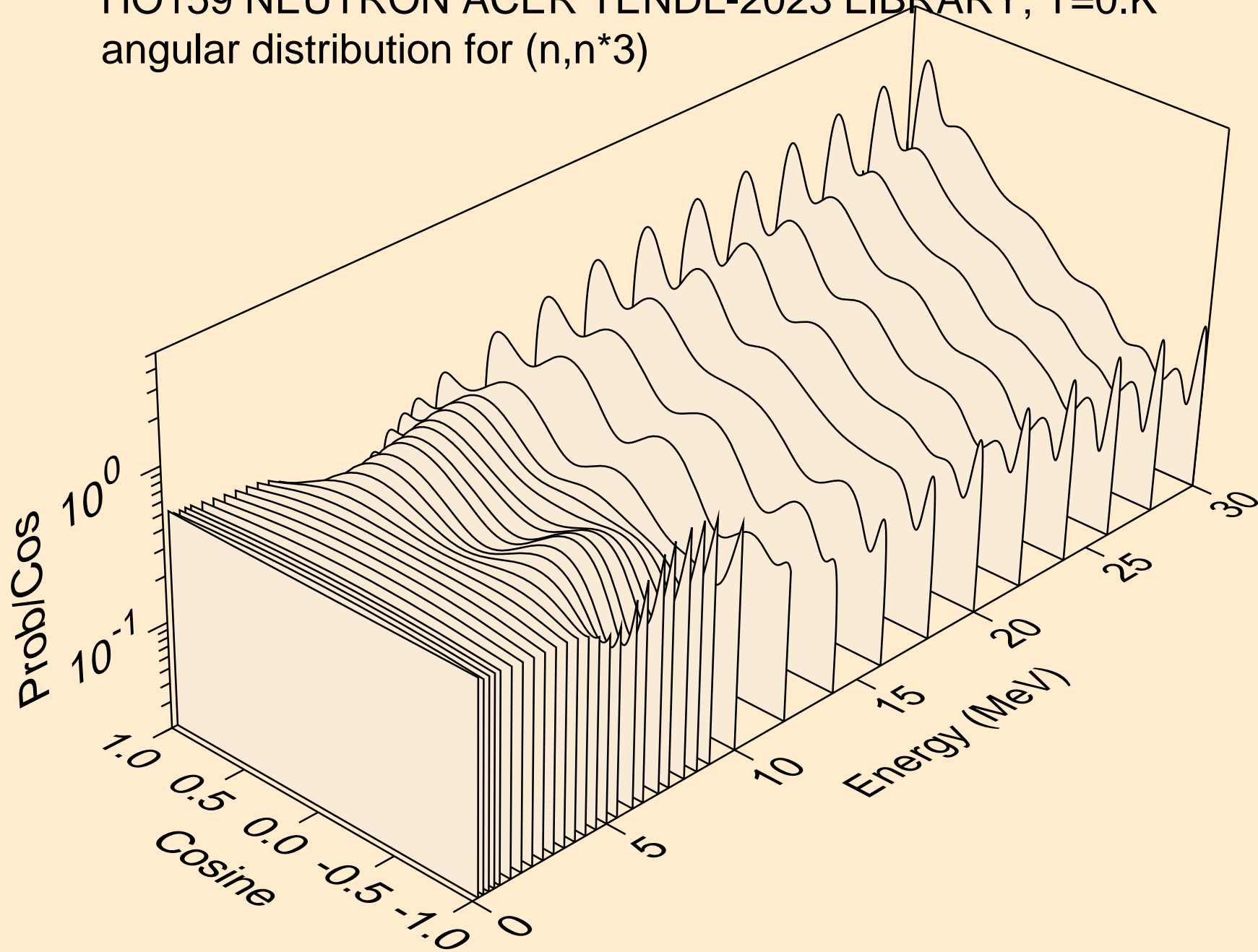

HO159 NEUTRON ACER TENDL-2023 LIBRARY; T=0.K  
angular distribution for (n,n\*4)

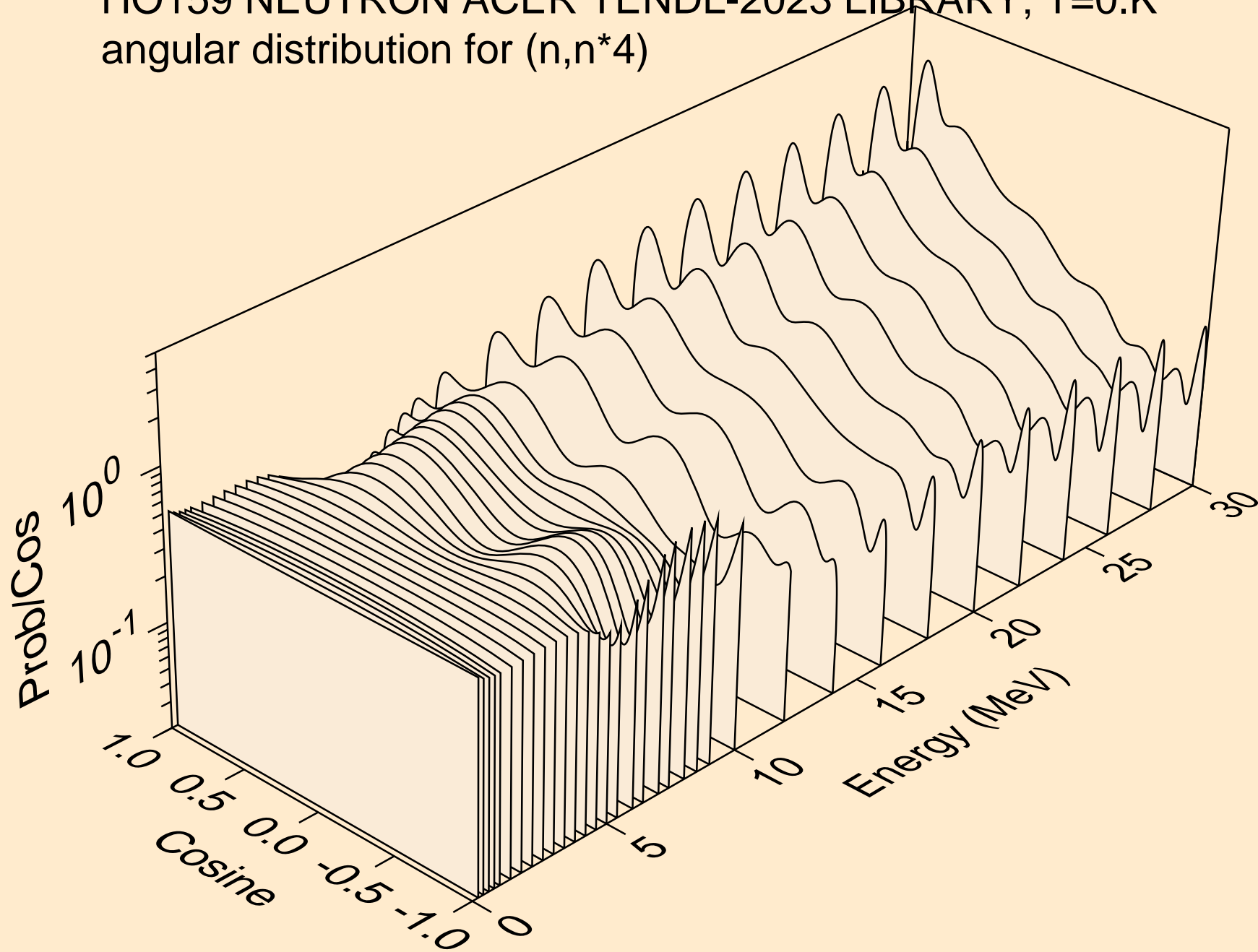

HO159 NEUTRON ACER TENDL-2023 LIBRARY; T=0.K  
angular distribution for (n,n\*5)

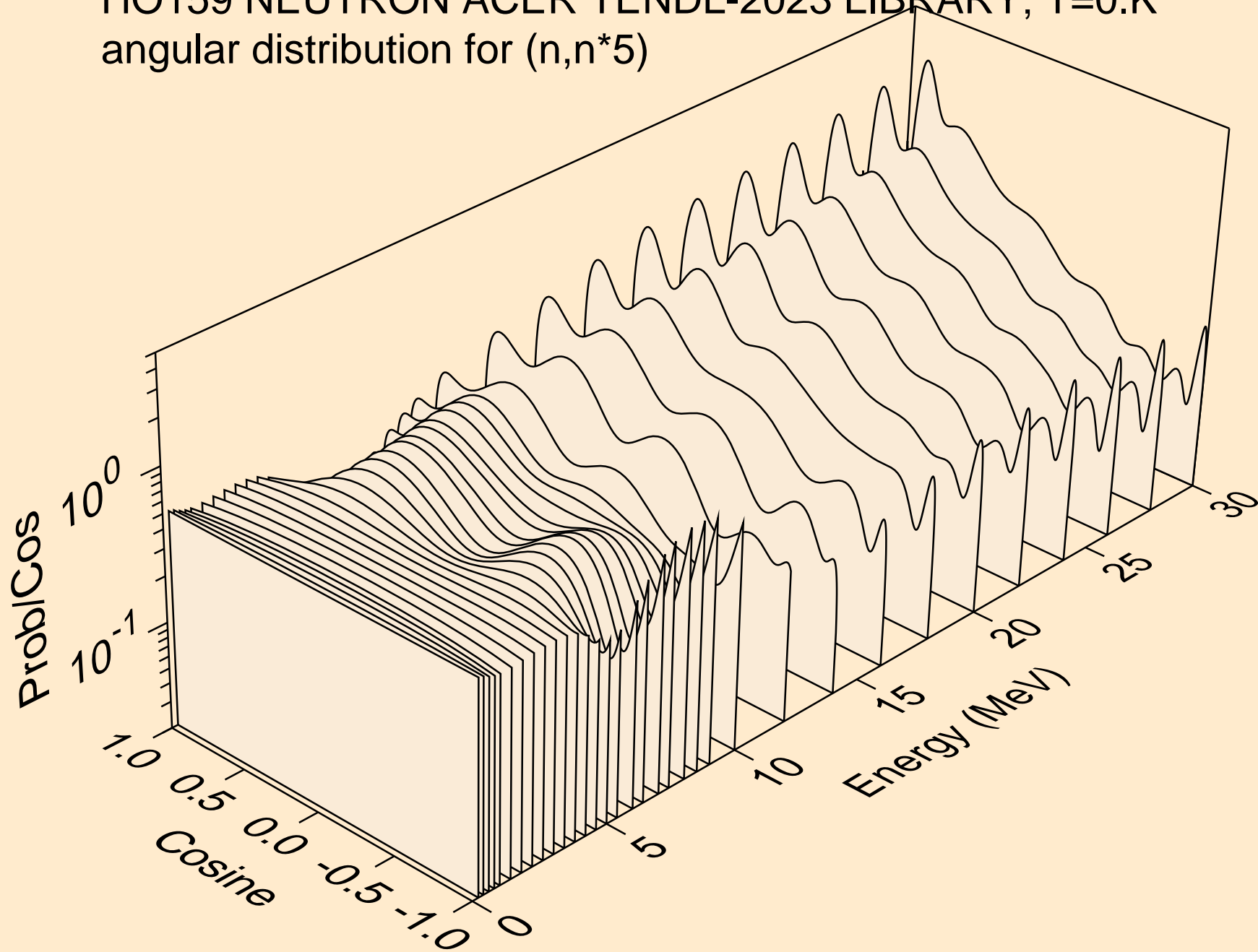

HO159 NEUTRON ACER TENDL-2023 LIBRARY; T=0.K  
angular distribution for (n,n\*6)

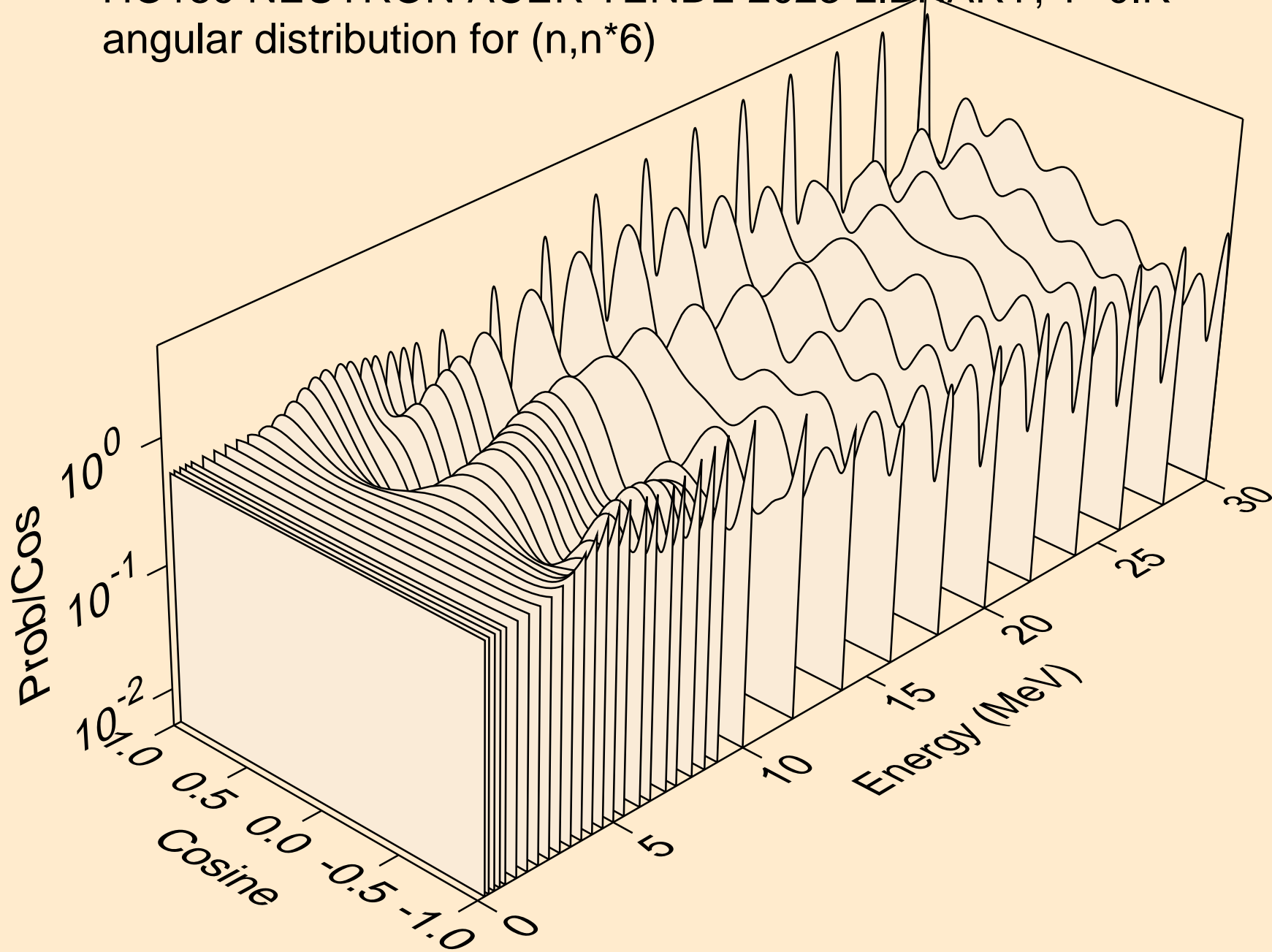

HO159 NEUTRON ACER TENDL-2023 LIBRARY; T=0.K  
angular distribution for (n,n\*7)

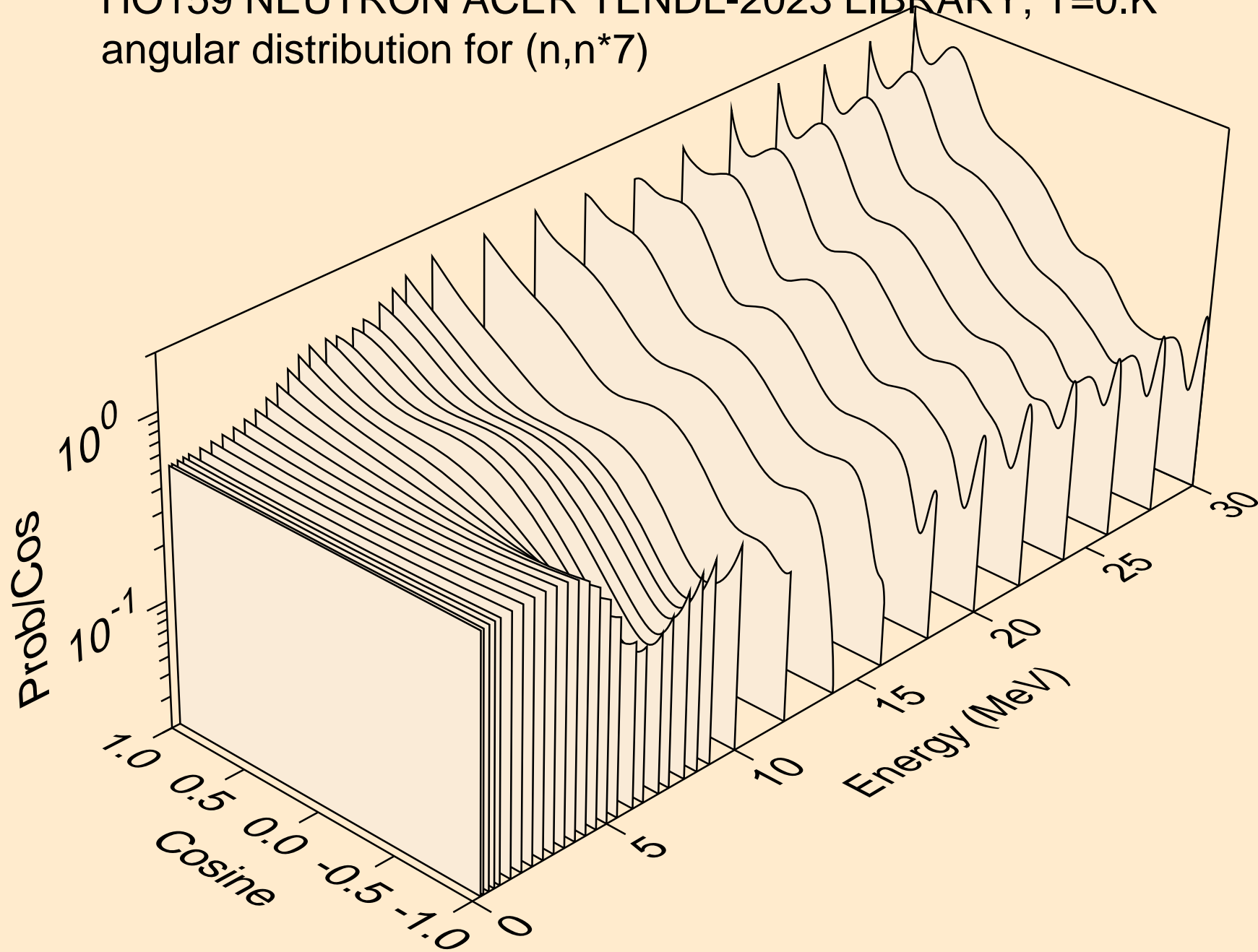

HO159 NEUTRON ACER TENDL-2023 LIBRARY; T=0.K  
angular distribution for (n,n\*8)

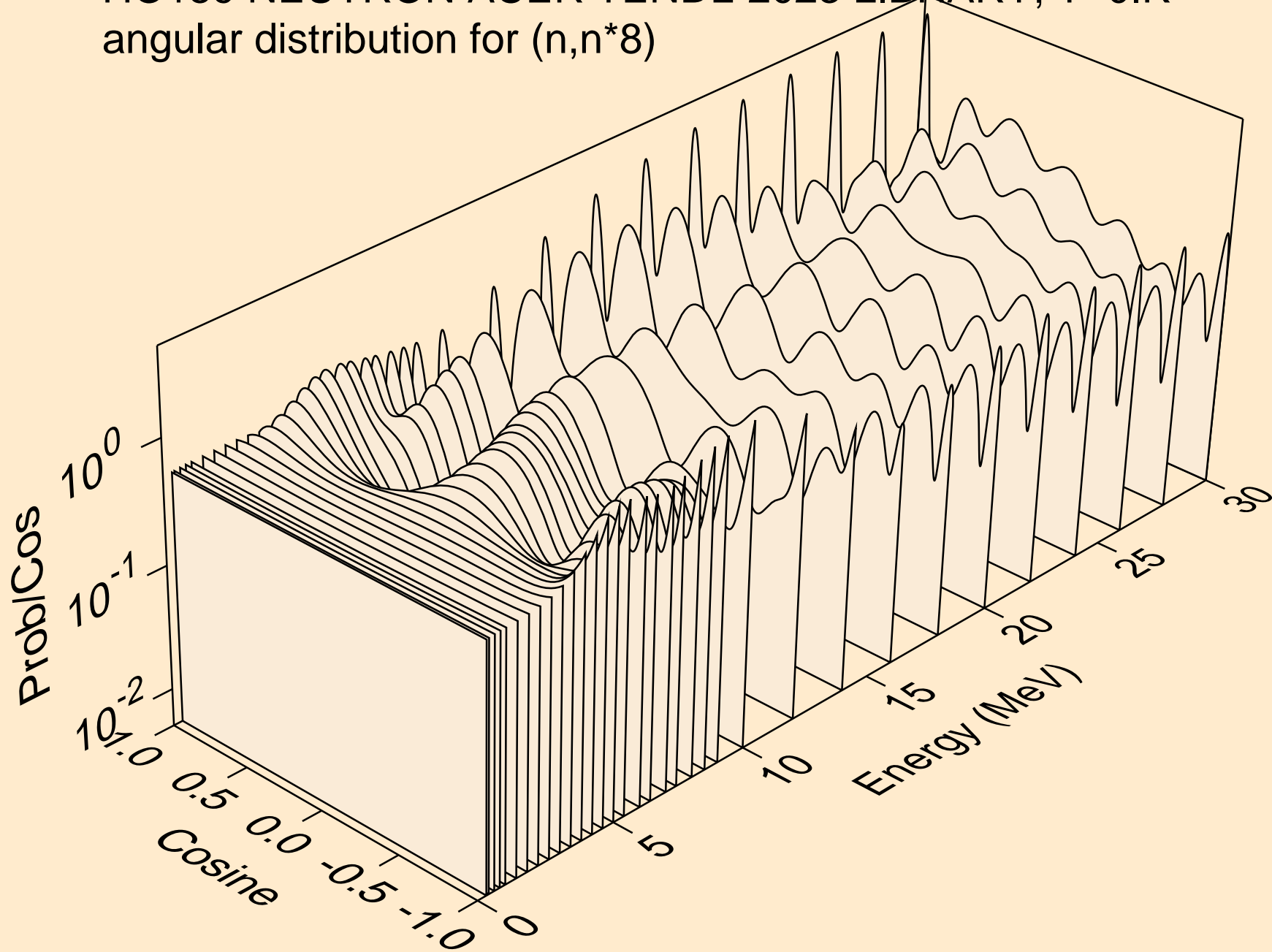

HO159 NEUTRON ACER TENDL-2023 LIBRARY; T=0.K  
angular distribution for (n,n\*9)

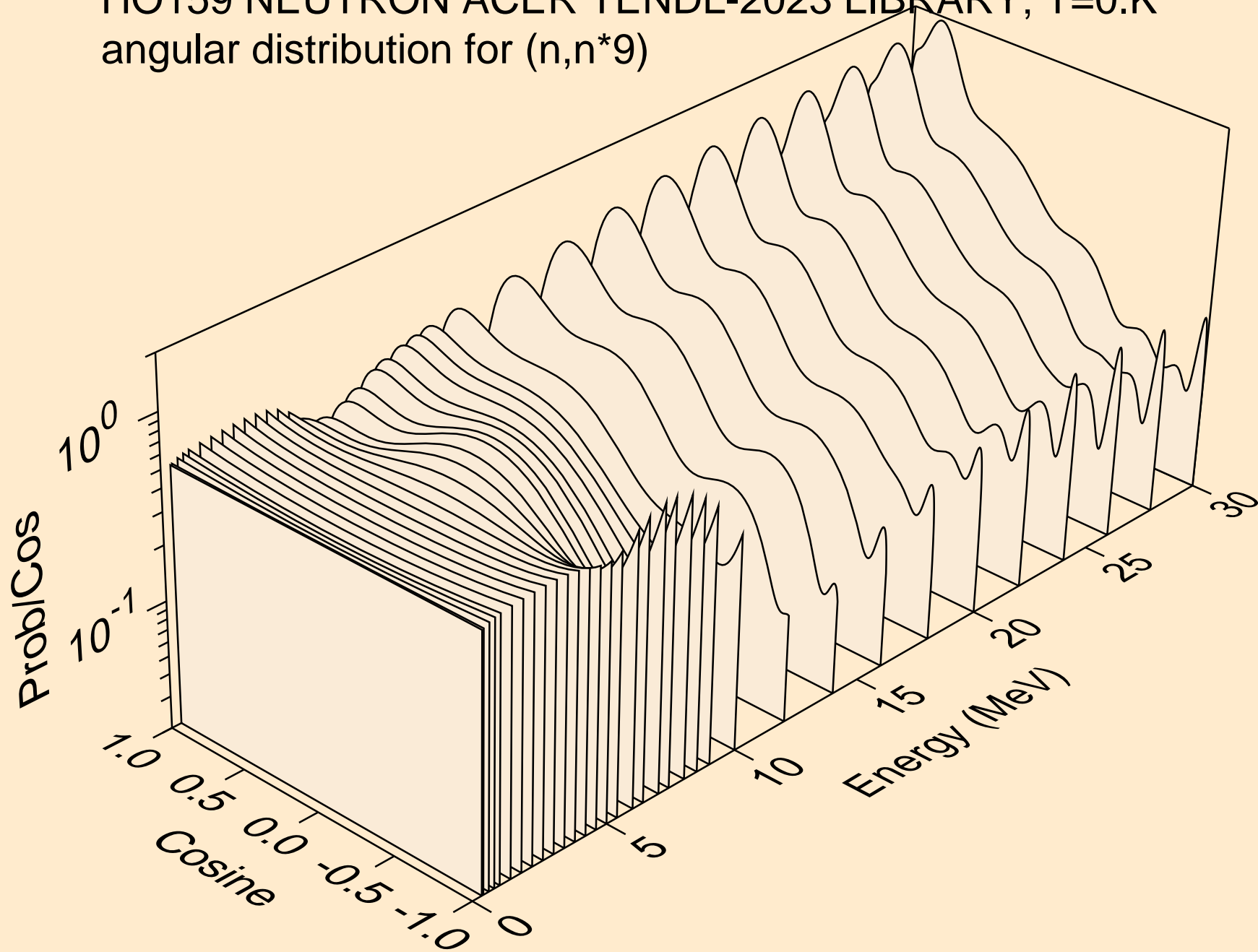

HO159 NEUTRON ACER TENDL-2023 LIBRARY; T=0.K  
angular distribution for (n,n\*10)

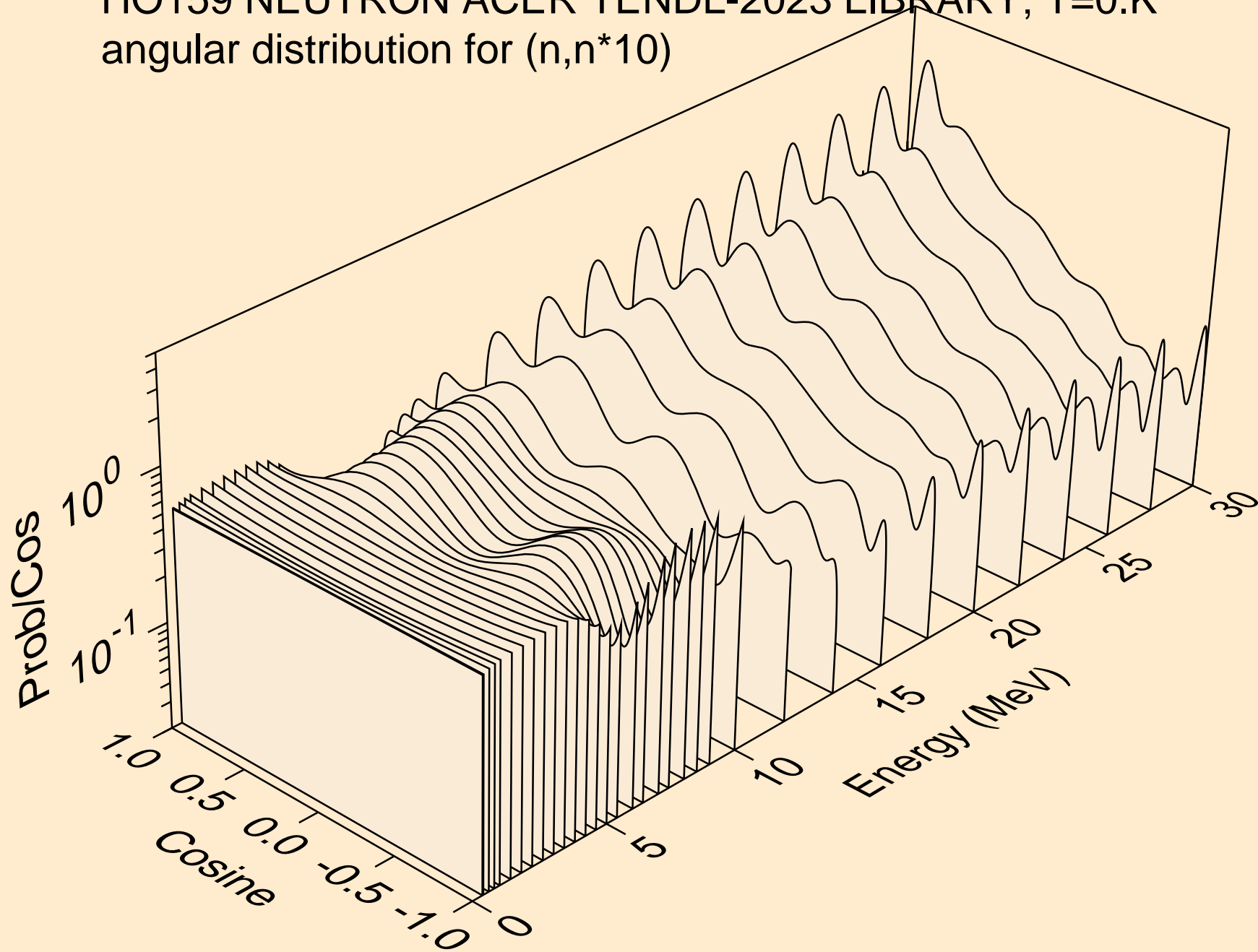

HO159 NEUTRON ACER TENDL-2023 LIBRARY; T=0.K  
angular distribution for (n,n\*11)

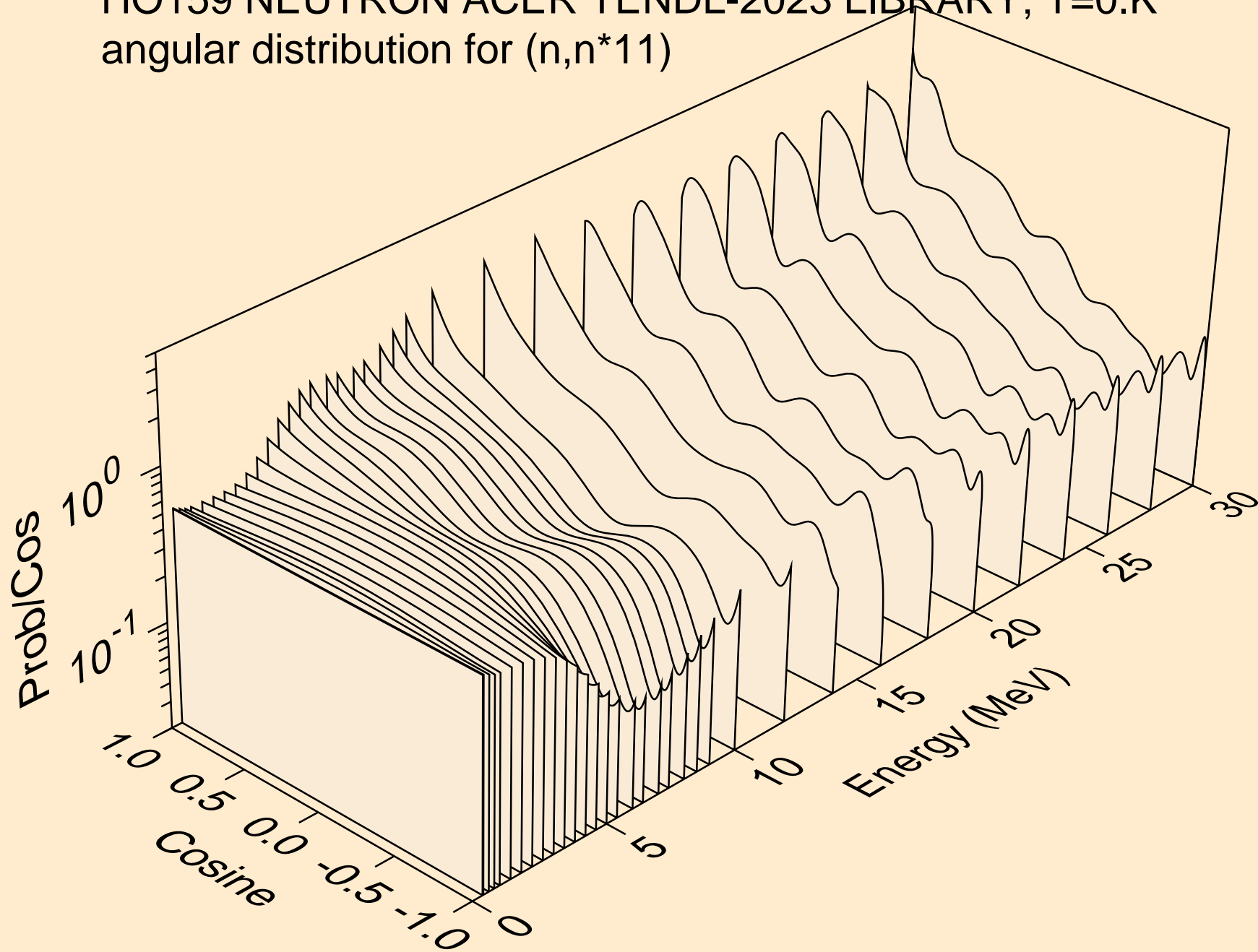

HO159 NEUTRON ACER TENDL-2023 LIBRARY; T=0.K  
angular distribution for (n,n\*12)

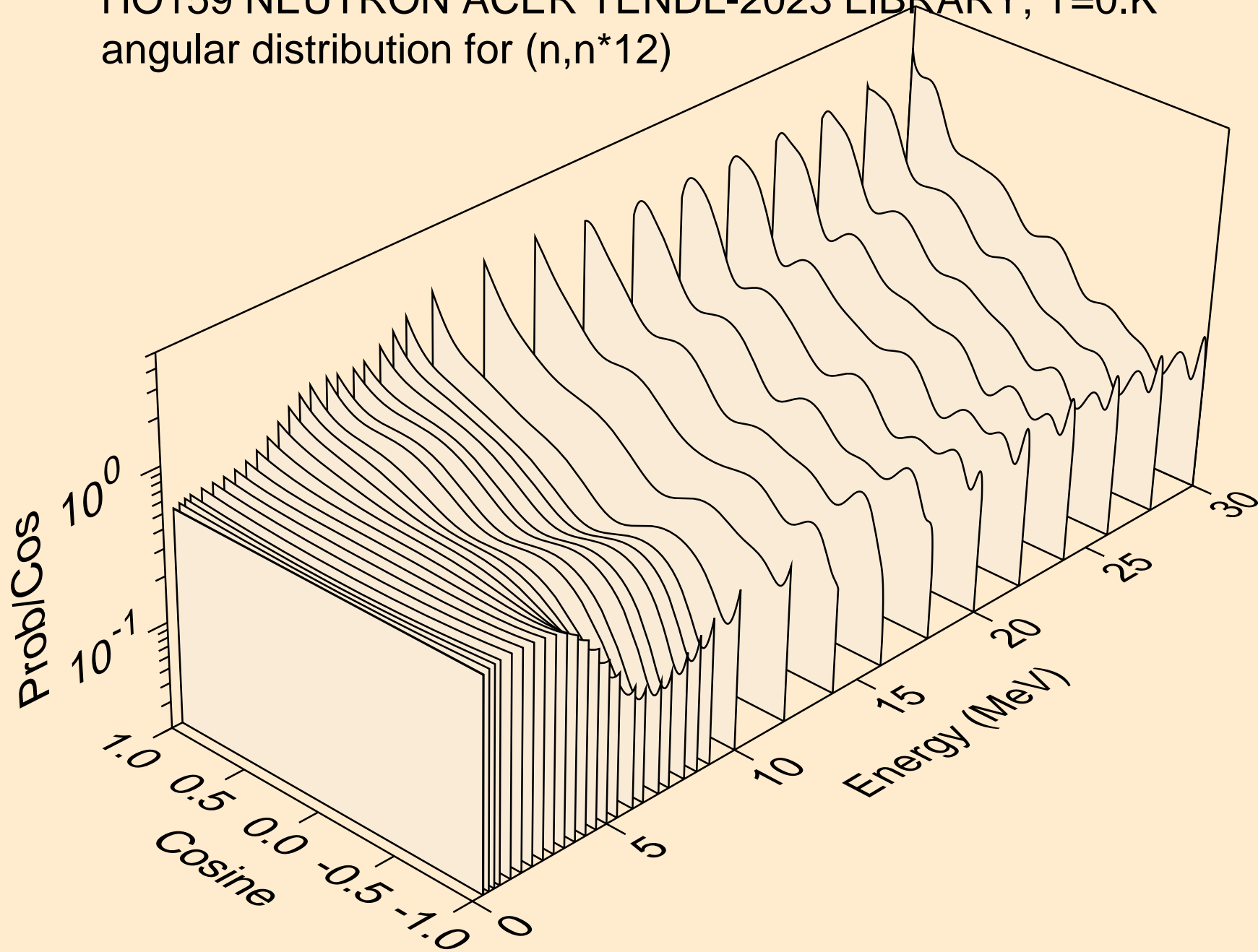

HO159 NEUTRON ACER TENDL-2023 LIBRARY; T=0.K  
angular distribution for (n,n\*13)

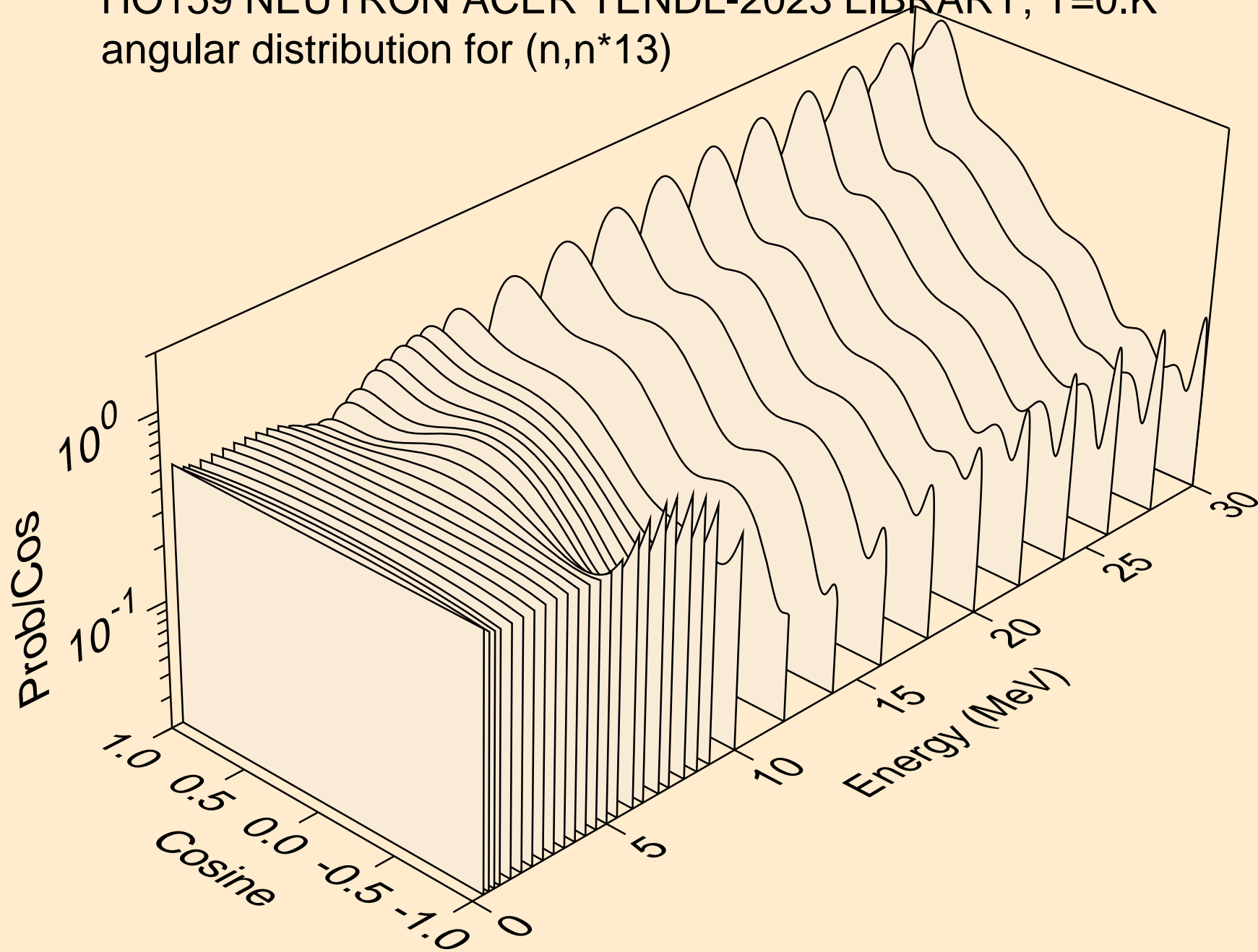

HO159 NEUTRON ACER TENDL-2023 LIBRARY; T=0.K  
angular distribution for (n,n\*14)

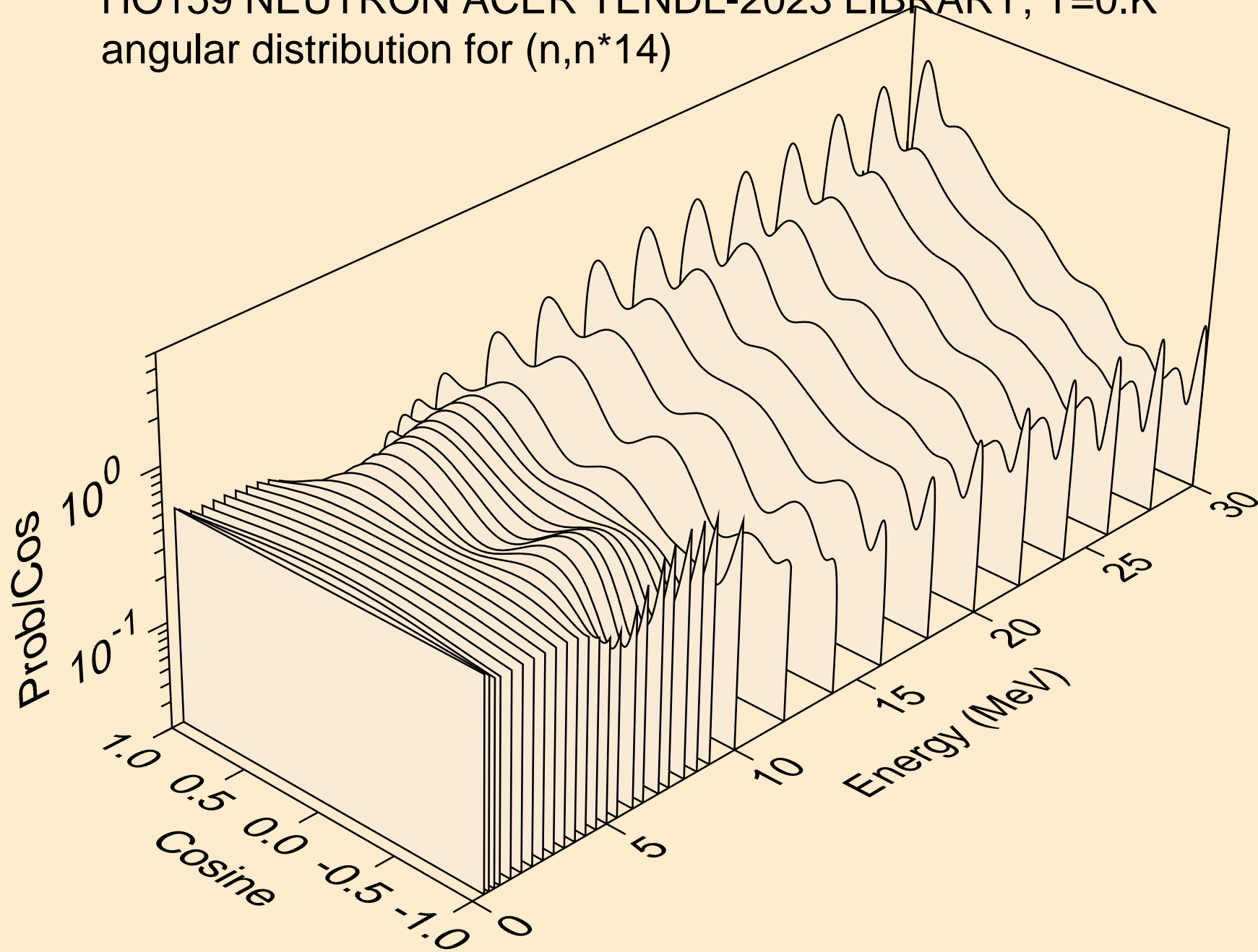

HO159 NEUTRON ACER TENDL-2023 LIBRARY; T=0.K  
angular distribution for (n,n\*15)

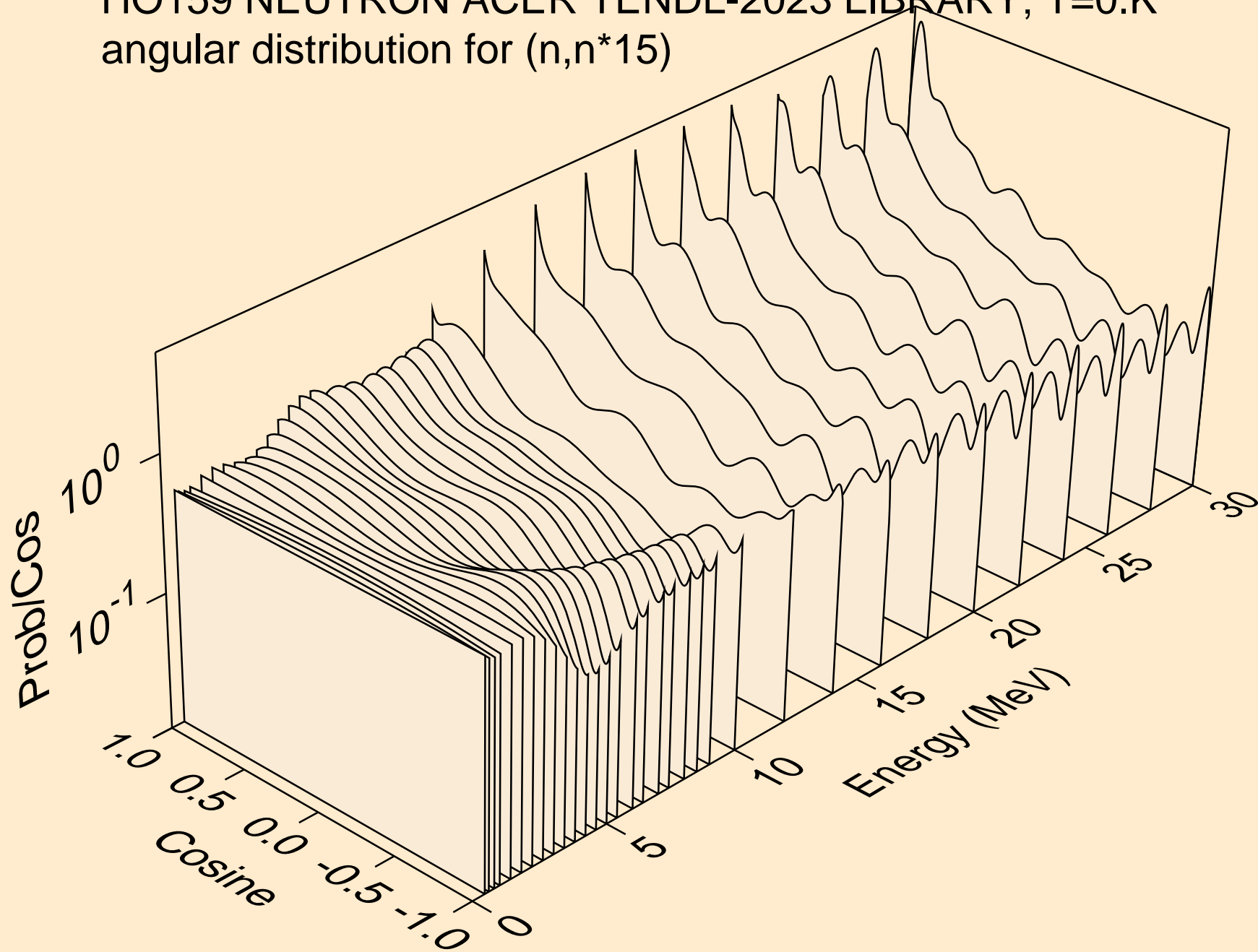

HO159 NEUTRON ACER TENDL-2023 LIBRARY; T=0.K  
angular distribution for (n,n\*16)

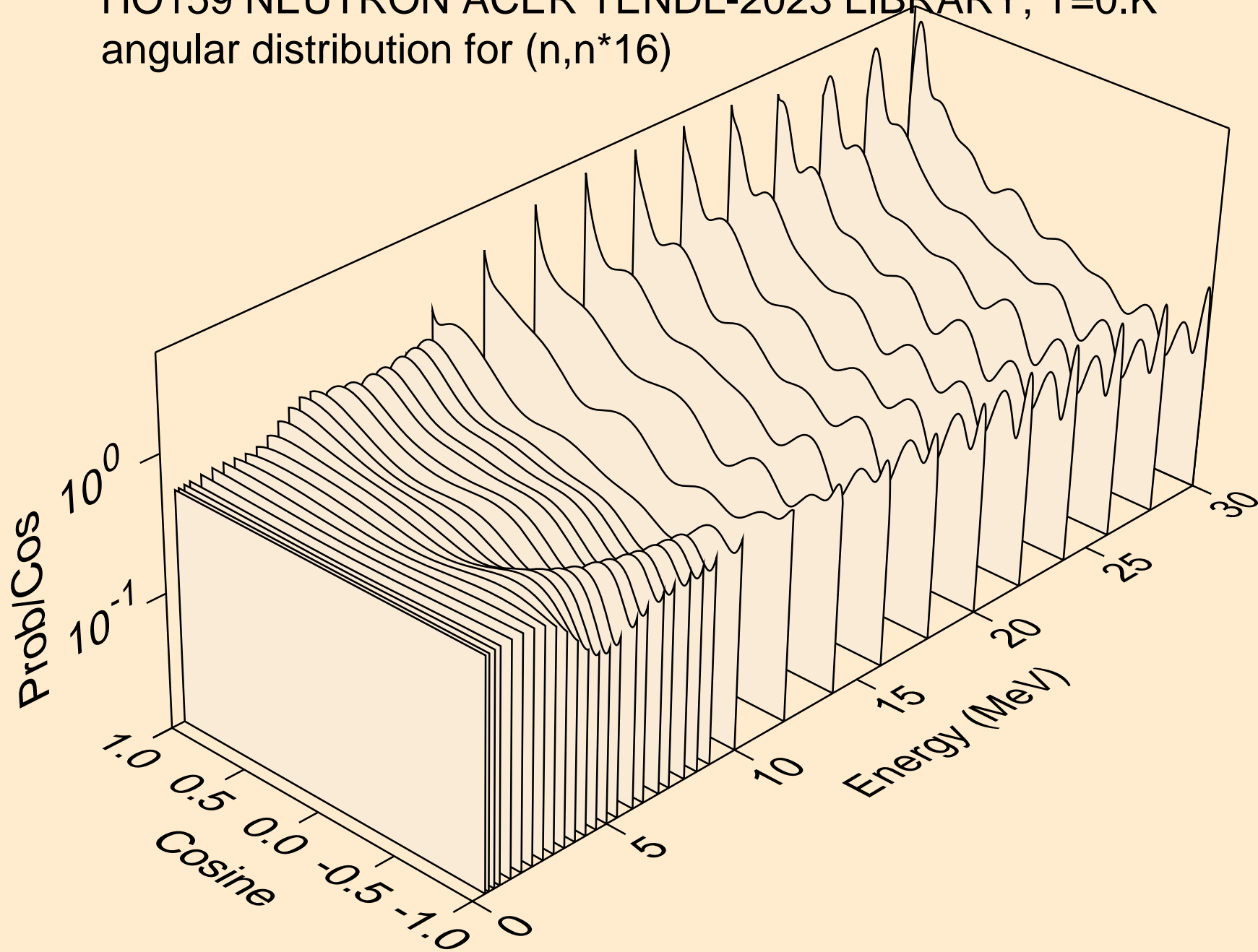

HO159 NEUTRON ACER TENDL-2023 LIBRARY; T=0.K  
angular distribution for (n,n\*17)

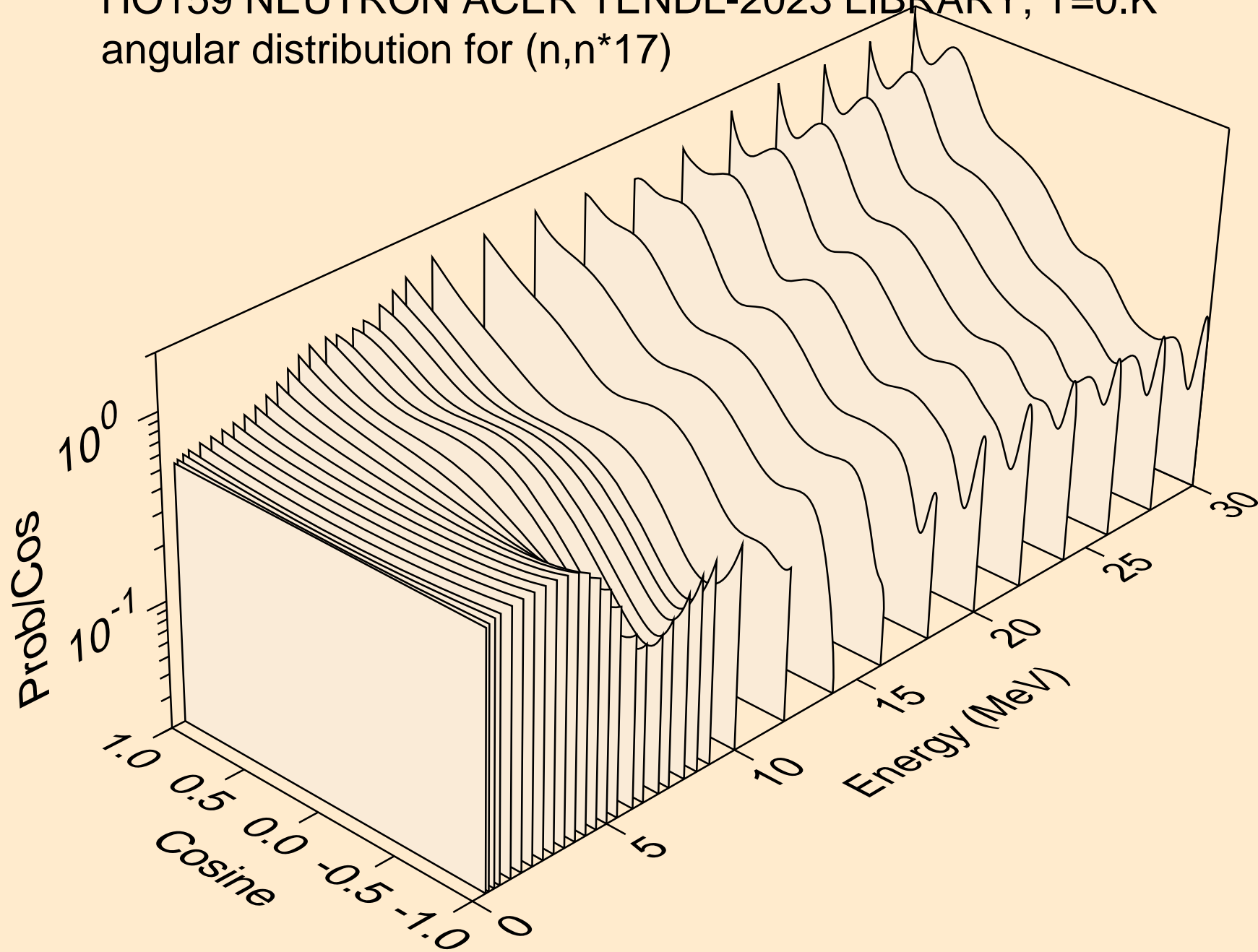

HO159 NEUTRON ACER TENDL-2023 LIBRARY; T=0.K  
Neutron emission for (n,x)

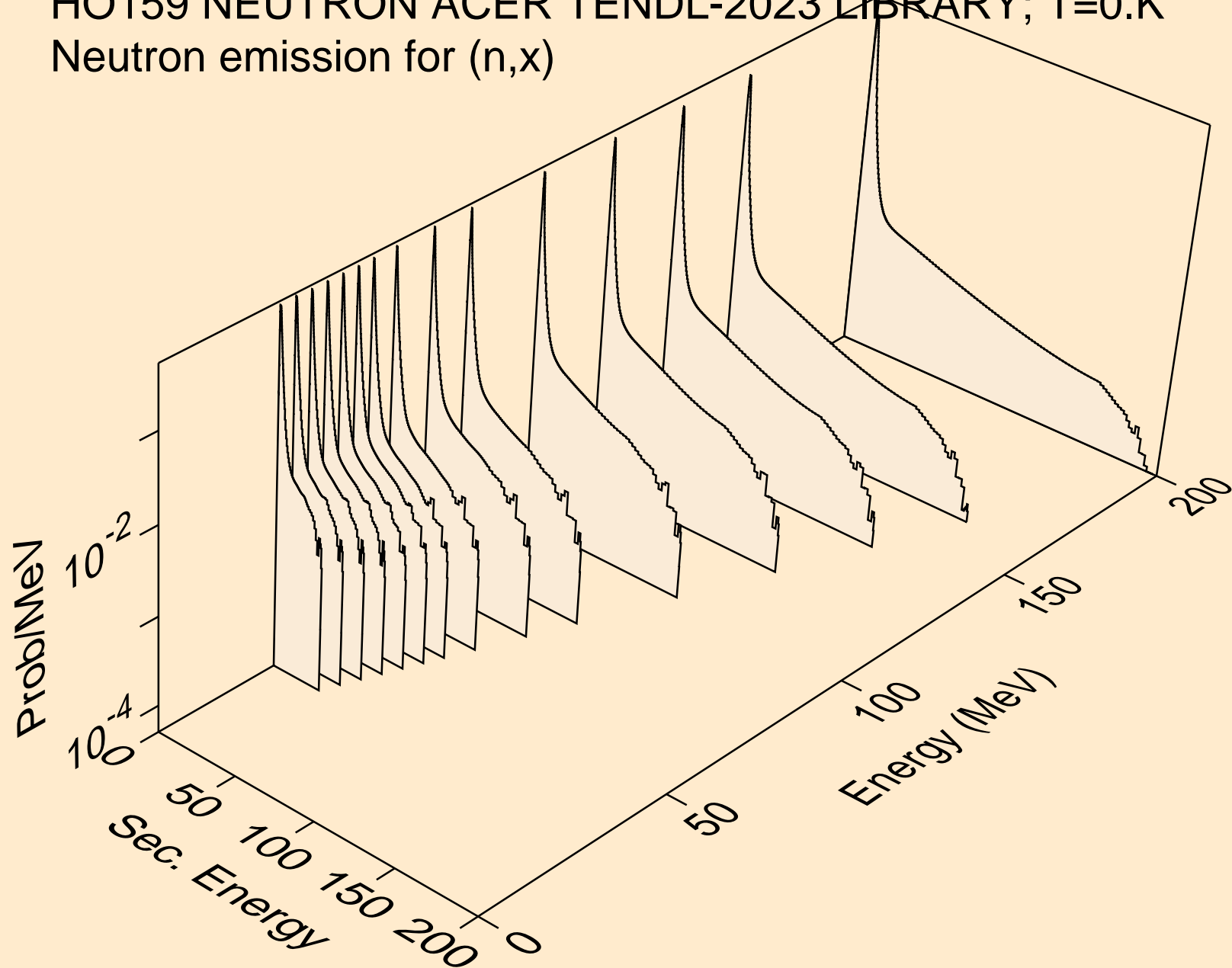

HO159 NEUTRON ACER TENDL-2023 LIBRARY; T=0.K  
Neutron emission for (n,2nd)

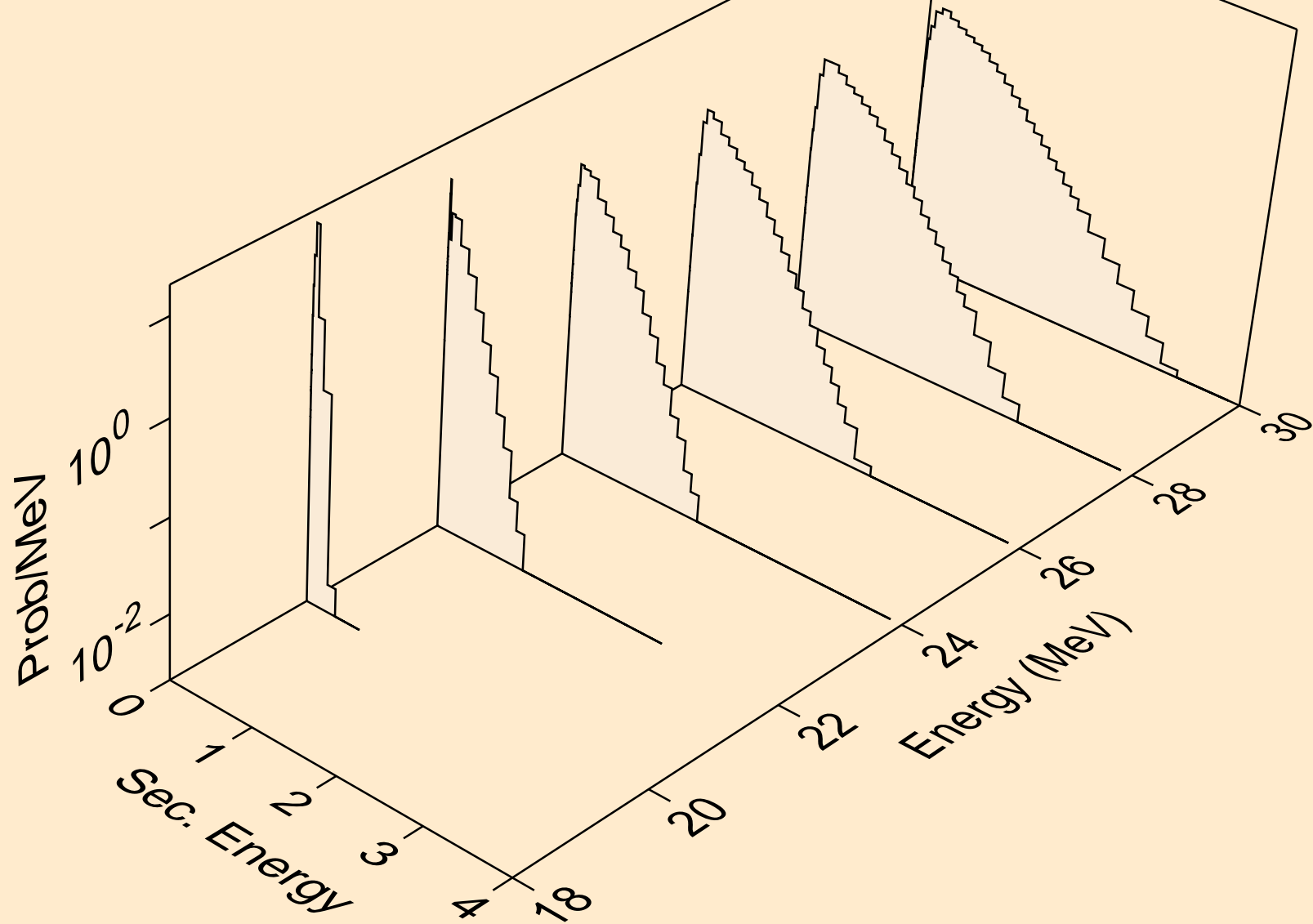

HO159 NEUTRON ACER TENDL-2023 LIBRARY; T=0.K  
Neutron emission for (n,2n)

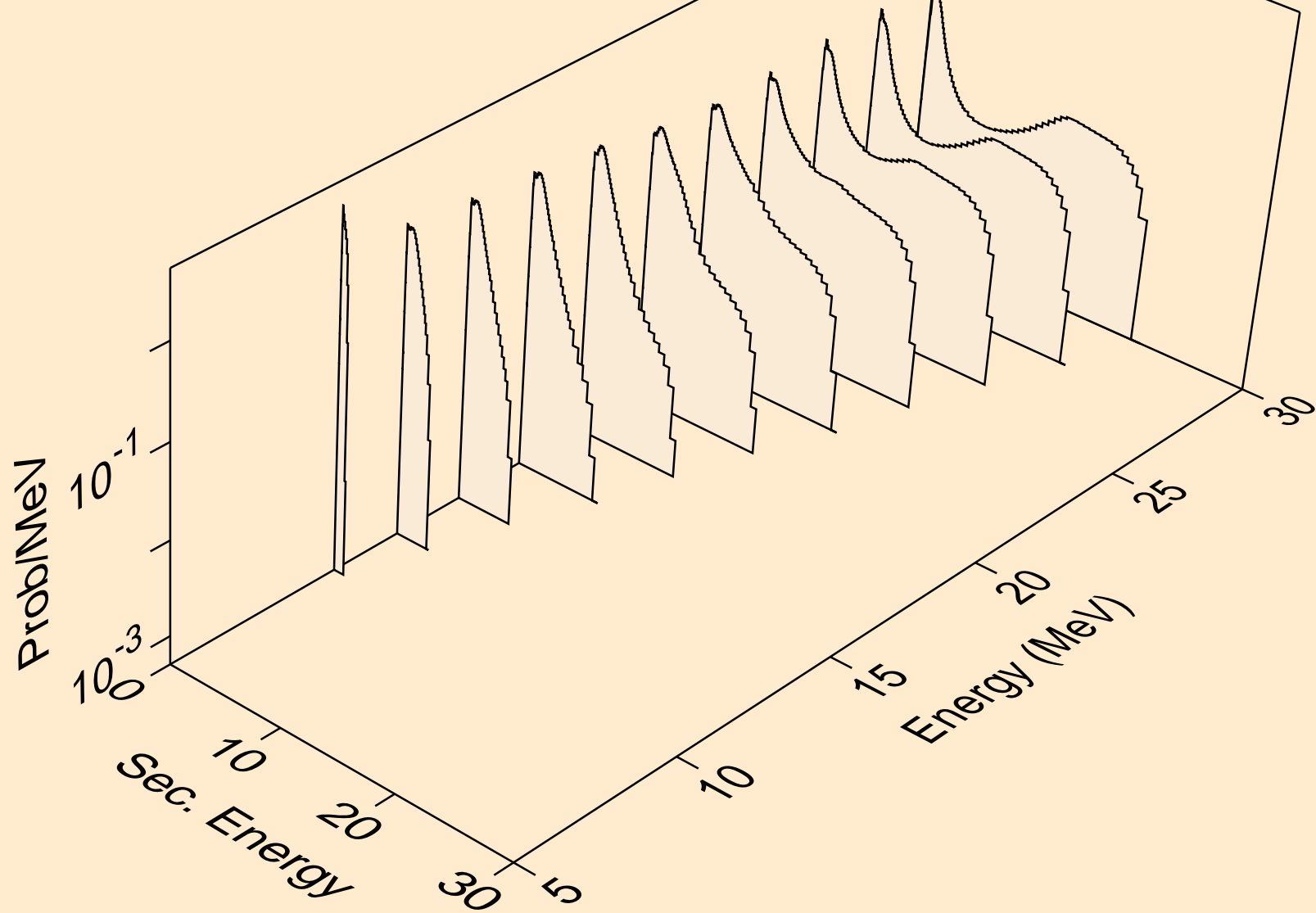

HO159 NEUTRON ACER TENDL-2023 LIBRARY; T=0.K  
Neutron emission for (n,3n)

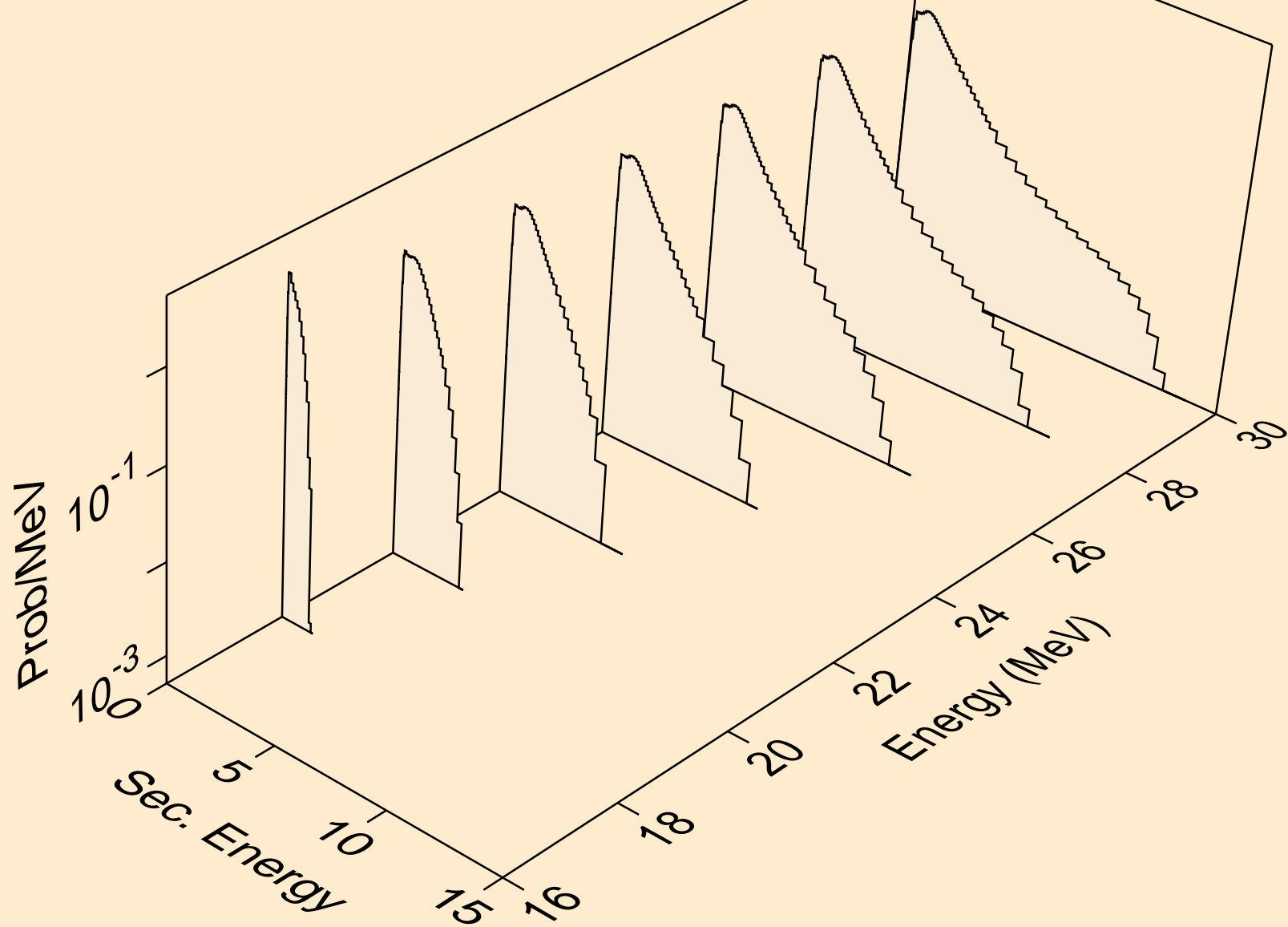

HO159 NEUTRON ACER TENDL-2023 LIBRARY; T=0.K  
Neutron emission for (n,n\*)a

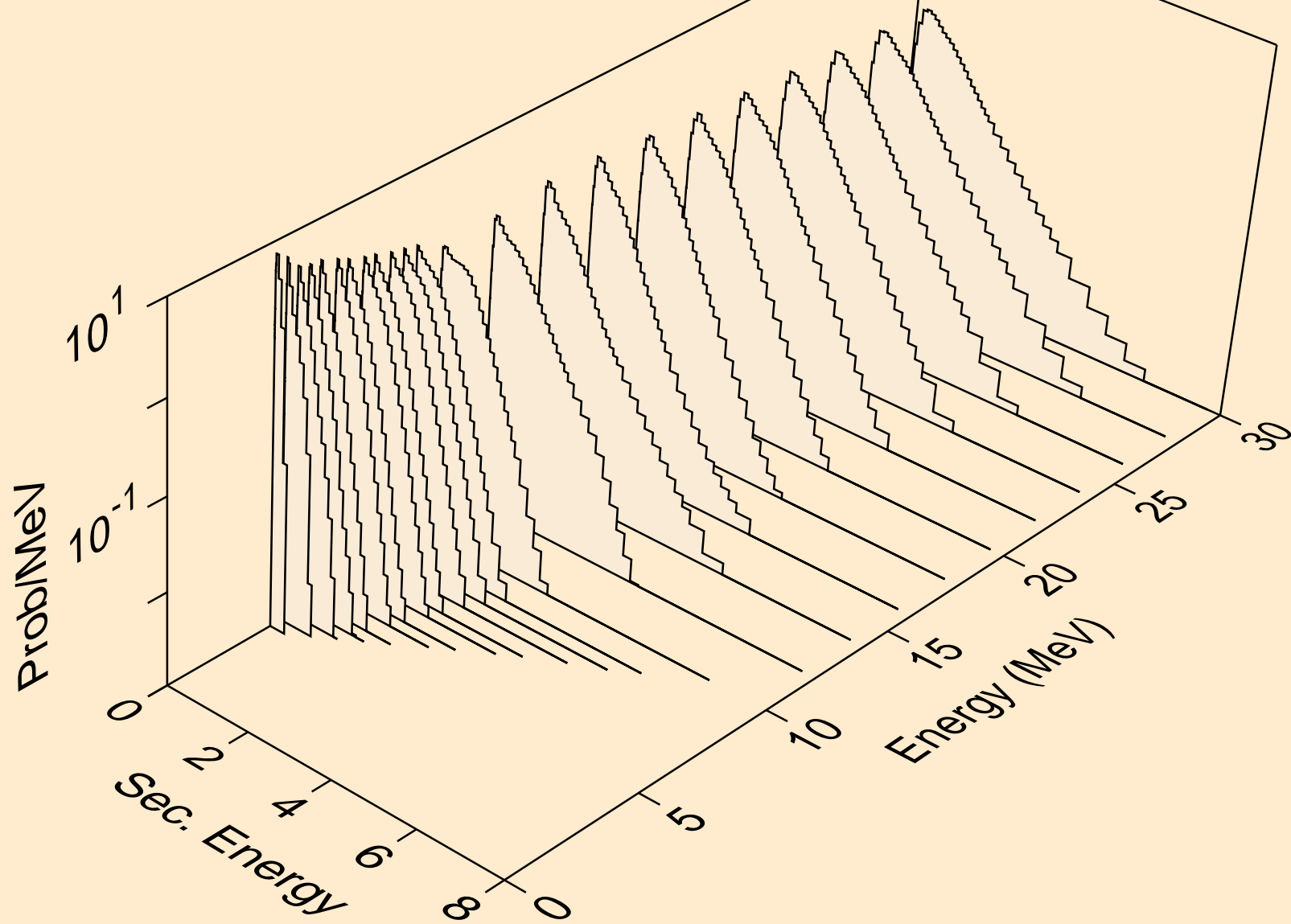

HO159 NEUTRON ACER TENDL-2023 LIBRARY; T=0.K  
Neutron emission for (n,2n)a

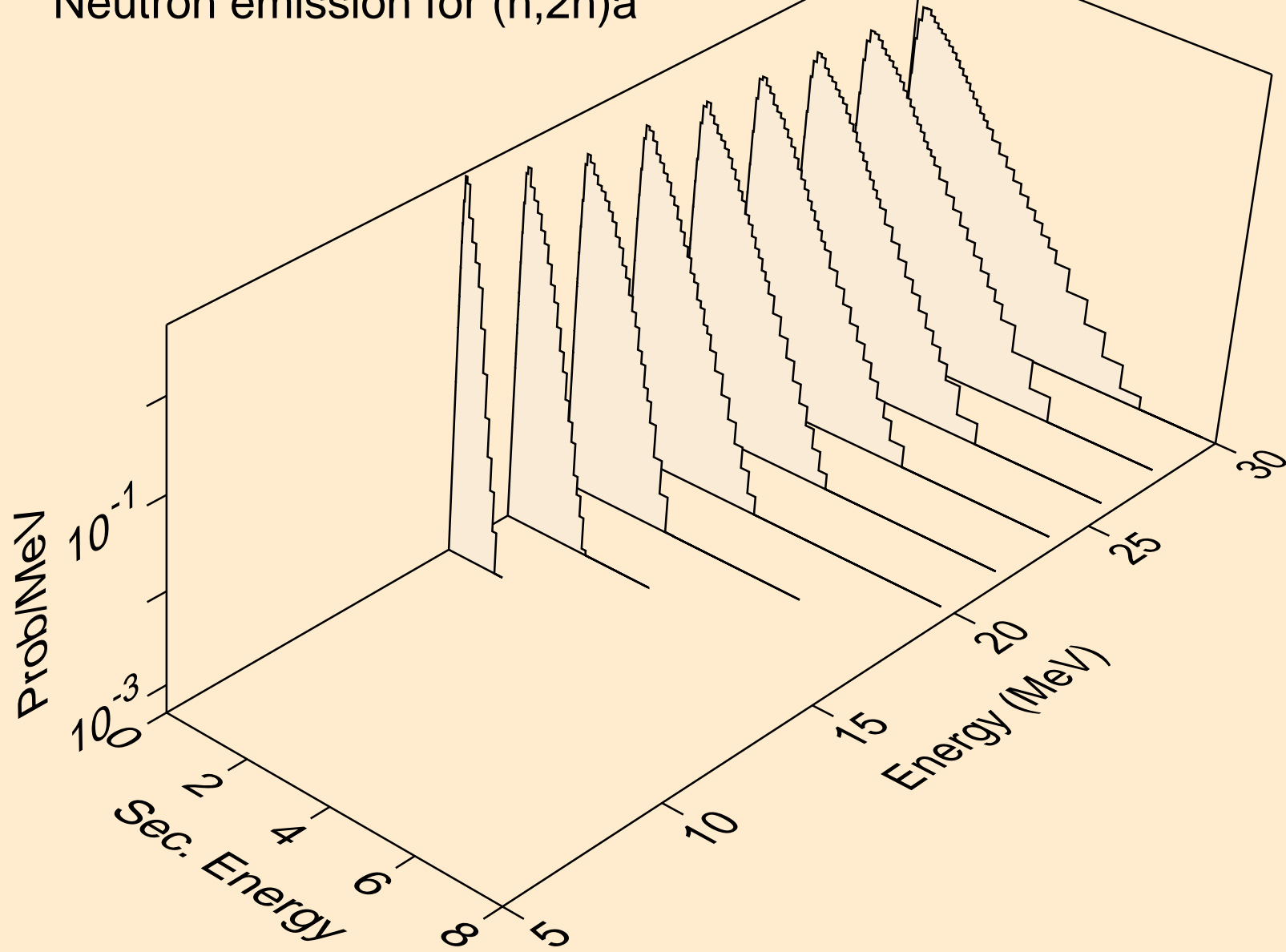

HO159 NEUTRON ACER TENDL-2023 LIBRARY; T=0.K  
Neutron emission for (n,3n)a

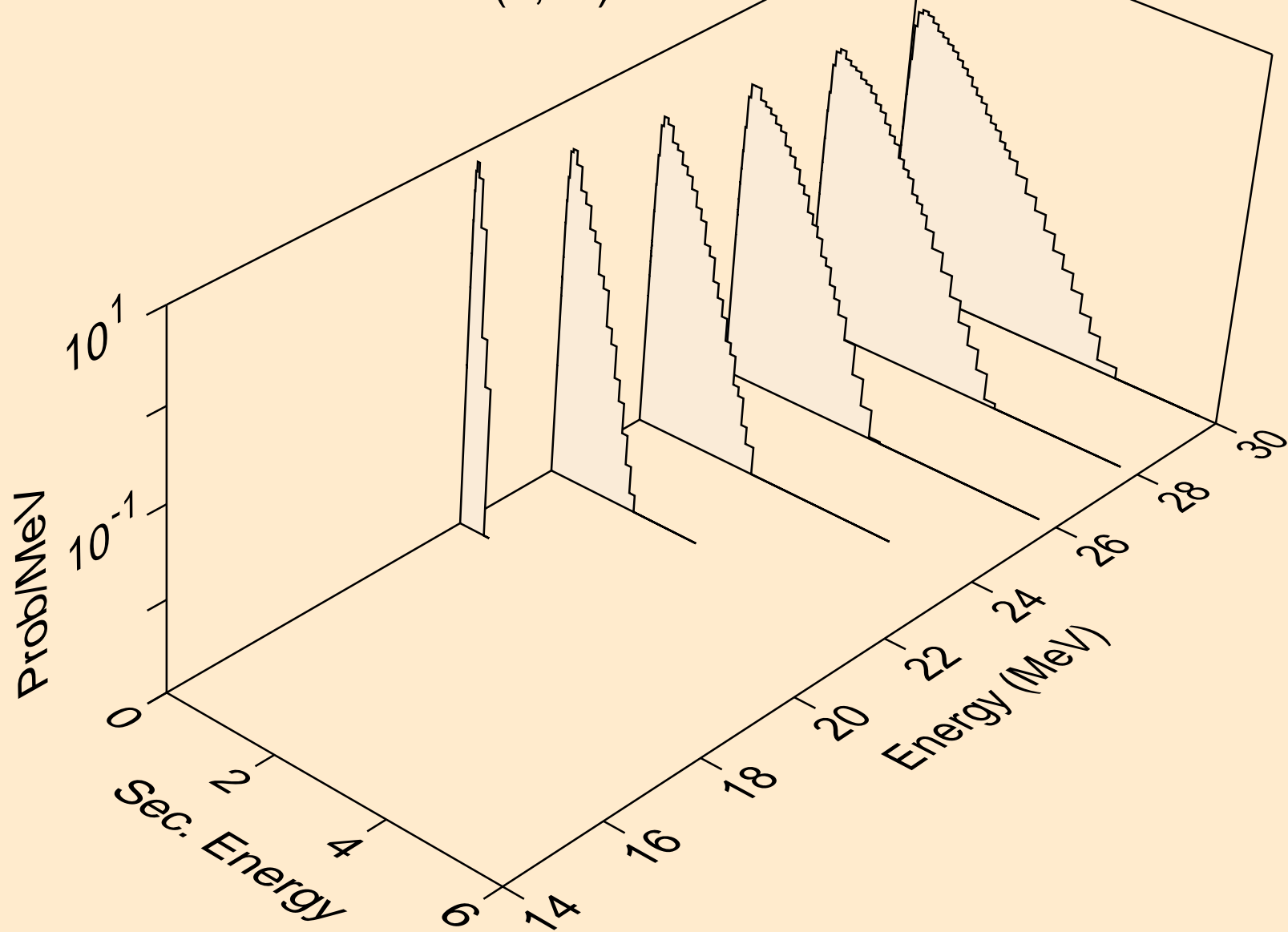

HO159 NEUTRON ACER TENDL-2023 LIBRARY; T=0.K  
Neutron emission for (n,n\*)p

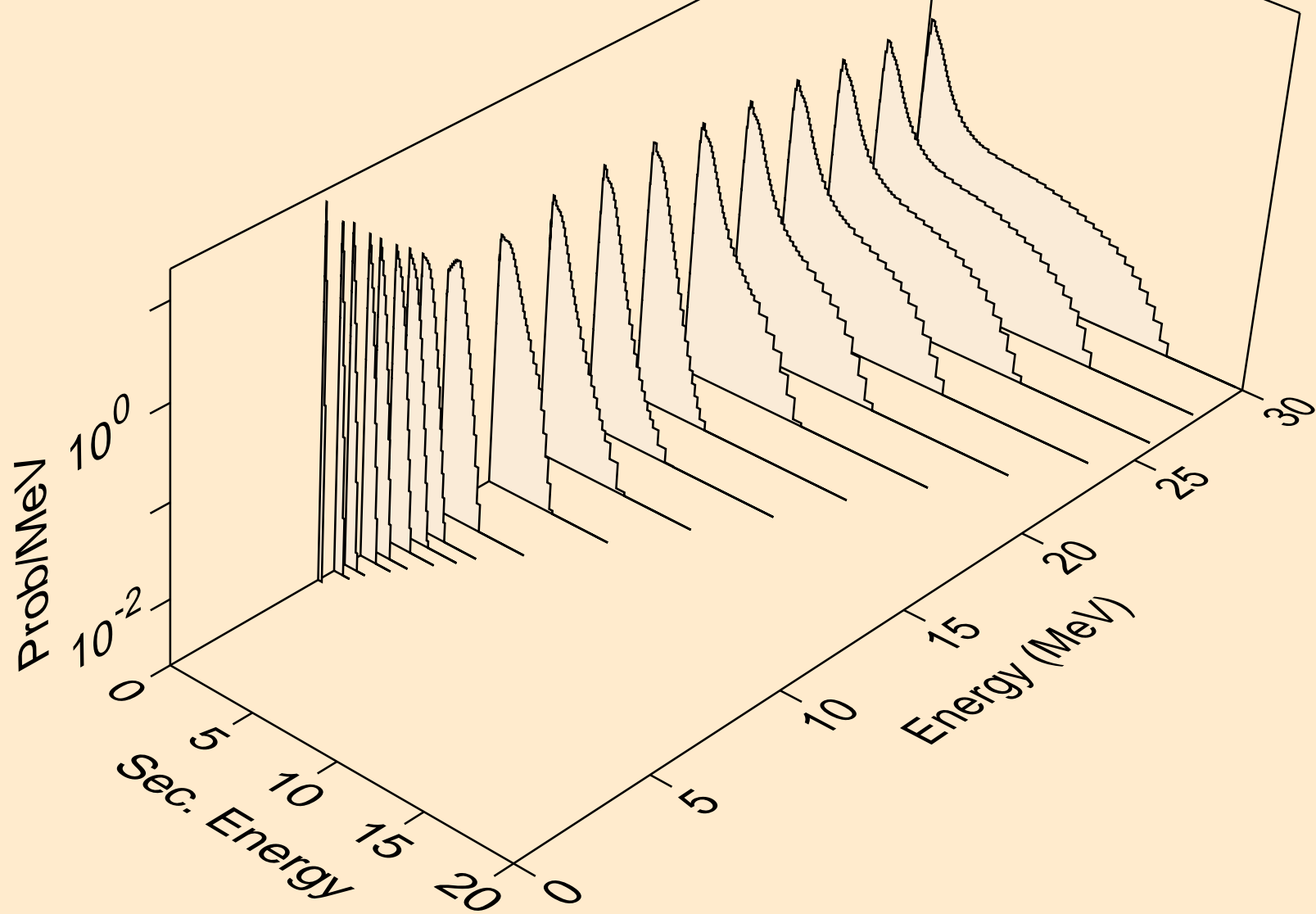

HO159 NEUTRON ACER TENDL-2023 LIBRARY; T=0.K  
Neutron emission for (n,n\*)2a

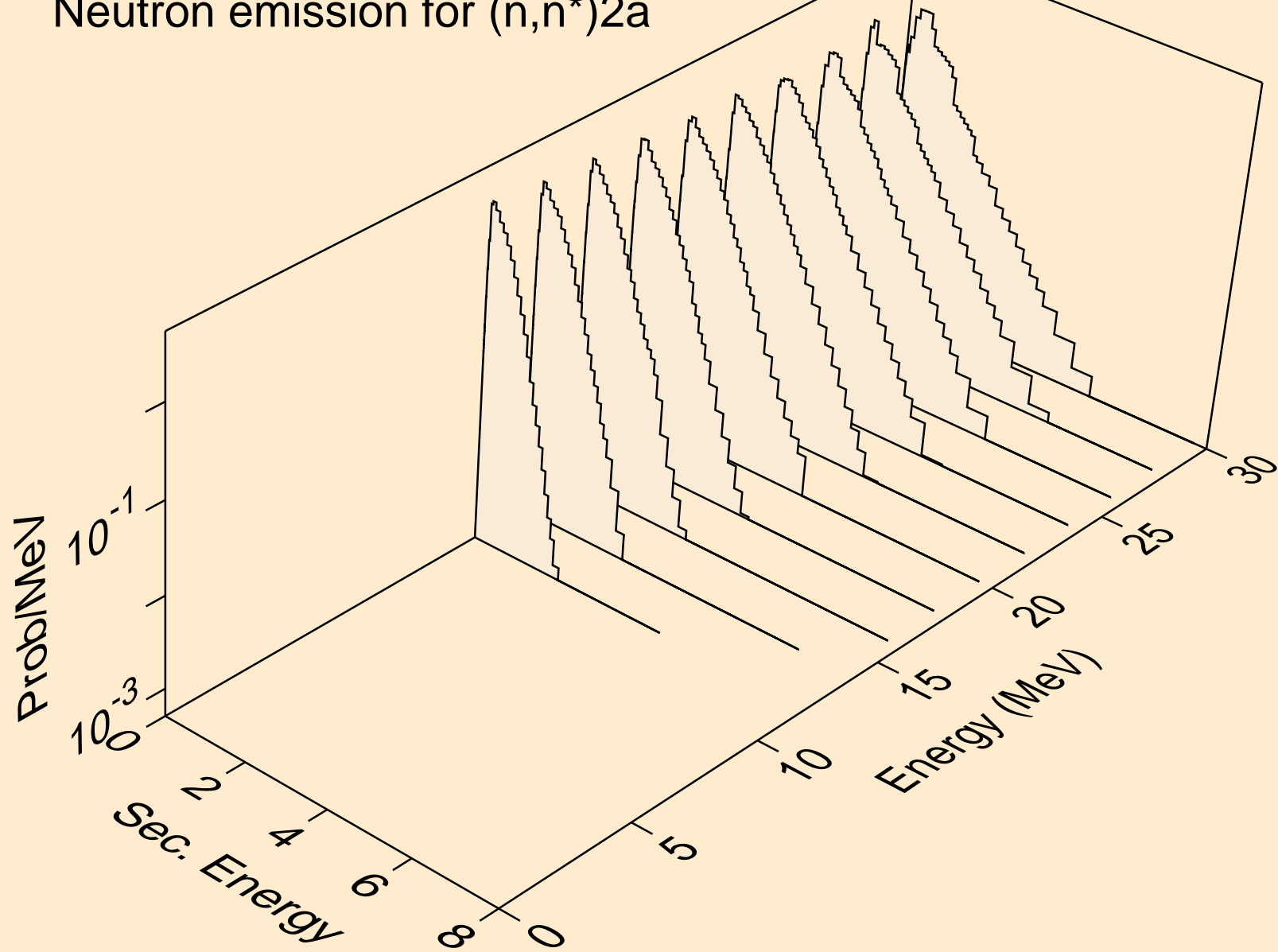

HO159 NEUTRON ACER TENDL-2023 LIBRARY; T=0.K  
Neutron emission for (n,n\*)d

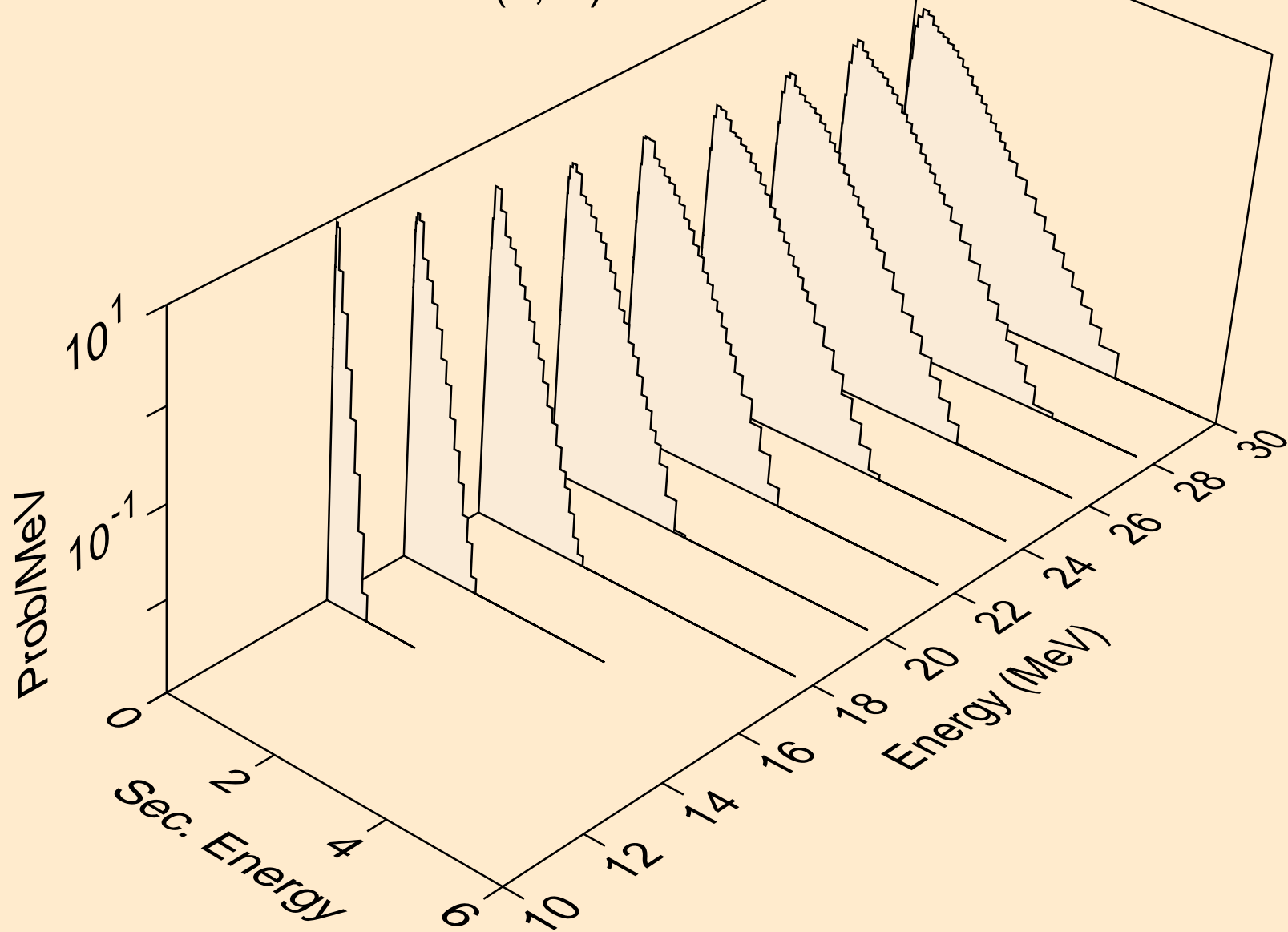

HO159 NEUTRON ACER TENDL-2023 LIBRARY; T=0.K  
Neutron emission for (n,n\*)t

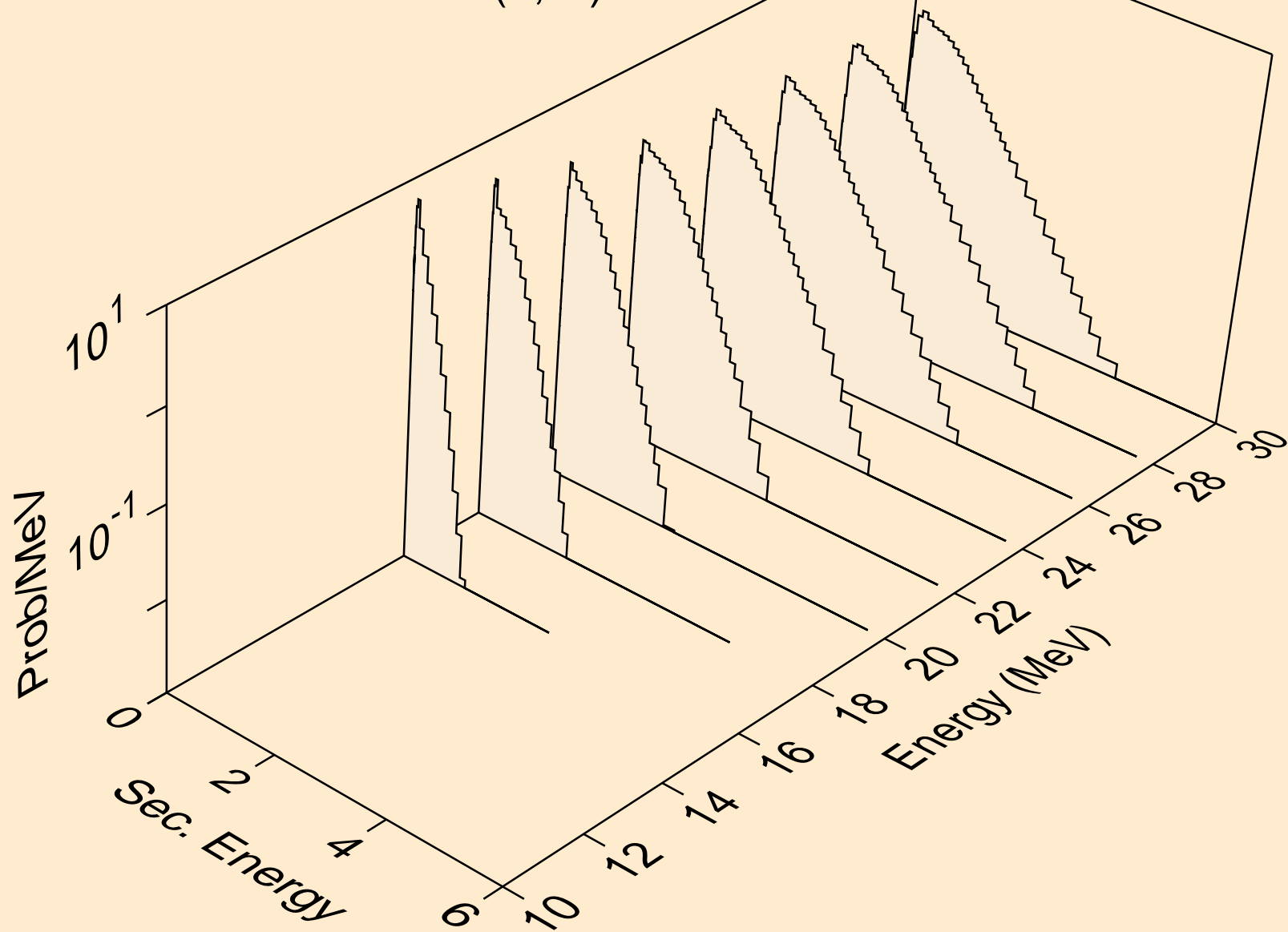

HO159 NEUTRON ACER TENDL-2023 LIBRARY; T=0.K  
Neutron emission for (n,n\*)he3

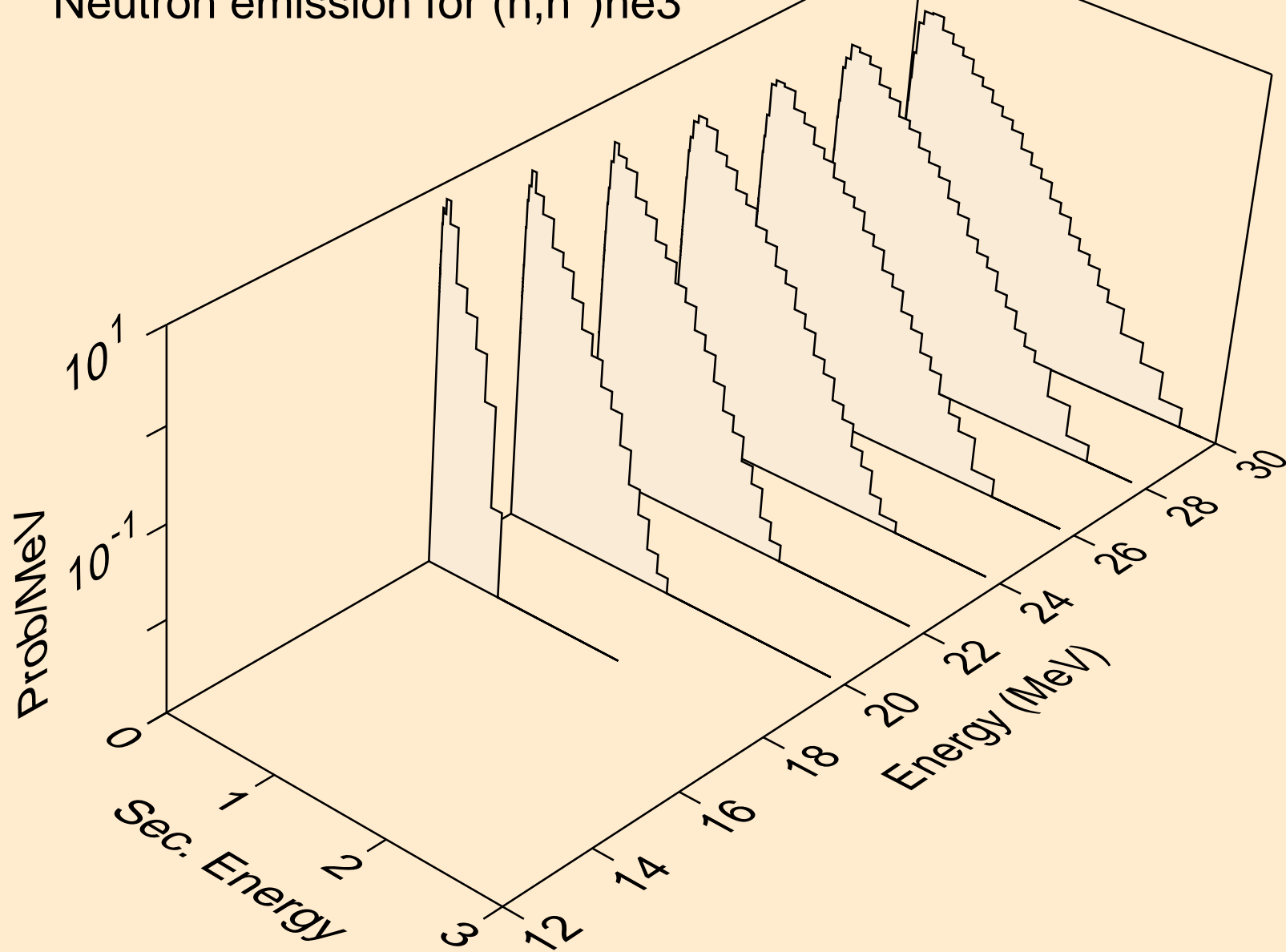

HO159 NEUTRON ACER TENDL-2023 LIBRARY; T=0.K  
Neutron emission for (n,4n)

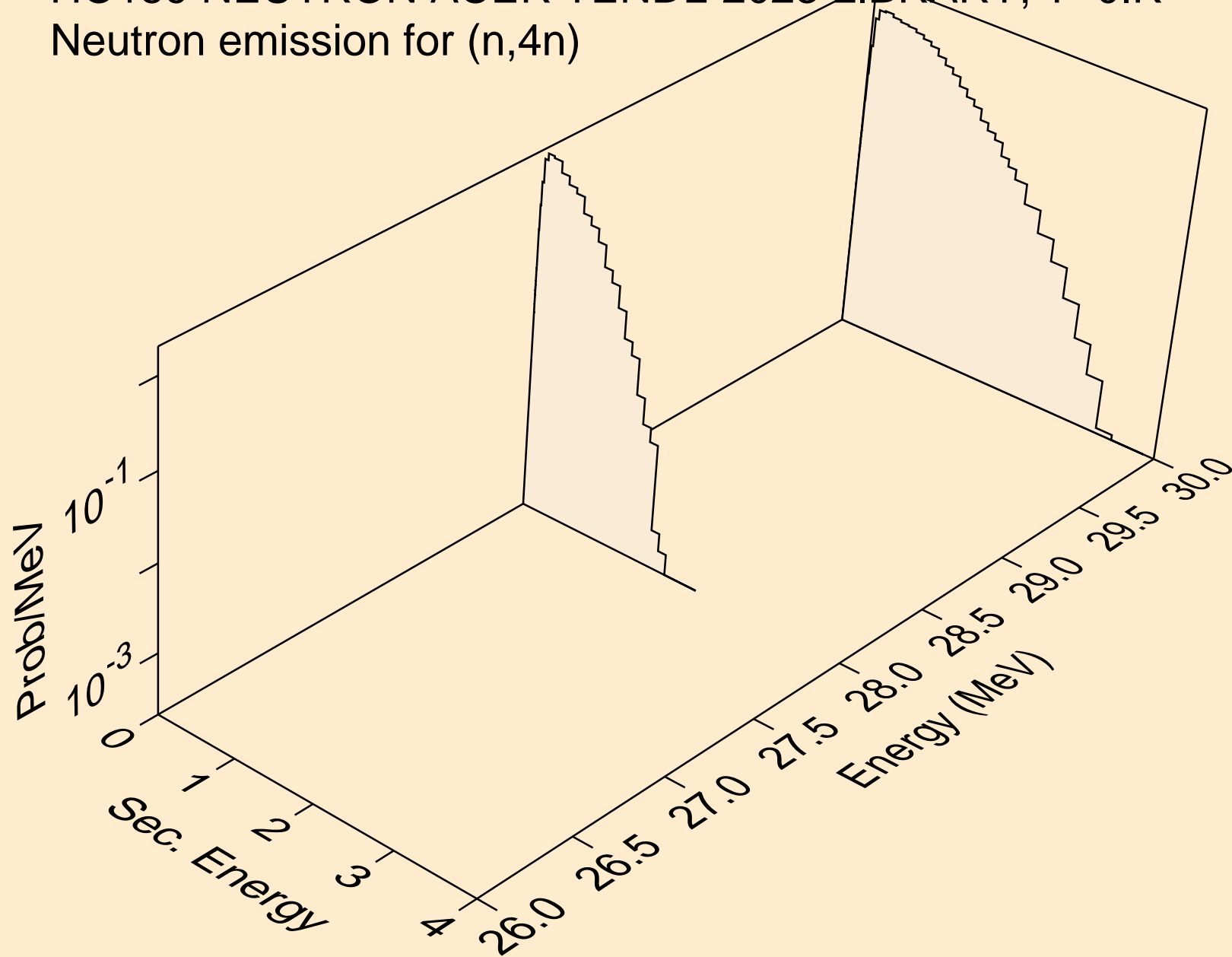

HO159 NEUTRON ACER TENDL-2023 LIBRARY; T=0.K  
Neutron emission for (n,2np)

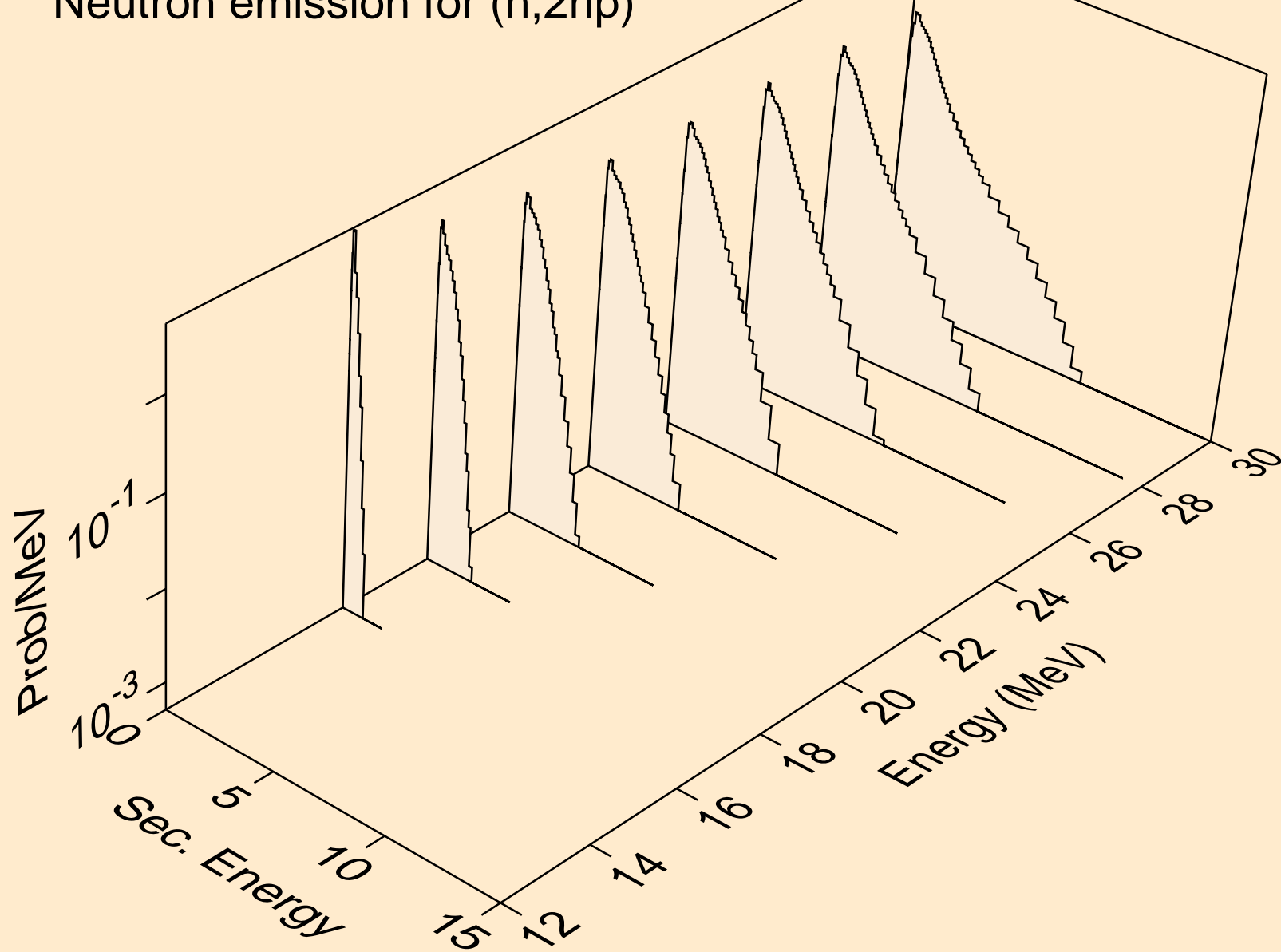

HO159 NEUTRON ACER TENDL-2023 LIBRARY; T=0.K  
Neutron emission for (n,3np)

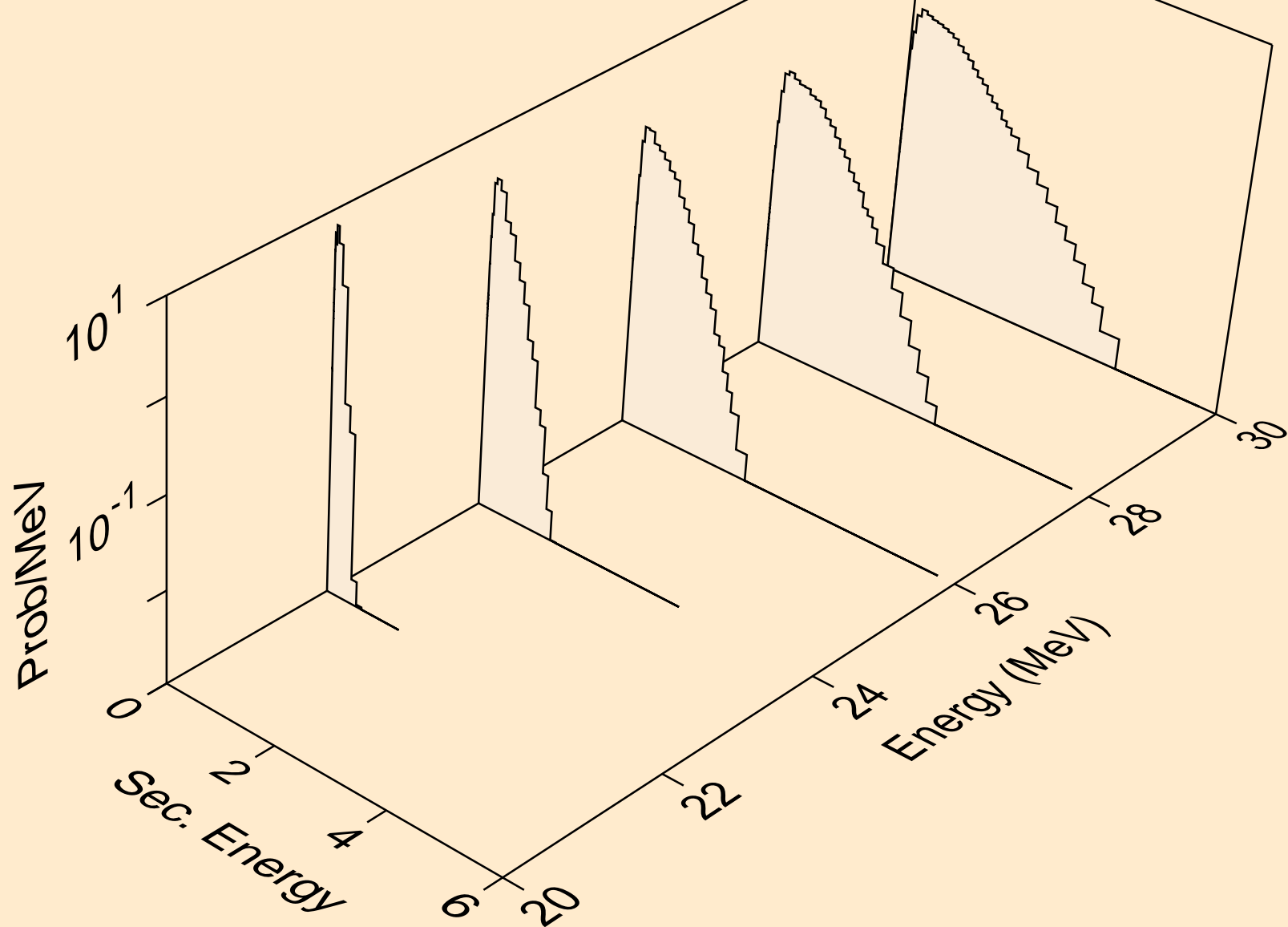

HO159 NEUTRON ACER TENDL-2023 LIBRARY; T=0.K  
Neutron emission for (n,n2p)

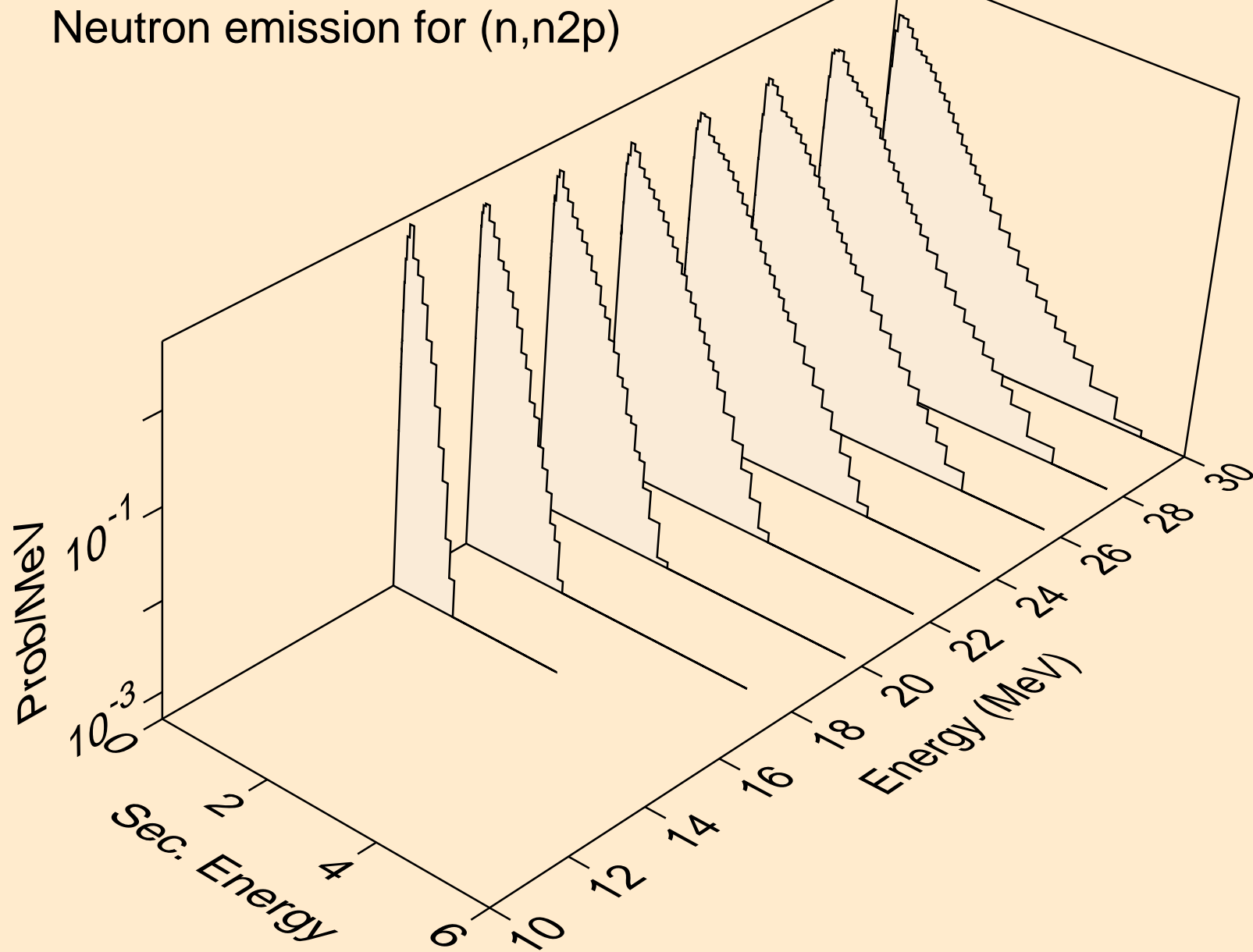

HO159 NEUTRON ACER TENDL-2023 LIBRARY; T=0.K  
Neutron emission for (n,npa)

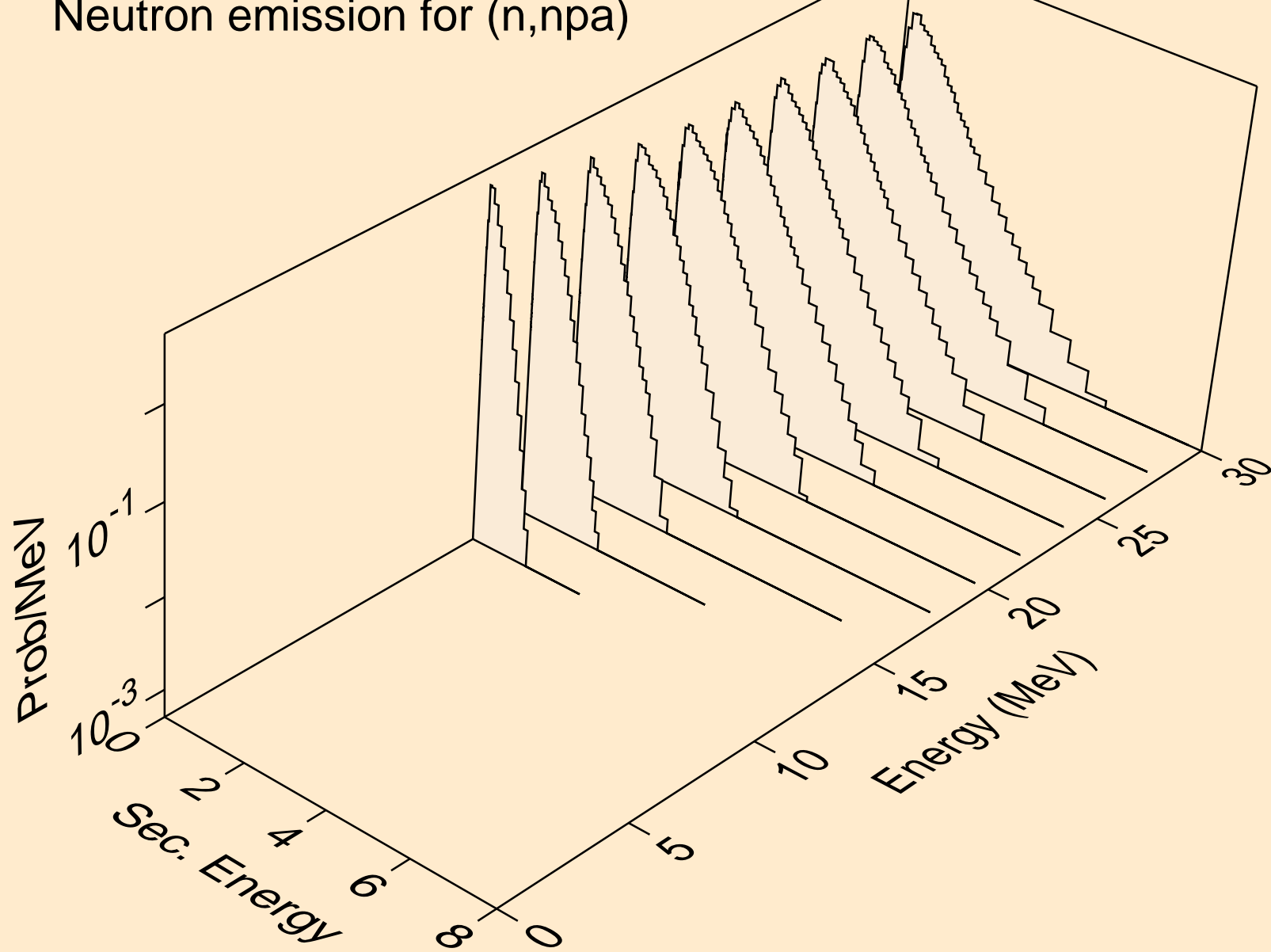

HO159 NEUTRON ACER TENDL-2023 LIBRARY; T=0.K  
Neutron emission for (n,n\*c)

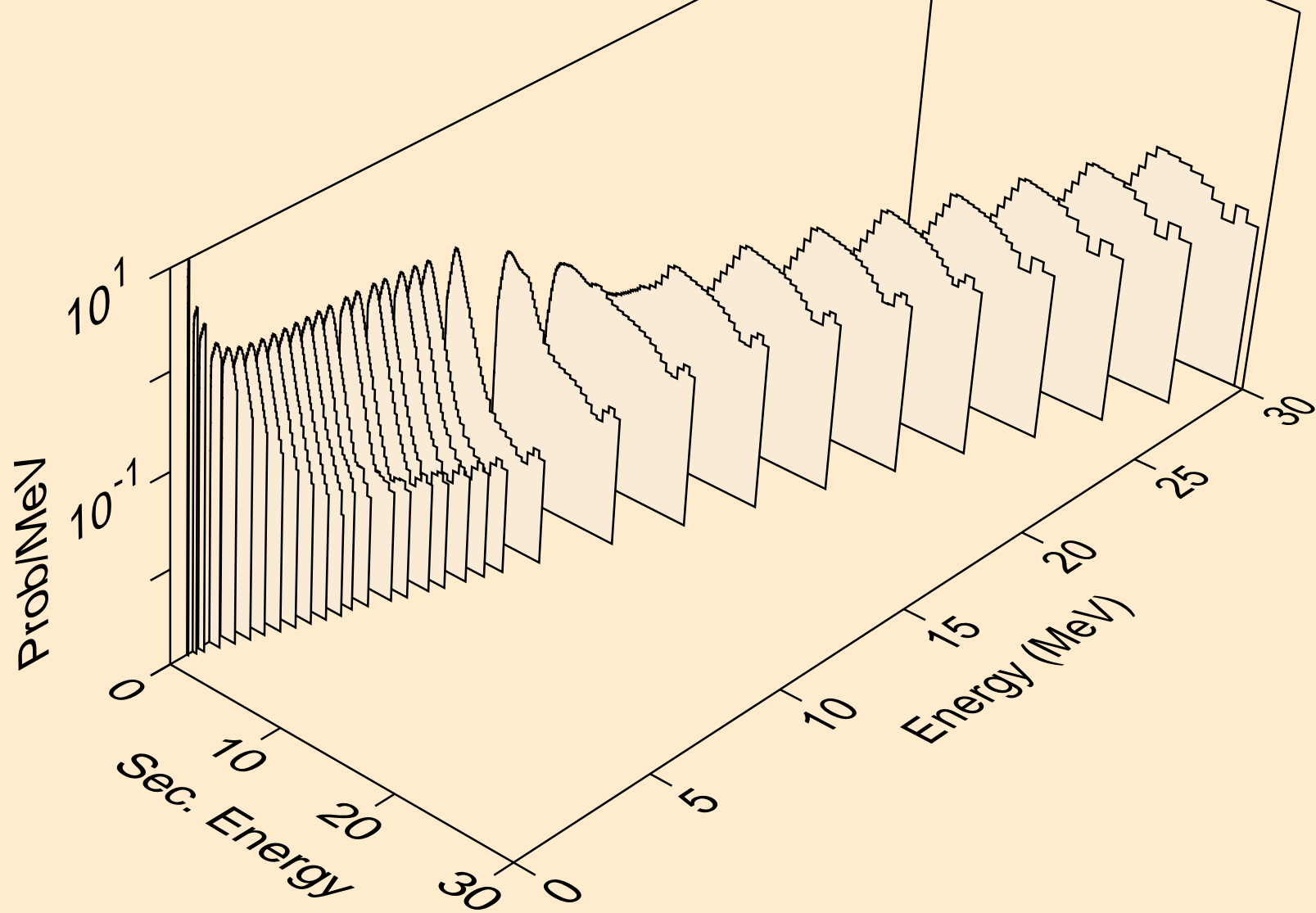

HO159 NEUTRON ACER TENDL-2023 LIBRARY; T=0.K  
Photon emission for (n,x)

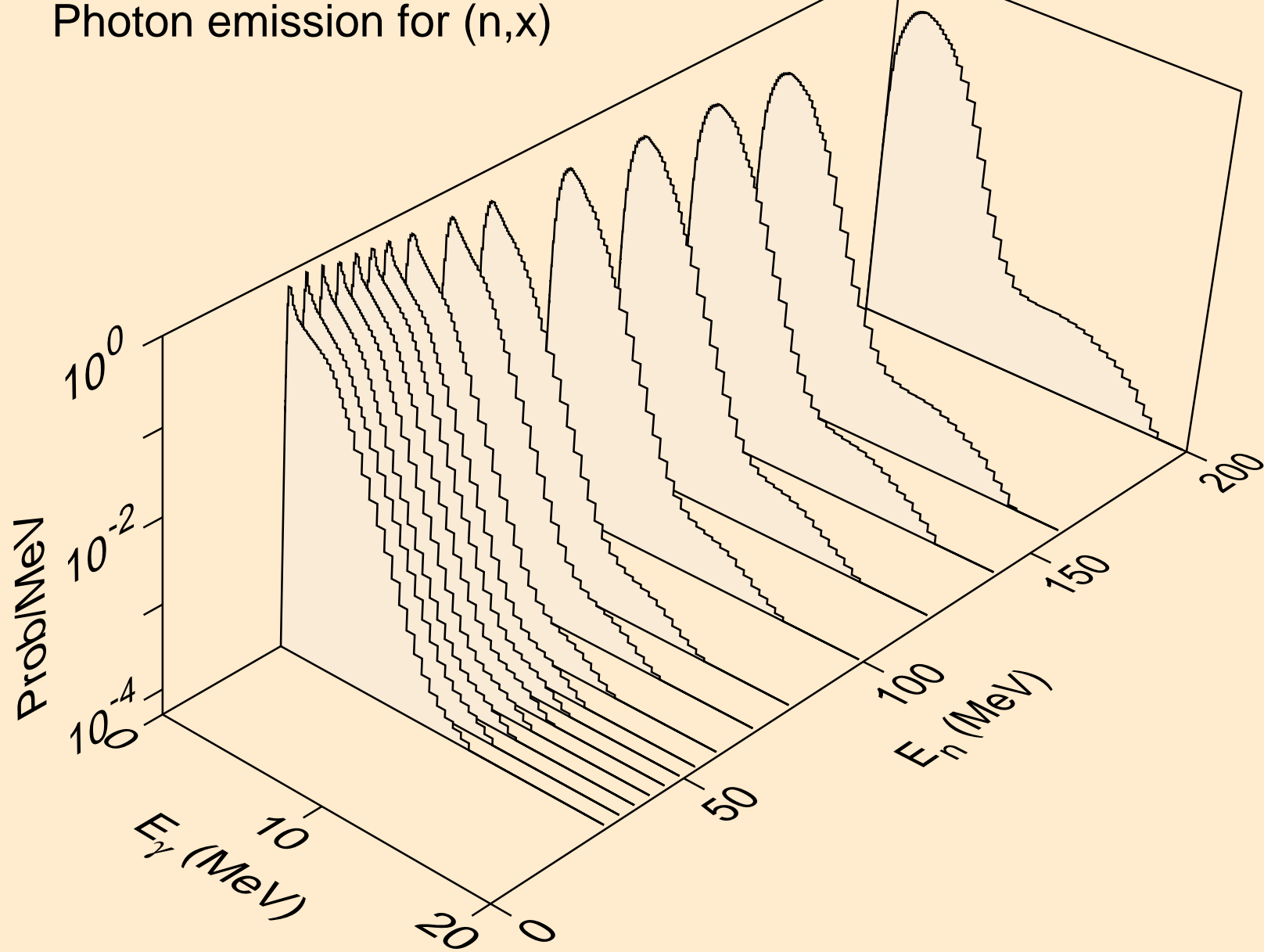

HO159 NEUTRON ACER TENDL-2023 LIBRARY; T=0.K  
Photon emission for (n,2nd)

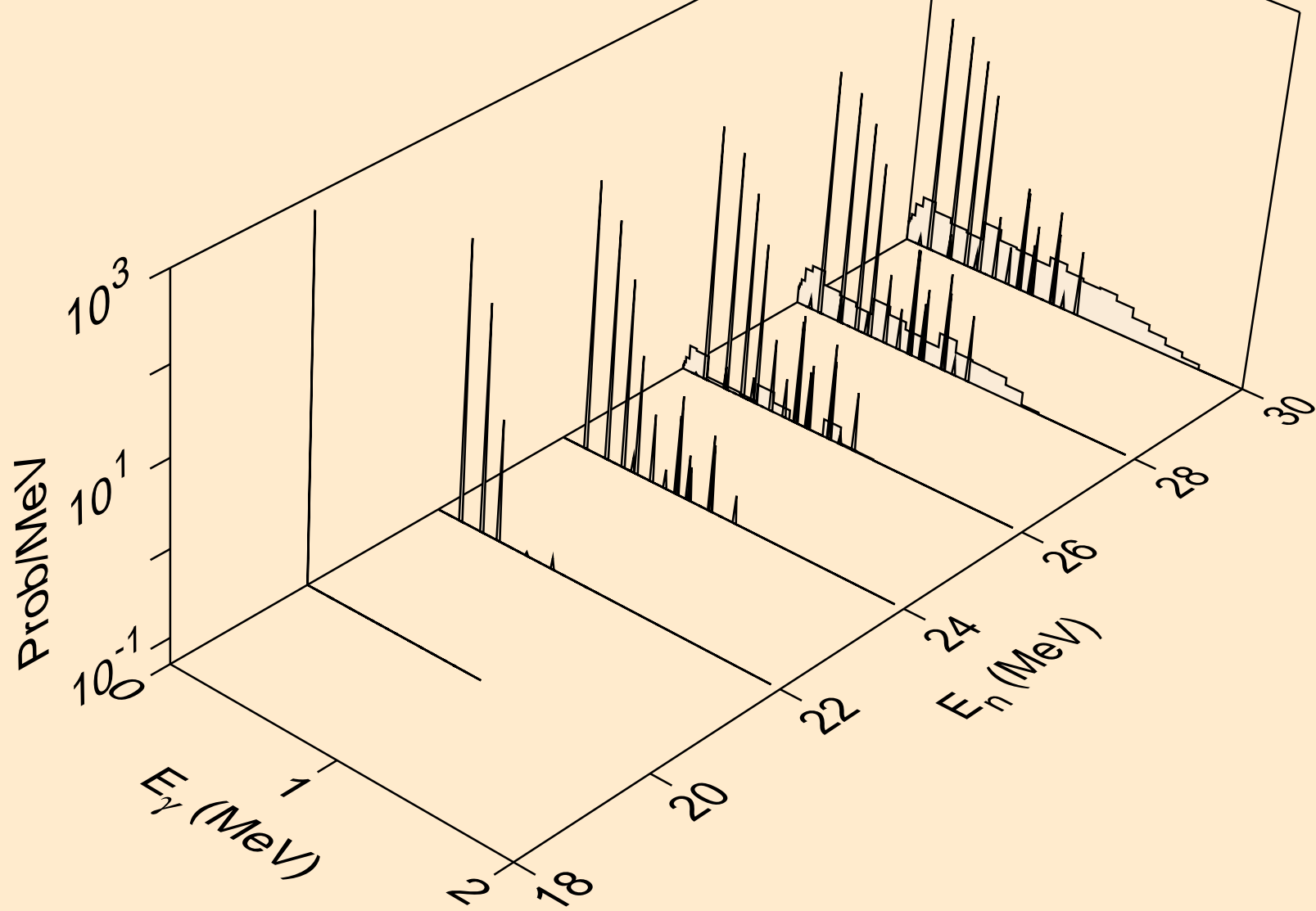

HO159 NEUTRON ACER TENDL-2023 LIBRARY; T=0.K  
Photon emission for (n,2n)

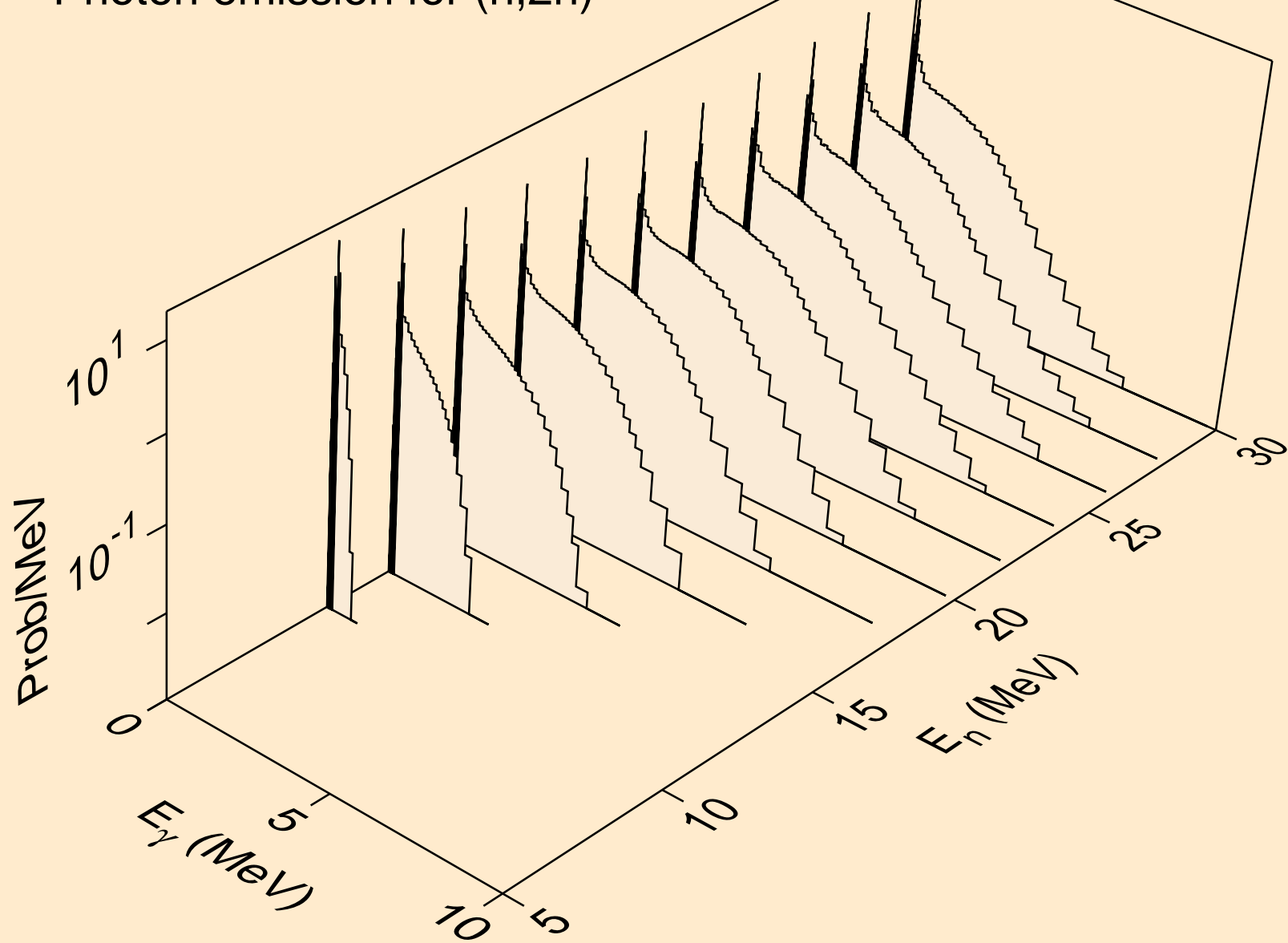

HO159 NEUTRON ACER TENDL-2023 LIBRARY; T=0.K  
Photon emission for (n,3n)

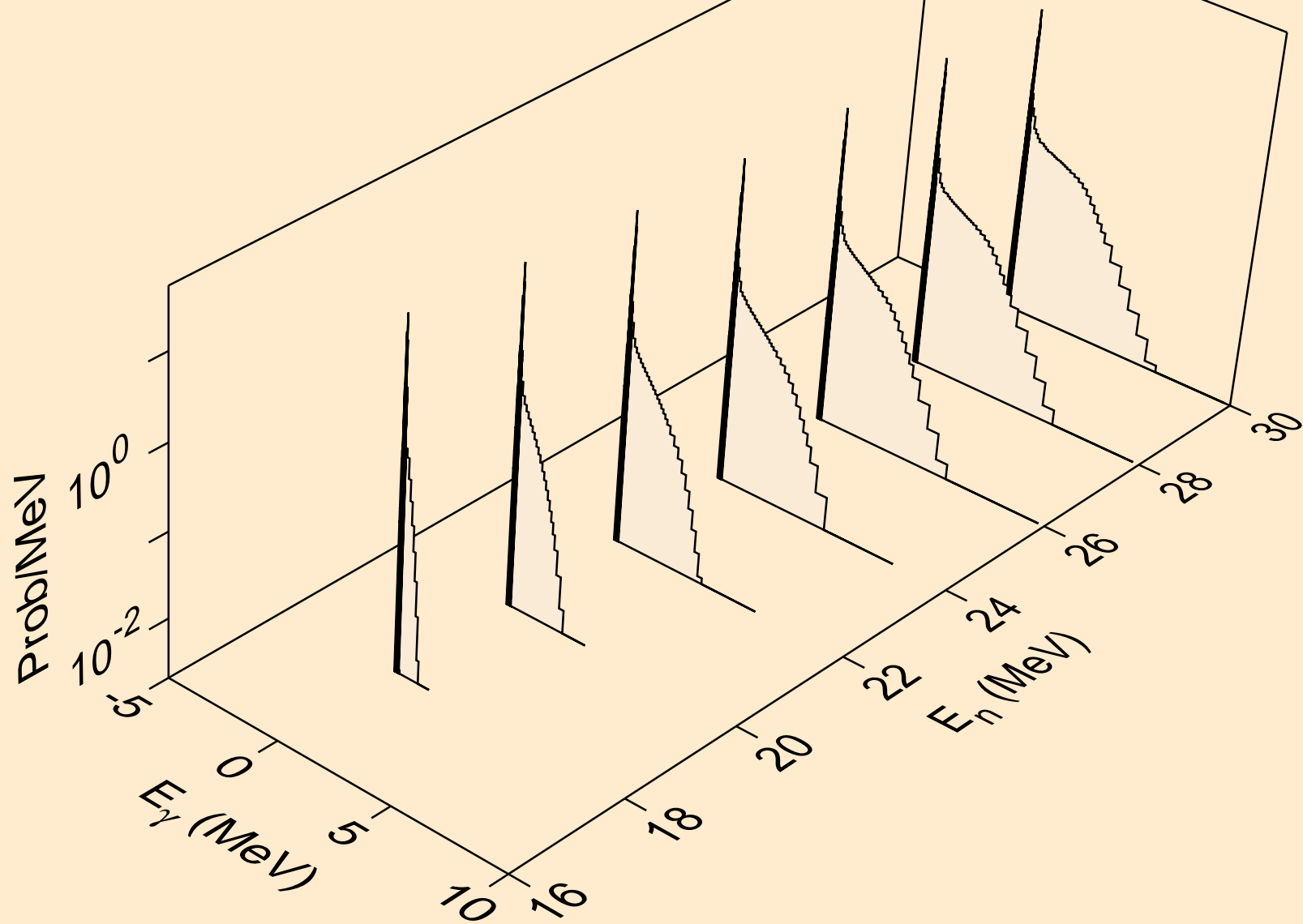

HO159 NEUTRON ACER TENDL-2023 LIBRARY; T=0.K  
Photon emission for (n,n\*)a

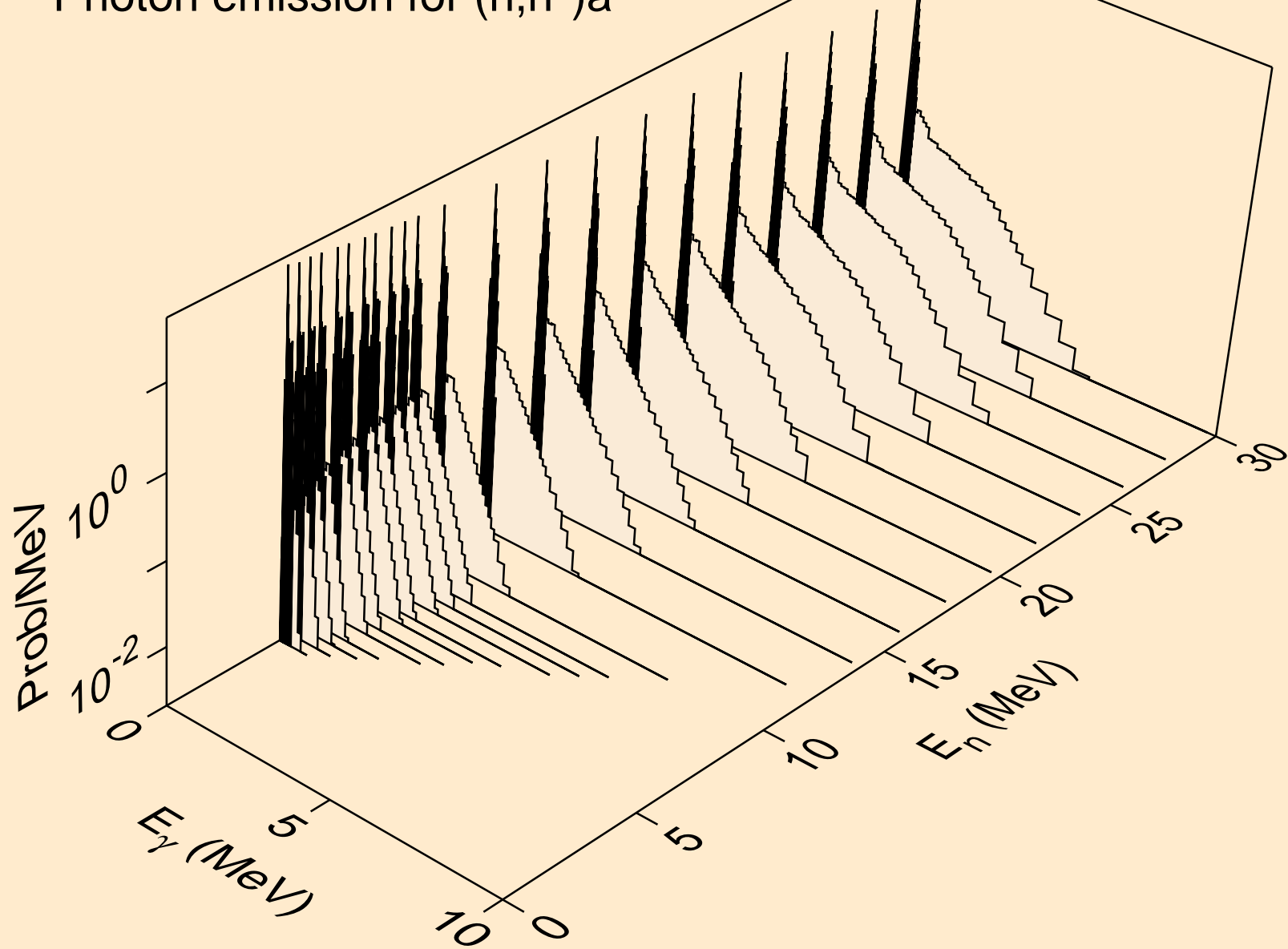

HO159 NEUTRON ACER TENDL-2023 LIBRARY; T=0.K  
Photon emission for (n,2n)a

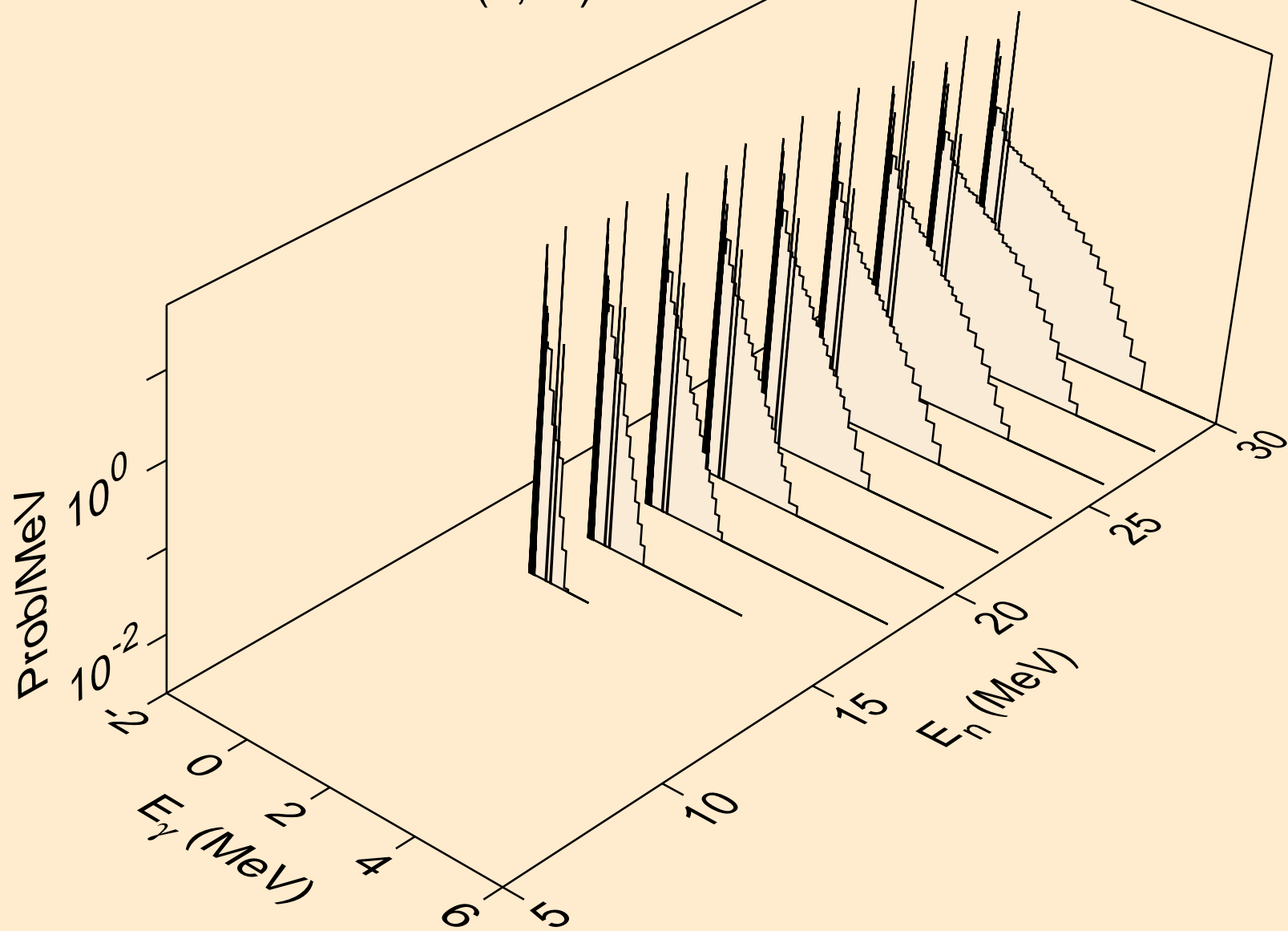

HO159 NEUTRON ACER TENDL-2023 LIBRARY; T=0.K  
Photon emission for (n,3n)a

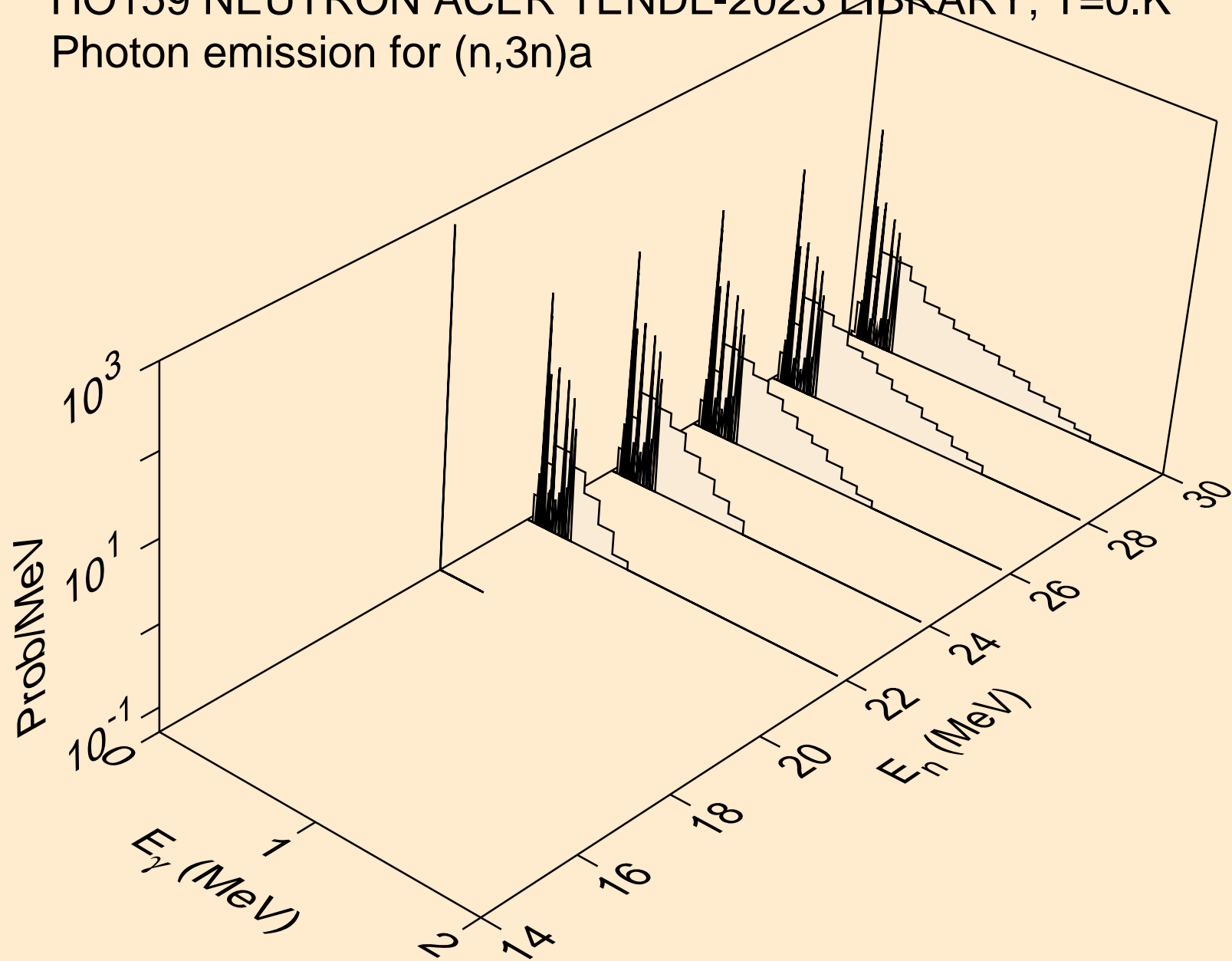

HO159 NEUTRON ACER TENDL-2023 LIBRARY; T=0.K  
Photon emission for (n,n\*)p

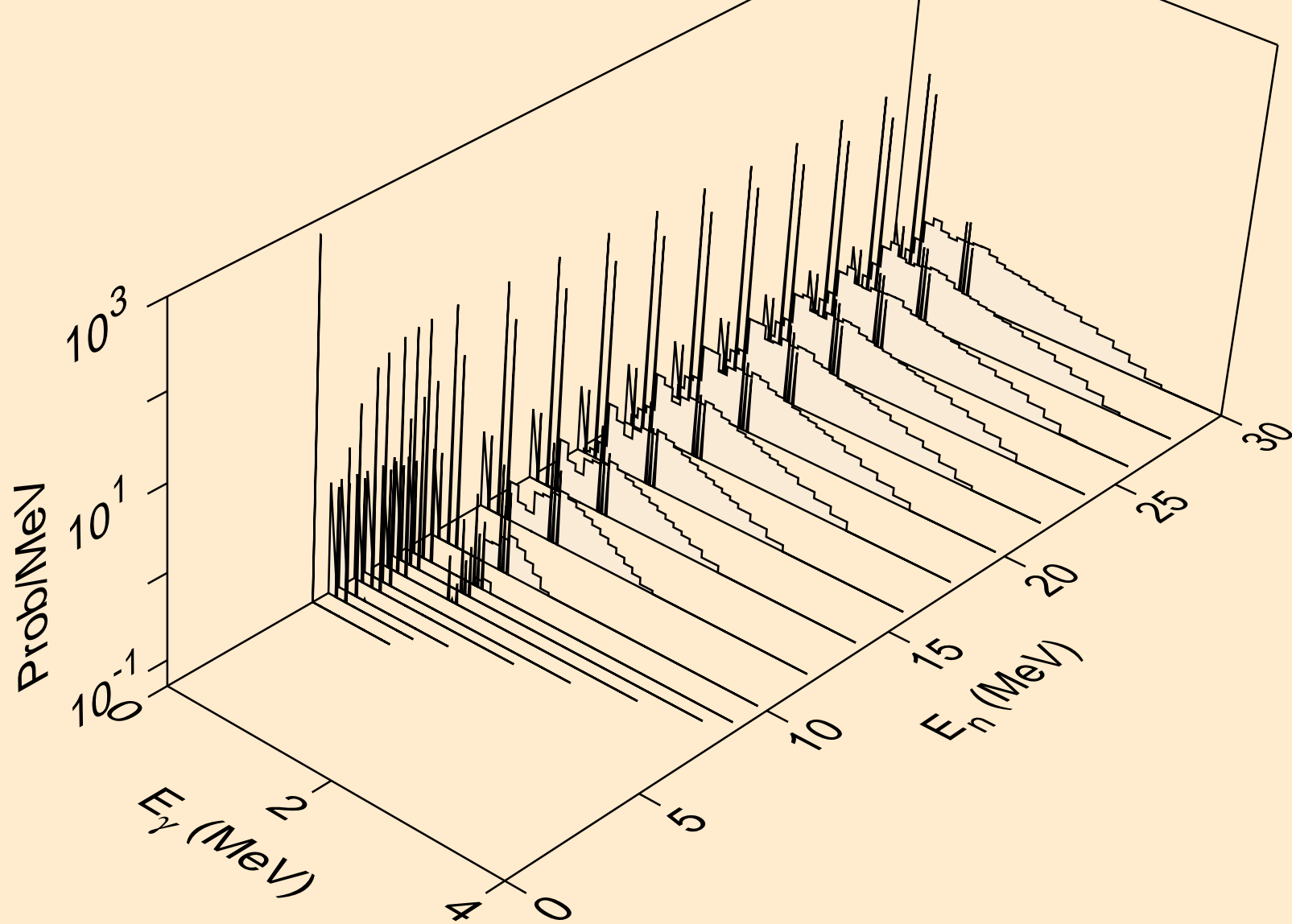

HO159 NEUTRON ACER TENDL-2023 LIBRARY; T=0.K  
Photon emission for (n,n\*)2a

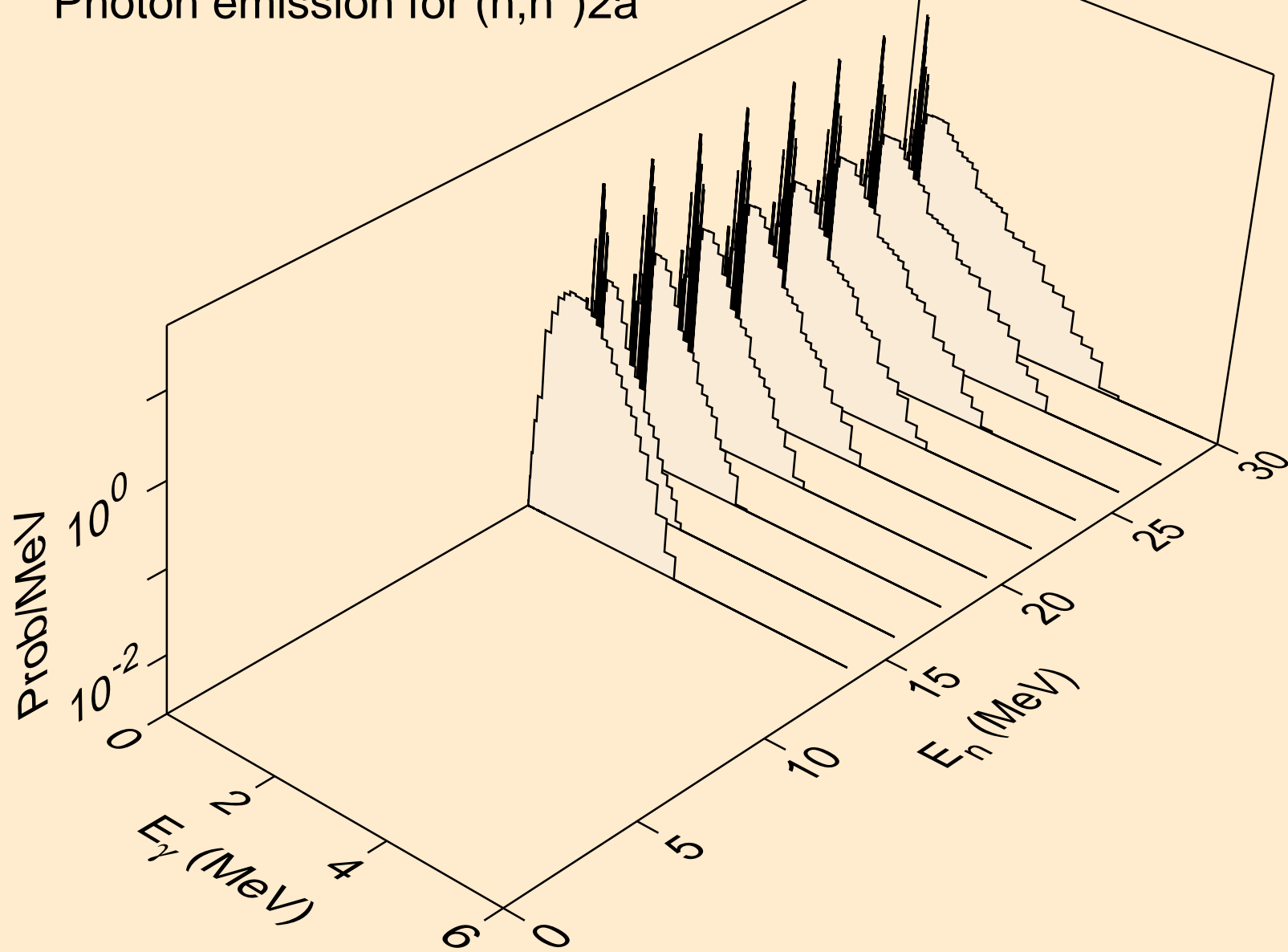

HO159 NEUTRON ACER TENDL-2023 LIBRARY; T=0.K  
Photon emission for (n,n\*)d

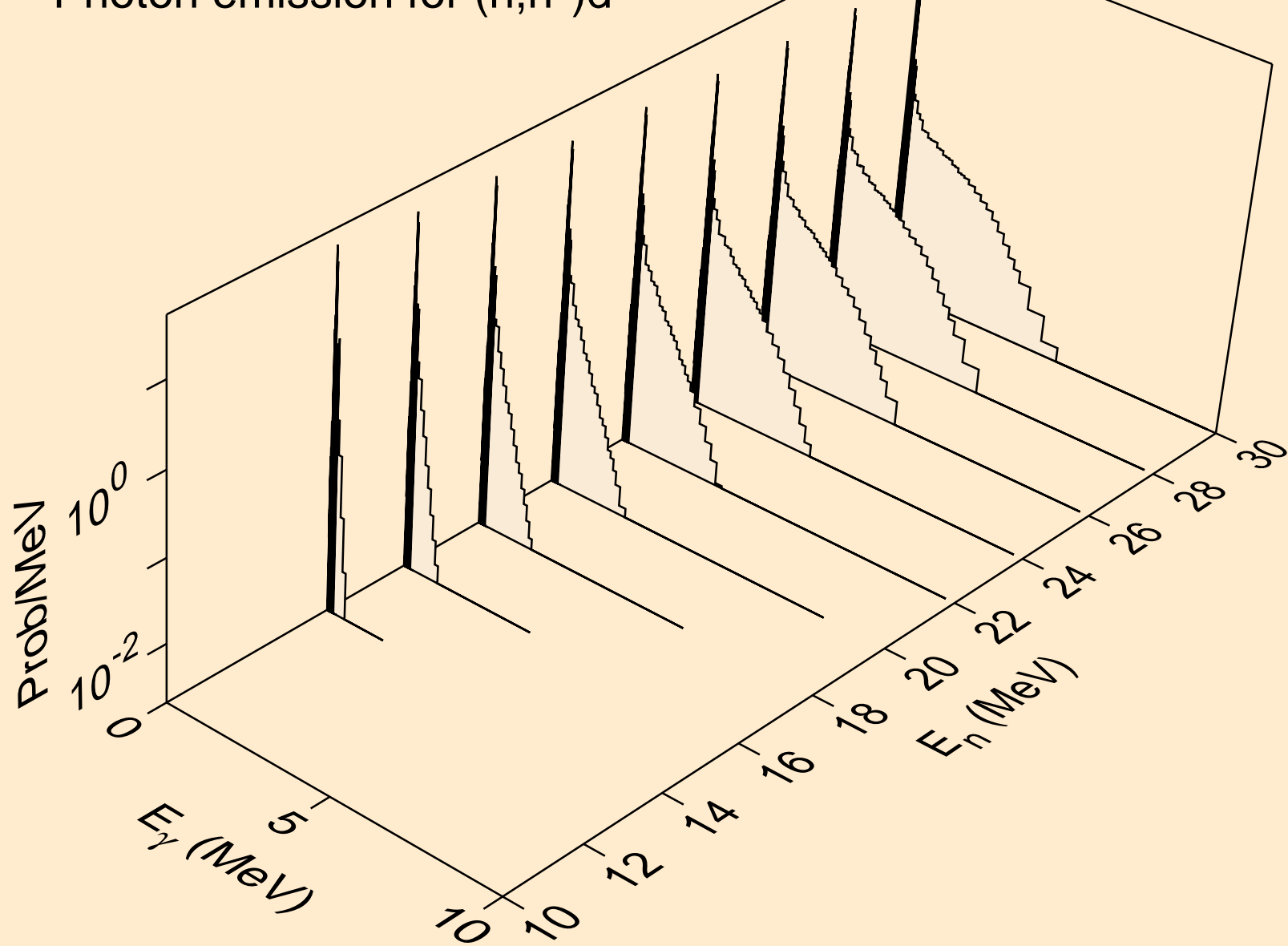

HO159 NEUTRON ACER TENDL-2023 LIBRARY; T=0.K  
Photon emission for (n,n\*)t

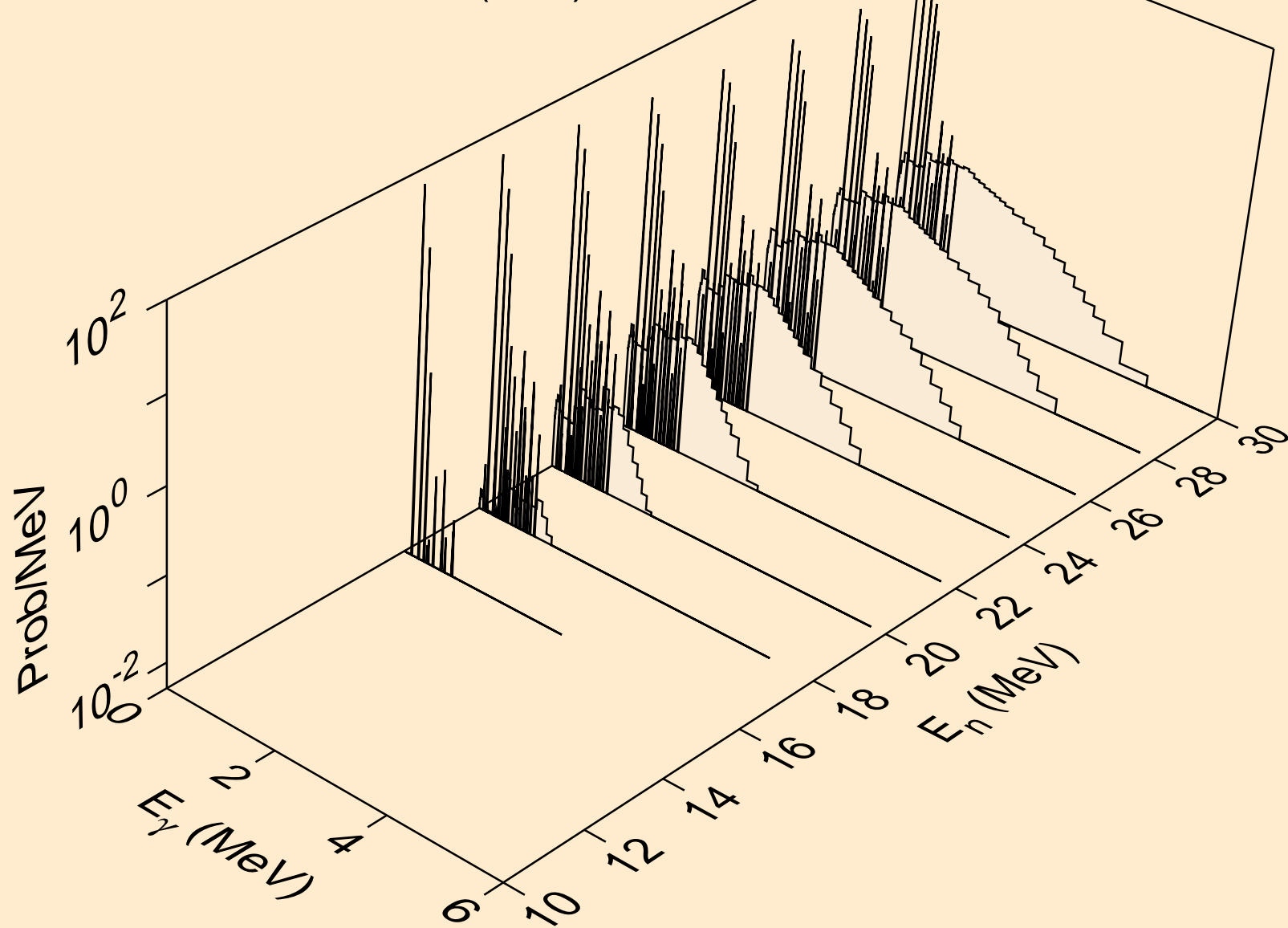

HO159 NEUTRON ACER TENDL-2023 LIBRARY; T=0.K  
Photon emission for (n,n\*)he3

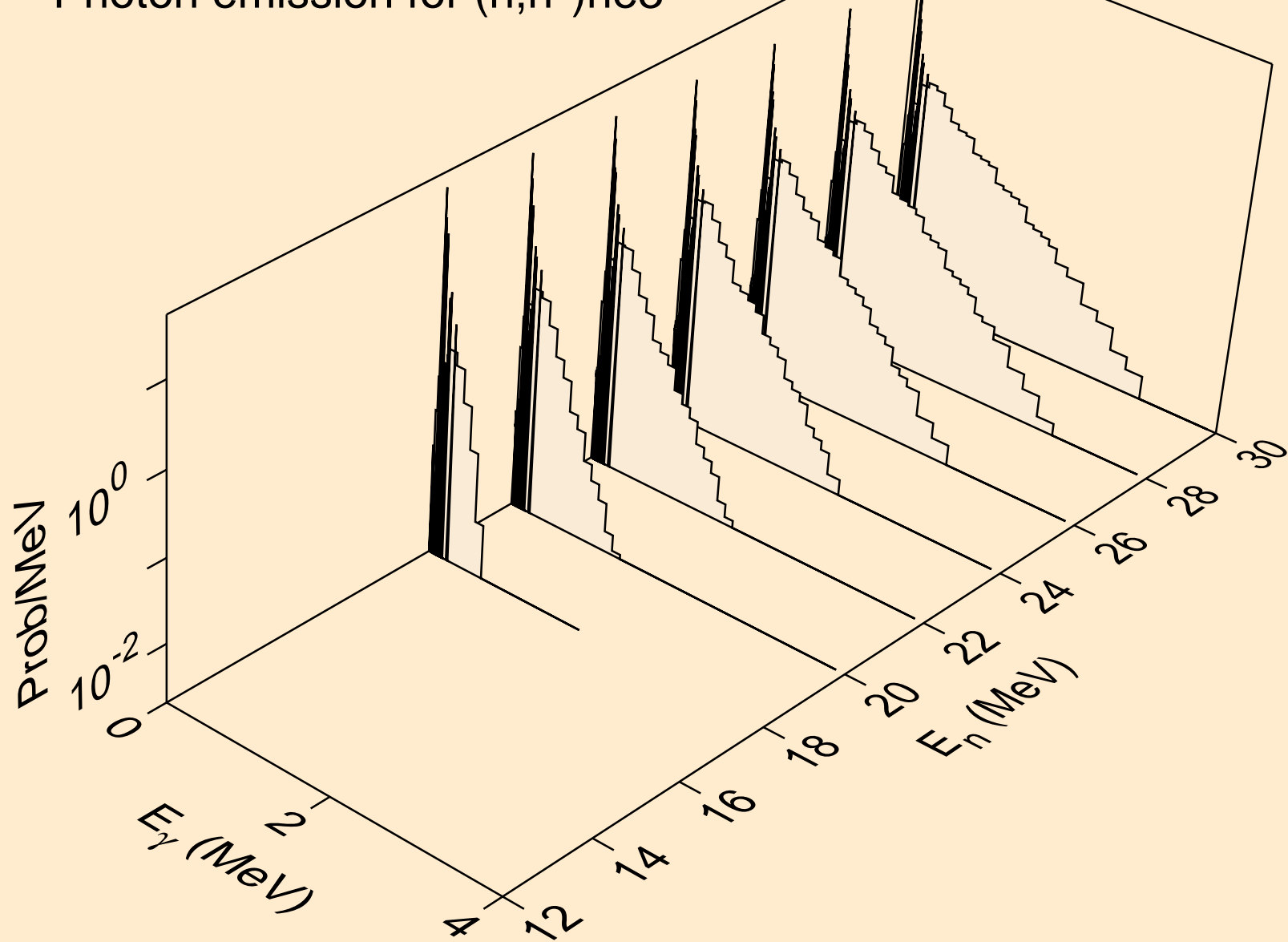

HO159 NEUTRON ACER TENDL-2023 LIBRARY; T=0.K  
Photon emission for (n,4n)

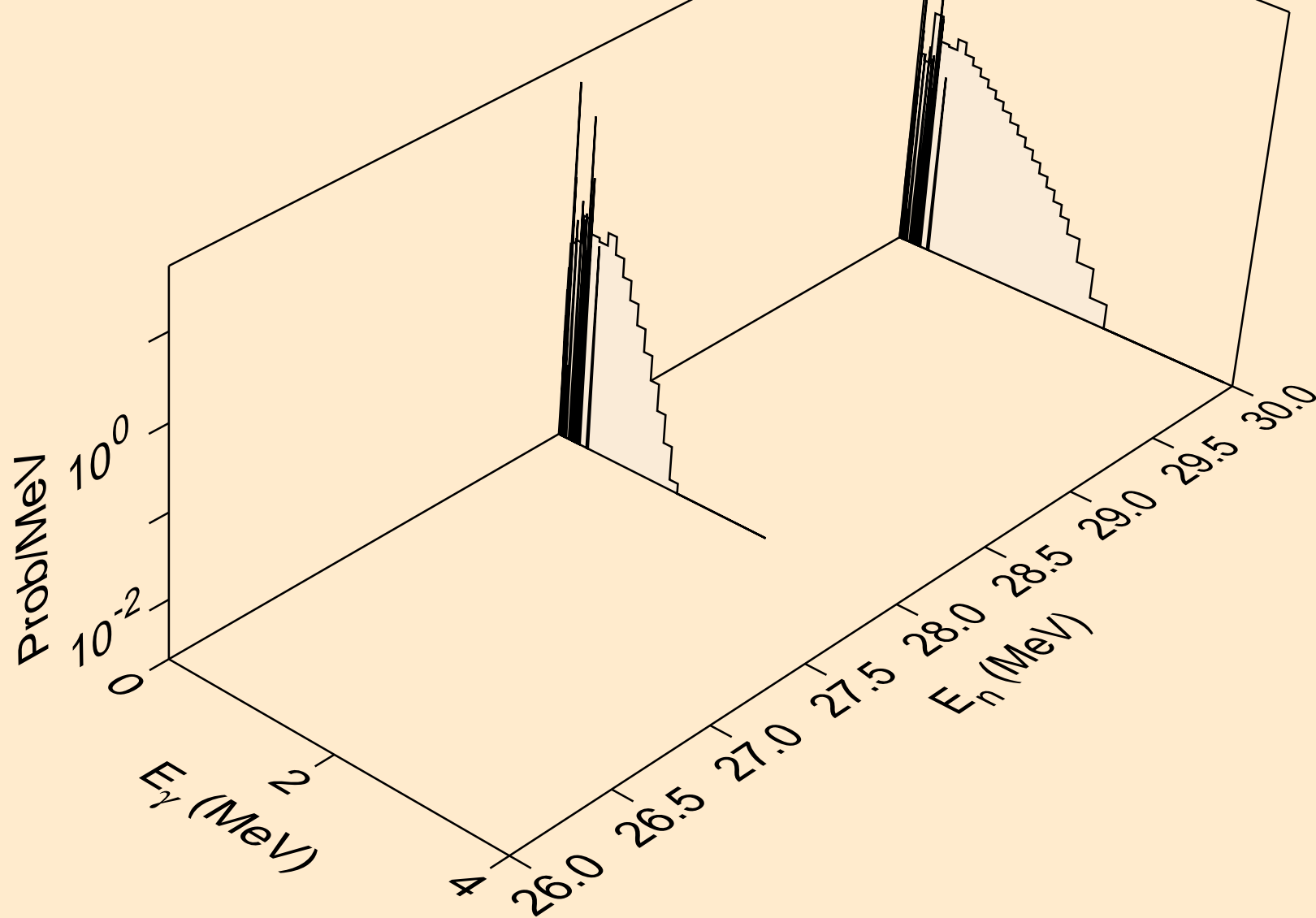

HO159 NEUTRON ACER TENDL-2023 LIBRARY; T=0.K  
Photon emission for (n,2np)

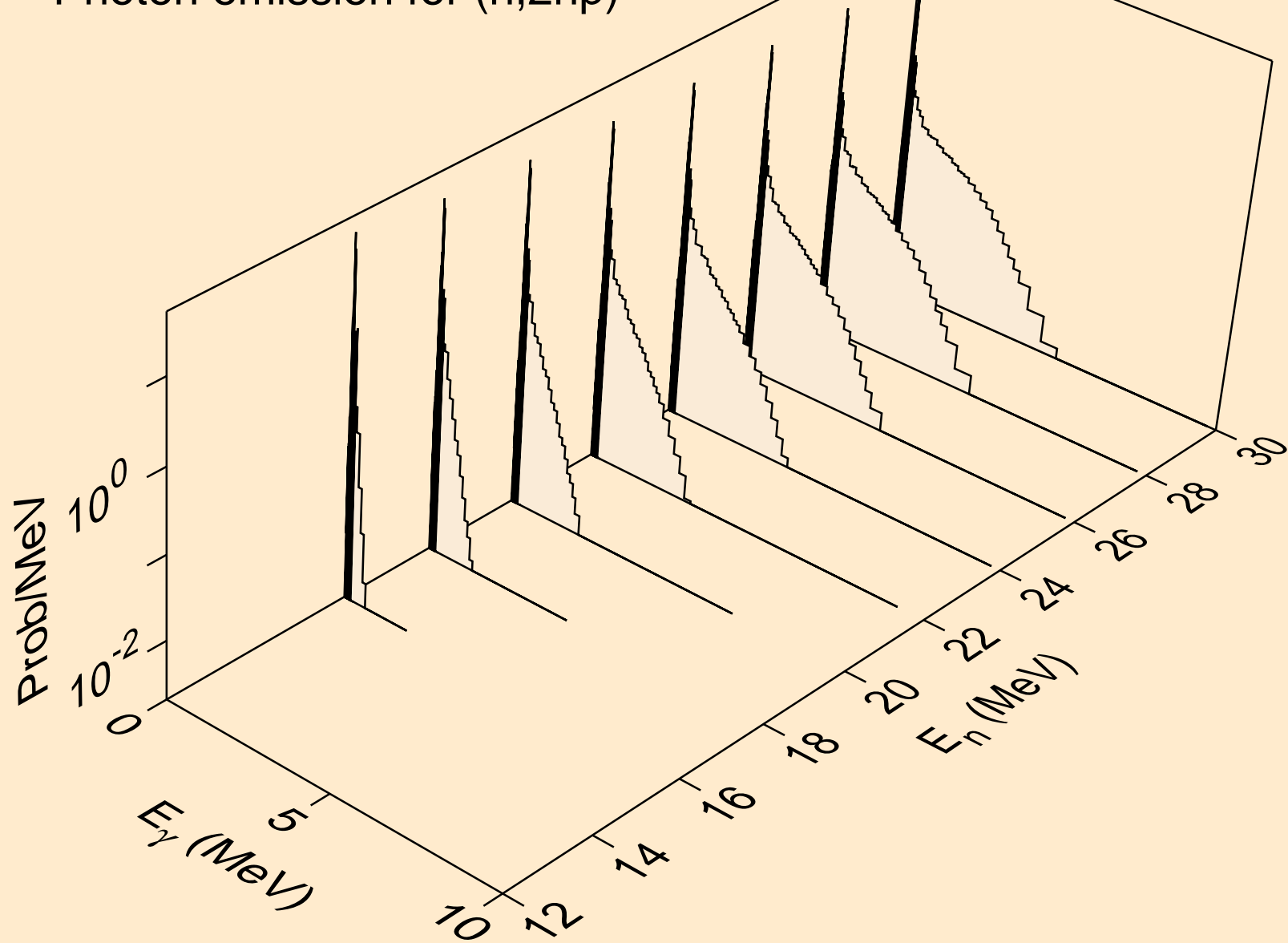

HO159 NEUTRON ACER TENDL-2023 LIBRARY; T=0.K  
Photon emission for (n,3np)

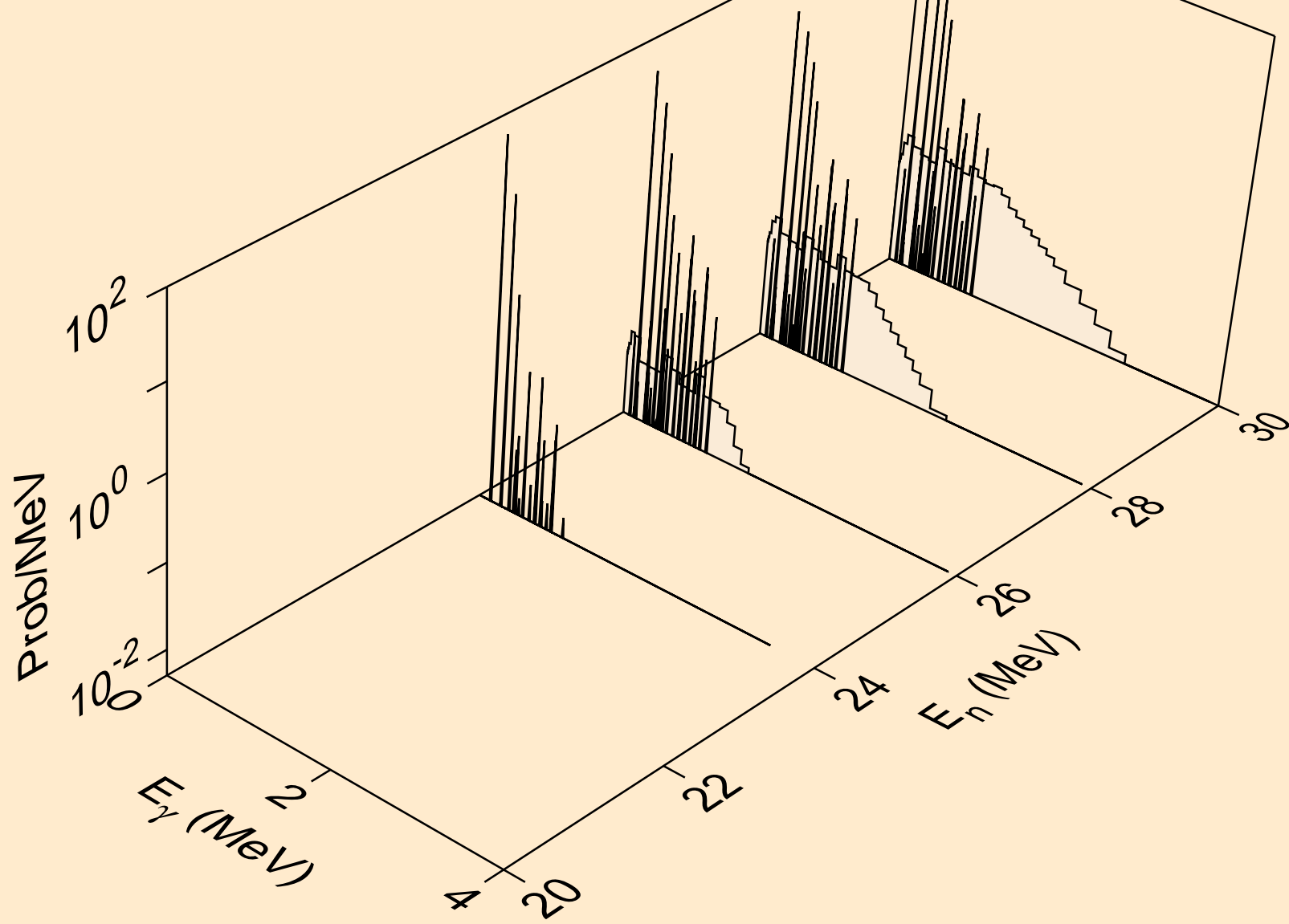

HO159 NEUTRON ACER TENDL-2023 LIBRARY; T=0.K  
Photon emission for (n,n2p)

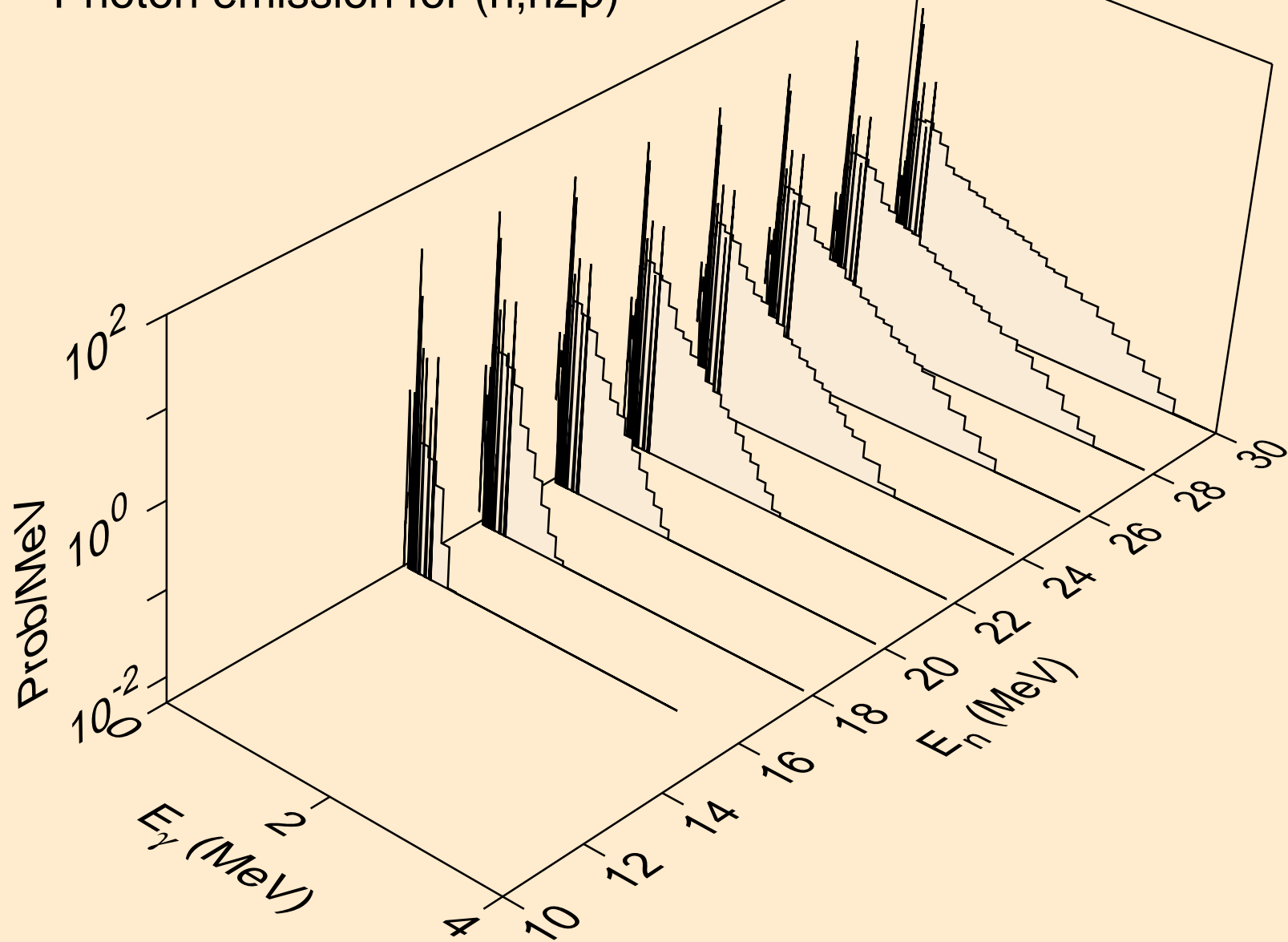

HO159 NEUTRON ACER TENDL-2023 LIBRARY; T=0.K  
Photon emission for (n,npa)

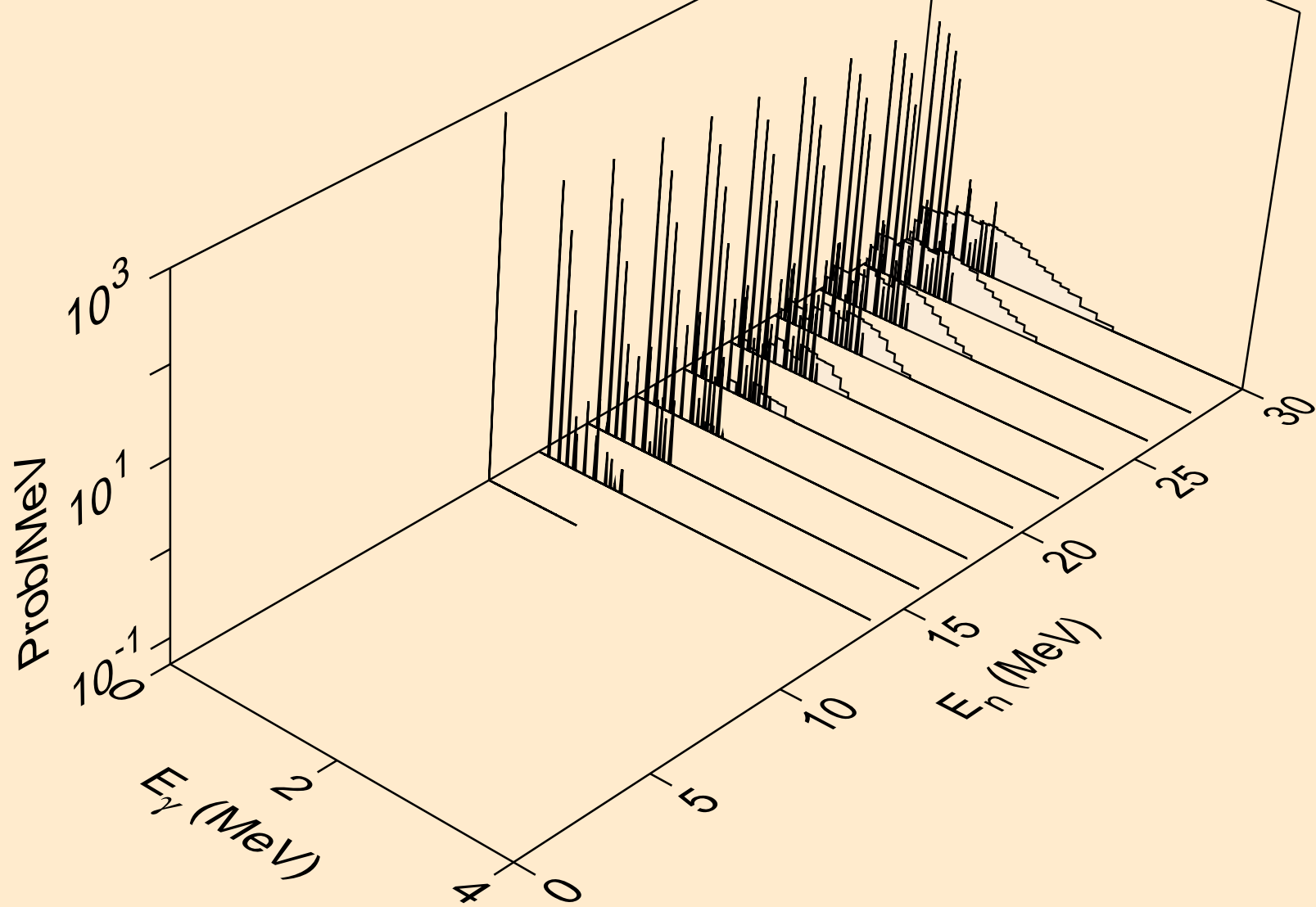

HO159 NEUTRON ACER TENDL-2023 LIBRARY; T=0.K  
Photon emission for (n,n\*c)

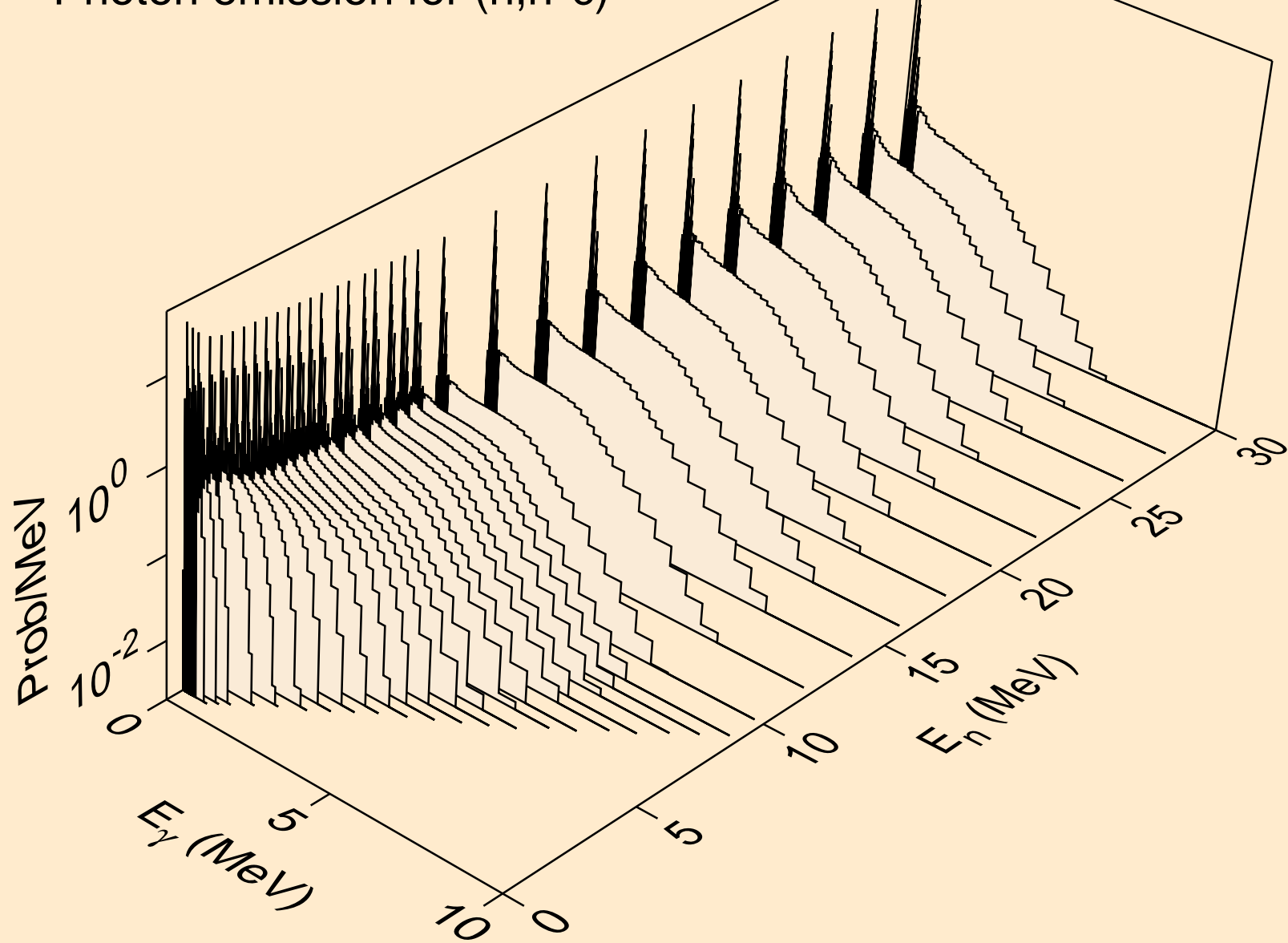

HO159 NEUTRON ACER TENDL-2023 LIBRARY; T=0.K  
Photon emission for (n,gma)

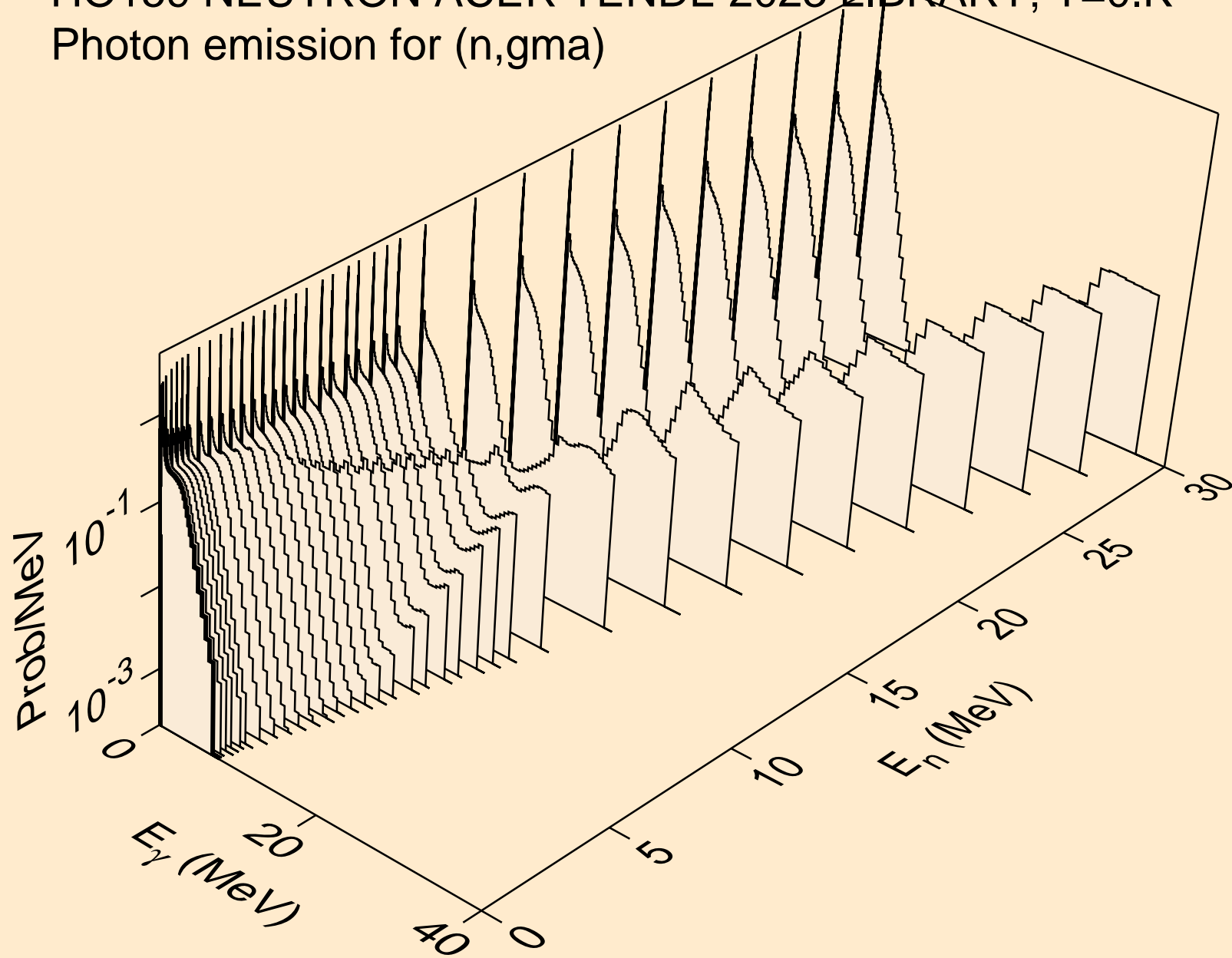

HO159 NEUTRON ACER TENDL-2023 LIBRARY; T=0.K  
Photon emission for (n,p)

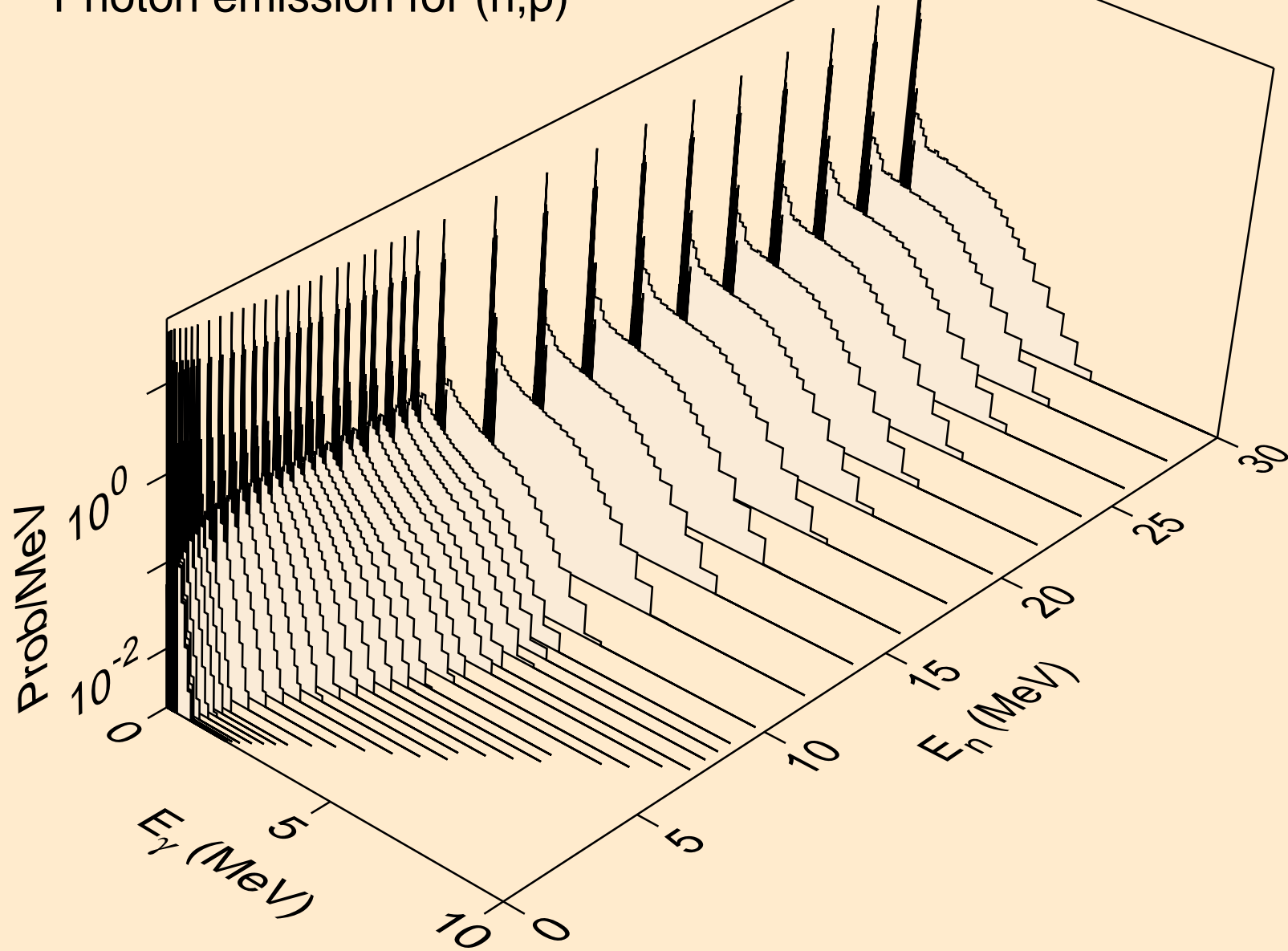

HO159 NEUTRON ACER TENDL-2023 LIBRARY; T=0.K  
Photon emission for (n,d)

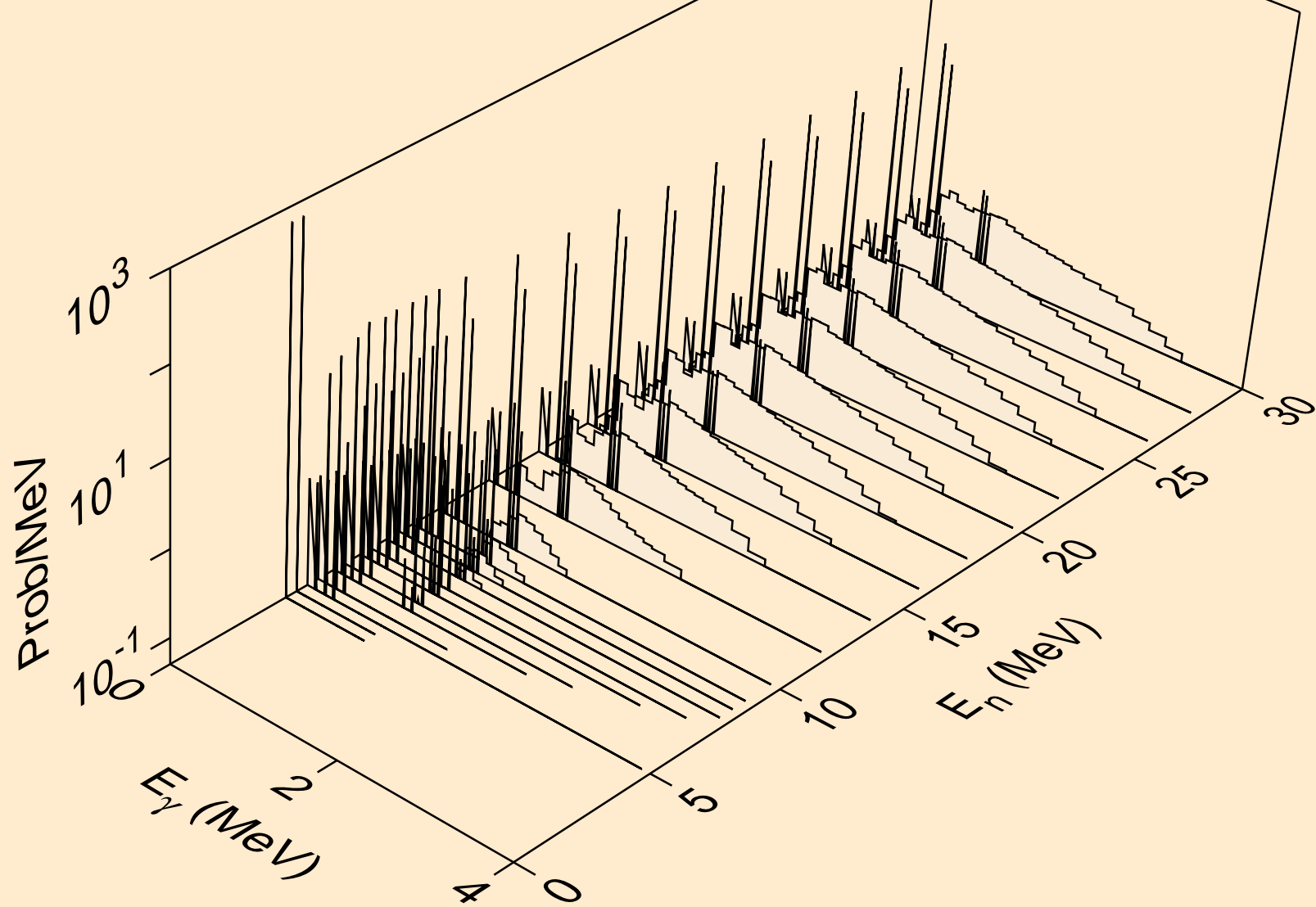

HO159 NEUTRON ACER TENDL-2023 LIBRARY; T=0.K  
Photon emission for (n,t)

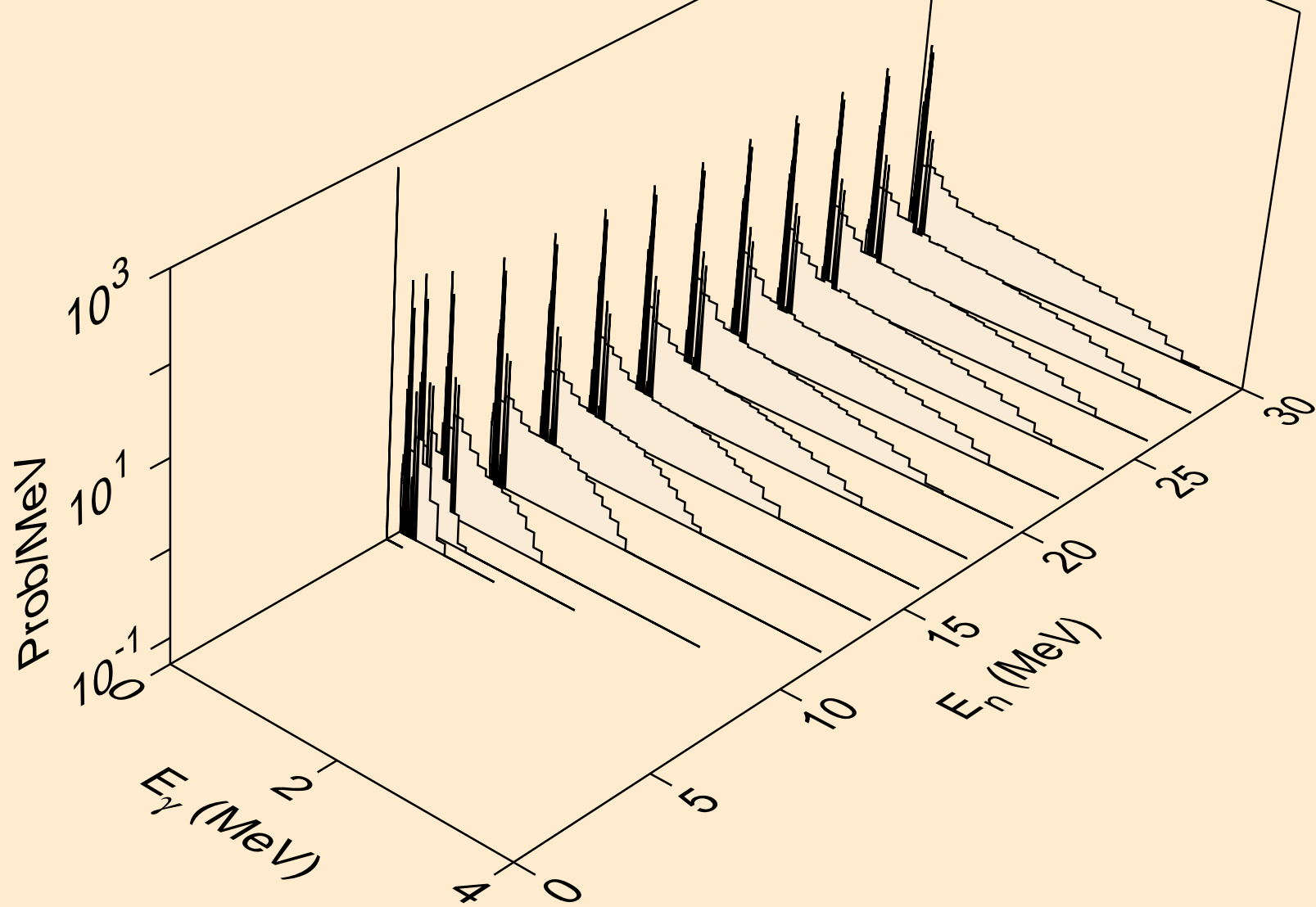

HO159 NEUTRON ACER TENDL-2023 LIBRARY; T=0.K  
Photon emission for (n,he3)

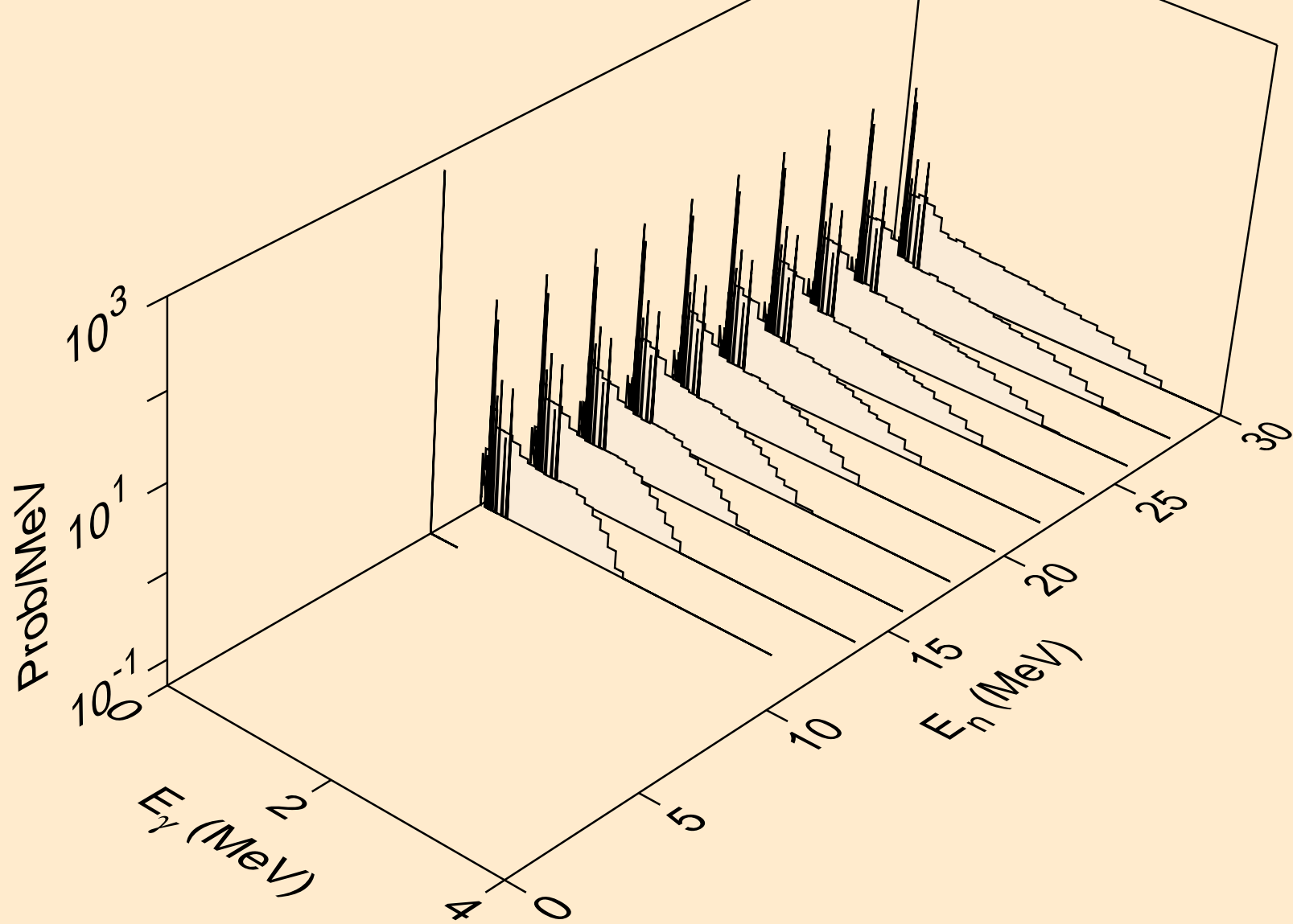

HO159 NEUTRON ACER TENDL-2023 LIBRARY; T=0.K  
Photon emission for (n,a)

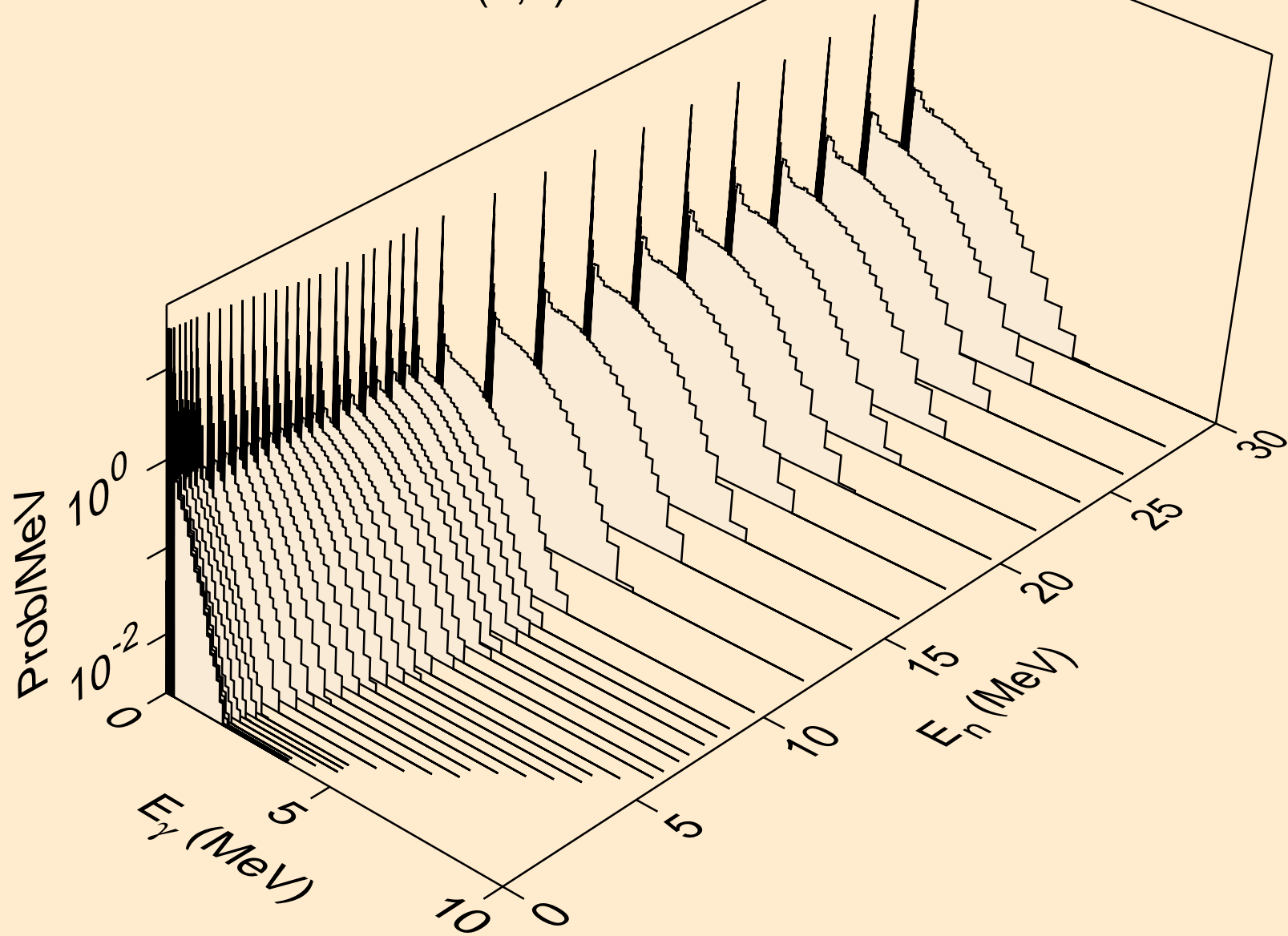

HO159 NEUTRON ACER TENDL-2023 LIBRARY; T=0.K  
Photon emission for (n,2a)

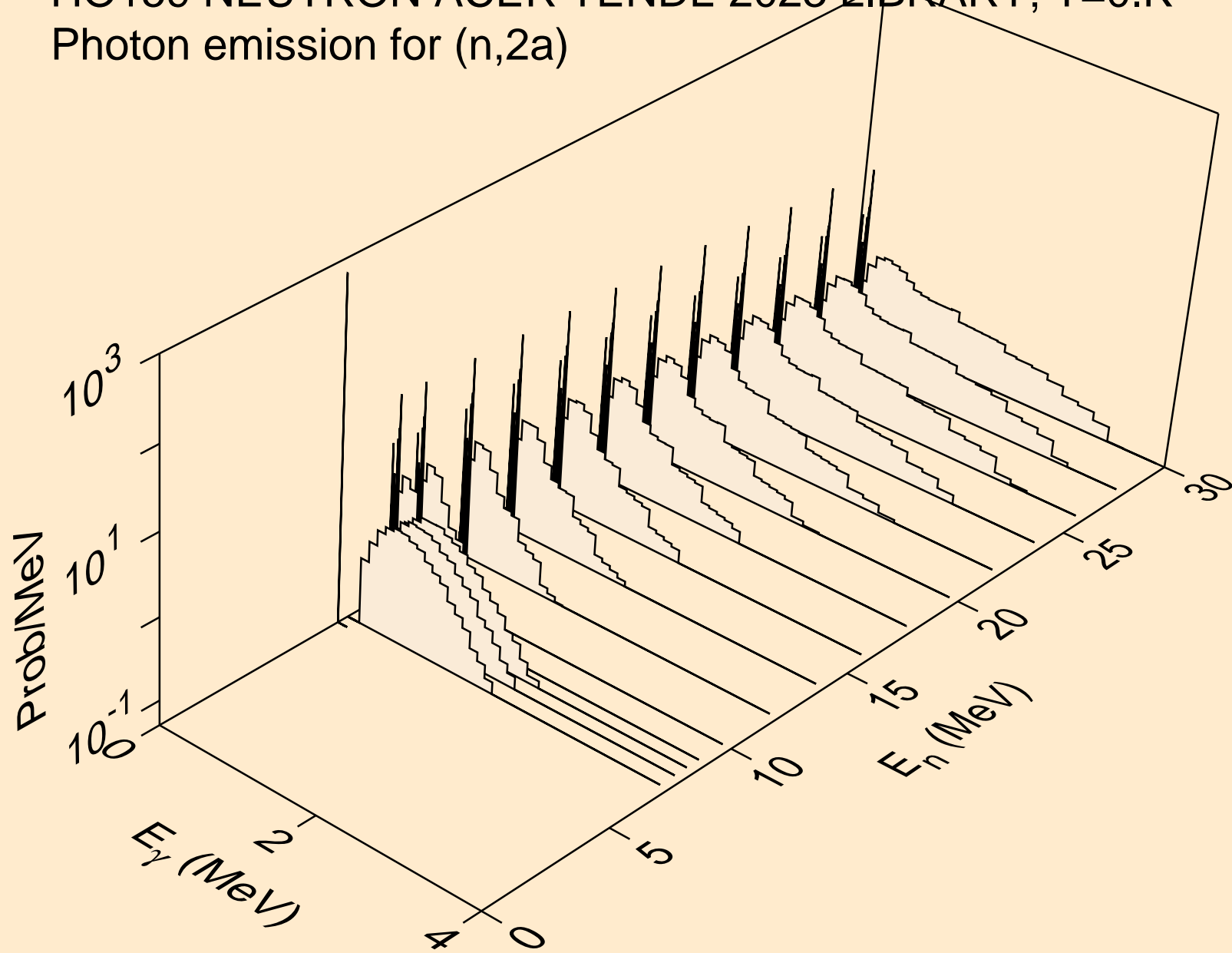

HO159 NEUTRON ACER TENDL-2023 LIBRARY; T=0.K  
Photon emission for (n,2p)

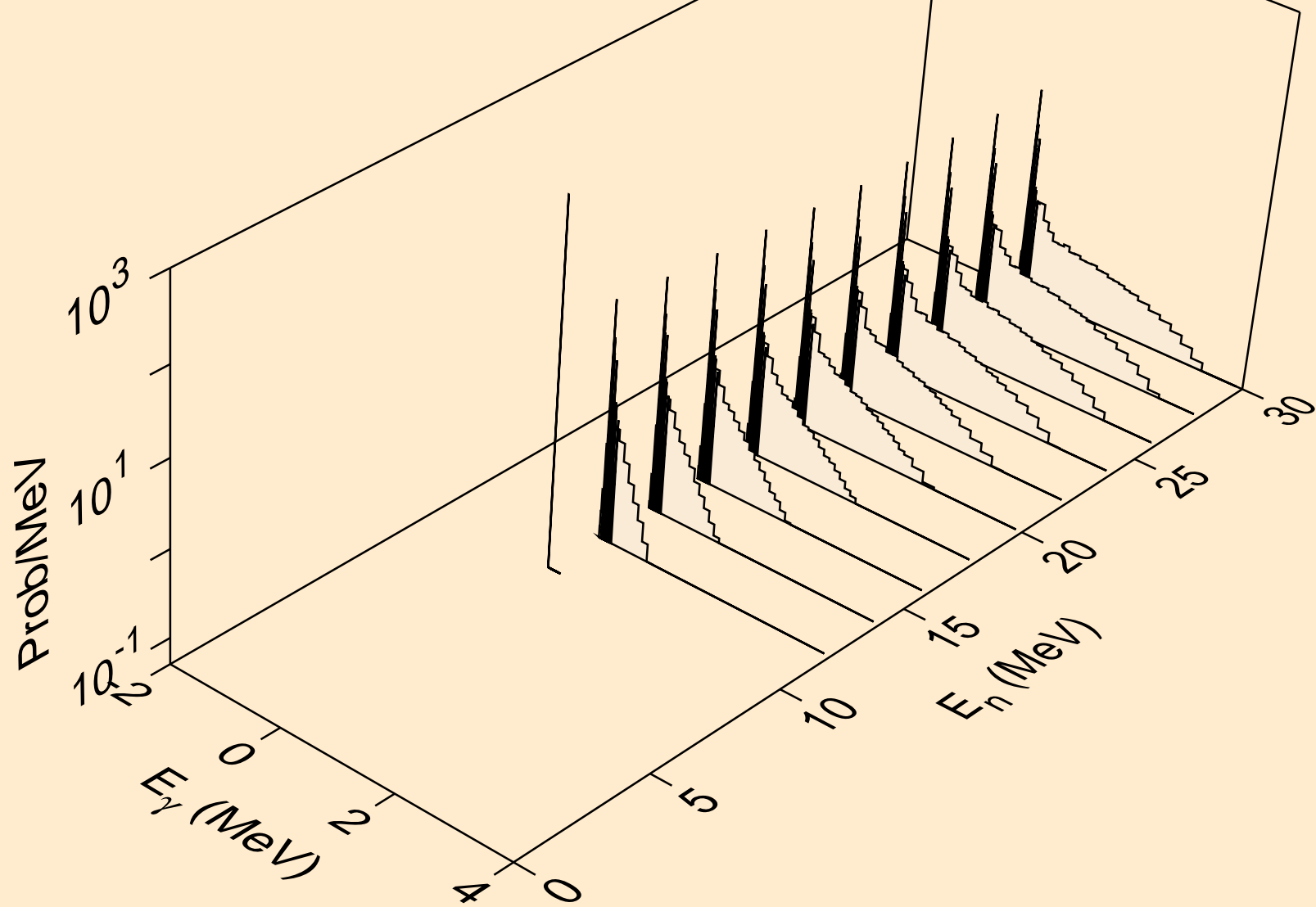

HO159 NEUTRON ACER TENDL-2023 LIBRARY; T=0.K  
Photon emission for (n,p)

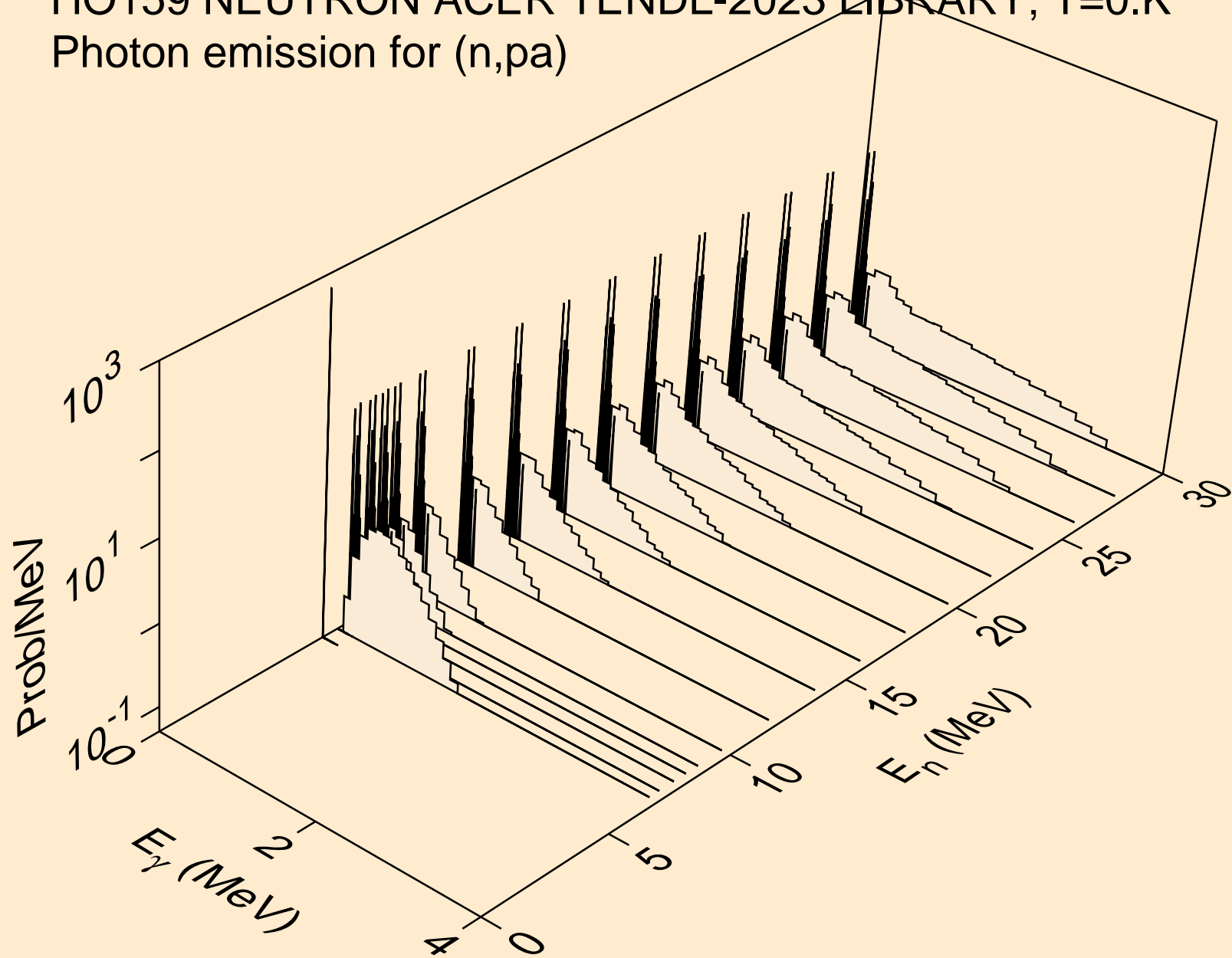

HO159 NEUTRON ACER TENDL-2023 LIBRARY; T=0.K  
Photon emission for (n,pd)

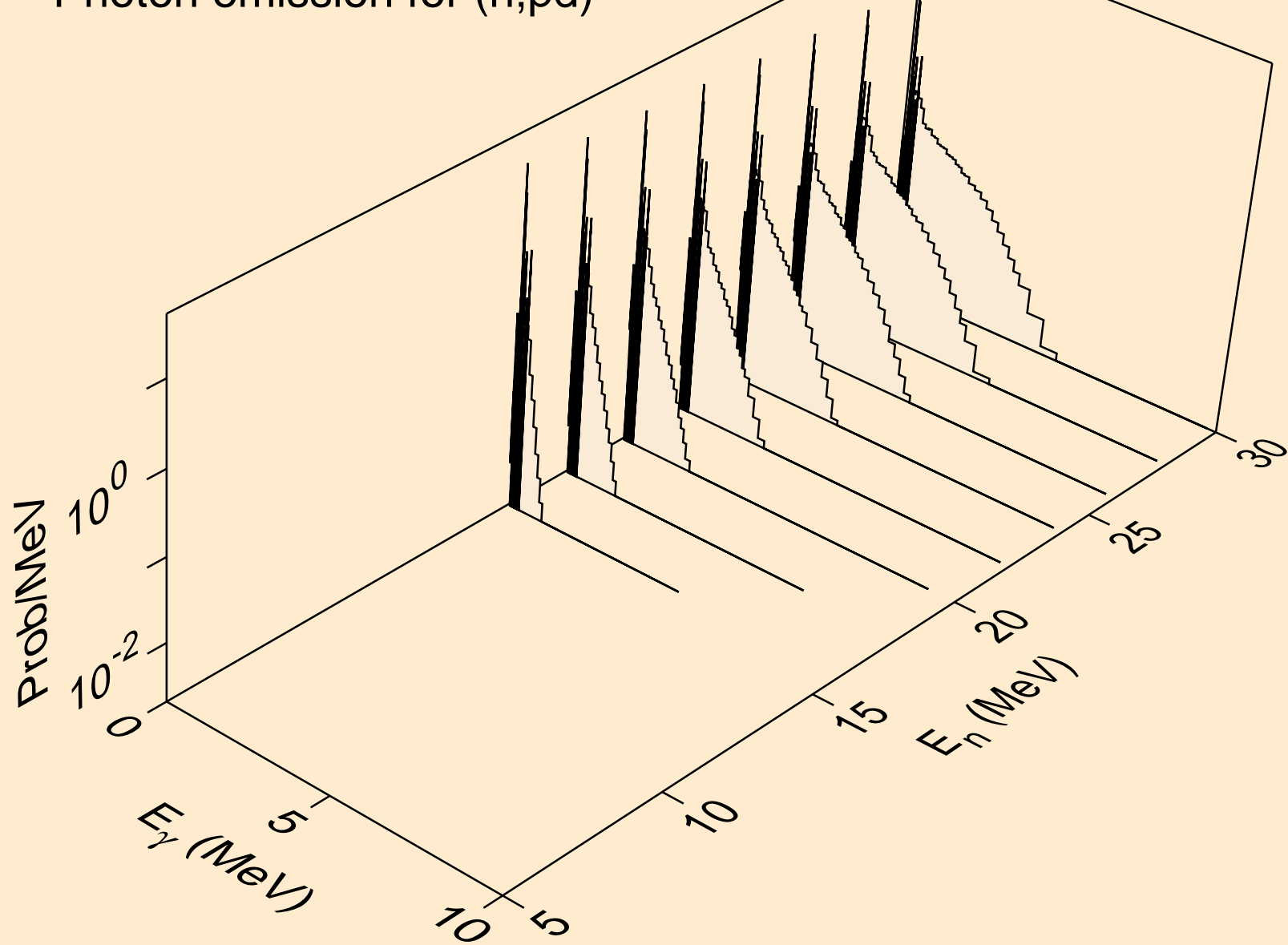

HO159 NEUTRON ACER TENDL-2023 LIBRARY; T=0.K  
Photon emission for (n,pt)

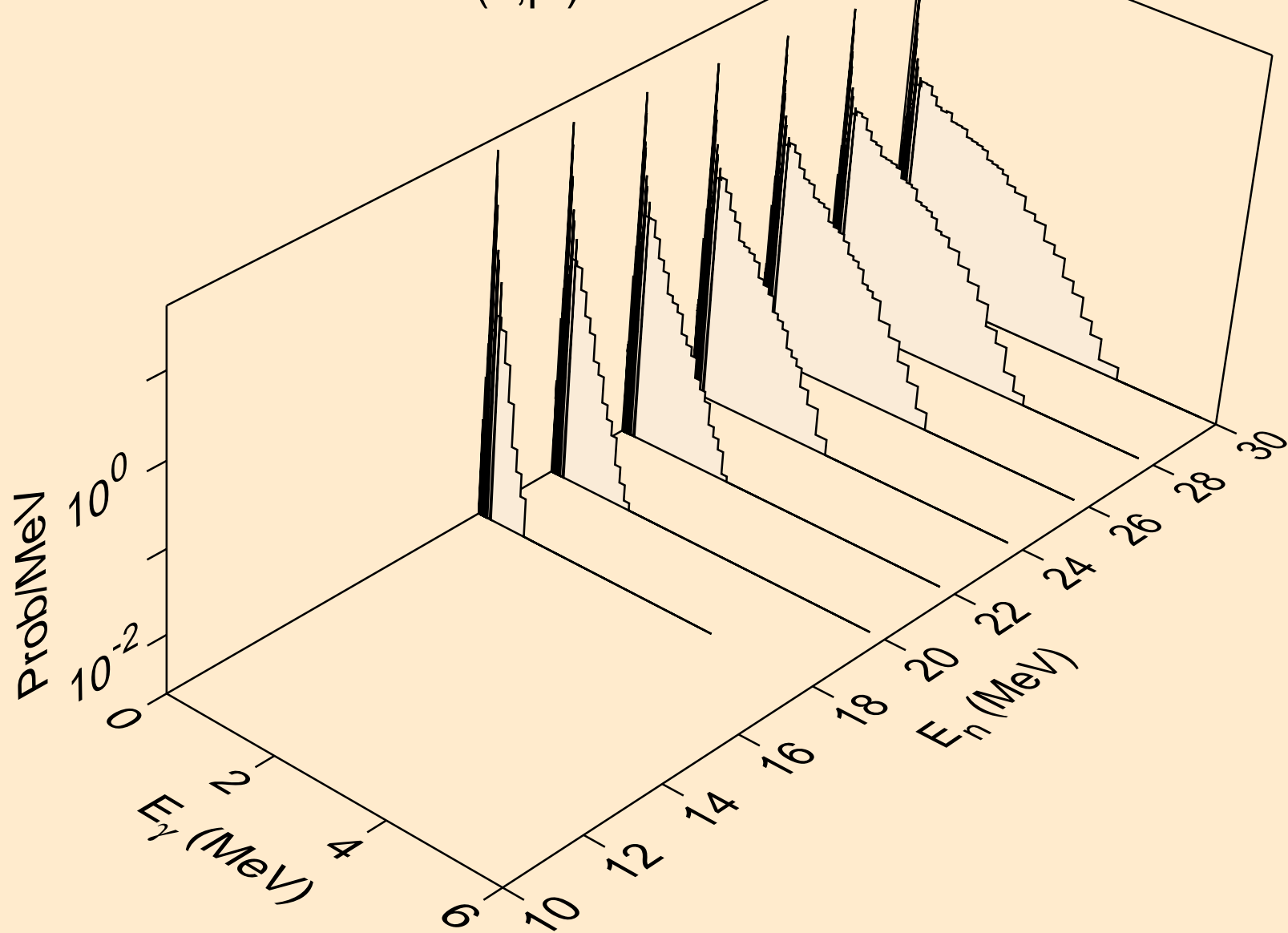

HO159 NEUTRON ACER TENDL-2023 LIBRARY; T=0.K  
Photon emission for (n,da)

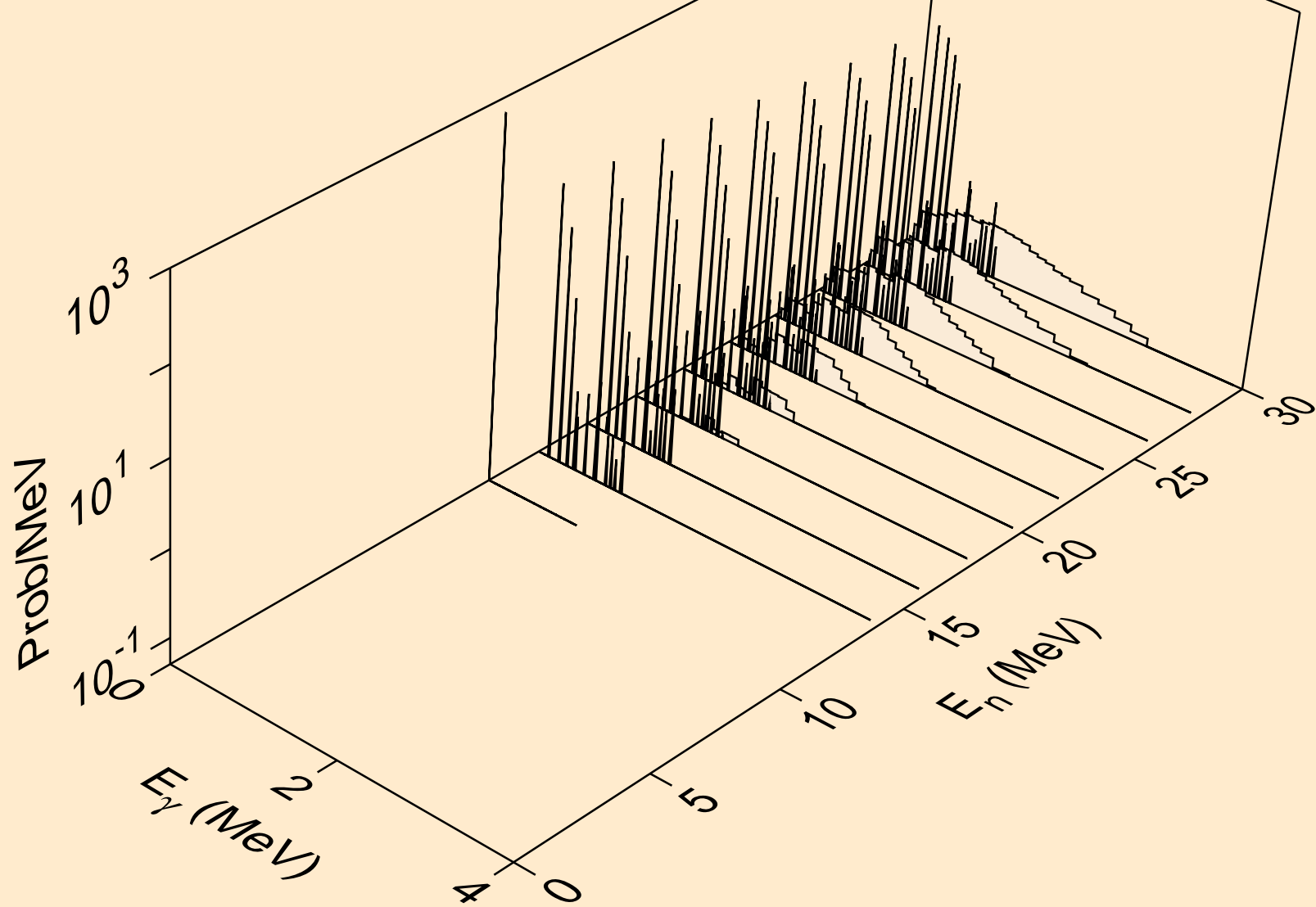

HO159 NEUTRON ACER TENDL-2023 LIBRARY; T=0.K  
thermal capture photon spectrum

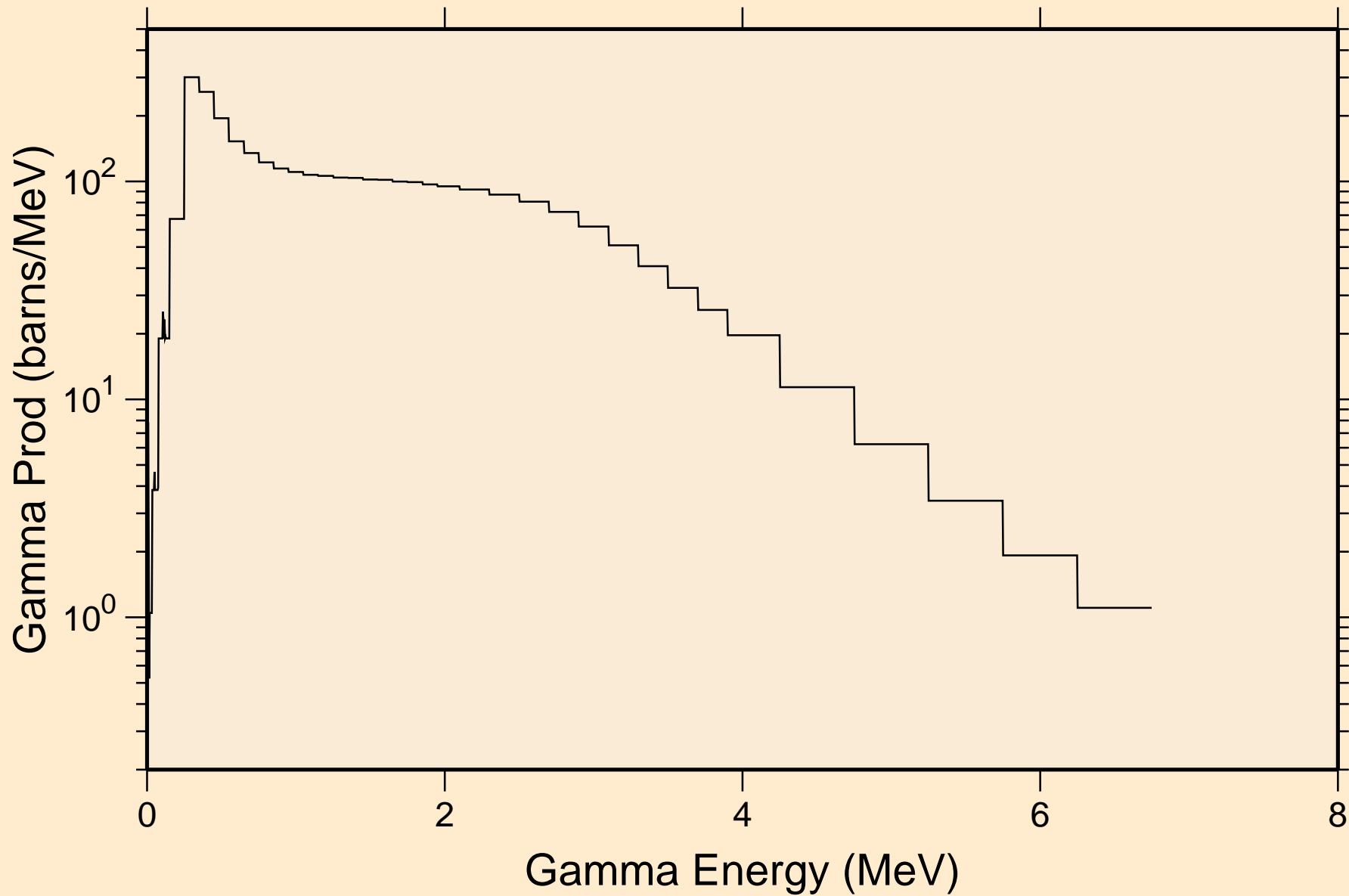

HO159 NEUTRON ACER TENDL-2023 LIBRARY; T=0.K  
14 MeV photon spectrum

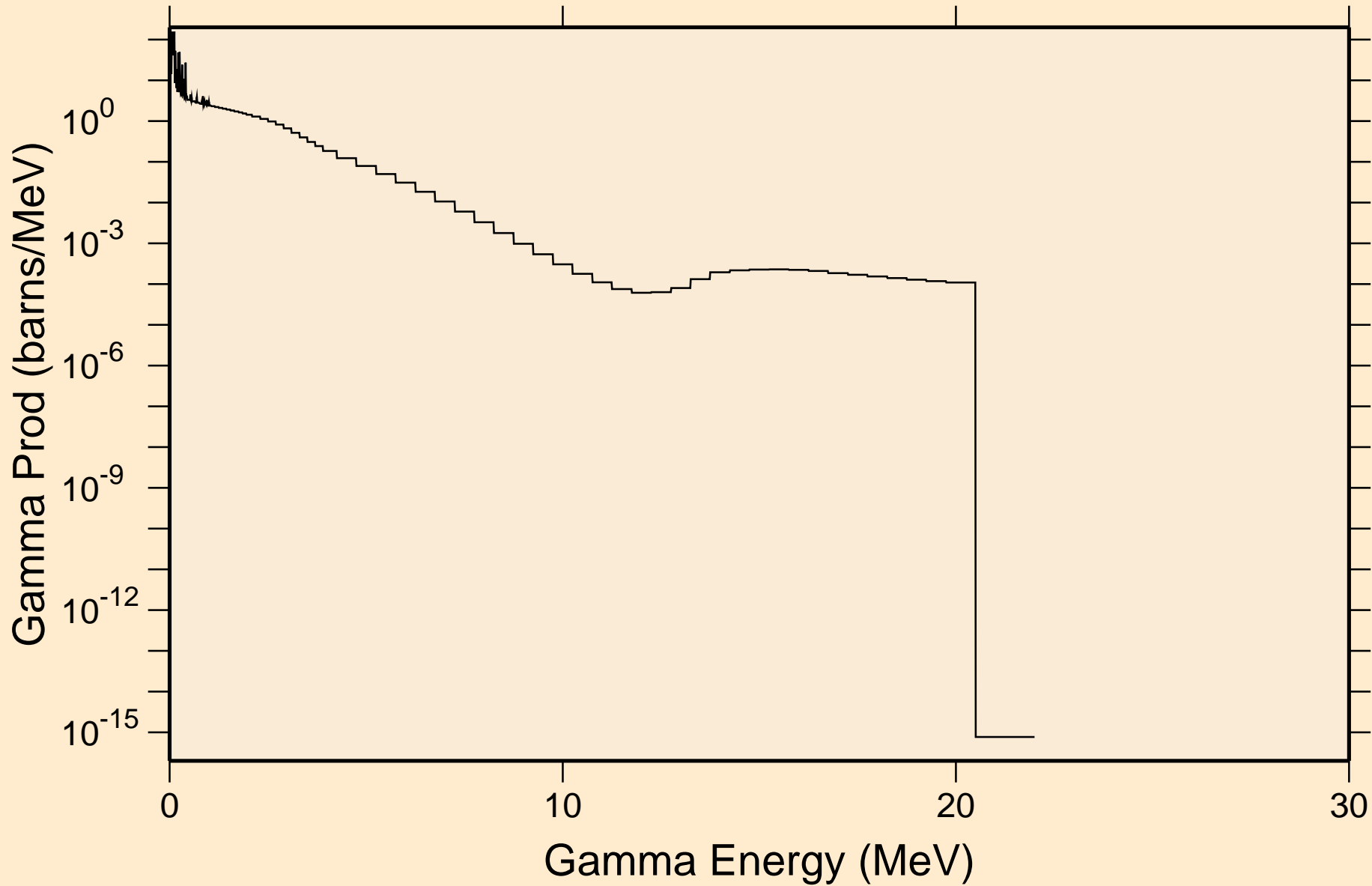

# HO159 NEUTRON ACER TENDL-2023 LIBRARY; T=0.K

## Particle heating contributions

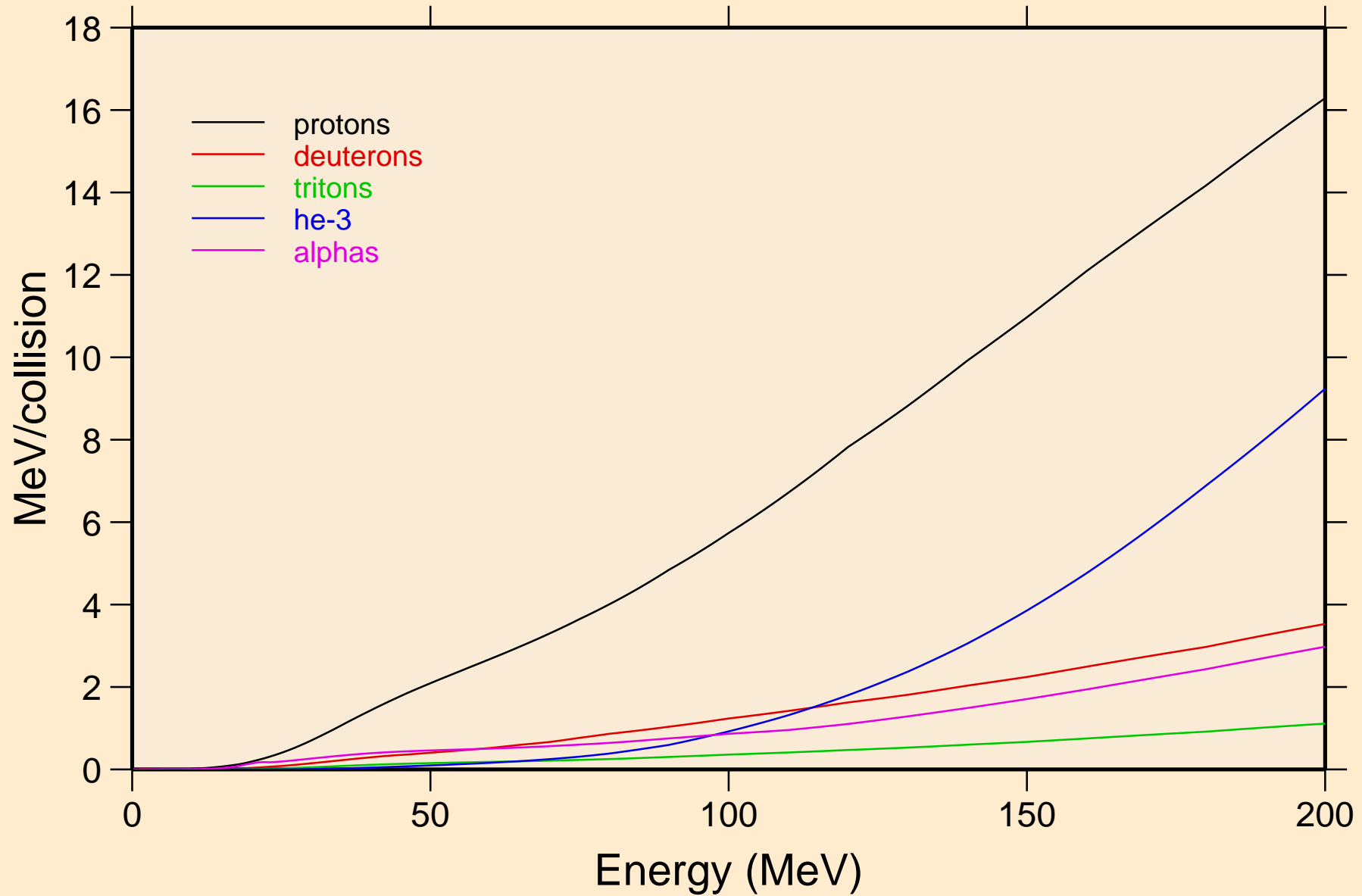

# HO159 NEUTRON ACER TENDL-2023 LIBRARY; T=0.K

## Recoil Heating

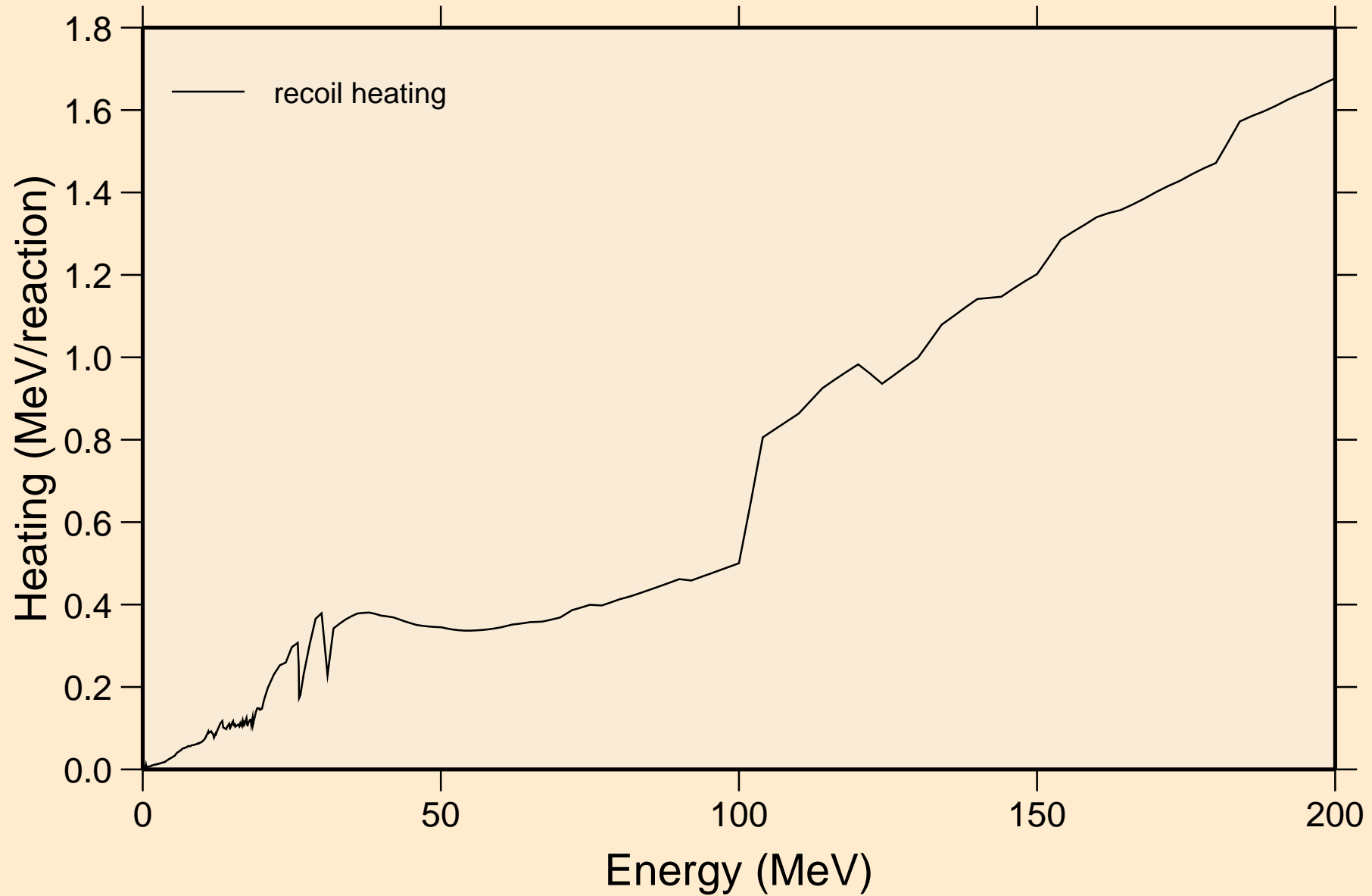

# HO159 NEUTRON ACER TENDL-2023 LIBRARY; T=0.K

## Particle production cross sections

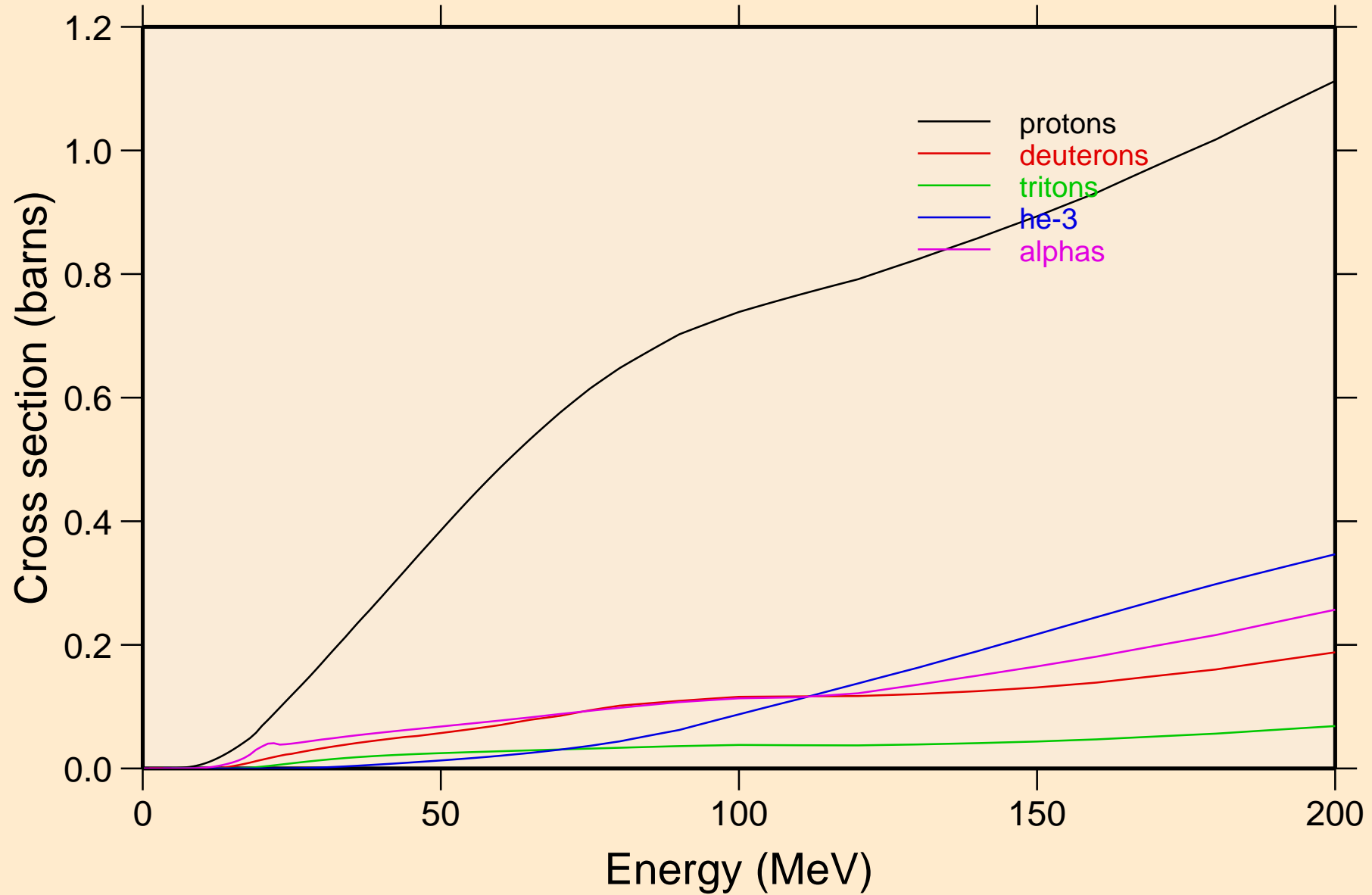

HO159 NEUTRON ACER TENDL-2023 LIBRARY; T=0.K  
protons from (n,x)

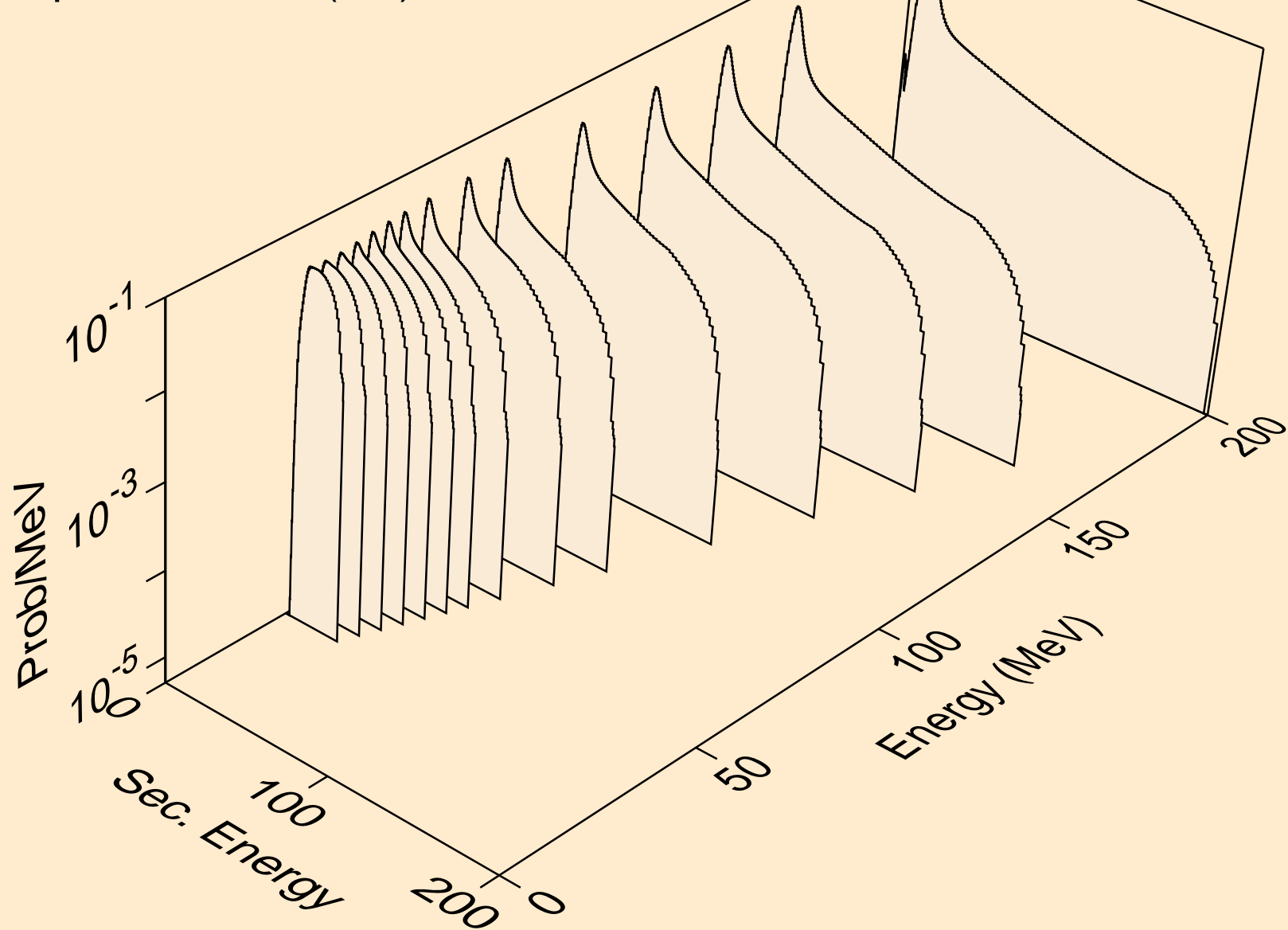

HO159 NEUTRON ACER TENDL-2023 LIBRARY; T=0.K  
protons from (n,n\*)p

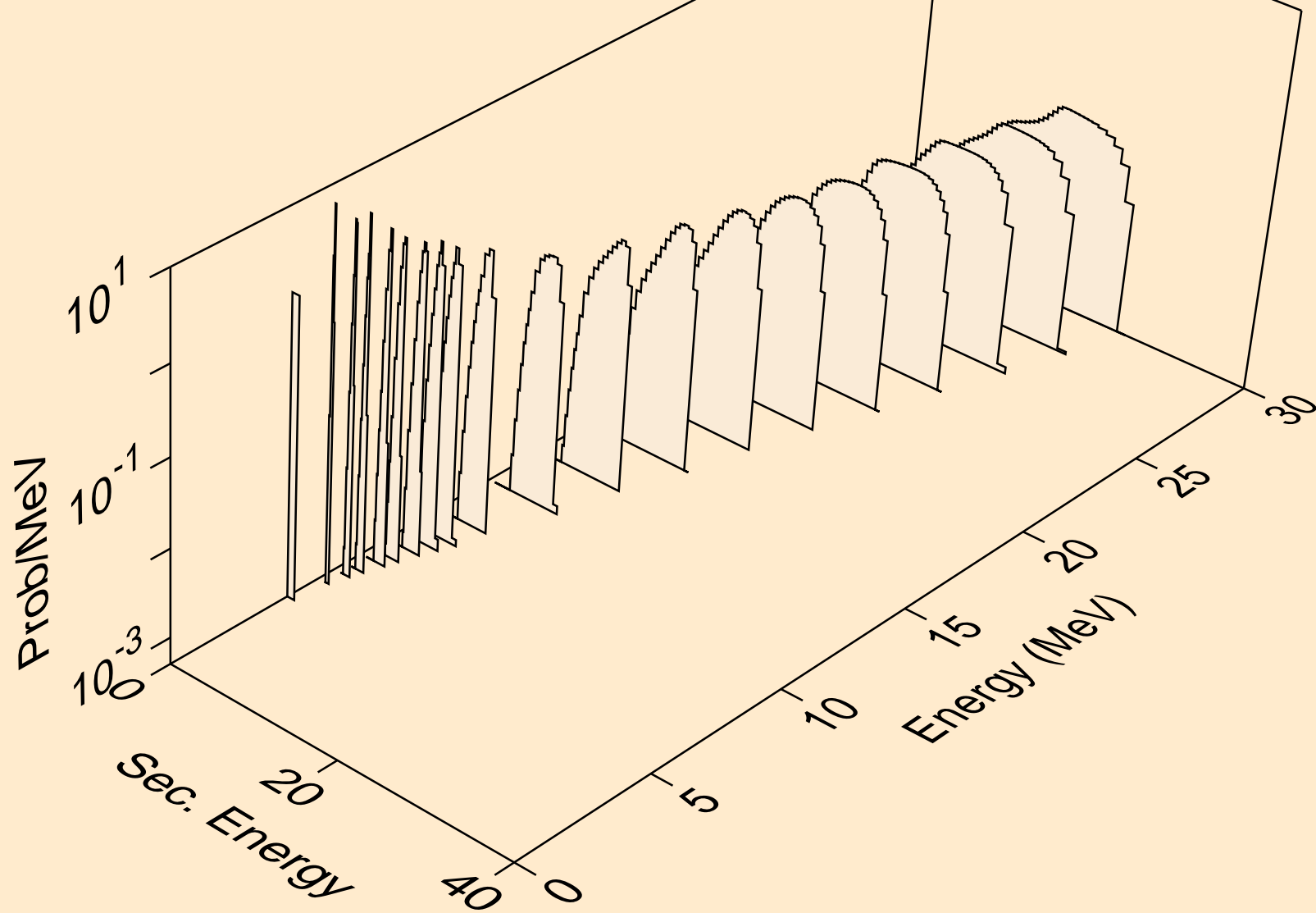

HO159 NEUTRON ACER TENDL-2023 LIBRARY; T=0.K  
protons from (n,2np)

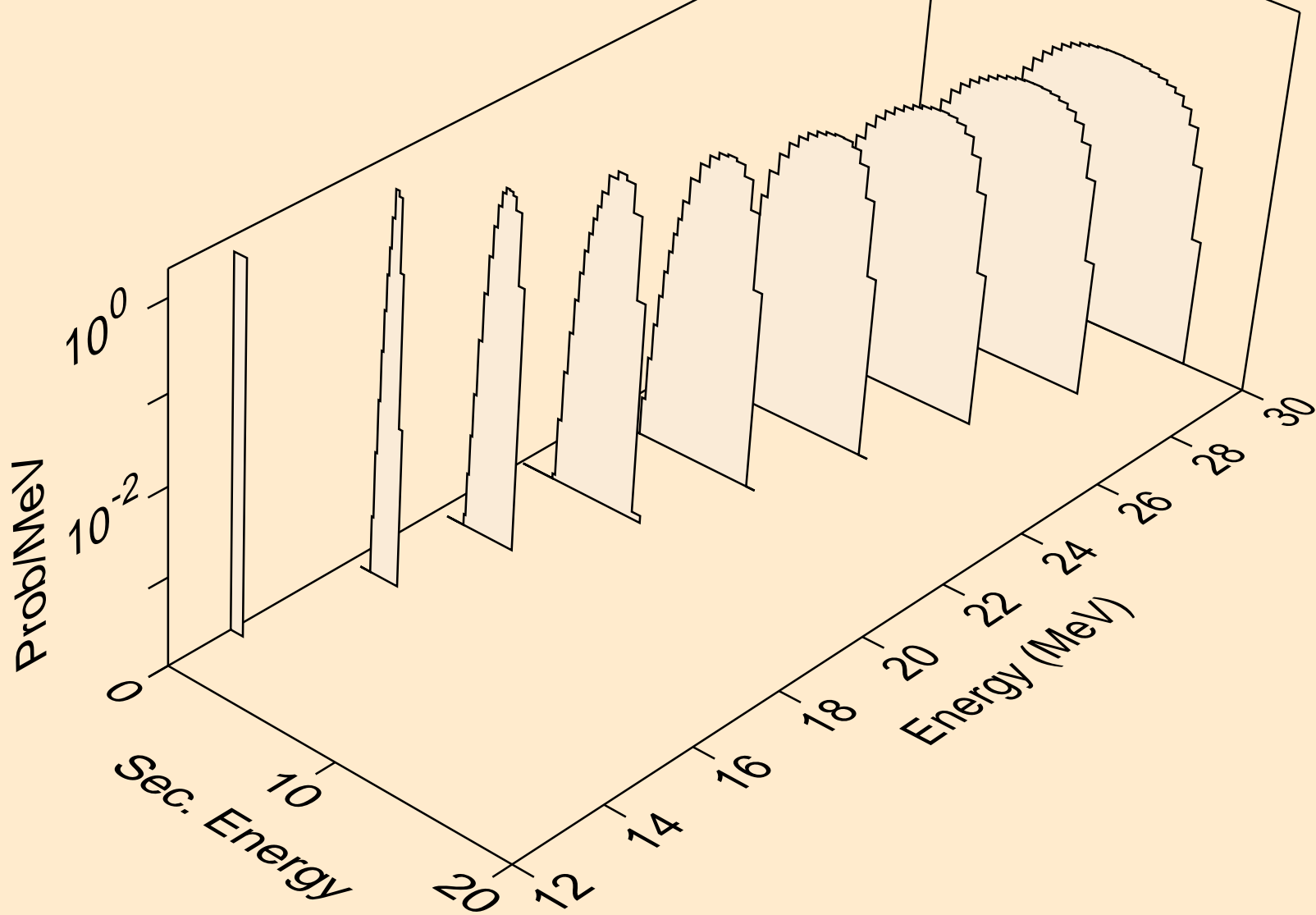

HO159 NEUTRON ACER TENDL-2023 LIBRARY; T=0.K  
protons from (n,3np)

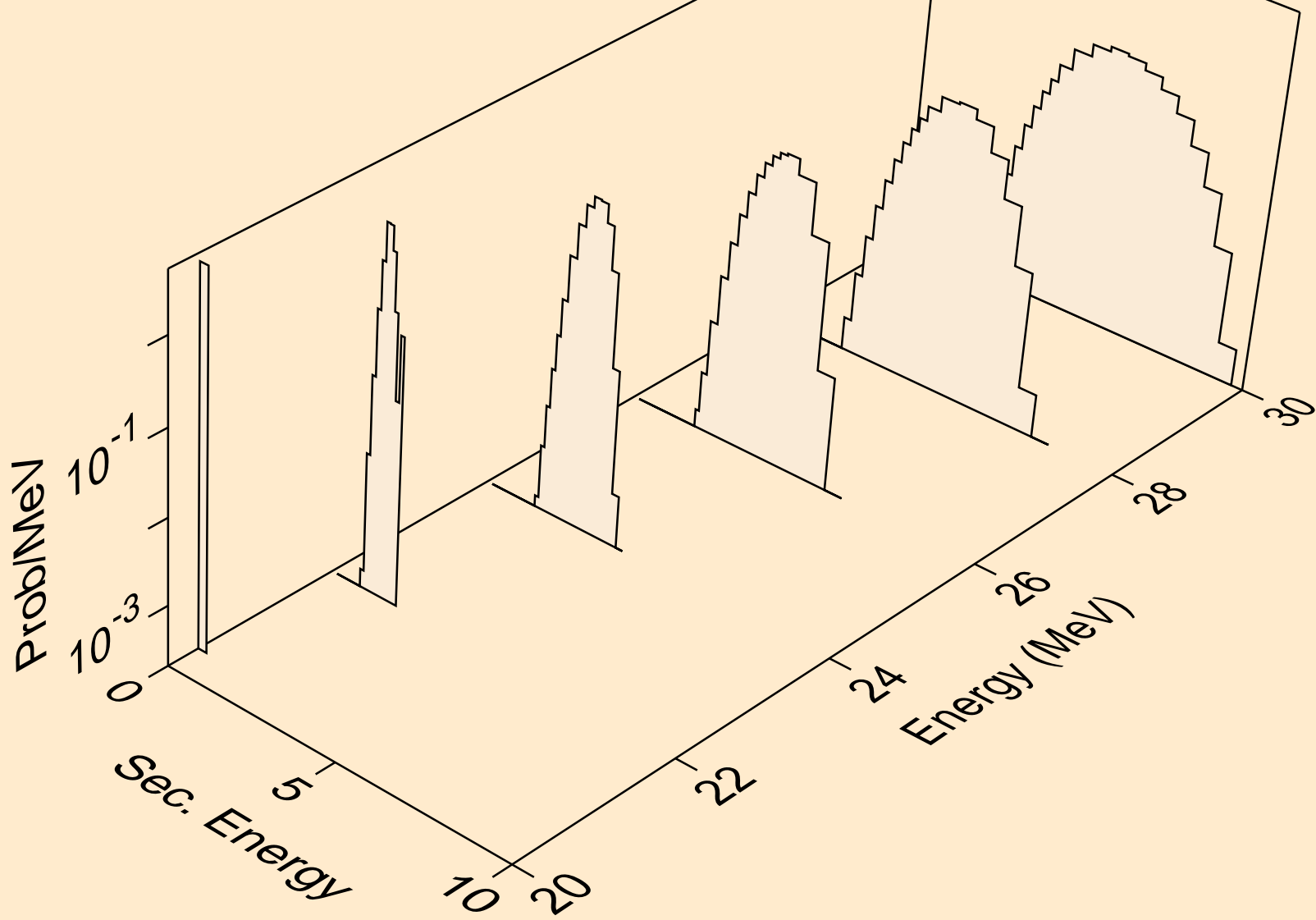

HO159 NEUTRON ACER TENDL-2023 LIBRARY; T=0.K  
protons from (n,n2p)

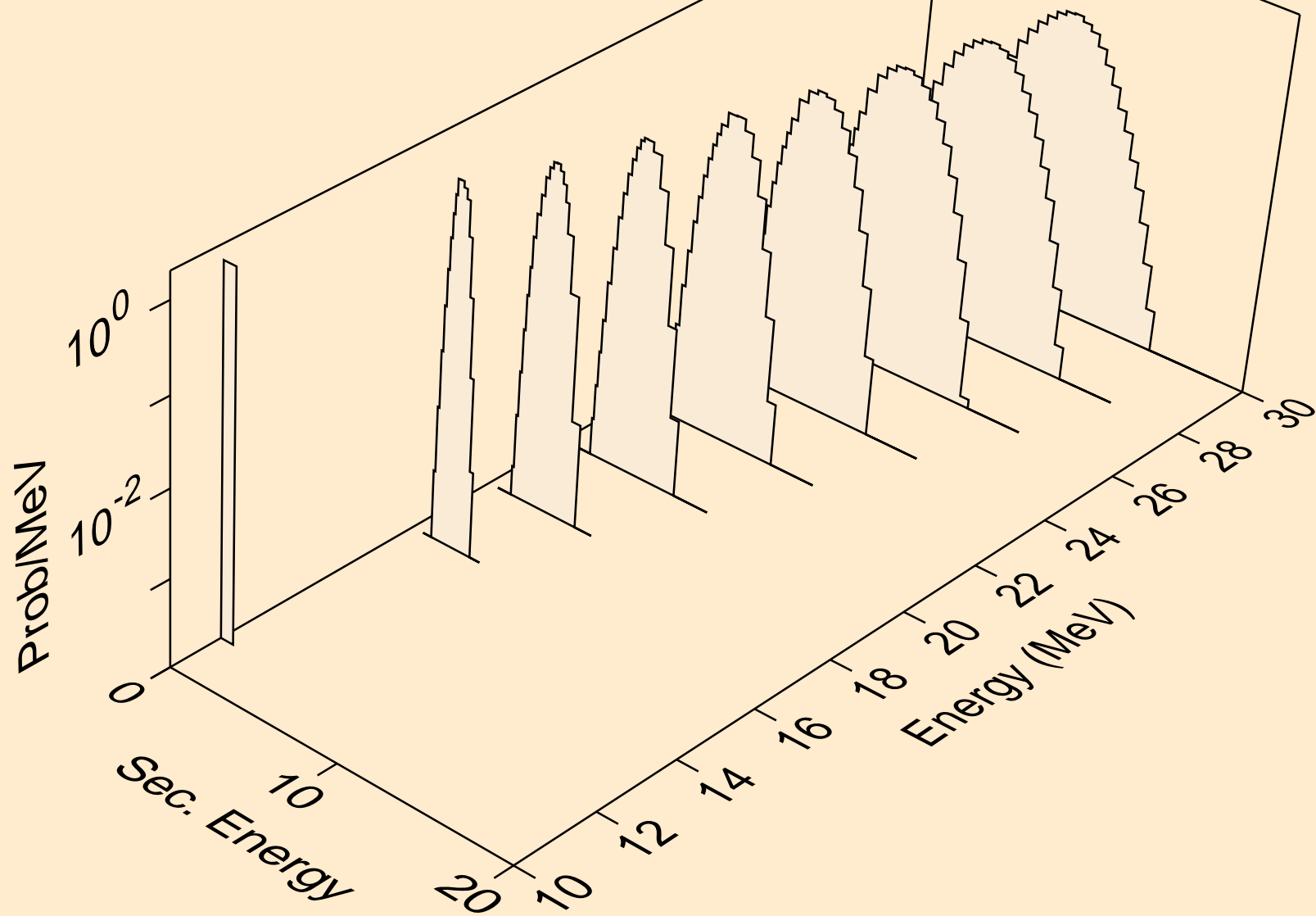

HO159 NEUTRON ACER TENDL-2023 LIBRARY; T=0.K  
protons from (n,npa)

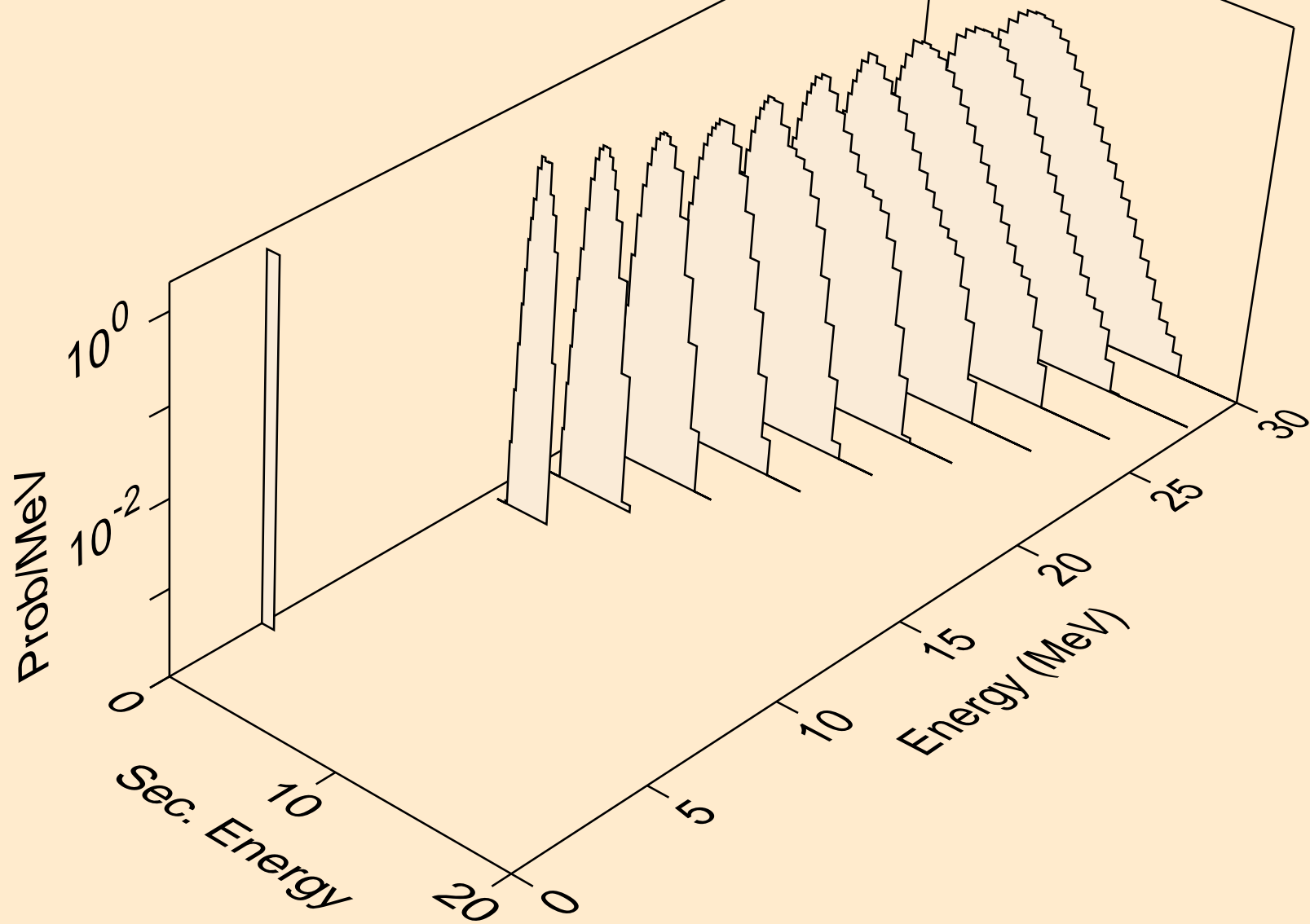

HO159 NEUTRON ACER TENDL-2023 LIBRARY; T=0.K  
protons from (n,p)

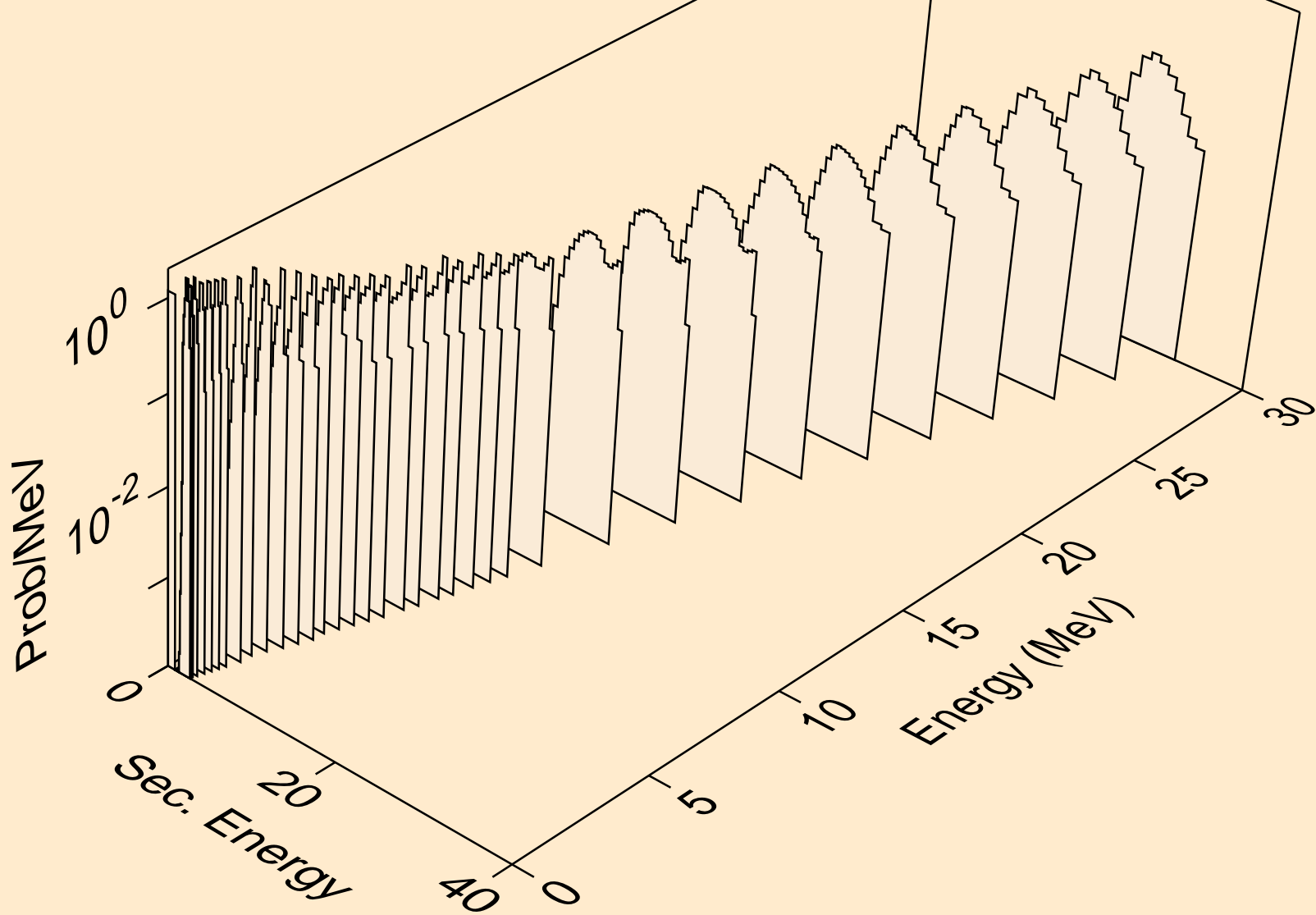

HO159 NEUTRON ACER TENDL-2023 LIBRARY; T=0.K  
protons from (n,2p)

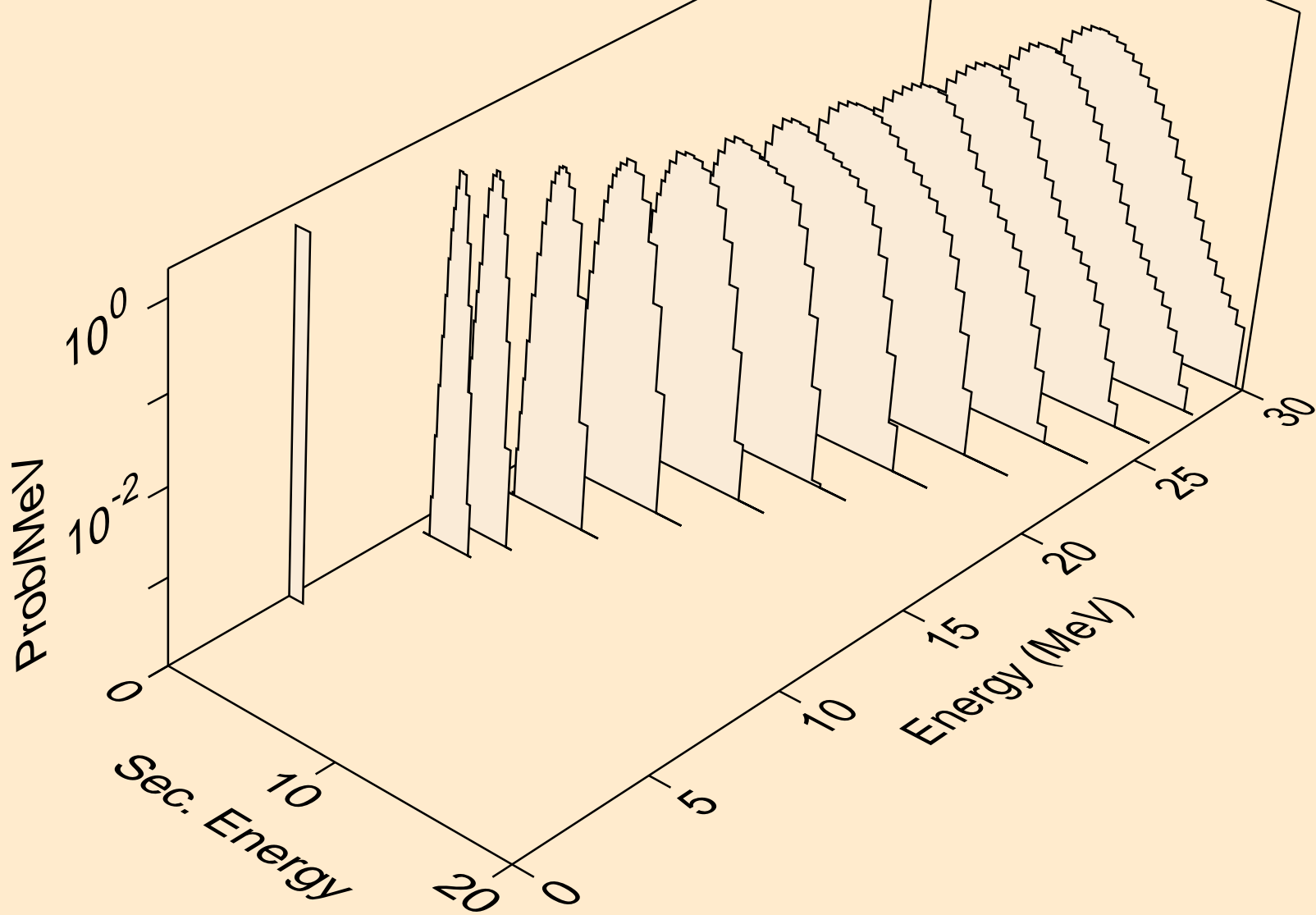

HO159 NEUTRON ACER TENDL-2023 LIBRARY; T=0.K  
protons from (n,p)

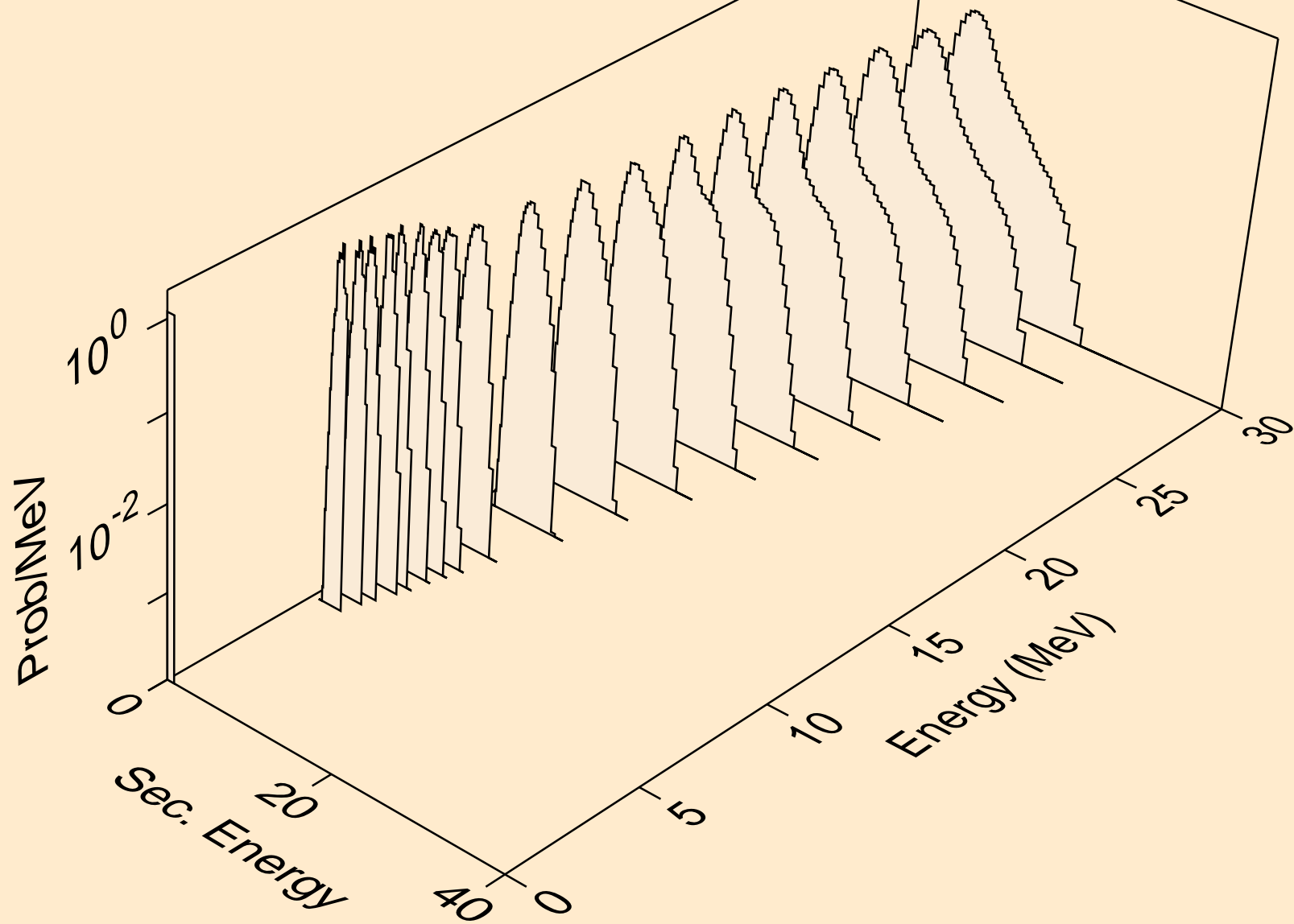

HO159 NEUTRON ACER TENDL-2023 LIBRARY; T=0.K  
protons from (n,pd)

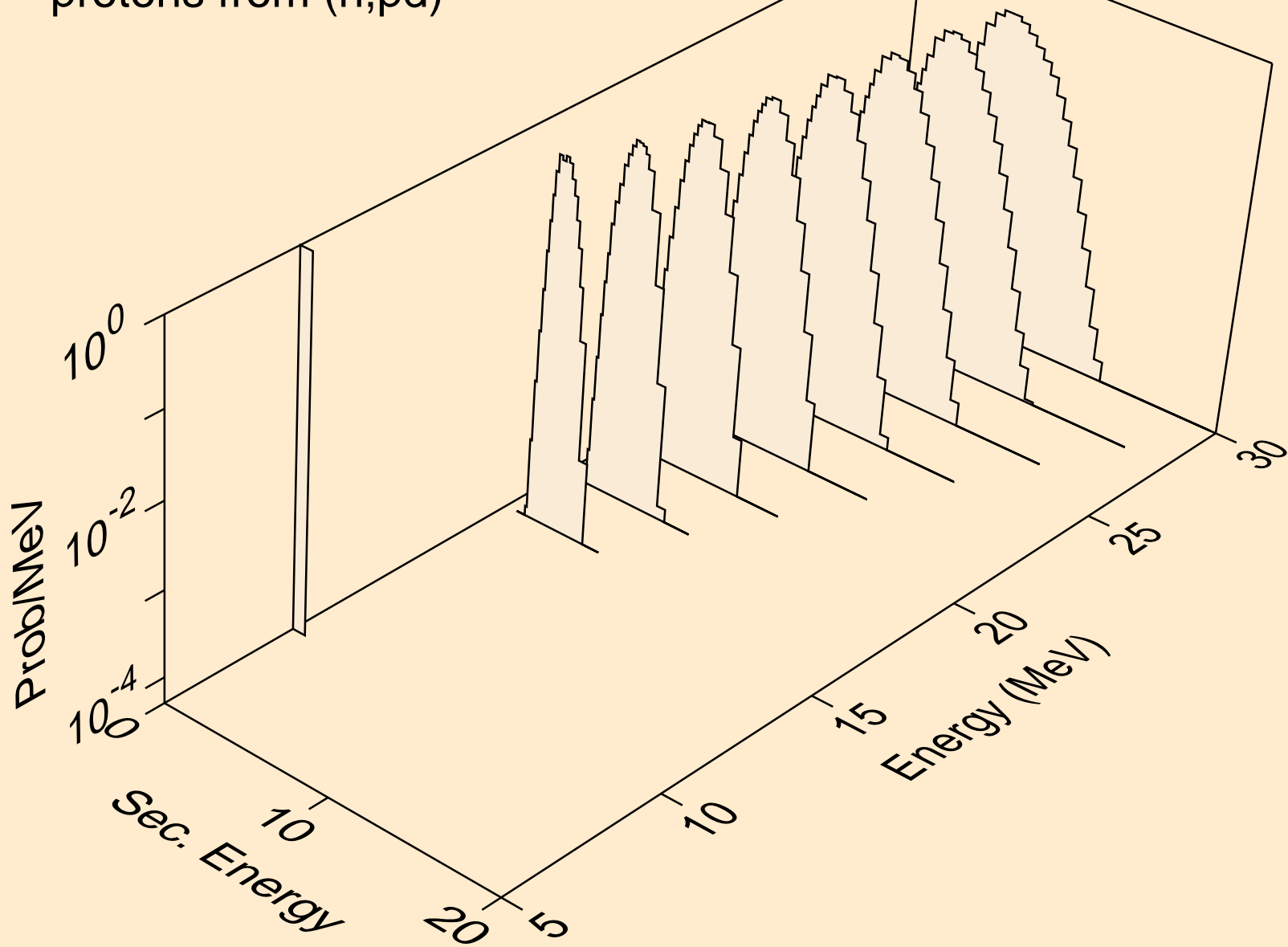

HO159 NEUTRON ACER TENDL-2023 LIBRARY; T=0.K  
protons from (n,pt)

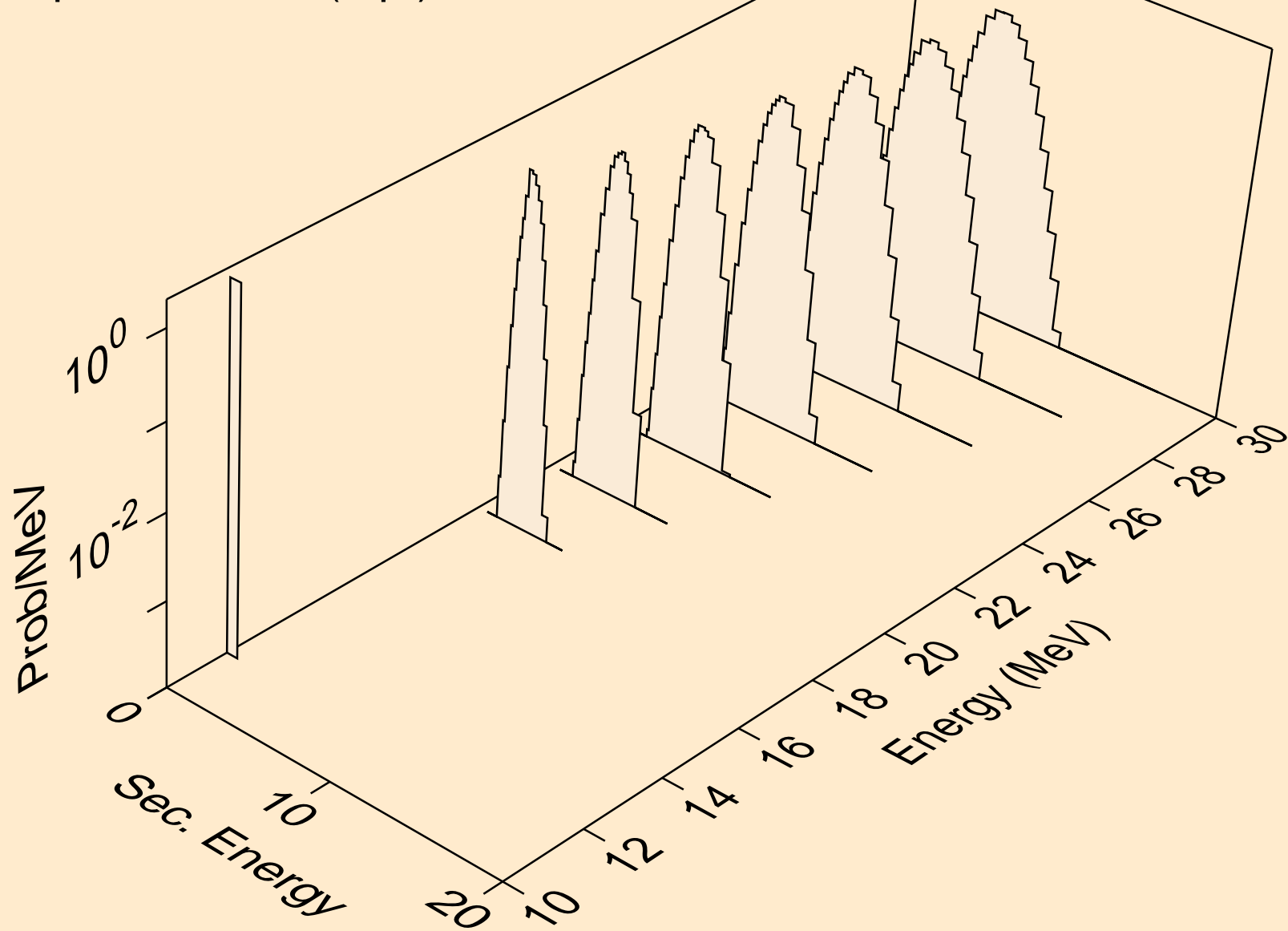

HO159 NEUTRON ACER TENDL-2023 LIBRARY; T=0.K  
deuterons from (n,x)

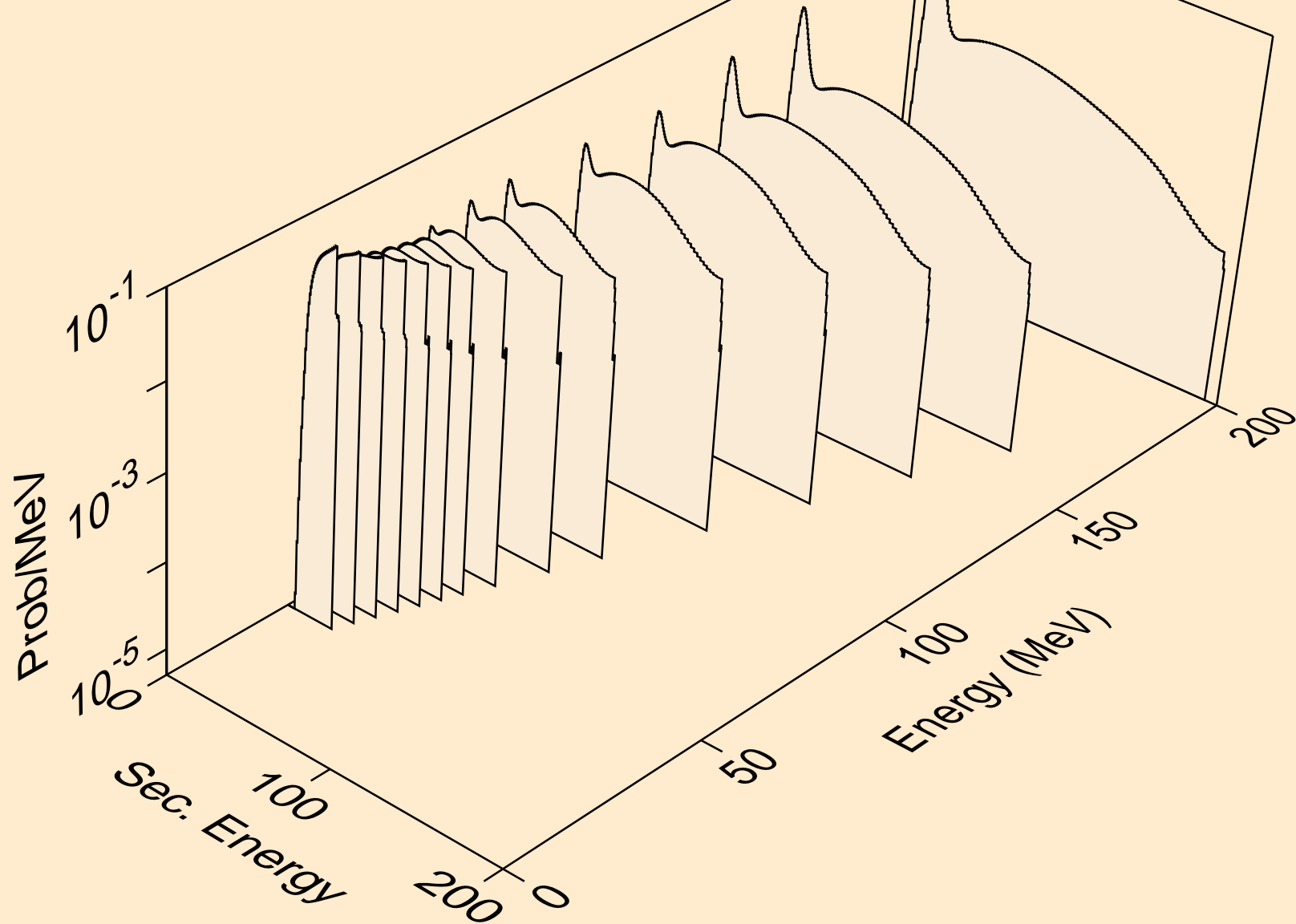

HO159 NEUTRON ACER TENDL-2023 LIBRARY; T=0.K  
deuterons from (n,2nd)

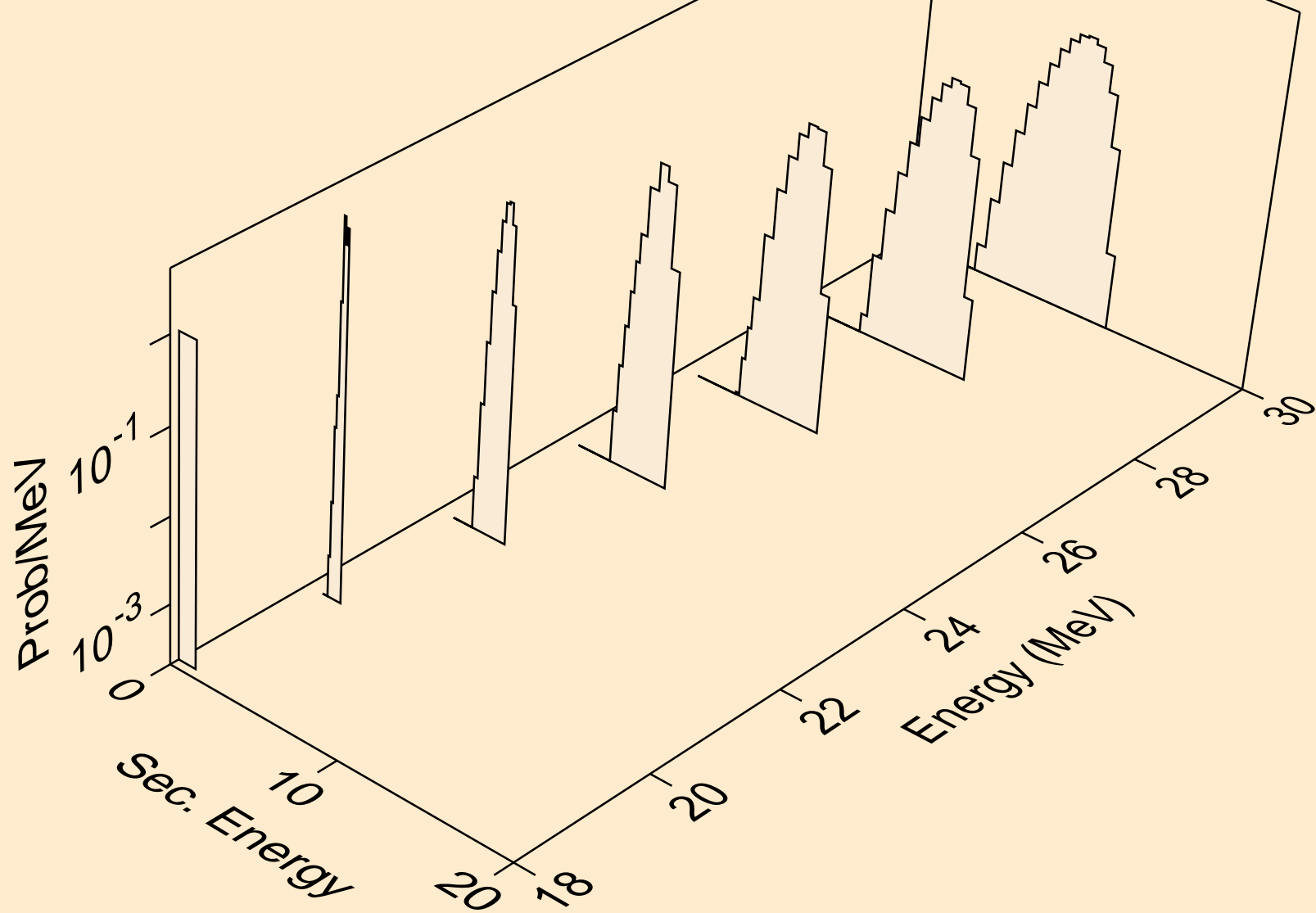

HO159 NEUTRON ACER TENDL-2023 LIBRARY; T=0.K  
deuterons from (n,n\*)d

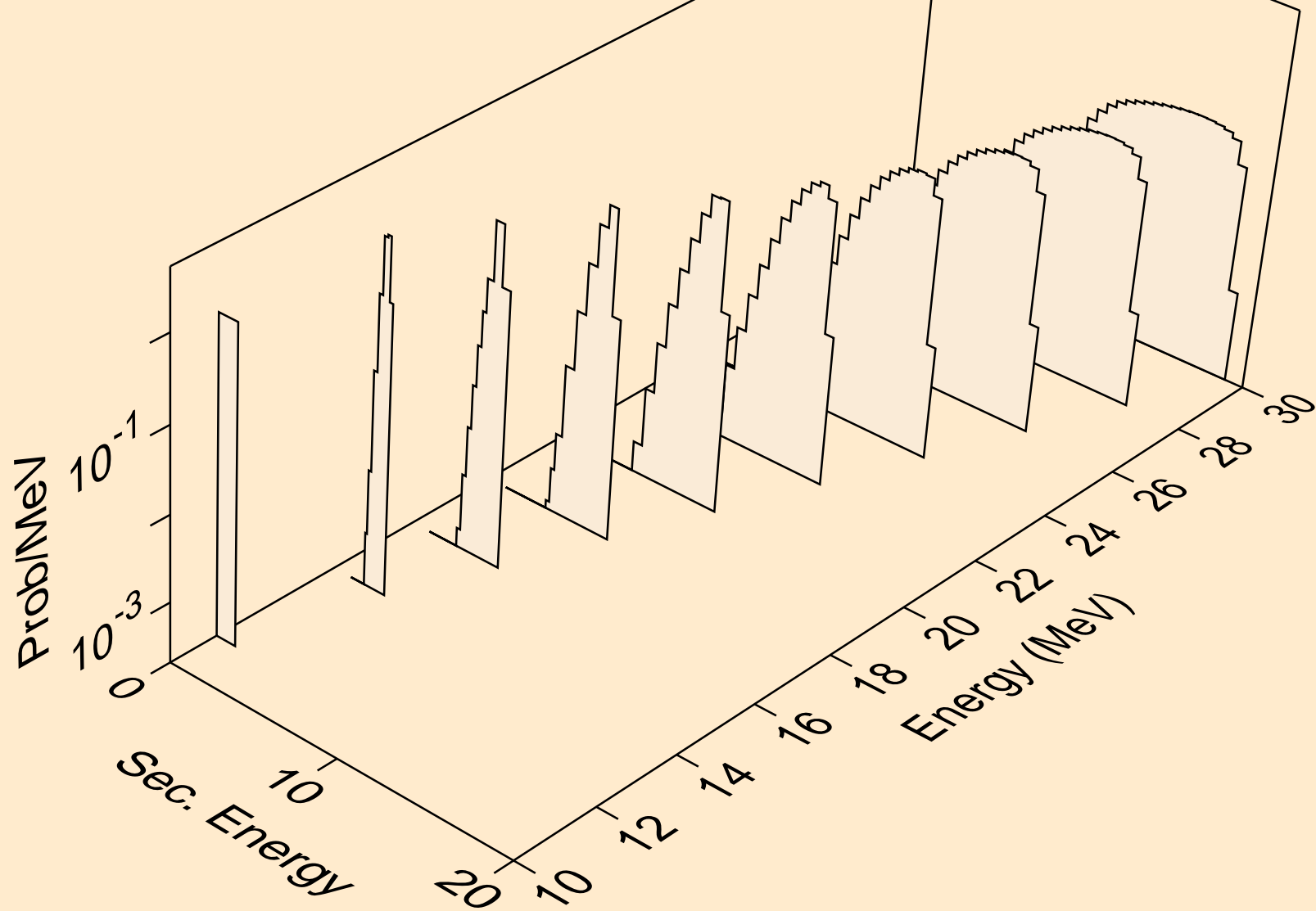

HO159 NEUTRON ACER TENDL-2023 LIBRARY; T=0.K  
deuterons from (n,d)

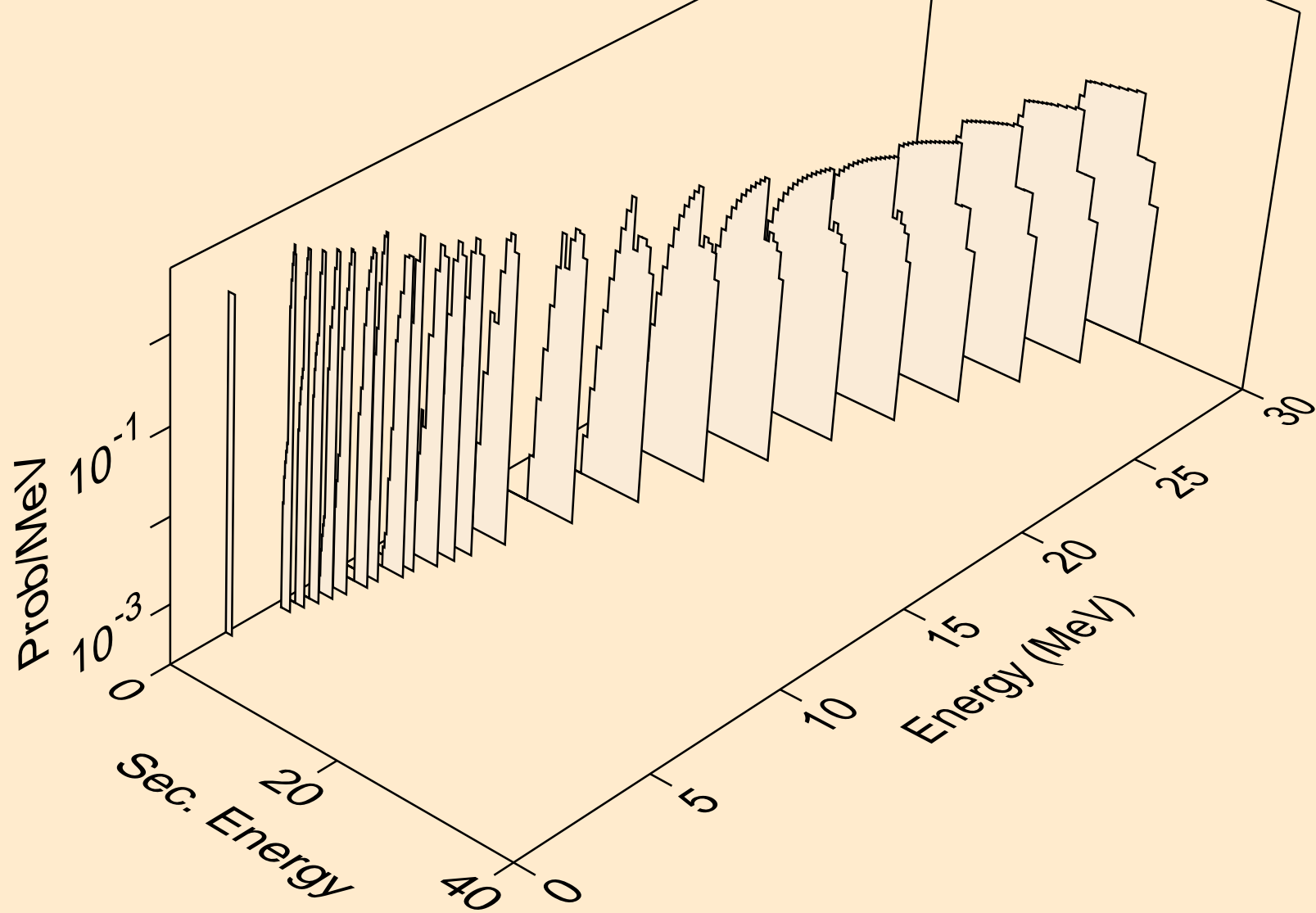

HO159 NEUTRON ACER TENDL-2023 LIBRARY; T=0.K  
deuterons from (n,pd)

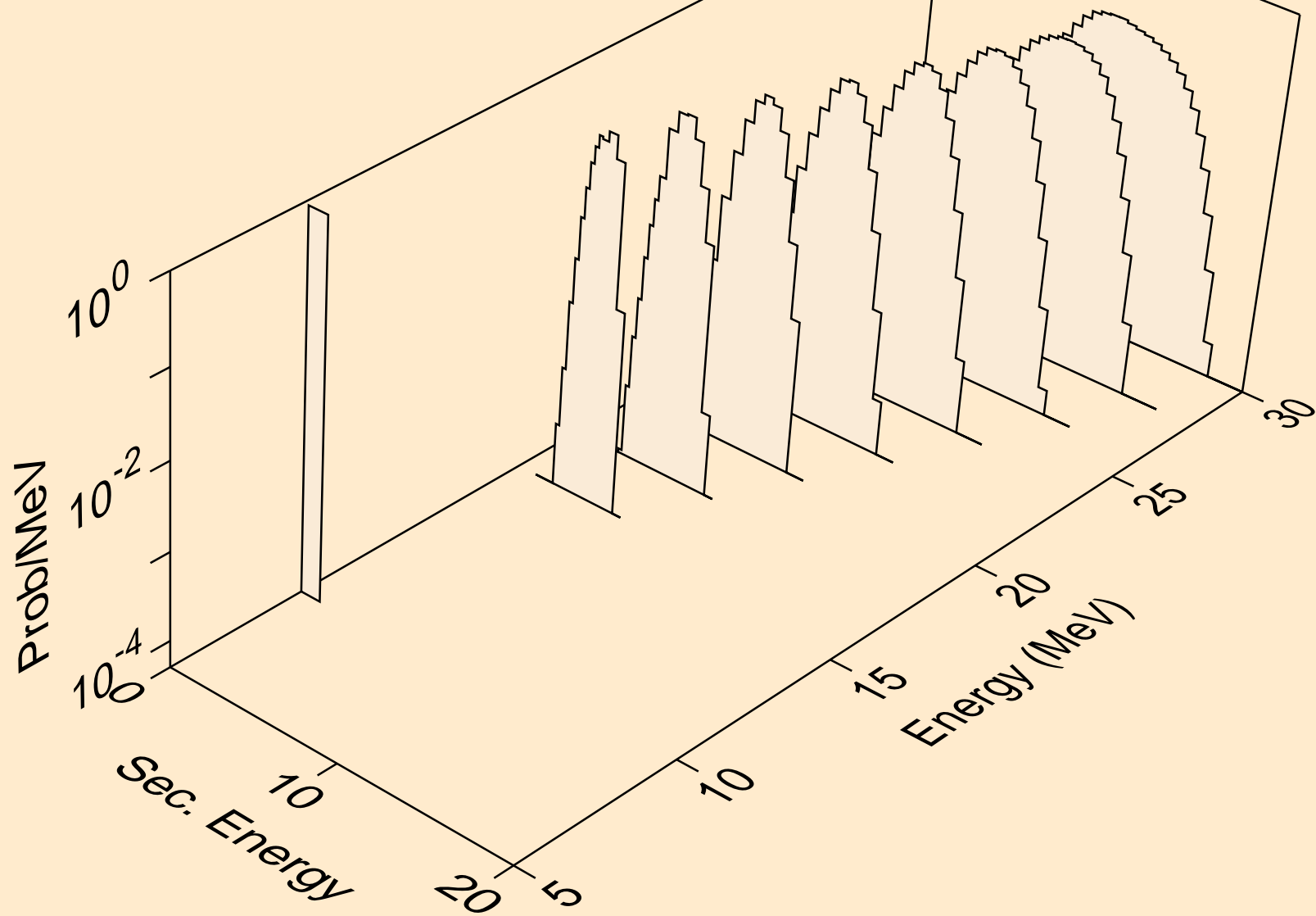

HO159 NEUTRON ACER TENDL-2023 LIBRARY; T=0.K  
deuterons from (n,da)

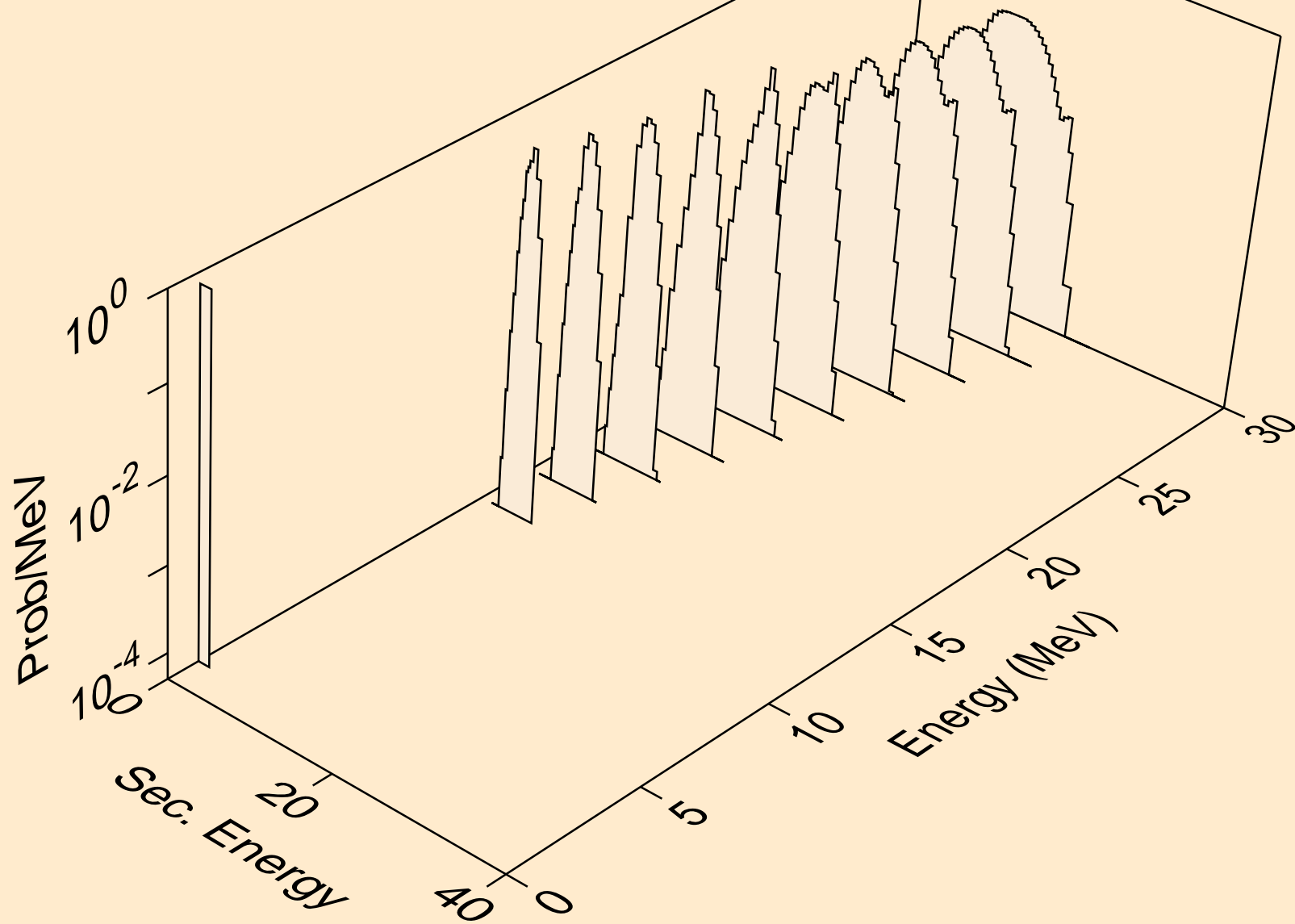

HO159 NEUTRON ACER TENDL-2023 LIBRARY; T=0.K  
tritons from (n,x)

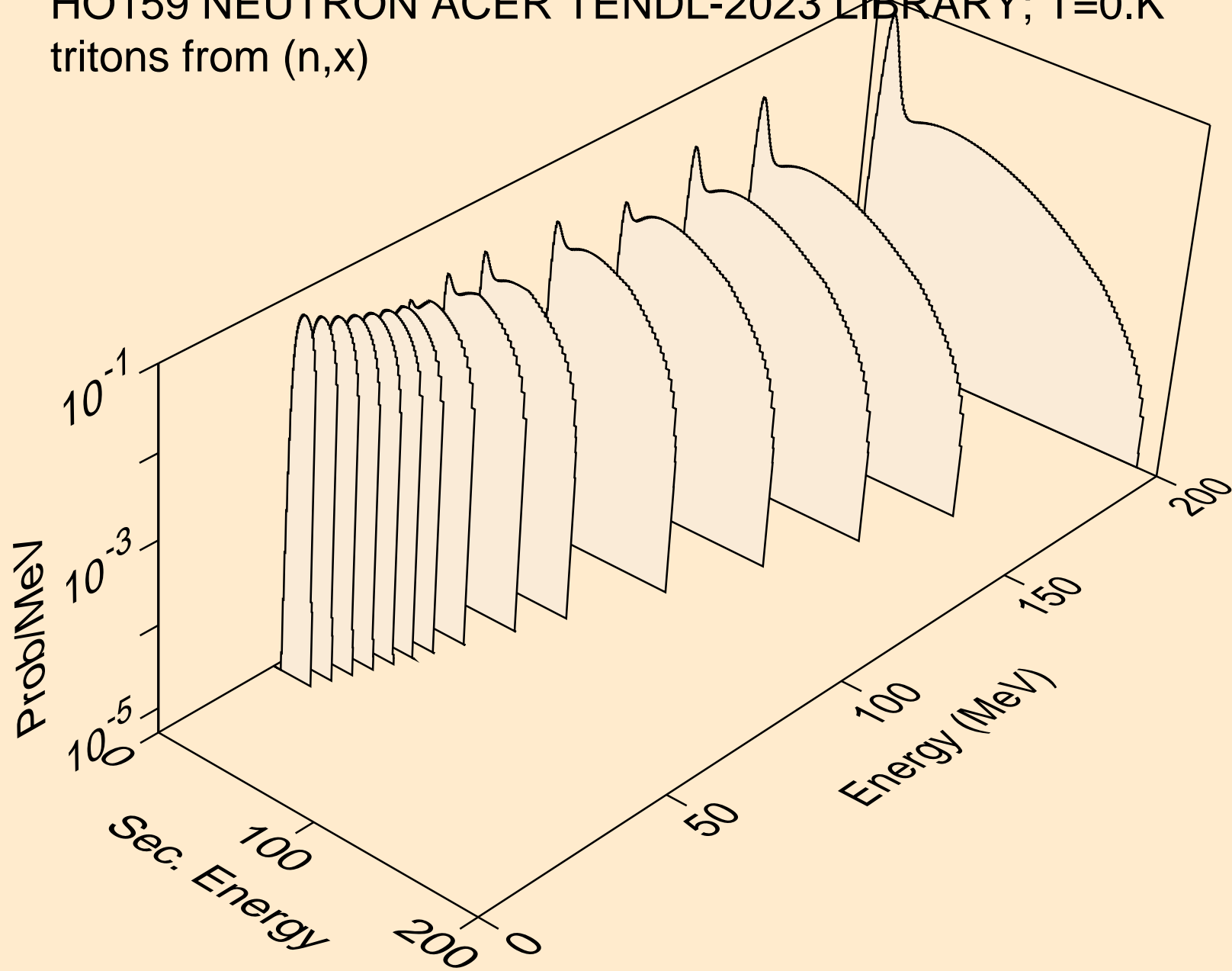

HO159 NEUTRON ACER TENDL-2023 LIBRARY; T=0.K  
tritons from (n,n\*)t

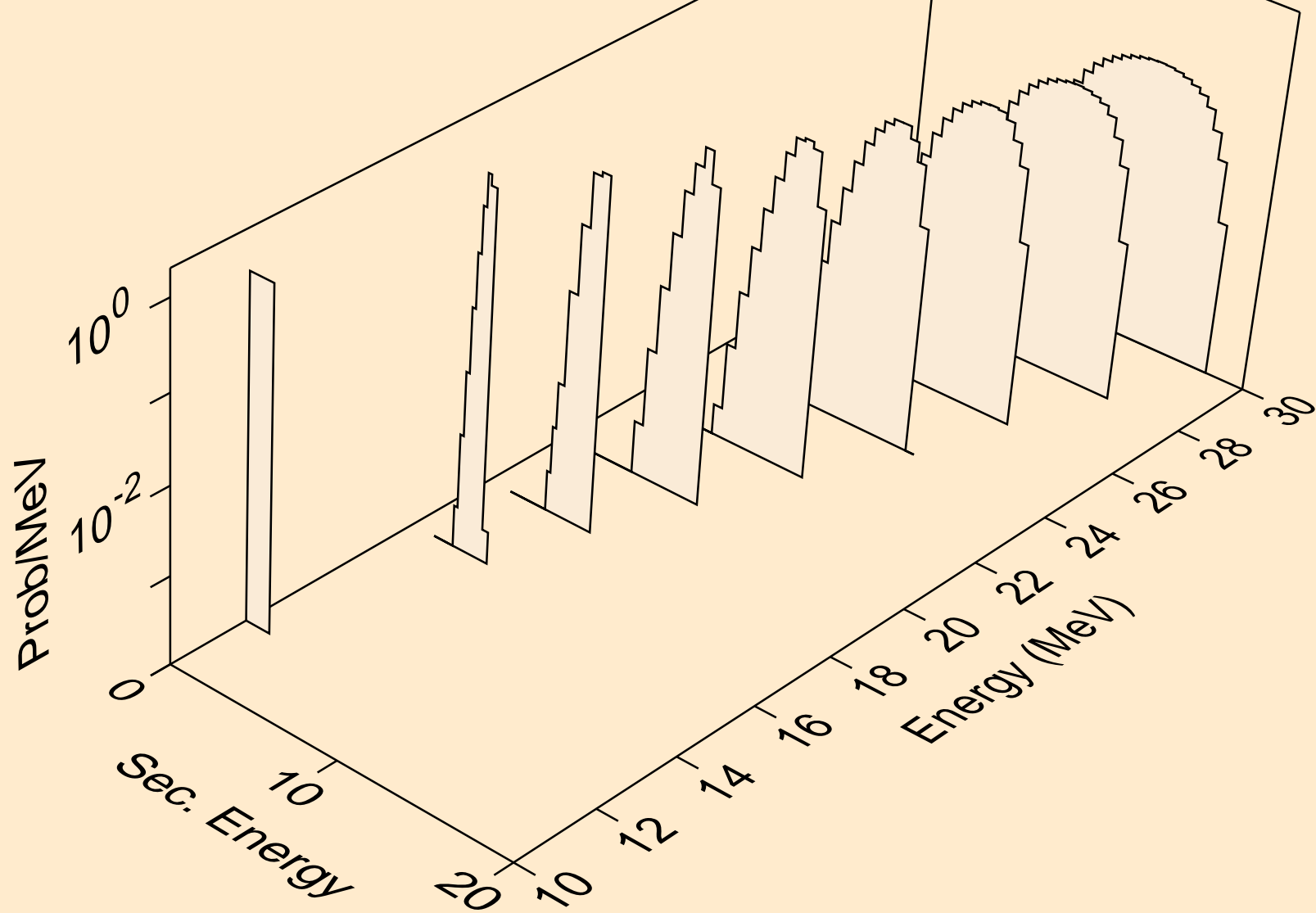

HO159 NEUTRON ACER TENDL-2023 LIBRARY; T=0.K  
tritons from (n,t)

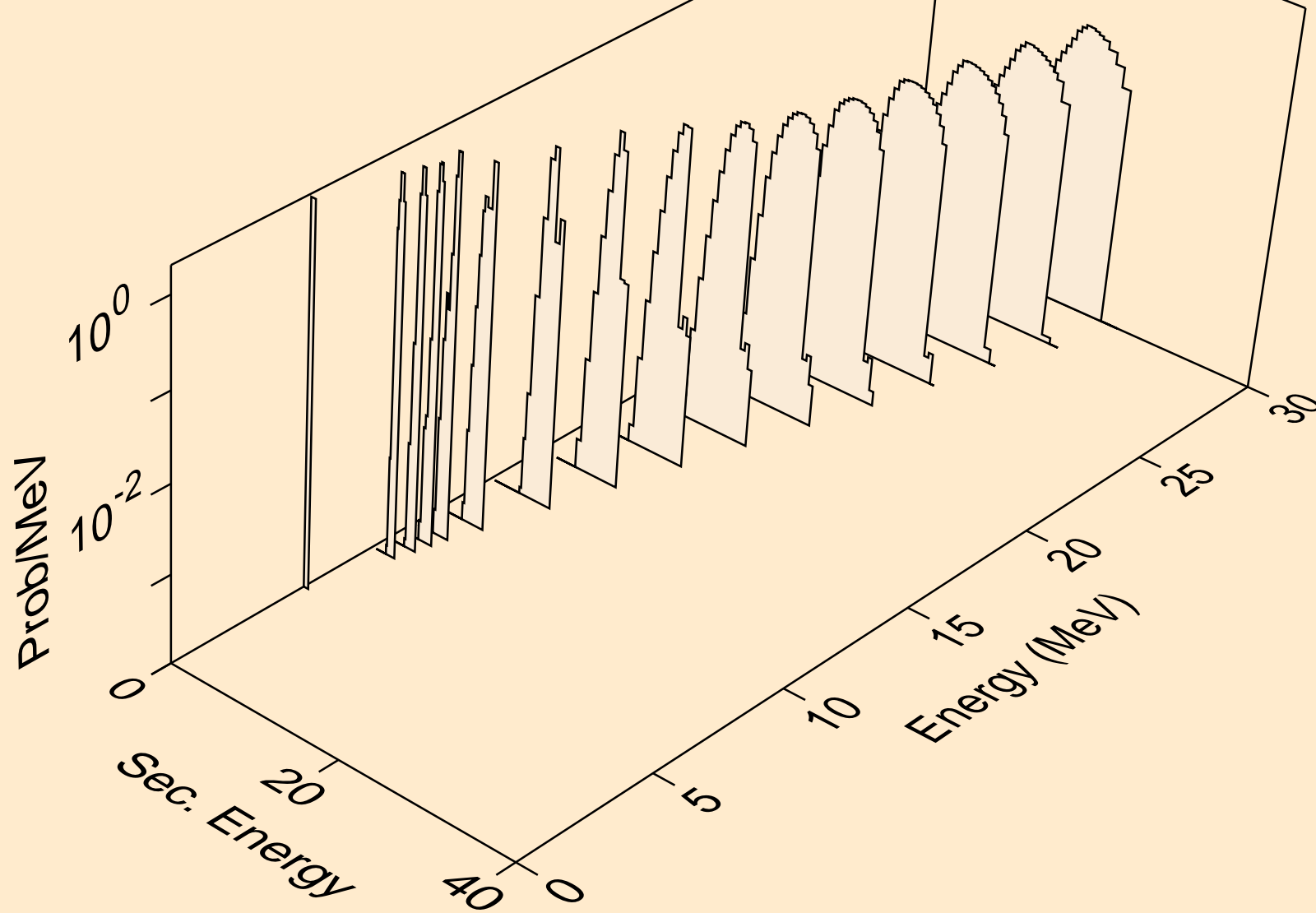

HO159 NEUTRON ACER TENDL-2023 LIBRARY; T=0.K  
tritons from (n,pt)

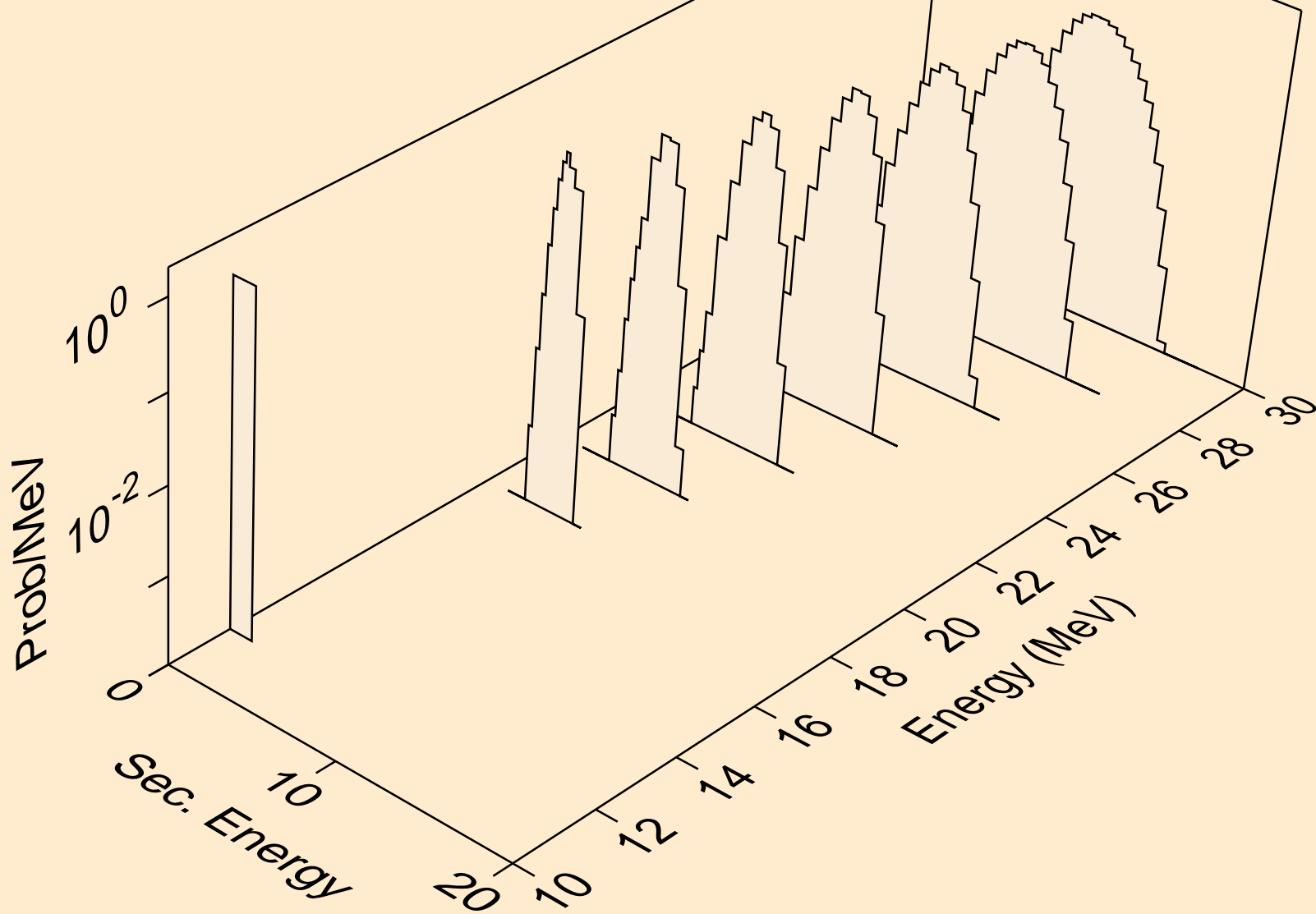

HO159 NEUTRON ACER TENDL-2023 LIBRARY; T=0.K  
he3s from (n,x)

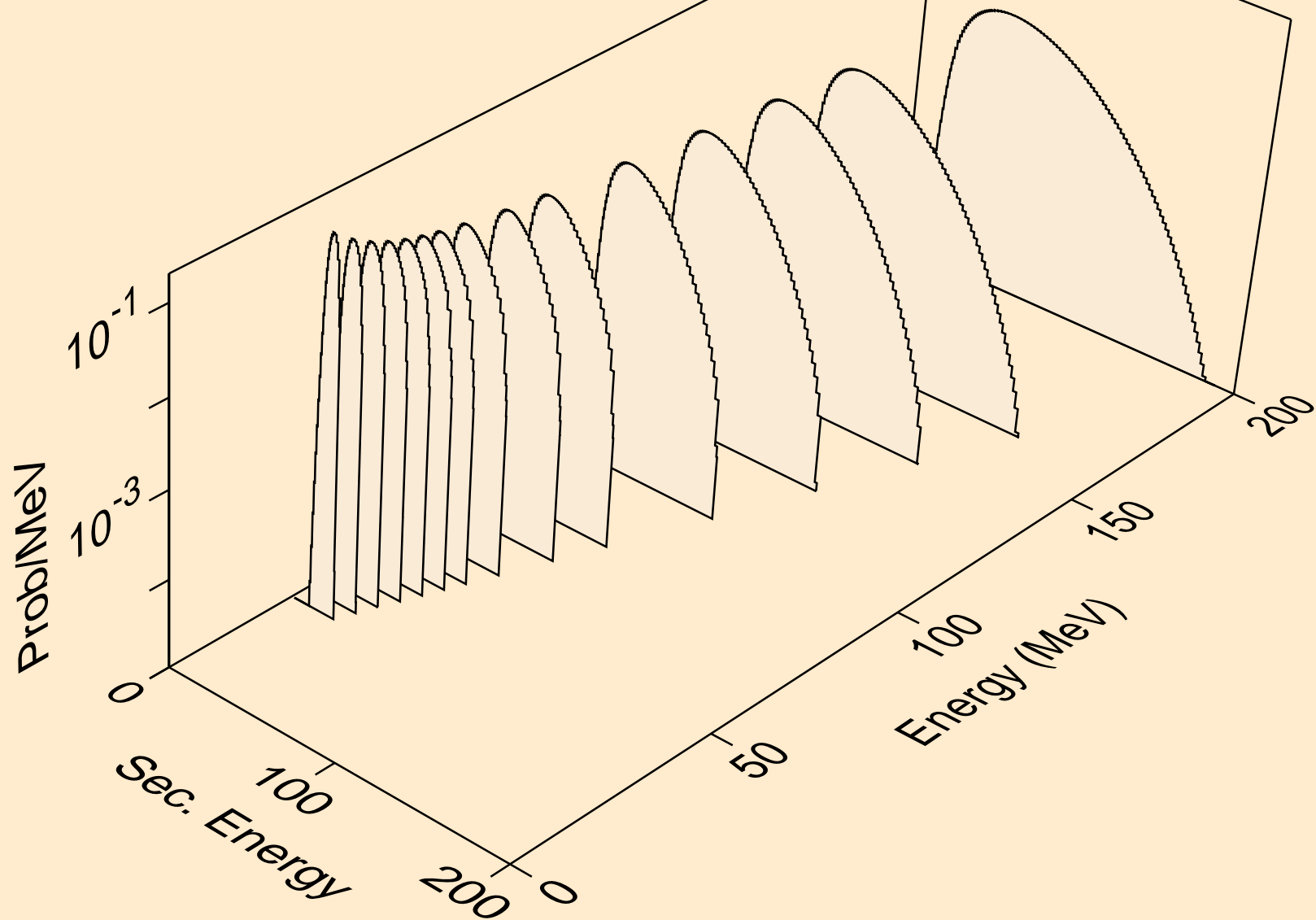

HO159 NEUTRON ACER TENDL-2023 LIBRARY; T=0.K  
he3s from (n,n\*)he3

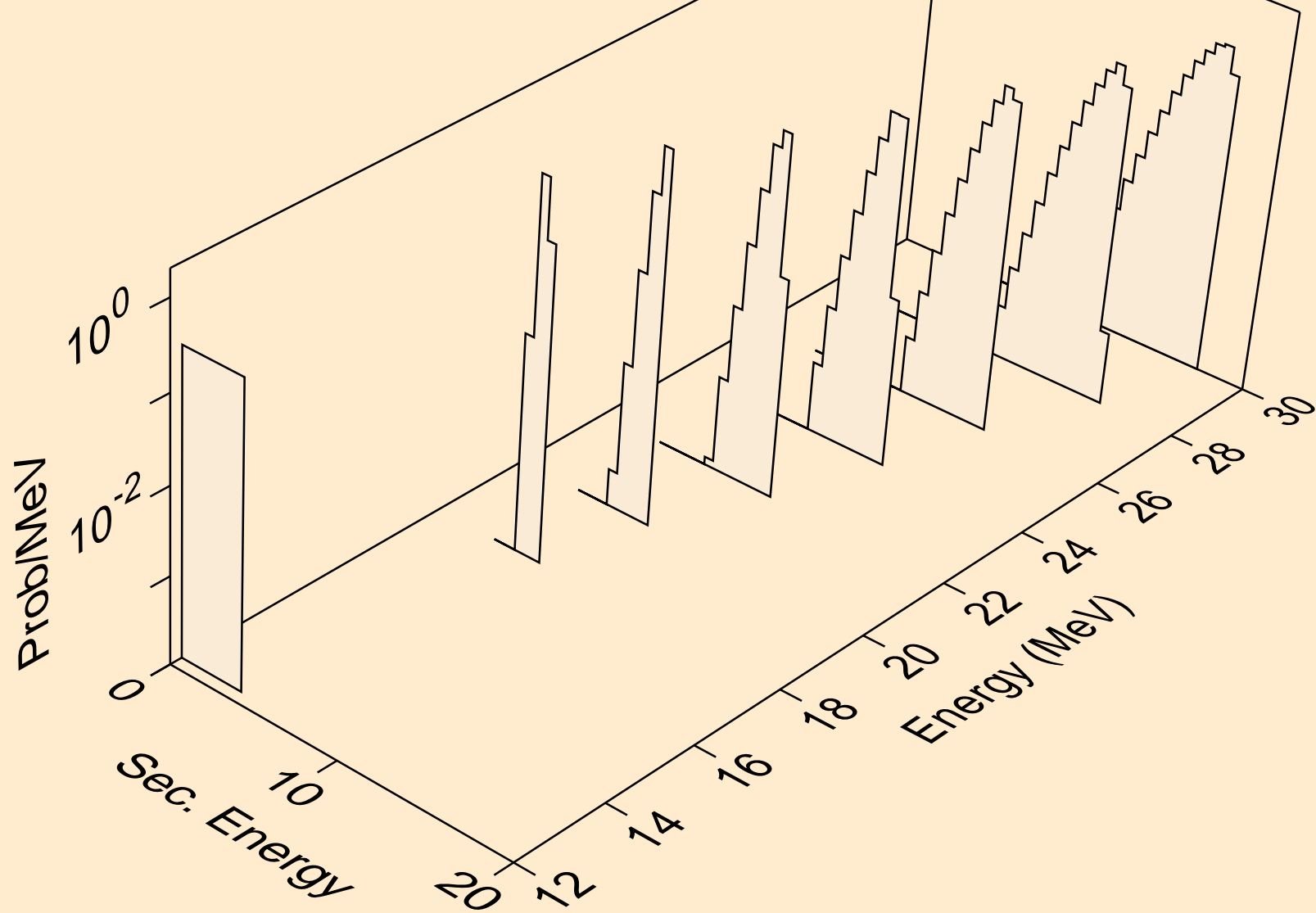

HO159 NEUTRON ACER TENDL-2023 LIBRARY; T=0.K  
he3s from (n,he3)

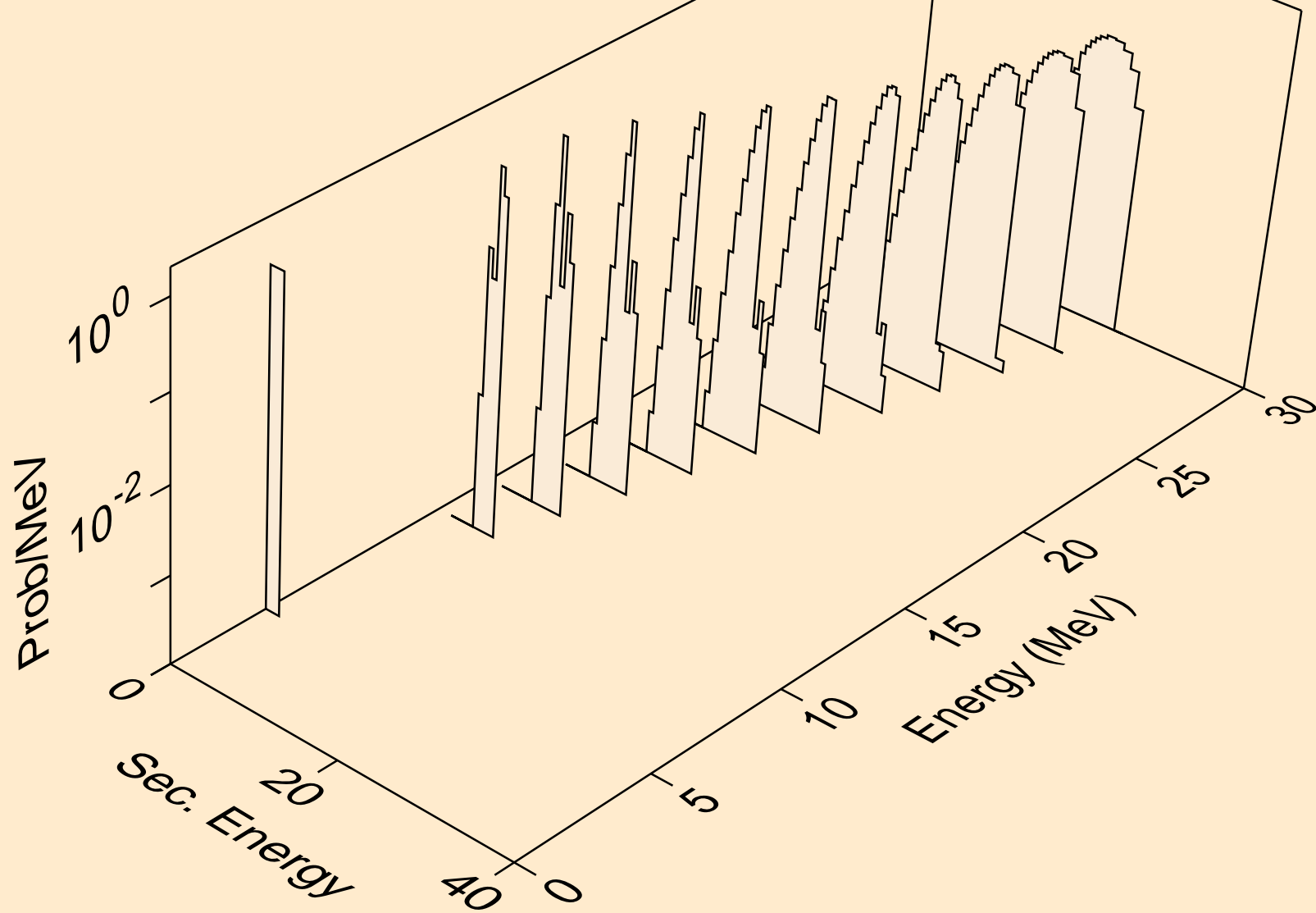

HO159 NEUTRON ACER TENDL-2023 LIBRARY; T=0.K  
alphas from (n,x)

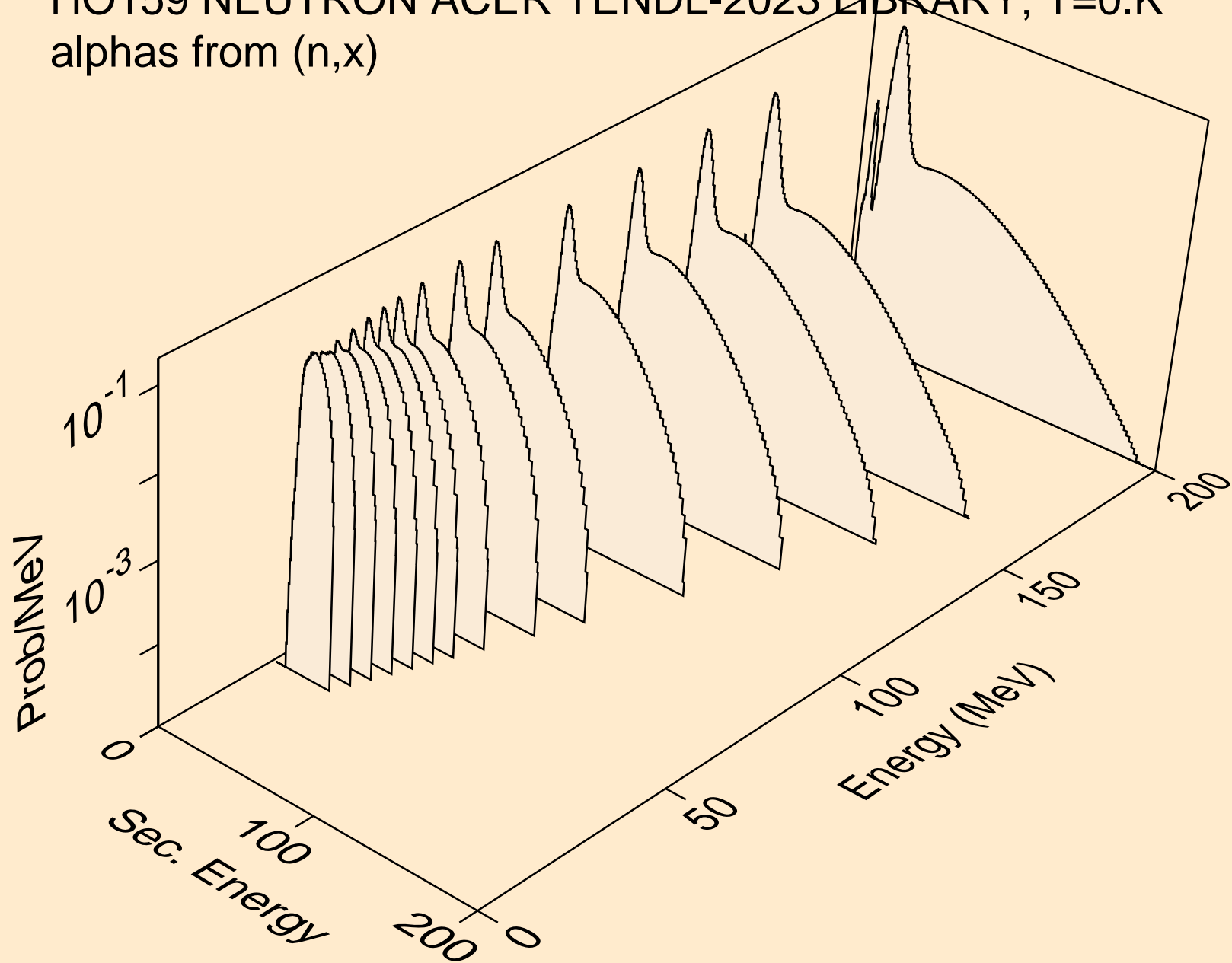

HO159 NEUTRON ACER TENDL-2023 LIBRARY; T=0.K  
alphas from (n,n\*)a

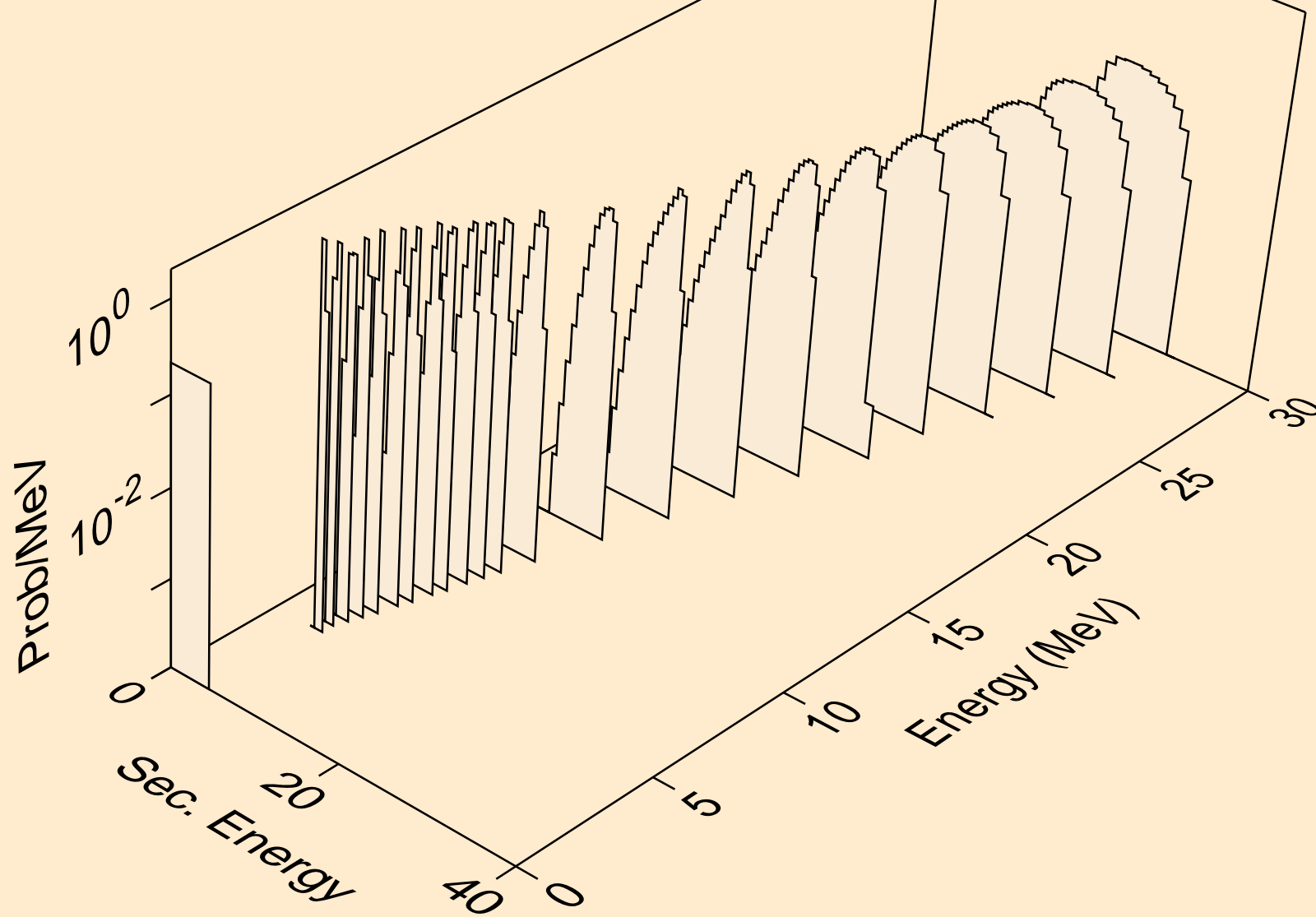

HO159 NEUTRON ACER TENDL-2023 LIBRARY; T=0.K  
alphas from (n,2n)a

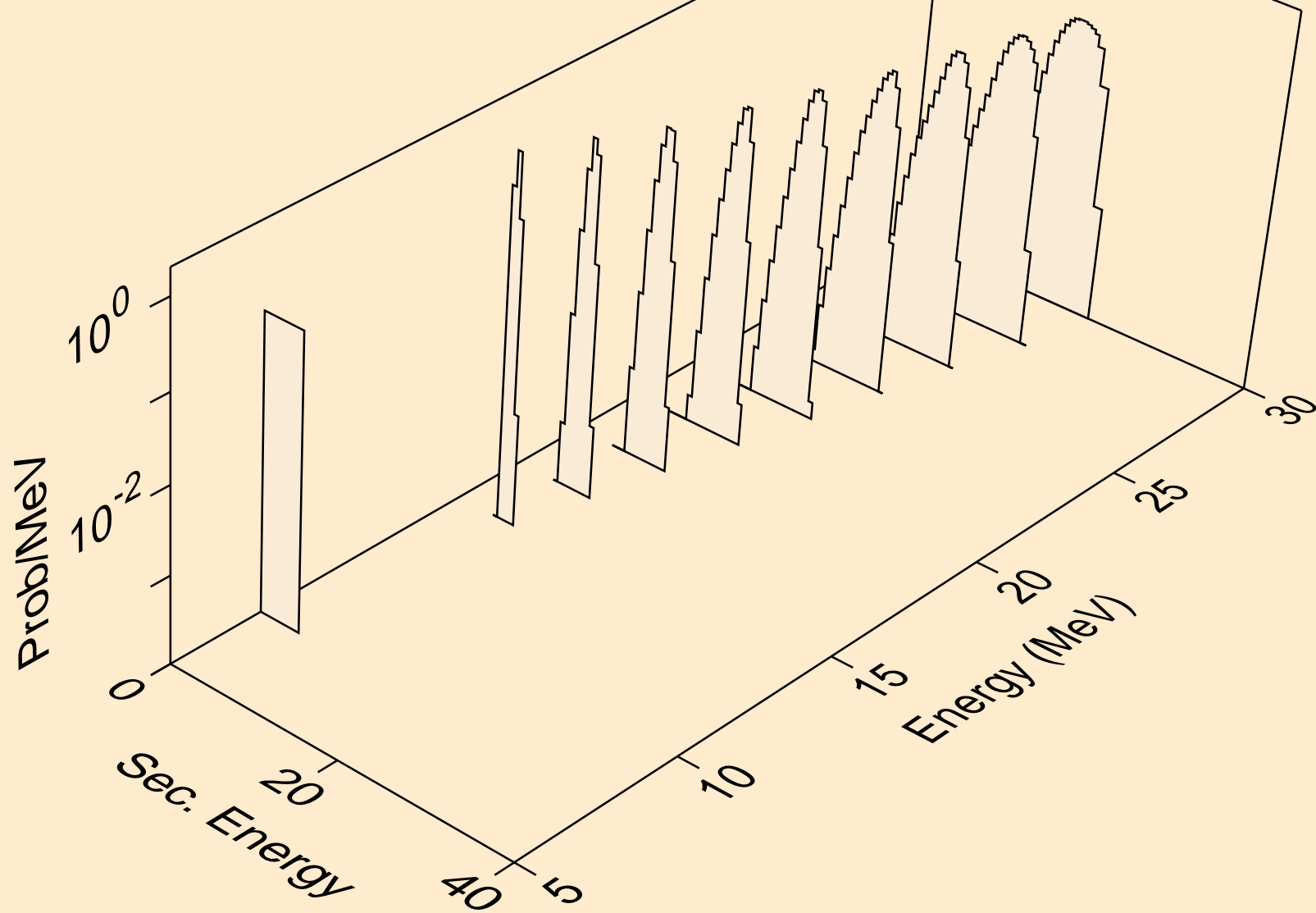

HO159 NEUTRON ACER TENDL-2023 LIBRARY; T=0.K  
alphas from (n,3n)a

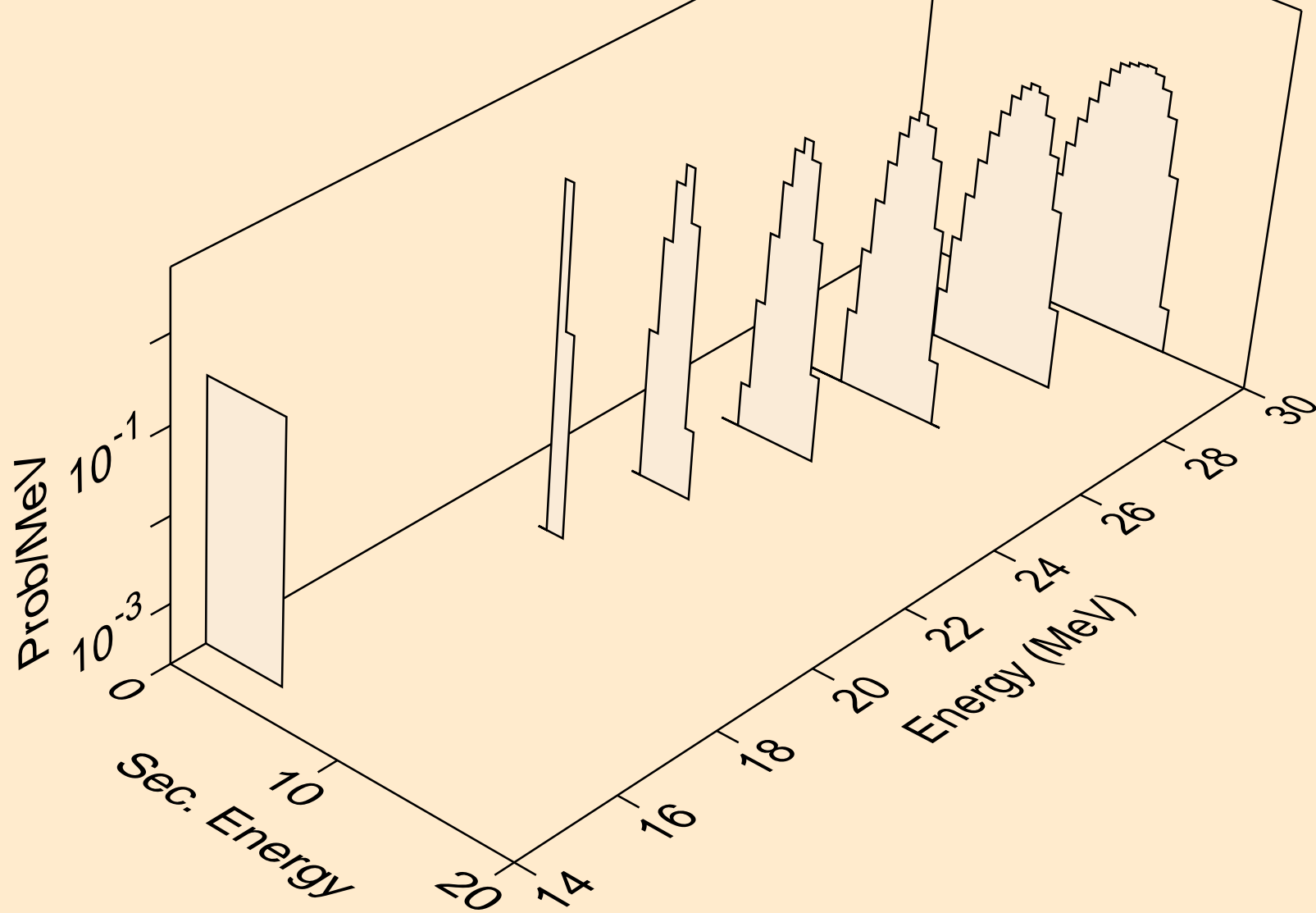

HO159 NEUTRON ACER TENDL-2023 LIBRARY; T=0.K  
alphas from (n,n\*)2a

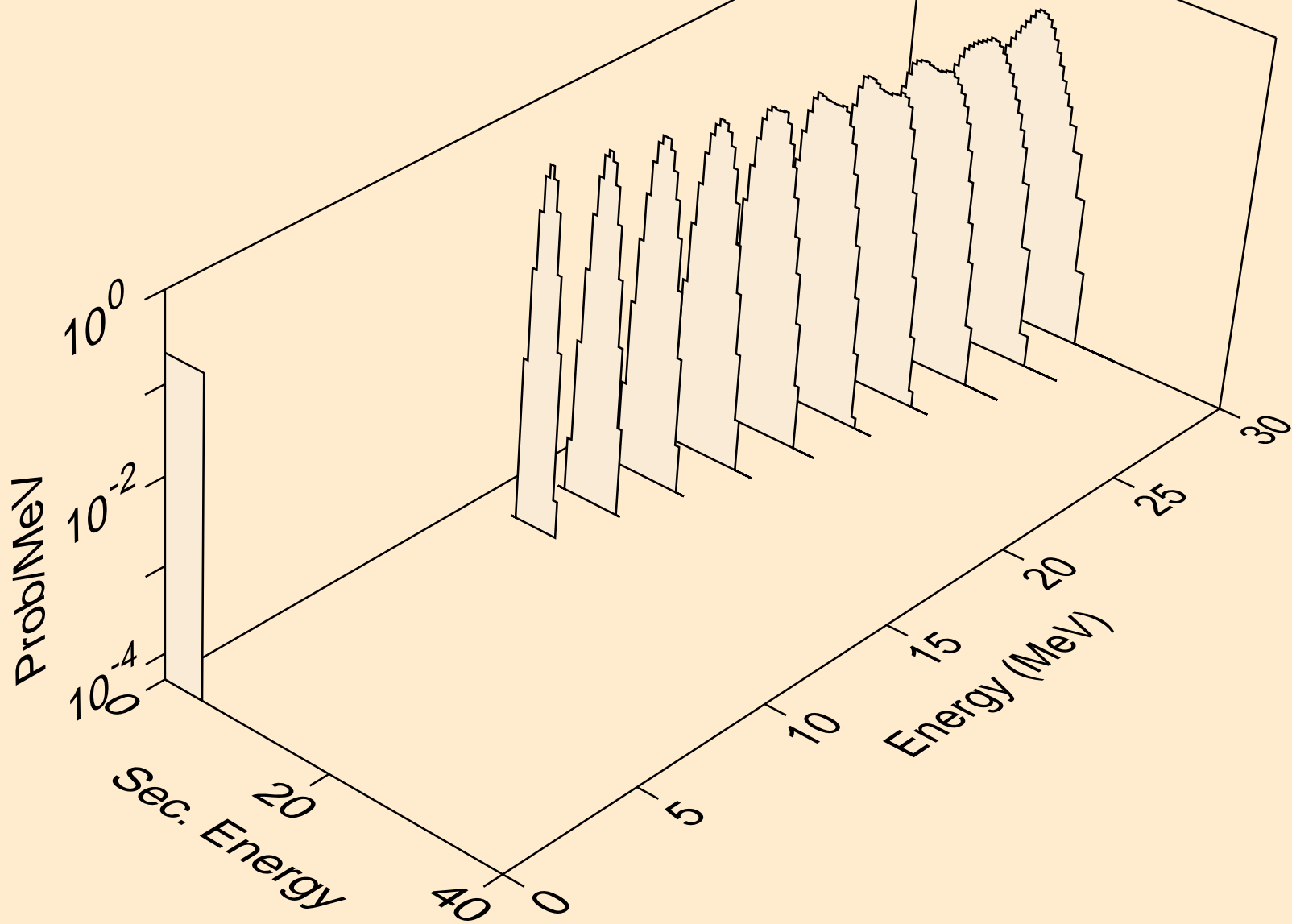

HO159 NEUTRON ACER TENDL-2023 LIBRARY; T=0.K  
alphas from (n,npa)

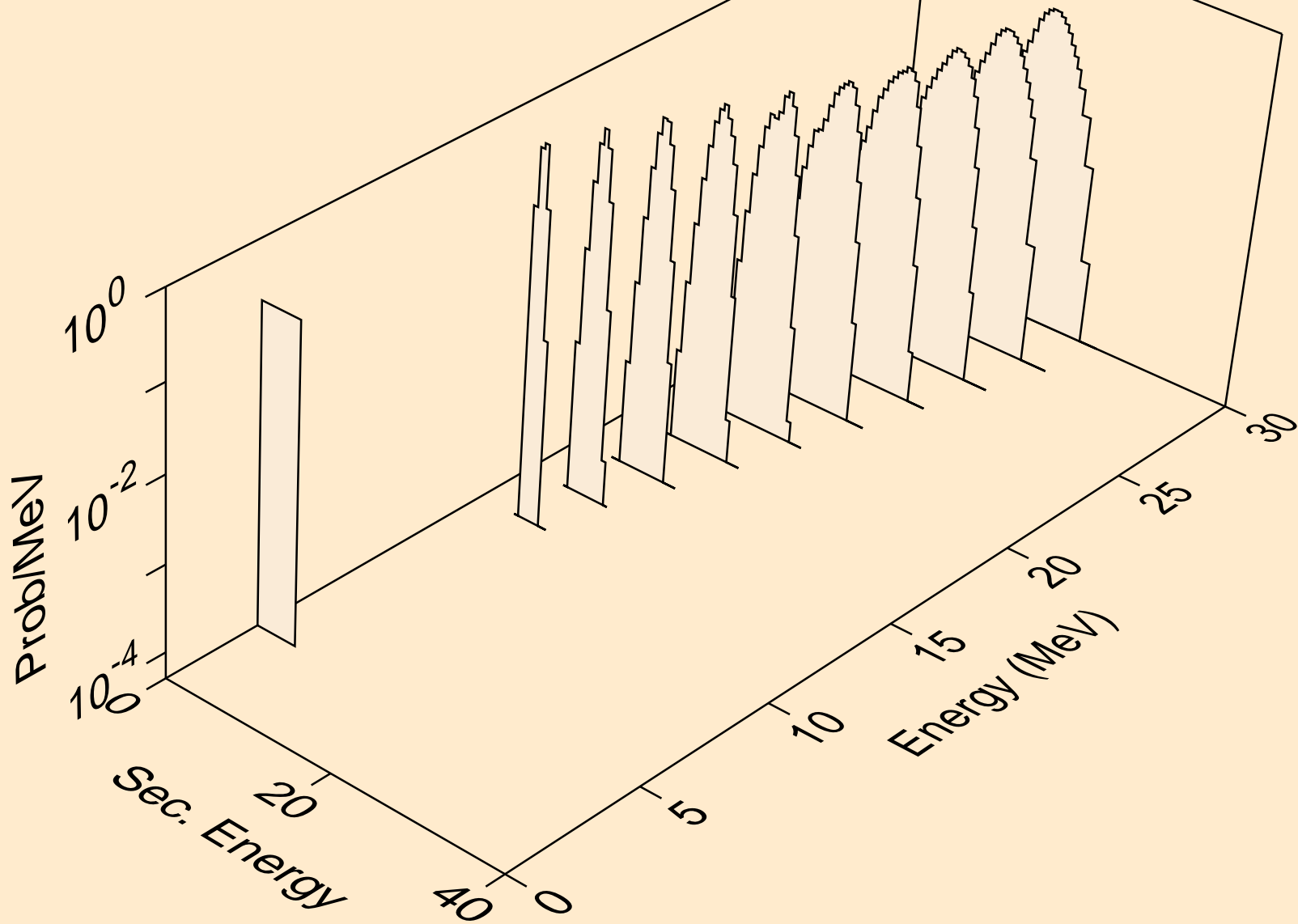

HO159 NEUTRON ACER TENDL-2023 LIBRARY; T=0.K  
alphas from (n,a)

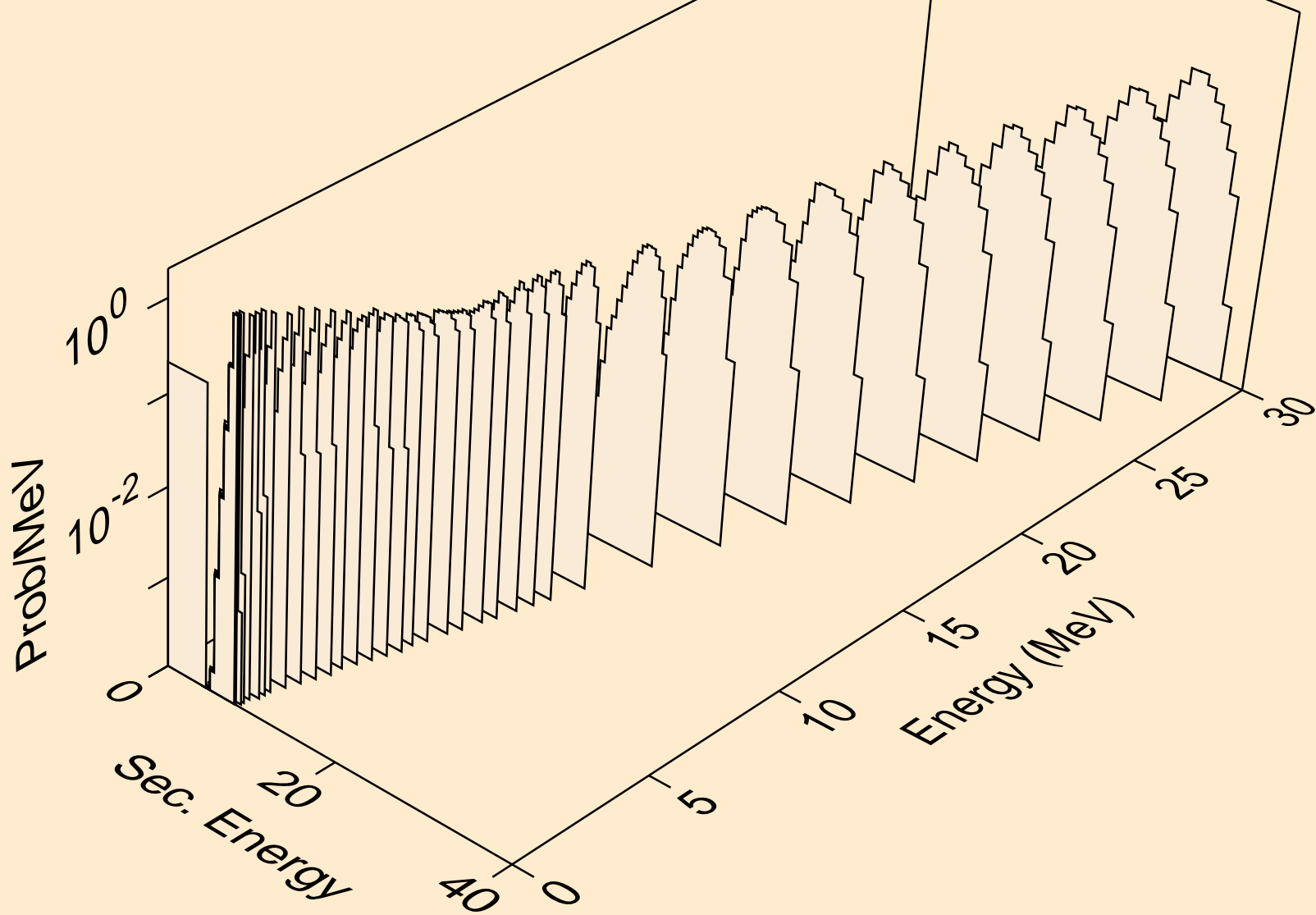

HO159 NEUTRON ACER TENDL-2023 LIBRARY; T=0.K  
alphas from (n,2a)

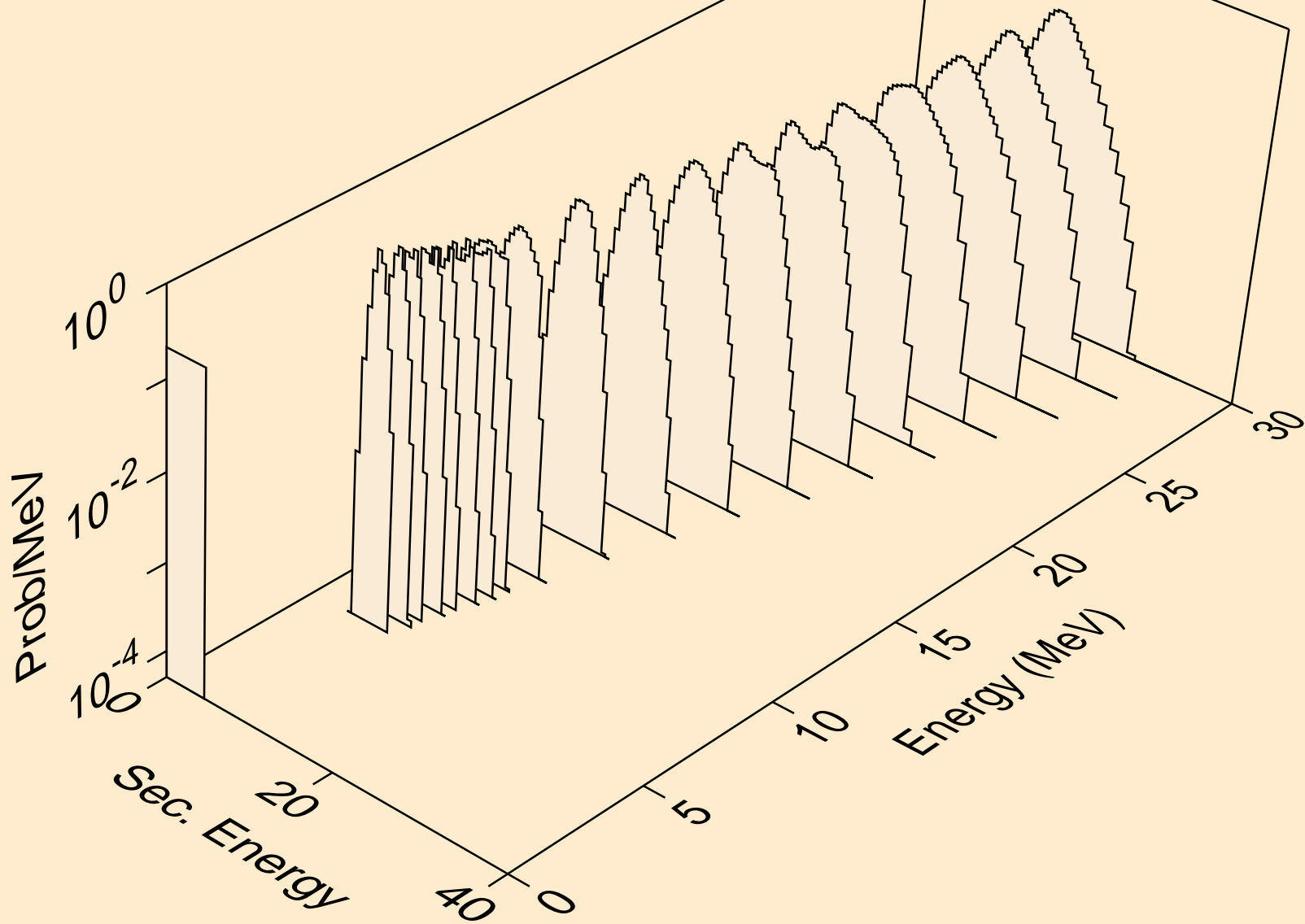

HO159 NEUTRON ACER TENDL-2023 LIBRARY; T=0.K  
alphas from (n,pa)

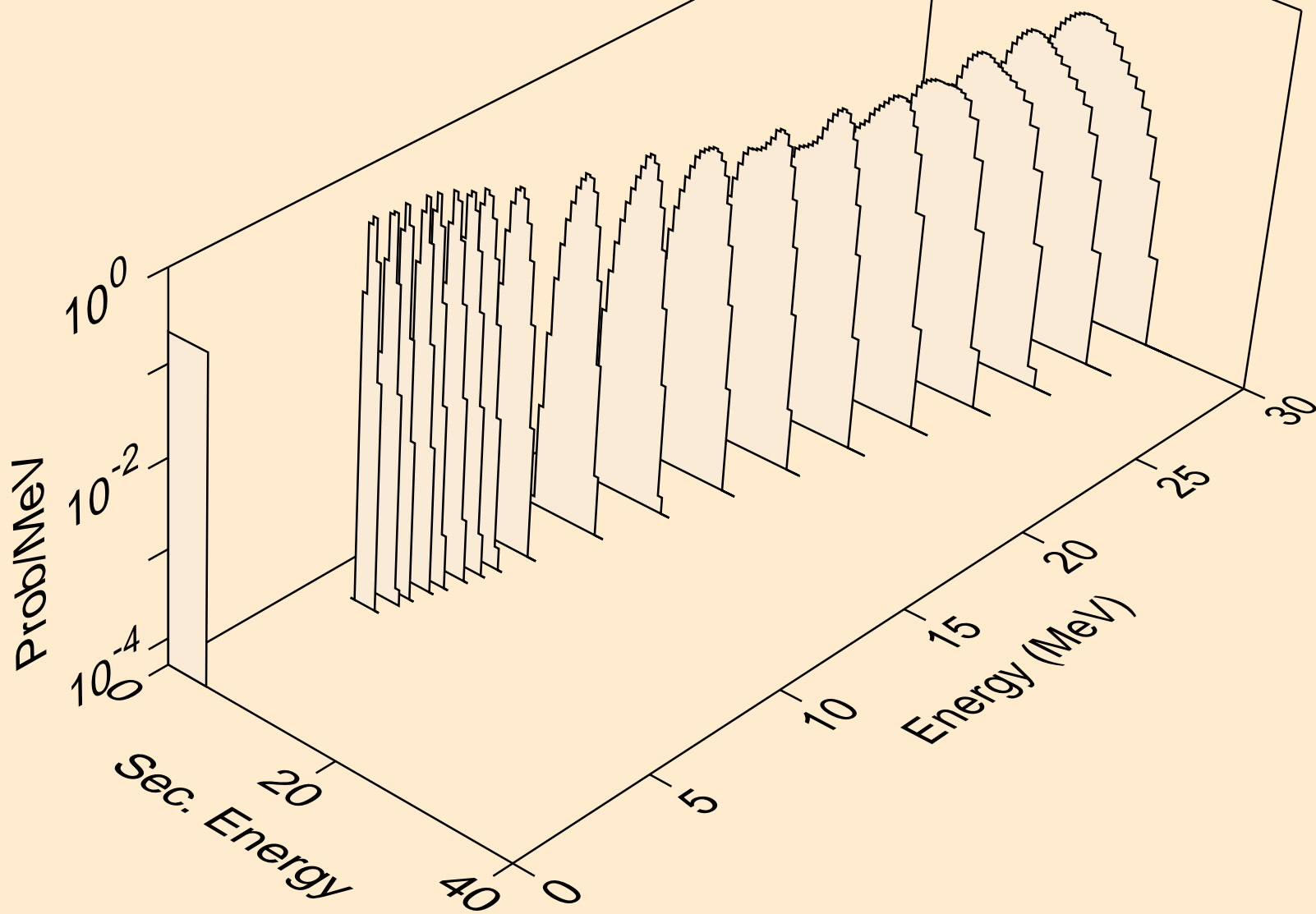

HO159 NEUTRON ACER TENDL-2023 LIBRARY; T=0.K  
alphas from (n,da)

