

# IR174 NEUTRON ACER TENDL-2023 LIBRARY; T=0.K

## Principal cross sections

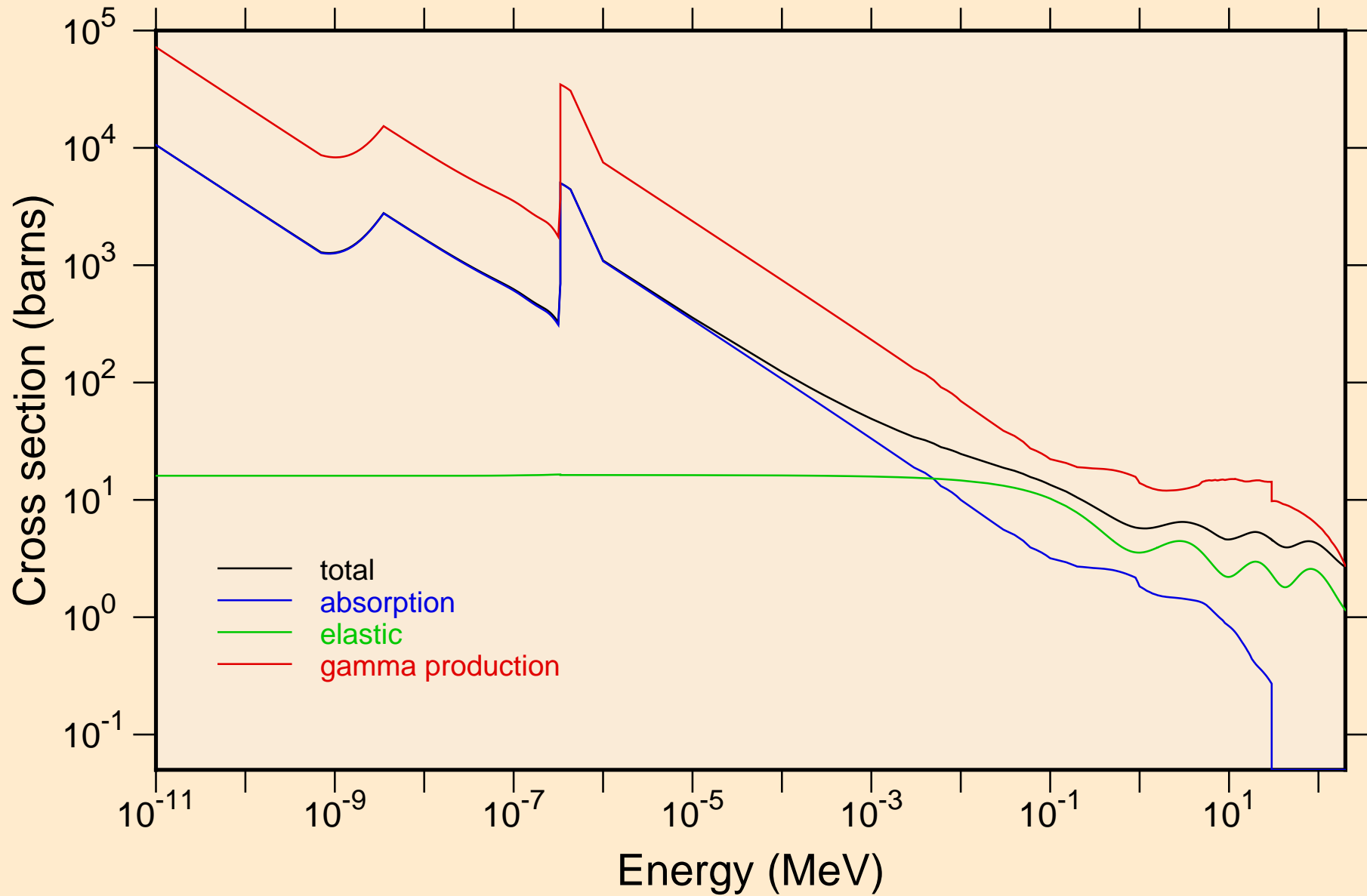

# IR174 NEUTRON ACER TENDL-2023 LIBRARY; T=0.K

## Heating

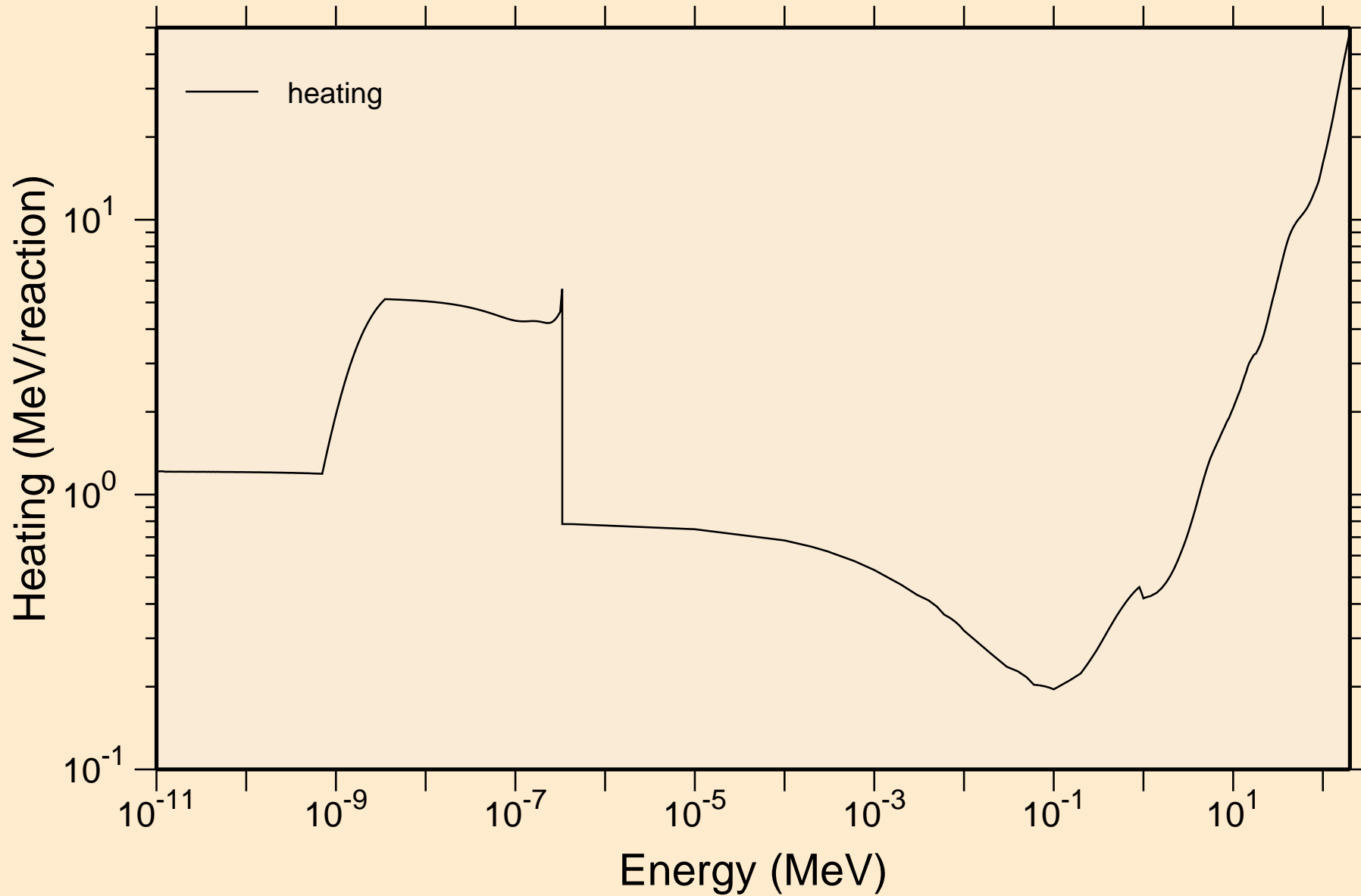

# IR174 NEUTRON ACER TENDL-2023 LIBRARY; T=0.K

## Damage

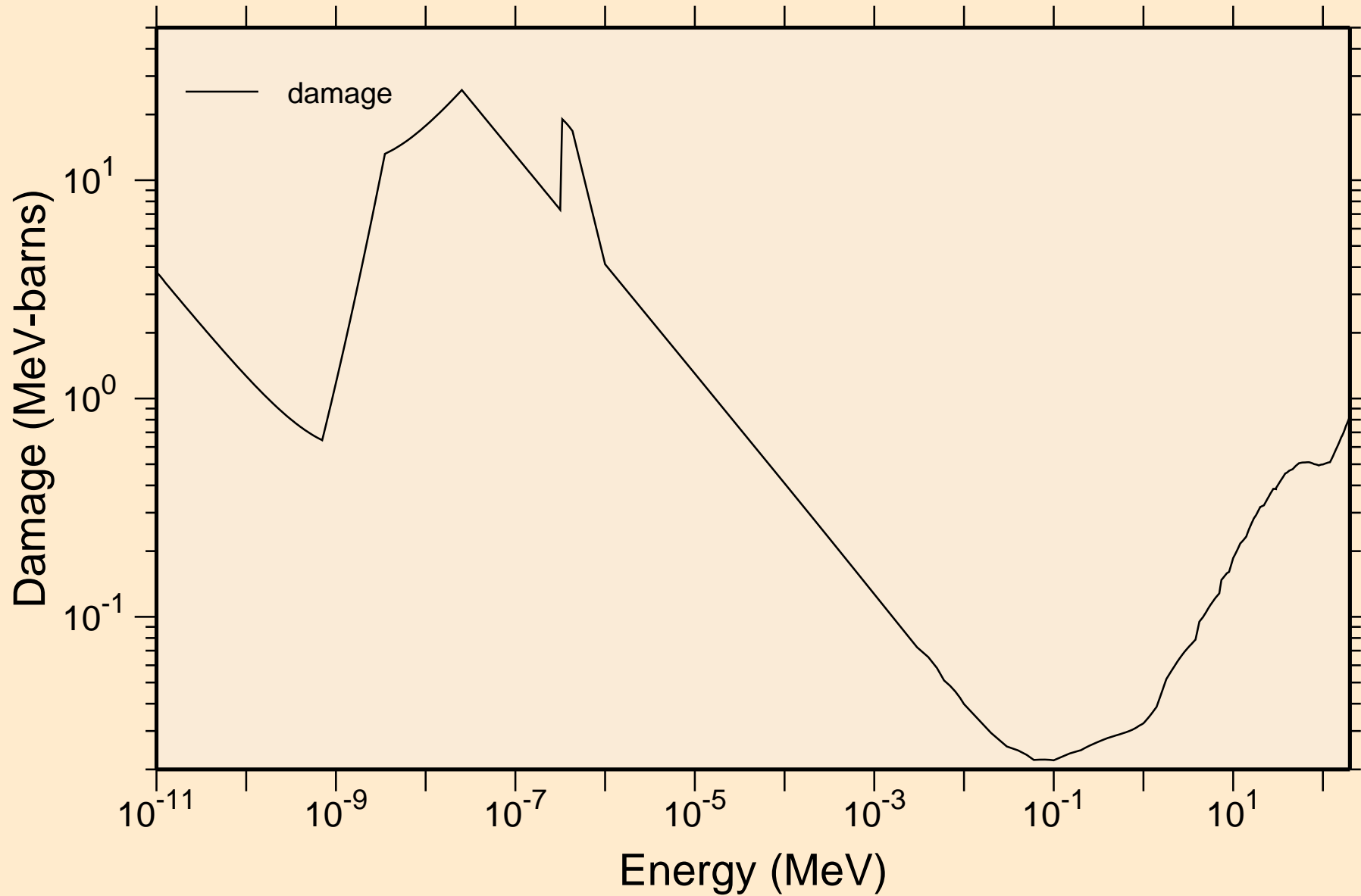

IR174 NEUTRON ACER TENDL-2023 LIBRARY; T=0.K  
Non-threshold reactions

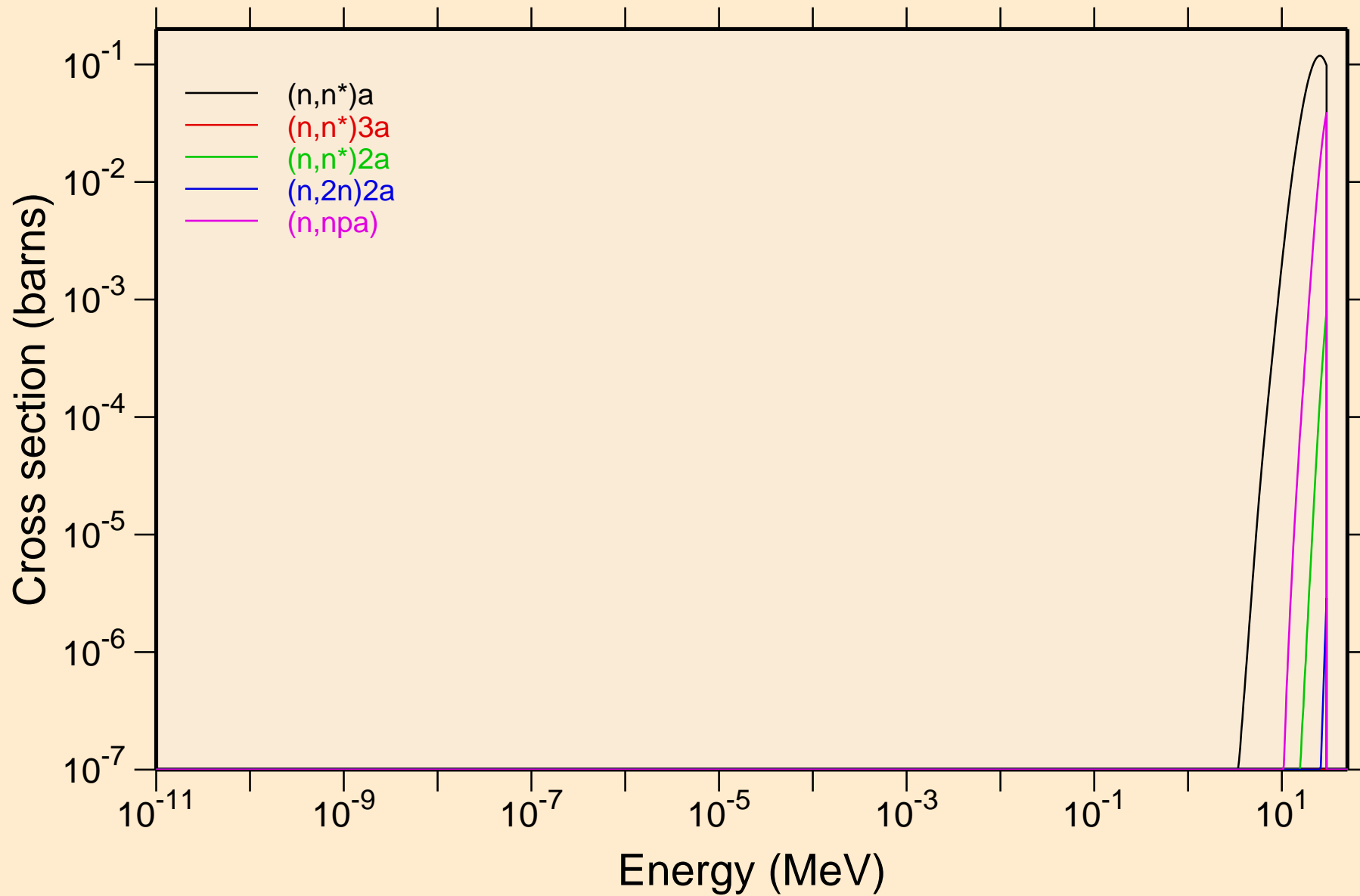

IR174 NEUTRON ACER TENDL-2023 LIBRARY; T=0.K  
Non-threshold reactions

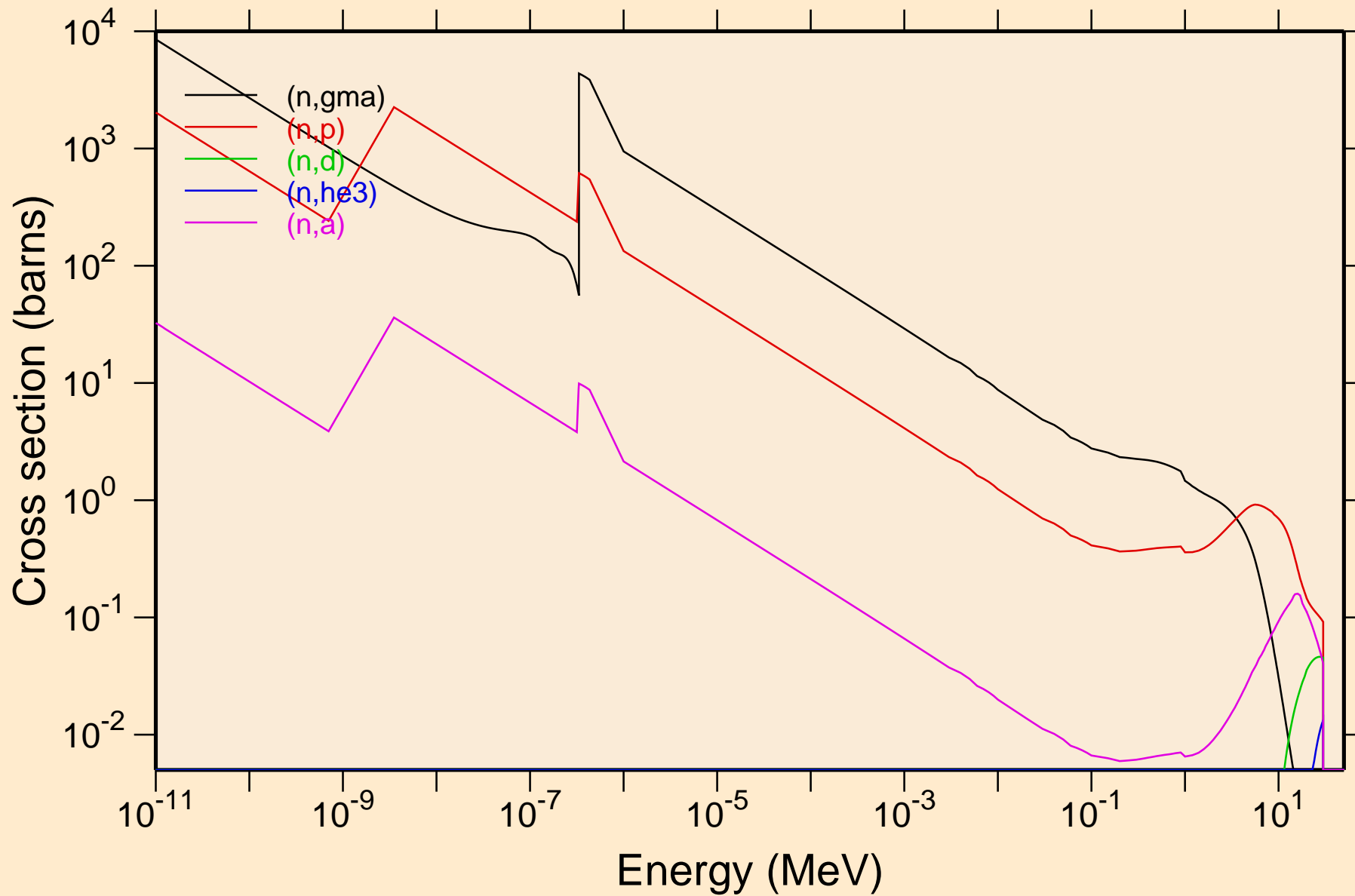

# IR174 NEUTRON ACER TENDL-2023 LIBRARY; T=0.K

## Non-threshold reactions

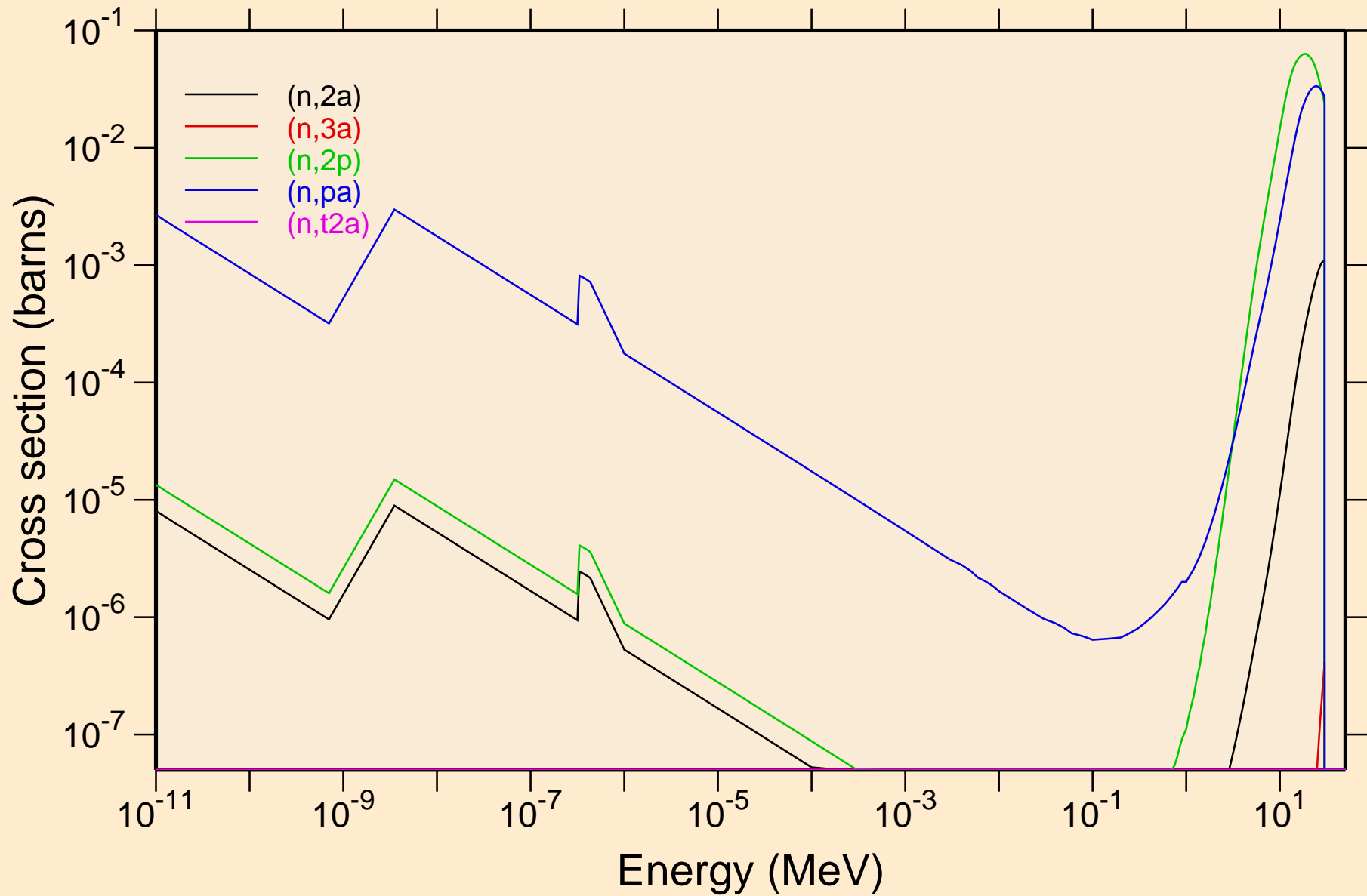

IR174 NEUTRON ACER TENDL-2023 LIBRARY; T=0.K  
Non-threshold reactions

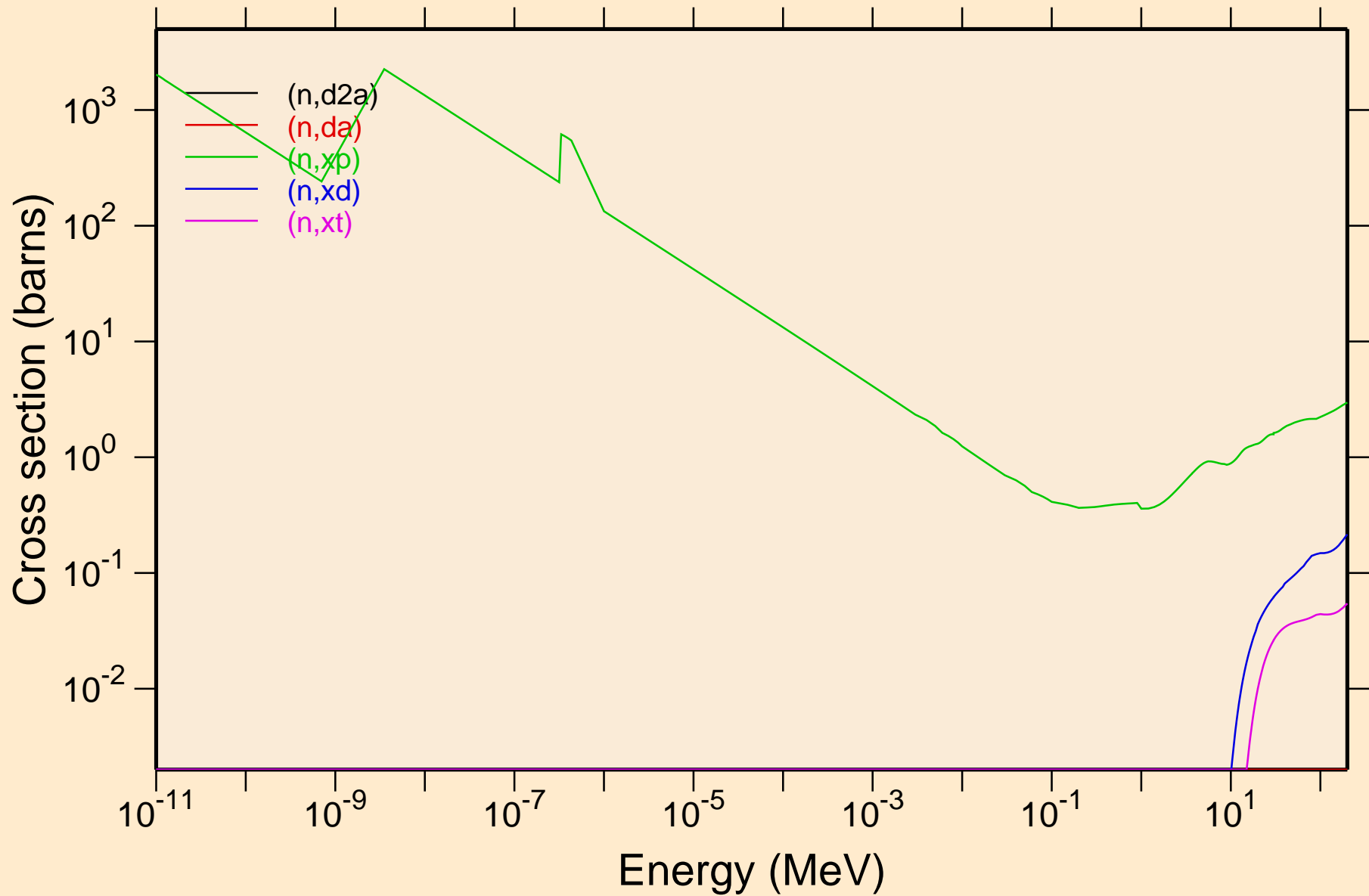

IR174 NEUTRON ACER TENDL-2023 LIBRARY; T=0.K  
Non-threshold reactions

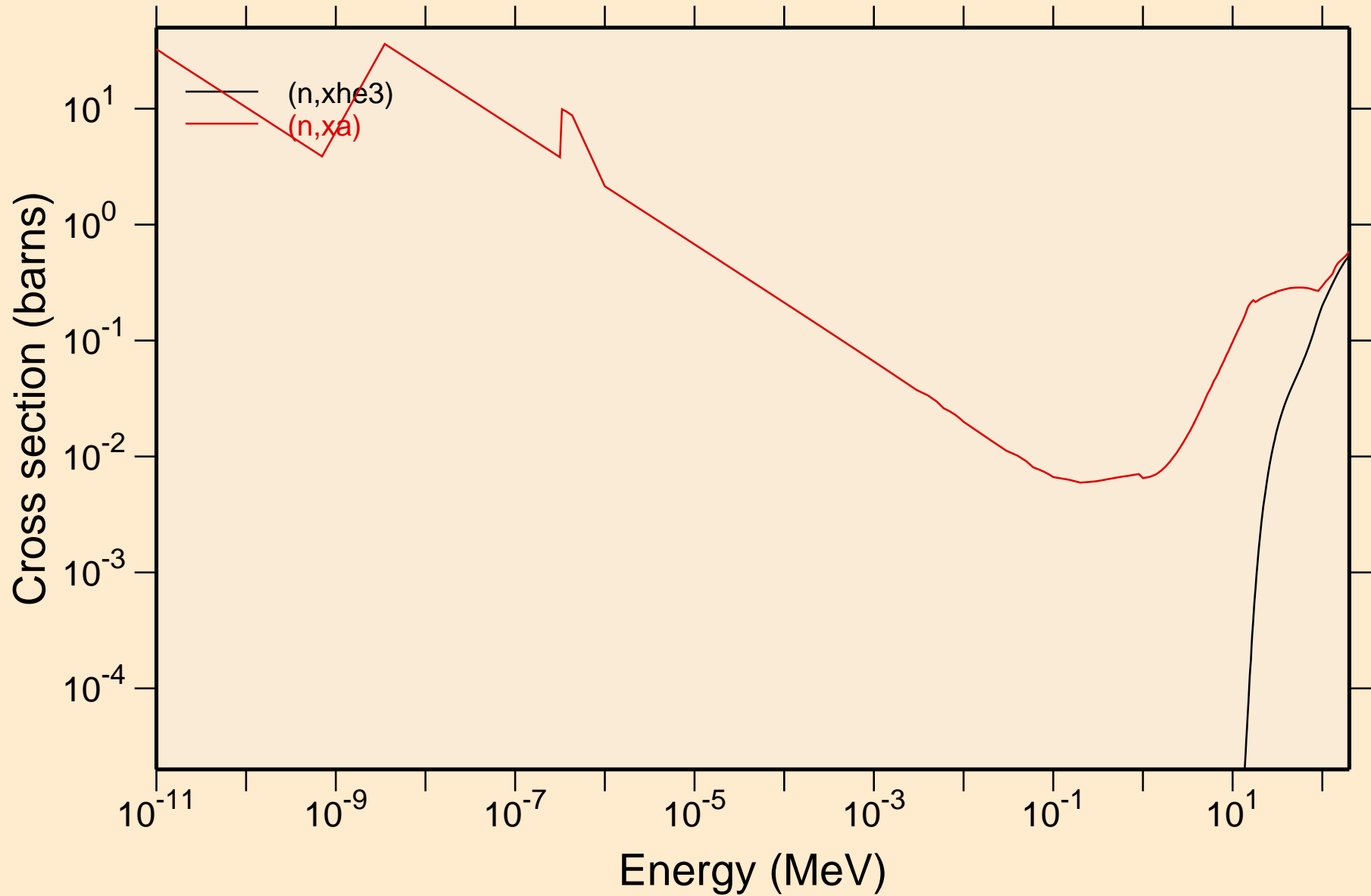

# IR174 NEUTRON ACER TENDL-2023 LIBRARY; T=0.K

## Principal cross sections

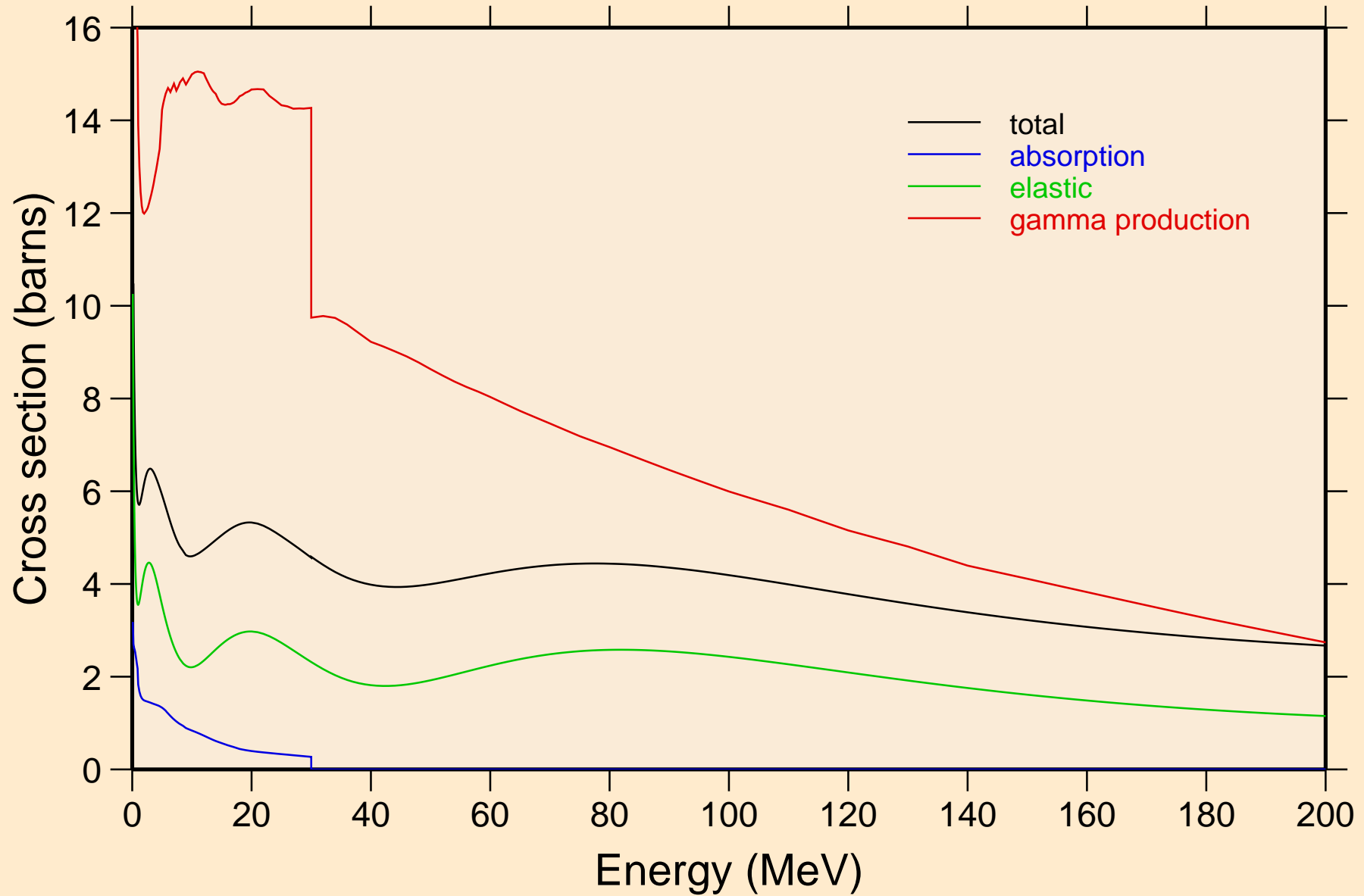

# IR174 NEUTRON ACER TENDL-2023 LIBRARY; T=0.K

## Heating

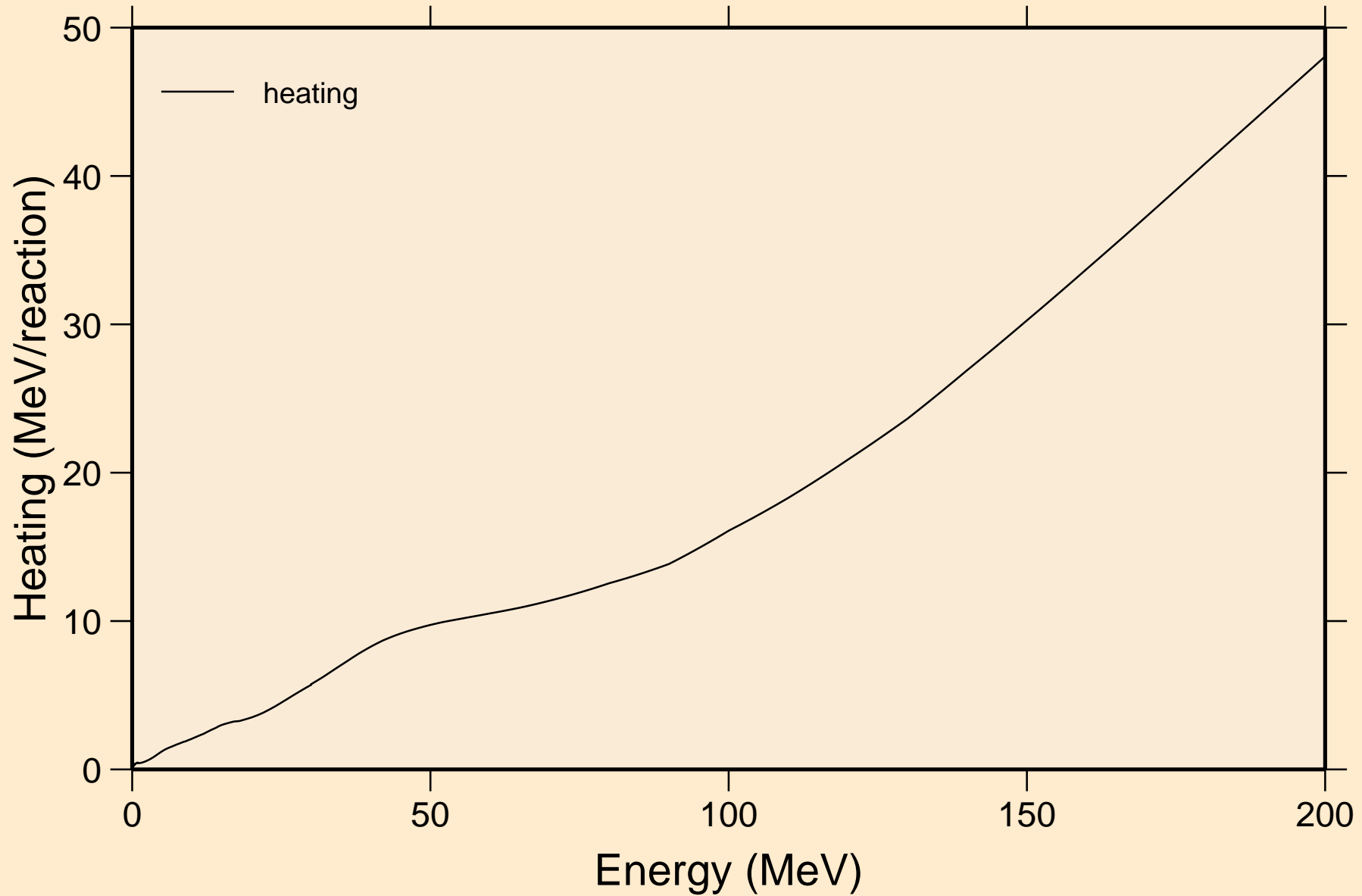

# IR174 NEUTRON ACER TENDL-2023 LIBRARY; T=0.K

## Damage

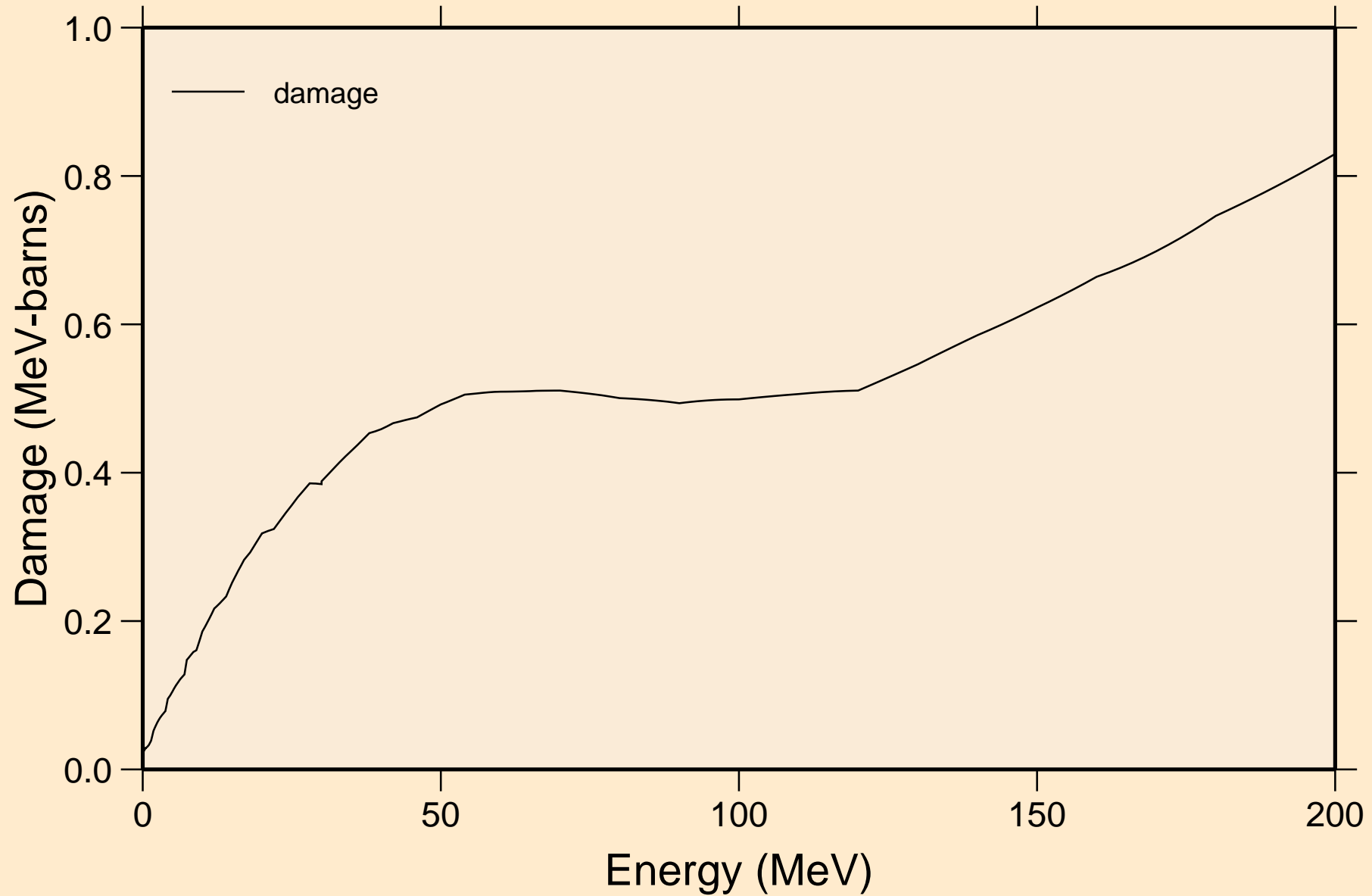

IR174 NEUTRON ACER TENDL-2023 LIBRARY; T=0.K  
Non-threshold reactions

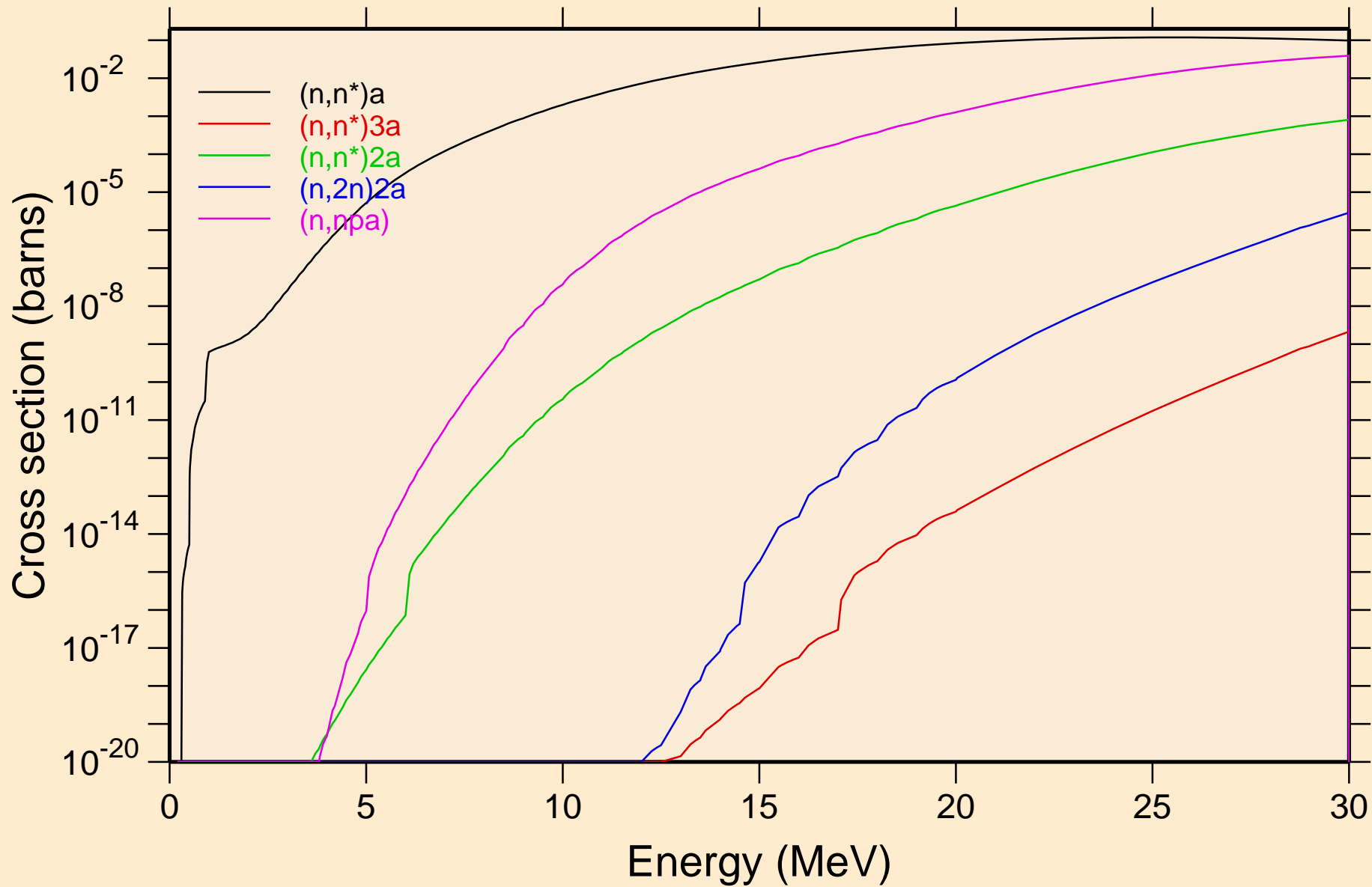

IR174 NEUTRON ACER TENDL-2023 LIBRARY; T=0.K  
Non-threshold reactions

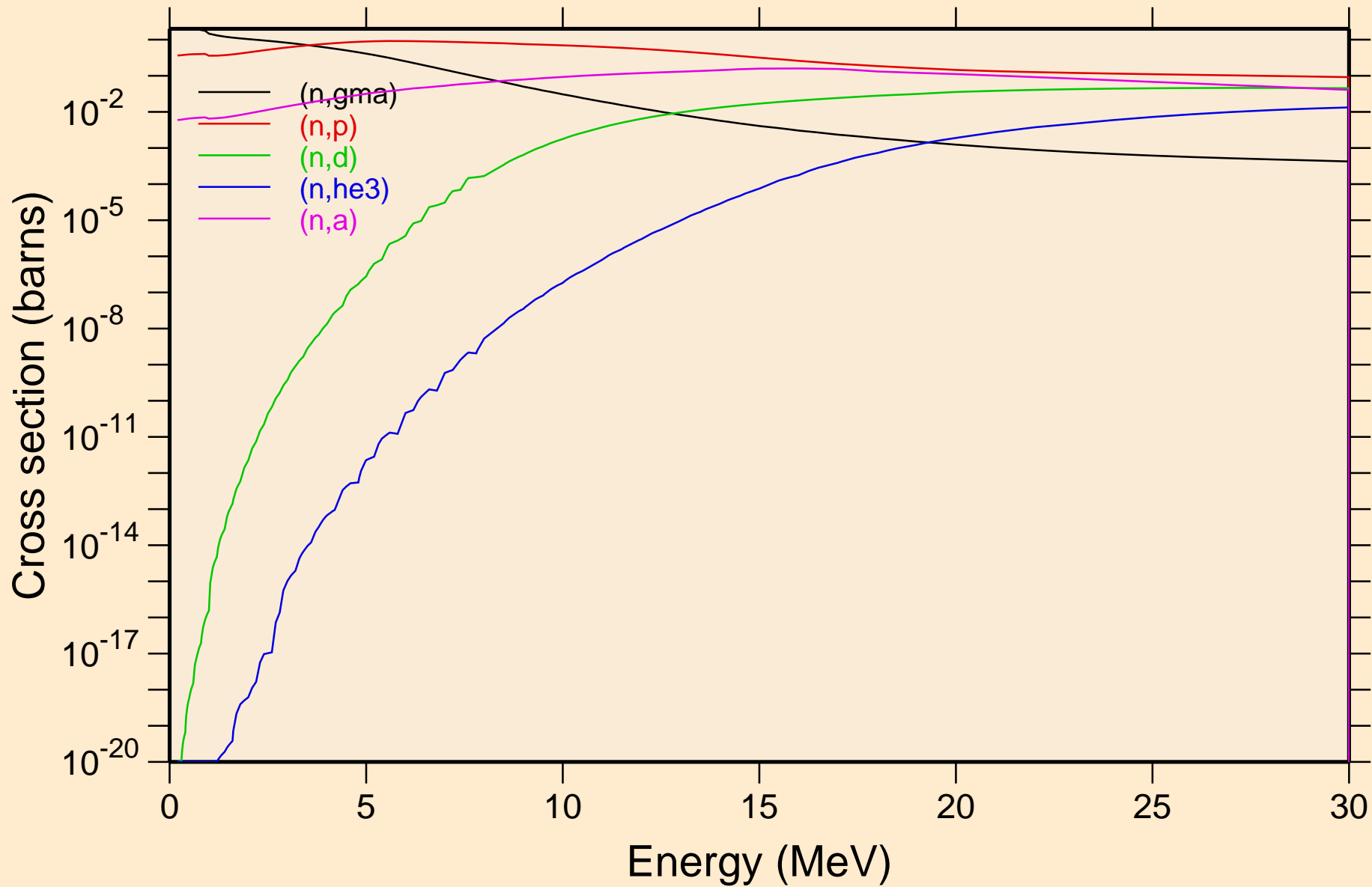

IR174 NEUTRON ACER TENDL-2023 LIBRARY; T=0.K  
Non-threshold reactions

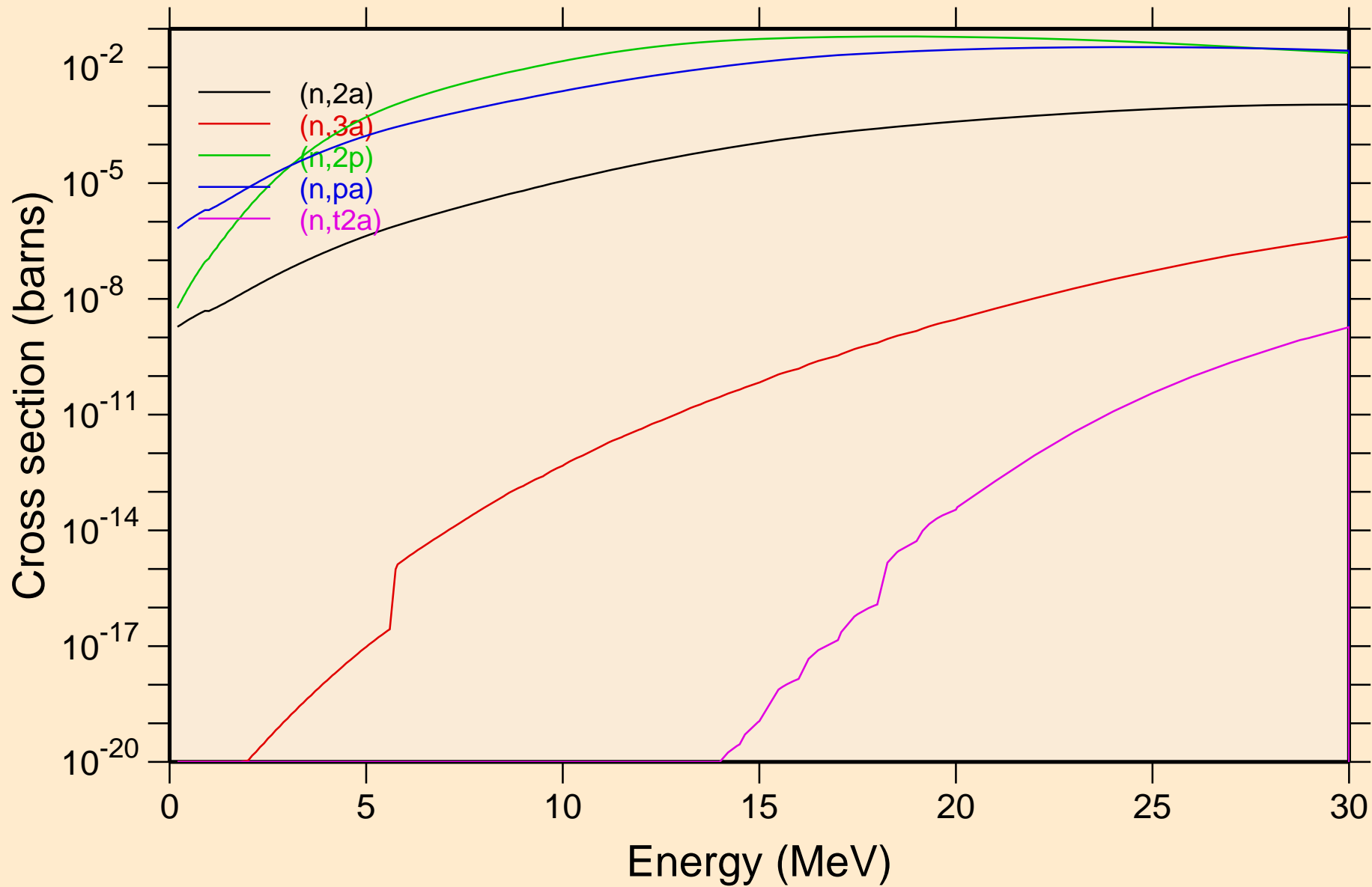

# IR174 NEUTRON ACER TENDL-2023 LIBRARY; T=0.K

## Non-threshold reactions

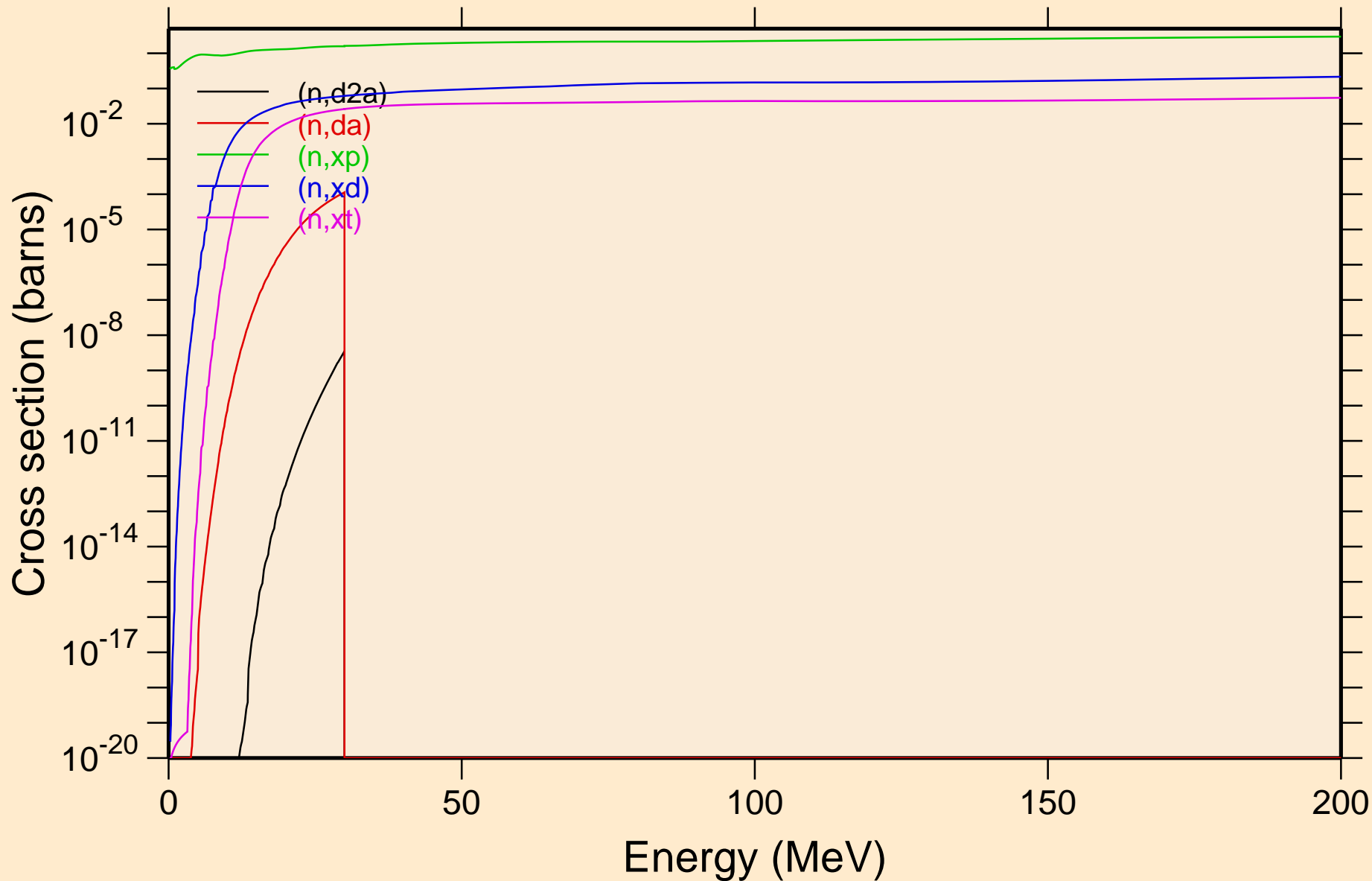

IR174 NEUTRON ACER TENDL-2023 LIBRARY; T=0.K  
Non-threshold reactions

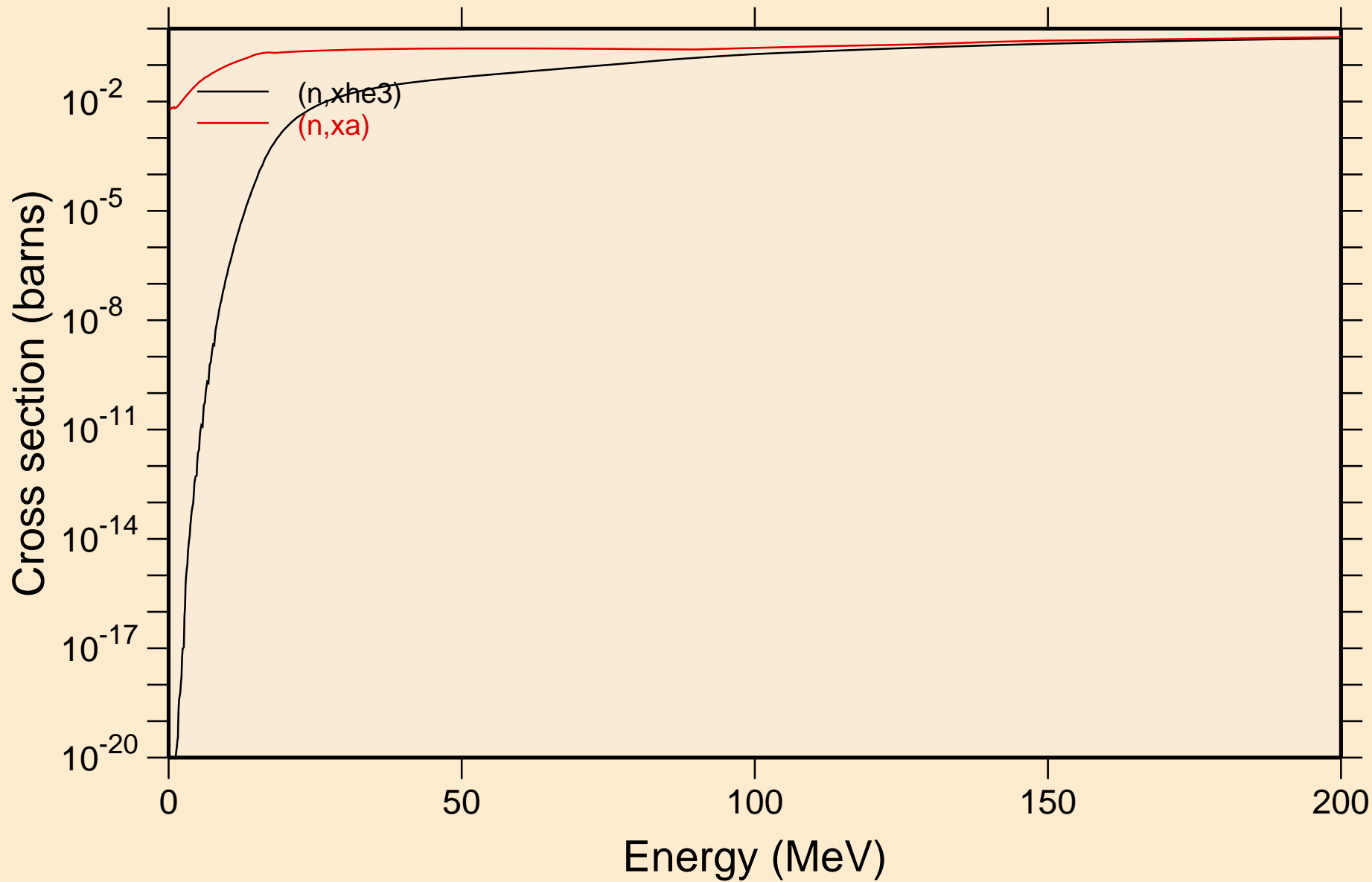

# IR174 NEUTRON ACER TENDL-2023 LIBRARY; T=0.K

## Inelastic levels

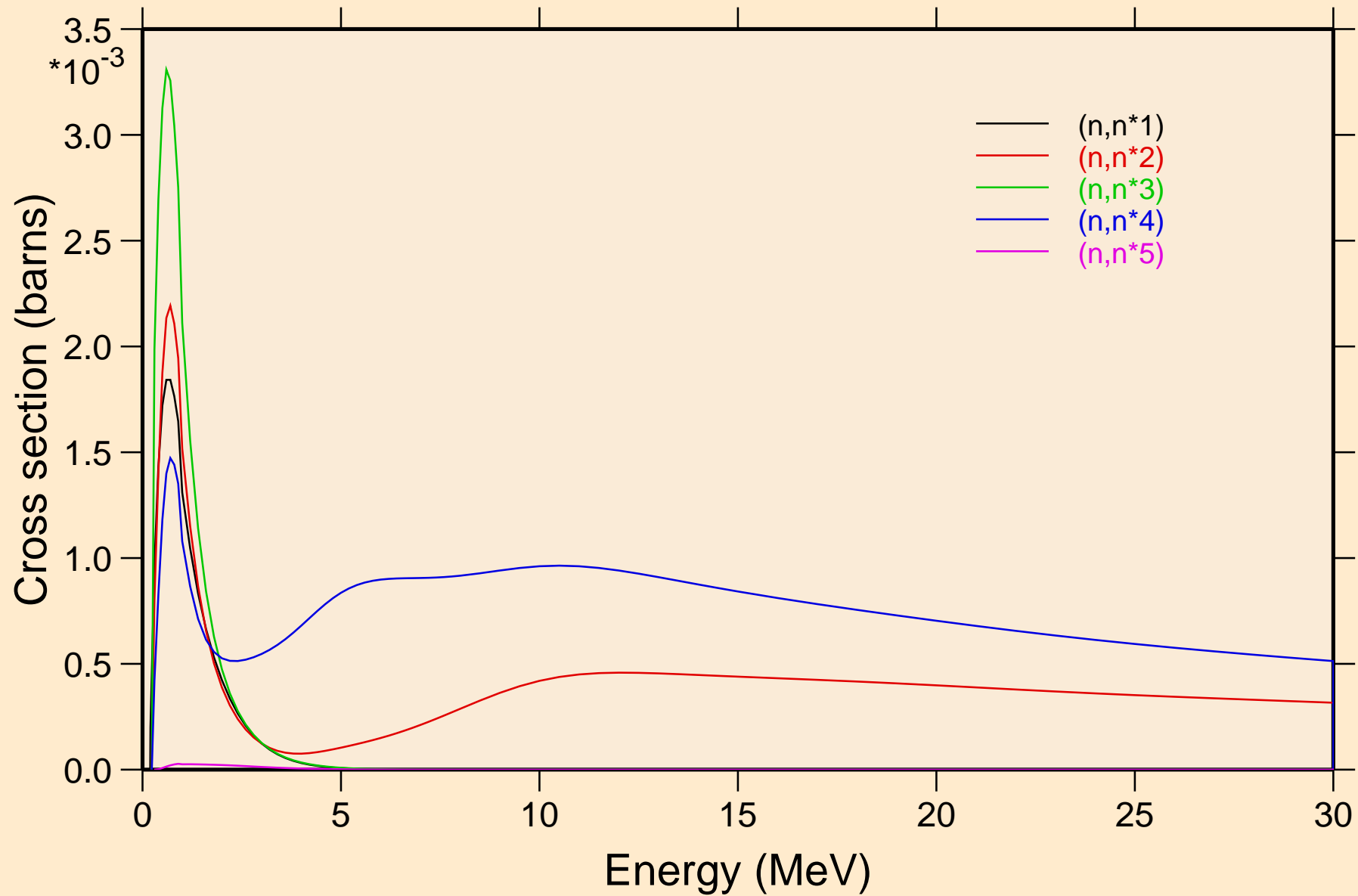

IR174 NEUTRON ACER TENDL-2023 LIBRARY; T=0.K  
Inelastic levels

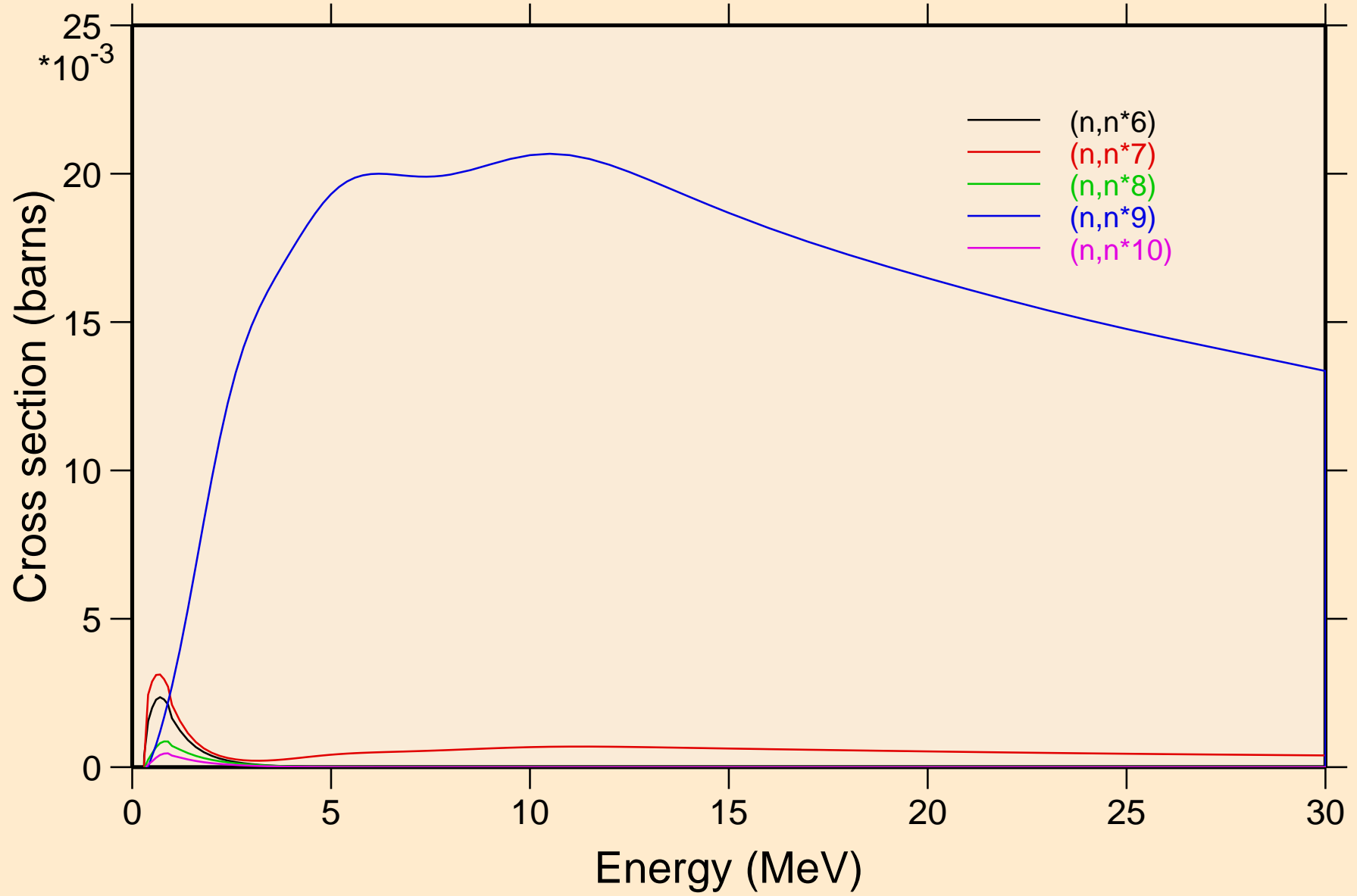

IR174 NEUTRON ACER TENDL-2023 LIBRARY; T=0.K  
Inelastic levels

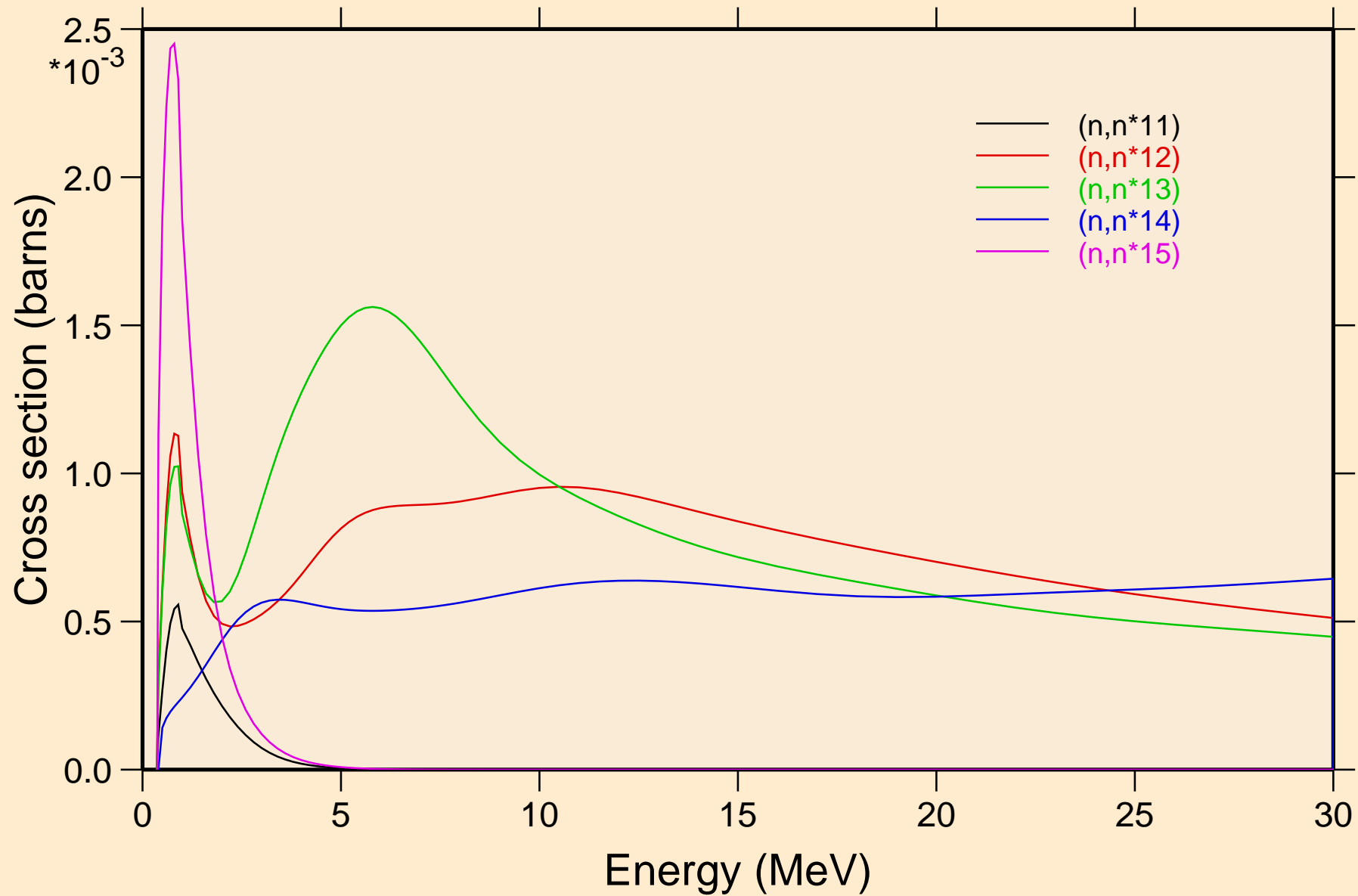

IR174 NEUTRON ACER TENDL-2023 LIBRARY; T=0.K  
Inelastic levels

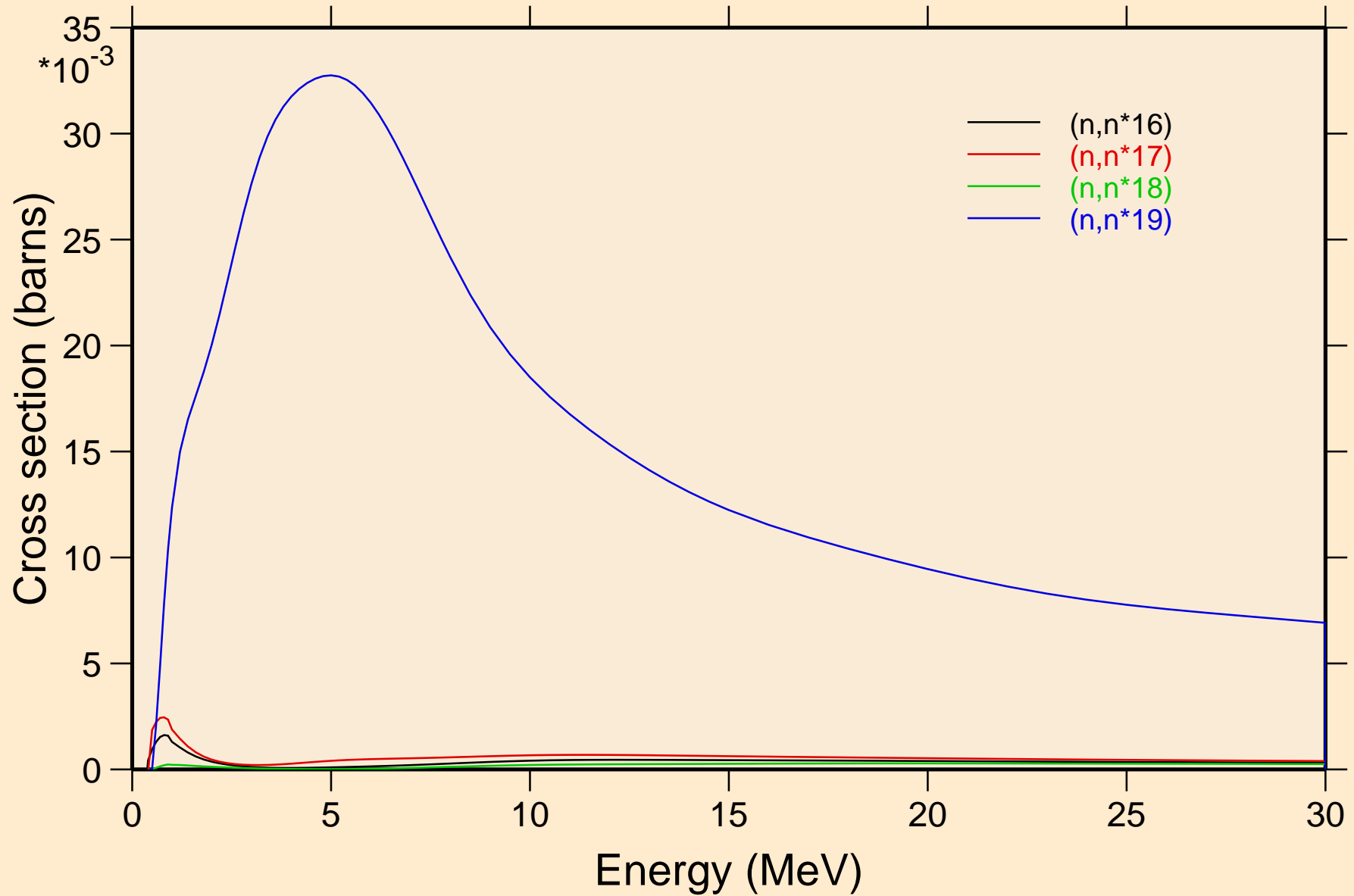

IR174 NEUTRON ACER TENDL-2023 LIBRARY; T=0.K  
Threshold reactions

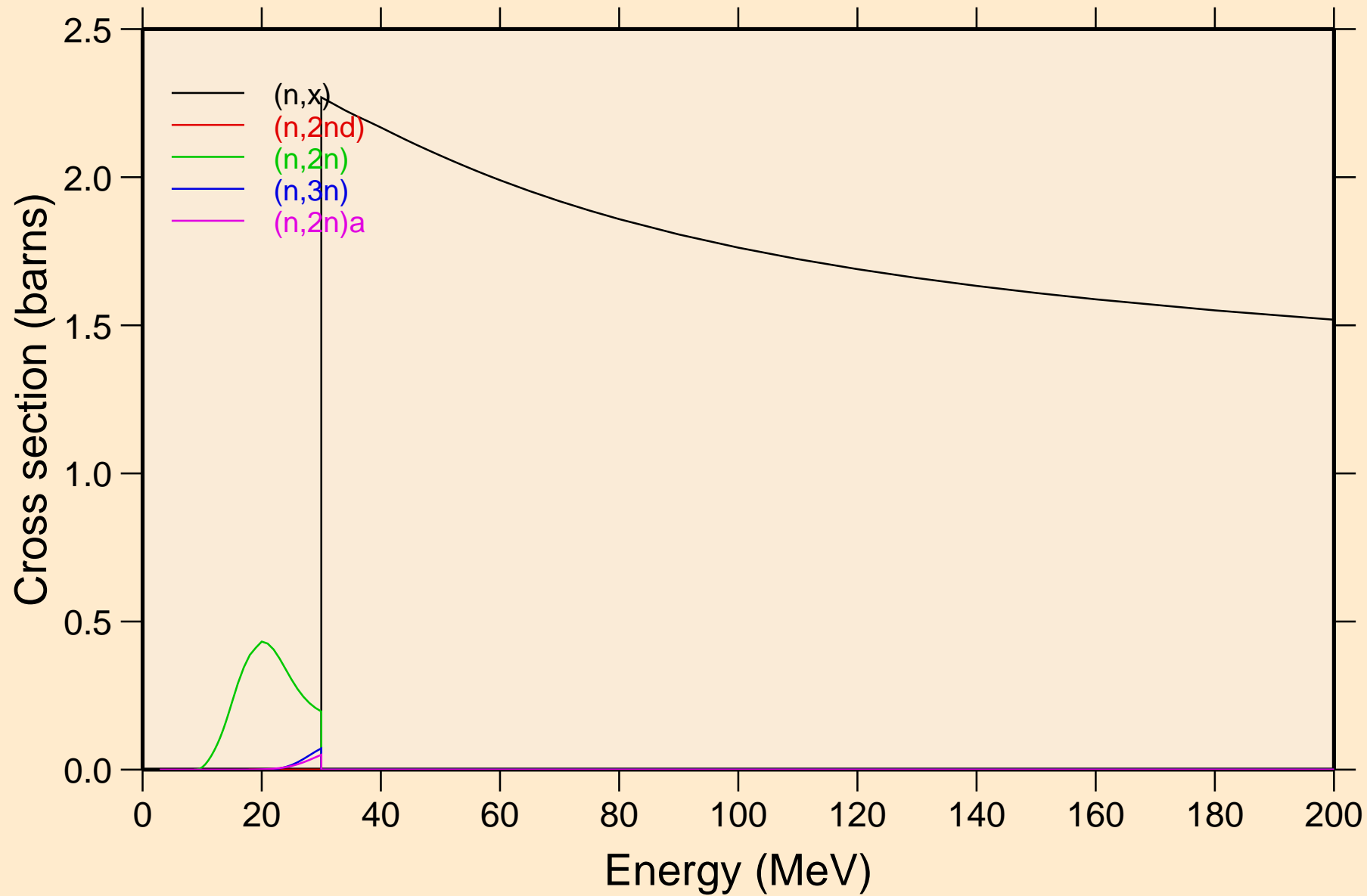

IR174 NEUTRON ACER TENDL-2023 LIBRARY; T=0.K  
Threshold reactions

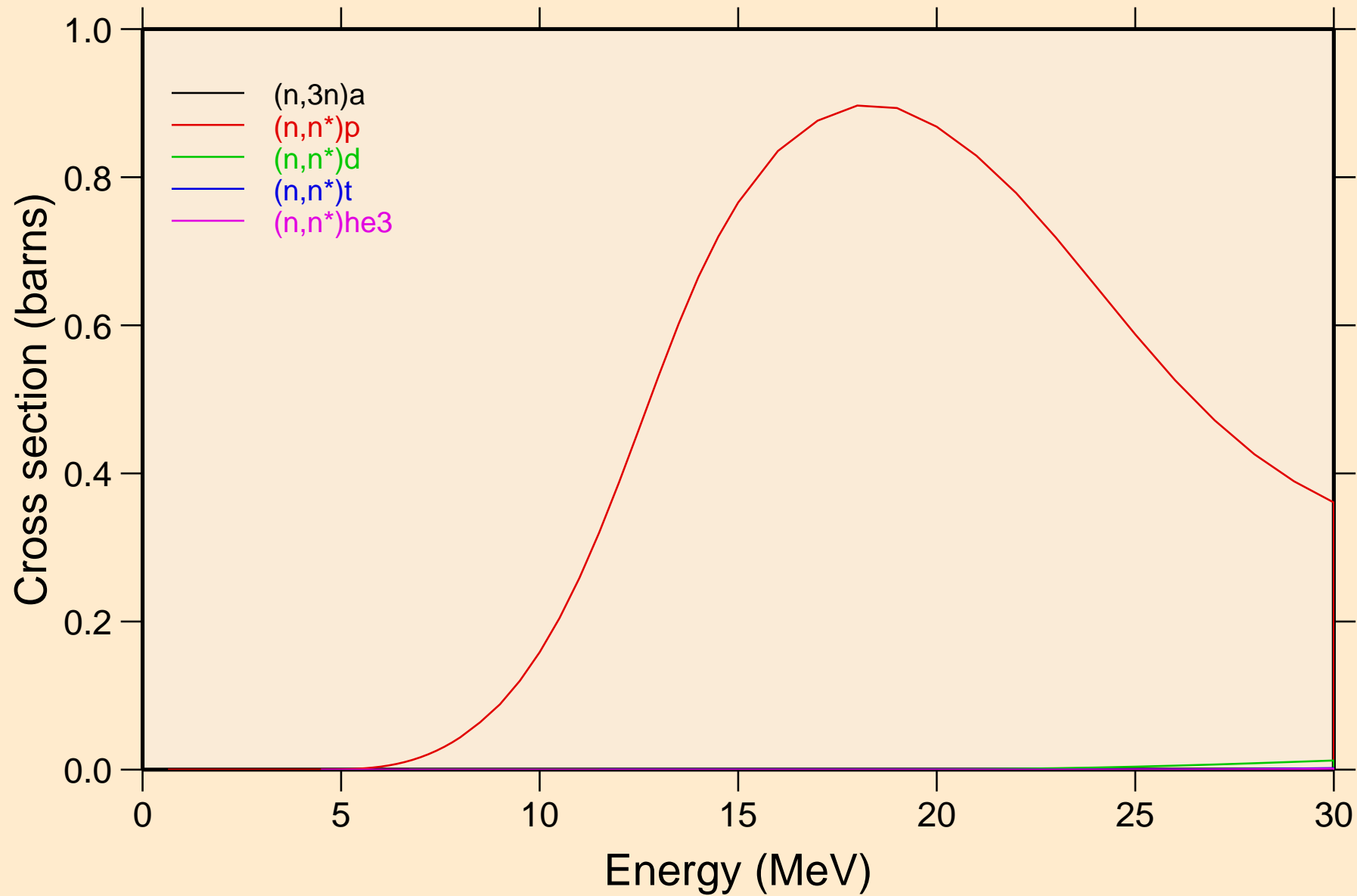

IR174 NEUTRON ACER TENDL-2023 LIBRARY; T=0.K  
Threshold reactions

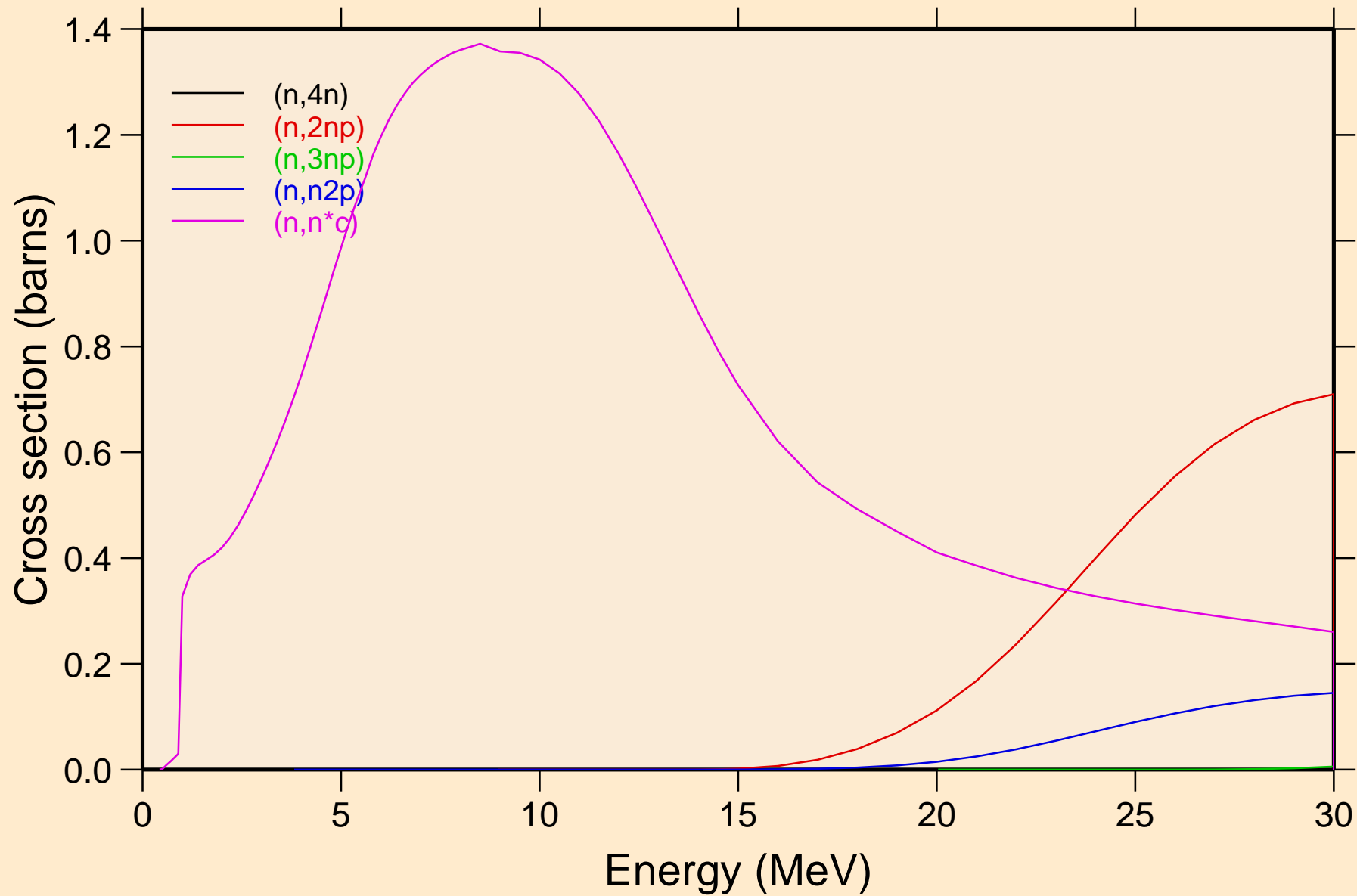

IR174 NEUTRON ACER TENDL-2023 LIBRARY; T=0.K  
Threshold reactions

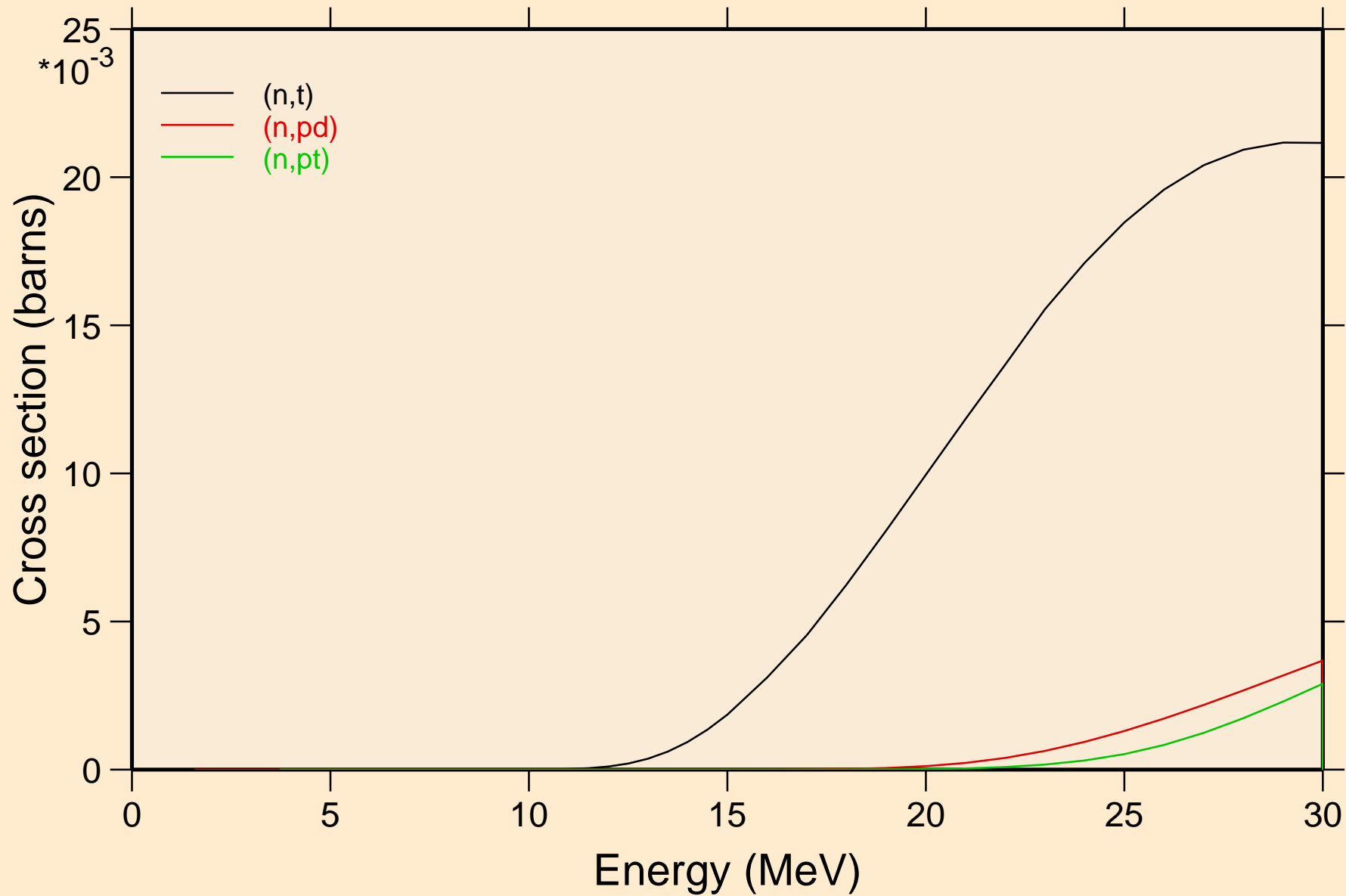

IR174 NEUTRON ACER TENDL-2023 LIBRARY; T=0.K  
angular distribution for elastic

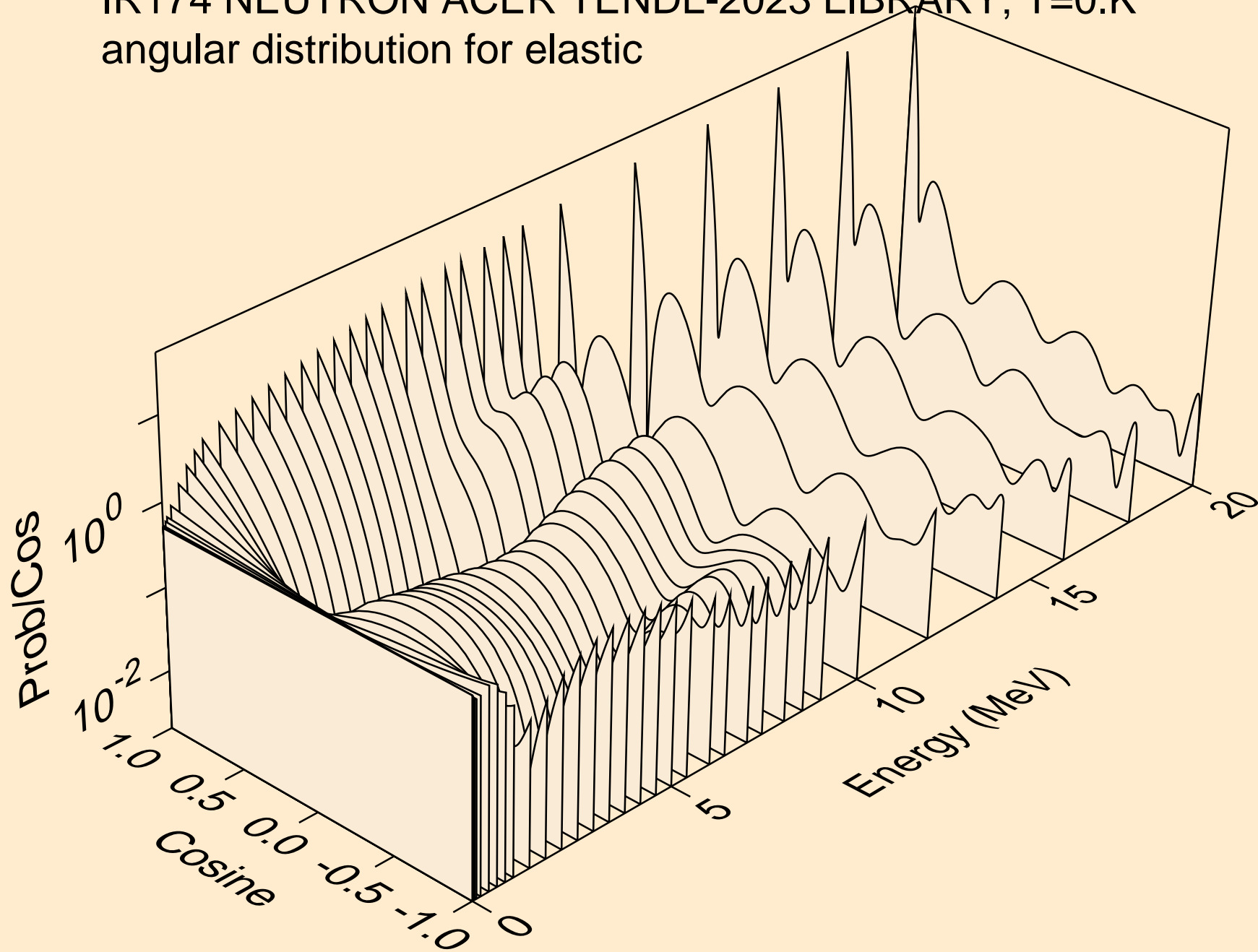

IR174 NEUTRON ACER TENDL-2023 LIBRARY; T=0.K  
angular distribution for elastic

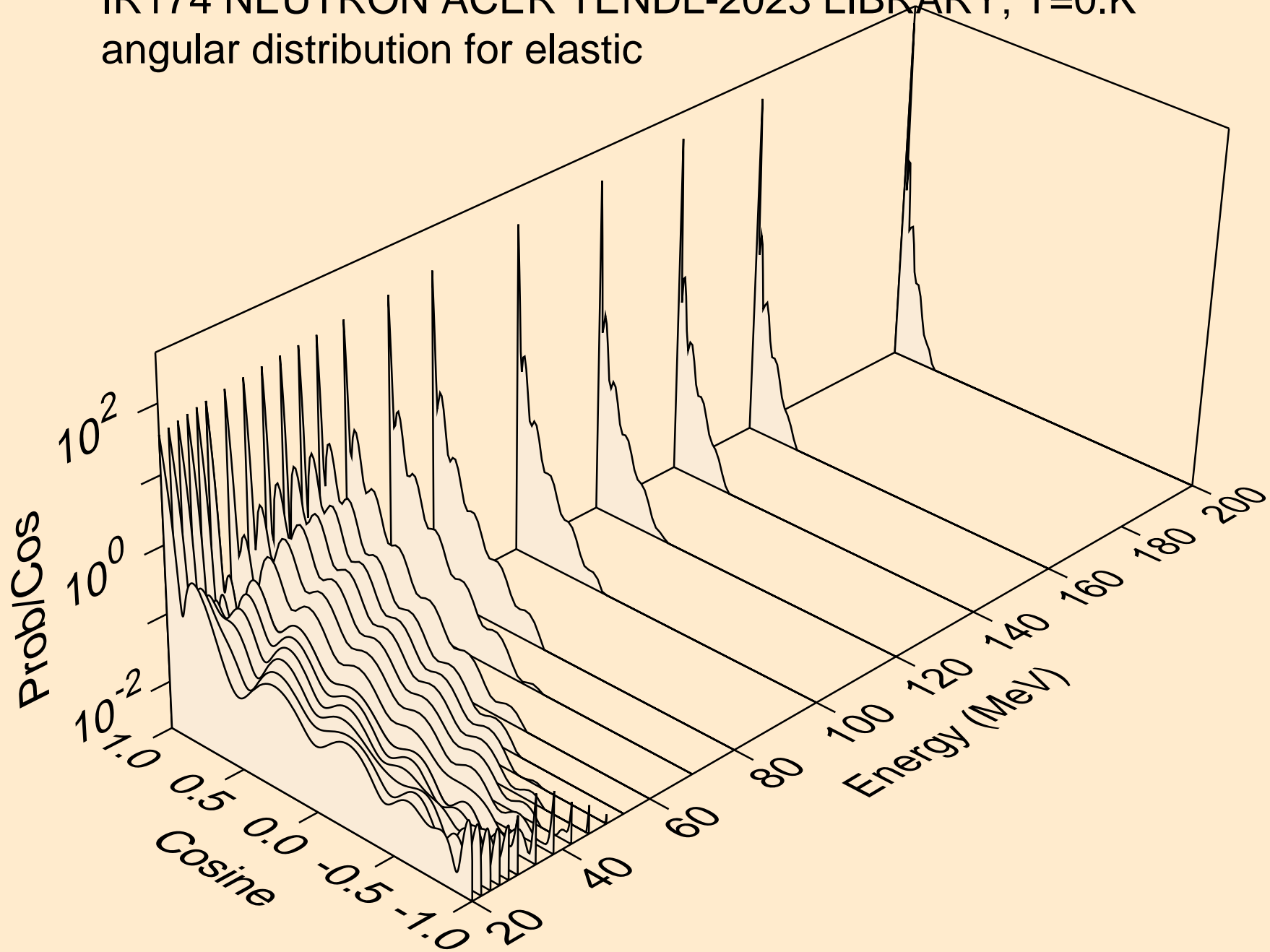

IR174 NEUTRON ACER TENDL-2023 LIBRARY; T=0.K  
angular distribution for (n,n\*1)

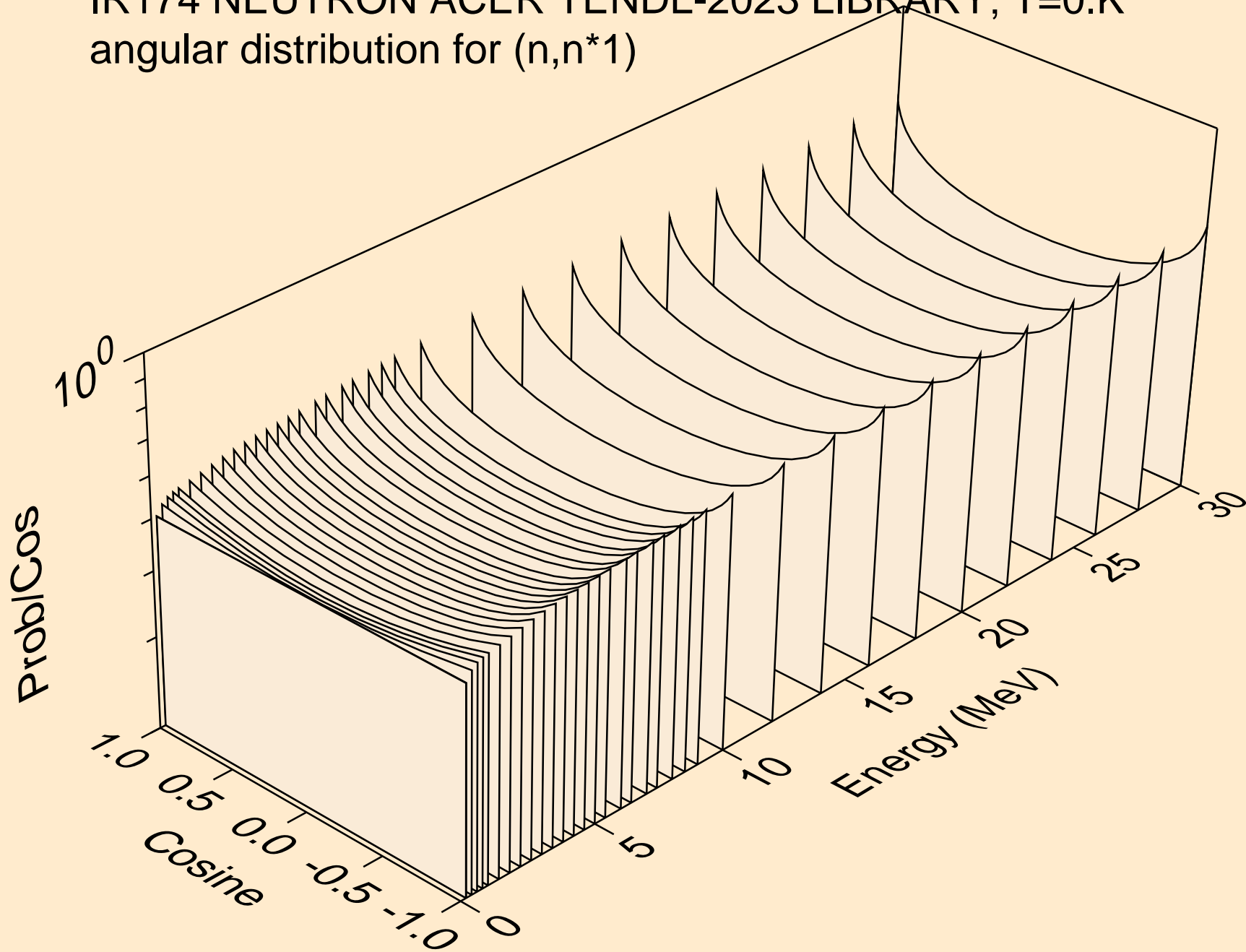

IR174 NEUTRON ACER TENDL-2023 LIBRARY; T=0.K  
angular distribution for (n,n\*2)

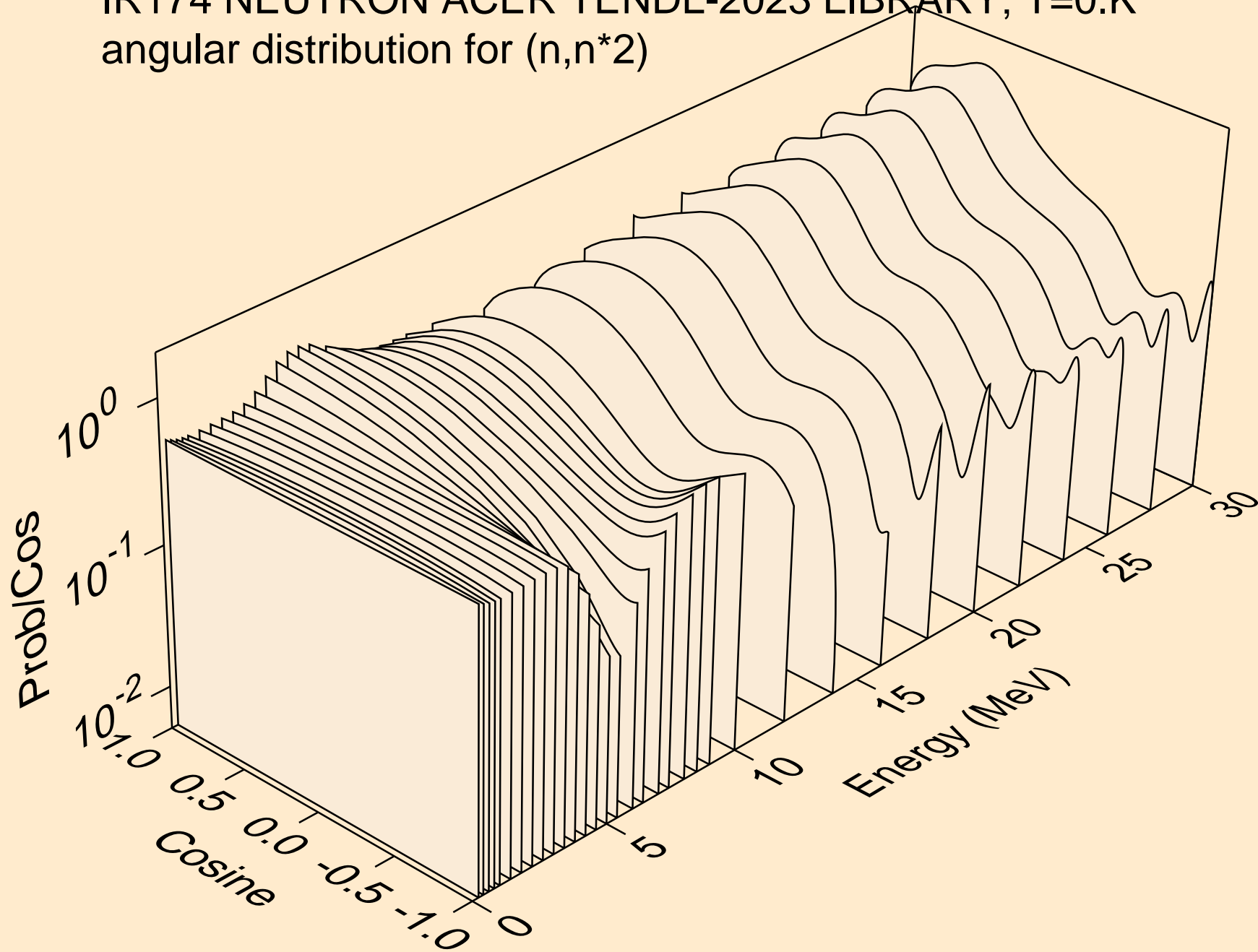

IR174 NEUTRON ACER TENDL-2023 LIBRARY; T=0.K  
angular distribution for (n,n\*3)

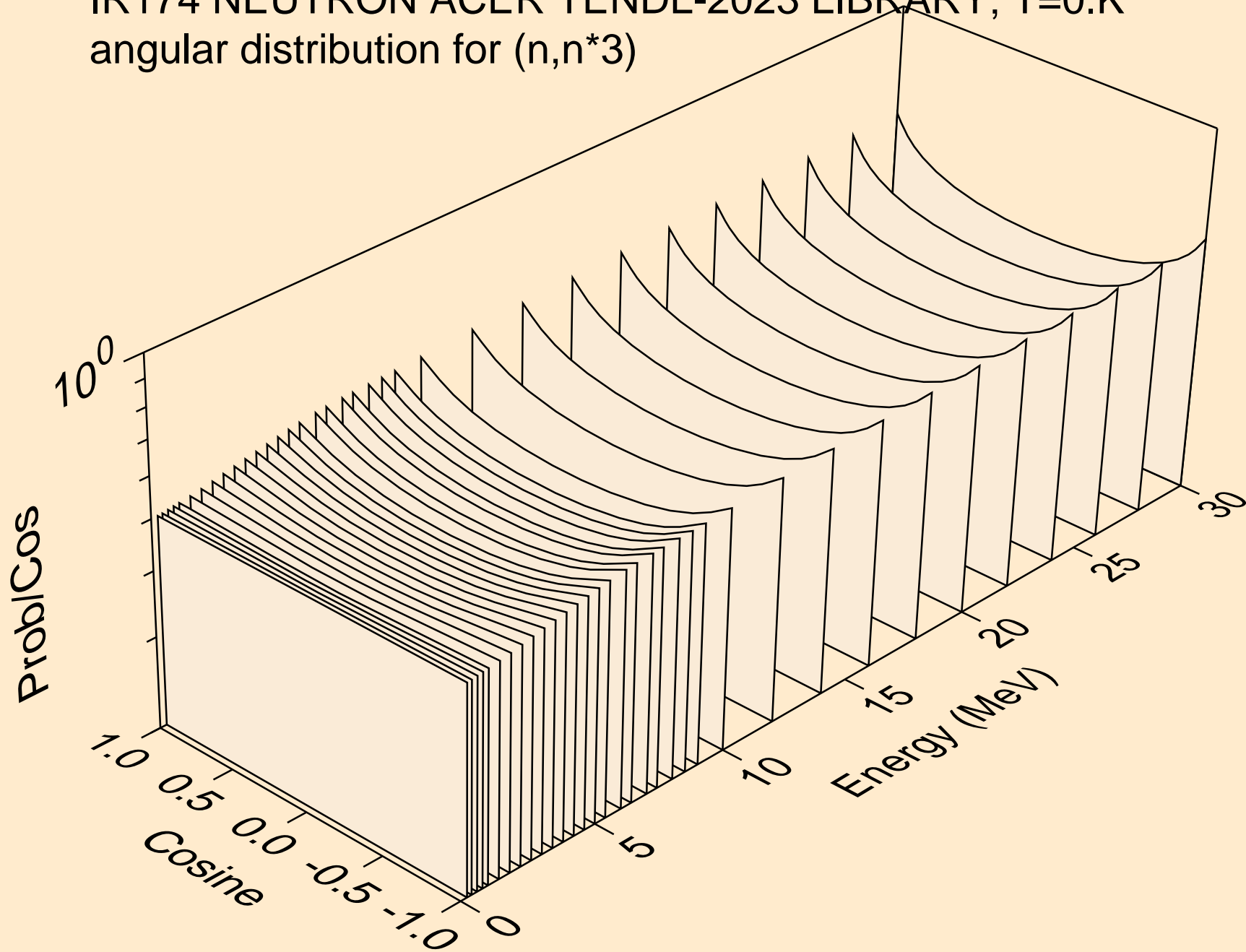

IR174 NEUTRON ACER TENDL-2023 LIBRARY; T=0.K  
angular distribution for (n,n\*4)

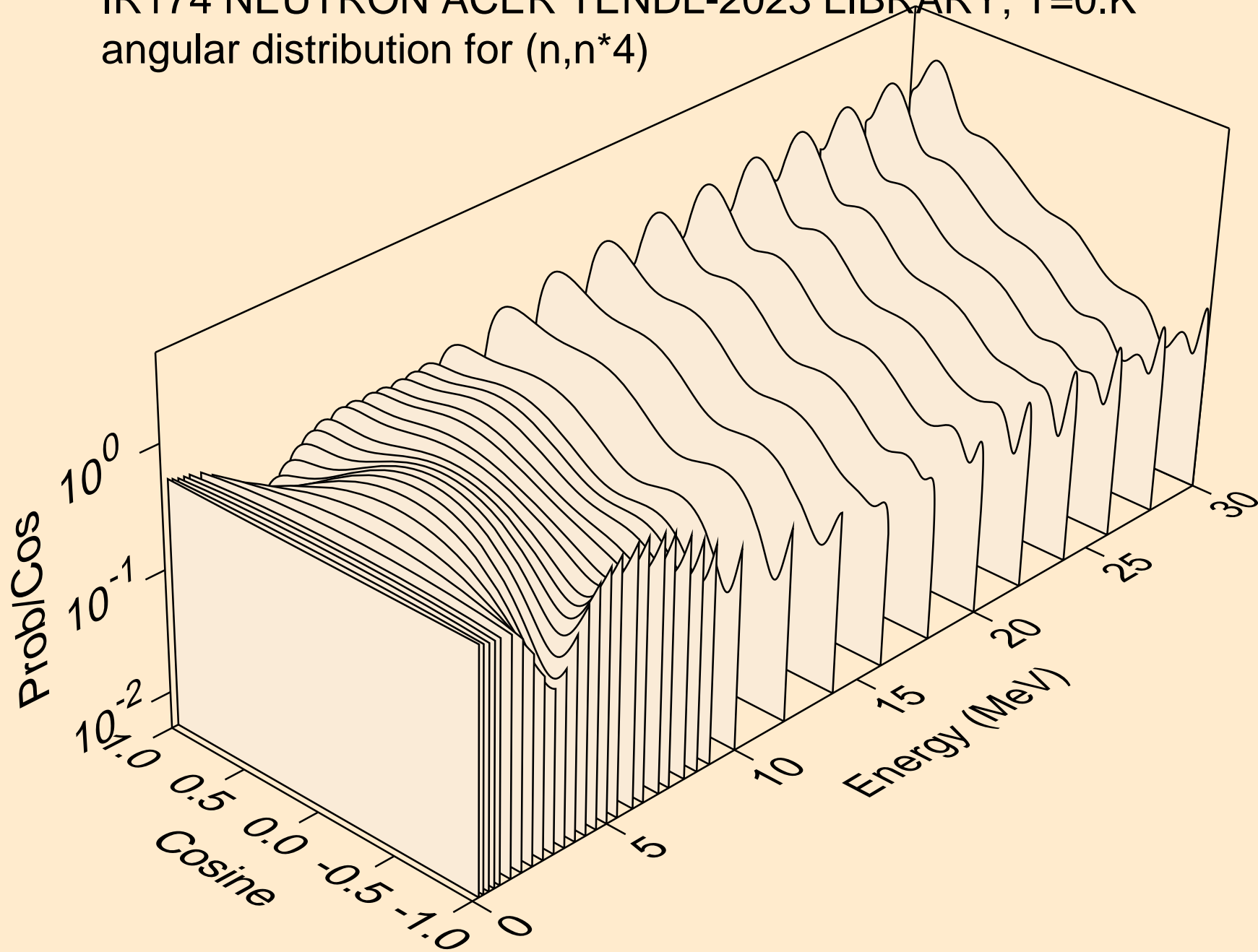

IR174 NEUTRON ACER TENDL-2023 LIBRARY; T=0.K  
angular distribution for (n,n\*5)

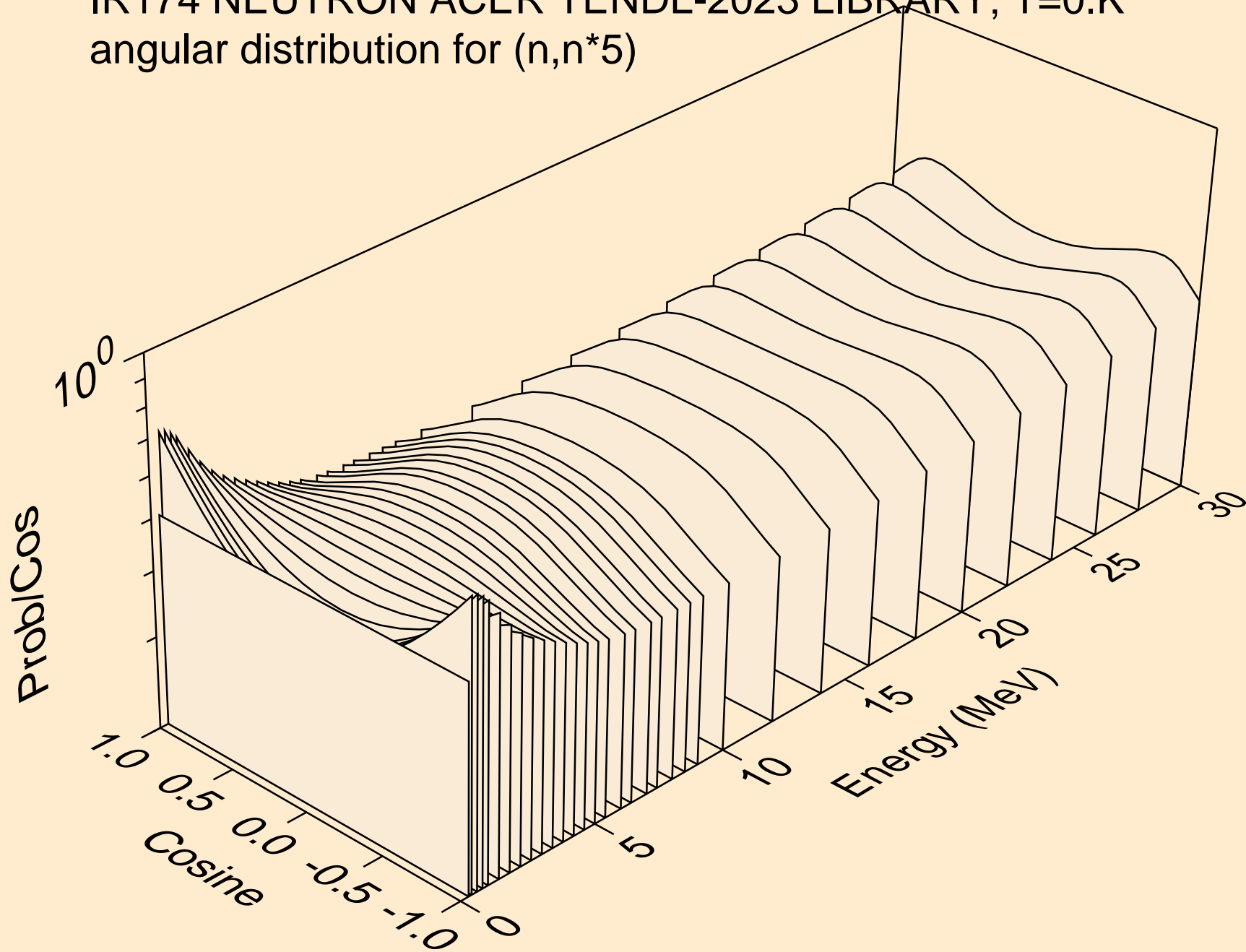

IR174 NEUTRON ACER TENDL-2023 LIBRARY; T=0.K  
angular distribution for (n,n\*6)

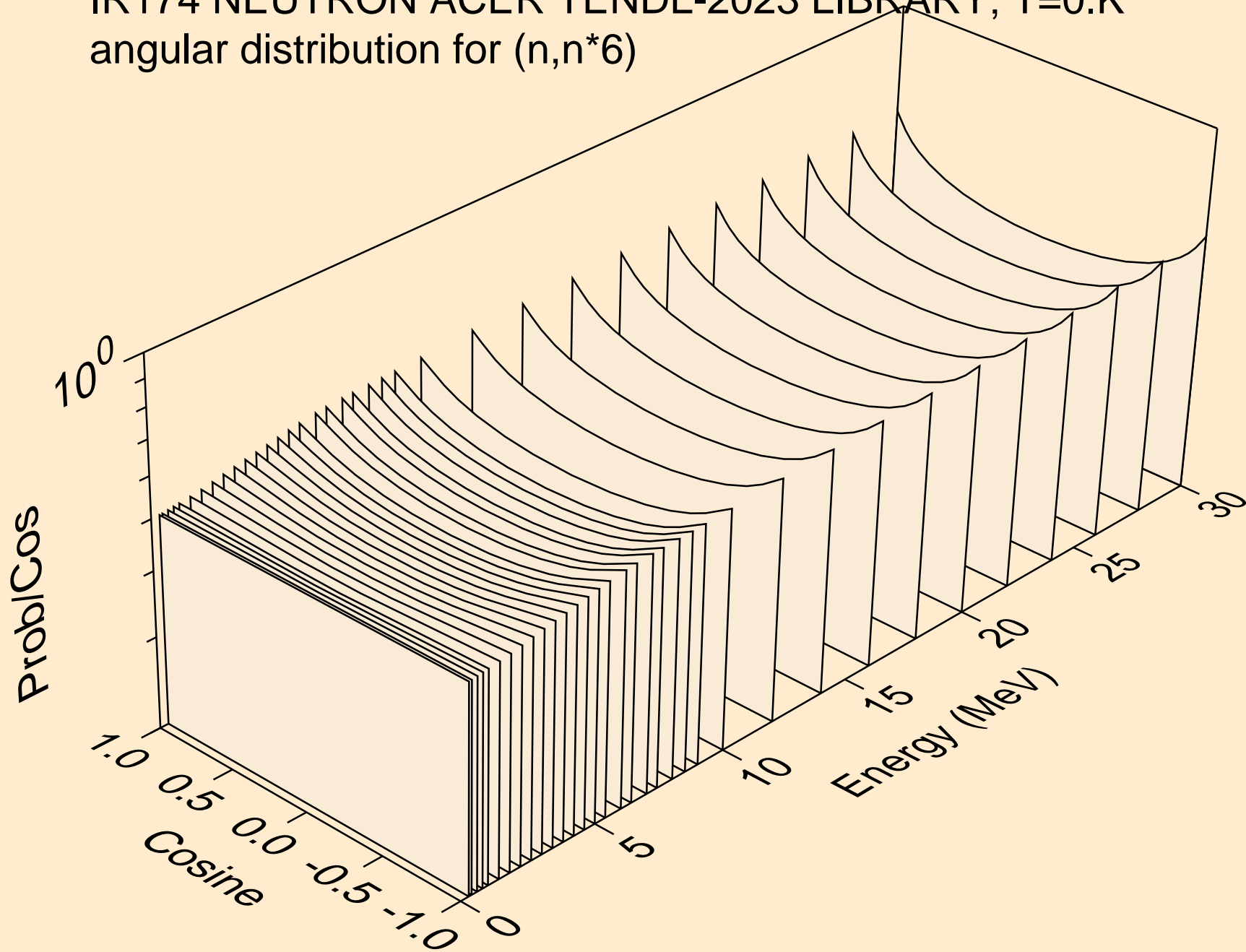

IR174 NEUTRON ACER TENDL-2023 LIBRARY; T=0.K  
angular distribution for (n,n\*7)

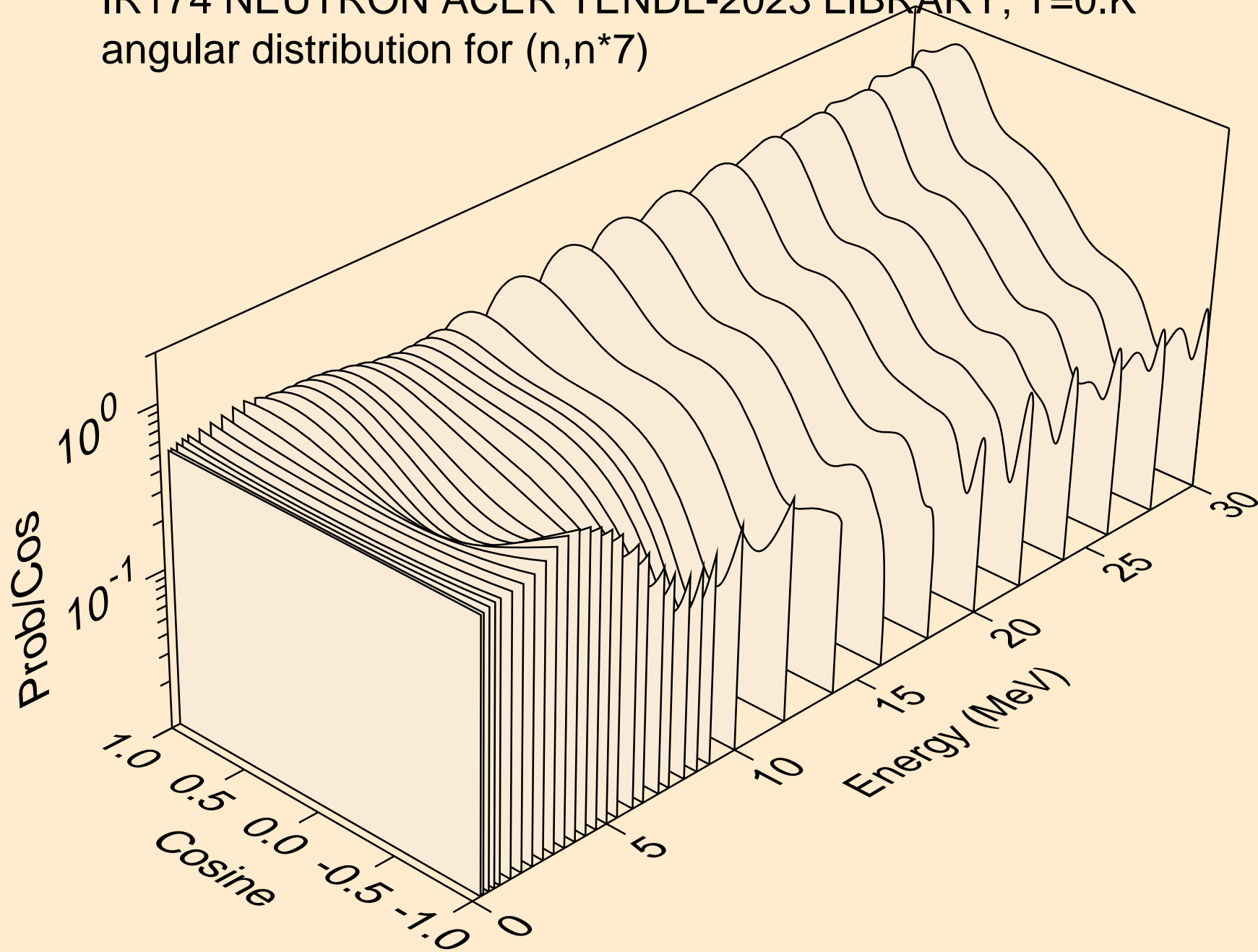

IR174 NEUTRON ACER TENDL-2023 LIBRARY; T=0.K  
angular distribution for (n,n\*8)

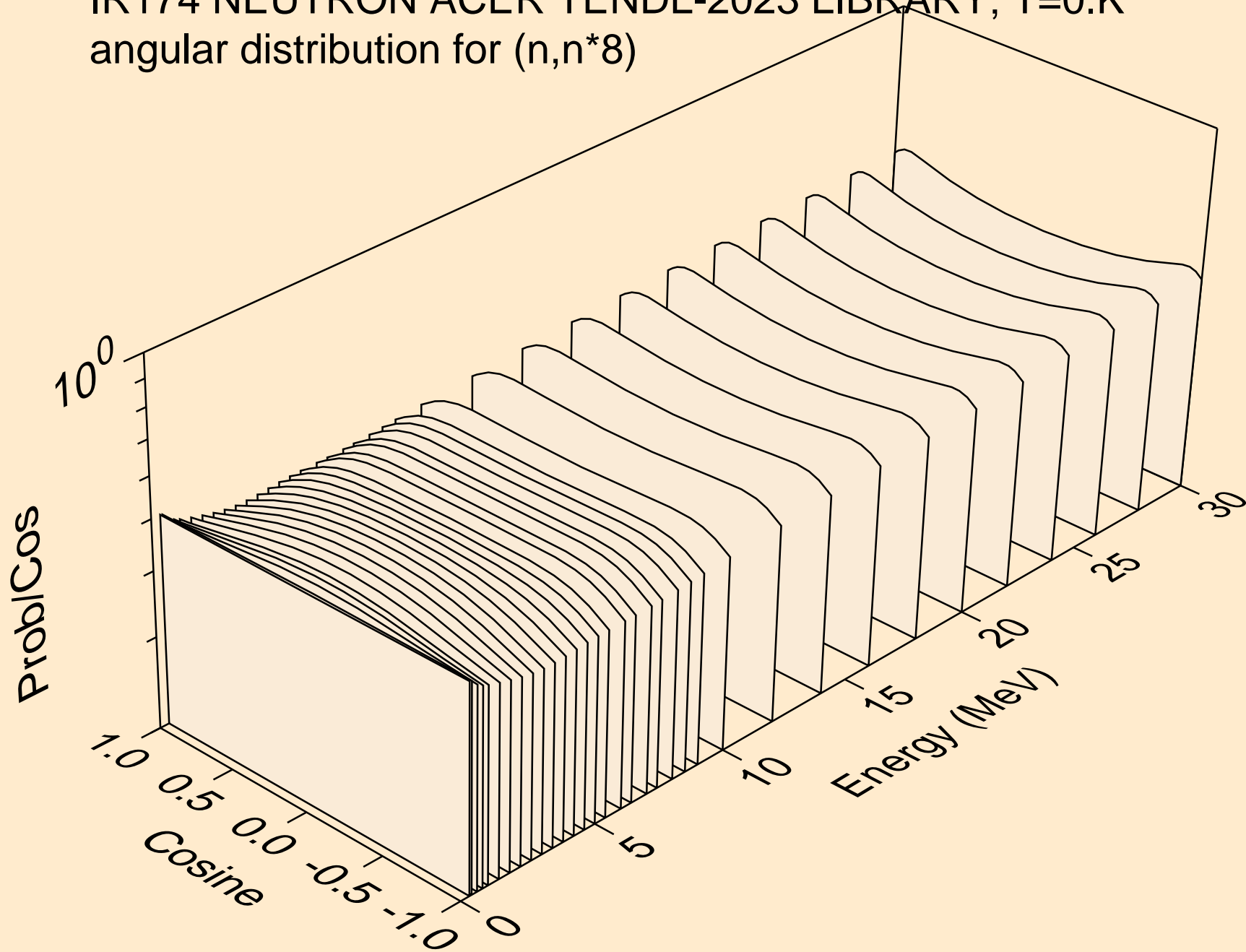

IR174 NEUTRON ACER TENDL-2023 LIBRARY; T=0.K  
angular distribution for (n,n\*9)

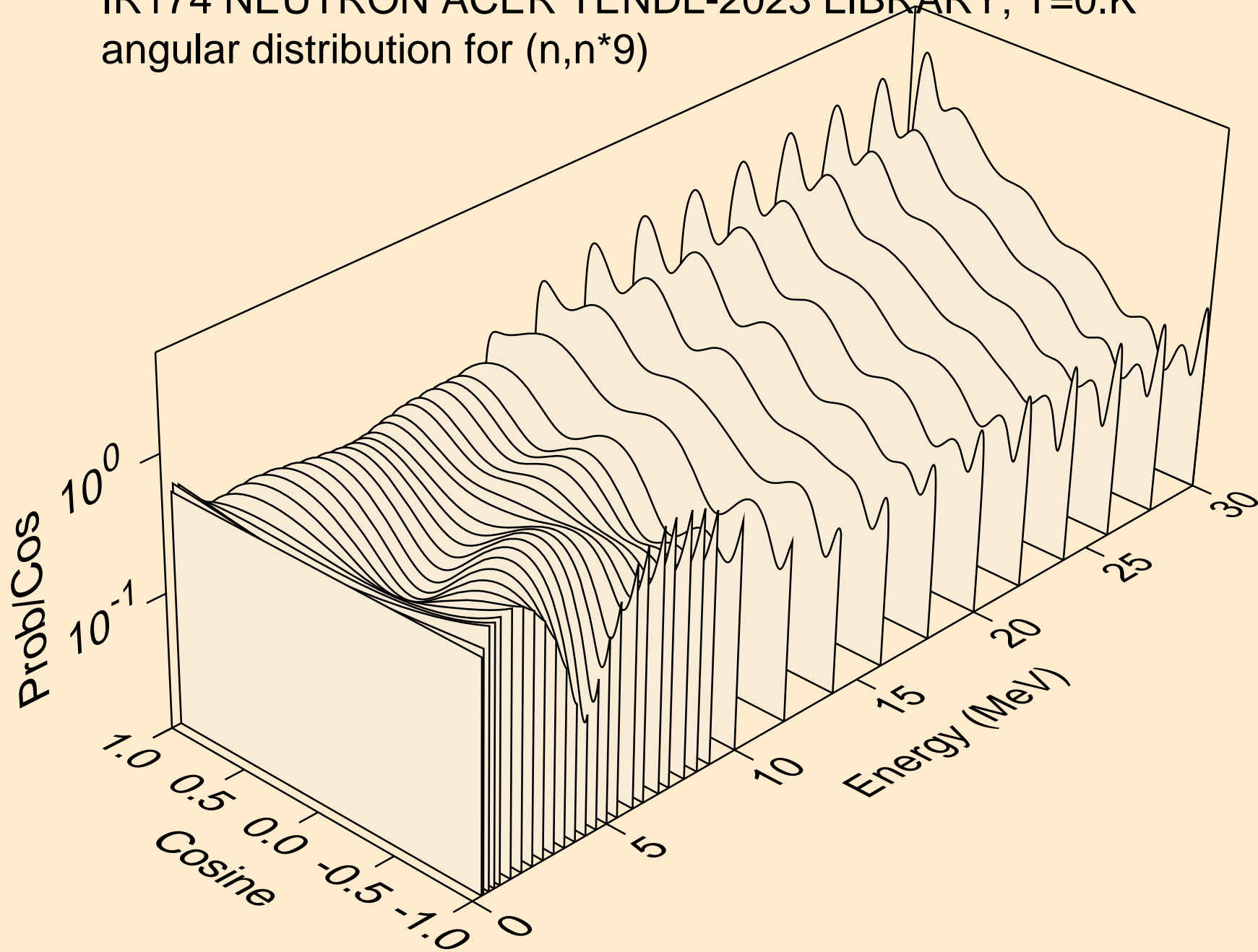

IR174 NEUTRON ACER TENDL-2023 LIBRARY; T=0.K  
angular distribution for (n,n\*10)

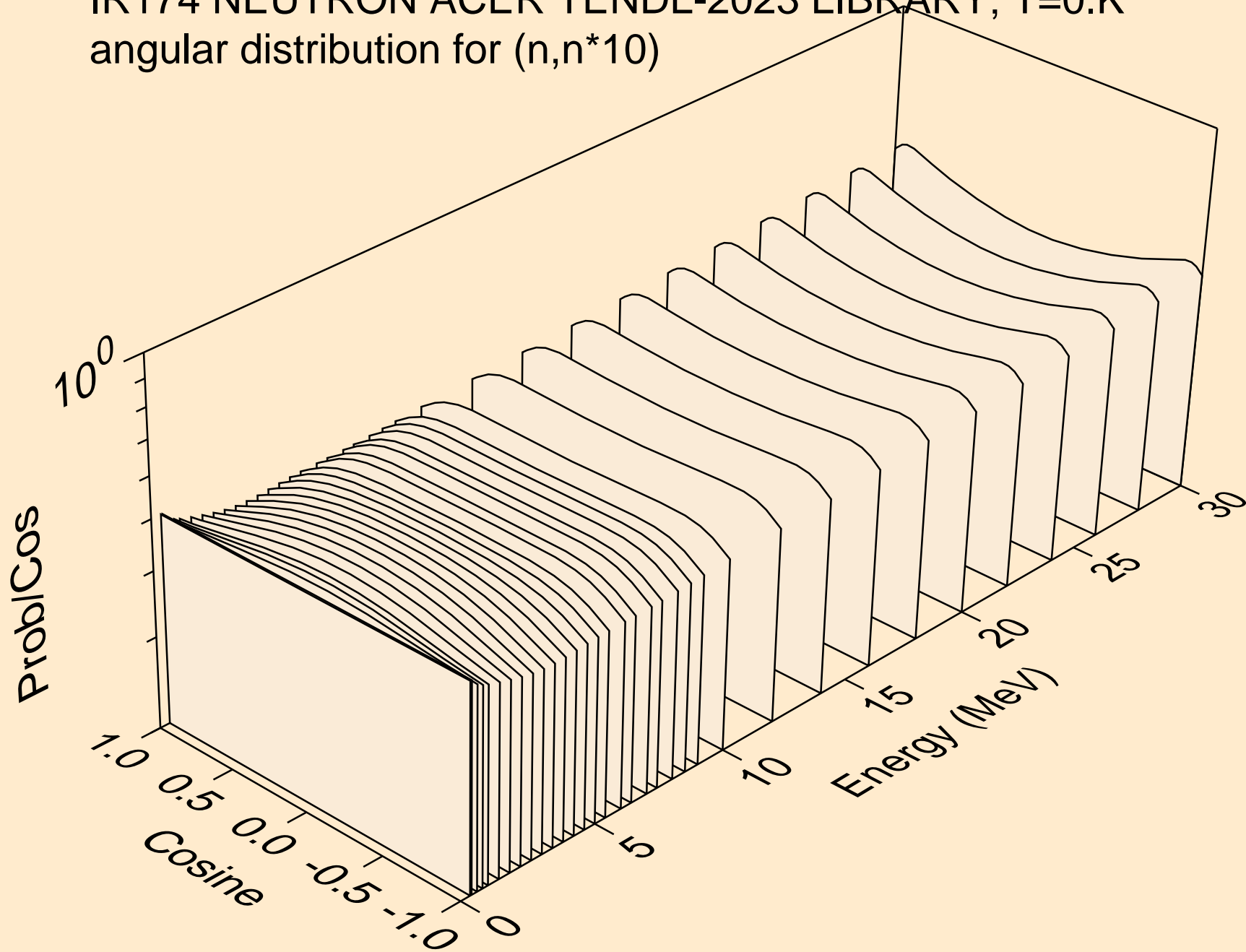

IR174 NEUTRON ACER TENDL-2023 LIBRARY; T=0.K  
angular distribution for (n,n\*11)

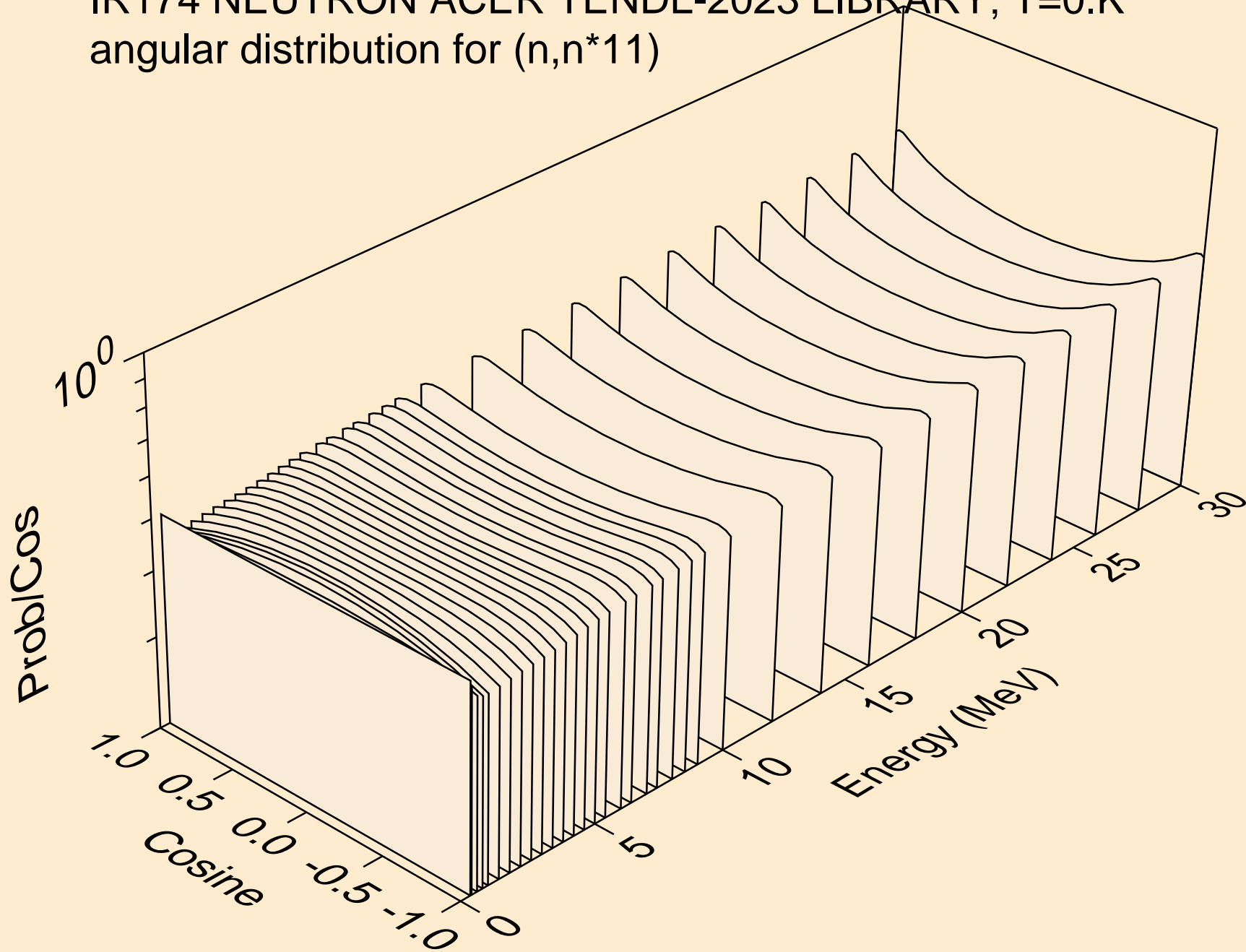

IR174 NEUTRON ACER TENDL-2023 LIBRARY; T=0.K  
angular distribution for (n,n\*12)

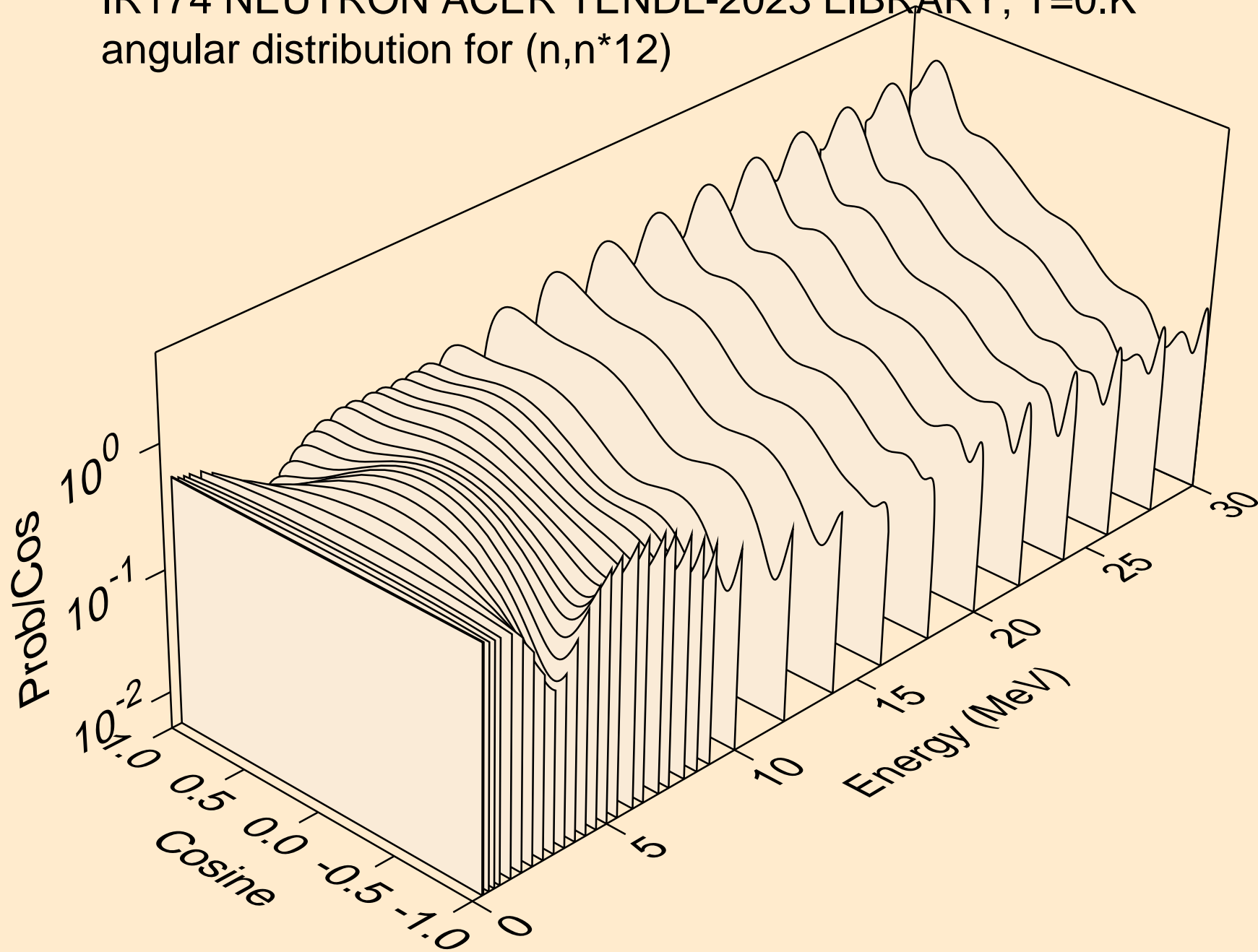

IR174 NEUTRON ACER TENDL-2023 LIBRARY; T=0.K  
angular distribution for (n,n\*13)

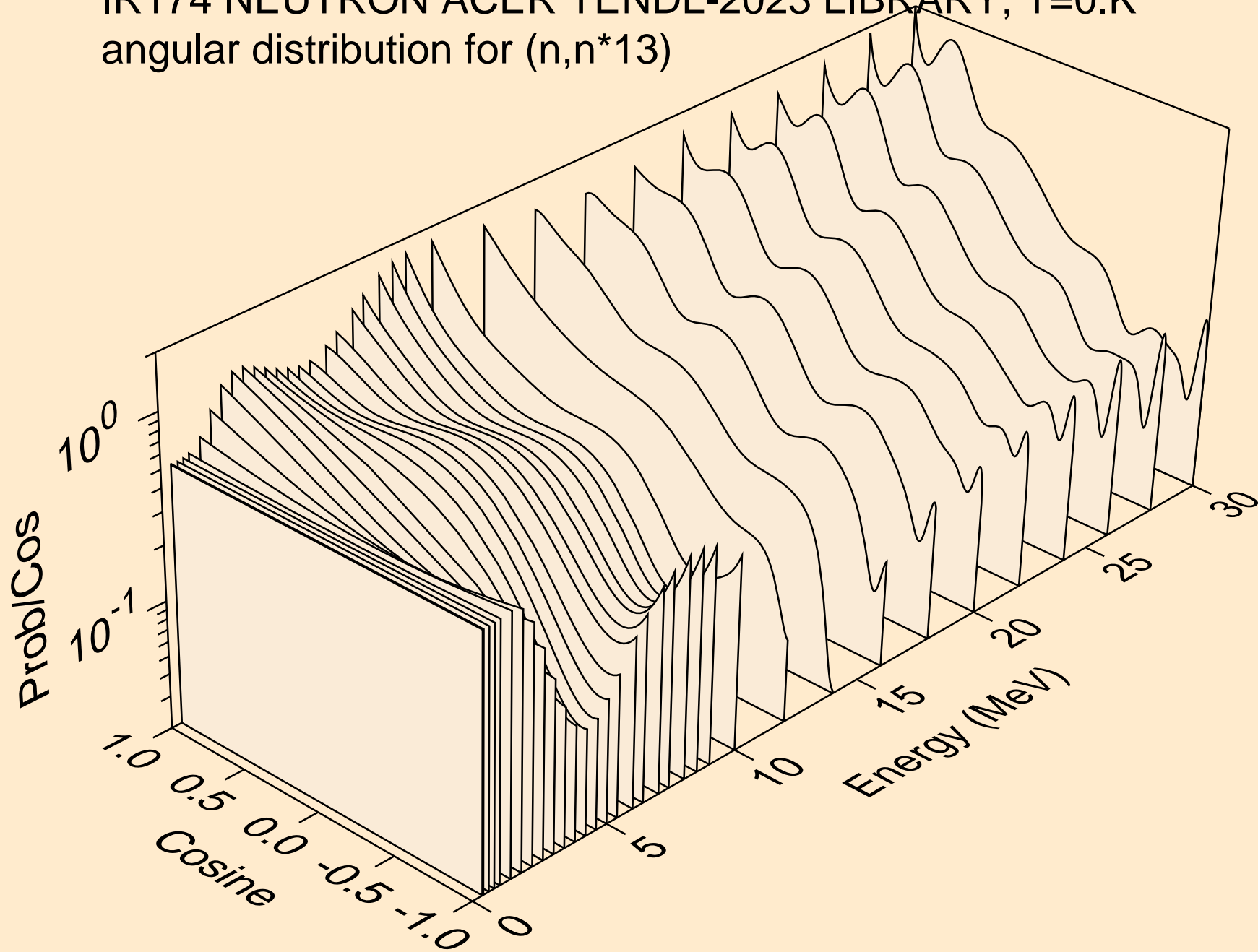

IR174 NEUTRON ACER TENDL-2023 LIBRARY; T=0.K  
angular distribution for (n,n\*14)

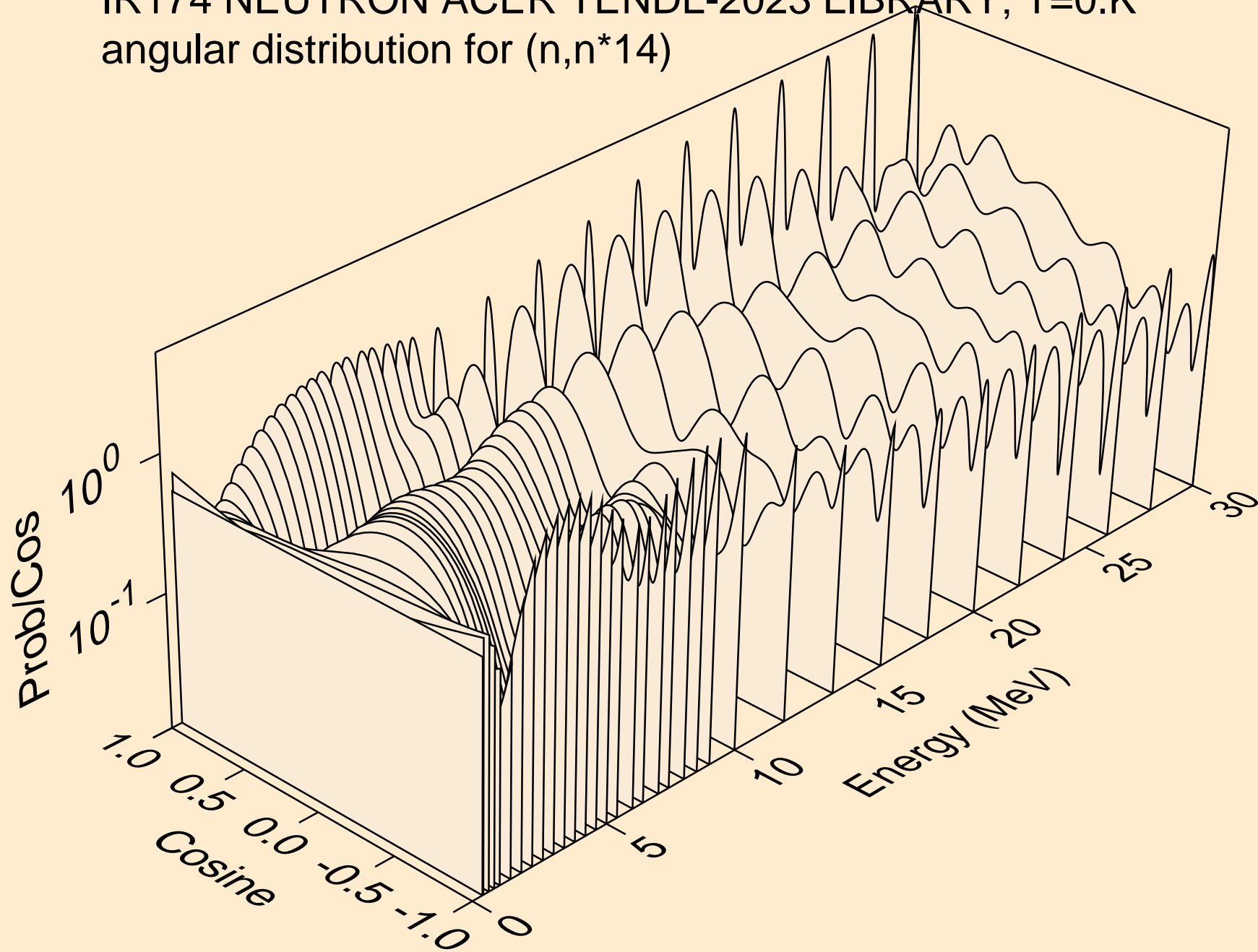

IR174 NEUTRON ACER TENDL-2023 LIBRARY; T=0.K  
angular distribution for (n,n\*15)

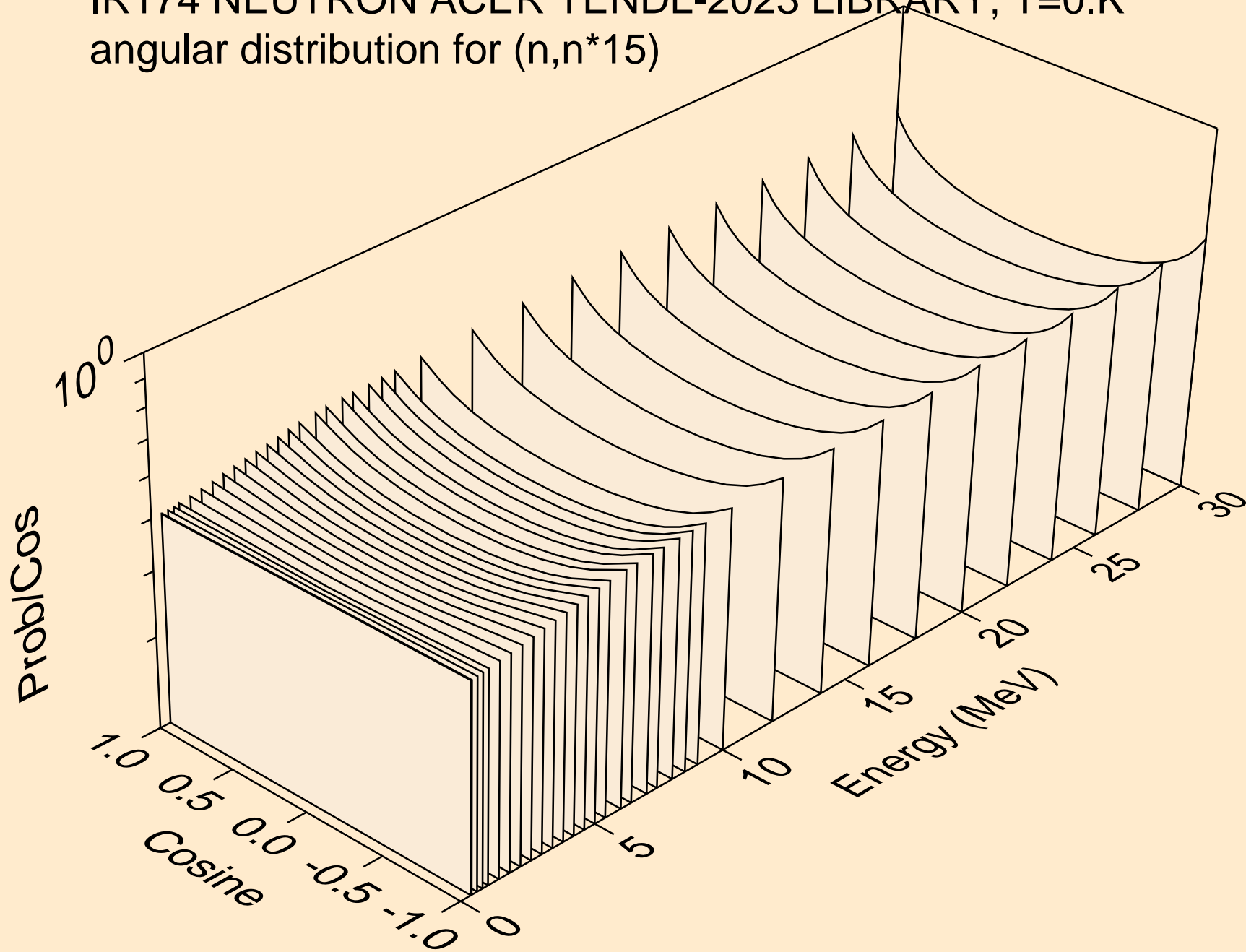

IR174 NEUTRON ACER TENDL-2023 LIBRARY; T=0.K  
angular distribution for (n,n\*16)

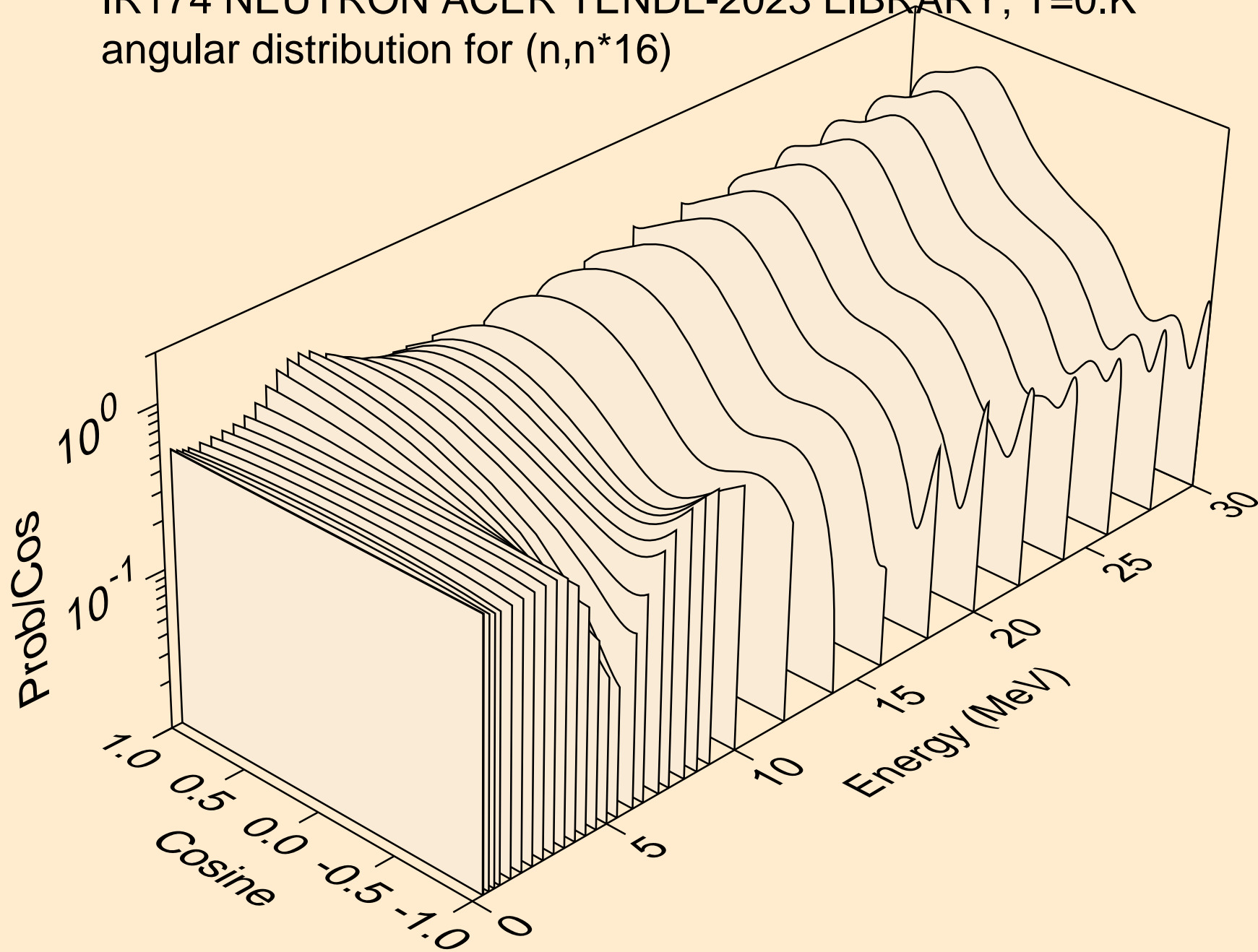

IR174 NEUTRON ACER TENDL-2023 LIBRARY; T=0.K  
angular distribution for (n,n\*17)

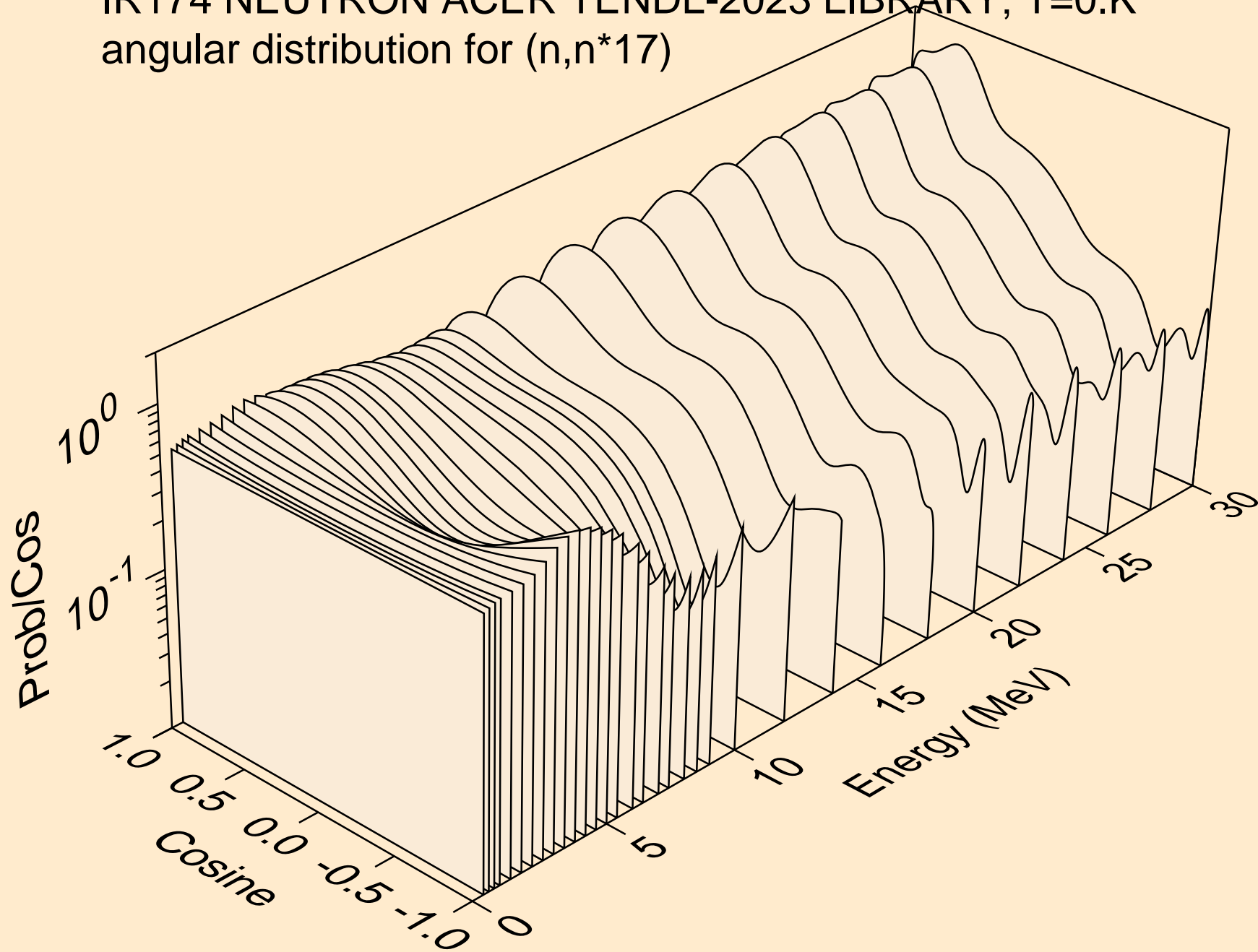

IR174 NEUTRON ACER TENDL-2023 LIBRARY; T=0.K  
angular distribution for (n,n\*18)

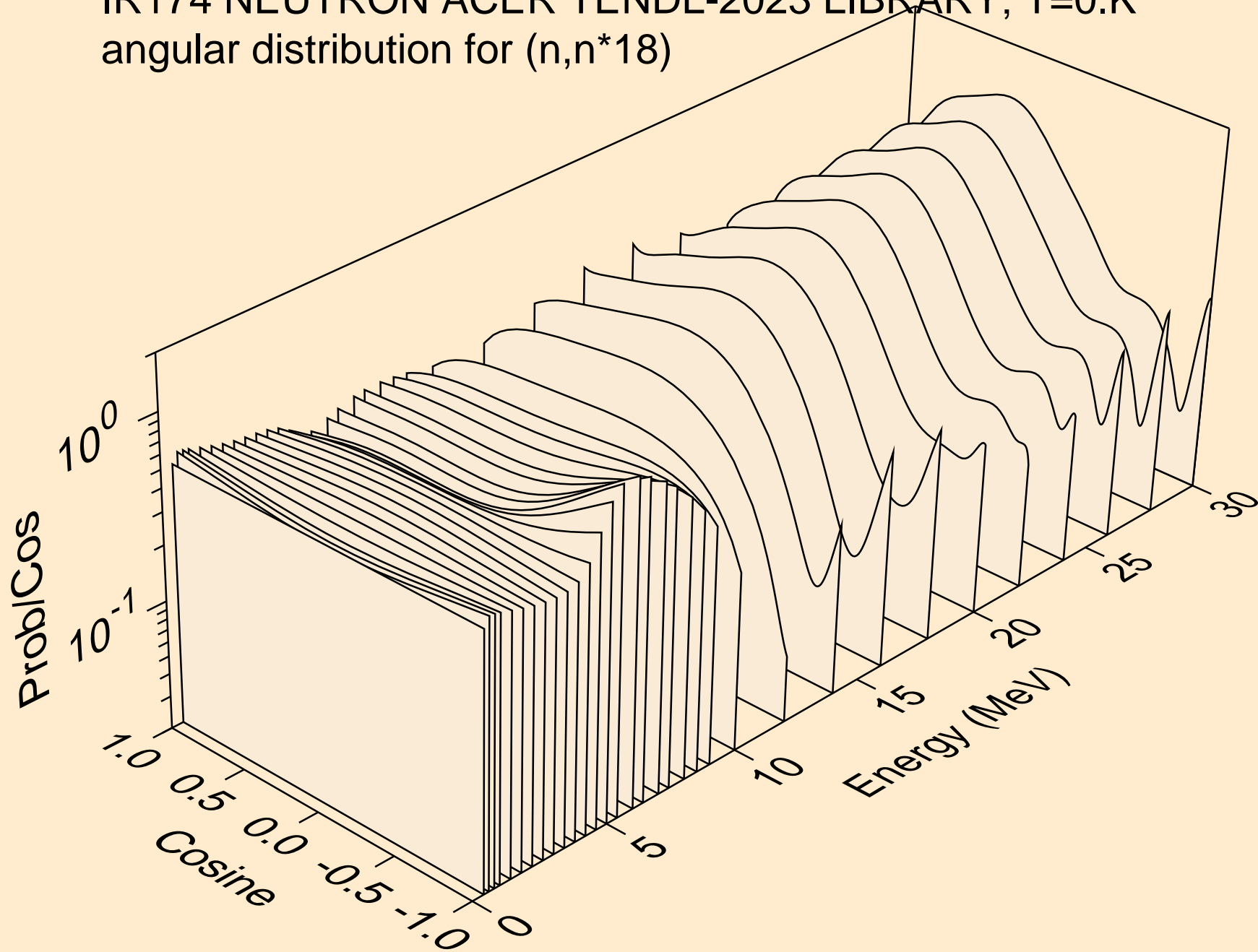

IR174 NEUTRON ACER TENDL-2023 LIBRARY; T=0.K  
angular distribution for (n,n\*19)

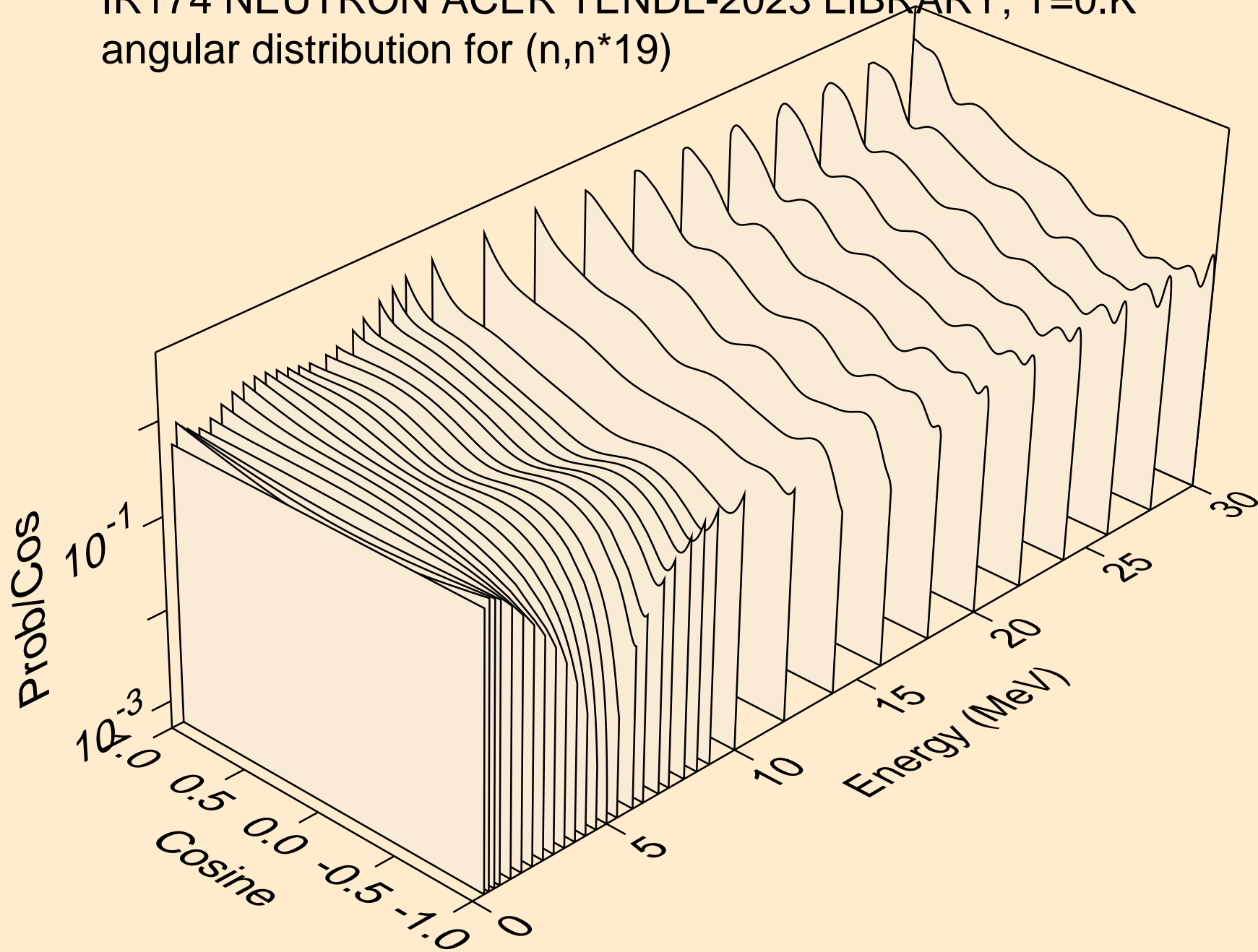

IR174 NEUTRON ACER TENDL-2023 LIBRARY; T=0.K  
Neutron emission for (n,x)

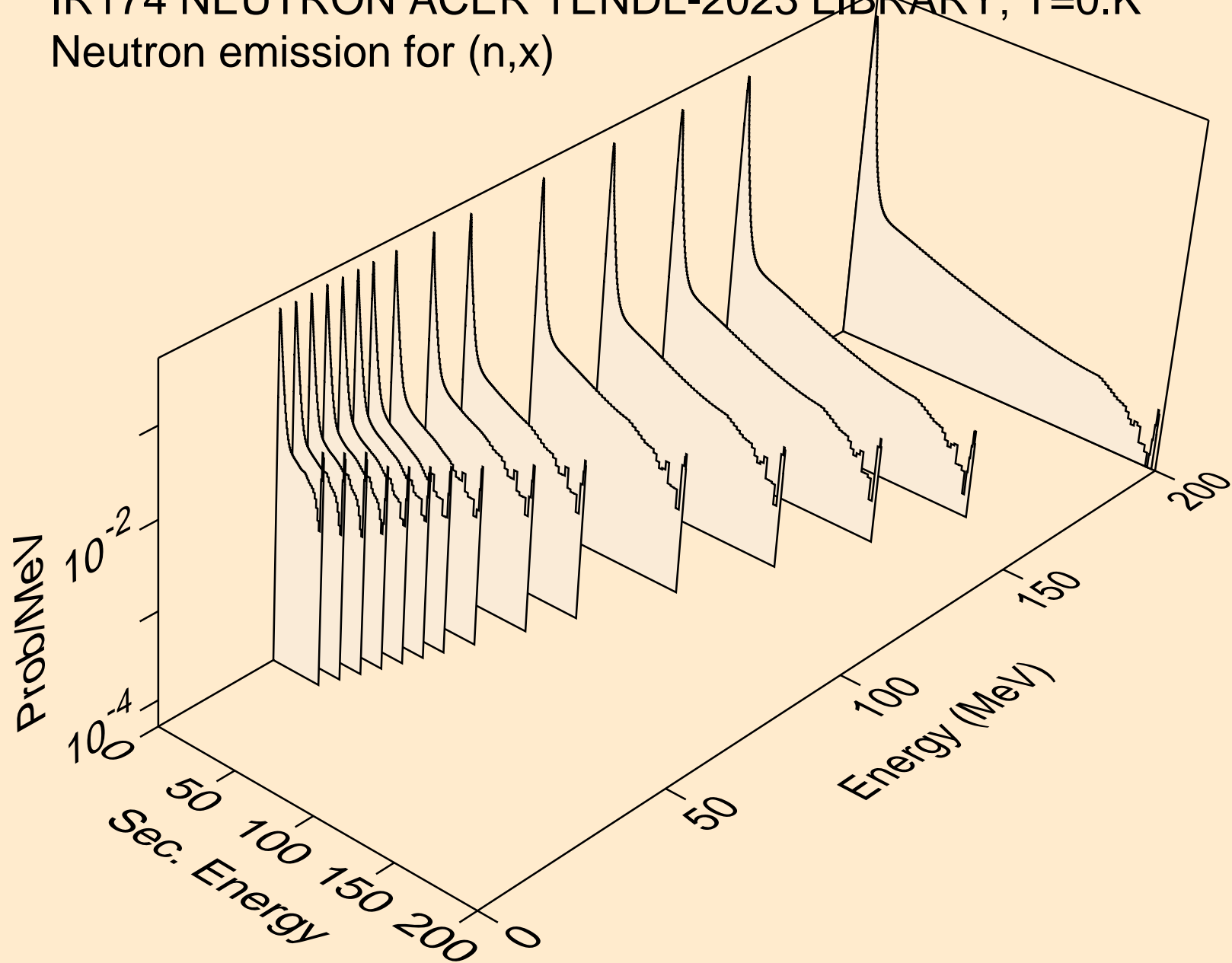

IR174 NEUTRON ACER TENDL-2023 LIBRARY; T=0.K  
Neutron emission for (n,2nd)

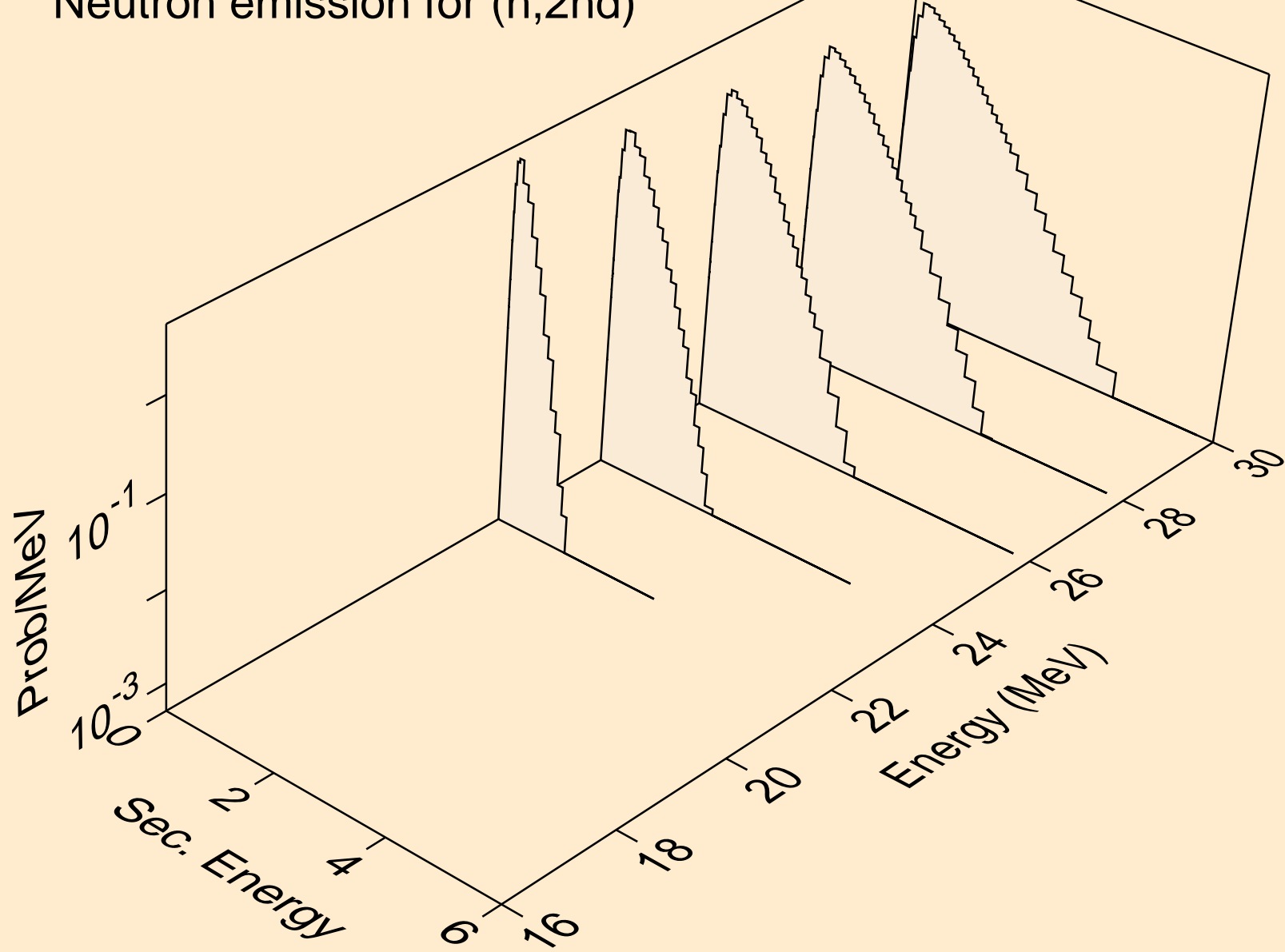

IR174 NEUTRON ACER TENDL-2023 LIBRARY; T=0.K  
Neutron emission for (n,2n)

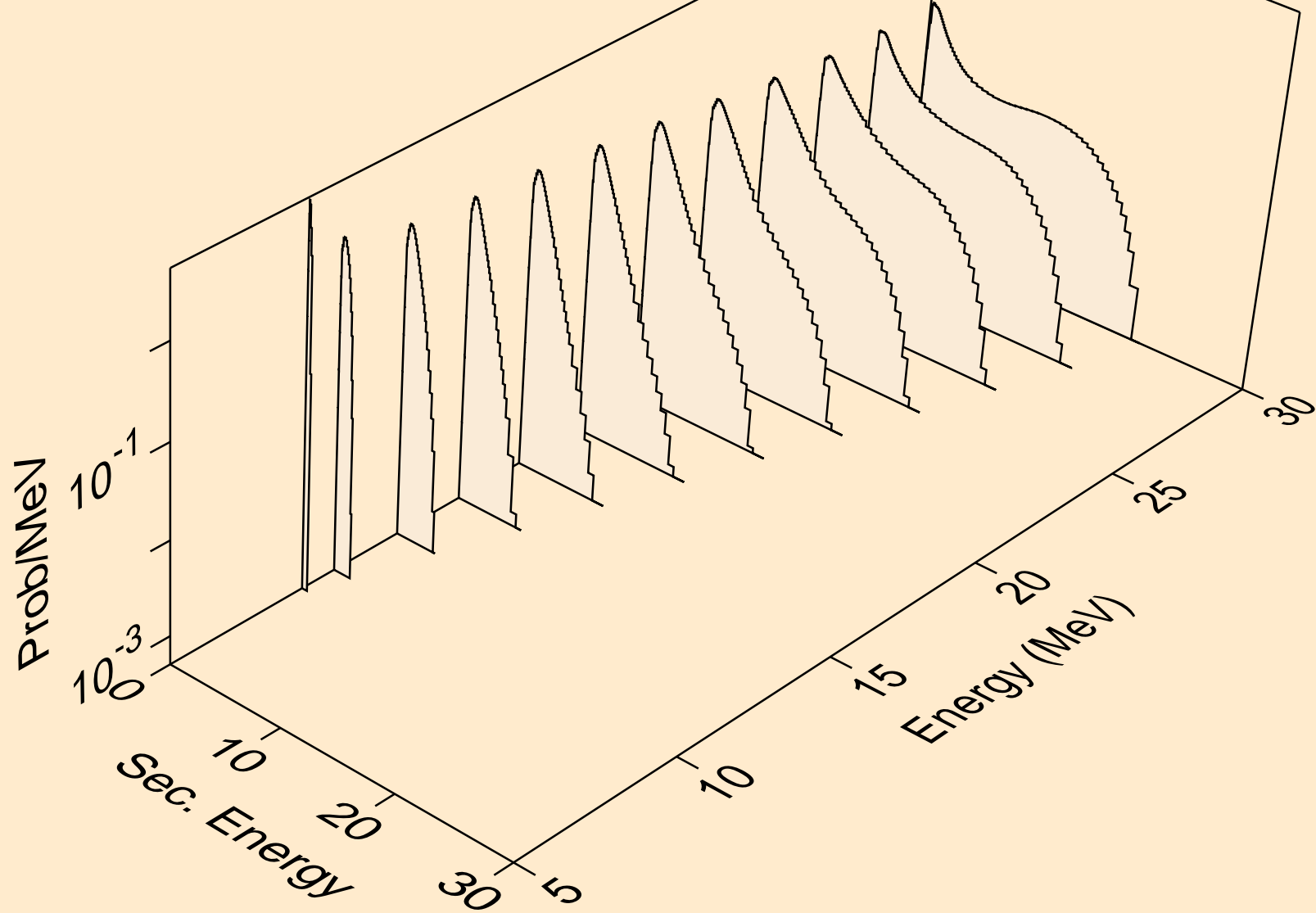

IR174 NEUTRON ACER TENDL-2023 LIBRARY; T=0.K  
Neutron emission for (n,3n)

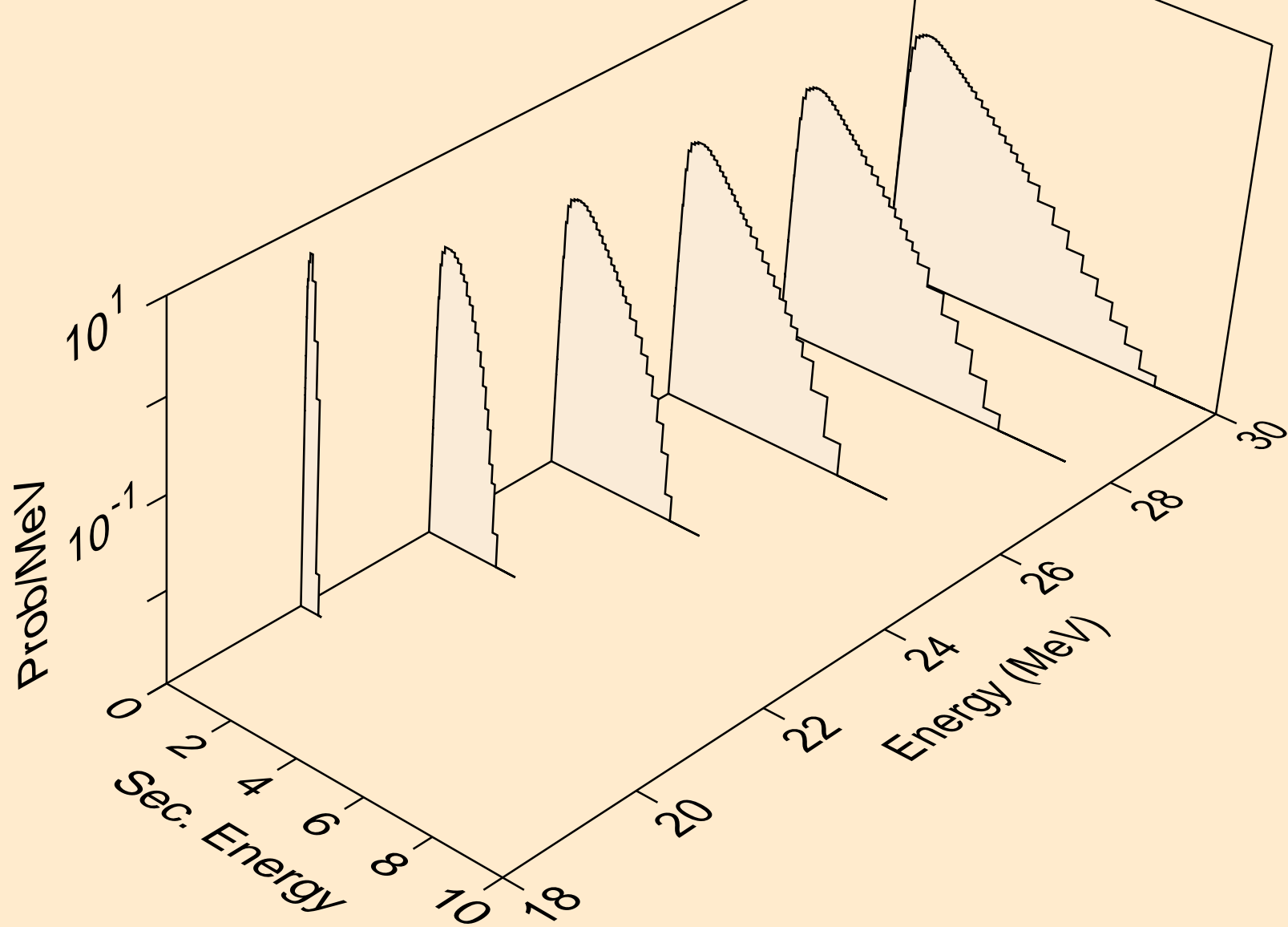

IR174 NEUTRON ACER TENDL-2023 LIBRARY; T=0.K  
Neutron emission for (n,n\*)a

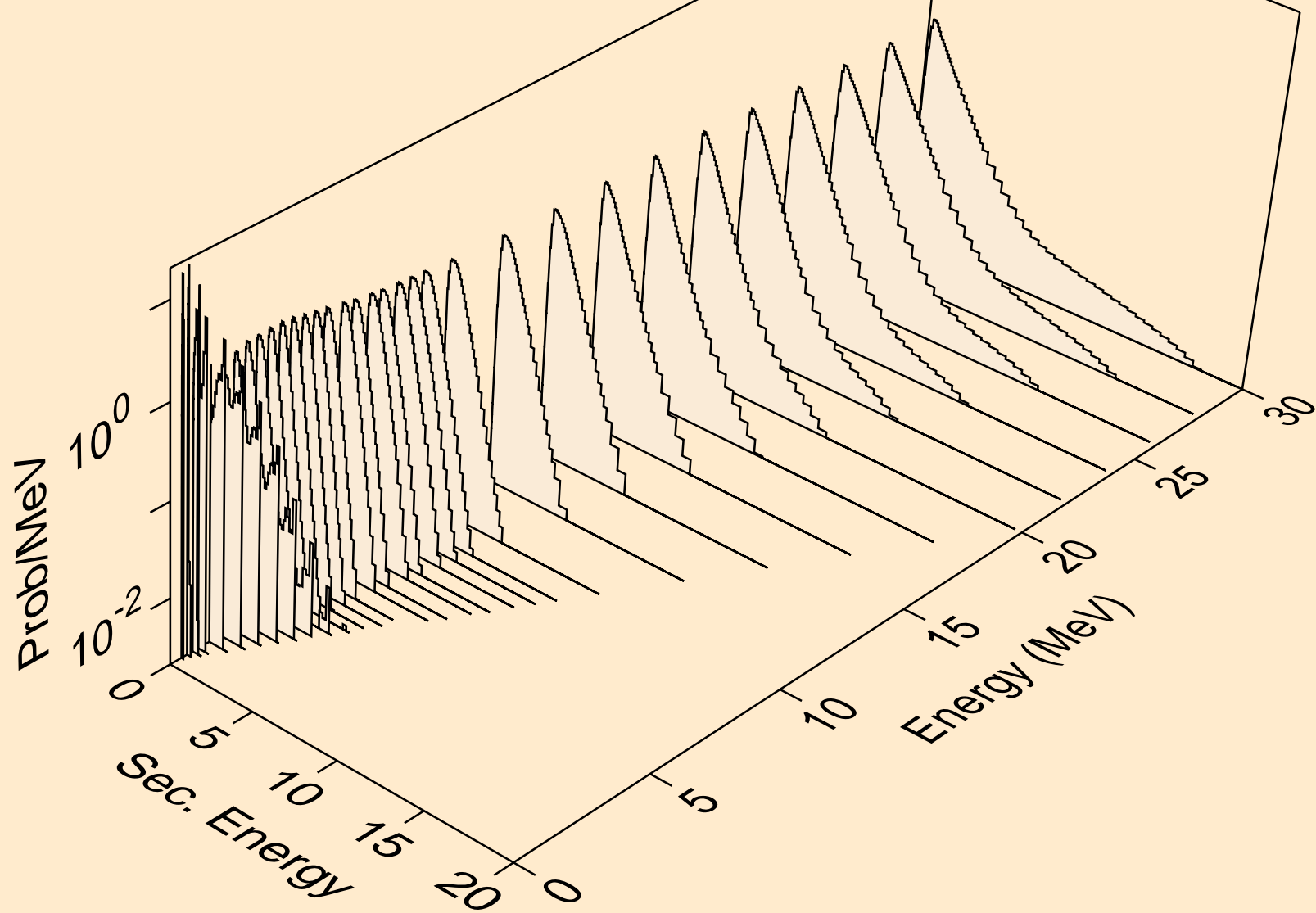

IR174 NEUTRON ACER TENDL-2023 LIBRARY; T=0.K  
Neutron emission for (n,n\*)3a

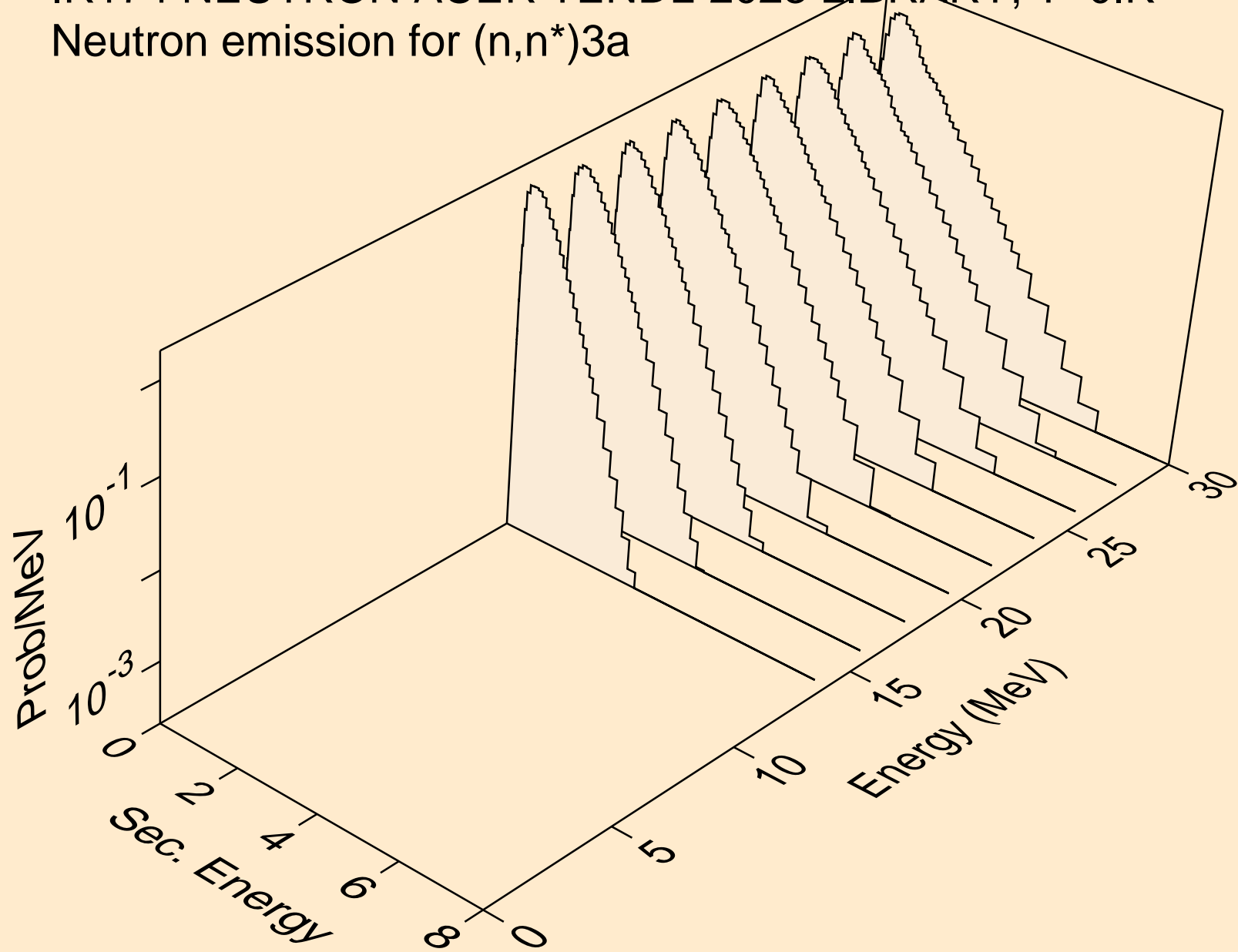

IR174 NEUTRON ACER TENDL-2023 LIBRARY; T=0.K  
Neutron emission for (n,2n)a

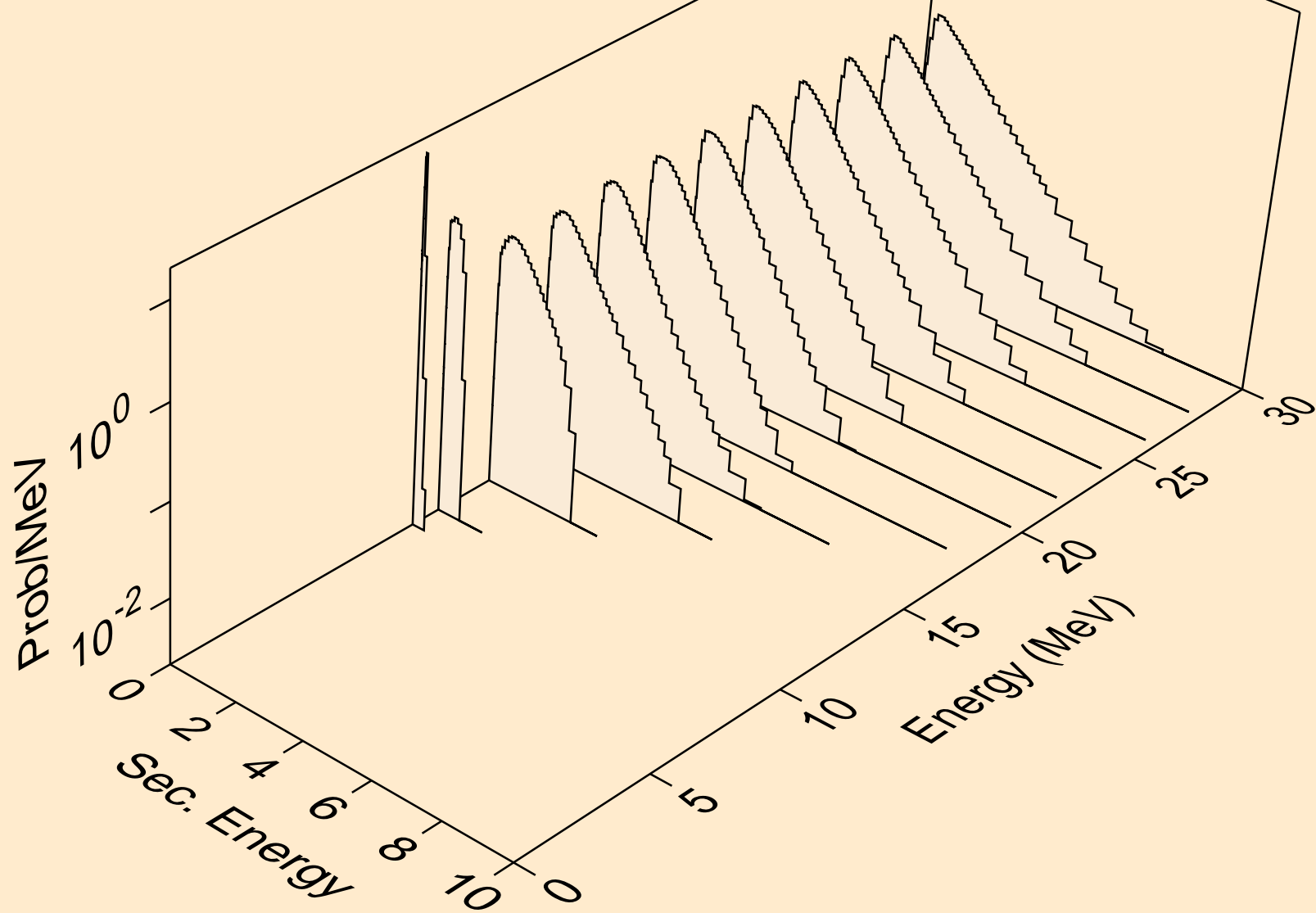

IR174 NEUTRON ACER TENDL-2023 LIBRARY; T=0.K  
Neutron emission for (n,3n)a

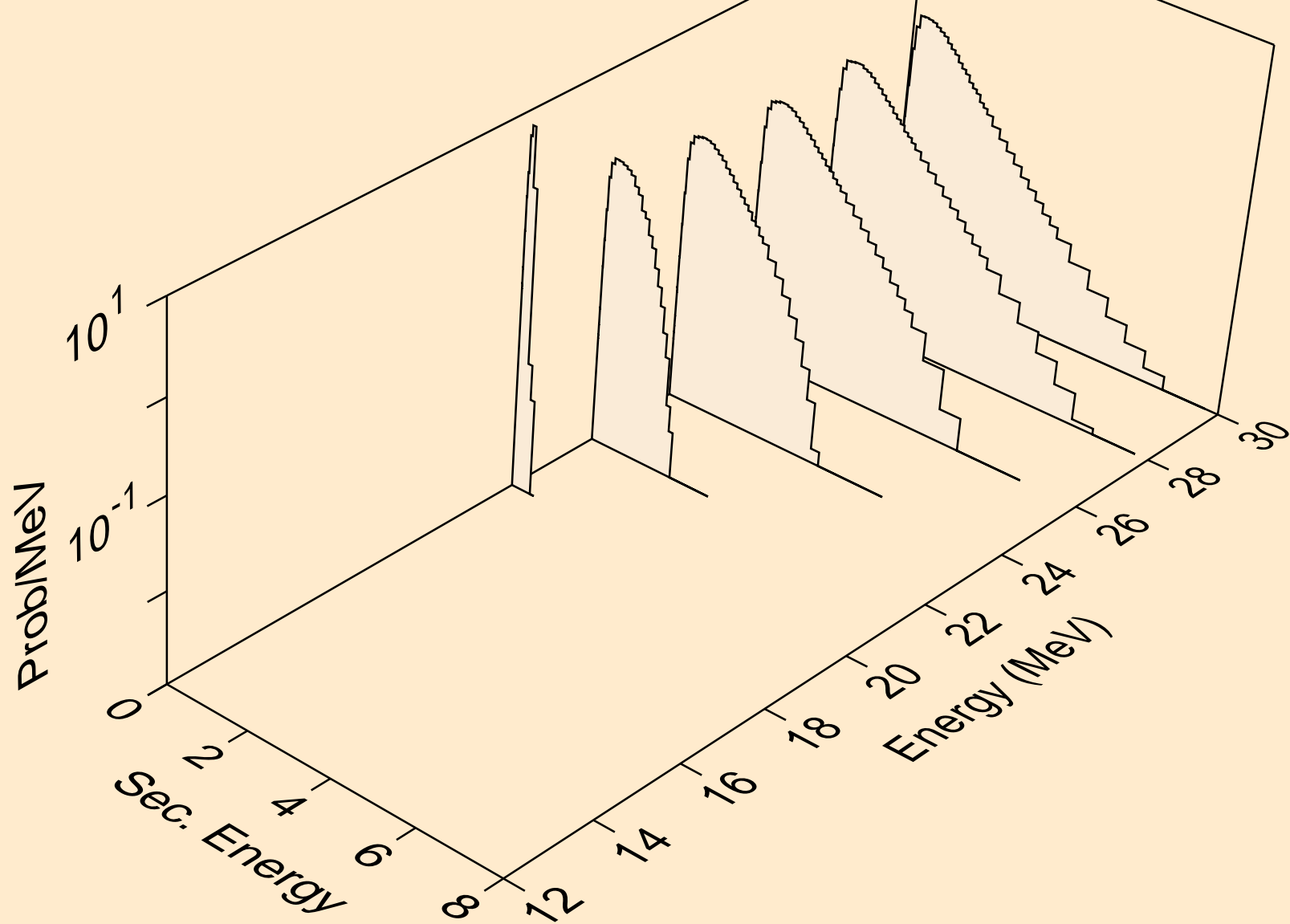

IR174 NEUTRON ACER TENDL-2023 LIBRARY; T=0.K  
Neutron emission for (n,n\*)p

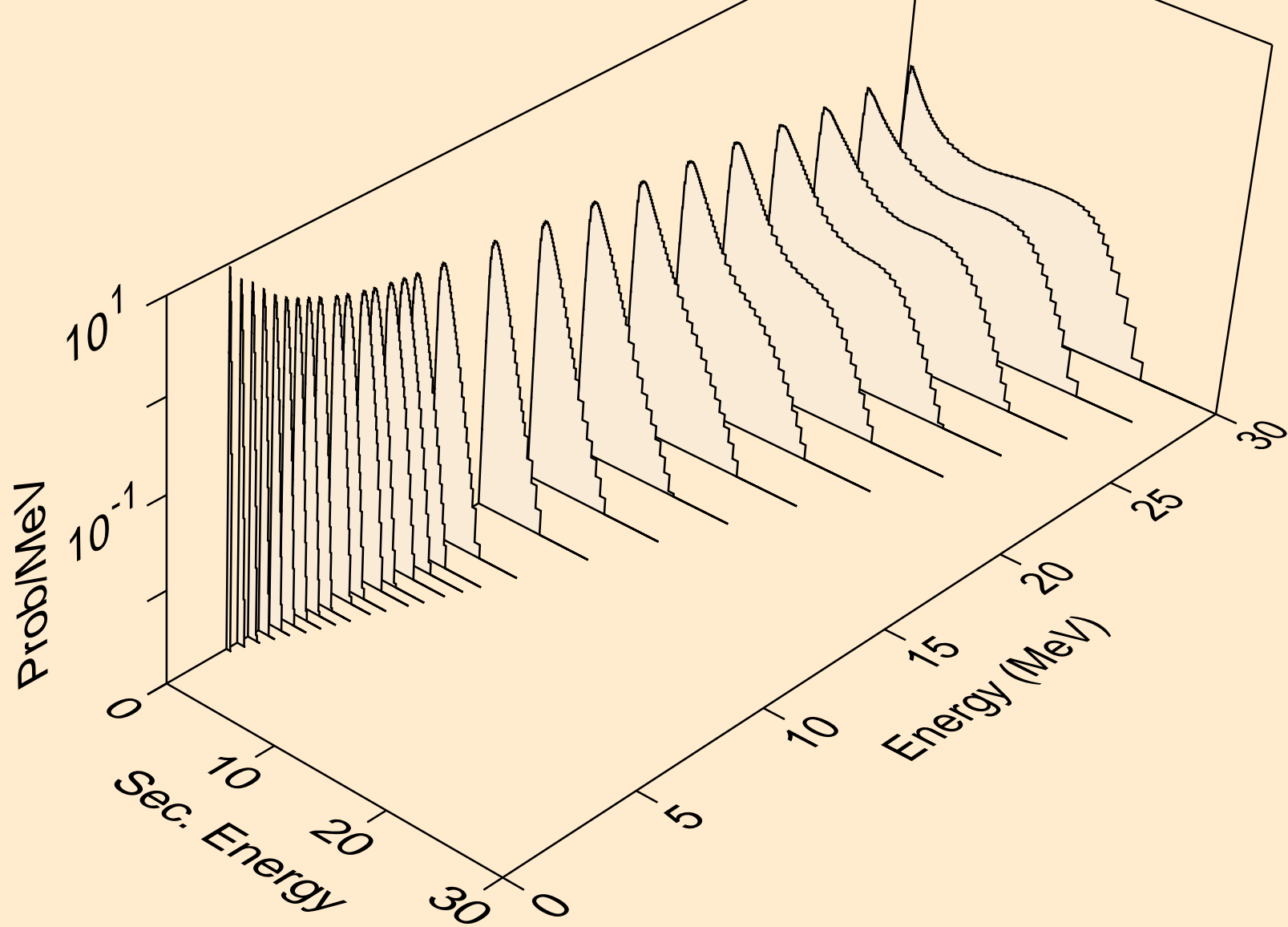

IR174 NEUTRON ACER TENDL-2023 LIBRARY; T=0.K  
Neutron emission for (n,n\*)2a

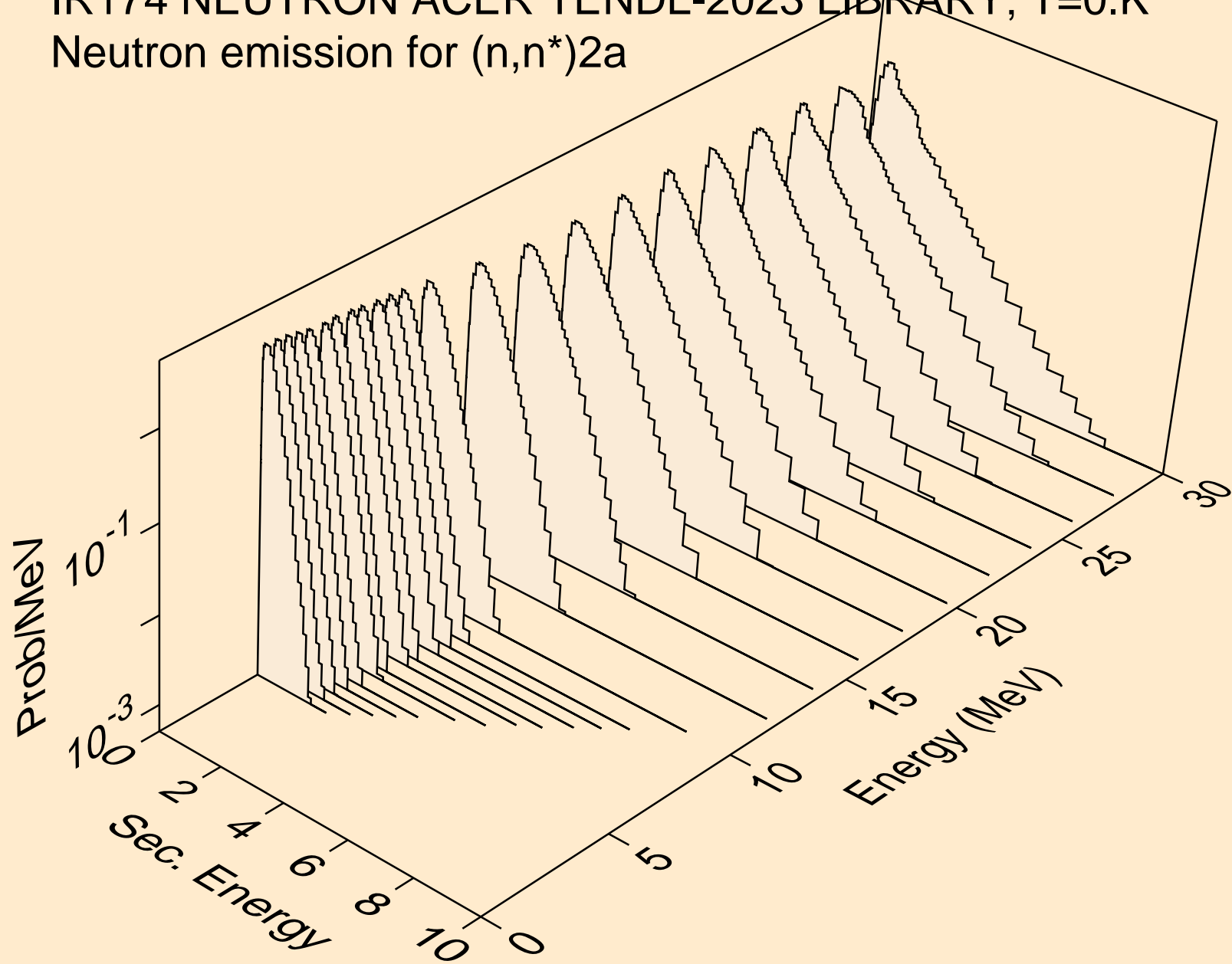

IR174 NEUTRON ACER TENDL-2023 LIBRARY; T=0.K  
Neutron emission for (n,2n)2a

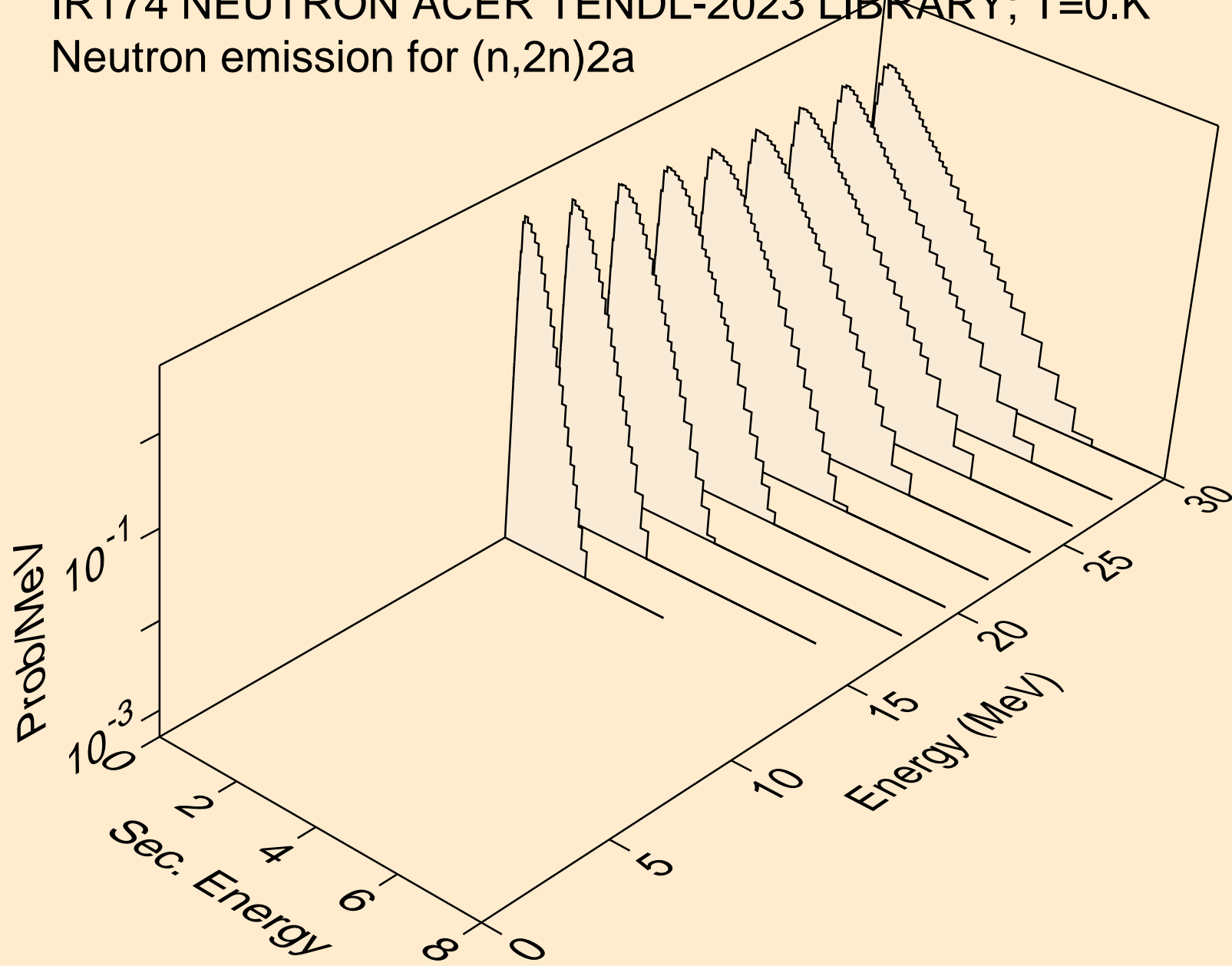

IR174 NEUTRON ACER TENDL-2023 LIBRARY; T=0.K  
Neutron emission for (n,n\*)d

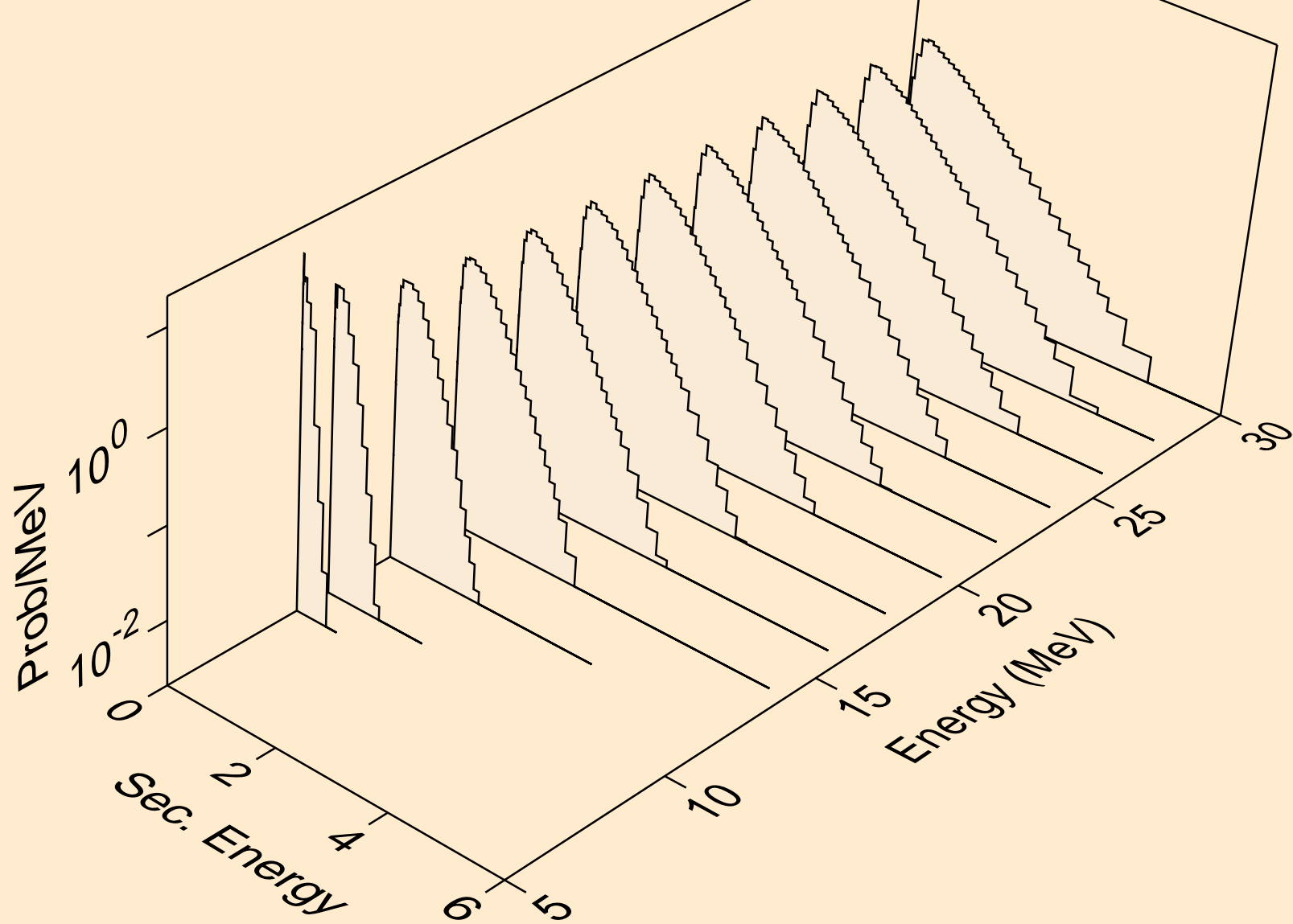

IR174 NEUTRON ACER TENDL-2023 LIBRARY; T=0.K  
Neutron emission for (n,n\*)t

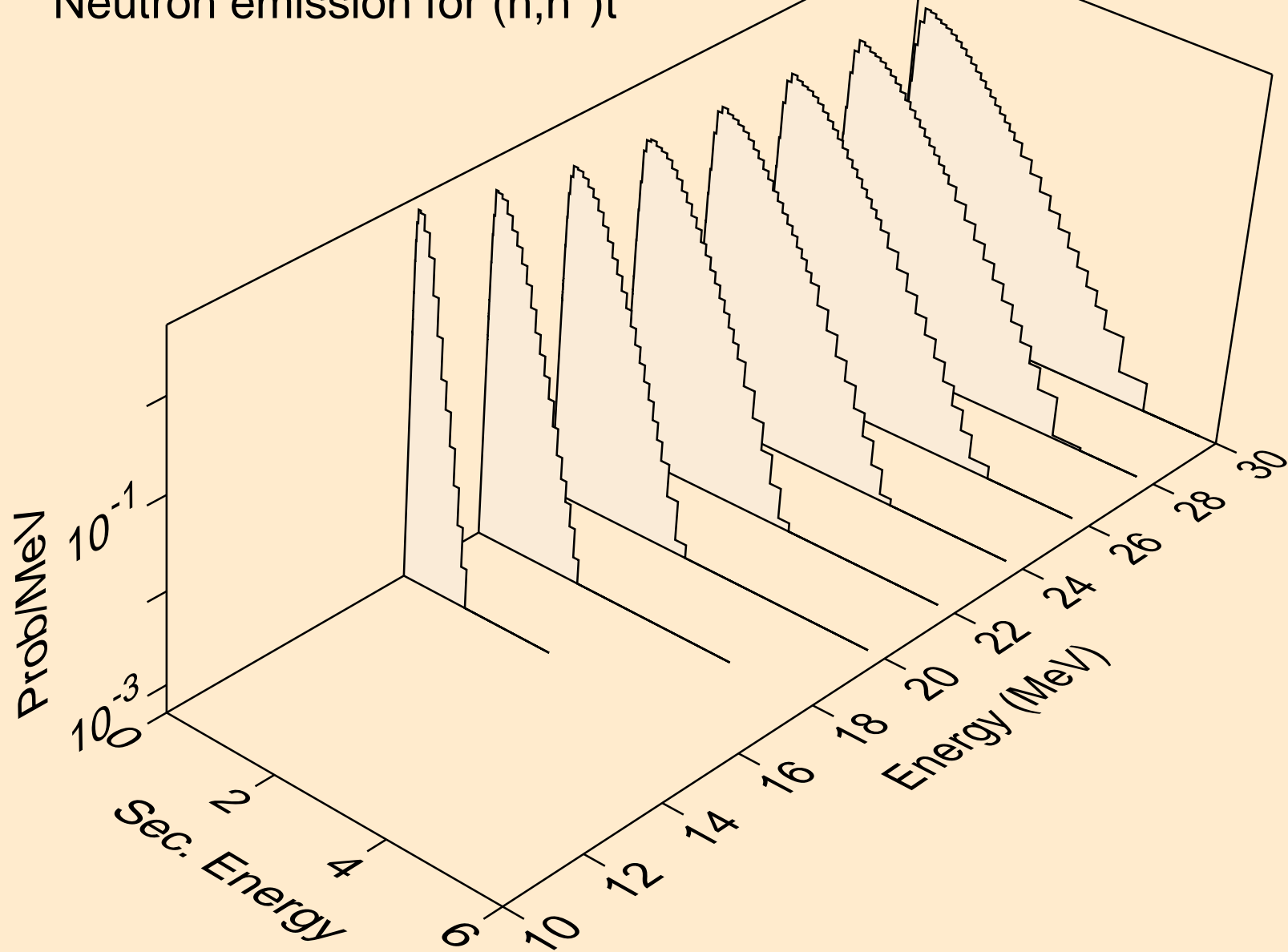

IR174 NEUTRON ACER TENDL-2023 LIBRARY; T=0.K  
Neutron emission for (n,n\*)he3

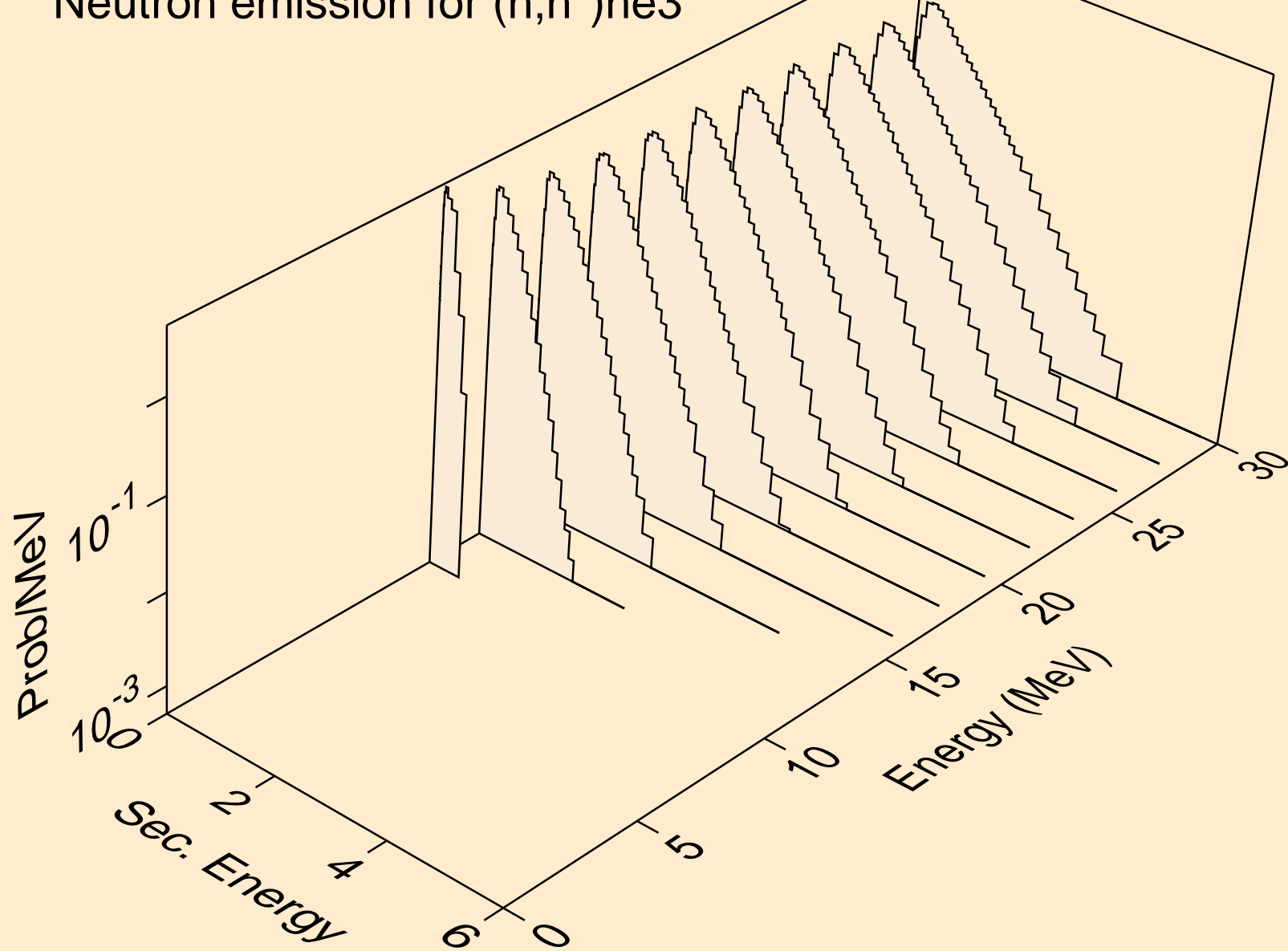

IR174 NEUTRON ACER TENDL-2023 LIBRARY; T=0.K  
Neutron emission for (n,4n)

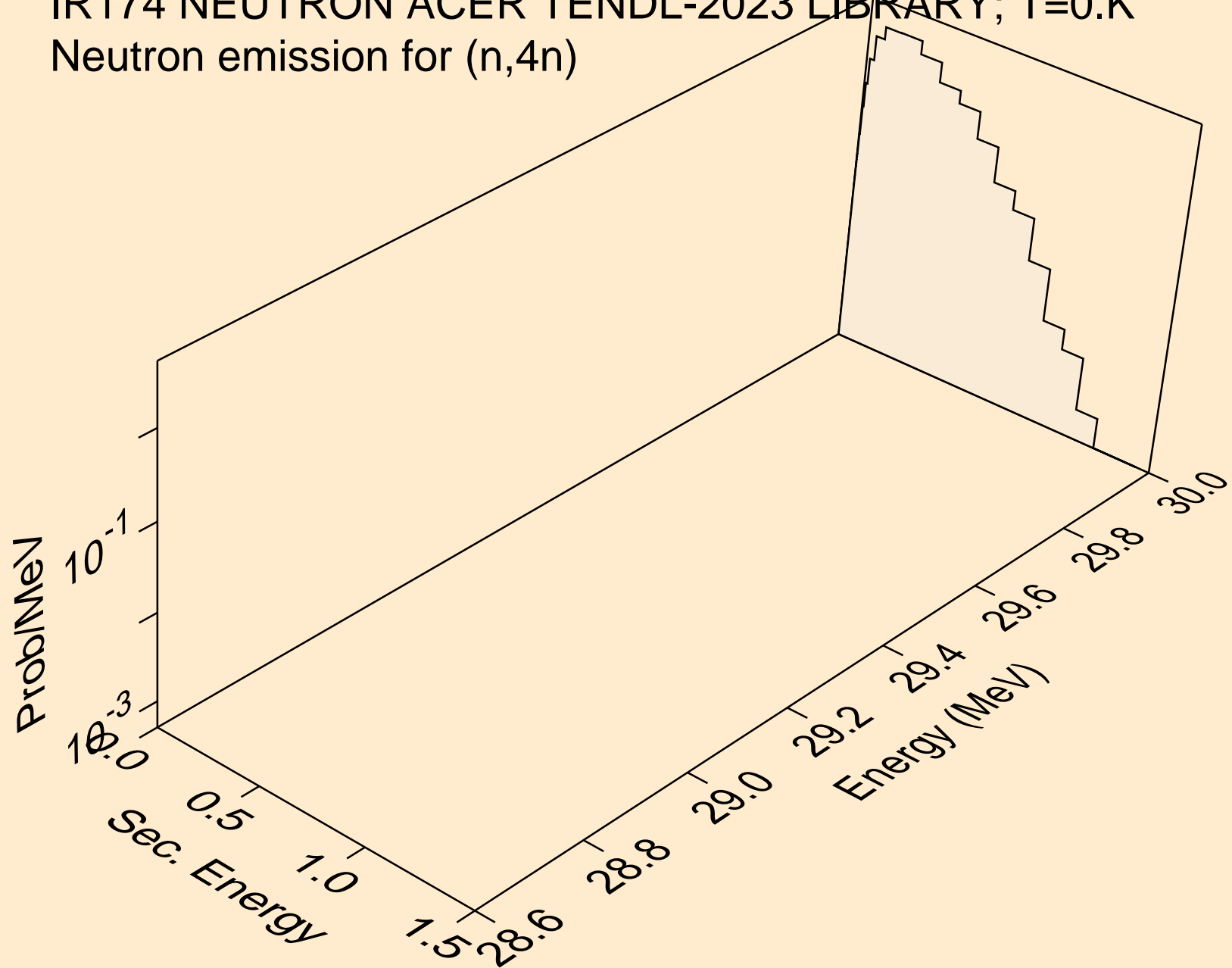

IR174 NEUTRON ACER TENDL-2023 LIBRARY; T=0.K  
Neutron emission for (n,2np)

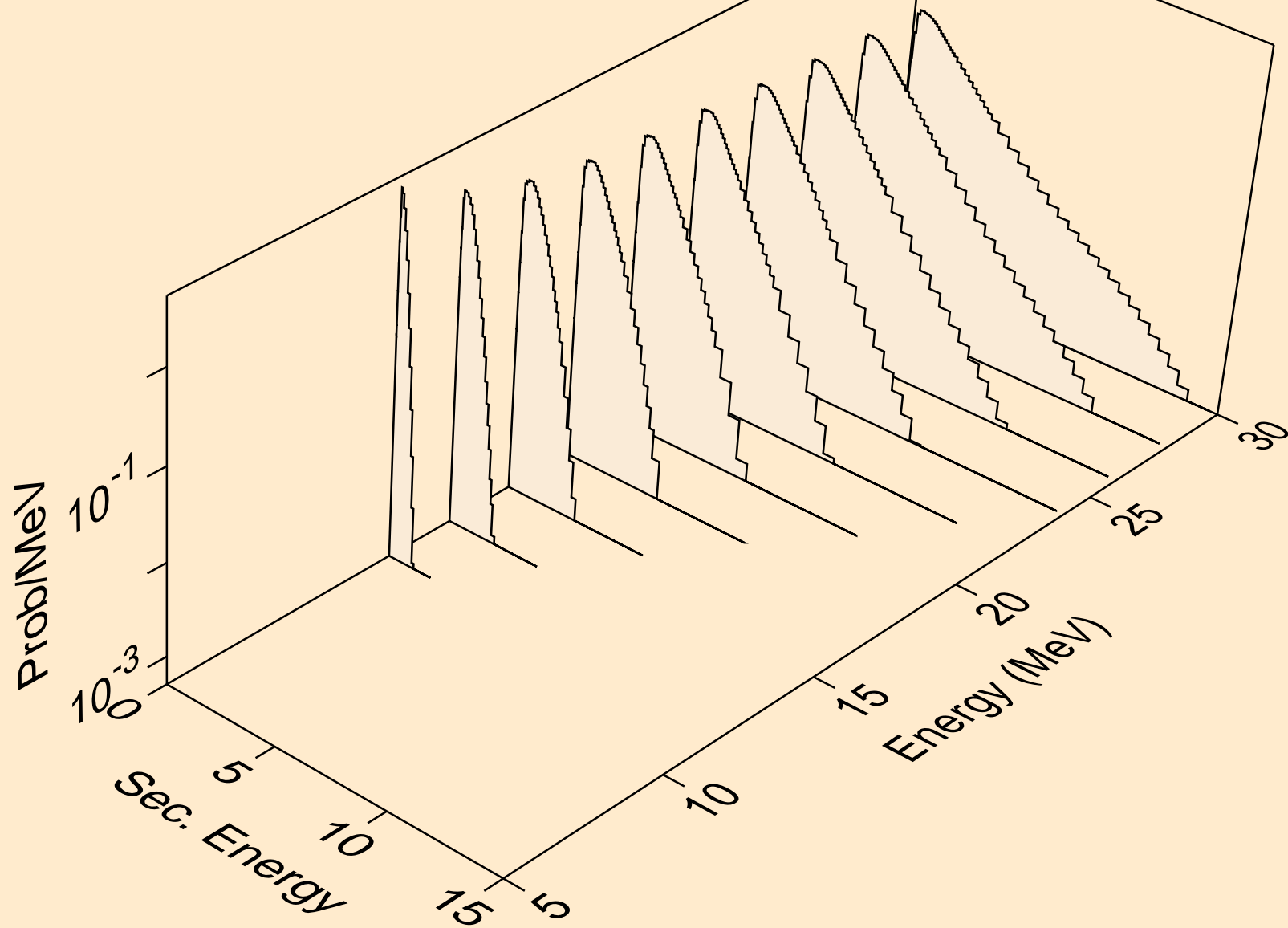

IR174 NEUTRON ACER TENDL-2023 LIBRARY; T=0.K  
Neutron emission for (n,3np)

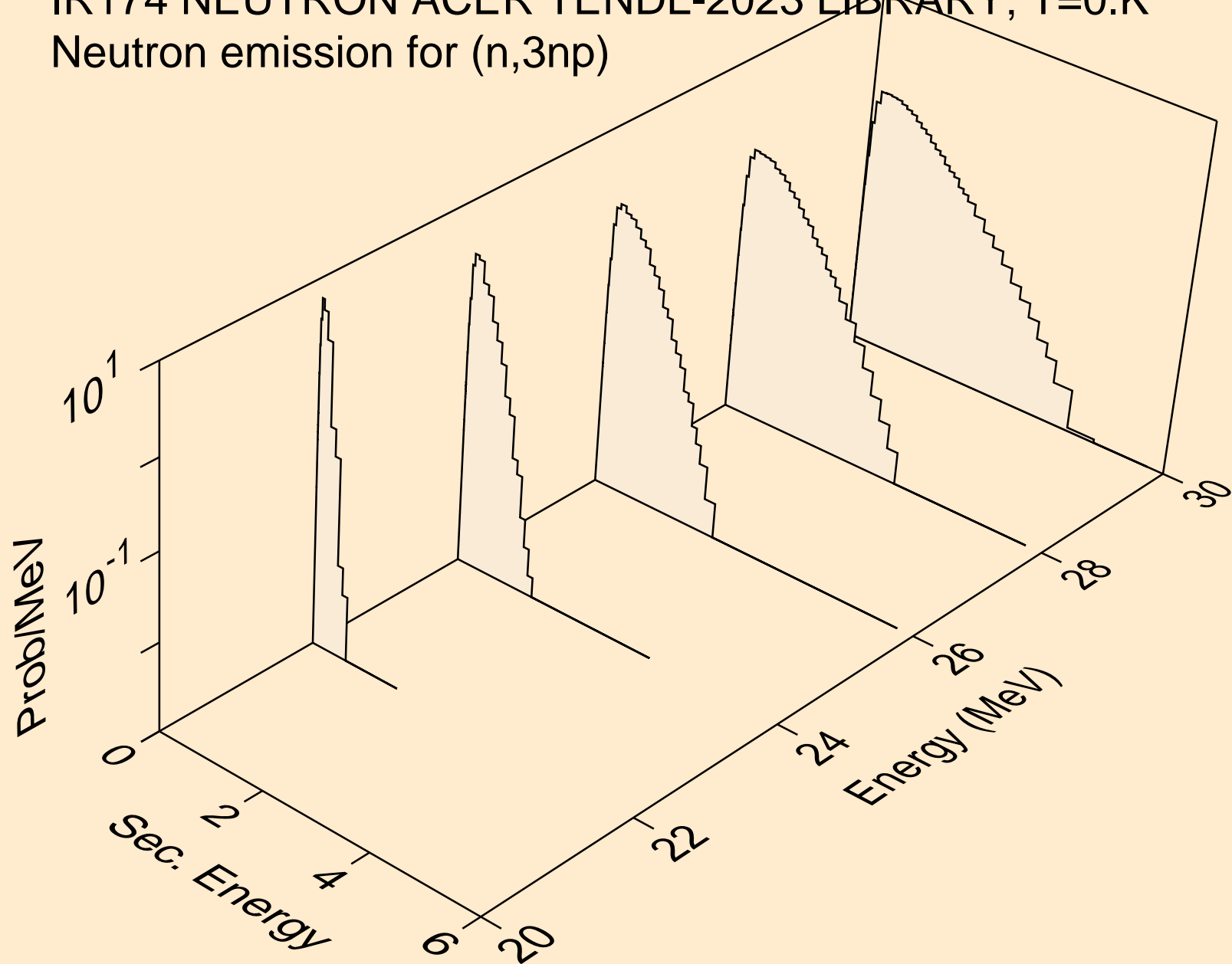

IR174 NEUTRON ACER TENDL-2023 LIBRARY; T=0.K  
Neutron emission for (n,n2p)

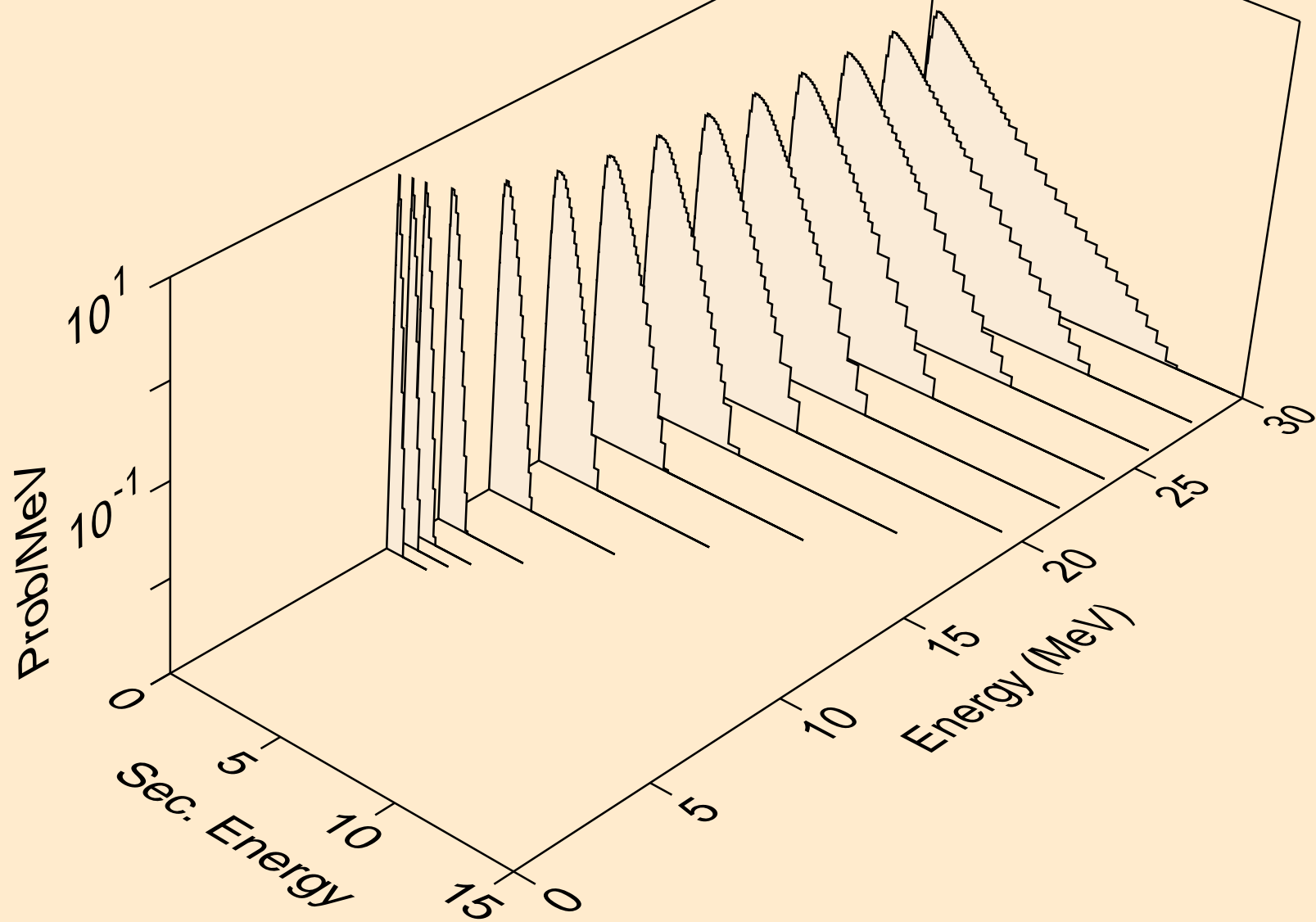

IR174 NEUTRON ACER TENDL-2023 LIBRARY; T=0.K  
Neutron emission for (n,npa)

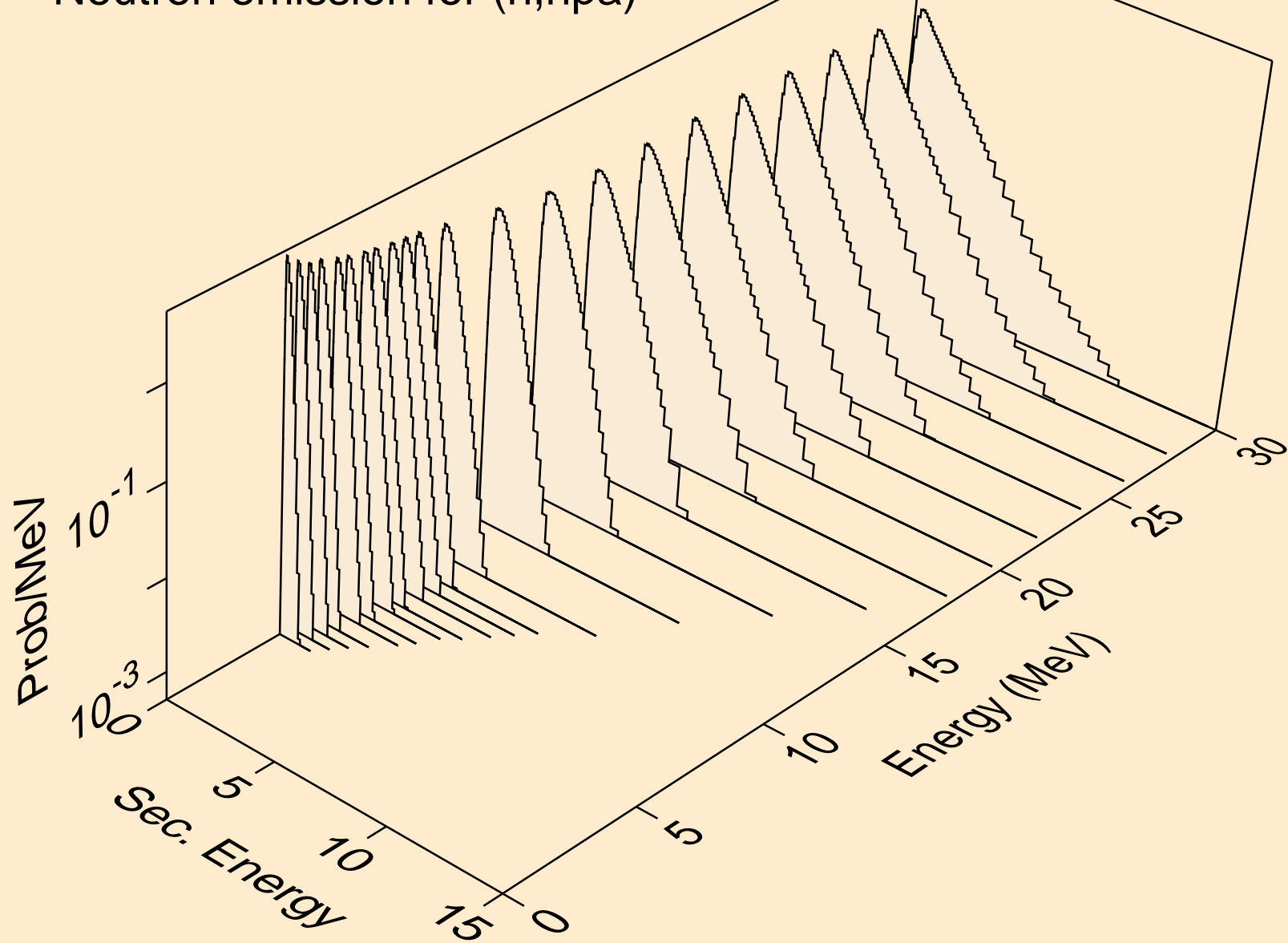

IR174 NEUTRON ACER TENDL-2023 LIBRARY; T=0.K  
Neutron emission for (n,n\*c)

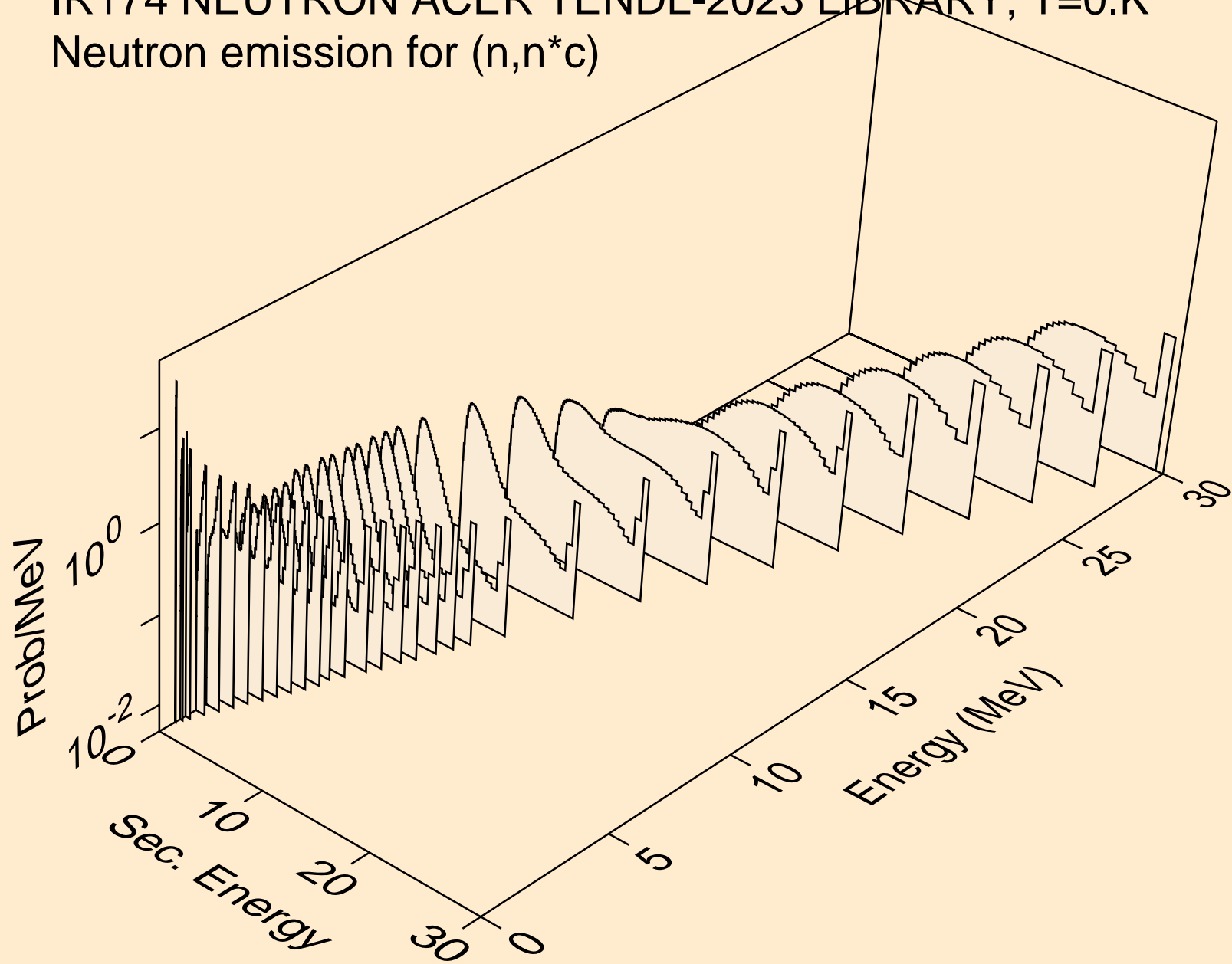

IR174 NEUTRON ACER TENDL-2023 LIBRARY; T=0.K  
Photon emission for (n,x)

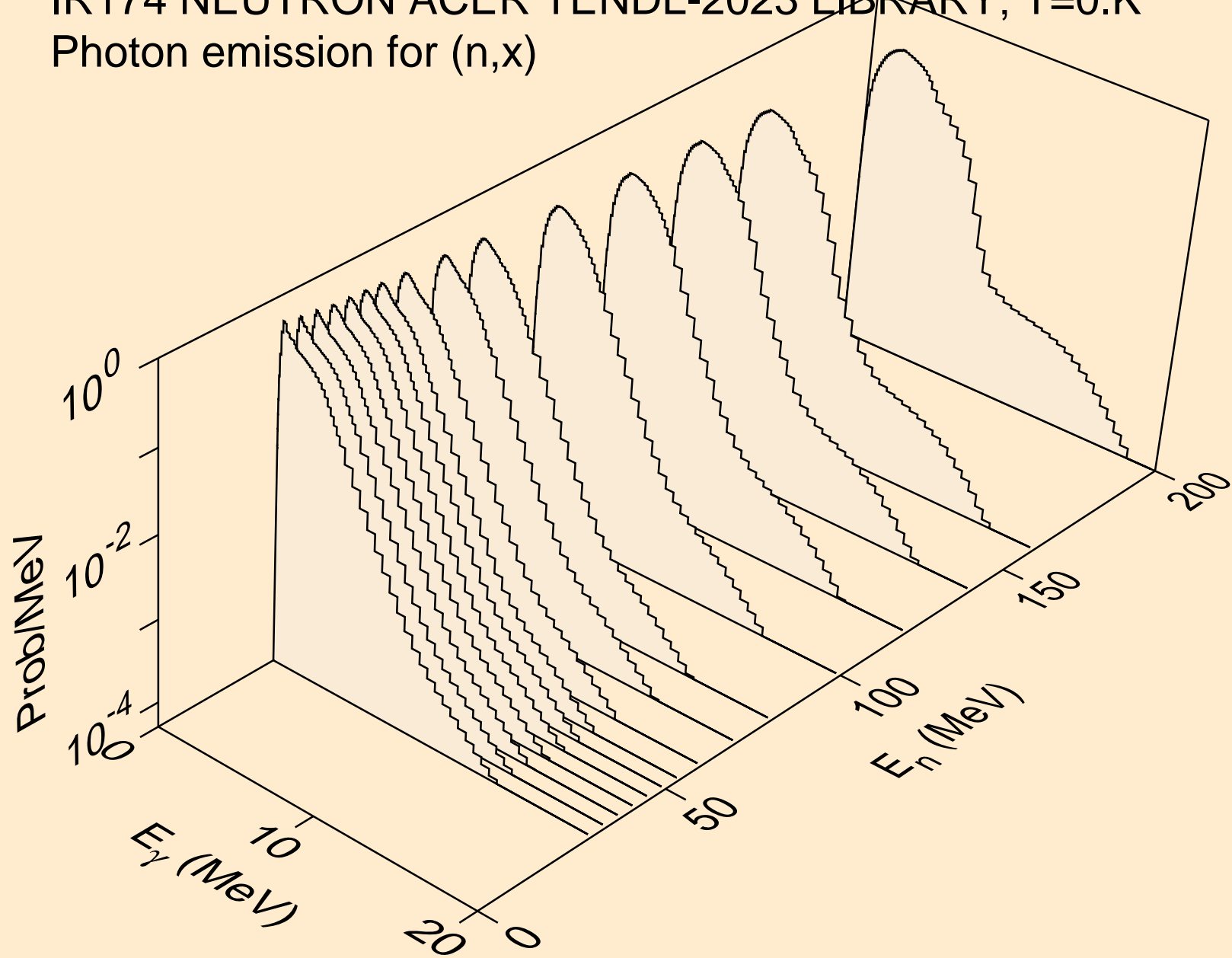

IR174 NEUTRON ACER TENDL-2023 LIBRARY; T=0.K  
Photon emission for (n,2nd)

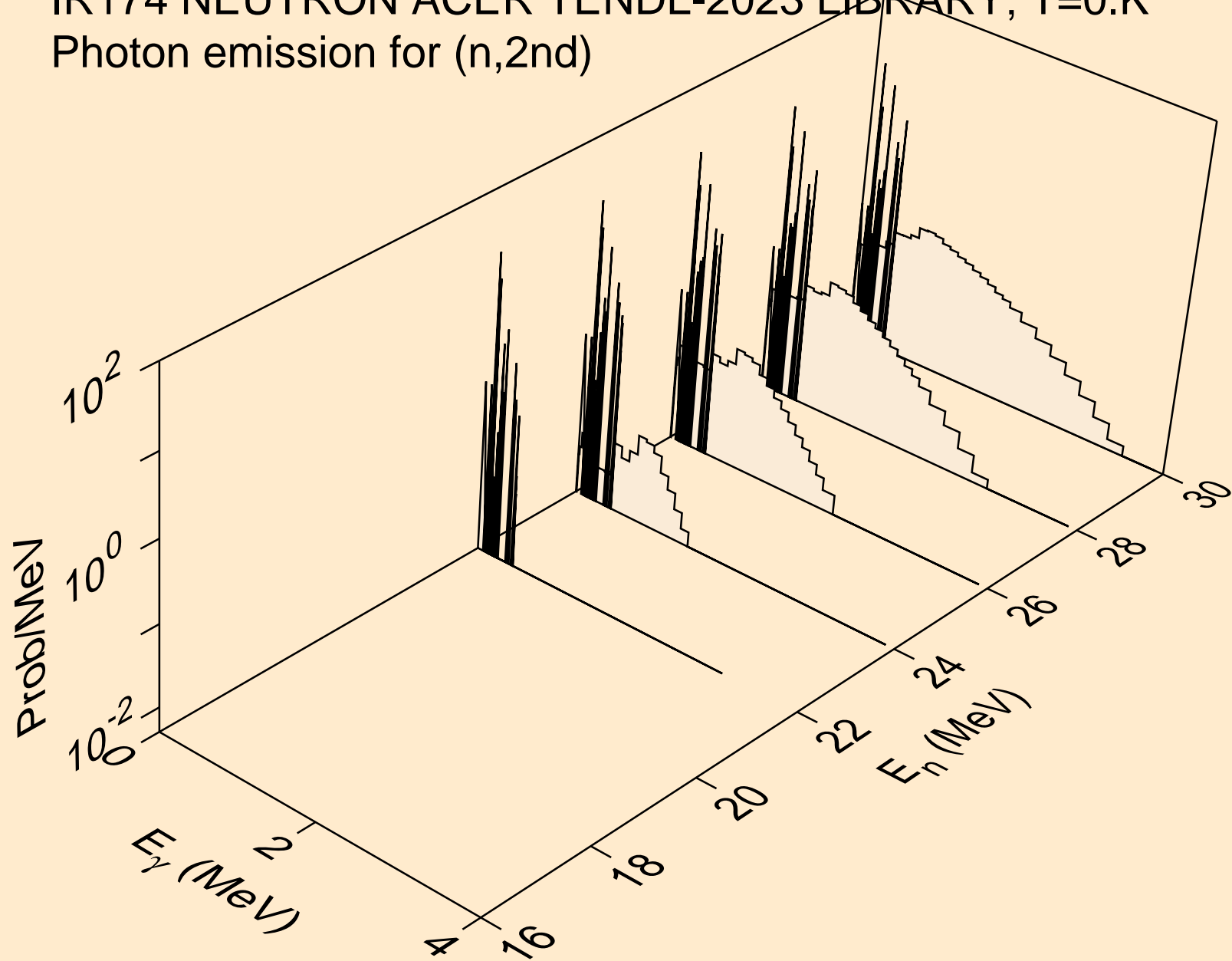

IR174 NEUTRON ACER TENDL-2023 LIBRARY; T=0.K  
Photon emission for (n,2n)

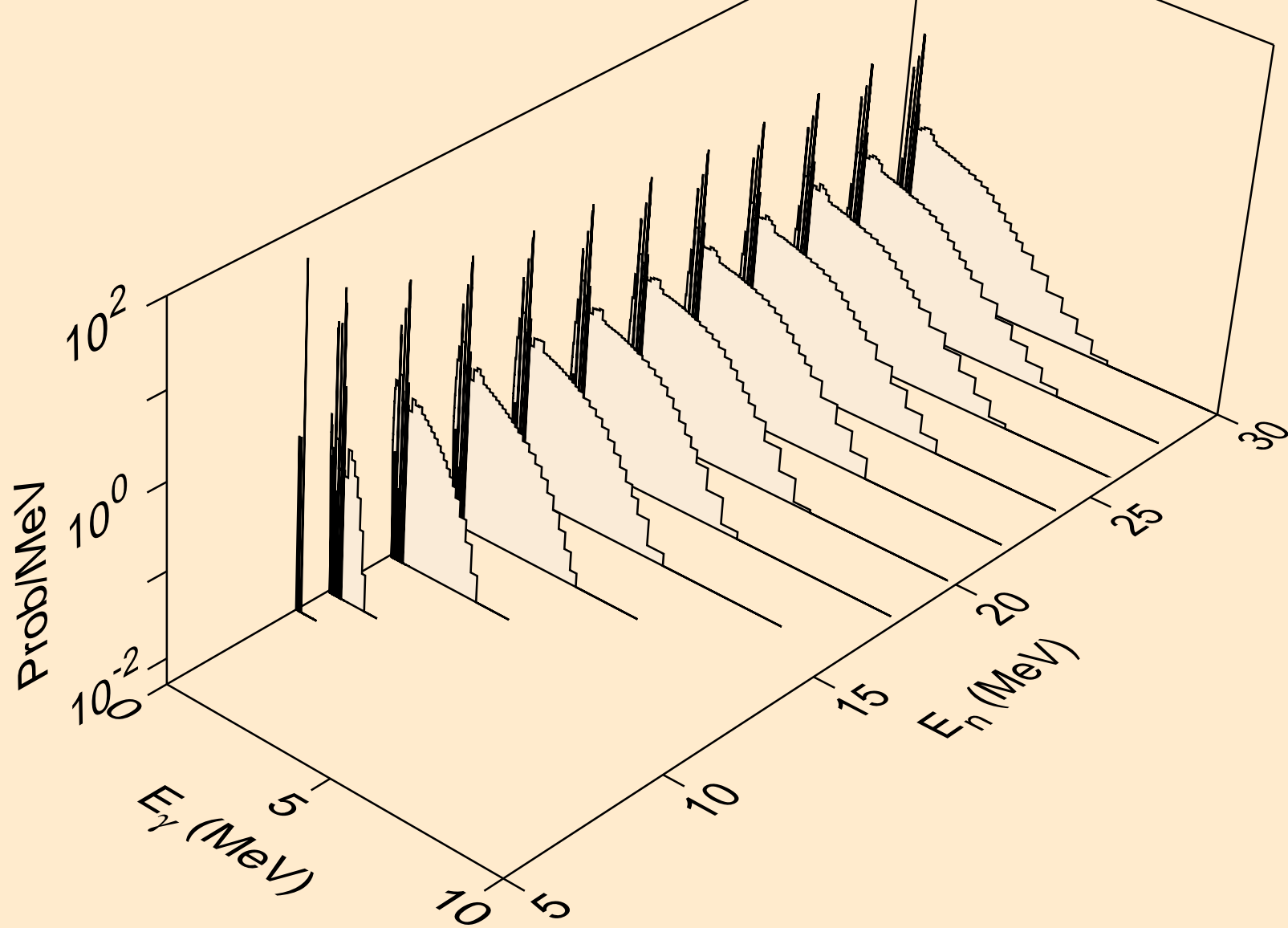

IR174 NEUTRON ACER TENDL-2023 LIBRARY; T=0.K  
Photon emission for (n,3n)

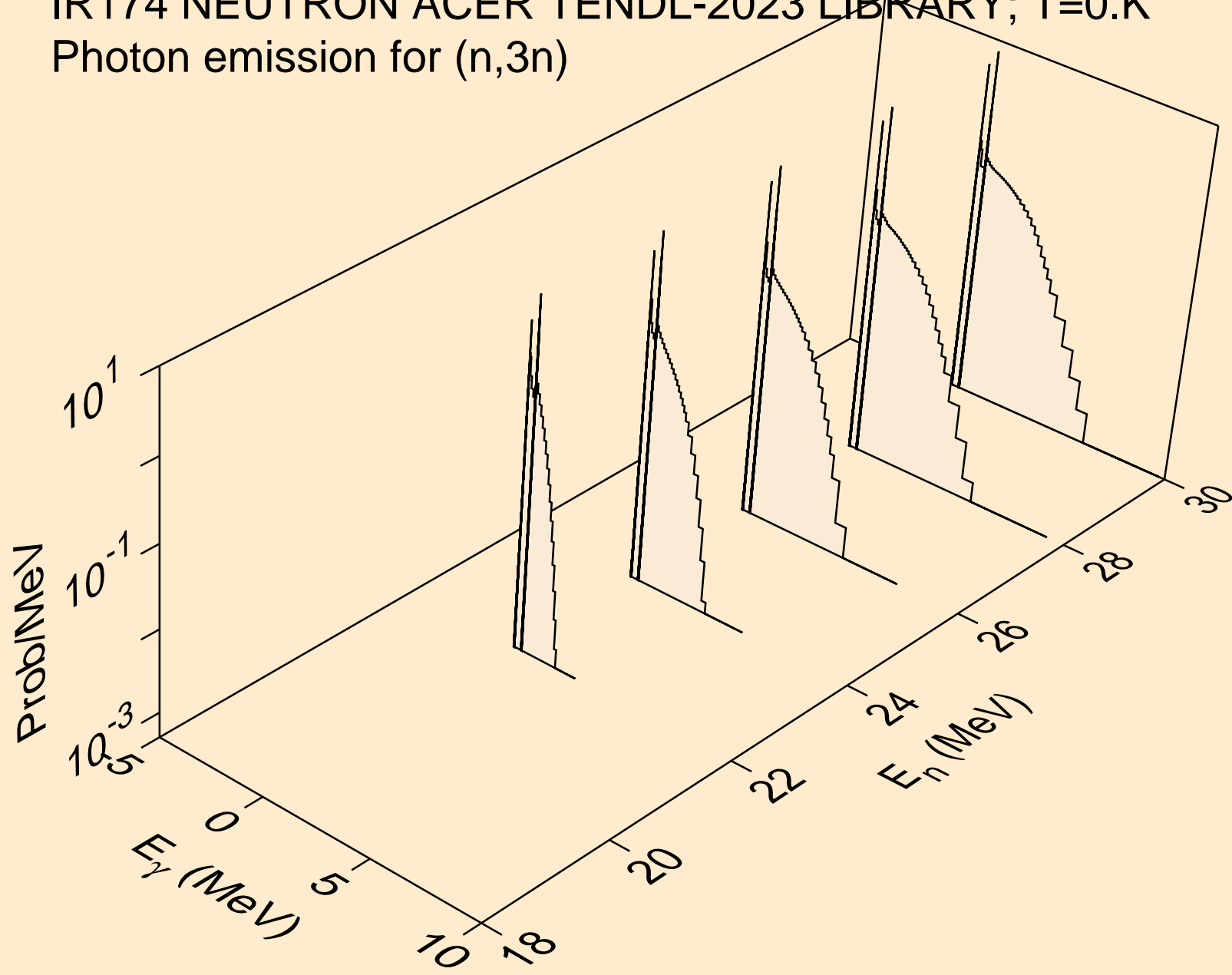

IR174 NEUTRON ACER TENDL-2023 LIBRARY; T=0.K  
Photon emission for (n,n\*)a

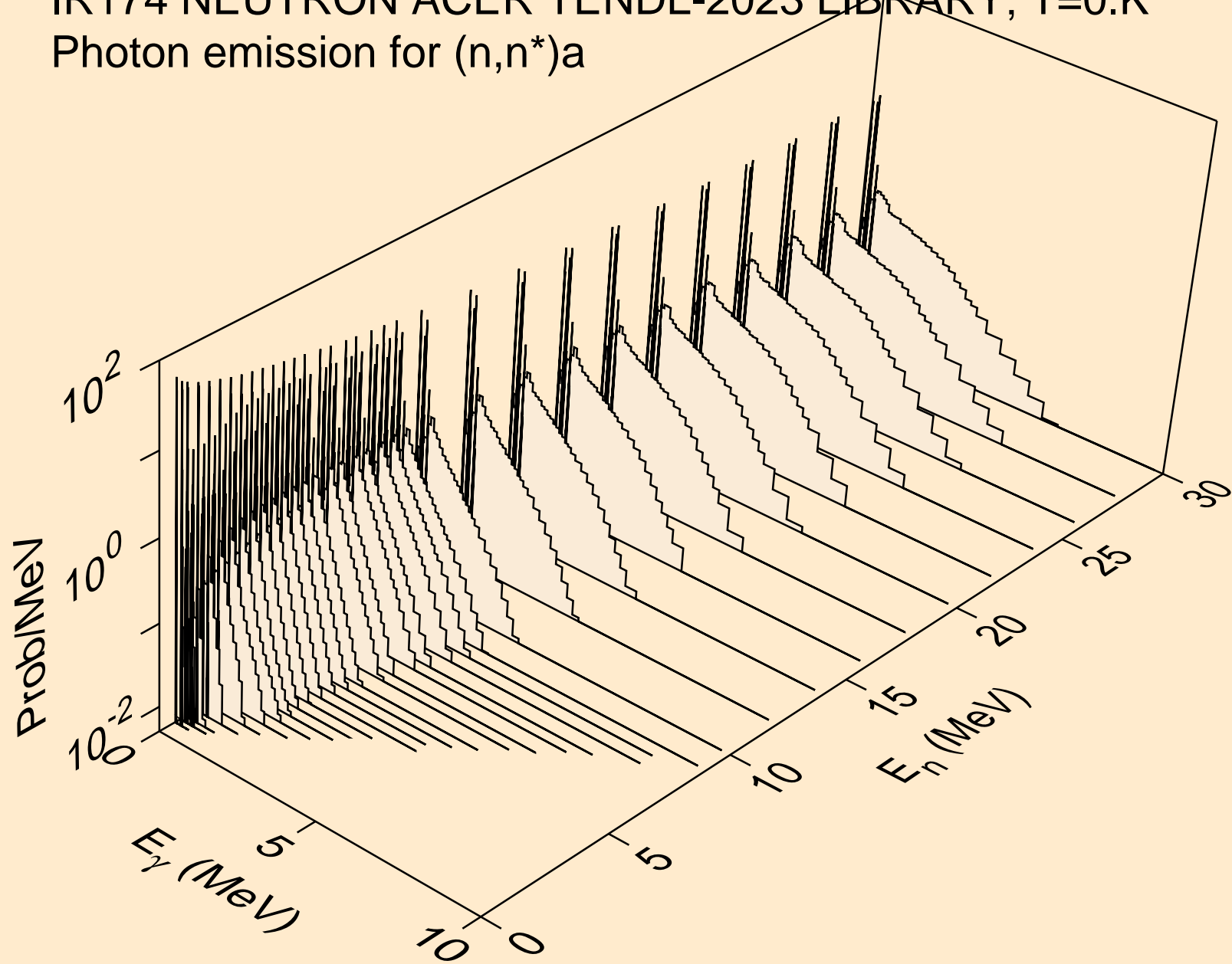

IR174 NEUTRON ACER TENDL-2023 LIBRARY; T=0.K  
Photon emission for (n,n\*)3a

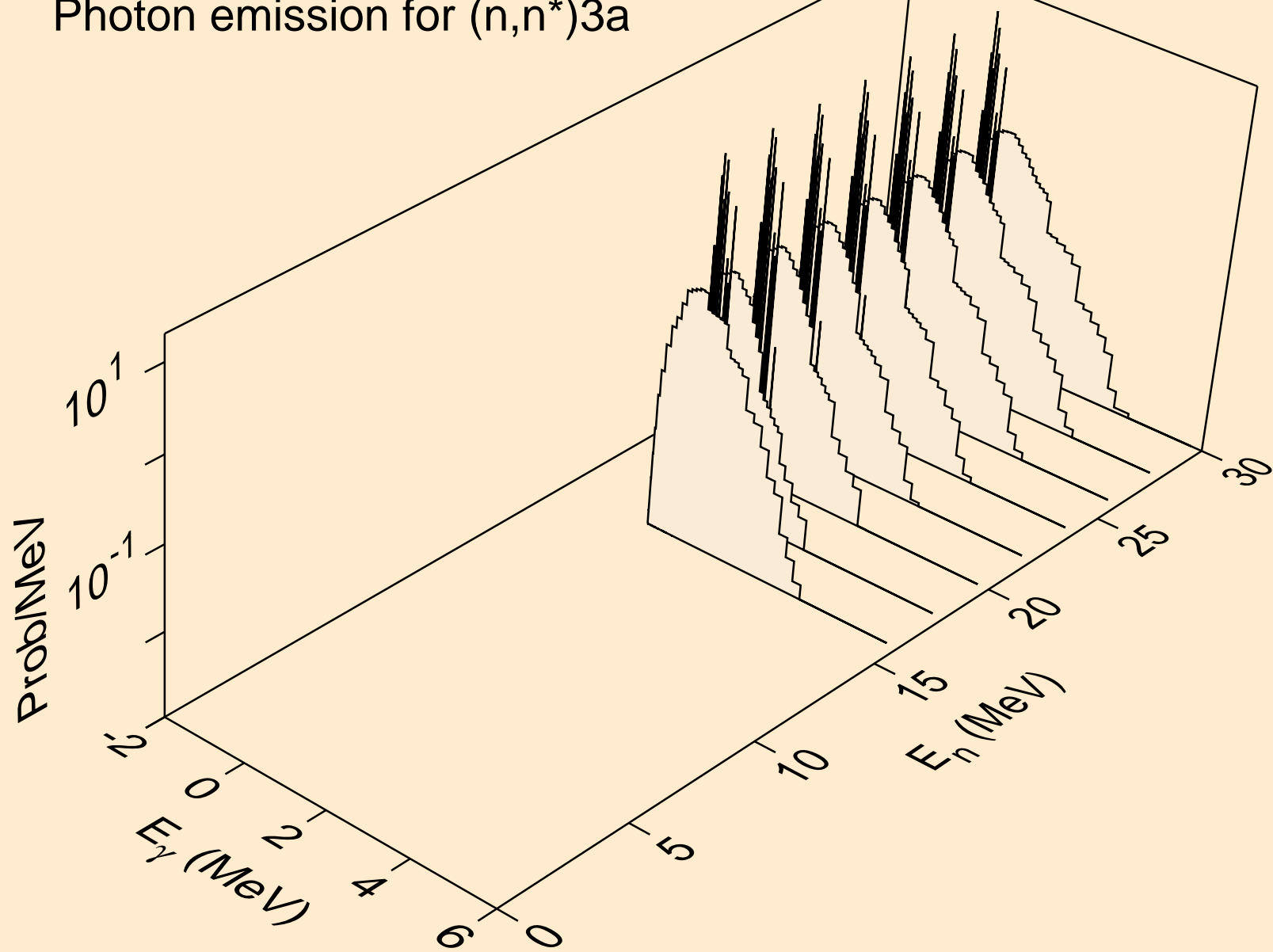

IR174 NEUTRON ACER TENDL-2023 LIBRARY; T=0.K  
Photon emission for (n,2n)a

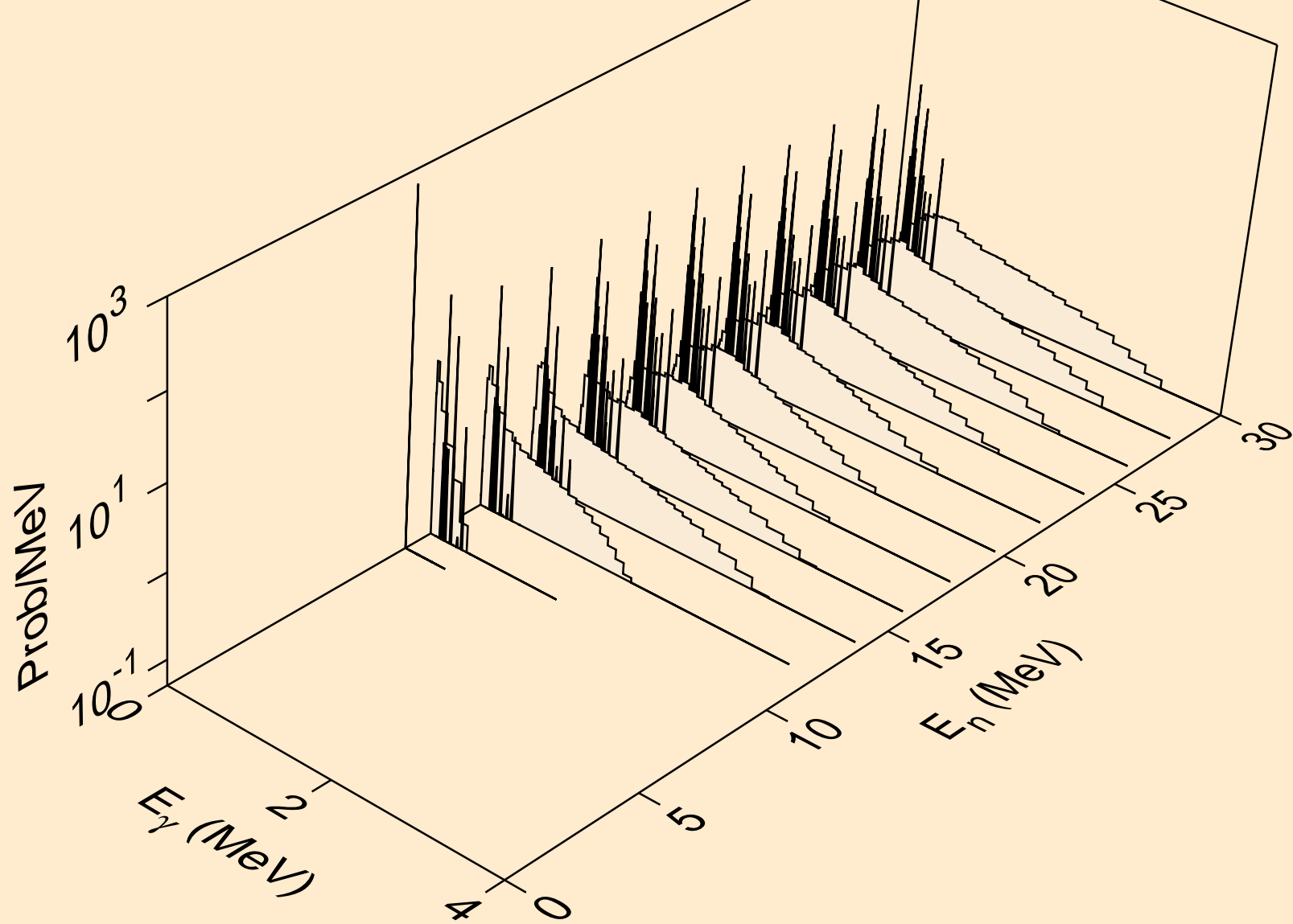

IR174 NEUTRON ACER TENDL-2023 LIBRARY; T=0.K  
Photon emission for (n,3n)a

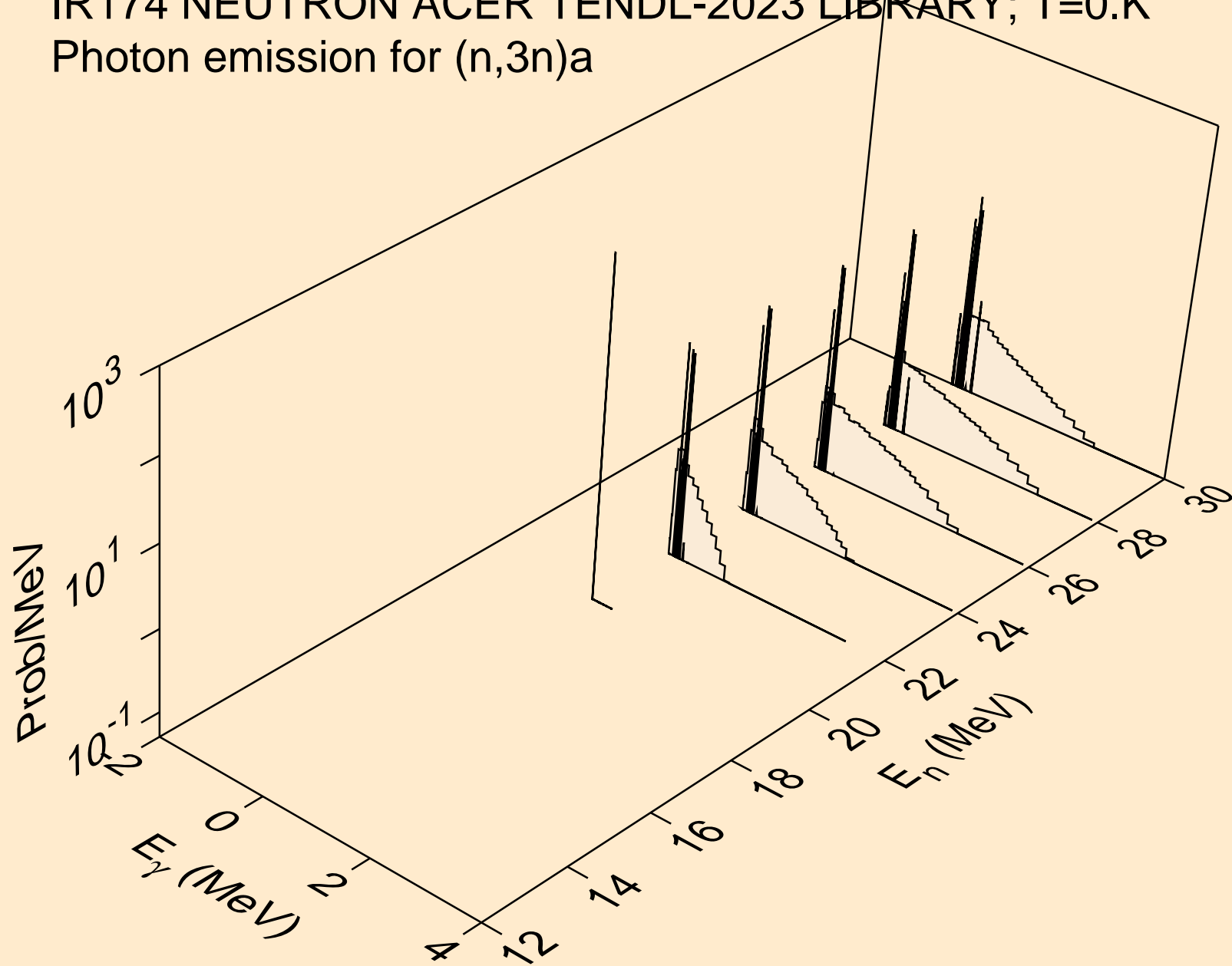

IR174 NEUTRON ACER TENDL-2023 LIBRARY; T=0.K  
Photon emission for (n,n\*)p

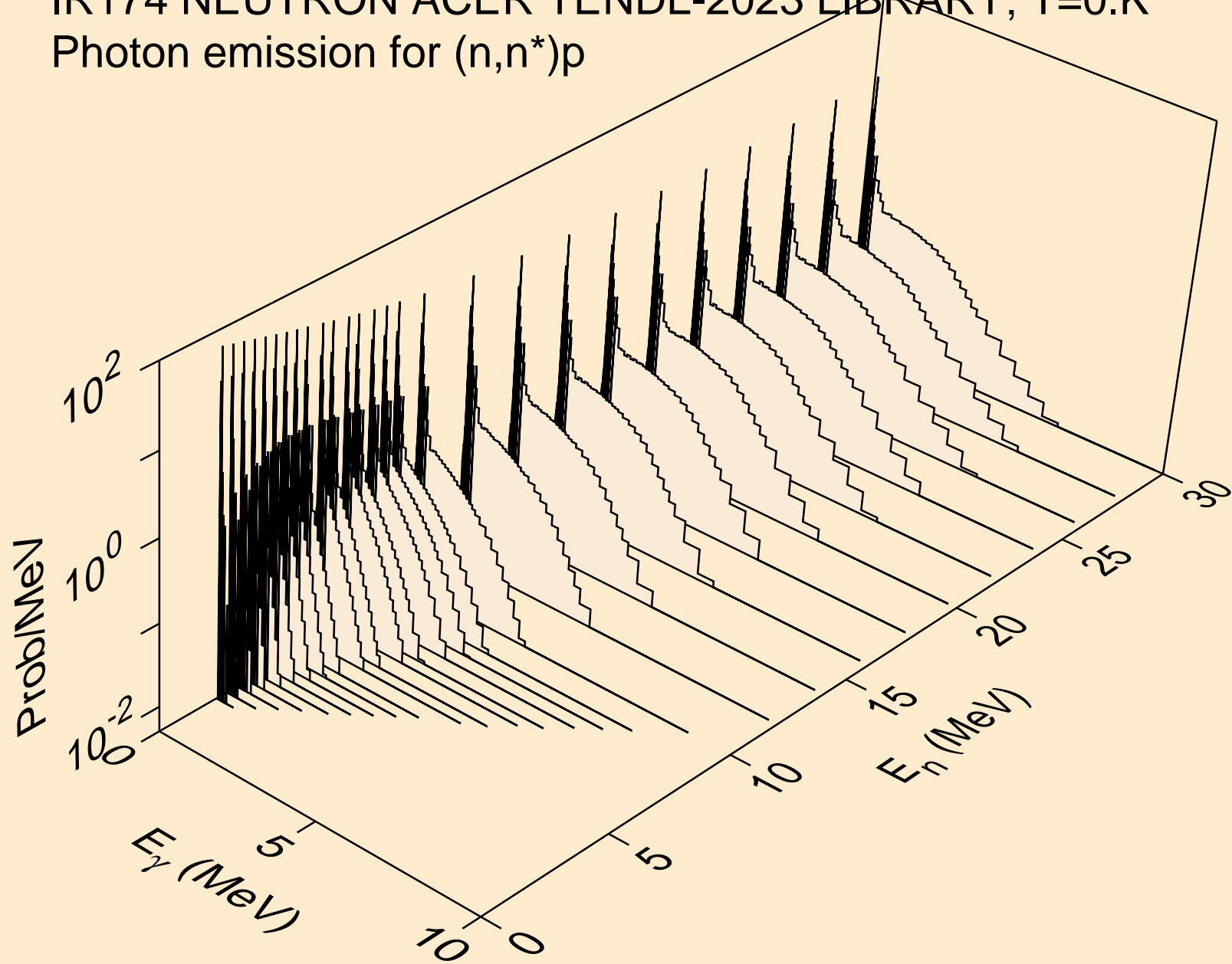

IR174 NEUTRON ACER TENDL-2023 LIBRARY; T=0.K  
Photon emission for (n,n\*)2a

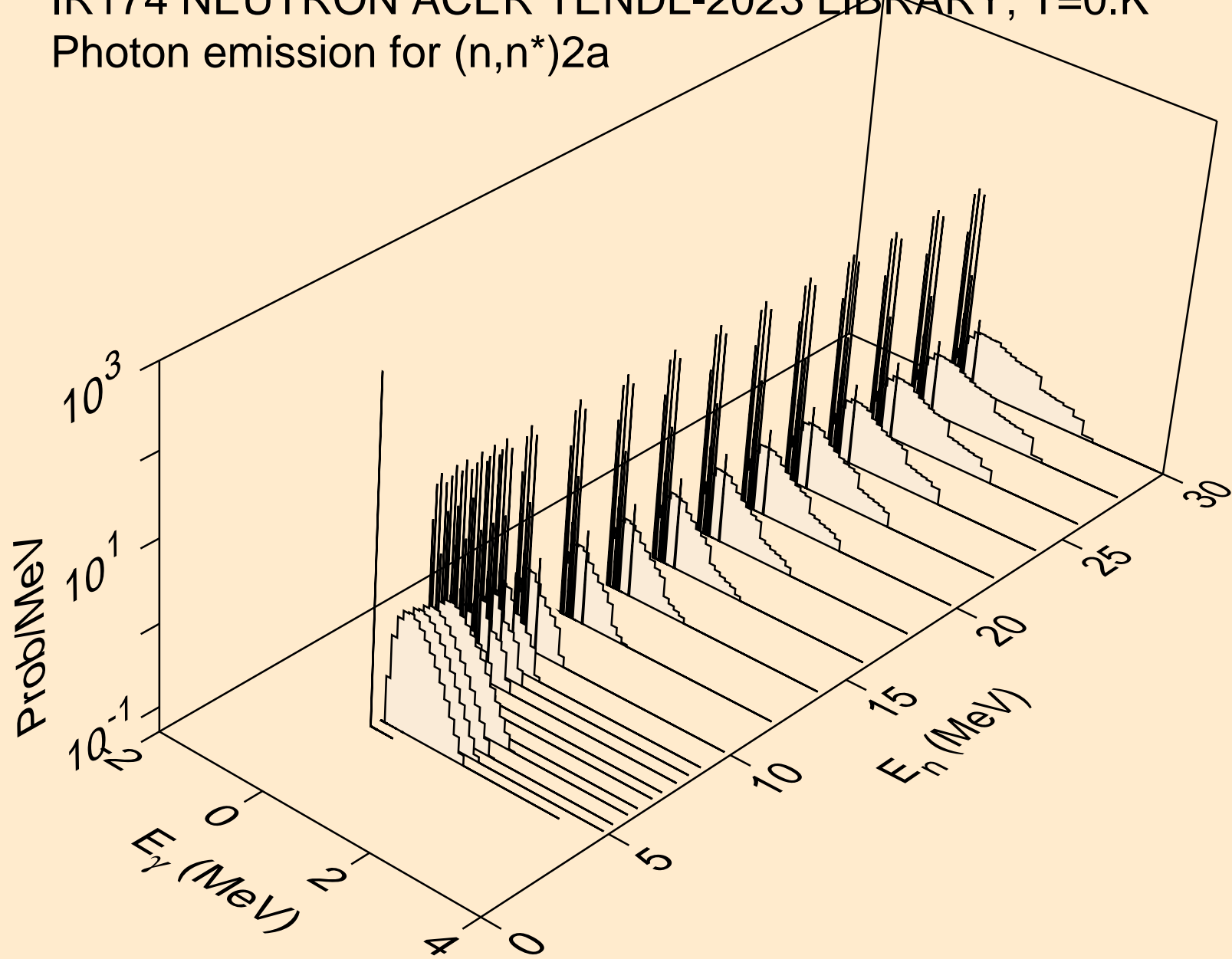

IR174 NEUTRON ACER TENDL-2023 LIBRARY; T=0.K  
Photon emission for (n,2n)2a

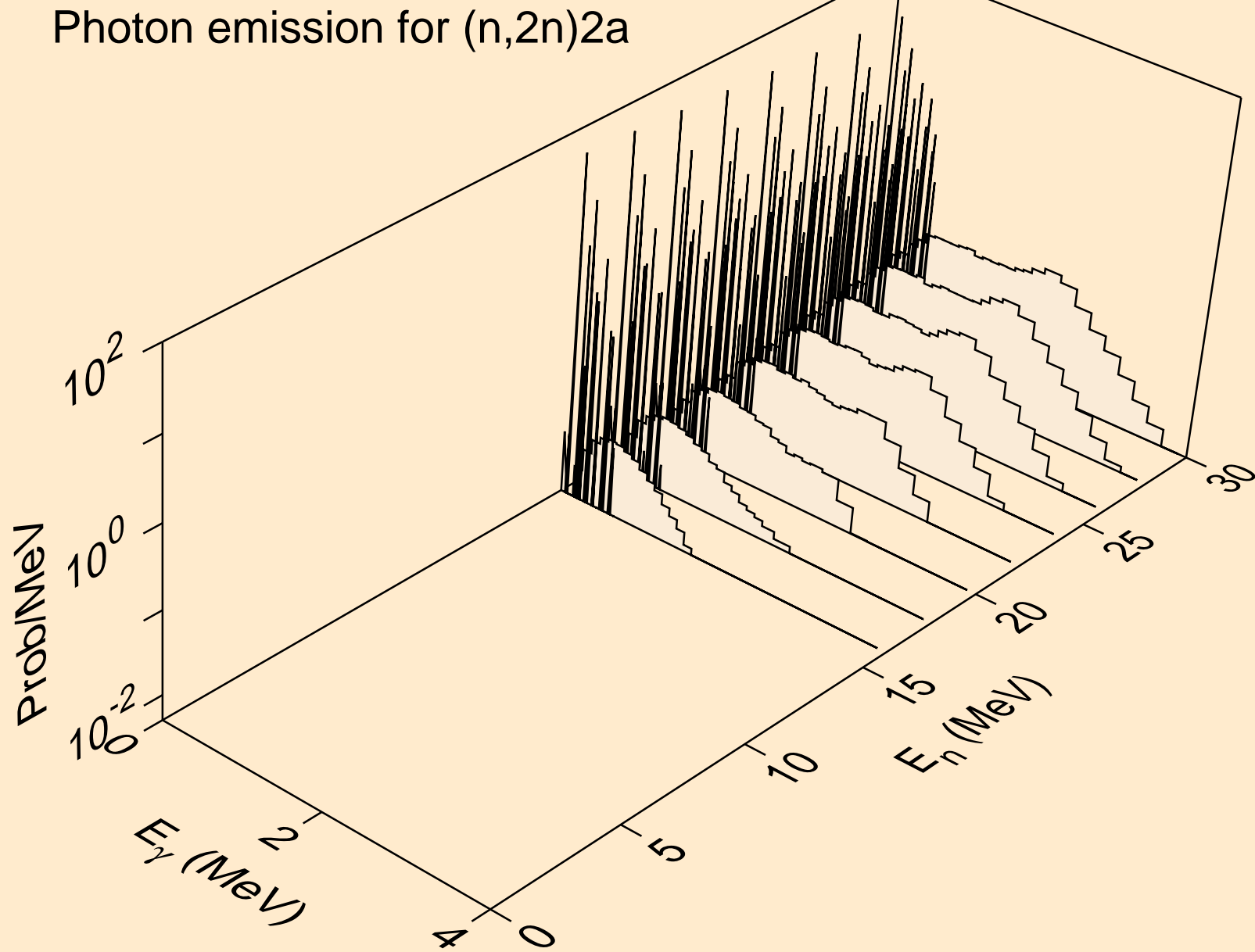

IR174 NEUTRON ACER TENDL-2023 LIBRARY; T=0.K  
Photon emission for (n,n\*)d

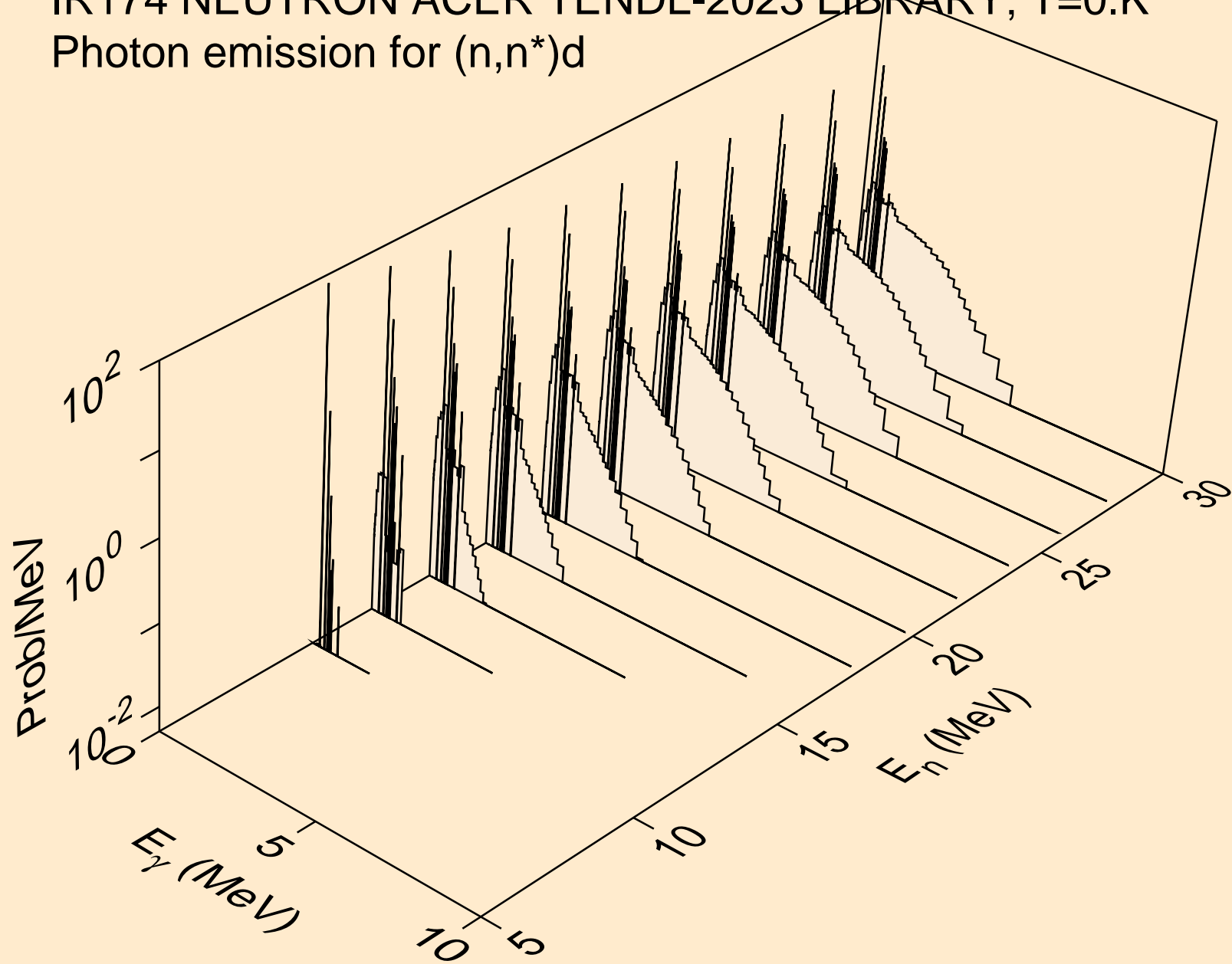

IR174 NEUTRON ACER TENDL-2023 LIBRARY; T=0.K  
Photon emission for (n,n\*)t

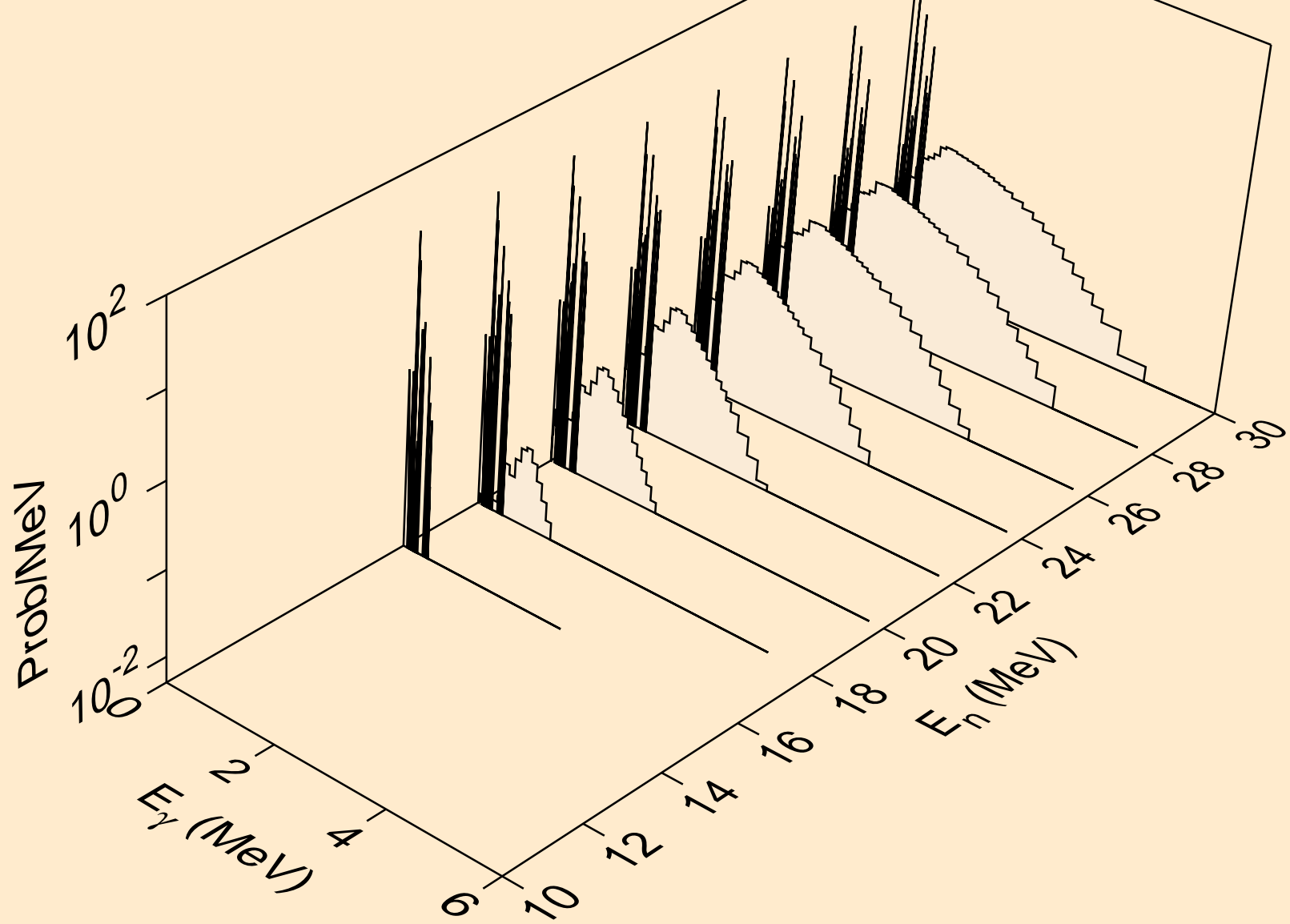

IR174 NEUTRON ACER TENDL-2023 LIBRARY; T=0.K  
Photon emission for (n,n\*)he3

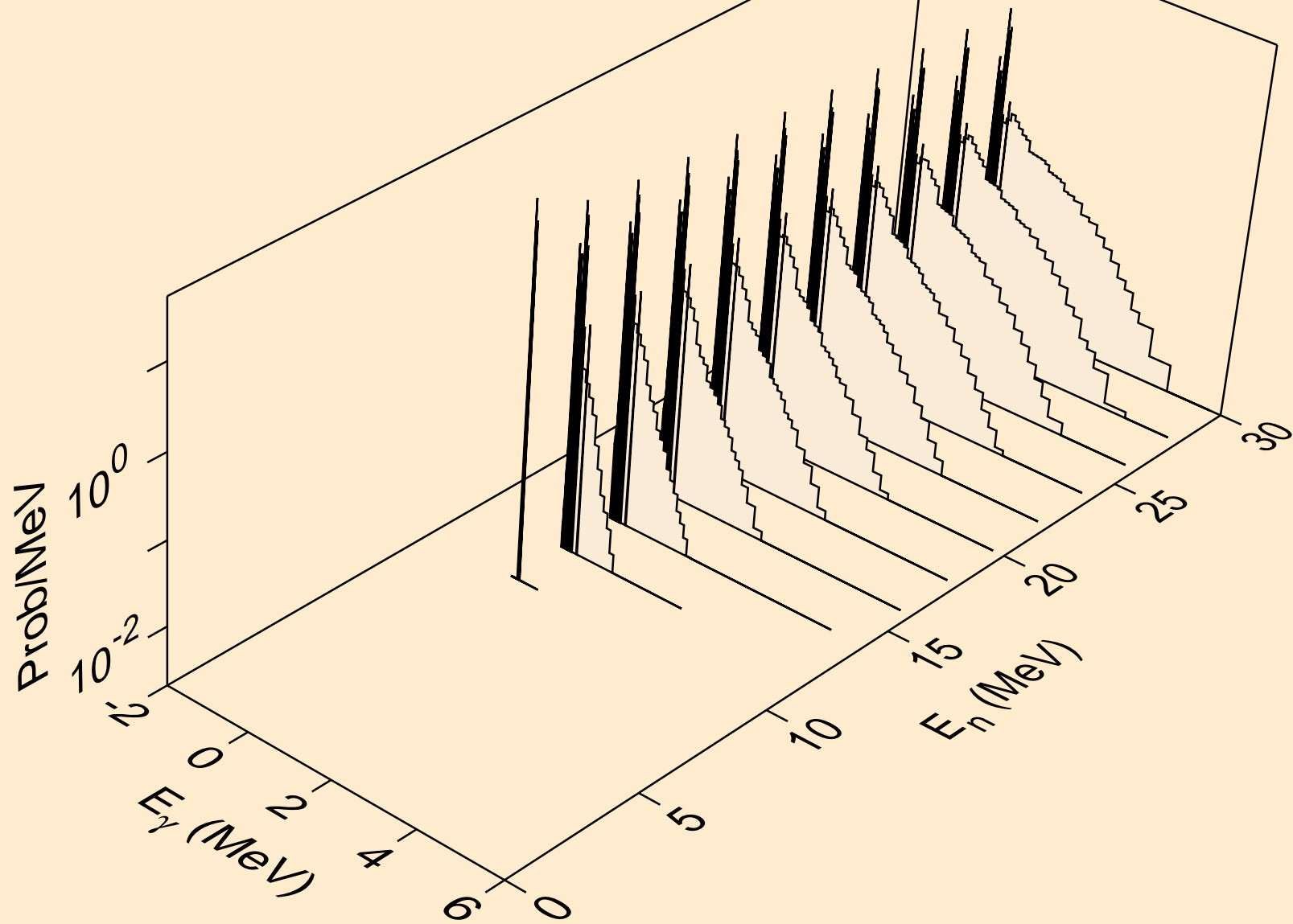

IR174 NEUTRON ACER TENDL-2023 LIBRARY; T=0.K  
Photon emission for (n,4n)

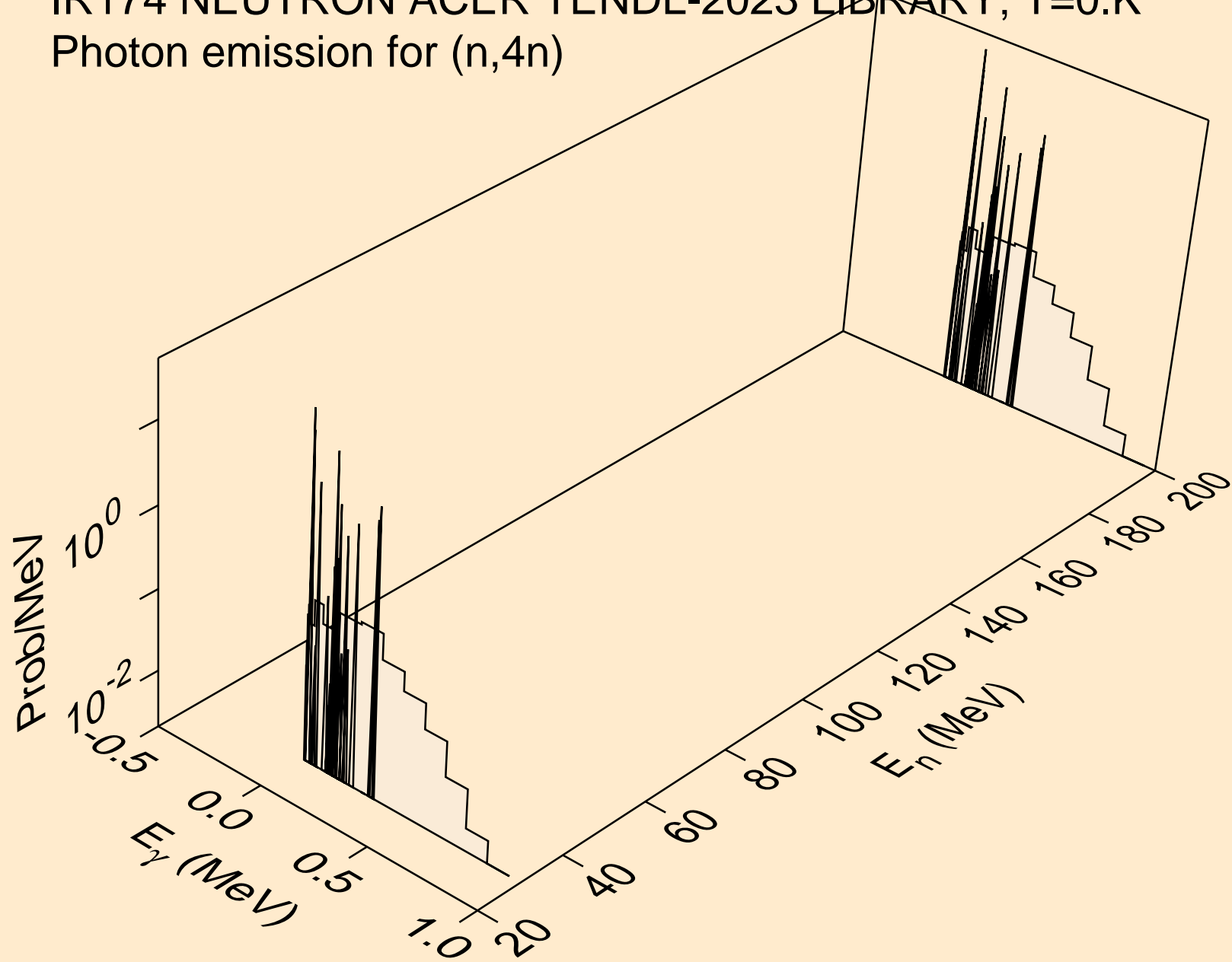

IR174 NEUTRON ACER TENDL-2023 LIBRARY; T=0.K  
Photon emission for (n,2np)

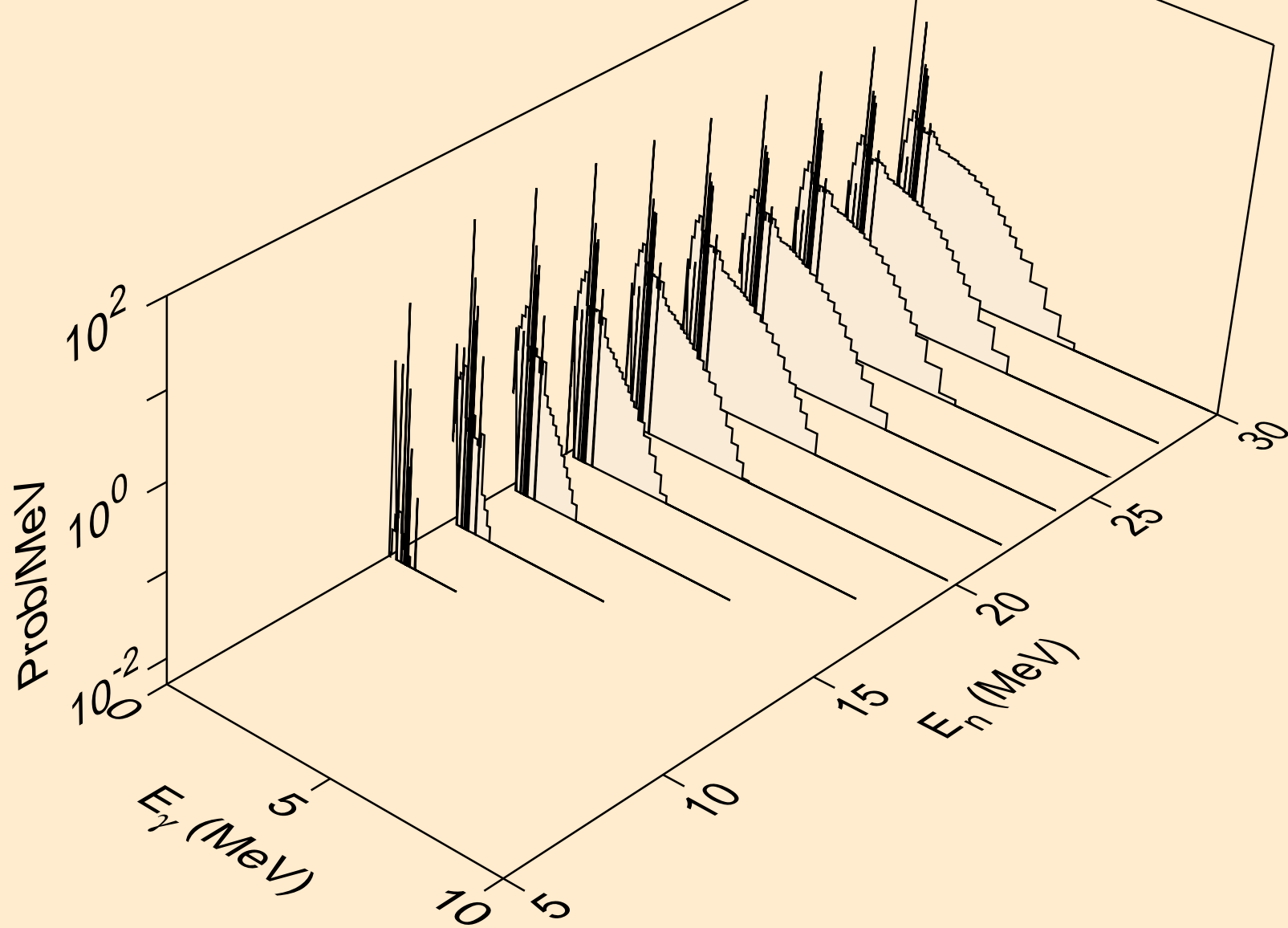

IR174 NEUTRON ACER TENDL-2023 LIBRARY; T=0.K  
Photon emission for (n,3np)

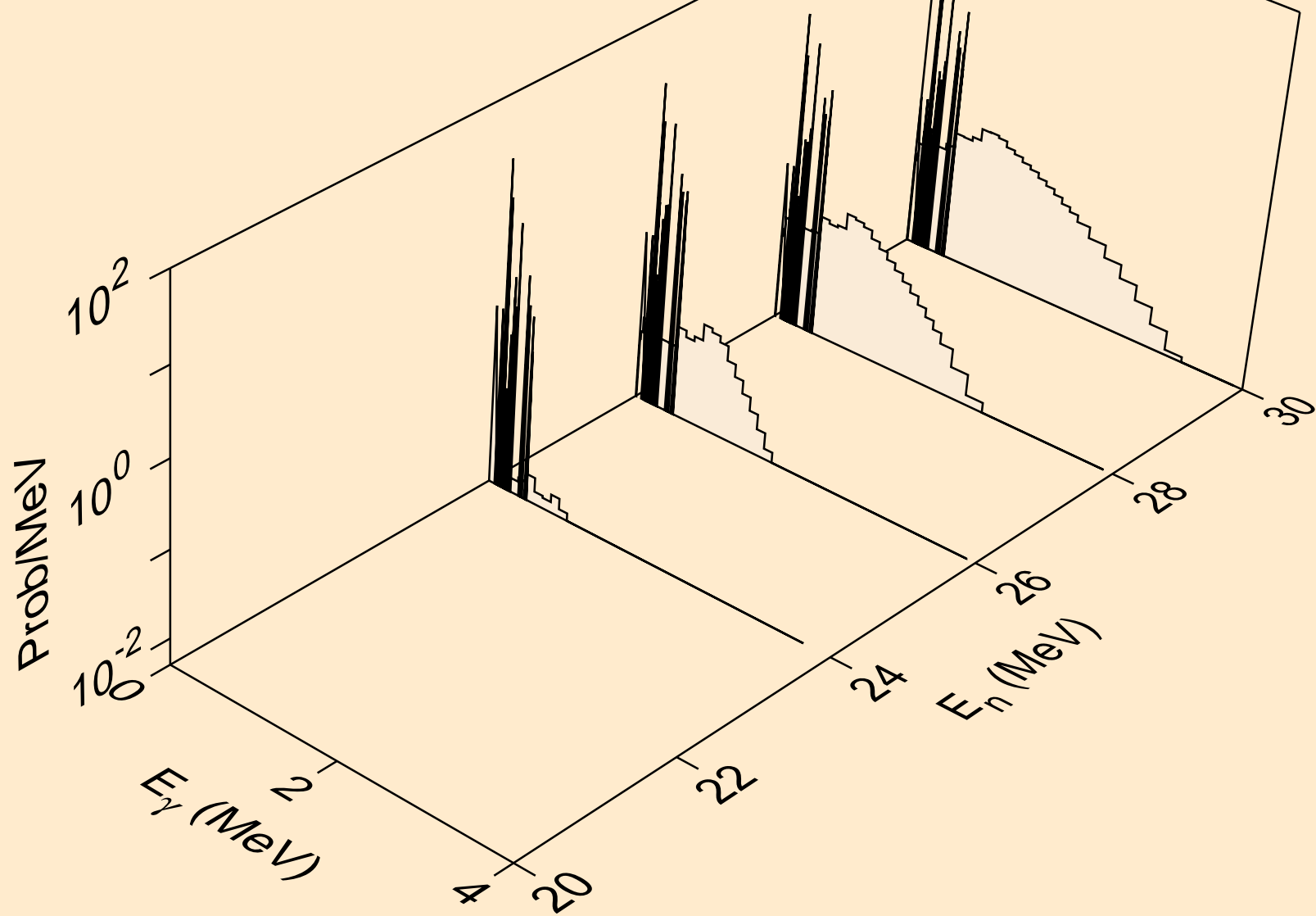

IR174 NEUTRON ACER TENDL-2023 LIBRARY; T=0.K  
Photon emission for (n,n2p)

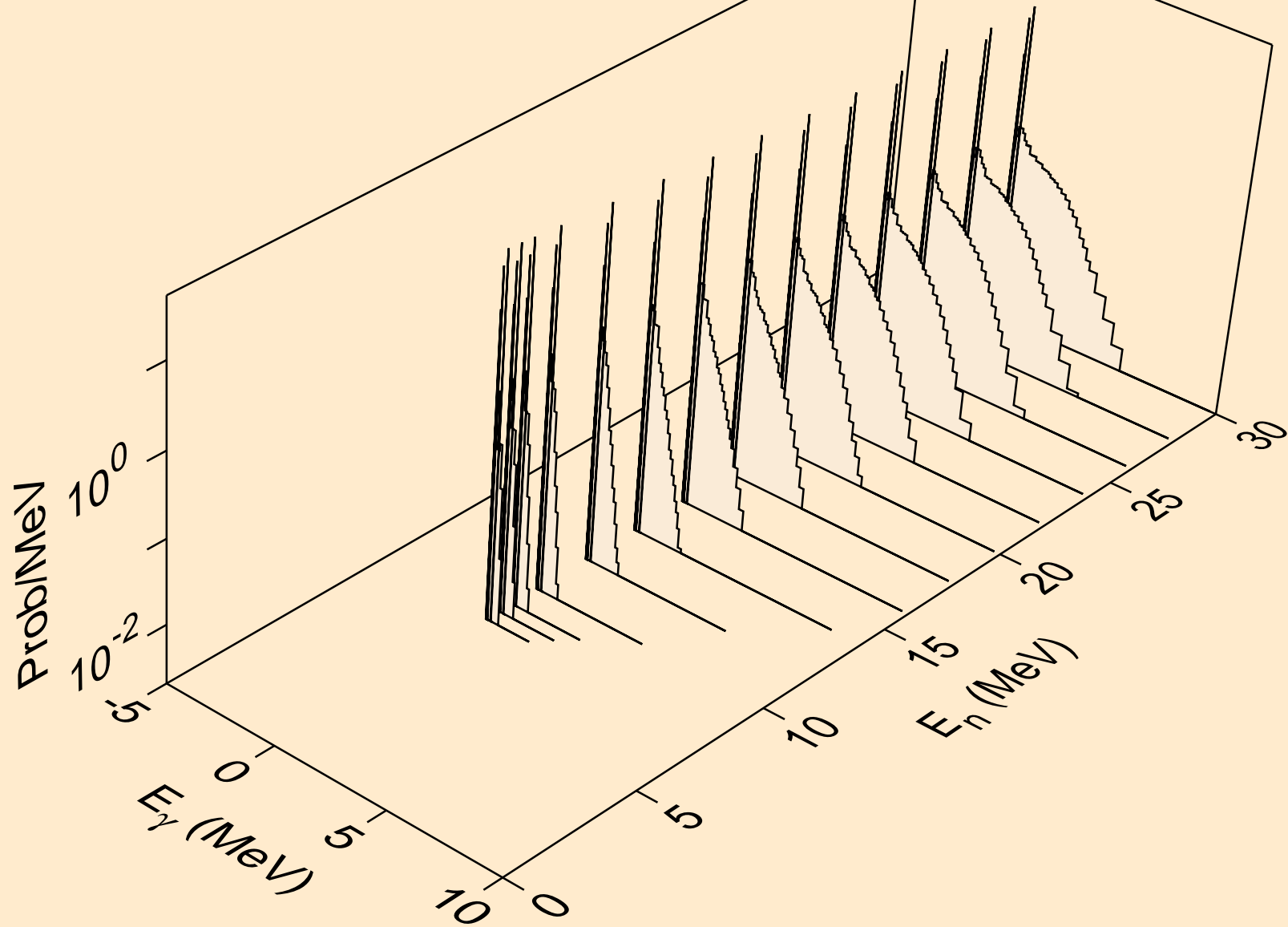

IR174 NEUTRON ACER TENDL-2023 LIBRARY; T=0.K  
Photon emission for (n,npa)

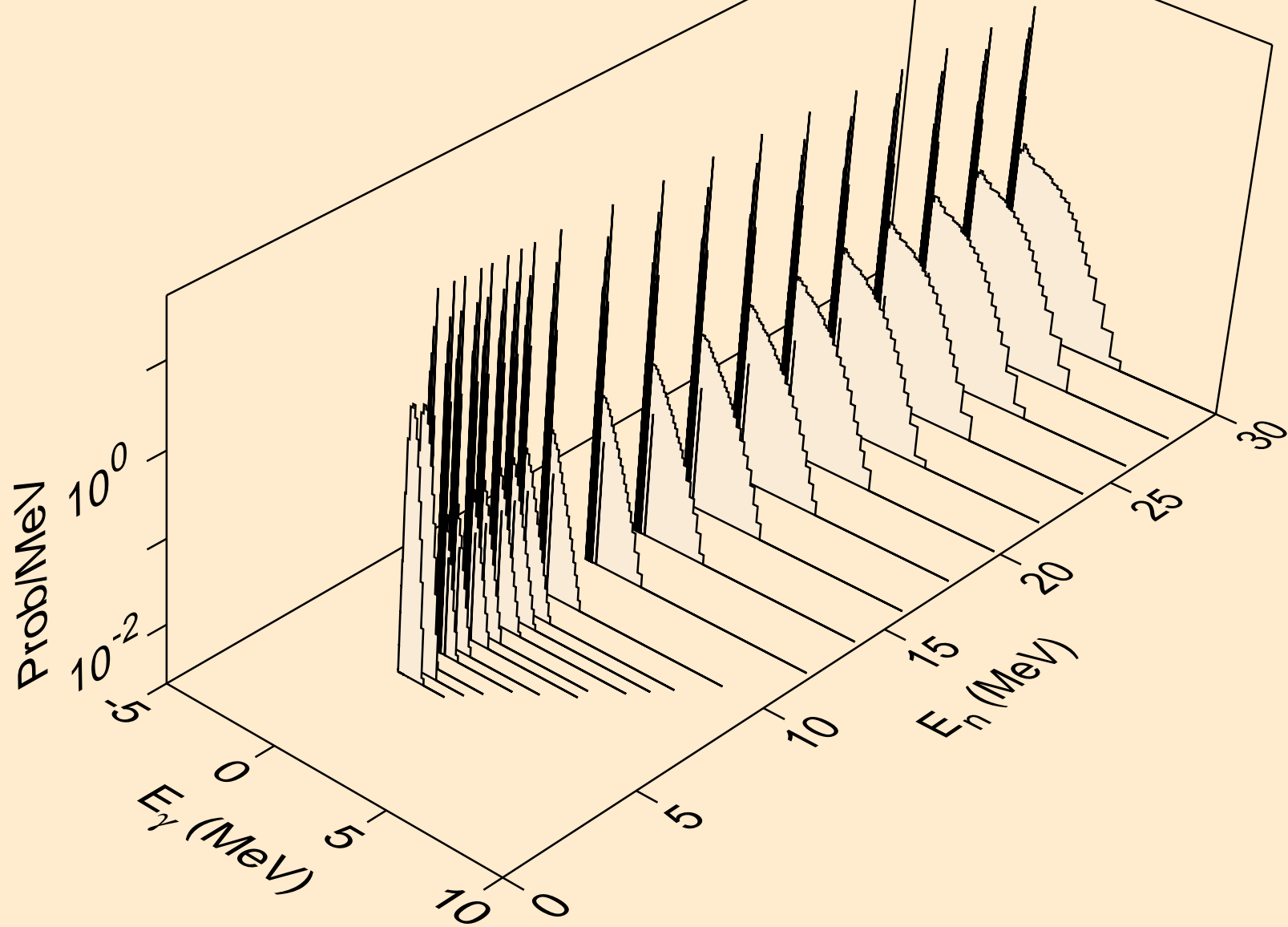

IR174 NEUTRON ACER TENDL-2023 LIBRARY; T=0.K  
Photon emission for (n,n\*c)

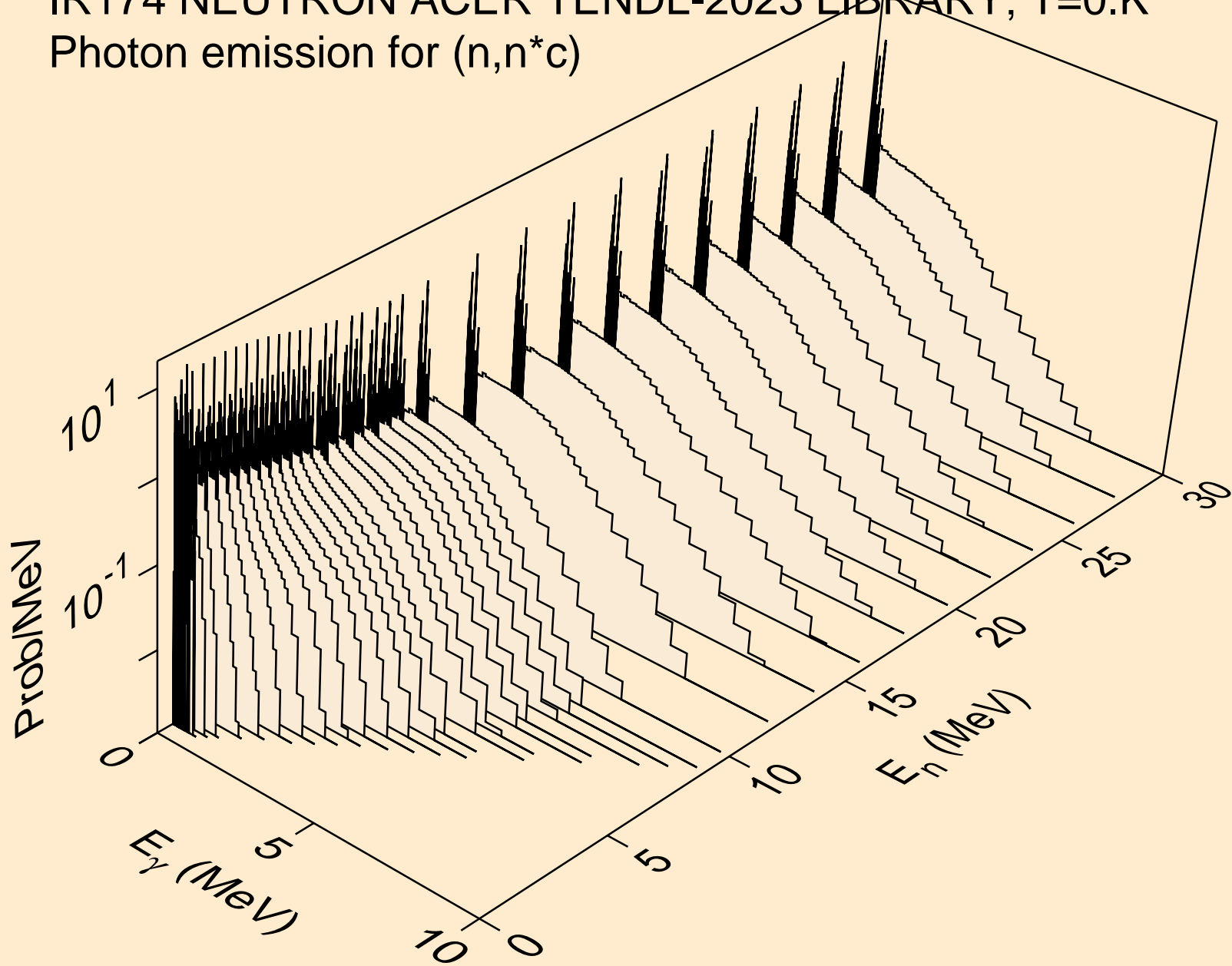

IR174 NEUTRON ACER TENDL-2023 LIBRARY; T=0.K  
Photon emission for (n,gma)

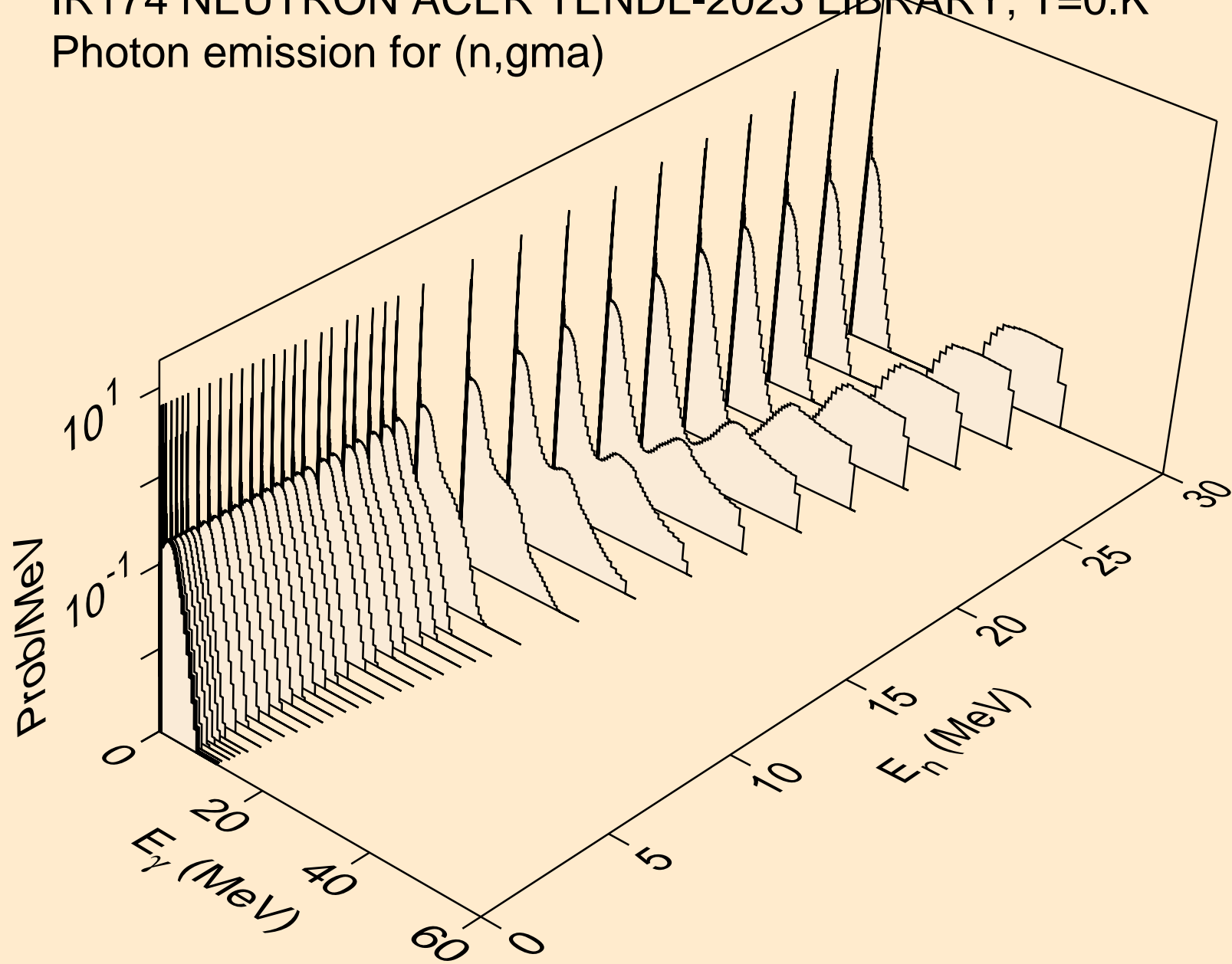

IR174 NEUTRON ACER TENDL-2023 LIBRARY; T=0.K  
Photon emission for (n,p)

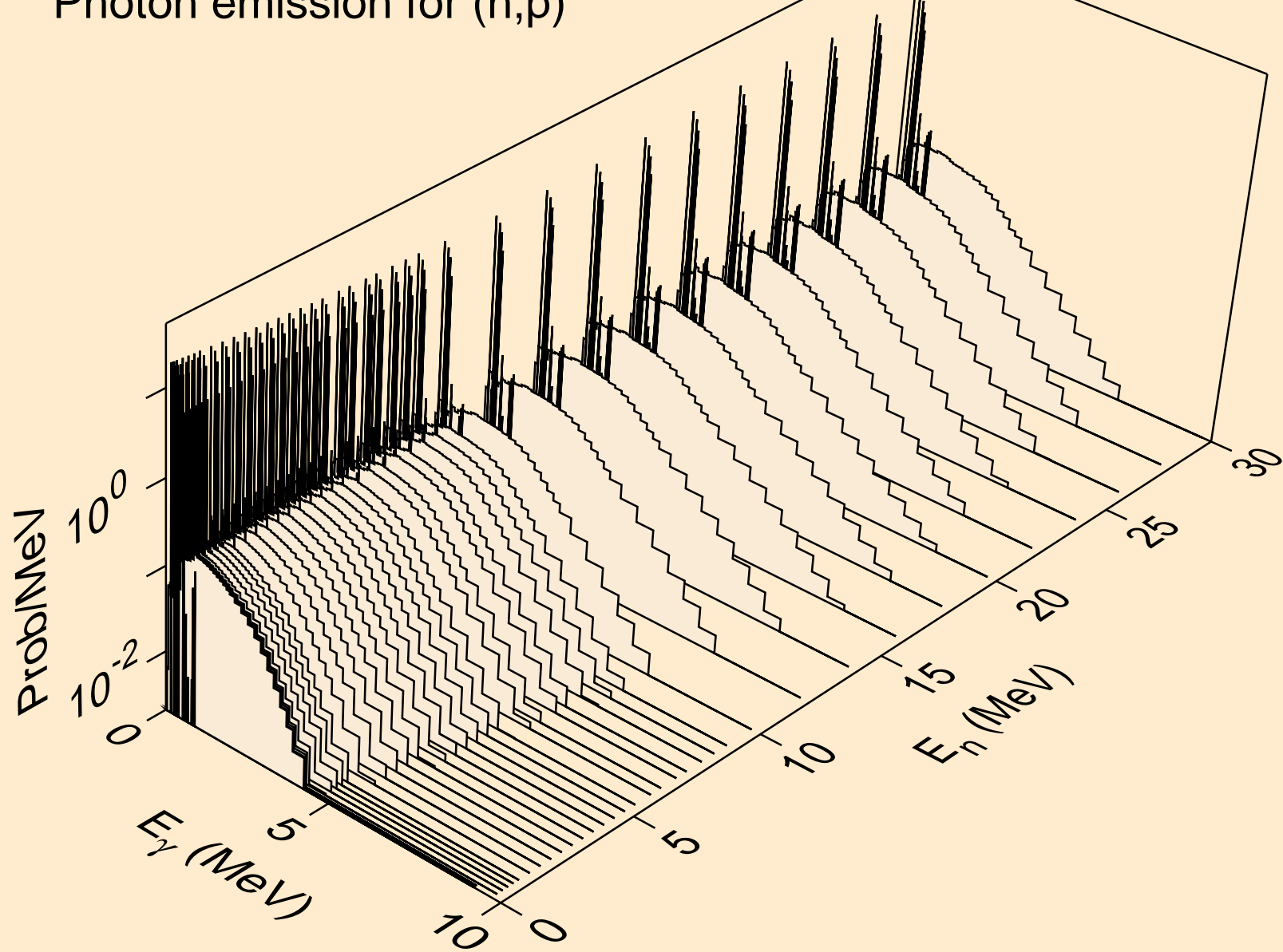

IR174 NEUTRON ACER TENDL-2023 LIBRARY; T=0.K  
Photon emission for (n,d)

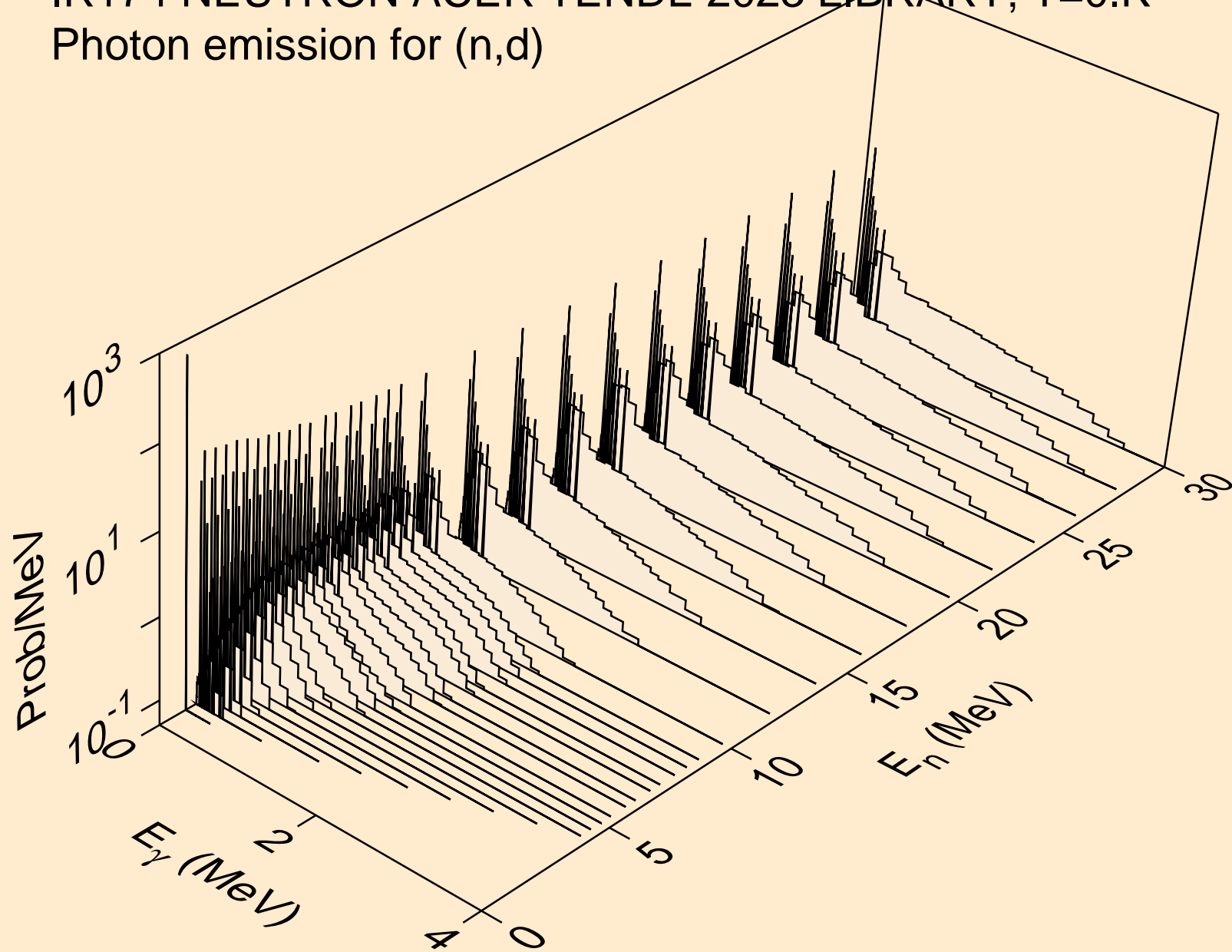

IR174 NEUTRON ACER TENDL-2023 LIBRARY; T=0.K  
Photon emission for (n,t)

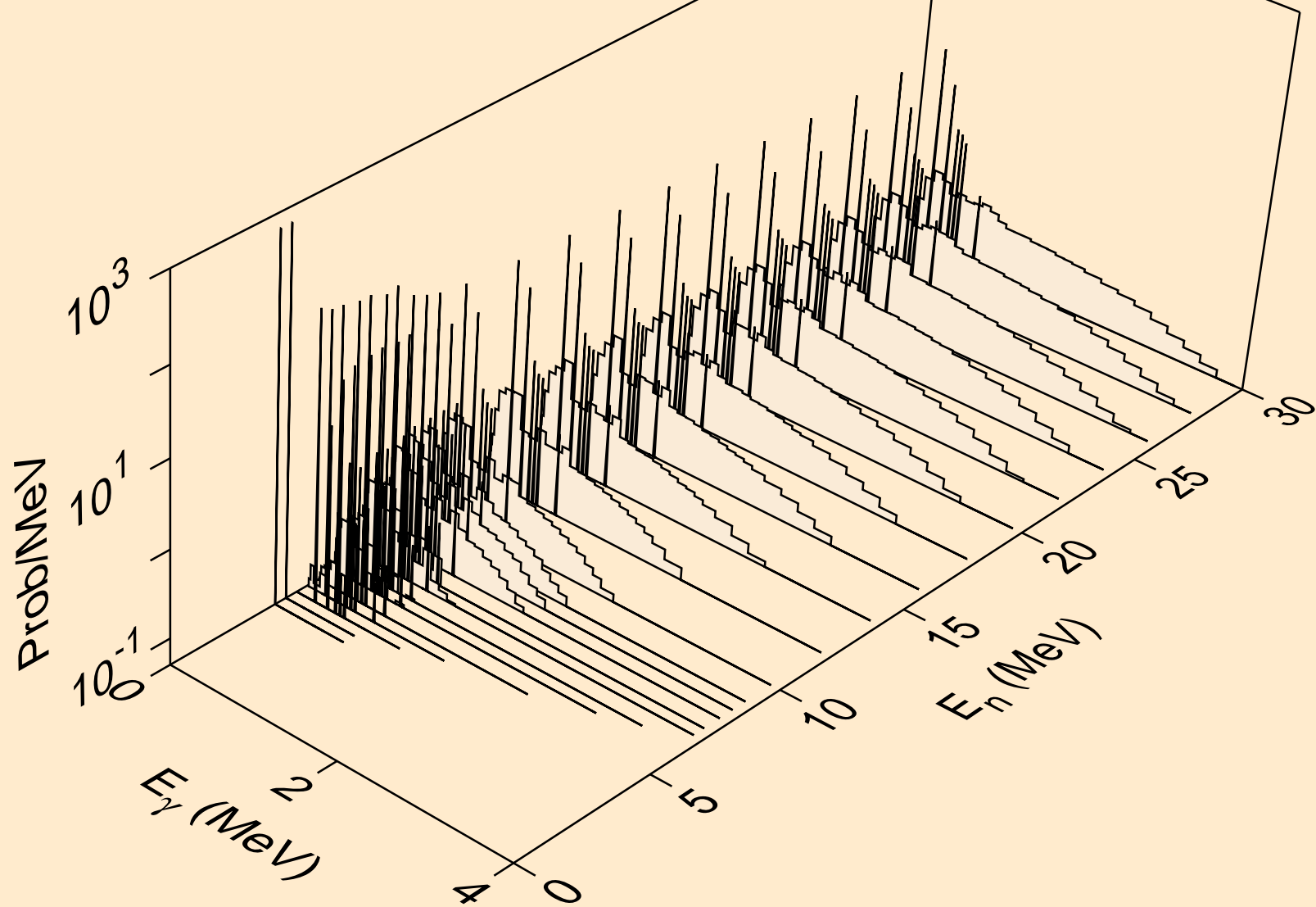

IR174 NEUTRON ACER TENDL-2023 LIBRARY; T=0.K  
Photon emission for (n,he3)

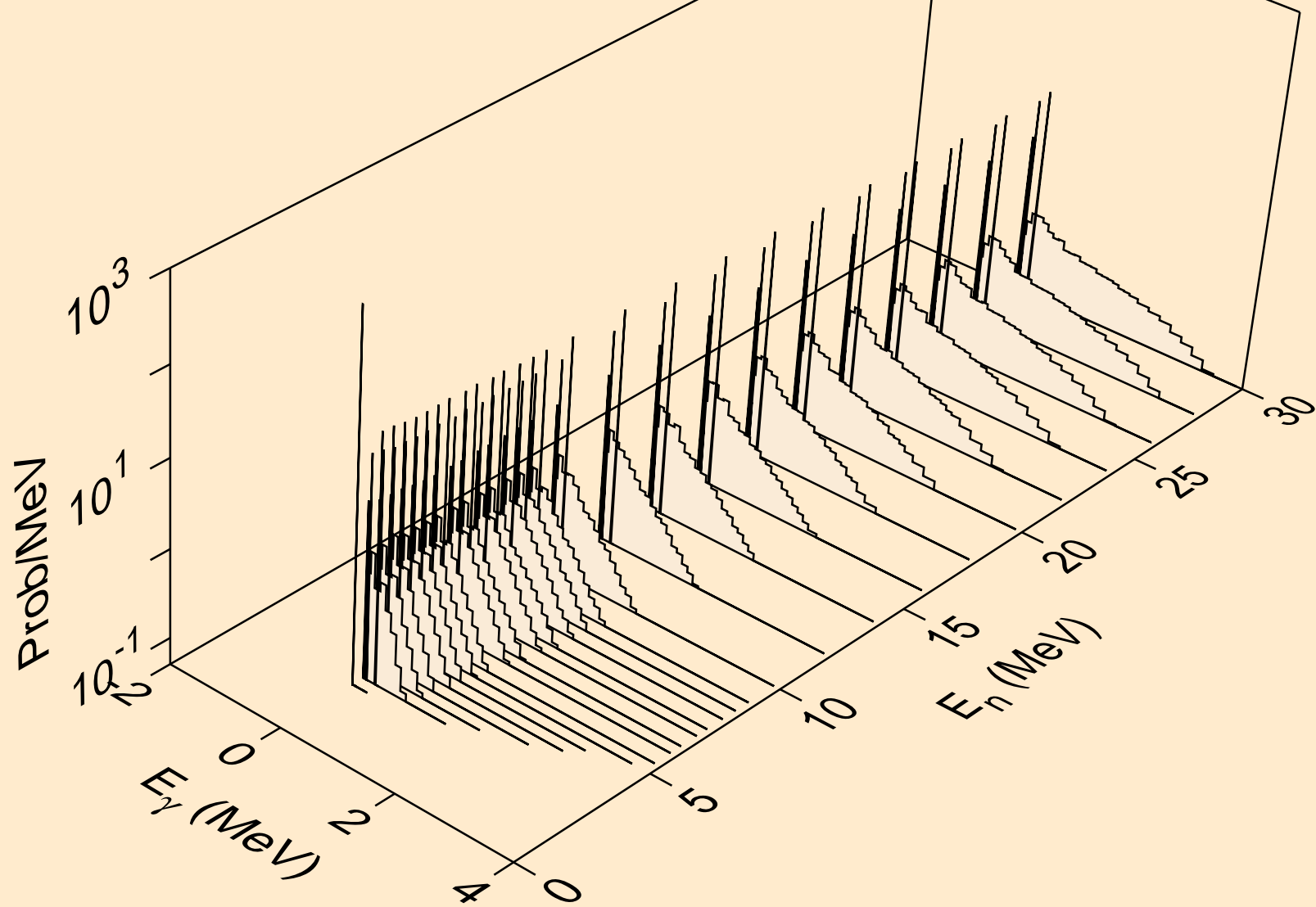

IR174 NEUTRON ACER TENDL-2023 LIBRARY; T=0.K  
Photon emission for (n,a)

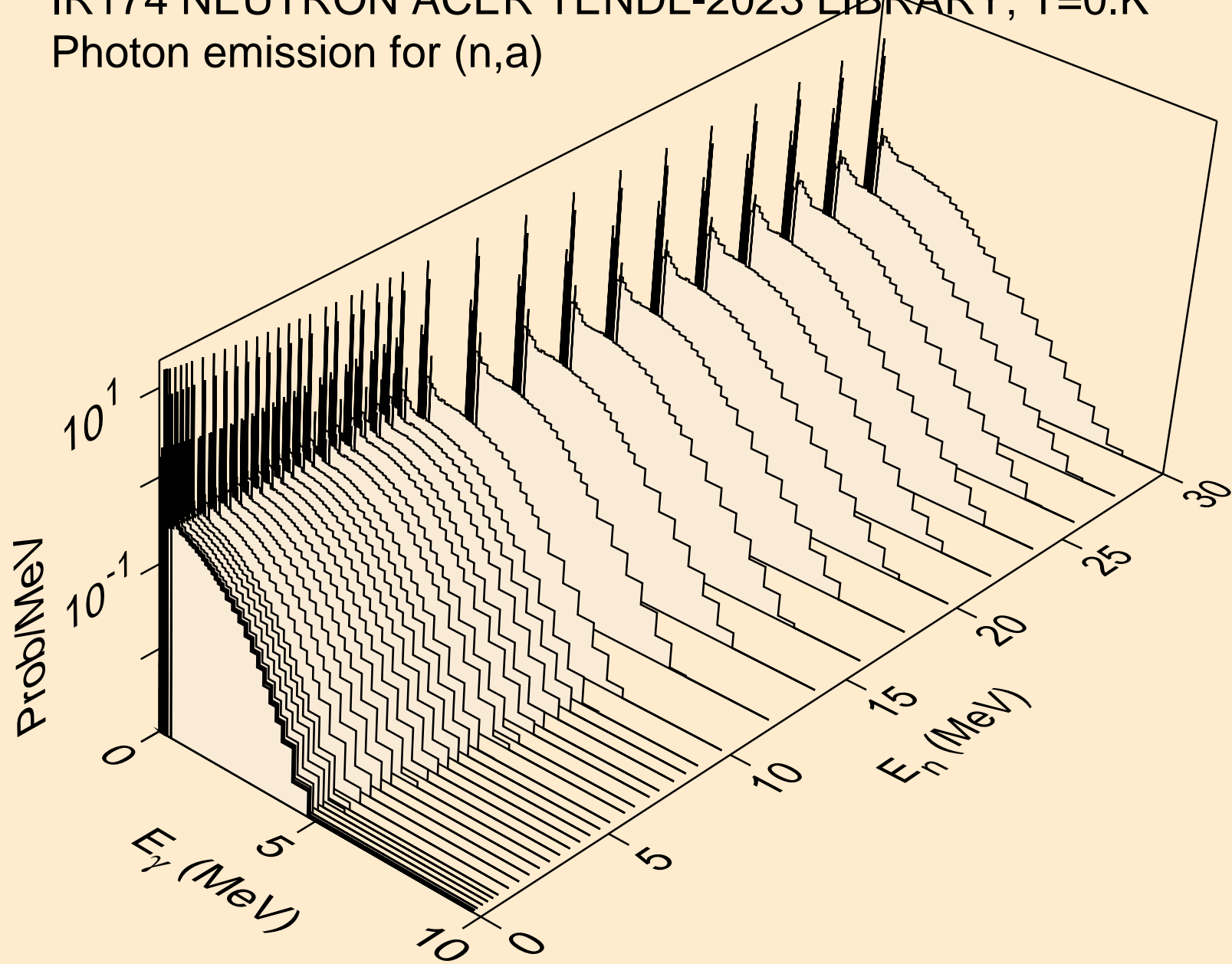

IR174 NEUTRON ACER TENDL-2023 LIBRARY; T=0.K  
Photon emission for (n,2a)

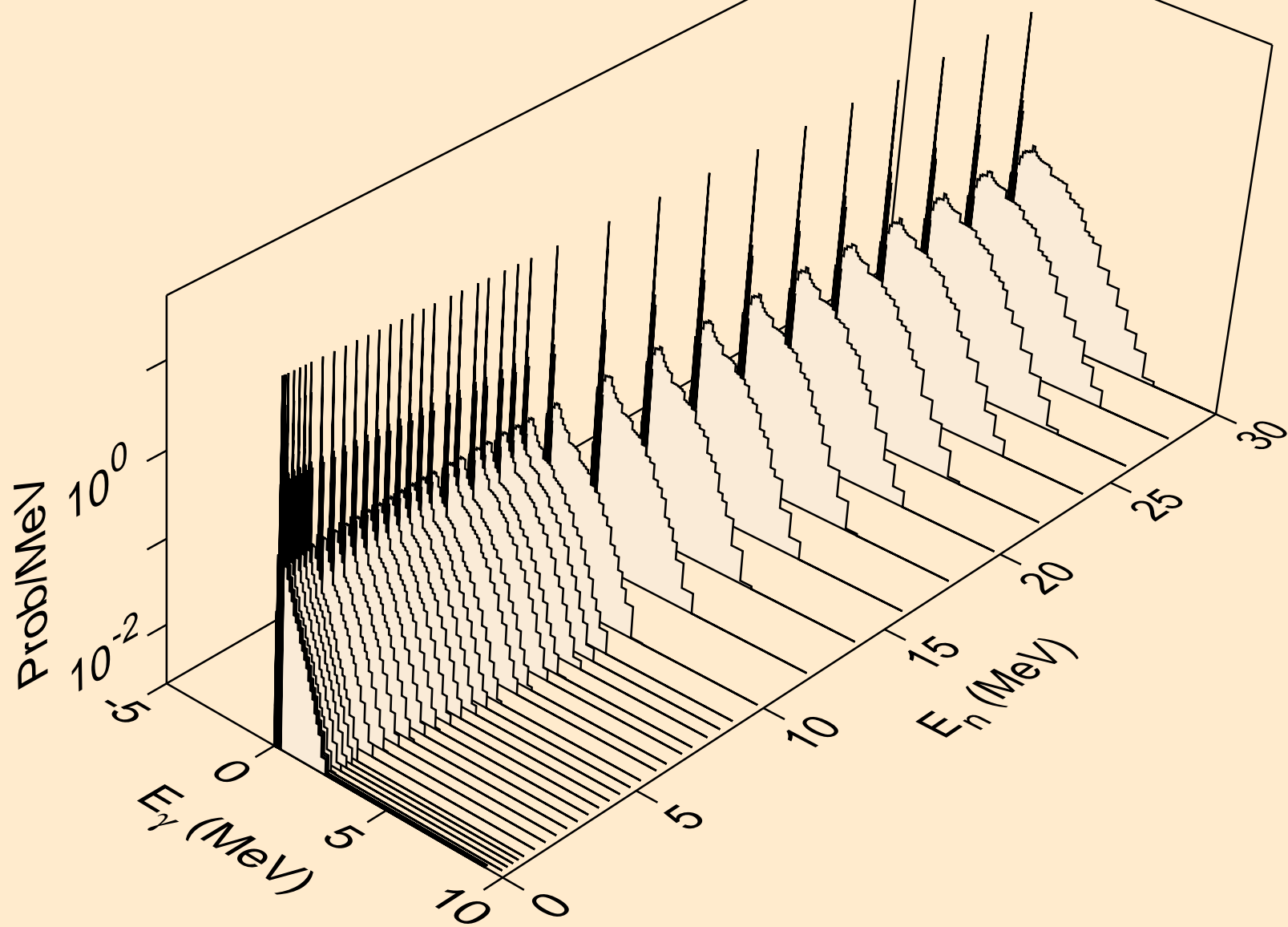

IR174 NEUTRON ACER TENDL-2023 LIBRARY; T=0.K  
Photon emission for (n,3a)

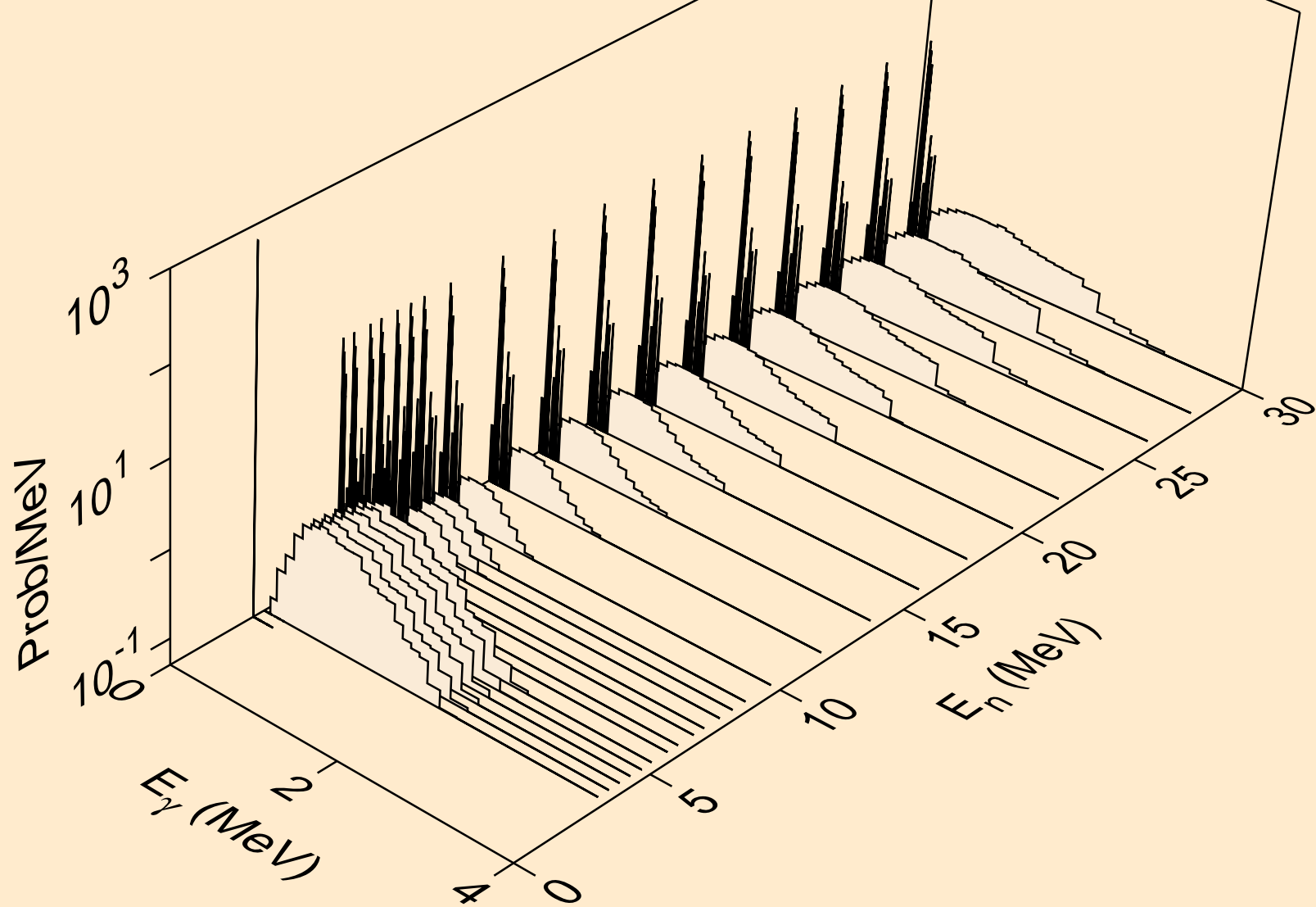

IR174 NEUTRON ACER TENDL-2023 LIBRARY; T=0.K  
Photon emission for (n,2p)

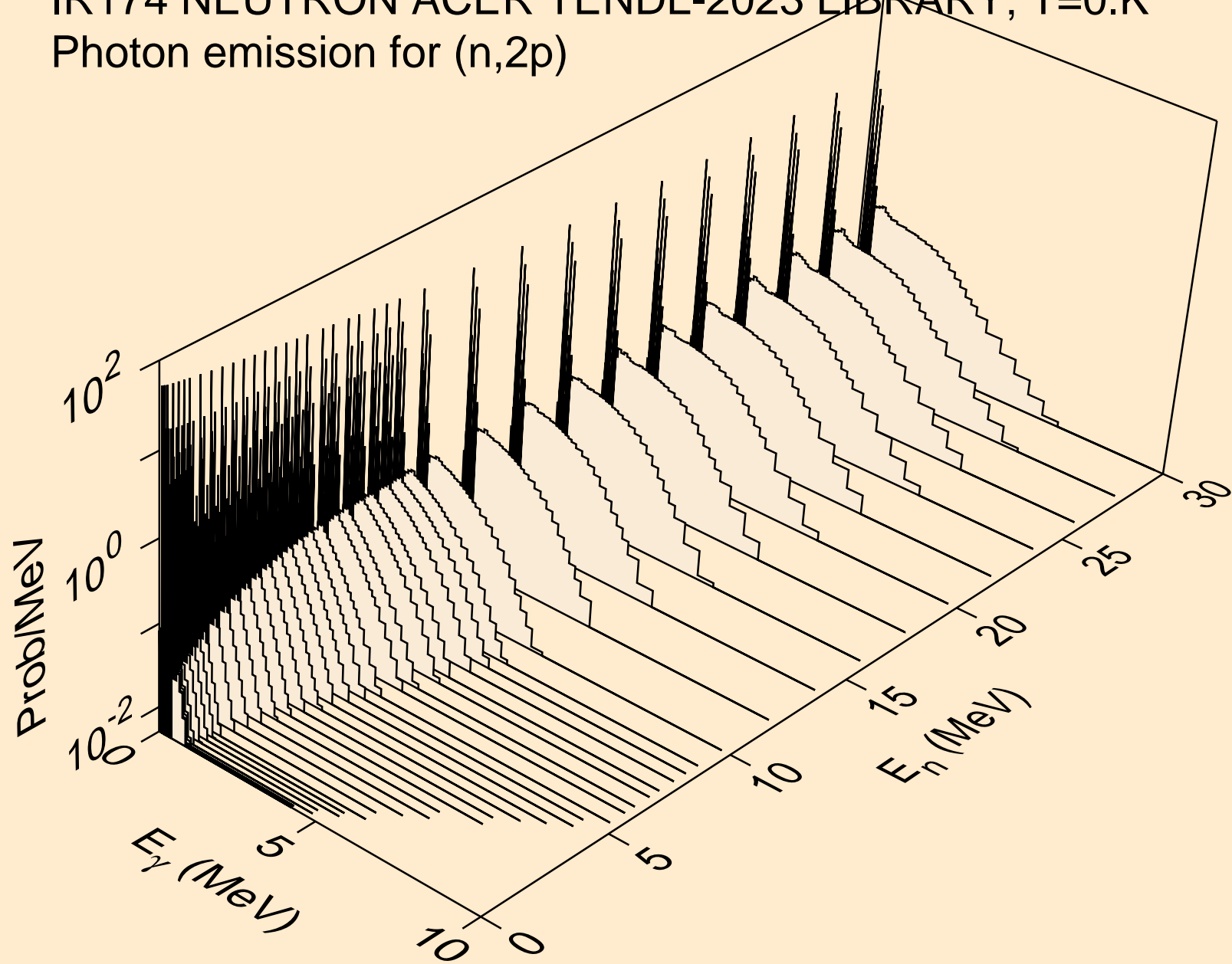

IR174 NEUTRON ACER TENDL-2023 LIBRARY; T=0.K  
Photon emission for (n,p $\alpha$ )

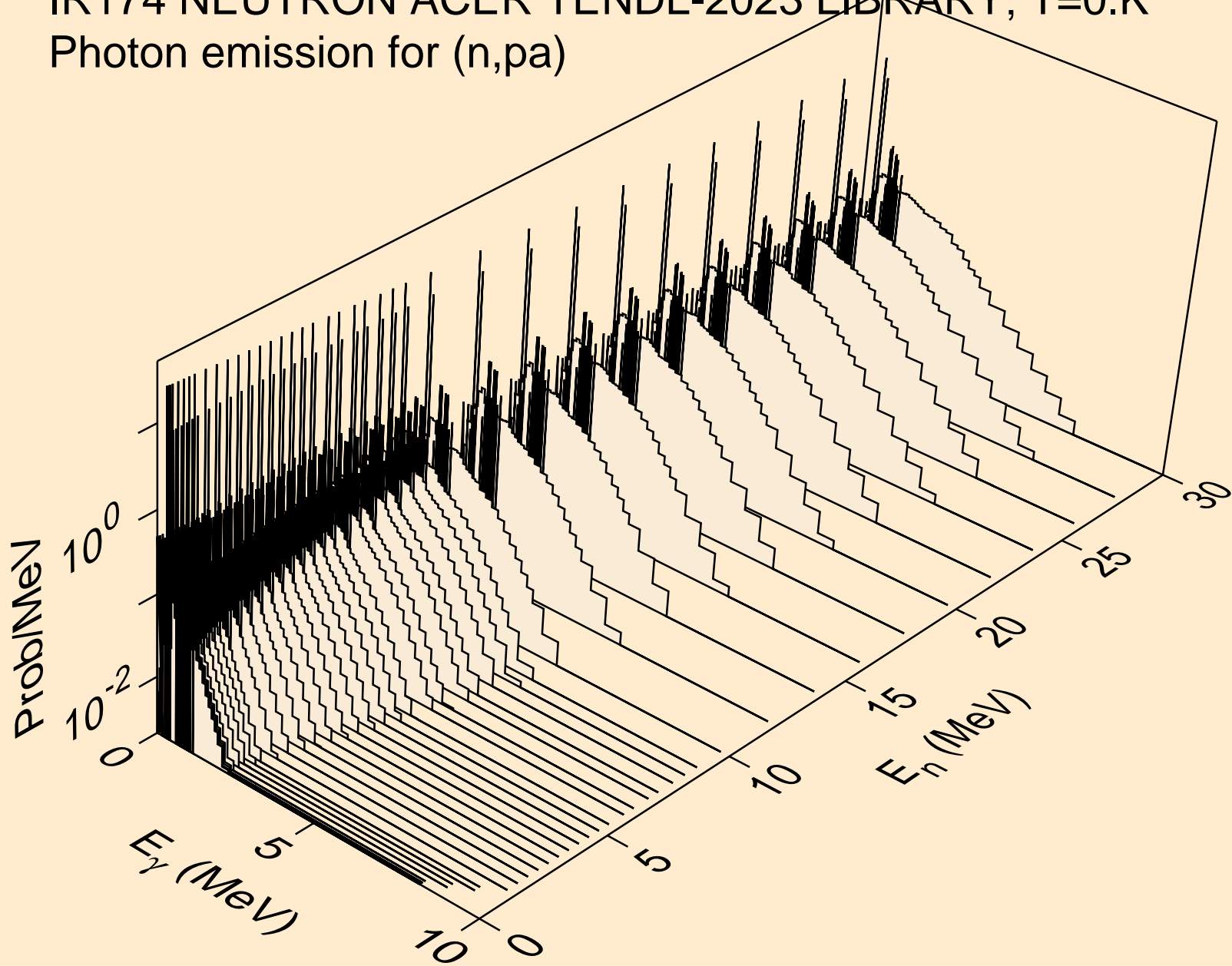

IR174 NEUTRON ACER TENDL-2023 LIBRARY; T=0.K  
Photon emission for (n,t2a)

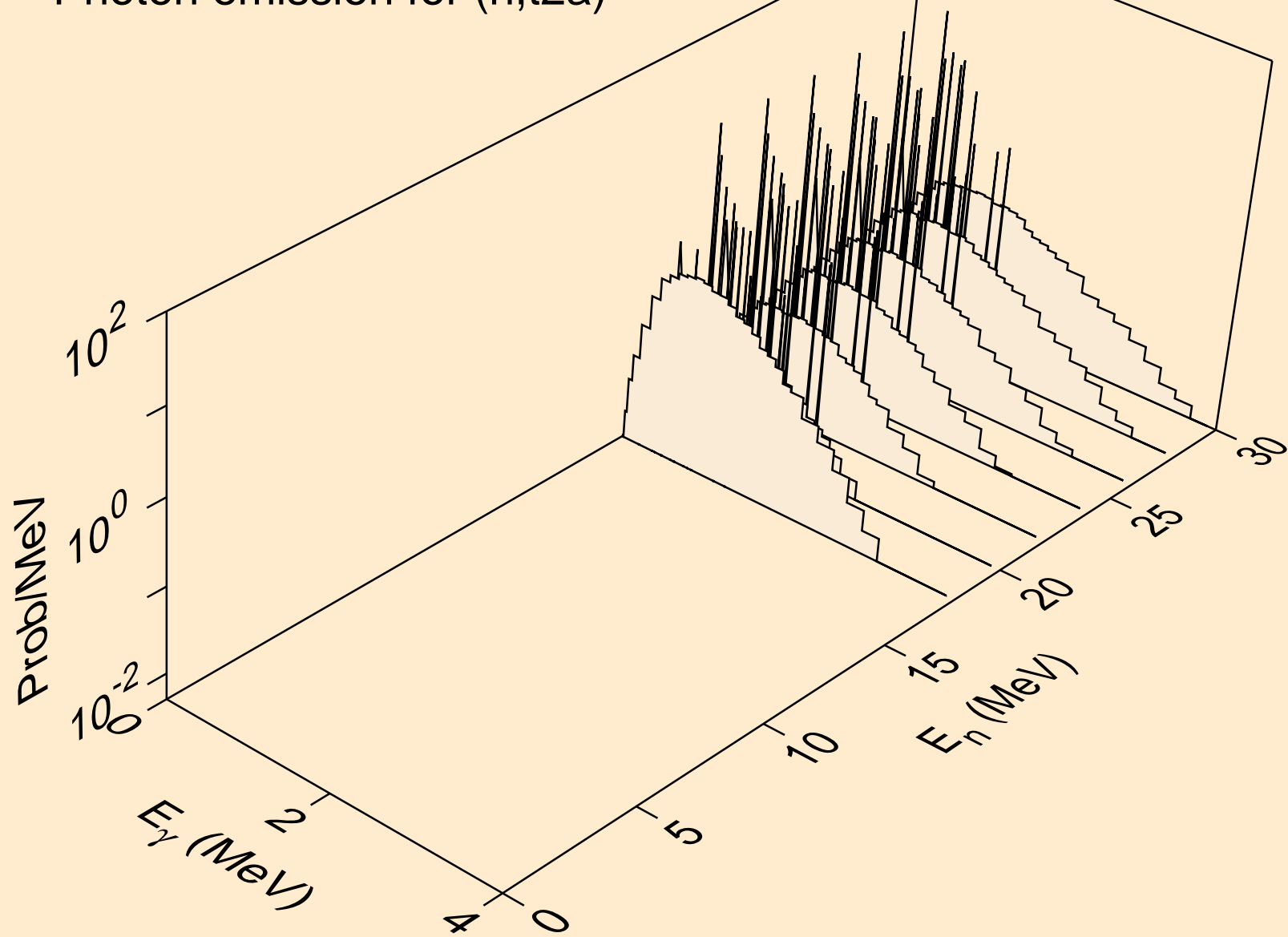

IR174 NEUTRON ACER TENDL-2023 LIBRARY; T=0.K  
Photon emission for (n,d2a)

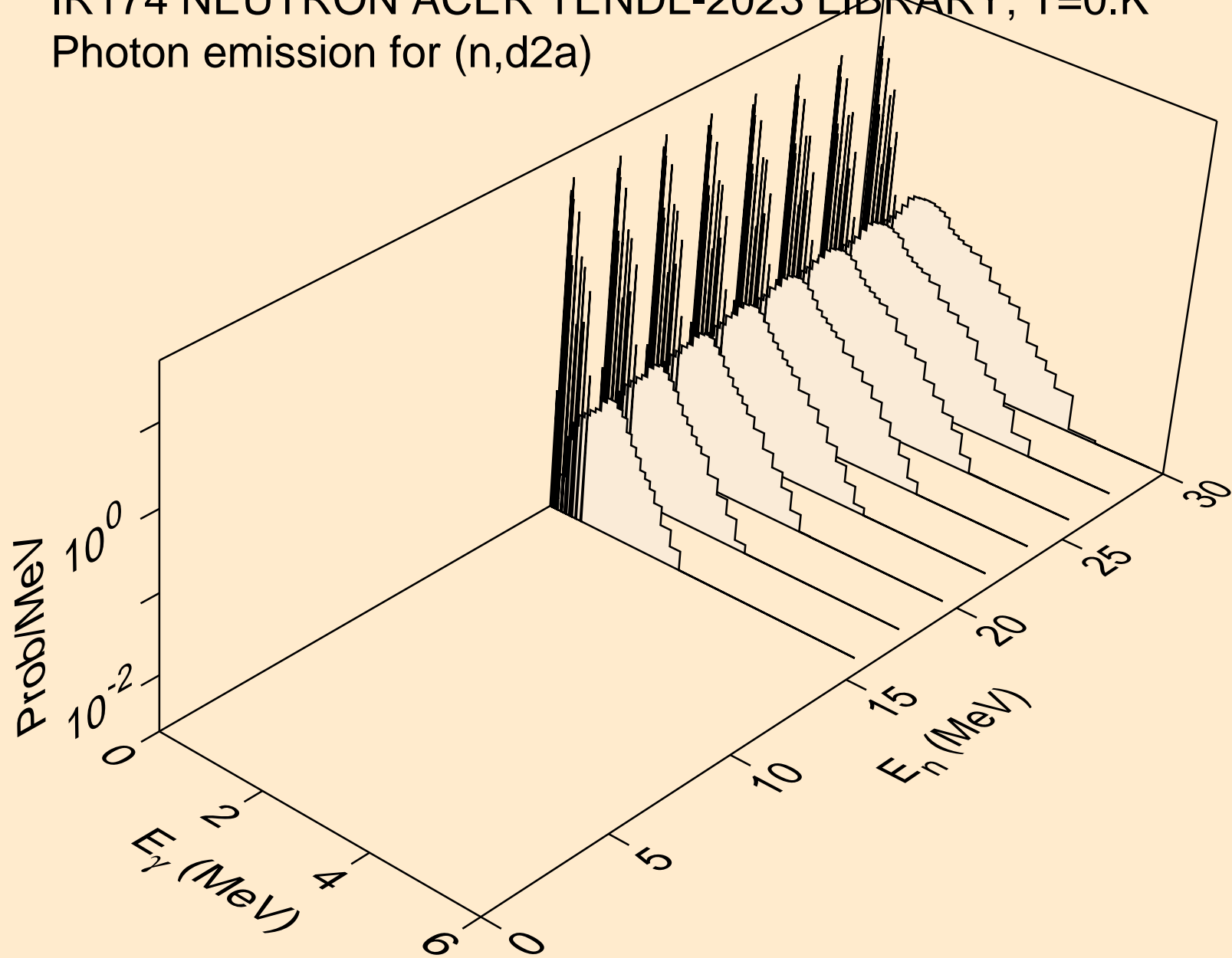

IR174 NEUTRON ACER TENDL-2023 LIBRARY; T=0.K  
Photon emission for (n,pd)

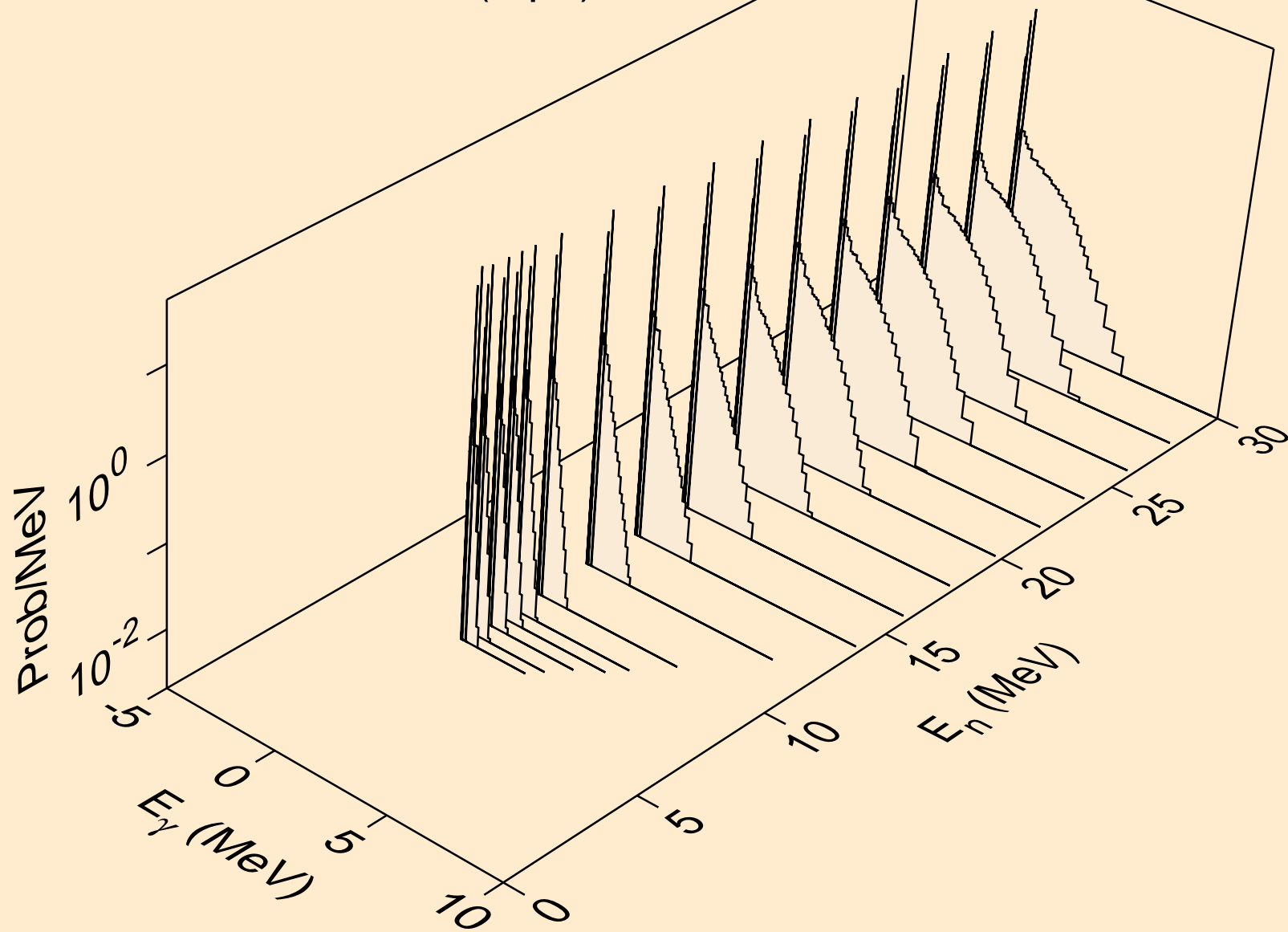

IR174 NEUTRON ACER TENDL-2023 LIBRARY; T=0.K  
Photon emission for (n,pt)

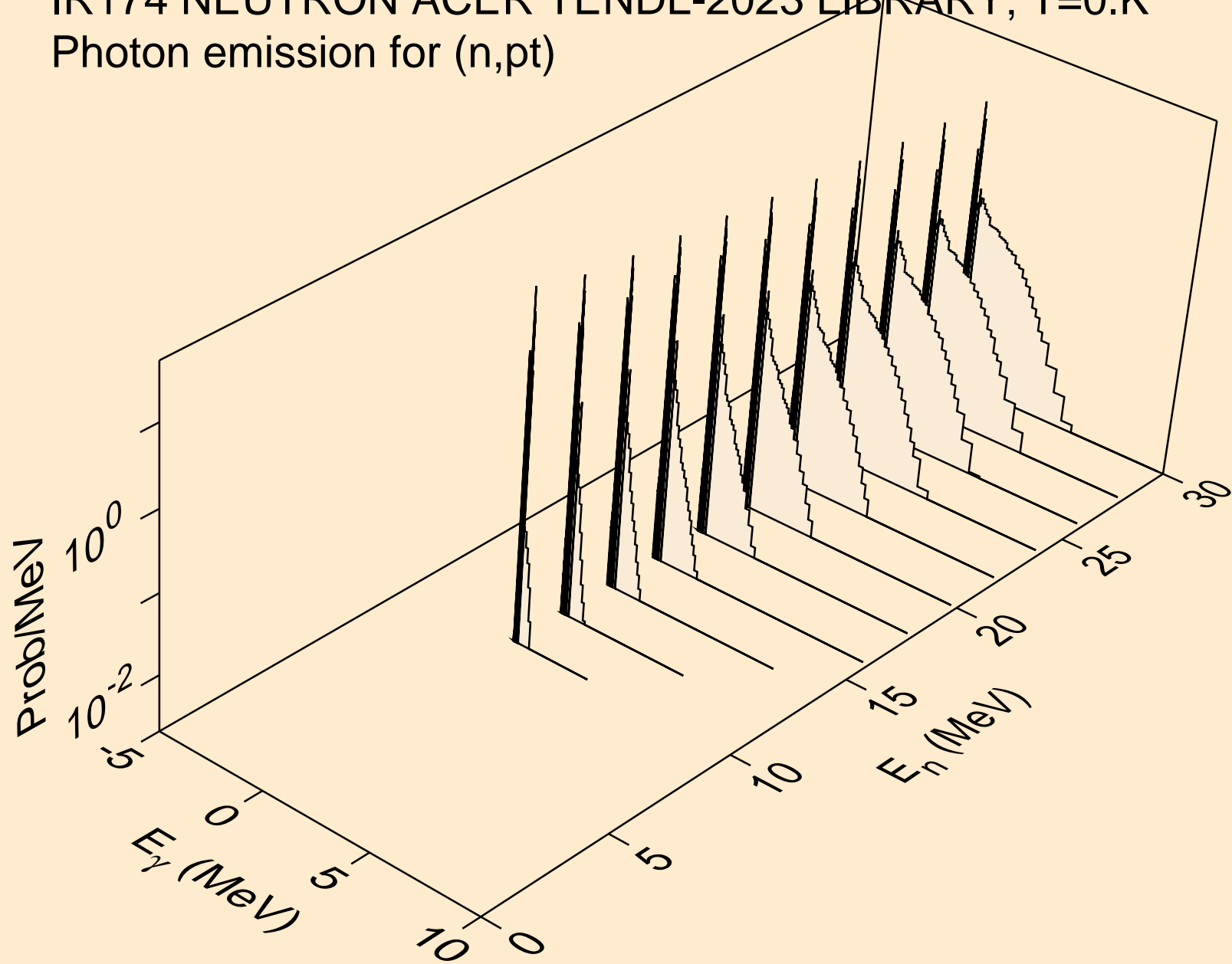

IR174 NEUTRON ACER TENDL-2023 LIBRARY; T=0.K  
Photon emission for (n,da)

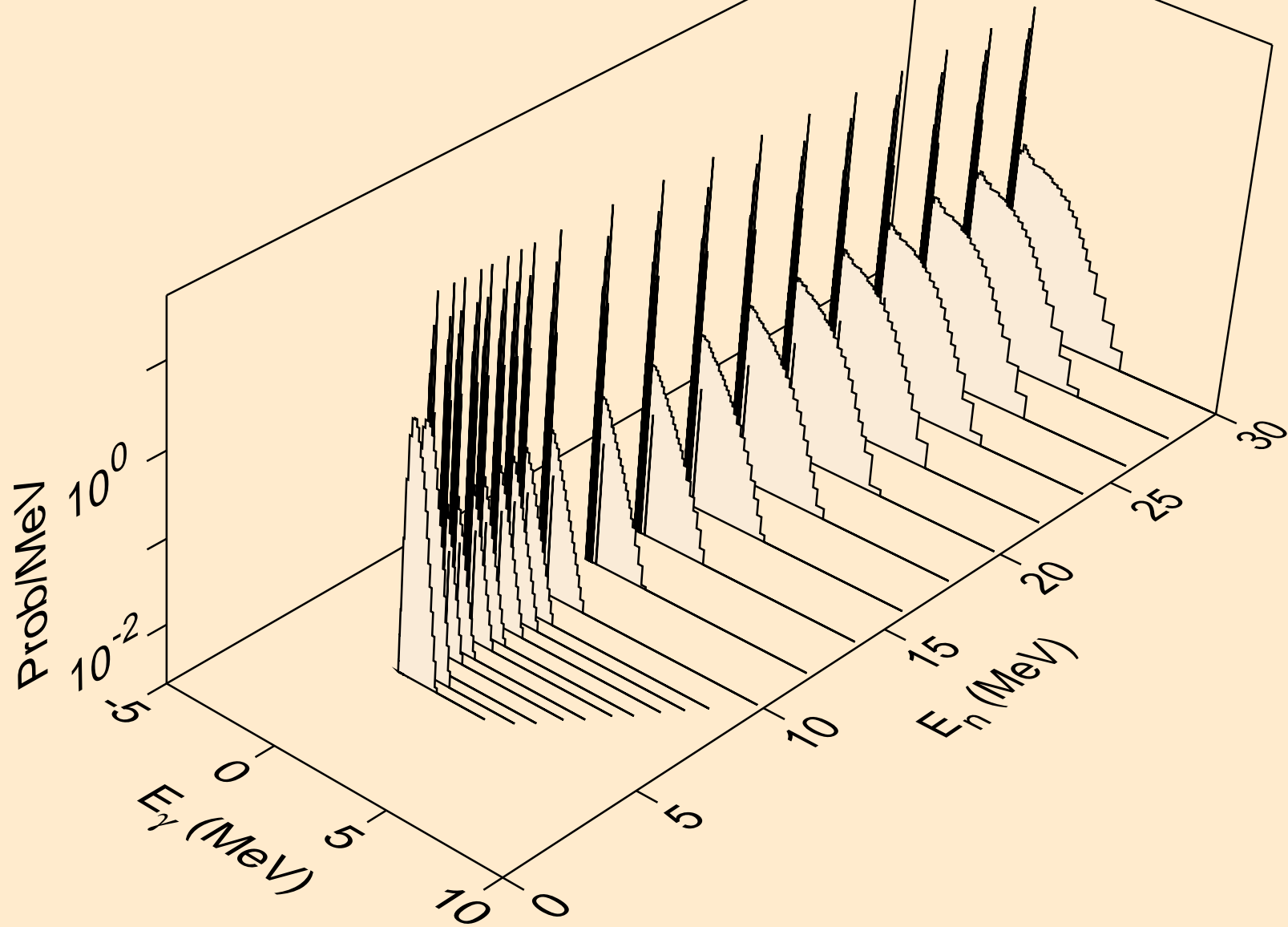

IR174 NEUTRON ACER TENDL-2023 LIBRARY; T=0.K  
thermal capture photon spectrum

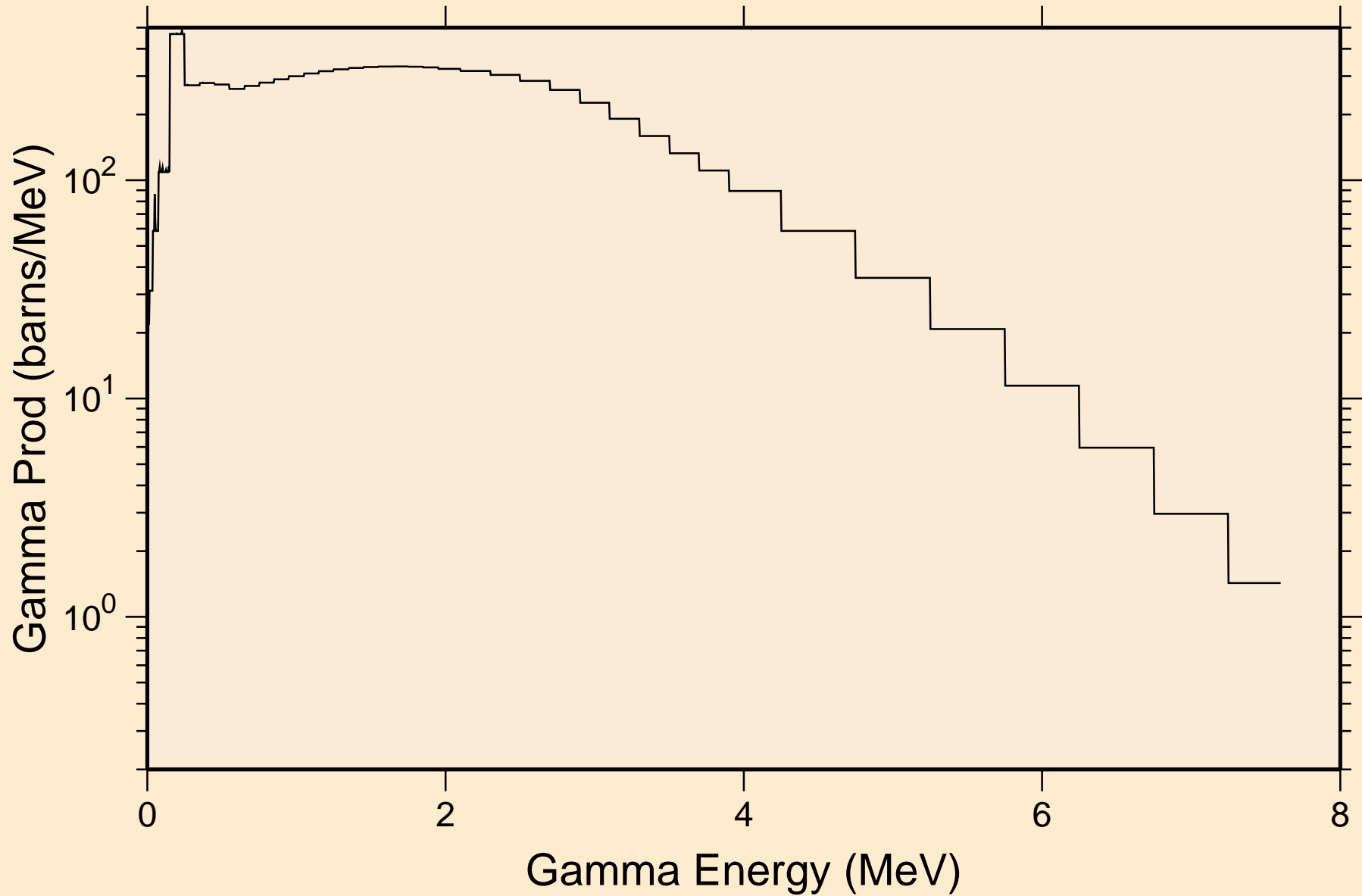

IR174 NEUTRON ACER TENDL-2023 LIBRARY; T=0.K  
14 MeV photon spectrum

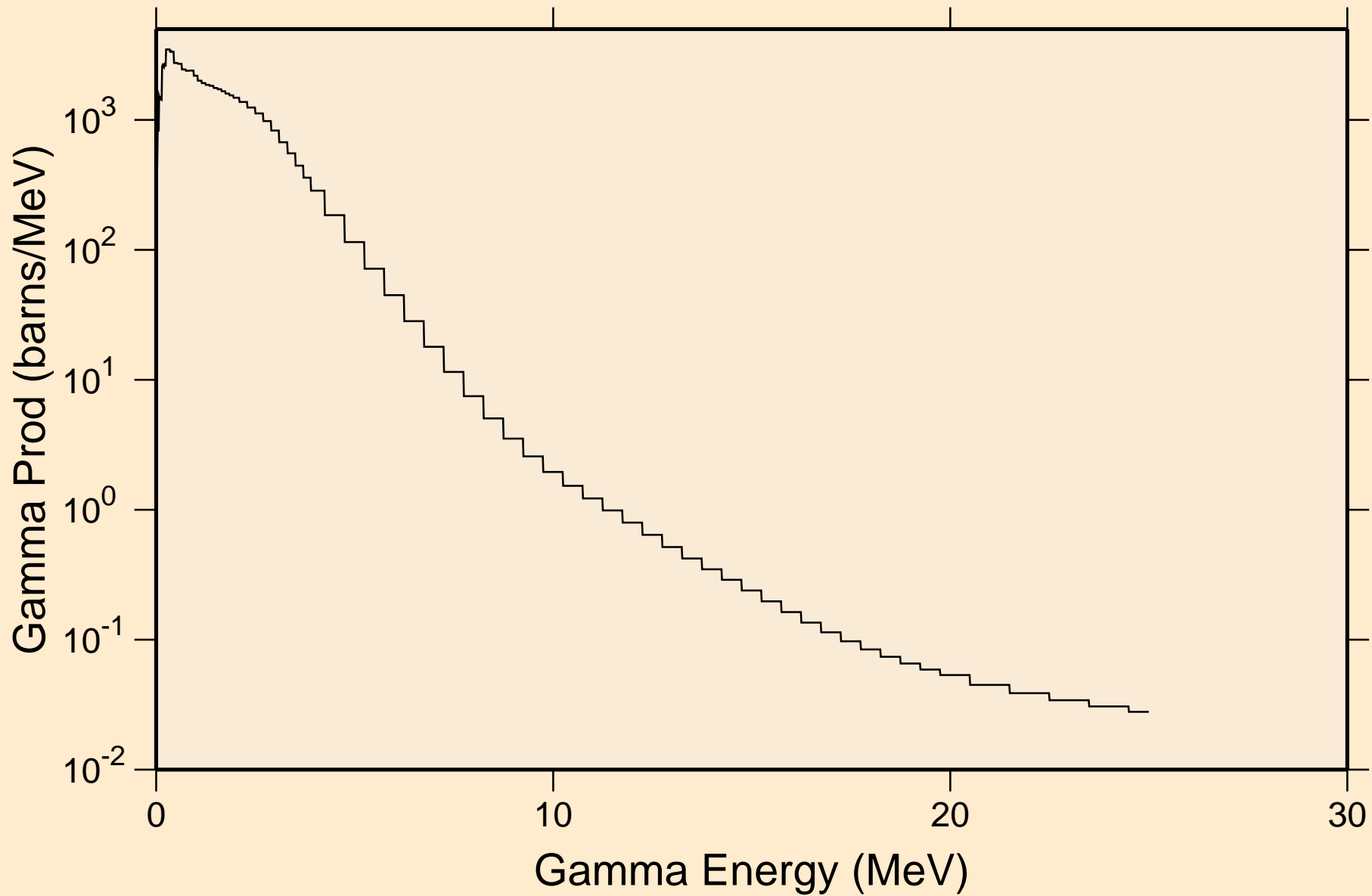

IR174 NEUTRON ACER TENDL-2023 LIBRARY; T=0.K  
Particle heating contributions

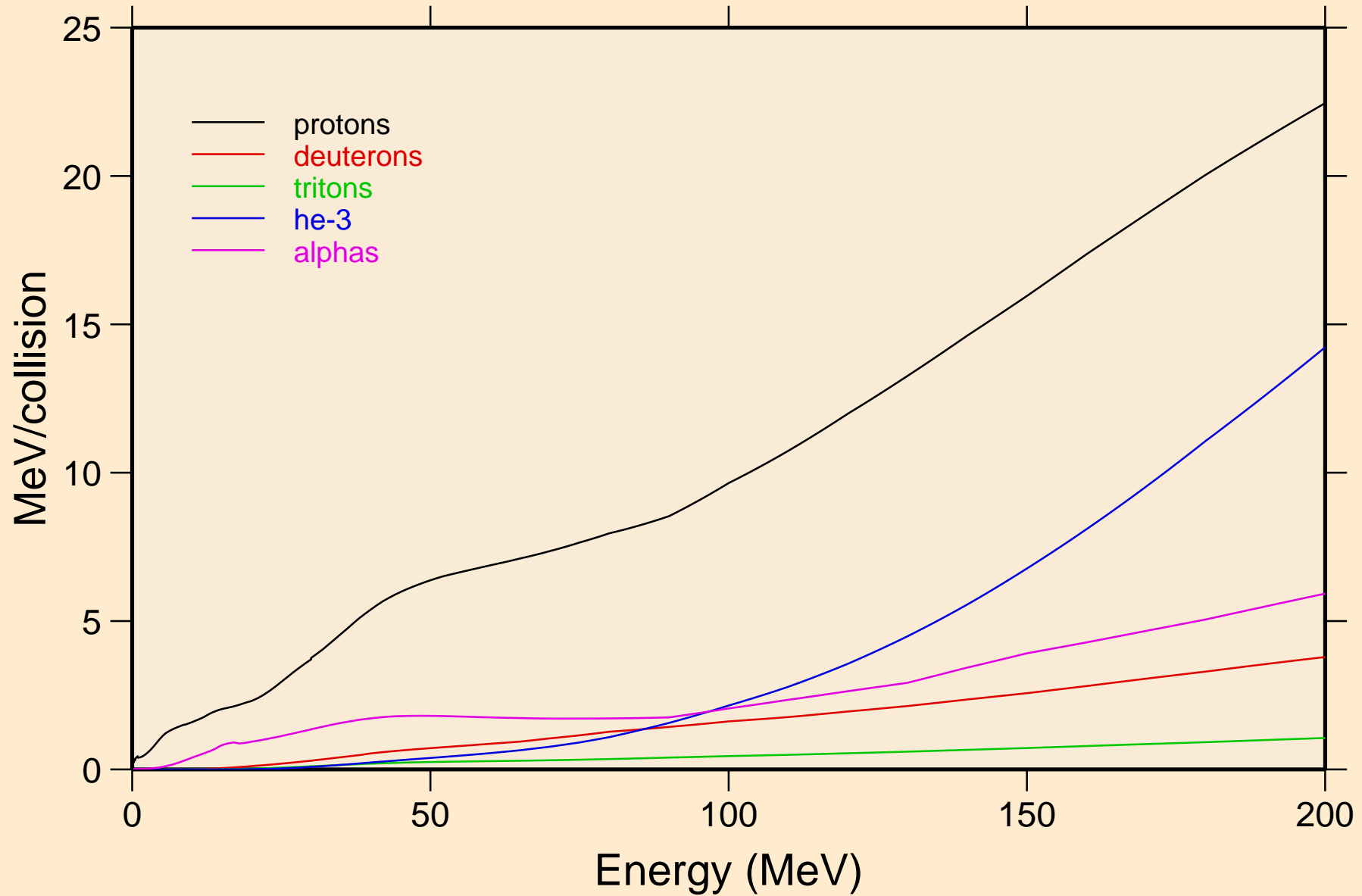

IR174 NEUTRON ACER TENDL-2023 LIBRARY; T=0.K  
Recoil Heating

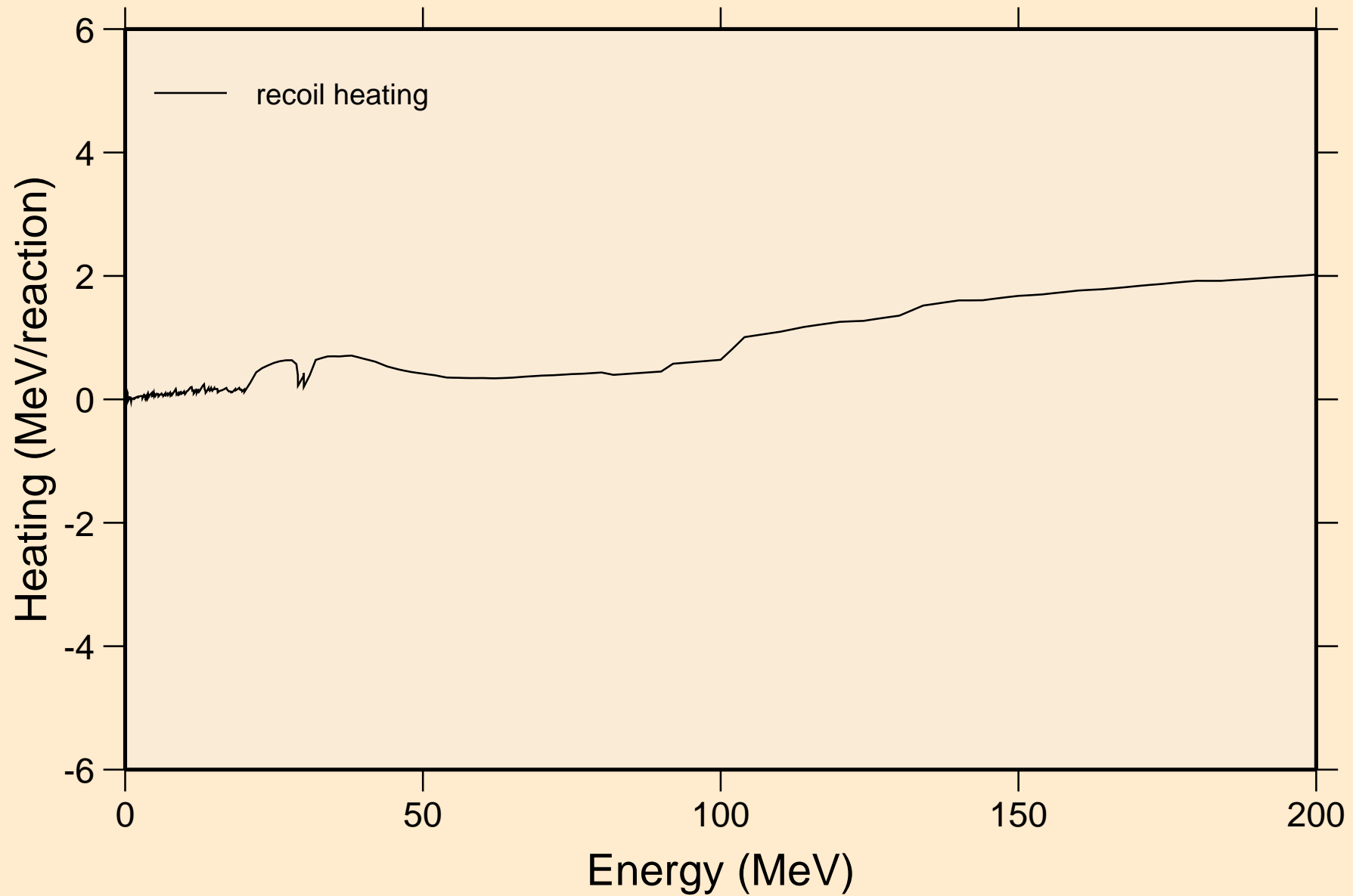

# IR174 NEUTRON ACER TENDL-2023 LIBRARY; T=0.K

## Particle production cross sections

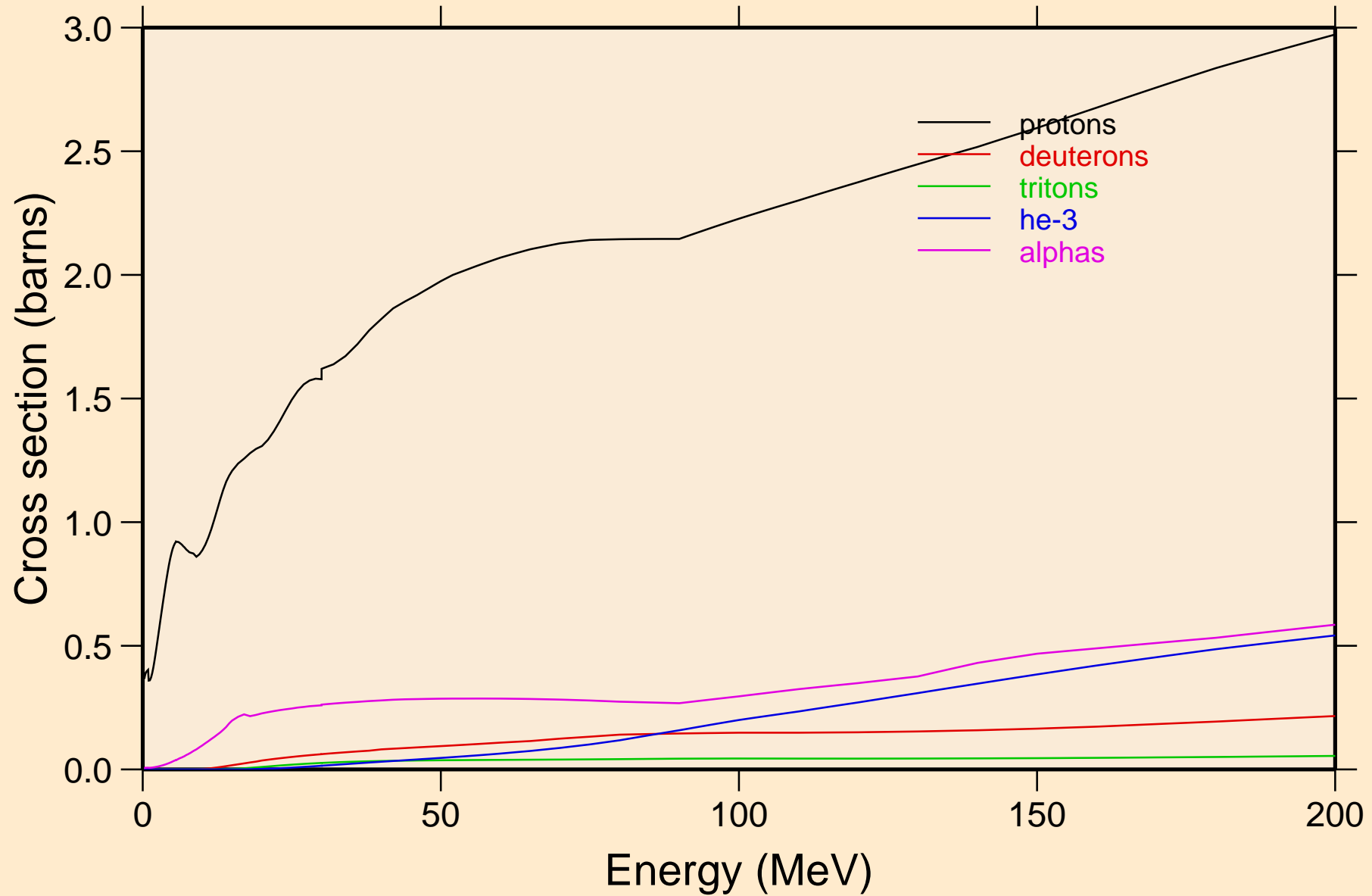

IR174 NEUTRON ACER TENDL-2023 LIBRARY; T=0.K  
protons from (n,x)

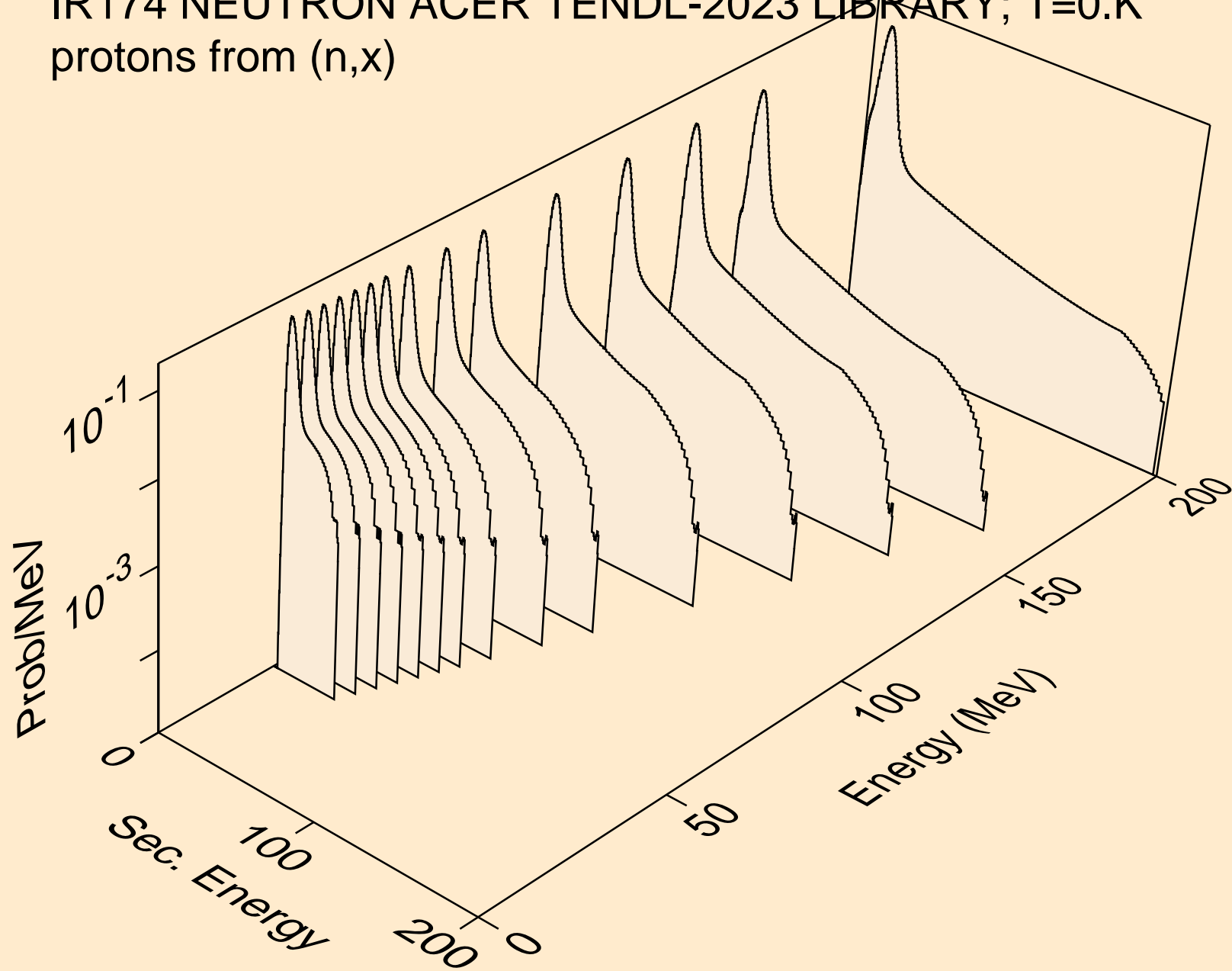

IR174 NEUTRON ACER TENDL-2023 LIBRARY; T=0.K  
protons from (n,n\*)p

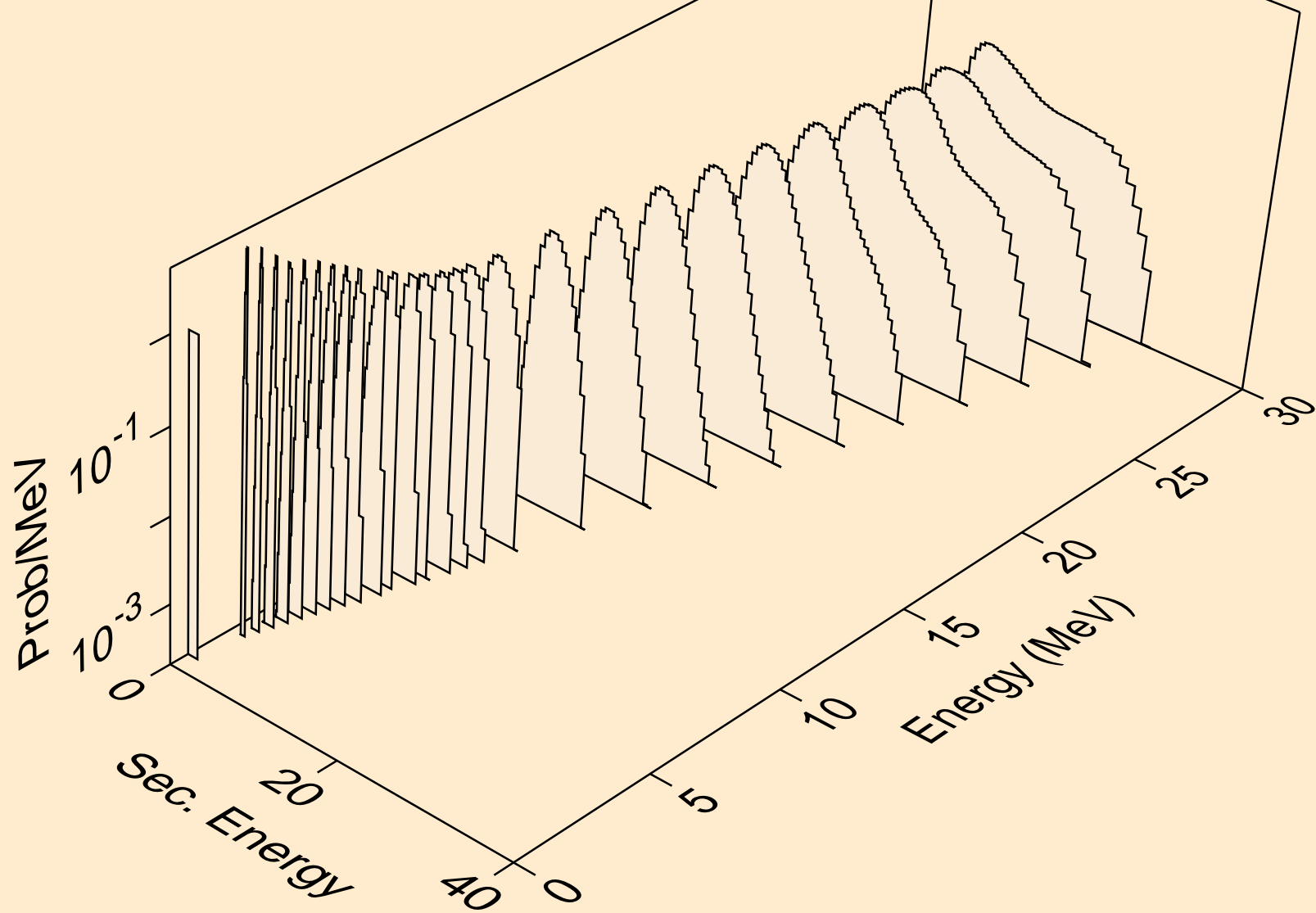

IR174 NEUTRON ACER TENDL-2023 LIBRARY; T=0.K  
protons from (n,2np)

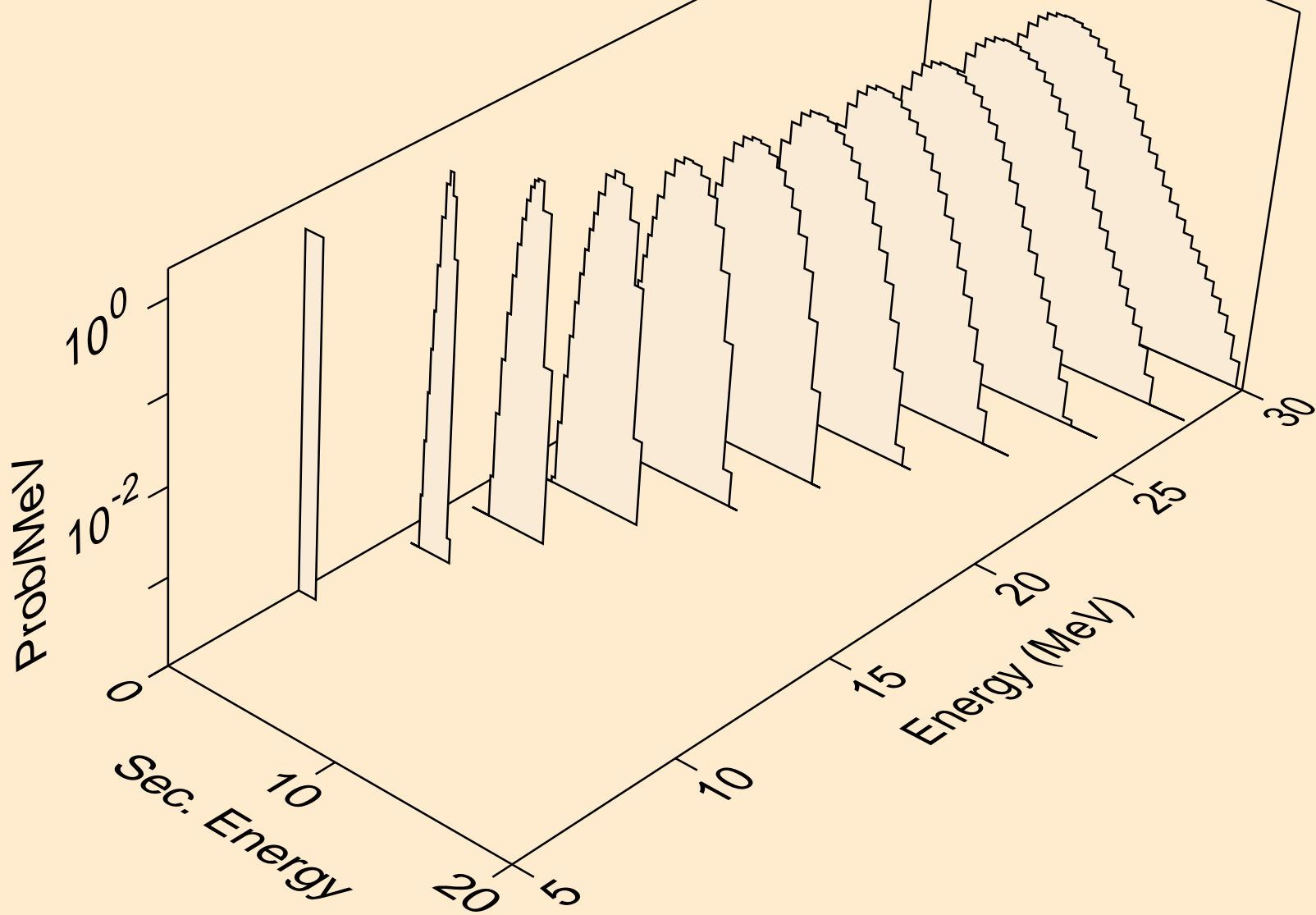

IR174 NEUTRON ACER TENDL-2023 LIBRARY; T=0.K  
protons from (n,3np)

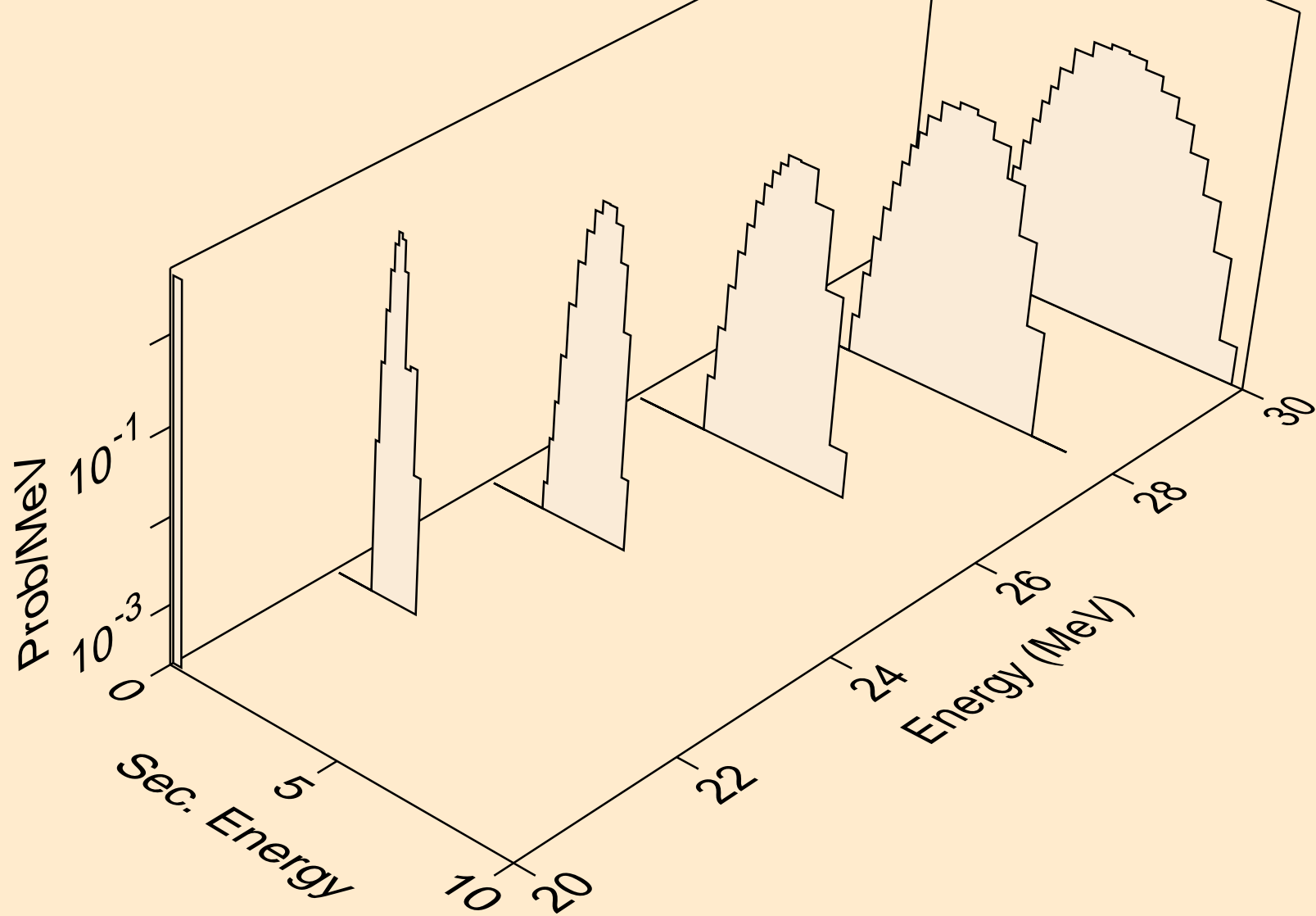

IR174 NEUTRON ACER TENDL-2023 LIBRARY; T=0.K  
protons from (n,n2p)

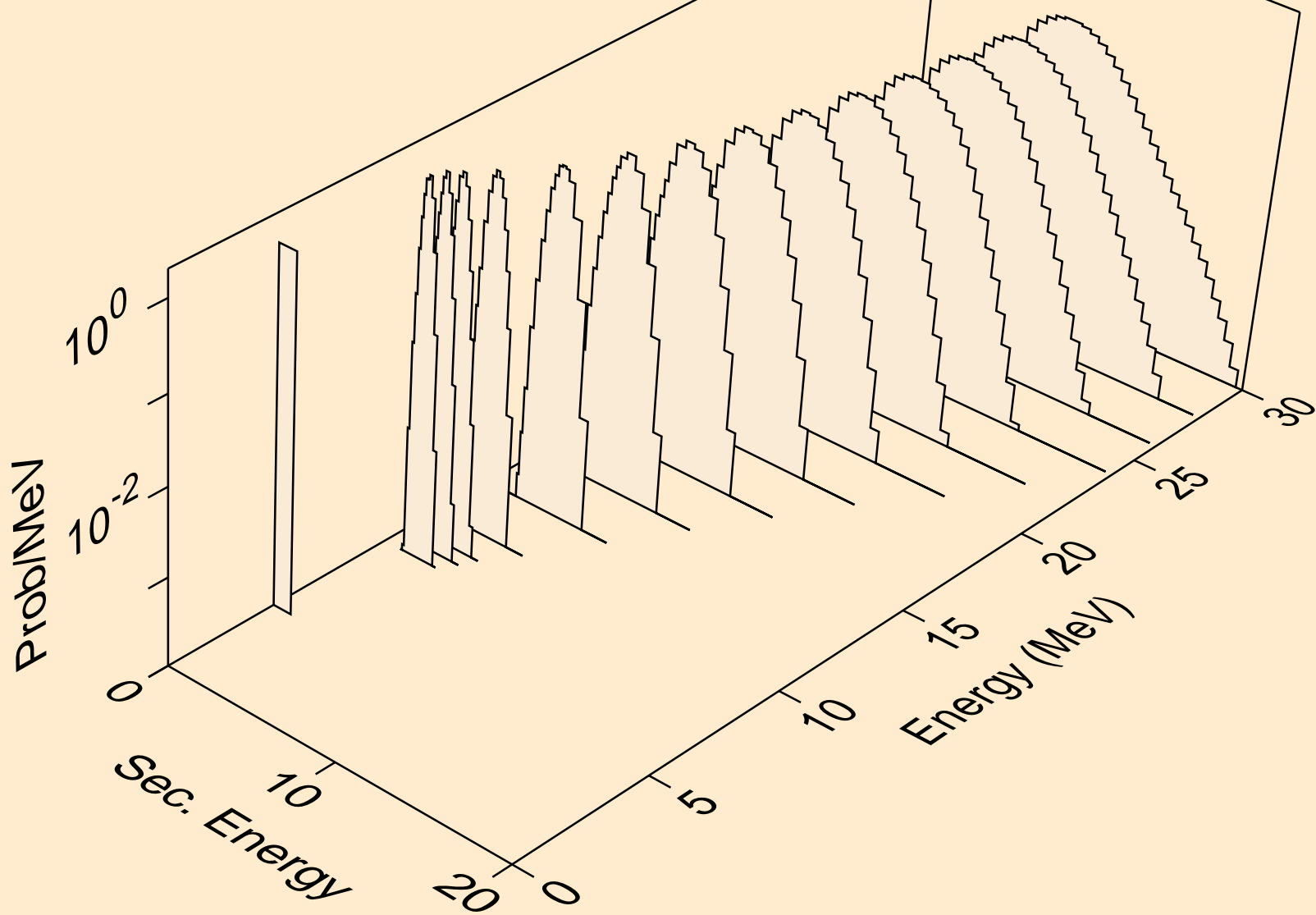

IR174 NEUTRON ACER TENDL-2023 LIBRARY; T=0.K  
protons from (n,npa)

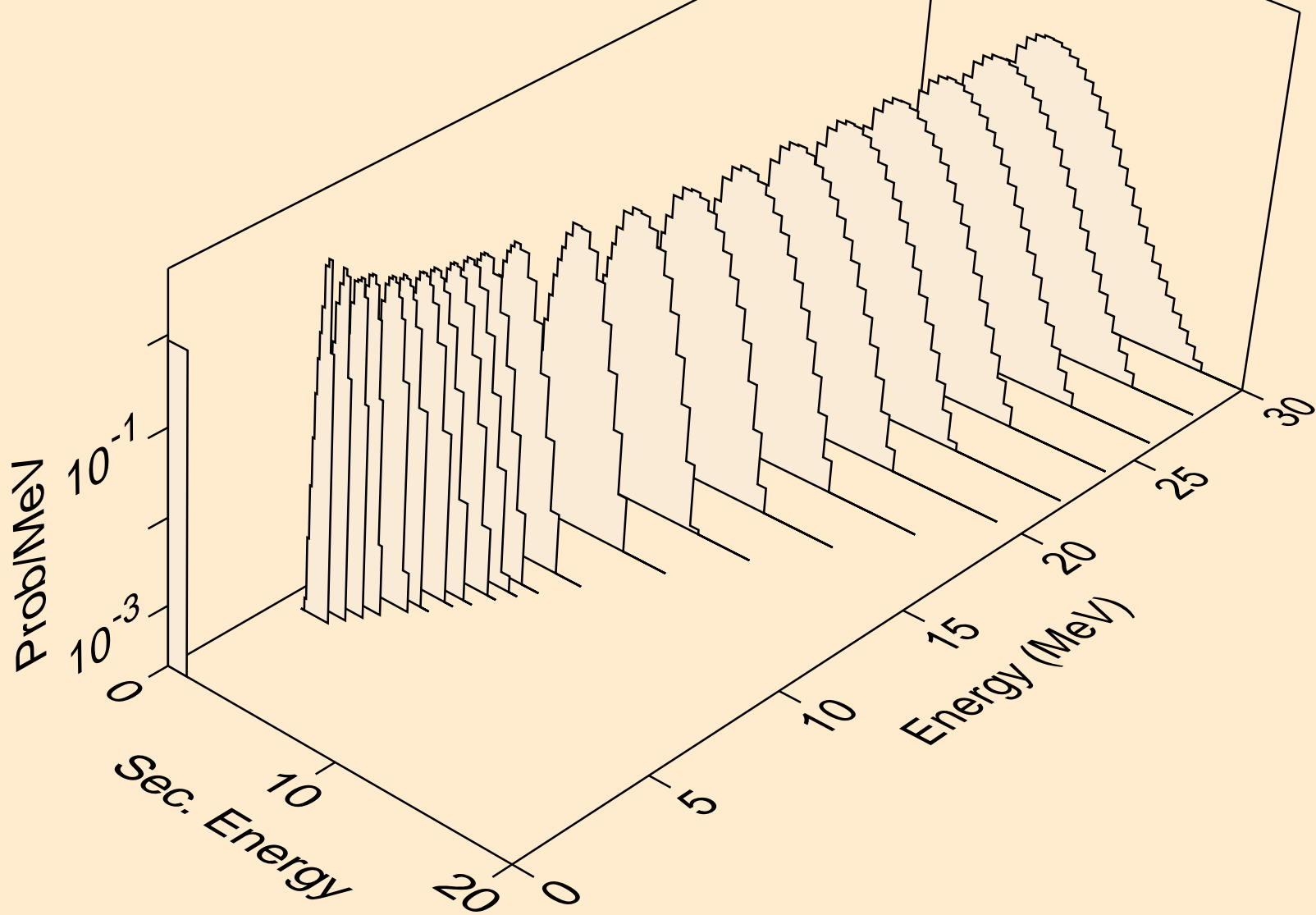

IR174 NEUTRON ACER TENDL-2023 LIBRARY; T=0.K  
protons from (n,p)

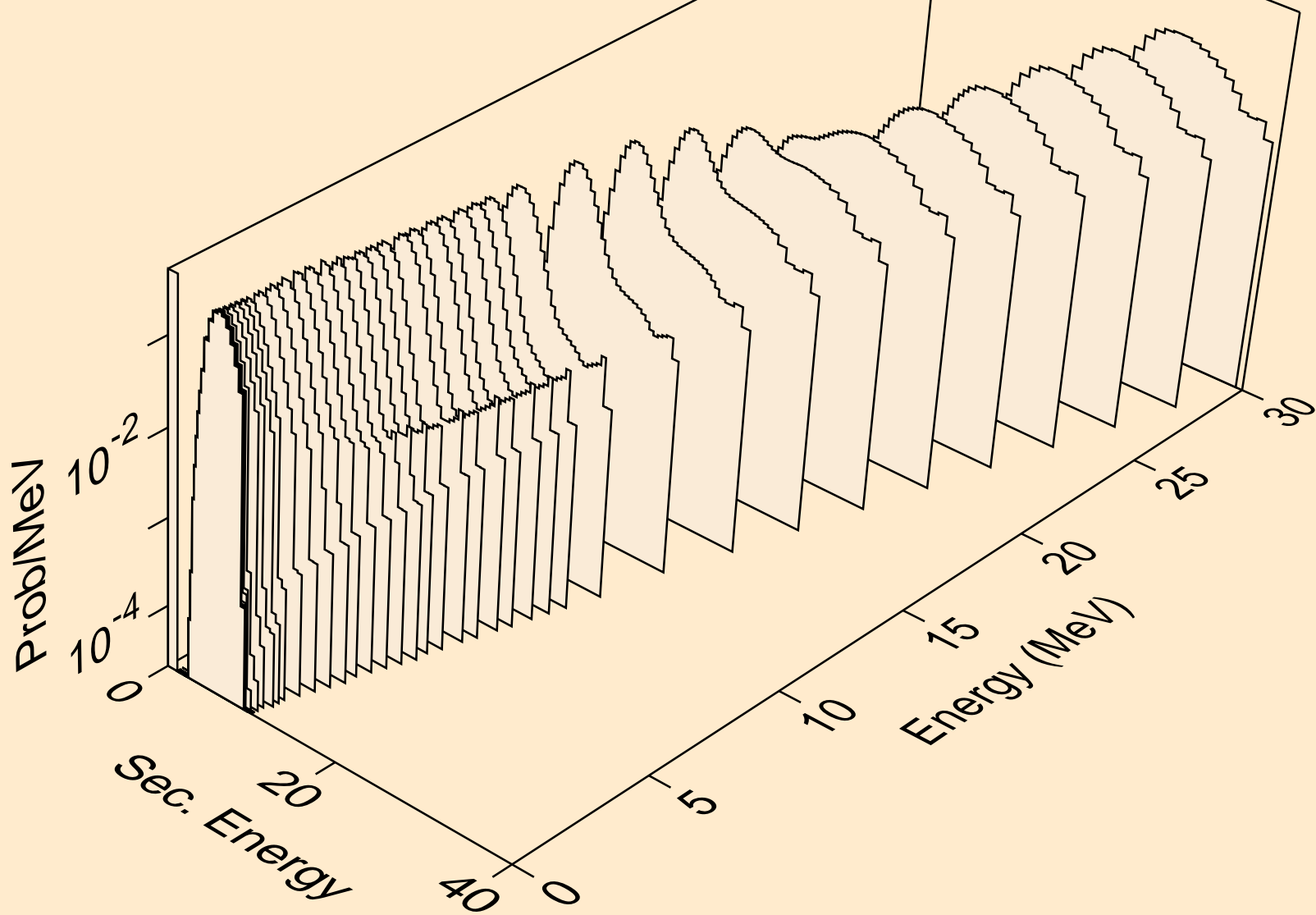

IR174 NEUTRON ACER TENDL-2023 LIBRARY; T=0.K  
protons from (n,2p)

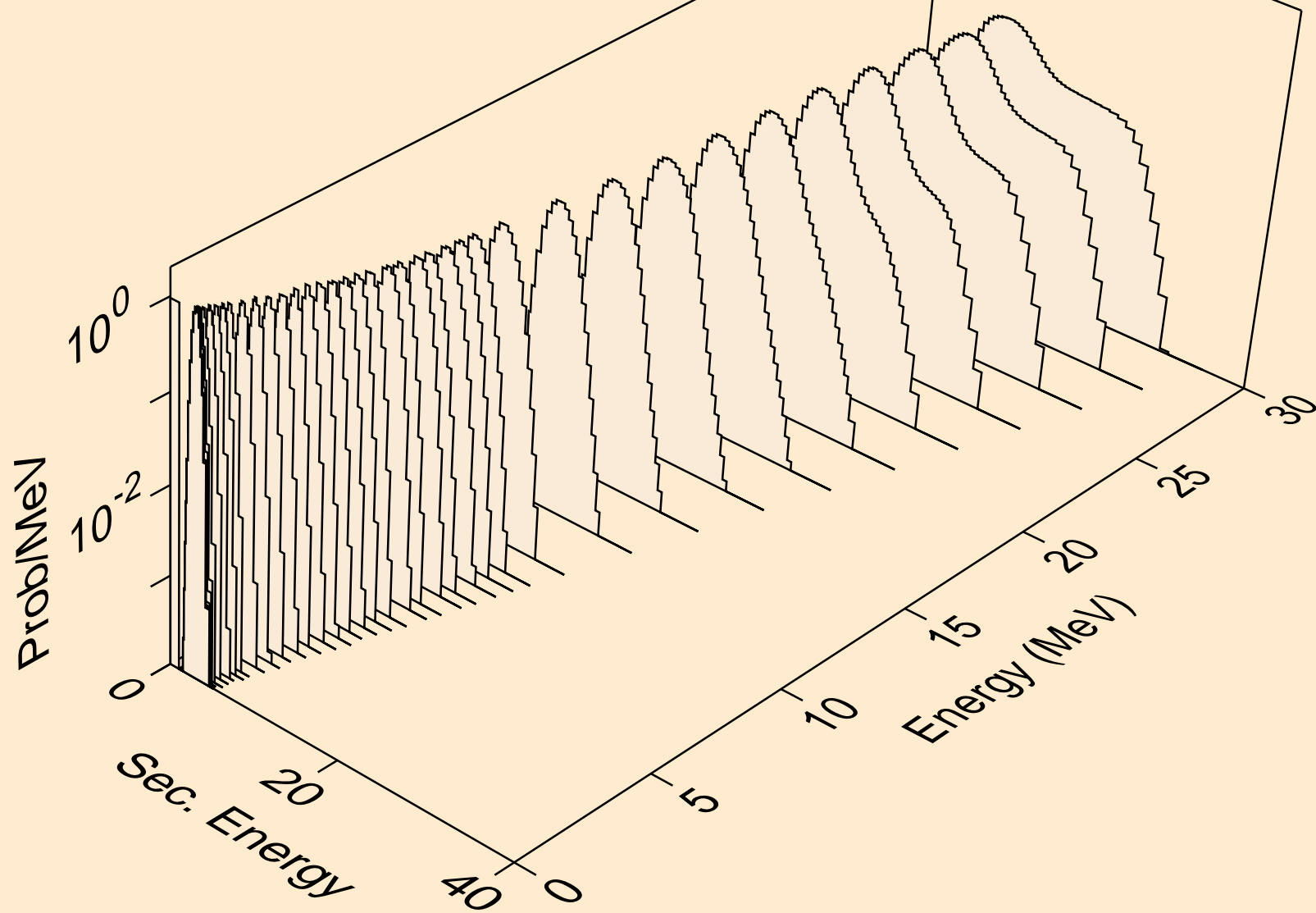

IR174 NEUTRON ACER TENDL-2023 LIBRARY; T=0.K  
protons from (n,p)

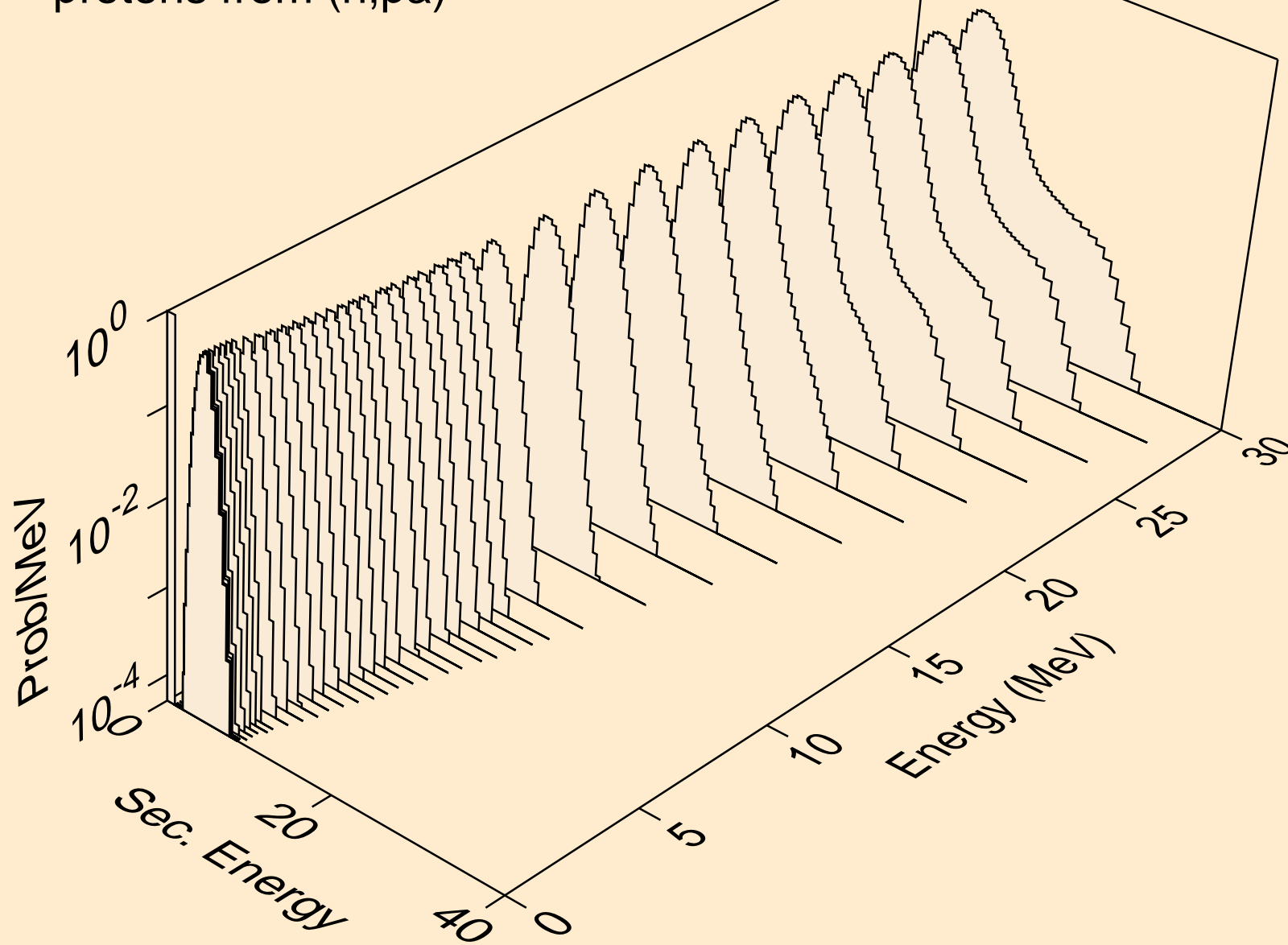

IR174 NEUTRON ACER TENDL-2023 LIBRARY; T=0.K  
protons from (n,pd)

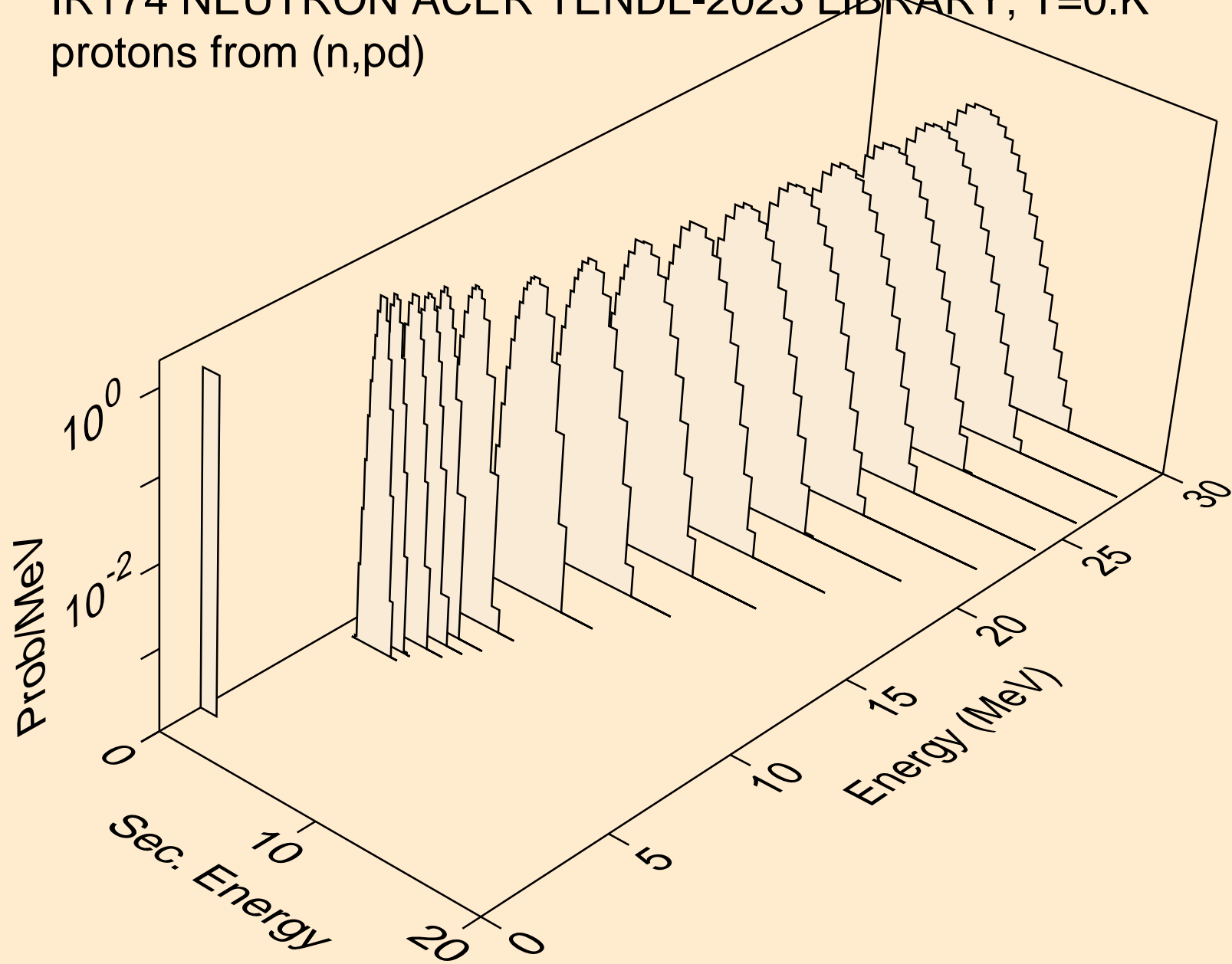

IR174 NEUTRON ACER TENDL-2023 LIBRARY; T=0.K  
protons from (n,pt)

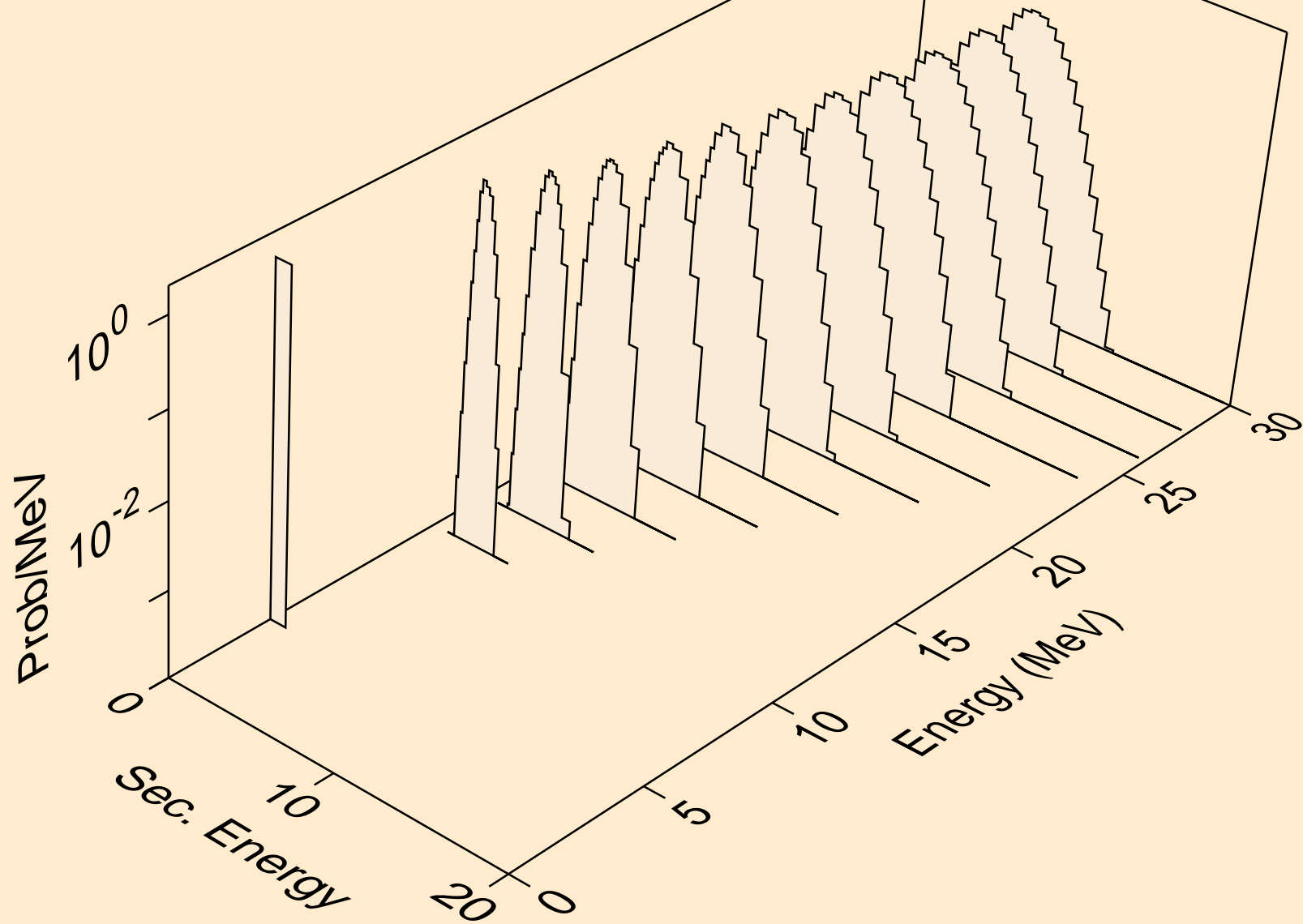

IR174 NEUTRON ACER TENDL-2023 LIBRARY; T=0.K  
deuterons from (n,x)

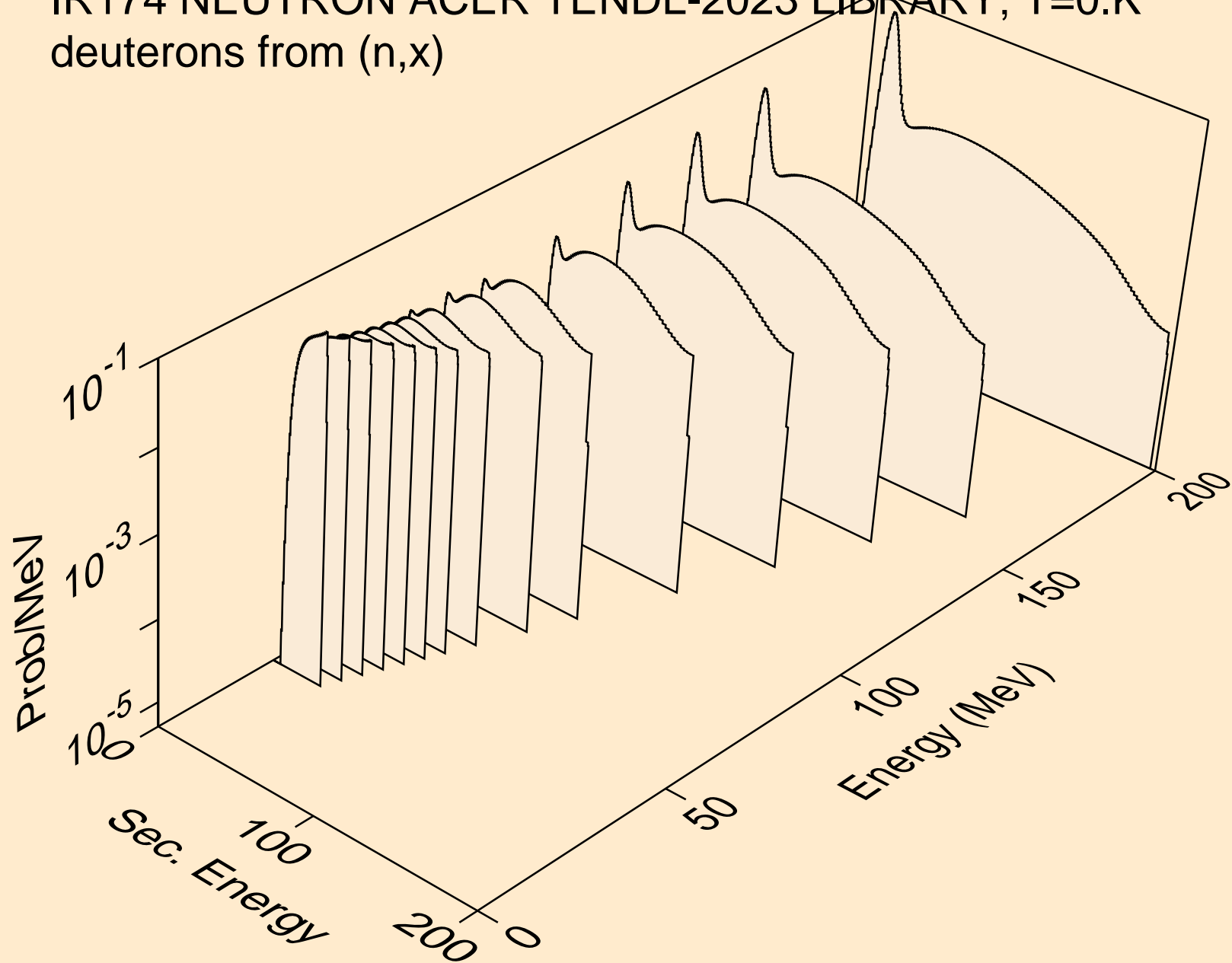

IR174 NEUTRON ACER TENDL-2023 LIBRARY; T=0.K  
deuterons from (n,2nd)

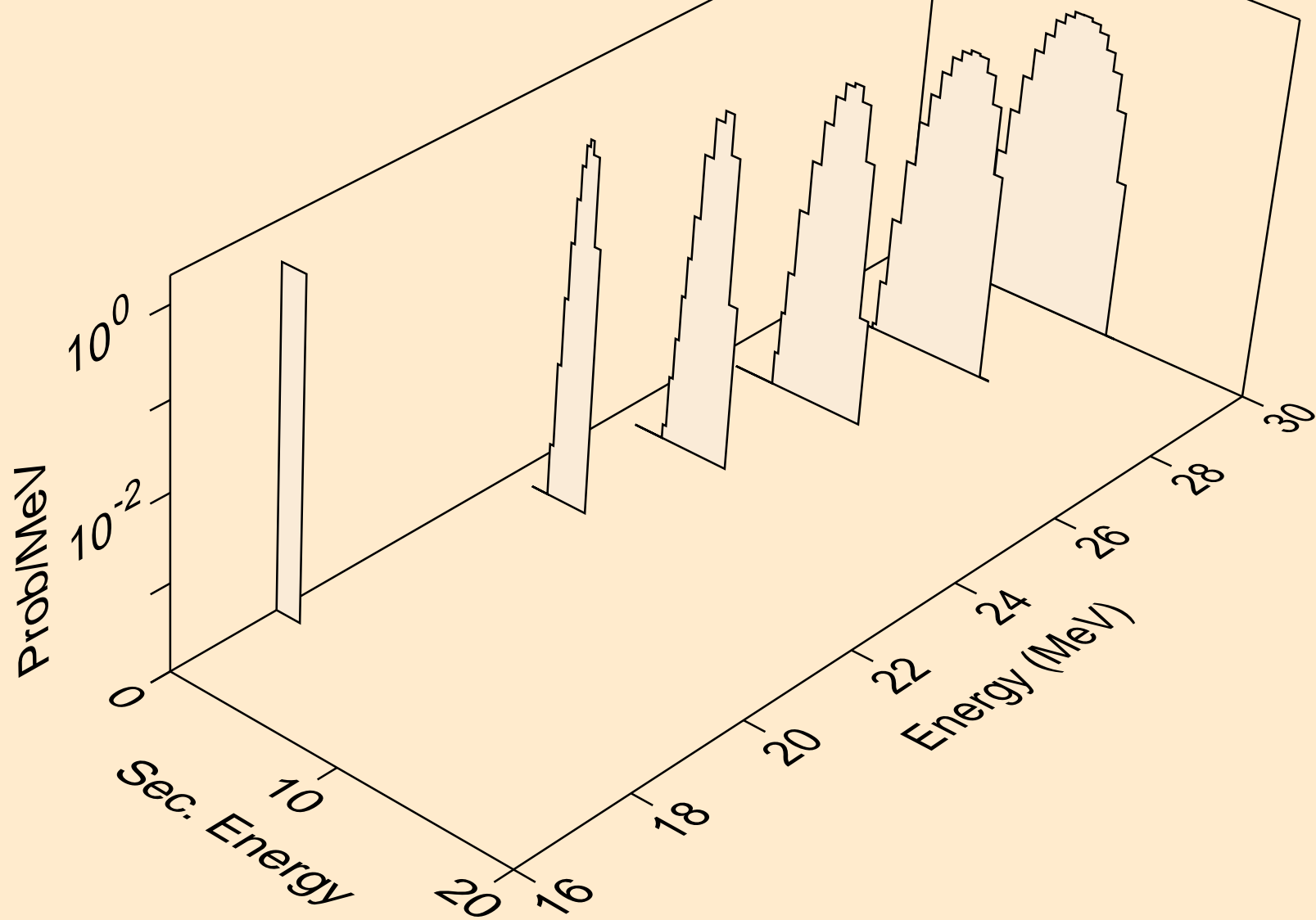

IR174 NEUTRON ACER TENDL-2023 LIBRARY; T=0.K  
deuterons from (n,n\*)d

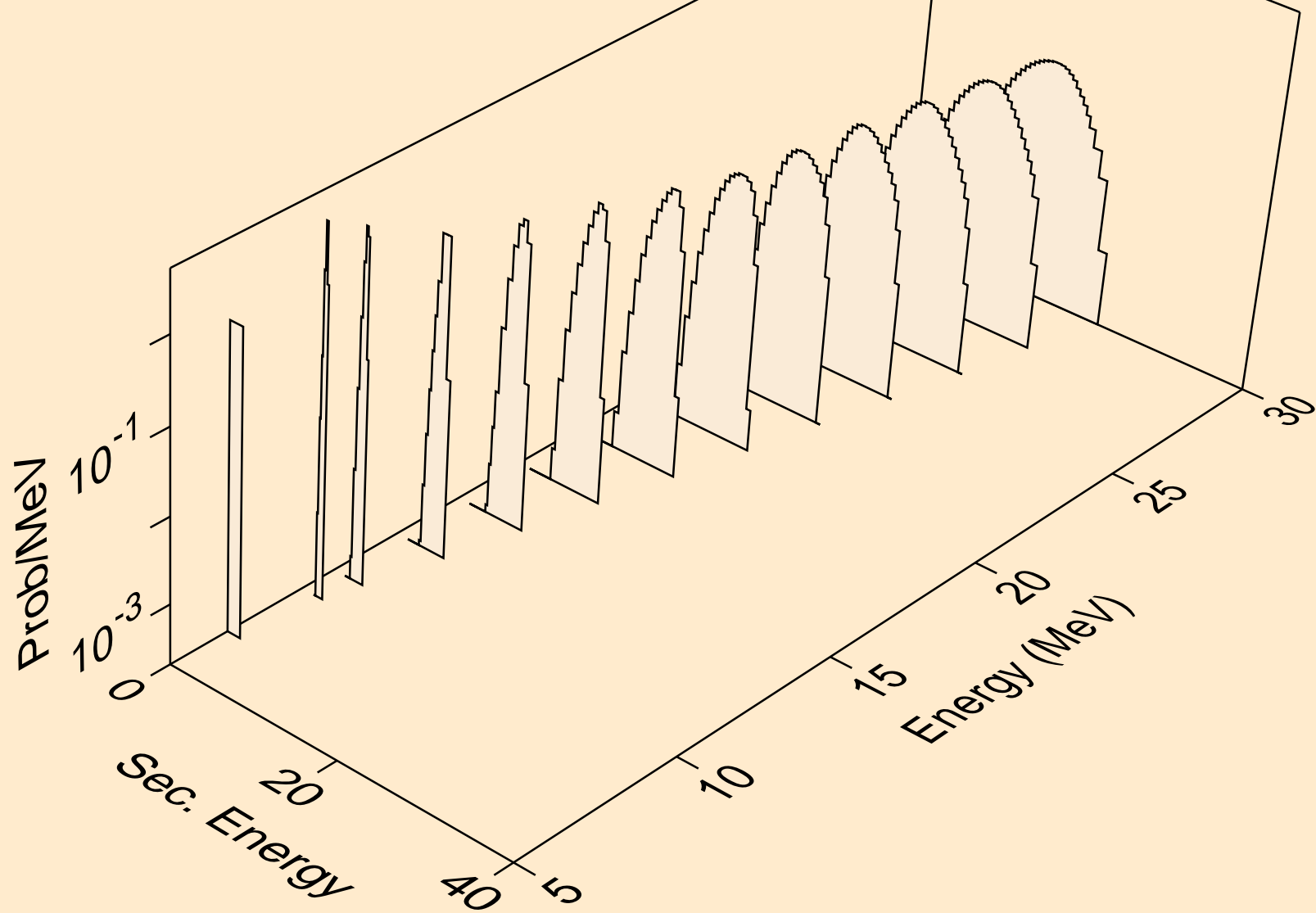

IR174 NEUTRON ACER TENDL-2023 LIBRARY; T=0.K  
deuterons from (n,d)

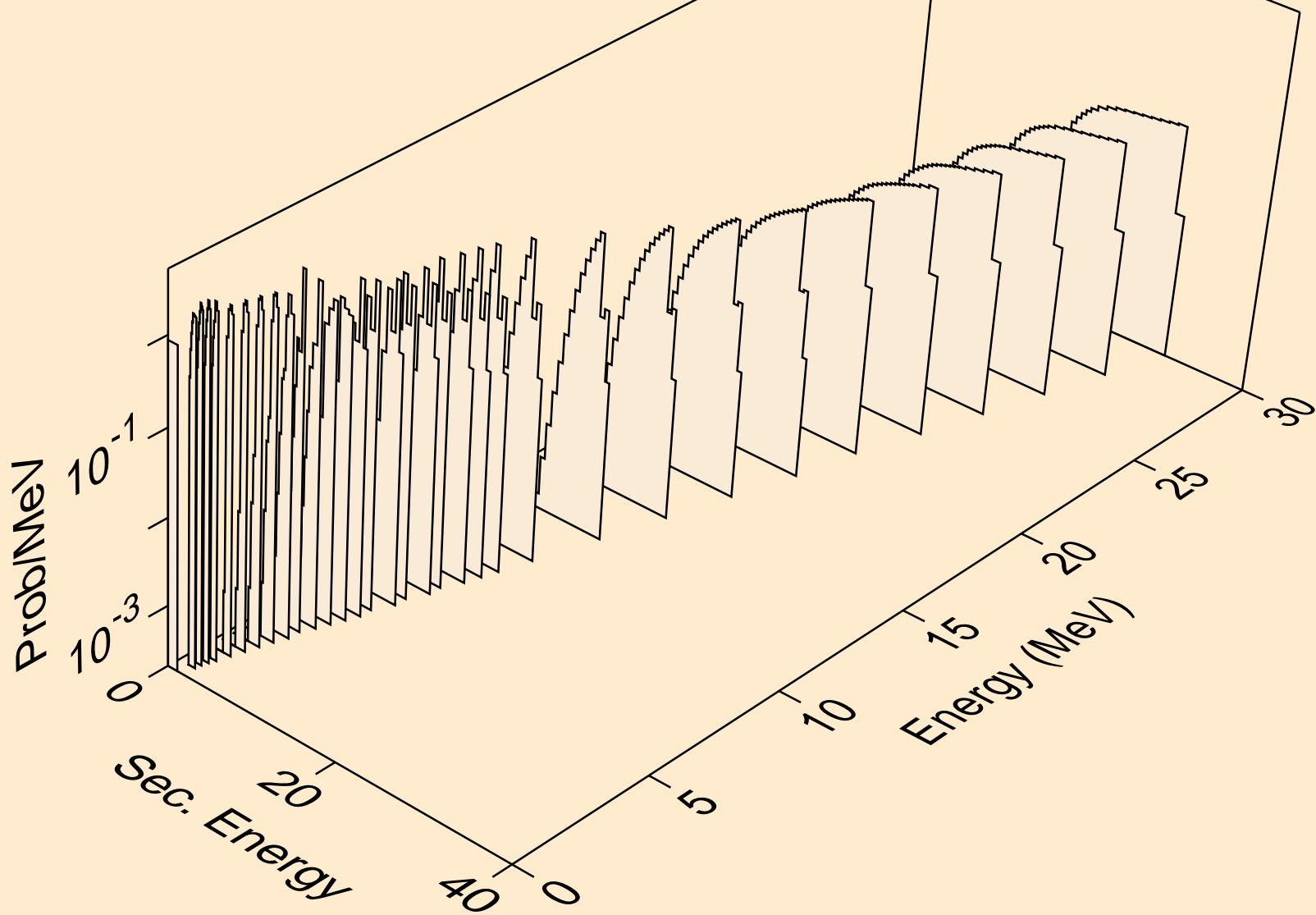

IR174 NEUTRON ACER TENDL-2023 LIBRARY; T=0.K  
deuterons from (n,d2a)

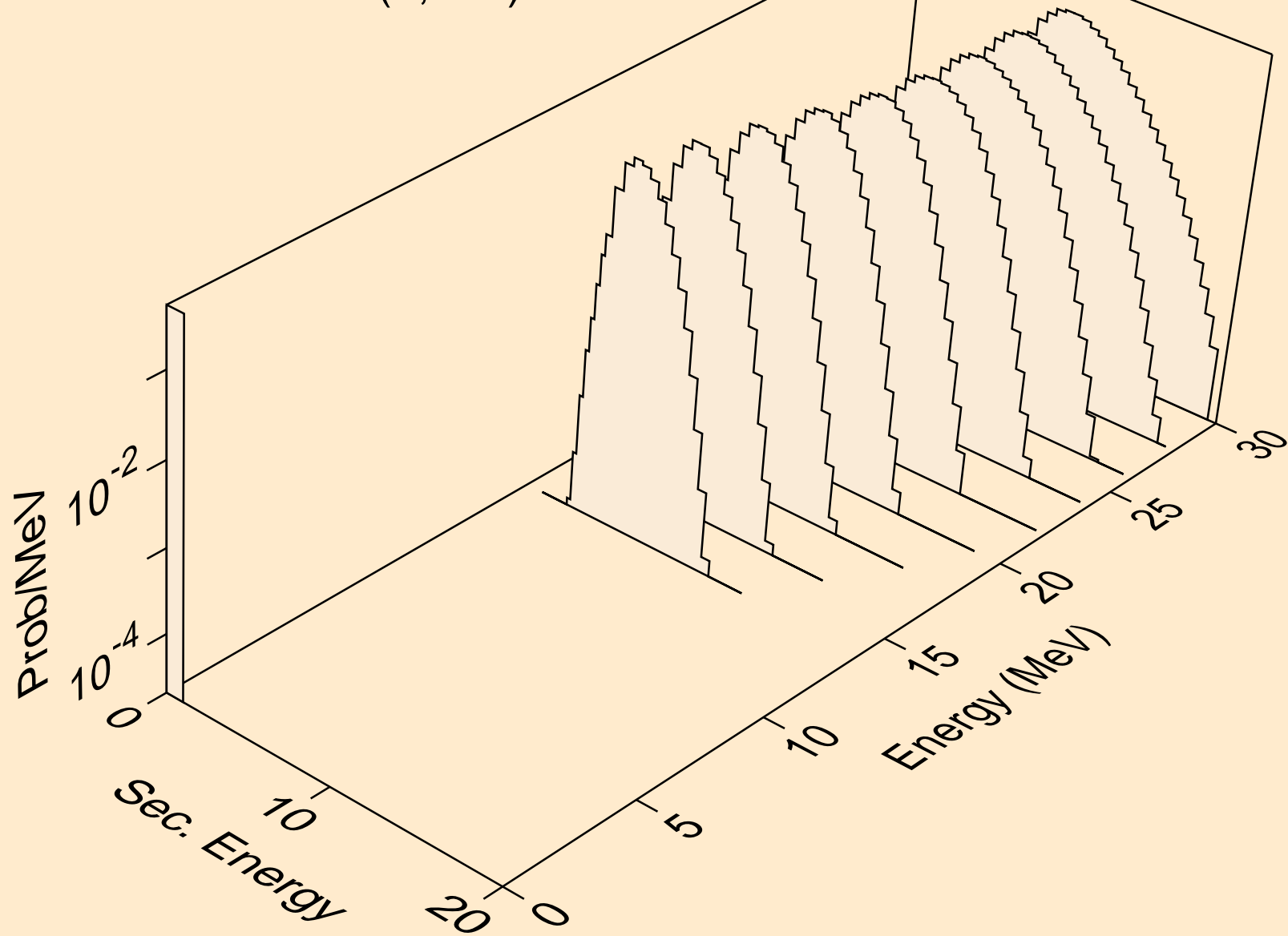

IR174 NEUTRON ACER TENDL-2023 LIBRARY; T=0.K  
deuterons from (n,pd)

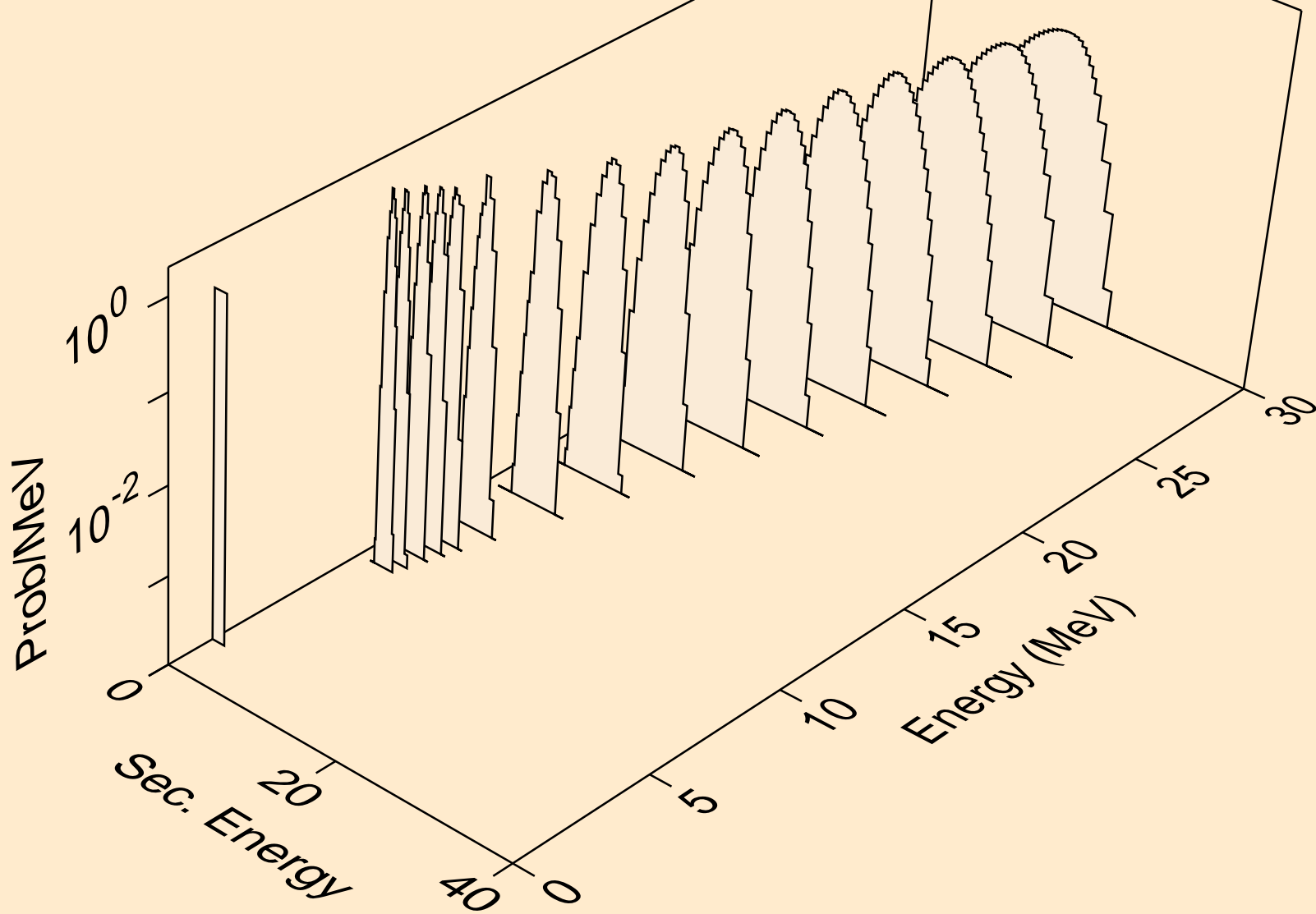

IR174 NEUTRON ACER TENDL-2023 LIBRARY; T=0.K  
deuterons from (n,da)

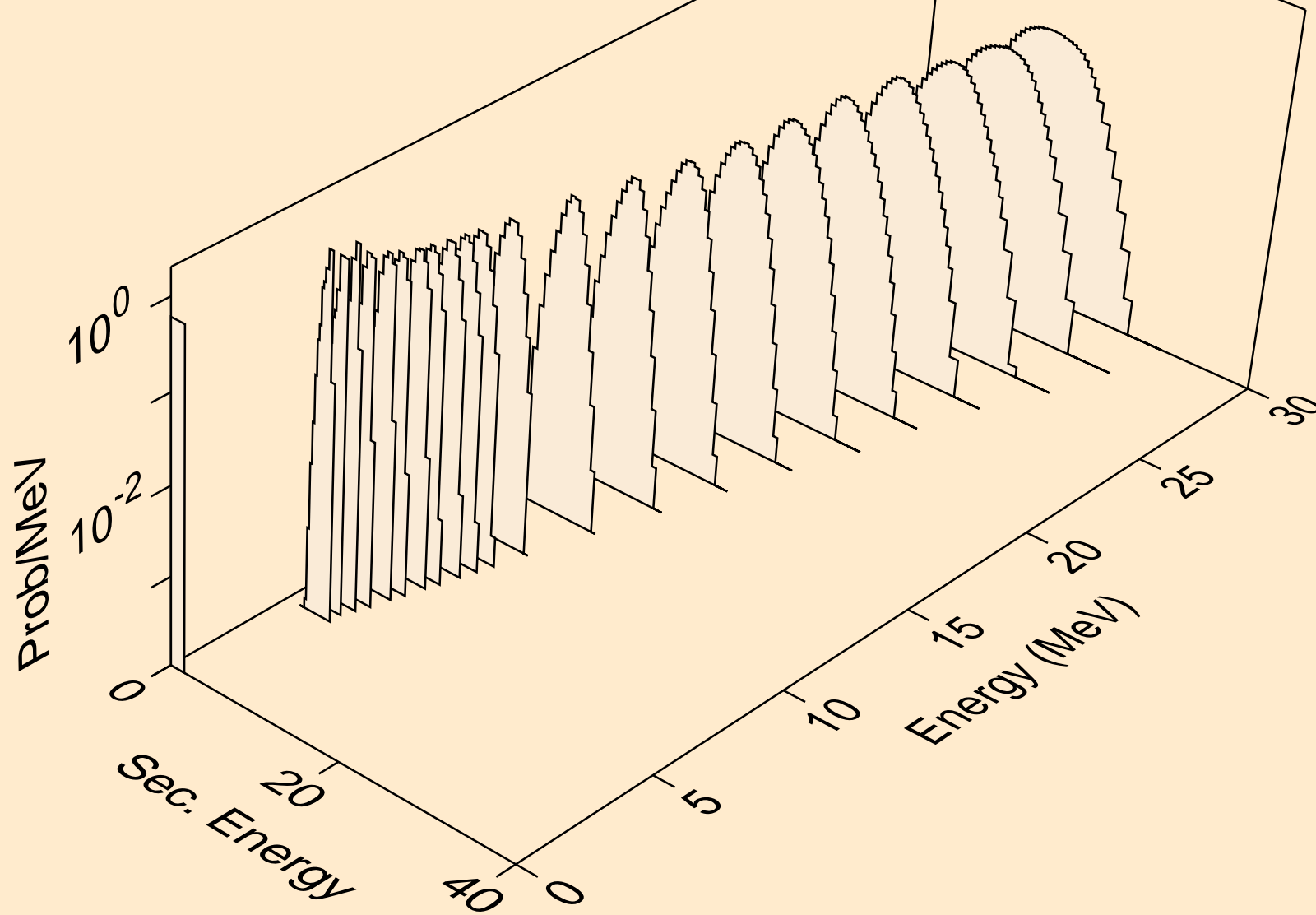

IR174 NEUTRON ACER TENDL-2023 LIBRARY; T=0.K  
tritons from (n,x)

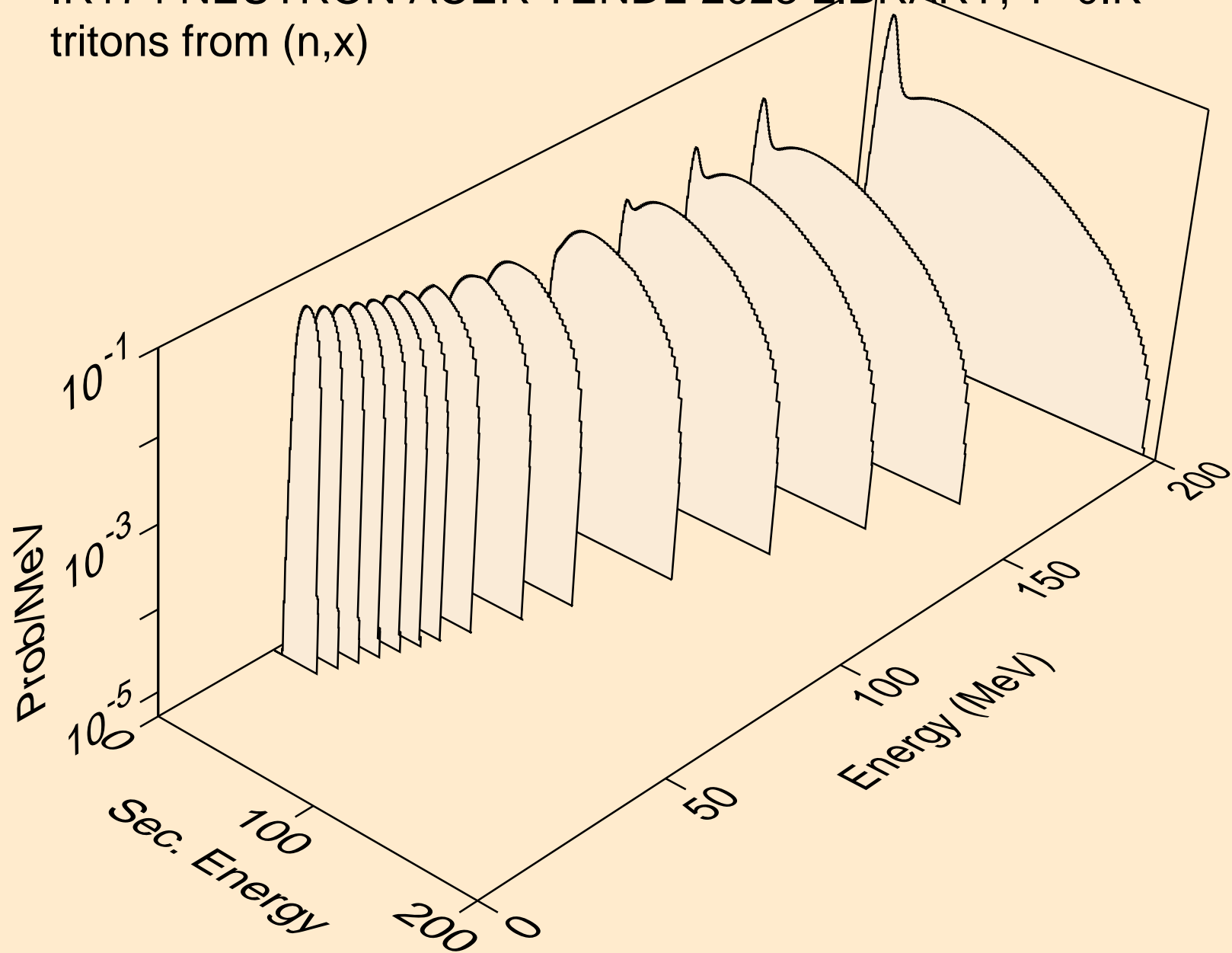

IR174 NEUTRON ACER TENDL-2023 LIBRARY; T=0.K  
tritons from (n,n\*)t

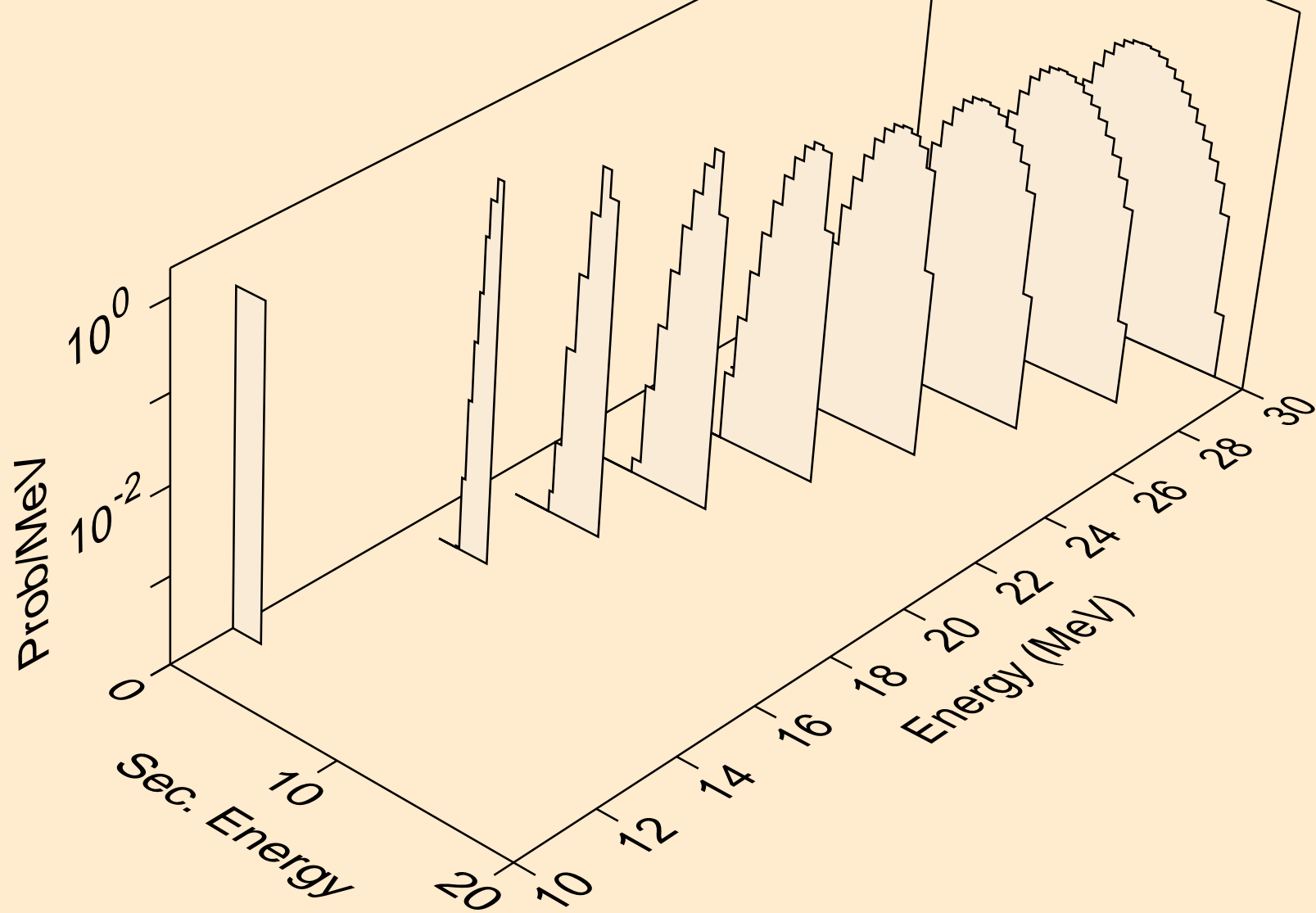

IR174 NEUTRON ACER TENDL-2023 LIBRARY; T=0.K  
tritons from (n,t)

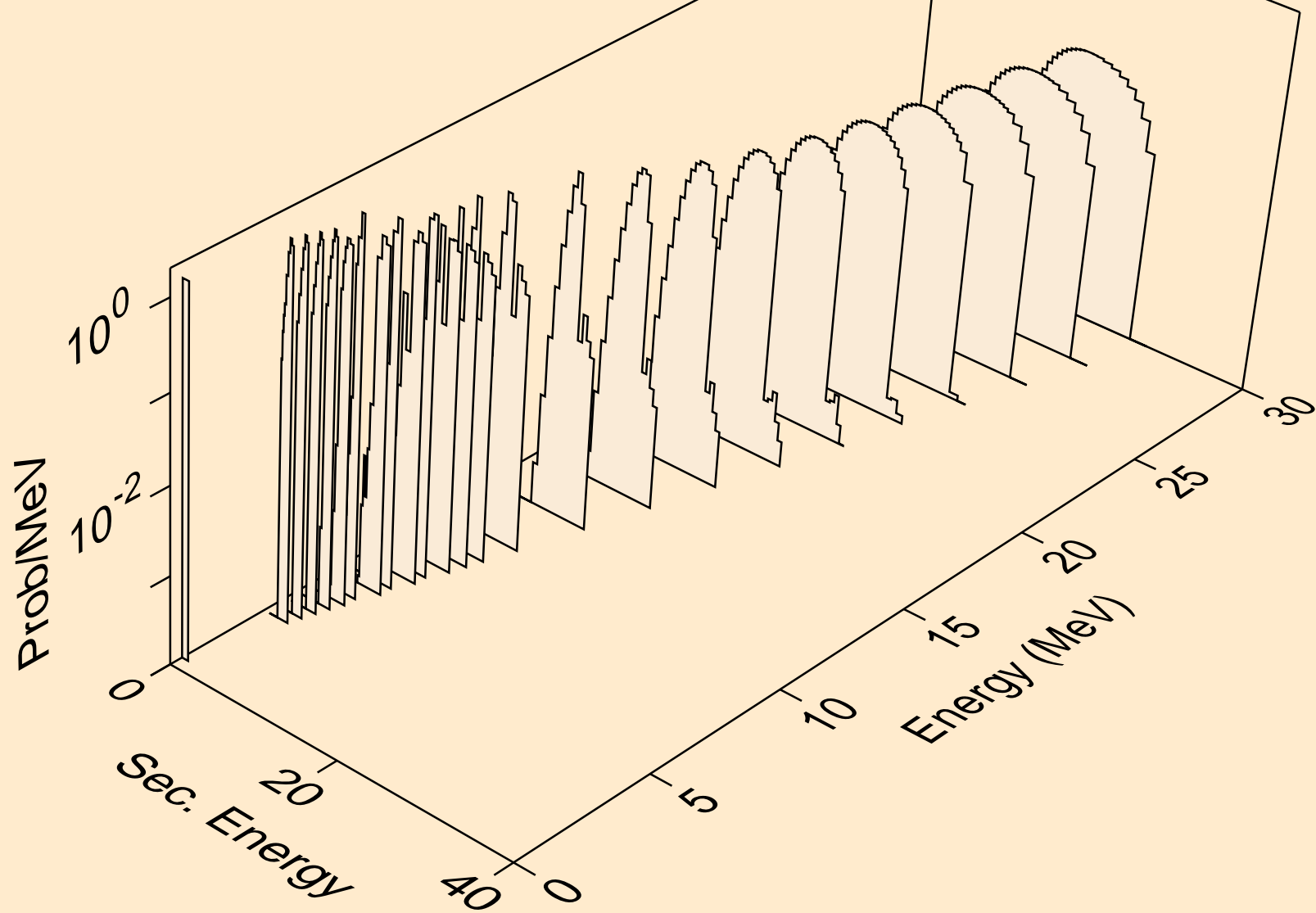

IR174 NEUTRON ACER TENDL-2023 LIBRARY; T=0.K  
tritons from (n,t2a)

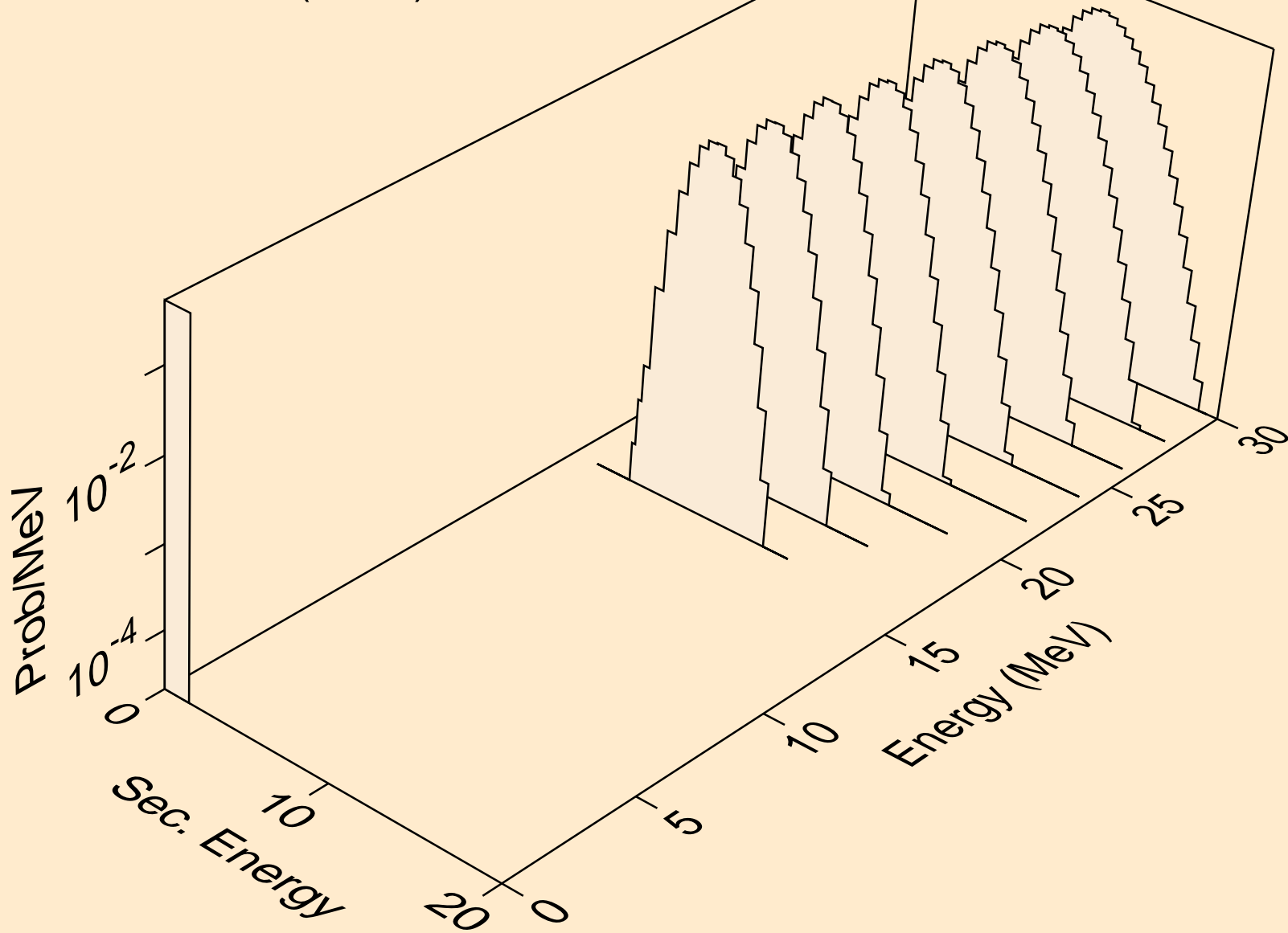

IR174 NEUTRON ACER TENDL-2023 LIBRARY; T=0.K  
tritons from (n,pt)

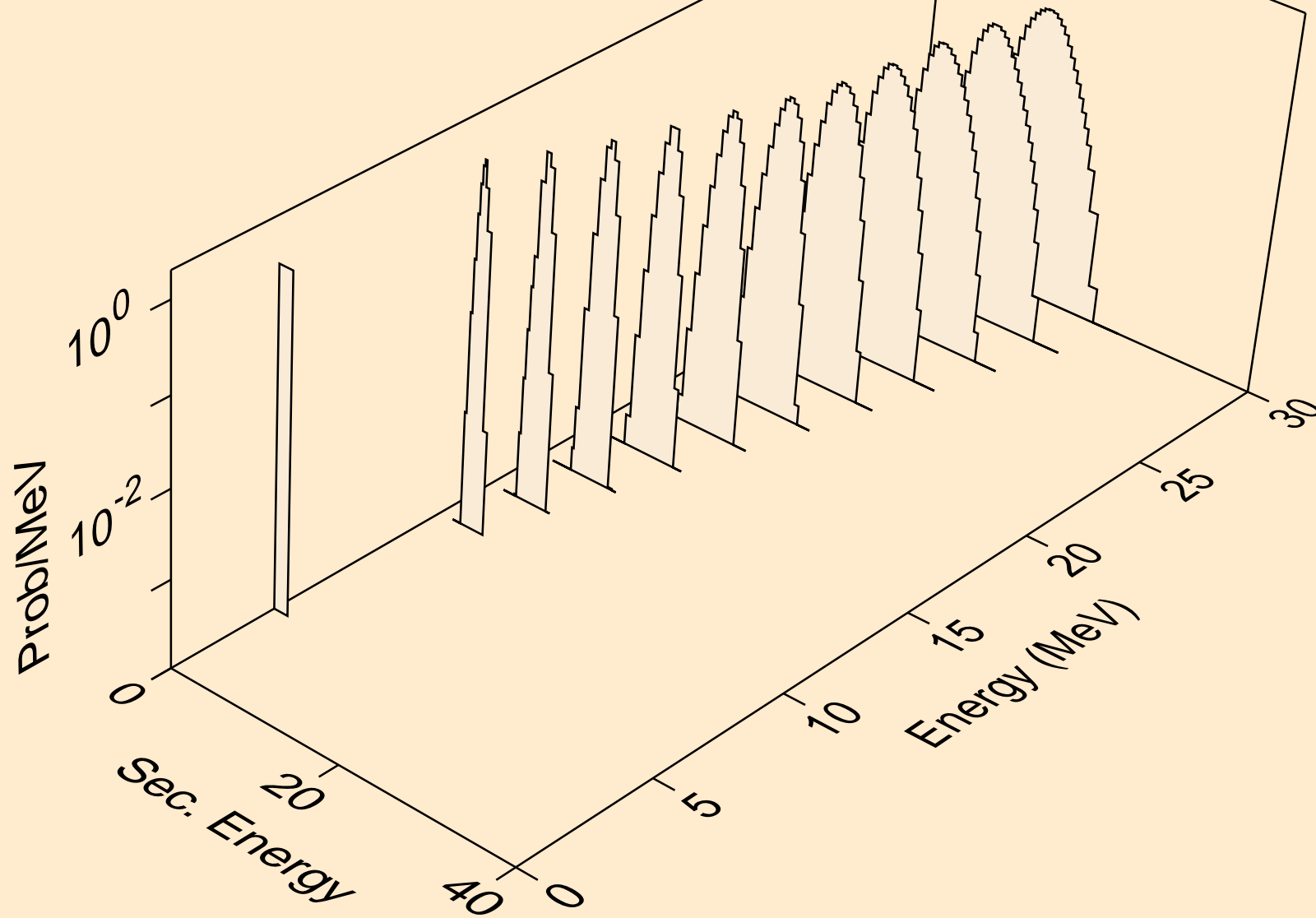

IR174 NEUTRON ACER TENDL-2023 LIBRARY; T=0.K  
he3s from (n,x)

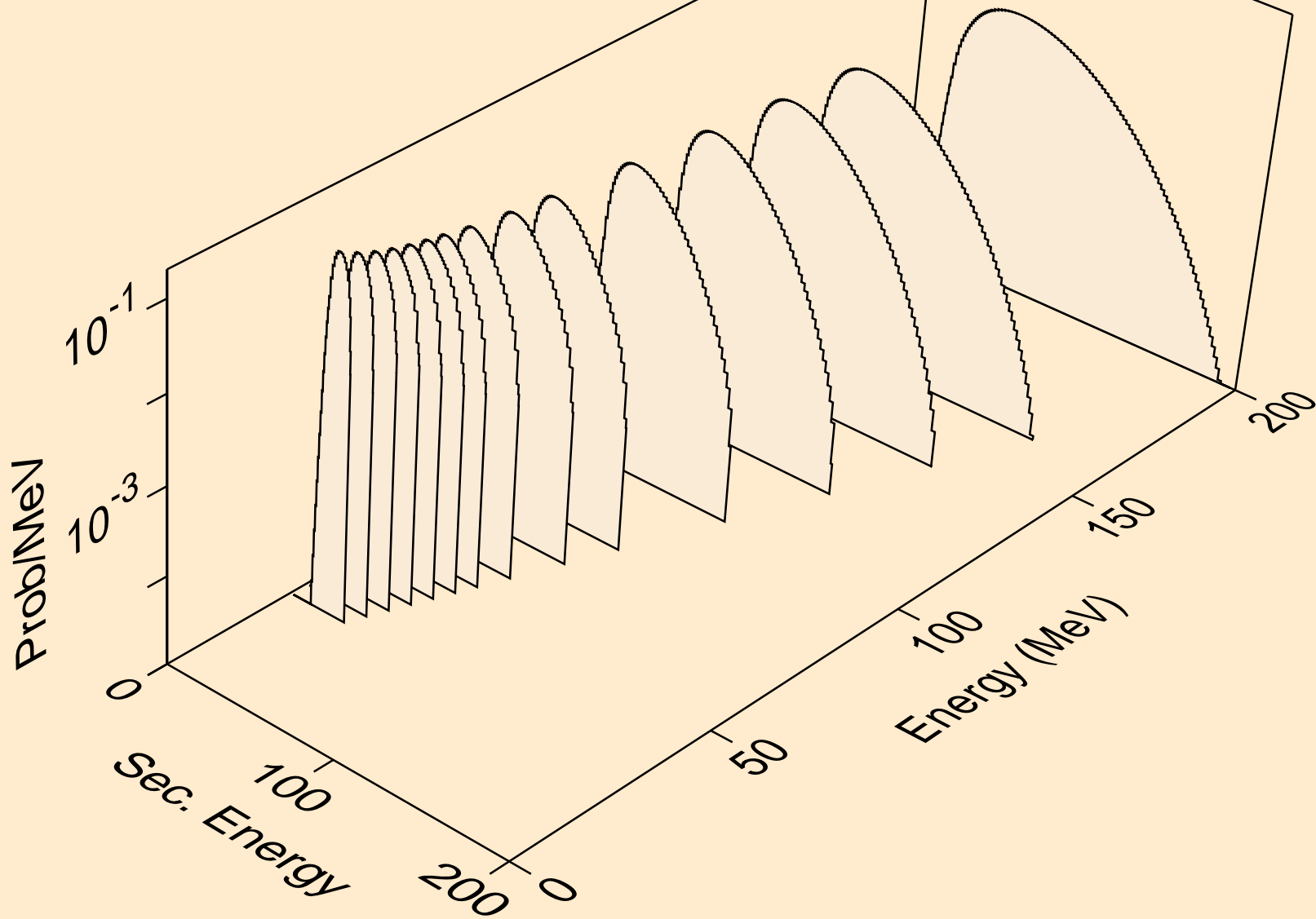

IR174 NEUTRON ACER TENDL-2023 LIBRARY; T=0.K  
he3s from (n,n\*)he3

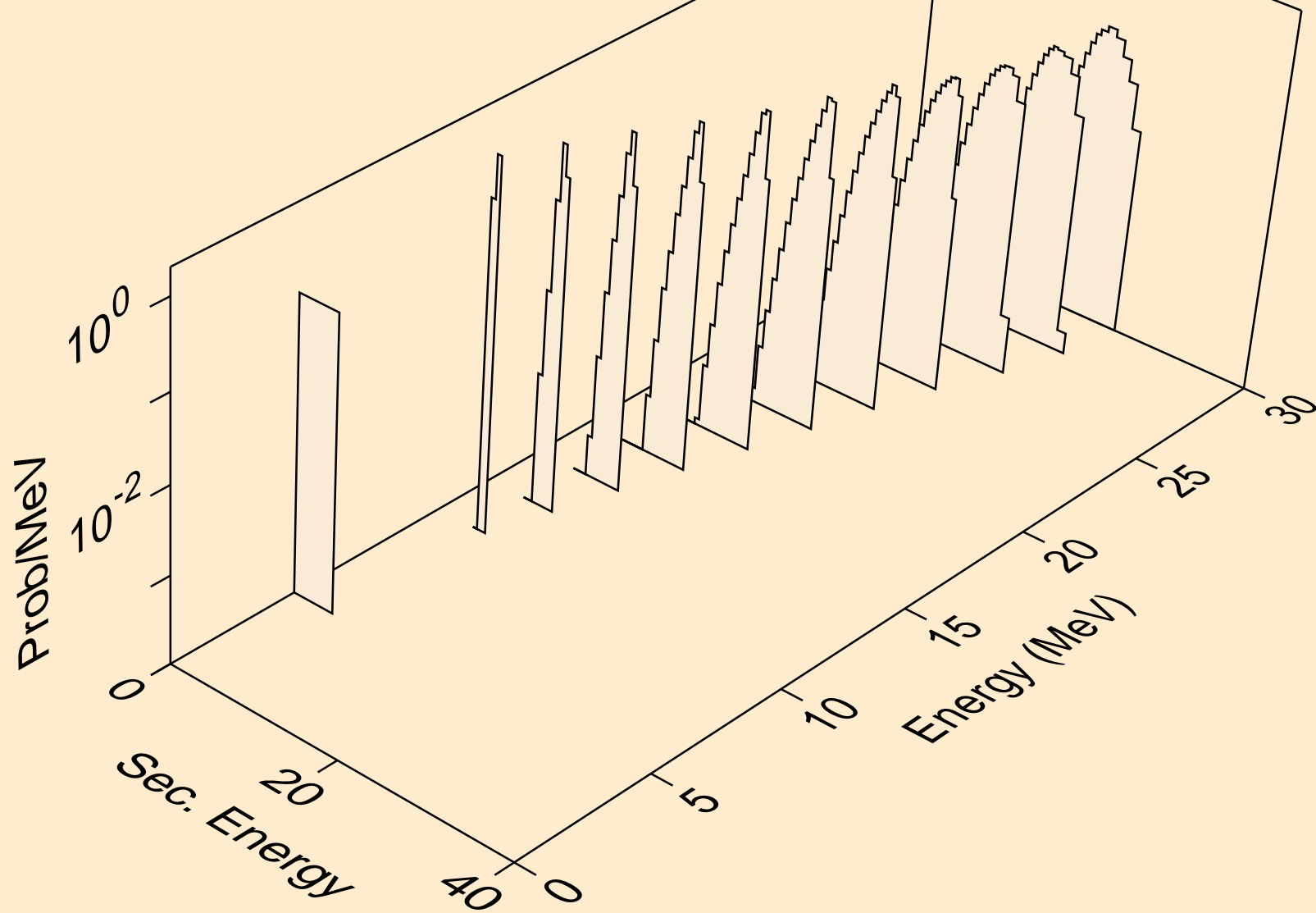

IR174 NEUTRON ACER TENDL-2023 LIBRARY; T=0.K  
he3s from (n,he3)

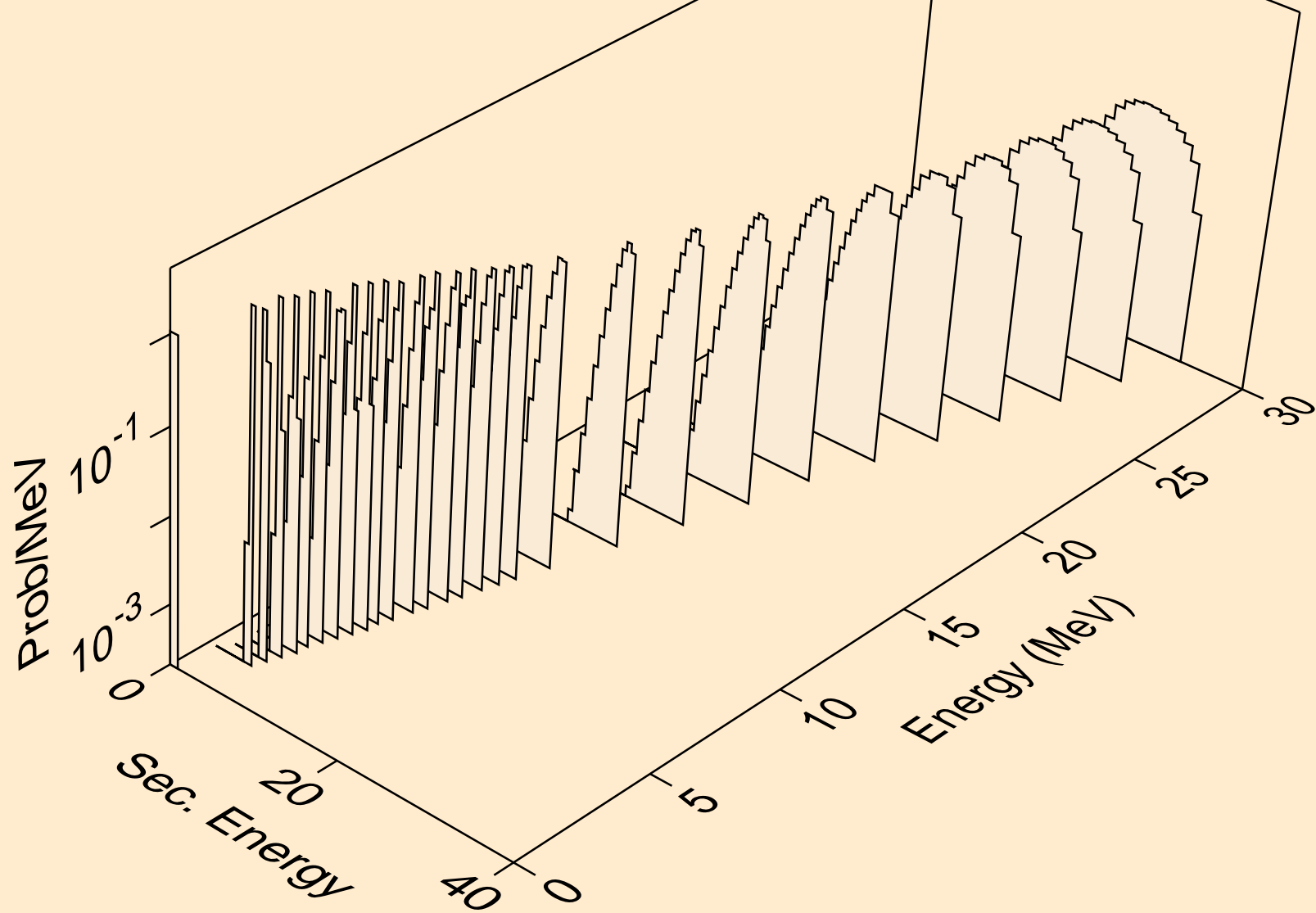

IR174 NEUTRON ACER TENDL-2023 LIBRARY; T=0.K  
alphas from (n,x)

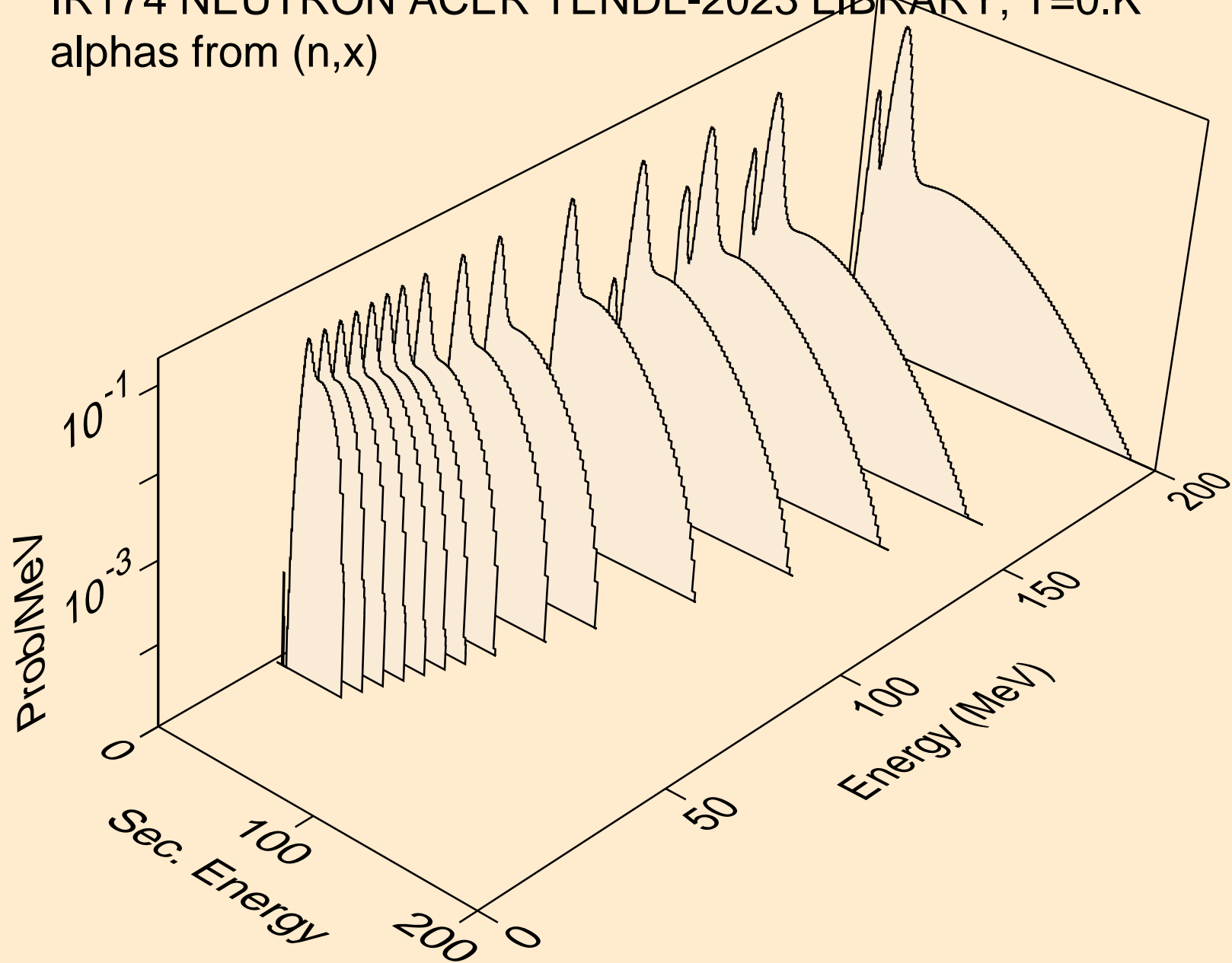

IR174 NEUTRON ACER TENDL-2023 LIBRARY; T=0.K  
alphas from (n,n\*)a

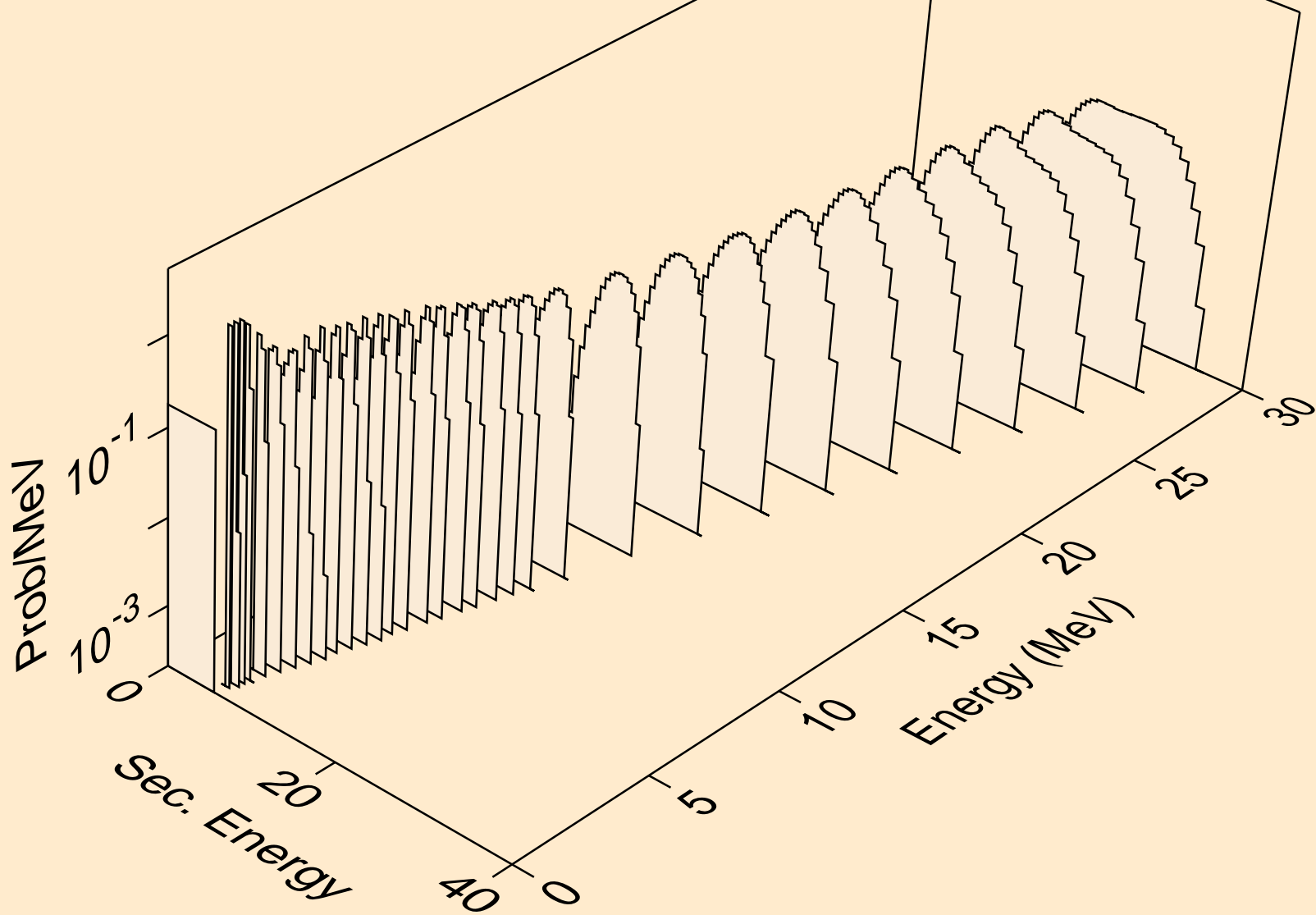

IR174 NEUTRON ACER TENDL-2023 LIBRARY; T=0.K  
alphas from (n,n\*)3a

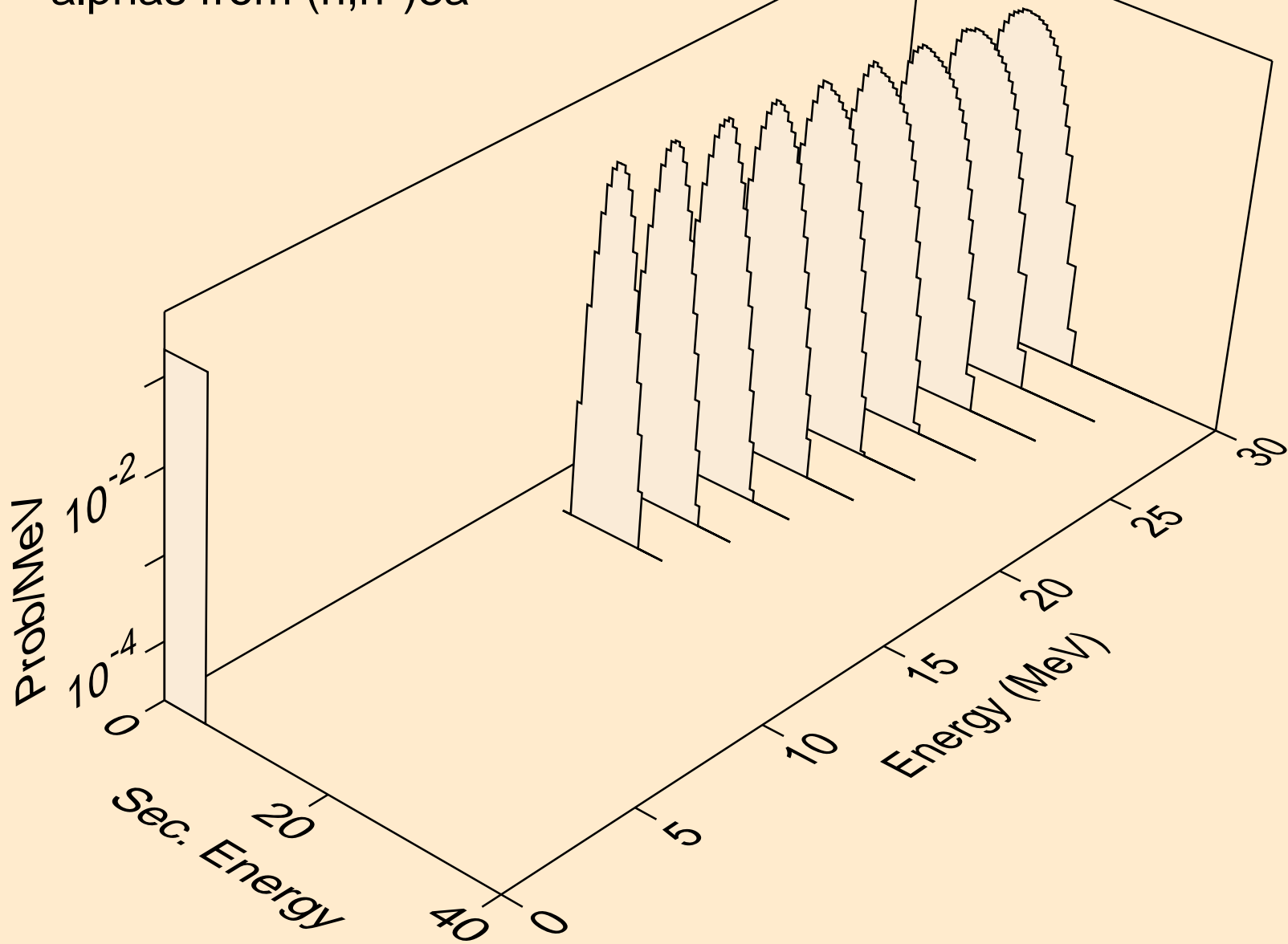

IR174 NEUTRON ACER TENDL-2023 LIBRARY; T=0.K  
alphas from (n,2n)a

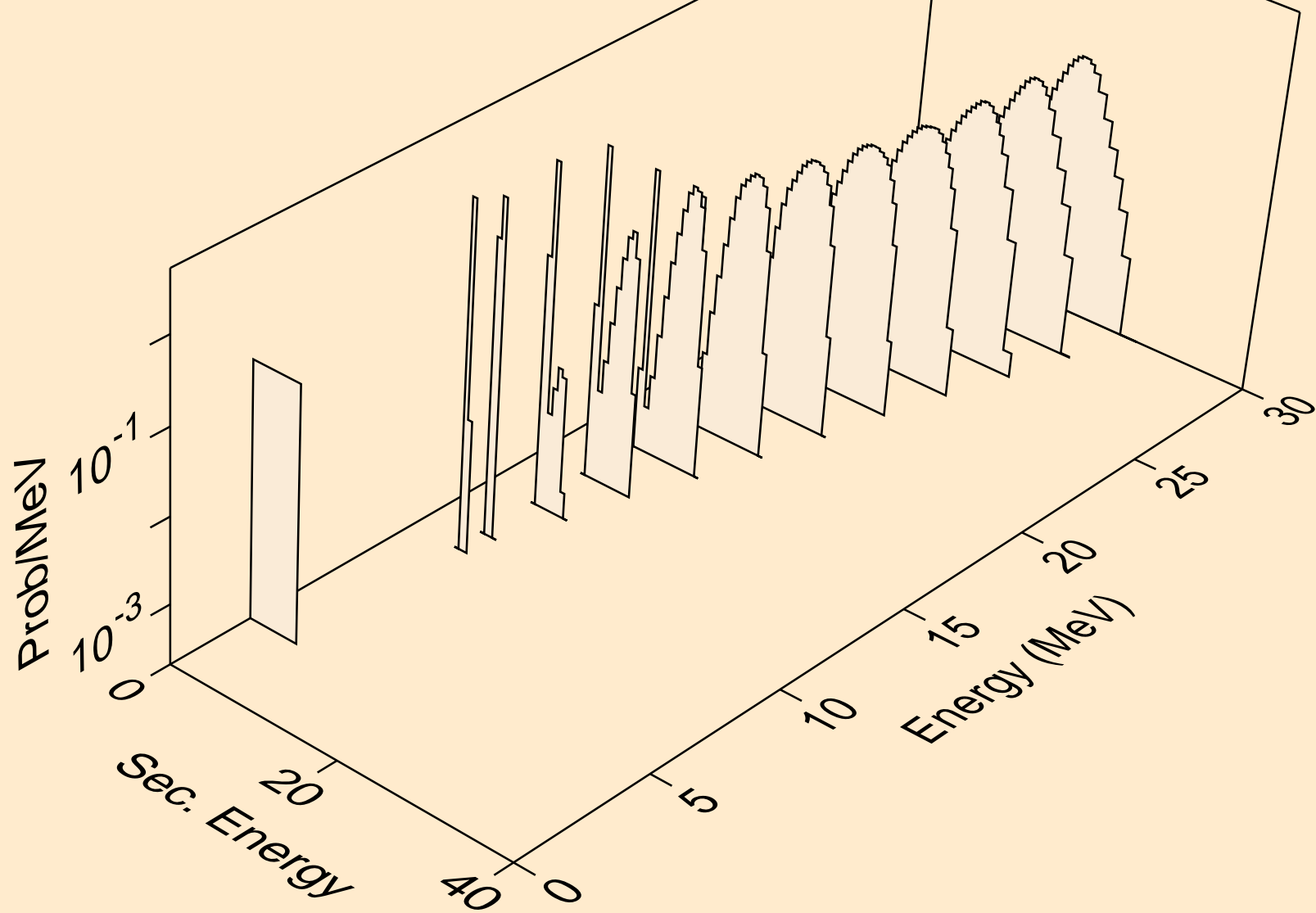

IR174 NEUTRON ACER TENDL-2023 LIBRARY; T=0.K  
alphas from (n,3n)a

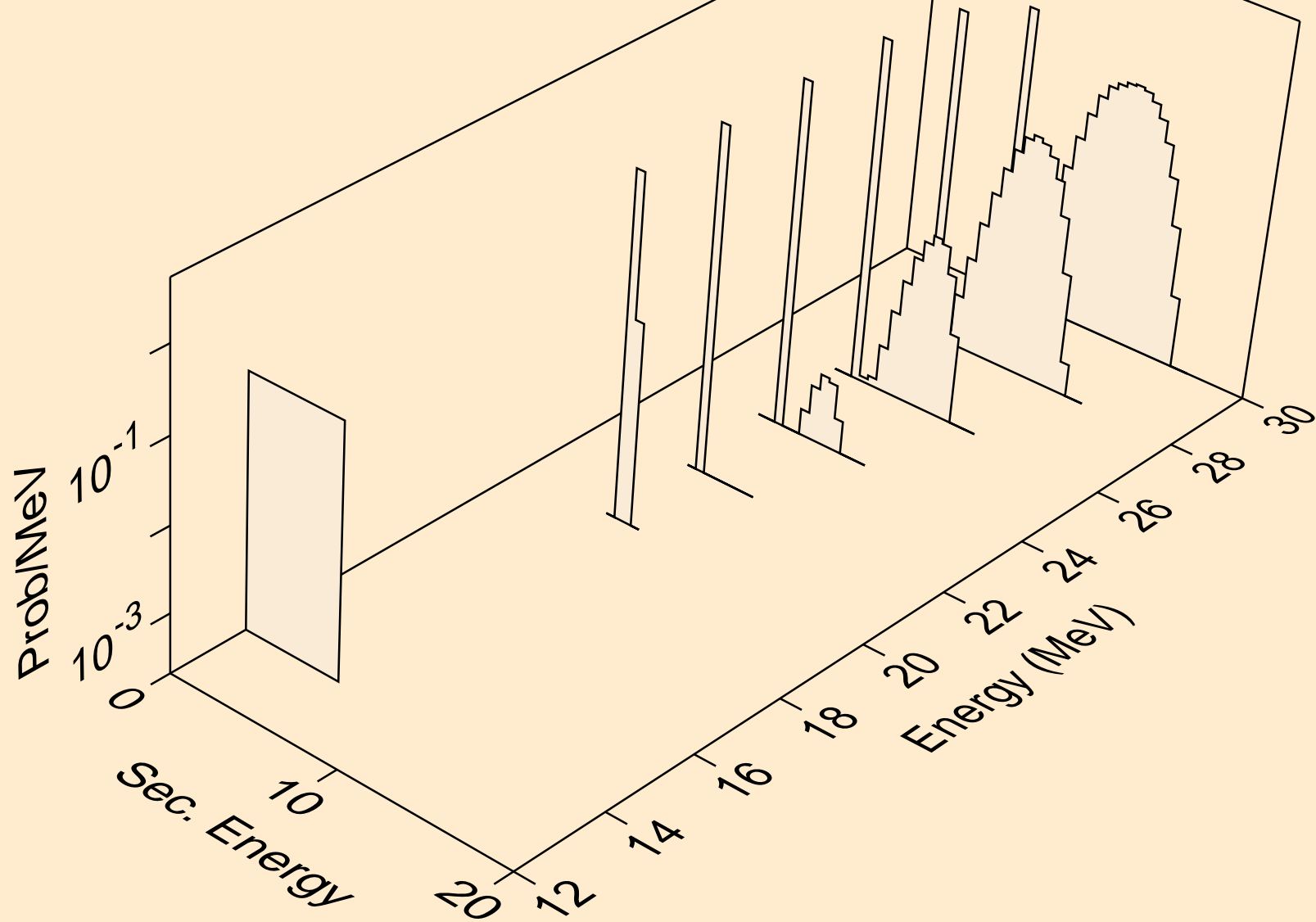

IR174 NEUTRON ACER TENDL-2023 LIBRARY; T=0.K  
alphas from (n,n\*)2a

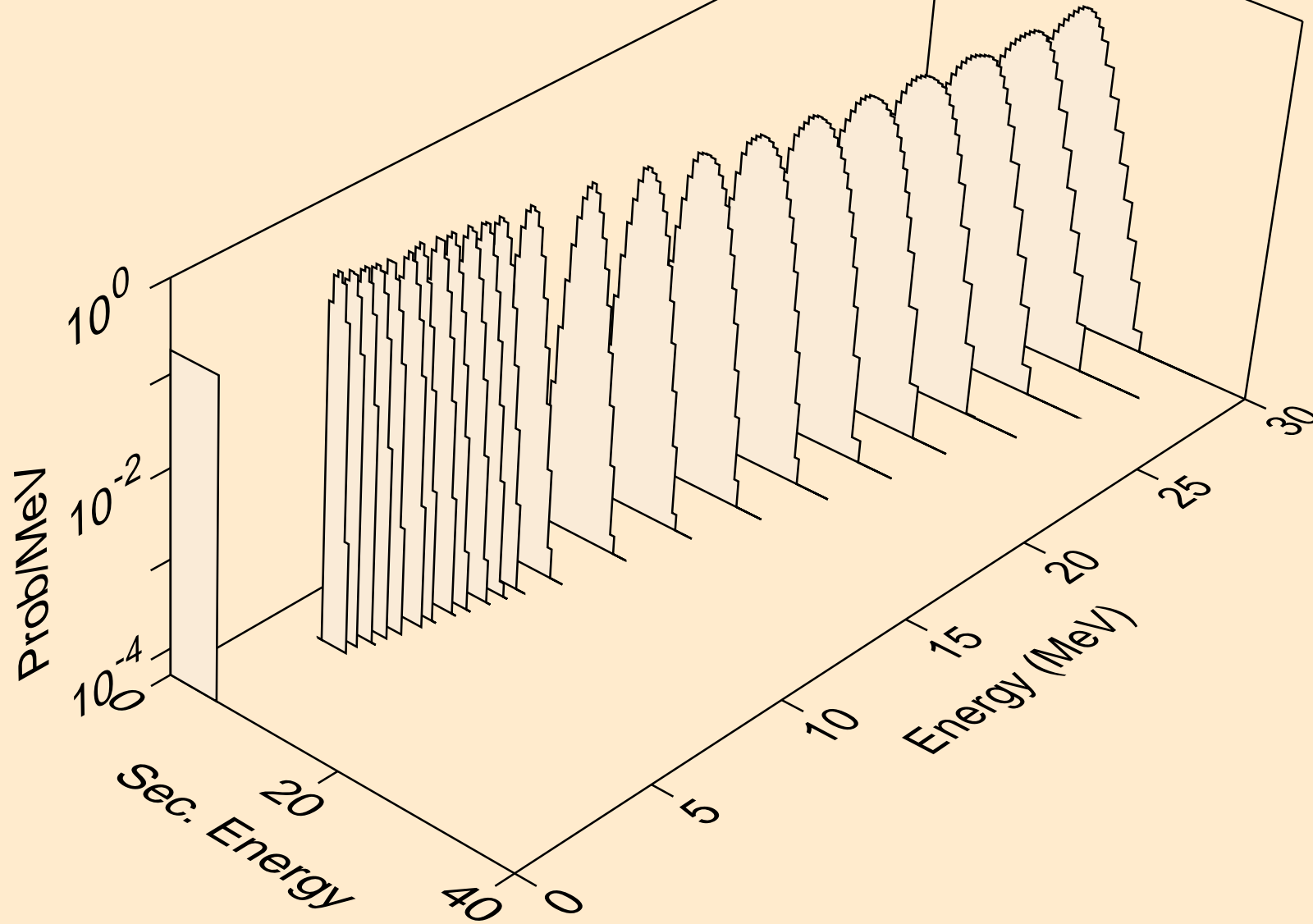

IR174 NEUTRON ACER TENDL-2023 LIBRARY; T=0.K  
alphas from (n,2n)2a

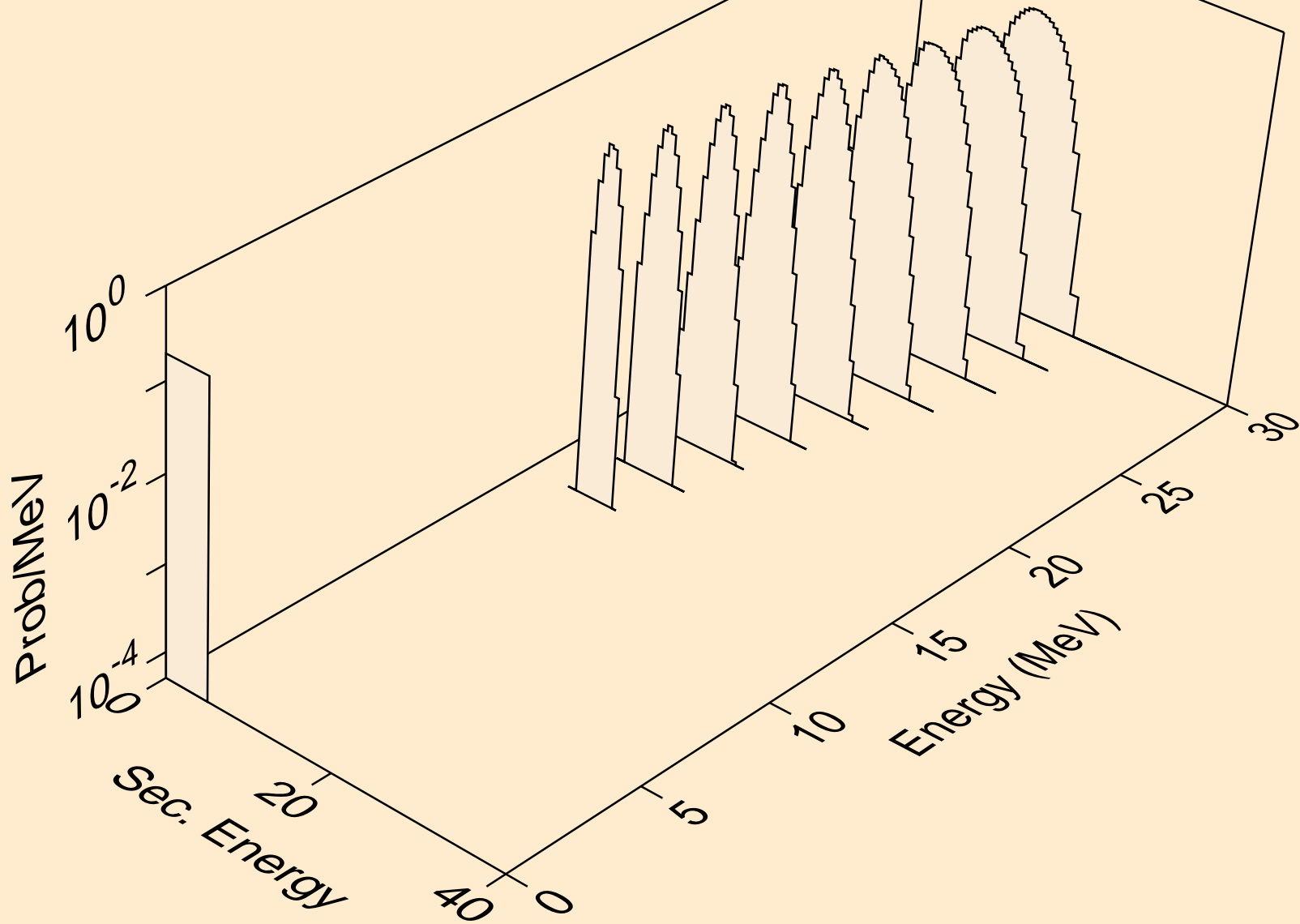

IR174 NEUTRON ACER TENDL-2023 LIBRARY; T=0.K  
alphas from (n,npa)

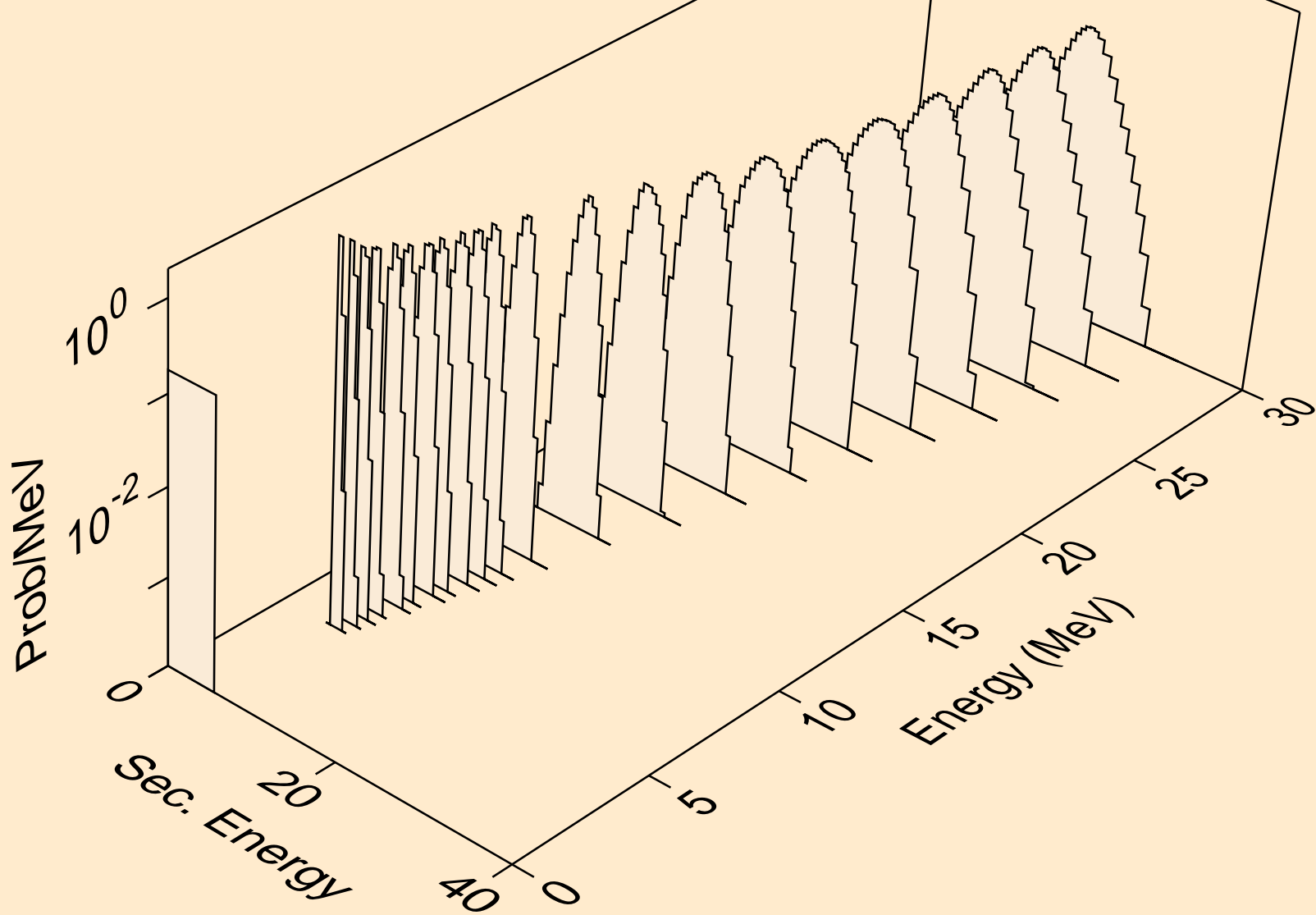

IR174 NEUTRON ACER TENDL-2023 LIBRARY; T=0.K  
alphas from (n,a)

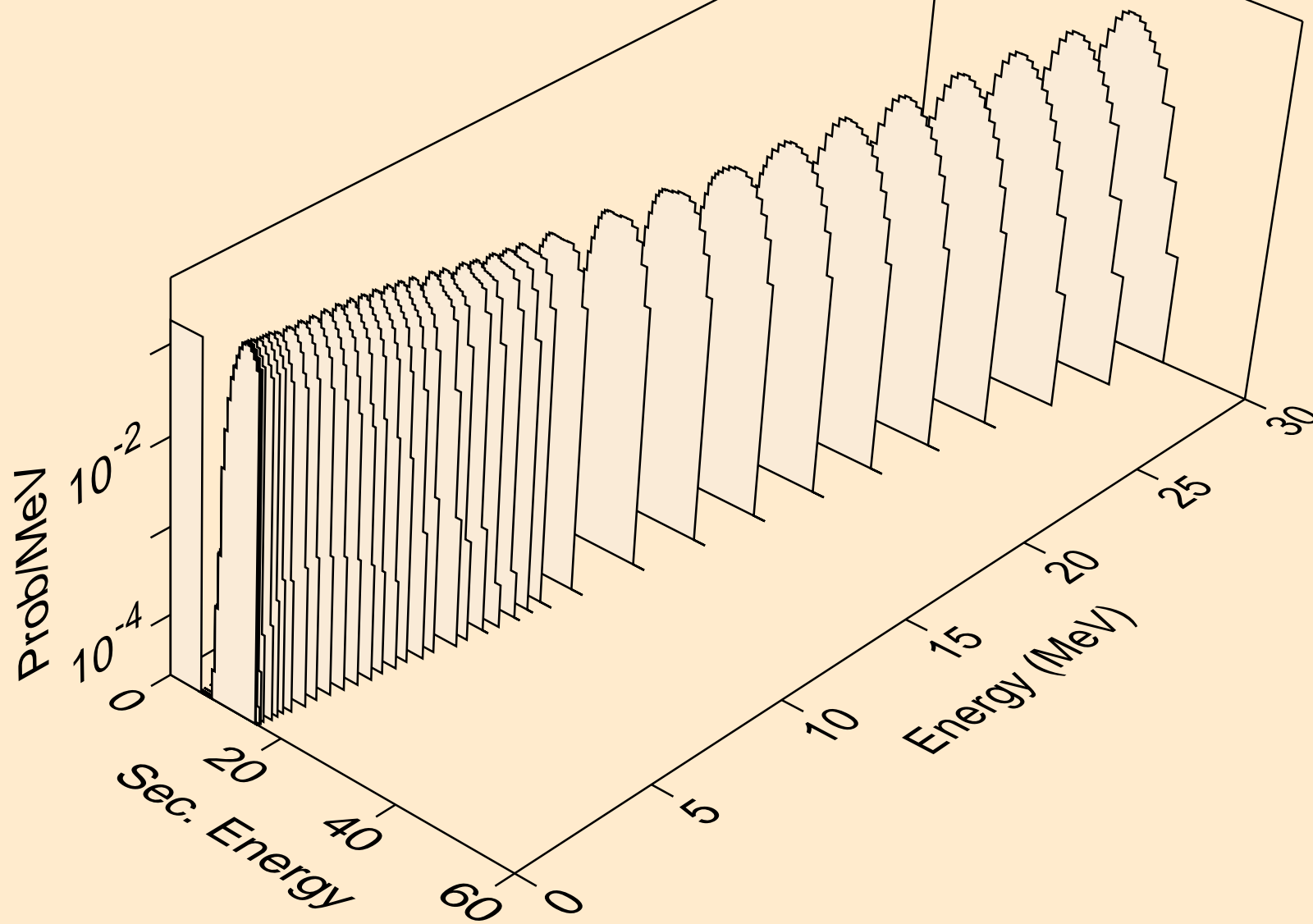

IR174 NEUTRON ACER TENDL-2023 LIBRARY; T=0.K  
alphas from (n,2a)

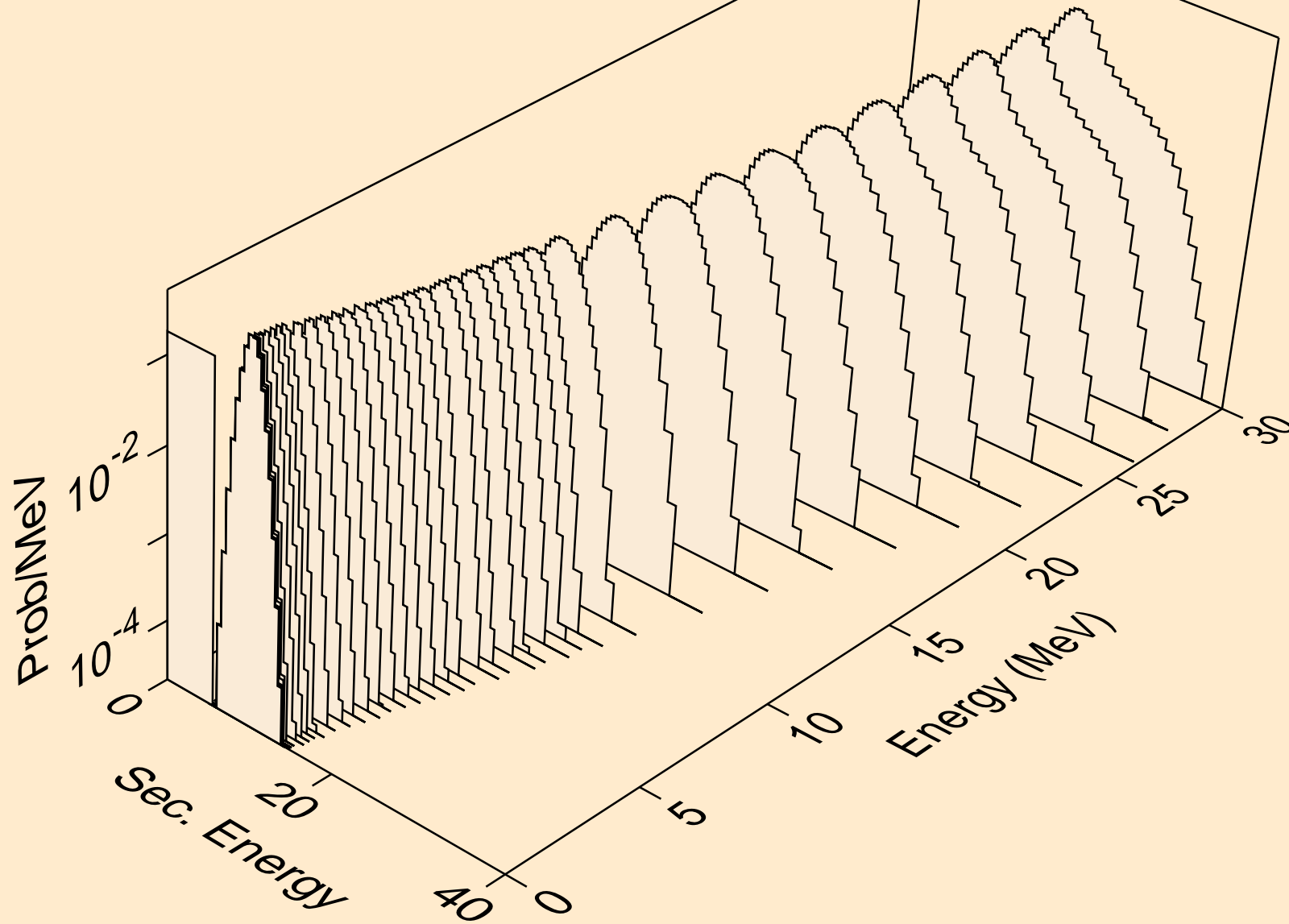

IR174 NEUTRON ACER TENDL-2023 LIBRARY; T=0.K  
alphas from (n,3a)

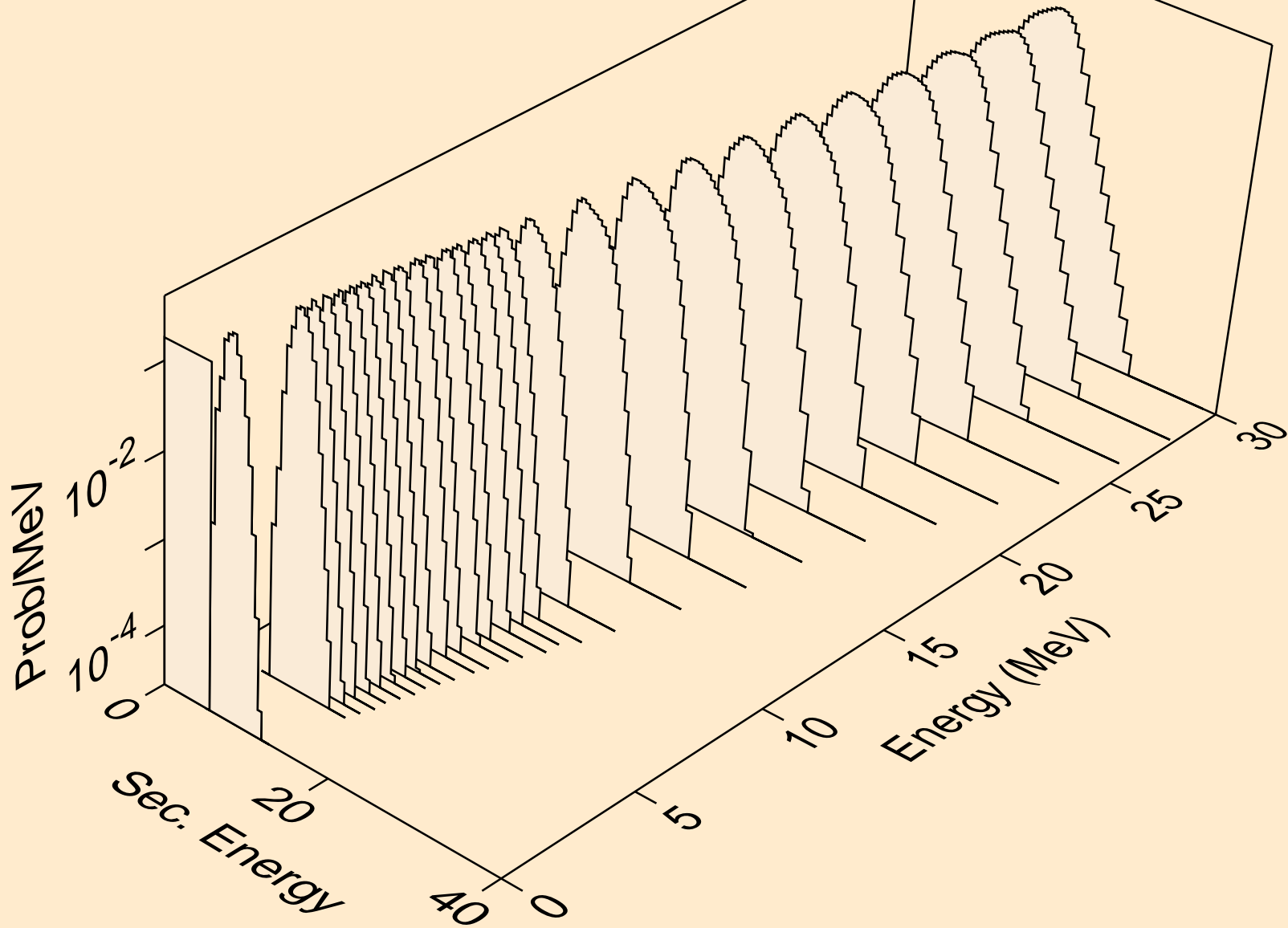

IR174 NEUTRON ACER TENDL-2023 LIBRARY; T=0.K  
alphas from (n,pa)

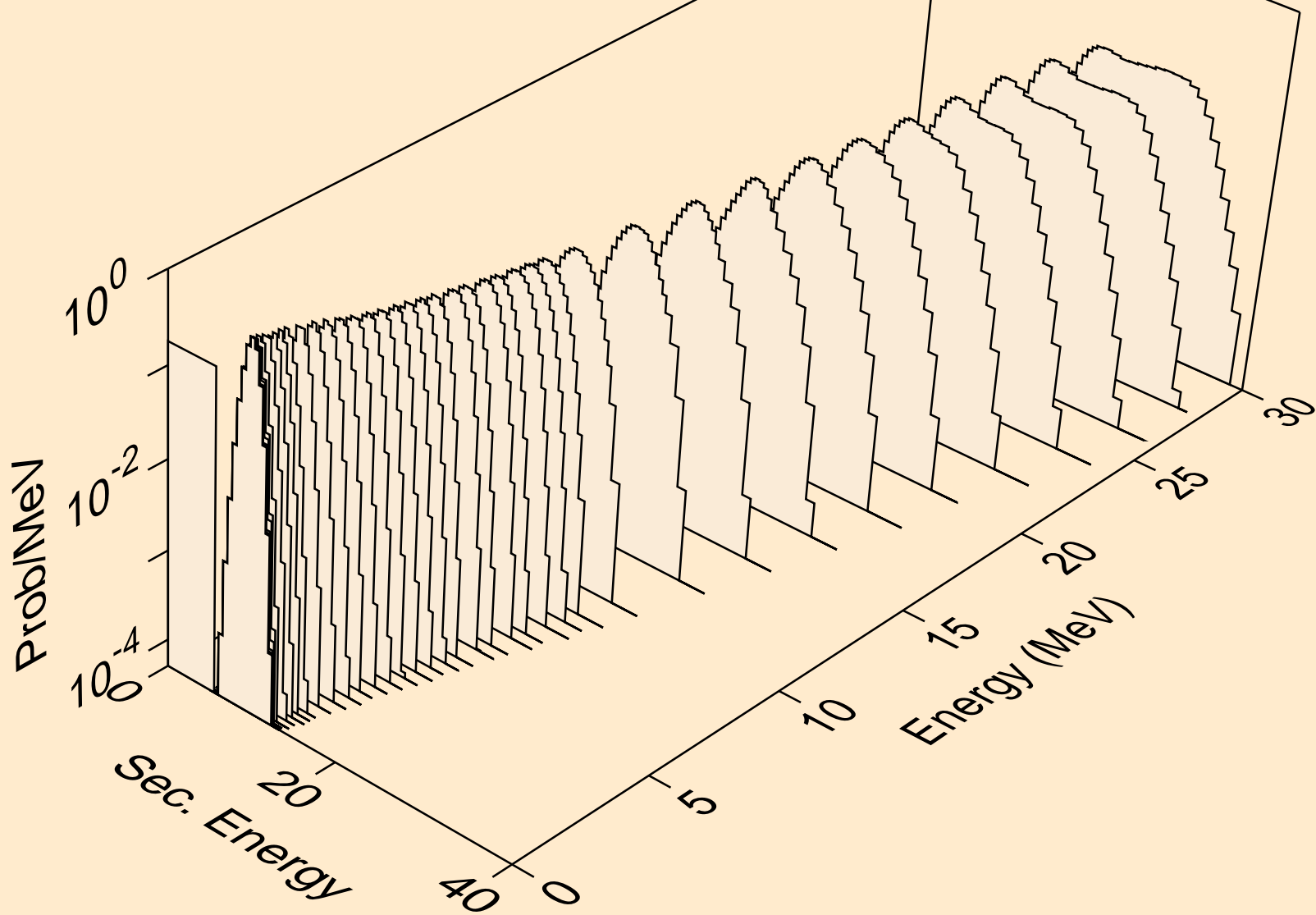

IR174 NEUTRON ACER TENDL-2023 LIBRARY; T=0.K  
alphas from (n,t2a)

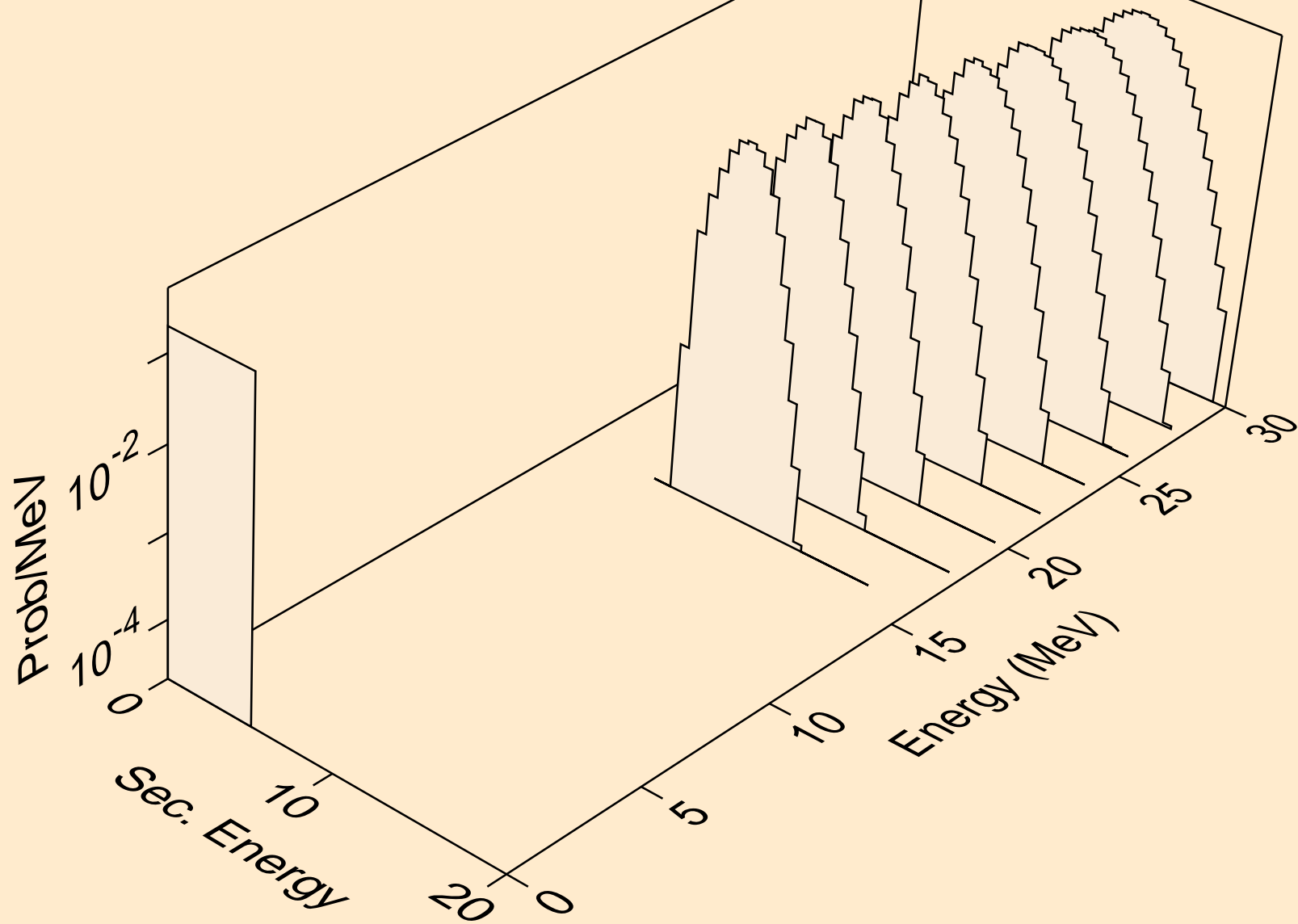

IR174 NEUTRON ACER TENDL-2023 LIBRARY; T=0.K  
alphas from (n,d2a)

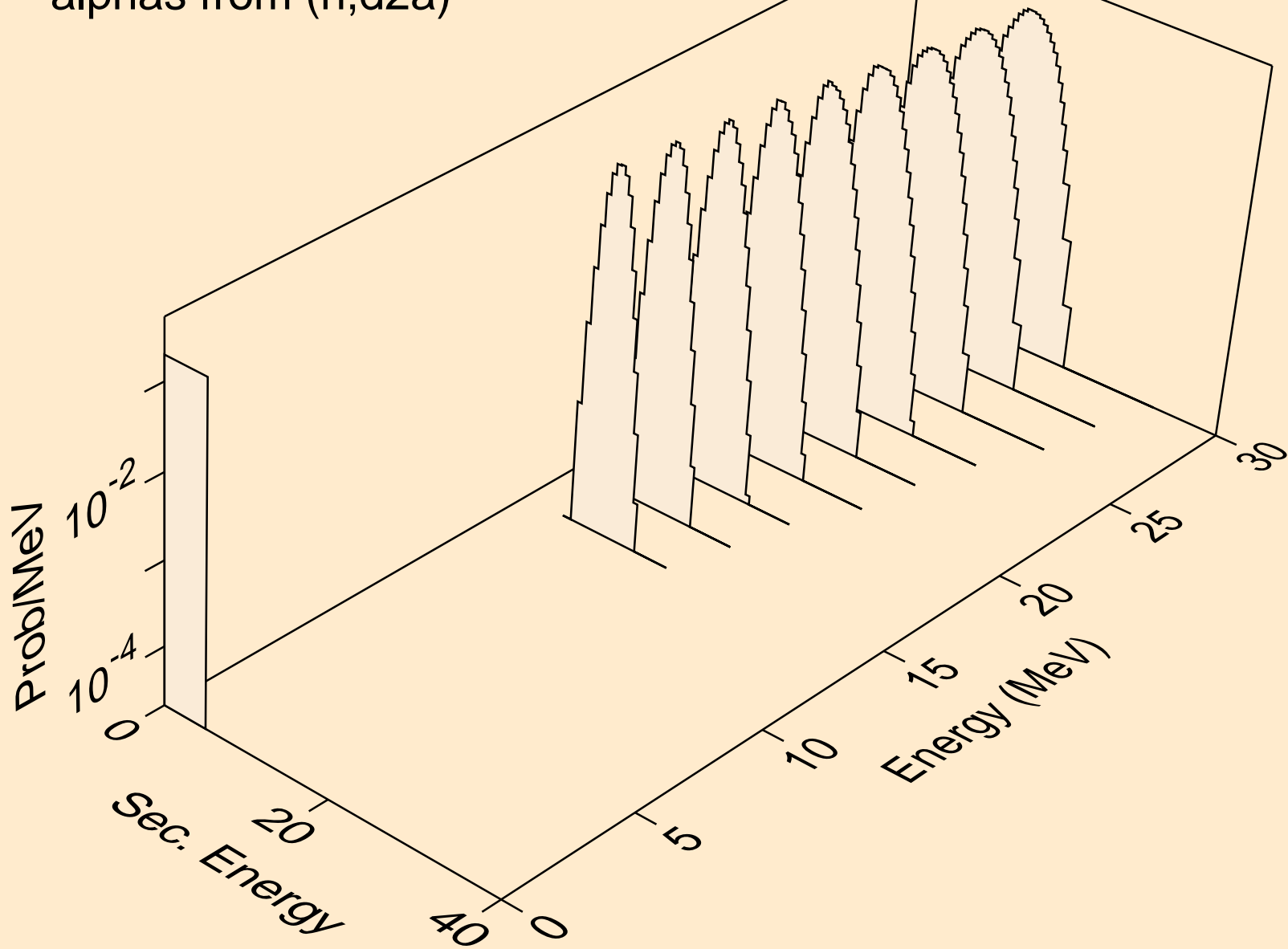

IR174 NEUTRON ACER TENDL-2023 LIBRARY; T=0.K  
alphas from (n,da)

