

IR185 NEUTRON ACER TENDL-2023 LIBRARY; T=0.K

Principal cross sections

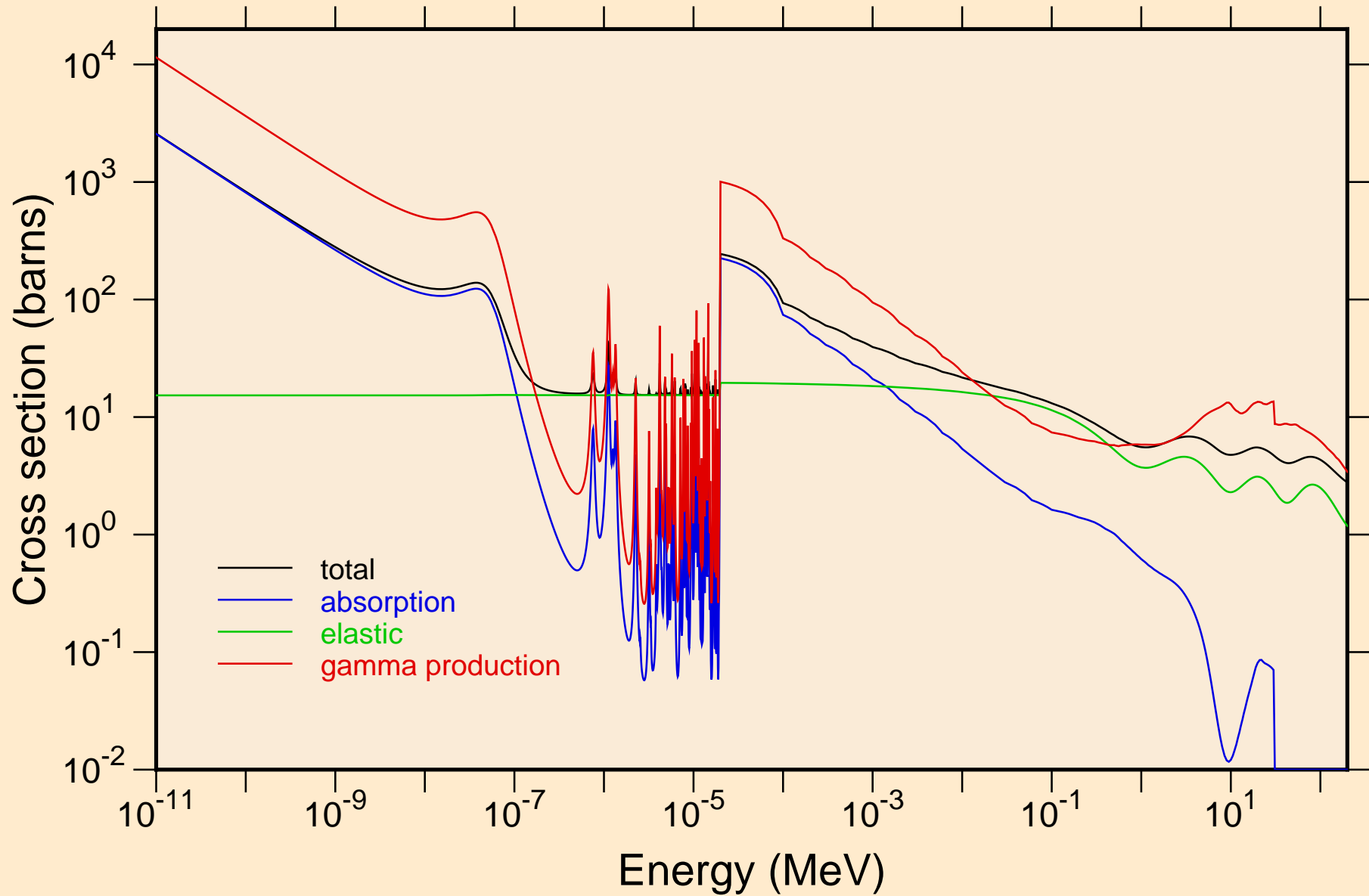

IR185 NEUTRON ACER TENDL-2023 LIBRARY; T=0.K
resonance total cross section

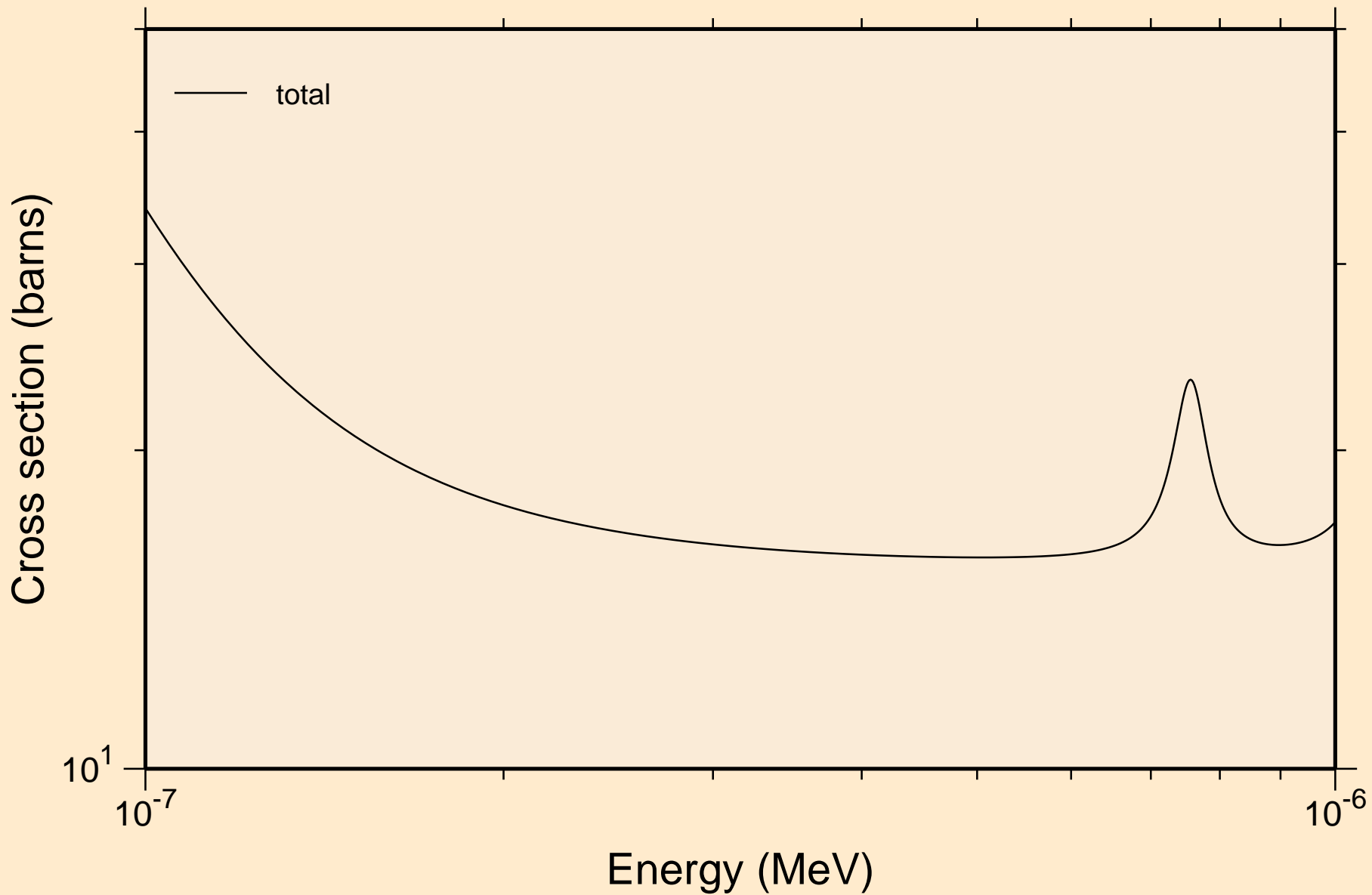

IR185 NEUTRON ACER TENDL-2023 LIBRARY; T=0.K
resonance total cross section

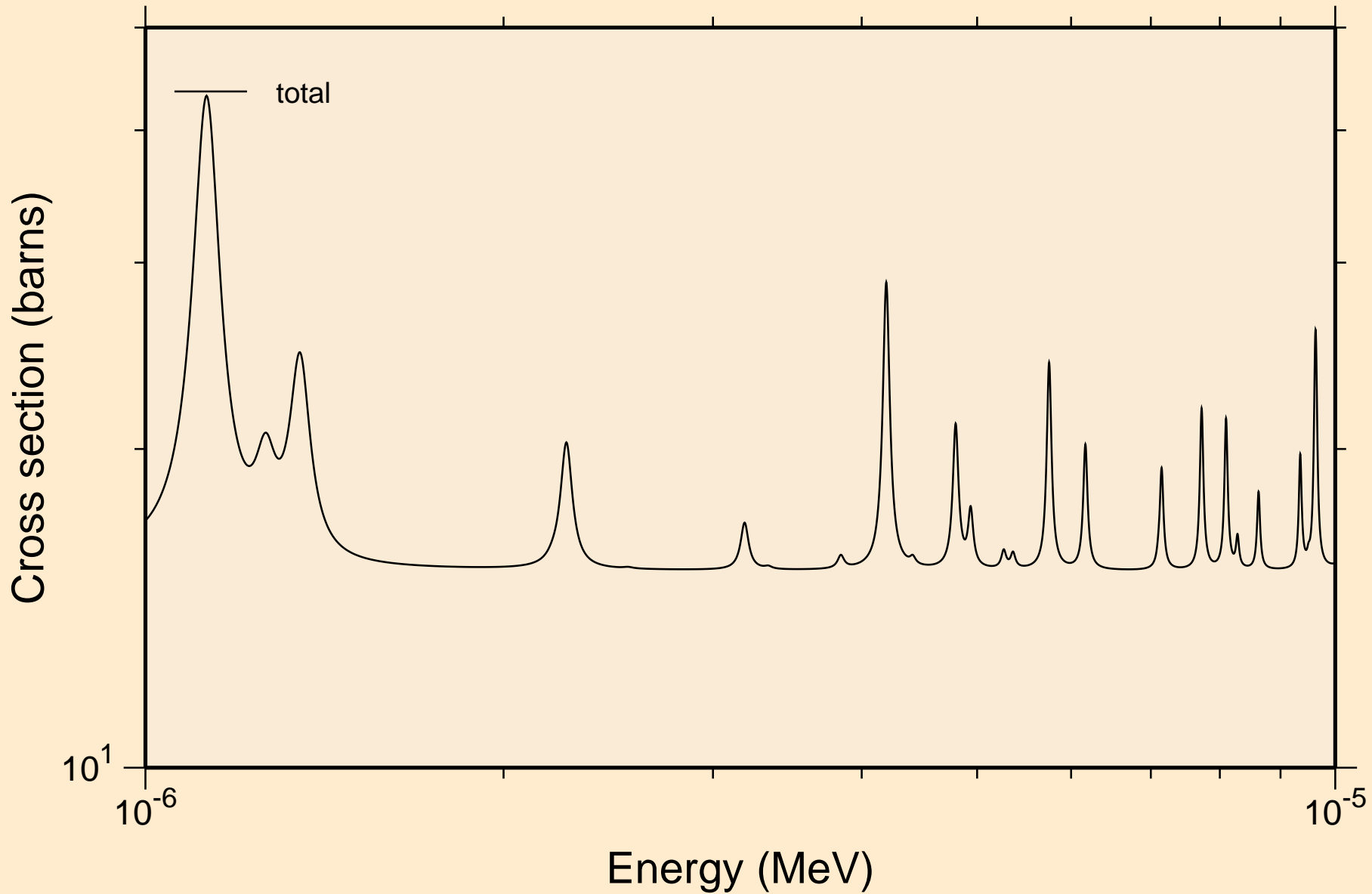

IR185 NEUTRON ACER TENDL-2023 LIBRARY; T=0.K
resonance total cross section

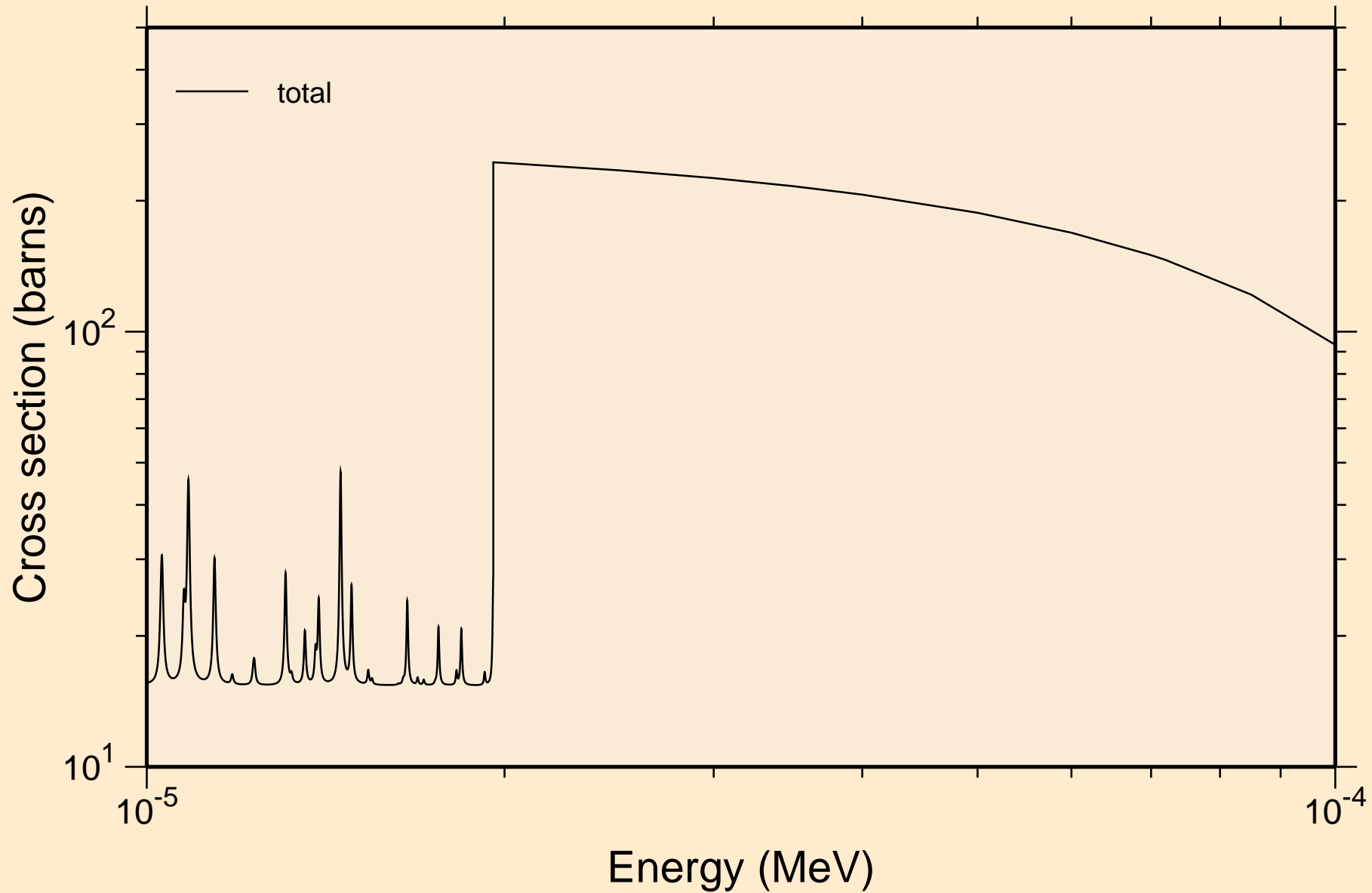

IR185 NEUTRON ACER TENDL-2023 LIBRARY; T=0.K
resonance total cross section

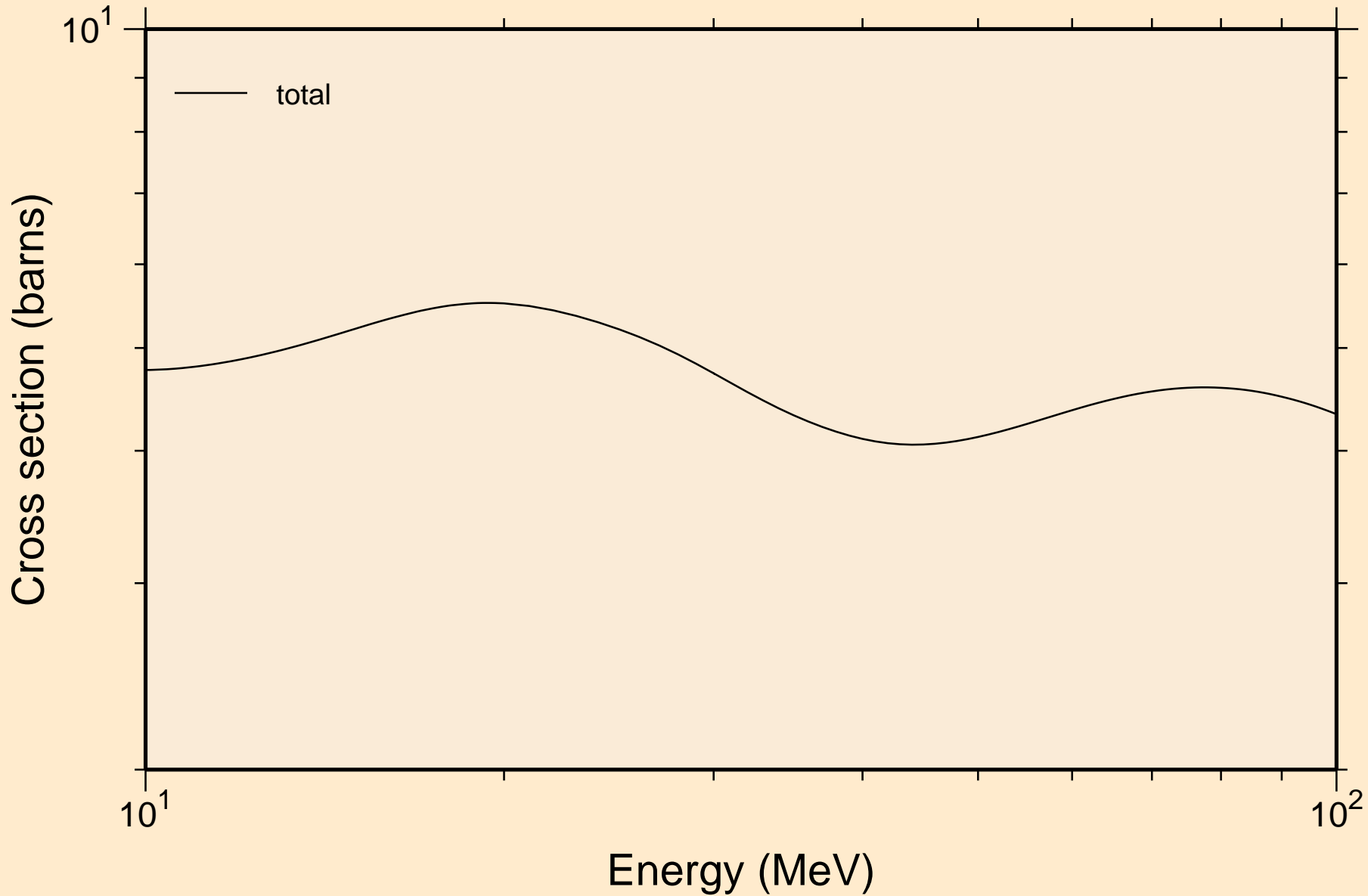

IR185 NEUTRON ACER TENDL-2023 LIBRARY; T=0.K
resonance absorption cross sections

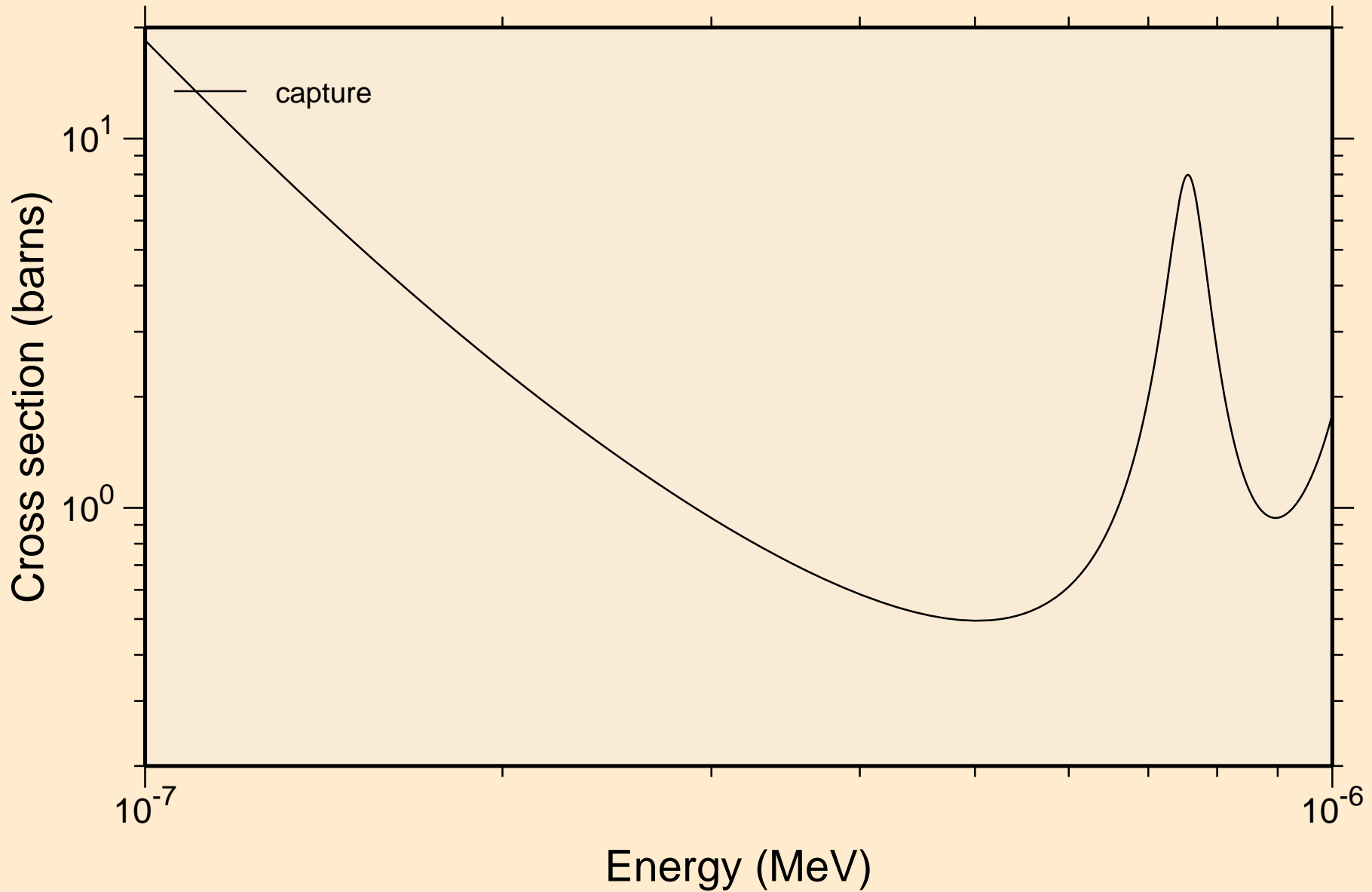

IR185 NEUTRON ACER TENDL-2023 LIBRARY; T=0.K
resonance absorption cross sections

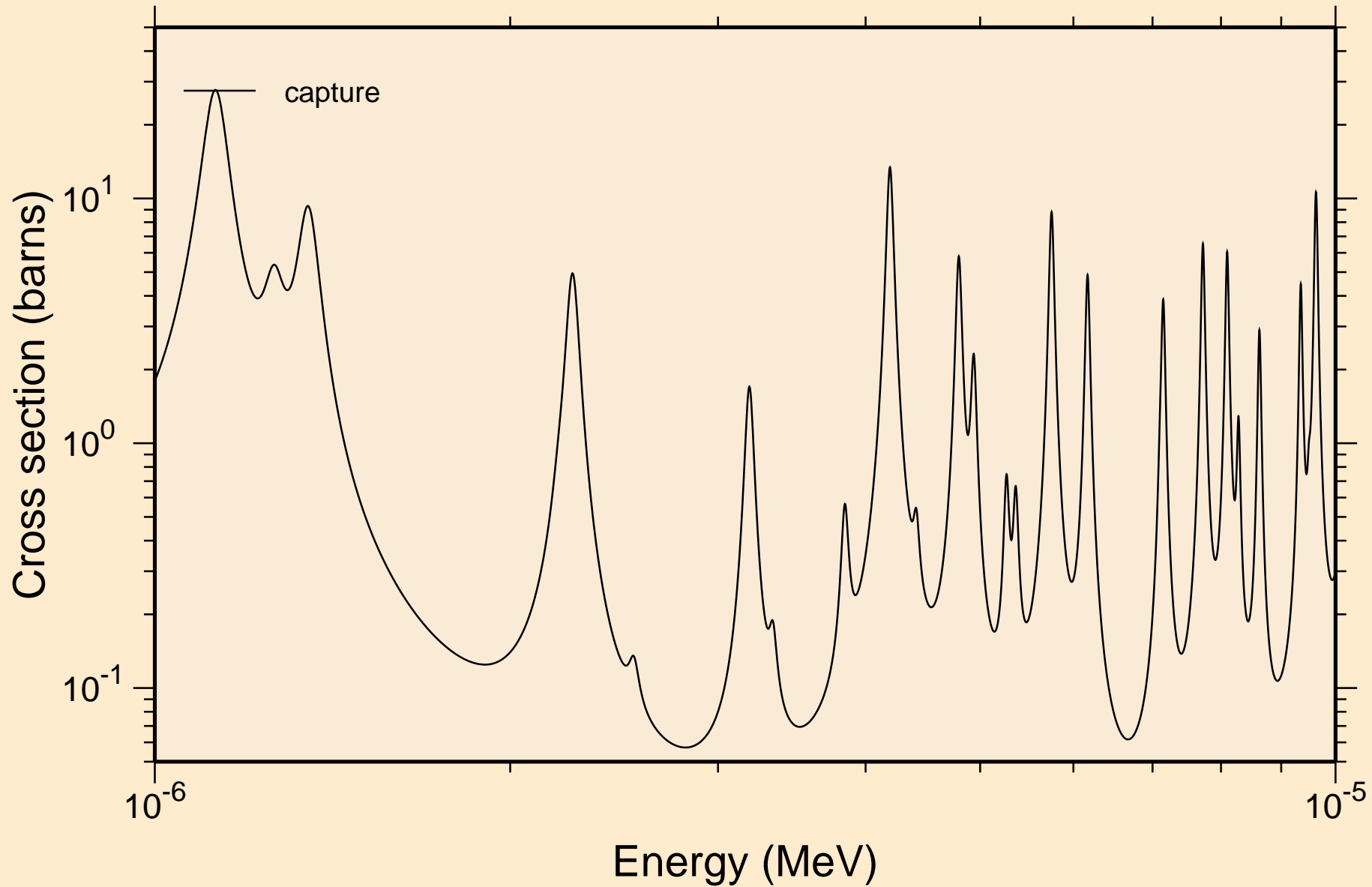

IR185 NEUTRON ACER TENDL-2023 LIBRARY; T=0.K
resonance absorption cross sections

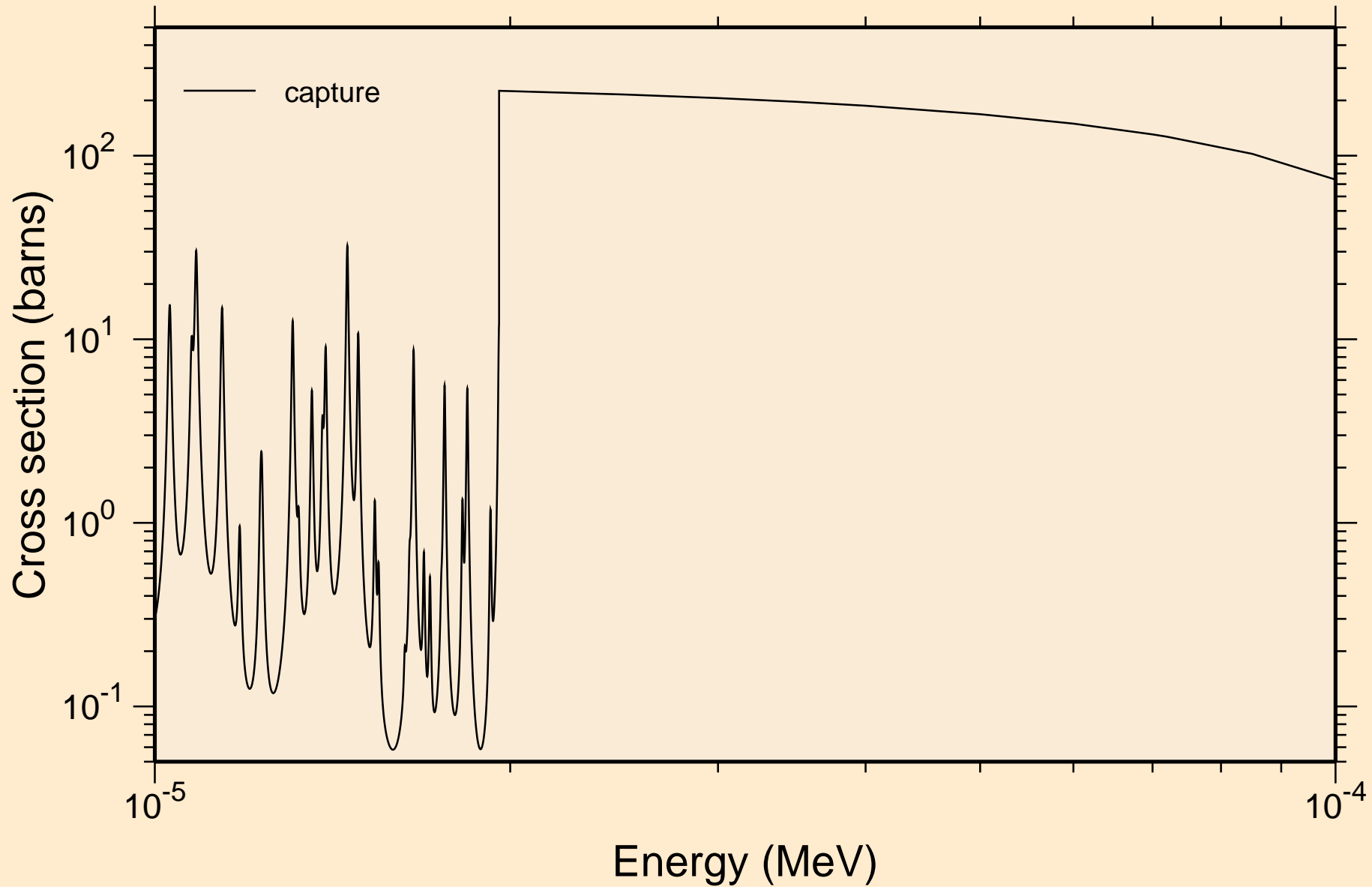

IR185 NEUTRON ACER TENDL-2023 LIBRARY; T=0.K
resonance absorption cross sections

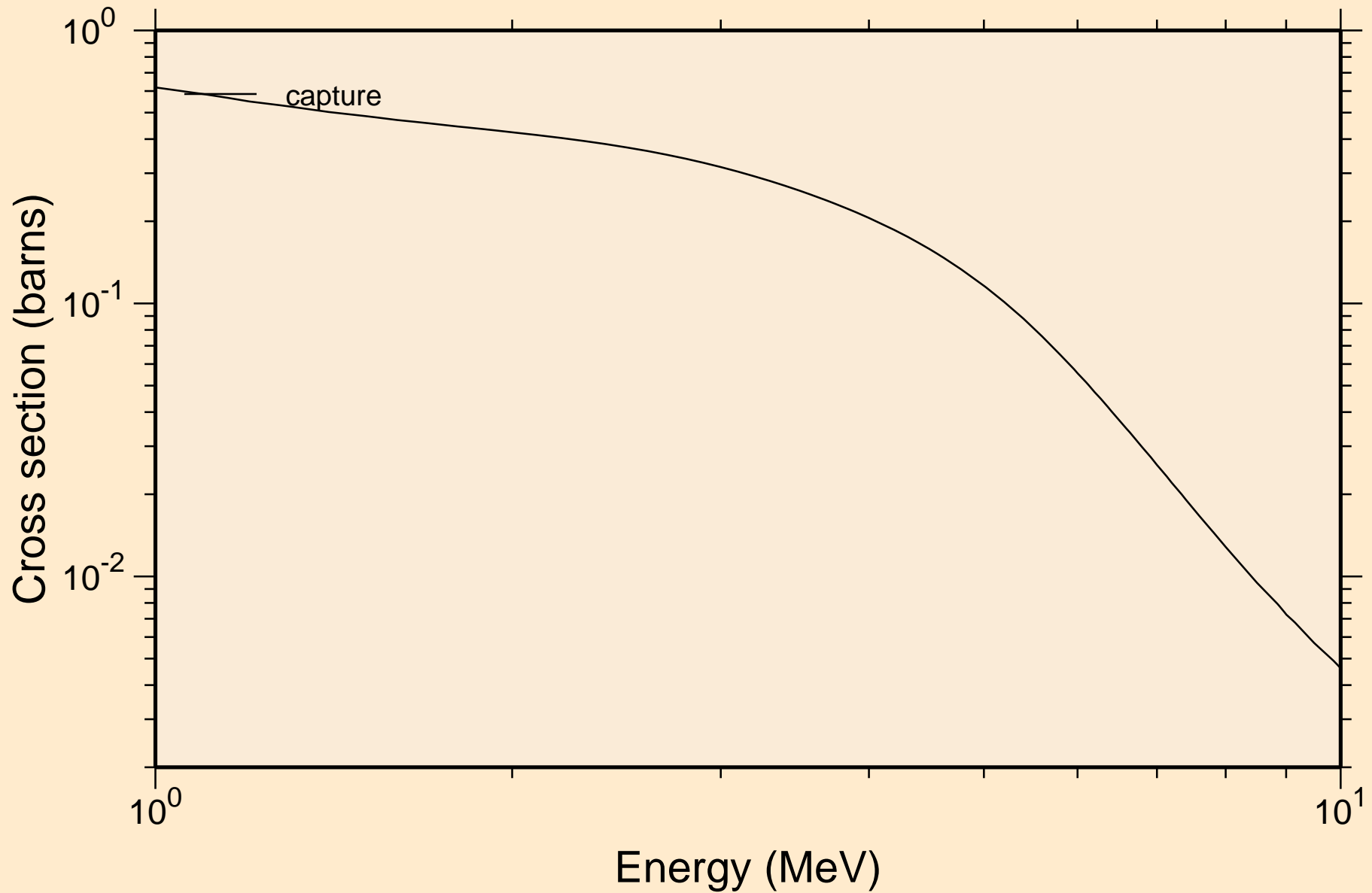

IR185 NEUTRON ACER TENDL-2023 LIBRARY; T=0.K

Heating

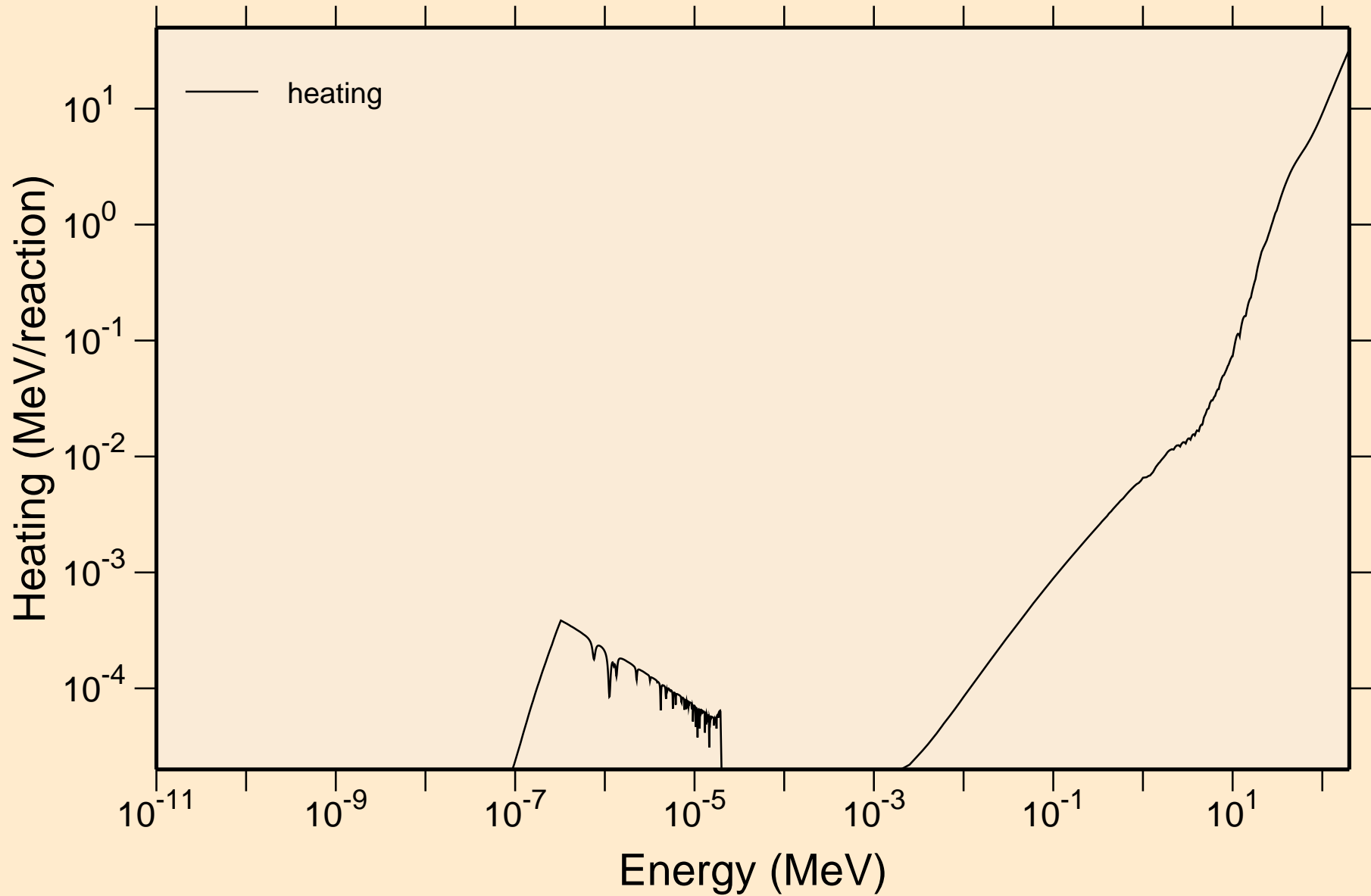

IR185 NEUTRON ACER TENDL-2023 LIBRARY; T=0.K

Damage

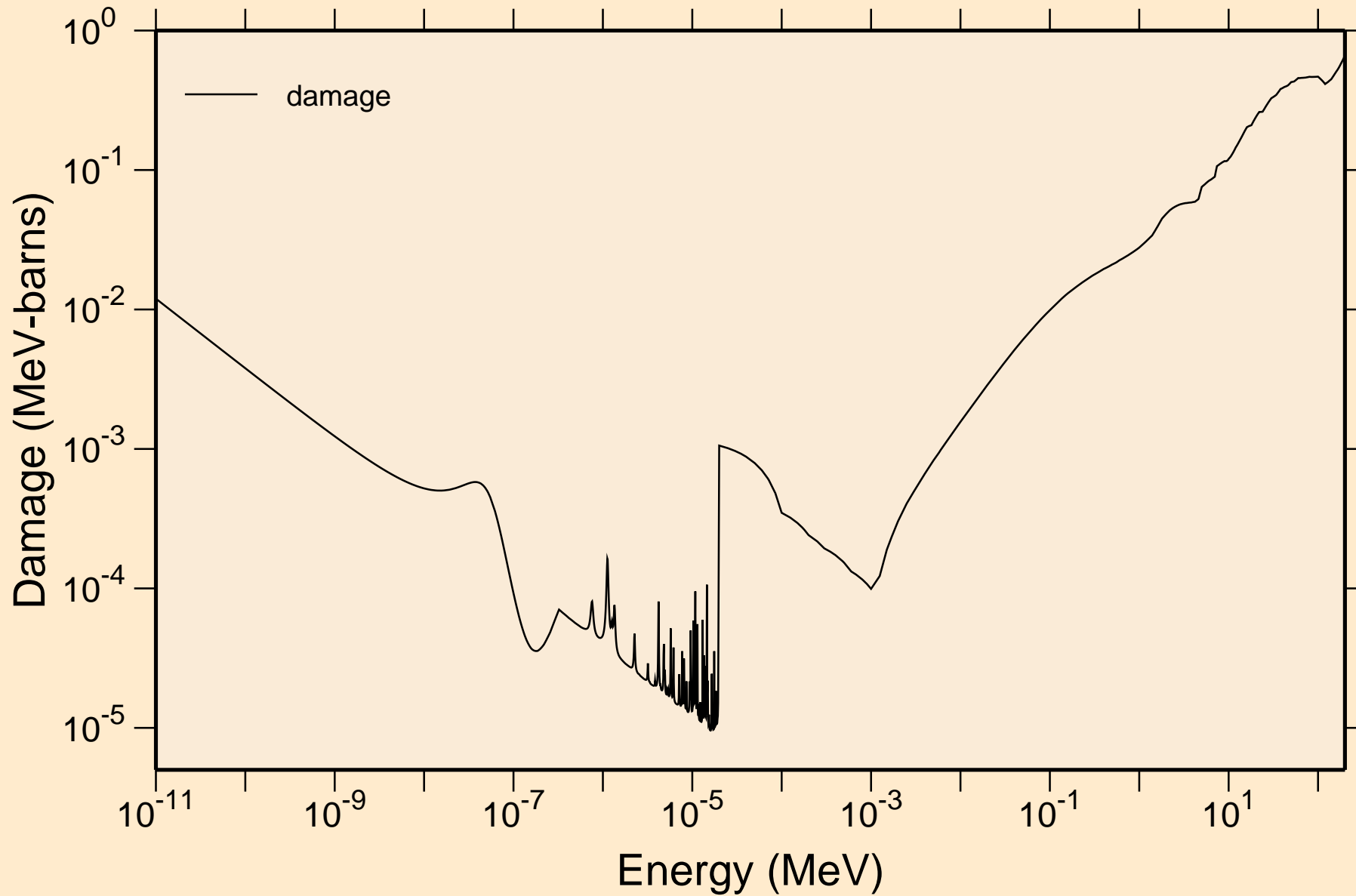

IR185 NEUTRON ACER TENDL-2023 LIBRARY; T=0.K

Non-threshold reactions

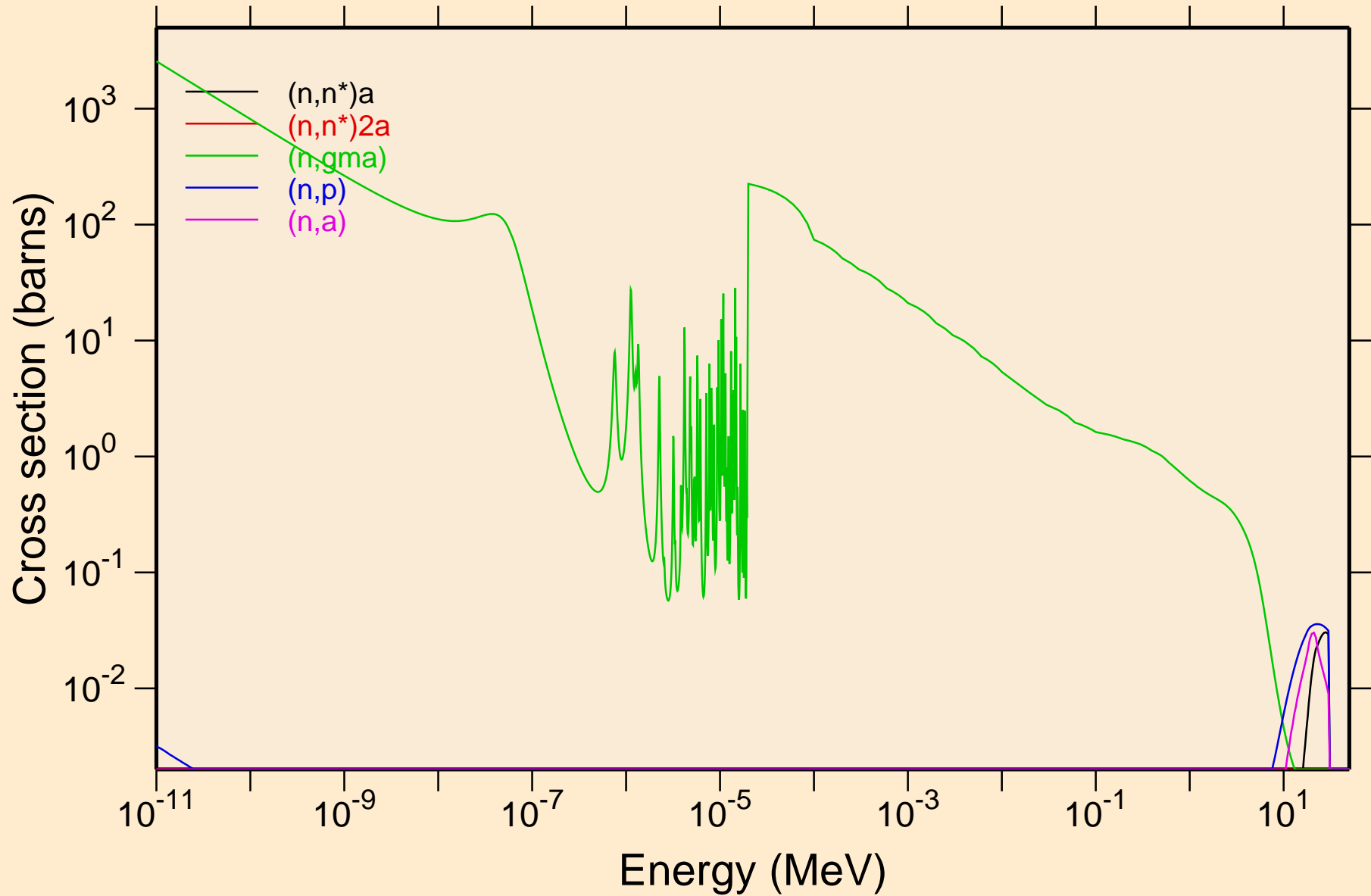

IR185 NEUTRON ACER TENDL-2023 LIBRARY; T=0.K
Non-threshold reactions

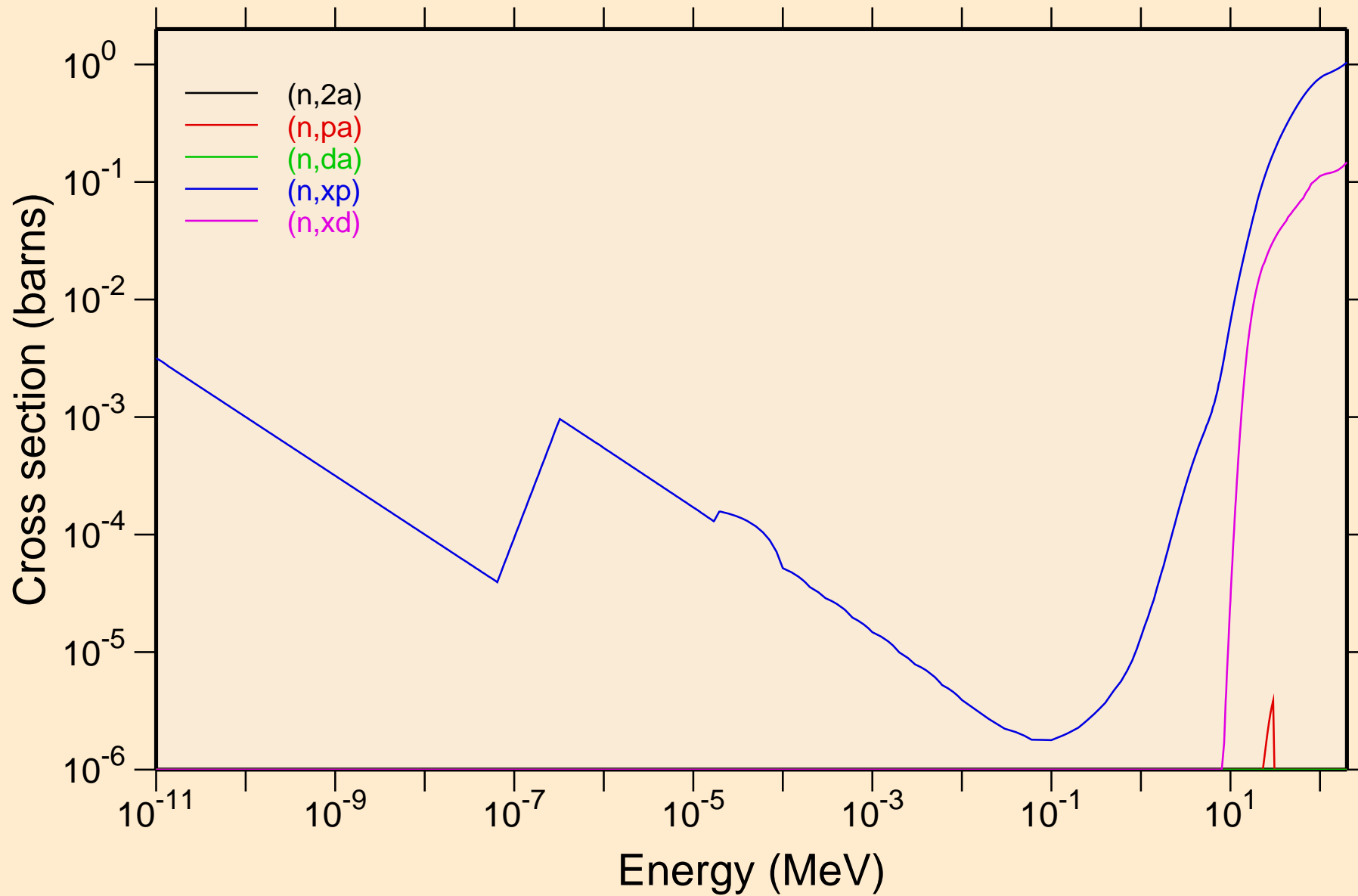

IR185 NEUTRON ACER TENDL-2023 LIBRARY; T=0.K
Non-threshold reactions

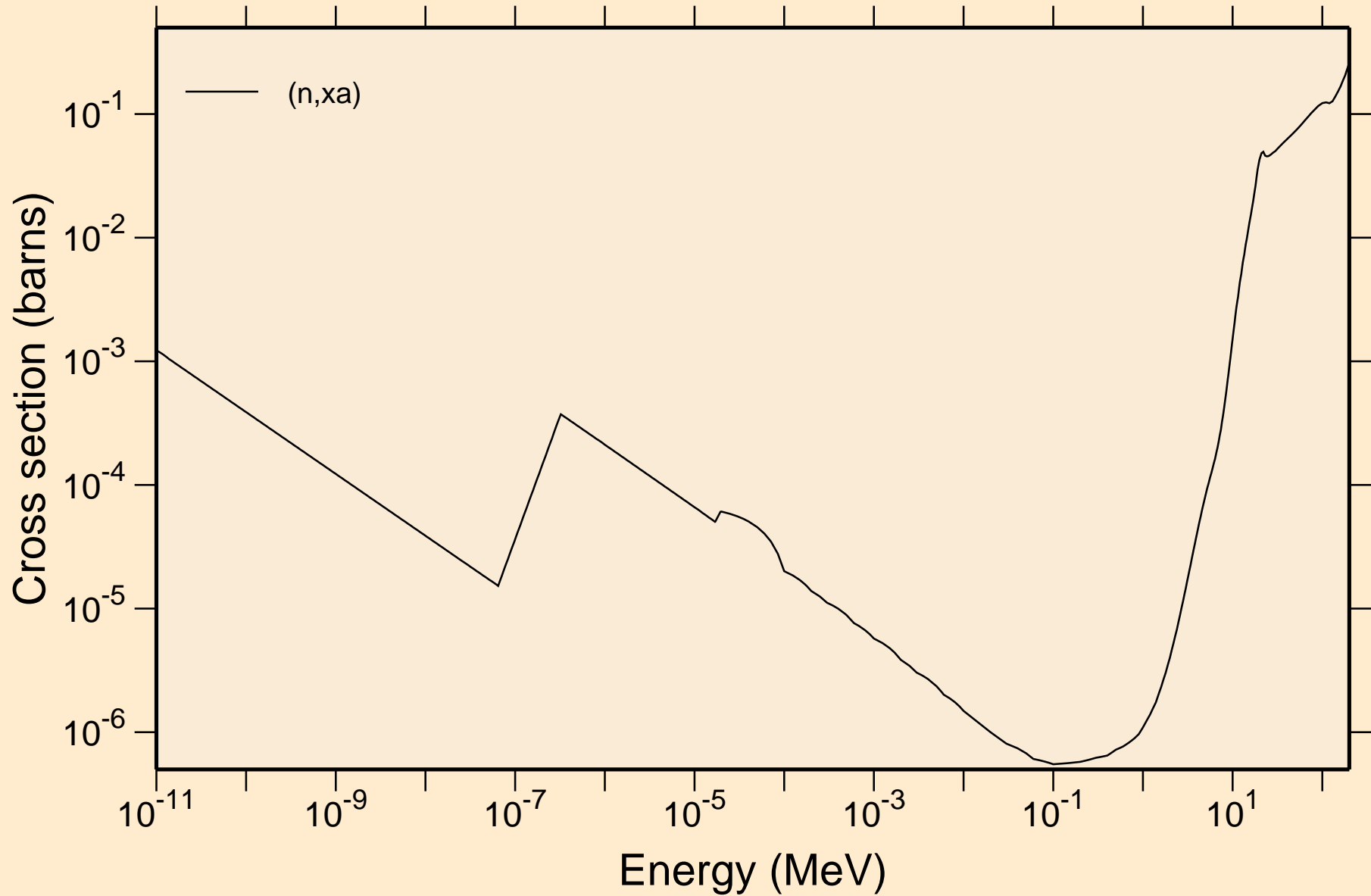

IR185 NEUTRON ACER TENDL-2023 LIBRARY; T=0.K

Principal cross sections

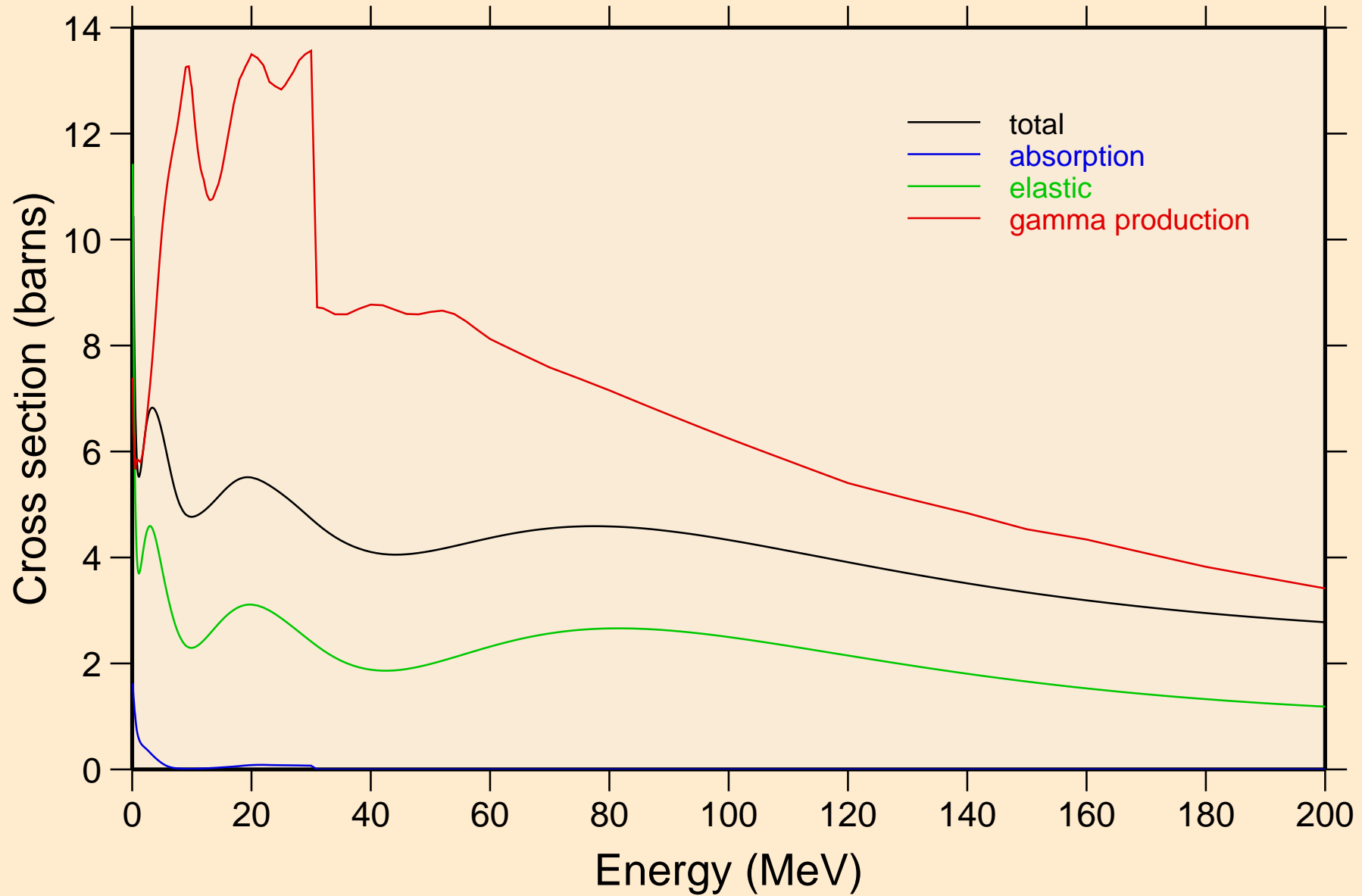

IR185 NEUTRON ACER TENDL-2023 LIBRARY; T=0.K

Heating

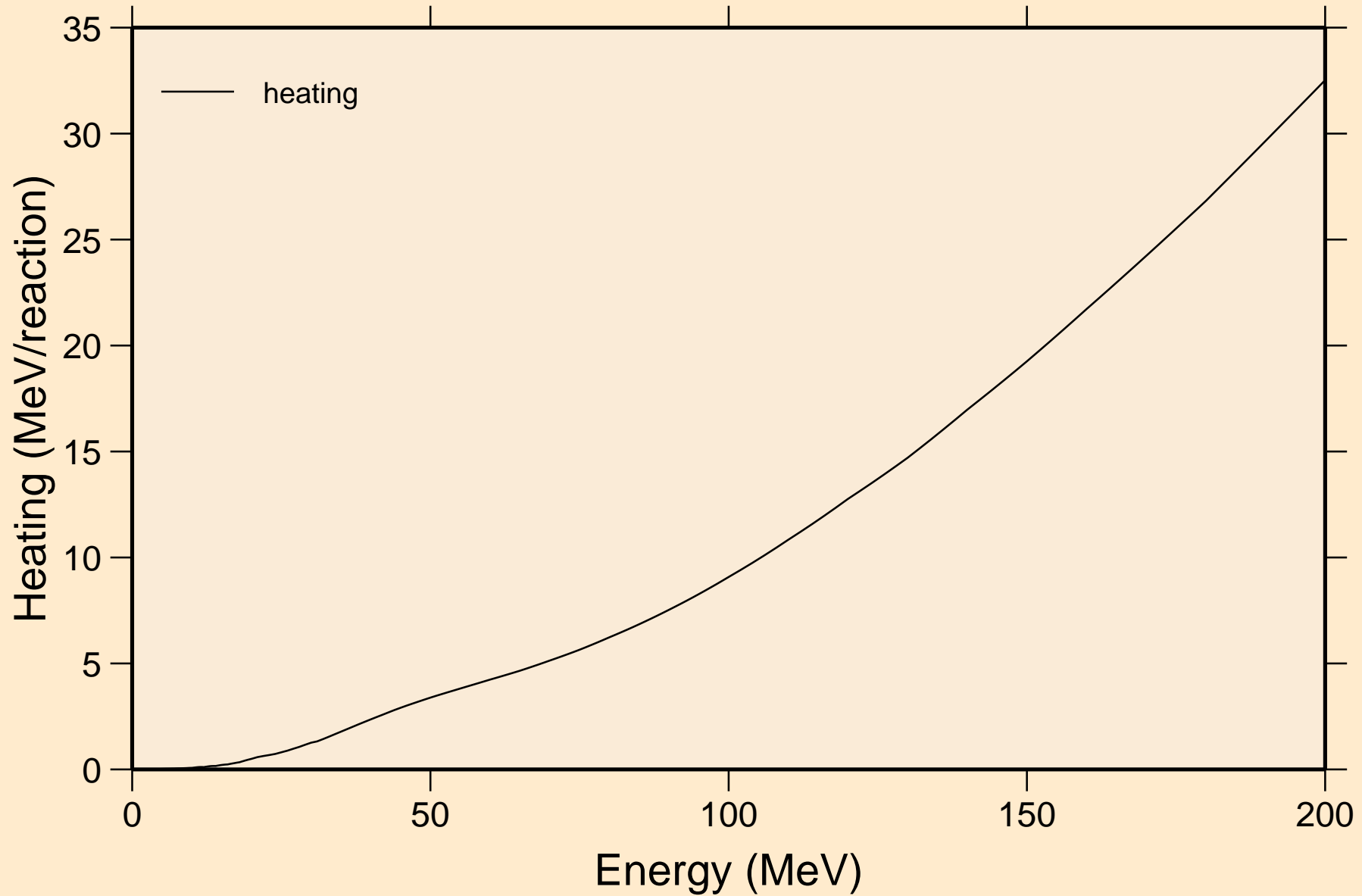

IR185 NEUTRON ACER TENDL-2023 LIBRARY; T=0.K

Damage

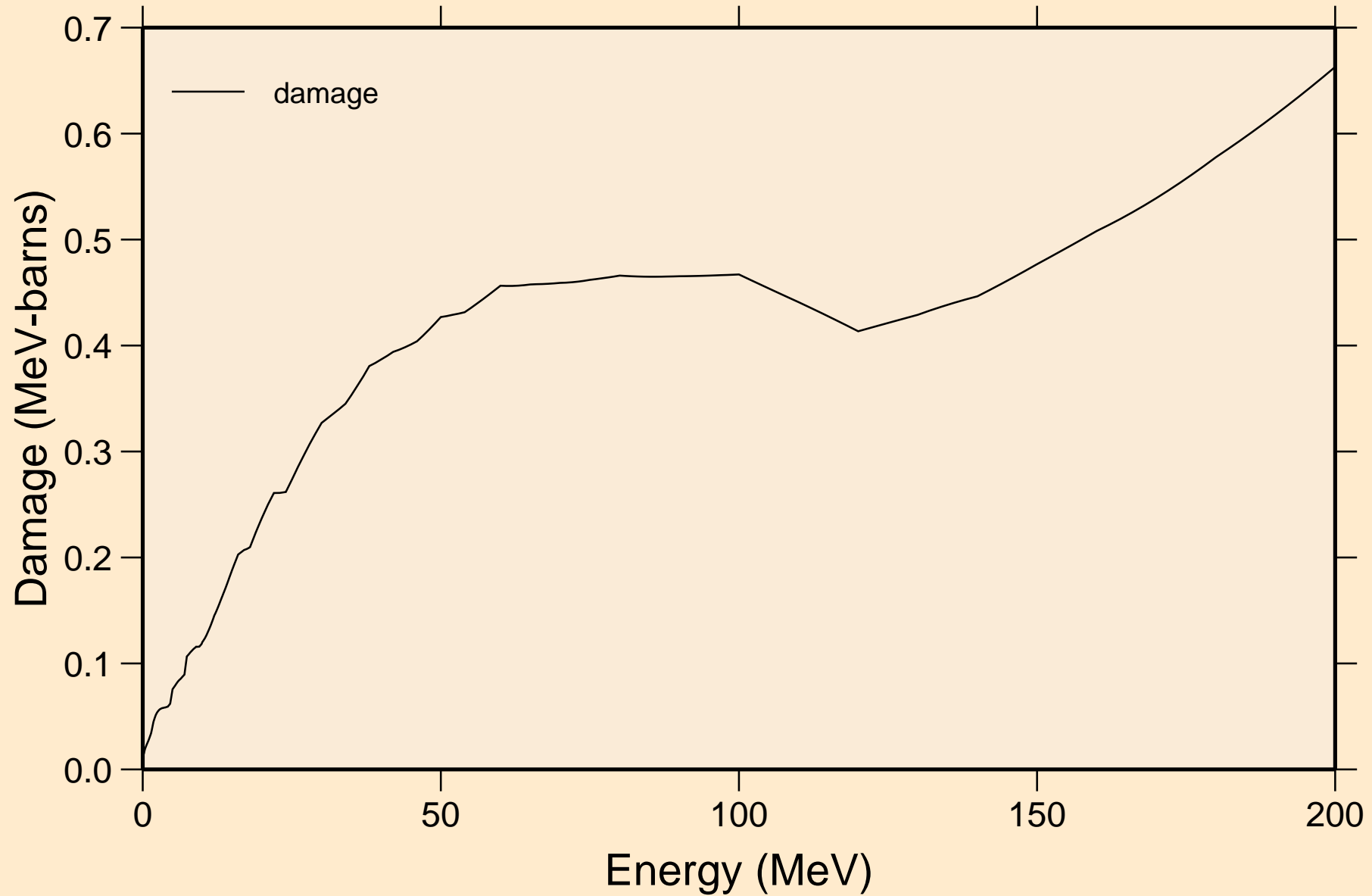

IR185 NEUTRON ACER TENDL-2023 LIBRARY; T=0.K
Non-threshold reactions

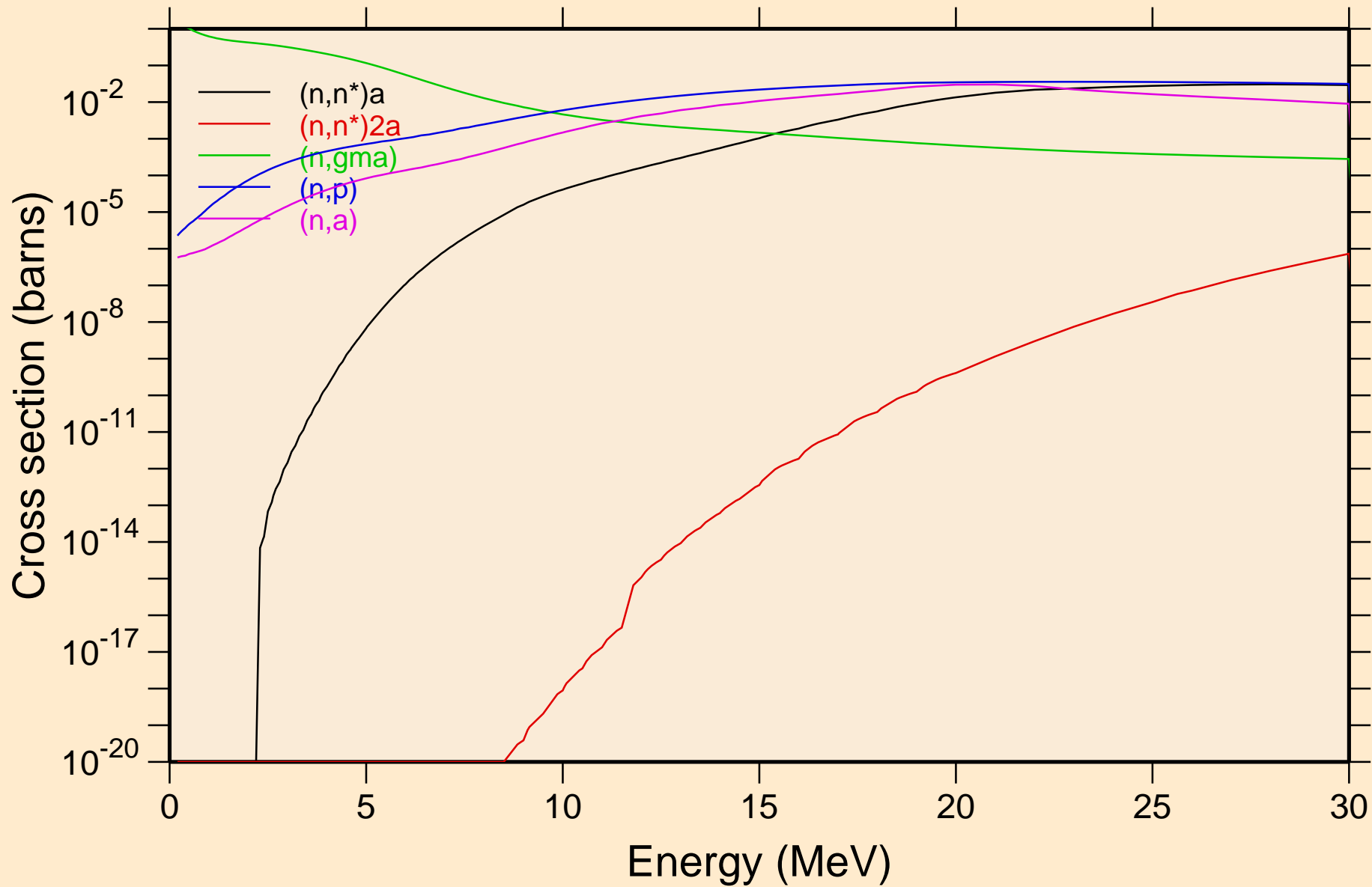

IR185 NEUTRON ACER TENDL-2023 LIBRARY; T=0.K
Non-threshold reactions

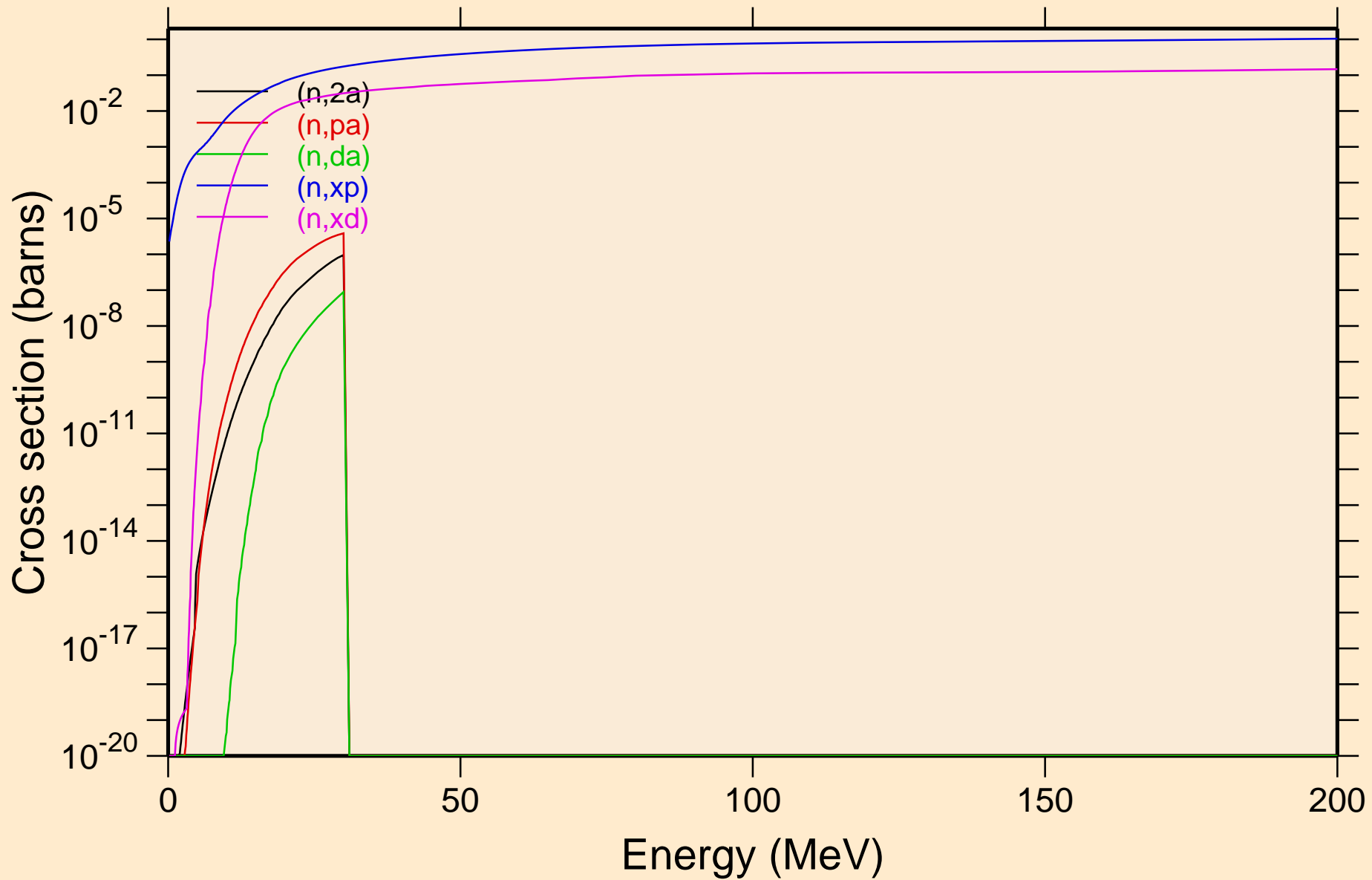

IR185 NEUTRON ACER TENDL-2023 LIBRARY; T=0.K
Non-threshold reactions

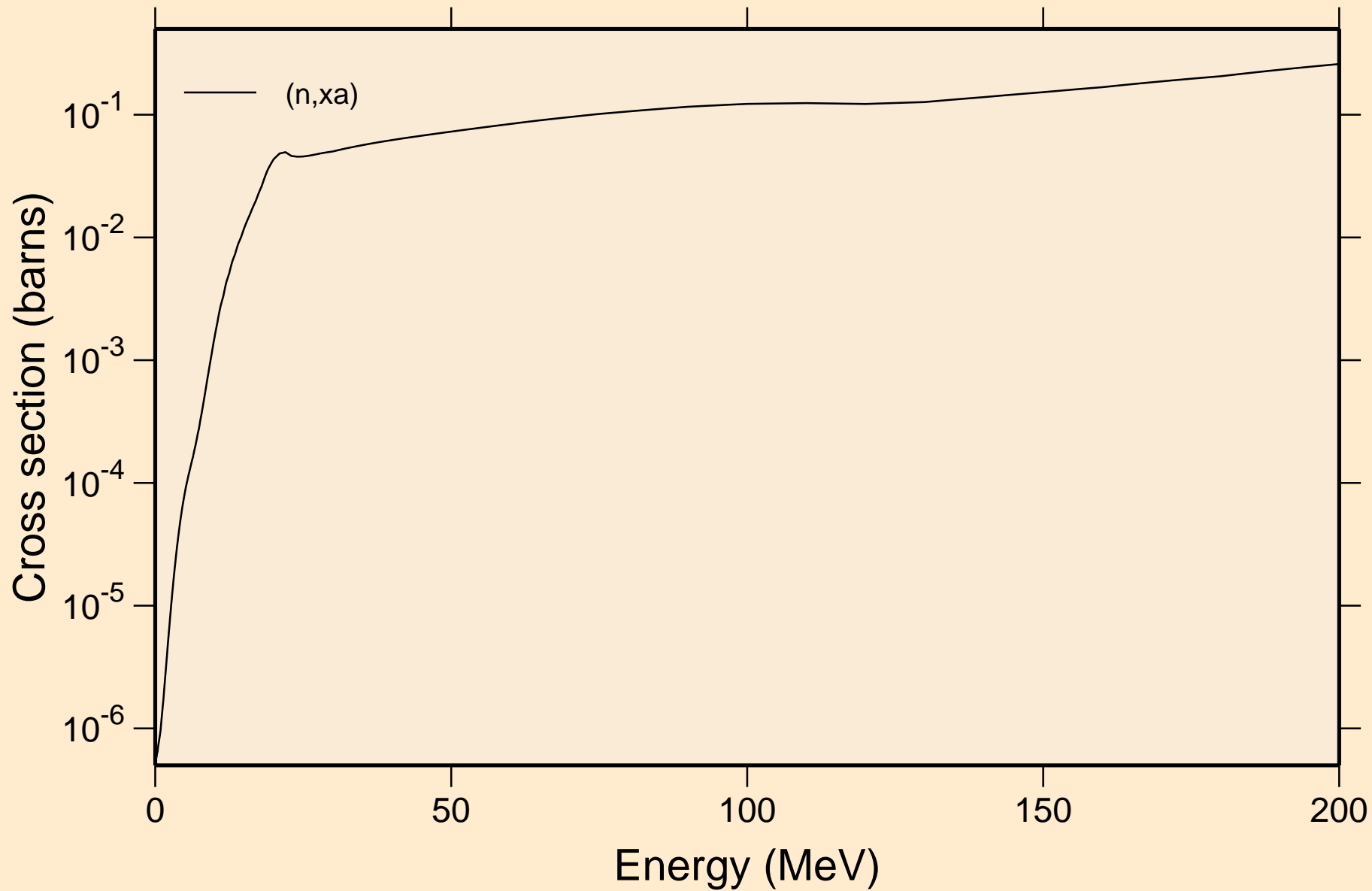

IR185 NEUTRON ACER TENDL-2023 LIBRARY; T=0.K
Inelastic levels

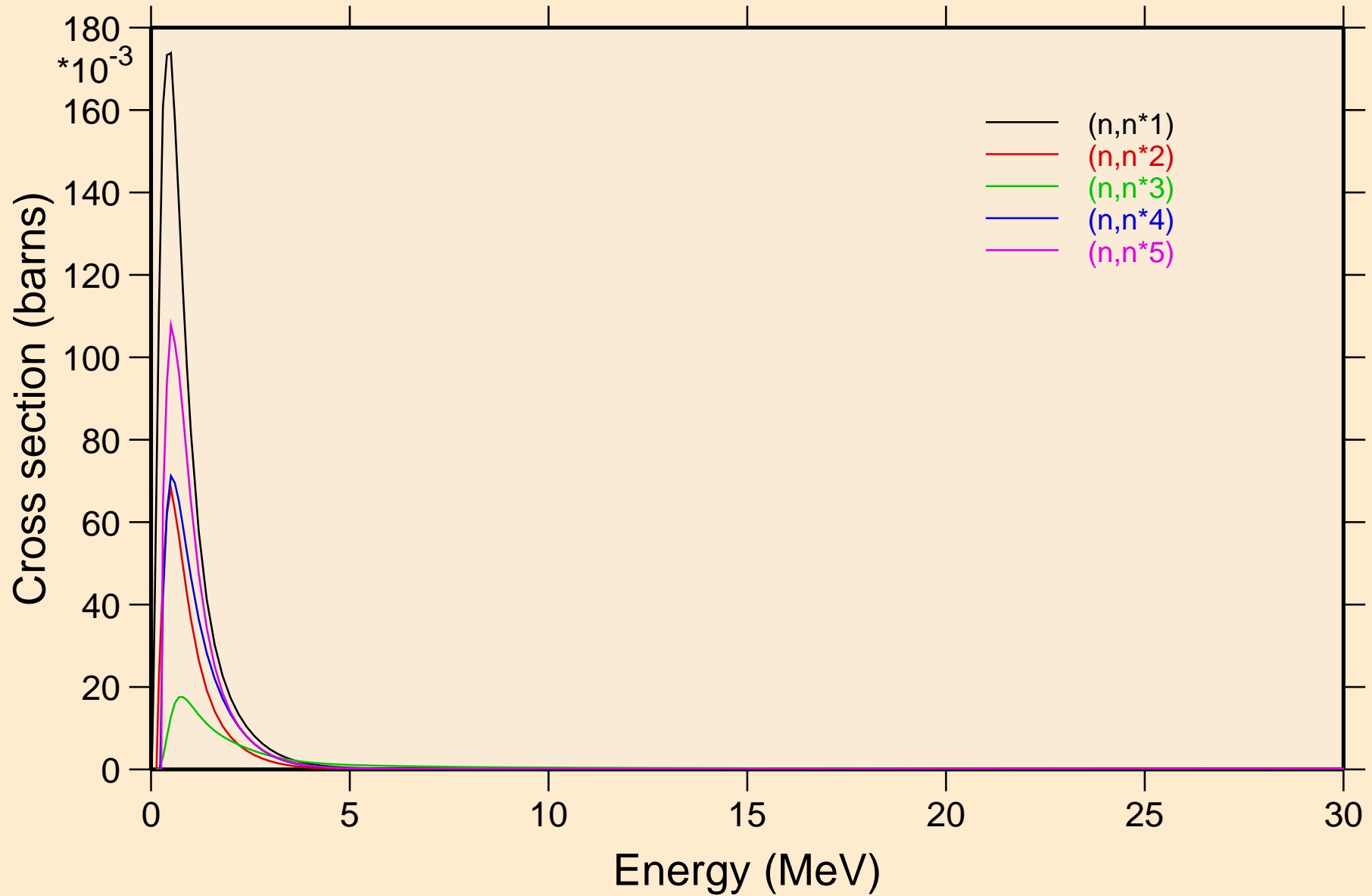

IR185 NEUTRON ACER TENDL-2023 LIBRARY; T=0.K
Inelastic levels

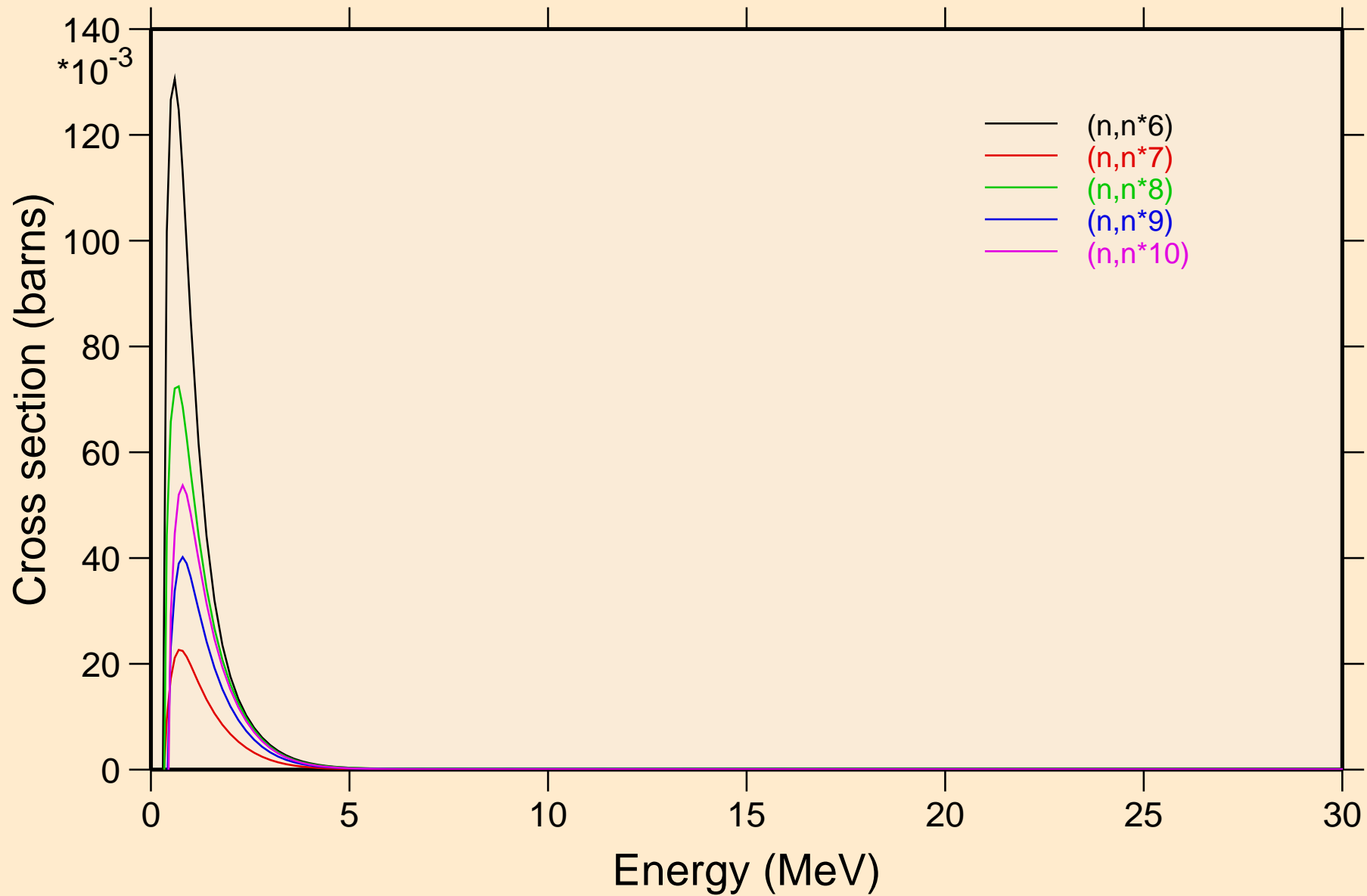

IR185 NEUTRON ACER TENDL-2023 LIBRARY; T=0.K
Inelastic levels

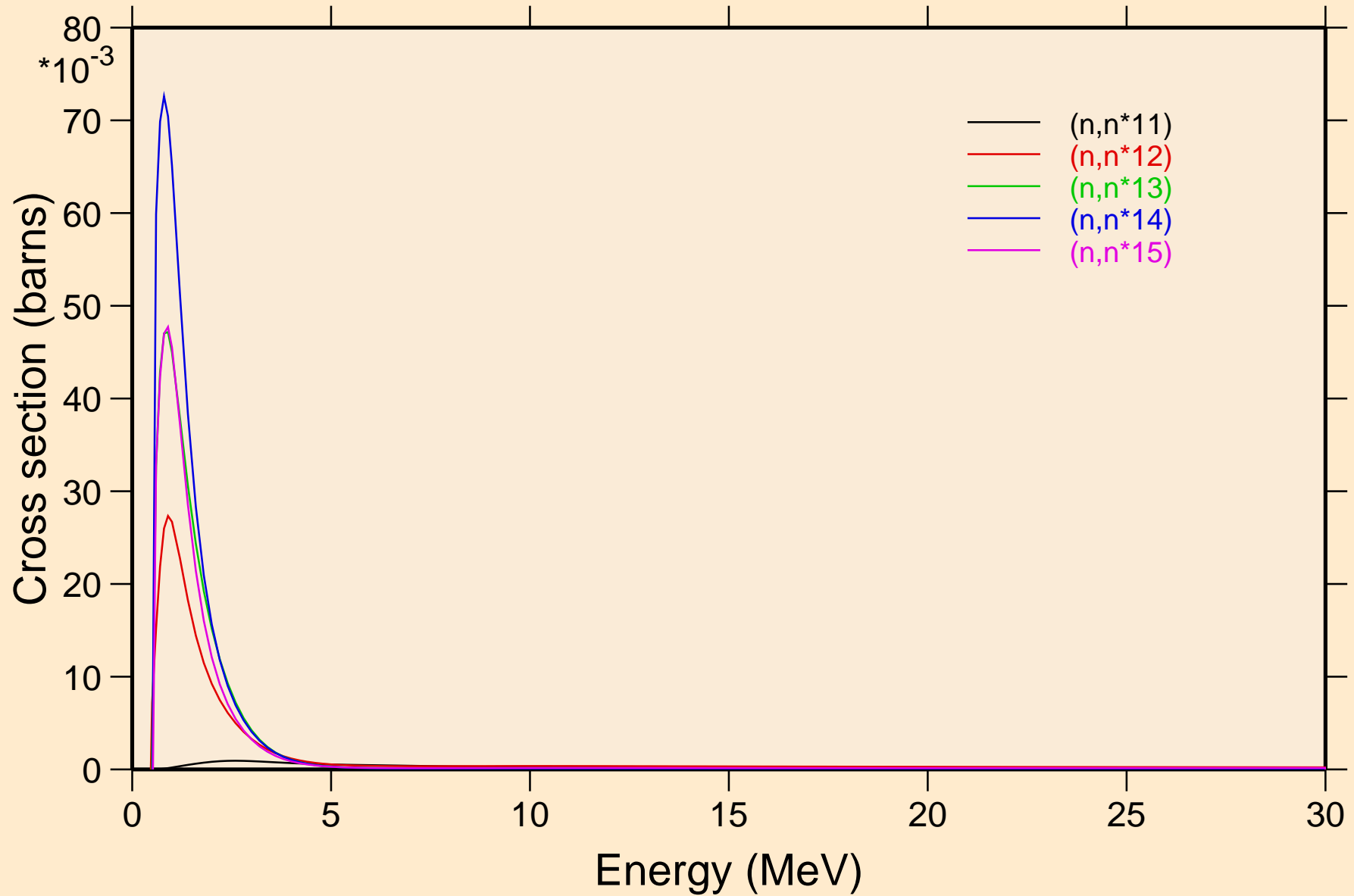

IR185 NEUTRON ACER TENDL-2023 LIBRARY; T=0.K
Inelastic levels

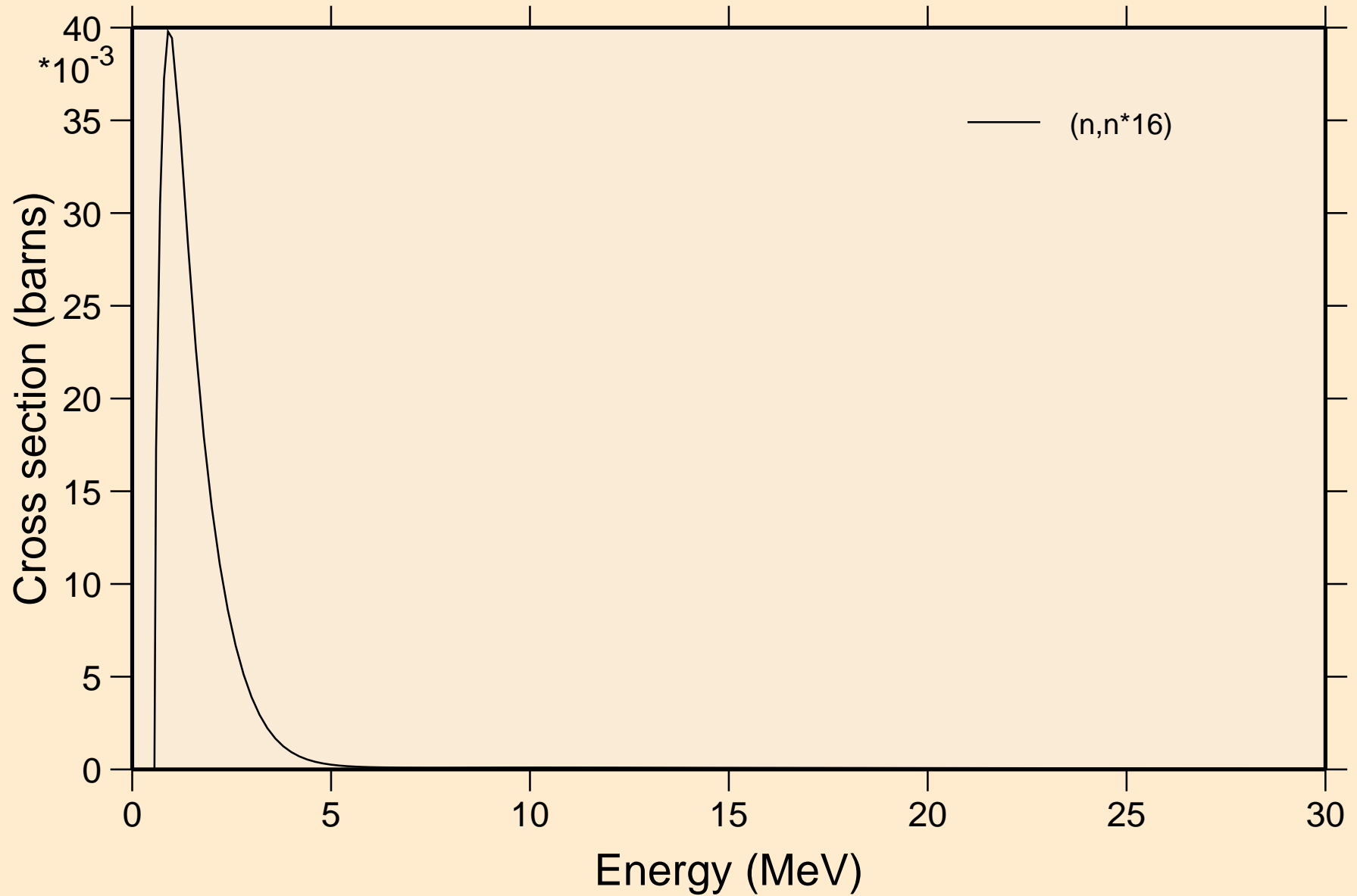

IR185 NEUTRON ACER TENDL-2023 LIBRARY; T=0.K
Threshold reactions

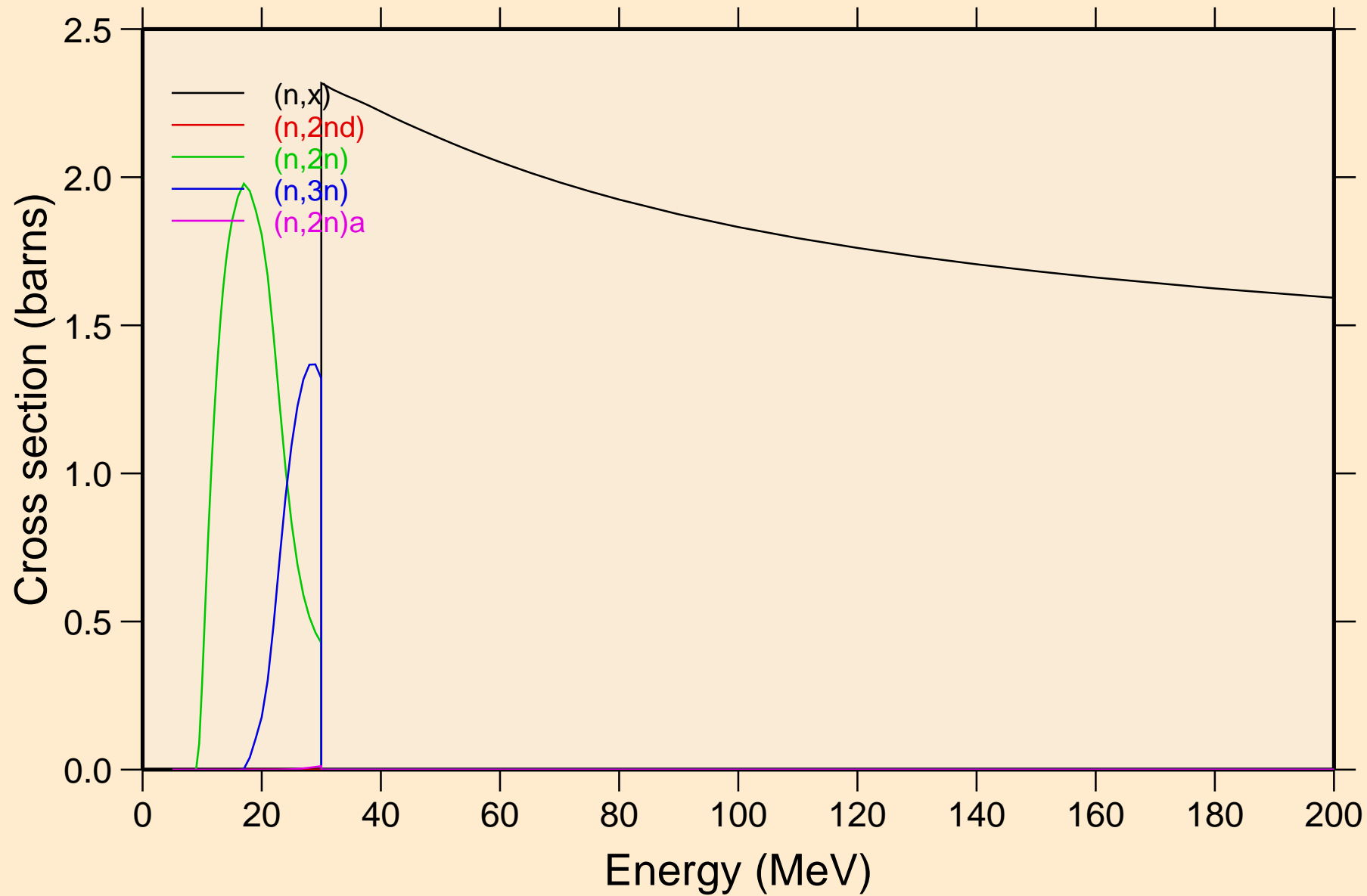

IR185 NEUTRON ACER TENDL-2023 LIBRARY; T=0.K
Threshold reactions

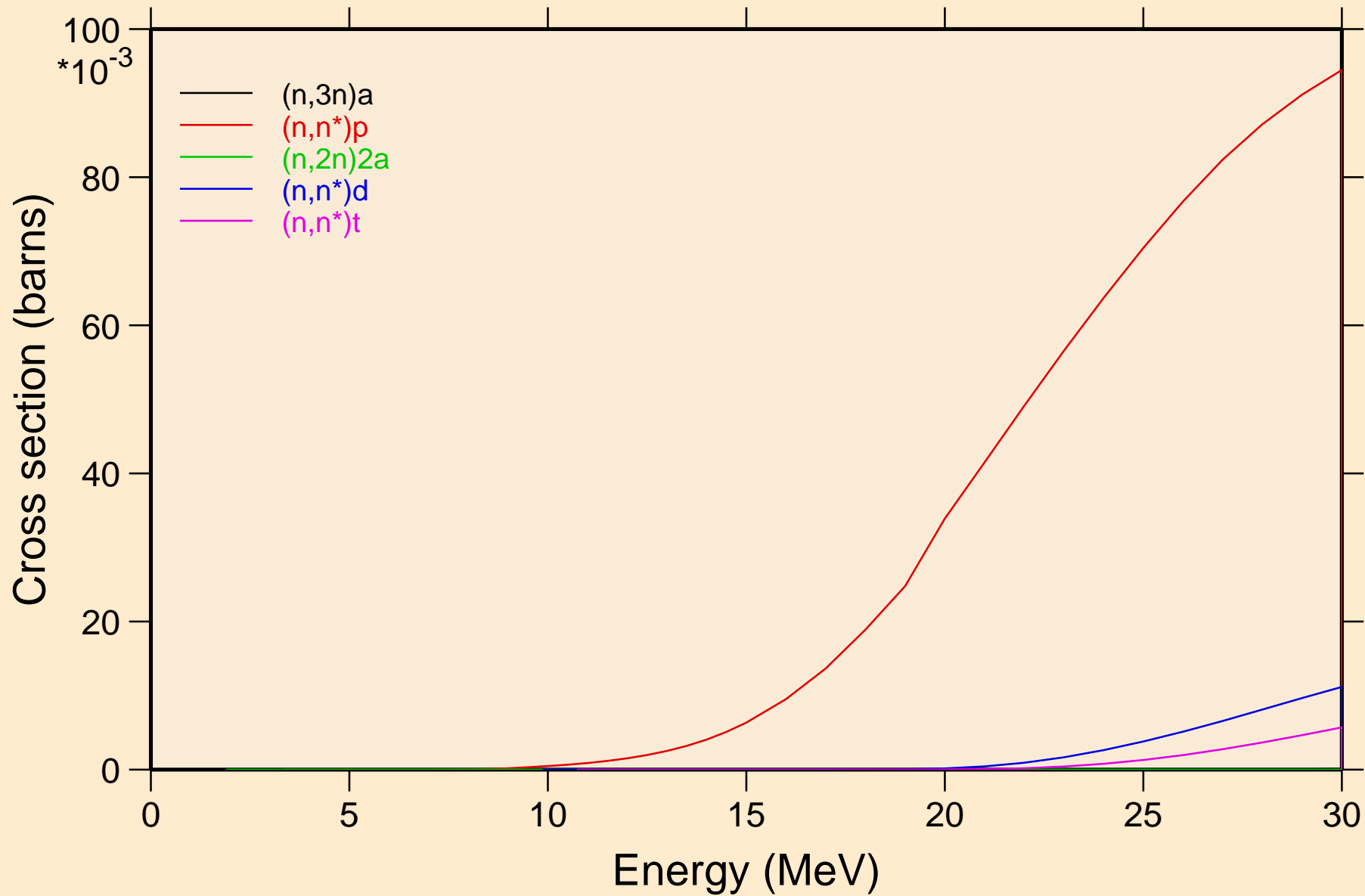

IR185 NEUTRON ACER TENDL-2023 LIBRARY; T=0.K

Threshold reactions

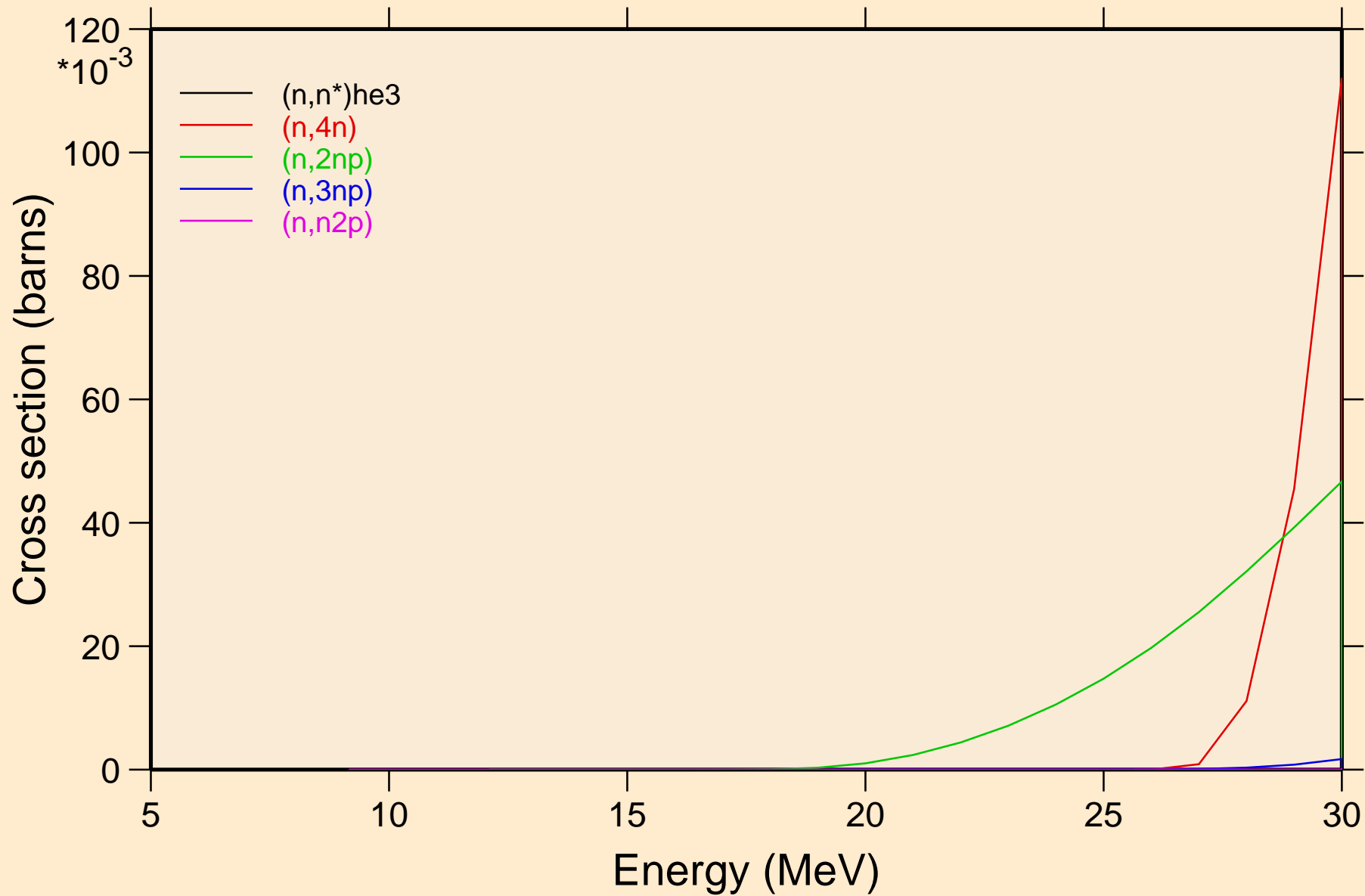

IR185 NEUTRON ACER TENDL-2023 LIBRARY; T=0.K
Threshold reactions

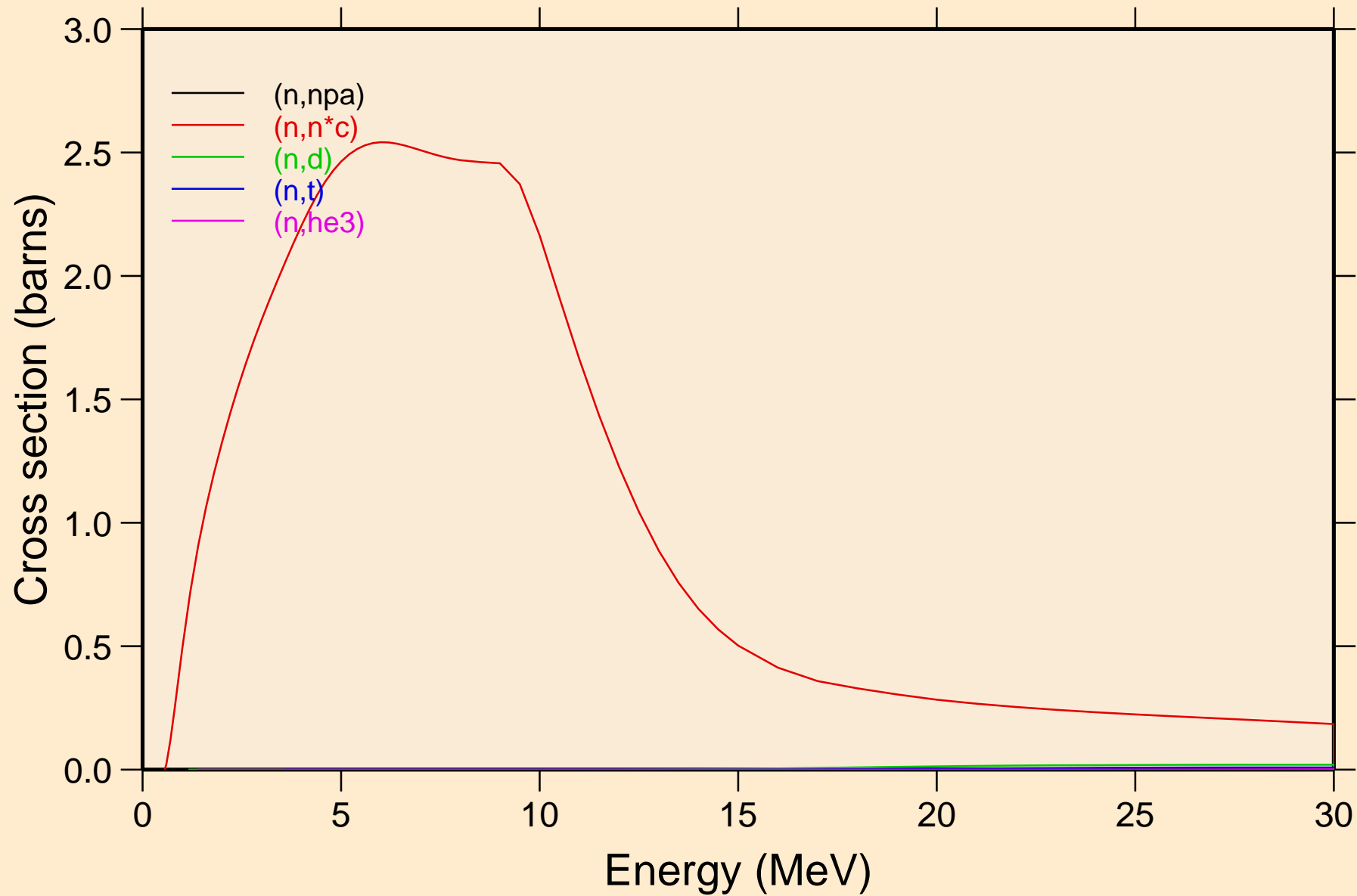

IR185 NEUTRON ACER TENDL-2023 LIBRARY; T=0.K

Threshold reactions

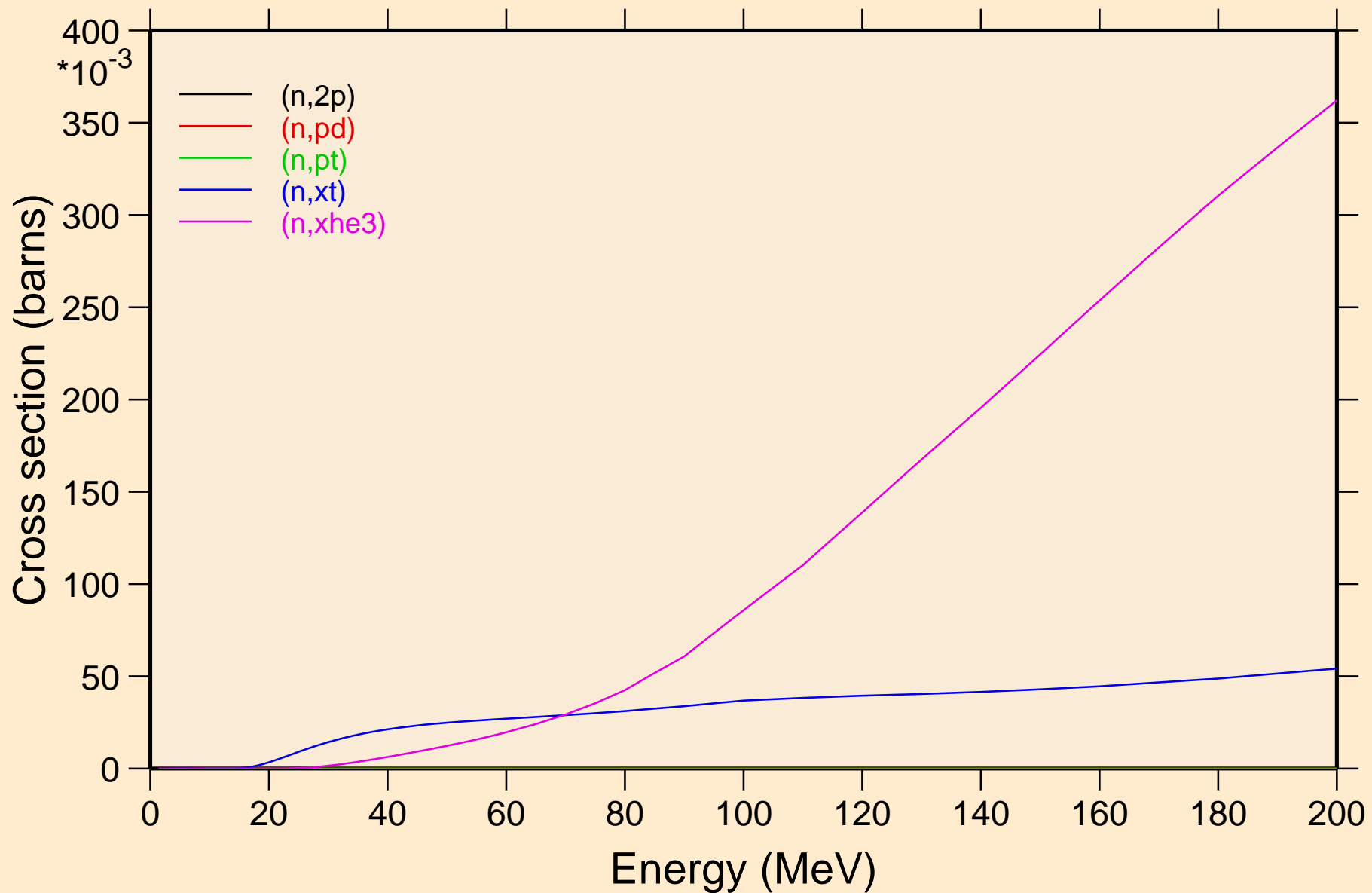

IR185 NEUTRON ACER TENDL-2023 LIBRARY; T=0.K
angular distribution for elastic

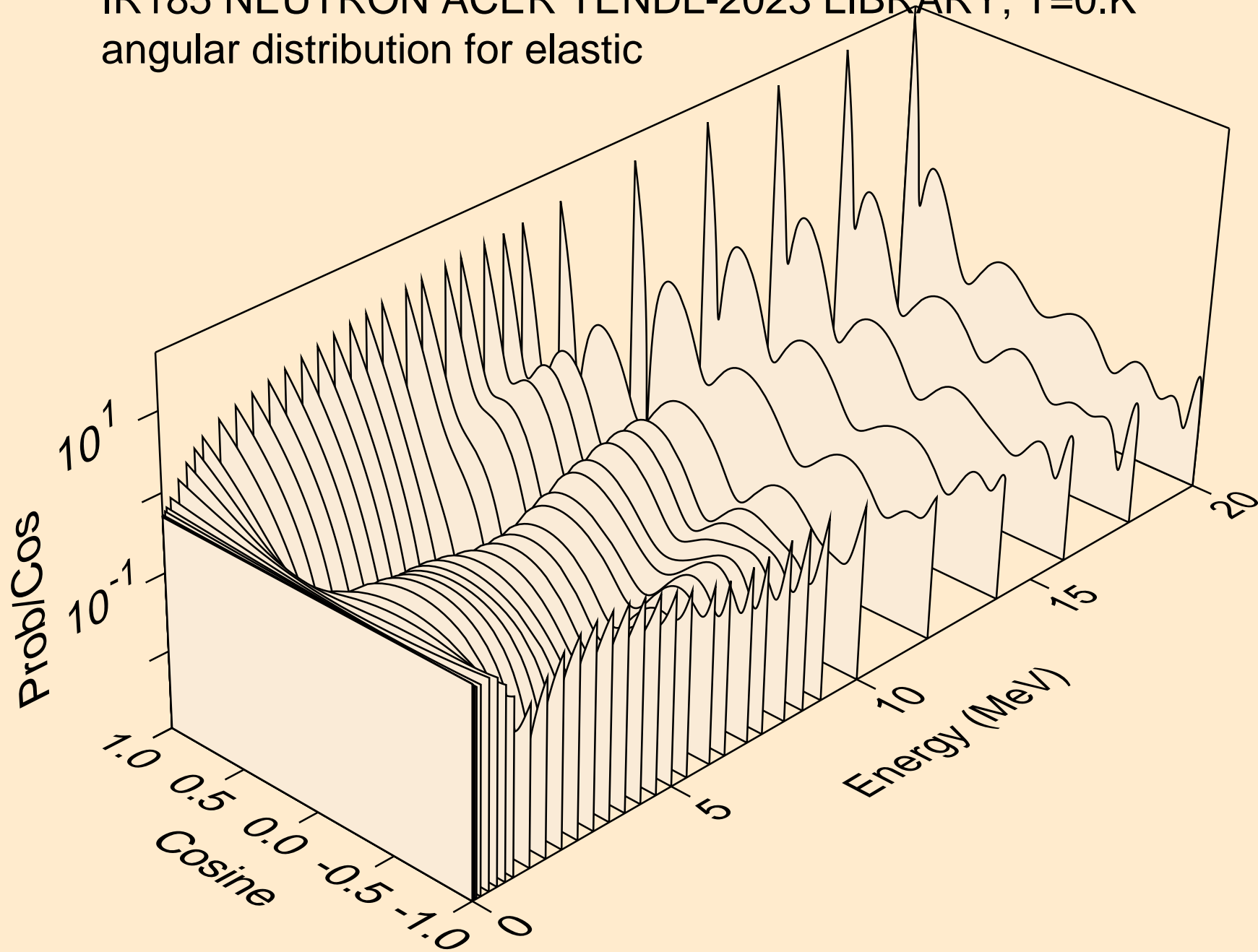

IR185 NEUTRON ACER TENDL-2023 LIBRARY; T=0.K
angular distribution for elastic

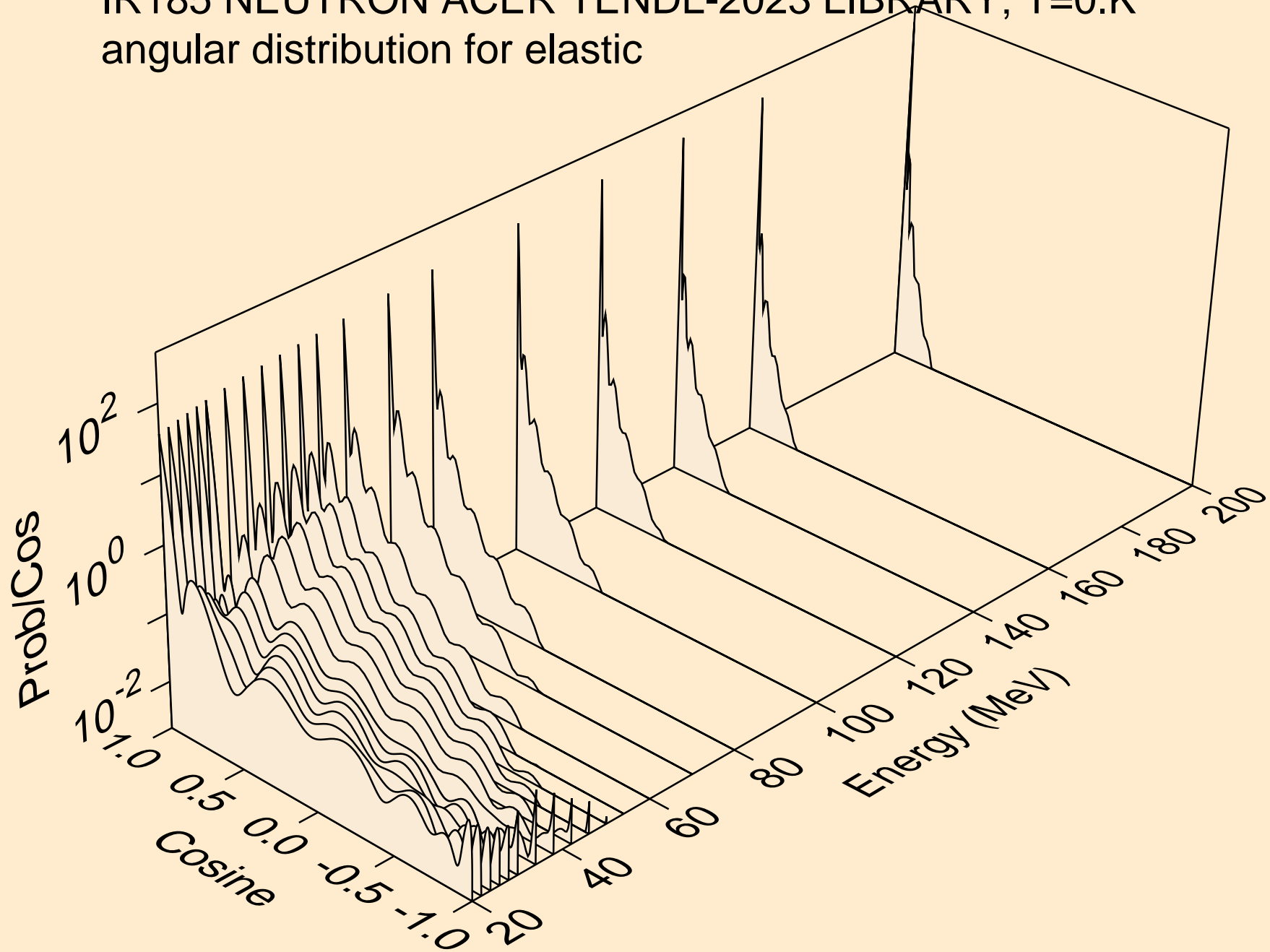

IR185 NEUTRON ACER TENDL-2023 LIBRARY; T=0.K
angular distribution for (n,n*1)

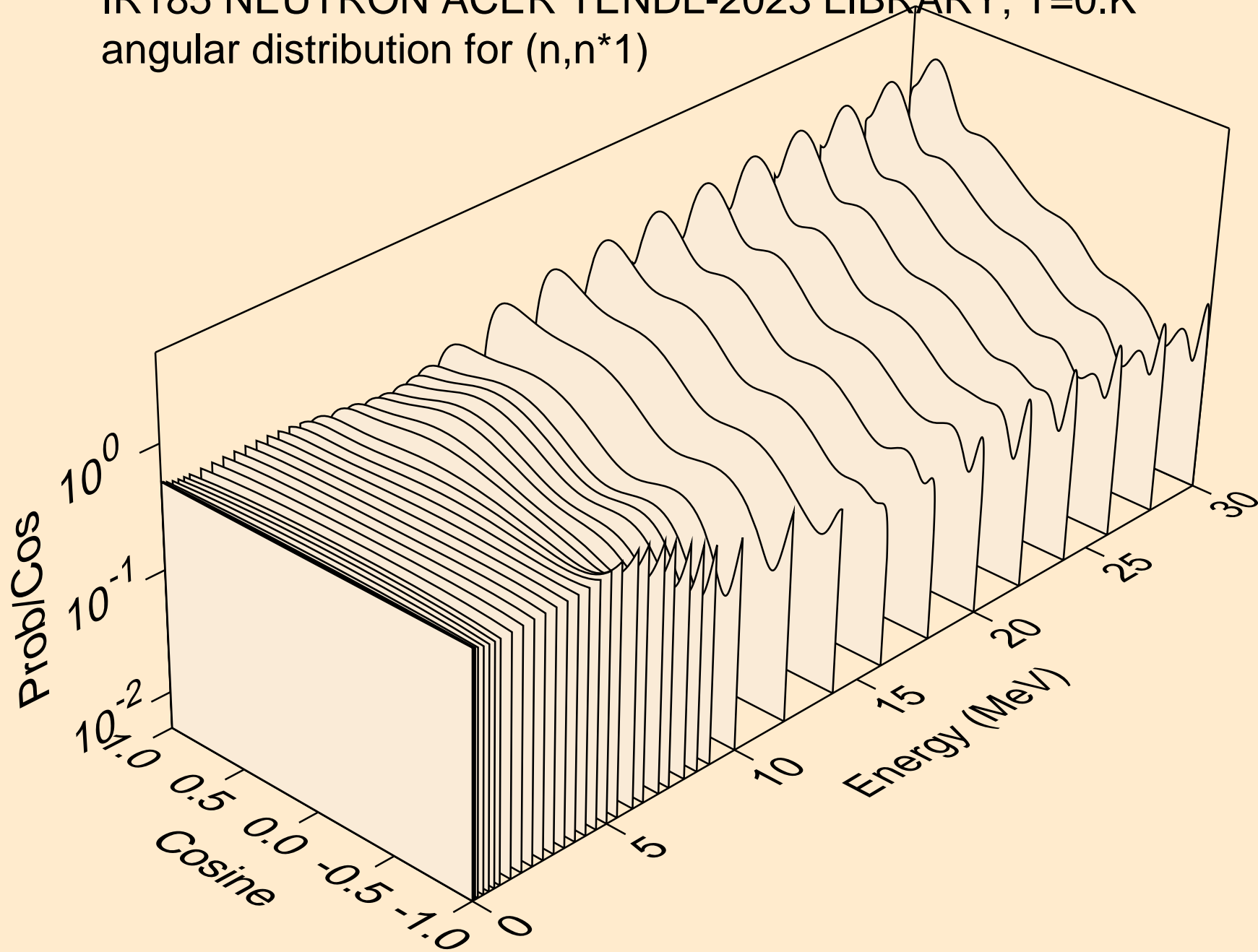

IR185 NEUTRON ACER TENDL-2023 LIBRARY; T=0.K
angular distribution for (n,n*2)

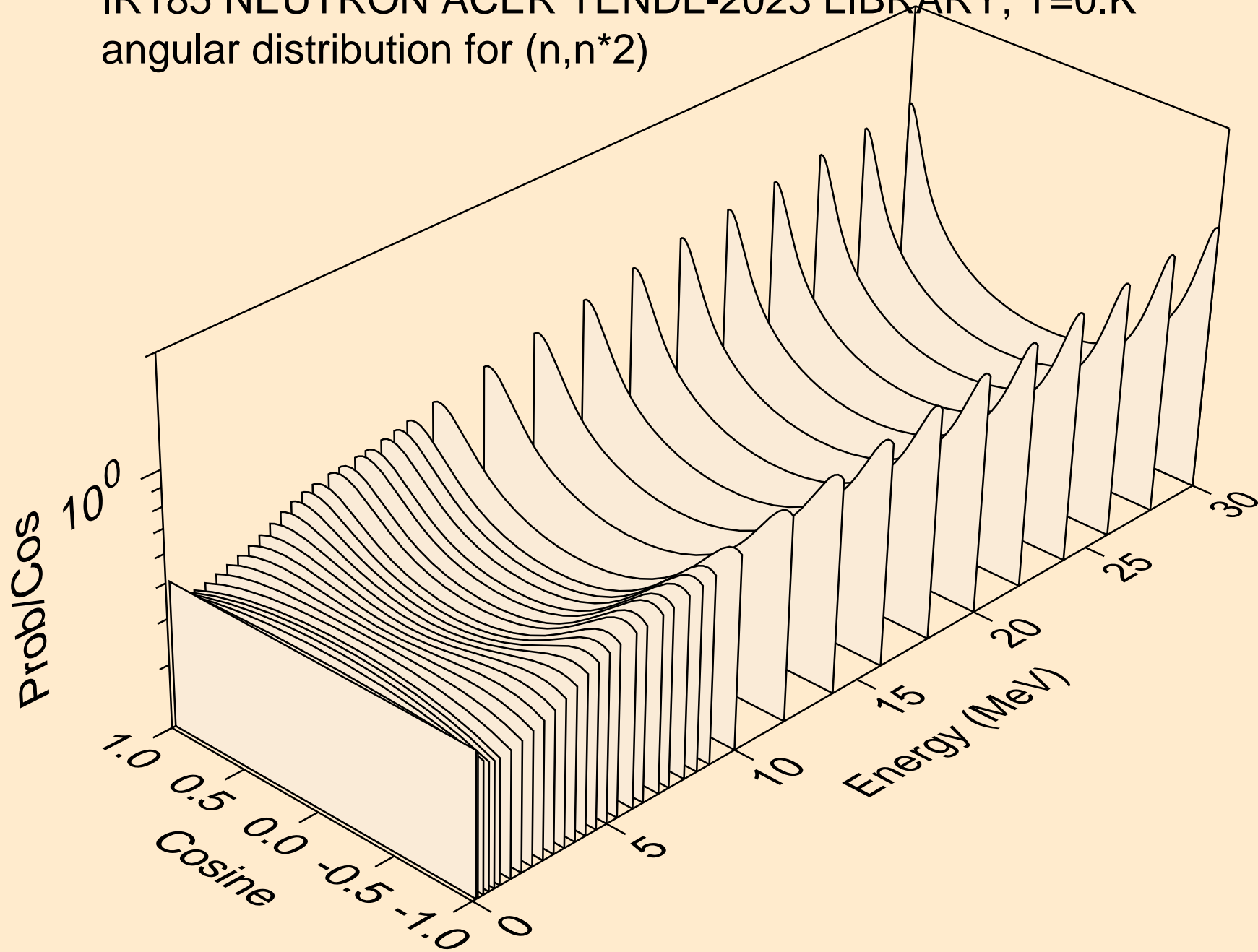

IR185 NEUTRON ACER TENDL-2023 LIBRARY; T=0.K
angular distribution for (n,n*3)

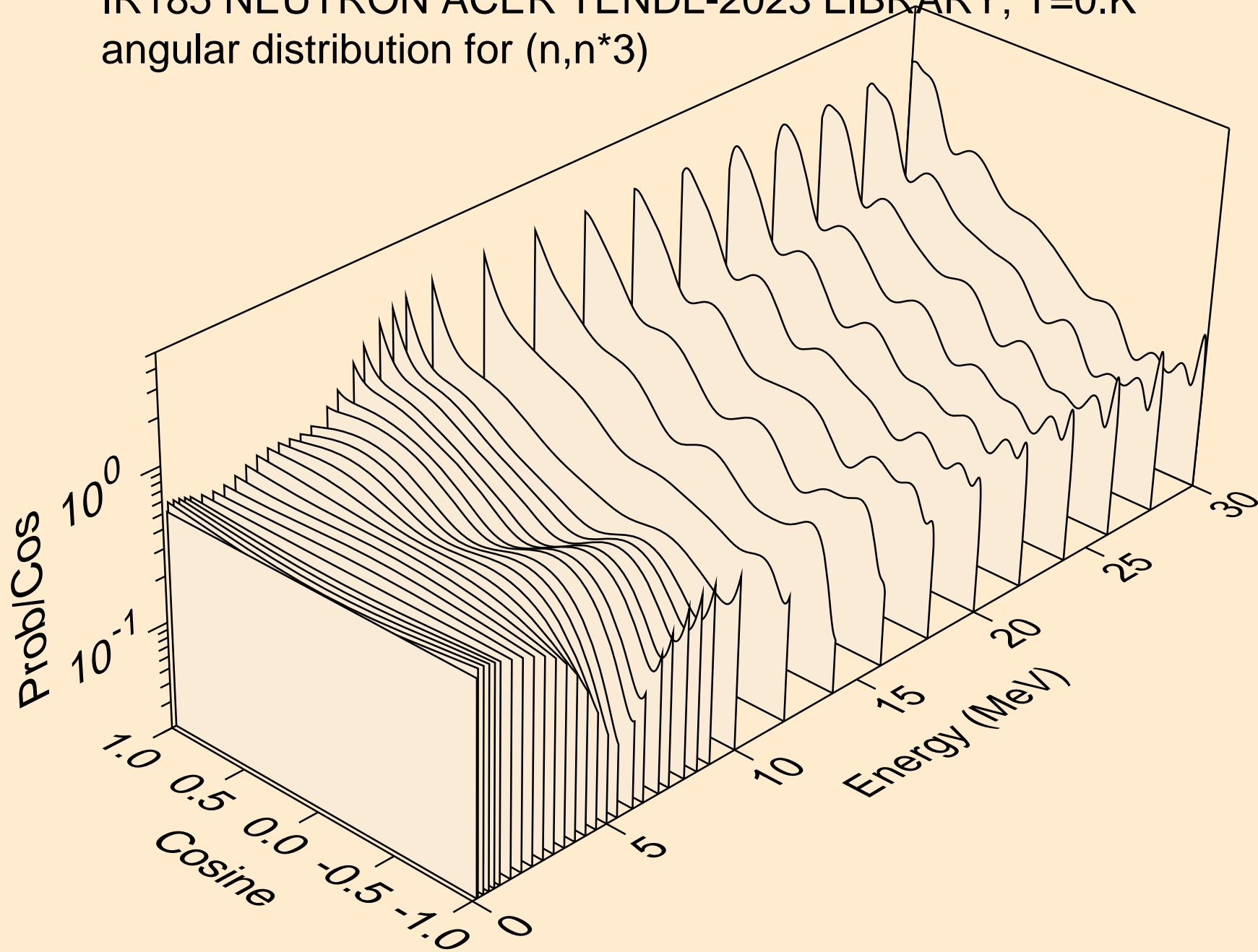

IR185 NEUTRON ACER TENDL-2023 LIBRARY; T=0.K
angular distribution for (n,n*4)

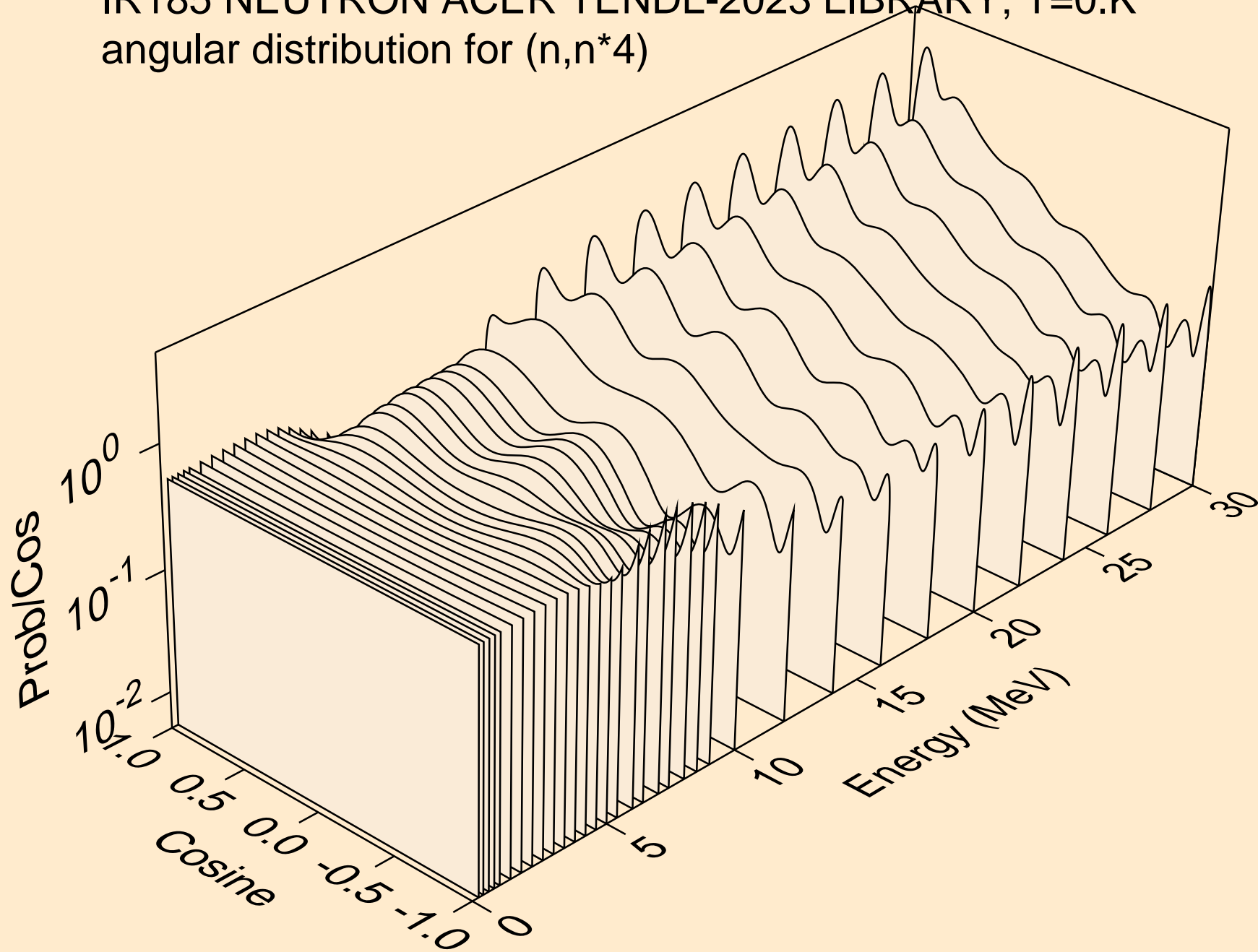

IR185 NEUTRON ACER TENDL-2023 LIBRARY; T=0.K
angular distribution for (n,n*5)

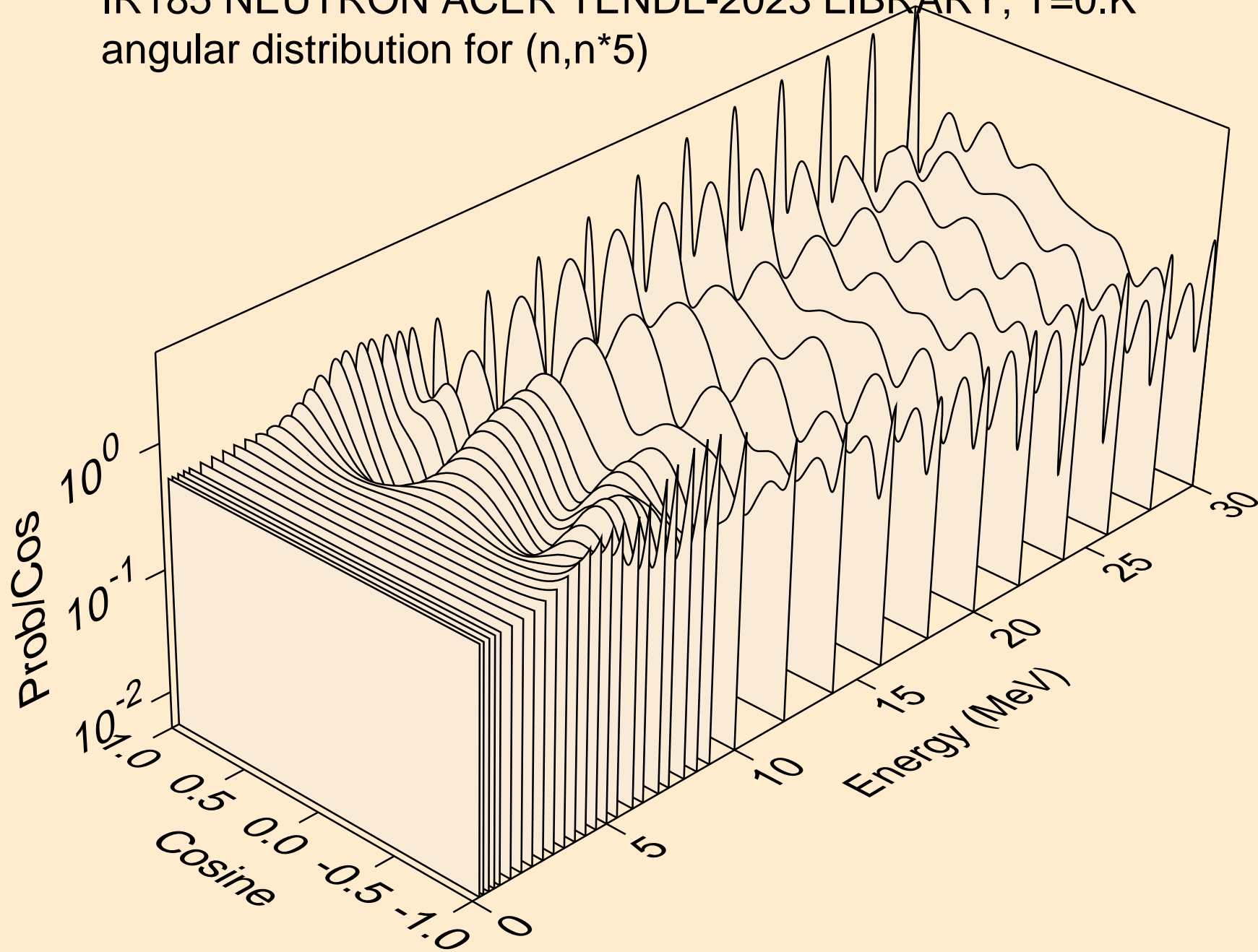

IR185 NEUTRON ACER TENDL-2023 LIBRARY; T=0.K
angular distribution for (n,n*6)

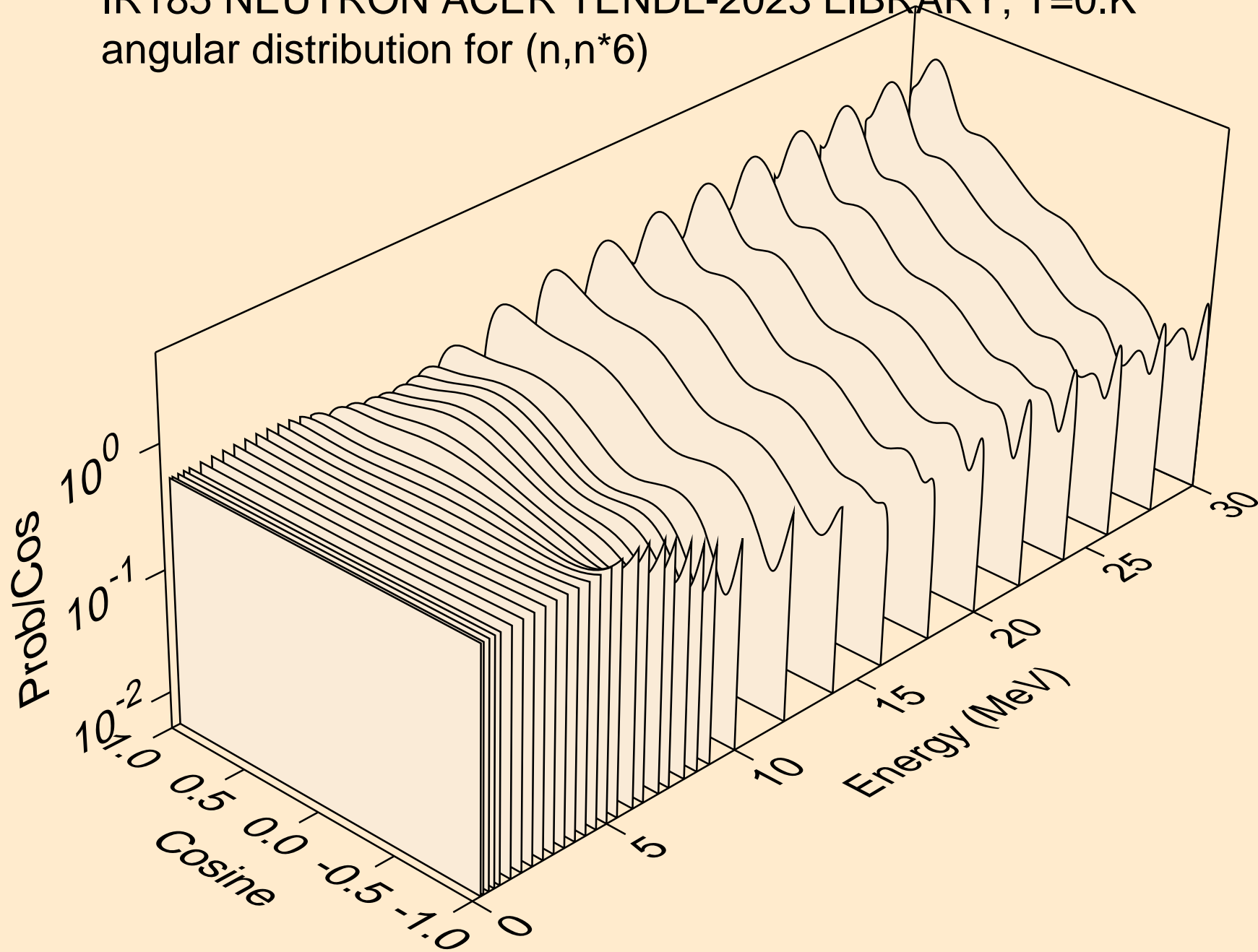

IR185 NEUTRON ACER TENDL-2023 LIBRARY; T=0.K
angular distribution for (n,n*7)

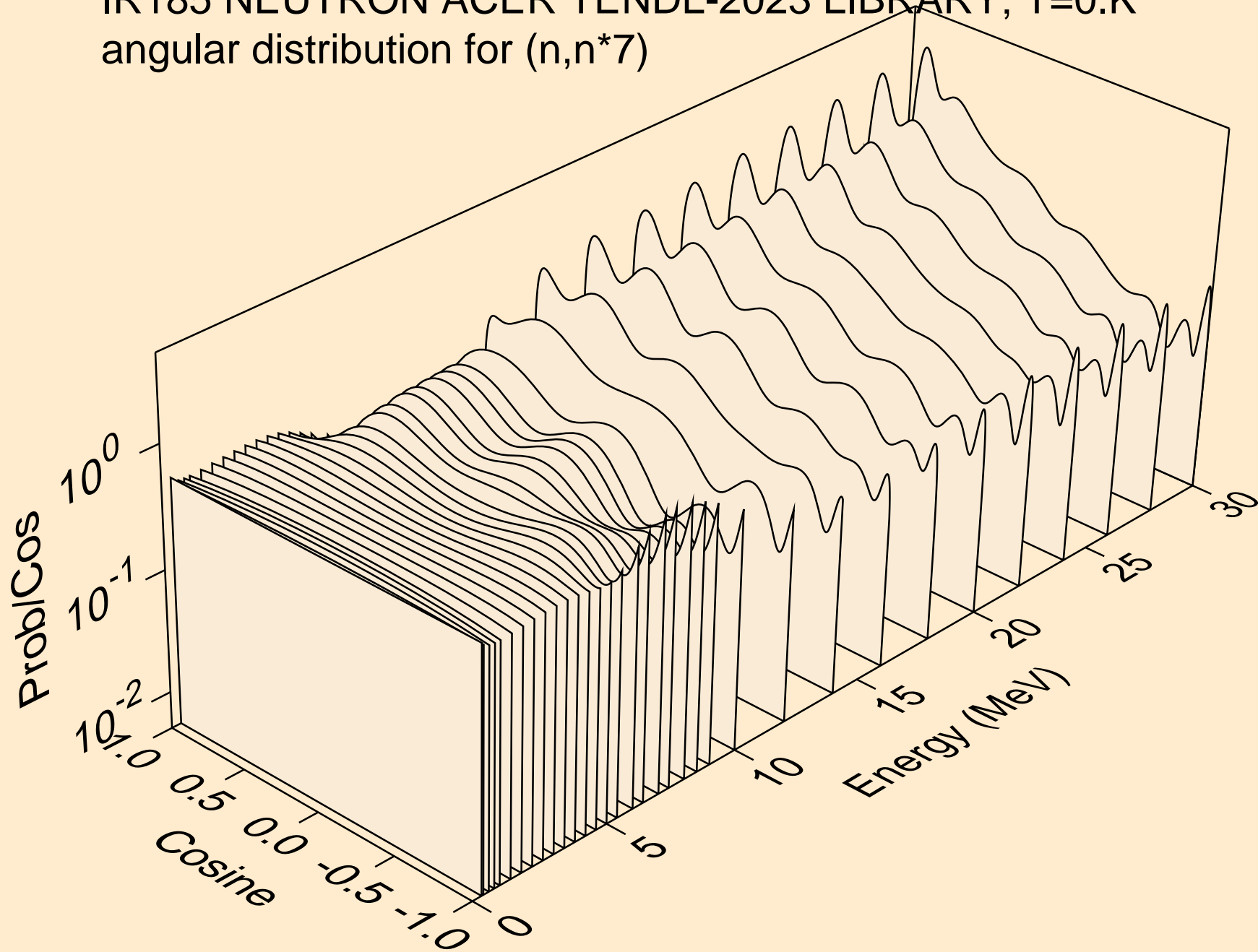

IR185 NEUTRON ACER TENDL-2023 LIBRARY; T=0.K
angular distribution for (n,n*8)

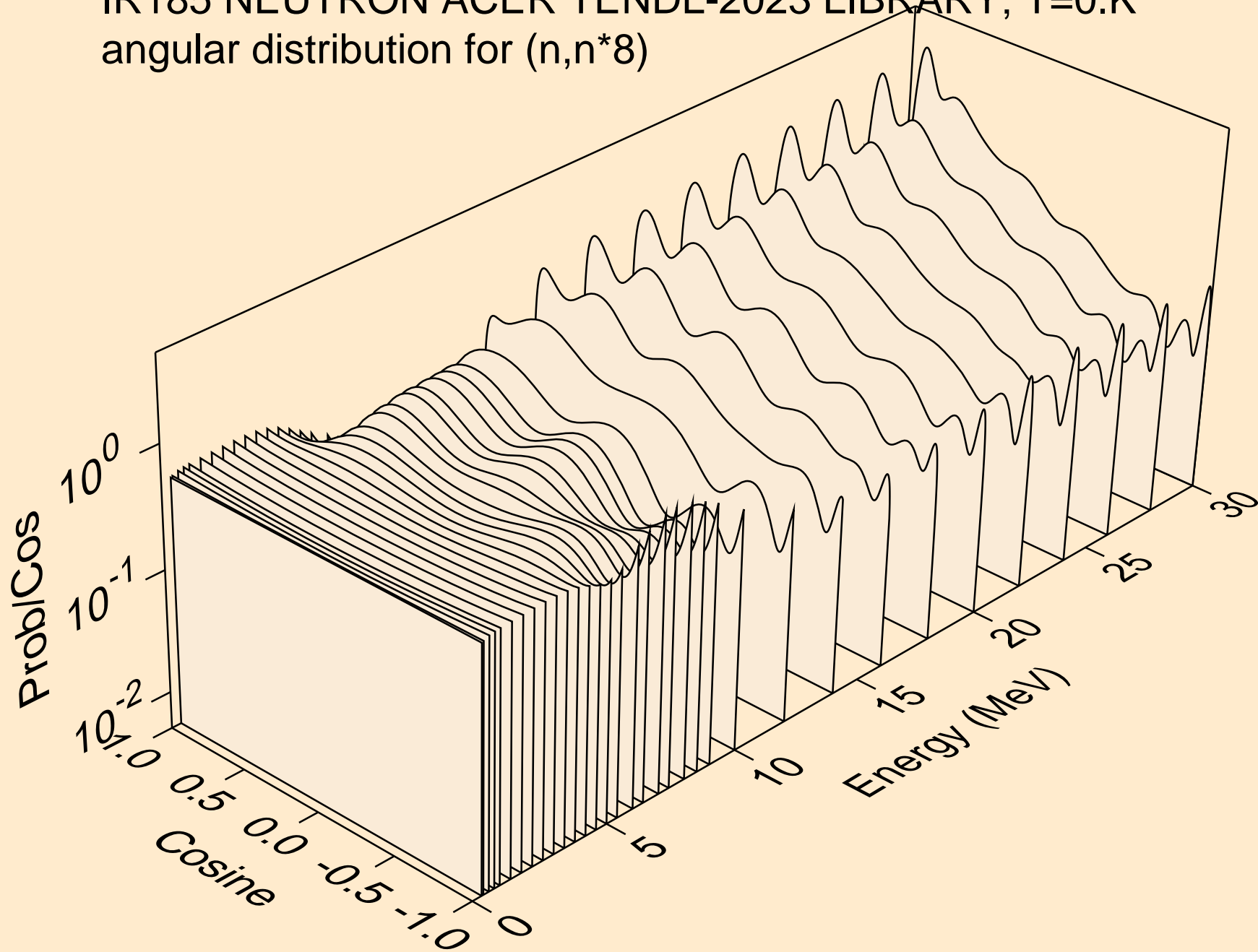

IR185 NEUTRON ACER TENDL-2023 LIBRARY; T=0.K
angular distribution for (n,n*9)

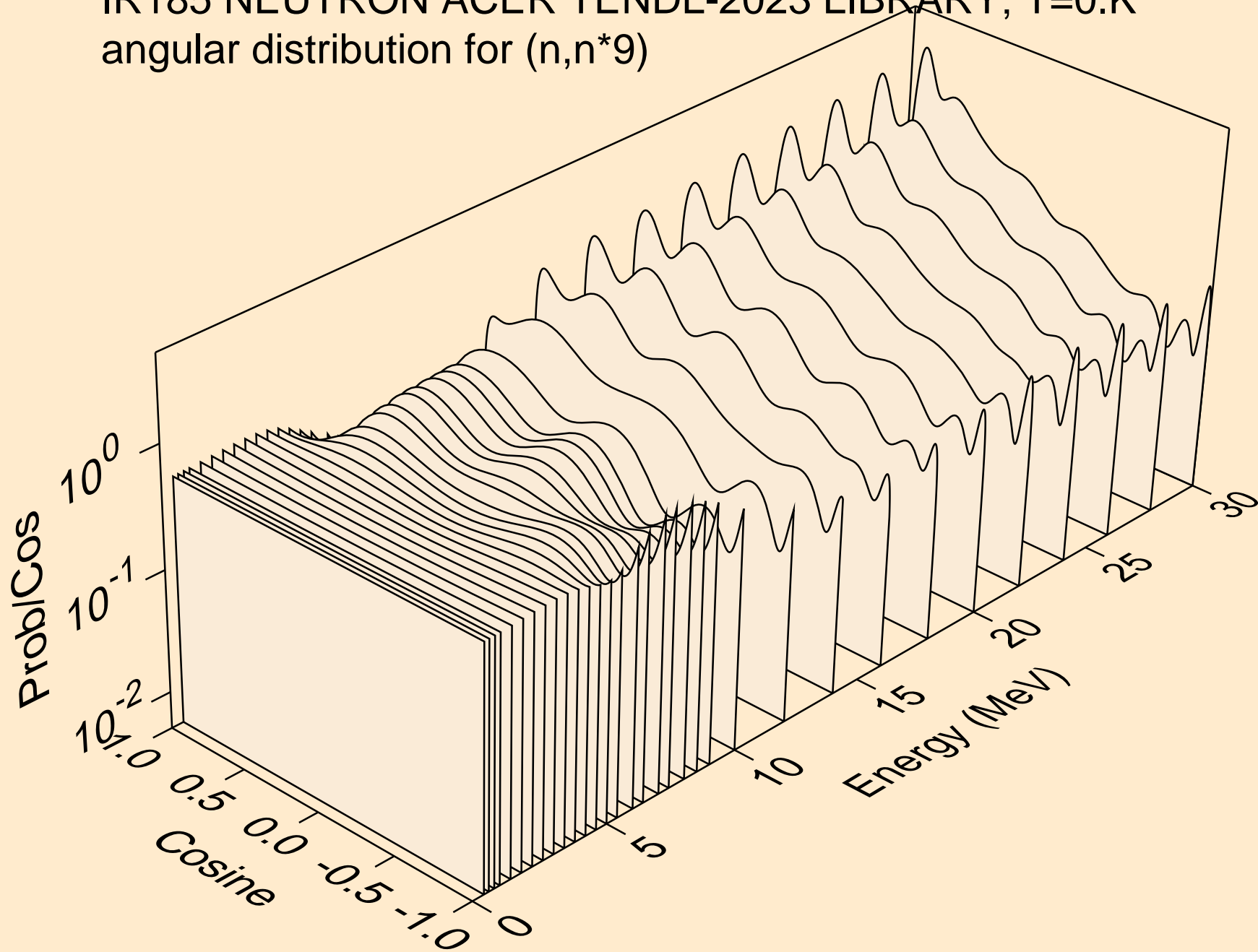

IR185 NEUTRON ACER TENDL-2023 LIBRARY; T=0.K
angular distribution for (n,n*10)

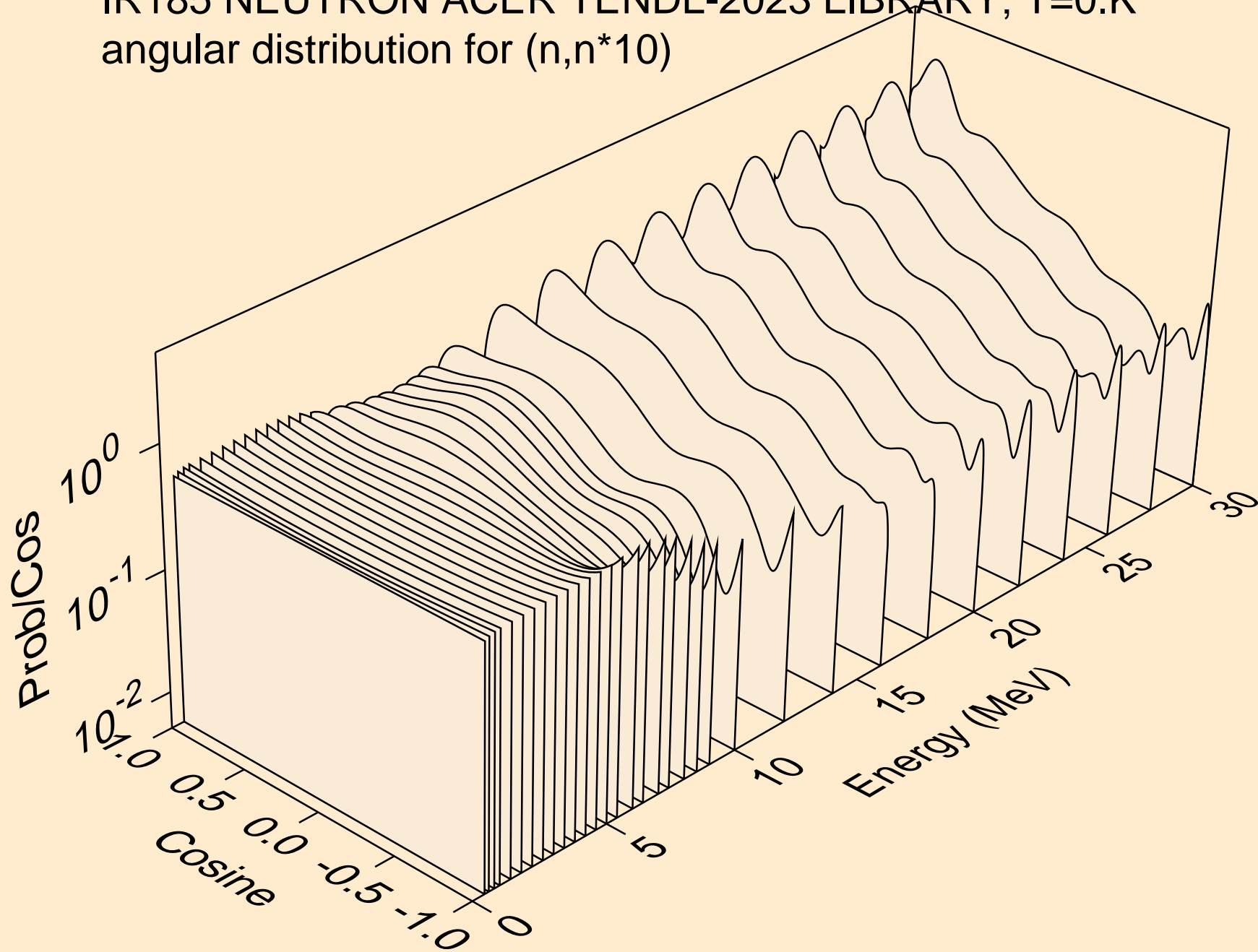

IR185 NEUTRON ACER TENDL-2023 LIBRARY; T=0.K
angular distribution for (n,n*11)

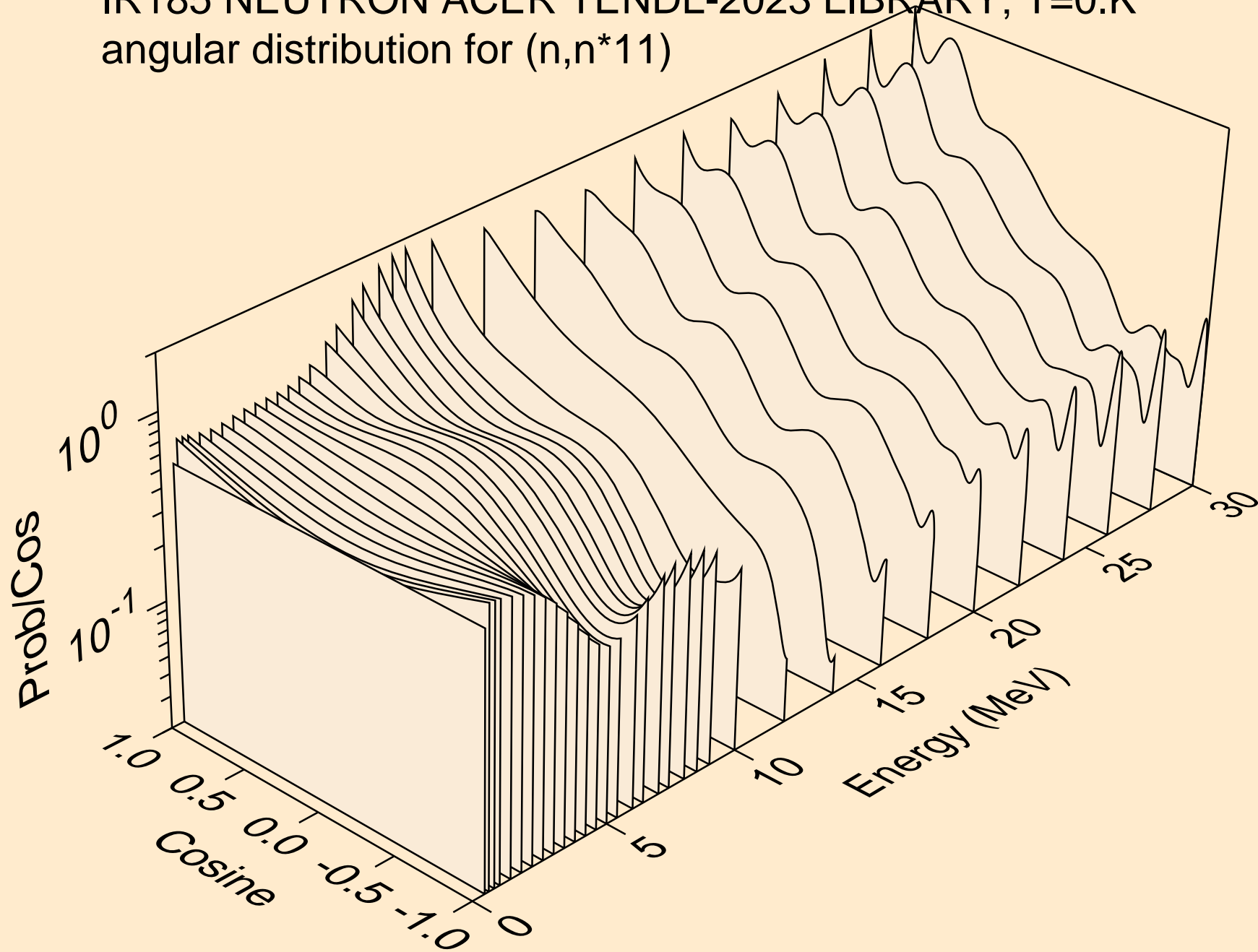

IR185 NEUTRON ACER TENDL-2023 LIBRARY; T=0.K
angular distribution for (n,n*12)

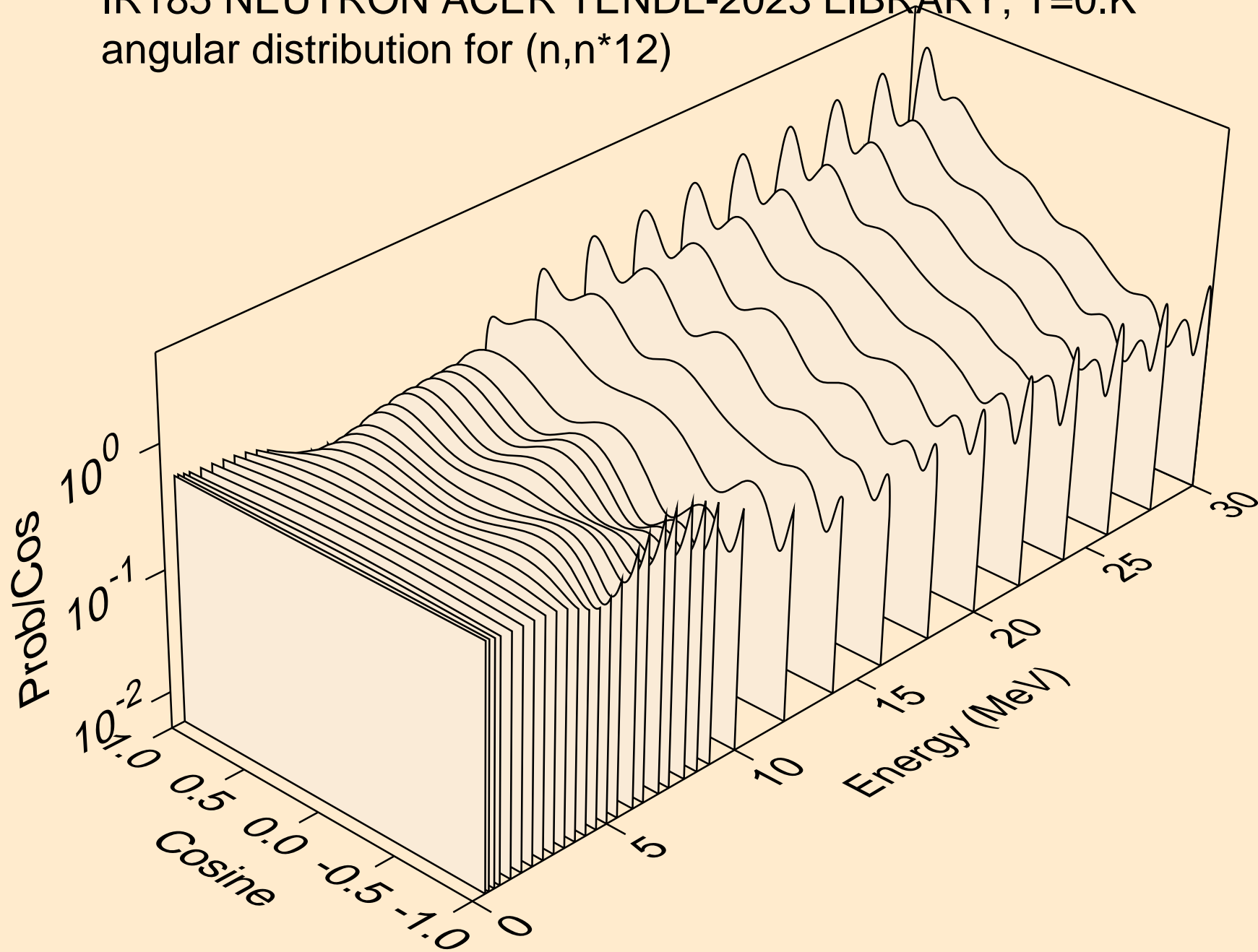

IR185 NEUTRON ACER TENDL-2023 LIBRARY; T=0.K
angular distribution for (n,n*13)

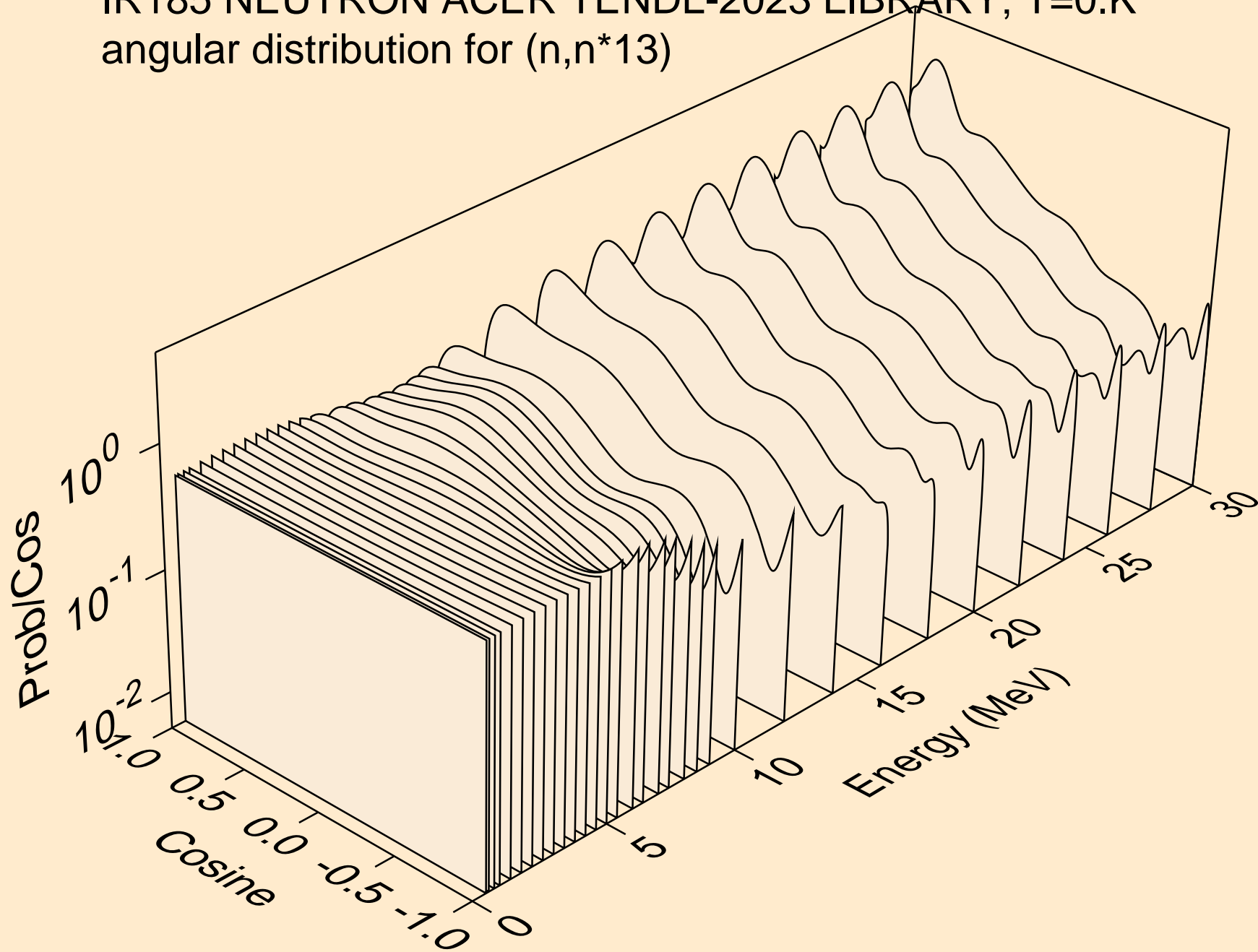

IR185 NEUTRON ACER TENDL-2023 LIBRARY; T=0.K
angular distribution for (n,n*14)

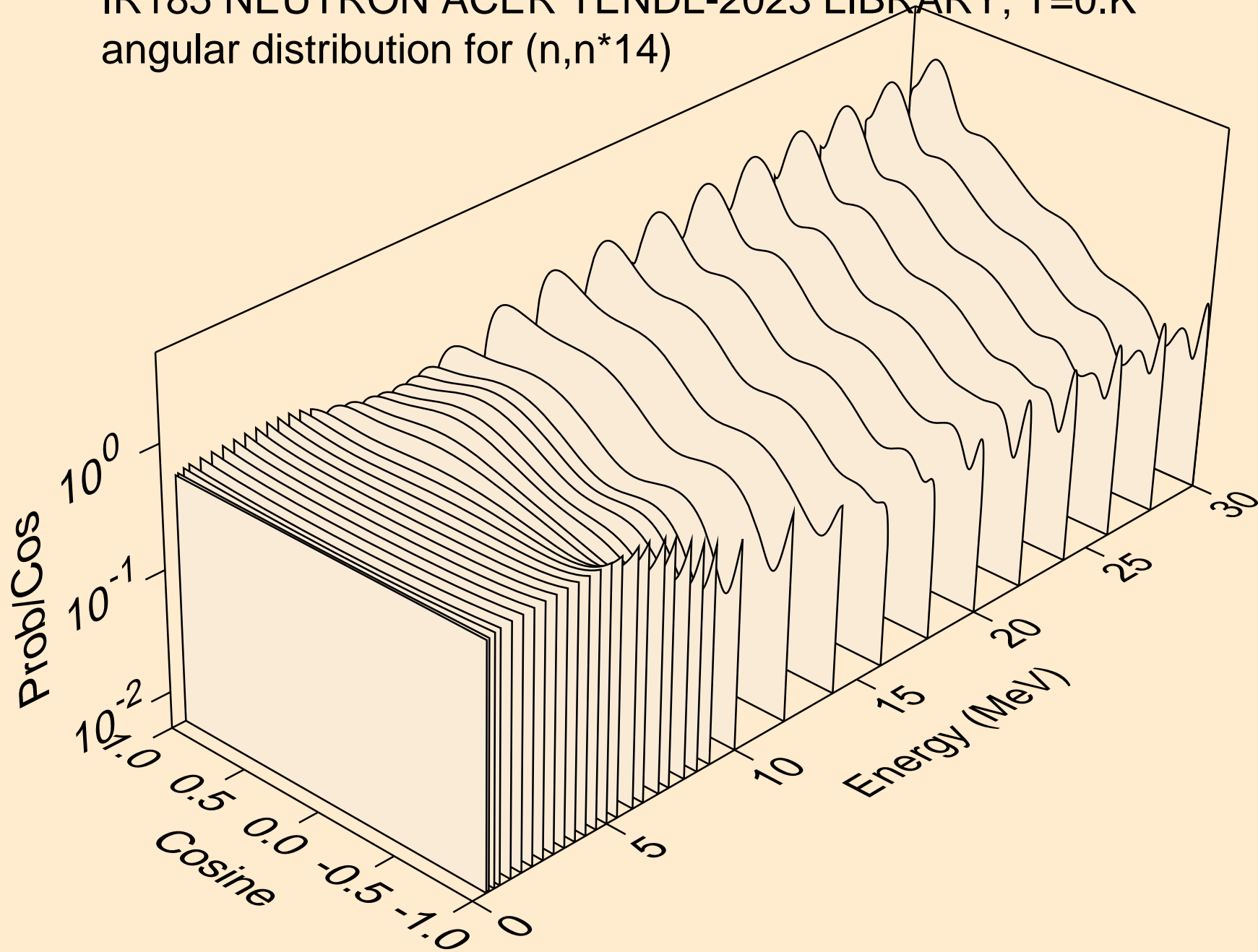

IR185 NEUTRON ACER TENDL-2023 LIBRARY; T=0.K
angular distribution for (n,n*15)

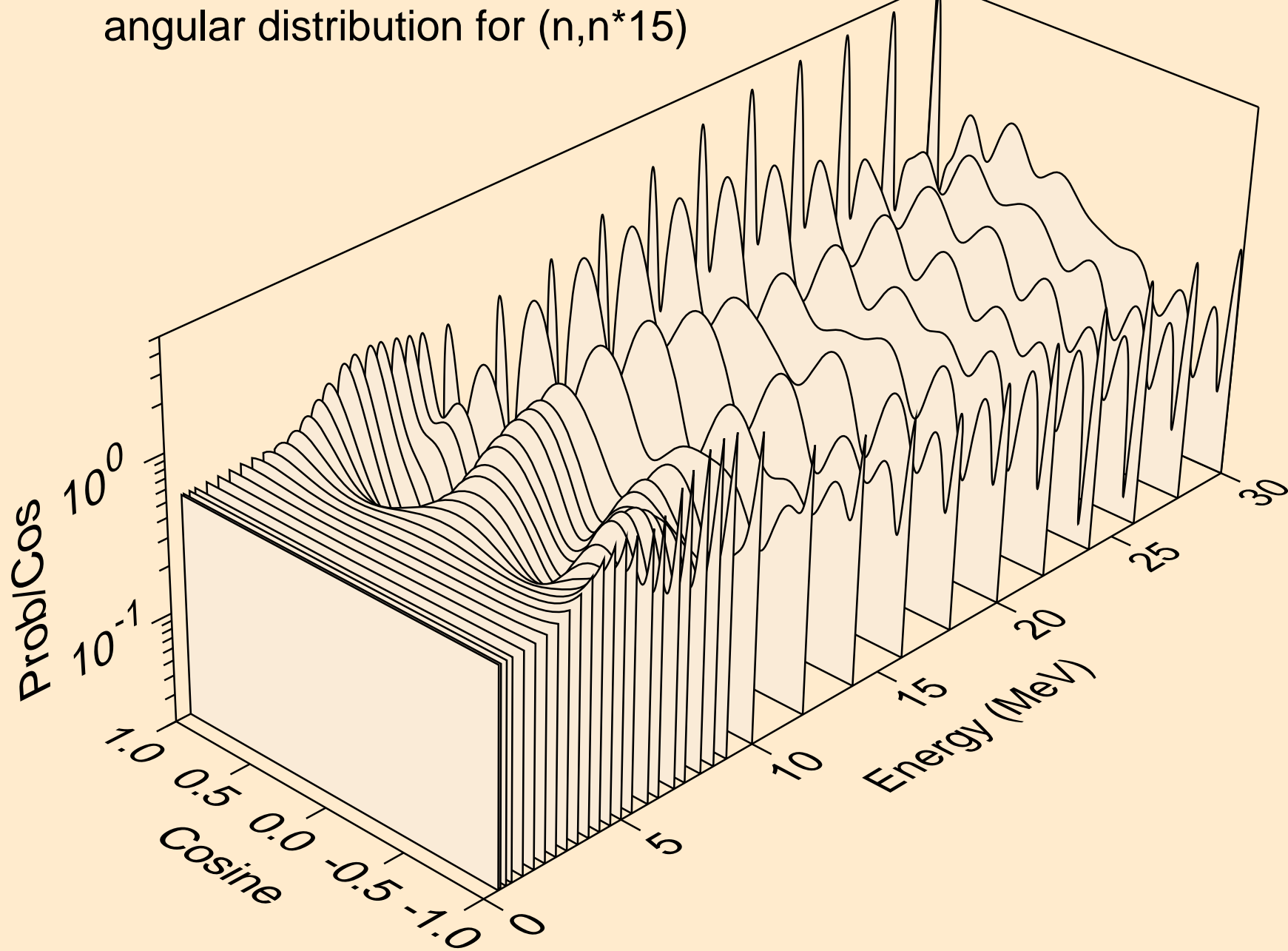

IR185 NEUTRON ACER TENDL-2023 LIBRARY; T=0.K
angular distribution for (n,n*16)

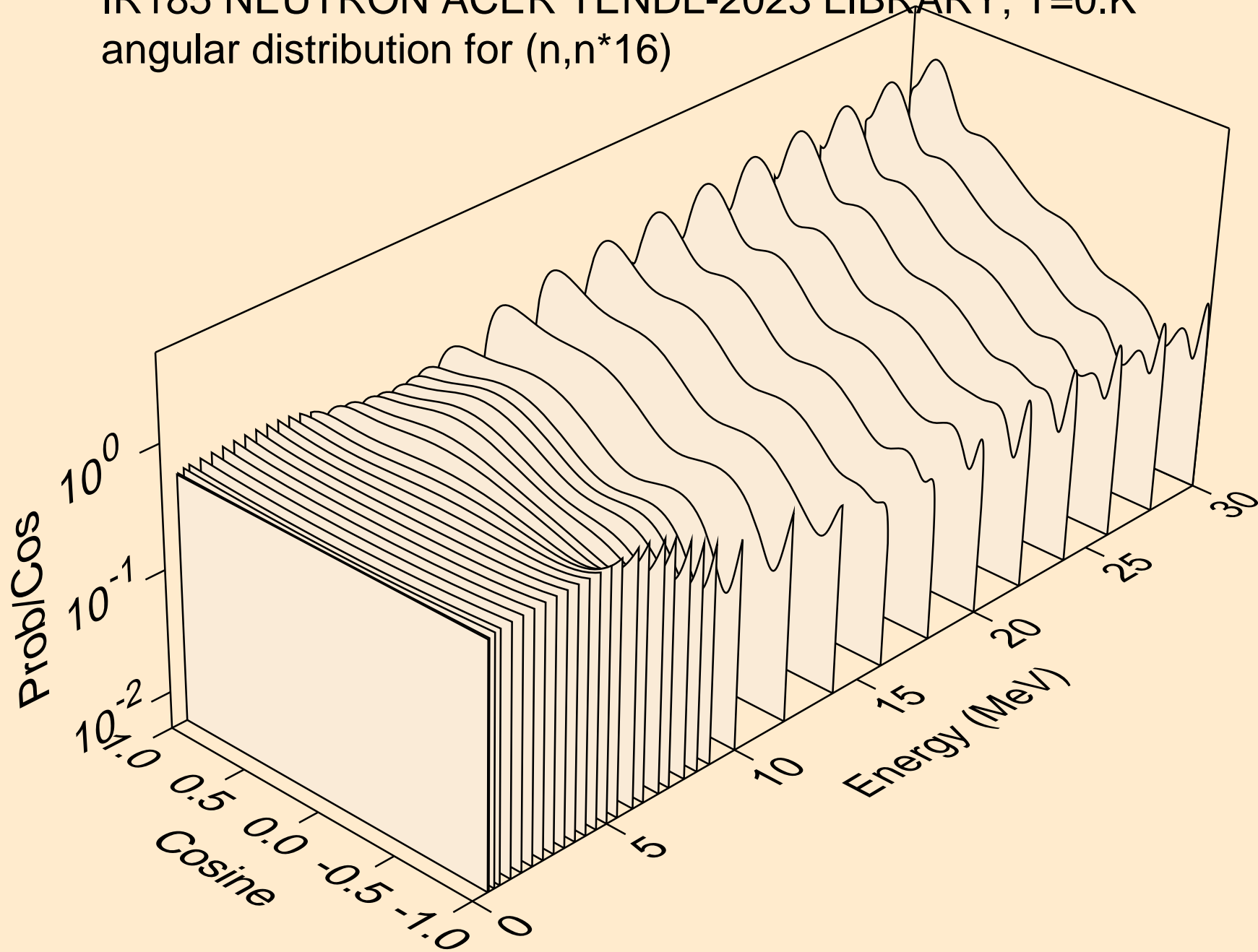

IR185 NEUTRON ACER TENDL-2023 LIBRARY; T=0.K
Neutron emission for (n,x)

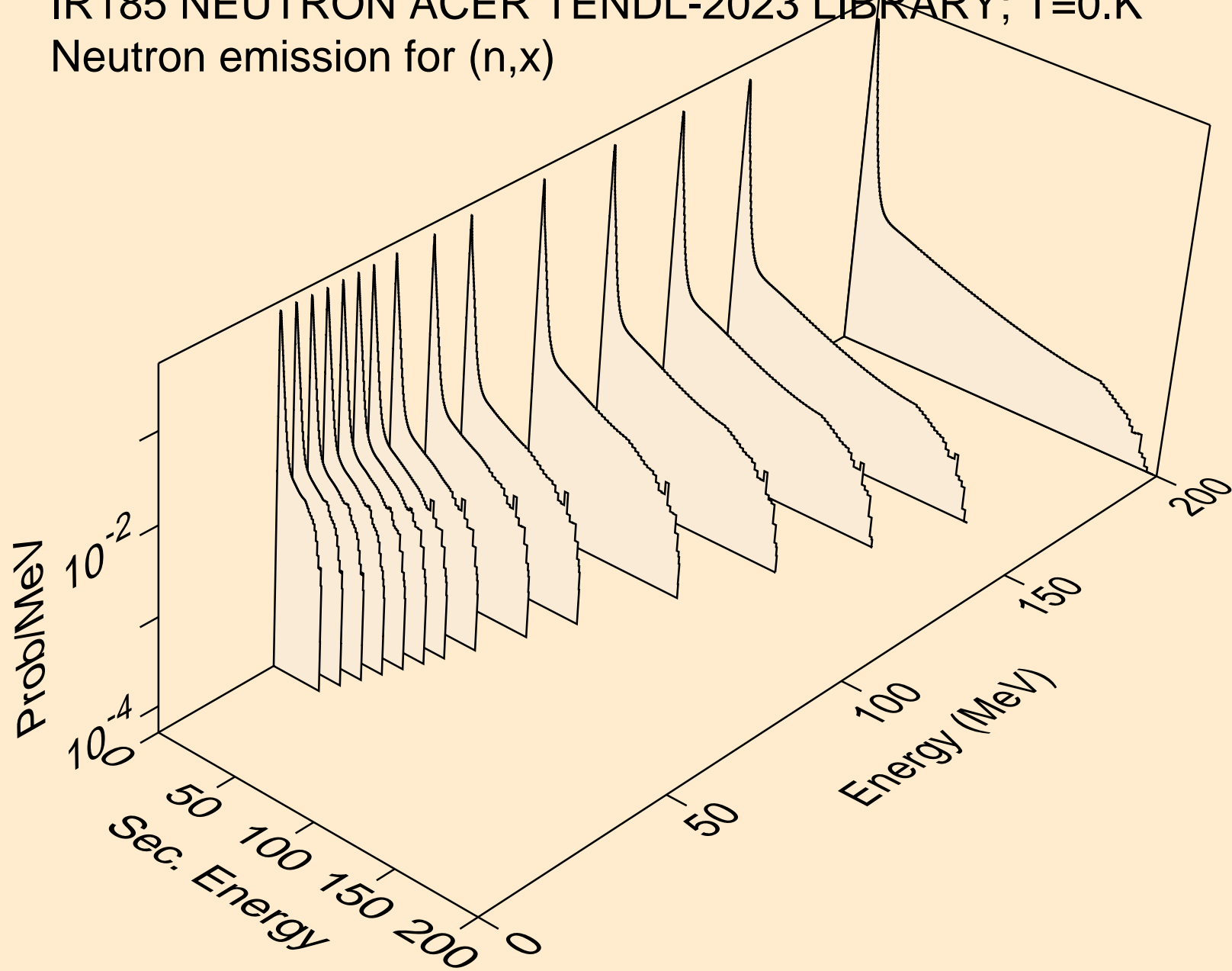

IR185 NEUTRON ACER TENDL-2023 LIBRARY; T=0.K
Neutron emission for (n,2nd)

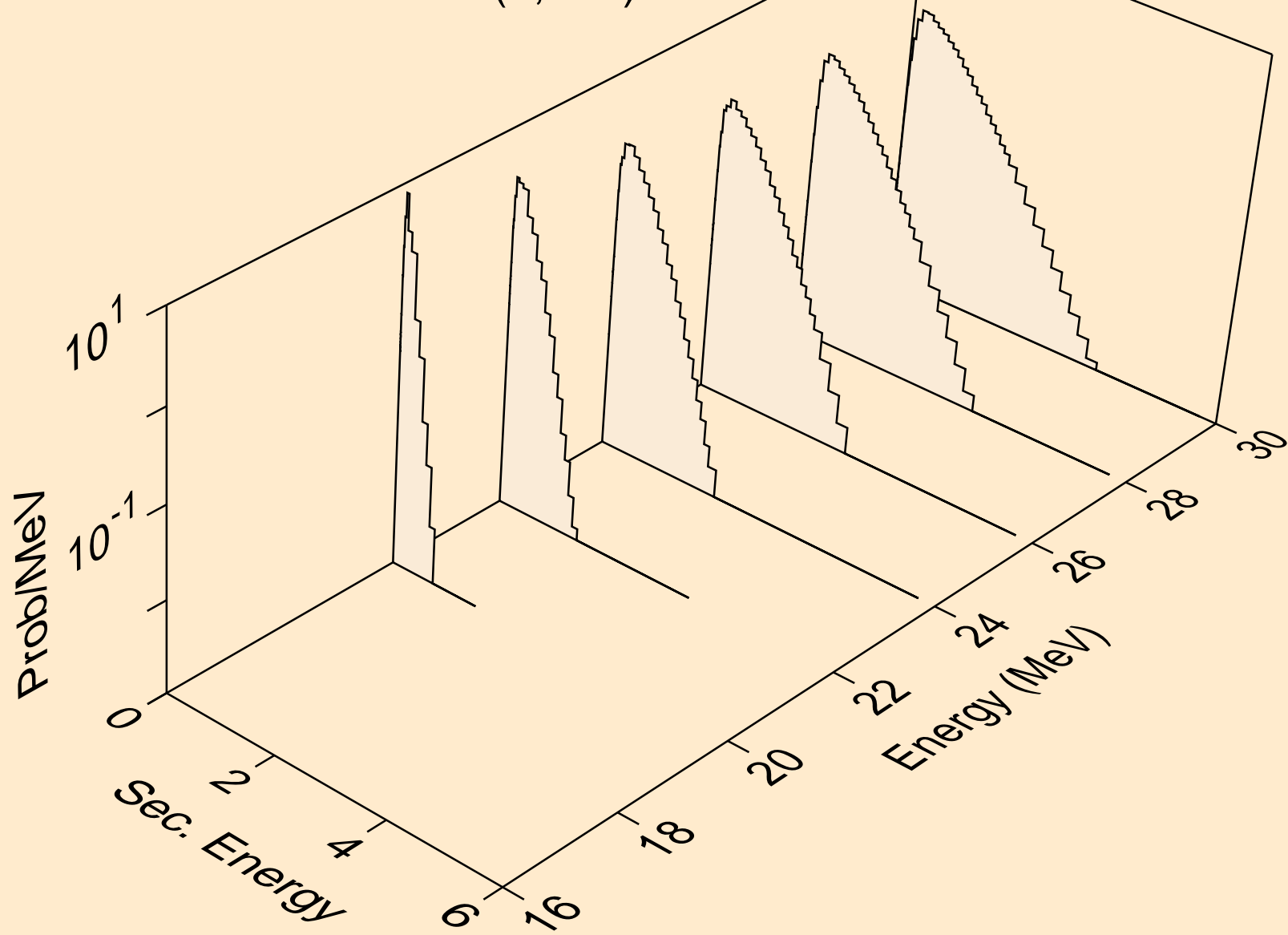

IR185 NEUTRON ACER TENDL-2023 LIBRARY; T=0.K
Neutron emission for (n,2n)

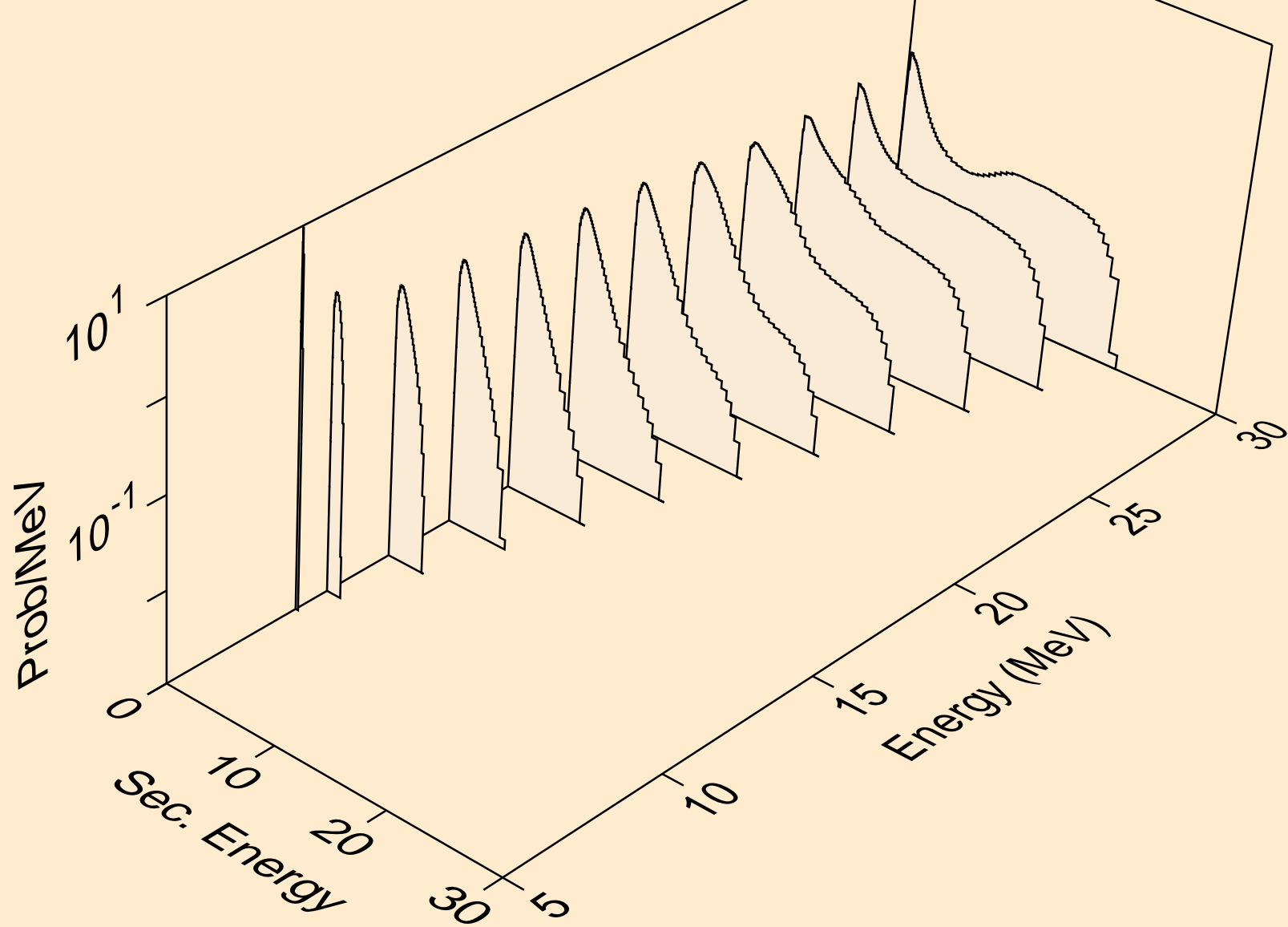

IR185 NEUTRON ACER TENDL-2023 LIBRARY; T=0.K
Neutron emission for (n,3n)

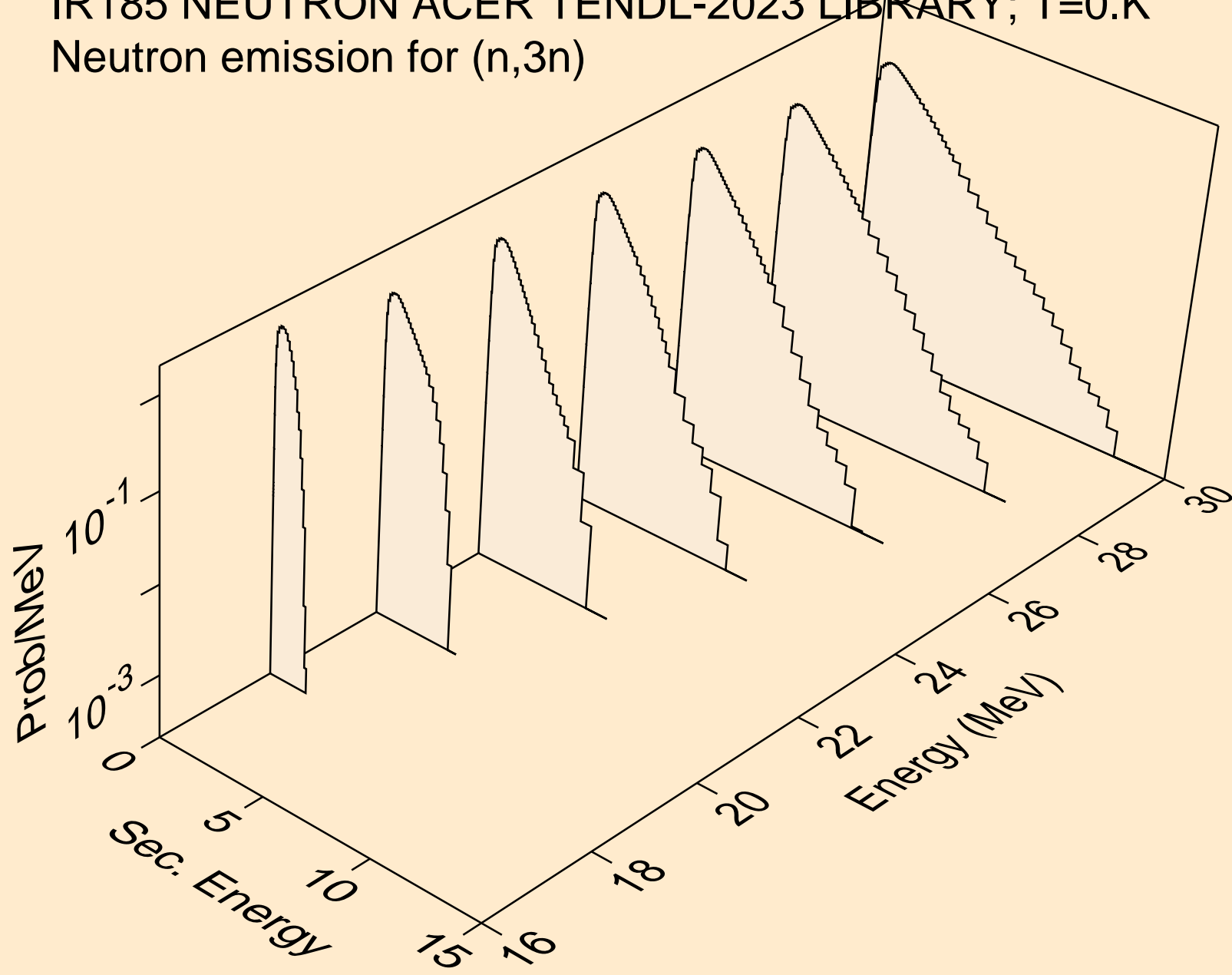

IR185 NEUTRON ACER TENDL-2023 LIBRARY; T=0.K
Neutron emission for (n,n*)a

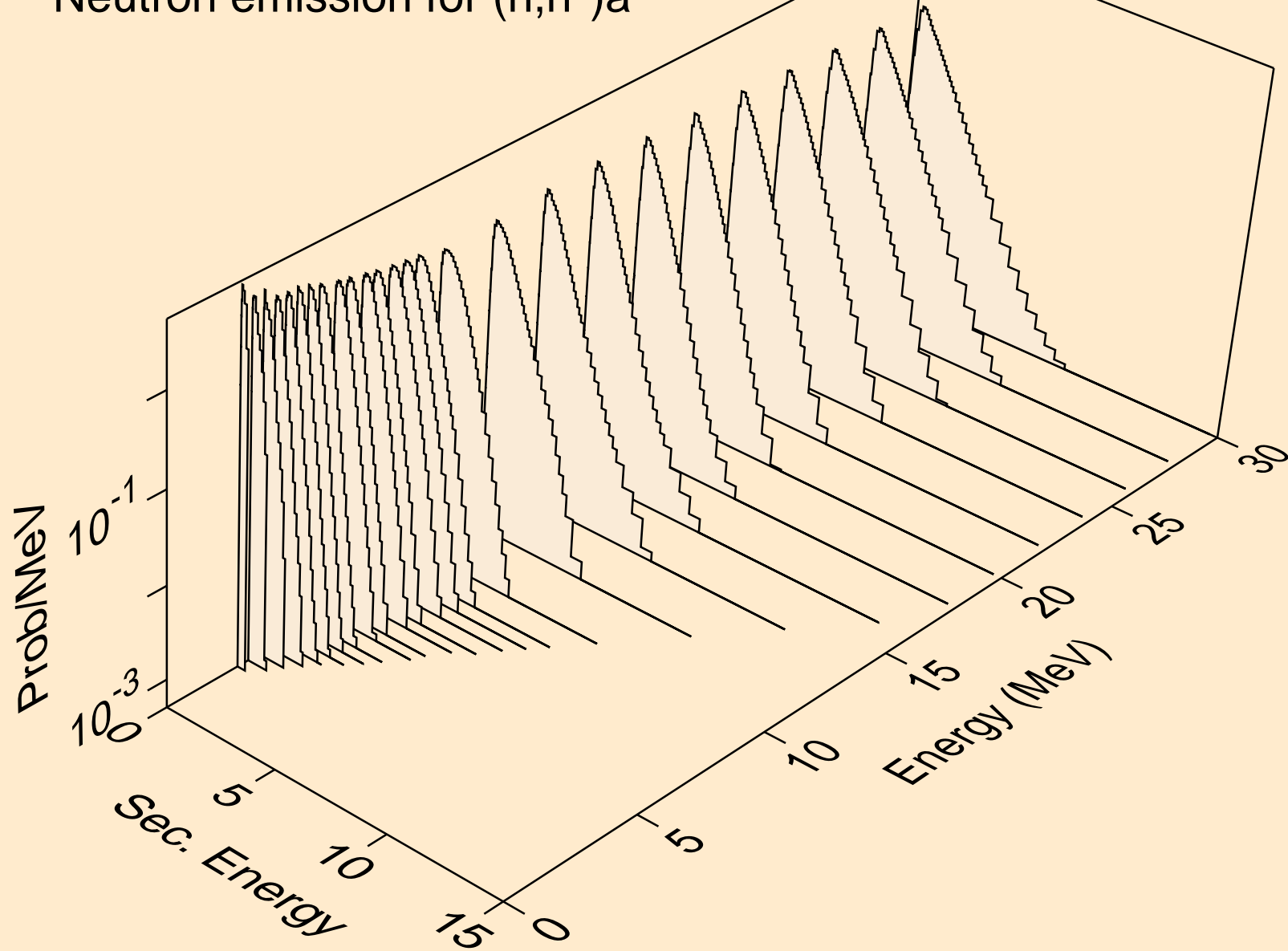

IR185 NEUTRON ACER TENDL-2023 LIBRARY; T=0.K
Neutron emission for (n,2n)a

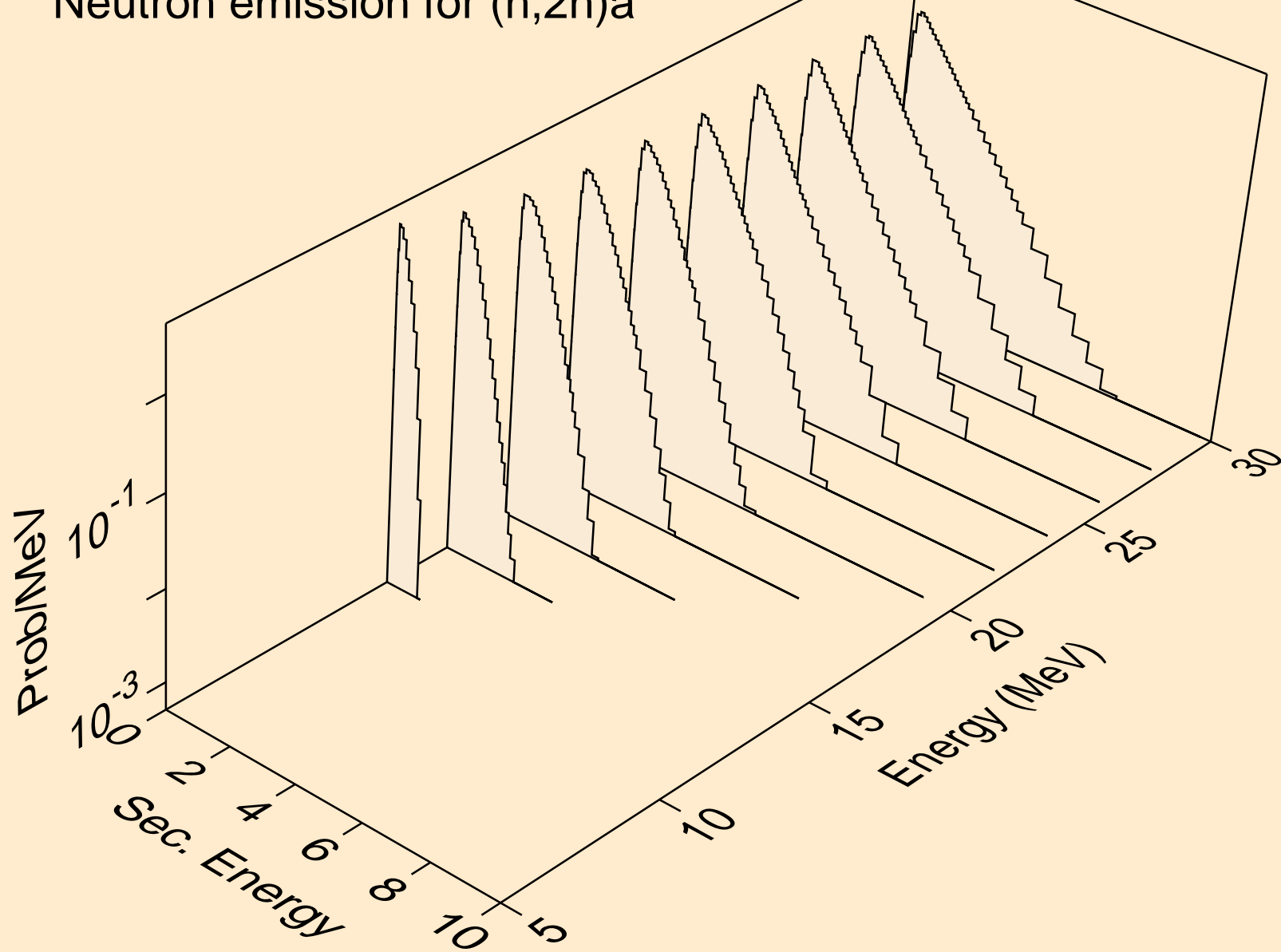

IR185 NEUTRON ACER TENDL-2023 LIBRARY; T=0.K
Neutron emission for (n,3n)a

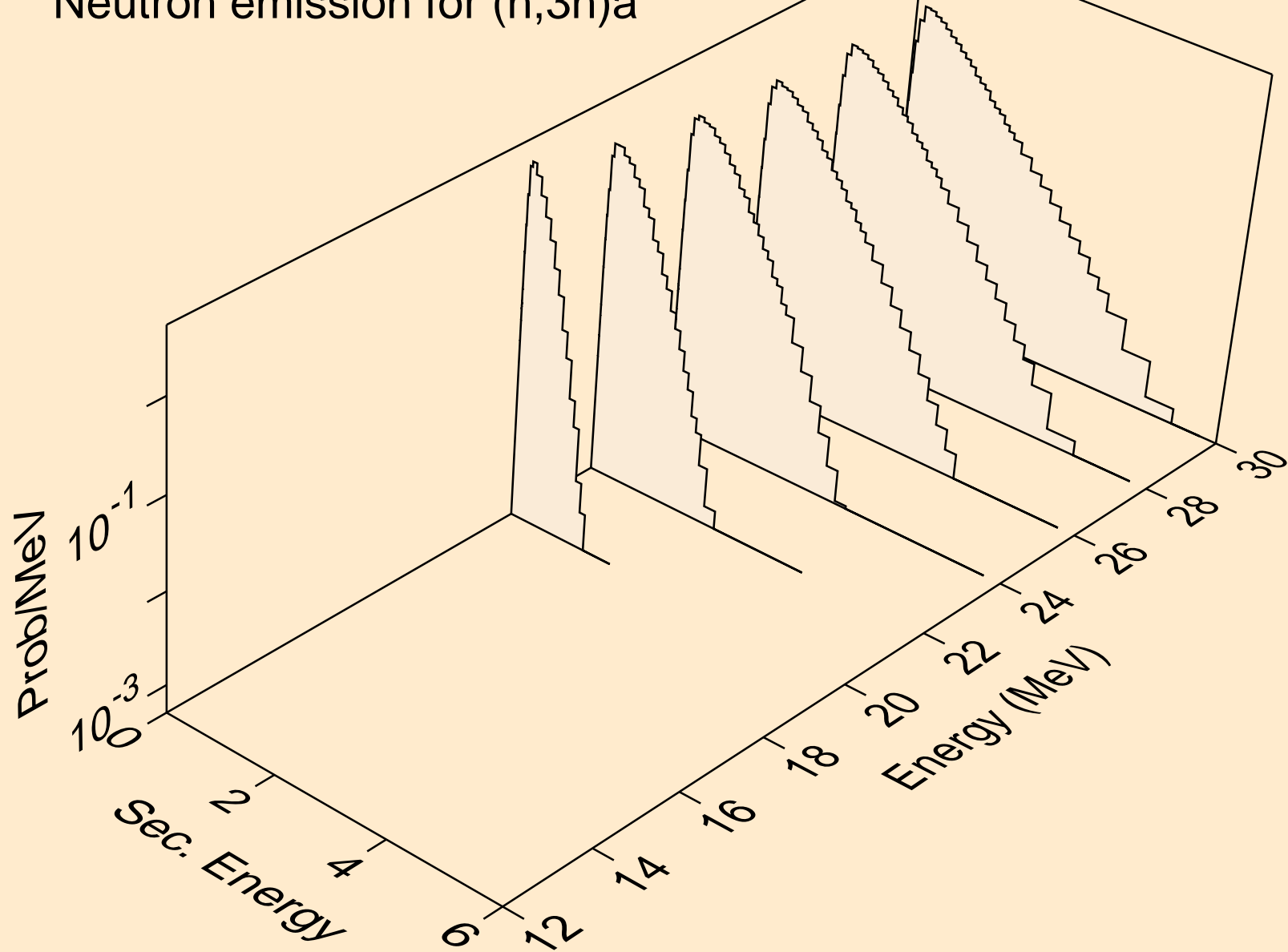

IR185 NEUTRON ACER TENDL-2023 LIBRARY; T=0.K
Neutron emission for (n,n*)p

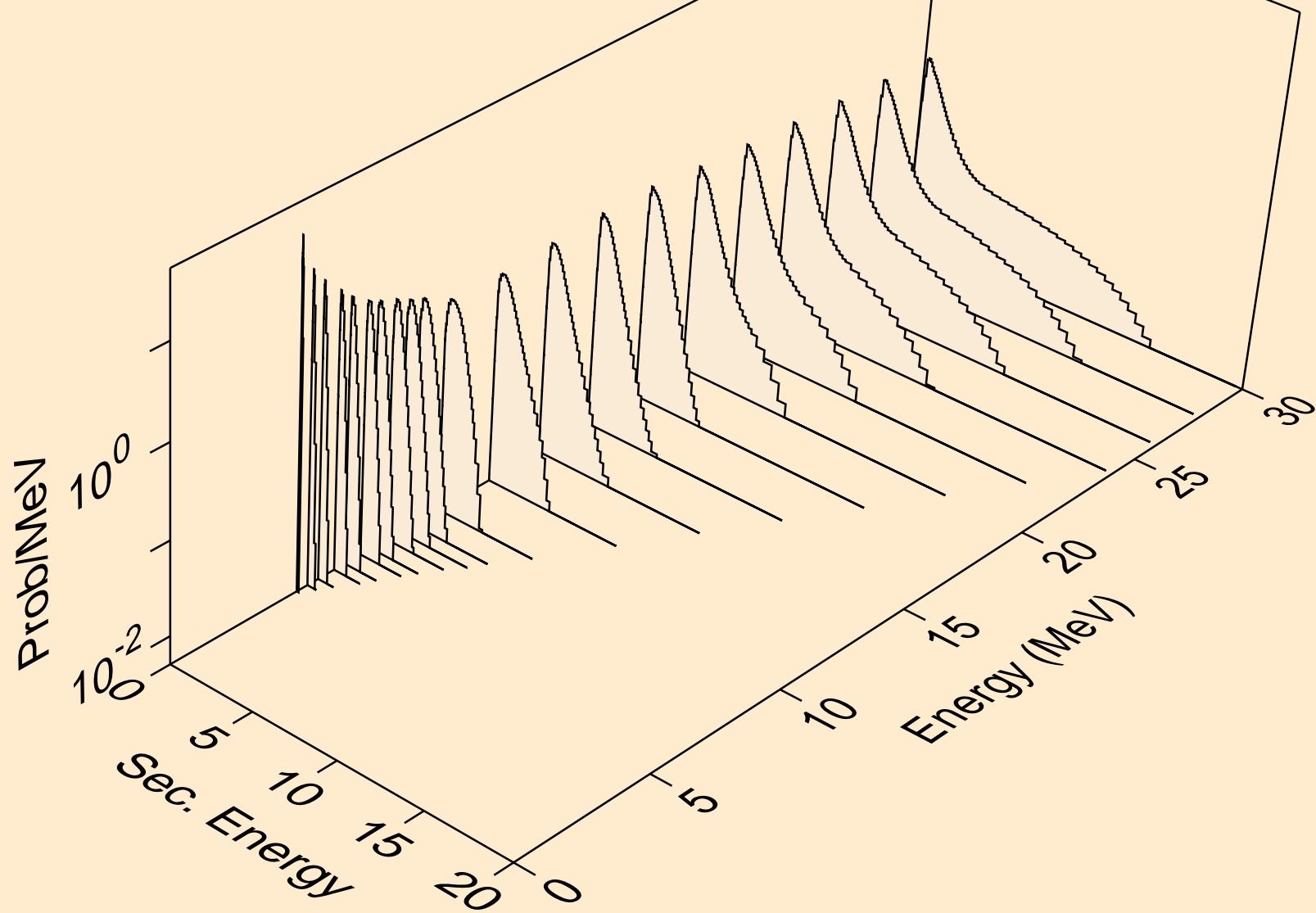

IR185 NEUTRON ACER TENDL-2023 LIBRARY; T=0.K
Neutron emission for (n,n*)2a

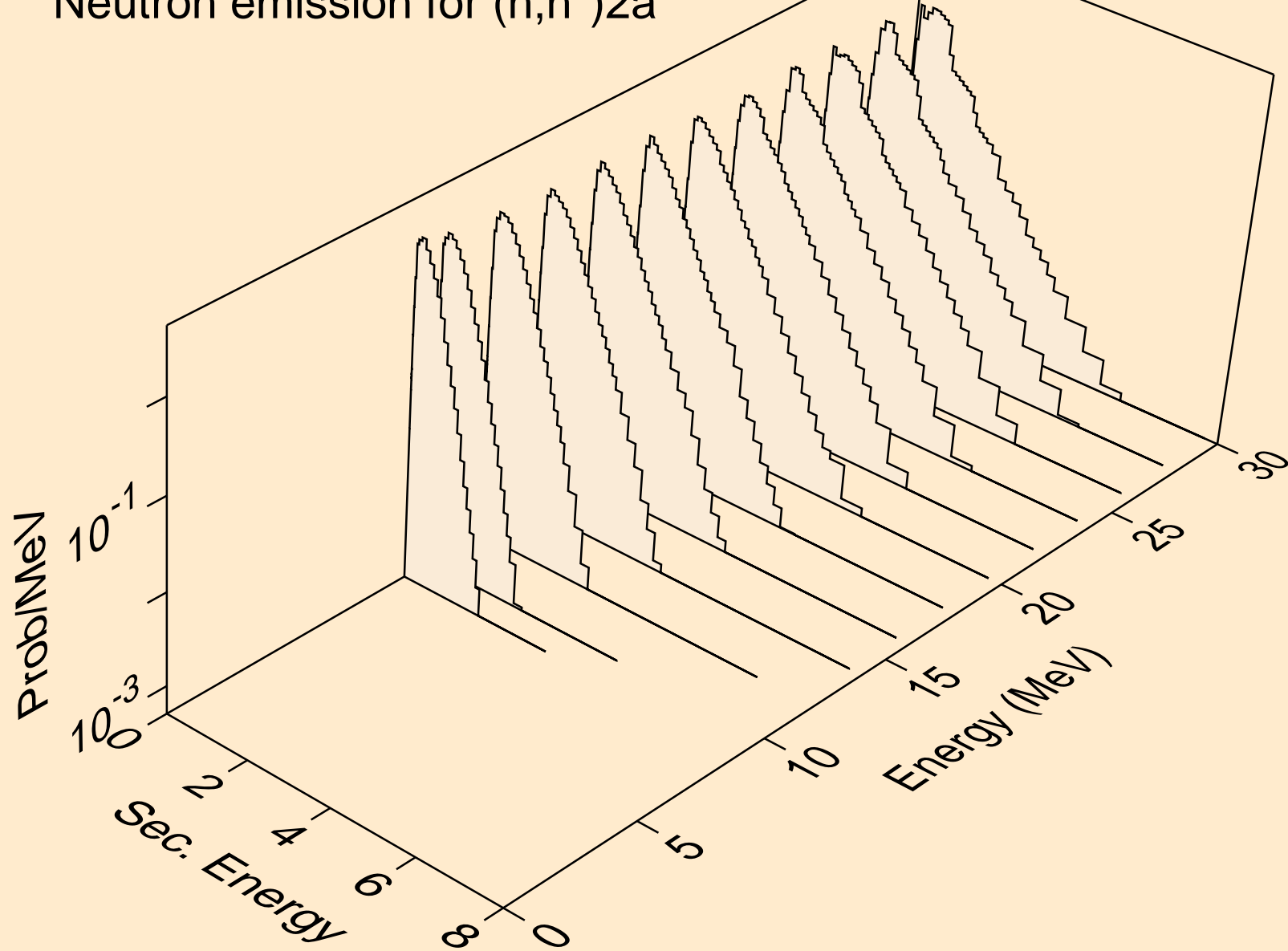

IR185 NEUTRON ACER TENDL-2023 LIBRARY; T=0.K
Neutron emission for (n,2n)2a

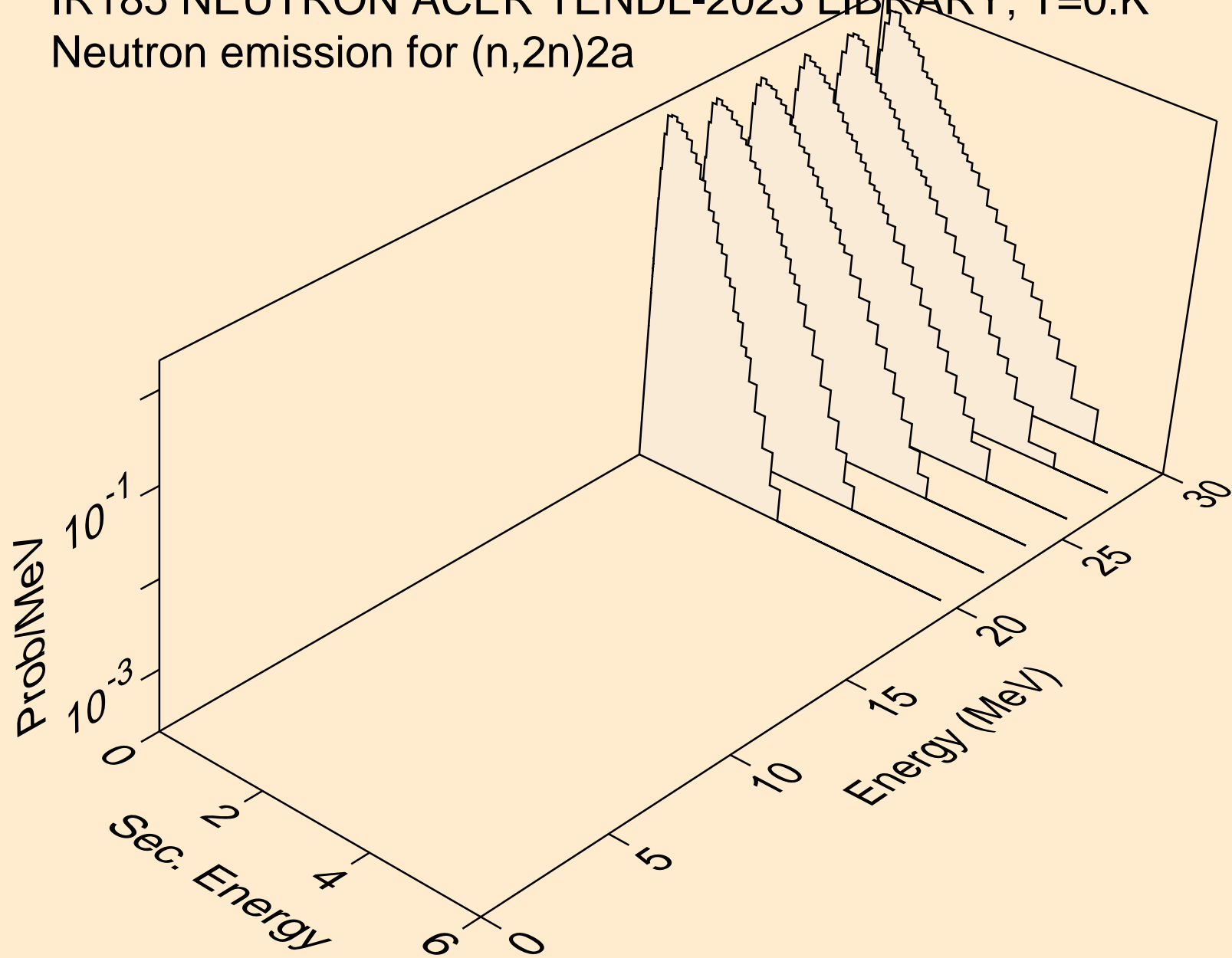

IR185 NEUTRON ACER TENDL-2023 LIBRARY; T=0.K
Neutron emission for (n,n*)d

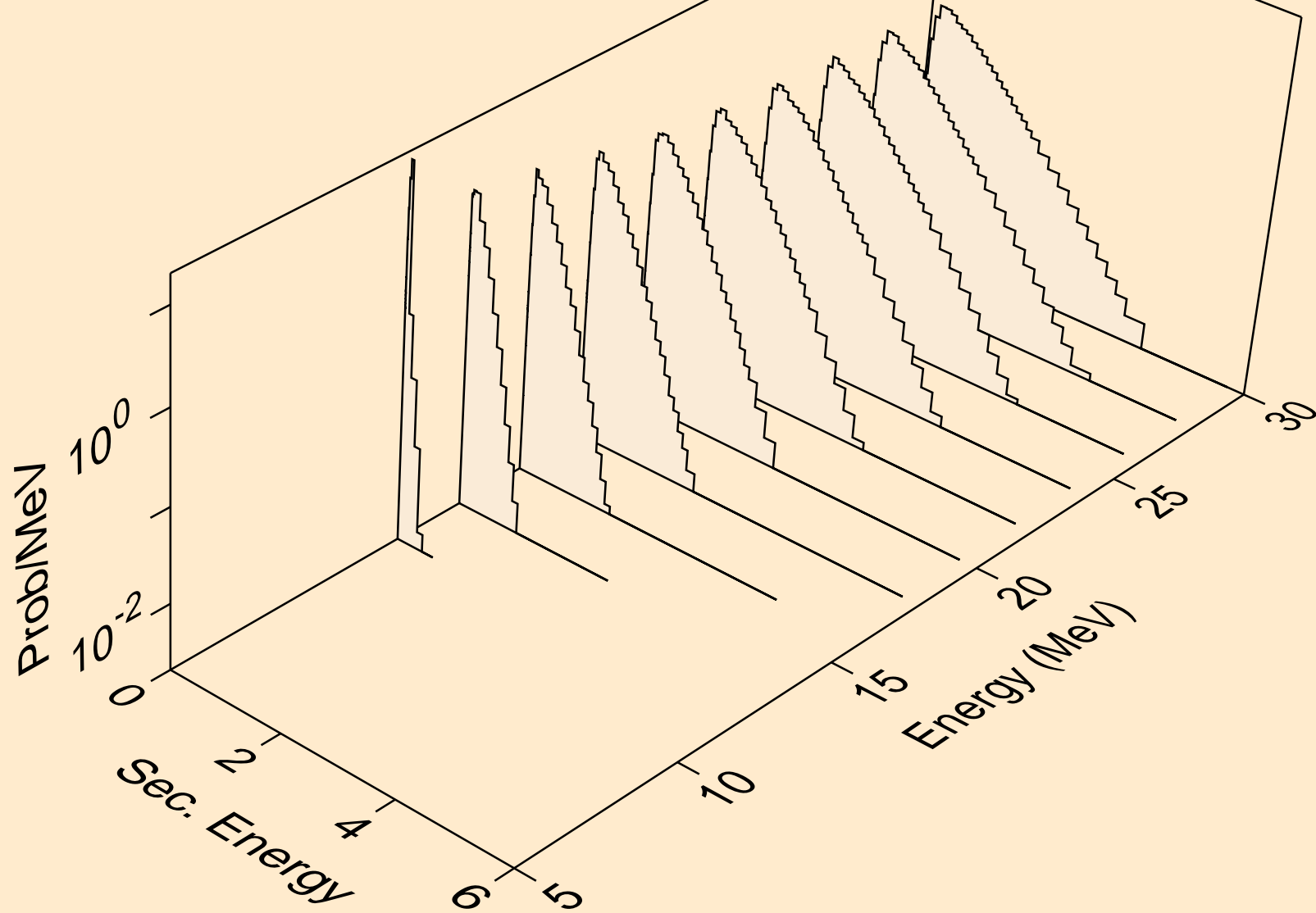

IR185 NEUTRON ACER TENDL-2023 LIBRARY; T=0.K
Neutron emission for (n,n*)t

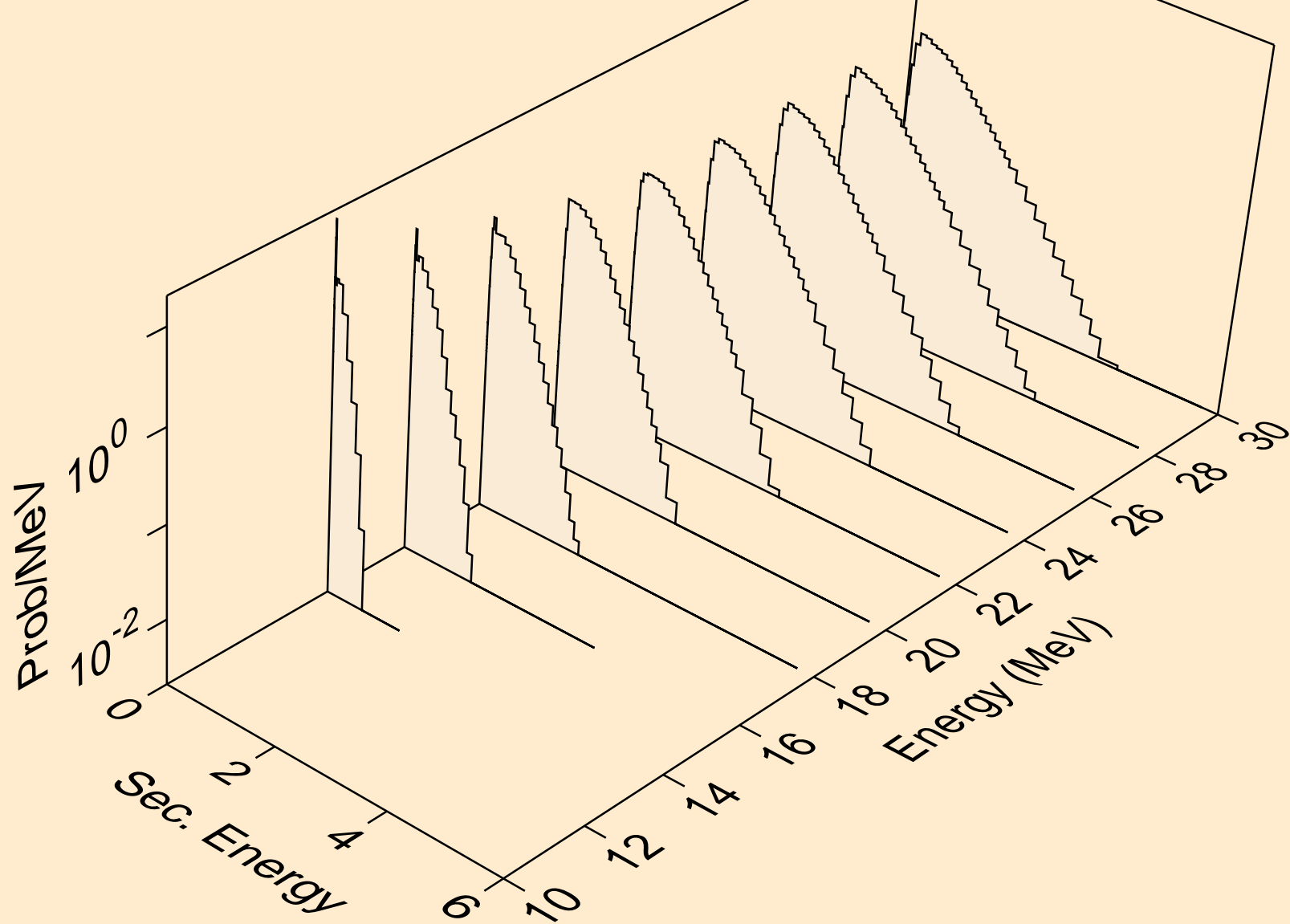

IR185 NEUTRON ACER TENDL-2023 LIBRARY; T=0.K
Neutron emission for (n,n*)he3

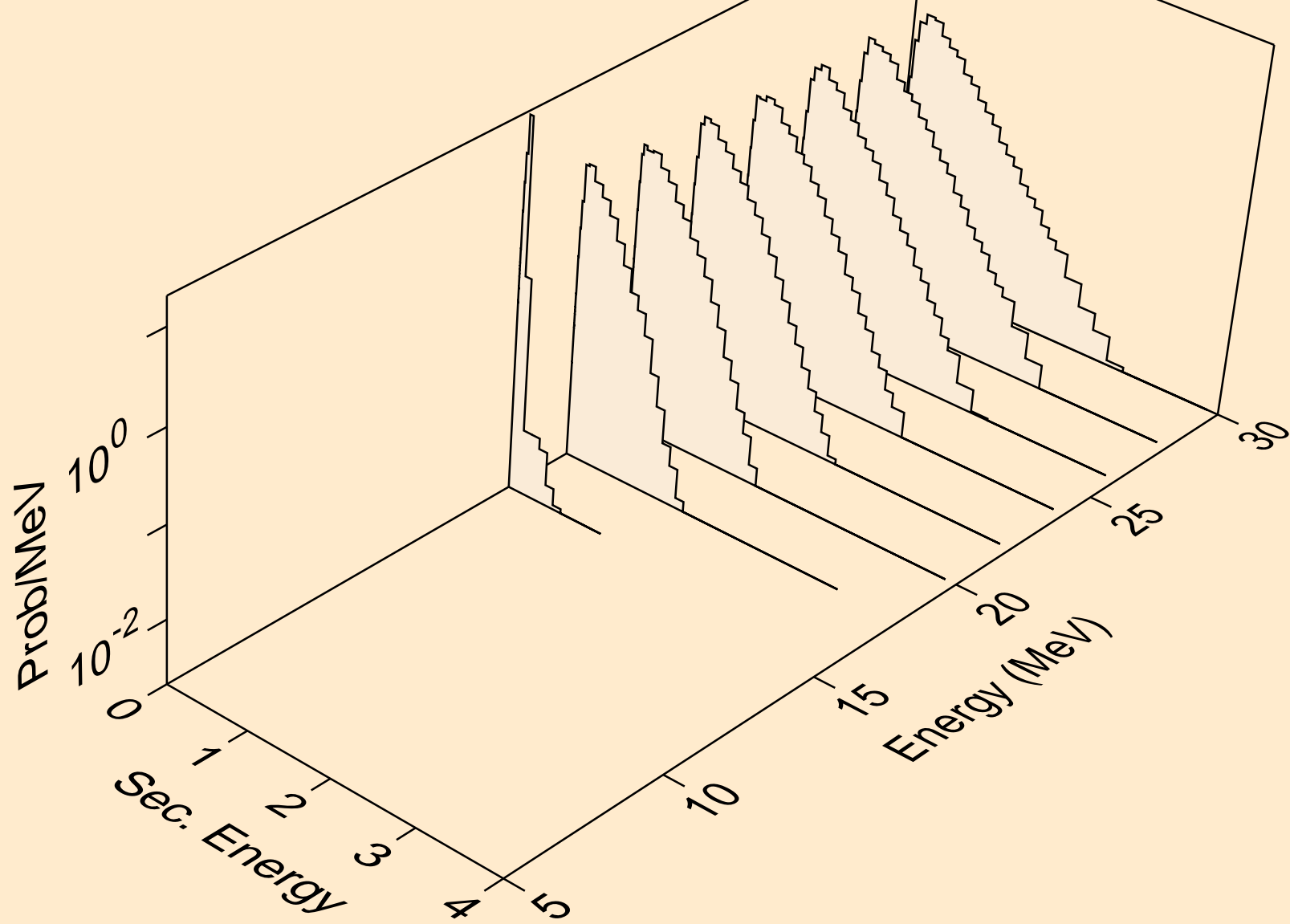

IR185 NEUTRON ACER TENDL-2023 LIBRARY; T=0.K
Neutron emission for (n,4n)

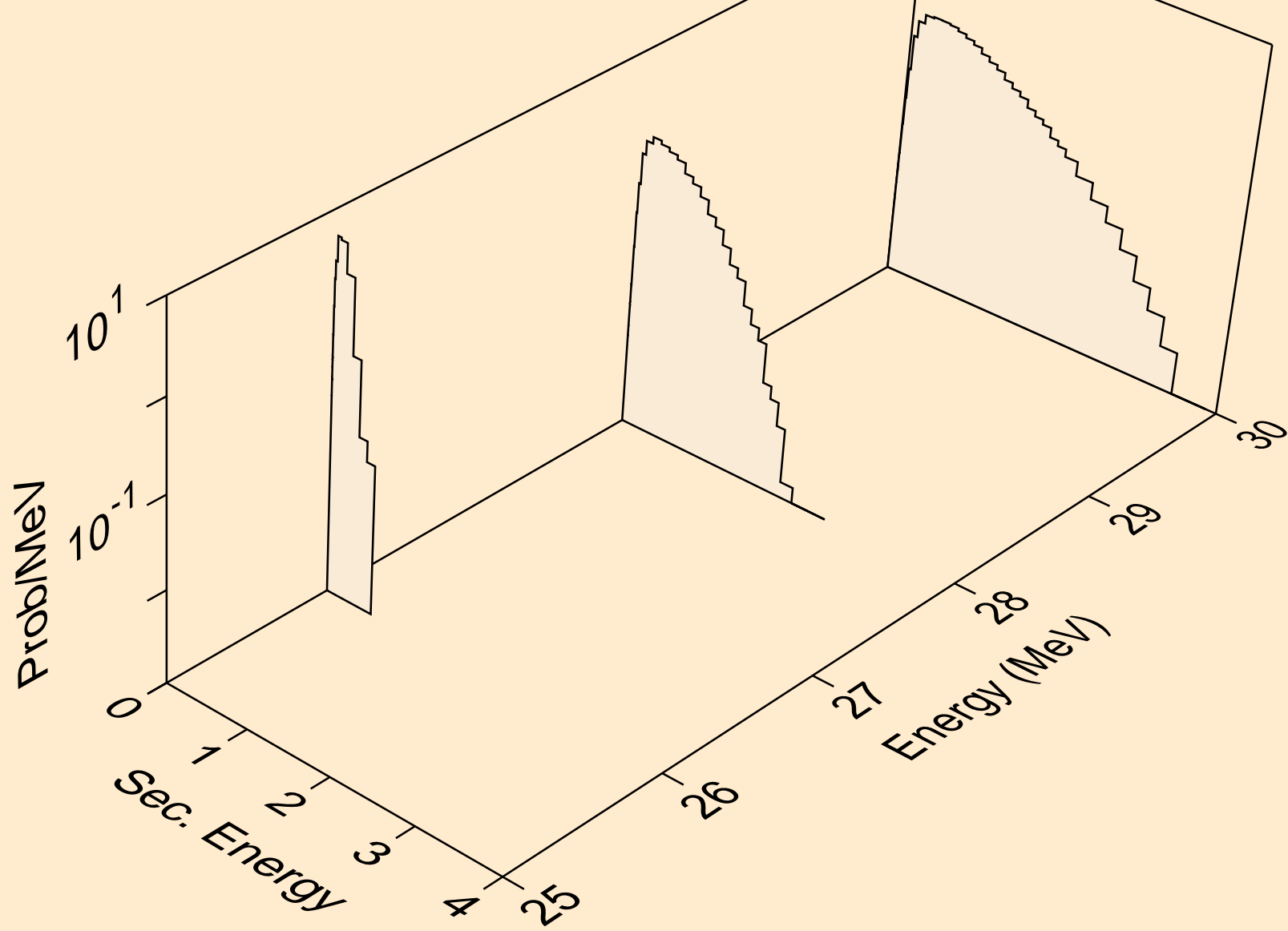

IR185 NEUTRON ACER TENDL-2023 LIBRARY; T=0.K
Neutron emission for (n,2np)

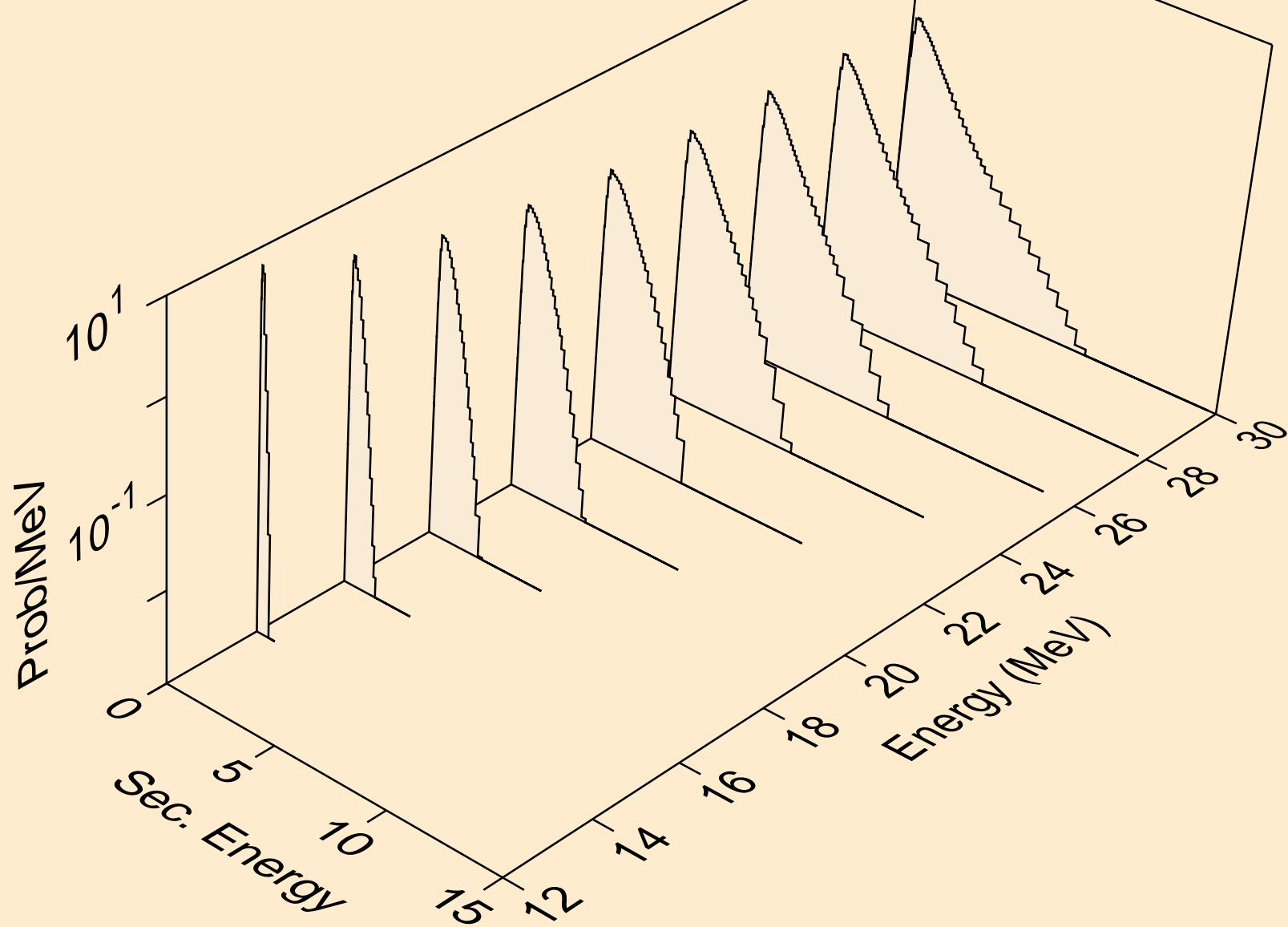

IR185 NEUTRON ACER TENDL-2023 LIBRARY; T=0.K
Neutron emission for (n,3np)

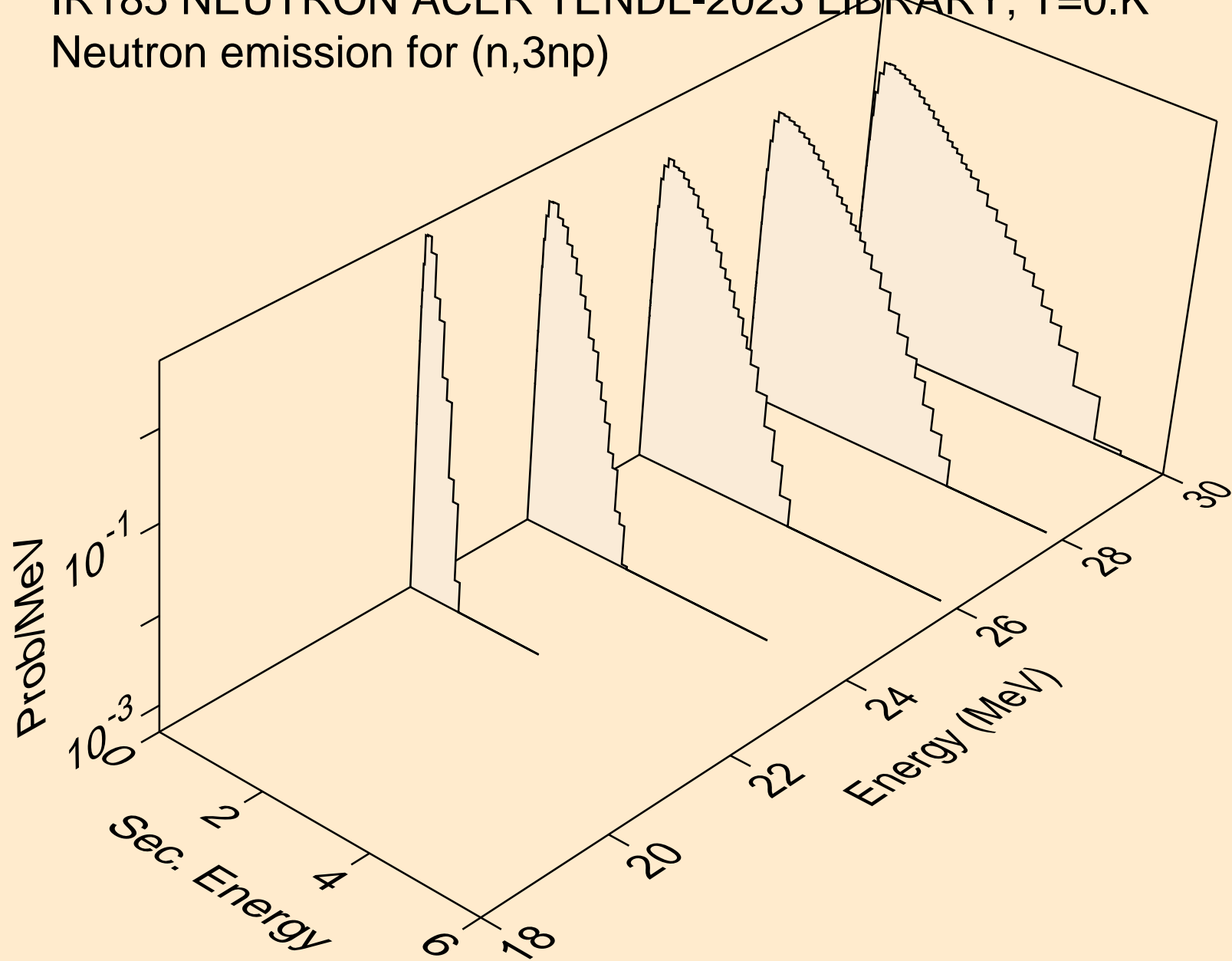

IR185 NEUTRON ACER TENDL-2023 LIBRARY; T=0.K
Neutron emission for (n,n2p)

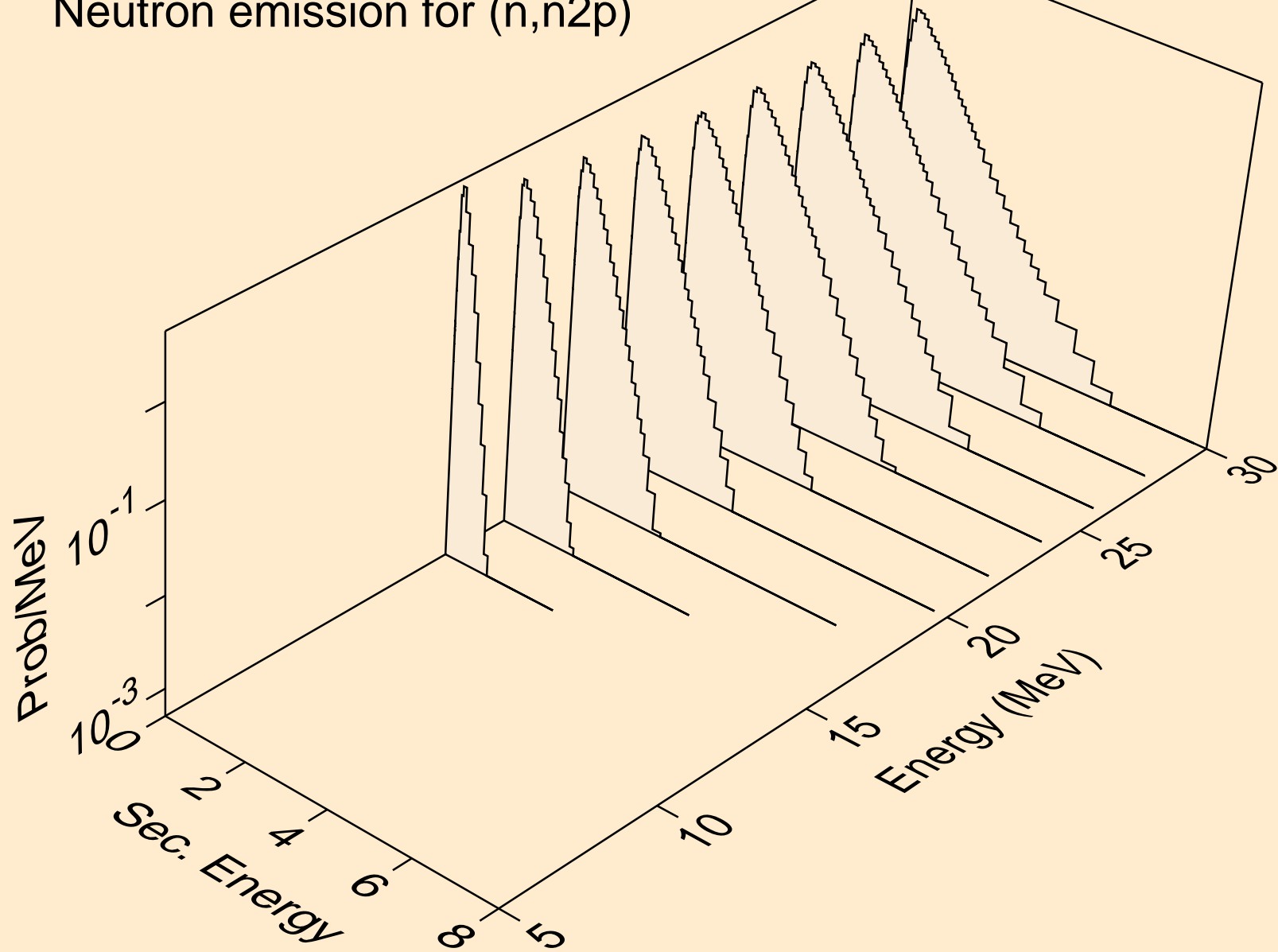

IR185 NEUTRON ACER TENDL-2023 LIBRARY; T=0.K
Neutron emission for (n,npa)

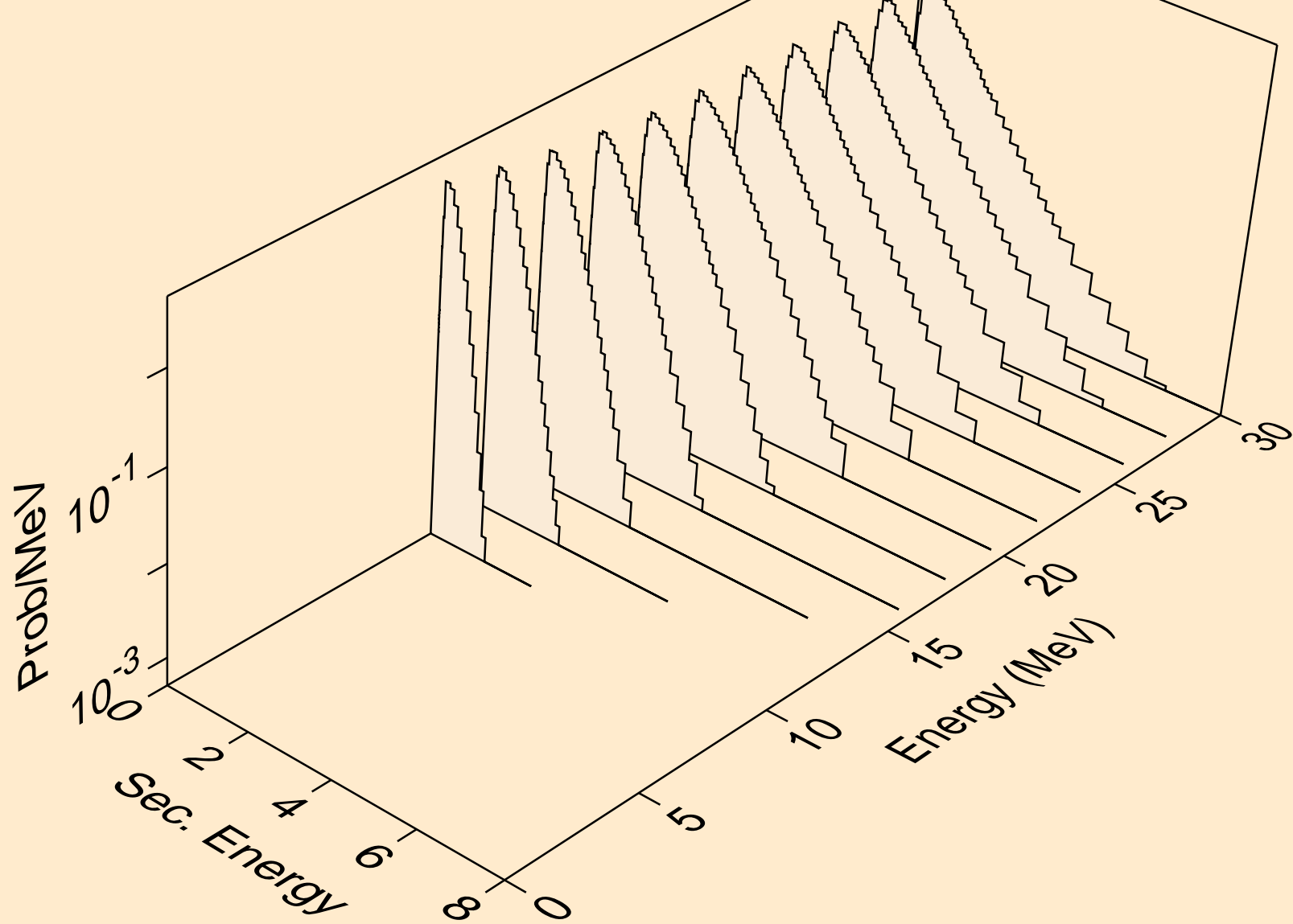

IR185 NEUTRON ACER TENDL-2023 LIBRARY; T=0.K
Neutron emission for (n,n*c)

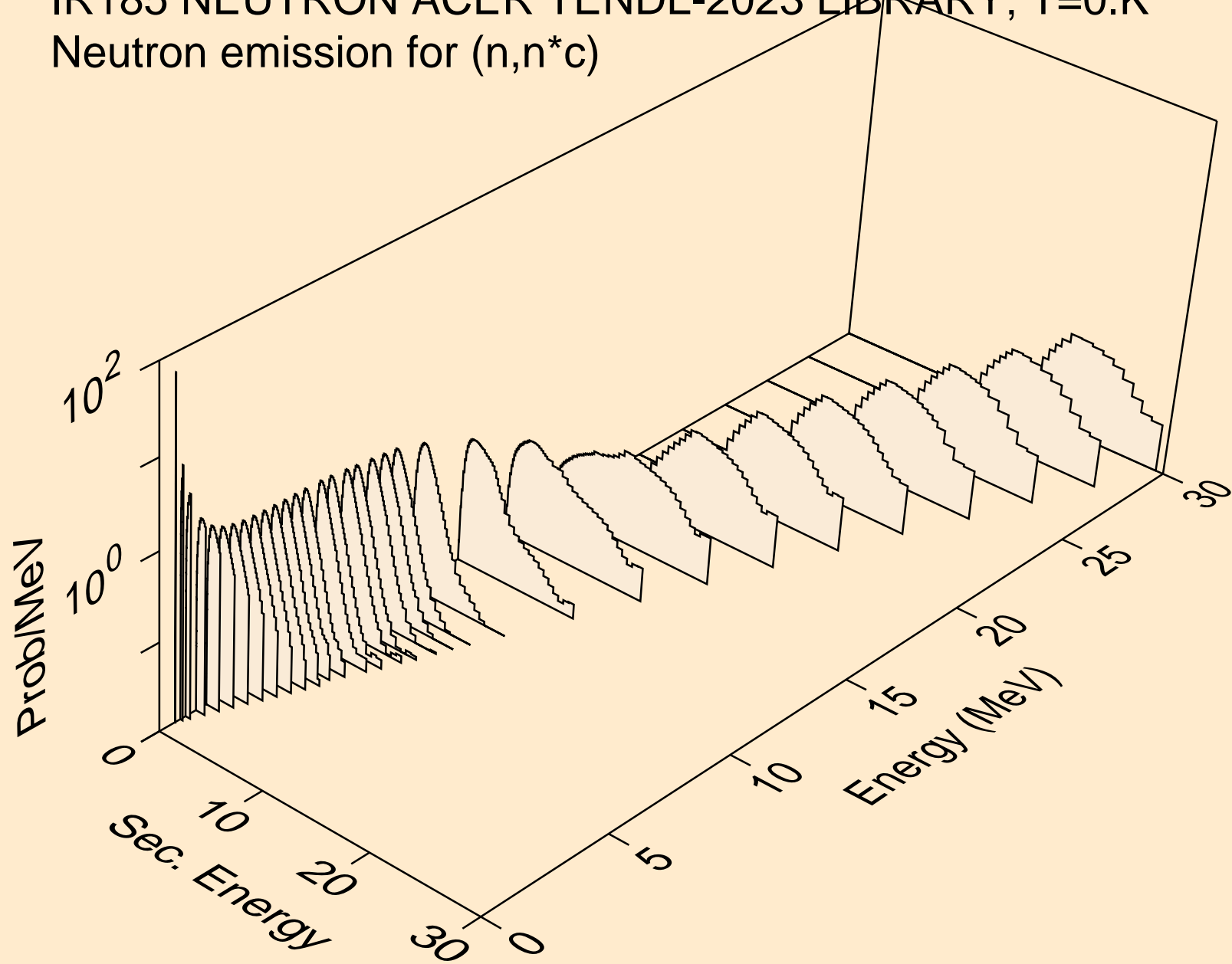

IR185 NEUTRON ACER TENDL-2023 LIBRARY; T=0.K
Photon emission for (n,x)

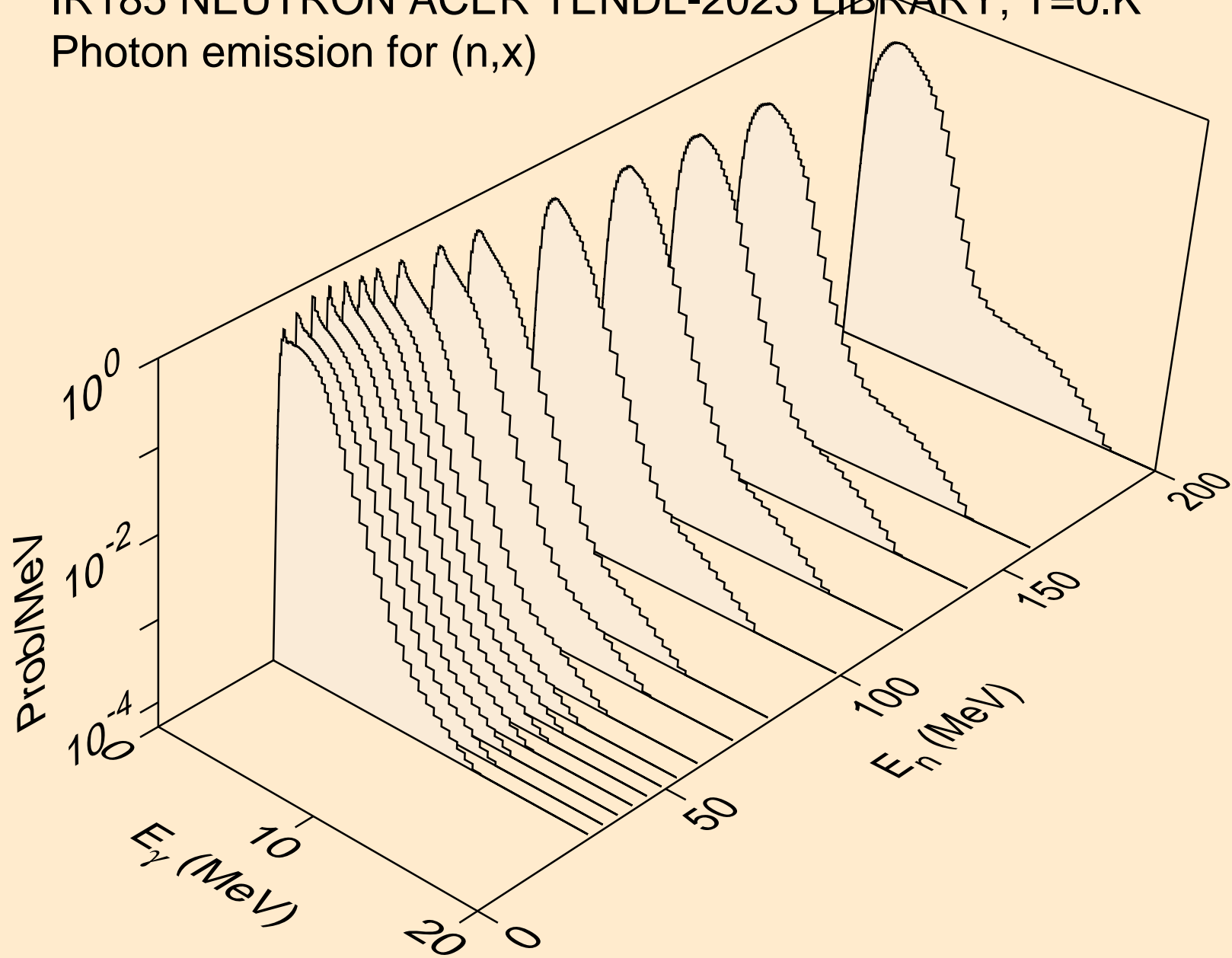

IR185 NEUTRON ACER TENDL-2023 LIBRARY; T=0.K
Photon emission for (n,2nd)

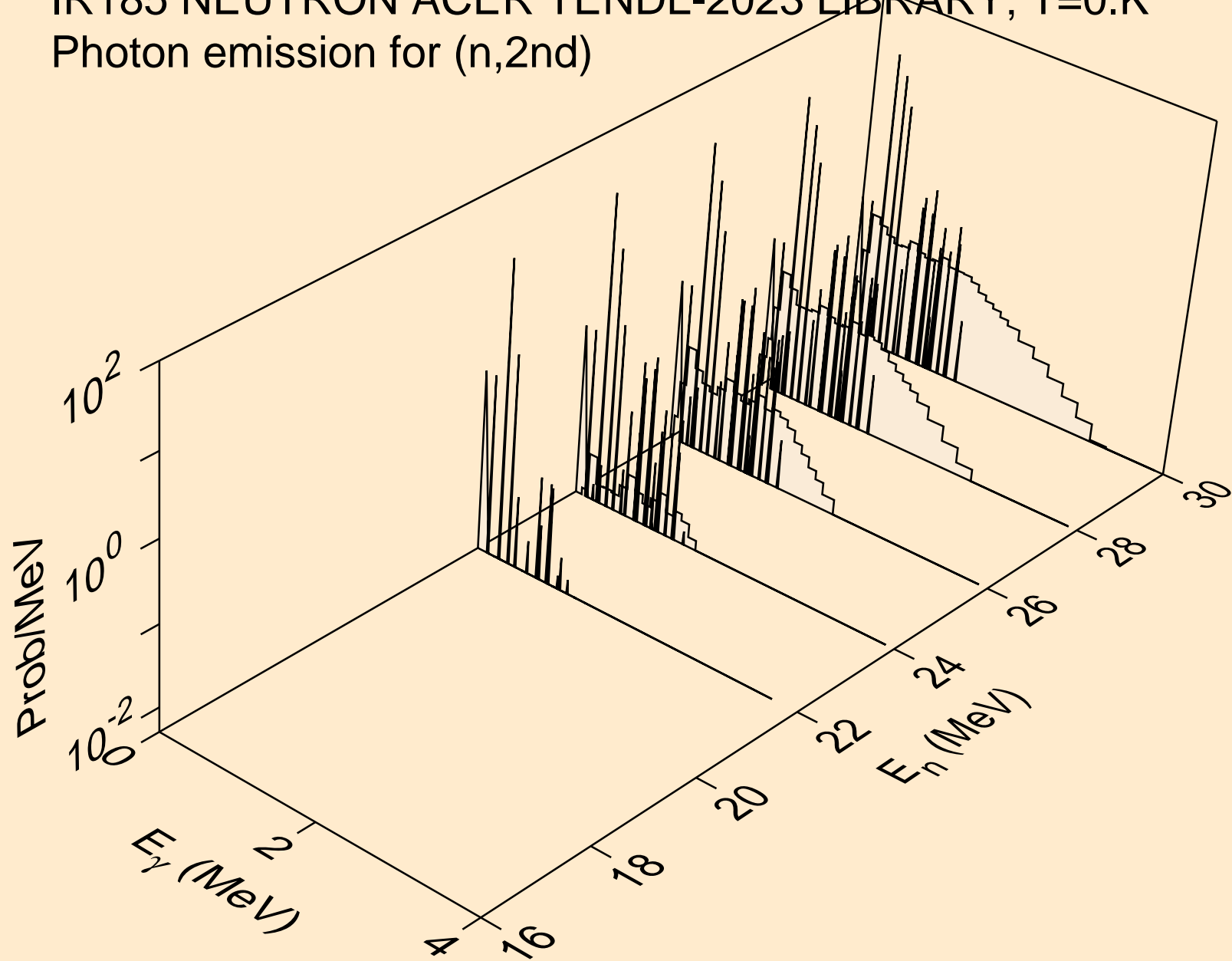

IR185 NEUTRON ACER TENDL-2023 LIBRARY; T=0.K
Photon emission for (n,2n)

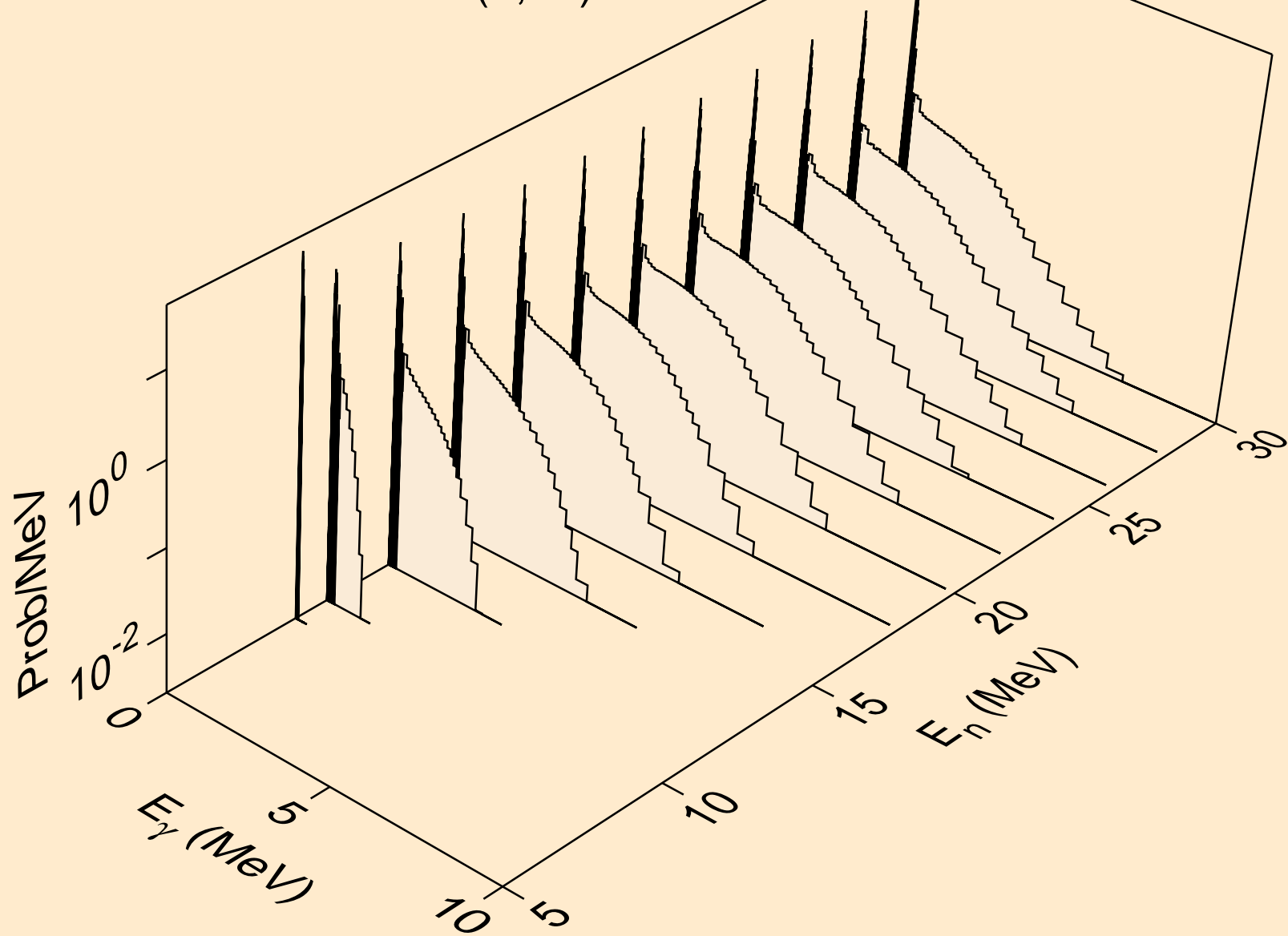

IR185 NEUTRON ACER TENDL-2023 LIBRARY; T=0.K
Photon emission for (n,3n)

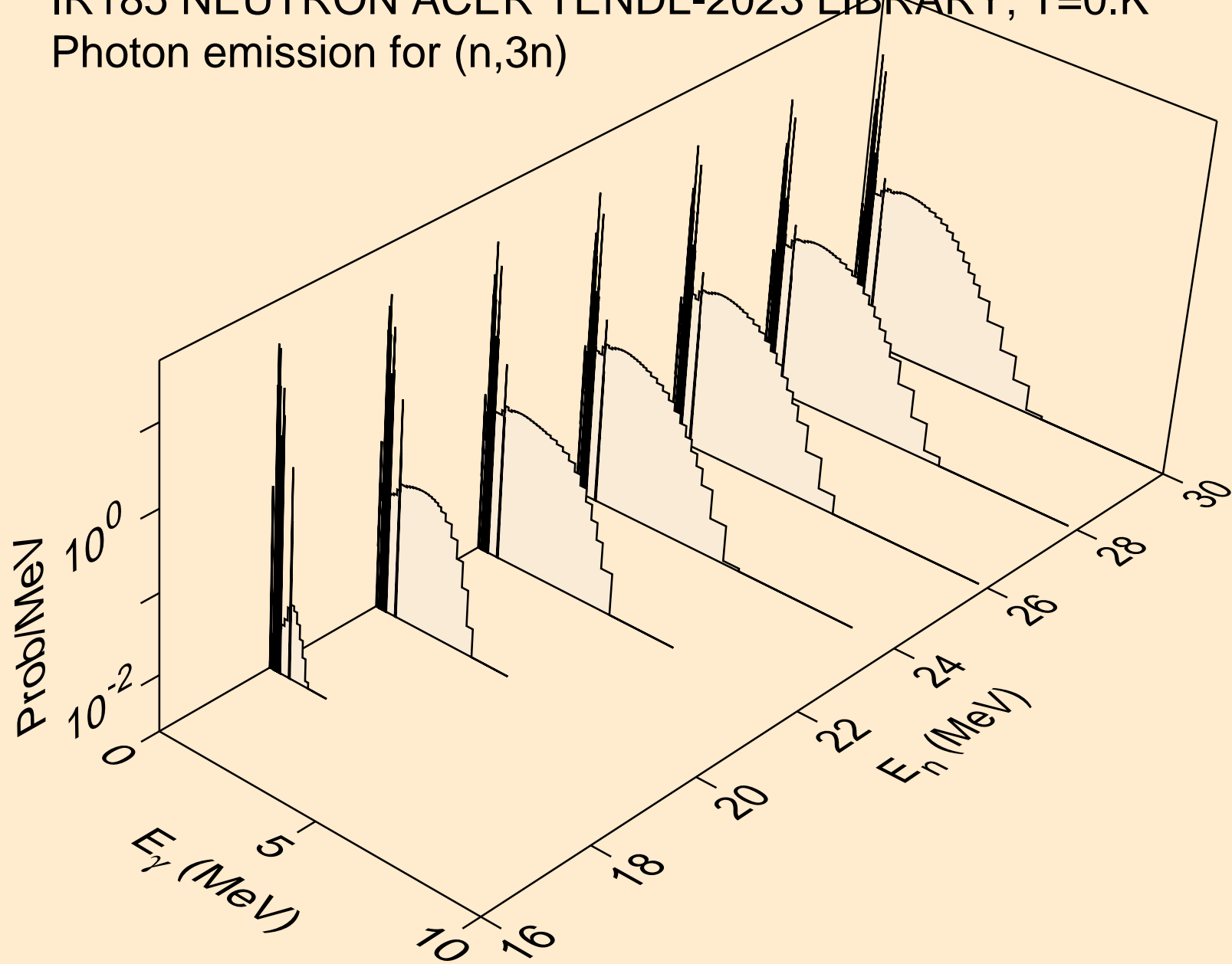

IR185 NEUTRON ACER TENDL-2023 LIBRARY; T=0.K
Photon emission for (n,n*)a

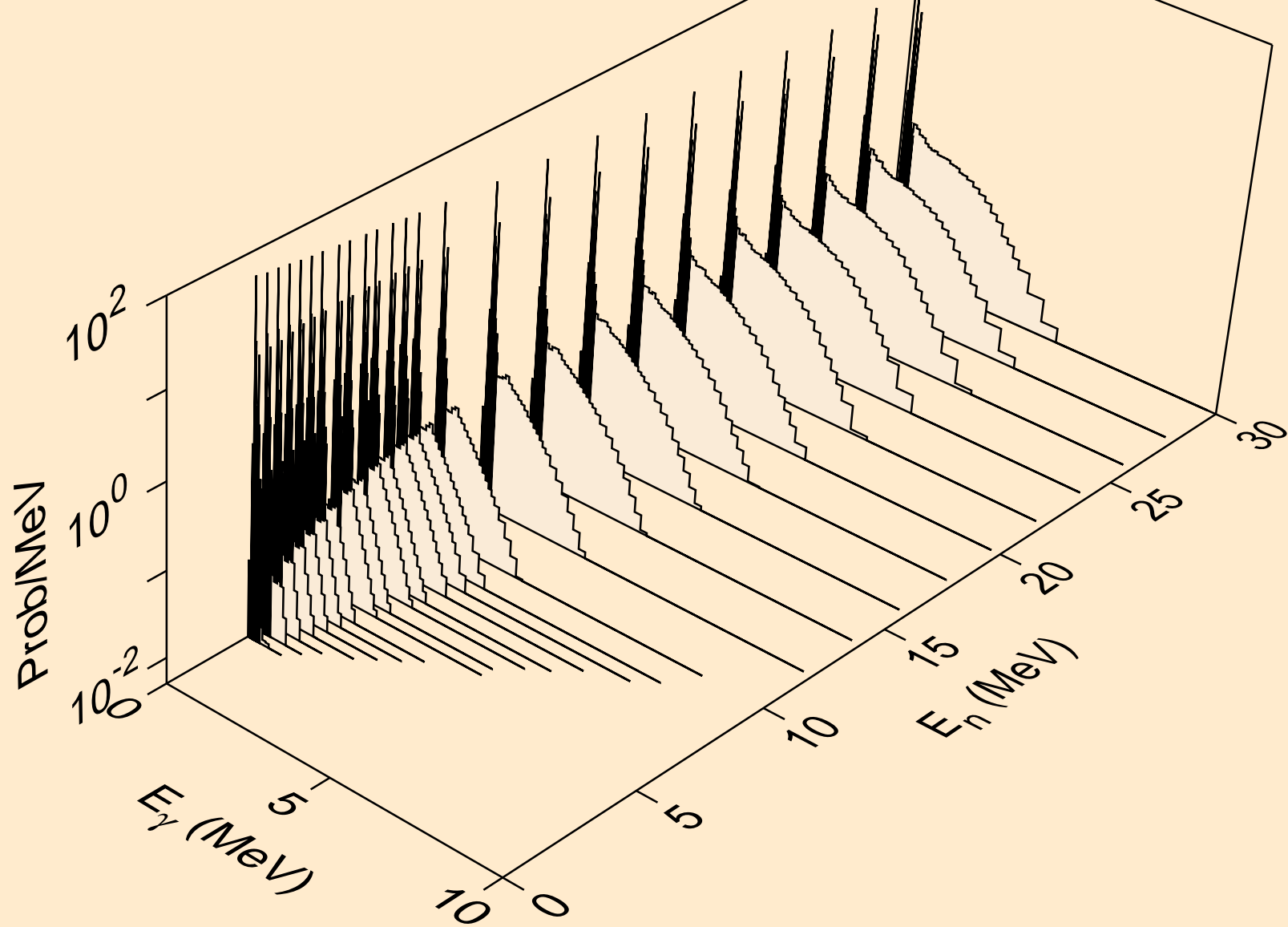

IR185 NEUTRON ACER TENDL-2023 LIBRARY; T=0.K
Photon emission for (n,2n)a

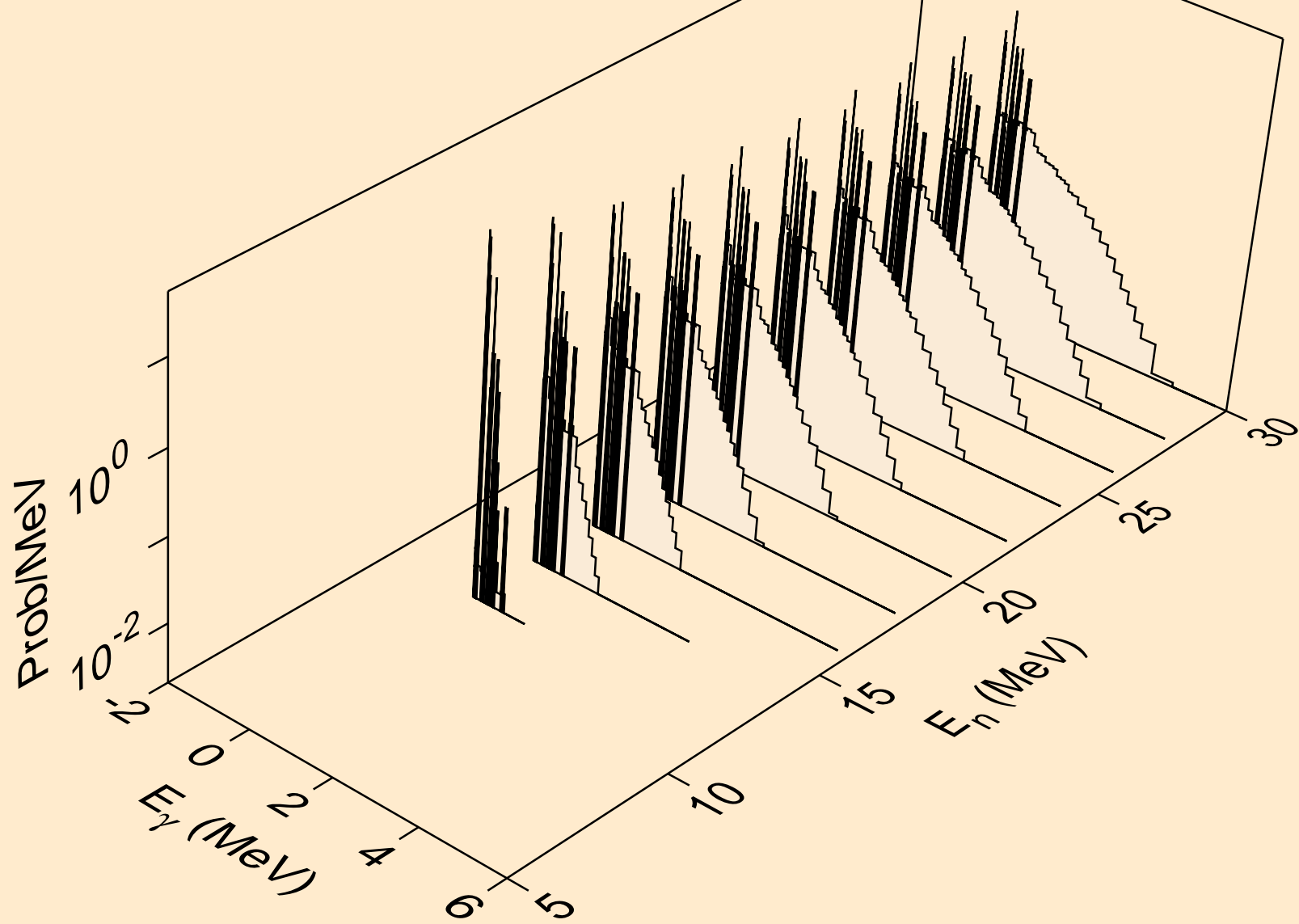

IR185 NEUTRON ACER TENDL-2023 LIBRARY; T=0.K
Photon emission for (n,3n)a

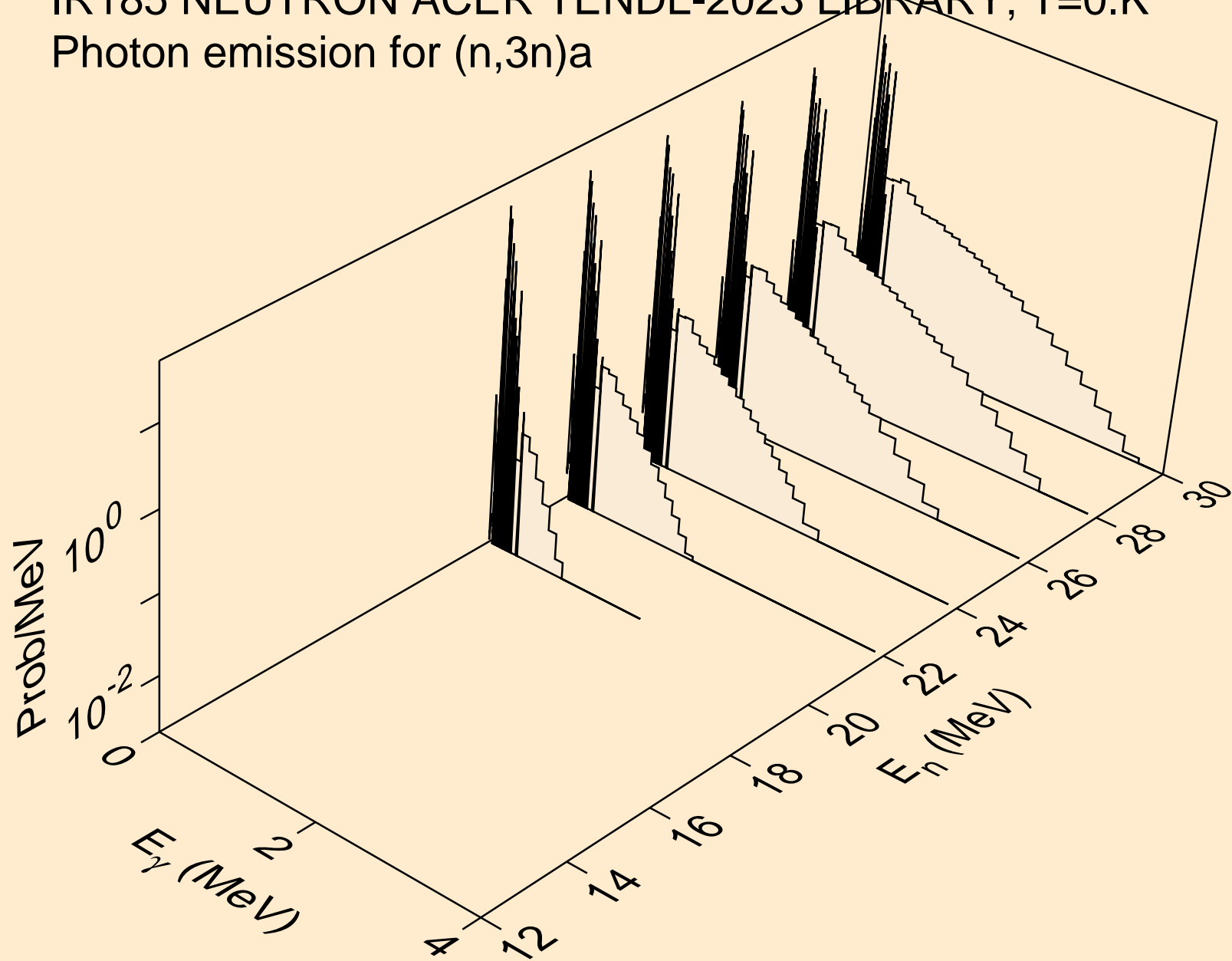

IR185 NEUTRON ACER TENDL-2023 LIBRARY; T=0.K
Photon emission for (n,n*)p

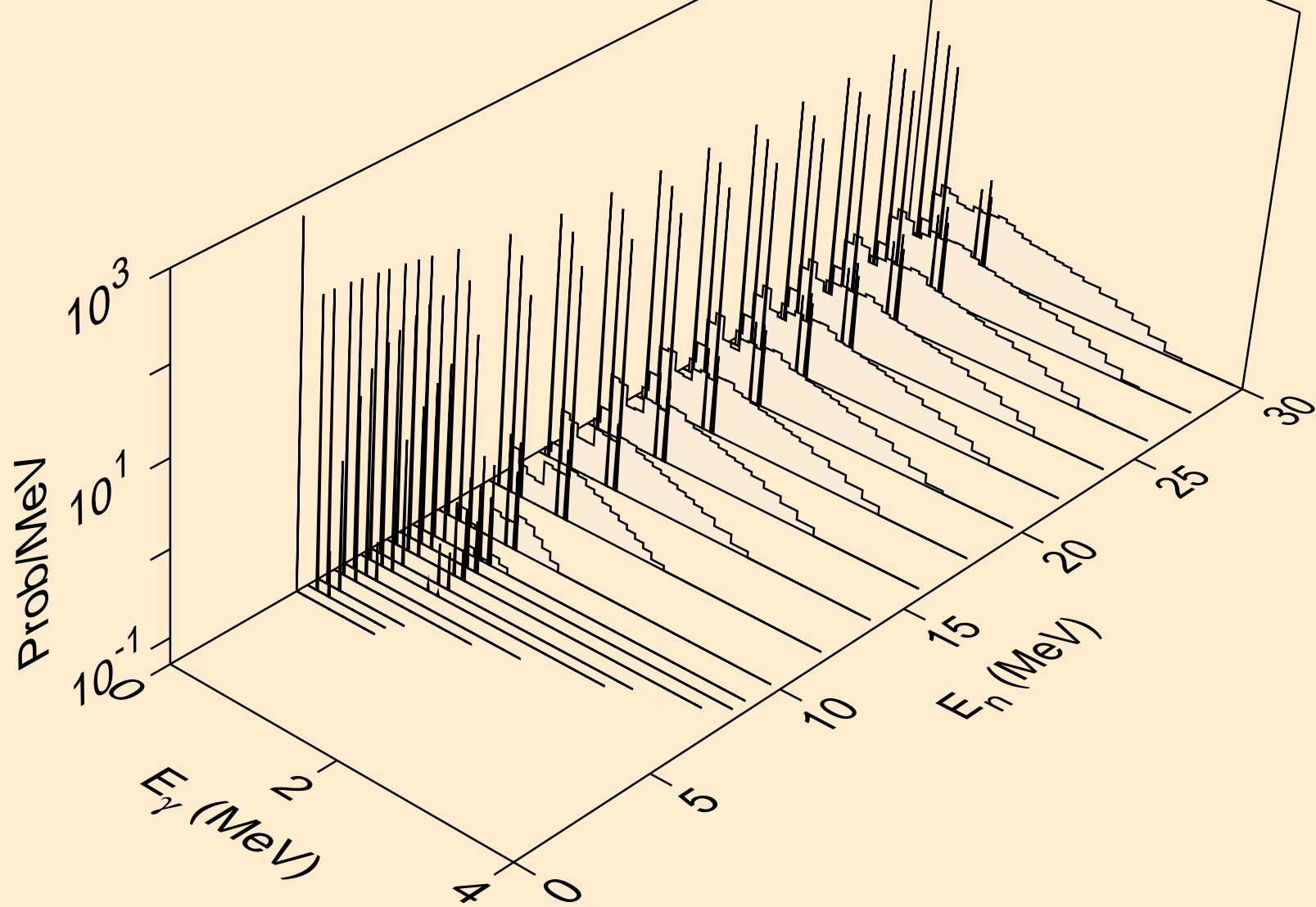

IR185 NEUTRON ACER TENDL-2023 LIBRARY; T=0.K
Photon emission for (n,n*)2a

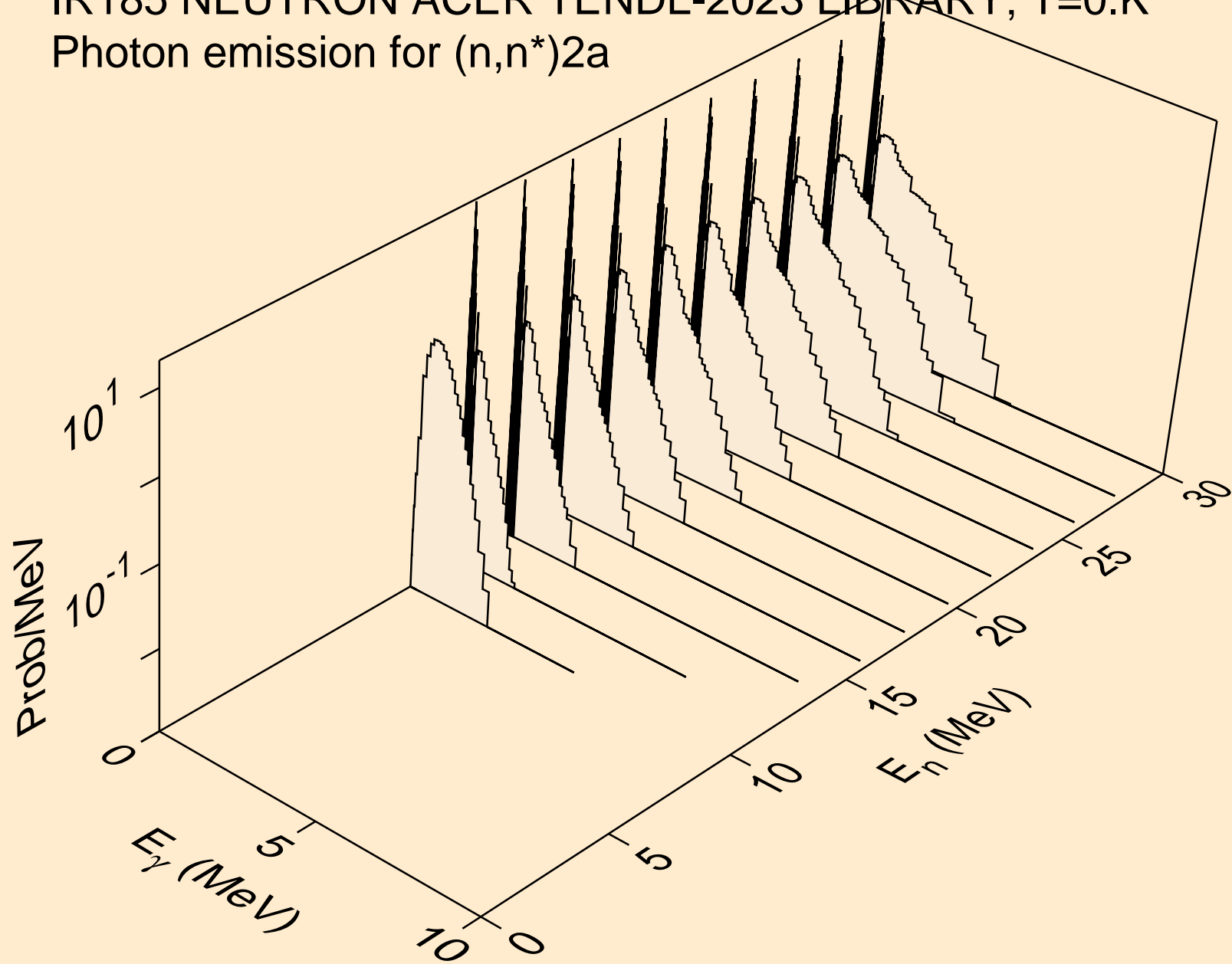

IR185 NEUTRON ACER TENDL-2023 LIBRARY; T=0.K
Photon emission for (n,2n)2a

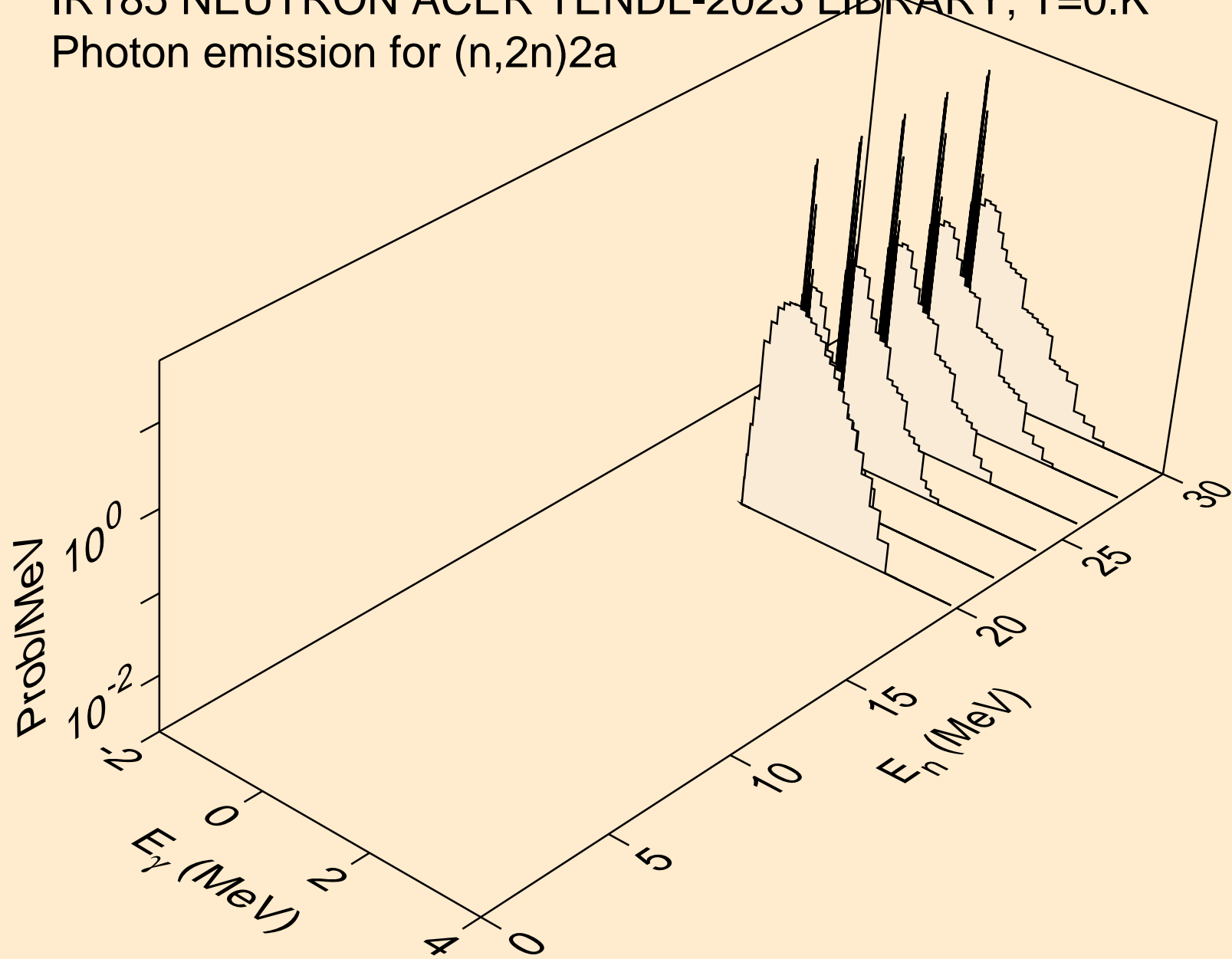

IR185 NEUTRON ACER TENDL-2023 LIBRARY; T=0.K
Photon emission for (n,n*)d

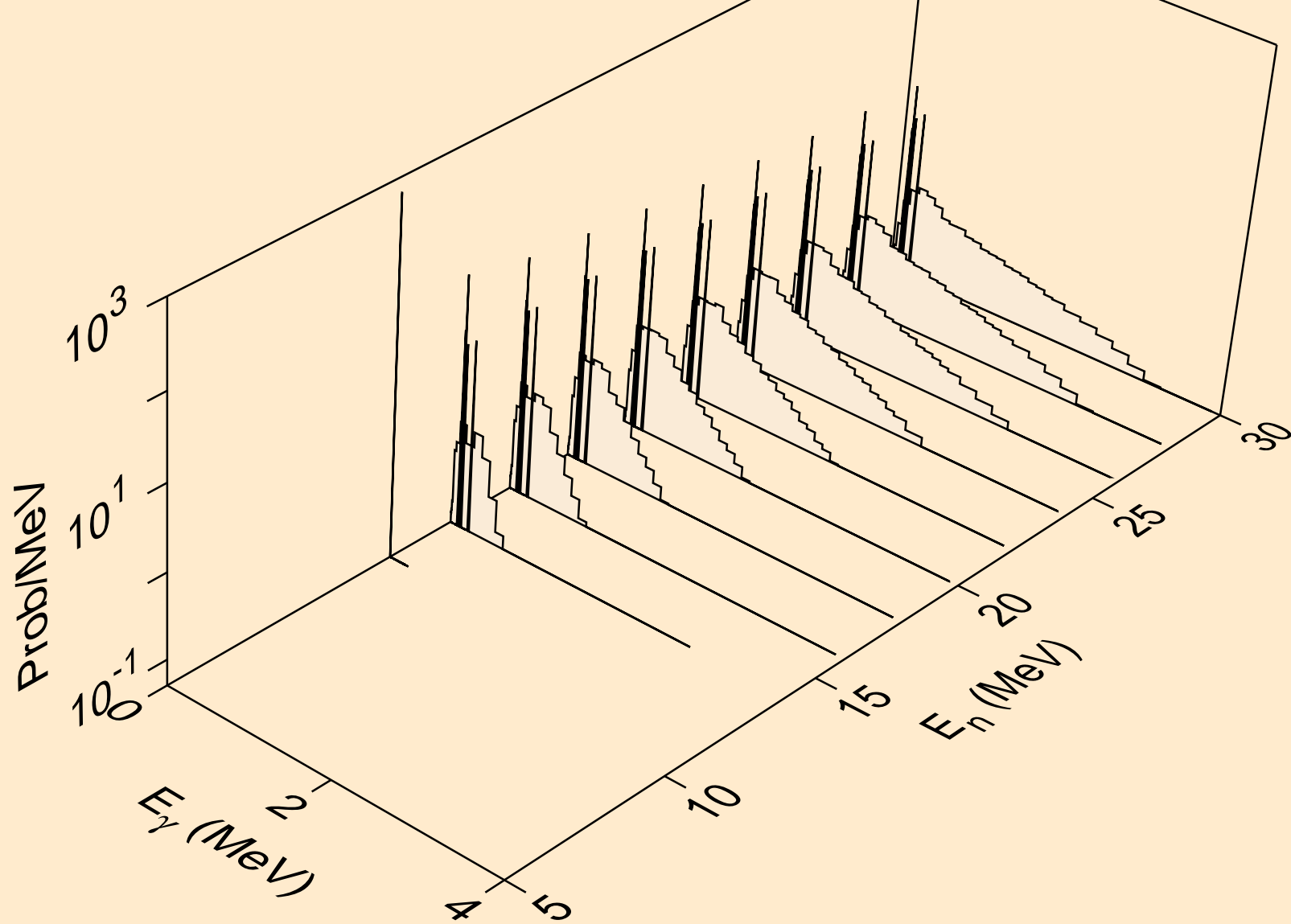

IR185 NEUTRON ACER TENDL-2023 LIBRARY; T=0.K
Photon emission for (n,n*)t

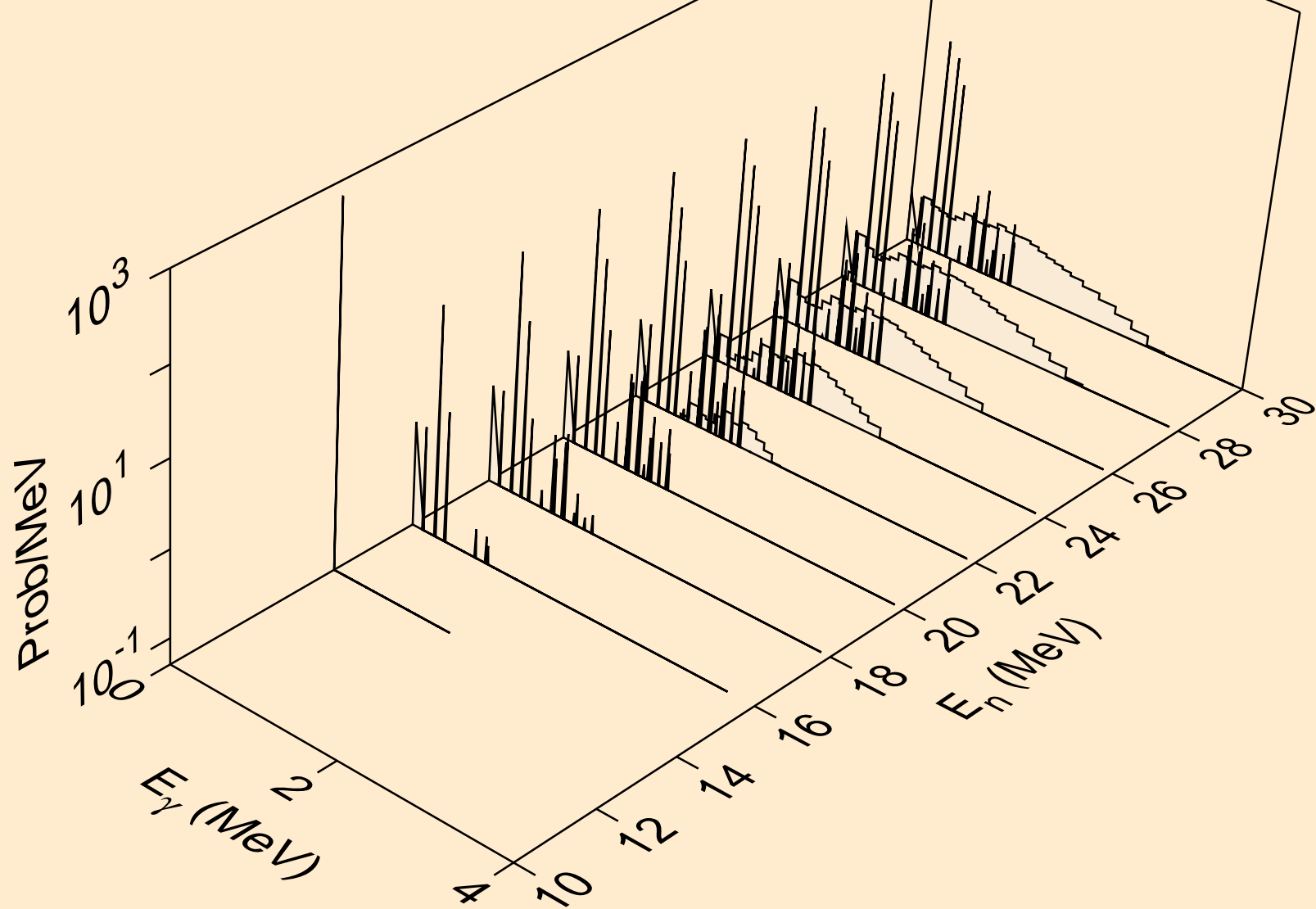

IR185 NEUTRON ACER TENDL-2023 LIBRARY; T=0.K
Photon emission for (n,n*)he3

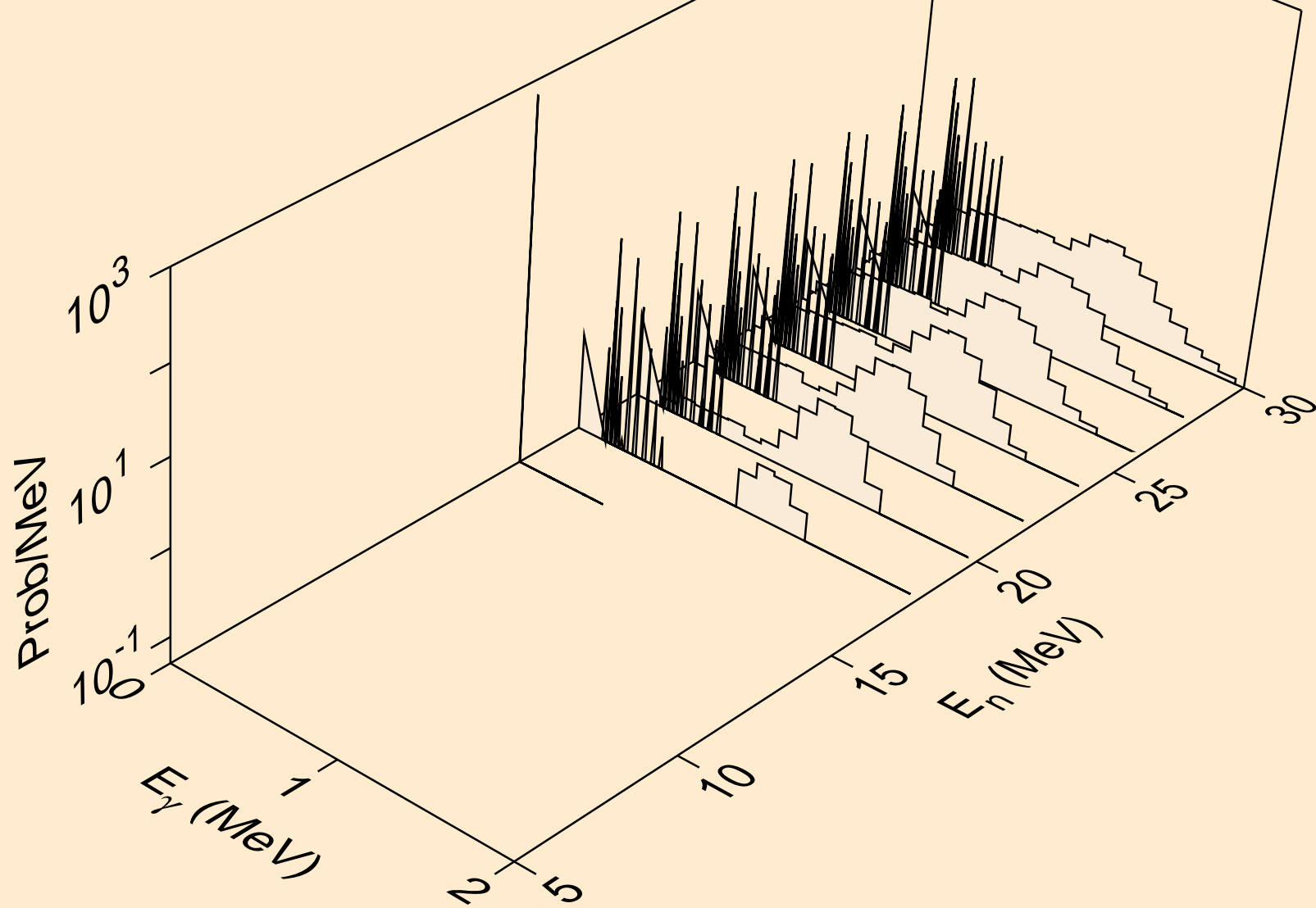

IR185 NEUTRON ACER TENDL-2023 LIBRARY; T=0.K
Photon emission for (n,4n)

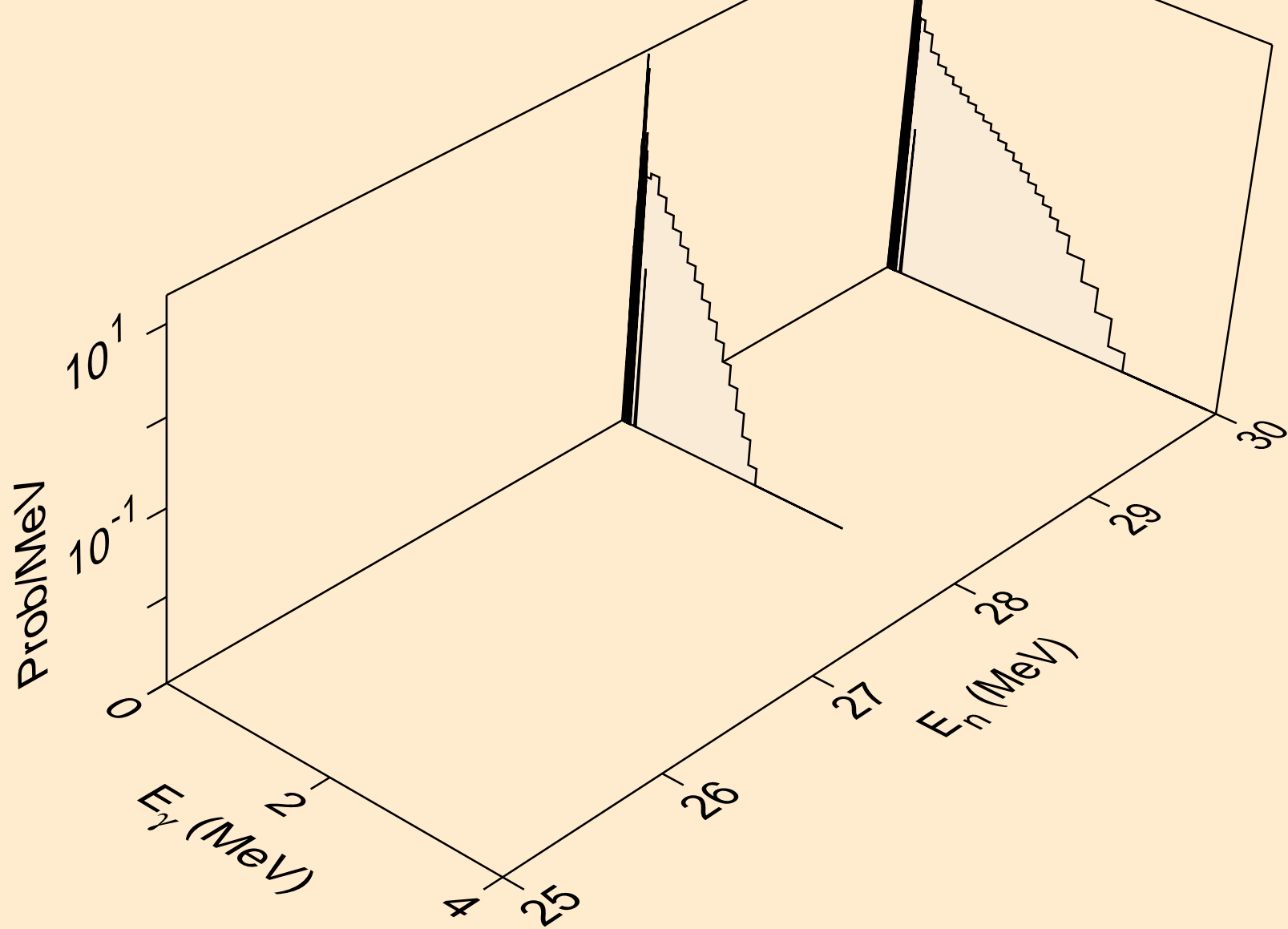

IR185 NEUTRON ACER TENDL-2023 LIBRARY; T=0.K
Photon emission for (n,2np)

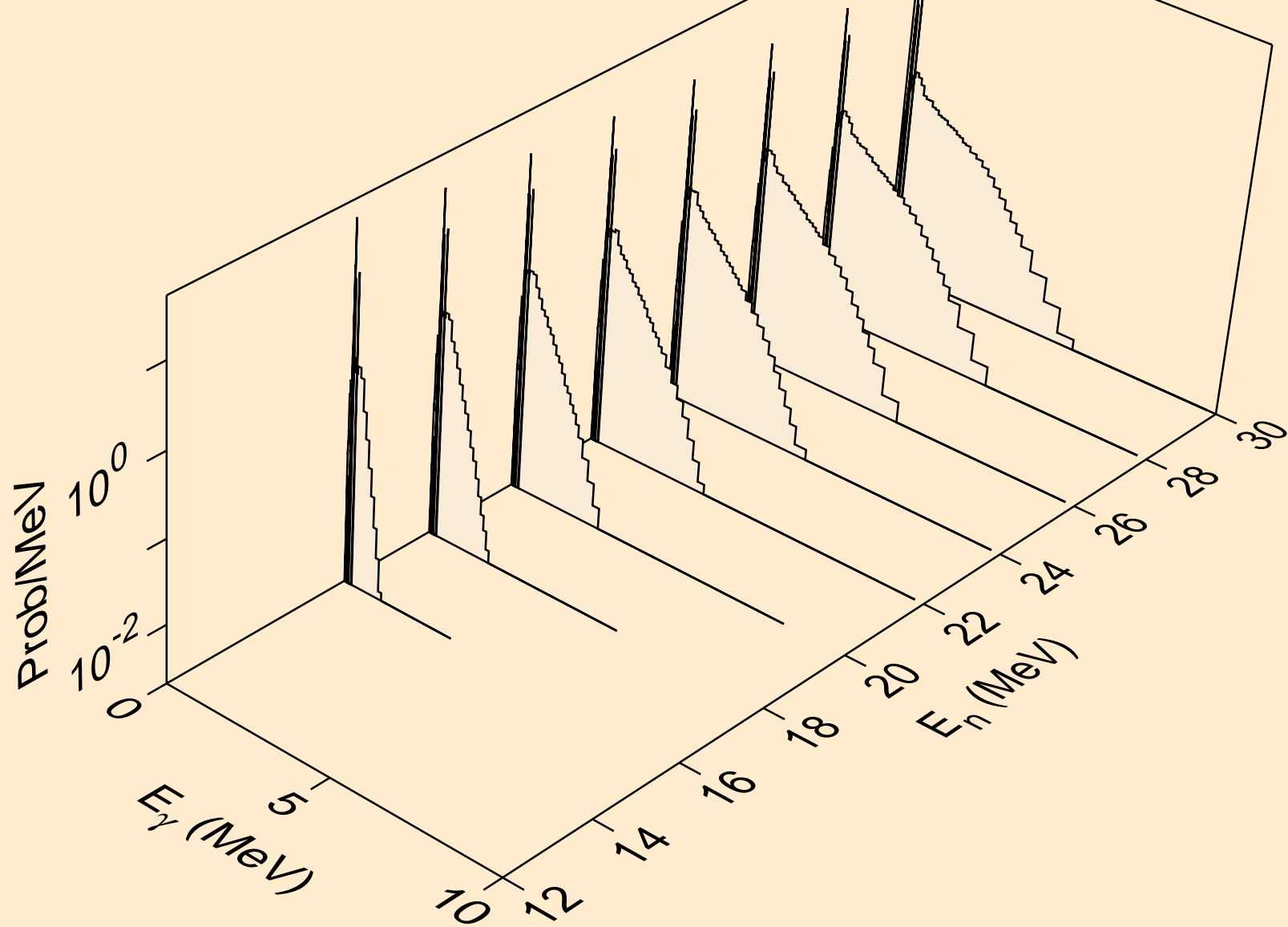

IR185 NEUTRON ACER TENDL-2023 LIBRARY; T=0.K
Photon emission for (n,3np)

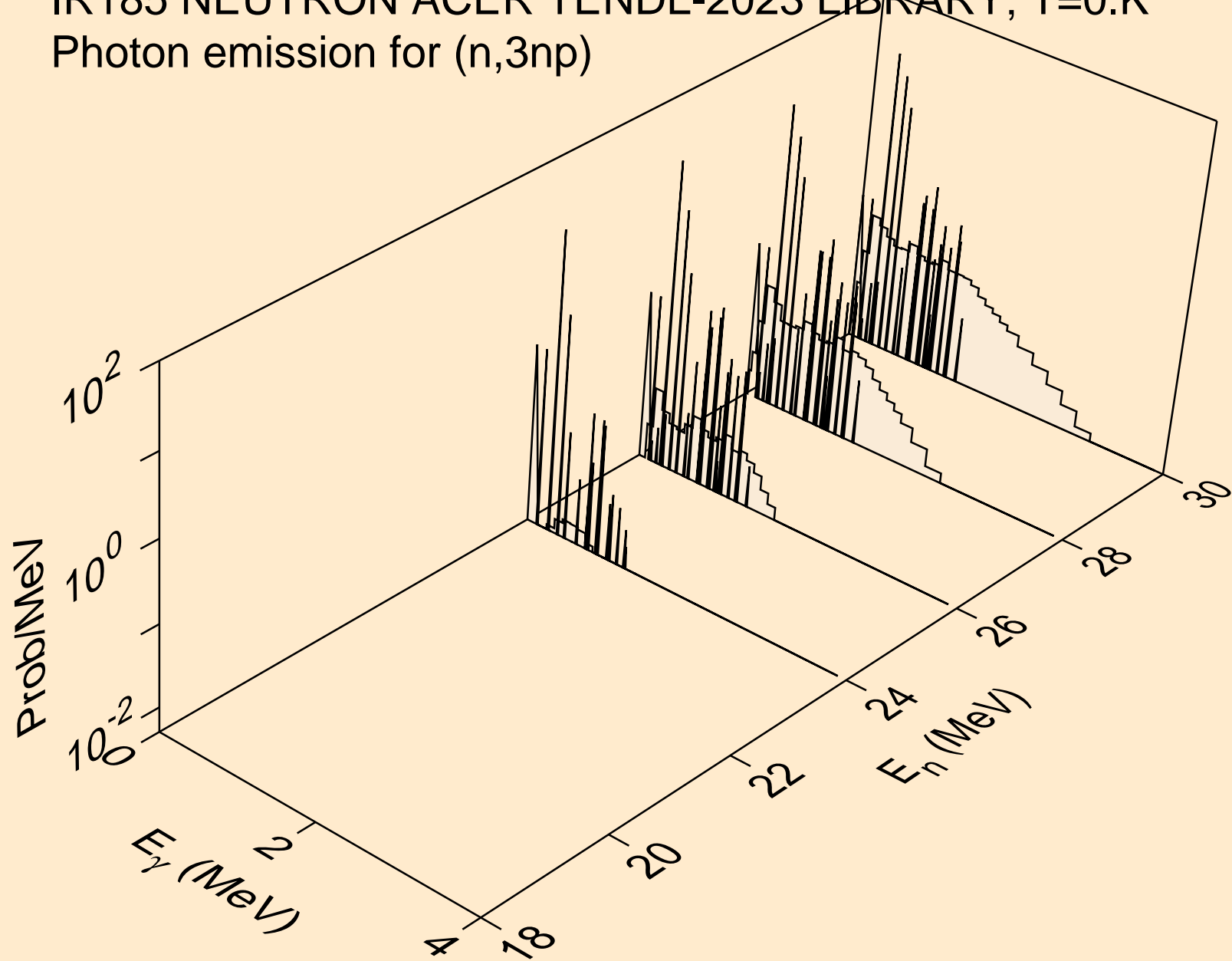

IR185 NEUTRON ACER TENDL-2023 LIBRARY; T=0.K
Photon emission for (n,n2p)

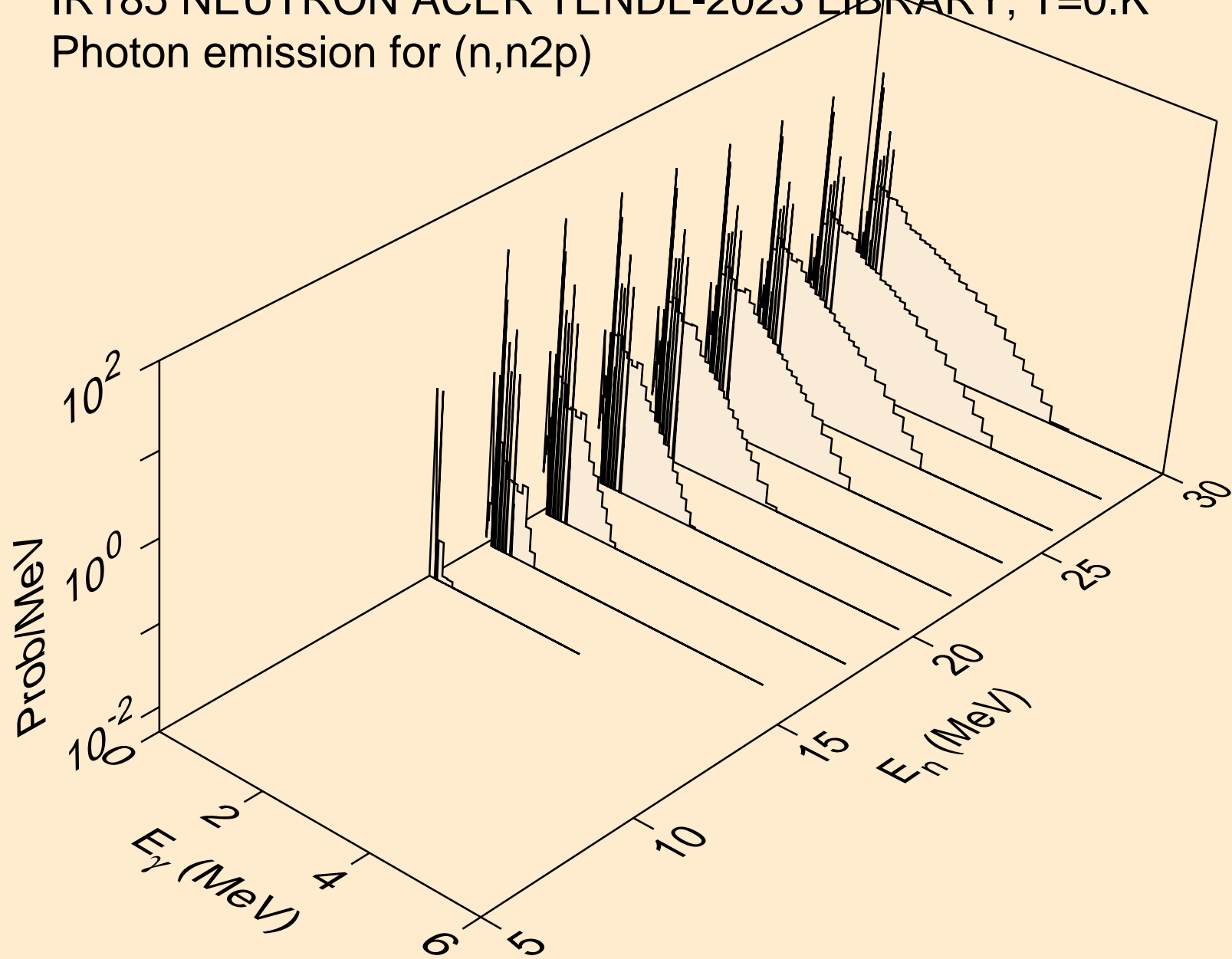

IR185 NEUTRON ACER TENDL-2023 LIBRARY; T=0.K
Photon emission for (n,npa)

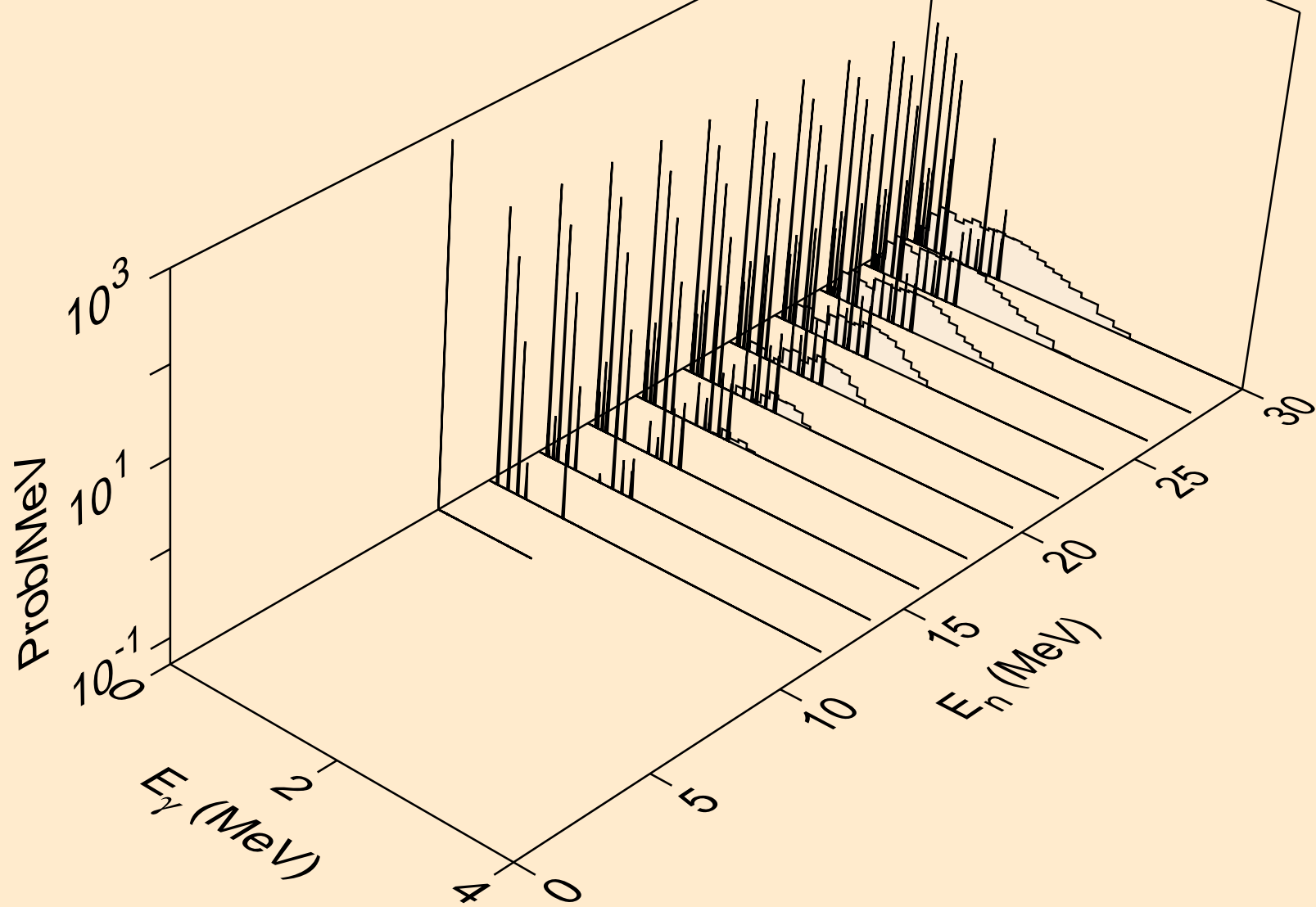

IR185 NEUTRON ACER TENDL-2023 LIBRARY; T=0.K
Photon emission for (n,n*c)

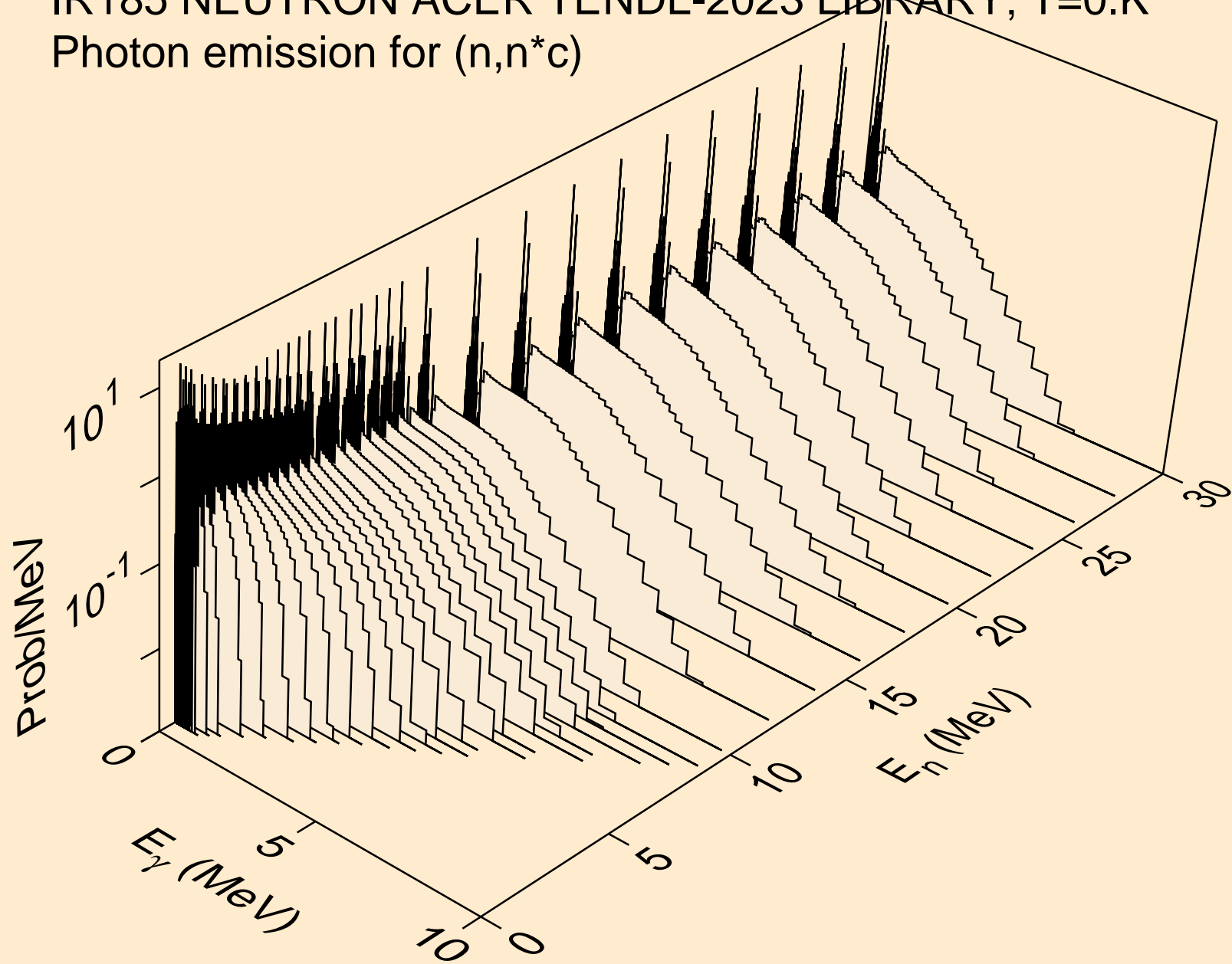

IR185 NEUTRON ACER TENDL-2023 LIBRARY; T=0.K
Photon emission for (n,gma)

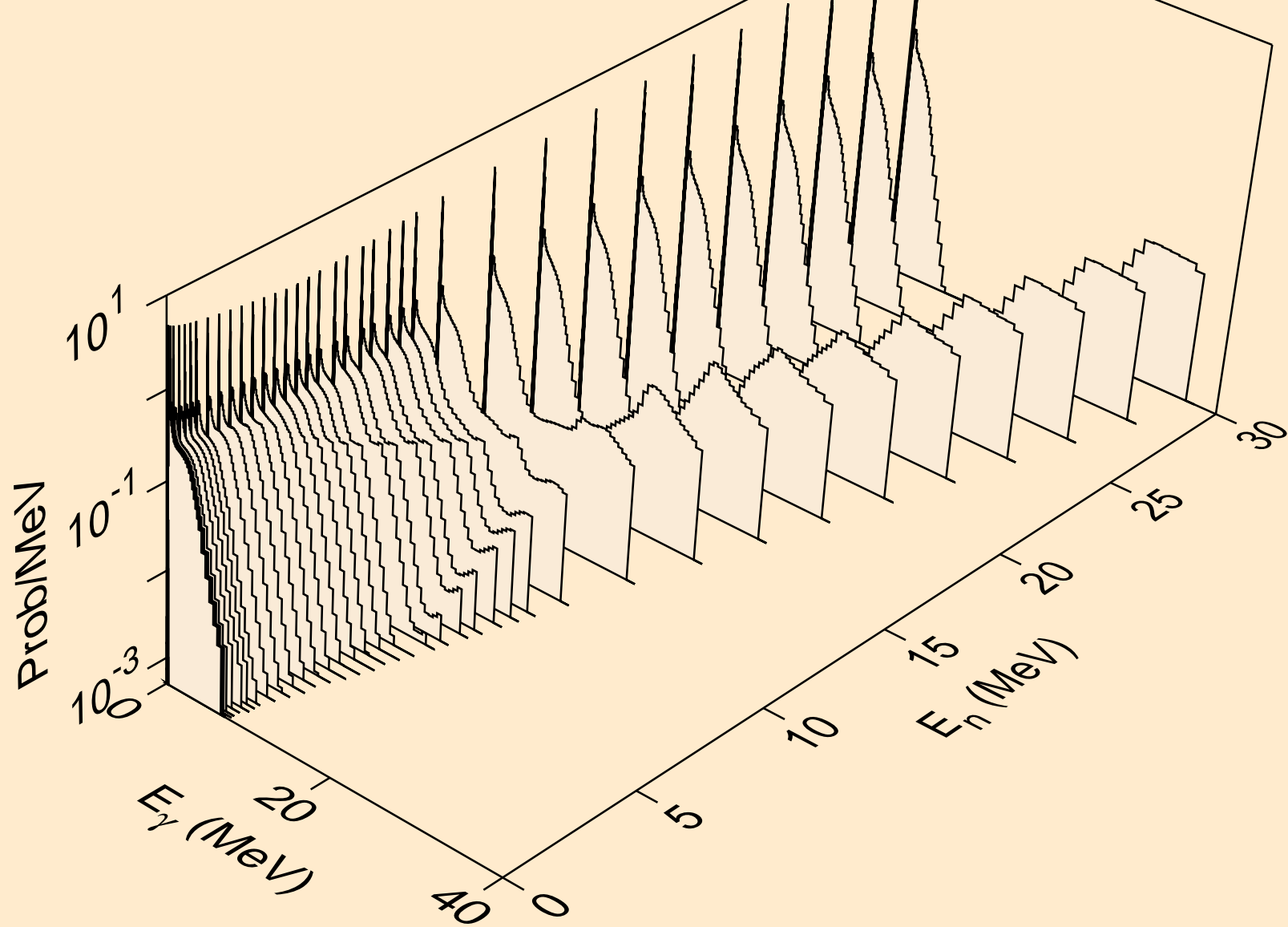

IR185 NEUTRON ACER TENDL-2023 LIBRARY; T=0.K
Photon emission for (n,p)

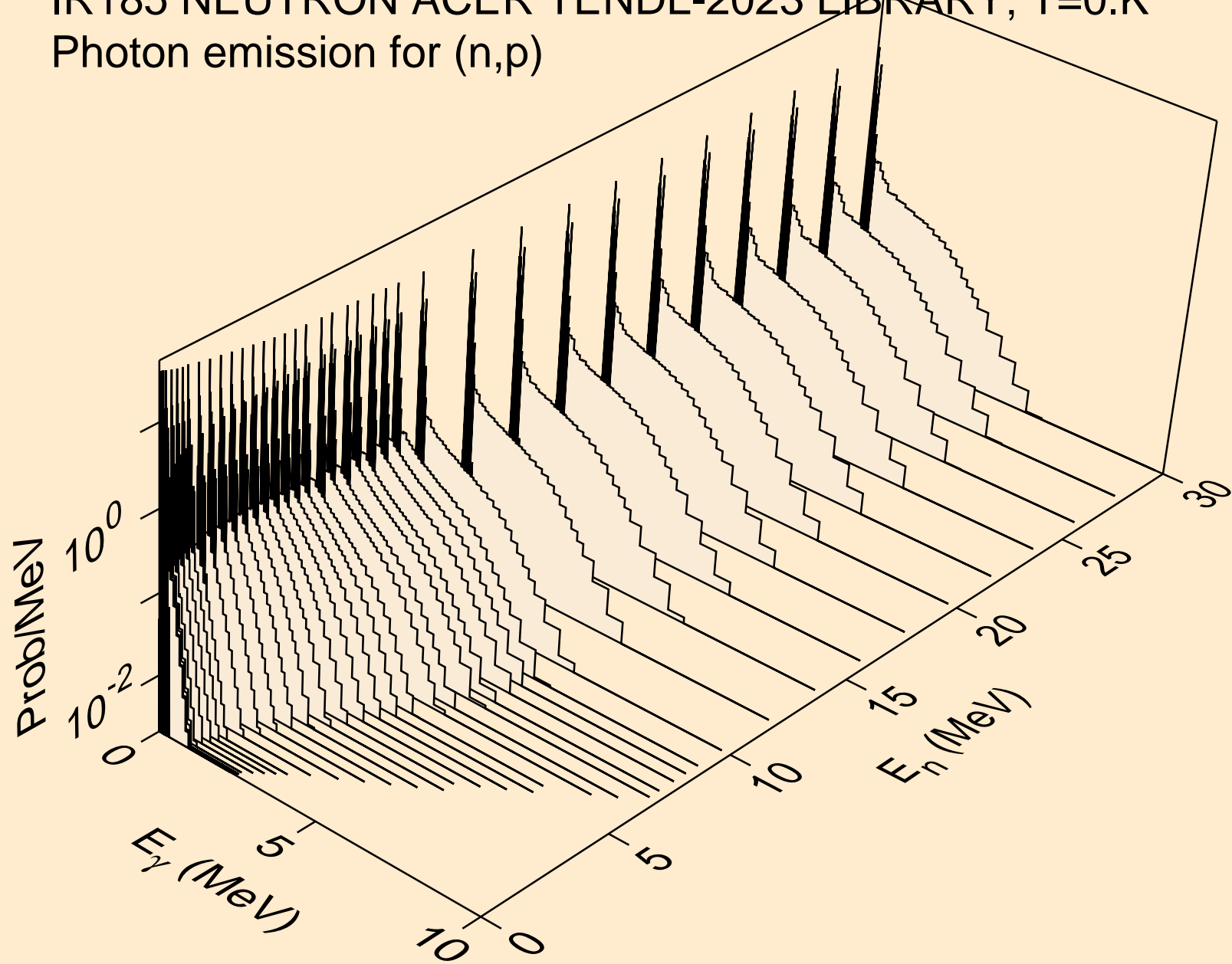

IR185 NEUTRON ACER TENDL-2023 LIBRARY; T=0.K
Photon emission for (n,d)

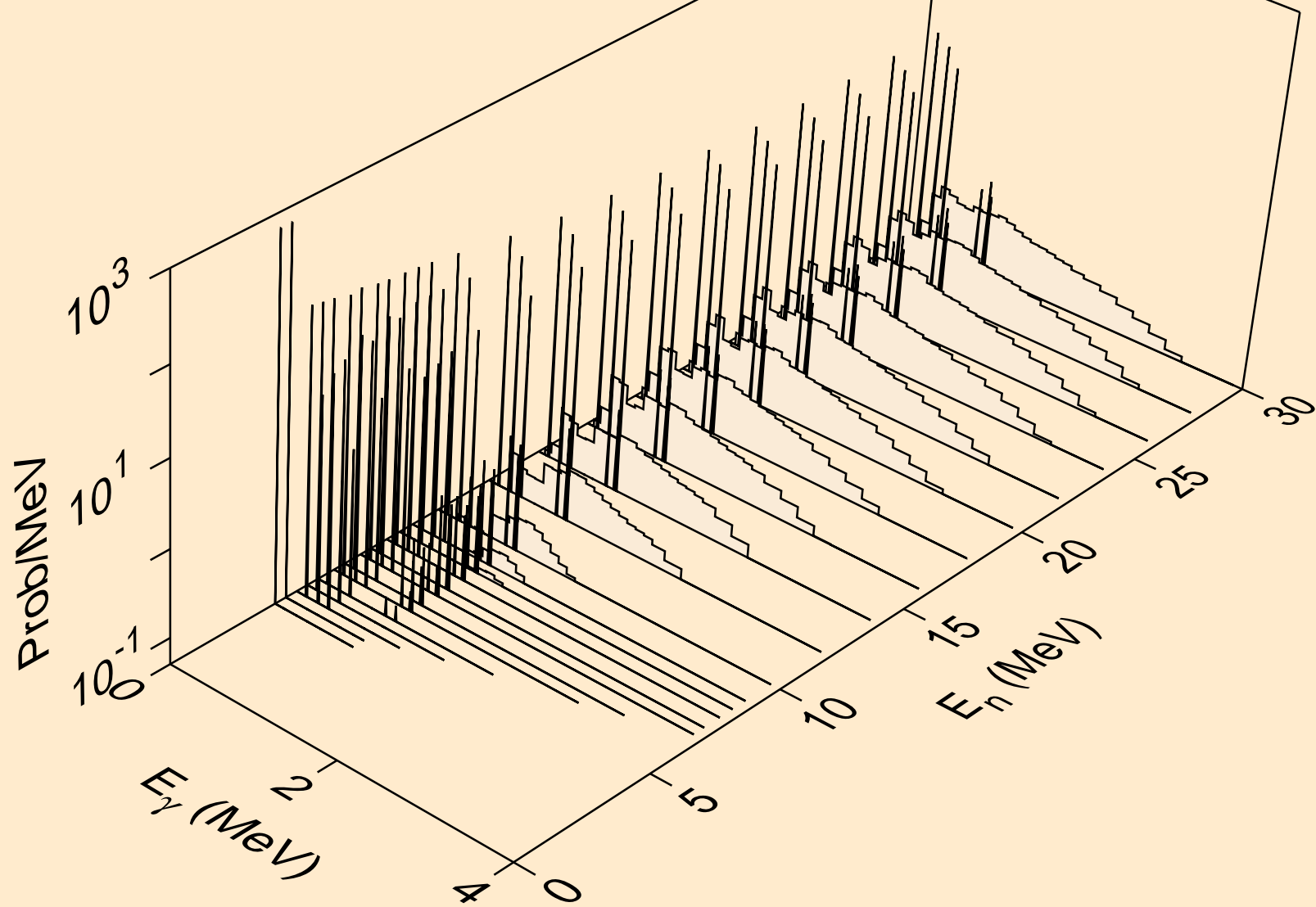

IR185 NEUTRON ACER TENDL-2023 LIBRARY; T=0.K
Photon emission for (n,t)

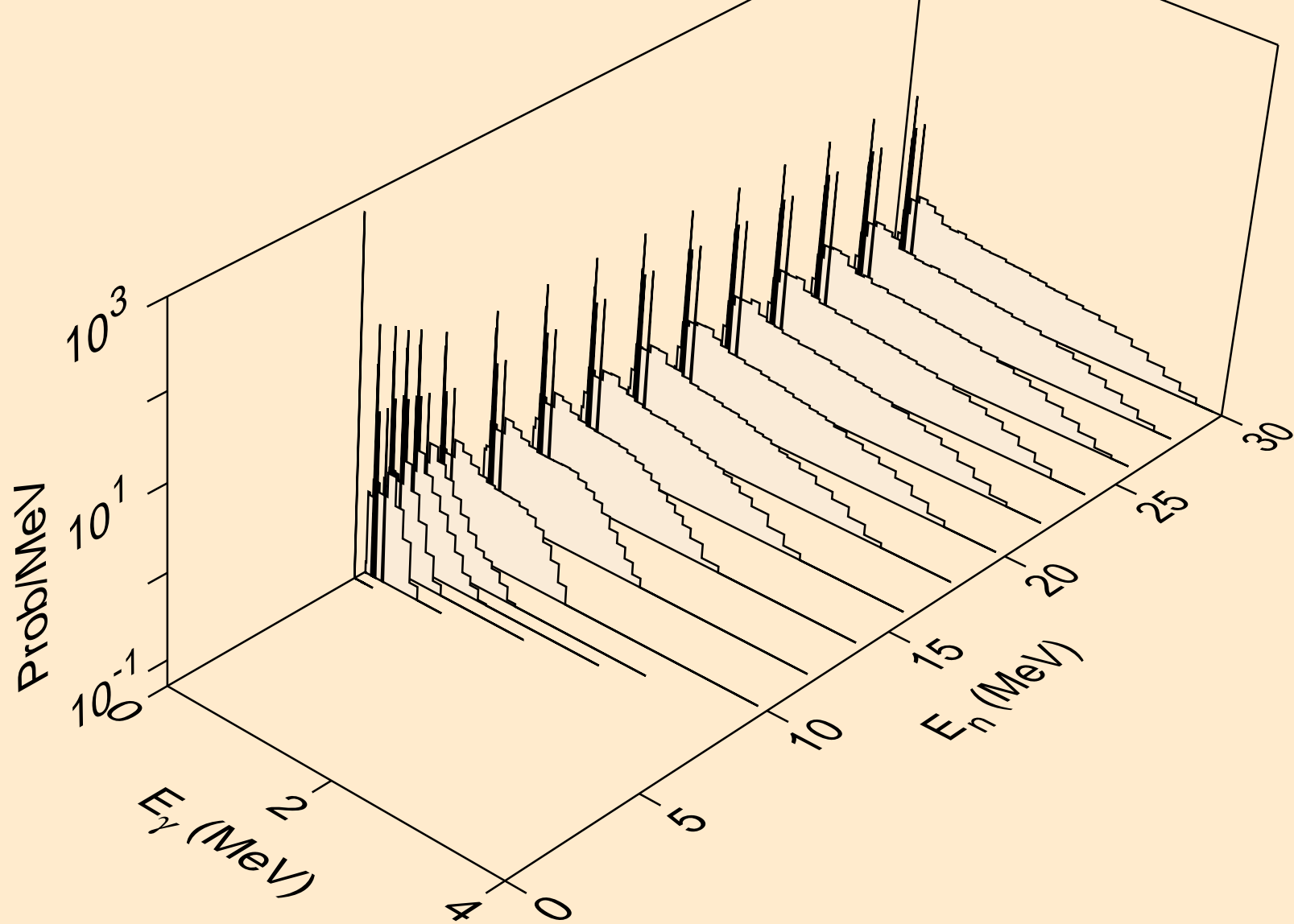

IR185 NEUTRON ACER TENDL-2023 LIBRARY; T=0.K
Photon emission for (n,he3)

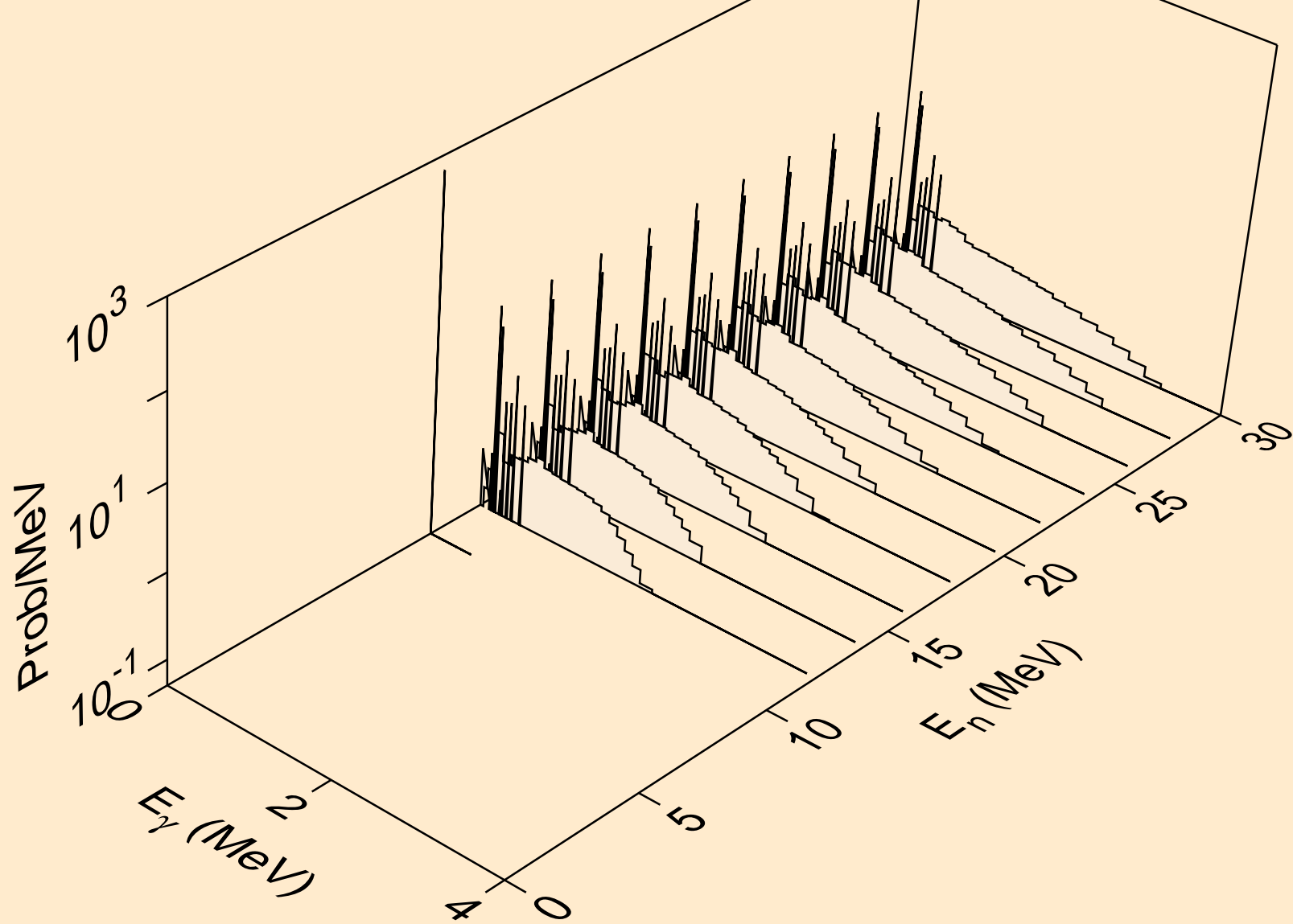

IR185 NEUTRON ACER TENDL-2023 LIBRARY; T=0.K
Photon emission for (n,a)

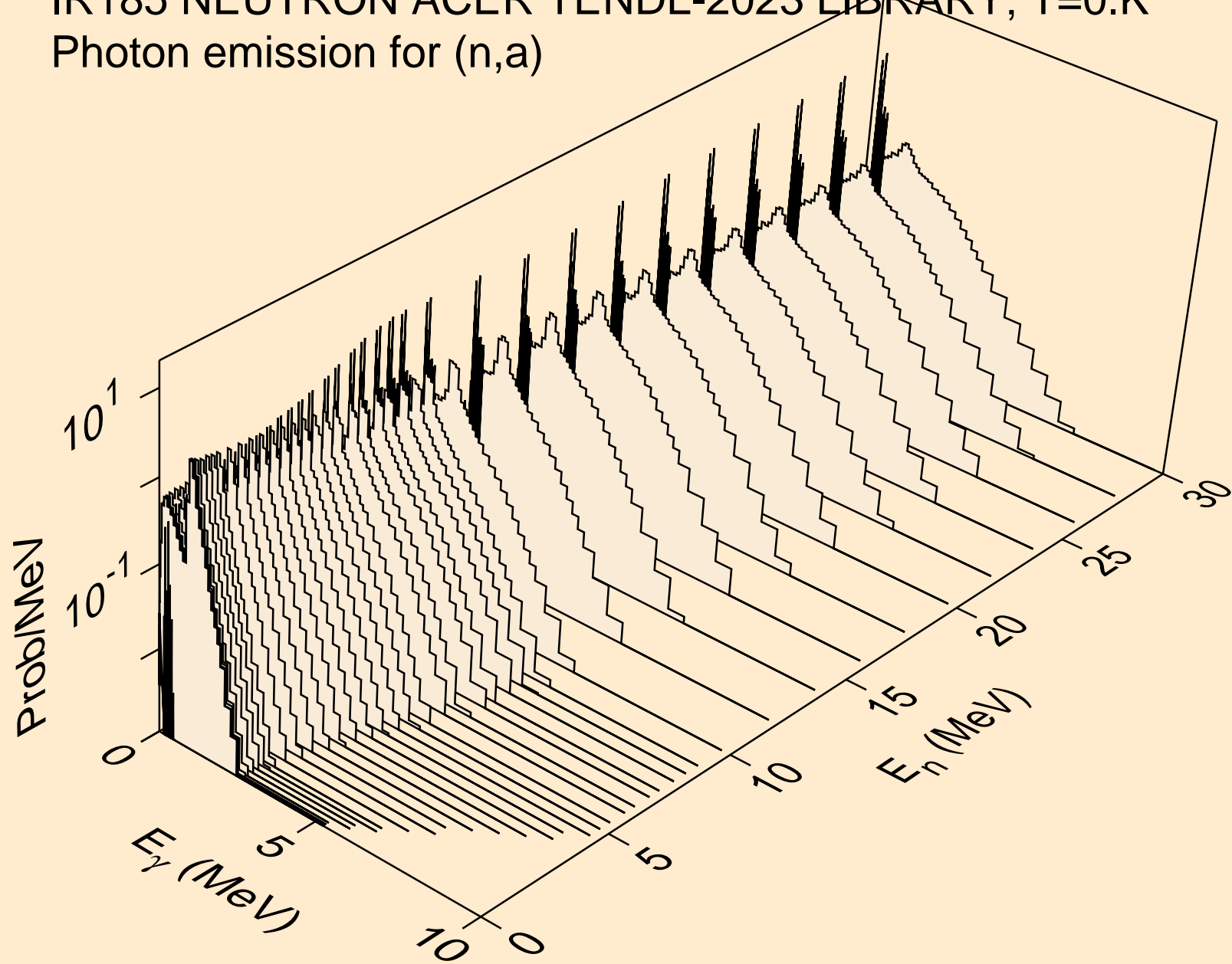

IR185 NEUTRON ACER TENDL-2023 LIBRARY; T=0.K
Photon emission for (n,2a)

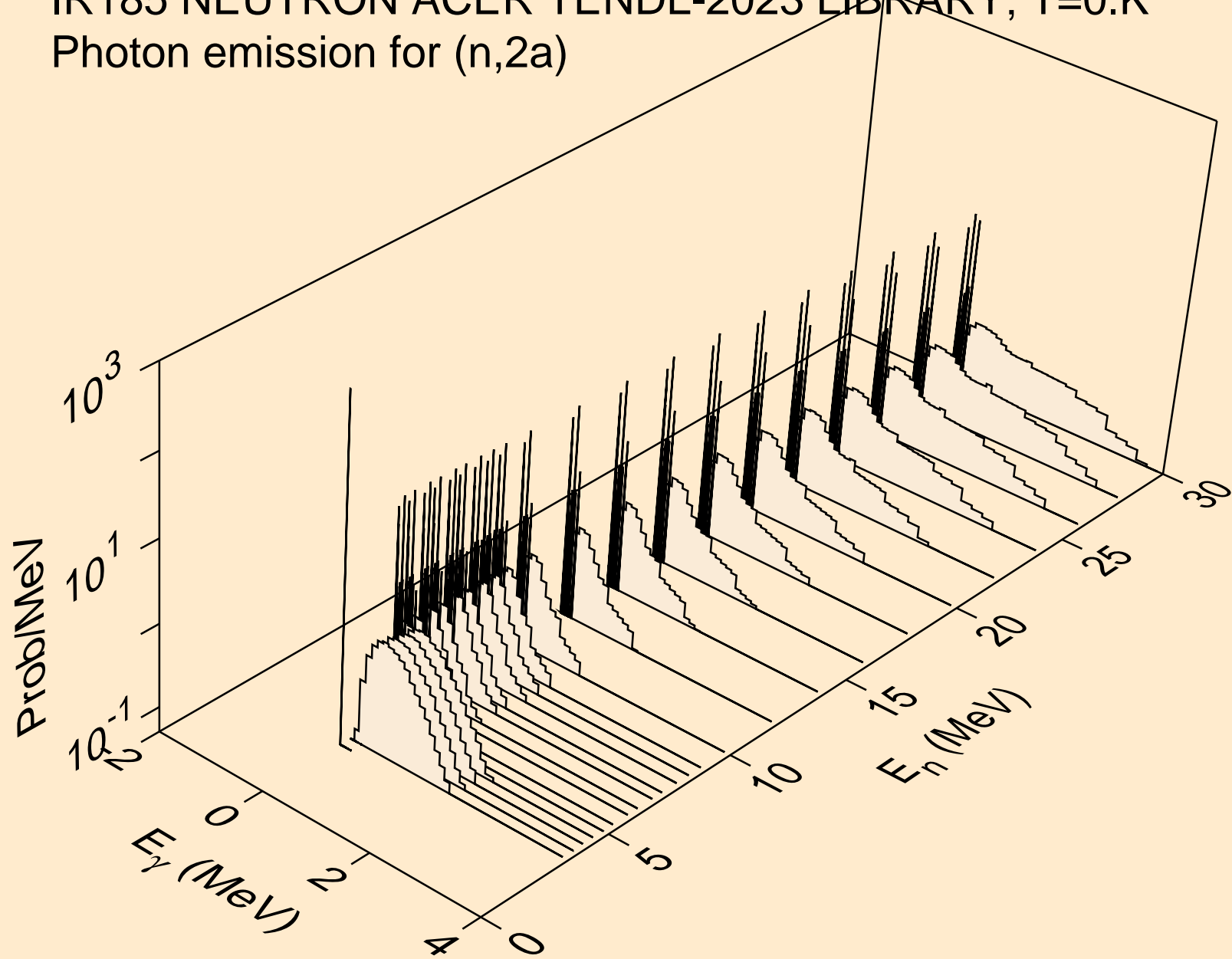

IR185 NEUTRON ACER TENDL-2023 LIBRARY; T=0.K
Photon emission for (n,2p)

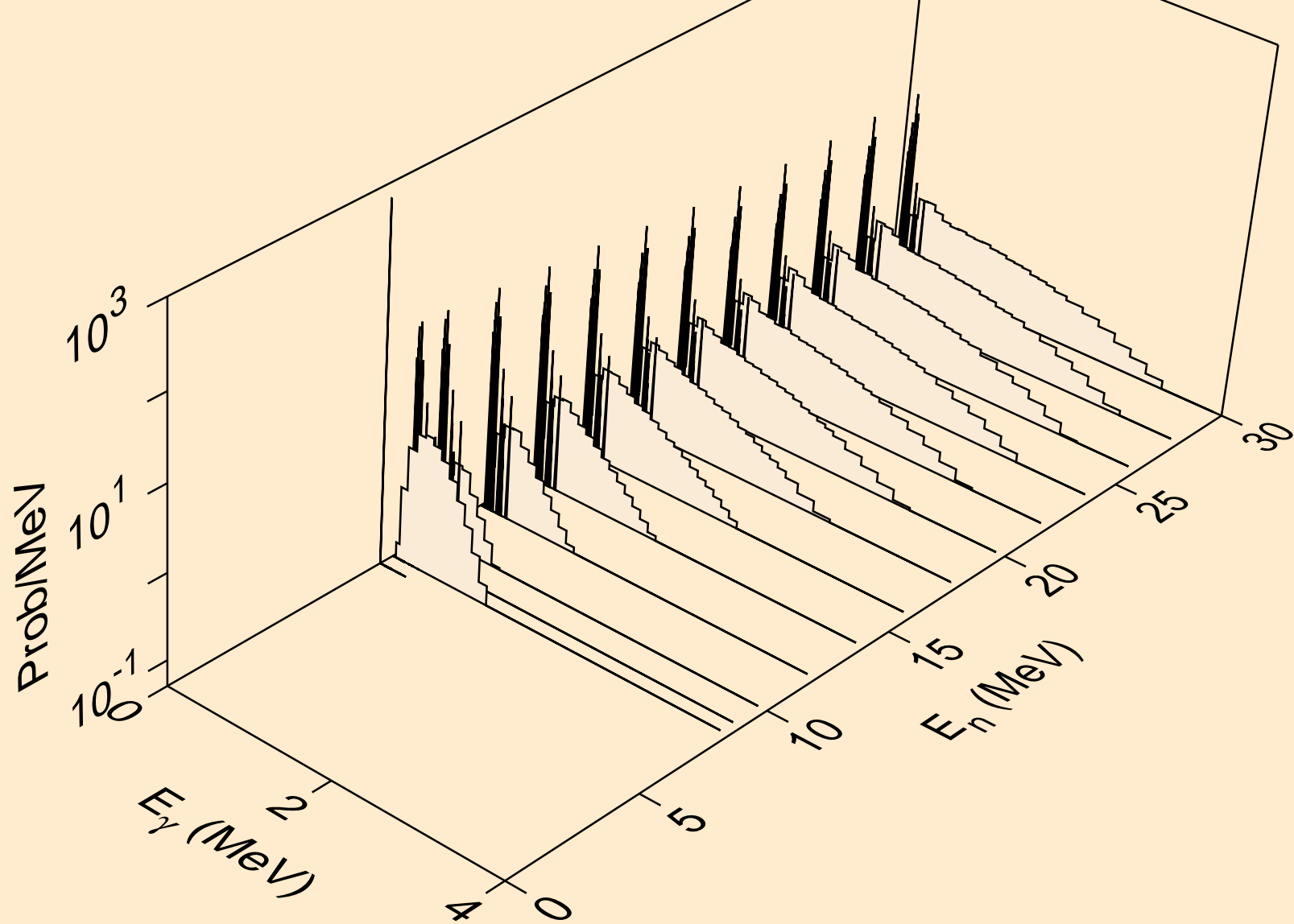

IR185 NEUTRON ACER TENDL-2023 LIBRARY; T=0.K
Photon emission for (n,p)

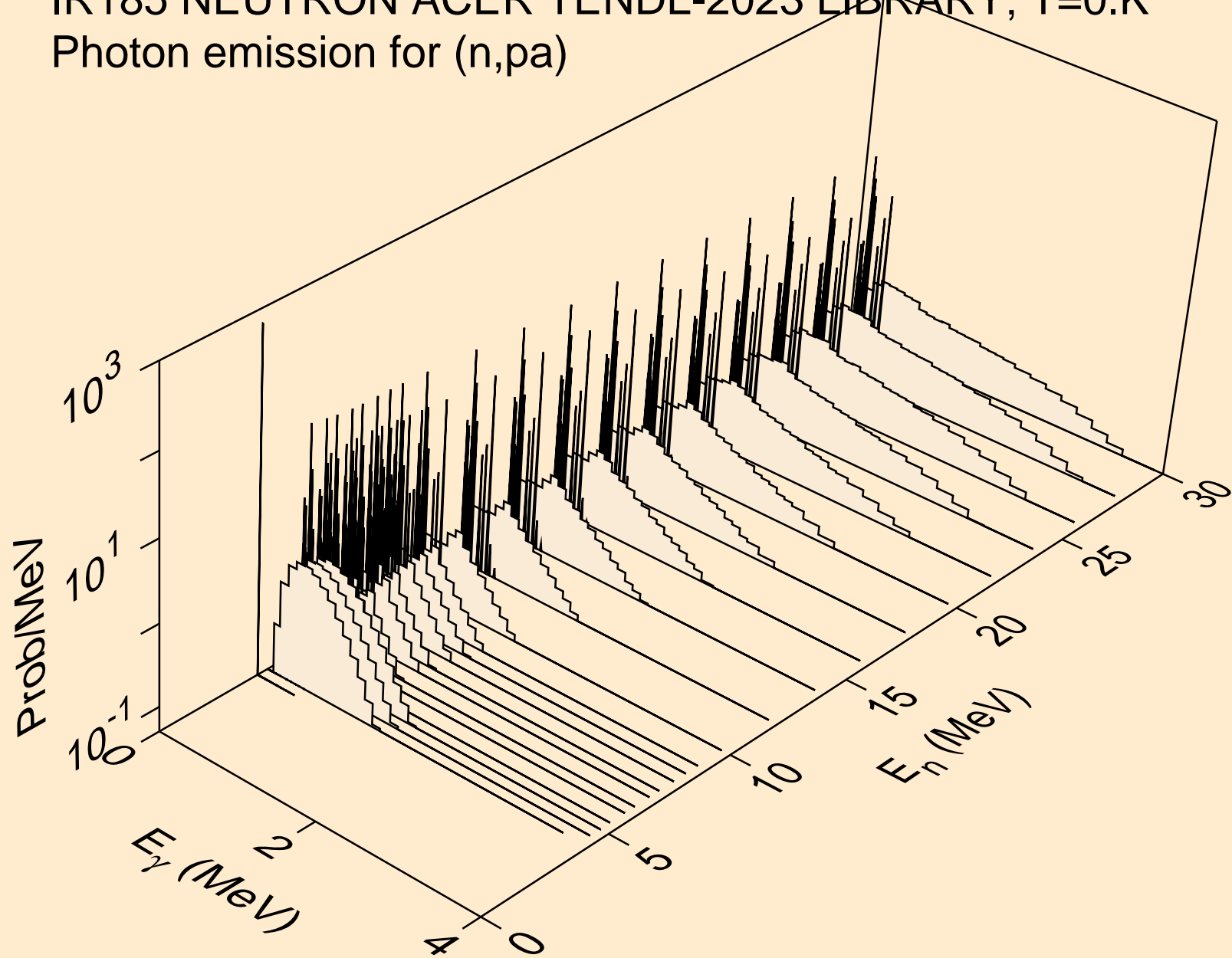

IR185 NEUTRON ACER TENDL-2023 LIBRARY; T=0.K
Photon emission for (n,pd)

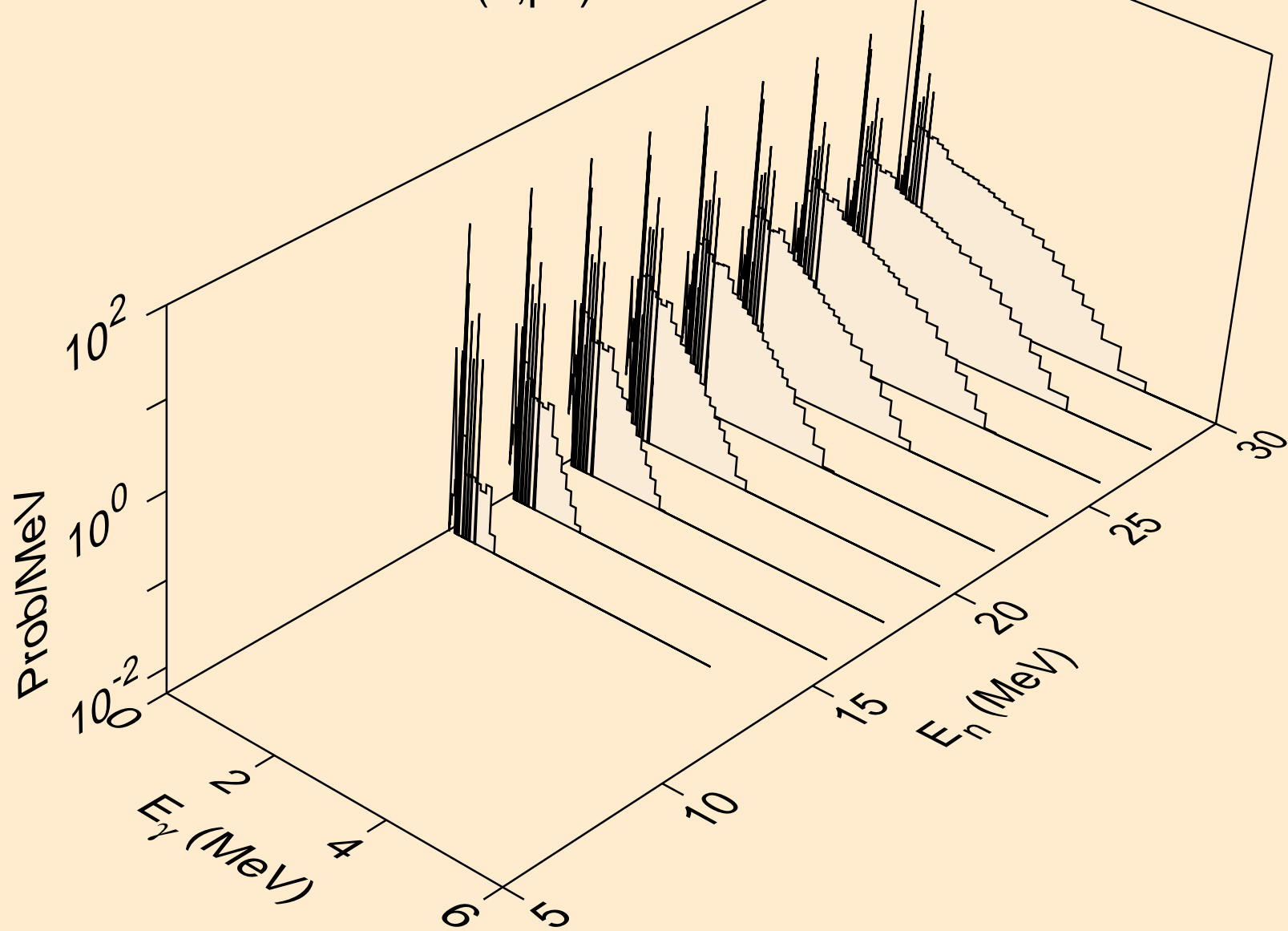

IR185 NEUTRON ACER TENDL-2023 LIBRARY; T=0.K
Photon emission for (n,pt)

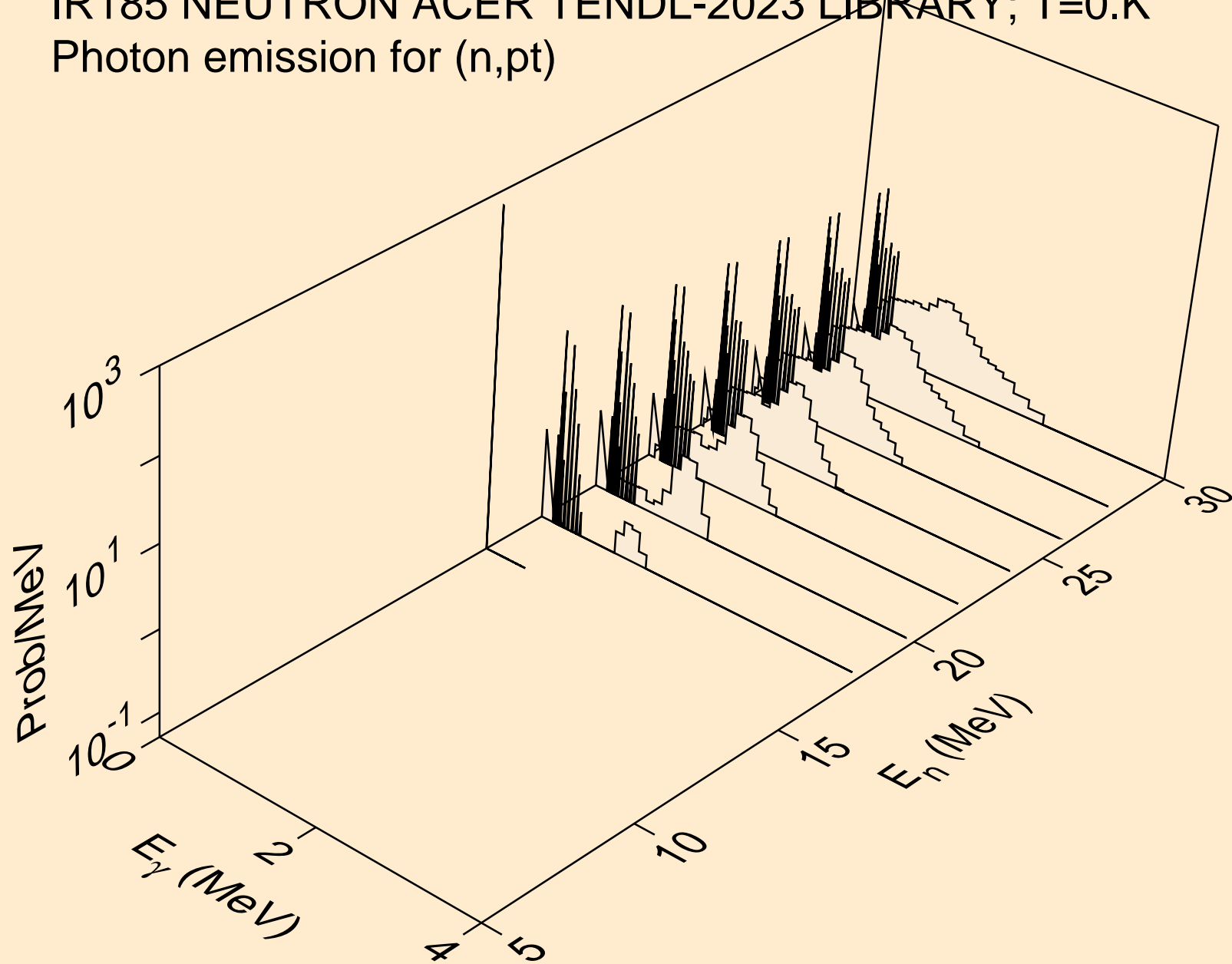

IR185 NEUTRON ACER TENDL-2023 LIBRARY; T=0.K
Photon emission for (n,da)

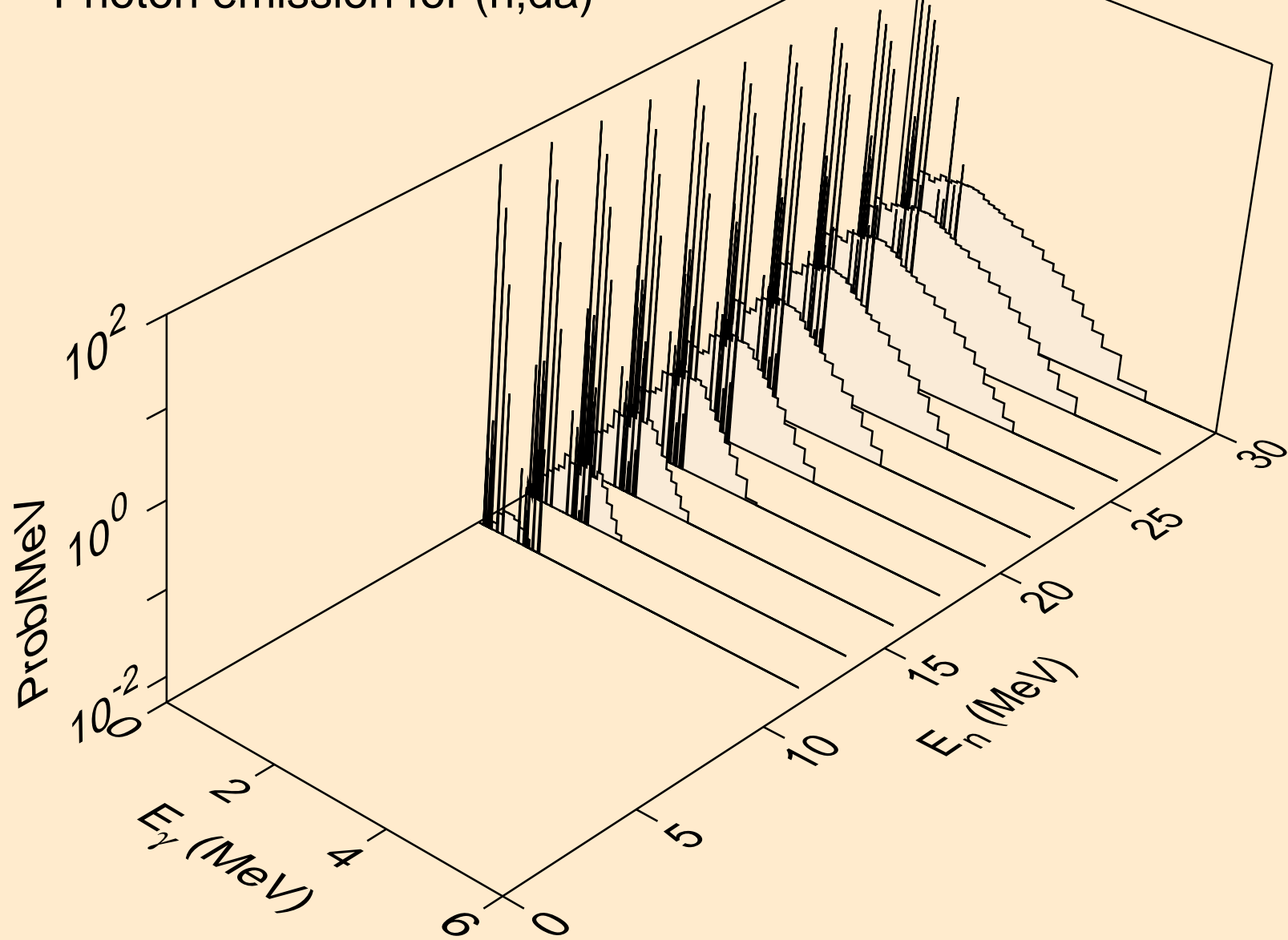

IR185 NEUTRON ACER TENDL-2023 LIBRARY; T=0.K
thermal capture photon spectrum

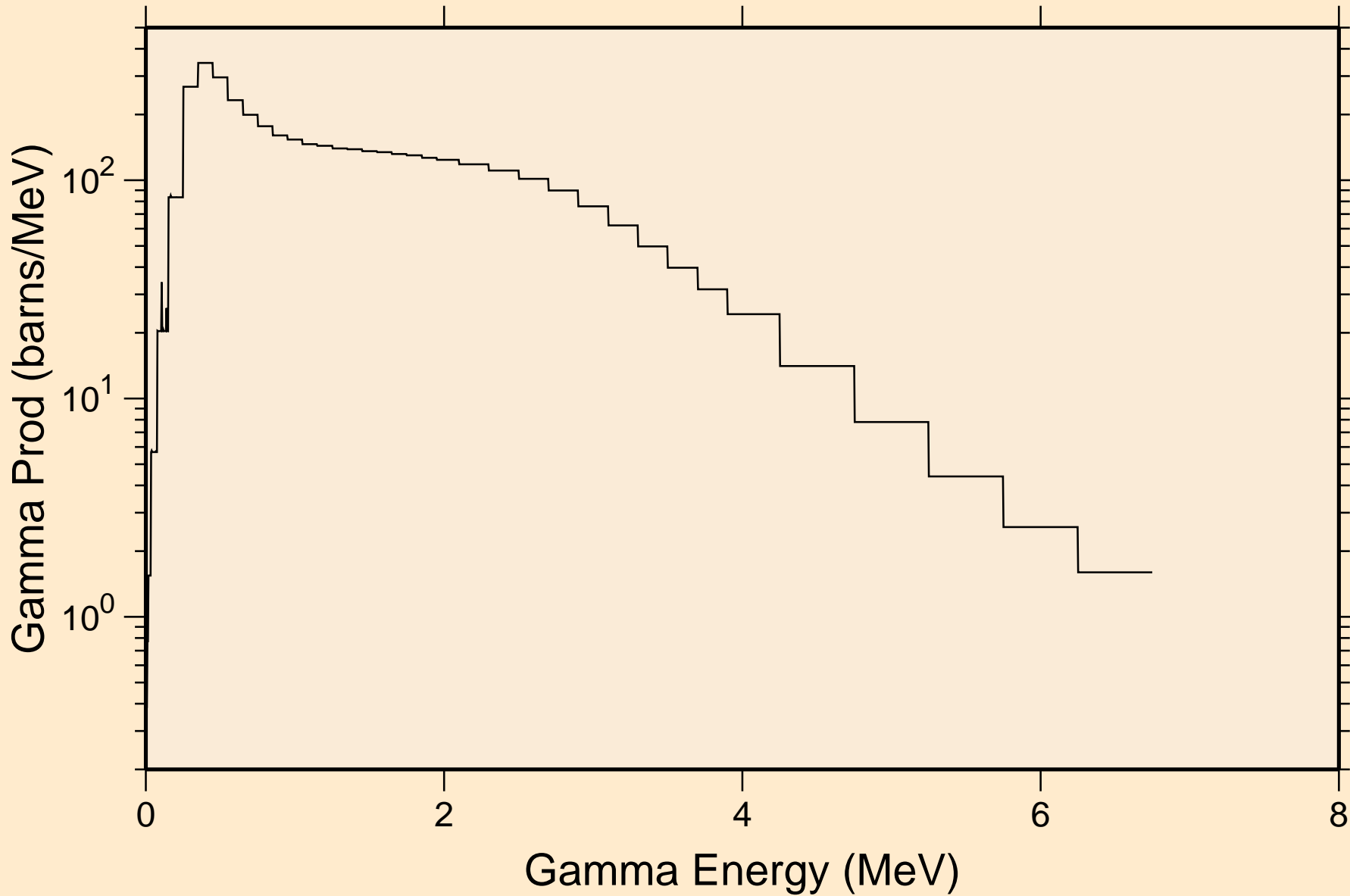

IR185 NEUTRON ACER TENDL-2023 LIBRARY; T=0.K
14 MeV photon spectrum

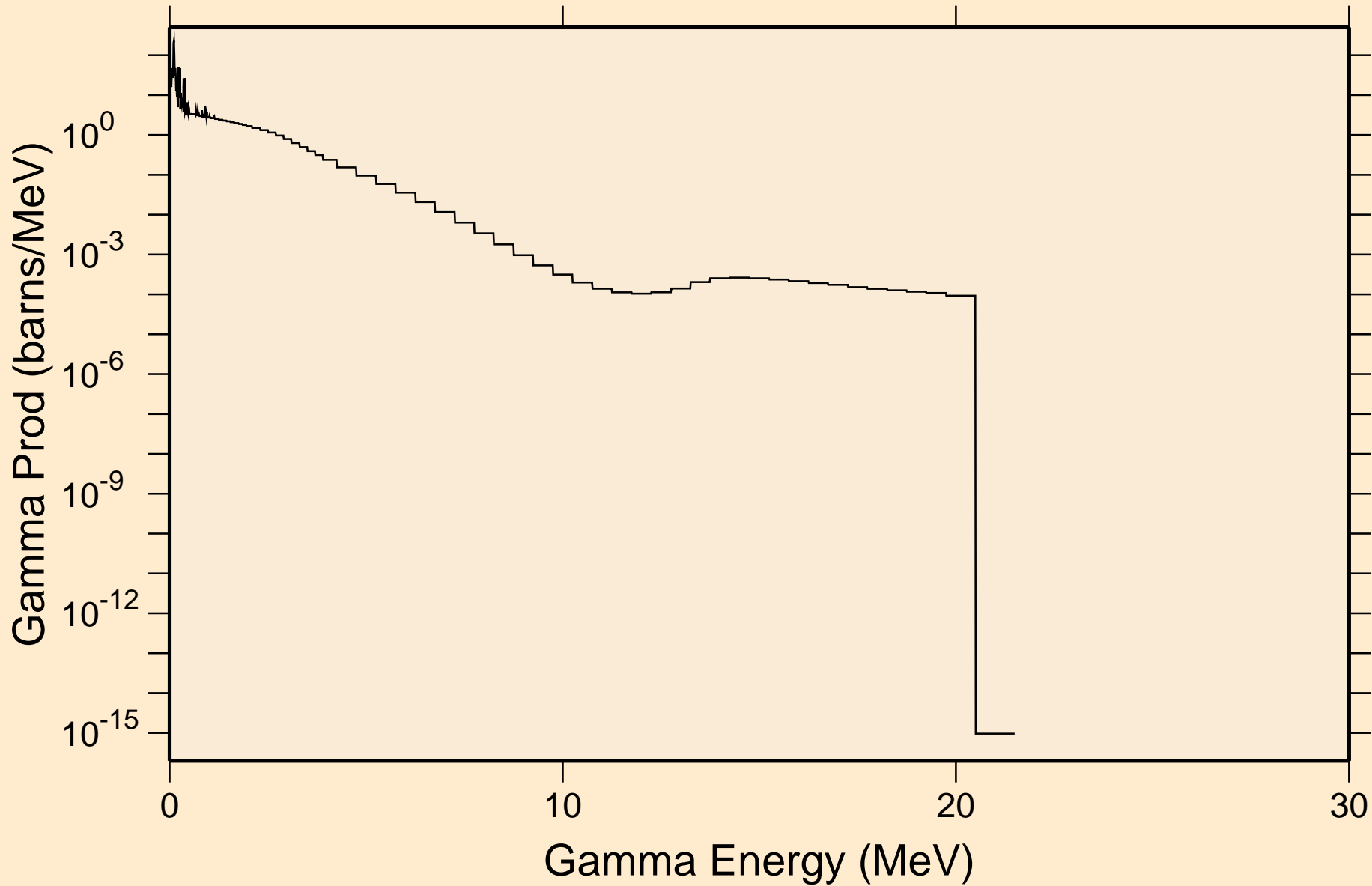

IR185 NEUTRON ACER TENDL-2023 LIBRARY; T=0.K
Particle heating contributions

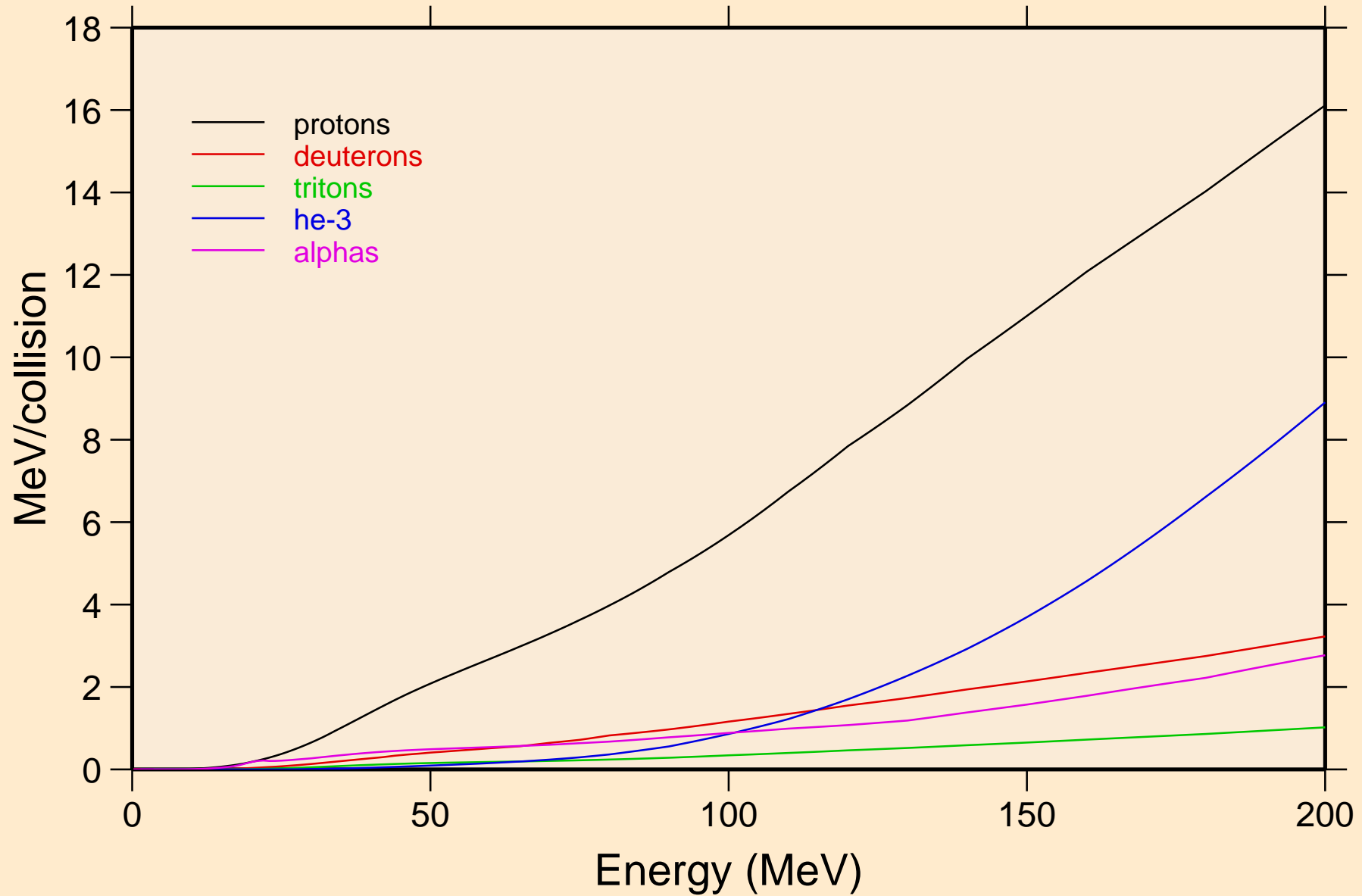

IR185 NEUTRON ACER TENDL-2023 LIBRARY; T=0.K
Recoil Heating

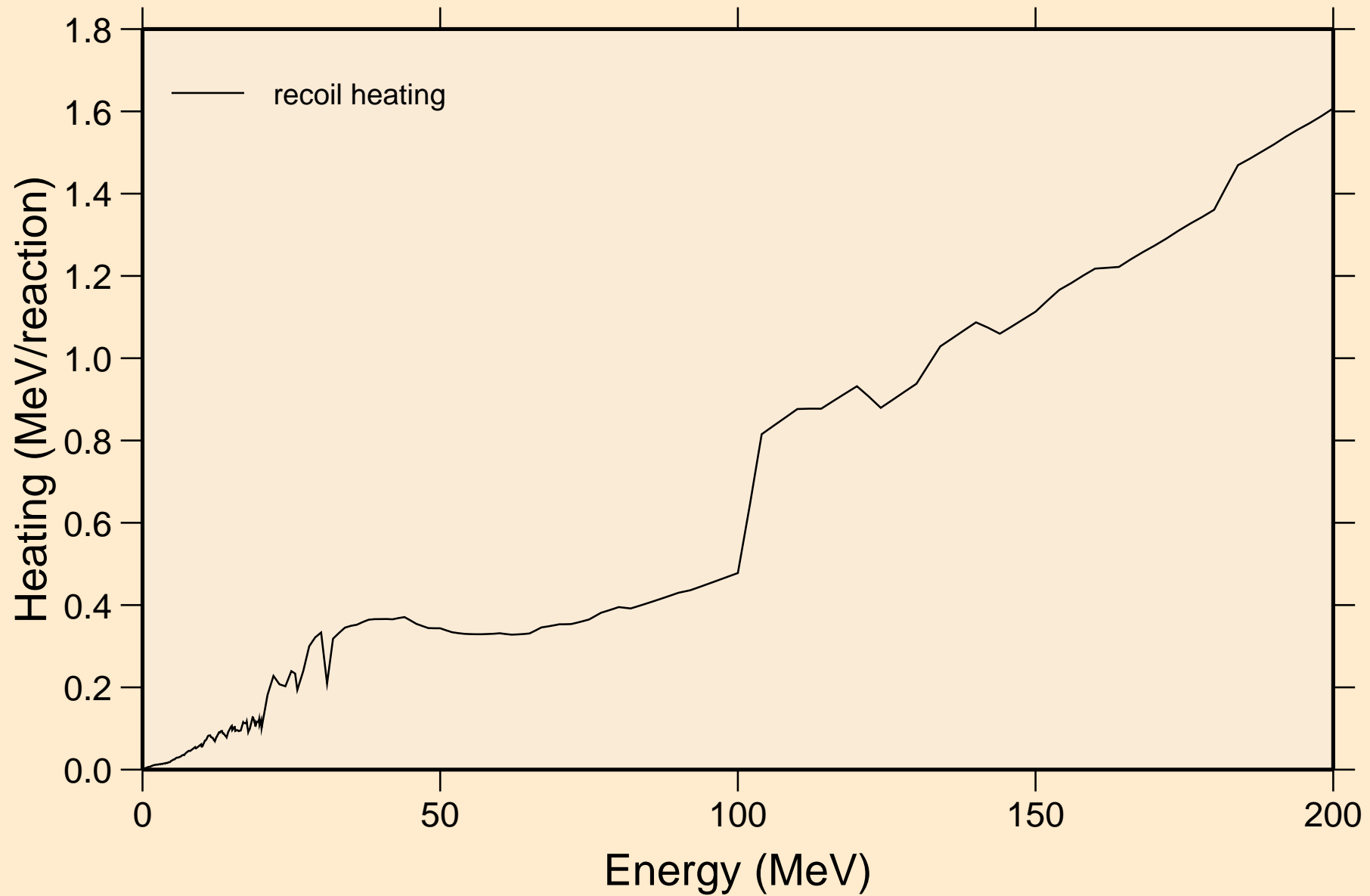

IR185 NEUTRON ACER TENDL-2023 LIBRARY; T=0.K
Particle production cross sections

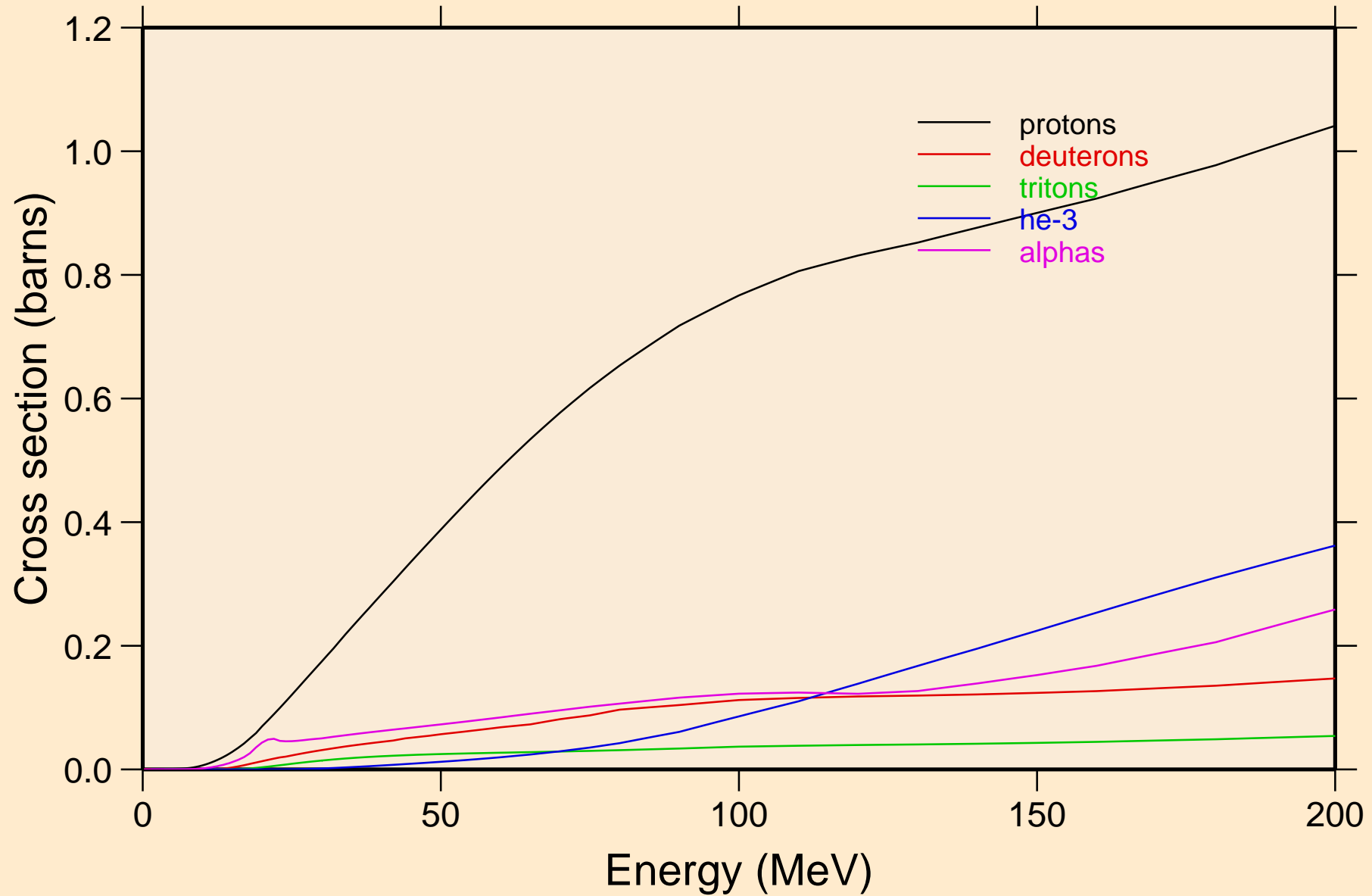

IR185 NEUTRON ACER TENDL-2023 LIBRARY; T=0.K
protons from (n,x)

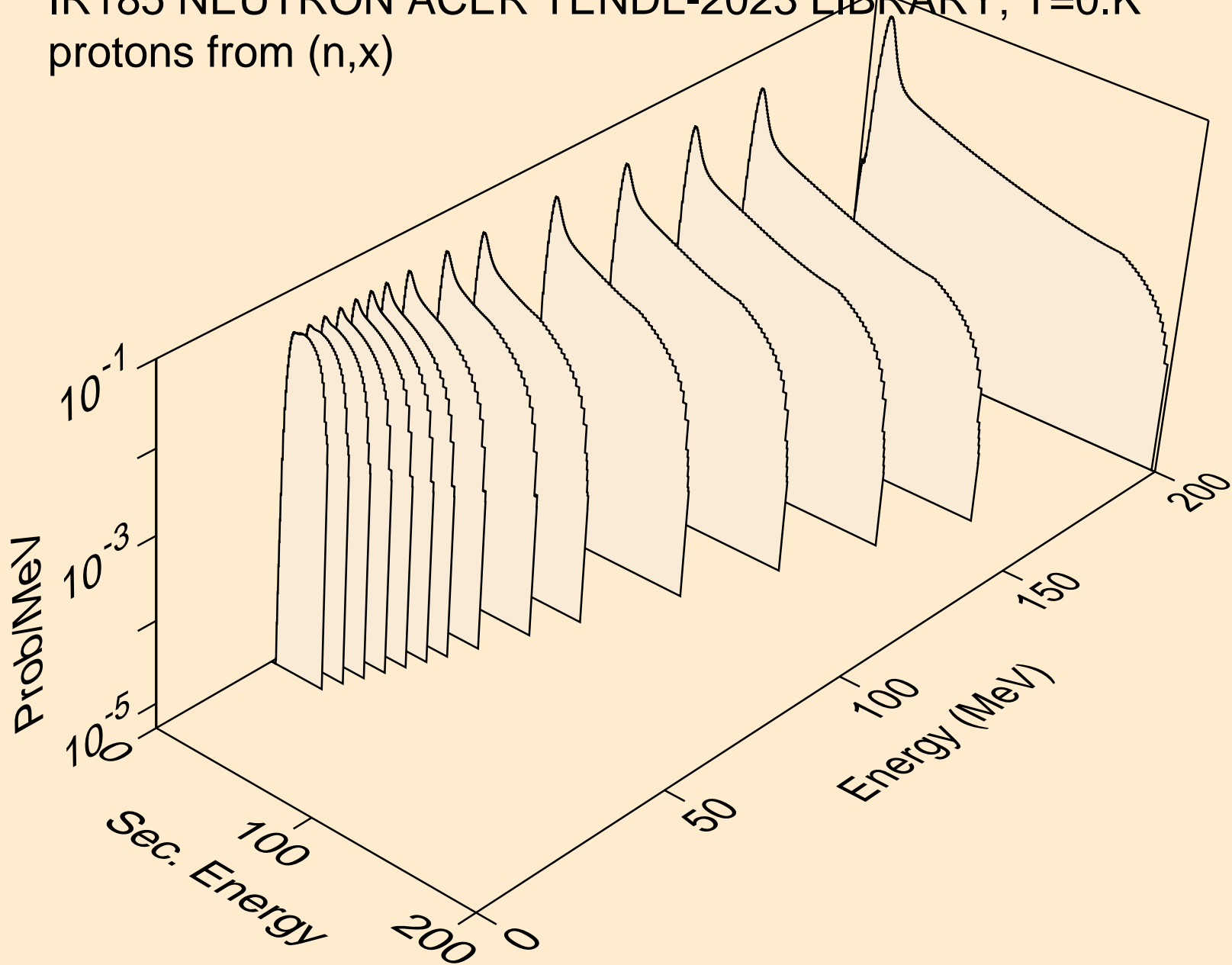

IR185 NEUTRON ACER TENDL-2023 LIBRARY; T=0.K
protons from (n,n*)p

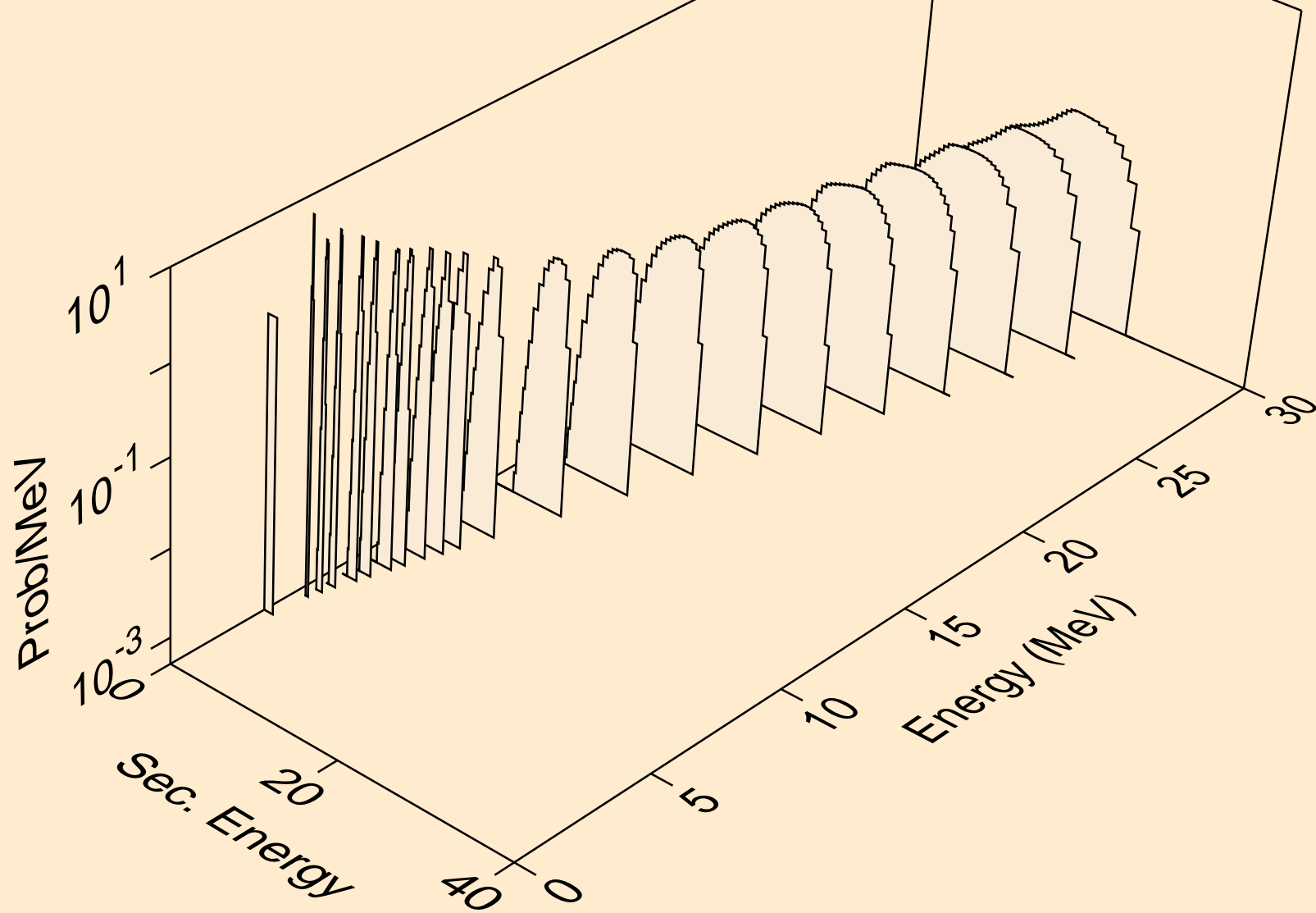

IR185 NEUTRON ACER TENDL-2023 LIBRARY; T=0.K
protons from (n,2np)

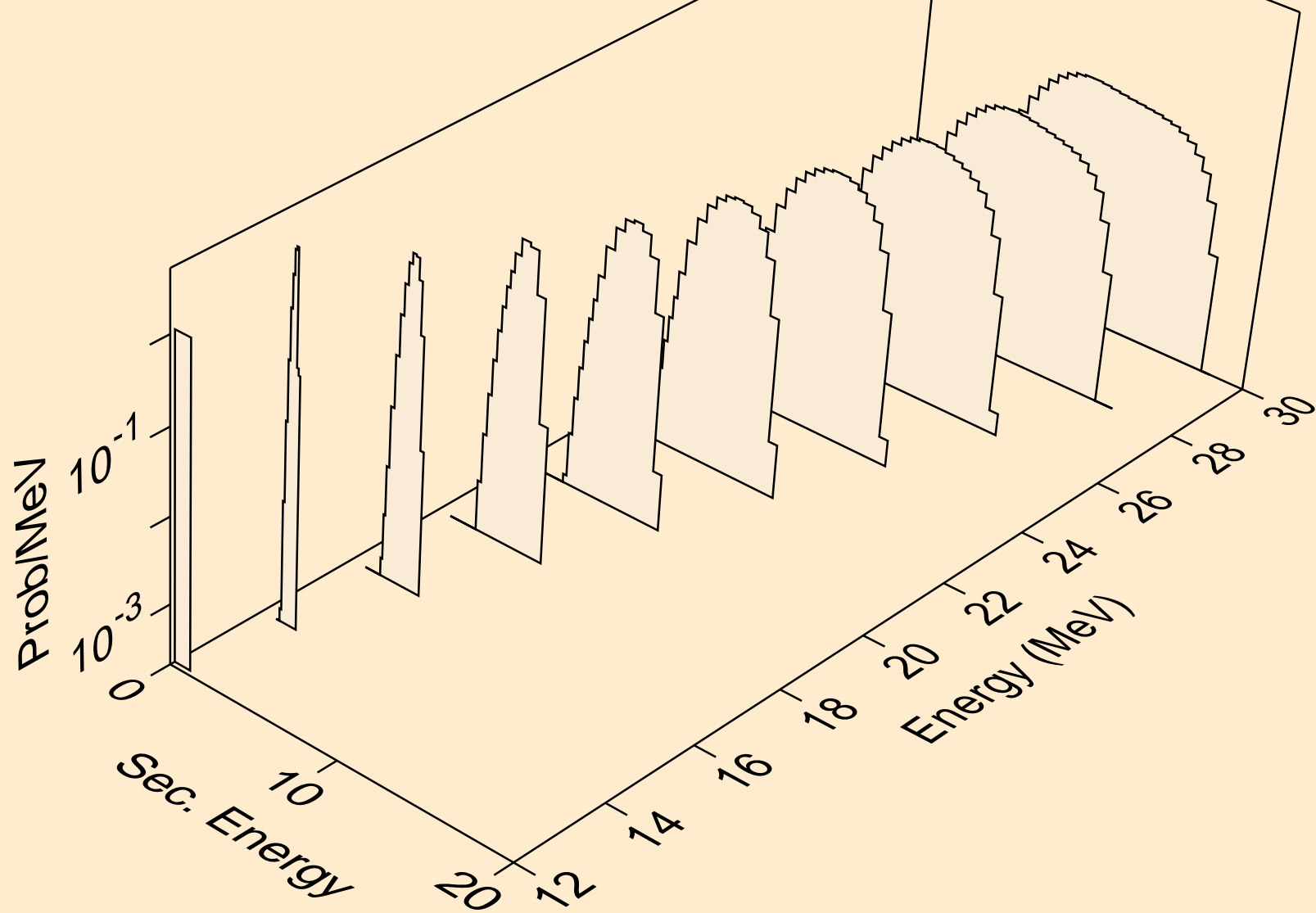

IR185 NEUTRON ACER TENDL-2023 LIBRARY; T=0.K
protons from (n,3np)

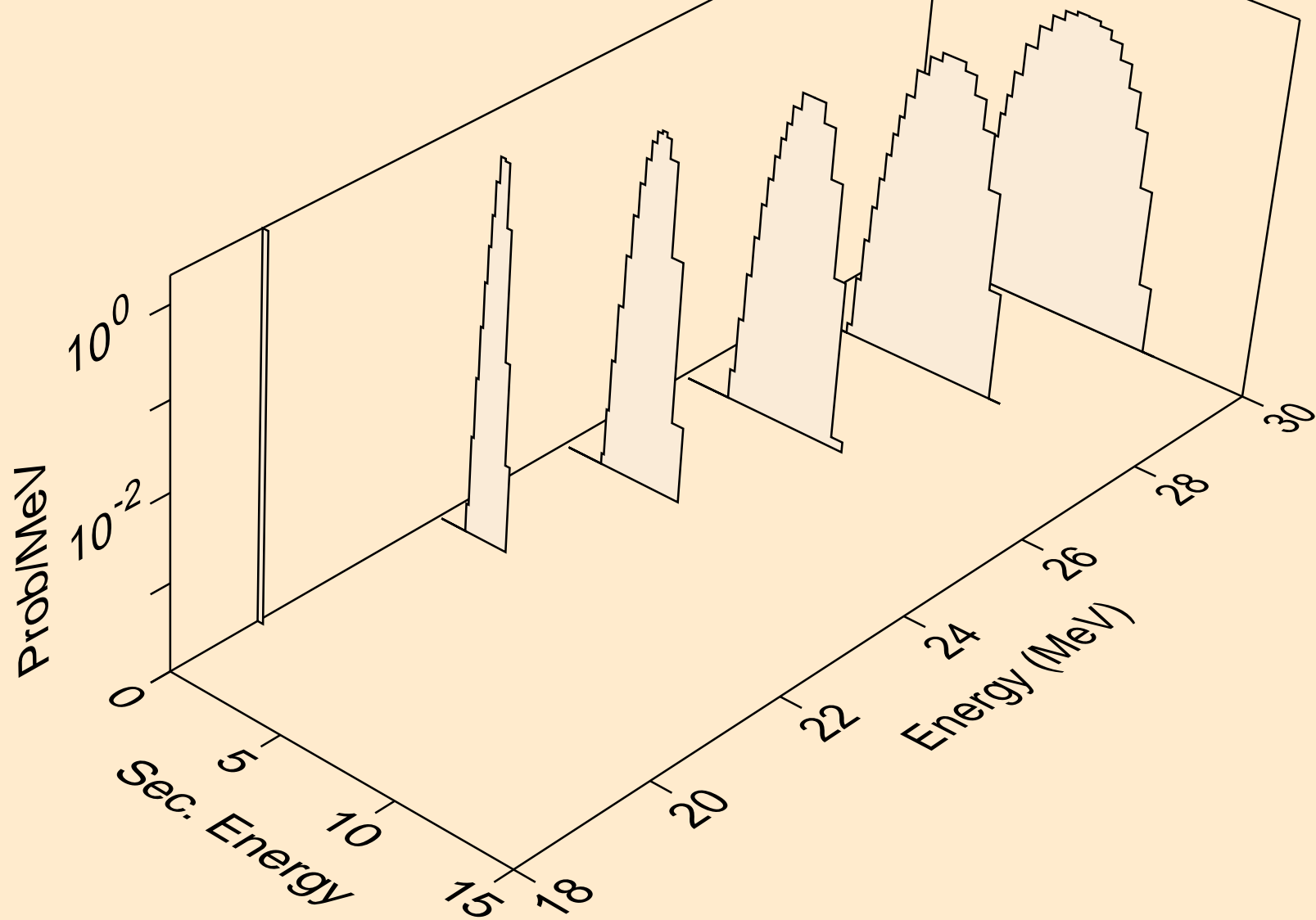

IR185 NEUTRON ACER TENDL-2023 LIBRARY; T=0.K
protons from (n,n2p)

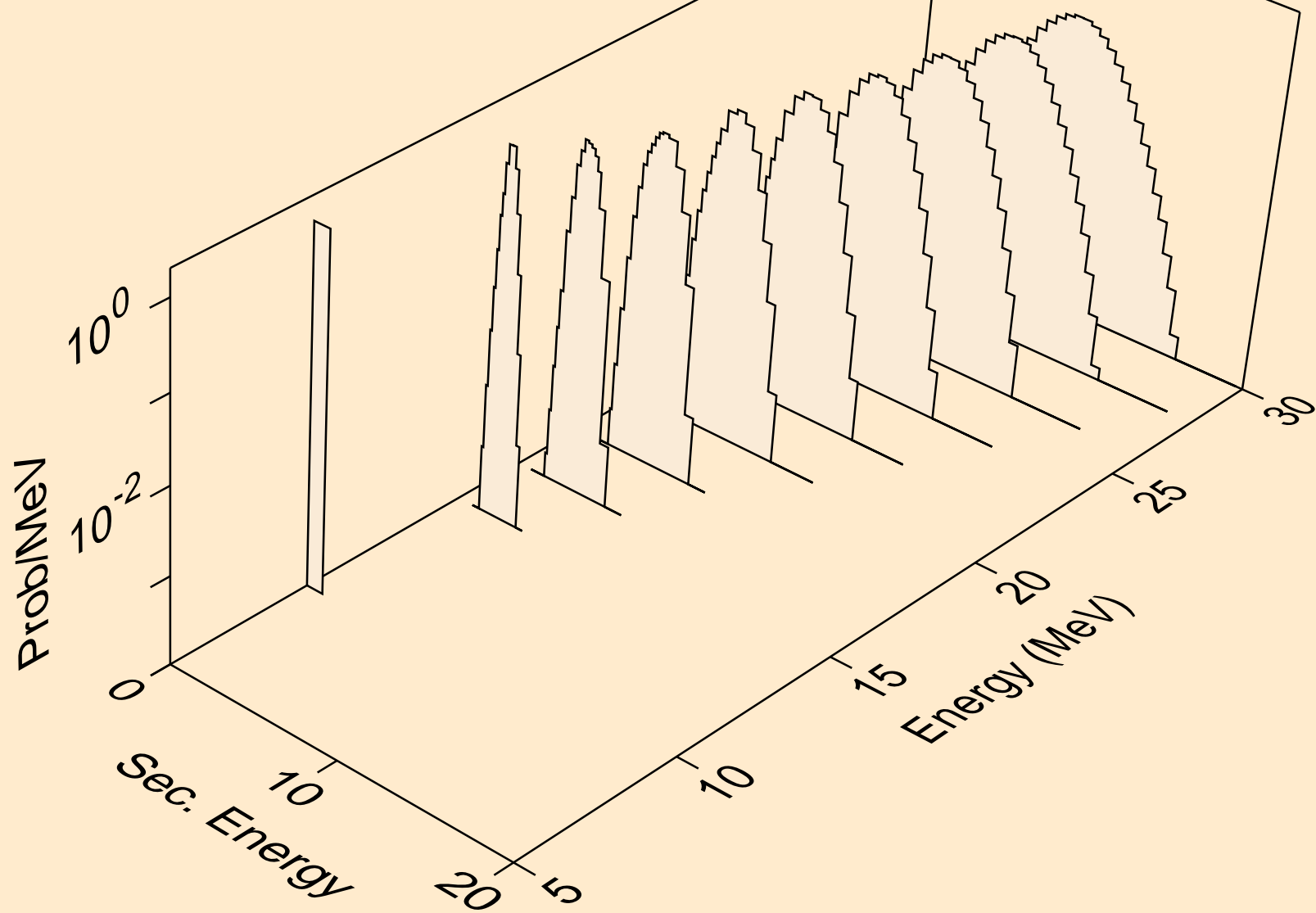

IR185 NEUTRON ACER TENDL-2023 LIBRARY; T=0.K
protons from (n,npa)

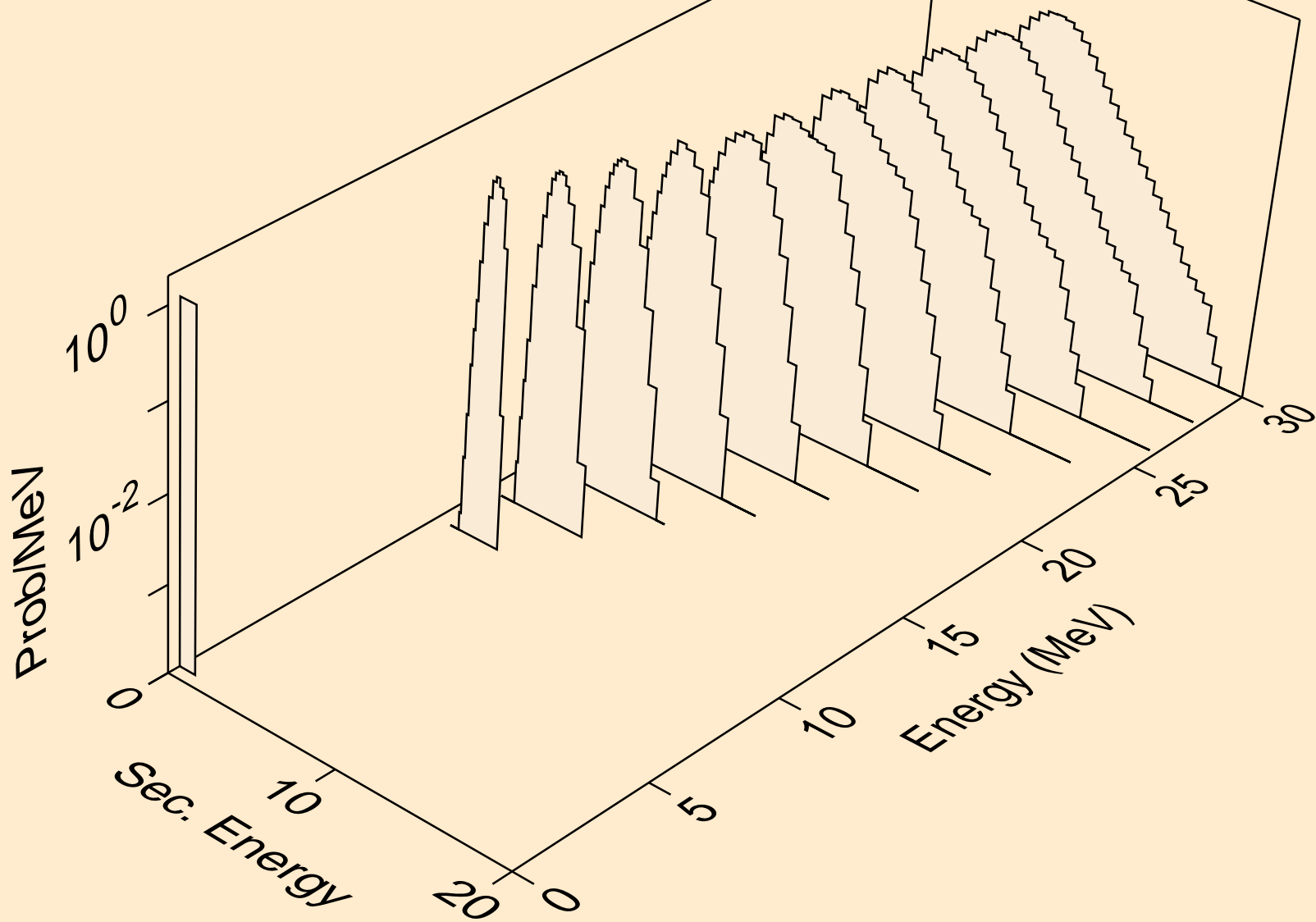

IR185 NEUTRON ACER TENDL-2023 LIBRARY; T=0.K
protons from (n,p)

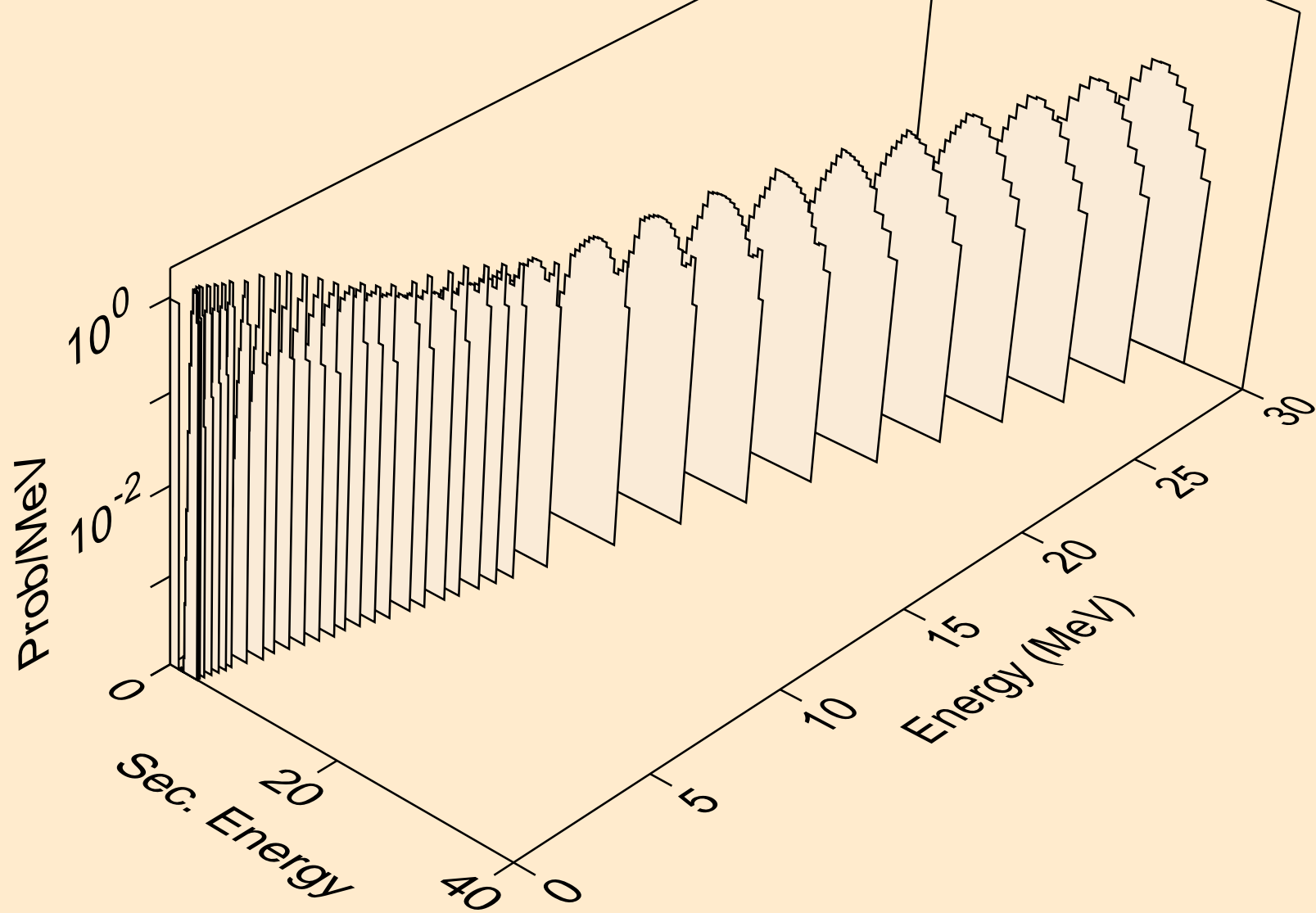

IR185 NEUTRON ACER TENDL-2023 LIBRARY; T=0.K
protons from (n,2p)

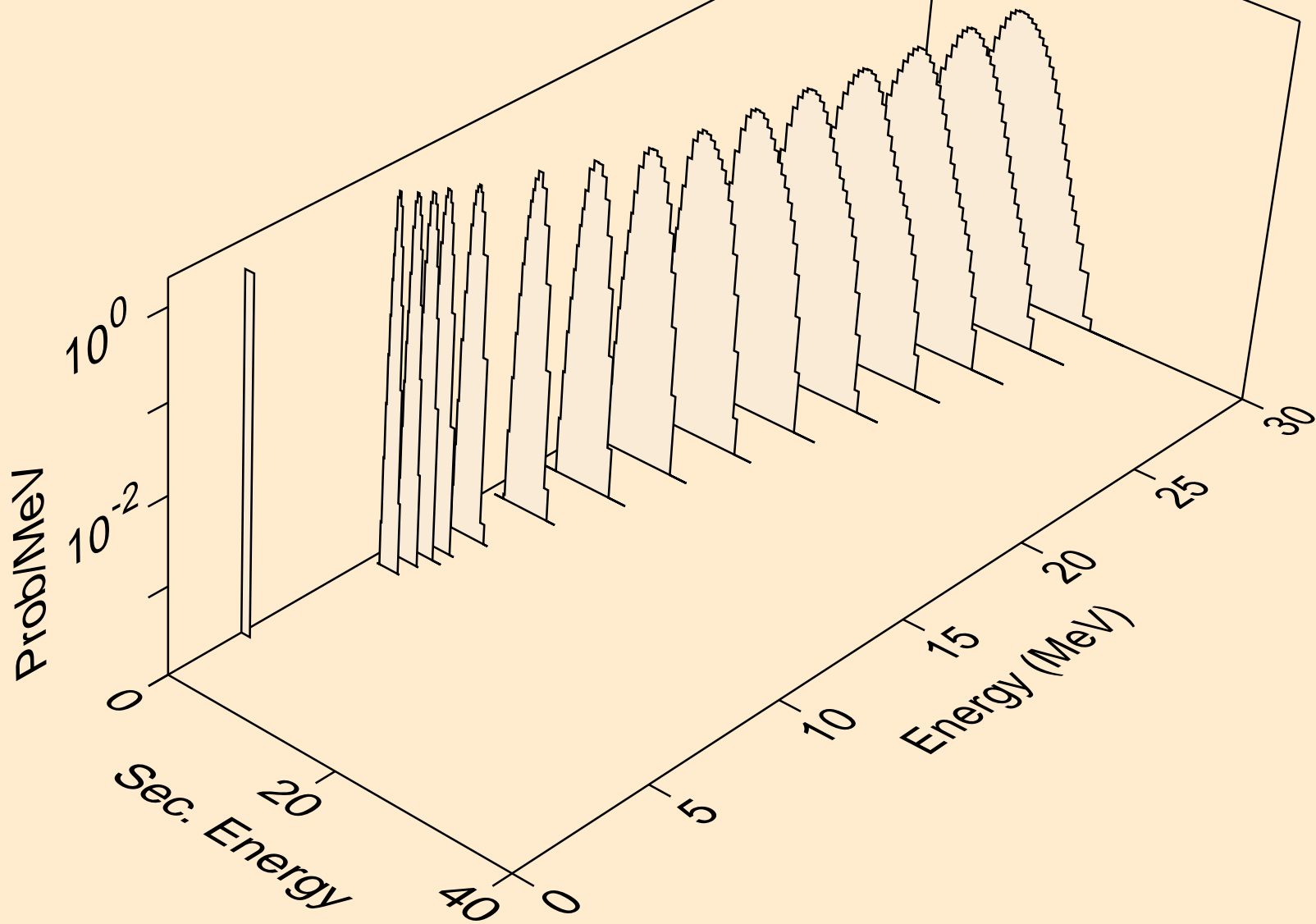

IR185 NEUTRON ACER TENDL-2023 LIBRARY; T=0.K
protons from (n,p)

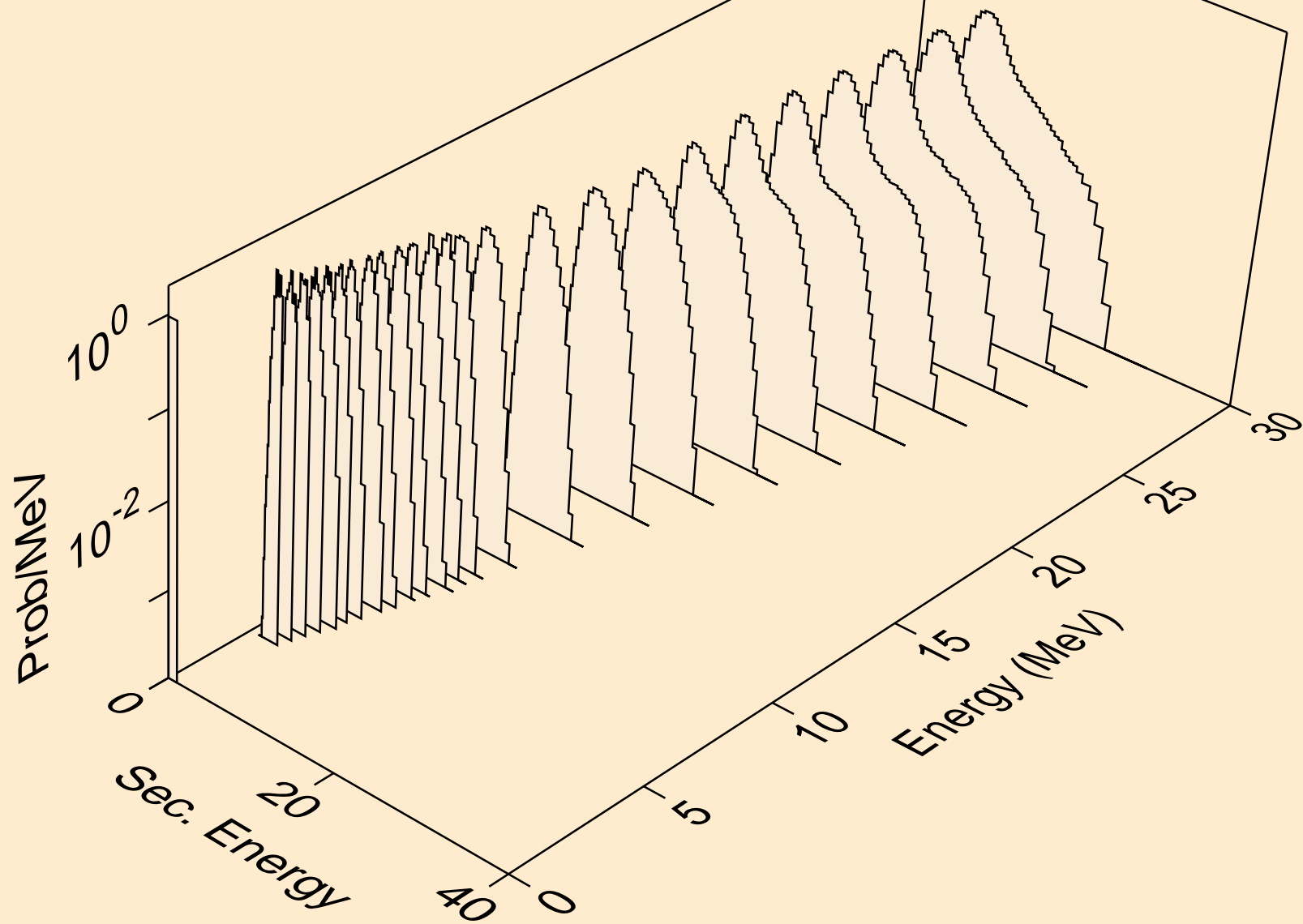

IR185 NEUTRON ACER TENDL-2023 LIBRARY; T=0.K
protons from (n,pd)

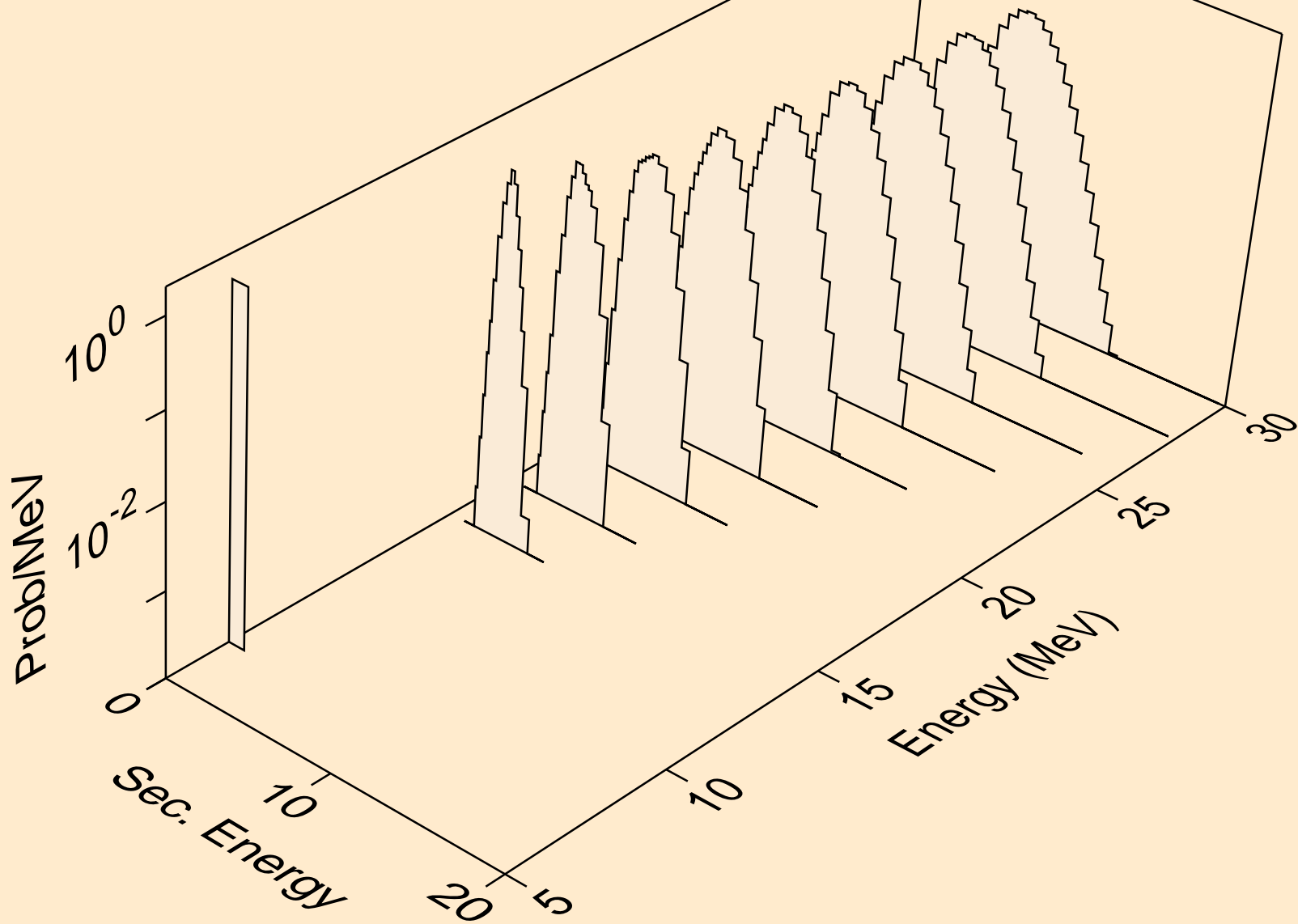

IR185 NEUTRON ACER TENDL-2023 LIBRARY; T=0.K
protons from (n,pt)

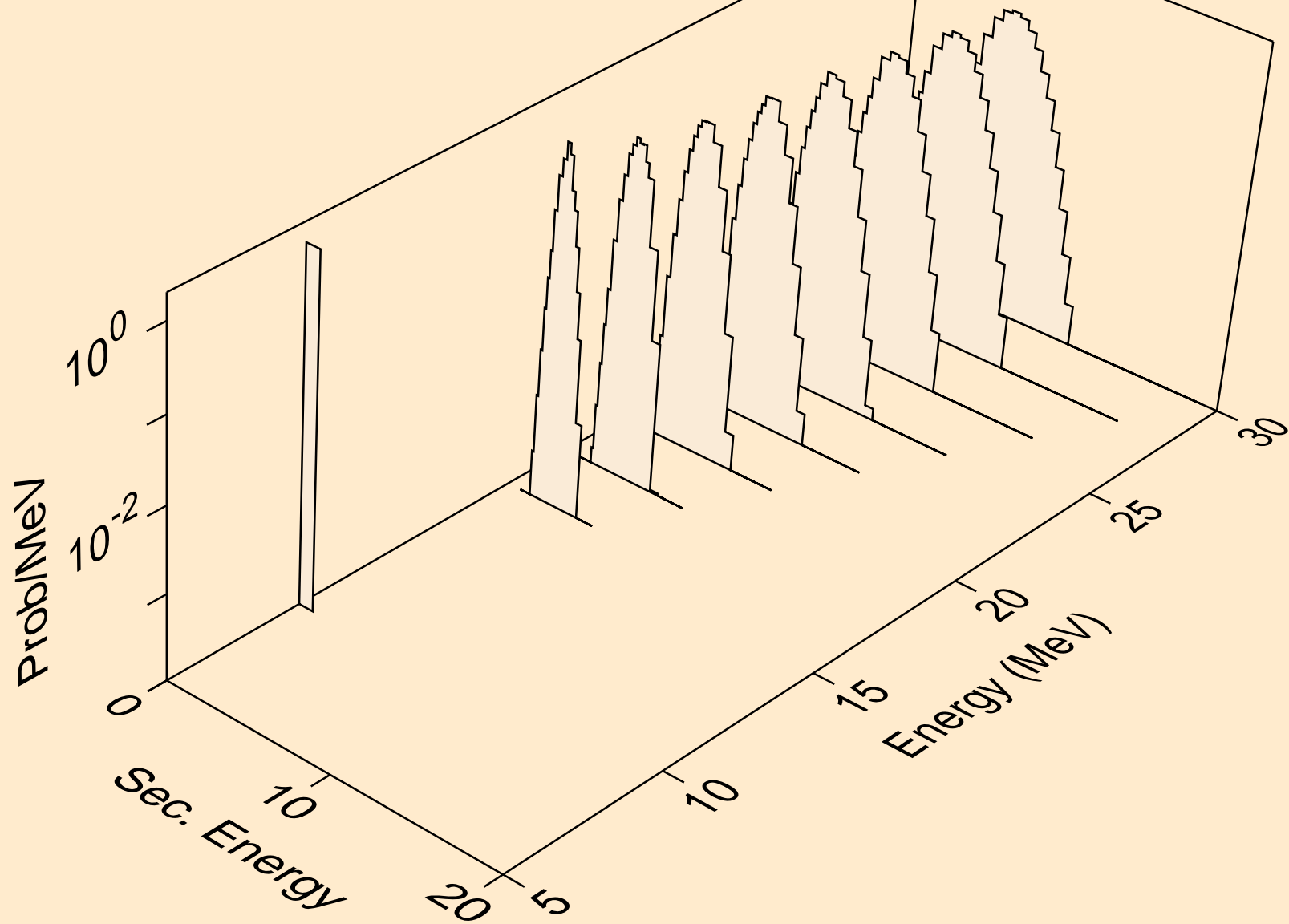

IR185 NEUTRON ACER TENDL-2023 LIBRARY; T=0.K
deuterons from (n,x)

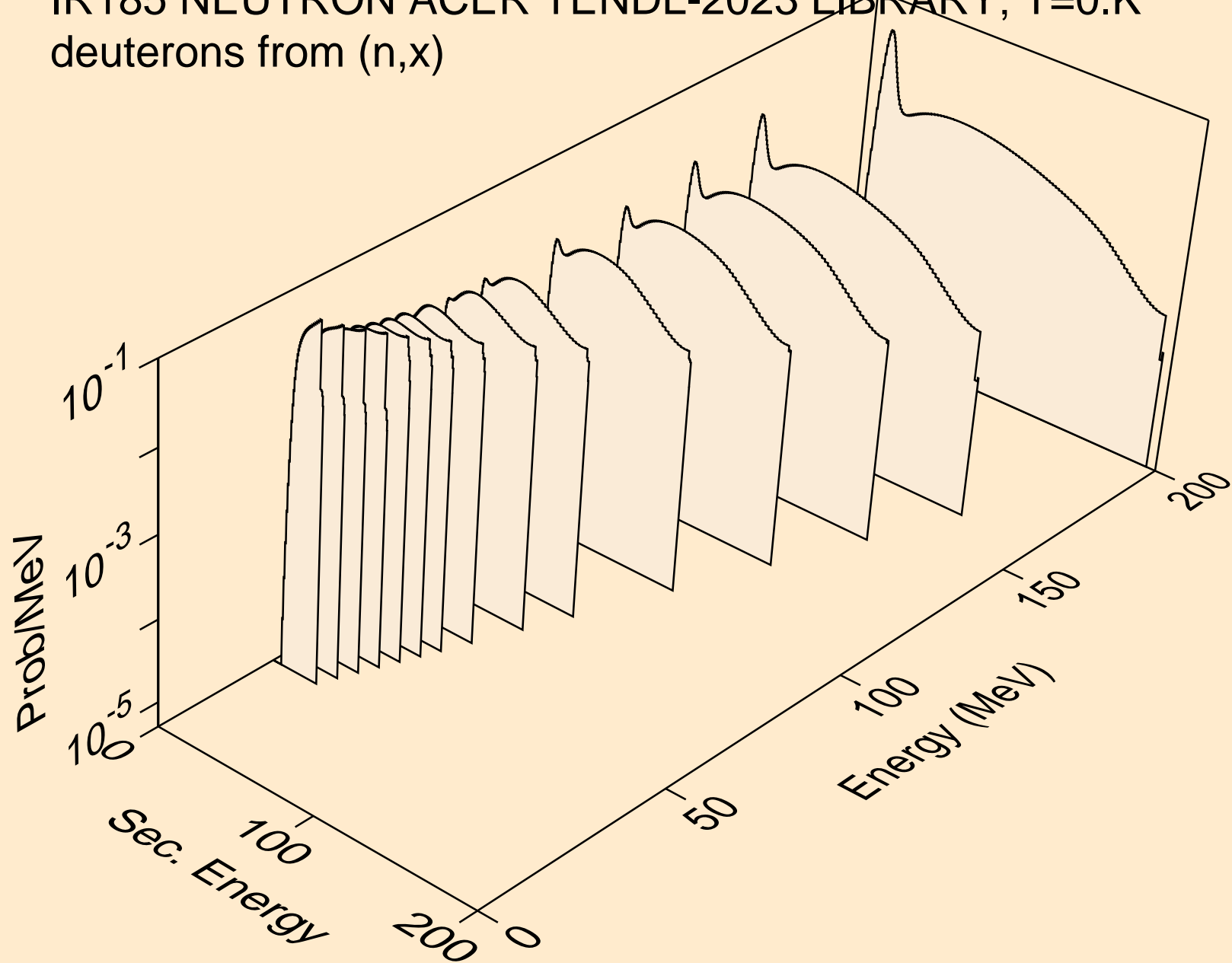

IR185 NEUTRON ACER TENDL-2023 LIBRARY; T=0.K
deuterons from (n,2nd)

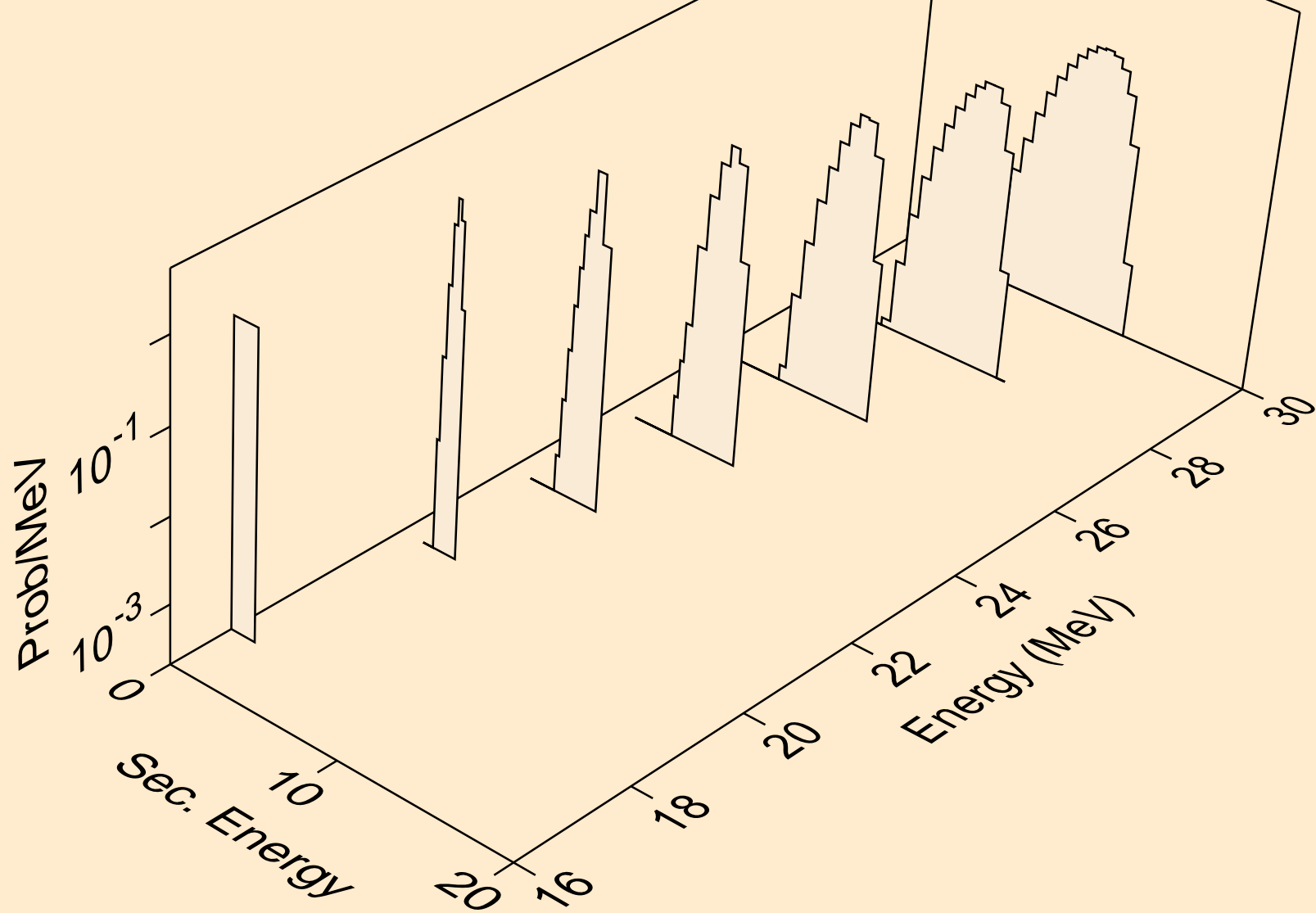

IR185 NEUTRON ACER TENDL-2023 LIBRARY; T=0.K
deuterons from (n,n*)d

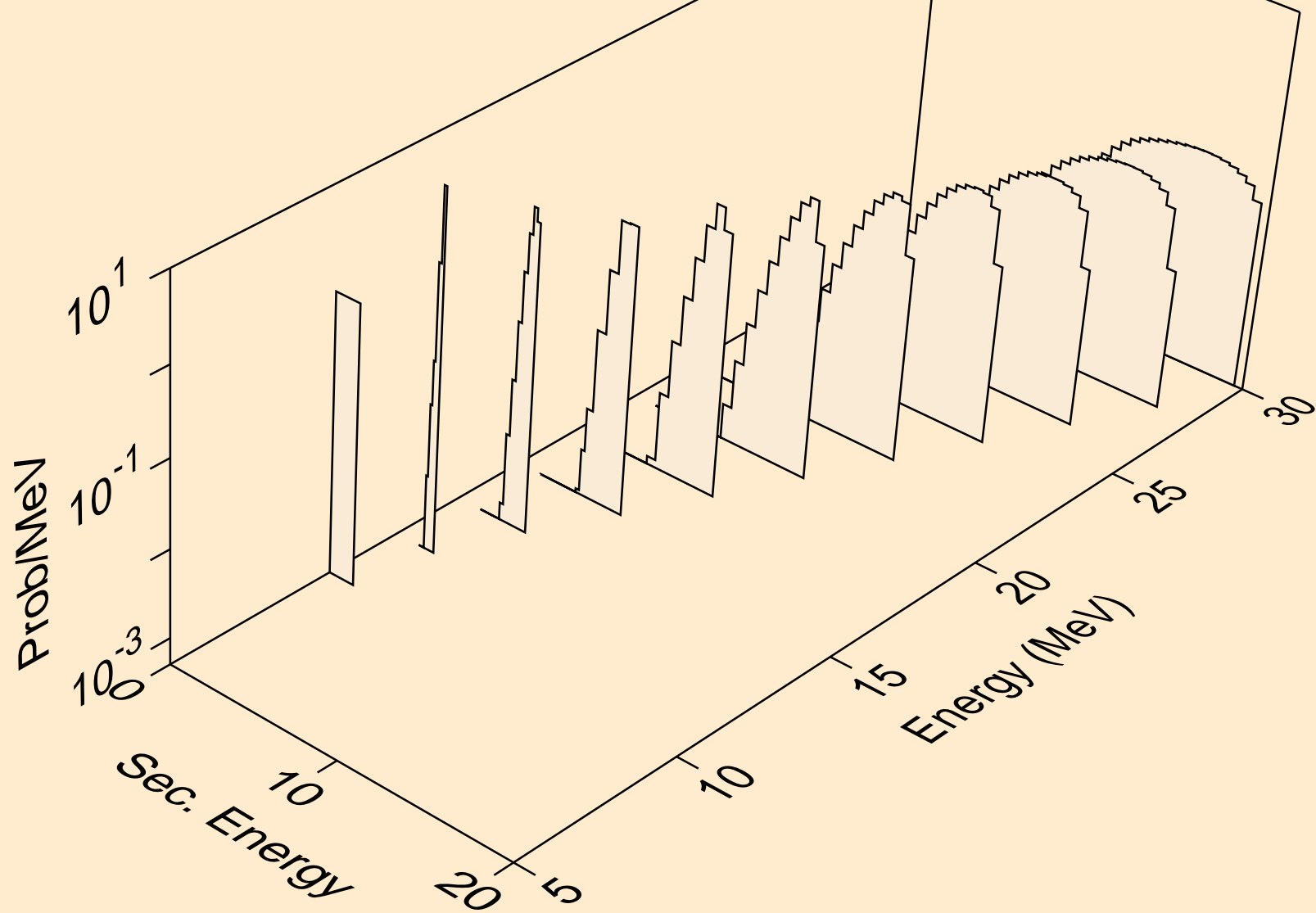

IR185 NEUTRON ACER TENDL-2023 LIBRARY; T=0.K
deuterons from (n,d)

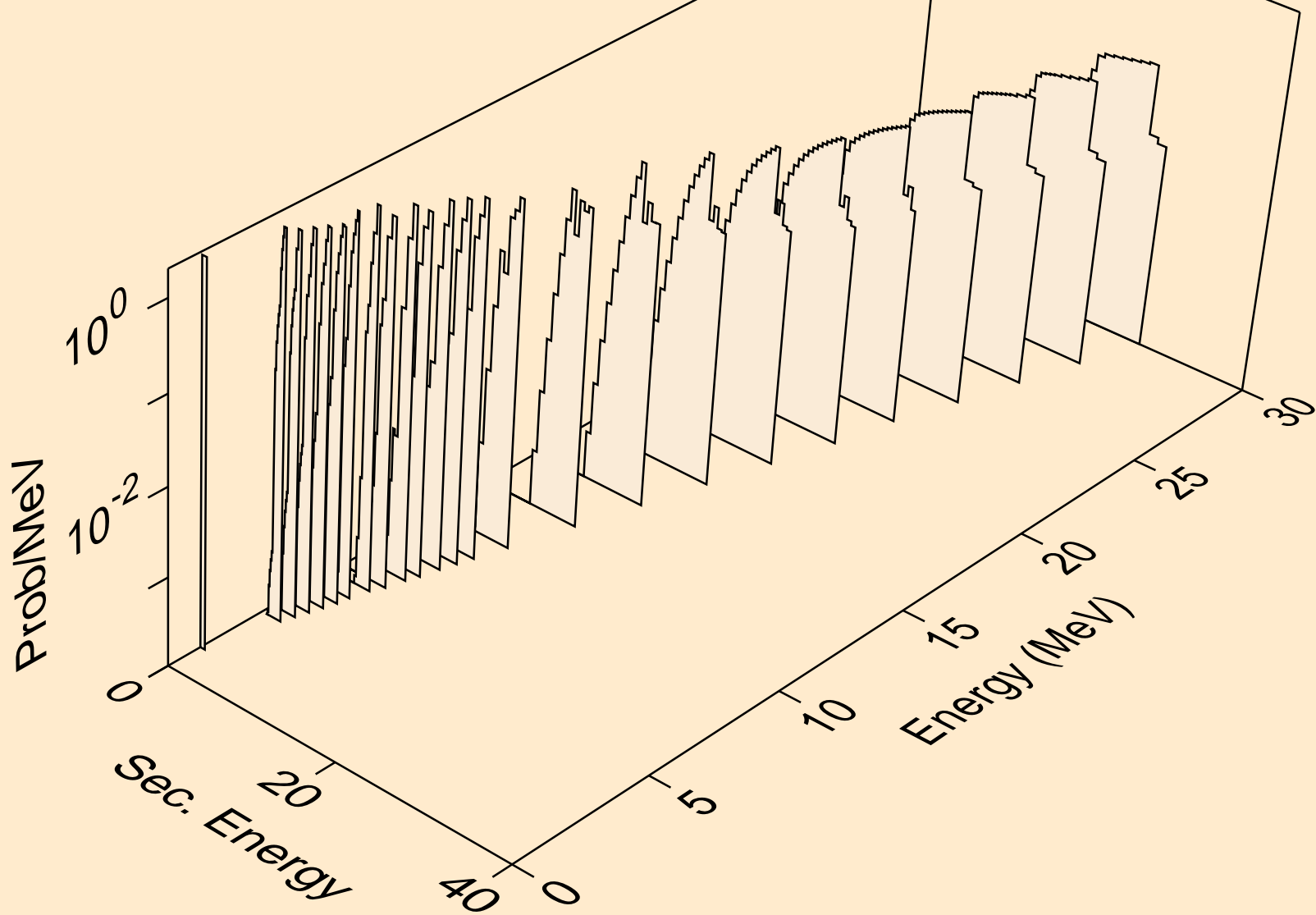

IR185 NEUTRON ACER TENDL-2023 LIBRARY; T=0.K
deuterons from (n,pd)

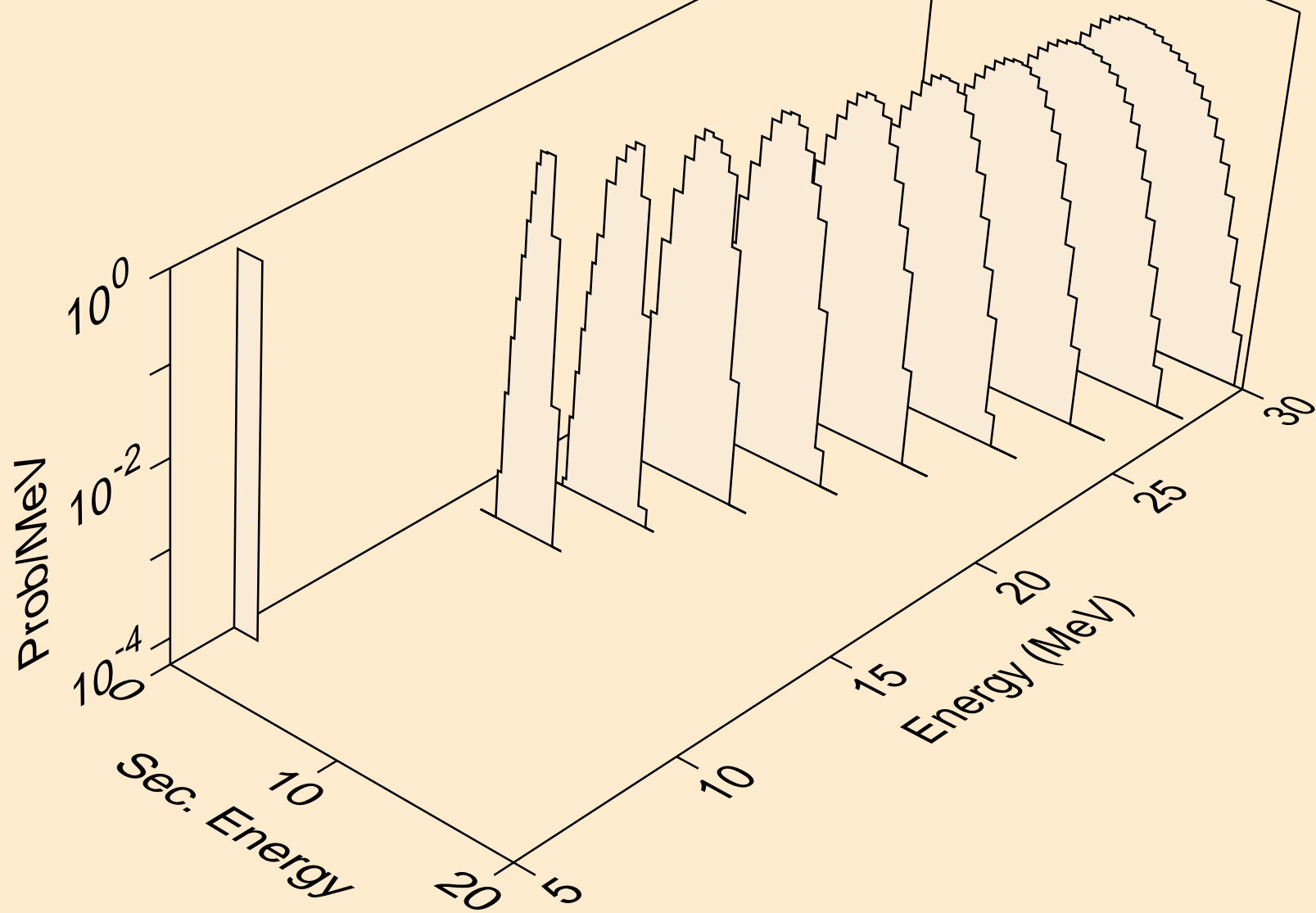

IR185 NEUTRON ACER TENDL-2023 LIBRARY; T=0.K
deuterons from (n,da)

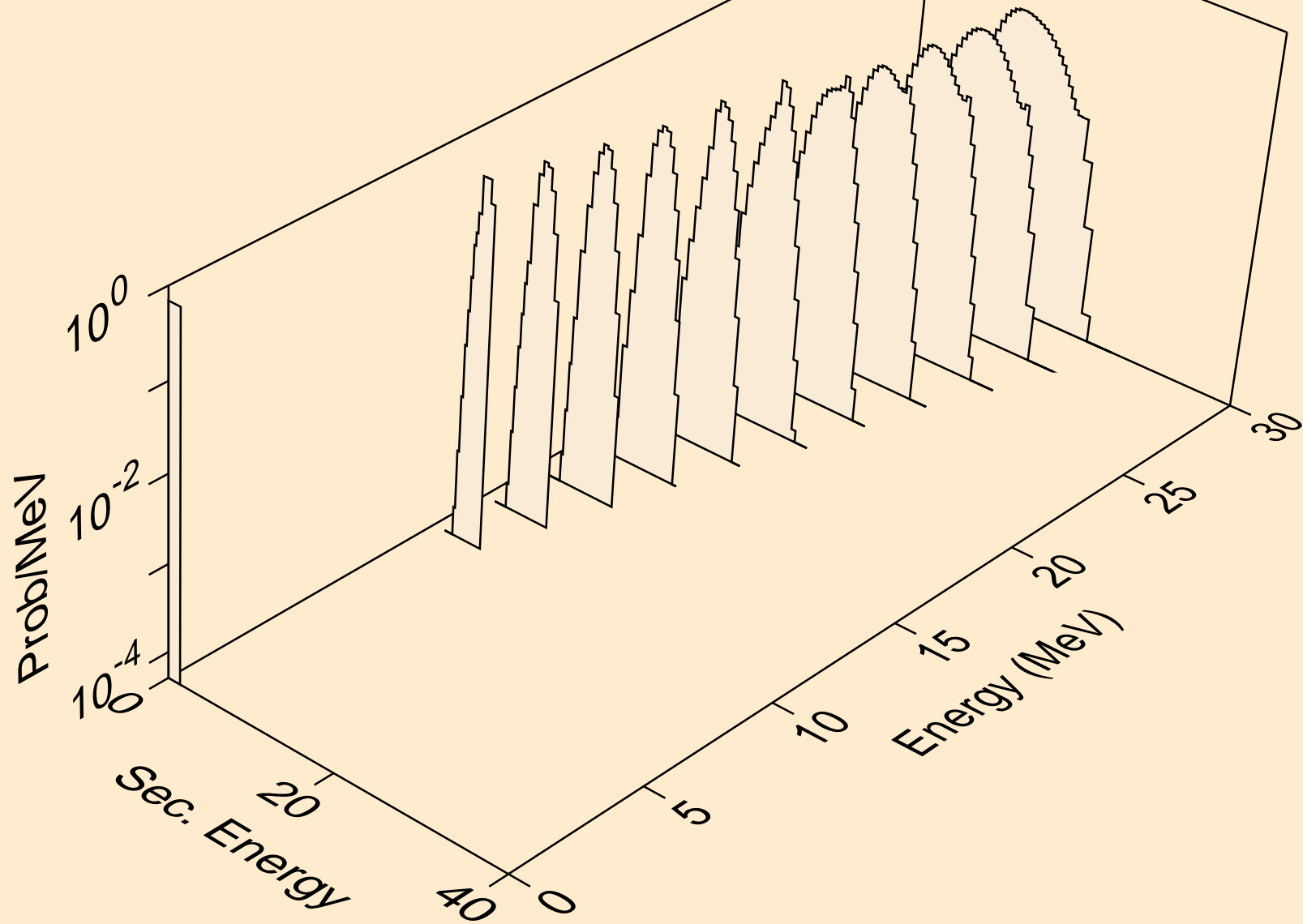

IR185 NEUTRON ACER TENDL-2023 LIBRARY; T=0.K
tritons from (n,x)

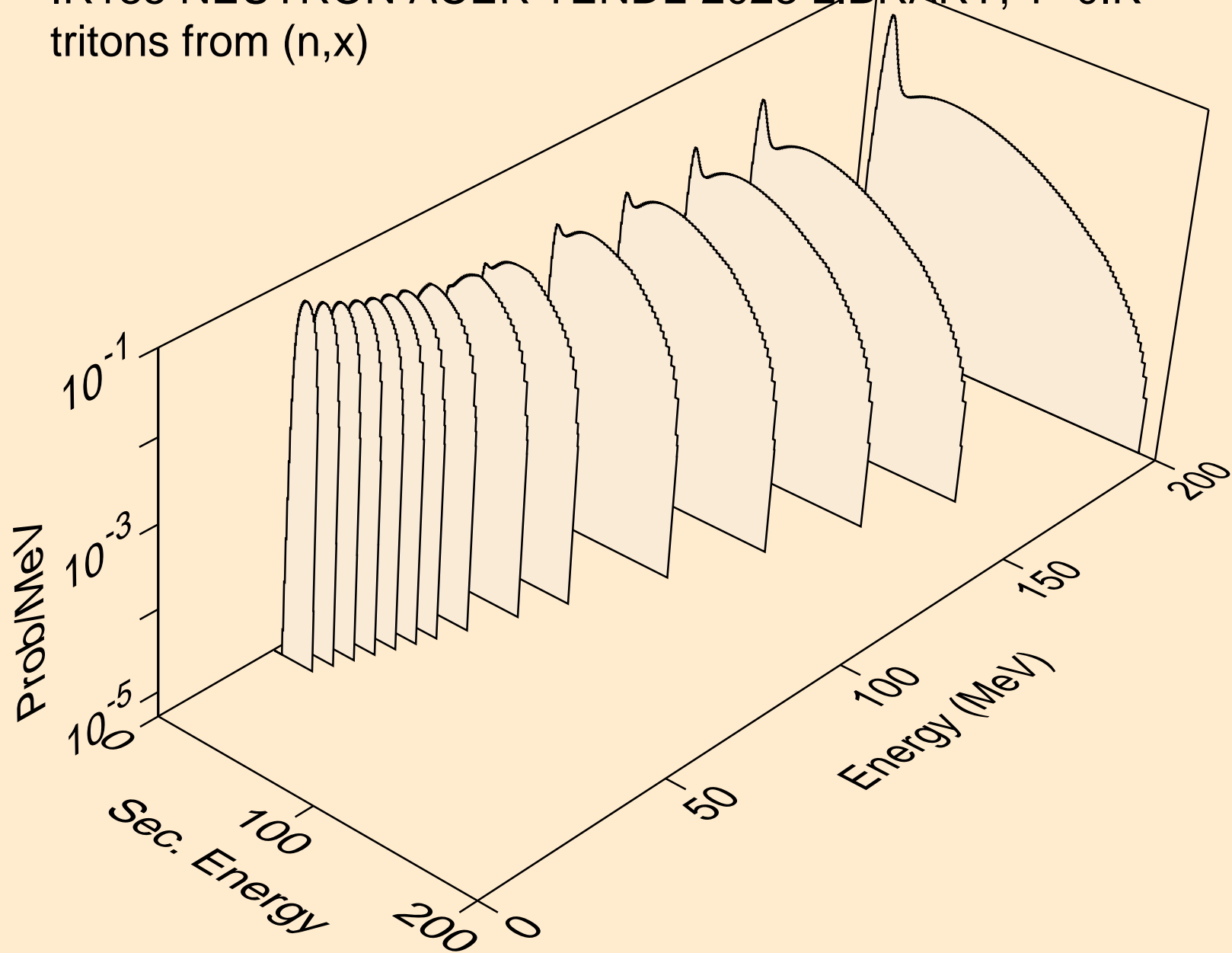

IR185 NEUTRON ACER TENDL-2023 LIBRARY; T=0.K
tritons from (n,n*)t

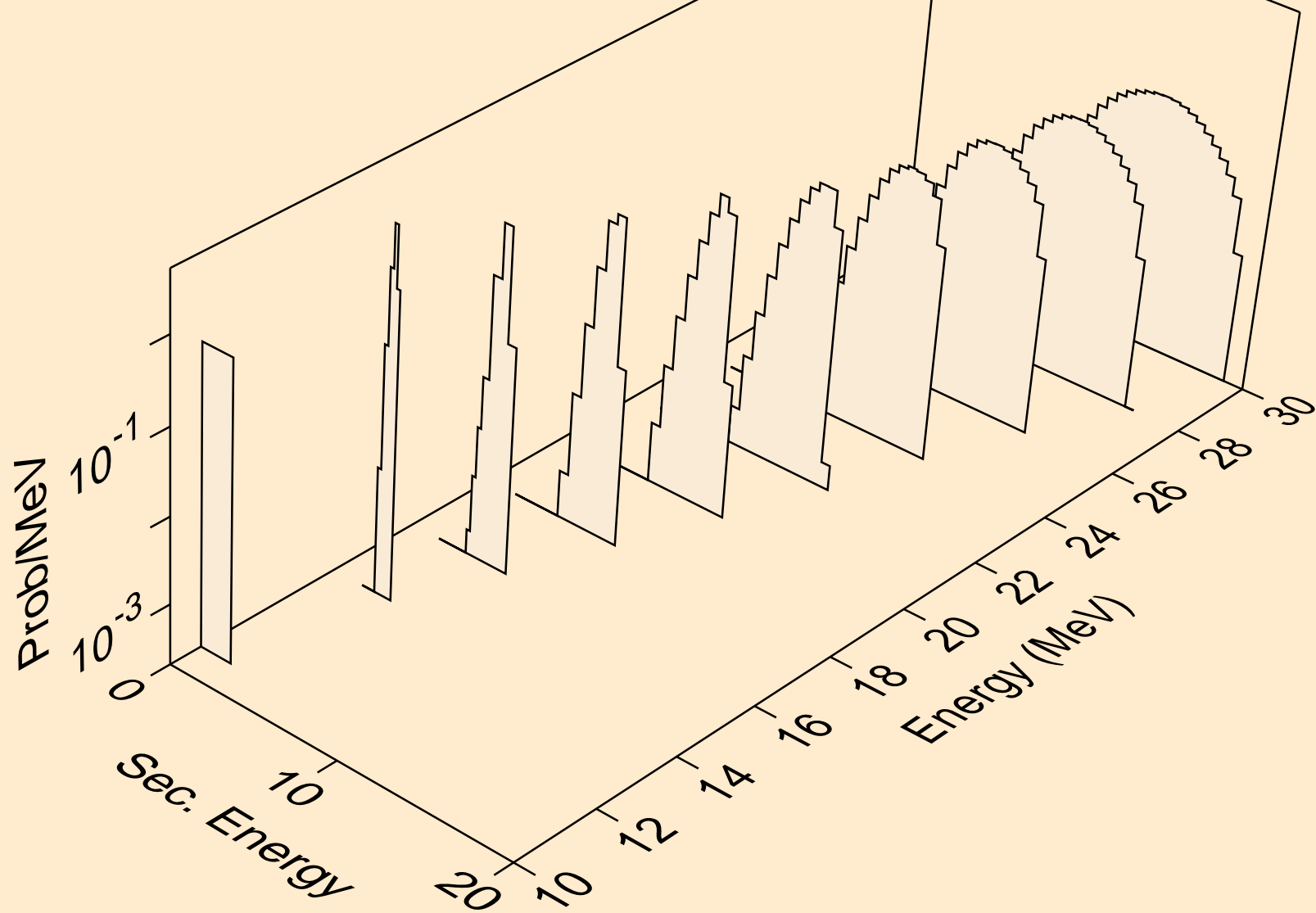

IR185 NEUTRON ACER TENDL-2023 LIBRARY; T=0.K
tritons from (n,t)

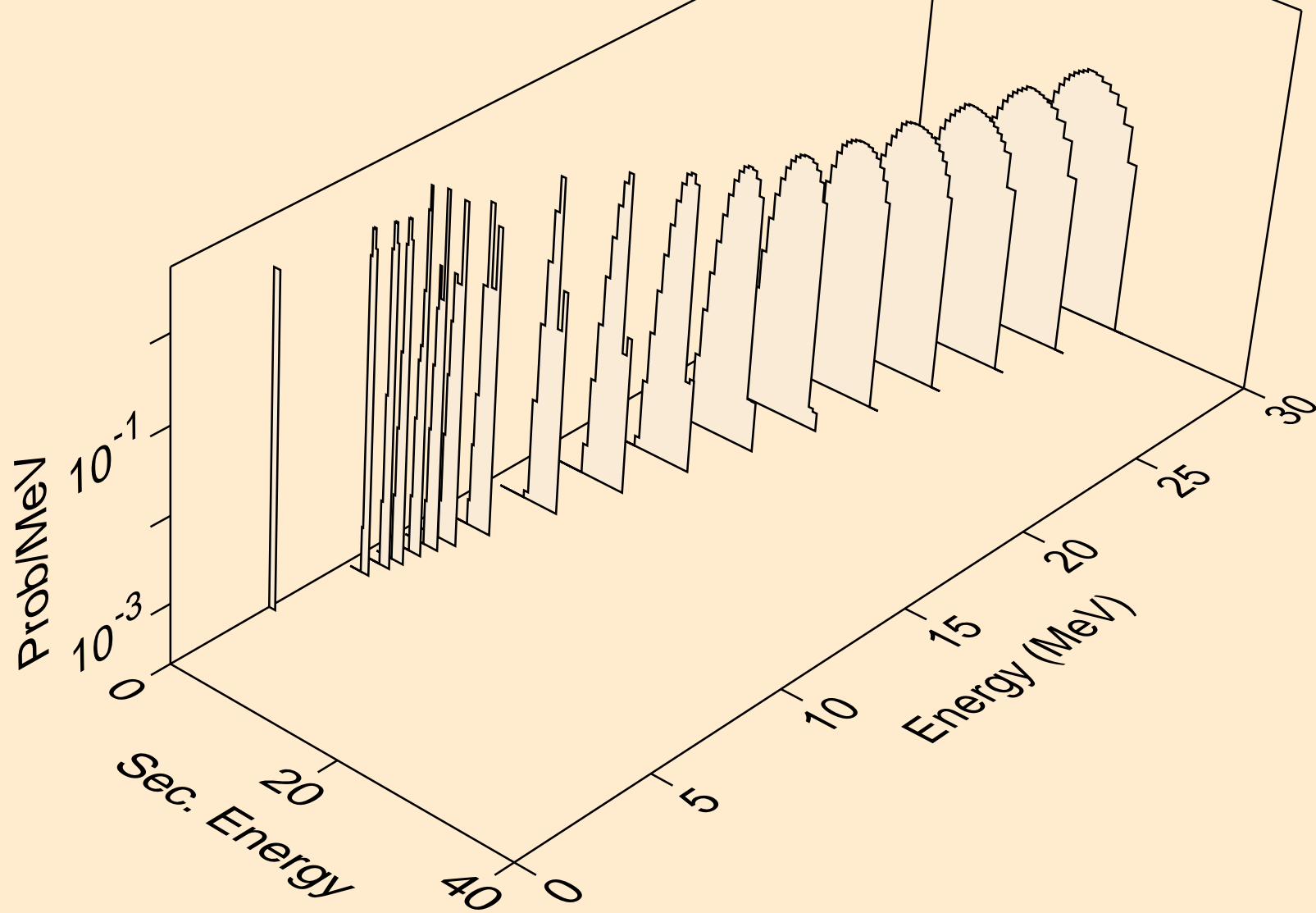

IR185 NEUTRON ACER TENDL-2023 LIBRARY; T=0.K
tritons from (n,pt)

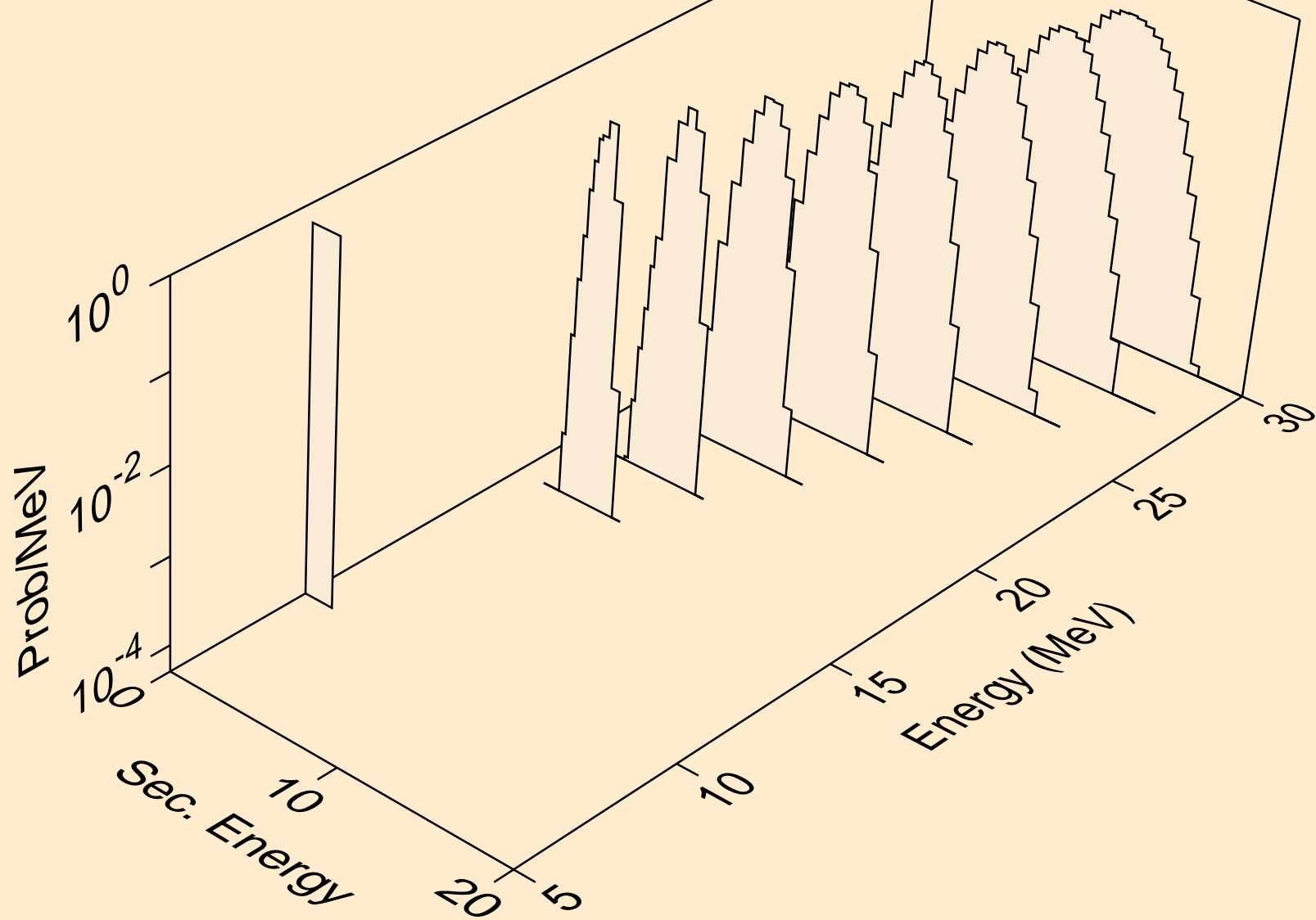

IR185 NEUTRON ACER TENDL-2023 LIBRARY; T=0.K
he3s from (n,x)

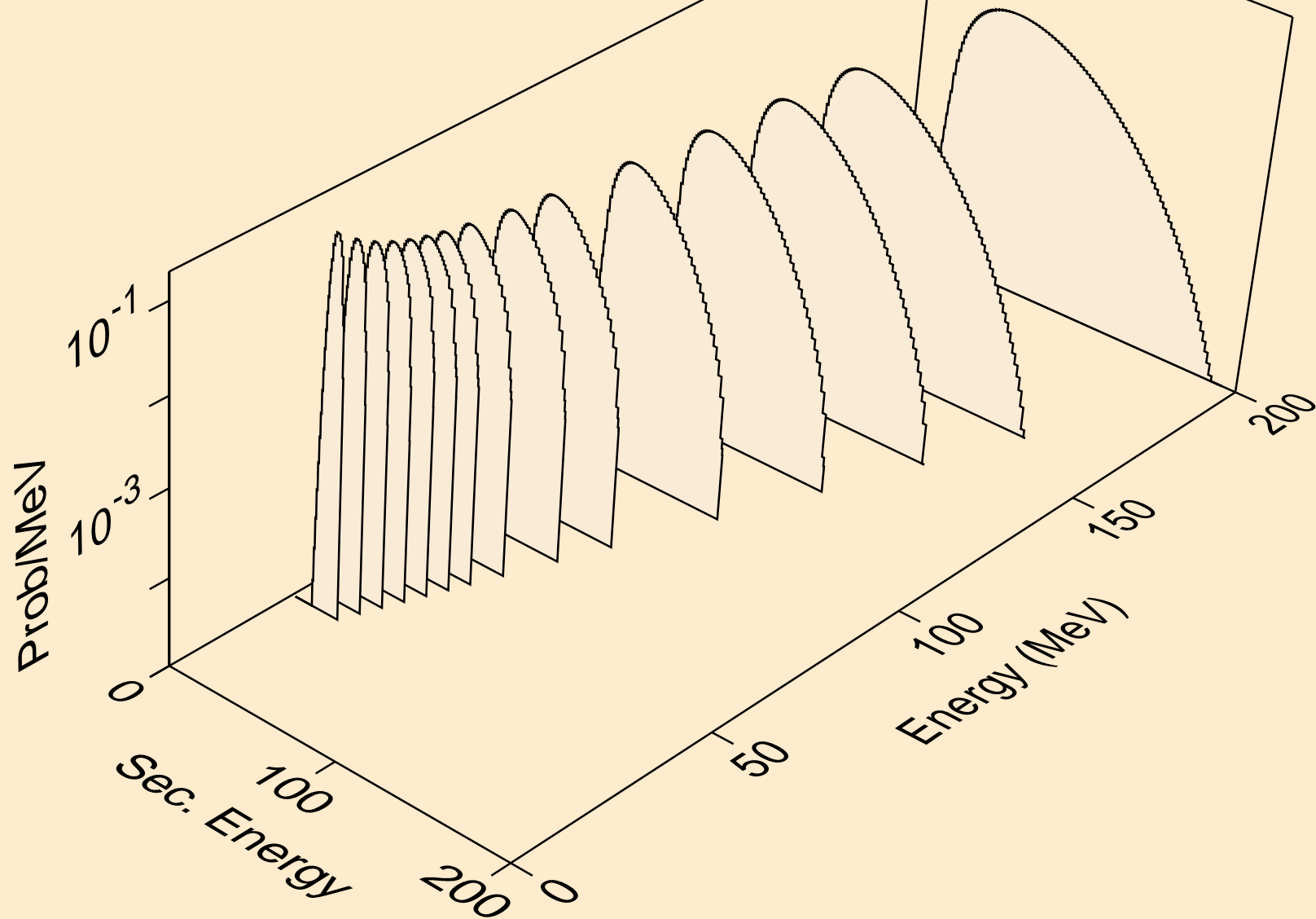

IR185 NEUTRON ACER TENDL-2023 LIBRARY; T=0.K
he3s from (n,n*)he3

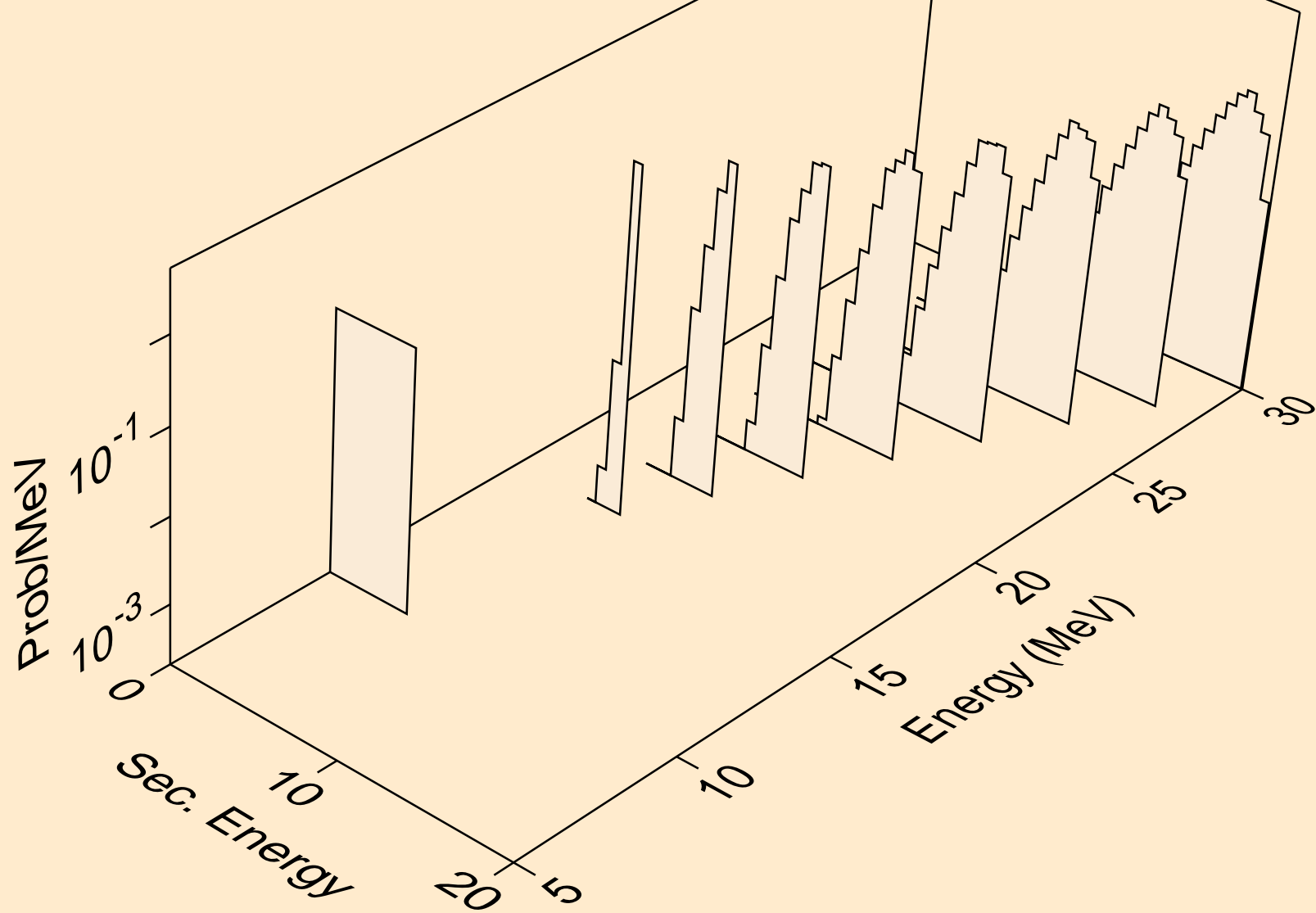

IR185 NEUTRON ACER TENDL-2023 LIBRARY; T=0.K
he3s from (n,he3)

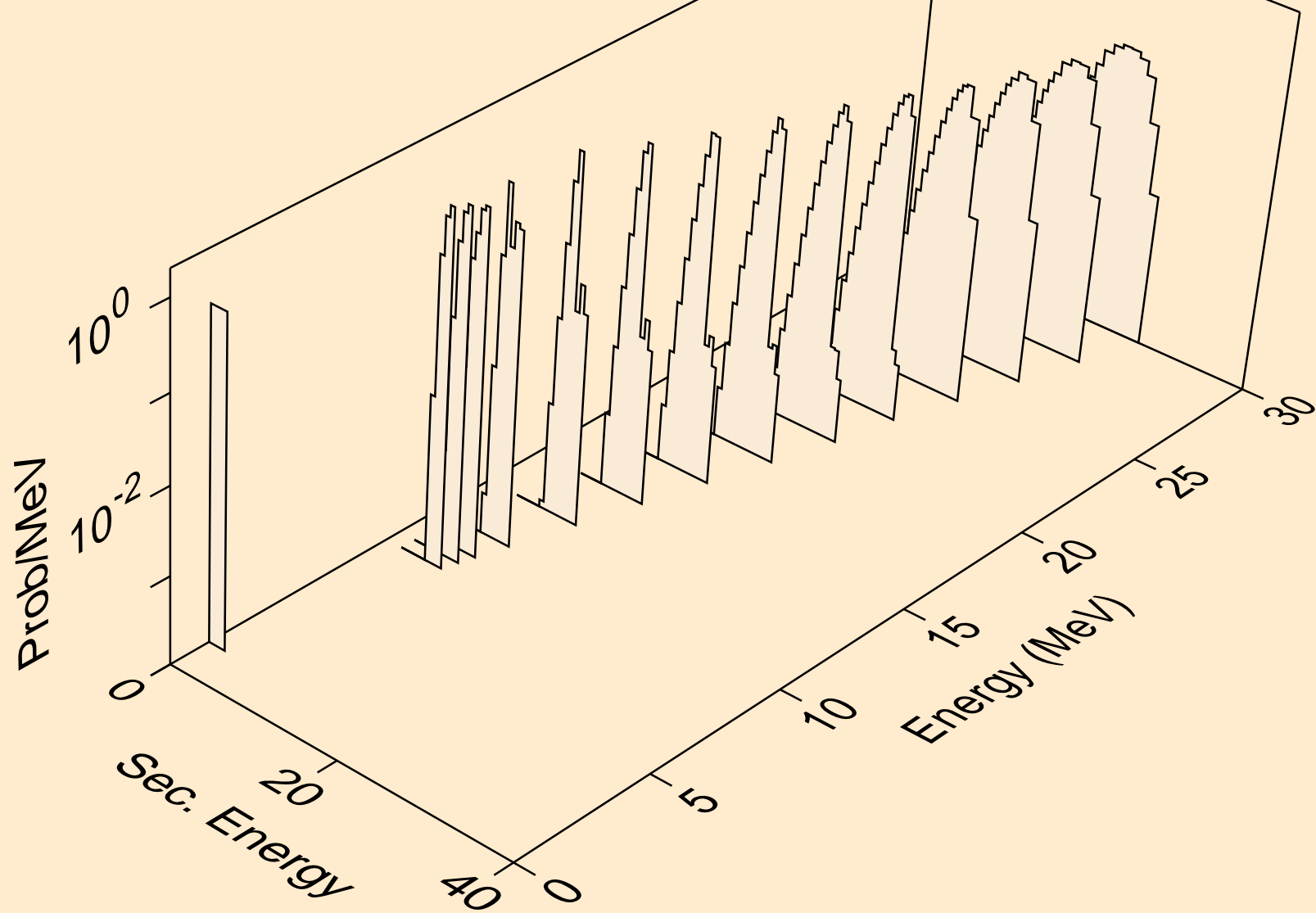

IR185 NEUTRON ACER TENDL-2023 LIBRARY; T=0.K
alphas from (n,x)

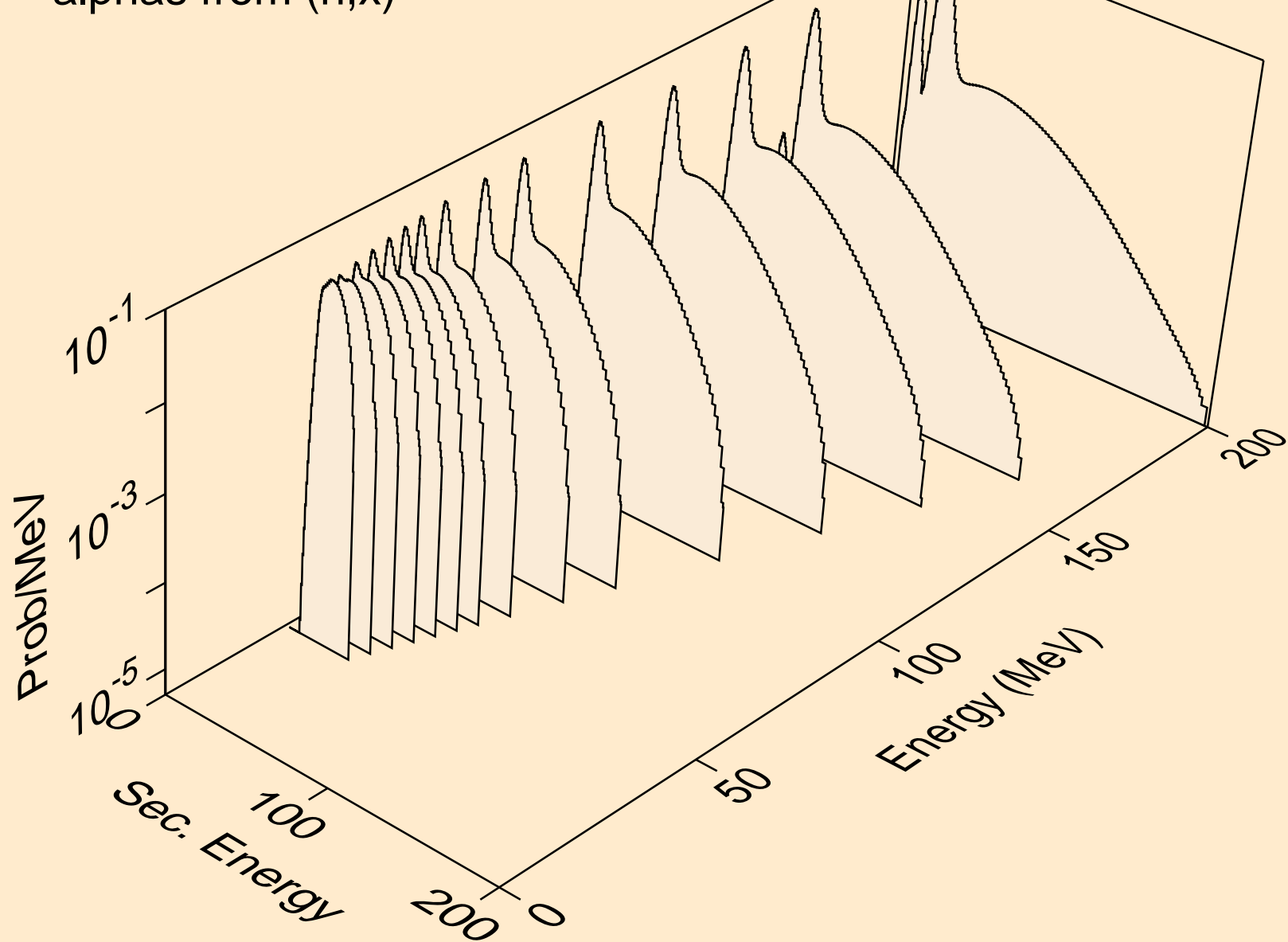

IR185 NEUTRON ACER TENDL-2023 LIBRARY; T=0.K
alphas from (n,n*)a

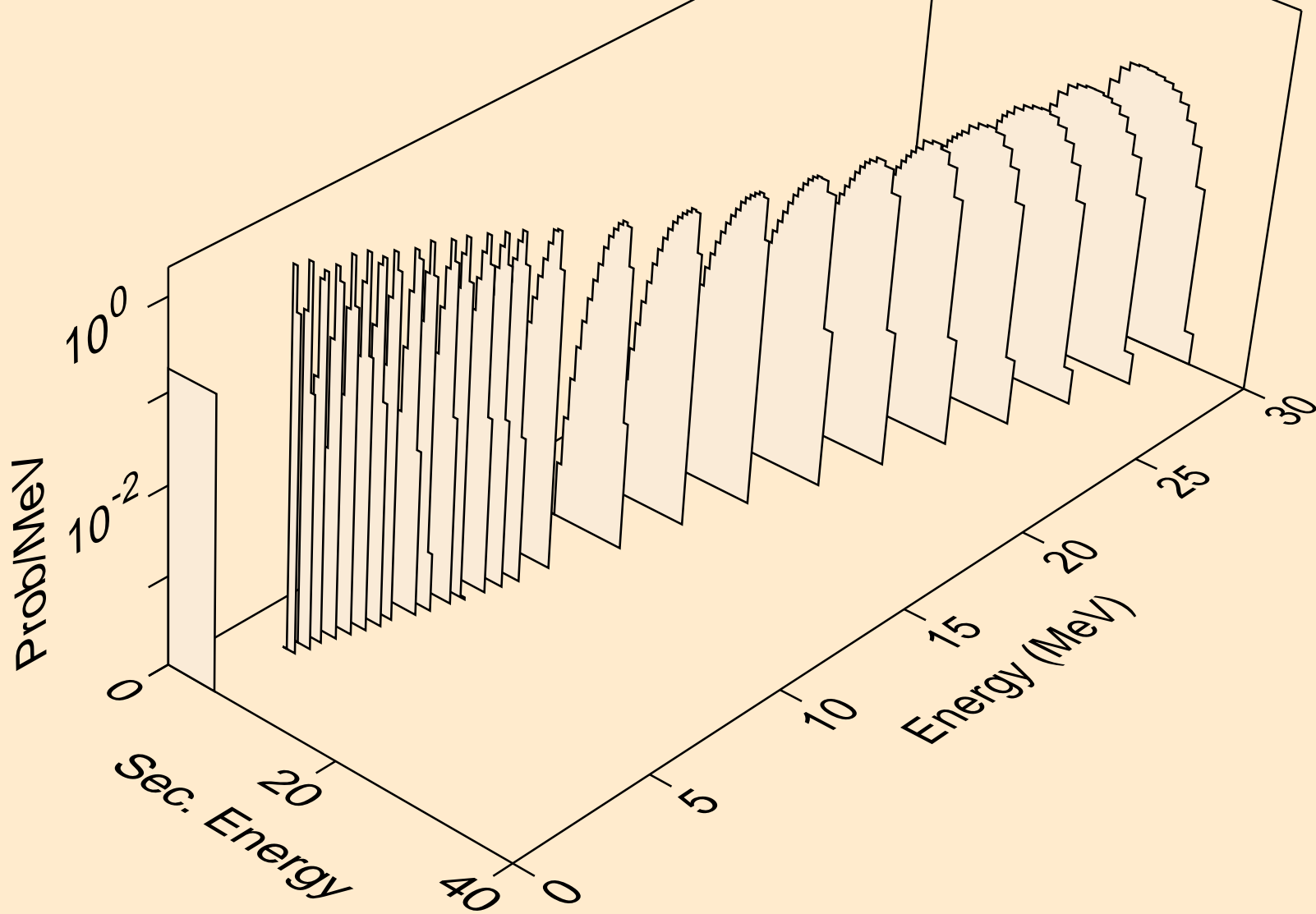

IR185 NEUTRON ACER TENDL-2023 LIBRARY; T=0.K
alphas from (n,2n)a

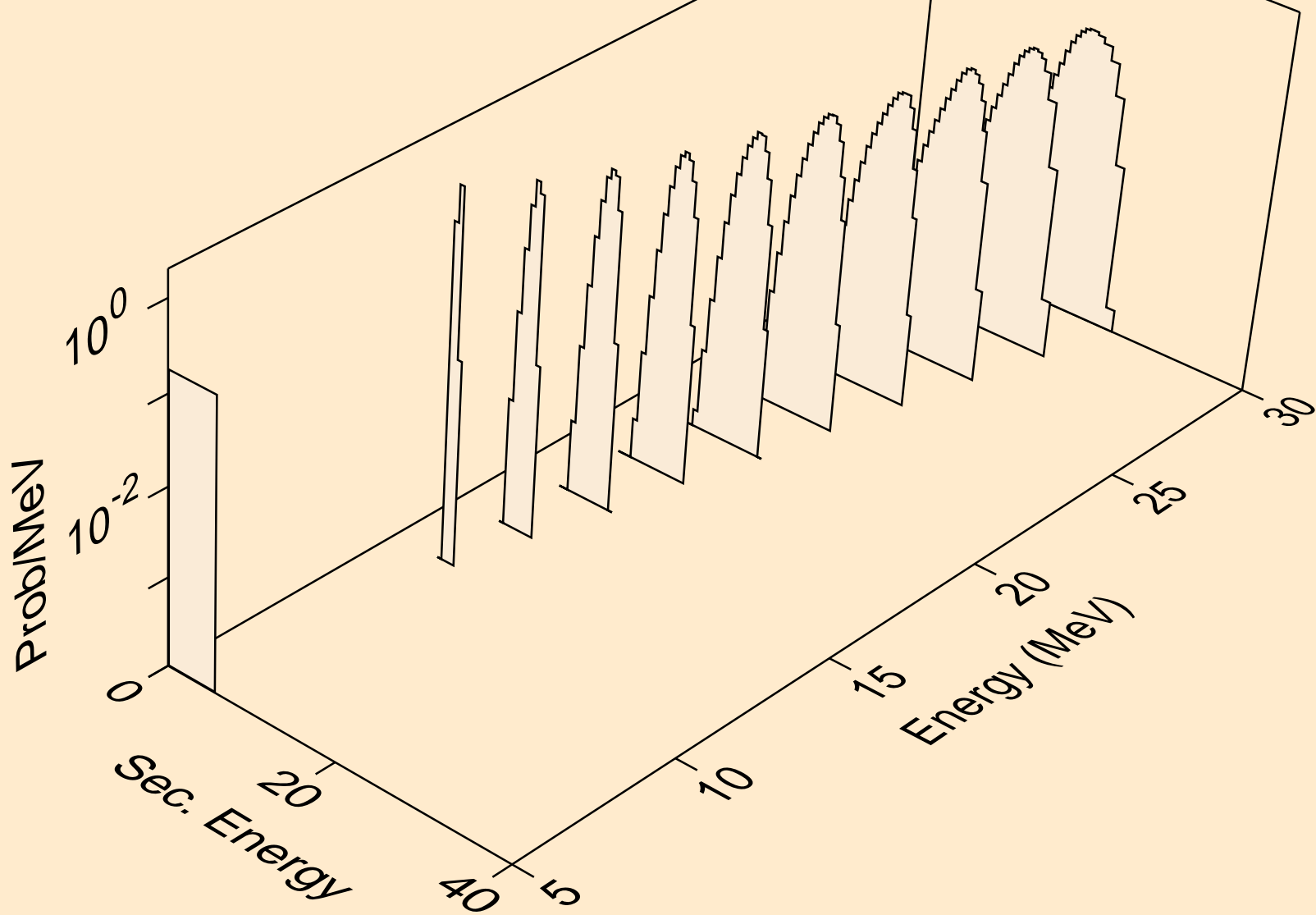

IR185 NEUTRON ACER TENDL-2023 LIBRARY; T=0.K
alphas from (n,3n)a

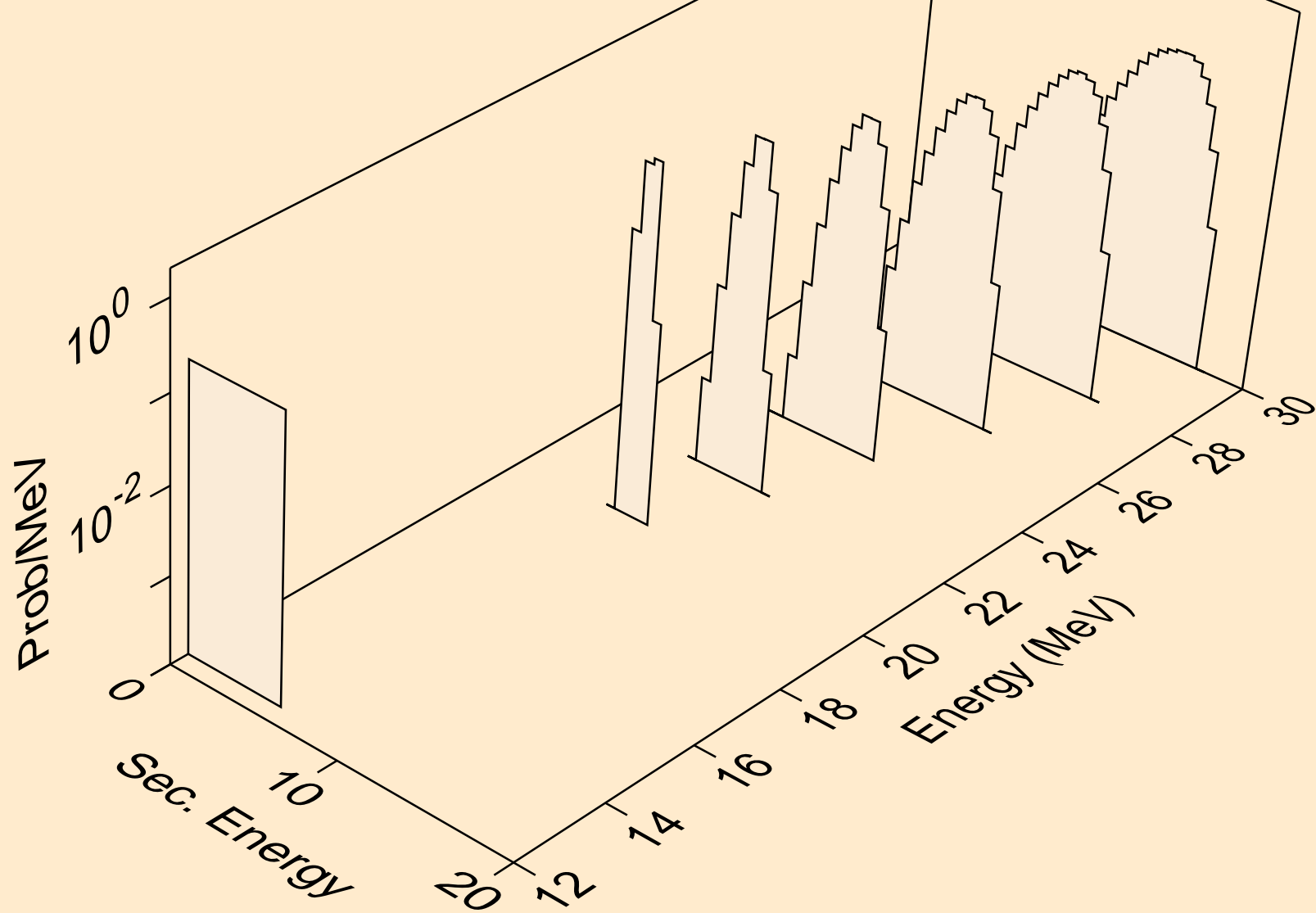

IR185 NEUTRON ACER TENDL-2023 LIBRARY; T=0.K
alphas from (n,n*)2a

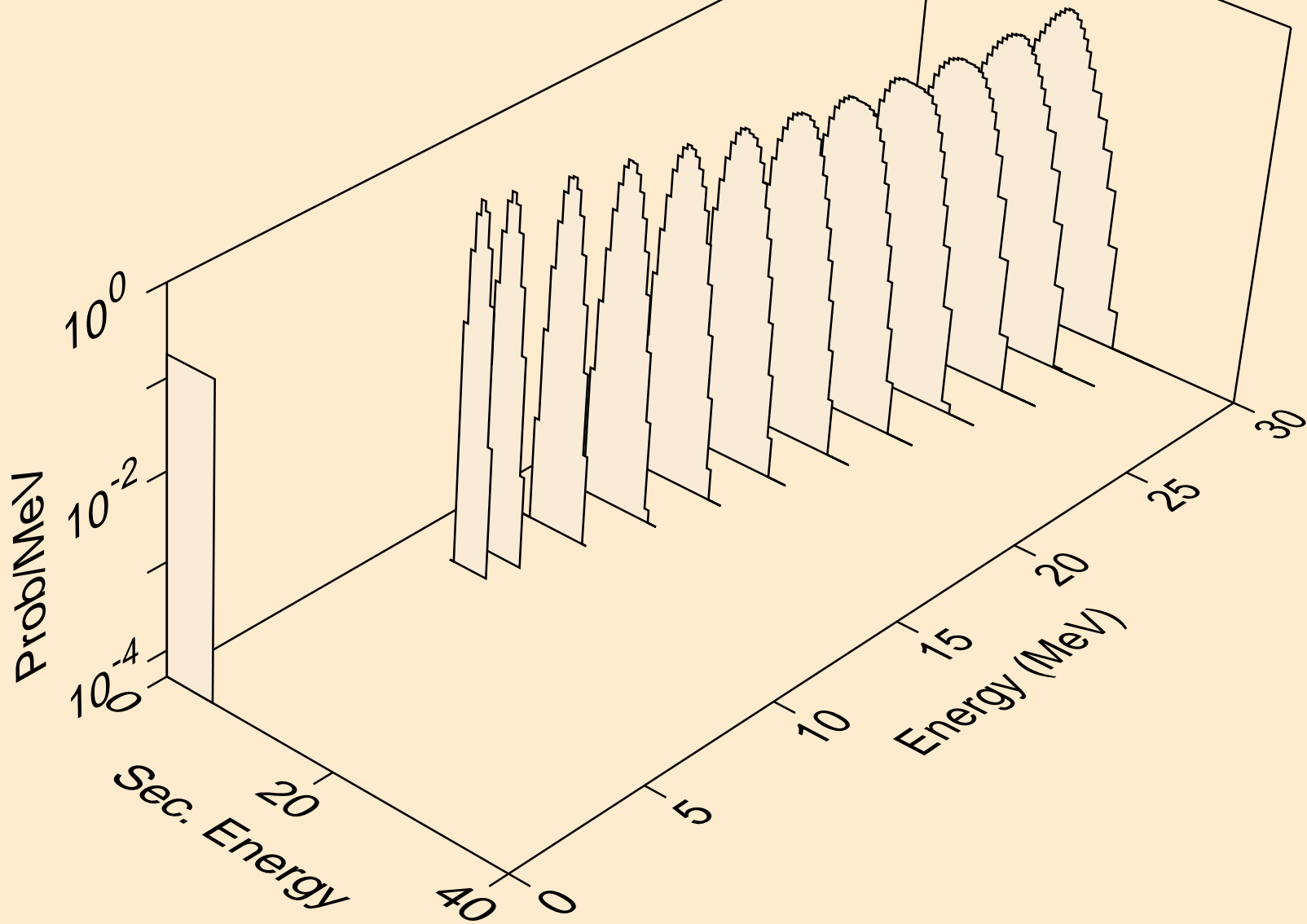

IR185 NEUTRON ACER TENDL-2023 LIBRARY; T=0.K
alphas from (n,2n)2a

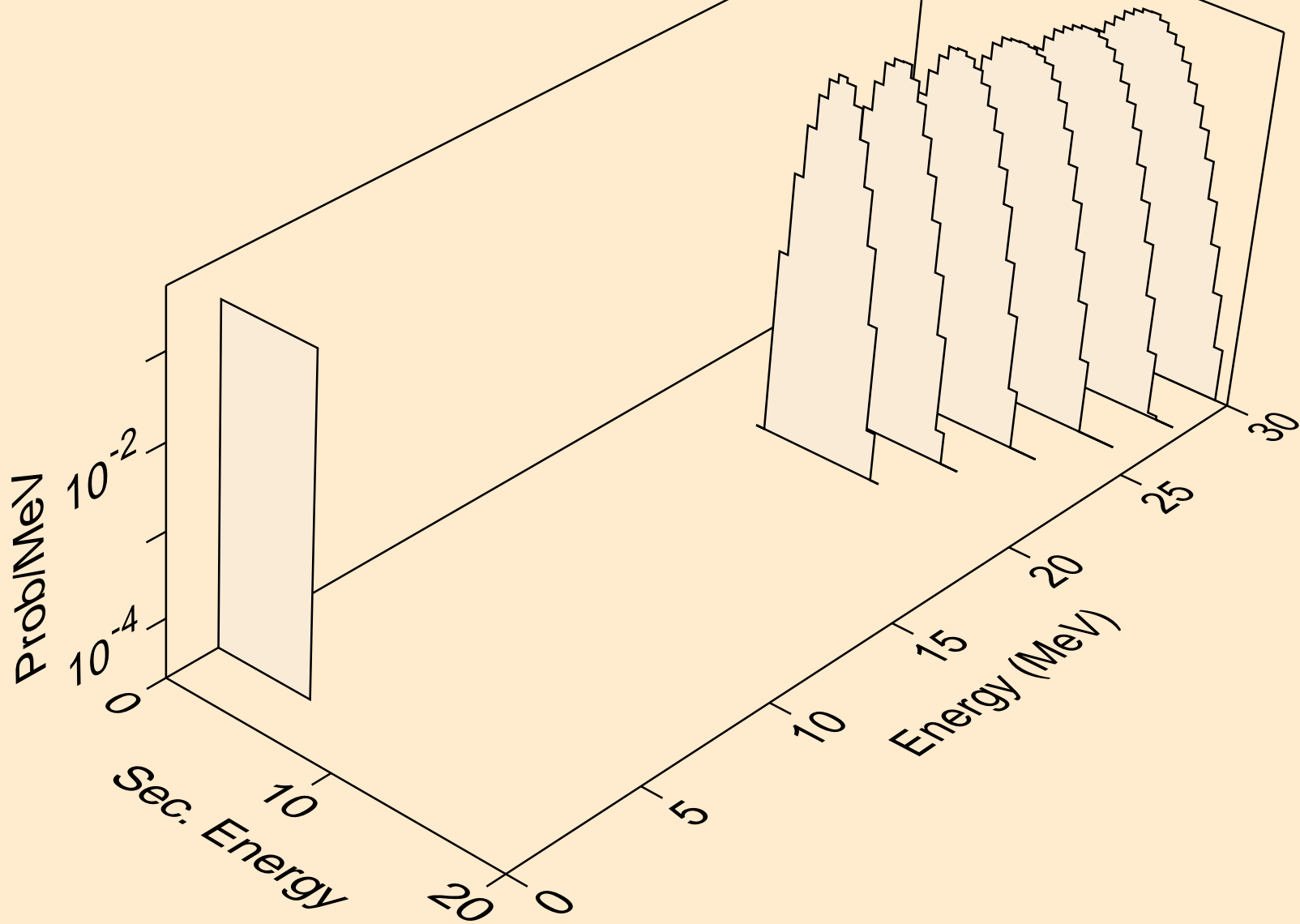

IR185 NEUTRON ACER TENDL-2023 LIBRARY; T=0.K
alphas from (n,npa)

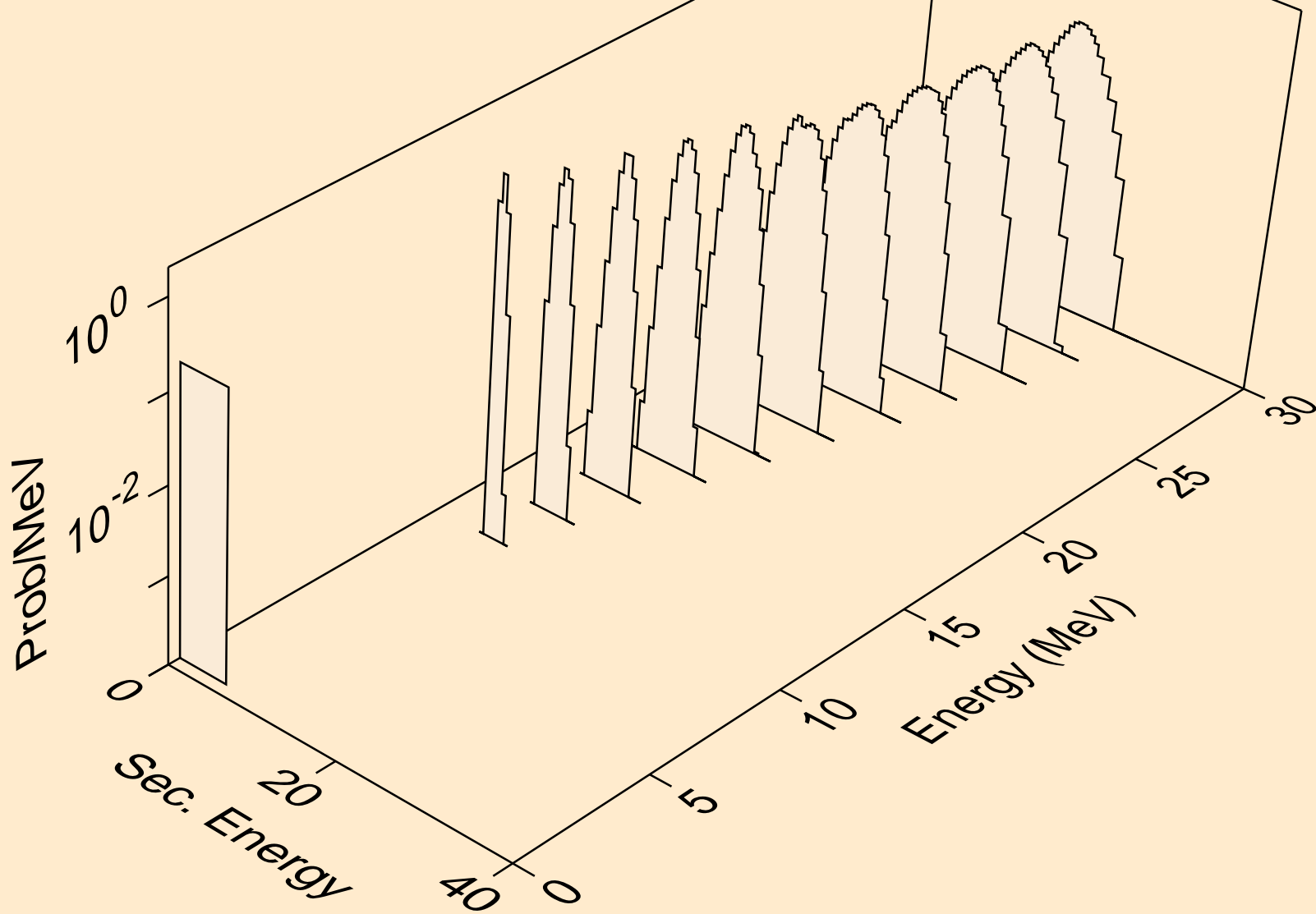

IR185 NEUTRON ACER TENDL-2023 LIBRARY; T=0.K
alphas from (n,a)

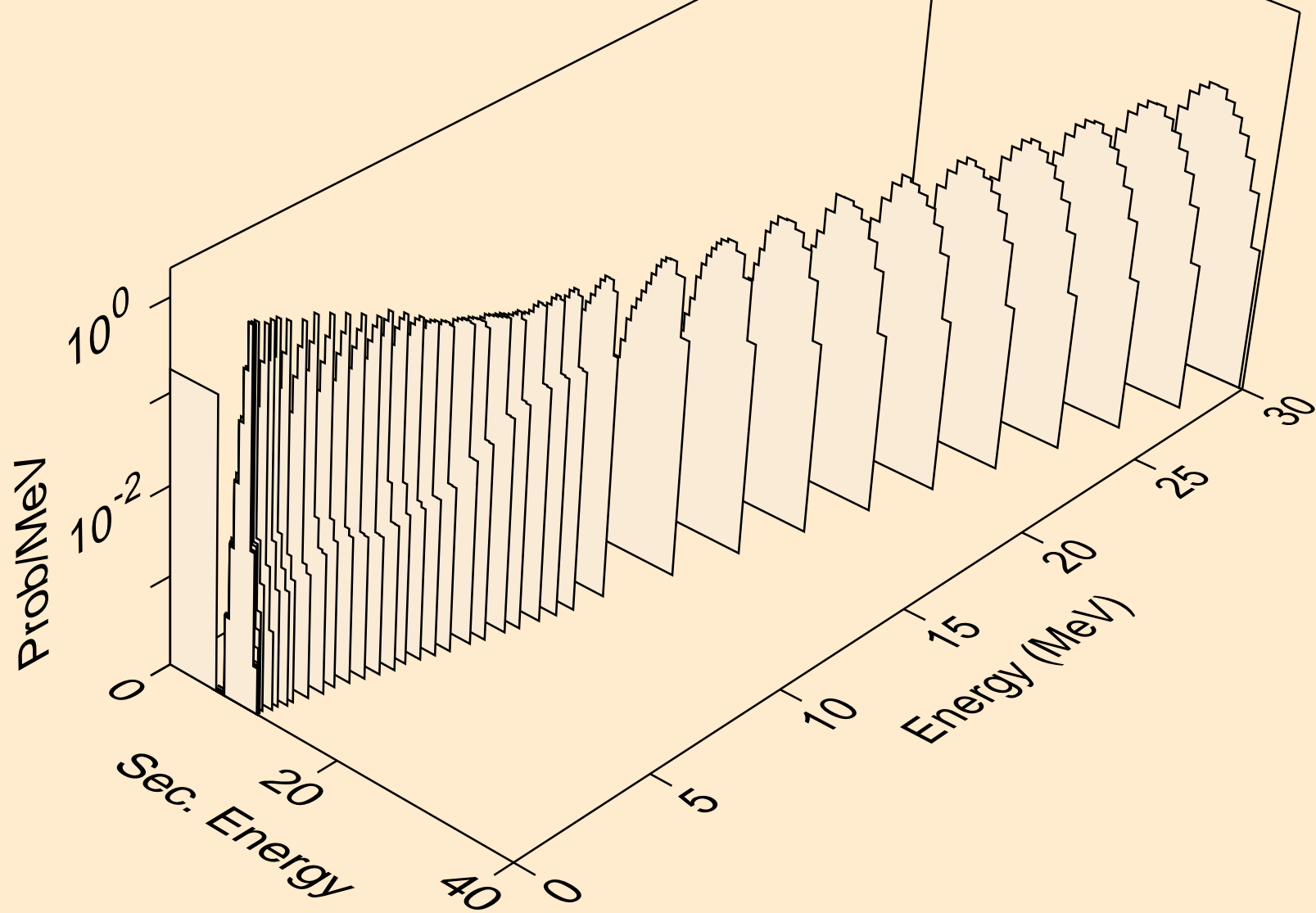

IR185 NEUTRON ACER TENDL-2023 LIBRARY; T=0.K
alphas from (n,2a)



IR185 NEUTRON ACER TENDL-2023 LIBRARY; T=0.K
alphas from (n,pa)

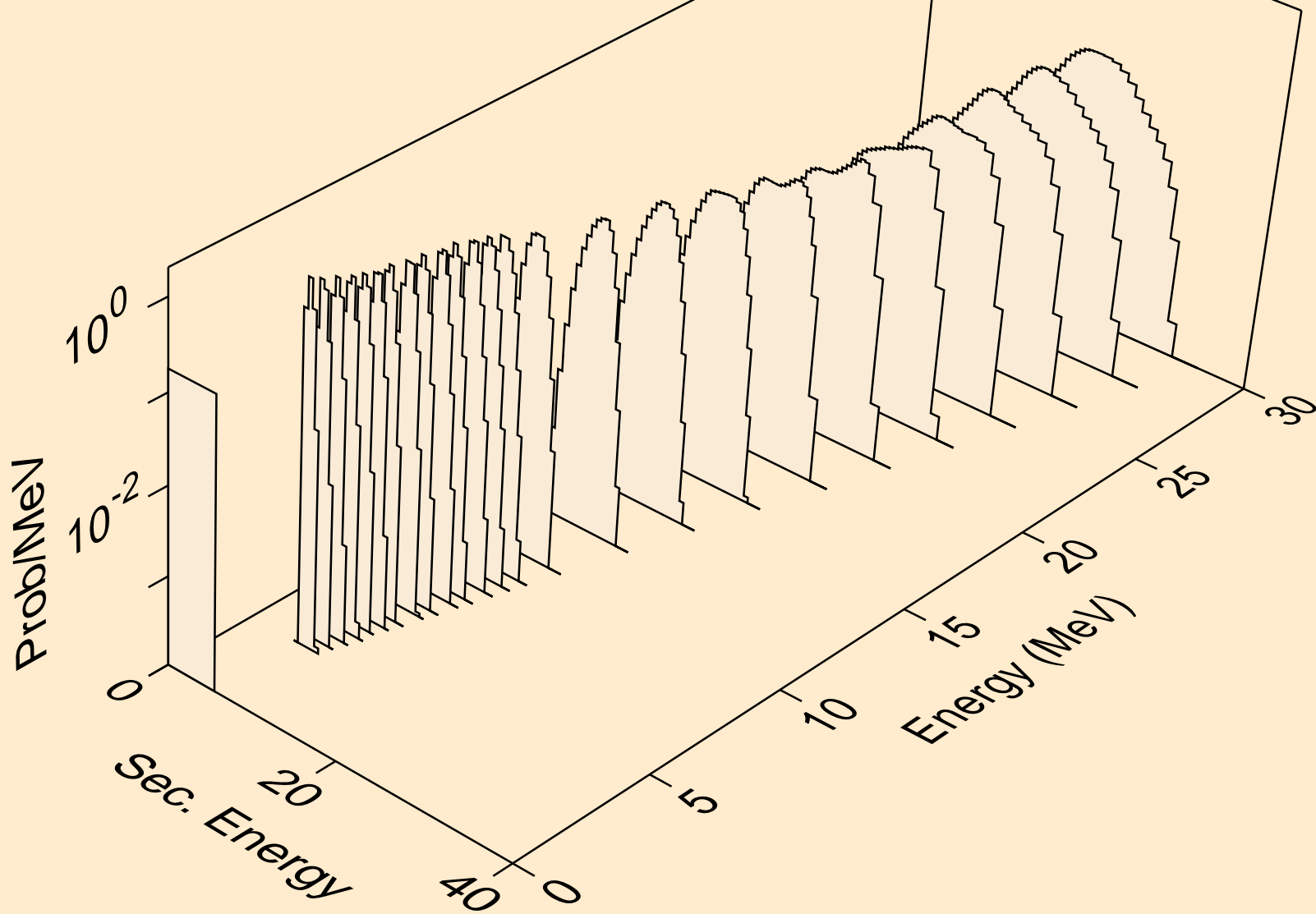

IR185 NEUTRON ACER TENDL-2023 LIBRARY; T=0.K
alphas from (n,da)

