

LR258 NEUTRON ACER TENDL-2023 LIBRARY; T=0.K

Principal cross sections

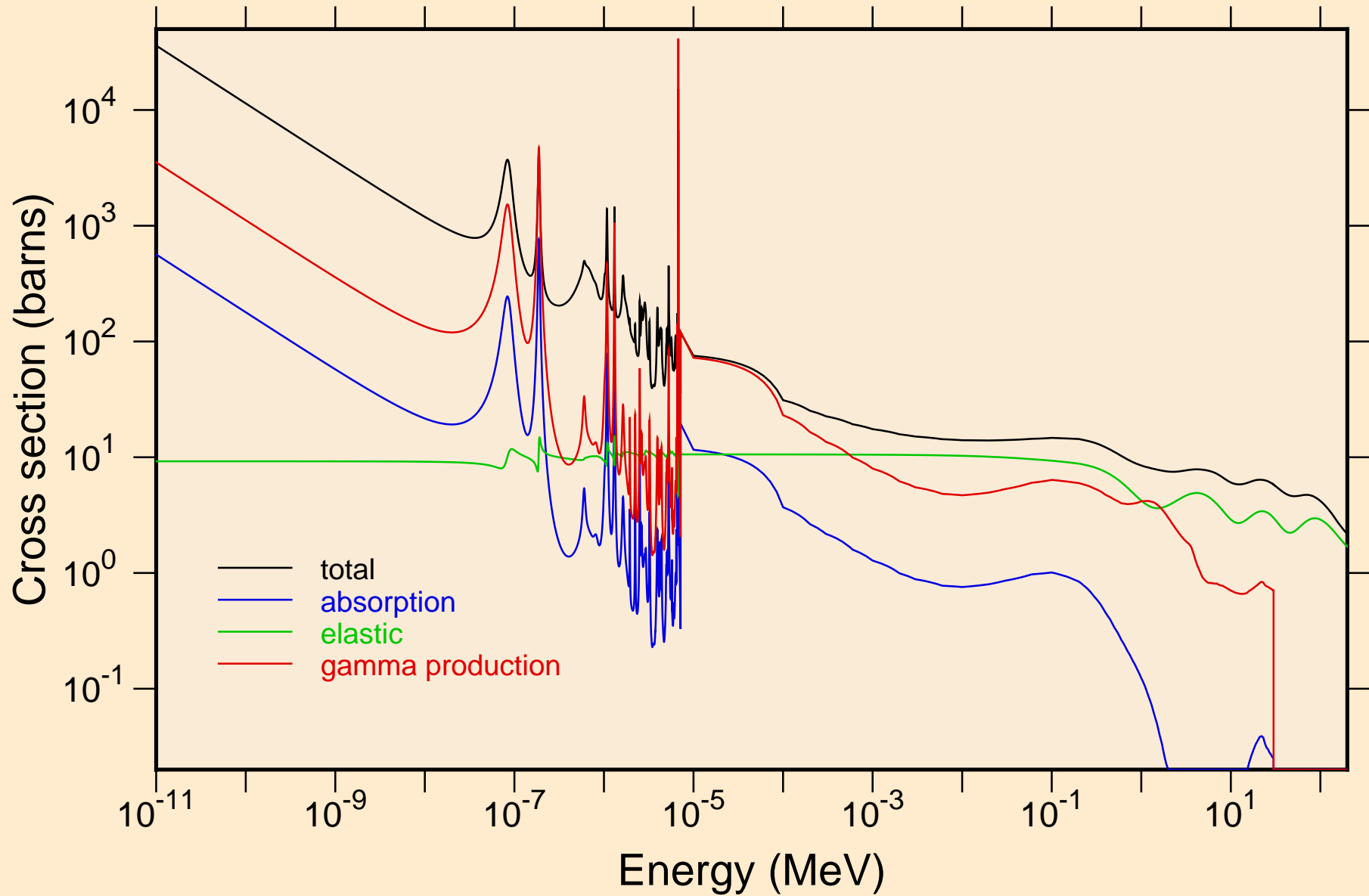

LR258 NEUTRON ACER TENDL-2023 LIBRARY; T=0.K
resonance total cross section

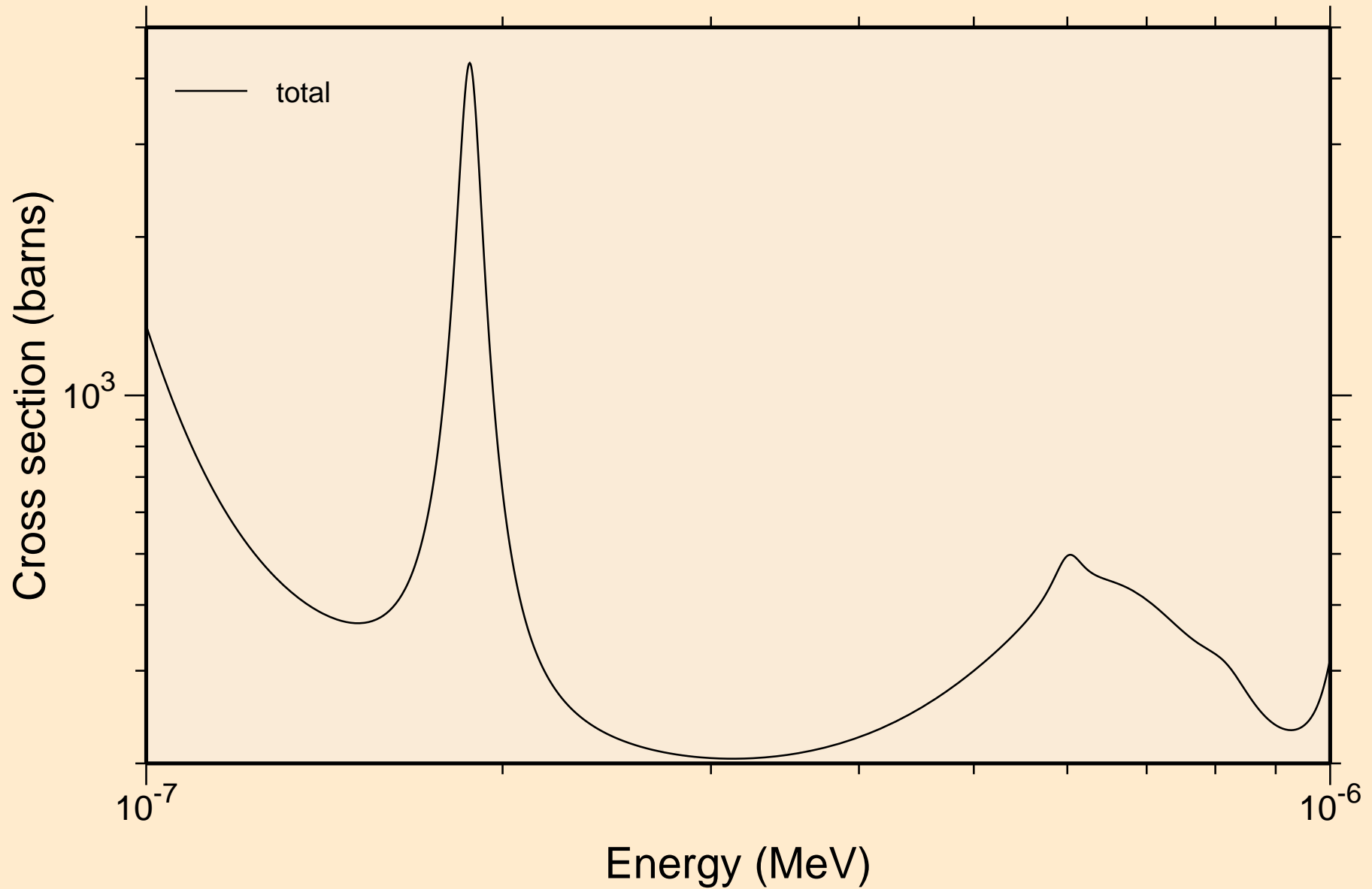

LR258 NEUTRON ACER TENDL-2023 LIBRARY; T=0.K
resonance total cross section

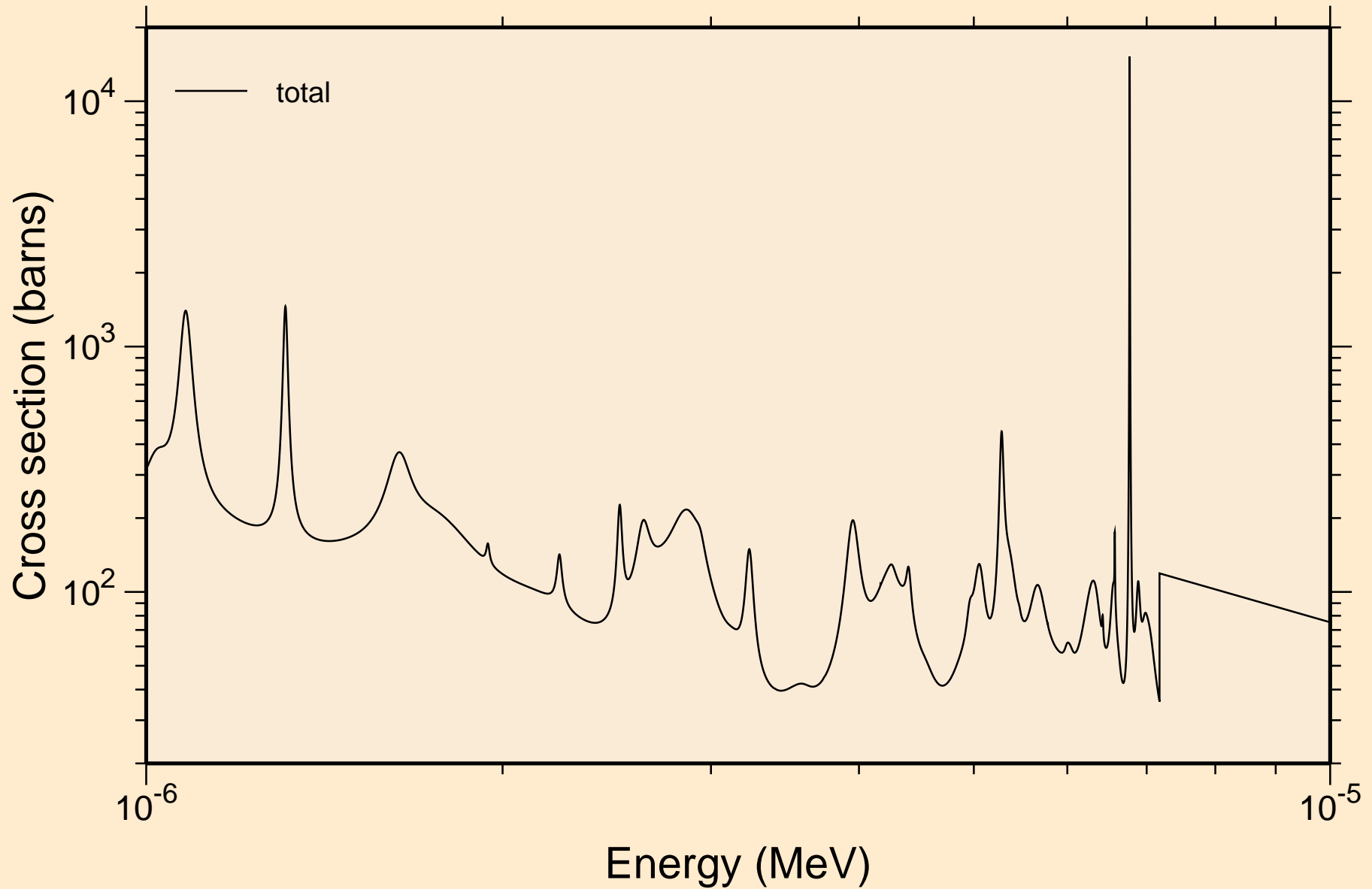

LR258 NEUTRON ACER TENDL-2023 LIBRARY; T=0.K
resonance total cross section

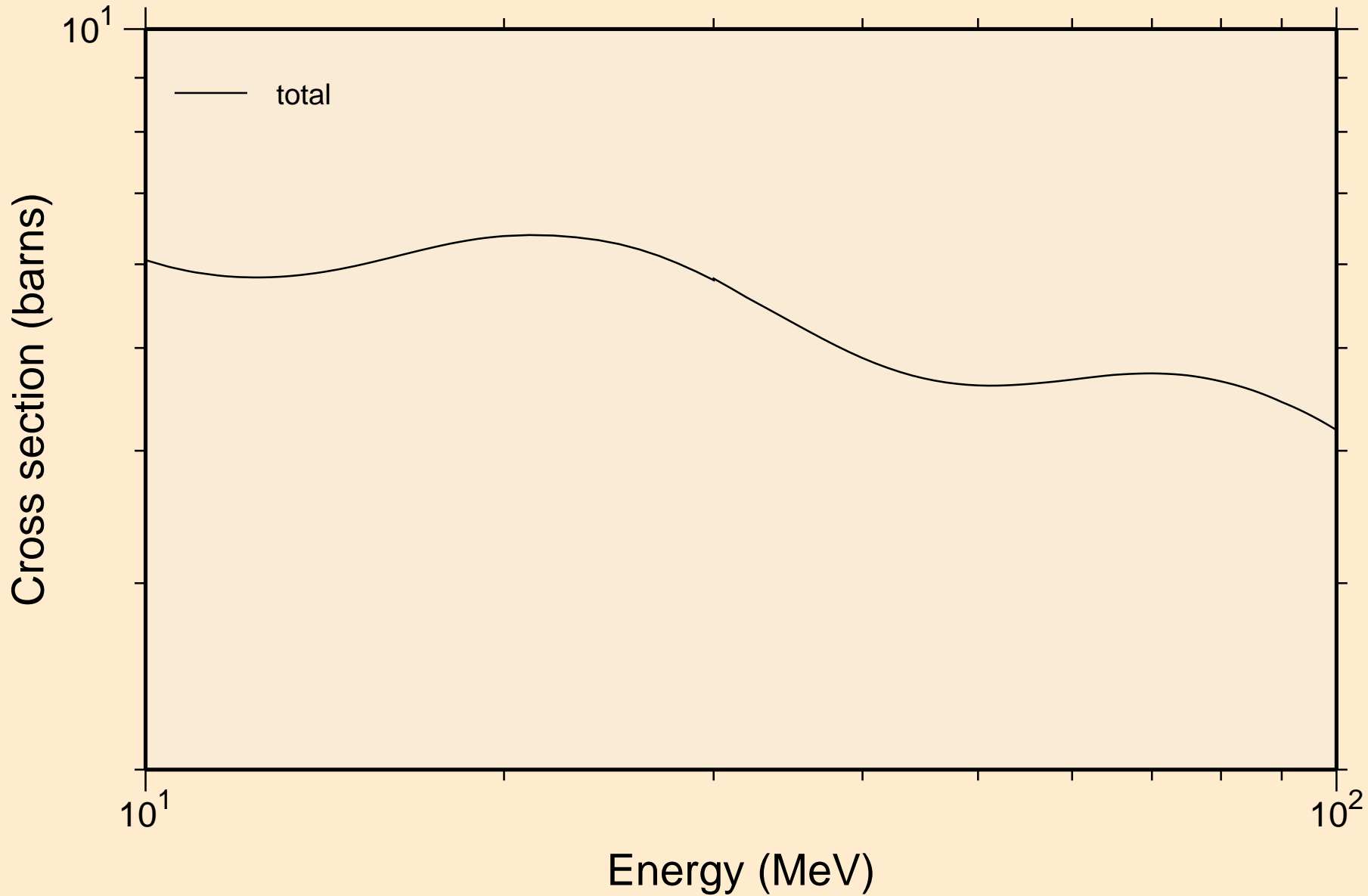

LR258 NEUTRON ACER TENDL-2023 LIBRARY; T=0.K
resonance absorption cross sections

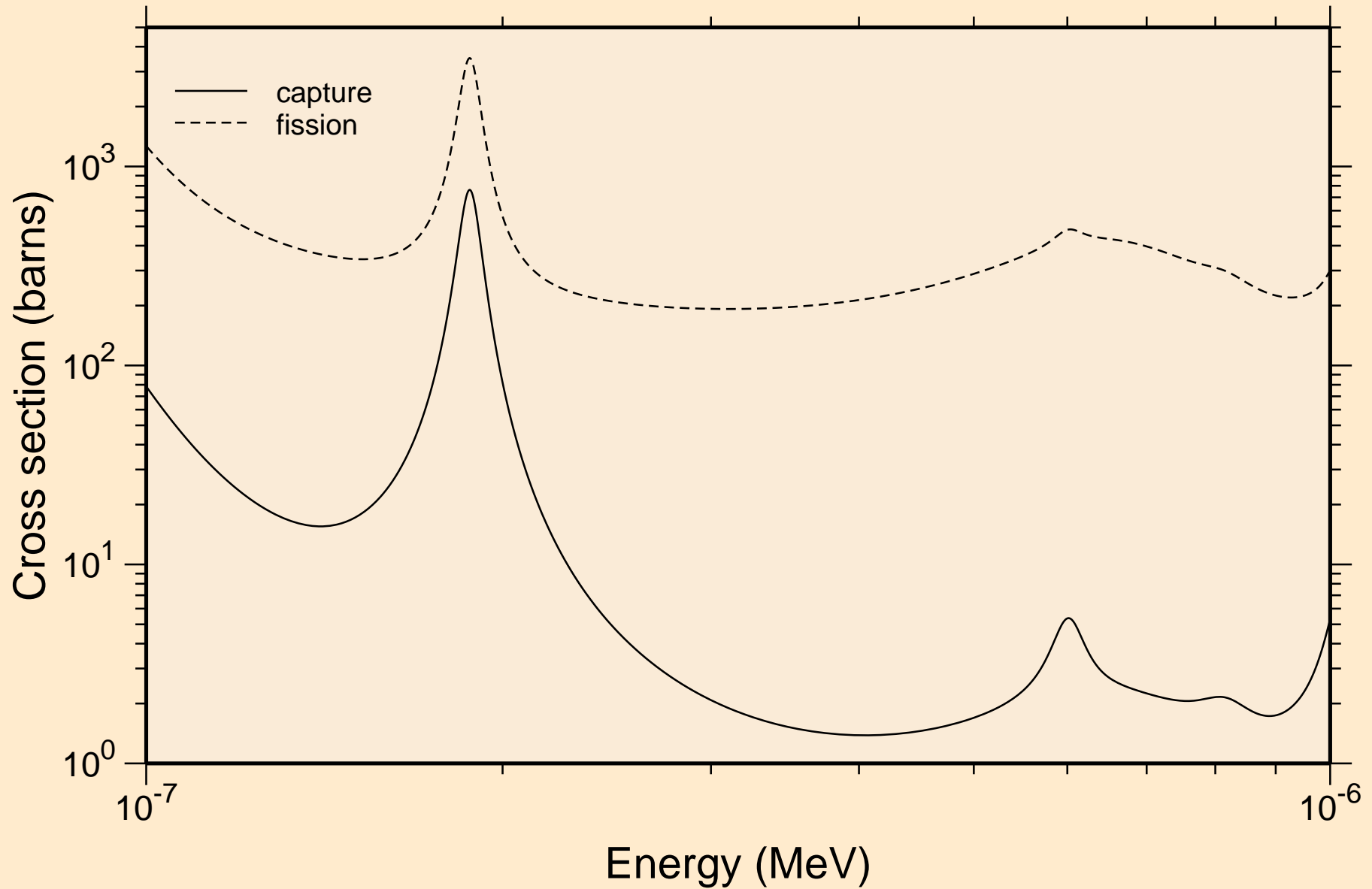

LR258 NEUTRON ACER TENDL-2023 LIBRARY; T=0.K
resonance absorption cross sections

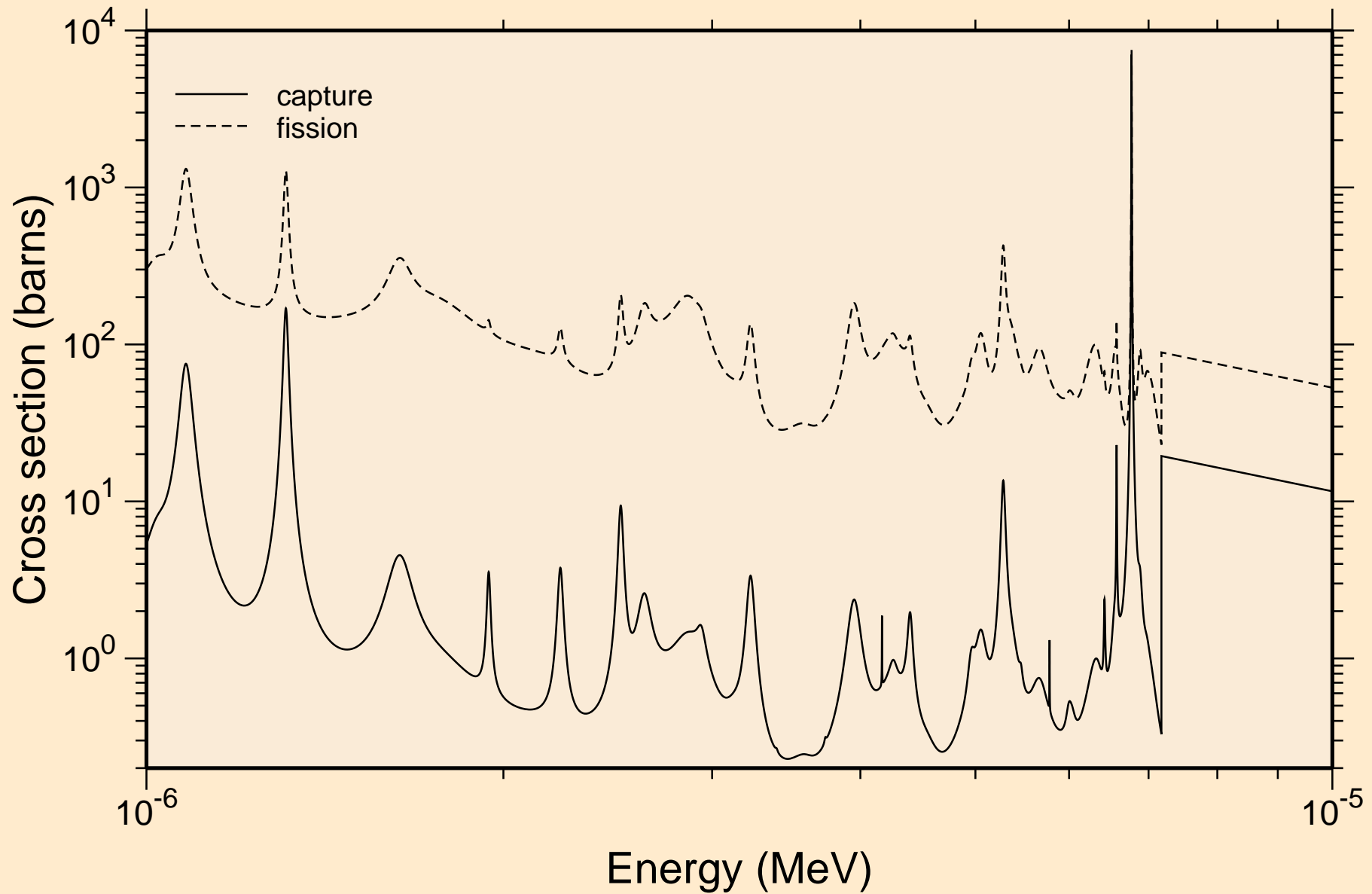

LR258 NEUTRON ACER TENDL-2023 LIBRARY; T=0.K
resonance absorption cross sections

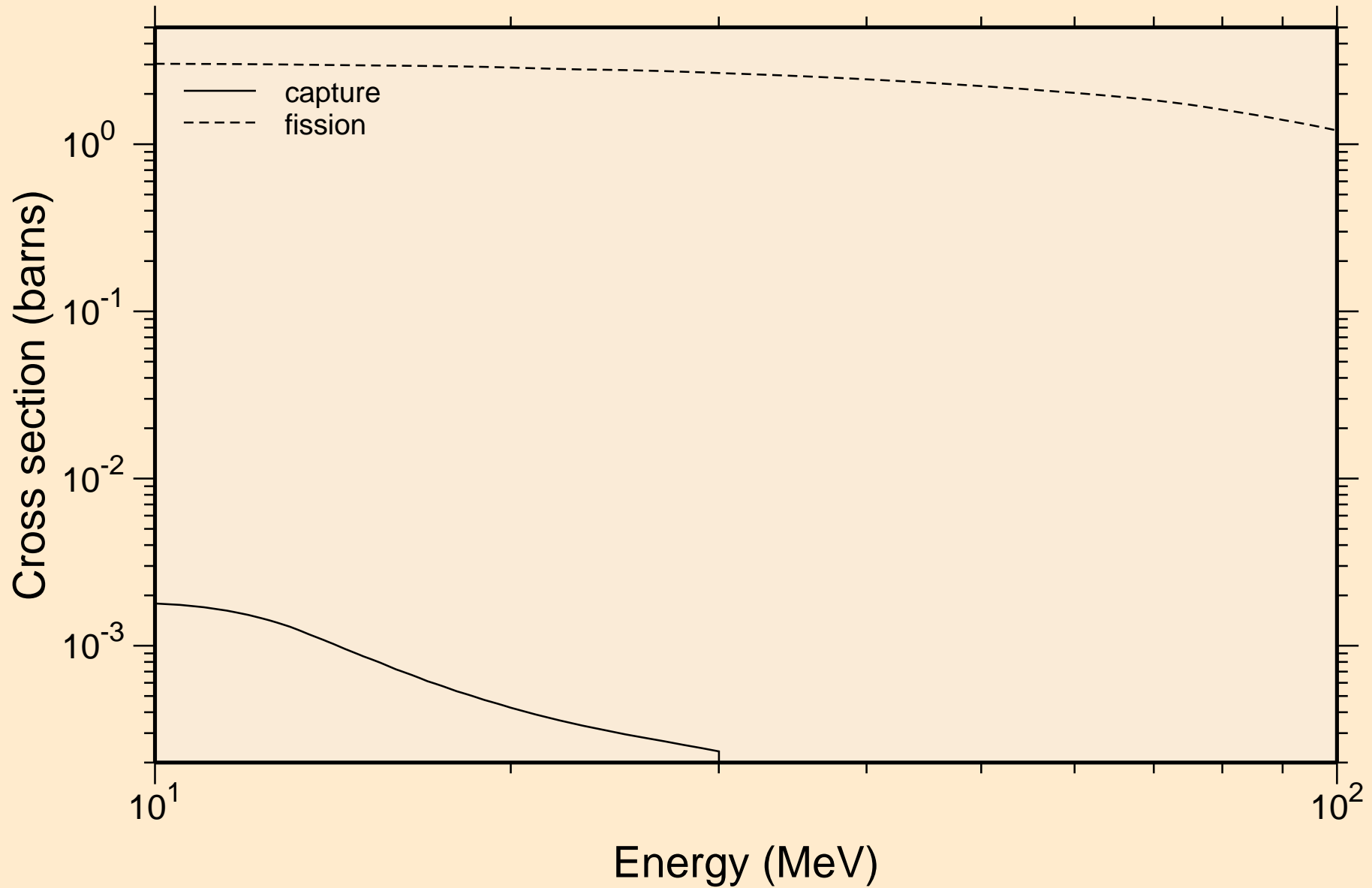

LR258 NEUTRON ACER TENDL-2023 LIBRARY; T=0.K

Heating

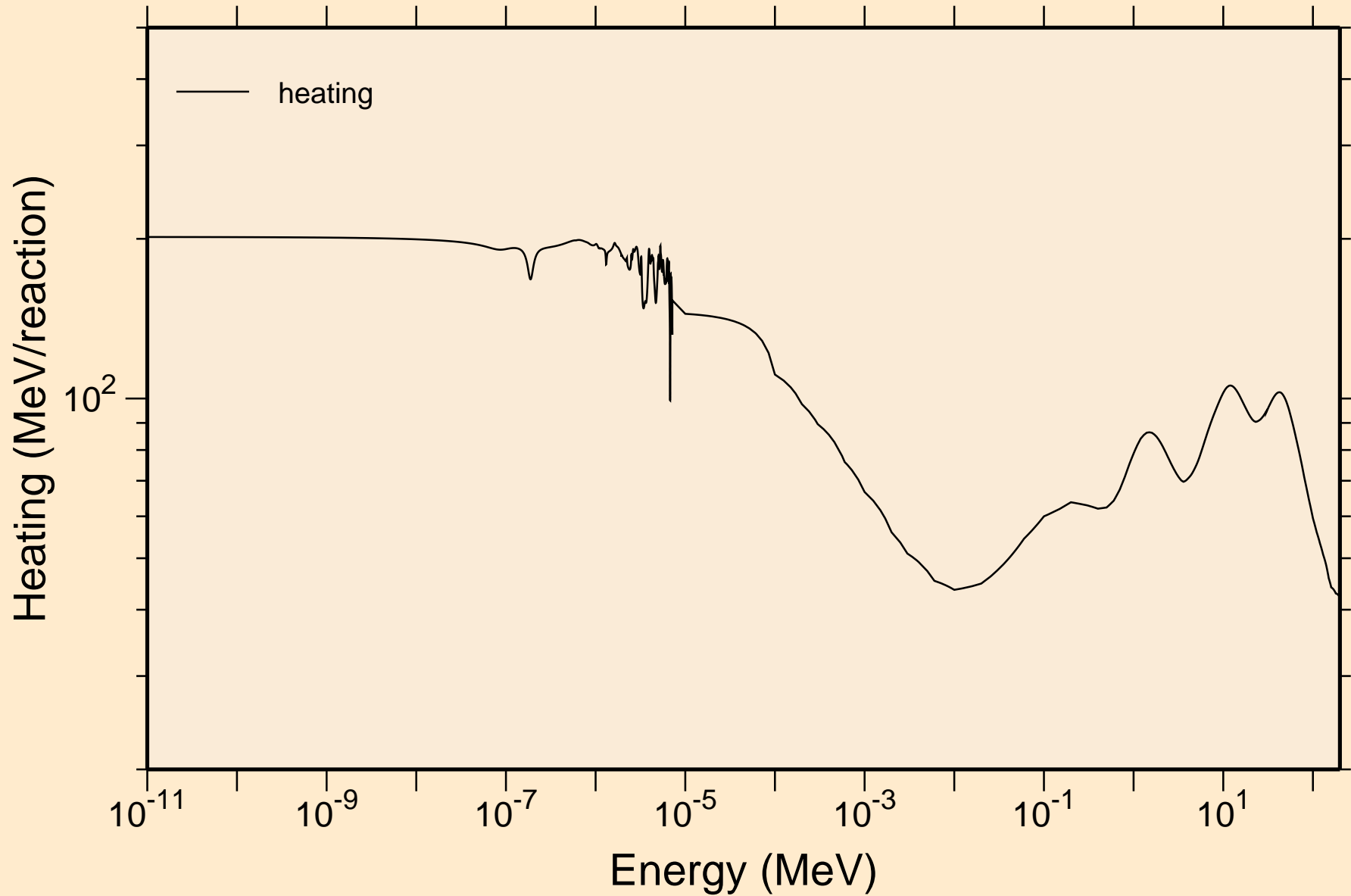

LR258 NEUTRON ACER TENDL-2023 LIBRARY; T=0.K
Damage

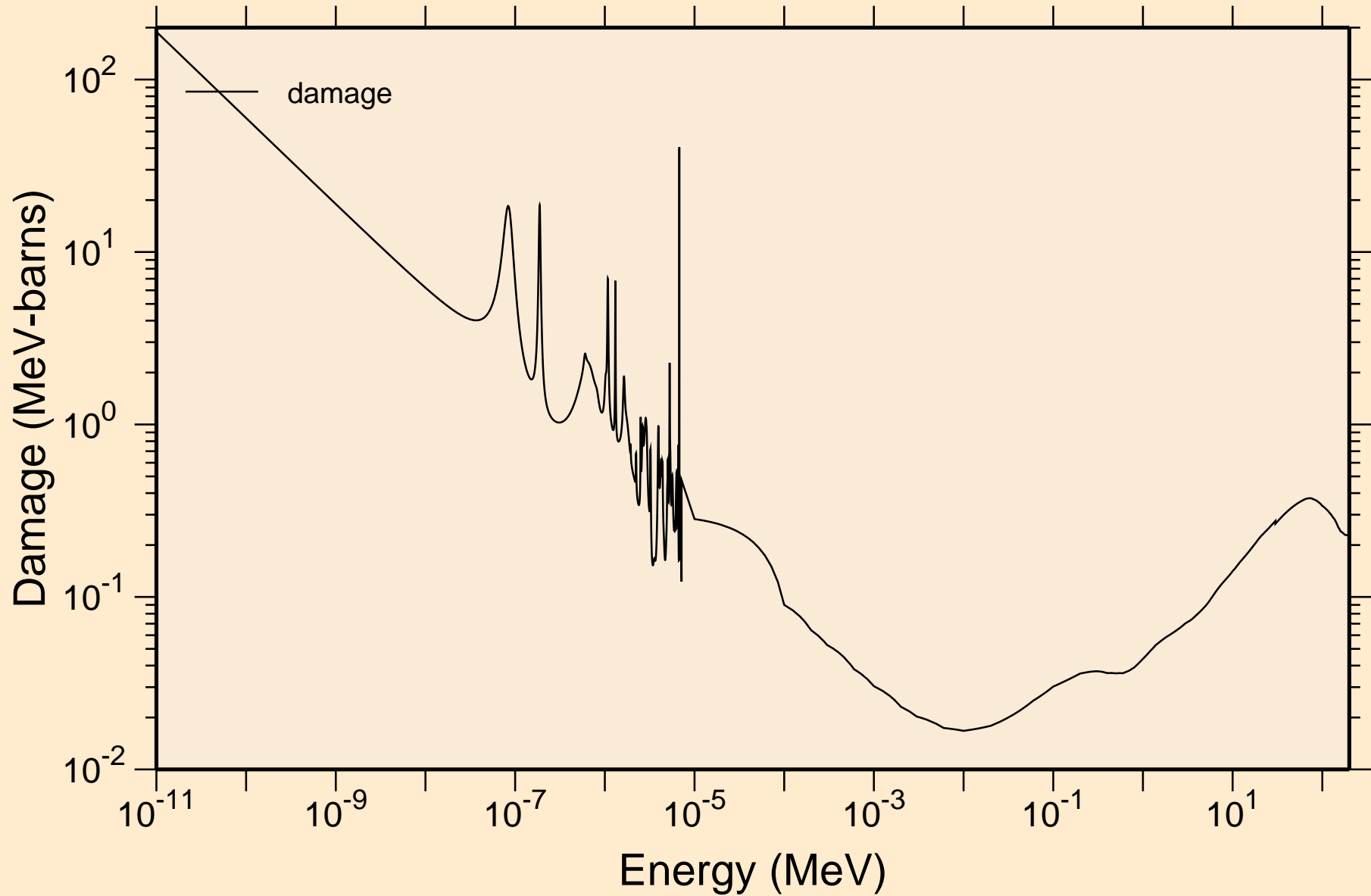

LR258 NEUTRON ACER TENDL-2023 LIBRARY; T=0.K

Non-threshold reactions

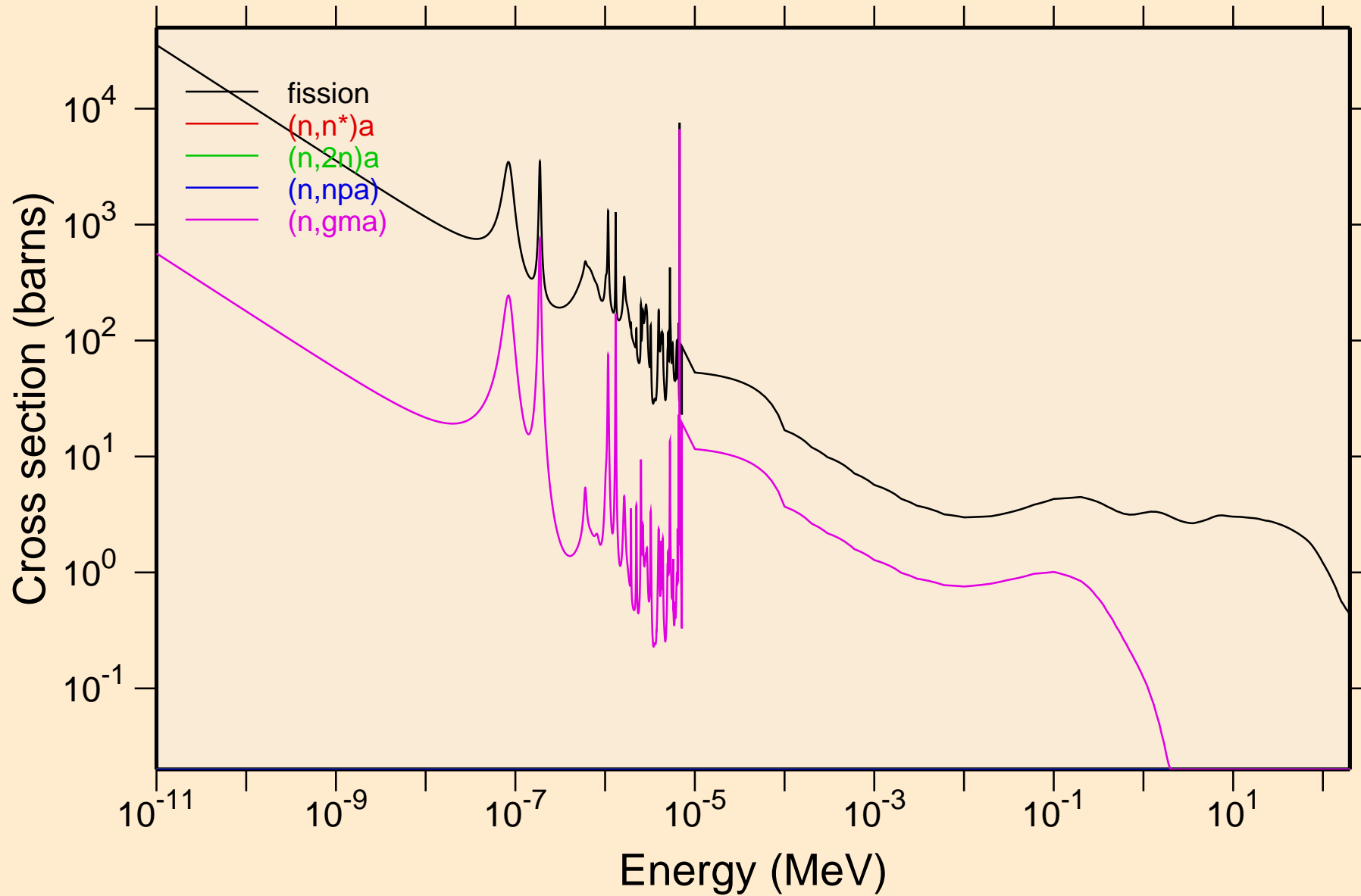

LR258 NEUTRON ACER TENDL-2023 LIBRARY; T=0.K
Non-threshold reactions

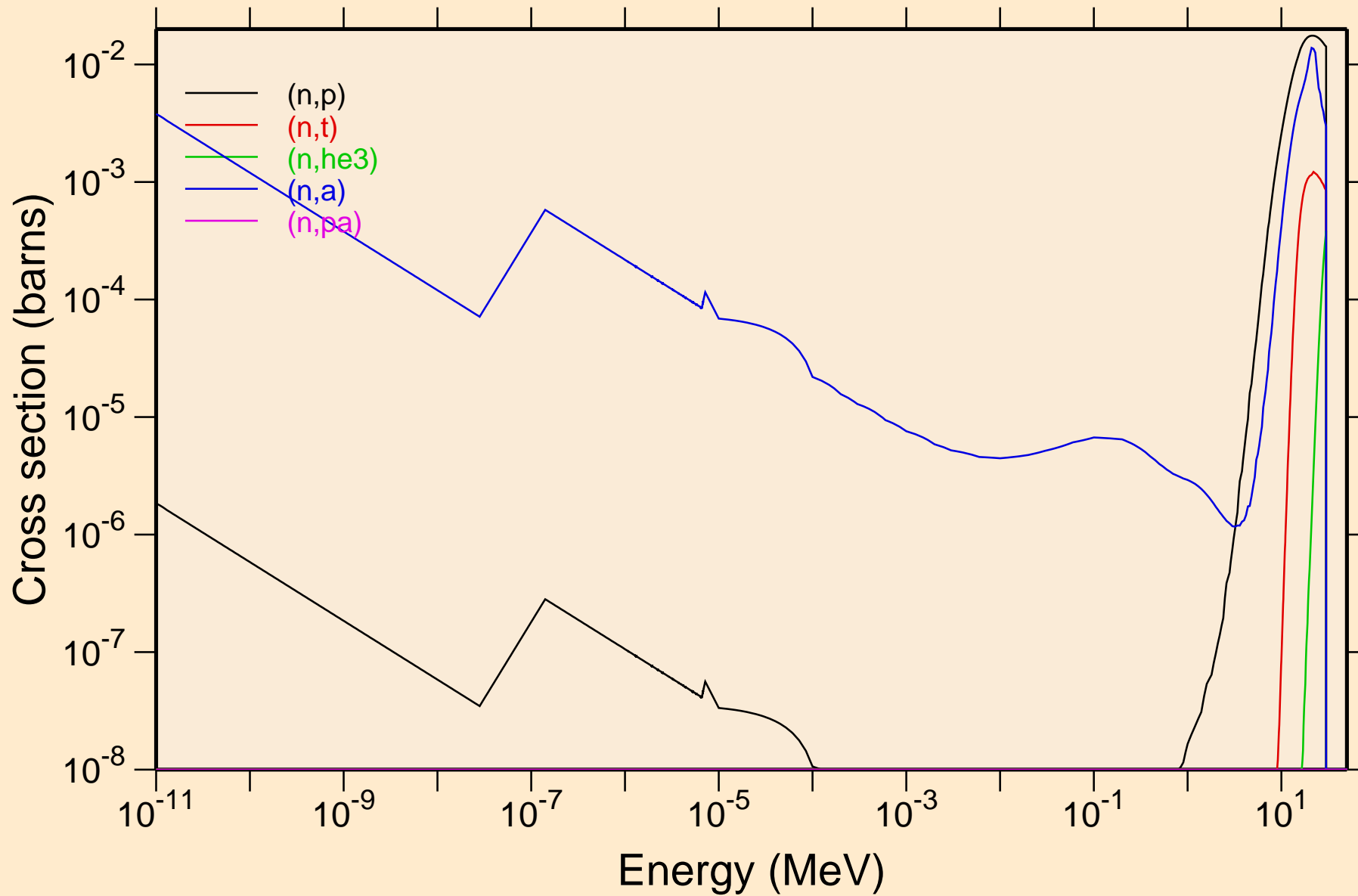

LR258 NEUTRON ACER TENDL-2023 LIBRARY; T=0.K
Non-threshold reactions

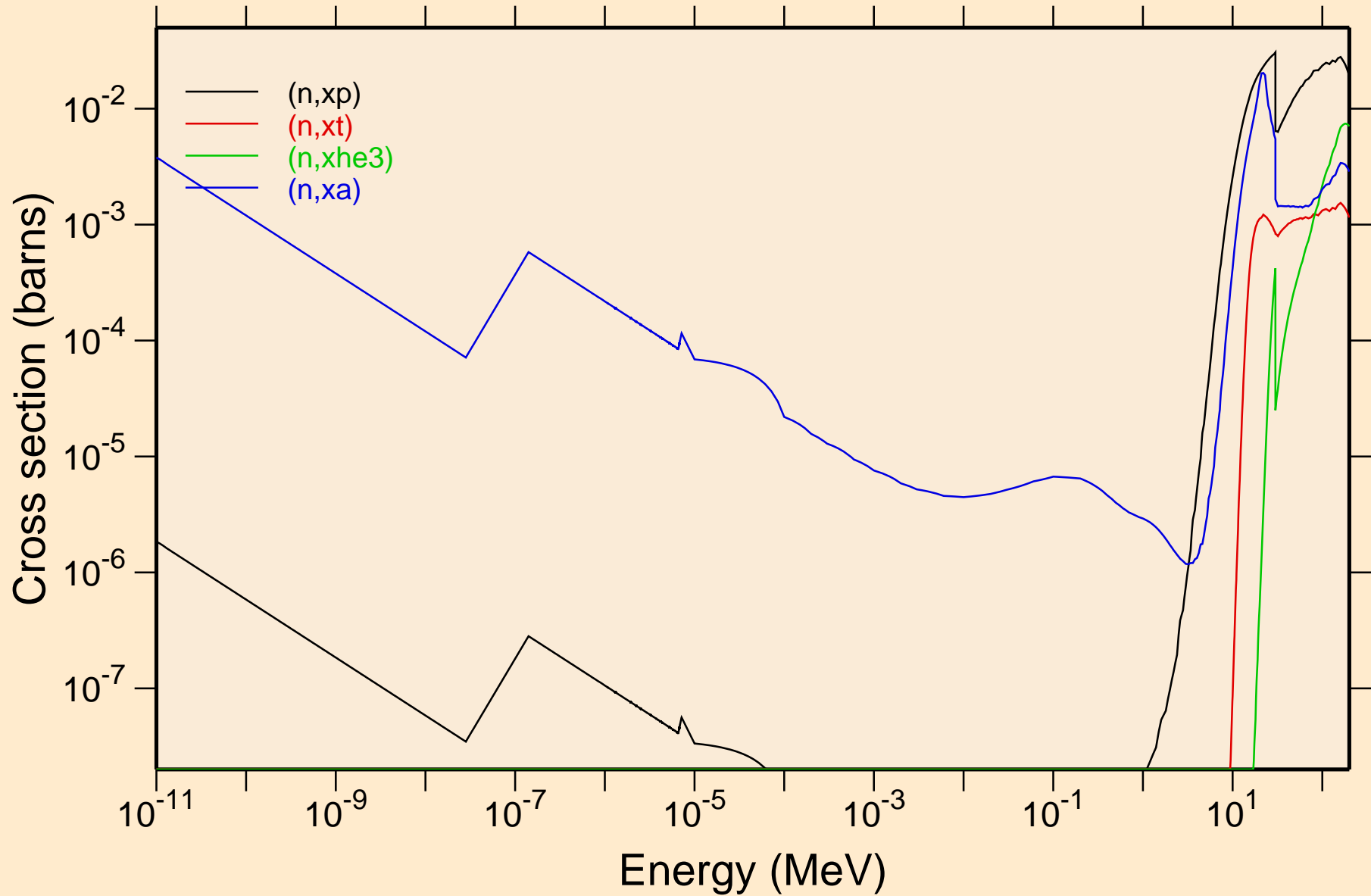

LR258 NEUTRON ACER TENDL-2023 LIBRARY; T=0.K

Principal cross sections

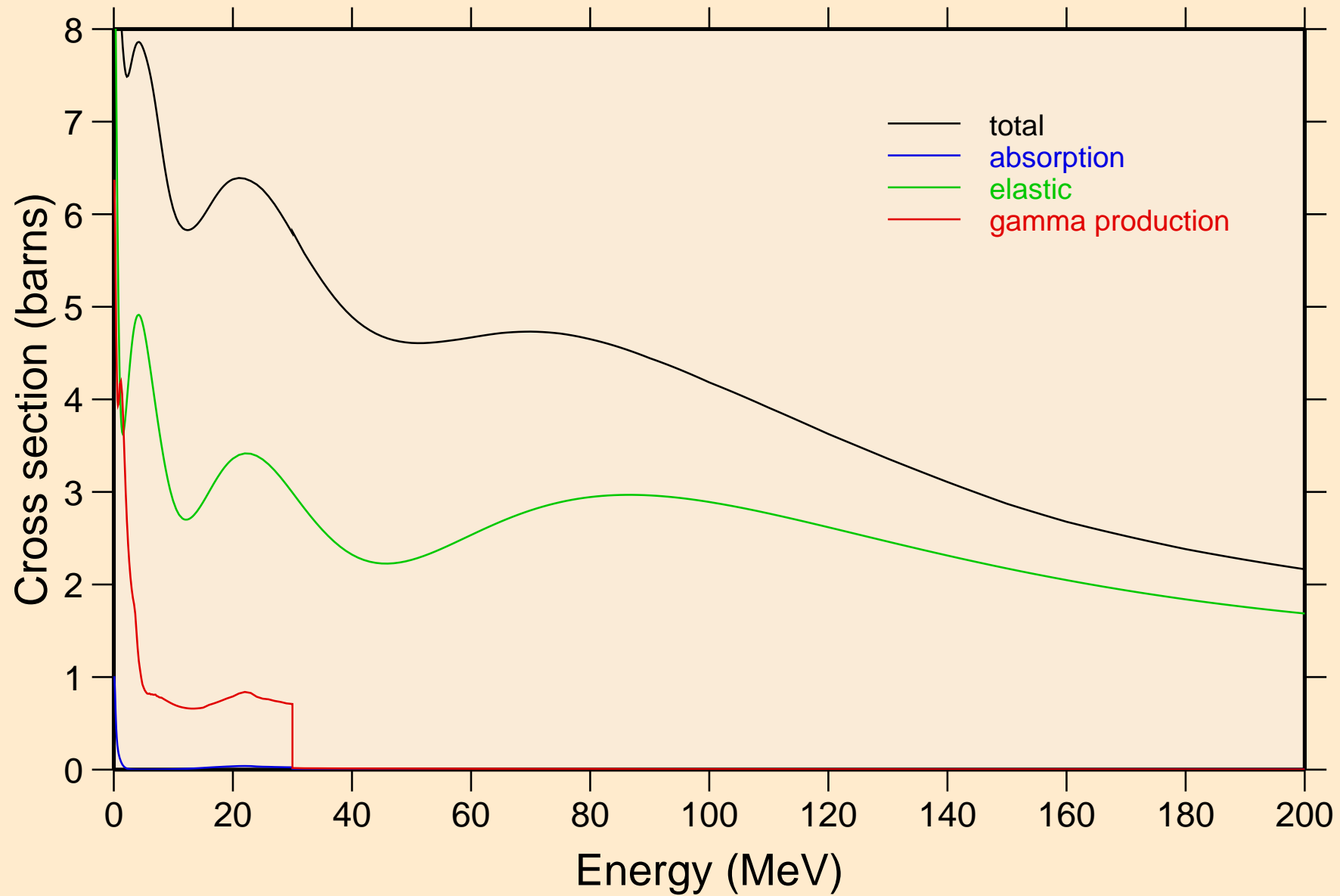

LR258 NEUTRON ACER TENDL-2023 LIBRARY; T=0.K

Heating

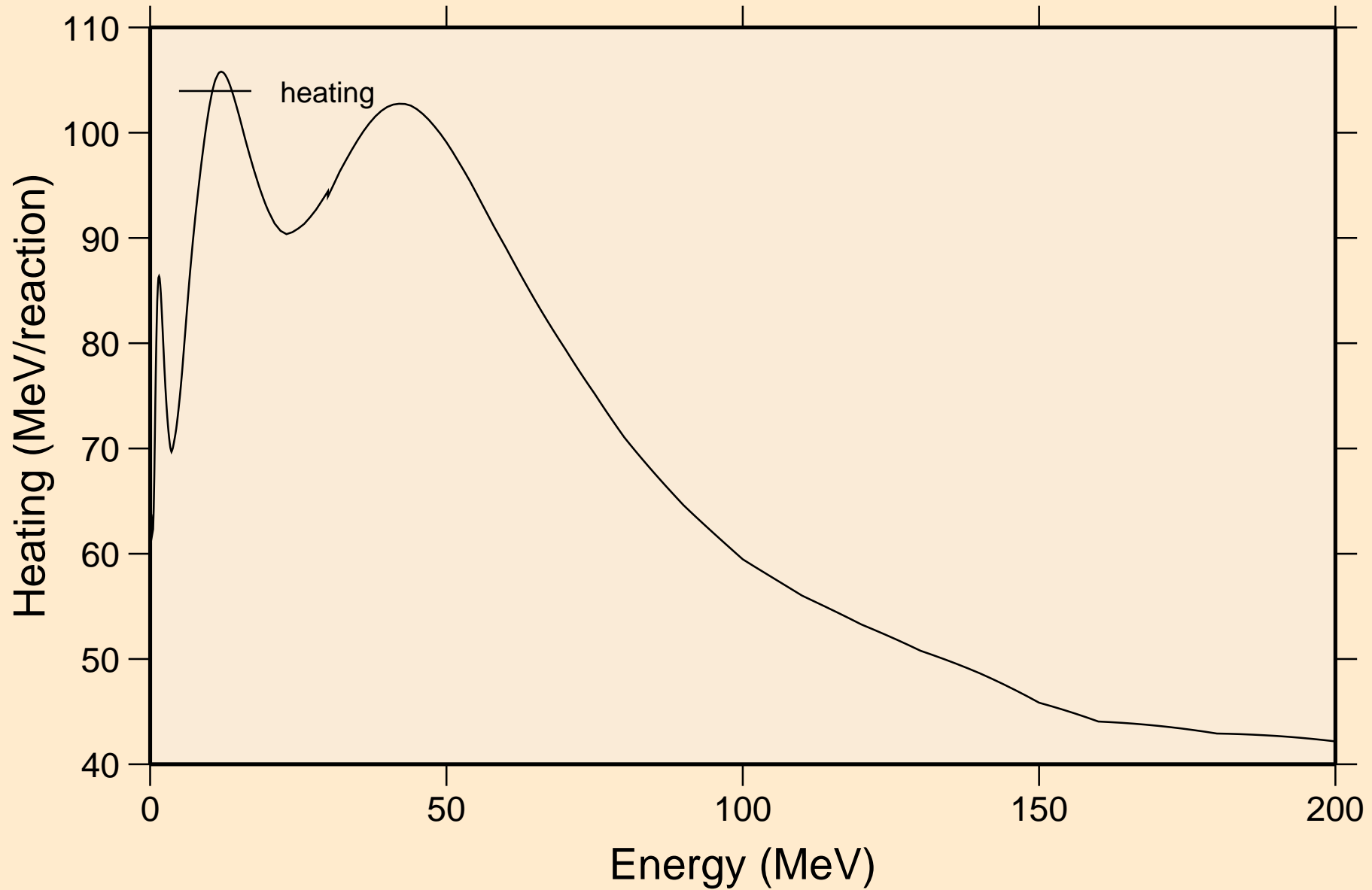

LR258 NEUTRON ACER TENDL-2023 LIBRARY; T=0.K
Damage

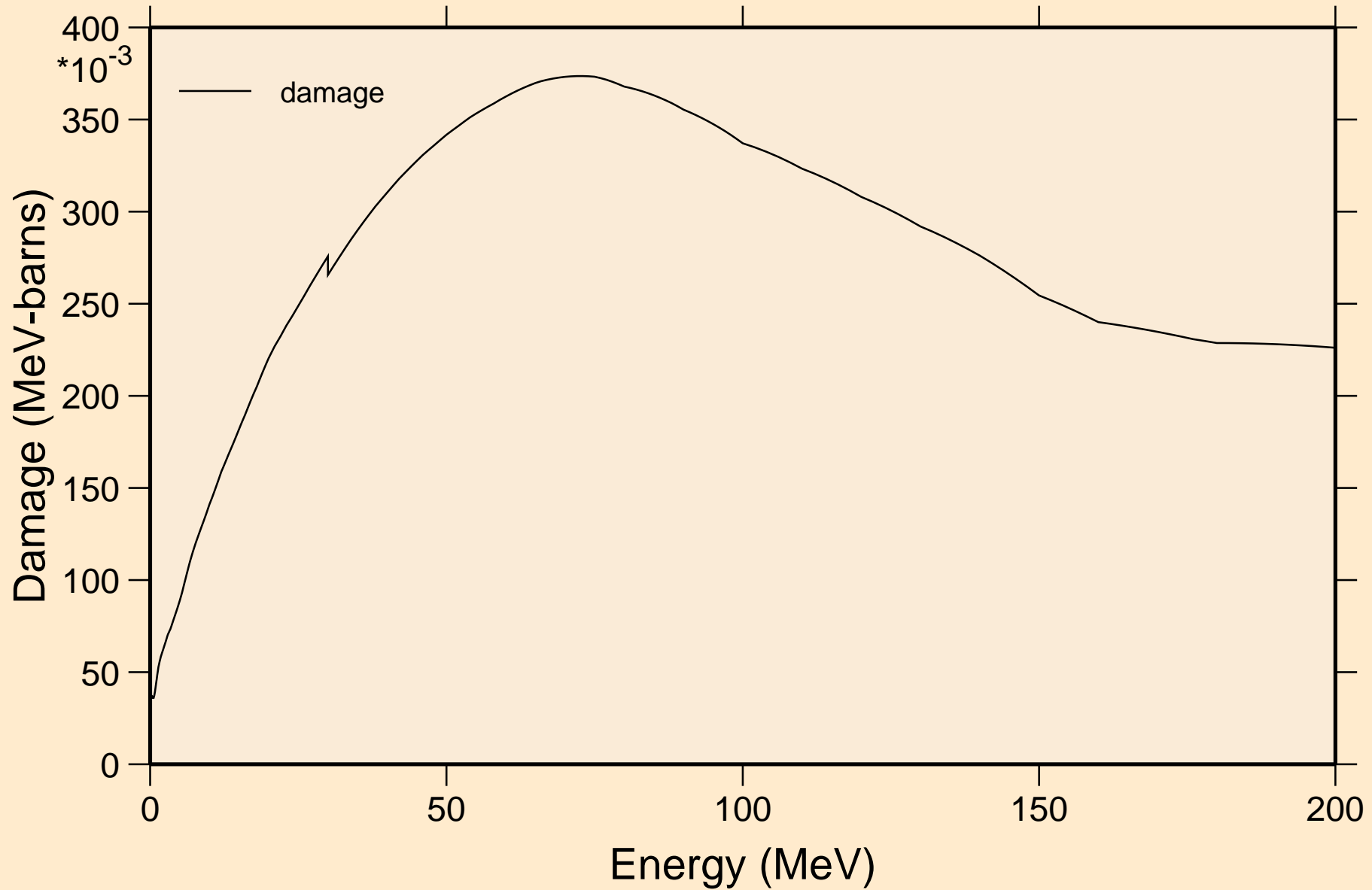

LR258 NEUTRON ACER TENDL-2023 LIBRARY; T=0.K
Non-threshold reactions

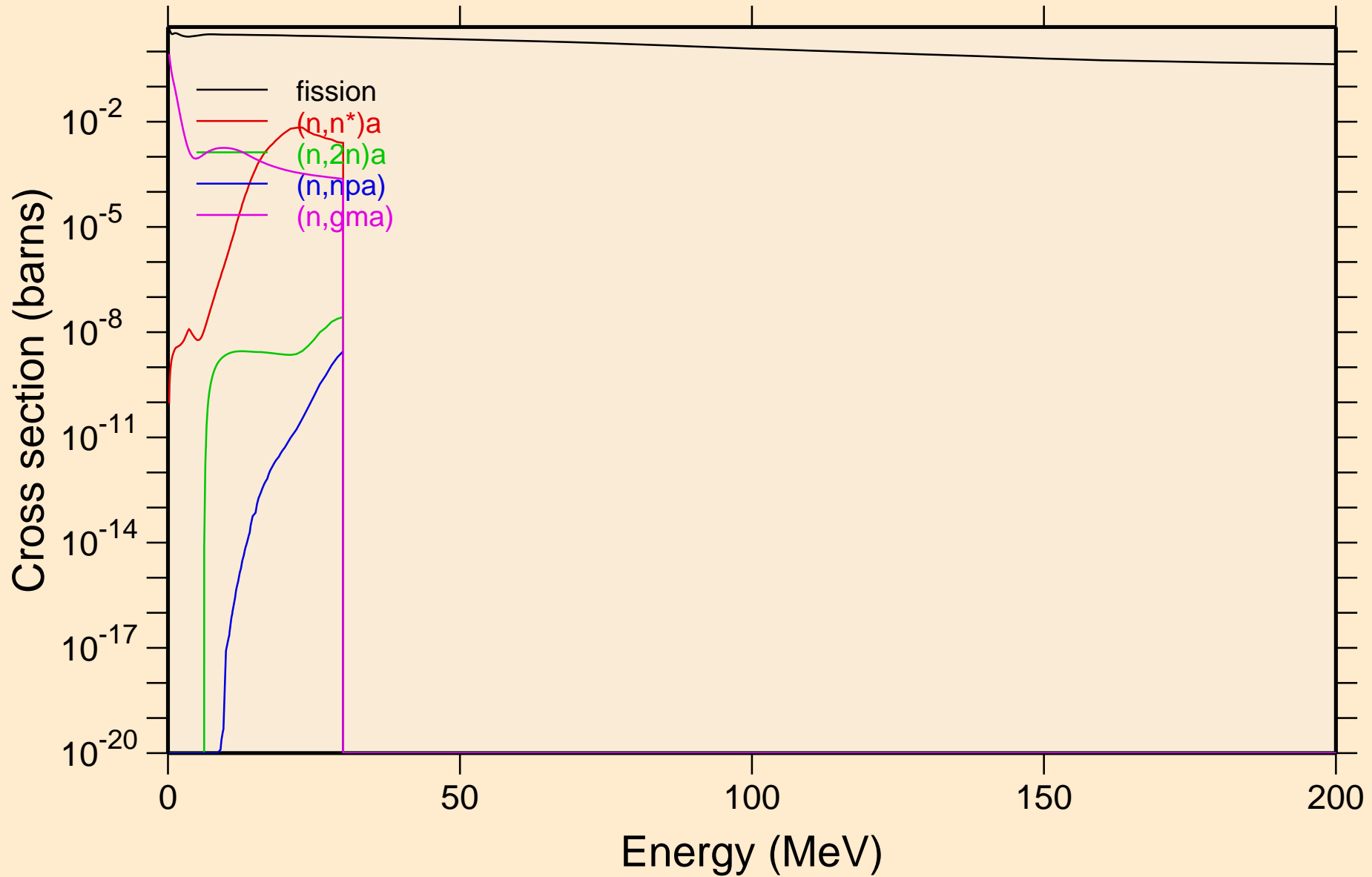

LR258 NEUTRON ACER TENDL-2023 LIBRARY; T=0.K
Non-threshold reactions

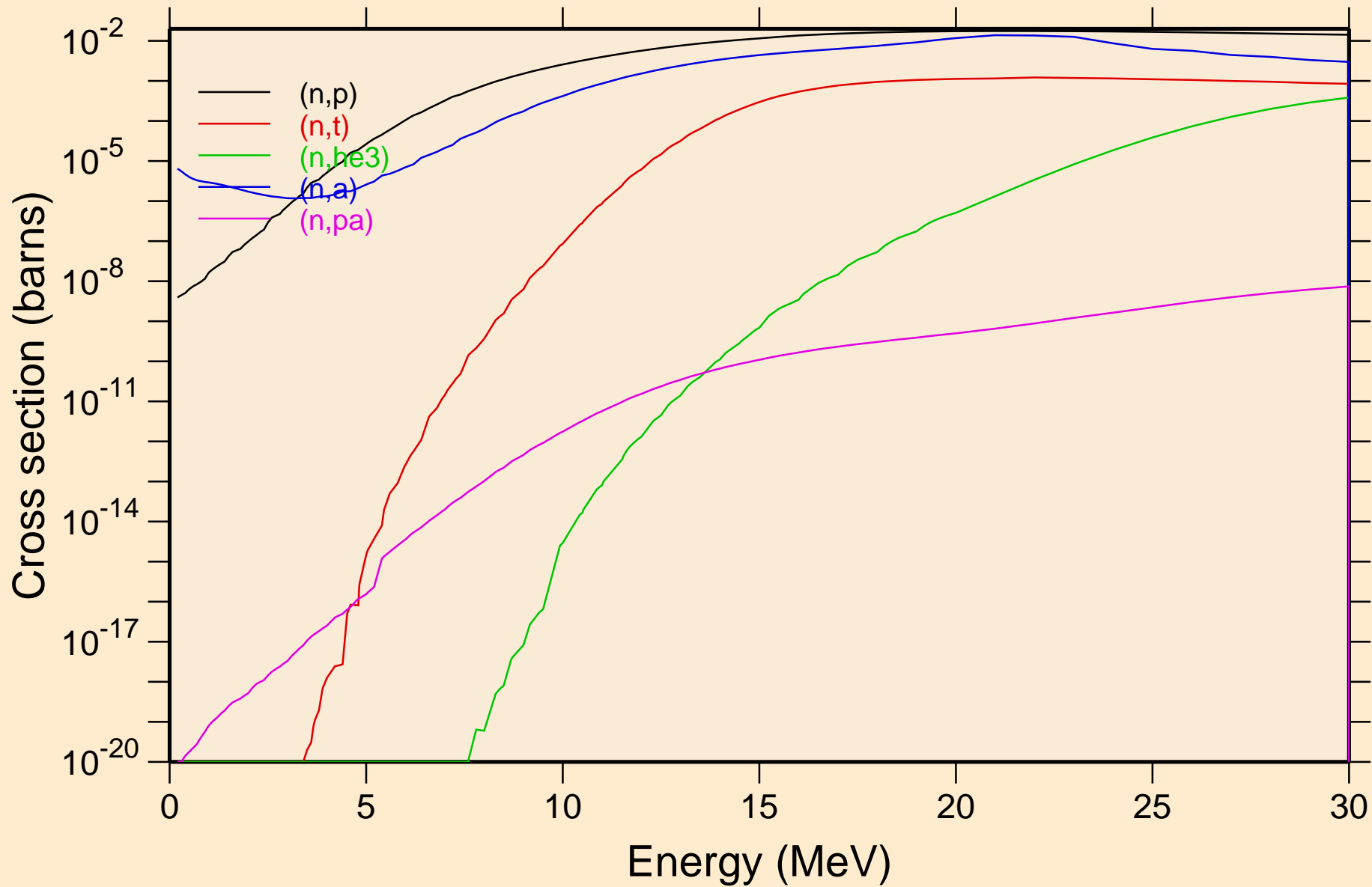

LR258 NEUTRON ACER TENDL-2023 LIBRARY; T=0.K
Non-threshold reactions

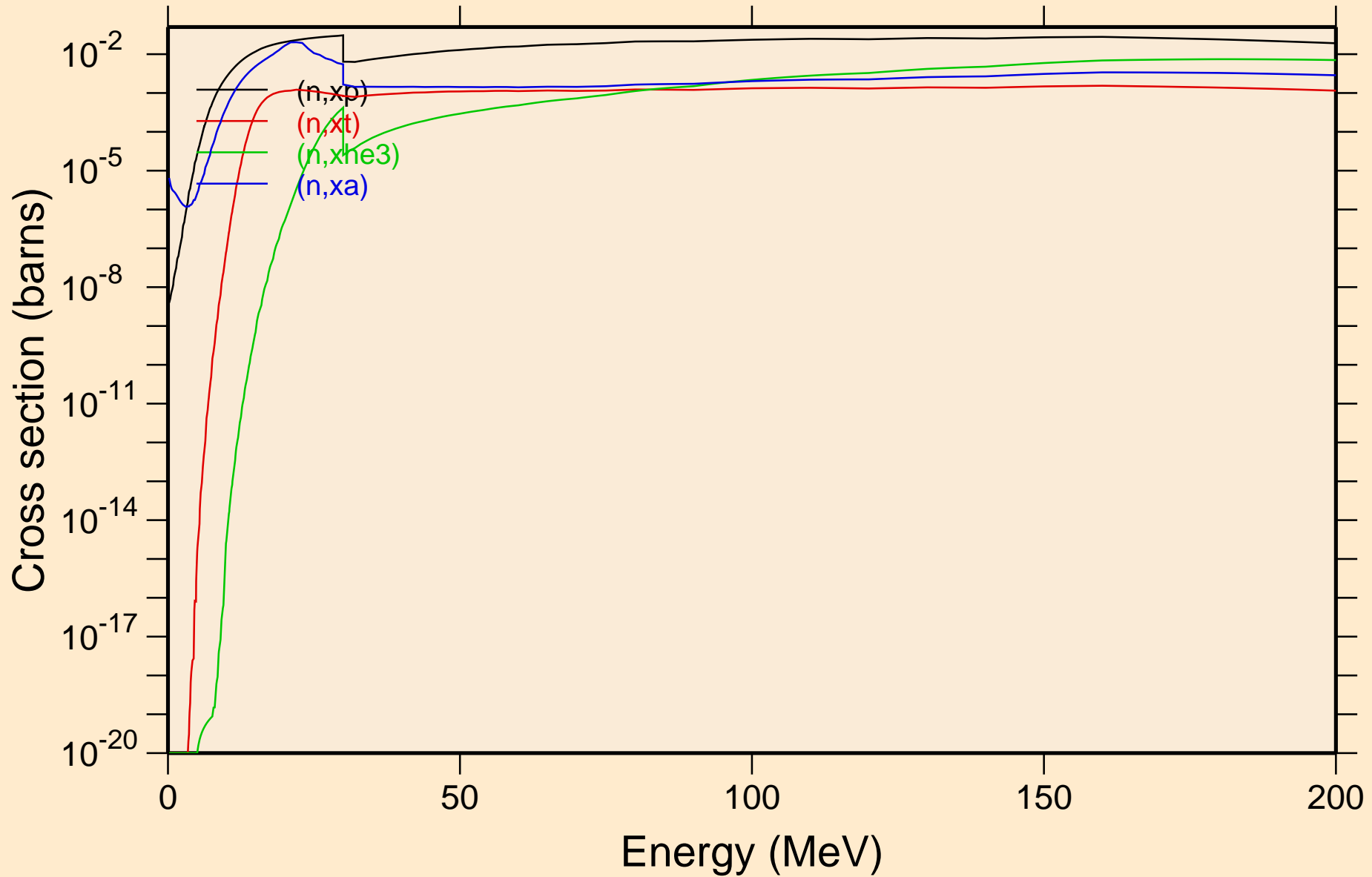

LR258 NEUTRON ACER TENDL-2023 LIBRARY; T=0.K
Inelastic levels

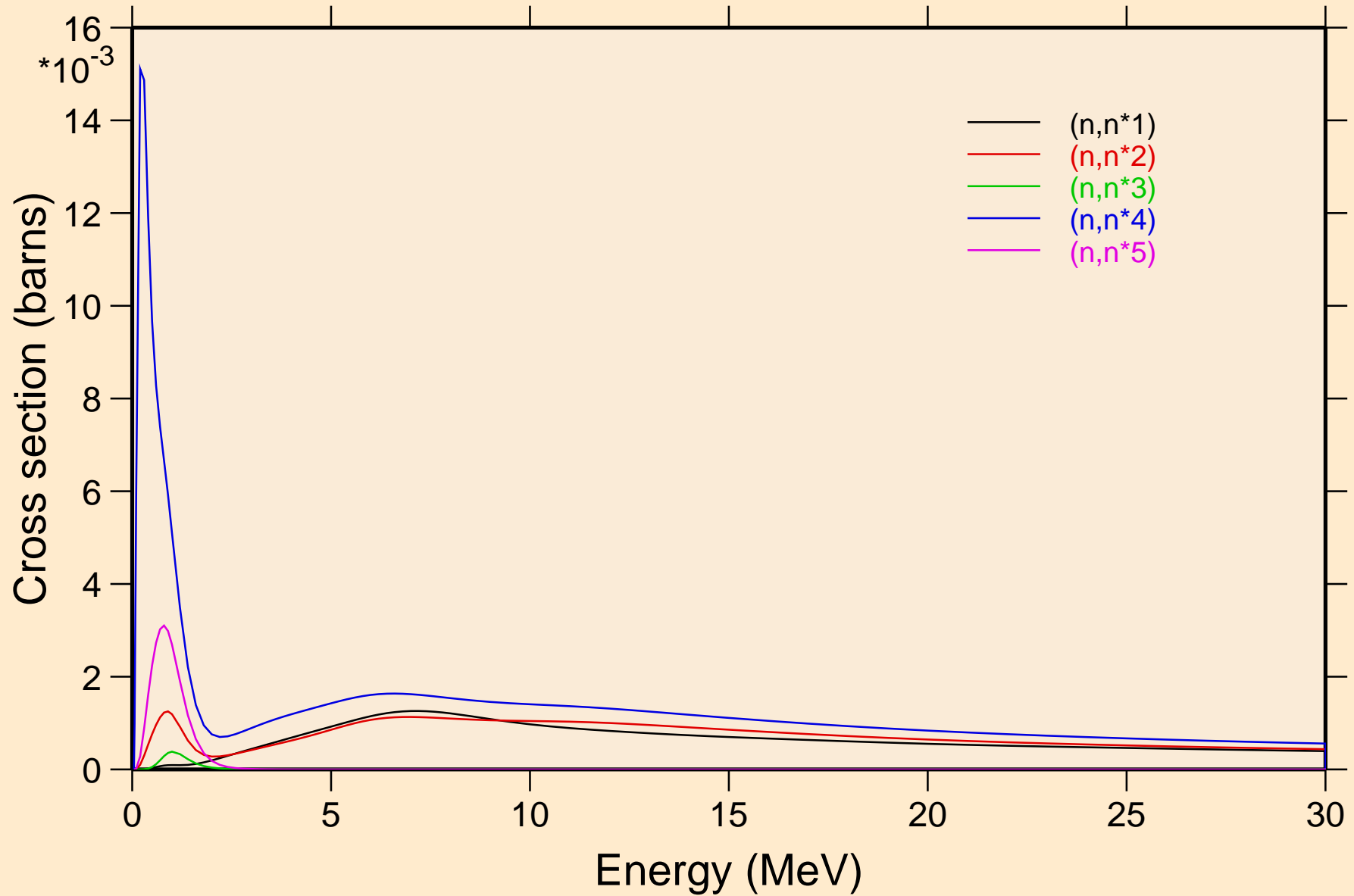

LR258 NEUTRON ACER TENDL-2023 LIBRARY; T=0.K
Inelastic levels

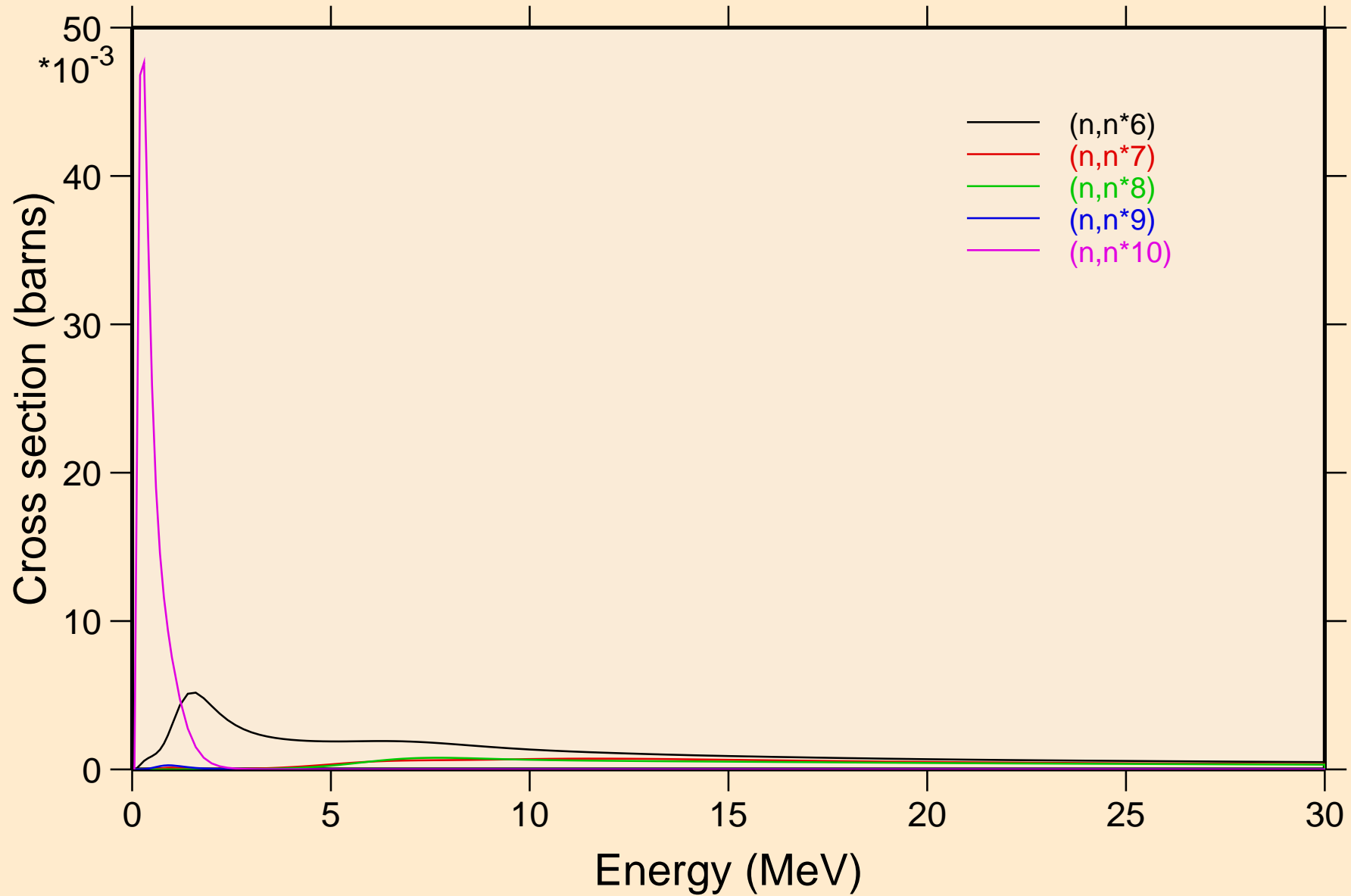

LR258 NEUTRON ACER TENDL-2023 LIBRARY; T=0.K
Inelastic levels

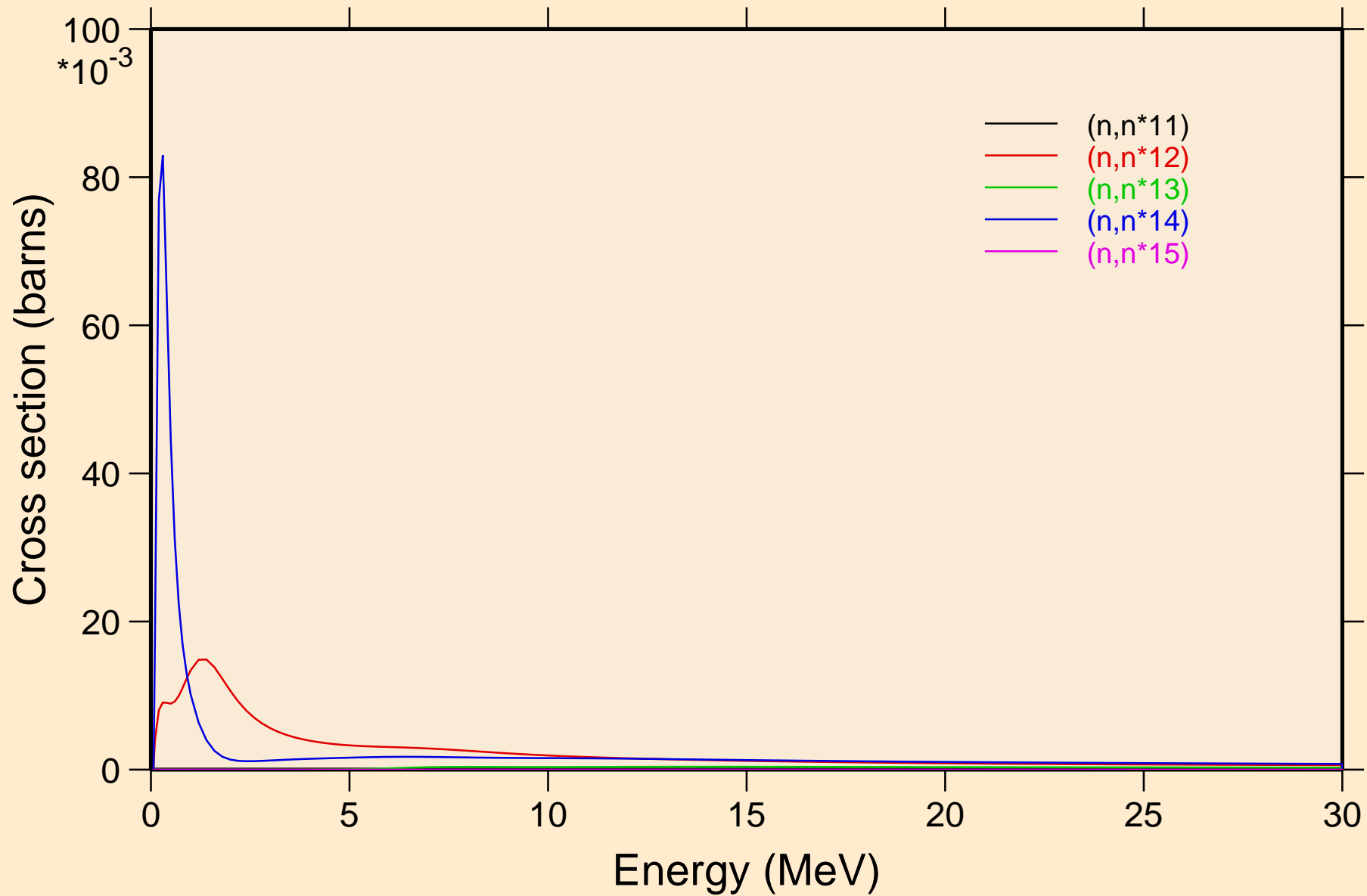

LR258 NEUTRON ACER TENDL-2023 LIBRARY; T=0.K
Inelastic levels

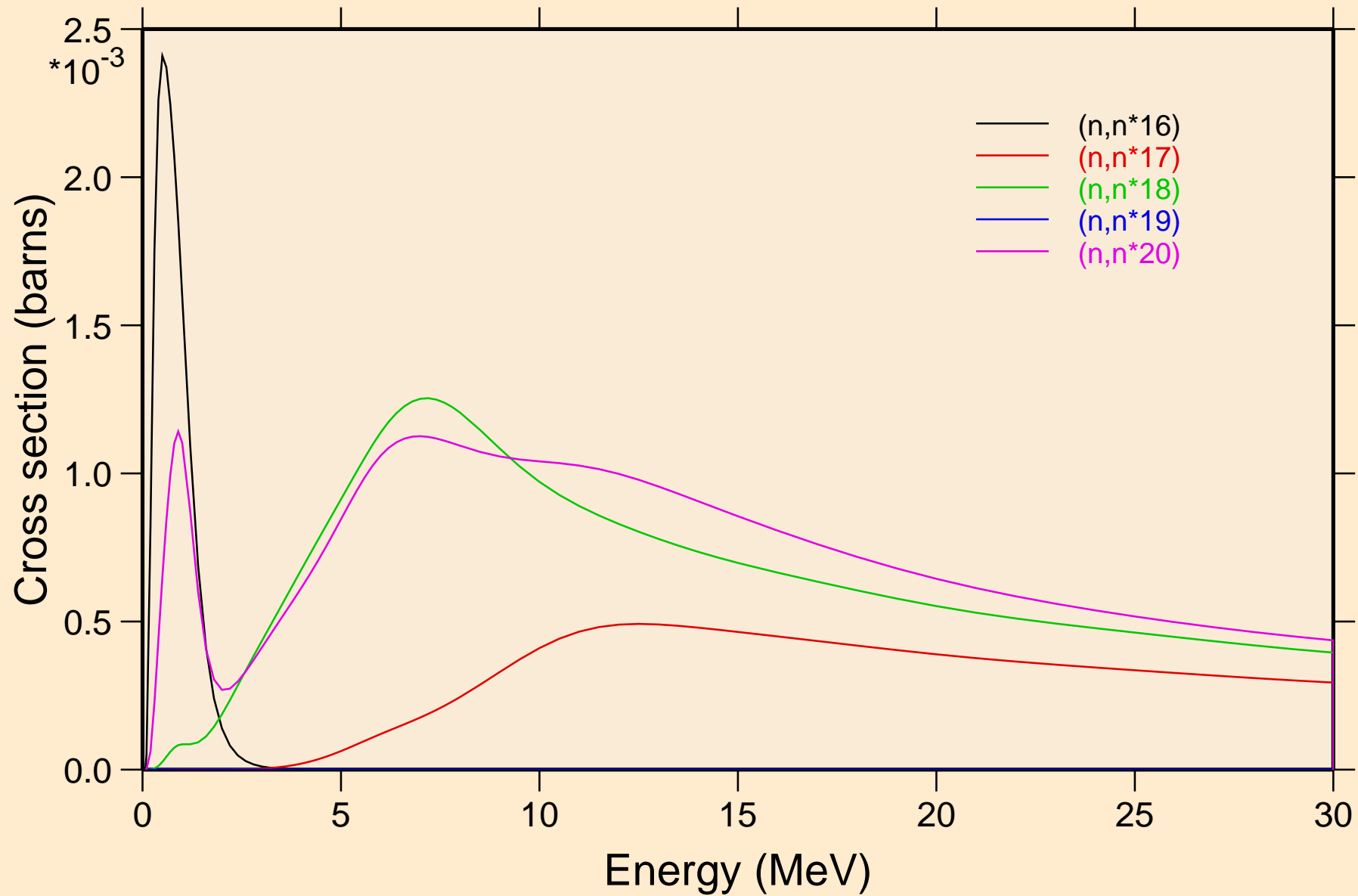

LR258 NEUTRON ACER TENDL-2023 LIBRARY; T=0.K
Inelastic levels

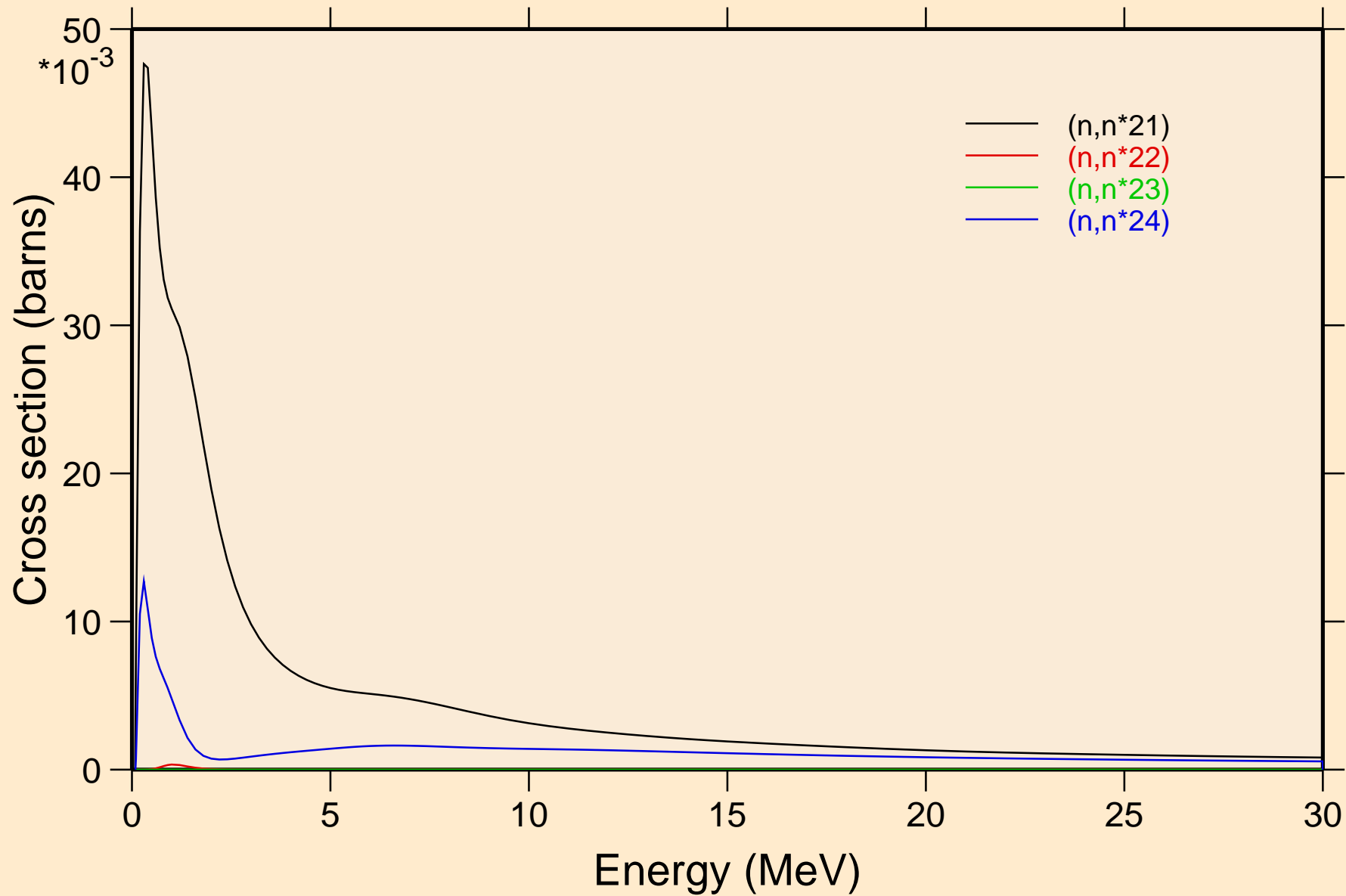

LR258 NEUTRON ACER TENDL-2023 LIBRARY; T=0.K

Threshold reactions

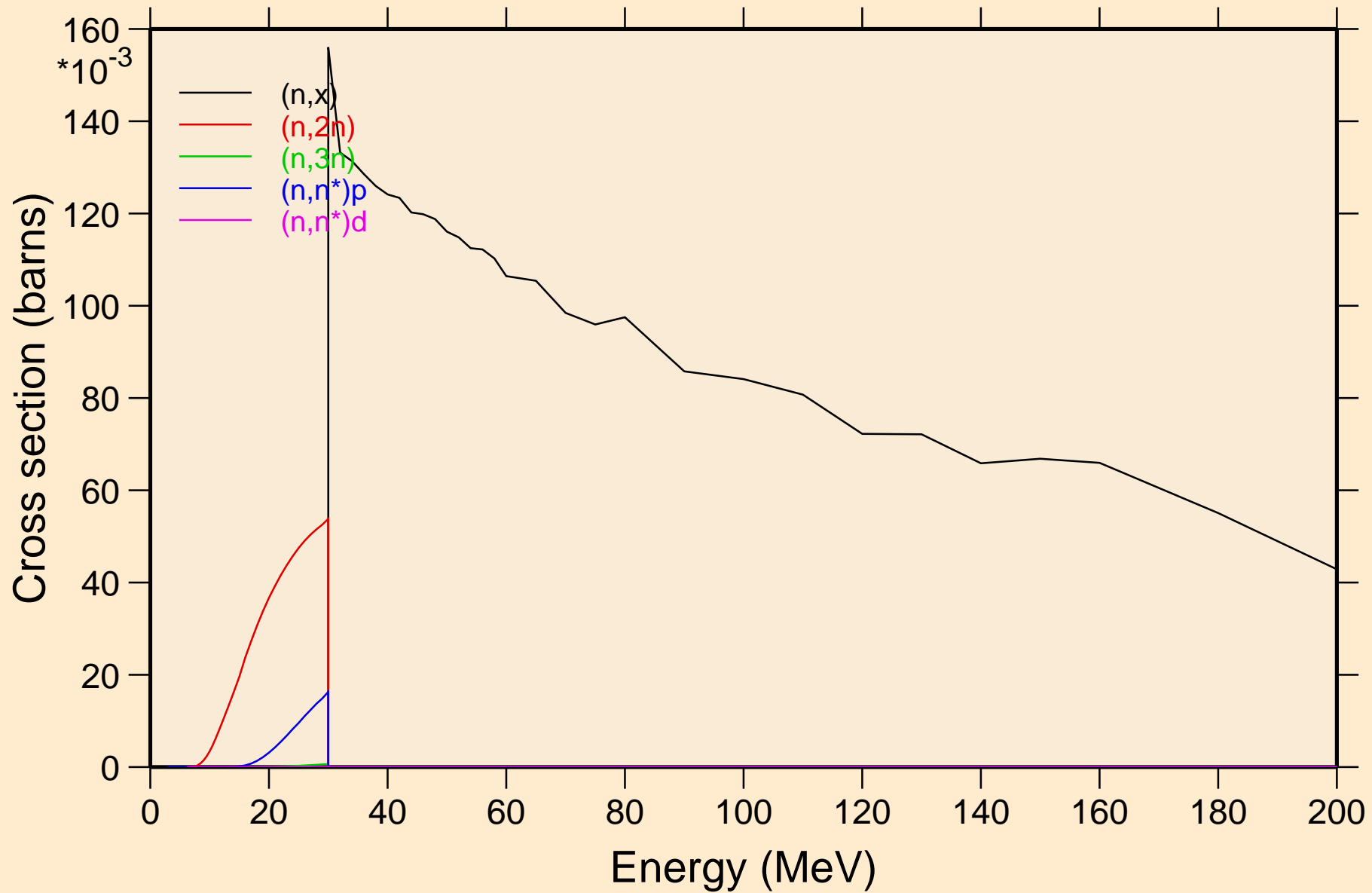

LR258 NEUTRON ACER TENDL-2023 LIBRARY; T=0.K

Threshold reactions

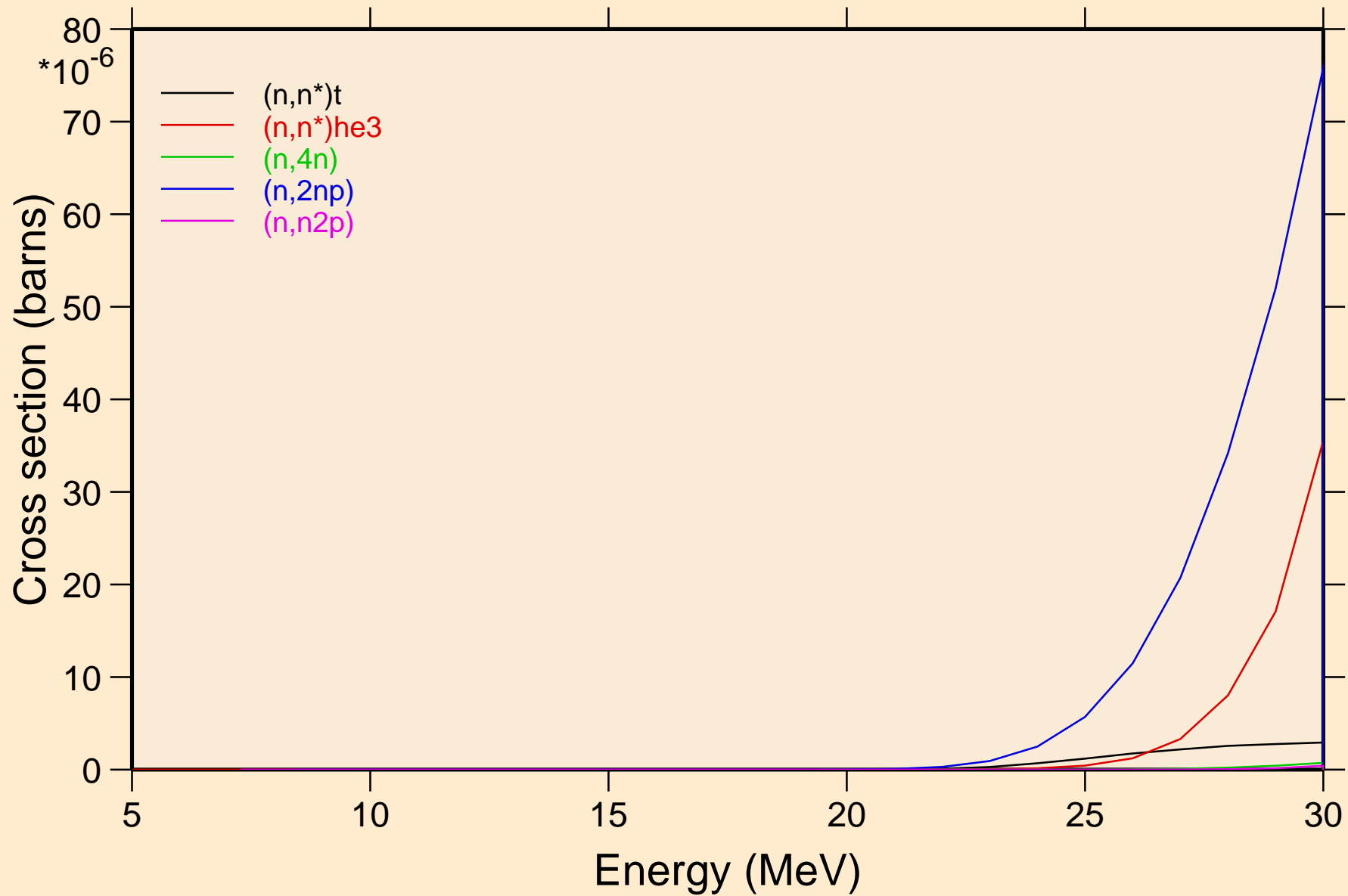

LR258 NEUTRON ACER TENDL-2023 LIBRARY; T=0.K
Threshold reactions

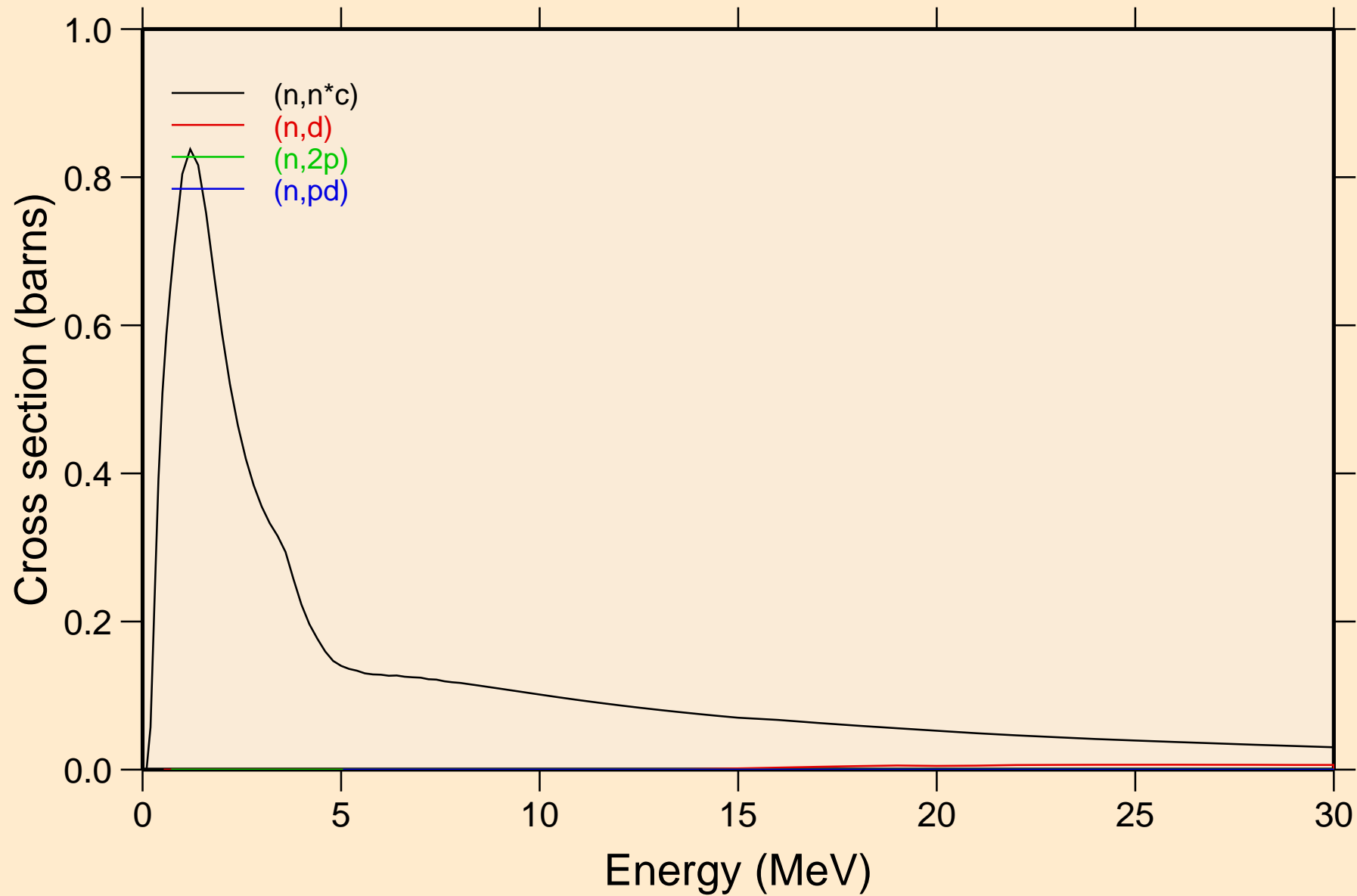

LR258 NEUTRON ACER TENDL-2023 LIBRARY; T=0.K
Threshold reactions

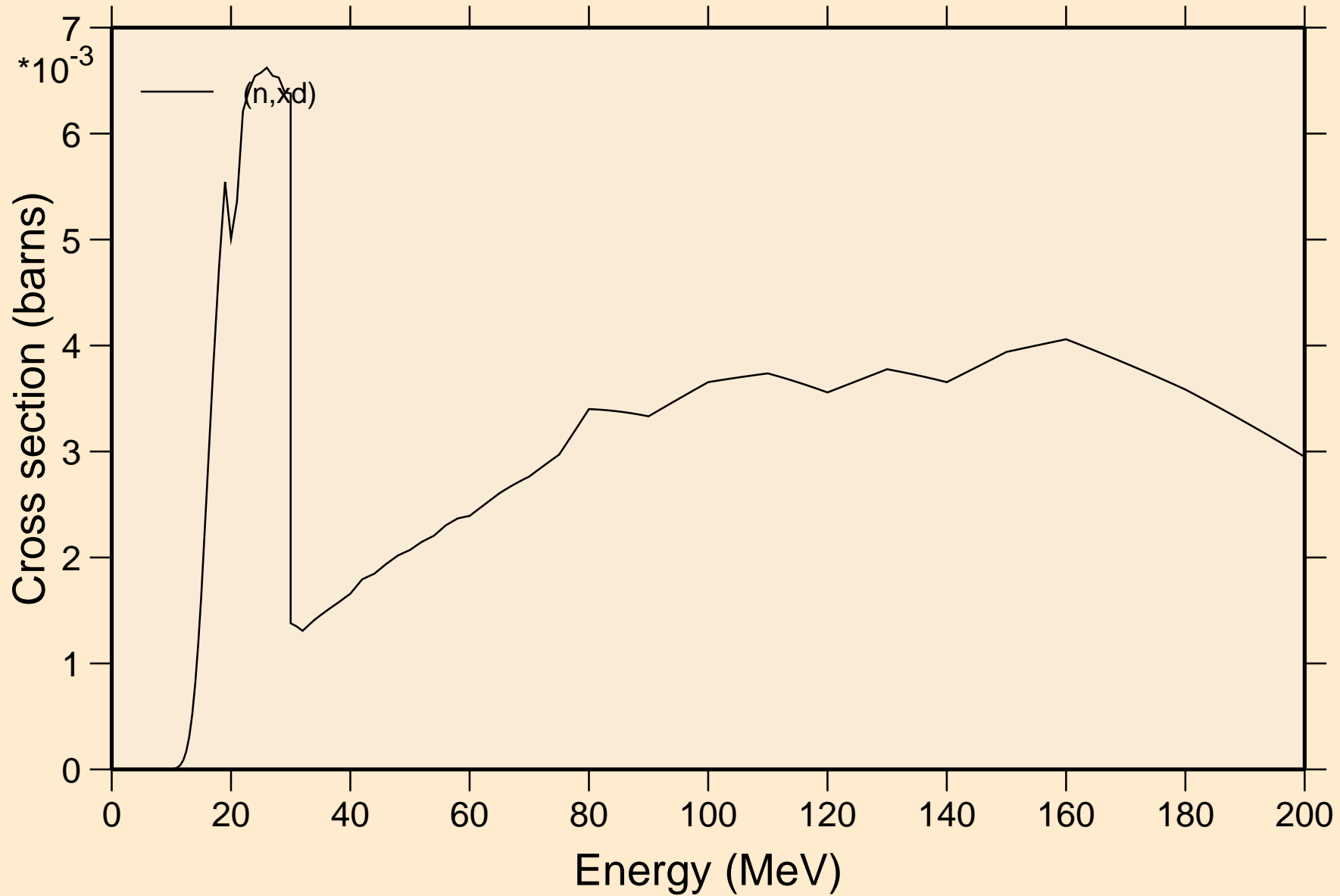

LR258 NEUTRON ACER TENDL-2023 LIBRARY; T=0.K
angular distribution for elastic

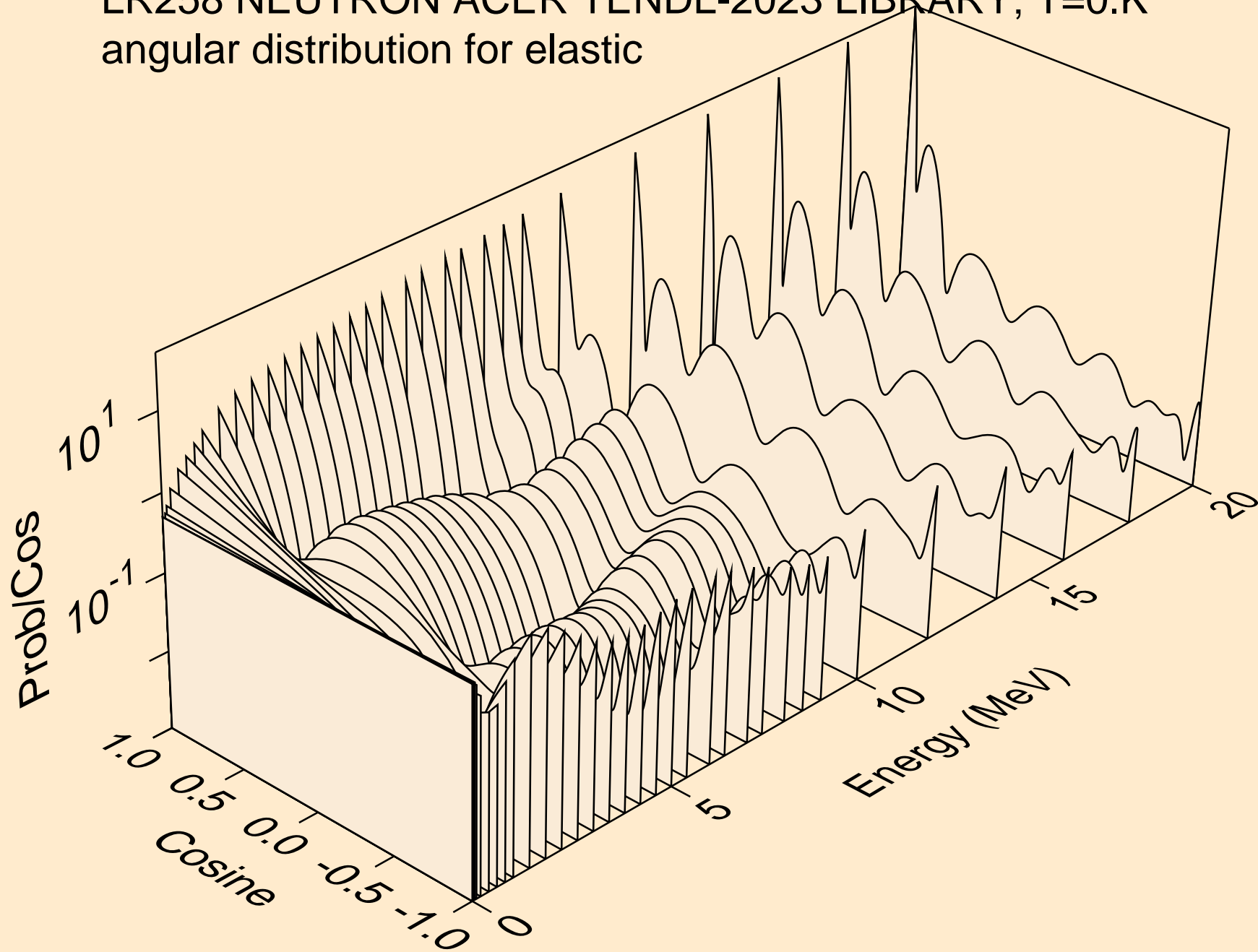

LR258 NEUTRON ACER TENDL-2023 LIBRARY; T=0.K
angular distribution for elastic

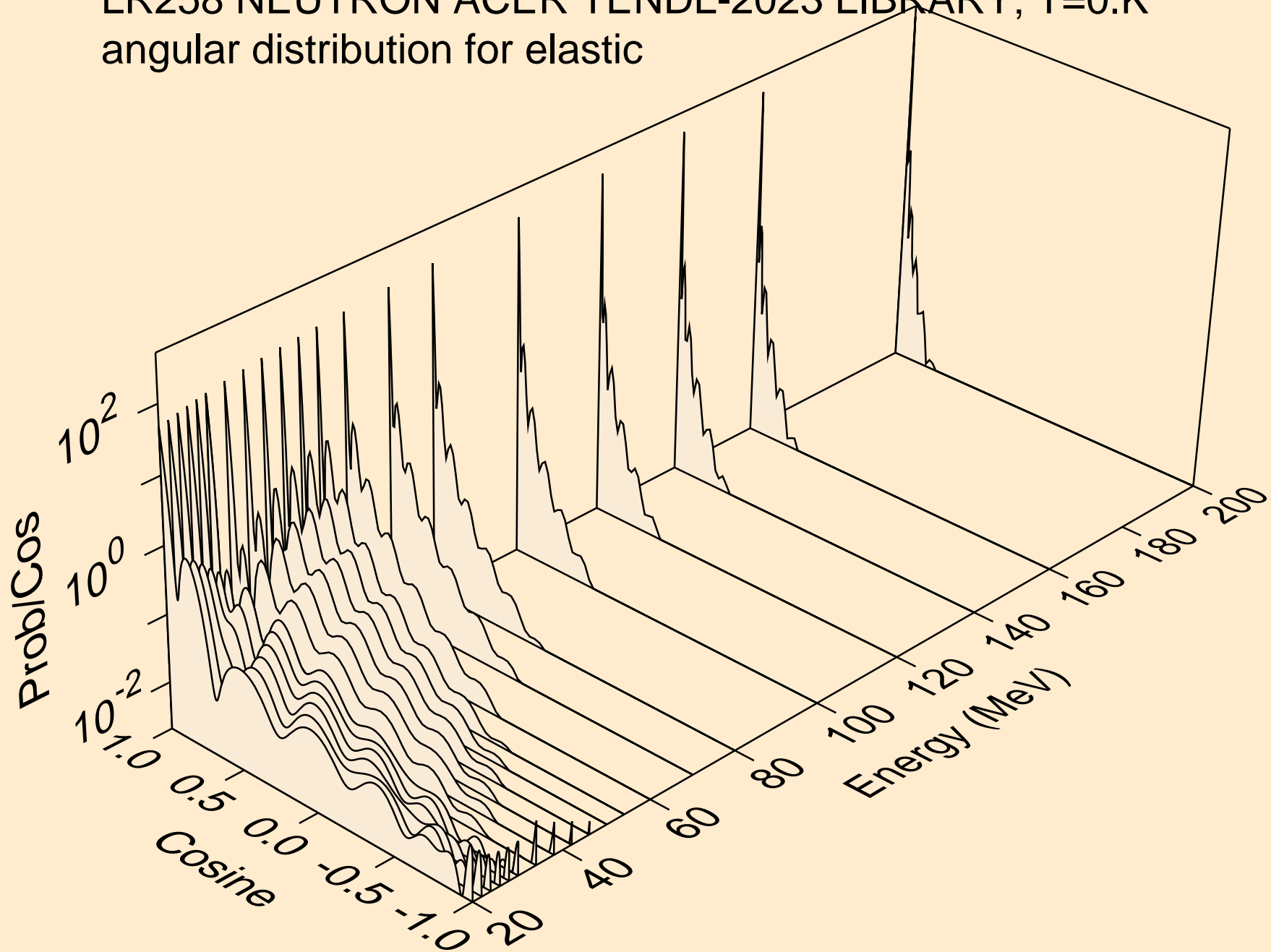

LR258 NEUTRON ACER TENDL-2023 LIBRARY; T=0.K
angular distribution for (n,n*1)

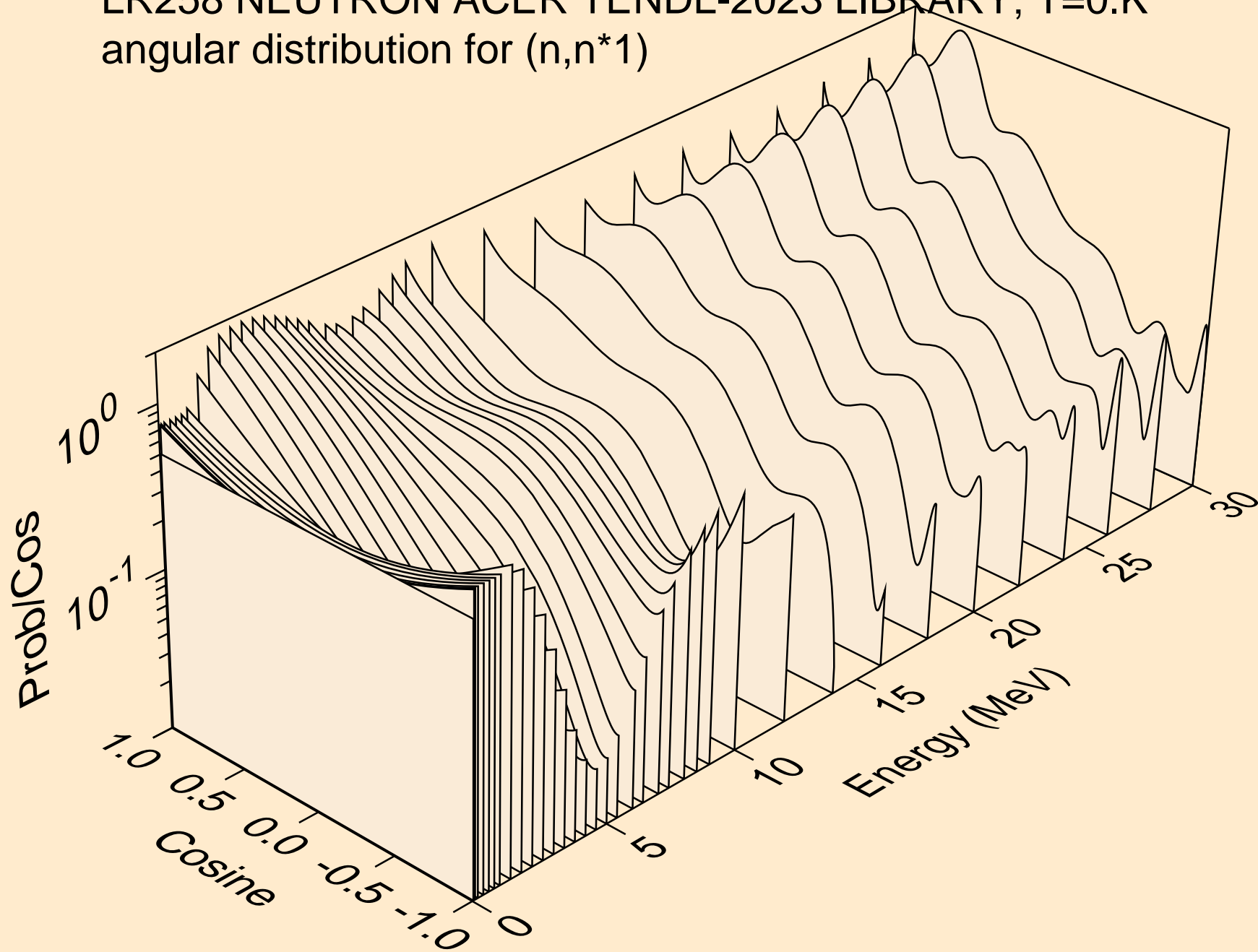

LR258 NEUTRON ACER TENDL-2023 LIBRARY; T=0.K
angular distribution for (n,n*2)

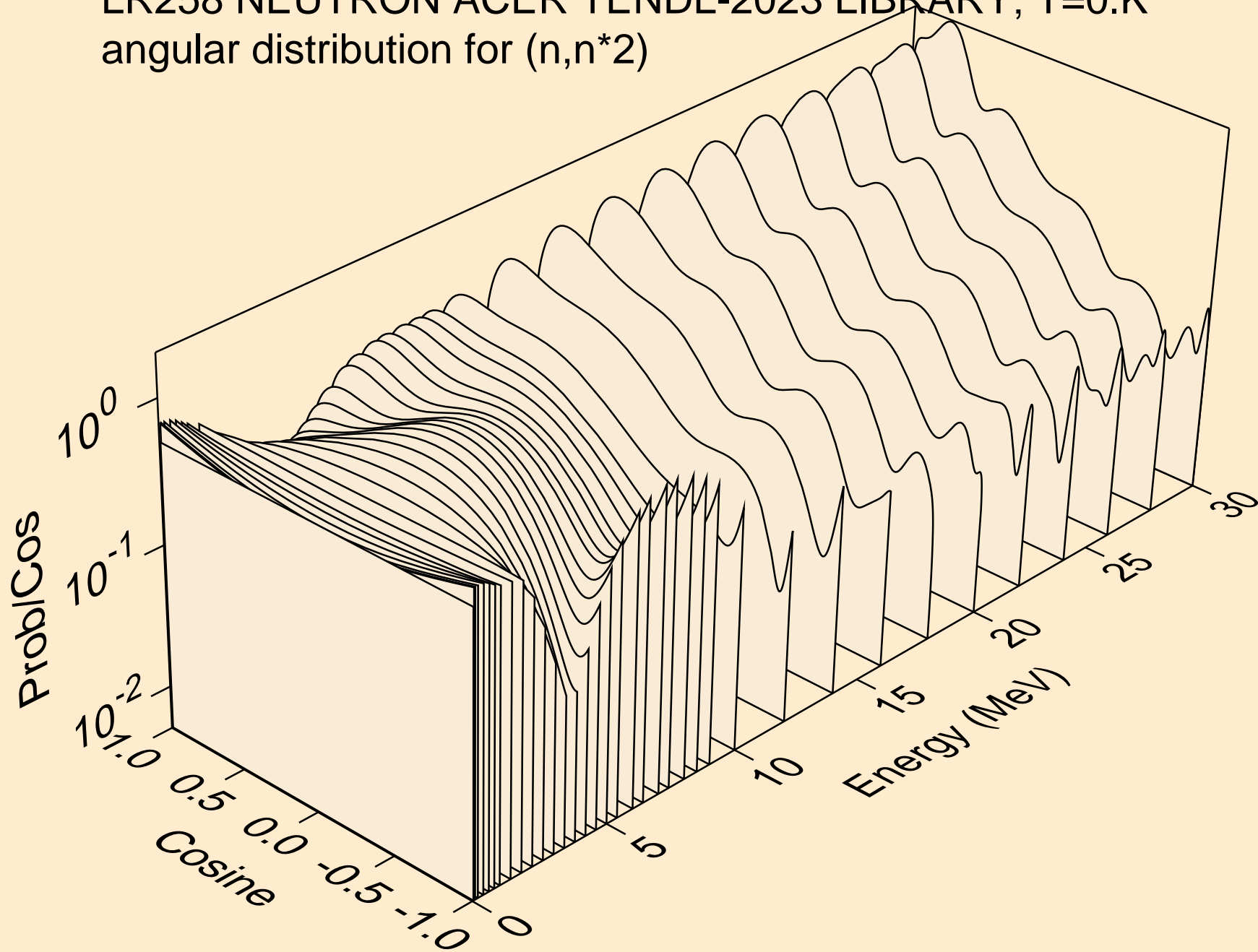

LR258 NEUTRON ACER TENDL-2023 LIBRARY; T=0.K
angular distribution for (n,n*3)

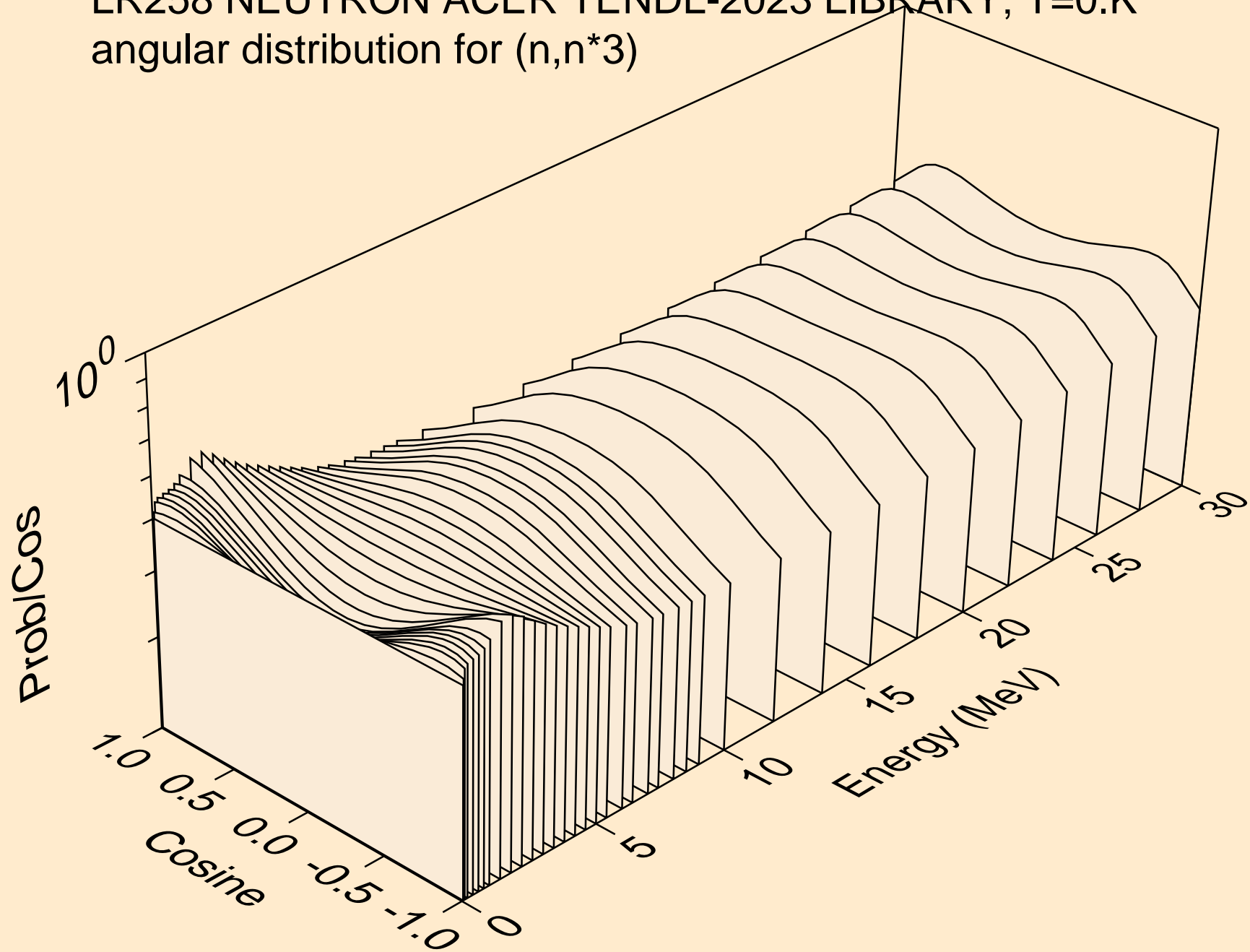

LR258 NEUTRON ACER TENDL-2023 LIBRARY; T=0.K
angular distribution for (n,n*4)

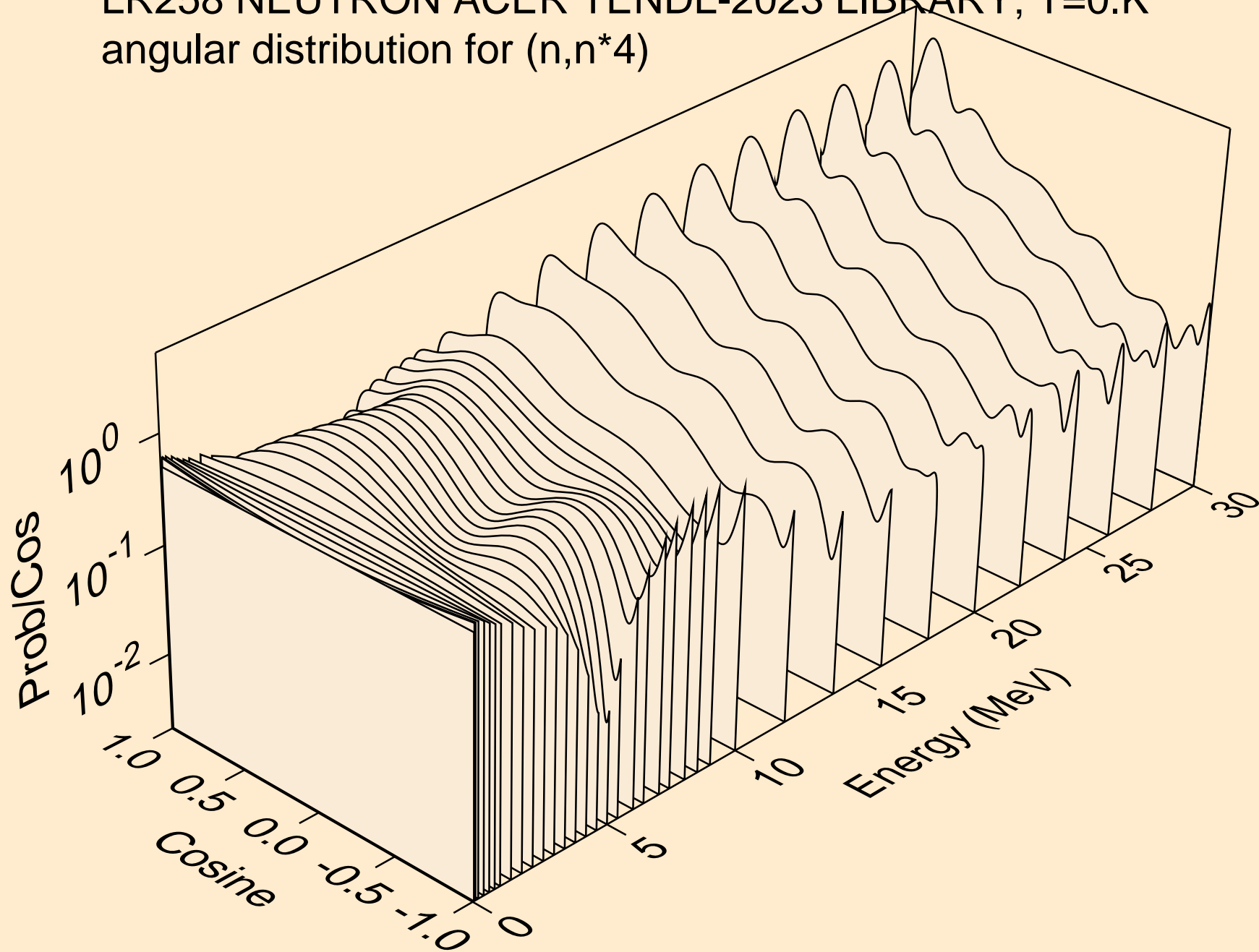

LR258 NEUTRON ACER TENDL-2023 LIBRARY; T=0.K
angular distribution for (n,n*5)

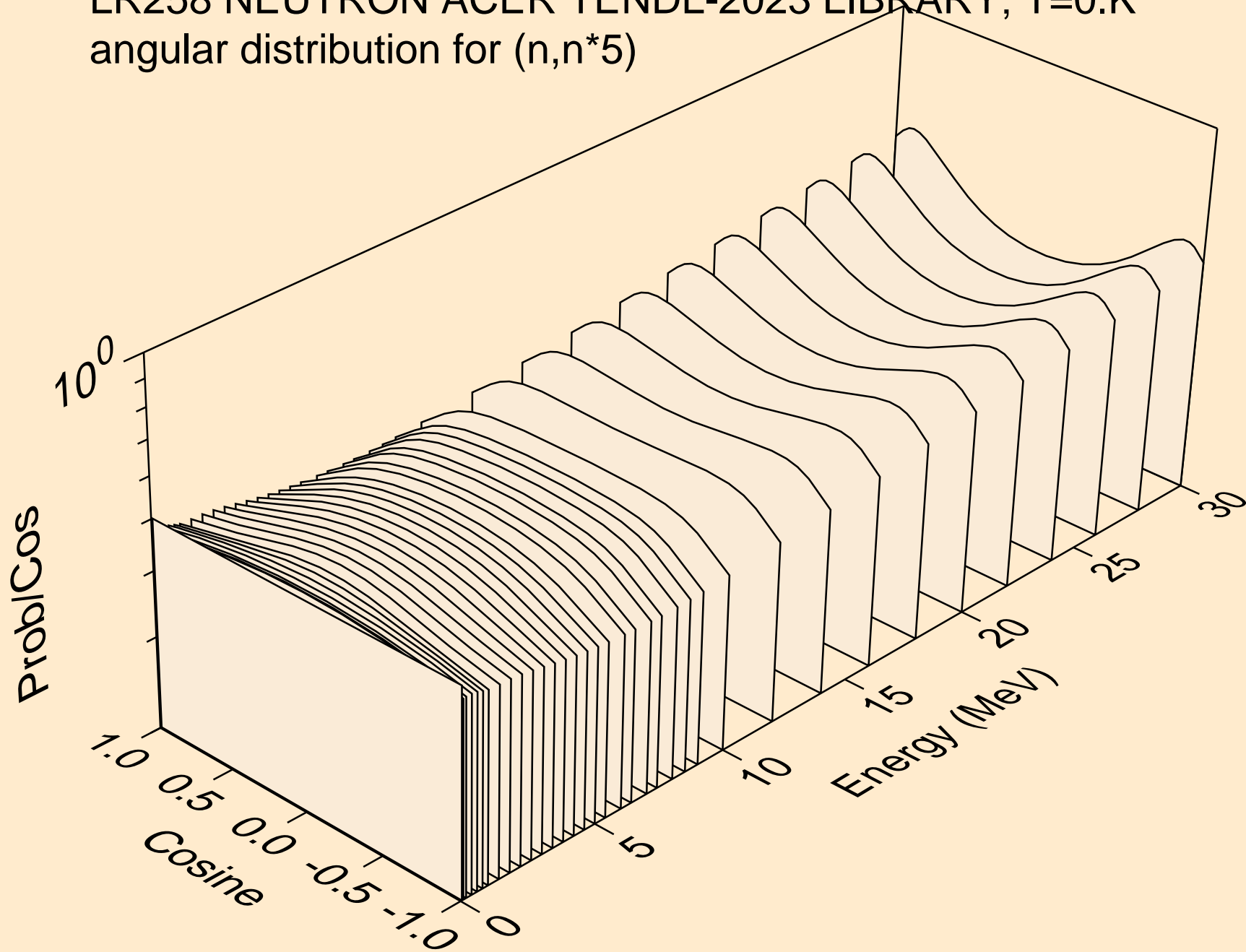

LR258 NEUTRON ACER TENDL-2023 LIBRARY; T=0.K
angular distribution for (n,n*6)

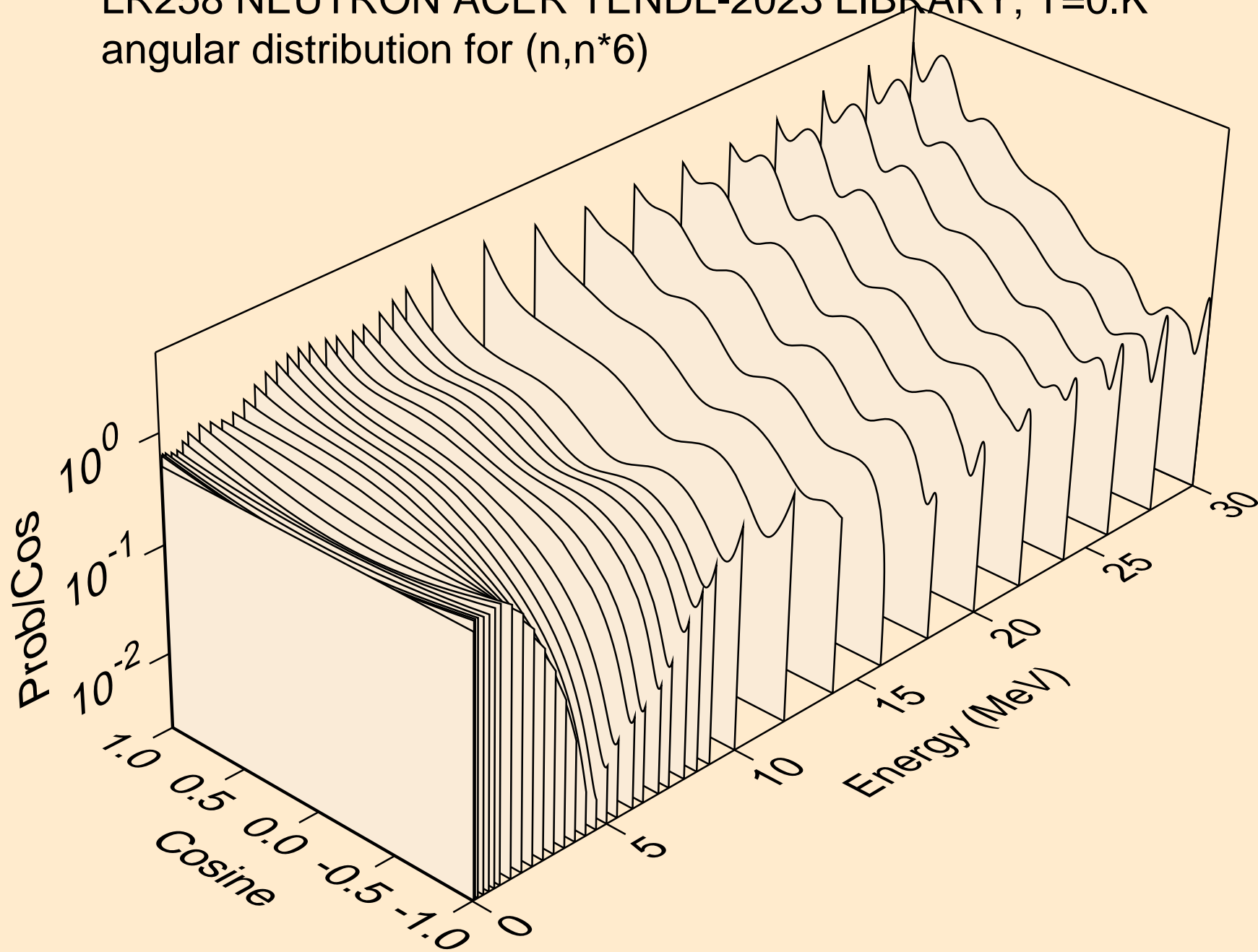

LR258 NEUTRON ACER TENDL-2023 LIBRARY; T=0.K
angular distribution for (n,n*7)

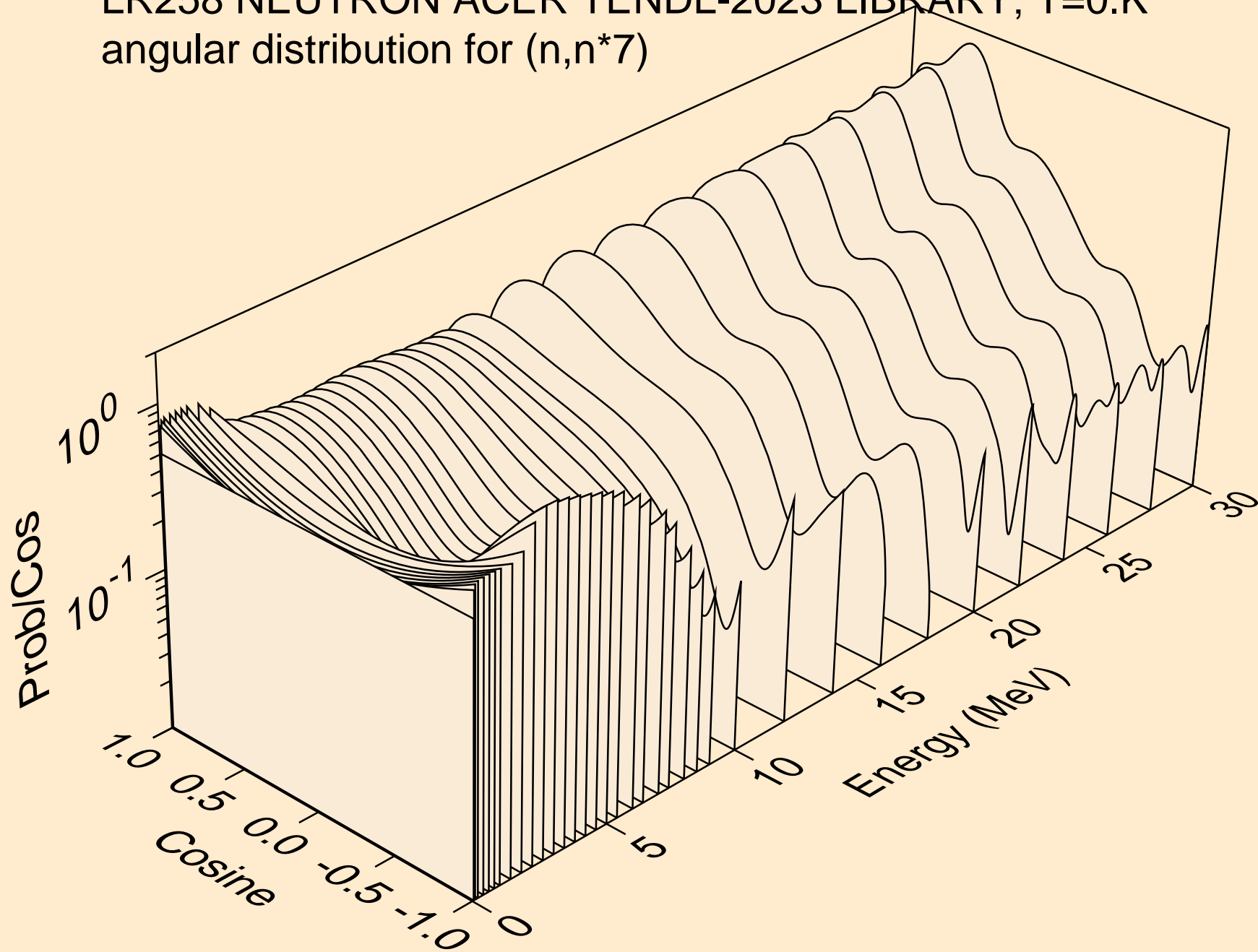

LR258 NEUTRON ACER TENDL-2023 LIBRARY; T=0.K
angular distribution for (n,n*8)

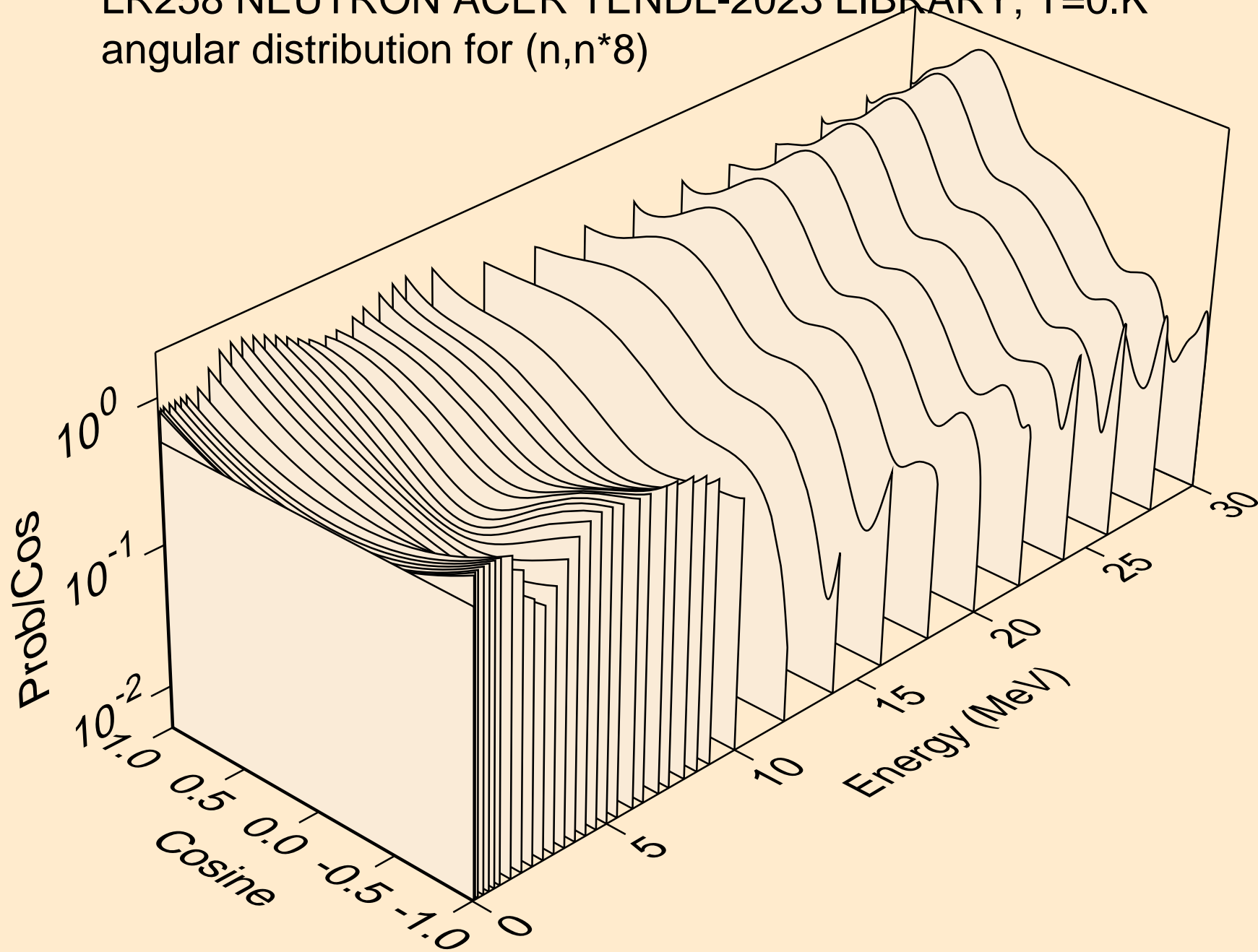

LR258 NEUTRON ACER TENDL-2023 LIBRARY; T=0.K
angular distribution for (n,n*9)

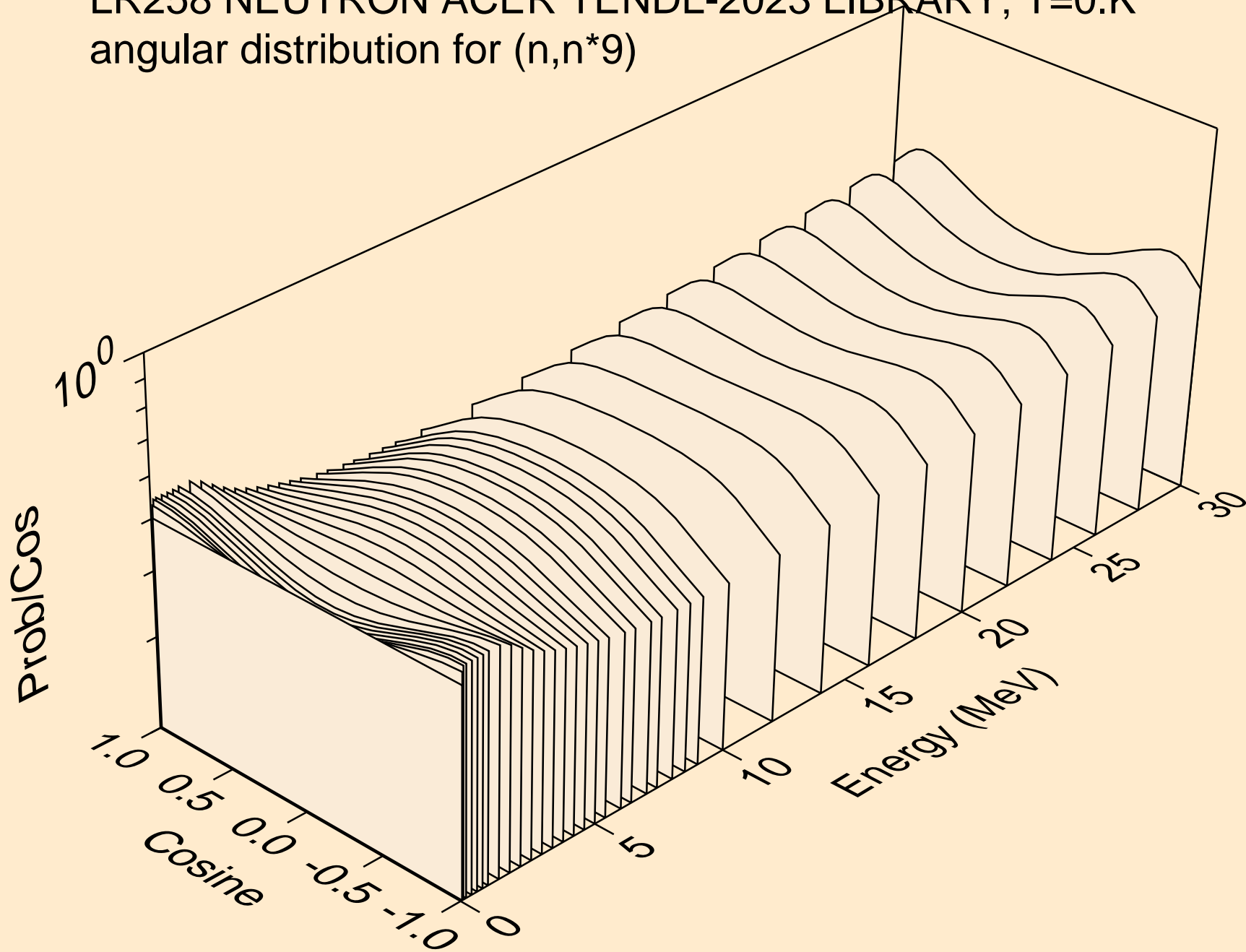

LR258 NEUTRON ACER TENDL-2023 LIBRARY; T=0.K
angular distribution for (n,n*10)

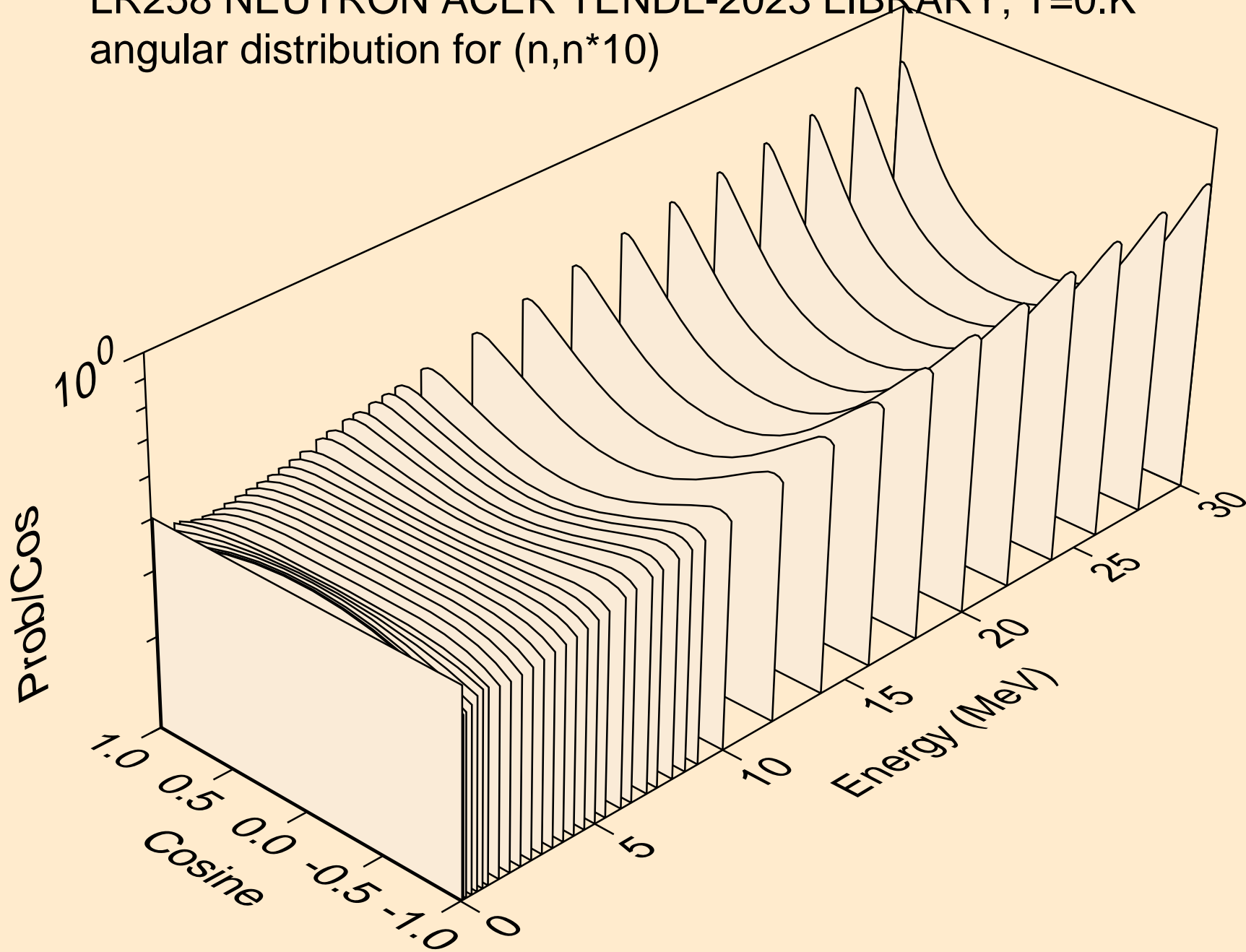

LR258 NEUTRON ACER TENDL-2023 LIBRARY; T=0.K
angular distribution for (n,n*11)

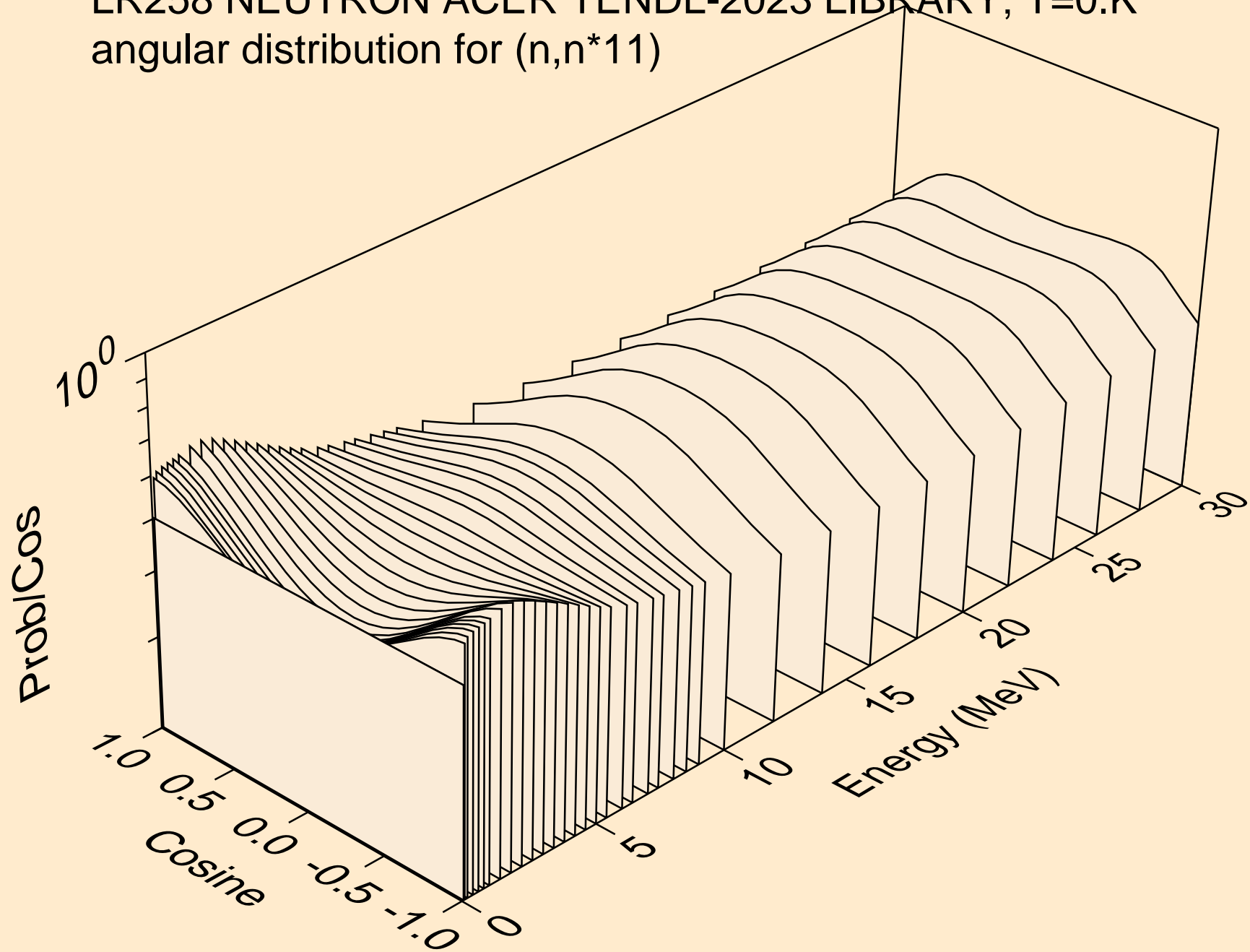

LR258 NEUTRON ACER TENDL-2023 LIBRARY; T=0.K
angular distribution for (n,n*12)

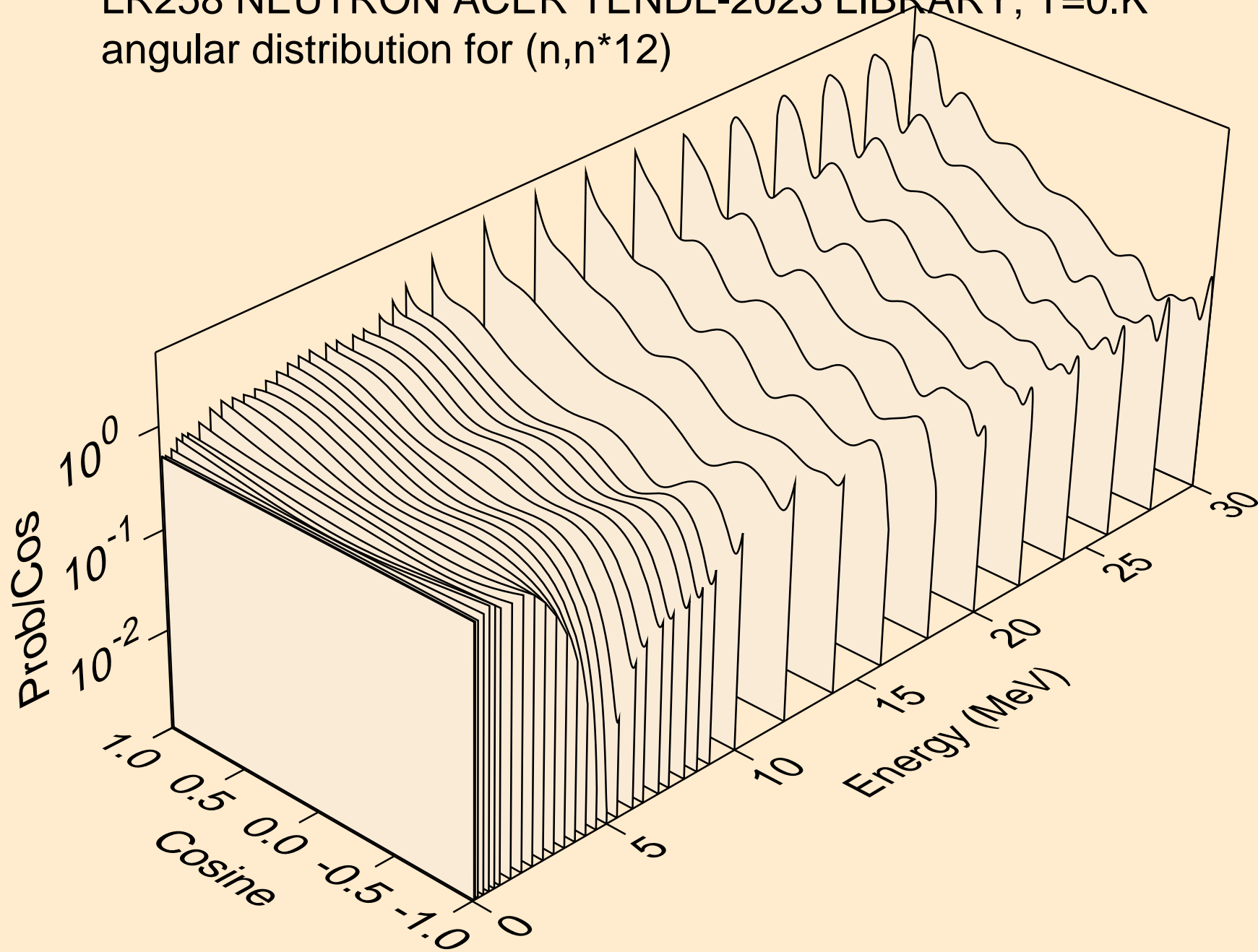

LR258 NEUTRON ACER TENDL-2023 LIBRARY; T=0.K
angular distribution for (n,n*13)

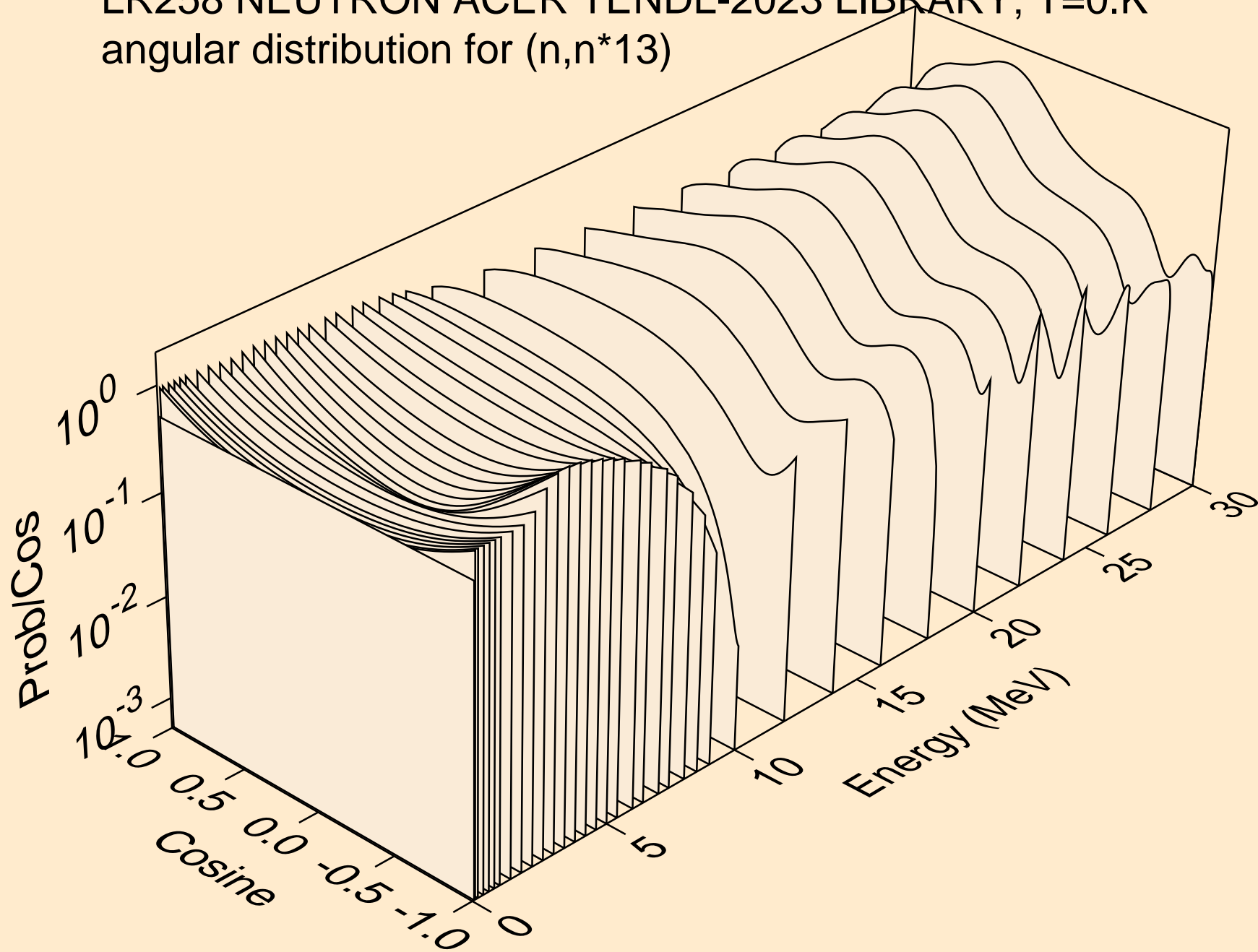

LR258 NEUTRON ACER TENDL-2023 LIBRARY; T=0.K
angular distribution for (n,n*14)

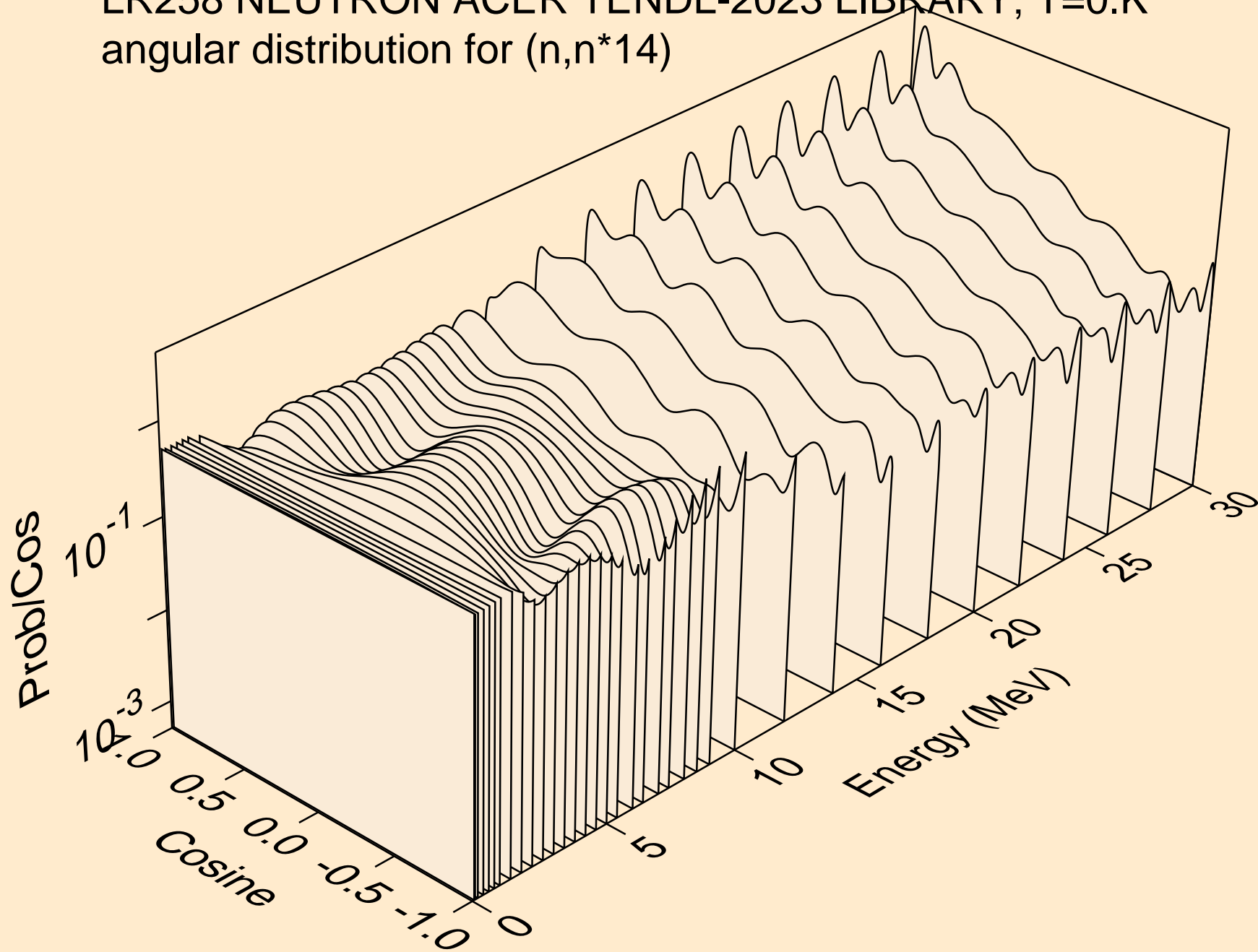

LR258 NEUTRON ACER TENDL-2023 LIBRARY; T=0.K
angular distribution for (n,n*15)

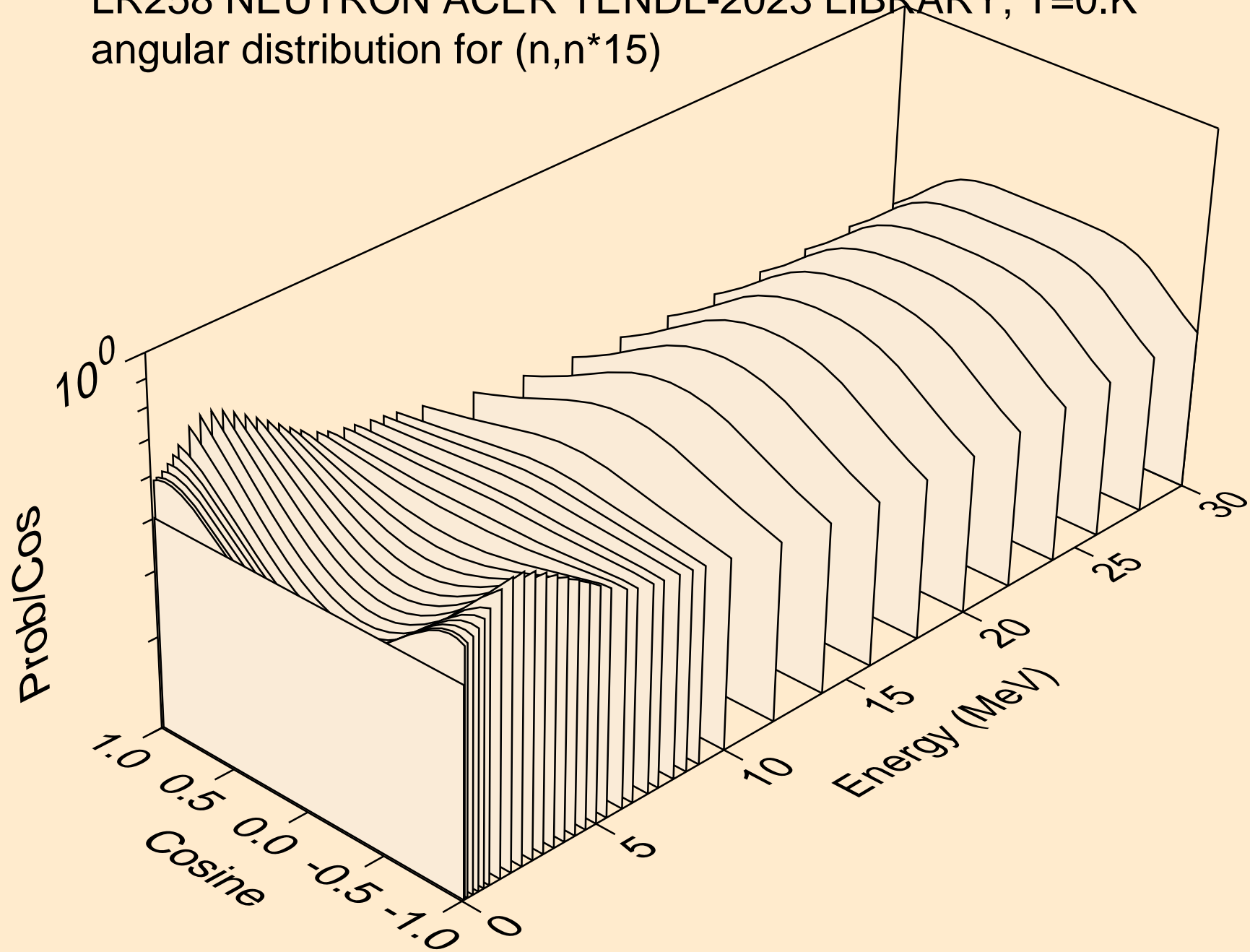

LR258 NEUTRON ACER TENDL-2023 LIBRARY; T=0.K
angular distribution for (n,n*16)

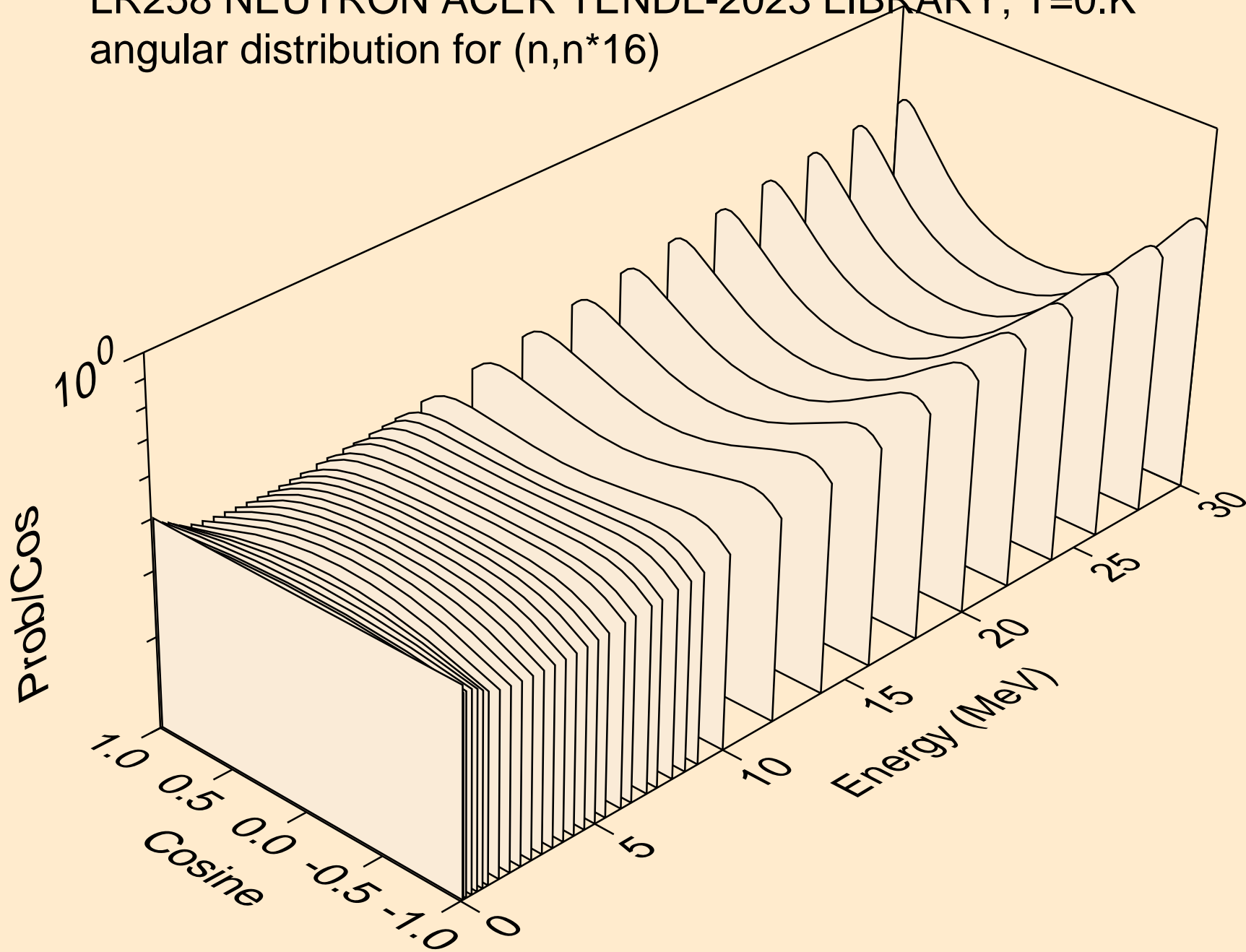

LR258 NEUTRON ACER TENDL-2023 LIBRARY; T=0.K
angular distribution for (n,n*17)

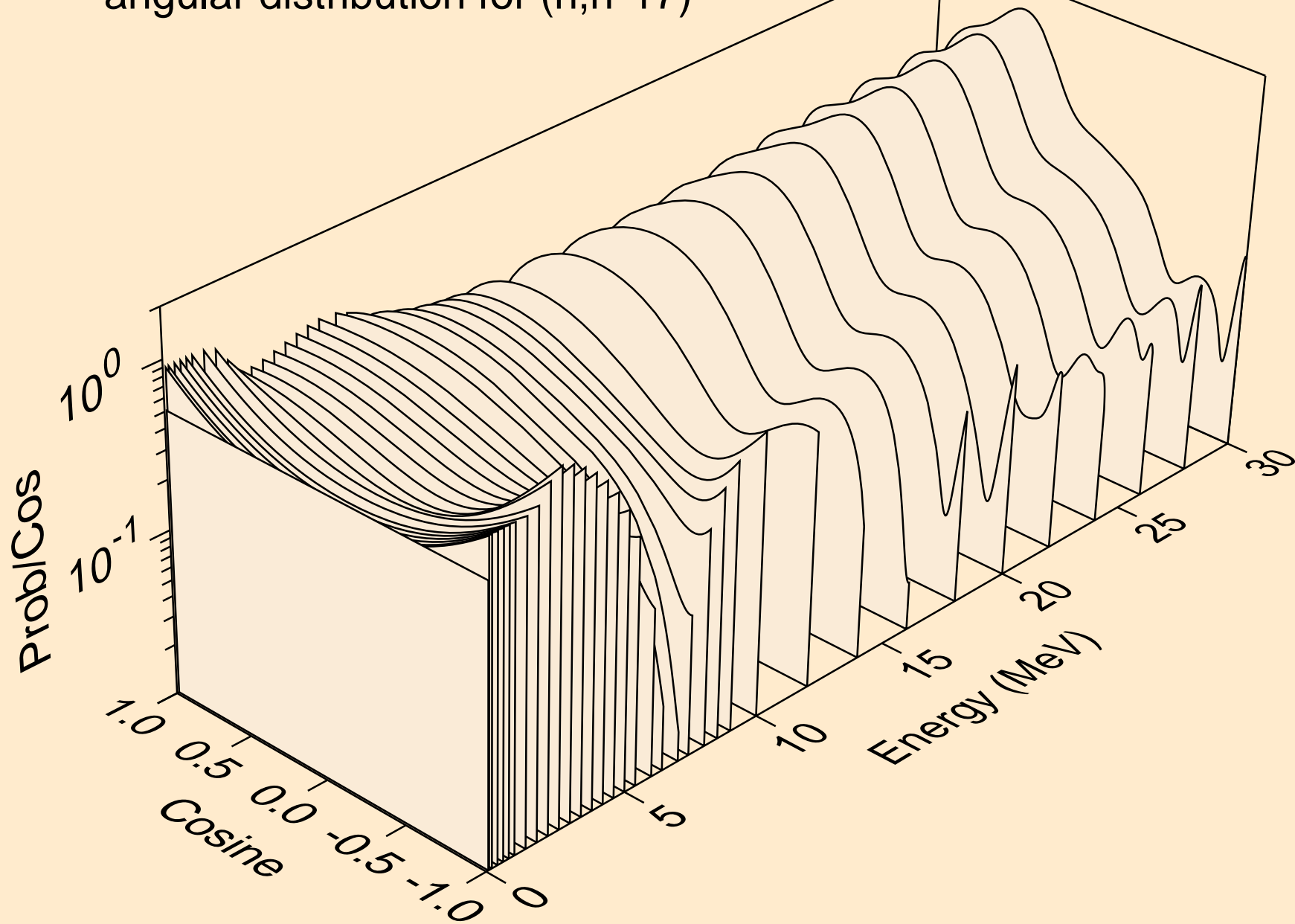

LR258 NEUTRON ACER TENDL-2023 LIBRARY; T=0.K
angular distribution for (n,n*18)

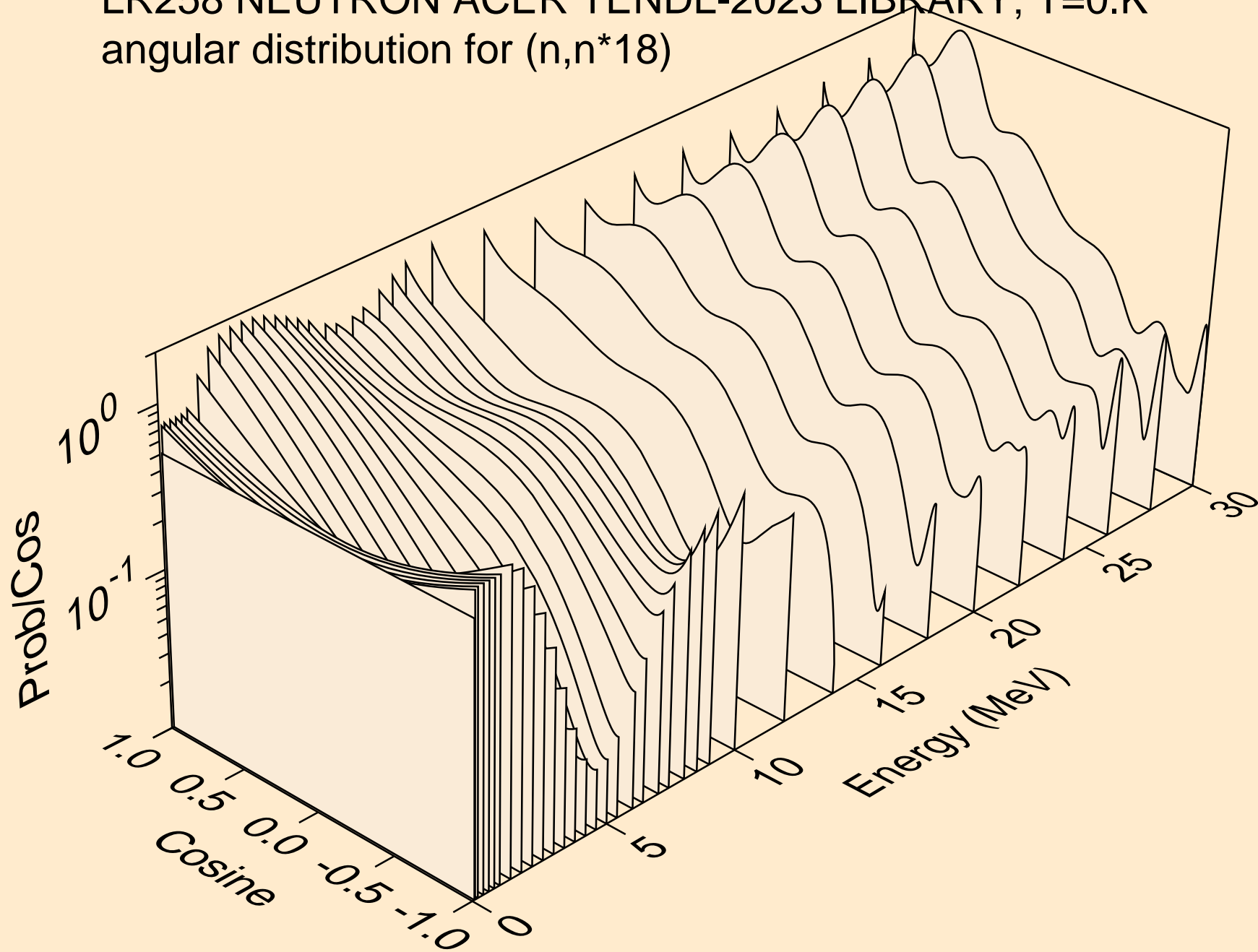

LR258 NEUTRON ACER TENDL-2023 LIBRARY; T=0.K
angular distribution for (n,n*19)

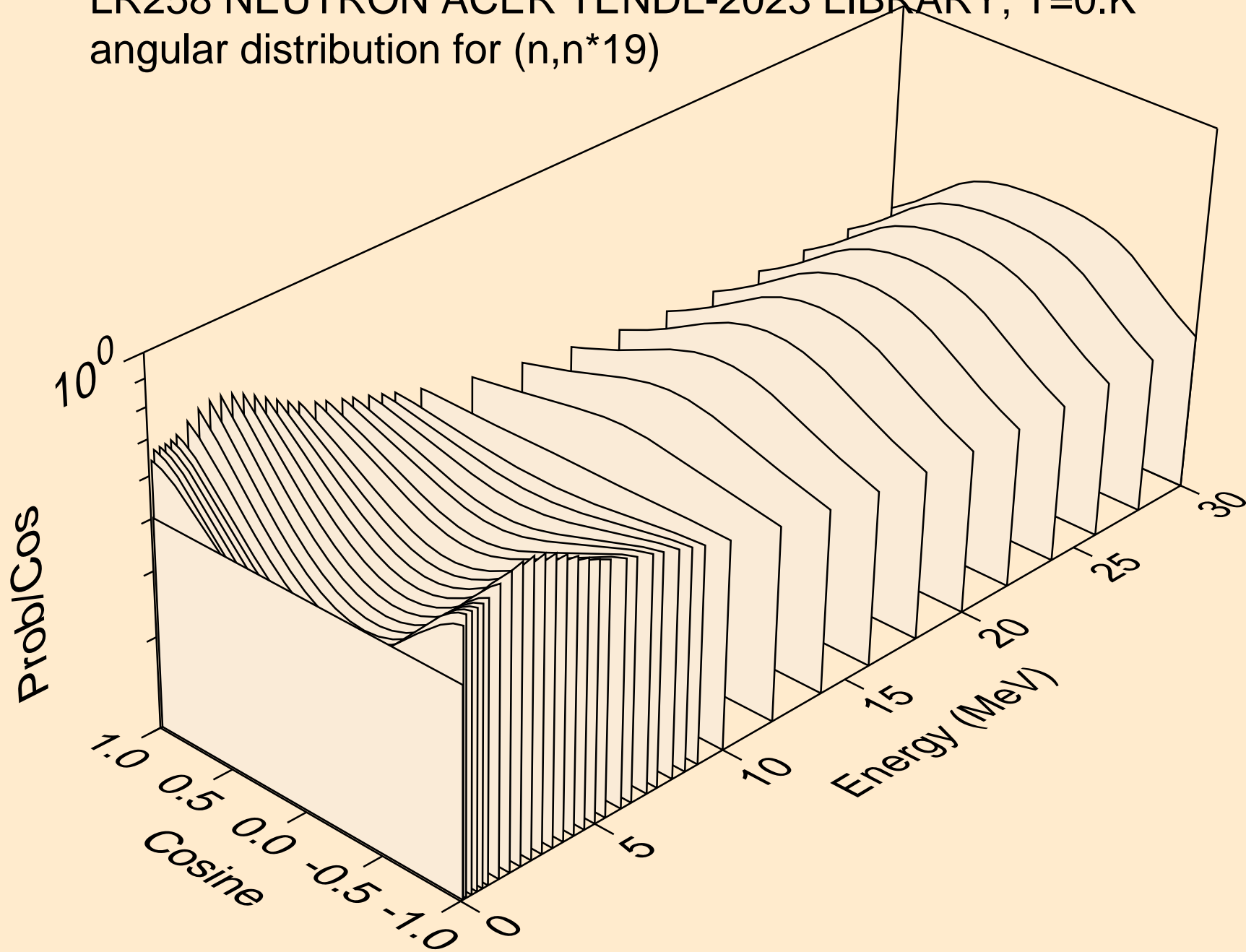

LR258 NEUTRON ACER TENDL-2023 LIBRARY; T=0.K
angular distribution for (n,n*20)

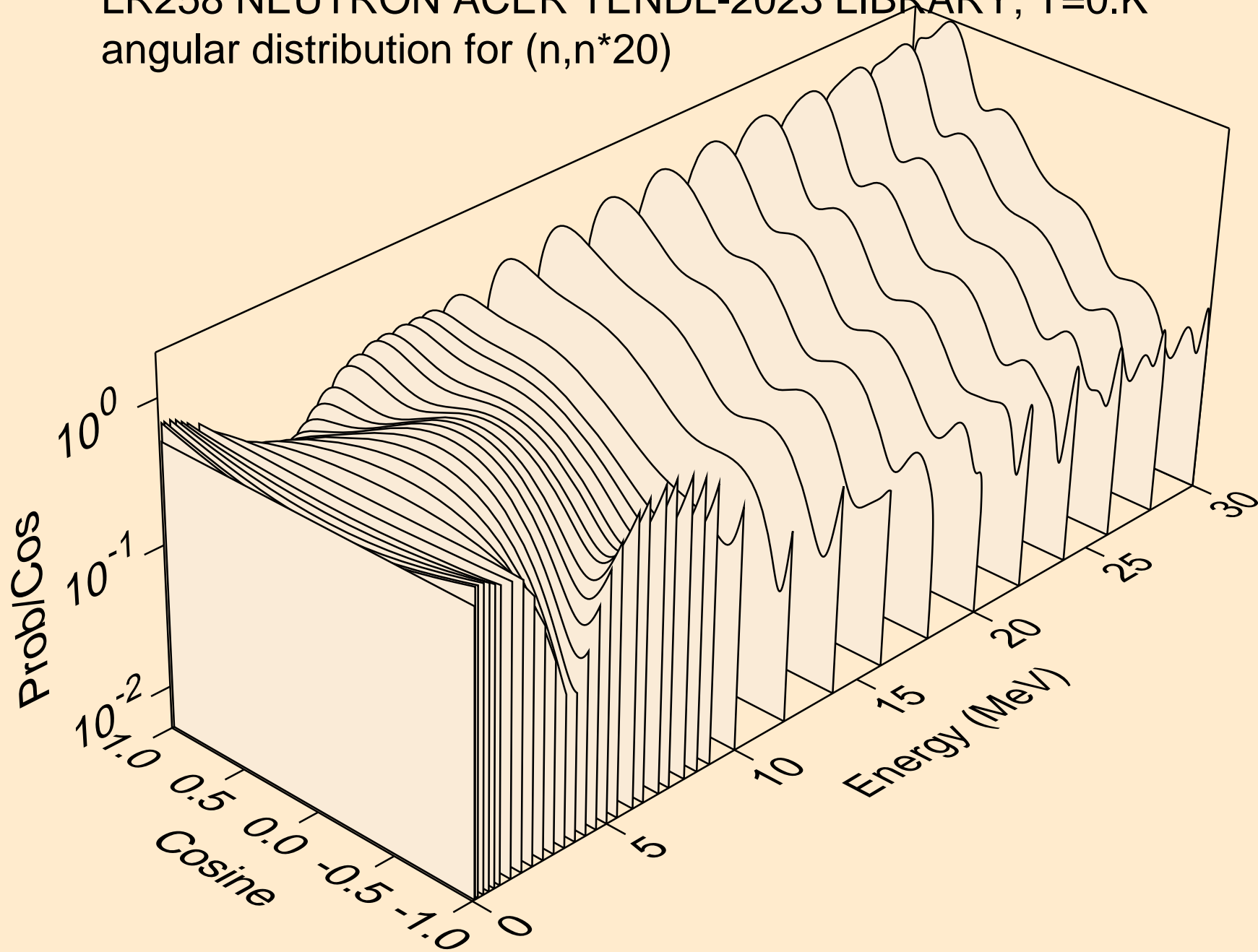

LR258 NEUTRON ACER TENDL-2023 LIBRARY; T=0.K
angular distribution for (n,n*21)

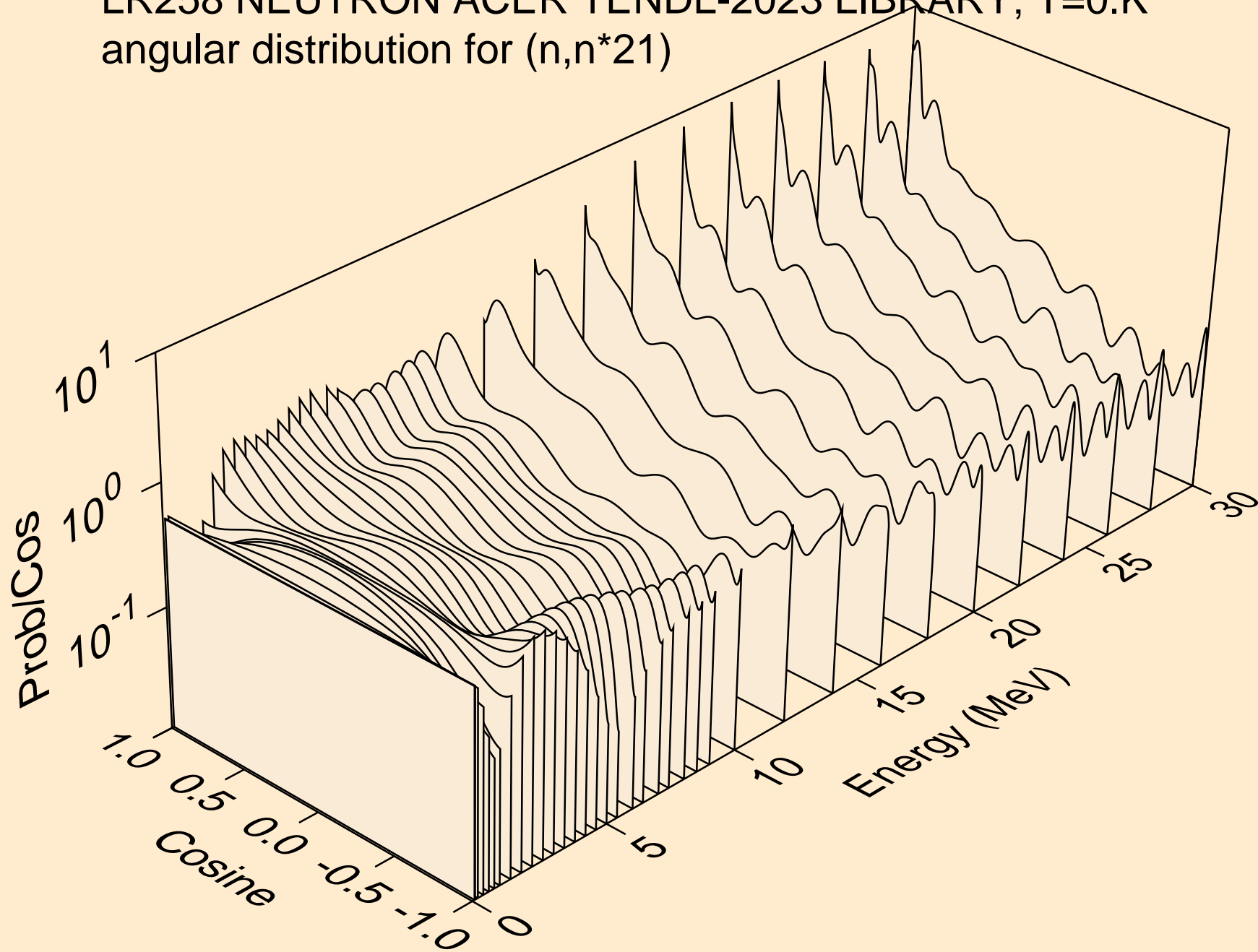

LR258 NEUTRON ACER TENDL-2023 LIBRARY; T=0.K
angular distribution for (n,n*22)

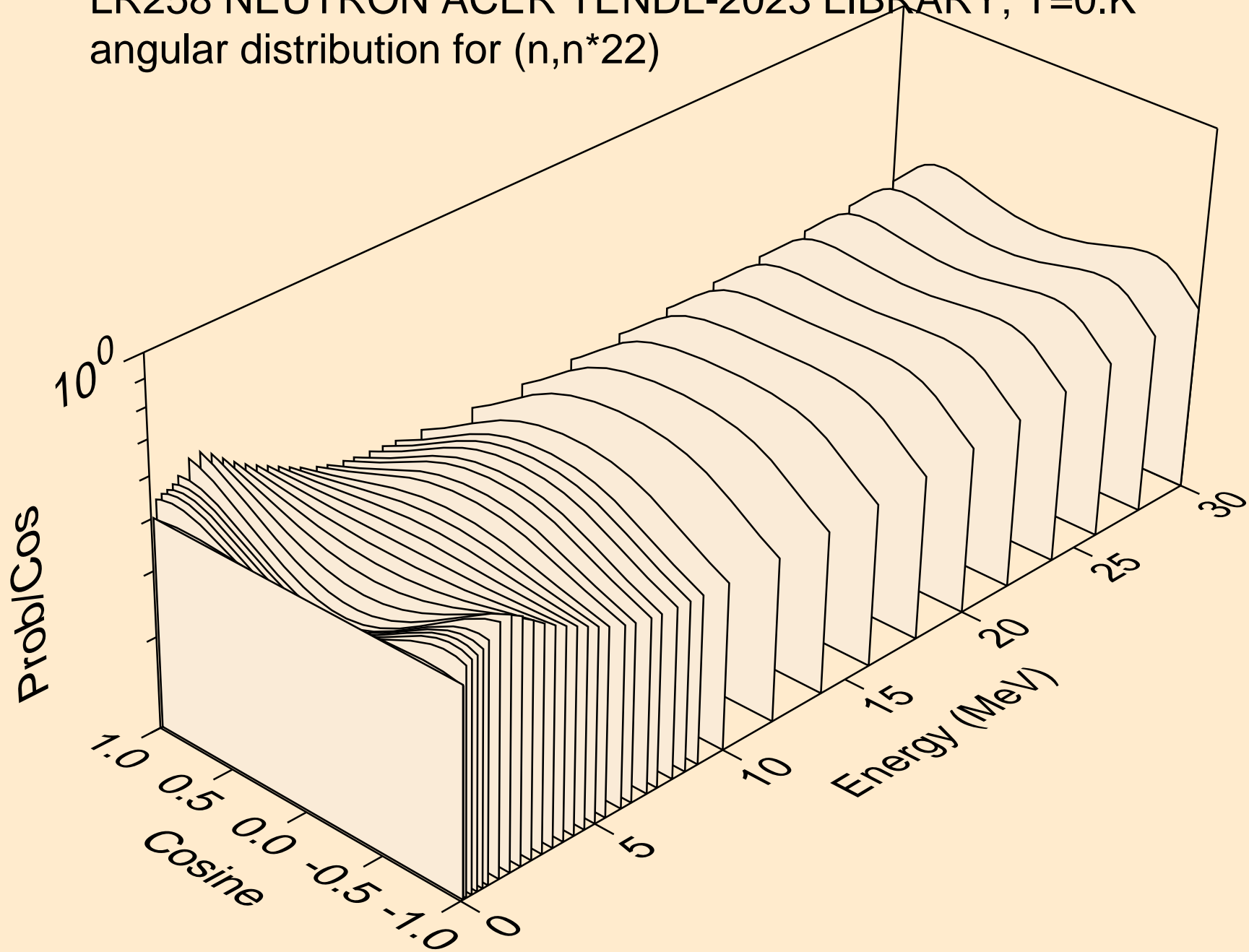

LR258 NEUTRON ACER TENDL-2023 LIBRARY; T=0.K
angular distribution for (n,n*23)

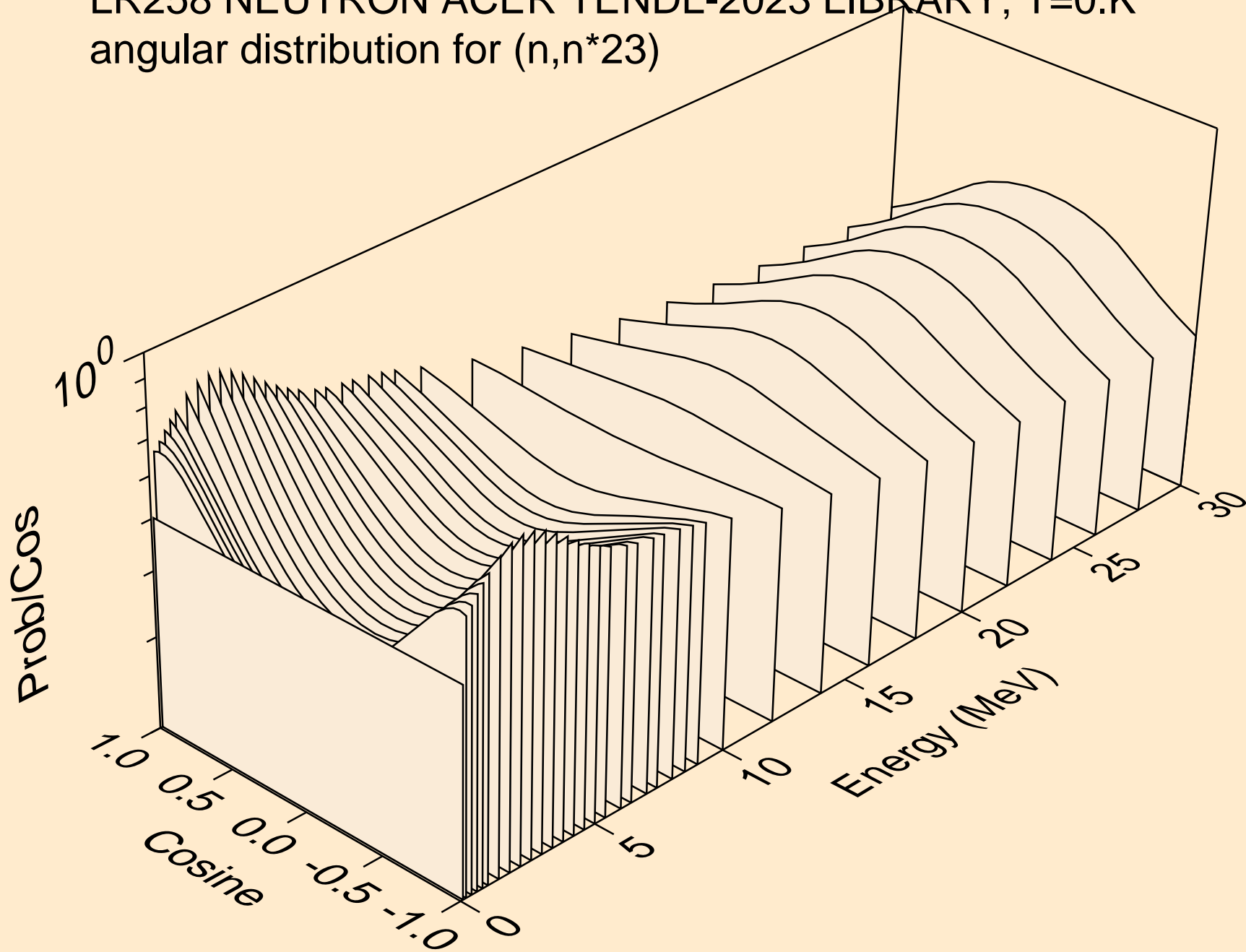

LR258 NEUTRON ACER TENDL-2023 LIBRARY; T=0.K
angular distribution for (n,n*24)

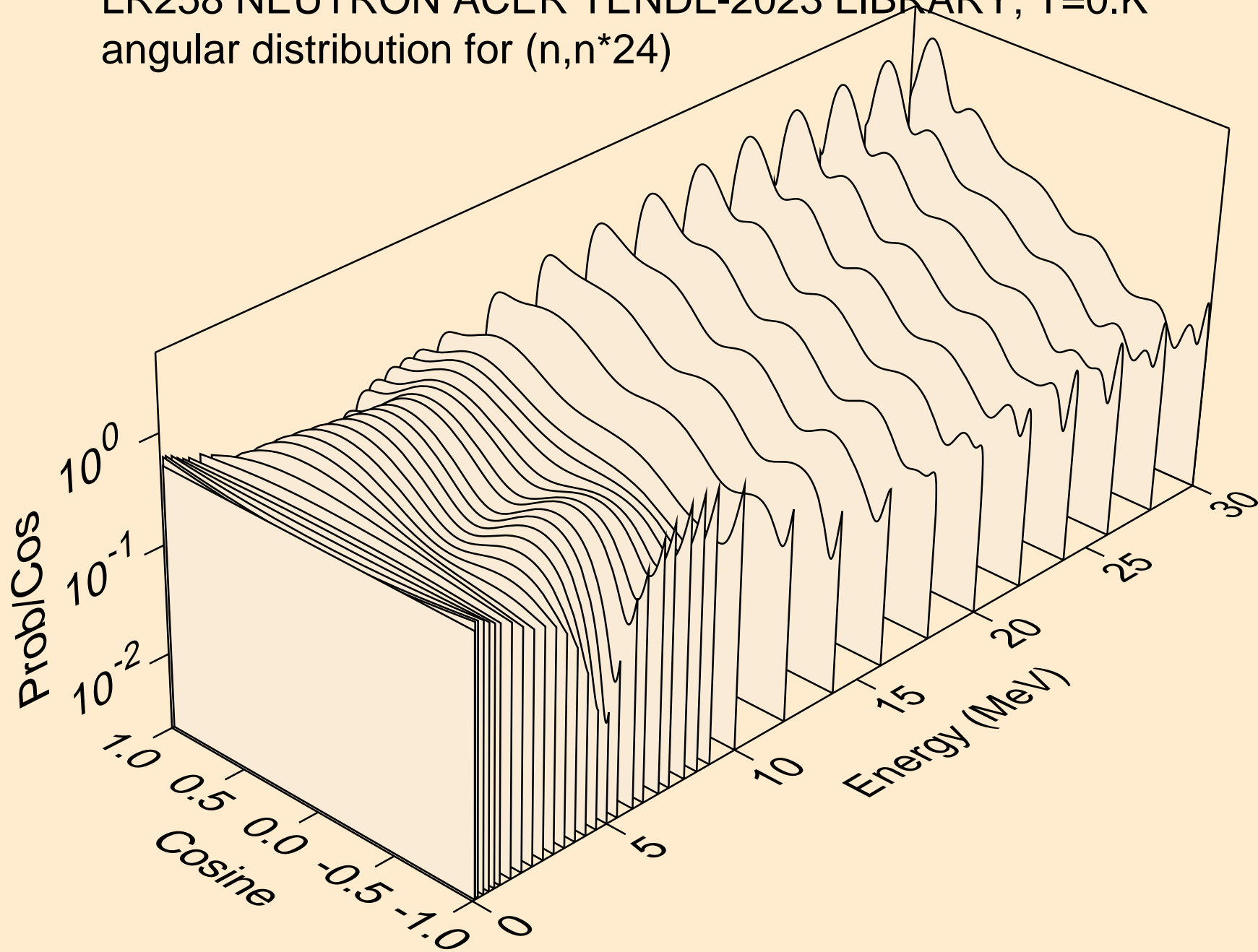

LR258 NEUTRON ACER TENDL-2023 LIBRARY; T=0.K

Total fission nubar

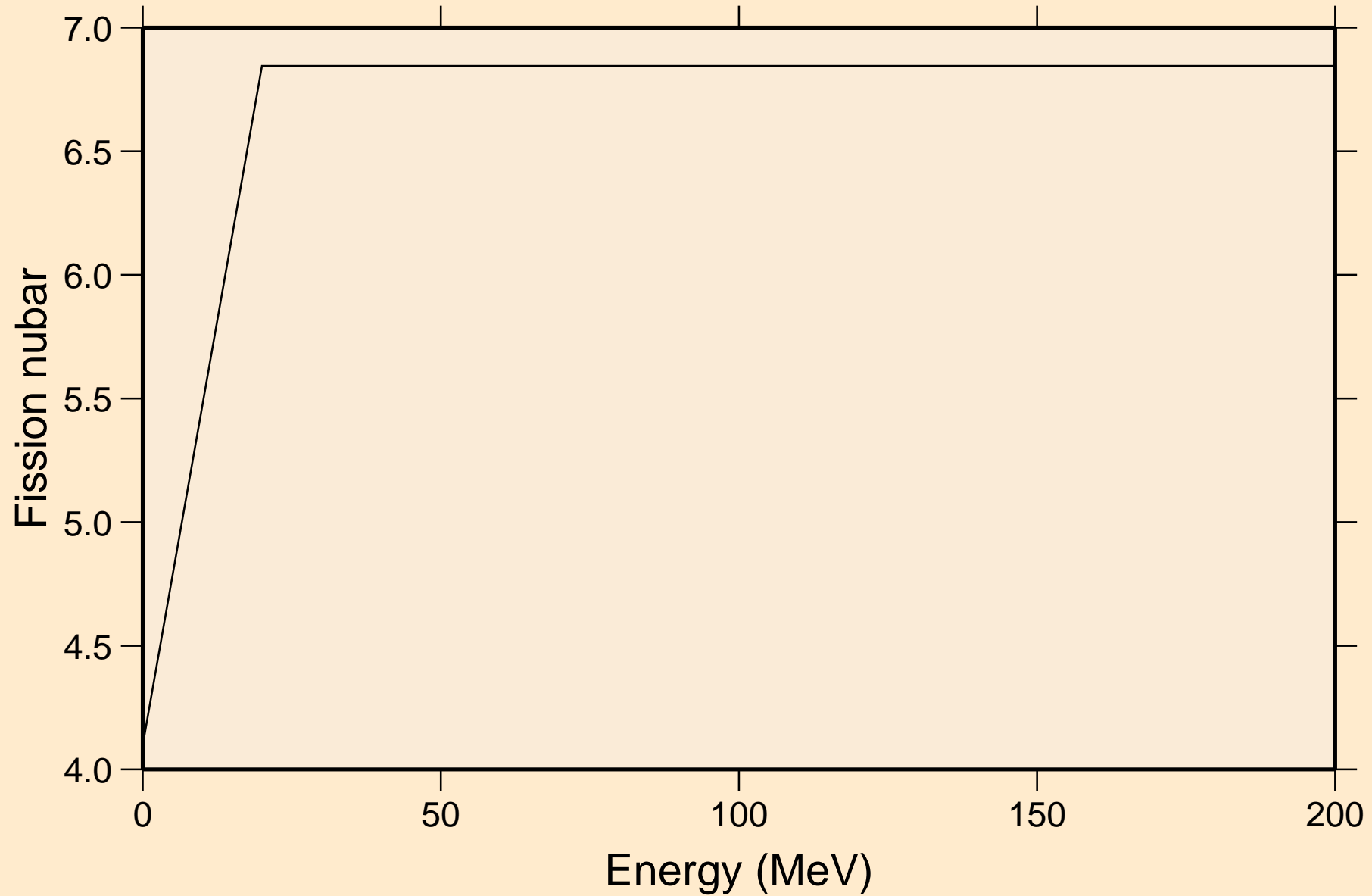

LR258 NEUTRON ACER TENDL-2023 LIBRARY; T=0.K
Neutron emission for (n,x)

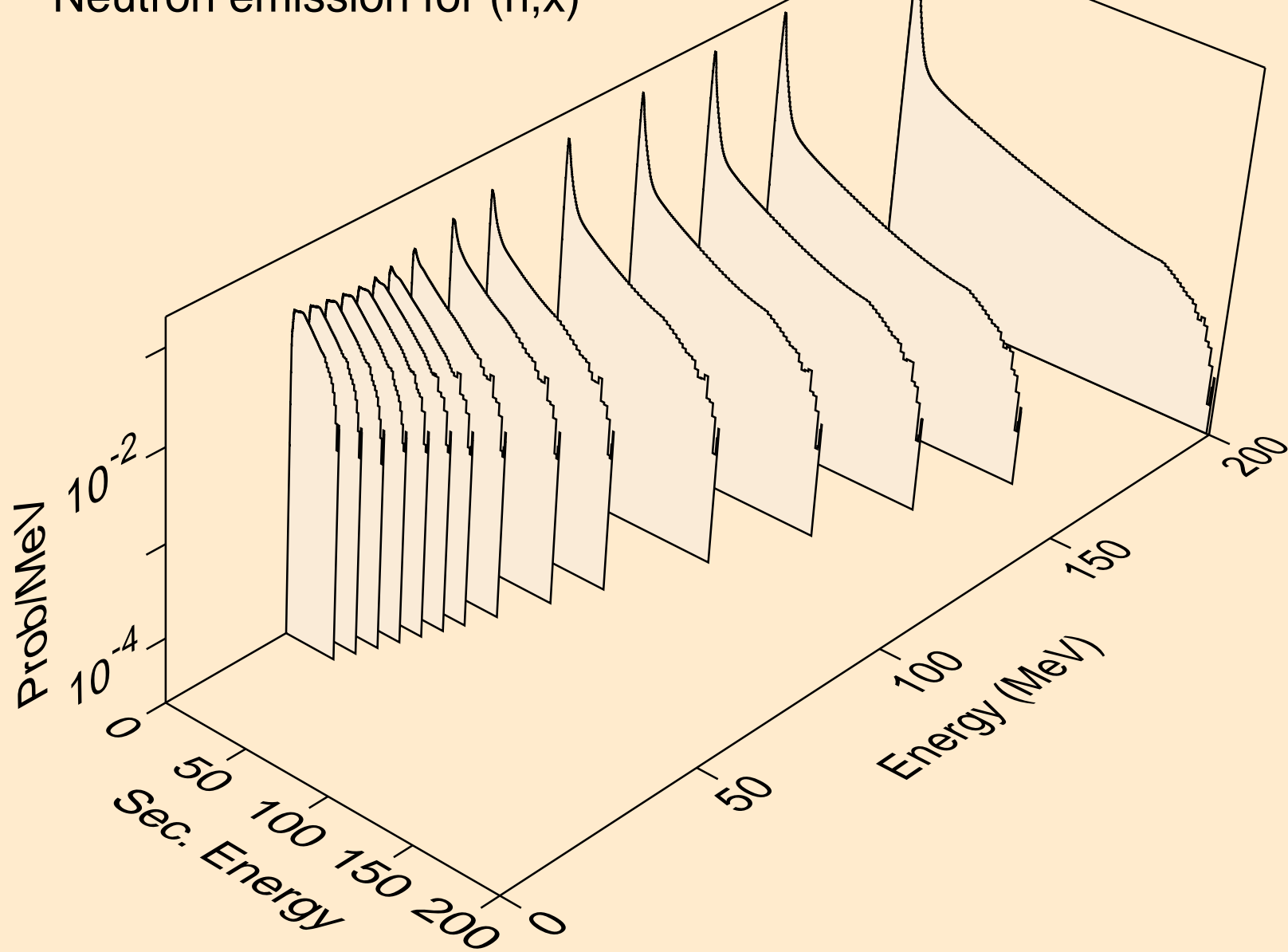

LR258 NEUTRON ACER TENDL-2023 LIBRARY; T=0.K
Neutron emission for (n,2n)

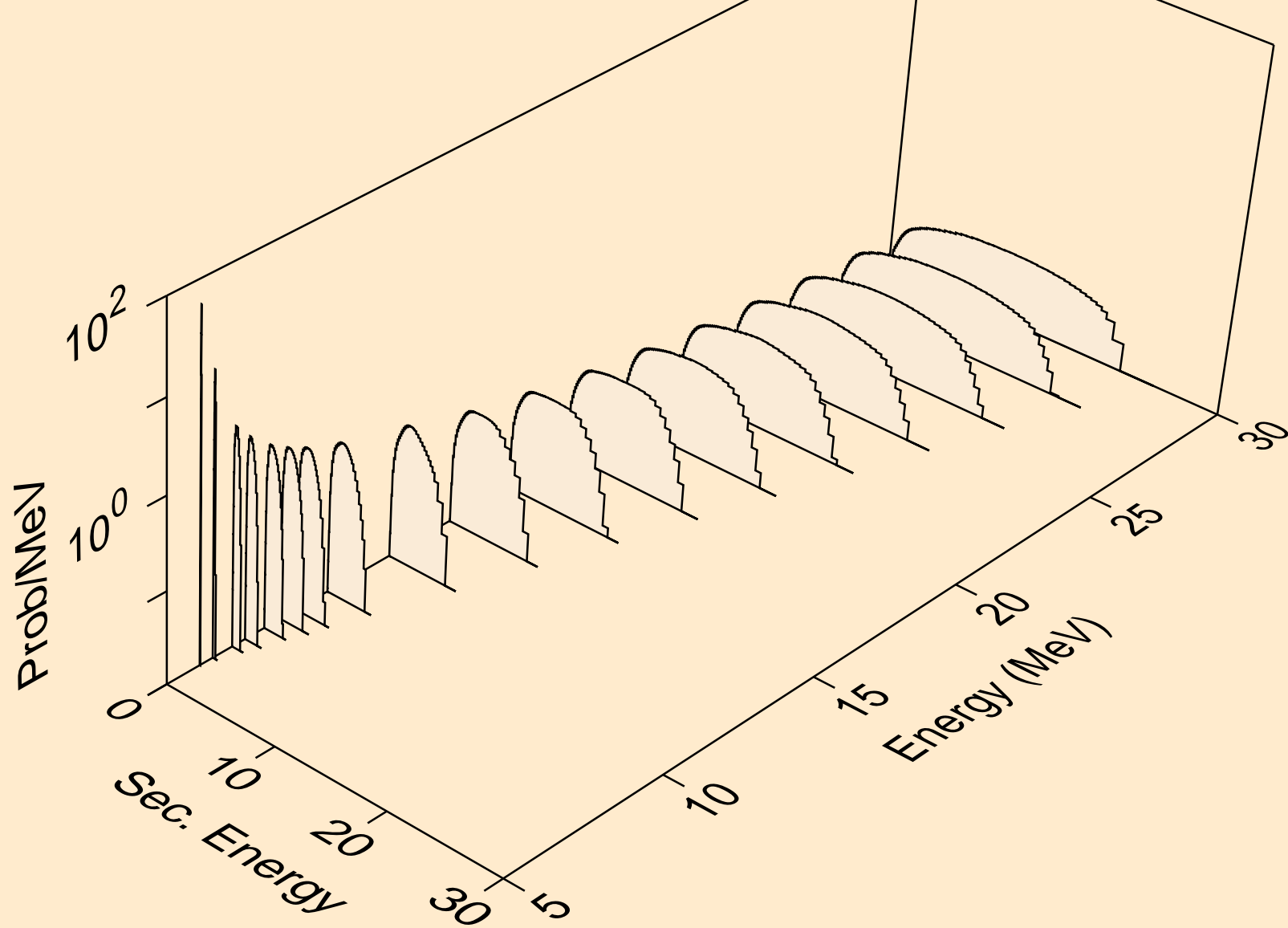

LR258 NEUTRON ACER TENDL-2023 LIBRARY; T=0.K
Neutron emission for (n,3n)

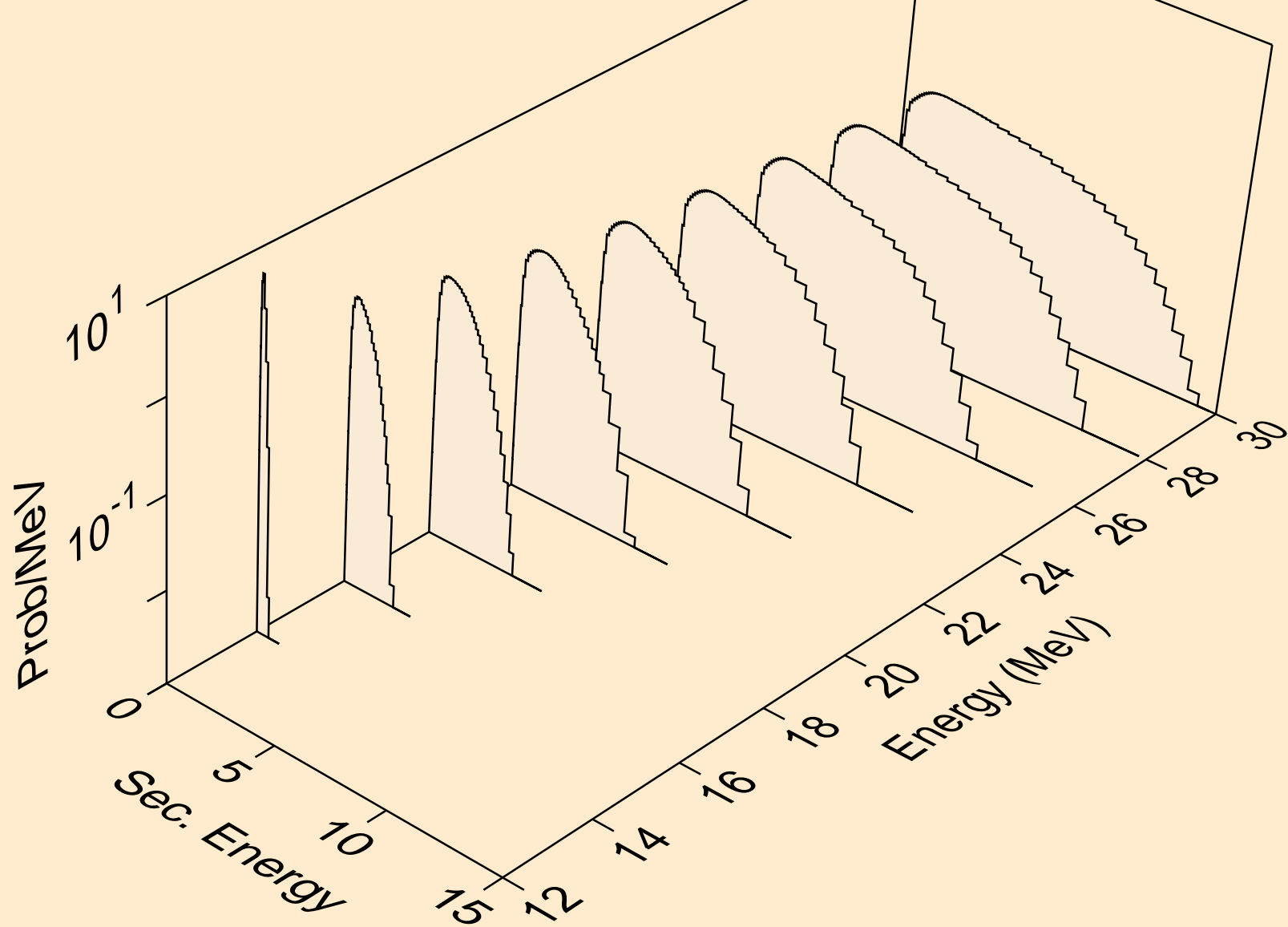

LR258 NEUTRON ACER TENDL-2023 LIBRARY; T=0.K
Neutron emission for fission

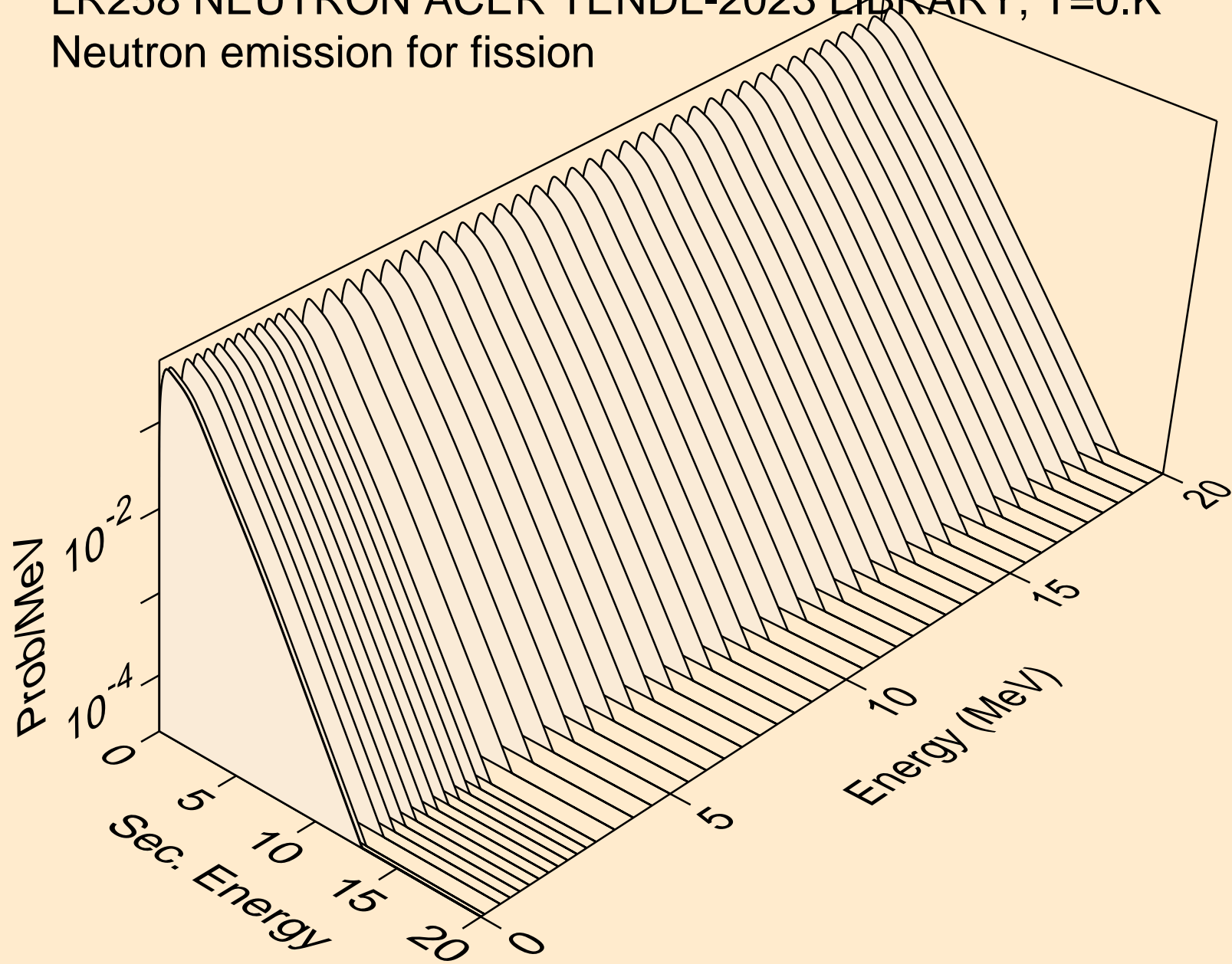

LR258 NEUTRON ACER TENDL-2023 LIBRARY; T=0.K
Neutron emission for (n,n*)a

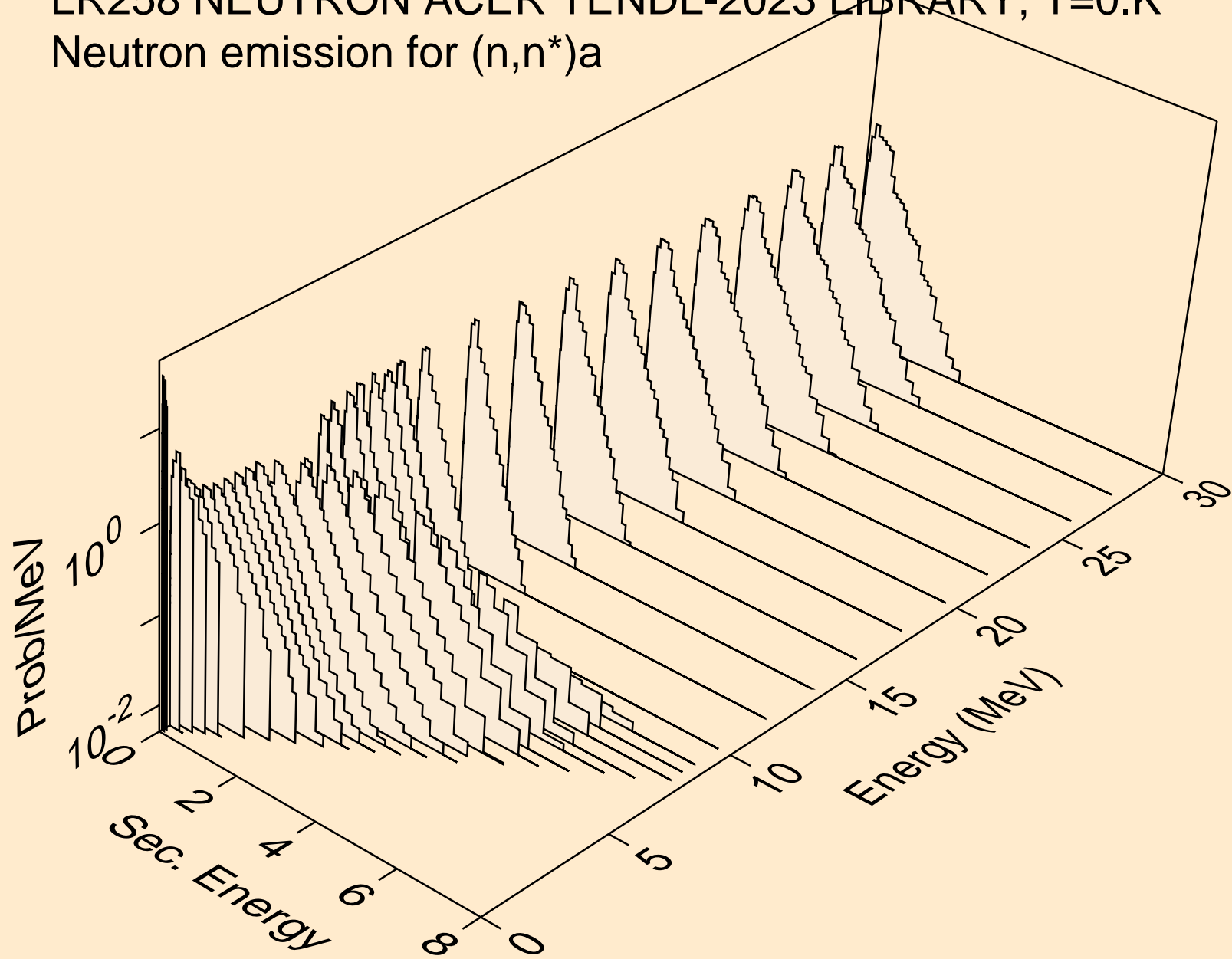

LR258 NEUTRON ACER TENDL-2023 LIBRARY; T=0.K
Neutron emission for (n,2n)a

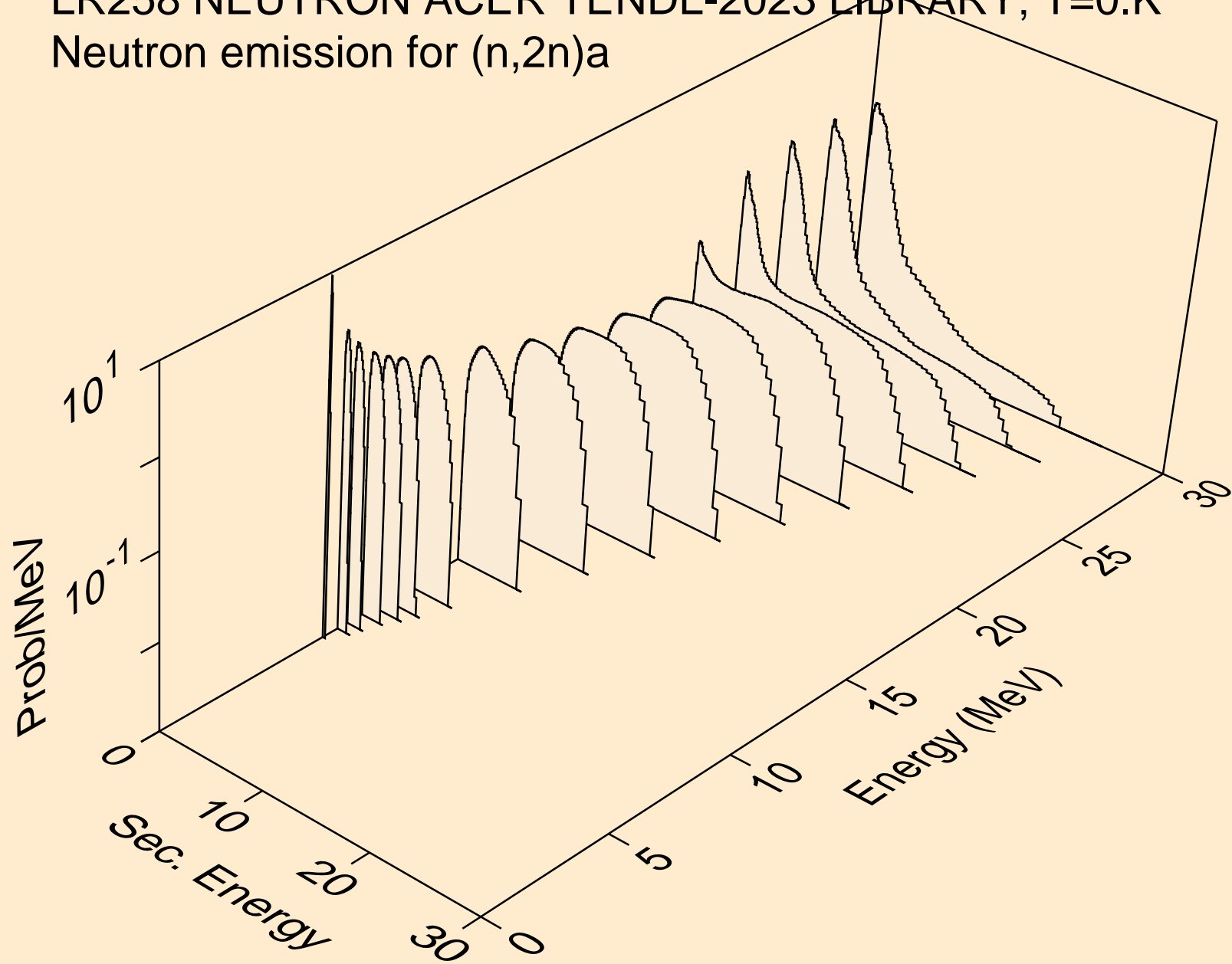

LR258 NEUTRON ACER TENDL-2023 LIBRARY; T=0.K
Neutron emission for (n,n*)p

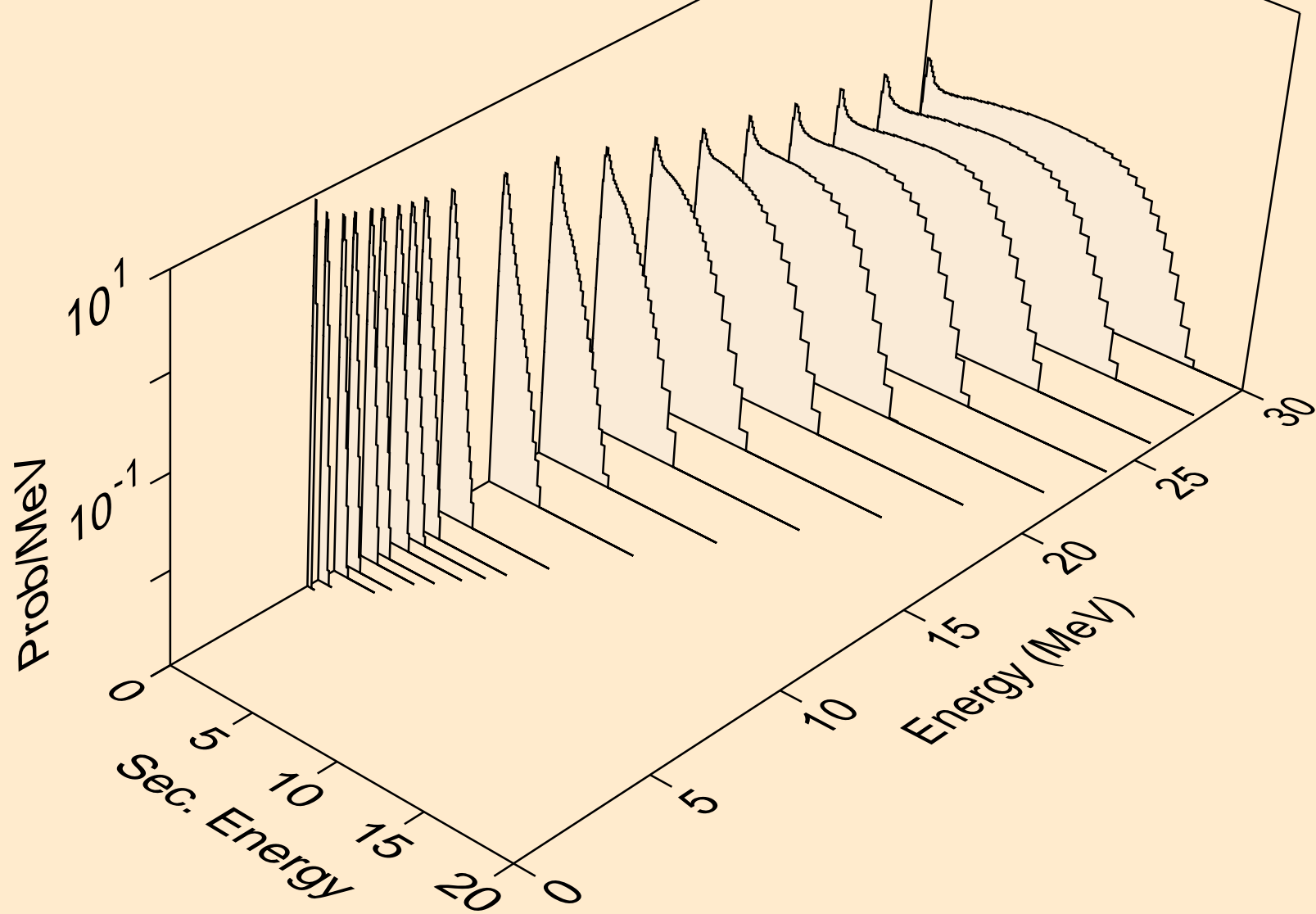

LR258 NEUTRON ACER TENDL-2023 LIBRARY; T=0.K
Neutron emission for (n,n*)d

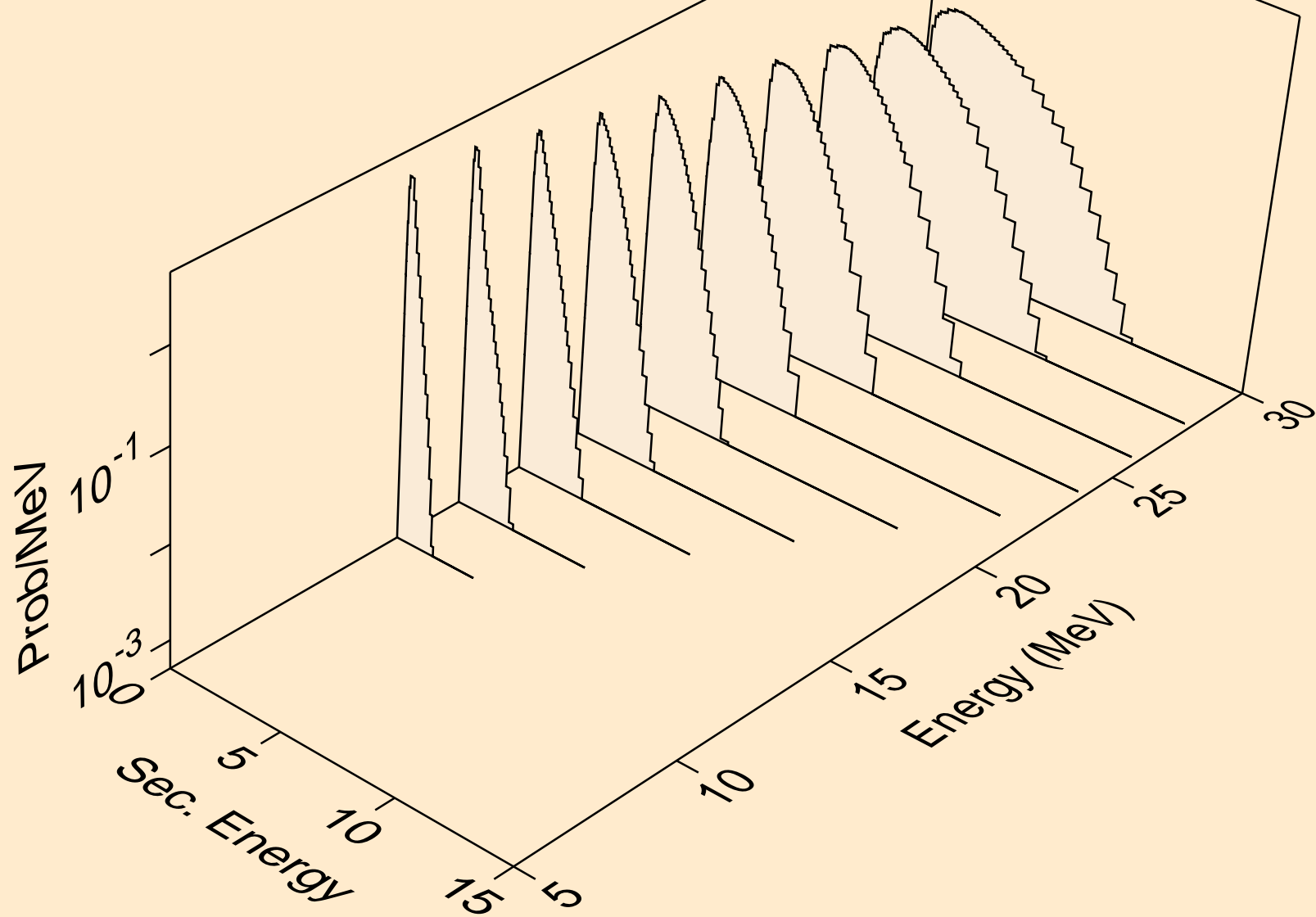

LR258 NEUTRON ACER TENDL-2023 LIBRARY; T=0.K
Neutron emission for (n,n*)t

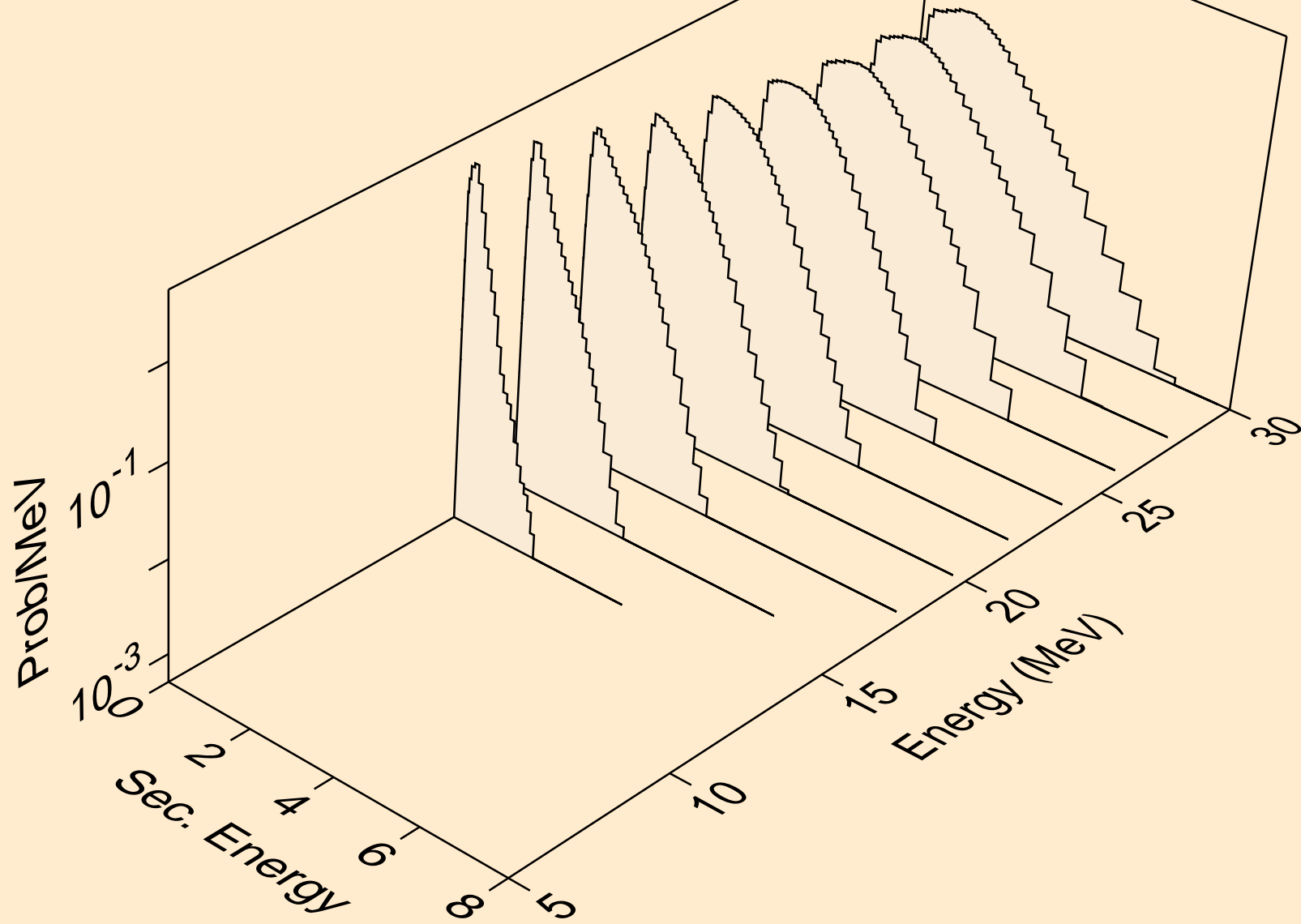

LR258 NEUTRON ACER TENDL-2023 LIBRARY; T=0.K
Neutron emission for (n,n*)he3

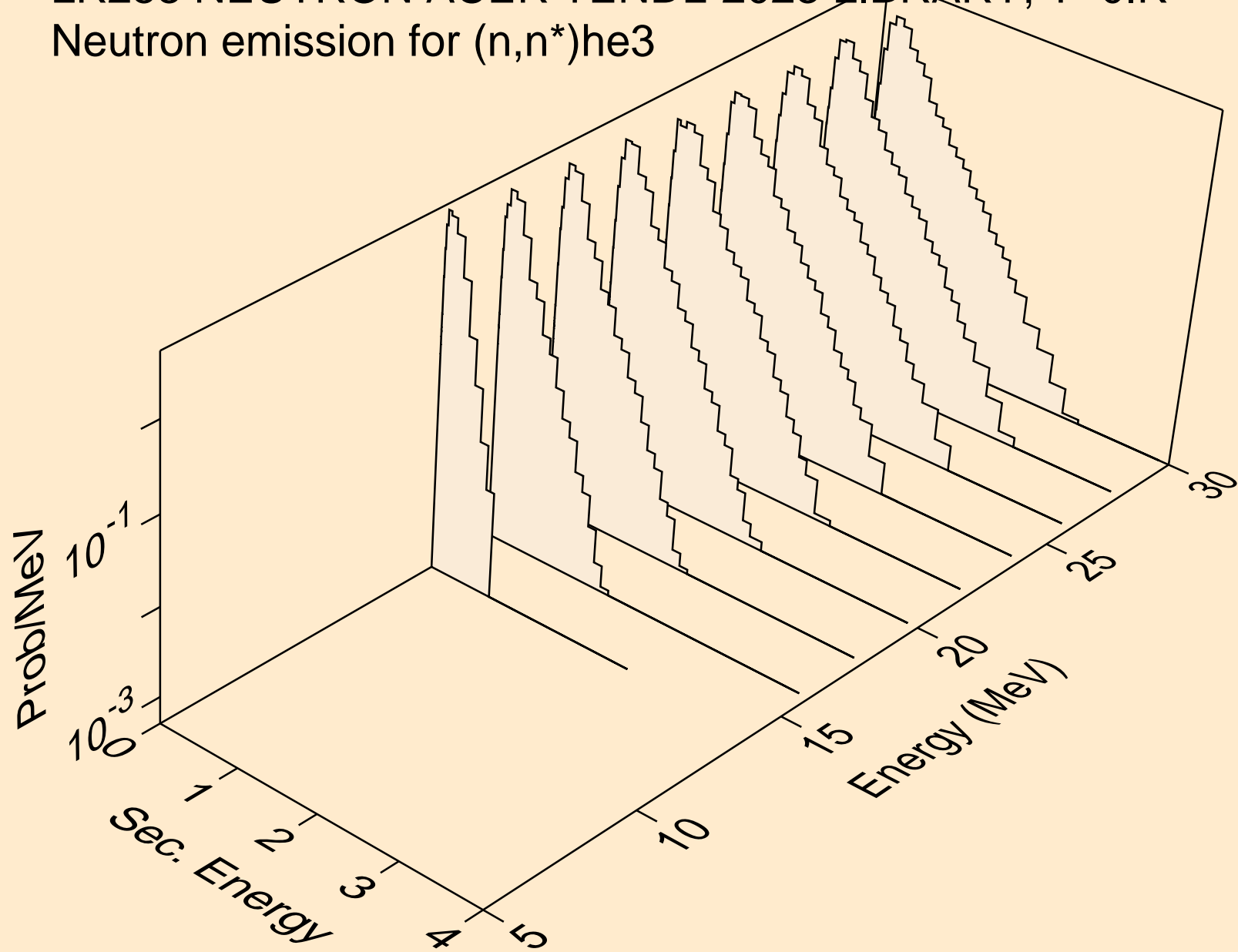

LR258 NEUTRON ACER TENDL-2023 LIBRARY; T=0.K
Neutron emission for (n,4n)

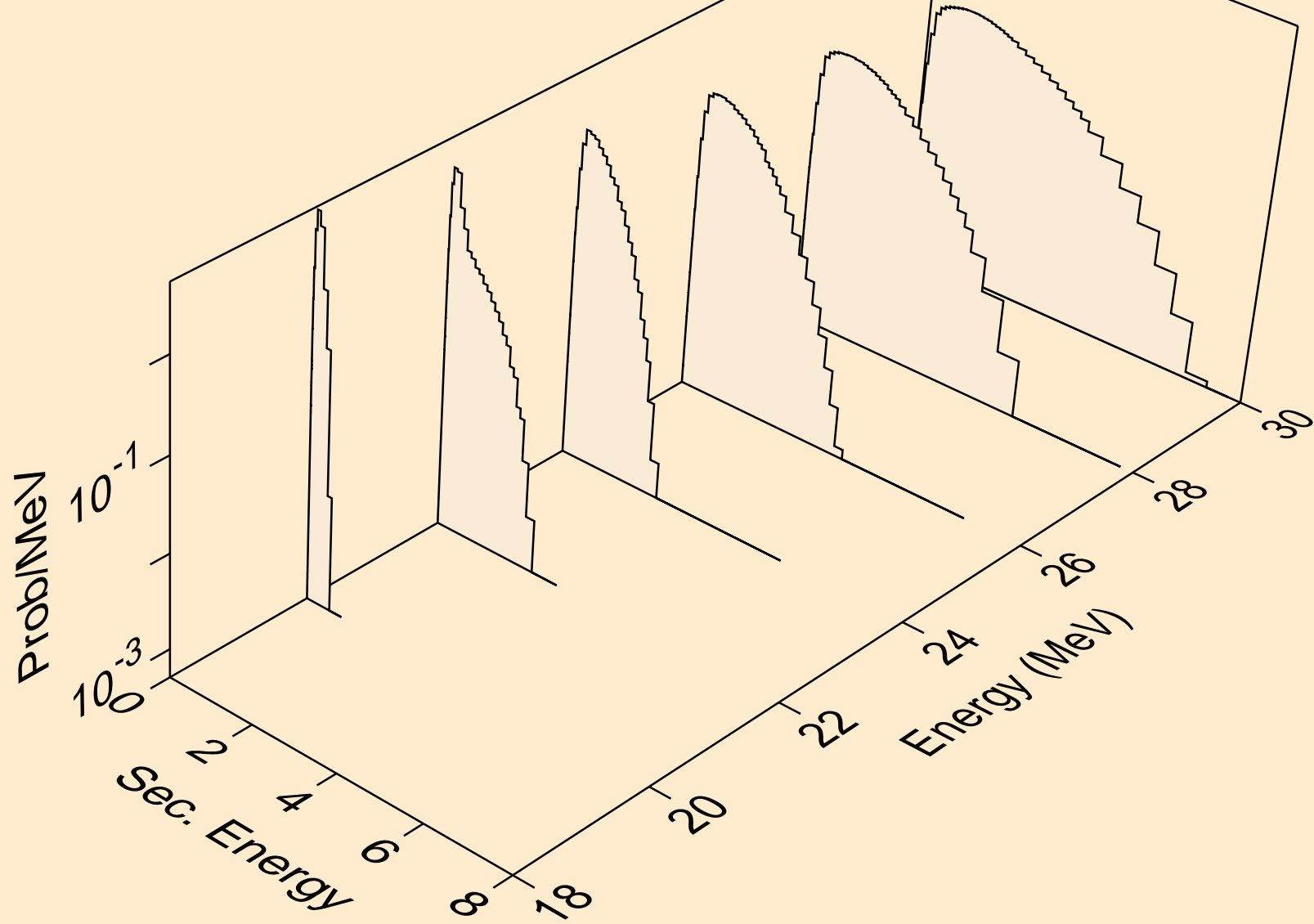

LR258 NEUTRON ACER TENDL-2023 LIBRARY; T=0.K
Neutron emission for (n,2np)

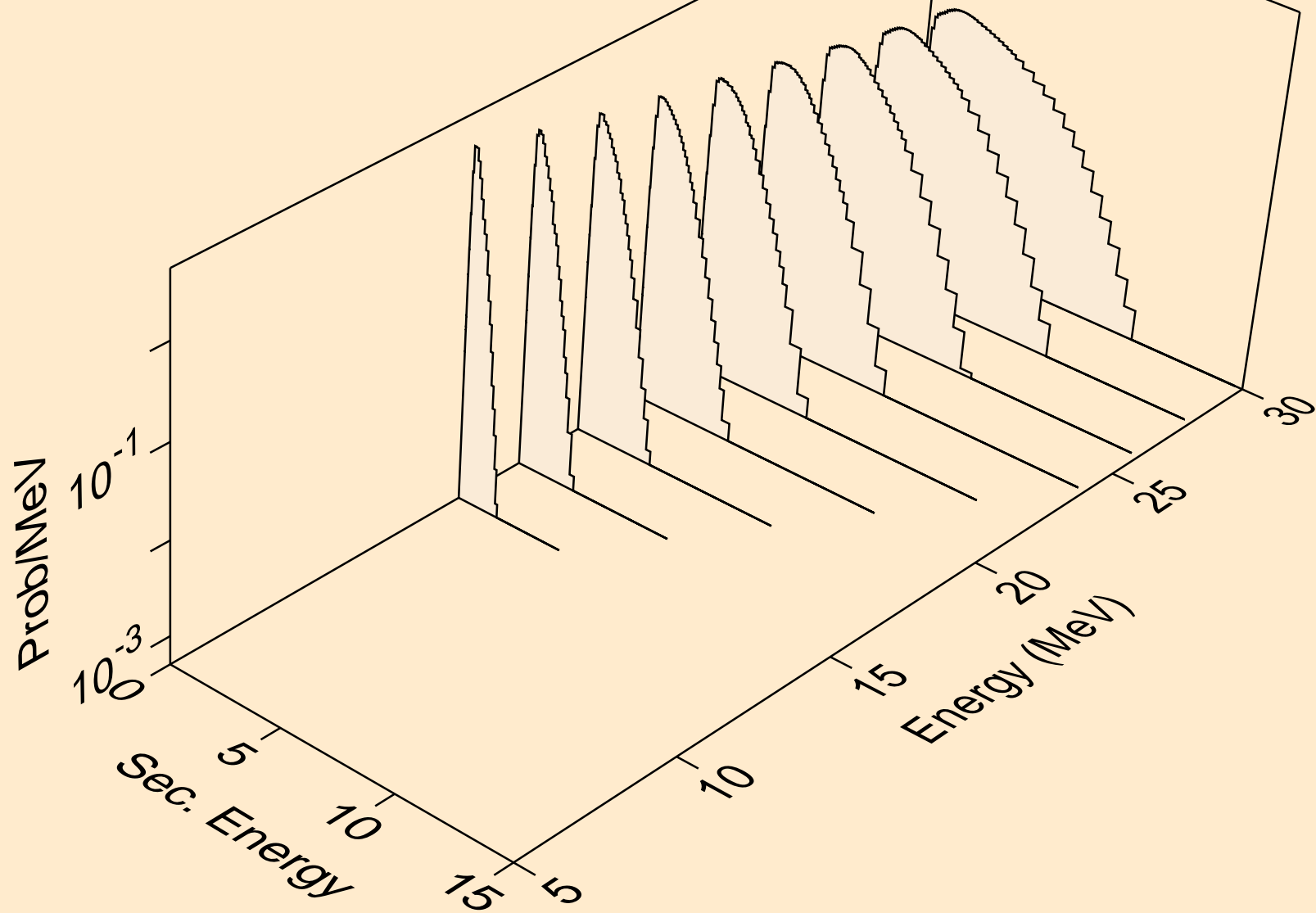

LR258 NEUTRON ACER TENDL-2023 LIBRARY; T=0.K
Neutron emission for (n,n2p)

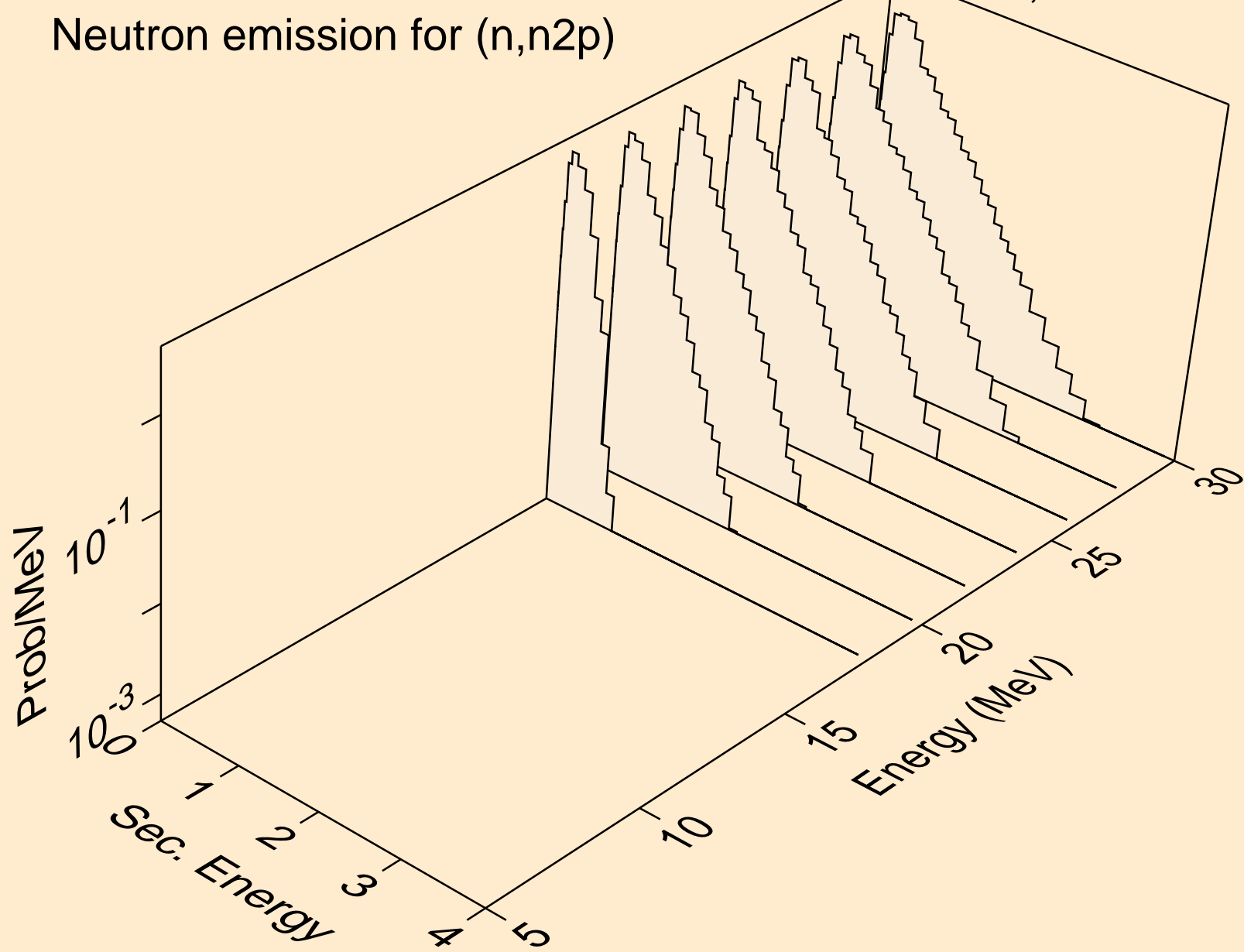

LR258 NEUTRON ACER TENDL-2023 LIBRARY; T=0.K
Neutron emission for (n,npa)

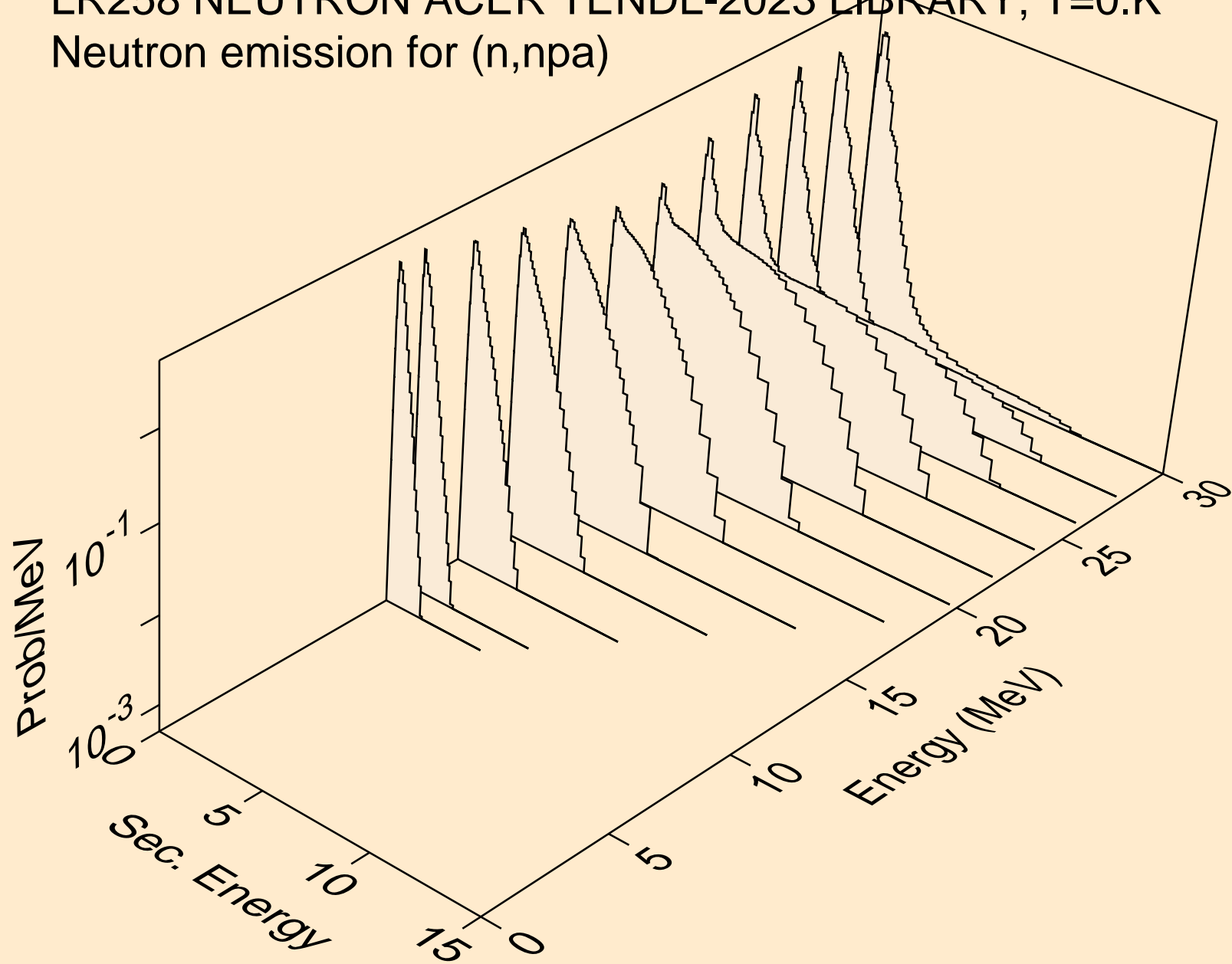

LR258 NEUTRON ACER TENDL-2023 LIBRARY; T=0.K
Neutron emission for (n,n*c)

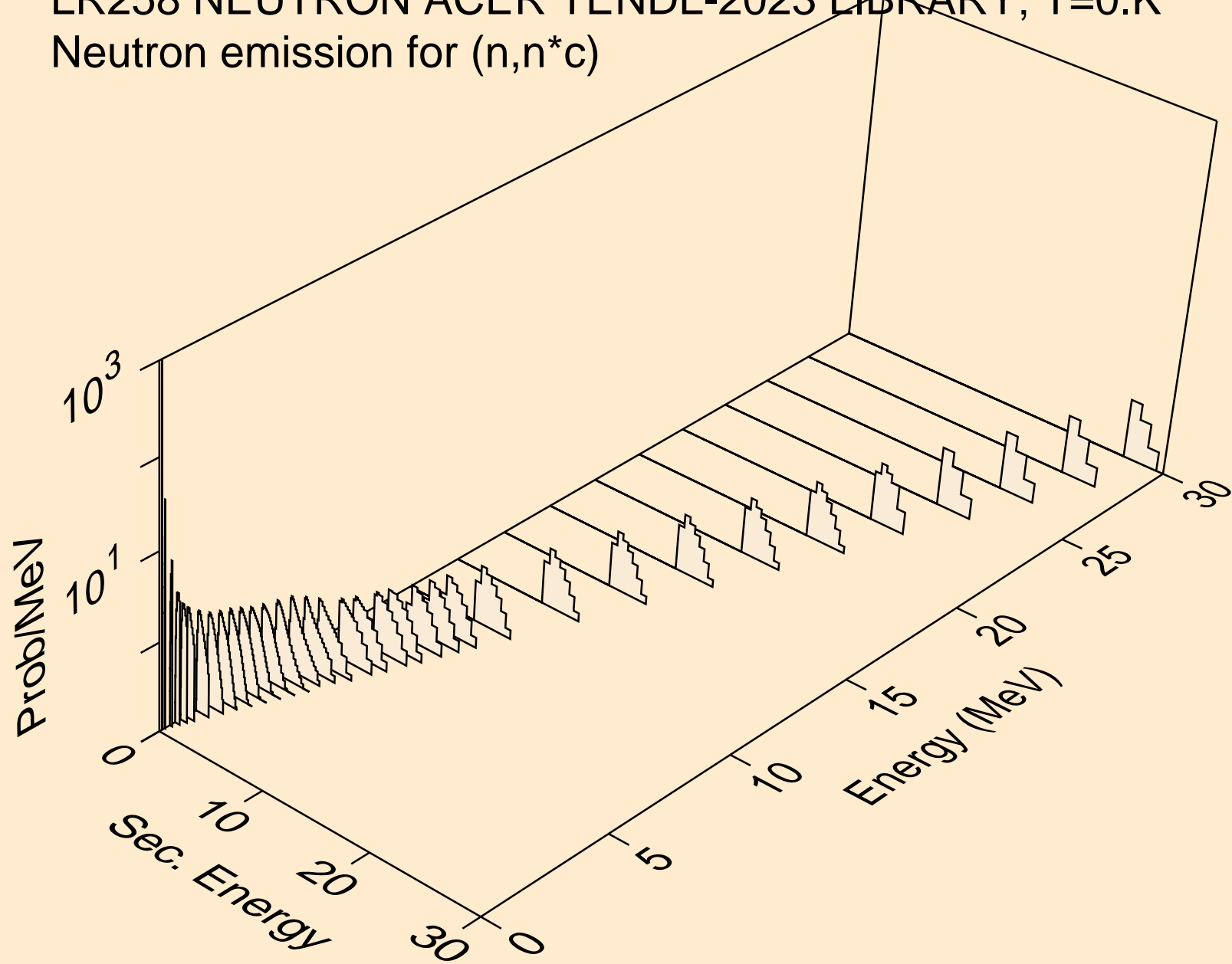

LR258 NEUTRON ACER TENDL-2023 LIBRARY; T=0.K

Delayed nubar

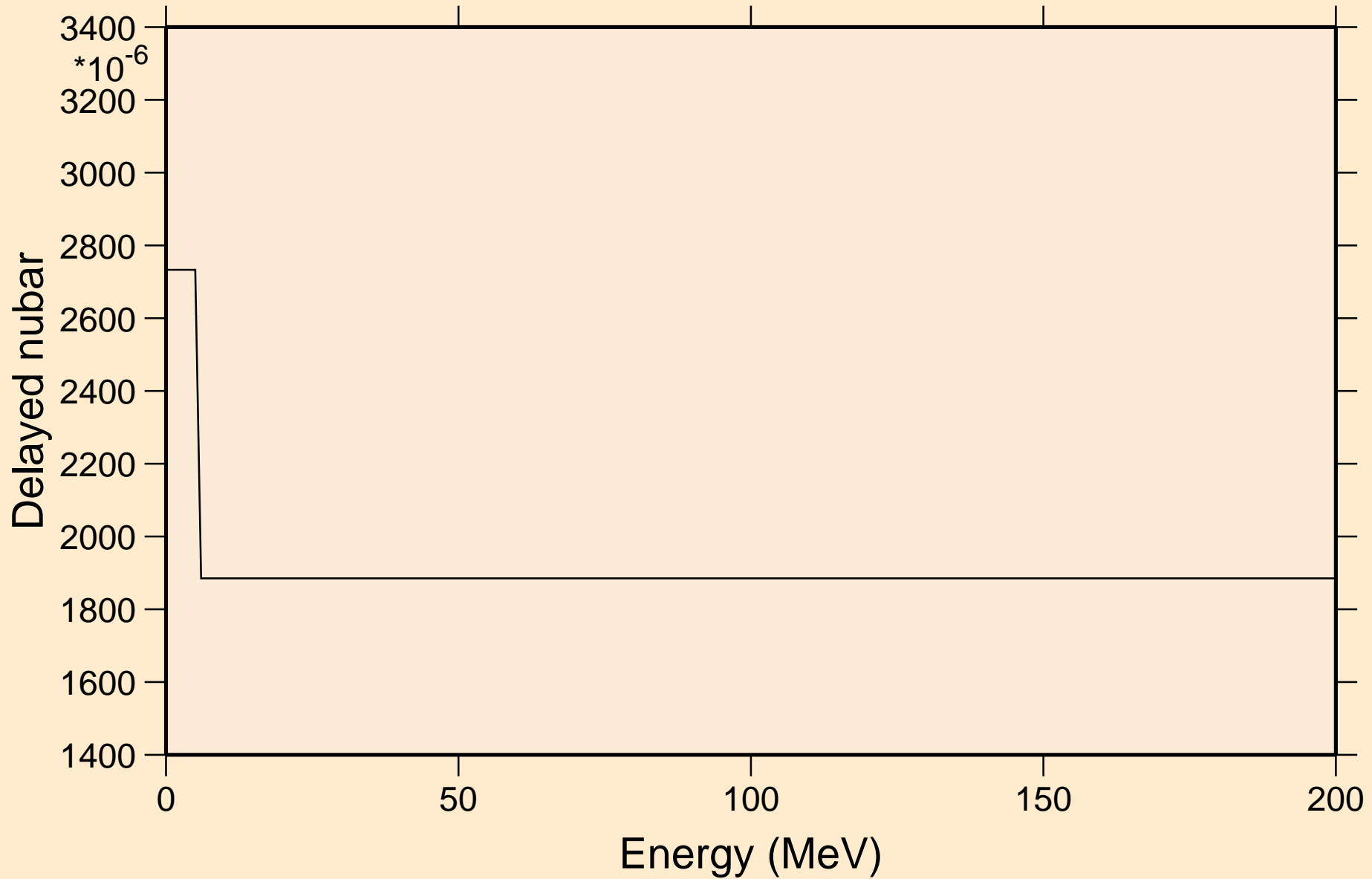

LR258 NEUTRON ACER TENDL-2023 LIBRARY; T=0.K

Delayed neutron spectra

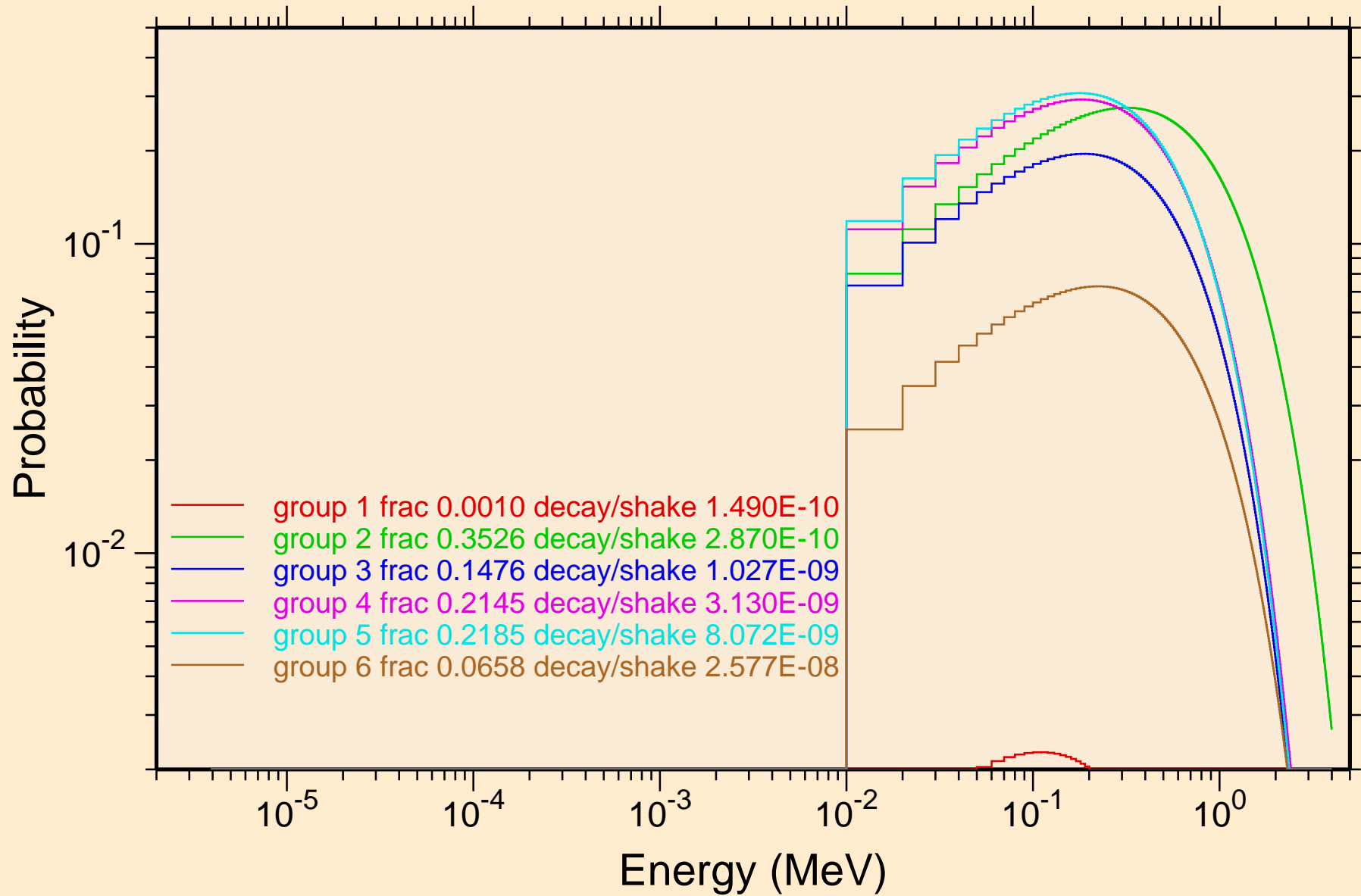

LR258 NEUTRON ACER TENDL-2023 LIBRARY; T=0.K
Photon emission for (n,x)

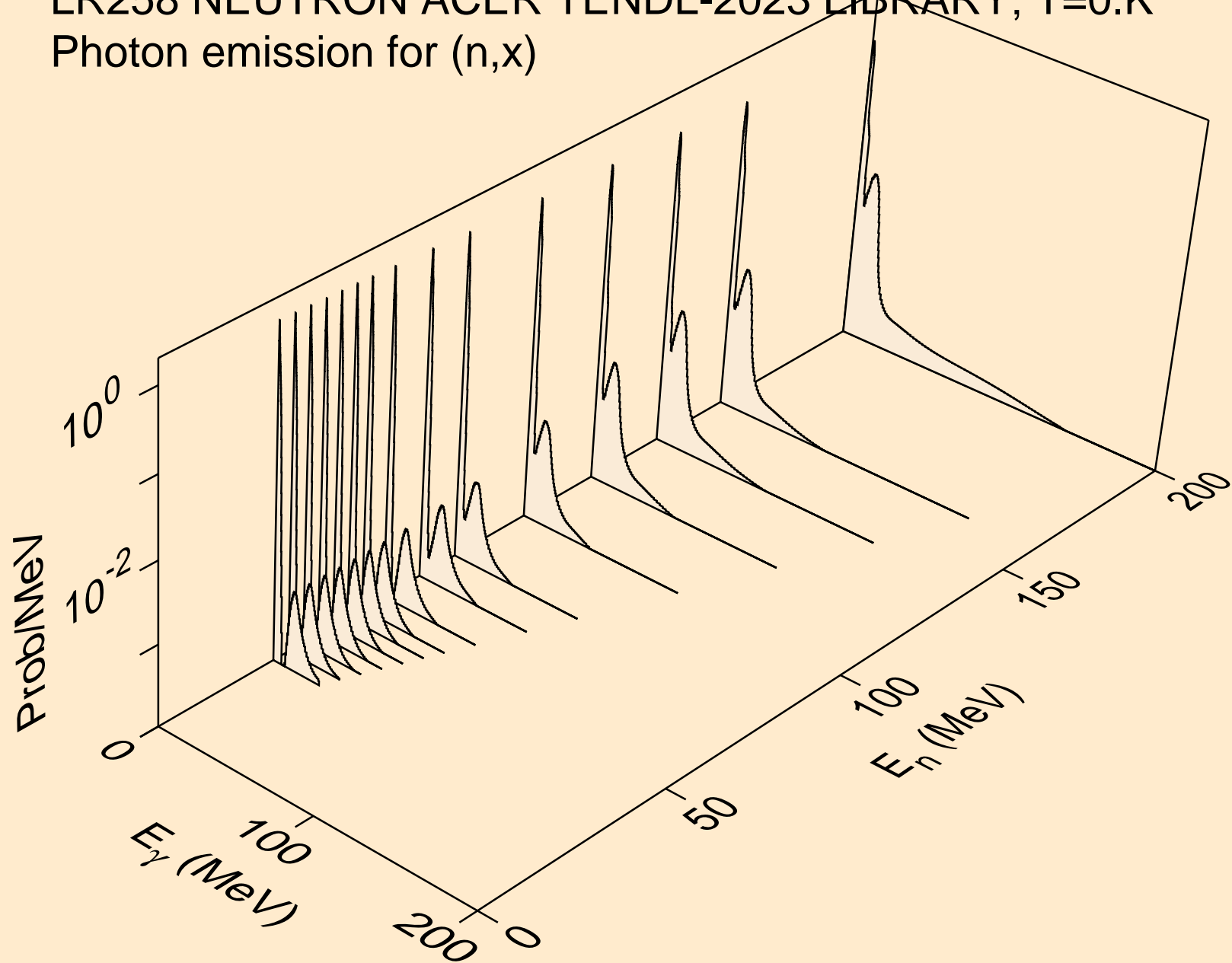

LR258 NEUTRON ACER TENDL-2023 LIBRARY; T=0.K
Photon emission for (n,2n)

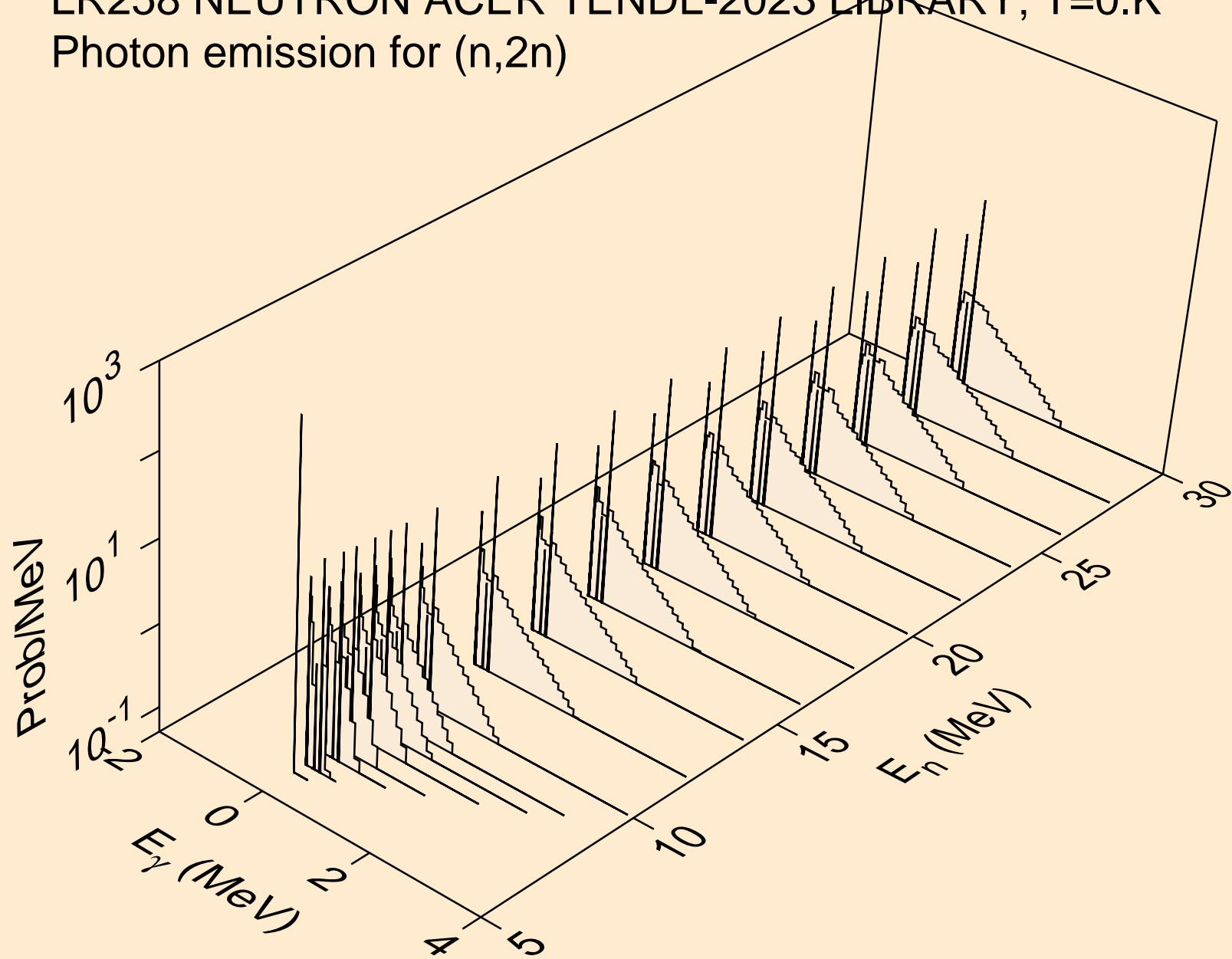

LR258 NEUTRON ACER TENDL-2023 LIBRARY; T=0.K
Photon emission for (n,3n)

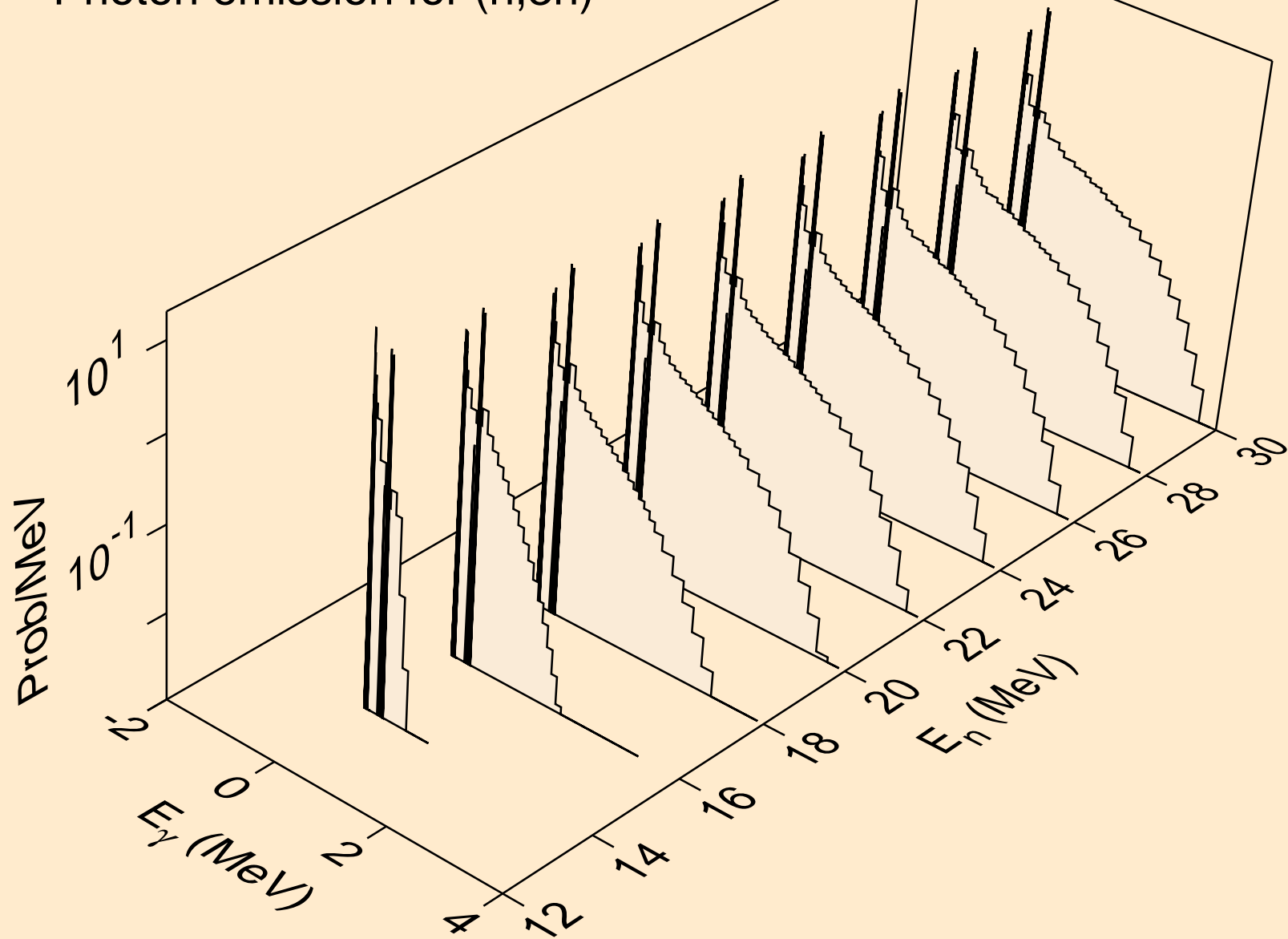

LR258 NEUTRON ACER TENDL-2023 LIBRARY; T=0.K
Photon emission for (n,n*)a

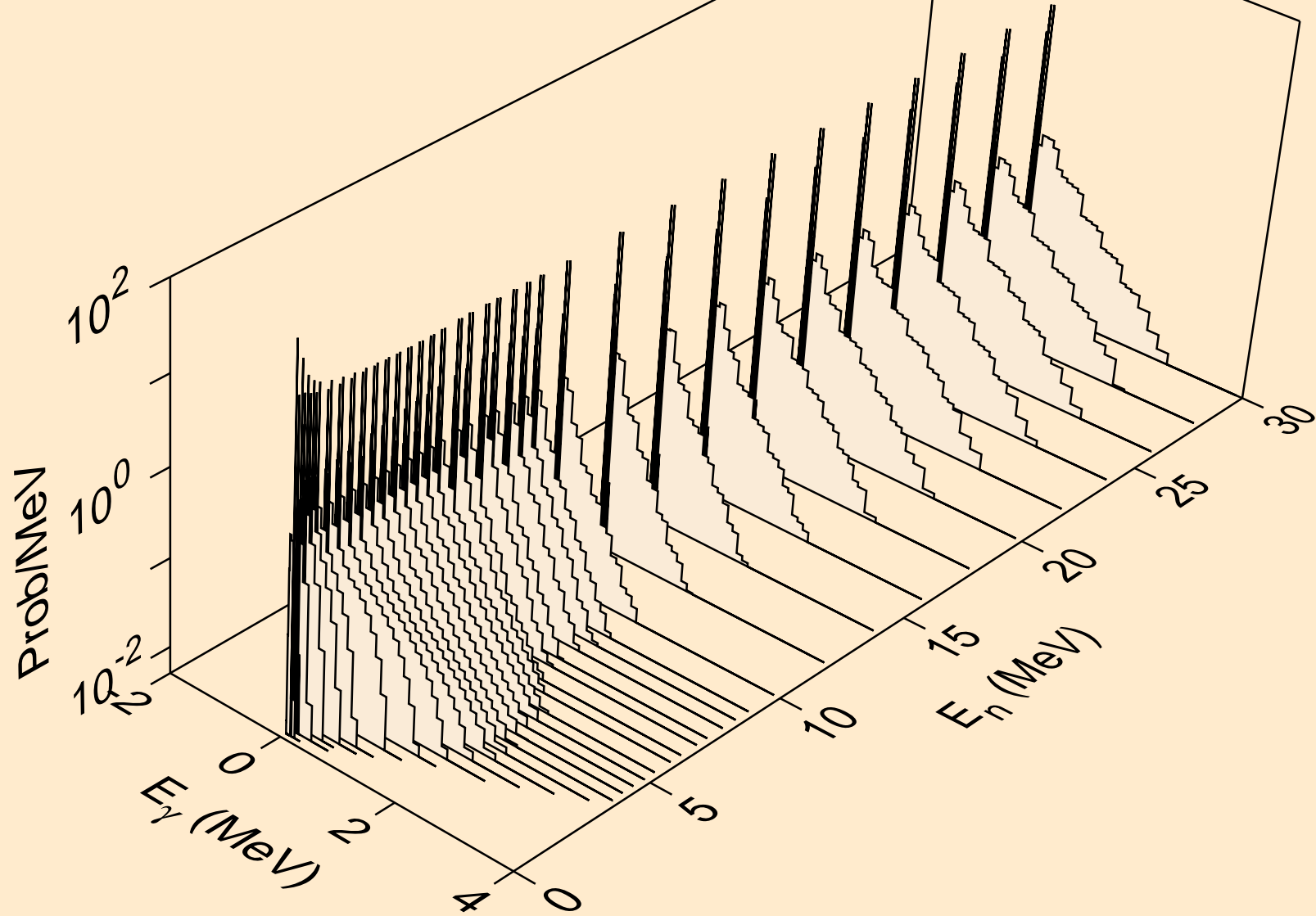

LR258 NEUTRON ACER TENDL-2023 LIBRARY; T=0.K
Photon emission for (n,2n)a

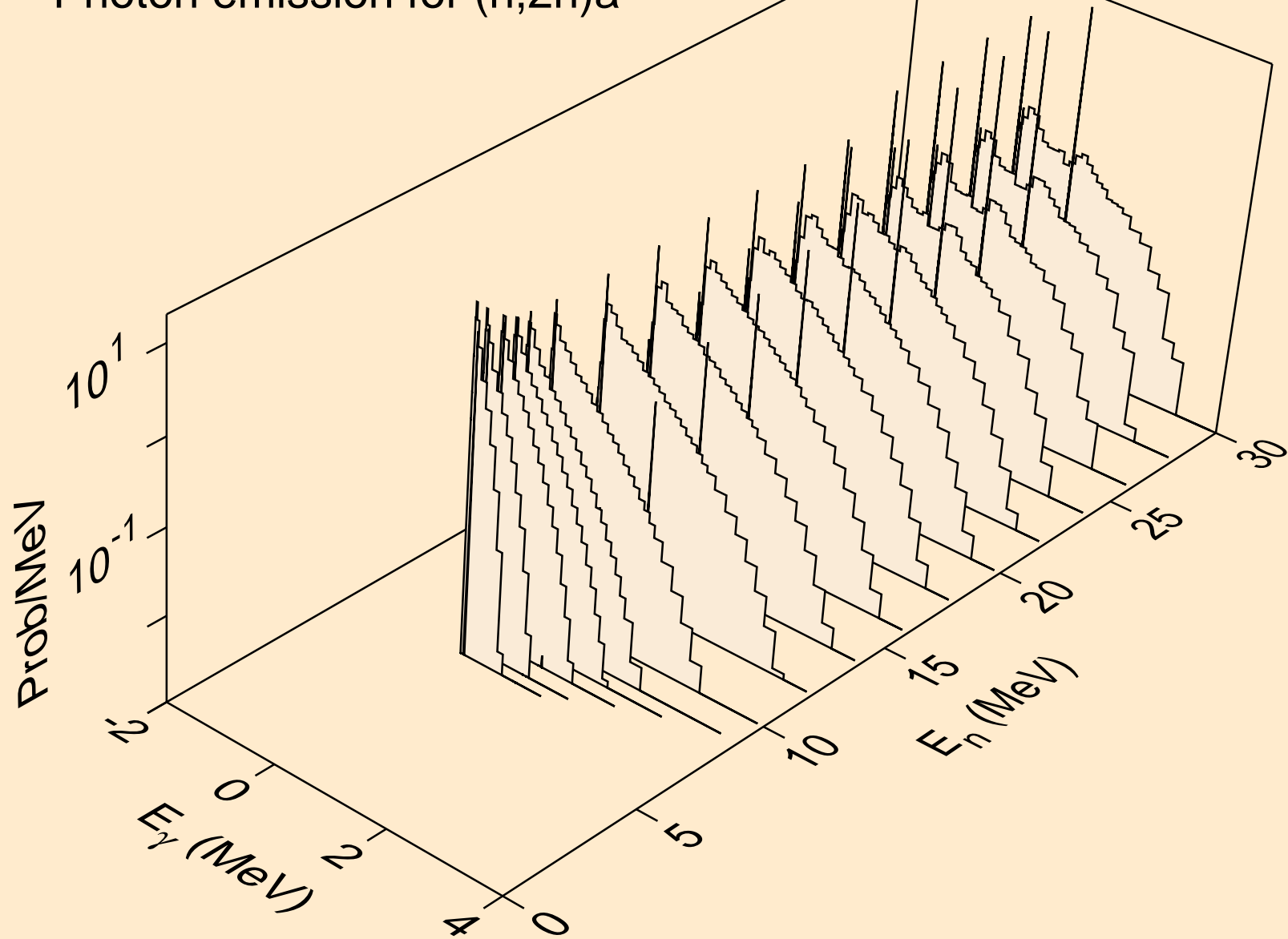

LR258 NEUTRON ACER TENDL-2023 LIBRARY; T=0.K
Photon emission for (n,n*)p

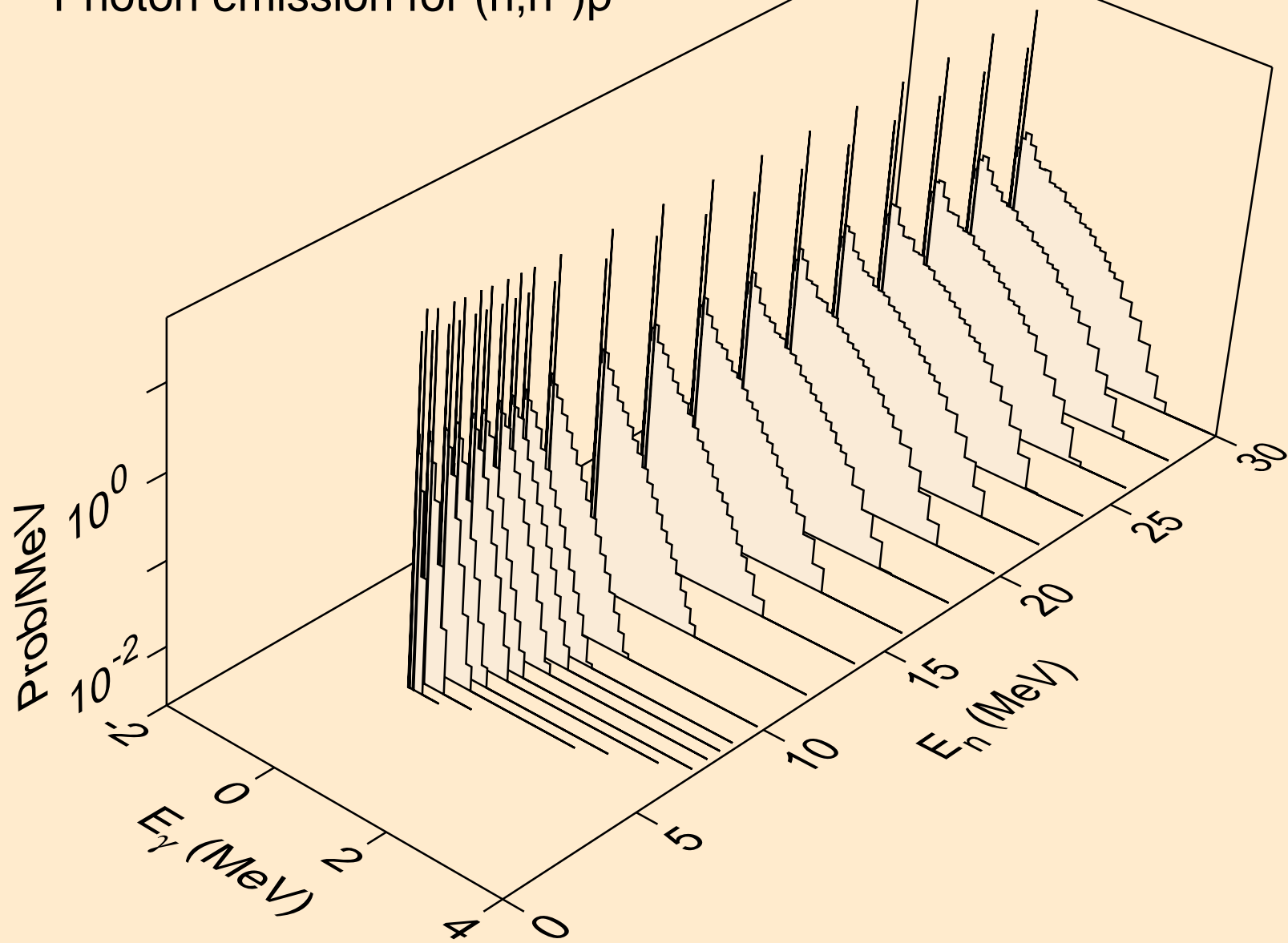

LR258 NEUTRON ACER TENDL-2023 LIBRARY; T=0.K
Photon emission for (n,n*)d

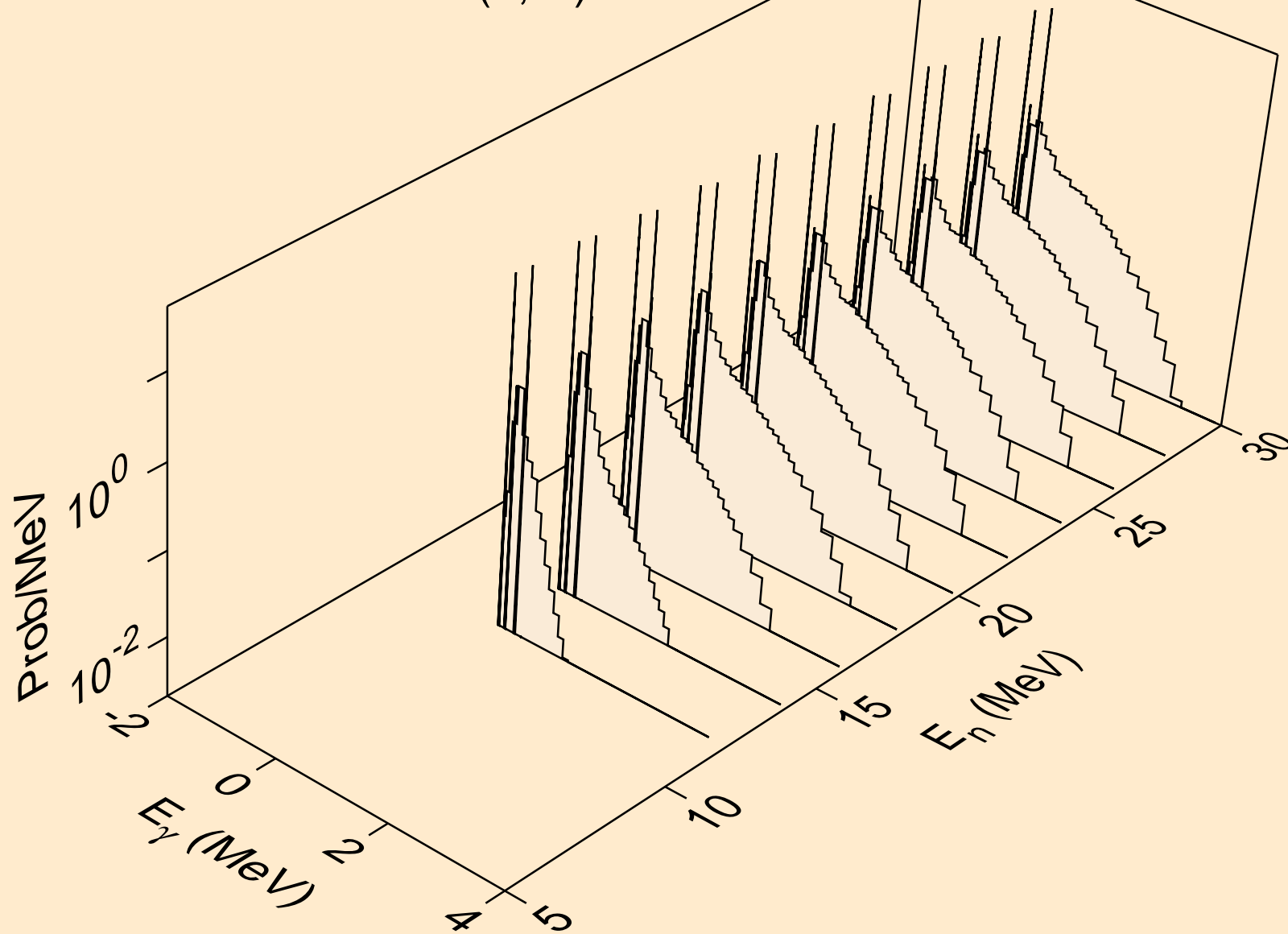

LR258 NEUTRON ACER TENDL-2023 LIBRARY; T=0.K
Photon emission for (n,n*)t

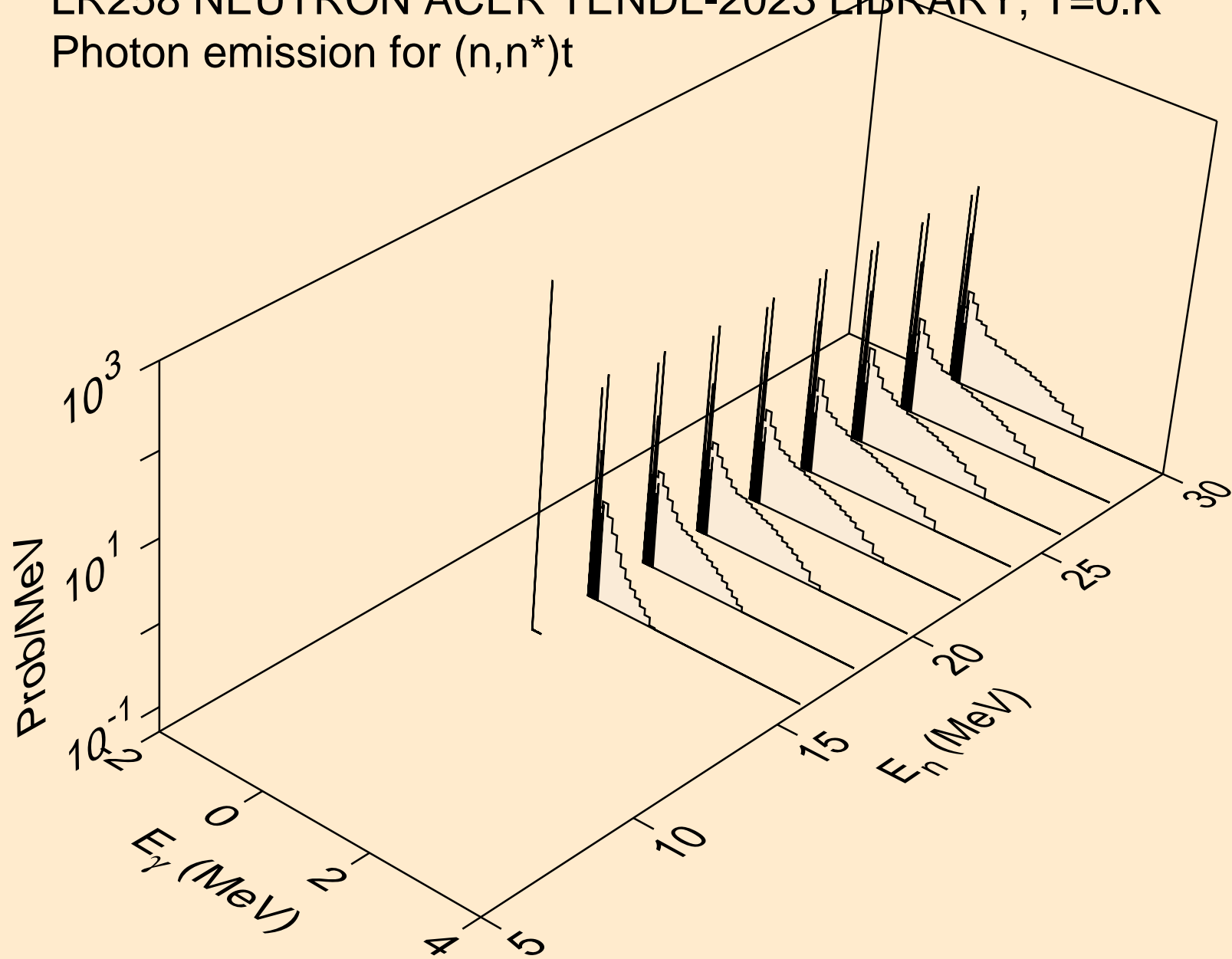

LR258 NEUTRON ACER TENDL-2023 LIBRARY; T=0.K
Photon emission for (n,n*)he3

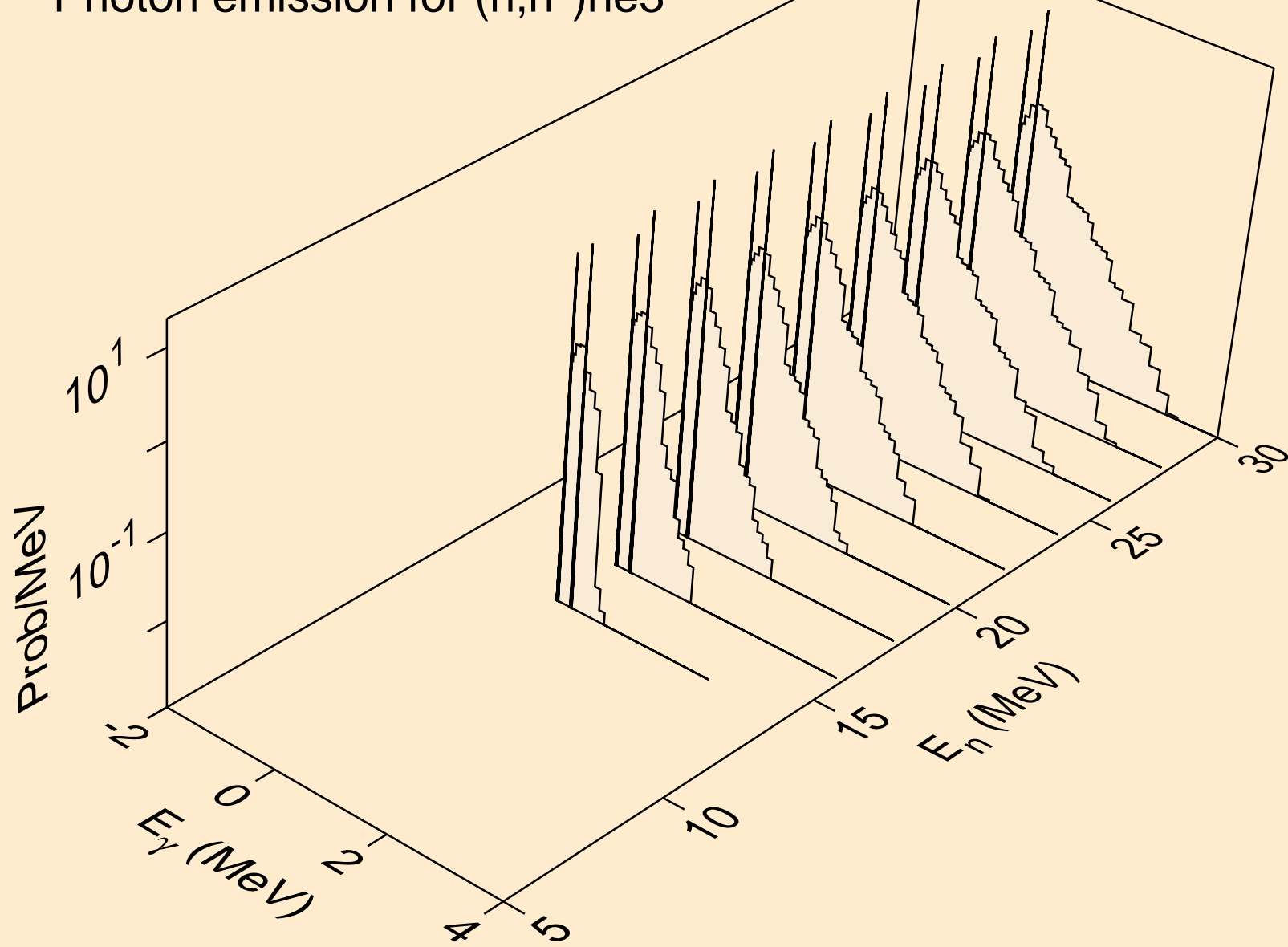

LR258 NEUTRON ACER TENDL-2023 LIBRARY; T=0.K
Photon emission for (n,4n)

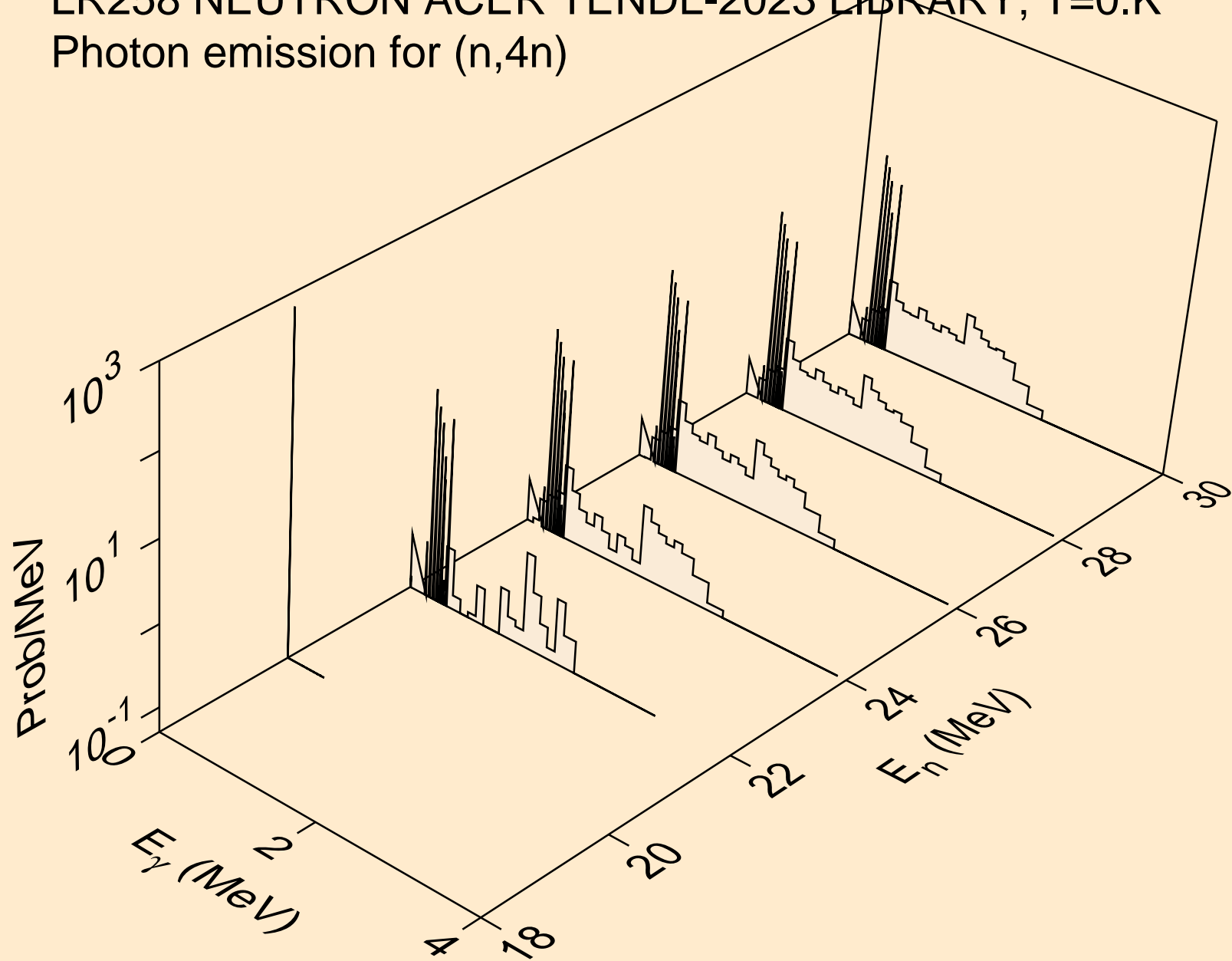

LR258 NEUTRON ACER TENDL-2023 LIBRARY; T=0.K
Photon emission for (n,2np)

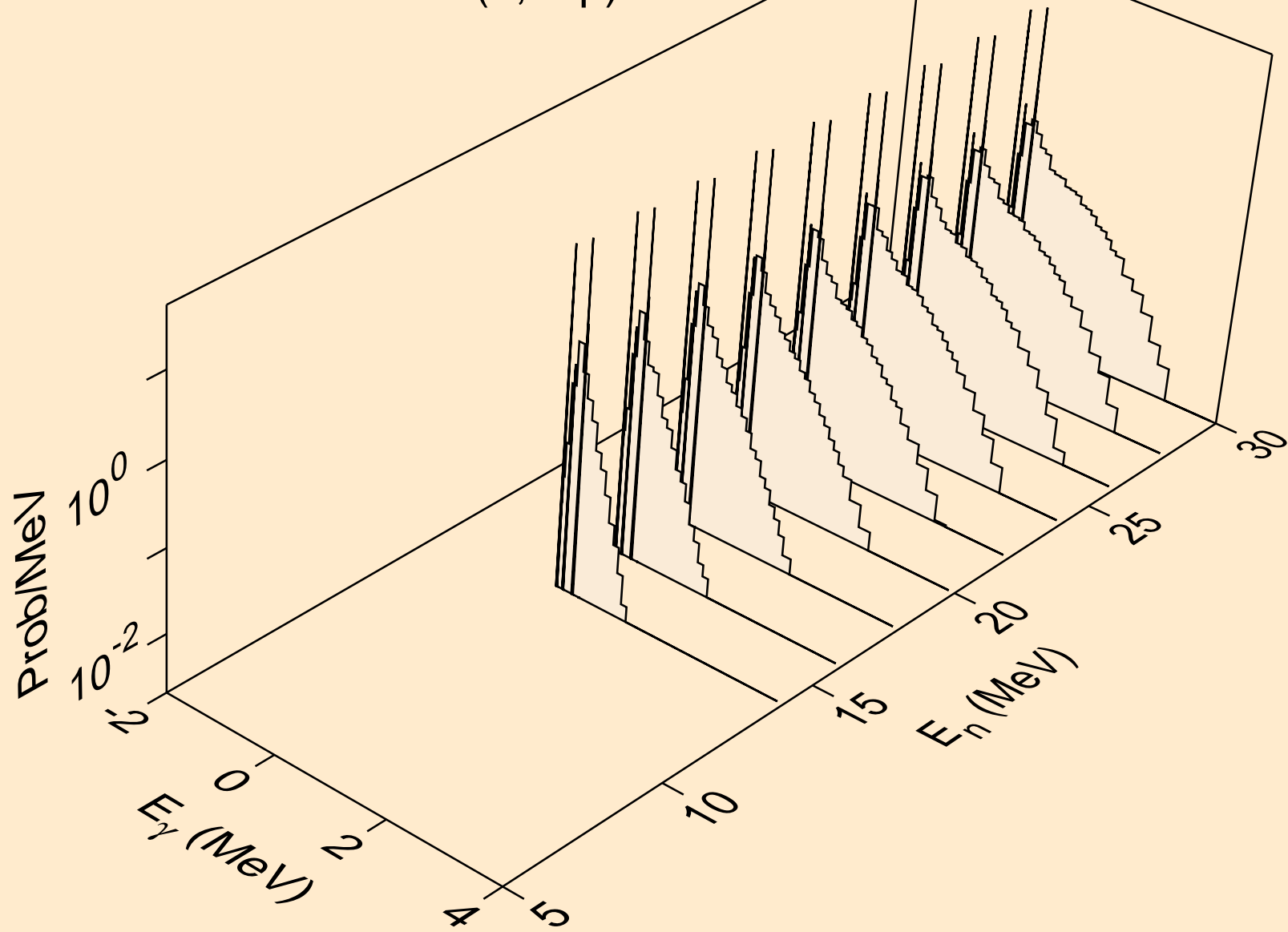

LR258 NEUTRON ACER TENDL-2023 LIBRARY; T=0.K
Photon emission for (n,n2p)

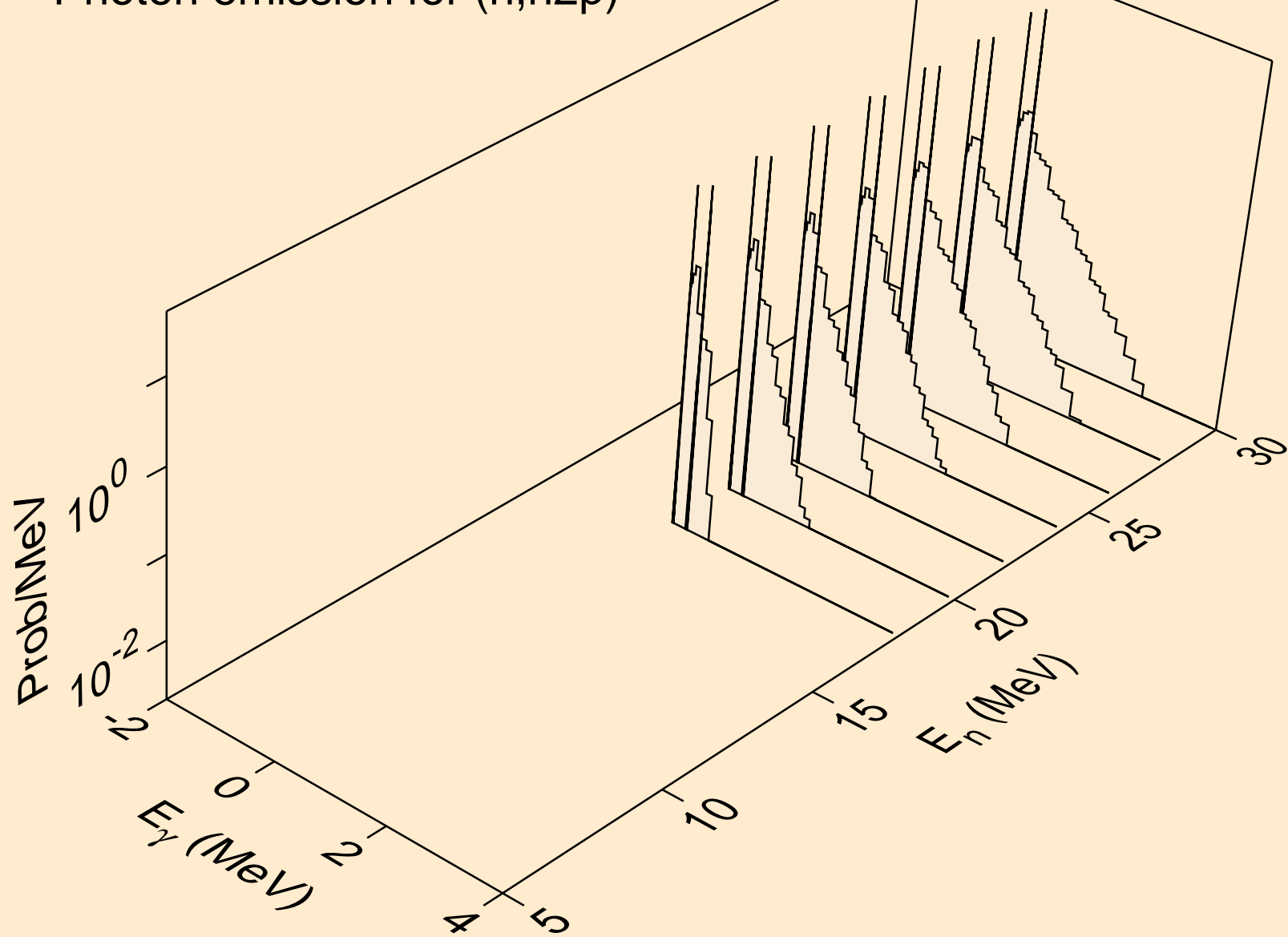

LR258 NEUTRON ACER TENDL-2023 LIBRARY; T=0.K
Photon emission for (n,npa)

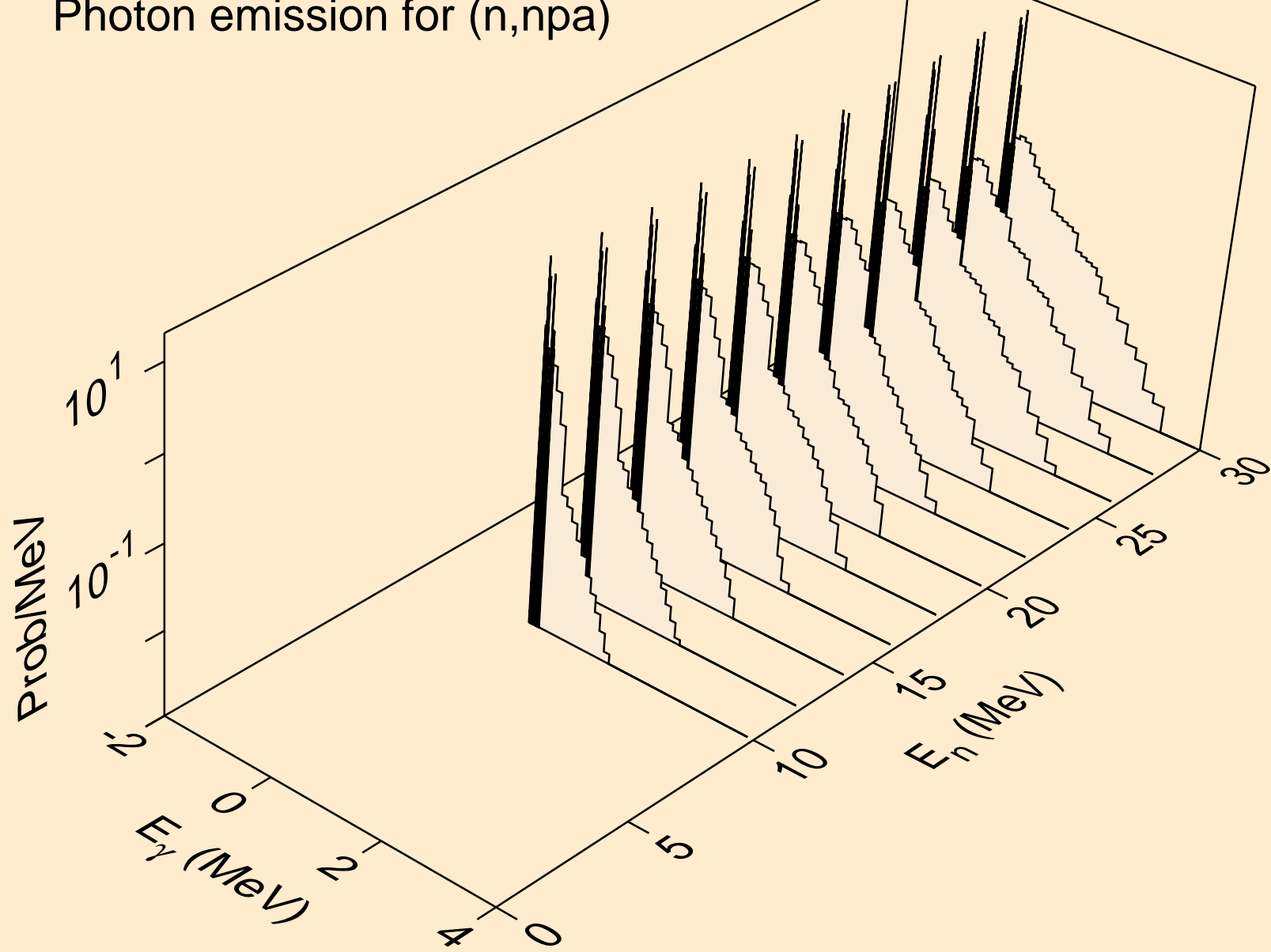

LR258 NEUTRON ACER TENDL-2023 LIBRARY; T=0.K
Photon emission for (n,n*c)

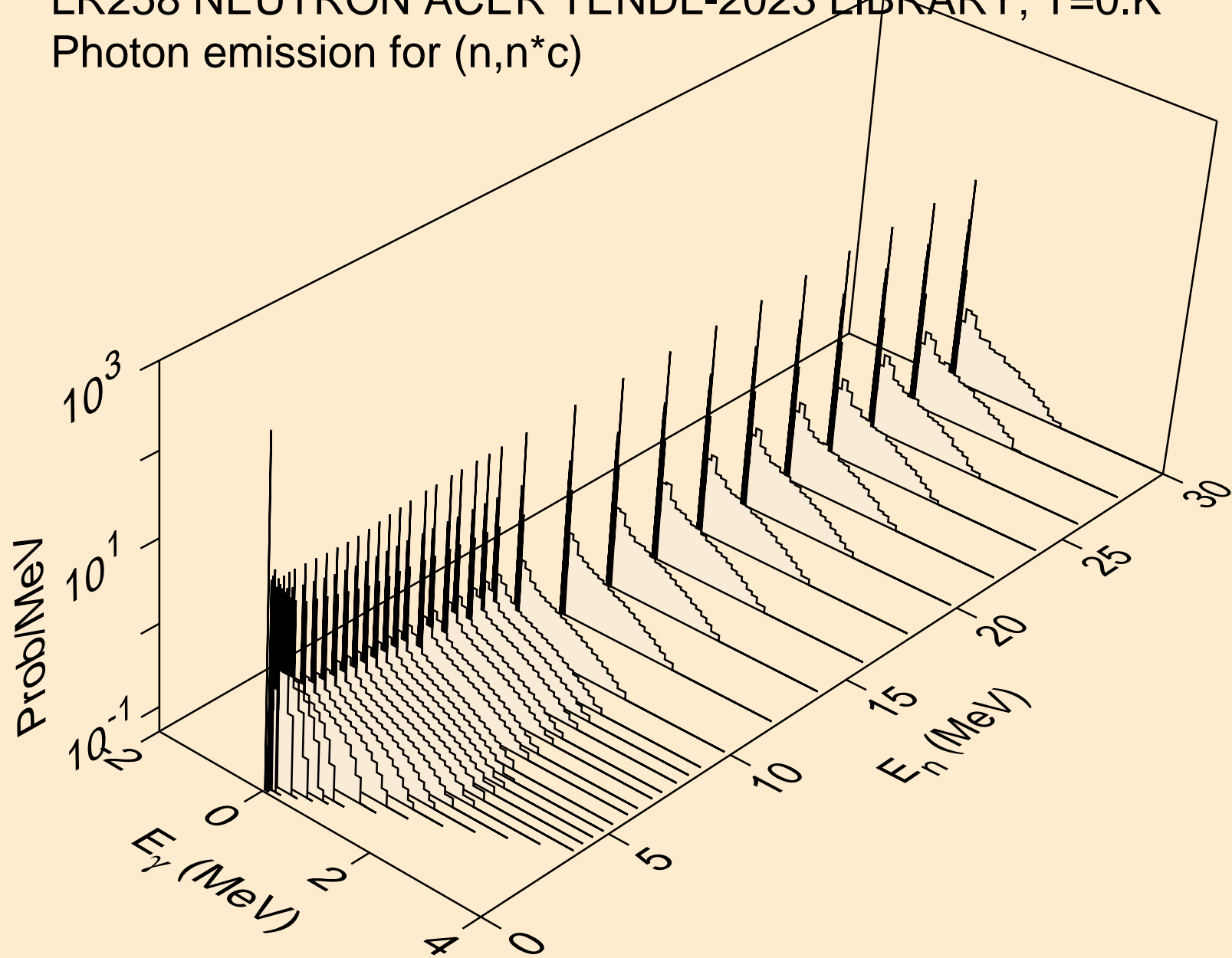

LR258 NEUTRON ACER TENDL-2023 LIBRARY; T=0.K
Photon emission for (n,gma)

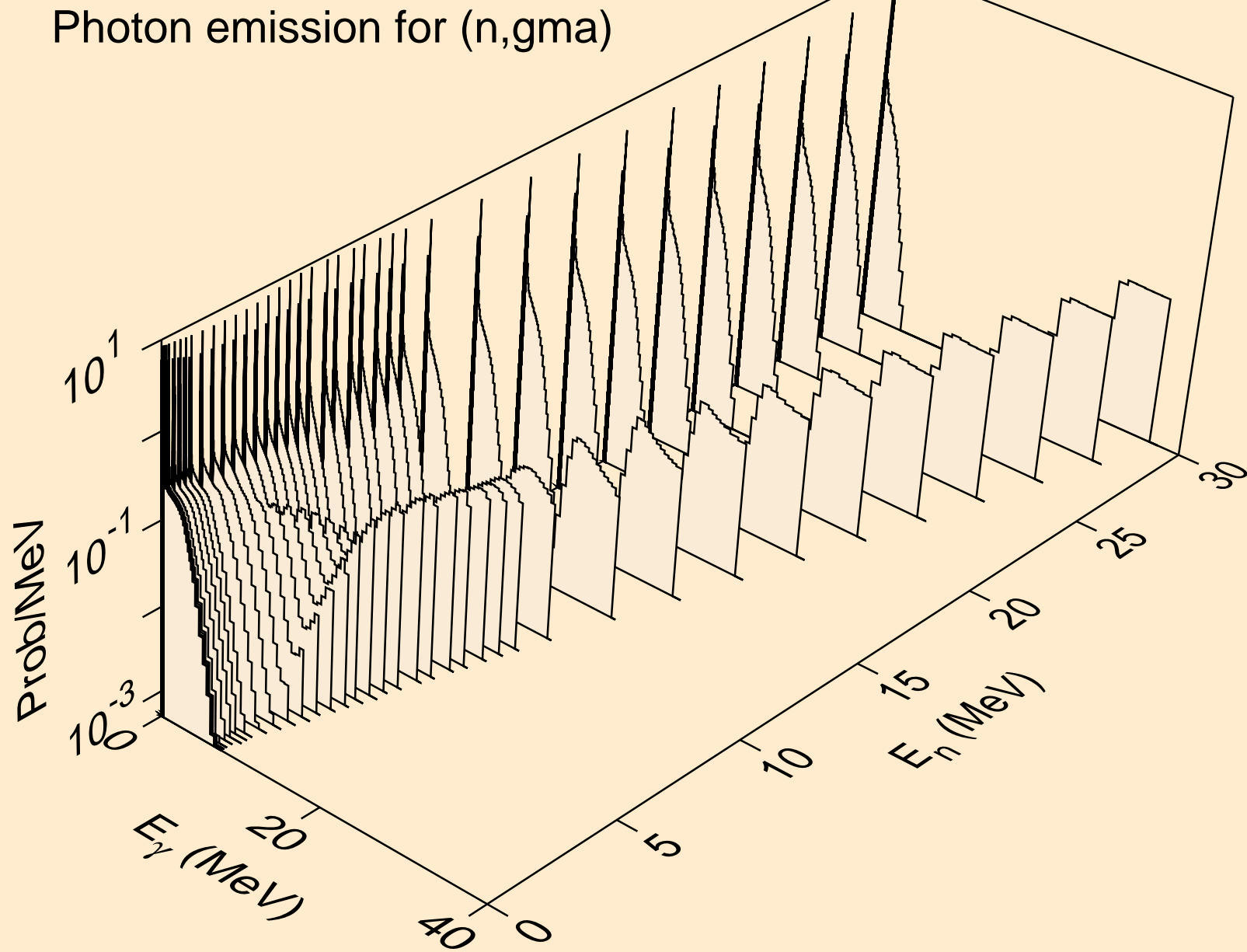

LR258 NEUTRON ACER TENDL-2023 LIBRARY; T=0.K
Photon emission for (n,p)

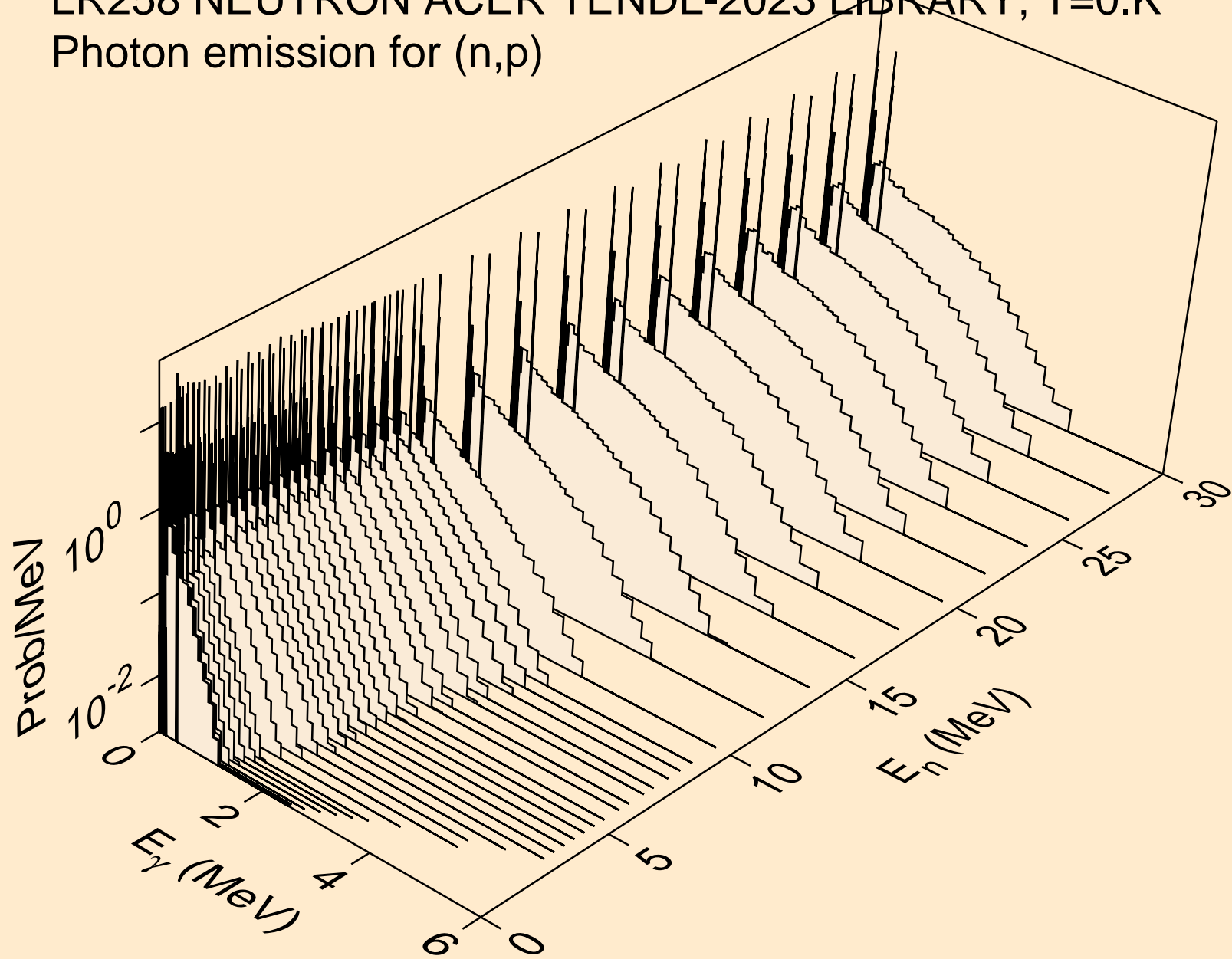

LR258 NEUTRON ACER TENDL-2023 LIBRARY; T=0.K
Photon emission for (n,d)

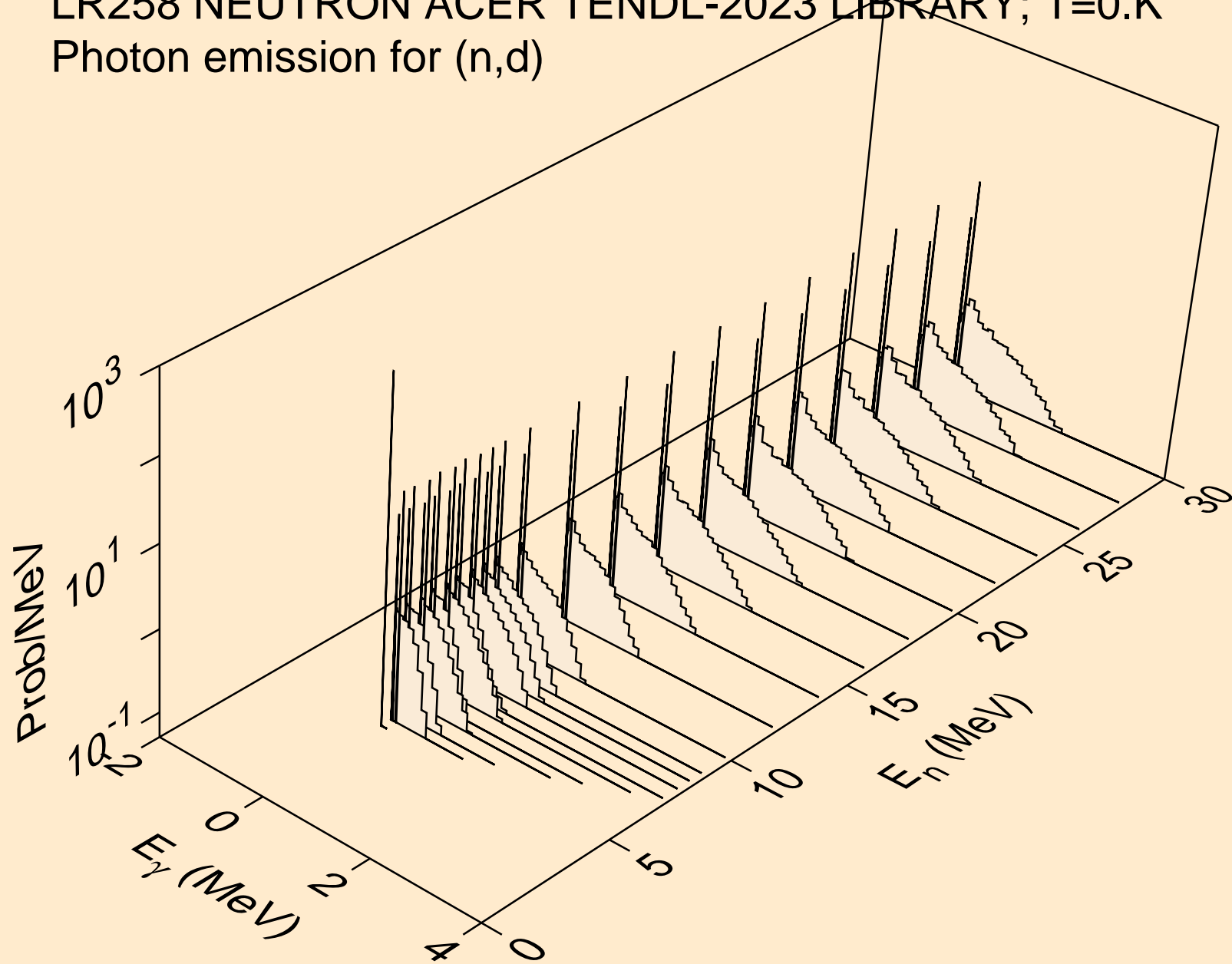

LR258 NEUTRON ACER TENDL-2023 LIBRARY; T=0.K
Photon emission for (n,t)

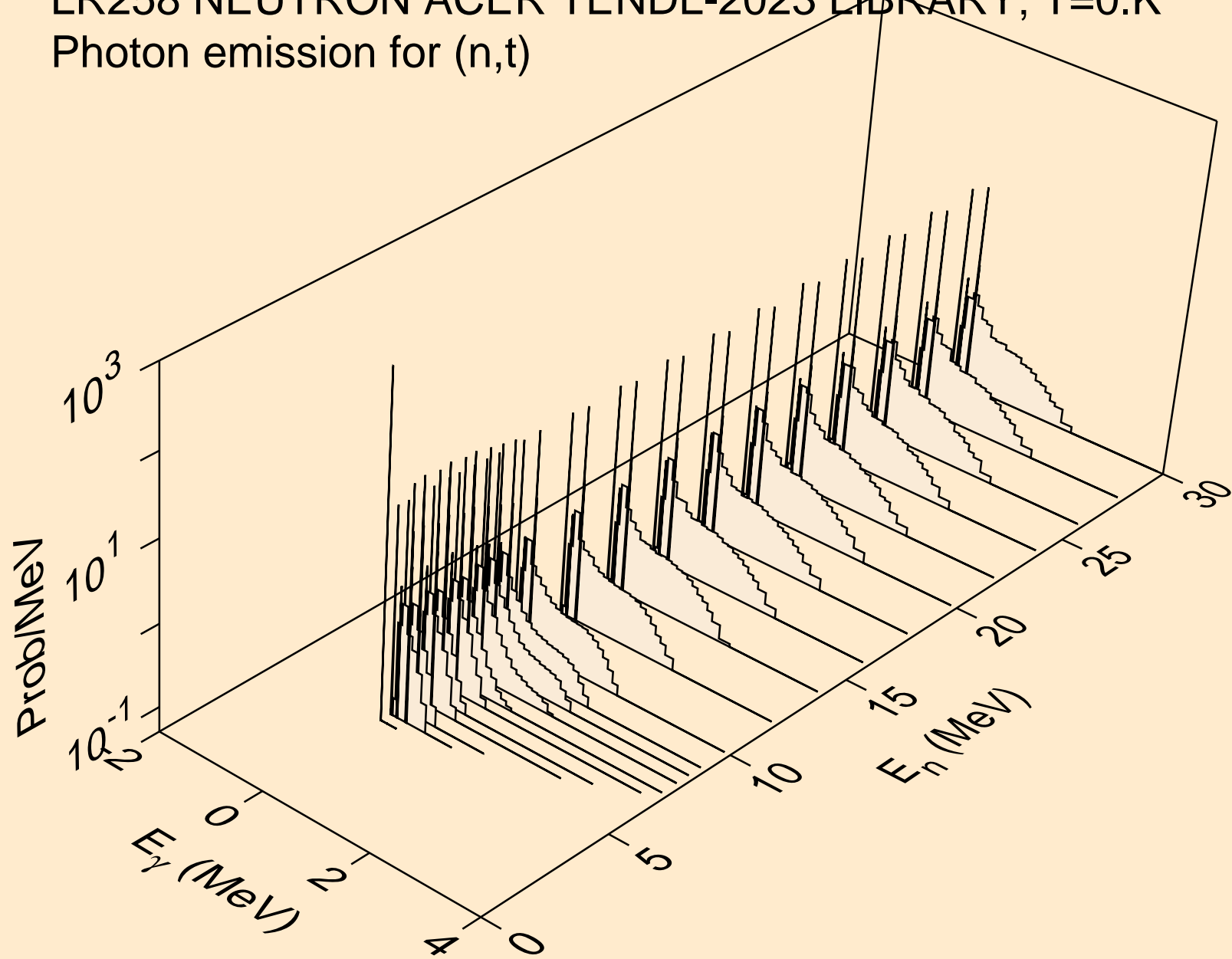

LR258 NEUTRON ACER TENDL-2023 LIBRARY; T=0.K
Photon emission for (n,he3)

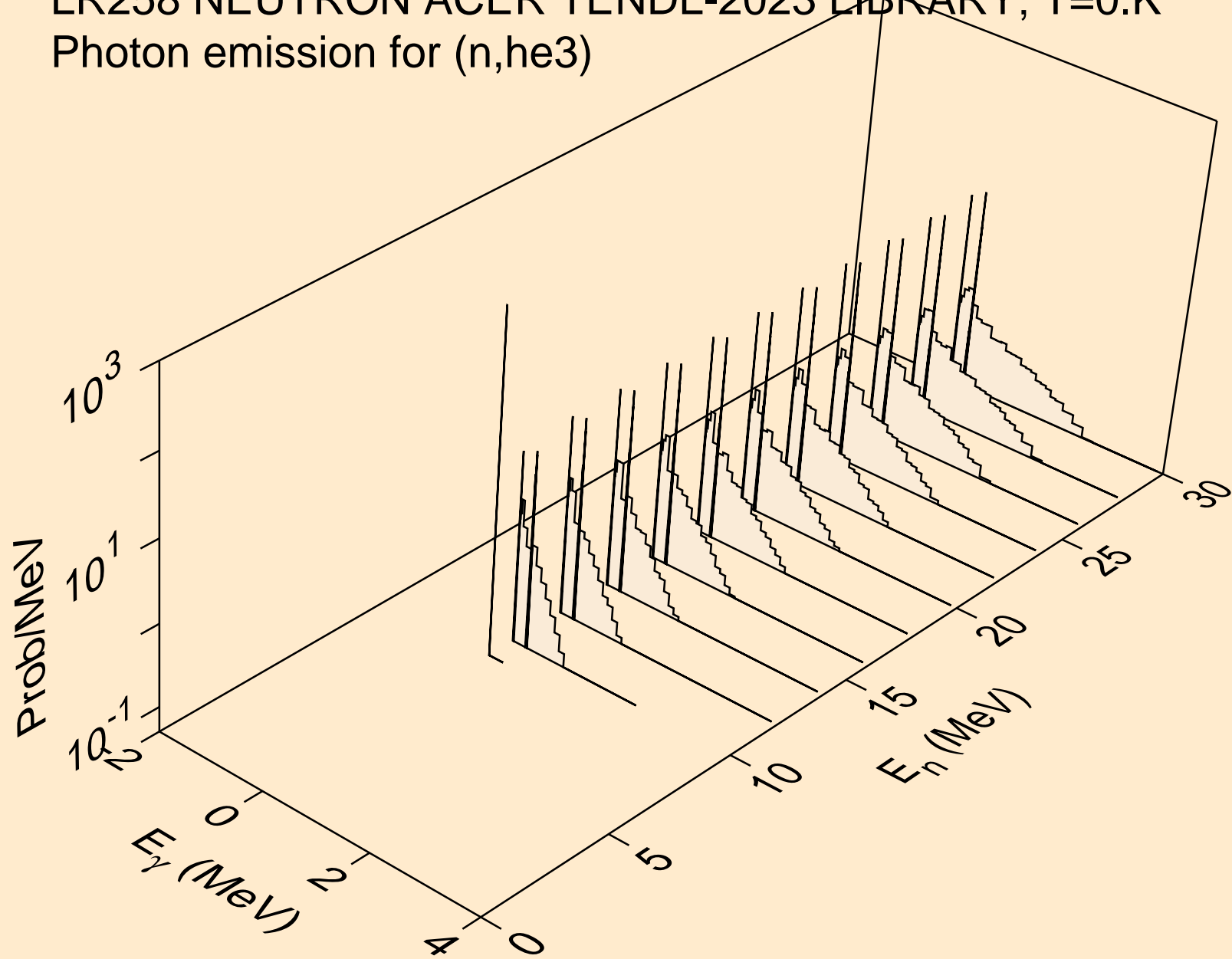

LR258 NEUTRON ACER TENDL-2023 LIBRARY; T=0.K
Photon emission for (n,a)

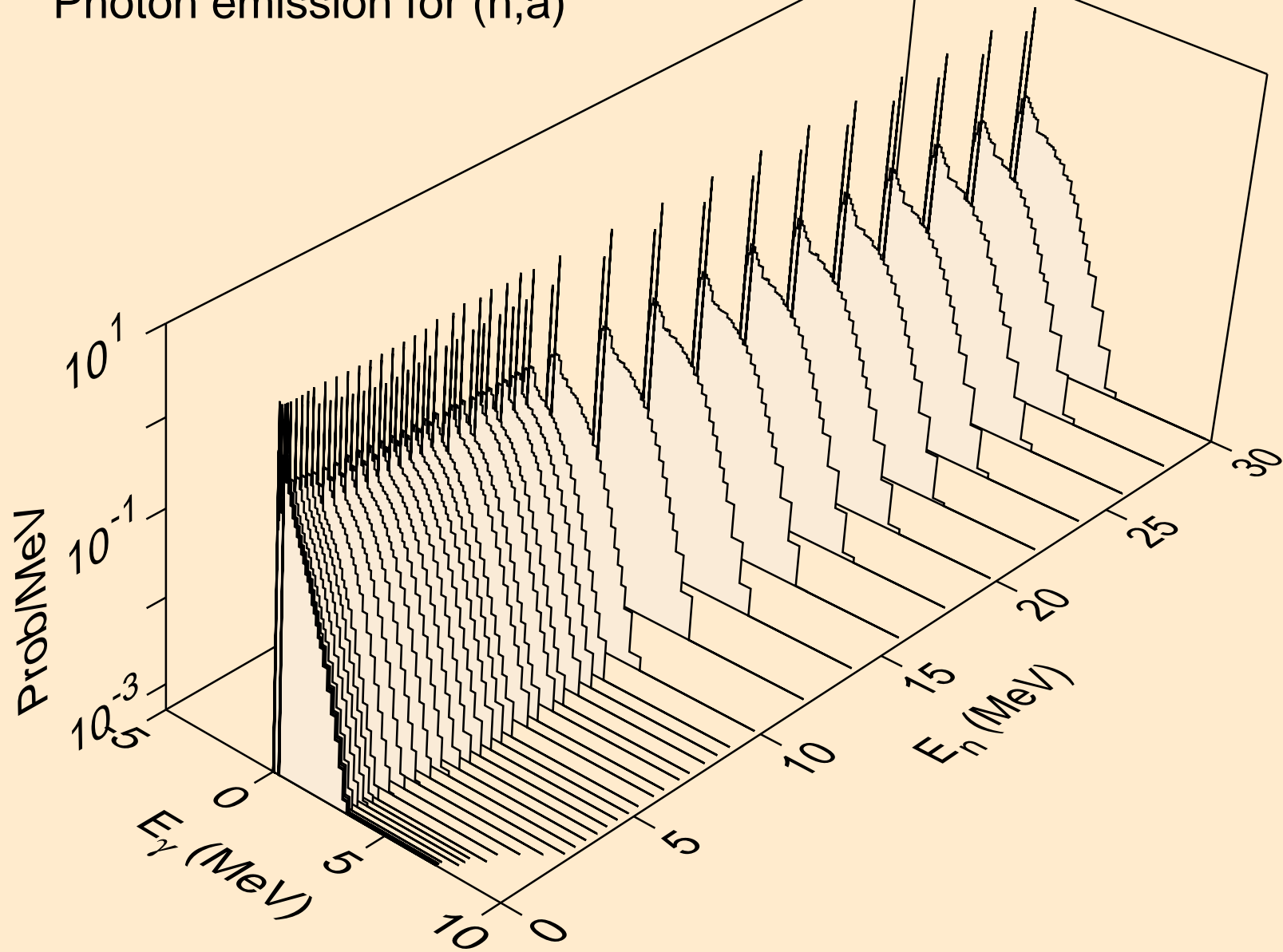

LR258 NEUTRON ACER TENDL-2023 LIBRARY; T=0.K
Photon emission for (n,2p)

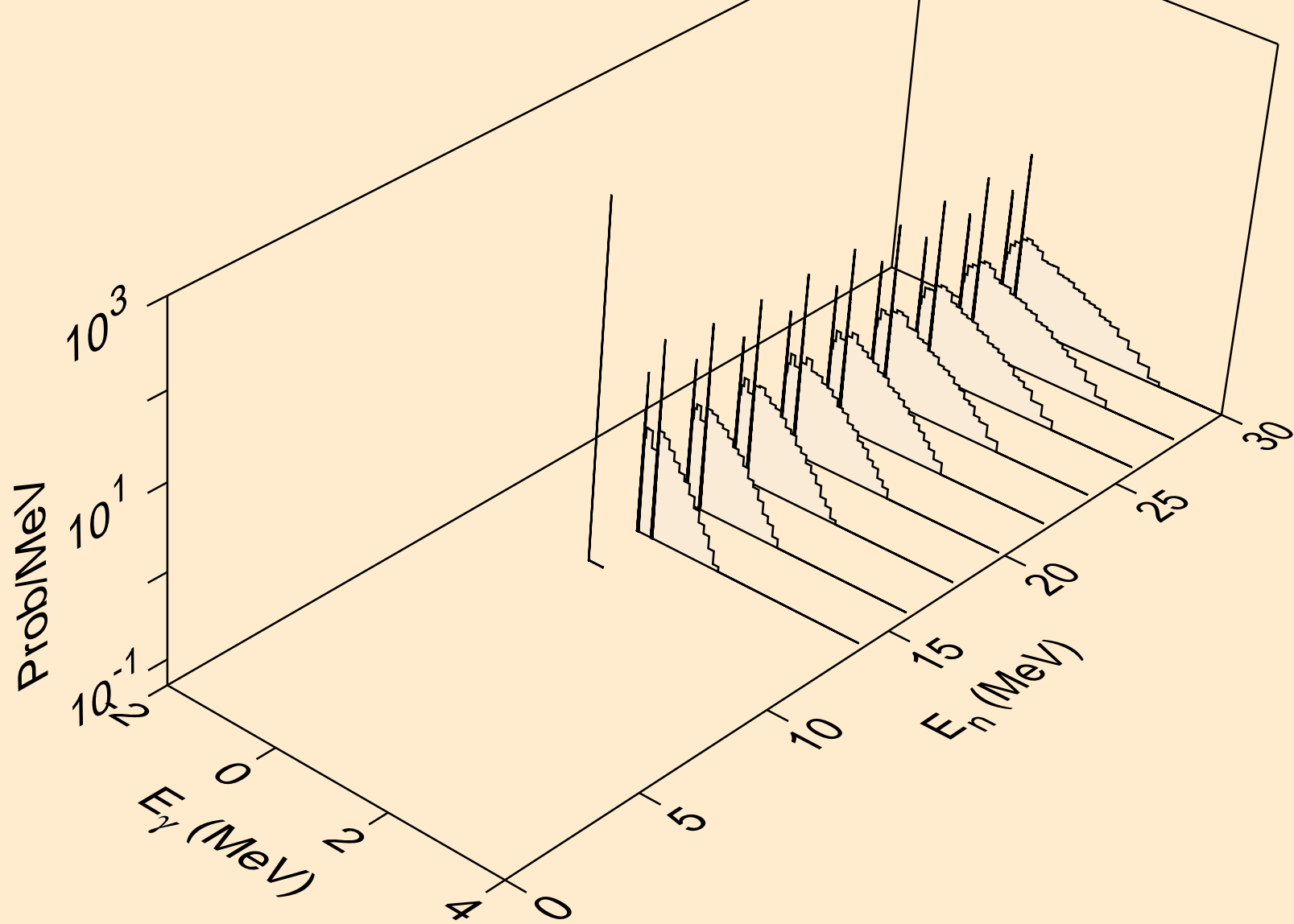

LR258 NEUTRON ACER TENDL-2023 LIBRARY; T=0.K
Photon emission for (n,p α)

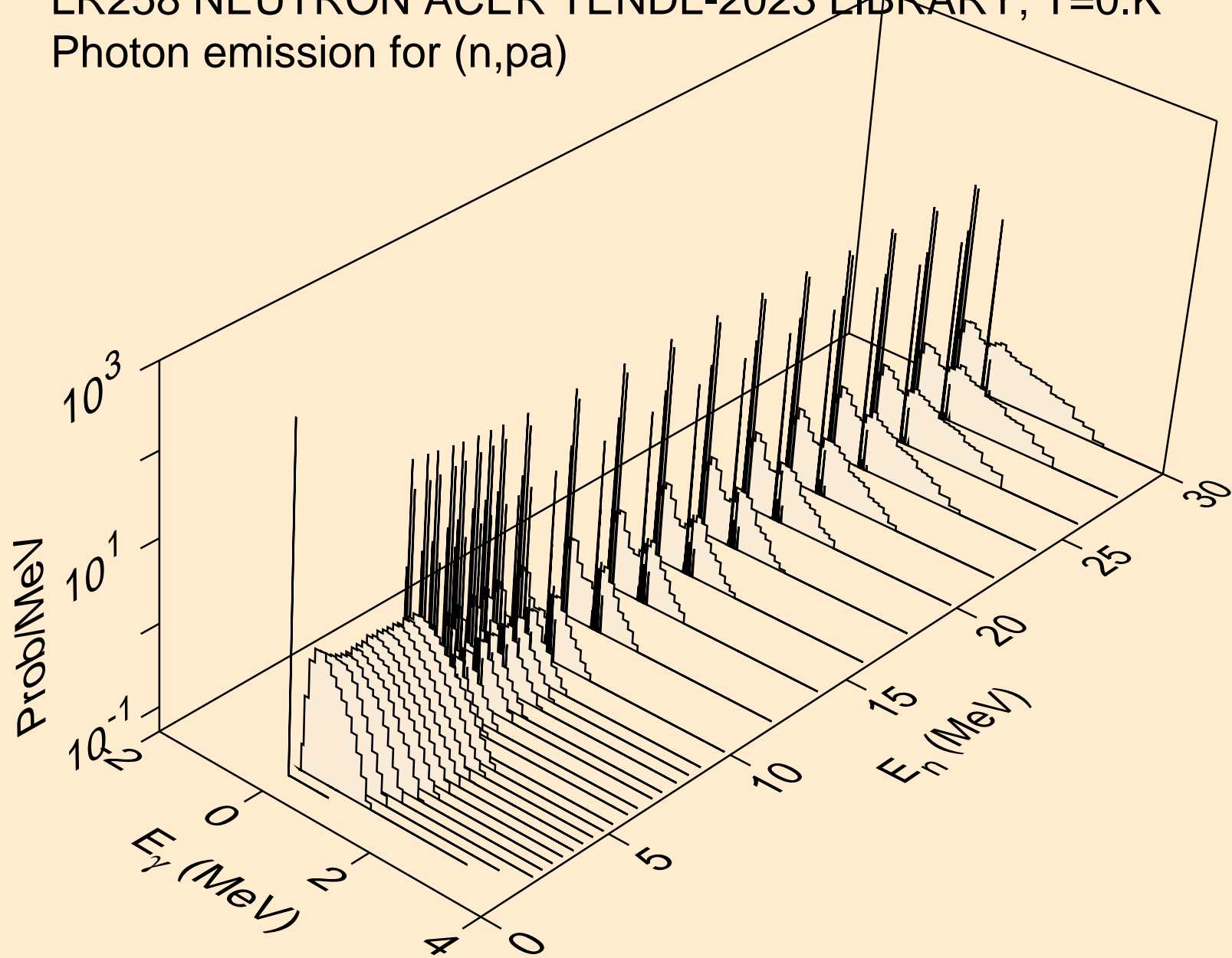

LR258 NEUTRON ACER TENDL-2023 LIBRARY; T=0.K
Photon emission for (n,pd)

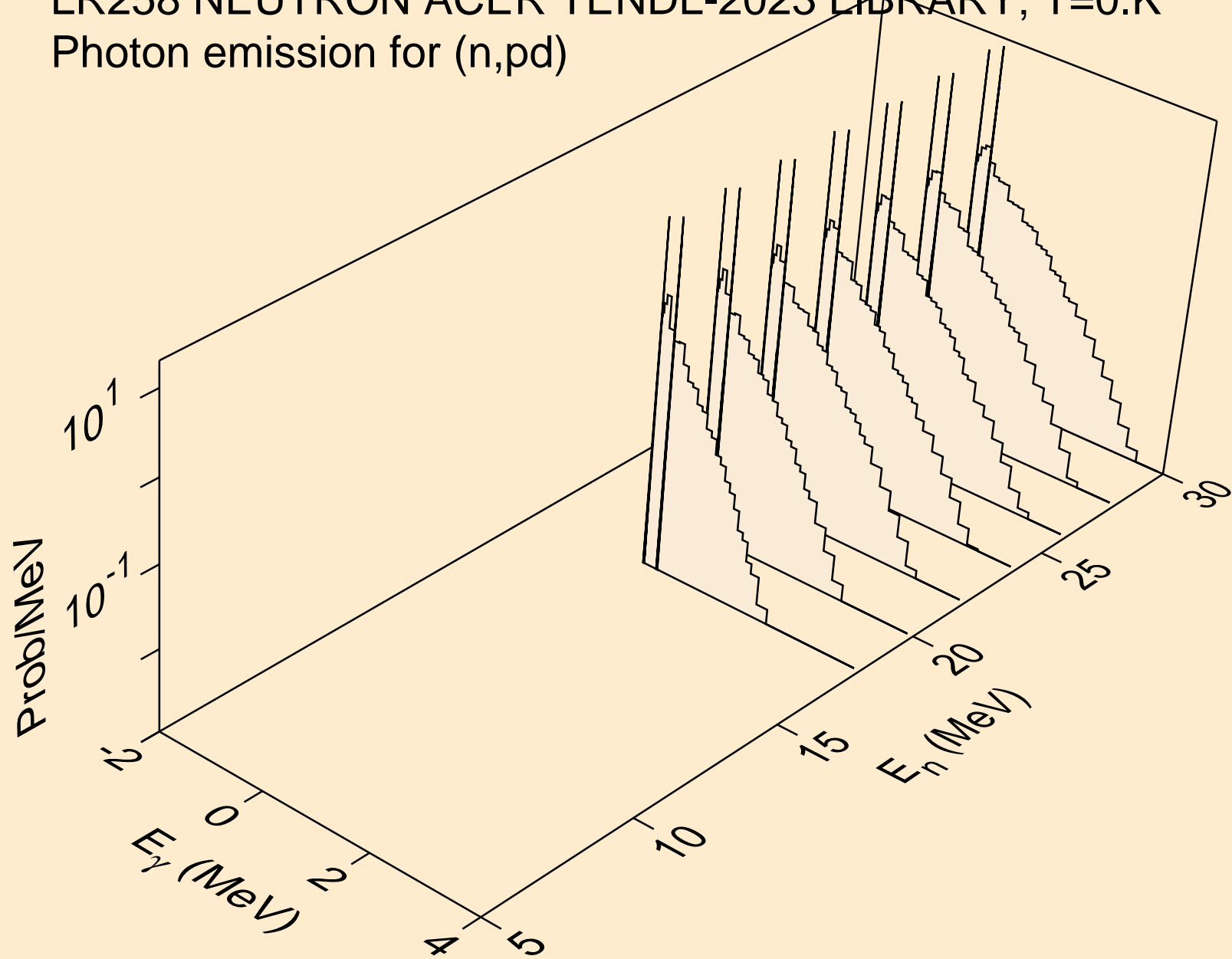

LR258 NEUTRON ACER TENDL-2023 LIBRARY; T=0.K
thermal capture photon spectrum

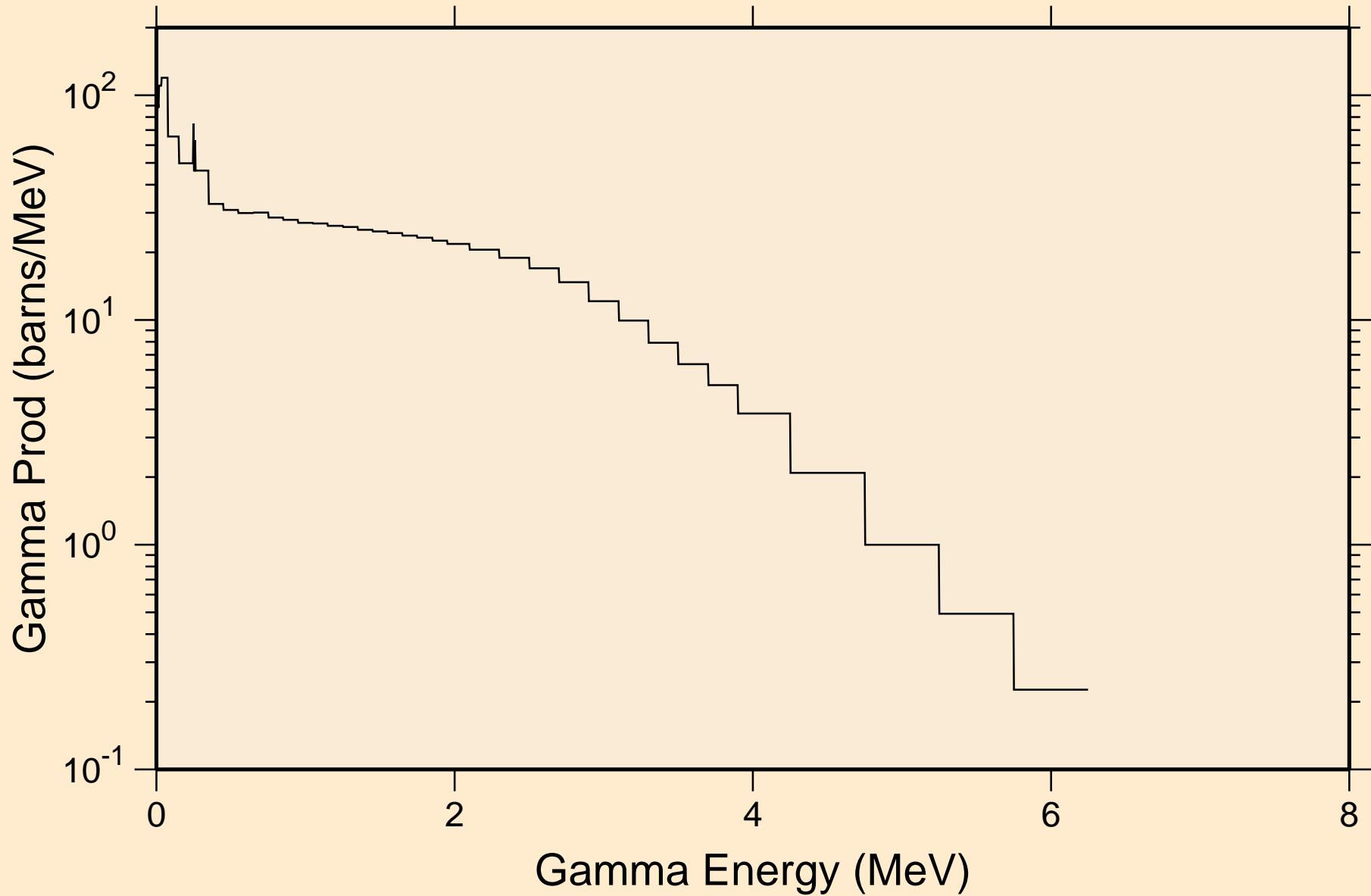

LR258 NEUTRON ACER TENDL-2023 LIBRARY; T=0.K
14 MeV photon spectrum

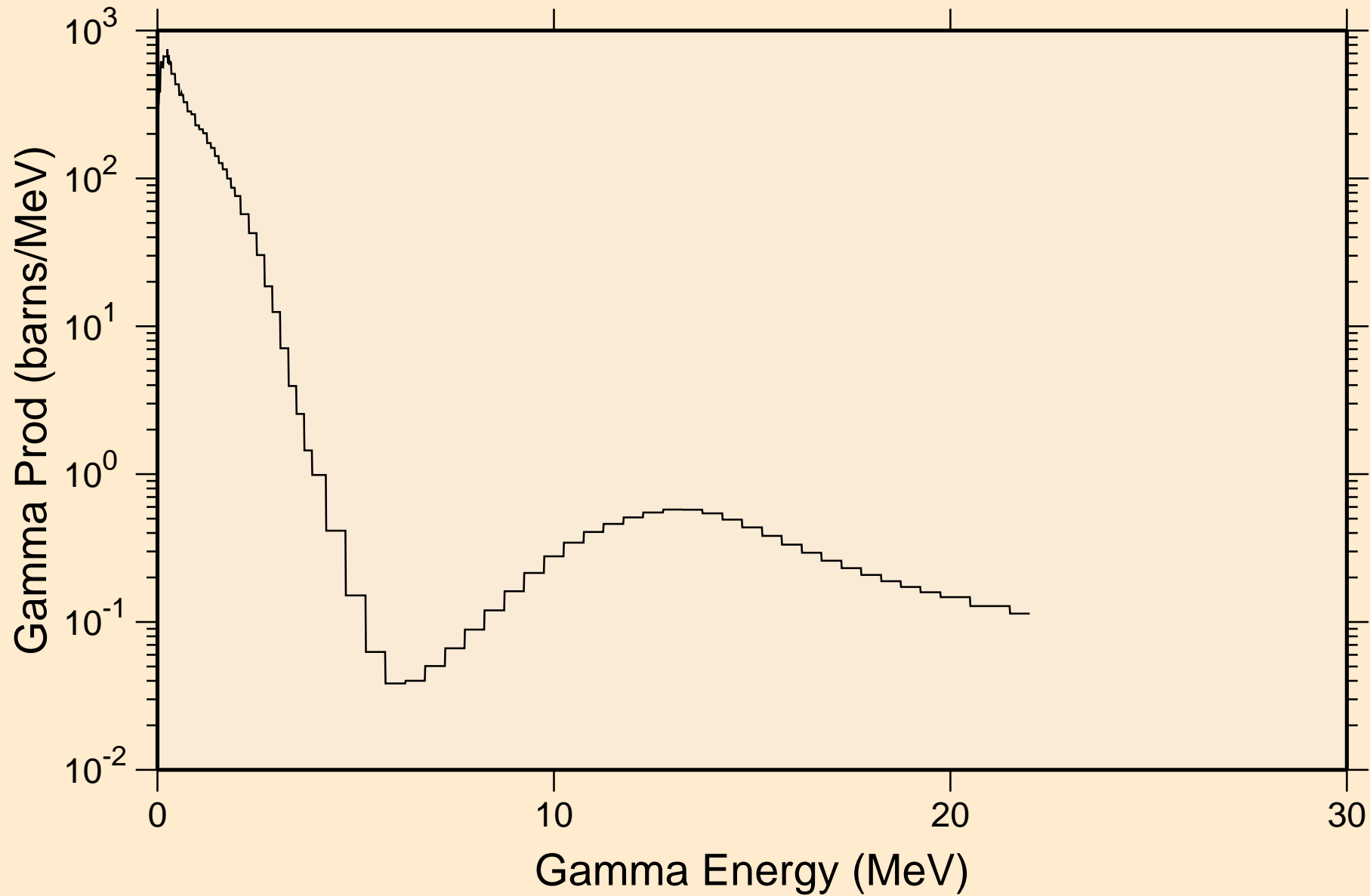

LR258 NEUTRON ACER TENDL-2023 LIBRARY; T=0.K

Particle heating contributions

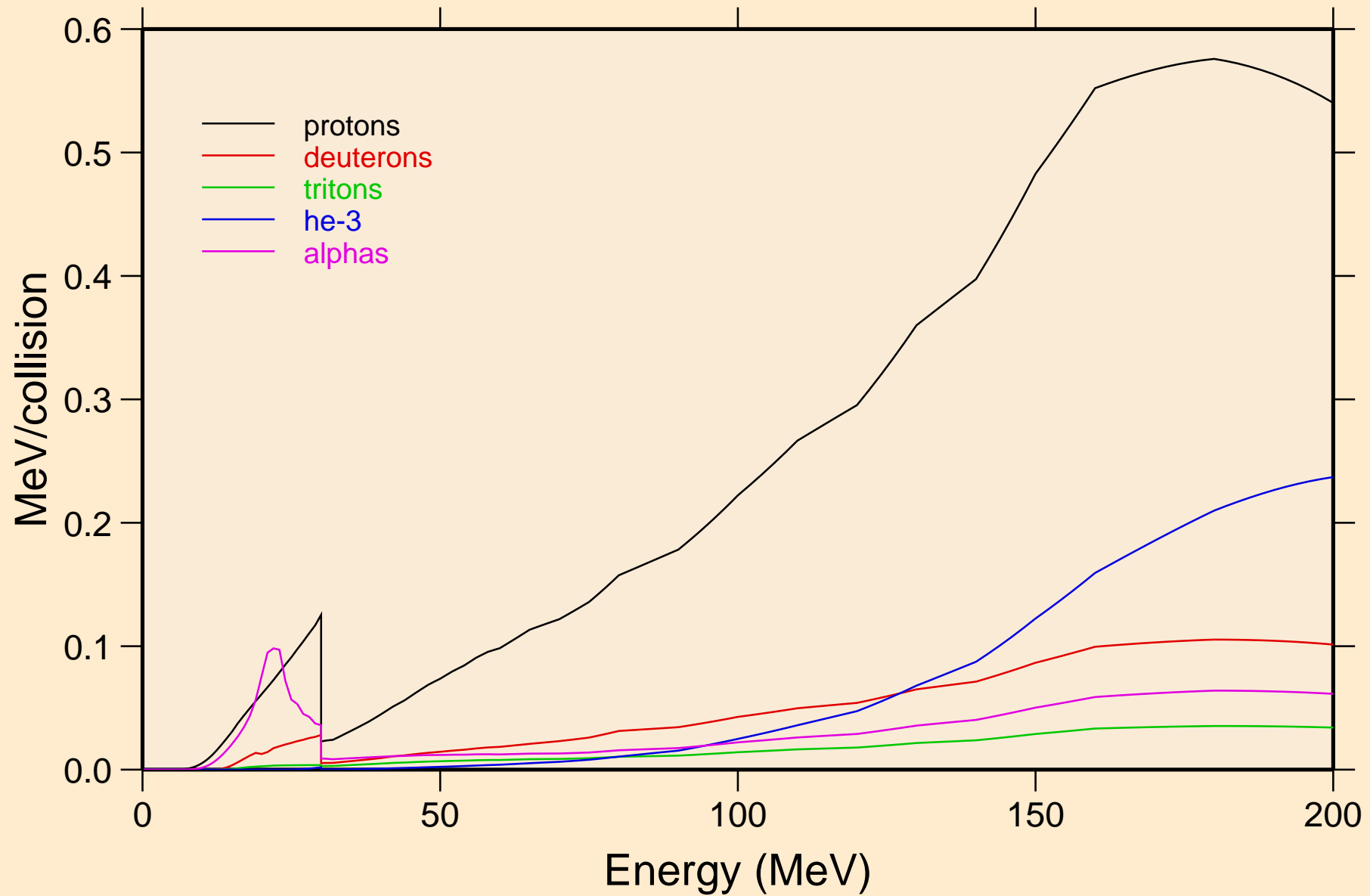

LR258 NEUTRON ACER TENDL-2023 LIBRARY; T=0.K
Recoil Heating

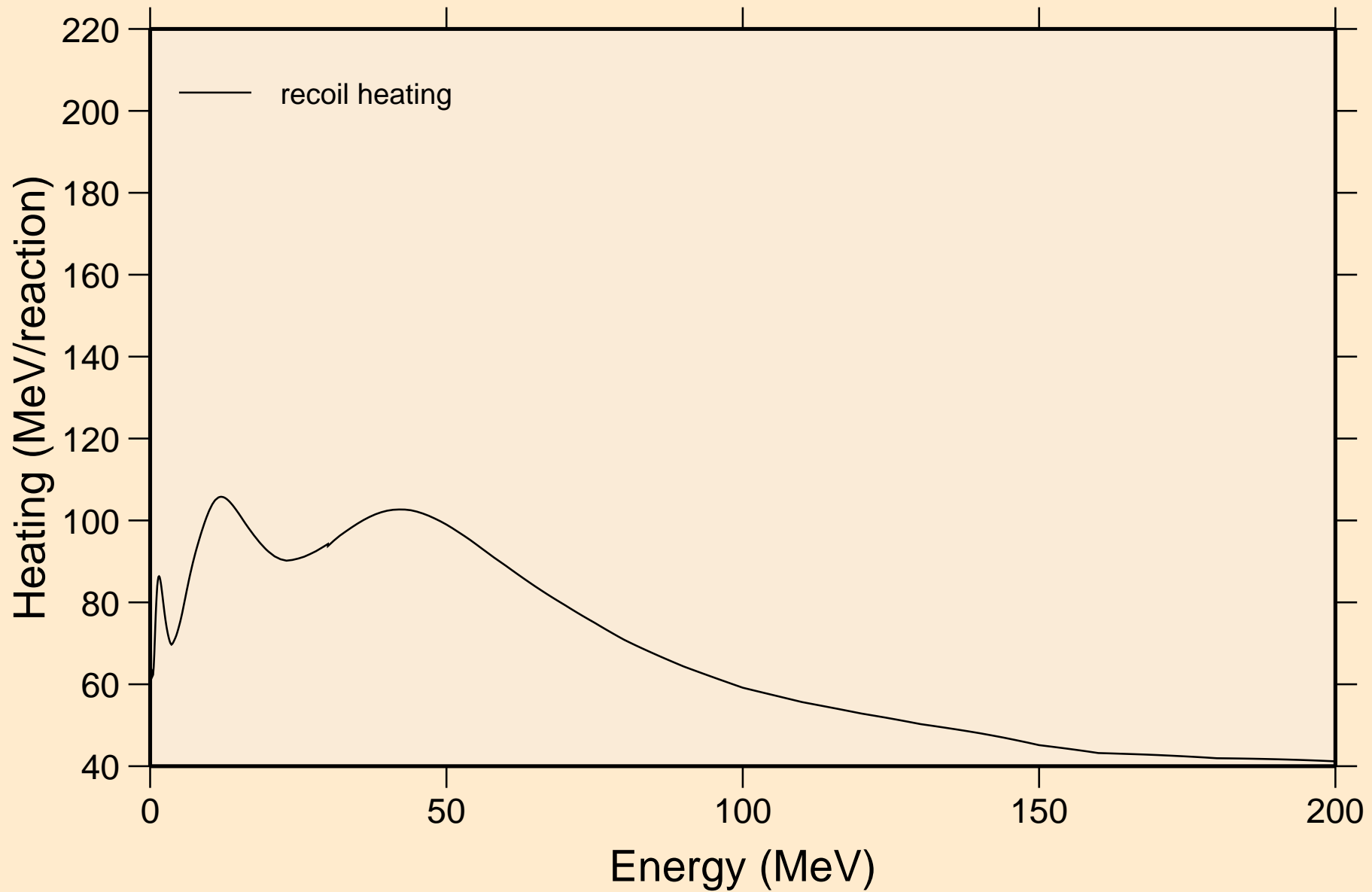

LR258 NEUTRON ACER TENDL-2023 LIBRARY; T=0.K

Particle production cross sections

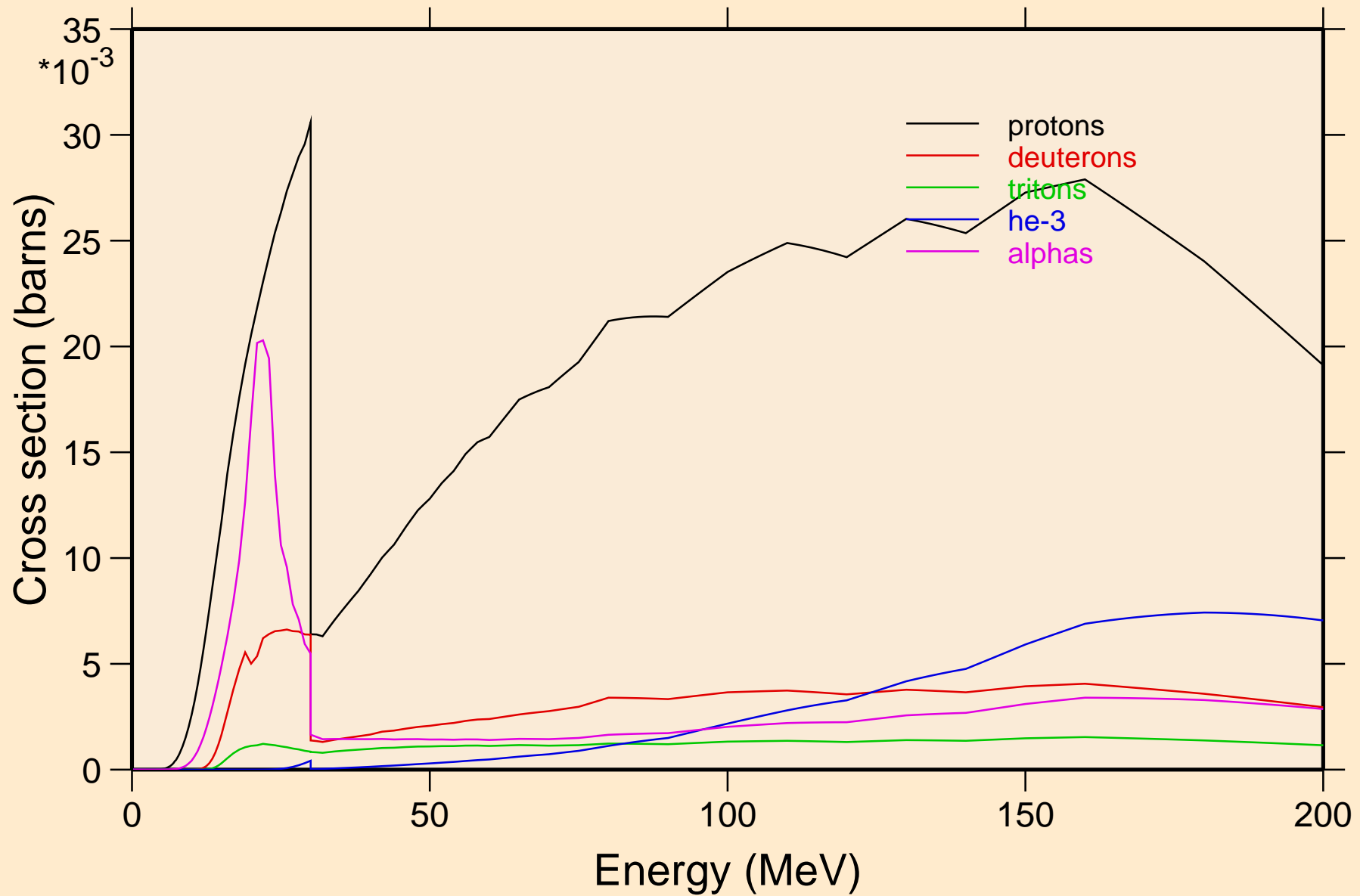

LR258 NEUTRON ACER TENDL-2023 LIBRARY; T=0.K
protons from (n,x)

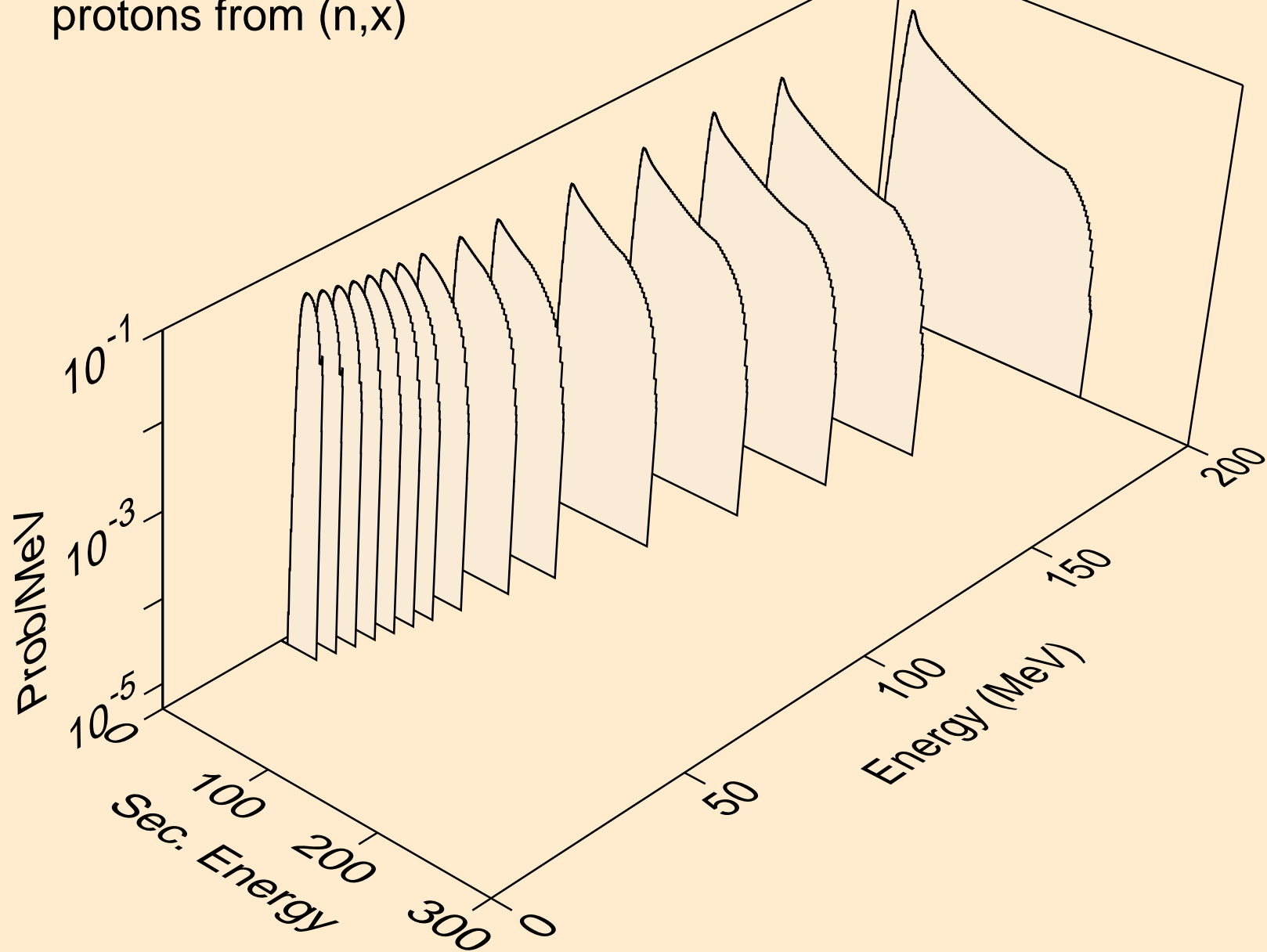

LR258 NEUTRON ACER TENDL-2023 LIBRARY; T=0.K
protons from (n,n*)p

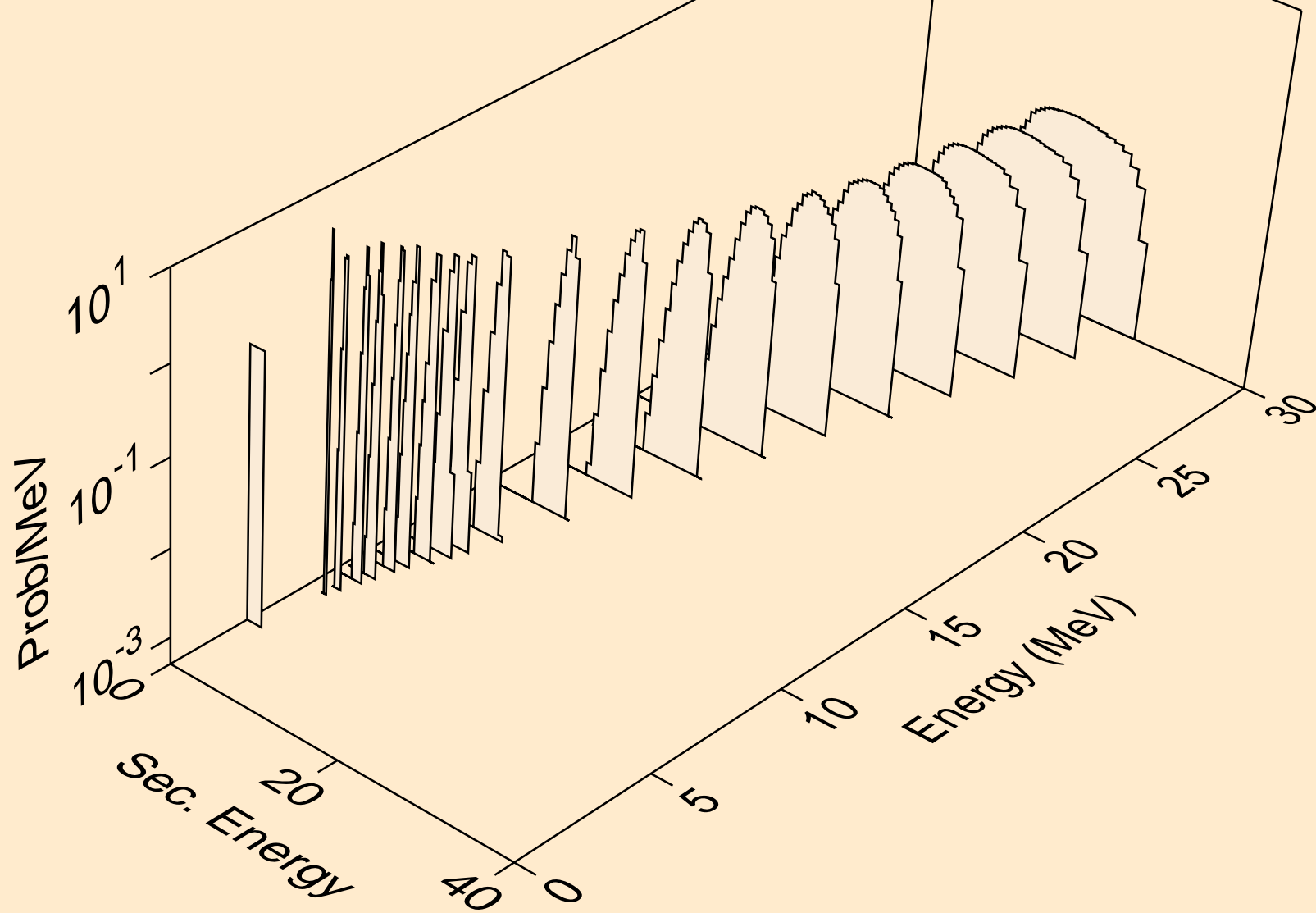

LR258 NEUTRON ACER TENDL-2023 LIBRARY; T=0.K
protons from (n,2np)

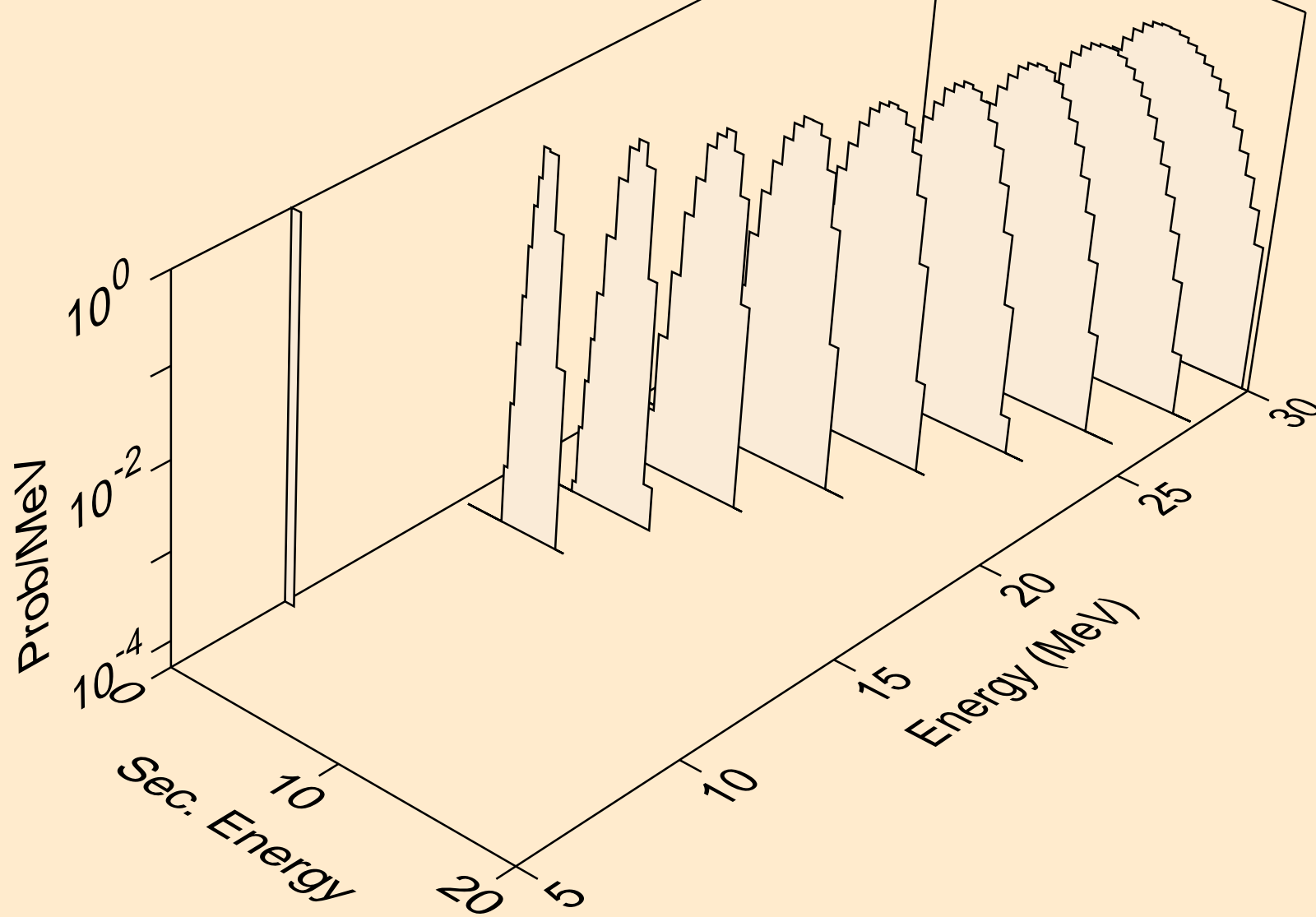

LR258 NEUTRON ACER TENDL-2023 LIBRARY; T=0.K
protons from (n,n2p)

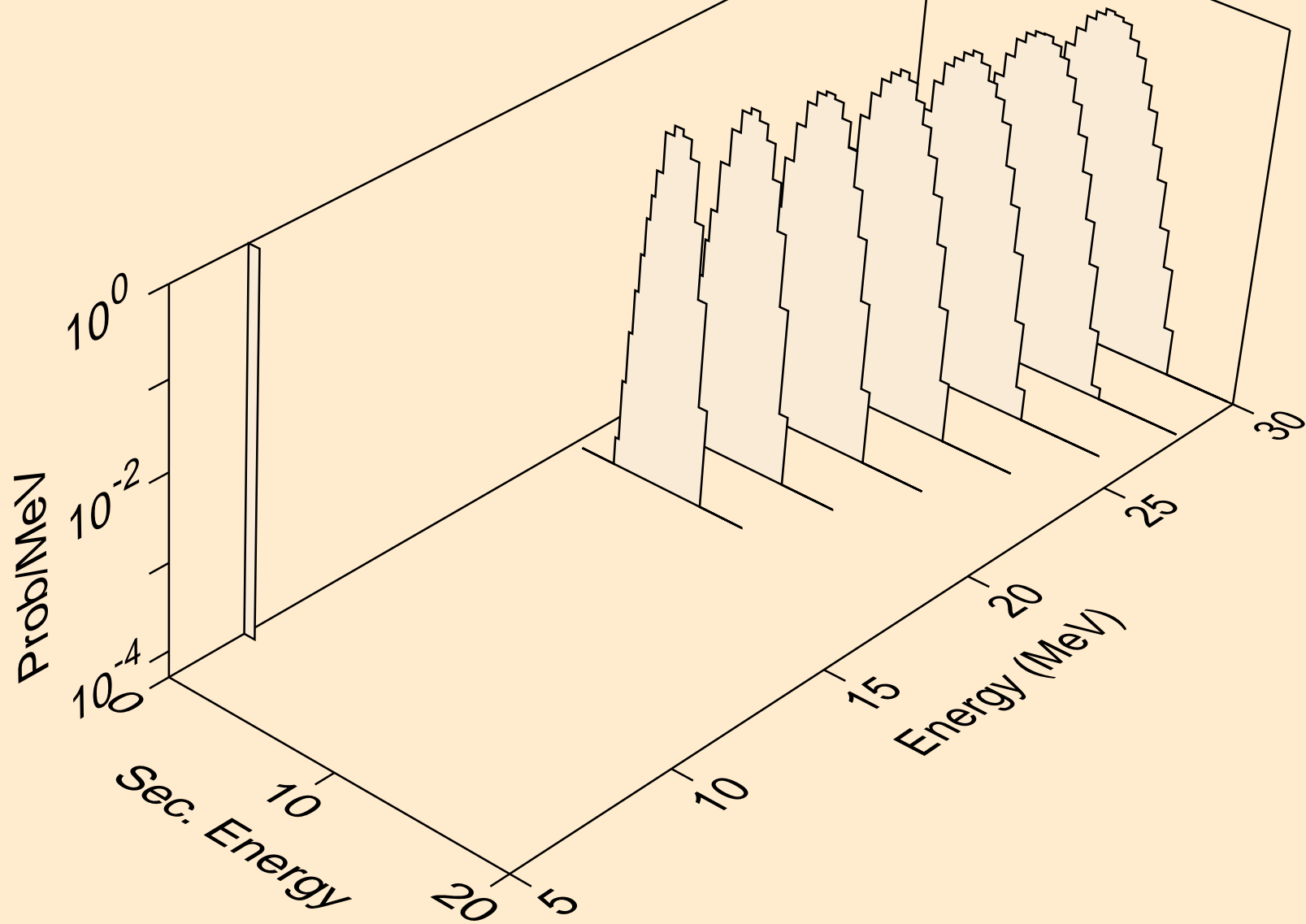

LR258 NEUTRON ACER TENDL-2023 LIBRARY; T=0.K
protons from (n,npa)

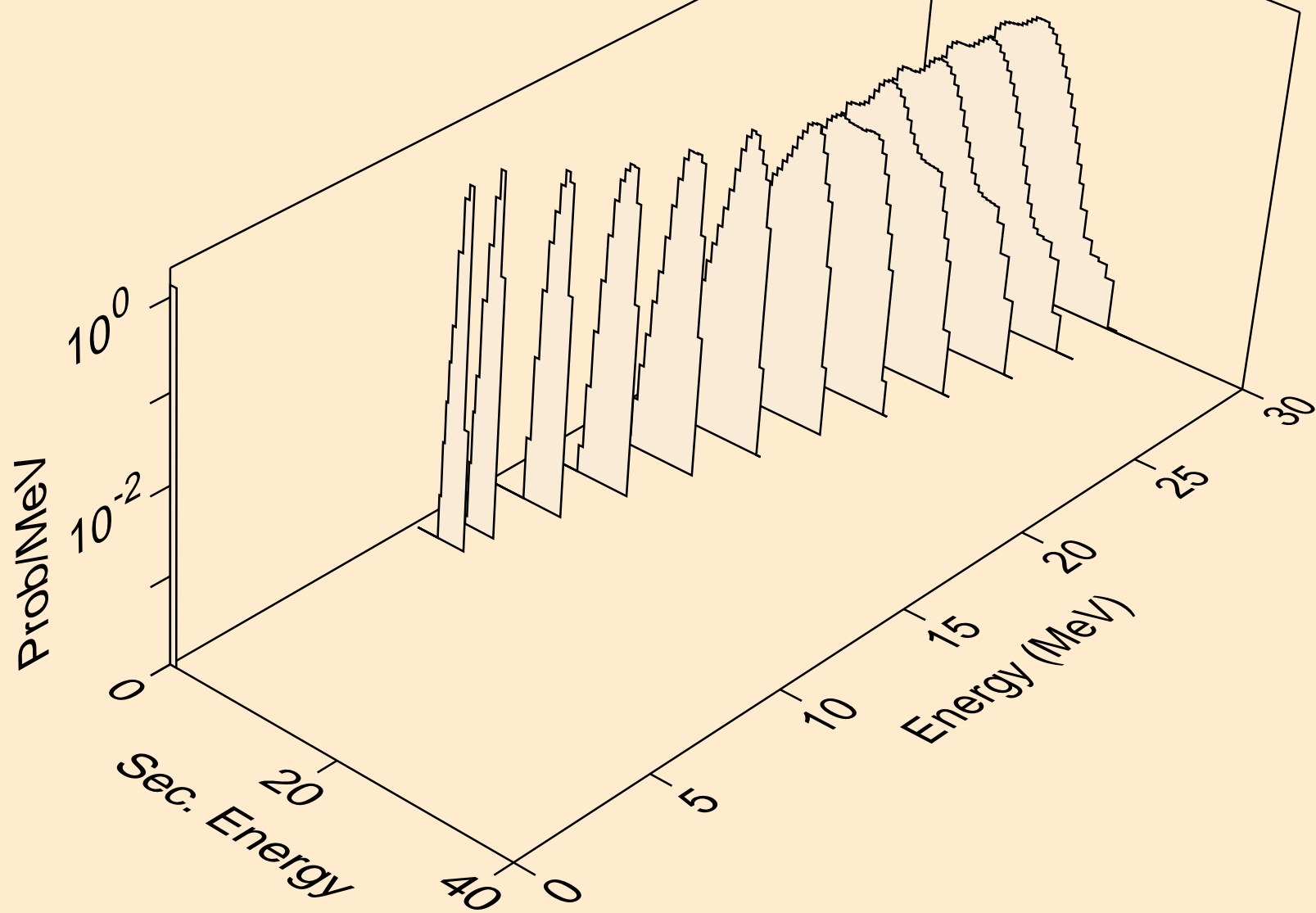

LR258 NEUTRON ACER TENDL-2023 LIBRARY; T=0.K
protons from (n,p)

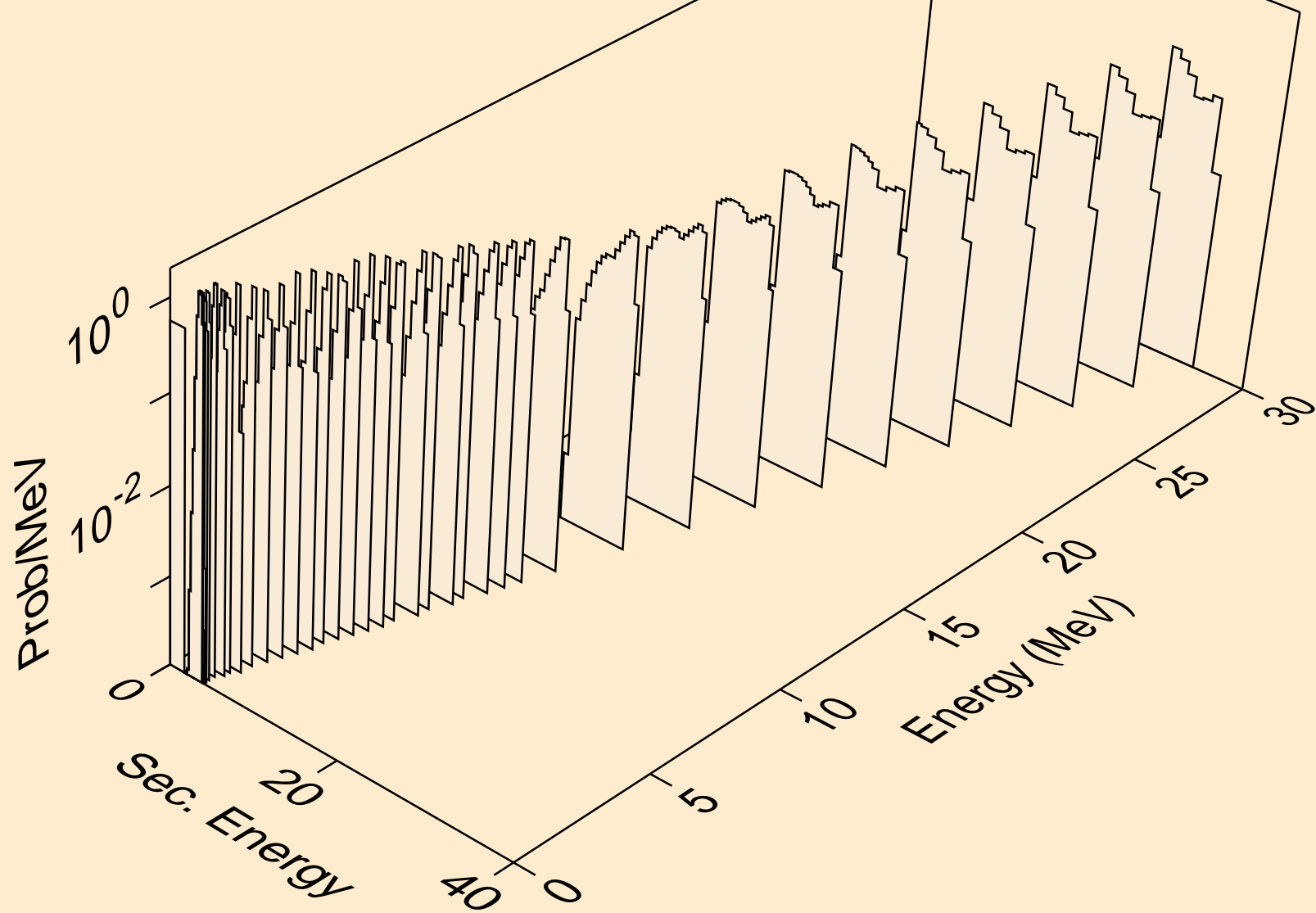

LR258 NEUTRON ACER TENDL-2023 LIBRARY; T=0.K
protons from (n,2p)

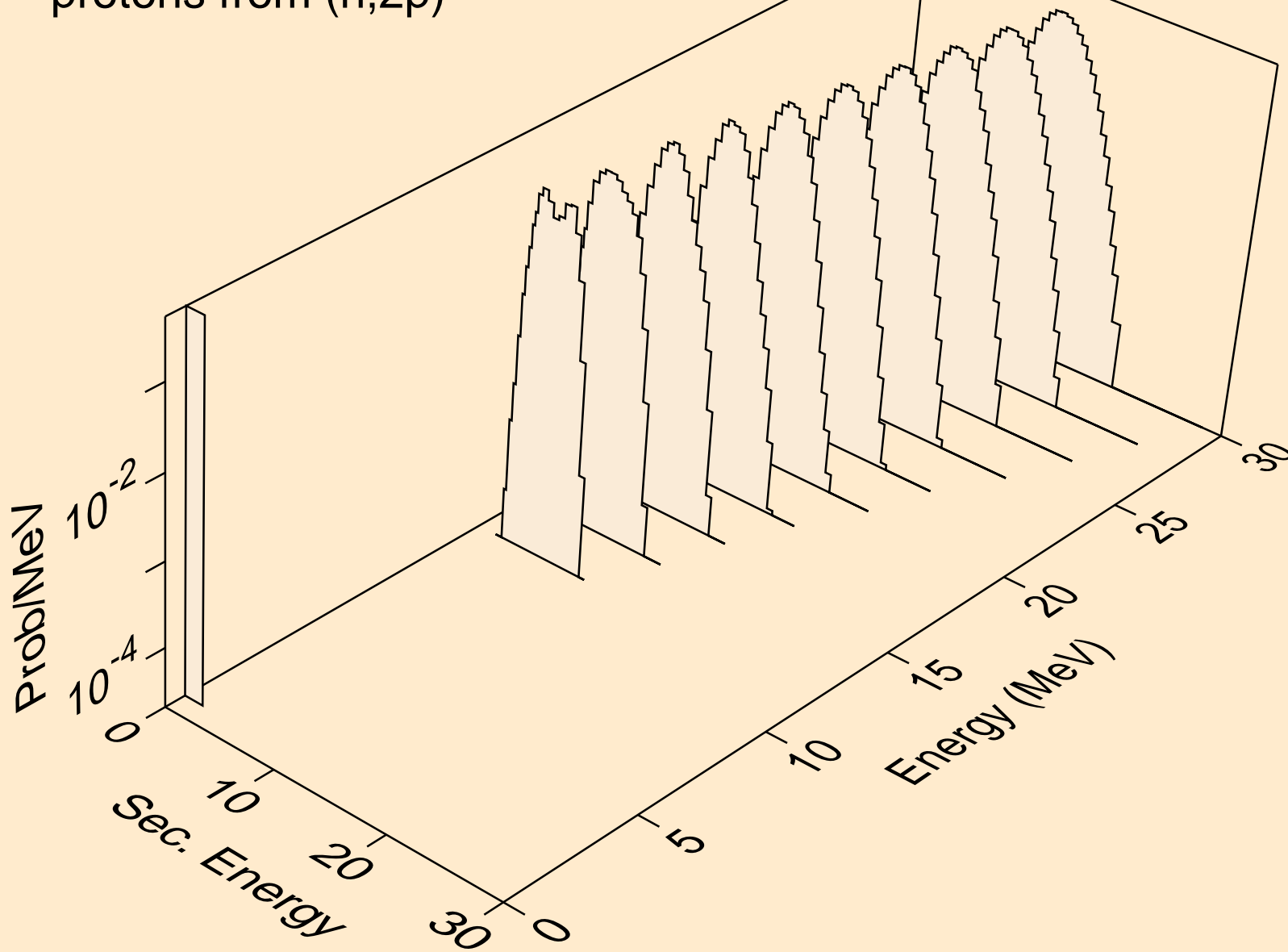

LR258 NEUTRON ACER TENDL-2023 LIBRARY; T=0.K
protons from (n,p)

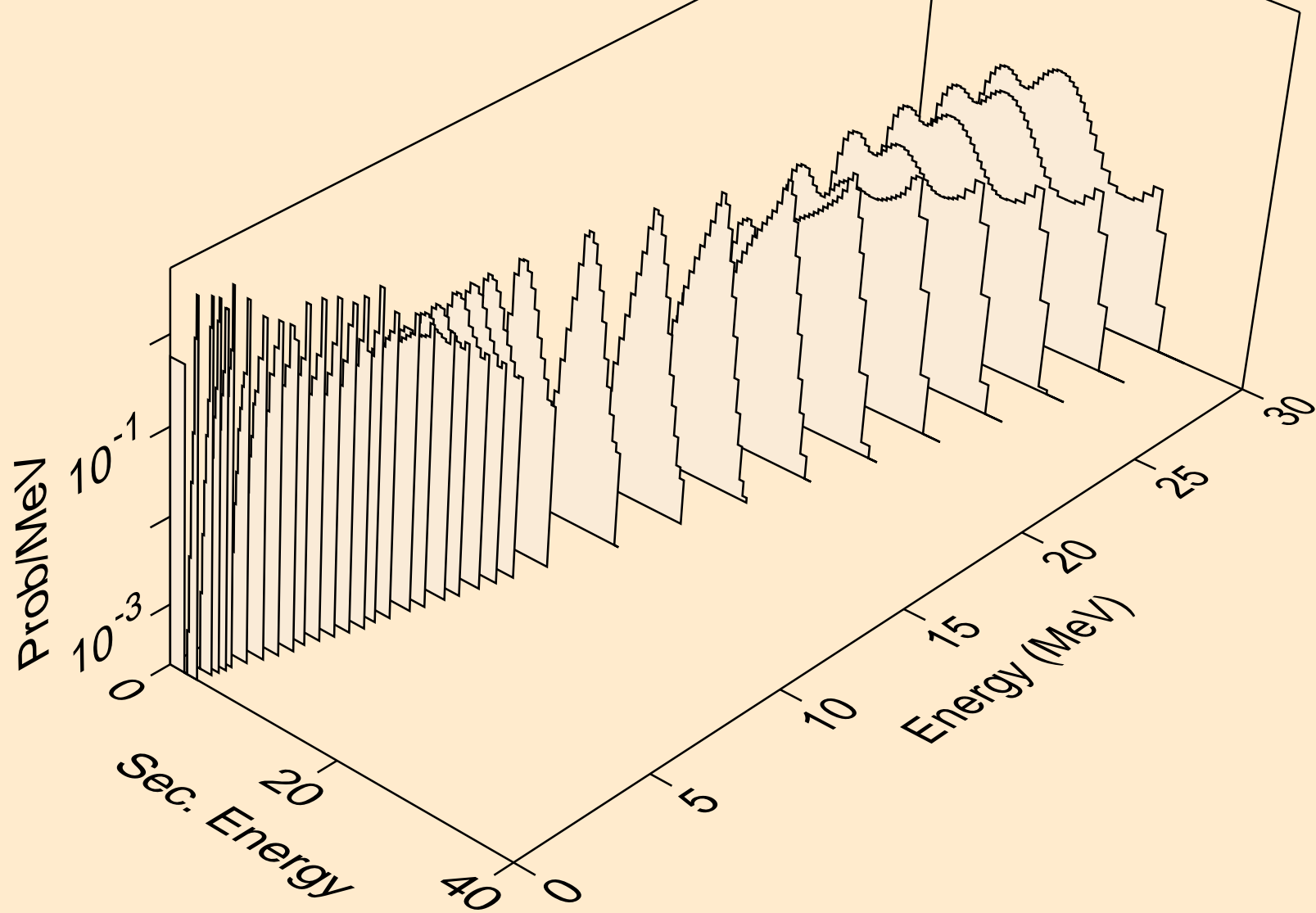

LR258 NEUTRON ACER TENDL-2023 LIBRARY; T=0.K
protons from (n,pd)

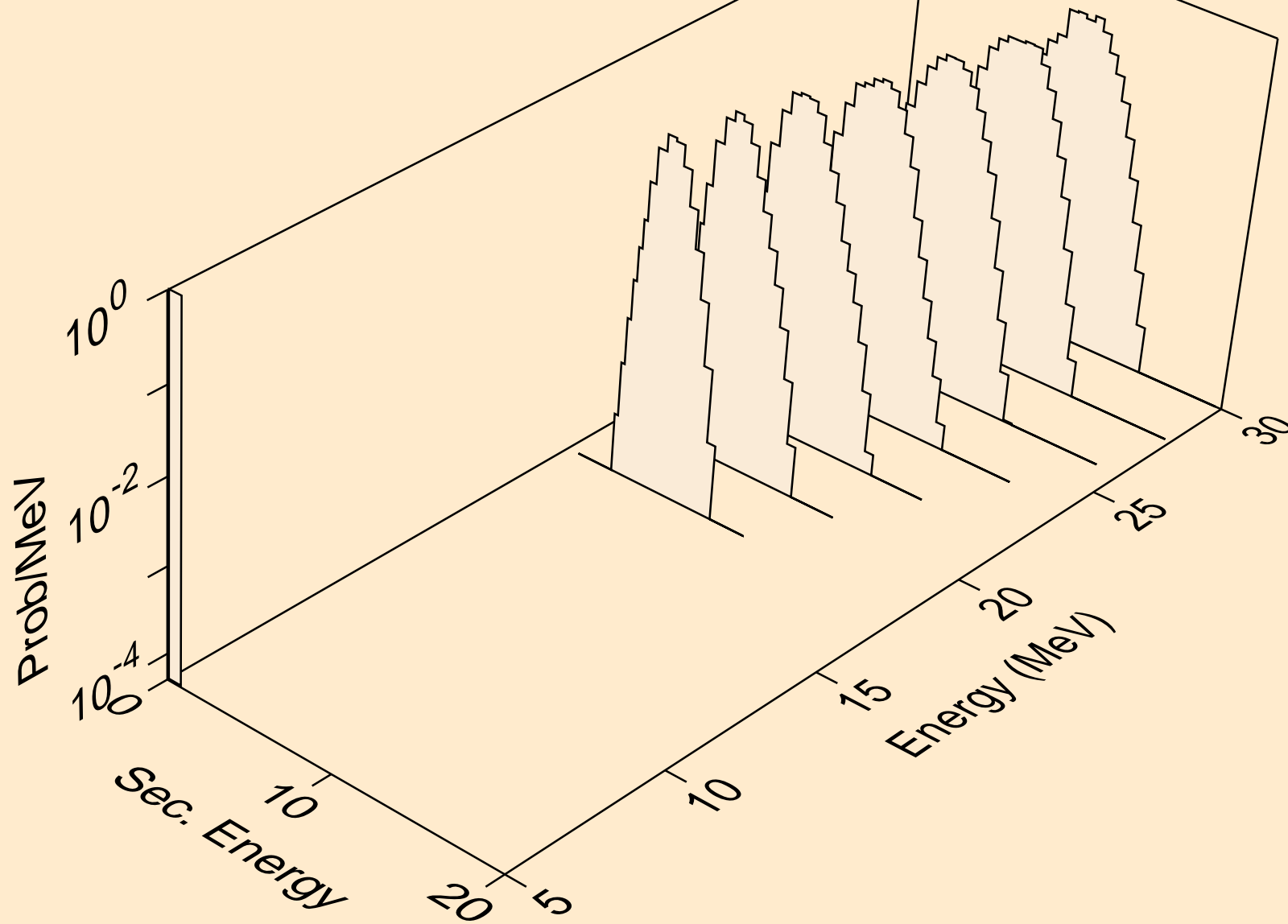

LR258 NEUTRON ACER TENDL-2023 LIBRARY; T=0.K
deuterons from (n,x)

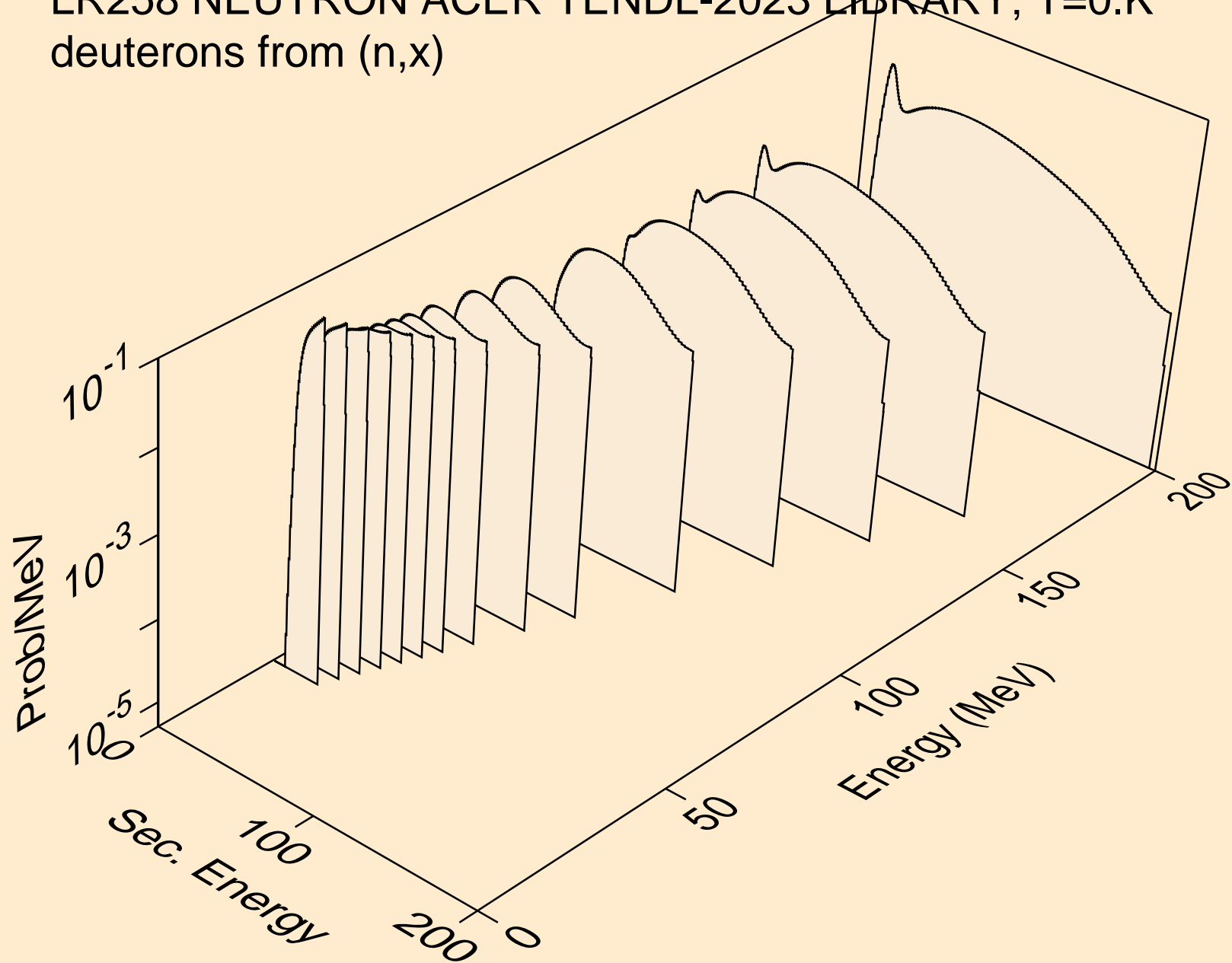

LR258 NEUTRON ACER TENDL-2023 LIBRARY; T=0.K
deuterons from (n,n*)d

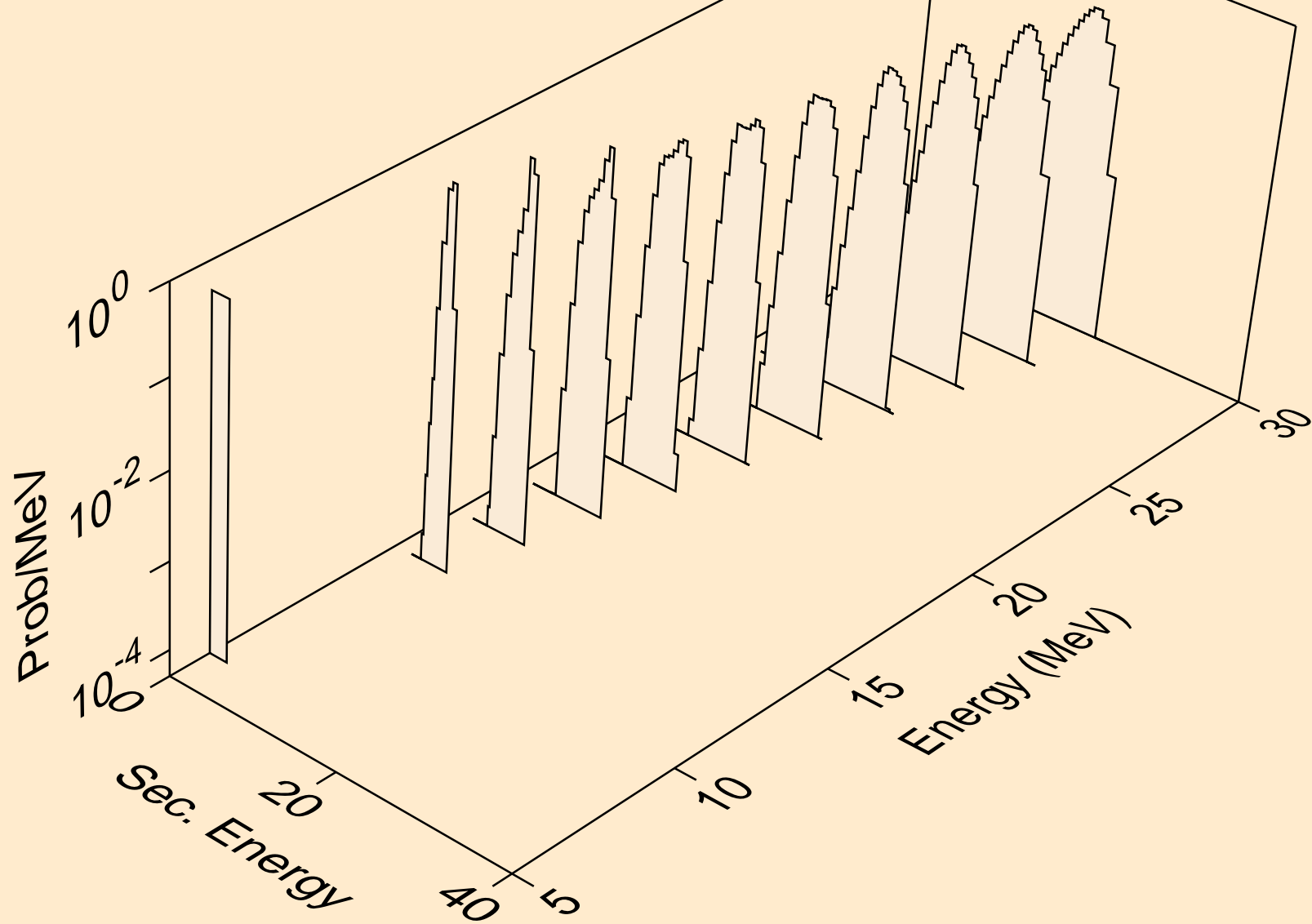

LR258 NEUTRON ACER TENDL-2023 LIBRARY; T=0.K
deuterons from (n,d)

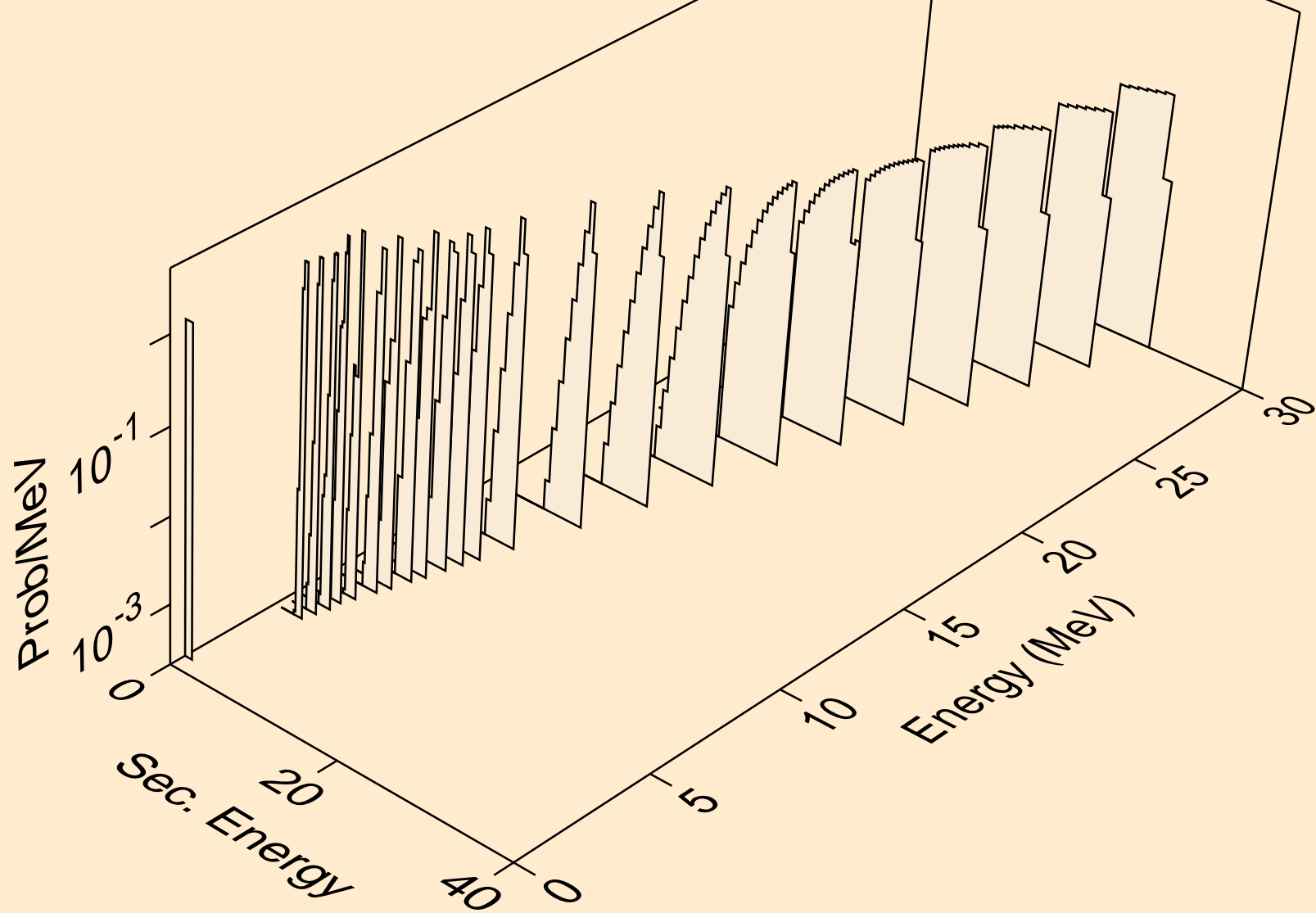

LR258 NEUTRON ACER TENDL-2023 LIBRARY; T=0.K
deuterons from (n,pd)

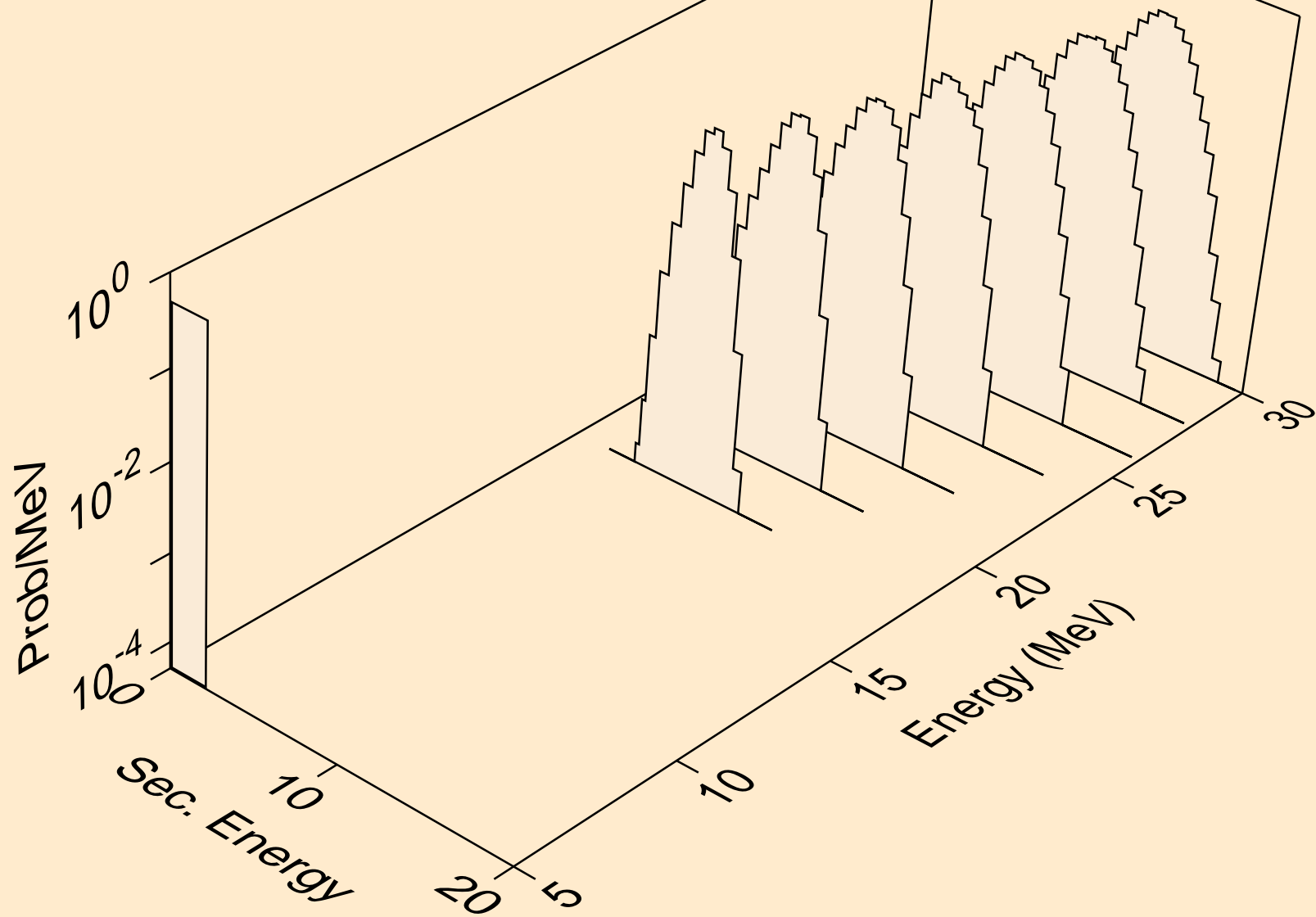

LR258 NEUTRON ACER TENDL-2023 LIBRARY; T=0.K
tritons from (n,x)

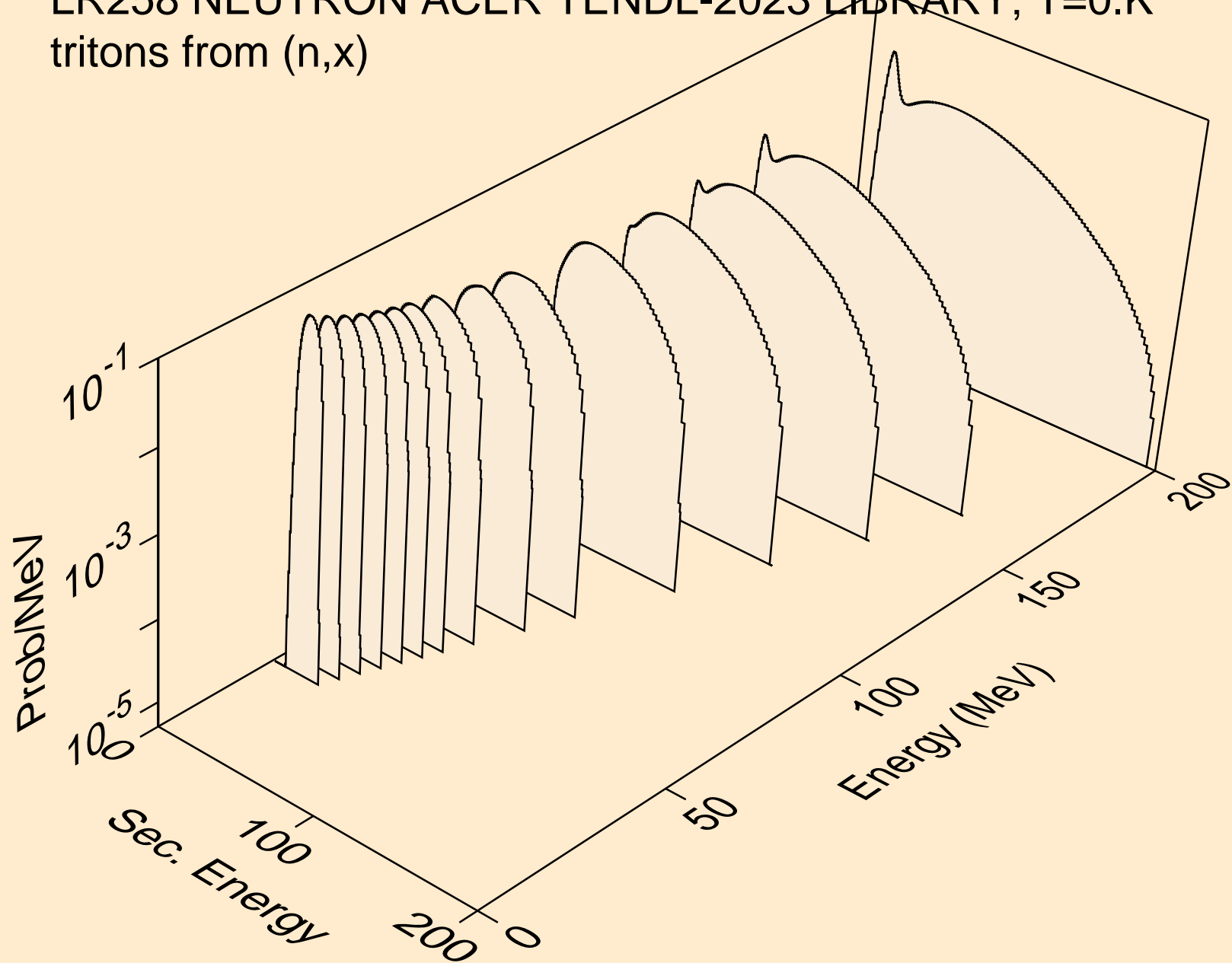

LR258 NEUTRON ACER TENDL-2023 LIBRARY; T=0.K
tritons from (n,n*)t

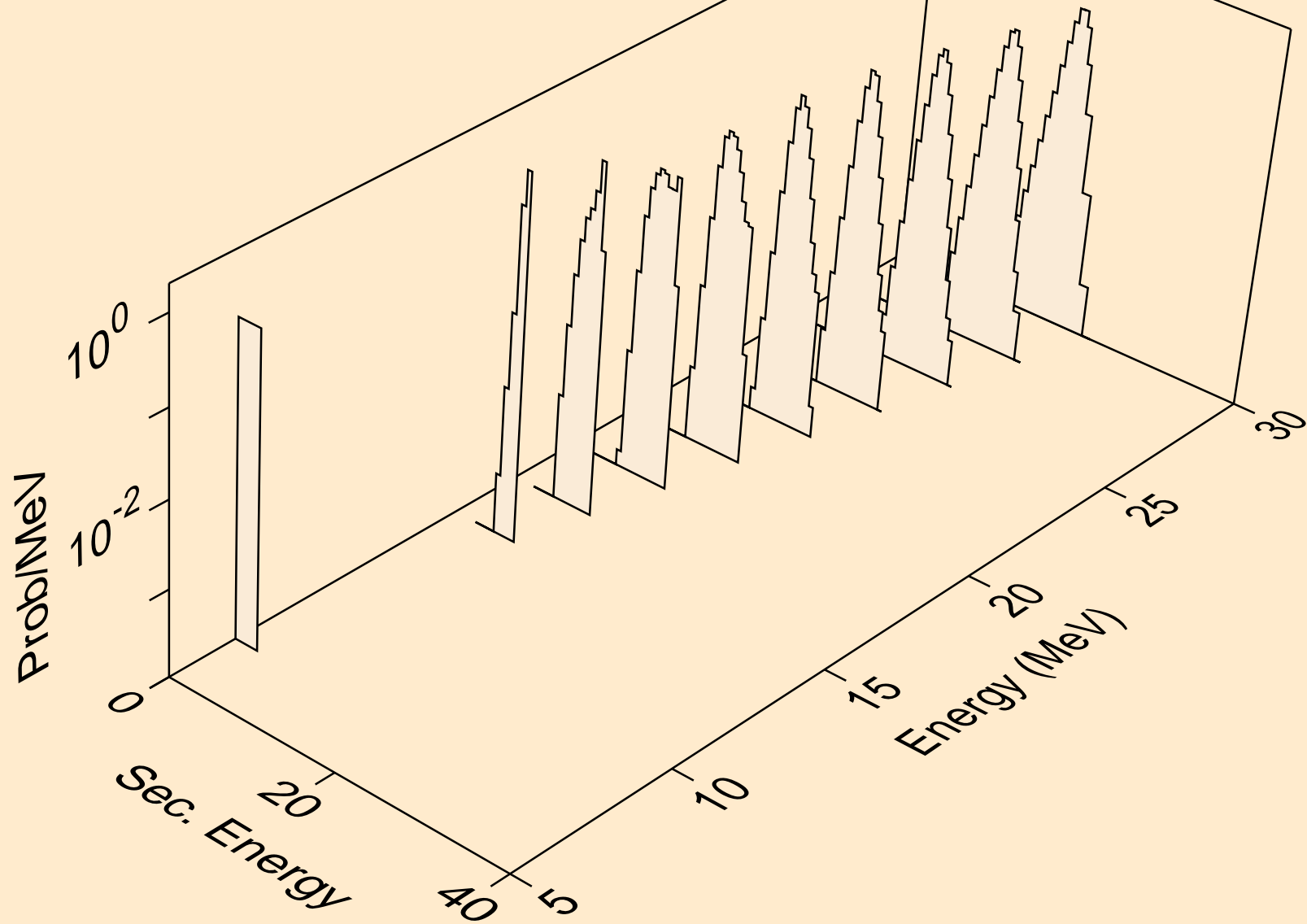

LR258 NEUTRON ACER TENDL-2023 LIBRARY; T=0.K
tritons from (n,t)

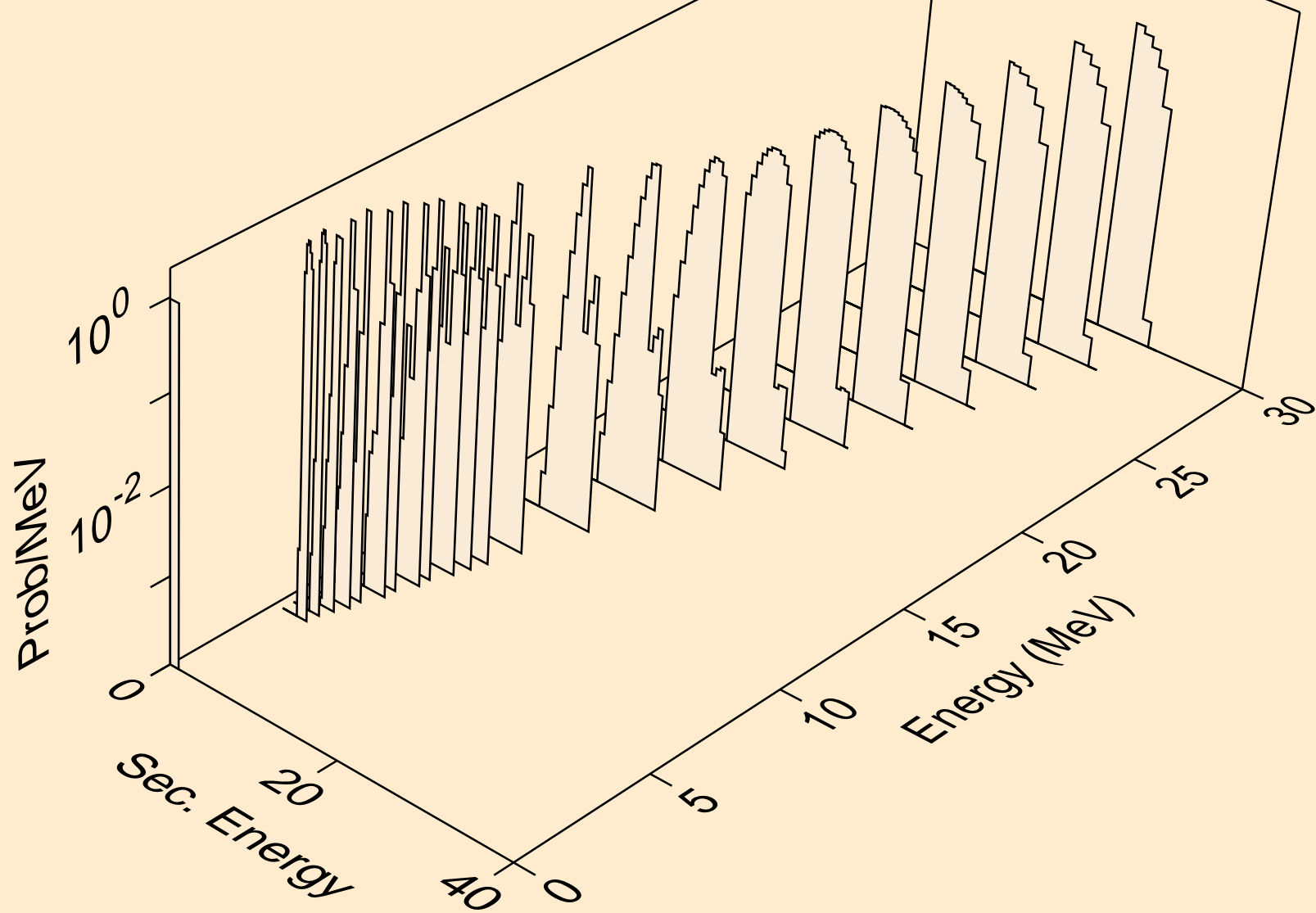

LR258 NEUTRON ACER TENDL-2023 LIBRARY; T=0.K
he3s from (n,x)

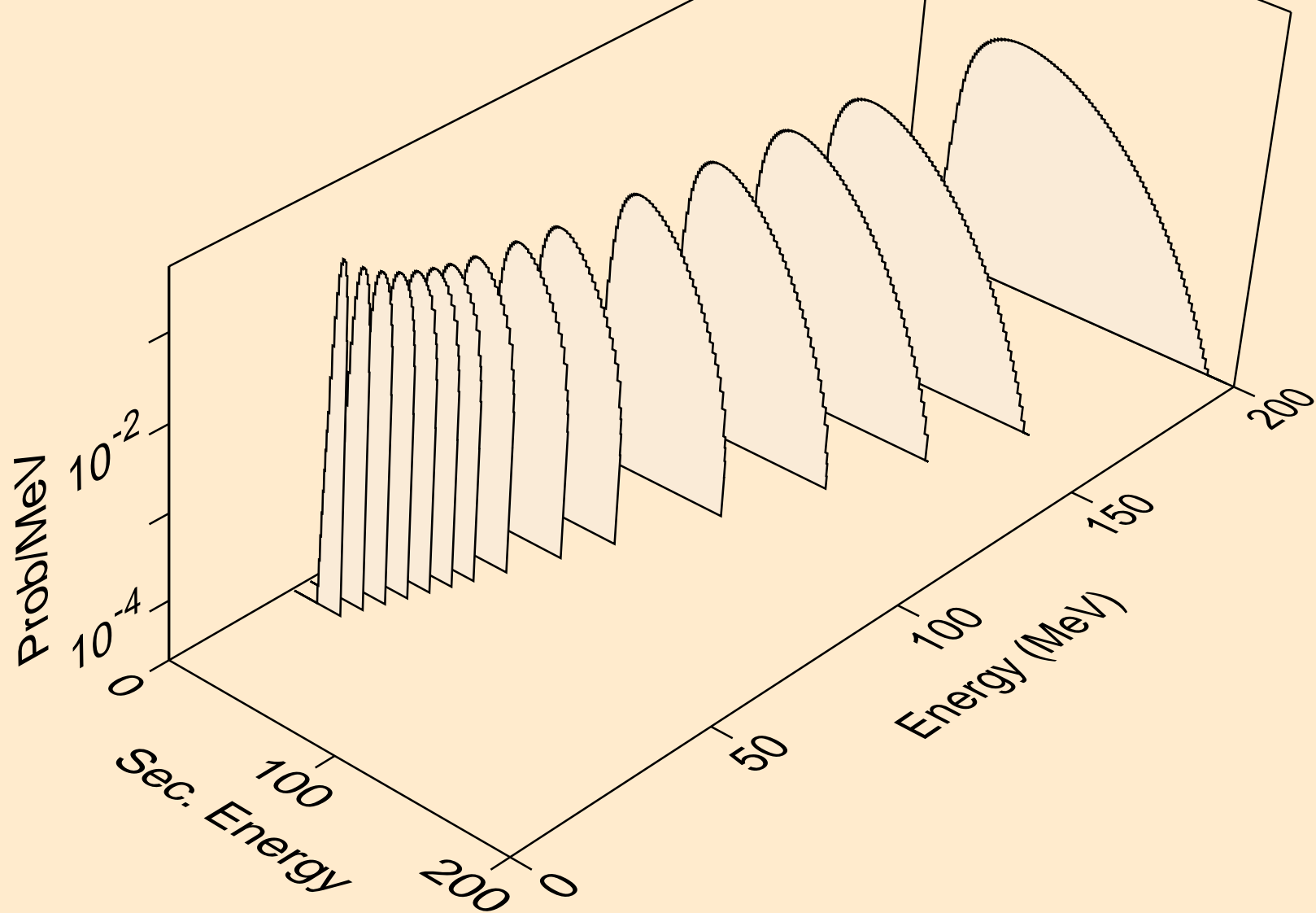

LR258 NEUTRON ACER TENDL-2023 LIBRARY; T=0.K
he3s from (n,n*)he3

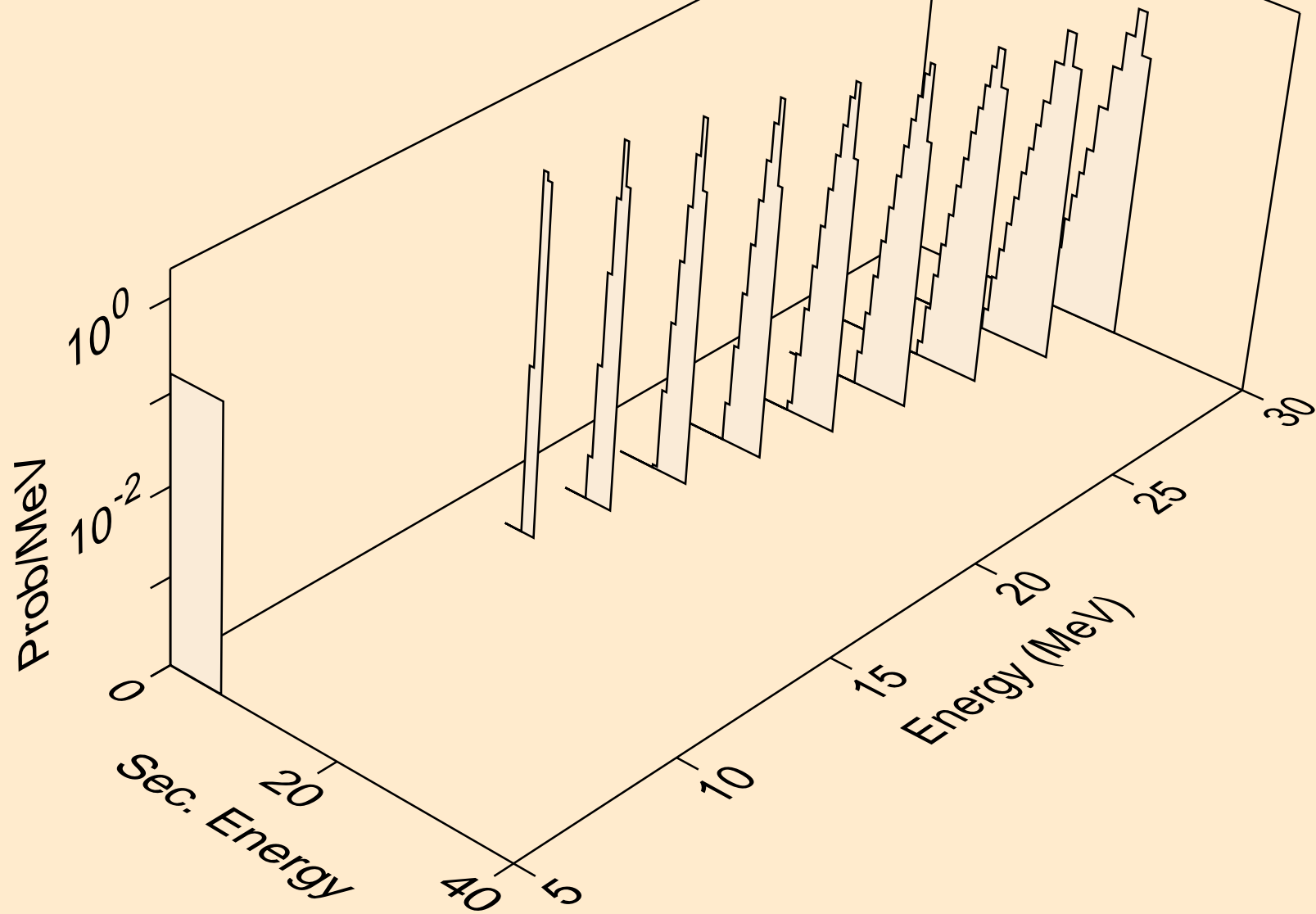

LR258 NEUTRON ACER TENDL-2023 LIBRARY; T=0.K
he3s from (n,he3)

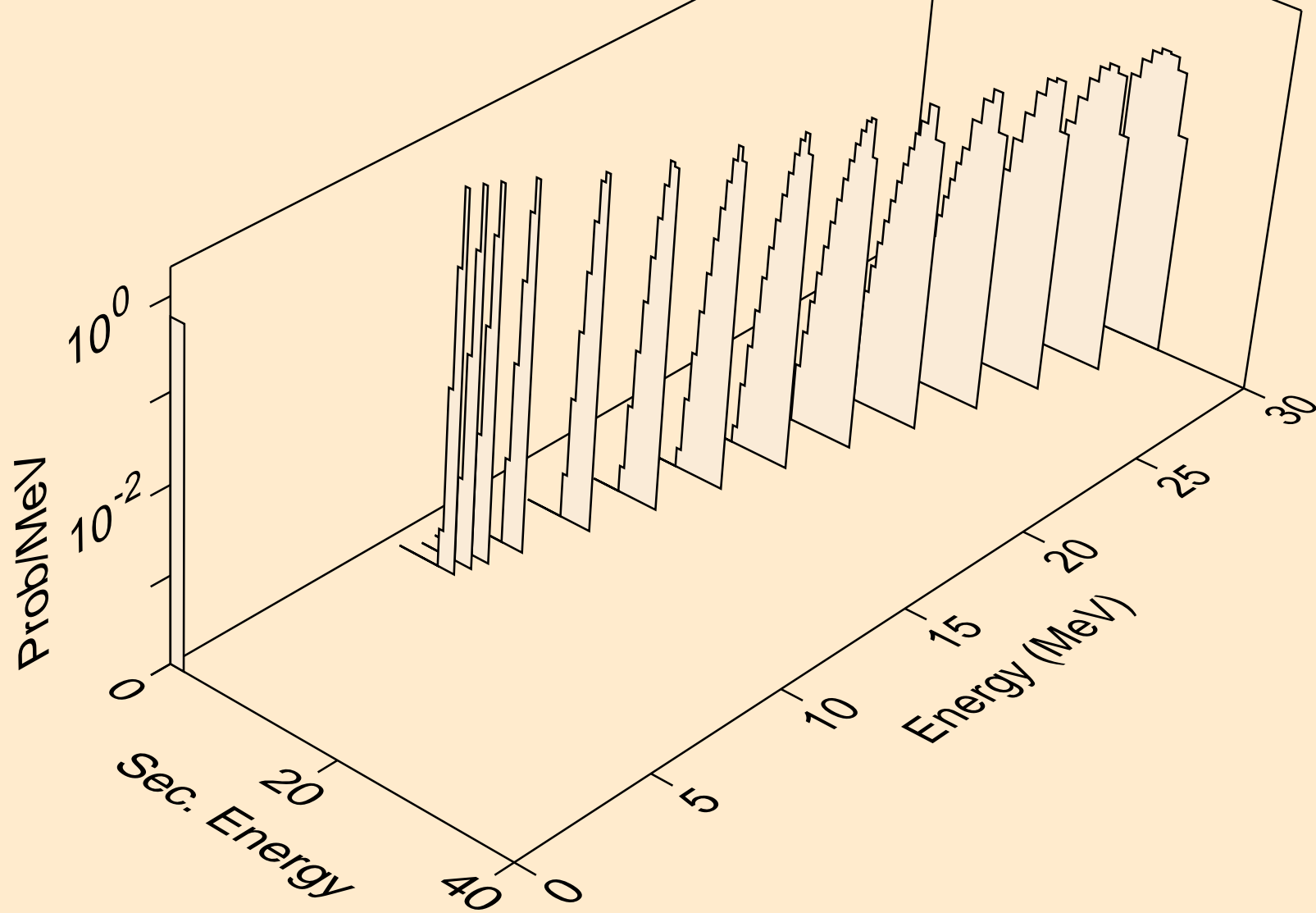

LR258 NEUTRON ACER TENDL-2023 LIBRARY; T=0.K
alphas from (n,x)

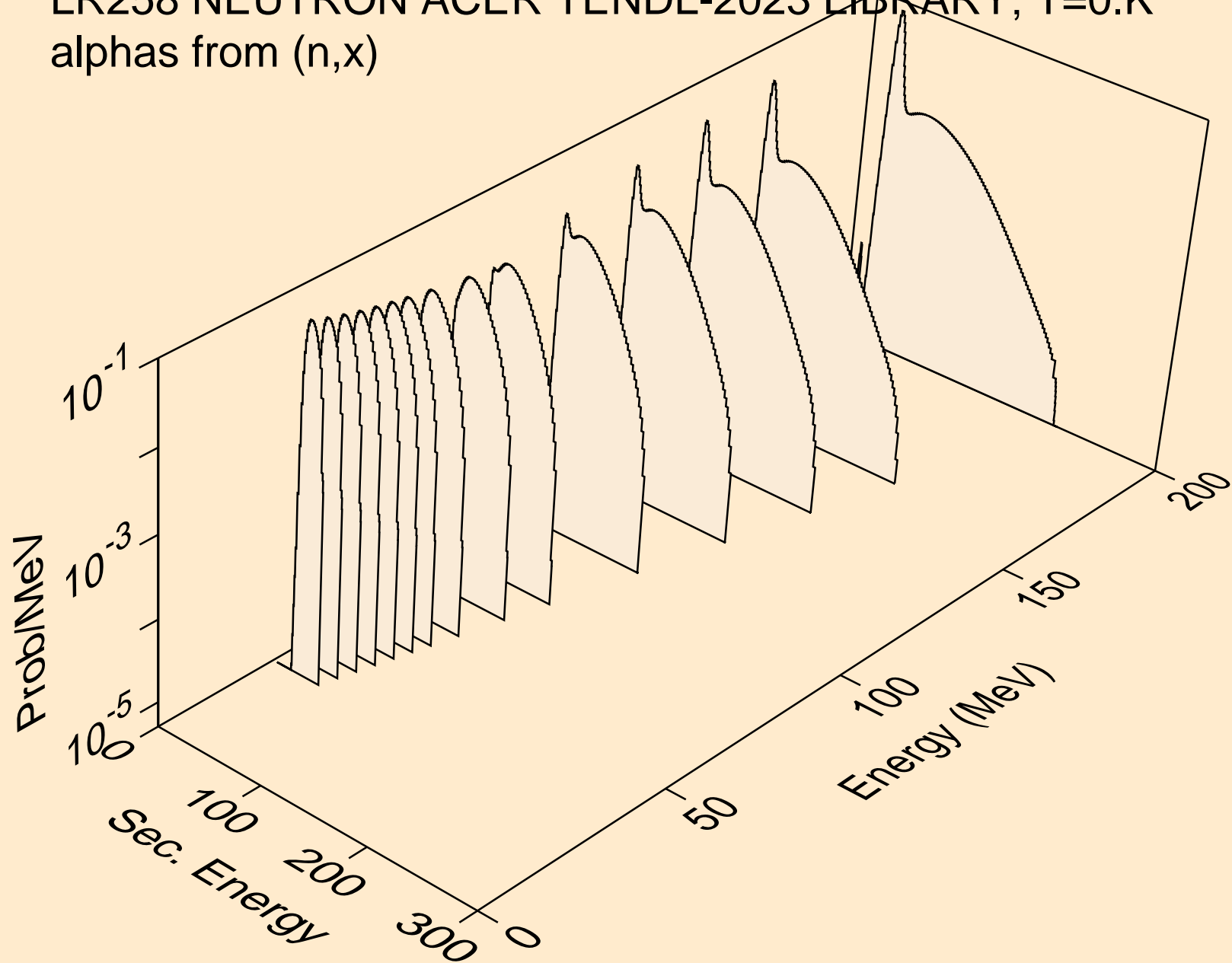

LR258 NEUTRON ACER TENDL-2023 LIBRARY; T=0.K
alphas from (n,n*)a

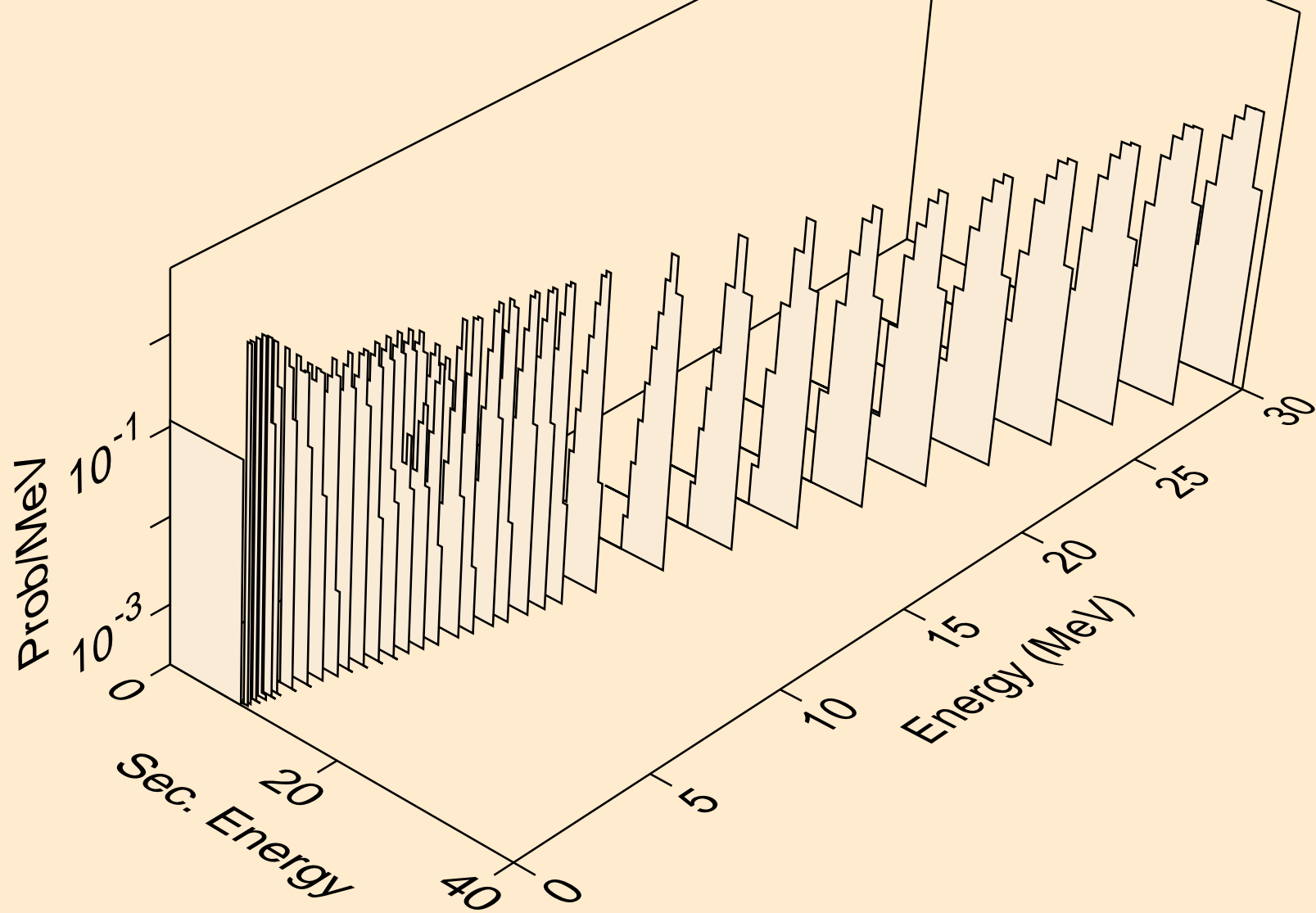

LR258 NEUTRON ACER TENDL-2023 LIBRARY; T=0.K
alphas from (n,2n)a

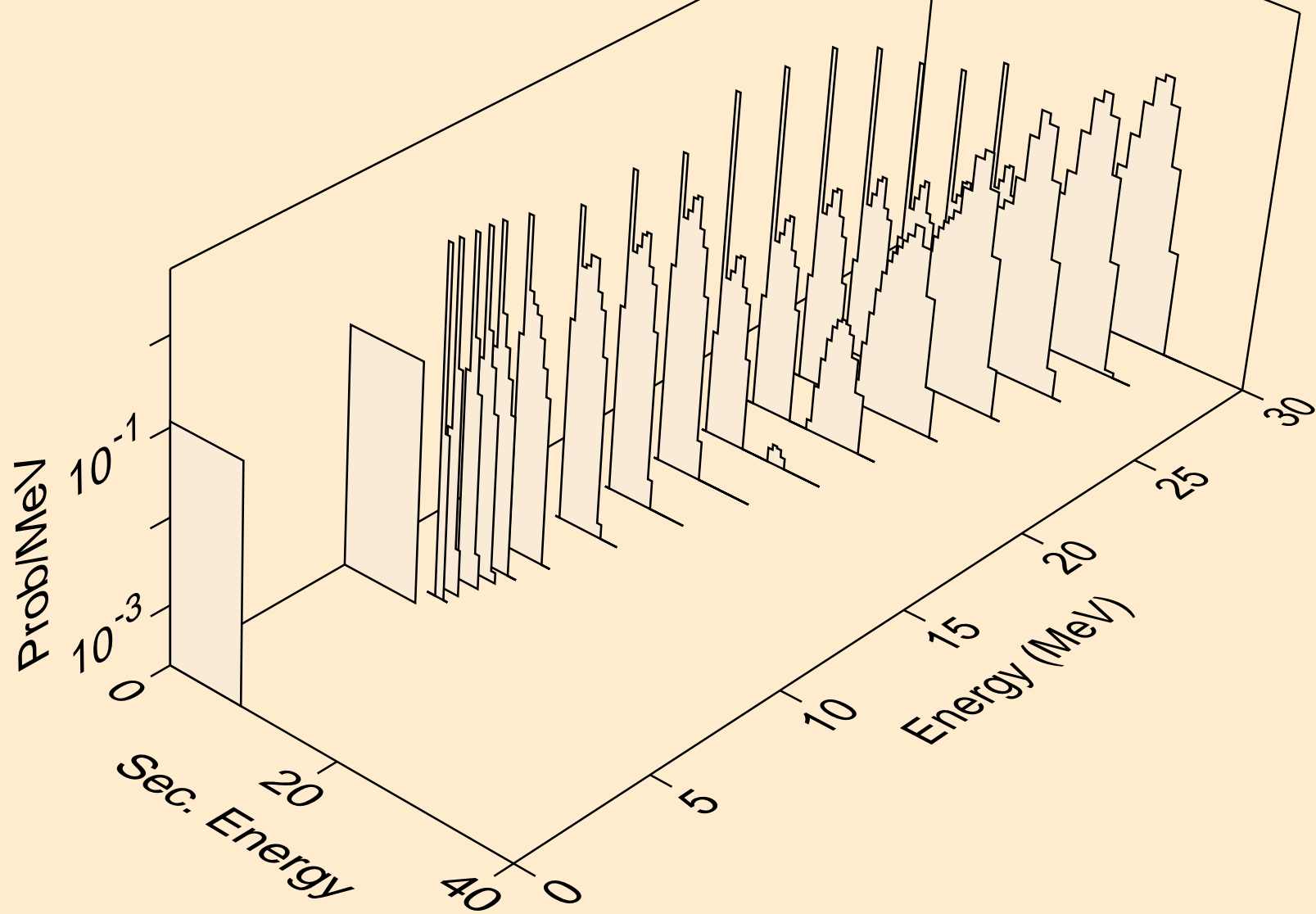

LR258 NEUTRON ACER TENDL-2023 LIBRARY; T=0.K
alphas from (n,npa)

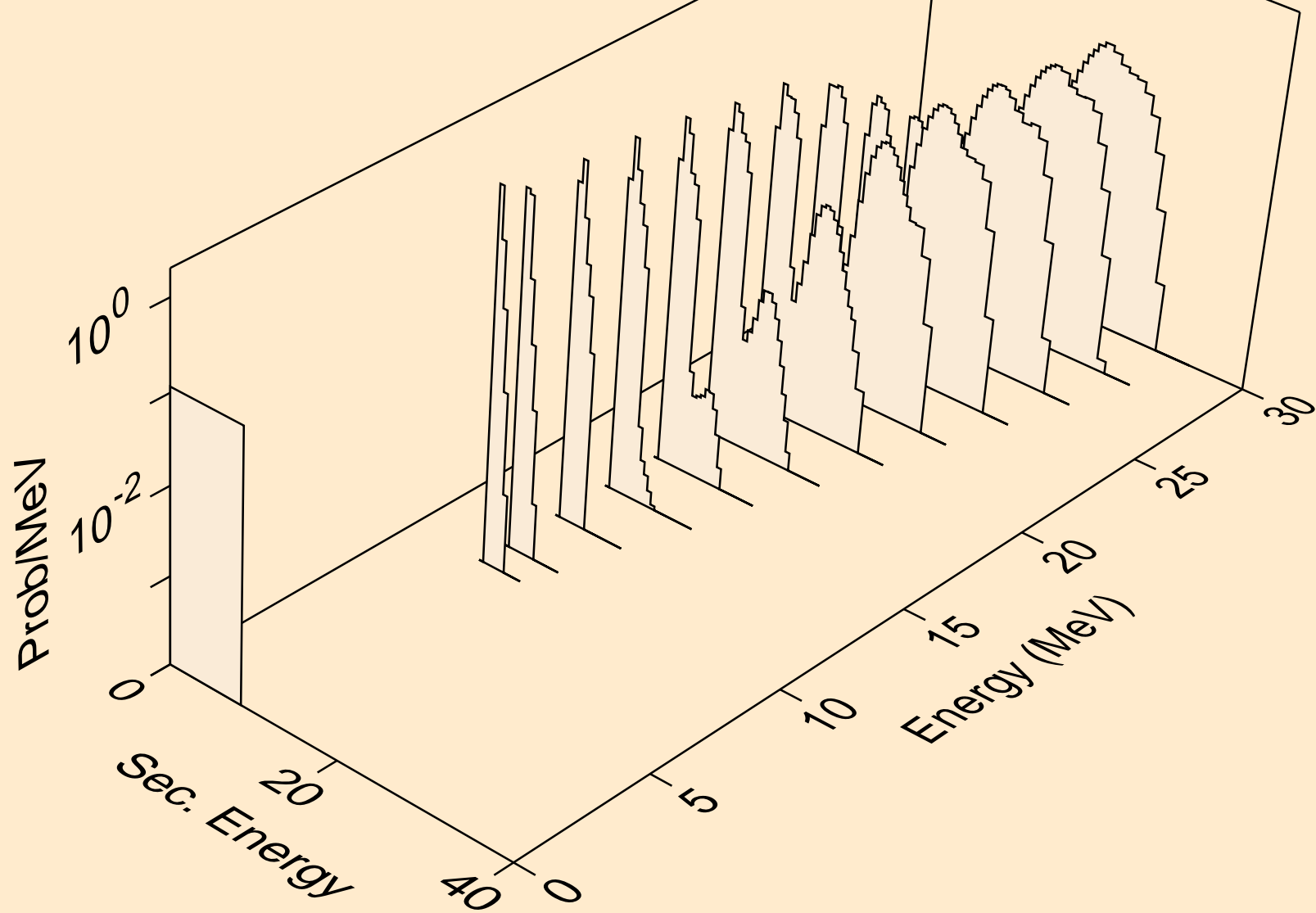

LR258 NEUTRON ACER TENDL-2023 LIBRARY; T=0.K
alphas from (n,a)

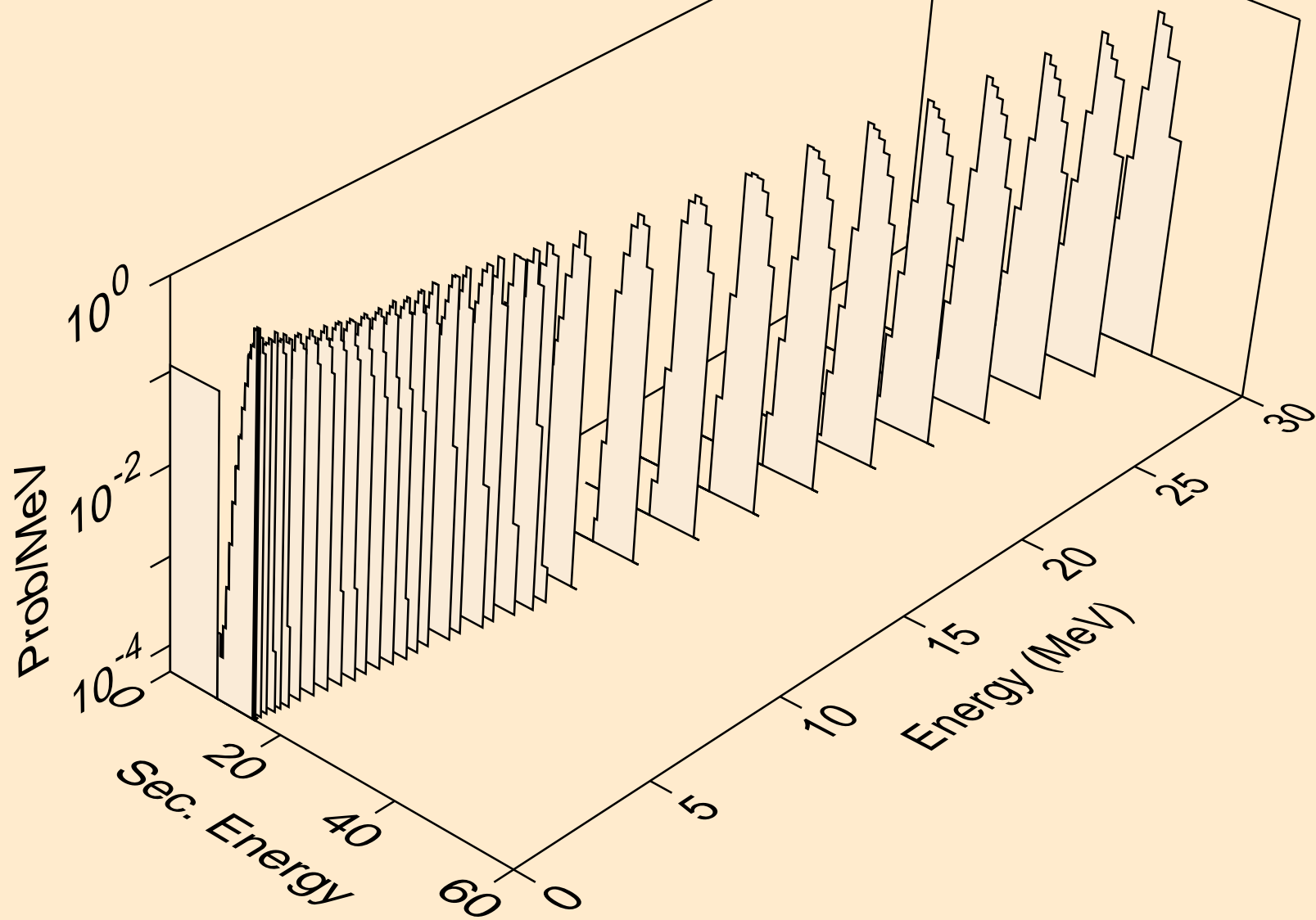

LR258 NEUTRON ACER TENDL-2023 LIBRARY; T=0.K
alphas from (n,pa)

